

TUNG-SOL

TECHNICAL DATA



TUNG-SOL

ELECTRONIC TUBES

*Property of
Geo. W. Lister*

TUNG-SOL LAMP WORKS INC.
ELECTRONIC TUBE DIVISION
NEWARK, N. J.
U. S. A.

PLATE
101

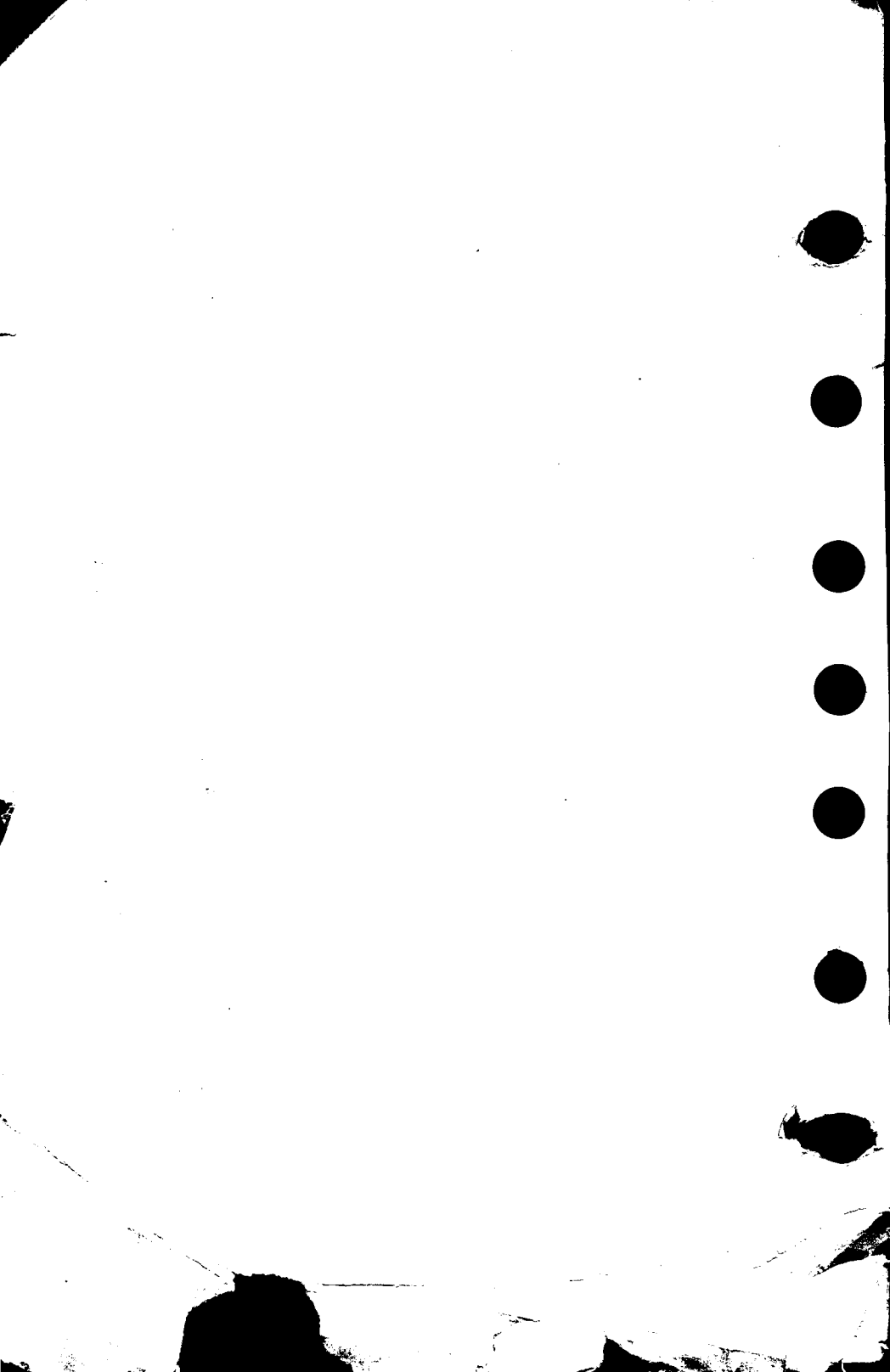

INTRODUCTION

This Technical Data Book has been compiled for the use of the radio industry. Inclusion of data for a specific tube type does not necessarily mean that the tube will be available and for sale by Tung-Sol.

The technical data sheets in this book are arranged in numerical order, with respect to tube type numbers. The Table of Contents on the next page will, in all cases, list the sheets which have been issued to the current date. If any sheets, listed in the Table of Contents, are missing from your book, additional copies of such missing sheets may be obtained from the address given below.

Additional sheets covering new tube types or changes on existing tubes will be issued from time to time. A complete new index sheet will be issued with each new group of sheets.

Requests for further technical data on any Tung-Sol tubes should be addressed to

*TUNG-SOL LAMP WORKS INC.
ELECTRONIC TUBE DIVISION
NEWARK, N. J.
U. S. A.*

Price \$4.75

Subscription Rate \$2.00 Per Year

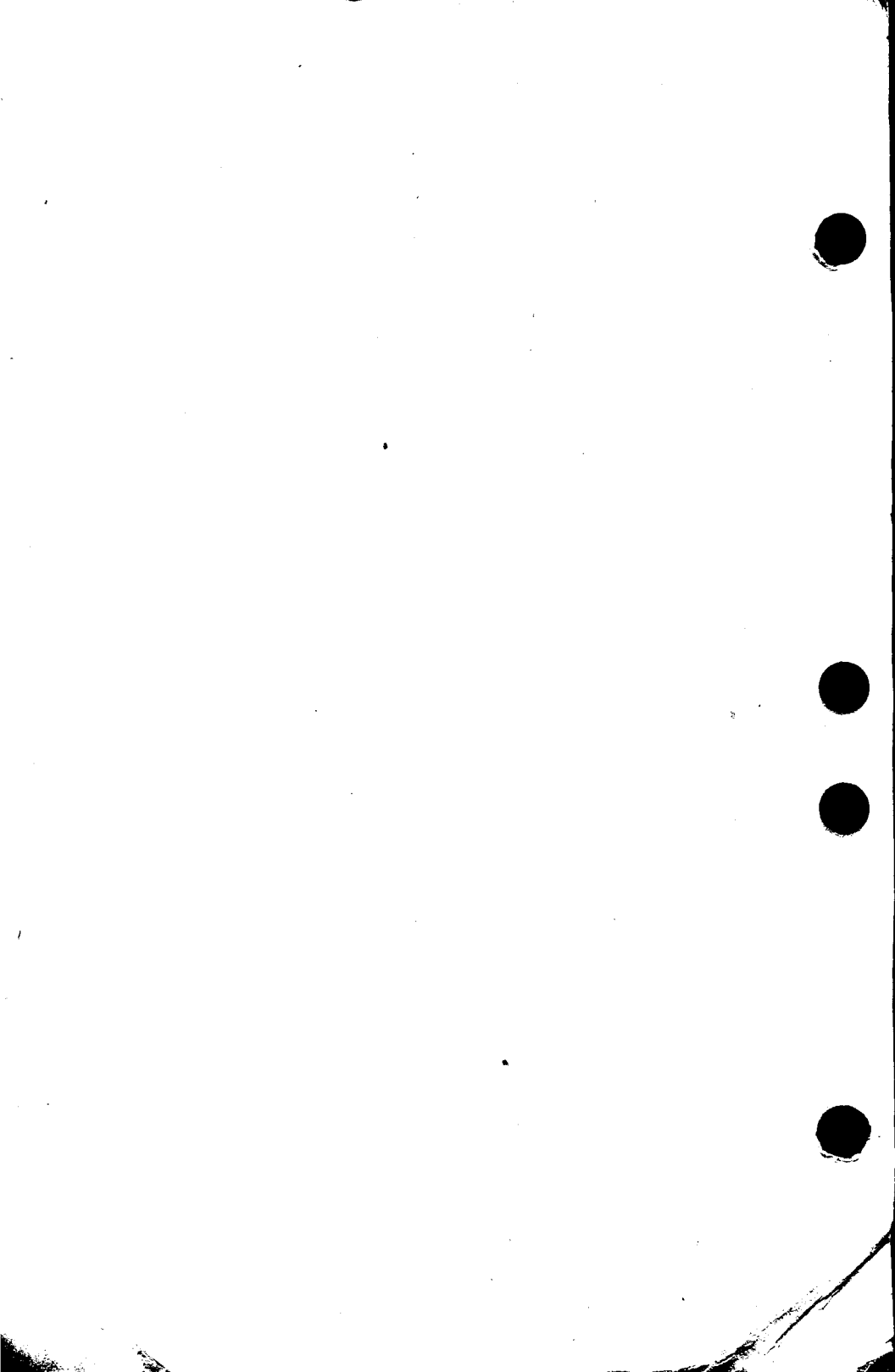

TUNG-SOL

ADDITIONAL BINDERS



Additional binders may be purchased at any time. The cost of a binder is \$2.00. This offer is made for the convenience of those who wish to divide their sheets in a certain way and for those who feel the book may be getting too heavy. We prefer not to formally issue a Volume II, but to let the individual subscriber decide for himself when he would like to have two binders rather than one for his data sheets.

PRINTED IN U. S. A.

PLATE
1902
CT. 1,
1947



TUNG-SOL

IDENTIFICATION OF SYMBOLS USED ON CONTENTS PAGE

- ▶ A change or addition.
- Obsolete types—for replacement use only. These types are not recommended for new equipment design. Data sheets for these types are retained for your information.
- Formerly GT/G types. The GT/G designation is now obsolete, having been superseded by GT. The data sheets for these types already in the book will remain as they are until further revisions are necessary.
- Both obsolete types and former GT/G types. See ○ and ● above.

Page	Plate	Page	Plate	Page	Plate	Page	Plate
TITLE PAGE	1014-3	1B7G, 1B7GT	1525	1S5	1766	5CP1	1399
▶ INTRODUCTION	1941	● 1C5GT	1071-3	1S5	1768	5CP1	1401
BINDERS	1902	1C6	914-2	○ 1SA6GT	1511	5CP4	1411
▶ CONTENTS	2043	1C7G	914-2	○ 1SB6GT	1512	5CP4	1413
▶ CONTENTS	2045	1D5GP	1458	▶ 1T4	1904	5R4GY	1599
DEFINITIONS	617-1	1D5GP	1459	▶ 1T4	1906	5R4GY	1601
DEFINITIONS	619-1	1D7G	217-1	1T5GT	1077-2	5T4	870-1
DEFINITIONS	621-1	1D8GT	1498	▶ 1U4	1907	5U4G	687-2
SYMBOLS	1452	○ 1E5GP	1500	1U5	1772	5V4G	699-2
INTERPRETATION	1349-1	○ 1E5GP	1502	1U5	1774	5W4	991-2
OF RATINGS	1349-1	○ 1E7G	241-2	1V	685-2	● 5W4GT	991-2
▶ PREFERRED LIST	2016	1F4	987-2	1Z2	1717	5X4G	689-2
VT NOS. LIST	1620	1F5G	987-2	2A3	1539	● 5Y3GT	1335-1
TYPICAL	1730	○ 1F6, 1F7GH	1527	2A3	295-1	5Y4G	1335-1
CIRCUITS	1730	● 1G4GT	1503	2A4G	1541	5Z3	691-2
TYPICAL	1731	○ 1G5G	1170-3	2A5	1387-1	5Z4	705-2
CIRCUITS	1731	● 1G6GT	1190-1	2A5	1370-1	6A3	893-2
TYPICAL	1733	1H4G	206-1	2A6	1542	○ 6A4/LA	894-1
CIRCUITS	1733	1H4G	200-1	2A6	1544	6A6	1139-2
TYPICAL	1839	● 1H5GT	1529	2A7	916-2	6A7	918-2
CIRCUITS	1839	1H6G	1505	2AP1	1395	6A8	1078-3
INDIVIDUAL TUBE		○ 1J5G	536-2	○ 2B7	1545	6A8G	1078-3
DATA		1J6G	537-2	2C4	1742	6A8GT	1078-3
▶ OA2	2018	1L4	1825	○ 2E5	891-2	○ 6AB5/6N5	872-1
OA3	1454	1LA4	1531	2E22	1562	6AB7, 1853	1602
OB2	1715	1LA6	1102-2	2E22	1564	6AB7, 1853	1622
OB3	1454	1LB4	989-1	2E22	1566	● 6AC5GT	1173-1
OC3	1454	1LC6	1533	2G5	892-1	6AC7/1852	1867
OD3	1454	1LD5	1535	2V3G	1410	6AC7/1852	1869
OY4	1695	1LE3	1172-1	2X2, 879	1402	○ 6AD6G	1513
OY4G	1696	1LG5	1697	3A4	1744	○ 6AE5GT	1175-1
OZ4	1489	1LG5	1699	3A4	1746	○ 6AE6G	730-1
OZ4G	1489	1LH4	1537	3A4	1746	○ 6AF5G	1574
1A3	1490	1LN5	1038-2	3A5	1909	6AF6G	238-1
1A4P	1455	1N5G	1073-3	3A5	1911	6AF6G	283-1
1A4P	1456	1N5GT	1073-3	3A5	1911	6AG5	1871
● 1A5GT	1523	○ 1N6G	1012-2	3A8GT	1461	6AG5	1873
1A6	378-1	1P5G	1013-2	3A8GT	724-1	▶ 6AG7	1954
1A7G	1491	1P5GT	1013-2	○ 3B5GT	1571	▶ 6AG7	1956
1A7GT	1491	● 1Q5GT	1075-3	3BP1	1397	▶ 6AG7	1958
1AB5	1716	1R5	1738	▶ 3Q4	1982	▶ 6AH6	1987
▶ 1B3GT	2008	1R5	1740	● 3Q5GT	1104-2	▶ 6AH6	1989
○ 1B4P	1493	1S4	1827	▶ 3S4	1984	6AJ5	1515
○ 1B4P	1495	1S4	1827	▶ 3S4	1986	6AJ5	1700
1B5/255	1496	1S4	1829	3V4	1776	6AK5	1428
				3V4	1778	6AK6	1779
						6AK6	1781

(CONTINUED NEXT PAGE)

PRINTED IN U. S. A.

PLATE 2043
JULY 1, 1948

TUNG-SOL

Page	Plate	Page	Plate	Page	Plate	Page	Plate
▶ 6AL5	1920	6F6	1385-1	6R7	1084-2	● 6V6GT	1052-2
6AN6	1747	6F6	1339-1	6R7G	1084-2	○ 6V7G	1439
6AQ5	1856	● 6F6GT	1385-1	6R7GT	1084-2	○ 6W7G	964-2
6AQ5	1784	● 6F6GT	1339-1	6S7	876-1	6X4	1656
6AQ6	1674	6F7	371-2	6S7	878-3	6X5	1008-2
▶ 6AR5	2010	6F7	482-1	6S7G	877-3	● 6X5GT	1008-2
6AR6	1749	6F8G	1106-2	6S7G	878-3	○ 6Y5	901-1
▶ 6AS5	1996	6G6G	468-3	6S8GT	1886	6Y6G	995-2
▶ 6AS6	2019	○ 6H4GT	1577	6S8GT	1888	○ 6Y7G	348-2
▶ 6AS6	2021	6H6	1341-1	6SA7	1110-1	○ 6Z5/1Z5	903-1
▶ 6AS6	2023	● 6H6GT	1341-1	6SA7, 6SA7GT	1874	○ 6Z7G	904-2
6AS7G	1704	6J4	1830	6SA7, 6SA7GT	1876	6ZY5G	709-2
6AT6	1840	▶ 6J5, 6J5GT	1944	6SA7, 6SA7GT	1878	7A4	1475
6AU6	1786	▶ 6J5, 6J5GT	1946	6SB7Y	1719	7A5	1477
6AU6	1788	6J6	1832	6SB7Y	1721	7A6	1478
▶ 6AV6	1959	6J6	1834	6SB7Y	1723	7A7	1177-2
▶ 6AV6	1961	6J7	1004-3	6SC7	1345-1	▶ 7A8	1998
6B4G	174-1	6J7	1006-2	6SC7GT	1345-1	7B8	2000
6B5	219-1	6J7G	1004-3	6SD7GT	1143-2	7AB7/1204	1687
○ 6B6G	1548	6J7GT	1004-3	6SF5	1086-2	7AG7	1707
○ 6B6G	1550	6J8G		6SF5GT	1086-2	7B4	1587
6B7	1551	○ 6K5G	399-2	6SF7	1608	7B5	1588
6B8		● 6K6GT	1045-2	6SF7	1610	7B6	820-1
6B8G	1553	● 6K6GT	1047-2	6SG7	1434	7B7	822-1
○ 6B8GT	1576	6K7	633-3	6SH7GT	1581	7B8	1130-2
6BA6	1789	6K7G	633-3	6SH7GT	1583	7C5	1088-2
6BA6	1791	6K7GT	633-3	6SH7L	1706	7C5	1090-1
6BD6	1718	6K8	1108-1	6SJ7, 6SJ7GT	1435	7C6	1590
6BE6	1793	○ 6K8G	1108-1	6SJ7, 6SJ7GT	1437	7C7	831-1
6BE6	1795	6K8GT	1108-1	● 6SK7, 6SK7GT	1112-1	7E6	854-1
6BE6	1797	6L5G	421-2	● 6SK7,		7E7	1592
6BF6	1842	6L6	1517	6SK7GT	1114-1	7F7	856-1
6BF6	1844	6L6	1470	6SL7GT	1611	7G7/1232	1594
▶ 6BG6G	1990	6L6	1472	6SN7GT	1584	7G8/1206	1708
▶ 6BG6G	1992	6L6G	1517	6SN7GT	1586	7H7	1595
▶ 6BH6	1922	6L6G	1470	▶ 6SQ7,		7J7	858-1
▶ 6BH6	1924	6L6G	1472	6SQ7GT	1925	7L7	1596
6BJ6	1798	6L6GA	1470	▶ 6SQ7,		7N7	1179-1
6BJ6	1800	6L6GA	1472	6SQ7GT	1967	7Q7	T750-1
▶ 6C4	1963	6L6GA	1517	6SR7	1347-1	▶ 7R7	2011
▶ 6C4	1965	6L7	922-2	6SR7GT	1347-1	▶ 7R7	2013
6C5	625-2	6L7G	924-1	6SS7, 6SS7GT	1802	▶ 7W7	2024
6C5G	625-2	6L7G	922-2	6SU7GT	1684	▶ 7W7	2026
6C5GT	625-2	6L7G	924-1	6SZ7	1685	7Y4	824-1
6C6	895-4	6L7G	924-1	6T7G		10	1628
6C6	897-2	6N4	1681	6T7G	162-1	○ 12A5	1323-2
○ 6C7	898-1	6N6G	230-1	6T8	1889	12A6GT	1303-1
6C8G	459-2	6N7	1343-1	6T8	1891	12A7	1328-3
6D4	1679	● 6N7GT	1343-1	6T8	1891	12A8GT	1324-3
6D6	579-4	● 6P5GT	1141-1	6U5/6G5	1147-3	▶ 12A7GT	1317-1
6D6	248-1	6Q7	1116-4	6U6GT	1149-2	12AL5	1929
6D8G	920-2	6Q7G	1116-4	6U7G	497-3	12AT6	1847
6E5	899-2	6Q7G	1116-4	6U7G	266-1	12AT7	1892
○ 6E7	900-1	6Q7GT	1116-4	6V6	1050-2	12AT7	1894
6F5	1192-1			6V6	1050-2	12AU6	1858
6F5G	1192-1			● 6V6GT	1050-2	12AU6	1860
6F5GT	1192-1					12AU7	1861

(CONTINUED NEXT PAGE)

PLATE
2044
JULY 1,
1948

TUNG-SOL

Page	Plate	Page	Plate	Page	Plate	Page	Plate
12AU7	1863	12SX7GT	1754	35Z6G	1187-2	83	713-1
▶ 12AV6	1969	12SX7GT	1756	36	472-1	○ 83V	701-2
▶ 12AV6	1971	12SY7	1711	37	473-1	84/6Z4	715-2
12AW6	1912	12SY7GT	1712	38	470-1	85	1447
12AW6	1914	12Z3	711-2	39/44	471-1	○ 89	212-1
▶ 12AX7	1931	14C7	1153-1	41	669-2	B-100	1558
▶ 12AX7	1933	14H7	1155-1	41	632-2	117L7/M7GT	1815
12B7	1329-2	14Q7	1181-1	42	1389-1	117L7/M7GT	1817
○ 12B8GT	1326-3	14R7	1182-1	42	1372-1	117N7GT	1615
12BA6	1804	○ 15	662-2	43	480-2	117P7GT	1161-1
12BA6	1806	19	542-2	45	301-1	117P7GT	1163-1
12BD6	1724	19T8	1898	45Z3	1188-1	117Z3	1637
12BE6	1808	19T8	1900	45Z5GT	860-2	○ 117Z4GT	1617
12BE6	1810	24	543-2	46	474-1	● 117Z6GT	1128-2
12BE6	1812	25A6	1056-2	47	475-1	○ 183	657-1
12BF6	1849	○ 25A6GT	1056-2	○ 49	907-2	316A	1379-1
12BF6	1851	○ 25A7GT	1157-1	50	908-2	○ 485	658-1
12C8	1330-2	○ 25AC5GT	1159-1	50A5	1864	703A	1380-1
○ 12E5GT	651-1	○ 25B5	461-2	50B5	1813	705A	1381-1
○ 12F5GT	1613	○ 25B6G	926-2	50C5	2004	713A; 717A	1382-1
▶ 12J5GT	1948	○ 25B8GT	T857-1	○ 50C6G	1061-1	○ 950	578-1
▶ 12J5GT	1950	○ 25C6G	T857-1	50L6GT	1002-2	954	1351-1
12J7GT	1022-2	○ 25D8GT	T842-1	● 50Y6GT	1063-2	955	1353-1
12J7GT	1024-1	25L6	1016-3	○ 50Z7G	862-1	956	1355-1
12K7GT	695-3	● 25L6GT	1016-3	53	902-2	1625; 1626	1383
12K7GT	639-1	○ 25N6G	215-1	○ 55	1444	1629	1384
○ 12K8GT	1151-1	25Z5	928-3	56	1446	1654	1688
12L8GT	1378-1	25Z6	928-3	57	319-1	9001	1403
12Q7GT	1118-2	● 25Z6GT	930-4	58	320-1	9002	1482
12S8GT	1895	26	1757	○ 59	529-1	9003	1405
12S8GT	1897	26	1759	○ 70A7GT	T751-1	9004	1407
12SA7		▶ 26A7GT	2027	70L7GT	1633	9005	1408
12SA7GT	1879	▶ 26A7GT	2029	70L7GT	1635	9006	1409
12SA7		27	1760	71A	575-1	XXD	1165-1
12SA7GT	1883	30	186-1	75	1555	XXL	1166-1
12SC7	968-1	30	158-1	76	332-1	NOTES	1331-3
12SF5	1092-2	○ 31	544-2	77	655-2	PLATE NUMBERS	
12SF5GT	1092-2	32	545-2	○ 78	515-2	REFER TO FRONT OF	
12SF7GT	1709	32L7GT	340-1	79	373-2	SHEET ONLY EX-	
12SJ7		33	507-2	80	1364-1	CEPT WHERE BACK	
12SJ7GT	1441	34	258-2	81	576-1	OF SHEET REPRESENTS	
12SJ7		34	224-1	82	713-1	ANOTHER TUBE TYPE.	
12SJ7GT	1443	35	486-1				
● 12SK7		35A5	1632				
12SK7GT	1122-1	35B5	1835				
● 12SK7		▶ 35C5	2002				
12SK7GT	1124-1	● 35L6GT	1058-1				
12SL7GT	1318-1	35W4	1661				
12SN7GT	1319-1	35Z3	826-1				
▶ 12SQ7		35Z4GT	932-3				
12SQ7GT	1934	● 35Z5GT	1184-1				
▶ 12SQ7		● 35Z5GT	1186-1				
12SQ7GT	1973						
12SR7GT	1320-1						
12SW7	1751						
12SW7	1753						

PRINTED IN U. S. A.

PLATE 2045 JULY 1, 1948



TUNG-SOL

SUPPLEMENTAL CONTENTS

This Supplemental Contents page will be revised with each monthly issue of data sheets. Since May 1, 1947 sheets have been issued on the first of each month. To do this it has been found necessary to discontinue the monthly revision of the main Contents Pages. The main Contents pages will be brought up to date approximately every six months.

Please retain in your book the main Contents pages dated July 1, 1948 in addition to the most recent Supplemental Contents page.

Page	Plate	Page	Plate
SUPPLEMENTAL CONTENTS	2097	7V7	2103
6AJ5	2033	7V7	2105
6AJ5	2035	7W7	2057
6AQ6	2036	7Y4	2107
6BA7	2079	12AT7	2070
6BA7	2081	12BA7	2086
6BA7	2083	12BA7	2088
6BE6	2048	12BA7	2090
6BE6	2050	12BE6	2059
6BE6	2052	12BE6	2061
6SG7,6SG7GT	2053	12BE6	2063
6SG7,6SG7GT	2055	12SG7	2064
6T8	2084	12SG7	2066
6W4GT	2098	19T8	2091
7AD7	2099	35Y4	2072
7AD7	2101	50X6	2074
7S7	2038	50Y7GT	2076
7S7	2040	117Z3	2093
		TYPICAL CIRCUIT	2096

PRINTED IN U. S. A.

PLATE
2097
NOV. 1,
1948



TUNG-SOL

DEFINITIONS

CLASS A AMPLIFIER:

The Class A Amplifier is an amplifier in which the grid bias and the exciting grid voltage are such that plate current flows approximately 360 electrical degrees of the cycle. The ideal Class A Amplifier operates on the linear portion of the plate current vs grid voltage characteristic in such a manner that the wave form of the plate current is an exact reproduction of the exciting grid voltage. The Class A Amplifier is characterized by low efficiency, low output and low percentage of harmonic distortion.

CLASS AB AMPLIFIER:

The Class AB Amplifier is an amplifier in which the grid bias and the exciting grid voltage are such that plate current flows for appreciably more than 180 electrical degrees but less than 360 electrical degrees of the cycle. This class of amplifier, sometimes designated as "Class A' (prime) Amplifier" is characterized by efficiency, output and percentage of harmonic distortion intermediate to those of Class A and Class B Amplifiers.

CLASS B AMPLIFIER:

The Class B Amplifier is an amplifier in which the grid bias and the exciting grid voltage are such that plate current flows approximately 180 electrical degrees of the cycle. The grid bias is approximately equal to the plate current cut-off value, and the power output is proportional to the square of the excitation grid voltage. The Class B Amplifier is characterized by medium efficiency, medium output and medium percentage of harmonic distortion.

CLASS BC AMPLIFIER:

The Class BC Amplifier is an amplifier in which the grid bias and the exciting grid voltage are such that the plate current flows slightly less than 180 electrical degrees of the cycle. The Class BC Amplifier is characterized by an efficiency, an output and a percentage of harmonic distortion intermediate to those of Class B and Class C Amplifiers.

CLASS C AMPLIFIER:

The Class C Amplifier is an amplifier in which the grid bias voltage and the exciting grid voltage are such that the plate current flows for considerably less than 180 electrical degrees of the cycle. The Class C Amplifier is characterized by high plate-circuit efficiency, high power output and a high percentage of harmonic distortion.

NOTE: The suffix 1 added to the letter or letters of the class identification denotes that grid current does not flow during any part of the input cycle. The suffix 2 denotes that grid current flows during some part of the cycle.

AMPLIFICATION FACTOR:

The amplification factor μ is the ratio of a small change in plate voltage to a small change in control-grid voltage under the conditions that the plate current remains unchanged and that all other electrode voltages are maintained constant. It is a measure of the effectiveness of the control-grid voltage relative to that of the plate voltage upon the plate current.

PLATE RESISTANCE

The plate resistance r_p is the ratio of a small change in the alternating plate voltage to a small change of the in-phase component of the alternating current produced thereby, all other electrode voltages being maintained constant.

TRANSCONDUCTANCE:

Transconductance g_m from one electrode to another is the ratio of a small change in the magnitude of the alternating currents' in-phase component that flows in the second electrode to a small change in the alternating voltage of the first electrode, all other electrode voltages being maintained constant.

CONVERSION TRANSCONDUCTANCE:

Conversion transconductance s_c is the ratio of a small magnitude of single beat-frequency component $(F_1 + F_2)$ or $(F_1 - F_2)$ of the output electrode current to the magnitude of a small control-electrode voltage of frequency F_1 . This is under the conditions that all direct electrode voltages and the magnitude of the electrode alternating voltage F_2 remains constant and that no impedances at the frequencies F_1 or F_2 are present in the output circuit.

TUNG-SOL

CONVERSION PLATE IMPEDANCE:

Conversion plate impedance is the ratio of a small change in the plate voltage of a frequency converter to a small change in its plate current under the conditions that all direct voltages remain constant and that no impedances to the oscillator frequency or to the measurement frequency are present in its plate circuit.

CONVERSION GAIN:

Conversion gain is the ratio of the magnitude of the intermediate frequency voltage developed at the output circuit of the frequency converter, to the magnitude of the exciting voltage applied to the signal grid.

VOLTAGE GAIN:

The voltage gain of an amplifier stage is the ratio of voltage developed across the plate impedance to the exciting grid voltage.

VOLTAGE AMPLIFIER:

A voltage amplifier is an amplifier whose primary purpose is to obtain a voltage gain without regard to the power delivered into its output circuit.

PHASE INVERTER:

Phase inverter is an amplifier whose purpose is shifting the phase of an incoming signal voltage by 180 degrees to provide a driving voltage in combination with the original signal for a push-pull amplifier.

POWER AMPLIFIER:

Power amplifier is an amplifier whose primary purpose is to deliver power into a load circuit.

PUSH-PULL AMPLIFIER:

A push-pull amplifier consists of two similar amplifiers so arranged, that the output voltage of one is 180° out of phase with the other. Push-pull amplifiers are characterized by increased power output for a given total harmonic distortion as this type of connection cancels the even harmonics.

UNDISTORTED POWER OUTPUT:

The undistorted power output is defined as the power output delivered by a vacuum tube into a resistance load, under the conditions that the total generated harmonic distortion with a sinusoidal excitation voltage shall not exceed an arbitrary criterion of permissible total harmonic distortion of five per cent.

TUNG-SOL

POWER OUTPUT:

The power output is the AC power developed in an external non-inductive resistor of rated value connected in the plate circuit of the amplifier. The maximum power output is limited by an arbitrary criterion of permissible total harmonic distortion.

POWER SENSITIVITY:

Power sensitivity of an output tube is the ratio of the undistorted power output to the square of the exciting grid voltage. The unit of power sensitivity is the mho or μmho .

MODULATION:

Modulation is the process by which some characteristic of a periodic wave is varied with time in accordance with a signal.

DEMODULATION:

The process of recovering a modulating signal (in a detector) from a modulated wave.

INTERMODULATION:

Intermodulation is the production in a non-linear circuit element of frequencies corresponding to the sums and differences of the fundamentals and harmonics of two or more frequencies which are transmitted through that element.

CROSS MODULATION:

Cross modulation is the modulation of the carrier of the desired signal by a modulating voltage of an undesired signal.

AMPLITUDE DISTORTION:

Amplitude distortion results from non-linear amplification in such a manner that the output wave form is not exactly proportional to the amplitude of the input signal, and harmonics of the signal are generated in the amplifier.

FREQUENCY DISTORTION:

Frequency distortion results when the frequency components of the input signal are not amplified with equal magnitude.

PHASE DISTORTION:

Phase distortion results when the phase relation of the frequency components in the output differ from the phase relation of the frequency components in the input.

TUNG-SOL

PEAK FORWARD ANODE VOLTAGE:

Peak forward anode voltage is the maximum instantaneous voltage appearing across the anode and cathode in the direction in which the tube is designed to conduct current.

PEAK INVERSE ANODE VOLTAGE:

Peak inverse anode voltage is the maximum instantaneous voltage appearing across the anode and cathode in the direction opposite to that in which the tube is designed to conduct current.

TUBE VOLTAGE DROP:

In a vacuum tube, the tube voltage drop varies with the current and is the anode voltage produced by a specified plate current. Tube voltage drop in a gas or vapor-filled tube is the anode to cathode voltage during the conducting period.

MAXIMUM PEAK PLATE CURRENT:

Maximum peak plate current is the highest peak current that the plate of a vacuum tube can safely pass in the direction in which the tube is designed to conduct the current.

CATHODE CURRENT:

Cathode current is the total electronic current passing to or from the cathode through the vacuous space.



TUNG-SOL

SYMBOLS OF TUBE CHARACTERISTICS

C_{gk}	Grid to cathode capacitance (input).
C_{pk}	Plate to cathode capacitance (output)
C_{gp}	Grid to plate capacitance
E_b	Average or quiescent value of plate voltage
E_{bb}	Plate supply voltage
E_c	Average or quiescent value of grid voltage
E_{c1}	Average or quiescent value of #1 grid voltage
E_{c2}	Average or quiescent value of #2 grid voltage
E_{cc1}	#1 Grid supply voltage
E_{cc2}	#2 Grid supply voltage
E_f	Filament or heater terminal voltage
E_{ff}	Heater or filament supply voltage
E_{inv}	Peak (or crest) inverse voltage
E_{sig}	Signal voltage (input to control grid)
g_m	Grid-plate transconductance (mutual conductance)
I_b	Average or quiescent value of plate current
I_c	Average or quiescent value of grid current
I_{c1}	Average or quiescent value of #1 grid current
I_{c2}	Average or quiescent value of #2 grid current
I_f	Filament or heater current
I_L	Load current
I_s	Total electron emission (total cathode current)
ma.	Current in milliamperes
megohm	Resistance in millions of ohms
mw.	Milliwatts is power expressed in thousandths of watts
P_i	Power input
P_o	Power output
P_p	Anode dissipation
RMS	Root-Mean-Square
R_L	Load resistance
r_p	Plate resistance
s_c	Conversion transconductance
t_k	Cathode heating time
μ	Amplification factor
μfd	Capacitance in microfarads
$\mu\mu fd$	Capacitance in micro-microfarads
$\mu mhos$	Conductance in micromhos

TUNG-SOL

SYMBOLS OF TUBE ELEMENTS

(AS EMPLOYED IN CONNECTION WITH BASE DIAGRAMS)

**USE THIS COLUMN FOR ALL DATA
SHEETS DATED PRIOR TO
JUNE 15, 1944**

G _a	Anode Grid
R	Ray Control Electrode
F	Filament
F _t	Filament Tap
G	Control Grid
H	Heater
H _t	Heater Tap
I _c	Internal Connection
K	Cathode
N _c	No Connection
P	Plate
D _p	Diode Plate
S	Metal Shell
S _i	Internal Shield
X _s	External Shield
T	Target
■	Beam Plate
F _c	Filament Center (Electrical)
G _m	Modulator Grid
G _o	Oscillator Grid
G _s	Screen Grid
H _c	Heater Center (Electrical)
P _i	Input Plate
P _o	Oscillator Plate
P _r	Remote Cut-Off Plate
P _s	Sharp Cut-Off Plate
S _u	Suppressor Grid

**USE THIS COLUMN FOR ALL DATA
SHEETS DATED JUNE 15, 1944
AND LATER**

A (A ₁ , A ₂ , etc.)	Anode
D (D ₁ , D ₂ , etc.)	Deflectors, Ray Control Electrode
F	Filament
F _t	Filament Tap
G (G ₁ , G ₂ , etc.)	Grid
H	Heater
H _t	Heater Tap
I _c	Internal Connection (Not For External Use)
J	Jumper
K	Cathode
N _c	No Connection
P (P ₁ , P ₂ , etc.)	Plate, Diode Plate
S	Shell
S _i	Internal Shield
S _x	External Shield
T	Target
■	Beam Plate

A GRID SUBSCRIPT NUMBERS ARE USED ONLY WHEN THERE IS MORE THAN ONE GRID IN THE TUBE. THEY SIGNIFY THE SEQUENCE FROM THE CATHODE. FOR EXAMPLE, G₃ INDICATES THE 3RD. GRID FROM THE CATHODE. WHEN THERE ARE TWIN ELEMENTS IN A TUBE, SUBSCRIPTS ARE USED ONLY IF THERE IS MORE THAN ONE GRID IN ANY GIVEN UNIT. FOR EXAMPLE, A TRIODE-PENTODE IS LABELLED G₂, G₃ FOR A PENTODE SECTION, WHEREAS THE TRIODE SECTION IS LABELLED G. IF THERE ARE 2 PENTODE SECTIONS, THERE ARE THEN TWO SETS OF SUBSCRIPTS.

ALL BASING DIAGRAMS ARE BOTTOM VIEWS. THEY ARE SYMBOLIC AND DO NOT NECESSARILY REPRESENT INTERNAL TUBE CONSTRUCTION.

TUNG-SOL

RMA RECEIVING TUBE RATINGS

M8-210 IT SHALL BE STANDARD TO INTERPRET THE RATINGS ON RECEIVING TYPES OF TUBES ACCORDING TO THE FOLLOWING CONDITIONS.

1. CATHODE

THE HEATER OR FILAMENT VOLTAGE IS GIVEN AS A NORMAL VALUE UNLESS OTHERWISE STATED. THIS MEANS THAT TRANSFORMERS OR RESISTANCES IN THE HEATER OR FILAMENT CIRCUIT SHOULD BE DESIGNED TO OPERATE THE HEATER OR FILAMENT AT RATED VALUE FOR FULL-LOAD OPERATING CONDITIONS UNDER AVERAGE SUPPLY-VOLTAGE CONDITIONS. A REASONABLE AMOUNT OF LEEWAY IS INCORPORATED IN THE CATHODE DESIGN SO THAT MODERATE FLUCTUATIONS OF HEATER OR FILAMENT VOLTAGE DOWNWARD WILL NOT CAUSE MARKED FALLING OFF IN RESPONSE; ALSO, MODERATE VOLTAGE FLUCTUATIONS UPWARD WILL NOT REDUCE THE LIFE OF THE CATHODE TO AN UNSATISFACTORY DEGREE.

A. 1.4 VOLT BATTERY TUBE TYPES

THE FILAMENT POWER SUPPLY MAY BE OBTAINED FROM DRY-CELL BATTERIES, FROM STORAGE BATTERIES, OR FROM A POWER LINE. WITH DRY-CELL BATTERY SUPPLY, THE FILAMENT MAY BE CONNECTED EITHER DIRECTLY ACROSS A BATTERY RATED AT A TERMINAL POTENTIAL OF 1.5 VOLTS, OR IN SERIES WITH THE FILAMENTS OF SIMILAR TUBES ACROSS A POWER SUPPLY CONSISTING OF DRY CELLS IN SERIES. IN EITHER CASE, THE VOLTAGE ACROSS EACH 1.4-VOLT SECTION OF FILAMENT SHOULD NOT EXCEED 1.6 VOLTS. WITH POWER-LINE OR STORAGE-BATTERY SUPPLY, THE FILAMENT MAY BE OPERATED IN SERIES WITH THE FILAMENTS OF SIMILAR TUBES. FOR SUCH OPERATION, DESIGN ADJUSTMENTS SHOULD BE MADE SO THAT WITH TUBES OF RATED CHARACTERISTICS, OPERATING WITH ALL ELECTRODE VOLTAGES APPLIED AND ON A NORMAL LINE VOLTAGE OF 117 VOLTS OR ON A NORMAL STORAGE-BATTERY VOLTAGE OF 2.0 VOLTS PER CELL (WITHOUT A CHARGER) OR 2.2 VOLTS PER CELL (WITH A CHARGER), THE VOLTAGE DROP ACROSS EACH 1.4-VOLT SECTION OF FILAMENT WILL BE MAINTAINED WITHIN A RANGE OF 1.25 TO 1.4 VOLTS WITH A NOMINAL CENTER OF 1.3 VOLTS. IN ORDER TO MEET THE RECOMMENDED CONDITIONS FOR OPERATING FILAMENTS IN SERIES FROM DRY-BATTERY, STORAGE-BATTERY, OR POWER-LINE SOURCES IT MAY BE NECESSARY TO USE SHUNTING RESISTORS ACROSS THE INDIVIDUAL 1.4-VOLT SECTIONS OF FILAMENT.

B. 2.0 VOLT BATTERY TUBE TYPES

THE 2.0-VOLT LINE OF TUBES IS DESIGNED TO BE OPERATED WITH 2.0 VOLTS ACROSS THE FILAMENT. IN ALL CASES THE OPERATING VOLTAGE RANGE SHOULD BE MAINTAINED WITHIN THE LIMITS OF 1.8 VOLTS TO 2.2 VOLTS.

2. POSITIVE POTENTIAL ELECTRODES

THE POWER SOURCES FOR THE OPERATION OF RADIO EQUIPMENT ARE SUBJECT TO VARIATIONS IN THEIR TERMINAL POTENTIAL. CONSEQUENTLY, THE MAXIMUM RATINGS SHOWN ON THE RMA VACUUM TUBE DATA SHEETS HAVE BEEN ESTABLISHED FOR CERTAIN DESIGN CENTER VOLTAGES WHICH EXPERIENCE HAS SHOWN TO BE REPRESENTATIVE. THE DESIGN CENTER VOLTAGES TO BE USED FOR THE VARIOUS POWER SUPPLIES TOGETHER WITH OTHER RATING CONSIDERATIONS ARE AS GIVEN BELOW:

A. AC OR DC POWER LINE SERVICE IN U.S.A.

THE DESIGN CENTER VOLTAGE FOR THIS TYPE OF POWER SUPPLY IS 117 VOLTS. THE MAXIMUM RATINGS OF PLATE VOLTAGES SCREEN-SUPPLY VOLTAGES DISSEMINATIONS, AND RECTIFIER OUTPUT CURRENTS ARE DESIGN MAXIMUMS AND SHOULD NOT BE EXCEEDED IN EQUIPMENT OPERATED AT A LINE VOLTAGE OF 117 VOLTS.

(CONTINUED NEXT PAGE)

TUNG-SOL

B. STORAGE-BATTERY SERVICE

WHEN STORAGE-BATTERY EQUIPMENT IS OPERATED WITHOUT A CHARGER, IT SHOULD BE DESIGNED SO THAT THE PUBLISHED RMA MAXIMUM VALUES OF PLATE VOLTAGES, SCREEN-SUPPLY VOLTAGES, DISSIPATIONS AND RECTIFIER OUTPUT CURRENTS ARE NEVER EXCEEDED FOR A TERMINAL POTENTIAL AT THE BATTERY SOURCE OF 2.0 VOLTS PER CELL. WHEN STORAGE-BATTERY EQUIPMENT IS OPERATED WITH A CHARGER, IT SHOULD BE DESIGNED SO THAT 90% OF THE SAME RMA VALUES ARE NEVER EXCEEDED FOR A TERMINAL POTENTIAL AT THE BATTERY SOURCE OF 2.2 VOLTS.

C. "B" -BATTERY SERVICE

THE DESIGN CENTER VOLTAGE FOR "B" BATTERIES IS THE NORMAL VOLTAGE RATING OF THE BATTERY BLOCK, SUCH AS 45 VOLTS, 90 VOLTS, ETC. EQUIPMENT SHOULD BE DESIGNED SO THAT UNDER NO CONDITION OF BATTERY VOLTAGE WILL THE PLATE VOLTAGES, THE SCREEN-SUPPLY VOLTAGES, OR DISSIPATIONS EVER EXCEED THE RECOMMENDED RESPECTIVE MAXIMUM VALUES SHOWN IN THE DATA FOR EACH TUBE TYPE BY MORE THAN 10%.

D. OTHER CONSIDERATIONS

A. CLASS A AMPLIFIERS

THE MAXIMUM PLATE DISSIPATION OCCURS AT THE "ZERO-SIGNAL" CONDITION. THE MAXIMUM SCREEN DISSIPATION USUALLY OCCURS AT THE CONDITION WHERE THE PEAK-INPUT SIGNAL VOLTAGE IS EQUAL TO THE BIAS VOLTAGE.

B. CLASS B AMPLIFIERS

THE MAXIMUM PLATE DISSIPATION THEORETICALLY OCCURS AT APPROXIMATELY 63% OF THE "MAXIMUM-SIGNAL" CONDITION, BUT PRACTICALLY MAY OCCUR AT ANY SIGNAL VOLTAGE VALUE.

C. CONVERTERS

THE MAXIMUM PLATE DISSIPATION OCCURS AT THE "ZERO-SIGNAL" CONDITION AND THE FREQUENCY AT WHICH THE OSCILLATOR-DEVELOPED BIAS IS A MINIMUM. THE SCREEN DISSIPATION FOR ANY REASONABLE VARIATION IN SIGNAL VOLTAGE MUST NEVER EXCEED THE RATED VALUE BY MORE THAN 10%.

D. SCREEN RATINGS

WHEN THE SCREEN VOLTAGE IS SUPPLIED THROUGH A SERIES VOLTAGE-DROPPING RESISTOR, THE MAXIMUM SCREEN VOLTAGE RATING MAY BE EXCEEDED, PROVIDED THE MAXIMUM SCREEN DISSIPATION RATING IS NOT EXCEEDED AT ANY SIGNAL CONDITION, AND THE MAXIMUM SCREEN VOLTAGE RATING IS NOT EXCEEDED, AT THE MAXIMUM-SIGNAL CONDITION. PROVIDED THESE CONDITIONS ARE FULFILLED, THE SCREEN-SUPPLY VOLTAGE MAY BE AS HIGH AS BUT NOT ABOVE THE MAXIMUM PLATE VOLTAGE RATING.

3. TYPICAL OPERATION

FOR MANY RECEIVING TUBES, THE DATA SHOW TYPICAL OPERATING CONDITIONS IN PARTICULAR SERVICES. THESE TYPICAL OPERATING VALUES ARE GIVEN TO SHOW CONCISELY SOME GUIDING INFORMATION FOR THE USE OF EACH TYPE. THEY ARE NOT TO BE CONSIDERED AS RATINGS, BECAUSE THE TUBE CAN BE USED UNDER ANY SUITABLE CONDITIONS WITHIN ITS RATING LIMITATIONS.

ADOPTED STANDARD NOVEMBER, 1939

REVISED NOVEMBER 1940

PLATE
1350-1
OCT. 25
1943

TUNG-SOL

RECEIVING TUBE PREFERRED LIST

PRINCIPAL APPLICATION		BATTERY OPERATED RADIO RECEIVERS	6-VOLT HOME & AUTO RADIO RECEIVERS	AC - DC HOME RADIO RECEIVERS
RECTIFIERS		117Z3	5U4G 5Y3GT 6X4 6X5GT	25Z6GT 35W4 35Z5GT
CONVERTERS		1R5	6BE6 6SA7GT	12BE6 12SA7GT
TRIODES			6C4 6U5GT	
SHARP CUT-OFF PENTODES	MEDIUM G_m	1U4	6SJ7GT	12SJ7GT
	HIGH G_m		6AK5 6AU6 6BH6	12AU6
REMOTE CUT-OFF PENTODES	MEDIUM G_m	1T4	6SK7GT	12SK7GT
	HIGH G_m		6BA6 6BJ6	12BA6
TWIN TRIODES			6J6 6SL7GT 6SN7GT 12AU7[▲] 12AX7[▲]	
AMPLIFIER WITH DIODES		1S5	6AT6 6BF6 6SBGT 6SQ7GT	12AT6 12SQ7GT
DIODE DETECTORS			6AL5 6H6GT	12AL5
POWER TUBES		3S4 3V4	6AQ5 6L6GA 6V6GT	25L6GT 35B5 50B5 50L6GT

MINIATURE TYPES SHOWN IN BOLD FACE

[▲] ADAPTABLE TO EITHER 6 OR 12 VOLT OPERATIONPLATE
2016
MAY 3
1948



VT NUMBER LIST

TUNG-SOL

VT NUMBERS IDENTIFICATION LIST

VT NUMBERS	RMA NUMBERS	VT NUMBERS	RMA NUMBERS
VT-4B	211	VT-76	76
VT-4C	211 SPECIAL	VT-77	77
VT-17	860	VT-78	78
VT-19	861	VT-80	80
VT-22	204A	VT-83	83
VT-24	864	VT-84	84/624
VT-25	10	VT-86	6K7 ✓
VT-25A	10 SPECIAL	VT-86A	6K7G
VT-26	22	VT-86B	6K7GT
VT-27	30	VT-87	6L7
VT-28	24, 24A	VT-87A	6L7G
VT-29	27	VT-88	6R7
VT-30	01-A	VT-88A	6R7G
VT-31	31	VT-88B	6R7GT
VT-33	33	VT-89	89
VT-34	207	VT-90	6H6
VT-35	35/51	VT-90A	6H6GT
VT-36	36	VT-91	6J7
VT-37	37	VT-91A	6J7GT
VT-38	38	VT-92	6Q7
VT-39	869	VT-93	6B8 ✓
VT-39A	869B	VT-93A	6B8G
VT-40	40	VT-94	6J5
VT-41	851	VT-94A	6J5G
VT-42	872	VT-94B	6J5 SPEC. SELEC.
VT-42A	872A SPEC. FIL.	VT-94C	6J5G SPEC. SELEC.
VT-43	845W	VT-94D	6J5GT/G
VT-44	32	VT-95	2A3
VT-45	45	VT-96	6N7
VT-46	866	VT-96B	6N7 SPEC. SELEC.
VT-46A	866A	VT-97	5W4
VT-47	47	VT-98	6U5/6G5
VT-48	41 ✓	VT-99	6F8G
VT-49	39/44	VT-100	807
VT-50	50	VT-100A	807 MODIFIED
VT-51	841	VT-101	837
VT-52	45 SPECIAL	VT-103	6SQ7
VT-54	34	VT-104	12SQ7
VT-55	865	VT-105	6SC7
VT-56	56	VT-106	803
VT-57	57	VT-107	6V6
VT-58	58	VT-107A	6V6GT
VT-60	850	VT-107B	6V6G
VT-62	801, 801A	VT-108	450TH
VT-63	46	VT-109	2051
VT-64	800	VT-111	5BP4/1802P4
VT-65	6C5	VT-112	6AC7/1852
VT-65A	6C5G	VT-114	5T4
VT-66	6F6	VT-115	6L6
VT-66A	6F6G	VT-115A	6L6G
VT-67	30 SPECIAL	VT-116	6SJ7
VT-68	6B7	VT-116A	6SJ7GT
VT-69	6D6	VT-116B	6SJ7Y
VT-70	6F7 ✓	VT-117	6SK7
VT-72	842	VT-117A	6SK7GT
VT-73	843	VT-118	832
VT-74	924	VT-119	2X2/879
VT-75	75	VT-120	954

PLATE
1620
NOV. 30
1945

VT NUMBER LIST

TUNG-SOL

CONTINUED FROM PRECEDING PAGE

VT NUMBERS	RMA NUMBERS	VT NUMBERS	RMA NUMBERS
VT-121	955	VT-190	7H7
VT-122	530	VT-191	316A
VT-124	1A5GT	VT-192	7A4
VT-125	1C5GT	VT-193	7C7
VT-126	6X5	VT-194	7J7
VT-126A	6X5G	VT-195	1005
127-VT-126B	6X5GT	VT-196	6W5G
VT-128	1630 (A-5588)	VT-197A	6Y3GT/G
VT-129	304TL	VT-198A	6G6G
VT-130	250TL	VT-199	6SS7
VT-131	12SK7	VT-200	VR105-30
VT-132	12K8 SPECIAL	VT-201	25L6
VT-133	12SR7	VT-201C	25L6GT
VT-134	12A6	VT-202	9002
VT-135	12J5GT	VT-203	9003
VT-135A	12J5	VT-204	HK24G
VT-136	1625	VT-205	65T7
VT-137	1626	VT-206A	5V4G
VT-138	1629	VT-207	12AH7GT
VT-139	VR150-30	VT-208	788
VT-141	531	VT-209	12S67
VT-143	805	VT-210	1S4
VT-144	813	VT-211	6SG7
VT-145	523	VT-212	958
VT-146	1N5GT	VT-213A	6L5G
VT-147	1A7GT	VT-214	12H6
VT-148	108GT	VT-215	6E5
VT-149	3A8GT	VT-216	816
VT-150	6SA7	VT-217	811
VT-150A	6SA7GT	VT-218	100TH
VT-151	6A8G	VT-220	250TH
VT-151B	6A8GT	VT-221	3Q5GT
VT-152	6K6GT	VT-222	884
VT-152A	6K6G	VT-223	1H5GT
VT-153	12C8 SPECIAL	VT-224	2C34-RK34
VT-154	814	VT-225	307A
VT-161	12SA7	VT-226	3EP1/1806P1
VT-162	12SJ7	VT-227	7184
VT-163	6C8G	VT-228	8012
VT-164	1619	VT-229	6SL7GT
VT-165	1624	VT-230	350A
VT-166	371A	VT-231	6SN7GT
VT-167	6K8	VT-232	E-1148
VT-168A	6Y6G	VT-233	6SR7
VT-169	12C8	VT-236	836
VT-170	1E5-GP	VT-237	957
VT-171	1R5	VT-238	956
VT-171A	1R5 LOK. EQUIV.	VT-239	1LE3
VT-172	155	VT-240	710A
VT-173	174	VT-241	7E5/1201
VT-174	354	VT-243	7C4/1203A
VT-175	1613	VT-244	5U4G
VT-176	6A87/1853	VT-245	2050
VT-177	1LH4	VT-246	918
VT-178	1LC6	VT-247	5AG7
VT-179	1LN5	VT-249	1006
VT-181	724	VT-255	705A
VT-182	3B7/1291	VT-260	VR75-30
VT-183	1R4/1294	VT-264	3Q4
VT-184	VR90-30	VT-268	12SC7
VT-185	306/1299	VT-269	717A
VT-187	575A	VT-287	815
VT-188	7E6	VT-288	12SH7
VT-189	7F7	VT-289	12SL7GT

PLATE
1621
NOV. 30
1945

TUNG-SOL

FOREWORD

The circuit diagrams in the following section have been selected to represent satisfactory commercial practice in the application of receiving tube types. None of the circuits represent an actual commercial piece of equipment but rather a composite of several designs of a particular class. This has been necessary in order to illustrate in one diagram many different circuit possibilities which may not necessarily be economical in one commercial model. It is therefore quite feasible to utilize portions of several circuits to arrive at a design for a particular service.

Wherever possible, actual circuit values are shown with the exception of parallel coil and condenser combinations which should be chosen from commercial components for the frequencies desired. While values of resistances, capacitances, and voltages are furnished, it is most important that reference be made to the individual tube rating sheets to ascertain that maximum and minimum ratings are not exceeded when attempting to combine several of these circuits.

The scope of the diagrams included represents the most popular circuit applications. As a result, a strict adherence to the current "preferred tube types" list has been made wherever possible. In several instances two tube type designations are shown since comparable performance can be expected when interchanging the indicated types.

5 TUBE AC/DC SUPERHETERODYNE RECEIVER

TYPICAL CIRCUIT

TUNG-SOL

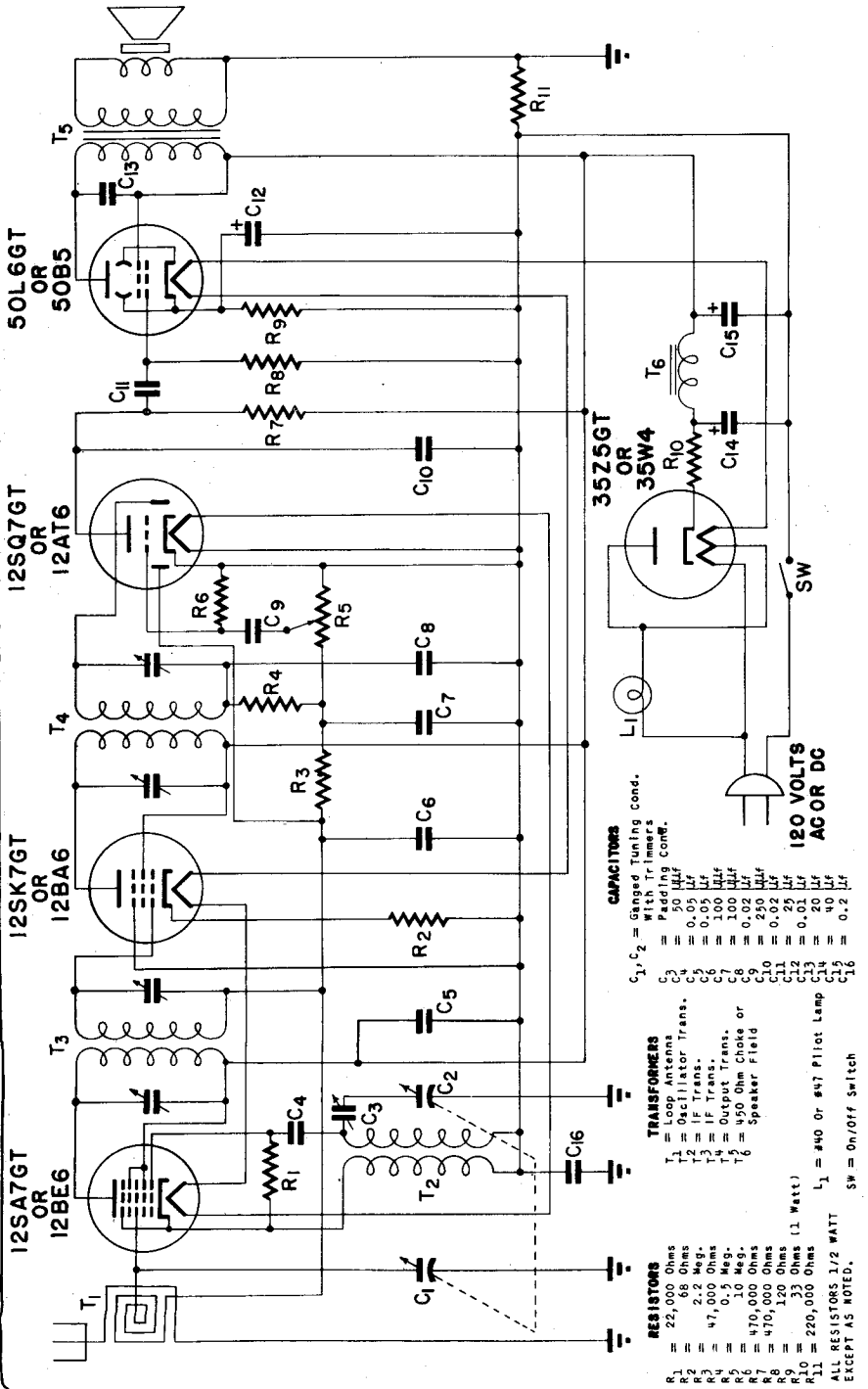

CAPACITORS
 C₁, C₂ = Ganged Tuning cond.
 C₃ = With or without
 C₄ = Padded
 C₅ = 50 μF
 C₆ = 0.05 μF
 C₇ = 100 μF
 C₈ = 100 μF
 C₉ = 250 μF
 C₁₀ = 0.02 μF
 C₁₁ = 25 μF
 C₁₂ = 0.01 μF
 C₁₃ = 20 μF
 C₁₄ = 40 μF
 C₁₅ = 0.2 μF
 C₁₆ = 0.2 μF

TRANSFORMERS
 T₁ = Loop Antenna
 T₂ = IF Trans. or Trans.
 T₃ = IF Trans.
 T₄ = Output Trans.
 T₅ = 450 Ohm Choke or
 T₆ = Speaker Field

RESISTORS
 R₁ = 22,000 Ohms
 R₂ = 25 Ohms
 R₃ = 47,000 Ohms
 R₄ = 1.0 Meg.
 R₅ = 10 Meg.
 R₆ = 470,000 Ohms
 R₇ = 470,000 Ohms
 R₈ = 120 Ohms
 R₉ = 120 Ohms
 R₁₀ = 35 Ohms (1 Watt)
 R₁₁ = 220,000 Ohms
 L₁ = #40 Or #47 Pilot Lamp
 SW = On/Off Switch

120 VOLTS
AC OR DC

6 TUBE AC/DC BATTERY PORTABLE RECEIVER

TYPICAL CIRCUIT

TUNG-SOL

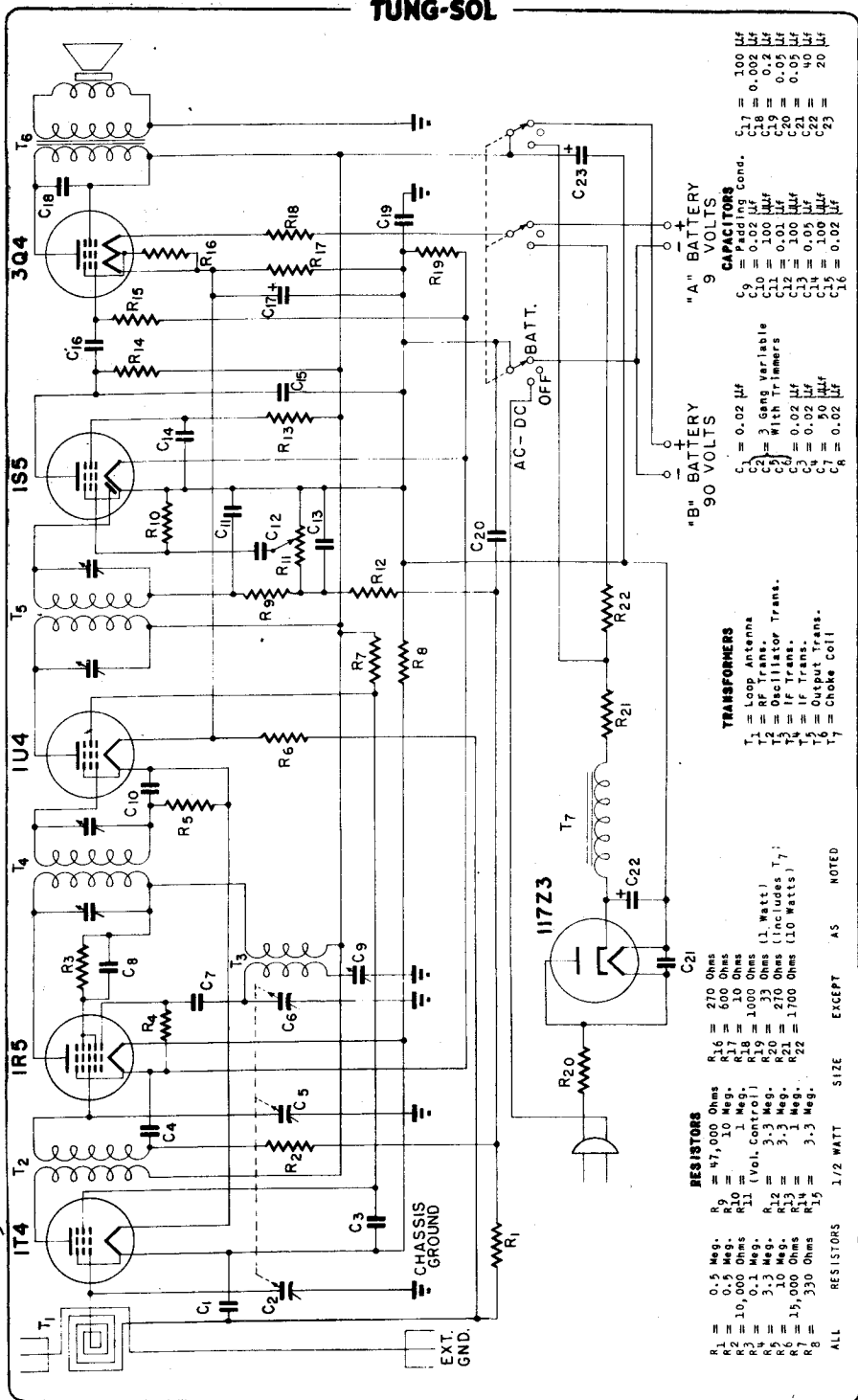

- "A" BATTERY 9 VOLTS**
- C₁ = 0.02 μf
 - C₂ = 3 Gang Variable
 - C₃ = With Trimmers
 - C₄ = 0.02 μf
 - C₅ = 0.02 μf
 - C₆ = 0.05 μf
 - C₇ = 100 μf
 - C₈ = 0.02 μf
 - C₉ = 100 μf
 - C₁₀ = 100 μf
 - C₁₁ = 100 μf
 - C₁₂ = 100 μf
 - C₁₃ = 0.05 μf
 - C₁₄ = 100 μf
 - C₁₅ = 100 μf
 - C₁₆ = 0.02 μf
 - C₁₇ = 100 μf
 - C₁₈ = 0.02 μf
 - C₁₉ = 0.2 μf
 - C₂₀ = 0.05 μf
 - C₂₁ = 0.10 μf
 - C₂₂ = 20 μf
 - C₂₃ = 25 μf
- "B" BATTERY 90 VOLTS**
- C₁ = 0.02 μf
 - C₂ = 3 Gang Variable
 - C₃ = With Trimmers
 - C₄ = 0.02 μf
 - C₅ = 0.02 μf
 - C₆ = 0.05 μf
 - C₇ = 100 μf
 - C₈ = 0.02 μf
 - C₉ = 100 μf
 - C₁₀ = 100 μf
 - C₁₁ = 100 μf
 - C₁₂ = 100 μf
 - C₁₃ = 0.05 μf
 - C₁₄ = 100 μf
 - C₁₅ = 100 μf
 - C₁₆ = 0.02 μf
 - C₁₇ = 100 μf
 - C₁₈ = 0.02 μf
 - C₁₉ = 0.2 μf
 - C₂₀ = 0.05 μf
 - C₂₁ = 0.10 μf
 - C₂₂ = 20 μf
 - C₂₃ = 25 μf

- TRANSFORMERS**
- T₁ = Loop Antenna
 - T₂ = RF Trans.
 - T₃ = Oscillator Trans.
 - T₄ = IF Trans.
 - T₅ = IF Trans.
 - T₆ = Output Trans.
 - T₇ = Choke Coil

- RESISTORS**
- R₁ = 0.5 Meg.
 - R₂ = 0.5 Meg.
 - R₃ = 10,000 Ohms
 - R₄ = 0.1 Meg.
 - R₅ = 3.3 Meg.
 - R₆ = 15,000 Ohms
 - R₇ = 330 Ohms
 - R₈ = 1.2 WATT
 - R₉ = 47,000 Ohms
 - R₁₀ = 10 Meg.
 - R₁₁ (Vol. Control)
 - R₁₂ = 3.3 Meg.
 - R₁₃ = 3.3 Meg.
 - R₁₄ = 15,000 Ohms
 - R₁₅ = 3.3 Meg.
 - R₁₆ = 270 Ohms (1 Watt)
 - R₁₇ = 600 Ohms
 - R₁₈ = 1000 Ohms
 - R₁₉ = 270 Ohms (10 Watts)
 - R₂₀ = 1700 Ohms (10 Watts)
 - R₂₁ = 1700 Ohms (10 Watts)
 - R₂₂ = 1700 Ohms (10 Watts)
- RESISTORS 1/2 WATT EXCEPT AS NOTED**

PRINTED IN U.S.A.
 PLATE 1733
 SEPT. 2 1946

6 TUBE AUTOMOBILE RECEIVER

TYPICAL CIRCUIT

TUNG-SOL

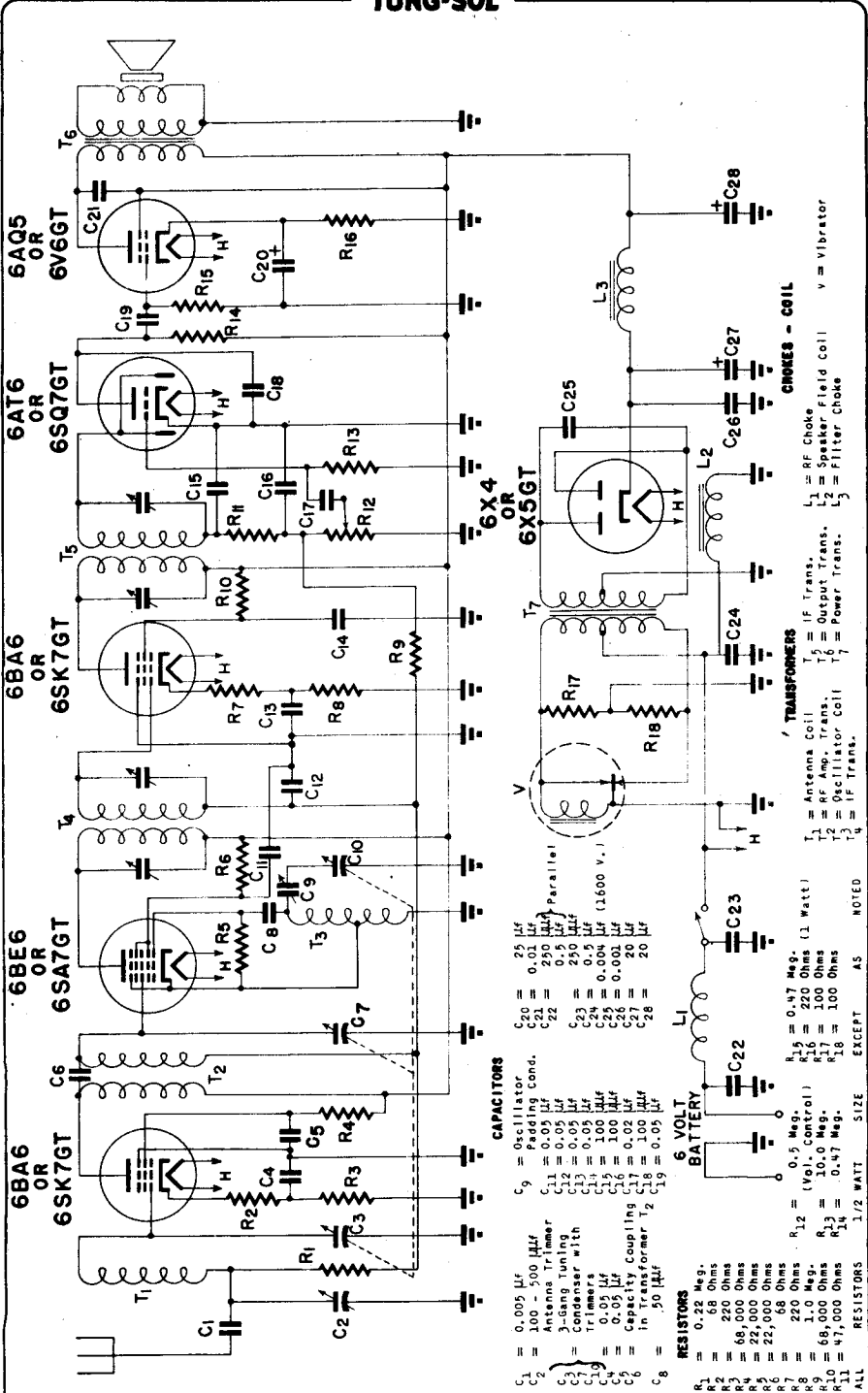

CAPACITORS

- C₁ = 0.005 μf
- C₂ = 100 - 500 μf
- C₃ = Antenna Trimmer
- C₄ = 3-Gang Tuning
- C₅ = Condenser with 100 μf
- C₆ = 0.05 μf
- C₇ = Capacity Coupling in Transformer T₂
- C₈ = 50 μf
- C₉ = Oscillator
- C₁₀ = 0.01 μf
- C₁₁ = 250 μf
- C₁₂ = 0.05 μf
- C₁₃ = 0.05 μf
- C₁₄ = 0.05 μf
- C₁₅ = 100 μf
- C₁₆ = 0.05 μf
- C₁₇ = 0.02 μf
- C₁₈ = 100 μf
- C₁₉ = 50 μf
- C₂₀ = 25 μf
- C₂₁ = 0.01 μf
- C₂₂ = 250 μf
- C₂₃ = 0.05 μf
- C₂₄ = 0.004 μf (1,600 v.)
- C₂₅ = 0.001 μf
- C₂₆ = 0.001 μf
- C₂₇ = 20 μf
- C₂₈ = 20 μf
- C₂₉ = 25 μf

RESISTORS

- R₁ = 0.22 Meg.
- R₂ = 68 Ohms
- R₃ = 220 Ohms
- R₄ = 68,000 Ohms
- R₅ = 22,000 Ohms
- R₆ = 22,000 Ohms
- R₇ = 58 Ohms
- R₈ = 2.0 Meg.
- R₉ = 68,000 Ohms
- R₁₀ = 47,000 Ohms
- R₁₁ = 100 Ohms
- R₁₂ = 0.47 Meg.
- R₁₃ = 220 Ohms (1 watt)
- R₁₄ = 100 Ohms
- R₁₅ = 100 Ohms
- R₁₆ = 100 Ohms
- R₁₇ = 100 Ohms
- R₁₈ = 100 Ohms
- R₁₉ = 1.2 WATT
- R₂₀ = 1.2 WATT
- R₂₁ = 1.2 WATT
- R₂₂ = 1.2 WATT
- R₂₃ = 1.2 WATT
- R₂₄ = 1.2 WATT
- R₂₅ = 1.2 WATT
- R₂₆ = 1.2 WATT
- R₂₇ = 1.2 WATT
- R₂₈ = 1.2 WATT
- R₂₉ = 1.2 WATT

TRANSFORMERS

- T₁ = Antenna Coil
- T₂ = IF Trans.
- T₃ = pr Amp. Trans.
- T₄ = Oscillator Coil
- T₅ = IF Trans.
- T₆ = Power Trans.
- T₇ = IF Trans.

CHOKES - COIL

- L₁ = RF Choke
- L₂ = Speaker Field Coil
- L₃ = Filter Choke

v = Vibrator

10 TUBE AC SUPERHETRODYNE RECEIVER

TUNG-SOL

TYPICAL CIRCUIT

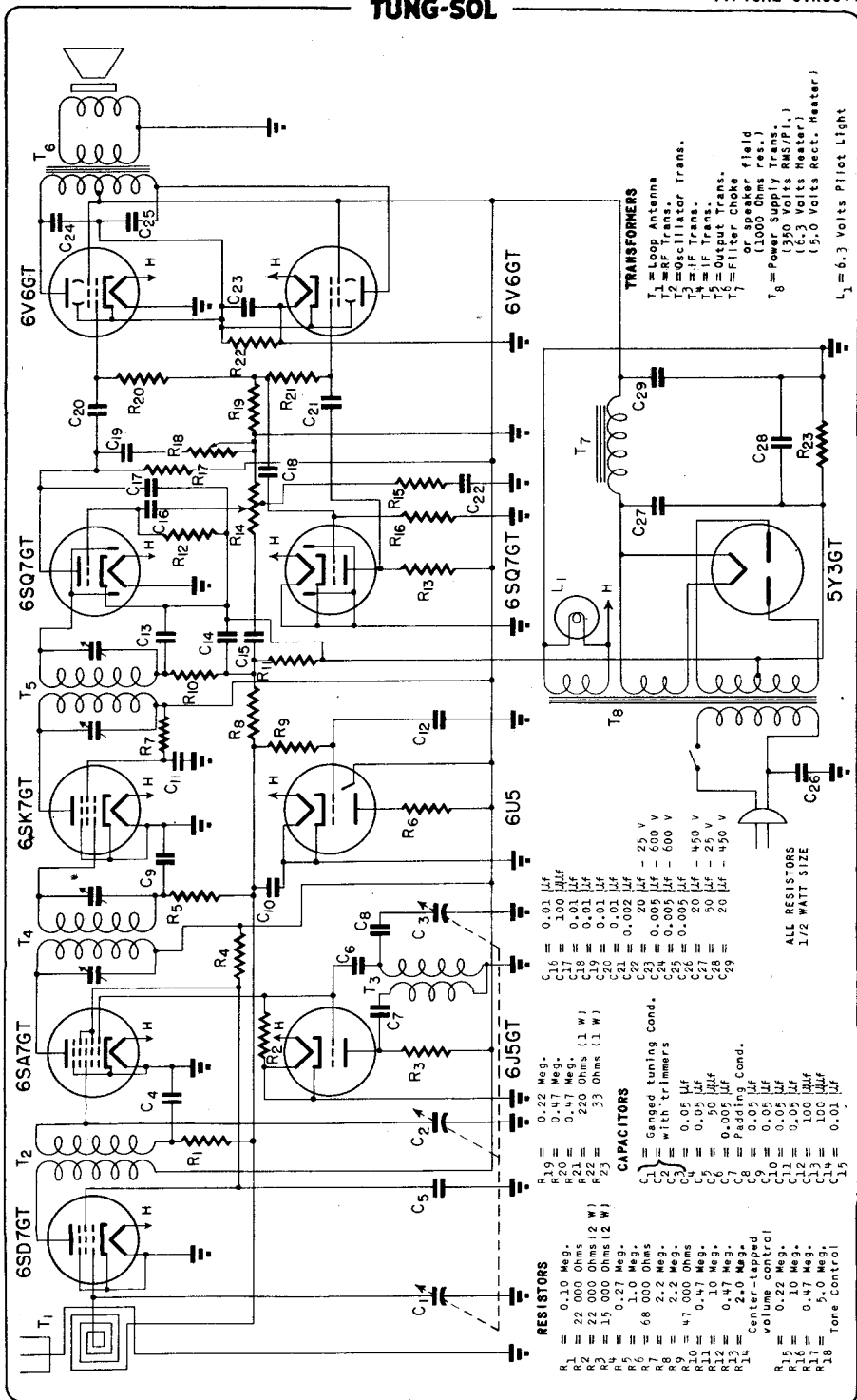

PRINTED IN U. S. A.

PLATE 1839 JULY 1, 1947



TUNG-SOL

VOLTAGE REGULATOR

MINIATURE TYPE

COLD-CATHODE GLOW DISCHARGE

ANY MOUNTING POSITION

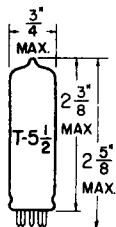

GLASS BULB

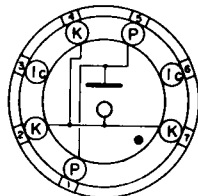

BOTTOM VIEW
MINIATURE BUTTON
7 PIN BASE

THE OA2 IS A COLD CATHODE GLOW-DISCHARGE TUBE USING THE MINIATURE CONSTRUCTION. IT IS INTENDED FOR USE AS A VOLTAGE REGULATOR TO MAINTAIN CONSTANT VOLTAGE ACROSS A LOAD WITH MODERATE CHANGES IN LOAD CURRENT AND SUPPLY VOLTAGE.

RATINGS

MAXIMUM AND MINIMUM RATINGS ARE ABSOLUTE VALUES

MAXIMUM AVERAGE STARTING CURRENT ^A	75	MA.
MAXIMUM DC OPERATING CURRENT (CONTINUOUS)	30	MA.
MINIMUM DC OPERATING CURRENT (CONTINUOUS)	5	MA.
MAXIMUM AMBIENT TEMPERATURE	+90	°C
MINIMUM AMBIENT TEMPERATURE	-55	°C

^A AVERAGED OVER STARTING PERIOD NOT EXCEEDING 10 SECONDS.

TYPICAL OPERATING CONDITIONS AND CHARACTERISTICS

MINIMUM DC ANODE SUPPLY VOLTAGE ^B	185	VOLTS
DC STARTING VOLTAGE (APPROX.)	155	VOLTS
DC OPERATING VOLTAGE (APPROX.)	150	VOLTS
SERIES RESISTOR	C	
MAXIMUM SHUNT CAPACITOR	0.1	μf
REGULATION (5 TO 30 MA.)	2	VOLTS

^B NOT LESS THAN INDICATED SUPPLY VOLTAGE SHOULD BE PROVIDED TO INSURE "STARTING" THROUGHOUT TUBE LIFE.

^C SHOULD BE SUFFICIENT TO LIMIT OPERATING CURRENT THROUGH TUBE TO 30 MA. AT ALL TIMES AFTER THE STARTING PERIOD.

SIMILAR TYPE REFERENCE: Ratings and characteristics somewhat similar to type OD3/VR150.

POWERED BY E. A.

PLATE
2018
JUNE 1,
1948



TUNG-SOL

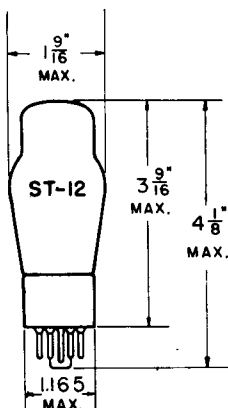

VOLTAGE REGULATOR

COLD CATHODE - GLOW DISCHARGE

GLASS BULB

SMALL SHELL OCTAL 6-PIN BASE

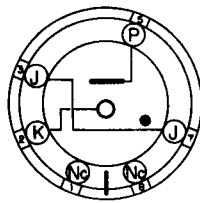

BOTTOM VIEW

THE 0A3/VR75, 0B3/VR90, 0C3/VR105, AND 0D3/VR150 ARE COLD-CATHODE, GLOW-DISCHARGE TUBES. THEY ARE INTENDED FOR USE AS VOLTAGE REGULATORS IN APPLICATIONS WHERE IT IS NECESSARY TO MAINTAIN A CONSTANT DC OUTPUT VOLTAGE ACROSS A LOAD, INDEPENDENT OF LOAD CURRENT AND MODERATE LINE-VOLTAGE VARIATIONS. LIKE OTHER GLOW-DISCHARGE TUBES, THEY MAY ALSO BE USED AS RELAXATION OSCILLATORS, AND FOR SPARK-OVER PROTECTION.

RATINGS AND TYPICAL OPERATING CONDITIONS AND CHARACTERISTICS

MAXIMUM AND MINIMUM RATINGS ARE ABSOLUTE VALUES

	0A3/VR75	0B3/VR90	
DC ANODE SUPPLY VOLTAGE ^A	105 MIN.	125 MIN.	VOLTS
DC OPERATING CURRENT (CONTINUOUS)	40 MAX.	30 MAX.	MA.
DC OPERATING CURRENT (CONTINUOUS)	5.0 MIN.	10 MIN.	MA.
AMBIENT TEMPERATURE RANGE	-55 TO + 90		°C
DC STARTING VOLTAGE (APPROX.)	100		VOLTS
DC OPERATING VOLTAGE (APPROX.)	75	90	VOLTS
REGULATION (5 TO 30 MA.)	3.0		VOLTS
REGULATION (5 TO 40 MA.)	5.0		VOLTS
REGULATION (10 TO 30 MA.)		8.0	VOLTS
	0C3/VR105	0D3/VR150	
DC ANODE SUPPLY VOLTAGE ^A	133 MIN.	185 MIN.	VOLTS
DC OPERATING CURRENT (CONTINUOUS)	40 MAX.	40 MAX.	MA.
DC OPERATING CURRENT (CONTINUOUS)	5.0 MIN.	5.0 MIN.	MA.
AMBIENT TEMPERATURE RANGE	-55 TO + 90	-55 TO + 90	°C
DC STARTING VOLTAGE (APPROX.)	115	160	VOLTS
DC OPERATING VOLTAGE (APPROX.)	105	150	VOLTS
REGULATION (5 TO 30 MA.)	1.0	2.0	VOLTS
REGULATION (5 TO 40 MA.)	2.0	4.0	VOLTS

^A NOT LESS THAN INDICATED SUPPLY VOLTAGES SHOULD BE PROVIDED TO INSURE "STARTING" THROUGHOUT TUBE LIFE.

PLATE
1454
AUG. 31
1944



TUNG-SOL

VOLTAGE REGULATOR

MINIATURE TYPE
PHYSICAL SPECIFICATIONS

EMITTER COLD CATHODE - GAS	PIN CONNECTIONS	
BASE MINIATURE BUTTON 7-PIN	PIN 1 PLATE	PIN 7 CATHODE
CAP ---	PIN 2 CATHODE	PIN 8 NONE
BULB T-5 $\frac{1}{2}$	PIN 3 NO CONNECTION	
MAX. DIAMETER $\frac{3}{4}$ "	PIN 4 CATHODE	MOUNTING POS. ANY
MAX. SEATED HEIGHT $2 \frac{3}{8}$ "	PIN 5 PLATE	
MAX. OVERALL LENGTH $2 \frac{5}{8}$ "	PIN 6 NO CONNECTION	
"HOLD-DOWN" HEIGHT 2" (APPROX.)		

RATINGS AND CHARACTERISTICS

MINIMUM DC SUPPLY VOLTAGE	133	VOLTS
OPERATING DC VOLTAGE (APPROX.)	108	VOLTS
OPERATING CURRENT:		
MAXIMUM ALLOWED	30	MA.
MINIMUM	5	MA.
REGULATION	2	VOLTS
STARTING VOLTAGE	125	VOLTS

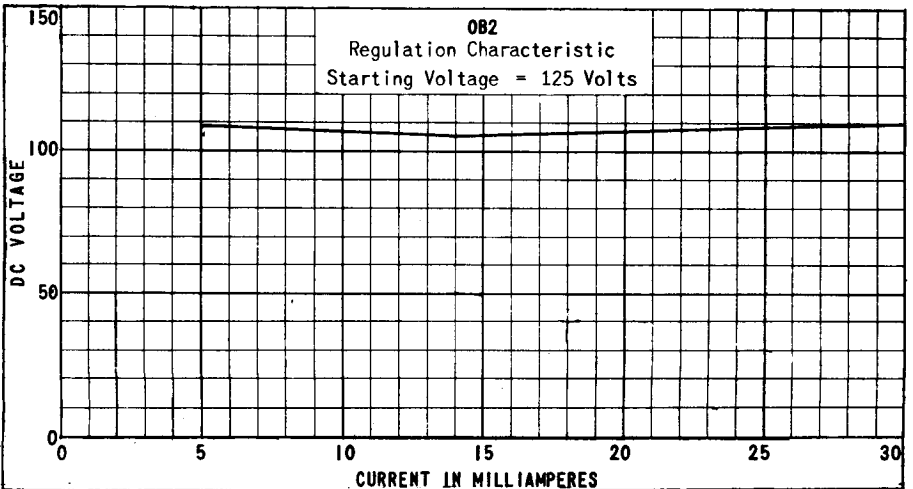
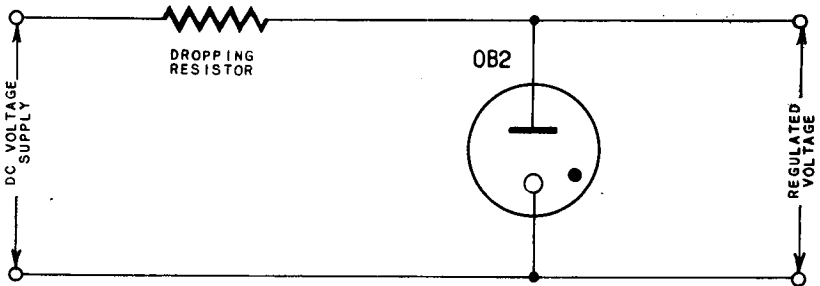

PLATE 1715
JUNE 17 1946



TUNG-SOL

GAS RECTIFIER

PHYSICAL SPECIFICATIONS

EMITTER IONICALLY HEATED		PIN CONNECTIONS	
BASE SMALL WAFER OCTAL 5-PIN		PIN 1 SHELL	PIN 7 FILAMENT
CAP ---		PIN 2 NONE	PIN 8 FILAMENT
BULB MT-8		PIN 3 STARTER ANODE	
MAX. DIAMETER 1 5/16"		PIN 4 NONE	MOUNTING POS. ANY
MAX. SEATED HEIGHT 2 1/16"		PIN 5 PLATE	
MAX. OVERALL LENGTH 2 5/8"		PIN 6 NONE	

THE OY4 IS A HALF-WAVE GAS RECTIFIER WITH A STARTER ANODE WHICH MAKES IT POSSIBLE TO OPERATE DIRECTLY FROM A 117-VOLT AC OR DC LINE.

RATINGS AND CHARACTERISTICS

HALF-WAVE RECTIFIER WITH CONDENSER INPUT TO FILTER

PINS 7 AND 8 MUST BE CONNECTED TOGETHER^A

MAXIMUM INVERSE PEAK VOLTAGE	300	VOLTS
MAXIMUM PEAK CURRENT	500	MA.
MAXIMUM DC OUTPUT CURRENT	75	MA.
MINIMUM DC OUTPUT CURRENT	40	MA.
MINIMUM SERIES ANODE RESISTANCE (117-VOLT LINE OPERATION)	50	OHMS
APPROXIMATE TUBE DROP	12	VOLTS
MAXIMUM DC STARTING VOLTAGE ^B	95	VOLTS

^A RAPID INTERMITTENT OPERATION IS UNDESIRABLE.

^B WITH STARTER ANODE CONNECTED TO THE ANODE THROUGH A 10 MEGOHM RESISTOR BY-PASSED WITH A 0.002 μ F CONDENSER.

PRINTED IN U. S. A.

PLATE
1695
APRIL 15
1946

TUNG-SOL

GAS RECTIFIER

PHYSICAL SPECIFICATIONS

EMITTER IONICALLY HEATED		PIN CONNECTIONS	
BASE	OCTAL 5-PIN DWARF	PIN 1	NO CONNECTION
CAP	---	PIN 2	NONE
BULB	T-7	PIN 3	STARTER ANODE
MAX. DIAMETER	1 5/64"	PIN 4	NONE
MAX. SEATED HEIGHT	2 1/16"	PIN 5	PLATE
MAX. OVERALL LENGTH	2 5/8"	PIN 6	NONE
		PIN 7	FILAMENT
		PIN 8	FILAMENT
			MOUNTING POS. ANY

THE OY4G IS A HALF-WAVE GAS RECTIFIER WITH A STARTER ANODE WHICH MAKES IT POSSIBLE TO OPERATE DIRECTLY FROM A 117-VOLT AC OR DC LINE.

RATINGS AND CHARACTERISTICS

HALF-WAVE RECTIFIER WITH CONDENSER INPUT TO FILTER

PINS 7 AND 8 MUST BE CONNECTED TOGETHER^A

MAXIMUM INVERSE PEAK VOLTAGE	300	VOLTS
MAXIMUM PEAK CURRENT	500	MA.
MAXIMUM DC OUTPUT CURRENT	75	MA.
MINIMUM DC OUTPUT CURRENT	40	MA.
MINIMUM SERIES ANODE RESISTANCE (117-VOLT LINE OPERATION)	50	OHMS
APPROXIMATE TUBE DROP	12	VOLTS
MAXIMUM DC STARTING VOLTAGE ^B	95	VOLTS

^A RAPID INTERMITTENT OPERATION IS UNDESIRABLE.

^B WITH STARTER ANODE CONNECTED TO THE ANODE THROUGH A 10 MEGOHM RESISTOR BY-PASSED WITH A 0.102 μ F CONDENSER.

TUNG-SOL

FULL WAVE GAS FILLED RECTIFIER

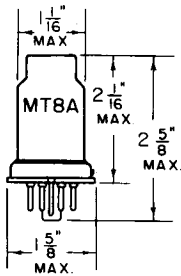

OZ4

COLD CATHODE TYPE

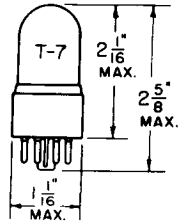

OZ4G

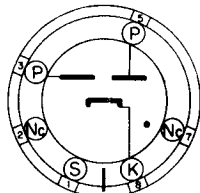

BOTTOM VIEW

SMALL WAFER
6 PIN OCTAL BASE

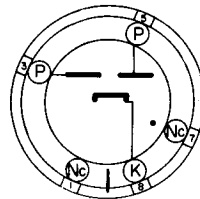

BOTTOM VIEW

DWARF SHELL
5 PIN OCTAL BASE

THE OZ4 AND OZ4G ARE FULL WAVE GAS FILLED RECTIFIER TUBES WITH COLD CATHODES REQUIRING NO HEATER SUPPLY VOLTAGE. THEY ARE USED WHERE HIGH OVERALL EFFICIENCY IS DESIRED.

MAXIMUM RATINGS

MINIMUM PEAK STARTING SUPPLY VOLTAGE PER PLATE	300	VOLTS
MAXIMUM PEAK PLATE TO PLATE VOLTAGE	1000	VOLTS
MAXIMUM PEAK PLATE CURRENT PER PLATE	200	MA.
MAXIMUM DC OUTPUT CURRENT	75	MA.
MINIMUM DC OUTPUT CURRENT	30	MA.
MAXIMUM DC OUTPUT VOLTAGE	300	VOLTS
TUBE VOLTAGE DROP	24	VOLTS

PLATE
1489

OCT. 31
1944

TUNG-SOL

H-F DIODE

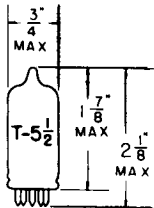

COATED UNIPOTENTIAL CATHODE

HEATER

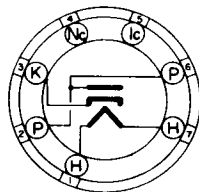
1.4 VOLTS 0.15 AMPERE
AC OR DC

BOTTOM VIEW

MINIATURE BUTTON
7 PIN BASE

ANY MOUNTING POSITION

THE 1A3 IS A HEATER CATHODE TYPE OF MINIATURE DIODE PARTICULARLY USEFUL AS A DISCRIMINATOR TUBE IN PORTABLE FM RECEIVERS, AND IN PORTABLE HIGH FREQUENCY MEASURING EQUIPMENT. ITS INTERELECTRODE CAPACITANCES ARE VERY LOW, BEING IN THE ORDER OF $0.5 \mu\mu\text{f}$. THE RESONANT FREQUENCY OF THE 1A3 IS APPROXIMATELY 1000 Mc. THE GLASS BUTTON BASE PROVIDES FOR SHORT LEADS AND SHORT LEAD INDUCTANCE.

RATINGS

INTERPRETED ACCORDING TO RMA STANDARD NB-210

MAXIMUM PEAK INVERSE PLATE VOLTAGE	330	VOLTS
MAXIMUM PEAK PLATE CURRENT	5.0	MA.
MAXIMUM DC OUTPUT CURRENT	0.5	MA.
MAXIMUM DC HEATER-CATHODE POTENTIAL	140	VOLTS

DIRECT INTERELECTRODE CAPACITANCES

HEATER TO CATHODE	0.6	$\mu\mu\text{f}$
PLATE TO CATHODE	0.4	$\mu\mu\text{f}$
PLATE TO HEATER	0.8	$\mu\mu\text{f}$

TYPICAL OPERATING CONDITIONS AND CHARACTERISTICS

AC PLATE SUPPLY VOLTAGE (RMS)	117	VOLTS
FILTER INPUT CONDENSER	2.0	μf
MINIMUM TOTAL EFFECTIVE PLATE-SUPPLY IMPEDANCE	0	OHMS

A THE CENTER HOLE IN SOCKETS DESIGNED FOR THIS BASE PROVIDES FOR THE POSSIBILITY THAT THIS TUBE TYPE MAY BE MANUFACTURED WITH THE EXHAUST-TUBE TIP AT THE BASE END. FOR THIS REASON, IT IS RECOMMENDED THAT IN EQUIPMENT EMPLOYING THIS TUBE TYPE, NO MATERIAL BE PERMITTED TO OBSTRUCT THE SOCKET HOLE.

PLATE
1490
OCT. 31
1944

TUNG-SOL

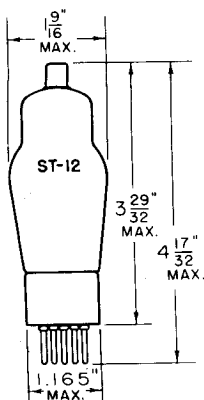

1A4P

SMALL METAL CAP
SMALL 4 PIN BASE

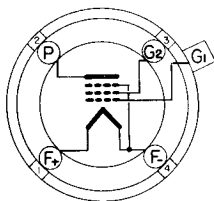

BOTTOM VIEW

REMOTE CUT-OFF
PENTODE AMPLIFIER

COATED FILAMENT

2.0 VOLTS 0.060 AMPERE

AC OR DC

GLASS BULB

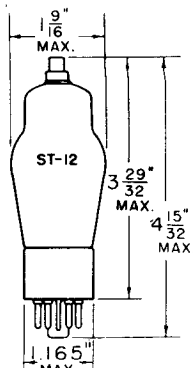

1D5GP

MINIATURE METAL CAP
SMALL 7 PIN OCTAL BASE

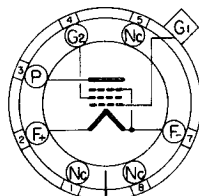

BOTTOM VIEW

THESE TUBES ARE REMOTE CUT-OFF PENTODE AMPLIFIERS DESIGNED FOR USE IN BATTERY OPERATED RECEIVERS. EITHER TUBE IS SUITABLE FOR USE WITH AUTOMATIC VOLUME CONTROL IN RF AND IF AMPLIFIERS WITH A MINIMUM OF CROSS MODULATION.

MOUNTING POSITION

THESE TUBES SHOULD BE OPERATED VERTICALLY WITH THE BASE DOWN. HOWEVER, HORIZONTAL OPERATIONS MAY BE PERMITTED IN THE 1D5GP TUBE TYPE IF PINS 2 AND 7 ARE ON A VERTICAL PLANE. THE SAME WILL BE TRUE FOR THE 1A4P TUBE TYPE IF PINS 1 AND 4 ARE ON A VERTICAL PLANE.

DIRECT INTERELECTRODE CAPACITANCES

MAXIMUM CONTROL GRID TO PLATE (WITH EXTERNAL SHIELD)	0.007	μf
INPUT (G_1 TO G_2 , G_3 , F)	5.0	μf
OUTPUT (P TO G_2 , G_3 , F)	11	μf

TYPICAL OPERATING CONDITIONS AND CHARACTERISTICS

CLASS A AMPLIFIER

PLATE VOLTAGE	90	180 MAX.	VOLTS
SCREEN VOLTAGE	67.5	67.5 MAX.	VOLTS
MINIMUM CONTROL GRID VOLTAGE	-3	-3	VOLTS
PLATE CURRENT	2.2	2.3	MA.
SCREEN CURRENT	0.9	0.8	MA.
PLATE RESISTANCE (APPROX.)	0.6	1.0	MEG OHM
TRANSCONDUCTANCE	720	750	μMHOS
AMPLIFICATION FACTOR (APPROX.)	425	750	
CONTROL GRID VOLTAGE			VOLTS
FOR TRANSCONDUCTANCE OF 15 μMHOS	-15	-15	



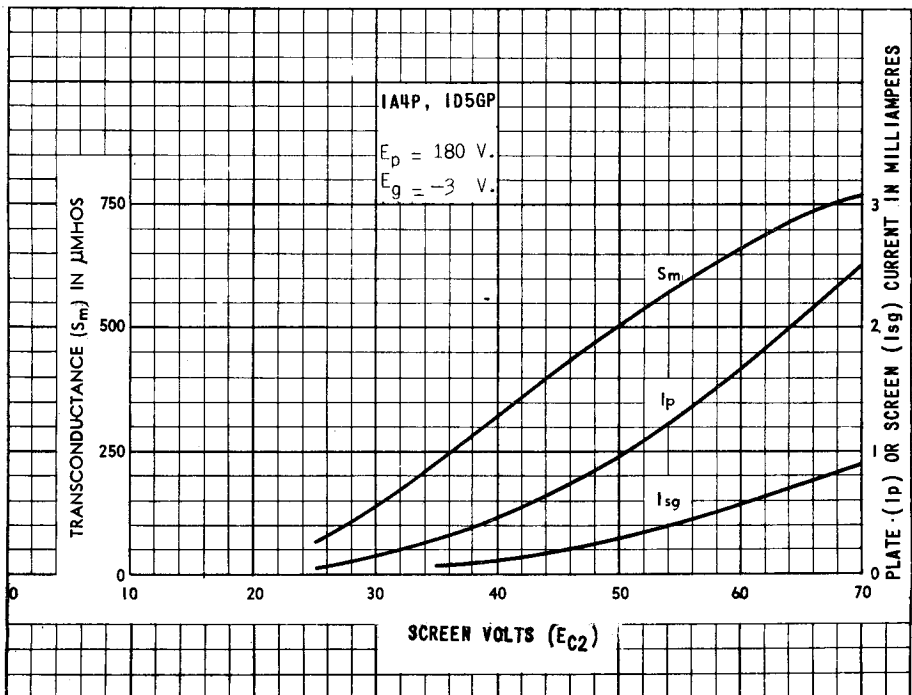
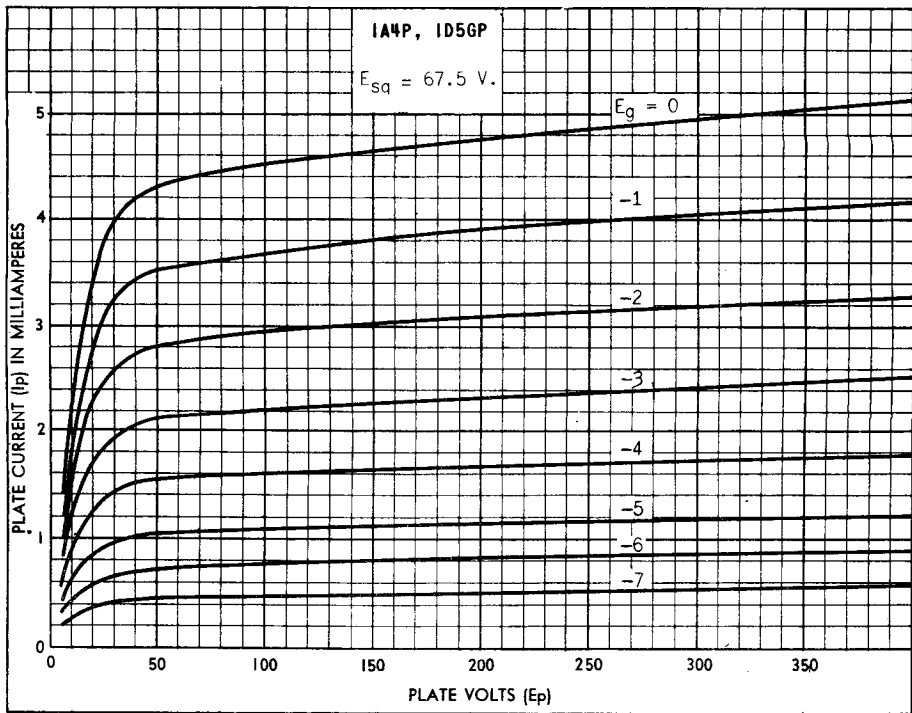

PRINTED IN U. S. A.

PLATE 1456
AUG. 31 1944

1A4P (1D5GP)

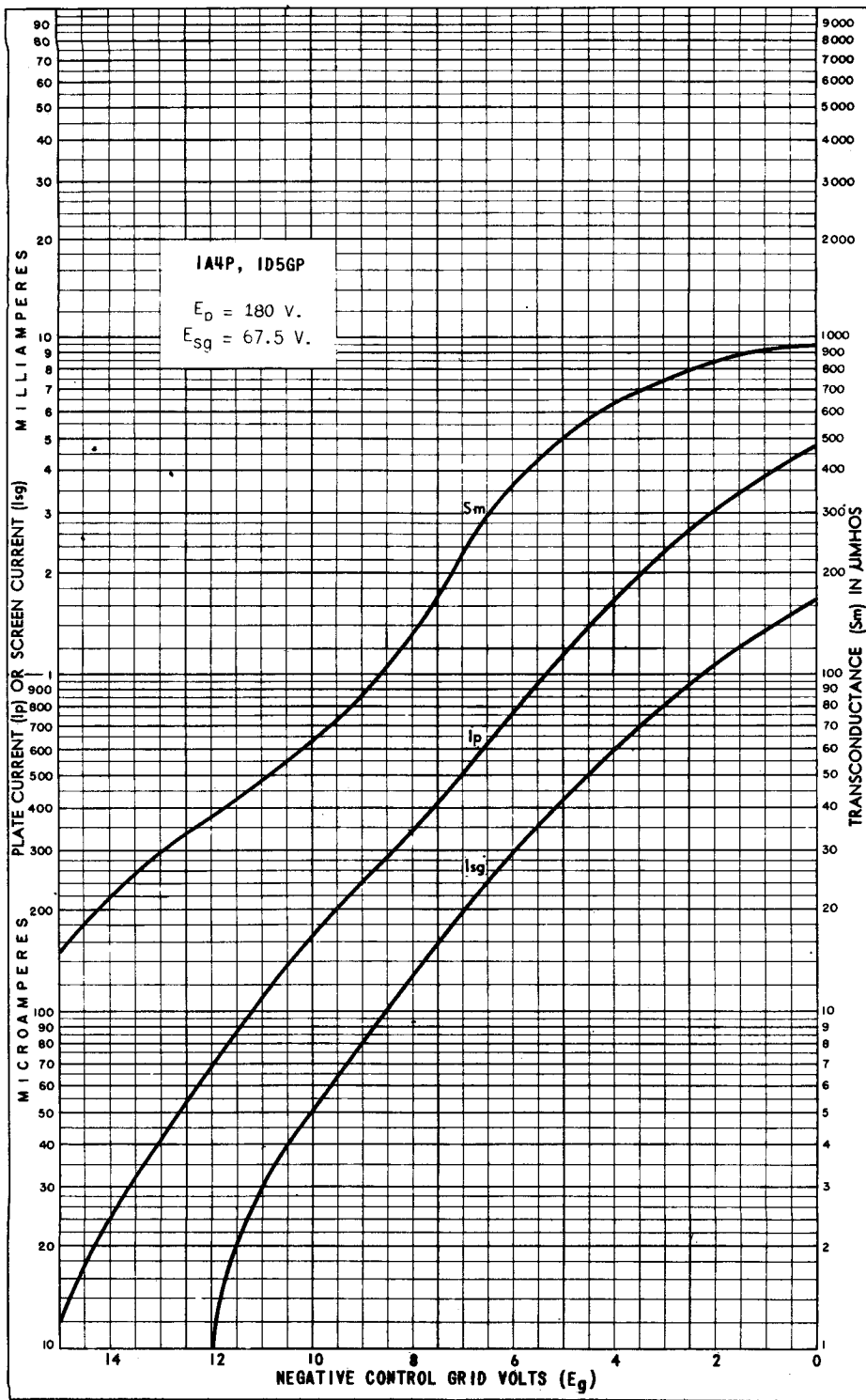

PLATE
 1457
 AUG. 31
 1944

TUNG-SOL

PENTODE POWER AMPLIFIER

COATED FILAMENT

1.4 VOLTS 0.05 AMPERE

DC

GLASS BULB

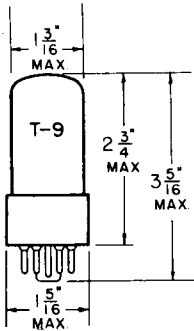

IA5GT/G

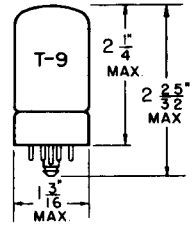

1LA4

ANY MOUNTING POSITION

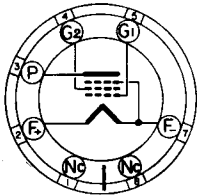

BOTTOM VIEW

INTERMEDIATE SHELL

7-PIN OCTAL BASE

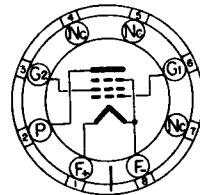

BOTTOM VIEW

LOCKING-IN

8-PIN

RATINGS

INTERPRETED ACCORDING TO RMA STANDARD M8-210

MAXIMUM PLATE VOLTAGE	110	VOLTS
MAXIMUM SCREEN VOLTAGE	110	VOLTS
MAXIMUM CATHODE CURRENT	6.0	MA.

TYPICAL OPERATING CONDITIONS AND CHARACTERISTICS

CLASS A₁ AMPLIFIER

PLATE VOLTAGE	85	90	VOLTS
SCREEN VOLTAGE	85	90	VOLTS
GRID VOLTAGE ^A	-4.5	-4.5	VOLTS
PEAK A-F GRID VOLTAGE	4.5	4.5	VOLTS
ZERO-SIG. PLATE CURRENT	3.5	4.0	MA.
MAXIMUM SIG. PLATE CURRENT	3.5	4.0	MA.
ZERO-SIG. SCREEN CURRENT	0.7	0.8	MA.
MAXIMUM SIG. SCREEN CURRENT	1.0	1.1	MA.
PLATE RESISTANCE	0.3	0.3	MEGOHM
TRANSCONDUCTANCE	800	850	μMHOS
LOAD RESISTANCE	25 000	25 000	OHMS
TOTAL HARMONIC DISTORTION	10	7.0	PER CENT
MAXIMUM SIG. POWER OUTPUT	100	115	MW.

^A RETURN TO NEGATIVE FILAMENT

PRINTED IN U. S. A.

PLATE
1523
JAN. 15
1945

1A5GT/G (1LA4)

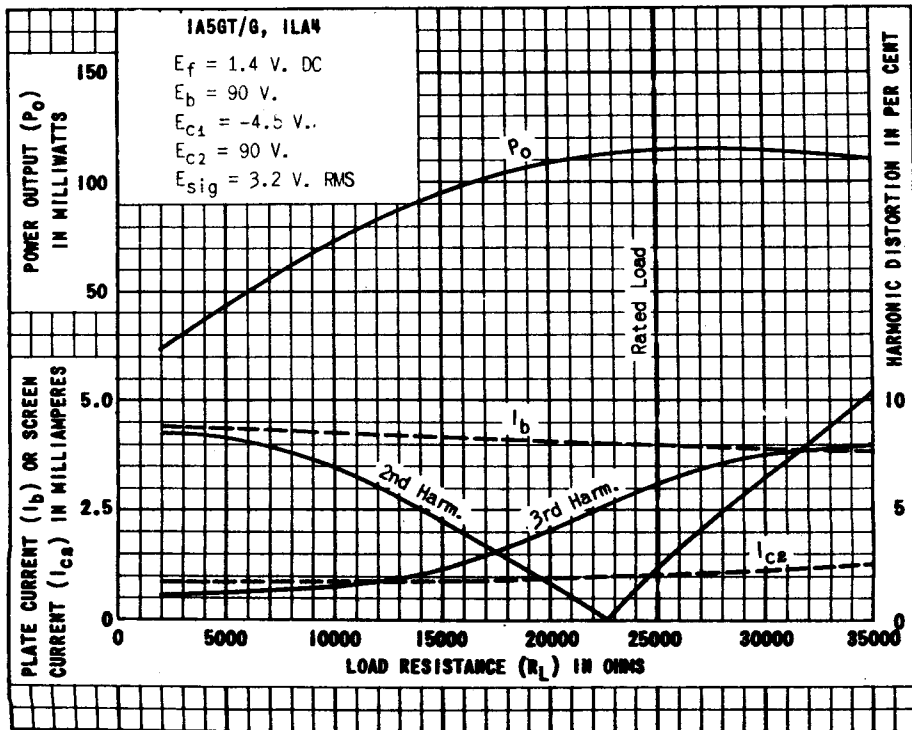
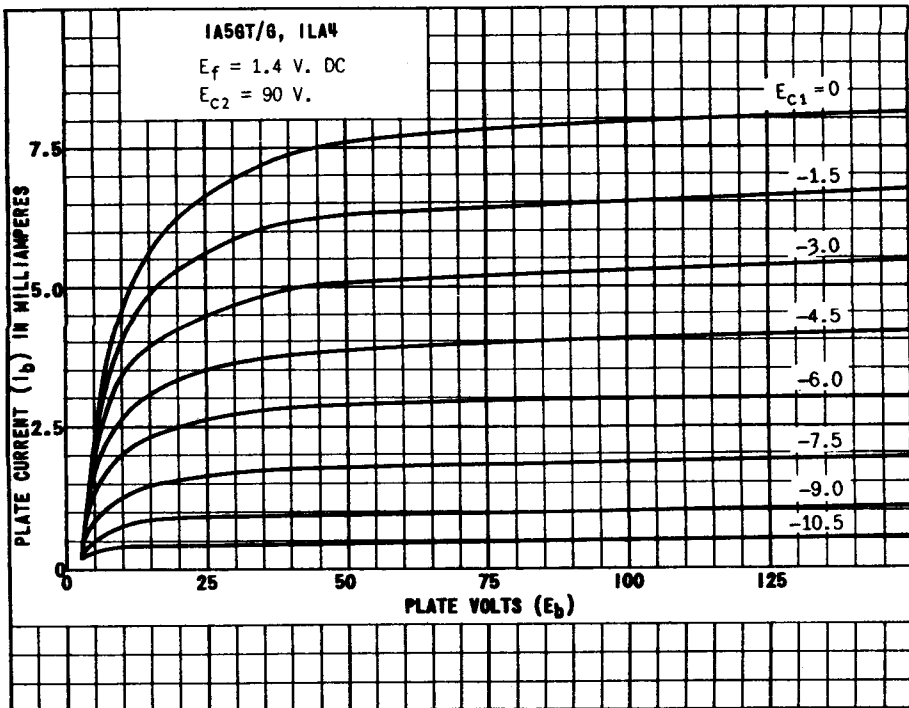
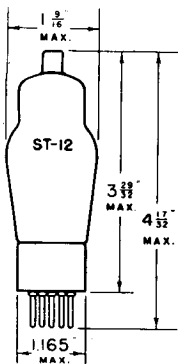

PLATE 1524
 JAN. 15 1945

TUNG-SOL



PENTAGRID CONVERTER

COATED FILAMENT

2.0 VOLTS 0.06 AMPERE
DC

GLASS BULB

SMALL 6 PIN BASE

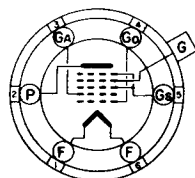

6L

BOTTOM VIEW

THE TUNG-SOL 1A6 IS A COMBINED OSCILLATOR AND MIXER DESIGNED FOR SERVICE AS THE FIRST DETECTOR IN BATTERY OPERATED SUPERHETERODYNE RECEIVERS WHERE ECONOMY IN FILAMENT CURRENT CONSUMPTION IS DESIRED. WITH THE EXCEPTION OF CAPACITANCES ITS RATINGS AND CHARACTERISTICS ARE IDENTICAL WITH THOSE OF THE 1D7G.

OPERATING CONDITIONS AND CHARACTERISTICS

PLATE (P) VOLTAGE ^{MAX.}	180	VOLTS
SCREEN (Gs) VOLTAGE ^{MAX.}	67.5	VOLTS
ANODE GRID (GA) VOLTAGE ^{MAX.}	135	VOLTS
ANODE GRID (GA) VOLTAGE SUPPLY ^{MAX.}	180 ^A	VOLTS
CONTROL GRID (G) VOLTAGE ^{MIN.}	-3	VOLTS
TOTAL CATHODE CURRENT ^{MAX.}	9	MA.

CONVERTER SERVICE

PLATE (P) VOLTAGE	135	180	VOLTS
SCREEN (Gs) VOLTAGE	67.5	67.5	VOLTS
ANODE GRID (GA) VOLTAGE	135	135	VOLTS
ANODE GRID (GA) SUPPLY VOLTAGE	135	180 ^A	VOLTS
CONTROL GRID (G) VOLTAGE	-3	-3	VOLTS
OSCILLATOR GRID RESISTOR	50 000	50 000	OHMS
PLATE CURRENT	1.2	1.3	MA.
SCREEN CURRENT	2.5	2.4	MA.
ANODE GRID CURRENT	2.3	2.3	MA.
OSCILLATOR GRID CURRENT	0.2	0.2	MA.
TOTAL CATHODE CURRENT	6.2	6.2	MA.
PLATE RESISTANCE	0.4	0.5	MEGOHM
CONVERSION CONDUCTANCE	275	300	μMHOS
CONTROL GRID (G) VOLTAGE ^{APPROX.}	-22.5	-22.5	VOLTS

FOR CONVERSION CONDUCTANCE = 4 μMHOS

^A APPLIED THROUGH 20 000 OHM DROPPING RESISTOR.

CONTINUED NEXT PAGE

PRINTED IN U. S. A.

PLATE 378-1
APR. 14 1939

TUNG-SOL

STATIC CHARACTERISTICS OF OSCILLATOR SECTION - NOT OSCILLATING

PLATE (P) VOLTAGE	135 to 180	VOLTS
SCREEN (G _s) VOLTAGE	67.5	VOLTS
ANODE GRID (G _A) VOLTAGE	135	VOLTS
CONTROL GRID (G) VOLTAGE	-3	VOLTS
OSCILLATOR GRID (G _o) VOLTAGE	0	VOLTS
TRANSCONDUCTANCE - OSCILLATOR GRID (G _o) TO ANODE GRID (G _A)	425	μMHOS
ANODE GRID CURRENT	2.3	MA.

DIRECT INTERELECTRODE CAPACITANCES

CONTROL GRID (G) TO PLATE (P) ⁵	0.26	μf
CONTROL GRID (G) TO OSCILLATOR GRID (G _o) ⁵	0.1	μf
CONTROL GRID (G) TO ANODE GRID (G _A) ⁵	0.2	μf
OSCILLATOR GRID (G _o) TO ANODE GRID (G _A)	0.8	μf
RF INPUT ELECTRODE, GRID (G) TO ALL OTHER ELECTRODES	10.5	μf
OSC. INPUT ELECTRODE, GRID (G _o) TO ALL OTHER ELECTRODES	5.0	μf
OSC. OUTPUT ELECTRODE, GRID (G _A) TO ALL OTHER ELECTRODES	6.0	μf
MIXER OUTPUT ELECTRODE, PLATE (P) TO ALL OTHER ELECTRODES	9.0	μf

⁵ WITH SHIELD

TUNG-SOL

PENTAGRID CONVERTER

COATED FILAMENT

1.4 VOLTS 0.05 AMPERE
DC

GLASS BULB

ANY MOUNTING POSITION

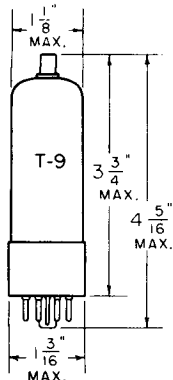

1A7G

SKIRTED MINIATURE
CAP

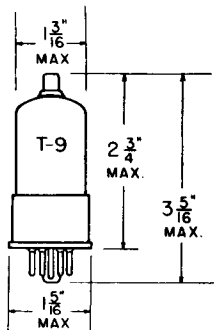

1A7GT

SKIRTED MINIATURE
CAP

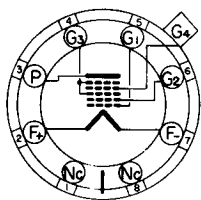

BOTTOM VIEW

SMALL 8 PIN OCTAL
BASE

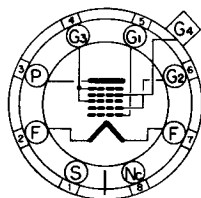

BOTTOM VIEW

SMALL WAFER 8 PIN OCTAL
BASE WITH METAL SHELL

THE 1A7G AND 1A7GT ARE FILAMENT TYPE PENTAGRID CONVERTERS DESIGNED FOR SERVICE AS COMBINED OSCILLATORS AND MIXERS IN PORTABLE BATTERY OPERATED EQUIPMENT. THEY FEATURE HIGH EFFICIENCY FILAMENTS AND PROVIDE REASONABLE CONVERSION GAINS WITH LOW BATTERY VOLTAGES AND LOW ELECTRON CURRENTS.

RATINGS

INTERPRETED ACCORDING TO RMA STANDARD MB-210

MAXIMUM PLATE VOLTAGE	110	VOLTS
MAXIMUM SCREEN (G3 AND G5) VOLTAGE	60	VOLTS
MAXIMUM SCREEN SUPPLY VOLTAGE	110	VOLTS
MAXIMUM ANODE-GRID (G2) VOLTAGE	110	VOLTS
MAXIMUM TOTAL ZERO-SIGNAL CATHODE CURRENT	4.0	MA.

CONTINUED ON NEXT PAGE

TUNG-SOL

CONTINUED FROM PRECEDING PAGE

DIRECT INTERELECTRODE CAPACITANCES

WITH EXTERNAL SHIELD CONNECTED TO NEGATIVE FILAMENT TERMINAL

GRID #4 TO PLATE	0.5 MAX.	μf
GRID #4 TO GRID #2	0.4 MAX.	μf
GRID #4 TO GRID #1	0.2 MAX.	μf
GRID #1 TO GRID #2	0.9	μf
GRID #4 TO ALL OTHER ELECTRODES (R-F INPUT)	7.0	μf
GRID #2 TO ALL OTHER ELECTRODES EXCEPT GRID #1 (OSCILLATOR OUTPUT)	4.4	μf
GRID #1 TO ALL OTHER ELECTRODES EXCEPT GRID #2 (OSCILLATOR INPUT)	3.4	μf
PLATE TO ALL OTHER ELECTRODES (MIXER OUTPUT)	10	μf

TYPICAL OPERATING CONDITIONS AND CHARACTERISTICS

CONVERTER SERVICE

PLATE VOLTAGE	90	VOLTS
SCREEN (G2 AND G5) VOLTAGE ^A	45	VOLTS
ANODE-GRID (G2) VOLTAGE	90	VOLTS
CONTROL-GRID (G4) VOLTAGE ^B	0	VOLTS
OSCILLATOR-GRID (G1) RESISTOR	200 000	OHMS
PLATE RESISTANCE	0.6	MEGOHM
CONVERSION TRANSCONDUCTANCE	250	μMHOS
CONVERSION TRANSCONDUCTANCE WITH GRID #4 BIAS OF -3 VOLTS	5.0 APPROX.	μMHOS
PLATE CURRENT	0.6	MA.
SCREEN (G3 AND G5) CURRENT	0.7	MA.
ANODE-GRID (G2) CURRENT	1.2	MA.
OSCILLATOR-GRID (G1) CURRENT	0.035	MA.
TOTAL CATHODE CURRENT	2.5	MA.

THE TRANSCONDUCTANCE OF THE OSCILLATOR PORTION (NOT OSCILLATING) IS 550 MICROMHOS UNDER THE FOLLOWING CONDITIONS: PLATE VOLTS, 90; SCREEN VOLTS, 45; CONTROL-GRID VOLTS, 0; ANODE-GRID VOLTS, 90; AND OSCILLATOR-GRID VOLTS, 0.

^A OBTAINED PREFERABLY BY USING A PROPERLY BY-PASSED 45 000 TO 75 000 OHM VOLTAGE-DROPPING RESISTOR IN SERIES WITH THE 90 VOLT SUPPLY.

^B A RESISTANCE OF AT LEAST 1.0 MEGOHM SHOULD BE USED IN THE GRID RETURN TO NEGATIVE FILAMENT PIN.

TUNG-SOL

REMOTE CUT-OFF RF PENTODE

PHYSICAL SPECIFICATIONS

EMITTER COATED FILAMENT		PIN CONNECTIONS	
BASE LOCK-IN 8 PIN		PIN 1 FILAMENT +	PIN 7 FILAMENT-, G3
CAP ---		PIN 2 PLATE	PIN 8 FILAMENT-, G3
BULB SHORT T-9		PIN 3 GRID 2	
MAXIMUM DIAMETER 1 3/16"		PIN 4 Nc	MOUNTING POS. ANY
MAXIMUM OVERALL LENGTH 2 1/32"		PIN 5 Nc	
MAXIMUM SEATED HEIGHT 1 1/2"		PIN 6 GRID 1	

RATINGS

INTERPRETED ACCORDING TO RMA STANDARD MB-210

HEATER OR FILAMENT VOLTAGE (DC)	1.2	VOLTS
HEATER OR FILAMENT CURRENT	0.130	AMP.
MAXIMUM PLATE VOLTAGE	150	VOLTS
MAXIMUM SCREEN VOLTAGE	150	VOLTS
MAXIMUM PLATE DISSIPATION	1.0	WATT
MAXIMUM SCREEN DISSIPATION	0.3	WATT
MINIMUM EXTERNAL CONTROL GRID BIAS VOLTAGE	0	VOLTS
MAXIMUM SCREEN SUPPLY VOLTAGE	150	VOLTS

CAPACITANCES

RMA SHIELD MB-308 CONNECTED TO NEGATIVE FILAMENT

INPUT	2.80	μ f
OUTPUT	4.2	μ f
CONTROL GRID TO PLATE (MAX.)	0.25	μ f

TYPICAL OPERATING CONDITIONS AND CHARACTERISTICS

HEATER OR FILAMENT VOLTAGE (DC)	1.2	1.2	VOLTS
HEATER OR FILAMENT CURRENT	0.130	0.130	AMP.
PLATE VOLTAGE	90	150	VOLTS
SCREEN VOLTAGE	90	150	VOLTS
CONTROL GRID VOLTAGE	0	-1.5	VOLTS
CONTROL GRID RESISTANCE (MIN.)	1	--	MEGOHM
PLATE CURRENT	3.5	6.8	MA.
SCREEN CURRENT	0.8	2.0	MA.
MAXIMUM-SIGNAL PLATE CURRENT			MA.
MAXIMUM-SIGNAL SCREEN CURRENT			MA.
PLATE RESISTANCE	0.275	0.125	MEGOHM
TRANSCONDUCTANCE	1100	1350	μ MHOS
AMPLIFICATION FACTOR			
LOAD RESISTANCE			OHMS
TOTAL HARMONIC DISTORTION			PER CENT
POWER OUTPUT			WATTS
CONTROL GRID VOLTAGE			
FOR TRANSCONDUCTANCE = 10 μ MHOS	14	23	VOLTS
CONTROL GRID VOLTAGE			
FOR TRANSCONDUCTANCE = 725 μ MHOS	3	6	VOLTS



TUNG-SOL

DIODE

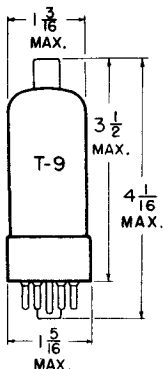

GLASS BULB
SMALL CAP

COATED FILAMENT

FILAMENT

1.25 VOLTS^A 200 MA.

AC

ANY MOUNTING POSITION

^ATHE FILAMENT VOLTAGE MUST NEVER EXCEED 1.5 VOLTS, EVEN MOMENTARILY.

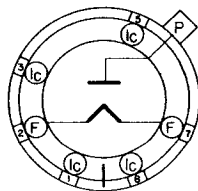

BOTTOM VIEW
SHORT INTERMEDIATE SHELL
6 PIN OCTAL

THE 1B3GT IS A FILAMENTARY DIODE DESIGNED TO OPERATE AT RELATIVELY HIGH UNIVERSE PEAK VOLTAGES OVER A CONSIDERABLE RANGE OF SUPPLY VOLTAGE FREQUENCIES. IT IS INTENDED TO SUPPLY THE REQUIRED HIGH VOLTAGES FOR THE CATHODE RAY PICTURE TUBE IN TELEVISION SERVICE.

DIRECT INTERELECTRODE CAPACITANCES - APPROX.
WITH NO EXTERNAL SHIELD

PLATE TO FILAMENT 1.5 $\mu\mu\text{f}$

RATINGS

INTERPRETED ACCORDING TO RMA STANDARD M8-210

FILAMENT VOLTAGE	1.25	VOLTS
FILAMENT CURRENT	200	MA.
MAXIMUM PEAK INVERSE PLATE VOLTAGE	40 000	VOLTS
MAXIMUM PEAK PLATE CURRENT	17	MA.
MAXIMUM AVERAGE PLATE CURRENT	2	MA.
MAXIMUM FREQUENCY OF SUPPLY VOLTAGE	300	KC

WHEN THE FILAMENT IS TO BE OPERATED ON RF, IT IS RECOMMENDED THAT THE FILAMENT BE CONNECTED FIRST TO A DC OR LOW-FREQUENCY AC SUPPLY OF 1.25 VOLTS. THE COLOR TEMPERATURE OF THE FILAMENT CORRESPONDING TO THIS VOLTAGE MAY THEN BE CHECKED VISUALLY BY OBSERVING IN A DARKENED ROOM THE REFLECTION OF THE INCANDESCENT FILAMENT UPON THE UPPER SURFACE OF THE INTERNAL SHIELD. A VISUAL COMPARISON OF THIS COLOR TEMPERATURE WITH THAT OBTAINED WITH THE FILAMENT OPERATED FROM AN RF VOLTAGE PROVIDES A CONVENIENT MEANS FOR ADJUSTING THE AMOUNT OF RF EXCITATION TO PRODUCE 1.25 VOLTS (RMS) AT THE FILAMENT TERMINALS.

THE VOLTAGES EMPLOYED IN SOME TELEVISION RECEIVERS AND OTHER HIGH-VOLTAGE EQUIPMENT ARE SUFFICIENTLY HIGH THAT HIGH-VOLTAGE RECTIFIER TUBES MAY PRODUCE SOFT X-RAYS WHICH CAN CONSTITUTE A HEALTH HAZARD, UNLESS SUCH TUBES ARE ADEQUATELY SHIELDED. RELATIVELY SIMPLE SHIELDING SHOULD PROVE ADEQUATE, BUT THE NEED FOR THIS PRECAUTION SHOULD BE CONSIDERED IN EQUIPMENT DESIGN.

PLATE
2008
MAY 3
1948

1B3GT

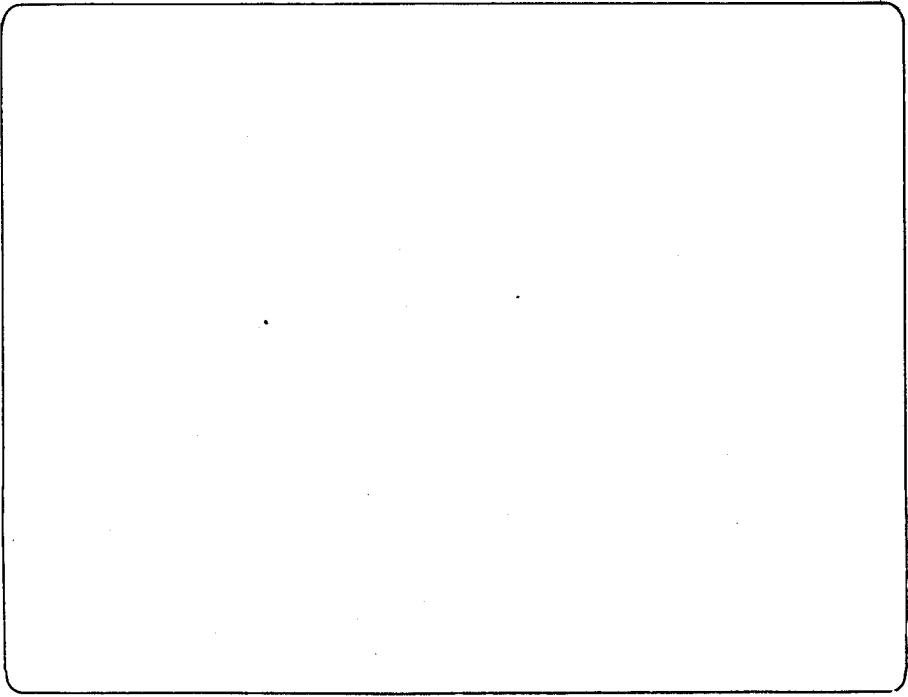
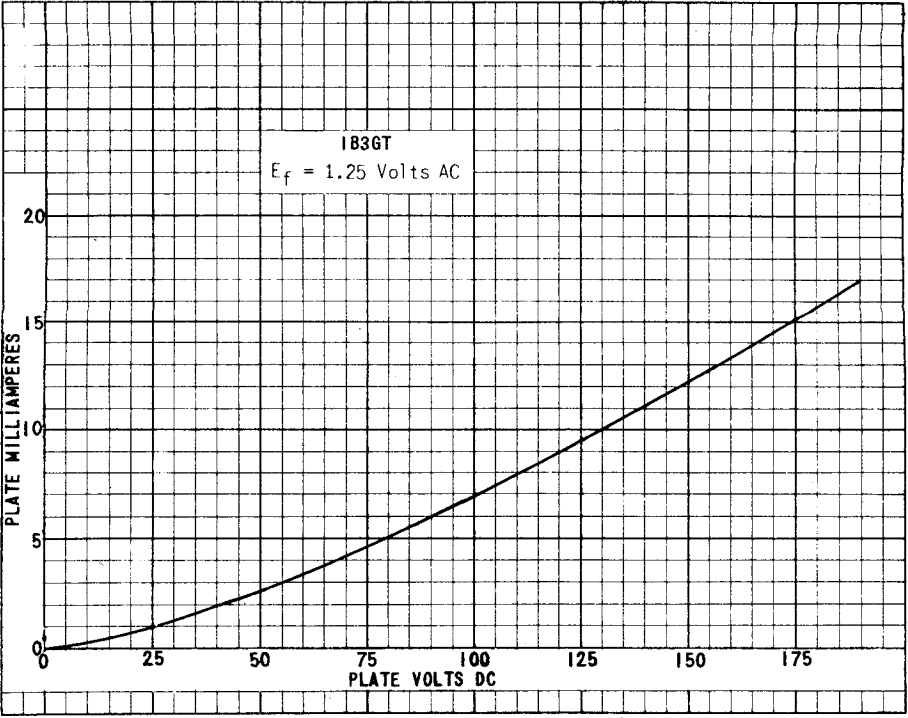
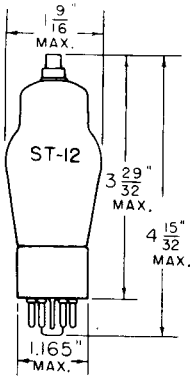

PLATE
2009
MAY 3
1948

TUNG-SOL



1E5GP
SKIRTED MINIATURE
CAP

R-F PENTODE AMPLIFIER

COATED FILAMENT

2.0 VOLTS 0.06 AMPERE

DC

GLASS BULB

MOUNTING POSITION

FOR TUBE TYPE 1B4P, HORIZONTAL
OPERATION WILL BE PERMITTED IF
PINS 1 AND 4 ARE IN A VERTICAL
PLANE. THE SAME WILL HOLD TRUE
FOR TYPE 1E5GP IF PINS 5 AND 7
ARE IN A VERTICAL PLANE.

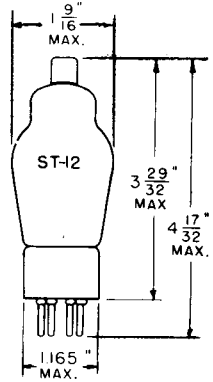

1B4P
SMALL METAL
CAP

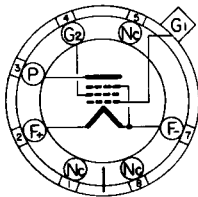

BOTTOM VIEW
SMALL SHELL OCTAL
7 PIN BASE

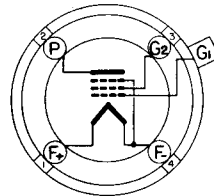

BOTTOM VIEW
SMALL 4 PIN BASE

THE 1E5GP AND 1B4P ARE DESIGNED FOR SERVICE AS GENERAL PURPOSE SHARP
CUT-OFF PENTODE AMPLIFIERS IN BATTERY OPERATED EQUIPMENTS.

RATINGS

MAXIMUM PLATE VOLTAGE	180	VOLTS
MAXIMUM SCREEN VOLTAGE	67.5	VOLTS
MAXIMUM CATHODE CURRENT	6.0	MA.

DIRECT INTERELECTRODE CAPACITANCES

GRID TO PLATE (WITH SHIELD)	0.007 MAX.	μf
INPUT	5.0	μf
OUTPUT	11	μf

TUNG-SOL

CONTINUED FROM PRECEDING PAGE

TYPICAL OPERATING CONDITIONS AND CHARACTERISTICS

CLASS A₁ AMPLIFIER

PLATE VOLTAGE	90	180	VOLTS
SCREEN VOLTAGE	67.5	67.5	VOLTS
CONTROL GRID VOLTAGE ^A	-3.0	-3.0	VOLTS
PLATE CURRENT	1.6	1.7	MA.
SCREEN CURRENT	0.7	0.6	MA.
PLATE RESISTANCE (APPROX.)	1.0	1.5	MEG OHMS
TRANSCONDUCTANCE	600	650	μMHOS
AMPLIFICATION FACTOR (APPROX.)	550	1000	
CONTROL GRID VOLTAGE FOR PLATE CURRENT CUT-OFF ^A	-8.0	-8.0	VOLTS

^A RETURN TO NEGATIVE FILAMENT (PIN #7)

PLATE
1494
OCT. 31
1944

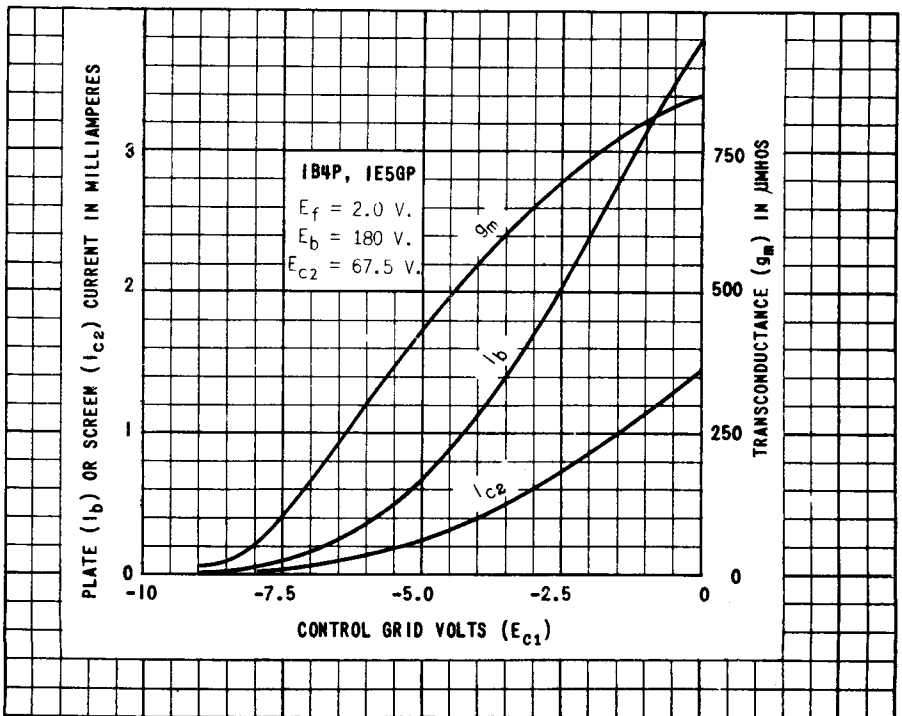
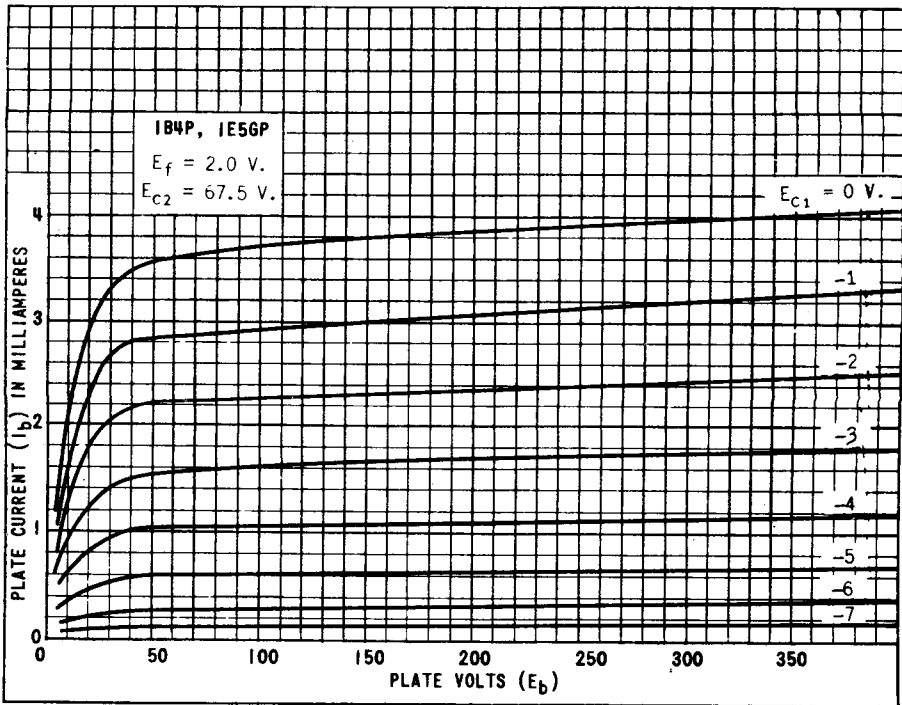
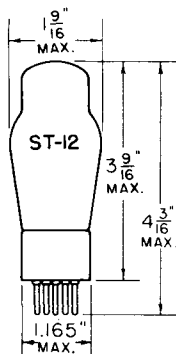

PLATE 1495
OCT. 31 1944



TUNG-SOL

DUO-DIODE TRIODE AMPLIFIER



1B5/25S

COATED FILAMENT
2.0 VOLTS 0.06 AMPERE
DC

GLASS BULB

MOUNTING POSITION

THESE TUBES SHOULD BE OPERATED VERTICALLY WITH BASE DOWN. HOWEVER, HORIZONTAL OPERATION MAY BE PERMITTED FOR TUBE TYPE 1B5/25S WHEN PINS 2 AND 5 ARE HORIZONTAL. THE SAME WILL BE TRUE FOR THE 1H6G TUBE TYPE WHEN PINS 2 AND 7 ARE HORIZONTAL.

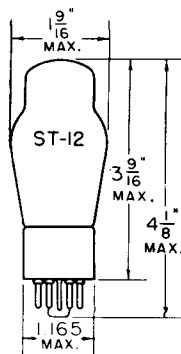

1H6G

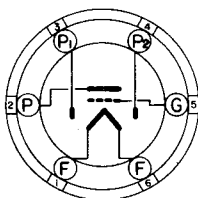

BOTTOM VIEW

SMALL 6 PIN BASE

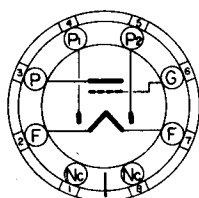

BOTTOM VIEW

SMALL 8 PIN OCTAL BASE

THE 1B5/25S AND 1H6G COMBINE TWO DIODES AND A TRIODE IN A SINGLE BULB. THEY ARE DESIGNED FOR SERVICE AS DIODE DETECTORS, AVC RECTIFIERS, AND IMPEDANCE OR RESISTANCE COUPLED AMPLIFIERS IN BATTERY OPERATED RECEIVERS.

DIRECT INTERELECTRODE CAPACITANCES

	1B5/25S	1H6G	
GRID TO PLATE	3.6	3.6	μmf
INPUT	1.6	1.6	μmf
OUTPUT	1.9	1.9	μmf

OPERATING CONDITIONS AND CHARACTERISTICS

TRIODE UNIT - CLASS A₁ AMPLIFIER

MAXIMUM PLATE VOLTAGE	135	VOLTS
CONTROL GRID VOLTAGE	-3.0	VOLTS
PLATE CURRENT	0.8	MA.
PLATE RESISTANCE	35 000	OHMS
TRANSCONDUCTANCE	575	μMHOS
AMPLIFICATION FACTOR	20	

1B5/25S (1H6G)

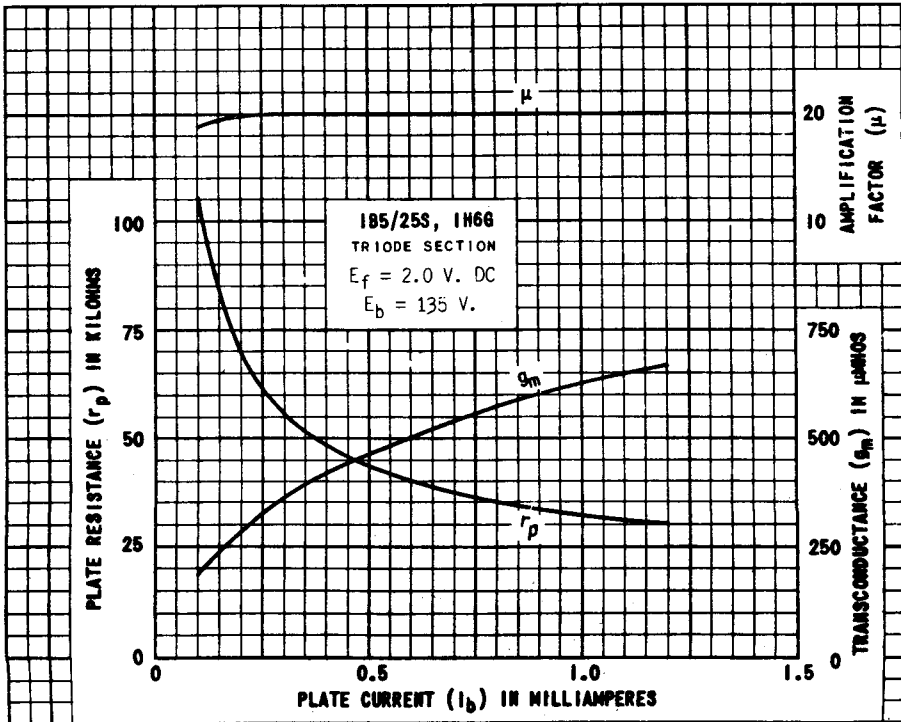
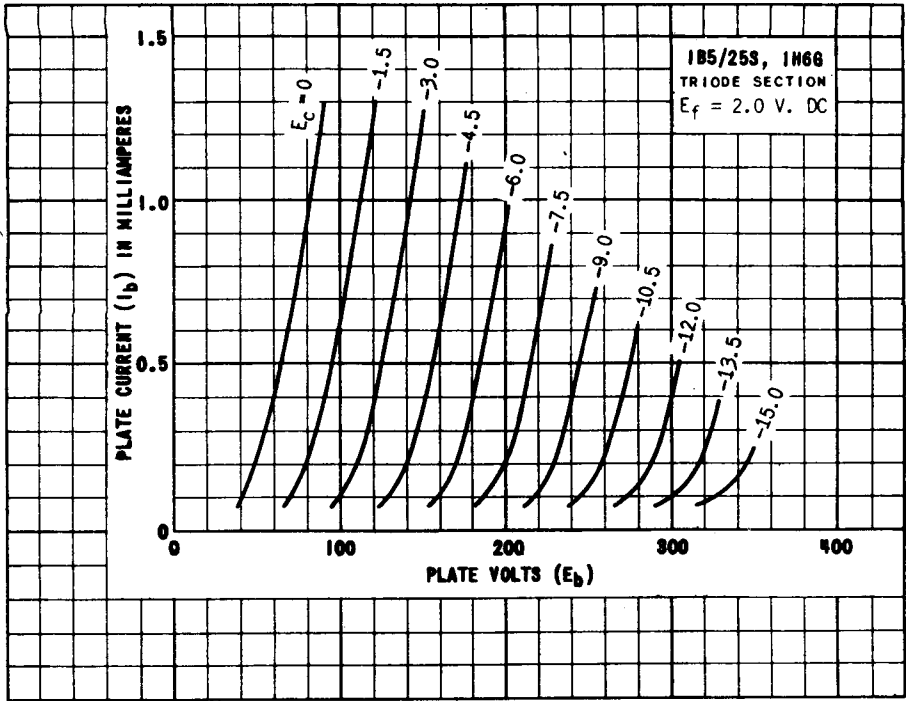

PLATE
 1497
 OCT. 31
 1944

TUNG-SOL

PENTAGRID CONVERTER

COATED FILAMENT

1.4 VOLTS 0.10 AMPERE

DC

GLASS BULB

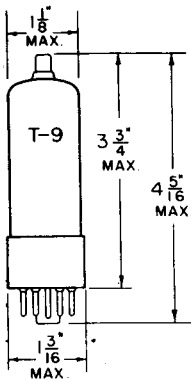

IB7G

SKIRTED MINIATURE
STYLE C CAP

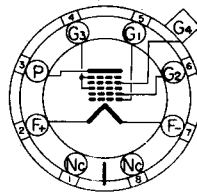

BOTTOM VIEW

SMALL 8-PIN OCTAL

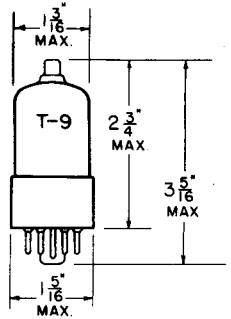

IB7GT

SKIRTED MINIATURE
STYLE C CAP

ANY MOUNTING POSITION

RATINGS

INTERPRETED ACCORDING TO RMA STANDARD M8-210

MAXIMUM PLATE VOLTAGE	100	VOLTS
MAXIMUM SCREEN (G3 AND G5) VOLTAGE	55	VOLTS
MAXIMUM SCREEN SUPPLY VOLTAGE	90	VOLTS
MAXIMUM ANODE GRID (G2) VOLTAGE	90	VOLTS
MAXIMUM TOTAL CATHODE CURRENT	6.0	MA.

DIRECT INTERELECTRODE CAPACITANCES

TUBE SHIELD CONNECTED TO NEGATIVE FILAMENT

SIGNAL GRID (G4) TO MIXER PLATE (P)	0.34	$\mu\mu\text{f}$
SIGNAL GRID (G4) TO OSC. PLATE (G2)	0.26	$\mu\mu\text{f}$
SIGNAL GRID (G4) TO OSC. GRID (G1)	0.12	$\mu\mu\text{f}$
OSC. GRID (G1) TO OSC. PLATE (G2)	0.90	$\mu\mu\text{f}$
SIGNAL INPUT: G4 TO (F+G1+G2+G3+G5+P+SHIELD)	7.00	$\mu\mu\text{f}$
OSC. OUTPUT: G2 TO (F+G3+G4+G5+P+SHIELD)	4.20	$\mu\mu\text{f}$
OSC. INPUT: G1 TO (F+G3+G4+G5+P+SHIELD)	4.00	$\mu\mu\text{f}$
MIXER OUTPUT: P TO (F+G1+G2+G3+G4+G5+SHIELD)	7.50	$\mu\mu\text{f}$

CONTINUED ON NEXT PAGE

-PLATE
1525
JAN. 15
1945

TUNG-SOL

CONTINUED FROM PRECEDING PAGE.

TYPICAL OPERATING CONDITIONS AND CHARACTERISTICS

CONVERTER SERVICE

PLATE VOLTAGE	90	VOLTS
SCREEN (G3 AND G5) VOLTAGE	45	VOLTS
ANODE GRID (G2) VOLTAGE	90	VOLTS
CONTROL GRID (G4) VOLTAGE ^A	0	VOLTS
OSC. GRID (G4) RESISTOR	200 000	OHMS
PLATE RESISTANCE	0.35	MEGOHM
CONVERSION TRANSCONDUCTANCE	350	μMHOS
CONTROL GRID VOLTAGE FOR TRANSCONDUCTANCE=2 μMHOS (APPROX.)	-14.5	VOLTS
PLATE CURRENT	1.5	MA.
SCREEN CURRENT	1.3	MA.
ANODE GRID CURRENT	1.6	MA.
OSC. GRID (G4) CURRENT	0.035	MA.
TOTAL CATHODE CURRENT	4.4	MA.

^A RETURN TO NEGATIVE FILAMENT PIN #7

TUNG-SOL

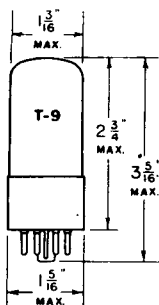

PENTODE POWER AMPLIFIER

COATED FILAMENT

1.4 VOLTS 0.10 AMPERE
DC

GLASS BULB

INTERMEDIATE 7 PIN OCTAL BASE

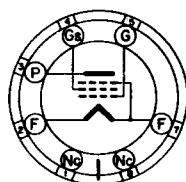

G-6X

BOTTOM VIEW

THE TUNG-SOL IC5GT/G IS A LOW VOLTAGE, LOW CURRENT DRAIN, BATTERY TYPE PENTODE POWER AMPLIFIER. IT IS DESIGNED FOR SERVICE WITH 90 VOLTS OF "B" BATTERY AND A SINGLE DRY CELL "A" BATTERY.

RATINGS

MAXIMUM FILAMENT VOLTAGE

DRY BATTERY OPERATION - VOLTAGE MUST NEVER EXCEED 1.6 VOLTS

AC - DC POWER LINE OPERATION - DESIGN CENTER 1.3 VOLTS

MAXIMUM PLATE VOLTAGE 110 VOLTS

MAXIMUM SCREEN VOLTAGE 110 VOLTS

MAXIMUM CATHODE CURRENT (ZERO SIGNAL) 12 MA.

TYPICAL OPERATING CONDITIONS AND CHARACTERISTICS

CLASS A₁ AMPLIFIER

FILAMENT VOLTAGE	1.4 dc	1.4 dc	VOLTS
FILAMENT CURRENT	0.10	0.10	AMPERE
PLATE VOLTAGE	83	90	VOLTS
SCREEN VOLTAGE	83	90	VOLTS
CONTROL GRID VOLTAGE ^A	-7.0	-7.5	VOLTS
PEAK AF SIGNAL VOLTAGE	7.0	7.5	VOLTS
ZERO-SIGNAL PLATE CURRENT	7.0	7.5	MA.
MAXIMUM SIGNAL PLATE CURRENT	7.3	7.8	MA.
ZERO-SIGNAL SCREEN CURRENT	1.6	1.6	MA.
MAXIMUM-SIGNAL SCREEN CURRENT	3.5	3.5	MA.
PLATE RESISTANCE ^{APPROX.}	110000	115000	OHMS
TRANSCONDUCTANCE	1500	1550	μMHOS
LOAD RESISTANCE	9000	8000	OHMS
TOTAL HARMONIC DISTORTION	10	10	PER CENT
POWER OUTPUT	200	240	MILLIWATTS

^A REFERRED TO NEGATIVE FILAMENT TERMINAL

CONTINUED NEXT PAGE

IC5GT/G

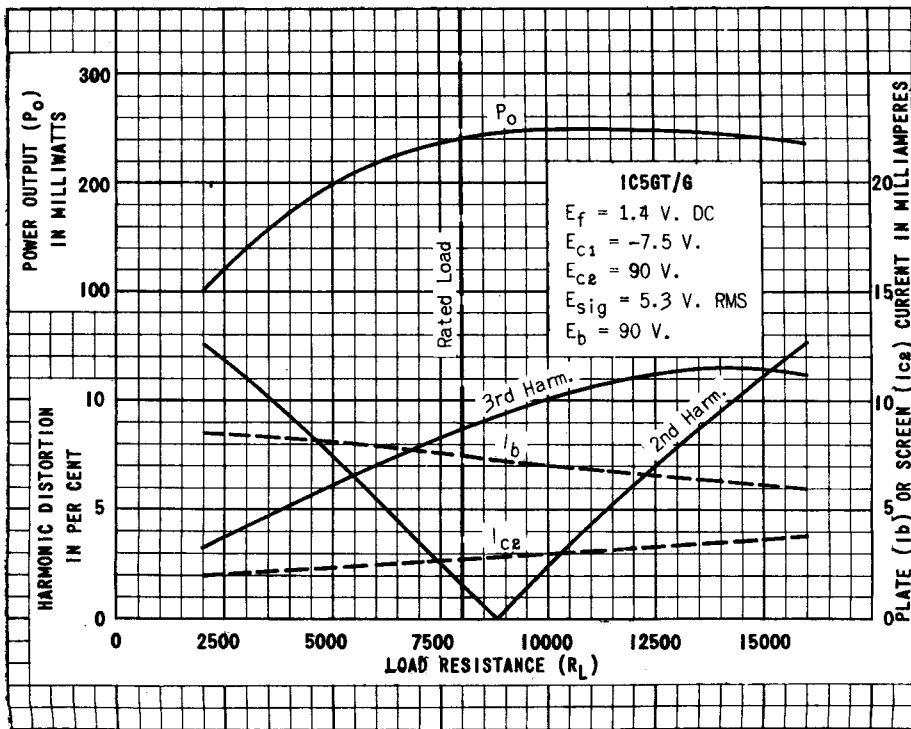
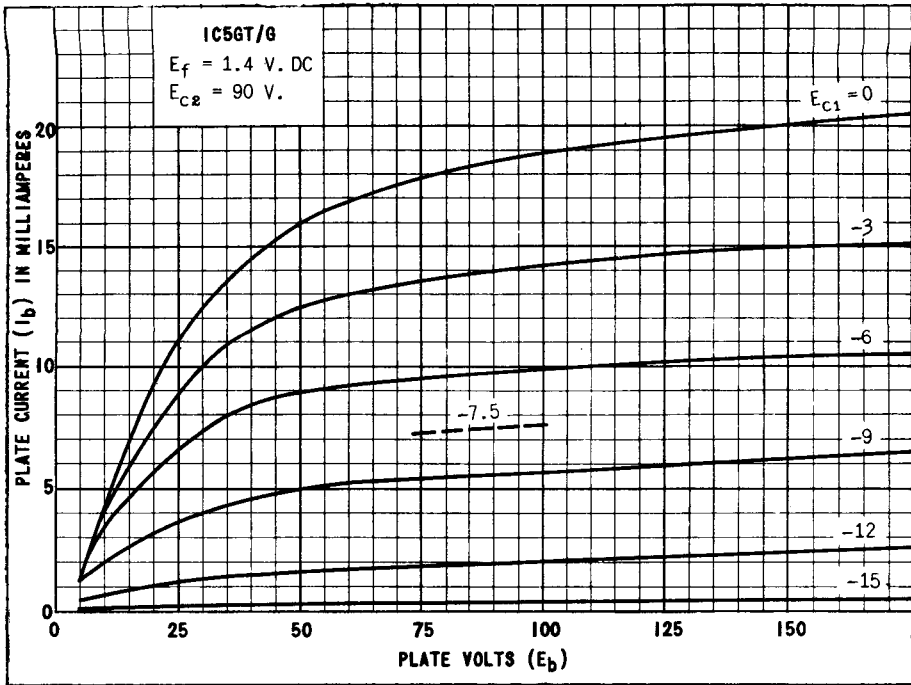

TUNG-SOL

PENTAGRID CONVERTER

COATED FILAMENT

2.0 VOLTS 0.12 AMPERE
DC

GLASS BULB

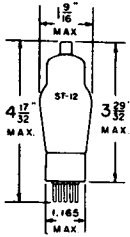

SMALL 6 PIN BASE
1C6

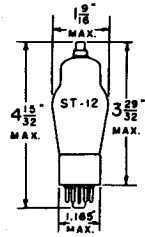

SMALL 8 PIN OCTAL BASE
1C7G

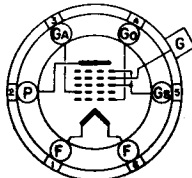

6L

BOTTOM VIEW

1C6

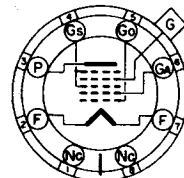

G-7Z

BOTTOM VIEW

1C7G

THE TUNG-SOL 1C6 AND 1C7G ARE FILAMENT TYPE PENTAGRID CONVERTERS DESIGNED FOR SERVICE AS OSCILLATORS AND MIXERS IN BATTERY OPERATED RECEIVERS.

RATINGS

MAXIMUM PLATE (P) VOLTAGE	180	VOLTS
MAXIMUM SCREEN (Gs) SUPPLY VOLTAGE	180	VOLTS
MAXIMUM SCREEN VOLTAGE	67.5	VOLTS
MINIMUM EXTERNAL CONTROL GRID (G) BIAS VOLTAGE	0	VOLTS
MAXIMUM OSCILLATOR ANODE (GA) SUPPLY VOLTAGE	180	VOLTS
MAXIMUM OSCILLATOR ANODE VOLTAGE	135	VOLTS
MAXIMUM CATHODE CURRENT	9	MA.
MAXIMUM PLATE DISSIPATION	0.3	WATT
MAXIMUM SCREEN DISSIPATION	0.2	WATT
MAXIMUM OSCILLATOR ANODE DISSIPATION	0.4	WATT

FOR "INTERPRETATION OF RATINGS" REFER TO FRONT OF BOOK.

TUNG-SOL

DIRECT INTERELECTRODE CAPACITANCES

	1C6	1C7G ^S	
CONTROL GRID (G) TO MIXER PLATE (P)	0.3 ^S	0.26	μf
CONTROL GRID (G) TO OSCILLATOR ANODE (G _A)	0.3 ^S	0.32	μf
CONTROL GRID (G) TO OSCILLATOR GRID (G ₀)	0.15 ^S	0.11	μf
OSCILLATOR GRID (G ₀) TO OSCILLATOR ANODE (G _A)	1.5	1.2	μf
RF INPUT: CONTROL GRID (G) TO ALL OTHER ELECTRODES	10	10	μf
OSCILLATOR INPUT: OSCILLATOR GRID (G ₀) TO ALL OTHER ELECTRODES	6	4.8 ^A	μf
OSCILLATOR OUTPUT: OSCILLATOR ANODE (G _A) TO ALL OTHER ELECTRODES	6	5.5 ^B	μf
MIXER OUTPUT: MIXER PLATE (P) TO ALL OTHER ELECTRODES	10	14	μf

TYPICAL OPERATING CONDITIONS AND CHARACTERISTICS

CONVERTER SERVICE

PLATE (P) VOLTAGE	135	180	VOLTS
SCREEN (G _S) VOLTAGE	67.5	67.5	VOLTS
CONTROL GRID (G) VOLTAGE ^C	-3	-3	VOLTS
OSCILLATOR ANODE (G _A) SUPPLY VOLTAGE ^D	135	180	VOLTS
OSCILLATOR GRID (G ₀) RESISTOR	50 000	50 000	OHMS
PLATE CURRENT	1.3	1.5	MA.
SCREEN CURRENT	2.5	2.0	MA.
OSCILLATOR ANODE CURRENT	3.1	4.0	MA.
OSCILLATOR GRID CURRENT	0.2	0.2	MA.
TOTAL CATHODE CURRENT	7.1	7.7	MA.
PLATE RESISTANCE ^A APPROX.	0.6	0.7	MEGOHM
CONVERSION TRANSCONDUCTANCE	440	450	μMHOS
FOR CONTROL GRID (G) VOLTAGE = -1.5 V.			
CONVERSION TRANSCONDUCTANCE	300	325	μMHOS
FOR CONTROL GRID (G) VOLTAGE = -3.0 V.			
CONVERSION TRANSCONDUCTANCE	95	105	μMHOS
FOR CONTROL GRID (G) VOLTAGE = -6.0 V.			
CONVERSION TRANSCONDUCTANCE ^A APPROX.	4	4	μMHOS
FOR CONTROL GRID (G) VOLTAGE = -14.0 V.			

^A EXCEPT OSCILLATOR ANODE (G_A)^B EXCEPT OSCILLATOR GRID (G₀)^C RETURN TO NEGATIVE FILAMENT (PIN #6 - 1C6 AND PIN #7 - 1C7G)^D APPLIED THROUGH 20 000 OHM DROPPING RESISTOR^S WITH EXTERNAL SHIELD CONNECTED TO NEGATIVE FILAMENT (PIN #6 - 1C6 AND PIN #7 - 1C7G)PLATE
915-2

TUNG-SOL

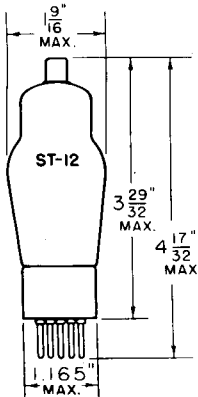

1A4P

SMALL METAL CAP
SMALL 4 PIN BASE

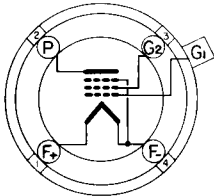

BOTTOM VIEW

REMOTE CUT-OFF
PENTODE AMPLIFIER

COATED FILAMENT

2.0 VOLTS 0.060 AMPERE

AC OR DC

GLASS BULB

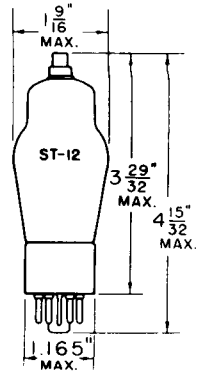

ID5GP

MINIATURE METAL CAP
SMALL 7 PIN OCTAL BASE

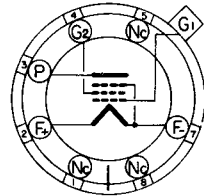

BOTTOM VIEW

THESE TUBES ARE REMOTE CUT-OFF PENTODE AMPLIFIERS DESIGNED FOR USE IN BATTERY OPERATED RECEIVERS. EITHER TUBE IS SUITABLE FOR USE WITH AUTOMATIC VOLUME CONTROL IN RF AND IF AMPLIFIERS WITH A MINIMUM OF CROSS MODULATION.

MOUNTING POSITION

THESE TUBES SHOULD BE OPERATED VERTICALLY WITH THE BASE DOWN. HOWEVER, HORIZONTAL OPERATIONS MAY BE PERMITTED IN THE ID5GP TUBE TYPE IF PINS 2 AND 7 ARE ON A VERTICAL PLANE. THE SAME WILL BE TRUE FOR THE 1A4P TUBE TYPE IF PINS 1 AND 4 ARE ON A VERTICAL PLANE.

DIRECT INTERELECTRODE CAPACITANCES

MAXIMUM CONTROL GRID TO PLATE (WITH EXTERNAL SHIELD)	0.007	μf
INPUT (G_1 TO G_2 , G_3 , F)	5.0	μf
OUTPUT (P TO G_2 , G_3 , F)	11	μf

TYPICAL OPERATING CONDITIONS AND CHARACTERISTICS

CLASS A AMPLIFIER

PLATE VOLTAGE	90	180 MAX.	VOLTS
SCREEN VOLTAGE	67.5	67.5 MAX.	VOLTS
MINIMUM CONTROL GRID VOLTAGE	-3	-3	VOLTS
PLATE CURRENT	2.2	2.3	MA.
SCREEN CURRENT	0.9	0.8	MA.
PLATE RESISTANCE (APPROX.)	0.6	1.0	MEG OHM
TRANSCONDUCTANCE	720	750	μMHOS
AMPLIFICATION FACTOR (APPROX.)	425	750	
CONTROL GRID VOLTAGE			
FOR TRANSCONDUCTANCE OF 15 μMHOS	-15	-15	VOLTS



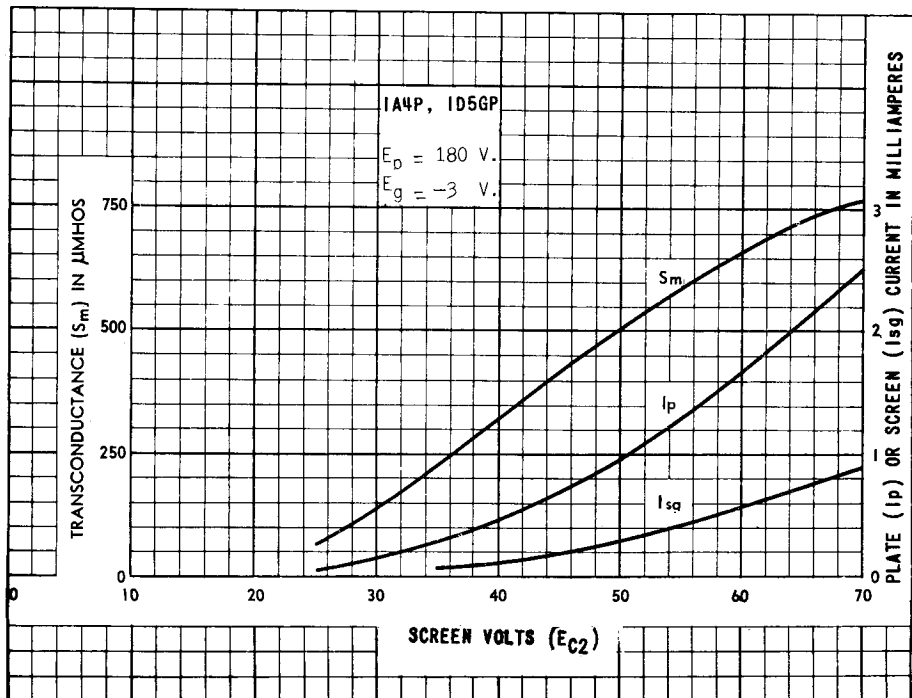
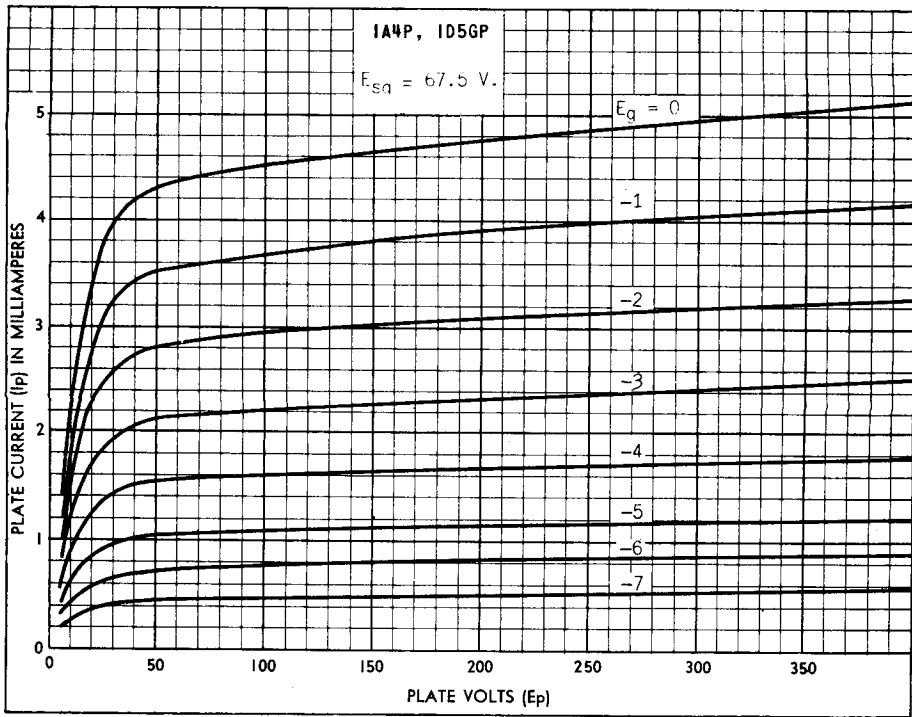

PRINTED IN U. S. A.

PLATE 1459
AUG. 31 1944

ID5GP (1A4P)

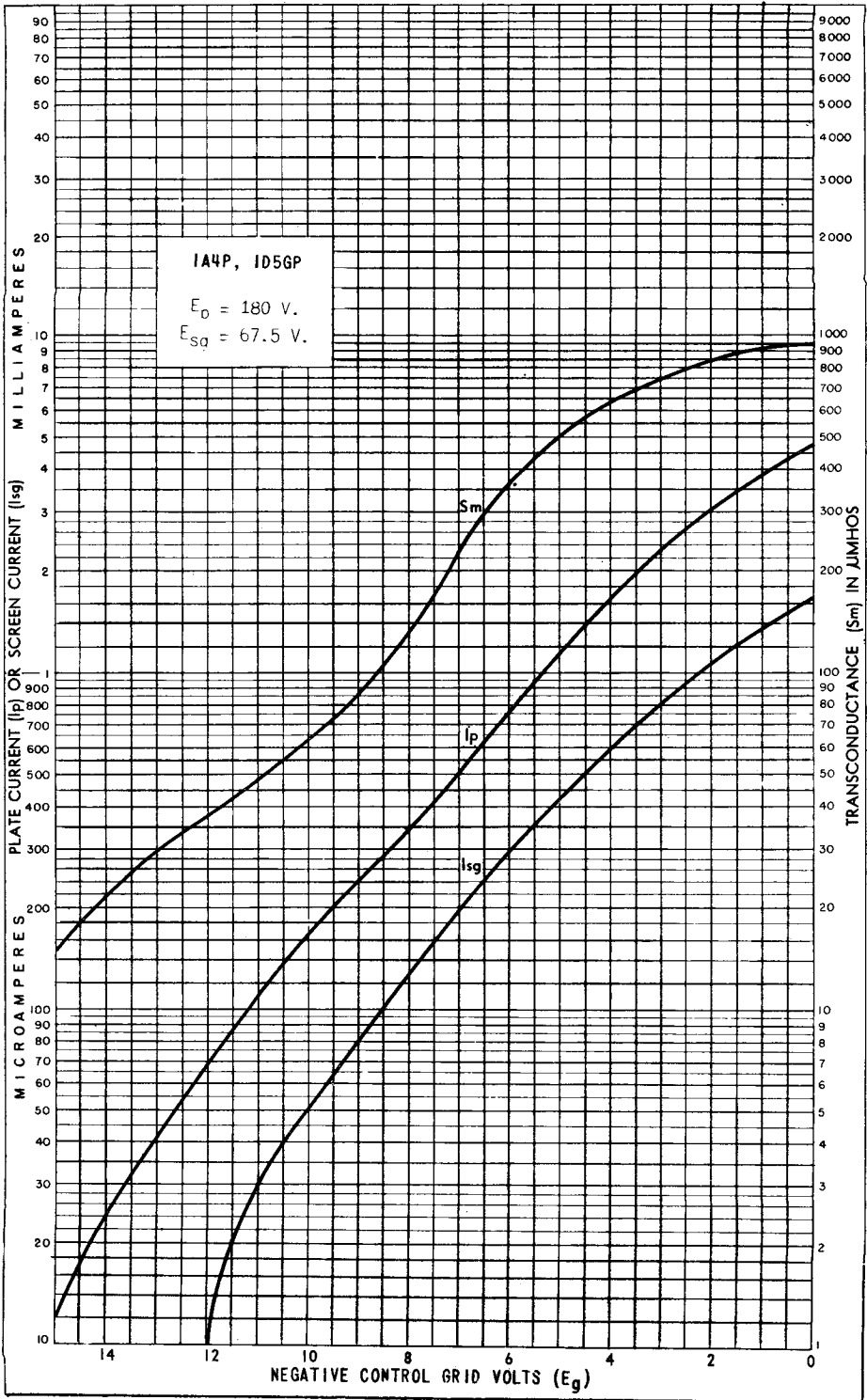
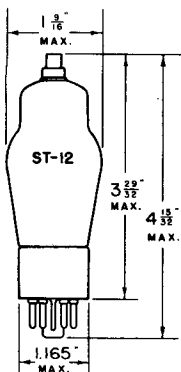

PLATE
 1460
 AUG. 31
 1944

TUNG-SOL



PENTAGRID CONVERTER

COATED FILAMENT

2.0 VOLTS 0.06 AMPERE
DC

GLASS BULB

SMALL 8 PIN OCTAL BASE

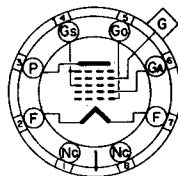

G-7Z

THE TUNG-SOL 1D7G IS A COMBINED OSCILLATOR AND MIXER DESIGNED FOR SERVICE AS THE FIRST DETECTOR IN BATTERY OPERATED SUPERHETERODYNE RECEIVERS WHERE ECONOMY IN FILAMENT CURRENT CONSUMPTION IS DESIRED. WITH THE EXCEPTION OF CAPACITANCES ITS RATINGS AND CHARACTERISTICS ARE IDENTICAL WITH THOSE OF THE 1A6.

OPERATING CONDITIONS AND CHARACTERISTICS

PLATE (P) VOLTAGE ^{MAX.}	180	VOLTS
SCREEN (Gs) VOLTAGE ^{MAX.}	67.5	VOLTS
ANODE GRID (Ga) VOLTAGE ^{MAX.}	135	VOLTS
ANODE GRID (Ga) VOLTAGE SUPPLY ^{MAX.}	180 ^A	VOLTS
CONTROL GRID (G) VOLTAGE ^{MIN.}	-3	VOLTS
TOTAL CATHODE CURRENT ^{MAX.}	9	MA.

CONVERTER SERVICE

PLATE (P) VOLTAGE	135	180	VOLTS
SCREEN (Gs) VOLTAGE	67.5	67.5	VOLTS
ANODE GRID (Ga) VOLTAGE	135	135	VOLTS
ANODE GRID (Ga) SUPPLY VOLTAGE	135	180 ^A	VOLTS
CONTROL GRID (G) VOLTAGE	-3	-3	VOLTS
OSCILLATOR GRID RESISTOR	50 000	50 000	OHMS
PLATE CURRENT	1.2	1.3	MA.
SCREEN CURRENT	2.5	2.4	MA.
ANODE GRID CURRENT	2.3	2.3	MA.
OSCILLATOR GRID CURRENT	0.2	0.2	MA.
TOTAL CATHODE CURRENT	6.2	6.2	MA.
PLATE RESISTANCE	0.4	0.5	MEGOHM
CONVERSION CONDUCTANCE	275	300	μMHOS
CONTROL GRID (G) VOLTAGE ^{APPROX.}	-22.5	-22.5	VOLTS

FOR CONVERSION CONDUCTANCE = 4 μMHOS

^A APPLIED THROUGH 20 000 OHM DROPPING RESISTOR.

PRINTED IN U. S. A.

PLATE
217-1

CONTINUED NEXT PAGE

TUNG-SOL

STATIC CHARACTERISTICS OF OSCILLATOR SECTION - NOT OSCILLATING

PLATE (P) VOLTAGE	135 to 180	VOLTS
SCREEN (G _s) VOLTAGE	67.5	VOLTS
ANODE GRID (G _A) VOLTAGE	135	VOLTS
CONTROL GRID (G) VOLTAGE	-3	VOLTS
OSCILLATOR GRID (G ₀) VOLTAGE	0	VOLTS
TRANSCONDUCTANCE - OSCILLATOR GRID (G ₀) TO ANODE GRID (G _A)	425	μMHOS
ANODE GRID CURRENT	2.3	MA.

DIRECT INTERELECTRODE CAPACITANCES^S

CONTROL GRID (G) TO PLATE (P)	0.26	μμf
CONTROL GRID (G) TO OSCILLATOR GRID (G ₀)	0.11	μμf
CONTROL GRID (G) TO ANODE GRID (G _A)	0.32	μμf
OSCILLATOR GRID (G ₀) TO ANODE GRID (G _A)	1.2	μμf
RF INPUT ELECTRODE, GRID (G) TO ALL OTHER ELECTRODES	10	μμf
OSC. INPUT ELECTRODE, GRID (G ₀) TO ALL OTHER ELECTRODES	4.8	μμf
OSC. OUTPUT ELECTRODE, GRID (G _A) TO ALL OTHER ELECTRODES	5.5	μμf
MIXER OUTPUT ELECTRODE, PLATE (P) TO ALL OTHER ELECTRODES	14	μμf

^S WITH SHIELD

TUNG-SOL

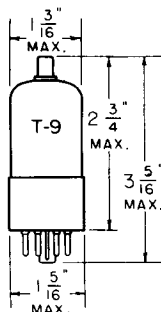

SKIRTED MINIATURE
CAP

DIODE-TRIODE POWER
PENTODE AMPLIFIER

COATED FILAMENT

1.4 VOLTS 0.10 AMPERE
DC

GLASS BULB

ANY MOUNTING POSITION

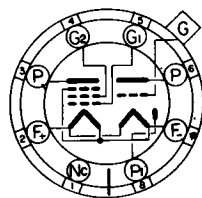

BOTTOM VIEW

INTERMEDIATE 8 PIN
OCTAL BASE

THE ID8GT IS A LOW VOLTAGE, LOW CURRENT BATTERY TYPE TUBE, WHICH COMBINES A SINGLE DIODE, TRIODE AND A POWER PENTODE IN ONE BULB.

RATINGS

INTERPRETED ACCORDING TO RMA STANDARD M8-210

MAXIMUM PLATE VOLTAGE (TRIODE SECTION)	110	VOLTS
MAXIMUM PLATE VOLTAGE (PENTODE SECTION)	110	VOLTS
MAXIMUM SCREEN VOLTAGE (PENTODE SECTION)	110	VOLTS
MAXIMUM CATHODE CURRENT-ZERO SIGNAL (PENTODE SECTION)	6.0	MA.
MINIMUM DIODE CURRENT WITH 10 VOLTS DC APPLIED	0.5	MA.

TYPICAL OPERATING CONDITIONS AND CHARACTERISTICS

CLASS A₁ AMPLIFIER

TRIODE UNIT

PLATE VOLTAGE	45	67.5	90	VOLTS
GRID VOLTAGE	0	0	0	VOLTS
PLATE CURRENT	0.3	0.6	1.1	MA.
PLATE RESISTANCE (APPROX.)	77 000	55 500	43 500	OHMS
TRANSCONDUCTANCE	325	450	575	UMHOS
AMPLIFICATION FACTOR	25	25	25	

PLATE
1498
OCT. 31
1944

CONTINUED ON NEXT PAGE

TUNG-SOL

CONTINUED FROM PRECEDING PAGE

PENTODE UNIT

PLATE VOLTAGE	45	62.5	67.5	90	VOLTS
SCREEN VOLTAGE	45	62.5	67.5	90	VOLTS
CONTROL GRID VOLTAGE	-4.5	-5.0	-6.0	-9.0	VOLTS
PEAK AF SIGNAL VOLTAGE	4.5	5.0	6.0	9.0	VOLTS
PLATE CURRENT	1.6	3.8	3.8	5.0	MA.
SCREEN CURRENT	0.3	0.8	0.8	1.0	MA.
PLATE RESISTANCE (APPROX.)	0.3	0.2	0.2	0.2	MEGOHM
TRANSCONDUCTANCE	650	875	875	925	UMHOS
LOAD RESISTANCE	20 000	16 000	16 000	12 000	OHMS
TOTAL HARMONIC DISTORTION	10	10	10	10	PER CENT
POWER OUTPUT	35	90	100	200	MW.

DIODE UNIT

THE DIODE IS LOCATED AT THE NEGATIVE END OF THE FILAMENT, AND IS INDEPENDENT OF THE TRIODE UNIT AND OF THE PENTODE UNIT EXCEPT FOR THE COMMON FILAMENT.

TUNG-SOL

R-F PENTODE AMPLIFIER

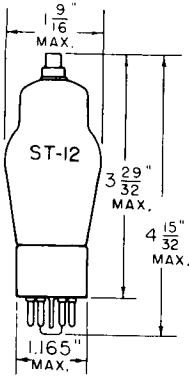

1E5GP
SKIRTED MINIATURE
CAP

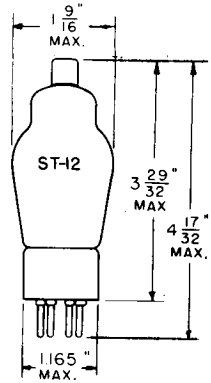

1B4P
SMALL METAL
CAP

COATED FILAMENT

2.0 VOLTS 0.06 AMPERE

DC

GLASS BULB

MOUNTING POSITION

FOR TUBE TYPE 1B4P, HORIZONTAL OPERATION WILL BE PERMITTED IF PINS 1 AND 4 ARE IN A VERTICAL PLANE. THE SAME WILL HOLD TRUE FOR TYPE 1E5GP IF PINS 5 AND 7 ARE IN A VERTICAL PLANE.



BOTTOM VIEW
SMALL SHELL OCTAL
7 PIN BASE

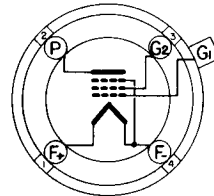

BOTTOM VIEW
SMALL 4 PIN BASE

THE 1E5GP AND 1B4P ARE DESIGNED FOR SERVICE AS GENERAL PURPOSE SHARP CUT-OFF PENTODE AMPLIFIERS IN BATTERY OPERATED EQUIPMENTS.

RATINGS

MAXIMUM PLATE VOLTAGE	180	VOLTS
MAXIMUM SCREEN VOLTAGE	67.5	VOLTS
MAXIMUM CATHODE CURRENT	6.0	MA.

DIRECT INTERELECTRODE CAPACITANCES

GRID TO PLATE (WITH SHIELD)	0.007 MAX.	μuf
INPUT	5.0	μuf
OUTPUT	11	μuf

CONTINUED ON NEXT PAGE

PRINTED IN U. S. A.

PLATE
1500
OCT. 31
1944

TUNG-SOL

CONTINUED FROM PRECEDING PAGE

TYPICAL OPERATING CONDITIONS AND CHARACTERISTICS

CLASS A₁ AMPLIFIER

PLATE VOLTAGE	90	180	VOLTS
SCREEN VOLTAGE	67.5	67.5	VOLTS
CONTROL GRID VOLTAGE ^A	-3.0	-3.0	VOLTS
PLATE CURRENT	1.6	1.7	MA.
SCREEN CURRENT	0.7	0.6	MA.
PLATE RESISTANCE (APPROX.)	1.0	1.5	MEGOHMS
TRANSCONDUCTANCE	600	650	μMHOS
AMPLIFICATION FACTOR (APPROX.)	550	1000	
CONTROL GRID VOLTAGE FOR PLATE CURRENT CUT-OFF ^A	-8.0	-8.0	VOLTS

^A RETURN TO NEGATIVE FILAMENT (PIN #7)

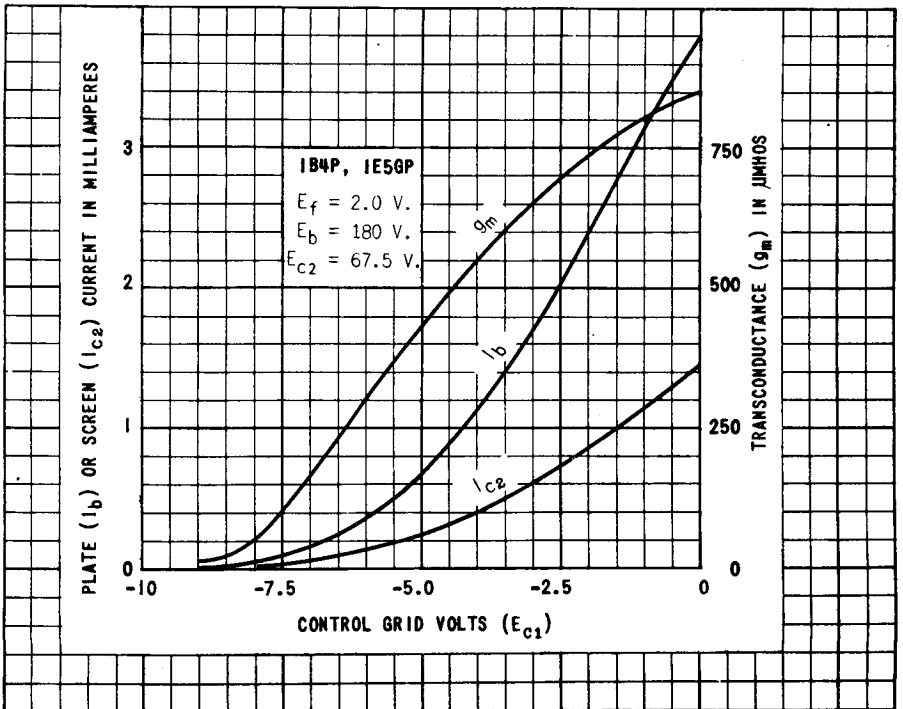
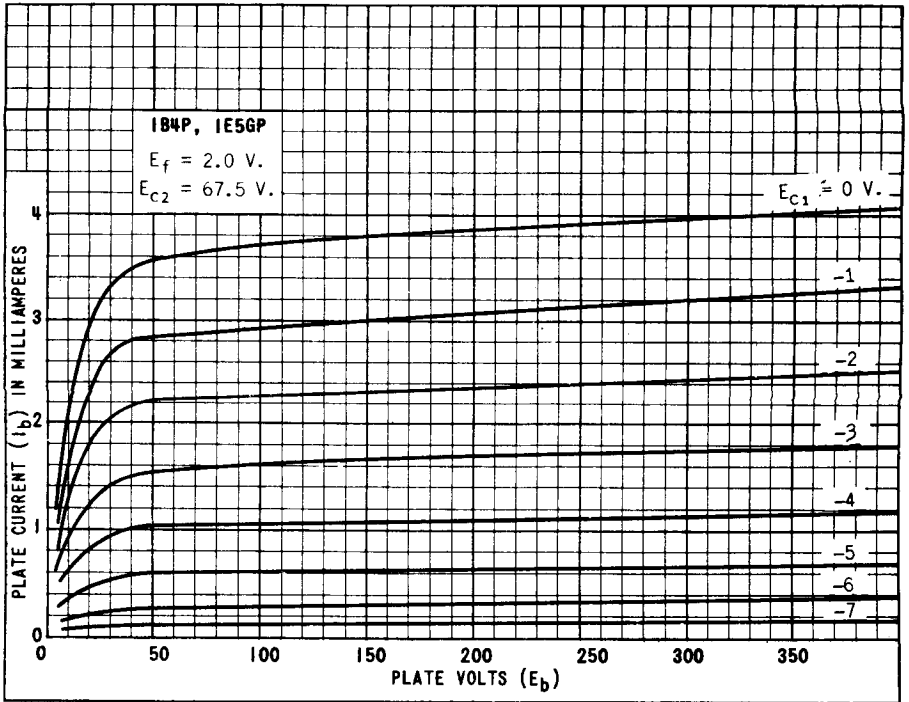
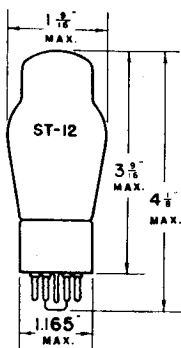

PLATE
1502
OCT. 31
1944



TUNG-SOL

TWIN PENTODE
POWER AMPLIFIER



COATED FILAMENT

2.0 VOLTS 0.24 AMPERE
DC

GLASS BULB



SMALL 8 PIN OCTAL BASE

THE TUNG-SOL 1E7G COMBINES TWO FILAMENT TYPE POWER PENTODES IN A SINGLE BULB. IT IS DESIGNED FOR SERVICE AS A PUSH-PULL POWER AMPLIFIER IN BATTERY OPERATED RECEIVERS.

OPERATING CONDITIONS AND CHARACTERISTICS

CLASS A₁ AMPLIFIER

EACH PENTODE SECTION

PLATE VOLTAGE	90	135	VOLTS
SCREEN VOLTAGE	90	135	VOLTS
CONTROL GRID VOLTAGE ^A	-3	-4.5	VOLTS
GRID CIRCUIT RESISTANCE MAX.			
FIXED BIAS	0.5	0.5	MEGOHM
SELF BIAS	1.0	1.0	MEGOHM
ZERO-SIGNAL PLATE CURRENT	3.8	7.5	MA.
ZERO-SIGNAL SCREEN CURRENT	1.1	2.2	MA.
TRANSCONDUCTANCE	1150	1425	μMHOS
AMPLIFICATION FACTOR	390	370	
LOAD RESISTANCE	20 000	16 000	OHMS
PEAK SIGNAL VOLTAGE	3	4.5	VOLTS
TOTAL DISTORTION	5.5	4.5	PER CENT
POWER OUTPUT	.110	.290	WATT

^A RETURN TO NEGATIVE FILAMENT (PIN 97)

CONTINUED NEXT PAGE

TUNG-SOL

CLASS A₁ PUSH-PULL AMPLIFIER

VALUES ARE FOR TWO TUBES

PLATE VOLTAGE	135	VOLTS
SCREEN VOLTAGE	135	VOLTS
CONTROL GRID VOLTAGE	-7.5	VOLTS
GRID CIRCUIT RESISTANCE		
FIXED BIAS	0.5	MEGOHM
SELF BIAS	1.0	MEGOHM
ZERO-SIGNAL PLATE CURRENT	14	MA.
MAX.-SIGNAL PLATE CURRENT	21	MA.
ZERO-SIGNAL SCREEN CURRENT	4	MA.
MAX.-SIGNAL SCREEN CURRENT	7	MA.
LOAD RESISTANCE	24 000	OHMS
PLATE TO PLATE		
PEAK SIGNAL VOLTAGE	15	VOLTS
GRID TO GRID		
TOTAL DISTORTION	5.5	PER CENT
THIRD HARMONIC	4.5	PER CENT
POWER OUTPUT ^P	.575	WATT

^P WITH A PEAK SIGNAL VOLTAGE (GRID TO GRID) OF 21 VOLTS, A POWER OUTPUT OF ONE WATT CAN BE OBTAINED WITH 10% DISTORTION. (CLASS A₂).

DIRECT INTERELECTRODE CAPACITANCES^S

	PENTODE A	PENTODE B	
CONTROL GRID TO FILAMENT	7.5	7.5	μf
PLATE TO FILAMENT	12	12	μf
CONTROL GRID TO PLATE	0.9	0.9	μf
CONTROL GRID A TO CONTROL GRID B		0.3	μf
PLATE A TO PLATE B		2.0	μf
CONTROL GRID B TO PLATE A		0.16	μf
CONTROL GRID A TO PLATE B		0.16	μf

PENTODE A - PENTODE WITH PLATE BROUGHT OUT TO PIN #6.

PENTODE B - PENTODE WITH PLATE BROUGHT OUT TO PIN #3.

^S WITH SHIELD

TUNG-SOL

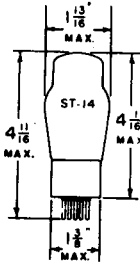

MEDIUM 5 PIN BASE
1F4

PENTODE POWER AMPLIFIER

COATED FILAMENT

2.0 VOLTS 0.12 AMPERE
DC

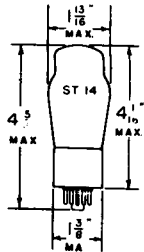

MEDIUM 7 PIN OCTAL BASE
1F5G

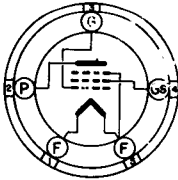

5K
BOTTOM VIEW
1F4

GLASS BULB



G-6X
BOTTOM VIEW
1F5G

THE TUNG-SOL 1F4 AND 1F5G ARE PENTODE POWER AMPLIFIERS OF THE FILAMENT TYPE. THEY ARE DESIGNED FOR SERVICE IN THE OUTPUT STAGE OF BATTERY OPERATED RECEIVERS. THEIR RATINGS AND ELECTRICAL CHARACTERISTICS ARE IDENTICAL.

RATINGS

MAXIMUM PLATE VOLTAGE	180	VOLTS
MAXIMUM SCREEN VOLTAGE	180	VOLTS
MAXIMUM PLATE DISSIPATION	1.75	WATTS
MAXIMUM SCREEN DISSIPATION	0.75	WATT

FOR "INTERPRETATION OF RATINGS" REFER TO FRONT OF BOX.

CONTINUED NEXT PAGE

TUNG-SOL

TYPICAL OPERATING CONDITIONS AND CHARACTERISTICS

CLASS A₁ AMPLIFIER

PLATE VOLTAGE	90	135	VOLTS
SCREEN VOLTAGE	90	135	VOLTS
CONTROL GRID VOLTAGE ^A	-3	-4.5	VOLTS
PEAK AF SIGNAL VOLTAGE	3	4.5	VOLTS
PLATE CURRENT	4.0	8.0	MA.
SCREEN CURRENT	1.1	2.4	MA.
PLATE RESISTANCE APPROX.	0.24	0.20	MEGOHM
TRANSCONDUCTANCE	1400	1700	μMHOS
LOAD RESISTANCE	20000	16000	OHMS
TOTAL HARMONIC DISTORTION	6	5	PER CENT
POWER OUTPUT	0.110	0.310	WATT

CLASS AB₁ PUSH-PULL AMPLIFIER

VALUES ARE FOR TWO TUBES

PLATE VOLTAGE	180	VOLTS
SCREEN VOLTAGE	180	VOLTS
CONTROL GRID VOLTAGE ^A	-7.5	VOLTS
PEAK AF SIGNAL VOLTAGE GRID TO GRID	15	VOLTS
ZERO-SIGNAL PLATE CURRENT	19	MA.
ZERO-SIGNAL SCREEN CURRENT	5.5	MA.
MAXIMUM-SIGNAL PLATE CURRENT	21	MA.
MAXIMUM-SIGNAL SCREEN CURRENT	7	MA.
LOAD RESISTANCE PLATE-TO-PLATE	20000	OHMS
TOTAL HARMONIC DISTORTION	4.5	PER CENT
POWER OUTPUT	1.25	WATTS

^A RETURN TO NEGATIVE FILAMENT (1F4: PIN 95 - 1F5G: PIN 97)

TUNG-SOL

DUO-DIODE PENTODE AMPLIFIER

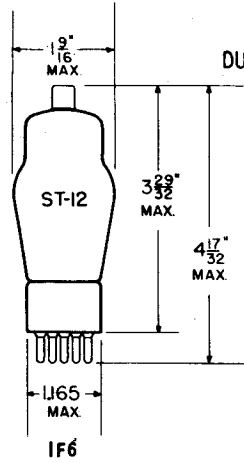

SMALL METAL CAP

COATED FILAMENT
2.0 VOLTS 0.06 AMPERE DC

GLASS BULB

MOUNTING POSITION

HORIZONTAL OPERATION MAY BE PERMITTED IN THE IF6 TUBE TYPE IF PINS 1 AND 6 ARE ON A VERTICAL PLANE. THE SAME WILL BE TRUE FOR THE IF7GH TUBE TYPE IF PINS 2 AND 7 ARE ON A VERTICAL PLANE.

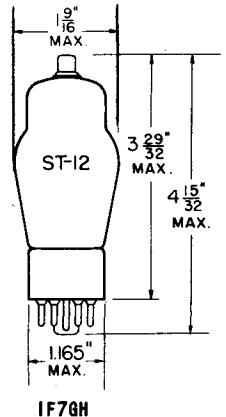

SKIRTED MINIATURE CAP

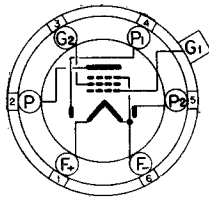

BOTTOM VIEW
SMALL 6-PIN

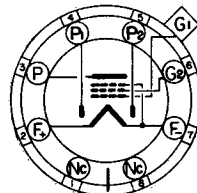

BOTTOM VIEW
SMALL SHELL 8-PIN OCTAL

THE IF6 AND IF7GH CONSIST OF TWO DIODES AND A PENTODE IN A SINGLE BULB. THEY ARE DESIGNED FOR SERVICE AS DIODE DETECTORS, AVC RECTIFIERS AND PENTODE AMPLIFIERS. WITH THE EXCEPTION OF CAPACITANCES, THEIR ELECTRICAL CHARACTERISTICS ARE IDENTICAL.

RATINGS

MAXIMUM PLATE VOLTAGE	180	VOLTS
MAXIMUM SCREEN VOLTAGE	67.5	VOLTS
MAXIMUM PLATE DISSIPATION	0.4	WATT
MAXIMUM SCREEN DISSIPATION	0.05	WATT
MINIMUM DIODE CURRENT PER PLATE WITH 10 VOLTS DC APPLIED.	0.5	MA.
MAXIMUM DIODE CURRENT PER PLATE FOR CONTINUOUS OPERATION.	0.25	MA.

CONTINUED ON NEXT PAGE

PLATE
1927
JAN. 15
1945

CONTINUED FROM PRECEDING PAGE

DIRECT INTERELECTRODE CAPACITANCES

	IF6	IF7GH	
GRID TO PLATE ^A	0.007 MAX.	0.01 MAX.	μmf
INPUT: G1 TO (F+G2+G3)	4.0	3.8	μmf
OUTPUT: P TO (F+G2+G3)	9.0	9.5	μmf

TYPICAL OPERATING CONDITIONS AND CHARACTERISTICS

-RF OR IF AMPLIFIER

PENTODE UNIT

PLATE VOLTAGE	180	VOLTS
SCREEN VOLTAGE	67.5	VOLTS
CONTROL GRID VOLTAGE	-1.5	VOLTS
PLATE RESISTANCE (APPROX.)	1.0	MEG OHM
TRANSCONDUCTANCE	650	μMHOS
TRANSCONDUCTANCE FOR $E_{C1} = -12$ VOLTS	20	μMHOS
PLATE CURRENT	2.2	MA.
SCREEN CURRENT	0.7	MA.

^A WITH SHIELD CAN

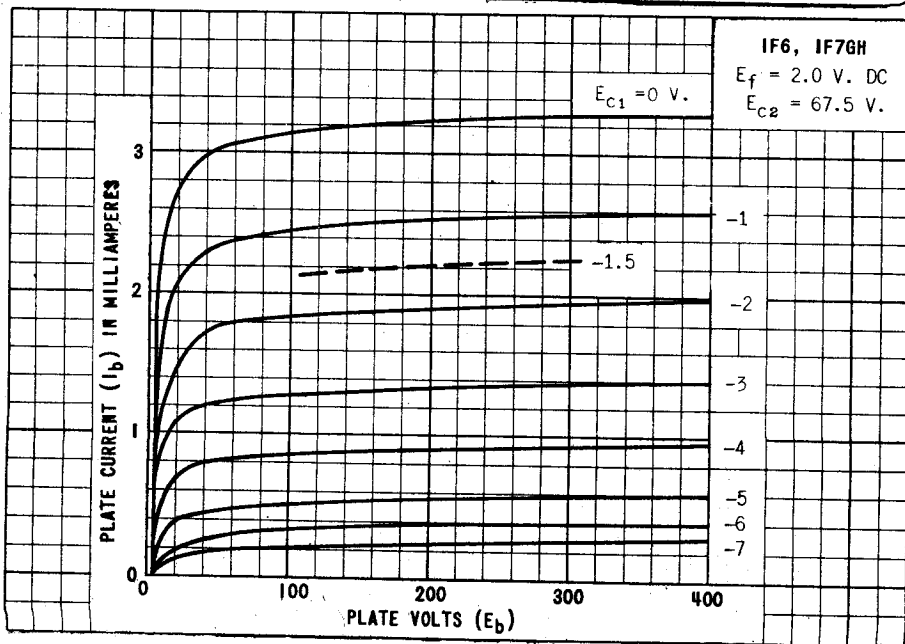
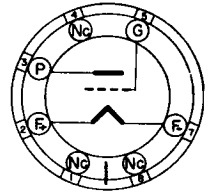
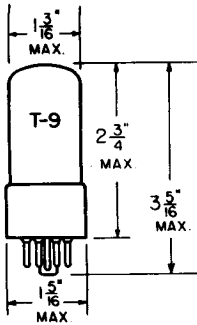

PLATE
1928
JAN. 15
1945

TUNG-SOL

TRIODE AMPLIFIER



COATED FILAMENT
 1.4 VOLTS 0.05 AMPERE
 DC

INTERMEDIATE 7 PIN
 OCTAL BASE

GLASS BULB

ANY MOUNTING POSITION

THE 1G4GT/G IS A FILAMENT TYPE GENERAL PURPOSE TRIODE ESPECIALLY DESIGNED FOR USE IN LOW DRAIN BATTERY OPERATED RECEIVERS.

RATINGS

INTERPRETED ACCORDING TO RMA STANDARD M8-210

MAXIMUM PLATE VOLTAGE	110	VOLTS
MAXIMUM TOTAL CATHODE CURRENT	4.0	MA.

DIRECT INTERELECTRODE CAPACITANCES

GRID TO PLATE	2.8	μf
INPUT	2.2	μf
OUTPUT	3.4	μf

TYPICAL OPERATING CONDITIONS AND CHARACTERISTICS

CLASS A_1 AMPLIFIER

PLATE VOLTAGE	90	VOLTS
GRID VOLTAGE ^A	-6.0	VOLTS
PLATE CURRENT	2.3	MA.
PLATE RESISTANCE	10 700	OHMS
MUTUAL CONDUCTANCE	825	μMHOS
AMPLIFICATION FACTOR	8.8	

^A NEGATIVE FILAMENT RETURN

PLATE
 1503
 OCT. 31
 1944

1G4GT/G

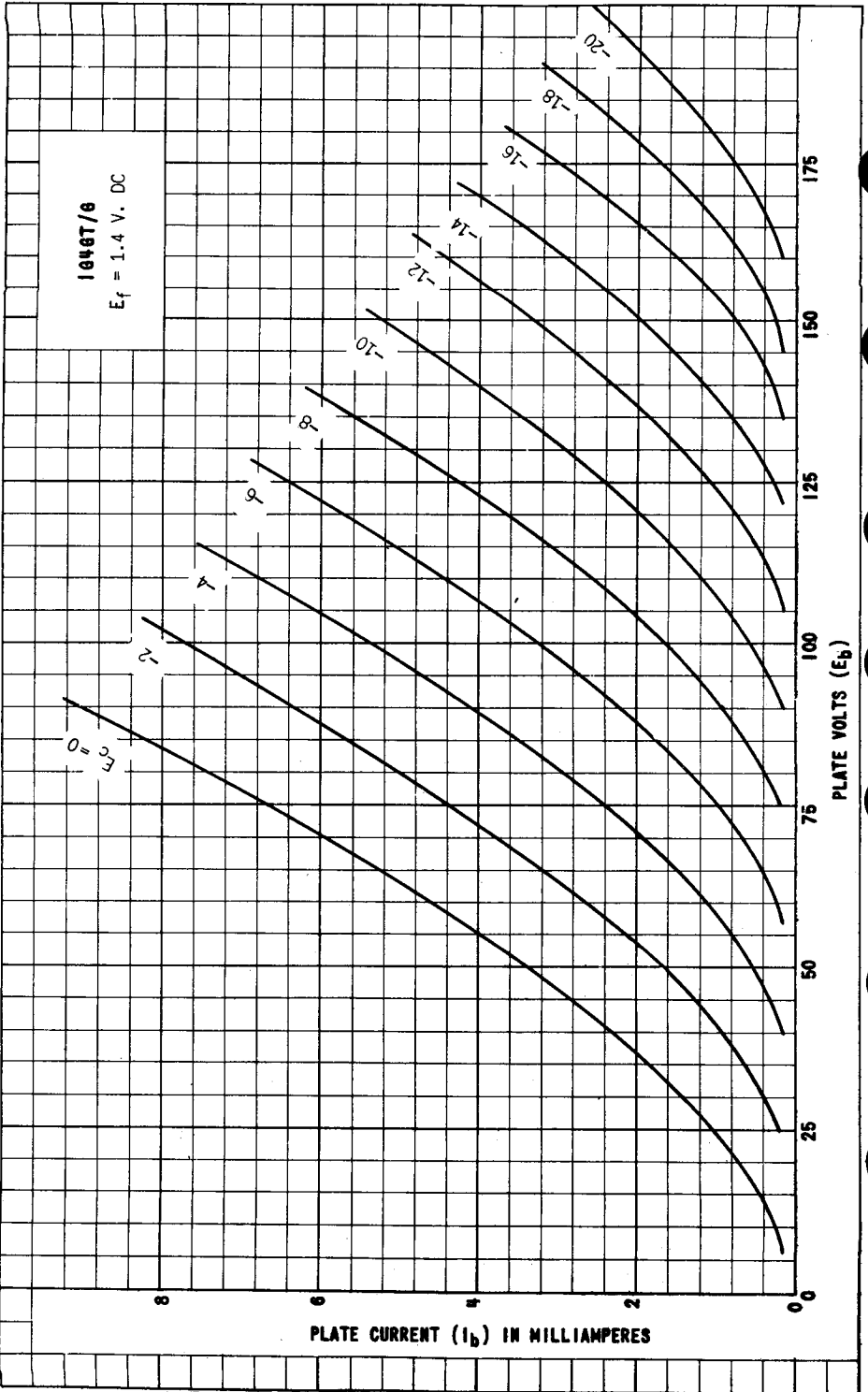

TUNG-SOL

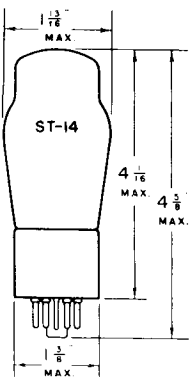

PENTODE POWER AMPLIFIER

COATED FILAMENT

2.0 VOLTS 0.12 AMPERE
DC

GLASS BULB

MEDIUM 7 PIN OCTAL BASE

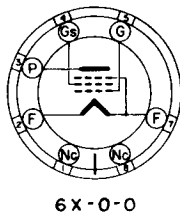

THE TUNG-SOL 1G5G IS A FILAMENT TYPE PENTODE POWER AMPLIFIER DESIGNED FOR SERVICE IN THE OUTPUT STAGE OF BATTERY OPERATED RECEIVERS.

RATINGS

MAXIMUM PLATE VOLTAGE	135	VOLTS
MAXIMUM SCREEN VOLTAGE	135	VOLTS
MAXIMUM PLATE DISSIPATION	1.25	WATTS
MAXIMUM SCREEN DISSIPATION	0.6	WATT

TYPICAL OPERATING CONDITIONS AND CHARACTERISTICS

CLASS A₁ AMPLIFIER

PLATE VOLTAGE	90	124	135	VOLTS
SCREEN VOLTAGE	90	124	135	VOLTS
CONTROL GRID VOLTAGE ^A	-6	-11	-13.5	VOLTS
PEAK AF SIGNAL VOLTAGE	6	9.9	9.2	VOLTS
ZERO-SIGNAL PLATE CURRENT	8.5	10.0	8.7	MA.
ZERO-SIGNAL SCREEN CURRENT	2.5	3.0	2.5	MA.
MAXIMUM-SIGNAL PLATE CURRENT	8.7	10.7	9.7	MA.
MAXIMUM-SIGNAL SCREEN CURRENT	3.0	4.3	3.6	MA.
PLATE RESISTANCE APPROX.	133 000	145 000	160 000	OHMS
TRANSCONDUCTANCE	1500	1500	1550	μMHOS
LOAD RESISTANCE	8500	8000	9000	OHMS
TOTAL HARMONIC DISTORTION	6	10.5	11	PER CENT
SECOND HARMONIC DISTORTION	3	7	8	PER CENT
THIRD HARMONIC DISTORTION	5	7.5	7	PER CENT
POWER OUTPUT	.250	.600 ^B	.550 ^C	WATT

^A REFERRED TO NEGATIVE FILAMENT TERMINAL.

^B WITH A PEAK AF GRID VOLTAGE OF 11 VOLTS, A POWER OUTPUT OF .650 WATT CAN BE OBTAINED WITH 13% TOTAL DISTORTION (6% SECOND, 11% THIRD).

^C WITH A PEAK AF GRID VOLTAGE OF 13.5 VOLTS, A POWER OUTPUT OF .750 WATT CAN BE OBTAINED WITH 18% TOTAL DISTORTION (9% SECOND, 15% THIRD).

PRINTED IN U. S. A.

PLATE 1170-3

FEB. 28 1942

CONTINUED NEXT PAGE

1G5G

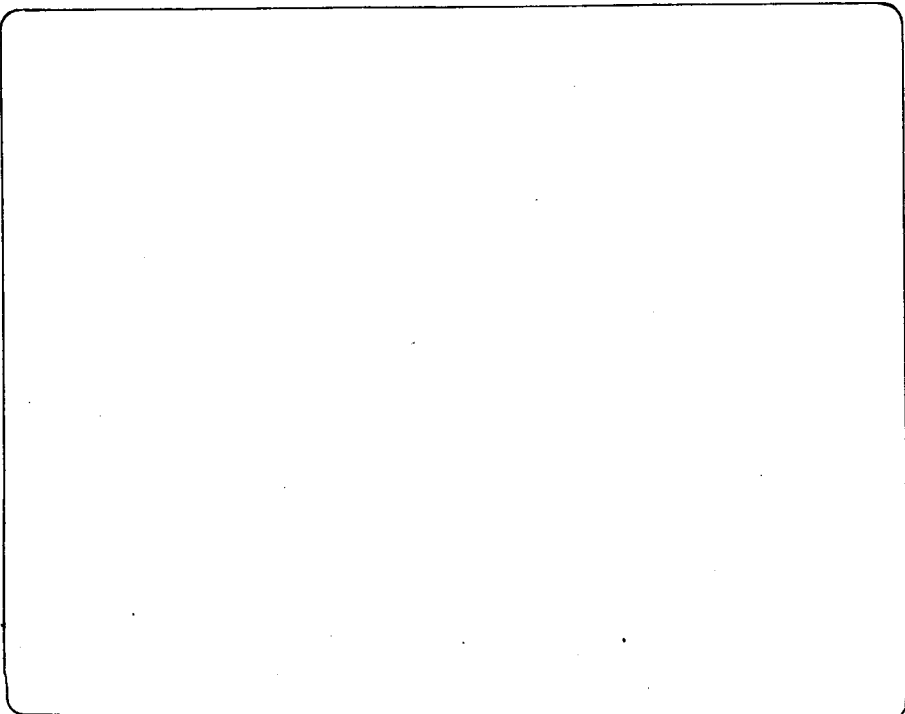
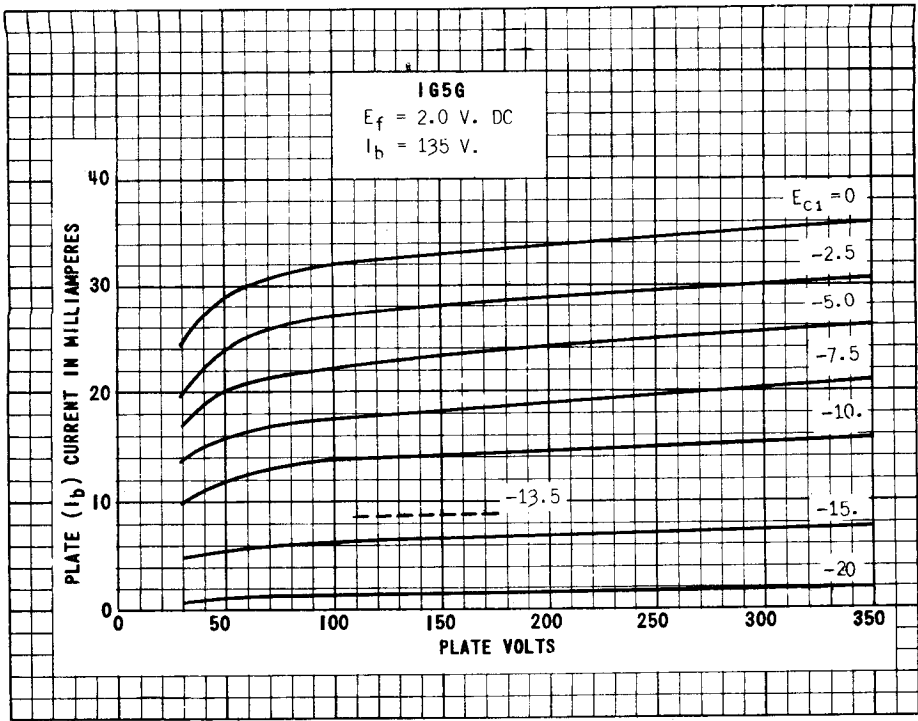

TUNG-SOL

CLASS B TWIN TRIODE AMPLIFIER

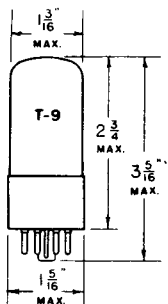

COATED FILAMENT

1.4 VOLTS 0.10 AMPERE
DC

GLASS BULB

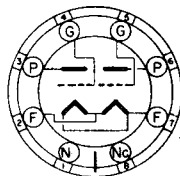

7AB-0-0

INTERMEDIATE 8 PIN OCTAL BASE

THE TUNG-SOL 1G6GT/G IS A LOW VOLTAGE, LOW CURRENT DRAIN, TWIN TRIODE AMPLIFIER. IT IS DESIGNED FOR SERVICE AS A ZERO BIAS CLASS "B" POWER AMPLIFIER.

RATINGS

MAXIMUM FILAMENT VOLTAGE

DRY BATTERY OPERATION — VOLTAGE MUST NEVER EXCEED	1.6	VOLTS
AC — DC POWER LINE OPERATION — DESIGN CENTER	1.3	VOLTS
MAXIMUM PLATE VOLTAGE PER PLATE	110	VOLTS
MAXIMUM PEAK PLATE CURRENT PER PLATE	20	MA.

TYPICAL OPERATING CONDITIONS AND CHARACTERISTICS

CLASS B POWER AMPLIFIER

VALUES ARE FOR 2 UNITS UNLESS OTHERWISE SPECIFIED

PLATE VOLTAGE	90	90	VOLTS
DC GRID VOLTAGE ^A	0	0	VOLTS
PEAK AF SIGNAL VOLTAGE GRID TO GRID B	42	48	VOLTS
ZERO SIGNAL DC PLATE CURRENT	2	2	MA.
MAXIMUM SIGNAL DC PLATE CURRENT	14	11	MA.
PEAK GRID CURRENT PER UNIT	5	6	MA.
PLATE SUPPLY IMPEDANCE	0	0 ^C	OHMS
EFFECTIVE GRID CIRCUIT IMPEDANCE PER UNIT	0	2530 ^D	OHMS
EFFECTIVE LOAD RESISTANCE PLATE TO PLATE	12 000	12 000	OHMS
TOTAL HARMONIC DISTORTION	3	4	PER CENT
POWER OUTPUT APPROX.	0.675	0.350	WATT

^A RETURN TO NEGATIVE FILAMENT TERMINAL (PIN #7).

^B INCLUDES PEAK GRID IMPEDANCE VOLTAGE DROP.

^C BATTERY SUPPLY.

^D AT 400 CYCLES THE EFFECTIVE RESISTANCE PER GRID CIRCUIT IS 2500 OHMS, AND THE LEAKAGE REACTANCE OF THE COUPLING TRANSFORMER IS 155 MILLIHENRYS.

CONTINUED NEXT PAGE

TUNG-SOL

TYPICAL OPERATING CONDITIONS AND CHARACTERISTICS

CLASS A₁ AMPLIFIER

EACH TRIODE UNIT

FILAMENT VOLTAGE	1.4 DC	VOLTS
FILAMENT CURRENT	0.1	AMPERE
PLATE VOLTAGE	90	VOLTS
CONTROL GRID VOLTAGE ^A	0	VOLTS
PLATE CURRENT	1.0	MA.
PLATE RESISTANCE APPROX.	45 000	OHMS
TRANSCONDUCTANCE	675	μMHOS
AMPLIFICATION FACTOR	30	

^A REFERRED TO NEGATIVE FILAMENT TERMINAL.

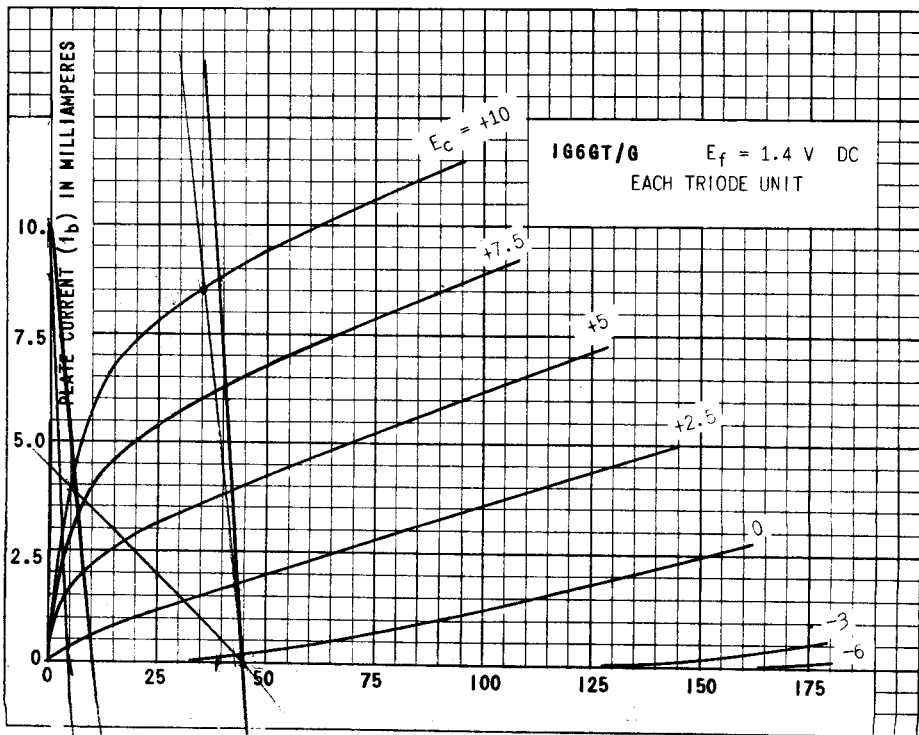
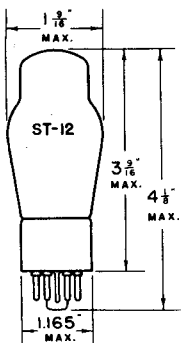

PLATE
1191-1

TUNG-SOL



TRIODE AMPLIFIER

COATED FILAMENT
2.0 VOLTS 0.06 AMPERE
DC

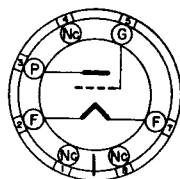

G-5Z

GLASS BULB

SMALL 7 PIN OCTAL BASE

THE TUNG-SOL IH4G IS A GENERAL PURPOSE FILAMENT TYPE TRIODE DESIGN-ED FOR SERVICE IN BATTERY OPERATED RECEIVERS. WITH THE EXCEPTION OF CAPACITANCES ITS RATINGS AND CHARACTERISTICS ARE IDENTICAL WITH THOSE OF THE 30.

OPERATING CONDITIONS AND CHARACTERISTICS

CLASS A₁ AMPLIFIER

PLATE VOLTAGE	90	135	180 ^{MAX.}	VOLTS
GRID VOLTAGE	-4.5	-9	-13.5	VOLTS
GRID CIRCUIT RESISTANCE ^{MAX.}	2	2	2	MEGOHMS
PLATE CURRENT	2.5	3.0	3.1	MA.
PLATE RESISTANCE	11 000	10 300	10 300	OHMS
TRANSCONDUCTANCE	850	900	900	μMHOS
AMPLIFICATION FACTOR	9.3	9.3	9.3	

DETECTOR

	BIASED		GRID LEAK	
PLATE VOLTAGE	90	135	180 ^{MAX.}	45 ^{MAX.} VOLTS
GRID VOLTAGE	-9 ^A	-13.5 ^A	-18 ^A	RETURN TO (+) FILAMENT VOLTS
PLATE CURRENT ^P	ADJUSTED TO 0.2 MA. WITH NO INPUT SIGNAL			-
GRID LEAK	-	-	-	1 TO 5 MEGOHMS
GRID CONDENSER	-	-	-	250 μf

^A APPROXIMATE. GRID RETURN TO NEGATIVE END OF FILAMENT.

^P WITH MAXIMUM SIGNAL THE AVERAGE DC PLATE CURRENT SHOULD NOT EXCEED 2.0 MA.

TUNG-SOL

CLASS B₂ AMPLIFIER

PLATE VOLTAGE	180 ^{MAX.}	VOLTS
PEAK PLATE CURRENT PER TUBE	50 ^{MAX.}	MA.
ZERO-SIGNAL PLATE CURRENT PER TUBE	1.5 ^{MAX.}	MA.

TYPICAL OPERATING CONDITIONS

VALUES ARE FOR TWO TUBES

PLATE VOLTAGE	157.5	VOLTS
GRID VOLTAGE	-15	VOLTS
ZERO-SIGNAL PLATE CURRENT	1	MA.
LOAD RESISTANCE PER TUBE	2000	OHMS
EFFECTIVE LOAD RESISTANCE ^{PLATE TO PLATE}	8000	OHMS
PEAK POWER INPUT ^{GRID TO GRID}	260 ^{MAX.}	MILLIWATTS
POWER OUTPUT ^D (6% TO 7% DISTORTION)	2.1	WATTS

^D WITH ONE TYPE 1M4G AS DRIVER, OPERATED WITH PLATE VOLTAGE = 157.5 VOLTS, GRID VOLTAGE = -11.3 VOLTS, PLATE LOAD OF APPROXIMATELY 18 000 OHMS, AND INPUT TRANSFORMER RATIO, PRIMARY TO ONE HALF SECONDARY = 1.165.

DIRECT INTERELECTRODE CAPACITANCES^S

GRID TO FILAMENT	3.6	μf
PLATE TO FILAMENT	5.0	μf
GRID TO PLATE	5.0	μf

^S WITH SHIELD

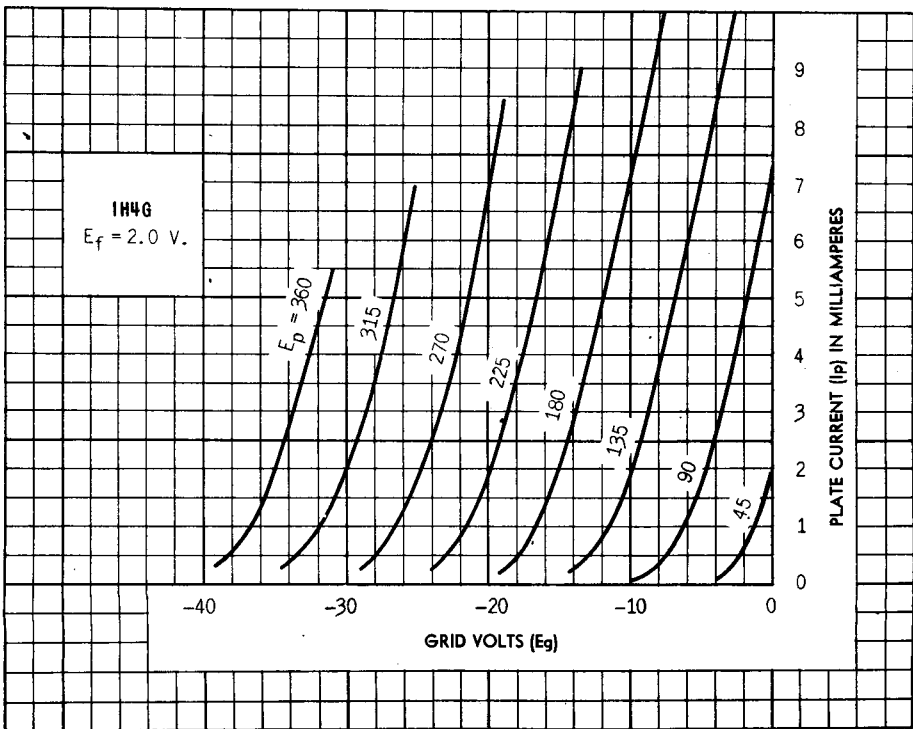
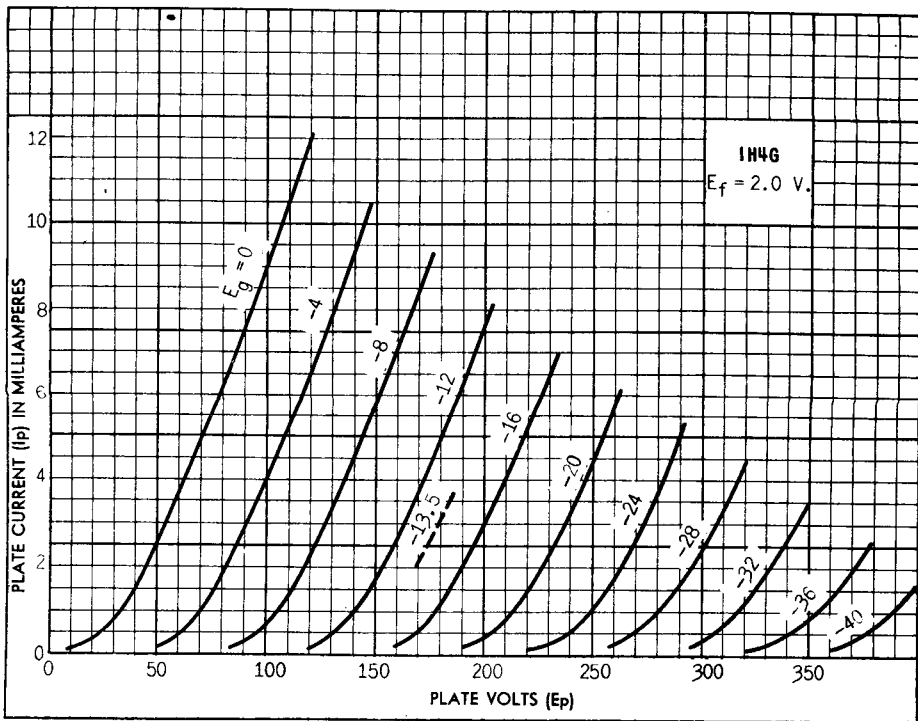

IH4 G

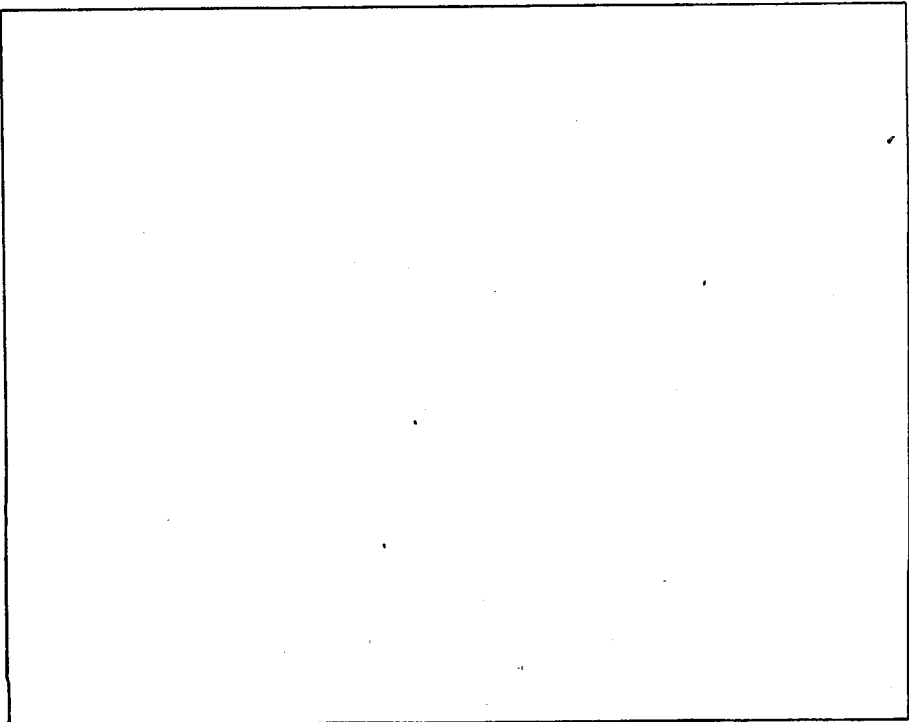
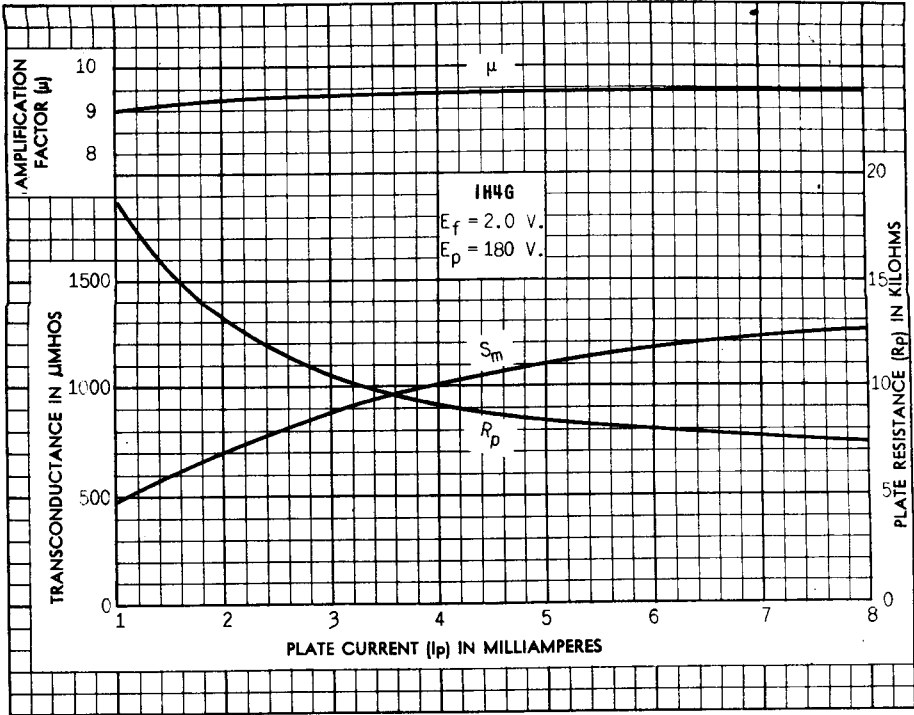

PLATE
201-1

TUNG-SOL

DIODE TRIODE AMPLIFIER

COATED FILAMENT

1.4 VOLTS 0.05 AMPERE

DC

GLASS BULB

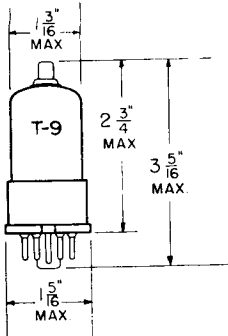

IH5GT/G
SKIRTED
MINIATURE CAP

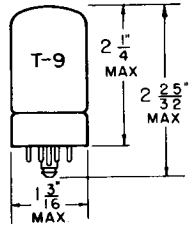

1LH4

ANY MOUNTING POSITION

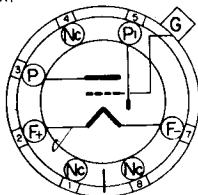

BOTTOM VIEW

7-PIN OCTAL BASE
WITH METAL SHELL

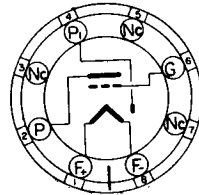

BOTTOM VIEW

LOCKING-IN
8-PIN

THE IH5GT/G AND 1LH4 ARE TUBES COMBINING A SINGLE DIODE AND A HIGH-MU TRIODE IN ONE BULB. THEY ARE DESIGNED FOR SERVICE AS DIODE DETECTORS, AVC RECTIFIERS, AND AS RESISTANCE COUPLED AMPLIFIERS.

RATINGS

INTERPRETED ACCORDING TO RMA STANDARD MB-210

MAXIMUM PLATE VOLTAGE	110	VOLTS
MINIMUM DIODE CURRENT WITH 10 VOLTS DC APPLIED	0.5	MA.

TYPICAL OPERATING CONDITIONS AND CHARACTERISTICS

CLASS A₁ AMPLIFIER

TRIODE UNIT

PLATE VOLTAGE	90	VOLTS
CONTROL GRID VOLTAGE ^A	0	VOLTS
PLATE CURRENT	0.15	MA.
PLATE RESISTANCE	0.24	MEGOHM
TRANSCONDUCTANCE	275	μMHOS
AMPLIFICATION FACTOR	65	

^A REFERRED TO NEGATIVE FILAMENT TERMINAL

DIODE UNIT

THE DIODE IS LOCATED AT THE NEGATIVE END OF THE FILAMENT AND IS INDEPENDENT OF THE TRIODE UNIT EXCEPT FOR THE COMMON FILAMENT.

PRINTED IN U. S. A.

PLATE
1529
JAN. 15
1945

IH5GT/G (ILH4)

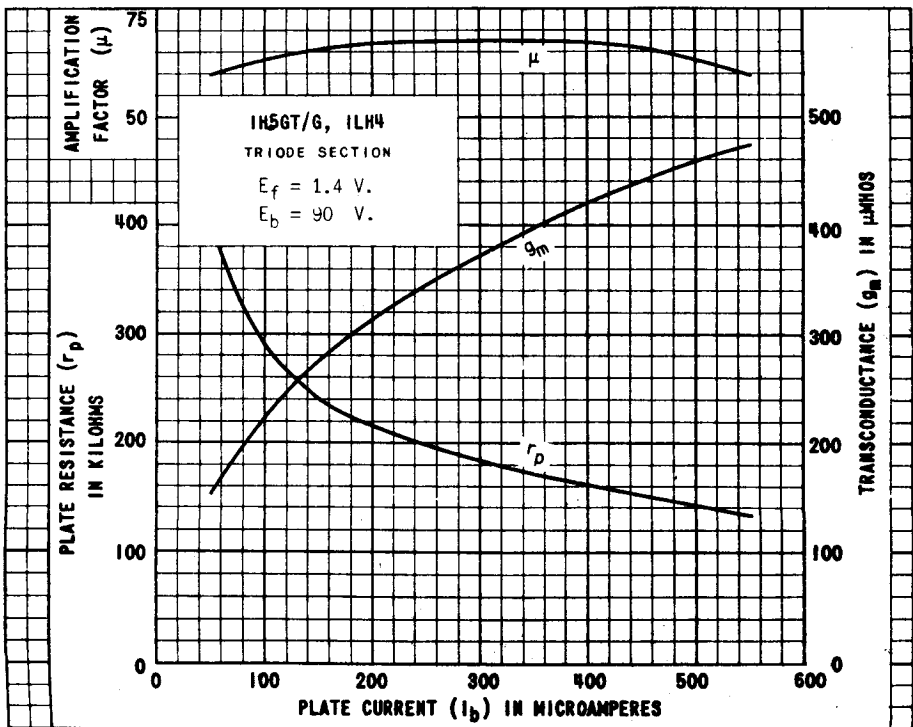
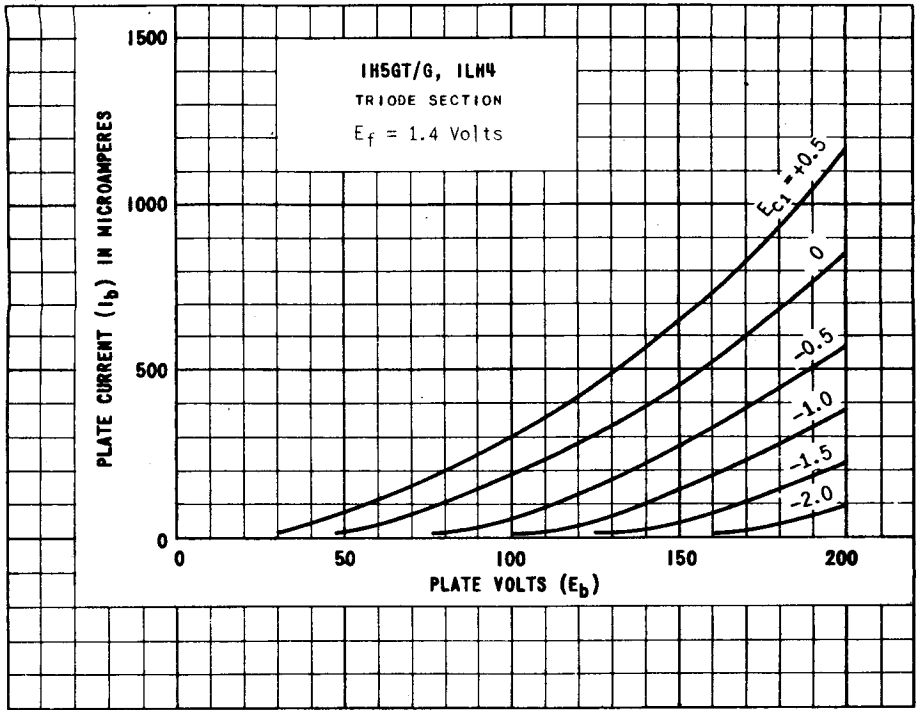
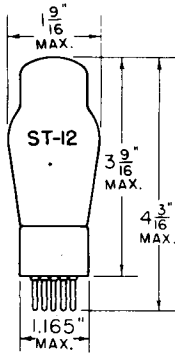

PLATE 1530
JAN. 15 1945

TUNG-SOL

DUO-DIODE TRIODE AMPLIFIER



1B5/25S

COATED FILAMENT
 2.0 VOLTS 0.06 AMPERE
 DC
 GLASS BULB

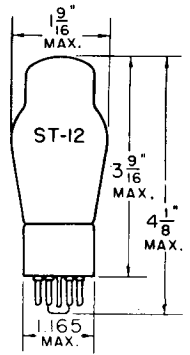

1H6G

MOUNTING POSITION

THESE TUBES SHOULD BE OPERATED VERTICALLY WITH BASE DOWN. HOWEVER, HORIZONTAL OPERATION MAY BE PERMITTED FOR TUBE TYPE 1B5/25S WHEN PINS 2 AND 5 ARE HORIZONTAL. THE SAME WILL BE TRUE FOR THE 1H6G TUBE TYPE WHEN PINS 2 AND 7 ARE HORIZONTAL.

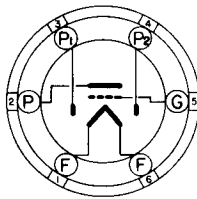

BOTTOM VIEW

SMALL 6 PIN BASE

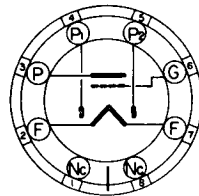

BOTTOM VIEW

SMALL 8 PIN OCTAL BASE

THE 1B5/25S AND 1H6G COMBINE TWO DIODES AND A TRIODE IN A SINGLE BULB. THEY ARE DESIGNED FOR SERVICE AS DIODE DETECTORS, AVC RECTIFIERS, AND IMPEDANCE OR RESISTANCE COUPLED AMPLIFIERS IN BATTERY OPERATED RECEIVERS.

DIRECT INTERELECTRODE CAPACITANCES

	1B5/25S	1H6G	
GRID TO PLATE	3.6	3.6	μuf
INPUT	1.6	1.6	μuf
OUTPUT	1.9	1.9	μuf

OPERATING CONDITIONS AND CHARACTERISTICS

TRIODE UNIT - CLASS A₁ AMPLIFIER

MAXIMUM PLATE VOLTAGE	135	VOLTS
CONTROL GRID VOLTAGE	-3.0	VOLTS
PLATE CURRENT	0.8	MA.
PLATE RESISTANCE	35 000	OHMS
TRANSCONDUCTANCE	575	μMMS
AMPLIFICATION FACTOR	20	

PRINTED IN U. S. A.

PLATE 1505 OCT. 31 1944

IH6G (1B5/25S)

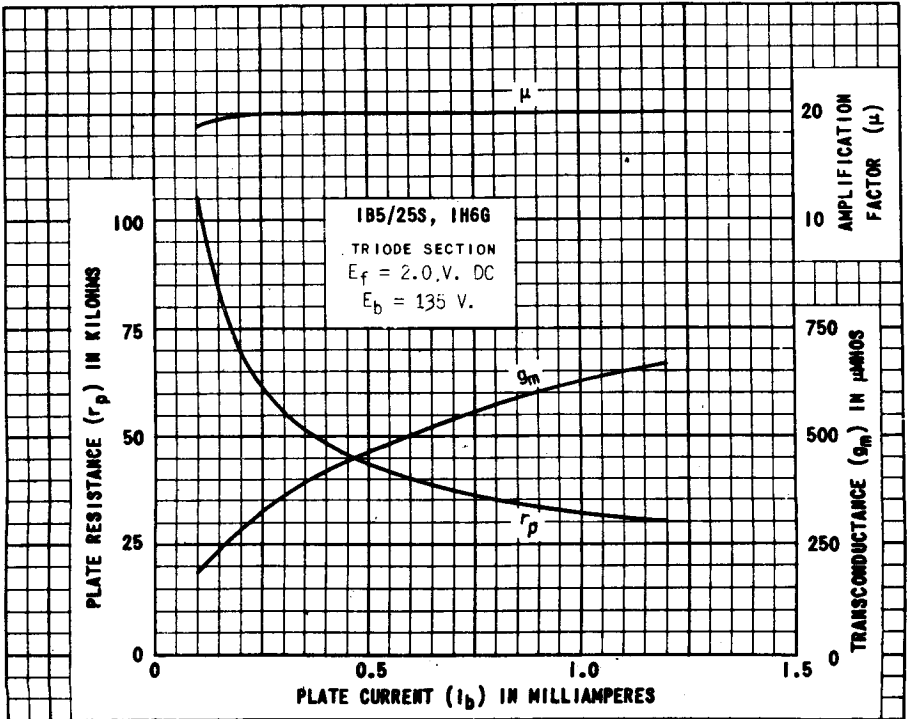
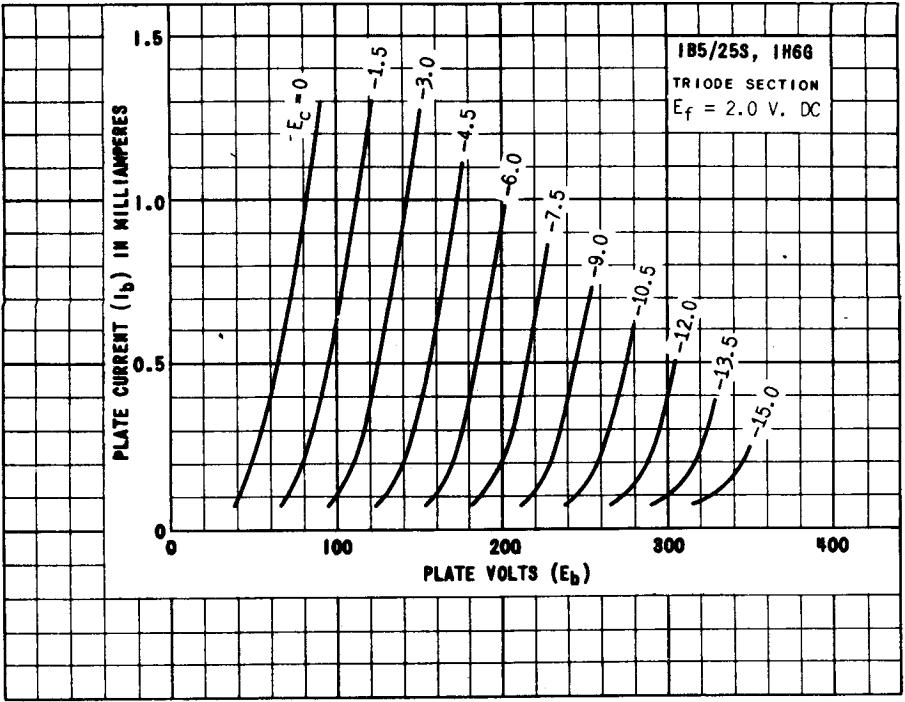

TUNG-SOL

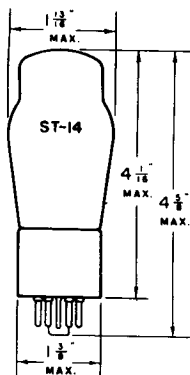

PENTODE POWER AMPLIFIER

COATED FILAMENT

2.0 VOLTS 0.12 AMPERE
DC

GLASS BULB

MEDIUM 7 PIN OCTAL BASE

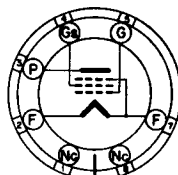

G-6X

BOTTOM VIEW

THE TUNG-SOL 1J5G IS A FILAMENT TYPE PENTODE POWER AMPLIFIER DESIGNED FOR SERVICE IN THE OUTPUT STAGE OF BATTERY OPERATED RECEIVERS. ITS RATINGS AND CHARACTERISTICS ARE IDENTICAL WITH THOSE OF THE 950.

OPERATING CONDITIONS AND CHARACTERISTICS

CLASS A₁ AMPLIFIER

PLATE VOLTAGE	135	VOLTS
SCREEN VOLTAGE	135	VOLTS
CONTROL GRID VOLTAGE ^A	-16.5	VOLTS
GRID CIRCUIT RESISTANCE WITH FIXED BIAS ^{MAX.}	0.5	MEGOHM
PLATE CURRENT	7	MA.
SCREEN CURRENT	2	MA.
TRANSCONDUCTANCE	950	μMHOS
AMPLIFICATION FACTOR	100	
LOAD RESISTANCE	13 500	OHMS
POWER OUTPUT	0.45	WATT

^A RETURN TO NEGATIVE FILAMENT (PIN #7)DIRECT INTERELECTRODE CAPACITANCES ⁵

CONTROL GRID TO FILAMENT	8	μμf
PLATE TO FILAMENT	14	μμf
CONTROL GRID TO PLATE	0.8	μμf

⁵ WITH SHIELD

TUNG-SOL

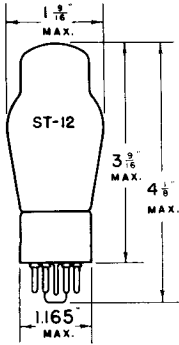

TWIN TRIODE POWER AMPLIFIER

COATED FILAMENT

2.0 VOLTS 0.24 AMPERE
DC

GLASS BULB

SMALL 8 PIN OCTAL BASE

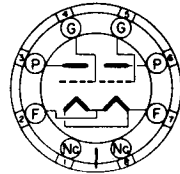

G-7AB

BOTTOM VIEW

THE TUNG-SOL 1J6G IS DESIGNED FOR SERVICE AS A CLASS B POWER OUTPUT AMPLIFIER IN BATTERY OPERATED RECEIVERS. WITH THE EXCEPTION OF FILAMENT CURRENT AND CAPACITANCES, ITS RATINGS AND CHARACTERISTICS ARE IDENTICAL WITH THOSE OF THE 19.

OPERATING CONDITIONS AND CHARACTERISTICS

PLATE VOLTAGE ^{MAX.}	135	VOLTS
PEAK PLATE CURRENT PER PLATE ^{MAX.}	50	MA.

CLASS B₂ AMPLIFIER

PLATE VOLTAGE ^{MAX.}	135	135	135	VOLTS
GRID VOLTAGE ^A	-6	-3	0	VOLTS
ZERO-SIGNAL PLATE CURRENT PER PLATE	0.1	1.7	5	MA.
LOAD RESISTANCE PER PLATE	2500	2500	2500	OHMS
EFFECTIVE LOAD RESISTANCE ^{PLATE TO PLATE}	10 000	10 000	10 000	OHMS
AVERAGE POWER INPUT ^{APPROX. GRID TO GRID}	0.095	0.130	0.170	WATT
POWER OUTPUT ^{APPROX.}	1.6	1.9	2.1	WATTS

^A RETURN TO NEGATIVE FILAMENT (PIN #7)

DIRECT INTERELECTRODE CAPACITANCES ⁵

	TRIODE 2	TRIODE 1	
GRID TO FILAMENT	3.2	3.2	μμf
PLATE TO FILAMENT	4.4	4.4	μμf
GRID TO PLATE	7.5	7.5	μμf
GRID 1 TO GRID 2		0.26	μμf
PLATE 1 TO PLATE 2		0.5	μμf
GRID 2 TO PLATE 1		0.05	μμf
GRID 1 TO PLATE 2		0.05	μμf

TRIODE 2 IS TRIODE HAVING GRID BROUGHT OUT TO PIN #4.

TRIODE 1 IS TRIODE HAVING GRID BROUGHT OUT TO PIN #5.

⁵ WITH SHIELD

PLATE
537-2

TUNG-SOL

RF AMPLIFIER PENTODE

MINIATURE TYPE

COATED FILAMENT

FILAMENT

1.4 VOLTS 0.05 AMPERE

DC

ANY MOUNTING POSITION

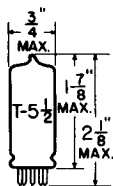

GLASS BULB

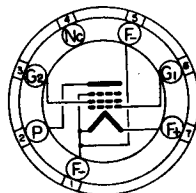

BOTTOM VIEW
MINIATURE BUTTON
7 PIN BASE

THE 1L4 IS A RF PENTODE OF THE MINIATURE TYPE WITH A SHARP CUT-OFF CHARACTERISTIC. IT IS RECOMMENDED FOR USE WHEREVER A SHARP CUT-OFF PENTODE IS REQUIRED IN COMPACT, LIGHT-WEIGHT, PORTABLE RECEIVERS. THE TUBE IS, THEREFORE, OF INTEREST IN FM RECEIVERS AND IN OTHER CIRCUITS NOT REQUIRING AVC. THE 1L4 FEATURES INTERNAL SHIELDING WHICH ELIMINATES THE NEED FOR AN EXTERNAL BULB SHIELD, BUT A SOCKET WITH SHIELDING IS ESSENTIAL IF MINIMUM GRID-PLATE CAPACITANCE IS TO BE OBTAINED.

DIRECT INTERELECTRODE CAPACITANCES

WITH NO EXTERNAL SHIELD

GRID TO PLATE: (G ₁ TO P) MAX.	0.008	μlf
INPUT: G ₁ TO (F + G ₂ + G ₃ + I.S.)	3.6	μlf
OUTPUT: P TO (F + G ₂ + G ₃ + I.S.)	7.5	μlf

RATINGS

INTERPRETED ACCORDING TO RMA STANDARD MB-210

FILAMENT VOLTAGE	1.4	VOLTS
MAXIMUM PLATE VOLTAGE	110	VOLTS
MAXIMUM GRID #2 VOLTAGE	90	VOLTS
MAXIMUM GRID #2 SUPPLY VOLTAGE	110	VOLTS
MINIMUM GRID #1 VOLTAGE	0	VOLTS
MAXIMUM TOTAL CATHODE CURRENT	6.5	MA.

TYPICAL OPERATING CONDITIONS AND CHARACTERISTICS

CLASS A₁ AMPLIFIER

FILAMENT VOLTAGE	1.4	1.4	VOLTS
FILAMENT CURRENT	0.05	0.05	AMP.
PLATE VOLTAGE	90	90	VOLTS
GRID #2 VOLTAGE	67.5	90	VOLTS
GRID #1 VOLTAGE	0	0	VOLTS
PLATE CURRENT	2.9	4.5	MA.
GRID #2 CURRENT	1.2	2.0	MA.
PLATE RESISTANCE (APPROX.)	0.6	0.35	MEGOHM
TRANSCONDUCTANCE	925	1 025	μMHOS
GRID #1 VOLTAGE FOR PLATE CURRENT = 10 μAMPS	-6	-8	VOLTS

SIMILAR TYPE REFERENCE: Characteristics somewhat similar to 1LH5 and 1F50T.

→ INDICATES A CHANGE OR ADDITION.

PRINTED IN U. S. A.

PLATE 1825

JUNE 2, 1947

1L4

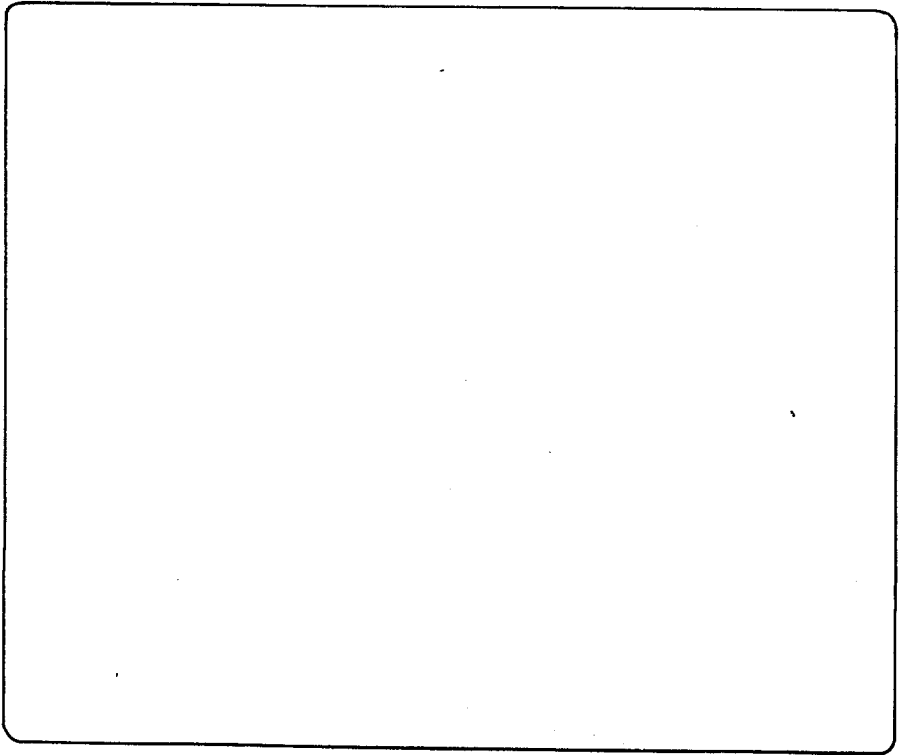
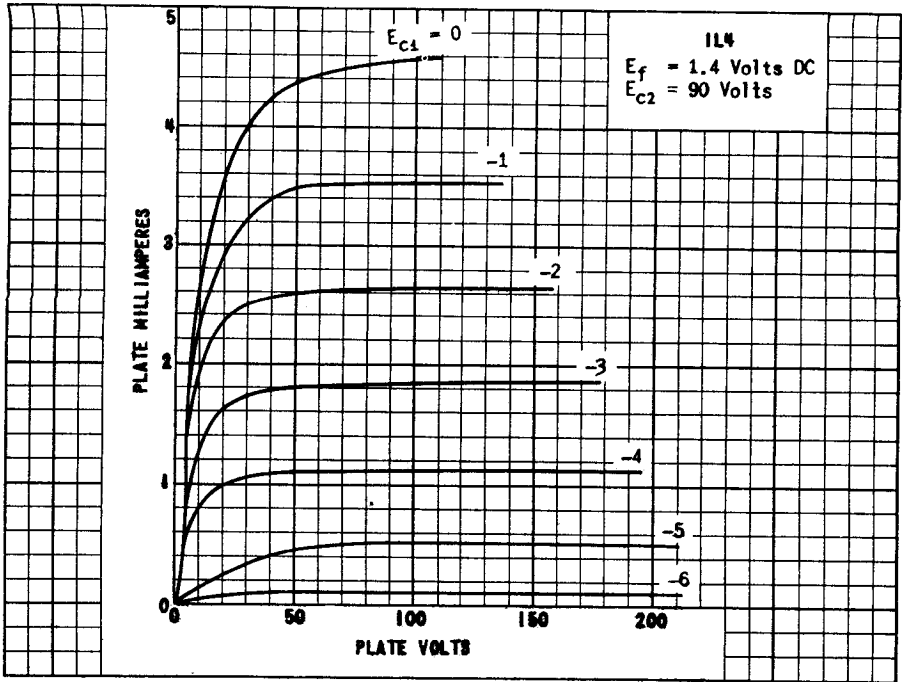

PLATE
1826
JUNE 2,
1947

TUNG-SOL

PENTODE POWER AMPLIFIER

COATED FILAMENT

1.4 VOLTS 0.05 AMPERE

DC

GLASS BULB

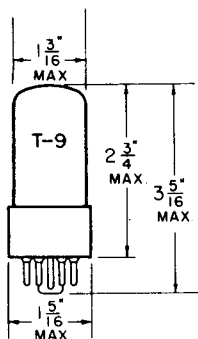

1A5GT/G

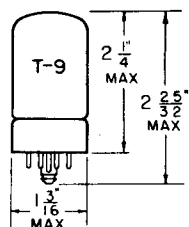

ILA4

ANY MOUNTING POSITION

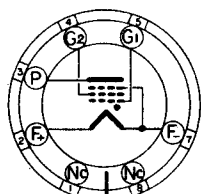

BOTTOM VIEW

INTERMEDIATE SHELL

7-PIN OCTAL BASE

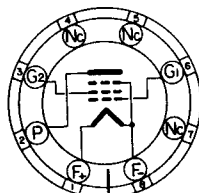

BOTTOM VIEW

LOCKING-IN

8-PIN

RATINGS

INTERPRETED ACCORDING TO RMA STANDARD M8-210

MAXIMUM PLATE VOLTAGE	110	VOLTS
MAXIMUM SCREEN VOLTAGE	110	VOLTS
MAXIMUM CATHODE CURRENT	6.0	MA.

TYPICAL OPERATING CONDITIONS AND CHARACTERISTICS

CLASS A₁ AMPLIFIER

PLATE VOLTAGE	85	90	VOLTS
SCREEN VOLTAGE	85	90	VOLTS
GRID VOLTAGE ^A	-4.5	-4.5	VOLTS
PEAK A-F GRID VOLTAGE	4.5	4.5	VOLTS
ZERO-SIG. PLATE CURRENT	3.5	4.0	MA.
MAXIMUM SIG. PLATE CURRENT	3.5	4.0	MA.
ZERO-SIG. SCREEN CURRENT	0.7	0.8	MA.
MAXIMUM SIG. SCREEN CURRENT	1.0	1.1	MA.
PLATE RESISTANCE	0.3	0.3	MEGOHM
TRANSCONDUCTANCE	800	850	μMHOS
LOAD RESISTANCE	25 000	25 000	OHMS
TOTAL HARMONIC DISTORTION	10	7.0	PER CENT
MAXIMUM SIG. POWER OUTPUT	100	115	MW.

^A RETURN TO NEGATIVE FILAMENT

1LA4 (1A5GT/G)

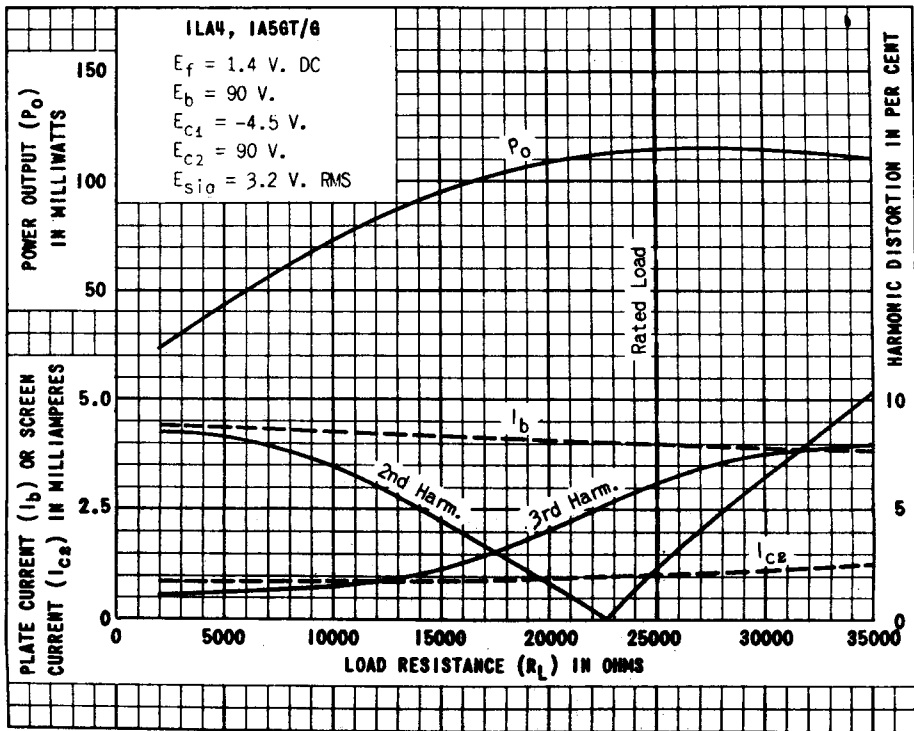
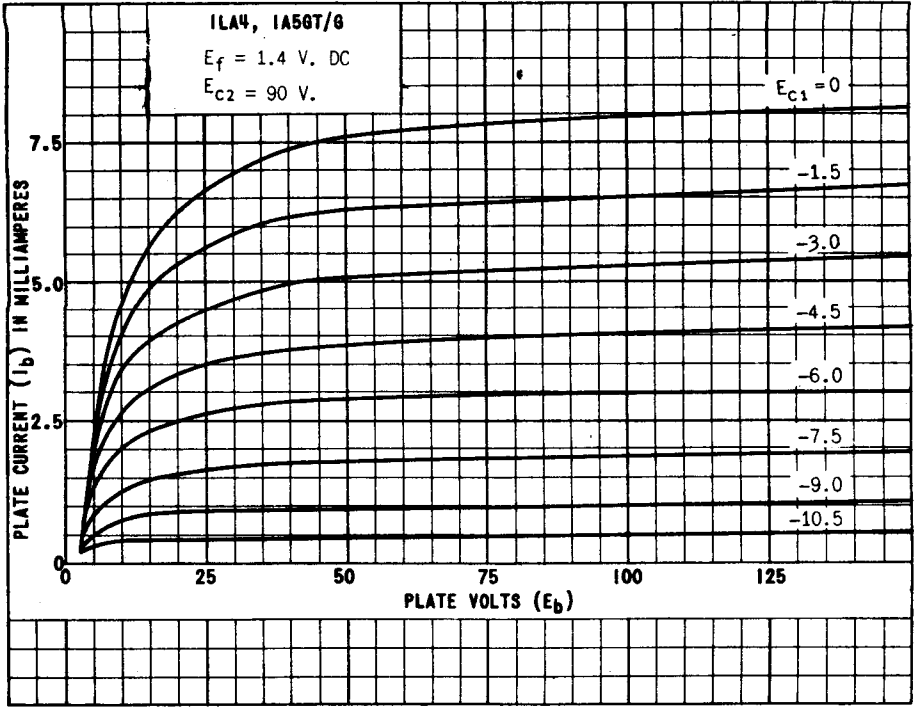

TUNG-SOL

PENTAGRID CONVERTER

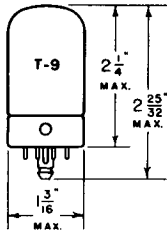

COATED FILAMENT

1.4 VOLTS 0.05 AMPERE
DC

GLASS BULB

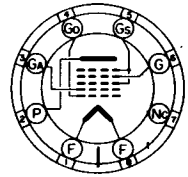

7AK

BOTTOM VIEW

LOCKING-IN 8 PIN BASE

THE TUNG-SOL ILA6 IS A LOW VOLTAGE, LOW CURRENT DRAIN, BATTERY TYPE PENTAGRID CONVERTER. IT IS DESIGNED FOR SERVICE AS AN OSCILLATOR AND MIXER IN SUPERHETERODYNE RECEIVERS WHICH REQUIRE ONLY 90 VOLTS OF "B" BATTERY AND A SINGLE DRY CELL "A" BATTERY. ITS ELECTRICAL CHARACTERISTICS ARE SIMILAR TO THOSE OF THE 1A7G.

RATINGS

MAXIMUM FILAMENT VOLTAGE

DRY BATTERY OPERATION - VOLTAGE MUST NEVER EXCEED	1.6	VOLTS
AC - DC POWER LINE OPERATION - DESIGN CENTER	1.3	VOLTS
MAXIMUM PLATE (P) VOLTAGE	90	VOLTS
MAXIMUM SCREEN (G ₅) SUPPLY VOLTAGE	90	VOLTS
MAXIMUM SCREEN VOLTAGE ^A	55	VOLTS
MAXIMUM OSCILLATOR ANODE (G _A) VOLTAGE	90	VOLTS
MAXIMUM TOTAL CATHODE CURRENT-ZERO SIGNAL	3	MA.

^A OBTAINED BY USING A PROPERLY BY-PASSED VOLTAGE DROPPING RESISTOR OF 45000 TO 75000 OHMS IN SERIES WITH A "B" SUPPLY VOLTAGE.

FOR "INTERPRETATION OF RATINGS" REFER TO FRONT OF BOOK.

CONTINUED NEXT PAGE

PRINTED IN U. S. A.

PLATE
1102-2
SEPT. 17
1941

TUNG-SOL

TYPICAL OPERATING CONDITIONS AND CHARACTERISTICS

CONVERTER SERVICE

PLATE (P) VOLTAGE	90	VOLTS
SCREEN (G _s) VOLTAGE ^A	45	VOLTS
CONTROL GRID (G) VOLTAGE ^B	0	VOLTS
OSCILLATOR ANODE (G _A) VOLTAGE	90	VOLTS
OSCILLATOR GRID (G _o) RESISTOR	200 000	OHMS
PLATE CURRENT	0.55	MA.
SCREEN CURRENT	0.6	MA.
OSCILLATOR ANODE CURRENT	1.2	MA.
OSCILLATOR GRID CURRENT	0.035	MA.
TOTAL CATHODE CURRENT	2.4	MA.
PLATE RESISTANCE	0.75	MEGOHM
CONVERSION TRANSCONDUCTANCE	250	μMHOS
FOR CONTROL GRID (G) VOLTAGE = 0 V.		
CONVERSION TRANSCONDUCTANCE ^{APPROX.}	10	μMHOS
FOR CONTROL GRID VOLTAGE = -3 V.		

DIRECT INTERELECTRODE CAPACITANCES^S

CONTROL GRID (G) TO MIXER PLATE (P)	0.4	μμf
CONTROL GRID (G) TO OSCILLATOR ANODE (G _A)	0.3	μμf
CONTROL GRID (G) TO OSCILLATOR GRID (G _o)	0.15	μμf
OSCILLATOR GRID (G _o) TO OSCILLATOR ANODE (G _A)	0.6	μμf
RF INPUT: CONTROL GRID (G) TO ALL OTHER ELECTRODES	7.7	μμf
OSCILLATOR INPUT: OSCILLATOR GRID (G _o) TO ALL OTHER ELECTRODES EXCEPT OSCILLATOR ANODE (G _A)	2.9	μμf
OSCILLATOR OUTPUT: OSCILLATOR ANODE (G _A) TO ALL OTHER ELECTRODES EXCEPT OSCILLATOR GRID (G _o)	3.3	μμf
MIXER OUTPUT: MIXER PLATE (P) TO ALL OTHER ELECTRODES	8.0	μμf

^A OBTAINED PREFERABLY BY USING A PROPERLY BY-PASSED VOLTAGE DROPPING RESISTOR OF 45000 TO 75000 OHMS IN SERIES WITH A "B" SUPPLY VOLTAGE.

^B A RESISTANCE OF AT LEAST 1 MEGOHM SHOULD BE IN GRID RETURN TO NEGATIVE FILAMENT TERMINAL (PIN 66).

^S WITH EXTERNAL SHIELD CONNECTED TO NEGATIVE FILAMENT TERMINAL.

NOTE: THE TRANSCONDUCTANCE OF THE OSCILLATOR SECTION (NOT OSCILLATING) IS APPROXIMATELY 550 μMHOS, THE AMPLIFICATION FACTOR IS 40, AND THE OSCILLATOR ANODE CURRENT IS 2.2 MA. CONDITIONS: PLATE VOLTAGE = 90 VOLTS, OSCILLATOR ANODE VOLTAGE = 90 VOLTS, SCREEN VOLTAGE = 45 VOLTS, AND THE GRID VOLTAGE = 0 VOLTS.

TUNG-SOL

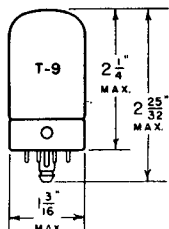

PENTODE POWER AMPLIFIER

COATED FILAMENT

1.4 VOLTS 0.05 AMPERE
DC

GLASS BULB

LOCKING-IN 8 PIN BASE

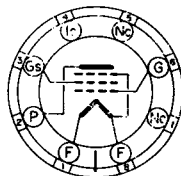
5A0 α

BOTTOM VIEW

NOTE: 1C DEROTES
HT WIAL CONNECTION.

THE TUNG-SOL 1LB4 IS A LOW VOLTAGE, LOW CURRENT DRAIN, BATTERY TYPE POWER PENTODE. IT IS DESIGNED FOR SERVICE WITH 90 VOLTS OF "B" BATTERY AND A SINGLE DRY CELL "A" BATTERY. ITS RATINGS AND ELECTRICAL CHARACTERISTICS ARE IDENTICAL TO THOSE OF THE PENTODE SECTION OF THE 1D8GT.

RATINGS

MAXIMUM FILAMENT VOLTAGE:

DRY BATTERY OPERATION — VOLTAGE MUST NEVER EXCEED	1.6	VOLTS
AC-DC POWER LINE OPERATION — DESIGN CENTER	1.3	VOLTS
MAXIMUM PLATE VOLTAGE	110	VOLTS
MAXIMUM SCREEN VOLTAGE	110	VOLTS
MAXIMUM CATHODE CURRENT — ZERO SIGNAL	6	MA.

TYPICAL OPERATING CONDITIONS AND CHARACTERISTICS

CLASS A₁ AMPLIFIER

PLATE VOLTAGE	45	62.5	67.5	90	VOLTS
SCREEN VOLTAGE	45	62.5	67.5	90	VOLTS
CONTROL GRID VOLTAGE ^A	-4.0	-6.0	-6.0	-9.0	VOLTS
PEAK AF SIGNAL VOLTAGE	4.5	5.0	6.0	9.0	VOLTS
PLATE CURRENT	1.6	3.8	3.8	5.0	MA.
SCREEN CURRENT	0.3	0.8	0.8	1.0	MA.
PLATE RESISTANCE ^{APPROX.}	0.3	0.2	0.2	0.2	MEG OHM
TRANSCONDUCTANCE	650	875	875	925	μMhos
LOAD RESISTANCE	20000	16000	16000	12000	OHMS
TOTAL HARMONIC DISTORTION	10	10	10	10	PER CENT
POWER OUTPUT	35	90	100	200	MILLIWATTS

^A RETURN TO NEGATIVE FILAMENT (PIN 88)

FOR "INTERPRETATION OF RATINGS" REFER TO FRONT OF BOOK.

PLATE
989-1JAN-31
1941

CONTINUED NEXT PAGE

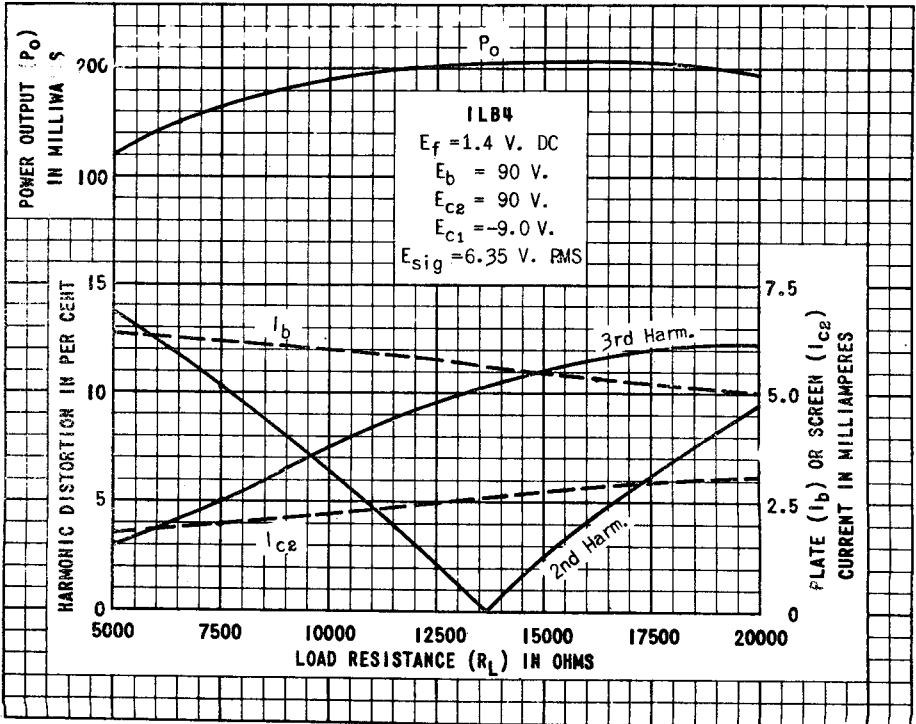
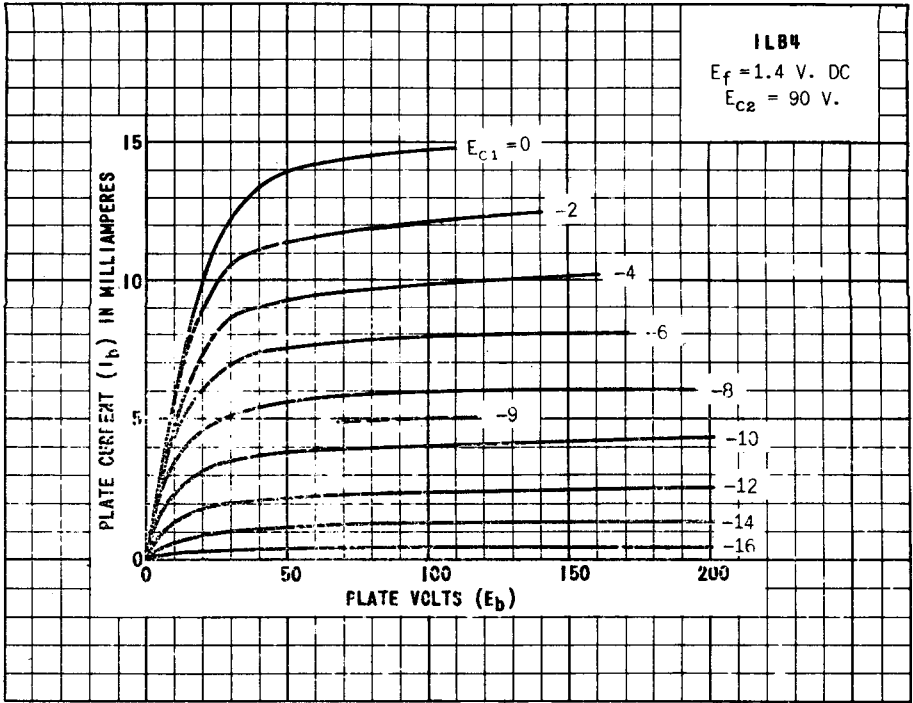

TUNG-SOL

PENTAGRID CONVERTER

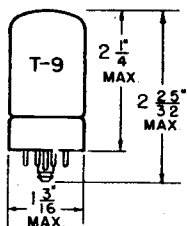

COATED FILAMENT

1.4 VOLTS 0.050 AMPERE

DC

GLASS BULB

ANY MOUNTING POSITION

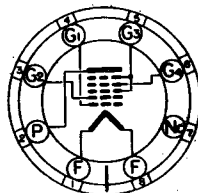

BOTTOM VIEW

LOCKING-IN
8-PIN BASE

THE ILC6 IS A PENTAGRID CONVERTER, DESIGNED FOR SERVICE AS AN OSCILLATOR AND MIXER IN SUPERHETERODYNE RECEIVERS.

RATINGS

INTERPRETED ACCORDING TO RMA STANDARD M8-210

MAXIMUM PLATE VOLTAGE	90	VOLTS
MAXIMUM SCREEN (G3 AND G5) VOLTAGE	35	VOLTS
MAXIMUM SCREEN SUPPLY VOLTAGE	90	VOLTS
MAXIMUM TOTAL CATHODE CURRENT	3.0	MA.
MAXIMUM ANODE GRID (G2) VOLTAGE	45	VOLTS

DIRECT INTERELECTRODE CAPACITANCES

WITH EXTERNAL SHIELD CONNECTED TO NEGATIVE FILAMENT (PIN 8)

SIGNAL GRID (G4) TO MIXER PLATE (P)	0.28	μ f
SIGNAL GRID (G4) TO OSC. PLATE (G2)	0.38	μ f
SIGNAL GRID (G4) TO OSC. GRID (G1)	0.11	μ f
OSC. GRID (G1) TO OSC. PLATE (G2)	0.6	μ f
SIGNAL INPUT: G4 TO ALL OTHER ELECTRODES	9.0	μ f
OSC. INPUT: G1 TO ALL OTHER ELECTRODES EXCEPT G2	2.4	μ f
OSC. OUTPUT: G2 TO ALL OTHER ELECTRODES EXCEPT G1	4.8	μ f
MIXER OUTPUT: P TO ALL OTHER ELECTRODES	5.5	μ f

CONTINUED ON NEXT PAGE

PRINTED IN U. S. A.

PLATE
1533
JAN. 15
1945

CONTINUED FROM PRECEDING PAGE;

TYPICAL OPERATING CONDITIONS AND CHARACTERISTICS

CONVERTER SERVICE

PLATE VOLTAGE	45	90	VOLTS
SCREEN (G3 AND G5) VOLTAGE	35	35	VOLTS
CONTROL GRID (G4) VOLTAGE ^A	0	0	VOLTS
ANODE GRID (G2) VOLTAGE	45	45	VOLTS
PLATE CURRENT	0.7	0.75	MA.
SCREEN CURRENT	0.75	0.7	MA.
ANODE GRID CURRENT	1.4	1.4	MA.
OSC. GRID CURRENT	0.035	0.035	MA.
TOTAL CATHODE CURRENT	2.9	2.9	MA.
OSC. GRID (G1) RESISTOR	0.2	0.2	MEGOHM
CONVERSION TRANSCONDUCTANCE AT EC4 = 0	250	275	μMHOS
CONVERSION TRANSCONDUCTANCE AT EC4 = -2	50	50	μMHOS
CONVERSION TRANSCONDUCTANCE AT EC4 = -3	5.0	5.0	μMHOS
PLATE RESISTANCE	0.3	0.65	MEGOHM

^A UNDER MAXIMUM RATED CONDITIONS THERE SHOULD BE A RESISTANCE OF AT LEAST 1.0 MEGOHM IN THE RETURN TO THE NEGATIVE FILAMENT PIN.

TUNG-SOL

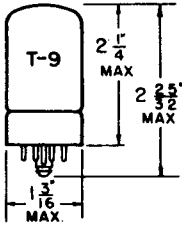

DIODE-AUDIO PENTODE

COATED FILAMENT
1.4 VOLTS 0.050 AMPERE

GLASS BULB

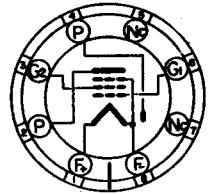

BOTTOM VIEW

LOCKING-IN
8-PIN BASE

ANY MOUNTING POSITION

THE 1LD5 IS A DIODE-AUDIO PENTODE DESIGNED ESPECIALLY FOR SERVICE AS A COMBINED DIODE DETECTOR AND PENTODE AUDIO AMPLIFIER. THE DIODE PLATE IS LOCATED AT THE NEGATIVE END OF THE FILAMENT.

RATINGS

INTERPRETED ACCORDING TO RMA STANDARD M8-220

MAXIMUM PLATE VOLTAGE	90	VOLTS
MAXIMUM SCREEN VOLTAGE	45	VOLTS
MINIMUM DIODE CURRENT WITH 10 VOLTS DC APPLIED	0.5	MA.

DIRECT INTERELECTRODE CAPACITANCES

WITH SHIELD CONNECTED TO NEGATIVE FILAMENT

GRID (G ₁) TO PLATE	0.18 MAX.	μmf
INPUT: G ₁ TO (F+G ₂ +G ₃)	3.2	μmf
OUTPUT: PLATE TO (F+G ₂ +G ₃)	6.0	μmf

TYPICAL OPERATING CONDITIONS AND CHARACTERISTICS

PLATE VOLTAGE	45	90	VOLTS
SCREEN VOLTAGE	45	45	VOLTS
GRID VOLTAGE	0	0	VOLTS
PLATE CURRENT	0.55	0.6	MA.
SCREEN CURRENT	0.12	0.1	MA.
PLATE RESISTANCE	0.9	0.75	MEG OHM
TRANSCONDUCTANCE	550	575	μMHOS

CONTINUED ON NEXT PAGE

PRINTED IN U. S. A.

PLATE
1533
JAN. 15
1945

TUNG-SOL

CONTINUED FROM PRECEDING PAGE

AS RESISTANCE COUPLED AMPLIFIER

PLATE SUPPLY VOLTAGE ^A	40.5	81	VOLTS
SCREEN SUPPLY VOLTAGE ^A	40.5	81	VOLTS
GRID VOLTAGE	0	0	VOLTS
LOAD RESISTOR	1.0	1.0	MEG OHM
SERIES SCREEN RESISTOR	5.0	7.0	MEG OHMS
SCREEN BY-PASS CONDENSER	0.1	0.1	μ f
GRID RESISTOR	5.0	5.0	MEG OHMS
VOLTAGE GAIN (APPROX.)	70	120	

^A "B" SUPPLY VOLTAGE MINUS POWER OUTPUT TUBE BIAS.

TUNG-SOL

TRIODE AMPLIFIER

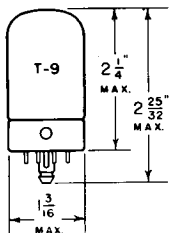

COATED FILAMENT

1.4 VOLTS 0.05 AMPERE
DC

GLASS BULB

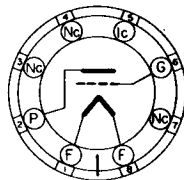

4AA-L-0

LOCKING IN 8 PIN BASE

THE TUNG-SOL 1LE3 IS A LOW VOLTAGE, LOW CURRENT DRAIN, BATTERY TYPE TRIODE. IT IS DESIGNED FOR SERVICE AS AN OSCILLATOR, DETECTOR OR AMPLIFIER IN RECEIVERS USING 90 VOLTS OF "B" BATTERY AND A SINGLE DRY CELL "A" BATTERY.

RATINGS

MAXIMUM FILAMENT VOLTAGE

DRY BATTERY OPERATION—VOLTAGE MUST NEVER EXCEED

1.6 VOLTS

AC—DC POWER LINE OPERATION — DESIGN CENTER

1.3 VOLTS

MAXIMUM PLATE VOLTAGE

110 VOLTS

TYPICAL OPERATING CONDITIONS AND CHARACTERISTICS

CLASS A₁ AMPLIFIER

PLATE VOLTAGE	90	90	VOLTS
CONTROL GRID VOLTAGE ^A	0	-3	VOLTS
PLATE CURRENT	4.5	1.4	MA.
PLATE RESISTANCE	11 200	19 000	OHMS
TRANSCONDUCTANCE	1300	760	μMHOS
AMPLIFICATION FACTOR	14.5	14.5	

DIRECT INTERELECTRODE CAPACITANCES^S

INPUT: GRID TO FILAMENT	1.7	μμf
OUTPUT: PLATE TO FILAMENT	3.0	μμf
GRID TO PLATE	1.7	μμf

^A RETURN TO NEGATIVE FILAMENT TERMINAL (PIN #8).

^S WITH EXTERNAL SHIELD CONNECTED TO NEGATIVE FILAMENT TERMINAL (PIN #8).

PRINTED IN U. S. A.

PLATE
1172-1

FEB. 28
1942



TUNG-SOL

PENTODE VOLTAGE AMPLIFIER

PHYSICAL SPECIFICATIONS

EMITTER COATED FILAMENT		PIN CONNECTIONS	
BASE LOCK-IN 8 PIN		PIN 1 FILAMENT +	PIN 7 Nc
CAP ---		PIN 2 PLATE	PIN 8 FILAMENT- _{S1}
BULB T-9		PIN 3 GRID 2	
MAX. DIAMETER 1 3/16"		PIN 4 GRID 3	MOUNTING POS. ANY
MAX. SEATED HEIGHT 2 1/4"		PIN 5 1C	
MAX. OVERALL LENGTH 2 25/32"		PIN 6 GRID 1	

RATINGS

INTERPRETED ACCORDING TO RMA STANDARD MB-210

MAXIMUM FILAMENT VOLTAGE (DC)		
BATTERY OPERATION (MAX. ALLOWED)	1.6	VOLTS
AC/DC POWER LINE OPERATION	1.3	VOLTS
MAXIMUM PLATE VOLTAGE (DC)	110	VOLTS
MAXIMUM SCREEN VOLTAGE (DC)	110	VOLTS

CAPACITANCES

WITH RMA SHIELD MB-308 CONNECTED TO FILAMENT

CONTROL GRID TO PLATE (MAX.)	0.007	μmf
INPUT	3.2	μmf
OUTPUT	7.0	μmf

TYPICAL OPERATING CONDITIONS AND CHARACTERISTICS

CLASS A1 AMPLIFIER

FILAMENT VOLTAGE (DC)	1.4	VOLTS
FILAMENT CURRENT	0.05	AMP.
PLATE VOLTAGE (DC)	90	VOLTS
SCREEN VOLTAGE (DC)	45	VOLTS
CONTROL GRID VOLTAGE (DC)	0	VOLTS
CONTROL GRID RESISTOR	2.0	MEGOHMS
PLATE CURRENT (DC)	1.7	MA.
SCREEN CURRENT (DC)	0.4	MA.
TRANSCONDUCTANCE	800	μMHOS
PLATE RESISTANCE (APPROX.)	1.0	MEGOHM
CONTROL GRID VOLTAGE FOR $S_m = 10$ μMHOS	-10.0	VOLTS
SUPPRESSOR GRID	CONNECTED TO FILAMENT- AT SOCKET	

PLATE
1697

APRIL 15
1946

ILG5

ILG5

$E_f = 1.4$ Volts
 $E_b = 90$ Volts
 $E_{c2} = 45$ Volts
 $E_{c3} = 0$ Volts

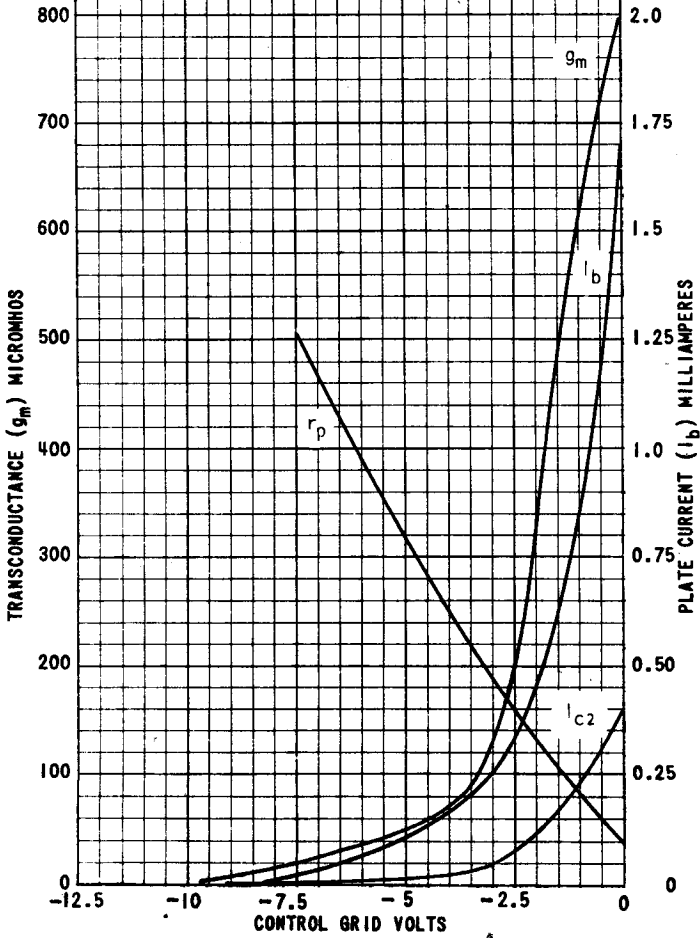
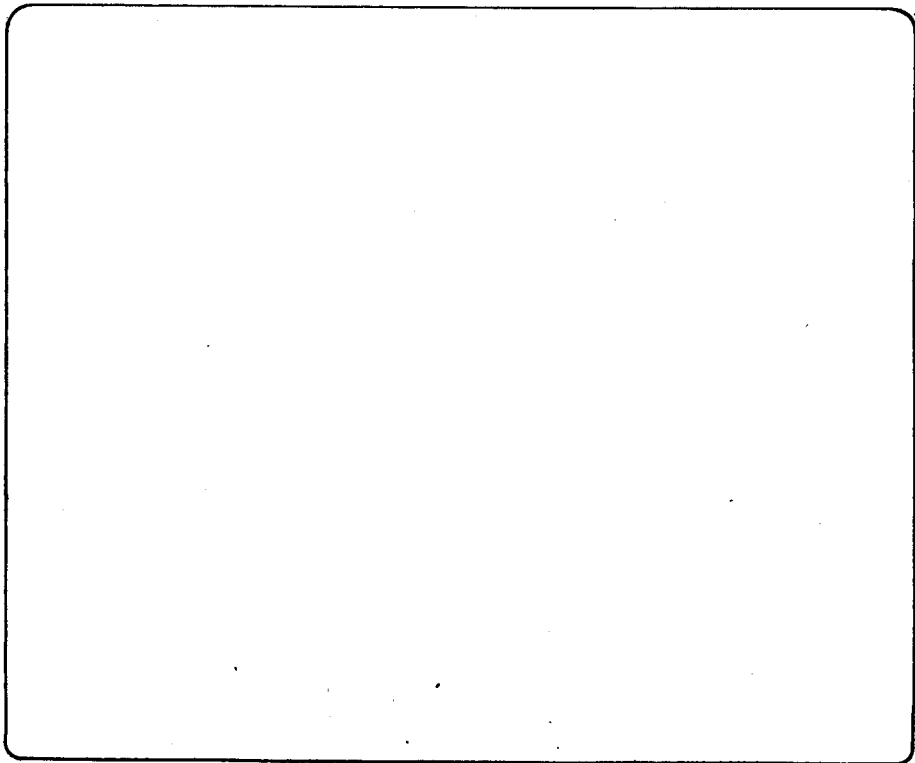
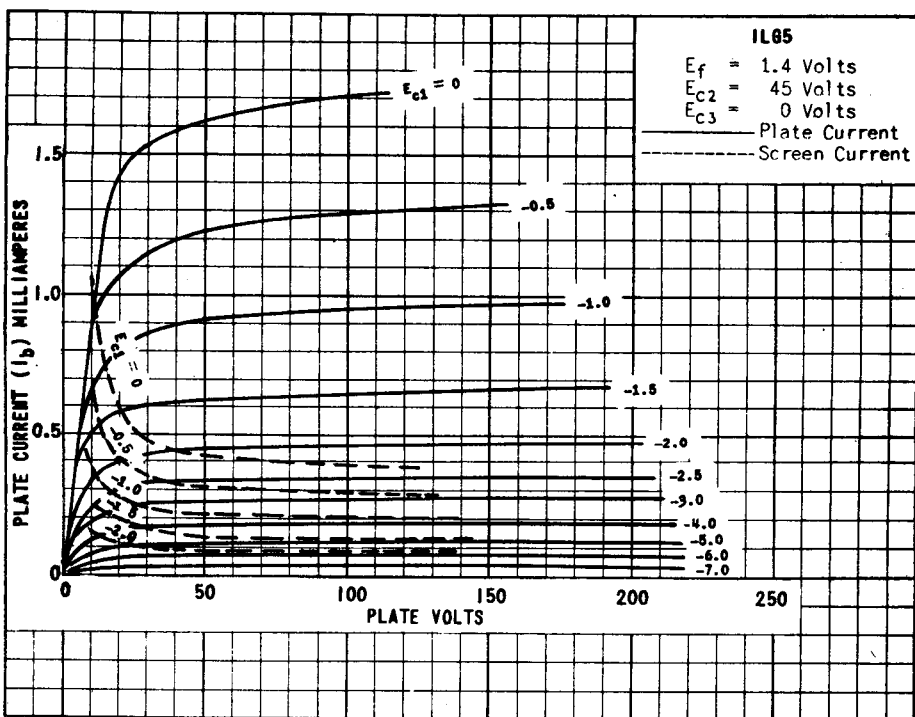

PLATE
 1698
 APRIL
 1946



PRINTED IN U. S. A.

PLATE
 1699
 APRIL 15
 1946



TUNG-SOL

DIODE TRIODE AMPLIFIER

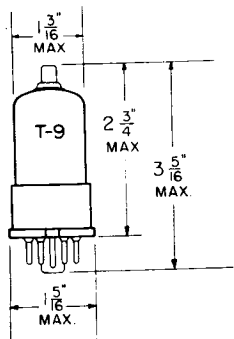

1H5GT/G
SKIRTED
MINIATURE CAP

COATED FILAMENT
1.4 VOLTS 0.05 AMPERE
DC

GLASS BULB

ANY MOUNTING POSITION

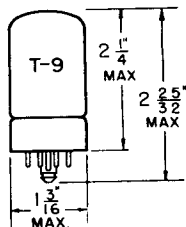

1LH4

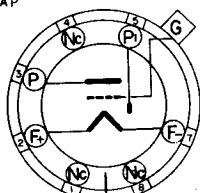

BOTTOM VIEW
7-PIN OCTAL BASE
WITH METAL SHELL

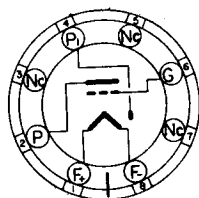

BOTTOM VIEW
LOCKING-IN
8-PIN

THE 1H5GT/G AND 1LH4 ARE TUBES COMBINING A SINGLE DIODE AND A HIGH-MU TRIODE IN ONE BULB. THEY ARE DESIGNED FOR SERVICE AS DIODE DETECTORS, AVC RECTIFIERS, AND AS RESISTANCE COUPLED AMPLIFIERS.

RATINGS

INTERPRETED ACCORDING TO RMA STANDARD M8-210

MAXIMUM PLATE VOLTAGE	110	VOLTS
MINIMUM DIODE CURRENT WITH 10 VOLTS DC APPLIED	0.5	MA.

TYPICAL OPERATING CONDITIONS AND CHARACTERISTICS

CLASS A₁ AMPLIFIER

TRIODE UNIT

PLATE VOLTAGE	90	VOLTS
CONTROL GRID VOLTAGE ^A	0	VOLTS
PLATE CURRENT	0.15	MA.
PLATE RESISTANCE	0.24	MEGOHM
TRANSCONDUCTANCE	275	μMHOS
AMPLIFICATION FACTOR	65	

^A REFERRED TO NEGATIVE FILAMENT TERMINAL

DIODE UNIT

THE DIODE IS LOCATED AT THE NEGATIVE END OF THE FILAMENT AND IS INDEPENDENT OF THE TRIODE UNIT EXCEPT FOR THE COMMON FILAMENT.

PLATE
1537
JAN. 15
1945

1LH4 (1H5GT/G)

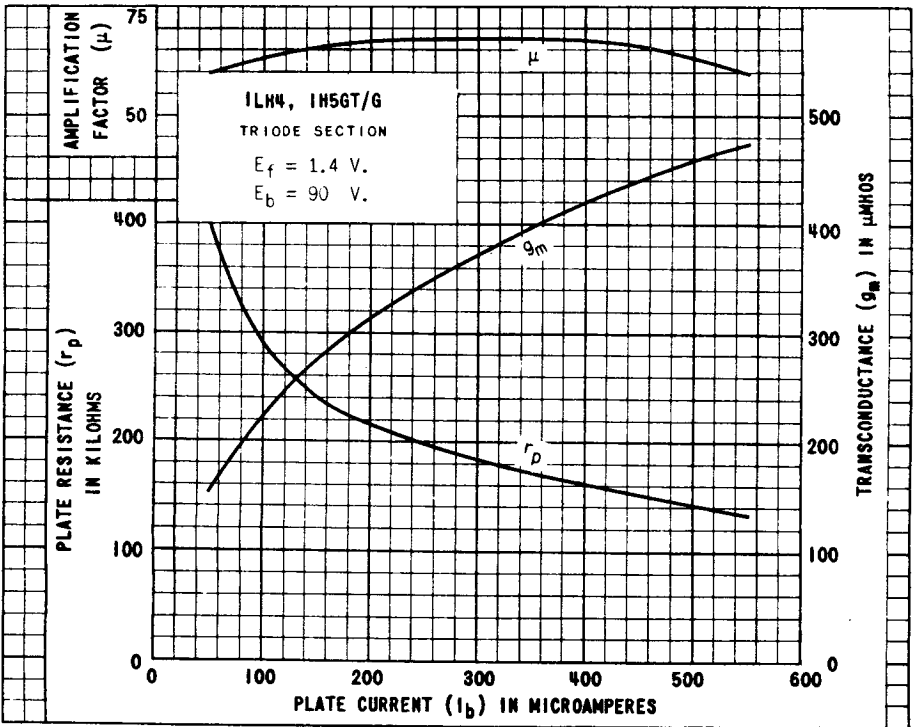
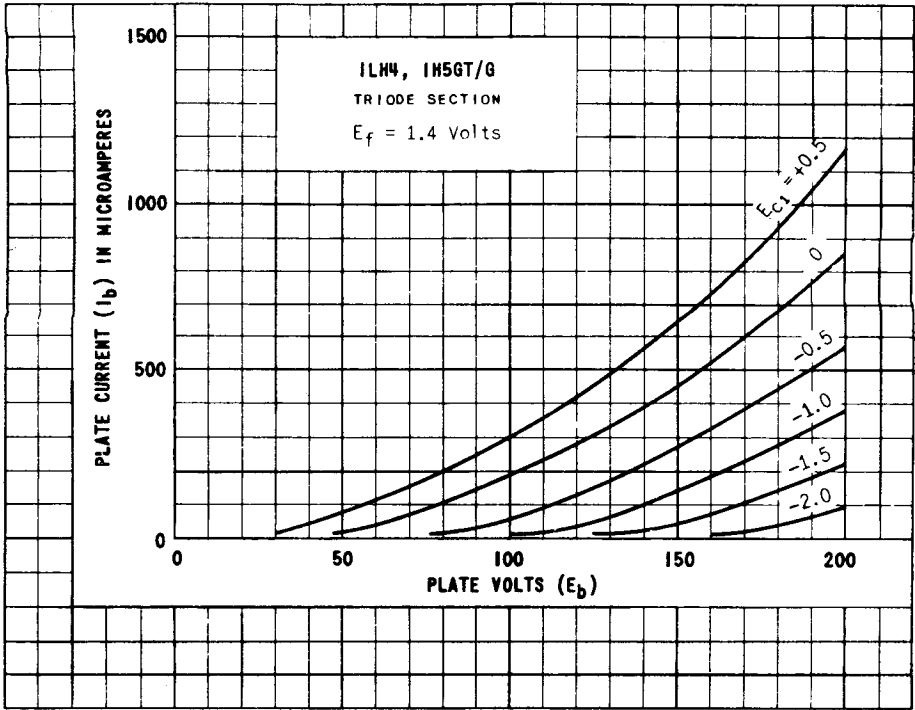
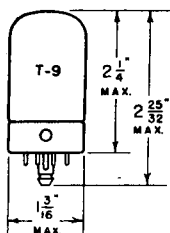

PLATE
1538
JAN. 15
1945

TUNG-SOL

PENTODE AMPLIFIER



COATED FILAMENT
1.4 VOLTS 0.05 AMPERE
DC

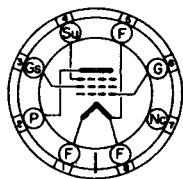

GLASS BULB

7A0

BOTTOM VIEW

LOCKING-IN 8 PIN BASE

THE TUNG-SOL 1LN5 IS A LOW VOLTAGE, LOW CURRENT DRAIN BATTERY TYPE RF PENTODE. IT IS DESIGNED FOR SERVICE WITH 90 VOLTS OF "B" BATTERY AND A SINGLE DRY CELL "A" BATTERY. ITS ELECTRICAL CHARACTERISTICS ARE SIMILAR TO THOSE OF THE 1N5G AND 1N5GT.

RATINGS

MAXIMUM FILAMENT VOLTAGE

DRY BATTERY OPERATION—VOLTAGE MUST NEVER EXCEED	1.6	VOLTS
AC-DC POWER LINE OPERATION—DESIGN CENTER	1.3	VOLTS
MAXIMUM PLATE VOLTAGE	110	VOLTS
MAXIMUM SCREEN VOLTAGE	110	VOLTS

TYPICAL OPERATING CONDITIONS AND CHARACTERISTICS

CLASS A₁ AMPLIFIER

PLATE VOLTAGE	90	VOLTS
SCREEN VOLTAGE	90	VOLTS
CONTROL GRID VOLTAGE ^A	0	VOLTS
SUPPRESSOR GRID VOLTAGE	0	VOLTS
PLATE CURRENT	1.6	MA.
SCREEN CURRENT	0.35	MA.
PLATE RESISTANCE APPROX.	1.1	MEGOHM
TRANSCONDUCTANCE	800	μMHOS
CONTROL GRID VOLTAGE APPROX.	-4.5	VOLTS
FOR TRANSCONDUCTANCE = 10 μMHOS		

^A RETURN TO NEGATIVE FILAMENT (PIN #5 AND #8).

FOR "INTERPRETATION OF RATINGS" REFER TO FRONT OF BOOK.

CONTINUED NEXT PAGE

PLATE
1038-2
JUNE 6
1941

PRINTED IN U. S. A.

TUNG-SOL

DIRECT INTERELECTRODE CAPACITANCES⁵

CONTROL GRID TO FILAMENT	3.4	μf
PLATE TO FILAMENT	8.0	μf
CONTROL GRID TO PLATE	0.007 ^{MAX.}	μf

⁵ WITH EXTERNAL SHIELD CONNECTED TO NEGATIVE FILAMENT (PIN 95 AND 96).

TUNG-SOL

PENTODE AMPLIFIER

COATED FILAMENT

1.4 VOLTS 0.05 AMPERE
DC

GLASS BULBS

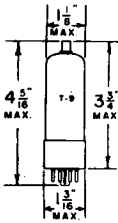

SMALL
7 PIN
OCTAL BASE
IN5G

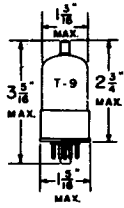

7 PIN
OCTAL BASE
WITH METAL SHELL
IN5GT

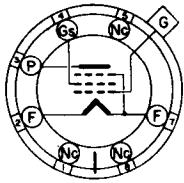

G-5Y

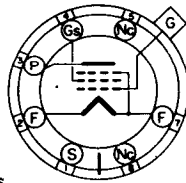

5Y

BOTTOM VIEWS

THE TUNG-SOL IN5G AND IN5GT ARE LOW VOLTAGE, LOW CURRENT DRAIN BATTERY TYPE RF PENTODES. THEY ARE DESIGNED FOR SERVICE WITH 90 VOLTS OF "B" BATTERY AND A SINGLE DRY CELL "A" BATTERY. THEIR ELECTRICAL CHARACTERISTICS ARE SIMILAR TO THOSE OF THE 1LN5.

RATINGS

MAXIMUM FILAMENT VOLTAGE

DRY BATTERY OPERATION - VOLTAGE MUST NEVER EXCEED	1.6	VOLTS
AC - DC POWER LINE OPERATION - DESIGN CENTER	1.3	VOLTS
MAXIMUM PLATE VOLTAGE	110	VOLTS
MAXIMUM SCREEN VOLTAGE	110	VOLTS

DIRECT INTERELECTRODE CAPACITANCES⁵

CONTROL GRID TO FILAMENT	3.0	μμf
PLATE TO FILAMENT	10	μμf
CONTROL GRID TO PLATE	.007 MAX.	μμf

⁵ WITH EXTERNAL SHIELD CONNECTED TO NEGATIVE FILAMENT (PIN #7).

FOR "INTERPRETATION OF RATINGS" REFER TO FRONT OF BOOK.

TYPICAL OPERATING CONDITIONS AND CHARACTERISTICS

CLASS A₁ AMPLIFIER

PLATE VOLTAGE	90	VOLTS
SCREEN VOLTAGE	90	VOLTS
CONTROL GRID VOLTAGE ^A	0	VOLTS
PLATE CURRENT	1.2	MA.
SCREEN CURRENT	0.3	MA.
PLATE RESISTANCE APPROX.	1.5	MEGOHM
TRANSCONDUCTANCE	750	μMHOS
CONTROL GRID VOLTAGE	-3.2	VOLTS
FOR TRANSCONDUCTANCE = 50 μMHOS		
CONTROL GRID VOLTAGE APPROX.	-4.0	VOLTS
FOR TRANSCONDUCTANCE = 5 μMHOS		

^A RETURN TO NEGATIVE FILAMENT.

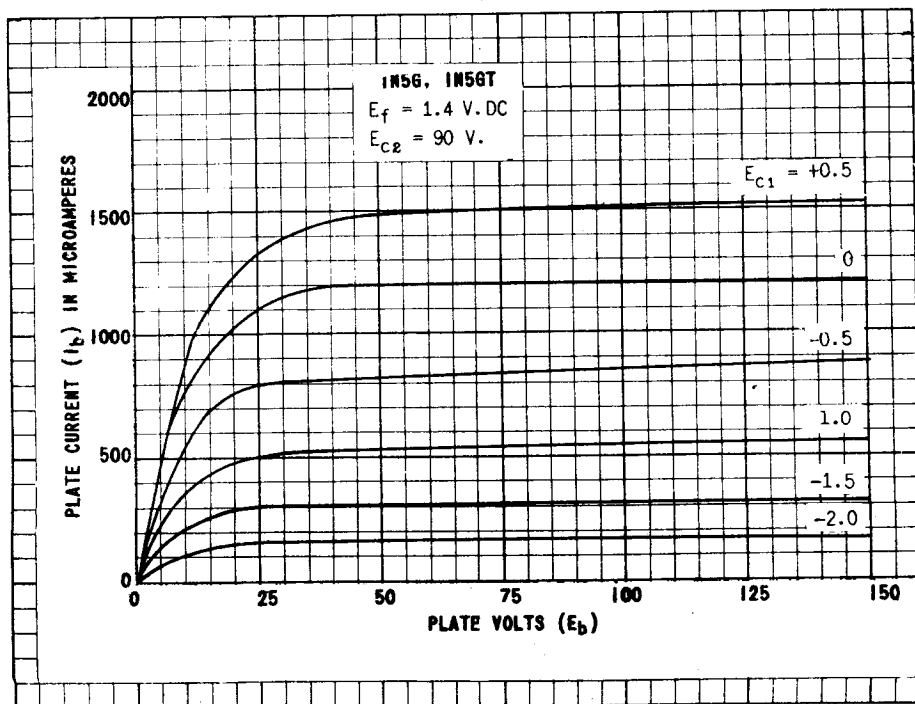

TUNG-SOL

DIODE-POWER PENTODE AMPLIFIER

COATED FILAMENT

1.4 VOLTS 0.05 AMPERE
DC

GLASS BULB

SMALL 8 PIN OCTAL BASE

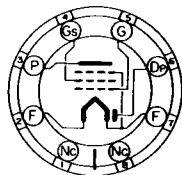
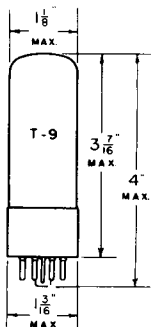

G-7AM

BOTTOM VIEW

THE TUNG-SOL IN6G IS A LOW VOLTAGE, LOW CURRENT DRAIN BATTERY TYPE POWER PENTODE WITH A SINGLE DIODE SECTION. IT IS DESIGNED FOR SERVICE WITH 90 VOLTS OF "B" BATTERY AND A SINGLE DRY CELL "A" BATTERY.

RATINGS

MAXIMUM FILAMENT VOLTAGE

DRY BATTERY OPERATION—VOLTAGE MUST NEVER EXCEED

1.6 VOLTS

AC-DC POWER LINE OPERATION—DESIGN CENTER

1.3 VOLTS

MAXIMUM PLATE VOLTAGE

110 VOLTS

MAXIMUM SCREEN VOLTAGE

110 VOLTS

MAXIMUM TOTAL CATHODE CURRENT OF THE PENTODE SECTION

ZERO-SIGNAL

6 MA.

MINIMUM DIODE CURRENT^A

0.5 MA.

WITH 10 VOLTS DC APPLIED

TYPICAL OPERATING CONDITIONS AND CHARACTERISTICS

CLASS A₁ AMPLIFIER

PLATE VOLTAGE	90	VOLTS
SCREEN VOLTAGE	90	VOLTS
CONTROL GRID VOLTAGE ^B	-4.5	VOLTS
PEAK AF SIGNAL VOLTAGE	4.9	VOLTS
ZERO-SIGNAL PLATE CURRENT	3.4	MA.
ZERO-SIGNAL SCREEN CURRENT	0.7	MA.
MAXIMUM-SIGNAL PLATE CURRENT	3.4	MA.
MAXIMUM-SIGNAL SCREEN CURRENT	1.2	MA.
PLATE RESISTANCE APPROX.	0.3	MEG OHM
TRANSCONDUCTANCE	800	μMHOS
LOAD RESISTANCE	25 000	OHMS
TOTAL HARMONIC DISTORTION	7	PER CENT
POWER OUTPUT — AT PEAK SIGNAL	100	MILLIWATTS

^A DIODE PLATE LOCATED AT THE NEGATIVE END OF THE FILAMENT (PIN #7).

^B RETURN TO NEGATIVE FILAMENT (PIN #7).

FOR "INTERPRETATION OF RATINGS" REFER TO FRONT OF BOOK.

PRINTED IN U. S. A.

PLATE 1012-2
APR. 21 1941

TUNG-SOL

PENTODE AMPLIFIER

COATED FILAMENT

1.4 VOLTS 0.05 AMPERE
DC

GLASS BULB

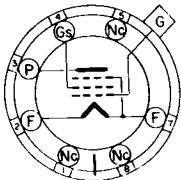
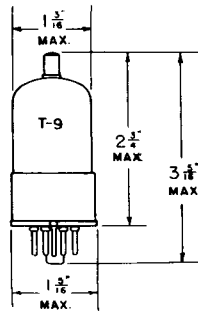
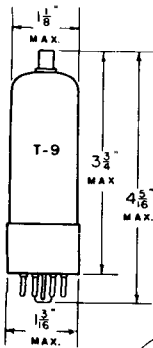

G-5Y

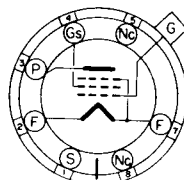

5Y

BOTTOM VIEWS

THE TUNG-SOL 1P5G AND 1P5GT ARE LOW VOLTAGE, LOW CURRENT DRAIN BATTERY TYPE RF PENTODES. WITH THE EXCEPTION OF CAPACITANCES, THEIR ELECTRICAL CHARACTERISTICS ARE IDENTICAL.

RATINGS

MAXIMUM FILAMENT VOLTAGE

DRY BATTERY OPERATION - VOLTAGE MUST NEVER EXCEED 1.6 VOLTS

AC/DC POWER LINE OPERATION - DESIGN CENTER 1.3 VOLTS

MAXIMUM PLATE VOLTAGE 110 VOLTS

MAXIMUM SCREEN VOLTAGE 110 VOLTS

DIRECT INTERELECTRODE CAPACITANCES⁵

CONTROL GRID TO FILAMENT	1P5G - 2.2 μ f	1P5GT - 3 μ f
PLATE TO FILAMENT	10	μ f
CONTROL GRID TO PLATE	.007	μ f

⁵ WITH EXTERNAL SHIELD CONNECTED TO NEGATIVE FILAMENT (PIN #7).

TYPICAL OPERATING CONDITIONS AND CHARACTERISTICS

CLASS A₁ AMPLIFIER

PLATE VOLTAGE	90	VOLTS
SCREEN VOLTAGE	90	VOLTS
CONTROL GRID VOLTAGE	RETURN TO NEGATIVE FILAMENT	
PLATE CURRENT	2.3	MA.
SCREEN CURRENT	0.7	MA.
PLATE RESISTANCE	APPROX. 0.8	MEG OHM
TRANSCONDUCTANCE	750	μ MHOS
CONTROL GRID VOLTAGE FOR	- 12	VOLTS
TRANSCONDUCTANCE OF 10 μ MHOS		

FOR "INTERPRETATION OF RATINGS" REFER TO FRONT OF BOOK.

PLATE
1013-2

APR. 21
1941

TUNG-SOL

BEAM POWER AMPLIFIER

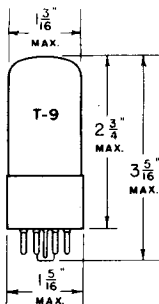

COATED FILAMENT

1.4 VOLTS 0.10 AMPERE
DC

GLASS BULB

INTERMEDIATE 7 PIN OCTAL BASE

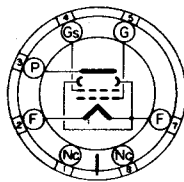

6 AF

BOTTOM VIEW

THE TUNG-SOL 1Q5GT/G IS A LOW VOLTAGE, LOW CURRENT DRAIN BATTERY TYPE BEAM POWER OUTPUT TUBE. IT IS DESIGNED FOR SERVICE WITH 90 VOLTS OF "B" BATTERY AND A SINGLE DRY CELL "A" BATTERY.

RATINGS

MAXIMUM FILAMENT VOLTAGE

DRY BATTERY OPERATION-VOLTAGE MUST NEVER EXCEED	1.6	VOLTS
AC -DC POWER LINE OPERATION-DESIGN CENTER	1.3	VOLTS
MAXIMUM PLATE VOLTAGE	110	VOLTS
MAXIMUM SCREEN VOLTAGE	110	VOLTS
MAXIMUM CATHODE CURRENT (ZERO-SIGNAL)	12	MA.

TYPICAL OPERATING CONDITIONS AND CHARACTERISTICS

CLASS A₁ AMPLIFIER

FILAMENT VOLTAGE	1.4 DC	1.4 DC	VOLTS
FILAMENT CURRENT	0.10	0.10	AMPERE
PLATE VOLTAGE	85	90	VOLTS
SCREEN VOLTAGE	85	90	VOLTS
CONTROL GRID VOLTAGE ^A	-5	-4.5	VOLTS
PEAK AF SIGNAL VOLTAGE	5	4.5	VOLTS
ZERO-SIGNAL PLATE CURRENT	7	9.5	MA.
ZERO-SIGNAL SCREEN CURRENT (NOMINAL)	0.8	1.3	MA.
TRANSCONDUCTANCE	1950	2200	μMHOS
LOAD RESISTANCE	9000	8000	OHMS
TOTAL HARMONIC DISTORTION	5.5	6.0	PER CENT
POWER OUTPUT	250	270	MILLIWATTS

^A GRID RETURN SHOULD BE MADE TO NEGATIVE SIDE OF FILAMENT, PIN #7.

FOR "INTERPRETATION OF RATINGS" REFER TO FRONT OF BOOK.

CONTINUED NEXT PAGE

1Q5GT/G

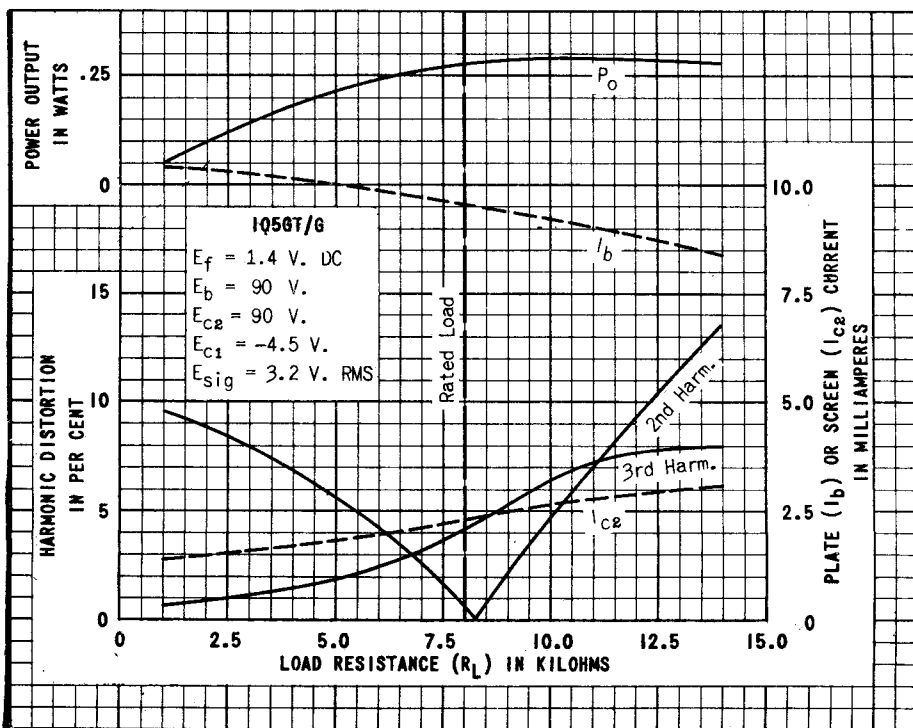
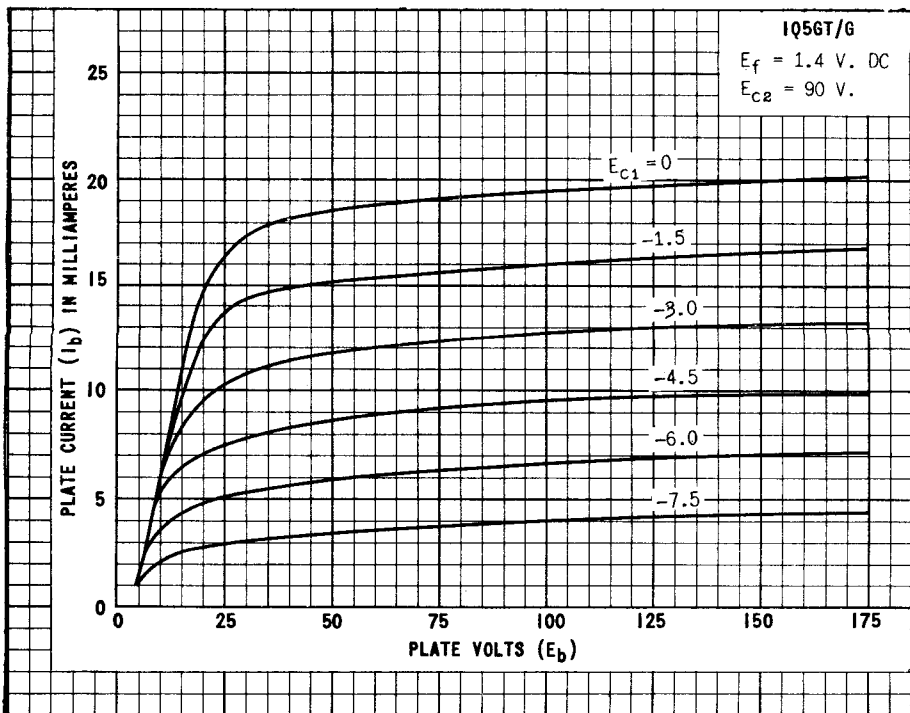

TUNG-SOL

PENTAGRID CONVERTER
MINIATURE TYPE

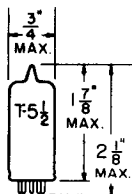

GLASS BULB

COATED FILAMENT

FILAMENT

1.4 VOLTS 0.05 AMPERE
 DC

ANY MOUNTING POSITION

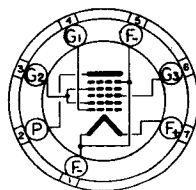

BOTTOM VIEW

MINIATURE BUTTON
 7 PIN BASE

THE 1R5 IS A PENTAGRID CONVERTER DESIGNED FOR SERVICE AS COMBINED OSCILLATOR AND MIXER IN COMPACT, LIGHT-WEIGHT, PORTABLE BATTERY OPERATED EQUIPMENT. IT FEATURES A HIGH EFFICIENCY FILAMENT, ADAPTIBILITY TO AVC AND PROVIDES REASONABLE CONVERSION GAIN WITH LOW BATTERY VOLTAGES AND LOW ELECTRODE CURRENTS. IT IS RECOMMENDED THAT NO MATERIAL BE PERMITTED TO OBSTRUCT THE HOLE IN THE BASE SOCKET AS THIS TYPE MAY BE MANUFACTURED WITH THE EXHAUST-TUBE TIP AT THE BASE END.

RATINGS

INTERPRETED ACCORDING TO RMA STANDARD M8-210

FILAMENT VOLTAGE	1.4	VOLTS
FILAMENT CURRENT	0.05	AMP.
MAXIMUM PLATE VOLTAGE	90	VOLTS
MAXIMUM SCREEN (G ₂ AND G ₄) VOLTAGE	67.5	VOLTS
MAXIMUM SCREEN (G ₂ AND G ₄) SUPPLY VOLTAGE	90	VOLTS
MINIMUM CONTROL GRID (G ₃) VOLTAGE (REFERRED TO F-)	0	VOLTS
MAXIMUM ZERO-SIGNAL TOTAL CATHODE CURRENT	5.5	MA.

DIRECT INTERELECTRODE CAPACITANCES

WITH NO EXTERNAL SHIELD

CONTROL GRID (G ₃) TO PLATE (MAX.)	0.4	μuf
OSCILLATOR GRID (G ₄) TO PLATE (MAX.)	0.1	μuf
OSCILLATOR GRID (G ₄) TO CONTROL GRID (G ₃) (MAX.)	0.2	μuf
CONTROL GRID (G ₃) TO ALL OTHER ELECTRODES (RF INPUT)	7.0	μuf
OSCILLATOR GRID (G ₄) TO ALL OTHER ELECTRODES (OSC. INPUT)	3.8	μuf
PLATE TO ALL OTHER ELECTRODES (MIXER OUTPUT)	7.5	μuf

CONTINUED ON FOLLOWING PAGE

→ INDICATES A CHANGE OR ADDITION

PLATE
 1738
 NOV. 1,
 1946

TUNG-SOL

CONTINUED FROM PRECEDING PAGE

TYPICAL OPERATING CONDITIONS AND CHARACTERISTICS

CONVERTER SERVICE

PLATE VOLTAGE	45	67.5	90	90	VOLTS
SCREEN (G ₂ AND G ₄) VOLTAGE	45	67.5	45	67.5	VOLTS
CONTROL GRID (G ₃) VOLTAGE	0	0	0	0	VOLTS
PLATE CURRENT	0.7	1.4	0.8	1.6	MA.
SCREEN (G ₂ AND G ₄) CURRENT	1.9	3.2	1.9	3.2	MA.
OSCILLATOR GRID (G ₁) CURRENT	0.15	0.25	0.15	0.25	MA.
TOTAL CATHODE CURRENT	2.75	5.0	2.75	5.0	MA.
OSCILLATOR GRID (G ₁) RESISTOR	0.1	0.1	0.1	0.1	MEGOHM
PLATE RESISTANCE (APPROX.)	0.6	0.5	0.8	0.6	MEGOHM
CONVERSION TRANSDUCANCE FOR CONTROL GRID (G ₃) VOLTAGE = 0 VOLTS	235	280	250	300	μMHOS
CONTROL GRID (G ₃) BIAS (APPROX.) FOR CONVERSION TRANSDUCANCE = 5.0 μMHOS	-9	-14	-9	-14	VOLTS

OSCILLATOR TRANSDUCANCE NOT OSCILLATING

CONTROL GRID (G ₃) VOLTAGE	0	VOLTS
OSCILLATOR GRID (G ₁) VOLTAGE	0	VOLTS
SCREEN (G ₂ AND G ₄) CONNECTED TO PLATE	67.5	VOLTS
PLATE AND SCREEN (G ₂ AND G ₄) CURRENT	8.5	MA.
PLATE RESISTANCE (APPROX.)	2000	OHMS
TRANSDUCANCE BETWEEN OSCILLATOR GRID (G ₁) AND SCREEN (G ₂ AND G ₄) TIED TO PLATE (APPROX.)	1400	μMHOS
AMPLIFICATION FACTOR	7	

IR5

E_f = 1.4 Volts DC

CURVE	PLATE VOLTS	GRIDS 2 & 4 VOLTS	GRID 1 RESISTOR MEG OHM	GRID 1 CURRENT μAMP
1	45	45	0.1	150
2	90	45	0.1	150
3	67.5	67.5	0.1	250
4	90	67.5	0.1	250

OSCILLATOR VOLTAGE ON GRIDS 2 & 4 AND ON FILAMENT = 0 VOLTS.

^A OBTAINED BY ADJUSTMENT OF OSCILLATOR GRID (GRID 1) VOLTAGE TO GIVE INDICATED VALUES.

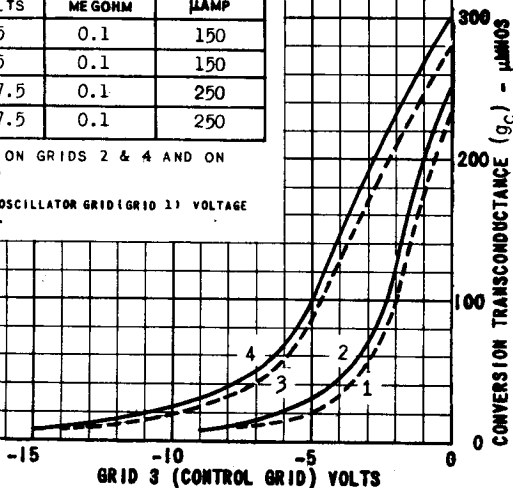

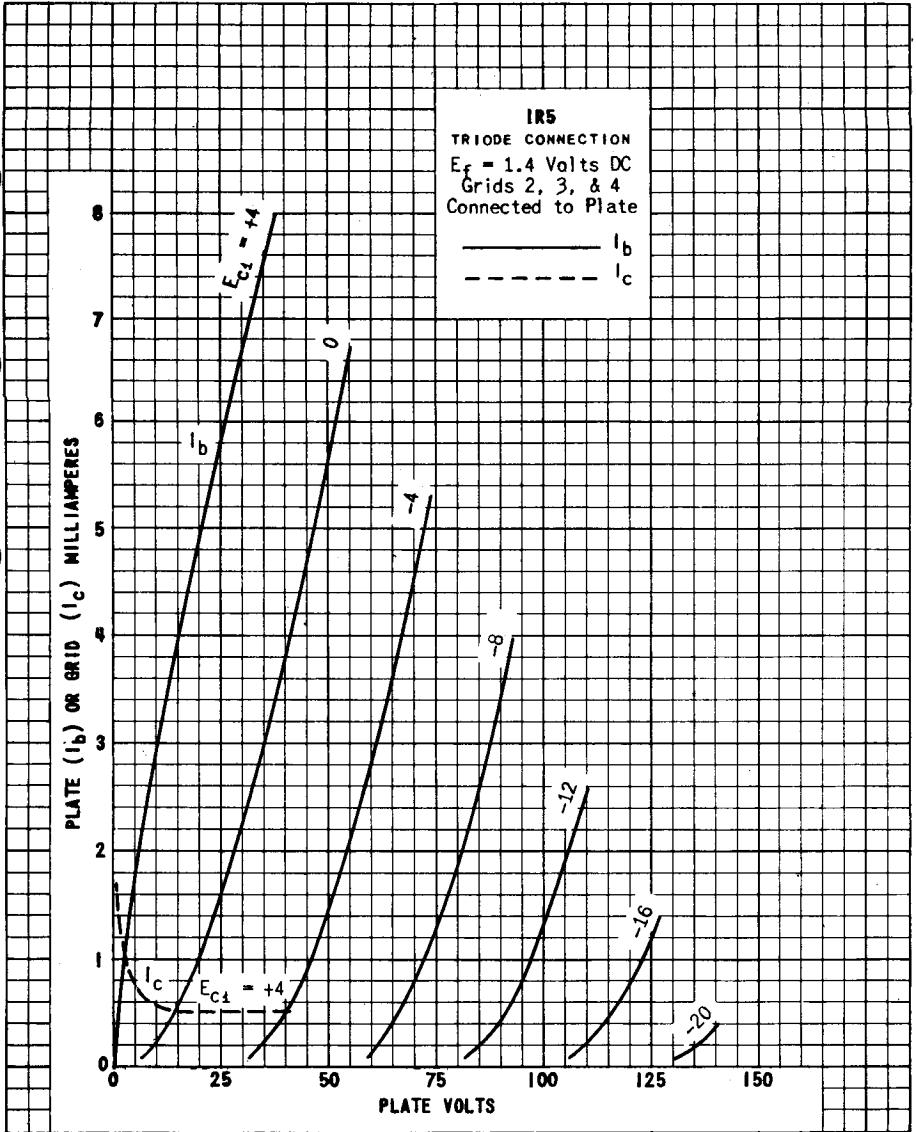

PRINTED IN U. S. A.

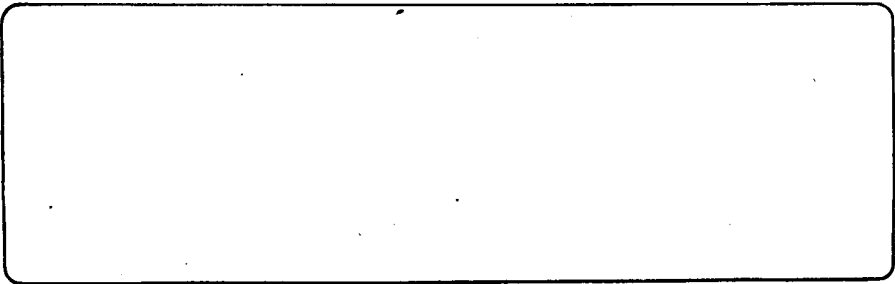
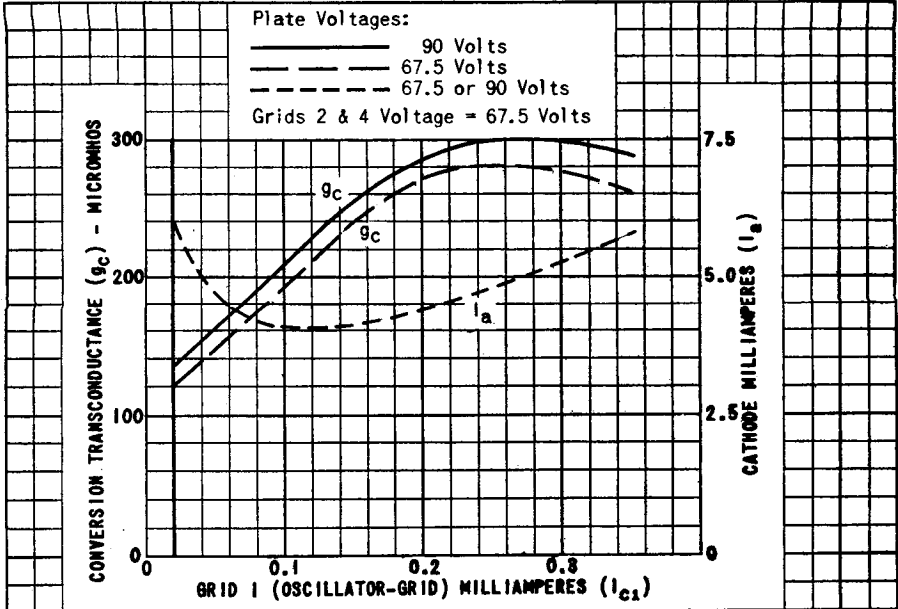

PLATE
 1740
 NOV. 1,
 1946



1R5

$E_f = 1.4$ Volts DC

Grid 3 Voltage = 0 Volts

Oscillator Voltage on Grids 2 & 4 & on Fil. = 0 Volts

Grid 1 Resistor = 0.1 Meg.

Recommended Min. $I_{c1} = 0.02$ Ma.

Grid 1 Current Varied by Adjustment of Oscillator Voltage.

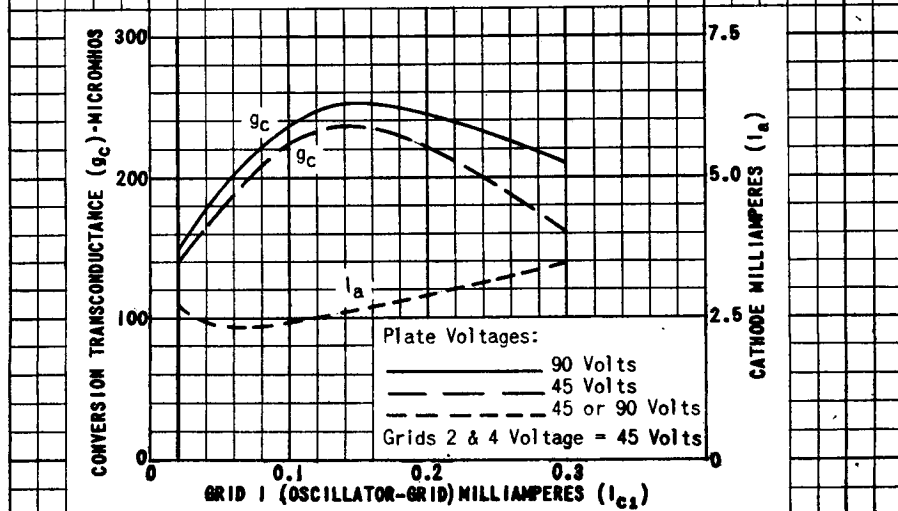
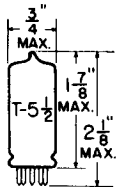

PLATE
1741
NOV. 1,
1946

TUNG-SOL

POWER AMPLIFIER PENTODE



GLASS BULB

COATED FILAMENT

FILAMENT

1.4 VOLTS 0.1 AMPERE
DC

ANY MOUNTING POSITION

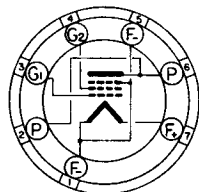

BOTTOM VIEW

MINIATURE BUTTON
7 PIN BASE

THE 1S4 IS A POWER AMPLIFIER PENTODE OF THE MINIATURE CONSTRUCTION, ESPECIALLY DESIGNED FOR OUTPUT SERVICE IN COMPACT, LIGHT-WEIGHT PORTABLE EQUIPMENT. THE HIGH OPERATING EFFICIENCY ALLOWS THE TUBE TO BE USED EXTREMELY LOW B SUPPLY VOLTAGES.

RATINGS

INTERPRETED ACCORDING TO RMA STANDARD MB-210

FILAMENT VOLTAGE	1.4	VOLTS
MAXIMUM PLATE VOLTAGE	90	VOLTS
MAXIMUM GRID #2 VOLTAGE	67.5	VOLTS
MAXIMUM CATHODE CURRENT (MAX.-SIGNAL)	11	MA.
MAXIMUM CATHODE CURRENT (ZERO-SIGNAL)	9	MA.

TYPICAL OPERATING CONDITIONS AND CHARACTERISTICS

CLASS A₁ AMPLIFIER

FILAMENT VOLTAGE	1.4	1.4	1.4	VOLTS
FILAMENT CURRENT	0.10	0.10	0.10	AMP.
PLATE VOLTAGE	45	67.5	90	VOLTS
GRID #2 VOLTAGE	45	67.5	67.5	VOLTS
GRID #4 VOLTAGE (REFERRED TO NEG. FIL. TERMINAL)	-4.5	-7	-7	VOLTS
PEAK AF GRID VOLTAGE	4.5	7	7	VOLTS
ZERO-SIGNAL PLATE CURRENT	3.8	7.2	7.4	MA.
ZERO-SIGNAL GRID #2 CURRENT	0.8	1.5	1.4	MA.
PLATE RESISTANCE (APPROX.)	0.1	0.1	0.1	MEGOHM
TRANSCONDUCTANCE	1 250	1 550	1 575	μMHOS
LOAD RESISTANCE	8 000	5 000	8 000	OHMS
TOTAL HARMONIC DISTORTION	12	10	12	PERCENT
MAXIMUM-SIGNAL POWER OUTPUT	0.065	0.18	0.27	WATTS

SIMILAR TYPE REFERENCE: Characteristics somewhat similar to type 354.

→ INDICATES A CHANGE OR ADDITION.

PRINTED IN U. S. A.

PLATE
1827
JUNE 2,
1947

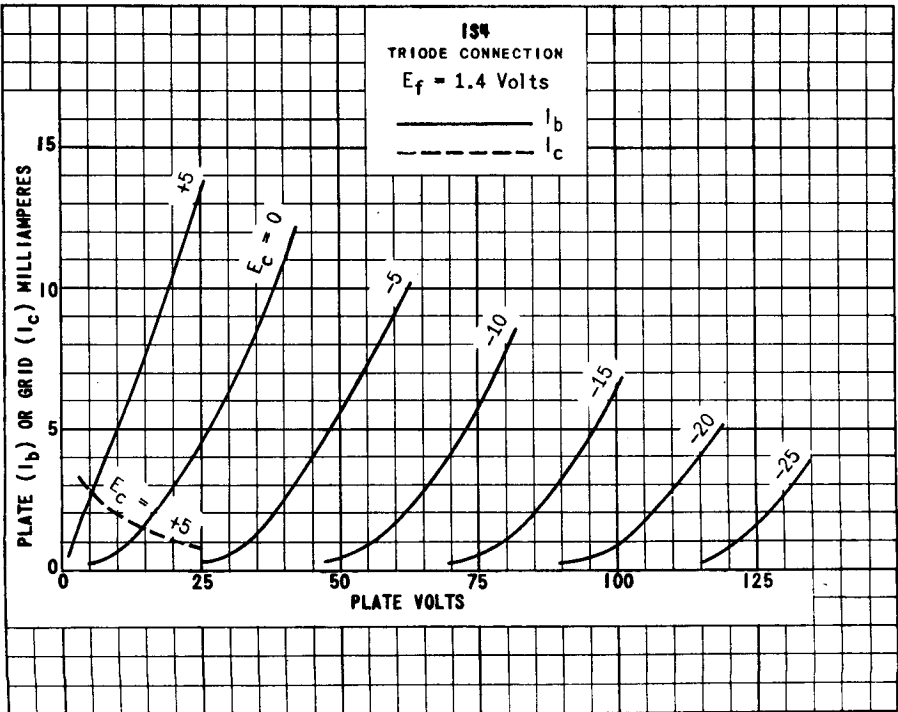
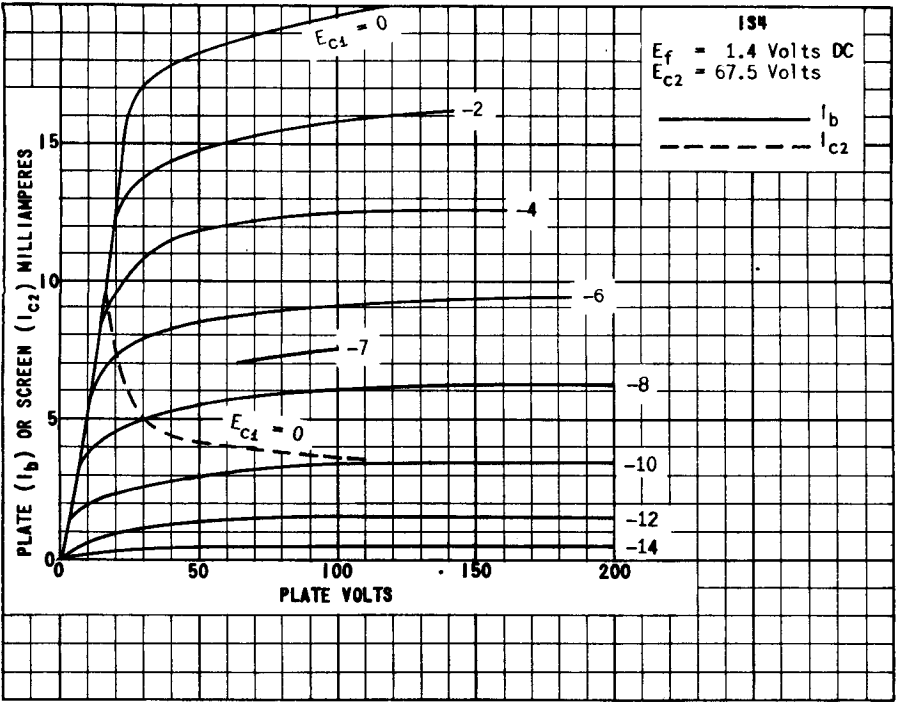
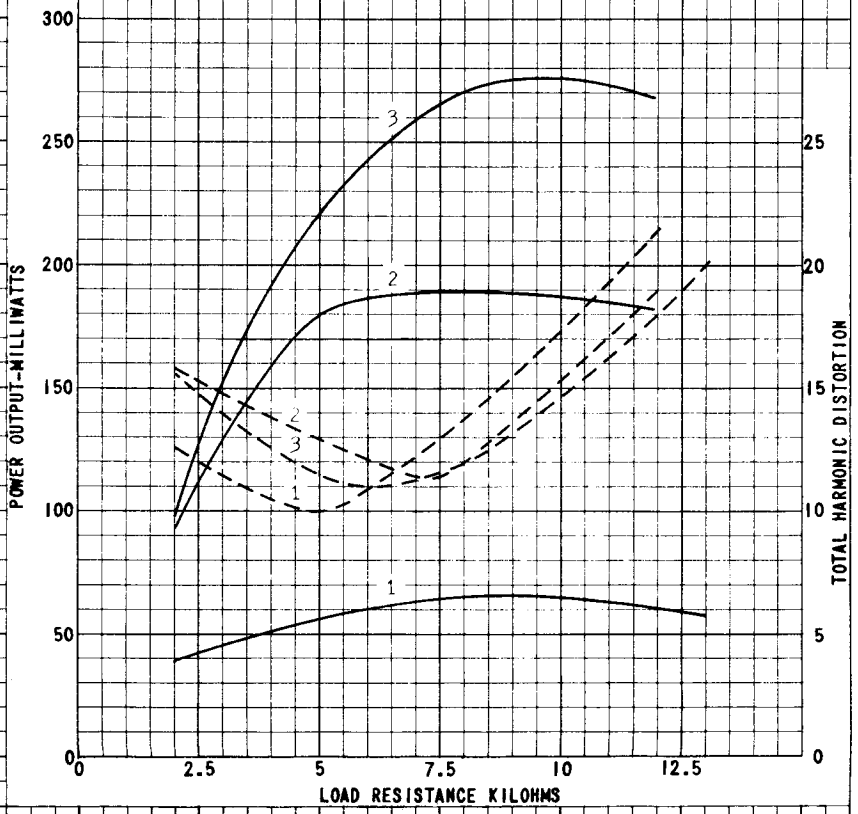

PLATE 1828
 JUNE 2, 1947

IS4
E_f = 1.4 Volts DC

CURVE	PLATE VOLTS	SCREEN VOLTS	GRID VOLTS	SIGNAL VOLTS
1	45	45	-4.5	3.2
2	67.5	67.5	-7	4.95
3	90	67.5	-7	4.95

————— P_o
 - - - - - Dist.



PRINTED IN U. S. A.

PLATE 1829
JUNE 2, 1947



TUNG-SOL

DIODE PENTODE AMPLIFIER
MINIATURE TYPE

COATED FILAMENT

FILAMENT

1.4 VOLTS 0.05 AMPERE
DC

ANY MOUNTING POSITION

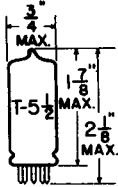

GLASS BULB

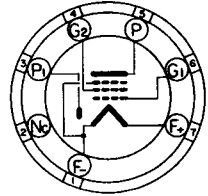

BOTTOM VIEW
MINIATURE BUTTON
7-PIN BASE

THE IS5 IS A DIODE PENTODE AMPLIFIER ESPECIALLY DESIGNED FOR DETECTOR-AUDIO SERVICE IN COMPACT, LIGHT-WEIGHT, PORTABLE EQUIPMENT. THE HIGH OPERATING EFFICIENCY ALLOWS IT TO BE USED WITH EXTREMELY LOW PLATE-SUPPLY VOLTAGE.

RATINGS

INTERPRETED ACCORDING TO RMA STANDARD MB-210

FILAMENT VOLTAGE	1.4	VOLTS
FILAMENT CURRENT	0.05	AMP.
MAXIMUM PLATE VOLTAGE	90	VOLTS
MAXIMUM SCREEN VOLTAGE	90	VOLTS
MINIMUM GRID VOLTAGE	0	VOLTS
MAXIMUM SIGNAL MAXIMUM TOTAL CATHODE CURRENT	4.5	MA.
MAXIMUM DIODE CURRENT (CONTINUOUS OPERATION)	0.25	MA.

DIRECT INTERELECTRODE CAPACITANCES - APPROX.
WITH NO EXTERNAL SHIELD

GRID TO PLATE	0.2	$\mu\mu\text{f}$
INPUT	2.2	$\mu\mu\text{f}$
OUTPUT	2.4	$\mu\mu\text{f}$

TYPICAL OPERATING CONDITIONS AND CHARACTERISTICS

PENTODE UNIT - CLASS A_1 AMPLIFIER

PLATE VOLTAGE	67.5	90	VOLTS
SCREEN VOLTAGE	67.5	90	VOLTS
GRID VOLTAGE	0	0	VOLTS
PLATE CURRENT	1.6	2.7	MA.
SCREEN CURRENT	0.4	0.5	MA.
PLATE RESISTANCE (APPROX.)	0.6	0.5	MEGOHM
TRANSCONDUCTANCE	625	720	μMHOS

CONTINUED ON FOLLOWING PAGE

→ INDICATES A CHANGE OR ADDITION.

TUNG-SOL

CONTINUED FROM PRECEDING PAGE

TYPICAL OPERATING CONDITIONS AND CHARACTERISTICS

RESISTANCE COUPLED AMPLIFIER

PLATE SUPPLY VOLTAGE	45	67.5	90	VOLTS
SCREEN SUPPLY VOLTAGE	45	67.5	90	VOLTS
GRID VOLTAGE	0	0	0	VOLTS
GRID RESISTOR	10	10	10	MEGOHMS
LOAD RESISTANCE	1	1	1	MEGOHM
SERIES SCREEN RESISTOR	3	3	3	MEGOHMS
SCREEN BY-PASS CONDENSER	0.1	0.1	0.1	μ f
VOLTAGE GAIN (APPROX.) ^A	30	40	50	

^A OBTAINED WHEN THE GRID OF THE PENTODE UNIT IS FED FROM A SOURCE HAVING AN IMPEDANCE OF 1.0 MEGOHM.

DIODE UNIT

THE DIODE UNIT IS LOCATED AT THE NEGATIVE END OF THE FILAMENT AND IS INDEPENDENT OF THE PENTODE UNIT EXCEPT FOR THE COMMON FILAMENT.

SIMILAR TYPE REFERENCE: Ratings and characteristics identical to 1D5; somewhat similar to 1LD5.

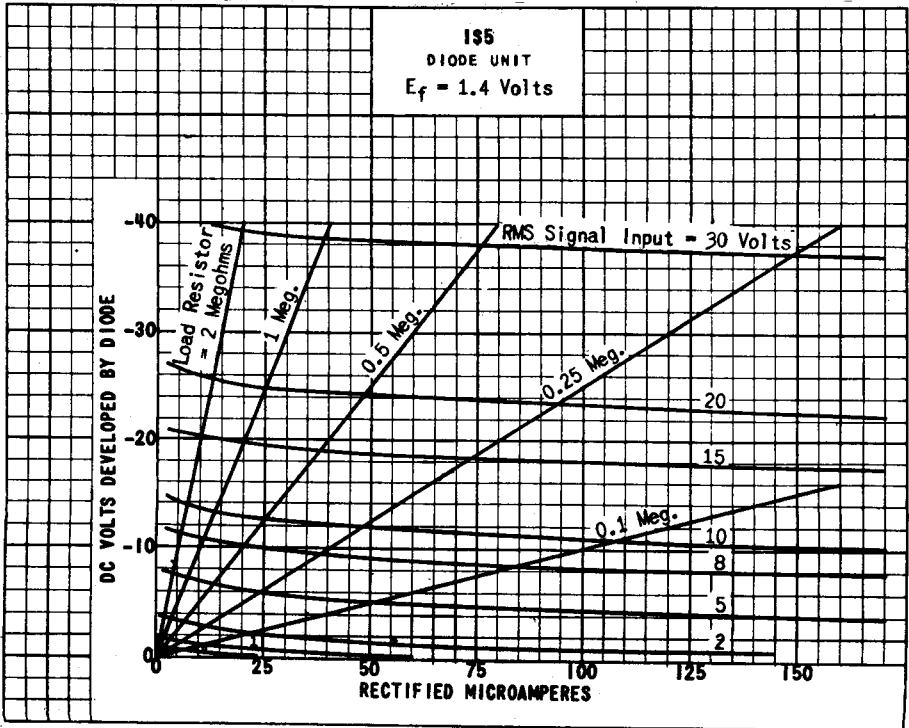
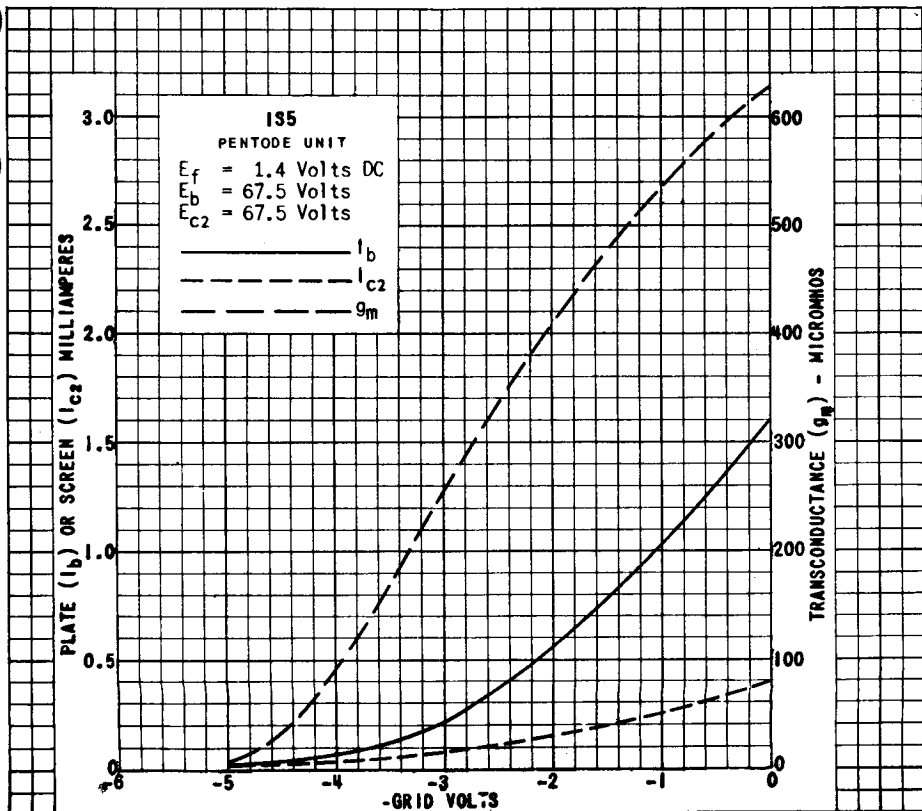
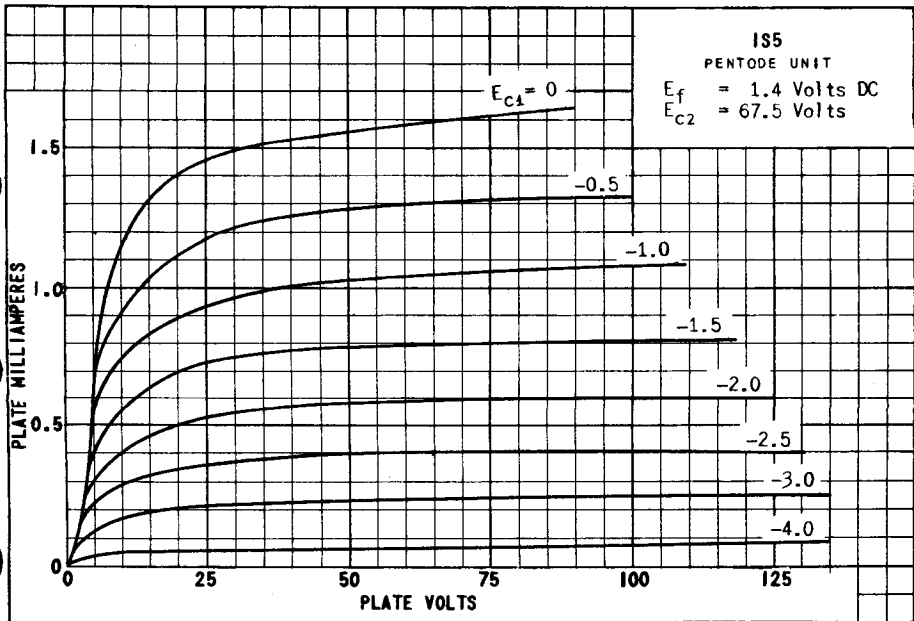

PLATE 1767
FEB. 3, 1947



PRINTED IN U. S. A.

PLATE 1768
FEB. 3, 1947

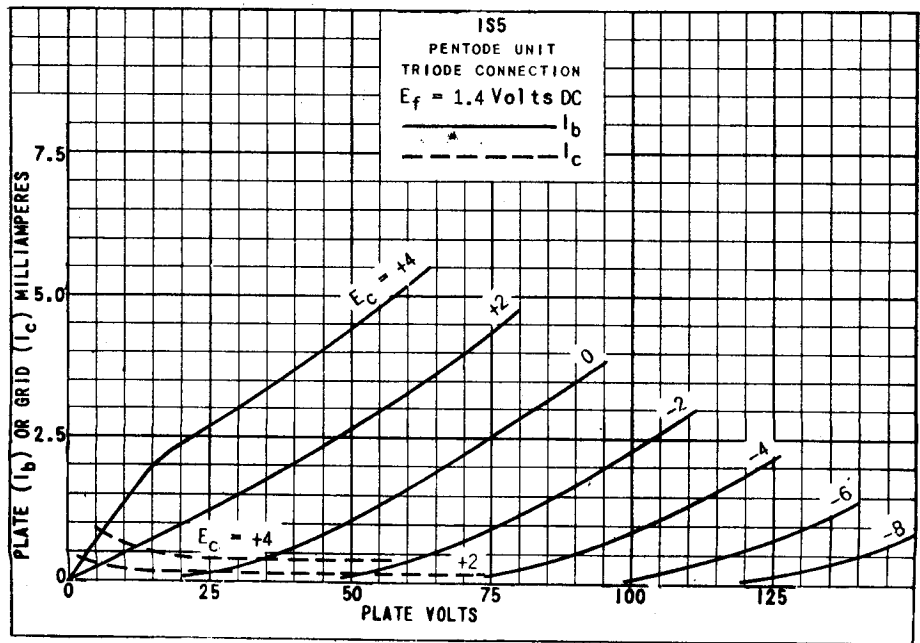
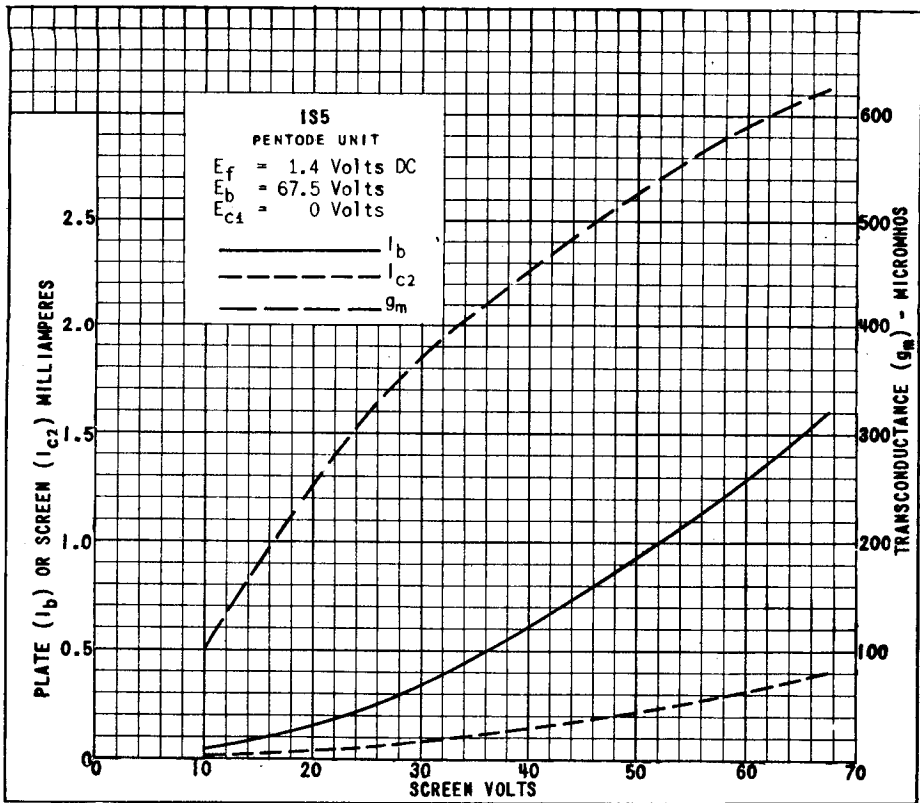
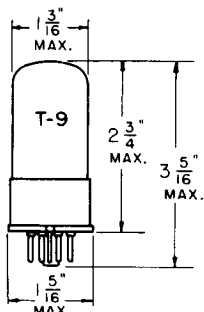

PLATE
1769
FEB. 3,
1947

TUNG-SOL

R. F. PENTODE



COATED FILAMENT

1.4 VOLTS .050 AMPERE
DC

GLASS BULB

ANY MOUNTING POSITION

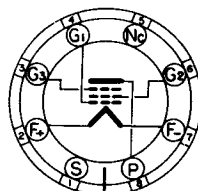

BOTTOM VIEW

SMALL WAFER OCTAL
8 PIN BASE WITH
METAL SHELL

ISA6GT IS A FILAMENT TYPE MEDIUM CUT-OFF PENTODE AMPLIFIER DESIGNED FOR PORTABLE EQUIPMENT. IT PROVIDES HIGH GAIN THROUGH THE USE OF HIGH TRANSCONDUCTANCE AND ADEQUATE SHIELDING TO MAINTAIN LOW GRID-PLATE CAPACITANCE WITH SINGLE ENDED STRUCTURE.

RATINGS

INTERPRETED ACCORDING TO RMA STANDARD WB-210

MAXIMUM PLATE VOLTAGE	90	VOLTS
MAXIMUM SCREEN VOLTAGE	67.5	VOLTS
MAXIMUM TOTAL CATHODE CURRENT	6.0	MA.

DIRECT INTERELECTRODE CAPACITANCES

CONTROL GRID TO PLATE	0.01	MAX.	μmf
INPUT (CONTROL GRID - FIL, G2, G3)	5.2		μmf
OUTPUT (PENTODE PLATE - FIL, G2, G3)	8.6		μmf

TYPICAL OPERATING CONDITIONS AND CHARACTERISTICS

PLATE VOLTAGE	45	67.5	90	VOLTS
SCREEN GRID (G2) VOLTAGE	45	67.5	67.5	VOLTS
CONTROL GRID (G4) VOLTAGE	0	0	0	VOLTS
SUPPRESSOR GRID (G3) VOLTAGE	0	0	0	VOLTS
PLATE CURRENT	1.1	2.4	2.45	MA.
SCREEN GRID CURRENT	0.3	0.7	0.68	MA.
TRANSCONDUCTANCE	750	950	970	μMHOS
PLATE RESISTANCE	0.7	0.6	0.8	MEGOHM
APPROXIMATE CONTROL GRID VOLT FOR TRANSCONDUCTANCE = 5 μMHOS	-3.5	-5.5	-5.5	VOLTS

PLATE
1511
OCT. 31
1944

TUNG-SOL

DIODE PENTODE AMPLIFIER

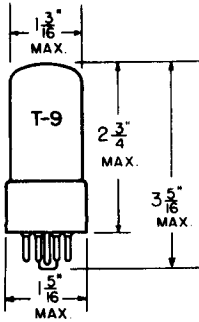

COATED FILAMENT

1.4 VOLTS 0.05 AMPERE
D C

GLASS BULB

ANY MOUNTING POSITION

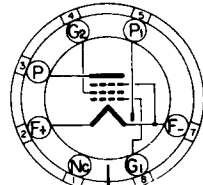

BOTTOM VIEW
INTERMEDIATE SHELL
OCTAL 7 PIN BASE

THE 1SB6GT IS A LOW DRAIN FILAMENT TYPE SINGLE DIODE-PENTODE TUBE DESIGNED FOR USE IN BATTERY OPERATED EQUIPMENT. IT FEATURES SINGLE ENDED CONSTRUCTION AND INCORPORATES A PENTODE CAPABLE OF RELATIVELY HIGH VOLTAGE GAIN.

RATINGS

INTERPRETED ACCORDING TO RMA STANDARD MB-210

MAXIMUM PENTODE PLATE VOLTAGE	90	VOLTS
MAXIMUM SCREEN GRID VOLTAGE	67.5	VOLTS

DIRECT INTERELECTRODE CAPACITANCES

CONTROL GRID TO PENTODE PLATE	0.25	$\mu\mu\text{f}$
INPUT (CONTROL GRID - FIL, G2, G3)	3.2	$\mu\mu\text{f}$
OUTPUT (PENTODE PLATE - FIL, G2, G3)	3.0	$\mu\mu\text{f}$
PENTODE PLATE TO DIODE PLATE	0.5	$\mu\mu\text{f}$

TYPICAL OPERATING CONDITIONS AND CHARACTERISTICS

PENTODE PLATE VOLTAGE	45	67.5	90	VOLTS
SCREEN GRID VOLTAGE	45	67.5	67.5	VOLTS
CONTROL GRID VOLTAGE	0	0	0	VOLTS
PLATE CURRENT	0.6	1.4	1.45	MA.
SCREEN GRID CURRENT	0.16	0.4	0.38	MA.
TRANSCONDUCTANCE	500	650	665	μMHMS
PLATE RESISTANCE	0.9	0.6	0.7	MEGOHMS

AS VOLTAGE AMPLIFIER

PLATE SUPPLY VOLTAGE	45	67.5	90	VOLTS
SCREEN GRID SUPPLY VOLTAGE	45	67.5	90	VOLTS
CONTROL GRID VOLTAGE ^A	0	0	0	VOLTS
LOAD RESISTOR*	1.0	1.0	1.0	MEGOHMS
SERIES SCREEN GRID RESISTOR	5.0	5.0	5.0	MEGOHMS
SCREEN GRID BY-PASS CONDENSER	0.1	0.1	0.1	μf
CONTROL GRID RESISTOR	5.0	5.0	5.0	MEGOHMS
VOLTAGE GAIN	65	90	110	

^A REFERRED TO NEGATIVE FILAMENT TERMINAL

TUNG-SOL

PENTODE

MINIATURE TYPE

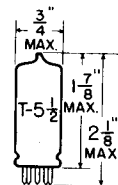

GLASS BULB

COATED FILAMENT

FILAMENT

1.4 VOLTS 50 MA.

DC

ANY MOUNTING POSITION

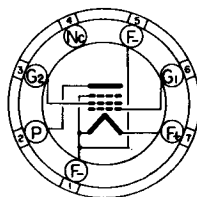

BOTTOM VIEW

MINIATURE BUTTON
7 PIN BASE

THE IT4 IS A MINIATURE SUPER-CONTROL RF PENTODE. IT IS RECOMMENDED FOR USE IN COMPACT, LIGHT-WEIGHT, PORTABLE RECEIVERS WHERE AVC IS REQUIRED. THE IT4 FEATURES ADEQUATE INTERNAL SHIELDING FOR MOST PURPOSES, BUT EXTERNAL SHIELDING IS RECOMMENDED WHERE MINIMUM GRID-PLATE CAPACITANCE IS TO BE OBTAINED.

DIRECT INTERELECTRODE CAPACITANCES

WITH CLOSE-FITTING TUBE SHIELD CONNECTED TO NEGATIVE FILAMENT

GRID TO PLATE: (G_1 TO P) MAX.	0.01	μmf
INPUT: G_1 TO ($F&G_3+G_2$)	3.6	μmf
OUTPUT: P TO ($F&G_3+G_2$)	7.5	μmf

RATINGS

INTERPRETED ACCORDING TO RMA STANDARD MB-210

FILAMENT VOLTAGE	1.4	VOLTS
MAXIMUM PLATE VOLTAGE	90	VOLTS
MAXIMUM GRID #2 VOLTAGE	67.5	VOLTS
MAXIMUM GRID #2 SUPPLY VOLTAGE	90	VOLTS
MAXIMUM GRID #1 VOLTAGE	0	VOLTS
MAXIMUM CATHODE CURRENT	5.5	MA.

TYPICAL OPERATING CONDITIONS AND CHARACTERISTICS

CLASS A_1 AMPLIFIER

FILAMENT VOLTAGE	1.4	1.4	1.4	1.4	VOLTS
FILAMENT CURRENT	50	50	50	50	MA.
PLATE VOLTAGE	45	67.5	90	90	VOLTS
GRID #2 VOLTAGE	45	67.5	45	67.5	VOLTS
GRID #1 VOLTAGE ^A	0	0	0	0	VOLTS
PLATE RESISTANCE (APPROX.)	0.35	0.25	0.8	0.5	MEG OHM
TRANSCONDUCTANCE	700	875	750	900	μMHOS
PLATE CURRENT	1.7	3.4	1.8	3.5	MA.
GRID #2 CURRENT	0.7	1.5	0.65	1.4	MA.
GRID #1 VOLTAGE FOR $g_m = 10 \mu\text{MHOS}$	-10	-16	-10	-16	VOLTS

^AREFERRED TO NEGATIVE FILAMENT TERMINAL.

→ INDICATES A CHANGE OR ADDITION.

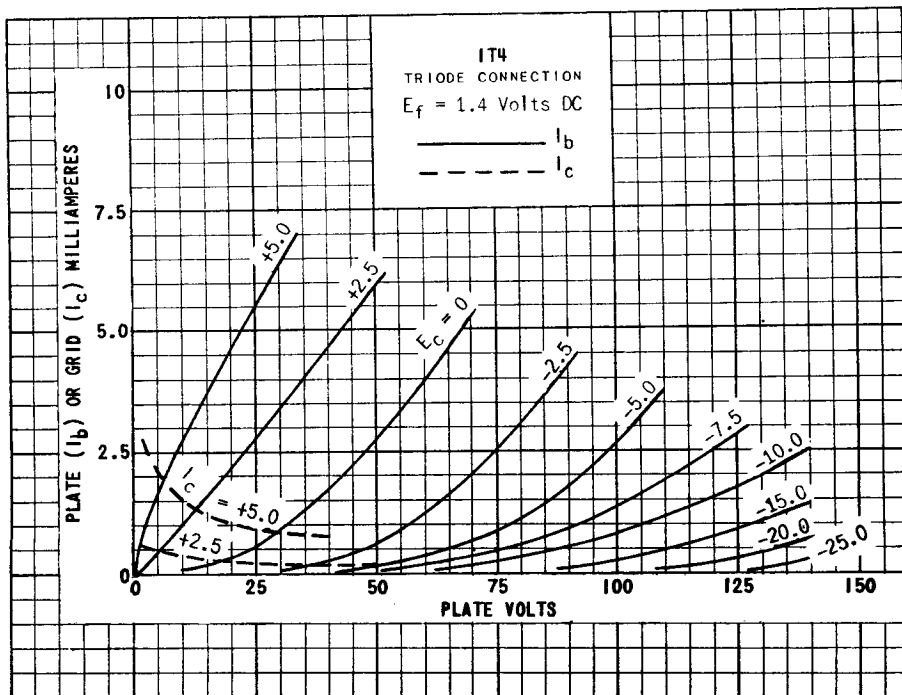
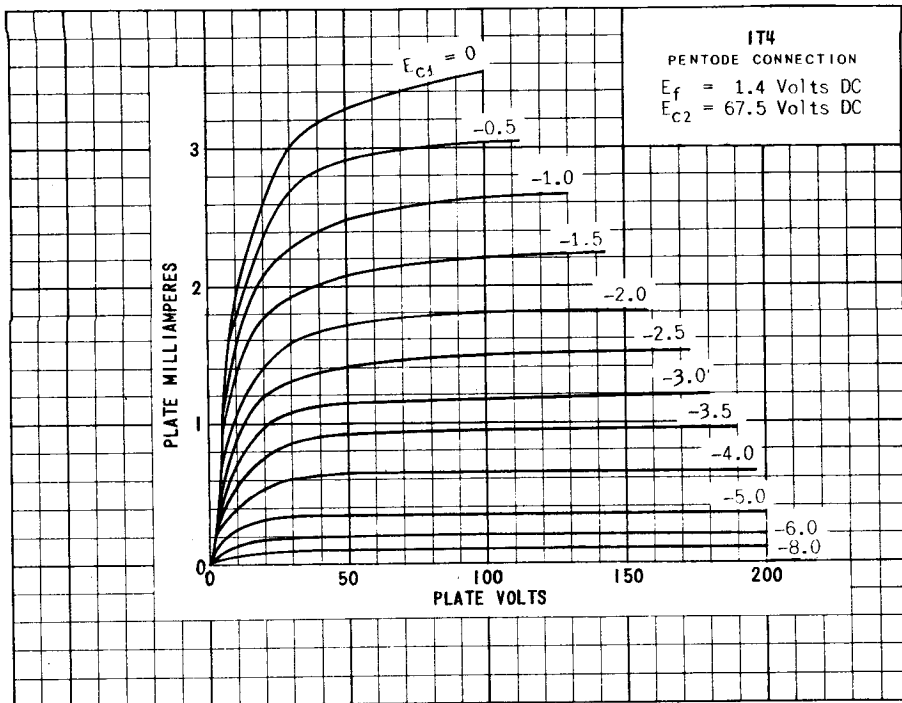

1T4
 PENTODE CONNECTION
 $E_f = 1.4$ Volts DC
 $E_b = 90$ Volts
 $I_{c2} = 67.5$ Volts
 _____ I_b
 - - - - - I_{c2}
 - - - - - g_m

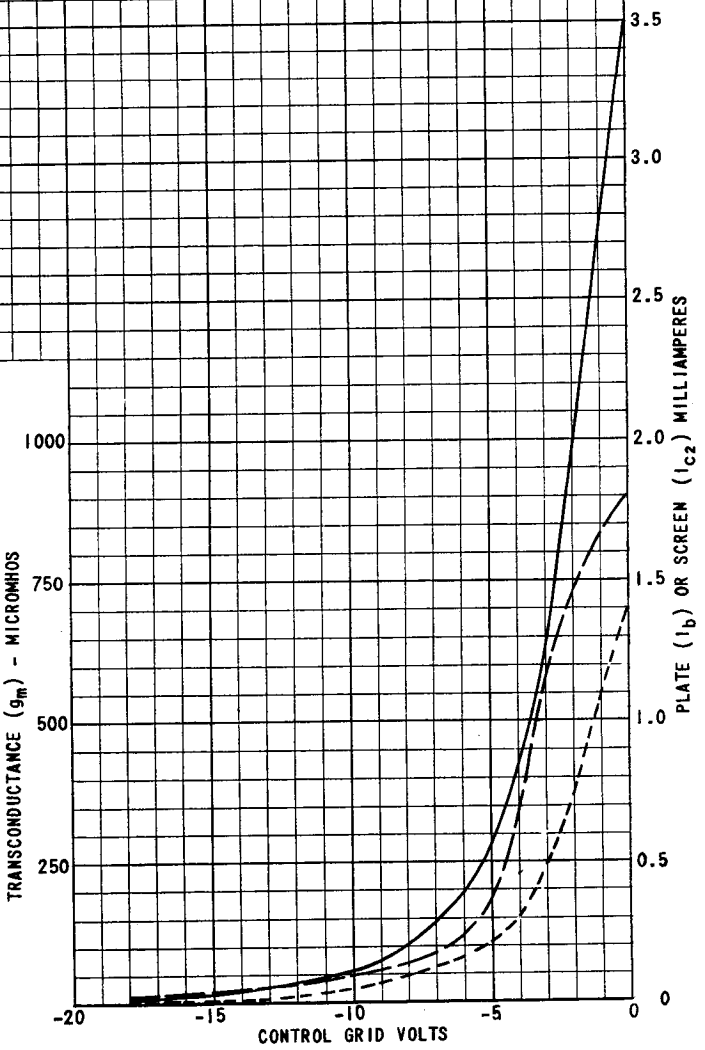

PRINTED IN U. S. A.

PLATE
 1906
 NOV. 1,
 1947



TUNG-SOL

BEAM POWER AMPLIFIER

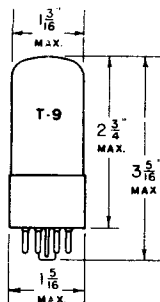

COATED FILAMENT

1.4 VOLTS 0.050 AMPERE

DC

GLASS BULB

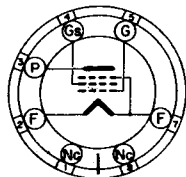

G-6X

BOTTOM VIEW

INTERMEDIATE 7 PIN OCTAL BASE

THE TUNG-SOL 1T5GT IS A LOW VOLTAGE, LOW CURRENT DRAIN BATTERY TYPE BEAM POWER OUTPUT TUBE. IT IS DESIGNED FOR SERVICE WITH 90 VOLTS OF "B" BATTERY AND A SINGLE DRY CELL "A" BATTERY.

RATINGS

MAXIMUM FILAMENT VOLTAGE

DRY BATTERY OPERATION - VOLTAGE MUST NEVER EXCEED	1.6	VOLTS
AC - DC POWER LINE OPERATION - DESIGN CENTER	1.3	VOLTS
MAXIMUM PLATE VOLTAGE	110	VOLTS
MAXIMUM SCREEN VOLTAGE	110	VOLTS
MAXIMUM CATHODE CURRENT (ZERO SIGNAL)	7.3	MA.

TYPICAL OPERATING CONDITIONS AND CHARACTERISTICS

CLASS A₁ AMPLIFIER

	SELF-BIAS	FIXED-BIAS	
FILAMENT VOLTAGE	1.4 DC	1.4 DC	VOLTS
FILAMENT CURRENT	0.050	0.050	AMPERE
PLATE VOLTAGE	84	90	VOLTS
SCREEN VOLTAGE	84	90	VOLTS
CONTROL GRID VOLTAGE ^A	-6	-6	VOLTS
ZERO SIGNAL PLATE CURRENT	5.4	6.5	MA.
ZERO SIGNAL SCREEN CURRENT (NOMINAL)	0.6	0.8	MA.
MAXIMUM SIGNAL PLATE CURRENT	5.5	6.5	MA.
MAXIMUM SIGNAL SCREEN CURRENT (NOMINAL)	1.5	1.5	MA.
PLATE RESISTANCE APPROX.	.25	.25	MEGOHM
TRANSCONDUCTANCE	1050	1150	μMHOS
LOAD RESISTANCE	14000	14000	OHMS
TOTAL HARMONIC DISTORTION	7.5	7.5	PER CENT
POWER OUTPUT	145	170	MILLIWATTS

^A REFERRED TO NEGATIVE FILAMENT TERMINAL.

PLATE 1077-2

JULY 28 1941



TUNG-SOL

PENTODE

MINIATURE TYPE

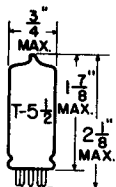

GLASS BULB

COATED FILAMENT

FILAMENT

1.4 VOLTS 50 MA.

DC

ANY MOUNTING POSITION

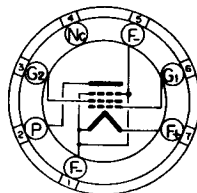

BOTTOM VIEW
MINIATURE BUTTON
7 PIN BASE

THE 1U4 IS A MINIATURE FILAMENTARY TYPE SHARP CUT-OFF PENTODE AMPLIFIER. IT IS INTENDED FOR RF OR AF APPLICATION WHERE CONSERVATION OF BATTERY POWER IS IMPORTANT.

RATINGS

INTERPRETED ACCORDING TO RMA STANDARD MB-210

FILAMENT VOLTAGE	1.4	VOLTS
MAXIMUM PLATE VOLTAGE	110	VOLTS
MAXIMUM SCREEN VOLTAGE	110	VOLTS
MAXIMUM POSITIVE DC GRID VOLTAGE	0	VOLTS
MAXIMUM CATHODE CURRENT	6.0	MA.

DIRECT INTERELECTRODE CAPACITANCES

WITH EXTERNAL SHIELD CONNECTED TO NEGATIVE FILAMENT TERMINAL

GRID TO PLATE (MAX.)	0.01	μ f
INPUT	3.6	μ f
OUTPUT	7.5	μ f

TYPICAL OPERATING CONDITIONS AND CHARACTERISTICS

CLASS A₁ AMPLIFIER

FILAMENT VOLTAGE	1.4	VOLTS
FILAMENT CURRENT	50	MA.
PLATE VOLTAGE	90	VOLTS
SCREEN VOLTAGE	90	VOLTS
GRID VOLTAGE	0	VOLTS
PLATE CURRENT	1.6	MA.
SCREEN CURRENT	0.5	MA.
PLATE RESISTANCE (APPROX.)	1.0	MEG OHMS
TRANSCONDUCTANCE	900	μ MHOS
GRID VOLTAGE FOR $I_b = 10 \mu$ A	-4.0	VOLTS

→ INDICATES A CHANGE OR ADDITION.

PRINTED IN U. S. A.

PLATE
1907
NOV. 1,
1947

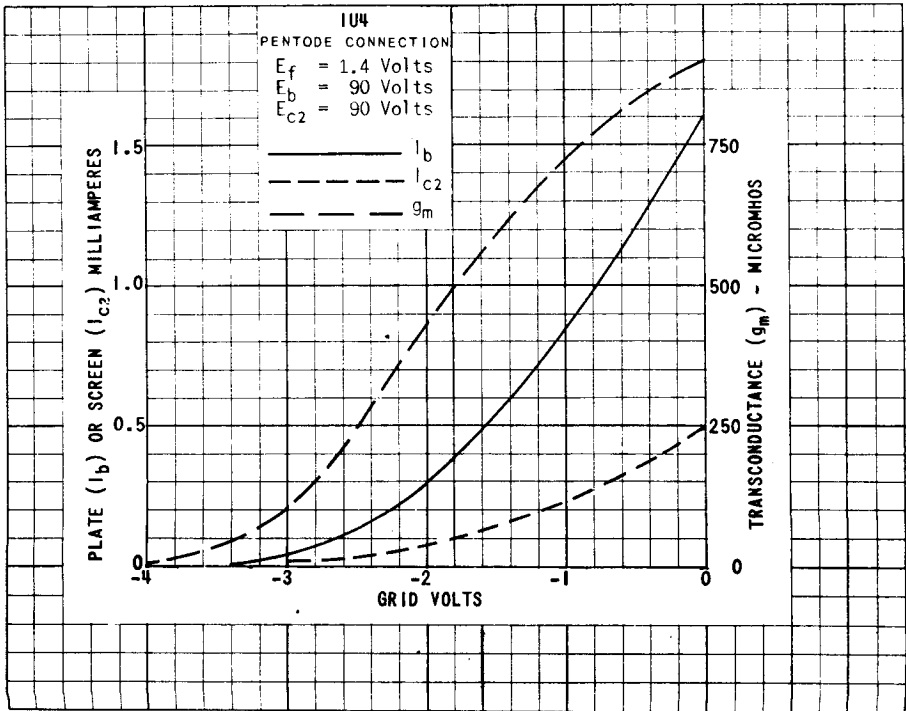
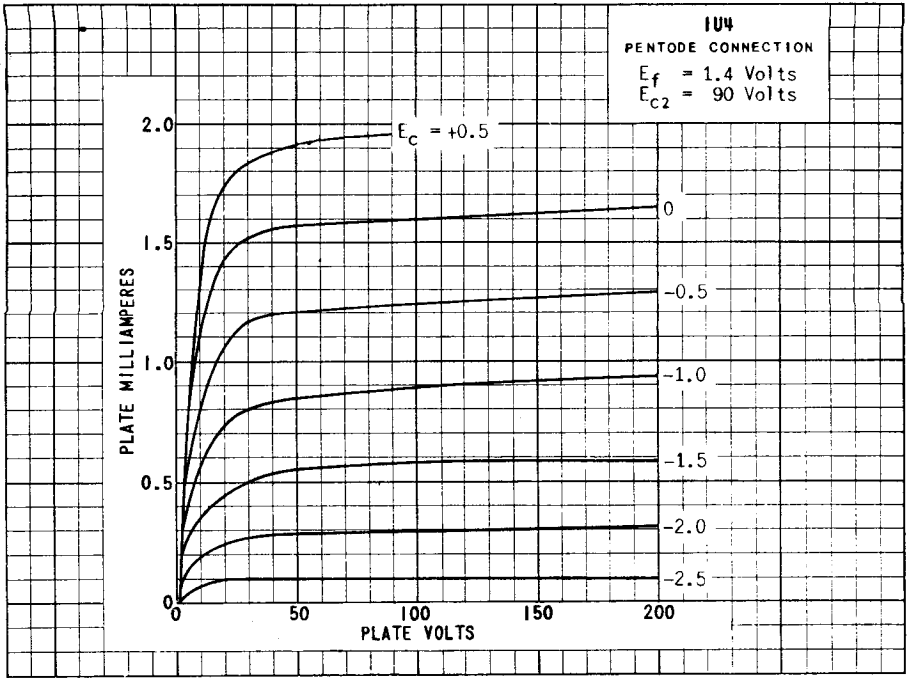

TUNG-SOL

DIODE PENTODE AMPLIFIER
MINIATURE TYPE

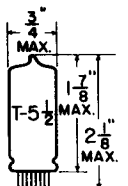

GLASS BULB

COATED FILAMENT

FILAMENT

1.4 VOLTS 0.05 AMPERE
DC

ANY MOUNTING POSITION

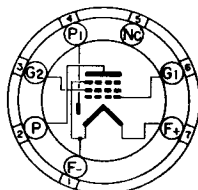

BOTTOM VIEW
MINIATURE BUTTON
7 PIN BASE

THE 1U5 IS A MINIATURE TYPE SHARP CUT-OFF DIODE PENTODE. IT IS INTENDED FOR USE AS A COMBINED DETECTOR AND AUDIO AMPLIFIER OR AS A COMBINED IF AMPLIFIER AND DETECTOR IN PORTABLE RECEIVERS.

RATINGS

INTERPRETED ACCORDING TO RMA STANDARD MB-210

FILAMENT VOLTAGE	1.4	VOLTS
FILAMENT CURRENT	0.05	AMP.
MAXIMUM PLATE VOLTAGE	90	VOLTS
MAXIMUM SCREEN VOLTAGE	90	VOLTS
MINIMUM GRID VOLTAGE	0	VOLTS
MAXIMUM-SIGNAL MAXIMUM TOTAL CATHODE CURRENT	3	MA.
MINIMUM DIODE CURRENT WITH 10 VOLTS DC APPLIED	0.5	MA.

TYPICAL OPERATING CONDITIONS AND CHARACTERISTICS

PENTODE UNIT - CLASS A₁ AMPLIFIER

PLATE VOLTAGE	67.5	90	VOLTS
SCREEN VOLTAGE	67.5	90	VOLTS
GRID VOLTAGE (REFERRED TO F-)	0	0	VOLTS
PLATE CURRENT	1.6	2.7	MA.
SCREEN CURRENT	0.4	0.5	MA.
PLATE RESISTANCE (APPROX.)	0.6	0.5	MEGOHM
TRANSCONDUCTANCE	625	720	μMHOS

PRINTED IN U. S. A.

PLATE
1772
FEB. 3,
1947

CONTINUED ON FOLLOWING PAGE

→ INDICATES A CHANGE OR ADDITION

TUNG-SOL

CONTINUED FROM PRECEDING PAGE

TYPICAL OPERATING CONDITIONS AND CHARACTERISTICS

PENTODE UNIT - RESISTANCE COUPLED AMPLIFIER

PLATE SUPPLY VOLTAGE	45	67.5	90	VOLTS
SCREEN SUPPLY VOLTAGE	45	67.5	90	VOLTS
GRID VOLTAGE	0	0	0	VOLTS
LOAD RESISTANCE	1	1	1	MEGOHM
GRID RESISTOR	10	10	10	MEGOHMS
SERIES SCREEN RESISTANCE	3	3	3	MEGOHMS
SCREEN BY-PASS CONDENSER	0.1	0.1	0.1	μ f
VOLTAGE GAIN (APPROX.) ^A	30	40	50	

^AOBTAINED WHEN THE GRID OF THE PENTODE UNIT IS FED FROM A SOURCE HAVING AN IMPEDANCE OF 1.0 MEGOHM.

DIODE UNIT

THE DIODE UNIT IS LOCATED AT THE NEGATIVE END OF THE FILAMENT AND IS INDEPENDENT OF THE PENTODE UNIT EXCEPT FOR THE COMMON FILAMENT.

SIMILAR TYPE REFERENCE: Ratings and characteristics identical to 1S5; somewhat similar to 1K8S.

IU5
DIODE UNIT
 $E_f = 1.4$ Volts

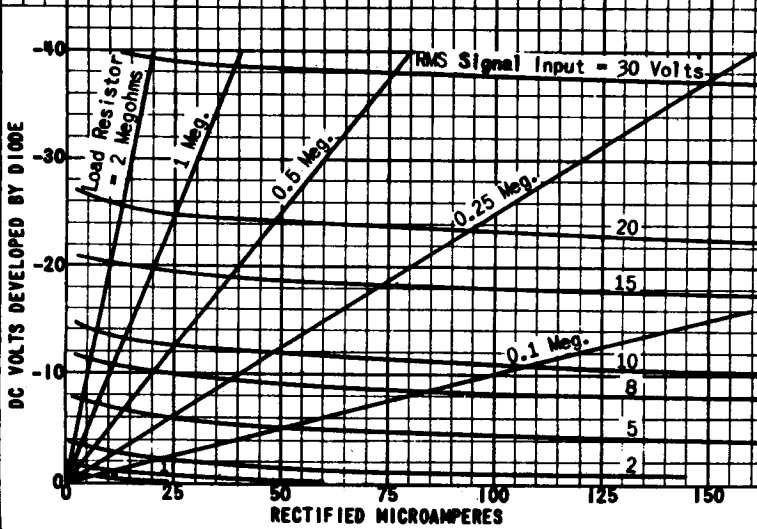
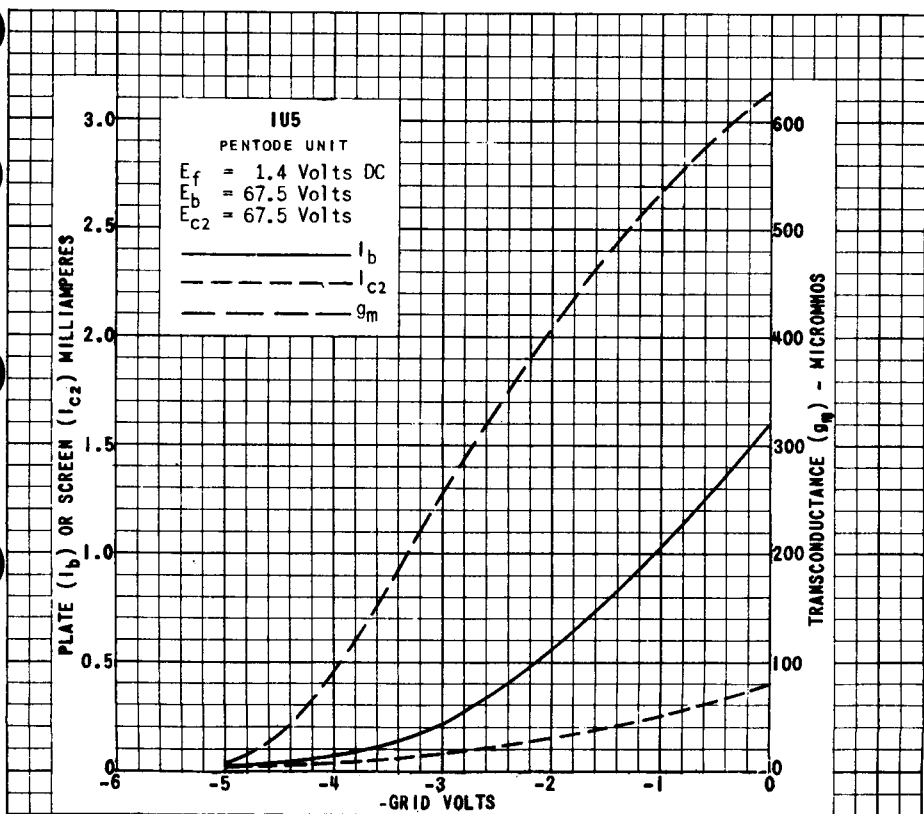
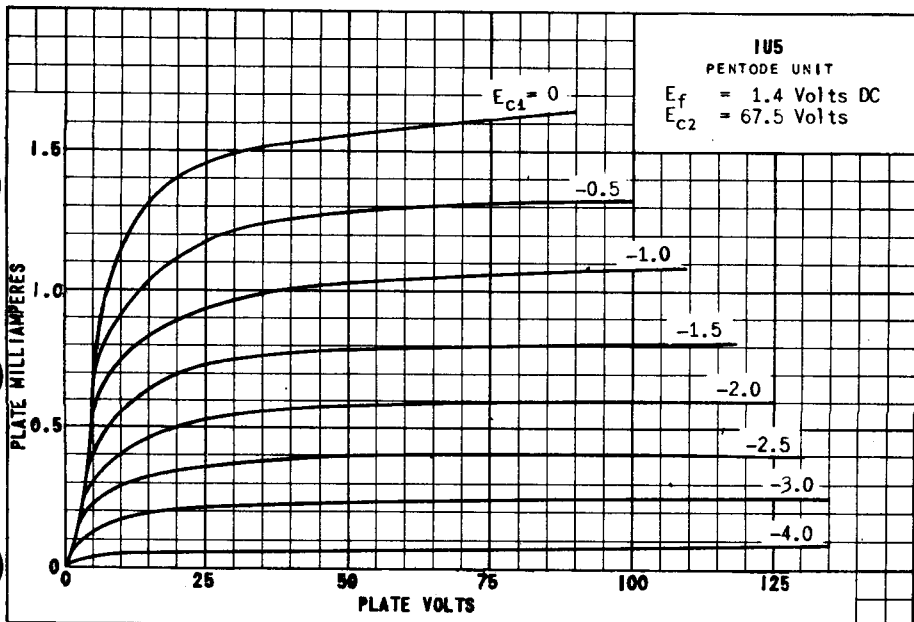

PLATE
1773
FEB. 3,
1947



PRINTED IN U. S. A.

PLATE 1774
FEB. 3, 1947

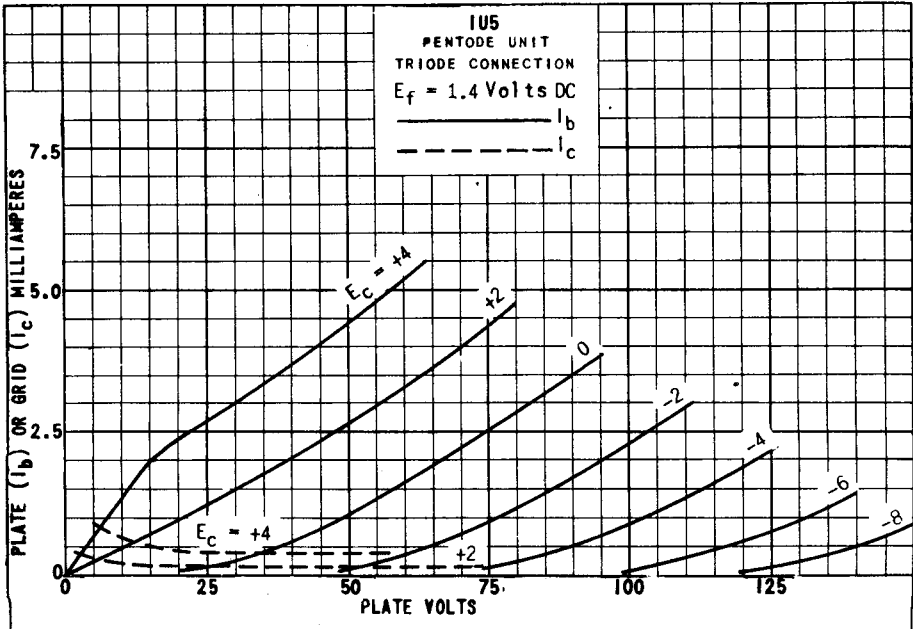
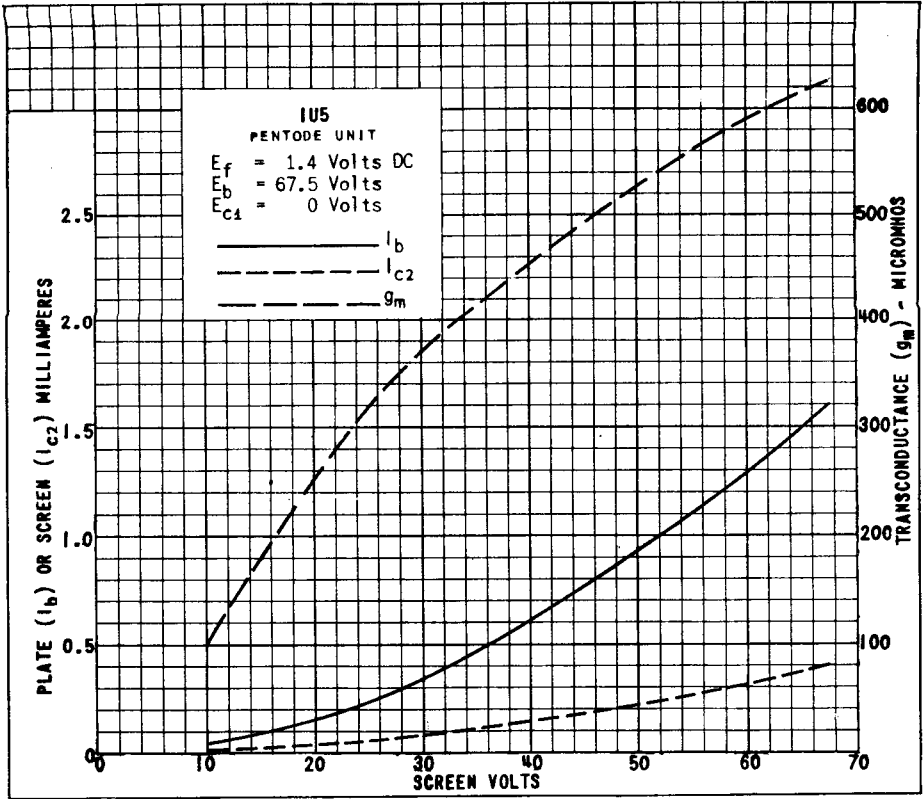
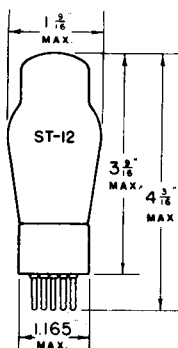

PLATE
1775
FEB. 3,
1947

TUNG-SOL



HALF WAVE
HIGH VACUUM RECTIFIER

UNIPOENTIAL CATHODE

HEATER
6.3 VOLTS 0.3 AMPERE
AC OR DC

GLASS BULB

SMALL 4 PIN BASE

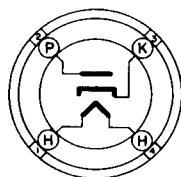

4G

BOTTOM VIEW

THE TUNG-SOL 1V IS DESIGNED FOR SERVICE IN EITHER STORAGE BATTERY, AC OR AC - DC OPERATED RECEIVERS.

RATINGS

MAXIMUM DC HEATER TO CATHODE POTENTIAL	500	VOLTS
MAXIMUM PEAK INVERSE VOLTAGE	1000	VOLTS
MAXIMUM STEADY-STATE PEAK PLATE CURRENT	270	MA.

OPERATING CONDITIONS AND CHARACTERISTICS

HALF WAVE RECTIFIER

CONDENSER INPUT TO FILTER

AC PLATE VOLTAGE (RMS)	117	150	325 ^{MAX.}	VOLTS
DC OUTPUT CURRENT ^{MAX.}	45	45	45	MA.
TOTAL EFFECTIVE PLATE SUPPLY IMPEDANCE ^{MIN.-A}	0	30	75	OHMS
TUBE VOLTAGE DROP	20			VOLTS
AT 90 MA. PLATE CURRENT				

^A WHEN FILTER CONDENSERS LARGER THAN 40 μ FDS ARE USED, IT MAY BE NECESSARY TO ADD ADDITIONAL PLATE SUPPLY IMPEDANCE.

CONTINUED NEXT PAGE

PLATE
685-2

JAN. 29
1940

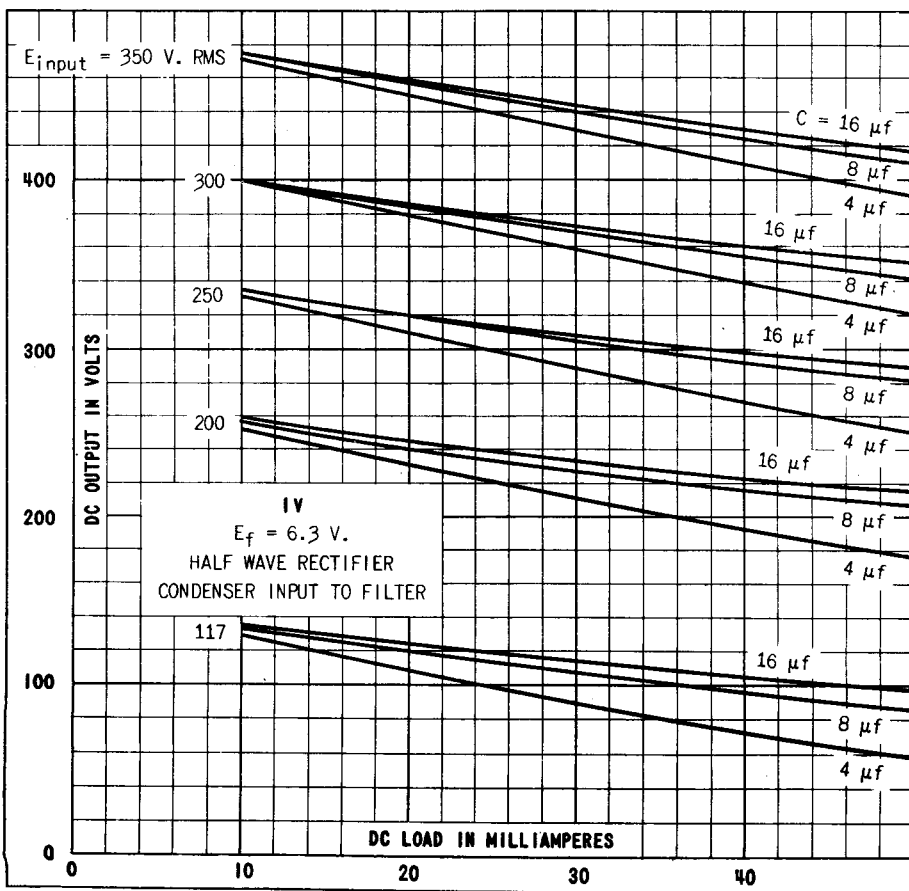
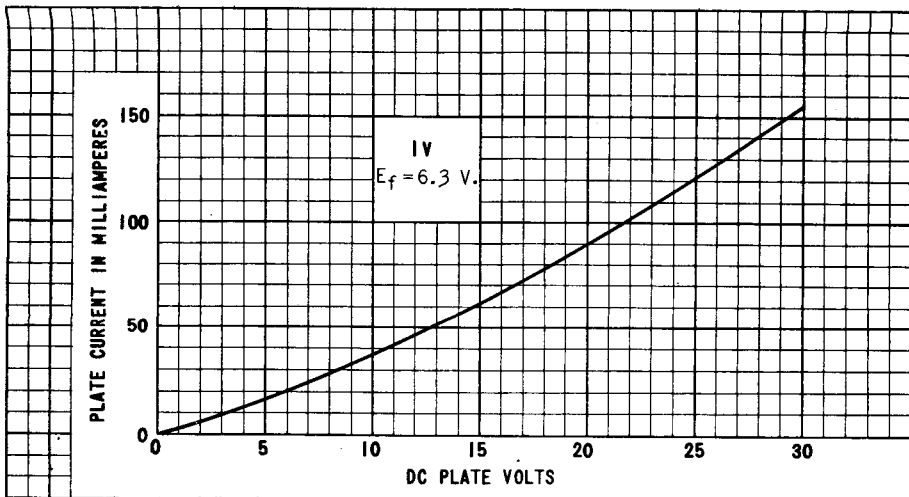



TUNG-SOL

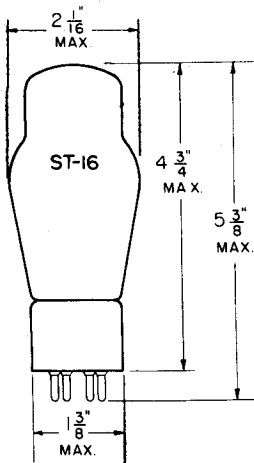

TRIODE POWER AMPLIFIER

COATED FILAMENT
2.5 VOLTS 2.5 AMPERE
AC OR DC

GLASS BULB

MOUNTING POSITION

THIS TUBE SHOULD BE MOUNTED VERTICALLY. HOWEVER HORIZONTAL OPERATION IS PERMISSIBLE IF PINS 1 AND 4 ARE IN A HORIZONTAL PLANE.

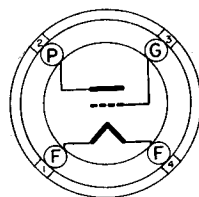

BOTTOM VIEW

MEDIUM
4-PIN BASE

THE 2A3 IS A FILAMENT TYPE TRIODE POWER AMPLIFIER. IT IS DESIGNED FOR SERVICE IN THE OUTPUT STAGE OF AUDIO AMPLIFIERS WHERE HIGH OUTPUT AND LOW HARMONIC DISTORTION IS DESIRED.

RATINGS

INTERPRETED ACCORDING TO RMA STANDARD MB-210

MAXIMUM PLATE VOLTAGE	300	VOLTS
MAXIMUM PLATE DISSIPATION	15	WATTS

DIRECT INTERELECTRODE CAPACITANCES (APPROX.)

GRID TO PLATE	16.5	$\mu\mu\text{f}$
INPUT	7.5	$\mu\mu\text{f}$
OUTPUT	5.5	$\mu\mu\text{f}$

TYPICAL OPERATING CONDITIONS AND CHARACTERISTICS

CLASS A₁ AMPLIFIER

SINGLE TUBE

PLATE VOLTAGE	250	VOLTS
GRID VOLTAGE, (MEASURED FROM MID-POINT OF AC OPERATED FILAMENT)	-45	VOLTS
MAXIMUM GRID CIRCUIT RESISTANCE		
FIXED BIAS	0.05	MEGOHM
SELF BIAS	0.5	MEGOHM
PLATE CURRENT	60	MA.
PLATE RESISTANCE	800	OHMS
TRANSCONDUCTANCE	5 250	μMHOS
AMPLIFICATION FACTOR	4.2	
LOAD RESISTANCE	2 500	OHMS
POWER OUTPUT	3.5	WATTS
SECOND HARMONIC DISTORTION	5.0	PER CENT

CONTINUED ON NEXT PAGE

PLATE
1539
JAN. 15
1945

TUNG-SOL

CONTINUED FROM PRECEDING PAGE

CLASS AB₁ AMPLIFIER — PUSH-PULL

VALUES ARE FOR TWO TUBES

	FIXED BIAS	SELF BIAS	
PLATE VOLTAGE	300	300	VOLTS
GRID VOLTAGE ^A	-62	-	VOLTS
CATHODE BIAS RESISTOR	-	780	OHMS
ZERO-SIGNAL PLATE CURRENT	80	80	MA.
LOAD RESISTANCE (PER TUBE)	750	1 250	OHMS
EFFECTIVE LOAD RESISTANCE (PLATE TO PLATE)	3 000	5 000	OHMS
TOTAL HARMONIC DISTORTION	2.5	5.0	PER CENT
POWER OUTPUT	15	10	WATTS

^A GRID VOLTAGE MEASURED FROM MID-POINT OF AC OPERATED FILAMENT. THE TOTAL EFFECTIVE GRID CIRCUIT RESISTANCE SHOULD BE KEPT AT A MINIMUM. UNDER FIXED BIAS CONDITIONS IT SHOULD NEVER EXCEED 50,000 OHMS WHILE WITH SELF BIAS IT SHOULD NEVER EXCEED 0.5 MEGOHM.

PLATE
1540
JAN. 15
1945

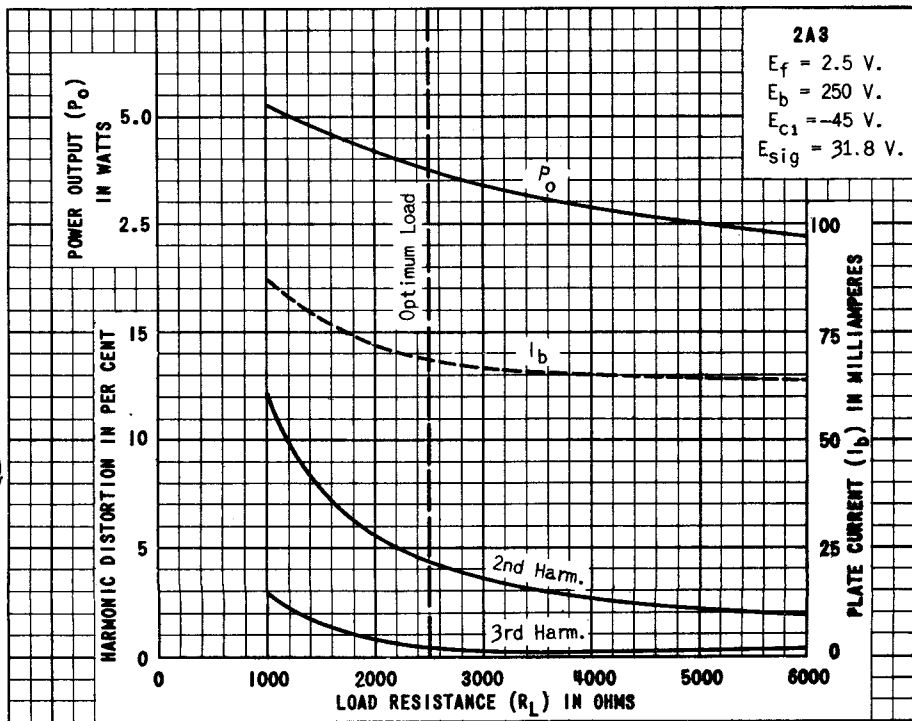
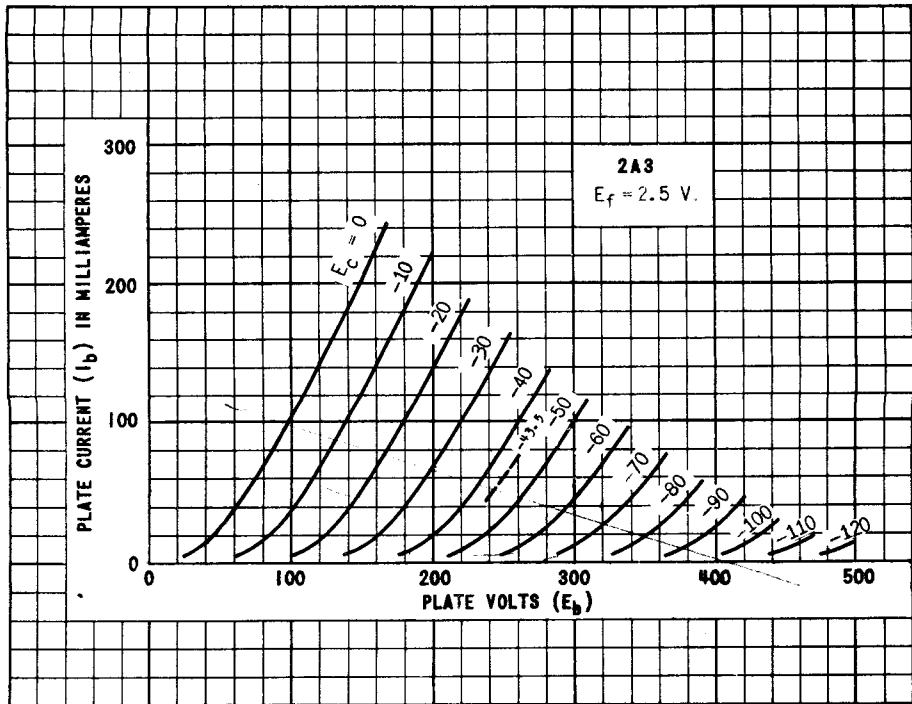

PRINTED IN U. S. A.
PLATE 295-1
JAN. 23 1939

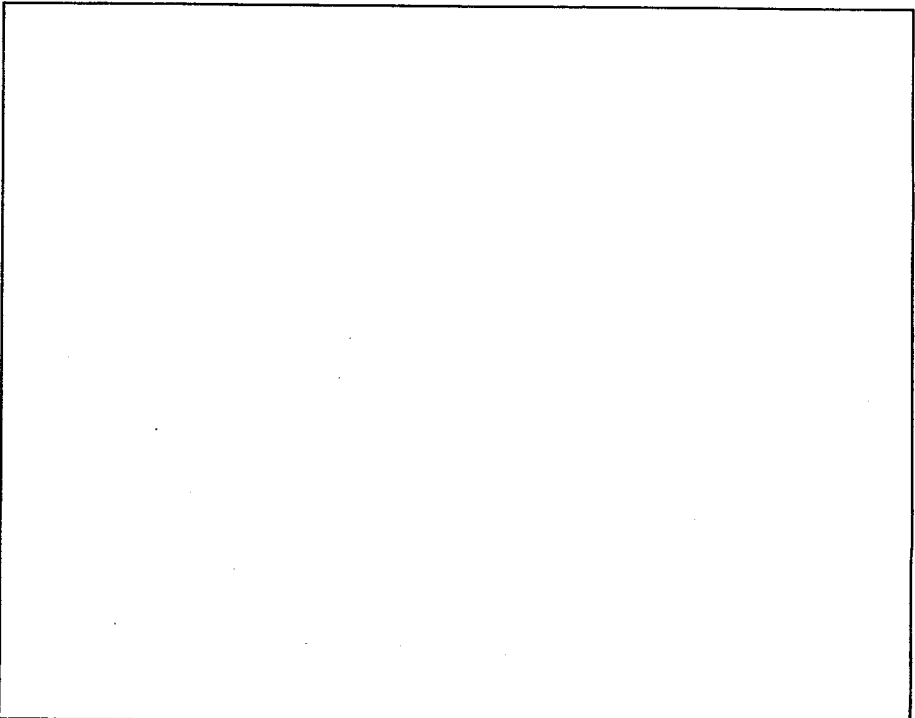
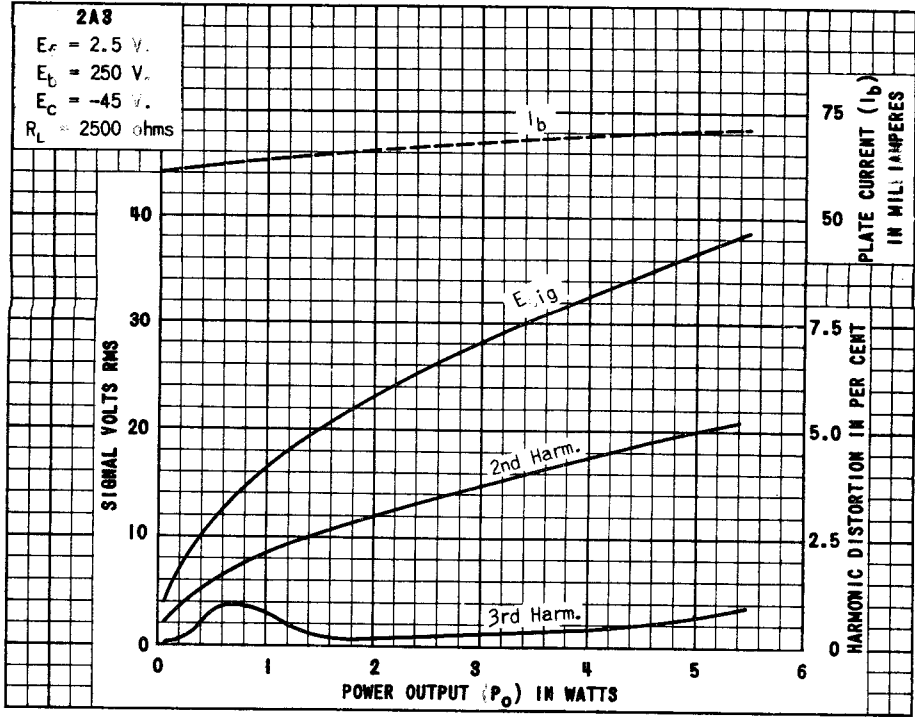

TUNG-SOL

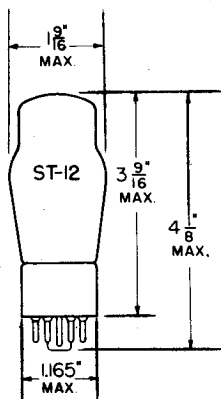

ARGON FILLED THYATRION

COATED FILAMENT

2.5 VOLTS 2.5 AMPERE
DC

GLASS BULB

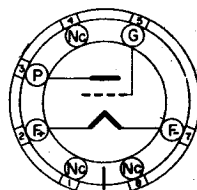
SMALL
7-PIN OCTAL BASE

THE 2A4G IS A HOT CATHODE, ARGON FILLED, SINGLE GRID, THYATRION TUBE PARTICULARLY USEFUL IN APPLICATIONS WHERE CONSTANCY OF CHARACTERISTICS IS NECESSARY EVEN WITH LARGE VARIATIONS IN AMBIENT TEMPERATURE.

RATINGS

MAXIMUM ANODE VOLTAGE: (INSTANTANEOUS)		
FORWARD	200	VOLTS
INVERSE	200	VOLTS
MAXIMUM VOLTAGE BETWEEN ANY TWO ELECTRODES	250	VOLTS
MAXIMUM ANODE CURRENT:		
PEAK	1.25	AMPERS
AVERAGE	0.10	AMPERE
MAXIMUM AVERAGING TIME	45	SECONDS
TUBE VOLTAGE DROP	15	VOLTS
COLD STARTING TIME	2.0	SECONDS



TUNG-SOL

PENTODE POWER AMPLIFIER

COATED UNIPOTENTIAL CATHODE

HEATERS

6F6, 6F6GT/G, 42 - 6.3 V., 0.7 AMPERE

2A5 - 2.5 V., 1.75 AMPERES

TYPES 6F6, 6F6GT/G, 2A5 AND 42 ARE PENTODE AMPLIFIERS DESIGNED FOR APPLICATION IN POWER OUTPUT STAGES OF RECEIVERS. WITH THE EXCEPTION OF HEATER RATINGS, THEIR ELECTRICAL CHARACTERISTICS ARE IDENTICAL.

MAXIMUM RATINGS

	PENTODE CONNECTION	TRIODE CONNECTION	
MAXIMUM PLATE VOLTAGE	375	350	VOLTS
MAXIMUM SCREEN VOLTAGE	285	-	VOLTS
MAXIMUM PLATE DISSIPATION	11	-	WATTS
MAXIMUM SCREEN DISSIPATION	3.75	-	WATTS
MAXIMUM TOTAL PLATE AND SCREEN DISSIPATION	-	10	WATTS

TYPICAL OPERATING CONDITIONS AND CHARACTERISTICS

CLASS A₁ AMPLIFIER - SINGLE TUBE ^C

	PENTODE CONNECTION		TRIODE CONNECTION	
PLATE VOLTAGE	250	285	250	VOLTS
SCREEN VOLTAGE	250	285	-	VOLTS
CONTROL GRID VOLTAGE ^A	-16.5	-20	-20	VOLTS
PEAK AF SIGNAL VOLTAGE	16.5	20	20	VOLTS
ZERO-SIGNAL PLATE CURRENT	34	38	31	MA.
ZERO-SIGNAL SCREEN CURRENT	6.5	7	-	MA.
MAXIMUM-SIGNAL PLATE CURRENT	36	40	34	MA.
MAXIMUM-SIGNAL SCREEN CURRENT	10.5	13	-	MA.
PLATE RESISTANCE (APPROX.)	80000	78000	2600	OHMS
TRANSCONDUCTANCE	2500	2550	2600	UMHOS
AMPLIFICATION FACTOR	-	-	6.8	
LOAD RESISTANCE	7000	7000	4000	OHMS
TOTAL HARMONIC DISTORTION	8	9	6.5	PER CENT
POWER OUTPUT	3.2	4.8	0.85	WATTS

PUSH-PULL AMPLIFIER - TWO TUBES ^PCLASS A₁ AMPLIFIER ^C CLASS AB₁ AMPLIFIER ^D

	PENTODE CONNECTION	PENTODE CONNECTION	TRIODE CONNECTION	
PLATE VOLTAGE	315	375	350	VOLTS
SCREEN VOLTAGE	285	250	-	VOLTS
CONTROL GRID VOLTAGE	-24 ^A	-26	-38	VOLTS
PEAK AF SIGNAL VOLTAGE (GRID TO GRID)	48	82	123	VOLTS
ZERO-SIGNAL PLATE CURRENT	62	34	48	MA.
ZERO-SIGNAL SCREEN CURRENT	12	5	-	MA.
MAXIMUM-SIGNAL PLATE CURRENT	80	82	92	MA.
MAXIMUM-SIGNAL SCREEN CURRENT	19.5	19.5	-	MA.
EFFECTIVE LOAD RESISTANCE (PLATE TO PLATE)	10000	10000	6000	OHMS
TOTAL HARMONIC DISTORTION	4	3.5	2	PER CENT
POWER OUTPUT	11	18.5	13	WATTS

(CONTINUED NEXT PAGE)

TUNG-SOL

TYPICAL OPERATING CONDITIONS FOR CATHODE BIAS

CLASS A₁ AMPLIFIER^C

CLASS AB₂ AMPLIFIER^D

	SINGLE TUBE AMPLIFIER		PUSH-PULL AMPLI.		PUSH-PULL AMPLI.		
	Pentode Conn.	Triode Conn.	Pentode Conn. ^F	Pentode Conn. ^F	Triode Conn. ^F		
Plate	250	285	250	315	375	350	Volts
Screen	250	285	-	285	250	-	Volts
Cathode Resistor	410	-	650	320	340 ^B	730 ^B	Ohms
Peak A-F Grid Voltage	16.5	20	20	-	-	-	Volts
Peak A-F Grid-to-Grid Voltage	-	-	-	58	94	132	Volts
Zero-Sig. Plate Cur.	34	38	31	62	54	50	Ma.
Max.-Sig. Plate Cur.	35	38	32	73	77	60	Ma.
Zero-Sig. Screen Cur.	6.5	7	-	12	8	-	Ma.
Max.-Sig. Screen Cur.	9.7	12	-	18	18	-	Ma.
Load Resistance	7000	7000	4000	-	-	-	Ohms
Effective Load Resis. (plate to plate)	-	-	-	10000	10000	10000	Ohms
Total Harmonic Dist.	8.5	9	6.5	3	5	3	%
Max.-Sig. Power Output	3.1	4.5	0.8	10.5	19	9	Watts

- ^A THE DC RESISTANCE IN THE GRID CIRCUIT, UNDER RATED MAXIMUM CONDITIONS, SHOULD NOT EXCEED 0.5 MEGOHM FOR SELF-BIAS OPERATION AND 0.1 MEGOHM FOR FIXED-BIAS OPERATION.
- ^B THE VALUE GIVEN FOR THE CATHODE RESISTOR IS DETERMINED FOR A GRID BIAS OF -21 VOLTS.
- ^C SUBSCRIPT 1 INDICATES THAT GRID CURRENT DOES NOT FLOW DURING ANY PART OF INPUT CYCLE.
- ^D SUBSCRIPT 2 INDICATES THAT GRID CURRENT FLOWS DURING SOME PART OF INPUT CYCLE.
- ^E THE VALUE GIVEN FOR THE CATHODE RESISTOR IS DETERMINED FOR A GRID BIAS OF -36.5 VOLTS.
- ^F UNLESS OTHERWISE SPECIFIED, VALUES ARE FOR 2 TUBES.

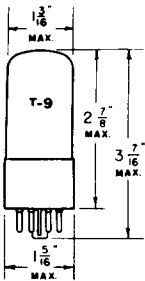

GLASS BULB
6F6GT/G

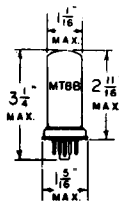

METAL SHELL
6F6

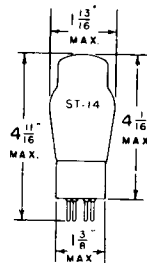

GLASS BULB
2A5 - 42

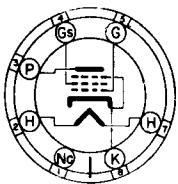

MEDIUM 7 PIN OCTAL BASE

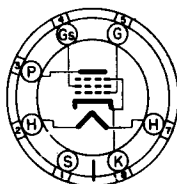

7 PIN OCTAL BASE

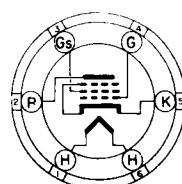

MEDIUM 6 PIN BASE

PLATE
1388-1
DEC. 15
1943

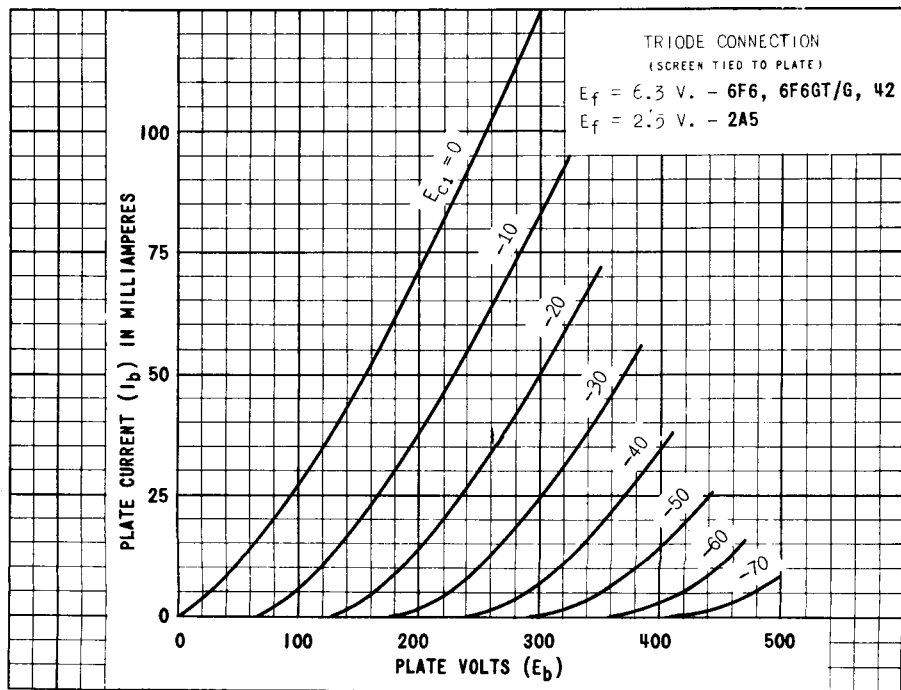
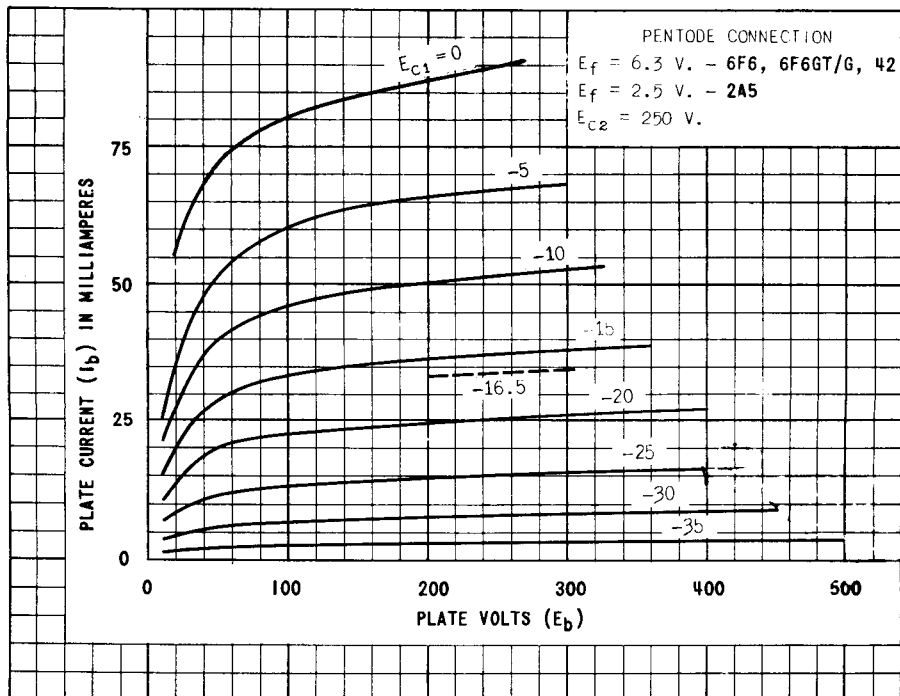

PRINTED IN U. S. A.

PLATE
1370-1
OCT. 25
1943

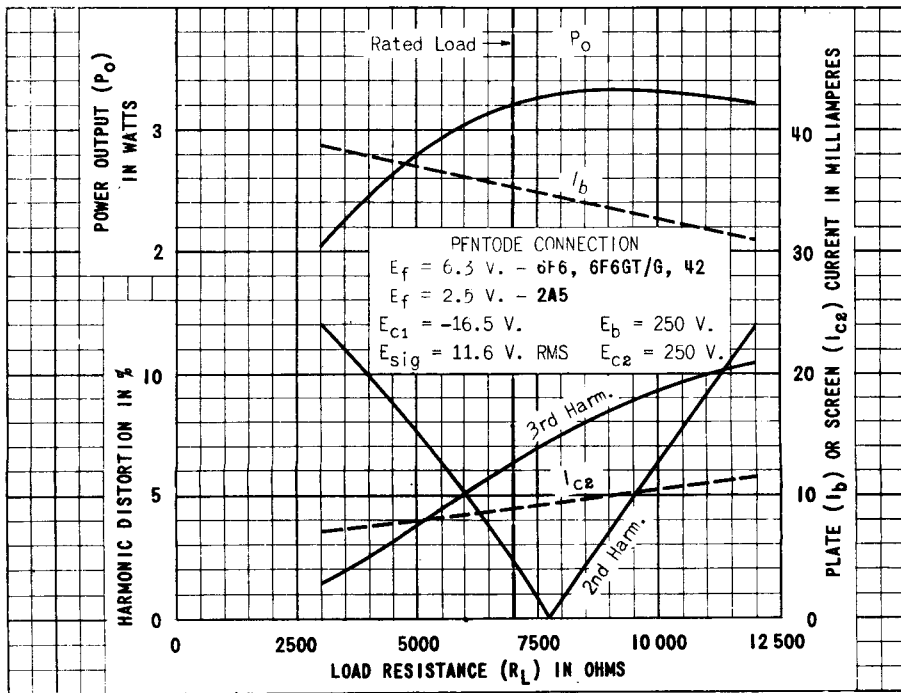
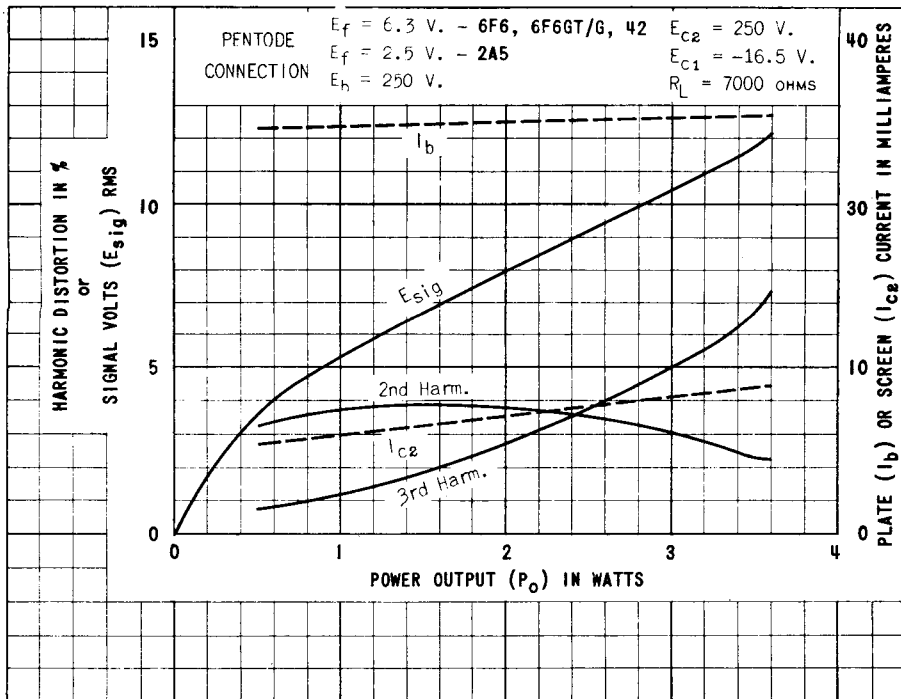
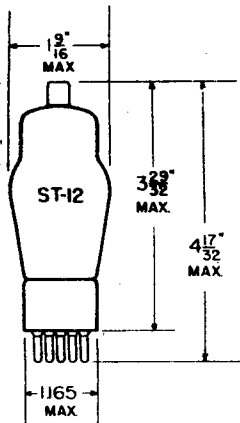

PLATE 1371-1
 OCT. 25 1943

TUNG-SOL



2A6, 75

SMALL METAL CAP

DUO-DIODE HIGH-MU TRIODE AMPLIFIER

COATED UNIPOTENTIAL CATHODE

2A6	2.5 VOLTS	0.8 AMPERE
75	6.3 VOLTS	0.3 AMPERE
6B6G	6.3 VOLTS	0.3 AMPERE
	AC OR DC	

GLASS BULB

ANY MOUNTING POSITION

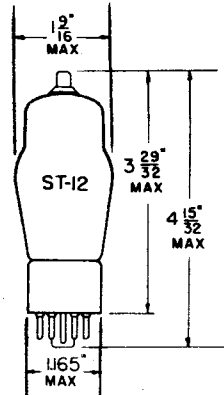

6B6G

SKIRTED MINIATURE CAP

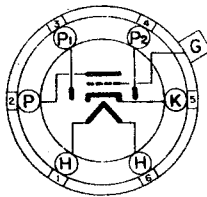

BOTTOM VIEW

SMALL 6-PIN BASE

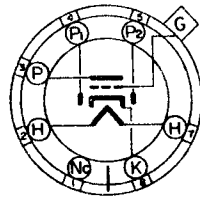

BOTTOM VIEW

SMALL 7-PIN OCTAL BASE

THE 2A6, 6B6G AND 75 COMBINE TWO DIODES AND A HIGH-MU TRIODE IN A SINGLE BULB, USING A COMMON CATHODE. THEY ARE DESIGNED FOR USE AS DIODE DETECTORS, AVC RECTIFIERS AND RESISTANCE COUPLED AMPLIFIERS.

RATINGS

INTERPRETED ACCORDING TO RMA STANDARD WB-210

MAXIMUM PLATE VOLTAGE	250	VOLTS
MINIMUM DIODE CURRENT PER PLATE WITH 10 VOLTS DC APPLIED	0.8	MA.
MAXIMUM CATHODE VOLTAGE	100	VOLTS

CONTINUED ON NEXT PAGE

PRINTED IN U. S. A.

PLATE 1542
JAN. 15 1945

TUNG-SOL

CONTINUED FROM PRECEDING PAGE.

DIRECT INTERELECTRODE CAPACITANCES (APPROX.)

TRIODE UNIT

GRID TO PLATE	1.7	μmf
INPUT	1.7	μmf
OUTPUT	3.8	μmf

TYPICAL OPERATING CONDITIONS AND CHARACTERISTICS

CLASS A₁ AMPLIFIER

TRIODE UNIT

PLATE VOLTAGE	250	VOLTS
GRID VOLTAGE	-2.0	VOLTS
PLATE CURRENT	0.9	MA.
PLATE RESISTANCE	91 000	OHMS
TRANSCONDUCTANCE	1 100	μMHOS
AMPLIFICATION FACTOR	100	

RESISTANCE COUPLED AMPLIFIER

PLATE SUPPLY VOLTAGE	100	100	250	VOLTS
PLATE LOAD RESISTOR	0.25	0.25	0.25	MEGOHM
CATHODE RESISTOR	0.0	10 000	4 000	OHMS
GRID CIRCUIT RESISTOR	6.0	1.0	1.0	MEGOHMS
GRID COUPLING CONDENSER	0.01	0.05	0.05	μf
VOLTAGE GAIN	35	35	52	

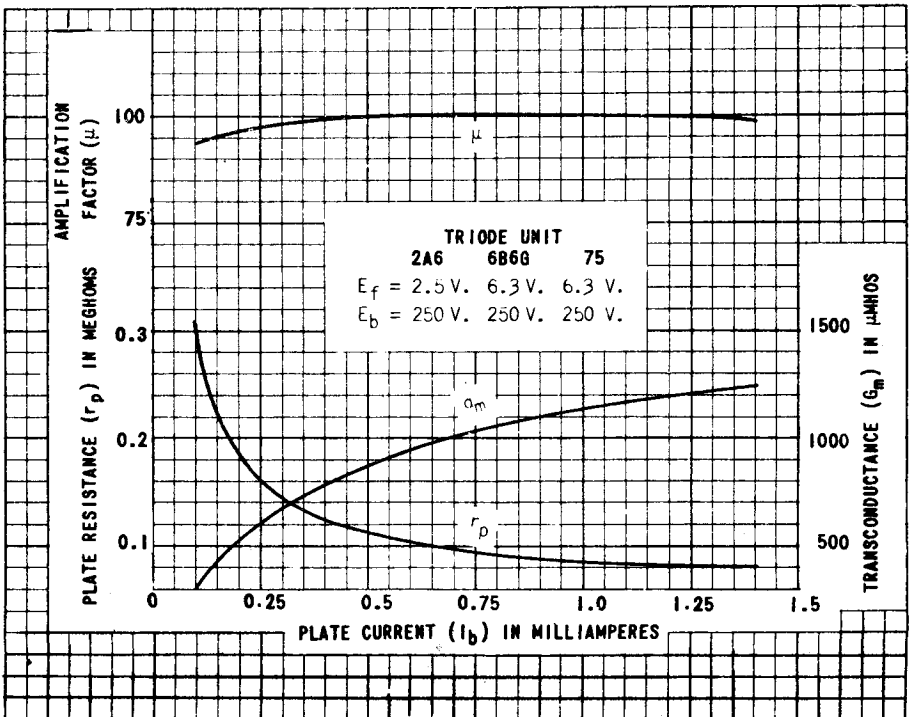
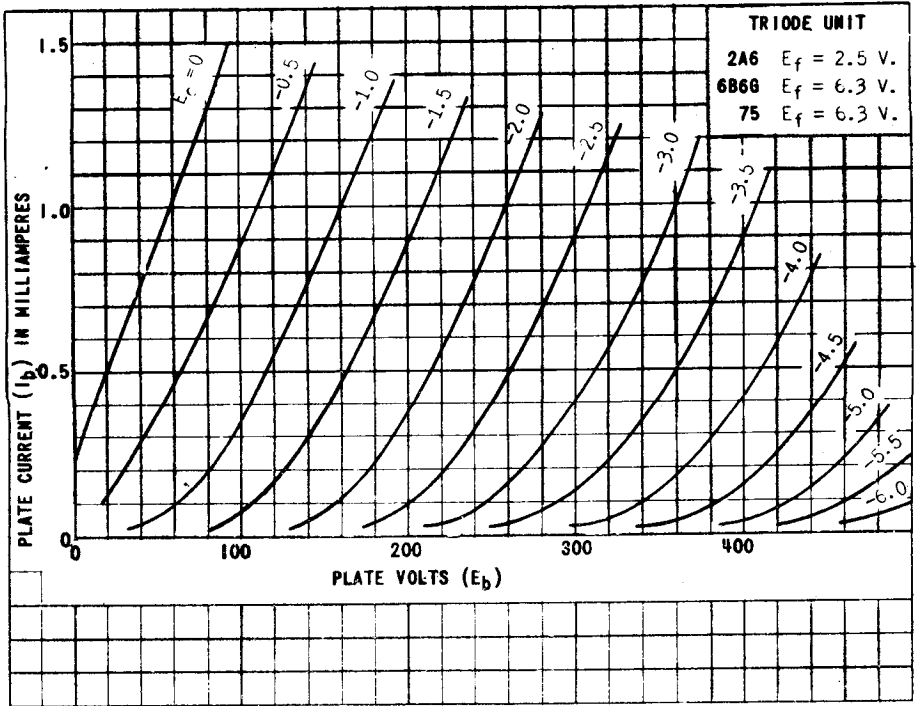



TUNG-SOL

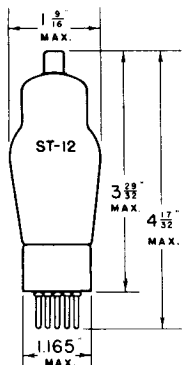

PENTAGRID CONVERTER

UNI-POTENTIAL CATHODE

HEATER

2A7 - 2.5 VOLTS 0.8 AMPERE

6A7 - 6.3 VOLTS 0.3 AMPERE

AC OR DC

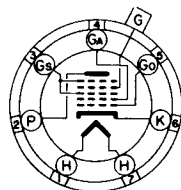
7C
BOTTOM VIEW

GLASS BULB

SMALL 7 PIN BASE

THE TUNG-SOL 2A7 AND 6A7 ARE PENTAGRID CONVERTERS DESIGNED FOR SERVICE AS OSCILLATORS AND MIXERS IN AC OPERATED AND AC-DC OPERATED RECEIVERS. WITH THE EXCEPTION OF HEATER RATINGS, THEY HAVE IDENTICAL RATINGS AND ELECTRICAL CHARACTERISTICS.

RATINGS

MAXIMUM PLATE (P) VOLTAGE	300	VOLTS
MAXIMUM SCREEN (Gs) SUPPLY VOLTAGE	300	VOLTS
MAXIMUM SCREEN VOLTAGE	100	VOLTS
MINIMUM EXTERNAL CONTROL GRID (G) BIAS VOLTAGE	0	VOLTS
MAXIMUM OSCILLATOR ANODE (Ga) SUPPLY VOLTAGE	300	VOLTS
MAXIMUM OSCILLATOR ANODE VOLTAGE	200	VOLTS
MAXIMUM TOTAL CATHODE CURRENT	14	MA.
MAXIMUM PLATE DISSIPATION	1.0	WATT
MAXIMUM SCREEN DISSIPATION	0.3	WATT
MAXIMUM OSCILLATOR ANODE DISSIPATION	0.75	WATT

FOR "INTERPRETATION OF RATINGS" REFER TO FRONT OF BOOK.

CONTINUED NEXT PAGE

PLATE
916-2DEC. 30
1940

TUNG-SOL

DIRECT INTERELECTRODE CAPACITANCES

CONTROL GRID (G) TO MIXER PLATE (P) ^S	0.3	μμf
CONTROL GRID (G) TO OSCILLATOR ANODE (G _A) ^S	0.15	μμf
CONTROL GRID (G) TO OSCILLATOR GRID (G ₀) ^S	0.15	μμf
OSCILLATOR GRID (G ₀) TO OSCILLATOR ANODE (G _A)	1.0	μμf
RF INPUT: CONTROL GRID (G) TO ALL OTHER ELECTRODES	8.5	μμf
OSCILLATOR INPUT: OSCILLATOR GRID (G ₀) TO ALL OTHER ELECTRODES	7.0	μμf
OSCILLATOR OUTPUT: OSCILLATOR ANODE (G _A) TO ALL OTHER ELECTRODES	5.5	μμf
MIXER OUTPUT: MIXER PLATE (P) TO ALL OTHER ELECTRODES	9.0	μμf

TYPICAL OPERATING CONDITIONS AND CHARACTERISTICS

CONVERTER SERVICE

PLATE (P) VOLTAGE	100	250	VOLTS
SCREEN (G _S) VOLTAGE	50	100	VOLTS
CONTROL GRID (G) VOLTAGE ^{MIM-}	-1.5	-3	VOLTS
OSCILLATOR ANODE (G _A) SUPPLY VOLTAGE ^A	-	250	VOLTS
OSCILLATOR ANODE VOLTAGE	100	-	VOLTS
OSCILLATOR GRID (G ₀) RESISTOR	50 000	50 000	OHMS
PLATE CURRENT	1.1	3.5	MA.
SCREEN CURRENT	1.3	2.7	MA.
OSCILLATOR ANODE CURRENT	2.0	4.0	MA.
OSCILLATOR GRID CURRENT	0.25	0.4	MA.
TOTAL CATHODE CURRENT	4.6	10.6	MA.
PLATE RESISTANCE ^{APPROX.}	0.6	0.36	MEGOHM
CONVERSION TRANSCONDUCTANCE	360	-	μMHOS
FOR CONTROL GRID (G) VOLTAGE = -1.5 V.			
CONVERSION TRANSCONDUCTANCE	180	550	μMHOS
FOR CONTROL GRID (G) VOLTAGE = -3 V.			
CONVERSION TRANSCONDUCTANCE	50	325	μMHOS
FOR CONTROL GRID (G) VOLTAGE = -6 V.			
CONVERSION TRANSCONDUCTANCE	-	100	μMHOS
FOR CONTROL GRID (G) VOLTAGE = -10 V.			
CONVERSION TRANSCONDUCTANCE ^{APPROX.}	3	-	μMHOS
FOR CONTROL GRID (G) VOLTAGE = -20 V.			
CONVERSION TRANSCONDUCTANCE ^{APPROX.}	-	6	μMHOS
FOR CONTROL GRID (G) VOLTAGE = -35 V.			

^A APPLIED THROUGH A 20 000 OHM DROPPING RESISTOR

^S WITH EXTERNAL SHIELD CONNECTED TO CATHODE

PLATE
917-2

TUNG-SOL

HIGH VACUUM CATHODE-RAY TUBE
ELECTROSTATIC DEFLECTION AND FOCUSING

NO. 1 PHOSPHOR
 GREEN FLUORESCENT SCREEN
 MEDIUM PERSISTENCE

HEATER
 6.3 VOLTS ($\pm 10\%$) 0.6 AMPERE
 AC OR DC

COATED UNIPOTENTIAL CATHODE

GLASS BULB

SMALL SHELL MAGNAL 11 PIN BASE

RATINGS*

MAXIMUM ANODE NO. 2 VOLTAGE (HIGH VOLTAGE ELECTRODE)	1100	VOLTS
MAXIMUM ANODE NO. 1 VOLTAGE (FOCUSING ELECTRODE)	550	VOLTS
GRID VOLTAGE (CONTROL ELECTRODE)	NEVER POSITIVE	
MAXIMUM PEAK VOLTAGE BETWEEN ANODE NO. 2 AND ANY DEFLECTOR	660	VOLTS
MAXIMUM DC HEATER CATHODE POTENTIAL ^A	125	VOLTS
MAXIMUM GRID CIRCUIT RESISTANCE	1.5	MEGOHMS
MAXIMUM IMPEDANCE OF ANY DEFLECTOR CIRCUIT AT HEATER SUPPLY FREQUENCY	1.0	MEGOHM

*MAXIMUM RATINGS ARE ABSOLUTE VALUES

DIRECT INTERELECTRODE CAPACITANCES (APPROX.)

CONTROL ELECTRODE TO ALL OTHER ELECTRODES	8.0	μf
CATHODE TO ALL OTHER ELECTRODES	5.5	μf
D1 TO D2	0.6	μf
D3 TO D4	1.1	μf
D1 TO ALL OTHER ELECTRODES	8.5	μf
D3 TO ALL OTHER ELECTRODES	9.0	μf
D1 TO ALL OTHER ELECTRODES EXCEPT D2	8.0	μf
D2 TO ALL OTHER ELECTRODES EXCEPT D1	4.6	μf
D3 TO ALL OTHER ELECTRODES EXCEPT D4	7.5	μf
D4 TO ALL OTHER ELECTRODES EXCEPT D3	3.6	μf

TYPICAL OPERATING CONDITIONS AND CHARACTERISTICS

ANODE NO. 2 VOLTAGE ^B	500	1000	VOLTS
ANODE NO. 1 VOLTAGE FOR FOCUS AT 75% OF GRID VOLTAGE CUT-OFF (APPROX.) ^C	125	250	VOLTS
GRID VOLTAGE FOR CUT-OFF ^D	-30 ^E	-60 ^E	VOLTS
DEFLECTION SENSITIVITY: ^F			
D1 AND D2	0.220	0.110	MM/VOLT DC
D3 AND D4	0.260	0.130	MM/VOLT DC
DEFLECTION FACTOR: ^F			
D1 AND D2	115	230	VOLTS DC/IN
D3 AND D4	98	196	VOLTS DC/IN

CONTINUED NEXT PAGE

TUNG-SOL

CONTINUED FROM PRECEDING PAGE

SPOT POSITION AND TEST CONDITIONS

THE UNDEFLECTED FOCUSED SPOT FALLS WITHIN A 10 MM. SQUARE CENTERED ON THE TUBE FACE.

TEST CONDITIONS ARE:

ANODE NO. 2 VOLTAGE	1000	VOLTS
ANODE NO. 1 VOLTAGE	ADJUSTED FOR FOCUS	
GRID VOLTAGE	NEAR CUT-OFF	
DEFLECTOR RESISTORS (CONNECTED TO ANODE NO. 2)	1	MEG OHM EACH

NOTE: SHIELD TUBE FROM ALL STRAY FIELDS.

- A WHEN THE HEATER IS OPERATED AT A NEGATIVE POTENTIAL WITH RESPECT TO THE CATHODE THEN THE CATHODE RETURN SHOULD BE MADE AT THE CENTER TAP OF THE FILAMENT TRANSFORMER.
- B USE OF LESS THAN 500 VOLTS RESULTS IN DECREASED BRILLIANCE.
- C CERTAIN TUBES MAY REQUIRE ADJUSTMENT OF $\pm 20\%$ TO -45% WITH GRID VOLTAGE BETWEEN ZERO AND CUT-OFF.
- D THE VISUAL EXTINCTION OF A FOCUSED SPOT.
- E THE GRID SUPPLY SHOULD BE VARIABLE TO $\pm 50\%$.
- F VALUES SUBJECT TO VARIATION OF $\pm 20\%$.

DEFLECTOR LOCATIONS:

D1 AND D2
D3 AND D4
D1
D3

NEAREST TO SCREEN
NEAREST TO BASE
SAME SIDE OF TUBE AS PIN NO. 4
SAME SIDE AS PIN NO. 1

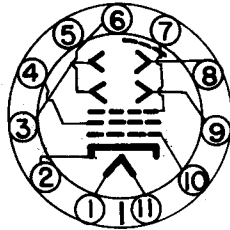
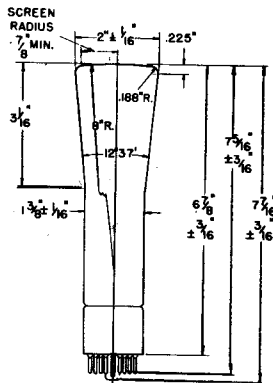

BOTTOM VIEW

1. HEATER
2. CATHODE
3. DEFLECTOR NO. 1 (D1)
4. ANODE NO. 1
5. NO CONNECTION
6. DEFLECTOR NO. 4 (D4)
7. ANODE NO. 2
8. DEFLECTOR NO. 2 (D2)
9. DEFLECTOR NO. 3 (D3)
10. GRID
11. HEATER

PLATE
1396
MARCH 15
1944

TUNG-SOL

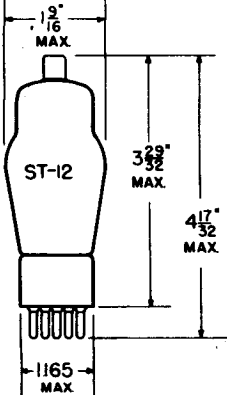

2B7, 6B7

SMALL METAL
CAP

DUO-DIODE PENTODE AMPLIFIER

COATED UNIPOTENTIAL CATHODE

- 2B7** - 2.5 VOLTS 0.8 AMPERE
- 6B7** - 6.3 VOLTS 0.3 AMPERE
- 6B8G** - 6.3 VOLTS 0.3 AMPERE

AC OR DC

GLASS BULB

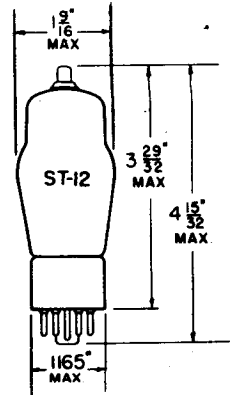

6B8G

SKIRTED MINIATURE
CAP

ANY MOUNTING POSITION

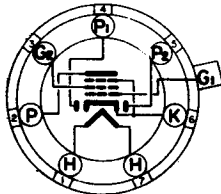

BOTTOM VIEW

SMALL
7-PIN BASE

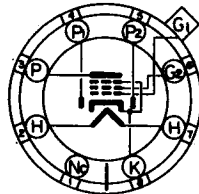

BOTTOM VIEW

SMALL SHELL
8-PIN OCTAL BASE

THE 2B7, 6B7, AND 6B8G CONSIST OF TWO DIODES AND A PENTODE UTILIZING A COMMON CATHODE. THEY ARE DESIGNED FOR SERVICE AS COMBINED DETECTORS, AVC RECTIFIERS AND PENTODE AMPLIFIERS.

RATINGS

INTERPRETED ACCORDING TO RMA STANDARD W8-210

MAXIMUM PLATE VOLTAGE	300	VOLTS
MAXIMUM SCREEN SUPPLY VOLTAGE	300	VOLTS
MAXIMUM SCREEN VOLTAGE	125	VOLTS
MINIMUM EXTERNAL GRID BIAS VOLTAGE	0	VOLTS
MINIMUM DIODE CURRENT PER PLATE WITH 10 VOLTS DC	0.8	MA.
MAXIMUM PLATE DISSIPATION	2.25	WATTS
MAXIMUM SCREEN DISSIPATION	0.3	WATTS

CONTINUED ON NEXT PAGE

TUNG-SOL

CONTINUED FROM PRECEDING PAGE

DIRECT INTERELECTRODE CAPACITANCES

WITH EXTERNAL SHIELD CONNECTED TO CATHODE

PENTODE UNIT

	2B7, 6B7	6B8G	
INPUT: G1 TO (F+K+G2+G3)	3.5	3.6	μmf
OUTPUT: P TO (F+K+G2+G3)	9.5	9.5	μmf
CONTROL GRID TO PLATE	0.007 (MAX.)	0.01 (MAX.)	μmf

TYPICAL OPERATING CONDITIONS AND CHARACTERISTICS

CLASS A₁ AMPLIFIER

PENTODE UNIT

PLATE VOLTAGE	100	180	250	250	VOLTS
SCREEN VOLTAGE	100	75	100	125	VOLTS
CONTROL GRID VOLTAGE	-3.0	-3.0	-3.0	-3.0	VOLTS
PLATE CURRENT	5.8	3.4	6.0	9.0	MA.
SCREEN CURRENT	1.7	0.9	1.5	2.3	MA.
PLATE RESISTANCE (APPROX.)	0.3	1.0	0.8	0.6	MEGOHM
TRANSCONDUCTANCE	950	840	1 000	1 125	μMHOS
GRID BIAS (FOR CATHODE CURRENT CUT-OFF, APPROX.)	-17	-13	-17	-21	VOLTS

TUNG-SOL

THYRATRON
MINIATURE TYPE

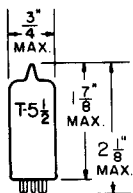

GLASS BULB

COATED UNIPOTENTIAL CATHODE
HEATER
2.5 VOLTS 0.650 AMPERE
AC OR DC
ANY MOUNTING POSITION

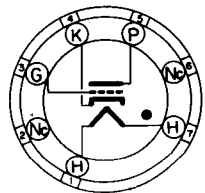

BOTTOM VIEW
MINIATURE BUTTON
7 PIN BASE

THE 2C4 IS A THYRATRON DESIGNED FOR USE IN COMPACT, LIGHT-WEIGHT, PORTABLE EQUIPMENT. IT IS RECOMMENDED THAT NO MATERIAL BE PERMITTED TO OBSTRUCT THE HOLE IN THE BASE SOCKET AS THIS TYPE MAY BE MANUFACTURED WITH THE EXHAUST-TUBE TIP AT THE BASE END.

RATINGS

INTERPRETED ACCORDING TO RMA STANDARD M8-210

HEATER VOLTAGE	2.5	VOLTS
HEATER CURRENT	0.650	AMP.
HEATING TIME (MINIMUM)	30	SECONDS
MAXIMUM VOLTAGE BETWEEN ELEMENTS	450	VOLTS
AVERAGE ANODE CURRENT ^A	5.0	MA.
PEAK ANODE CURRENT	20	MA.
TUBE VOLTAGE DROP AT 5.0 MA. (APPROX.)	16	VOLTS

^A AVERAGED OVER PERIOD OF NOT MORE THAN 30 SECONDS.

→ INDICATES A CHANGE OR ADDITION.

PRINTED IN U. S. A.

PLATE
1742
NOV. 1,
1946

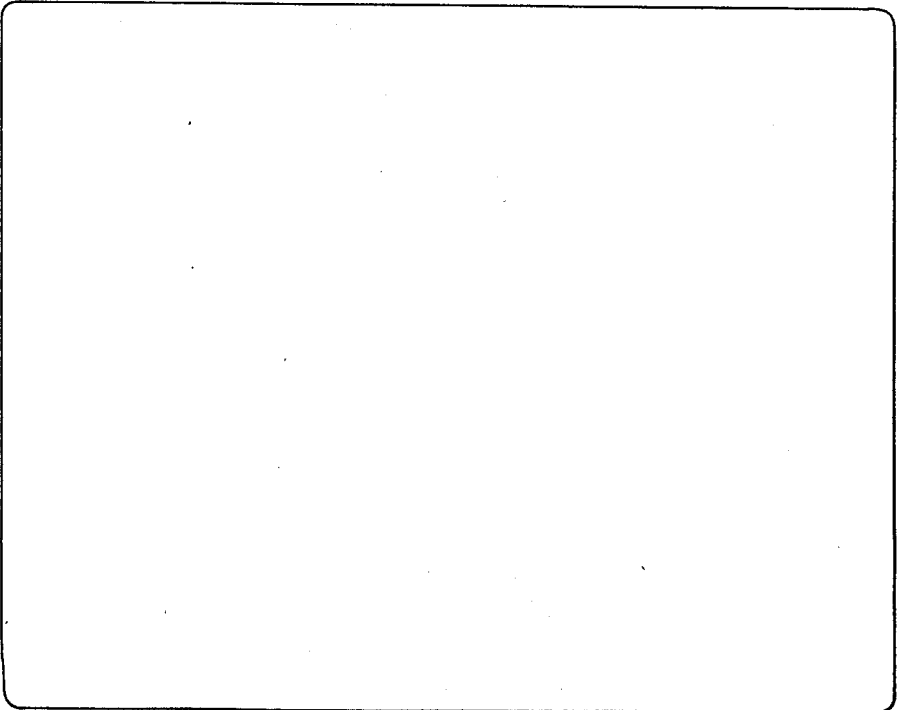
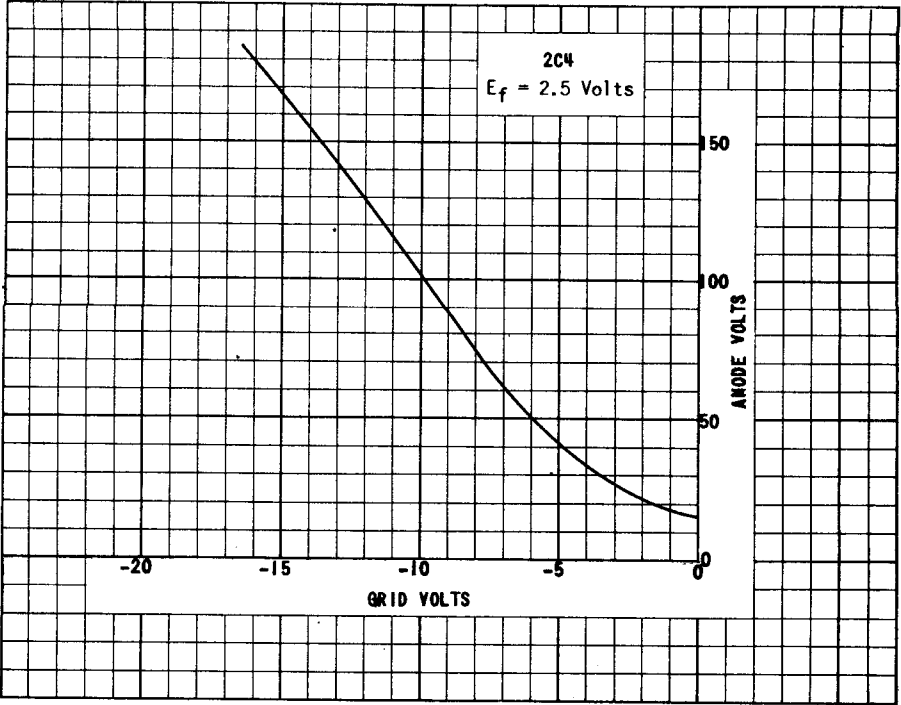

TUNG-SOL

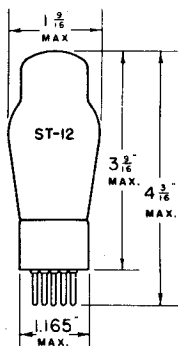

CATHODE RAY TUNING INDICATOR

UNIPOTENTIAL CATHODE

HEATER

2.5 VOLTS 0.8 AMPERE

AC OR DC

GLASS BULB

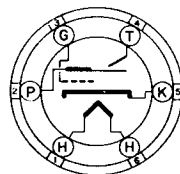
6R
BOTTOM VIEW

SMALL 6 PIN BASE

THE TUNG-SOL 2E5 CONSISTS OF A CIRCULAR FLUORESCENT TARGET WITH AN INDICATING SHADOW ANGLE CONTROLLED BY AN INTERNALLY CONNECTED SHARP CUT-OFF AMPLIFIER. WHEN THE 2E5 IS USED AS A TUNING INDICATOR AVC VOLTAGE IS APPLIED TO THE TRIODE GRID. WITH THE EXCEPTION OF HEATER RATINGS, ITS RATINGS AND ELECTRICAL CHARACTERISTICS ARE IDENTICAL TO THOSE OF THE 6E5.

RATINGS

MAXIMUM PLATE SUPPLY VOLTAGE	250	VOLTS
MAXIMUM TARGET VOLTAGE	250	VOLTS
MINIMUM TARGET VOLTAGE	100	VOLTS

OPERATING CONDITIONS AND CHARACTERISTICS

PLATE AND TARGET SUPPLY VOLTAGE	100	200	250	VOLTS
TRIODE GRID VOLTAGE (0° SHADOW ANGLE) APPROX.	-3.3	-6.5	-8.0	VOLTS
TRIODE GRID VOLTAGE (90° SHADOW ANGLE) APPROX.	0	0	0	VOLTS
SERIES TRIODE PLATE RESISTOR	0.5	1	1	MEGOHM
TRIODE PLATE CURRENT (TRIODE GRID V.=0)	0.19	0.19	0.24	MA.
TARGET CURRENT (TRIODE GRID V.=0) ^b	1	3	4	MA.

^b SUBJECT TO WIDE VARIATIONS

FOR "INTERPRETATION OF RATINGS" REFER TO FRONT OF BOOK.

PLATE
891-2NOV. 8
1940

TUNG-SOL

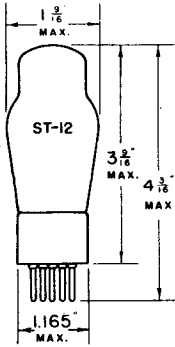

CATHODE RAY TUNING INDICATOR

UNI-POTENTIAL CATHODE

HEATER
2.5 VOLTS 0.8 AMPERE
AC OR DC

GLASS BULB

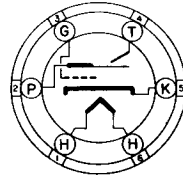

6R
BOTTOM VIEW

SMALL 6 PIN BASE

THE TUNG-SOL 2G5 CONSISTS OF A CIRCULAR FLUORESCENT TARGET WITH AN INDICATING SHADOW ANGLE CONTROLLED BY AN INTERNALLY CONNECTED REMOTE CUT-OFF AMPLIFIER. WHEN THE 2G5 IS USED AS A TUNING INDICATOR, AVC VOLTAGE IS APPLIED TO THE TRIODE GRID. WITH THE EXCEPTION OF HEATER RATINGS, ITS RATINGS AND ELECTRICAL CHARACTERISTICS ARE IDENTICAL TO THOSE OF THE 6U5/6G5.

RATINGS

MAXIMUM PLATE SUPPLY VOLTAGE	250	VOLTS
MAXIMUM TARGET VOLTAGE	250	VOLTS
MINIMUM TARGET VOLTAGE	100	VOLTS

OPERATING CONDITIONS AND CHARACTERISTICS

PLATE AND TARGET SUPPLY VOLTAGE	100	200	250	VOLTS
TRIODE GRID VOLTAGE (0° SHADOW ANGLE) ^{APPROX.}	-8	-18.5	-22	VOLTS
TRIODE GRID VOLTAGE (90° SHADOW ANGLE) ^{APPROX.}	0	0	0	VOLT
SERIES TRIODE PLATE RESISTOR	0.5	1	1	MEGOHM
TRIODE PLATE CURRENT (TRIODE GRID V.=0)	0.19	0.19	0.24	MA.
TARGET CURRENT (TRIODE GRID V.=0) ^A	1	3	4	MA.

^A SUBJECT TO WIDE VARIATIONS

FOR "INTERPRETATION OF RATINGS" REFER TO FRONT OF BOOK.

PLATE
892-1

TUNG-SOL

PENTODE POWER AMPLIFIER OSCILLATOR

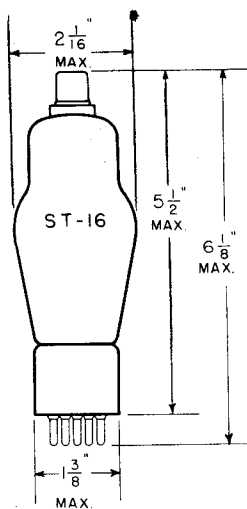

MEDIUM METAL CAP

COATED FILAMENT

6.3 VOLTS^A 1.5 AMPS.
AC OR DC

GLASS BULB

MOUNTING POSITION

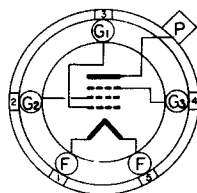
HORIZONTAL OPERATION PERMITTED IF
PINS 2 AND 4 ARE IN A VERTICAL
PLANE.

BOTTOM VIEW

MEDIUM 5 PIN
MICANOL BASETYPE 2E22 IS DESIGNED PRIMARILY FOR CLASS C AMPLIFIER OR OSCILLATOR
SERVICE IN PORTABLE EQUIPMENT.

RATINGS

INTERPRETED ACCORDING TO RMA STANDARD M8-210

MAXIMUM PLATE VOLTAGE	750	VOLTS
MAXIMUM SCREEN GRID VOLTAGE	250	VOLTS
MAXIMUM CONTROL GRID VOLTAGE	-200	VOLTS
MAXIMUM PLATE DISSIPATION	30	WATTS
MAXIMUM SCREEN DISSIPATION	10	WATTS
MAXIMUM PLATE CURRENT	110	MA.
MAXIMUM CONTROL GRID CURRENT	9.0	MA.

DIRECT INTERELECTRODE CAPACITANCES

GRID TO PLATE (WITH SHIELD)	0.20 MAX.	μf
INPUT	13	μf
OUTPUT	8.0	μf

^A THE FILAMENT VOLTAGE SHOULD BE HELD AS CLOSE TO 6.3 VOLTS AS POSSIBLE. INTERMITTENT OPERATION TO AS HIGH AS 7.0 OR AS LOW AS 5.5 VOLTS IS PERMISSIBLE.

CONTINUED NEXT PAGE

PLATE
1562
FEB. 28
1945

TUNG-SOL

CONTINUED FROM PRECEDING PAGE

TYPICAL OPERATING CONDITIONS AND CHARACTERISTICS

CLASS C, R-F AMPLIFIER OR OSCILLATOR

PLATE VOLTAGE	500	500	750	750	VOLTS
SCREEN VOLTAGE	250	250	250	250	VOLTS
SCREEN RESISTOR ^B	15 000	15 000	30 000	30 000	OHMS
SUPPRESSOR VOLTAGE	0	22.5	0	22.5	VOLTS
PLATE CURRENT	100	100	100	100	MA.
SCREEN CURRENT	16	16	16	16	MA.
CONTROL GRID CURRENT (APPROX.)	6.0	6.0	6.0	6.0	MA.
CONTROL GRID RESISTOR ^C	10 000	10 000	10 000	10 000	OHMS
PEAK R-F GRID VOLTAGE (APPROX.)	100	100	100	100	VOLTS
GRID DRIVING POWER (APPROX.)	0.55	0.55	0.55	0.55	WATT
POWER OUTPUT (APPROX.)	30	34	48	53	WATTS

SUPPRESSOR MODULATED CLASS C AMPLIFIER

PLATE VOLTAGE	500	750	VOLTS
SCREEN VOLTAGE	250	250	VOLTS
SCREEN RESISTOR	8 500	17 000	OHMS
SUPPRESSOR VOLTAGE	-65	-90	VOLTS
PEAK A-F INPUT	65	90	VOLTS
PEAK R-F GRID VOLTAGE	100	100	VOLTS
PLATE CURRENT	50	55	MA.
SCREEN CURRENT (APPROX.)	29	29	MA.
CONTROL GRID CURRENT (APPROX.)	6.5	6.5	MA.
CONTROL GRID RESISTOR ^C	10 000	10 000	OHMS
GRID DRIVING POWER (APPROX.)	0.6	0.6	WATT
POWER OUTPUT (APPROX.)	10.5	16.5	WATTS
MODULATION	95	95	PER CENT

^B SERIES SCREEN DROPPING RESISTOR SHOULD NOT BE USED IF UNDER KEY-UP CONDITIONS THE SCREEN VOLTAGE EXCEEDS 500 VOLTS.

^C THE TOTAL EFFECTIVE GRID CIRCUIT RESISTANCE SHALL NOT EXCEED 25,000 OHMS.

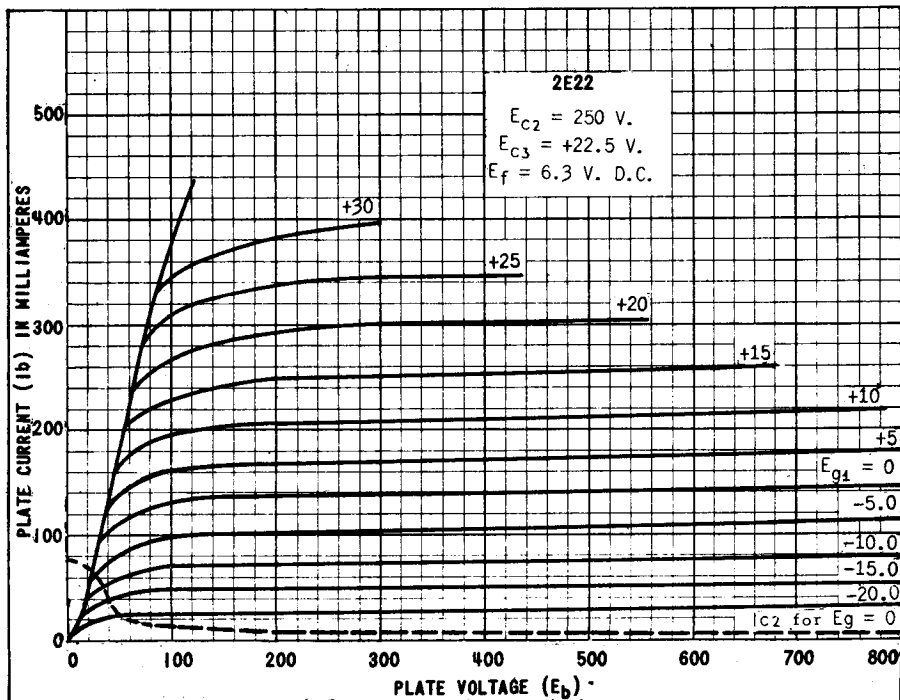
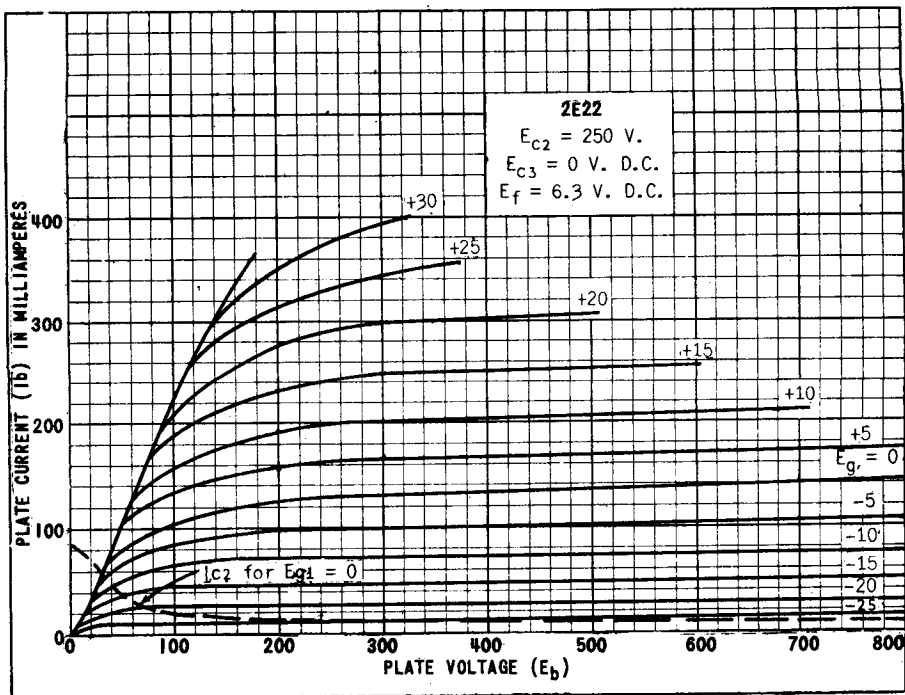

PLATE
 1564
 FEB. 28
 1945

PRINTED IN U.S.A.

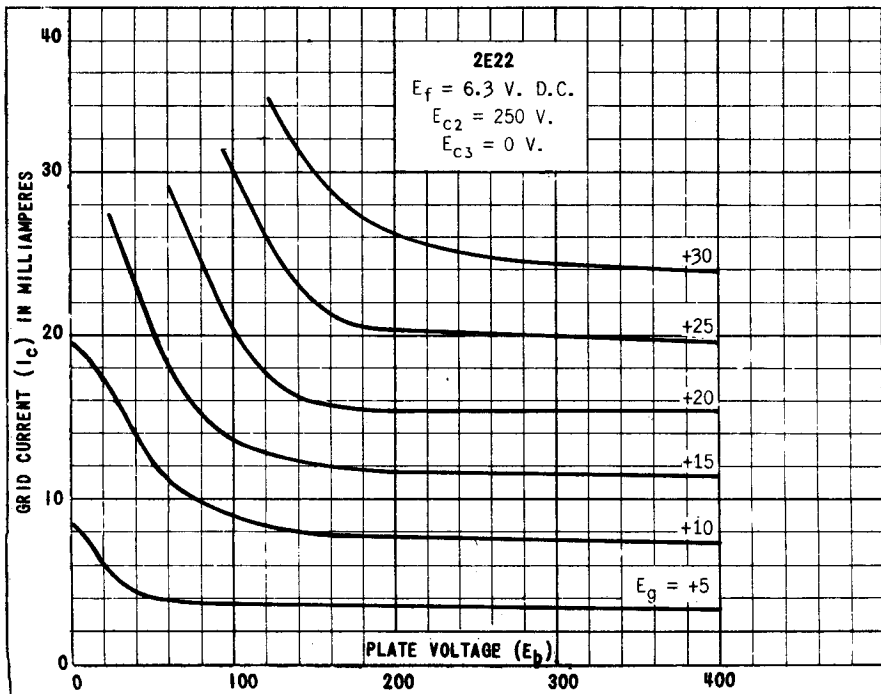
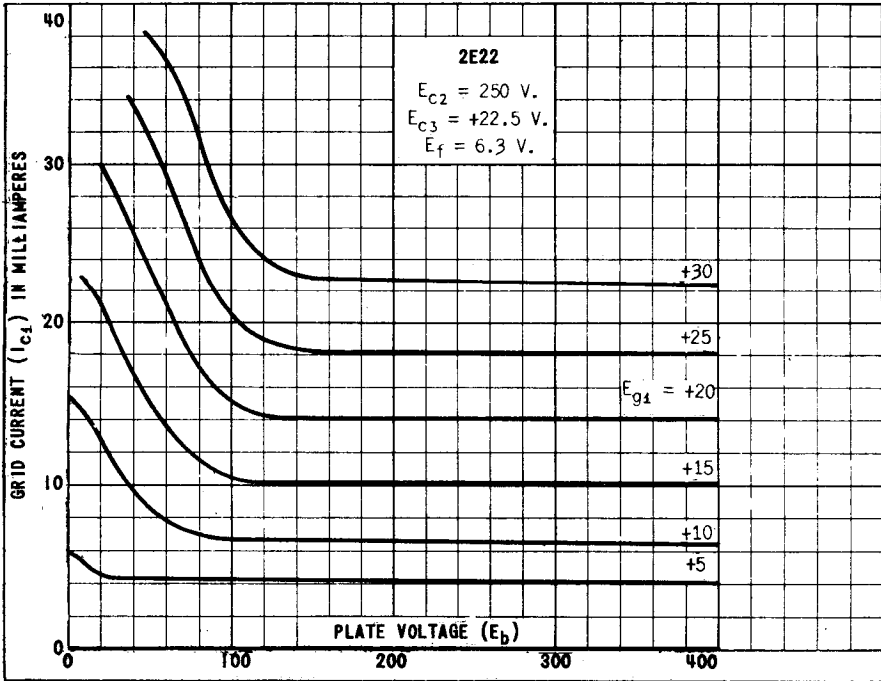
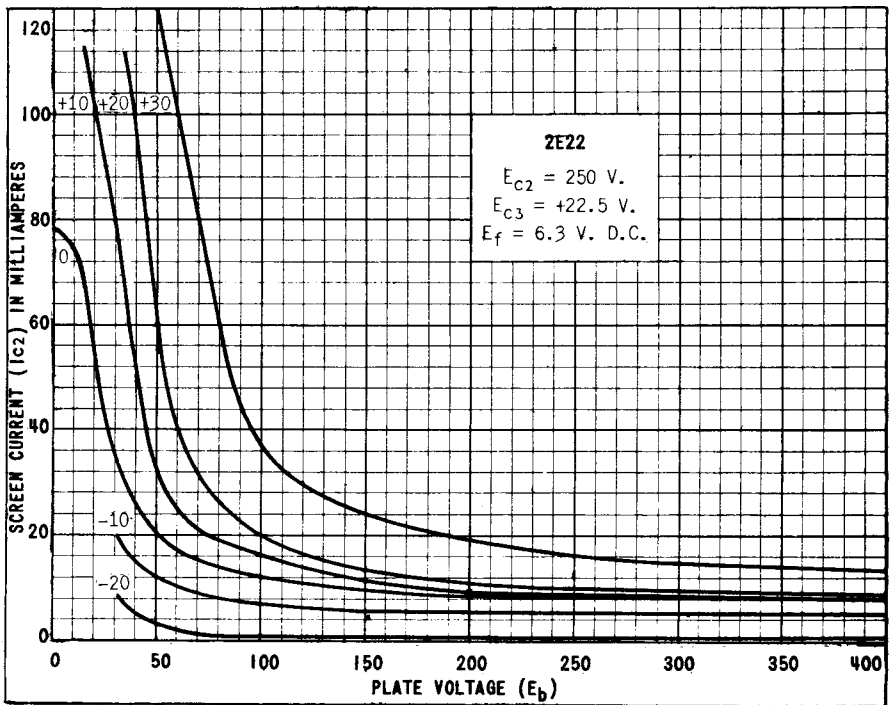
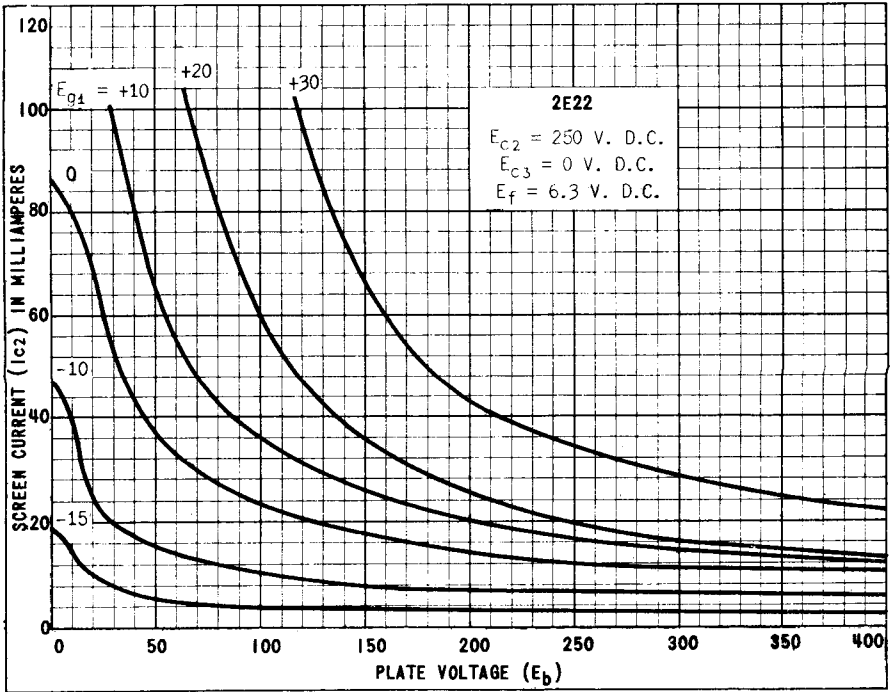

PLATE
 1965
 FEB. 28
 1945



PRINTED IN U. S.

PLATE 1566
 FEB. 28 1945



TUNG-SOL

HALF WAVE, HIGH VACUUM RECTIFIER

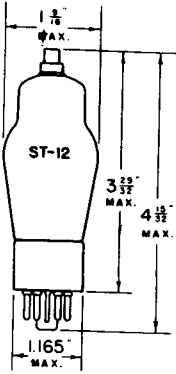

TUNGSTEN FILAMENT

2.5 VOLTS

5 AMPERES

AC

GLASS BULB

SMALL SHELL OCTAL 6 PIN BASE

MOUNTING POSITION - VERTICAL ONLY

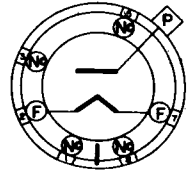

BOTTOM VIEW

THE 2V3G IS INTENDED FOR USE AS THE RECTIFIER IN THE HIGH VOLTAGE SUPPLY FOR CATHODE-RAY TUBES.

RATINGS*

MAXIMUM PEAK INVERSE VOLTAGE	16500	VOLTS
MAXIMUM PEAK PLATE CURRENT	12	MA.
MAXIMUM AVERAGE PLATE CURRENT	2	MA.

* INTERPRETED ACCORDING TO RMA STANDARD MB-210

PRINTED IN U. S. A.

PLATE
1410
MARCH 15
1944

TUNG-SOL

HALF WAVE, HIGH VACUUM RECTIFIER

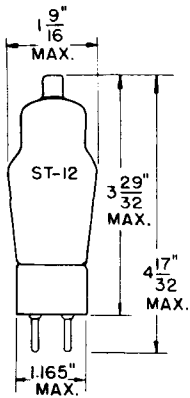

COATED UNIPOTENTIAL CATHODE

HEATER
2.5 VOLTS^A 1.75 AMPERES
AC

GLASS BULB

SMALL 4 PIN BASE

MOUNTING POSITION - ANY

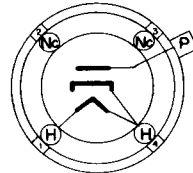

BOTTOM VIEW

THE 2X2 (879) IS INTENDED FOR USE AS THE RECTIFIER IN THE HIGH VOLTAGE SUPPLY FOR CATHODE-RAY TUBES.

RATINGS*

MAXIMUM AC PLATE VOLTAGE (RMS) ^B	4500	VOLTS
MAXIMUM PEAK INVERSE VOLTAGE	12500	VOLTS
MAXIMUM PEAK PLATE CURRENT	100	MA.
MAXIMUM DC OUTPUT CURRENT	7.5	MA.
TOTAL EFFECTIVE PLATE-SUPPLY IMPEDANCE (MIN.)		

* INTERPRETED ACCORDING TO RMA STANDARD M8-210

^A IT IS IMPORTANT THAT THE HEATER TRANSFORMER SECONDARY BE INSULATED TO WITHSTAND THE MAXIMUM PEAK INVERSE VOLTAGE ENCOUNTERED IN THE INSTALLATION.

^B IN A VOLTAGE DOUBLER CIRCUIT THE TWO 2X2 TUBES MAY BE OPERATED TO DELIVER APPROXIMATELY TWICE THE VOLTAGE OBTAINABLE FROM A HALF-WAVE RECTIFIER CIRCUIT FOR THE SAME AC INPUT VOLTAGE. IN THIS CASE A SEPARATE HEATER SUPPLY WINDING IS REQUIRED FOR EACH TUBE.

SMOOTHING FILTER REQUIREMENTS, DUE TO THE LOW CURRENT DEMAND OF CATHODE-RAY TUBES, MAY BE MET BY A SIMPLE RESISTIVE CAPACITIVE FILTER. WITH A BLEEDER LOAD CURRENT OF 1 MILLIAMPERE A CONDENSER OF 0.05 μ f FOLLOWED BY A 0.5 MEGOHM RESISTOR AND A SECOND CONDENSER OF 0.15 μ f IS ADEQUATE. WHEN THE VOLTAGE DROP MUST BE KEPT AT A MINIMUM, A CONDENSER OF 0.5 TO 2 μ f MAY BE SHUNTED ACROSS THE BLEEDER. FILTER CONDENSERS MUST HAVE A RATING TO WITHSTAND THE INSTANTANEOUS PEAK AC INPUT VOLTAGE.

TUNG-SOL

POWER AMPLIFIER PENTODE

MINIATURE TYPE

COATED FILAMENT

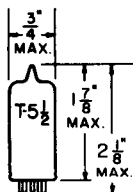

GLASS BULB

SERIES FILAMENT
 E_f APPLIED BETWEEN PINS 1 & 7
 E_{g1} REFERRED TO PIN 1

2.8 VOLTS
 0.1 AMP.

PARALLEL FILAMENT
 E_f APPLIED BETWEEN PIN 5 AND PINS 1 & 7 TIED TOGETHER.
 E_{g1} REFERRED TO PIN 5

1.4 VOLTS
 0.2 AMP.

DC

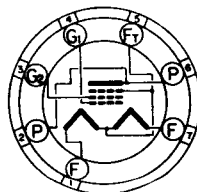

BOTTOM VIEW
 MINIATURE BUTTON
 7 PIN BASE

A SHUNTING RESISTOR MUST BE CONNECTED BETWEEN PINS 1 AND 5 FOR SERIES-FILAMENT OPERATION. ITS VALUE SHOULD BE SUCH THAT THE VOLTAGE ACROSS THE SHUNTED SECTION IS EQUAL TO THE VOLTAGE BETWEEN PINS 5 AND 7. AN ADDITIONAL SHUNTING RESISTOR MAY BE NECESSARY BETWEEN PINS 1 AND 7 IF OTHER TUBES USED IN SERIES-FILAMENT ARRANGEMENT CONTRIBUTE TO THE FILAMENT CURRENT OF THE 3A4.

ANY MOUNTING POSITION

THE 3A4 IS DESIGNED FOR USE IN COMPACT, LIGHTWEIGHT, PORTABLE EQUIPMENT. THE RELATIVELY LARGE FILAMENT EMPLOYED IN THE 3A4 ENABLES IT TO SUPPLY THE HIGH PEAK CURRENTS REQUIRED IN RF POWER APPLICATIONS. IN RF AMPLIFIER SERVICE THE 3A4 WILL DELIVER A POWER OUTPUT OF ABOUT 1.2 WATTS AT 10 MEGACYCLES. IT IS RECOMMENDED THAT NO MATERIAL BE PERMITTED TO OBSTRUCT THE HOLE IN THE BASE SOCKET AS THIS TYPE MAY BE MANUFACTURED WITH THE EXHAUST-TUBE TIP AT THE BASE END.

RATINGS

INTERPRETED ACCORDING TO RMA STANDARD WG-210

	AF POWER AMPLIFIER	RF POWER AMPLIFIER	
MAXIMUM PLATE VOLTAGE	150	150	VOLTS
MAXIMUM SCREEN VOLTAGE	90	135	VOLTS
MAXIMUM GRID VOLTAGE	---	-30	VOLTS
MAXIMUM PLATE CURRENT	---	20	MA.
MAXIMUM GRID CURRENT	---	0.25	MA.
MAXIMUM TOTAL CATHODE CURRENT	18	25	MA.
MAXIMUM PLATE INPUT	---	3.0	WATTS
MAXIMUM PLATE DISSIPATION	2.0	2.0	WATTS
MAXIMUM SCREEN DISSIPATION	0.4	0.9	WATT

DIRECT INTERELECTRODE CAPACITANCES

WITH NO EXTERNAL SHIELD

GRID TO PLATE (MAX.)	0.34	μuf
INPUT	4.8	μuf
OUTPUT	4.2	μuf

CONTINUED ON FOLLOWING PAGE

→ INDICATES A CHANGE OR ADDITION

TUNG-SOL

CONTINUED FROM PRECEDING PAGE

TYPICAL OPERATING CONDITIONS AND CHARACTERISTICS

CLASS A₁ AMPLIFIER

VALUES FOR SERIES-FILAMENT OPERATION WILL BE APPROXIMATELY THE SAME AS FOR PARALLEL-FILAMENT OPERATION.

	PARALLEL FILAMENT ARRANGEMENT			
	AF POWER AMPLIFIER		RF POWER AMPLIFIER AT 10 MC.	
PLATE VOLTAGE	135	150	150	VOLTS
SCREEN VOLTAGE	90	90	135	VOLTS
GRID VOLTAGE	-7.5	-8.4	---	VOLTS
PEAK AF GRID VOLTAGE	7.5	8.4	---	VOLTS
ZERO-SIGNAL PLATE CURRENT	14.8	13.3	---	MA.
ZERO-SIGNAL SCREEN CURRENT	2.6	2.2	---	MA.
MAXIMUM-SIGNAL PLATE CURRENT	14.9	14.1	18.3	MA.
MAXIMUM-SIGNAL SCREEN CURRENT	3.5	3.5	6.5	MA.
GRID CURRENT	---	---	0.13	MA.
GRID RESISTOR	---	---	0.2	MEG OHM
LOAD RESISTANCE	8 000	8 000	---	OHMS
PLATE RESISTANCE	90 000	100 000	---	OHMS
TRANSCONDUCTANCE	1 900	1 900	---	μMHOS
MAXIMUM-SIGNAL POWER OUTPUT	0.6	0.7	1.2 (APPROX.)	WATTS
TOTAL HARMONIC DISTORTION	5.0	6.0	---	PER CENT

→ INDICATES A CHANGE OR ADDITION

PLATE
1745
NOV. 1,
1946

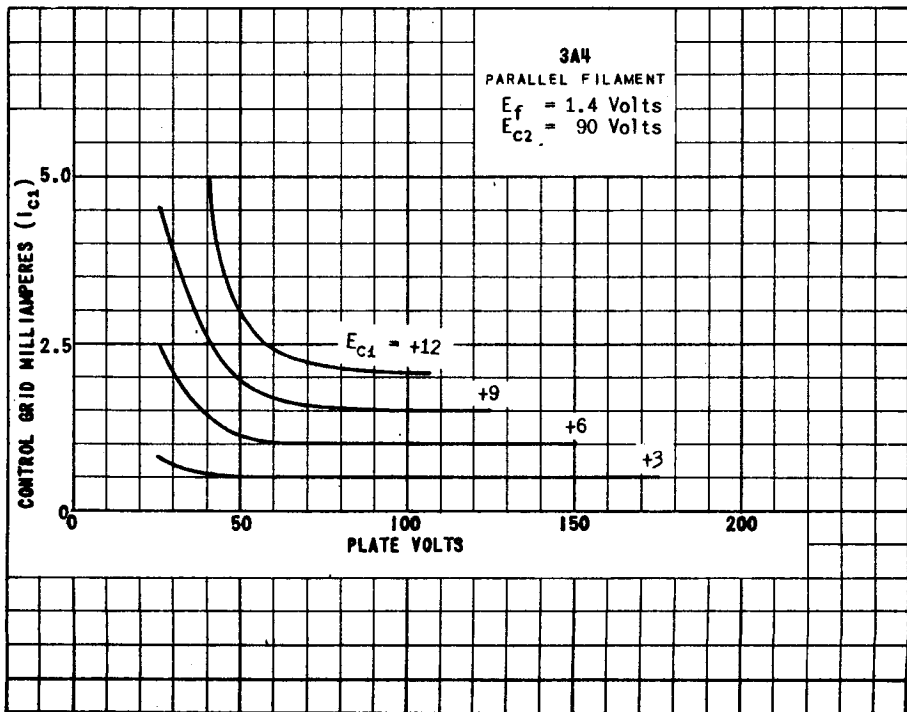
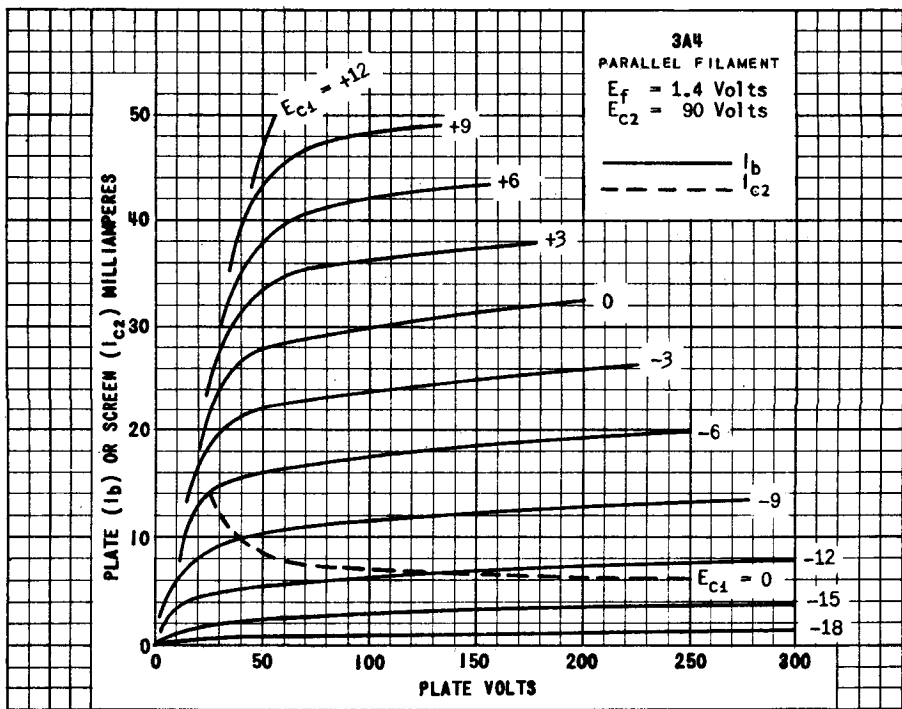

PRINTED IN U. S. A.

PLATE
1746
NOV. 1,
1946

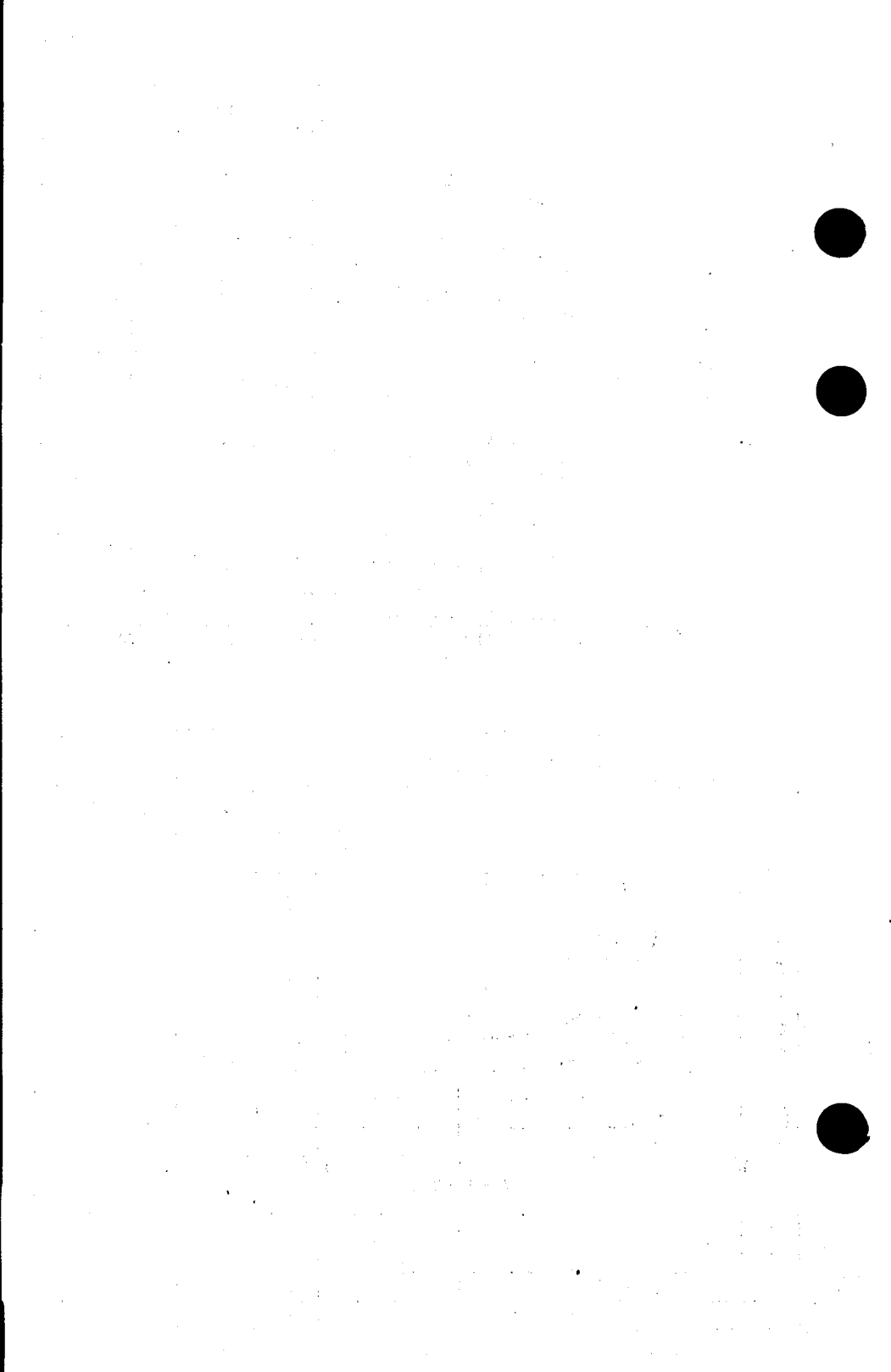

TUNG-SOL

DOUBLE TRIODE

MINIATURE TYPE

COATED FILAMENT

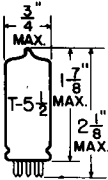

GLASS BULB

SERIES FILAMENT
 E_f APPLIED BETWEEN PINS 1 & 7
 E_g REFERRED TO PIN 1

2.8 VOLTS
 110 MA.

PARALLEL FILAMENT
 E_f APPLIED BETWEEN PIN 4 AND PINS 1 & 7 TIED TOGETHER.
 E_g REFERRED TO PIN 4

1.4 VOLTS
 220 MA.

DC

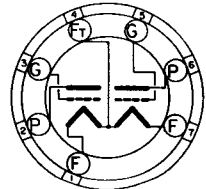

BOTTOM VIEW
 MINIATURE BUTTON
 7 PIN BASE

A SHUNTING RESISTOR MUST BE CONNECTED BETWEEN PINS 1 AND 4 FOR SERIES-FILAMENT OPERATION. ITS VALUE SHOULD BE SUCH THAT THE VOLTAGE ACROSS THE SHUNTED SECTION IS EQUAL TO THE VOLTAGE BETWEEN PINS 4 AND 7. AN ADDITIONAL SHUNTING RESISTOR MAY BE NECESSARY BETWEEN PINS 1 AND 7 IF OTHER TUBES USED IN SERIES-FILAMENT ARRANGEMENT CONTRIBUTE TO THE FILAMENT CURRENT OF THE 3A5.

ANY MOUNTING POSITION

THE 3A5 IS INTENDED FOR USE IN HIGH FREQUENCY APPLICATIONS. THE RELATIVELY LARGE FILAMENT EMPLOYED IN THE 3A5 ENABLES IT TO SUPPLY THE HIGH PEAK CURRENTS REQUIRED IN RF POWER APPLICATIONS. IN CLASS C SERVICE, A 3A5 WITH ITS UNITS IN PUSH-PULL WILL DELIVER A POWER OUTPUT OF APPROXIMATELY 2 WATTS AT 40 MEGACYCLES. IT MAY BE USED AT STILL HIGHER FREQUENCIES WITH REDUCED EFFICIENCY. EACH TRIODE MAY BE USED INDEPENDENTLY OF THE OTHER.

DIRECT INTERELECTRODE CAPACITANCES

	TRIODE UNIT 1	TRIODE UNIT 2	
GRID TO PLATE: (G TO P)	3.2	3.2	$\mu\mu\text{f}$
INPUT: (G TO H)	0.9	0.9	$\mu\mu\text{f}$
OUTPUT: (P TO H)	1.0	1.0	$\mu\mu\text{f}$
PLATE TO PLATE: (P TO P)	0.32		$\mu\mu\text{f}$

RATINGS

INTERPRETED ACCORDING TO RMA STANDARD W8-210

	AF AMPLIFIER	RF AMPLIFIER	
FILAMENT VOLTAGE	1.4 2.8	1.4 2.8	VOLTS
MAXIMUM PLATE VOLTAGE	135	135	VOLTS
MAXIMUM DC GRID VOLTAGE	---	-30	VOLTS
MAXIMUM PLATE CURRENT	5	---	MA.
MAXIMUM DC PLATE CURRENT (PER UNIT)	---	15	MA.
MAXIMUM DC GRID CURRENT (PER UNIT)	---	2.5	MA.
MAXIMUM PLATE DISSIPATION	0.5	---	WATT
MAXIMUM PLATE DISSIPATION (PER UNIT)	---	1.0	WATT
MAXIMUM PLATE INPUT (PER UNIT)	---	2.0	WATT

CONTINUED ON FOLLOWING PAGE

PRINTED IN U. S. A.

PLATE 1909
 NOV. 1, 1947

TUNG-SOL

CONTINUED FROM PRECEDING PAGE

TYPICAL OPERATING CONDITIONS AND CHARACTERISTICS

AF AMPLIFIER

HEATER VOLTAGE	1.4	2.8	VOLTS
HEATER CURRENT	220	110	MA.
PLATE VOLTAGE	90		VOLTS
GRID VOLTAGE	-2.5		VOLTS
PLATE CURRENT	3.7		MA.
PLATE RESISTANCE	8 300		OHMS
TRANSCONDUCTANCE	1 800		μMHOS
AMPLIFICATION FACTOR	15		

RF POWER AMPLIFIER AND OSCILLATOR—CLASS "C" TELEGRAPHY

AT 40 MC WITH BOTH UNITS IN PUSH-PULL
(KEY-DOWN CONDITIONS PER TUBE WITHOUT MODULATION)

FILAMENT VOLTAGE	1.4	2.8	VOLTS
FILAMENT CURRENT	220	110	MA.
DC PLATE VOLTAGE	135		VOLTS
DC GRID VOLTAGE:			
FROM A FIXED SUPPLY OF	-20		VOLTS
FROM A GRID RESISTOR OF	4 000		OHMS
FROM A CATHODE RESISTOR OF	570		OHMS
PEAK RF GRID-TO-GRID VOLTAGE	90		VOLTS
DC PLATE CURRENT	30		MA.
DC GRID CURRENT (APPROX.)	5		MA.
DRIVING POWER (APPROX.)	0.2		WATT
POWER OUTPUT (APPROX.)	2		WATTS

PLATE
1910
NOV. 1,
1947

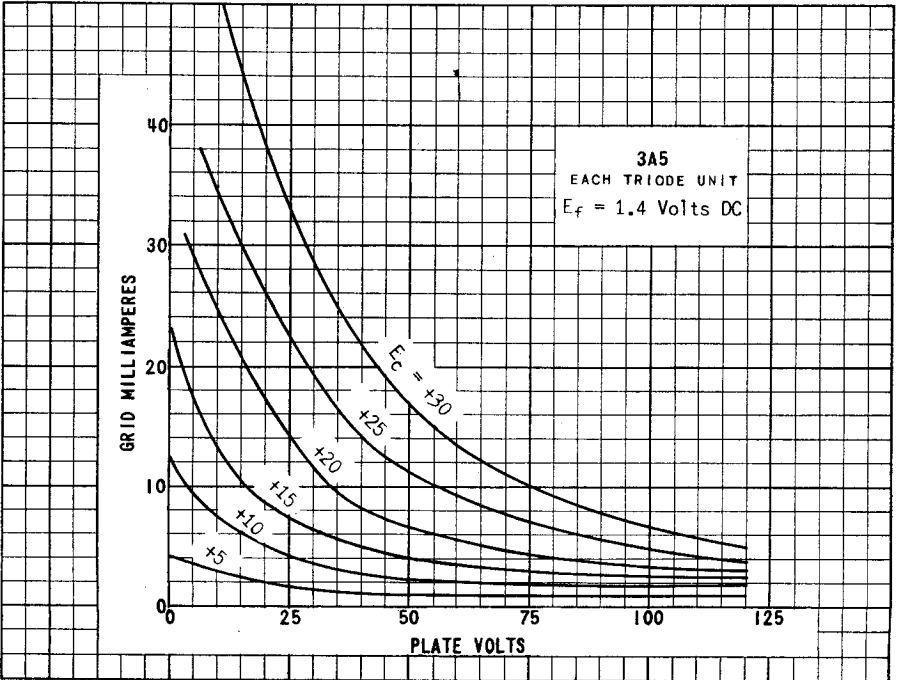
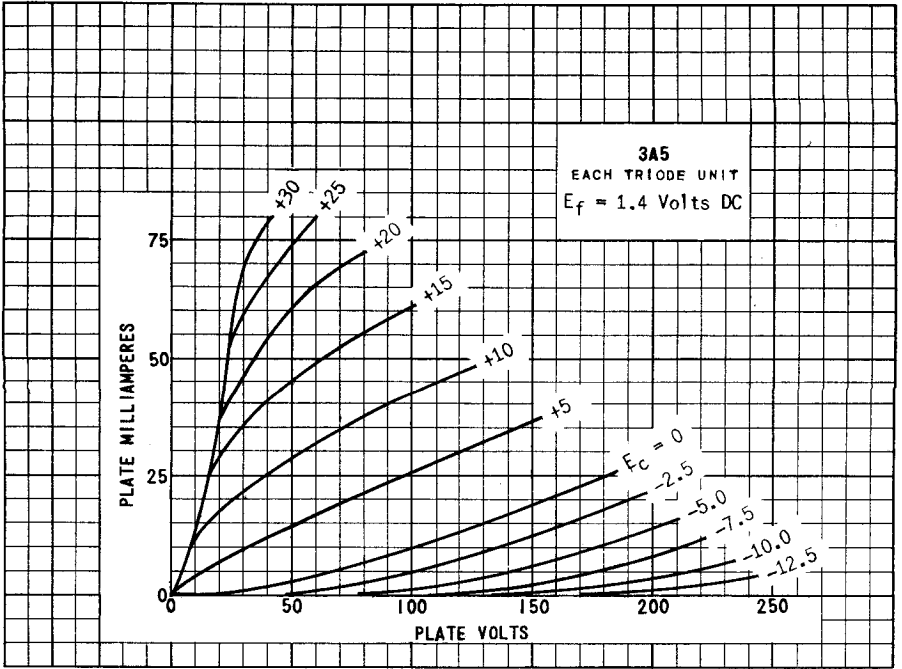

PRINTED IN U. S. A.

PLATE 1911
NOV. 1,
1947



TUNG-SOL

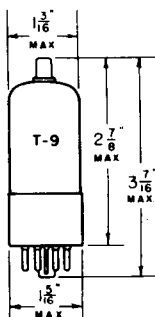

DIODE TRIODE PENTODE

DETECTOR AMPLIFIER

COATED FILAMENT

SERIES	PARALLEL
2.8 V.	1.4 V.
.05 A.	0.1 A.

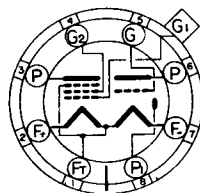

BOTTOM VIEW

GLASS BULB

INTERMEDIATE 8 PIN OCTAL BASE

THE 3A8GT IS A LOW FILAMENT DRAIN TYPE INCORPORATING IN ONE ENVELOPE A SINGLE DIODE, A HIGH MU-TRIODE, AND A VOLTAGE AMPLIFIER PENTODE. THE THREE UNITS ARE INDEPENDENT WITH THE EXCEPTION OF THE COMMON TAPPED FILAMENT. THE TUBE IS ESSENTIALLY THE EQUIVALENT OF A 1H5GT AND A 1N5GT IN ONE ENVELOPE.

RATINGS

	TRIODE	PENTODE	
MAXIMUM PLATE VOLTAGE	110	110	VOLTS
MAXIMUM SCREEN VOLTAGE	-	110	VOLTS

DIRECT INTERELECTRODE CAPACITANCES

WITH CLOSE FITTING SHIELD CONNECTED TO FILAMENT

	TRIODE	PENTODE	
GRID TO PLATE	2.0	.012	μmf
INPUT	2.6	3.0	μmf
OUTPUT	4.2	10.0	μmf

CONTINUED NEXT PAGE

FILAMENTS CONNECTED
IN SERIES

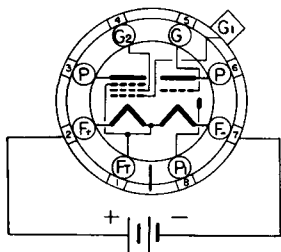

FILAMENTS CONNECTED
IN PARALLEL

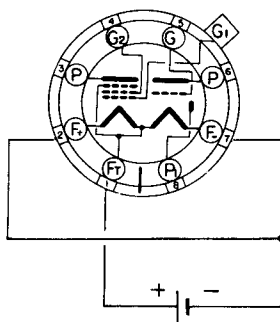

TYPICAL OPERATING CONDITIONS AND CHARACTERISTICS

CLASS A_1 AMPLIFIER

	TRIODE	PENTODE	
PLATE VOLTAGE	90	90	VOLTS
SCREEN VOLTAGE	-	90	VOLTS
GRID VOLTAGE ^A	0	0	VOLTS
PLATE CURRENT	0.2	1.5	MA.
SCREEN CURRENT	-	0.5	MA.
PLATE RESISTANCE (APPROX.)	0.2	0.8	MEGOHM
TRANSCONDUCTANCE	325	750	μ MHOS
AMPLIFICATION FACTOR	65	-	

^A GRID BIAS MEASURED FROM THE NEGATIVE FILAMENT OF EACH SECTION.

DIODE UNIT

THE DIODE PLATE IS LOCATED AT THE NEGATIVE END OF THE FILAMENT, AND IS INDEPENDENT OF THE TRIODE UNIT AND OF THE PENTODE UNIT EXCEPT FOR THE COMMON FILAMENT.

MINIMUM DIODE CURRENT WITH 10 VOLTS DC APPLIED IS 0.5 MA.

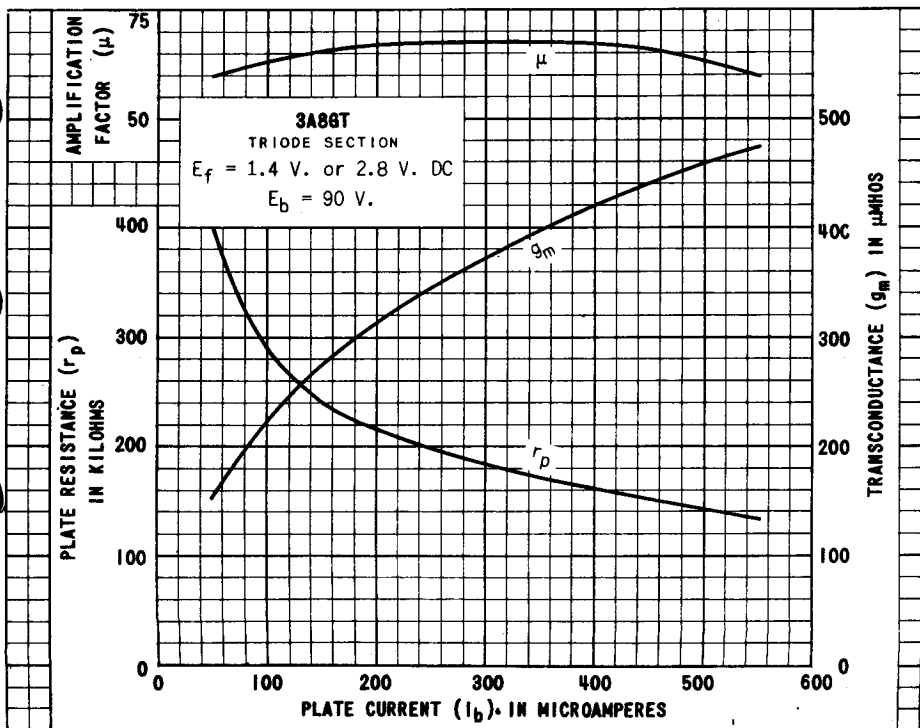
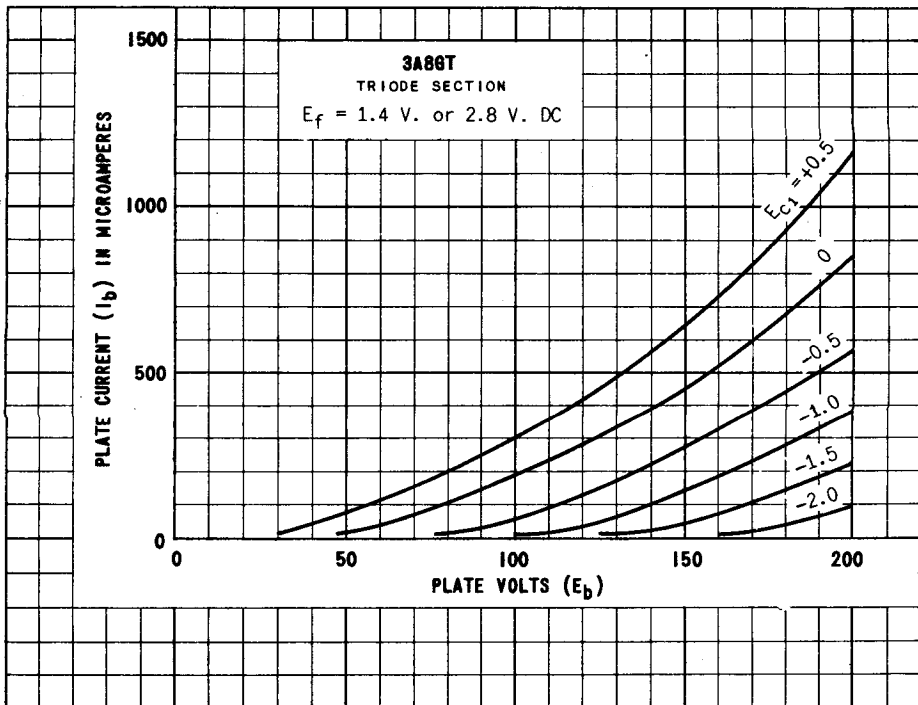

3A8 GT

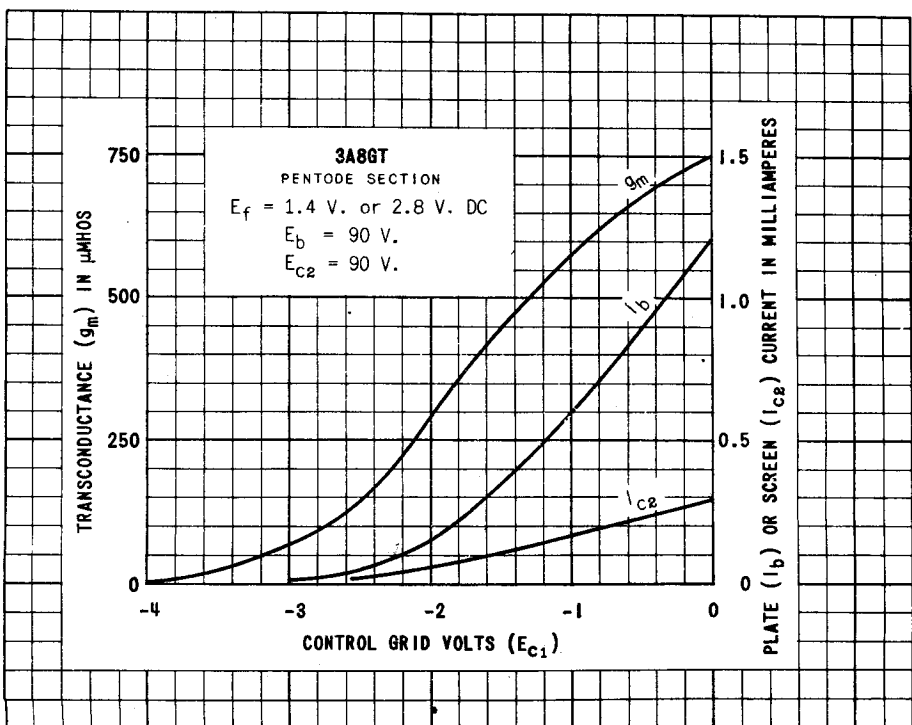
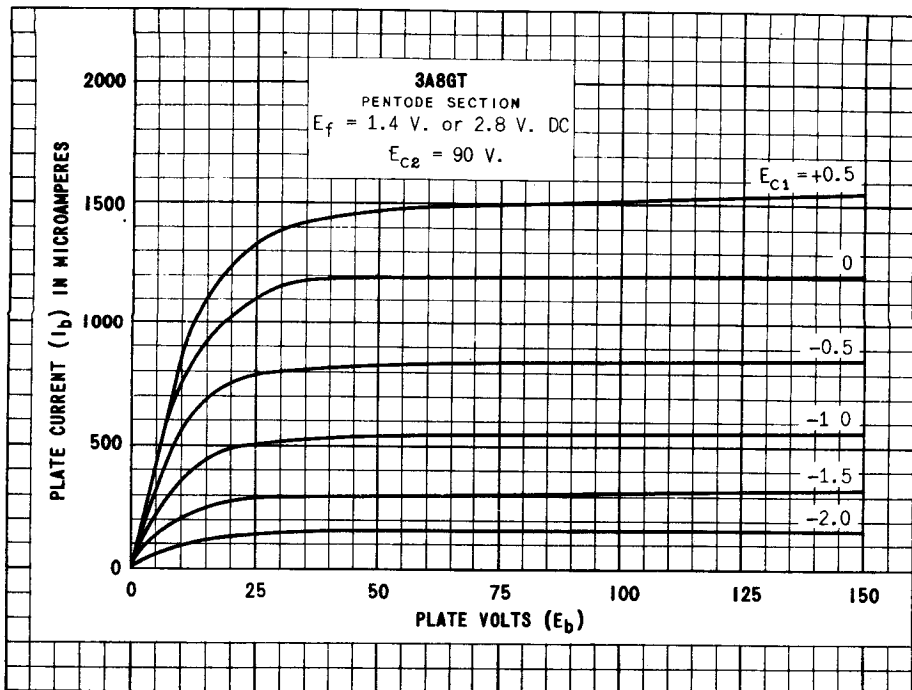
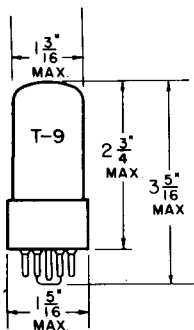

PLATE 725-1

TUNG-SOL

BEAM POWER AMPLIFIER



COATED FILAMENT

SERIES FILAMENTS

2.8 VOLTS
.05 AMP.

PARALLEL FILAMENTS

1.4 VOLTS
.10 AMP.

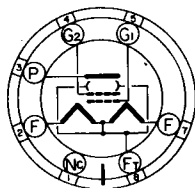

BOTTOM VIEW

INTERMEDIATE SHELL
OCTAL 7 PIN BASE

GLASS BULB

ANY MOUNTING POSITION

TYPE 3B5GT IS DESIGNED FOR AUDIO SERVICE IN PORTABLE EQUIPMENT WHERE THE PLATE VOLTAGE SUPPLY IS LIMITED.

RATINGS

INTERPRETED ACCORDING TO RMA STANDARD MB-210

	SERIES FILAMENTS	PARALLEL FILAMENTS	
MAXIMUM PLATE VOLTAGE	67.5	67.5	VOLTS
MAXIMUM CATHODE CURRENT	6.0 ^A	12	MA.
MAXIMUM SCREEN VOLTAGE	67.5	67.5	VOLTS

TYPICAL OPERATING CONDITIONS AND CHARACTERISTICS

	SERIES FILAMENTS	PARALLEL FILAMENTS	
PLATE VOLTAGE	67.5	45 67.5	VOLTS
SCREEN GRID VOLTAGE	67.5	45 67.5	VOLTS
CONTROL GRID VOLTAGE	-7.0	-4.5 -7.0	VOLTS
PLATE CURRENT	6.7	4.4 8.0	MA.
SCREEN CURRENT	0.5	0.3 0.6	MA.
TRANSCONDUCTANCE	1 500	1 400 1 650	µMHOS
PLATE RESISTANCE	0.1	0.1 0.1	MEGOHM
LOAD RESISTANCE	5 000	8 000 5 000	OHMS
POWER OUTPUT	180	70 200	MW.
TOTAL HARMONIC DISTORTION	10	12 10	PER CENT

^A PER 1.4 VOLT FILAMENT SECTION (SHUNTING RESISTOR ACROSS NEGATIVE SECTION OF FILAMENT MAY BE NECESSARY TO LIMIT CURRENT TO VALUE SHOWN.)



TUNG-SOL

HIGH VACUUM CATHODE-RAY TUBE

ELECTROSTATIC DEFLECTION AND FOCUSING

NO. 1 PHOSPHOR
GREEN FLUORESCENT SCREEN
MEDIUM PERSISTENCE

HEATER
6.3 VOLTS 0.6 AMPERE
AC OR DC

COATED UNIPOTENTIAL CATHODE

GLASS BULB

MEDIUM SHELL DIHEPTAL 12 PIN BASE

RATINGS*

MAXIMUM ANODE NO. 2 VOLTAGE (HIGH-VOLTAGE ELECTRODE)	2200	VOLTS
MAXIMUM ANODE NO. 1 VOLTAGE (FOCUSING ELECTRODE)	1100	VOLTS
GRID VOLTAGE (CONTROL ELECTRODE)	NEVER	POSITIVE
MAXIMUM PEAK VOLTAGE BETWEEN ANODE NO. 2 AND ANY DEFLECTOR	550	VOLTS
MAXIMUM DC HEATER CATHODE POTENTIAL ^A	125	VOLTS
MAXIMUM GRID CIRCUIT RESISTANCE	1.5	MEGOHMS
MAXIMUM IMPEDANCE OF ANY DEFLECTOR CIRCUIT AT HEATER SUPPLY FREQUENCY	1.0	MEGOHM

*MAXIMUM RATINGS ARE ABSOLUTE VALUES

DIRECT INTERELECTRODE CAPACITANCES (APPROX.)

GRID TO ALL OTHER ELECTRODES	8.0	$\mu\mu\text{f}$
CATHODE TO ALL OTHER ELECTRODES	7.0	$\mu\mu\text{f}$
D1 TO D2	2.0	$\mu\mu\text{f}$
D3 TO D4	2.0	$\mu\mu\text{f}$
D1 TO ALL OTHER ELECTRODES	9.0	$\mu\mu\text{f}$
D3 TO ALL OTHER ELECTRODES	7.0	$\mu\mu\text{f}$
D1 TO ALL OTHER ELECTRODES EXCEPT D2	7.0	$\mu\mu\text{f}$
D2 TO ALL OTHER ELECTRODES EXCEPT D1	7.0	$\mu\mu\text{f}$
D3 TO ALL OTHER ELECTRODES EXCEPT D4	5.0	$\mu\mu\text{f}$
D4 TO ALL OTHER ELECTRODES EXCEPT D3	6.0	$\mu\mu\text{f}$

TYPICAL OPERATING CONDITIONS AND CHARACTERISTICS

ANODE NO. 2 VOLTAGE ^B	1500	2000	VOLTS
ANODE NO. 1 VOLTAGE FOR FOCUS AT 75% OF GRID VOLTAGE CUT-OFF ^C	430	575	VOLTS
GRID VOLTAGE FOR CUT-OFF ^D	-45 ^E	-60 ^E	VOLTS
DEFLECTION SENSITIVITY: ^F			
D1 AND D2	0.153	0.115	MM/VOLT DC
D3 AND D4	0.207	0.155	MM/VOLT DC
DEFLECTION FACTOR: ^F			
D1 AND D2	166	221	VOLTS DC/IN
D3 AND D4	123	164	VOLTS DC/IN

CONTINUED NEXT PAGE

TUNG-SOL

CONTINUED FROM PRECEDING PAGE

SPOT POSITION AND TEST CONDITIONS

THE UNDEFLECTED FOCUSED SPOT FALLS WITHIN A 15 MM. SQUARE CENTERED ON THE TUBE FACE.

TEST CONDITIONS ARE:

ANODE NO. 2 VOLTAGE	2000	VOLTS
ANODE NO. 1 VOLTAGE	ADJUSTED FOR FOCUS	
GRID VOLTAGE	NEAR CUT-OFF	
DEFLECTOR RESISTORS (CONNECTED TO ANODE NO. 2)	1 MEGOHM EACH	

NOTE: SHIELD TUBE FROM ALL STRAY FIELDS.

- ^A WHEN THE HEATER IS OPERATED AT A NEGATIVE POTENTIAL WITH RESPECT TO THE CATHODE THEN THE CATHODE RETURN SHOULD BE MADE AT THE CENTER TAP OF THE FILAMENT TRANSFORMER.
- ^B USE OF LESS THAN 1500 VOLTS RESULTS IN DECREASED BRILLIANCE.
- ^C CERTAIN TUBES MAY REQUIRE ADJUSTMENT OF +20% TO -35% WITH GRID VOLTAGE BETWEEN ZERO AND CUT-OFF.
- ^D THE VISUAL EXTINCTION OF A FOCUSED SPOT.
- ^E THE GRID SUPPLY SHOULD BE VARIABLE TO $\pm 50\%$.
- ^F VALUES SUBJECT TO VARIATION OF $\pm 20\%$.

DEFLECTOR LOCATIONS:

D1 AND D2
D3 AND D4
D1
D3

NEAREST TO SCREEN
NEAREST TO BASE
SAME SIDE OF TUBE AS PIN NO. 5
SAME SIDE AS PIN NO. 2

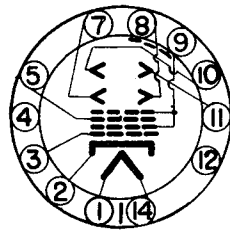
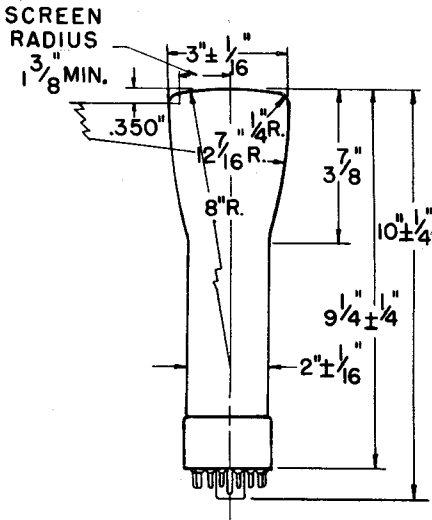

BOTTOM VIEW

1. HEATER
2. CATHODE
3. GRID NO. 1
4. INTERNAL CONNECTION (DO NOT USE)
5. ANODE NO. 1
6. ANODE NO. 2
7. DEFLECTOR NO. 3 (D3)
8. DEFLECTOR NO. 4 (D4)
9. GRID NO. 2
10. DEFLECTOR NO. 2 (D2)
11. DEFLECTOR NO. 1 (D1)
12. NO CONNECTION
13. HEATER
14. HEATER

PLATE
1398
MARCH 15
1944

TUNG-SOL

PENTODE

MINIATURE TYPE

COATED FILAMENT

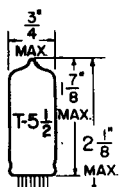

GLASS BULB

SERIES FILAMENT
 E_f APPLIED BETWEEN
 PINS 1 & 7

E_{g1} REFERRED TO PIN 1

2.8 VOLTS
 50 MA.

PARALLEL FILAMENT
 E_f APPLIED BETWEEN
 PIN 5 AND PINS 1 &
 7 TIED TOGETHER.

E_{g1} REFERRED TO -F

1.4 VOLTS
 100 MA.

DC

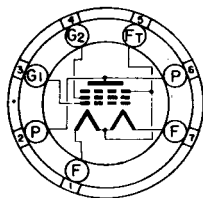

BOTTOM VIEW

MINIATURE BUTTON
 7 PIN BASE

A SHUNTING RESISTOR MUST BE CONNECTED BETWEEN PINS 1 AND 5 FOR SERIES-FILAMENT OPERATION TO BY-PASS ANY CATHODE CURRENT IN EXCESS OF THE 6 MA. RATED MAXIMUM PER SECTION. AN ADDITIONAL SHUNTING RESISTOR MAY BE NECESSARY BETWEEN PINS 1 AND 7 IF OTHER TUBES USED IN SERIES-FILAMENT ARRANGEMENT CONTRIBUTE TO THE FILAMENT CURRENT OF THE 3Q4.

ANY MOUNTING POSITION

THE 3Q4 IS A FILAMENTARY TYPE POWER OUTPUT PENTODE IN THE MINIATURE CONSTRUCTION. IT IS CHARACTERIZED BY ECONOMY OF FILAMENT POWER AND HIGH POWER SENSITIVITY ADAPTING IT TO USE IN THE "3-WAY" OPERATED PORTABLE RECEIVERS.

RATINGS

INTERPRETED ACCORDING TO RMA STANDARD M8-210

	SERIES FILAMENT	PARALLEL FILAMENT	
FILAMENT VOLTAGE	2.8	1.4	VOLTS
MAXIMUM PLATE VOLTAGE	90	90	VOLTS
MAXIMUM GRID #2 VOLTAGE	90	90	VOLTS
MAXIMUM CATHODE CURRENT	6 ^A	12	MA.

^A FOR EACH 1.4 VOLT FILAMENT SECTION.

TYPICAL OPERATING CONDITIONS AND CHARACTERISTICS

CLASS A₁ AMPLIFIER

FILAMENT VOLTAGE	2.8	1.4	1.4	VOLTS
FILAMENT CURRENT	50	100	100	MA.
PLATE VOLTAGE	90	85	90	VOLTS
GRID #2 VOLTAGE	90	85	90	VOLTS
GRID #1 VOLTAGE	-4.5	-5	-4.5	VOLTS
PEAK AF SIGNAL VOLTAGE	4.5	5	4.5	VOLTS
ZERO-SIGNAL PLATE CURRENT	7.7	6.9	9.5	MA.
ZERO-SIGNAL GRID #2 CURRENT (NOMINAL)	1.7	1.5	2.1	MA.
PLATE RESISTANCE (APPROX.)	0.12	0.12	0.1	MEGOHM
TRANSCONDUCTANCE	2 000	1 975	2 150	μMHOS
LOAD RESISTANCE	10 000	10 000	10 000	OHMS
TOTAL HARMONIC DISTORTION	7	10	7	PERCENT
POWER OUTPUT	240	250	270	MW

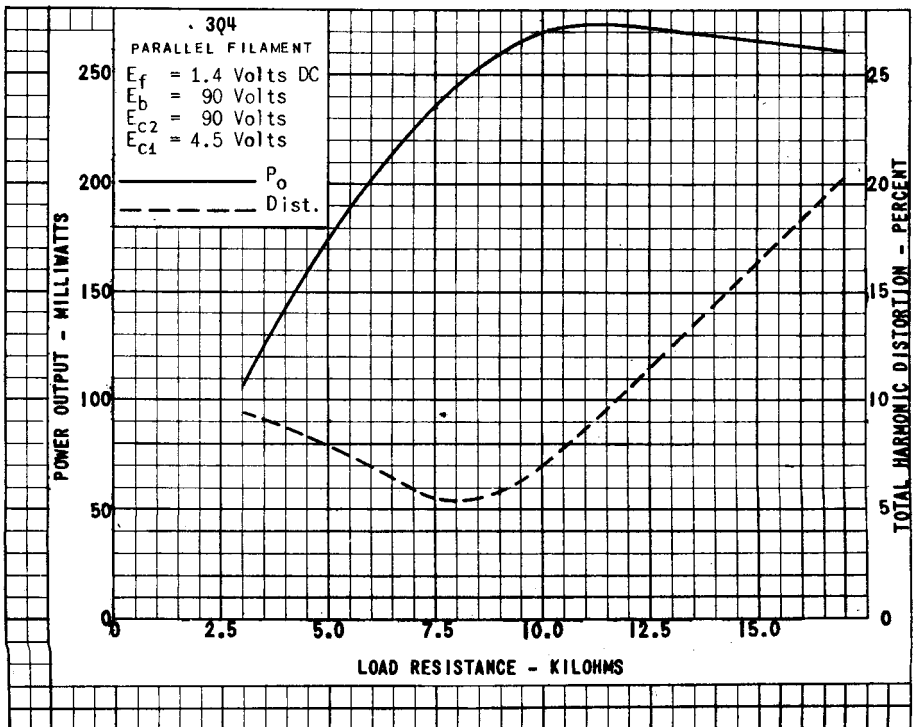
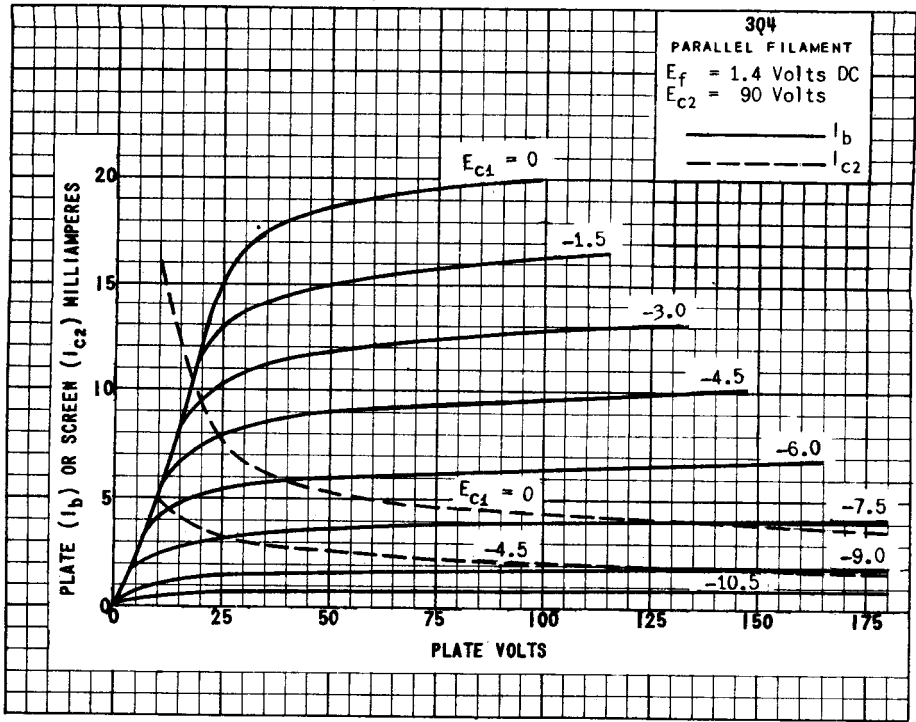
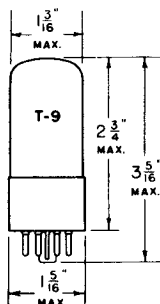

PLATE
 1983
 MAR. 1,
 1948

TUNG-SOL



BEAM POWER AMPLIFIER

COATED FILAMENT

1.4 VOLTS 0.10 AMPERE

2.8 VOLTS 0.05 AMPERE

DC

GLASS BULB

INTERMEDIATE 7 PIN OCTAL BASE

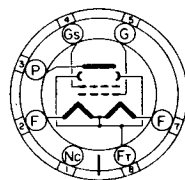

7A TAP

BOTTOM VIEW

THE TUNG-SOL 3Q5GT/G IS A LOW CURRENT DRAIN FILAMENT TYPE BEAM POWER AMPLIFIER. IT IS DESIGNED FOR SERVICE IN THE OUTPUT STAGE OF THREE WAY PORTABLE RECEIVERS. ITS ELECTRICAL CHARACTERISTICS ARE SIMILAR TO THOSE OF THE 1Q5GT/G EXCEPT THAT THE FILAMENT IS CENTER TAPPED FOR EITHER SERIES OPERATION AT 2.8 VOLTS OR PARALLEL OPERATION AT 1.4 VOLTS.

RATINGS

	PARALLEL FILAMENT	SERIES FILAMENT	VOLTS
MAXIMUM FILAMENT VOLTAGE			
DRY BATTERY OPERATION - VOLTAGE MUST NEVER EXCEED	1.6	3.2	VOLTS
AC - DC POWER LINE OPERATION - DESIGN CENTER	1.3	2.6	VOLTS
MAXIMUM PLATE VOLTAGE	110	110	VOLTS
MAXIMUM SCREEN VOLTAGE	110	110	VOLTS
MAXIMUM CATHODE CURRENT (ZERO SIGNAL)	12	6 ^A	MA.

TYPICAL OPERATING CONDITIONS AND CHARACTERISTICS

CLASS A₁ AMPLIFIER

	PARALLEL FILAMENT		SERIES FILAMENT	
PLATE VOLTAGE	85	90	90	VOLTS
SCREEN VOLTAGE	85	90	90	VOLTS
CONTROL GRID VOLTAGE	-5 ^B	-4.5 ^B	-4.5 ^C	VOLTS
PEAK AF SIGNAL VOLTAGE	5	4.5	4.5	VOLTS
PLATE CURRENT	7.0	9.5	8.0	MA.
SCREEN CURRENT (NOMINAL)	0.8	1.3	1.0	MA.
PLATE RESISTANCE APPROX.	70 000	75 000	80 000	OHMS
TRANSCONDUCTANCE	1950	2200	2000	μMHOS
LOAD RESISTANCE	9000	8000	8000	OHMS
TOTAL HARMONIC DISTORTION	5.5	6.0	8.5	PER CENT
POWER OUTPUT	0.250	0.270	0.230	WATTS

^A PER 1.4 V. FILAMENT SECTION. SHUNTING RESISTOR ACROSS NEGATIVE FILAMENT SECTION IS NECESSARY TO LIMIT CURRENT TO VALUE SHOWN.

^B RETURN TO NEGATIVE FILAMENT (PIN #8).

^C RETURN TO NEGATIVE FILAMENT (PIN #7).

CONTINUED NEXT PAGE

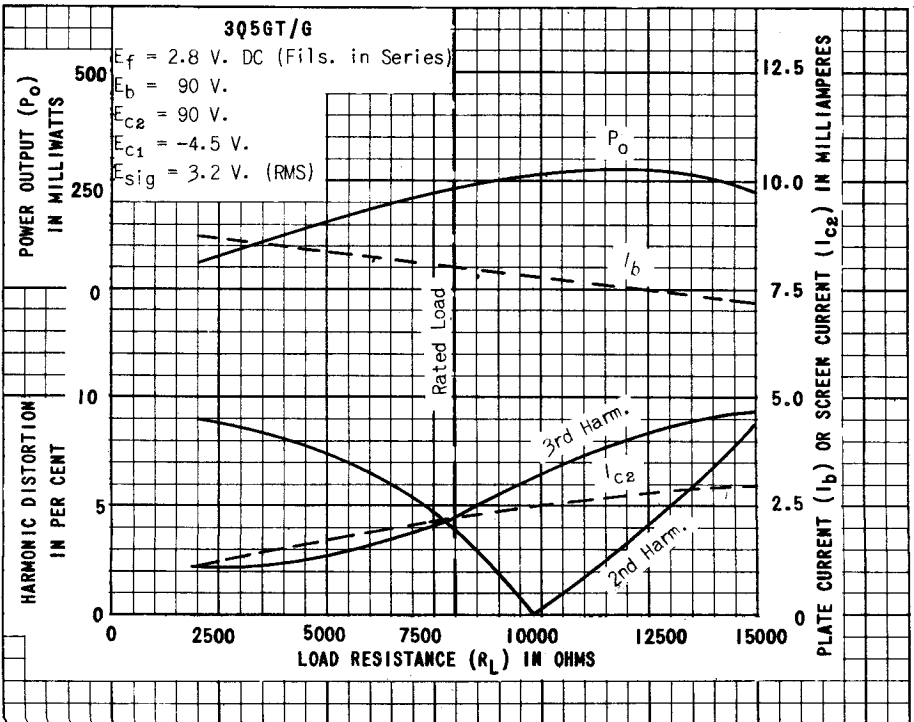
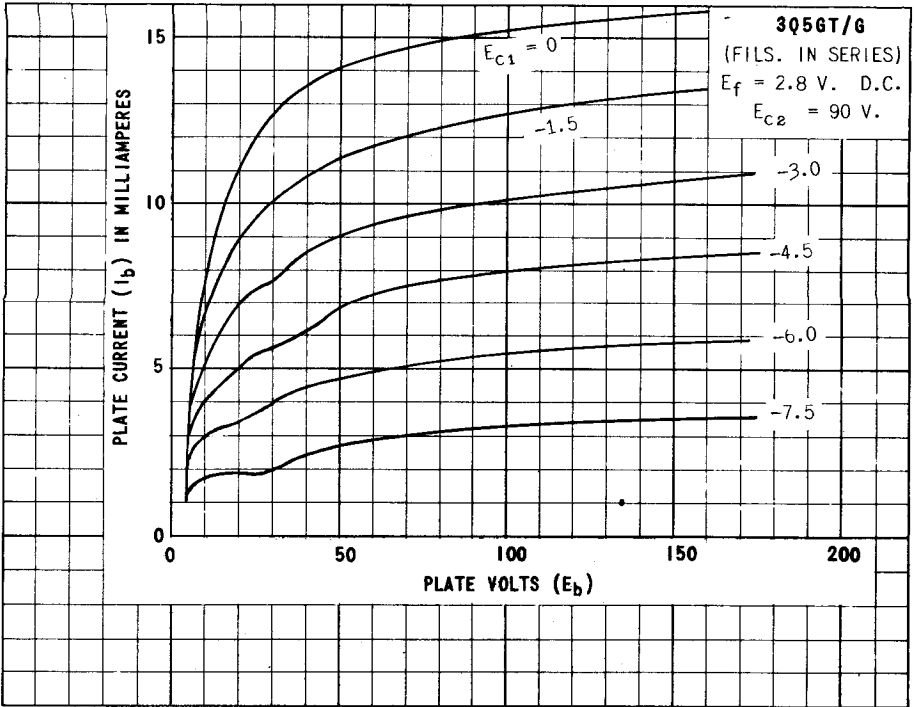

TUNG-SOL

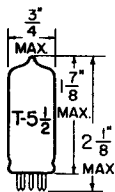
PENTODE
MINIATURE TYPE

GLASS BULB

COATED FILAMENT

SERIES FILAMENT

E_f APPLIED BETWEEN
PINS 1 & 7

E_{g1} REFERRED TO PIN 1

2.8 VOLTS
50 MA.

PARALLEL FILAMENT

E_f APPLIED BETWEEN
PIN 5 AND PINS 1 &
7 TIED TOGETHER

E_{g1} REFERRED TO -F

1.4 VOLTS
100 MA.

DC

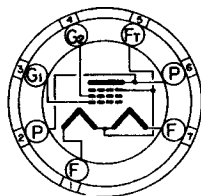

BOTTOM VIEW
MINIATURE BUTTON
7 PIN BASE

A SHUNTING RESISTOR MUST BE CONNECTED BETWEEN PINS 1 AND 5 FOR SERIES-FILAMENT OPERATION TO BY-PASS ANY CATHODE CURRENT IN EXCESS OF THE 5.5 MA. RATED MAXIMUM PER SECTION. AN ADDITIONAL SHUNTING RESISTOR MAY BE NECESSARY BETWEEN PINS 1 & 7 IF OTHER TUBES USED IN SERIES FILAMENT ARRANGEMENT CONTRIBUTE TO THE FILAMENT CURRENT OF THE 3S4.

ANY MOUNTING POSITION

THE 3S4 IS A FILAMENTARY TYPE POWER OUTPUT PENTODE IN THE MINIATURE CONSTRUCTION. IT IS CHARACTERIZED BY ECONOMY OF FILAMENT POWER AND ABILITY TO PERFORM WELL AT LOW PLATE SUPPLY VOLTAGES SUCH AS ENCOUNTERED IN PORTABLE EQUIPMENT.

RATINGS

INTERPRETED ACCORDING TO RMA STANDARD M8-210

	SERIES FILAMENT	PARALLEL FILAMENT	
FILAMENT VOLTAGE	2.8	1.4	VOLTS
MAXIMUM PLATE VOLTAGE	90	90	VOLTS
MAXIMUM GRID #2 VOLTAGE	67.5	67.5	VOLTS
MAXIMUM CATHODE CURRENT (MAX-SIGNAL)	5.5 ^A	11	MA.
MAXIMUM CATHODE CURRENT (ZERO-SIGNAL)	4.5 ^A	9	MA.

^A FOR EACH 1.4 FILAMENT SECTION.

TYPICAL OPERATING CONDITIONS AND CHARACTERISTICS

CLASS A₁ AMPLIFIER

	SERIES FILAMENT		PARALLEL FILAMENT		
FILAMENT VOLTAGE	2.8	2.8	1.4	1.4	VOLTS
FILAMENT CURRENT	50	50	100	100	MA.
PLATE VOLTAGE	67.5	90	67.5	90	VOLTS
GRID #2 VOLTAGE	67.5	67.5	67.5	67.5	VOLTS
GRID #1 VOLTAGE	-7	-7	-7	-7	VOLTS
PEAK AF SIGNAL VOLTAGE	7	7	7	7	VOLTS
PLATE RESISTANCE (APPROX.)	0.1	0.1	0.1	0.1	MEGOHM
TRANSCONDUCTANCE	1 400	1 425	1 550	1 575	MMHOS
ZERO-SIGNAL PLATE CURRENT	6	6.1	7.2	7.4	MA.
ZERO-SIGNAL GRID #2 CURRENT	1.2	1.1	1.5	1.4	MA.
LOAD RESISTANCE	5 000	8 000	5 000	8 000	OHMS
TOTAL HARMONIC DISTORTION	12	13	10	12	PERCENT
MAXIMUM-SIGNAL POWER OUTPUT	160	235	180	270	MW

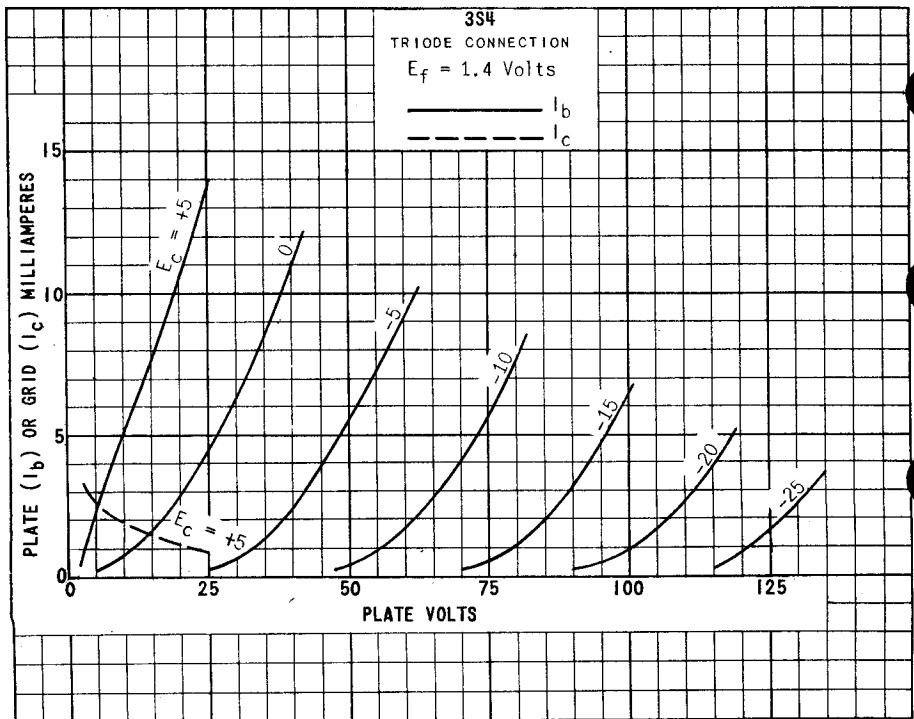
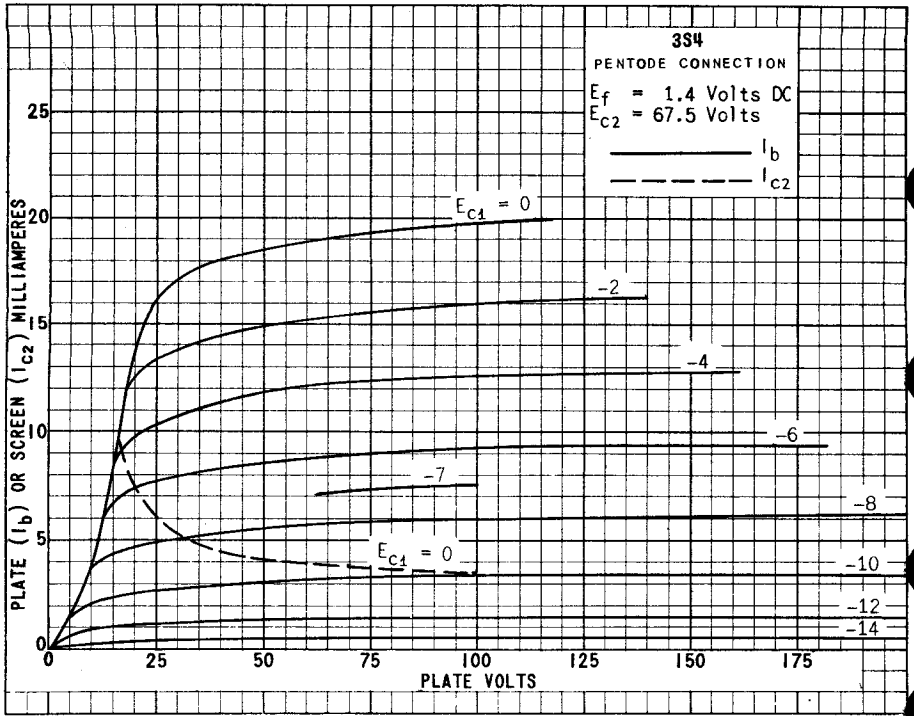
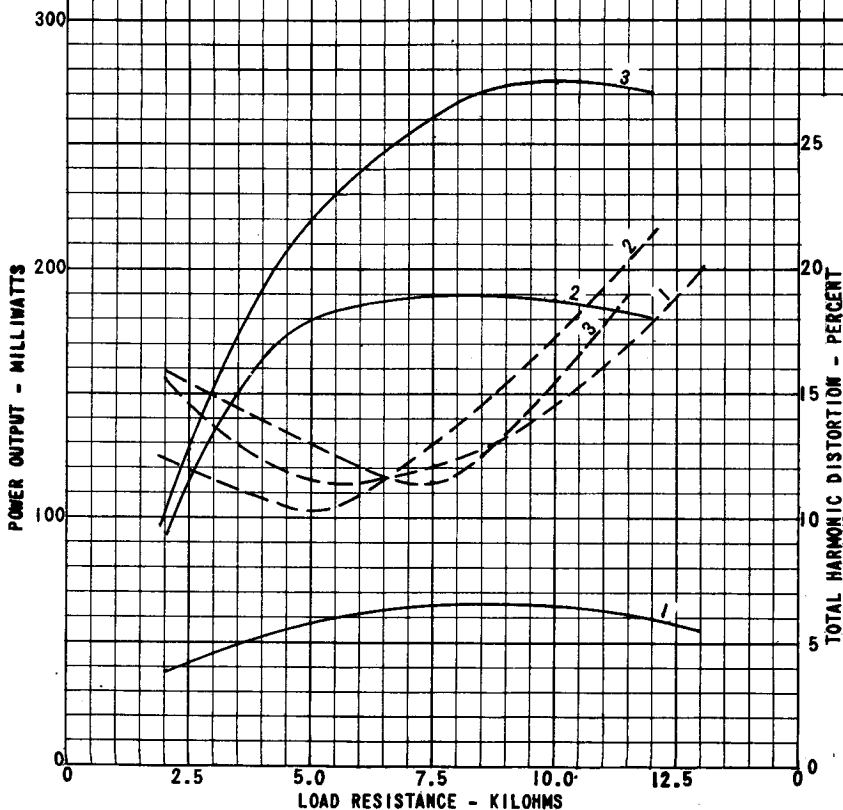

PLATE
1985
MAR. 1,
1948

3S4
PENTODE CONNECTION
 $E_f = 1.4$ Volts DC

————— P_o
- - - - - Dist.

CURVE	PLATE VOLTS	SCREEN VOLTS	GRID VOLTS	SIGNAL VOLTS
1	45	45	-4.5	3.2
2	67.5	67.5	-7	4.95
3	90	67.5	-7	4.95





TUNG-SOL

POWER AMPLIFIER PENTODE

MINIATURE TYPE

COATED FILAMENT

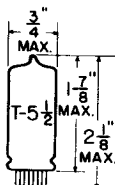

GLASS BULB

SERIES FILAMENT
 E_f APPLIED BETWEEN PINS 1 & 7
 E_{g1} REFERRED TO PIN 1

2.8 VOLTS
 0.05 AMP.

PARALLEL FILAMENT
 E_f APPLIED BETWEEN PIN 5 AND PINS 1 & 7 TIED TOGETHER.
 E_{g1} REFERRED TO PIN 5

1.4 VOLTS
 0.1 AMP.

DC

A SHUNTING RESISTOR MUST BE CONNECTED BETWEEN PINS 1 AND 5 FOR SERIES-FILAMENT OPERATION TO BY-PASS ANY CATHODE CURRENT IN EXCESS OF THE 6 MA. RATED MAXIMUM PER SECTION. AN ADDITIONAL SHUNTING RESISTOR MAY BE NECESSARY BETWEEN PINS 1 AND 7 IF OTHER TUBES USED IN SERIES-FILAMENT ARRANGEMENT CONTRIBUTE TO THE FILAMENT CURRENT OF THE 3V4.

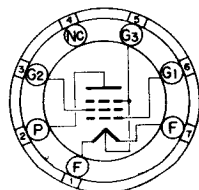

BOTTOM VIEW
 MINIATURE BUTTON
 7 PIN BASE

ANY MOUNTING POSITION

THE 3V4 IS A POWER AMPLIFIER PENTODE UTILIZING THE MINIATURE CONSTRUCTION. IT IS DESIGNED FOR USE IN THE OUTPUT STAGE OF AC/DC BATTERY PORTABLE RECEIVERS. IT IS IDENTICAL TO THE 3Q4 EXCEPT FOR THE DIFFERENT BASING ARRANGEMENT.

RATINGS

INTERPRETED ACCORDING TO RMA STANDARD MB-210

	SERIES FILAMENT	PARALLEL FILAMENT	
FILAMENT VOLTAGE	2.8	1.4	VOLTS
FILAMENT CURRENT	0.05	0.1	AMP.
MAXIMUM PLATE VOLTAGE	90	90	VOLTS
MAXIMUM SCREEN VOLTAGE	90	90	VOLTS
MAXIMUM TOTAL CATHODE CURRENT	6 ^A	12	MA.

^AFOR EACH 1.4 VOLT FILAMENT SECTION.

DIRECT INTERELECTRODE CAPACITANCES - APPROX.
 WITH NO EXTERNAL SHIELD

GRID TO PLATE	0.20	μf
INPUT	5.5	μf
OUTPUT	3.8	μf

CONTINUED ON FOLLOWING PAGE

→ INDICATES A CHANGE OR ADDITION.

TUNG-SOL

CONTINUED FROM PRECEDING PAGE

TYPICAL OPERATING CONDITIONS AND CHARACTERISTICS

AF POWER AMPLIFIER - CLASS A₁

	SERIES FILAMENT		PARALLEL FILAMENT		
PLATE VOLTAGE	90	85	90		VOLTS
SCREEN VOLTAGE	90	85	90		VOLTS
GRID VOLTAGE	-4.5	-5	-4.5		VOLTS
PEAK AF GRID VOLTAGE	4.5	5	4.5		VOLTS
ZERO-SIGNAL PLATE CURRENT	7.7	6.9	9.5		MA.
ZERO-SIGNAL SCREEN CURRENT	1.7	1.5	2.1		MA.
LOAD RESISTANCE	10 000	10 000	10 000		OHMS
PLATE RESISTANCE (APPROX.)	0.12	0.12	0.1		MEGOHM
TRANSCONDUCTANCE	2 000	1 975	2 150		μMHOS
MAXIMUM-SIGNAL POWER OUTPUT	0.24	0.25	0.27		WATT
TOTAL HARMONIC DISTORTION	7	10	7		PER CENT

SIMILAR TYPE REFERENCE: Ratings and characteristics identical to 3Q4; somewhat similar to 1Q5GT, 3Q5GT, 3LPH, 3LPH.

PLATE
1777
FEB. 3,
1947

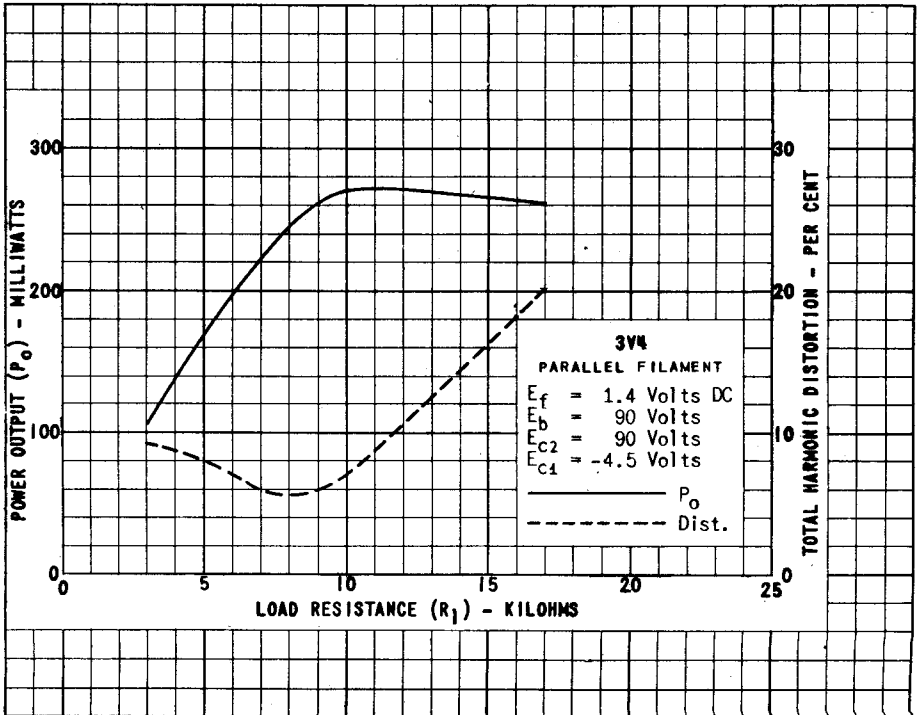
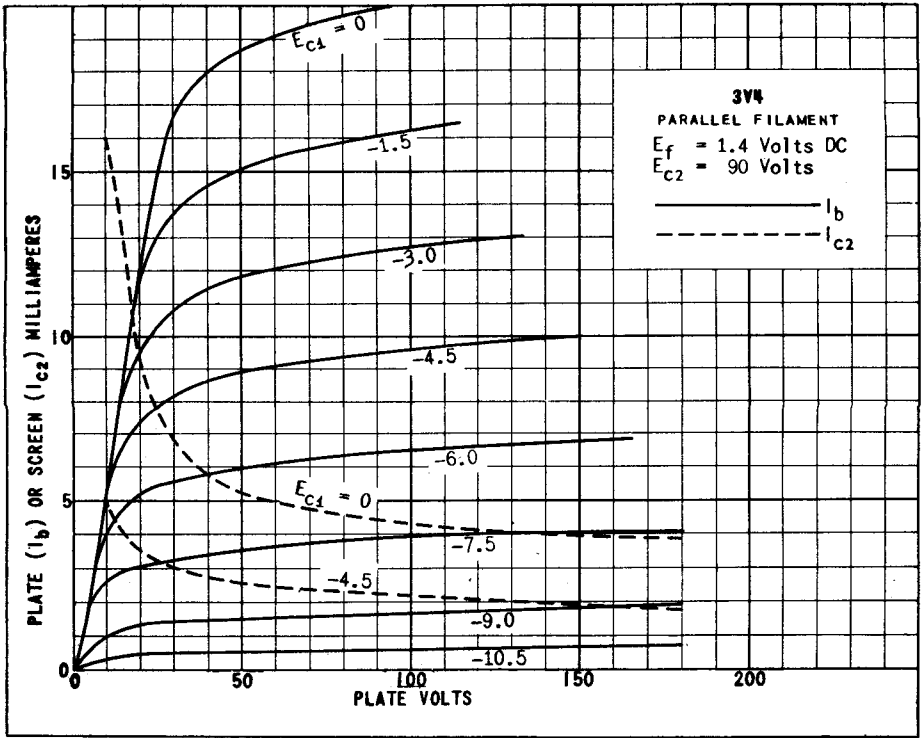

PRINTED IN U. S. A.

PLATE 1778
 FEB. 3, 1947



TUNG-SOL

HIGH VACUUM CATHODE-RAY TUBE

ELECTROSTATIC DEFLECTION AND FOCUSING

5CP1
NO. 1 PHOSPHOR
GREEN FLUORESCENT SCREEN
MEDIUM PERSISTENCE

5CP4
NO. 4 PHOSPHOR
WHITE FLUORESCENT SCREEN
MEDIUM PERSISTENCE

COATED UNIPOTENTIAL CATHODE

HEATER
6.3 VOLTS 0.6 AMPERE
AC OR DC

GLASS BULB

MEDIUM SHELL DIHEPTAL 12 PIN BASE

RATINGS*

MAXIMUM ANODE NO. 3 VOLTAGE (SUPPLEMENTARY HIGH VOLTAGE ELECTRODE)	4400	VOLTS
MAXIMUM ANODE NO. 2 VOLTAGE (HIGH VOLTAGE ELECTRODE)	2200	VOLTS
MAXIMUM ANODE NO. 1 VOLTAGE (FOCUSING ELECTRODE)	1100	VOLTS
GRID VOLTAGE (CONTROL ELECTRODE)	NEVER POSITIVE	
MAXIMUM PEAK VOLTAGE BETWEEN ANODE NO. 2 AND ANY DEFLECTOR	550	VOLTS
MAXIMUM DC HEATER CATHODE POTENTIAL ^A	125	VOLTS
MAXIMUM GRID CIRCUIT RESISTANCE	1.5	MEGOHMS
MAXIMUM IMPEDANCE OF ANY DEFLECTOR CIRCUIT AT HEATER SUPPLY FREQUENCY	1.0	MEGOHM

* MAXIMUM RATINGS ARE ABSOLUTE VALUES

DIRECT INTERELECTRODE CAPACITANCES (APPROX.)

GRID TO ALL OTHER ELECTRODES	8.0	$\mu\mu\text{f}$
CATHODE TO ALL OTHER ELECTRODES	8.0	$\mu\mu\text{f}$
D1 TO D2	2.0	$\mu\mu\text{f}$
D3 TO D4	2.0	$\mu\mu\text{f}$
D1 TO ALL OTHER ELECTRODES	9.0	$\mu\mu\text{f}$
D3 TO ALL OTHER ELECTRODES	7.0	$\mu\mu\text{f}$
D1 TO ALL OTHER ELECTRODES EXCEPT D2	7.0	$\mu\mu\text{f}$
D2 TO ALL OTHER ELECTRODES EXCEPT D1	7.0	$\mu\mu\text{f}$
D3 TO ALL OTHER ELECTRODES EXCEPT D4	5.0	$\mu\mu\text{f}$
D4 TO ALL OTHER ELECTRODES EXCEPT D3	6.0	$\mu\mu\text{f}$

TUNG-SOL

CONTINUED FROM PRECEDING PAGE

TYPICAL OPERATING CONDITIONS AND CHARACTERISTICS

ANODE NO. 3 VOLTAGE	2000	3000	4000	VOLTS
ANODE NO. 2 VOLTAGE ^B	2000	1500	2000	VOLTS
ANODE NO. 1 VOLTAGE FOR FOCUS AT 75% OF GRID VOLTAGE CUT-OFF ^C	575	430	575	VOLTS
GRID VOLTAGE FOR CUT-OFF ^D	-60 ^E	-45 ^E	-60 ^E	VOLTS
DEFLECTION SENSITIVITY: ^F				
D1 AND D2	0.350	0.370	0.280	MM/VOLT DC
D3 AND D4	0.390	0.450	0.340	MM/VOLT DC
DEFLECTION FACTOR ^F				
D1 AND D2	73	69	92	VOLTS DC/IN
D3 AND D4	64	56	74	VOLTS DC/IN

SPOT POSITION AND TEST CONDITIONS

THE UNDEFLECTED FOCUSED SPOT FALLS WITHIN A 25 MM. SQUARE CENTERED ON THE TUBE FACE.

TEST CONDITIONS ARE:

ANODE NO. 3 VOLTAGE	4000	VOLTS
ANODE NO. 2 VOLTAGE	2000	VOLTS
ANODE NO. 1 VOLTAGE	ADJUSTED FOR FOCUS	
GRID VOLTAGE	NEAR CUT-OFF	
DEFLECTOR RESISTORS (CONNECTED TO ANODE NO. 2)	1 MEGOHM EACH	

NOTE: SHIELD TUBE FROM ALL STRAY FIELDS.

- ^A WHEN THE HEATER IS OPERATED AT A NEGATIVE POTENTIAL WITH RESPECT TO THE CATHODE THEN THE CATHODE RETURN SHOULD BE MADE AT THE CENTER TAP OF THE FILAMENT TRANSFORMER.
- ^B USE OF LESS THAN 1500 VOLTS RESULTS IN DECREASED BRILLIANCE.
- ^C CERTAIN TUBES MAY REQUIRE ADJUSTMENT OF +25% TO -30% WITH GRID VOLTAGE BETWEEN ZERO AND CUT-OFF.
- ^D THE VISUAL EXTINCTION OF A FOCUSED SPOT.
- ^E THE GRID SUPPLY SHOULD BE VARIABLE TO $\pm 50\%$.
- ^F VALUES SUBJECT TO VARIATION OF $\pm 20\%$.

DEFLECTOR LOCATIONS:

D1 AND D2	NEAREST TO SCREEN
D3 AND D4	NEAREST TO BASE
D1	SAME SIDE OF TUBE AS PIN NO. 5
D3	SAME SIDE AS PIN NO. 2

CONTINUED NEXT PAGE

PLATE
1400
MARCH 15
1944

TUNG-SOL

CONTINUED FROM PRECEDING PAGE

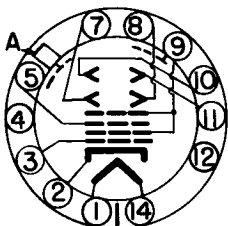
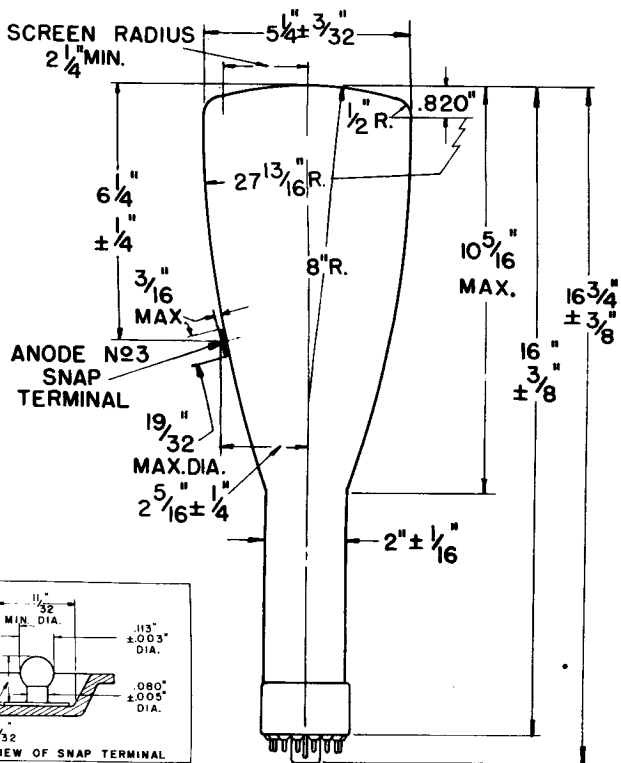

BOTTOM VIEW

- 1. HEATER
- 2. CATHODE
- 3. GRID NO. 1
- 4. INTERNAL CONNECTION (DO NOT USE)
- 5. ANODE NO. 1
- 7. DEFLECTOR NO. 3 (D3)
- 8. DEFLECTOR NO. 4 (D4)
- 9. GRID NO. 2
- ANODE NO. 2
- 10. DEFLECTOR NO. 2 (D2)
- 11. DEFLECTOR NO. 1 (D1)
- 12. NO CONNECTION
- 14. HEATER
- A. ANODE NO. 3 (SNAP TERMINAL)

PRINTED IN U. S. A.

PLATE 1401 MARCH 15 1944



TUNG-SOL

HIGH VACUUM CATHODE-RAY TUBE

ELECTROSTATIC DEFLECTION AND FOCUSING

5CP1
 NO. 1 PHOSPHOR
 GREEN FLUORESCENT SCREEN
 MEDIUM PERSISTENCE

5CP4
 NO. 4 PHOSPHOR
 WHITE FLUORESCENT SCREEN
 MEDIUM PERSISTENCE

COATED UNIPOTENTIAL CATHODE

HEATER
 6.3 VOLTS 0.6 AMPERE
 AC OR DC

GLASS BULB

MEDIUM SHELL DIHEPTAL 12 PIN BASE

RATINGS*

MAXIMUM ANODE NO. 3 VOLTAGE (SUPPLEMENTARY HIGH VOLTAGE ELECTRODE)	4400	VOLTS
MAXIMUM ANODE NO. 2 VOLTAGE (HIGH VOLTAGE ELECTRODE)	2200	VOLTS
MAXIMUM ANODE NO. 1 VOLTAGE (FOCUSING ELECTRODE)	1100	VOLTS
GRID VOLTAGE (CONTROL ELECTRODE)	NEVER POSITIVE	
MAXIMUM PEAK VOLTAGE BETWEEN ANODE NO. 2 AND ANY DEFLECTOR	550	VOLTS
MAXIMUM DC HEATER CATHODE POTENTIAL ^A	125	VOLTS
MAXIMUM GRID CIRCUIT RESISTANCE	1.5	MEGOHMS
MAXIMUM IMPEDANCE OF ANY DEFLECTOR CIRCUIT AT HEATER SUPPLY FREQUENCY	1.0	MEGOHM

* MAXIMUM RATINGS ARE ABSOLUTE VALUES

DIRECT INTERELECTRODE CAPACITANCES (APPROX.)

GRID TO ALL OTHER ELECTRODES	8.0	$\mu\mu\text{f}$
CATHODE TO ALL OTHER ELECTRODES	8.0	$\mu\mu\text{f}$
D1 TO D2	2.0	$\mu\mu\text{f}$
D3 TO D4	2.0	$\mu\mu\text{f}$
D1 TO ALL OTHER ELECTRODES	9.0	$\mu\mu\text{f}$
D3 TO ALL OTHER ELECTRODES	7.0	$\mu\mu\text{f}$
D1 TO ALL OTHER ELECTRODES EXCEPT D2	7.0	$\mu\mu\text{f}$
D2 TO ALL OTHER ELECTRODES EXCEPT D1	7.0	$\mu\mu\text{f}$
D3 TO ALL OTHER ELECTRODES EXCEPT D4	5.0	$\mu\mu\text{f}$
D4 TO ALL OTHER ELECTRODES EXCEPT D3	6.0	$\mu\mu\text{f}$

CONTINUED NEXT PAGE

TUNG-SOL

CONTINUED FROM PRECEDING PAGE

TYPICAL OPERATING CONDITIONS AND CHARACTERISTICS

ANODE NO. 3 VOLTAGE	2000	3000	4000	VOLTS
ANODE NO. 2 VOLTAGE ^B	2000	1500	2000	VOLTS
ANODE NO. 1 VOLTAGE FOR FOCUS AT 75% OF GRID VOLTAGE CUT-OFF ^C	575	430	575	VOLTS
GRID VOLTAGE FOR CUT-OFF ^D	-60 ^E	-45 ^E	-60 ^E	VOLTS
DEFLECTION SENSITIVITY: ^F				
D1 AND D2	0.350	0.370	0.280	MM/VOLT DC
D3 AND D4	0.390	0.450	0.340	MM/VOLT DC
DEFLECTION FACTOR ^F				
D1 AND D2	73	69	92	VOLTS DC/IN
D3 AND D4	64	56	74	VOLTS DC/IN

SPOT POSITION AND TEST CONDITIONS

THE UNDEFLECTED FOCUSED SPOT FALLS WITHIN A 25 MM. SQUARE CENTERED ON THE TUBE FACE.

TEST CONDITIONS ARE:

ANODE NO. 3 VOLTAGE	4000	VOLTS
ANODE NO. 2 VOLTAGE	2000	VOLTS
ANODE NO. 1 VOLTAGE	ADJUSTED FOR FOCUS	
GRID VOLTAGE	NEAR CUT-OFF	
DEFLECTOR RESISTORS (CONNECTED TO ANODE NO. 2)	1 MEGOHM EACH	

NOTE: SHIELD TUBE FROM ALL STRAY FIELDS.

^A WHEN THE HEATER IS OPERATED AT A NEGATIVE POTENTIAL WITH RESPECT TO THE CATHODE THEN THE CATHODE RETURN SHOULD BE MADE AT THE CENTER TAP OF THE FILAMENT TRANSFORMER.

^B USE OF LESS THAN 1500 VOLTS RESULTS IN DECREASED BRILLIANCE.

^C CERTAIN TUBES MAY REQUIRE ADJUSTMENT OF +25% TO -30% WITH GRID VOLTAGE BETWEEN ZERO AND CUT-OFF.

^D THE VISUAL EXTINCTION OF A FOCUSED SPOT.

^E THE GRID SUPPLY SHOULD BE VARIABLE TO $\pm 50\%$.

^F VALUES SUBJECT TO VARIATION OF $\pm 20\%$.

DEFLECTOR LOCATIONS:

D1 AND D2	NEAREST TO SCREEN
D3 AND D4	NEAREST TO BASE
D1	SAME SIDE OF TUBE AS PIN NO. 5
D3	SAME SIDE AS PIN NO. 2

CONTINUED NEXT PAGE

PLATE
1412
MARCH 15
1944

TUNG-SOL

CONTINUED FROM PRECEDING PAGE

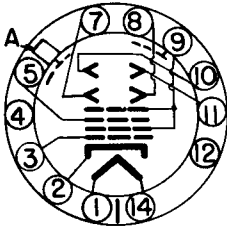
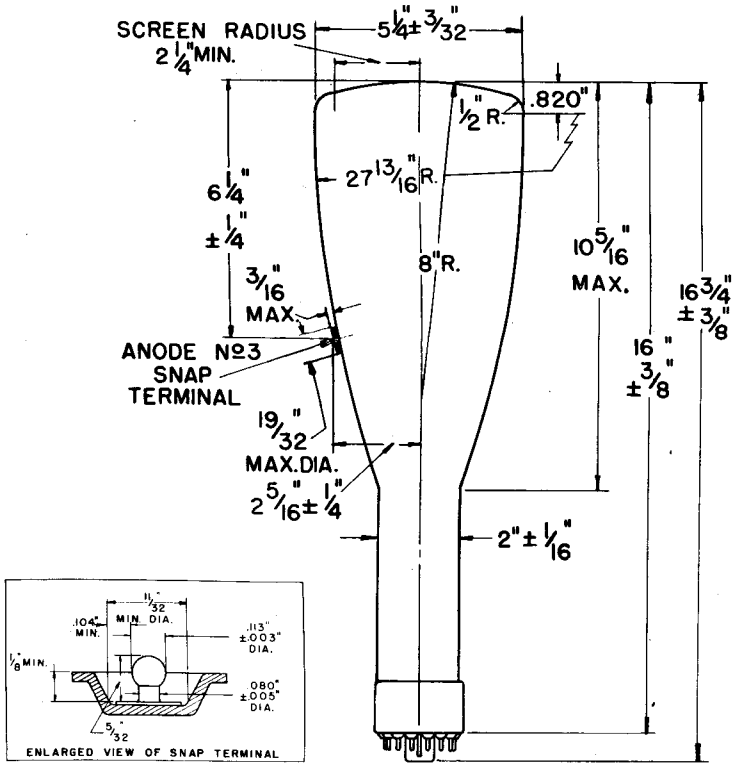

BOTTOM VIEW

1. HEATER
 2. CATHODE
 3. GRID NO. 1
 4. INTERNAL CONNECTION (DO NOT USE)
 5. ANODE NO. 1
 7. DEFLECTOR NO. 3 (D3)
 8. DEFLECTOR NO. 4 (D4)
 9. GRID NO. 2
 10. ANODE NO. 2
 11. DEFLECTOR NO. 1 (D1)
 12. NO CONNECTION
 14. HEATER
- A: ANODE NO. 3 (SNAP TERMINAL)



TUNG-SOL

FULL-WAVE HIGH-VACUUM RECTIFIER

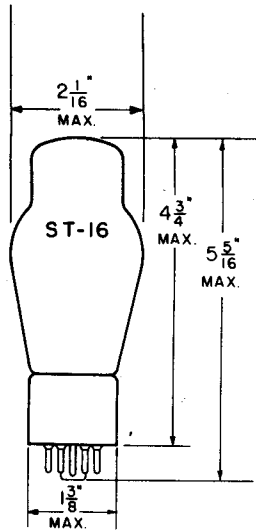

GLASS BULB

COATED FILAMENT

HEATER

5.0 VOLTS 2.0 AMPERES

AC

VERTICAL MOUNTING POSITION

HORIZONTAL OPERATION IS
PERMISSIBLE IF PINS 1 AND
4 ARE IN A VERTICAL PLANE.

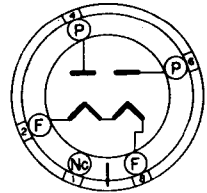

BOTTOM VIEW

MEDIUM SHELL 5-PIN
OCTAL MICANOL BASE

THE 5R4GY IS DESIGNED FOR RECTIFIER USE IN EQUIPMENT REQUIRING A HIGH PEAK INVERSE VOLTAGE RATING. SATISFACTORY OPERATION OF THIS TUBE TYPE UNDER CONDITIONS FALLING WITHIN AREA 1 ON CURVE NO. 1 MAY BE OBTAINED WITHOUT FILAMENT PREHEATING. FILAMENT PREHEATING FOR 10 SECONDS BEFORE PLATE VOLTAGE IS APPLIED IS RECOMMENDED FOR SATISFACTORY OPERATION UNDER CONDITIONS FALLING WITHIN AREA 2 ON THE SAME CURVE.

RATINGS

INTERPRETED ACCORDING TO RMA STANDARD W8-210

FULL-WAVE RECTIFIER

FILAMENT VOLTAGE (AC)	5.0	5.0	5.0	VOLTS
FILAMENT CURRENT	2.0	2.0	2.0	AMPS.
MAX. PEAK INVERSE PLATE VOLTAGE (NO LOAD)	2100	2400	2800	VOLTS
MAX. PEAK PLATE CURRENT PER PLATE	650	650	650	MA.
DC OUTPUT CURRENT:				
WITH CONDENSER INPUT TO FILTER	250	175	150	MA.
WITH CHOKE INPUT TO FILTER	250	250 ^A	175 ^B	MA.

^A FOR INPUT CHOKE FILTER=5 HENRIES MINIMUM.

^B FOR INPUT CHOKE FILTER=10 HENRIES MINIMUM.

CONTINUED ON FOLLOWING PAGE

TUNG-SOL

CONTINUED FROM PRECEDING PAGE

TYPICAL OPERATING CONDITIONS AND CHARACTERISTICS

FULL-WAVE RECTIFIER

	CONDENSER- INPUT FILTER		CHOKE- INPUT FILTER		
	1400	1800	1500	1900	
AC PLATE-TO-PLATE SUPPLY VOLTAGE (RMS)					VOLTS
FULL LOAD	1500	2000	1700	2000	VOLTS
NO LOAD	4	4	-	-	μ f
FILTER INPUT CONDENSER					μ f
TOTAL EFFECTIVE PLATE-SUPPLY IMPEDANCE PER PLATE ^C	125	575	-	-	OHMS
FILTER INPUT CHOKE	-	-	5	10	H.
DC OUTPUT CURRENT	250	250	250	175	MA.
DC OUTPUT VOLTAGE (APPROX.) (AT INPUT TO FILTER)	700	700	550	750	VOLTS
VOLTAGE REGULATION (APPROX.) (HALF-LOAD TO FULL-LOAD CURRENT)	90	110	40	60	VOLTS

^C PEAK PLATE CURRENT WILL BE LIMITED TO MAXIMUM RATED VALUE FOR THE GIVEN CONDITIONS AND VALUES. FOR A FILTER-INPUT CONDENSER GREATER THAN 4 μ f, MORE PLATE-SUPPLY IMPEDANCE MAY BE REQUIRED TO LIMIT THE PEAK PLATE CURRENT TO THE RATED VALUE.

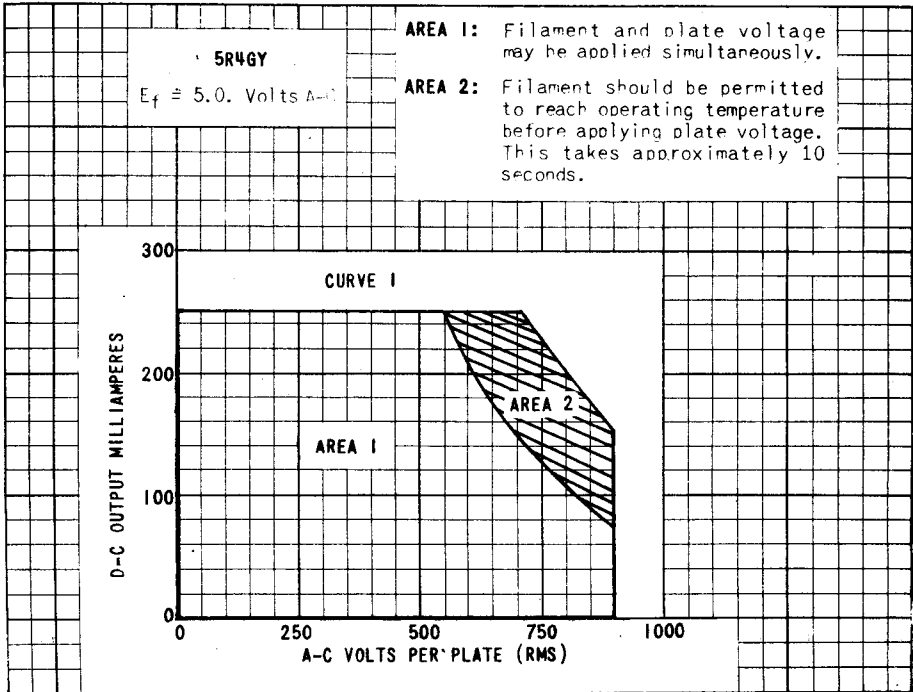

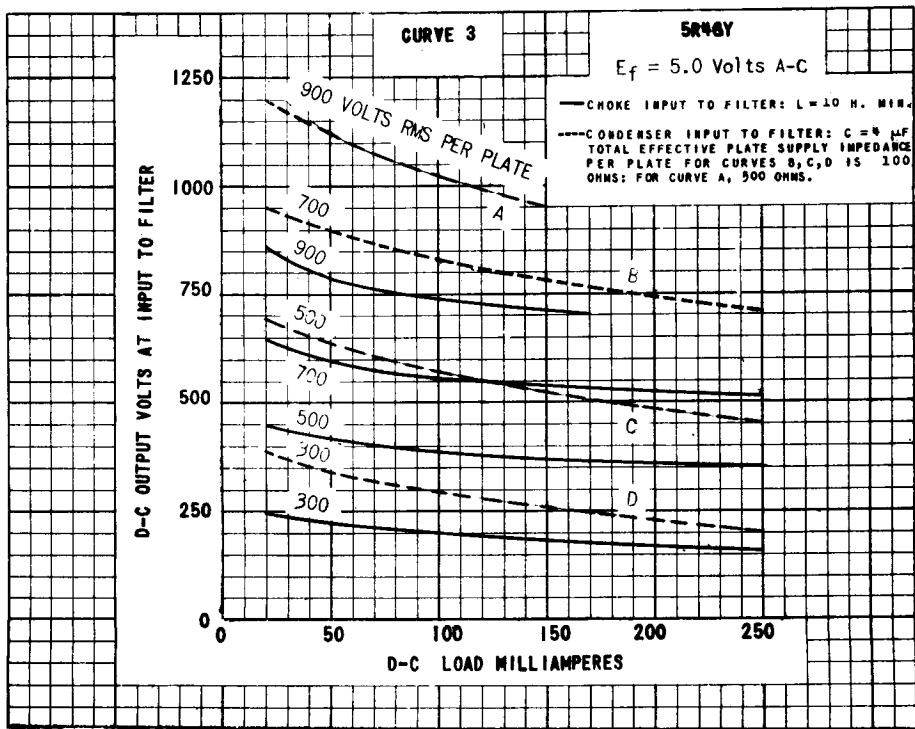
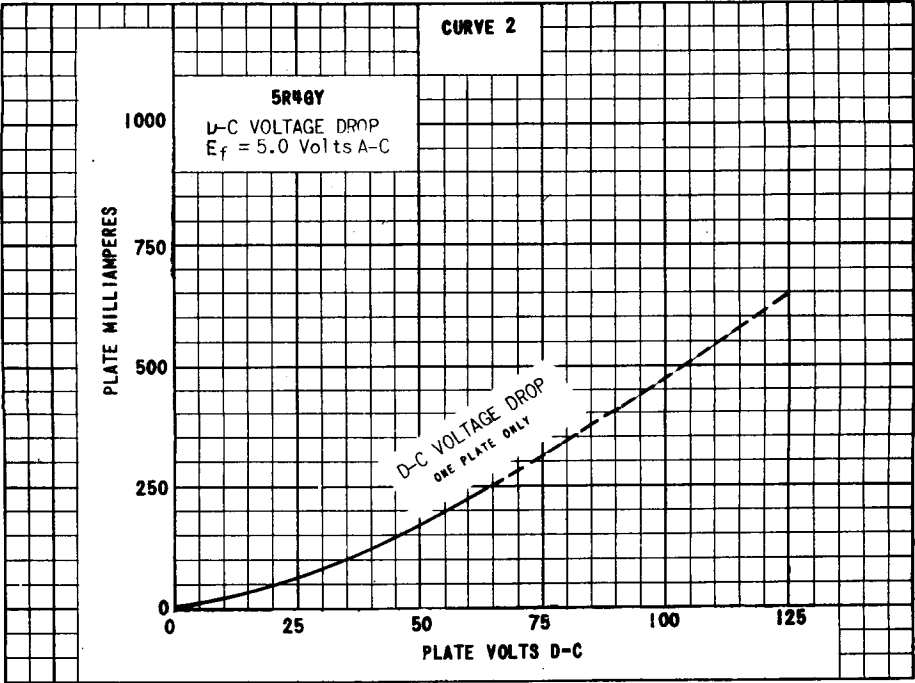

PRINTED IN U. S. A.

PLATE
 1601
 OCT. 19,
 1945



TUNG-SOL

FULL WAVE
HIGH VACUUM RECTIFIER

COATED FILAMENT

5.0 VOLTS 2.0 AMPERES
AC

METAL SHELL

5 PIN OCTAL BASE

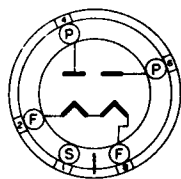
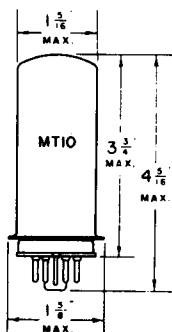

5T

BOTTOM VIEW

THE TUNG-SOL 5T4 IS DESIGNED FOR SERVICE AS A POWER RECTIFIER IN AC OPERATED RECEIVERS.

RATINGS

MAXIMUM PEAK INVERSE VOLTAGE	1550	VOLTS
MAXIMUM STEADY-STATE PEAK PLATE CURRENT PER PLATE	675	MA.
TUBE VOLTAGE DROP AT 225 MA. DC PER PLATE	45	VOLTS

TYPICAL OPERATING CONDITIONS AND CHARACTERISTICS

FULL WAVE RECTIFIER WITH CONDENSER INPUT TO FILTER

AC PLATE VOLTAGE PER PLATE (RMS) ^{MAX.}	450	VOLTS
DC OUTPUT CURRENT ^{MAX.}	225	MA.
TOTAL EFFECTIVE PLATE SUPPLY IMPEDANCE PER PLATE ^{MIN.-A}	150	OHMS

FULL WAVE RECTIFIER WITH CHOKE INPUT TO FILTER

AC PLATE VOLTAGE PER PLATE (RMS) ^{MAX.}	550	VOLTS
DC OUTPUT CURRENT ^{MAX.}	225	MA.
VALUE OF INPUT CHOKE ^{MIN.}	3	HENRYS

^A WHEN FILTER CONDENSERS LARGER THAN 40 μ FDS ARE USED, IT MAY BE NECESSARY TO ADD ADDITIONAL PLATE SUPPLY IMPEDANCE.

FOR "INTERPRETATION OF RATINGS" REFER TO FRONT OF BOOK.

CONTINUED NEXT PAGE

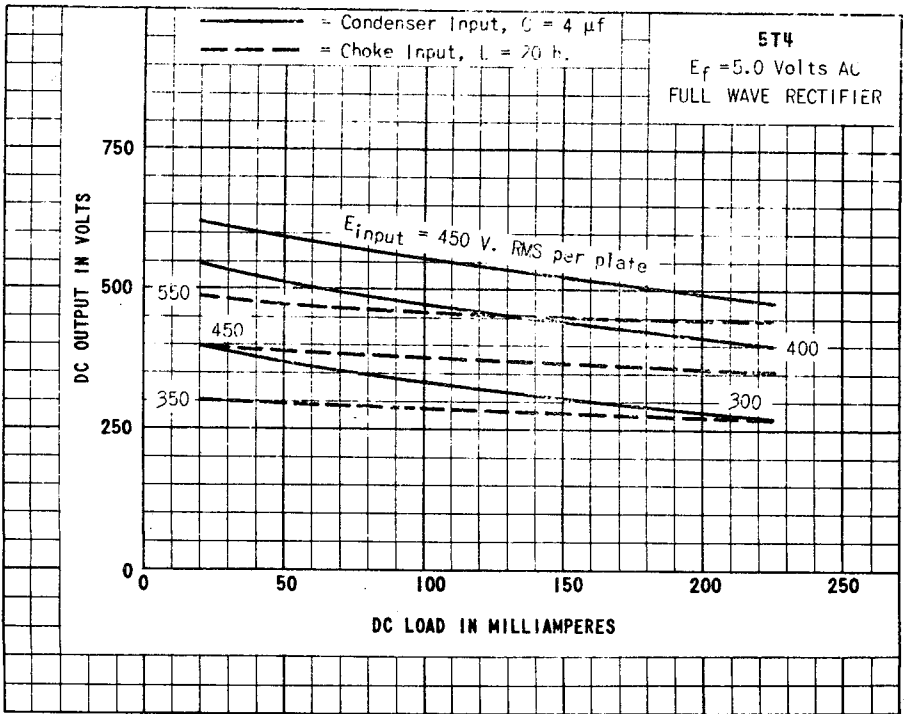
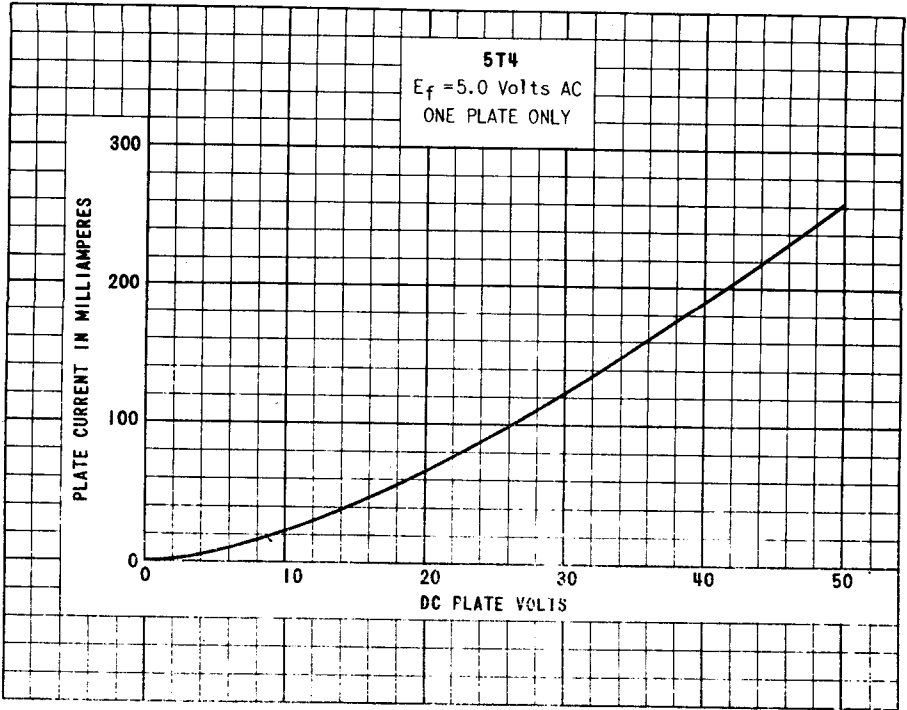

TUNG-SOL

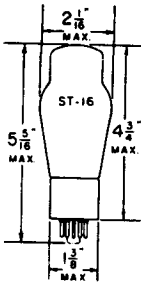

5U4G - MEDIUM 5 PIN OCTAL BASE
5X4G - MEDIUM 8 PIN OCTAL BASE

FULL WAVE
HIGH VACUUM RECTIFIER

COATED FILAMENT
5.0 VOLTS 3.0 AMPERES
AC

GLASS BULB

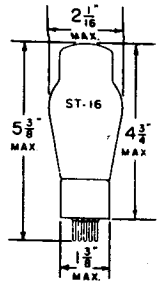

5Z3 - MEDIUM 4 PIN BASE

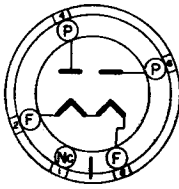

G-5Ta
BOTTOM VIEW
5U4G

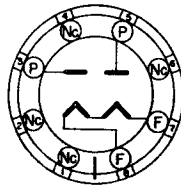

G-5Q
BOTTOM VIEW
5X4G

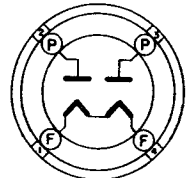

4C
BOTTOM VIEW
5Z3

THE TUNG-SOL 5U4G, 5X4G AND 5Z3 ARE DESIGNED FOR SERVICE AS POWER RECTIFIERS IN AC OPERATED RECEIVERS WHICH REQUIRE HIGH CURRENTS. THEIR RATINGS AND ELECTRICAL CHARACTERISTICS ARE IDENTICAL.

RATINGS

MAXIMUM PEAK INVERSE VOLTAGE	1550	VOLTS
MAXIMUM STEADY-STATE PEAK PLATE CURRENT PER PLATE	675	MA.

OPERATING CONDITIONS AND CHARACTERISTICS

FULL WAVE RECTIFIER WITH CONDENSER INPUT TO FILTER

AC PLATE VOLTAGE PER PLATE (RMS) ^{MAX.}	450	VOLTS
DC OUTPUT CURRENT ^{MAX.}	225	MA.
TOTAL EFFECTIVE PLATE SUPPLY IMPEDANCE PER PLATE ^{MIN. A}	75	OHMS

FULL WAVE RECTIFIER WITH CHOKE INPUT TO FILTER

AC PLATE VOLTAGE PER PLATE (RMS) ^{MAX.}	550	VOLTS
DC OUTPUT CURRENT ^{MAX.}	225	MA.
VALUE OF INPUT CHOKE ^{MIN. B}	3	HENRYS
TUBE VOLTAGE DROP AT 225 MA. PER PLATE	58	VOLTS

^A WHEN FILTER CONDENSERS LARGER THAN 40 μ FDS ARE USED, IT MAY BE NECESSARY TO ADD ADDITIONAL PLATE SUPPLY IMPEDANCE.

CONTINUED NEXT PAGE

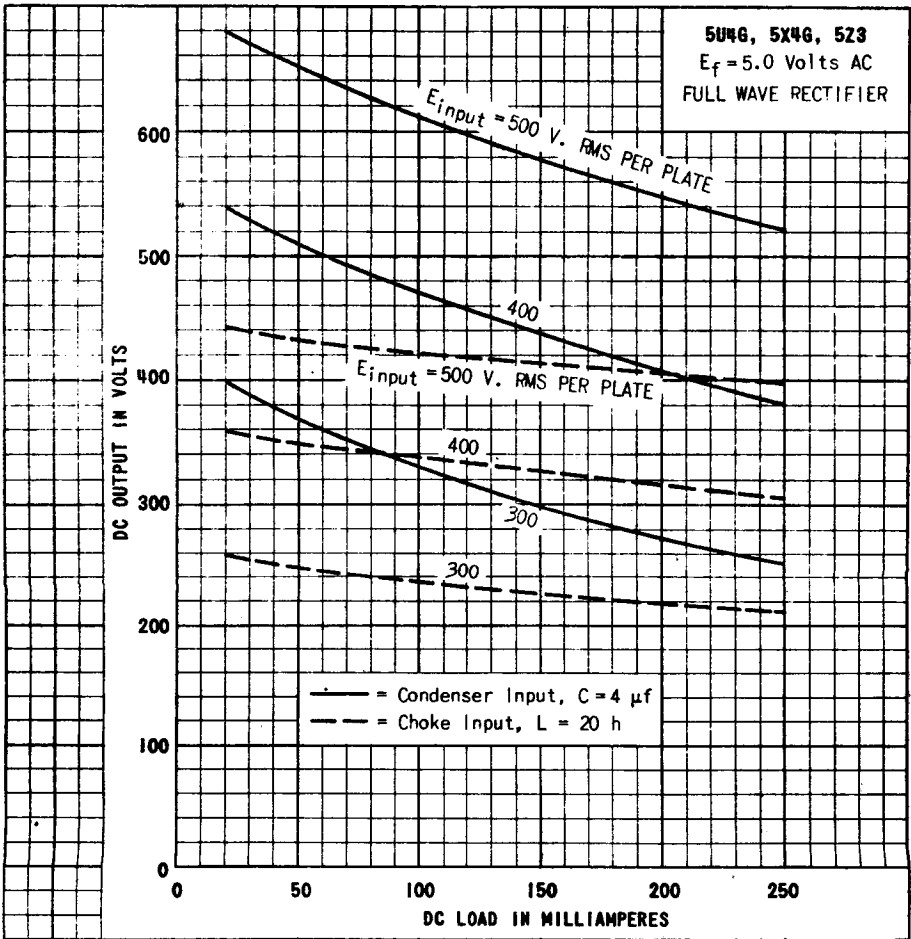
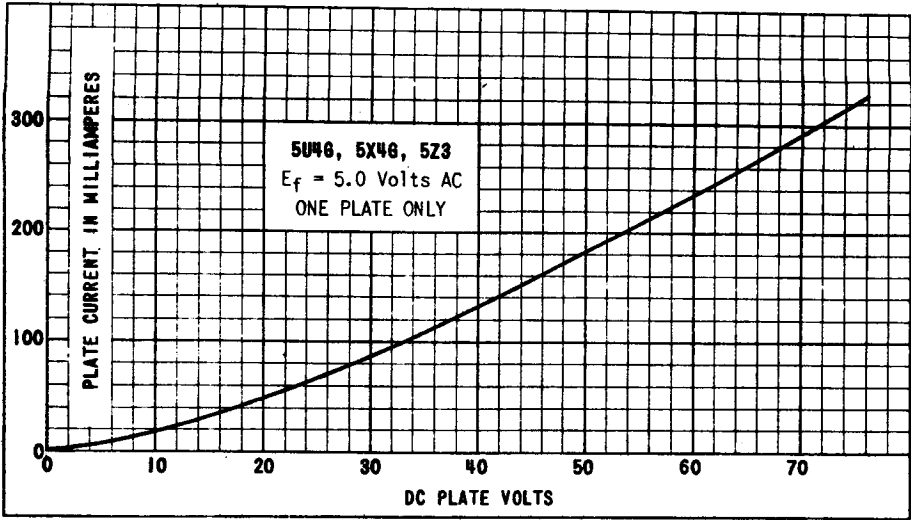

TUNG-SOL

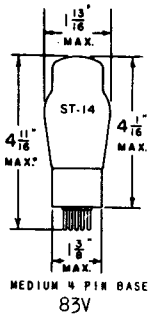

FULL WAVE
HIGH VACUUM RECTIFIER

UNI-POTENTIAL CATHODE

HEATER
5.0 VOLTS 2.0 AMPERES
AC

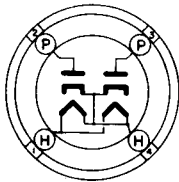
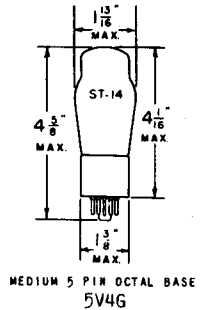

4 L

BOTTOM VIEW

GLASS BULB

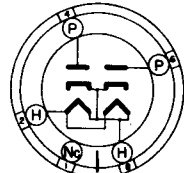

G-5L

BOTTOM VIEW

THE TUNG-SOL 5V4G AND 83V ARE POWER RECTIFIERS WITH LOW INTERNAL VOLTAGE DROPS. THEY ARE DESIGNED FOR SERVICE IN AC OPERATED RECEIVERS THAT REQUIRE HIGH CURRENTS. THEIR RATINGS AND ELECTRICAL CHARACTERISTICS ARE IDENTICAL.

RATINGS

MAXIMUM PEAK INVERSE VOLTAGE	1400	VOLTS
MAXIMUM STEADY-STATE PEAK PLATE CURRENT PER PLATE	525	MA.

OPERATING CONDITIONS AND CHARACTERISTICS

FULL WAVE RECTIFIER WITH CONDENSER INPUT TO FILTER

AC PLATE VOLTAGE PER PLATE (RMS) ^{MAX.}	375	VOLTS
DC OUTPUT CURRENT ^{MAX.}	175	MA.
TOTAL EFFECTIVE PLATE SUPPLY IMPEDANCE PER PLATE ^{MIN. A}	65	OHMS

FULL WAVE RECTIFIER WITH CHOKE INPUT TO FILTER

AC PLATE VOLTAGE PER PLATE (RMS) ^{MAX.}	500	VOLTS
DC OUTPUT CURRENT ^{MAX.}	175	MA.
VALUE OF INPUT CHOKE ^{MIN.}	4.0	HENRY'S
TUBE VOLTAGE DROP	23	VOLTS

AT 175 MA. PER PLATE

^A WHEN FILTER CONDENSERS LARGER THAN 40 μ FDS ARE USED, IT MAY BE NECESSARY TO ADD ADDITIONAL PLATE SUPPLY IMPEDANCE.

FOR "INTERPRETATION OF RATINGS", REFER TO FRONT OF BOOK.

CONTINUED NEXT PAGE

5V4G (83V)

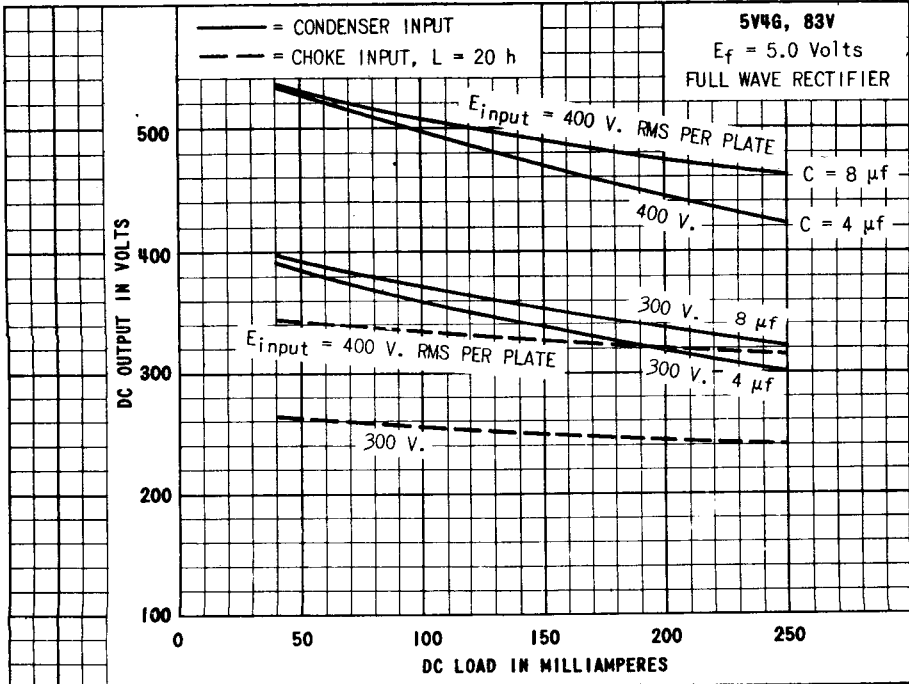
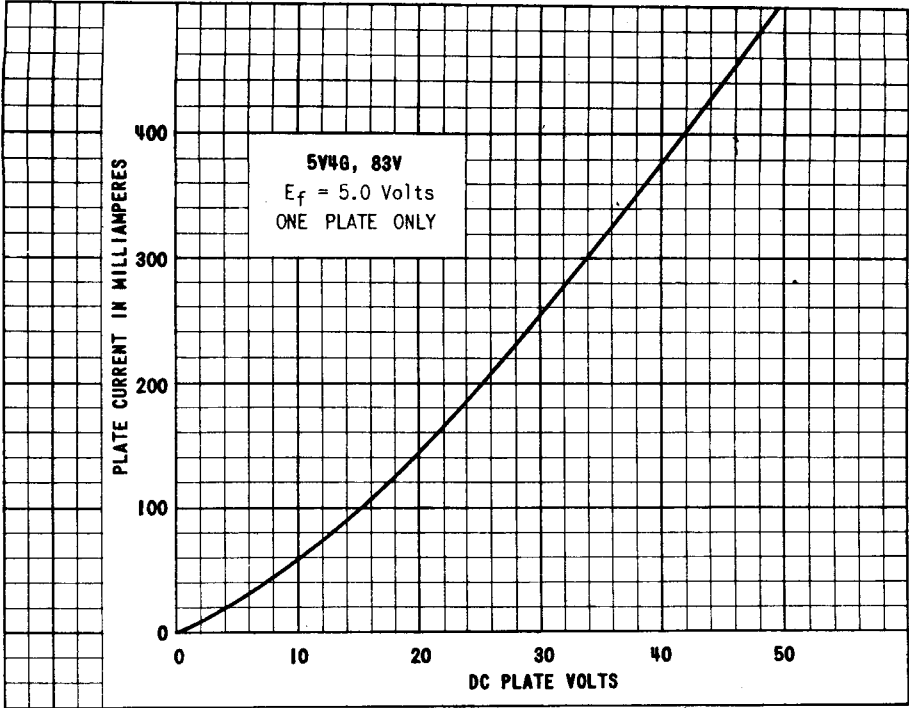
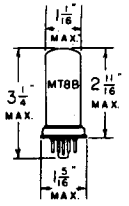

PLATE 700-1

TUNG-SOL



METAL SHELL
5 PIN OCTAL BASE
5W4

FULL WAVE
HIGH VACUUM RECTIFIER

COATED FILAMENT
5.0 VOLTS 1.5 AMPERES
AC

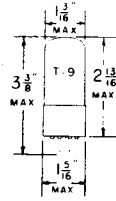

GLASS BULB
INTERMEDIATE 5 PIN OCTAL BASE
5W4GT/G

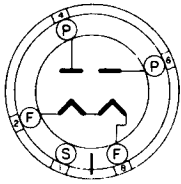

5T
BOTTOM VIEW
5W4

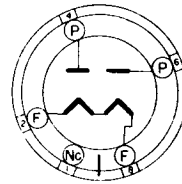

G-5T_a
BOTTOM VIEW
5W4GT/G

THE TUNG-SOL 5W4 AND 5W4GT/G ARE DESIGNED FOR SERVICE AS POWER RECTIFIERS IN AC OPERATED RECEIVERS. THEIR RATINGS AND ELECTRICAL CHARACTERISTICS ARE IDENTICAL.

RATINGS

MAXIMUM AC PLATE VOLTAGE (RMS) CONDENSER INPUT PER PLATE	350	VOLTS
MAXIMUM AC PLATE VOLTAGE (RMS) CHOKE INPUT PER PLATE	500	VOLTS
MAXIMUM PEAK INVERSE VOLTAGE	1400	VOLTS
MAXIMUM STEADY-STATE PEAK PLATE CURRENT PER PLATE	300	MA.
TUBE VOLTAGE DROP AT 100 MA. PER PLATE	45	VOLTS

TYPICAL OPERATING CONDITIONS AND CHARACTERISTICS

FULL WAVE RECTIFIER WITH CONDENSER INPUT TO FILTER

AC PLATE VOLTAGE PER PLATE (RMS)	350	VOLTS
DC OUTPUT CURRENT ^{MAX.}	100	MA.
TOTAL EFFECTIVE PLATE SUPPLY IMPEDANCE PER PLATE ^{MIN.^A}	25	OHMS

FULL WAVE RECTIFIER WITH CHOKE INPUT TO FILTER

AC PLATE VOLTAGE PER PLATE (RMS)	500	VOLTS
DC OUTPUT CURRENT ^{MAX.}	100	MA.
VALUE OF INPUT CHOKE ^{MIN.}	6	HENRY'S

^A WHEN FILTER CONDENSERS LARGER THAN 40 μ FDS ARE USED, IT MAY BE NECESSARY TO ADD ADDITIONAL PLATE SUPPLY IMPEDANCE.

FOR "INTERPRETATION OF RATINGS" REFER TO FRONT OF BOOK.

CONTINUED NEXT PAGE

PRINTED IN U.S.

PLATE 991-2

JAN-31 1941

5W4, 5W4GT/G

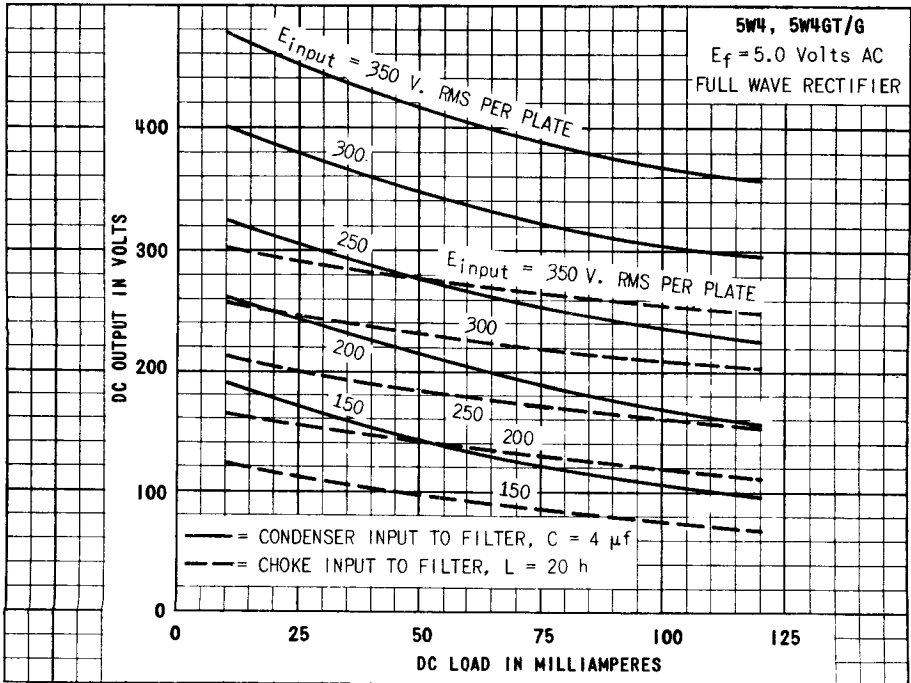
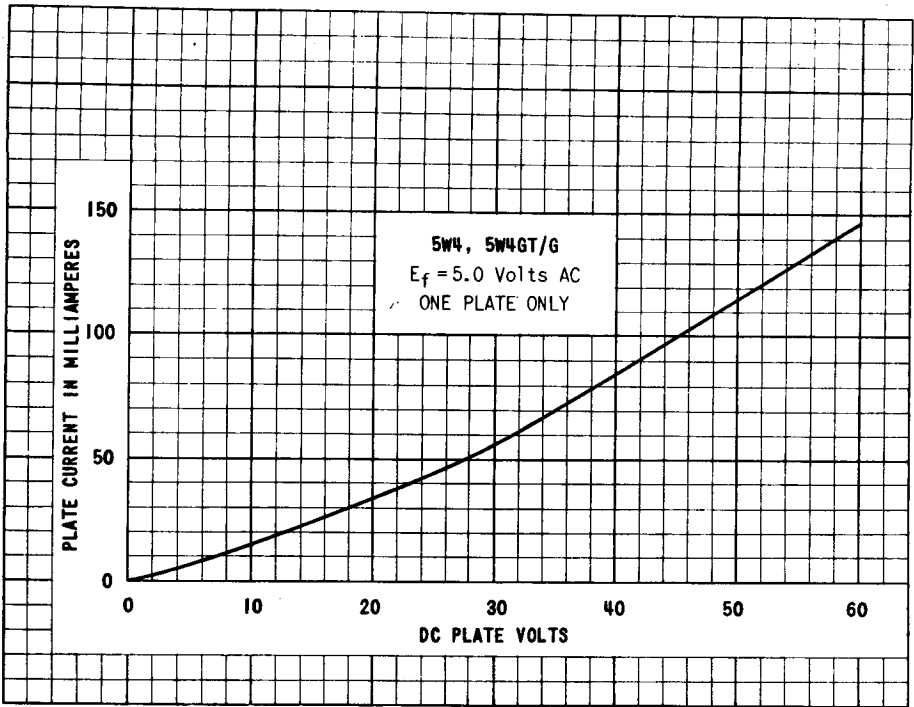

TUNG-SOL

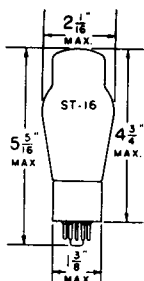

5U4G - MEDIUM 9 PIN OCTAL BASE

5X4G - MEDIUM 8 PIN OCTAL BASE

**FULL WAVE
HIGH VACUUM RECTIFIER**

COATED FILAMENT

5.0 VOLTS 3.0 AMPERES
AC

GLASS BULB

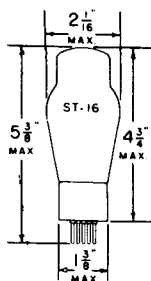

5Z3 - MEDIUM 4 PIN BASE

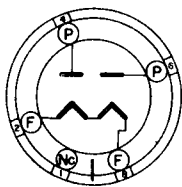

G-5Ta

BOTTOM VIEW

5U4G

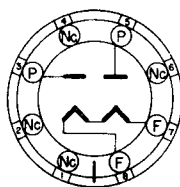

G-5Q

BOTTOM VIEW

5X4G

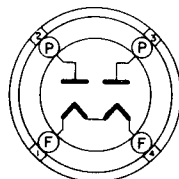

4C

BOTTOM VIEW

5Z3

THE TUNG-SOL 5U4G, 5X4G AND 5Z3 ARE DESIGNED FOR SERVICE AS POWER RECTIFIERS IN AC OPERATED RECEIVERS WHICH REQUIRE HIGH CURRENTS. THEIR RATINGS AND ELECTRICAL CHARACTERISTICS ARE IDENTICAL.

RATINGS

MAXIMUM PEAK INVERSE VOLTAGE	1550	VOLTS
MAXIMUM STEADY-STATE PEAK PLATE CURRENT PER PLATE	675	MA.

OPERATING CONDITIONS AND CHARACTERISTICS

FULL WAVE RECTIFIER WITH CONDENSER INPUT TO FILTER

AC PLATE VOLTAGE PER PLATE (RMS) ^{MAX.}	450	VOLTS
DC OUTPUT CURRENT ^{MAX.}	225	MA.
TOTAL EFFECTIVE PLATE SUPPLY IMPEDANCE PER PLATE ^{MIN. A}	75	OHMS

FULL WAVE RECTIFIER WITH CHOKE INPUT TO FILTER

AC PLATE VOLTAGE PER PLATE (RMS) ^{MAX.}	550	VOLTS
DC OUTPUT CURRENT ^{MAX.}	225	MA.
VALUE OF INPUT CHOKE ^{MIN.}	3	HENRYS
TUBE VOLTAGE DROP	58	VOLTS
AT 225 MA. PER PLATE		

^A WHEN FILTER CONDENSERS LARGER THAN 40 μ fd. ARE USED, IT MAY BE NECESSARY TO ADD ADDITIONAL PLATE SUPPLY IMPEDANCE.

CONTINUED NEXT PAGE

5X4G (5U4G, 5Z3)

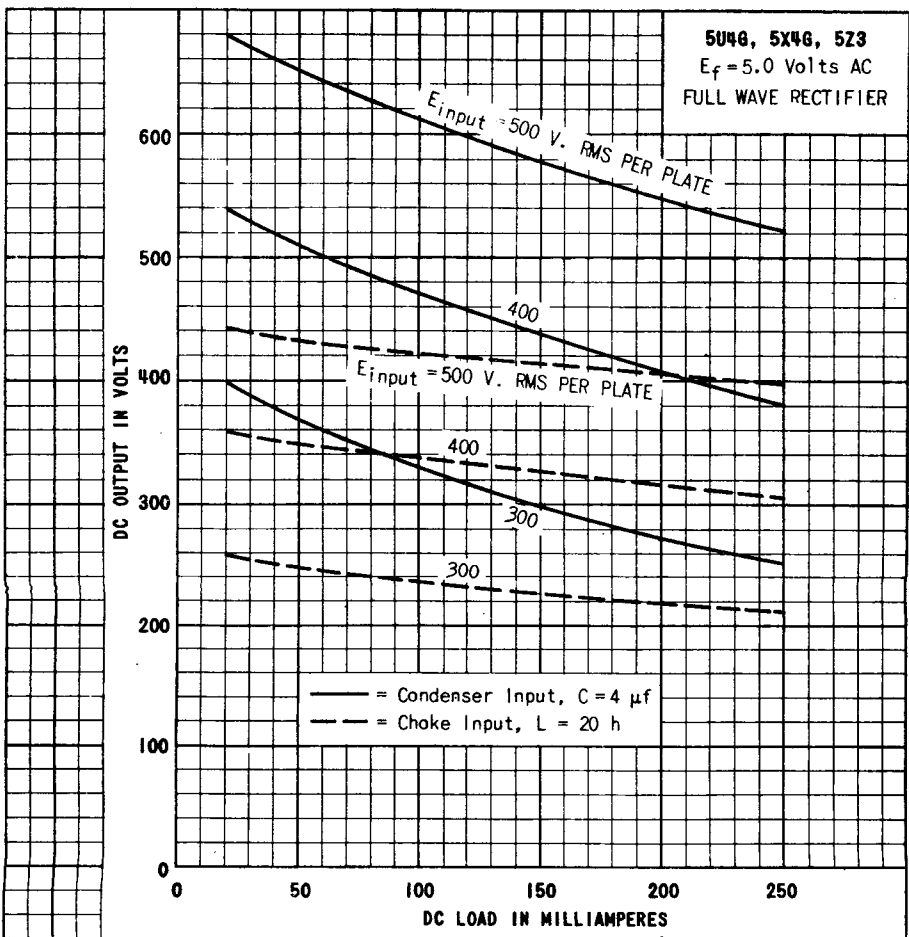
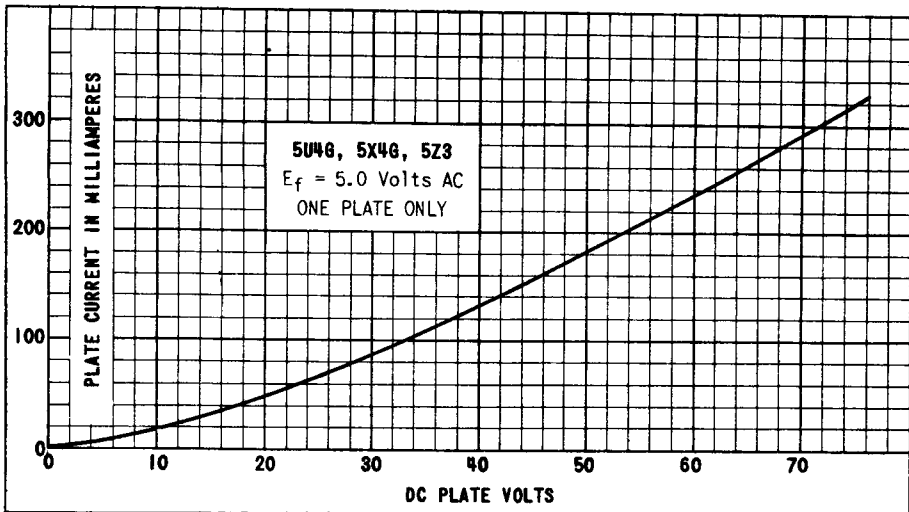

TUNG-SOL

FULL WAVE HIGH VACUUM RECTIFIER

COATED FILAMENT

THE TUNG-SOL 5Y3GT/G,, 5Y4G AND 80 ARE DESIGNED FOR USE AS POWER RECTIFIERS IN AC OPERATED RECEIVERS. THEIR RATINGS AND ELECTRICAL CHARACTERISTICS ARE IDENTICAL.

HORIZONTAL OPERATION PERMITTED ONLY IF PLANE OF THE FILAMENTS IS VERTICAL.

RATINGS

FILAMENT VOLTAGE	5.0 AC	VOLTS
FILAMENT CURRENT	2.0	AMPS.
MAXIMUM PEAK INVERSE VOLTAGE	1400	VOLTS
MAXIMUM STEADY-STATE PEAK PLATE CURRENT PER PLATE	375	MA.
MAXIMUM AC PLATE VOLTAGE PER PLATE (RMS)	350	VOLTS
CONDENSER INPUT	500	VOLTS
MAXIMUM AC PLATE VOLTAGE PER PLATE (RMS)	500	VOLTS
CHOKE INPUT	60	VOLTS
TUBE VOLTAGE DROP: MEASURED WITH APPLIED DC AT 125 MA. PER PLATE		

FOR INTERPRETATION OF RATINGS REFER TO RMA STANDARD M3-210

OPERATING CONDITIONS AND CHARACTERISTICS
FULL WAVE RECTIFIER

	CONDENSER INPUT	CHOKE INPUT	
FILAMENT VOLTAGE	5.0 AC	5.0 AC	VOLTS
AC PLATE VOLTAGE PER PLATE (RMS) MAX.	350	500	VOLTS
DC OUTPUT CURRENT MAX.	125	125	MA.
TOTAL EFFECTIVE PLATE SUPPLY IMPEDANCE PER PLATE MIN.	50		OHMS
MINIMUM VALUE OF INPUT CHOKE		5	HENRYS

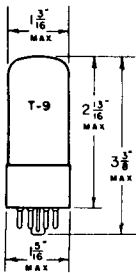

5Y3GT/G - MEDIUM 5 PIN OCTAL BASE

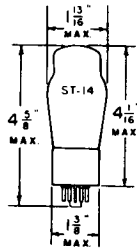

5Y4G - MEDIUM 8 PIN OCTAL BASE

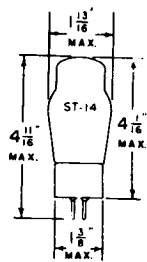

80 - MEDIUM 4 PIN BASE

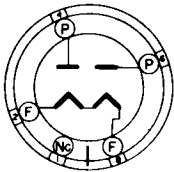

5Y3GT/G

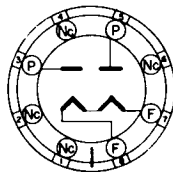

5Y4G

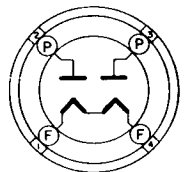

80

SEE OTHER SIDE OF SHEET FOR CURVES

5Y3GT/G, 5Y4G (80)

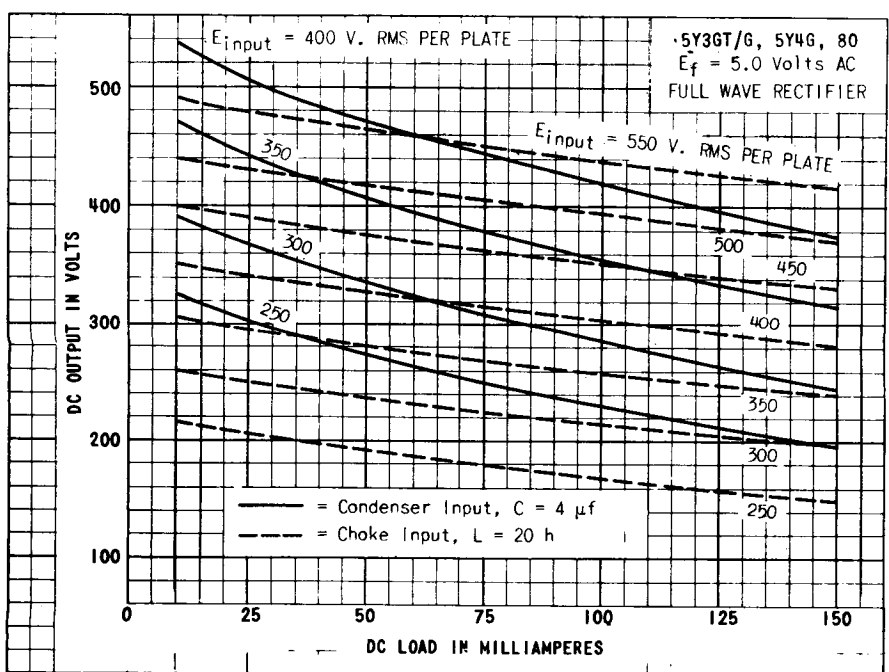
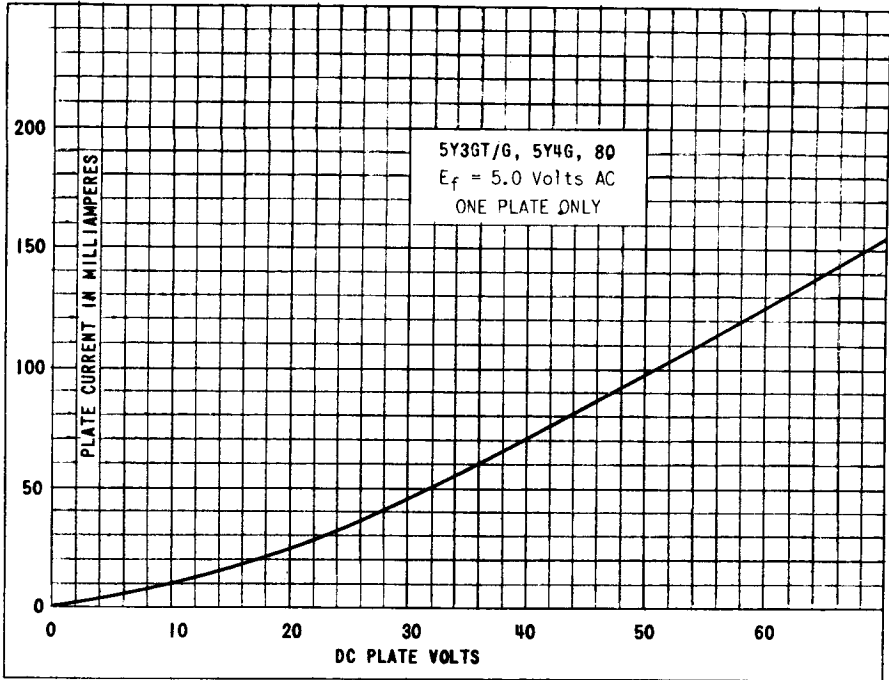
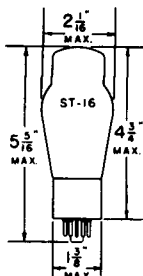

PLATE
 133F-2
 OCT. 25,
 1943

TUNG-SOL



5U4G - MEDIUM 5 PIN OCTAL BASE
5X4G - MEDIUM 8 PIN OCTAL BASE

FULL WAVE
HIGH VACUUM RECTIFIER

COATED FILAMENT

5.0 VOLTS 3.0 AMPERES
AC

GLASS BULB

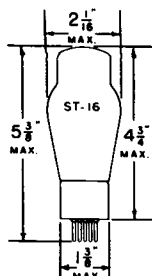

5Z3 - MEDIUM 4 PIN BASE

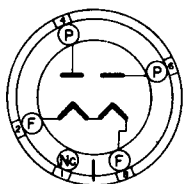

G-5T_a
BOTTOM VIEW
5U4G

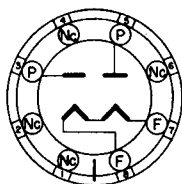

G-5Q
BOTTOM VIEW
5X4G

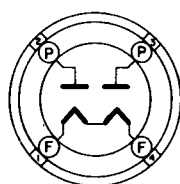

4C
BOTTOM VIEW
5Z3

THE TUNG-SOL 5U4G, 5X4G AND 5Z3 ARE DESIGNED FOR SERVICE AS POWER RECTIFIERS IN AC OPERATED RECEIVERS WHICH REQUIRE HIGH CURRENTS. THEIR RATINGS AND ELECTRICAL CHARACTERISTICS ARE IDENTICAL.

RATINGS

MAXIMUM PEAK INVERSE VOLTAGE	1550	VOLTS
MAXIMUM STEADY-STATE PEAK PLATE CURRENT PER PLATE	675	MA.

OPERATING CONDITIONS AND CHARACTERISTICS

FULL WAVE RECTIFIER WITH CONDENSER INPUT TO FILTER

AC PLATE VOLTAGE PER PLATE (RMS) ^{MAX.}	450	VOLTS
DC OUTPUT CURRENT ^{MAX.}	225	MA.
TOTAL EFFECTIVE PLATE SUPPLY IMPEDANCE PER PLATE ^{MIN. A}	75	OHMS

FULL WAVE RECTIFIER WITH CHOKE INPUT TO FILTER

AC PLATE VOLTAGE PER PLATE (RMS) ^{MAX.}	550	VOLTS
DC OUTPUT CURRENT ^{MAX.}	225	MA.
VALUE OF INPUT CHOKE ^{MIN.}	3	HENRYS
TUBE VOLTAGE DROP AT 225 MA. PER PLATE	58	VOLTS

^A WHEN FILTER CONDENSERS LARGER THAN 40 μfd ARE USED, IT MAY BE NECESSARY TO ADD ADDITIONAL PLATE SUPPLY IMPEDANCE.

CONTINUED NEXT PAGE

5Z3 (5U4G, 5X4G)

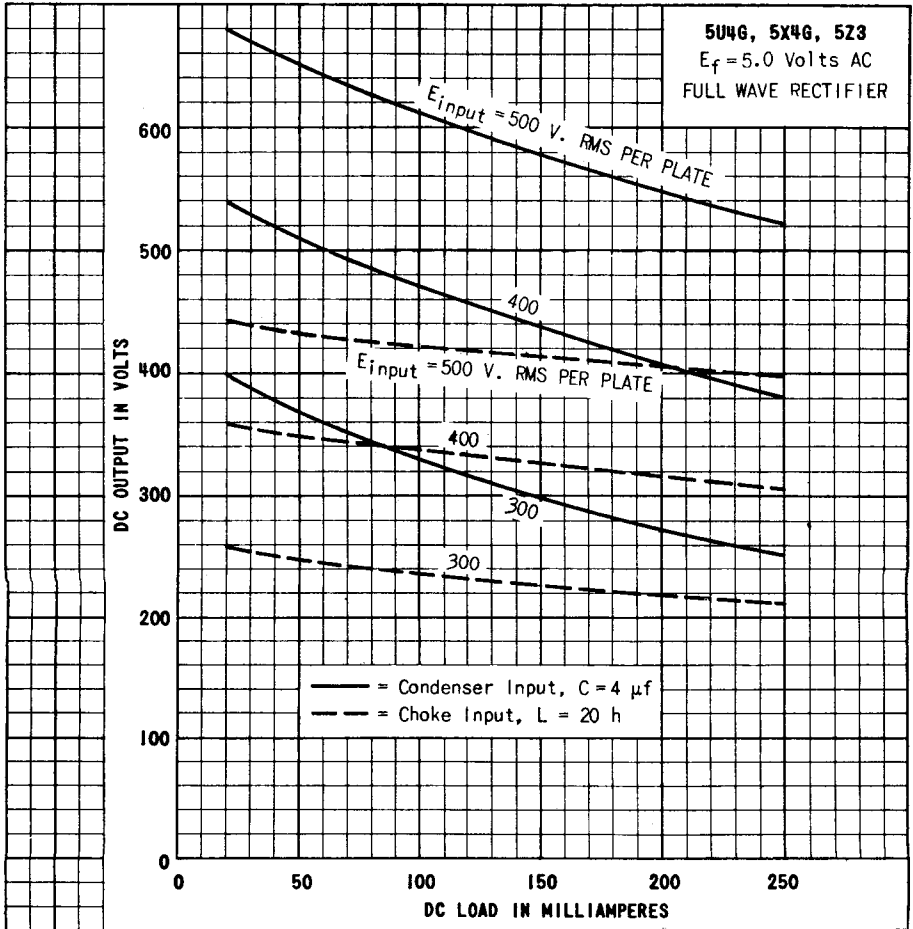
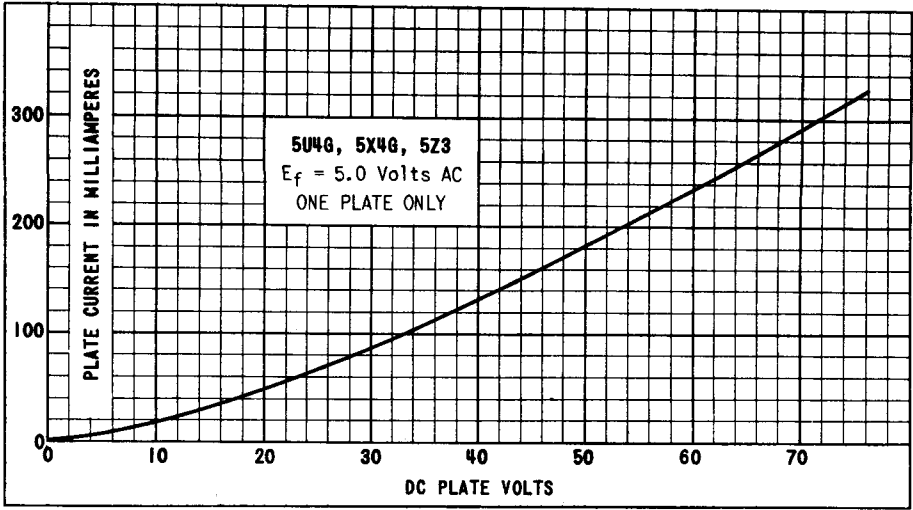
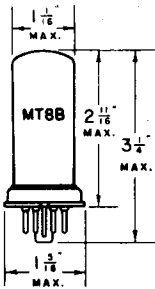

PLATE
692-1

TUNG-SOL

FULL WAVE
HIGH VACUUM RECTIFIER



UNIPOTENTIAL CATHODE

HEATER
5.0 VOLTS 2.0 AMPERES
AC

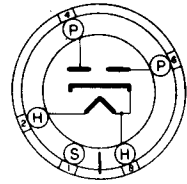

5L

BOTTOM VIEW

METAL SHELL

5 PIN OCTAL BASE

THE TUNG-SOL 524 IS DESIGNED FOR SERVICE AS A POWER RECTIFIER IN AC OPERATED RECEIVERS.

RATINGS

MAXIMUM PEAK INVERSE VOLTAGE	1400	VOLTS
MAXIMUM STEADY-STATE PEAK PLATE CURRENT PER PLATE	375	MA.

OPERATING CONDITIONS AND CHARACTERISTICS

FULL WAVE RECTIFIER WITH CONDENSER INPUT TO FILTER

AC PLATE VOLTAGE PER PLATE (RMS) ^{MAX.}	350	VOLTS
DC OUTPUT CURRENT ^{MAX.}	125	MA.
TOTAL EFFECTIVE PLATE SUPPLY IMPEDANCE PER PLATE ^{MIN. A}	30	OHMS

FULL WAVE RECTIFIER WITH CHOKE INPUT TO FILTER

AC PLATE VOLTAGE PER PLATE (RMS) ^{MAX.}	500	VOLTS
DC OUTPUT CURRENT ^{MAX.}	125	MA.
VALUE OF INPUT CHOKE ^{MIN. A}	5	HENRYS
TUBE VOLTAGE DROP	20	VOLTS
AT 125 MA. PER PLATE		

^A WHEN FILTER CONDENSERS LARGER THAN 40 μ FDS ARE USED, IT MAY BE NECESSARY TO ADD ADDITIONAL PLATE SUPPLY IMPEDANCE.

FOR "INTERPRETATION OF RATINGS", REFER TO FRONT OF BOOK.

PLATE
705-2

FEB. 15
1940

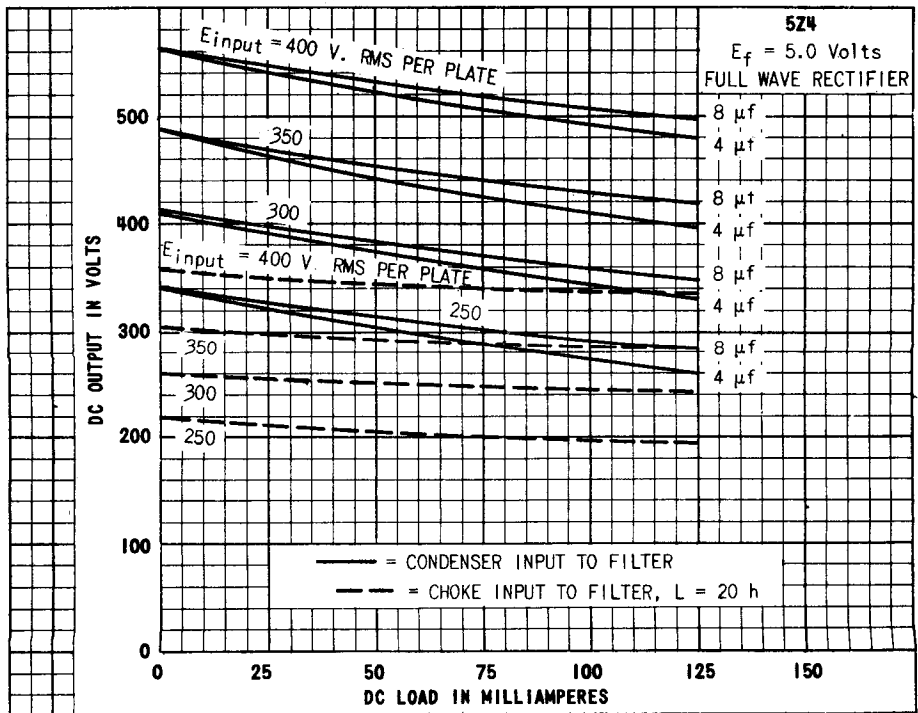
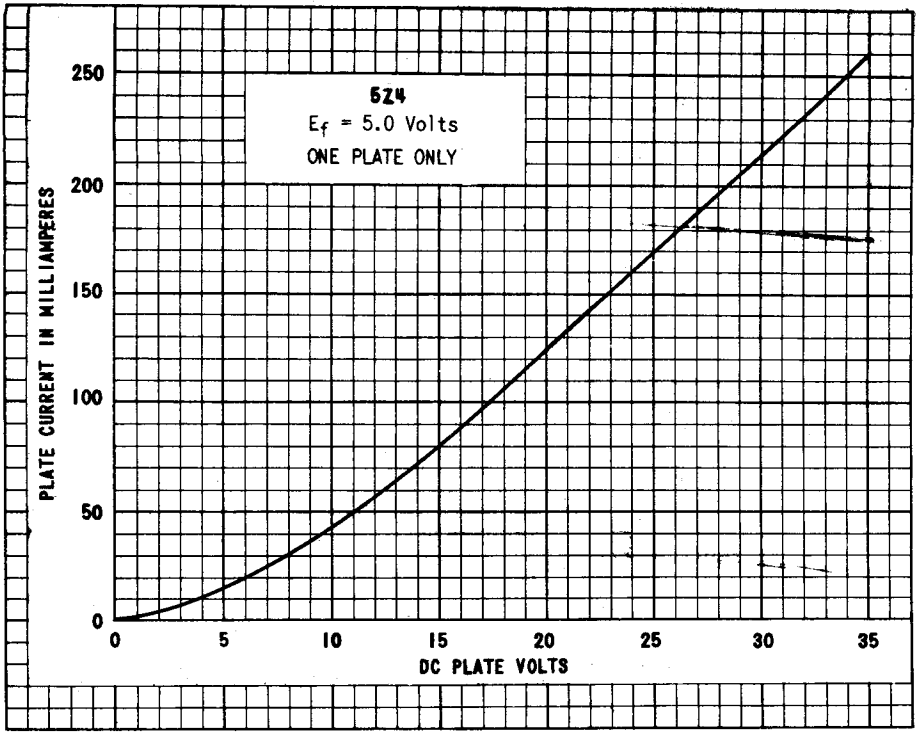
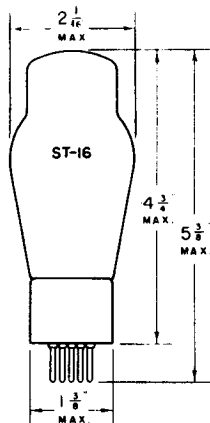

PLATE
706-1

TUNG-SOL



TRIODE POWER AMPLIFIER

COATED FILAMENT

6.3 VOLTS 1.0 AMPERE
AC OR DC

GLASS BULB

MEDIUM 4 PIN BASE

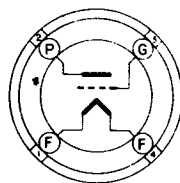

4D

BOTTOM VIEW

THE TUNG-SOL 6A3 IS A FILAMENT TYPE TRIODE POWER AMPLIFIER DESIGNED FOR SERVICE IN THE OUTPUT STAGE OF AUDIO AMPLIFIERS WHERE HIGH OUTPUT AND LOW HARMONIC DISTORTION ARE DESIRED. ITS RATINGS AND CHARACTERISTICS ARE SIMILAR TO THOSE OF THE 2A3 AND 6B4G.

OPERATING CONDITIONS AND CHARACTERISTICS

CLASS A₁ AMPLIFIER - ONE TUBE

PLATE VOLTAGE ^{MAX.}	250	VOLTS
GRID VOLTAGE ^G	-45	VOLTS
GRID CIRCUIT RESISTANCE ^{MAX.}		
FIXED BIAS	0.05	MEGOHM
SELF BIAS	0.5	MEGOHM
PLATE CURRENT	60	MA.
PLATE RESISTANCE	800	OHMS
TRANSCONDUCTANCE	5250	μMHMS
AMPLIFICATION FACTOR	4.2	
LOAD RESISTANCE	2500	OHMS
POWER OUTPUT	3.2	WATTS
SECOND HARMONIC DISTORTION	5	PER CENT

CLASS AB₁ PUSH-PULL AMPLIFIER

VALUES FOR TWO TUBES

	FIXED BIAS	SELF BIAS	
PLATE VOLTAGE ^{MAX.}	325	325	VOLTS
GRID VOLTAGE ^G	-68	-	VOLTS
SELF BIAS RESISTOR	-	850	OHMS
ZERO-SIGNAL PLATE CURRENT ^{PER TUBE}	40	40	MA.
LOAD RESISTANCE ^{PER TUBE}	750	1250	OHMS
EFFECTIVE LOAD RESISTANCE ^{PLATE TO PLATE}	3000	5000	OHMS
TOTAL HARMONIC DISTORTION	2.5	5	PER CENT
POWER OUTPUT	15	10	WATTS

^G GRID VOLTAGE MEASURED FROM MID-POINT OF AC OPERATED FILAMENT.

TUNG-SOL

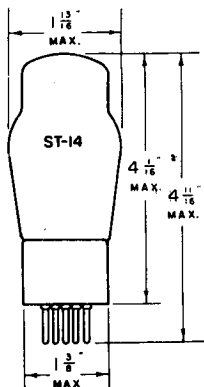

PENTODE POWER AMPLIFIER

COATED FILAMENT

6.3 VOLTS 0.3 AMPERE
AC OR DC

GLASS BULB

MEDIUM 5 PIN BASE

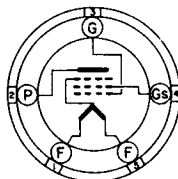

5B

BOTTOM VIEW

THE TUNG-SOL 6A4/LA IS A FILAMENT TYPE POWER OUTPUT PENTODE.

OPERATING CONDITIONS AND CHARACTERISTICS

CLASS A₁ AMPLIFIER

PLATE VOLTAGE	135	180 MAX.	VOLTS
SCREEN VOLTAGE	135	180 MAX.	VOLTS
CONTROL GRID VOLTAGE ^A	-9	-12	VOLTS
PLATE CURRENT	14	22	MA.
SCREEN CURRENT	2.5	3.9	MA.
PLATE RESISTANCE APPROX.	52600	45500	OHMS
TRANSCONDUCTANCE	1900	2200	μMHOS
AMPLIFICATION FACTOR APPROX.	100	100	
LOAD RESISTANCE	9500	8000	OHMS
TOTAL HARMONIC DISTORTION	9	9	PER CENT
POWER OUTPUT	0.7	1.4	WATTS

^A GRID VOLTAGE MEASURED FROM NEGATIVE END OF DC OPERATED FILAMENT. IF THE FILAMENT IS AC OPERATED, THE TABULATED VALUES OF GRID VOLTAGE SHOULD BE INCREASED BY 4 VOLTS, AND THEY SHOULD BE REFERRED TO THE MID-POINT OF THE FILAMENT.

TUNG-SOL

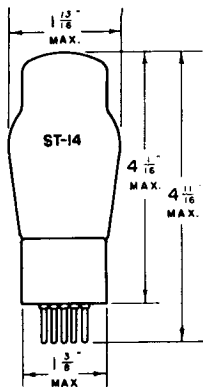

TWIN TRIODE
POWER AMPLIFIER

UNI-POTENTIAL CATHODE
HEATER
6.3 VOLTS 0.8 AMPERE
AC OR DC

GLASS BULB

MEDIUM 7 PIN BASE

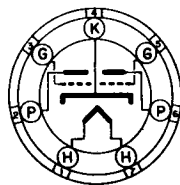

7B

BOTTOM VIEW

THE TUNG-SOL 6A6 IS A TWIN TRIODE DESIGNED FOR SERVICE AS A CLASS B POWER AMPLIFIER AND AS A CLASS A₁ DRIVER. WITH THE EXCEPTION OF HEATER RATINGS, ITS RATINGS AND CHARACTERISTICS ARE IDENTICAL TO THOSE OF TYPES 6N7, 6N7G, 6N7GT AND 53.

RATINGS

CLASS A₁ AMPLIFIER

MAXIMUM PLATE VOLTAGE	300	VOLTS
MAXIMUM PEAK PLATE CURRENT PER PLATE	125	MA.
MAXIMUM AVERAGE DISSIPATION PER PLATE	1.0	WATT

TYPICAL OPERATING CONDITIONS AND CHARACTERISTICS

CLASS A₁ AMPLIFIER - TRIODES CONNECTED IN PARALLEL

PLATE VOLTAGE	250	294	VOLTS
CONTROL GRID VOLTAGE	-5	-6	VOLTS
PLATE CURRENT	6	7	MA.
PLATE RESISTANCE	11 300	11 000	OHMS
TRANSCONDUCTANCE	3100	3200	μMHOS
AMPLIFICATION FACTOR	35	35	

RATINGS

CLASS B POWER AMPLIFIER

MAXIMUM PLATE VOLTAGE	300	VOLTS
MAXIMUM PEAK PLATE CURRENT	125	MA.
MAXIMUM AVERAGE DISSIPATION PER PLATE	5.5	WATTS

PLATE
1139-2NOV-17
1941

CONTINUED NEXT PAGE

TUNG-SOL

OPERATING CONDITIONS AND CHARACTERISTICS^A

CLASS B AMPLIFIER	IDEAL	TYPICAL	
ZERO SIGNAL PLATE VOLTAGE	300	300	VOLTS
DC GRID VOLTAGE	0	0	VOLT
PEAK AF SIGNAL VOLTAGE ^{PER GRID(B)} *	29	41 ^C	VOLTS
MAXIMUM SIGNAL PEAK GRID CURRENT ^{PER GRID}	20	22	MA.
ZERO SIGNAL PLATE CURRENT ^{PER PLATE}	17.5	17.5	MA.
MAXIMUM SIGNAL DC PLATE CURRENT ^{PER PLATE}	35	35	MA.
GRID IMPEDANCE AT 400 CYCLES	0	516 ^D	OHMS
PLATE SUPPLY IMPEDANCE	0	1000	OHMS
EFFECTIVE LOAD RESISTANCE ^{PLATE TO PLATE}	8000	8000	OHMS
TOTAL HARMONIC DISTORTION	4	8	PER CENT
THIRD HARMONIC DISTORTION	3.5	7.5	PER CENT
FIFTH HARMONIC DISTORTION	1.5	2.5	PER CENT
POWER OUTPUT	10	10	WATTS

^A UNLESS OTHERWISE SPECIFIED, VALUES ARE FOR BOTH UNITS

^B FOR POWER OUTPUT SHOWN.

^C INCLUDES PEAK GRID IMPEDANCE VOLTAGE DROP.

^D THE 516 OHMS IMPEDANCE CONSISTS OF A 50 MH. INDUCTANCE AND A 500 OHM RESISTANCE.

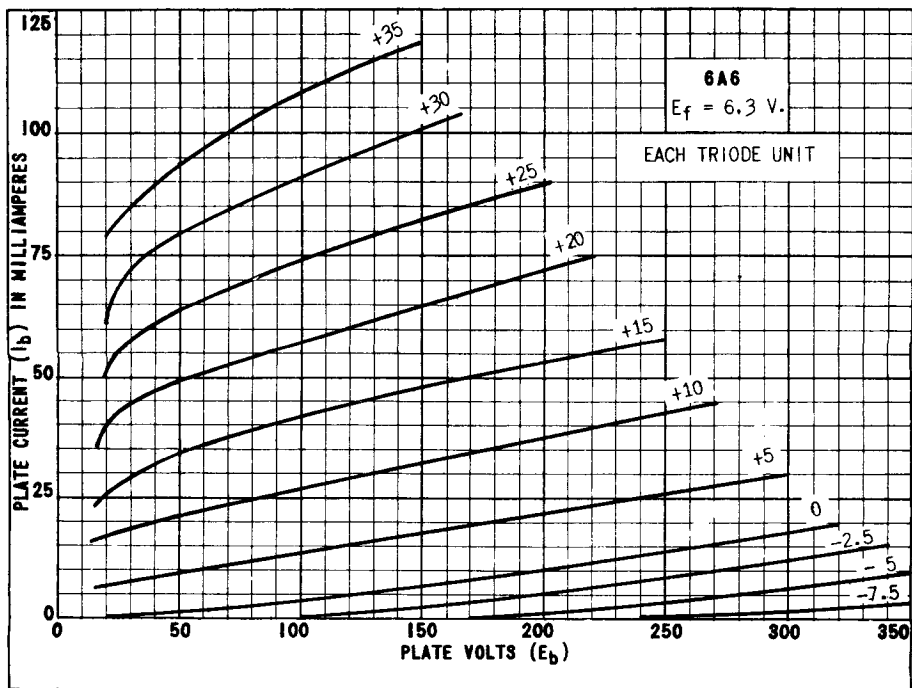
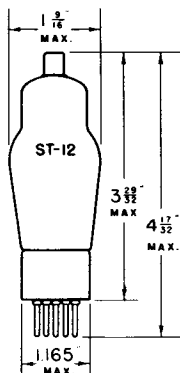

PLATE
1140-1

TUNG-SOL



PENTAGRID CONVERTER

UNIPOTENTIAL CATHODE

HEATER

2A7 - 2.5 VOLTS 0.8 AMPERE

6A7 - 6.3 VOLTS 0.3 AMPERE

AC OR DC

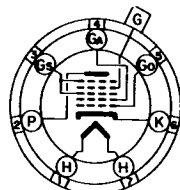
7 C
BOTTOM VIEW

GLASS BULB

SMALL 7 PIN BASE

THE TUNG-SOL 2A7 AND 6A7 ARE PENTAGRID CONVERTERS DESIGNED FOR SERVICE AS OSCILLATORS AND MIXERS IN AC OPERATED AND AC-DC OPERATED RECEIVERS. WITH THE EXCEPTION OF HEATER RATINGS, THEY HAVE IDENTICAL RATINGS AND ELECTRICAL CHARACTERISTICS.

RATINGS

MAXIMUM PLATE (P) VOLTAGE	300	VOLTS
MAXIMUM SCREEN (Gs) SUPPLY VOLTAGE	300	VOLTS
MAXIMUM SCREEN VOLTAGE	100	VOLTS
MINIMUM EXTERNAL CONTROL GRID (G) BIAS VOLTAGE	0	VOLTS
MAXIMUM OSCILLATOR ANODE (Ga) SUPPLY VOLTAGE	300	VOLTS
MAXIMUM OSCILLATOR ANODE VOLTAGE	200	VOLTS
MAXIMUM TOTAL CATHODE CURRENT	14	MA.
MAXIMUM PLATE DISSIPATION	1.0	WATT
MAXIMUM SCREEN DISSIPATION	0.3	WATT
MAXIMUM OSCILLATOR ANODE DISSIPATION	0.75	WATT

FOR "INTERPRETATION OF RATINGS" REFER TO FRONT OF BOOK.

CONTINUED NEXT PAGE

PLATE
918-2DEC. 30
1940

TUNG-SOL

DIRECT INTERELECTRODE CAPACITANCES

CONTROL GRID (G) TO MIXER PLATE (P) ⁵	0.3	μf
CONTROL GRID (G) TO OSCILLATOR ANODE (G _A) ⁵	0.15	μf
CONTROL GRID (G) TO OSCILLATOR GRID (G ₀) ⁵	0.15	μf
OSCILLATOR GRID (G ₀) TO OSCILLATOR ANODE (G _A)	1.0	μf
RF INPUT: CONTROL GRID (G) TO ALL OTHER ELECTRODES	8.5	μf
OSCILLATOR INPUT: OSCILLATOR GRID (G ₀) TO ALL OTHER ELECTRODES	7.0	μf
OSCILLATOR OUTPUT: OSCILLATOR ANODE (G _A) TO ALL OTHER ELECTRODES	5.5	μf
MIXER OUTPUT: MIXER PLATE (P) TO ALL OTHER ELECTRODES	9.0	μf

TYPICAL OPERATING CONDITIONS AND CHARACTERISTICS

CONVERTER SERVICE

PLATE (P) VOLTAGE	100	250	VOLTS
SCREEN (G _s) VOLTAGE	50	100	VOLTS
CONTROL GRID (G) VOLTAGE ^{MIX.}	-1.5	-3	VOLTS
OSCILLATOR ANODE (G _A) SUPPLY VOLTAGE ^A	-	250	VOLTS
OSCILLATOR ANODE VOLTAGE	100	-	VOLTS
OSCILLATOR GRID (G ₀) RESISTOR	50 000	50 000	OHMS
PLATE CURRENT	1.1	3.5	MA.
SCREEN CURRENT	1.3	2.7	MA.
OSCILLATOR ANODE CURRENT	2.0	4.0	MA.
OSCILLATOR GRID CURRENT	0.25	0.4	MA.
TOTAL CATHODE CURRENT	4.6	10.6	MA.
PLATE RESISTANCE ^{APPROX.}	0.6	0.36	MEG OHM
CONVERSION TRANSCONDUCTANCE	360	-	μMHOS
FOR CONTROL GRID (G) VOLTAGE = -1.5 V.			
CONVERSION TRANSCONDUCTANCE	180	550	μMHOS
FOR CONTROL GRID (G) VOLTAGE = -3 V.			
CONVERSION TRANSCONDUCTANCE	50	325	μMHOS
FOR CONTROL GRID (G) VOLTAGE = -6 V.			
CONVERSION TRANSCONDUCTANCE	-	100	μMHOS
FOR CONTROL GRID (G) VOLTAGE = -10 V.			
CONVERSION TRANSCONDUCTANCE ^{APPROX.}	3	-	μMHOS
FOR CONTROL GRID (G) VOLTAGE = -20 V.			
CONVERSION TRANSCONDUCTANCE ^{APPROX.}	-	6	μMHOS
FOR CONTROL GRID (G) VOLTAGE = -35 V.			

^A APPLIED THROUGH A 20 000 OHM DROPPING RESISTOR

⁵ WITH EXTERNAL SHIELD CONNECTED TO CATHODE

TUNG-SOL

PENTAGRID CONVERTER

UNIPOTENTIAL CATHODE

HEATER

6.3 VOLTS 0.3 AMPERE
AC OR DC

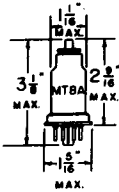

METAL SHELL
8 PIN OCTAL BASE
6A8

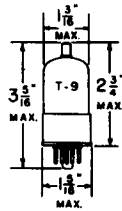

GLASS BULB
8 PIN OCTAL BASE
WITH METAL SHELL
6A8GT

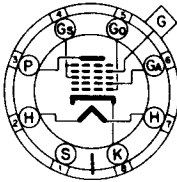

8A

BOTTOM VIEW
6A8, 6A8GT

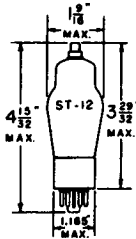

GLASS BULB
SMALL 8 PIN OCTAL BASE
6A8G

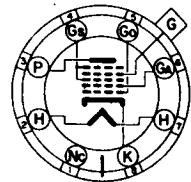

G-8A

BOTTOM VIEW
6A8G

THE TUNG-SOL 6A8, 6A8G, AND 6A8GT ARE PENTAGRID CONVERTERS DESIGNED FOR SERVICE AS COMBINED OSCILLATORS AND MIXERS IN AC, STORAGE BATTERY, AND AC - DC OPERATED RECEIVERS. WITH THE EXCEPTION OF CAPACITANCES, THEIR RATINGS AND CHARACTERISTICS ARE IDENTICAL WITH THOSE OF THE 6A7.

RATINGS

MAXIMUM PLATE VOLTAGE	300	VOLTS
MAXIMUM SCREEN (G _s) SUPPLY VOLTAGE	300	VOLTS
MAXIMUM SCREEN VOLTAGE	100	VOLTS
MINIMUM EXTERNAL CONTROL GRID (G) BIAS VOLTAGE	0	VOLTS
MAXIMUM OSCILLATOR ANODE (G _a) SUPPLY VOLTAGE	300	VOLTS
MAXIMUM OSCILLATOR ANODE VOLTAGE	200	VOLTS
MAXIMUM TOTAL CATHODE CURRENT	14	MA.
MAXIMUM PLATE DISSIPATION	1.0	WATT
MAXIMUM SCREEN DISSIPATION	0.3	WATT
MAXIMUM OSCILLATOR ANODE DISSIPATION	.75	WATT

FOR "INTERPRETATION OF RATINGS" REFER TO FRONT OF BOOK.

CONTINUED NEXT PAGE

TUNG-SOL

DIRECT INTERELECTRODE CAPACITANCES ^S

	6A8	6A8G, 6A8GT	
CONTROL GRID (G) TO MIXER PLATE (P)	0.06	.26	$\mu\mu\text{f}$
CONTROL GRID (G) TO OSCILLATOR ANODE (G _A)	0.1	.19	$\mu\mu\text{f}$
CONTROL GRID (G) TO OSCILLATOR GRID (G ₀)	0.09	.16	$\mu\mu\text{f}$
OSCILLATOR GRID (G ₀) TO OSCILLATOR ANODE (G _A)	0.8	1.1	$\mu\mu\text{f}$
RF INPUT: CONTROL GRID (G) TO ALL OTHER ELECTRODES	12.0	9.5	$\mu\mu\text{f}$
OSCILLATOR INPUT: OSCILLATOR GRID (G ₀) TO ALL OTHER ELECTRODES	6.5	6.0	$\mu\mu\text{f}$
OSCILLATOR OUTPUT: OSCILLATOR ANODE (G _A) TO ALL OTHER ELECTRODES	5	4.6	$\mu\mu\text{f}$
MIXER OUTPUT: MIXER PLATE (P) TO ALL OTHER ELECTRODES	12	12	$\mu\mu\text{f}$

TYPICAL OPERATING CONDITIONS AND CHARACTERISTICS

CONVERTER SERVICE

PLATE (P) VOLTAGE	100	250	VOLTS
SCREEN (G _s) VOLTAGE	50	100	VOLTS
CONTROL GRID (G) VOLTAGE MIN.	-1.5	-3	VOLTS
OSCILLATOR ANODE (G _A) SUPPLY VOLTAGE ^A	-	250	VOLTS
OSCILLATOR ANODE VOLTAGE	100	-	VOLTS
OSCILLATOR GRID (G ₀) RESISTOR	50000	50000	OHMS
PLATE CURRENT	1.1	3.5	MA.
SCREEN CURRENT	1.3	2.7	MA.
OSCILLATOR ANODE CURRENT	2.0	4.0	MA.
OSCILLATOR GRID CURRENT	0.25	0.4	MA.
TOTAL CATHODE CURRENT	4.6	10.6	MA.
PLATE RESISTANCE	0.6	0.36	MEGOHM
CONVERSION TRANSCONDUCTANCE	360	-	μMHOS
FOR CONTROL GRID (G) VOLTAGE = -1.5 V.			
CONVERSION TRANSCONDUCTANCE	180	550	μMHOS
FOR CONTROL GRID (G) VOLTAGE = -3 V.			
CONVERSION TRANSCONDUCTANCE	50	325	μMHOS
FOR CONTROL GRID (G) VOLTAGE = -6 V.			
CONVERSION TRANSCONDUCTANCE	-	100	μMHOS
FOR CONTROL GRID (G) VOLTAGE = -10 V.			
CONVERSION TRANSCONDUCTANCE ^{APPROX.}	3	-	μMHOS
FOR CONTROL GRID (G) VOLTAGE = -20 V.			
CONVERSION TRANSCONDUCTANCE ^{APPROX.}	-	6	μMHOS
FOR CONTROL GRID (G) VOLTAGE = -35 V.			

^A APPLIED THROUGH A 20 000 OHM DROPPING RESISTOR

^S WITH EXTERNAL SHIELD OR SHELL CONNECTED TO CATHODE

PLATE
1079-1

TUNG-SOL

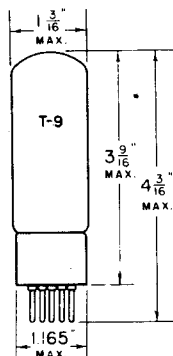

CATHODE RAY TUNING INDICATOR

UNIPOTENTIAL CATHODE

HEATER

6.3 VOLTS 0.15 AMPERE

AC OR DC

GLASS BULB

SMALL 6 PIN BASE

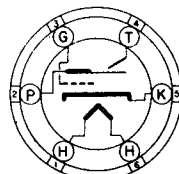

6R

BOTTOM VIEW

THE TUNG-SOL 6AB5/6N5 CONSISTS OF A CIRCULAR FLUORESCENT SCREEN WITH AN INDICATING SHADOW ANGLE, WHICH IS CONTROLLED BY AN INTERNALLY CONNECTED AMPLIFIER. WHEN THE 6AB5/6N5 IS USED AS A TUNING INDICATOR, AVC VOLTAGE IS APPLIED TO THE TRIODE GRID. IT IS RECOMMENDED FOR APPLICATIONS WHICH REQUIRE A HEATER OF LOW CURRENT DRAIN.

RATINGS

MAXIMUM PLATE SUPPLY VOLTAGE	180	VOLTS
MAXIMUM TARGET VOLTAGE	180	VOLTS
MINIMUM TARGET VOLTAGE	100	VOLTS

TYPICAL OPERATING CONDITIONS AND CHARACTERISTICS

PLATE AND TARGET SUPPLY VOLTAGE	135	VOLTS
SERIES TRIODE PLATE RESISTOR	0.25	MEGOHM
TRIODE GRID VOLTAGE (0° SHADOW ANGLE)	-10 APPROX.	VOLTS
TRIODE GRID VOLTAGE (90° SHADOW ANGLE)	0 APPROX.	VOLTS
TRIODE PLATE CURRENT (TRIODE GRID V. _r =0)	0.5 ^A	MA.
TARGET CURRENT (TRIODE GRID V. _r =0)	2.0 ^A	MA.

^A SUBJECT TO WIDE VARIATION

FOR "INTERPRETATION OF RATINGS", REFER TO FRONT OF BOOK.

NOTE: THIS DOUBLE-BRANDED TUBE, 6AB5/6N5, REPLACES EITHER THE 6AB5 OR THE 6N5.

PLATE
872-1

OCT. 21
1940

CONTINUED NEXT PAGE

6AB5/6N5

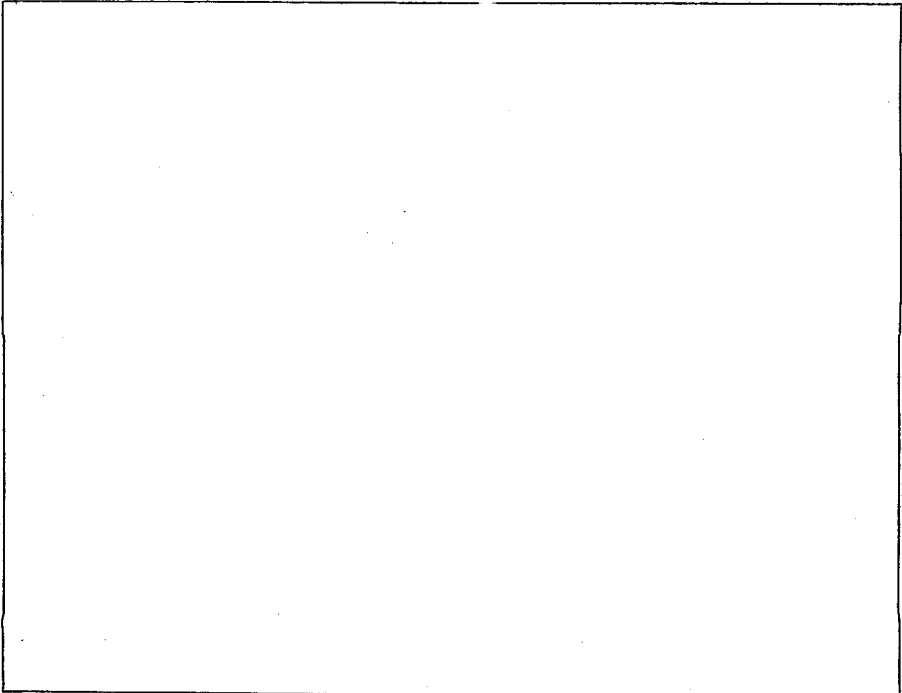
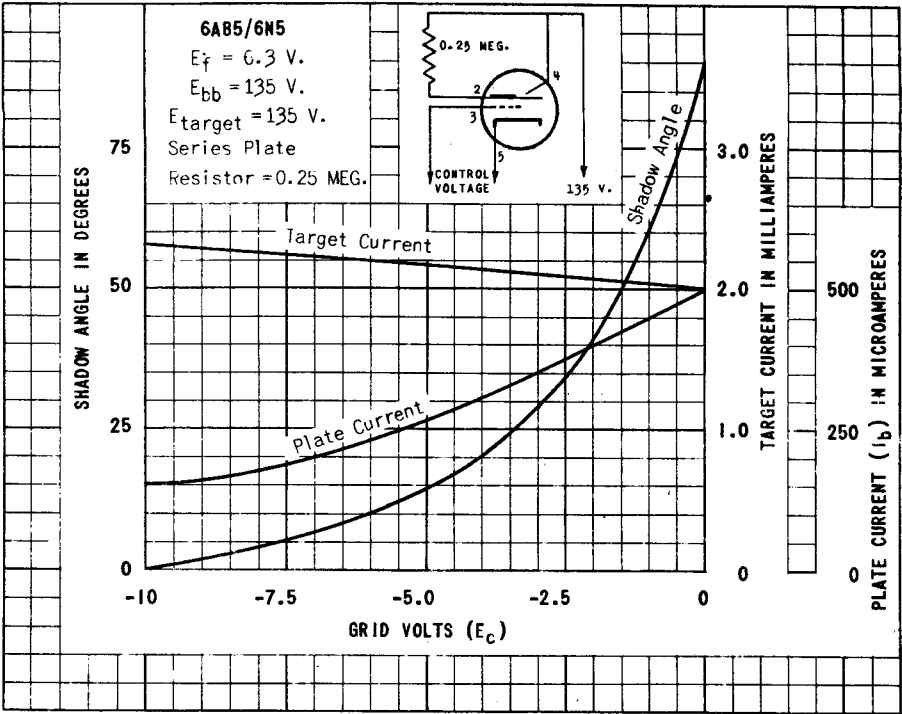

TUNG-SOL

TELEVISION AMPLIFIER PENTODE

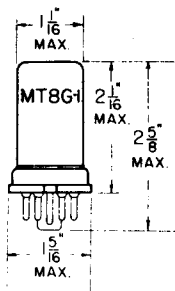

METAL SHELL

COATED UNIPOTENTIAL CATHODE

HEATER

6.3 VOLTS 0.45 AMPERE
AC OR DC

ANY MOUNTING POSITION

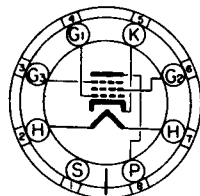
BOTTOM VIEW
SMALL WAFER
8-PIN OCTAL

THE 6AB7/1853 IS A HIGH TRANSCONDUCTANCE SEMI-REMOTE CUT-OFF AMPLIFIER TUBE. THIS TUBE IS DESIGNED FOR TELEVISION RF AND IF AMPLIFIER SERVICE. PRECAUTIONS SHOULD BE TAKEN NOT TO EXCEED DISSIPATION RATING WITH EXPECTED LINE-VOLTAGE FLUCTUATIONS, ESPECIALLY WITH FIXED-BIAS OPERATION.

RATINGS

INTERPRETED ACCORDING TO RMA STANDARD WB-21C

HEATER VOLTAGE (AC OR DC)	6.3	VOLTS
HEATER CURRENT	0.45	AMP.
MAX. PLATE VOLTAGE	300	VOLTS
MAX. SCREEN VOLTAGE	200	VOLTS
MAX. SCREEN SUPPLY VOLTAGE	300	VOLTS
MAX. PLATE DISSIPATION	3.75	WATTS
MAX. SCREEN DISSIPATION	0.65	WATT
HEATER-CATHODE VOLTAGE	AS LOW AS POSSIBLE	

DIRECT INTERELECTRODE CAPACITANCES

WITH SHELL CONNECTED TO CATHODE

GRID TO PLATE (MAX.)	0.015	$\mu\mu\text{f}$
INPUT	8	$\mu\mu\text{f}$
OUTPUT	5	$\mu\mu\text{f}$

CONTINUED ON FOLLOWING PAGE

CONTINUED FROM PRECEDING PAGE

TYPICAL OPERATING CONDITIONS AND CHARACTERISTICS

CLASS A₁ AMPLIFIER

	WITH FIXED SCREEN SUPPLY	WITH SERIES SCREEN RESISTOR	
HEATER VOLTAGE	0.3	6.3	VOLTS
PLATE VOLTAGE	300	300	VOLTS
SCREEN SUPPLY VOLTAGE ^A	200	300	VOLTS
GRID VOLTAGE (MIN.) ^B	-3	-3	VOLTS
SUPPRESSOR VOLTAGE ^C	0	0	VOLTS
PLATE CURRENT	12.5	12.5	MA.
SCREEN CURRENT	3.2	3.2	MA.
PLATE RESISTANCE (APPROX.)	0.7	0.7	MEGOHM
SERIES SCREEN RESISTOR		30 000	OHMS
GRID RESISTOR (MAX.)			
FIXED BIAS	0.25	0.25	MEGOHM
CATHODE BIAS	0.25	0.5	MEGOHM
TRANSCONDUCTANCE	5000	5000	μMHOS
AMPLIFICATION FACTOR (APPROX.)	3500	3500	
GRID BIAS FOR TRANSCONDUCTANCE OF 50 μMHOS	-15	-22.5	VOLTS

^A SCREEN SUPPLY VOLTAGES GREATER THAN 200 VOLTS REQUIRE THE USE OF A SERIES DROPPING RESISTOR TO LIMIT THE VOLTAGE AT THE SCREEN TO 200 VOLTS WITH NORMAL PLATE CURRENT OF 12.5 MA.

^B THE GRID BIAS MAY BE OBTAINED FROM A CATHODE BIAS RESISTOR HAVING A VALUE OF 190 OHMS MINIMUM.

^C IN RF AND IF STAGES, THE SUPPRESSOR SHOULD BE CONNECTED DIRECTLY TO GROUND TO MINIMIZE FEEDBACK.

NOTE: PRECAUTIONS MUST BE TAKEN IN HIGH FREQUENCY CIRCUITS TO MINIMIZE THE CHARACTERISTICALLY LARGE VARIATION OF INPUT CAPACITANCE AND INPUT CONDUCTANCE WITH PLATE CURRENT.

SIMILAR TYPE REFERENCE: Somewhat similar to type 6SG7.

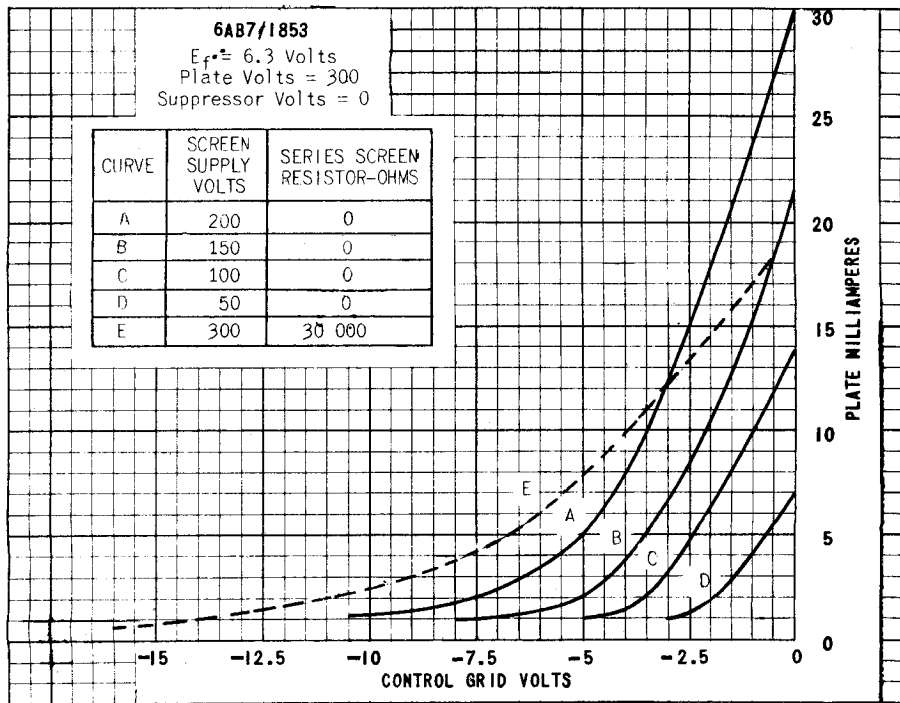
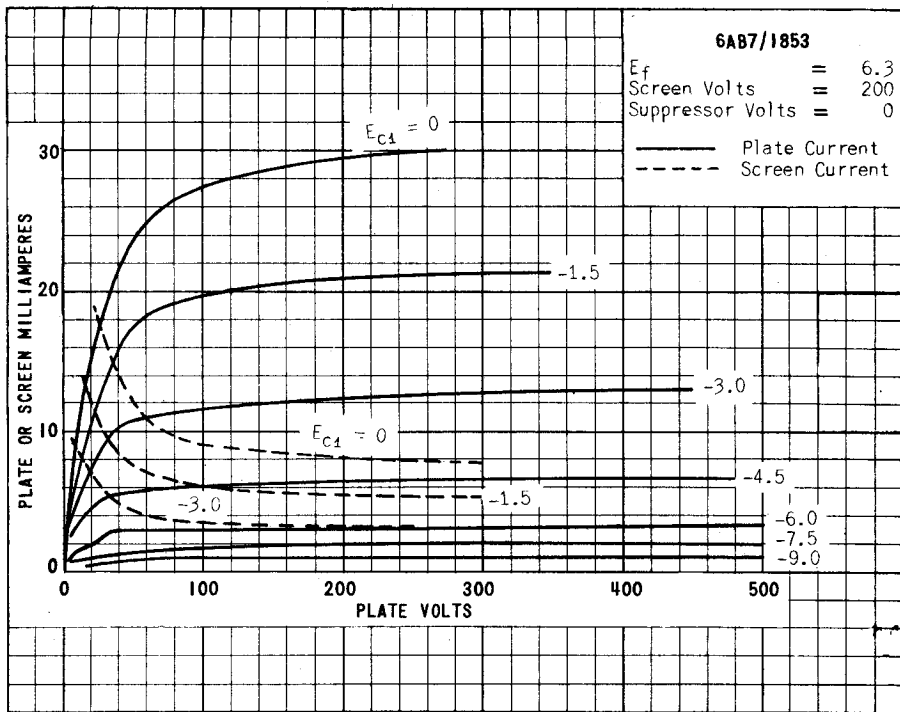

PRINTED IN U. S. A.

PLATE 1622
NOV. 50
1945

6AB7/1853

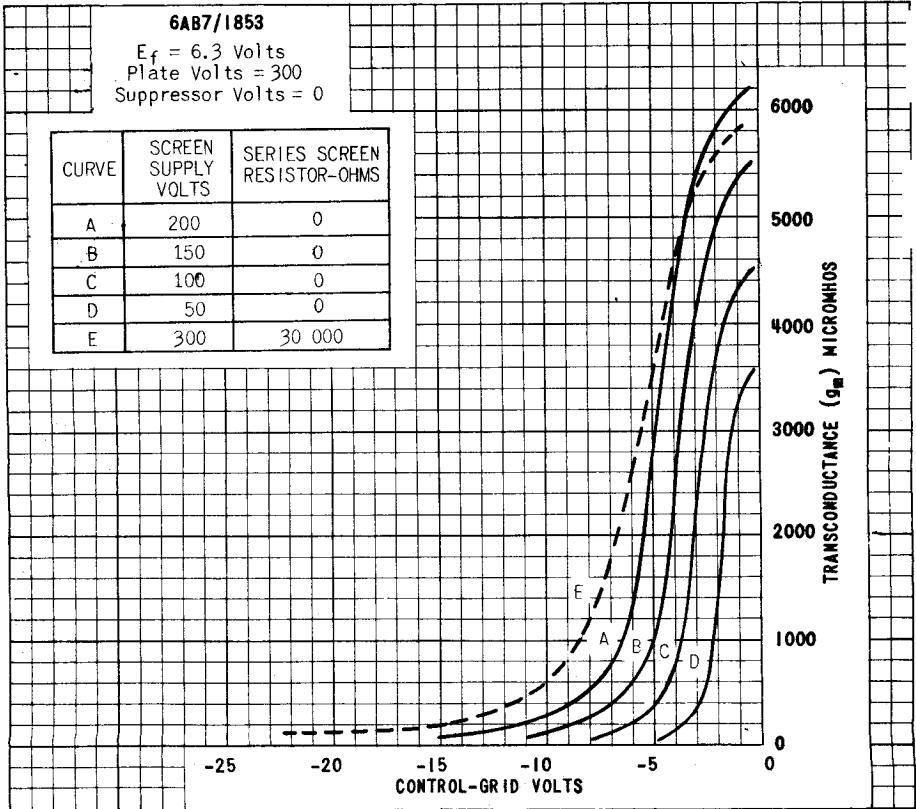
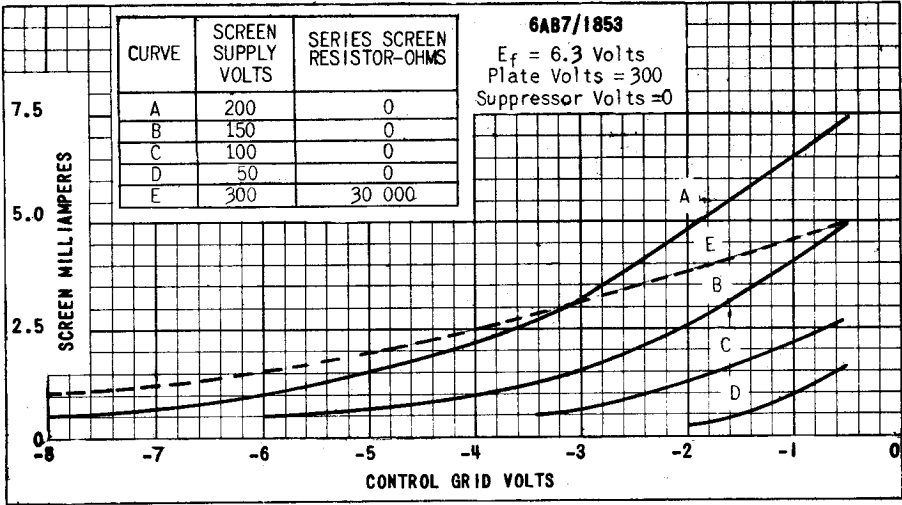

PLATE
 1691
 FEB. 15
 1946

TUNG-SOL

HIGH-MU
TRIODE POWER AMPLIFIER

UNIPOTENTIAL CATHODE

HEATER
6.3 VOLTS 0.4 AMPERE
AC OR DC

GLASS BULB

INTERMEDIATE 6 PIN OCTAL BASE

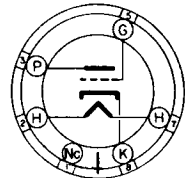
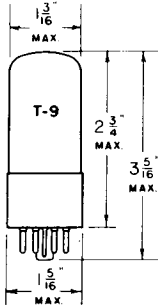

6Q-0-0

THE TUNG-SOL 6AC5GT/G IS A HIGH MU POWER OUTPUT TRIODE DESIGNED FOR SERVICE IN DYNAMIC COUPLED CIRCUITS USING A TYPE 76, 6P5GT/G OR 6J5GT/G AS A DRIVER. TWO TUNG-SOL 6AC5GT/G'S MAY BE USED AS A ZERO BIAS CLASS B AMPLIFIER.

RATINGS

MAXIMUM PLATE VOLTAGE	250	VOLTS
MAXIMUM PEAK PLATE CURRENT	110	MA.
MAXIMUM AVERAGE PLATE DISSIPATION	10	WATTS

AVERAGE CHARACTERISTICS

PLATE VOLTAGE	250	VOLTS
CONTROL GRID VOLTAGE	+13	VOLTS
PLATE CURRENT	32	MA.
GRID CURRENT	5	MA.
PLATE RESISTANCE	36 700	OHMS
TRANSCONDUCTANCE	3400	μMHOS
AMPLIFICATION FACTOR	125	

TYPICAL OPERATING CONDITIONS AND CHARACTERISTICS

CLASS B POWER AMPLIFIER

VALUES ARE FOR TWO TUBES UNLESS OTHERWISE SPECIFIED

PLATE VOLTAGE	250	VOLTS
CONTROL GRID VOLTAGE	0	VOLTS
PEAK AF SIGNAL VOLTAGE GRID TO GRID	70	VOLTS
ZERO-SIGNAL PLATE CURRENT	5	MA.
PEAK PLATE CURRENT PER TUBE	110	MA.
EFFECTIVE LOAD RESISTANCE PLATE TO PLATE	10 000	OHMS
PEAK POWER INPUT	9.50	WATT
POWER OUTPUT APPROX.	8	WATTS

CONTINUED NEXT PAGE

TYPICAL OPERATION

DYNAMIC COUPLED CLASS A₁ AMPLIFIER

WITH TYPE 6P5GT/G OR 76 AS DRIVER

PLATE SUPPLY VOLTAGE	250	VOLTS
CONTROL GRID VOLTAGE ^A	0	VOLT
DRIVER GRID RESISTOR ^{MAX.}	1.0	MEGOHM
ZERO-SIGNAL PLATE CURRENT	32	MA.
AVERAGE PLATE CURRENT OF DRIVER	5.5	MA.
INPUT SIGNAL TO DRIVER (RMS)	16.5	VOLTS
LOAD RESISTANCE	7000	OHMS
TOTAL HARMONIC DISTORTION	10	PER CENT
POWER OUTPUT ^B	3.7	WATTS

^A BIAS VOLTAGE FOR BOTH THE 6AC5GT/G AND THE DRIVER TUBE IS DEVELOPED BY THE "DYNAMIC COUPLED" CIRCUIT CONNECTION SHOWN BELOW. THE 25 000 OHM RESISTOR IS CONNECTED BETWEEN GRID AND CATHODE OF THE 6AC5GT/G TO PREVENT A CURRENT SURGE OCCURRING WHEN THE TUBE IS HEATING.

^B AT THE POINT WHERE DRIVER GRID CURRENT BEGINS TO FLOW, THE POWER OUTPUT IS 4.3 WATTS WITH 16% DISTORTION.

DYNAMIC-COUPLED CONNECTION

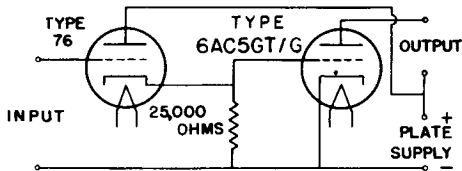

RESISTANCE COUPLED AMPLIFIER OPERATION ZERO CATHODE RESISTOR CIRCUIT

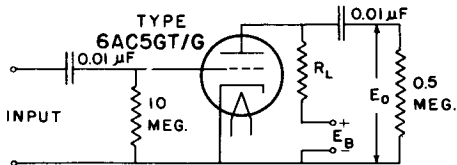

THE CIRCUITS SHOWN HEREIN ARE FOR YOUR INFORMATION. TUNG-SOL LAMP WORKS INC. ASSUMES NO LIABILITY WITH RESPECT TO THEIR USE IN THE INFRINGEMENT OF ANY PATENT.

PLATE
1174-1

TUNG-SOL

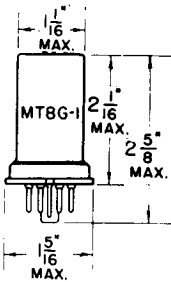

AMPLIFIER PENTODE

SINGLE-ENDED METAL TYPE

COATED UNIPOTENTIAL CATHODE

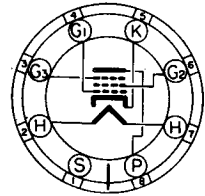

BOTTOM VIEW

HEATER

6.3 VOLTS 0.45 AMPERE

AC OR DC

IN CIRCUITS WHERE THE CATHODE IS NOT DIRECTLY CONNECTED TO THE HEATER, THE POTENTIAL DIFFERENCE BETWEEN HEATER AND CATHODE SHOULD BE KEPT AS LOW AS POSSIBLE. UNDER NO CONDITIONS SHOULD IT EXCEED 100 VOLTS.

METAL SHELL

SMALL WAFER OCTAL 8 PIN

THE 6AC7/1852 INCORPORATES FEATURES MAKING IT SUITABLE FOR HIGH GAIN AMPLIFIER CIRCUITS. IT HAS A HIGH RATIO OF TRANSCONDUCTANCE TO PLATE CURRENT, MAINTAINING REASONABLE LOW CAPACITANCE AND CLOSE ELECTRODE SPACING.

RATINGS

INTERPRETED ACCORDING TO RMA STANDARD M8-210

AMPLIFIER

MAXIMUM PLATE VOLTAGE	300	VOLTS
MAXIMUM SCREEN VOLTAGE	150	VOLTS
MAXIMUM SCREEN SUPPLY VOLTAGE	300	VOLTS
MAXIMUM PLATE DISSIPATION	3.02	WATTS
MAXIMUM SCREEN DISSIPATION	0.38	WATT

DIRECT INTERELECTRODE CAPACITANCES

WITH SHELL CONNECTED TO CATHODE

MAXIMUM GRID TO PLATE	0.015	$\mu\mu\text{f}$
INPUT	11	$\mu\mu\text{f}$
OUTPUT	5.0	$\mu\mu\text{f}$

PLATE
1463
AUG. 31
1944

CONTINUED NEXT PAGE

TYPICAL OPERATING CONDITIONS AND CHARACTERISTICS

CLASS A₁ AMPLIFIER

	CONDITION 1 ^A	CONDITION 2 ^B	
PLATE VOLTAGE	300	300	VOLTS
SUPPRESSOR ^C	0	0	VOLTS
SCREEN SUPPLY	150	300	VOLTS
SCREEN SERIES RESISTOR	-	60000	OHMS
MINIMUM CATHODE BIAS RESISTOR ^D	160	160	OHMS
PLATE RESISTANCE (APPROX.)	0.75	0.75	MEGOHM
TRANSCONDUCTANCE	9000	9000	μMHOS
PLATE CURRENT	10	10	MA.
SCREEN CURRENT	2.5	2.5	MA.
AMPLIFICATION FACTOR (APPROX.)	6750	6750	

^A CONDITION 1 WITH FIXED SCREEN SUPPLY GIVES A SHARP CUT-OFF CHARACTERISTIC.

^B CONDITION 2 WITH SERIES SCREEN RESISTOR GIVES AN EXTENDED CUT-OFF CHARACTERISTIC FOR APPLICATIONS WHERE GAIN IS CONTROLLED BY VARIATION OF GRID BIAS.

^C IN ORDER TO MINIMIZE FEEDBACK THE SUPPRESSOR SHOULD BE CONNECTED DIRECTLY TO GROUND IF USED IN R-F AND I-F STAGES.

^D CATHODE-BIAS RESISTOR SHOULD BE ADJUSTED TO GIVE A PLATE CURRENT OF 10 MA. THE DC RESISTANCE IN THE GRID CIRCUIT SHOULD NOT EXCEED 0.25 MEGOHM WHEN THE SCREEN VOLTAGE IS OBTAINED FROM A FIXED SOURCE. WHEN A SERIES SCREEN RESISTOR IS USED WITH FULL CATHODE BIAS, THE DC RESISTANCE IN THE GRID CIRCUIT MAY BE AS HIGH AS 0.5 MEGOHM.

TUNG-SOL

**ELECTRON-RAY TUBE
TWIN INDICATOR TYPE**

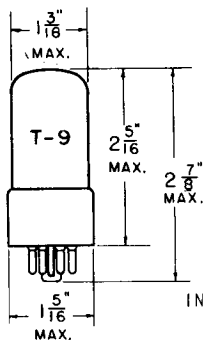

COATED UNIPOTENTIAL CATHODE
HEATER
6.3 VOLTS 0.15 AMPERE
AC OR DC
GLASS BULB

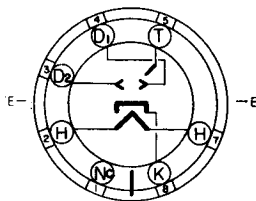

BOTTOM VIEW

INTERMEDIATE SHELL OCTAL 7-PIN BASE

MOUNTING POSITION - ANY ^A

THE 6AD6G IS A TUNING INDICATOR WITH A CIRCULAR FLUORESCENT SCREEN WITH TWO INDEPENDENT INDICATING SHADOW ANGLES. EACH SHADOW ANGLE IS CONTROLLED BY A RAY-CONTROL ELECTRODE. WHEN THE TUBE IS USED AS A TUNING INDICATOR, ITS RAY-CONTROL ELECTRODES MAY BE CONNECTED IN PARALLEL TO PRODUCE TWO IDENTICAL SHADOWS, OR EACH RAY-CONTROL ELECTRODE MAY BE SUPPLIED WITH A SEPARATE CONTROLLING VOLTAGE FROM A 6AE6G TUBE.

RATINGS

INDICATOR SERVICE

INTERPRETED ACCORDING TO RMA STANDARD M8-210

MAXIMUM TARGET VOLTAGE	150	VOLTS
MINIMUM TARGET VOLTAGE	100	VOLTS
MAXIMUM RAY-CONTROL ELECTRODE SUPPLY VOLTAGE	150	VOLTS
MAXIMUM HEATER-CATHODE POTENTIAL	100	VOLTS

TYPICAL OPERATING CONDITIONS AND CHARACTERISTICS

TUNING INDICATOR

TARGET VOLTAGE	100	150	VOLTS
TARGET CURRENT (APPROX.) ^B	1.5	3.0	MA.
TARGET CURRENT (APPROX.) ^C	1.0	2.0	MA.
TARGET CURRENT (APPROX.) ^D	0.8	1.2	MA.
RAY-CONTROL ELECTRODE VOLTAGE ^B	45	75 APPROX.	VOLTS
RAY-CONTROL ELECTRODE VOLTAGE ^C	0	8.0 APPROX.	VOLTS
RAY-CONTROL ELECTRODE VOLTAGE ^D	-23	-50 APPROX.	VOLTS

- A THE PLANE OF THE RAY-CONTROL ELECTRODES PASSES THROUGH THE LINE E-E ON THE SOCKET CONNECTION DIAGRAM.
- B FOR SHADOW ANGLE OF 0° PRODUCED BY EITHER RAY-CONTROL ELECTRODE.
- C FOR SHADOW ANGLE OF 90° PRODUCED BY EITHER RAY-CONTROL ELECTRODE.
- D FOR SHADOW ANGLE OF 135° PRODUCED BY EITHER RAY-CONTROL ELECTRODE.

PLATE
1513
OCT. 31
1944

PRINTED IN U. S. A.

6AD6G

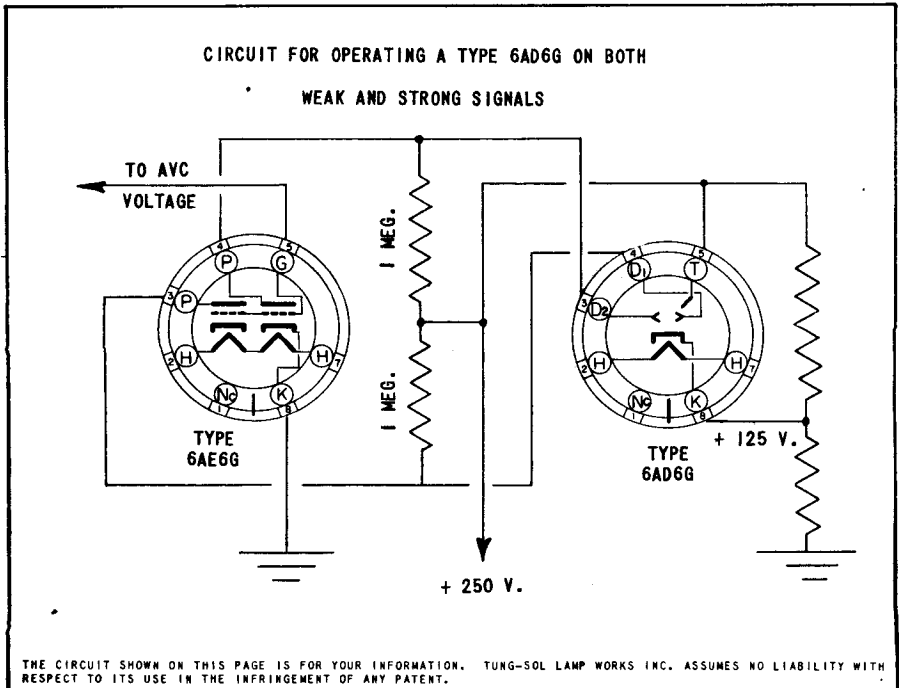
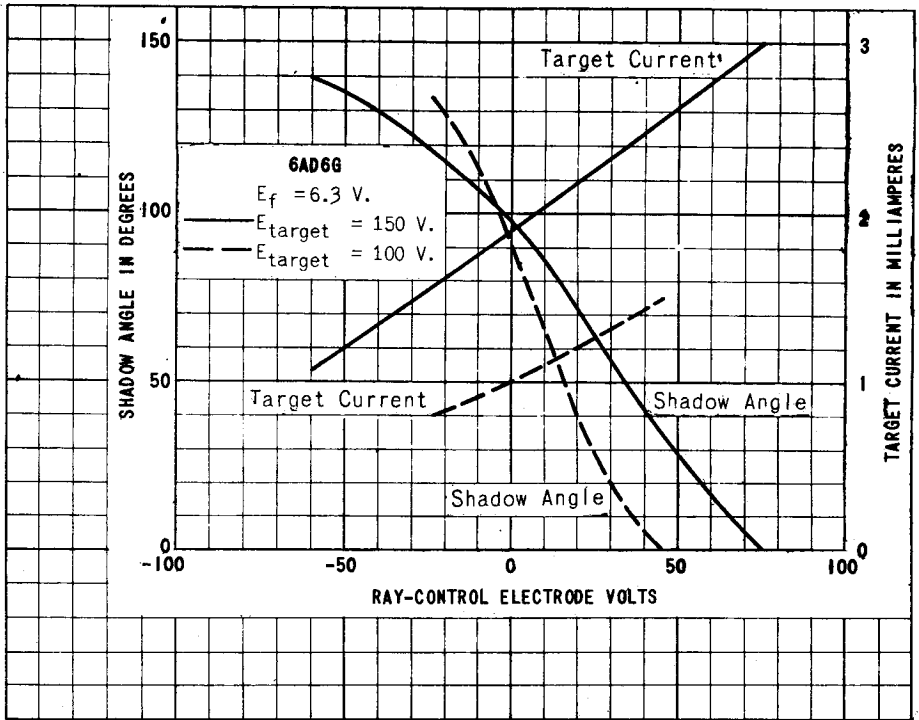

PLATE
 1514
 OCT. 31
 1944

THE CIRCUIT SHOWN ON THIS PAGE IS FOR YOUR INFORMATION. TUNG-SOL LAMP WORKS INC. ASSUMES NO LIABILITY WITH RESPECT TO ITS USE IN THE INFRINGEMENT OF ANY PATENT.

TUNG-SOL

TRIODE AMPLIFIER

UNIPOTENTIAL CATHODE

HEATER

6.3 VOLTS 0.3 AMPERE
AC OR DC

GLASS BULB

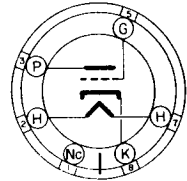
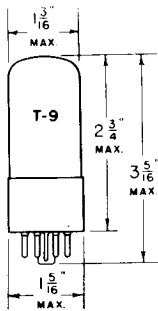

6Q-0-0

INTERMEDIATE 6 PIN OCTAL BASE

THE TUNG-SOL 6AE5GT/G IS A GENERAL PURPOSE LOW-MU TRIODE. IT IS DESIGNED PRIMARILY FOR SERVICE AS A "DYNAMIC-COUPLED" DRIVER TO A 25AC5GT/G IN AC - DC OPERATED RECEIVERS.

RATINGS

MAXIMUM PLATE VOLTAGE	300	VOLTS
MAXIMUM PLATE DISSIPATION	2.5	WATTS

TYPICAL OPERATING CONDITIONS AND CHARACTERISTICS

CLASS A₁ AMPLIFIER

PLATE VOLTAGE	95	VOLTS
CONTROL GRID VOLTAGE ^A	-15	VOLTS
PLATE CURRENT	7	MA.
PLATE RESISTANCE	3500	OHMS
TRANSCONDUCTANCE	1200	μMHOS
AMPLIFICATION FACTOR	4.2	

^A THE DC RESISTANCE IN THE GRID CIRCUIT OF THE 6AE5GT/G SHOULD NOT EXCEED 1.0 MEGOHM UNDER MAXIMUM RATED CONDITIONS.

6AE5GT/G

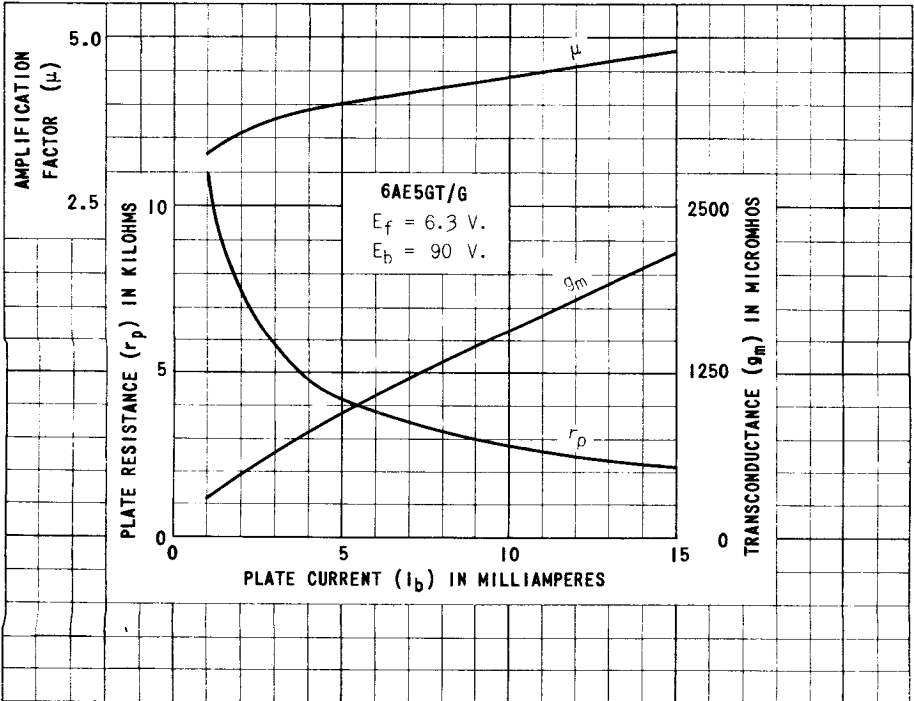
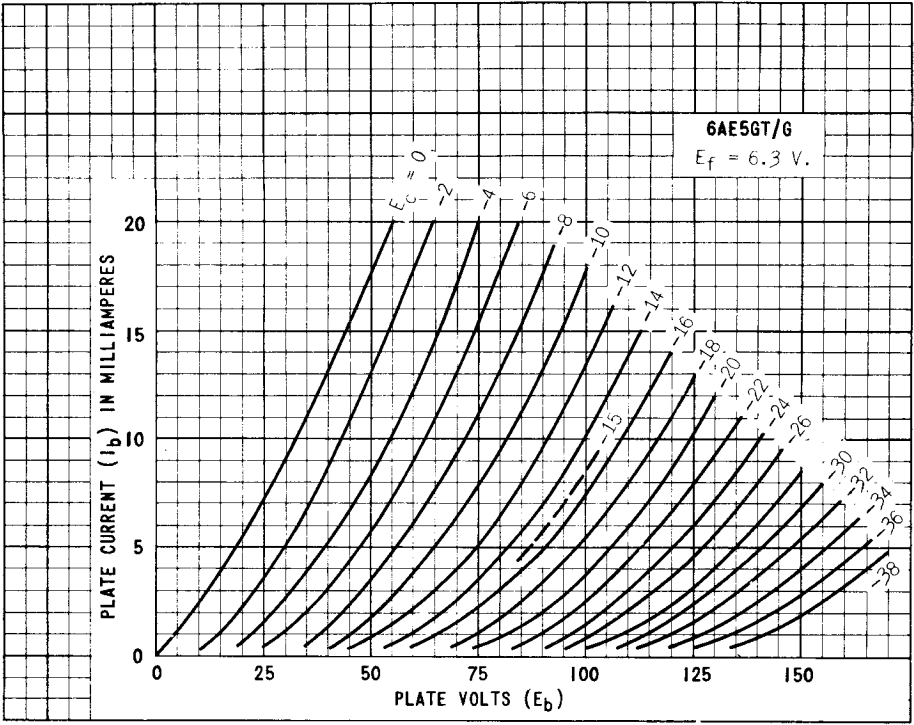

TUNG-SOL

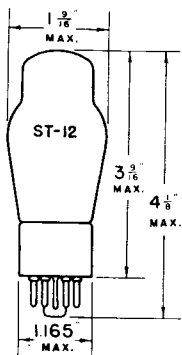

SINGLE GRID - TWIN PLATE
CONTROL TUBE

UNI POTENTIAL CATHODE

HEATER

6.3 VOLTS 0.15 AMPERE
AC OR DC

GLASS BULB

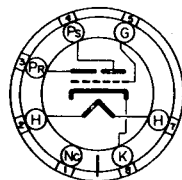

G-7AH

BOTTOM VIEW

SMALL 7 PIN OCTAL BASE

THE TUNG-SOL 6AE6G CONSISTS OF A REMOTE CUT-OFF SECTION AND A SHARP CUT-OFF SECTION WHICH HAVE A COMMON CATHODE AND GRID FOR CONTROLLING ELECTRON-RAY TUNING INDICATORS. IN CONJUNCTION WITH EITHER TYPES 6AD6G OR 6AF6G, THE REMOTE CUT-OFF SECTION IS SENSITIVE TO STRONG SIGNALS, AND THE SHARP CUT-OFF SECTION IS SENSITIVE TO WEAK SIGNALS.

OPERATING CONDITIONS AND CHARACTERISTICS

REMOTE CUT-OFF SECTION (PIN #3)

PLATE VOLTAGE	250	250	250	250	VOLTS
GRID VOLTAGE	-35	-15	-6	-1.5	VOLTS
PLATE CURRENT	0.01	0.8	2.8	6.5	MA.
TRANSCONDUCTANCE				1000	μMHOS
AMPLIFICATION FACTOR				25	

SHARP CUT-OFF SECTION (PIN #4)

PLATE VOLTAGE	250	250		VOLTS
GRID VOLTAGE	-9.5	-1.5		VOLTS
PLATE CURRENT	0.01	4.5		MA.
TRANSCONDUCTANCE		950		μMHOS
AMPLIFICATION FACTOR		33		

FOR "INTERPRETATION OF RATINGS" REFER TO FRONT OF BOOK.

PLATE
730-1

MAY 20
1940

CONTINUED NEXT PAGE

6AE6 G

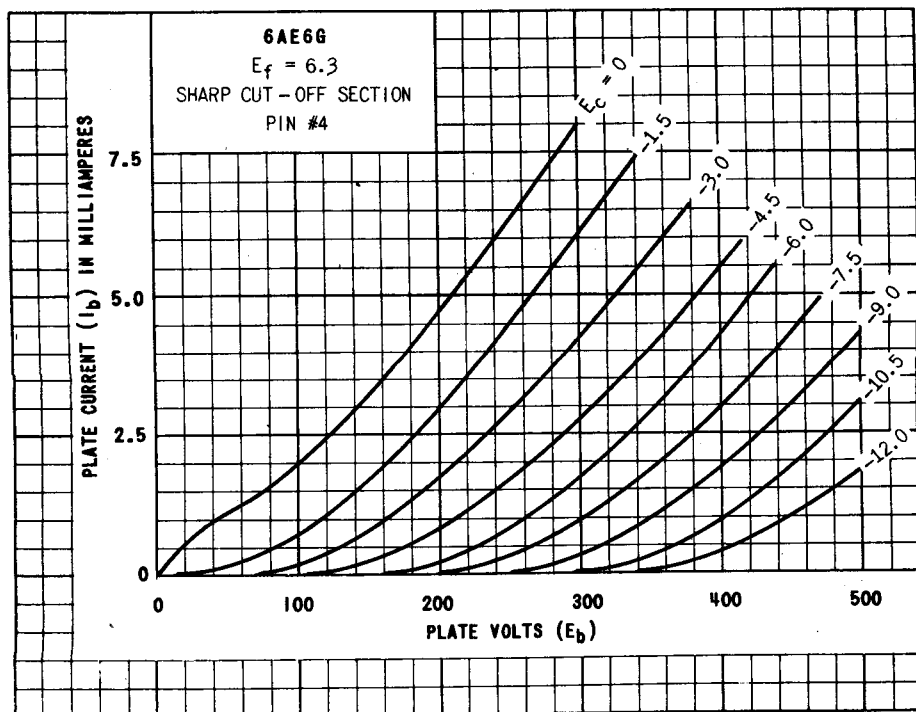
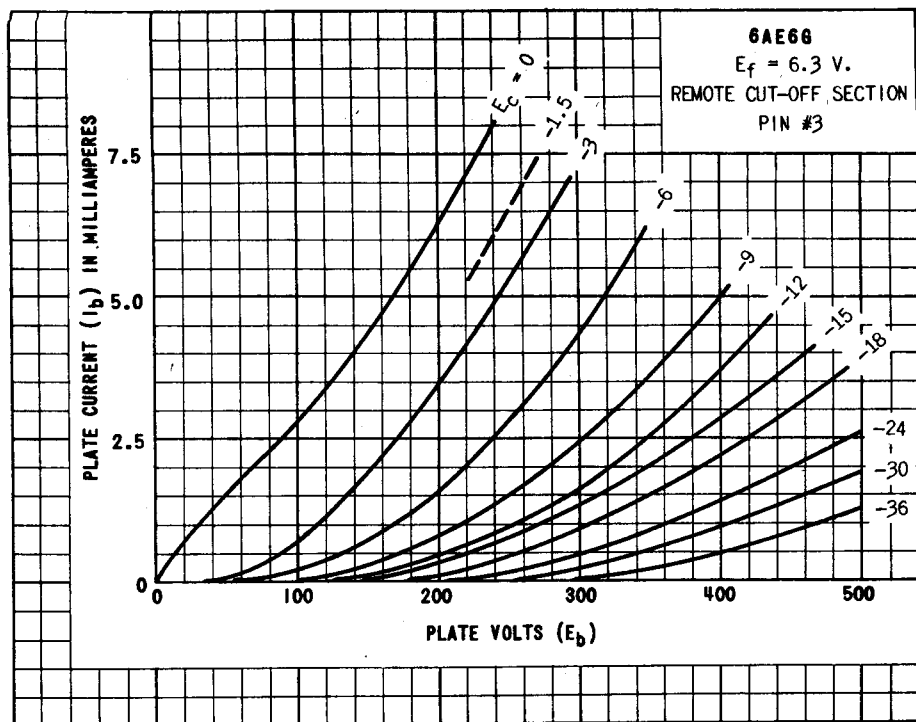
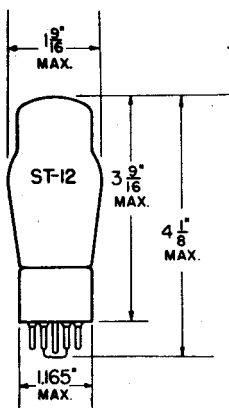

PLATE
731-1

TUNG-SOL



TRIODE VOLTAGE AMPLIFIER

UNIPOTENTIAL CATHODE

HEATER

6.3 VOLTS 0.3 AMP.
AC OR DC

GLASS BULB

ANY MOUNTING POSITION

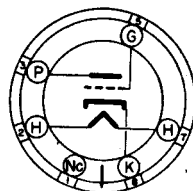

BOTTOM VIEW

SMALL OCTAL 6 PIN BASE

TYPE 6AF5G IS A TRIODE DESIGNED SPECIFICALLY AS THE DRIVER FOR EITHER TYPE 6AC5GT OR 25AC5G WHEN USED IN DIRECT COUPLED AMPLIFIER CIRCUITS.

TYPICAL OPERATING CONDITIONS AND CHARACTERISTICS

CLASS A₁ AMPLIFIER

PLATE VOLTAGE	180	VOLTS
GRID VOLTAGE	-18	VOLTS
PLATE CURRENT	7.0	MA.
TRANSCONDUCTANCE	1 500	μMHOS
AMPLIFICATION FACTOR	7.4	
PLATE RESISTANCE	4 900	OHMS

TYPE 6AF5G DIRECT COUPLED TO 6AC5GT OR 25AC5G

PLATE-SUPPLY VOLTAGE	165	VOLTS
POWER TUBE PLATE CURRENT	46	MA.
DRIVER TUBE PLATE CURRENT	6.6	MA.
INPUT SIGNAL (RMS)	18	VOLTS
LOAD RESISTANCE	3 500	OHMS
POWER OUTPUT (10% TOTAL DISTORTION)	3.3	WATTS

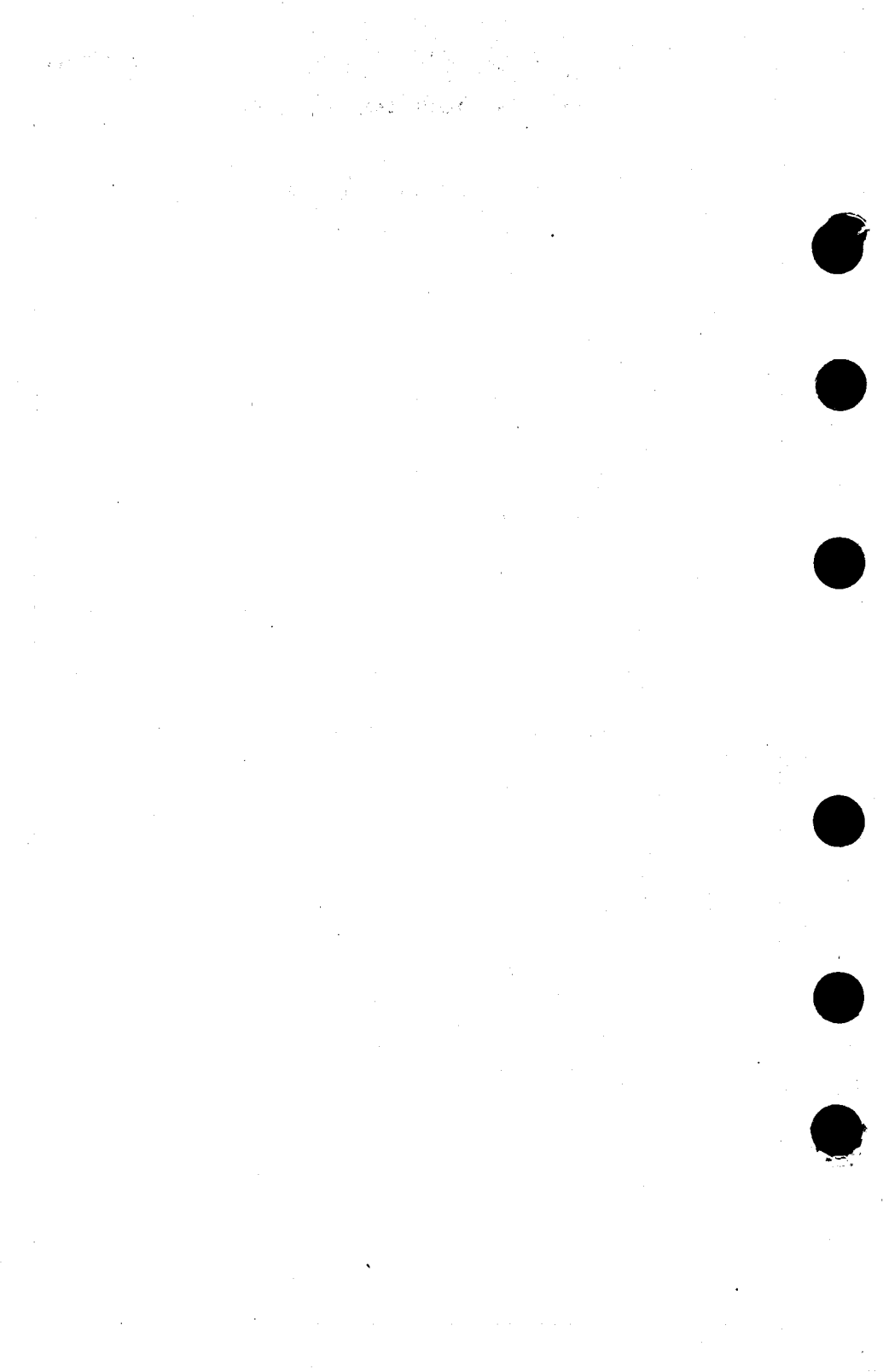

TUNG-SOL

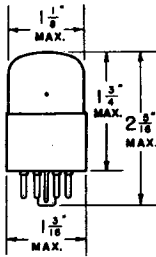

CATHODE RAY TUNING INDICATOR

UNIPOTENTIAL CATHODE

HEATER

6.3 VOLTS 0.15 AMPERE

AC OR DC

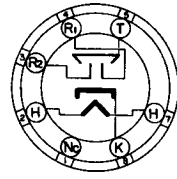

G-7A

GLASS BULB

SMALL 7 PIN OCTAL BASE

THE TUNG-SOL 6AF6G CONSISTS OF A CIRCULAR FLUORESCENT SCREEN WITH TWO INDEPENDENT INDICATING SHADOW ANGLES, EACH CONTROLLED BY A RAY-CONTROL ELECTRODE. WHEN THE 6AF6G IS USED AS A TUNING INDICATOR THE SHADOW ANGLE IS CONTROLLED BY POSITIVE VOLTAGES APPLIED TO THE RAY CONTROL ELECTRODES.

OPERATING CONDITIONS AND CHARACTERISTICS

TARGET VOLTAGE ^{MAX.}	135	VOLTS
TARGET VOLTAGE ^{MIN.}	90	VOLTS
RAY-CONTROL ELECTRODE SUPPLY VOLTAGE ^{MAX.}	135	VOLTS

TUNING INDICATOR

TARGET VOLTAGE	100	135	VOLTS
TARGET CURRENT ^T	0.9	1.5	MA.
RAY-CONTROL ELECTRODE VOLTAGE ^P	60	81	APPROX. VOLTS
RAY-CONTROL ELECTRODE VOLTAGE ^{PP}	0	0	APPROX. VOLTS

^T WITH 0 VOLTS ON RAY-CONTROL ELECTRODES. SUBJECT TO WIDE VARIATION.

^P FOR 0° SHADOW ANGLE PRODUCED BY EITHER RAY-CONTROL ELECTRODE.

^{PP} FOR 100° SHADOW ANGLE PRODUCED BY EITHER RAY-CONTROL ELECTRODE.

THE PLANE OF THE CONTROL ELECTRODES PASSES THROUGH PINS #3 AND #7.

NOTE: A DOUBLE TRIODE, SUCH AS THE 6CB6 OR THE 6F86, CAN BE USED TO OBTAIN TWO SENSITIVITIES FOR A TUNING INDICATOR BY APPLYING FULL A.V.C. VOLTAGE TO ONE TRIODE AND 1/10 OF THE A.V.C. VOLTAGE TO THE OTHER.

IN AC-DC SUPERHETERODYNE RECEIVERS A SHADOW ANGLE VARIATION OF 0 TO 90° WITH A.V.C. ACTION MAY BE OBTAINED WITHOUT AN AMPLIFIER TUBE BY RAISING THE CATHODE OF THE 6AF6G TO +30 VOLTS, SUPPLYING I F TUBE SCREEN THROUGH A 50 000 OHM RESISTOR AND CONNECTING THE CONTROL ELECTRODES TO THE SCREEN.



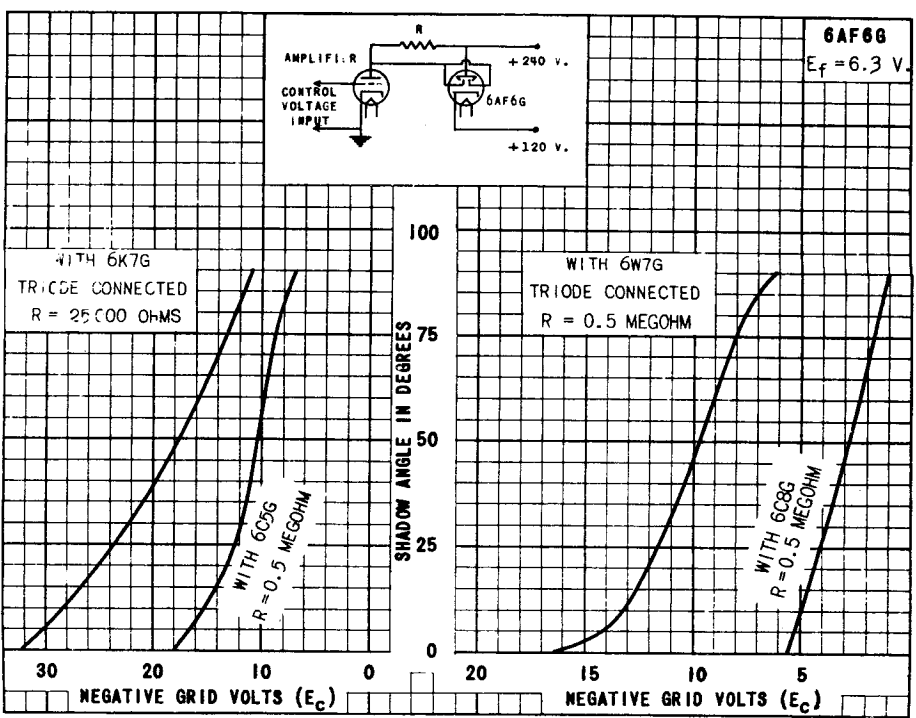
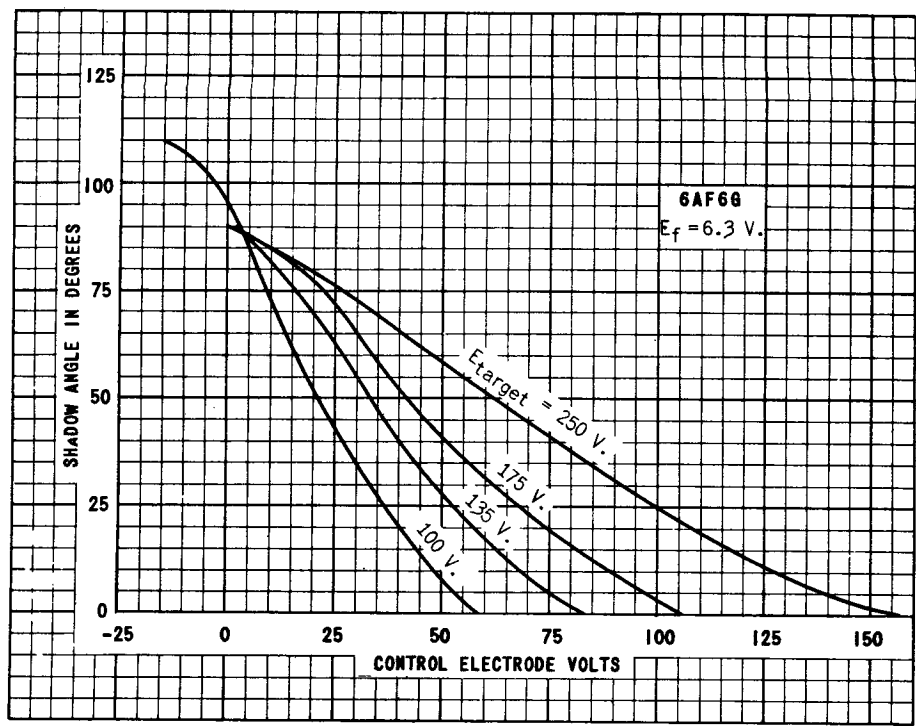

PRINTED IN U. S.

PLATE 283-1

JAN. 3 1939

6AF6 G

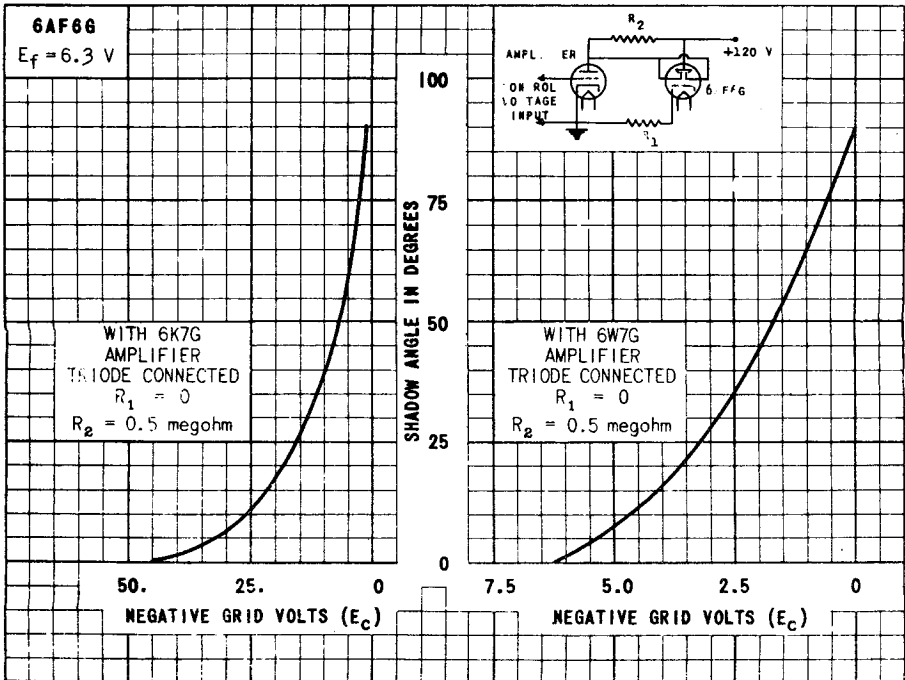
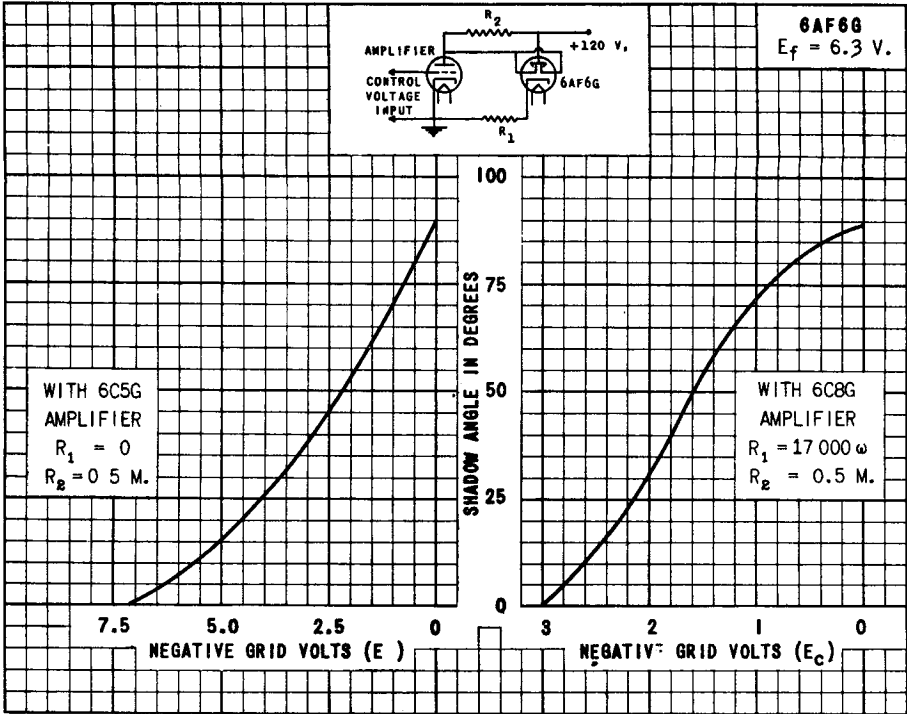

TUNG-SOL

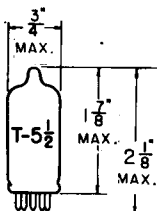
R-F AMPLIFIER PENTODE
MINIATURE TYPE

COATED UNIPOTENTIAL CATHODE

HEATER
6.3 VOLTS 0.3 AMPERE
AC OR DC

GLASS BULB

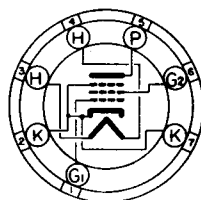
MINIATURE BUTTON 7-PIN BASE ^A

BOTTOM VIEW

THE 6AG5 IS A MINIATURE TYPE R-F PENTODE HAVING A SHARP CUT-OFF CHARACTERISTIC AND A HIGH VALUE OF TRANSCONDUCTANCE. IN COMPACT, LIGHT-WEIGHT EQUIPMENT IT IS USEFUL AS AN R-F AMPLIFIER UP TO ABOUT 400 MEGACYCLES, AND AS A HIGH-FREQUENCY, INTERMEDIATE AMPLIFIER. IT HAS LOW INPUT CAPACITANCE AND LOW OUTPUT CAPACITANCE^A.

RATINGS

AMPLIFIER

INTERPRETED ACCORDING TO RMA STANDARD MB-210

MAXIMUM PLATE VOLTAGE	300	VOLTS
MAXIMUM SCREEN VOLTAGE	150	VOLTS
MAXIMUM PLATE DISSIPATION	2.0	WATTS
MAXIMUM SCREEN DISSIPATION	0.5	WATT
MAXIMUM HEATER-CATHODE POTENTIAL	100	VOLTS

DIRECT INTERELECTRODE CAPACITANCES (APPROX.)

WITH NO EXTERNAL SHIELD

GRID TO PLATE	0.025 MAX.	μf
INPUT	6.5	μf
OUTPUT	1.8	μf

TYPICAL OPERATING CONDITIONS AND CHARACTERISTICS

CLASS A₁ AMPLIFIER

PLATE VOLTAGE	100	125	250	VOLTS
SCREEN VOLTAGE	100	125	150	VOLTS
PLATE CURRENT	5.5	7.2	7.0	MA.
SCREEN CURRENT	1.6	2.1	2.0	MA.
PLATE RESISTANCE (APPROX.)	0.3	0.5	0.8	MEGOHM
TRANSCONDUCTANCE	4 750	5 100	5 000	μMHOS
CATHODE-BIAS RESISTOR	100	100	200	OHMS
GRID BIAS FOR PLATE CURRENT = 10 μAMPS .	-5.0	-6.0	-8.0	VOLTS

^A THE CENTER HOLE IN SOCKETS DESIGNED FOR THIS BASE PROVIDES FOR THE POSSIBILITY THAT THIS TUBE TYPE MAY BE MANUFACTURED WITH THE EXHAUST-TUBE TIP AT THE BASE END. FOR THIS REASON, IT IS RECOMMENDED THAT IN EQUIPMENT EMPLOYING THIS TUBE TYPE, NO MATERIAL BE PERMITTED TO OBSTRUCT THE SOCKET HOLE.



TUNG-SOL

PENTODE

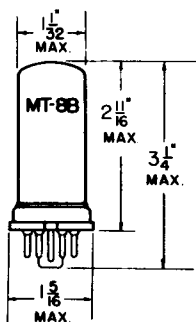

METAL SHELL

COATED UNIPOTENTIAL CATHODE

HEATER

6.3 VOLTS 0.65 AMPERE

AC OR DC

VERTICAL MOUNTING POSITION

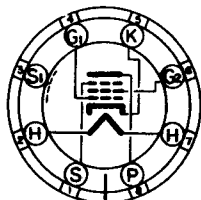
HORIZONTAL OPERATION PERMITTED IF
PINS 2 & 7 ARE IN A VERTICAL PLANE.

BOTTOM VIEW

SMALL WAFER
8 PIN OCTAL

THE 6AG7 IS A POWER OUTPUT PENTODE USING THE OCTAL BASE AND METAL SHELL CONSTRUCTION. IT HAS HIGH PERVEANCE, LOW CAPACITANCES, AND THE POWER REQUIREMENTS NECESSARY FOR EITHER STRAIGHT VIDEO OUTPUT AMPLIFIER OR CATHODE FOLLOWER SERVICE.

DIRECT INTERELECTRODE CAPACITANCES

WITH SHELL AND INTERLEAD SHIELD CONNECTED TO CATHODE

GRID TO PLATE: (G TO P) MAX.	0.06	μ f
INPUT: G TO (H+K+G ₂ +G ₃ +S+IS)	13	μ f
OUTPUT: P TO (H+K+G ₂ +G ₃ +S+IS)	7.5	μ f
GRID #1 TO GRID #2: (G ₁ TO G ₂) APPROX.	5.8	μ f
GRID #1 TO CATHODE: (G ₁ TO K) APPROX.	5.2	μ f
HEATER TO CATHODE: (H TO K) APPROX.	10.7	μ f

RATINGS

INTERPRETED ACCORDING TO RMA STANDARD MB-210

HEATER VOLTAGE (SHOULD NOT DEVIATE MORE THAN 10%)	6.3	VOLTS
MAXIMUM HEATER-CATHODE VOLTAGE	90	VOLTS
MAXIMUM PLATE VOLTAGE	300	VOLTS
MAXIMUM GRID #2 VOLTAGE	300	VOLTS
MINIMUM NEGATIVE DC GRID #1 VOLTAGE	0	VOLTS
MAXIMUM PLATE DISSIPATION	9	WATTS
MAXIMUM SCREEN DISSIPATION	1.5	WATTS
MAXIMUM GRID #1 CIRCUIT RESISTANCE (FIXED BIAS)	0.25	MEG OHM
MAXIMUM GRID #1 CIRCUIT RESISTANCE (SELF BIAS)	1	MEG OHM

CONTINUED ON FOLLOWING PAGE

→ INDICATES A CHANGE OR ADDITION.

TUNG-SOL

CONTINUED FROM PRECEDING PAGE

TYPICAL OPERATING CONDITIONS AND CHARACTERISTICS

CLASS A₁ AMPLIFIER

HEATER VOLTAGE (SHOULD NOT DEVIATE MORE THAN 10%)	6.3	VOLTS
HEATER CURRENT	0.65	AMP.
PLATE VOLTAGE	300	VOLTS
GRID #2 VOLTAGE	150	VOLTS
GRID #1 VOLTAGE	-3	VOLTS
PEAK AF GRID #1 VOLTAGE	3	VOLTS
ZERO-SIGNAL PLATE CURRENT	30	MA.
ZERO-SIGNAL GRID #2 CURRENT (NOMINAL)	7	MA.
MAXIMUM-SIGNAL PLATE CURRENT	30.5	MA.
MAXIMUM-SIGNAL SCREEN CURRENT (NOMINAL)	9	MA.
PLATE RESISTANCE (APPROX.)	0.13	MEGOHM
TRANSCONDUCTANCE	11 000	UMHOS
LOAD RESISTANCE	10 000	OHMS
TOTAL HARMONIC DISTORTION	7	PERCENT
POWER OUTPUT	3	WATTS

VIDEO VOLTAGE AMPLIFIER - CLASS A₁

4 MC BANDWIDTH

	GRID LEAK BIAS ^A	CATHODE BIAS	
HEATER VOLTAGE	6.3	6.3	VOLTS
HEATER CURRENT	0.65	0.65	AMP.
PLATE SUPPLY VOLTAGE	300	300	VOLTS
GRID #2 VOLTAGE	115 ^B	125 ^C	VOLTS
GRID #1 VOLTAGE	0 ^D	-2	VOLTS
GRID #1 RESISTOR (MINIMUM)	0.25	---	MEGOHM
GRID #1 RESISTOR (MAXIMUM)	0.5	---	MEGOHM
CATHODE RESISTOR (BY-PASSED BY 250 μ F APPROX.)	---	57	OHMS
ZERO-SIGNAL PLATE CURRENT	45	28	MA.
ZERO-SIGNAL GRID #2 CURRENT (NOMINAL)	13	7	MA.
LOAD RESISTANCE	3 500	3 500	OHMS
PEAK TO PEAK GRID SIGNAL SWING	4	4	VOLTS
PEAK TO PEAK VOLTAGE OUTPUT	135	140	VOLTS
INTERLEAD SHIELD		CONNECTED TO GROUND	

^A TO BE USED WHERE RESISTORATION IS ACCOMPLISHED IN THE GRID CIRCUIT.^B OBTAINED FROM SUPPLY HAVING GOOD REGULATION.^C OBTAINED PREFERABLY FROM THE 300 VOLT PLATE SUPPLY THROUGH A 25000 OHM SERIES SCREEN RESISTOR.^D ZERO-SIGNAL VALUE.

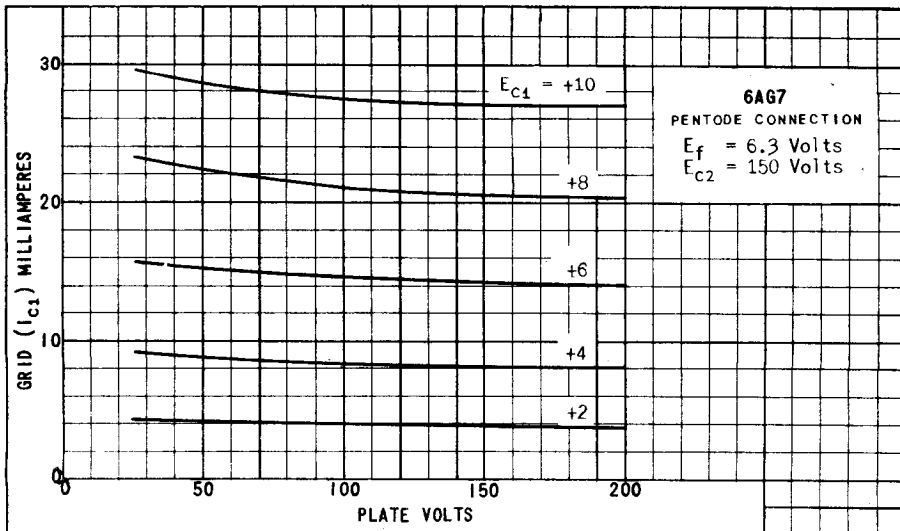
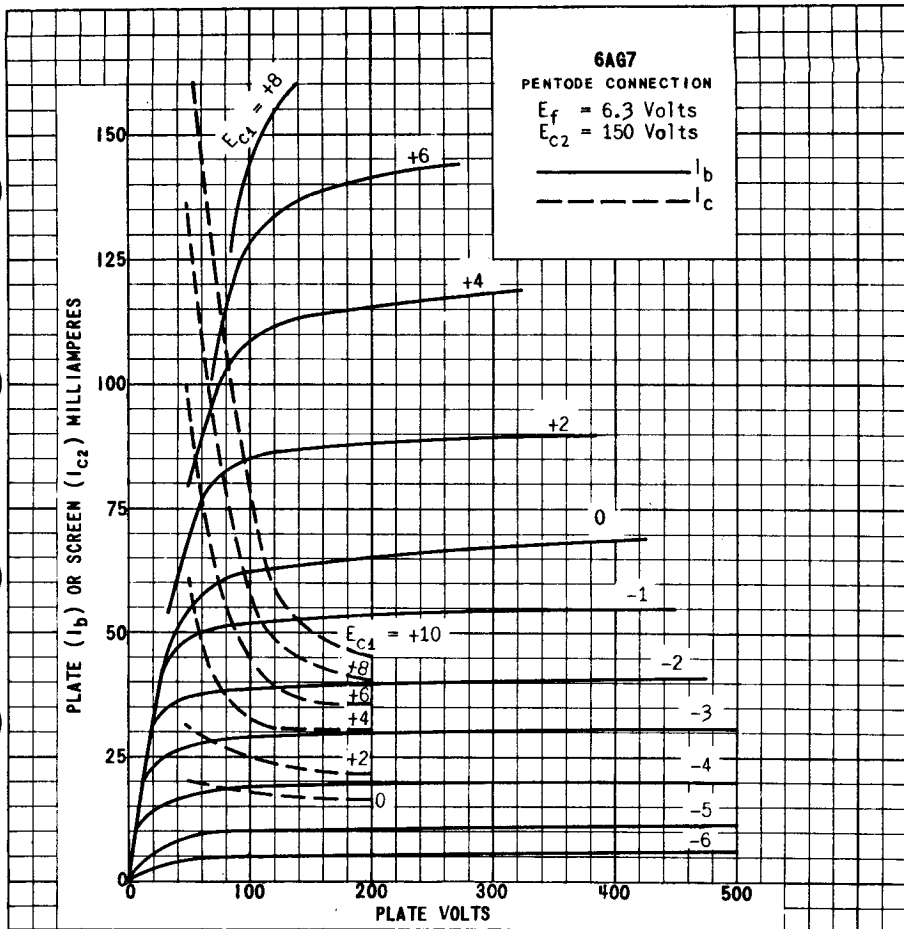

PRINTED IN U. S. A.

PLATE
 1956
 FEB. 2,
 1948

6AG7

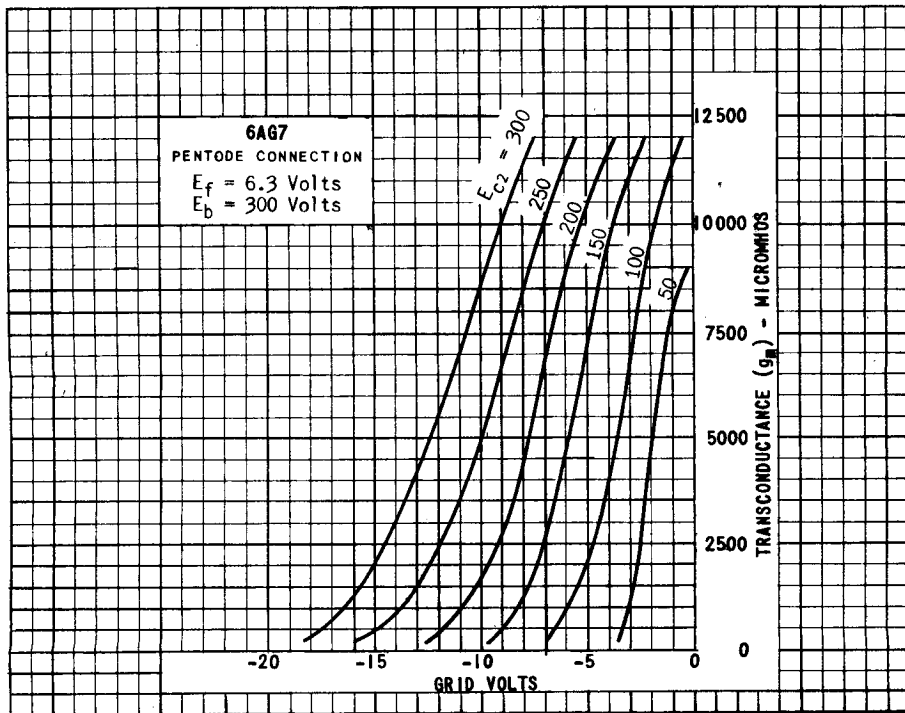
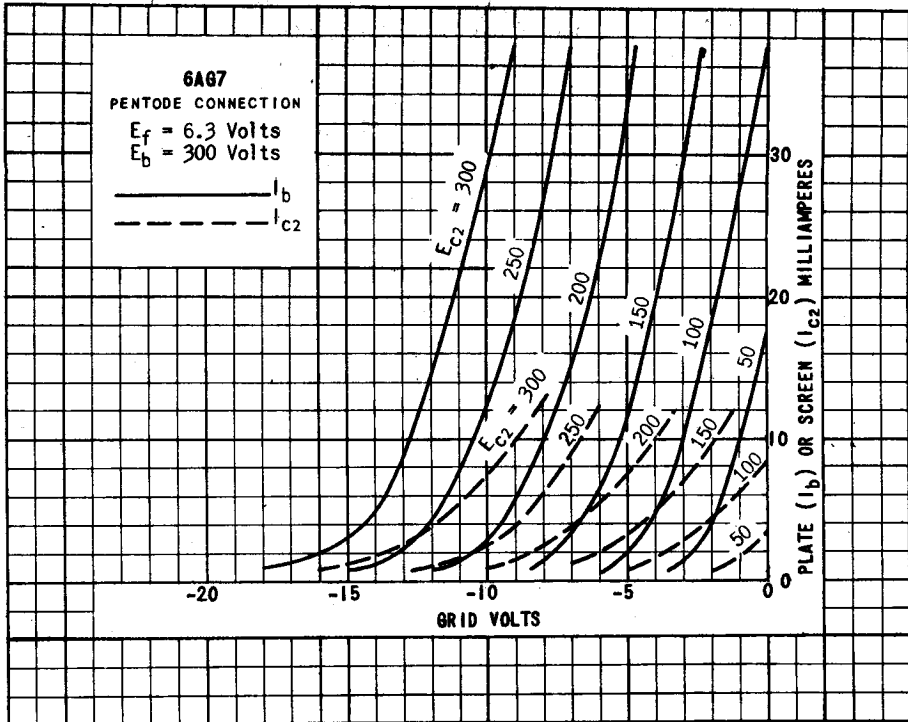
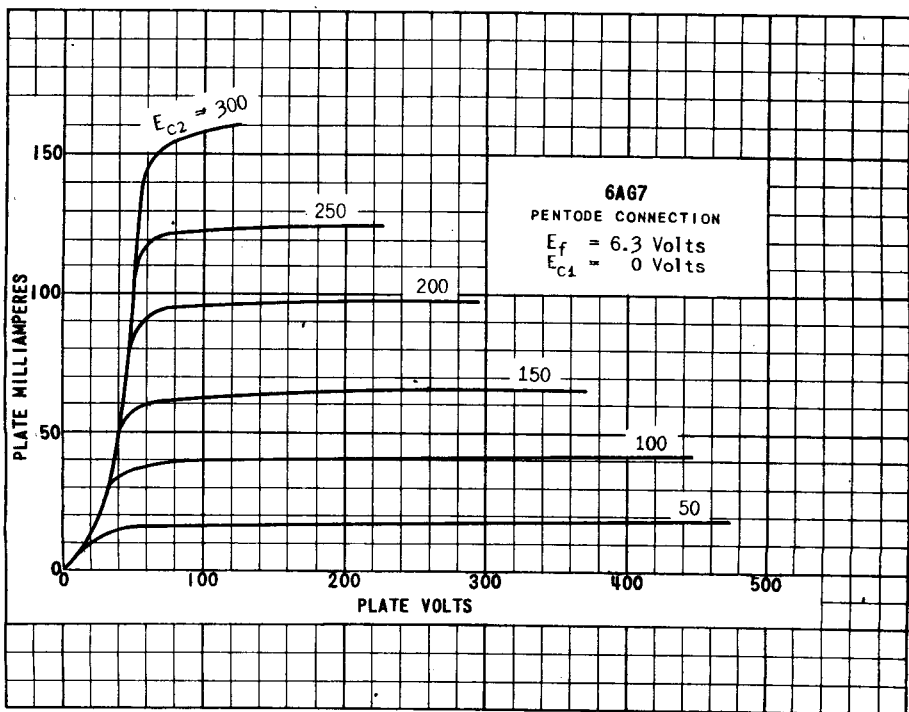
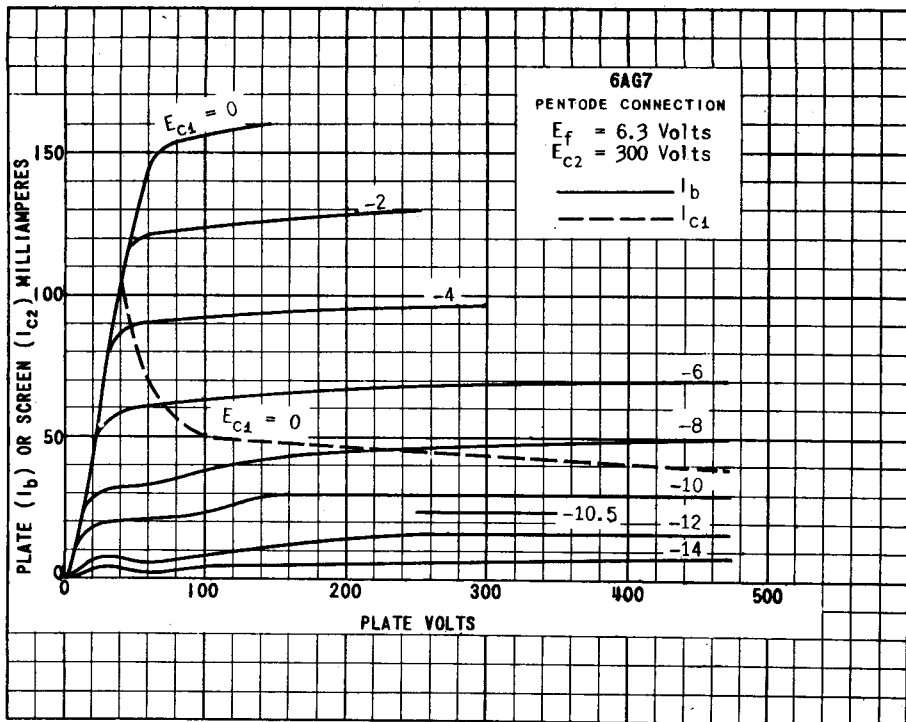

PLATE
 1997
 FEB. 2,
 1948



PRINTED IN U. S. A.

PLATE 1958
 FEB. 2, 1948



TUNG-SOL

PENTODE
MINIATURE TYPE

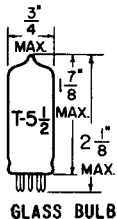

COATED UNIPOTENTIAL CATHODE

HEATER

6.3 VOLTS 450 MA.

AC OR DC

ANY MOUNTING POSITION

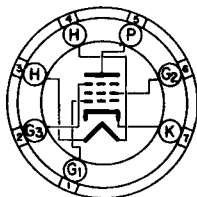

BOTTOM VIEW
MINIATURE BUTTON
7 PIN BASE

THE 6AH6 IS A SHARP CUT-OFF VOLTAGE AMPLIFIER IN THE MINIATURE CONSTRUCTION. IT IS CHARACTERIZED BY A VERY HIGH TRANSCONDUCTANCE AND MODERATELY LOW INTERELECTRODE CAPACITANCES WHICH ADAPT IT TO WIDE BAND VIDEO AND INTERMEDIATE FREQUENCY AMPLIFIER SERVICE.

DIRECT INTERELECTRODE CAPACITANCES

	WITH EXTERNAL SHIELD ^A	WITHOUT SHIELD	
GRID TO PLATE: (G ₄ TO P) MAX.	0.020	0.030	μμF
INPUT: G ₁ TO (H+K+G ₂ +G ₃)	10	10	μμF
OUTPUT: P TO (H+K+G ₂ +G ₃)	3.6	2	μμF

^A WITH RMA MINIATURE SHIELD NO. 313 CONNECTED TO CATHODE.

RATINGS

INTERPRETED ACCORDING TO RMA STANDARD M8-210

HEATER VOLTAGE	6.3	VOLTS
MAXIMUM HEATER-CATHODE VOLTAGE	90	VOLTS
MAXIMUM PLATE VOLTAGE	300	VOLTS
MAXIMUM GRID #2 VOLTAGE	150	VOLTS
MAXIMUM PLATE DISSIPATION ^B	3.2	WATTS
MAXIMUM GRID #2 DISSIPATION	0.4	WATT
MAXIMUM CATHODE CURRENT	13	MA.

^B AT MAXIMUM RATINGS, IT IS NECESSARY THAT AT LEAST ONE SURFACE OF THE SHIELD, IF USED, BE BLACKENED.

CONTINUED ON FOLLOWING PAGE

PLATE
1987
MAR. 1,
1948

TUNG-SOL

CONTINUED FROM PRECEDING PAGE

TYPICAL OPERATING CONDITIONS AND CHARACTERISTICS

CLASS A₁ AMPLIFIER

	PENTODE CONNECTION	TRIODE CONNECTION ^C	
HEATER VOLTAGE	6.3	6.3	VOLTS
HEATER CURRENT	450	450	MA.
PLATE VOLTAGE	300	150	VOLTS
GRID #2 VOLTAGE	150	---	VOLTS
CATHODE RESISTOR	160	160	OHMS
PLATE RESISTANCE (APPROX.)	0.5	0.0036	MEGOHM
TRANSCONDUCTANCE	9 000	11 000	μMHOS
AMPLIFICATION FACTOR	---	40	
PLATE CURRENT	10	12.5	MA.
GRID #2 CURRENT	2.5	---	MA.
GRID #1 VOLTAGE (APPROX.) FOR $I_b = 10 \mu A.$	-7	-7	VOLTS
TRANSCONDUCTANCE (GRID #3-PLATE) ^D			

GRID #2 AND GRID #3 CONNECTED TO PLATE.

^D GRID #3 HAS PRACTICALLY NO CONTROL CHARACTERISTIC AND IT IS NOT INTENDED TO BE USED AS A CONTROL ELECTRODE. ITS TRANSCONDUCTANCE TO THE PLATE IS APPROXIMATELY 2 μMHOS AND THE MU IS 0.7 TO 1.0.

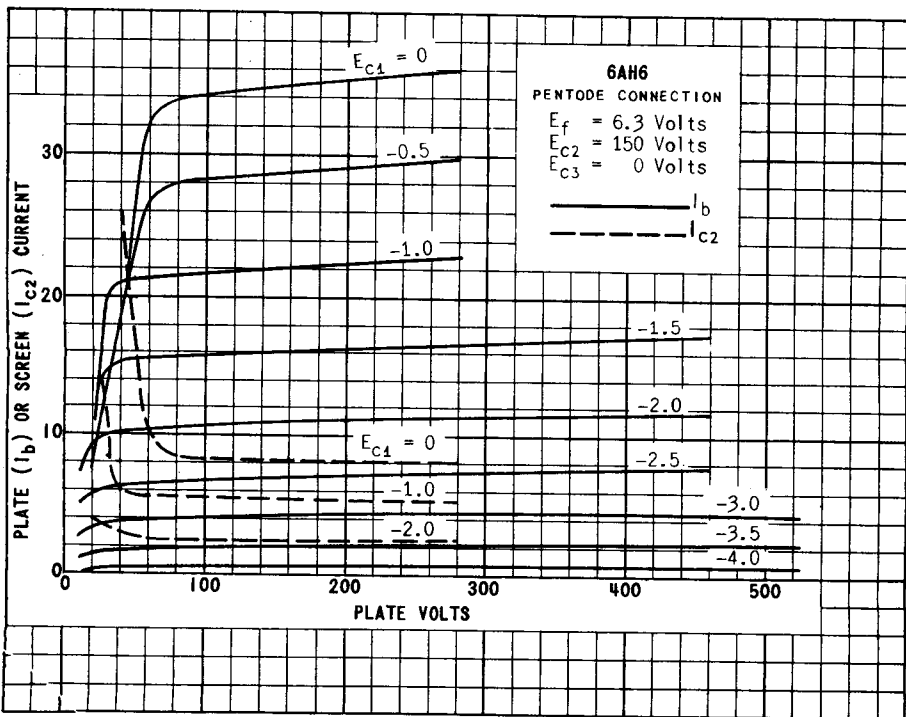

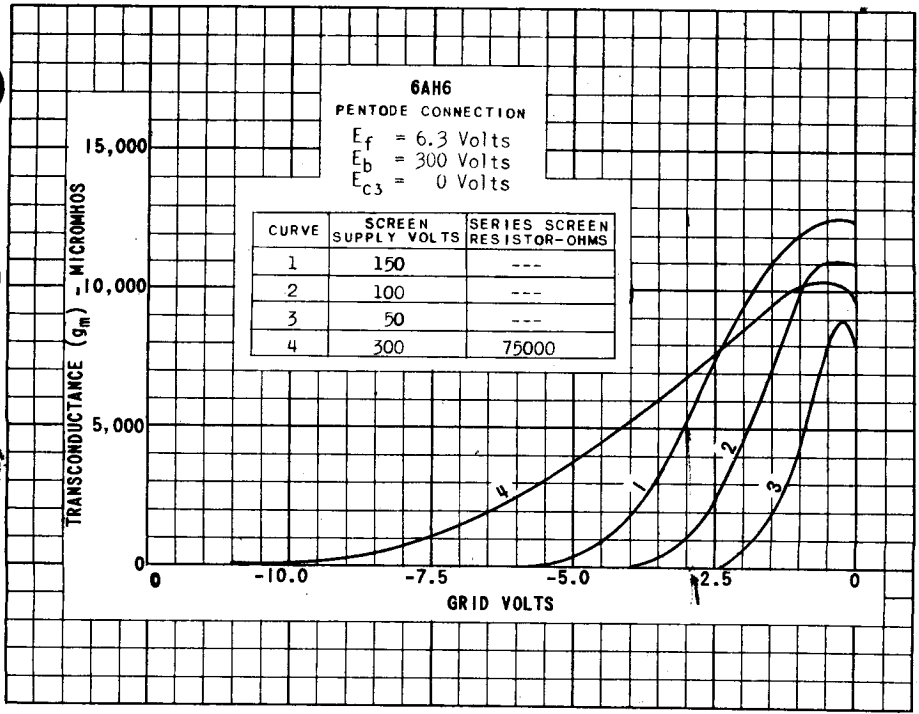
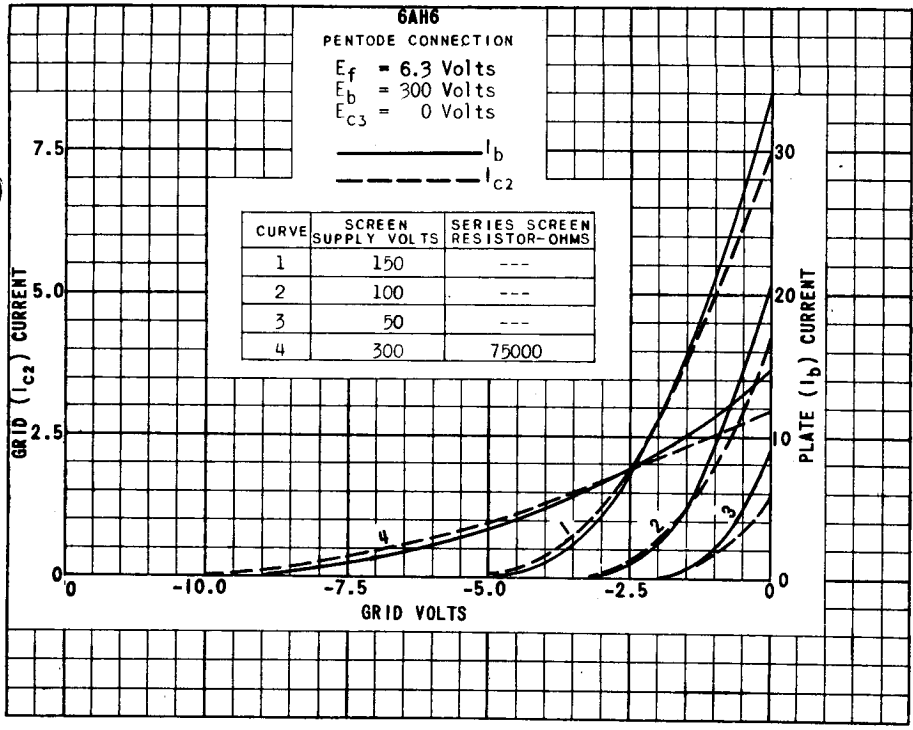
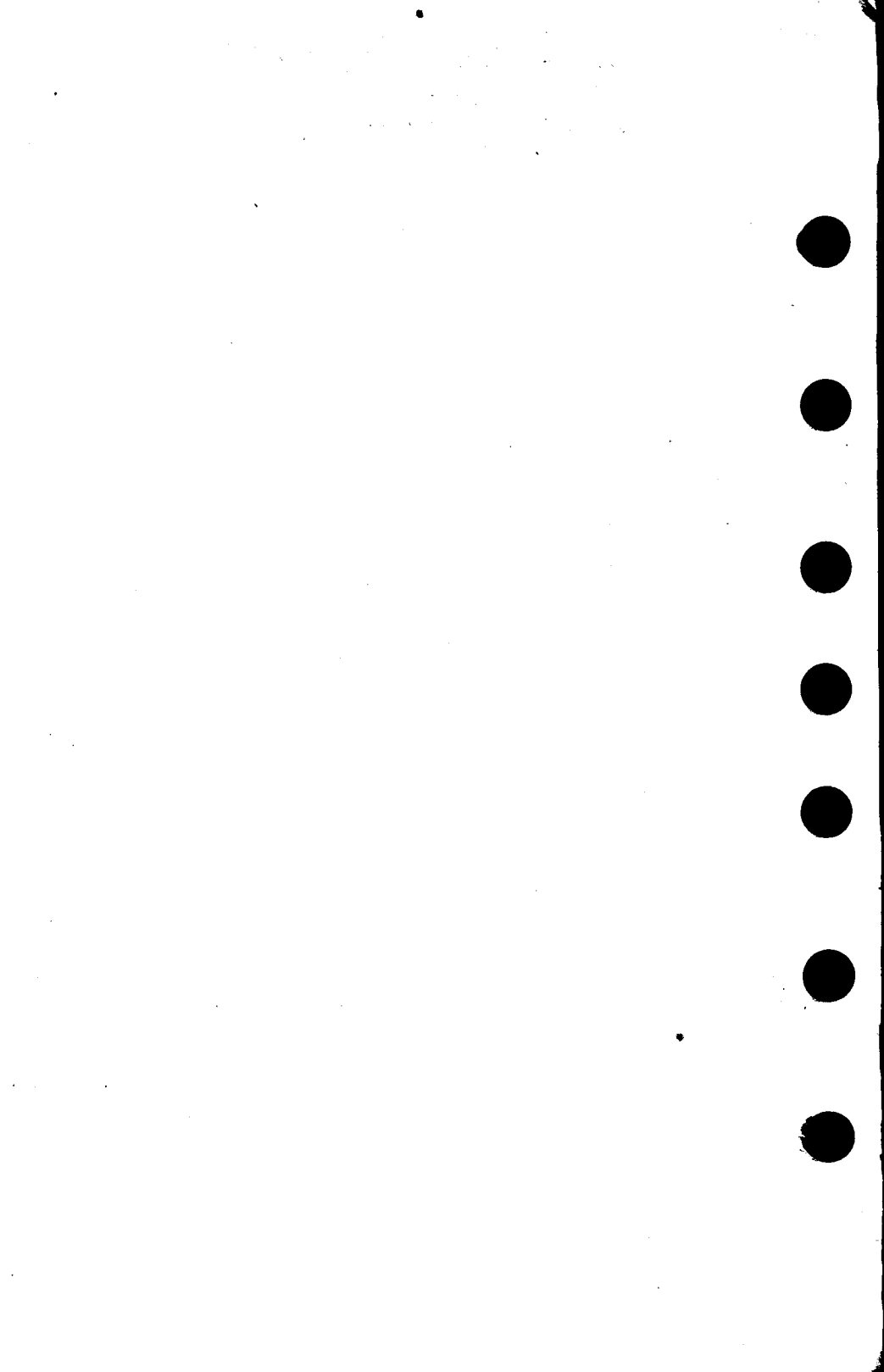

PLATE
1989
MAR. 1
1948



TUNG-SOL

PENTODE

MINIATURE TYPE

COATED UNIPOTENTIAL CATHODE

HEATER

6.3 VOLTS 175 MA.

AC OR DC

ANY MOUNTING POSITION

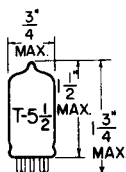

GLASS BULB

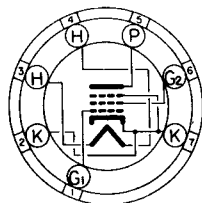

BOTTOM VIEW

MINIATURE BUTTON
7 PIN BASE

THE 6AJ5 IS A SHARP CUT-OFF PENTODE VOLTAGE AMPLIFIER IN THE MINIATURE CONSTRUCTION. IT IS CHARACTERIZED BY LOW HEATER POWER REQUIREMENTS, HIGH TRANSCONDUCTANCE, LOW CAPACITANCES, AND HIGH INPUT IMPEDANCE. ITS LOW TRIODE-MU ADAPTS IT TO SERVICE WHERE THE PLATE AND SCREEN SUPPLY POTENTIALS ARE LOW OR TO APPLICATIONS AS A SMALL POWER AMPLIFIER.

DIRECT INTERELECTRODE CAPACITANCES
WITH NO EXTERNAL SHIELD

GRID TO PLATE: (G TO P) WITH SHIELD	0.01	μmf
INPUT: G_1 TO (H+K&G ₃ +G ₂)	4.1	μmf
OUTPUT: P TO (H+K&G ₃ +G ₂)	2.0	μmf

RATINGS

INTERPRETED ACCORDING TO RMA STANDARD M8-210

HEATER VOLTAGE	6.3	VOLTS
MAXIMUM HEATER-CATHODE VOLTAGE	90	VOLTS
MAXIMUM PLATE VOLTAGE	180	VOLTS
MAXIMUM GRID #2 VOLTAGE	140	VOLTS
MAXIMUM PLATE DISSIPATION	1.7	WATTS
MAXIMUM GRID #2 DISSIPATION	0.5	WATT
MAXIMUM CATHODE CURRENT	18	MA.
MAXIMUM BULB TEMPERATURE	120	$^{\circ}\text{C}$

TYPICAL OPERATING CONDITIONS AND CHARACTERISTICS

CLASS A₁ AMPLIFIER

HEATER VOLTAGE	6.3	VOLTS
HEATER CURRENT	175	MA.
PLATE VOLTAGE	28	VOLTS
GRID #2 VOLTAGE	28	VOLTS
CATHODE BIAS RESISTOR	200	OHMS
PLATE RESISTANCE	90 000	OHMS
TRANSCONDUCTANCE	2 750	μMHOS
AMPLIFICATION FACTOR	250	
PLATE CURRENT	3	MA.
GRID #2 CURRENT	1.2	MA.

PLATE
2033
JULY 1,
1948

CONTINUED ON FOLLOWING PAGE

CONTINUED FROM PRECEDING PAGE

TYPICAL OPERATING CONDITIONS AND CHARACTERISTICS

CLASS AB₁ AMPLIFIER - TWO TUBES

HEATER VOLTAGE	6.3	VOLTS
HEATER CURRENT	175	MA.
PLATE VOLTAGE	180	VOLTS
GRID #2 VOLTAGE	75	VOLTS
GRID #1 VOLTAGE	-7.5	VOLTS
LOAD IMPEDANCE (PLATE TO PLATE)	28 000	OHMS
DRIVE	TO ZERO BIAS	
OUTPUT POWER	1	WATT
SECOND HARMONIC	2	PERCENT
THIRD HARMONIC	5	PERCENT
PLATE INPUT POWER (PER PLATE)	1.1	WATTS
GRID #2 DISSIPATION (PER SCREEN)	0.35	WATT

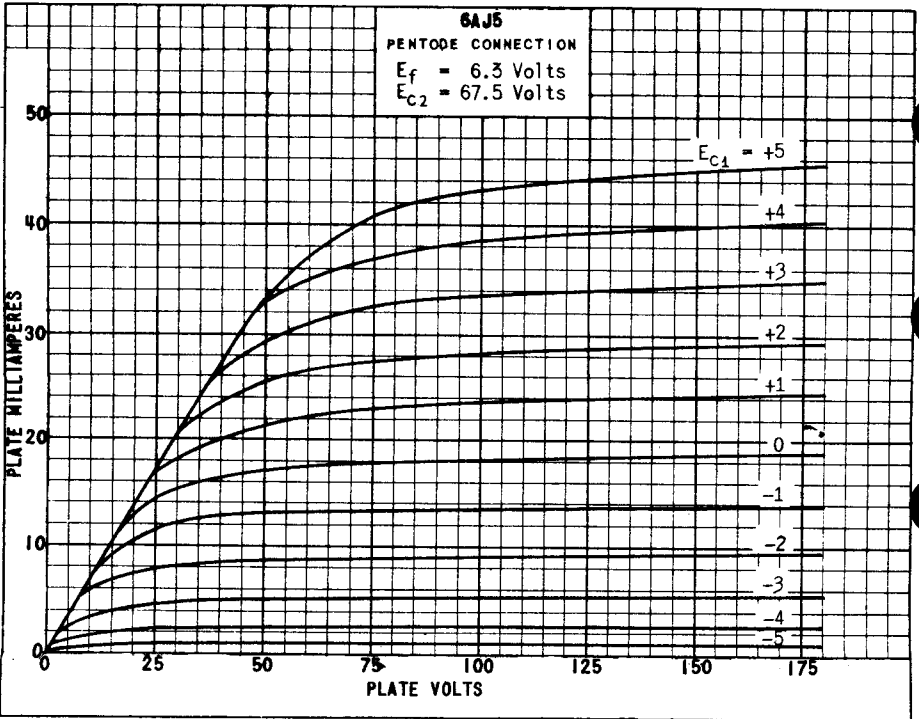
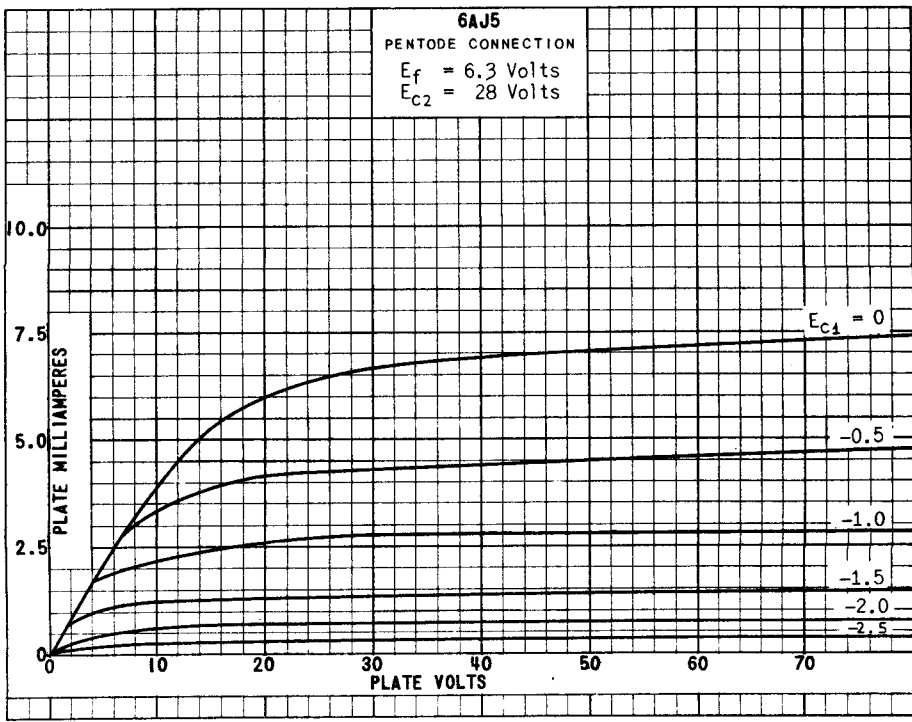
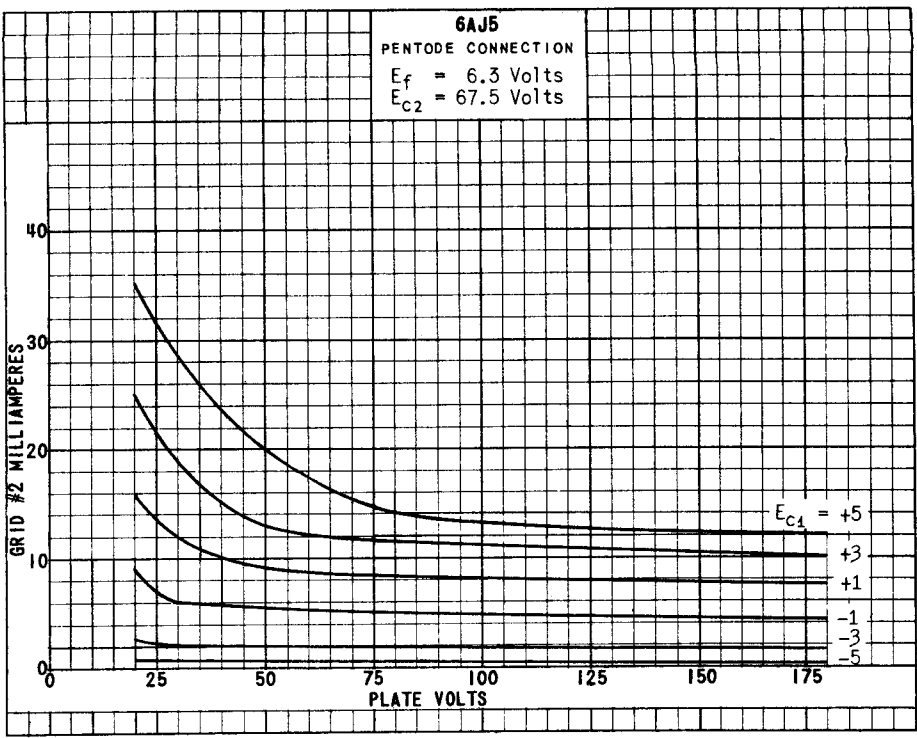

PLATE 2034
 JULY 1, 1948



PRINTED IN U. S. A.

PLATE
2035
JULY 1,
1948



TUNG-SOL

PENTODE

MINIATURE TYPE

COATED UNIPOTENTIAL CATHODE

HEATER

6.3 VOLTS- 175 MA.

AC OR DC

ANY MOUNTING POSITION

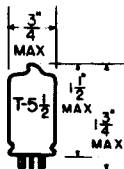

GLASS BULB

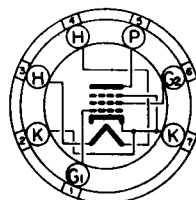

BOTTOM VIEW

MINIATURE BUTTON
7 PIN BASE

THE 6AK5 IS A SHARP CUT-OFF VOLTAGE AMPLIFIER USING THE MINIATURE CONSTRUCTION. IT IS CHARACTERIZED BY LOW HEATER POWER REQUIREMENTS, HIGH TRANSCONDUCTANCE AND INPUT IMPEDANCE, AND LOW INTERELECTRODE CAPACITANCES AND LEAD INDUCTANCES. THESE RESULT IN A HIGHLY FAVORABLE MERIT FACTOR FOR HIGH FREQUENCY WIDE-BAND AMPLIFIER APPLICATIONS.

DIRECT INTERELECTRODE CAPACITANCES

	WITH EXTERNAL SHIELD ^A	WITHOUT SHIELD	
GRID TO PLATE: (G ₁ TO P) MAX.	0.02	0.03	μμf
INPUT: G ₁ TO (H+K&G ₃ &I+S+G ₂)	4.0	4.3	μμf
OUTPUT: P TO (H+K&G ₃ &I+S+G ₃)	2.8	2.1	μμf

^A WITH EXTERNAL SHIELD CONNECTED TO CATHODE.

RATINGS

INTERPRETED ACCORDING TO RMA STANDARD M8-210

HEATER VOLTAGE	6.3	VOLTS
MAXIMUM HEATER-CATHODE VOLTAGE	90	VOLTS
MAXIMUM PLATE VOLTAGE	180	VOLTS
MAXIMUM GRID #2 VOLTAGE	140	VOLTS
MAXIMUM PLATE DISSIPATION	1.7	WATTS
MAXIMUM GRID #2 DISSIPATION	0.5	WATT
MAXIMUM CATHODE CURRENT	18	MA.

TYPICAL OPERATING CONDITIONS AND CHARACTERISTICS

CLASS A₁ AMPLIFIER

HEATER VOLTAGE	6.3	6.3	6.3	VOLTS
HEATER CURRENT	175	175	175	MA.
PLATE VOLTAGE	120	150	180	VOLTS
GRID #2 VOLTAGE	120	140	120	VOLTS
CATHODE-BIAS RESISTOR ^B	200	330	200	OHMS
PLATE RESISTANCE (APPROX.)	0.34	0.42	0.69	MEG OHM
TRANSCONDUCTANCE	5000	4300	5100	μMHOS
PLATE CURRENT	7.5	7.0	7.7	MA.
SCREEN CURRENT	2.5	2.2	2.4	MA.

^B FIXED BIAS OPERATION IS NOT RECOMMENDED.

→ INDICATES A CHANGE OR ADDITION.

PRINTED IN U. S. A.

PLATE
1942
JAN. 2,
1948

6AK5

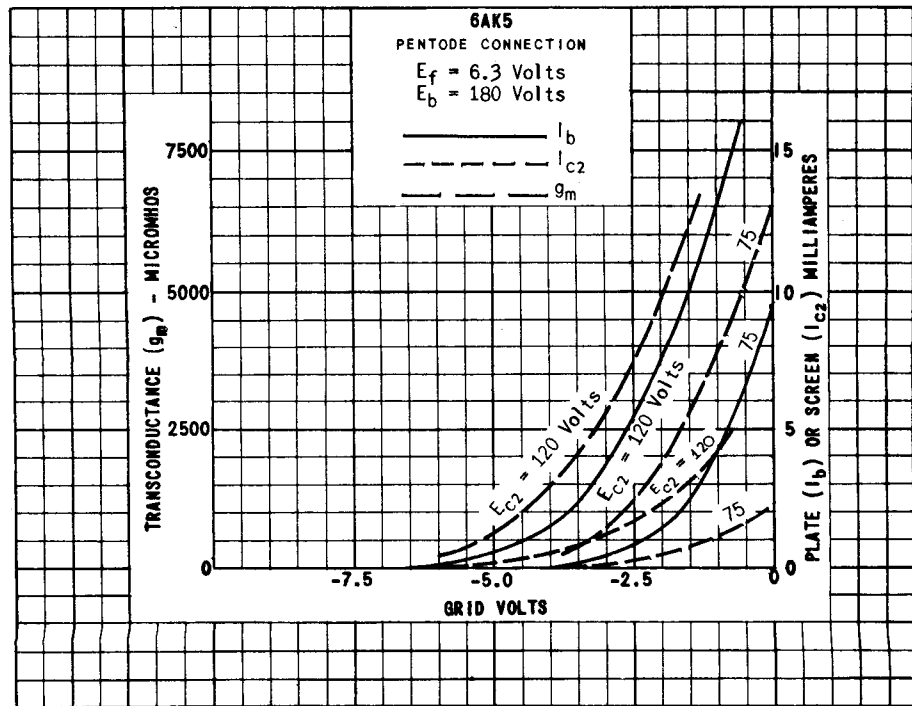
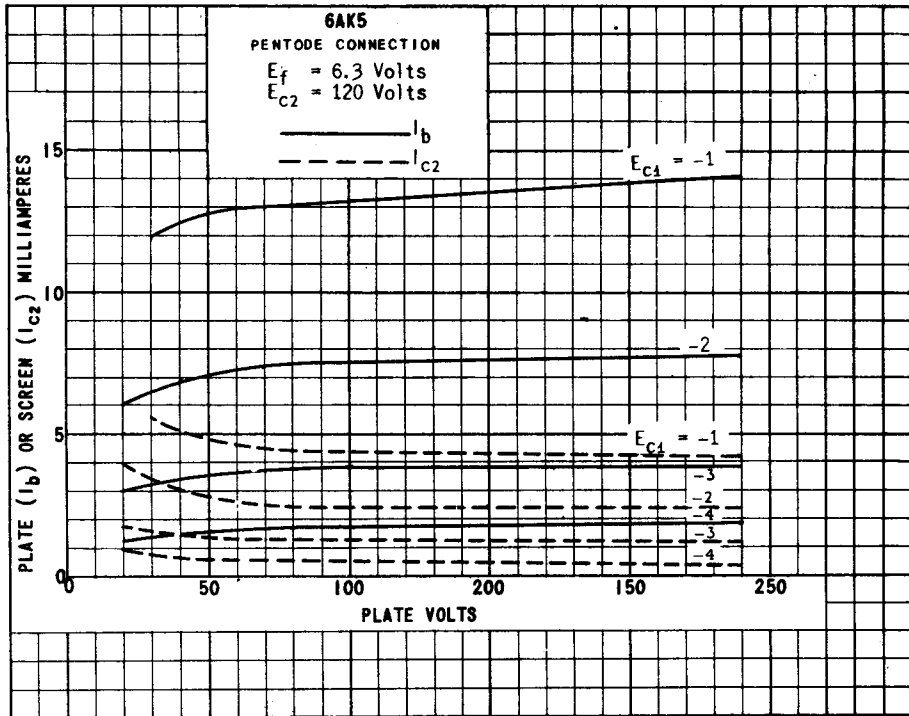

PLATE
1993
JAN. 2,
1968

TUNG-SOL

POWER AMPLIFIER PENTODE

MINIATURE TYPE

COATED UNIPOTENTIAL CATHODE

HEATER

6.3 VOLTS 0.15 AMPERE

AC OR DC

ANY MOUNTING POSITION

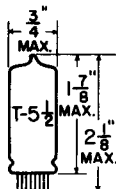

GLASS BULB

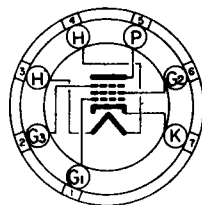
 BOTTOM VIEW
 MINIATURE BUTTON
 7 PIN BASE

THE 6AK6 IS A HEATER-CATHODE TYPE OF TUBE INTENDED FOR USE IN COMPACT, LIGHT-WEIGHT EQUIPMENT. BECAUSE OF ITS SMALL SIZE, THE 6AK6 CAN BE USED SINGLY OR IN PUSH-PULL TO EFFECT A MORE COMPACT DESIGN OF POWER-LINE RECEIVERS.

RATINGS

INTERPRETED ACCORDING TO RMA STANDARD M8-210

HEATER VOLTAGE	6.3	VOLTS
HEATER CURRENT	0.15	AMP.
MAXIMUM PLATE VOLTAGE	300	VOLTS
MAXIMUM SCREEN VOLTAGE	250	VOLTS
MAXIMUM PLATE DISSIPATION	2.75	WATTS
MAXIMUM SCREEN DISSIPATION	0.75	WATTS
MAXIMUM DC HEATER-CATHODE VOLTAGE	100	VOLTS

 DIRECT INTERELECTRODE CAPACITANCES - APPROX.
 WITH NO EXTERNAL SHIELD

GRID TO PLATE	0.12	μ f
INPUT	3.6	μ f
OUTPUT	4.2	μ f

TYPICAL OPERATING CONDITIONS AND CHARACTERISTICS

CLASS A₁ AMPLIFIER

PLATE VOLTAGE	180	VOLTS
SCREEN VOLTAGE	180	VOLTS
SUPPRESSOR VOLTAGE	0	VOLTS
GRID VOLTAGE	-9	VOLTS
PEAK AF GRID VOLTAGE	9	VOLTS
ZERO-SIGNAL PLATE CURRENT	15	MA.
ZERO-SIGNAL SCREEN CURRENT	2.5	MA.
GRID RESISTOR (MAX.):		
FOR FIXED BIAS	0.1	MEGOHM
FOR CATHODE BIAS	0.5	MEGOHM
LOAD RESISTANCE	10 000	OHMS
PLATE RESISTANCE	0.2	MEGOHM
TRANSCONDUCTANCE	2 300	μ MHOS
MAXIMUM-SIGNAL POWER OUTPUT	1.1	WATTS
TOTAL HARMONIC DISTORTION	10	PERCENT

SIMILAR TYPE REFERENCE: Rating and characteristics identical to 6000.

→ INDICATES A CHANGE OR ADDITION

6AK6

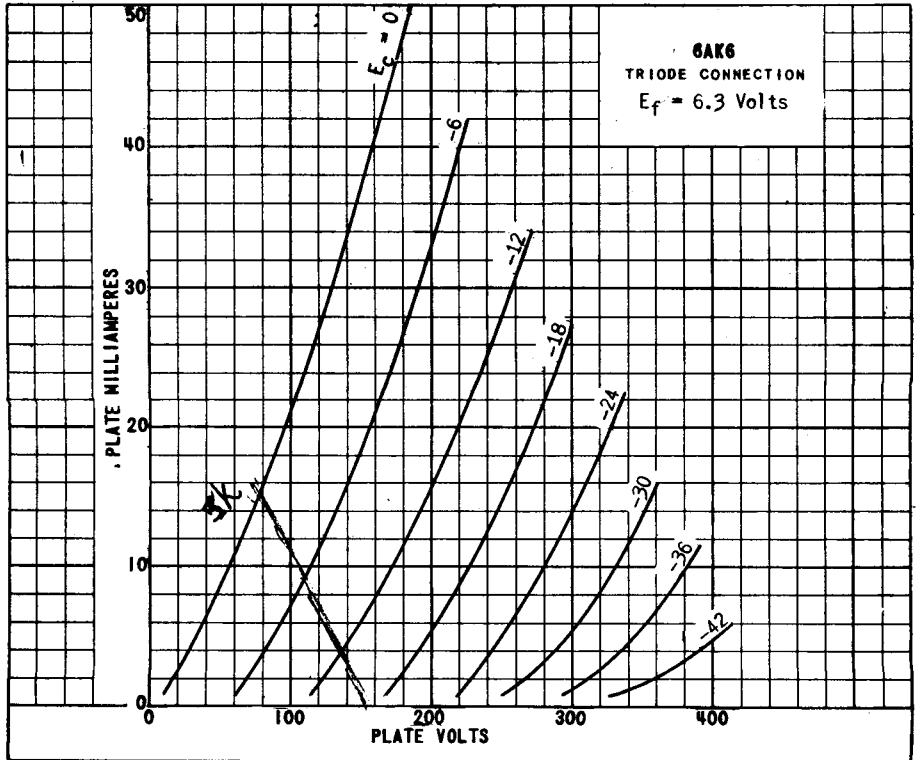
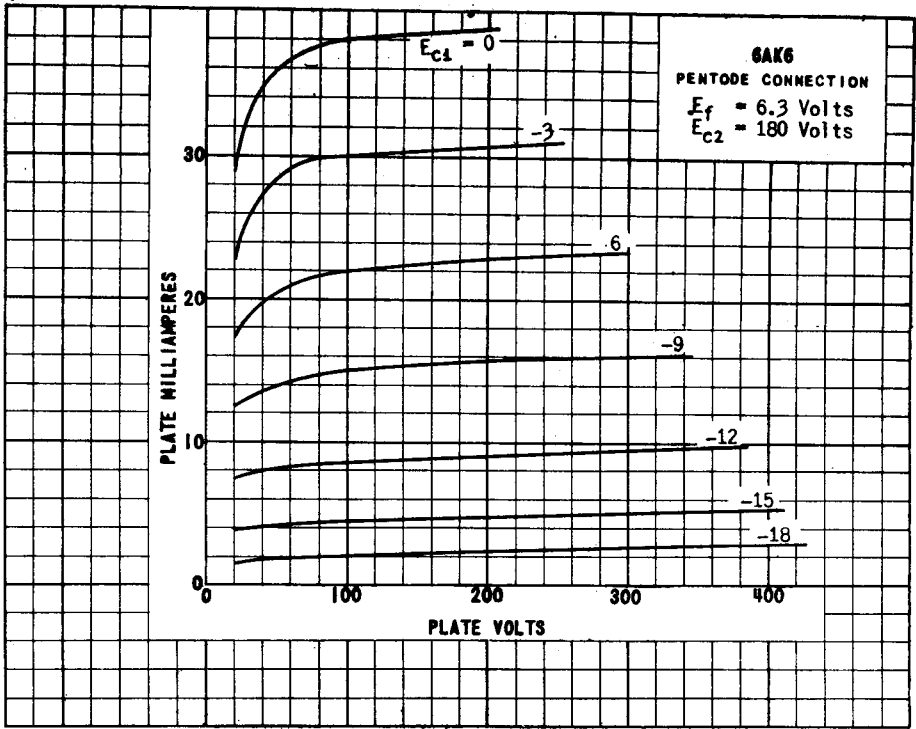
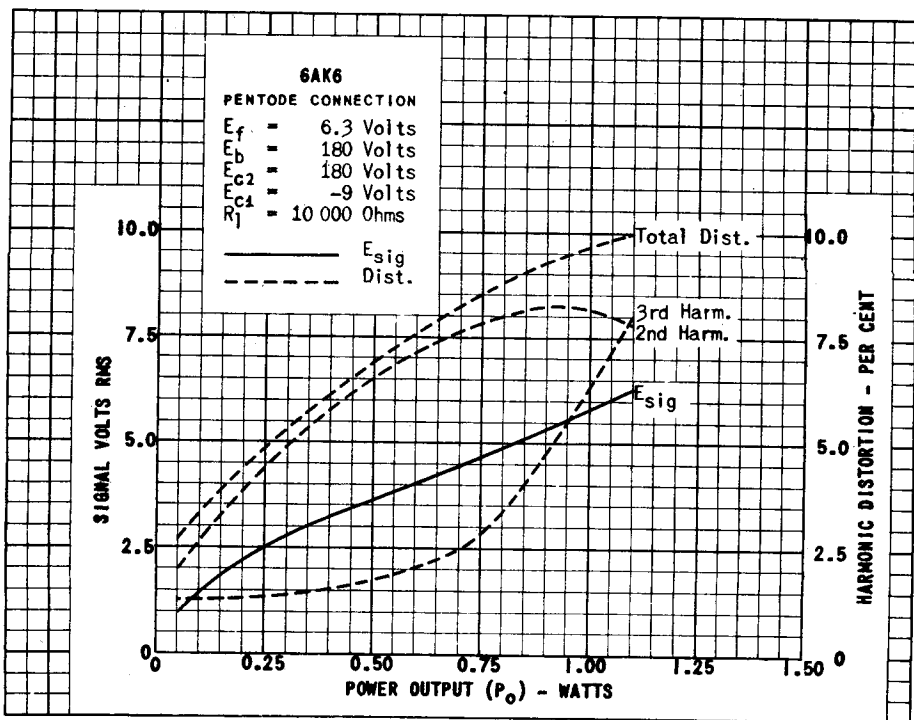
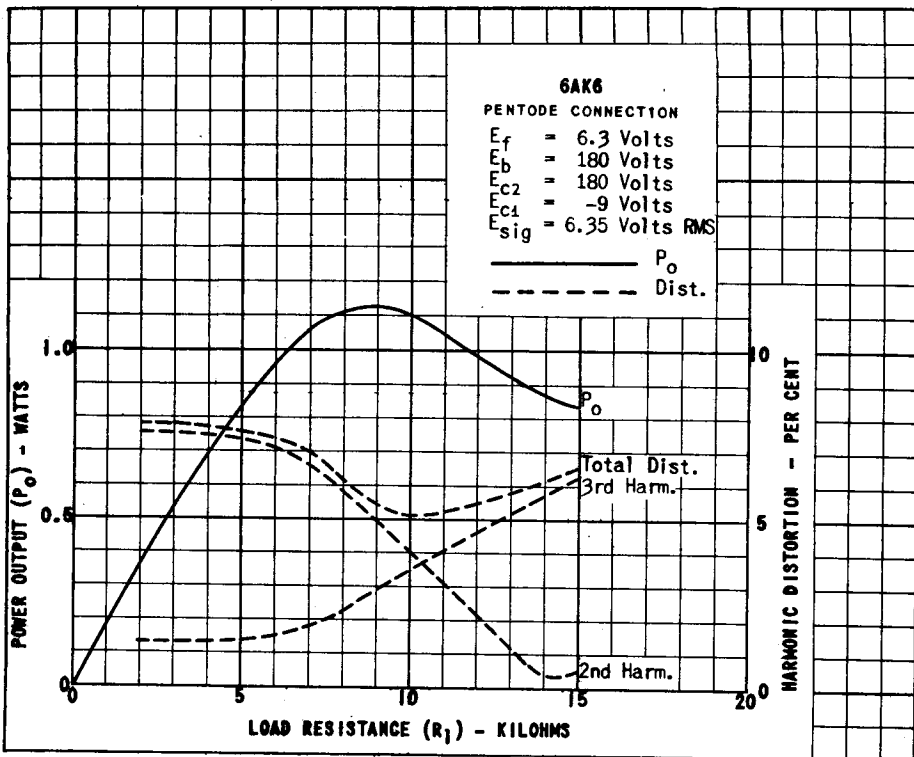

PLATE
 1780
 FEB. 9,
 1947



PRINTED IN U. S. A.

PLATE
1761
FEB. 3,
1947



TUNG-SOL

DOUBLE DIODE

MINIATURE TYPE

COATED UNIPOTENTIAL CATHODE

HEATER

6.3 VOLTS 300 MA.

AC OR DC

ANY MOUNTING POSITION

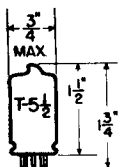

GLASS BULB

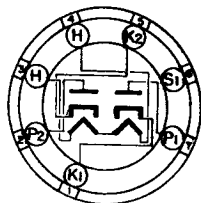
 BOTTOM VIEW
 MINIATURE BUTTON
 7 PIN BASE

THE 6AL5 COMBINES TWO INDEPENDENT DIODE UNITS IN THE 7-PIN MINIATURE CONSTRUCTION. ITS HIGH PERVEANCE PERMITS HIGH EFFICIENCY IN EITHER FM OR AM DETECTOR SERVICE.

DIRECT INTERELECTRODE CAPACITANCES

	EXTERNAL SHIELD	NO EXTERNAL SHIELD	
PLATE TO CATHODE, HEATER AND INTERNAL SHIELD: P TO (H+K+IS) EACH UNIT	3.2 ^A	2.5	μmf
CATHODE TO PLATE, HEATER AND INTERNAL SHIELD: K TO (P+H+IS) EACH UNIT	3.6 ^B	3.6	μmf
PLATE #1 TO PLATE #2: (P ₁ TO P ₂)	0.02 ^C	0.08	μmf

^ACLOSE-FITTING EXTERNAL SHIELD CONNECTED TO CATHODE.

^BCLOSE-FITTING EXTERNAL SHIELD CONNECTED TO PLATE.

^CCLOSE-FITTING EXTERNAL SHIELD CONNECTED TO GROUND.

RATINGS

INTERPRETED ACCORDING TO RMA STANDARD MG-210

HEATER VOLTAGE	6.3	VOLTS
MAXIMUM HEATER-CATHODE VOLTAGE	330	VOLTS
MAXIMUM PEAK INVERSE PLATE VOLTAGE	420	VOLTS
MAXIMUM PEAK PLATE CURRENT EACH PLATE	54	MA.
MAXIMUM DC OUTPUT CURRENT EACH PLATE	9	MA.
TUBE VOLTAGE DROP (MEASURED WITH TUBE CONDUCTING 60 MA. EACH PLATE)	10	VOLTS

TYPICAL OPERATING CONDITIONS AND CHARACTERISTICS

HALF-WAVE RECTIFIER

IN HALF-WAVE SERVICE THE TWO UNITS MAY BE USED SEPARATELY OR IN PARALLEL.

HEATER VOLTAGE	6.3	VOLTS
HEATER CURRENT	300	MA.
AC PLATE VOLTAGE EACH PLATE (RMS)	150	VOLTS
MINIMUM TOTAL EFFECTIVE PLATE SUPPLY IMPEDANCE EACH PLATE	300	OHMS
DC OUTPUT CURRENT EACH PLATE	9	MA.

THE RESONANT FREQUENCY OF EACH UNIT IS 700 MC APPROX.

→ INDICATES A CHANGE OR ADDITION.

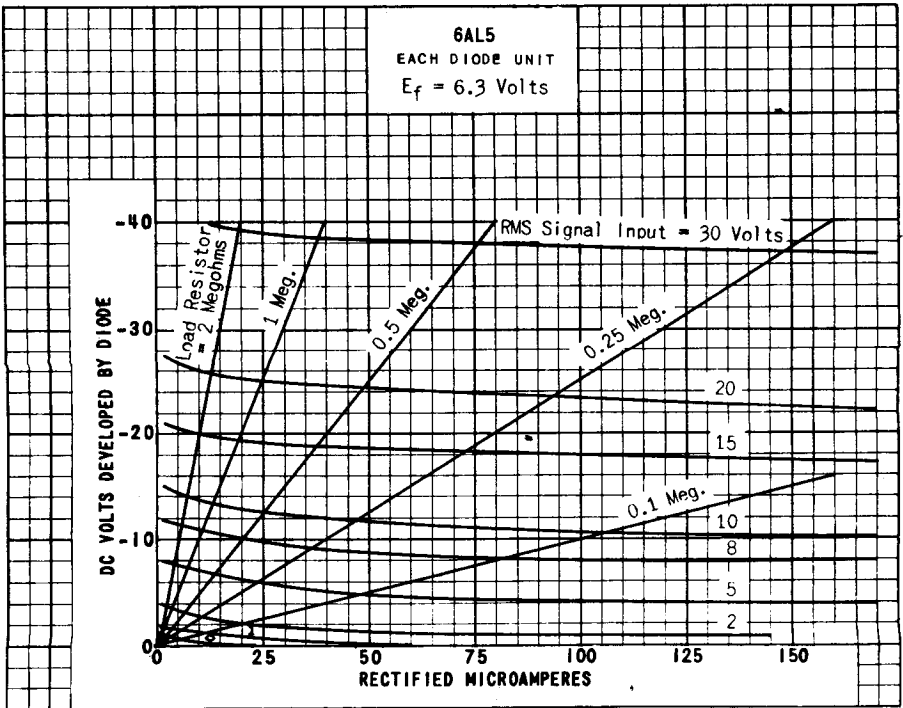
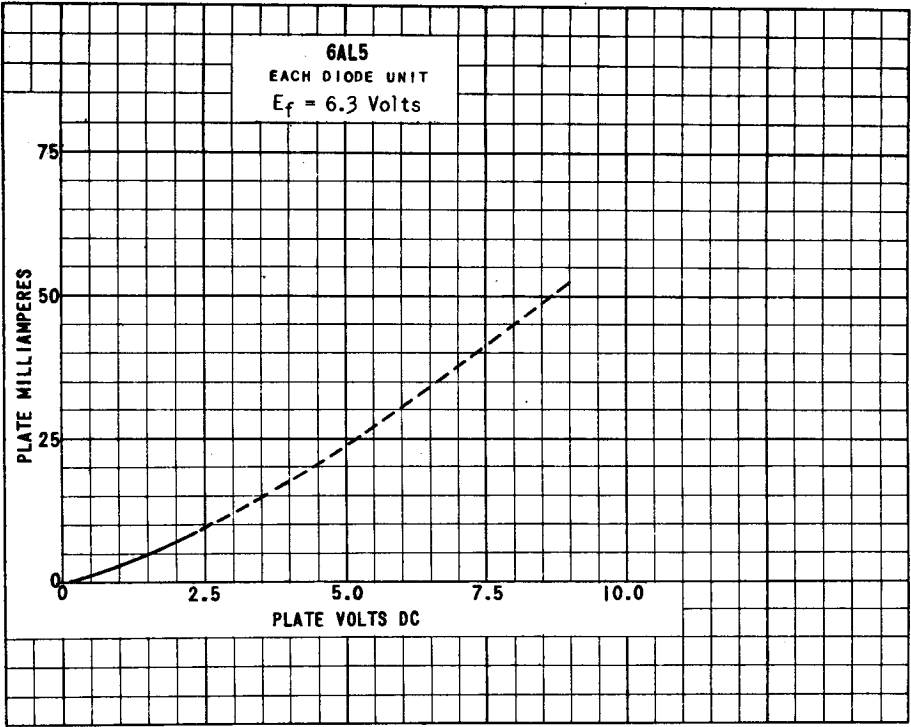

TUNG-SOL

QUADRUPLE DIODE

MINIATURE TYPE

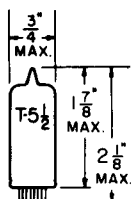

GLASS BULB

COATED UNIPOTENTIAL CATHODE

HEATER

6.3 VOLTS 0.20 AMPERE

AC OR DC

ANY MOUNTING POSITION

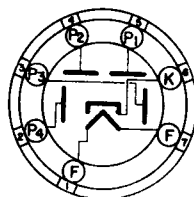

BOTTOM VIEW

MINIATURE BUTTON
7 PIN BASE

THE 6AN6 IS A QUADRUPLE DIODE. IT IS DESIGNED FOR USE IN COMPACT, LIGHT-WEIGHT, PORTABLE EQUIPMENT WHERE THE RECTIFICATION OF FOUR SEPARATE VOLTAGES IS REQUIRED. IT IS RECOMMENDED THAT NO MATERIAL BE PERMITTED TO OBSTRUCT THE HOLE IN THE BASE SOCKET AS THIS TYPE MAY BE MANUFACTURED WITH THE EXHAUST-TUBE TIP AT THE BASE END.

RATINGS

INTERPRETED ACCORDING TO RMA STANDARD MB-210

HEATER VOLTAGE	6.3	VOLTS
HEATER CURRENT	0.20	AMP.
MAXIMUM PEAK INVERSE PLATE VOLTAGE PER PLATE	210	VOLTS
MAXIMUM PEAK PLATE CURRENT PER PLATE	45	MA.
MAXIMUM DC OUTPUT CURRENT PER PLATE	8.0	MA.
TUBE VOLTAGE DROP PER PLATE AT 6.6 MA.	9.0	VOLTS
MAXIMUM HEATER-CATHODE VOLTAGE	90	VOLTS

DIRECT INTERELECTRODE CAPACITANCES

WITH NO EXTERNAL SHIELD

PLATE 1 TO PLATES 2, 3 AND 4	1.2	μμf
PLATE 2 TO PLATES 1, 3 AND 4	1.1	μμf
PLATE 3 TO PLATES 1, 2 AND 4	1.1	μμf
PLATE 4 TO PLATES 1, 2 AND 3	1.3	μμf
PLATE TO CATHODE PER PLATE	0.5	μμf

TYPICAL OPERATING CONDITIONS AND CHARACTERISTICS

HALF-WAVE RECTIFIER

PLATE VOLTAGE (RMS)	75	VOLTS
DC OUTPUT CURRENT PER PLATE	3.3	MA.

6AN6

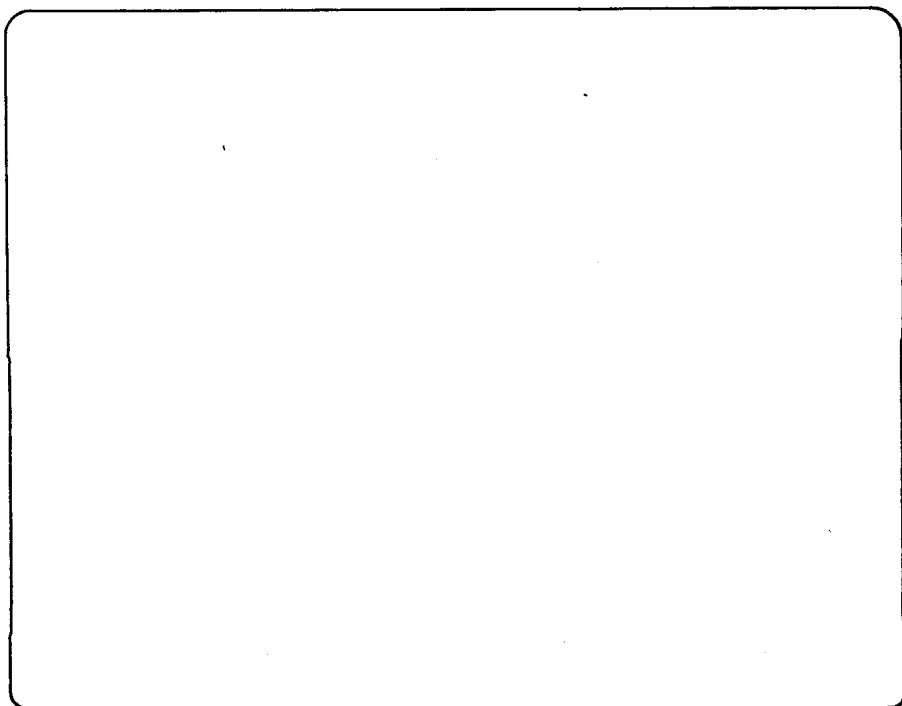
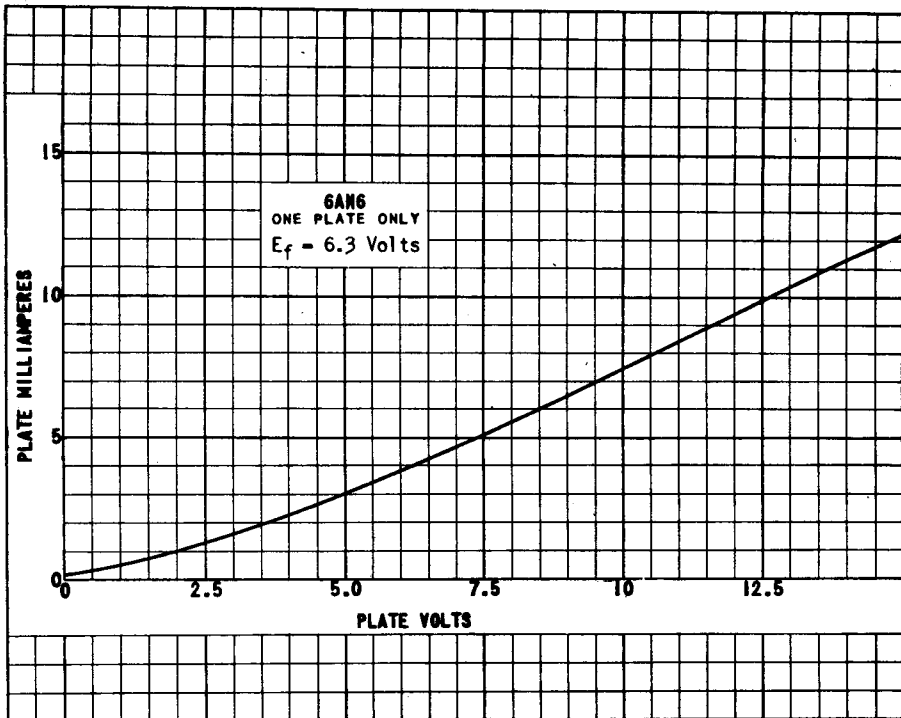

PLATE
1748
NOV. 1,
1946

TUNG-SOL

BEAM PENTODE

MINIATURE TYPE

COATED UNIPOTENTIAL CATHODE

HEATER

6.3 VOLTS 450 MA.

AC OR DC

ANY MOUNTING POSITION

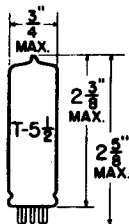

GLASS BULB

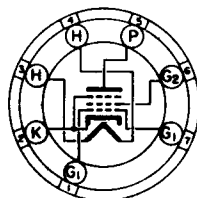
 BOTTOM VIEW
 MINIATURE BUTTON
 7 PIN BASE

THE 6AQ5 IS A BEAM POWER AMPLIFIER USING THE MINIATURE CONSTRUCTION. IT IS DESIGNED FOR SERVICE IN AC AND STORAGE BATTERY OPERATED RECEIVERS WHERE HIGH POWER SENSITIVITY AND HIGH POWER OUTPUT IS DESIRED.

RATINGS

INTERPRETED ACCORDING TO RMA STANDARD M8-210

HEATER VOLTAGE	6.3	VOLTS
HEATER CURRENT	450	MA.
MAXIMUM PLATE VOLTAGE	250	VOLTS
MAXIMUM SCREEN VOLTAGE	250	VOLTS
MAXIMUM PLATE DISSIPATION	12	WATTS
MAXIMUM SCREEN DISSIPATION	2	WATTS
MAXIMUM HEATER-CATHODE VOLTAGE	90	VOLTS

DIRECT INTERELECTRODE CAPACITANCES - APPROX.

	WITH EXTERNAL SHIELD CONNECTED TO CATHODE	WITH NO EXTERNAL SHIELD	
GRID TO PLATE	0.17	0.35	$\mu\mu\text{f}$
INPUT	8	7.6	$\mu\mu\text{f}$
OUTPUT	11	6	$\mu\mu\text{f}$

CONTINUED ON FOLLOWING PAGE

CONTINUED FROM PRECEDING PAGE

TYPICAL OPERATING CONDITIONS AND CHARACTERISTICS

AF POWER AMPLIFIER - CLASS A₁

PLATE VOLTAGE	180	250	VOLTS
SCREEN VOLTAGE	180	250	VOLTS
CONTROL GRID VOLTAGE	-8.5	-12.5	VOLTS
PEAK AF GRID VOLTAGE	8.5	12.5	VOLTS
ZERO-SIGNAL PLATE CURRENT	29	45	MA.
ZERO-SIGNAL SCREEN CURRENT (APPROX.)	3	4.5	MA.
MAXIMUM-SIGNAL PLATE CURRENT	30	47	MA.
MAXIMUM-SIGNAL SCREEN CURRENT (APPROX.)	4	7	MA.
GRID CIRCUIT RESISTANCE (MAX.):			
FOR FIXED BIAS	0.1	0.1	MEGOHM
FOR CATHODE BIAS	0.5	0.5	MEGOHM
LOAD RESISTANCE	5 500	5 000	OHMS
PLATE RESISTANCE	58 000	52 000	OHMS
TRANSCONDUCTANCE	3 700	4 100	μMHOS
MAXIMUM-SIGNAL POWER OUTPUT	2	4.5	WATTS
TOTAL HARMONIC DISTORTION	8	8	PERCENT

AF POWER AMPLIFIER - CLASS AB₁
TWO TUBES

PLATE VOLTAGE	250	VOLTS
SCREEN VOLTAGE	250	VOLTS
CONTROL GRID VOLTAGE	-15	VOLTS
PEAK AF GRID TO GRID VOLTAGE	30	VOLTS
ZERO-SIGNAL PLATE CURRENT	70	MA.
ZERO-SIGNAL SCREEN CURRENT	5	MA.
MAXIMUM-SIGNAL PLATE CURRENT	79	MA.
MAXIMUM-SIGNAL SCREEN CURRENT	13	MA.
GRID CIRCUIT RESISTANCE (MAX.):		
FOR FIXED BIAS	0.1	MEGOHM
FOR CATHODE BIAS	0.5	MEGOHM
EFFECTIVE LOAD RESISTANCE - PLATE TO PLATE	10 000	OHMS
PLATE RESISTANCE - PER TUBE (APPROX.)	60 000	OHMS
TRANSCONDUCTANCE - PER TUBE	3 750	μMHOS
MAXIMUM-SIGNAL POWER OUTPUT	10	WATTS
TOTAL HARMONIC DISTORTION	5	PERCENT

SIMILAR TYPE REFERENCE: Characteristics identical to 6V6, 6V6G, 6V6GT within its ratings.

→ INDICATES A CHANGE OR ADDITION

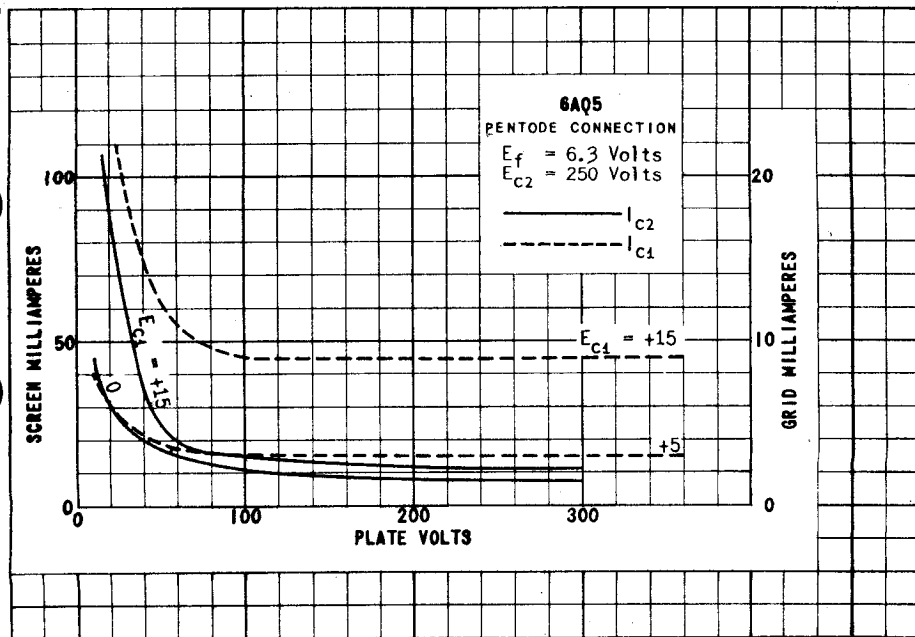
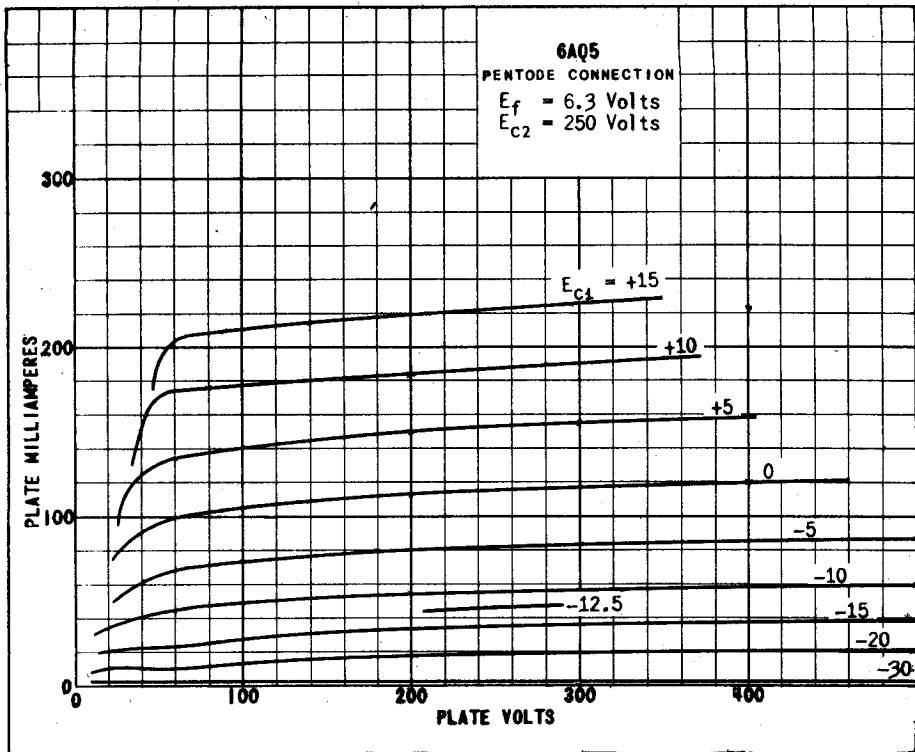

PRINTED IN U. S. A.

PLATE 1784
MAY 1 1947

6AQ5

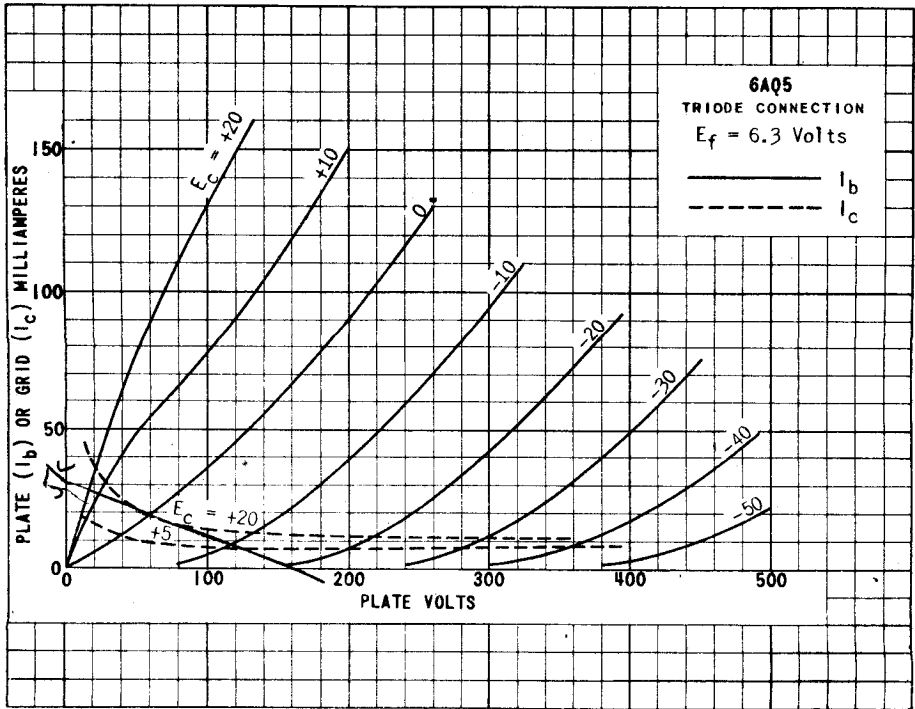
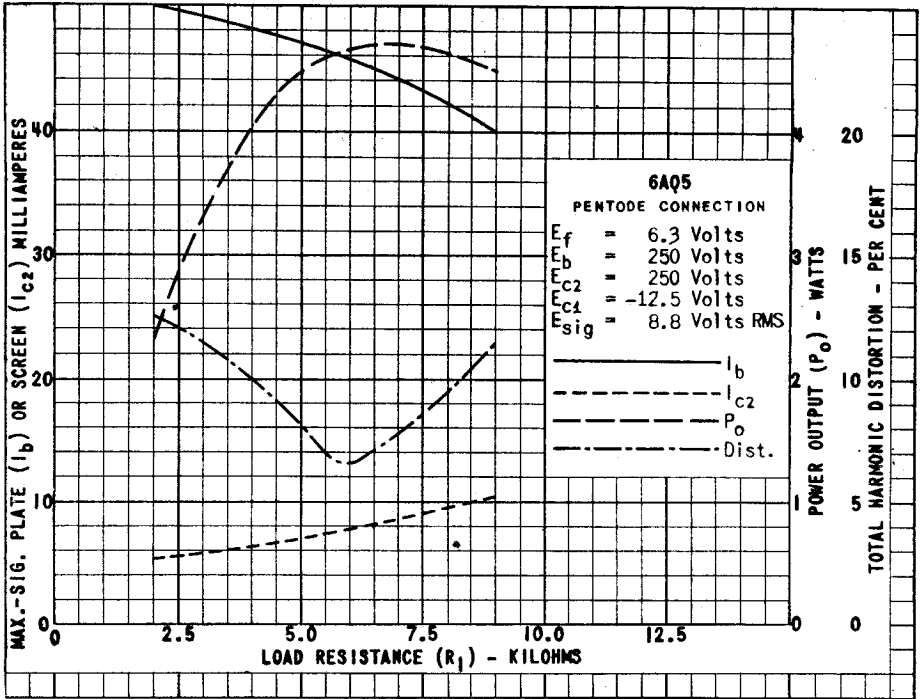

PLATE
1785
MAY 1
1941

$$R = \frac{\sum_{i=1}^{1000} z_i}{1000} = \sqrt{15000} \cdot 0.03$$



TUNG-SOL

DOUBLE-DIODE TRIODE

MINIATURE TYPE

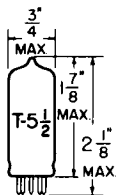

GLASS BULB

COATED UNIPOTENTIAL CATHODE

HEATER

6.3 VOLTS 150 MA.

AC OR DC

ANY MOUNTING POSITION

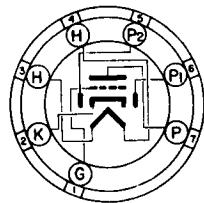

BOTTOM VIEW

MINIATURE BUTTON
7 PIN BASE

THE 6AQ6 COMBINES TWO DIODES AND A HIGH-MU TRIODE VOLTAGE AMPLIFIER IN THE MINIATURE CONSTRUCTION. THE THREE SECTIONS USE A COMMON CATHODE BUT ARE ADEQUATELY SHIELDED TO PROVIDE FOR SIMULTANEOUS SERVICE AS DETECTORS, AVC RECTIFIER, AND AUDIO VOLTAGE AMPLIFIER. THIS TUBE IS PARTICULARLY USEFUL IN DESIGNS REQUIRING ECONOMY OF HEATER POWER.

RATINGS

INTERPRETED ACCORDING TO RMA STANDARD MB-210

HEATER VOLTAGE	6.3	VOLTS
MAXIMUM HEATER-CATHODE VOLTAGE	90	VOLTS
MAXIMUM PLATE VOLTAGE	300	VOLTS

TYPICAL OPERATING CONDITIONS AND CHARACTERISTICS

TRIODE UNIT - CLASS A₁ AMPLIFIER

HEATER VOLTAGE	6.3	6.3	VOLTS
HEATER CURRENT	150	150	MA.
PLATE VOLTAGE	100	250	VOLTS
GRID VOLTAGE	-1	-3	VOLTS
PLATE CURRENT	0.8	1.0	MA.
PLATE RESISTANCE	61 000	56 000	OHMS
TRANSCONDUCTANCE	1 150	1 200	μMHMS
AMPLIFICATION FACTOR	70	70	

DIODE UNITS - TWO

THE DIODE UNITS ARE INDEPENDENT OF THE TRIODE UNIT EXCEPT FOR THE COMMON CATHODE SLEEVE. DIODE BIASING OF THE TRIODE IS NOT SUITABLE.

SIMILAR TYPE REFERENCES: Ratings and Characteristics somewhat similar to 6AT6, 6Q7, 6Q7GT, 6SQ7, 6SQ7GT, 7B6, 7C6.

6AQ6

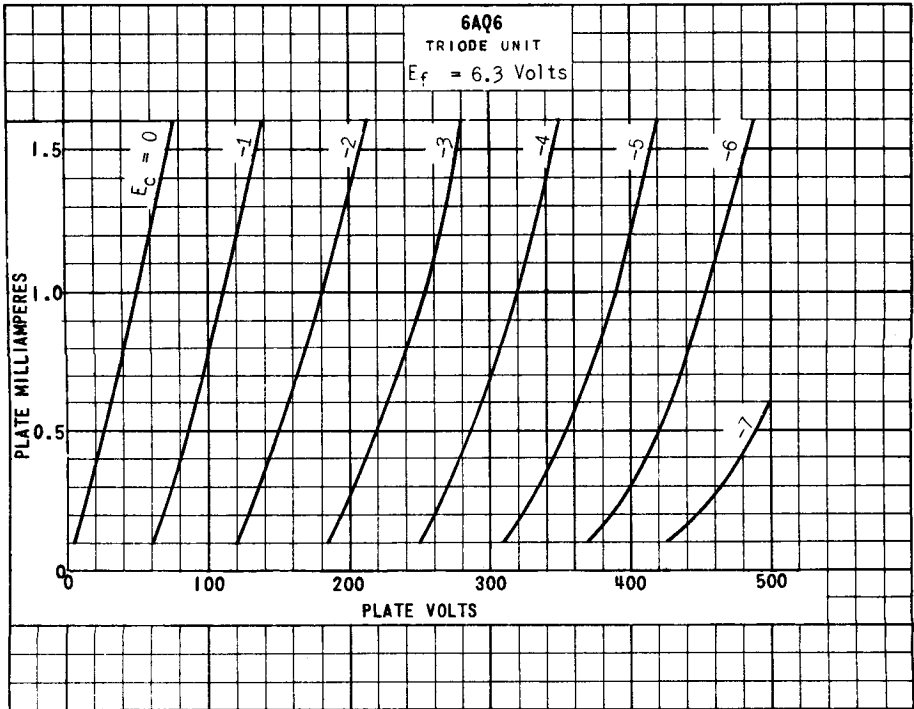
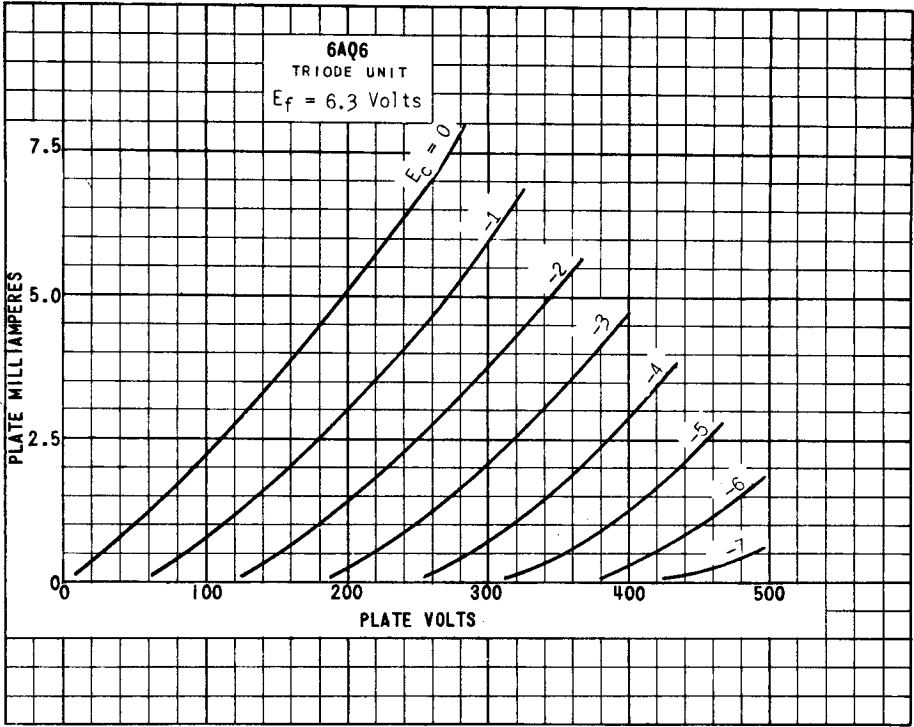

PLATE
2037
JULY 1,
1948

TUNG-SOL

PENTODE

MINIATURE TYPE

COATED UNIPOTENTIAL CATHODE

HEATER

6.3 VOLTS 400 MA.

AC OR DC

ANY MOUNTING POSITION

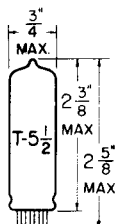

GLASS BULB

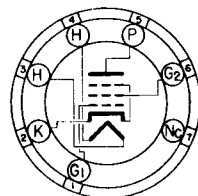

BOTTOM VIEW

MINIATURE BUTTON
7 PIN BASE

THE 6AR5 IS A PENTODE POWER AMPLIFIER USING THE MINIATURE CONSTRUCTION. IT IS INTENDED FOR SERVICE IN AC AND STORAGE BATTERY OPERATED RECEIVERS WHERE MODERATE POWER SENSITIVITY AND POWER OUTPUT IS DESIRED.

RATINGS

INTERPRETED ACCORDING TO RMA STANDARD M8-210

HEATER VOLTAGE	6.3	VOLTS
MAXIMUM HEATER-CATHODE VOLTAGE	90	VOLTS
MAXIMUM PLATE VOLTAGE	250	VOLTS
MAXIMUM GRID #2 VOLTAGE	250	VOLTS
MAXIMUM PLATE DISSIPATION	8.5	WATTS
MAXIMUM GRID #2 DISSIPATION	2.5	WATTS
MAXIMUM GRID #1 CIRCUIT RESISTANCE (FIXED BIAS)	0.1	MEGOHM
MAXIMUM GRID #1 CIRCUIT RESISTANCE (SELF BIAS)	0.5	MEGOHM

TYPICAL OPERATING CONDITIONS AND CHARACTERISTICS

CLASS A₁ AMPLIFIER

HEATER VOLTAGE	6.3	6.3	VOLTS
HEATER CURRENT	400	400	MA.
PLATE VOLTAGE	250	250	VOLTS
GRID #2 VOLTAGE	250	250	VOLTS
GRID #1 VOLTAGE	-16.5	-18	VOLTS
PEAK AF GRID #1 VOLTAGE	16.5	18	VOLTS
PLATE RESISTANCE (APPROX.)	65 000	68 000	OHMS
TRANSCONDUCTANCE	2 400	2 300	UMHOS
ZERO-SIGNAL PLATE CURRENT	34	32	MA.
ZERO-SIGNAL GRID #2 CURRENT (NOMINAL)	5.7	5.5	MA.
MAXIMUM SIGNAL PLATE CURRENT	35	33	MA.
MAXIMUM SIGNAL GRID #2 CURRENT (NOMINAL)	10	10	MA.
LOAD RESISTANCE	7 000	7 600	OHMS
TOTAL HARMONIC DISTORTION	7	11	PERCENT
POWER OUTPUT	3.2	3.4	WATTS



TUNG-SOL

BEAM PENTODE

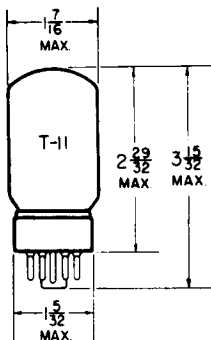

GLASS BULB

COATED UNIPOTENTIAL CATHODE

HEATER
6.3 VOLTS 1.2 AMPERES
AC OR DC

ANY MOUNTING POSITION

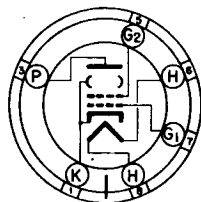

BOTTOM VIEW

INTERMEDIATE (SHORT)
SHELL 6 PIN OCTAL LOW
LOSS PHENOLIC BASE

THE 6AR6 IS A-BEAM POWER AMPLIFIER DESIGNED SPECIFICALLY FOR APPLICATIONS REQUIRING RELATIVELY HIGH PEAK PLATE CURRENTS AT NEGATIVE GRID POTENTIALS. IT IS CONSTRUCTED TO WITHSTAND RELATIVELY HIGH PLATE POTENTIALS.

RATINGS

INTERPRETED ACCORDING TO RMA STANDARD M8-210

FILAMENT VOLTAGE	6.3	VOLTS
MAXIMUM HEATER-CATHODE VOLTAGE	200	VOLTS
MAXIMUM DC PLATE VOLTAGE	565	VOLTS
MAXIMUM DC GRID #2 VOLTAGE	300	VOLTS
DC GRID #1 VOLTAGE	-300 TO 0	VOLTS
MAXIMUM PLATE DISSIPATION	19	WATTS
MAXIMUM GRID #2 DISSIPATION	3.2	WATTS
MAXIMUM DC PLATE CURRENT	115	MA.

DIRECT INTERELECTRODE CAPACITANCES

WITH NO EXTERNAL SHIELD

GRID TO PLATE: (G_1 TO P)	0.55	$\mu\mu\text{f}$
INPUT: G_2 TO (H + K + G_2)	11.0	$\mu\mu\text{f}$
OUTPUT: P TO (H + K + G_2)	7.0	$\mu\mu\text{f}$
HEATER TO CATHODE: (H TO K)	5.5	$\mu\mu\text{f}$

TYPICAL OPERATING CONDITIONS AND CHARACTERISTICS

CLASS A AMPLIFIER

	TRIODE CONNECTION	PENTODE CONNECTION	
FILAMENT VOLTAGE	6.3	6.3	VOLTS
FILAMENT CURRENT	1.2	1.2	AMP.
DC PLATE VOLTAGE	200	250	VOLTS
DC GRID #2 VOLTAGE	TIED TO PLATE	250	VOLTS
DC GRID #1 VOLTAGE	-12.5	-22.5	VOLTS
GRID #1 CIRCUIT RESISTANCE (MAX.)	100 000	100 000	OHMS
DC-PLATE CURRENT	90	.77	MA.
GRID #2 CURRENT	TIED TO PLATE	5	MA.
PLATE RESISTANCE (APPROX.)	1 000	21 000	OHMS
TRANSCONDUCTANCE	6 000	5 400	μMHOS
DC GRID #1 VOLTAGE FOR PLATE CURRENT CUTOFF		-65	VOLTS

→ INDICATES A CHANGE OF ADDITION

6AR6

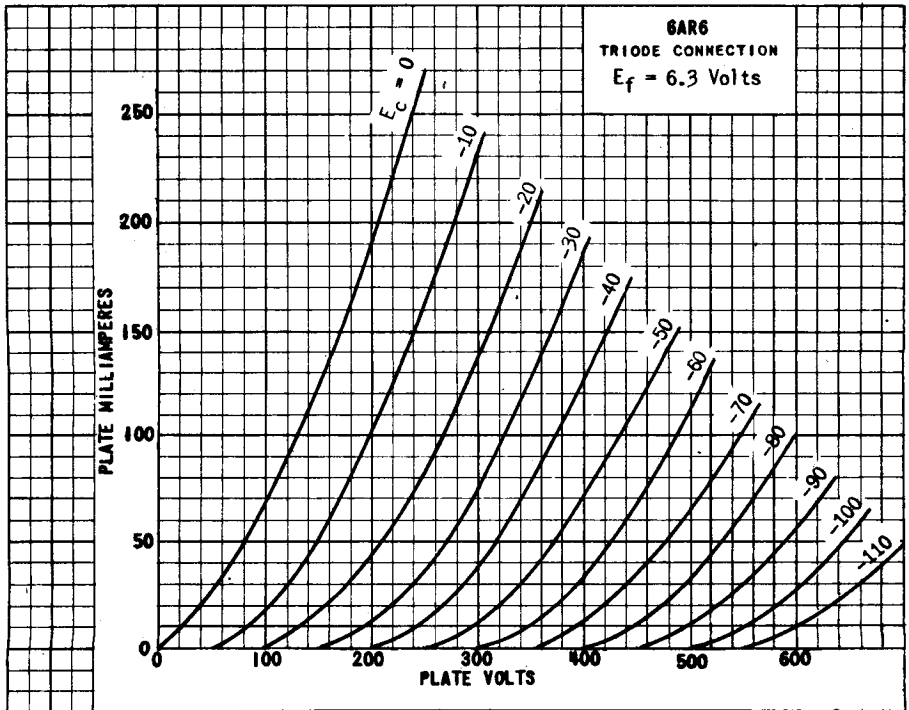
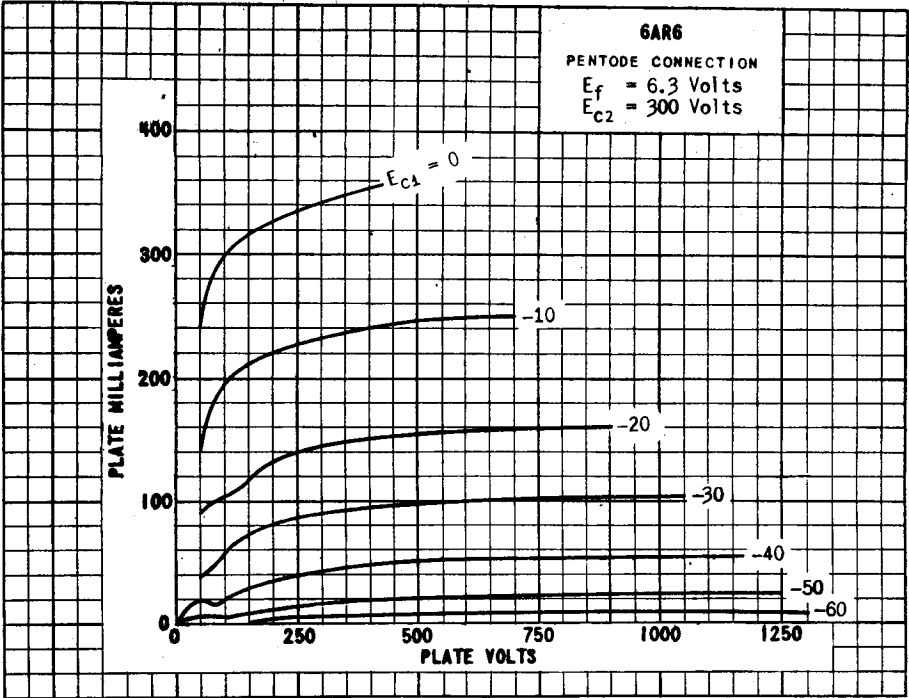
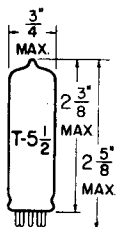

PLATE
 1750
 JULY 1,
 1947

TUNG-SOL

BEAM PENTODE
MINIATURE TYPE

GLASS BULB

UNIPOTENTIAL CATHODE

HEATER

6.3 VOLTS 0.8 AMPERE
AC OR DC

ANY MOUNTING POSITION

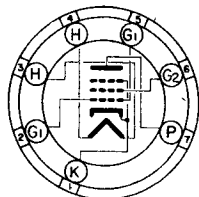
BOTTOM VIEW
MINIATURE BUTTON
7 PIN BASE

THE 6AS5 IS A BEAM POWER AMPLIFIER USING THE MINIATURE CONSTRUCTION. IT IS DESIGNED FOR USE IN MOBILE OR AC OPERATED RECEIVERS WHERE RELATIVELY HIGH POWER OUTPUT AND HIGH POWER SENSITIVITY ARE DESIRED AT LOW POWER SUPPLY VOLTAGES.

DIRECT INTERELECTRODE CAPACITANCES - APPROX.
WITH NO EXTERNAL SHIELD

GRID TO PLATE: (G_1 TO P)	0.6	μf
INPUT: G_1 TO (H+K& G_3 + G_2)	12	μf
OUTPUT: P TO (H+K& G_3 + G_2)	6.2	μf

RATINGS

INTERPRETED ACCORDING TO RMA STANDARD MB-210

HEATER VOLTAGE	6.3	VOLTS
MAXIMUM HEATER-CATHODE VOLTAGE	90	VOLTS
MAXIMUM PLATE VOLTAGE	150	VOLTS
MAXIMUM GRID #2 VOLTAGE	117	VOLTS
MAXIMUM PLATE DISSIPATION	5.5	WATTS
MAXIMUM GRID #2 DISSIPATION	1	WATT
MAXIMUM GRID #1 CIRCUIT RESISTANCE (FIXED BIAS)	0.1	MEGOHM
MAXIMUM GRID #1 CIRCUIT RESISTANCE (SELF BIAS)	0.5	MEGOHM
MAXIMUM BULB TEMPERATURE (AT HOTTEST POINT ON BULB SURFACE)	250	$^{\circ}\text{C}$

TYPICAL OPERATING CONDITIONS AND CHARACTERISTICS

CLASS A_1 AMPLIFIER

HEATER VOLTAGE	6.3	VOLTS
HEATER CURRENT	0.8	AMP.
PLATE VOLTAGE	150	VOLTS
GRID #2 VOLTAGE	110	VOLTS
GRID #1 VOLTAGE	-8.5	VOLTS
PEAK AF GRID #1 VOLTAGE	8.5	VOLTS
ZERO-SIGNAL PLATE CURRENT	35	MA.
ZERO-SIGNAL GRID #2 CURRENT (NOMINAL)	2	MA.
MAXIMUM SIGNAL PLATE CURRENT	36	MA.
MAXIMUM SIGNAL GRID #2 CURRENT (NOMINAL)	6.5	MA.
TRANSCONDUCTANCE	5 600	μMHOS
LOAD RESISTANCE	4 500	OHMS
TOTAL HARMONIC DISTORTION	10	PERCENT
MAXIMUM SIGNAL POWER OUTPUT	2.2	WATTS

6AS5

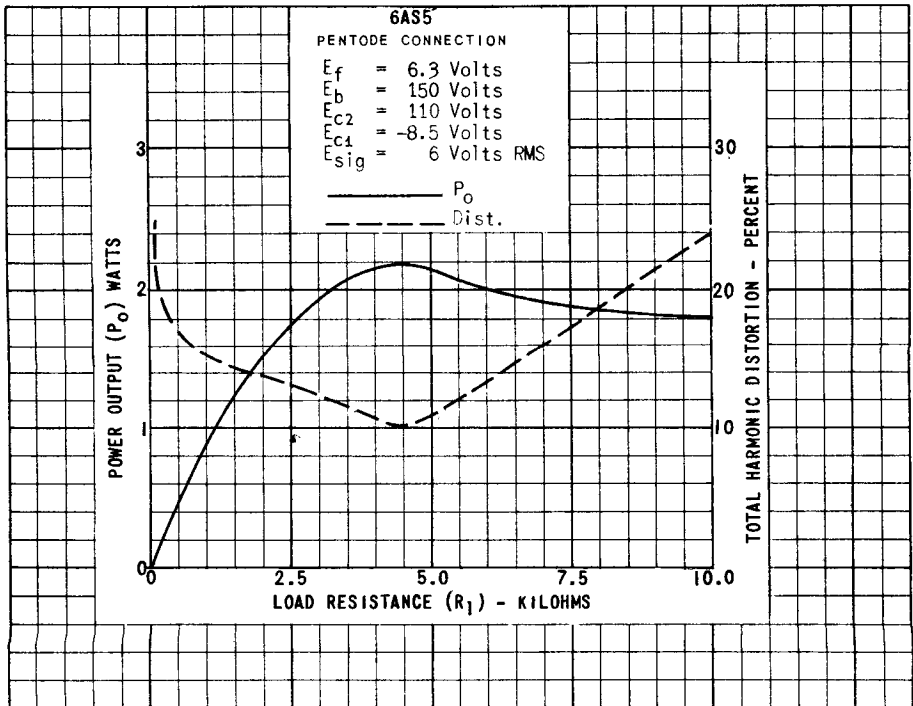
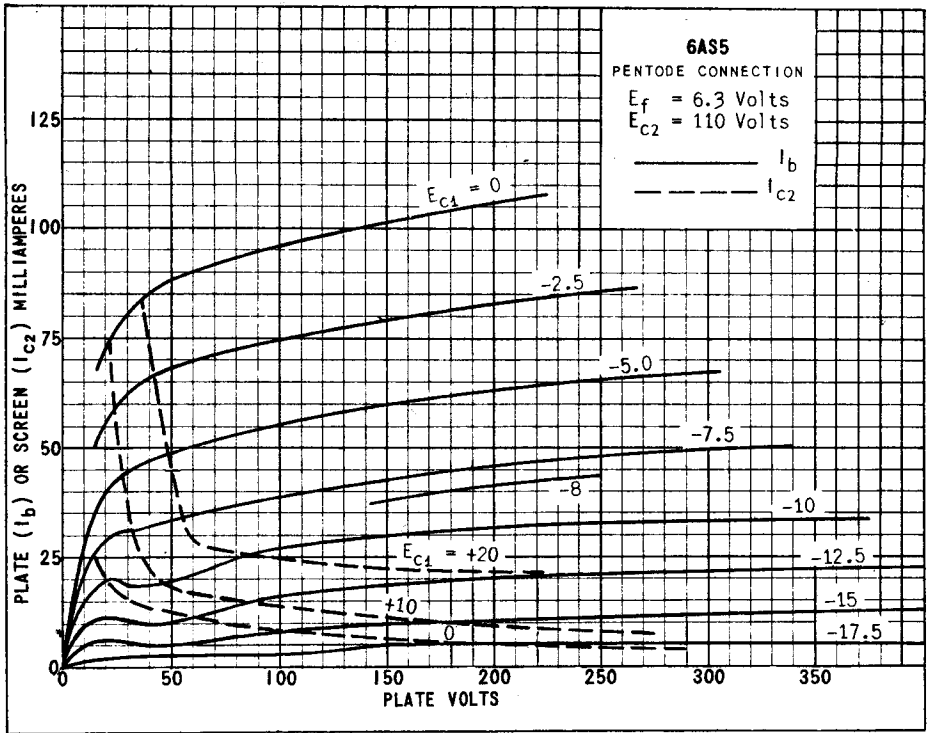

PLATE
 1997
 APRIL 1
 1948

TUNG-SOL

PENTODE

MINIATURE TYPE

COATED UNIPOTENTIAL CATHODE

HEATER

6.3 VOLTS 175 MA.

AC OR DC

ANY MOUNTING POSITION

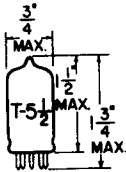

GLASS BULB

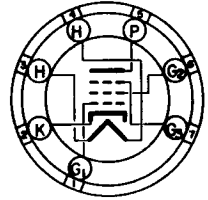

BOTTOM VIEW
MINIATURE BUTTON
7 PIN BASE

THE 6AS6 IS A SHARP CUT-OFF VOLTAGE AMPLIFIER PENTODE USING THE MINIATURE CONSTRUCTION. IT IS CHARACTERIZED BY AN EFFICIENT HEATER, LOW CAPACITANCES AND HIGH TRANSCONDUCTANCE. THE SUPPRESSOR GRID IS TERMINATED IN A SEPARATE BASE CONNECTION AND IS INTENDED TO BE USED AS AN ADDITIONAL CONTROL GRID IN GATING, SWITCHING, OR MIXER SERVICE.

DIRECT INTERELECTRODE CAPACITANCES WITH EXTERNAL SHIELD CONNECTED TO CATHODE

GRID TO PLATE: (G_1 TO P)	0.01	$\mu\mu\text{f}$
INPUT: G_1 TO ($H+K+G_2+G_3$)	3.9	$\mu\mu\text{f}$
OUTPUT: P TO ($H+K+G_2+G_3$)	3.0	$\mu\mu\text{f}$
GRID #1 TO GRID #3: (G_1 TO G_3)	0.1	$\mu\mu\text{f}$

RATINGS

INTERPRETED ACCORDING TO RMA STANDARD MB-210

HEATER VOLTAGE	6.3	VOLTS
MAXIMUM HEATER-CATHODE VOLTAGE	90	VOLTS
MAXIMUM PLATE VOLTAGE	180	VOLTS
MAXIMUM GRID #2 VOLTAGE	140	VOLTS
MAXIMUM GRID #3 VOLTAGE	27	VOLTS
MAXIMUM PLATE DISSIPATION	1.7	WATTS
MAXIMUM GRID #2 DISSIPATION	0.75	WATT
MAXIMUM CATHODE CURRENT	18	MA.
MAXIMUM BULB TEMPERATURE	120	$^{\circ}\text{C}$

TYPICAL OPERATING CONDITIONS AND CHARACTERISTICS

CLASS A_1 AMPLIFIER

HEATER VOLTAGE	6.3	6.3	VOLTS
HEATER CURRENT	175	175	MA.
PLATE VOLTAGE	120	120	VOLTS
GRID #2 VOLTAGE	120	120	VOLTS
GRID #3 VOLTAGE	-3	0	VOLTS
GRID #1 VOLTAGE	-2	-2	VOLTS
TRANSCONDUCTANCE (CONTROL-GRID)	1 850	3 200	μMHOS
TRANSCONDUCTANCE (SUPPRESSOR-GRID)	810	470	μMHOS
PLATE CURRENT	3.6	5.2	MA.
GRID #2 CURRENT	4.8	3.5	MA.

CONTINUED ON FOLLOWING PAGE

TUNG-SOL

CONTINUED FROM PRECEDING PAGE

CONTROL-GRID PLATE CURRENT CUT-OFF CHARACTERISTICS

PLATE VOLTAGE	120	VOLTS
GRID #2 VOLTAGE	120	VOLTS
GRID #3 VOLTAGE	0	VOLTS
NOMINAL CUT-OFF - GRID #1	-6	VOLTS
GUARANTEED CUT-OFF - GRID #1	-10	VOLTS

SUPPRESSOR-GRID PLATE CURRENT CUT-OFF CHARACTERISTICS

PLATE VOLTAGE	120	120	VOLTS
GRID #2 VOLTAGE	120	60	VOLTS
GRID #1 VOLTAGE	-2	0	VOLTS
NOMINAL CUT-OFF - GRID #3	-10	-8	VOLTS
GUARANTEED CUT-OFF - GRID #3	-15	-10	VOLTS

PLATE
2020
JUNE 1,
1948

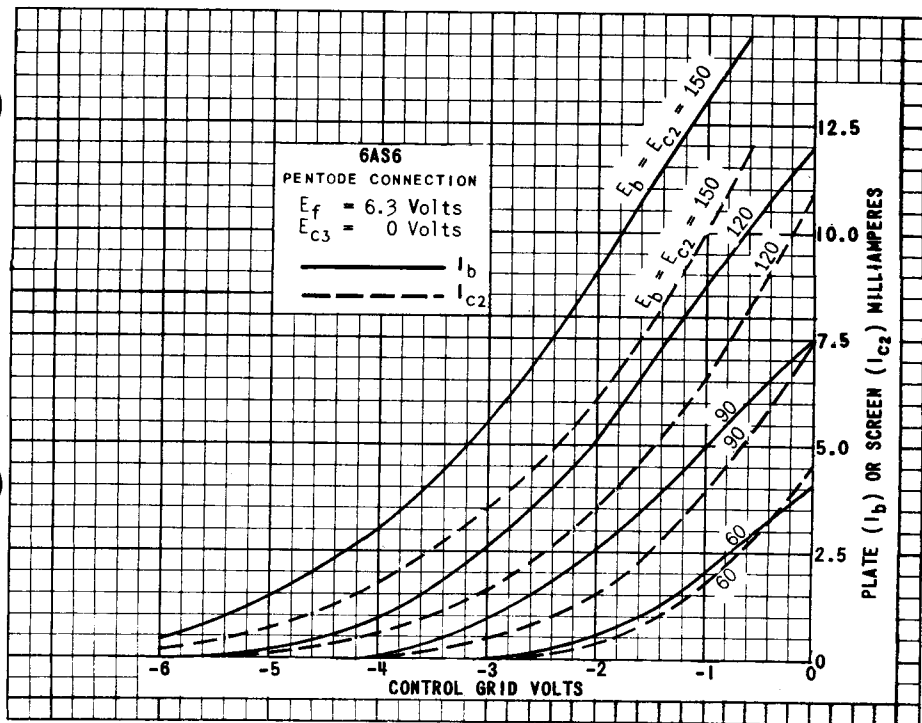
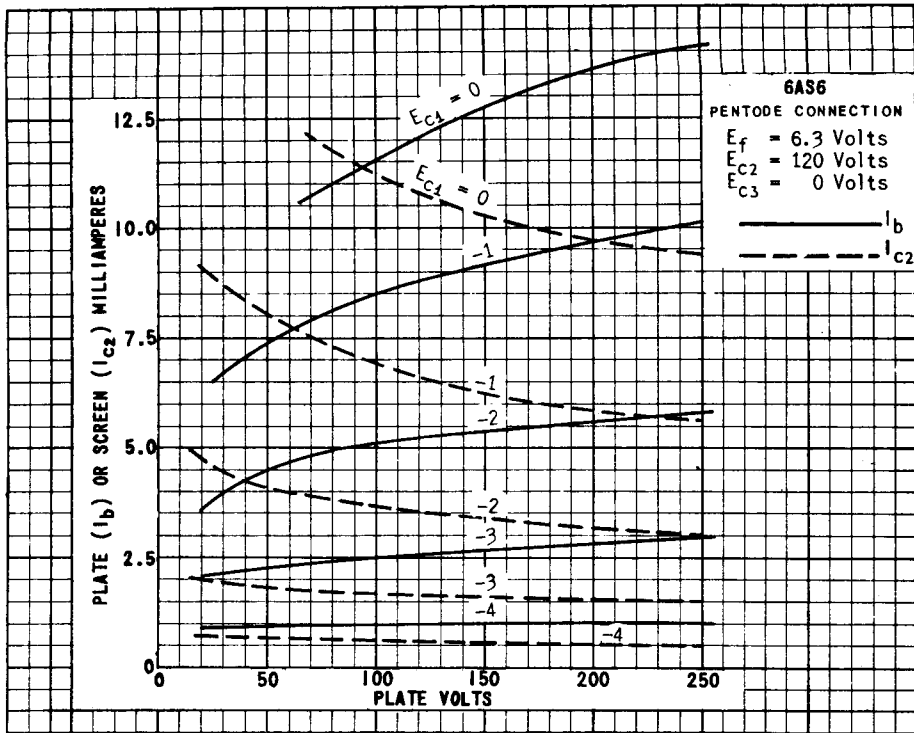

PRINTED IN U. S. A.

PLATE 2021
 JUNE 1, 1948

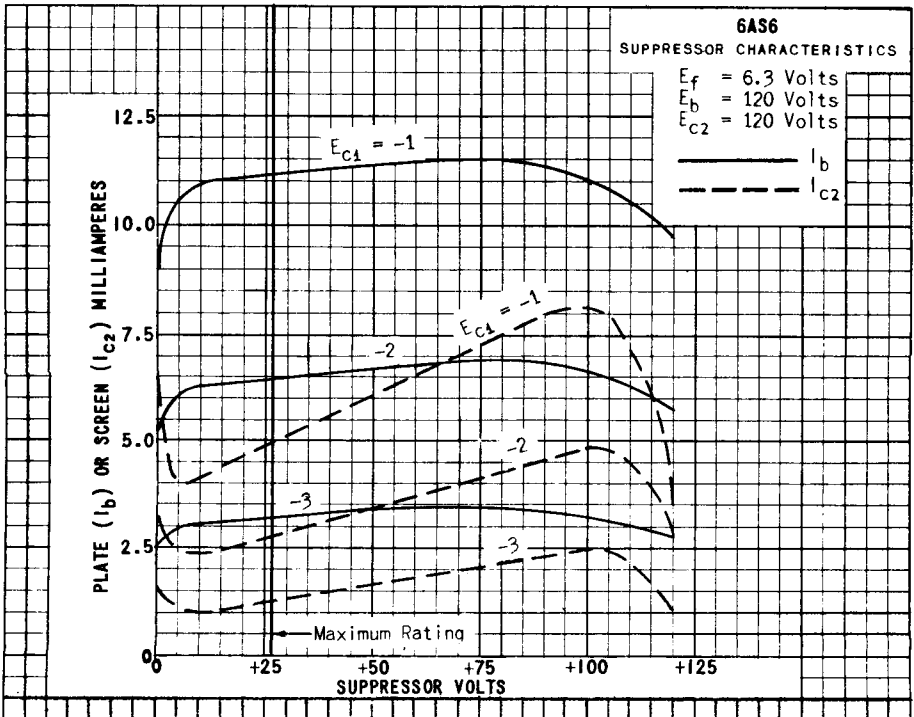
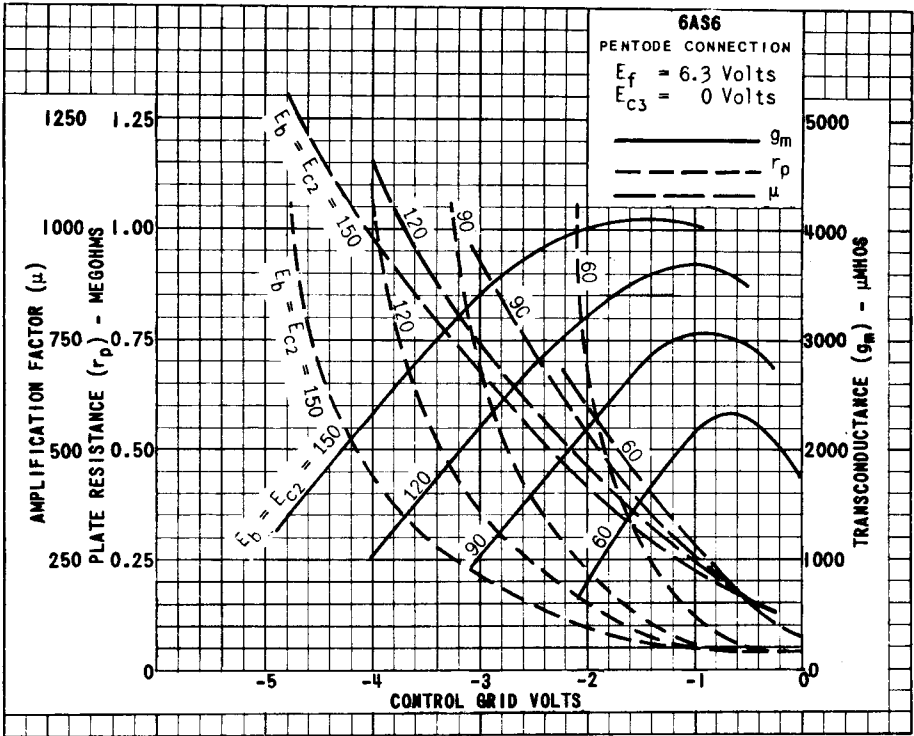
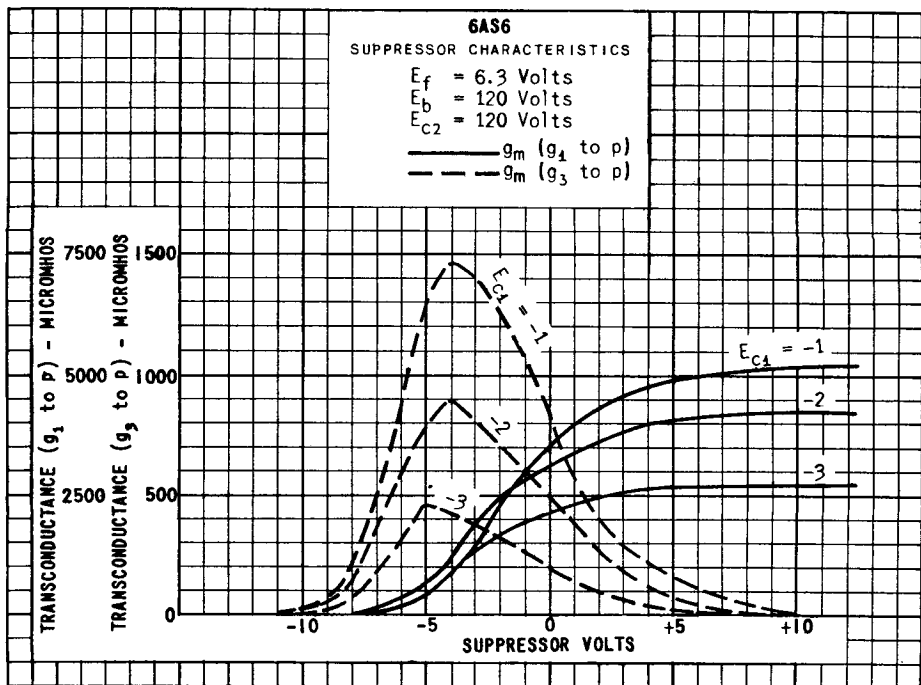
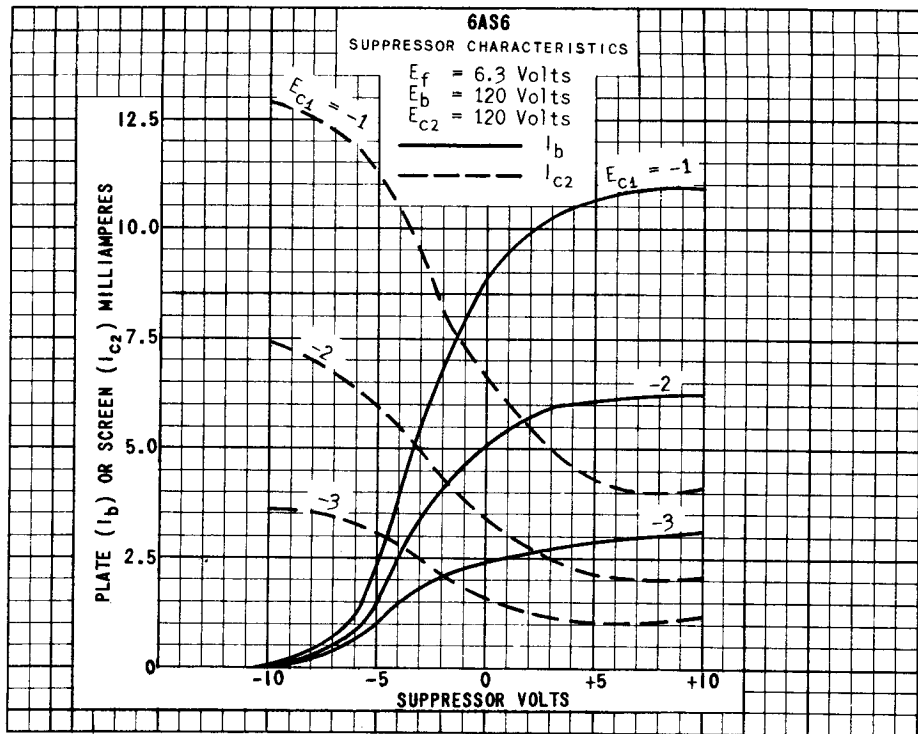

PLATE
 2022
 JUNE 1,
 1948





TUNG-SOL

DOUBLE-DIODE TRIODE

MINIATURE TYPE

UNIPOENTIAL CATHODE

HEATER

6.3 VOLTS 0.3 AMPERE

AC OR DC

ANY MOUNTING POSITION

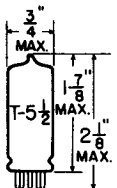

GLASS BULB

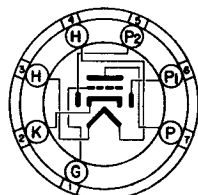

BOTTOM VIEW

MINIATURE BUTTON
7 PIN BASE

THE 6AT6 IS A COMBINED HIGH- μ VOLTAGE AMPLIFIER AND DOUBLE-DIODE DETECTOR USING THE 7-PIN MINIATURE CONSTRUCTION. IT IS INTENDED TO PROVIDE OUTPUT VOLTAGE ADEQUATE FOR FULL POWER OUTPUT OF MOST BEAM-POWER TUBES.

DIRECT INTERELECTRODE CAPACITANCES

WITH NO EXTERNAL SHIELD

GRID TO PLATE: (G TO P)	2.1	$\mu\mu\text{f}$
INPUT: G TO (H + K)	2.3	$\mu\mu\text{f}$
OUTPUT: P TO (H + K)	1.1	$\mu\mu\text{f}$
DIODE PLATE #2 TO TRIODE GRID: (P ₂ TO G) (MAX.)	0.025	$\mu\mu\text{f}$

RATINGS

INTERPRETED ACCORDING TO RMA STANDARD MB-210

HEATER VOLTAGE	6.3	VOLTS
MAXIMUM HEATER-CATHODE VOLTAGE	90	VOLTS
MAXIMUM PLATE VOLTAGE	300	VOLTS
MINIMUM DIODE CURRENT WITH 10 VOLTS DC APPLIED	0.8	MA.

TYPICAL OPERATING CONDITIONS AND CHARACTERISTICS

TRIODE UNIT - CLASS A₁ AMPLIFIER

HEATER VOLTAGE	6.3	6.3	VOLTS
HEATER CURRENT	0.3	0.3	AMP.
PLATE VOLTAGE	100	250	VOLTS
GRID VOLTAGE	-1	-3	VOLTS
PLATE CURRENT	0.8	1.0	MA.
PLATE RESISTANCE	54 000	58 000	OHMS
TRANSCONDUCTANCE	1 300	1 200	μMHOS
AMPLIFICATION FACTOR	70	70	

DIODE UNITS - TWO

THE DIODE UNITS ARE INDEPENDENT OF THE TRIODE UNIT EXCEPT FOR THE COMMON CATHODE SLEEVE.

SIMILAR TYPE REFERENCE: Ratings and characteristics somewhat similar to 6Q7, 6Q7GT, 6S27, 6S27GT, 7B6, 7C6.

→ INDICATES A CHANGE OR ADDITION:

6AT6

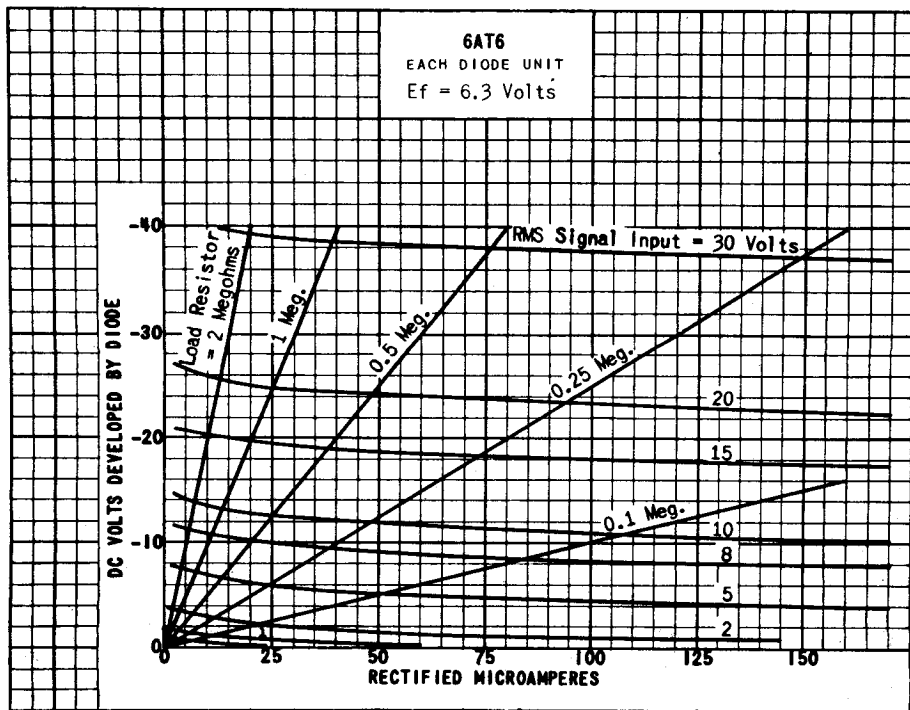
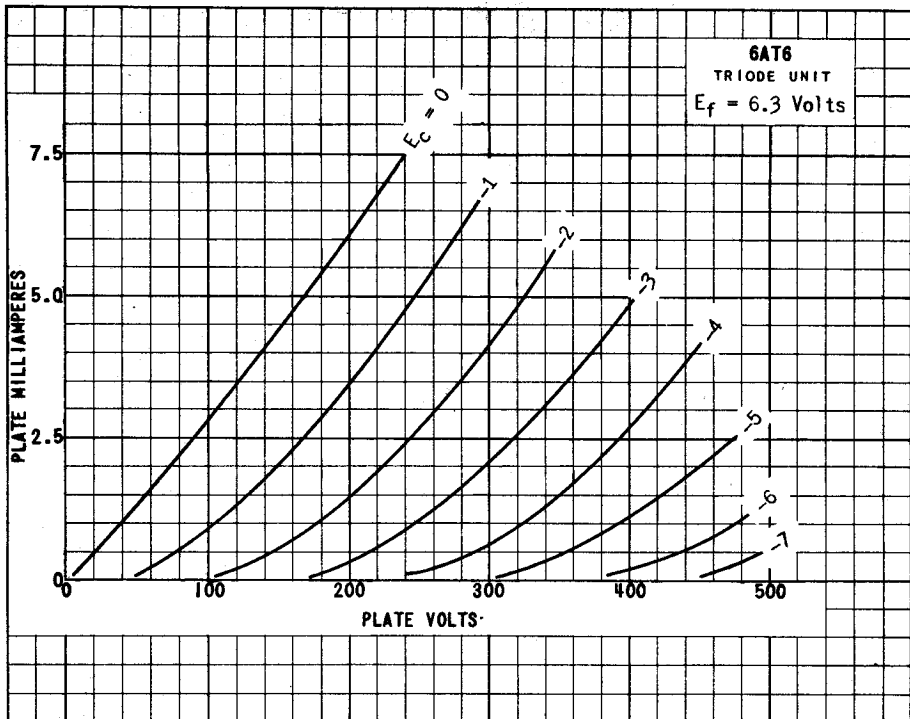

PLATE
1841
JULY 1,
1947

TUNG-SOL

LOW-MU TWIN POWER TRIODE

PHYSICAL SPECIFICATIONS

EMITTER UNIPOTENTIAL CATHODE	PIN CONNECTIONS	
BASE MEDIUM SHELL OCTAL 8-PIN	PIN 1-G TRI. 2	PIN 7-HEATER
CAP ---	PIN 2-P TRI. 2	PIN 8-HEATER
BULB ST-16	PIN 3-K TRI. 2	
MAXIMUM DIAMETER 2 1/16"	PIN 4-G TRI. 1	MOUNTING POS. ANY
MAXIMUM OVERALL LENGTH 5 5/16"	PIN 5-P TRI. 1	
MAXIMUM SEATED HEIGHT 4 3/4"	PIN 6-K TRI. 1	

RATINGS

INTERPRETED ACCORDING TO RMA STANDARD M8-210

PER TRIODE UNIT

HEATER OR FILAMENT VOLTAGE (AC OR DC)	6.3	VOLTS
HEATER OR FILAMENT CURRENT	2.5	AMPS.
MAXIMUM PLATE VOLTAGE	250	VOLTS
PLATE CURRENT	125	MA.
MAXIMUM PLATE DISSIPATION	13	WATTS
MAXIMUM SCREEN DISSIPATION		WATTS
MAXIMUM PEAK HEATER CATHODE VOLTAGE:		
HEATER POS. WITH RESPECT TO CATHODE	300	VOLTS
HEATER NEG. WITH RESPECT TO CATHODE	300	VOLTS

CAPACITANCES

CONTROL GRID TO CATHODE	μf
PLATE TO CATHODE	μf
GRID TO PLATE	μf

TYPICAL OPERATING CONDITIONS AND CHARACTERISTICS

DC AMPLIFIER

PER TRIODE UNIT

HEATER OR FILAMENT VOLTAGE	6.3	VOLTS
HEATER OR FILAMENT CURRENT	2.5	AMPS.
PLATE-SUPPLY VOLTAGE	135	VOLTS
CATHODE-BIAS RESISTOR	250	OHMS
PLATE CURRENT	125	MA.
PEAK AF SIGNAL VOLTAGE		VOLTS
ZERO-SIGNAL PLATE CURRENT		MA.
ZERO-SIGNAL SCREEN CURRENT		MA.
MAXIMUM-SIGNAL PLATE CURRENT		MA.
MAXIMUM-SIGNAL SCREEN CURRENT		MA.
PLATE RESISTANCE	280	OHMS
TRANSCONDUCTANCE	7500	μMHOS
AMPLIFICATION FACTOR	2.1	
TOTAL HARMONIC DISTORTION		PER CENT
POWER OUTPUT		WATTS

MAXIMUM CIRCUIT VALUES (FOR MAXIMUM RATED CONDITIONS):

MAXIMUM GRID RESISTANCE:	
FOR CATHODE BIAS	1.0 MEGOHM
FIXED BIAS	OPERATION NOT RECOMMENDED

PLATE
1704

APRIL 15
1946

6AS7G

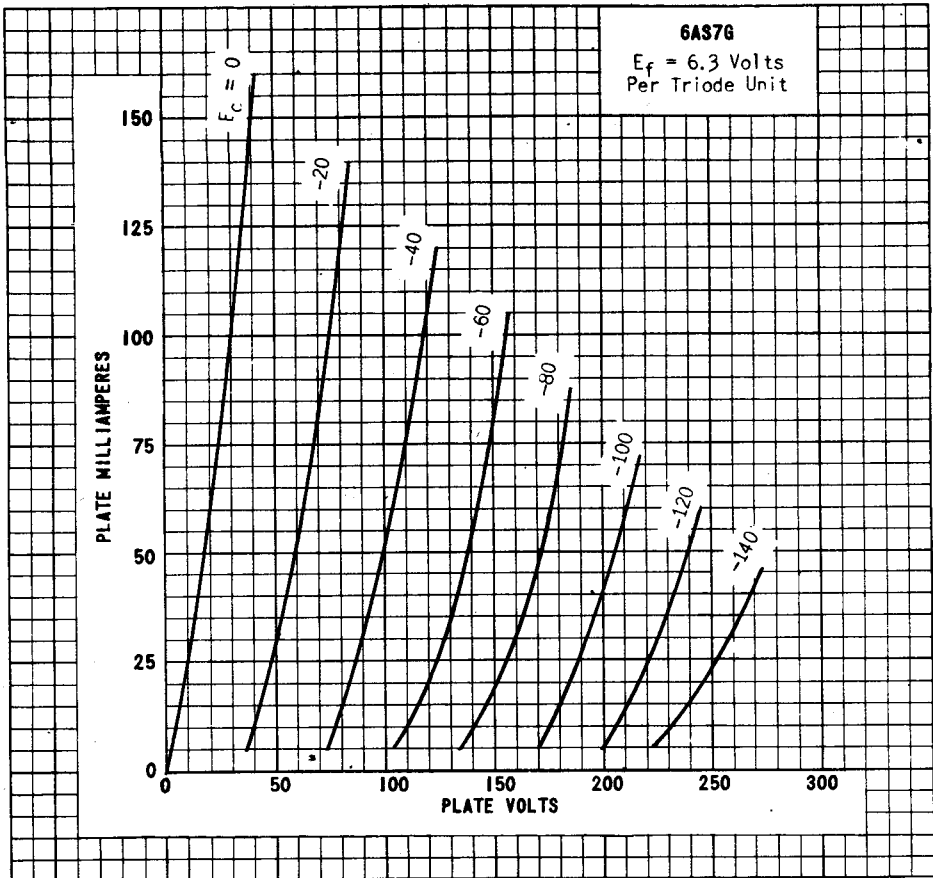

PLATE
1705
APRIL 15
1946

TUNG-SOL

RF AMPLIFIER PENTODE

MINIATURE TYPE

UNIPOENTIAL CATHODE

HEATER

6.3 VOLTS 0.3 AMPERE

AC OR DC

ANY MOUNTING POSITION

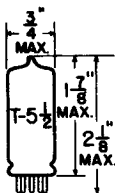

GLASS BULB

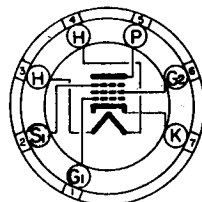

BOTTOM VIEW

MINIATURE BUTTON
7 PIN BASE

THE 6AU6 IS A PENTODE AMPLIFIER HAVING A SHARP CUT-OFF CONTROL CHARACTERISTIC USING THE MINIATURE CONSTRUCTION. WITH HIGH TRANSCONDUCTANCE, LOW GRID-PLATE CAPACITANCE, IT IS INTENDED FOR SERVICE AS EITHER AN RF OR AF AMPLIFIER.

RATINGS

INTERPRETED ACCORDING TO RMA STANDARD HB-210

HEATER VOLTAGE	6.3	VOLTS
HEATER CURRENT	0.3	AMP.
MAXIMUM PLATE VOLTAGE	300	VOLTS
MAXIMUM SCREEN VOLTAGE	150	VOLTS
MAXIMUM SCREEN SUPPLY VOLTAGE	300	VOLTS
MAXIMUM GRID VOLTAGE:		
NEGATIVE BIAS	50	VOLTS
POSITIVE BIAS	0	VOLTS
MAXIMUM PLATE DISSIPATION	3	WATTS
MAXIMUM SCREEN DISSIPATION	0.65	WATTS
MAXIMUM HEATER-CATHODE VOLTAGE	90	VOLTS

DIRECT INTERELECTRODE CAPACITANCES

WITH NO EXTERNAL SHIELD

GRID TO PLATE (MAX.)	0.0035	μ f
INPUT	5.5	μ f
OUTPUT	5	μ f

TYPICAL OPERATING CONDITIONS AND CHARACTERISTICS

CLASS A₁ AMPLIFIER

PLATE VOLTAGE	100	250	250	VOLTS
SCREEN VOLTAGE	100	125	150	VOLTS
GRID VOLTAGE	-1	-1	-1	VOLT
SUPPRESSOR VOLTAGE	0	0	0	VOLTS
PLATE CURRENT	5.2	7.6	10.8	MA.
SCREEN CURRENT	2.0	3.0	4.3	MA.
PLATE RESISTANCE (APPROX.)	0.5	1.5	1	MEG OHMS
TRANSCONDUCTANCE	3 900	4 450	5 200	μ MHOS
GRID VOLTAGE FOR PLATE CURRENT = 10 μ A.	-4.2	-5.2	-6.2	VOLTS

→ INDICATES A CHANGE OR ADDITION.

6AU6

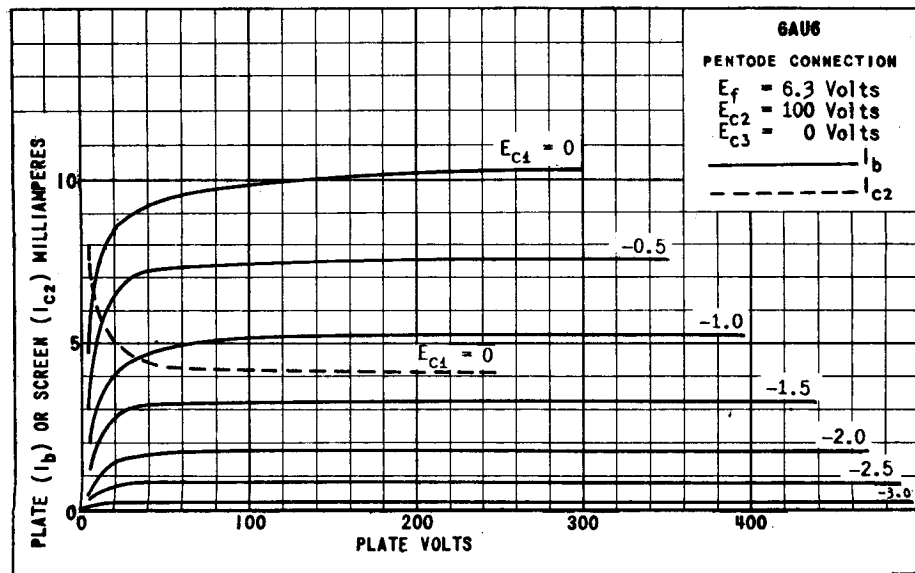
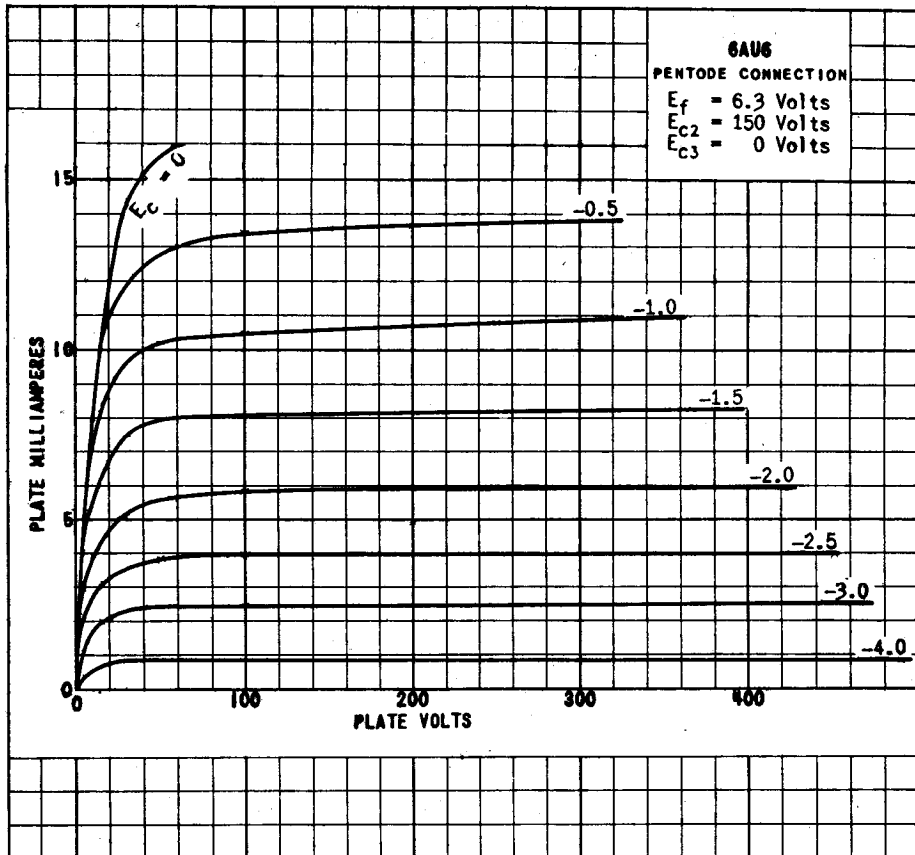
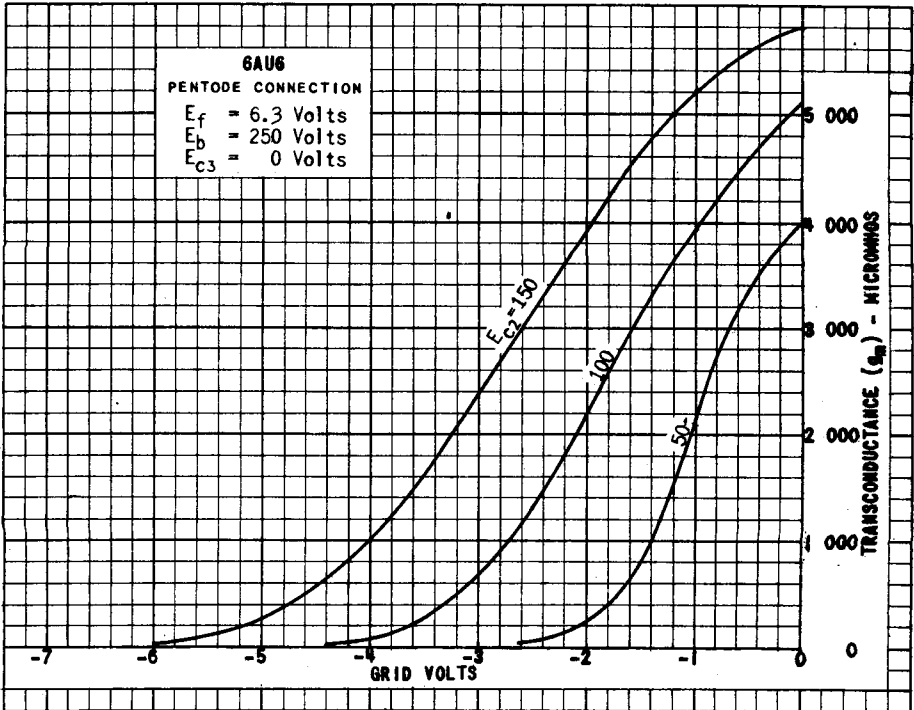
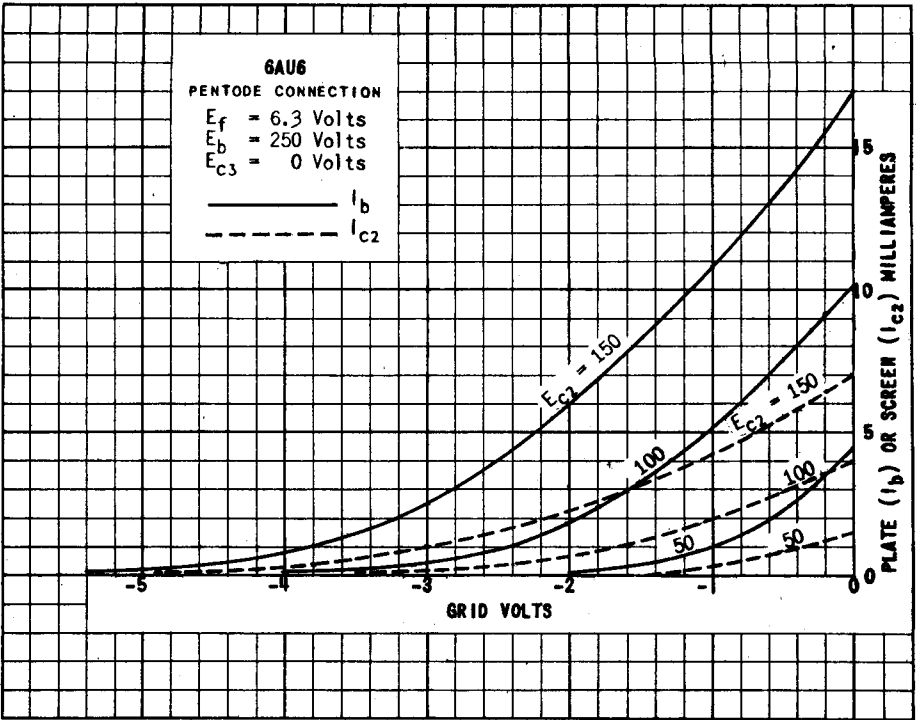

PLATE
 1787
 MAY 1
 1947



PRINTED IN U. S. A.

PLATE
1788
MAY 1
1947



TUNG-SOL

DOUBLE-DIODE TRIODE

MINIATURE TYPE

COATED UNIPOTENTIAL CATHODE

HEATER

6.3 VOLTS 300 MA.

AC OR DC

ANY MOUNTING POSITION

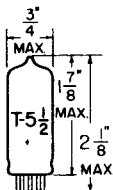

GLASS BULB

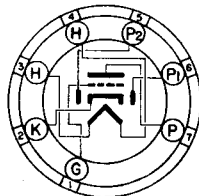

BOTTOM VIEW

MINIATURE BUTTON
7 PIN BASE

THE 6AV6 COMBINES A HIGH-MU TRIODE AND TWO INDEPENDENT DIODE UNITS IN THE 7-PIN MINIATURE CONSTRUCTION. IT PERMITS A SINGLE TUBE TO FUNCTION AS DETECTOR, AVC RECTIFIER, AND AUDIO AMPLIFIER. COUPLING BETWEEN THE DIODE AND TRIODE SECTIONS IS MINIMIZED BY THE USE OF INTERNAL SHIELDING.

RATINGS

INTERPRETED ACCORDING TO RMA STANDARD M8-210

FILAMENT VOLTAGE	6.3	VOLTS
MAXIMUM HEATER-CATHODE VOLTAGE	90	VOLTS
MAXIMUM PLATE VOLTAGE	300	VOLTS
MAXIMUM DIODE CURRENT EACH PLATE FOR CONTINUOUS OPERATION	1.0	MA.

TYPICAL OPERATING CONDITIONS AND CHARACTERISTICS

TRIODE UNIT - CLASS A₁ AMPLIFIER

FILAMENT VOLTAGE	6.3	6.3	VOLTS
FILAMENT CURRENT	300	300	MA.
PLATE VOLTAGE	100	250	VOLTS
GRID VOLTAGE	-1	-2	VOLTS
PLATE CURRENT	0.5	1.2	MA.
PLATE RESISTANCE	80 000	62 500	OHMS
TRANSCONDUCTANCE	1 250	1 600	μMHMS
AMPLIFICATION FACTOR	100	100	

DIODE UNITS - TWO

THE DIODE UNITS ARE INDEPENDENT OF THE TRIODE UNIT EXCEPT FOR THE COMMON CATHODE SLEEVE.

DIODE BIASING OF THE TRIODE UNIT IS NOT SUITABLE.

SIMILAR TYPE REFERENCE: Ratings and characteristics somewhat similar to 6AT6 except for the use of more thorough shielding of the diode units from the triode.

CONTINUED ON FOLLOWING PAGE

CONTINUED FROM PRECEDING PAGE

RESISTANCE COUPLED AMPLIFIER

R_L MEG.	R_C MEG.	$E_{bb} = 90$ VOLTS			$E_{bb} = 180$ VOLTS			$E_{bb} = 300$ VOLTS		
		R_k	GAIN	E_o	R_k	GAIN	E_o	R_k	GAIN	E_o
0.1	0.22	4700	35 ^A	4	2000	47	18	1500	52	40
0.22	0.47	7400	45 ^B	6	3500	59	24	2800	65	49
0.47	1.0	13000	52 ^C	8	6700	66	28	5200	73	54

 E_o IS RMS OUTPUT AT GRID CURRENT POINT.

GAIN MEASURED AT 5.0 VOLTS RMS OUTPUT EXCEPT AS INDICATED.

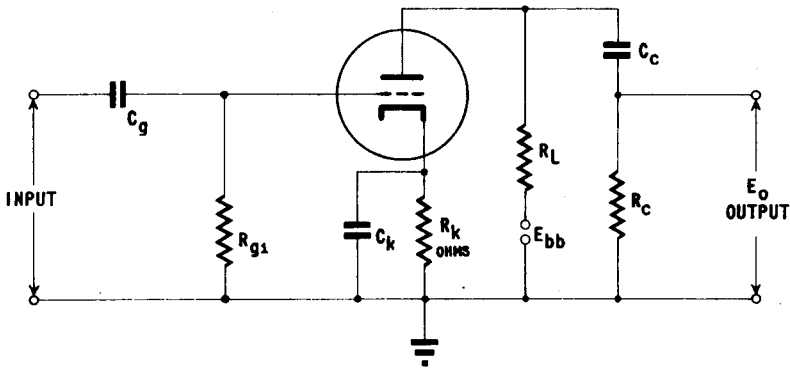
^A OUTPUT VOLTAGE OF 2 VOLTS RMS.^B OUTPUT VOLTAGE OF 3 VOLTS RMS.^C OUTPUT VOLTAGE OF 4 VOLTS RMS.

NOTE: COUPLING CAPACITORS C_g AND C_c SHOULD BE SELECTED TO GIVE DESIRED FREQUENCY RESPONSE. R_k SHOULD BE ADEQUATELY BY-PASSED BY CAPACITOR C_k .

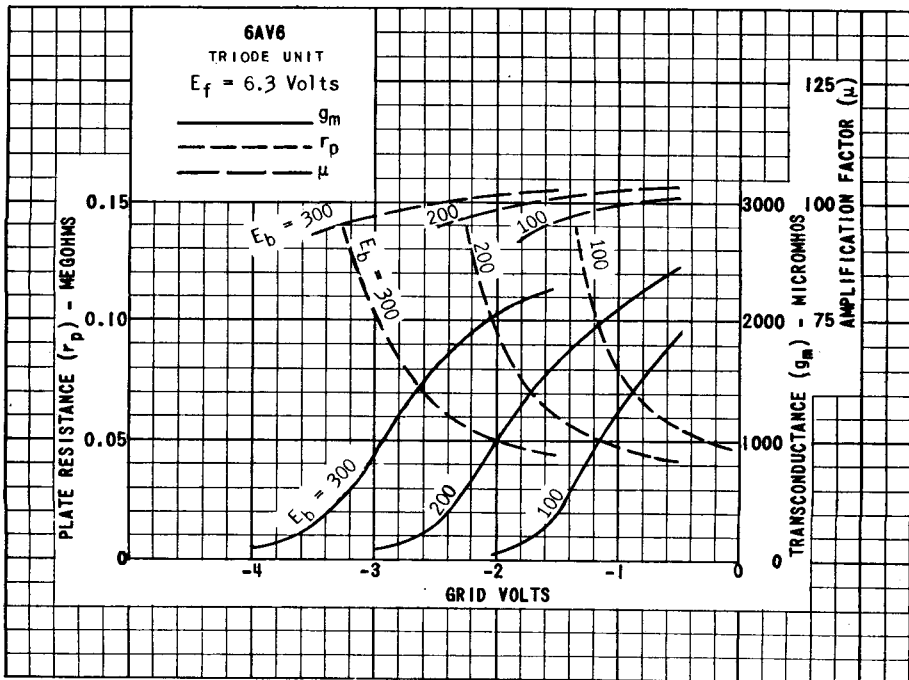
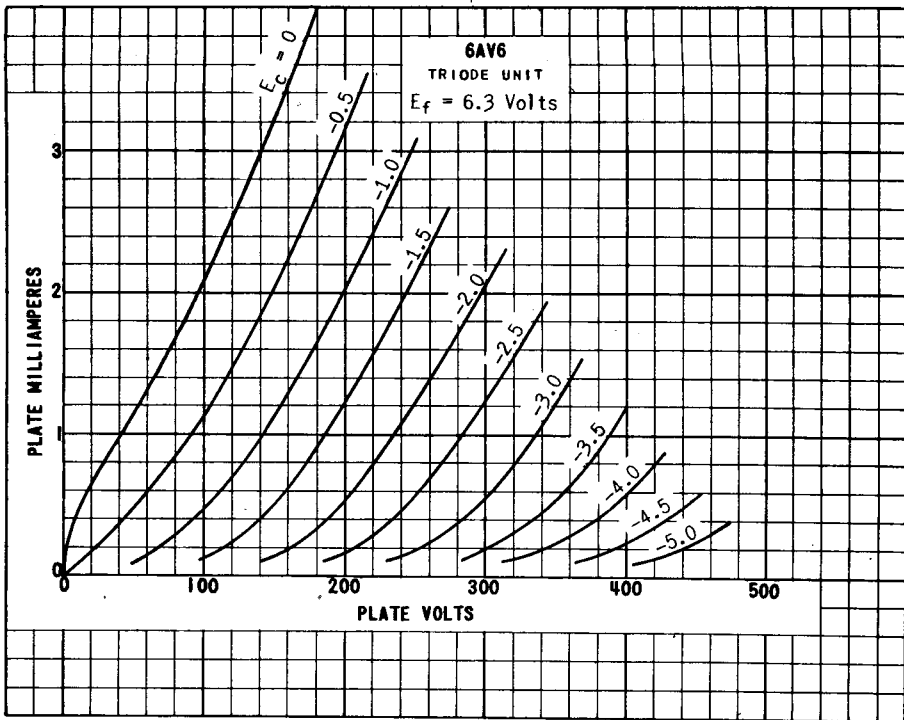

PRINTED IN U. S. A.

PLATE 1961
FEB. 2,
1948

6AV6

6AV6
EACH DIODE UNIT
 $E_f = 6.9$ Volts

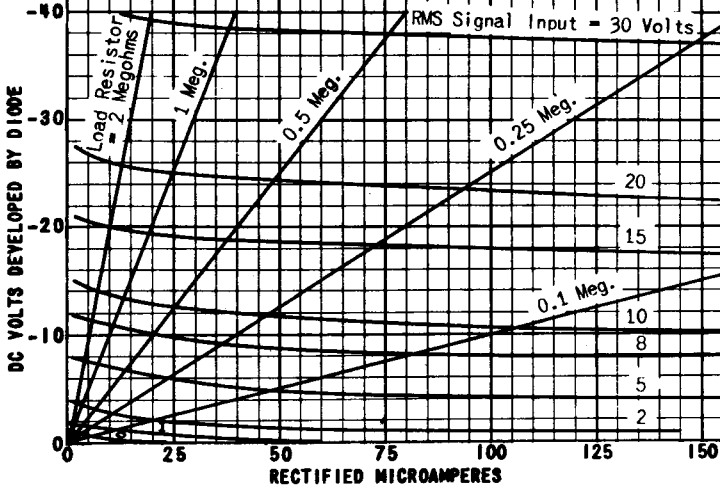

PLATE
1962
FEB. 2,
1948

TUNG-SOL

RF AMPLIFIER PENTODE

MINIATURE TYPE

UNIPOTENTIAL CATHODE

HEATER

6.3 VOLTS 0.30 AMPERE

AC OR DC

ANY MOUNTING POSITION

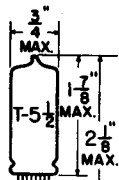

GLASS BULB

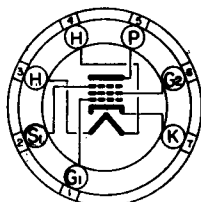

BOTTOM VIEW

MINIATURE BUTTON
7 PIN BASE

THE 6BA6 IS A PENTODE AMPLIFIER HAVING A REMOTE CONTROL GRID CHARACTERISTIC AND UTILIZING THE MINIATURE CONSTRUCTION. AS A RF AMPLIFIER IT IS CHARACTERIZED BY HIGH TRANSCONDUCTANCE AND LOW GRID-PLATE CAPACITANCE AND TRANSCONDUCTANCE.

RATINGS

INTERPRETED ACCORDING TO RMA STANDARD MB-210

HEATER VOLTAGE	6.3	VOLTS
HEATER CURRENT	0.30	AMP.
MAXIMUM PLATE VOLTAGE	300	VOLTS
MAXIMUM SCREEN VOLTAGE	125	VOLTS
MAXIMUM SCREEN SUPPLY VOLTAGE	300	VOLTS
MAXIMUM GRID VOLTAGE:		
NEGATIVE BIAS	50	VOLTS
POSITIVE BIAS	0	VOLTS
MAXIMUM PLATE DISSIPATION	3	WATTS
MAXIMUM SCREEN DISSIPATION	0.6	WATTS
MAXIMUM PEAK HEATER-CATHODE VOLTAGE:		
HEATER NEG. WITH RESPECT TO CATHODE	90	VOLTS
HEATER POS. WITH RESPECT TO CATHODE	90	VOLTS

DIRECT INTERELECTRODE CAPACITANCES

WITH NO EXTERNAL SHIELD

GRID TO PLATE (MAX.)	0.0035	$\mu\mu\text{f}$
INPUT	5.5	$\mu\mu\text{f}$
OUTPUT	5.0	$\mu\mu\text{f}$

TYPICAL OPERATING CONDITIONS AND CHARACTERISTICS

CLASS A₁ AMPLIFIER

PLATE VOLTAGE	100	250	VOLTS
SCREEN VOLTAGE	100	100	VOLTS
CATHODE BIAS RESISTOR	68	68	OHMS
SUPPRESSOR VOLTAGE	0	0	VOLTS
PLATE CURRENT	10.8	11	MA.
SCREEN CURRENT	4.4	4.2	MA.
PLATE RESISTANCE (APPROX.)	0.25	1.5	MEG OHMS
TRANSCONDUCTANCE	4 300	4 400	μMHOS
GRID VOLTAGE (APPROX.) FOR TRANSCONDUCTANCE = 40 μMHOS	-20	-20	VOLTS

→ INDICATES A CHANGE OR ADDITION.

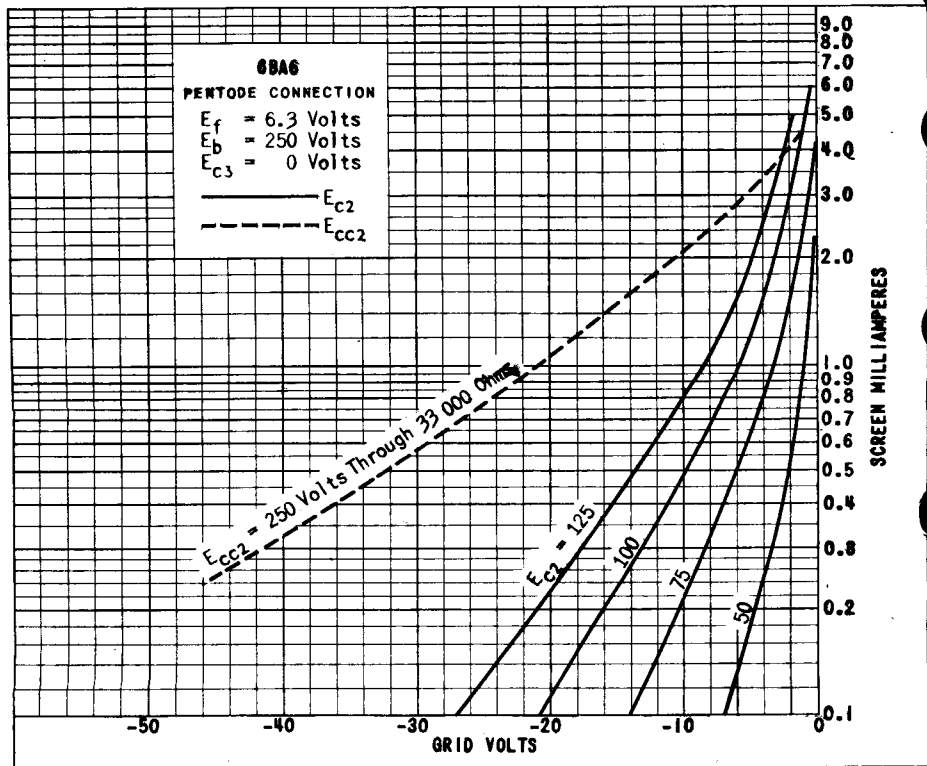
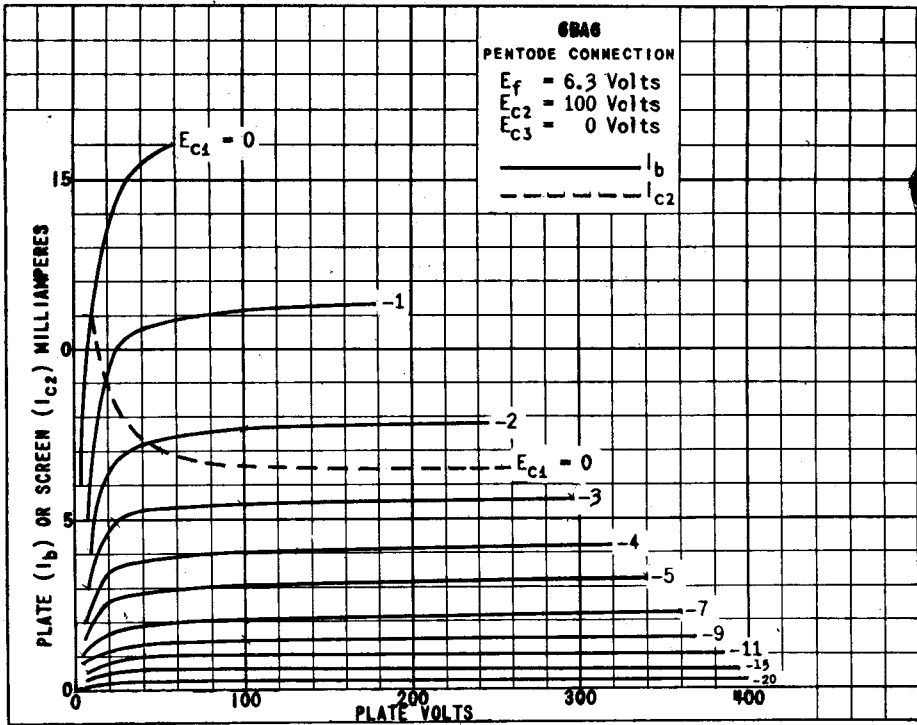

6BA6
PENTODE CONNECTION

$E_f = 6.3$ Volts
 $E_b = 250$ Volts
 $E_{c3} = 0$ Volts

————— E_{c2}
----- E_{cc2}

$E_{cc2} = 250$ Volts Through $33,000$ Ohms

$E_{c2} = 125$
100
75
50

-50 -40 -30 -20 -10 0
GRID VOLTS

20.0
10.0
9.0
8.0
7.0
6.0
5.0
4.0
3.0
2.0
1.0
0.9
0.8
0.7
0.6
0.5
0.4
0.3
0.2
0.1
PLATE MILLIAMPERES

PRINTED IN U. S. A.

PLATE
1791
MAY 1
1947

6BA6

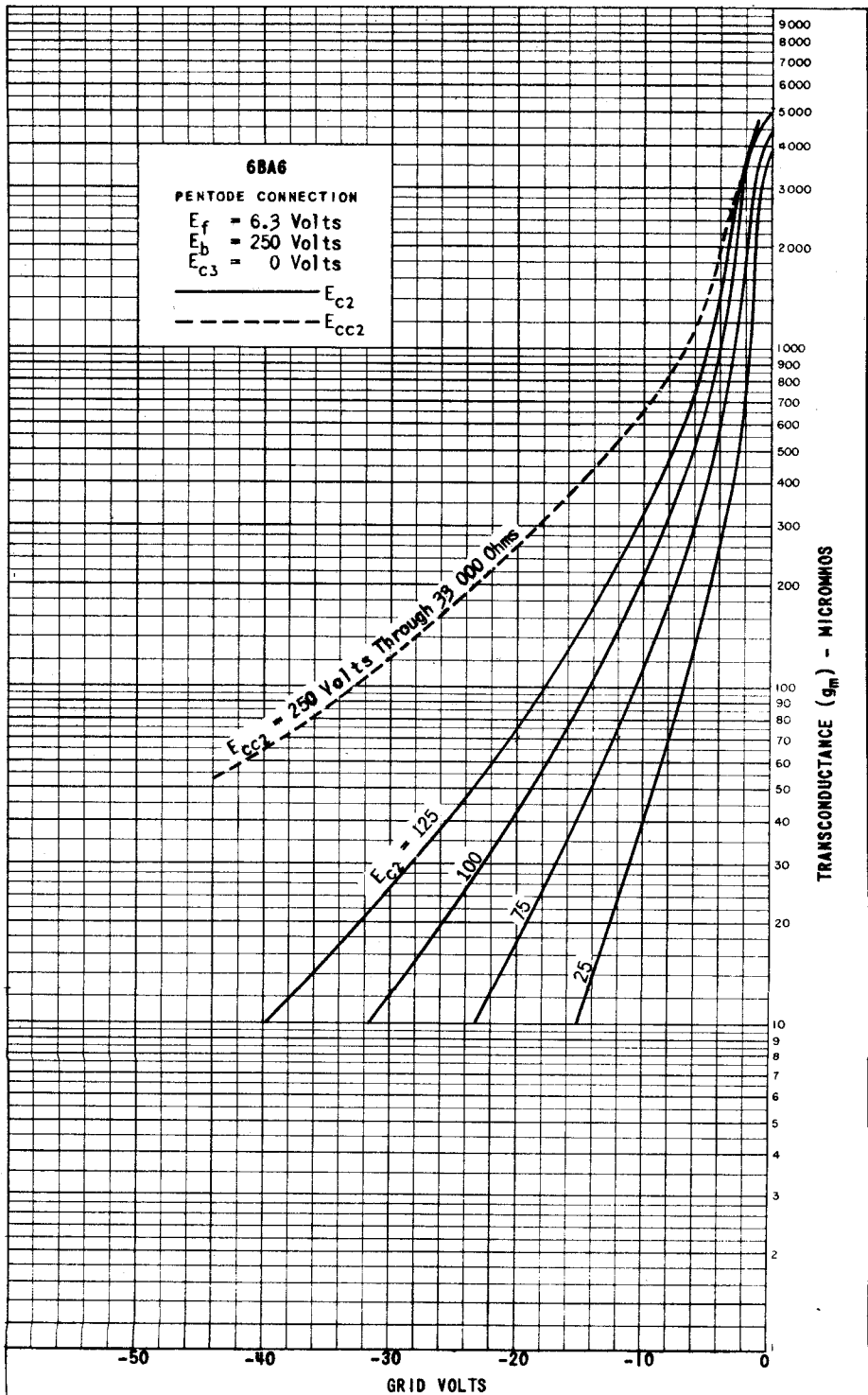

PLATE
 1792
 MAY 1
 1947

TUNG-SOL

HEPTODE

MINIATURE TYPE

UNIPOTENTIAL CATHODE

HEATER

6.3 VOLTS 300 MA.

AC OR DC

ANY MOUNTING POSITION

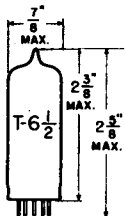

GLASS BULB

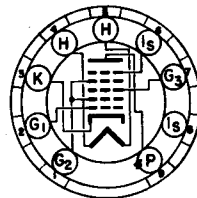

BOTTOM VIEW
SMALL BUTTON
9 PIN BASE

THE 6BA7 IS A CATHODE TYPE HIGH GAIN PENTAGRID CONVERTER IN THE SMALL 9-PIN BUTTON CONSTRUCTION. IT IS DESIGNED FOR SERVICE AS A COMBINED LOCAL OSCILLATOR AND MIXER AT HIGH FREQUENCIES, ESPECIALLY IN THE FM BROADCAST BAND.

DIRECT INTERELECTRODE CAPACITANCES

WITH NO EXTERNAL SHIELD

GRID #3 TO PLATE: (G ₃ TO P) MAX.	0.19	μf
GRID #1 TO GRID #3: (G ₁ TO G ₃) MAX.	0.1	μf
GRID #1 TO PLATE: (G ₁ TO P) MAX.	0.05	μf
GRID #1 TO CATHODE: (G ₁ TO K)	3.3	μf
GRID #1 TO ALL EXCEPT CATHODE: G ₁ TO (H+G ₂ +G ₄ +G ₃ +G ₅ +P+IS)	3.4	μf
CATHODE TO ALL EXCEPT GRID #1: K TO (H+G ₂ +G ₄ +G ₃ +G ₅ +P+IS)	4	μf
RF INPUT: G ₃ TO (H+K+G ₁ +G ₂ +G ₄ +G ₅ +P+IS)	9.5	μf
OSCILLATOR INPUT: G ₁ TO (H+K+G ₂ +G ₄ +G ₃ +G ₅ +P+IS)	6.7	μf
MIXER OUTPUT: P TO (H+K+G ₁ +G ₂ +G ₄ +G ₃ +G ₅ +IS)	8.3	μf

RATINGS

INTERPRETED ACCORDING TO RMA STANDARD M8-220

HEATER VOLTAGE	6.3	VOLTS
MAXIMUM HEATER-CATHODE VOLTAGE	90	VOLTS
MAXIMUM PLATE VOLTAGE	300	VOLTS
MAXIMUM GRIDS #2 & #4 VOLTAGE	100	VOLTS
MAXIMUM GRIDS #2 & #4 SUPPLY VOLTAGE	300	VOLTS
MAXIMUM NEGATIVE GRID #3 VOLTAGE	100	VOLTS
MAXIMUM POSITIVE GRID #3 VOLTAGE	0	VOLTS
MAXIMUM GRID #5 & INTERNAL SHIELD VOLTAGE ^A	0	VOLTS
MAXIMUM PLATE DISSIPATION	2	WATTS
MAXIMUM GRIDS #2 & #4 DISSIPATION	1.5	WATTS
MAXIMUM CATHODE CURRENT	22	MA.

^A INTERNAL SHIELD (PINS #6 AND #8) CONNECTED DIRECTLY TO GROUND.

PLATE
2079
OCT. 1,
1948

CONTINUED ON FOLLOWING PAGE

TUNG-SOL

CONTINUED FROM PRECEDING PAGE

TYPICAL OPERATING CONDITIONS AND CHARACTERISTICS

CONVERTER SERVICE - SEPARATE EXCITATION

THE CHARACTERISTICS SHOWN WITH SEPARATE EXCITATION
CORRESPOND VERY CLOSELY WITH THOSE OBTAINED IN A
SELF-EXCITED OSCILLATOR CIRCUIT OPERATING WITH ZERO
BIAS.

HEATER VOLTAGE	6.3	6.3	VOLTS
HEATER CURRENT	300	300	MA.
PLATE VOLTAGE	100	250	VOLTS
GRIDS #2 & #4 VOLTAGE	100	100	VOLTS
GRID #3 VOLTAGE	-1	-1	VOLTS
GRID #5 AND INTERNAL SHIELD ^A	CONNECTED DIRECTLY TO GROUND		
GRID #1 RESISTOR	20 000	20 000	OHMS
PLATE RESISTANCE (APPROX.)	0.5	1	MEGOHM
CONVERSION TRANSCONDUCTANCE	900	950	μMHOS
PLATE CURRENT	3.6	3.8	MA.
GRIDS #2 & #4 CURRENT	10.2	10	MA.
GRID #1 CURRENT	0.35	0.35	MA.
TOTAL CATHODE CURRENT	14.2	14.2	MA.
CONVERSION TRANSCONDUCTANCE WITH E _{C3} = -20 VOLTS	3.5	3.5	μMHOS

^A INTERNAL SHIELD (PINS #6 AND #8) CONNECTED DIRECTLY TO GROUND.

OSCILLATOR TRANSCONDUCTANCE
NOT OSCILLATING

GRID #3 VOLTAGE	0	VOLTS
GRID #1 VOLTAGE	0	VOLTS
GRIDS #2 & #4 CONNECTED TO PLATE	100	VOLTS
PLATE CURRENT	32	MA.
TRANSCONDUCTANCE BETWEEN GRID #1 & GRIDS #2 & #4 CONNECTED TO PLATE	8 000	μMHOS
AMPLIFICATION FACTOR	16.5	

SIMILAR TYPE REFERENCE: Ratings and Characteristics similar to 6SB7Y.

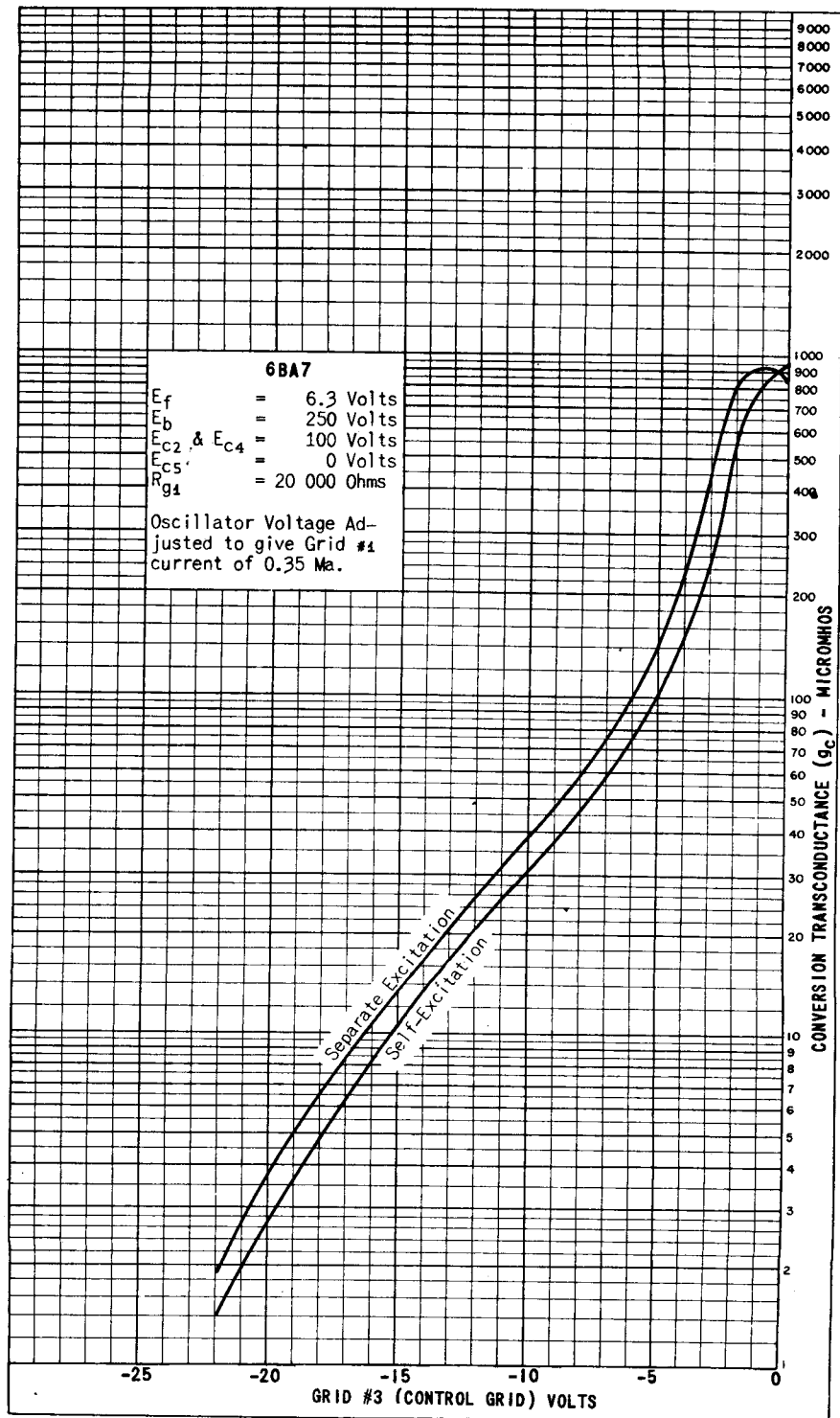

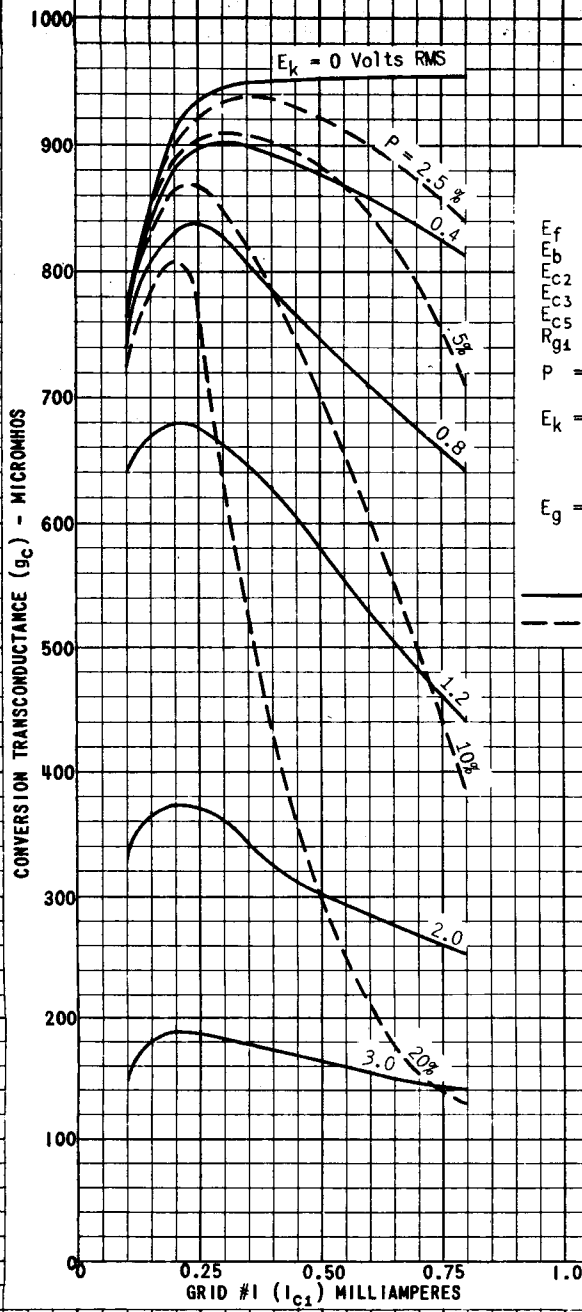

6BA7
 SELF-EXCITATION

$E_f = 6.3$ Volts
 $E_b = 250$ Volts
 $E_{C2} \text{ \& } E_{C4} = 100$ Volts
 $E_{C3} = -1$ Volt
 $E_{C5} = 0$ Volts
 $R_{g1} = 20\ 000$ Ohms

$P =$ Percentage Ratio of E_k to $E_k + E_g$ where
 $E_k =$ Voltage across Oscillator-coil Section between Ground and Cathode
 $E_g =$ Oscillator Voltage between Cathode and Grid.

— g_c for values of E_k
 - - g_c for values percent P

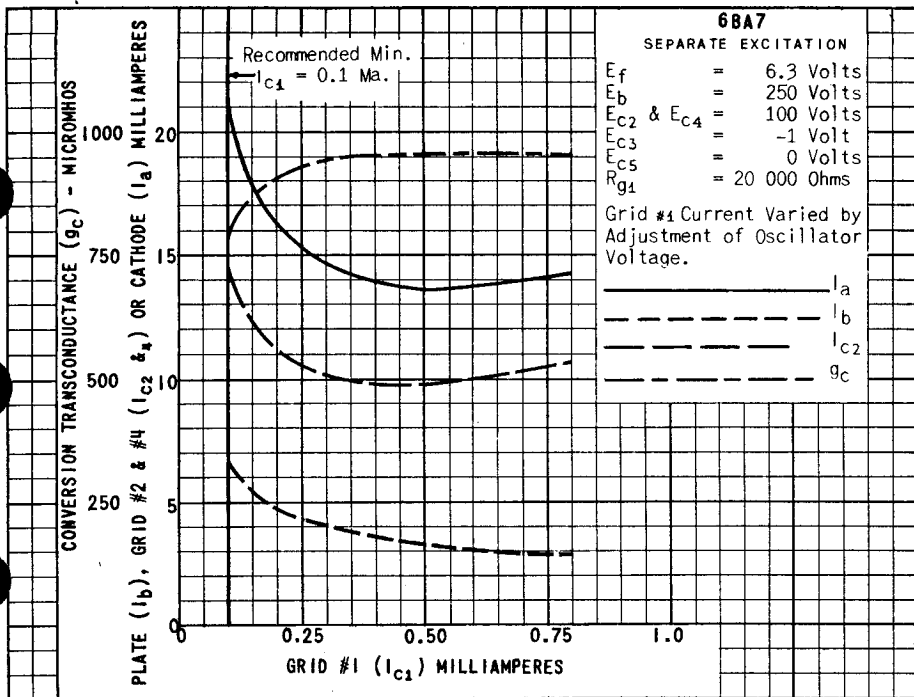

PRINTED IN U. S. A.

PLATE 2083
OCT. 1, 1948



TUNG-SOL

HEPTODE

MINIATURE TYPE

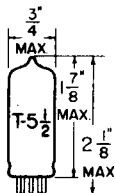

GLASS BULB

COATED UNIPOTENTIAL CATHODE

HEATER

6.3 VOLTS 300 MA.

AC OR DC

ANY MOUNTING POSITION

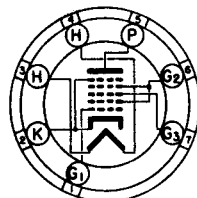

BOTTOM VIEW

MINIATURE BUTTON
7 PIN BASE

THE 6BE6 IS A PENTAGRID CONVERTER USING THE MINIATURE CONSTRUCTION AND, INTENDED FOR SERVICE AS COMBINED OSCILLATOR AND MIXER IN SUPERHETERODYNE RECEIVERS.

DIRECT INTERELECTRODE CAPACITANCES

WITH EXTERNAL SHIELD #316 CONNECTED TO PIN #2

SIGNAL GRID TO PLATE: (G ₃ TO P) MAX. (WITHOUT SHIELD)	0.30	μμf
SIGNAL GRID TO OSC. GRID: (G ₃ TO G ₁) MAX.	0.15	μμf
OSC. GRID TO PLATE: (G ₁ TO P) MAX.	0.05	μμf
RF INPUT: G ₃ TO (H+K&G ₅ +G ₁ +G ₂ &G ₄ +P)	7.4	μμf
OSC. INPUT: G ₁ TO (H+K&G ₅ +G ₂ &G ₄ +G ₃ +P)	5.7	μμf
MIXER OUTPUT: P TO (H+K&G ₅ +G ₁ +G ₂ &G ₄ +G ₃)	13.6	μμf
OSC. GRID TO CATHODE: (G ₁ TO K)	2.8	μμf
OSC. OUTPUT: K TO (H+G ₂ &G ₄ +G ₃ +P+S)	15.5	μμf

RATINGS

INTERPRETED ACCORDING TO RMA STANDARD M8-210

HEATER VOLTAGE	6.3	VOLTS
MAXIMUM HEATER-CATHODE VOLTAGE	90	VOLTS
MAXIMUM PLATE VOLTAGE	300	VOLTS
MAXIMUM GRID #2 AND #4 VOLTAGE	100	VOLTS
MAXIMUM GRID #2 AND #4 SUPPLY VOLTAGE	300	VOLTS
MAXIMUM NEGATIVE DC GRID #3 VOLTAGE	50	VOLTS
MAXIMUM POSITIVE DC GRID #3 VOLTAGE	0	VOLTS
MINIMUM GRID #3 EXTERNAL BIAS VOLTAGE ^A	0	VOLTS
MAXIMUM PLATE DISSIPATION	1	WATT
MAXIMUM GRID #2 DISSIPATION	1	WATT
MAXIMUM CATHODE CURRENT	14	MA.

^A WITH SELF-EXCITED OSCILLATOR

CONTINUED ON FOLLOWING PAGE

→ INDICATES A CHANGE OR ADDITION

TUNG-SOL

CONTINUED FROM PRECEDING PAGE

TYPICAL OPERATING CONDITIONS AND CHARACTERISTICS

CONVERTER SERVICE - SEPARATE EXCITATION
 CHARACTERISTICS SHOWN ARE OBTAINED IN THE STANDARD
 RMA CONVERSION CONDUCTANCE TEST SET WHICH USES SE-
 PARATE EXCITATION. THE CHARACTERISTICS UNDER THESE
 CONDITIONS CORRESPOND VERY CLOSELY WITH THOSE OB-
 TAINED IN A SELF-EXCITED OSCILLATORY CIRCUIT OPER-
 ATING AT ZERO-BIAS.

HEATER VOLTAGE	6.3	6.3	VOLTS
HEATER CURRENT	300	300	MA.
PLATE VOLTAGE	100	250	VOLTS
GRID #3 VOLTAGE	-1.5	-1.5	VOLTS
GRID #2 AND #4 VOLTAGE	100	100	VOLTS
PLATE RESISTANCE (APPROX.)	0.5	1	MEGOHMS
OSCILLATOR (GRID #1) RESISTOR	20 000	20 000	OHMS
OSCILLATOR (GRID #1) CURRENT	0.5	0.5	MA.
CONVERSION TRANSCONDUCTANCE	455	475	μ MHOS
PLATE CURRENT	2.8	3	MA.
GRID #2 AND #4 CURRENT	8	7.8	MA.
GRID #3 VOLTAGE (APPROX.) FOR $G_c = 5 \mu$ MHOS	-30	-30	VOLTS

OSCILLATOR CHARACTERISTICS
 BOOTON TYPE 10A STANDARD OSCILLATOR

PLATE VOLTAGE	100	250	VOLTS
GRIDS #2 AND #4 VOLTAGE	100	100	VOLTS
GRID #3 VOLTAGE	0	0	VOLTS
OSCILLATOR (GRID #1) RESISTOR	50 000	50 000	OHMS
OSCILLATOR (GRID #1) CURRENT FOR $Z_{g-k} = 3100$ OHMS	200	200	μ A
OSCILLATOR (GRID #1) CURRENT FOR $Z_{g-k} = 1250$ OHMS	75	75	μ A

OSCILLATOR TRANSCONDUCTANCE
 NOT OSCILLATING

GRID #3 VOLTAGE	0	VOLTS
OSCILLATOR (GRID #1) VOLTAGE	0	VOLTS
GRID #2 AND #4 CONNECTED TO PLATE	100	VOLTS
PLATE CURRENT	25	MA.
TRANSCONDUCTANCE BETWEEN GRID #1 AND GRID #2 & #4 CONNECTED TO PLATE	7 250	μ MHOS
AMPLIFICATION FACTOR	20	

→ INDICATES A CHANGE OR ADDITION

PLATE
 2049
 AUG. 2,
 1948

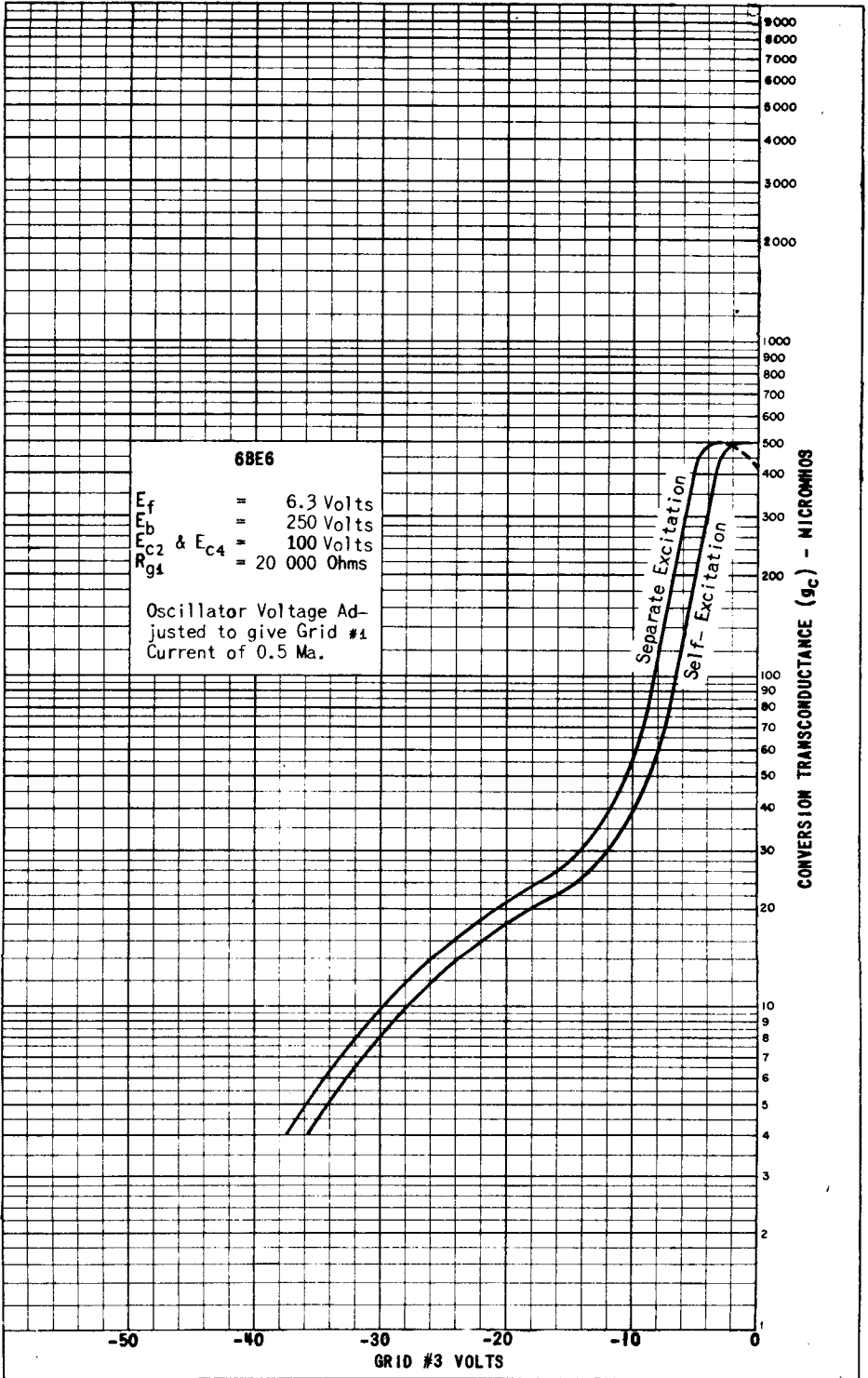

PRINTED IN U.S.A.

PLATE 2050
AUG. 2, 1948

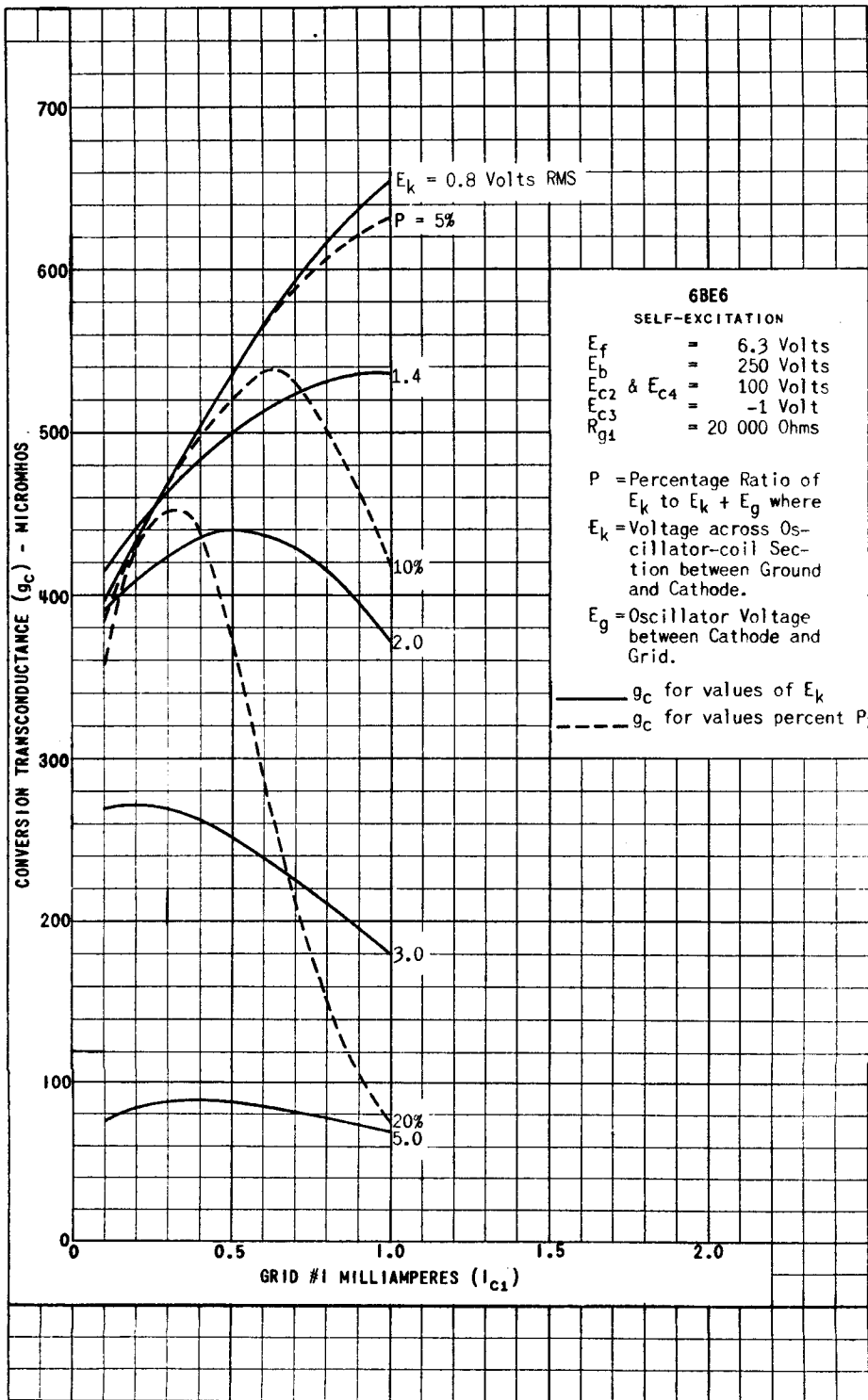

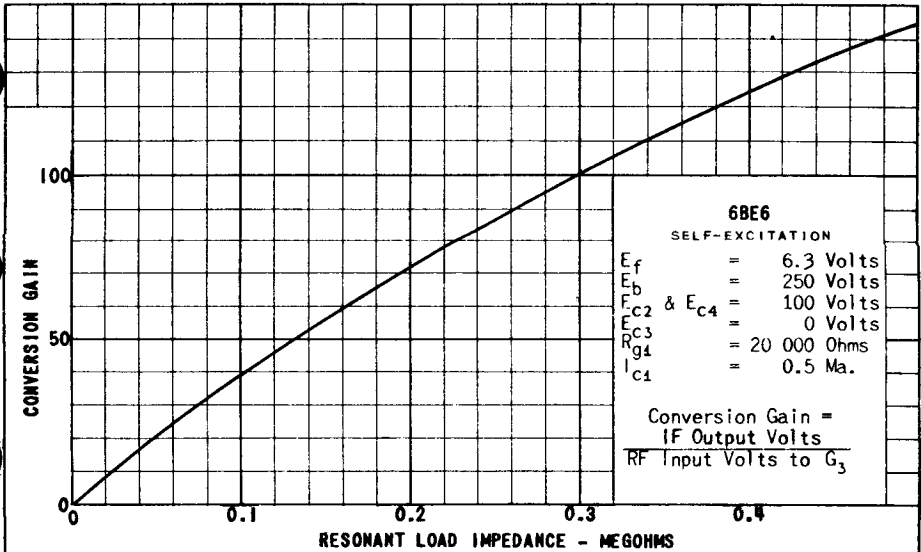
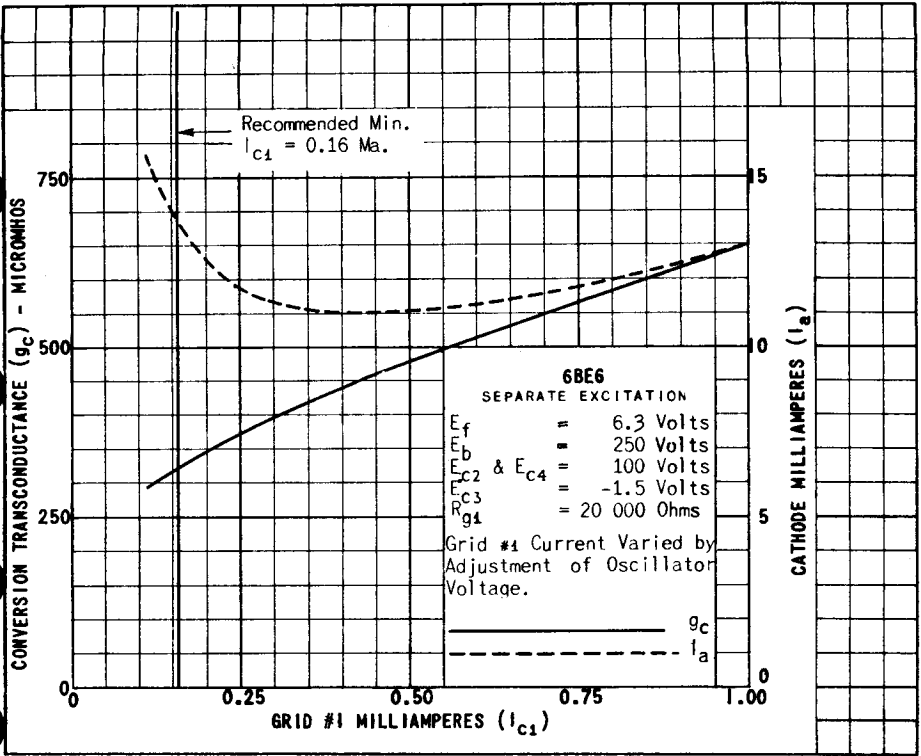

PLATE
2092
AUG. 2,
1948



TUNG-SOL

DOUBLE-DIODE TRIODE

MINIATURE TYPE

UNIPOENTIAL CATHODE

HEATER

6.3 VOLTS 0.3 AMPERE

AC OR DC

ANY MOUNTING POSITION

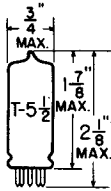

GLASS BULB

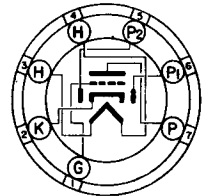

BOTTOM VIEW
MINIATURE BUTTON
7 PIN BASE

THE 6BF6 IS A COMBINED LOW- μ VOLTAGE AMPLIFIER AND DOUBLE-DIODE DETECTOR USING THE 7-PIN MINIATURE CONSTRUCTION. THE LOW AMPLIFICATION FACTOR OF THE TRIODE PERMITS LARGE VALUES OF OUTPUT SIGNAL WITH LOW DISTORTION.

DIRECT INTERELECTRODE CAPACITANCES

	WITH EXTERNAL SHIELD	WITH NO EXTERNAL SHIELD	
GRID TO PLATE: (G TO P)	2.0	2.0	μ f
INPUT: G TO (H + K)	1.8	1.8	μ f
OUTPUT: P TO (H + K)	1.4	1.1	μ f

RATINGS

INTERPRETED ACCORDING TO RMA STANDARD M8-210

HEATER VOLTAGE	6.3	VOLTS
MAXIMUM HEATER-CATHODE VOLTAGE	90	VOLTS
MAXIMUM PLATE VOLTAGE	300	VOLTS
MAXIMUM PLATE DISSIPATION	2.5	WATTS
MINIMUM DIODE CURRENT WITH 10 VOLTS DC APPLIED (EACH DIODE)	0.8	MA.

TYPICAL OPERATING CONDITIONS AND CHARACTERISTICS

CLASS A₁ AMPLIFIER - TRIODE UNIT

HEATER VOLTAGE	6.3	VOLTS
HEATER CURRENT	0.3	AMP.
PLATE VOLTAGE	250	VOLTS
GRID VOLTAGE	-9	VOLTS
PLATE CURRENT	9.5	MA.
PLATE RESISTANCE	8 500	OHMS
TRANSCONDUCTANCE	1 900	μ MHOS
AMPLIFICATION FACTOR	16	
LOAD RESISTANCE	10 000	OHMS
TOTAL HARMONIC DISTORTION	6.5	PERCENT
POWER OUTPUT	0.3	WATTS

DIODE UNITS - TWO

THE CATHODE OF THE 12BF6 IS COMMON TO THE TWO DIODE PLATES AND THE TRIODE UNIT. DIODE BIASING OF THE TRIODE UNIT OF THE 12BF6 IS NOT SUITABLE.

SIMILAR TYPE REFERENCE: Ratings and characteristics identical to 6R7, 6R7GT, 6SK7, 7R6. Except for heater ratings identical to 12SR2.

PLATE
1842
JULY 1,
1947

6BF6

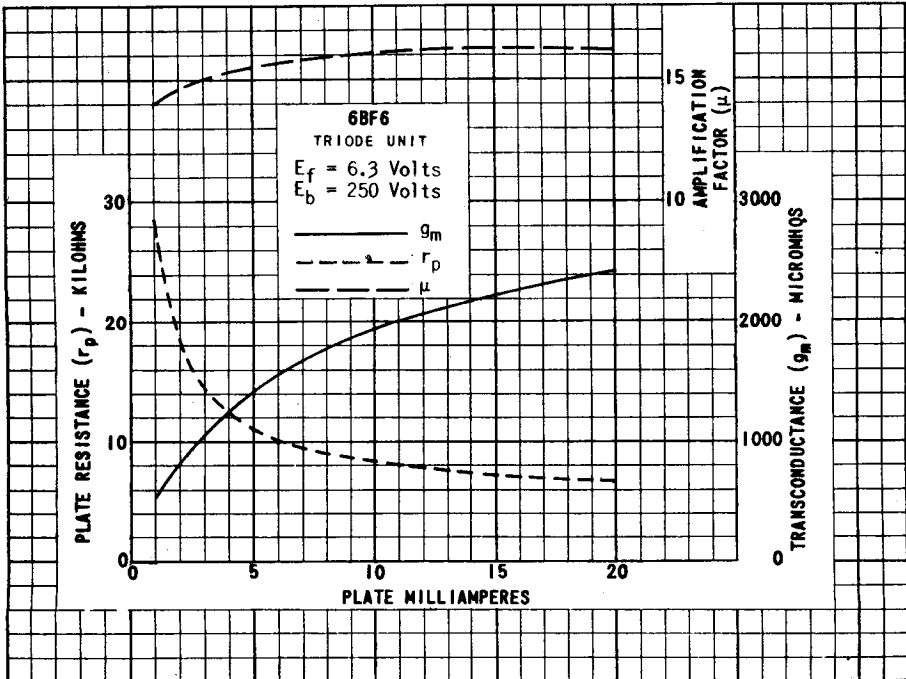
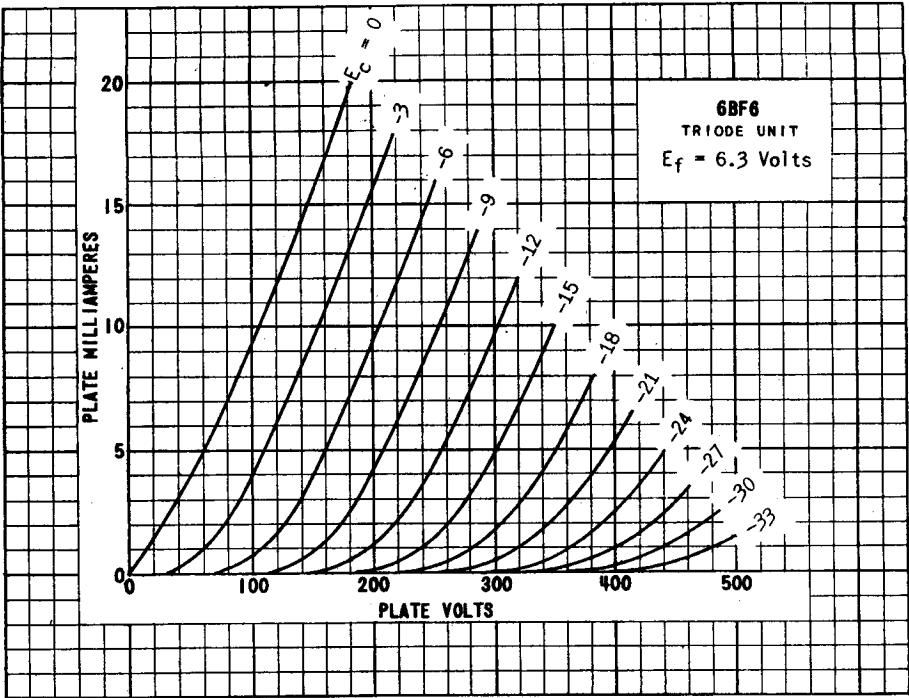
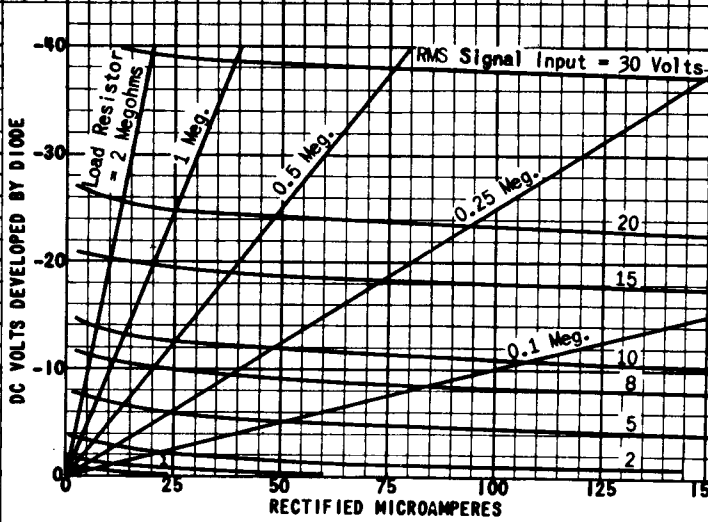

PLATE 1843
JULY 1, 1947

6BF6
 EACH DIODE UNIT
 $E_f = 6.3$ Volts



PRINTED IN U. S. A.

PLATE
 1844
 JULY 1,
 1947



TUNG-SOL

BEAM PENTODE

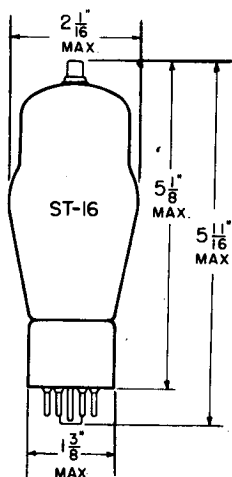

GLASS BULB
SMALL CAP

COATED UNIPOTENTIAL CATHODE

HEATER

6.3 VOLTS 0.9 AMPERE
AC OR DC

MOUNTING POSITION

VERTICAL - BASE UP OR
DOWN.
HORIZONTAL - PLANE OF
PINS 2&7 VERTICAL.

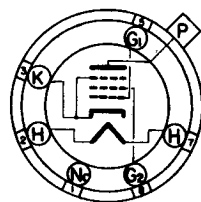

BOTTOM VIEW
MEDIUM SHELL
6 PIN OCTAL

THE 6BG6G IS ESSENTIALLY A MECHANICAL REDESIGN OF TYPE 6L6G TO PERMIT OPERATION AS A HORIZONTAL DEFLECTION AMPLIFIER FOR TELEVISION SERVICE. IT USES A TOP CAP CONNECTION AND ADDITIONAL INSULATION FOR THE PLATE STRUCTURE TO WITHSTAND THE HIGH PEAK PLATE VOLTAGE ENCOUNTERED IN SUCH CIRCUITS.

DIRECT INTERELECTRODE CAPACITANCES WITH NO EXTERNAL SHIELD

GRID TO PLATE: (G_1 TO P) MAX.	0.50	μmf
INPUT: G_1 TO (H+K+ G_3 + G_2)	11	μmf
OUTPUT: P TO (H+K+ G_3 + G_2)	6.5	μmf

RATINGS

INTERPRETED ACCORDING TO RMA STANDARD MB-210

HEATER VOLTAGE	6.3	VOLTS
MAXIMUM HEATER-CATHODE VOLTAGE	135	VOLTS
MAXIMUM DC PLATE VOLTAGE	500	VOLTS
MAXIMUM PEAK POSITIVE SURGE PLATE VOLTAGE ^A	6 000	VOLTS
MAXIMUM DC GRID #2 VOLTAGE ^B	350	VOLTS
MAXIMUM DC GRID #1 VOLTAGE	-50	VOLTS
MAXIMUM PEAK NEGATIVE SURGE GRID #1 VOLTAGE	-400	VOLTS
MAXIMUM PLATE DISSIPATION	20	WATTS
MAXIMUM GRID #2 INPUT	3.2	WATTS
MAXIMUM DC PLATE CURRENT	100	MA.
MAXIMUM GRID #1 CIRCUIT RESISTANCE	1	MEGOHM

^A THE DUTY CYCLE OF THE VOLTAGE PULSE MUST NOT EXCEED 15% OF ONE SCANNING CYCLE AND ITS DURATION MUST BE LIMITED TO TEN MICROSECONDS.

^B PREFERABLY OBTAINED FROM PLATE-VOLTAGE SUPPLY THROUGH A SERIES DROPPING RESISTOR OF SUFFICIENT MAGNITUDE TO LIMIT THE GRID #2 INPUT TO THE RATED MAXIMUM VALUE FOR WIDE VARIATION IN GRID #2 CURRENT.

CONTINUED ON FOLLOWING PAGE

PLATE
1990
MAR. 1,
1948

TUNG-SOL

CONTINUED FROM PRECEDING PAGE

TYPICAL OPERATING CONDITIONS AND CHARACTERISTICS

DEFLECTION AMPLIFIER

HEATER VOLTAGE	6.3	VOLTS
HEATER CURRENT	0.9	AMP.
DC SUPPLY VOLTAGE	400	VOLTS
PEAK POSITIVE SURGE PLATE VOLTAGE (APPROX.)	4 000	VOLTS
PEAK NEGATIVE SURGE GRID #1 VOLTAGE	-100	VOLTS
DC PLATE CURRENT	70	MA.
DC GRID #2 CURRENT	6	MA.
DC GRID #1 CURRENT	25	μAMP

PLATE
1991
MAR. 1,
1948

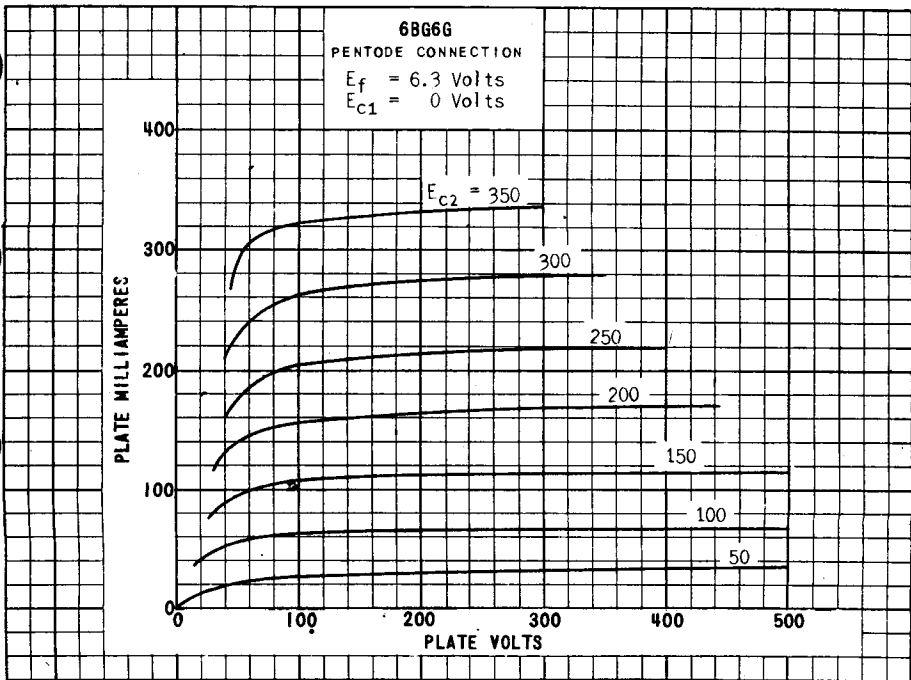
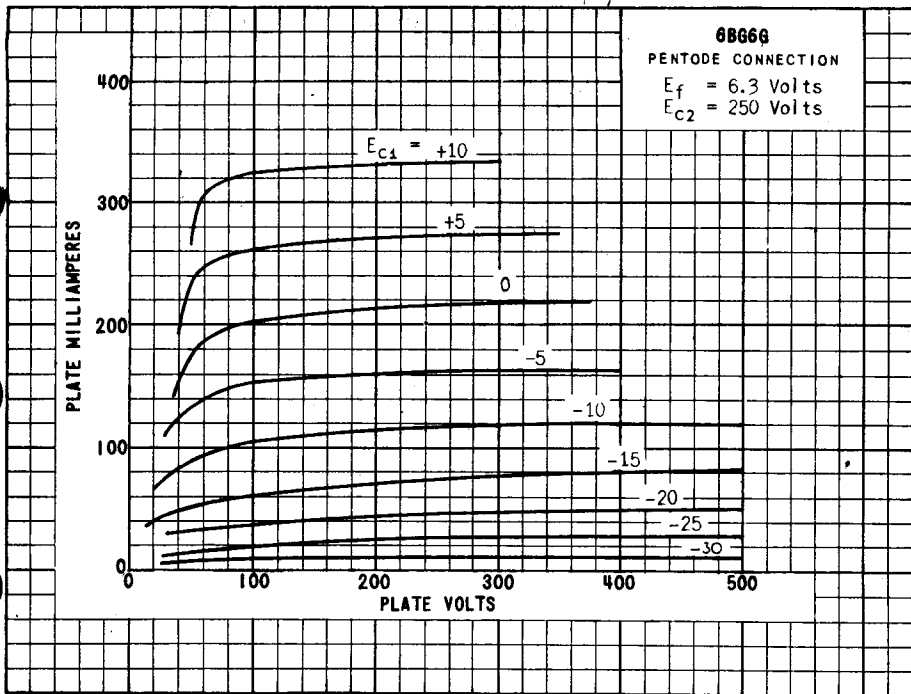

PRINTED IN U. S. A.

PLATE
 1992
 MAR. 1,
 1948

6BG6G

6BG6G
PENTODE CONNECTION
 $E_f = 6.3$ Volts
 $E_{c1} = 0$ Volts

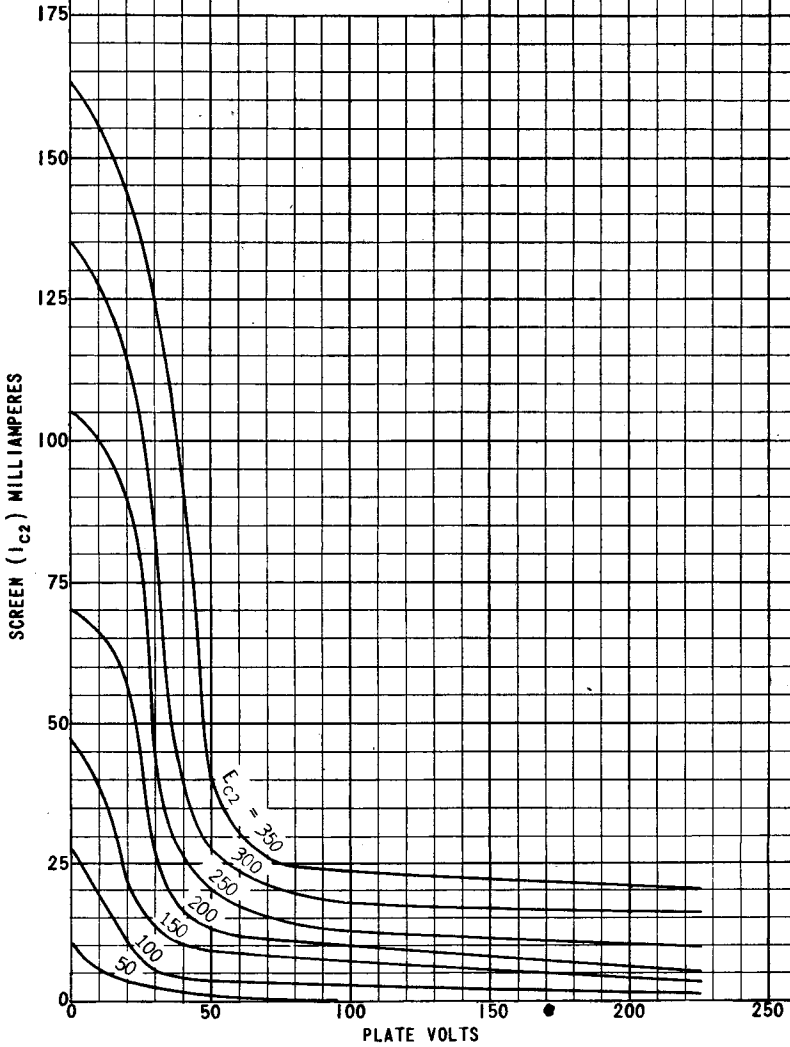

PLATE
1993
MAR. 1,
1948

TUNG-SOL

VOLTAGE AMPLIFIER PENTODE

MINIATURE TYPE

COATED UNIPOTENTIAL CATHODE

HEATER

6.3 VOLTS 0.15 AMPERE

AC OR DC

ANY MOUNTING POSITION

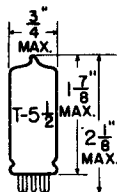

GLASS BULB

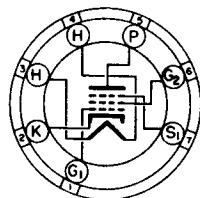

BOTTOM VIEW

MINIATURE BUTTON
7 PIN BASE

THE 6BJ6 IS A PENTODE VOLTAGE AMPLIFIER WITH A REMOTE CONTROL CHARACTERISTIC UTILIZING THE MINIATURE CONSTRUCTION. IT IS CHARACTERIZED BY HIGH TRANSCONDUCTANCE, LOW GRID-PLATE CAPACITANCE, AND AN EXTREMELY HIGH EFFICIENCY CATHODE. ADAPTING IT TO APPLICATION WHERE CONSERVATION OF HEATER POWER IS IMPORTANT.

RATINGS

INTERPRETED ACCORDING TO RMA STANDARD W8-210

HEATER VOLTAGE	6.3	VOLTS
HEATER CURRENT	0.15	AMP.
MAXIMUM PLATE VOLTAGE	300	VOLTS
MAXIMUM SCREEN VOLTAGE	125	VOLTS
MAXIMUM SCREEN SUPPLY VOLTAGE	300	VOLTS
MAXIMUM EXTERNAL GRID VOLTAGE:		
NEGATIVE BIAS	50	VOLTS
POSITIVE BIAS	0	VOLTS
MAXIMUM PLATE DISSIPATION	3	WATTS
MAXIMUM SCREEN DISSIPATION	0.6	WATT
MAXIMUM HEATER-CATHODE VOLTAGE	90	VOLTS

DIRECT INTERELECTRODE CAPACITANCES

WITH NO EXTERNAL SHIELD

GRID TO PLATE (MAX.)	0.0035	$\mu\mu\text{f}$
INPUT	4.5	$\mu\mu\text{f}$
OUTPUT	5	$\mu\mu\text{f}$

TYPICAL OPERATING CONDITIONS AND CHARACTERISTICS

CLASS A₁ AMPLIFIER

PLATE VOLTAGE	100	250	VOLTS
SCREEN VOLTAGE	100	100	VOLTS
GRID VOLTAGE	-1	-1	VOLT
SUPPRESSOR VOLTAGE	0	0	VOLTS
PLATE CURRENT	9	9.2	MA.
SCREEN CURRENT	3.5	3.3	MA.
PLATE RESISTANCE (APPROX.)	0.25	1.3	MEG OHMS
TRANSCONDUCTANCE	3 650	3 800	μMHOS
GRID VOLTAGE FOR TRANSCONDUCTANCE = 15 μMHOS	-20	-20	VOLTS

6BJ6

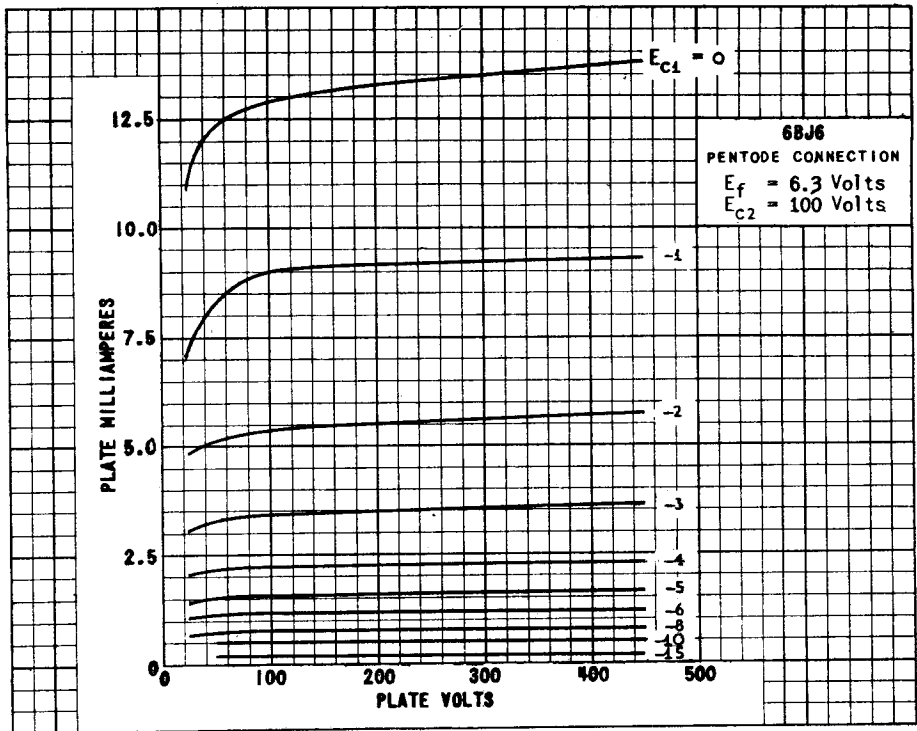
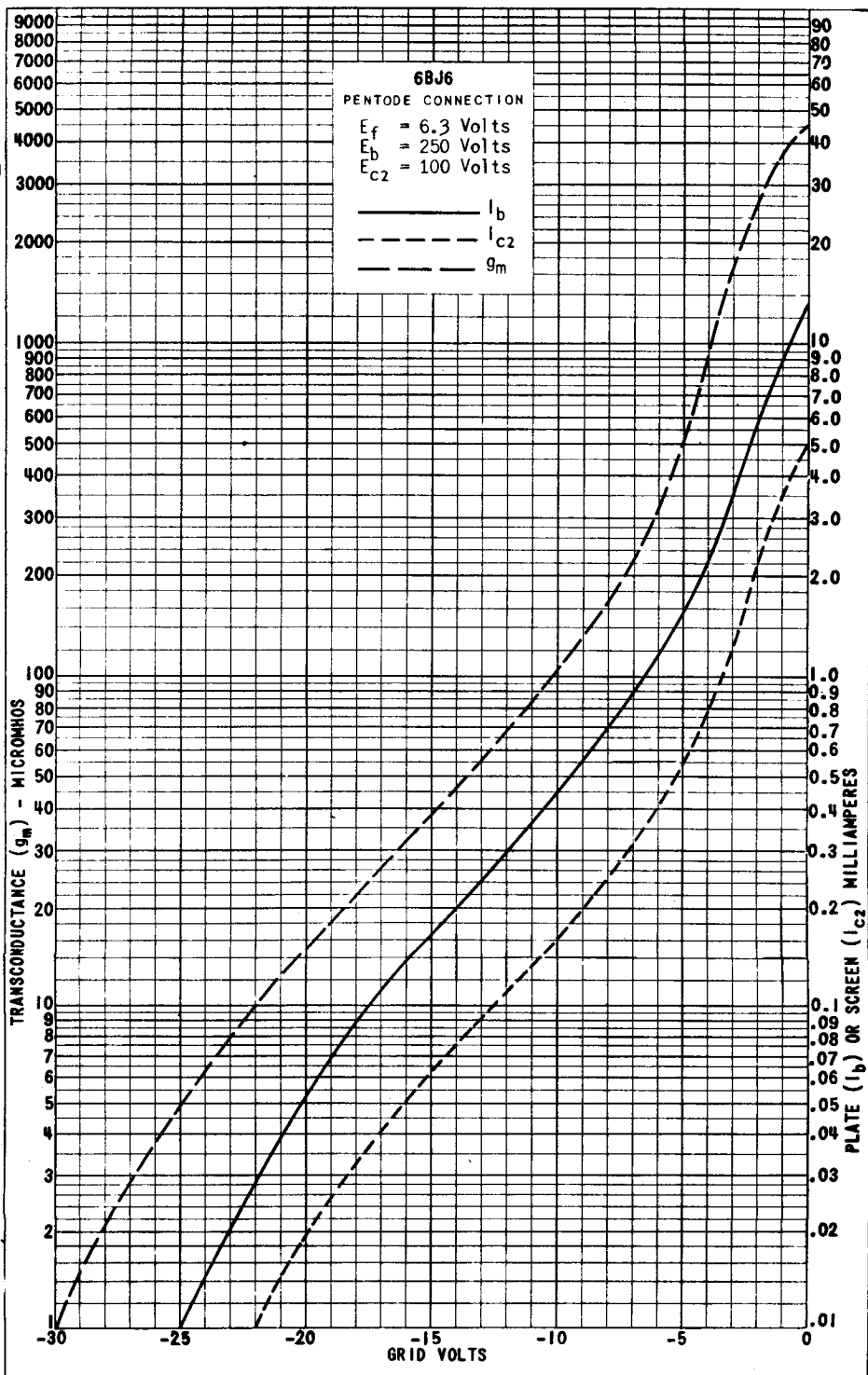

PLATE
1799
FEB. 3,
1947



PRINTED IN U. S. A.

PLATE 1800
 FEB. 3, 1947

6BJ6

6BJ6 PENTODE CONNECTION

$E_f = 6.3$ Volts
 $E_b = 250$ Volts
 $E_{c1} = -1$ Volt

————— I_b
 - - - - - I_{c2}
 - - - - - g_m
 - · - · - r_p

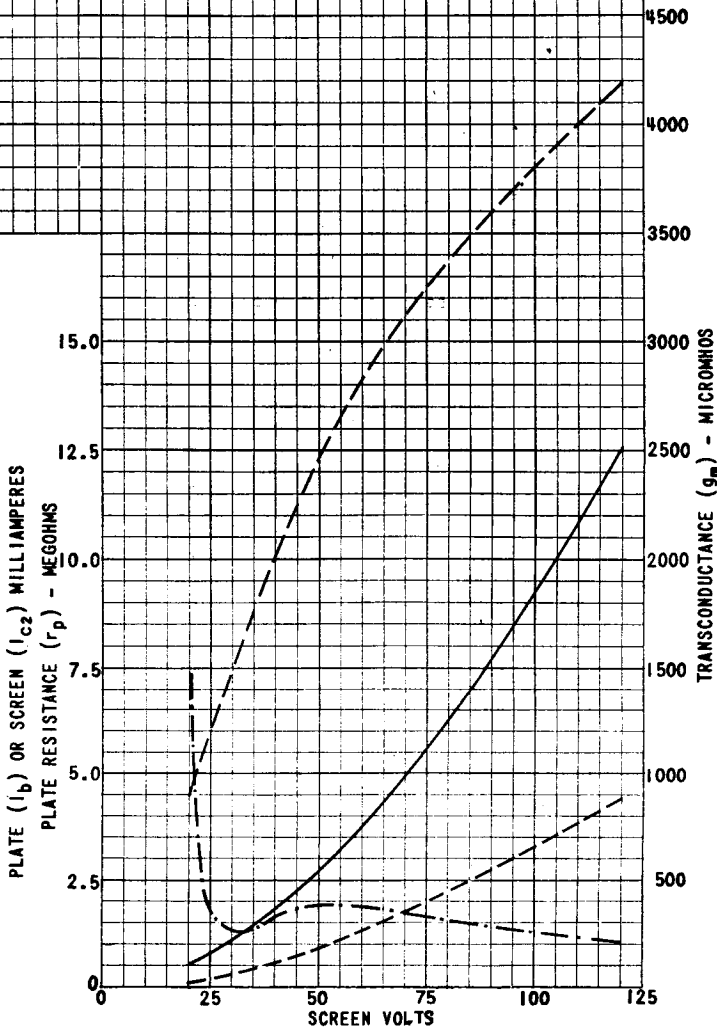
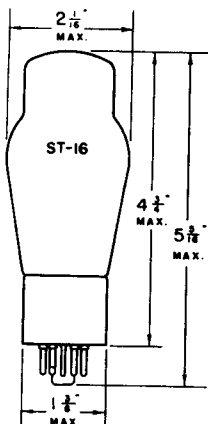

PLATE
 1801
 FEB. 3,
 1947

TUNG-SOL



TRIODE POWER AMPLIFIER

COATED FILAMENT

6.3 VOLTS 1.0 AMPERE
AC OR DC

GLASS BULB

MEDIUM 8 PIN OCTAL BASE



G-5S

THE TUNG-SOL 6B4G IS A FILAMENT TYPE TRIODE POWER AMPLIFIER DESIGNED FOR SERVICE IN THE OUTPUT STAGE OF AUDIO AMPLIFIERS WHERE HIGH OUTPUT AND LOW HARMONIC DISTORTION ARE DESIRED. ITS RATINGS AND CHARACTERISTICS ARE SIMILAR TO THOSE OF THE 2A3 AND 6A3.

OPERATING CONDITIONS AND CHARACTERISTICS

CLASS A₁ AMPLIFIER—ONE TUBE

PLATE VOLTAGE ^{MAX.}	250	VOLTS
GRID VOLTAGE ^G	-45	VOLTS
GRID CIRCUIT RESISTANCE ^{MAX.}		
FIXED BIAS	0.05	MEGOHM
SELF BIAS	0.5	MEGOHM
PLATE CURRENT	60	MA.
PLATE RESISTANCE	800	OHMS
TRANSCONDUCTANCE	5250	μMHOS
AMPLIFICATION FACTOR	4.2	
LOAD RESISTANCE	2500	OHMS
POWER OUTPUT	3.2	WATTS
SECOND HARMONIC DISTORTION	5	PER CENT

CLASS AB₁ PUSH-PULL AMPLIFIER

VALUES ARE FOR TWO TUBES

	FIXED BIAS	SELF BIAS	
PLATE VOLTAGE ^{MAX.}	325	325	VOLTS
GRID VOLTAGE ^G	-68	-	VOLTS
SELF BIAS RESISTOR	-	750	OHMS
ZERO-SIGNAL PLATE CURRENT ^{PER TUBE}	40	40	MA.
LOAD RESISTANCE ^{PER TUBE}	750	1250	OHMS
EFFECTIVE LOAD RESISTANCE ^{PLATE TO PLATE}	3000	5000	OHMS
TOTAL HARMONIC DISTORTION	2.5	5	PER CENT
POWER OUTPUT	15	10	WATTS

^G GRID VOLTAGE MEASURED FROM MID-POINT OF AC OPERATED FILAMENT.

CONTINUED NEXT PAGE

TUNG-SOL

DIRECT INTERELECTRODE CAPACITANCES

GRID TO FILAMENT	7	$\mu\mu\text{f}$
PLATE TO FILAMENT	5	$\mu\mu\text{f}$
GRID TO PLATE	16	$\mu\mu\text{f}$

TUNG-SOL

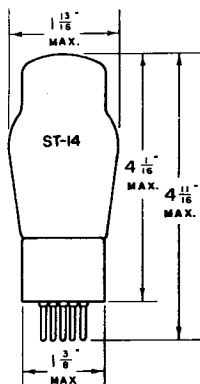

DYNAMIC COUPLED POWER AMPLIFIER

UNIPOTENTIAL CATHODES

HEATER
6.3 VOLTS 0.8 AMPERE
AC OR DC

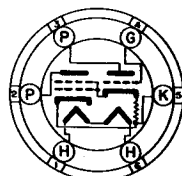

6B5

GLASS BULB

MEDIUM 6 PIN BASE

THE TUNG-SOL 6B5 CONSISTS OF TWO DYNAMICALLY COUPLED TRIODES AND IS DESIGNED FOR SERVICE IN THE POWER OUTPUT STAGE OF AC AND STORAGE BATTERY OPERATED RECEIVERS. ALL NECESSARY BIASES ARE SUPPLIED INTERNALLY. ITS RATINGS AND CHARACTERISTICS ARE IDENTICAL WITH THOSE OF THE 6N6G.

OPERATING CONDITIONS AND CHARACTERISTICS

CLASS A₁ AMPLIFIER

OUTPUT PLATE (2) VOLTAGE	250	300	325 ^{MAX.}	VOLTS
INPUT PLATE (3) VOLTAGE	250	300	325 ^{MAX.}	VOLTS
INPUT GRID (4) VOLTAGE	0	0	0	VOLTS
GRID CIRCUIT RESISTANCE ^{MAX.}	0.5	0.5	0.5	MEG OHM
OUTPUT PLATE CURRENT	33	45	51	MA.
INPUT PLATE CURRENT	6.5	8	9	MA.
PLATE RESISTANCE		24 100		OHMS
TRANSCONDUCTANCE		2400		μMHOS
AMPLIFICATION FACTOR		58		
LOAD RESISTANCE	7000	7000	7000	OHMS
SIGNAL VOLTS (RMS) ^S	13.5	15	17	VOLTS
TOTAL HARMONIC DISTORTION	5	5	5	PER CENT
POWER OUTPUT	2.5	4	5.2	WATTS

(2) BASE PIN #2

(3) BASE PIN #3

(4) BASE PIN #4

^S FOR RATED POWER OUTPUT

NOTE: THE VOLTAGE BETWEEN HEATER AND CATHODE SHOULD NOT EXCEED 50 VOLTS AND IN NO CASE SHOULD THE HEATER BE LEFT FLOATING.

TUNG-SOL

CLASS A₁ PUSH-PULL AMPLIFIER

UNLESS SPECIFIED, VALUES ARE FOR TWO TUBES

OUTPUT PLATE (2) VOLTAGE	250	300	325 ^{MAX.}	VOLTS
INPUT PLATE (3) VOLTAGE	250	300	325 ^{MAX.}	VOLTS
INPUT GRID (4) VOLTAGE	0	0	0	VOLTS
GRID CIRCUIT RESISTANCE ^{MAX.}	0.5	0.5	0.5	MEGOHM
OUTPUT PLATE CURRENT ^{PER TUBE}	33	45	51	MA.
INPUT PLATE CURRENT ^{PER TUBE}	6.5	8	9	MA.
LOAD RESISTANCE PLATE TO PLATE	10 000	10 000	10 000	OHMS
SIGNAL VOLTS (RMS) ^{S. GRID TO GRID}	38	38	42	VOLTS
TOTAL HARMONIC DISTORTION	5	5	5	PER CENT
POWER OUTPUT	8.5	10	13.5	WATTS

(2) BASE PIN #2

(3) BASE PIN #3

(4) BASE PIN #4

^S FOR RATED POWER OUTPUT

TUNG-SOL

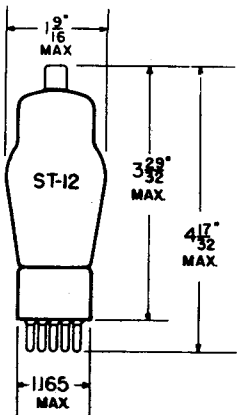

2A6, 75

SMALL METAL CAP

DUO-DIODE HIGH-MU TRIODE AMPLIFIER

COATED UNIPOTENTIAL CATHODE

2A6	2.5 VOLTS	0.8 AMPERE
75	6.3 VOLTS	0.3 AMPERE
6B6G	6.3 VOLTS	0.3 AMPERE

AC OR DC

GLASS BULB

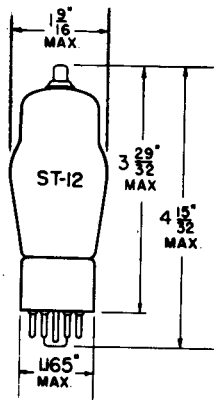

6B6G

ANY MOUNTING POSITION SKIRTED MINIATURE CAP

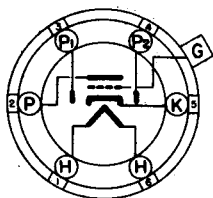

BOTTOM VIEW

SMALL
6-PIN BASE

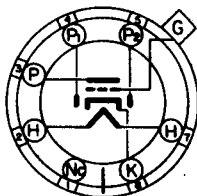

BOTTOM VIEW

SMALL
7-PIN OCTAL BASE

THE 2A6, 6B6G AND 75 COMBINE TWO DIODES AND A HIGH-MU TRIODE IN A SINGLE BULB, USING A COMMON CATHODE. THEY ARE DESIGNED FOR USE AS DIODE DETECTORS, AVC RECTIFIERS AND RESISTANCE COUPLED AMPLIFIERS.

RATINGS

INTERPRETED ACCORDING TO RMA STANDARD NO-210

MAXIMUM PLATE VOLTAGE	250	VOLTS
MINIMUM DIODE CURRENT PER PLATE WITH 10 VOLTS DC APPLIED	0.8	MA.
MAXIMUM CATHODE VOLTAGE	100	VOLTS

CONTINUED ON NEXT PAGE

PRINTED IN U.S.A.

PLATE
1548
JAN. 15
1945

TUNG-SOL

CONTINUED FROM PRECEDING PAGE.

DIRECT INTERELECTRODE CAPACITANCES (APPROX.)

TRIODE UNIT

GRID TO PLATE	1.7	μf
INPUT	1.7	μf
OUTPUT	3.8	μf

TYPICAL OPERATING CONDITIONS AND CHARACTERISTICS

CLASS A₁ AMPLIFIER

TRIODE UNIT

PLATE VOLTAGE	250	VOLTS
GRID VOLTAGE	-2.0	VOLTS
PLATE CURRENT	0.9	MA.
PLATE RESISTANCE	91 000	OHMS
TRANSCONDUCTANCE	1 100	μMHMS
AMPLIFICATION FACTOR	100	

RESISTANCE COUPLED AMPLIFIER

PLATE SUPPLY VOLTAGE	100	100	250	VOLTS
PLATE LOAD RESISTOR	0.25	0.25	0.25	MEGOHM
CATHODE RESISTOR	0.0	10 000	4 000	OHMS
GRID CIRCUIT RESISTOR	6.0	1.0	1.0	MEGOHMS
GRID COUPLING CONDENSER	0.01	0.05	0.05	μf
VOLTAGE GAIN	35	35	52	

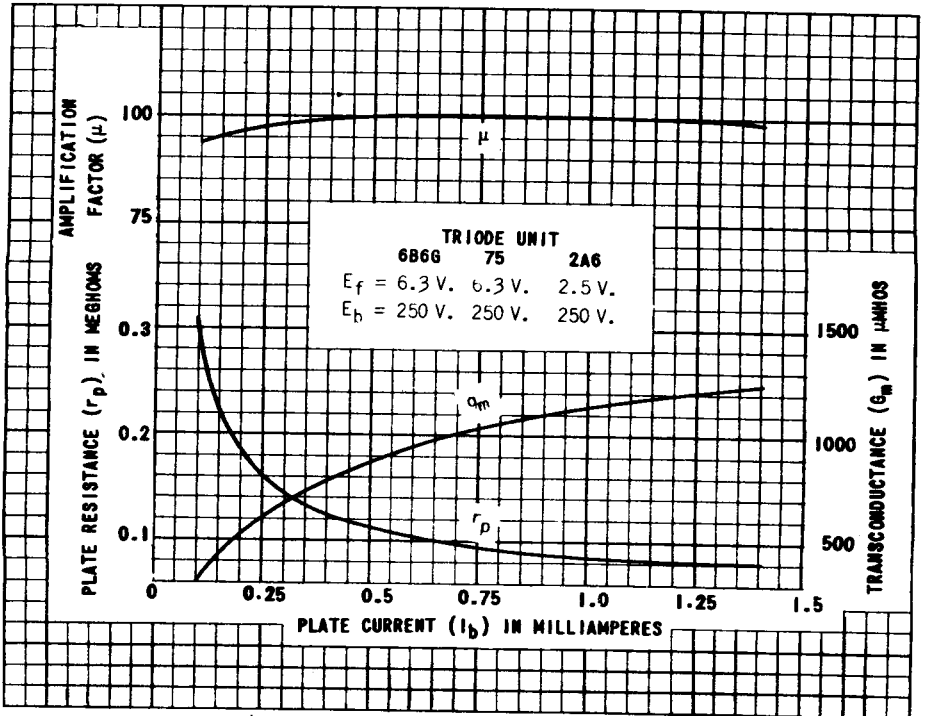
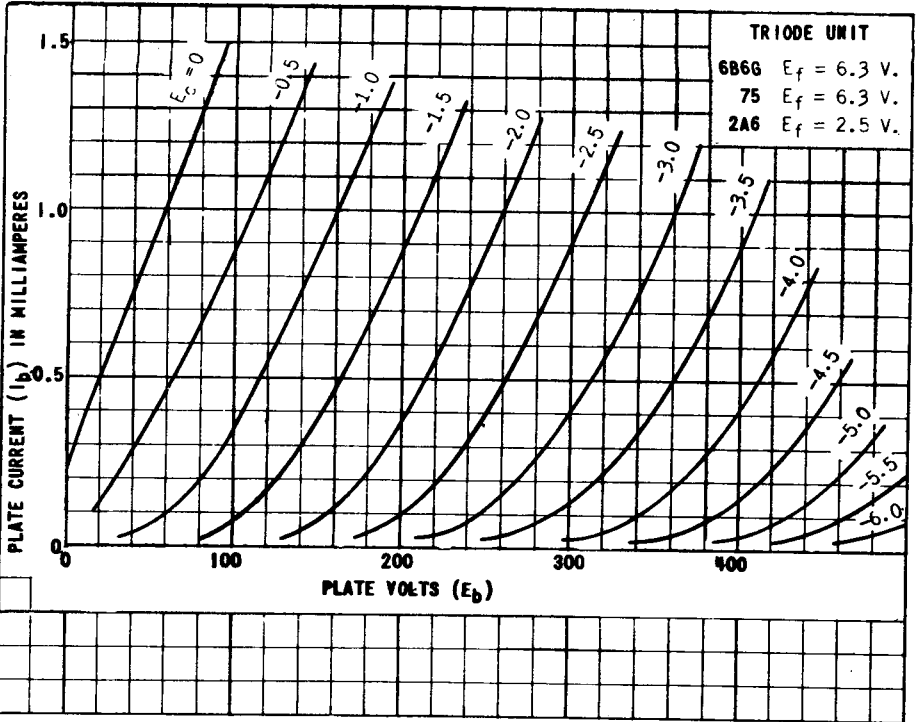



TUNG-SOL

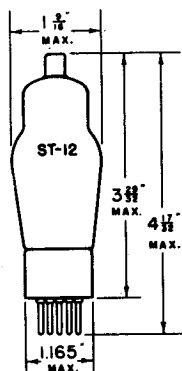

DUO-DIODE PENTODE AMPLIFIER

UNIPOTENTIAL CATHODE

HEATER
6.3 VOLTS 0.3 AMPERE
AC OR DC

GLASS BULB

SMALL 7 PIN BASE

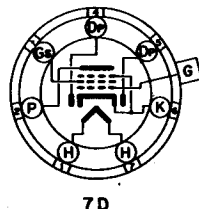

THE TUNG-SOL 6B7 COMBINES TWO DIODES AND A PENTODE UTILIZING A COMMON CATHODE. IT IS DESIGNED FOR SERVICE AS A COMBINED DETECTOR, AVC RECTIFIER AND PENTODE AMPLIFIER. THE RATINGS AND CHARACTERISTICS, WITH THE EXCEPTION OF HEATER VOLTAGE AND CURRENT, ARE IDENTICAL WITH THOSE OF THE 2B7.

OPERATING CONDITIONS AND CHARACTERISTICS

PENTODE UNIT AS CLASS A₁ AMPLIFIER

PLATE VOLTAGE	100	180	250	250	335 ^{MAX.}	VOLTS
SCREEN VOLTAGE	100	75	100	125 ^{MAX.}	110	VOLTS
CONTROL GRID VOLTAGE	-3	-3	-3	-3	-3	VOLTS
GRID CIRCUIT RESISTANCE ^{MAX.}	1	1	1	1	1	MEGOHM
PLATE CURRENT	5.8	3.4	6.0	9.0	7.5	MA.
SCREEN CURRENT	1.7	0.9	1.5	2.3	1.8	MA.
PLATE RESISTANCE ^{APPROX.}	0.3	1.0	0.8	0.65	0.88	MEGOHM
TRANSCONDUCTANCE	950	840	1000	1125	1075	μMHOS
AMPLIFICATION FACTOR ^{APPROX.}	285	840	800	730	950	
CONTROL GRID VOLTAGE ^{APPROX.}	-17	-13	-17	-21	-17	VOLTS

FOR CATHODE CURRENT CUT-OFF

PENTODE UNIT AS RESISTANCE COUPLED AMPLIFIER

PLATE, SCREEN SUPPLY VOLTAGE	100	100	250	250	VOLTS
PLATE LOAD RESISTOR	0.1	0.5	0.1	0.5	MEGOHM
CATHODE RESISTOR	2000	4800	1000	2800	OHMS
SCREEN RESISTOR	0.6	2.6	0.6	2.5	MEGOHMS
VOLTAGE GAIN	39	65	50	90	

DIRECT INTERELECTRODE CAPACITANCES

CONTROL GRID TO CATHODE	3.6	μf
PLATE TO CATHODE	9.5	μf
CONTROL GRID TO PLATE ^S	.007 ^{MAX.}	μf

^S WITH SHIELD

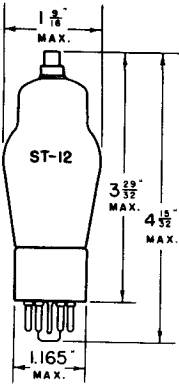

DUO - DIODE PENTODE AMPLIFIER

UNI-POTENTIAL CATHODE
 HEATER
 6.3 VOLTS 0.3 AMPERE
 AC OR DC

GLASS BULB

SMALL 8 PIN OCTAL BASE

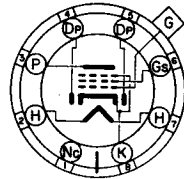

G-8E

BOTTOM VIEW

DIRECT INTERELECTRODE CAPACITANCES

CONTROL GRID TO CATHODE	3.6	μf
PLATE TO CATHODE	9.5	μf
CONTROL GRID TO PLATE ^S	.007 MAX.	μf

^S WITH SHIELD

ALL OTHER ELECTRICAL CHARACTERISTICS OF THE 6B8G ARE IDENTICAL WITH THOSE OF 6B7.

TUNG-SOL

DUO - DIODE PENTODE AMPLIFIER

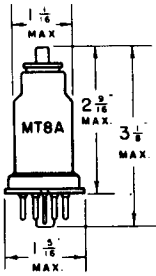

UNIPOTENTIAL CATHODE
 HEATER
 6.3 VOLTS 0.3 AMPERE
 AC OR DC

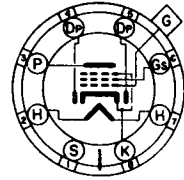

8E
 BOTTOM VIEW

METAL SHELL

8 PIN OCTAL BASE

THE TUNG-SOL 6B8 COMBINES TWO DIODES AND A PENTODE UTILIZING A COMMON CATHODE. IT IS DESIGNED FOR SERVICE AS A COMBINED DETECTOR, AVC RECTIFIER AND PENTODE AMPLIFIER.

OPERATING CONDITIONS AND CHARACTERISTICS

PENTODE UNIT AS CLASS A₁ AMPLIFIER

PLATE VOLTAGE	250	335 MAX.	VOLTS
SCREEN VOLTAGE	125 ^{MAX.}	110	VOLTS
CONTROL GRID VOLTAGE	-3	-3	VOLTS
GRID CIRCUIT RESISTANCE	1	1	MEGOHM
PLATE CURRENT	10	8.5	MA.
SCREEN CURRENT	2.3	1.8	MA.
PLATE RESISTANCE ^{APPROX.}	0.6	0.96	MEGOHM
TRANSCONDUCTANCE	1325	1250	μMHOS
AMPLIFICATION FACTOR ^{APPROX.}	800	1200	
CONTROL GRID VOLTAGE ^{APPROX.}	-21	-19	VOLTS

FOR CATHODE CURRENT CUT-OFF

PENTODE UNIT AS RESISTANCE COUPLED AMPLIFIER

PLATE, SCREEN SUPPLY VOLTAGE	100	100	250	250	VOLTS
PLATE LOAD RESISTOR	0.1	0.5	0.1	0.5	MEGOHM
CATHODE RESISTOR	2000	4800	1000	2800	OHMS
SCREEN RESISTOR	0.6	2.6	0.6	2.5	MEGOHMS
VOLTAGE GAIN	39	65	50	90	

DIRECT INTERELECTRODE CAPACITANCES^S

CONTROL GRID TO CATHODE	6	μμf
PLATE TO CATHODE	9	μμf
CONTROL GRID TO PLATE	.005 ^{MAX.}	μμf

^S WITH SHELL CONNECTED TO CATHODE



TUNG-SOL

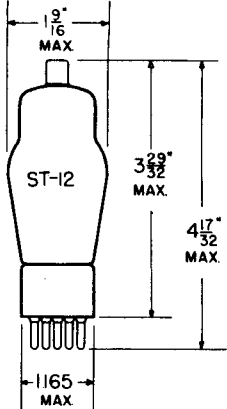

2B7, 6B7

SMALL METAL CAP

DUO-DIODE PENTODE AMPLIFIER

COATED UNIPOTENTIAL CATHODE

2B7 - 2.5 VOLTS 0.8 AMPERE

6B7 - 6.3 VOLTS 0.3 AMPERE

6B8G - 6.3 VOLTS 0.3 AMPERE

AC OR DC

GLASS BULB

ANY MOUNTING POSITION

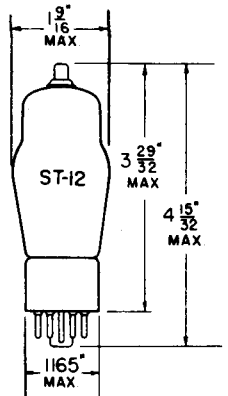

6B8G

SKIRTED MINIATURE CAP

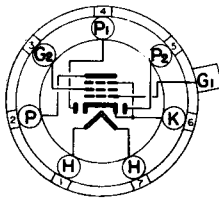

BOTTOM VIEW

SMALL 7-PIN BASE

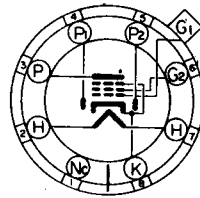

BOTTOM VIEW

SMALL SHELL 8-PIN OCTAL BASE

THE 2B7, 6B7, AND 6B8G CONSIST OF TWO DIODES AND A PENTODE UTILIZING A COMMON CATHODE. THEY ARE DESIGNED FOR SERVICE AS COMBINED DETECTORS, AVC RECTIFIERS AND PENTODE AMPLIFIERS.

RATINGS

INTERPRETED ACCORDING TO RMA STANDARD M8-210

MAXIMUM PLATE VOLTAGE	300	VOLTS
MAXIMUM SCREEN SUPPLY VOLTAGE	300	VOLTS
MAXIMUM SCREEN VOLTAGE	125	VOLTS
MINIMUM EXTERNAL GRID BIAS VOLTAGE	0	VOLTS
MINIMUM DIODE CURRENT PER PLATE WITH 10 VOLTS DC	0.8	MA.
MAXIMUM PLATE DISSIPATION	2.25	WATTS
MAXIMUM SCREEN DISSIPATION	0.3	WATTS

CONTINUED ON NEXT PAGE

PRINTED IN U. S. A.

PLATE 1553 JAN. 15 1945

TUNG-SOL

CONTINUED FROM PRECEDING PAGE.

DIRECT INTERELECTRODE CAPACITANCES

WITH EXTERNAL SHIELD CONNECTED TO CATHODE

PENTODE UNIT

	2B7, 6B7	6B8G	
INPUT: G1 TO (F+K+G2+G3)	3.5	3.6	μmf
OUTPUT: P TO (F+K+G2+G3)	9.5	9.5	μmf
CONTROL GRID TO PLATE	0.007 (MAX.)	0.01 (MAX.)	μmf

TYPICAL OPERATING CONDITIONS AND CHARACTERISTICS

CLASS A₁ AMPLIFIER

PENTODE UNIT

PLATE VOLTAGE	100	180	250	250	VOLTS
SCREEN VOLTAGE	100	75	100	125	VOLTS
CONTROL GRID VOLTAGE	-3.0	-3.0	-3.0	-3.0	VOLTS
PLATE CURRENT	5.8	3.4	6.0	9.0	MA.
SCREEN CURRENT	1.7	0.9	1.5	2.3	MA.
PLATE RESISTANCE (APPROX.)	0.3	1.0	0.8	0.6	MEGOHM
TRANSCONDUCTANCE	950	840	1 000	1 125	μMHOS
GRID BIAS (FOR CATHODE CURRENT CUT-OFF, APPROX.)	-17	-13	-17	-21	VOLTS

TUNG-SOL

DUO-DIODE PENTODE AMPLIFIER

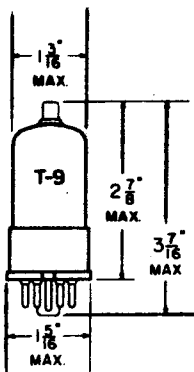

COATED UNIPOTENTIAL CATHODE

HEATER

6.3 VOLTS 0.3 AMP.
AC OR DC

GLASS BULB

ANY MOUNTING POSITION

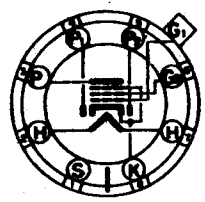

BOTTOM VIEW

SMALL WAFER OCTAL 8
PIN BASE

MINIATURE CAP

THE 6B8GT COMBINES TWO DIODES AND A PENTODE UTILIZING A COMMON CATHODE. IT IS DESIGNED FOR SERVICE AS A COMBINED DETECTOR, AVC RECTIFIER AND A PENTODE AMPLIFIER.

RATINGS

INTERPRETED ACCORDING TO RMA STANDARD NG-210

MAXIMUM PLATE VOLTAGE	300	VOLTS
MAXIMUM SCREEN SUPPLY VOLTAGE	300	VOLTS
MAXIMUM PLATE DISSIPATION	3.0	WATTS
MAXIMUM SCREEN DISSIPATION	0.3	WATT
MINIMUM EXTERNAL GRID BIAS VOLTAGE	0	VOLTS

DIRECT INTERELECTRODE CAPACITANCES

WITH EXTERNAL SHIELD CONNECTED TO CATHODE

GRID TO PLATE	0.005	μ mf
INPUT	4.5	μ mf
OUTPUT	10	μ mf

TYPICAL OPERATING CONDITIONS AND CHARACTERISTICS

CLASS A₁ AMPLIFIER

PENTODE UNIT

PLATE VOLTAGE	250	VOLTS
SCREEN VOLTAGE	125	VOLTS
GRID VOLTAGE	-3.0	VOLTS
PLATE RESISTANCE	0.6	MEG OHM
TRANSCONDUCTANCE	1 325	μ MHOS
PLATE CURRENT	10	MA.
SCREEN CURRENT	2.3	MA.
GRID BIAS (FOR CATHODE CURRENT CUT-OFF APPROXIMATE)	-21	MA.

DIODE UNITS - TWO

MINIMUM DIODE CURRENT PER PLATE WITH 10 VOLTS DC APPLIED	0.8	MA.
--	-----	-----

PRINTED IN U. S. A.

PLATE
1576
FEB. 28
1945

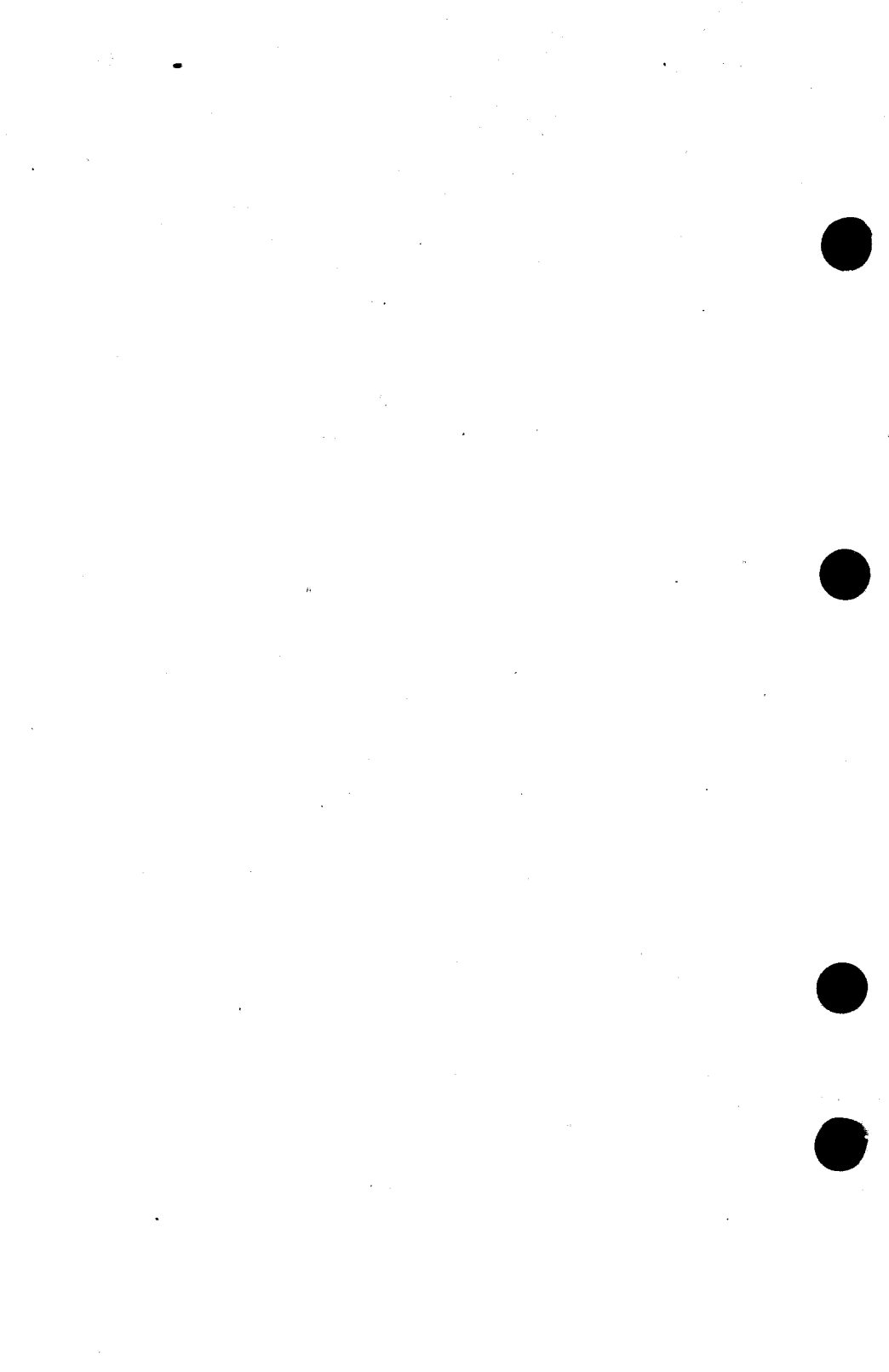

TUNG-SOL

**REMOTE CUT-OFF RF AMPLIFIER PENTODE
MINIATURE TYPE**

PHYSICAL SPECIFICATIONS

EMITTER UNIPOTENTIAL CATHODE		PIN CONNECTIONS		
BASE	MIN. BUTTON 7-PIN	PIN 1	GRID 1	PIN 7 CATHODE
CAP	NONE	PIN 2	GRID 3*	PIN 8 NONE
BULB	T-5½	PIN 3	HEATER	
MAXIMUM DIAMETER	3/4"	PIN 4	HEATER	MOUNTING POS. ANY
MAXIMUM OVERALL LENGTH	2-1/8"	PIN 5	PLATE	
MAXIMUM SEATED HEIGHT	1-7/8"	PIN 6	GRID 2	*ALSO INTERNAL SHIELD

RATINGS

INTERPRETED ACCORDING TO RMA STANDARD MB-210

HEATER OR FILAMENT VOLTAGE (AC OR DC)	6.3	VOLTS
HEATER OR FILAMENT CURRENT	0.30	AMPS.
MAXIMUM PLATE VOLTAGE	300	VOLTS
MAXIMUM SCREEN VOLTAGE	125	VOLTS
MAXIMUM PLATE DISSIPATION	3.0	WATTS
MAXIMUM SCREEN DISSIPATION	0.6	WATTS
MAXIMUM CONTROL GRID VOLTAGE: NEG. BIAS	50	VOLTS
POS. BIAS	0	VOLTS
MAXIMUM SCREEN SUPPLY VOLTAGE	300	VOLTS

MAXIMUM PEAK HEATER-CATHODE VOLTAGE:

HEATER NEG. WITH RESPECT TO CATHODE.	90	VOLTS
HEATER POS. WITH RESPECT TO CATHODE	90	VOLTS

**CAPACITANCES
WITH NO EXTERNAL SHIELD**

GRID NO. 1 TO PLATE (C _{G1P}) (MAX.)	0.0035	µuf
INPUT C _{G1} (K+H+G ₂ +G ₃ +INTERNAL SHIELD)	5.5	µuf
OUTPUT C _p (K+H+G ₂ +G ₃ +INTERNAL SHIELD)	5.0	µuf

**TYPICAL OPERATING CONDITIONS AND CHARACTERISTICS
CLASS A₁ AMPLIFIER**

HEATER OR FILAMENT VOLTAGE	6.3	6.3	VOLTS
HEATER OR FILAMENT CURRENT	0.30	0.30	AMPS.
PLATE VOLTAGE	100	250	VOLTS
SCREEN VOLTAGE	100	100	VOLTS
CONTROL GRID VOLTAGE			VOLTS
PEAK AF SIGNAL VOLTAGE			VOLTS
PLATE CURRENT	10.8	11	MA.
SCREEN CURRENT	4.4	4.2	MA.
MAXIMUM-SIGNAL PLATE CURRENT			MA.
MAXIMUM-SIGNAL SCREEN CURRENT			MA.
PLATE RESISTANCE (APPROX.)	0.25	1.5	MEG OHMS
TRANSCONDUCTANCE	4300	4400	µMHOS
AMPLIFICATION FACTOR			
LOAD RESISTANCE			OHMS
TOTAL HARMONIC DISTORTION			PER CENT
POWER OUTPUT			WATTS
CONTROL GRID VOLTAGE (APPROX.) FOR TRANSCONDUCTANCE 40 µMHOS	-20	-20	VOLTS
SUPPRESSOR GRID	CONNECTED TO CATHODE AT SOCKET		
CATHODE-BIAS RESISTOR	68	68	OHMS

PLATE
1652
DEC. 15
1945

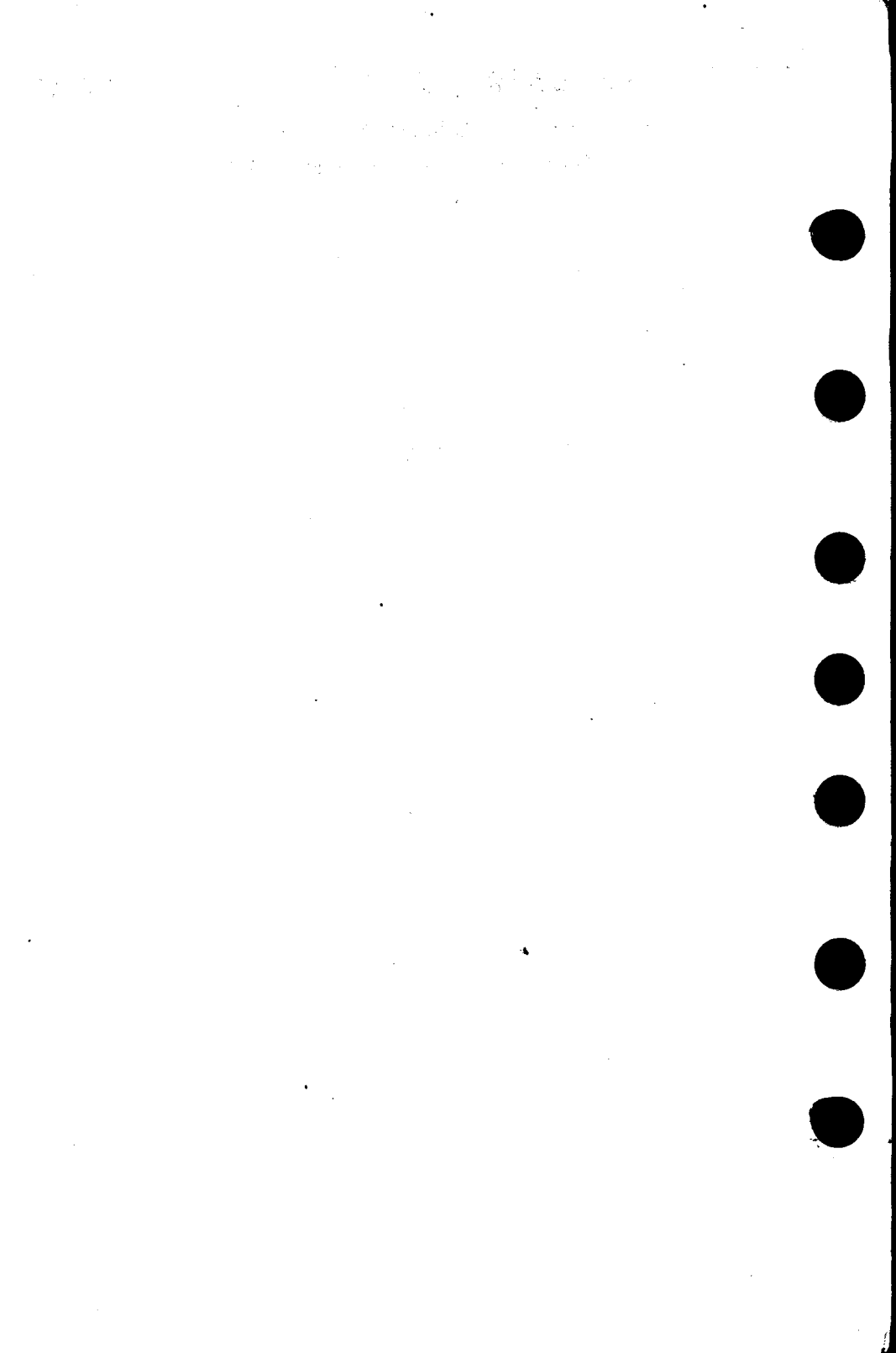

TUNG-SOL

RF PENTODE AMPLIFIER

MINIATURE TYPE

PHYSICAL SPECIFICATIONS

EMITTER CATHODE	PIN CONNECTIONS	
BASE MINIATURE BUTTON 7-PIN	PIN 1 GRID 1	PIN 7 CATHODE
CAP ---	PIN 2 S ₁ , GRID 3	PIN 8 NONE
BULB T-5½	PIN 3 HEATER	
MAXIMUM DIAMETER 3/4"	PIN 4 HEATER	MOUNTING POS. ANY
MAXIMUM OVERALL LENGTH 2 1/8"	PIN 5 PLATE	
MAXIMUM SEATED HEIGHT 1 7/8"	PIN 6 GRID 2	

RATINGS

INTERPRETED ACCORDING TO RMA STANDARD MB-210

HEATER OR FILAMENT VOLTAGE (AC OR DC)	6.3	VOLTS
HEATER OR FILAMENT CURRENT	0.3	AMP.
MAXIMUM PLATE VOLTAGE	300	VOLTS
MAXIMUM SCREEN VOLTAGE	125	VOLTS
MAXIMUM PLATE DISSIPATION	4.0	WATTS
MAXIMUM SCREEN DISSIPATION	0.4	WATT
MAXIMUM CATHODE CURRENT	14	MA.

CAPACITANCES

WITH RMA MIN. SHIELD CONNECTED TO CATHODE WITHOUT SHIELD

CONTROL GRID TO ALL OTHER ELECTRODES	4.3	4.3	µuf
PLATE TO ALL OTHER ELECTRODES	5.0	5.0	µuf
CONTROL GRID TO PLATE (MAX.)	0.005	0.004	µuf

TYPICAL OPERATING CONDITIONS AND CHARACTERISTICS

HEATER OR FILAMENT VOLTAGE	6.3	6.3	VOLTS
HEATER OR FILAMENT CURRENT	0.3	0.3	AMP.
PLATE VOLTAGE	100	250	VOLTS
SCREEN VOLTAGE	100	100	VOLTS
CONTROL GRID VOLTAGE	-1	-3	VOLTS
PEAK AF SIGNAL VOLTAGE			VOLTS
PLATE CURRENT	13	9	MA.
SCREEN CURRENT	5	3.5	MA.
MAXIMUM-SIGNAL PLATE CURRENT			MA.
MAXIMUM-SIGNAL SCREEN CURRENT			MA.
PLATE RESISTANCE	0.12	0.7	MEG OHM
TRANSCONDUCTANCE	2350	2000	µMHOS
AMPLIFICATION FACTOR			
LOAD RESISTANCE			OHMS
TOTAL HARMONIC DISTORTION			PER CENT
POWER OUTPUT			WATTS
CONTROL GRID VOLTAGE (APPROX.)			
FOR TRANSCONDUCTANCE = 10 µMHOS	-35	-35	VOLTS

PRINTED IN U. S. A.

PLATE 1718
JUNE 17 1946

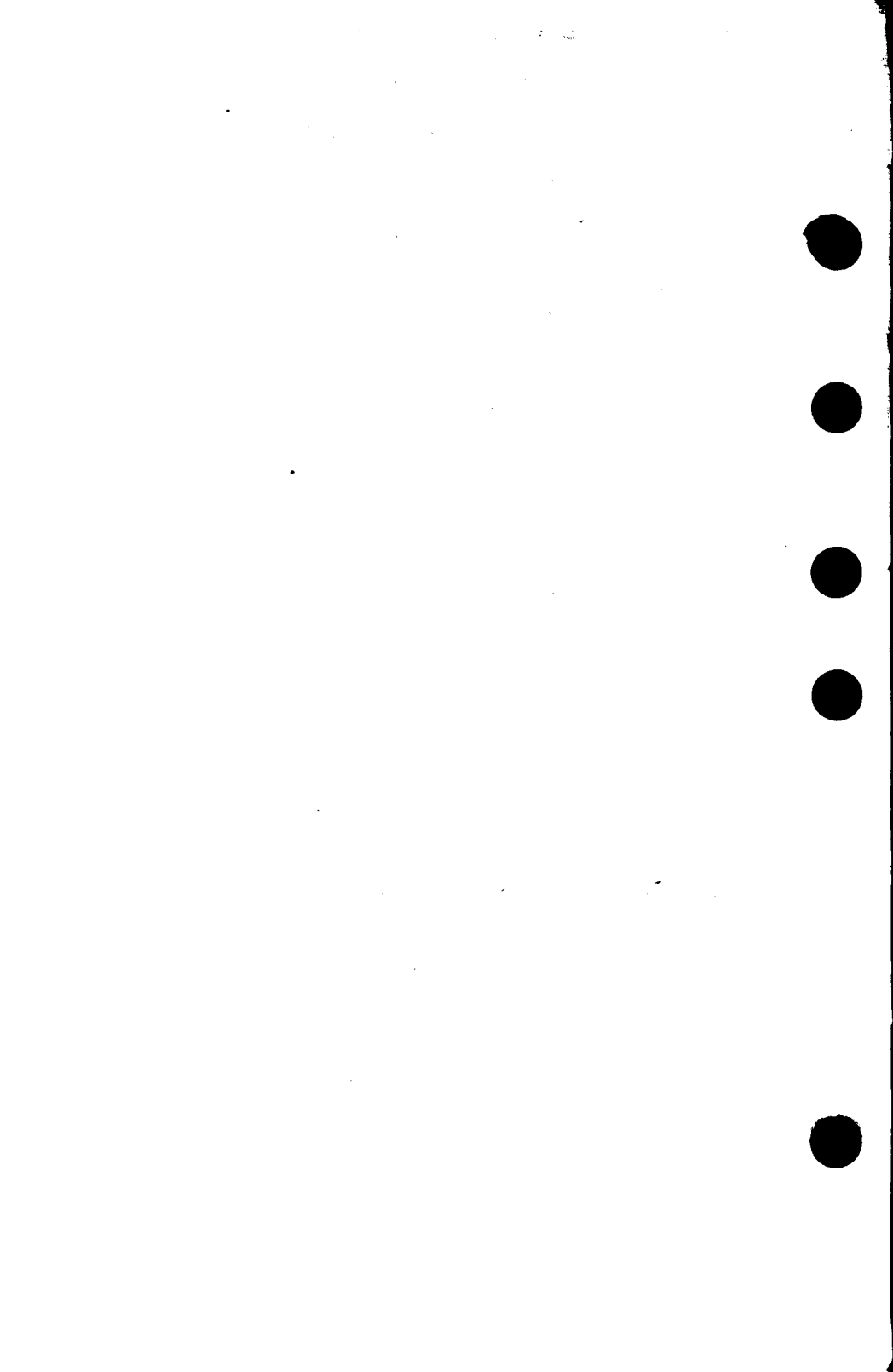

TUNG-SOL

PENTAGRID CONVERTER
MINIATURE TYPE

PHYSICAL SPECIFICATIONS

EMITTER UNIPOTENTIAL CATHODE		PIN CONNECTIONS	
BASE	MIN. BUTTON 7-PIN	PIN 1 GRID 1	PIN 7 GRID 3
CAP	NONE	PIN 2 GRID 5, CATHODE	PIN 8 NONE
BULB	T-5 $\frac{1}{2}$	PIN 3 HEATER	
MAX. DIAMETER	3/4"	PIN 4 HEATER	MOUNTING POS. ANY
MAX. SEATED HEIGHT	1-7/8"	PIN 5 PLATE	
MAX. OVERALL LENGTH	2-1/8"	PIN 6 GRID 2, GRID 4	

RATINGS

INTERPRETED ACCORDING TO RMA STANDARD W8-210

HEATER OR FILAMENT VOLTAGE (AC OR DC)	6.3	VOLTS
HEATER OR FILAMENT CURRENT	0.300	AMPS.
MAXIMUM PLATE VOLTAGE	300	VOLTS
MAXIMUM PLATE DISSIPATION	1.0	WATTS
MAXIMUM TOTAL CATHODE CURRENT	14	MA.
MAXIMUM GRID VOLTAGE (G_2 & G_4)	100	VOLTS
MAXIMUM GRID SUPPLY VOLTAGE (G_2 & G_4)	300	VOLTS
MAXIMUM GRID DISSIPATION (G_2 & G_4)	1.0	WATT
MAXIMUM PEAK HEATER-CATHODE VOLTAGE:		
HEATER NEG. WITH RESPECT TO CATHODE	90	VOLTS
HEATER POS. WITH RESPECT TO CATHODE	90	VOLTS
MAXIMUM GRID 3 VOLTAGE:		
NEG. BIAS	50	VOLTS
POS. BIAS	0	VOLTS

CAPACITANCES

WITH NO EXTERNAL SHIELD

G_3 TO PLATE (C_{G3P}) (MAX.)	0.30	μuf
G_4 TO PLATE (C_{G4P}) (MAX.)	0.05	μuf
G_4 TO G_3 (C_{G4G3}) (MAX.)	0.15	μuf
G_3 TO ALL OTHER ELECTRODES (RF INPUT) (C_{G3} ($H+K+G_1+G_2+G_4+G_5$))	7.2	μuf
PLATE TO ALL OTHER ELECTRODES (MIXER OUTPUT) C_p ($H+K+G_1+G_2+G_3+G_4+G_5$)	8.6	μuf
GRID NO. 1 TO ALL OTHER ELECTRODES (OSCILLATOR INPUT) C_{G1} ($H+K+G_2+G_3+G_4+G_5+P$)	5.5	μuf
GRID NO. 1 TO ALL OTHER ELECTRODES EXCEPT CATHODE C_{G1} ($H+G_2+G_3+G_4+G_5+P$)	2.7	μuf
GRID NO. 1 TO CATHODE (C_{G1K})	2.8	μuf
CATHODE TO ALL OTHER ELECTRODES EXCEPT G_1 C_K ($H+G_2+G_3+G_4+G_5+P$)	15	μuf

CONTINUED ON FOLLOWING PAGE

PLATE
1678FEB. 15
1946

TUNG-SOL

CONTINUED FROM PRECEDING PAGE

TYPICAL OPERATING CONDITIONS AND CHARACTERISTICS
CONVERTER SERVICE - SEPARATE EXCITATION

PLATE VOLTAGE	100	250	VOLTS
SCREEN GRID VOLTAGE (G_2 & G_4)	100	100	VOLTS
CONTROL GRID VOLTAGE (G_3)	-1.5	-1.5	VOLTS
PLATE CURRENT	2.8	3.0	MA.
SCREEN GRID CURRENT (G_2 & G_4)	7.3	7.1	MA.
TOTAL CATHODE CURRENT	10.6	10.6	MA.
OSCILLATOR-GRID (G_1) RESISTOR	20 000	20 000	OHMS
CONVERSION TRANSCONDUCTANCE	455	475	μ MHOS
PLATE RESISTANCE (APPROX.)	0.5	1.0	MEGOMM
CONVERSION TRANSCONDUCTANCE FOR G_3 BIAS OF -30 VOLTS (APPROX.)	4.0	4.0	μ MHOS
GRID (G_1) CURRENT	0.5	0.5	MA.

NOTE: (1) THE CHARACTERISTICS SHOWN WITH SEPARATE EXCITATION CORRESPOND VERY CLOSELY WITH THOSE OBTAINED IN A SELF-EXCITED OSCILLATOR CIRCUIT OPERATING WITH ZERO BIAS.

(2) THE TRANSCONDUCTANCE BETWEEN GRID 1 AND GRIDS 2 & 4 CONNECTED TO PLATE (NOT OSCILLATING) IS APPROXIMATELY 7250 MICROMHOS UNDER THE FOLLOWING CONDITIONS: GRIDS NO. 1 & NO. 3 AT 0 VOLTS; GRIDS NO. 2 & NO. 4 AND PLATE AT 100 VOLTS. UNDER THE SAME CONDITIONS, THE PLATE CURRENT IS 25 MA., AND THE AMPLIFICATION FACTOR IS 20.

TUNG-SOL

PENTODE

MINIATURE TYPE

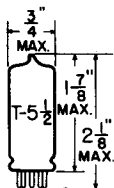

GLASS BULB

COATED UNIPOTENTIAL CATHODE

HEATER

6.3 VOLTS 150 MA.

AC OR DC

ANY MOUNTING POSITION

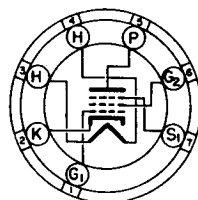

BOTTOM VIEW

MINIATURE BUTTON
7-PIN BASE

THE 6BH6 IS A SHARP CUT-OFF PENTODE VOLTAGE AMPLIFIER IN THE MINIATURE CONSTRUCTION. IT FEATURES HIGH TRANSCONDUCTANCE, LOW CAPACITANCES, AND ECONOMY OF HEATER POWER AND IS USEFUL AS A GENERAL PURPOSE AMPLIFIER AT BOTH LOW AND HIGH FREQUENCIES.

DIRECT INTERELECTRODE CAPACITANCES WITH NO EXTERNAL SHIELD

GRID TO PLATE: (G TO P) MAX.	0.0035	μμf
INPUT: G ₁ TO (H+K+G ₂ +G ₃ &IS)	5.4	μμf
OUTPUT: P TO (H+K+G ₂ +G ₃ &IS)	4.4	μμf

RATINGS

INTERPRETED ACCORDING TO RMA STANDARD M8-210

HEATER VOLTAGE	6.3	VOLTS
MAXIMUM HEATER-CATHODE VOLTAGE	90	VOLTS
MAXIMUM PLATE VOLTAGE	300	VOLTS
MAXIMUM GRID #2 VOLTAGE	150	VOLTS
MAXIMUM GRID #2 SUPPLY VOLTAGE	300	VOLTS
MAXIMUM NEGATIVE DC GRID #1 VOLTAGE	50	VOLTS
MAXIMUM POSITIVE DC GRID #1 VOLTAGE	0	VOLTS
MAXIMUM PLATE DISSIPATION	3	WATTS
MAXIMUM GRID #2 DISSIPATION	0.5	WATT

TYPICAL OPERATING CONDITIONS AND CHARACTERISTICS

CLASS A₁ AMPLIFIER

HEATER VOLTAGE	6.3	6.3	VOLTS
HEATER CURRENT	150	150	MA.
PLATE VOLTAGE	100	250	VOLTS
GRID #3 VOLTAGE			
GRID #2 VOLTAGE	100	150	VOLTS
GRID #1 VOLTAGE	-1	-1	VOLTS
PLATE RESISTANCE (APPROX.)	0.7	1.4	MEG OHMS
TRANSCONDUCTANCE	3 400	4 600	μMHOS
PLATE CURRENT	3.6	7.4	MA.
GRID #2 CURRENT	1.4	2.9	MA.
GRID #1 VOLTAGE FOR I _b = 10 μA	-5	-7.7	VOLTS

PIN #7 CONNECTED TO PIN #2 AT SOCKET

PRINTED IN U. S. A.

PLATE
1922
DEC. 1,
1947

6BH6

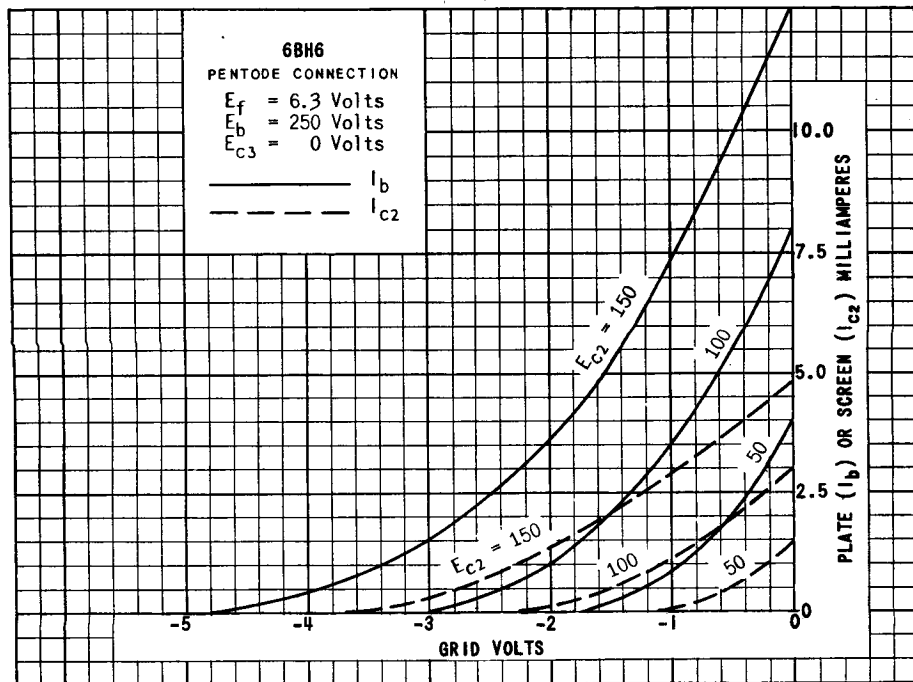
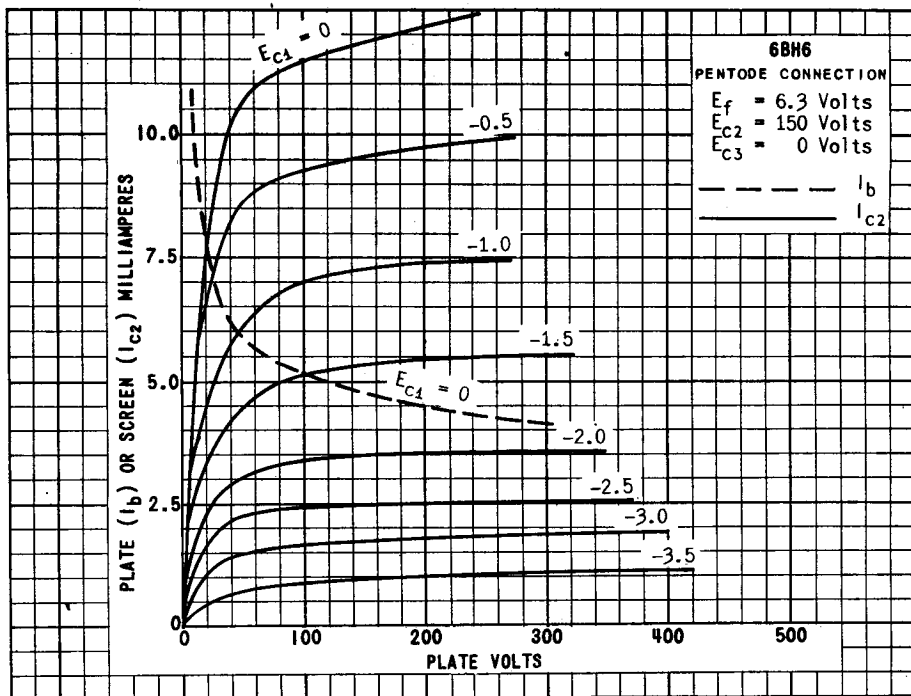
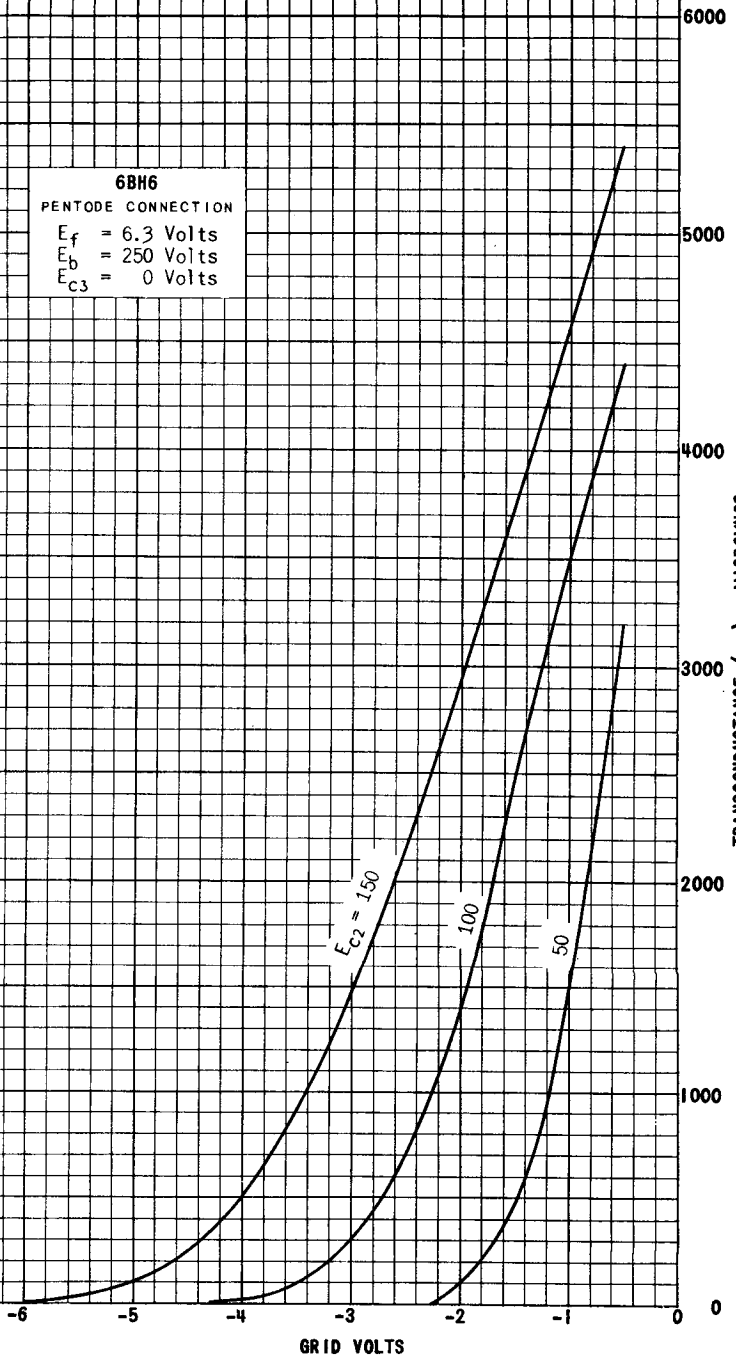

PLATE
 1923
 DEC. 1,
 1947

6BH6
 PENTODE CONNECTION
 $E_f = 6.3$ Volts
 $E_b = 250$ Volts
 $E_{c3} = 0$ Volts



PRINTED IN U. S. A.

PLATE
 1924
 DEC. 1,
 1947



TUNG-SOL

TRIODE

MINIATURE TYPE

COATED UNIPOTENTIAL CATHODE

HEATER

6.3 VOLTS 150 MA.

AC OR DC

ANY MOUNTING POSITION

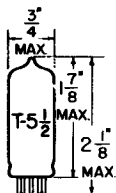

GLASS BULB

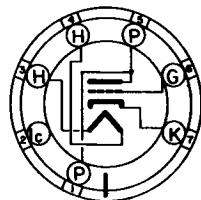
BOTTOM VIEW
 MINIATURE BUTTON
 7 PIN BASE

THE 6C4 IS A LOW-MU TRIODE VOLTAGE AMPLIFIER OF THE MINIATURE TYPE. IT IS PARTICULARLY USEFUL AS A HIGH FREQUENCY LOW-POWER OSCILLATOR DUE TO ITS HIGH TRANSCONDUCTANCE, LOW CAPACITANCES AND LEAD INDUCTANCES. LOW HEATER POWER REQUIREMENTS MAKE IT ATTRACTIVE FOR USE IN PORTABLE AND ALSO IN SERIES-HEATER CONNECTED CIRCUITS.

DIRECT INTERELECTRODE CAPACITANCES
 WITH NO EXTERNAL SHIELD

GRID TO PLATE: (G TO P)	1.6	μf
INPUT: G TO (H+K)	1.8	μf
OUTPUT: P TO (H+K)	1.3	μf

RATINGS

INTERPRETED ACCORDING TO RMA STANDARD M8-210

	AF AMPLIFIER	RF AMPLIFIER	
HEATER VOLTAGE	6.3	6.3	VOLTS
MAXIMUM HEATER-CATHODE VOLTAGE	90	90	VOLTS
MAXIMUM PLATE VOLTAGE	300	300	VOLTS
MAXIMUM NEGATIVE DC GRID VOLTAGE	---	50	VOLTS
MAXIMUM GRID CIRCUIT RESISTANCE (FIXED BIAS)	0.25	---	MEG.
MAXIMUM GRID CIRCUIT RESISTANCE (SELF BIAS)	1	---	MEG.
MAXIMUM DC PLATE CURRENT	---	25	MA.
MAXIMUM DC GRID CURRENT	---	8	MA.
PLATE DISSIPATION	3.5	5	WATTS

TYPICAL OPERATING CONDITIONS AND CHARACTERISTICS

CLASS A₁ AMPLIFIER

HEATER VOLTAGE	6.3	6.3	VOLTS
HEATER CURRENT	150	150	MA.
PLATE VOLTAGE	100	250	VOLTS
GRID VOLTAGE ^A	0	-8.5	VOLTS
PLATE CURRENT	11.8	10.5	MA.
PLATE RESISTANCE	6 250	7 700	OHMS
TRANSCONDUCTANCE	3 100	2 200	μMHOS
AMPLIFICATION FACTOR	19.5	17	

^ATHE TYPE OF INPUT COUPLING USED SHOULD NOT INTRODUCE TOO MUCH RESISTANCE IN THE GRID CIRCUIT. TRANSFORMER OR IMPEDANCE COUPLING DEVICES ARE RECOMMENDED.

CONTINUED ON FOLLOWING PAGE

→ INDICATES A CHANGE OR ADDITION.

CONTINUED FROM PRECEDING PAGE

TYPICAL OPERATING CONDITIONS AND CHARACTERISTICS

RF POWER AMPLIFIER AND OSCILLATOR - CLASS C TELEGRAPHY
 AS AN OSCILLATOR AT 150 MC APPROXIMATELY 2.5 WATTS CAN BE OBTAINED WITH
 A GRID RESISTOR OF 10000 OHMS AND MAXIMUM RATED INPUT.

HEATER VOLTAGE	6.3	VOLTS
HEATER CURRENT	150	MA.
DC PLATE VOLTAGE	300	VOLTS
DC GRID VOLTAGE	-27	VOLTS
DC PLATE CURRENT	25	MA.
DC GRID CURRENT (APPROX.)	7	MA.
DRIVING POWER (APPROX.)	0.35	WATT
POWER OUTPUT (APPROX.)	5.5	WATTS

RESISTANCE COUPLED AMPLIFIER

R_L MEG.	R_{g1} MEG.	R_c MEG.	$E_{bb} = 90$ VOLTS			$E_{bb} = 180$ VOLTS			$E_{bb} = 300$ VOLTS		
			R_k	GAIN	E_o	R_k	GAIN	E_o	R_k	GAIN	E_o
0.10	A	0.10	3000	11	12	2000	12	23	1600	13	34
0.10	A	0.24	3300	12	15	2400	12	30	1800	13	40
0.24	A	0.24	7500	12	14	4700	13	25	3600	13	37
0.24	A	0.51	8200	12	16	6200	13	32	4300	13	43
0.51	A	0.51	12000	12	13	8200	13	24	6200	13	33
0.51	A	1.0	13000	12	15	9100	13	28	6800	13	36
0.24	10	0.24	---	13	12	---	15	24	---	16	35
0.24	10	0.51	---	14	15	---	16	28	---	17	49
0.51	10	0.51	---	14	13	---	15	25	---	17	40
0.51	10	1.0	---	14	16	---	16	32	---	17	54

A VALUE OF R_{g1} IS NOT CRITICAL.

GAIN MEASURED AT $E_o = 2.0$ VOLTS RMS OUTPUT.

E_o IS RMS OUTPUT FOR 5% TOTAL HARMONIC DISTORTION.

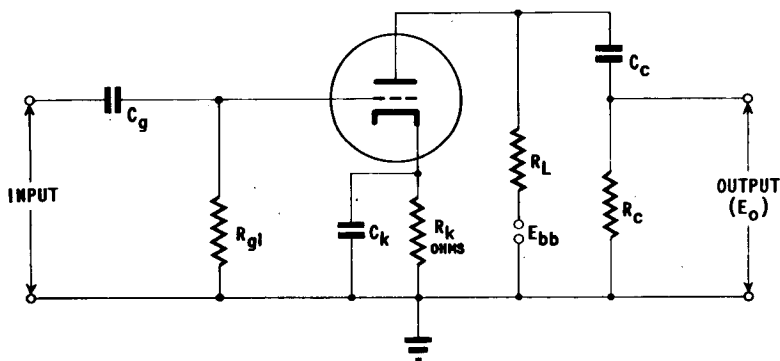

NOTE: COUPLING CAPACITORS C_g
 AND C_c SHOULD BE SE-
 LECTED TO GIVE DESIRED
 FREQUENCY RESPONSE. R_k
 SHOULD BE ADEQUATELY
 BY-PASSED BY CAPACITOR
 C_k .

PLATE
 1964
 FEB. 2,
 1948

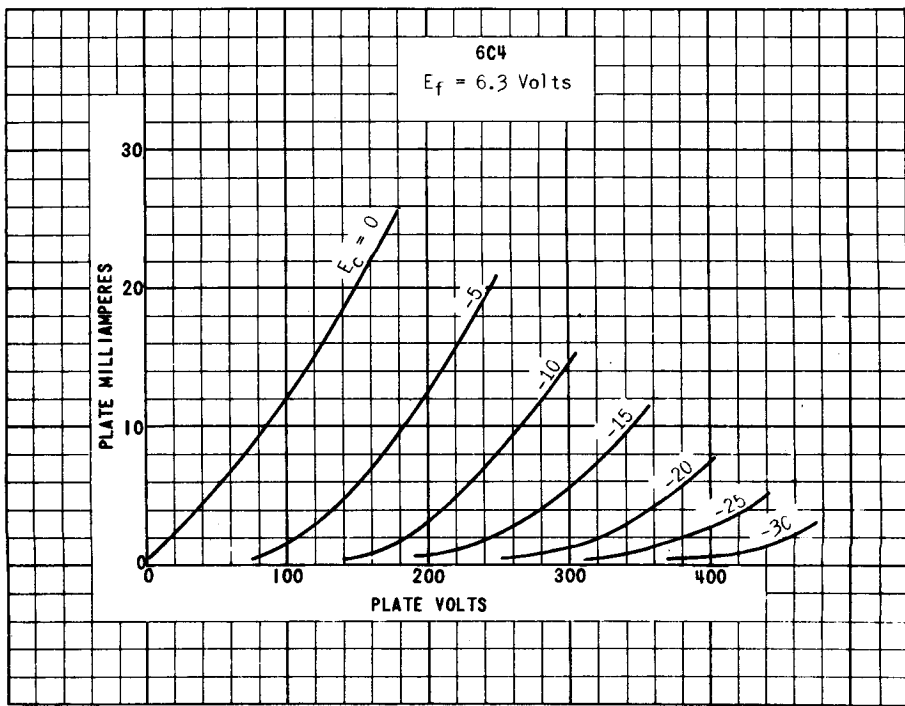
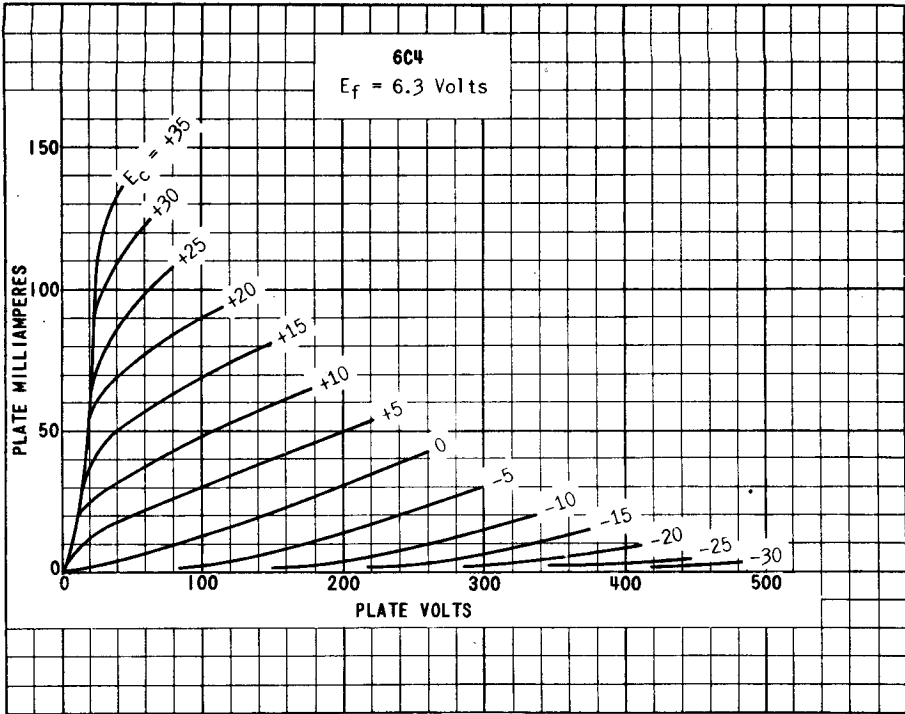

PRINTED IN U. S. A.

PLATE
1963
FEB. 2,
1948

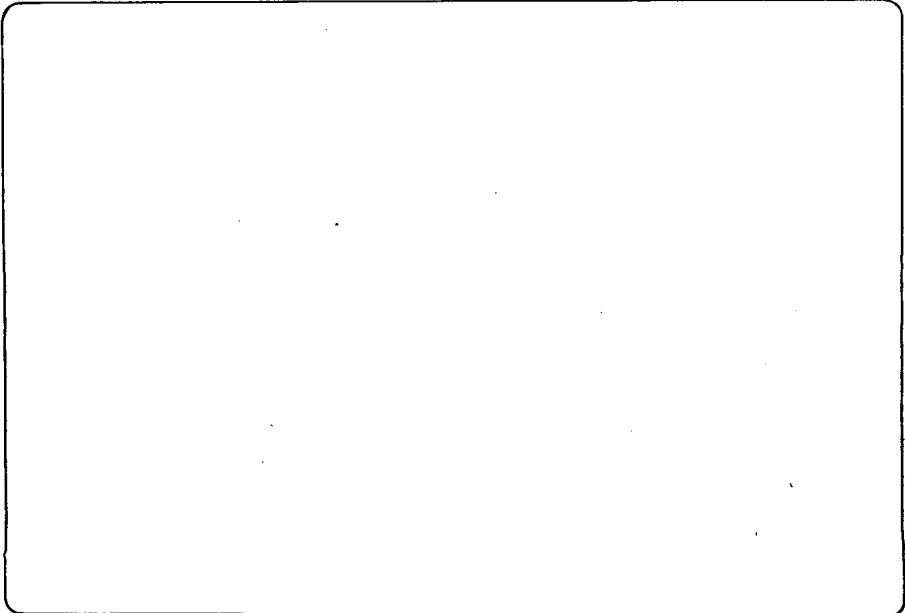
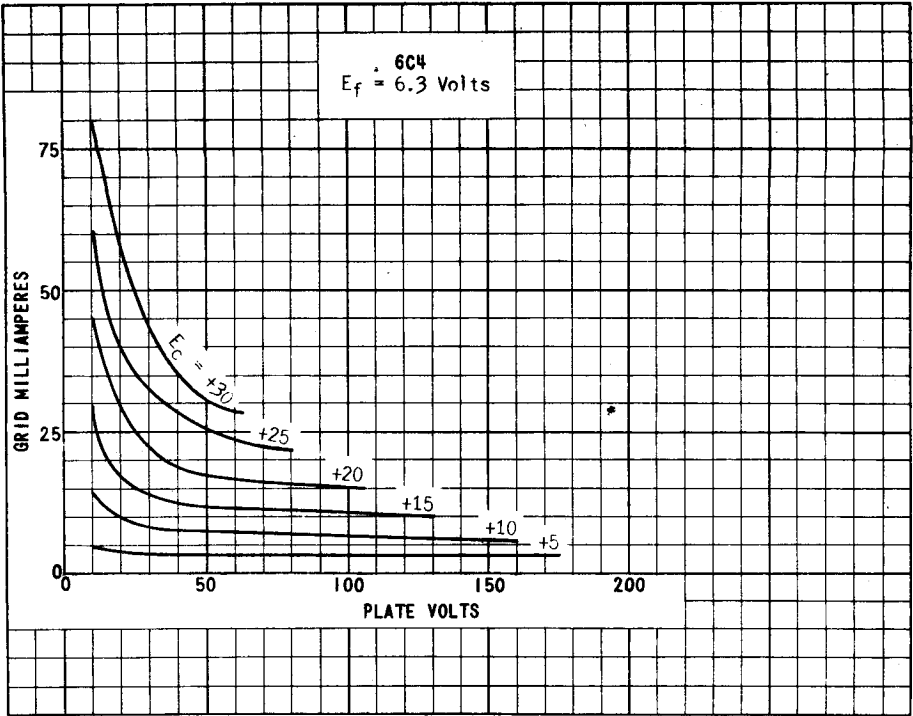
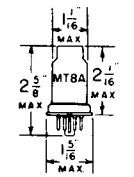

PLATE
1966
FEB. 2,
1948

TUNG-SOL

TRIODE AMPLIFIER

UNIPOTENTIAL CATHODE
HEATER
6.3 VOLTS 0.3 AMPERE
AC OR DC



METAL SHELL
6 PIN OCTAL BASE
6C5

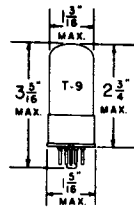

GLASS BULB
6 PIN OCTAL BASE
WITH METAL SHELL
6C5GT

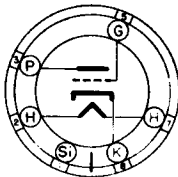

G-6Qb

BOTTOM VIEW
6C5G

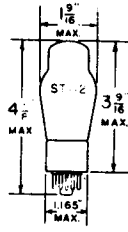

GLASS BULB
SMALL 6 PIN OCTAL BASE
6C5G

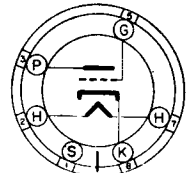

6Q

BOTTOM VIEW
6C5 6C5GT

THE TUNG-SOL 6C5, 6C5G AND 6C5GT ARE GENERAL PURPOSE TRIODES DESIGNED FOR SERVICE AS OSCILLATORS, DETECTORS OR AMPLIFIERS. WITH THE EXCEPTION OF CAPACITANCES, THEIR ELECTRICAL CHARACTERISTICS ARE IDENTICAL. THEY ARE SIMILAR IN CHARACTERISTICS TO THE 6C6, 6J7 AND 57 WITH TRIODE CONNECTION.

RATINGS

MAXIMUM PLATE VOLTAGE	300	VOLTS
MAXIMUM PLATE DISSIPATION	2.5	WATTS
MINIMUM GRID VOLTAGE	0	

TYPICAL OPERATING CONDITIONS AND CHARACTERISTICS

CLASS A₁ AMPLIFIER

PLATE VOLTAGE	250	VOLTS
GRID VOLTAGE ^A	-8	VOLTS
PLATE CURRENT	8	MA.
PLATE RESISTANCE	10 000	OHMS
TRANSCONDUCTANCE	2000	μMHOS
AMPLIFICATION FACTOR	20	

^A THE DC RESISTANCE IN THE GRID CIRCUIT SHOULD NOT EXCEED 1.0 MEGOHM.

CONTINUED NEXT PAGE

6C5, 6C5G, 6C5GT

TUNG-SOL

DIRECT INTERELECTRODE CAPACITANCES^B

	6C5	6C5G	6C5GT	
GRID TO CATHODE	3.0	4.4	3.6	μf
PLATE TO CATHODE	11	12	11	μf
GRID TO PLATE	2.0	2.2	1.6	μf

^B WITH SHELL OR SHIELD CONNECTED TO THE CATHODE

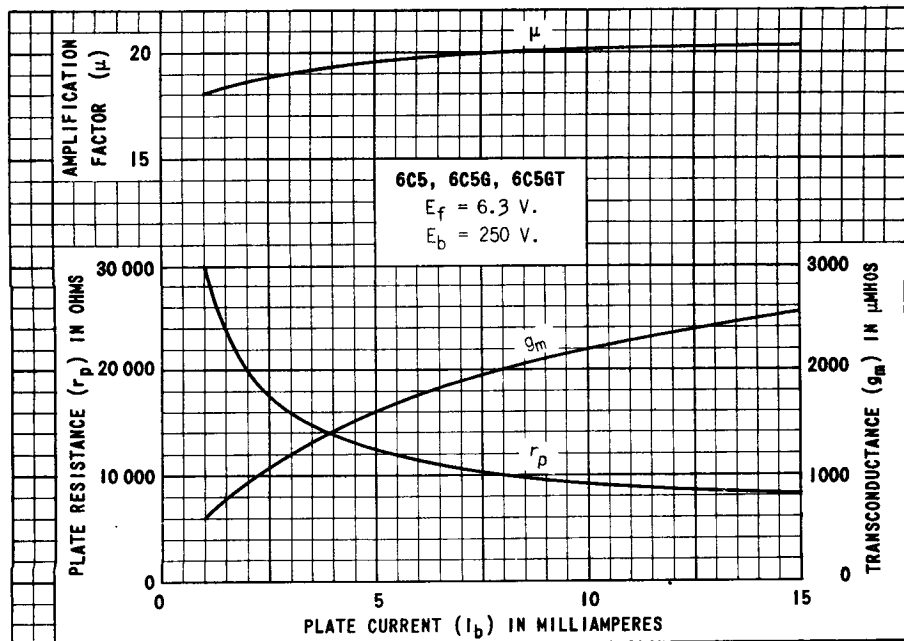
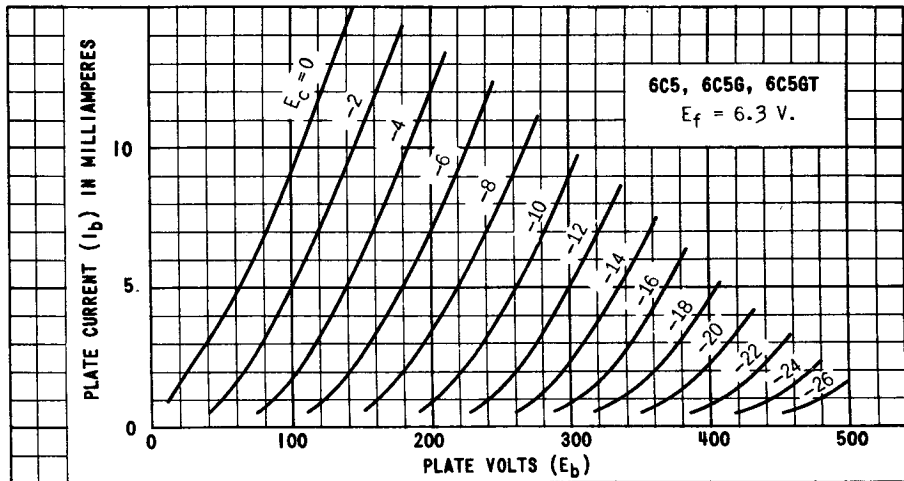
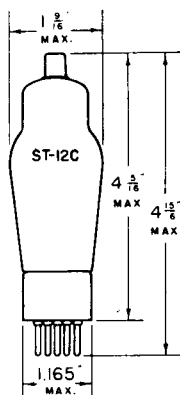

PLATE
626-2

TUNG-SOL



TRIPLE GRID
DETECTOR AMPLIFIER

UNIPOTENTIAL CATHODE

HEATER

6.3 VOLTS 0.3 AMPERE

AC OR DC

GLASS BULB

SMALL 6 PIN BASE

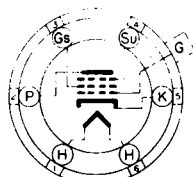

6F

BOTTOM VIEW

THE TUNG-SOL 6C6 IS A TRIPLE GRID GENERAL PURPOSE DETECTOR AMPLIFIER. WITH THE EXCEPTION OF CAPACITANCES, ITS ELECTRICAL CHARACTERISTICS ARE IDENTICAL WITH THOSE OF THE 6J7G AND THE 6J7GT.

RATINGS

	TRIODE ^D CONNECTION	PENTODE CONNECTION	
MAXIMUM PLATE VOLTAGE	250	300	VOLTS
MAXIMUM SCREEN SUPPLY VOLTAGE	PLATE	300	VOLTS
MAXIMUM SCREEN VOLTAGE	PLATE	125	VOLTS
MINIMUM EXTERNAL GRID BIAS VOLTAGE	0	0	VOLTS
MAXIMUM PLATE DISSIPATION	1.75	0.75	WATTS
MAXIMUM SCREEN DISSIPATION	—	0.10	WATT

TYPICAL OPERATING CONDITIONS AND CHARACTERISTICS

CLASS A₁ AMPLIFIER

	TRIODE CONNECTION		PENTODE CONNECTION		
PLATE VOLTAGE	180	250	100	250	VOLTS
SCREEN VOLTAGE	PLATE	PLATE	100	100	VOLTS
CONTROL GRID VOLTAGE ^A	-5.3	-8	-3	-3	VOLTS
SUPPRESSOR GRID VOLTAGE	PLATE	PLATE	CONNECTED TO CATHODE AT SOCKET		
PLATE CURRENT	5.3	6.5	2.0	2.0	MA.
SCREEN CURRENT	—	—	0.5	0.5	MA.
PLATE RESISTANCE	.0110	.0105	1.0	— ^B	MEGOHM
TRANSCONDUCTANCE	1800	1900	1185	1225	μMHOS
AMPLIFICATION FACTOR	20	20	—	—	
CONTROL GRID BIAS ^C	—	—	-7	-7	VOLTS

^A THE DC RESISTANCE IN THE GRID CIRCUIT SHOULD NOT EXCEED 1.0 MEGOHM.

^B GREATER THAN 1.0 MEGOHM

^C FOR CATHODE CURRENT CUT-OFF

^D SUPPRESSOR GRID AND SCREEN TIED TO PLATE

CONTINUED NEXT PAGE

TUNG-SOL

DIRECT INTERELECTRODE CAPACITANCES^s

	TRIODE CONNECTION	PENTODE CONNECTION	
CONTROL GRID TO CATHODE	3.0	5.0	μf
PLATE TO CATHODE	10.5	6.5	μf
CONTROL GRID TO PLATE ^{MAX.}	2.0	.007	μf

^s MEASURED WITH AN EXTERNAL SHIELD. THE INTERNAL SHIELD WITHIN THE DOME OF THE 6C6 IS CONNECTED TO THE CATHODE WITHIN THE TUBE.

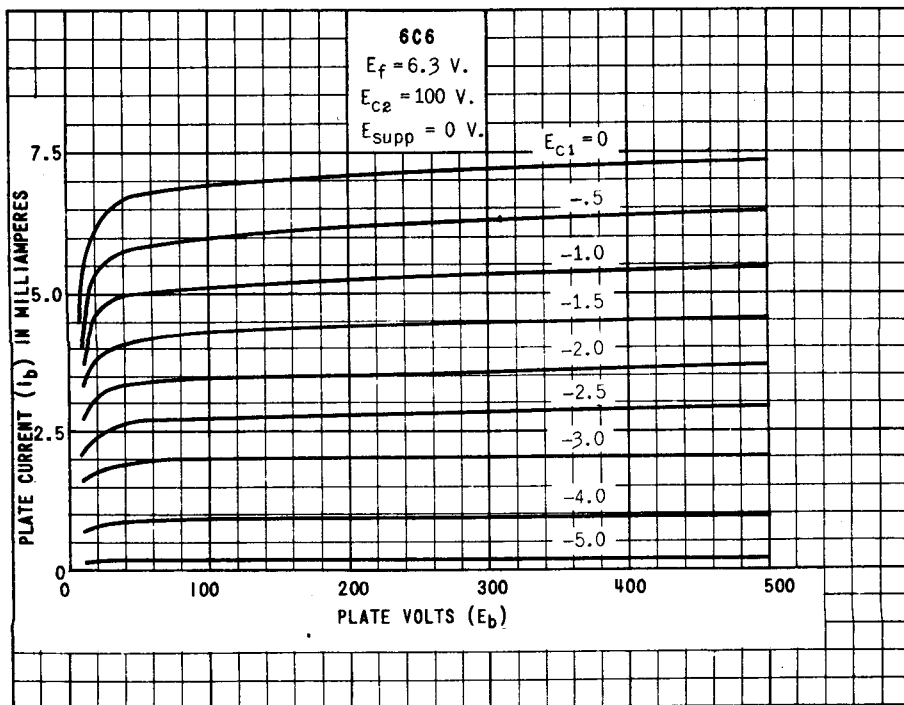

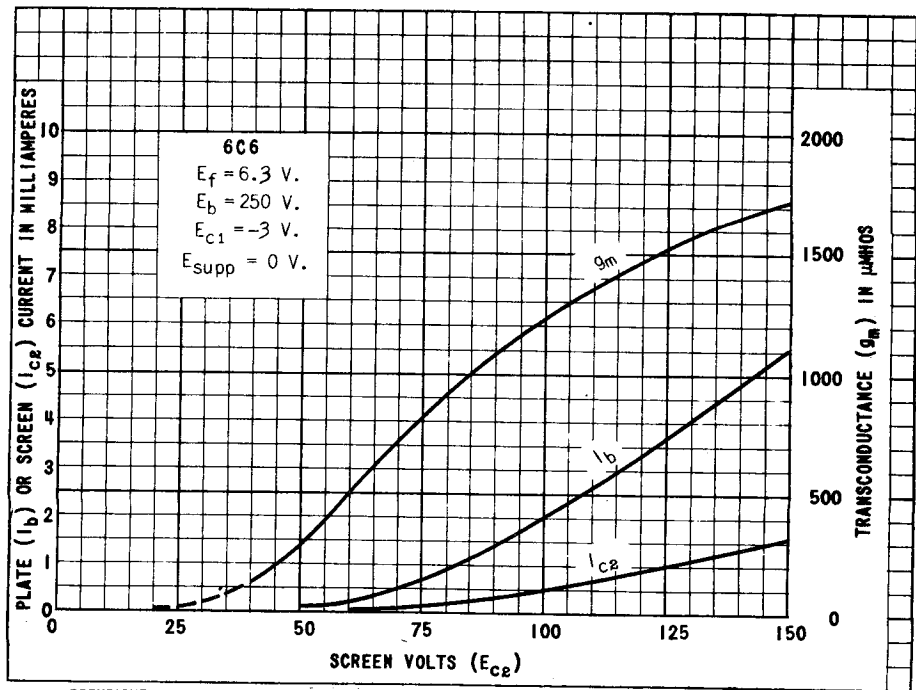
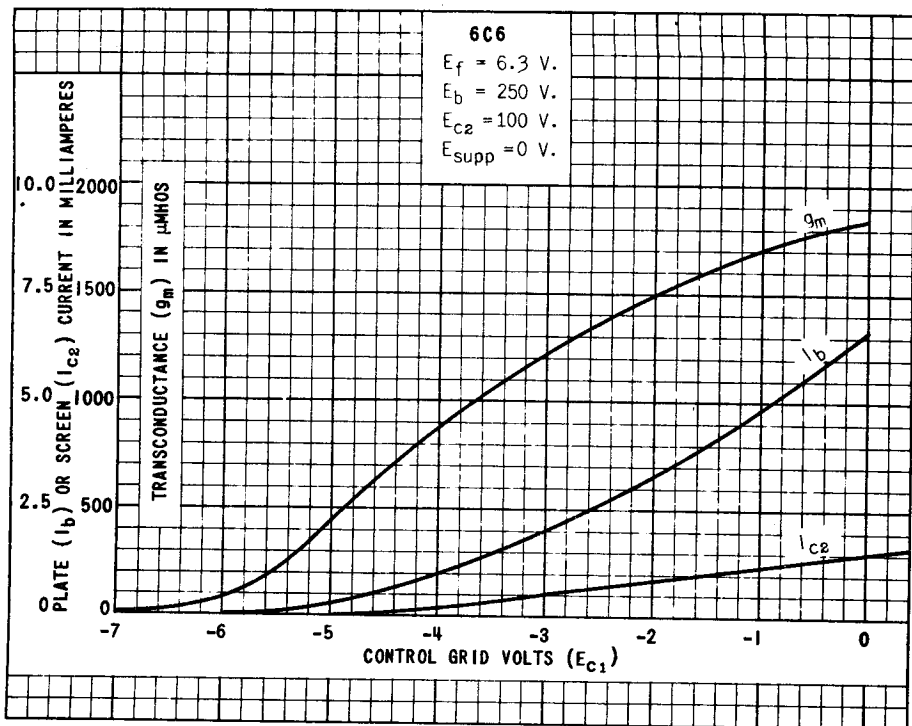

TUNG-SOL

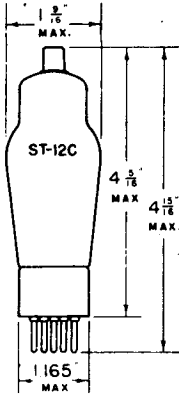

DUO-DIODE TRIODE AMPLIFIER

UNIPOTENTIAL CATHODE

HEATER

6.3 VOLTS 0.3 AMPERE
AC OR DC

GLASS BULB

SMALL 7 PIN BASE

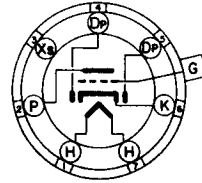

7 G

BOTTOM VIEW

THE TUNG-SOL 6C7 CONSISTS OF TWO DIODES AND A TRIODE WITH A COMMON CATHODE. ITS ELECTRICAL CHARACTERISTICS ARE SIMILAR TO THOSE OF THE 6R7, 6R7G, AND THE 6R7GT.

OPERATING CONDITIONS AND CHARACTERISTICS

CLASS A₁ AMPLIFIER

PLATE VOLTAGE	250	VOLTS
GRID VOLTAGE	-9.0	VOLTS
PLATE CURRENT	4.5	MA.
PLATE RESISTANCE	16 000	OHMS
TRANSCONDUCTANCE	1250	μMHOS
AMPLIFICATION FACTOR	20	

TUNG-SOL

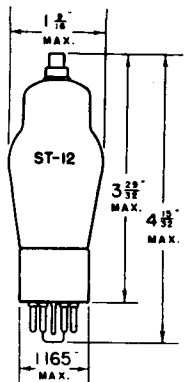

TWIN TRIODE AMPLIFIER

UNIPOTENTIAL CATHODES

HEATER

6.3 VOLTS 0.3 AMPERE

AC OR DC

GLASS BULB

SMALL 8 PIN OCTAL BASE

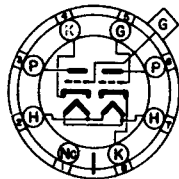

G-8G

BOTTOM VIEW

THE TUNG-SOL 6C8G IS A GENERAL PURPOSE TWIN TRIODE HAVING TWO INDEPENDENT UNITS, WITH ALL ELECTRODES BROUGHT OUT TO SEPARATE TERMINALS.

OPERATING CONDITIONS AND CHARACTERISTICS

CLASS A₁ AMPLIFIER - EACH TRIODE

PLATE VOLTAGE	250 MAX.	VOLTS
GRID VOLTAGE	-4.5	VOLTS
PLATE CURRENT	3.2	MA.
PLATE RESISTANCE	22 500	OHMS
TRANSCONDUCTANCE	1600	μMHOS
AMPLIFICATION FACTOR	36	

RESISTANCE COUPLED AMPLIFIER AND PHASE INVERTER

VALUES ARE FOR SINGLE TRIODE SECTION

PLATE SUPPLY VOLTAGE	100	100	250	250	VOLTS
PLATE LOAD RESISTOR	0.1	0.5	0.1	0.5	MEGOHM
CATHODE RESISTOR	3500	12 000	3000	10 000	OHMS
VOLTAGE GAIN	20	22	22	26	

DIRECT INTERELECTRODE CAPACITANCES

	TRIODE B	TRIODE T	
GRID TO CATHODE	3.4	2.5	μμf
PLATE TO CATHODE	3.5	3.9	μμf
GRID TO CATHODE	2.5	2.4	μμf
GRID TO GRID		0.1	μμf
PLATE TO PLATE		1.5	μμf

TRIODE B - TRIODE HAVING GRID BROUGHT OUT TO BASE PIN.

TRIODE T - TRIODE HAVING GRID BROUGHT OUT TO TOP CAP.

NOTE: THIS TUBE NOT RECOMMENDED FOR OPERATION IN SERIES WITH OTHER 0.3 AMPERE TUBES AS THE SURGE CURRENT MAY CAUSE HEATER BURNOUTS.

PLATE 459-2
JUNE 1 1939

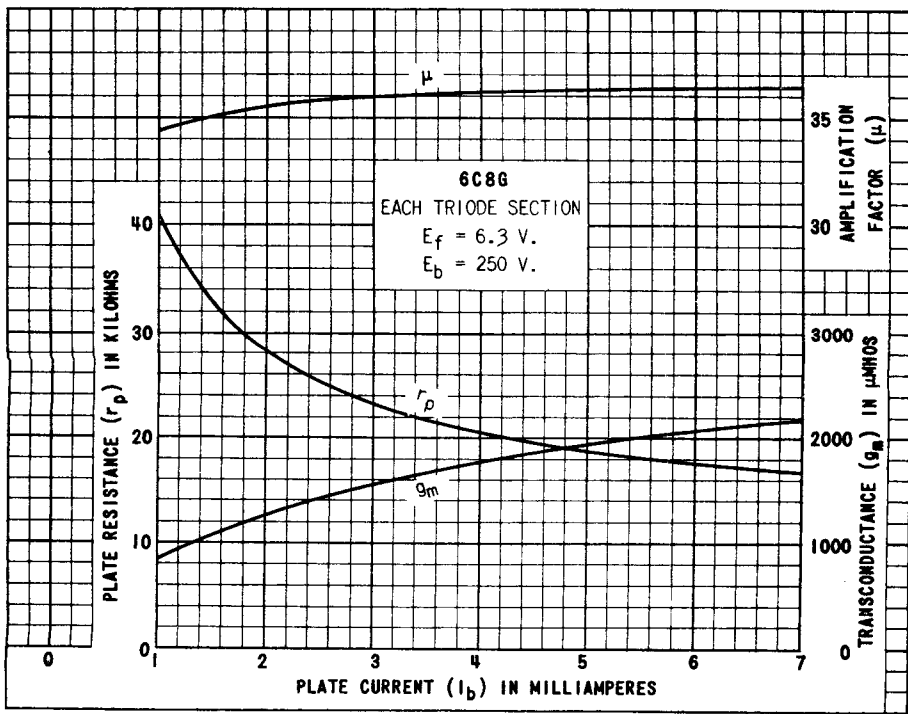
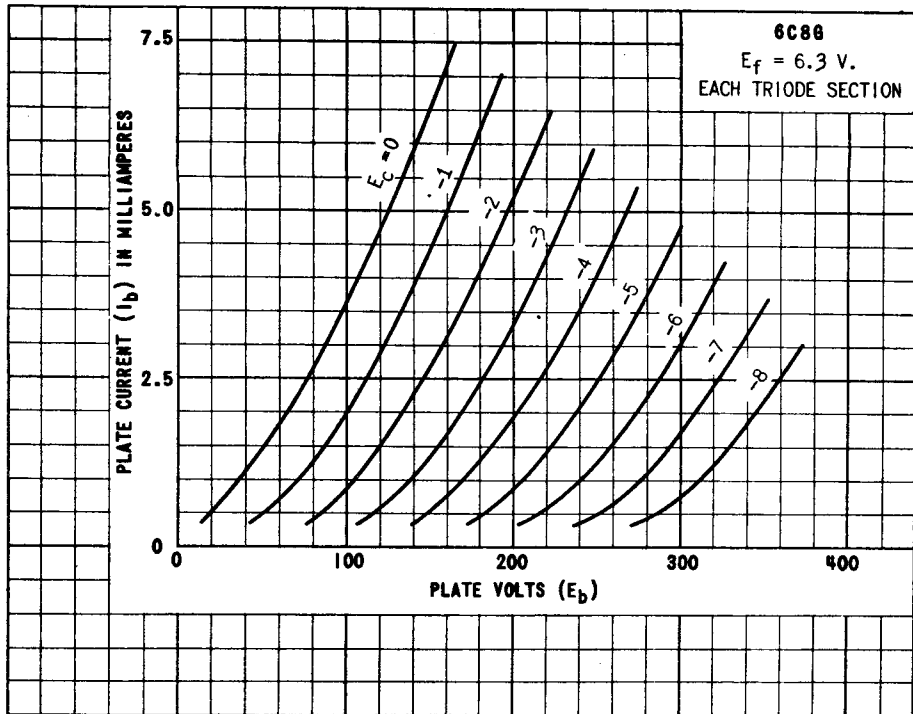

PLATE
 460-1

TUNG-SOL

THYRATRON
MINIATURE TYPE
PHYSICAL SPECIFICATIONS

EMITTER COATED UNIP. CATHODE	PIN CONNECTIONS	
BASE MIN. BUTTON 7-PIN	PIN 1 GRID	PIN 7 PLATE
CAP	PIN 2 NO CONNECTION	PIN 8 NONE
BULB T-5½	PIN 3 HEATER	
MAX. DIAMETER 3/4"	PIN 4 HEATER	MOUNTING POS. ANY
MAX. SEATED HEIGHT 1 7/8"	PIN 5 CATHODE	
MAX. OVERALL LENGTH 2 1/8"	PIN 6 NO CONNECTION	

RATINGS

INTERPRETED ACCORDING TO RMA STANDARD M8-210

HEATER VOLTAGE (AC OR DC)	6.3	VOLTS
HEATER CURRENT	0.250	AMPERE
MINIMUM HEATING TIME	30	SECONDS
MAXIMUM VOLTAGE BETWEEN ELEMENTS	450	VOLTS
PEAK ANODE CURRENT	100	MA.
AVERAGE ANODE CURRENT ^A	25	MA.
TUBE VOLTAGE DROP AT 25 MA. (APPROX.)	16	VOLTS

^AAVERAGED OVER PERIOD OF 30 SECONDS MAXIMUM.

PRINTED IN U. S. A.

PLATE
1679
FEB. 15
1946

6D4
 $E_f = 6.3$ Volts
Approximate Control
Characteristics

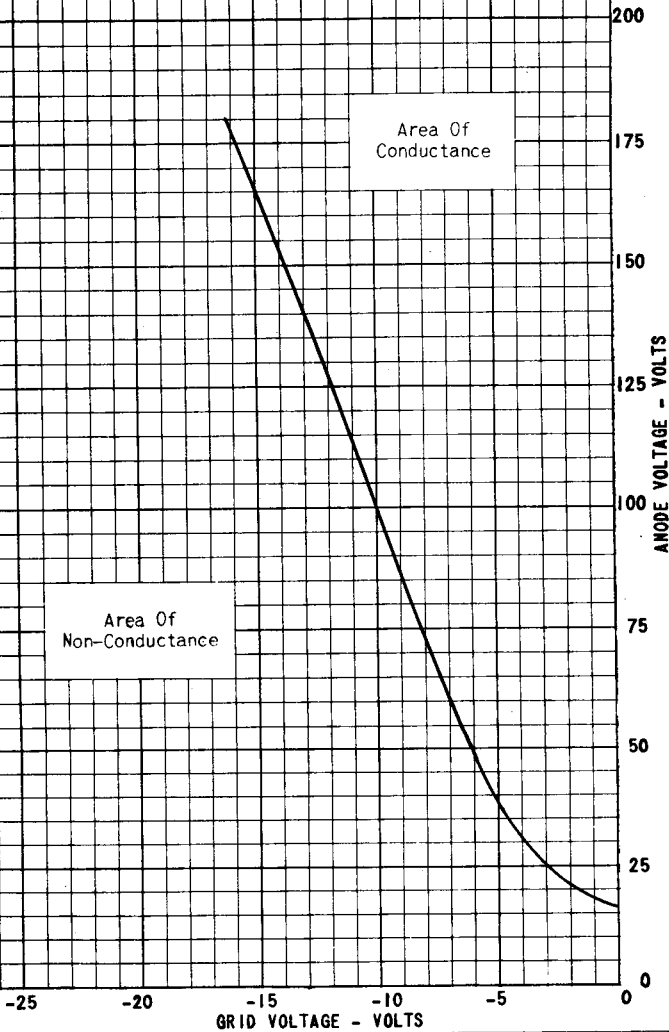
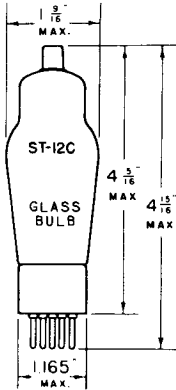

PLATE
1680
FEB. 15
1946

TUNG-SOL



SMALL 6 PIN BASE

TRIPLE GRID
REMOTE CUT-OFF AMPLIFIER

UNIPOTENTIAL CATHODE

HEATER

6.3 VOLTS 0.3 AMPERE
AC OR DC

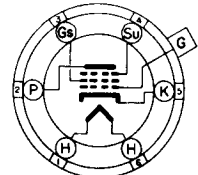

6F

BOTTOM VIEW

THE TUNG-SOL 6D6 IS A TRIPLE GRID VARIABLE MU AMPLIFIER. IT IS SUITABLE FOR USE WITH AVC IN RF AND IF AMPLIFIERS, AS IT MINIMIZES CROSS MODULATION. WITH THE EXCEPTION OF CAPACITANCES AND HEATER RATINGS, ITS ELECTRICAL CHARACTERISTICS ARE IDENTICAL WITH THOSE OF THE 6U7G AND THE 58.

RATINGS

MAXIMUM PLATE VOLTAGE	300	VOLTS
MAXIMUM SCREEN SUPPLY VOLTAGE	300	VOLTS
MAXIMUM SCREEN VOLTAGE	100	VOLTS
MINIMUM EXTERNAL GRID BIAS VOLTAGE	0	VOLT
MAXIMUM PLATE DISSIPATION	2.25	WATTS
MAXIMUM SCREEN DISSIPATION	0.25	WATT

TYPICAL OPERATING CONDITIONS AND CHARACTERISTICS

CLASS A₁ AMPLIFIER

PLATE VOLTAGE	100	250	VOLTS
SCREEN VOLTAGE	100	100	VOLTS
CONTROL GRID VOLTAGE	-3	-3	VOLTS
SUPPRESSOR GRID	CONNECTED TO CATHODE AT SOCKET		
PLATE CURRENT	8.0	8.2	MA.
SCREEN CURRENT	2.2	2.0	MA.
PLATE RESISTANCE APPROX.	0.25	0.8	MEGOHM
TRANSCONDUCTANCE	1500	1600	μMHOS
CONTROL GRID VOLTAGE	-50	-50	VOLTS
FOR TRANSCONDUCTANCE = 2 μMHOS			

TYPICAL OPERATING CONDITIONS WITH VARIABLE BIAS
AS MIXER IN SUPERHETERODYNE CIRCUIT

PLATE VOLTAGE	100	250	VOLTS
SCREEN VOLTAGE	100	100	VOLTS
SUPPRESSOR GRID	CONNECTED TO CATHODE AT SOCKET		
CONTROL GRID VOLTAGE APPROX. A	-10	-10	VOLTS

A MINIMUM FOR AN OSCILLATOR PEAK VOLTAGE OF 7 VOLTS. THESE VALUES ARE OPTIMUM.

CONTINUED NEXT PAGE

DIRECT INTERELECTRODE CAPACITANCES

CONTROL GRID TO CATHODE	4.7	$\mu\mu\text{f}$
PLATE TO CATHODE	6.5	$\mu\mu\text{f}$
GRID TO PLATE ⁵	.007 MAX.	$\mu\mu\text{f}$

⁵ WITH SHIELD. THE INTERNAL SHIELD WITHIN THE DOME OF THE 6D6 IS CONNECTED INTERNALLY TO THE CATHODE.

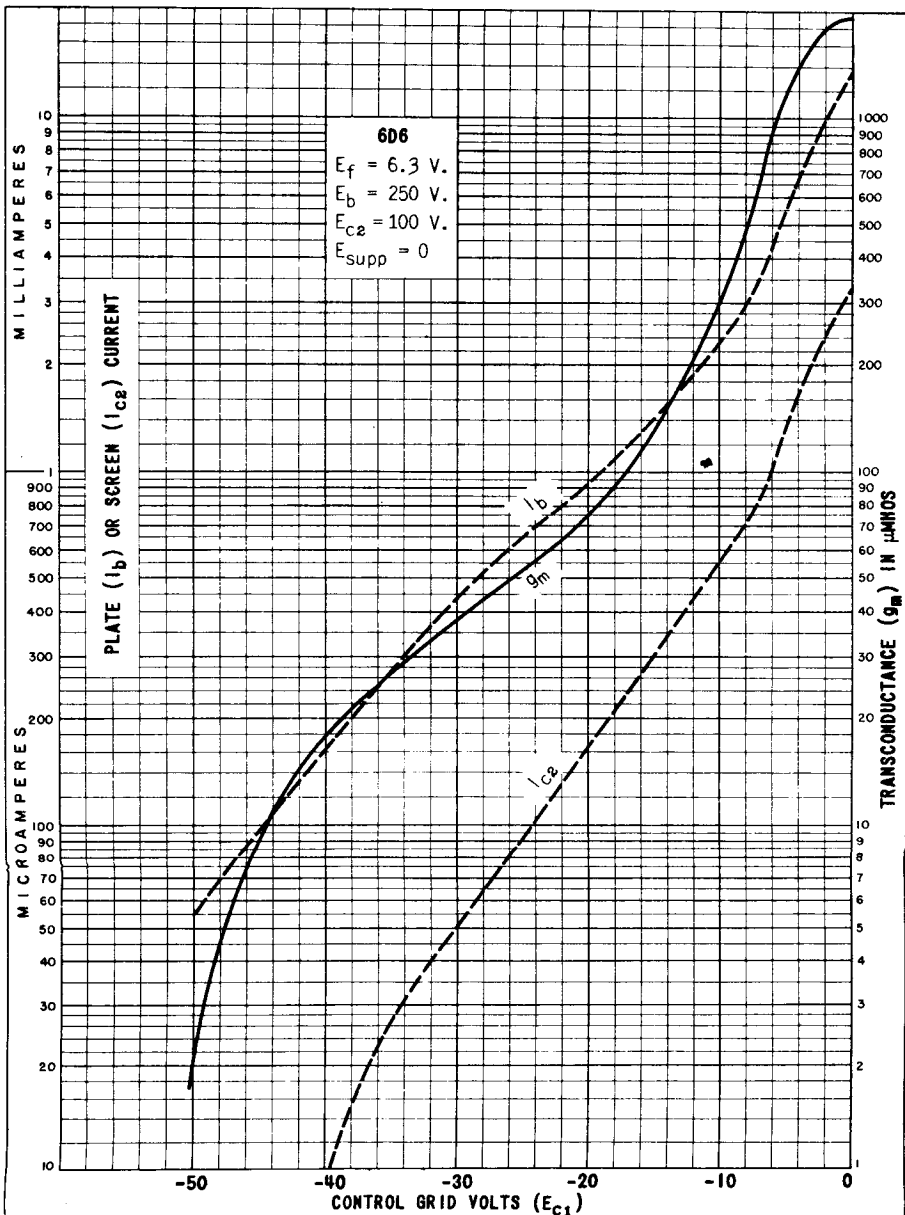

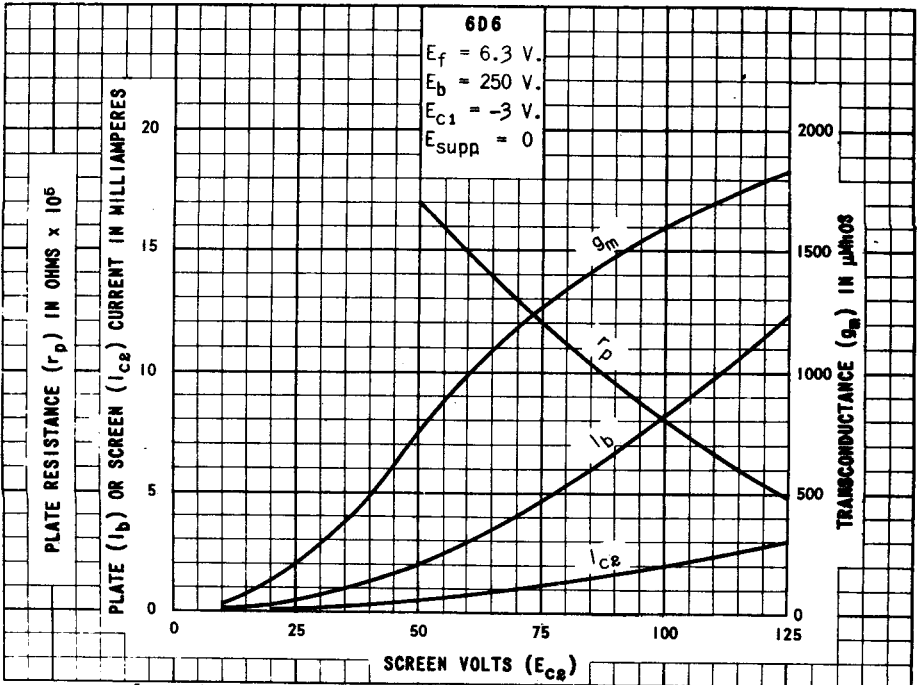
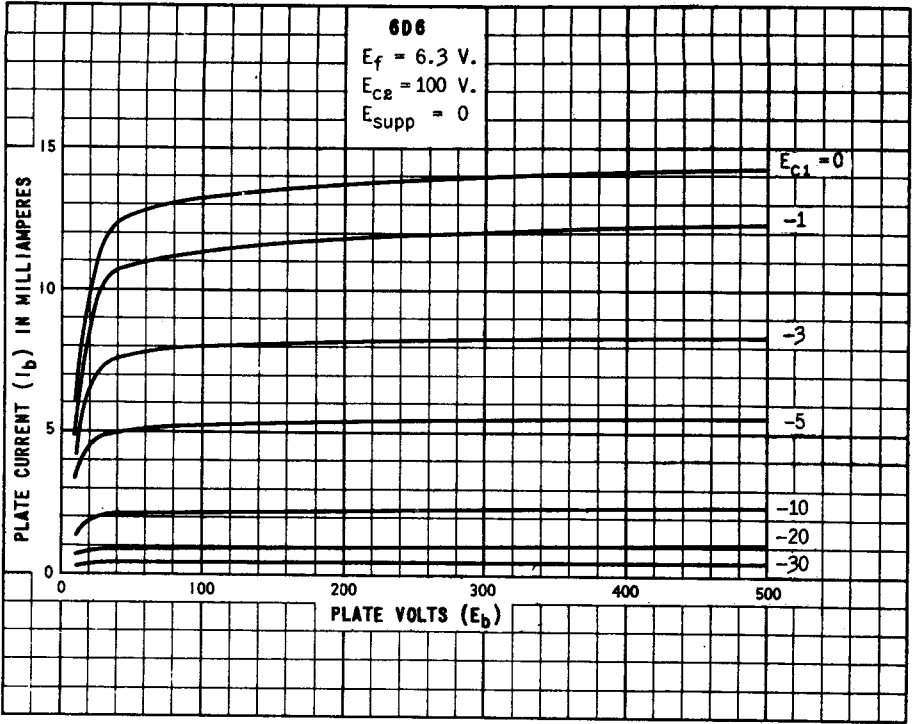

PRINTED IN U. S. A.

PLATE 248-1

DEC. 12 1938

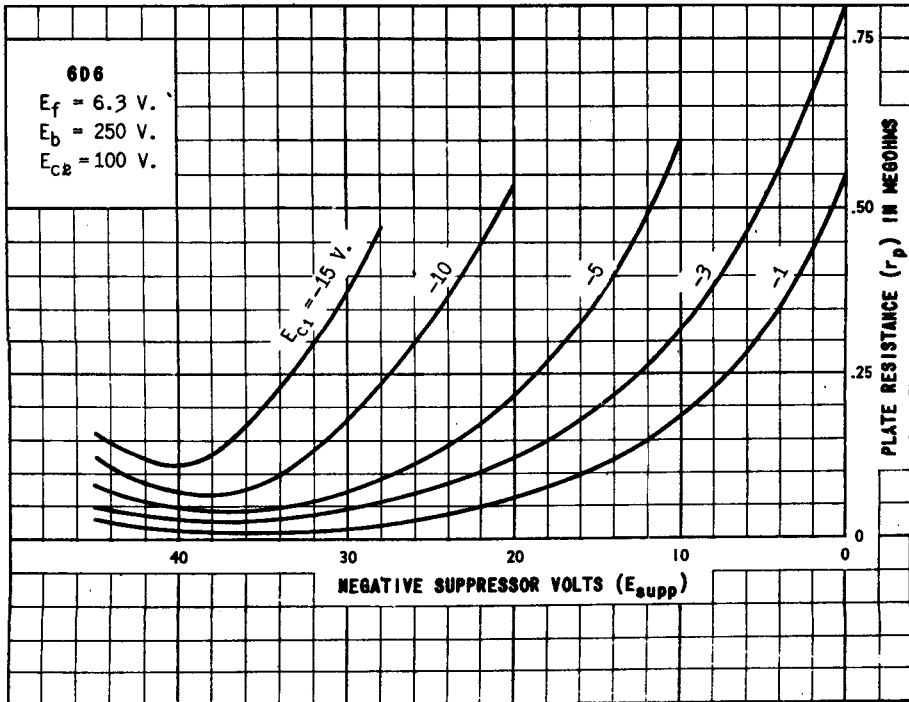
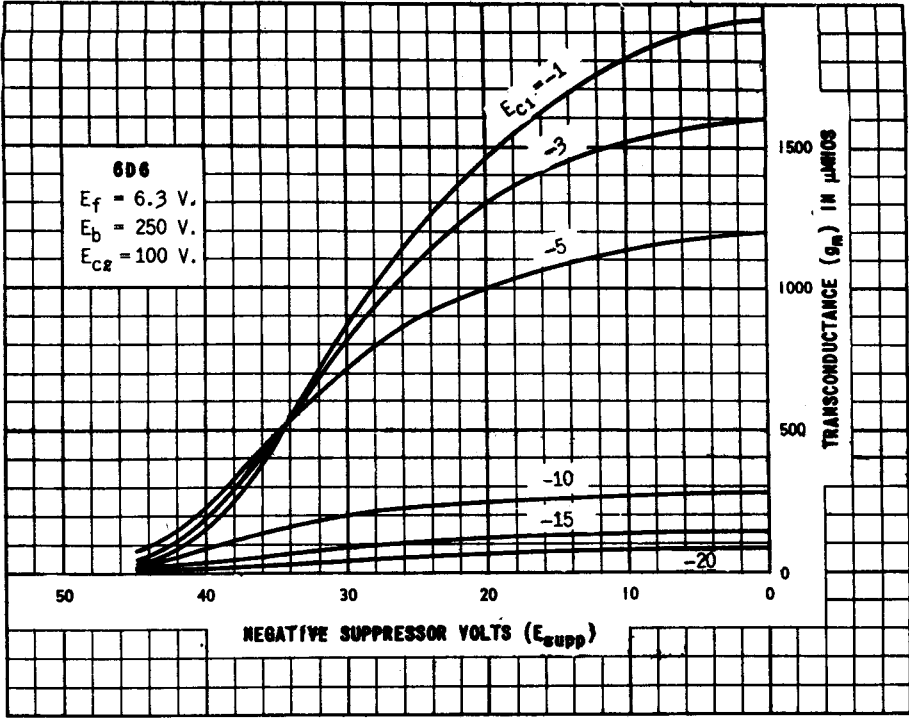

TUNG-SOL

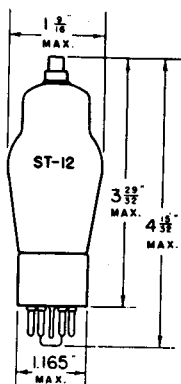

PENTAGRID CONVERTER

UNI-POTENTIAL CATHODE

HEATER

6.3 VOLTS 0.15 AMPERE

AC OR DC

GLASS BULB

SMALL 8 PIN OCTAL BASE

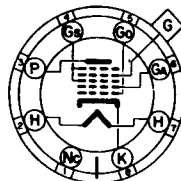

G-8A

BOTTOM VIEW

THE TUNG-SOL 6D8G IS A PENTAGRID CONVERTER DESIGNED FOR SERVICE AS AN OSCILLATOR AND MIXER IN SUPERHETERODYNE CIRCUITS. IT IS RECOMMENDED FOR USE WHERE ECONOMY OF HEATER CURRENT IS IMPORTANT.

RATINGS

MAXIMUM PLATE (P) VOLTAGE	300	VOLTS
MAXIMUM SCREEN (G ₅) SUPPLY VOLTAGE	300	VOLTS
MAXIMUM SCREEN VOLTAGE	100	VOLTS
MINIMUM EXTERNAL CONTROL GRID (G) BIAS VOLTAGE	0	VOLTS
MAXIMUM OSCILLATOR ANODE (G _A) SUPPLY VOLTAGE	300	VOLTS
MAXIMUM OSCILLATOR ANODE VOLTAGE	200	VOLTS
MAXIMUM TOTAL CATHODE CURRENT	13	MA.
MAXIMUM PLATE DISSIPATION	1.0	WATT
MAXIMUM SCREEN DISSIPATION	0.3	WATT
MAXIMUM OSCILLATOR ANODE DISSIPATION	0.75	WATT

FOR "INTERPRETATION OF RATINGS" REFER TO FRONT OF BOOK.

CONTINUED NEXT PAGE

TUNG-SOL

DIRECT INTERELECTRODE CAPACITANCES⁵

CONTROL GRID (G) TO MIXER PLATE (P)	0.20	$\mu\mu\text{f}$
CONTROL GRID (G) TO OSCILLATOR ANODE (G _A)	0.20	$\mu\mu\text{f}$
CONTROL GRID (G) TO OSCILLATOR GRID (G ₀)	0.16	$\mu\mu\text{f}$
OSCILLATOR GRID (G ₀) TO OSCILLATOR ANODE (G _A)	1.1	$\mu\mu\text{f}$
RF INPUT: CONTROL GRID (G) TO ALL OTHER ELECTRODES	8.0	$\mu\mu\text{f}$
OSCILLATOR INPUT: OSCILLATOR GRID (G ₀) TO ALL ELECTRODES EXCEPT OSCILLATOR ANODE (G _A)	5.5	$\mu\mu\text{f}$
OSCILLATOR OUTPUT: OSCILLATOR ANODE (G _A) TO ALL OTHER ELECTRODES EXCEPT OSCILLATOR GRID (G ₀)	4.6	$\mu\mu\text{f}$
MIXER OUTPUT: MIXER PLATE (P) TO ALL OTHER ELECTRODES	11	$\mu\mu\text{f}$

TYPICAL OPERATING CONDITIONS AND CHARACTERISTICS

CONVERTER SERVICE

PLATE (P) VOLTAGE	135	250	VOLTS
SCREEN (G _s) VOLTAGE	67.5	100	VOLTS
CONTROL GRID (G) VOLTAGE ^{MIX.}	-3	-3	VOLTS
OSCILLATOR ANODE (G _A) SUPPLY VOLTAGE ^A	-	250	VOLTS
OSCILLATOR ANODE VOLTAGE	135	-	VOLTS
OSCILLATOR GRID (G ₀) RESISTOR	50000	50000	OHMS
PLATE CURRENT	1.5	3.5	MA.
SCREEN CURRENT	1.7	2.6	MA.
OSCILLATOR ANODE CURRENT	3.0	4.3	MA.
OSCILLATOR GRID CURRENT	0.2	0.4	MA.
TOTAL CATHODE CURRENT	6.4	10.8	MA.
CONVERSION TRANSCONDUCTANCE	450	-	μMHOS
FOR CONTROL GRID (G) VOLTAGE = -2 V.			
CONVERSION TRANSCONDUCTANCE	325	550	μMHOS
FOR CONTROL GRID (G) VOLTAGE = -3 V.			
CONVERSION TRANSCONDUCTANCE	75	275	μMHOS
FOR CONTROL GRID (G) VOLTAGE = -6 V.			
CONVERSION TRANSCONDUCTANCE	35	100	μMHOS
FOR CONTROL GRID (G) VOLTAGE = -10 V.			
CONVERSION TRANSCONDUCTANCE ^{APPROX.}	5	-	μMHOS
FOR CONTROL GRID (G) VOLTAGE = -25 V.			
CONVERSION TRANSCONDUCTANCE ^{APPROX.}	-	6	μMHOS
FOR CONTROL GRID (G) VOLTAGE = -35 V.			

^A APPLIED THROUGH A 20 000 OHM DROPPING RESISTOR

⁵ WITH EXTERNAL SHIELD CONNECTED TO CATHODE

PLATE
921-2

TUNG-SOL

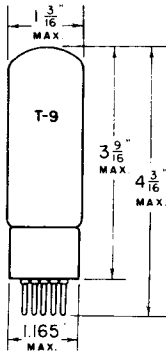

CATHODE RAY TUNING INDICATOR

UNIPOENTIAL CATHODE

HEATER

6.3 VOLTS 0.3 AMPERE

AC OR DC

GLASS BULB

SMALL 6 PIN BASE

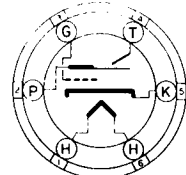

6R

BOTTOM VIEW

THE TUNG-SOL 6E5 CONSISTS OF A CIRCULAR FLUORESCENT TARGET WITH AN INDICATING SHADOW ANGLE, WHICH IS CONTROLLED BY AN INTERNALLY CONNECTED SHARP CUT-OFF AMPLIFIER. WHEN THE 6E5 IS USED AS A TUNING INDICATOR, AVC VOLTAGE IS APPLIED TO THE TRIODE GRID.

RATINGS

MAXIMUM PLATE SUPPLY VOLTAGE	250	VOLTS
MAXIMUM TARGET VOLTAGE	250	VOLTS
MINIMUM TARGET VOLTAGE	100	VOLTS

TYPICAL OPERATING CONDITIONS AND CHARACTERISTICS

PLATE AND TARGET SUPPLY VOLTAGE	100	200	250	VOLTS
TRIODE GRID VOLTAGE (0° SHADOW ANGLE)	-3.3	-6.5	-8.0	VOLTS
TRIODE GRID VOLTAGE (90° SHADOW ANGLE)	0	0	0	VOLTS
SERIES TRIODE PLATE RESISTOR	0.5	1	1	MEGOHM
TRIODE PLATE CURRENT (TRIODE GRID V.=0)	0.19	0.19	0.24	MA.
TARGET CURRENT (TRIODE GRID V.=0) ^A	1	3	4	MA.

^A SUBJECT TO WIDE VARIATIONS

FOR "INTERPRETATION OF RATINGS" REFER TO FRONT OF BOOK.

6E7

TUNG-SOL

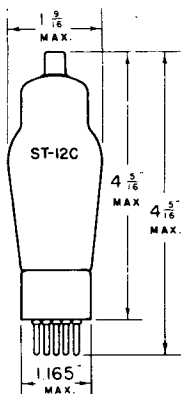

**TRIPLE GRID
REMOTE CUT - OFF AMPLIFIER**

UNIPOTENTIAL CATHODE
HEATER
6.3 VOLTS 0.3 AMPERE
AC OR DC

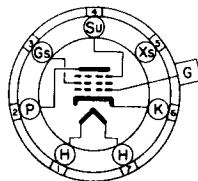

7 H
BOTTOM VIEW

GLASS BULB

SMALL 7 PIN BASE

THE TUNG-SOL 6E7 IS A TRIPLE GRID REMOTE CUT-OFF AMPLIFIER. IT IS SUITABLE FOR SERVICE WITH AVC IN RF AND IF AMPLIFIERS. ITS ELECTRICAL CHARACTERISTICS ARE SIMILAR TO THOSE OF THE 6D6, 6U7G AND THE 58.

OPERATING CONDITIONS AND CHARACTERISTICS

CLASS B₂ AMPLIFIER

PLATE VOLTAGE	100	250	VOLTS
SCREEN VOLTAGE	100	100	VOLTS
CONTROL GRID VOLTAGE	-3.0	-3.0	VOLTS
PLATE CURRENT	8.0	8.2	MA.
SCREEN CURRENT	2.2	2.0	MA.
PLATE RESISTANCE	0.25	0.8	MEGOHM
TRANSCONDUCTANCE	1500	1600	μMHOS
AMPLIFICATION FACTOR	375	1280	
CONTROL GRID VOLTAGE	-	-42.5	VOLTS

FOR TRANSCONDUCTANCE = 2 μMHOS

SUPPRESSOR GRID CONNECTED TO CATHODE AT SOCKET

PLATE
900-1

TUNG-SOL

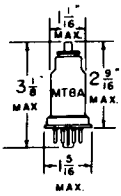

METAL SHELL
SMALL WAFER
5 PIN OCTAL BASE

6F5

HIGH-MU TRIODE AMPLIFIER

UNIPOTENTIAL CATHODE

HEATER

6.3 VOLTS 0.3 AMPERE

AC OR DC

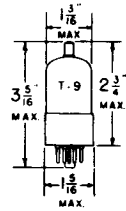

GLASS BULB
INTERMEDIATE
5 PIN OCTAL BASE

6F5GT

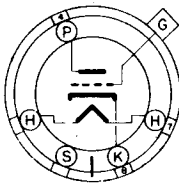

5M-0-1

6F5

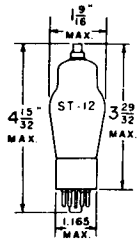

GLASS BULB
SMALL 5 PIN
OCTAL BASE

6F5G

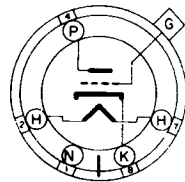

5M-0-0

6F5G, 6F5GT

THE TUNG-SOL 6F5, 6F5G AND 6F5GT ARE GENERAL PURPOSE HIGH-MU TRIODES. THEY ARE DESIGNED FOR SERVICE AS HIGH GAIN SPACE COUPLED AMPLIFIERS IN AC AND AC-DC OPERATED RECEIVERS.

RATINGS

HEATER VOLTAGE (AC OR DC)	6.3	VOLTS
HEATER CURRENT	0.3	AMPERE
MAXIMUM PLATE VOLTAGE	300	VOLTS

AVERAGE CHARACTERISTICS

PLATE VOLTAGE	100	250	VOLTS
CONTROL GRID VOLTAGE	-1	-2	VOLTS
PLATE CURRENT	0.4	0.9	MA.
PLATE RESISTANCE	85 000	66 000	OHMS
TRANSCONDUCTANCE	1150	1500	μMHOS
AMPLIFICATION FACTOR	100	100	

FOR "INTERPRETATION OF RATINGS" REFER TO FRONT OF BOOK.

CONTINUED NEXT PAGE

TUNG-SOL

TYPICAL OPERATING CONDITIONS AND CHARACTERISTICS

ZERO BIAS, RESISTANCE COUPLED, CLASS A₁ AMPLIFIER

PLATE SUPPLY VOLTAGE	100	300	VOLTS	
PLATE LOAD RESISTOR	0.25	0.25	MEGOHM	
GRID RESISTOR	10	10	MEGOHMS	
COUPLING CONDENSER	.01 TO .005	.01 TO .005	μf	
GRID RESISTOR FOR FOLLOWING TUBE	.5 TO 1.0	.5 TO 1.0	MEGOHM	
EXTERNAL GRID CIRCUIT IMPEDANCE	0	0	MEGOH	
VOLTAGE GAIN	48	52	66	71
VOLTAGE OUTPUT (RMS) ^A	7.0	8.5	44	50
			VOLTS	

^A AT FIVE PER CENT TOTAL HARMONIC DISTORTION.

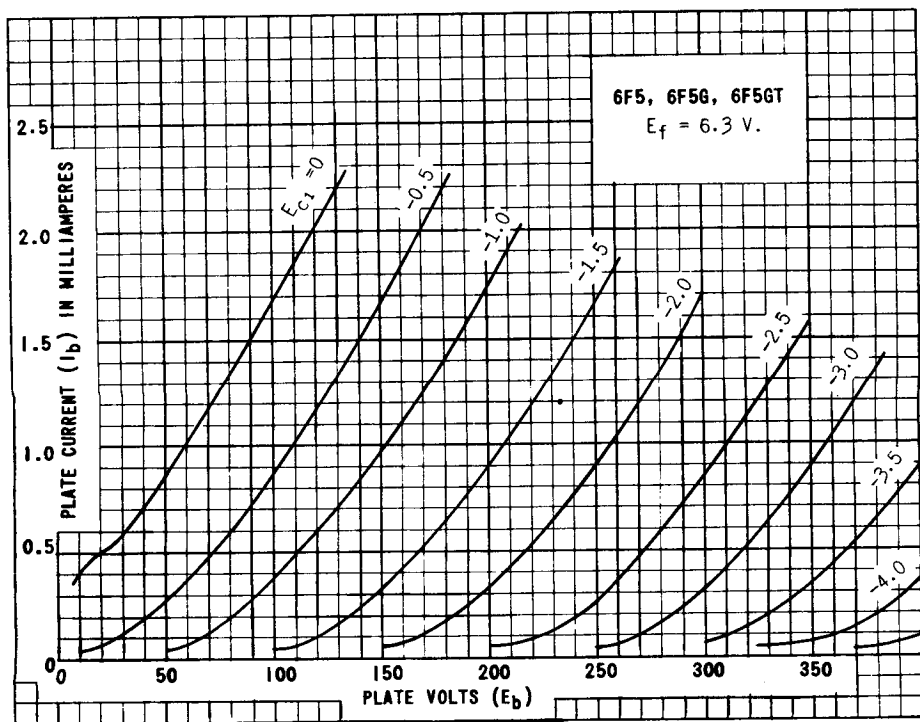

PLATE
1193-1

TUNG-SOL**PENTODE POWER AMPLIFIER**

COATED UNIPOTENTIAL CATHODE

HEATERS

6F6, 6F6GT/G, 42 - 6.3 V., 0.7 AMPERE
2A5 - 2.5 V., 1.75 AMPERES

TYPES 6F6, 6F6GT/G, 2A5 AND 42 ARE PENTODE AMPLIFIERS DESIGNED FOR APPLICATION IN POWER OUTPUT STAGES OF RECEIVERS. WITH THE EXCEPTION OF HEATER RATINGS, THEIR ELECTRICAL CHARACTERISTICS ARE IDENTICAL.

MAXIMUM RATINGS

	PENTODE CONNECTION	TRIODE CONNECTION	
MAXIMUM PLATE VOLTAGE	375	350	VOLTS
MAXIMUM SCREEN VOLTAGE	285	-	VOLTS
MAXIMUM PLATE DISSIPATION	11	-	WATTS
MAXIMUM SCREEN DISSIPATION	3.75	-	WATTS
MAXIMUM TOTAL PLATE AND SCREEN DISSIPATION	-	10	WATTS

TYPICAL OPERATING CONDITIONS AND CHARACTERISTICSCLASS A₁ AMPLIFIER - SINGLE TUBE ^C

	PENTODE CONNECTION		TRIODE CONNECTION	
PLATE VOLTAGE	250	285	250	VOLTS
SCREEN VOLTAGE	250	285	-	VOLTS
CONTROL GRID VOLTAGE ^A	-16.5	-20	-20	VOLTS
PEAK AF SIGNAL VOLTAGE	16.5	20	20	VOLTS
ZERO-SIGNAL PLATE CURRENT	34	38	31	MA.
ZERO-SIGNAL SCREEN CURRENT	6.5	7	-	MA.
MAXIMUM-SIGNAL PLATE CURRENT	36	40	34	MA.
MAXIMUM-SIGNAL SCREEN CURRENT	10.5	13	-	MA.
PLATE RESISTANCE (APPROX.)	80000	78000	2600	OHMS
TRANSCONDUCTANCE	2500	2550	2600	μMHOS
AMPLIFICATION FACTOR	-	-	6.8	
LOAD RESISTANCE	7000	7000	4000	OHMS
TOTAL HARMONIC DISTORTION	8	9	6.5	PER CENT
POWER OUTPUT	3.2	4.8	0.85	WATTS

PUSH-PULL AMPLIFIER - TWO TUBES ^PCLASS A₁ AMPLIFIER ^C CLASS AB₂ AMPLIFIER ^D

	PENTODE CONNECTION	PENTODE CONNECTION	TRIODE CONNECTION	
PLATE VOLTAGE	315	375	350	VOLTS
SCREEN VOLTAGE	285	250	-	VOLTS
CONTROL GRID VOLTAGE	-24 ^A	-26	-38	VOLTS
PEAK AF SIGNAL VOLTAGE (GRID TO GRID)	48	82	123	VOLTS
ZERO-SIGNAL PLATE CURRENT	62	34	48	MA.
ZERO-SIGNAL SCREEN CURRENT	12	5	-	MA.
MAXIMUM-SIGNAL PLATE CURRENT	80	82	92	MA.
MAXIMUM-SIGNAL SCREEN CURRENT	19.5	19.5	-	MA.
EFFECTIVE LOAD RESISTANCE (PLATE TO PLATE)	10000	10000	6000	OHMS
TOTAL HARMONIC DISTORTION	4	3.5	2	PER CENT
POWER OUTPUT	11	18.5	13	WATTS

(CONTINUED NEXT PAGE)

TUNG-SOL

TYPICAL OPERATING CONDITIONS FOR CATHODE BIAS

CLASS A₁ AMPLIFIER^C

CLASS AB₂ AMPLIFIER^D

	SINGLE TUBE AMPLIFIER		PUSH-PULL AMPLI.		PUSH-PULL AMPLI.		
	Pentode Conn.	Triode Conn.	Pentode Conn.	Pentode Conn. ^F	Pentode Conn. ^F	Triode Conn. ^F	
Plate	250	285	250	315	375	350	Volts
Screen	250	285	-	285	250	-	Volts
Cathode Resistor	410	-	650	320	340 ^B	720 ^E	Ohms
Peak A-F Grid Voltage	16.5	20	20	-	-	-	Volts
Peak A-F Grid-to-Grid Voltage	-	-	-	56	94	132	Volts
Zero-Sig. Plate Cur.	34	38	31	62	54	50	Ma.
Max.-Sig. Plate Cur.	35	38	32	73	77	60	Ma.
Zero-Sig. Screen Cur.	6.5	7	-	12	8	-	Ma.
Max.-Sig. Screen Cur.	9.7	12	-	18	18	-	Ma.
Load Resistance	7000	7000	4000	-	-	-	Ohms
Effective Load Resis. (plate to plate)	-	-	-	10000	10000	10000	Ohms
Total Harmonic Dist.	8.5	9	8.5	3	5	3	%
Max.-Sig. Power Output	3.1	4.5	0.8	10.5	19	9	Watts

- A THE DC RESISTANCE IN THE GRID CIRCUIT, UNDER RATED MAXIMUM CONDITIONS, SHOULD NOT EXCEED 0.5 MEGOHM FOR SELF-BIAS OPERATION AND 0.1 MEGOHM FOR FIXED-BIAS OPERATION.
- B THE VALUE GIVEN FOR THE CATHODE RESISTOR IS DETERMINED FOR A GRID BIAS OF -21 VOLTS.
- C SUBSCRIPT 1 INDICATES THAT GRID CURRENT DOES NOT FLOW DURING ANY PART OF INPUT CYCLE.
- D SUBSCRIPT 2 INDICATES THAT GRID CURRENT FLOWS DURING SOME PART OF INPUT CYCLE.
- E THE VALUE GIVEN FOR THE CATHODE RESISTOR IS DETERMINED FOR A GRID BIAS OF -36.5 VOLTS.
- F UNLESS OTHERWISE SPECIFIED, VALUES ARE FOR 2 TUBES.

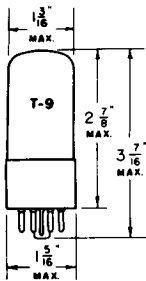

GLASS BULB

6F6GT/G

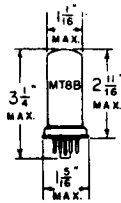

METAL SHELL

6F6

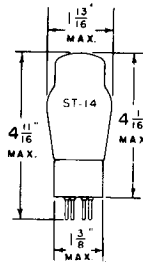

GLASS BULB

2A5 - 42

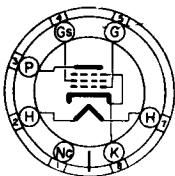

MEDIUM 7 PIN OCTAL BASE

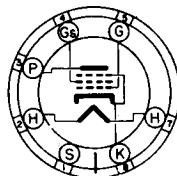

7 PIN OCTAL BASE

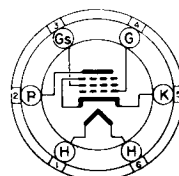

MEDIUM 6 PIN BASE

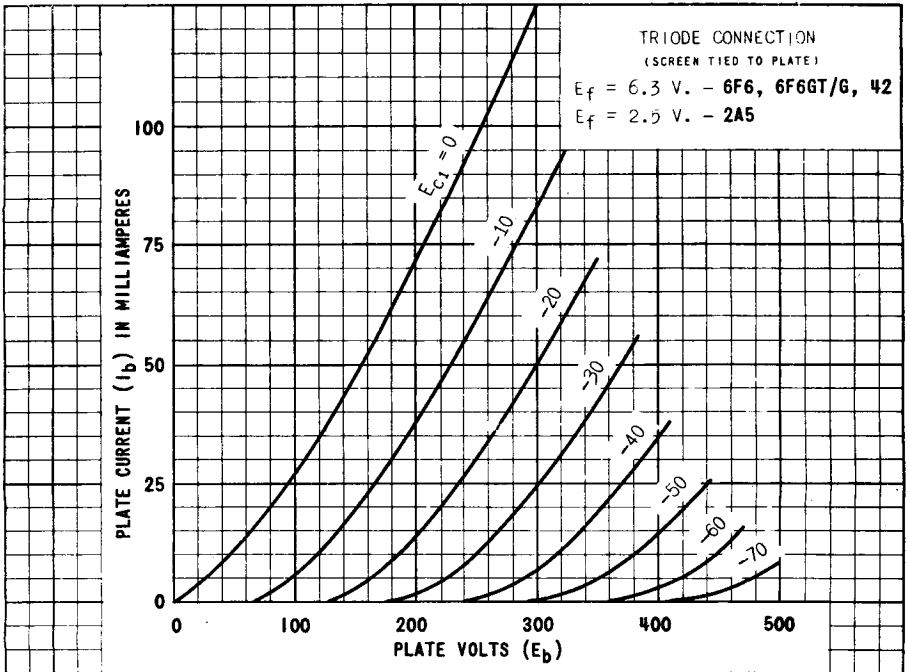
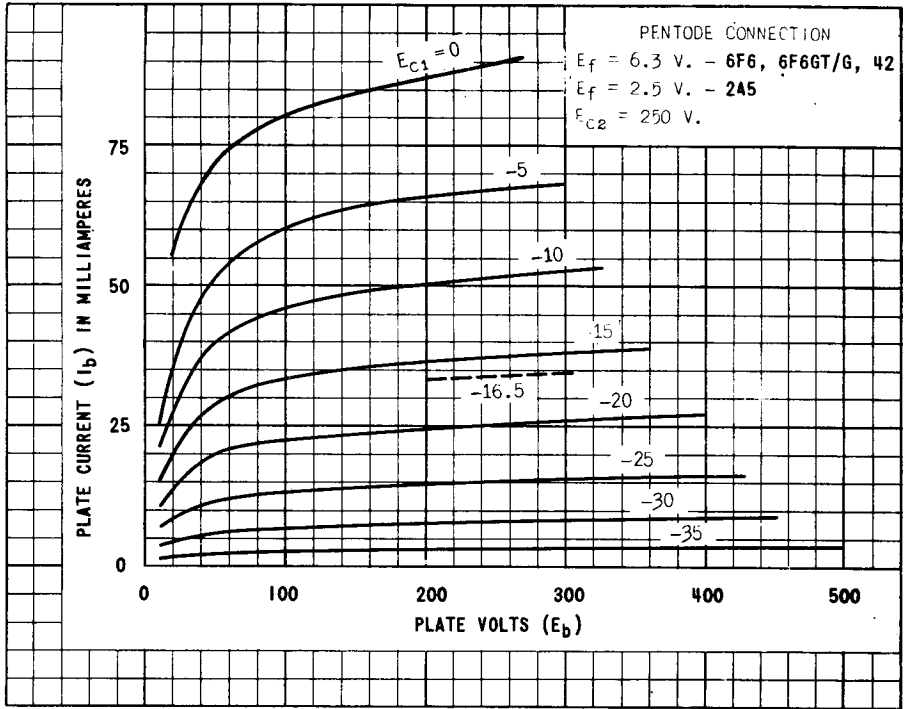

PRINTED IN U. S. A.

PLATE
1339-1
OCT. 25
1943

6F6, 6F6GT/G (2A5,42)

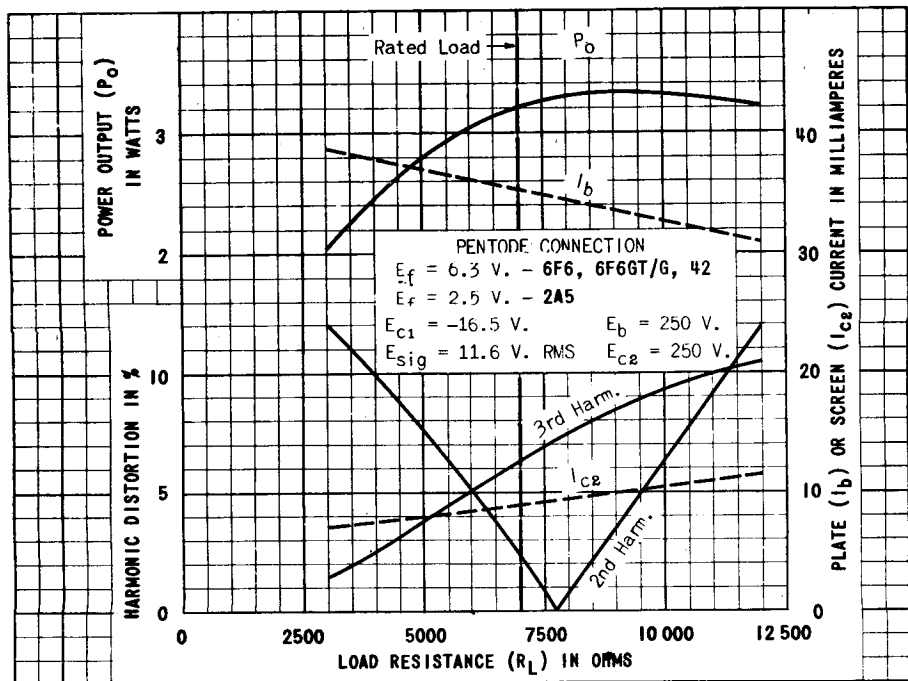
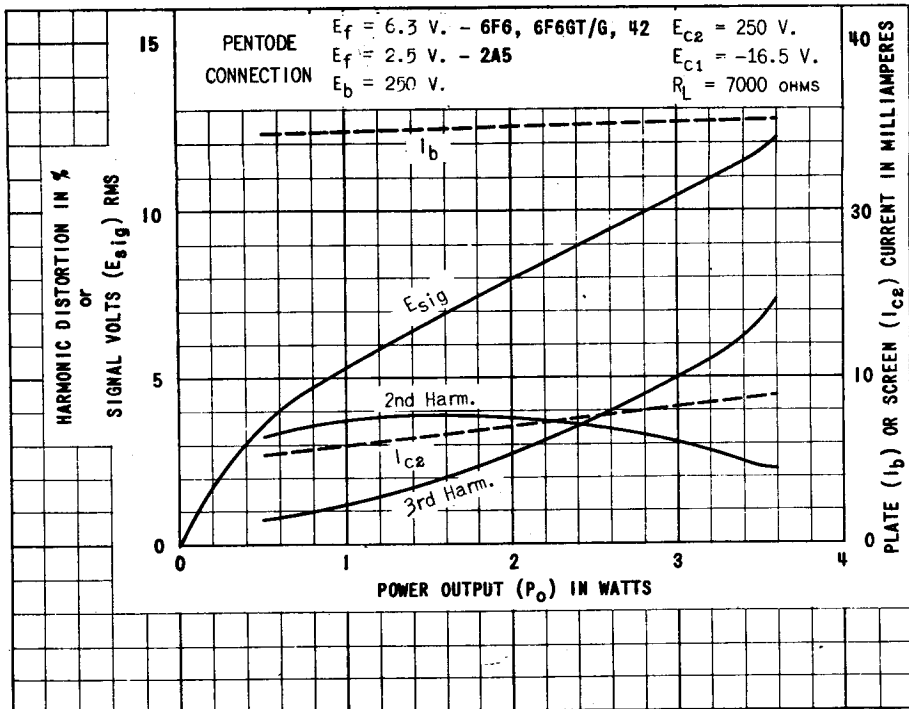
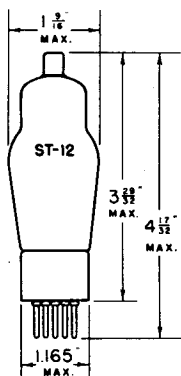
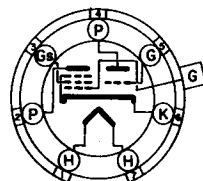

PLATE
1340-1
OCT. 25
1943

TUNG-SOL

**TRIODE PENTODE
AMPLIFIER AND CONVERTER**

UNIPOTENTIAL CATHODE
HEATER
6.3 VOLTS 0.3 AMPERE
AC OR DC



7E

BOTTOM VIEW

GLASS BULB

SMALL 7 PIN BASE

THE TUNG-SOL 6F7 COMBINES A TRIODE AND A REMOTE CUT-OFF PENTODE,
UTILIZING A COMMON CATHODE, IN A SINGLE BULB.

OPERATING CONDITIONS AND CHARACTERISTICS

CLASS A₁ AMPLIFIER

	TRIODE UNIT	PENTODE UNIT	
PLATE VOLTAGE	100 MAX.	100	250 MAX. VOLTS
SCREEN VOLTAGE MAX.	-	100	100 VOLTS
CONTROL GRID VOLTAGE MIN.	-3	-3	-3 VOLTS
PLATE CURRENT	3.5	6.3	6.5 MA.
SCREEN CURRENT	-	1.6	1.5 MA.
PLATE RESISTANCE	0.016	0.29 ^A	0.85 ^A MEGOHM
TRANSCONDUCTANCE	500	1050	1100 μMHOS
AMPLIFICATION FACTOR	8	300 ^A	900 ^A
TRANSCONDUCTANCE AT -35 VOLTS BIAS	-	9	10 μMHOS

^A APPROXIMATE

CONVERTER SERVICE

	TRIODE UNIT	PENTODE UNIT	
PLATE VOLTAGE MAX.	100	250	VOLTS
SCREEN VOLTAGE MAX.	-	100	VOLTS
CONTROL GRID VOLTAGE	L	-3 MIN.	G VOLTS
OSCILLATOR PLATE CURRENT (AVERAGE)	4 MAX.	-	MA.

^G GRID BIAS SHOULD BE AT LEAST 3 VOLTS GREATER THAN THE PEAK OSCILLATOR VOLTAGE APPLIED TO THE PENTODE GRID.

^L OBTAINED BY MEANS OF A GRID LEAK.

CONTINUED NEXT PAGE

TUNG-SOL

TYPICAL OPERATION

	TRIODE UNIT	PENTODE UNIT	
PLATE VOLTAGE	100 ^P	250	VOLTS
SCREEN VOLTAGE	-	100	VOLTS
GRID BIAS	L	-10 ^B	VOLTS
PLATE CURRENT	2.4	2.8	MA.
SCREEN CURRENT	-	0.6	MA.
GRID CURRENT	0.15	0	MA.
PLATE RESISTANCE	-	2	MEG OHMS
CONVERSION CONDUCTANCE	-	300	μMHOS
OSCILLATOR PEAK VOLTAGE INPUT	-	7	VOLTS

^B OBTAINED BY MEANS OF A 1700 OHMS CATHODE RESISTOR.

^L OBTAINED BY MEANS OF A GRID LEAK.

^P MAY BE OBTAINED FROM 250 VOLT SOURCE THROUGH 60 000 OHM DROPPING RESISTOR.

DIRECT INTERELECTRODE CAPACITANCES

	TRIODE UNIT	PENTODE UNIT	
CONTROL GRID TO CATHODE	2.4	3.2	μf
PLATE TO CATHODE	3.0	13	μf
CONTROL GRID TO PLATE	2.0	.007 ^S MAX.	μf

^S WITH SHIELD

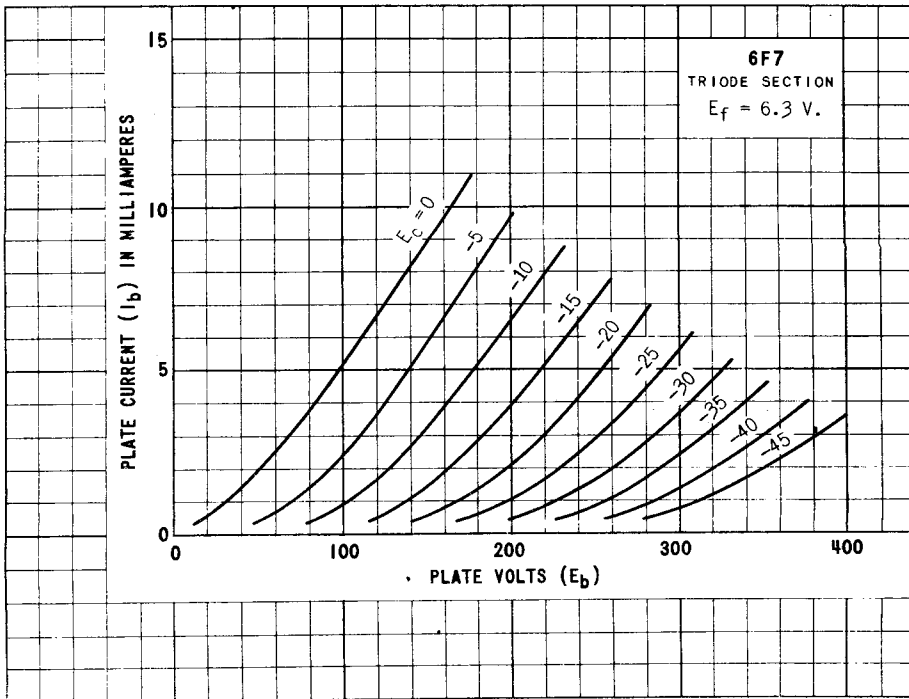
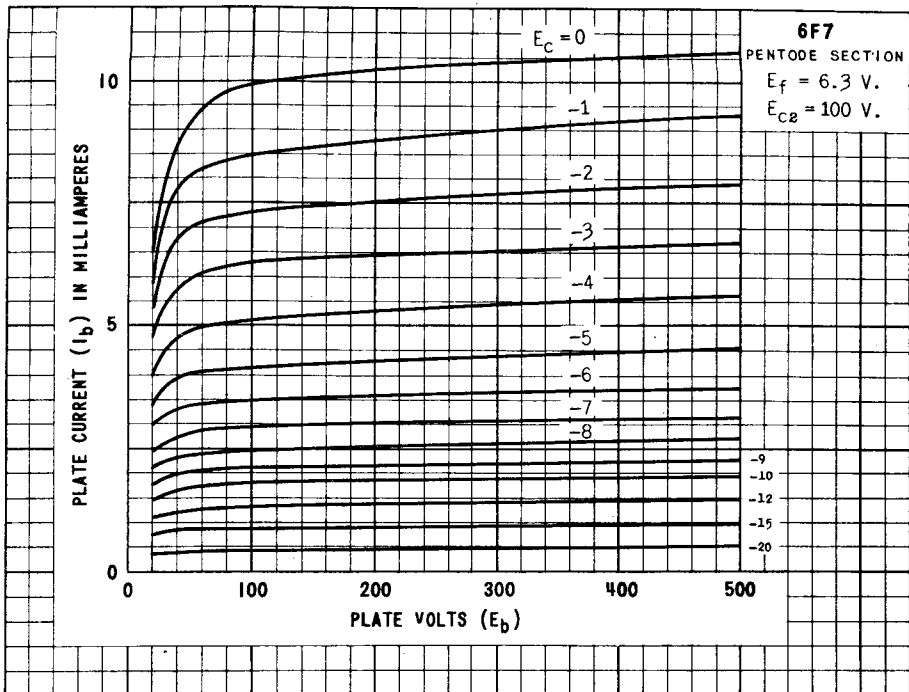

PRINTED IN U. S. A.

PLATE 482-1

JUNE 26 1939

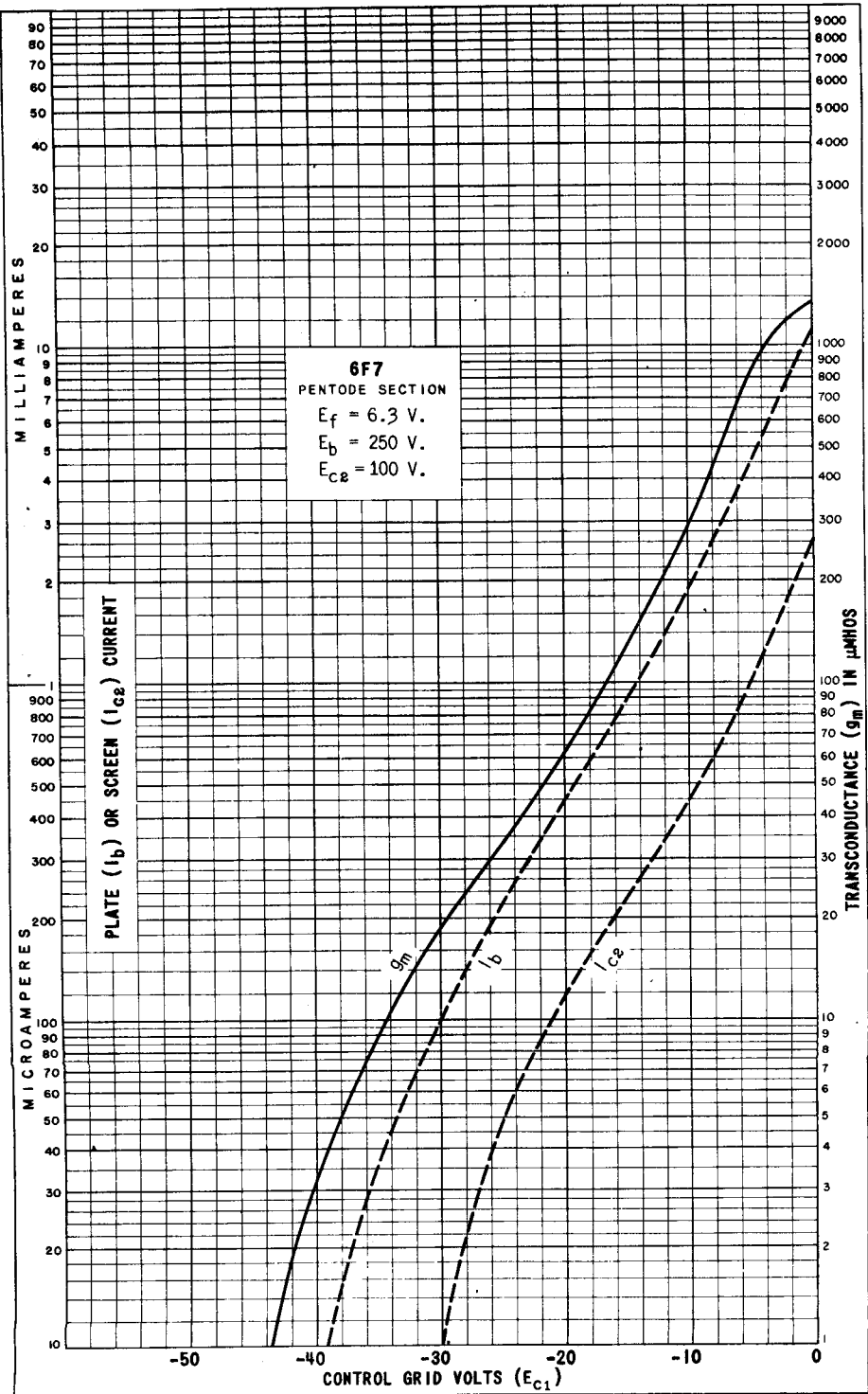

TUNG-SOL

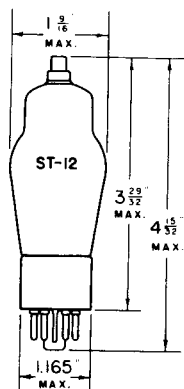

TWIN TRIODE AMPLIFIER

UNIPOTENTIAL CATHODES

HEATER

6.3 VOLTS 0.6 AMPERE
AC OR DC

GLASS BULB

SMALL 8 PIN OCTAL BASE

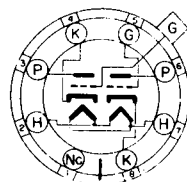
G-8G
BOTTOM VIEW

THE TUNG-SOL 6F8G IS A GENERAL PURPOSE TWIN TRIODE VOLTAGE AMPLIFIER HAVING TWO COMPLETELY INDEPENDENT TRIODE UNITS IN ONE BULB. WITH THE EXCEPTION OF CAPACITANCES, THE ELECTRICAL CHARACTERISTICS OF EACH TRIODE SECTION ARE IDENTICAL TO THOSE OF THE 6J5, 6J5G AND 6J5GT.

RATINGS

MAXIMUM PLATE VOLTAGE	300	VOLTS
MAXIMUM PLATE DISSIPATION PER UNIT	2.5	WATTS
MINIMUM CONTROL GRID VOLTAGE	0	VOLTS

TYPICAL OPERATING CONDITIONS AND CHARACTERISTICS

CLASS A₁ AMPLIFIER (EACH UNIT)

PLATE VOLTAGE	90	250	VOLTS
CONTROL GRID VOLTAGE	0	-8	VOLTS
PLATE CURRENT	10.0	9.0	MA.
PLATE RESISTANCE	6700	7700	OHMS
TRANSCONDUCTANCE	3000	2600	μMHMS
AMPLIFICATION FACTOR	20	20	

DIRECT INTERELECTRODE CAPACITANCES^A

	TRIODE UNIT 1	TRIODE UNIT 2	
GRID TO CATHODE	3.2	3.0	μμf
PLATE TO CATHODE	3.2	3.8	μμf
GRID TO PLATE	4.0	3.6	μμf
GRID 1 TO GRID 2		0.2	μμf
PLATE 1 TO PLATE 2		0.4	μμf
GRID 2 TO PLATE 1		0.1	μμf

^A WITH EXTERNAL SHIELD CONNECTED TO CATHODE.

TRIODE 1 - TRIODE HAVING GRID BROUGHT OUT TO BASE PIN.

TRIODE 2 - TRIODE HAVING GRID BROUGHT TO THE TOP CAP.

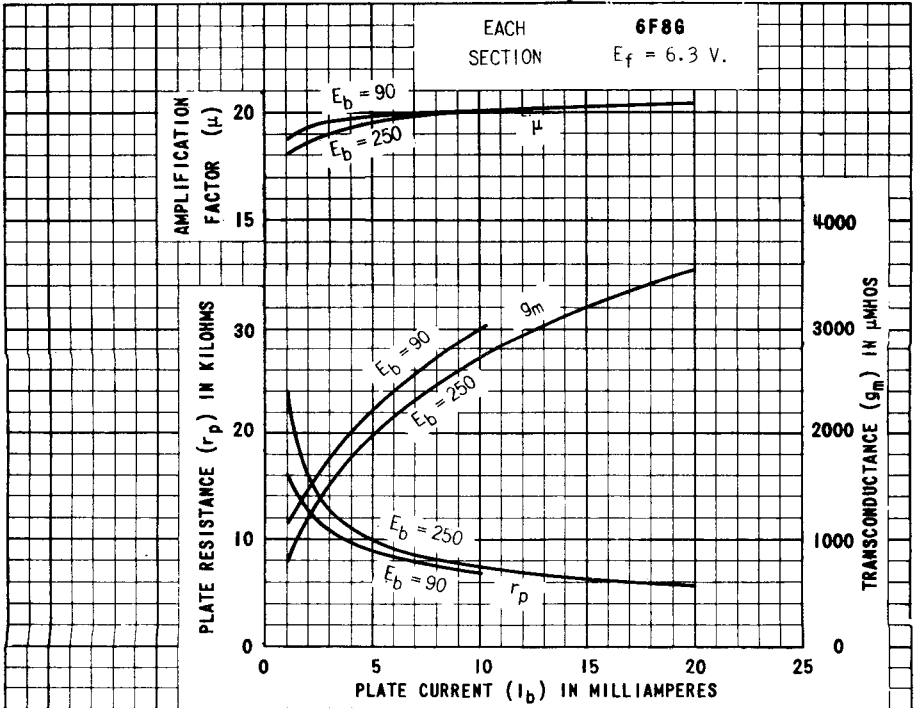
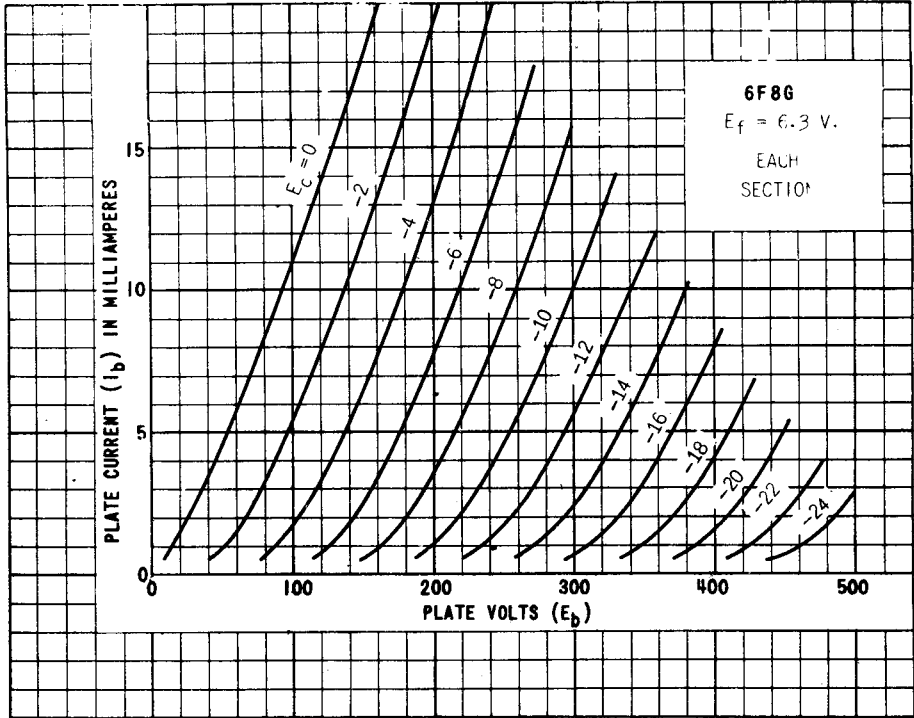

TUNG-SOL

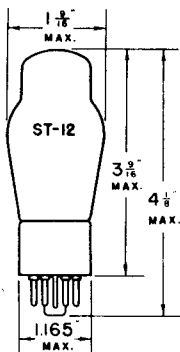

PENTODE POWER AMPLIFIER

UNIPOENTIAL CATHODE

HEATER

6.3 VOLTS 0.15 AMPERE
AC OR DC

GLASS BULB

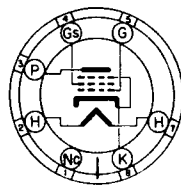

G-7S

BOTTOM VIEW

SMALL 7 PIN OCTAL BASE

THE TUNG-SOL 666G IS A PENTODE POWER AMPLIFIER DESIGNED FOR SERVICE WHERE ECONOMY IN CURRENT CONSUMPTION IS DESIRED.

MAXIMUM RATINGS

MAXIMUM PLATE VOLTAGE	180	VOLTS
MAXIMUM SCREEN VOLTAGE	180	VOLTS
MAXIMUM PLATE DISSIPATION	2.75	WATTS
MAXIMUM SCREEN DISSIPATION	0.50	WATT

OPERATING CONDITIONS AND CHARACTERISTICS

CLASS A₁ AMPLIFIER

	TRIODE	PENTODE		
PLATE VOLTAGE	180	135	180	VOLTS
SCREEN VOLTAGE	-	135	180	VOLTS
GRID VOLTAGE	-12	-6	-9	VOLTS
PEAK AF SIGNAL VOLTAGE	12	6	9	VOLTS
ZERO-SIG. PLATE CURRENT	11	11.5	15	MA.
ZERO-SIG. SCREEN CURRENT	-	2.0	2.5	MA.
PLATE RESISTANCE	4730	170 000	175 000	OHMS
TRANSCONDUCTANCE	2000	2100	2300	μMHOS
AMPLIFICATION FACTOR	9.5	360	400	
LOAD RESISTANCE	12 000	12 000	10 000	OHMS
TOTAL HARMONIC DISTORTION	5	7.5	10	PER CENT
POWER OUTPUT	0.25	0.6	1.1	WATTS

DIRECT INTERELECTRODE CAPACITANCES⁵

CONTROL GRID TO CATHODE	6	μf
PLATE TO CATHODE	10	μf
CONTROL GRID TO PLATE	0.2	μf

⁵ WITH SHIELD

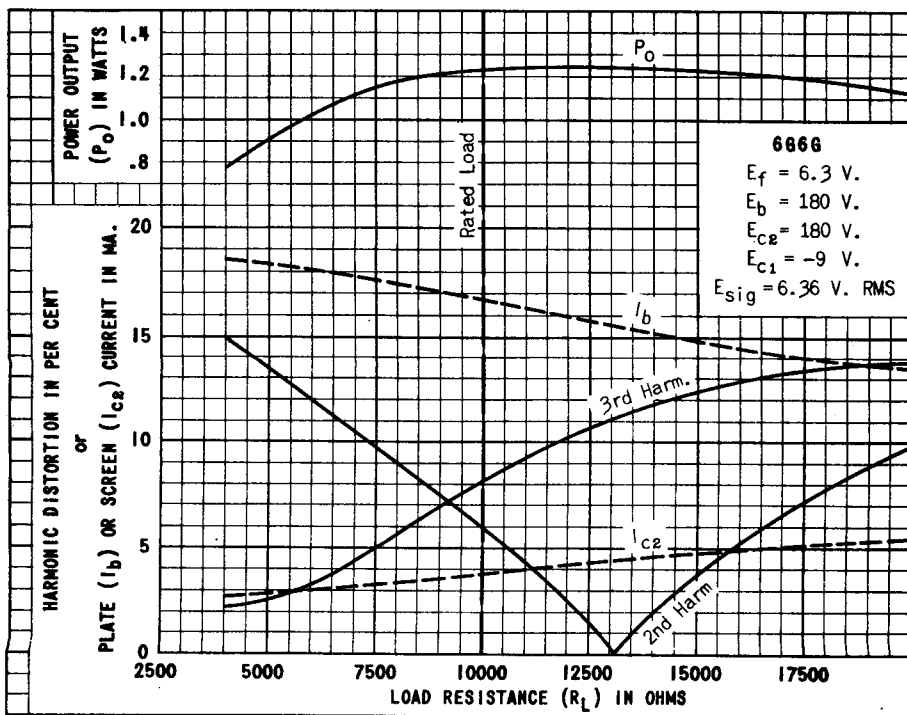
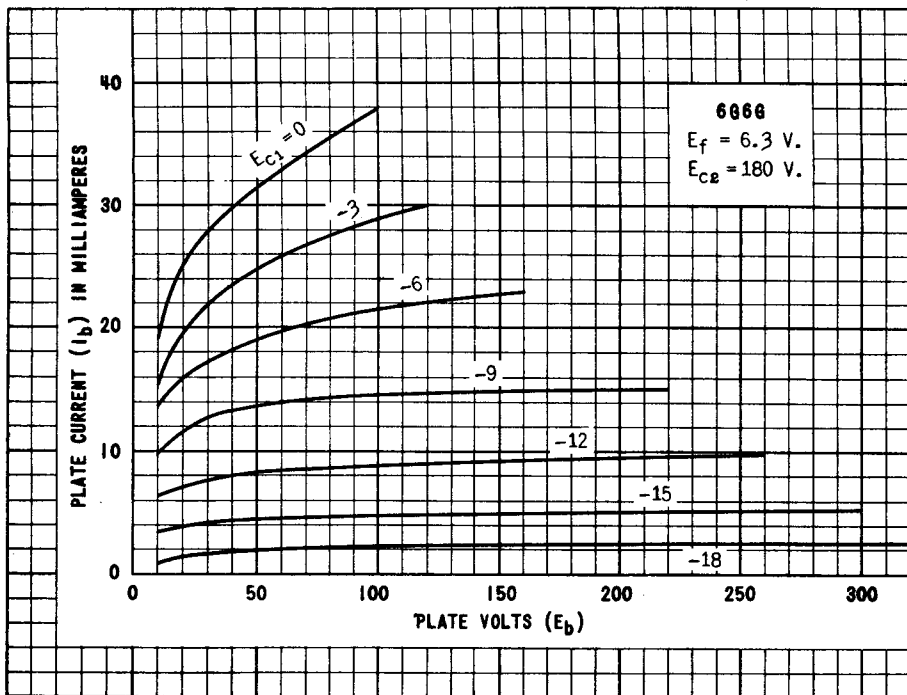
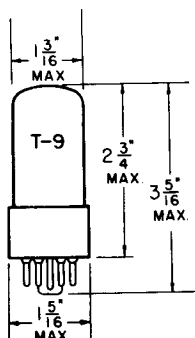

PLATE 469-1

TUNG-SOL



DIODE

UNIPOTENTIAL CATHODE

HEATER

6.3 VOLTS 0.150 AMP.

AC OR DC

GLASS BULB

ANY MOUNTING POSITION

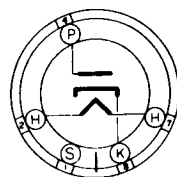

BOTTOM VIEW

INTERMEDIATE OCTAL
5 PIN BASE

RATINGS

MAXIMUM AC PLATE VOLTAGE (RMS)	100	VOLTS
MAXIMUM DC OUTPUT CURRENT	4.0	MA.
MAXIMUM PEAK PLATE CURRENT	18	MA.
PLATE RESISTANCE AT 0.25 MA. (APPROX.)	1 000	OHMS



TUNG-SOL

TWIN DIODE

UNIPOTENTIAL CATHODE

HEATER
6.3 VOLTS 0.3 AMPERE
AC OR DC

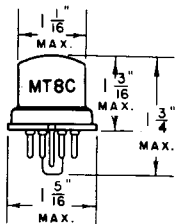

METAL SHELL
7 PIN OCTAL BASE
6H6

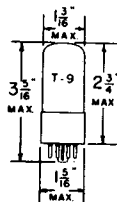

GLASS BULB
INTERMEDIATE
7 PIN OCTAL BASE
6H6GT/G

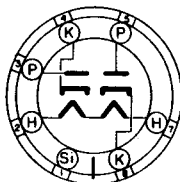
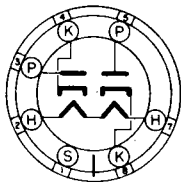

BOTTOM VIEWS

THE TUNG-SOL 6H6 AND 6H6GT/G ARE DESIGNED FOR USE AS DIODE DETECTORS, AVC RECTIFIERS, AND POWER RECTIFIERS IN LOW DRAIN APPLICATIONS. TWO SEPARATE RECTIFIER SECTIONS ALLOW CONSIDERABLE FLEXIBILITY IN THEIR APPLICATION. WITH THE EXCEPTION OF CAPACITANCES, THEIR ELECTRICAL CHARACTERISTICS ARE IDENTICAL.

RATINGS

MAXIMUM AC PLATE VOLTAGE PER PLATE (RMS)	150	VOLTS
MAXIMUM DC OUTPUT CURRENT PER PLATE	8	MA.
TUBE VOLTAGE DROP AT 16 MA. DC PER PLATE	11	VOLTS

DIRECT INTERELECTRODE CAPACITANCES ^A

	6H6	6H6GT/G	
PLATE (1) TO CATHODE (1)	3.0	3.0	μμf
PLATE (2) TO CATHODE (2)	3.4	4.0	μμf
PLATE TO PLATE	0.1 ^{MAX.}	0.1 ^{MAX.}	μμf

^A WITH EXTERNAL SHIELD OR SHELL CONNECTED TO CATHODE

FOR "INTERPRETATION OF RATINGS" REFER TO FRONT OF BOOK.

CONTINUED NEXT PAGE

6H6, 6H6GT/G

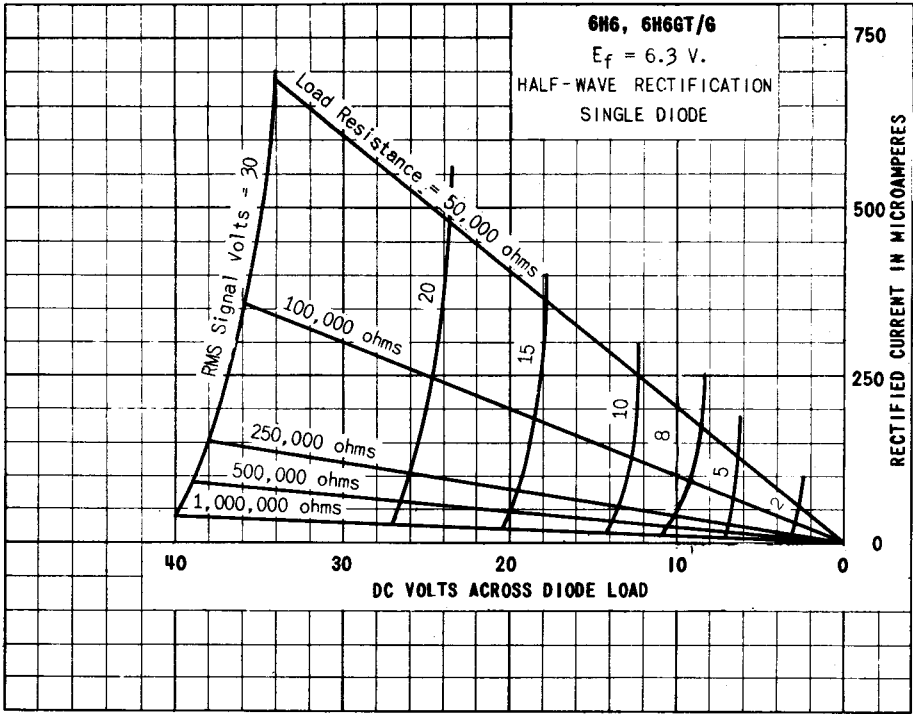

TUNG-SOL

UHF AMPLIFIER TRIODE

MINIATURE TYPE

COATED UNIPOTENTIAL CATHODE

HEATER

6.3 VOLTS 0.4 HEATER

AC OR DC

ANY MOUNTING POSITION

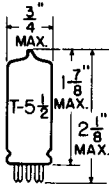

GLASS BULB

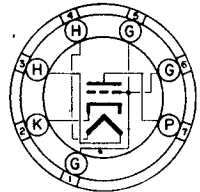

BOTTOM VIEW

MINIATURE BUTTON
7 PIN BASE

THE 6J4 IS A TRIODE USING THE MINIATURE CONSTRUCTION AND INTENDED FOR USE PRIMARILY AS A GROUNDED-GRID UHF AMPLIFIER AT FREQUENCIES UP TO APPROXIMATELY 500 MEGACYCLES. ITS DESIGN FEATURES AN AMPLIFICATION FACTOR OF 55 COMBINED WITH AN EXTREMELY HIGH TRANSCONDUCTANCE OF 12000 MICRO-MHOS, AND PERMITS GROUNDED-GRID OPERATION WITH A HIGH SIGNAL-TO-NOISE RATIO. THE 6J4 MAY ALSO BE USED IN CONVENTIONAL TRIODE CIRCUITS WITH UNGROUNDED GRID.

DIRECT INTERELECTRODE CAPACITANCES - APPROX.
 WITH CLOSE FITTING SHIELD CONNECTED TO GRID

	EACH UNIT	
GRID TO PLATE (G TO P) MAX.	4	$\mu\mu\text{f}$
INPUT G TO (H + K)	5.5	$\mu\mu\text{f}$
OUTPUT P TO (H + K)	0.24	$\mu\mu\text{f}$
HEATER TO CATHODE (H TO K)	2.8	$\mu\mu\text{f}$

RATINGS
 INTERPRETED ACCORDING TO RMA STANDARD M8-210

HEATER VOLTAGE	6.3	VOLTS
MAXIMUM HEATER-CATHODE VOLTAGE	90	VOLTS
MAXIMUM PLATE VOLTAGE	150	VOLTS
MAXIMUM PLATE DISSIPATION	2.25	WATTS
MAXIMUM PLATE CURRENT	20	MA.

TYPICAL OPERATING CONDITIONS AND CHARACTERISTICS

 GROUNDED-GRID CLASS A_1 AMPLIFIER - EACH UNIT

HEATER VOLTAGE	6.3	6.3	VOLTS
HEATER CURRENT	0.4	0.4	AMP.
PLATE VOLTAGE	100	150	VOLTS
GRID #1 RESISTOR ^A	100	100	OHMS
PLATE CURRENT	10	15	MA.
PLATE RESISTANCE (APPROX.)	5 000	4 500	OHMS
TRANSCONDUCTANCE	11 000	12 000	μMHOS
AMPLIFICATION FACTOR	55	55	

^A SHOULD ALWAYS BE USED WITH A CATHODE BIAS RESISTOR SUITABLY BY-PASSED. THE DC RESISTANCE IN THE GRID CIRCUIT SHOULD NEVER EXCEED 0.25 MEGOHM UNDER MAXIMUM RATED CONDITIONS.

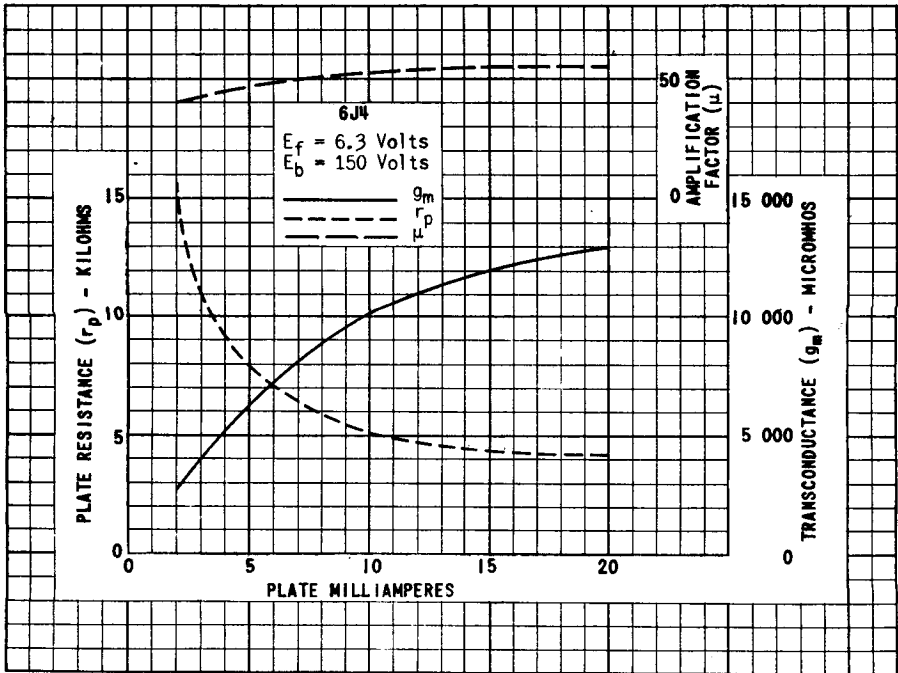
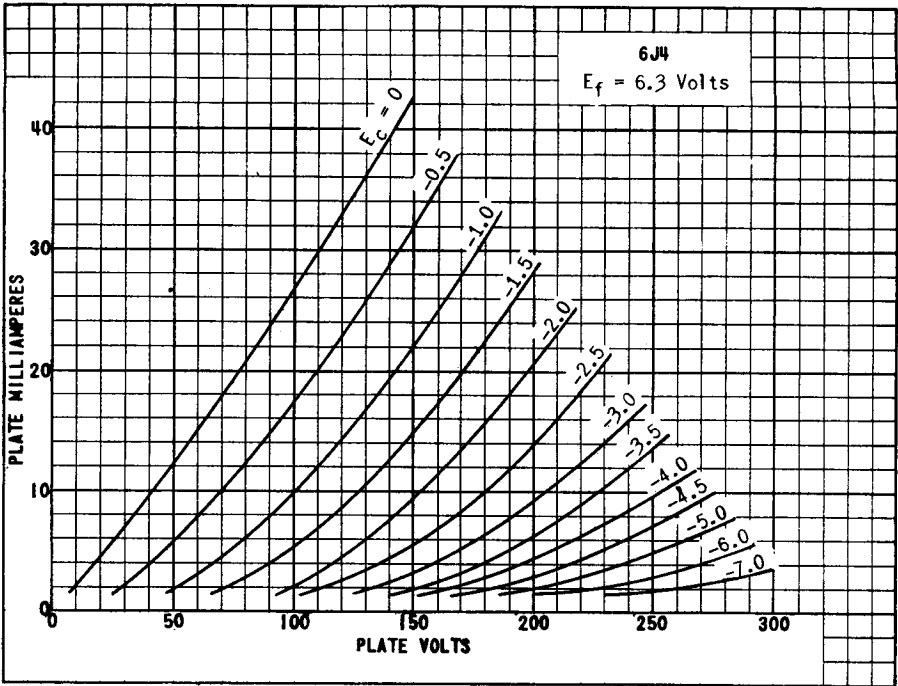

TUNG-SOL

TRIODE

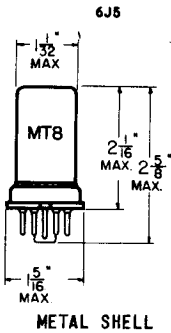

COATED UNIPOTENTIAL CATHODE

HEATER

6.3 VOLTS 300 MA.

AC OR DC

ANY MOUNTING POSITION

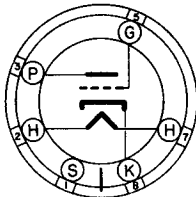
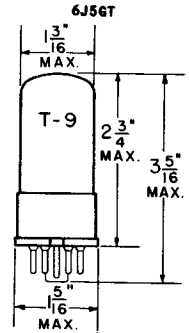

BOTTOM VIEW

SMALL WAFER
6 PIN OCTAL

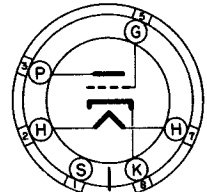

BOTTOM VIEW

SMALL WAFER
6 PIN OCTAL
METAL SLEEVE

THE 6J5 AND 6J5GT ARE GENERAL PURPOSE MEDIUM-MU TRIODES. THEY ARE USEFUL FOR SERVICE AS OSCILLATORS OR AUDIO-FREQUENCY AMPLIFIERS.

DIRECT INTERELECTRODE CAPACITANCES - APPROX.

	6J5 ^A	6J5GT ^B	
GRID TO PLATE: (G TO P)	3.4	3.8	μμf
INPUT: G TO (H+K)	3.4	4.2	μμf
OUTPUT: P TO (H+K)	3.6	5	μμf

^A WITH SHELL CONNECTED TO CATHODE.

^B WITH CLOSE-FITTING SHIELD CONNECTED TO CATHODE.

RATINGS

INTERPRETED ACCORDING TO RMA STANDARD M8-210

HEATER VOLTAGE	6.3	VOLTS
MAXIMUM HEATER-CATHODE VOLTAGE	90	VOLTS
MAXIMUM PLATE VOLTAGE	300	VOLTS
MINIMUM NEGATIVE DC GRID VOLTAGE	0	VOLTS
MAXIMUM GRID CIRCUIT RESISTANCE	1.0	MEG.
MAXIMUM PLATE DISSIPATION	2.5	WATTS
MAXIMUM CATHODE CURRENT	20	MA.

CONTINUED ON FOLLOWING PAGE

→ INDICATES A CHANGE OR ADDITION

CONTINUED FROM PRECEDING PAGE

TYPICAL OPERATING CONDITIONS AND CHARACTERISTICS

CLASS A₁ AMPLIFIER

HEATER VOLTAGE	6.3	6.3	VOLTS
HEATER CURRENT	300	300	MA.
PLATE VOLTAGE	90	250	VOLTS
GRID VOLTAGE	0	-8	VOLTS
PLATE CURRENT	10	9	MA.
PLATE RESISTANCE	6 700	7 700	OHMS
TRANSCONDUCTANCE	3 000	2 600	μMHMS
AMPLIFICATION FACTOR	20	20	

SIMILAR TYPE REFERENCE: Ratings and characteristics are identical to 714.

RESISTANCE COUPLED AMPLIFIER

R ₁ MEG.	R _{g1} MEG.	R _B MEG.	E _{bb} = 90 VOLTS			E _{bb} = 180 VOLTS			E _{bb} = 300 VOLTS		
			R _k	GAIN	E _o	R _k	GAIN	E _o	R _k	GAIN	E _o
0.10	A	0.10	3300	14	13	2200	14	26	1800	14	40
0.10	A	0.24	3600	14	16	2700	15	33	2200	15	51
0.24	A	0.24	7500	14	16	5100	15	30	4300	15	44
0.24	A	0.51	9100	14	19	6800	15	39	5100	15	54
0.51	A	0.51	13000	14	16	9100	15	30	6800	16	40
0.51	A	1.0	15000	14	19	10000	16	32	7500	16	45
0.24	10	0.24	---	15	13	---	16	33	----	17	46
0.24	10	0.51	---	16	17	---	17	38	----	18	62
0.51	10	0.51	---	16	14	---	18	32	----	18	53
0.51	10	1.0	---	17	18	---	18	41	----	19	68

^A VALUE OF R_{g1} IS NOT CRITICAL.

GAIN MEASURED AT E_o = 2.0 VOLTS RMS OUTPUT.

E_o IS RMS OUTPUT FOR 5% TOTAL HARMONIC DISTORTION.

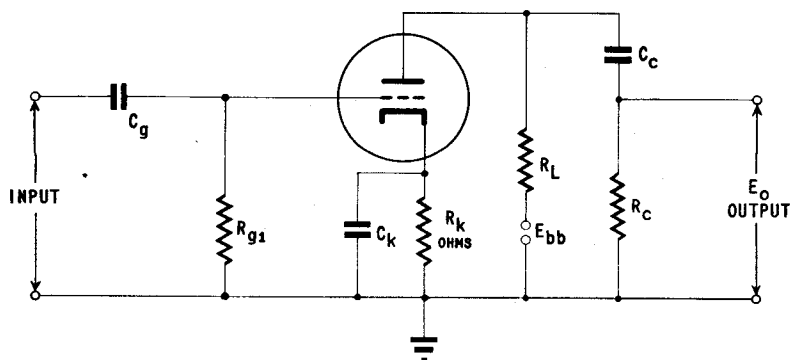

NOTE: COUPLING CAPACITORS C_g AND C_c SHOULD BE SELECTED TO GIVE DESIRED FREQUENCY RESPONSE. R_k SHOULD BE ADEQUATELY BY-PASSED BY CAPACITOR C_k.

→ INDICATES A CHANGE OR ADDITION

PLATE
1945
JAN. 2,
1948

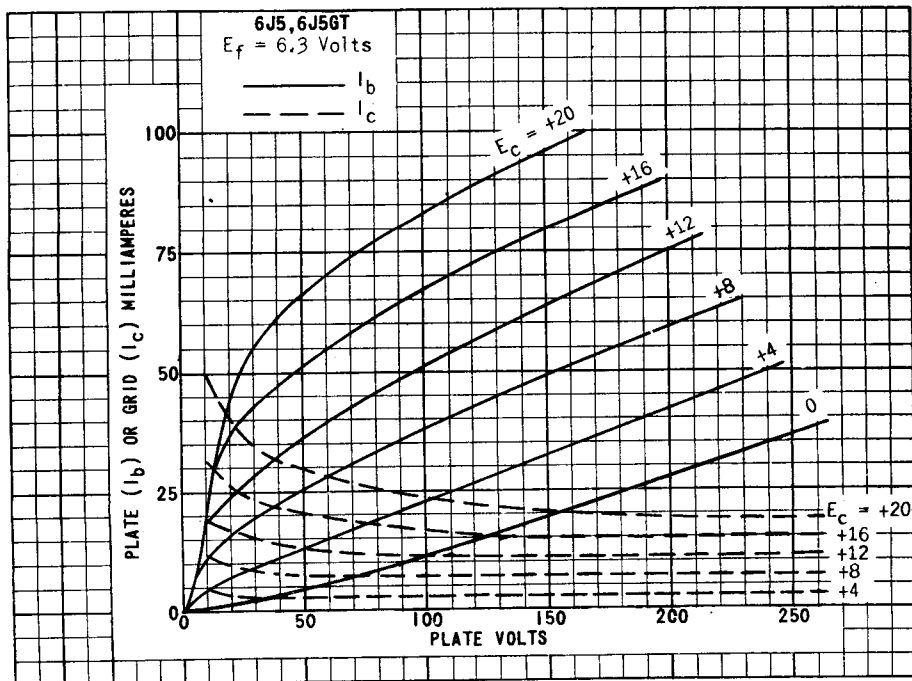
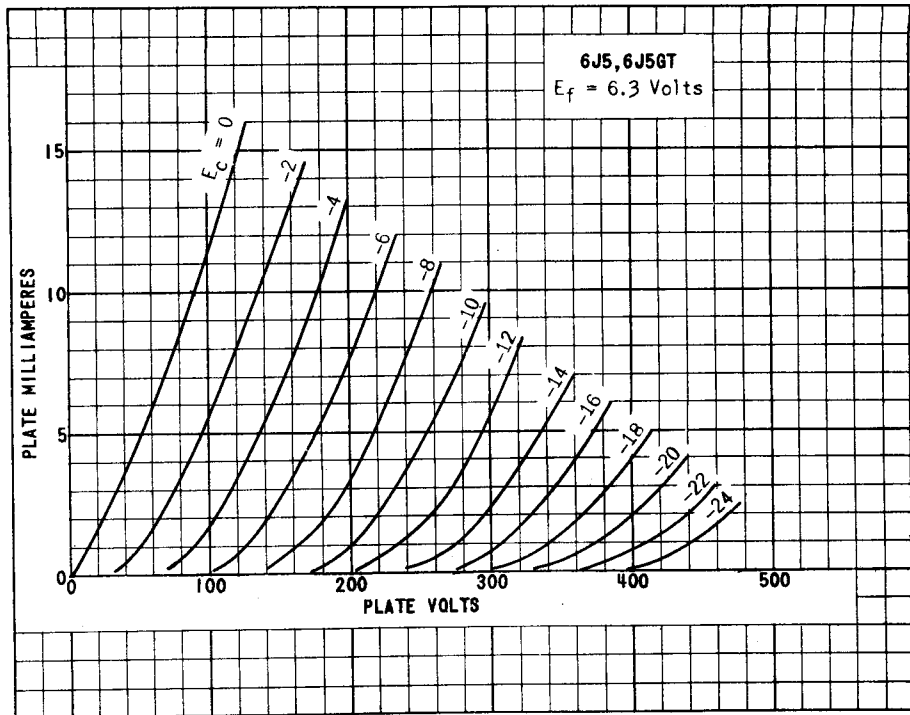

PRINTED IN U. S. A.

PLATE
1946
JAN. 2,
1948

6J5,6J5GT

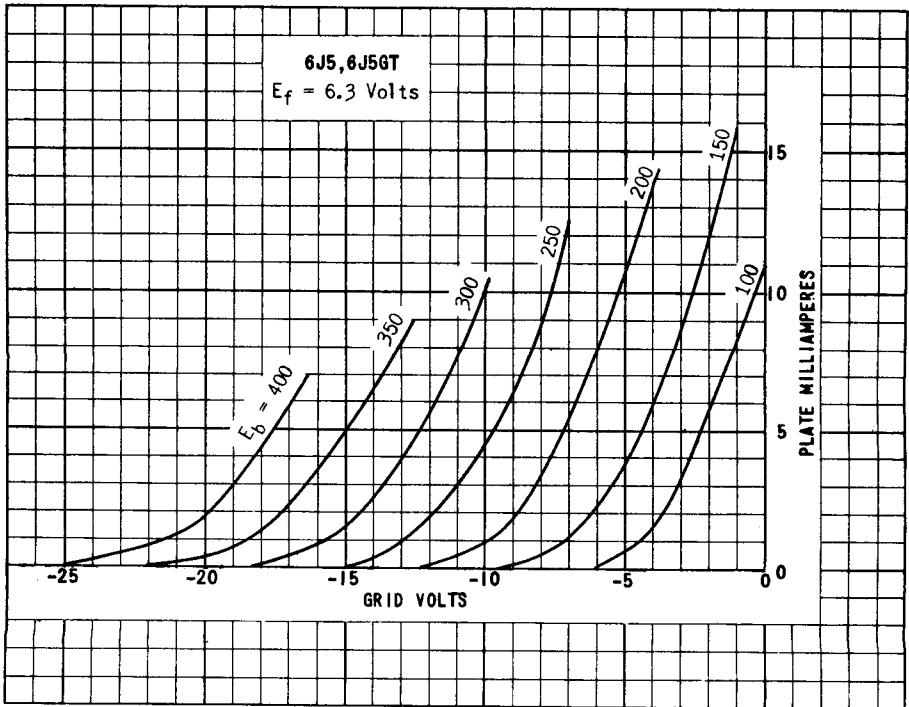
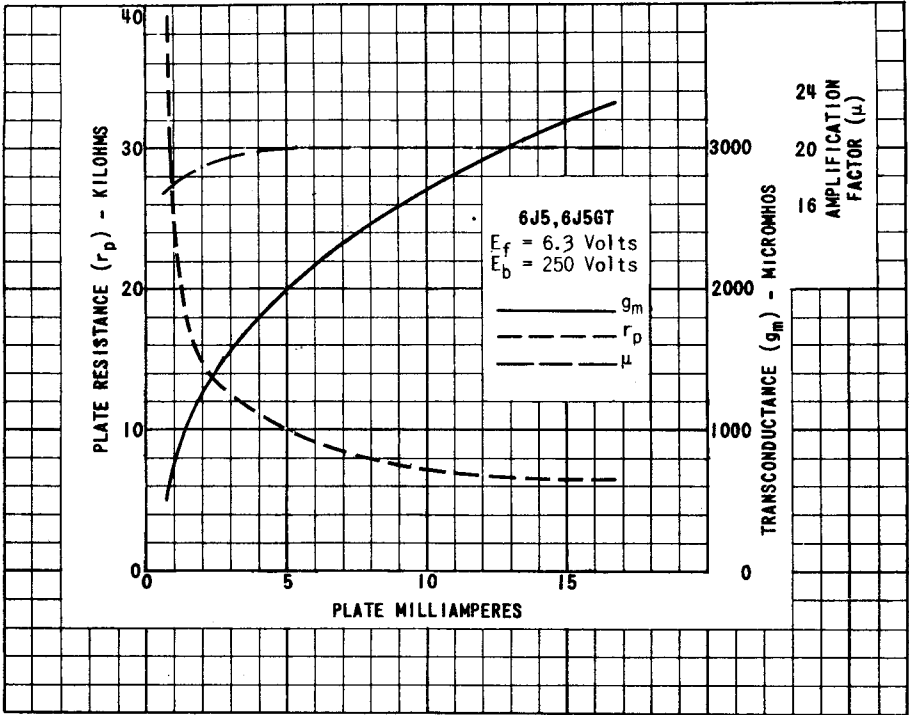
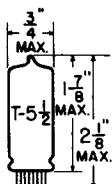

PLATE
 1947
 JAN. 2,
 1948

TUNG-SOL

TWIN TRIODE



GLASS BULB

UNIPOENTIAL CATHODE

HEATER

6.3 VOLTS 0.45 AMPERE

AC OR DC

ANY MOUNTING POSITION

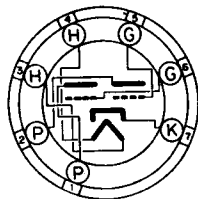
BOTTOM VIEW
MINIATURE BUTTON
7 PIN BASE

THE 6J6 IS A TWIN TRIODE HAVING TWO PLATES AND TWO GRIDS WITH A COMMON CATHODE, USING THE MINIATURE CONSTRUCTION. IT MAY BE OPERATED IN PARALLEL OR PUSH-PULL. WITH THE GRIDS IN A PUSH-PULL ARRANGEMENT AND THE PLATES IN PARALLEL, THE 6J6 IS PARTICULARLY APPLICABLE AS A MIXER AT FREQUENCIES AS HIGH AS 600 MEGACYCLES. IT IS ALSO USEFUL AS AN OSCILLATOR.

DIRECT INTERELECTRODE CAPACITANCES - APPROX.
WITH NO EXTERNAL SHIELD

	EACH UNIT	
GRID TO PLATE: (G TO P)	1.6	$\mu\mu\text{f}$
INPUT: G TO (H + K)	2.2	$\mu\mu\text{f}$
OUTPUT: P TO (H + K)	0.4	$\mu\mu\text{f}$

RATINGS

INTERPRETED ACCORDING TO RMA STANDARD M8-210

	AF AMPLIFIER	RF AMPLIFIER	
HEATER VOLTAGE	6.3	6.3	VOLTS
MAXIMUM HEATER-CATHODE VOLTAGE	100	100	VOLTS
MAXIMUM PLATE VOLTAGE	300	300	VOLTS
MAXIMUM DC GRID VOLTAGE	—	-40	VOLTS
MAXIMUM GRID RESISTOR (SELF BIAS)	0.5	—	OHMS
MAXIMUM DC PLATE CURRENT (PER UNIT)	—	15	MA.
MAXIMUM DC GRID CURRENT (PER UNIT)	—	8	MA.
MAXIMUM DC PLATE INPUT (PER UNIT)	—	4.5	WATTS
MAXIMUM PLATE DISSIPATION (PER UNIT)	1.5	1.5	WATTS

TYPICAL OPERATING CONDITIONS AND CHARACTERISTICS

CLASS A₁ - AF AMPLIFIER

HEATER VOLTAGE	6.3	VOLTS
HEATER CURRENT	0.45	AMP.
PLATE VOLTAGE	100	VOLTS
CATHODE BIAS RESISTOR ^A (BOTH UNITS)	50	OHMS
PLATE CURRENT	8.5	MA.
PLATE RESISTANCE	7 100	OHMS
TRANSCONDUCTANCE	5 300	μMHOS
AMPLIFICATION FACTOR	38	

^A FIXED BIAS OPERATION NOT RECOMMENDED. THE RESISTANCE IN THE GRID CIRCUIT SHOULD NOT EXCEED 0.5 MEGOHM UNDER MAXIMUM RATED CONDITIONS.

TUNG-SOL

TYPICAL OPERATING CONDITIONS AND CHARACTERISTICS

RF POWER AMPLIFIER AND OSCILLATOR - CLASS C TELEGRAPHY
PUSH-PULL - BOTH UNITS

HEATER VOLTAGE	6.3	VOLTS						
HEATER CURRENT	0.45	VOLTS						
DC PLATE VOLTAGE	150	VOLTS						
DC GRID VOLTAGE ^B	{ <table> <tbody> <tr> <td>-10</td> <td>VOLTS</td> </tr> <tr> <td>625</td> <td>OHMS</td> </tr> <tr> <td>220</td> <td>OHMS</td> </tr> </tbody> </table>	-10	VOLTS	625	OHMS	220	OHMS	
		-10	VOLTS					
		625	OHMS					
220	OHMS							
DC PLATE CURRENT	30	MA.						
DC GRID CURRENT (APPROX.)	16	MA.						
DRIVING POWER (APPROX.)	0.35	WATT						
POWER OUTPUT (APPROX.)	3.5	WATTS						

^B OBTAINED BY GRID RESISTOR (625 OHMS), CATHODE RESISTOR (220 OHMS), OR FIXED SUPPLY.

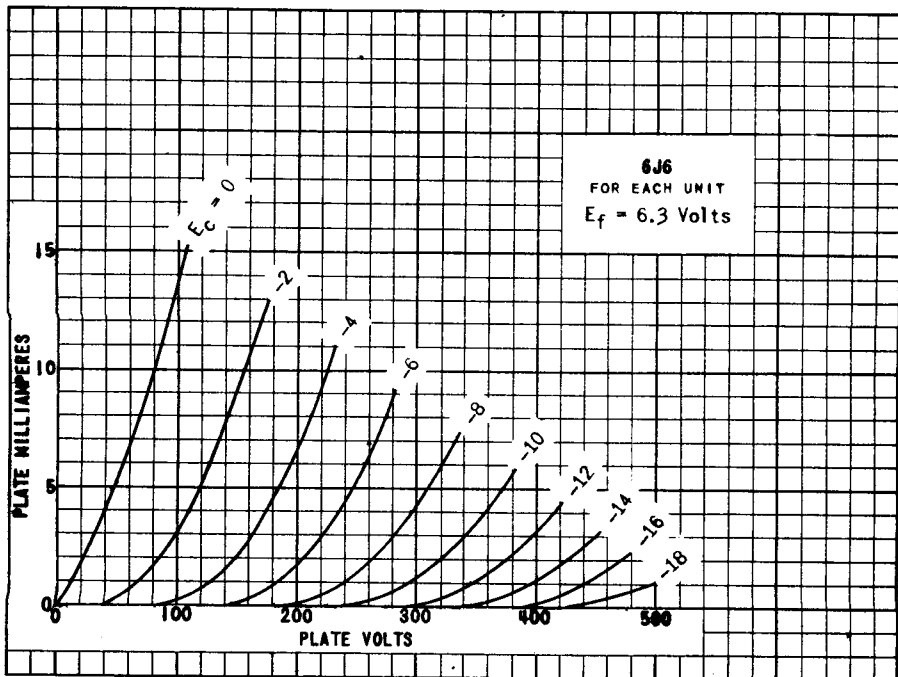
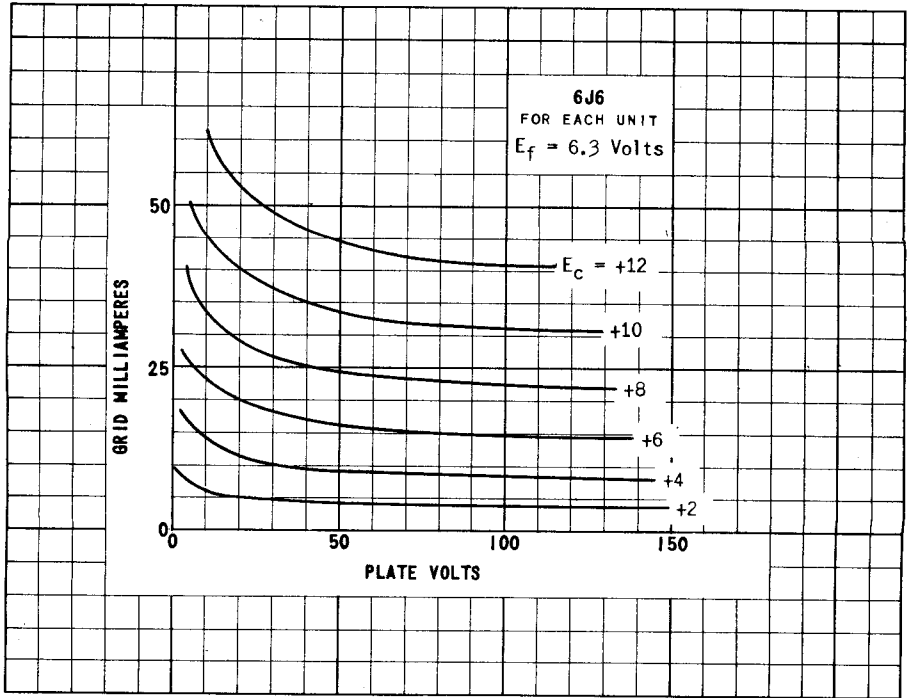
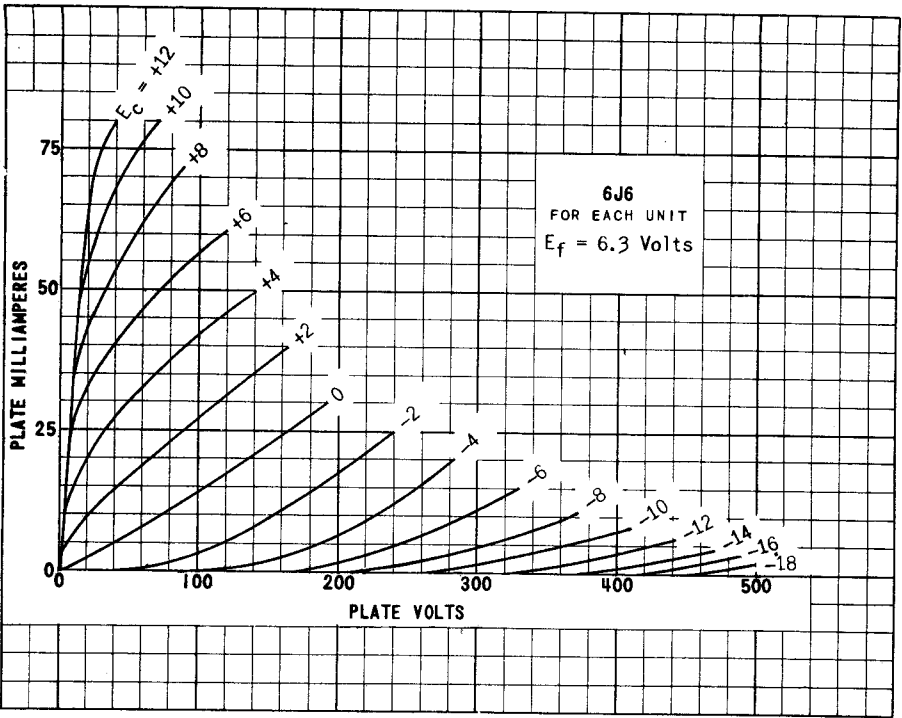

PLATE
1833
JUNE 2,
1947



PRINTED IN U. S. A.

PLATE 1834
JUNE 2,
1947



TUNG-SOL

**TRIPLE GRID
DETECTOR AMPLIFIER**

UNIPOTENTIAL CATHODE
HEATER
6.3 VOLTS 0.3 AMPERE
AC OR DC

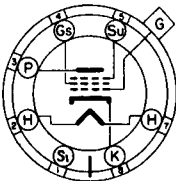
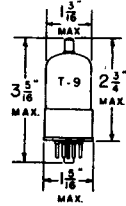
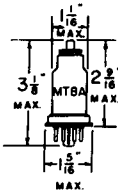

G-7Ra

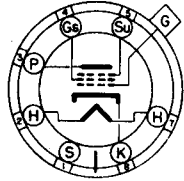
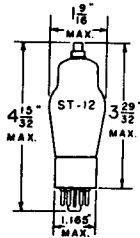

7R

THE TUNG-SOL 6J7, 6J7G, 6J7GT AND THE 12J7GT ARE SHARP CUT-OFF GENERAL PURPOSE AMPLIFIERS. WITH THE EXCEPTION OF HEATER AND CAPACITANCE RATINGS, THEIR ELECTRICAL CHARACTERISTICS ARE SIMILAR TO THOSE OF THE 6C6.

RATINGS

	TRIODE ^A CONNECTION	PENTODE CONNECTION	
MAXIMUM PLATE VOLTAGE	250	300	VOLTS
MAXIMUM SCREEN SUPPLY VOLTAGE	-	300	VOLTS
MAXIMUM SCREEN VOLTAGE	-	125	VOLTS
MINIMUM EXTERNAL CONTROL GRID BIAS VOLTAGE	0	0	VOLTS
MAXIMUM PLATE DISSIPATION	1.75	0.75	WATT
MAXIMUM SCREEN DISSIPATION	-	0.10	WATT

^A SUPPRESSOR GRID AND SCREEN TIED TO PLATE

FOR "INTERPRETATION OF RATINGS" REFER TO FRONT OF BOOK.

CONTINUED NEXT PAGE

TUNG-SOL

DIRECT INTERELECTRODE CAPACITANCES

TRIODE CONNECTION

	6J7	6J7G	6J7GT 12J7GT
CONTROL GRID TO CATHODE	5 ^B	2.6 ^C	2.6 ^C
PLATE TO CATHODE	14	17	17
CONTROL GRID TO PLATE	2.0	1.8	1.8

PENTODE CONNECTION

	6J7	6J7G	6J7GT 12J7GT
CONTROL GRID TO CATHODE	7 ^B	4.6 ^D	4.6 ^D
PLATE TO CATHODE	12	12	12
CONTROL GRID TO PLATE MAX.	0.005	0.007	0.005

^B WITH SHIELD CONNECTED TO CATHODE

^C WITHOUT EXTERNAL SHIELD

^D WITH EXTERNAL SHIELD CONNECTED TO CATHODE

TYPICAL OPERATING CONDITIONS AND CHARACTERISTICS

CLASS A₁ AMPLIFIER

	TRIODE CONNECTION		PENTODE CONNECTION		VOLTS
	180	250	100	250	
PLATE VOLTAGE	180	250	100	250	VOLTS
SCREEN VOLTAGE	PLATE	PLATE	100	100	VOLTS
CONTROL GRID VOLTAGE ^E	-5.3	-8	-3	-3	VOLTS
SUPPRESSOR GRID	PLATE	PLATE	CONNECTED TO CATHODE AT SOCKET		
PLATE CURRENT	5.3	6.5	2.0	2.0	MA.
SCREEN CURRENT	-	-	0.5	0.5	MA.
PLATE RESISTANCE ^{APPROX.}	0.0110	0.0105	1.0	- F	MEG OHM
TRANSCONDUCTANCE	1800	1900	1185	1225	μMHOS
CONTROL GRID VOLTAGE	-	-	-7	-7	VOLTS

FOR CATHODE CURRENT CUT-OFF

^E THE DC RESISTANCE IN THE GRID CIRCUIT SHOULD NOT EXCEED 1.0 MEG OHM

^F GREATER THAN 1 MEG OHM

PLATE
1005-3

APR. 21
1941

12J7GT 6J7, 6J7G, 6J7GT

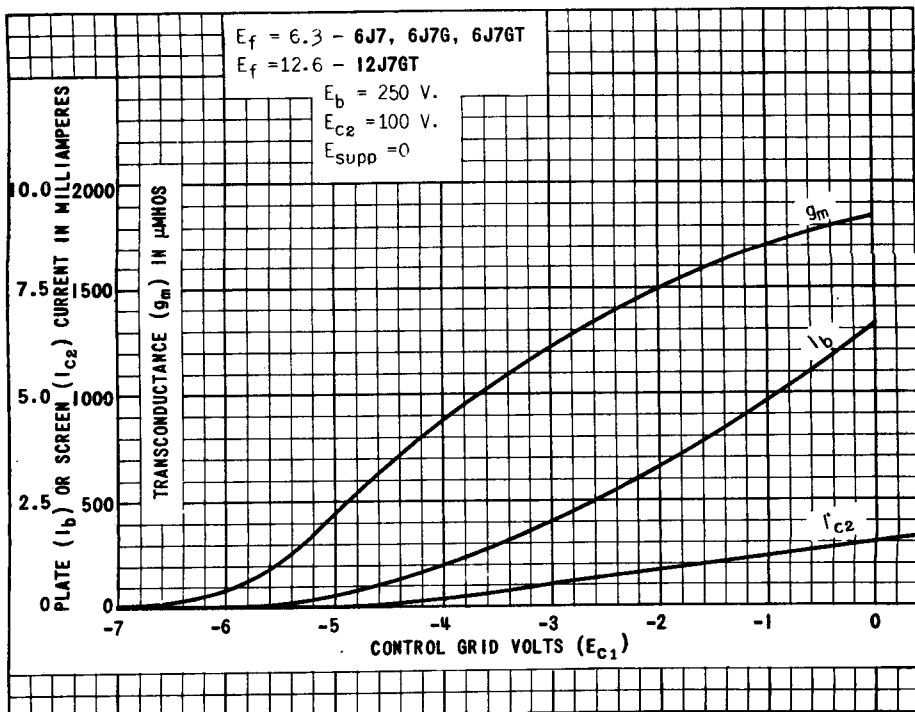
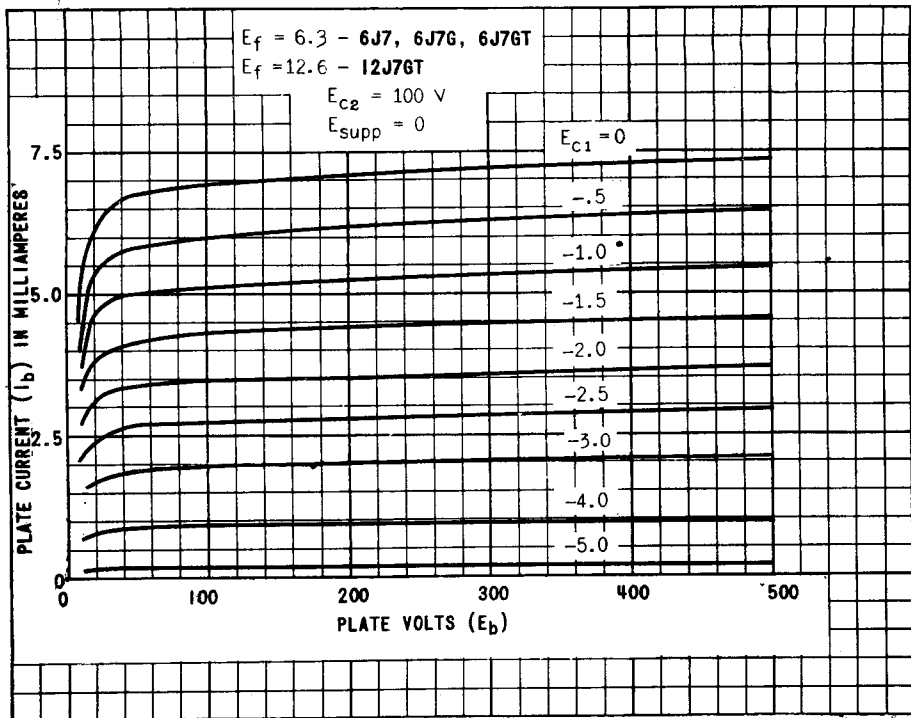

PLATE
 1006-2
 APR. 23
 1941

12J7GT 6J7, 6J7G, 6J7GT

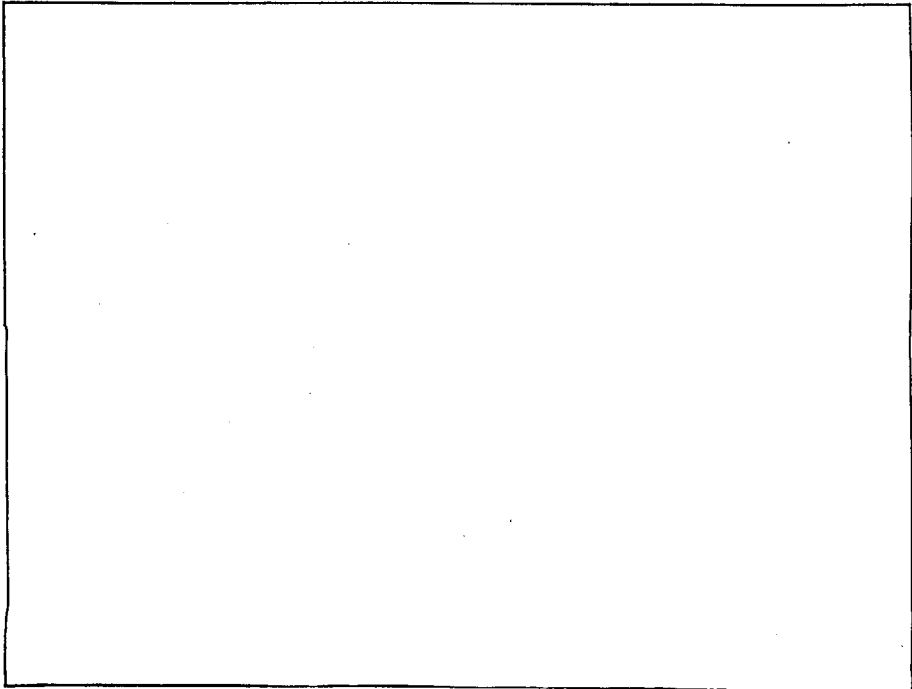
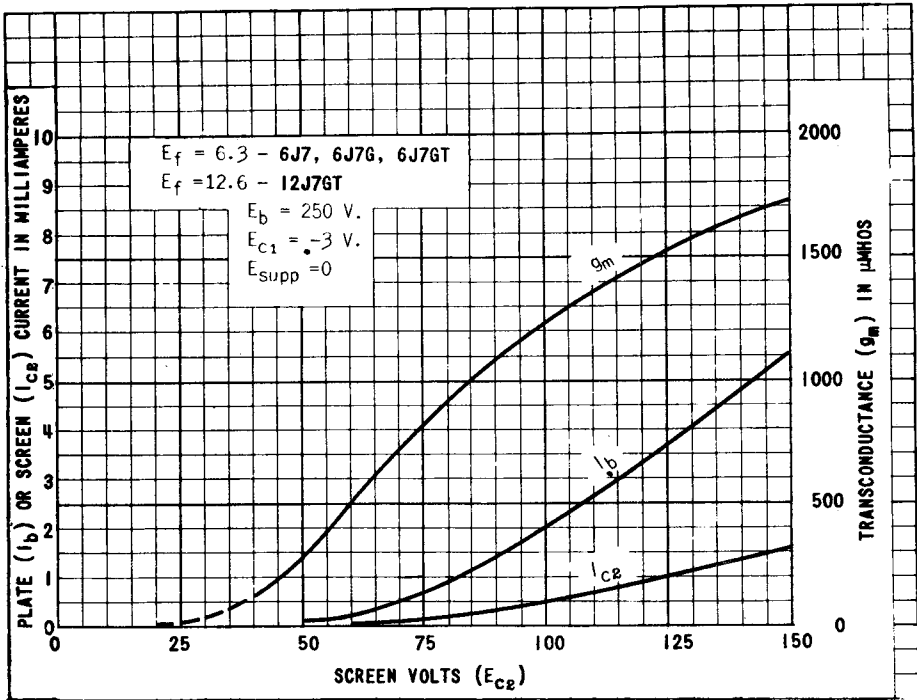
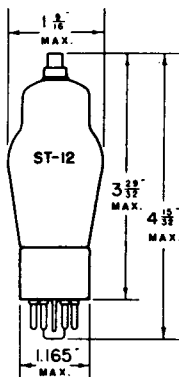

PLATE
1007-2

APR. 21
1941

TUNG-SOL



TRIODE HEPTODE CONVERTER

UNIPOTENTIAL CATHODE

HEATER

6.3 VOLTS 0.3 AMPERE

AC OR DC

GLASS BULB

SMALL 8 PIN OCTAL BASE

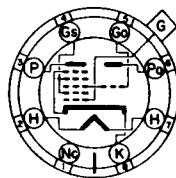

G-8H

THE TUNG-SOL 6J8G IS A CONVERTER TUBE DESIGNED FOR STABLE OPERATION OVER AN EXTENDED FREQUENCY RANGE. IT CONSISTS OF A HEPTODE MIXER AND A TRIODE OSCILLATOR, HAVING A COMMON CATHODE. THE INJECTOR GRID OF THE HEPTODE IS INTERNALLY CONNECTED TO THE TRIODE GRID.

OPERATING CONDITIONS AND CHARACTERISTICS

HEPTODE PLATE VOLTAGE	100	250 MAX.	VOLTS
HEPTODE CONTROL GRID VOLTAGE	-3	-3	VOLTS
HEPTODE SCREEN VOLTAGE	100 MAX.	100 MAX.	VOLTS
HEPTODE PLATE CURRENT	1.4	1.3	MA.
HEPTODE SCREEN CURRENT	3.0	2.9	MA.
TRIODE PLATE VOLTAGE	100	250 MAX. ^R	VOLTS
TRIODE PLATE CURRENT	3	5	MA.
TRIODE GRID RESISTOR	50 000	50 000	OHMS
TRIODE GRID CURRENT	0.3	0.4	MA.
HEPTODE PLATE RESISTANCE	0.9	4.0	MEG OHMS
CONVERSION CONDUCTANCE	250	290	μMHOS
HEPTODE CONTROL GRID VOLTAGE	-20	-20	VOLTS

FOR 2 μMHOS CONVERSION CONDUCTANCE

^R APPLIED THROUGH 20 000 OHMS DROPPING RESISTOR.

STATIC CHARACTERISTICS OF TRIODE SECTION

PLATE VOLTAGE	100	VOLTS
GRID VOLTAGE	0	VOLTS
PLATE CURRENT	7	MA.
PLATE RESISTANCE	10 600	OHMS
TRANSCONDUCTANCE	1600 APPROX.	μMHOS
AMPLIFICATION FACTOR	17 APPROX.	

TUNG-SOL

DIRECT INTERELECTRODE CAPACITANCES⁵

CONTROL GRID (G) AND HEPTODE PLATE (P)	0.01 ^{MAX.}	μuf
CONTROL GRID (G) AND TRIODE PLATE (P _o)	0.16	μuf
CONTROL GRID (G) AND TRIODE GRID (G _o)	0.14	μuf
CONTROL GRID (G) AND ALL OTHER ELECTRODES	4.4	μuf
TRIODE GRID (G _o) AND TRIODE PLATE (P _o)	2.2	μuf
TRIODE GRID (G _o) AND ALL OTHER ELECTRODES	12.0	μuf
TRIODE PLATE (P _o) AND ALL OTHER ELECTRODES	5.5	μuf
HEPTODE PLATE (P) AND ALL OTHER ELECTRODES	9.0	μuf

⁵ WITH STANDARD TUBE SHIELD (NOT CLOSE FITTING)

NOTE: VARIATION OF THE OSCILLATOR FREQUENCY, CAUSED BY AVC VOLTAGE AND REGULATION OF THE POWER SUPPLY, IS LESS IN THE 6J8G THAN IN THE PENTAGRID CONVERTER. THIS IMPROVEMENT IN FREQUENCY STABILITY IS DUE TO THE USE OF A SEPARATE TRIODE UNIT. THE HIGH INPUT IMPEDANCE RESULTING FROM THE LOW SIGNAL GRID TO PLATE CAPACITANCE AND THE HIGH PLATE RESISTANCE, MAINTAINS THE Q OF ASSOCIATED HIGH GAIN CIRCUITS. THE COUPLING EFFECTS WITHIN THE TUBE BETWEEN THE OSCILLATOR AND SIGNAL CIRCUITS ARE SMALL.

THE OSCILLATOR GRID CURRENT SHOULD EXCEED 150 MICROAMPERES THROUGH A 50 000 OHM GRID RESISTOR, AND THE PLATE LOAD IMPEDANCE SHOULD EXCEED 0.2 MEGOHM TO OBTAIN CONVERSION GAIN COMPARABLE TO THAT OF PENTAGRID CONVERTERS. THE HIGH PLATE LOAD IMPEDANCE MAY BE OBTAINED MORE ECONOMICALLY BY USING HIGHER L-C RATIOS THAN BY HIGHER Q COILS, AS A LOWER VALUE OF TUNING CAPACITY MAY BE USED THAN IS PERMISSIBLE WITH PENTAGRID CONVERTERS. OSCILLATOR CIRCUITS THAT REDUCE THE VOLTAGE ON THE TRIODE PLATE TO LESS THAN 100 VOLTS SHOULD BE AVOIDED.

TUNG-SOL

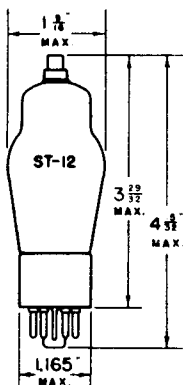

GENERAL PURPOSE

HIGH - MU TRIODE

UNI-POTENTIAL CATHODE

HEATER

6.3 VOLTS 0.3 AMPERE
AC OR DC

GLASS BULB

SMALL 7 PIN OCTAL BASE

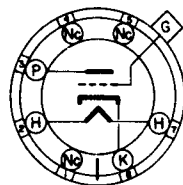

G-5U

BOTTOM VIEW

OPERATING CONDITIONS AND CHARACTERISTICS

CLASS A₁ AMPLIFIER

PLATE VOLTAGE	100	250	VOLTS
GRID VOLTAGE	-1.5	-3	VOLTS
PLATE CURRENT	0.35	1.1	MA.
PLATE RESISTANCE	78 000	50 000	OHMS
TRANSCONDUCTANCE	900	1400	μMHMS
AMPLIFICATION FACTOR	70	70	

DIRECT INTERELECTRODE CAPACITANCES⁵

GRID TO CATHODE	3.0	μuf
PLATE TO CATHODE	5.5	μuf
GRID TO PLATE	2.2	μuf

⁵ WITH SHIELD

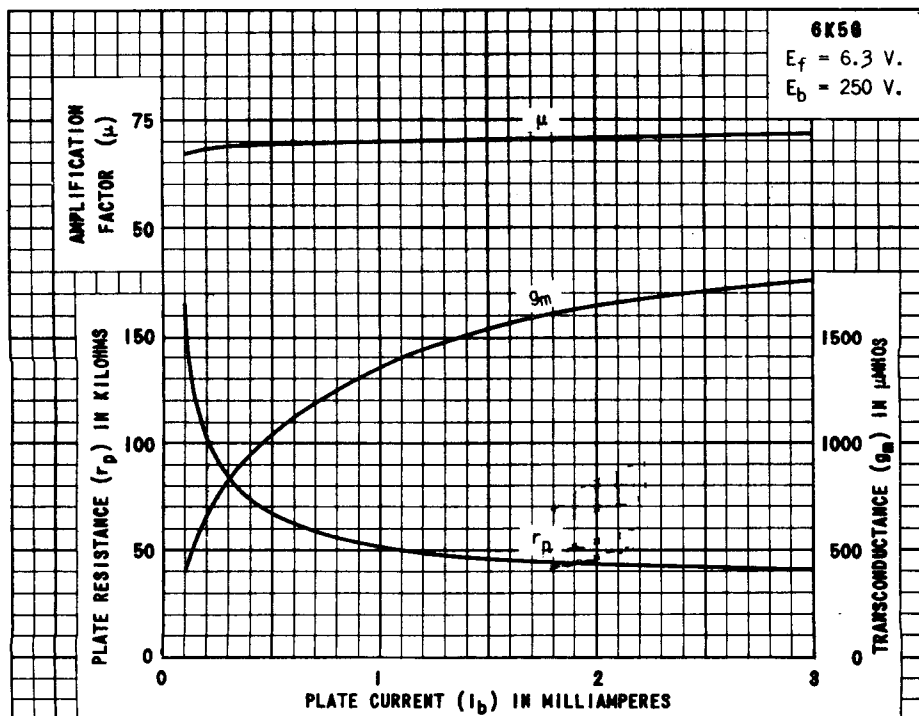
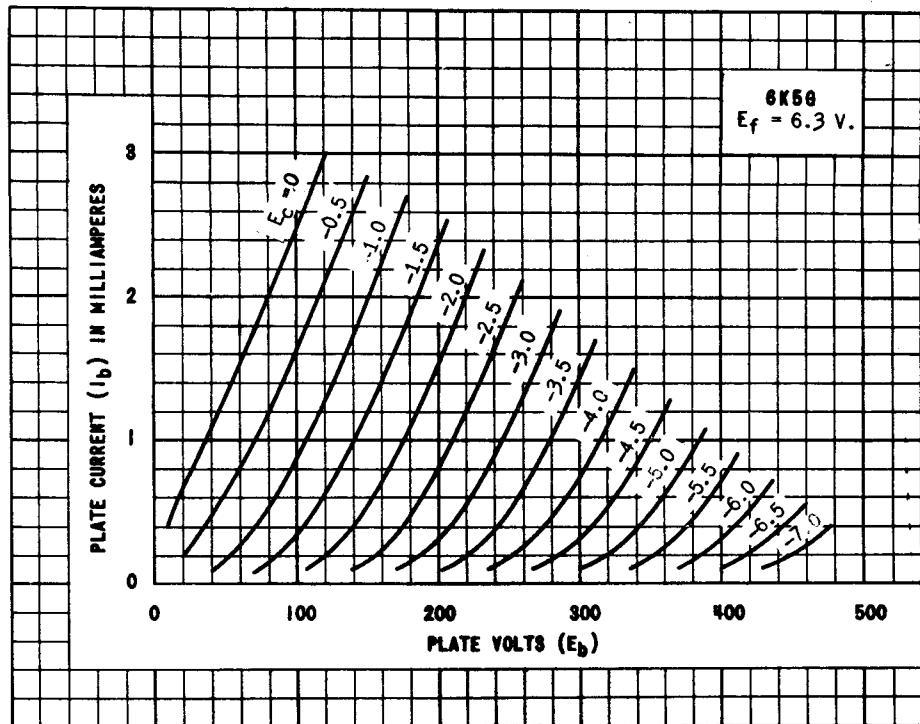

TUNG-SOL

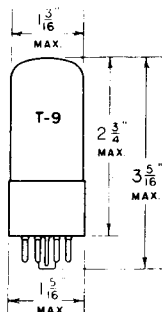

PENTODE POWER AMPLIFIER

UNIPOTENTIAL CATHODE

HEATER

0.3 VOLTS 0.4 AMPERE
AC OR DC

GLASS BULB

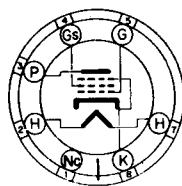

G-7S

BOTTOM VIEW

INTERMEDIATE 7 PIN OCTAL BASE

THE TUNG-SOL 6K6GT/G IS DESIGNED FOR SERVICE IN THE POWER OUTPUT STAGES OF AC, AC/DC, OR STORAGE BATTERY OPERATED RECEIVERS. ITS ELECTRICAL CHARACTERISTICS ARE IDENTICAL WITH THOSE OF THE TYPE 41.

RATINGS

MAXIMUM PLATE VOLTAGE	315	VOLTS
MAXIMUM SCREEN VOLTAGE	285	VOLTS
MAXIMUM PLATE DISSIPATION	8.5	WATTS
MAXIMUM SCREEN DISSIPATION	2.8	WATTS

TYPICAL OPERATING CONDITIONS AND CHARACTERISTICS

CLASS A₁ AMPLIFIER

PLATE VOLTAGE	100	250	315	VOLTS
SCREEN VOLTAGE	100	250	250	VOLTS
CONTROL GRID VOLTAGE ^A	-7	-18	-21	VOLTS
PEAK AF SIGNAL VOLTAGE	7	18	21	VOLTS
ZERO SIGNAL PLATE CURRENT	9.0	32	25.5	MA.
ZERO SIGNAL SCREEN CURRENT	1.6	5.5	4.0	MA.
MAXIMUM SIGNAL PLATE CURRENT	9.5	33	28	MA.
MAXIMUM SIGNAL SCREEN CURRENT	3	10	9	MA.
PLATE RESISTANCE APPROX.	104 000	68 000	75 000	OHMS
TRANSCONDUCTANCE	1500	2300	2100	μMHOS
LOAD RESISTANCE	12 000	7600	9000	OHMS
TOTAL HARMONIC DISTORTION	11	11	15	PER CENT
POWER OUTPUT	0.35	3.4	4.5	WATTS

^A THE DC RESISTANCE IN THE GRID CIRCUIT UNDER RATED MAXIMUM CONDITIONS SHOULD NOT EXCEED 0.5 MEGOHM FOR SELF-BIAS OPERATION AND 0.1 MEGOHM FOR FIXED BIAS OPERATION

CONTINUED NEXT PAGE

TUNG-SOL

PUSH PULL AMPLIFIER CLASS A₁

VALUES FOR TWO TUBES UNLESS OTHERWISE SPECIFIED

	FIXED BIAS	SELF BIAS ^A	
PLATE VOLTAGE	285	285	VOLTS
SCREEN VOLTAGE	285	285	VOLTS
CONTROL GRID VOLTAGE ^B	-25.5	-25.5	VOLTS
PEAK AF SIGNAL VOLTAGE GRID TO GRID	51	51	VOLTS
ZERO SIGNAL PLATE CURRENT	55	55	MA.
ZERO SIGNAL SCREEN CURRENT	9	9	MA.
MAXIMUM SIGNAL PLATE CURRENT	72	61	MA.
MAXIMUM SIGNAL SCREEN CURRENT	17	13	MA.
LOAD RESISTANCE PLATE TO PLATE	12 000	12 000	OHMS
TOTAL HARMONIC DISTORTION	6	4	PER CENT
MAXIMUM SIGNAL POWER OUTPUT	10.5	9.8	WATTS

^A 400 OHMS, BY-PASSED.

^B THE DC RESISTANCE IN THE GRID CIRCUIT UNDER RATED MAXIMUM CONDITIONS SHOULD NOT EXCEED 0.5 MEGOHM FOR SELF-BIAS OPERATION AND 0.1 MEGOHM FOR FIXED BIAS OPERATION.

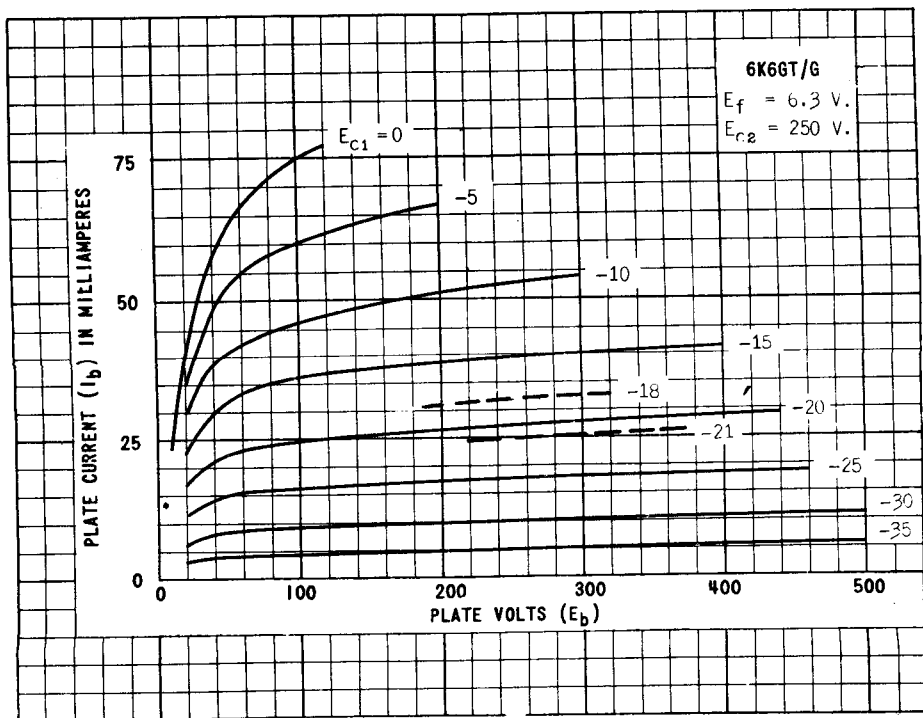
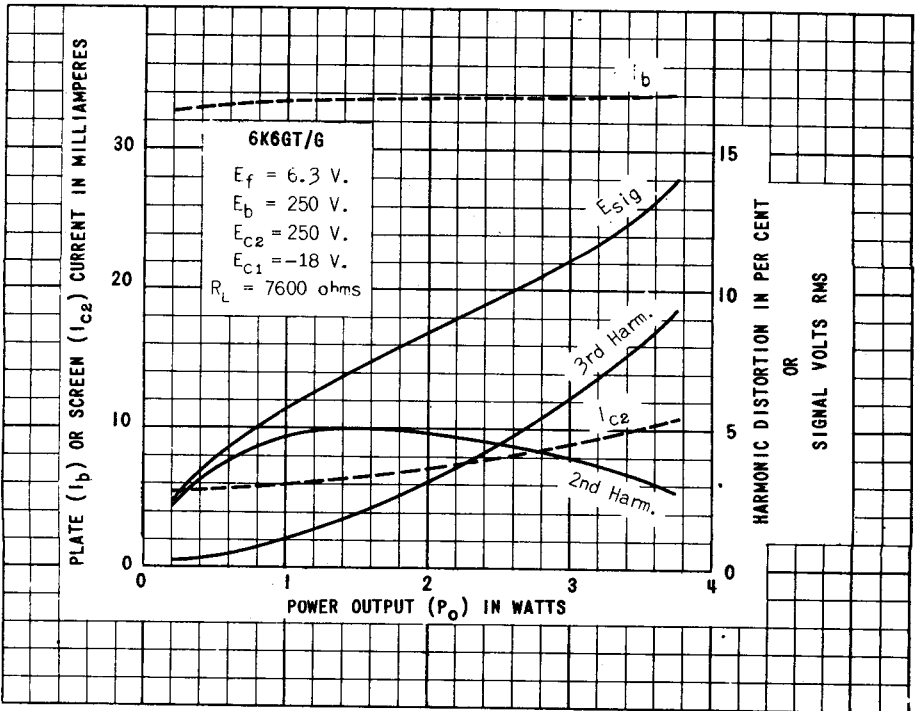
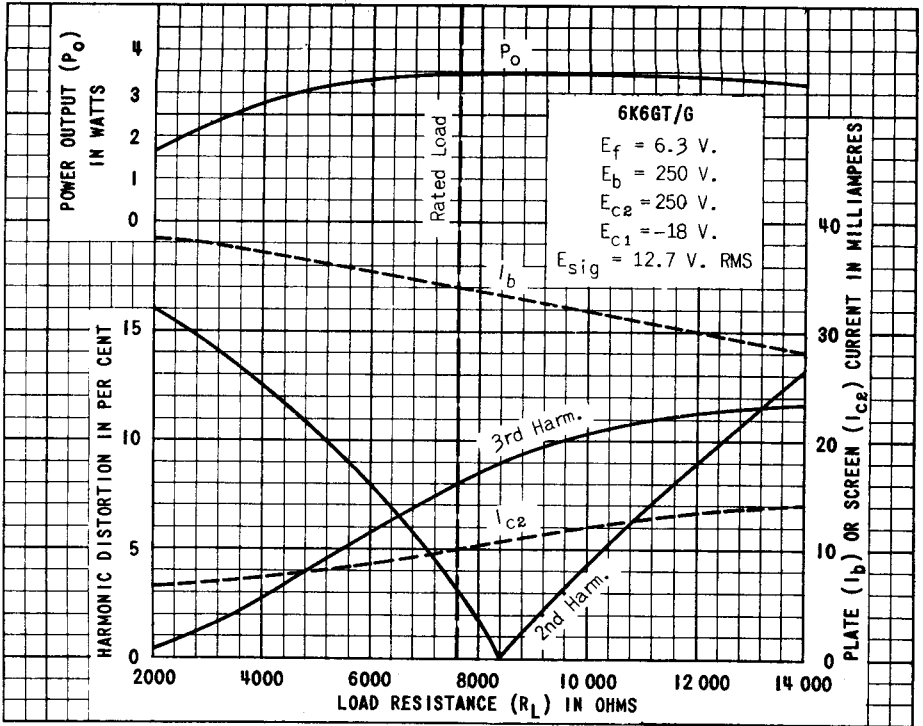
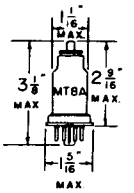

PLATE 1046-2





TUNG-SOL



METAL SHELL
7 PIN OCTAL BASE
6K7

**TRIPLE GRID
REMOTE CUT-OFF AMPLIFIER**

UNIPOTENTIAL CATHODE
HEATER
6.3 VOLTS 0.3 AMPERE
AC OR DC

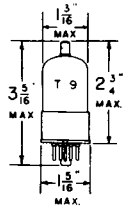

GLASS BULB
7 PIN OCTAL BASE
WITH METAL SHELL
6K7GT 12K7GT

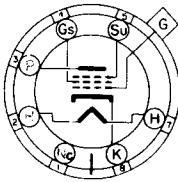

G-7R_a
BOTTOM VIEW
6K7G

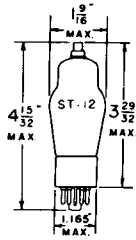

GLASS BULB
SMALL 7 PIN OCTAL BASE
6K7G

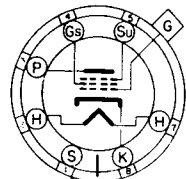

7R
BOTTOM VIEW
6K7 6K7GT

THE TUNG-SOL 6K7, 6K7G, 6K7GT AND THE 12K7GT ARE TRIPLE GRID VARIABLE MU AMPLIFIERS. THEY ARE SUITABLE FOR USE WITH AVC IN RF AND IF AMPLIFIERS, AND THEY MINIMIZE CROSS MODULATION. WITH THE EXCEPTION OF CAPACITANCES AND HEATER RATINGS THEIR ELECTRICAL CHARACTERISTICS ARE SIMILAR.

RATINGS

MAXIMUM PLATE VOLTAGE	300	VOLTS
MAXIMUM SCREEN SUPPLY VOLTAGE	300	VOLTS
MAXIMUM SCREEN VOLTAGE	125	VOLTS
MINIMUM EXTERNAL GRID BIAS VOLTAGE	0	
MAXIMUM PLATE DISSIPATION	2.75	WATTS
MAXIMUM SCREEN DISSIPATION	0.35	WATT

DIRECT INTERELECTRODE CAPACITANCES

	6K7 ^A	6K7G ^B	6K7GT ^A 12K7GT ^A	
CONTROL GRID TO CATHODE	7	5	5	μf
PLATE TO CATHODE	12	12	11	μf
CONTROL GRID TO PLATE	.005 ^{MAX.}	.007 ^{MAX.}	.007 ^{MAX.}	μf

^A SHELL IS CONNECTED TO THE CATHODE.

^B MEASURED WITH AN EXTERNAL SHIELD. THE INTERNAL SHIELD IN THE DOME IS CONNECTED TO THE CATHODE WITHIN THIS TUBE

CONTINUED NEXT PAGE

TUNG-SOL

TYPICAL OPERATING CONDITIONS AND CHARACTERISTICS

CLASS A₁ AMPLIFIER

PLATE VOLTAGE	90	180	250	250	VOLTS
SCREEN VOLTAGE	90	75	100	125	VOLTS
CONTROL GRID VOLTAGE	-3	-3	-3	-3	VOLTS
SUPPRESSOR GRID	CONNECTED TO CATHODE AT SOCKET				
PLATE CURRENT	5.4	4.0	7.0	10.5	MA.
SCREEN CURRENT	1.3	1.0	1.7	2.6	MA.
PLATE RESISTANCE ^{APPROX.}	0.3	1.0	0.8	0.6	MEGOHM
TRANSCONDUCTANCE	1275	1100	1450	1650	μMHOS
CONTROL GRID BIAS ^{APPROX.}	-38.5	-32.5	-42.5	-52.5	VOLTS
FOR TRANSCONDUCTANCE = 2 μMHOS					

TYPICAL OPERATING CONDITIONS WITH VARIABLE BIAS

MIXER IN SUPERHETERODYNE CIRCUITS

PLATE VOLTAGE	250	VOLTS
SCREEN VOLTAGE	100	VOLTS
CONTROL GRID VOLTAGE ^{APPROX. A}	-10	VOLTS
SUPPRESSOR GRID	CONNECTED TO THE CATHODE AT THE SOCKET	

^A THE GRID BIAS SHOWN IS MINIMUM FOR AN OSCILLATOR PEAK VOLTAGE OF 7 VOLTS. THESE VALUES ARE OPTIMUM.

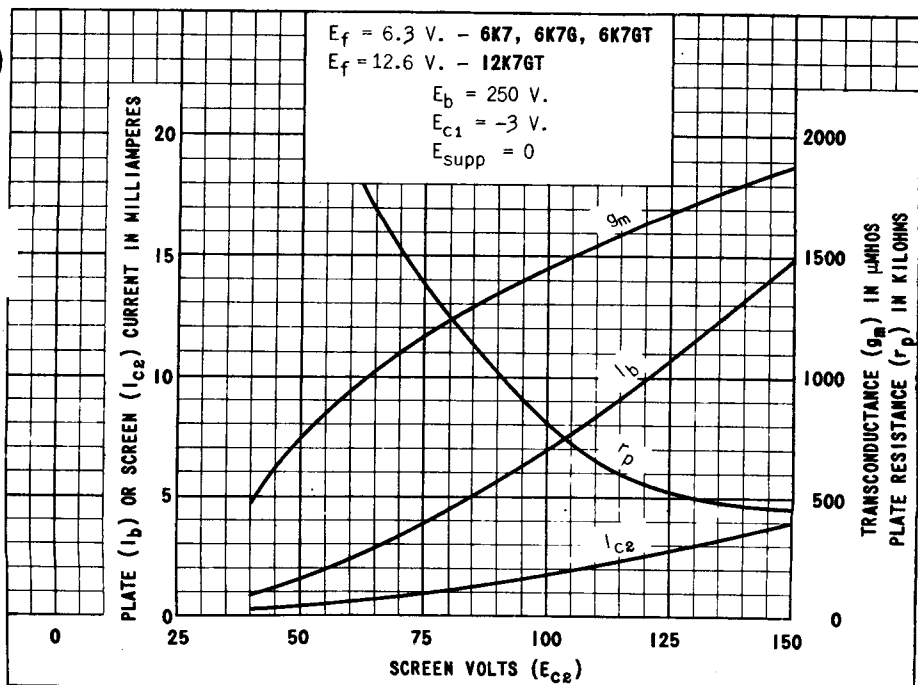
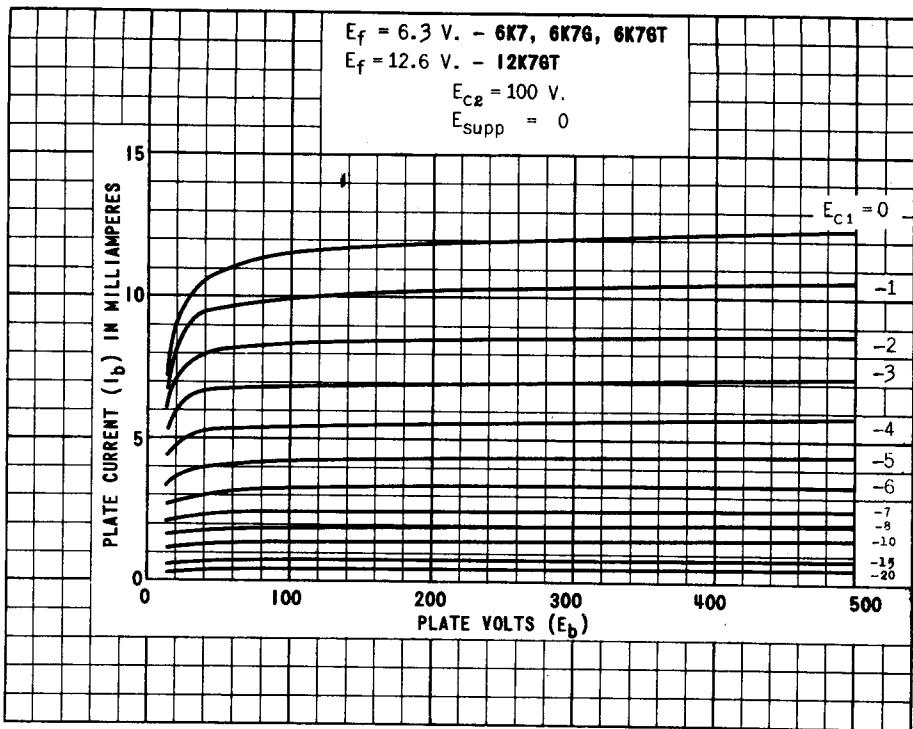

6K7, 6K7G, 6K7GT (12K7GT)

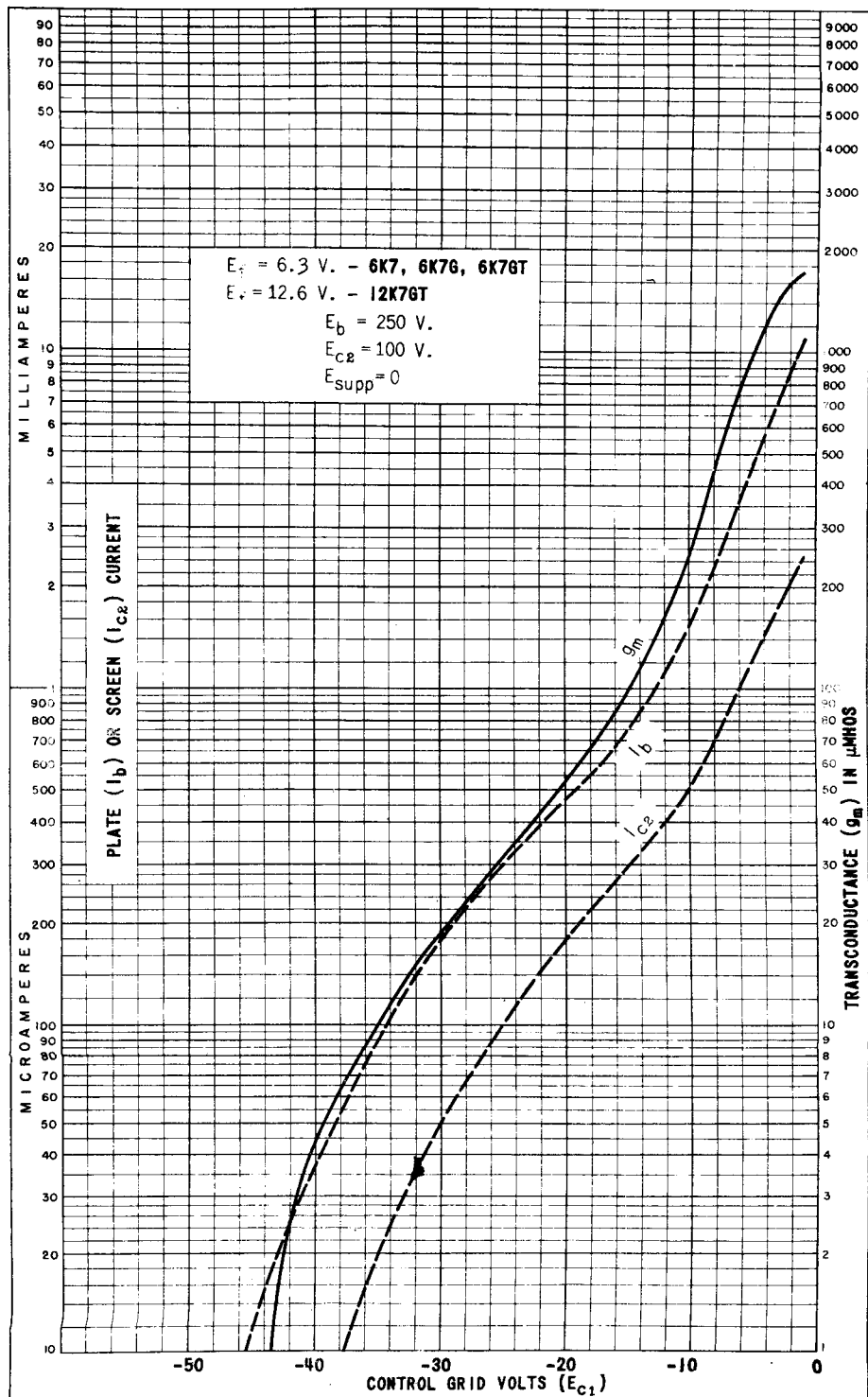

TUNG-SOL

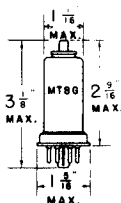

METAL TUBE
SMALL WAFER
8 PIN OCTAL BASE
6K8

TRIODE HEXODE CONVERTER

UNI-POTENTIAL CATHODE

HEATER

6.3 VOLTS 0.3 AMPERE

AC OR DC

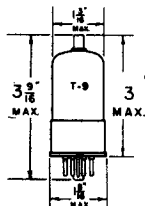

GLASS BULB
8 PIN OCTAL BASE
WITH METAL SHELL
6K8GT

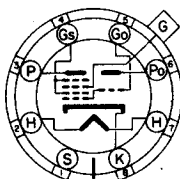

8K
6K8, 6K8GT

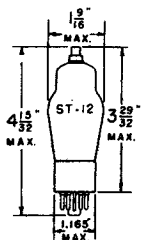

GLASS BULB
SMALL 8 PIN OCTAL BASE
6K8G

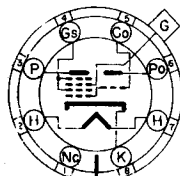

G-8K
6K8G

THE TUNG-SOL 6K8, 6K8G AND 6K8GT CONSIST OF A TRIODE OSCILLATOR AND A HEXODE MIXER IN A COMMON ENVELOPE. THE PHYSICAL DESIGN OF THESE TUBES REDUCES INTERACTION BETWEEN THE OSCILLATOR AND MIXER SECTIONS AND MAKES FOR STABLE OPERATION IN SUPERHETERODYNE RECEIVERS ON THE HIGH FREQUENCIES AS WELL AS THE BROADCAST BAND.

RATINGS

MAXIMUM HEXODE PLATE (P) VOLTAGE	300	VOLTS
MAXIMUM HEXODE SCREEN (Gs) SUPPLY VOLTAGE	300	VOLTS
MAXIMUM HEXODE SCREEN (Gs) VOLTAGE	150	VOLTS
MAXIMUM HEXODE PLATE DISSIPATION	0.75	WATT
MAXIMUM HEXODE SCREEN DISSIPATION	0.7	WATT
MAXIMUM TOTAL CATHODE CURRENT	16	MA.
MINIMUM EXTERNAL SIGNAL GRID (G) BIAS VOLTAGE	0	VOLTS
MAXIMUM OSCILLATOR ANODE (P0) VOLTAGE	125	VOLTS
MAXIMUM OSCILLATOR ANODE DISSIPATION	0.75	WATT

FOR "INTERPRETATION OF RATINGS" REFER TO FRONT OF BOOK.

CONTINUED NEXT PAGE

TUNG-SOL

TYPICAL OPERATING CONDITIONS AND CHARACTERISTICS

CONVERTER SERVICE

HEXODE PLATE (P) VOLTAGE	100	250	VOLTS
HEXODE SCREEN (G _S) VOLTAGE	100	100	VOLTS
HEXODE CONTROL GRID (G) VOLTAGE	-3	-3	VOLTS
OSCILLATOR ANODE (P ₀) VOLTAGE	100	100	VOLTS
HEXODE PLATE CURRENT	2.3	2.5	MA.
HEXODE SCREEN CURRENT	6.2	6.0	MA.
OSCILLATOR ANODE CURRENT	3.8	3.8	MA.
OSCILLATOR GRID (G ₀) CURRENT	0.15	0.15	MA.
TOTAL CATHODE CURRENT	12.5	12.5	MA.
OSCILLATOR GRID RESISTOR	50 000	50 000	OHMS
CONVERSION TRANSCONDUCTANCE	325	350	μMHOS
HEXODE PLATE RESISTANCE ^{APPROX.}	0.4	0.6	MEG OHM
HEXODE CONTROL GRID VOLTAGE ^{APPROX.}	-30	-30	VOLTS

FOR CONVERSION TRANSCONDUCTANCE = 2 μMHOS

DIRECT INTERELECTRODE CAPACITANCES⁵

	6K8	6K8G 6K8GT
SIGNAL GRID TO MIXER PLATE (G TO P)	0.03 ^{MAX.}	0.08 ^{MAX.}
SIGNAL GRID TO OSCILLATOR PLATE (G TO P ₀)	0.02 ^{MAX.}	0.05 ^{MAX.}
SIGNAL GRID TO OSCILLATOR GRID (G TO G ₀)	0.2 ^{MAX.}	0.2 ^{MAX.}
OSCILLATOR GRID TO OSCILLATOR PLATE (G ₀ TO P ₀)	1.1	1.8
SIGNAL INPUT: G ₀ TO ALL OTHER ELECTRODES	6.6	4.6
OSCILLATOR INPUT: G ₀ TO ALL OTHER ELECTRODES EXCEPT P ₀	6.0	6.5
OSCILLATOR OUTPUT: P ₀ TO ALL OTHER ELECTRODES EXCEPT G ₀	3.2	3.4
MIXER OUTPUT: P TO ALL OTHER ELECTRODES	3.5	4.8
OSCILLATOR GRID TO MIXER PLATE (G ₀ TO P)	0.1 ^{MAX.}	0.15 ^{MAX.}

^A WITH EXTERNAL SHIELD OR SHELL CONNECTED TO CATHODE.

NOTE: THE TRANSCONDUCTANCE OF THE OSCILLATOR SECTION (NOT OSCILLATING) IS APPROXIMATELY 3000 μMHOS WHEN THE TRIODE PLATE VOLTAGE IS 100 VOLTS, AND THE TRIODE GRID VOLTAGE IS ZERO VOLTS.

TUNG-SOL

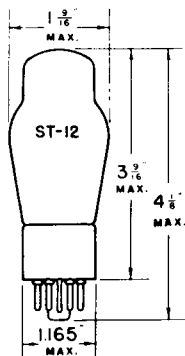

TRIODE AMPLIFIER

UNIPOENTIAL CATHODE

HEATER

6.3 VOLTS 0.15 AMPERE
AC OR DC

GLASS BULB

SMALL 6 PIN OCTAL BASE

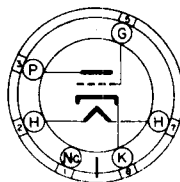

G-6Qa

BOTTOM VIEW

THE TUNG-SOL 6L5G IS A GENERAL PURPOSE TRIODE DESIGNED FOR SERVICE AS AN OSCILLATOR, DETECTOR OR AMPLIFIER. IT IS RECOMMENDED FOR USE WHERE ECONOMY OF HEATER CURRENT IS IMPORTANT.

OPERATING CONDITIONS AND CHARACTERISTICS

CLASS A₁ AMPLIFIER

PLATE VOLTAGE	135	250 ^{MAX.}	VOLTS
GRID VOLTAGE	-5	-9	VOLTS
PLATE CURRENT	3.5	8	MA.
PLATE RESISTANCE	11 300	9000	OHMS
TRANSCONDUCTANCE	1500	1900	μMHOS
AMPLIFICATION FACTOR	17	17	
GRID VOLTAGE ^{APPROX.}	-11	-20	VOLTS

FOR CATHODE CURRENT CUT-OFF

RESISTANCE COUPLED AMPLIFIER

PLATE AND SCREEN SUPPLY VOLTAGE	100	100	250	250	VOLTS
PLATE LOAD RESISTOR	0.05	0.25	0.05	0.25	MEGOHM
CATHODE RESISTOR	2800	10 000	2600	9000	OHMS
VOLTAGE GAIN	11	12	12	13	

DIRECT INTERELECTRODE CAPACITANCES^S

GRID TO CATHODE	2.8	μf
PLATE TO CATHODE	5.0	μf
GRID TO PLATE	2.8	μf

^S WITH SHIELD

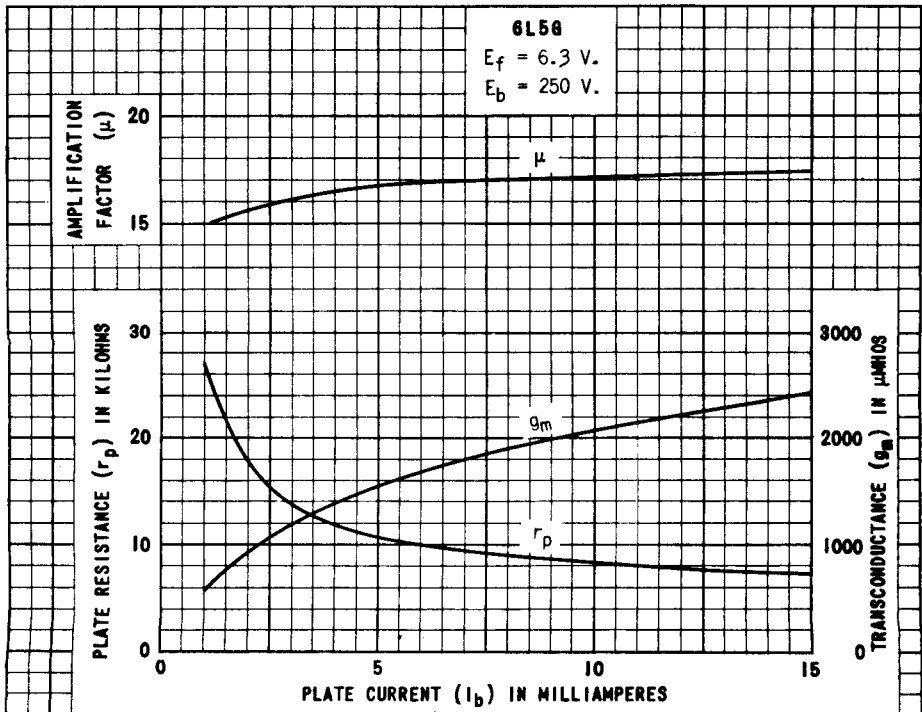
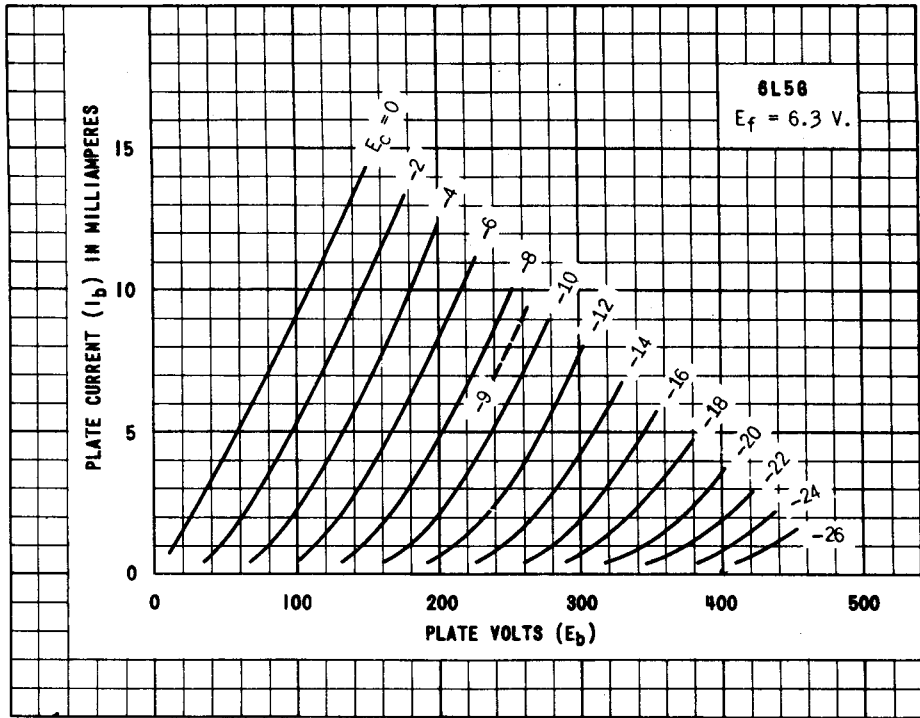

TUNG-SOL

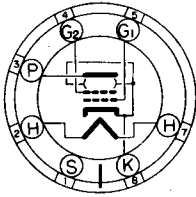

BOTTOM VIEW
6L6

BEAM POWER AMPLIFIER

UNIPOENTIAL CATHODE

HEATER

6.3 VOLTS 0.9 AMPERE

AC OR DC

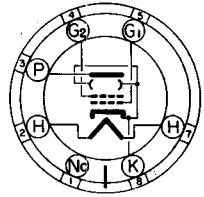

BOTTOM VIEW
6L6G, 6L6GA

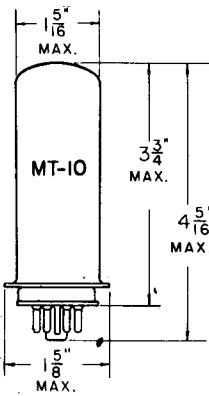

METAL SHELL
7 PIN OCTAL BASE
6L6

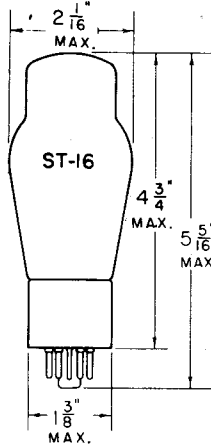

MEDIUM SHELL
7 PIN OCTAL BASE
6L6G

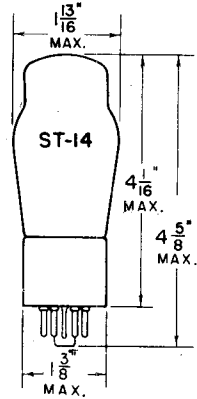

MEDIUM SHELL
7 PIN OCTAL BASE
6L6GA

THE 6L6, 6L6G, AND 6L6GA ARE DESIGNED WITH A HIGH POWER SENSITIVITY AND HIGH EFFICIENCY FOR SERVICE IN THE OUTPUT STAGES OF AC RECEIVERS. THEY ARE CAPABLE OF DELIVERING AN OUTPUT AT ALL POWER LEVELS WITH A VERY LOW PERCENTAGE OF HARMONIC DISTORTION.

MAXIMUM RATINGS

INTERPRETED ACCORDING TO RMA STANDARD M6-210

	PENTODE CONNECTION	TRIODE CONNECTION	
MAXIMUM PLATE VOLTAGE	360	250	VOLTS
MAXIMUM SCREEN VOLTAGE	270	-	VOLTS
MAXIMUM PLATE DISSIPATION	19	10	WATTS
MAXIMUM SCREEN DISSIPATION	2.5	-	WATTS

CONTINUED ON NEXT PAGE

TUNG-SOL

CONTINUED FROM PRECEDING PAGE

TYPICAL OPERATING CONDITIONS AND CHARACTERISTICS

SINGLE TUBE - CLASS A₁ AMPLIFIER

	PENTODE CONNECTION			TRIODE CONNECTION	
	SCREEN TIED TO PLATE				
PLATE VOLTAGE	250	300	350	250	VOLTS
GRID VOLTAGE	-14	-12.5	-18	-20	VOLTS
PEAK AF SIGNAL VOLTAGE	14	12.5	18	20	VOLTS
ZERO-SIGNAL PLATE CURRENT	72	48	54	40	MA.
ZERO-SIGNAL SCREEN CURRENT	5.0	2.5	2.5	-	MA.
MAXIMUM-SIGNAL PLATE CURRENT	79	55	66	44	MA.
MAXIMUM-SIGNAL SCREEN CURRENT	7.3	4.7	7.0	-	MA.
PLATE RESISTANCE	22 500	35 000	33 000	1 700	OHMS
TRANSCONDUCTANCE	6 000	5 300	5 200	4 700	μMHOS
AMPLIFICATION FACTOR	-	-	-	8.0	
LOAD RESISTANCE	2 500	4 500	4 200	5 000	OHMS
TOTAL HARMONIC DISTORTION	10	11	15	5.0	PER CENT
POWER OUTPUT	6.5	6.5	10.8	1.4	WATTS
SCREEN VOLTAGE	250	200	250	-	VOLTS

CLASS A₁ PUSH-PULL AMPLIFIER

VALUES ARE FOR TWO TUBES

PENTODE CONNECTION					
PLATE VOLTAGE	250	270	VOLTS		
SCREEN VOLTAGE	250	270	VOLTS		
GRID VOLTAGE	-16	-17.5	VOLTS		
PEAK AF SIGNAL VOLTAGE (GRID TO GRID)	32	35	VOLTS		
ZERO-SIGNAL PLATE CURRENT	120	134	MA.		
ZERO-SIGNAL SCREEN CURRENT	10	11	MA.		
MAXIMUM-SIGNAL PLATE CURRENT	140	155	MA.		
MAXIMUM-SIGNAL SCREEN CURRENT	16	17	MA.		
PLATE RESISTANCE	24 500	23 500	OHMS		
TRANSCONDUCTANCE	5 500	5 700	μMHOS		
EFFECTIVE LOAD RESISTANCE (PLATE TO PLATE)	5 000	5 000	OHMS		
TOTAL HARMONIC DISTORTION	2.0	2.0	PER CENT		
POWER OUTPUT	14.5	17.5	WATTS		

CONTINUED ON NEXT PAGE

PLATE
1518
OCT. 31
1944

TUNG-SOL

CONTINUED FROM PRECEDING PAGE

CLASS AB₁ PUSH-PULL AMPLIFIER

VALUES ARE FOR TWO TUBES

PENTODE CONNECTION

PLATE VOLTAGE	360	360	VOLTS
SCREEN VOLTAGE	270	270	VOLTS
GRID VOLTAGE	-22.5	-22.5	VOLTS
PEAK AF SIGNAL VOLTAGE (GRID TO GRID)	45	45	VOLTS
ZERO-SIGNAL PLATE CURRENT	88	88	MA.
ZERO-SIGNAL SCREEN CURRENT	5.0	5.0	MA.
MAXIMUM-SIGNAL PLATE CURRENT	132	140	MA.
MAXIMUM-SIGNAL SCREEN CURRENT	15	11	MA.
EFFECTIVE LOAD RESISTANCE PLATE TO PLATE	6 600	3 800	OHMS
TOTAL HARMONIC DISTORTION	2.0	2.0	PER CENT
POWER OUTPUT	26.5	18	WATTS

CLASS AB₂ PUSH-PULL AMPLIFIER

VALUES ARE FOR TWO TUBES

PENTODE CONNECTION

PLATE VOLTAGE	360	360	VOLTS
SCREEN VOLTAGE	225	270	VOLTS
CONTROL GRID VOLTAGE	-18	-22.5	VOLTS
PEAK AF SIGNAL VOLTAGE (GRID TO GRID)	52	72	VOLTS
ZERO-SIGNAL PLATE CURRENT	78	88	MA.
ZERO-SIGNAL SCREEN CURRENT	3.5	5.0	MA.
MAXIMUM-SIGNAL PLATE CURRENT	142	205	MA.
MAXIMUM-SIGNAL SCREEN CURRENT	11	16	MA.
EFFECTIVE LOAD RESISTANCE PLATE TO PLATE	6 000	3 800	OHMS
TOTAL HARMONIC DISTORTION	2.0	2.0	PER CENT
POWER OUTPUT	31	47	WATTS

6L6, 6L6G, 6L6GA

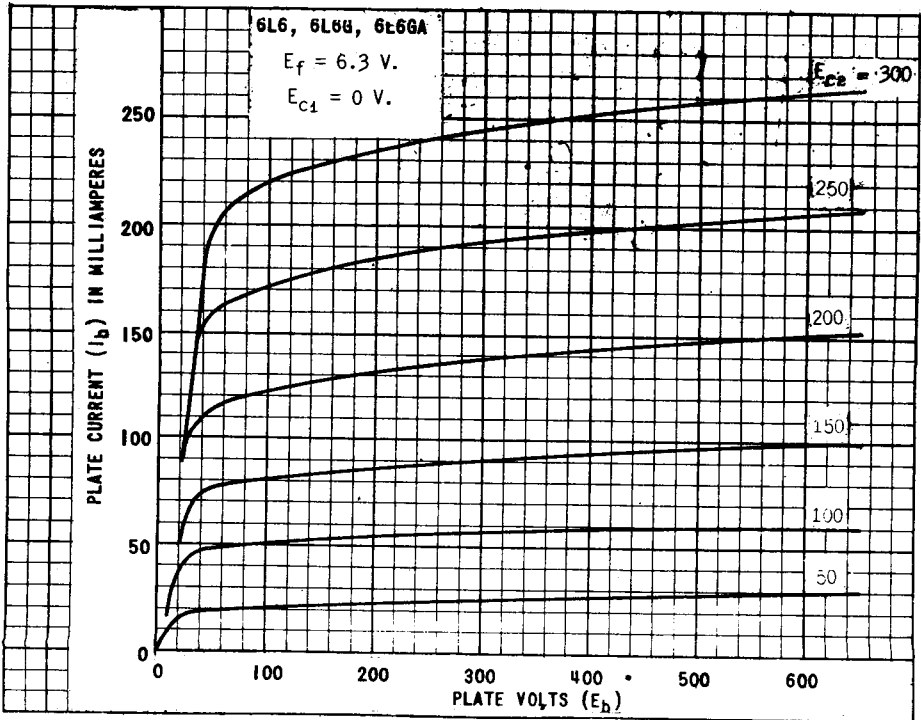
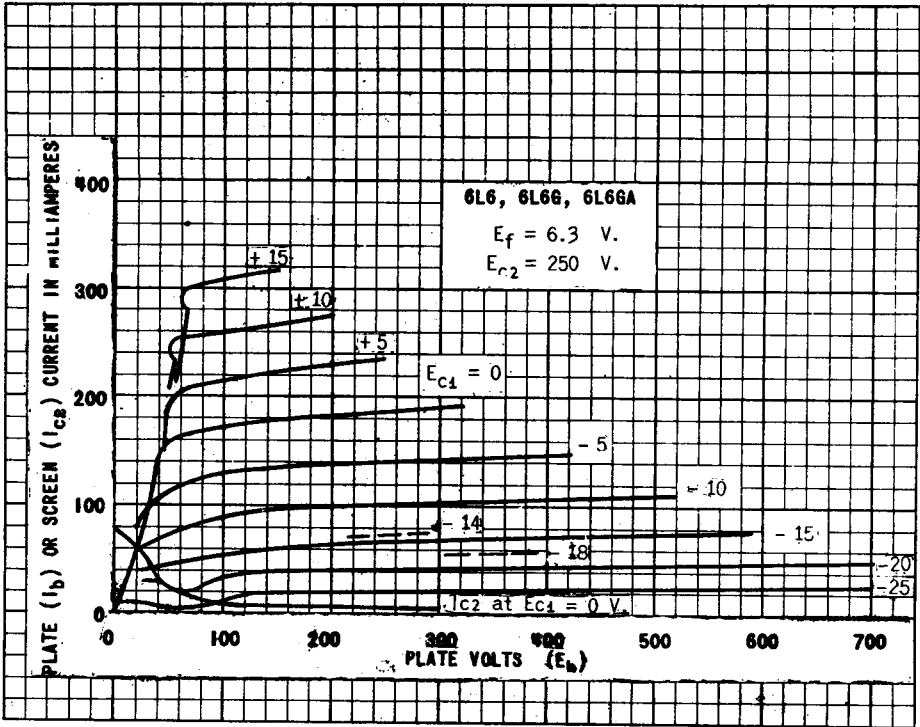

PL TE
 1471
 AUG. 31
 1944

6L6, 6L6G, 6L6GA

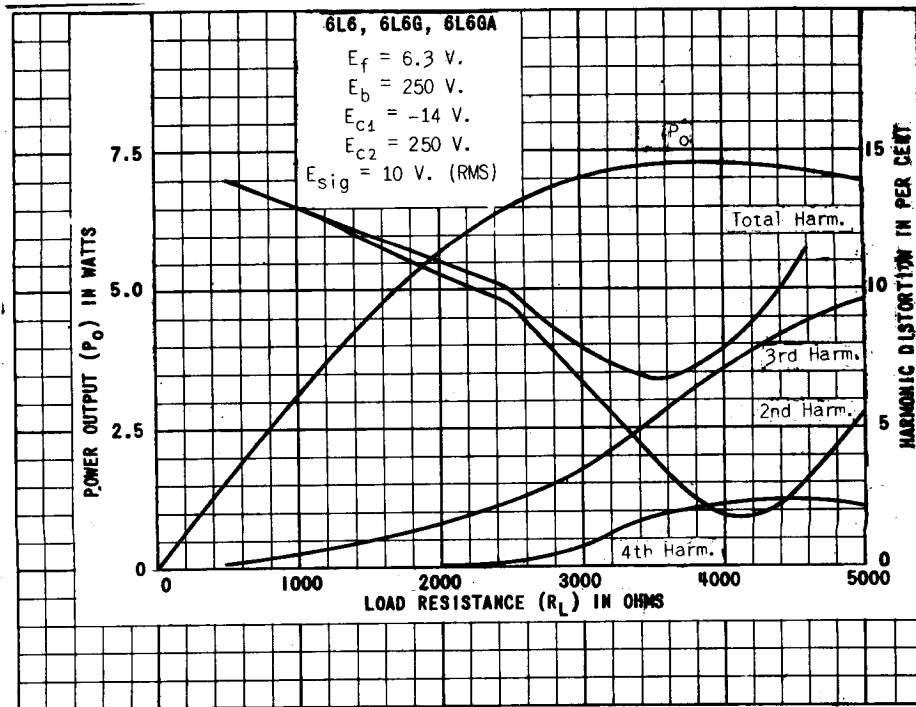
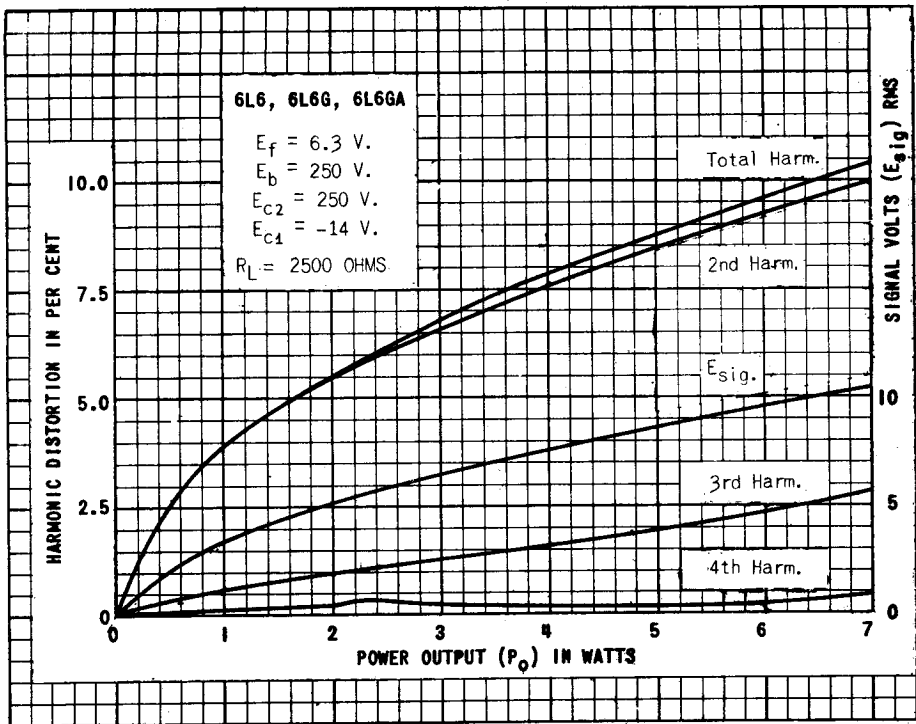

6L6, 6L6G, 6L6GA

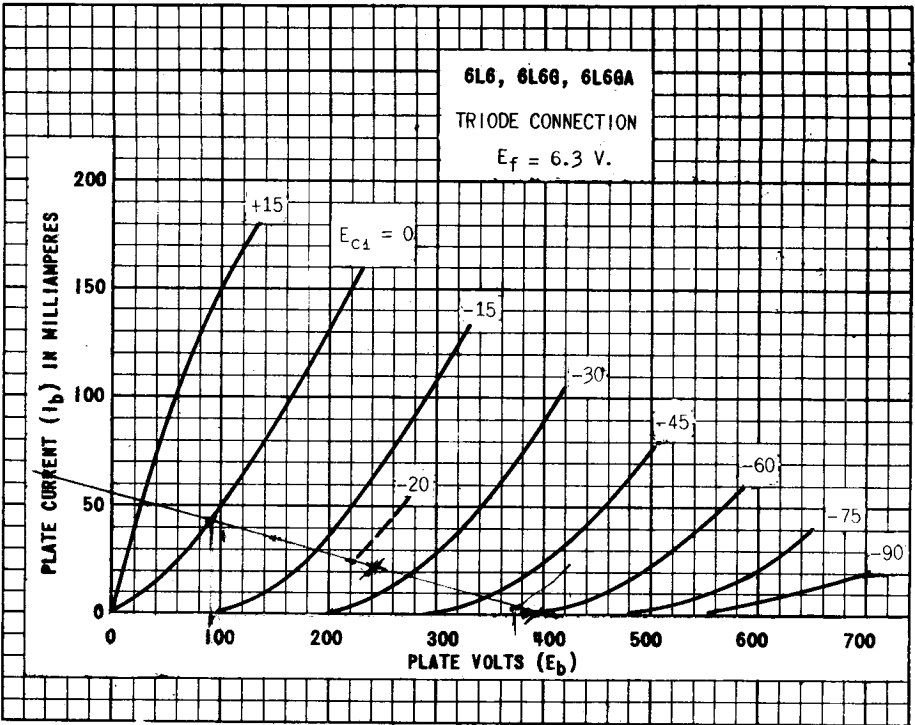

6L6, 6L6G, 6L6GA

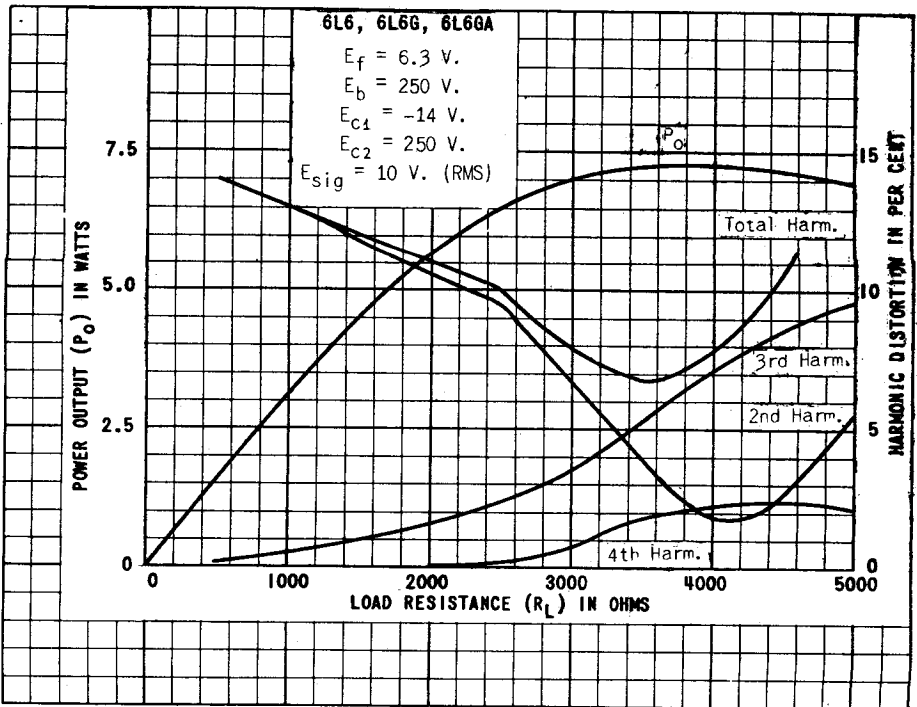
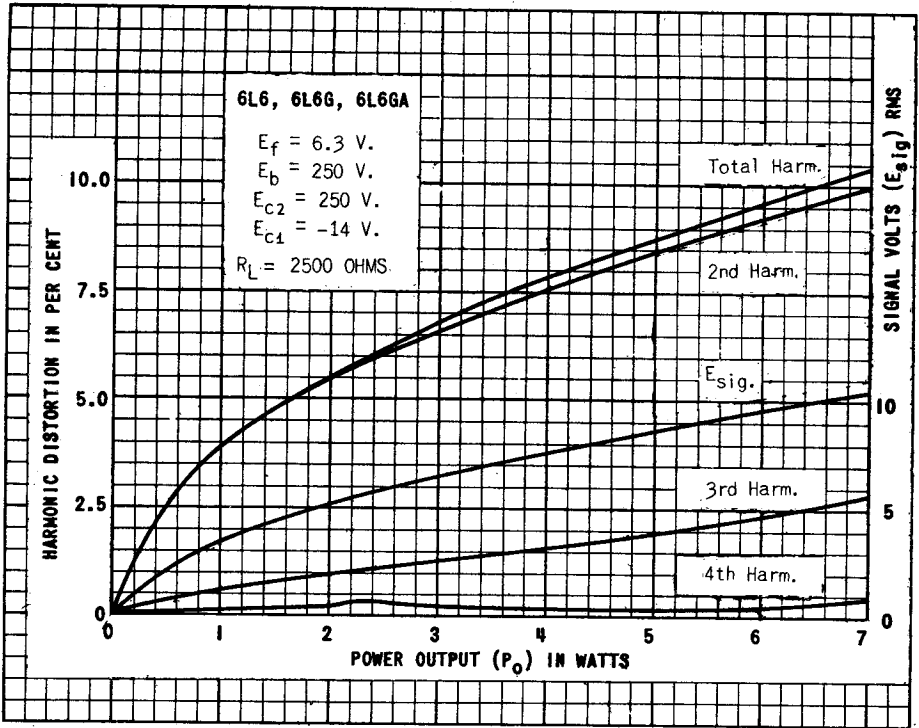

6L6, 6L6G, 6L6GA

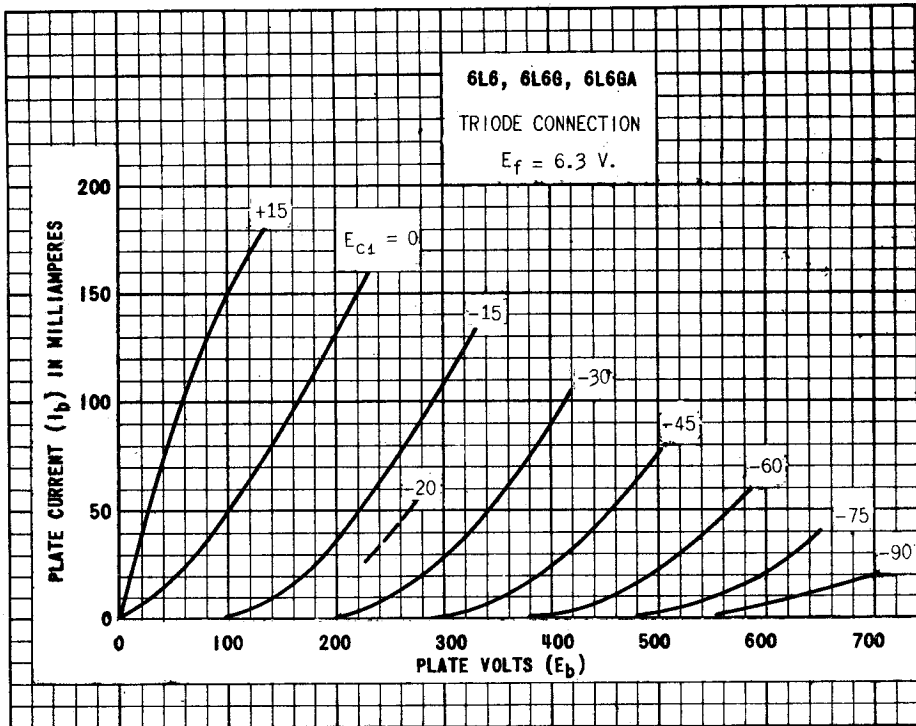

PLATE
1473
AUG. 31
1944

TUNG-SOL

U-H-F AMPLIFIER - OSCILLATOR TRIODE

MINIATURE TYPE

PHYSICAL SPECIFICATIONS

EMITTER COATED UNIPOT. CATHODE		PIN CONNECTIONS			
BASE	MIN. BUTTON 7-PIN	PIN 1	GRID	PIN 7	GRID
CAP		PIN 2	CATHODE	PIN 8	NONE
BULB	T-5 $\frac{1}{2}$	PIN 3	HEATER		
MAXIMUM DIAMETER	3/4"	PIN 4	HEATER	MOUNTING POS.	ANY
MAXIMUM OVERALL LENGTH	1 3/4"	PIN 5	PLATE		
MAXIMUM SEATED HEIGHT	1 1/2"	PIN 6	CATHODE		

MAXIMUM HEIGHT TO CIRCLE OF 7/16" DIAMETER - 1 1/8 ± 3/32"

RATINGS

INTERPRETED ACCORDING TO RMA STANDARD MB-210

HEATER OR FILAMENT VOLTAGE (AC OR DC)	6.3	VOLTS
HEATER OR FILAMENT CURRENT	0.200	AMP.
MAXIMUM PLATE VOLTAGE	180	VOLTS
MAXIMUM SCREEN VOLTAGE		VOLTS
MAXIMUM PLATE DISSIPATION	3.0	WATTS
MAXIMUM SCREEN DISSIPATION		WATTS

CAPACITANCES (APPROX.)

WITH CLOSE-FITTING SHIELD CONNECTED TO GRID

GRID TO PLATE	2.35	$\mu\mu\text{f}$
INPUT	3.10	$\mu\mu\text{f}$
OUTPUT	0.55	$\mu\mu\text{f}$
HEATER TO CATHODE	3.0	$\mu\mu\text{f}$

TYPICAL OPERATING CONDITIONS AND CHARACTERISTICS
CLASS A AMPLIFIER

HEATER OR FILAMENT VOLTAGE	6.3	VOLTS
HEATER OR FILAMENT CURRENT	0.200	AMPS.
PLATE VOLTAGE	180	VOLTS
SCREEN VOLTAGE		VOLTS
CONTROL GRID VOLTAGE	-3.5	VOLTS
PEAK AF SIGNAL VOLTAGE		VOLTS
ZERO-SIGNAL PLATE CURRENT		MA.
ZERO-SIGNAL SCREEN CURRENT		MA.
PLATE CURRENT	12	MA.
MAXIMUM-SIGNAL SCREEN CURRENT		MA.
PLATE RESISTANCE (APPROX.)	5400	OHMS
TRANSCONDUCTANCE (APPROX.)	6000	μMHOS
AMPLIFICATION FACTOR	32	
LOAD RESISTANCE		OHMS
TOTAL HARMONIC DISTORTION		PER CENT
POWER OUTPUT		WATTS

NOTE: THE 6N4 IS A HEATER-CATHODE TYPE OF MINIATURE TRIODE ESPECIALLY APPLICABLE AS AN AMPLIFIER OR OSCILLATOR AT FREQUENCIES EXTENDING TO APPROXIMATELY 500 MEGACYCLES.

PLATE
1681FEB. 15
1946



TUNG-SOL

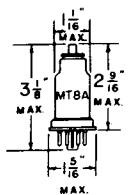

METAL SHELL
7 PIN OCTAL BASE
6L7

PENTAGRID MIXER
UNIPOTENTIAL CATHODE

HEATER
6.3 VOLTS 0.3 AMPERE
AC OR DC

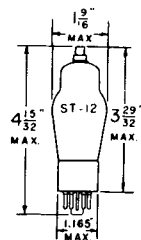

GLASS BULB
SMALL 7 PIN OCTAL BASE
6L7G

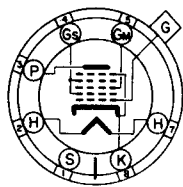

7T
BOTTOM VIEW
6L7

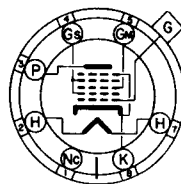

G-7T
BOTTOM VIEW
6L7G

THE TUNG-SOL 6L7 AND 6L7G IS A MIXER TUBE DESIGNED FOR SERVICE WITH A SEPARATE OSCILLATOR AS THE FIRST DETECTOR IN SUPERHETERODYNE RECEIVERS. THE CONTROL GRID (G) IS OF THE REMOTE CUT-OFF TYPE WHICH ALLOWS THE USE OF A.V.C. AND MINIMIZES CROSS-MODULATION. THE CONTROL GRID (G_m) IS OF THE SHARP CUT-OFF TYPE. THE TUBE MAY BE USED AS A VOLUME EXPANDER OR AS A DOUBLY CONTROLLED GENERAL PURPOSE AMPLIFIER.

RATINGS

CLASS A₁ AMPLIFIER

MAXIMUM PLATE VOLTAGE	300	VOLTS
MAXIMUM SCREEN VOLTAGE	100	VOLTS
MAXIMUM PLATE DISSIPATION	1.5	WATTS
MAXIMUM SCREEN DISSIPATION	1.0	WATT

MIXER

MAXIMUM PLATE VOLTAGE	300	VOLTS
MAXIMUM SCREEN VOLTAGE	150	VOLTS
MAXIMUM PLATE DISSIPATION	1.0	WATT
MAXIMUM SCREEN DISSIPATION	1.5	WATTS

FOR "INTERPRETATION OF RATINGS" REFER TO FRONT OF BOOK.

CONTINUED NEXT PAGE

TUNG-SOL

TYPICAL OPERATING CONDITIONS AND CHARACTERISTICS

CLASS A₁ AMPLIFIER

PLATE VOLTAGE	250	VOLTS
SCREEN (G _s) VOLTAGE	100	VOLTS
CONTROL GRID (G _M) VOLTAGE	-3	VOLTS
CONTROL GRID (G) VOLTAGE	-3	VOLTS
PLATE CURRENT	5.3	MA.
SCREEN CURRENT	6.5	MA.
PLATE RESISTANCE ^{APPROX.}	0.6	MEGOHM
TRANSCONDUCTANCE ^A	1100	μMHOS
AMPLIFICATION FACTOR ^{APPROX.}	670	
TRANSCONDUCTANCE ^A	475	μMHOS
FOR CONTROL GRIDS (G & G _M) VOLTAGES = -6 VOLTS		
TRANSCONDUCTANCE ^A	75	μMHOS
FOR CONTROL GRIDS (G & G _M) VOLTAGES = -10 VOLTS		
TRANSCONDUCTANCE ^A APPROX.	5	μMHOS
FOR CONTROL GRIDS (G & G _M) VOLTAGES = -15 VOLTS		

^A TRANSCONDUCTANCE BETWEEN THE CONTROL GRID (G) AND THE PLATE (P).

MIXER

PLATE VOLTAGE	250	250	VOLTS
SCREEN (G _s) VOLTAGE	100	150	VOLTS
OSCILLATOR GRID (G _M) VOLTAGE	-10	-15	VOLTS
PEAK OSCILLATOR VOLTAGE APPLIED TO (G _M) ^{MIX.}	12	18	VOLTS
CONTROL GRID (G) VOLTAGE ^{MIX.}	-3	-6	VOLTS
PLATE CURRENT	2.4	3.3	MA.
SCREEN CURRENT	7.1	9.2	MA.
PLATE RESISTANCE	GREATER THAN 1.0 MEGOHM		
CONVERSION TRANSCONDUCTANCE	375	-	μMHOS
FOR CONTROL GRID (G) VOLTAGE = -3 VOLTS			
CONVERSION TRANSCONDUCTANCE	225	350	μMHOS
FOR CONTROL GRID (G) VOLTAGE = -6 VOLTS			
CONVERSION TRANSCONDUCTANCE	30	75	μMHOS
FOR CONTROL GRID (G) VOLTAGE = -15 VOLTS			
CONVERSION TRANSCONDUCTANCE	5	15	μMHOS
FOR CONTROL GRID (G) VOLTAGE = -30 VOLTS			
CONVERSION TRANSCONDUCTANCE	-	5	μMHOS
FOR CONTROL GRID (G) VOLTAGE = -45 VOLTS			

CONTINUED NEXT PAGE

TUNG-SOL

DIRECT INTERELECTRODE CAPACITANCES

	6L7 ^A	6L7G ^B	
GRID (G) TO GRID (G _M) ^{MAX.}	0.20	0.20	μf
GRID (G) TO PLATE ^{MAX.}	0.001	0.005	μf
GRID (G _M) TO PLATE	0.10 ^{MAX.}	0.24	μf
GRID (G) TO ALL OTHER ELECTRODES	7.5	6	μf
GRID (G _M) TO ALL OTHER ELECTRODES	10	12	μf
PLATE TO ALL OTHER ELECTRODES	11	10	μf

^A WITH SHELL CONNECTED TO CATHODE

^B WITH EXTERNAL SHIELD CONNECTED TO CATHODE

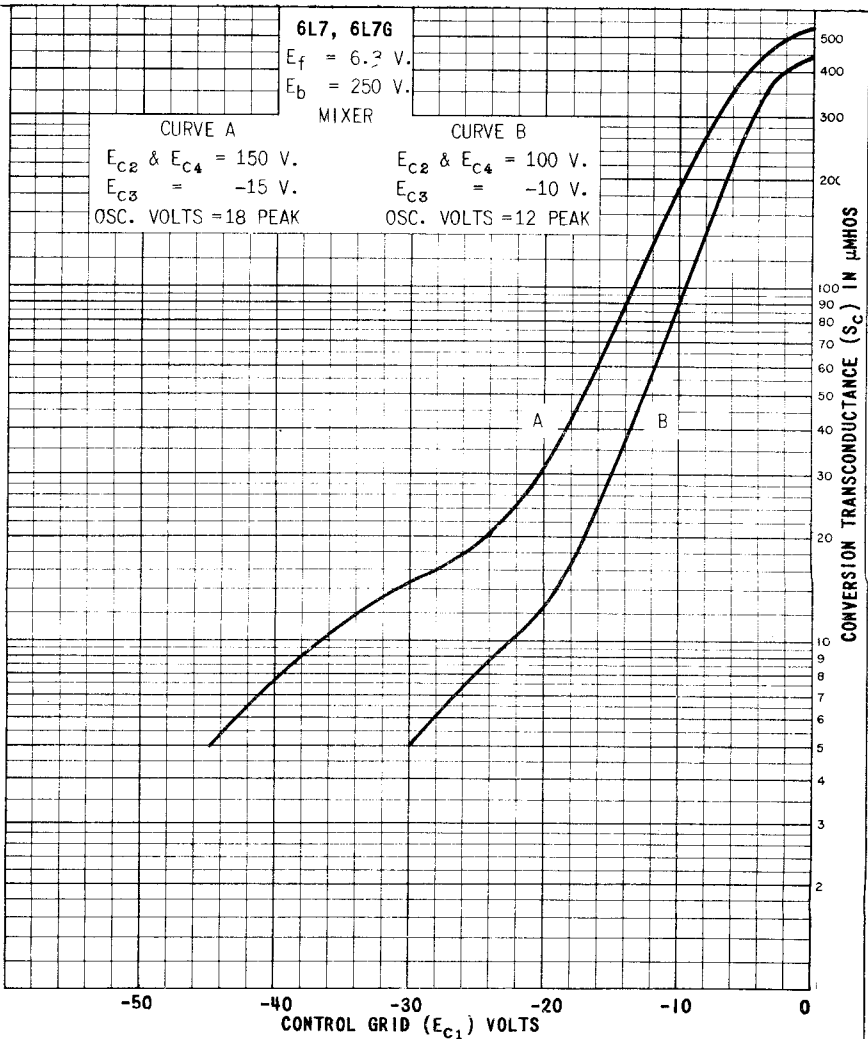

6L7, 6L7G

6L7, 6L7G
 $E_f = 6.3$ V.
 E_{C2} & $E_{C4} = 100$ V.
 $E_b = 250$ V.

--- AVC CHARACTERISTIC

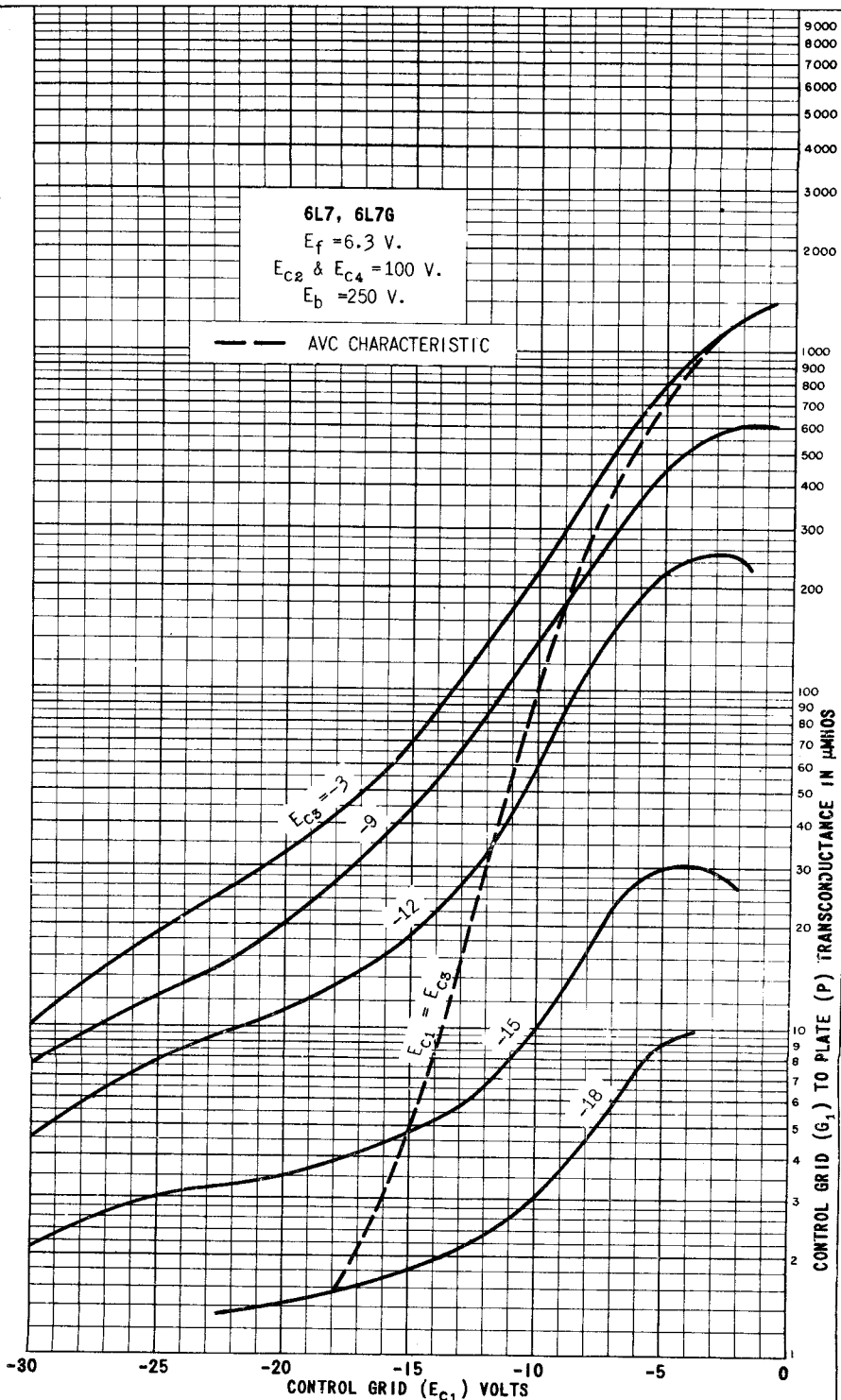

TUNG-SOL

DYNAMIC COUPLED POWER AMPLIFIER

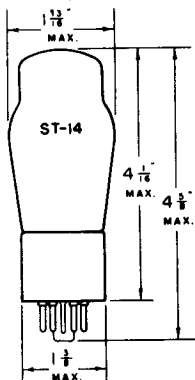

UNI-POTENTIAL CATHODES

HEATER

6.3 VOLTS 0.8 AMPERE

AC OR DC

GLASS BULB

MEDIUM 7 PIN OCTAL BASE

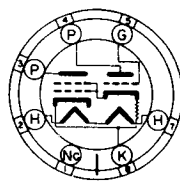

G-7Wb

THE TUNG-SOL 6N6G CONSISTS OF TWO DYNAMICALLY COUPLED TRIODES AND IS DESIGNED FOR SERVICE IN THE POWER OUTPUT STAGE OF AC AND STORAGE BATTERY OPERATED RECEIVERS. ALL NECESSARY BIASES ARE SUPPLIED INTERNALLY. ITS RATINGS AND CHARACTERISTICS ARE IDENTICAL WITH THOSE OF THE 685.

OPERATING CONDITIONS AND CHARACTERISTICS

CLASS A₁ AMPLIFIER

OUTPUT PLATE (3) VOLTAGE	250	300	325 ^{MAX.}	VOLTS
INPUT PLATE (4) VOLTAGE	250	300	325 ^{MAX.}	VOLTS
INPUT GRID (5) VOLTAGE	0	0	0	VOLTS
GRID CIRCUIT RESISTANCE ^{MAX.}	0.5	0.5	0.5	MEGOHM
OUTPUT PLATE CURRENT	33	45	51	MA.
INPUT PLATE CURRENT	6.5	8	9	MA.
PLATE RESISTANCE		24 100		OHMS
TRANSCONDUCTANCE		2400		μMHOS
AMPLIFICATION FACTOR		58		
LOAD RESISTANCE	7000	7000	7000	OHMS
SIGNAL VOLTS (RMS) ⁵	13.5	15	17	VOLTS
TOTAL HARMONIC DISTORTION	5	5	5	PER CENT
POWER OUTPUT	2.5	4	5.2	WATTS

(3) BASE PIN 03

(4) BASE PIN 04

(5) BASE PIN 05

⁵ FOR RATED POWER OUTPUT

NOTE: THE VOLTAGE BETWEEN HEATER AND CATHODE SHOULD NOT EXCEED 50 VOLTS AND IN NO CASE SHOULD THE HEATER BE LEFT FLOATING.

CONTINUED NEXT PAGE

TUNG-SOL

CLASS A₁ PUSH-PULL AMPLIFIER

UNLESS SPECIFIED, VALUES ARE FOR TWO TUBES

OUTPUT PLATE (3) VOLTAGE	250	300	325 ^{MAX.}	VOLTS
INPUT PLATE (4) VOLTAGE	250	300	325 ^{MAX.}	VOLTS
INPUT GRID (5) VOLTAGE	0	0	0	VOLTS
GRID CIRCUIT RESISTANCE ^{MAX.}	0.5	0.5	0.5	MEGOHM
OUTPUT PLATE CURRENT PER TUBE	33	45	51	MA.
INPUT PLATE CURRENT ^{PER TUBE}	6.5	8	9	MA.
LOAD RESISTANCE ^{PLATE TO PLATE}	10 000	10 000	10 000	OHMS
SIGNAL VOLTS (RMS) ^S GRID TO GRID	38	38	42	VOLTS
TOTAL HARMONIC DISTORTION	5	5	5	WATTS
POWER OUTPUT	8.5	10	13.5	WATTS

(3) BASE PIN #3

(4) BASE PIN #4

(5) BASE PIN #5

^S FOR RATED POWER OUTPUT

TUNG-SOL

TWIN TRIODE AMPLIFIERS

COATED UNIPOTENTIAL CATHODE

HEATER

6.3 VOLTS 0.8 AMPERE

AC OR DC

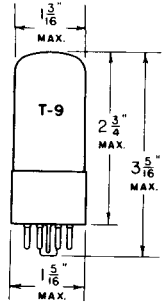
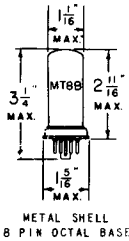

6N7

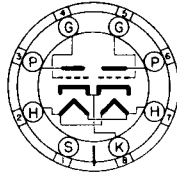

BOTTOM VIEW

6N7GT/G

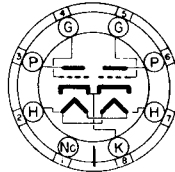

BOTTOM VIEW

THE TUNG-SOL 6N7, 6N7GT/G ARE TWIN TRIODES DESIGNED PRIMARILY FOR SERVICE AS CLASS B AMPLIFIERS. THEIR ELECTRICAL CHARACTERISTICS ARE IDENTICAL.

RATINGS

MAXIMUM PLATE VOLTAGE	300	VOLTS
MAXIMUM PEAK PLATE CURRENT PER PLATE	125	MA.
MAXIMUM AVERAGE DISSIPATION PER PLATE	5.5	WATTS

TYPICAL OPERATING CONDITIONS AND CHARACTERISTICS

CLASS A₁ AMPLIFIER

TRIODES CONNECTED IN PARALLEL

PLATE VOLTAGE	250.	294	VOLTS
GRID VOLTAGE	-5	-6	VOLTS
PLATE CURRENT	6	7	MA.
PLATE RESISTANCE	11 300	11 000	OHMS
TRANSCONDUCTANCE	3100	3200	μMHOS.
AMPLIFICATION FACTOR	35	35	

RESISTANCE COUPLED AMPLIFIER AND PHASE INVERTER

PLATE SUPPLY VOLTAGE	100	100	250	250	VOLTS
PLATE LOAD RESISTOR	0.1	0.5	0.1	0.5	MEGOHM
CATHODE RESISTOR	2500	7000	1800	5000	OHMS
VOLTAGE GAIN	20	22	23	24	

CONTINUED NEXT PAGE

6N7, 6N7GT/G

TUNG-SOL

TYPICAL AND IDEAL OPERATING CONDITIONS AND CHARACTERISTICS

CLASS B₂ AMPLIFIER - PUSH-PULL

	IDEAL	TYPICAL	
ZERO-SIGNAL PLATE VOLTAGE	300	300	VOLTS
DC GRID VOLTAGE	0	0	VOLT
AF-PEAK SIGNAL VOLTAGE PER GRID A	29	41	VOLTS
MAXIMUM-PEAK-SIGNAL GRID CURRENT PER GRID	20	22	MA.
ZERO-SIGNAL PLATE CURRENT PER PLATE	17.5	17.5	MA.
MAXIMUM-SIGNAL DC PLATE CURRENT PER PLATE	35	35	MA.
GRID IMPEDANCE AT 400 CYCLES	0	516 ^B	OHMS
PLATE SUPPLY IMPEDANCE	0	1000	OHMS
EFFECTIVE LOAD RESISTANCE PLATE TO PLATE	8000	8000	OHMS
TOTAL HARMONIC DISTORTION	4	8	PER CENT
THIRD HARMONIC	3.5	7.5	PER CENT
FIFTH HARMONIC	1.5	2.5	PER CENT
POWER OUTPUT	10	10	WATTS

^A FOR POWER OUTPUT SHOWN

^B 500 OHMS AND 50 MH.

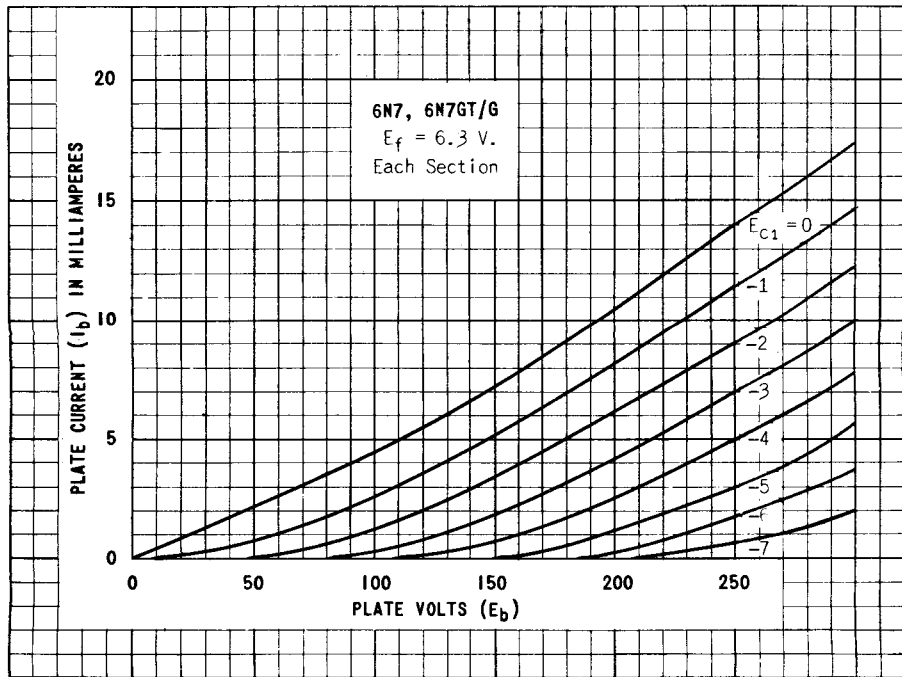
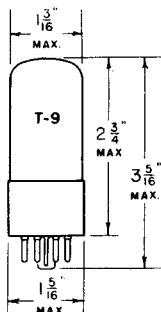

PLATE
 1344-1
 OCT. 25
 1943

TUNG-SOL



TRIODE AMPLIFIER

UNI-POTENTIAL CATHODE

HEATER

6.3 VOLTS 0.3 AMPERE
AC OR DC

GLASS BULB

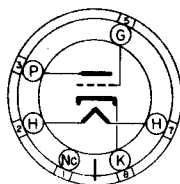
G-6Q_a

BOTTOM VIEW

INTERMEDIATE 6 PIN OCTAL BASE

THE TUNG-SOL 6P5GT/G IS A GENERAL PURPOSE TRIODE DESIGNED FOR SERVICE AS AN OSCILLATOR, DETECTOR OR AMPLIFIER. ITS ELECTRICAL CHARACTERISTICS ARE IDENTICAL TO THOSE OF THE 76.

RATINGS

MAXIMUM PLATE VOLTAGE	250	VOLTS
MAXIMUM PLATE DISSIPATION	1.25	WATTS

TYPICAL OPERATING CONDITIONS AND CHARACTERISTICS

CLASS A₁ AMPLIFIER

PLATE VOLTAGE	100	250	VOLTS
CONTROL GRID VOLTAGE ^A	-5	-13.5	VOLTS
PLATE CURRENT	2.5	5.0	MA.
PLATE RESISTANCE	12000	9500	OHMS
TRANSCONDUCTANCE	1150	1450	μMHMS
AMPLIFICATION FACTOR	13.8	13.8	

DIRECT INTERELECTRODE CAPACITANCES^S

GRID TO CATHODE	3.4	μμf
PLATE TO CATHODE	5.5	μμf
GRID TO PLATE	2.6	μμf

^A THE DC RESISTANCE IN THE GRID CIRCUIT OF THE 6P5GT/G, UNDER MAXIMUM RATED CONDITIONS, SHOULD NOT EXCEED 1.0 MEGOHM.

^S WITH EXTERNAL SHIELD CONNECTED TO CATHODE.

CONTINUED NEXT PAGE

6P5GT/G

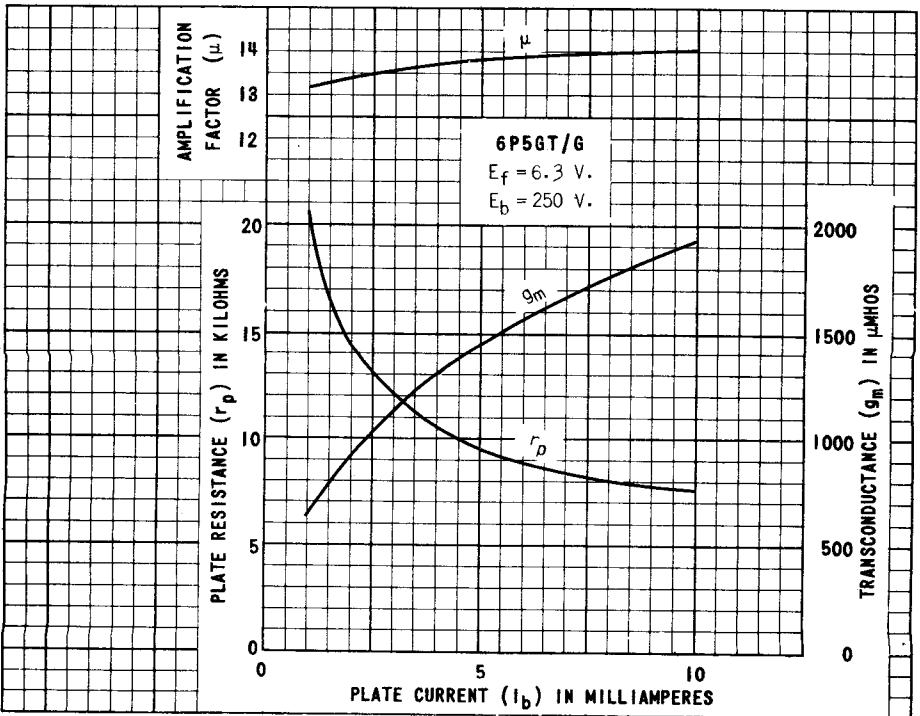
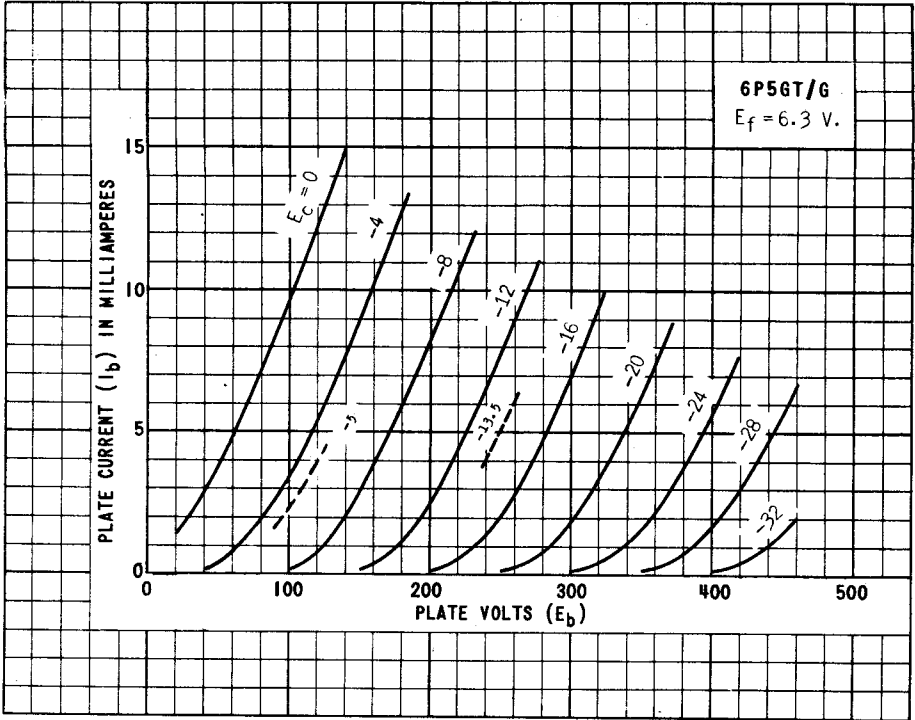
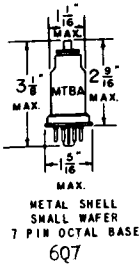

PLATE 1142-1

TUNG-SOL



DUO-DIODE HIGH-MU TRIODE AMPLIFIER

UNIPOTENTIAL CATHODE
HEATER
6.3 VOLTS 0.3 AMPERE
AC OR DC

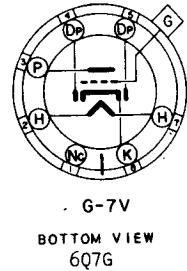
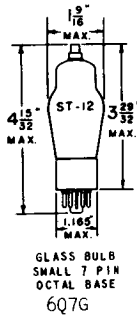
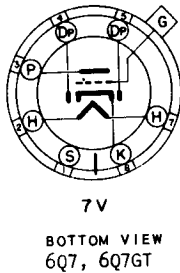
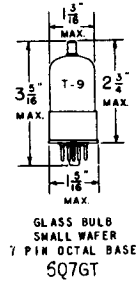

THE TUNG-SOL 6Q7, 6Q7G AND 6Q7GT COMBINE TWO DIODES AND A HIGH-MU TRIODE IN A SINGLE ENVELOPE, USING A COMMON CATHODE. THEY ARE DESIGNED FOR SERVICE AS DIODE DETECTORS, AVC RECTIFIERS, AND AS HIGH GAIN RESISTANCE COUPLED AMPLIFIERS IN AC, STORAGE BATTERY, AND AC-DC OPERATED RECEIVERS.

RATINGS

MAXIMUM PLATE VOLTAGE	300	VOLTS
MINIMUM DIODE CURRENT WITH 10 VOLTS DC APPLIED PER PLATE	0.8	MA.

AVERAGE CHARACTERISTICS OF TRIODE UNIT

PLATE VOLTAGE	100	250	VOLTS
CONTROL GRID VOLTAGE	-1	-3	VOLTS
PLATE CURRENT	0.8	1.0	MA.
PLATE RESISTANCE	58 000	58 000	OHMS
TRANSCONDUCTANCE	1200	1200	μMHMS
AMPLIFICATION FACTOR	70	70	

FOR "INTERPRETATION OF RATINGS" REFER TO FRONT OF BOOK.

CONTINUED NEXT PAGE

6Q7, 6Q7G, 6Q7GT

TUNG-SOL

TYPICAL OPERATING CONDITIONS AND CHARACTERISTICS

ZERO BIAS, RESISTANCE COUPLED, CLASS A₁ AMPLIFIER

PLATE SUPPLY VOLTAGE	100	300	VOLTS		
PLATE LOAD RESISTOR	0.25	0.25	MEGOHM		
GRID RESISTOR	10	10	MEGOHM		
COUPLING CONDENSER	.01 TO .005	.01 TO .005	μ f		
GRID RESISTOR FOR FOLLOWING TUBE	.5 TO 1.0	.5 TO 1.0	MEGOHM		
EXTERNAL GRID CIRCUIT IMPEDANCE	0	0	MEGOHM		
VOLTAGE GAIN	40	42	50	56	
VOLTAGE OUTPUT (RMS) ^A	11	13	51	58	VOLTS

^A AT 5% TOTAL HARMONIC DISTORTION.

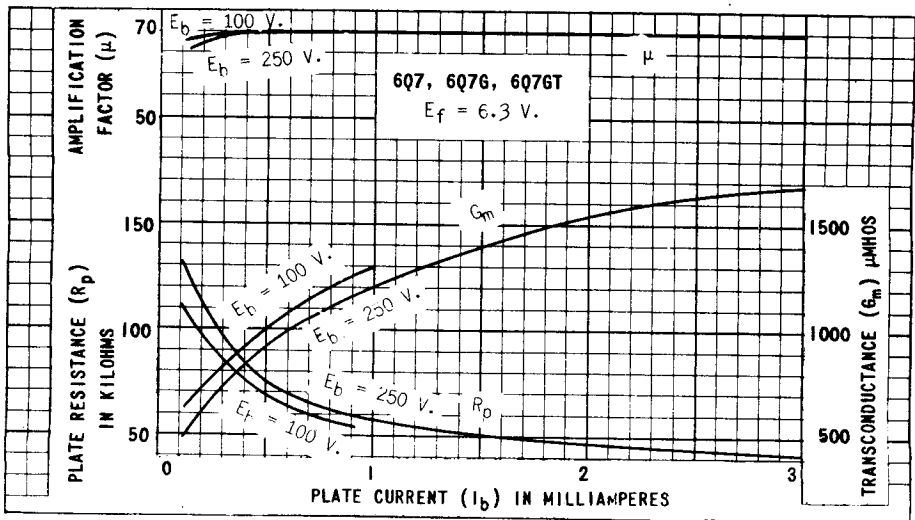
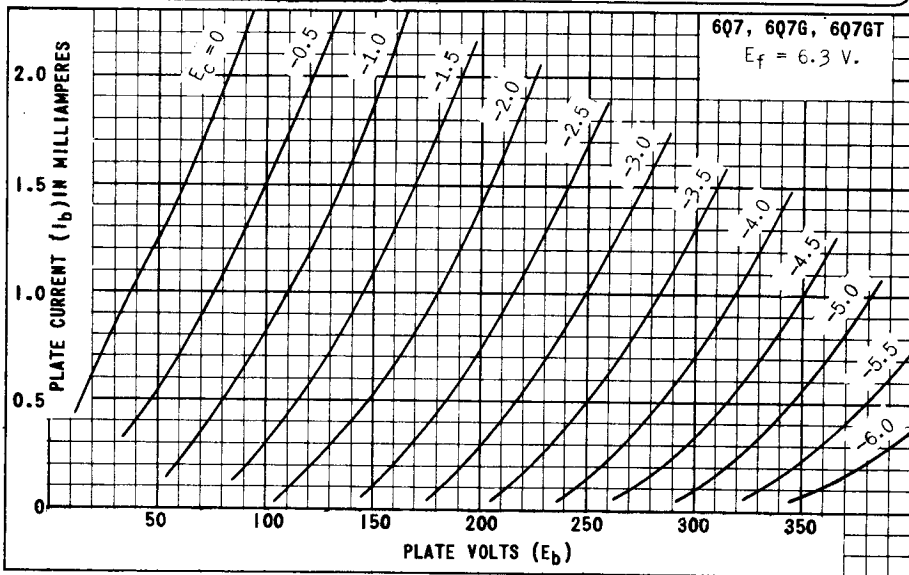
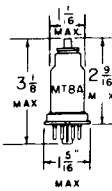

PLATE
1117-1

TUNG-SOL



META: SHELL
SMALL WAFER
7 PIN OCTAL BASE
6R7



7V
BOTTOM VIEW
6R7

DUO - DIODE TRIODE AMPLIFIER

UNI-POTENTIAL CATHODE

HEATER

6.3 VOLTS 0.3 AMPERE
AC OR DC

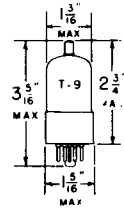

GLASS BULB
INTERMEDIATE
7 PIN OCTAL BASE
6R7GT

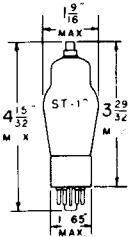

GLASS BULB
SMALL 7 PIN
OCTAL BASE
6R7G

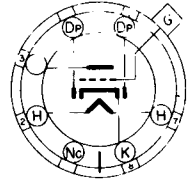

G-7V
BOTTOM VIEW
6R7G, 6R7GT

THE TUNG-SOL 6R7, 6R7G AND 6R7GT COMBINE TWO DIODES AND A TRIODE IN A SINGLE ENVELOPE, USING A COMMON CATHODE. THEY ARE DESIGNED FOR SERVICE AS DIODE DETECTORS, AVC RECTIFIERS, AND AUDIO AMPLIFIERS IN AC, STORAGE BATTERY, AND AC - DC CONVERSION RECEIVERS.

RATINGS

MAXIMUM PLATE VOLTAGE	250	VOLTS
MAXIMUM PLATE DISSIPATION	2.5	WATTS
MINIMUM DIODE CURRENT WITH 10 VOLTS DC APPLIED PER PLATE	0.8	MA.

TYPICAL OPERATING CONDITIONS AND CHARACTERISTICS

CLASS A1 AMPLIFIER

PLATE VOLTAGE	250	VOLTS
CONTROL GRID VOLTAGE ^A	-9	VOLTS
PLATE CURRENT	9.5	MA.
PLATE RESISTANCE	8500	OHMS
TRANSIMPEDANCE	1900	μMHMS
AMPLIFICATION FACTOR	16	

^A THE DC RESISTANCE IN THE GRID CIRCUIT UNDER MAXIMUM RATED CONDITIONS SHOULD NOT EXCEED 1.0 MEGOHM.

CONTINUED NEXT PAGE

6R7, 6R7G, 6R7GT

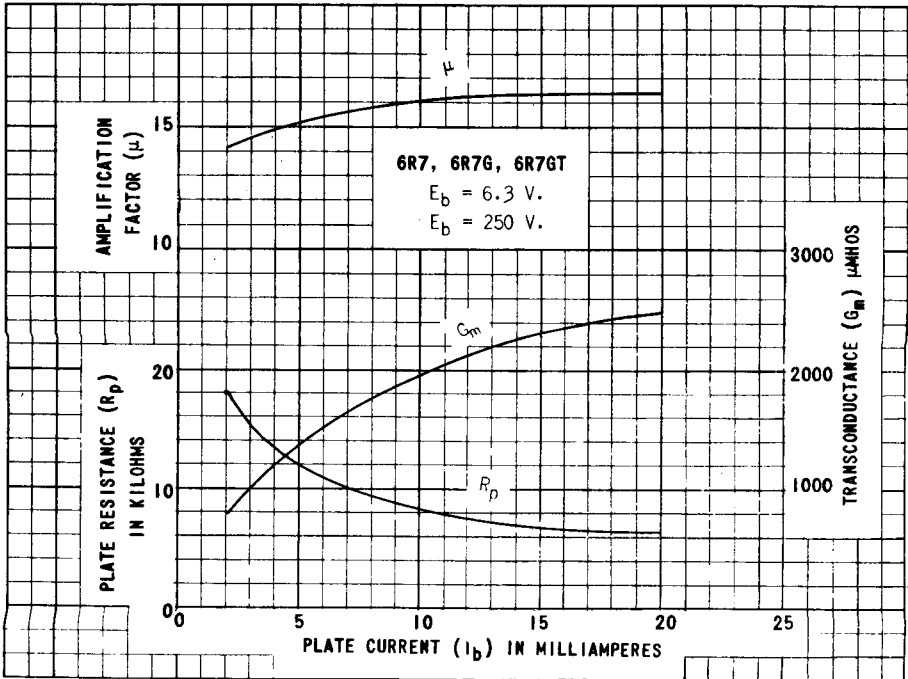
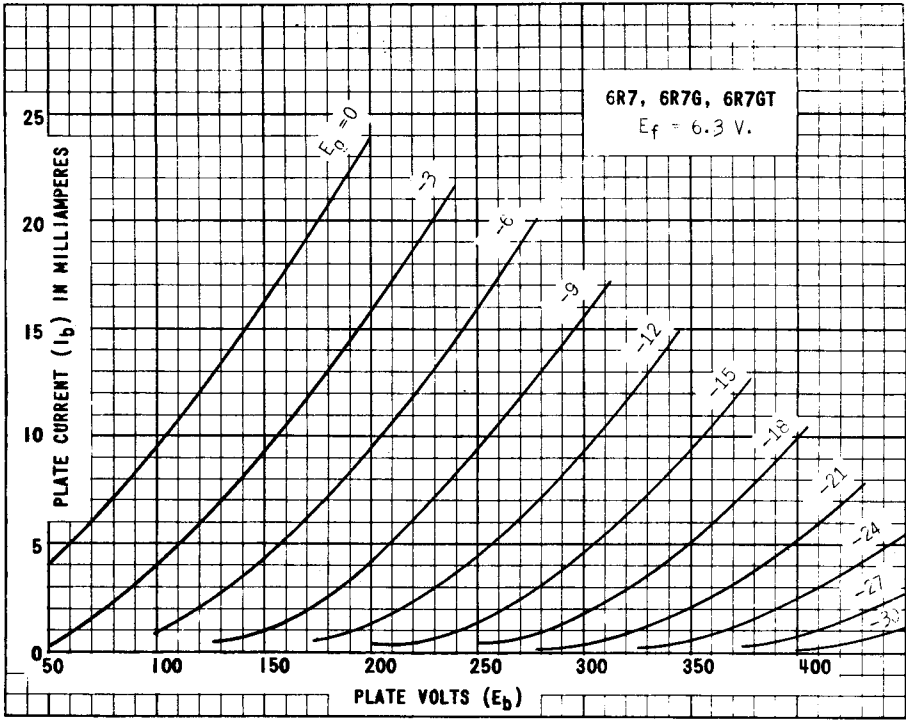

TUNG-SOL

TRIPLE GRID
REMOTE CUT - OFF AMPLIFIER

UNIPOTENTIAL CATHODE

HEATER

6.3 VOLTS 0.15 AMPERE

AC OR DC

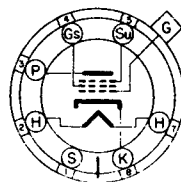

7 R

BOTTOM VIEW
7 PIN OCTAL BASE

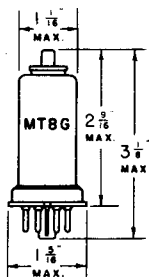

METAL SHELL

THE TUNG-SOL 6S7 IS A TRIPLE GRID REMOTE CUT-OFF AMPLIFIER RECOMMENDED FOR USE IN APPLICATIONS WHICH REQUIRE A HEATER OF LOW CURRENT DRAIN. IT IS SUITABLE FOR USE WITH AVC IN RF AND IF AMPLIFIERS, AND IT MINIMIZES CROSS MODULATION. ITS RATINGS AND ELECTRICAL CHARACTERISTICS ARE SIMILAR TO THOSE OF THE 6D6.

RATINGS

MAXIMUM PLATE VOLTAGE	300	VOLTS
MAXIMUM SCREEN SUPPLY VOLTAGE	300	VOLTS
MAXIMUM SCREEN VOLTAGE	100	VOLTS
MAXIMUM PLATE DISSIPATION	2.25	WATTS
MAXIMUM SCREEN DISSIPATION	0.25	WATT
MINIMUM EXTERNAL GRID BIAS VOLTAGE	0	VOLT

TYPICAL OPERATING CONDITIONS AND CHARACTERISTICS

CLASS A₁ AMPLIFIER

PLATE VOLTAGE	135	250	VOLTS
SCREEN VOLTAGE	67.5	100	VOLTS
CONTROL GRID VOLTAGE ^{MIN.}	-3	-3	VOLTS
SUPPRESSOR GRID CONNECTED TO CATHODE AT SOCKET			
PLATE CURRENT	3.7	8.5	MA.
SCREEN CURRENT	0.9	2.0	MA.
PLATE RESISTANCE ^{APPROX.}	1.0	1.0	MEGOHM
TRANSCONDUCTANCE	1250	1750	μMHOS
CONTROL GRID VOLTAGE	-2E	-38.5	VOLTS
FOR TRANSCONDUCTANCE = 10 μMHOS			

DIRECT INTERELECTRODE CAPACITANCES^S

CONTROL GRID TO CATHODE	6.5	μμf
PLATE TO CATHODE	10.5	μμf
CONTROL GRID TO PLATE	0.005 ^{MAX.}	μμf

^S WITH SHELL CONNECTED TO CATHODE

FOR "INTERPRETATION OF RATINGS" REFER TO FRONT OF BOOK.

TUNG-SOL

TRIPLE GRID

REMOTE CUT-OFF AMPLIFIER

UNIPOTENTIAL CATHODE

HEATER

6.3 VOLTS 0.15 AMPERE
AC OR DC

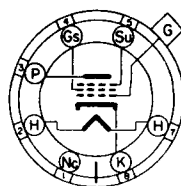
G-7R_a

BOTTOM VIEW
SMALL 7 PIN OCTAL BASE

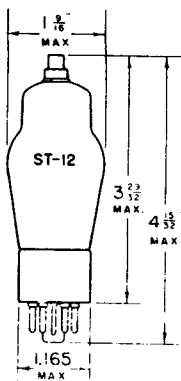

GLASS BULB

THE TUNG-SOL 6S7G IS A TRIPLE GRID REMOTE CUT-OFF AMPLIFIER RECOMMENDED FOR USE WHERE LOW HEATER CURRENT DRAIN IS DESIRABLE. IT IS SUITABLE FOR USE WITH AVC IN RF AND IF AMPLIFIERS, AND IT MINIMIZES CROSS MODULATION. ITS ELECTRICAL CHARACTERISTICS ARE SIMILAR TO THOSE OF THE 6D6.

RATINGS

MAXIMUM PLATE VOLTAGE	300	VOLTS
MAXIMUM SCREEN SUPPLY VOLTAGE	300	VOLTS
MAXIMUM SCREEN VOLTAGE	100	VOLTS
MINIMUM EXTERNAL GRID BIAS VOLTAGE	0	VOLTS
MAXIMUM PLATE DISSIPATION	2.25	WATTS
MAXIMUM SCREEN DISSIPATION	0.25	WATT

TYPICAL OPERATING CONDITIONS AND CHARACTERISTICS

CLASS A₁ AMPLIFIER

PLATE VOLTAGE	135	250 ^{MAX.}	VOLTS
SCREEN VOLTAGE	67.5	100 ^{MAX.}	VOLTS
CONTROL GRID VOLTAGE ^{MIN.}	-3	-3	VOLTS
SUPPRESSOR GRID	CONNECTED TO CATHODE AT SOCKET		
PLATE CURRENT	3.7	8.5	MA.
SCREEN CURRENT	0.9	2.0	MA.
PLATE RESISTANCE ^{APPROX.}	1.0	1.0	MEG OHM
TRANSCONDUCTANCE	1250	1750	μMHOS
CONTROL GRID VOLTAGE FOR TRANSCONDUCTANCE = 10 μMHOS	-25	-38.5	VOLTS

DIRECT INTERELECTRODE CAPACITANCES^A

CONTROL GRID TO CATHODE	4.4	μμf
PLATE TO CATHODE	8.0	μμf
GRID TO PLATE	0.008 ^{MAX.}	μμf

^A WITH EXTERNAL SHIELD CONNECTED TO CATHODE

FOR "INTERPRETATION OF RATINGS" REFER TO FRONT OF BOOK.

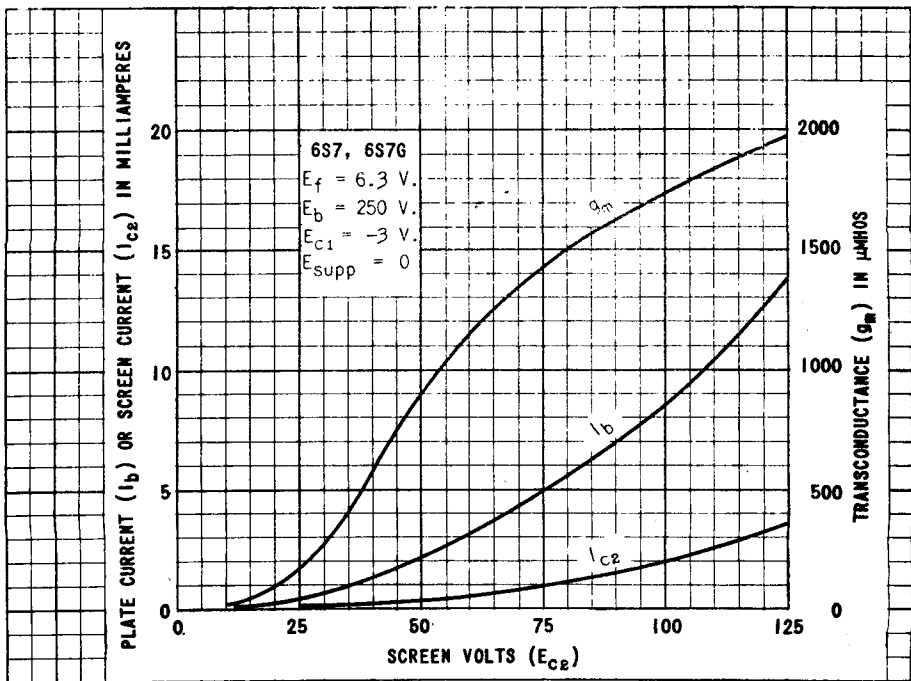
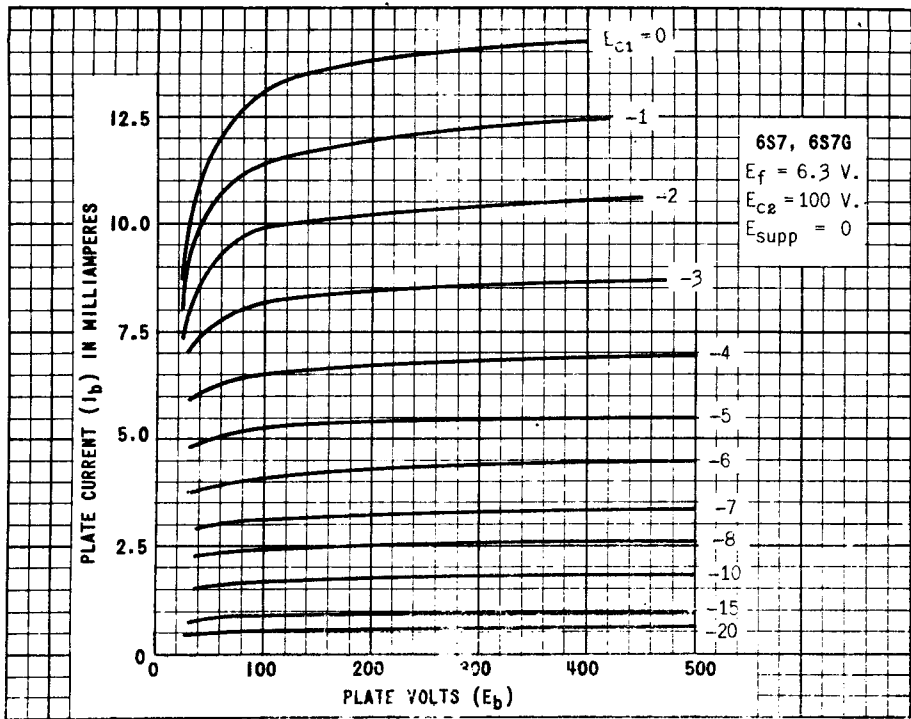

6S7, 6S7G

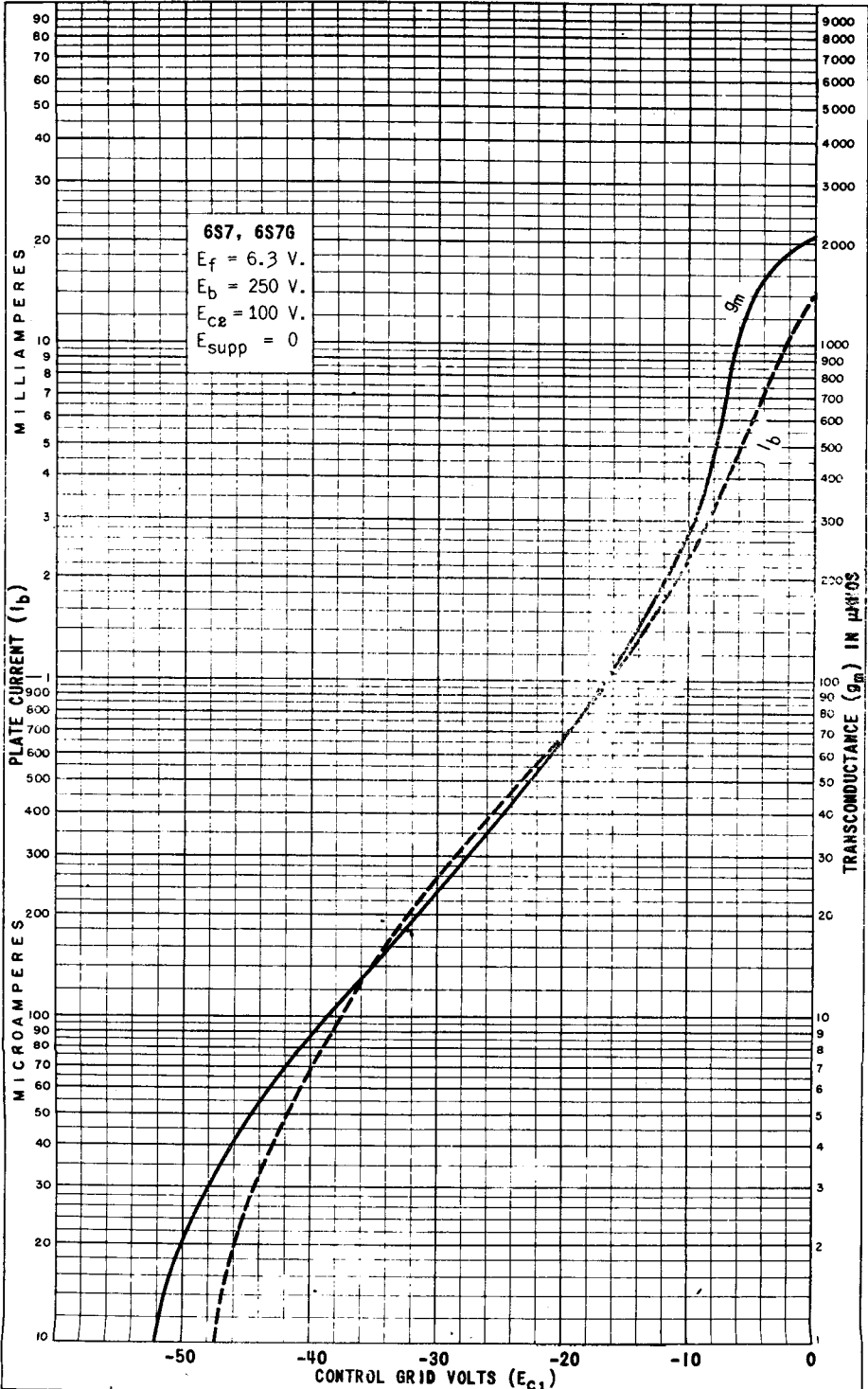

TUNG-SOL

TRIPLE-DIODE TRIODE

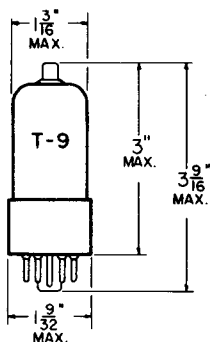

GLASS BULB
SKIRTED
MINIATURE CAP

COATED UNIPOTENTIAL CATHODES

HEATER

6.3 VOLTS 300 MA.

AC OR DC

ANY MOUNTING POSITION

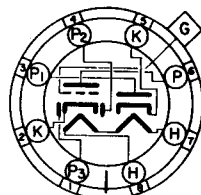

BOTTOM VIEW

INTERMEDIATE SHELL
8 PIN OCTAL BASE

THE 6S8GT COMBINES IN ONE ENVELOPE A HIGH- μ TRIODE AND THREE SEPARATE DIODES. ONE OF THE THREE DIODES HAS A SEPARATE CATHODE PERMITTING USE AS A BALANCED DISCRIMINATOR OR DETECTOR. IN COMBINATION FM/AM RECEIVERS THIS TUBE PROVIDES THE NECESSARY ELEMENTS FOR DETECTION OF BOTH TYPES OF SIGNAL WITHOUT NEED FOR ADDITIONAL SWITCHING.

DIRECT INTERELECTRODE CAPACITANCES

WITH EXTERNAL SHIELD M8-308 CONNECTED TO CATHODE

GRID TO PLATE: (G TO P)	1.2	μuf
INPUT: (G TO K)	2.0	μuf
OUTPUT: (P TO K)	3.8	μuf
DIODE INPUT (EACH DIODE) (APPROX.)	1.0	μuf

RATINGS

INTERPRETED ACCORDING TO RMA STANDARD M8-210

HEATER VOLTAGE	6.3	VOLTS
MAXIMUM HEATER-CATHODE VOLTAGE	90	VOLTS
MAXIMUM TRIODE PLATE VOLTAGE	300	VOLTS
MAXIMUM TRIODE PLATE DISSIPATION	0.5	WATT
MAXIMUM CONTINUOUS DIODE CURRENT (EACH DIODE)	1.0	MA.

TYPICAL OPERATING CONDITIONS AND CHARACTERISTICS

HEATER VOLTAGE	6.3	6.3	6.3	VOLTS
HEATER CURRENT	300	300	300	MA.
TRIODE PLATE VOLTAGE	50	100	250	VOLTS
GRID VOLTAGE	0	-1	-2	VOLTS
GRID CIRCUIT RESISTOR	10	0	0	MEG OHM
TRIODE PLATE CURRENT	0.07	0.4	0.9	MA.
PLATE RESISTANCE	285 000	110 000	91 000	OHMS
TRANSCONDUCTANCE	300	900	1 100	μMHOS
AMPLIFICATION FACTOR	85	100	100	
AVERAGE DIODE CURRENT WITH 40 VOLTS DC APPLIED (EACH DIODE)	2.5	2.5	2.5	MA.

ONE DIODE HAS A SEPARATE CATHODE, THE OTHER CATHODE IS COMMON TO TWO DIODES AND THE TRIODE UNIT.

IT IS RECOMMENDED THAT DIODE #1 (PIN 3) AND DIODE #3 (PIN 1) BE USED IN BALANCED DETECTOR CIRCUITS.

→ INDICATES A CHANGE OR ADDITION.

CONTINUED FROM PRECEDING PAGE

RESISTANCE COUPLED AMPLIFIER

R1 MEG.	Rg1 MEG.	Rc MEG.	Ebb = 90 VOLTS			Ebb = 180 VOLTS			Ebb = 300 VOLTS		
			Rk	GAIN	Eo	Rk	GAIN	Eo	Rk	GAIN	Eo
0.1	A	0.1	6800	25	6	4700	27	10	2200	36	29
0.1	A	0.27	8200	29	7	4700	35	15	2700	45	35
0.27	A	0.27	10000	35	9	6800	44	19	4700	53	42
0.27	A	0.47	12000	39	10	6800	48	21	5600	56	48
0.47	A	0.47	18000	39	10	10000	45	24	8200	58	51
0.47	A	1	18000	46	15	12000	54	29	9100	63	59
0.27	10	0.27	---	34	5	---	54	20	---	58	40
0.27	10	0.47	---	38	6	---	57	25	---	60	49
0.47	10	0.47	---	39	7	---	60	23	---	62	47
0.47	10	1	---	42	9.5	---	65	33	---	70	63

^A VALUE OF Rg1 IS NOT CRITICAL.

Rk TAKEN TO NEAREST RNA VALUE FOR EACH CASE INSTEAD OF ABSOLUTE OPTIMUM VALUE.

Eo IS RMS OUTPUT AT 5% TOTAL HARMONIC DISTORTION.

GAIN MEASURED AT Eo = 2.0 VOLTS RMS OUTPUT.

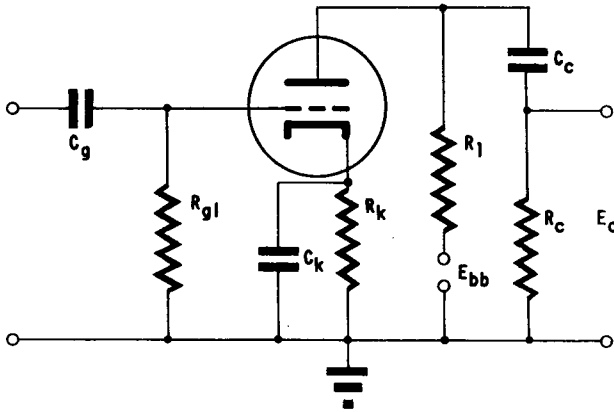

→ INDICATES A CHANGE OR ADDITION.

PLATE
1887
OCT. 1,
1947

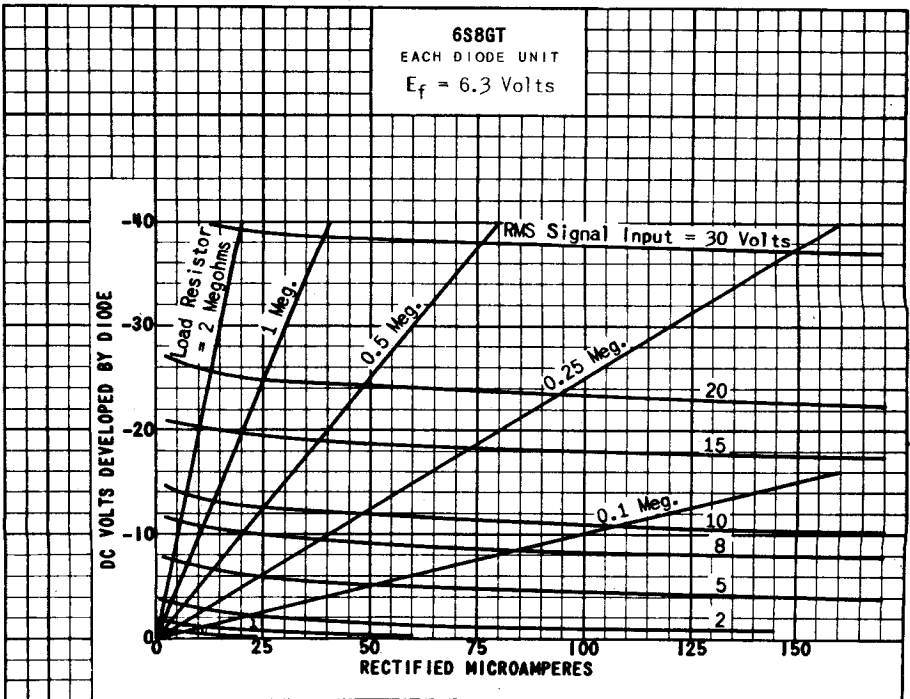
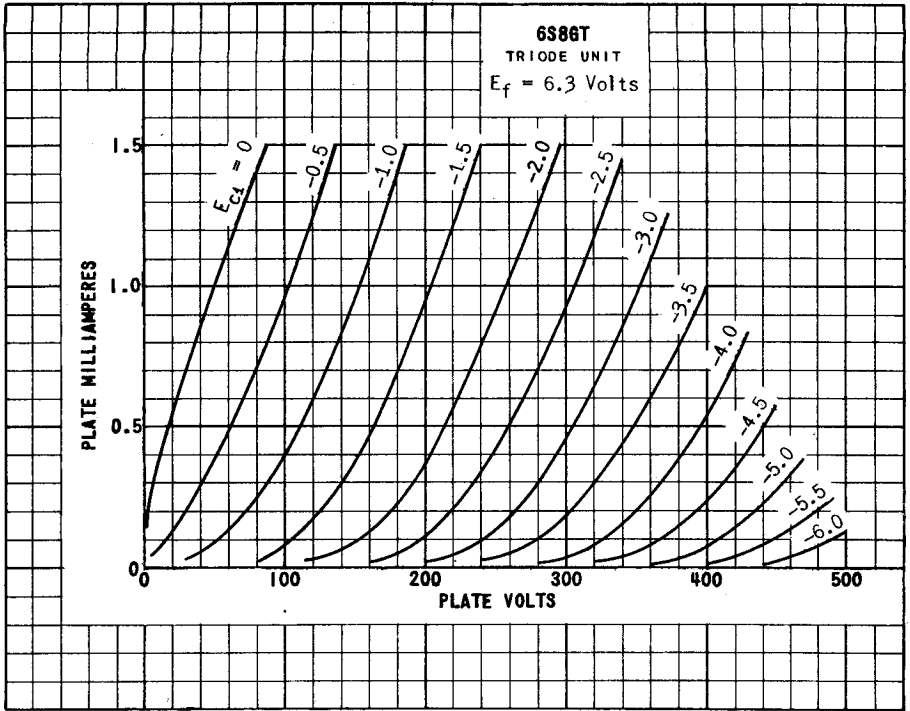

PRINTED IN U. S. A.

PLATE
1888
OCT. 1,
1947



TUNG-SOL

PENTAGRID CONVERTER

UNIPOTENTIAL CATHODE

HEATER

6.3 VOLTS 0.3 AMPERE
AC OR DC

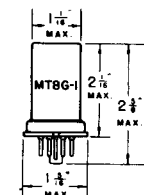

METAL TUBE
SMALL WAFER
8 PIN OCTAL BASE
6SA7

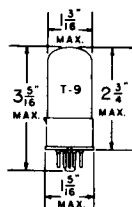

GLASS BULB
8 PIN OCTAL BASE
WITH METAL SHELL
6SA7GT/G

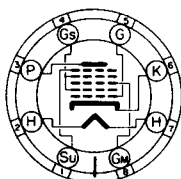

8R

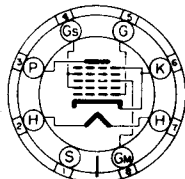

8AD

BOTTOM VIEWS

THE TUNG-SOL 6SA7 AND 6SA7GT/G ARE PENTAGRID CONVERTERS, DESIGNED TO MINIMIZE FREQUENCY DRIFT. THEY ARE INTENDED FOR SERVICE AS COMBINED OSCILLATORS AND MIXERS IN AC, STORAGE BATTERY AND AC-DC OPERATED SUPERHETERODYNES.

RATINGS

MAXIMUM PLATE VOLTAGE	300	VOLTS
MAXIMUM SCREEN (Gs) SUPPLY VOLTAGE	300	VOLTS
MAXIMUM SCREEN VOLTAGE	100	VOLTS
MINIMUM EXTERNAL CONTROL GRID (G) BIAS VOLTAGE ^A	0	VOLT
MAXIMUM TOTAL CATHODE CURRENT	14	MA.
MAXIMUM PLATE DISSIPATION	1.0	WATT
MAXIMUM SCREEN DISSIPATION	1.0	WATT

^A WITH SELF-EXCITED OSCILLATOR.

FOR "INTERPRETATION OF RATINGS" REFER TO FRONT OF BOOK.

CONTINUED NEXT PAGE

TUNG-SOL

DIRECT INTERELECTRODE CAPACITANCES

	6SA7	6SA7GT/G	
CONTROL GRID (G) TO MIXER PLATE (P) ⁵	0.13 MAX.	0.2 MAX.	μμf
CONTROL GRID (G) TO OSCILLATOR GRID (G _o) ⁵	0.15 MAX.	0.2 MAX.	μμf
RF INPUT: CONTROL GRID (G) TO ALL OTHER ELECTRODES ⁵	9.5	11	μμf
OSCILLATOR GRID (G _o) TO PLATE (P) ⁵	0.06 MAX.	0.2 MAX.	μμf
OSCILLATOR INPUT: OSCILLATOR GRID (G _o) TO ALL OTHER ELECTRODES ⁵	7	8	μμf
OSCILLATOR GRID (G _o) TO ALL OTHER ELECTRODES EXCEPT CATHODE (K)	4.4	5	μμf
OSCILLATOR GRID (G _o) TO CATHODE (K)	2.6	3	μμf
MIXER OUTPUT: PLATE (P) TO ALL OTHER ELECTRODES ⁵	12	12	μμf
CATHODE (K) TO ALL OTHER ELECTRODES EXCEPT OSCILLATOR GRID (G _o)	5	30	μμf

⁵ WITH SHELL CONNECTED TO CATHODE.

TYPICAL OPERATING CONDITIONS AND CHARACTERISTICS

CONVERTER SERVICE - SEPARATE EXCITATION^A

PLATE (P) VOLTAGE	100	250	VOLTS
SCREEN (G _s) VOLTAGE	100	100	VOLTS
CONTROL GRID (G) VOLTAGE	-2	-2	VOLTS
OSCILLATOR GRID (G _o) RESISTOR	20000	20000	OHMS
PLATE CURRENT	3.3	3.5	MA.
SCREEN CURRENT	8.5	8.5	MA.
OSCILLATOR GRID CURRENT	0.5	0.5	MA.
TOTAL CATHODE CURRENT	12.3	12.5	MA.
PLATE RESISTANCE	0.5	1.0	MEG OHM
CONVERSION TRANSCONDUCTANCE	425	450	μMHOS
FOR CONTROL GRID (G) VOLTAGE = -2 V.			
CONVERSION TRANSCONDUCTANCE	310	325	μMHOS
FOR CONTROL GRID (G) VOLTAGE = -6 V.			
CONVERSION TRANSCONDUCTANCE	75	80	μMHOS
FOR CONTROL GRID (G) VOLTAGE = -10 V.			
CONVERSION TRANSCONDUCTANCE APPROX.	2	2	μMHOS
FOR CONTROL GRID (G) VOLTAGE = -35 V.			

^A THE CHARACTERISTICS UNDER THESE CONDITIONS CORRESPOND VERY CLOSELY WITH THOSE OBTAINED IN A SELF-EXCITED OSCILLATORY CIRCUIT OPERATING WITH ZERO-BIAS.

TUNG-SOL

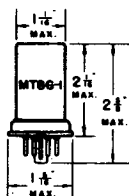

METAL TUBE
SMALL WAFER
8 PIN OCTAL BASE
6SA7

PENTAGRID CONVERTER

UNIPOTENTIAL CATHODE

HEATER

6.3 VOLTS 0.3 AMPERE
AC OR DC

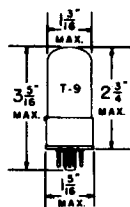

GLASS BULB
8 PIN OCTAL BASE
WITH METAL SHELL
6SA7GT/G

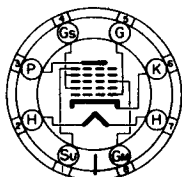

8R

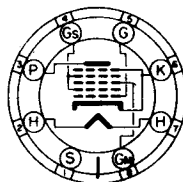

8AD

BOTTOM VIEWS

THE TUNG-SOL 6SA7 AND 6SA7GT/G ARE PENTAGRID CONVERTERS, DESIGNED TO MINIMIZE FREQUENCY DRIFT. THEY ARE INTENDED FOR SERVICE AS COMBINED OSCILLATORS AND MIXERS IN AC, STORAGE BATTERY AND AC-DC OPERATED SUPERHETERODYNES.

RATINGS

MAXIMUM PLATE VOLTAGE	300	VOLTS
MAXIMUM SCREEN (Gs) SUPPLY VOLTAGE	300	VOLTS
MAXIMUM SCREEN VOLTAGE	100	VOLTS
MINIMUM EXTERNAL CONTROL GRID (G) BIAS VOLTAGE ^A	0	VOLT
MAXIMUM TOTAL CATHODE CURRENT	14	MA.
MAXIMUM PLATE DISSIPATION	1.0	WATT
MAXIMUM SCREEN DISSIPATION	1.0	WATT

^A WITH SELF-EXCITED OSCILLATOR.

FOR "INTERPRETATION OF RATINGS" REFER TO FRONT OF BOOK.

CONTINUED NEXT PAGE

TUNG-SOL

DIRECT INTERELECTRODE CAPACITANCES

	6SA7	6SA7GT/G	
CONTROL GRID (G) TO MIXER PLATE (P) ^S	0.13 MAX.	0.2 MAX.	μf
CONTROL GRID (G) TO OSCILLATOR GRID (G _o) ^S	0.15 MAX.	0.2 MAX.	μf
RF INPUT: CONTROL GRID (G) TO ALL OTHER ELECTRODES ^S	9.5	11	μf
OSCILLATOR GRID (G _o) TO PLATE (P) ^S	0.06 MAX.	0.2 MAX.	μf
OSCILLATOR INPUT: OSCILLATOR GRID (G _o) TO ALL OTHER ELECTRODES ^S	7	8	μf
OSCILLATOR GRID (G _o) TO ALL OTHER ELECTRODES EXCEPT CATHODE (K)	4.4	5	μf
OSCILLATOR GRID (G _o) TO CATHODE (K)	2.6	3	μf
MIXER OUTPUT: PLATE (P) TO ALL OTHER ELECTRODES ^S	12	12	μf
CATHODE (K) TO ALL OTHER ELECTRODES EXCEPT OSCILLATOR GRID (G _o)	5	30	μf

^S WITH SHELL CONNECTED TO CATHODE.

TYPICAL OPERATING CONDITIONS AND CHARACTERISTICS

CONVERTER SERVICE - SEPARATE EXCITATION^A

PLATE (P) VOLTAGE	100	250	VOLTS
SCREEN (G _s) VOLTAGE	100	100	VOLTS
CONTROL GRID (G) VOLTAGE	-2	-2	VOLTS
OSCILLATOR GRID (G _o) RESISTOR	20000	20000	OHMS
PLATE CURRENT	3.3	3.5	MA.
SCREEN CURRENT	8.5	8.5	MA.
OSCILLATOR GRID CURRENT	0.5	0.5	MA.
TOTAL CATHODE CURRENT	12.3	12.5	MA.
PLATE RESISTANCE	0.5	1.0	MEGOHM
CONVERSION TRANSCONDUCTANCE	425	450	μMHOS
FOR CONTROL GRID (G) VOLTAGE = -2 V.			
CONVERSION TRANSCONDUCTANCE	310	325	μMHOS
FOR CONTROL GRID (G) VOLTAGE = -6 V.			
CONVERSION TRANSCONDUCTANCE	75	80	μMHOS
FOR CONTROL GRID (G) VOLTAGE = -10 V.			
CONVERSION TRANSCONDUCTANCE ^{APPROX.}	2	2	μMHOS
FOR CONTROL GRID (G) VOLTAGE = -35 V.			

^A THE CHARACTERISTICS UNDER THESE CONDITIONS CORRESPOND VERY CLOSELY WITH THOSE OBTAINED IN A SELF-EXCITED OSCILLATORY CIRCUIT OPERATING WITH ZERO-BIAS.

TUNG-SOL

PENTAGRID CONVERTER

PHYSICAL SPECIFICATIONS

EMITTER UNIPOTENTIAL CATHODE	PIN CONNECTIONS	
BASE SMALL WAFER OCTAL 8-PIN	PIN 1 SHELL, G5	PIN 7 HEATER
MICANOL	PIN 2 HEATER	PIN 8 GRID 3
BULB MT-8G	PIN 3 PLATE	
MAXIMUM DIAMETER 1 5/16"	PIN 4 GRIDS 2 & 4	MOUNTING POS. ANY
MAXIMUM OVERALL LENGTH 2 5/8"	PIN 5 GRID 1	
MAXIMUM SEATED HEIGHT 2 1/16"	PIN 6 CATHODE	

RATINGS

INTERPRETED ACCORDING TO RMA STANDARD MB-210

HEATER VOLTAGE (AC OR DC)	6.3	VOLTS
HEATER CURRENT	0.3	AMP.
MAXIMUM PLATE VOLTAGE	300	VOLTS
MAXIMUM GRIDS 2 & 4 VOLTAGE	100	VOLTS
MAXIMUM GRIDS 2 & 4 SUPPLY VOLTAGE	300	VOLTS
MAXIMUM GRID 3 VOLTAGE:		
NEGATIVE BIAS VOLTAGE	100	VOLTS
POSITIVE BIAS VOLTAGE	0	VOLTS
MAXIMUM PEAK HEATER-CATHODE VOLTAGE:		
HEATER NEG. WITH RESPECT TO CATHODE	90	VOLTS
HEATER POS. WITH RESPECT TO CATHODE	90	VOLTS
MAXIMUM TOTAL CATHODE CURRENT	22	MA.
MAXIMUM PLATE DISSIPATION	2.0	WATTS
MAXIMUM GRIDS 2 & 4 DISSIPATION	1.5	WATTS

DIRECT INTERELECTRODE CAPACITANCES

GRID 3 TO ALL OTHER ELECTRODES (RF INPUT) ^A [C _{G3} (H+K+G ₁ +G ₂ +G ₄ +G ₅ +P)]	9.6	μf
PLATE TO ALL OTHER ELECTRODES (MIXER OUTPUT) ^A [C _P (H+K+G ₁ +G ₂ +G ₄ +G ₃ +G ₅)]	9.2	μf
GRID 1 TO ALL OTHER ELECTRODES (OSCILLATOR INPUT) ^A [C _{G1} (H+K+G ₂ +G ₄ +G ₃ +G ₅ +P)]	7.3	μf
GRID 3 TO PLATE [C _{G3P}] (MAX.) ^A	0.15	μf
GRID 1 TO GRID 3 [C _{G1G3}] (MAX.) ^A	0.16	μf
GRID 1 TO PLATE [C _{G1P}] (MAX.) ^A	0.06	μf
GRID 1 TO ALL OTHER ELECTRODES AND SHELL EXCEPT CATHODE [C _{G1} (S+H+G ₂ +G ₄ +G ₃ +G ₅ +P)]	3.8	μf
GRID 1 TO CATHODE [C _{G1K}]	3.4	μf
CATHODE TO ALL OTHER ELECTRODES AND SHELL EXCEPT GRID 1 [C _K (S+H+G ₂ +G ₄ +G ₃ +G ₅ +P)]	4.5	μf

^A WITH SHELL CONNECTED TO CATHODE

TUNG-SOL

CONTINUED FROM PRECEDING PAGE

TYPICAL OPERATING CONDITIONS AND CHARACTERISTICS
SEPARATE EXCITATION

CHARACTERISTICS SHOWN WITH SEPARATE EXCITATION CORRESPOND VERY CLOSELY WITH THOSE OBTAINED IN A SELF-EXCITED OSCILLATOR CIRCUIT OPERATING WITH ZERO BIAS.

PLATE VOLTAGE	100	250	VOLTS
SCREEN (GRIDS 2 & 4) VOLTAGE	100	100	VOLTS
CONTROL GRID (GRID 3) VOLTAGE	-1.0	-1.0	VOLT
PLATE CURRENT	3.6	3.8	MA.
SCREEN (GRIDS 2 & 4) CURRENT	10.2	10	MA.
OSCILLATOR (GRID 1) CURRENT	0.35	0.35	MA.
TOTAL CATHODE CURRENT	14.2	14.2	MA.
PLATE RESISTANCE (APPROX.)	0.5	1.0	MEG OHM
OSCILLATOR GRID (GRID 1) RESISTOR	20 000	20 000	OHMS
CONVERSION TRANSCONDUCTANCE	900	950	MICROMHOS
CONVERSION TRANSCONDUCTANCE (APPROX.) FOR GRID 3 BIAS = -20 VOLTS	3.5	3.5	MICROMHOS

OSCILLATOR IN FM BAND (88-108 MC.)

PLATE VOLTAGE	250	VOLTS	
SCREEN (GRIDS 2 & 4) SUPPLY VOLTAGE	250	VOLTS	
SCREEN (GRIDS 2 & 4) RESISTOR	12 000	OHMS	
OSCILLATOR GRID (GRID 1) RESISTOR	22 000	OHMS	
SIGNAL FREQUENCY	88	108	MC.
OSCILLATION FREQUENCY	98.7	118.7	MC.
PLATE CURRENT	6.8	6.5	MA.
SCREEN (GRIDS 2 & 4) CURRENT	12.6	12.5	MA.
OSCILLATOR (GRID 1) CURRENT	0.130	0.140	MA.

OSCILLATOR TRANSCONDUCTANCE

GRID 3	CONNECTED TO GROUND	
GRIDS 2 & 4 CONNECTED TO PLATE (NOT OSCILLATING)	100	VOLTS
GRID 1 SIGNAL VOLTAGE	0	VOLTS
TRANSCONDUCTANCE (APPROX.) BETWEEN GRID 1 & PLATE WITH GRIDS 2 & 4 CONNECTED TO PLATE	8000	MICROMHOS
PLATE CURRENT	32	MA.
AMPLIFICATION FACTOR	16.5	
PLATE RESISTANCE (APPROX.)	2060	OHMS

PLATE
1720
JUNE 17
1946

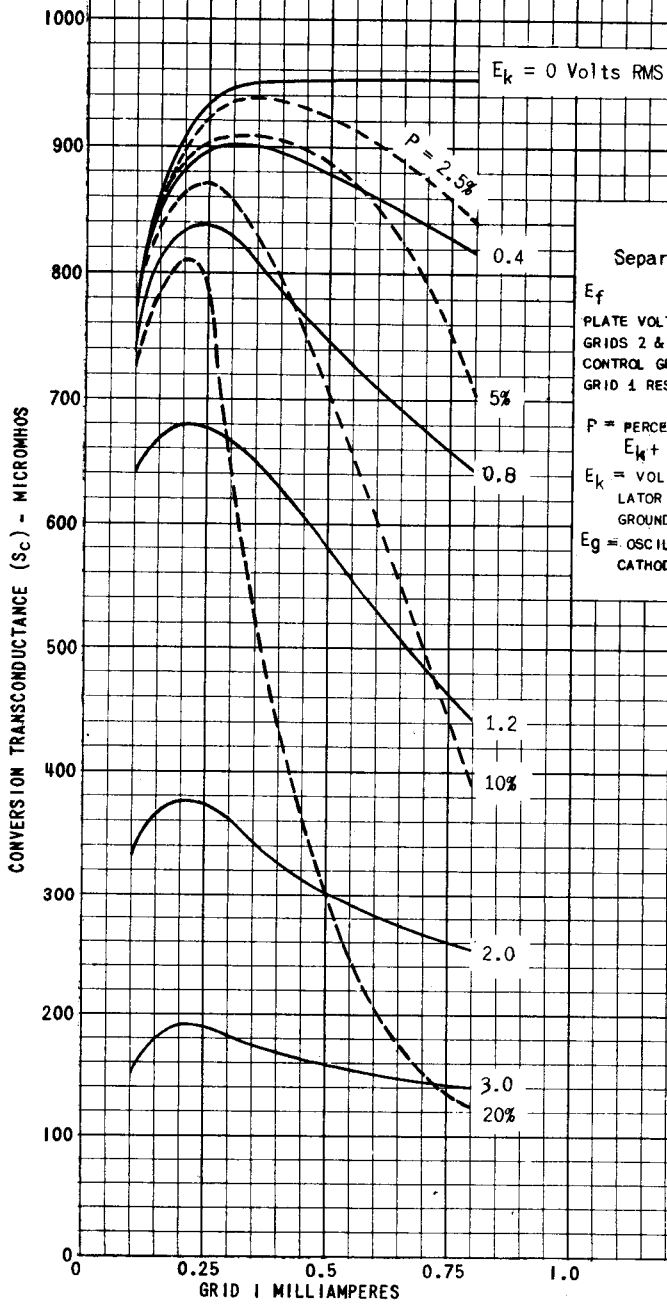

PRINTED IN U. S. A.

PLATE
1721
JUNE 17
1946

6SB7Y

6SB7Y

E_f = 6.3 Volts
Plate Voltage = 250 Volts
Grids 2 & 4 Voltage = 100 Volts
Grid 1 Resistor = 20,000 Ohms

Oscillator voltage adjusted to give grid 1 current of 0.35 ma.

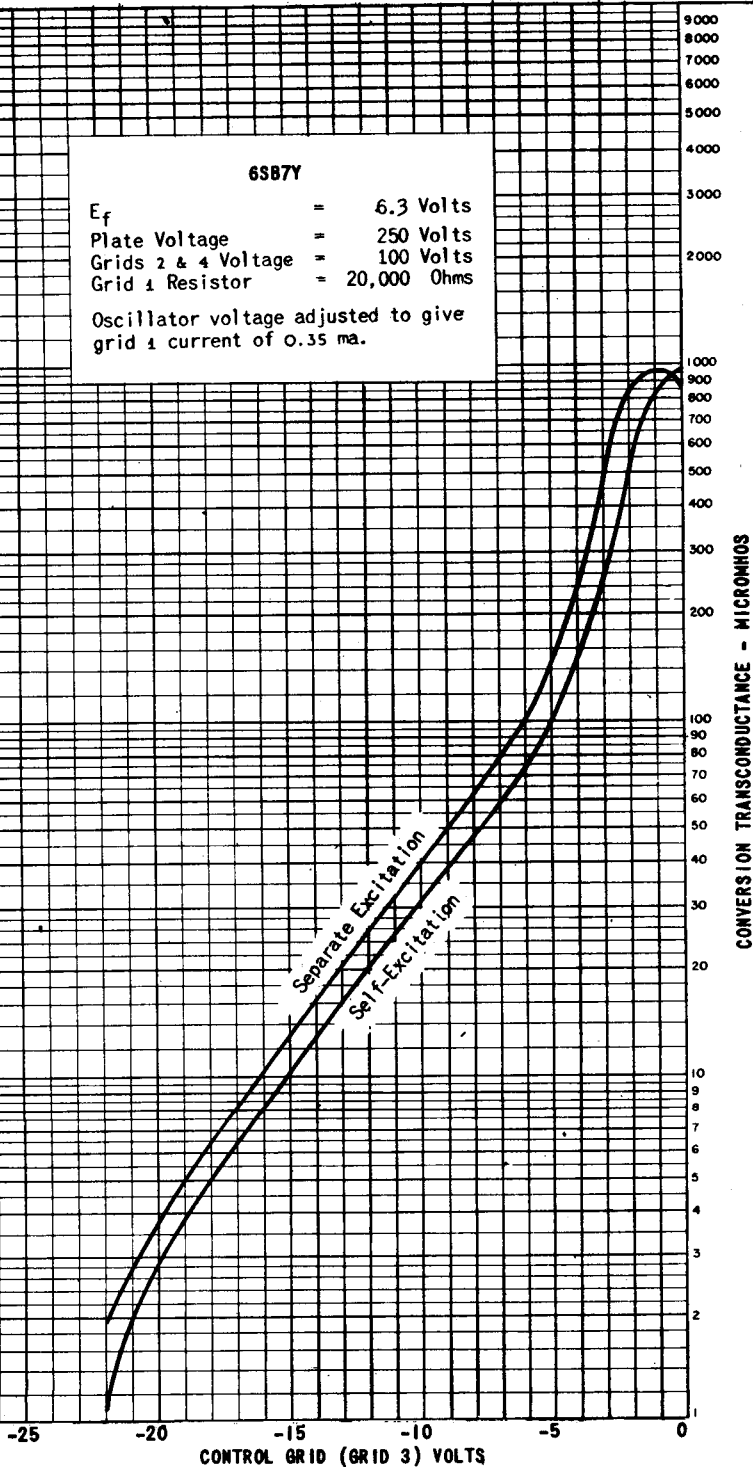
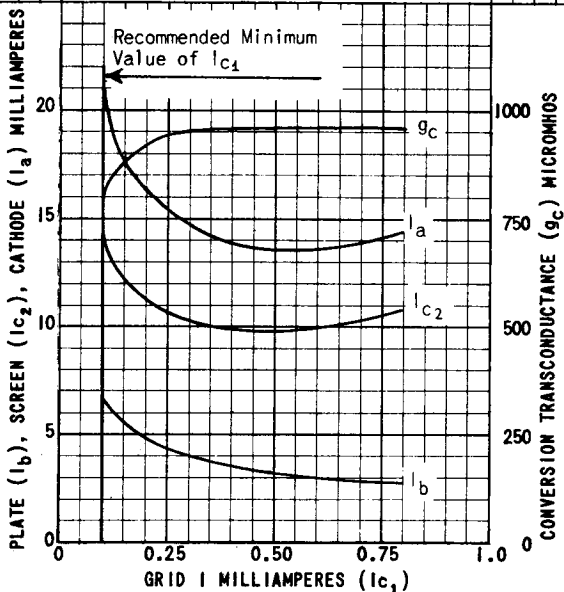

PLATE
1722
JUNE 17
1946

6SB7Y Separate Excitation

E_f = 6.3 Volts
 Plate Voltage = 250 Volts
 Grids 2 & 4 Voltage = 100 Volts
 Grid 3 Voltage = 1 Volt
 Grid 1 Resistor = 20,000 Ohms
 Grid 1 current varied by adjustment of oscillator voltage.



PRINTED IN U. S. A.

PLATE
 1723
 JUNE 17
 1946



TUNG-SOL

TWIN TRIODE AMPLIFIER

COATED UNIPOTENTIAL CATHODE

HEATER

6.3 VOLTS ^A 0.3 AMPERE

AC OR DC

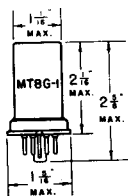

METAL SHELL



SMALL WAFER 8 PIN OCTAL BASE

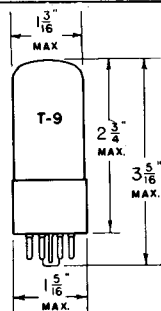

GLASS BULB

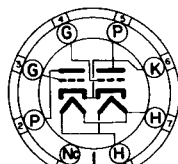

INTERMEDIATE 8 PIN OCTAL BASE

THE TUNG-SOL 6SC7 AND 6SC7GT ARE TWIN TRIODE AMPLIFIERS WITH HIGH AMPLIFICATION FACTORS. THEIR PRIMARY APPLICATION IS A PHASE INVERTER AND AUDIO AMPLIFIER.

RATINGS

MAXIMUM PLATE VOLTAGE 250 VOLTS

TYPICAL OPERATING CONDITIONS AND CHARACTERISTICS

CLASS A₁ AMPLIFIER

VALUES ARE FOR EACH TRIODE SECTION

PLATE VOLTAGE	250	VOLTS
GRID VOLTAGE	-2	VOLTS
PLATE CURRENT	2	MA.
PLATE RESISTANCE	53000	OHMS
TRANSCONDUCTANCE	1325	μMHMS
AMPLIFICATION FACTOR	70	

^A SHOULD NOT DEVIATE MORE THAN ± 10% FROM RATED VALUE.

FOR "INTERPRETATION OF RATINGS" REFER TO FRONT OF BOOK

SEE OTHER SIDE OF SHEET FOR CURVES

6SC7, 6SC7GT

6SC7, 6SC7GT
EACH TRIODE SECTION
 $E_f = 6.3 \text{ V.}$

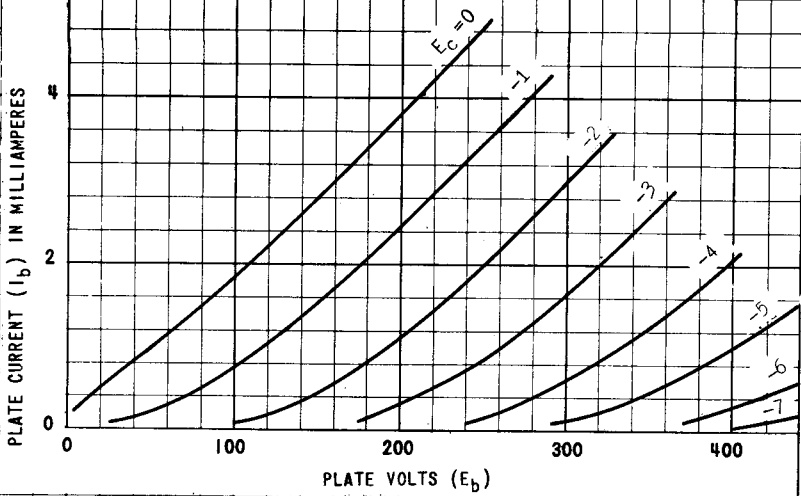
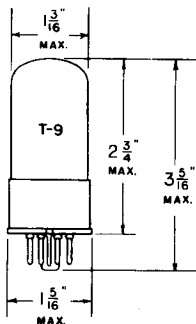

PLATE
1346-1
OCT. 25
1943

TUNG-SOL



TRIPLE GRID
SEMI-REMOTE CUT-OFF AMPLIFIER

UNIPOTENTIAL CATHODE

HEATER

6.3 VOLTS 0.3 AMPERE
AC OR DC

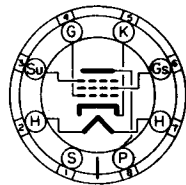

8N

BOTTOM VIEW

GLASS BULB

SMALL WAFER 8 PIN OCTAL BASE WITH METAL SHELL

THE TUNG-SOL 6SD7GT IS A TRIPLE GRID SEMI-REMOTE CUT-OFF AMPLIFIER. IT IS DESIGNED FOR SERVICE AS A HIGH GAIN RF AND IF AMPLIFIER.

RATINGS

MAXIMUM PLATE VOLTAGE	300	VOLTS
MAXIMUM SCREEN SUPPLY VOLTAGE	300	VOLTS
MAXIMUM SCREEN VOLTAGE	125	VOLTS
MAXIMUM PLATE DISSIPATION	4	WATTS
MAXIMUM SCREEN DISSIPATION	0.4	WATT

DIRECT INTERELECTRODE CAPACITANCES⁵

INPUT: CONTROL GRID TO ALL OTHER ELECTRODES EXCEPT PLATE	9.0	μf
OUTPUT: PLATE TO ALL OTHER ELECTRODES EXCEPT CONTROL GRID	7.5	μf
CONTROL GRID TO PLATE	.0035	MAX. μf

⁵ WITH EXTERNAL SHIELD CONNECTED TO CATHODE.

FOR "INTERPRETATION OF RATINGS" REFER TO FRONT OF BOOK.

CONTINUED NEXT PAGE

PLATE
1143-2

NOV. 17
1941

TUNG-SOL

TYPICAL OPERATING CONDITIONS AND CHARACTERISTICS

CLASS A₁ AMPLIFIER

PLATE VOLTAGE	100	250	250	VOLTS
SCREEN SUPPLY VOLTAGE	100	100	250	VOLTS
SCREEN VOLTAGE	100	100	125 ^A	VOLTS
CONTROL GRID VOLTAGE	-2	-2	-2	VOLTS
SUPPRESSOR GRID VOLTAGE	0	0	0	VOLT
PLATE CURRENT	5.7	6.0	9.5	MA.
SCREEN CURRENT	2.0	1.9	3.0	MA.
PLATE RESISTANCE APPROX.	0.25	1.0	0.7	MEGOHM
TRANSCONDUCTANCE	3350	3600	4250	μMHOS
CONTROL GRID VOLTAGE	-11	-11	-27	VOLTS

FOR TRANSCONDUCTANCE = 20 μMHOS

^A OBTAINED THROUGH A SUITABLE VOLTAGE DROPPING RESISTOR.

TUNG-SOL

HIGH MU TRIODE AMPLIFIER

UNIPOTENTIAL CATHODE

HEATER

6.3 VOLTS 0.3 AMPERE

AC OR DC

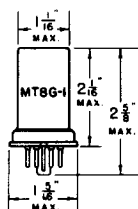

METAL SHELL
SMALL WAFER
6 PIN OCTAL BASE
6SF5

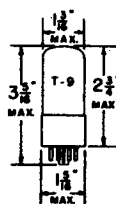

GLASS BULB
INTERMEDIATE
6 PIN OCTAL BASE
6SF5GT



6AB

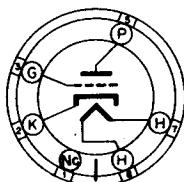

G-6AB

BOTTOM VIEWS

THE TUNG-SOL 6SF5 AND 6SF5GT ARE GENERAL PURPOSE HIGH MU TRIODES. THEY ARE DESIGNED FOR SERVICE AS HIGH GAIN RESISTANCE COUPLED AMPLIFIERS IN AC AND AC-DC OPERATED RECEIVERS.

RATINGS

HEATER VOLTAGE (AC OR DC)	6.3	VOLTS
HEATER CURRENT	0.3	AMPERE
MAXIMUM PLATE VOLTAGE	300	VOLTS

AVERAGE CHARACTERISTICS

PLATE VOLTAGE	100	250	VOLTS
CONTROL GRID VOLTAGE	-1	-2	VOLTS
PLATE CURRENT	0.4	0.9	MA.
PLATE RESISTANCE	85000	66000	OHMS
TRANSCONDUCTANCE	1150	1500	μMHOS
AMPLIFICATION FACTOR	100	100	

FOR "INTERPRETATION OF RATINGS" REFER TO FRONT OF BOOK.

PLATE
1086-2

JULY 28
1941

CONTINUED NEXT PAGE

6SF5, 6SF5GT

TUNG-SOL

TYPICAL OPERATING CONDITIONS AND CHARACTERISTICS

ZERO BIAS, RESISTANCE COUPLED, CLASS A₁ AMPLIFIER

PLATE SUPPLY VOLTAGE	100	300	VOLTS	
PLATE LOAD RESISTOR	0.25	0.25	MEGOHM	
GRID RESISTOR	10	10	MEGOHM	
COUPLING CONDENSER	.01 TO .005	.01 TO .005	μf	
GRID RESISTOR FOR FOLLOWING TUBE	.5 TO 1.0	.5 TO 1.0	MEGOHM	
EXTERNAL GRID CIRCUIT IMPEDANCE	0	0	MEGOHM	
VOLTAGE GAIN	48	52	66	71
VOLTAGE OUTPUT (RMS) ^A	7.0	8.5	44	50
			VOLTS	

^A AT FIVE PER CENT TOTAL HARMONIC DISTORTION

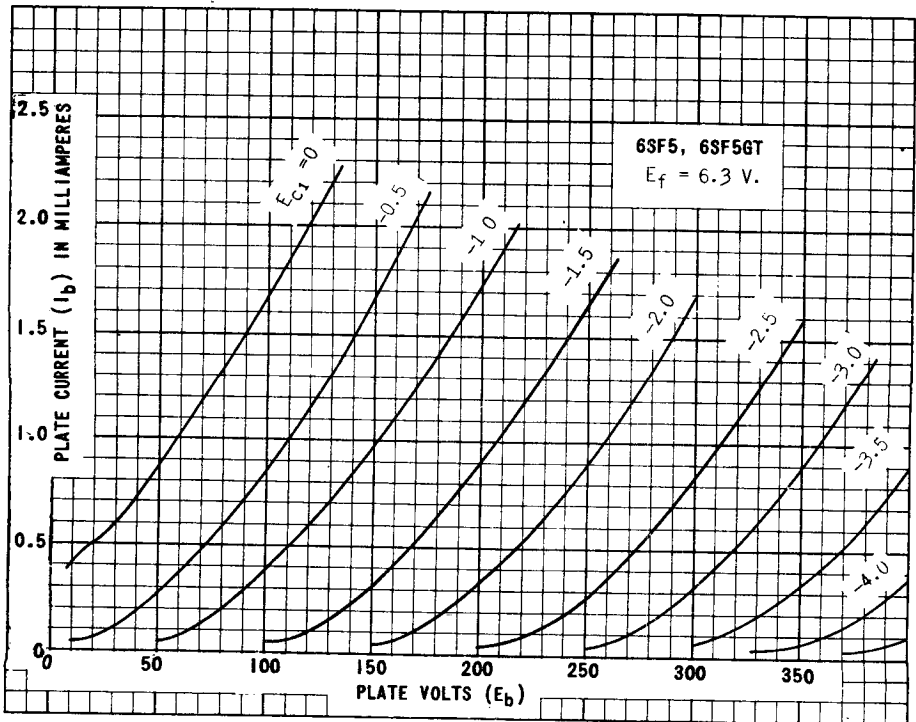
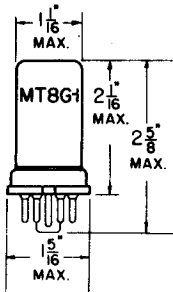

PLATE
1087-1

TUNG-SOL

**DIODE-SUPER-CONTROL
AMPLIFIER PENTODE**



COATED UNIPOTENTIAL CATHODE

HEATER
6.3 VOLTS 0.3 AMPERE
AC OR DC

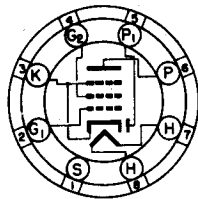

ANY MOUNTING POSITION

METAL SHELL

BOTTOM VIEW

SMALL WAFER
8-PIN OCTAL

THE 6SF7 COMBINES A DIODE AND PENTODE IN A SINGLE-ENDED CONSTRUCTION. IT IS DESIGNED FOR SERVICE AS A COMBINED IF AMPLIFIER, DETECTOR AND A.V.C. RECTIFIER.

RATINGS

INTERPRETED ACCORDING TO RMA STANDARD WB-210

PENTODE UNIT

HEATER VOLTAGE (AC OR-DC)	6.3	VOLTS
HEATER CURRENT	0.3	AMP.
MAX. PLATE VOLTAGE	300	VOLTS
MAX. SCREEN VOLTAGE	100	VOLTS
MAX. SCREEN SUPPLY VOLTAGE	300	VOLTS
MIN. GRID VOLTAGE	0	VOLTS
MAX. PLATE DISSIPATION	3.5	WATTS
MAX. SCREEN DISSIPATION	0.5	WATT
HEATER-CATHODE VOLTAGE	AS LOW AS POSSIBLE	

DIRECT INTERELECTRODE CAPACITANCES

WITH SHELL CONNECTED TO CATHODE

PENTODE UNIT

GRID TO PLATE (MAX.)	0.004	$\mu\mu\text{f}$
INPUT	5.5	$\mu\mu\text{f}$
OUTPUT	6.0	$\mu\mu\text{f}$
PENTODE PLATE TO DIODE	0.8	$\mu\mu\text{f}$
PENTODE GRID TO DIODE (MAX.)	0.002	$\mu\mu\text{f}$

CONTINUED ON FOLLOWING PAGE

PLATE
1608
OCT. 15,
1945

TUNG-SOL

CONTINUED FROM PRECEDING PAGE

TYPICAL OPERATING CONDITIONS AND CHARACTERISTICS

PENTODE UNIT - CLASS A₁ AMPLIFIER

PLATE VOLTAGE	100	250	VOLTS
SCREEN VOLTAGE	100	100	VOLTS
GRID VOLTAGE	-1	-1	VOLTS
PLATE CURRENT	12	12.4	MA.
SCREEN CURRENT	3.4	3.3	MA.
PLATE RESISTANCE (APPROX.)	0.2	0.7	MEGOHM
TRANSCONDUCTANCE	1975	2050	μMHOS
GRID BIAS (APPROX.) FOR TRANSCONDUCTANCE OF 10 μMHOS	-35	-35	VOLTS

DIODE UNIT

THE DIODE UNIT IS PLACED AROUND THE CATHODE, THE SLEEVE OF WHICH IS COMMON TO THE PENTODE UNIT.

SIMILAR TYPE REFERENCE: *Except for heater ratings, same characteristics and application as type 12SF7.*

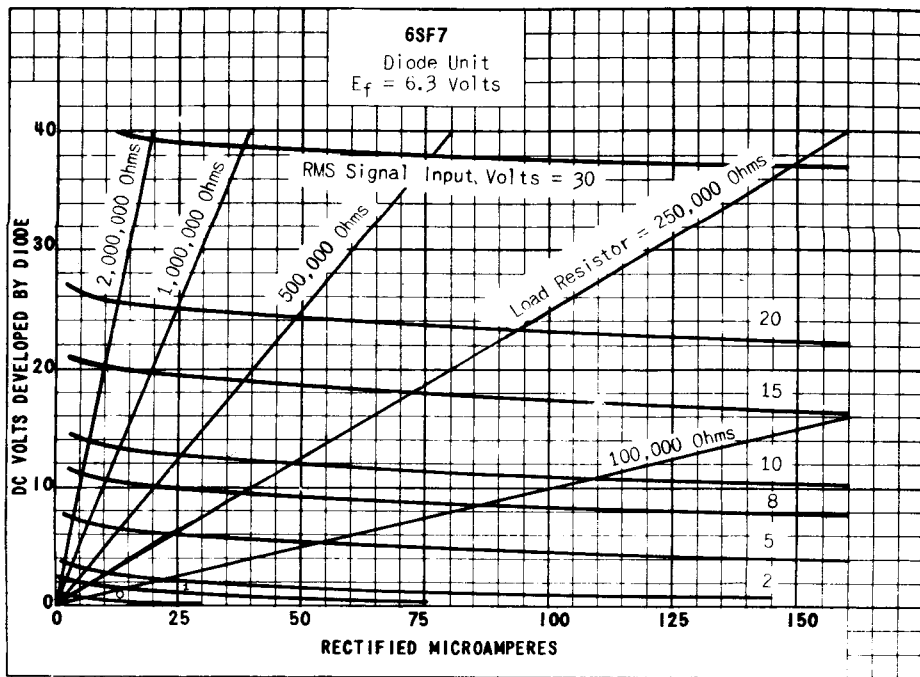
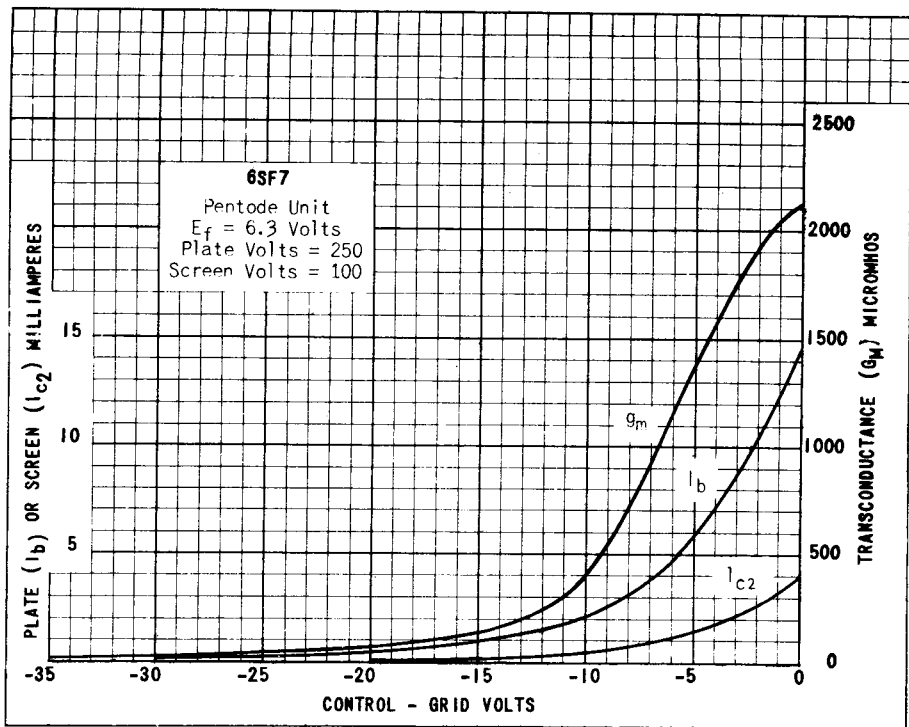

PLATE 1610
 OCT. 15 1945

PRINTED IN U. S. A.



TUNG-SOL

PENTODE

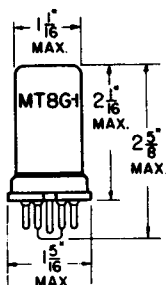

METAL SHELL

COATED UNIPOTENTIAL CATHODE

HEATER

6.3 VOLTS 300 MA.

AC OR DC

ANY MOUNTING POSITION

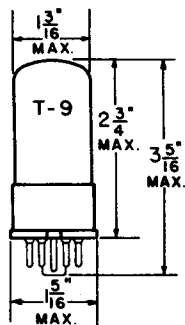

GLASS BULB

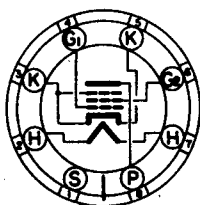

BOTTOM VIEW

SMALL WAFER
8 PIN OCTAL

THE 6SG7, 6SG7GT IS A SEMI-REMOTE CUT OFF PENTODE VOLTAGE AMPLIFIER IN THE OCTAL METAL (GLASS) CONSTRUCTION. IT FEATURES HIGH TRANSCONDUCTANCE WITH LOW GRID-PLATE CAPACITANCE AND A DUAL CATHODE CONNECTION TO MINIMIZE EFFECTS OF COMMON CATHODE CIRCUIT COUPLING.

DIRECT INTERELECTRODE CAPACITANCES

	6SG7 ^A	6SG7GT ^B	
GRID TO PLATE: (G TO P) MAX.	0.003	0.035	μuf
INPUT: G ₁ TO (H+K&G ₃ +G ₂)	8.5	8.5	μuf
OUTPUT: P TO (H+K&G ₃ +G ₂)	7	7	μuf

^A WITH SHELL CONNECTED TO CATHODE.^B WITH EXTERNAL SHIELD CONNECTED TO CATHODE.

RATINGS

INTERPRETED ACCORDING TO RMA STANDARD M8-210

HEATER VOLTAGE	6.3	VOLTS
MAXIMUM HEATER-CATHODE VOLTAGE	90	VOLTS
MAXIMUM PLATE VOLTAGE	300	VOLTS
MAXIMUM GRID #2 VOLTAGE	200	VOLTS
MAXIMUM GRID #2 SUPPLY VOLTAGE	300	VOLTS
MINIMUM EXTERNAL GRID #1 VOLTAGE	0	VOLTS
MAXIMUM PLATE DISSIPATION	3	WATTS
MAXIMUM GRID #2 DISSIPATION	0.6	WATT

CONTINUED ON NEXT PAGE

TUNG-SOL

CONTINUED FROM PRECEDING PAGE

TYPICAL OPERATING CONDITIONS AND CHARACTERISTICS

CLASS A₁ AMPLIFIER

HEATER VOLTAGE	6.3	6.3	6.3	VOLTS
HEATER CURRENT	300	300	300	MA.
PLATE VOLTAGE	100	250	250	VOLTS
GRID #2 VOLTAGE	100	125	150	VOLTS
GRID #1 VOLTAGE	-1	-1	-2.5	VOLTS
SELF BIAS RESISTOR	90	60	190	OHMS
PLATE RESISTANCE (APPROX.)	0.25	0.9	^c	MEGOMM
TRANSCONDUCTANCE	4100	4700	4000	μMHOS
PLATE CURRENT	8.2	11.8	9.2	MA.
GRID #2 CURRENT	3.2	4.4	3.4	MA.
GRID #1 VOLTAGE (APPROX.) FOR $g_m = 40 \mu\text{MHOS}$	-11.5	-14	-17.5	VOLTS

^c GREATER THAN 1.0 MEGOMM.

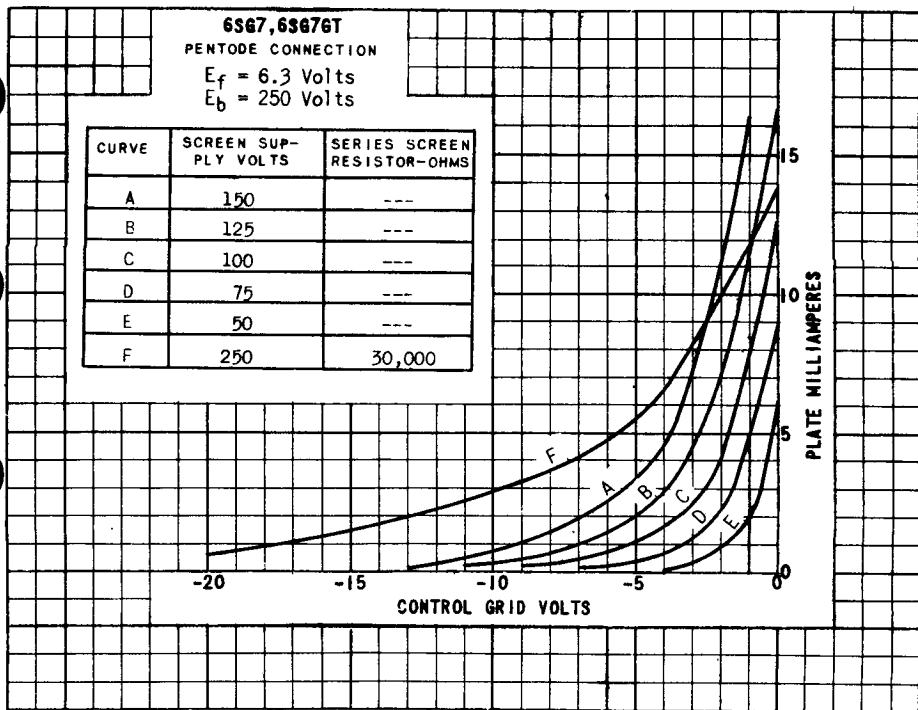
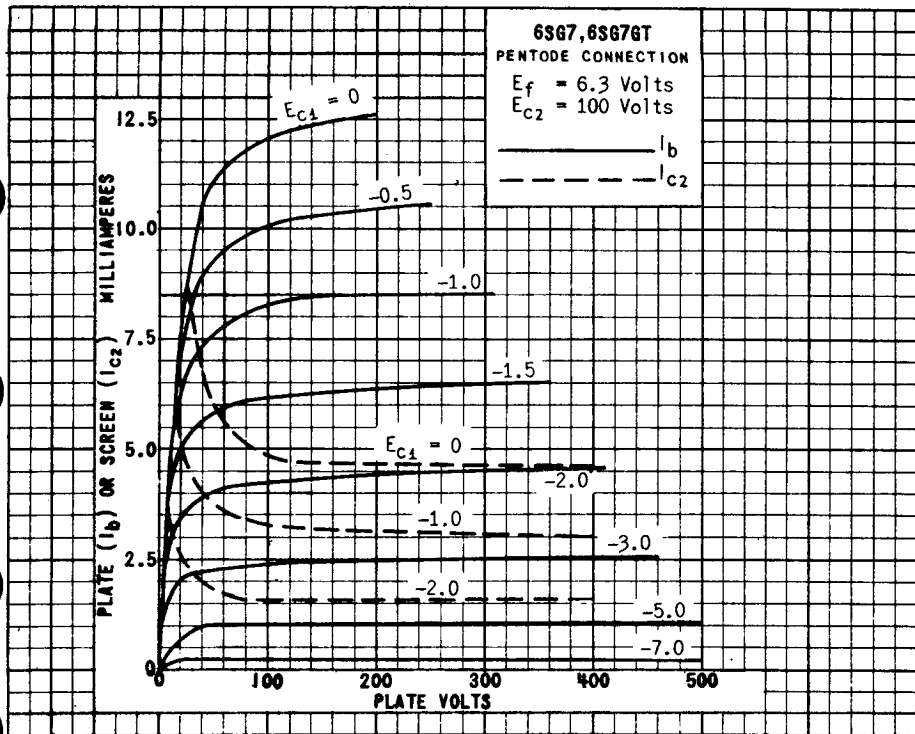

PLATE 2055
AUG. 2, 1948

6SG7, 6SG7GT (12SG7)

6SG7, 6SG7GT

PENTODE CONNECTION

$E_f = 6.3$ Volts

$E_b = 250$ Volts

CURVE	SCREEN SUPPLY VOLTS	SERIES SCREEN RESISTOR-OHMS
A	150	---
B	125	---
C	100	---
D	75	---
E	50	---
F	250	30,000

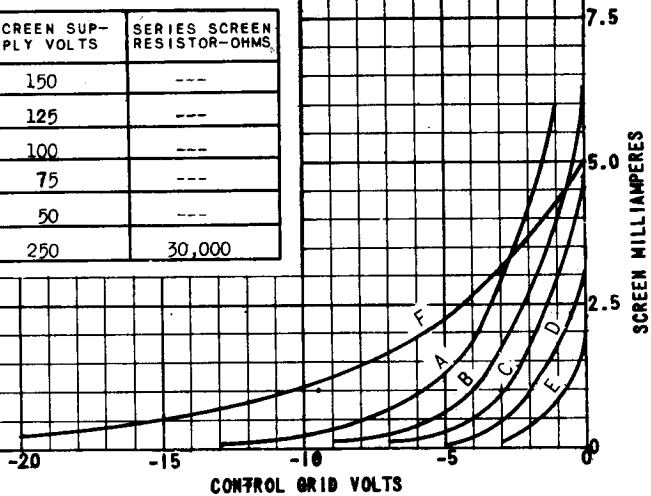

6SG7, 6SG7GT

PENTODE CONNECTION

$E_f = 6.3$ Volts

$E_b = 250$ Volts

CURVE	SCREEN SUPPLY VOLTS	SERIES SCREEN RESISTOR-OHMS
A	150	---
B	125	---
C	100	---
D	75	---
E	50	---
F	250	30,000

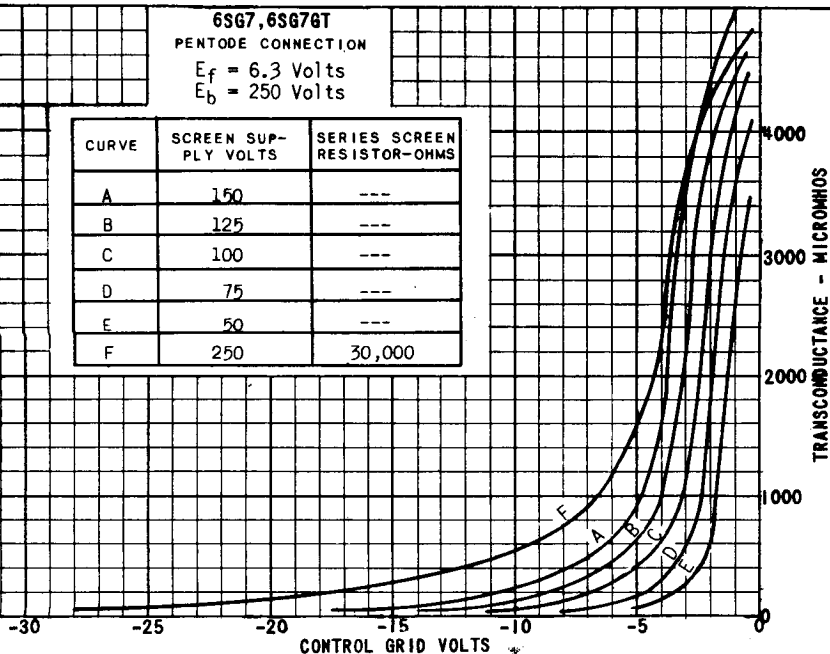
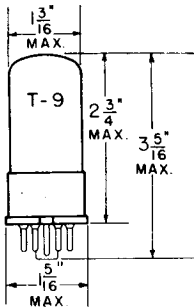

PLATE
2056
AUG. 2,
1948

TUNG-SOL

SHARP CUT-OFF RF AMPLIFIER PENTODE



COATED UNIPOTENTIAL CATHODE
6.3 VOLTS 0.3 AMPERE
AC OR DC

IN CIRCUITS WHERE THE CATHODE IS NOT DIRECTLY CONNECTED TO THE HEATER, THE POTENTIAL DIFFERENCE BETWEEN HEATER AND CATHODE SHOULD BE KEPT AS LOW AS POSSIBLE.

GLASS BULB

ANY MOUNTING POSITION

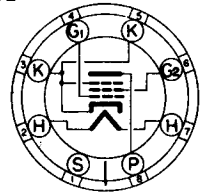

BOTTOM VIEW

SMALL WAFER 8 PIN
OCTAL AND METAL SHELL

THE 6SH7GT IS A TRIPLE GRID SHARP CUT-OFF AMPLIFIER. IT IS DESIGNED FOR SERVICE IN HIGH GAIN RF AND IF AMPLIFIER APPLICATIONS AND FOR LIMITER SERVICE IN FM RECEIVERS. THE DOUBLE CATHODE CONNECTION IS USEFUL IN REDUCING CATHODE CIRCUIT COUPLING.

RATINGS

INTERPRETED ACCORDING TO RMA STANDARD MB-210

MAXIMUM PLATE VOLTAGE	300	VOLTS
MAXIMUM SCREEN VOLTAGE	150	VOLTS
MAXIMUM SCREEN SUPPLY VOLTAGE	300	VOLTS
MAXIMUM PLATE DISSIPATION	3.0	WATTS
MAXIMUM SCREEN DISSIPATION	0.7	WATT

DIRECT INTERELECTRODE CAPACITANCES

WITH SHELL CONNECTED TO CATHODE

GRID TO PLATE	0.003 MAX.	μf
INPUT	8.5	μf
OUTPUT	7.0	μf

TYPICAL OPERATING CONDITIONS AND CHARACTERISTICS

PLATE VOLTAGE	100	250	VOLTS
SCREEN VOLTAGE	100	150	VOLTS
GRID VOLTAGE	-1.0	-1.0	VOLT
PLATE RESISTANCE (APPROX.)	0.35	0.90	MEG OHM
TRANSCONDUCTANCE	4 000	4 900	μMHOS
PLATE CURRENT	5.3	10.8	MA.
SCREEN CURRENT	2.1	4.1	MA.
GRID BIAS FOR PLATE CURRENT CUT-OFF (10 μA)	-4.0	-5.5	VOLTS

SIMILAR TYPE REFERENCES: Somewhat similar to type 7L7.

PLATE
1581

JULY 31,
1945

6SH7GT

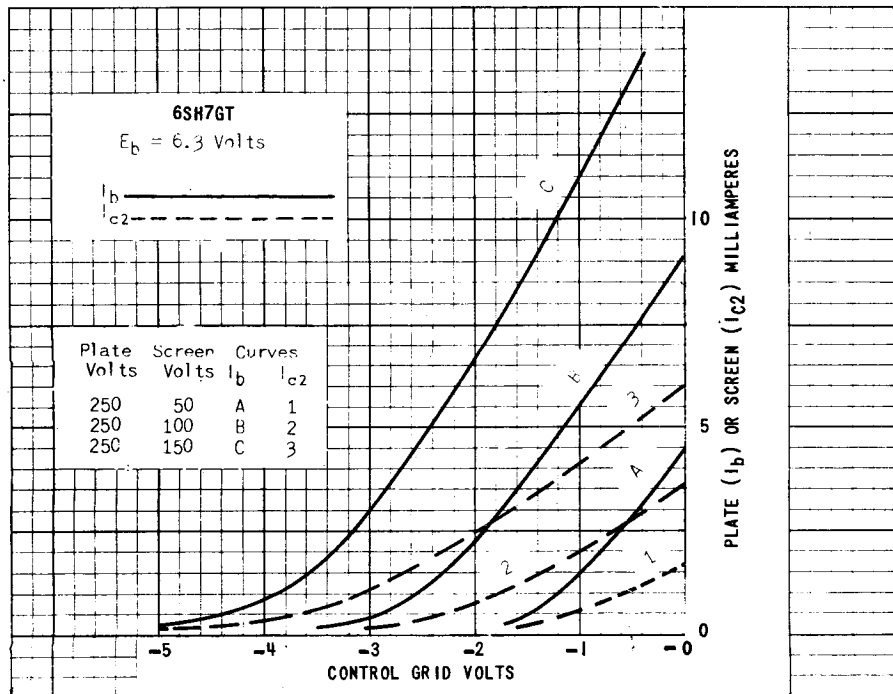
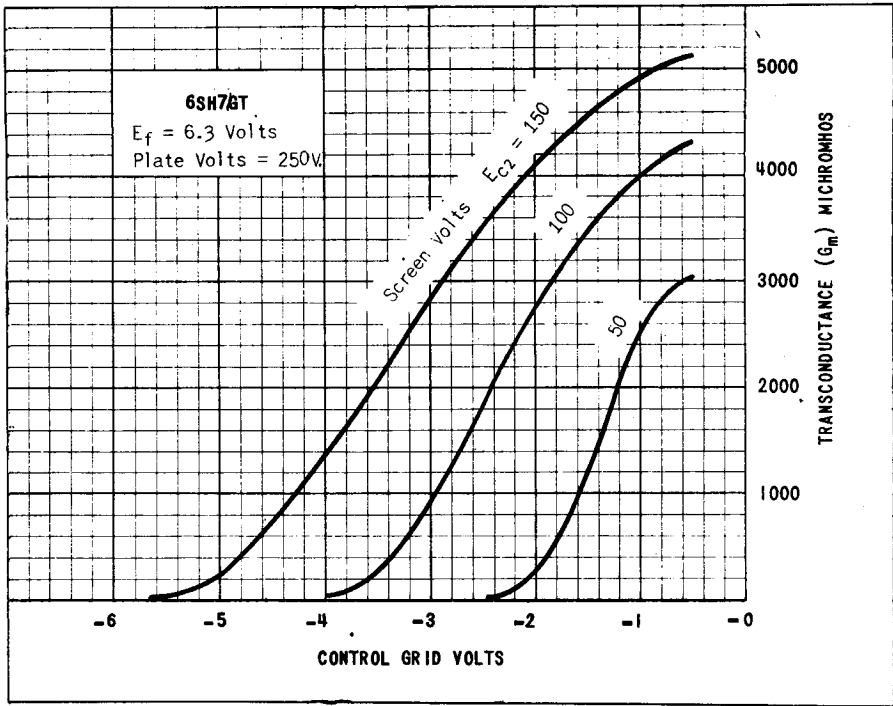
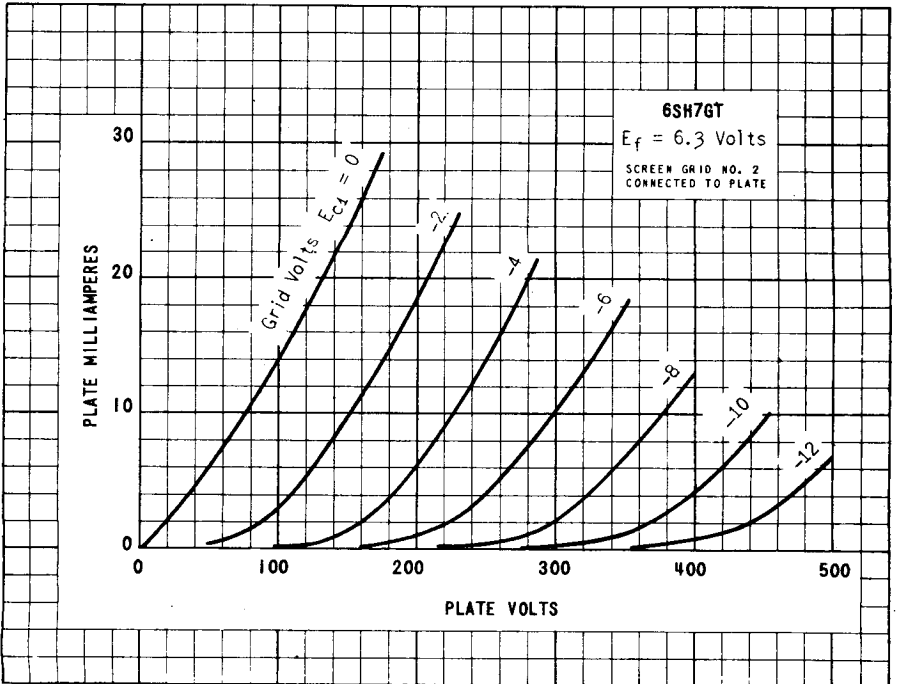
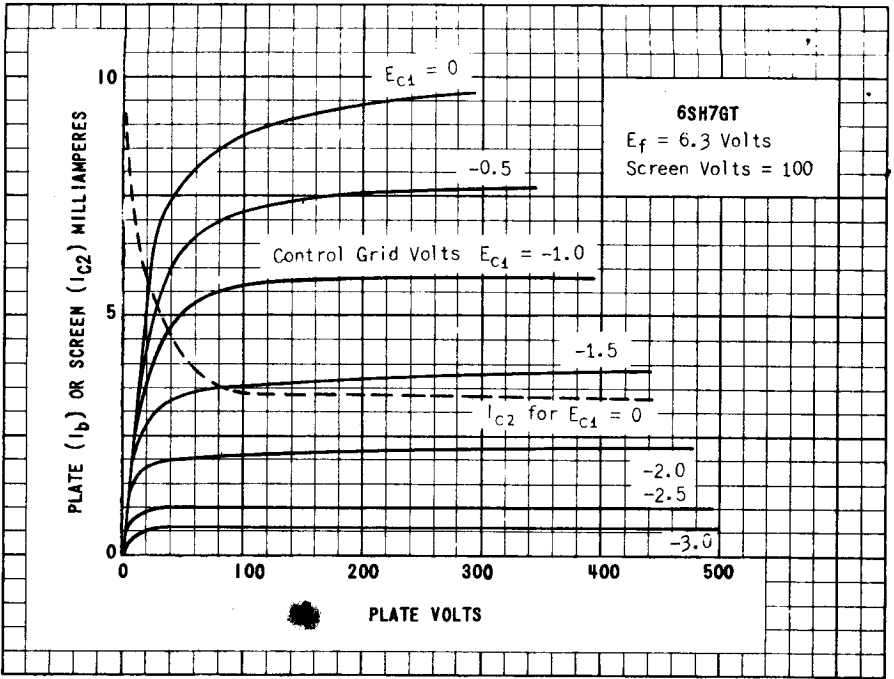
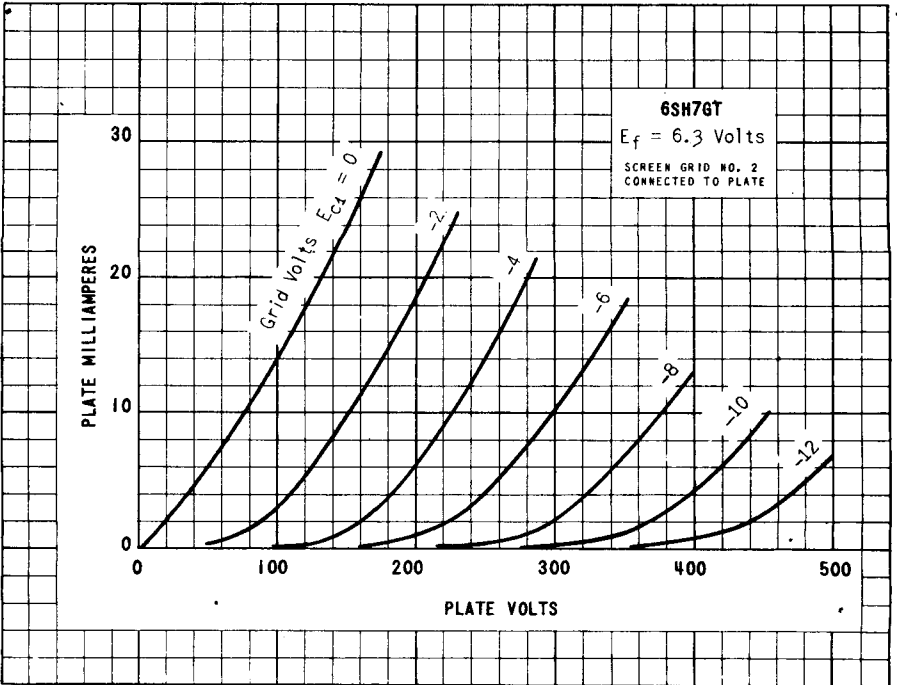
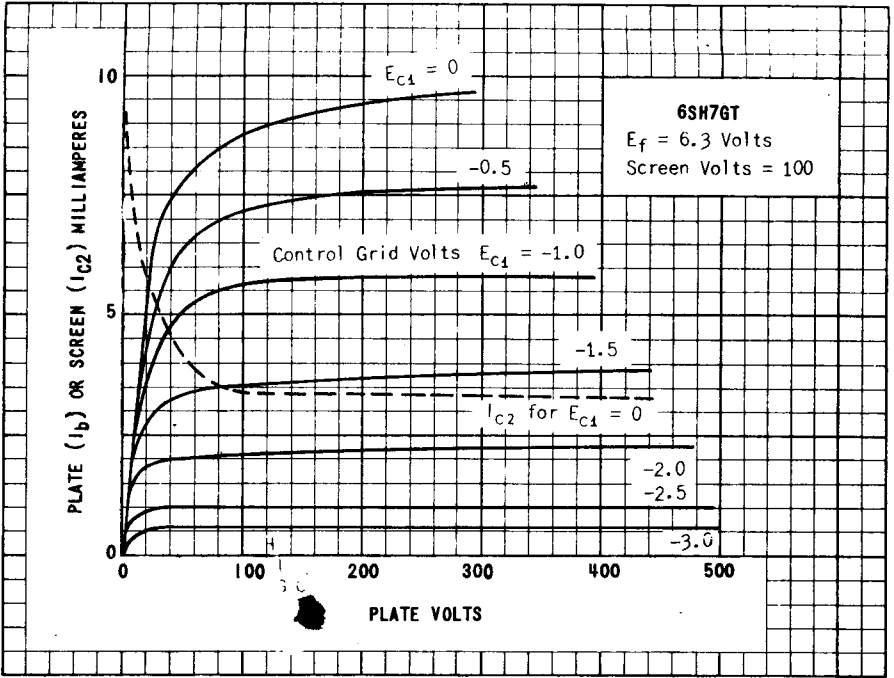

PLATE
 1582
 JULY 31,
 1945





6SH7GT



PRINTED IN U. S. A.

PLATE 1583
 JULY 31 1945



TUNG-SOL

RF PENTODE AMPLIFIER

PHYSICAL SPECIFICATIONS

EMITTER COATED UNIPOT. CATHODE		PIN CONNECTIONS	
BASE SMALL WAFER OCTAL 8-PIN	METAL SHELL	PIN 1 BASE SHELL, INTERNAL SHIELD	
		PIN 2 HEATER	PIN 7 HEATER
BULB T-9		PIN 3 CATHODE, G3	PIN 8 PLATE
MAXIMUM DIAMETER 1 5/16"		PIN 4 GRID 1	
MAXIMUM OVERALL LENGTH 3"		PIN 5 CATHODE, G3	
MAXIMUM SEATED HEIGHT 2 15/32"		PIN 6 GRID 2	MOUNTING POS. ANY

RATINGS

INTERPRETED ACCORDING TO RMA STANDARD MB-210

HEATER OR FILAMENT VOLTAGE (AC OR DC)	6.3	VOLTS
HEATER OR FILAMENT CURRENT	0.300	AMP.
MAXIMUM PLATE VOLTAGE	300	VOLTS
MAXIMUM SCREEN VOLTAGE	150	VOLTS
MAXIMUM PLATE DISSIPATION	3.0	WATTS
MAXIMUM SCREEN DISSIPATION	0.7	WATT
MAXIMUM SCREEN SUPPLY VOLTAGE	300	VOLTS
MINIMUM EXTERNAL CONTROL GRID VOLTAGE	0	VOLTS

CAPACITANCES

CONTROL GRID TO CATHODE	8.5	μ uf
PLATE TO CATHODE	7.0	μ uf
CONTROL GRID TO PLATE (MAX.)	0.0035	μ uf

TYPICAL OPERATING CONDITIONS AND CHARACTERISTICS
CLASS A₁ AMPLIFIER

HEATER OR FILAMENT VOLTAGE	6.3	6.3	VOLTS
HEATER OR FILAMENT CURRENT	0.300	0.300	AMP.
PLATE VOLTAGE (DC)	100	250	VOLTS
SCREEN VOLTAGE (DC)	100	150	VOLTS
CONTROL GRID VOLTAGE (DC)	-1	-1	VOLT
SUPPRESSOR VOLTAGE (DC)	0	0	VOLTS
PLATE CURRENT (DC)	5.3	10.8	MA.
SCREEN CURRENT (DC)	2.1	4.1	MA.
MAXIMUM-SIGNAL PLATE CURRENT			MA.
MAXIMUM-SIGNAL SCREEN CURRENT			MA.
PLATE RESISTANCE (APPROX.)	0.35	0.90	MEG OHM
TRANSCONDUCTANCE	4000	4900	UMHOS
AMPLIFICATION FACTOR			
LOAD RESISTANCE			OHMS
TOTAL HARMONIC DISTORTION			PER CENT
POWER OUTPUT			WATTS
CONTROL GRID VOLTAGE (DC) FOR I _b = 10 μ A (DC)	-4	-5.5	VOLTS

PLATE
1706
APRIL 15
1946



TUNG-SOL

TRIPLE-GRID DETECTOR AMPLIFIER

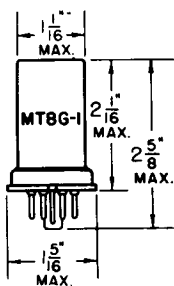

METAL SHELL
SMALL WAFER OCTAL
8 PIN BASE
6SJ7, 12SJ7

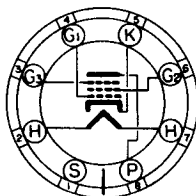

BOTTOM VIEW
6SJ7, 6SJ7GT
12SJ7, 12SJ7GT

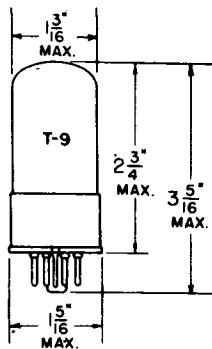

GLASS BULB
SMALL WAFER OCTAL 8 PIN
BASE WITH METAL SLEEVE
6SJ7GT, 12SJ7GT

UNI-POTENTIAL CATHODE

HEATER

6SJ7, 6SJ7GT - 6.3 V. 0.3 A.
12SJ7, 12SJ7GT - 12.6 V. 0.15 A.

AC OR DC

IN CIRCUITS WHERE THE CATHODE IS NOT DIRECTLY CONNECTED TO THE HEATER, THE POTENTIAL DIFFERENCE BETWEEN THE HEATER AND CATHODE SHOULD BE KEPT AS LOW AS POSSIBLE. UNDER NO CONDITIONS SHOULD IT EXCEED 100 VOLTS.

THESE TUBES ARE SINGLE ENDED PENTODES HAVING SHARP CUT-OFF CHARACTERISTICS. THEY MAY BE USED AS BIASED DETECTORS, RADIO FREQUENCY OSCILLATORS OR AS MIXER TUBES IN PROPERLY DESIGNED CIRCUITS. WITH THE EXCEPTION OF HEATER AND CAPACITANCE RATINGS, THEIR ELECTRICAL CHARACTERISTICS ARE IDENTICAL.

RATINGS

INTERPRETED ACCORDING TO RMA STANDARD MB-210

MAXIMUM PLATE VOLTAGE	300	VOLTS
MAXIMUM SCREEN VOLTAGE	125	VOLTS
MAXIMUM SCREEN SUPPLY VOLTAGE	300	VOLTS
MINIMUM GRID VOLTAGE	0	VOLTS
MAXIMUM PLATE DISSIPATION	2.5	WATTS
MAXIMUM SCREEN DISSIPATION	0.3	WATTS

CONTINUED NEXT PAGE

6SJ7, 6SJ7GT (12SJ7, 12SJ7GT)

TUNG-SOL

DIRECT INTERELECTRODE CAPACITANCES

SHELL CONNECTED TO CATHODE

	6SJ7-12SJ7	6SJ7GT-12SJ7GT	
GRID TO PLATE	0.005 MAX.	0.005 MAX.	$\mu\mu f$
INPUT	6.0	6.3	$\mu\mu f$
OUTPUT	7.0	10.0	$\mu\mu f$

TYPICAL OPERATING CONDITIONS AND CHARACTERISTICS

CLASS A₁ AMPLIFIER

	6SJ7-12SJ7	6SJ7GT-12SJ7GT	
PLATE VOLTAGE	100	250	VOLTS
SCREEN VOLTAGE	100	100	VOLTS
GRID VOLTAGE	-3	-3	VOLTS
SUPPRESSOR	TIE TO CATHODE		
PLATE CURRENT	2.9	3.0	MA.
SCREEN CURRENT	0.9	0.8	MA.
PLATE RESISTANCE (APPROX.)	0.7	1.5	MEG OHMS
TRANSCONDUCTANCE	1575	1650	μMHOS
GRID VOLTAGE (FOR CATHODE CURRENT CUT-OFF)	-9	-9	VOLTS

PLATE
1436
JUNE 15
1944

(12SJ7, 12SJ7GT) 6SJ7, 6SJ7GT

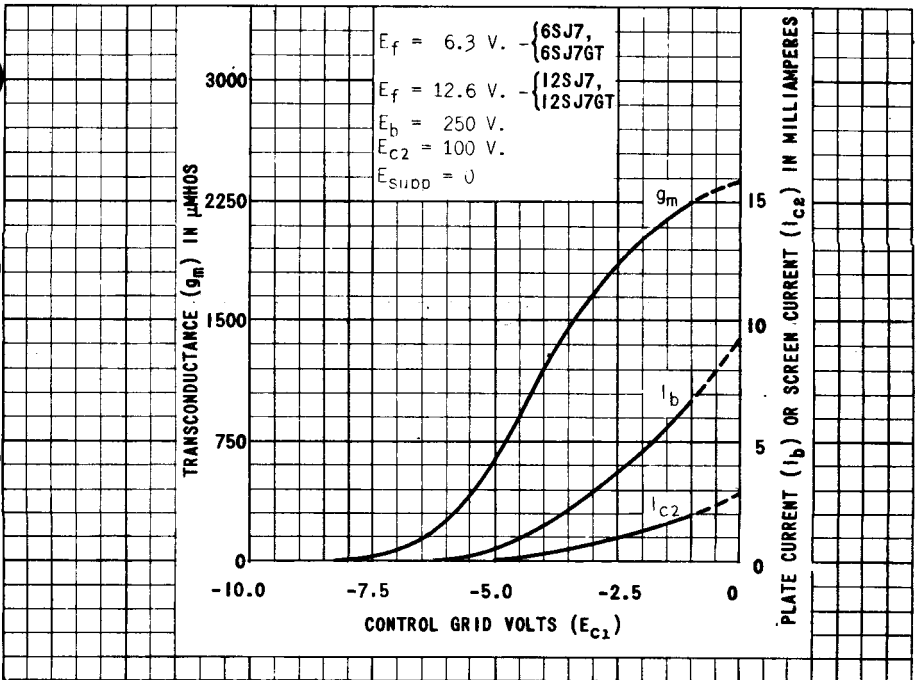
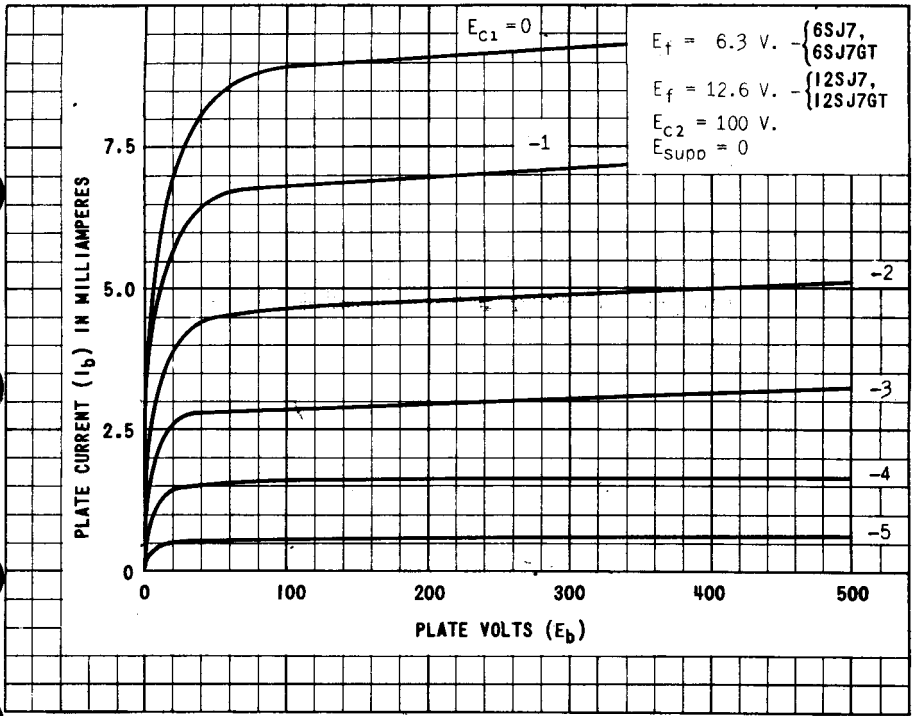

PLATE
1437
JUNE 15
1944



TUNG-SOL

TRIPLE GRID

REMOTE CUT-OFF AMPLIFIER

UNIPOTENTIAL CATHODE

HEATER

6.3 VOLTS 0.3 AMPERE

AC OR DC

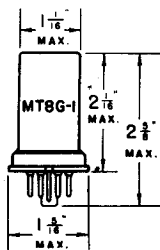

METAL SHELL
6SK7

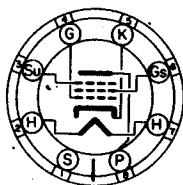

8N

BOTTOM VIEW

SMALL WAFER 8 PIN OCTAL BASE

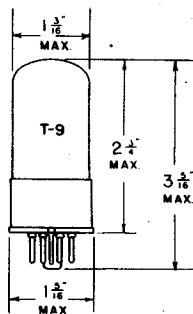

GLASS BULB
6SK7GT/G

THE TUNG-SOL 6SK7 AND 6SK7GT/G ARE TRIPLE GRID VARIABLE μ AMPLIFIERS. THEY ARE DESIGNED FOR USE WITH AVC IN RF AND IF AMPLIFIERS, AND THEY MINIMIZE CROSS MODULATION. WITH THE EXCEPTION OF HEATER RATINGS, THEIR RATINGS AND ELECTRICAL CHARACTERISTICS ARE IDENTICAL WITH THOSE OF THE 12SK7 AND 12SK7GT/G.

RATINGS

MAXIMUM PLATE VOLTAGE	300	VOLTS
MAXIMUM SCREEN SUPPLY VOLTAGE	300	VOLTS
MAXIMUM SCREEN VOLTAGE	125	VOLTS
MINIMUM EXTERNAL CONTROL GRID BIAS VOLTAGE	0	VOLTS
MAXIMUM PLATE DISSIPATION	4.0	WATTS
MAXIMUM SCREEN DISSIPATION	0.4	WATT

FOR "INTERPRETATION OF RATINGS" REFER TO FRONT OF BOOK.

CONTINUED NEXT PAGE

6SK7, 6SK7GT/G

TUNG-SOL

DIRECT INTERELECTRODE CAPACITANCES^s

	6SK7	6SK7GT/G	
CONTROL GRID TO CATHODE	6.0	6.5	$\mu\mu\text{f}$
PLATE TO CATHODE	7.0	7.5	$\mu\mu\text{f}$
CONTROL GRID TO PLATE	0.003 ^{MAX.}	0.005 ^{MAX.}	$\mu\mu\text{f}$

^s WITH SHELL CONNECTED TO CATHODE.

TYPICAL OPERATING CONDITIONS AND CHARACTERISTICS

CLASS A₁ AMPLIFIER

PLATE VOLTAGE	100	250	VOLTS
SCREEN VOLTAGE	100	100	VOLTS
CONTROL GRID VOLTAGE	-1	-3	VOLTS
SUPPRESSOR GRID	CONNECTED TO CATHODE AT SOCKET		
PLATE CURRENT	13	9.2	MA.
SCREEN CURRENT	4.0	2.6	MA.
PLATE RESISTANCE APPROX.	0.12	0.8	MEGOHM
TRANSCONDUCTANCE	2350	2000	μMHOS
CONTROL GRID VOLTAGE	-35	-35	VOLTS

FOR TRANSCONDUCTANCE = 10 μMHOS

35 -

24

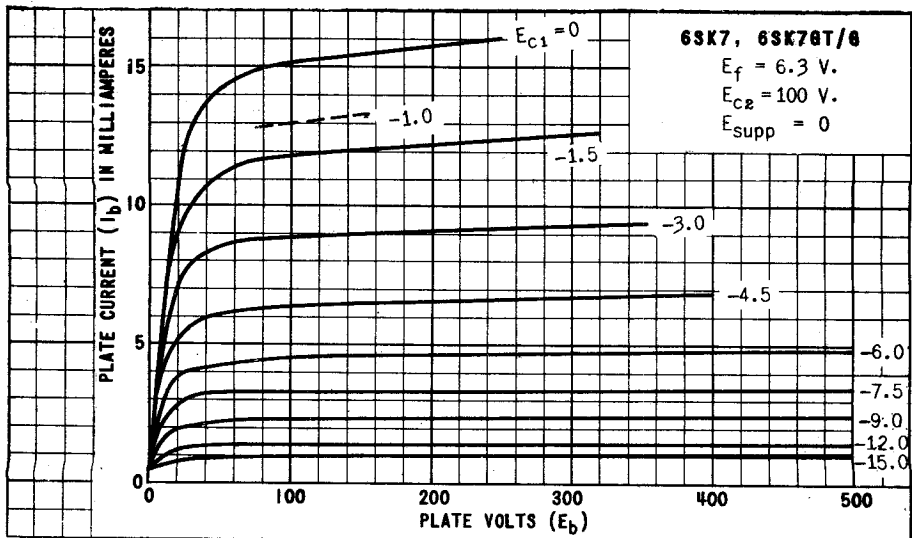
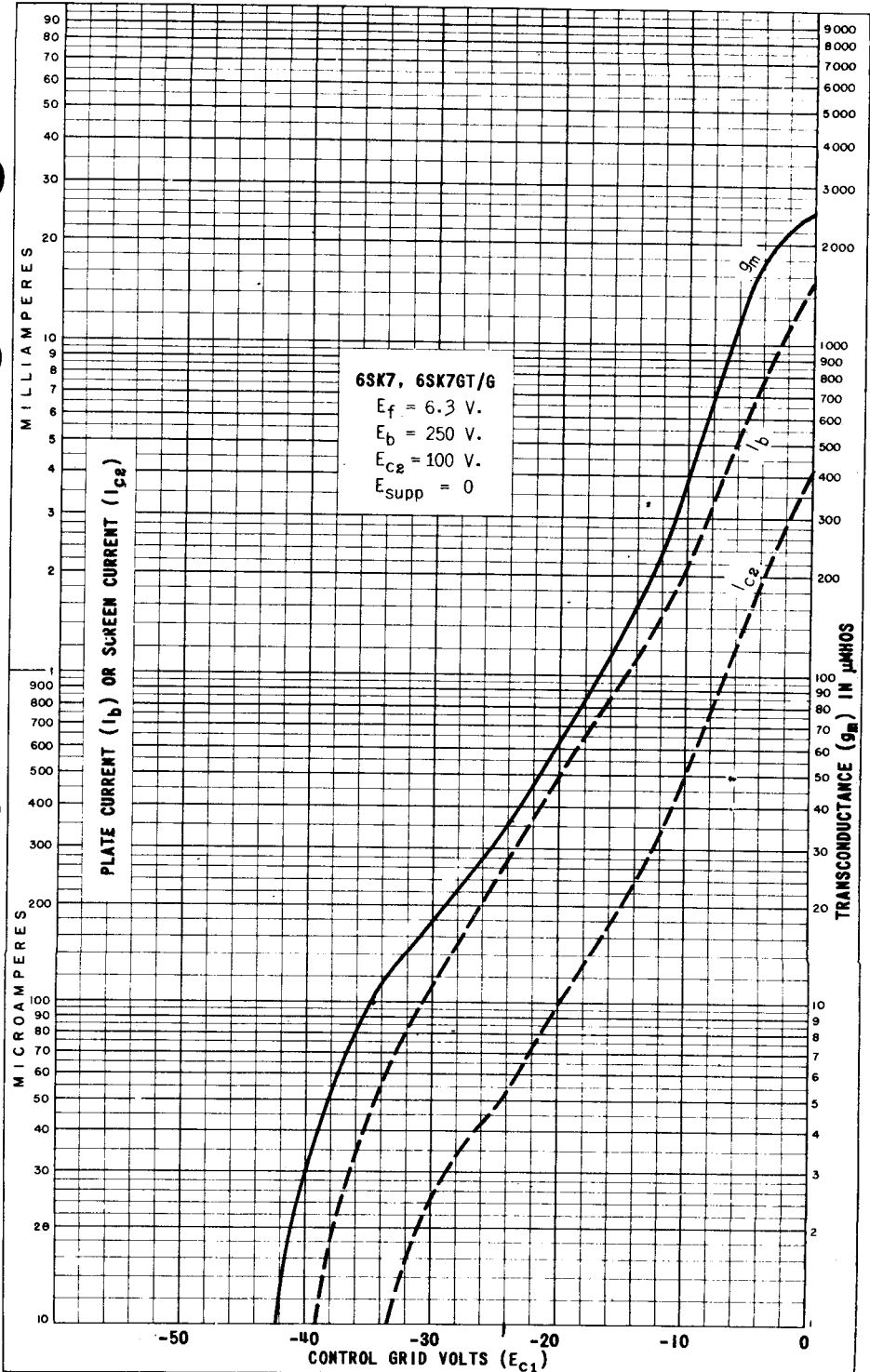
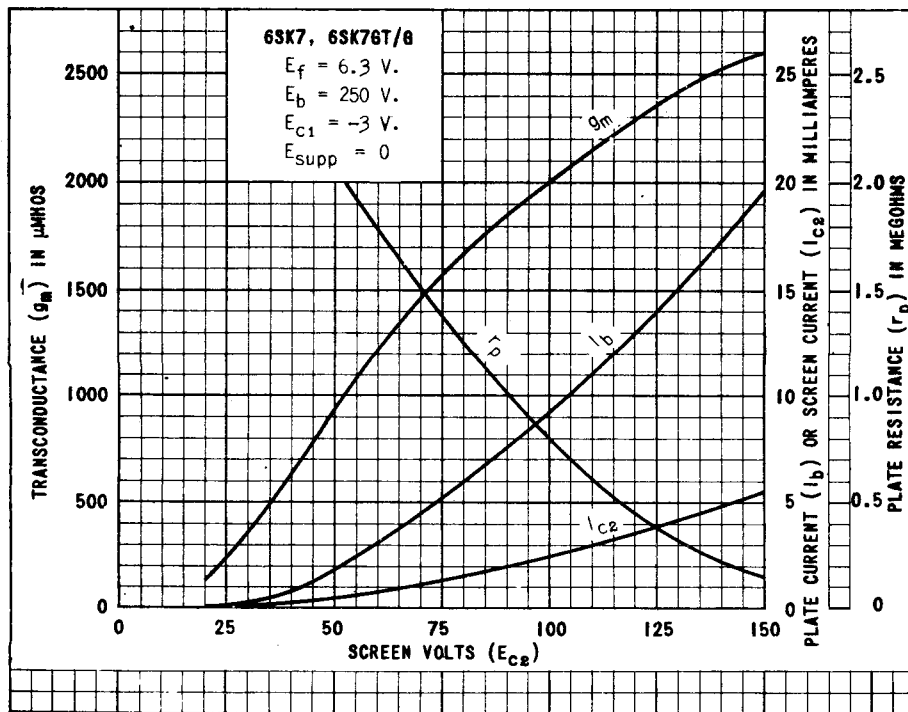
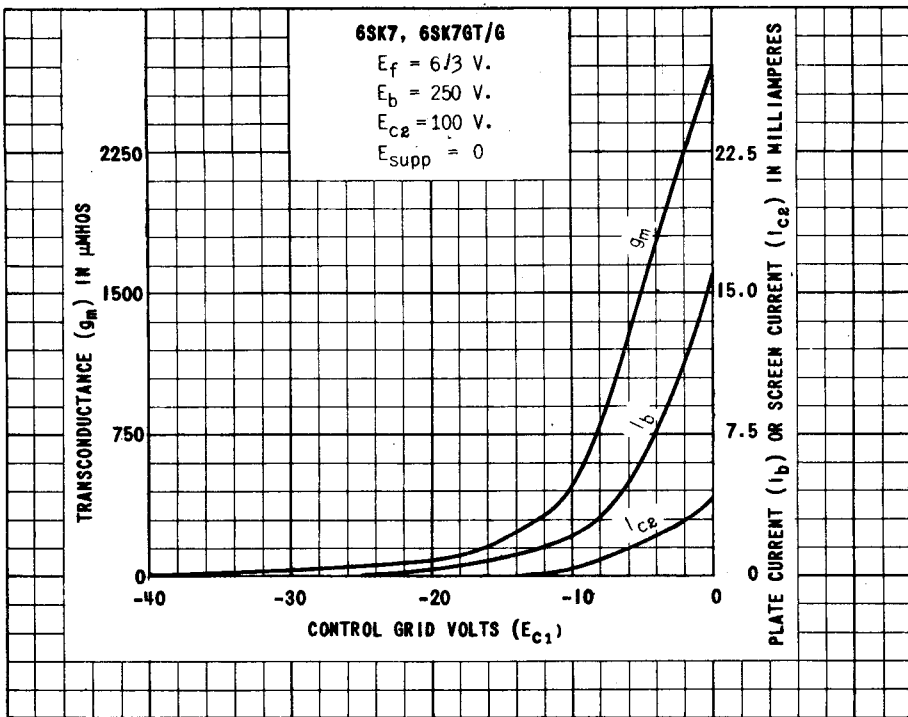

PLATE
1113-1



6SK7, 6SK7GT/G



TUNG-SOL

TWIN-TRIODE AMPLIFIER

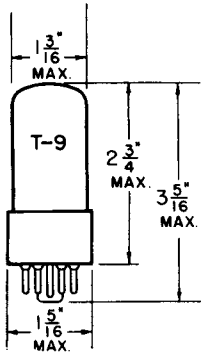

GLASS BULB

COATED UNIPOTENTIAL CATHODES

HEATER
6.3 VOLTS 0.3 AMPERE
AC OR DC

ANY MOUNTING POSITION

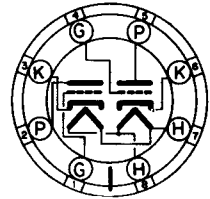

BOTTOM VIEW

INTERMEDIATE SHELL
8-PIN OCTAL

THE 6SL7GT IS A TWIN-TRIODE AMPLIFIER WITH HIGH AMPLIFICATION FACTORS DESIGNED PRIMARILY FOR PHASE INVERTER SERVICE. THE TWO CATHODES ARE CONNECTED TO SEPARATE PINS.

RATINGS

INTERPRETED ACCORDING TO RMA STANDARD M8-217.

AMPLIFIER - PER UNIT

HEATER VOLTAGE (AC OR DC)	6.3	VOLTS
HEATER CURRENT	0.3	AMP.
MAX. PLATE VOLTAGE	250	VOLTS
MIN. GRID VOLTAGE	0	VOLTS
MAX. PLATE DISSIPATION	1	WATT
HEATER-CATHODE VOLTAGE	AS LOW AS POSSIBLE	

DIRECT INTERELECTRODE CAPACITANCES (APPROX.)

WITH CLOSE-FITTING SHIELD CONNECTED TO CATHODE

	TRIODE UNIT T ₁	TRIODE UNIT T ₂	
GRID TO PLATE	2.8	2.8	μuf
GRID TO CATHODE	3.0	3.4	μuf
PLATE TO CATHODE	3.8	3.2	μuf
PLATE TO PLATE		0.4	μuf
GRID TO GRID		0.65	μuf
GRID T ₂ TO PLATE T ₁		0.13	μuf

CONTINUED ON FOLLOWING PAGE

PLATE
1611
OCT. 15,
1945

TUNG-SOL

CONTINUED FROM PRECEDING PAGE

TYPICAL OPERATING CONDITIONS AND CHARACTERISTICS

CLASS A₁ AMPLIFIER - PER UNIT

PLATE VOLTAGE	250	VOLTS
GRID VOLTAGE	-2	VOLTS
PLATE CURRENT	2.3	MA.
PLATE RESISTANCE	44000	OHMS
TRANSCONDUCTANCE	1600	μMHOS
AMPLIFICATION FACTOR	70	

SIMILAR TYPE REFERENCE: Same characteristics as types 7F7, 12SL7GT; somewhat similar to types 6SC7GT, 12SC7GT.

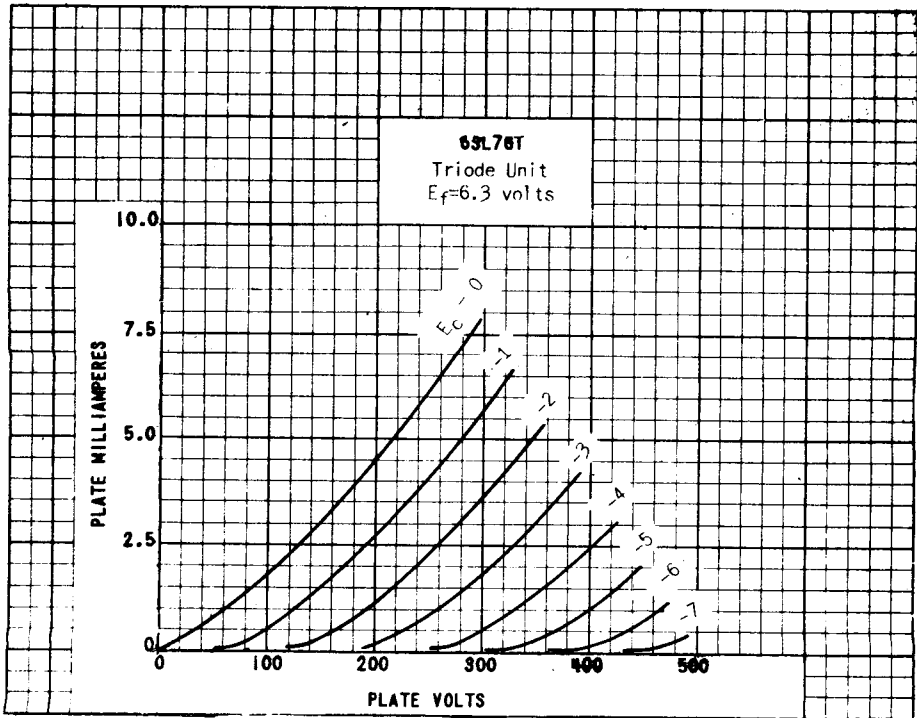
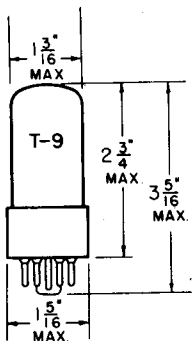

PLATE
1612
OCT. 15,
1945

TUNG-SOL

TWIN-TRIODE AMPLIFIER



COATED UNIPOTENTIAL CATHODE
6.3 VOLTS 0.6 AMPERE
AC OR DC

IN CIRCUITS WHERE THE CATHODE IS NOT DIRECTLY CONNECTED TO THE HEATER, THE POTENTIAL DIFFERENCE BETWEEN HEATER AND CATHODE SHOULD BE KEPT AS LOW AS POSSIBLE.

GLASS BULB

ANY MOUNTING POSITION

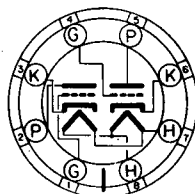

BOTTOM VIEW

INTERMEDIATE SHELL
OCTAL 8 PIN BASE

THE 6SN7GT IS A TWIN LOW MU TRIODE WHOSE SECTIONS ARE ELECTRICALLY INDEPENDENT EXCEPT FOR THE COMMON HEATER. IT IS USEFUL AS OSCILLATOR, CONVERTER, MULTI-VIBRATOR, AS WELL AS AUDIO AMPLIFIER.

RATINGS

INTERPRETED ACCORDING TO RMA STANDARD MB-210

AMPLIFIER - EACH UNIT

MAXIMUM PLATE VOLTAGE	300	VOLTS
MINIMUM GRID VOLTAGE	0	VOLTS
MAXIMUM PLATE DISSIPATION	2.5	WATTS

DIRECT INTERELECTRODE CAPACITANCES (APPROX.)

WITH CLOSE-FITTING SHIELD CONNECTED TO CATHODE

	TRIODE UNIT T ₁	TRIODE UNIT T ₂	
GRID TO PLATE	3.8	4.0	μuf
GRID TO CATHODE	2.8	3.0	μuf
PLATE TO CATHODE	.8	1.2	μuf

TYPICAL OPERATING CONDITIONS AND CHARACTERISTICS

CLASS A₁ AMPLIFIER

PLATE VOLTAGE	90	250	VOLTS
GRID VOLTAGE ^A	0	-8	VOLTS
AMPLIFICATION FACTOR	20	20	
PLATE RESISTANCE	6 700	7 700	OHMS
TRANSCONDUCTANCE	3 000	2 600	μMHOS
PLATE CURRENT	10	9	MA.

^A THE D-C RESISTANCE IN THE GRID CIRCUIT SHOULD NOT EXCEED 1.0 MEGOHM UNDER MAXIMUM RATED CONDITIONS PER UNIT.

CONTINUED NEXT PAGE

PRINTED IN U. S. A.

PLATE
1504
JULY 31,
1945

TUNG-SOL

CONTINUED FROM PRECEDING PAGE

TYPICAL OPERATING CONDITIONS AND CHARACTERISTICS

RESISTANCE COUPLED AMPLIFIER

VALUES ARE FOR ONE TRIODE UNIT

PLATE-SUPPLY VOLTAGE	90	180	300 ✓	VOLTS
PLATE RESISTOR	0.1	0.1	0.1	MEGOHM
GRID RESISTOR (FOR FOLLOWING STAGE)	0.25	0.25	0.25	MEGOHM
CATHODE RESISTOR	3 940	2 830	2 440 ✓	OHMS
CATHODE BY-PASS CONDENSER	1.29	1.35	1.42	μF
BLOCKING CONDENSER	0.012	0.012	0.0125	μF
VOLTAGE OUTPUT ^B	17	34	56	PEAK VOLTS
VOLTAGE GAIN ^C	13	14	14	

^B VOLTAGE ACROSS GRID RESISTOR (FOR FOLLOWING STAGE) AT GRID-CURRENT POINT.

^C AT 5.0 VOLTS (RMS) OUTPUT.

SIMILAR TYPE REFERENCE: Same ratings, characteristics and application for each unit, as types 6J5, 6J5G, 6J5GT, 6P6G. Except for heater ratings, characteristics same as types 12SN7GT, 12J7GT, 1833.

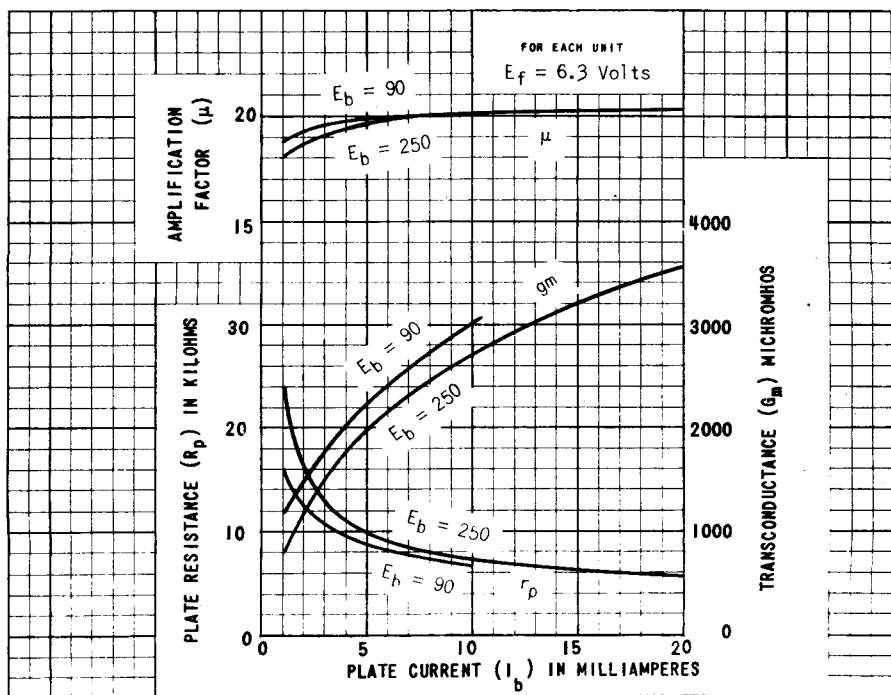
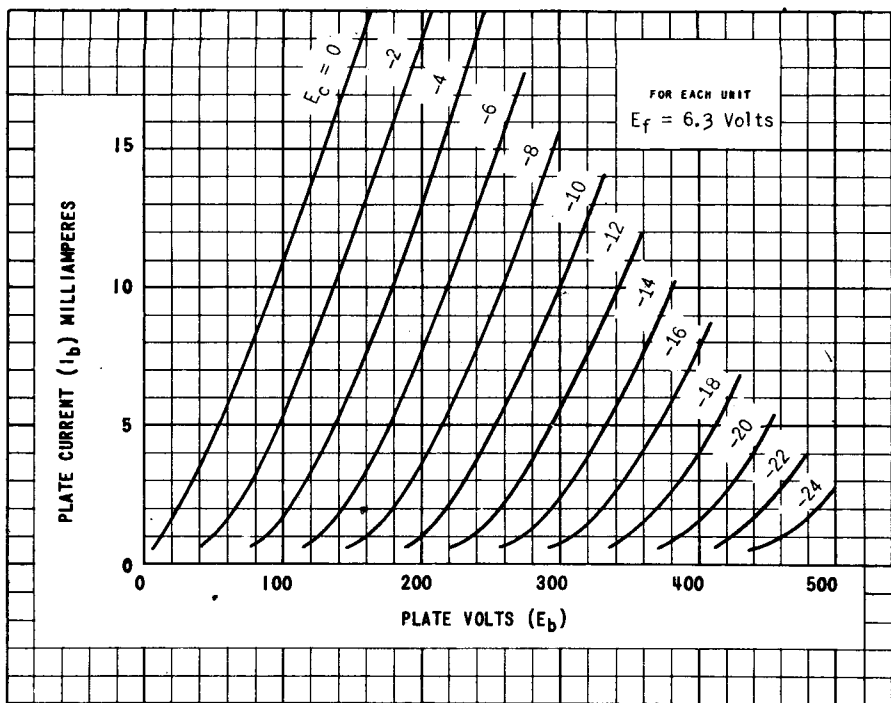

PRINTED IN U. S. A.

PLATE 1586
JULY 31, 1945

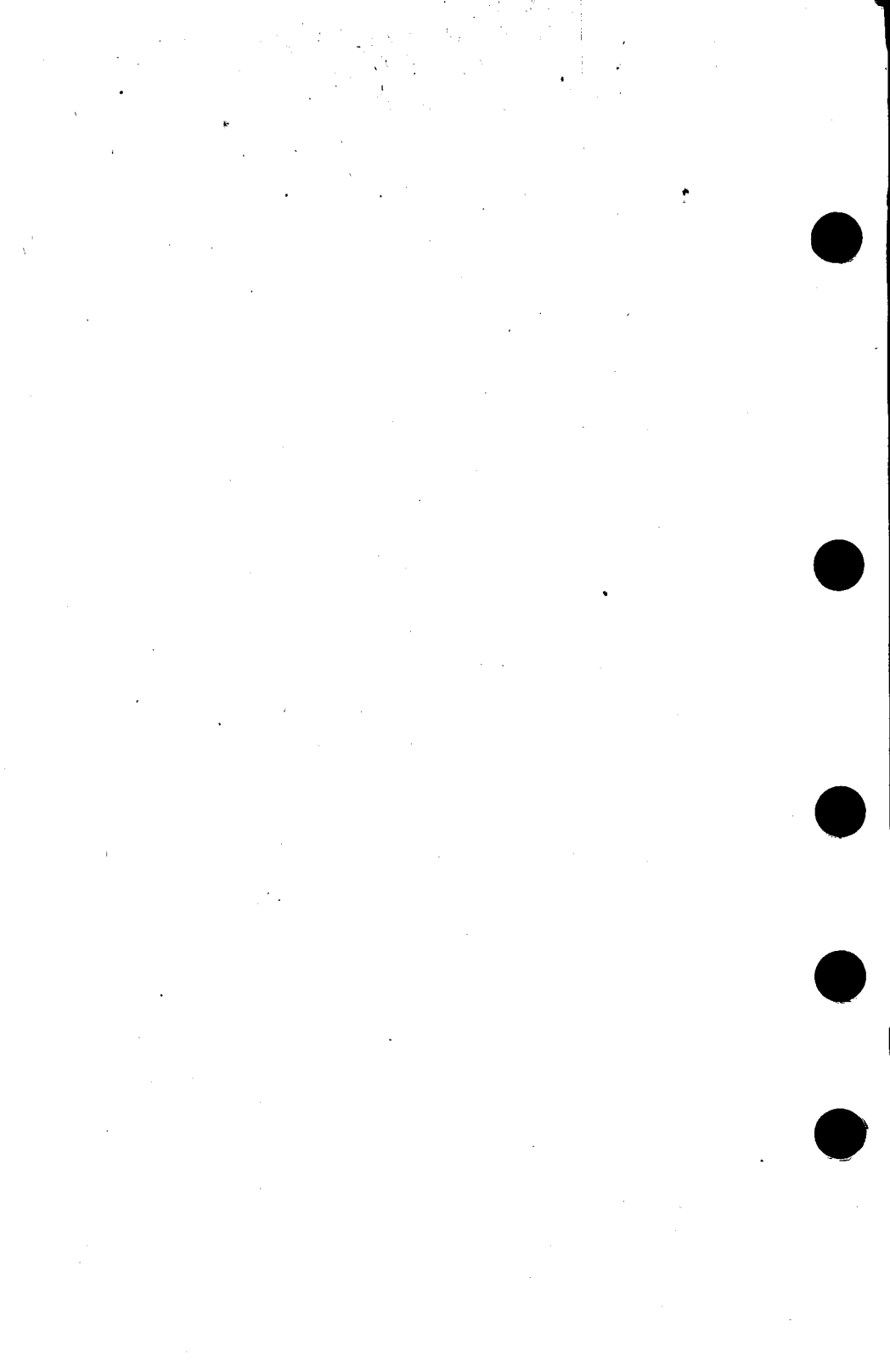

TUNG-SOL

DOUBLE-DIODE TRIODE

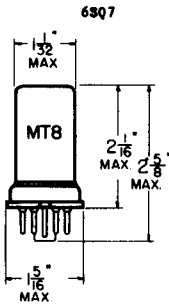

METAL SHELL



BOTTOM VIEW
SMALL WAFER
8-PIN OCTAL

COATED UNIPOTENTIAL CATHODE

HEATER
6.3 VOLTS 300 MA.
AC OR DC

ANY MOUNTING POSITION

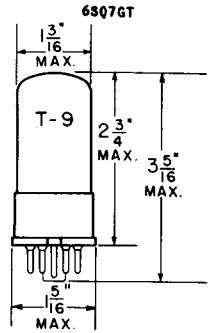

GLASS BULB



BOTTOM VIEW
SMALL WAFER
8-PIN OCTAL
METAL SLEEVE

THE 6SQ7 AND 6SQ7GT COMBINE TWO DIODE UNITS AND A HIGH-MU TRIODE IN A SINGLE ENVELOPE. EACH SECTION USES A COMMON CATHODE. IT IS INTENDED FOR SERVICE AS A COMBINED DETECTOR, AVC SOURCE, AND HIGH GAIN AUDIO AMPLIFIER.

DIRECT INTERELECTRODE CAPACITANCES - APPROX.

	6SQ7 ^A	6SQ7GT ^B	
GRID TO PLATE: (G TO P)	1.6	1.8	μμf
INPUT: G TO (H + K)	3.2	4.2	μμf
OUTPUT: P TO (H + K)	3.0	3.4	μμf

^A WITH SHELL CONNECTED TO CATHODE.

^B WITH NO EXTERNAL SHIELD.

RATINGS

INTERPRETED ACCORDING TO RMA STANDARD MG-210

HEATER VOLTAGE	6.3	VOLTS
MAXIMUM HEATER-CATHODE VOLTAGE	90	VOLTS
MAXIMUM PLATE VOLTAGE	300	VOLTS
MINIMUM DIODE CURRENT EACH PLATE WITH 10 VOLTS APPLIED	0.8	MA.
MAXIMUM DIODE CURRENT EACH PLATE FOR CONTINUOUS OPERATION	1.0	MA.

CONTINUED ON FOLLOWING PAGE

→ INDICATES A CHANGE OR ADDITION.

PRINTED IN U. S. A.

PLATE
1925
DEC. 1,
1947

CONTINUED FROM PRECEDING PAGE

TYPICAL OPERATING CONDITIONS AND CHARACTERISTICS

CLASS A₁ AMPLIFIER - TRIODE UNIT

HEATER VOLTAGE	6.3	6.3	VOLTS
HEATER CURRENT	300	300	MA.
PLATE VOLTAGE	100	250	VOLTS
GRID VOLTAGE	-1	-2	VOLTS
PLATE CURRENT	0.4	0.9	MA.
PLATE RESISTANCE	110 000	91 000	OHMS
TRANSCONDUCTANCE	900	1 100	μMHOS
AMPLIFICATION FACTOR	100	100	

DIODE UNITS - TWO

THE TWO DIODE PLATES ARE PLACED AROUND THE CATHODE AND ARE INDEPENDENT OF THE TRIODE UNIT EXCEPT FOR THE COMMON CATHODE.

SIMILAR TYPE REFERENCES: Ratings and characteristics identical to 7B6.

R ₁ MEG.	R _{g1} MEG.	R _c MEG.	E _{bb} = 90 VOLTS			E _{bb} = 180 VOLTS			E _{bb} = 300 VOLTS		
			R _k	GAIN	E _o	R _k	GAIN	E _o	R _k	GAIN	E _o
0.10	A	0.10	4300	22	5.0	2400	29	15	2000	31	28
0.10	A	0.24	4700	27	7.0	2700	35	20	2200	38	37
0.24	A	0.24	7500	31	7.5	4300	42	20	3300	46	36
0.24	A	0.51	8200	40	10	4700	50	26	3900	52	50
0.51	A	0.51	13000	39	9.5	7500	53	24	5600	58	47
0.51	A	1.0	15000	43	11	8200	58	31	6200	62	56
0.24	10	0.24	---	39	4.5	---	45	19	---	49	38
0.24	10	0.51	---	45	6.5	---	52	24	---	57	48
0.51	10	0.51	---	48	7.0	---	59	22	---	62	42
0.51	10	1.0	---	52	8.5	---	62	25	---	66	55

^A VALUE OF R_{g1} IS NOT CRITICAL.

GAIN MEASURED AT E_o = 2.0 VOLTS RMS OUTPUT.

E_o IS RMS OUTPUT FOR 5% TOTAL HARMONIC DISTORTION.

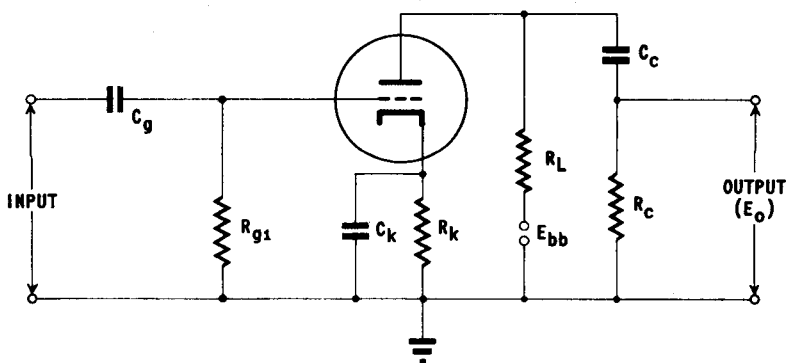

NOTE: COUPLING CAPACITORS C_g AND C_c SHOULD BE SELECTED TO GIVE DESIRED FREQUENCY RESPONSE. R_k SHOULD BE ADEQUATELY BY-PASSED BY CAPACITOR C_k.

→ INDICATES A CHANGE OR ADDITION

PLATE
1926
DEC. 1,
1947

6SQ7, 6SQ7GT

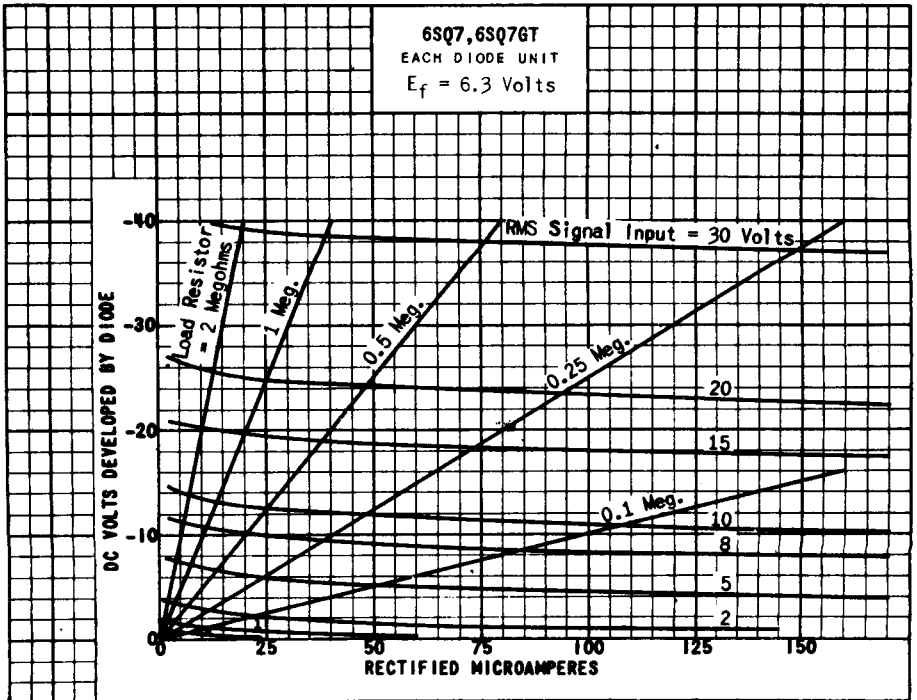
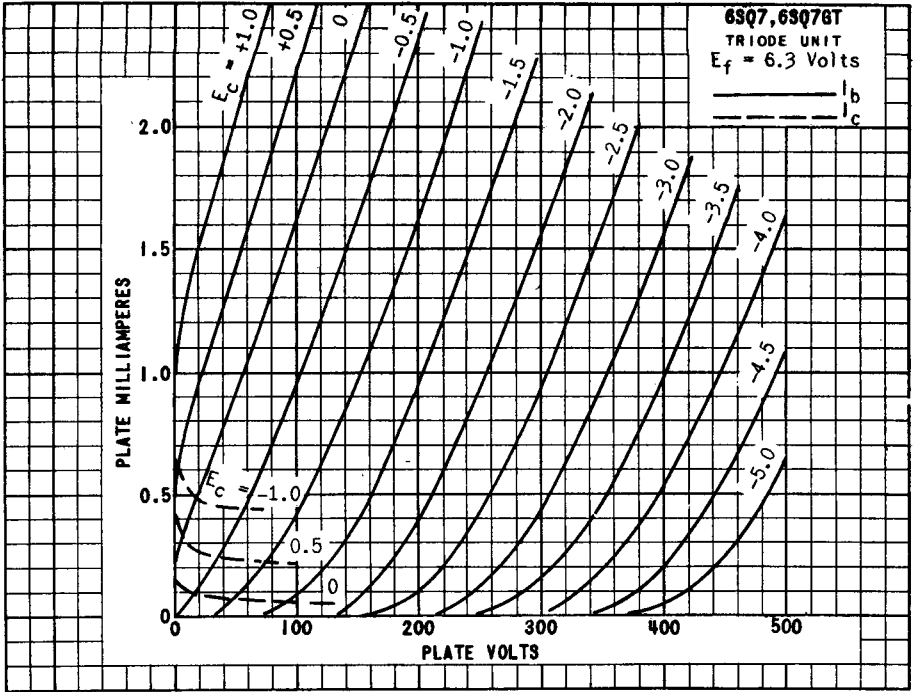

PRINTED IN U. S. A.

PLATE
 1967
 FEB. 2,
 1948

6SQ7, 6SQ7GT

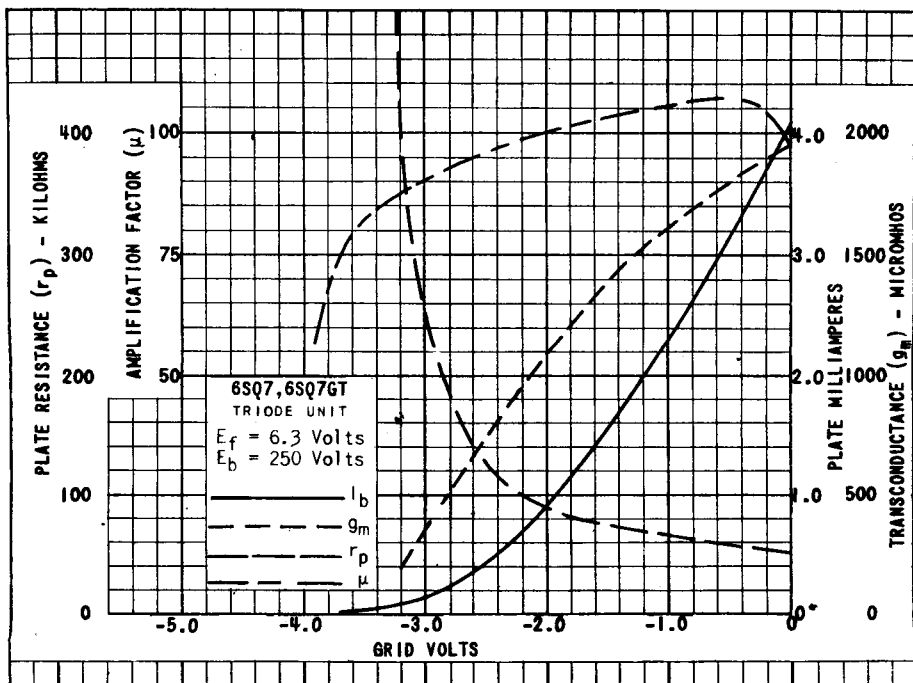
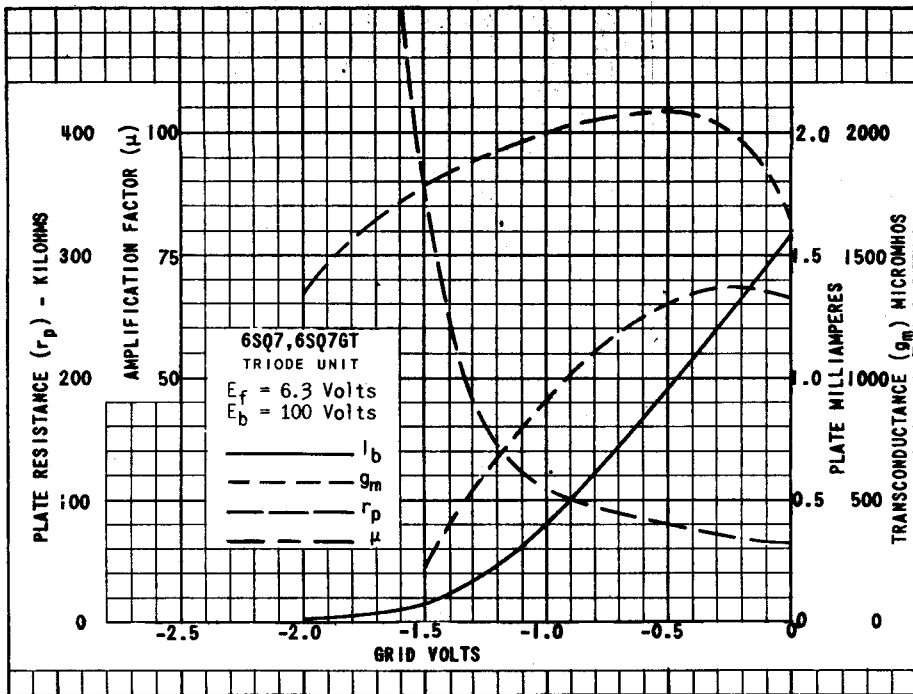
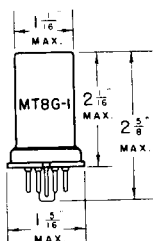

PLATE
1968
FEB. 2,
1948

6SR7, 6SR7GT

TUNG-SOL



METAL SHELL

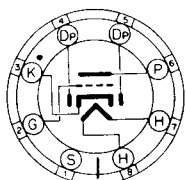

SMALL WAFER 8 PIN OCTAL BASE

DUO-DIODE TRIODE AMPLIFIER

COATED UNIPOTENTIAL CATHODE

HEATER

6.3 VOLTS ^A 0.3 AMPERE
AC OR DC

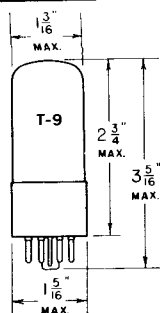

GLASS BULB

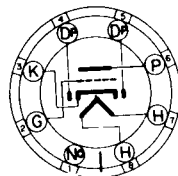

INTERMEDIATE 8 PIN OCTAL BASE

THE TUNG-SOL 6SR7 AND 6SR7GT COMBINE TWO DIODES AND A TRIODE IN A SINGLE ENVELOPE USING A COMMON CATHODE. THEY ARE DESIGNED FOR SERVICE AS DIODE DETECTORS, AVC RECTIFIERS AND AS AUDIO AMPLIFIERS IN AC, STORAGE BATTERY AND AC-DC OPERATED RECEIVERS.

RATINGS

MAXIMUM PLATE VOLTAGE	250	VOLTS
MAXIMUM PLATE DISSIPATION	2.5	WATTS
MINIMUM DIODE CURRENT WITH 10 VOLTS DC APPLIED	0.8	MA. PER PLATE

TYPICAL OPERATING CONDITIONS AND CHARACTERISTICS

CLASS A₁ AMPLIFIER

PLATE VOLTAGE	250	VOLTS
CONTROL GRID VOLTAGE	-9	VOLTS
PLATE CURRENT	9.5	MA.
PLATE RESISTANCE	8500	OHMS
TRANSCONDUCTANCE	1900	μMHOS
AMPLIFICATION FACTOR	16	

^A SHOULD NOT DEVIATE MORE THAN ± 10% FROM RATED VALUE.

SEE OTHER SIDE OF PAGE FOR CURVES

6SR7, 6SR7GT

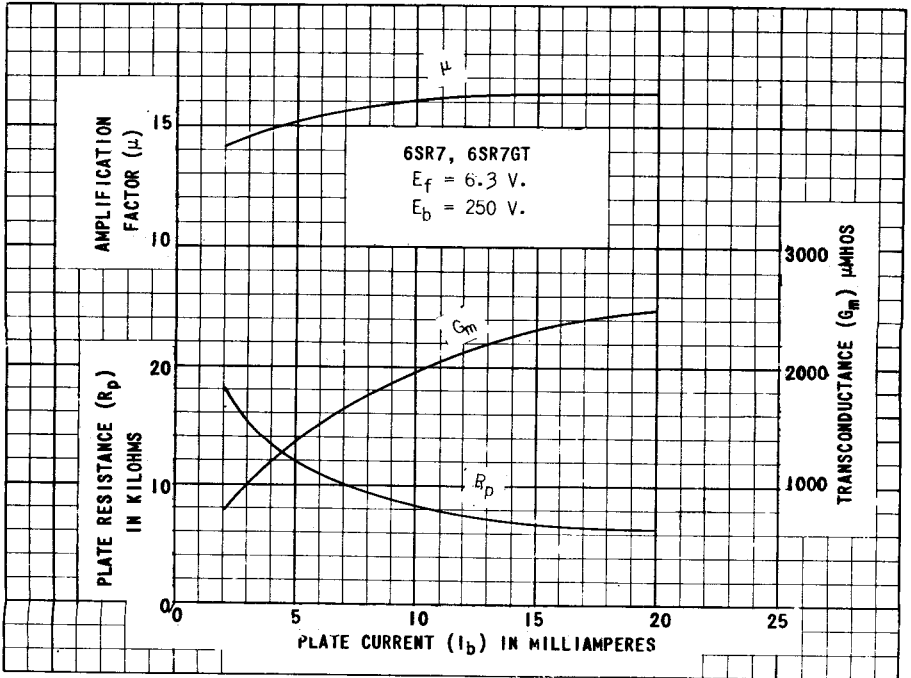
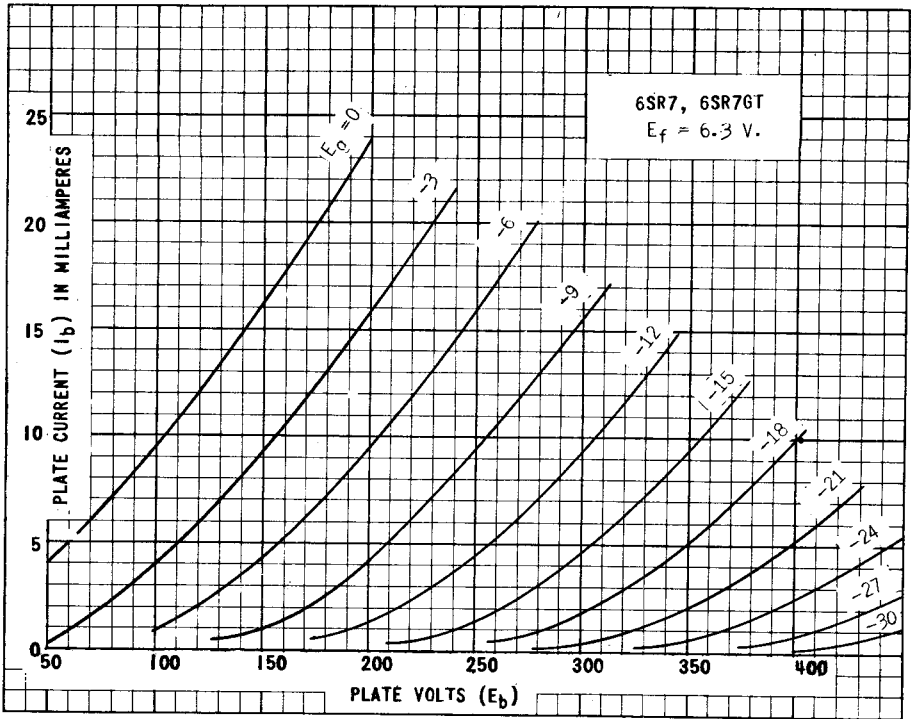
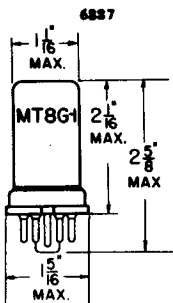

PLATE
 1348-1
 OCT. 26
 1943

TUNG-SOL

PENTODE AMPLIFIER



METAL SHELL

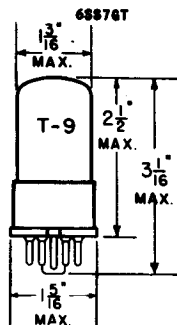

GLASS BULB

COATED UNIPOTENTIAL CATHODE

HEATER
6.3 VOLTS 0.15 AMPERE
AC OR DC

ANY MOUNTING POSITION

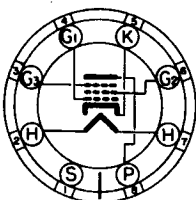

BOTTOM VIEW
SMALL WAFER
8 PIN OCTAL

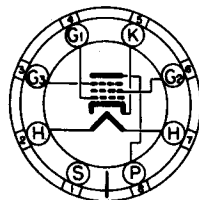

BOTTOM VIEW
SMALL WAFER
8 PIN OCTAL
METAL SLEEVE

THE 6SS7 AND 6SS7GT ARE RF PENTODES WHICH HAVE REMOTE PLATE CURRENT CUT-OFF. THEY ARE SUITABLE FOR OPERATING WITH AVC IN RF AND IF AMPLIFIERS. THE USE OF THESE TUBES WILL REDUCE CROSS MODULATION EFFECTS.

RATINGS

INTERPRETED ACCORDING TO RMA STANDARD MB-210

HEATER VOLTAGE	6.3	VOLTS
HEATER CURRENT	0.15	AMP.
MAXIMUM PLATE VOLTAGE	300	VOLTS
MAXIMUM SCREEN VOLTAGE	100	VOLTS
MAXIMUM SCREEN SUPPLY VOLTAGE	300	VOLTS
MINIMUM CONTROL GRID VOLTAGE	0	VOLTS
MAXIMUM PLATE DISSIPATION	2.25	WATTS
MAXIMUM SCREEN DISSIPATION	0.35	WATTS
MAXIMUM HEATER-CATHODE VOLTAGE	90	VOLTS

DIRECT INTERELECTRODE CAPACITANCES

	6SS7 WITH SHELL CON- NECTED TO CATHODE	6SS7GT WITH EXTERNAL SHIELD CONNECTED TO CATHODE	
GRID TO PLATE (MAX.)	0.004	0.004	μuf
INPUT	5.5	5	μuf
OUTPUT	7	6	μuf

CONTINUED ON FOLLOWING PAGE

→ INDICATES A CHANGE OR ADDITION.

CONTINUED FROM PRECEDING PAGE

TYPICAL OPERATING CONDITIONS AND CHARACTERISTICS

CLASS A₁ AMPLIFIER

	6SS7	6SS7GT	6SS7 6SS7GT	
PLATE VOLTAGE	100	100	250	VOLTS
SCREEN VOLTAGE	100	100	100	VOLTS
CONTROL GRID VOLTAGE	-1	-1	-3	VOLTS
SUPPRESSOR VOLTAGE	0	0	0	VOLTS
PLATE CURRENT	12.2	12.2	9	MA.
SCREEN CURRENT	3.1	3.1	2	MA.
PLATE RESISTANCE (APPROX.)	0.12	0.12	1	MEGOHM
TRANSCONDUCTANCE	1 930	2 200	1 850	μMHOS
GRID VOLTAGE (APPROX.) FOR TRANSCONDUCTANCE = 10 μMHOS	-35	-35	-35	VOLTS

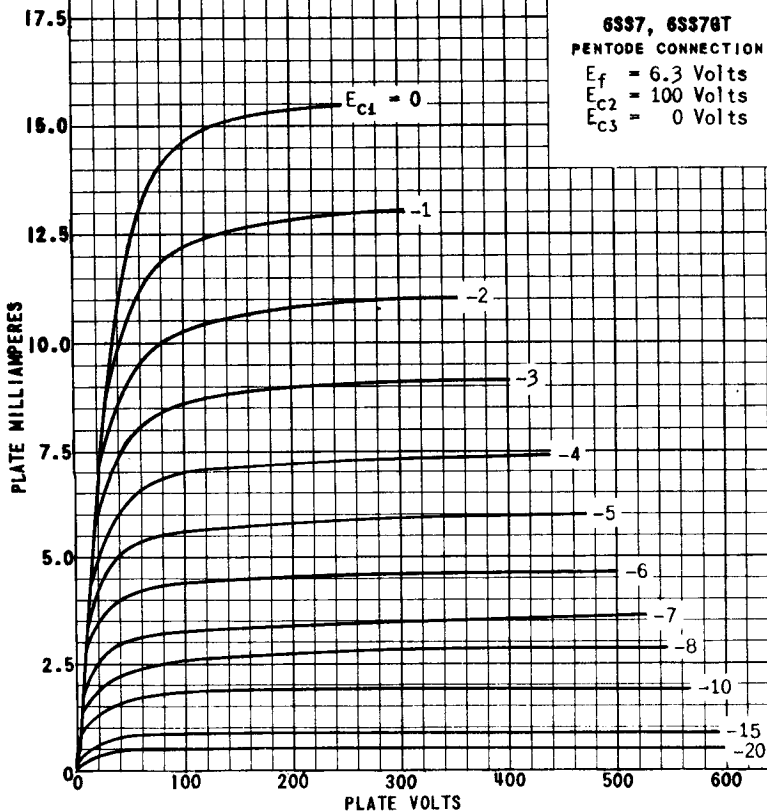
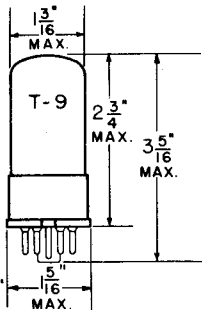

PLATE
1803
MAY 1
1947

TUNG-SOL

HI-MU TWIN TRIODE AMPLIFIER



GLASS BULB

COATED UNIPOTENTIAL CATHODE

HEATER
6.3 VOLTS 0.3 AMPERE
AC OR DC

ANY MOUNTING POSITION

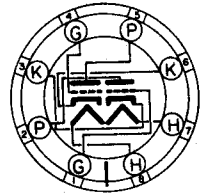

BOTTOM VIEW
INTERMEDIATE SHELL
8-PIN OCTAL MICANOL

THE TYPE 6SU7GT_Y IS A DOUBLE TRIODE HAVING THE SAME GENERAL CHARACTERISTICS AS THE 6SL7GT EXCEPT THAT IT HAS A LOW LOSS PHENOLIC BASE, HAS MINIMUM GAS AND LEAKAGE CURRENTS, AND IS SPECIALLY TESTED FOR PLATE CURRENT BALANCE BETWEEN THE TWO TRIODE UNITS.

RATINGS

INTERPRETED ACCORDING TO RMA STANDARD M8-210

AMPLIFIER - PER UNIT

HEATER VOLTAGE (AC OR DC)	6.3	VOLTS
HEATER CURRENT	0.3	AMP.
MAX. PLATE VOLTAGE	250	VOLTS
MIN. GRID VOLTAGE	0	VOLTS
MAX. PLATE DISSIPATION	1	WATT
HEATER-CATHODE VOLTAGE	AS LOW AS POSSIBLE	

TYPICAL OPERATING CONDITIONS AND CHARACTERISTICS

CLASS A₁ AMPLIFIER - PER UNIT

PLATE VOLTAGE	250	VOLTS
GRID VOLTAGE	-2	VOLTS
PLATE CURRENT	2.3	MA.
PLATE RESISTANCE	44 000	OHMS
TRANSCONDUCTANCE	1600	μMHOS
AMPLIFICATION FACTOR	70	

SIMILAR TYPE REFERENCE: Same characteristics as types 6SL7GT, 7F7; except for heater ratings same characteristics as types 12SL7GT, 14F7; somewhat similar to types 6SC7GT, 12SC7GT.

6SU7GT

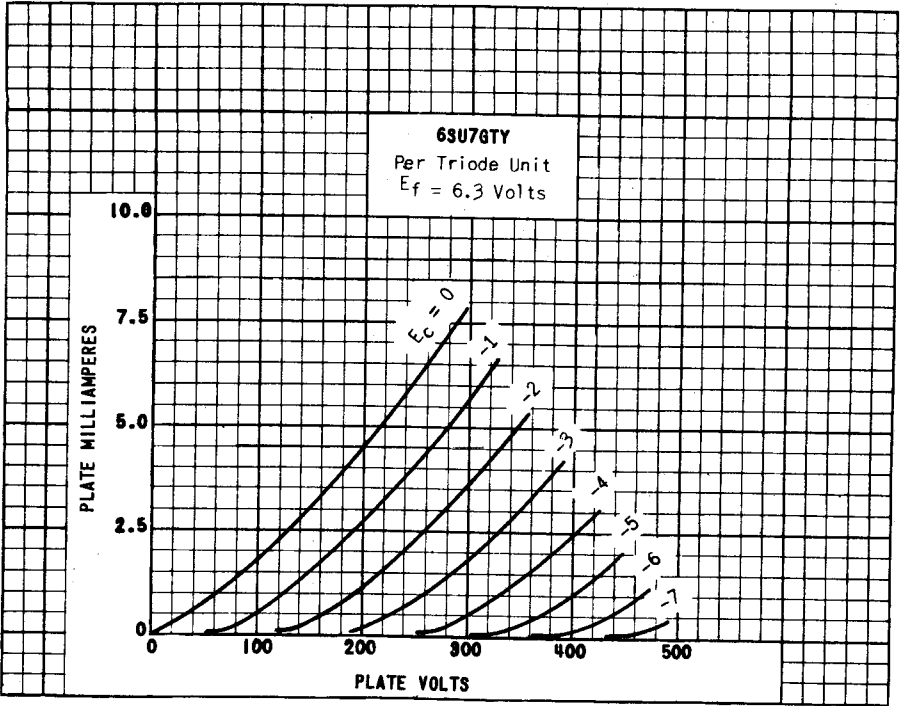

PLATE
1627
NOV. 30
1945

TUNG-SOL

DUPLEX-DIODE HIGH-MU TRIODE

PHYSICAL SPECIFICATIONS

EMITTER UNIPOTENTIAL CATHODE	PIN CONNECTIONS	
BASE SMALL WAFER OCTAL 8-PIN	PIN 1 SHELL	PIN 7 HEATER
CAP	PIN 2 TRIODE GRID	PIN 8 HEATER
BULB MT-8G	PIN 3 CATHODE	
MAXIMUM DIAMETER 1 5/16"	PIN 4 UP 2	MOUNTING POS. ANY
MAXIMUM OVERALL LENGTH 2 5/8"	PIN 5 UP 1	
MAXIMUM SEATED HEIGHT 2 1/16"	PIN 6 TRI. PLATE	

RATINGS

INTERPRETED ACCORDING TO RMA STANDARD M8-210

HEATER OR FILAMENT VOLTAGE (AC OR DC)	6.3	VOLTS
HEATER OR FILAMENT CURRENT	0.15	AMP.
MAXIMUM PLATE VOLTAGE	300	VOLTS
MAXIMUM SCREEN VOLTAGE		VOLTS
MAXIMUM PLATE DISSIPATION		WATTS
MAXIMUM SCREEN DISSIPATION		WATTS
MAXIMUM PEAK HEATER CATHODE VOLTAGE:		
HEATER POS. WITH RESPECT TO CATHODE	90	VOLTS
HEATER NEG. WITH RESPECT TO CATHODE	90	VOLTS

CAPACITANCES - TRIODE UNIT (APPROX.)

WITH SHELL CONNECTED TO CATHODE

CONTROL GRID TO CATHODE	2.6	μ f
PLATE TO CATHODE	2.8	μ f
GRID TO PLATE	1.1	μ f

TYPICAL OPERATING CONDITIONS AND CHARACTERISTICS

CLASS A₁ AMPLIFIER

HEATER OR FILAMENT VOLTAGE (AC OR DC)	6.3	VOLTS
HEATER OR FILAMENT CURRENT	0.15	AMP.
PLATE VOLTAGE	250	VOLTS
SCREEN VOLTAGE		VOLTS
CONTROL GRID VOLTAGE	-3	VOLTS
PEAK AF SIGNAL VOLTAGE		VOLTS
PLATE CURRENT	1	MA.
ZERO-SIGNAL SCREEN CURRENT		MA.
MAXIMUM-SIGNAL PLATE CURRENT		MA.
MAXIMUM-SIGNAL SCREEN CURRENT		MA.
PLATE RESISTANCE (APPROX.)	58 000	OHMS
TRANSCONDUCTANCE	1 200	μ MHOS
AMPLIFICATION FACTOR	70	
LOAD RESISTANCE		OHMS
TOTAL HARMONIC DISTORTION		PER CENT
POWER OUTPUT		WATTS
CONTROL GRID VOLTAGE		
FOR TRANSCONDUCTANCE	μ MHOS	VOLTS

DIODE UNITS - TWO

THE TWO DIODE PLATES ARE PLACED AROUND A CATHODE, THE SLEEVE OF WHICH IS COMMON TO THE TRIODE UNIT. EACH DIODE PLATE, HAS ITS OWN BASE PIN.

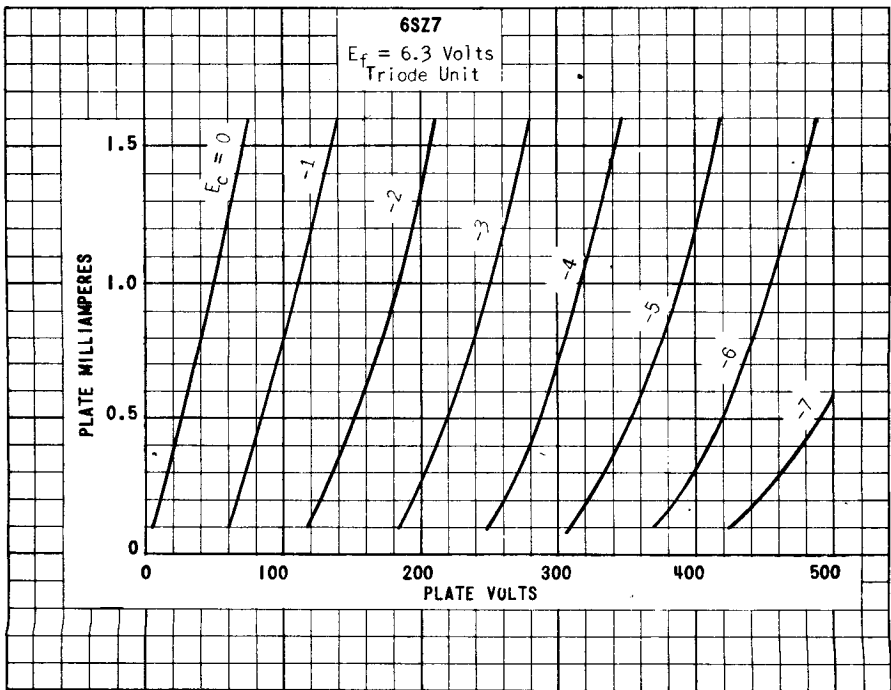
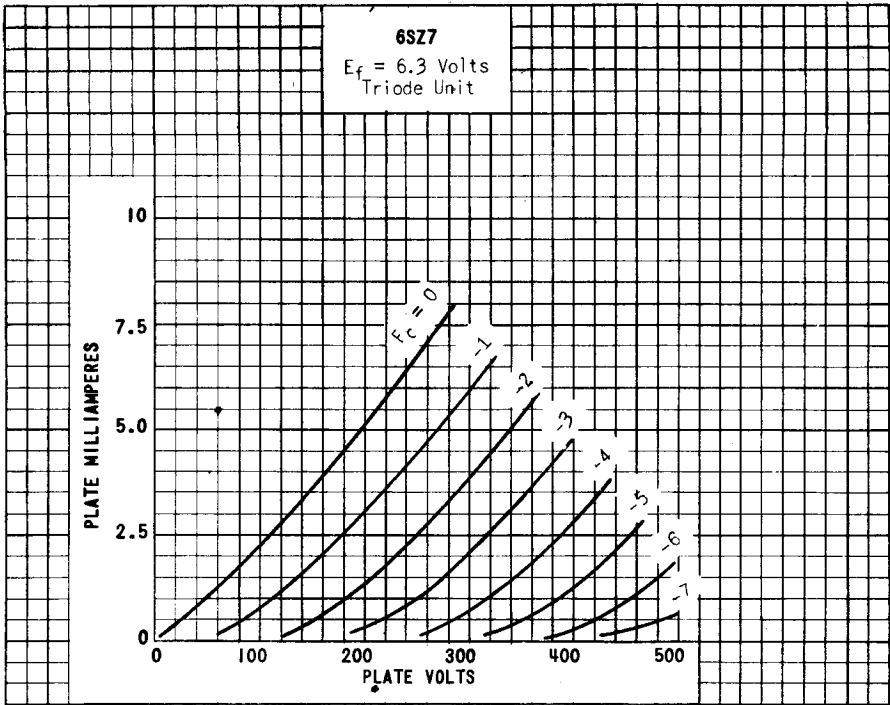

TUNG-SOL

DUO-DIODE

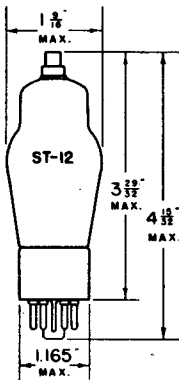
HIGH- μ U TRIODE AMPLIFIER

UNIPOTENTIAL CATHODE

HEATER

6.3 VOLTS 0.15 AMPERE

AC OR DC

GLASS BULB

SMALL 7 PIN OCTAL BASE

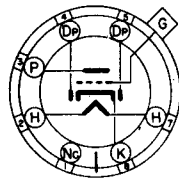

G-7V

THE TUNG-SOL 6T7G COMBINES TWO DIODES AND A TRIODE IN A SINGLE BULB, USING A COMMON CATHODE. IT IS QUITE SIMILAR TO THE 6Q7G AND IS DESIGNED FOR THE SAME TYPE OF SERVICE.

OPERATING CONDITIONS AND CHARACTERISTICS

CLASS A₁ AMPLIFIER - TRIODE SECTION

PLATE VOLTAGE	135	250	VOLTS
GRID VOLTAGE	-1.5	-3	VOLTS
PLATE CURRENT	0.9	1.2	MA.
PLATE RESISTANCE	65 000	62 000	OHMS
TRANSCONDUCTANCE	1000	1050	μ MHOS
AMPLIFICATION FACTOR	65	65	

DIRECT INTERELECTRODE CAPACITANCES

GRID TO CATHODE	1.2	μ f
PLATE TO CATHODE	3.7	μ f
GRID TO PLATE	2.0	μ f



6T7G
 $E_f = 6.3 \text{ V.}$

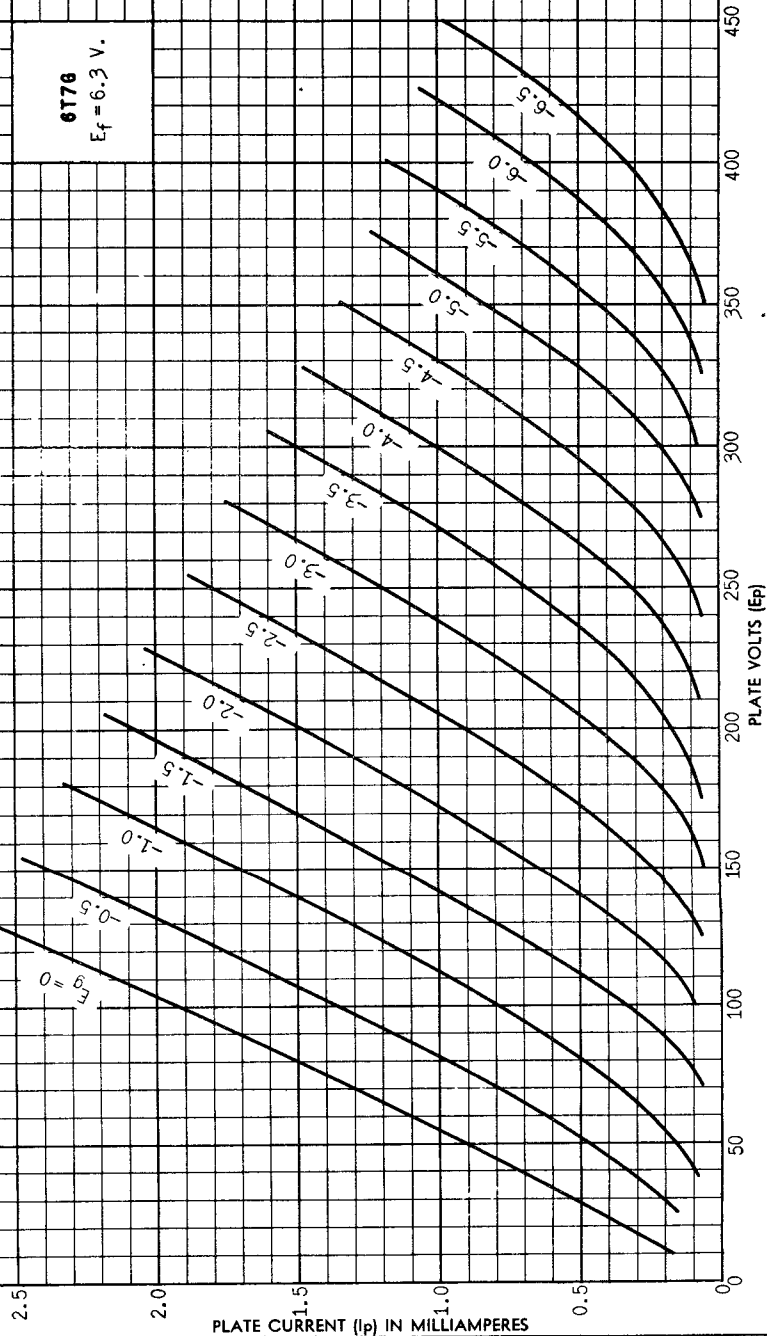

PRINTED IN U. S. A.

PLATE
162-1

6T7 G

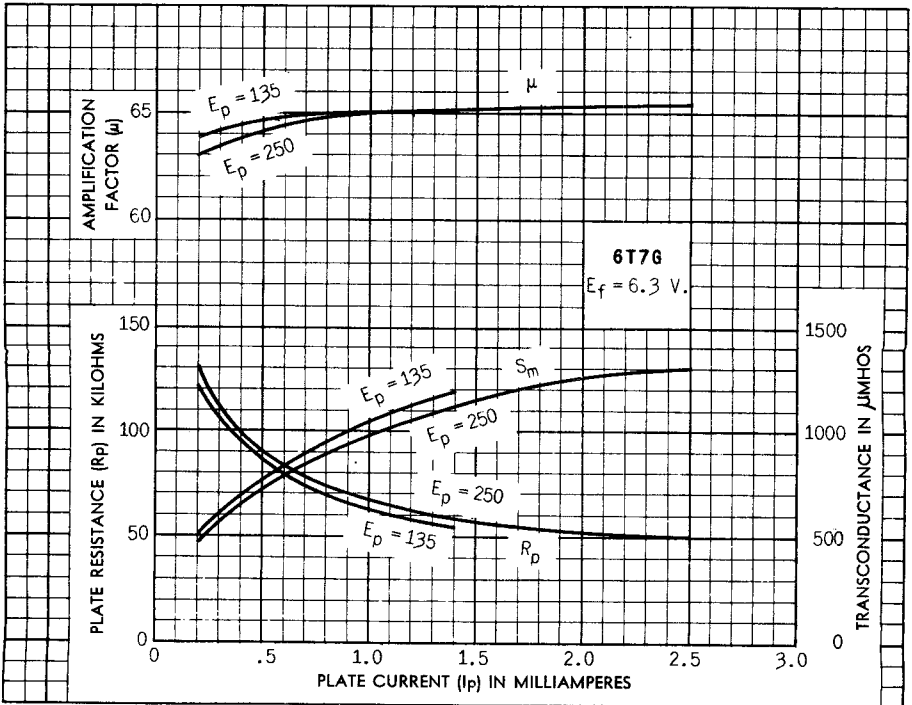
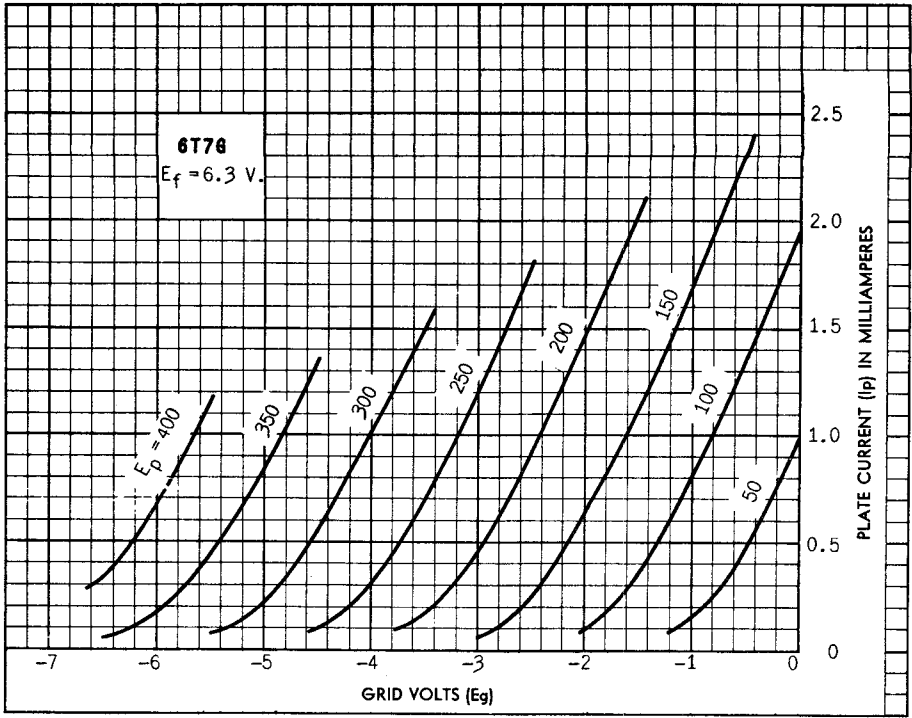

PLATE 163-1

TUNG-SOL

TRIPLE-DIODE TRIODE

MINIATURE TYPE

COATED UNIPOTENTIAL CATHODES

HEATER

6.3 VOLTS 450 MA.

AC OR DC

ANY MOUNTING POSITION

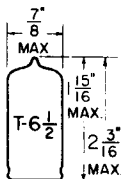

GLASS BULB

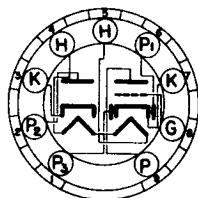

BOTTOM VIEW
SMALL BUTTON
9 PIN BASE

THE 6T8 COMPRISES THREE HIGH PERVEANCE DIODES AND A HIGH-MU TRIODE IN ONE ENVELOPE WITH THE 9-PIN MINIATURE CONSTRUCTION. ONE OF THE THREE DIODE PLATES HAS AN INDEPENDENT CATHODE PROVIDING SATISFACTORY OPERATION IN BALANCED LOW IMPEDANCE DETECTOR CIRCUITS. THIS TUBE STRUCTURE PERMITS THE CONSTRUCTION OF AM/FM RECEIVERS WITH A MINIMUM OF SWITCHING.

DIRECT INTERELECTRODE CAPACITANCES - APPROX. WITH NO EXTERNAL SHIELD

GRID TO EACH DIODE PLATE (MAX.)	0.035	μf
DIODE #1 INPUT: P ₁ TO (H+K)	3.8	μf
DIODE #2 INPUT: P ₂ TO (H+K)	4.5	μf
DIODE #3 INPUT: P ₃ TO (H+K)	3.8	μf
DIODE CATHODE TO ALL: K TO (H+K+P ₁ +P ₂ +P ₃ +P+G)	8.5	μf

RATINGS

INTERPRETED ACCORDING TO RMA STANDARD M8-320

HEATER VOLTAGE	6.3	VOLTS
MAXIMUM HEATER-CATHODE VOLTAGE	90	VOLTS
MAXIMUM PLATE VOLTAGE	300	VOLTS
MAXIMUM POSITIVE DC GRID VOLTAGE	0	VOLTS
MAXIMUM DIODE CURRENT EACH PLATE FOR CONTINUOUS OPERATION	5	MA.

TYPICAL OPERATING CONDITIONS AND CHARACTERISTICS

CLASS A₁ AMPLIFIER

HEATER VOLTAGE	6.3	6.3	VOLTS
HEATER CURRENT	450	450	MA.
PLATE VOLTAGE	100	250	VOLTS
GRID VOLTAGE	-1	-3	VOLTS
PLATE CURRENT	0.8	1	MA.
PLATE RESISTANCE	54 000	58 000	OHMS
TRANSCONDUCTANCE	1 300	1 200	μMHOS
AMPLIFICATION FACTOR	70	70	
AVERAGE DIODE CURRENT WITH 5 VOLTS DC APPLIED	20	20	MA.

ONE DIODE HAS A SEPARATE CATHODE, THE OTHER CATHODE IS COMMON TO TWO DIODES AND THE TRIODE UNIT.

IT IS RECOMMENDED THAT DIODE #2 (PIN 2) AND DIODE #3 (PIN 1) BE USED IN A RATIO-DETECTOR CIRCUIT FOR FM.

CONTINUED ON FOLLOWING PAGE

→ INDICATES A CHANGE OR ADDITION

PLATE
2084
OCT. 1,
1948

CONTINUED FROM PRECEDING PAGE

RESISTANCE COUPLED AMPLIFIER

R1 MEG.	Rg1 MEG.	Rc MEG.	Ebb = 90 VOLTS			Ebb = 180 VOLTS			Ebb = 300 VOLTS		
			Rk	GAIN	Eo	Rk	GAIN	Eo	Rk	GAIN	Eo
0.10	A	0.10	5700	21	7	2400	29	18	1800	33	35
0.10	A	0.24	6100	26	9	2700	34	23	2000	38	42
0.24	A	0.24	9100	30	10	4300	40	24	3000	44	43
0.24	A	0.51	10000	34	13	4700	45	31	3300	49	52
0.51	A	0.51	15000	37	14	7500	47	28	5600	51	50
0.51	A	1	16000	40	16	8200	50	35	6200	55	60
0.24	10	0.24	---	31	5	---	44	19	---	48	40
0.24	10	0.51	---	37	7	---	49	25	---	52	52
0.51	10	0.51	---	39	7.5	---	51	22	---	54	44
0.51	10	1	---	42	10	---	54	28	---	58	56

A VALUE OF Rg1 IS NOT CRITICAL.

Rk TAKEN TO NEAREST RVA VALUE FOR EACH CASE INSTEAD OF ABSOLUTE OPTIMUM VALUE.

Eo IS RMS OUTPUT AT 5% TOTAL HARMONIC DISTORTION.

GAIN MEASURED AT Eo = 2.0 VOLTS RMS OUTPUT.

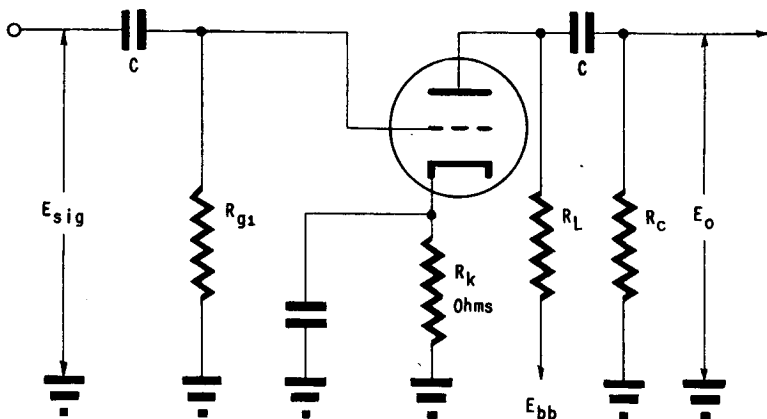

NOTE: COUPLING CAPACITORS (C) SHOULD BE SELECTED TO GIVE DESIRED FREQUENCY RESPONSE. Rk SHOULD BE ADEQUATELY BY-PASSED.

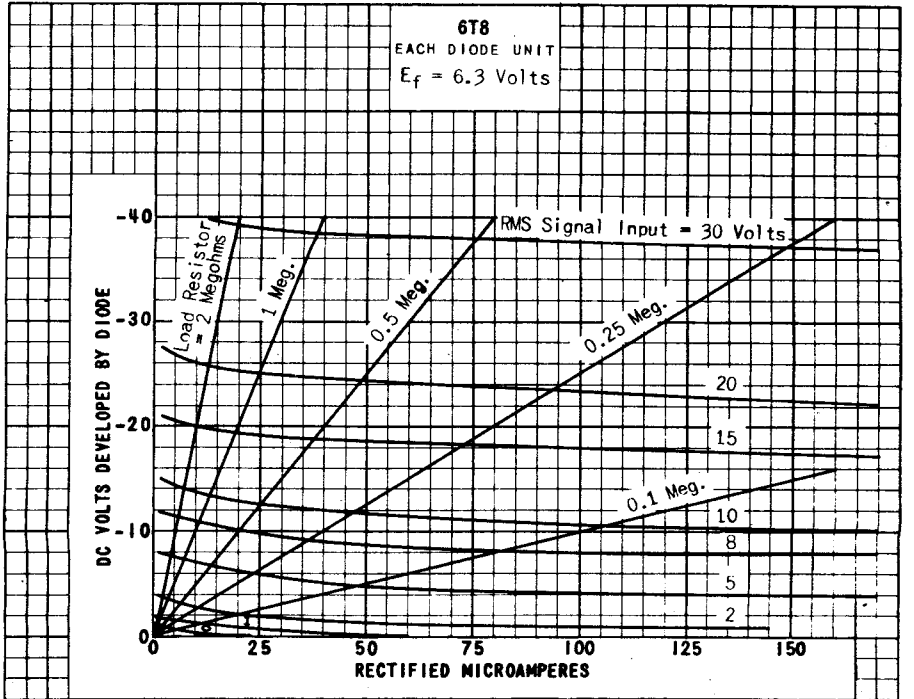
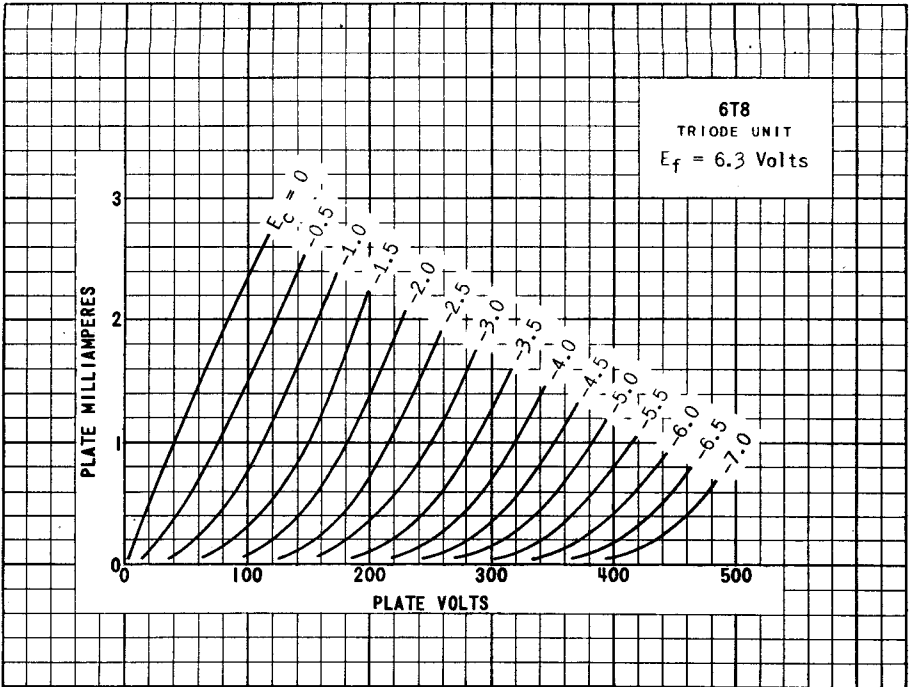

PRINTED IN U. S. A.

PLATE 1891
OCT. 1, 1947

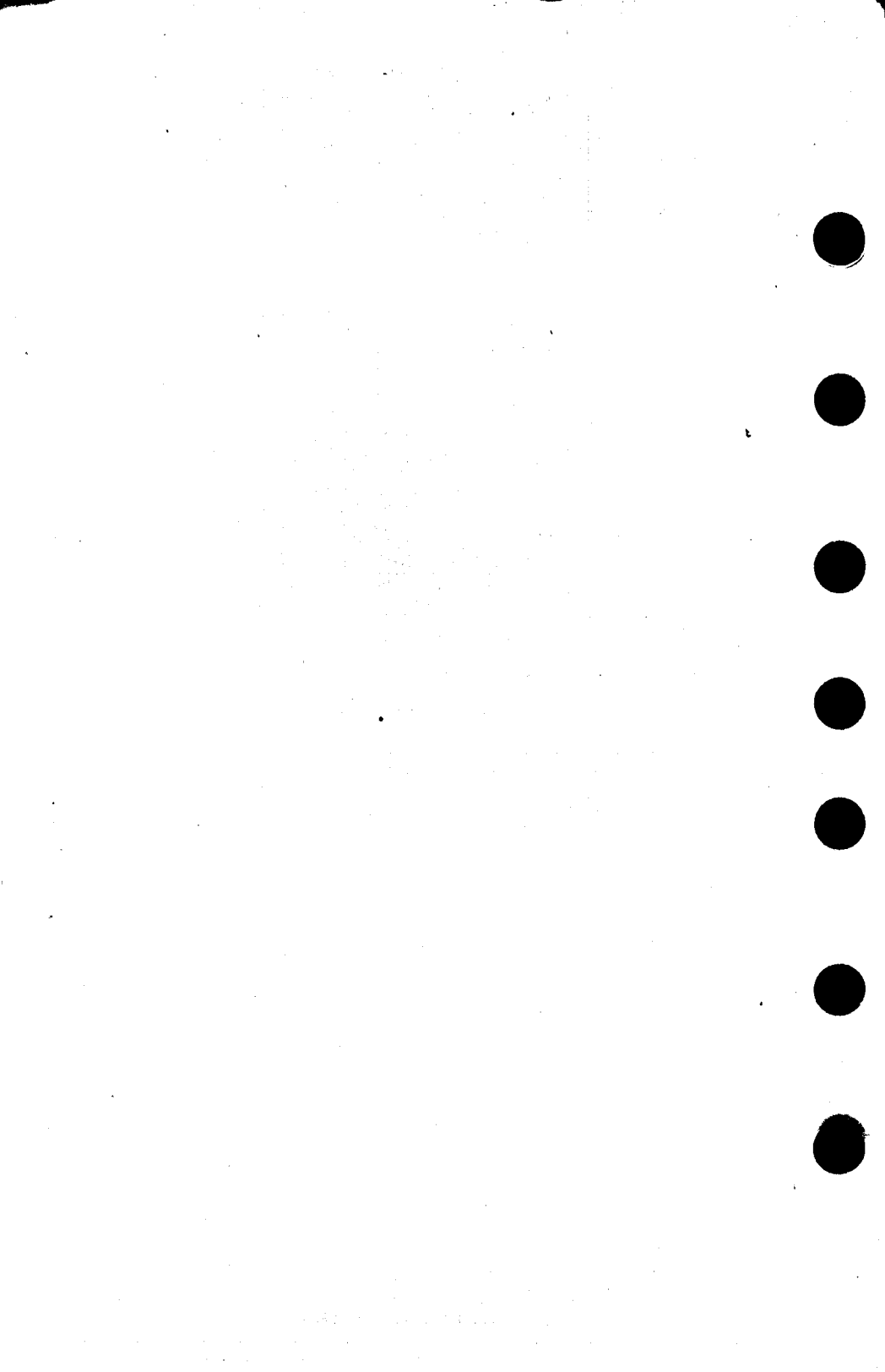

TUNG-SOL

CATHODE RAY TUNING INDICATOR

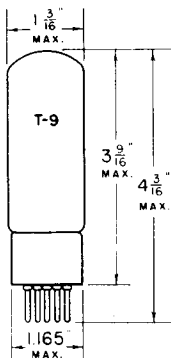

UNIPOTENTIAL CATHODE

HEATER

6.3 VOLTS 0.3 AMPERE

AC OR DC

GLASS BULB

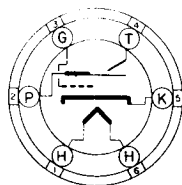

6R

BOTTOM VIEW

SMALL 6 PIN BASE

THE TUNG-SOL 6U5/6G5 CONSISTS OF A CIRCULAR FLUORESCENT TARGET WITH AN INDICATING SHADOW CONTROLLED BY AN INTERNALLY CONNECTED REMOTE CUT-OFF TRIODE AMPLIFIER. WHEN THE 6U5/6G5 IS USED AS A TUNING INDICATOR, AVC VOLTAGE IS APPLIED TO THE TRIODE GRID.

RATINGS

MAXIMUM PLATE SUPPLY VOLTAGE	285	VOLTS
MAXIMUM TARGET VOLTAGE	285	VOLTS
MINIMUM TARGET VOLTAGE	100	VOLTS
MAXIMUM PLATE DISSIPATION	1.0	WATT

TYPICAL OPERATING CONDITIONS AND CHARACTERISTICS

PLATE AND TARGET SUPPLY VOLTAGE	100	200	250	VOLTS
TRIODE GRID VOLTAGE (0° SHADOW ANGLE) ^A	-8	-18.5	-22	VOLTS
TRIODE GRID VOLTAGE (90° SHADOW ANGLE) ^A	0	0	0	VOLTS
SERIES TRIODE-PLATE RESISTOR	0.5	1	1	MEG OHM
TRIODE PLATE CURRENT (TRIODE GRID $V_g = 0$)	0.19	0.19	0.24	MA.
TARGET CURRENT (TRIODE GRID $V_g = 0$) ^B	1	3	4	MA.

^A APPROXIMATE.^B SUBJECT TO WIDE VARIATIONS.

NOTE: THIS DOUBLE BRANDED TUBE, 6U5/6G5, TAKES THE PLACE OF EITHER THE 6U5 OR THE 6G5. IT IS IDENTICAL ELECTRICALLY TO BOTH OF THEM. IT IS ALSO USED TO REPLACE TYPES 6T5 AND 6H5.

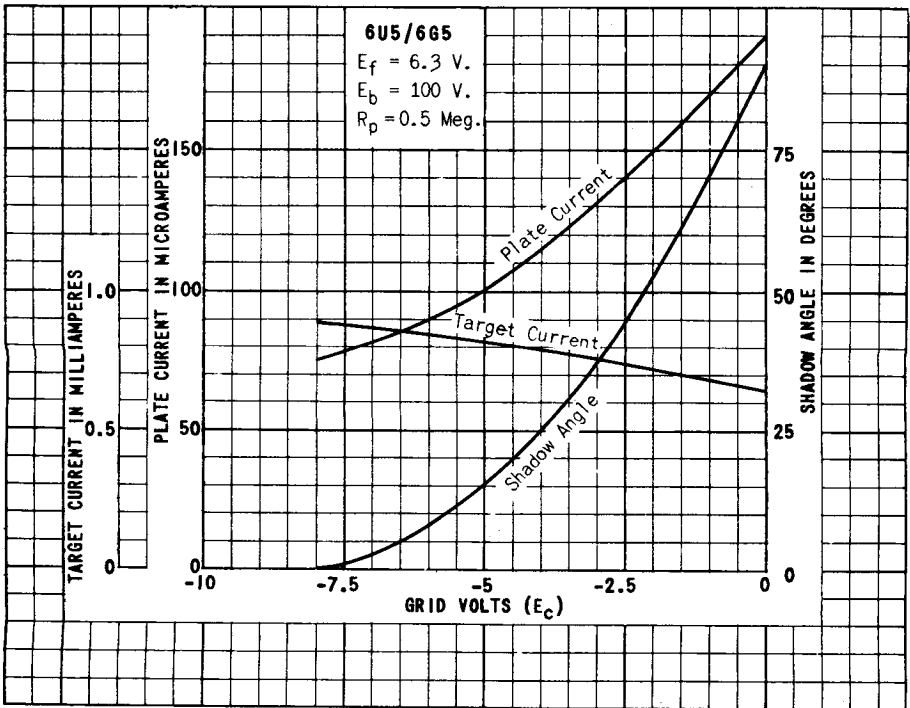
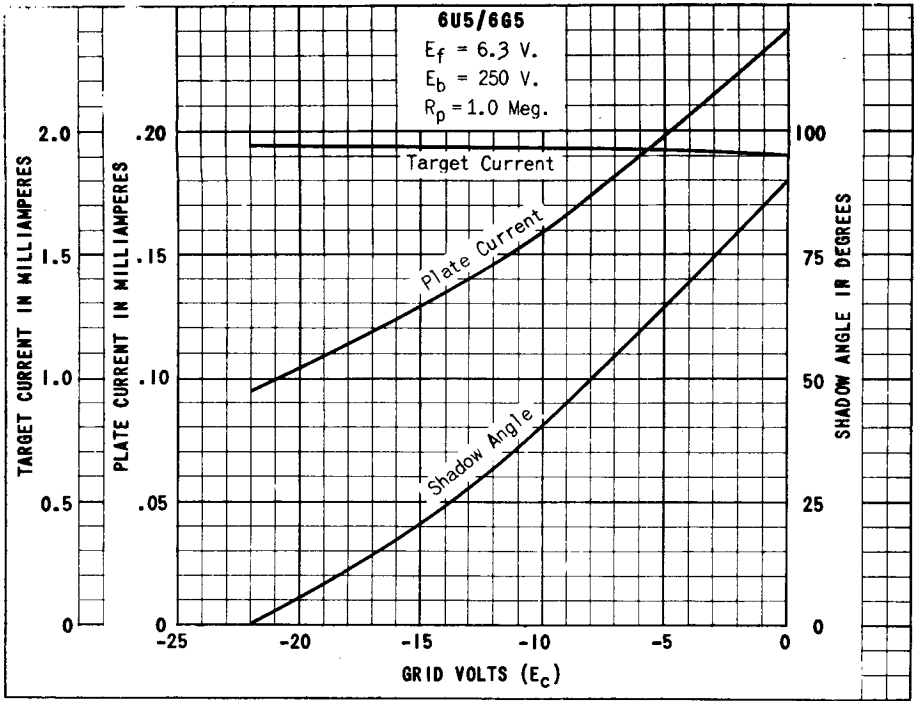

TUNG-SOL

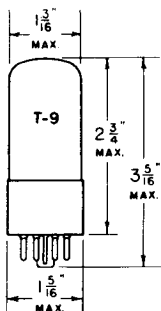

BEAM POWER AMPLIFIER

UNIPOTENTIAL CATHODE

HEATER

6.3 VOLTS 0.75 AMPERE
AC OR DC

GLASS BULB

INTERMEDIATE 7 PIN OCTAL BASE

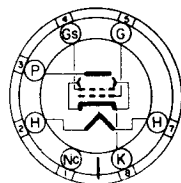

G-7AC
BOTTOM VIEW

THE TUNG-SOL 6U6GT IS A BEAM POWER AMPLIFIER DESIGNED FOR SERVICE IN THE OUTPUT STAGE OF STORAGE BATTERY OPERATED RECEIVERS. IT HAS HIGH POWER SENSITIVITY AND HIGH POWER OUTPUT AT COMPARATIVELY LOW SUPPLY VOLTAGES.

RATINGS

MAXIMUM PLATE VOLTAGE	200	VOLTS
MAXIMUM SCREEN VOLTAGE	135	VOLTS
MAXIMUM PLATE DISSIPATION	11	WATTS
MAXIMUM SCREEN DISSIPATION	2	WATTS

TYPICAL OPERATING CONDITIONS AND CHARACTERISTICS

CLASS A₁ AMPLIFIER

PLATE VOLTAGE	110	135	200	VOLTS
SCREEN VOLTAGE	110	135	135	VOLTS
CONTROL GRID VOLTAGE	-10.5	-13.5	-14	VOLTS
PEAK AF SIGNAL VOLTAGE	10.5	13.5	14	VOLTS
ZERO SIGNAL PLATE CURRENT	44	55	55	MA.
ZERO SIGNAL SCREEN CURRENT (NOMINAL)	4	5	3	MA.
MAXIMUM SIGNAL PLATE CURRENT	47	60	62	MA.
MAXIMUM SIGNAL SCREEN CURRENT (NOM.)	11	15	13	MA.
PLATE RESISTANCE APPROX.	10000	10000	20000	OHMS
TRANSCONDUCTANCE	5600	6200	6200	μMHOS
LOAD RESISTANCE	2000	2000	3000	OHMS
TOTAL HARMONIC DISTORTION	10	10	10	PER CENT
POWER OUTPUT	2.0	3.3	5.5	WATTS

FOR "INTERPRETATION OF RATINGS" REFER TO FRONT OF BOOK.

CONTINUED NEXT PAGE

6U6GT

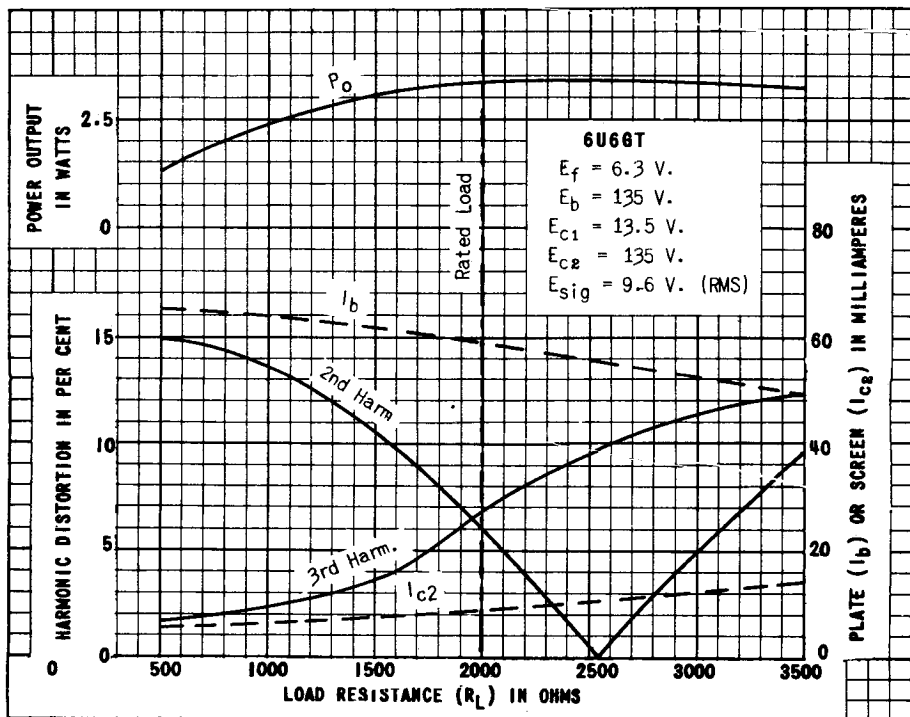
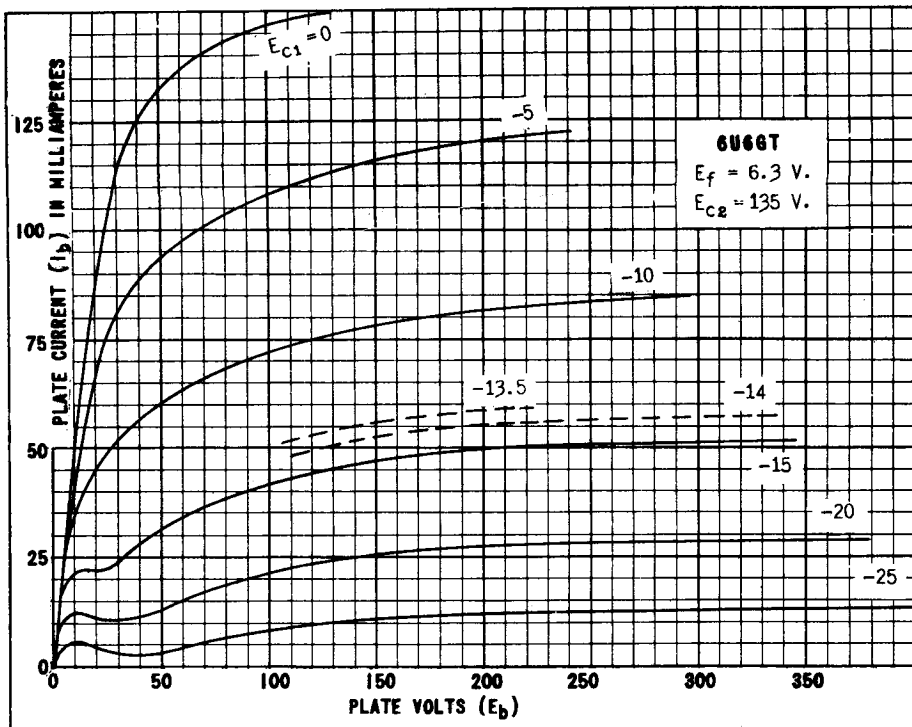
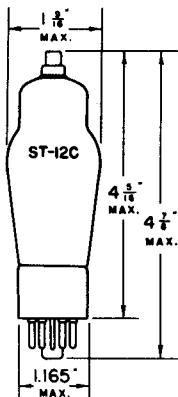

PLATE 1150-1

TUNG-SOL

TRIPLE GRID

REMOTE CUT-OFF AMPLIFIER



UNIPOTENTIAL CATHODE
 HEATER
 6.3 VOLTS 0.3 AMPERE
 AC OR DC

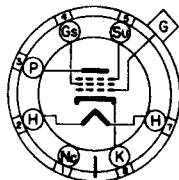

G-7Ra

BOTTOM VIEW

GLASS BULB

SMALL 7 PIN OCTAL BASE

THE TUNG-SOL 6U7G IS A TRIPLE GRID REMOTE CUT-OFF AMPLIFIER. IT IS SUITABLE FOR USE WITH A.V.C. IN RF AND IF AMPLIFIERS AND MINIMIZES CROSS MODULATION. ITS ELECTRICAL CHARACTERISTICS ARE SIMILAR TO THOSE OF THE 6D6.

TYPICAL OPERATING CONDITIONS AND CHARACTERISTICS

CLASS A₁ AMPLIFIER

PLATE VOLTAGE	100	250	VOLTS
SCREEN VOLTAGE	100	100	VOLTS
CONTROL GRID VOLTAGE	-3	-3	VOLTS
SUPPRESSOR GRID	CONNECTED TO CATHODE AT SOCKET		
PLATE CURRENT	8	8.2	MA.
SCREEN CURRENT	2.2	2	MA.
PLATE RESISTANCE ^{APPROX.}	0.25	0.8	MEGOHM
TRANSCONDUCTANCE	1500	1600	μMHOS

AS MIXER IN SUPERHETERODYNE CIRCUIT

PLATE VOLTAGE	100	250	VOLTS
SCREEN VOLTAGE	100	100	VOLTS
CONTROL GRID VOLTAGE ^{APPROX. A}	-10	-10	VOLTS
SUPPRESSOR GRID	CONNECTED TO CATHODE AT SOCKET		

^A THE GRID BIAS SHOWN IS MINIMUM FOR AN OSCILLATOR PEAK VOLTAGE OF 7 VOLTS. THESE VALUES ARE OPTIMUM.

DIRECT INTERELECTRODE CAPACITANCES ^S

GRID TO CATHODE	5	μμf
PLATE TO CATHODE	9	μμf
GRID TO PLATE	.007 ^{MAX.}	μμf

^S WITH SHIELD

NOTE: THE INTERNAL SHIELD IN THE DOME IS CONNECTED TO THE CATHODE WITHIN THE TUBE.

CONTINUED NEXT PAGE

PLATE
497-3

AUG. 14
1939

6U7 G

RATINGS

MAXIMUM PLATE VOLTAGE	300	VOLTS
MAXIMUM SCREEN SUPPLY VOLTAGE	300	VOLTS
MAXIMUM SCREEN VOLTAGE	100	VOLTS
MAXIMUM PLATE DISSIPATION	2.25	WATTS
MAXIMUM SCREEN DISSIPATION	0.25	WATT
MINIMUM EXTERNAL GRID BIAS VOLTAGE	0	VOLTS

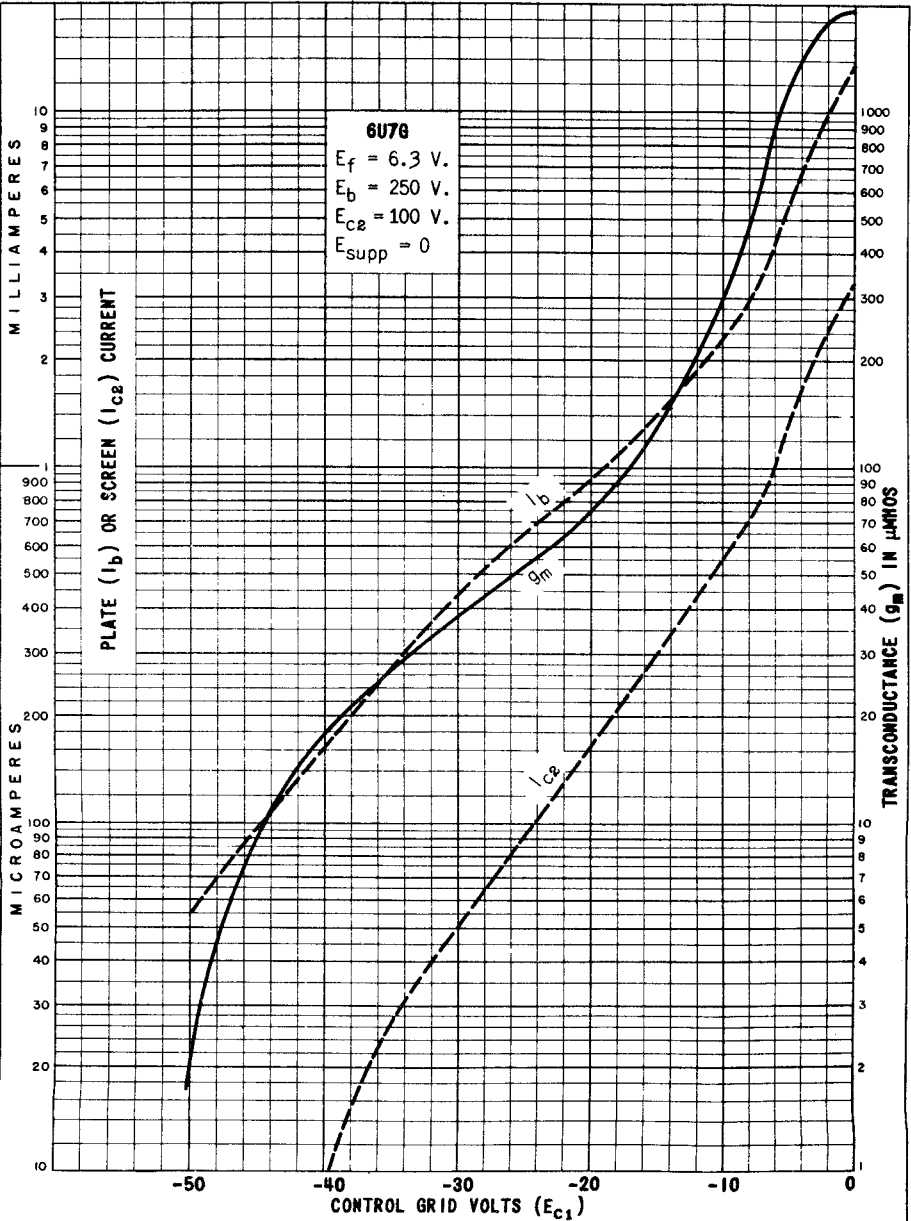

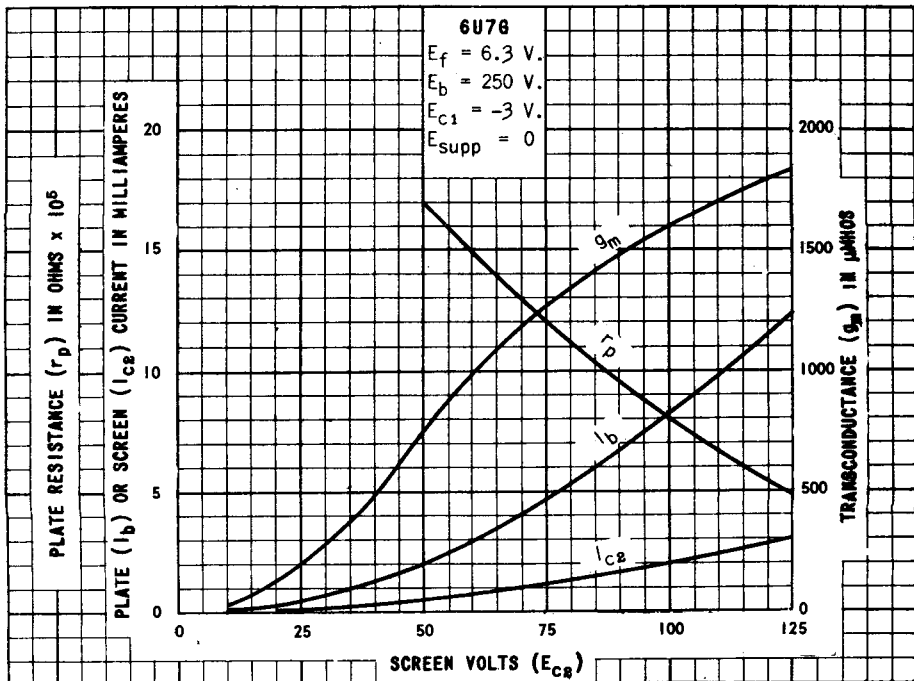
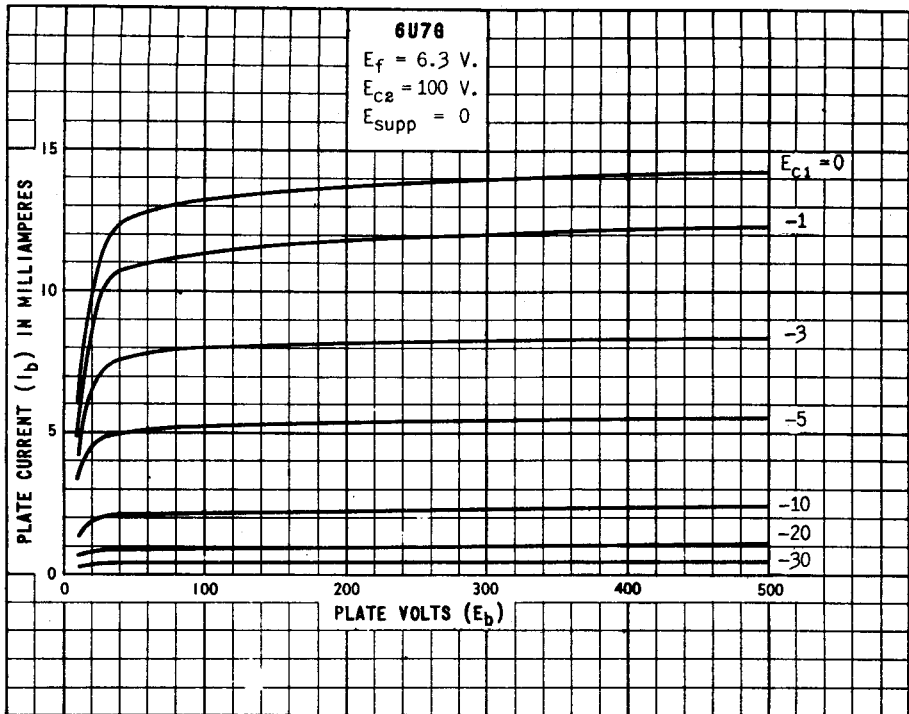

PRINTED IN U. S. A.

PLATE 266-1

JAN. 3 1939

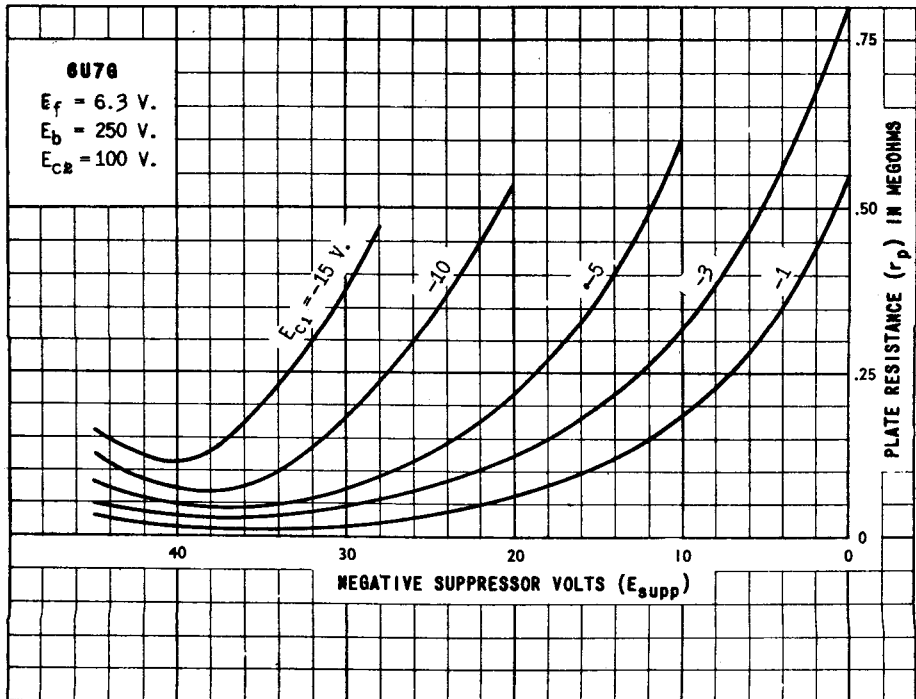
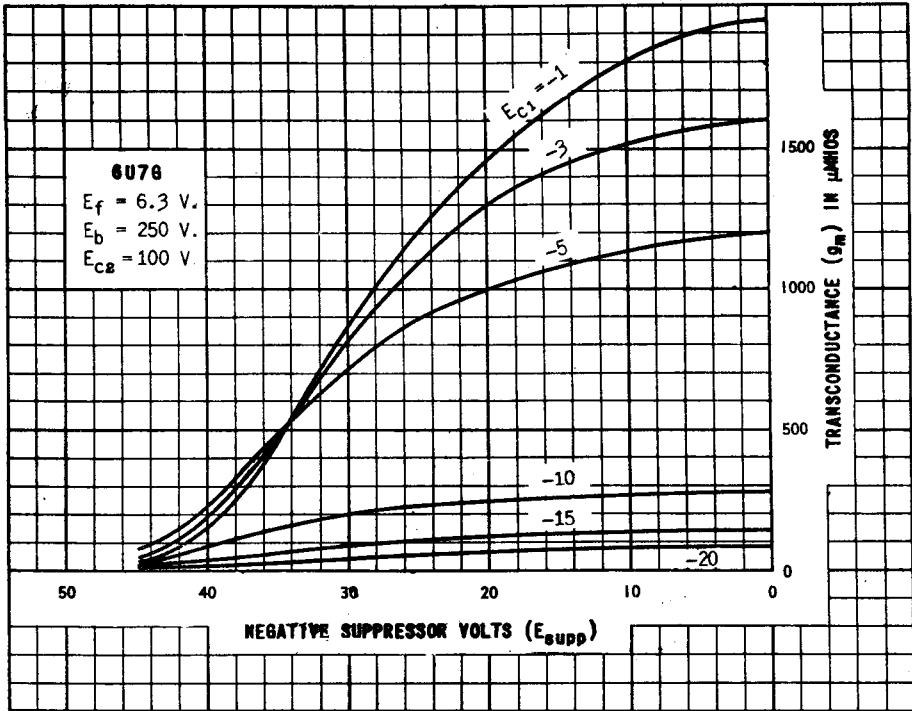

TUNG-SOL

BEAM POWER AMPLIFIER

UNI-POTENTIAL CATHODE

HEATER

6.3 VOLTS 0.45 AMPERE

AC OR DC

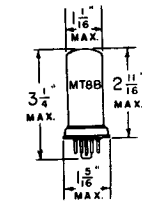

SMALL
7 PIN OCTAL BASE
METAL SHELL
6V6

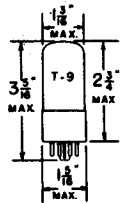

INTERMEDIATE
7 PIN OCTAL BASE
GLASS BULB
6V6GT/G

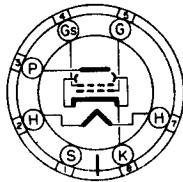

7AC

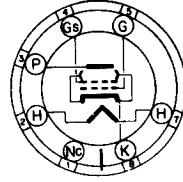

6-7AC

BOTTOM VIEWS

THE TUNG-SOL 6V6 AND 6V6GT/G ARE BEAM POWER AMPLIFIERS, DESIGNED FOR SERVICE IN THE OUTPUT STAGE OF AC AND STORAGE BATTERY OPERATED RECEIVERS. THEY HAVE HIGH POWER SENSITIVITY AND HIGH POWER OUTPUT WITH COMPARATIVELY LOW SUPPLY VOLTAGES.

RATINGS

MAXIMUM PLATE VOLTAGE	315	VOLTS
MAXIMUM SCREEN VOLTAGE	285	VOLTS
MAXIMUM PLATE DISSIPATION	12	WATTS
MAXIMUM SCREEN DISSIPATION	2	WATTS

TYPICAL OPERATING CONDITIONS AND CHARACTERISTICS

SINGLE TUBE CLASS A₁ AMPLIFIER

PLATE VOLTAGE	180	250	315	VOLTS
SCREEN VOLTAGE	180	250	225	VOLTS
CONTROL GRID VOLTAGE ^A	-8.5	-12.5	-13	VOLTS
PEAK AF SIGNAL VOLTAGE	8.5	12.5	13	VOLTS
ZERO-SIGNAL PLATE CURRENT	29	45	34	MA.
ZERO-SIGNAL SCREEN CURRENT (NOMINAL)	3	4.5	2.2	MA.
MAXIMUM-SIGNAL PLATE CURRENT	30	47	35	MA.
MAXIMUM-SIGNAL SCREEN CURRENT (NOMINAL)	4.	7	6	MA.
PLATE RESISTANCE APPROX.	58000	52000	77000	OHMS
TRANSCONDUCTANCE	3700	4100	3750	μMHOS
LOAD RESISTANCE	5500	5000	8500	OHMS
TOTAL HARMONIC DISTORTION	8	8	12	PER CENT
POWER OUTPUT	2.0	4.5	5.5	WATTS

^A THE DC RESISTANCE IN THE GRID CIRCUIT, UNDER MAXIMUM RATED CONDITIONS, SHOULD NOT EXCEED 0.5 MEGOHM FOR SELF-BIAS OPERATION AND 0.1 MEGOHM FOR FIXED BIAS OPERATION.

CONTINUED NEXT PAGE

TUNG-SOL

PUSH-PULL CLASS AB₁ AMPLIFIER

VALUES FOR 2 TUBES UNLESS OTHERWISE SPECIFIED

PLATE VOLTAGE	250	285	VOLTS
SCREEN VOLTAGE	250	285	VOLTS
CONTROL GRID VOLTAGE ^A	-15	-19	VOLTS
PEAK AF SIGNAL VOLTAGE GRID TO GRID	30	38	VOLTS
ZERO-SIGNAL PLATE CURRENT	70	70	MA.
ZERO-SIGNAL SCREEN CURRENT (NOMINAL)	5.0	4.0	MA.
MAXIMUM-SIGNAL PLATE CURRENT	79	92	MA.
MAXIMUM-SIGNAL SCREEN CURRENT (NOMINAL)	13	13.5	MA.
PLATE RESISTANCE APPROX.	66000	65000	OHMS
TRANSCONDUCTANCE	3750	3600	μMHOS
EFFECTIVE LOAD RESISTANCE PLATE TO PLATE	10000	8000	OHMS
TOTAL HARMONIC DISTORTION	5	3.5	PER CENT
POWER OUTPUT	10	14	WATTS

^A THE DC RESISTANCE IN THE GRID CIRCUIT, UNDER MAXIMUM RATED CONDITIONS, SHOULD NOT EXCEED 0.5 MEGOHM FOR FIXED BIAS OPERATION.

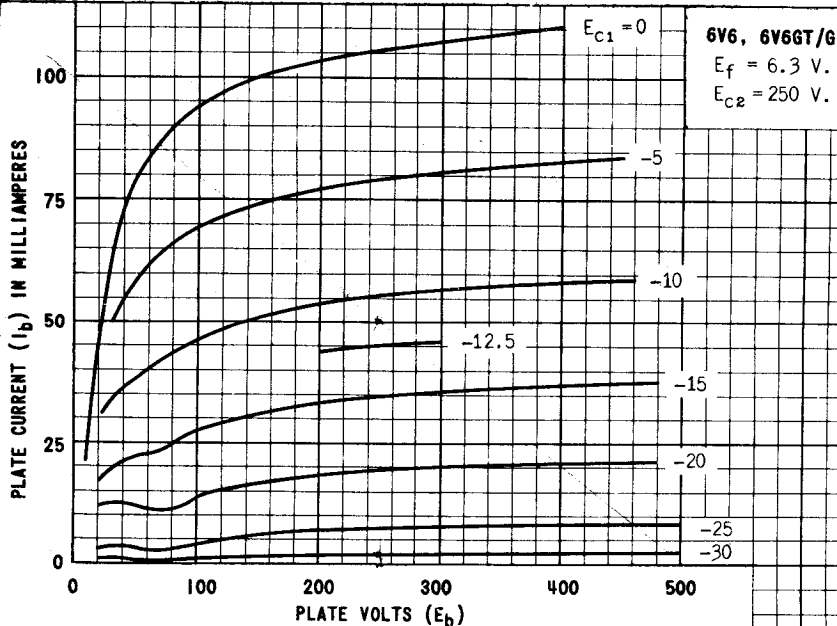
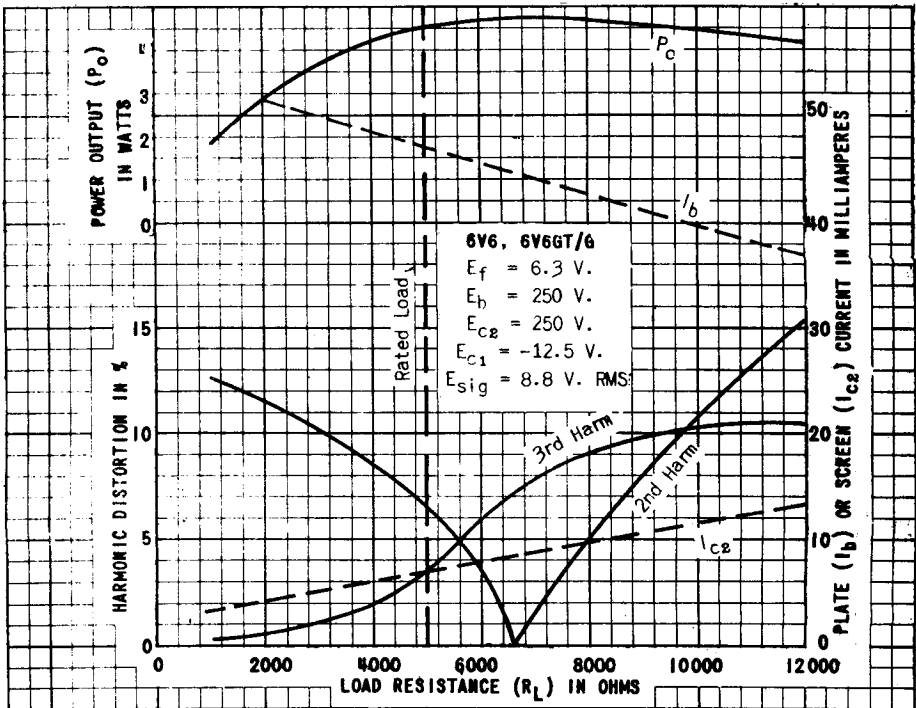
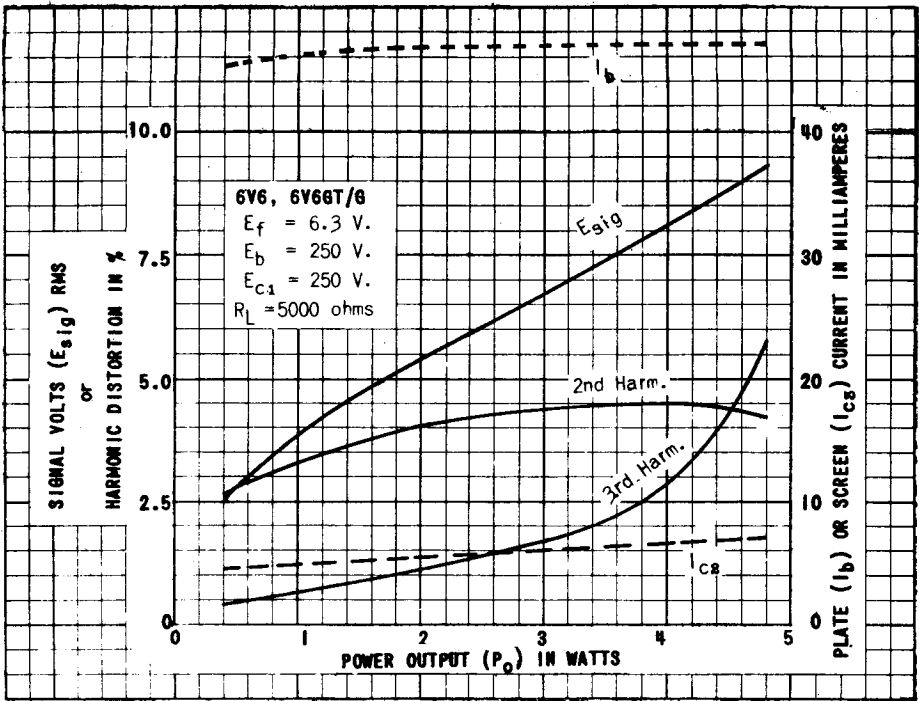

PLATE
1051-2

6V6, 6V6GT/G



PRINTED IN U. S. A.

PLATE 1052-2

JUNE 6 1941



TUNG-SOL

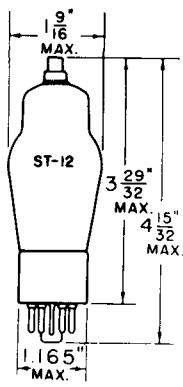

6V7G
SMALL 7 PIN
OCTAL BASE

DUPLEX-DIODE TRIODE

UNIPOTENTIAL CATHODE

HEATER

6V7G, 85	55
6.3 V.	2.5 V.
0.3 A.	1.0 A.

AC OR DC

IN CIRCUITS WHERE THE CATHODE IS NOT DIRECTLY CONNECTED TO THE HEATER, THE POTENTIAL DIFFERENCE BETWEEN HEATER AND CATHODE SHOULD BE KEPT AS LOW AS POSSIBLE. UNDER NO CONDITIONS SHOULD IT EXCEED 100 VOLTS.

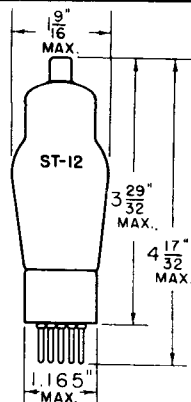

55, 85
SMALL 8 PIN
BASE



6V7G

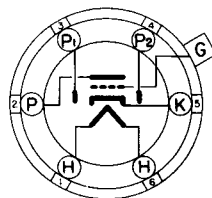

55, 85

BOTTOM VIEWS

THE 6V7G, 55 AND 85 ARE HEATER CATHODE TYPE TUBES CONSISTING OF TWO DIODES AND A TRIODE IN A SINGLE BULB. THEY ARE DESIGNED FOR USE AS COMBINED DETECTORS, AMPLIFIERS AND AUTOMATIC VOLUME CONTROL TUBES.

RATINGS

INTERPRETED ACCORDING TO RMA STANDARD M8-210

MAXIMUM PLATE VOLTAGE	250	VOLTS
MAXIMUM PLATE DISSIPATION	2.0	WATTS

DIRECT INTERELECTRODE CAPACITANCES

GRID TO PLATE	1.5	μf
INPUT	1.5	μf
OUTPUT	4.3	μf

TYPICAL OPERATING CONDITIONS AND CHARACTERISTICS

CLASS A AMPLIFIER

PLATE VOLTAGE	135	180	250	VOLTS
GRID VOLTAGE	-10.5	-13.5	-20	VOLTS
PLATE CURRENT	3.7	6.0	8.0	MA.
PLATE RESISTANCE	11000	8500	7500	OHMS
TRANSCONDUCTANCE	750	975	1100	μMHOS
AMPLIFICATION FACTOR	8.3	8.3	8.3	
LOAD RESISTANCE	25000	20000	20000	OHMS
POWER OUTPUT	75	160	350	MW.

PRINTED IN U.S.

PLATE
1439
JUNE 15
1944

6V7G (55, 85)

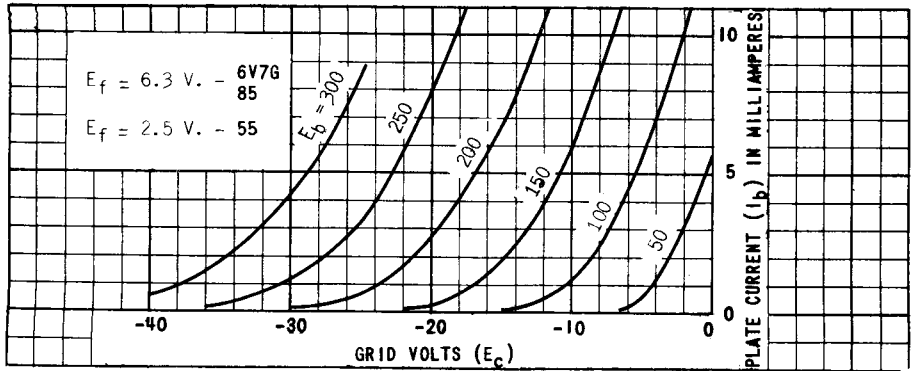
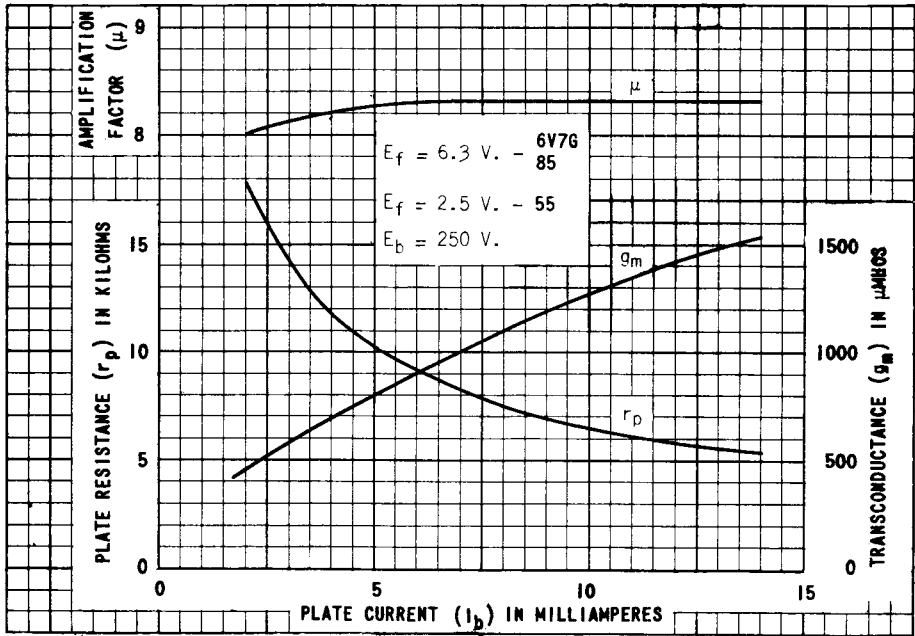
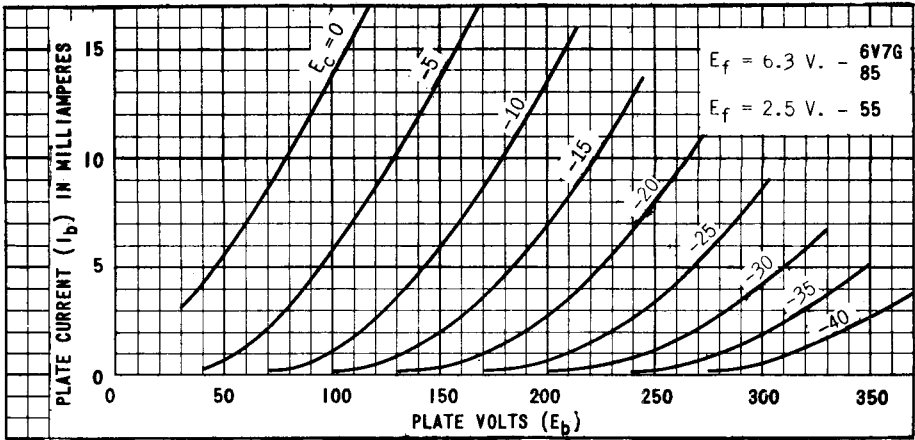
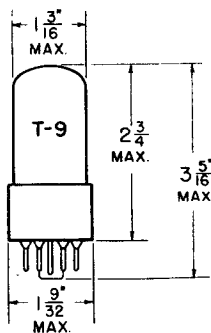

PLATE
 1440
 JUNE 15
 1944

TUNG-SOL

DIODE



GLASS BULB

UNIPOENTIAL CATHODE
 HEATER
 6.3 VOLTS 1.2 AMPERES
 AC
 ANY MOUNTING POSITION

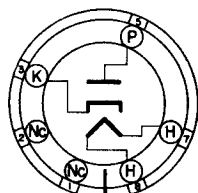

BOTTOM VIEW
 SHORT INTERMEDIATE
 SHELL 6 PIN OCTAL

THE 6W4GT IS A SINGLE HIGH VACUUM DIODE OF THE SEPARATE HEATER TYPE USING THE GLASS ENVELOPE OCTAL-BASE CONSTRUCTION. IT IS INTENDED FOR USE IN A TWO TUBE POWER RECTIFIER SUPPLYING MODERATE OUTPUT CURRENT OR IN DAMPER SERVICE FOR TELEVISION HORIZONTAL DEFLECTION SYSTEMS WHERE HIGH INVERSE PEAK VOLTAGES ARE ENCOUNTERED.

RATINGS

INTERPRETED ACCORDING TO RMA STANDARD M8-210

HEATER VOLTAGE	6.3	VOLTS
MAXIMUM PEAK HEATER-CATHODE VOLTAGE:		
HEATER NEGATIVE WITH RESPECT TO CATHODE	450	VOLTS
HEATER POSITIVE WITH RESPECT TO CATHODE	100	VOLTS
MAXIMUM PEAK INVERSE PLATE VOLTAGE:		
FOR TELEVISION DAMPER SERVICE ^A	2 000	VOLTS
FOR CONVENTIONAL RECTIFIER SERVICE	1 250	VOLTS
MAXIMUM PEAK PLATE CURRENT	600	MA.
MAXIMUM HOT SWITCHING TRANSIENT PLATE CURRENT		
FOR DURATION OF 0.2 SEC. MAX.	3.5	AMP.
MAXIMUM DC OUTPUT CURRENT	100	MA.
TUBE VOLTAGE DROP (MEASURED WITH TUBE CONDUCTING 200 MA. DC)	17	VOLTS

^A THIS RATING IS APPLICABLE WHERE THE DUTY CYCLE OF THE VOLTAGE PULSE DOES NOT EXCEED 15% OF ONE SCANNING CYCLE AND ITS DURATION IS LIMITED TO 10 MICROSECONDS.

TYPICAL OPERATING CONDITIONS AND CHARACTERISTICS

HALF-WAVE RECTIFIER

HEATER VOLTAGE	6.3	VOLTS
HEATER CURRENT	1.2	AMP.
AC PLATE VOLTAGE (RMS)	350	VOLTS
FILTER-INPUT CONDENSER	20	μF
TOTAL EFFECTIVE PLATE-SUPPLY IMPEDANCE	145	OHMS
DC OUTPUT CURRENT	100	MA.

PLATE
 2098
 NOV. 1,
 1948



TUNG-SOL

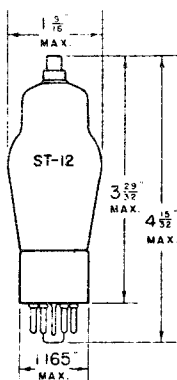

GLASS BULB

TRIPLE GRID
DETECTOR AMPLIFIER

UNIPOTENTIAL CATHODE

HEATER

6.3 VOLTS 0.15 AMPERE
AC OR DC

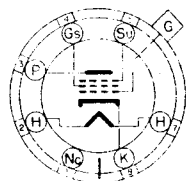
G-7R_a

BOTTOM VIEW

THE TUNG-SOL 6W7G IS A TRIPLE GRID GENERAL PURPOSE DETECTOR AMPLIFIER, WHICH IS DESIGNED FOR SERVICE IN APPLICATIONS THAT REQUIRE A LOW HEATER CURRENT.

RATINGS

MAXIMUM PLATE VOLTAGE	300	VOLTS
MAXIMUM SCREEN SUPPLY VOLTAGE	300	VOLTS
MAXIMUM SCREEN VOLTAGE	100	VOLTS
MINIMUM EXTERNAL CONTROL GRID BIAS VOLTAGE	0	VOLT
MAXIMUM PLATE DISSIPATION	0.5	WATT
MAXIMUM SCREEN DISSIPATION	0.1	WATT

TYPICAL OPERATING CONDITIONS AND CHARACTERISTICS

CLASS A₁ AMPLIFIER

PLATE VOLTAGE	250	VOLTS
SCREEN VOLTAGE	100	VOLTS
CONTROL GRID VOLTAGE	-3	VOLTS
SUPPRESSOR GRID	CONNECTED TO CATHODE AT SOCKET	
PLATE CURRENT	2.0	MA.
SCREEN CURRENT	0.5	MA.
PLATE RESISTANCE APPROX.	1.5	MEG OHMS
TRANSCONDUCTANCE	1200	MMHCS
CONTROL GRID VOLTAGE APPROX. FOR CATHODE CURRENT CUT-OFF	-7	VOLTS

DIRECT INTERELECTRODE CAPACITANCES^S

CONTROL GRID TO CATHODE	5.0	μf
PLATE TO CATHODE	8.5	μf
CONTROL GRID TO PLATE	0.007 ^{MAX.}	μf

^S WITH EXTERNAL SHIELD CONNECTED TO CATHODE. THE INTERNAL SHIELD WITHIN THE DOME OF THE 6W7G IS CONNECTED INTERNALLY TO THE CATHODE.

FOR "INTERPRETATION OF RATINGS" REFER TO FRONT OF BOOK

CONTINUED NEXT PAGE

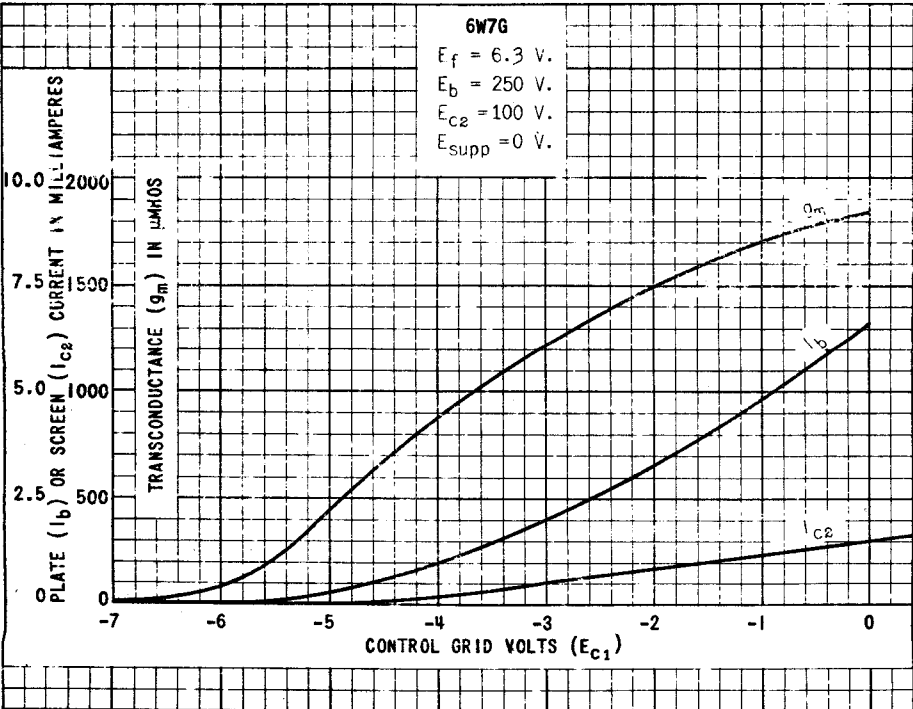
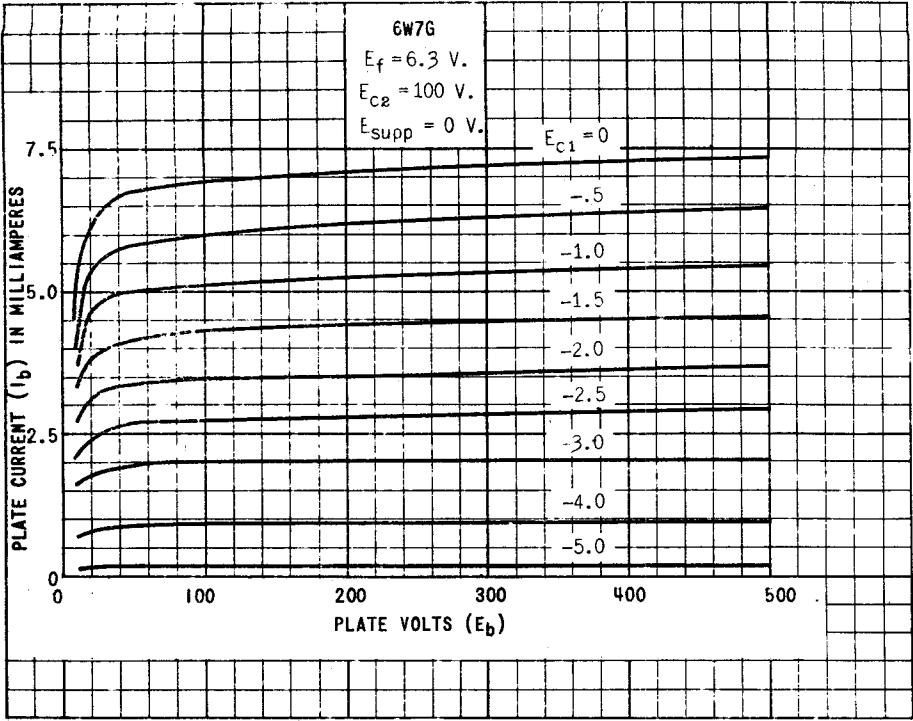

TUNG-SOL

FULL WAVE RECTIFIER

MINIATURE TYPE

PHYSICAL SPECIFICATIONS

EMITTER COATED UNIPOT. CATHODE		PIN CONNECTIONS	
BASE	MIN. BUTTON 7-PIN BASE	PIN 1 PLATE (UP.)	PIN 7 CATHODE
CAP	---	PIN 2 NONE	PIN 8 NONE
BULB	T-5 $\frac{1}{2}$	PIN 3 HEATER	
MAXIMUM DIAMETER	$\frac{3}{4}$ "	PIN 4 HEATER	
MAXIMUM OVERALL LENGTH	$2\frac{5}{8}$ "	PIN 5 NONE	
MAXIMUM SEATED HEIGHT	$2\frac{3}{8}$ "	PIN 6 PLATE (LOW.)	

RATINGS

INTERPRETED ACCORDING TO RMA STANDARD M8-210

HEATER OR FILAMENT VOLTAGE	6.3	VOLTS
HEATER OR FILAMENT CURRENT	0.600	AMPS.
MAXIMUM PLATE VOLTAGE PER PLATE (RMS)		VOLTS
MAXIMUM DC HEATER TO CATHODE POTENTIAL	450	VOLTS
MAXIMUM PEAK INVERSE VOLTAGE	1250	VOLTS
MAXIMUM STEADY-STATE PEAK PLATE CURRENT PER PLATE	210	MA.
TUBE VOLTAGE DROP AT		MA. PER PLATE
		VOLTS

TYPICAL OPERATING CONDITIONS AND CHARACTERISTICS

FULL-WAVE RECTIFIER WITH CONDENSER INPUT TO FILTER

HEATER OR FILAMENT VOLTAGE	6.3	VOLTS
AC PLATE VOLTAGE PER PLATE (RMS)	325	VOLTS
DC OUTPUT CURRENT	70	MA.
TOTAL EFFECTIVE PLATE SUPPLY IMPEDANCE PER PLATE	150	OHMS (MIN.)
FILTER INPUT CONDENSER	4	μ f

FULL-WAVE RECTIFIER WITH CHOKE INPUT TO FILTER

HEATER OR FILAMENT VOLTAGE		VOLTS
AC PLATE VOLTAGE PER PLATE (RMS)		VOLTS
DC OUTPUT CURRENT		MA.
MINIMUM VALUE OF INPUT CHOKE		HENRYS



TUNG-SOL

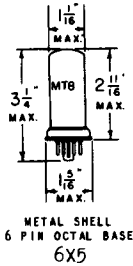

METAL SHELL
6 PIN OCTAL BASE
6X5

FULL WAVE
HIGH VACUUM RECTIFIER

UNIPOTENTIAL CATHODE

HEATER

6.3 VOLTS 0.6 AMPERE

AC OR DC

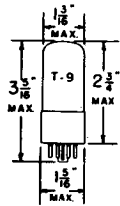

GLASS BULB
6 PIN OCTAL BASE
6X5GT/G

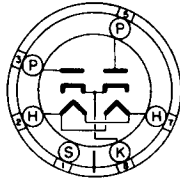

6S
BOTTOM VIEW
6X5

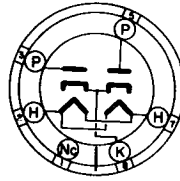

G-6S
BOTTOM VIEW
6X5GT/G

THE TUNG-SOL 6X5 AND 6X5GT/G ARE DESIGNED FOR SERVICE IN STORAGE BATTERY OR AC OPERATED RECEIVERS. THEIR CHARACTERISTICS ARE IDENTICAL.

RATINGS

MAXIMUM DC HEATER TO CATHODE POTENTIAL	450	VOLTS
MAXIMUM PEAK INVERSE VOLTAGE	1250	VOLTS
MAXIMUM STEADY-STATE PEAK PLATE CURRENT PER PLATE	210	MA.

TYPICAL OPERATING CONDITIONS AND CHARACTERISTICS

FULL WAVE RECTIFIER WITH CONDENSER INPUT TO FILTER

AC PLATE VOLTAGE PER PLATE (RMS) ^{MAX.}	325	VOLTS
DC OUTPUT CURRENT ^{MAX.}	70	MA.
TOTAL EFFECTIVE PLATE SUPPLY IMPEDANCE PER PLATE ^{MIN.^A}	150	OHMS

FULL WAVE RECTIFIER WITH CHOKE INPUT TO FILTER

AC PLATE VOLTAGE PER PLATE (RMS) ^{MAX.}	450	VOLTS
DC OUTPUT CURRENT ^{MAX.}	70	MA.
VALUE OF INPUT CHOKE ^{MIN.}	8	HENRY'S
TUBE VOLTAGE DROP	22	VOLTS
AT 70 MA. PER PLATE		

^A WHEN FILTER CONDENSERS LARGER THAN 40 μ FDS. ARE USED IT MAY BE NECESSARY TO ADD ADDITIONAL PLATE SUPPLY IMPEDANCE.

FOR "INTERPRETATION OF RATINGS" REFER TO FRONT OF BOOK.

CONTINUED NEXT PAGE.

PRINTED IN U. S. A.

6X5 6X5GT/G

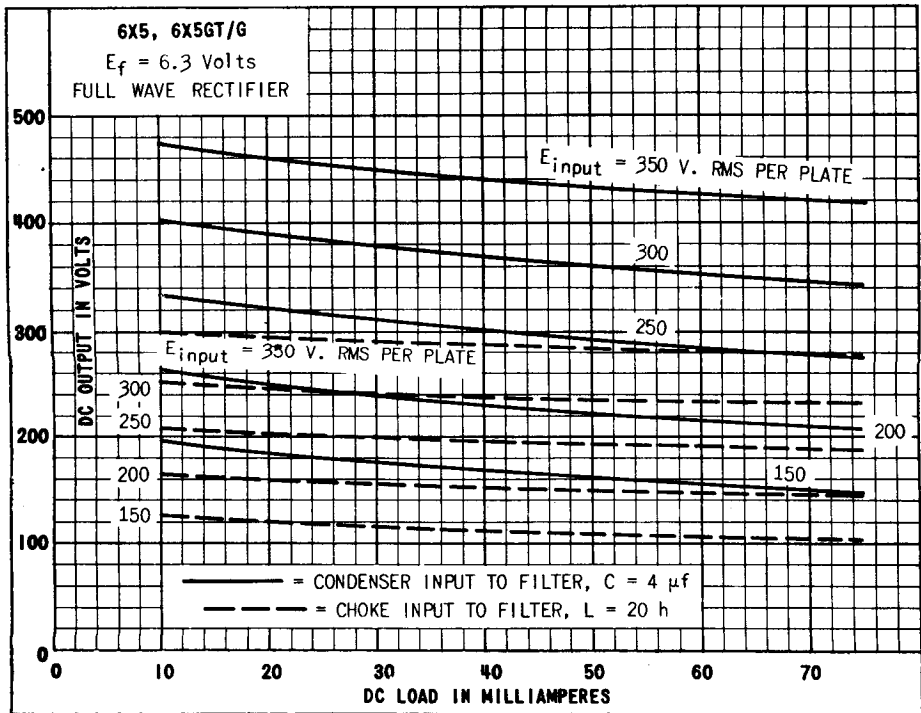
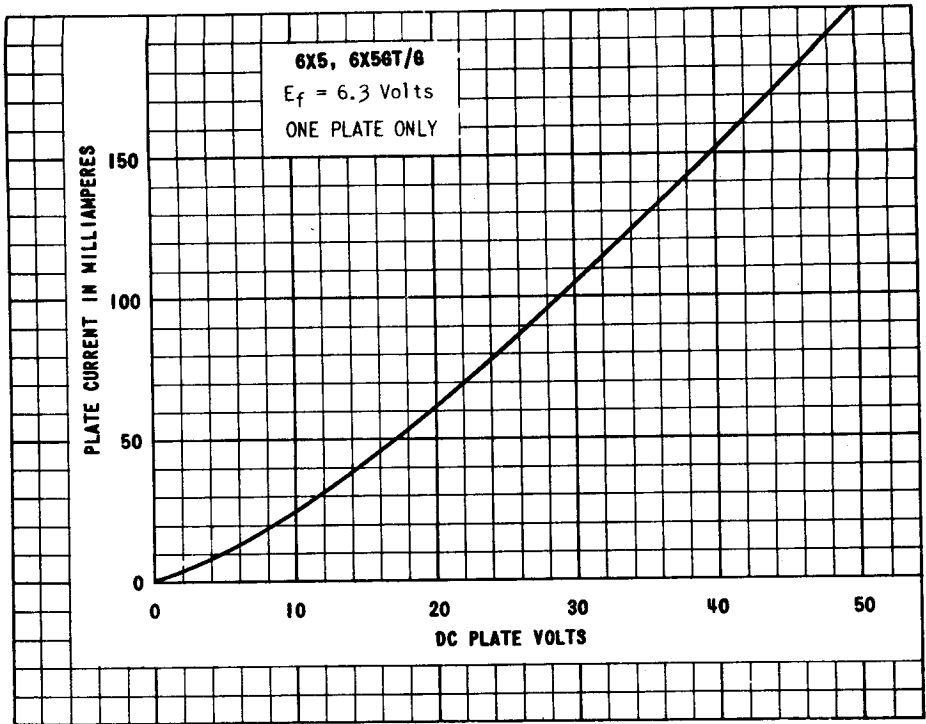
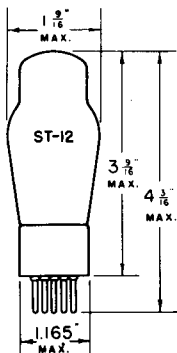

PLATE
1009-2
APR-21
1941

TUNG-SOL



**FULL-WAVE
HIGH VACUUM RECTIFIER**

UNIPOTENTIAL CATHODE

HEATER
6.3 VOLTS 0.80 AMPERE
AC OR DC

GLASS BULB

SMALL 6 PIN BASE

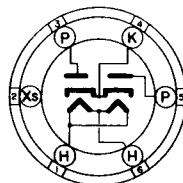

6J
BOTTOM VIEW

THE TUNG-SOL 6Y5 IS A HEATER TYPE HIGH VACUUM FULL-WAVE RECTIFIER, WHICH IS DESIGNED FOR USE IN STORAGE BATTERY OR AC OPERATED RECEIVERS.

OPERATING CONDITIONS AND CHARACTERISTICS

FULL WAVE RECTIFIER - CONDENSER INPUT TO FILTER

AC PLATE VOLTAGE PER PLATE (RMS) MAX.	350	VOLTS
DC OUTPUT CURRENT MAX.	50	MA.

FOR "INTERPRETATION OF RATINGS" REFER TO FRONT OF BOOK.

PLATE
902-1

NOV. 8
1940



TUNG-SOL

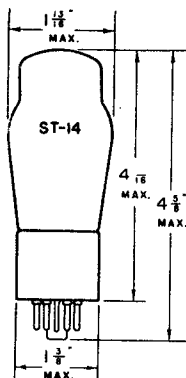

BEAM POWER AMPLIFIER

UNIPOENTIAL CATHODE

HEATER

6.3 VOLTS 1.25 AMPERES

AC OR DC

GLASS BULB

MEDIUM 7 PIN OCTAL BASE

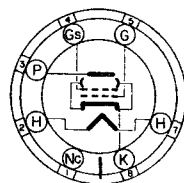

G-7AC

BOTTOM VIEW

THE TUNG-SOL 6Y6G IS A BEAM POWER AMPLIFIER HAVING HIGH POWER SENSITIVITY AND HIGH POWER OUTPUT AT COMPARATIVELY LOW DC SUPPLY VOLTAGES.

RATINGS

MAXIMUM PLATE VOLTAGE	200	VOLTS
MAXIMUM SCREEN VOLTAGE	135	VOLTS
MAXIMUM PLATE DISSIPATION	12.5	WATTS
MAXIMUM SCREEN DISSIPATION	1.75	WATTS

TYPICAL OPERATING CONDITIONS AND CHARACTERISTICS

CLASS A₁ AMPLIFIER

PLATE VOLTAGE	135	200	VOLTS
SCREEN VOLTAGE	135	135	VOLTS
CONTROL GRID VOLTAGE ^A	-13.5	-14	VOLTS
PEAK AF SIGNAL VOLTAGE	13.5	14	VOLTS
ZERO-SIGNAL PLATE CURRENT	58	61	MA.
ZERO-SIGNAL SCREEN CURRENT	3.5	2.2	MA.
MAXIMUM-SIGNAL PLATE CURRENT	60	66	MA.
MAXIMUM-SIGNAL SCREEN CURRENT	11.5	9.0	MA.
PLATE RESISTANCE APPROX.	9300	18300	OHMS
TRANSCONDUCTANCE	7000	7100	UMHOS
LOAD RESISTANCE	2000	2600	OHMS
TOTAL HARMONIC DISTORTION	10	10	PER CENT
POWER OUTPUT	3.6	6.0	WATTS

^A THE GRID CIRCUIT RESISTANCE SHOULD NOT EXCEED 0.1 MEGOHM WITH FIXED BIAS AND 0.5 MEGOHM WITH SELF BIAS.

NOTE: UNDER CONDITIONS OF MAXIMUM POWER DISSIPATION, THE HEATER VOLTAGE SHOULD NOT BE ALLOWED TO EXCEED 7.0 VOLTS WITH FLUCTUATIONS OF LINE VOLTAGE.

FOR "INTERPRETATION OF RATINGS" REFER TO FRONT OF BOOK.

CONTINUED NEXT PAGE

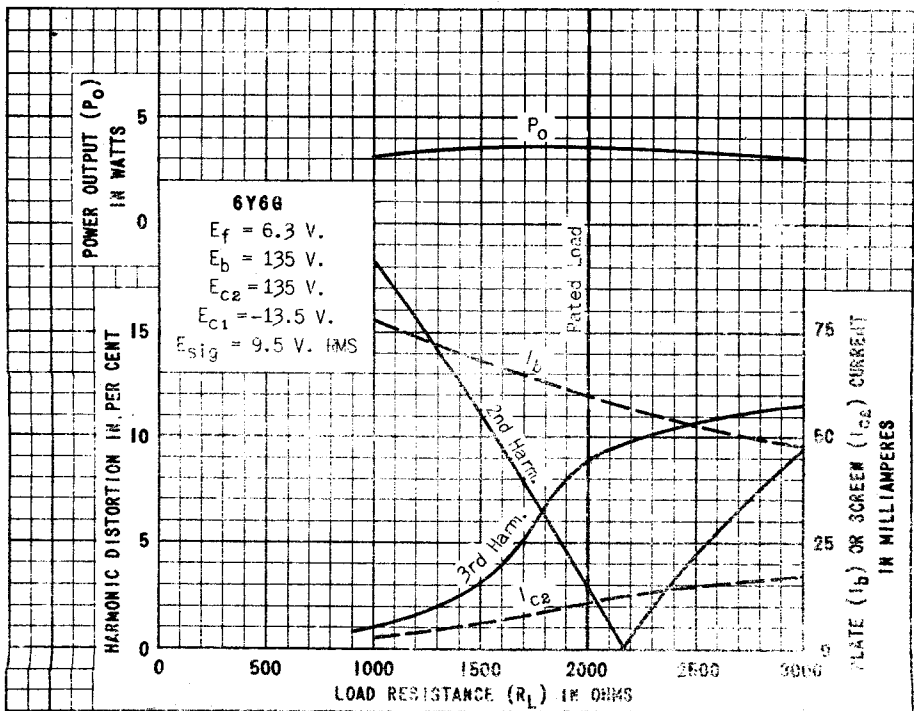
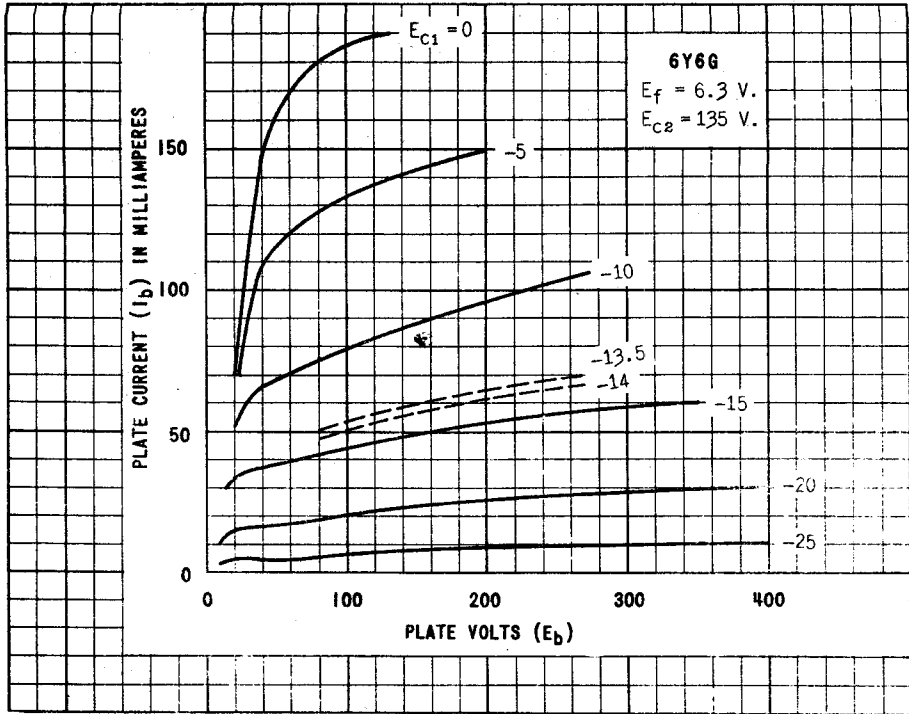

TUNG-SOL

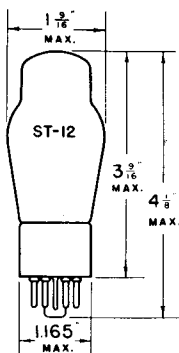

TWIN TRIODE POWER AMPLIFIER

UNIPOTENTIAL CATHODE

HEATER

6.3 VOLTS 0.6 AMPERE

AC OR DC

GLASS BULB

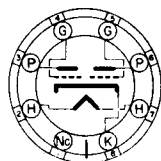

G-8B

SMALL 8 PIN OCTAL BASE

THE TUNG-SOL 6Y7G IS A TWIN TRIODE DESIGNED PRIMARILY FOR SERVICE AS A CLASS B POWER AMPLIFIER, VOLTAGE AMPLIFIER OR PHASE INVERTER. WITH THE EXCEPTION OF CAPACITANCES ITS RATINGS AND CHARACTERISTICS ARE IDENTICAL WITH THOSE OF THE 79.

OPERATING CONDITIONS AND CHARACTERISTICS

PLATE VOLTAGE ^{MAX.}	250	VOLTS
PEAK PLATE CURRENT PER PLATE ^{MAX.}	90	MA.
AVERAGE PLATE DISSIPATION ^{MAX.}	11.5	WATTS

CLASS B₂ AMPLIFIER

PLATE VOLTAGE	180	250 ^{MAX.}	VOLTS
GRID BIAS	0	0	VOLTS
ZERO-SIGNAL PLATE CURRENT PER PLATE	3.8	5.3	MA.
EFFECTIVE LOAD RESISTANCE ^{PLATE TO PLATE}	7000	14000	OHMS
AVERAGE POWER INPUT ^{GRID TO GRID}	380	380	MILLIWATTS
POWER OUTPUT ^{APPROX.}	5.5	8.0	WATTS

RESISTANCE COUPLED AMPLIFIER AND PHASE INVERTER

PLATE SUPPLY VOLTAGE	100	100	250	250	VOLTS
PLATE LOAD RESISTOR	0.1	0.5	0.1	0.5	MEG OHM
CATHODE RESISTOR	2000	6000	1200	3000	OHMS
VOLTAGE GAIN	30	35	35	43	

DIRECT INTERELECTRODE CAPACITANCES^S

	TRIODE 2	TRIODE 1	
GRID TO CATHODE	3.6	3.6	μf
PLATE TO CATHODE	4.6	4.6	μf
GRID TO PLATE	2.6	2.6	μf
GRID 1 TO GRID 2		0.3	μf
PLATE 1 TO PLATE 2		1.7	μf
GRID 1 TO PLATE 2		0.12	μf
GRID 2 TO PLATE 1		0.12	μf

TRIODE 2 IS TRIODE HAVING GRID BROUGHT OUT TO PIN #4.

TRIODE 1 IS TRIODE HAVING GRID BROUGHT OUT TO PIN #5.

^S WITH SHIELD

PLATE
348-2

MARCH 6
1939



TUNG-SOL

**FULL WAVE
HIGH VACUUM RECTIFIER**

UNI-POTENTIAL CATHODE

HEATER

6.3 VOLTS^A 0.80 AMPERE

12.6 VOLTS^B 0.40 AMPERE

AC OR DC

GLASS BULB

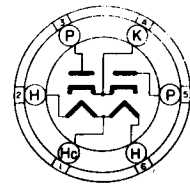
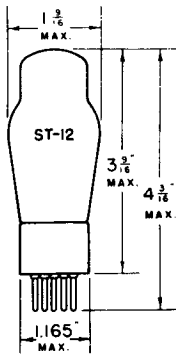

6K

BOTTOM VIEW

SMALL 6 PIN BASE

THE TUNG-SOL 6Z5/12Z5 IS A HEATER TYPE HIGH VACUUM FULL WAVE RECTIFIER. THE HEATER IS CENTER TAPPED SO THAT IT MAY BE OPERATED ON EITHER 6.3 VOLTS OR 12.6 VOLTS.

OPERATING CONDITIONS AND CHARACTERISTICS

FULL WAVE RECTIFIER - CONDENSER INPUT TO FILTER

AC PLATE VOLTAGE PER PLATE (RMS) ^{MAX.}	230	VOLTS
DC OUTPUT CURRENT ^{MAX.}	60	MA.

^A HEATERS CONNECTED IN PARALLEL

^B HEATERS CONNECTED IN SERIES

FOR "INTERPRETATION OF RATINGS" REFER TO FRONT OF BOOK.

TUNG-SOL

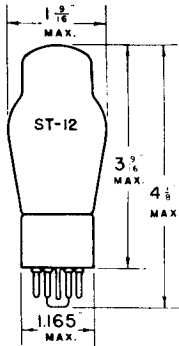

CLASS B TWIN TRIODE

UNI-POTENTIAL CATHODE

HEATER

6.3 VOLTS 0.3 AMPERE

AC OR DC

GLASS BULB

SMALL 8 PIN OCTAL BASE

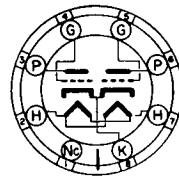

G-8B

BOTTOM VIEW

THE TUNG-SOL 6Z7G IS A TWIN TRIODE CLASS B POWER AMPLIFIER, DESIGN-ED PRIMARILY FOR SERVICE WHERE LOW HEATER CURRENT IS REQUIRED.

MAXIMUM OPERATING CONDITIONS

PLATE VOLTAGE	180 MAX.	VOLTS
PEAK PLATE CURRENT PER PLATE	60 MAX.	MA.
AVERAGE PLATE DISSIPATION	8 MAX.	WATTS

OPERATING CONDITIONS AND CHARACTERISTICS

CLASS B₂ POWER AMPLIFIER

PLATE VOLTAGE	135	135	180	180	VOLTS
GRID VOLTAGE	0	0	0	0	VOLTS
ZERO SIGNAL PLATE CURRENT ^P	6	6	8.4	8.4	MA.
EFFECTIVE LOAD RESISTANCE ^L	15 000	9000	20 000	12 000	OHMS
AVERAGE POWER INPUT ^G	80	320	80	320	MILLIWATTS
POWER OUTPUT	1.5	2.5	2.2	4.2	WATTS

^P BOTH PLATES^L PLATE TO PLATE^G GRID TO GRIDDIRECT INTERELECTRODE CAPACITANCES^S

	TRIODE 1	TRIODE 2	
GRID TO CATHODE	4	4	μf
PLATE TO CATHODE	5	5	μf
GRID TO PLATE	5	5	μf
GRID TO GRID		0.22	μf
PLATE TO PLATE		0.8	μf
GRID (2) TO PLATE (1)		0.1	μf

TRIODE 1 IS TRIODE HAVING GRID BROUGHT OUT TO PIN #5.

TRIODE 2 IS TRIODE HAVING GRID BROUGHT OUT TO PIN #4.

^S WITH SHIELD

CAPACITANCES BETWEEN ELEMENTS OF ONE TRIODE ARE MEASURED WITH THE ELEMENTS OF THE OTHER TRIODE GROUNDED.

NOTE: THIS TUBE IS NOT RECOMMENDED FOR OPERATION IN SERIES WITH OTHER 0.3 AMPERE HEATER TUBES AS THE SURGE CURRENT MAY CAUSE HEATER BURROUTS.

PLATE
904-2

TUNG-SOL

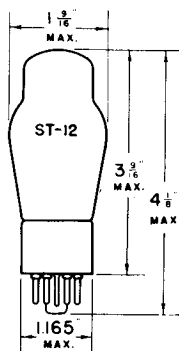

FULL WAVE
HIGH VACUUM RECTIFIER

UNIPOTENTIAL CATHODE

HEATER

6.3 VOLTS 0.3 AMPERE
AC OR DC

GLASS BULB

SMALL 6 PIN OCTAL BASE

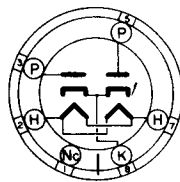

G-6S
BOTTOM VIEW

THE TUNG-SOL 6ZY5G IS DESIGNED FOR SERVICE IN RECEIVERS THAT REQUIRE SMALL LOAD CURRENTS, AND WHERE ECONOMY IS DESIRED IN HEATER CURRENT CONSUMPTION.

RATINGS

MAXIMUM PEAK INVERSE VOLTAGE	1250	VOLTS
MAXIMUM DC HEATER TO CATHODE POTENTIAL	450	VOLTS
MAXIMUM STEADY-STATE PEAK PLATE CURRENT PER PLATE	120	MA.

OPERATING CONDITIONS AND CHARACTERISTICS

FULL WAVE RECTIFIER WITH CONDENSER INPUT TO FILTER

AC PLATE VOLTAGE PER PLATE (RMS) ^{MAX.}	325	VOLTS
DC OUTPUT CURRENT ^{MAX.}	40	MA.
TOTAL EFFECTIVE PLATE SUPPLY IMPEDANCE PER PLATE ^{MIN. A}	225	OHMS

FULL WAVE RECTIFIER WITH CHOKE INPUT TO FILTER

AC PLATE VOLTAGE PER PLATE (RMS) ^{MAX.}	450	VOLTS
DC OUTPUT CURRENT ^{MAX.}	40	MA.
VALUE OF INPUT CHOKE ^{MIN.}	13.5	HENRYS
TUBE VOLTAGE DROP AT 40 MA. PER PLATE	18	VOLTS

^A WHEN FILTER CONDENSERS LARGER THAN 40 μ FDS ARE USED, IT MAY BE NECESSARY TO ADD ADDITIONAL PLATE SUPPLY IMPEDANCE.

FOR "INTERPRETATION OF RATINGS", REFER TO FRONT OF BOOK.

CONTINUED NEXT PAGE

6ZY5G

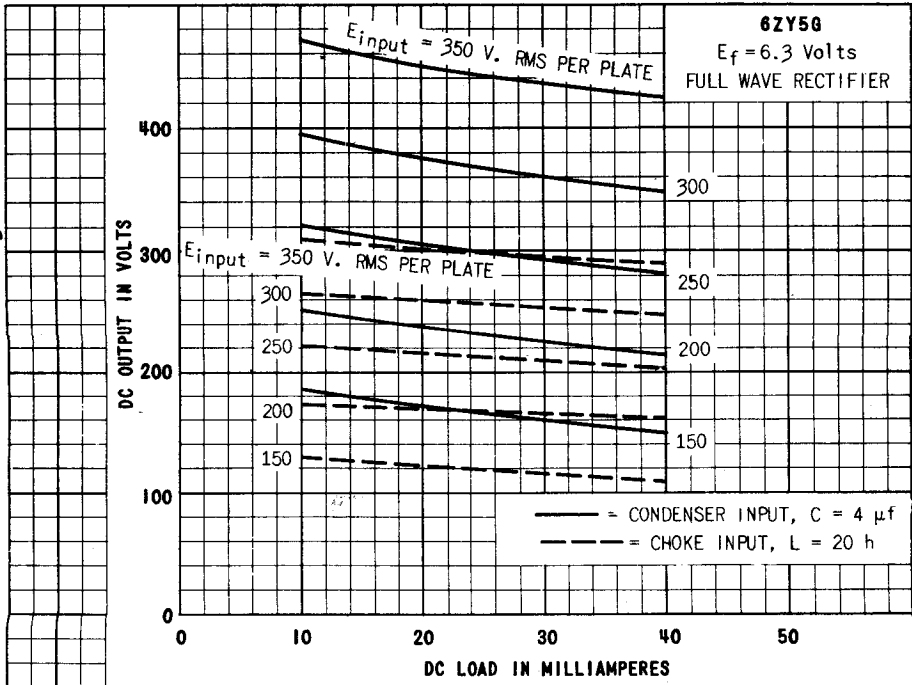
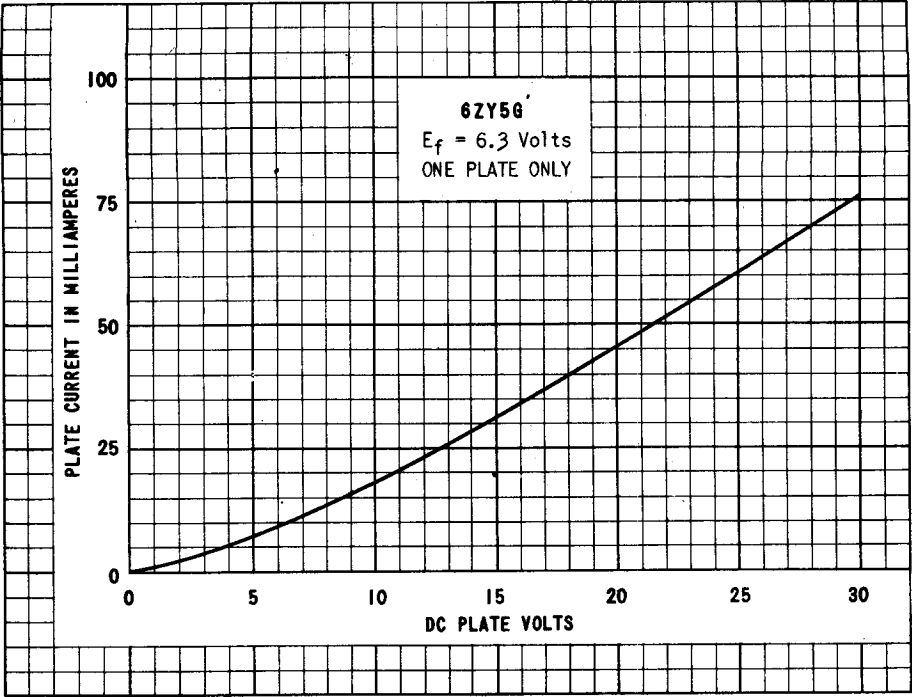
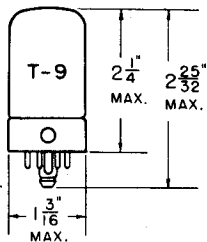

PLATE 710-1

TUNG-SOL

TRIODE AMPLIFIER



COATED UNIPOTENTIAL CATHODE

HEATER

6.3 VOLTS 0.3 AMPERE

AC OR DC

GLASS BULB

LOCKING-IN 8-PIN BASE

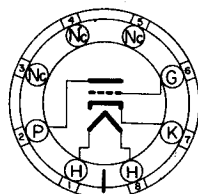

BOTTOM VIEW

THE 7A4 IS A MEDIUM-MU GENERAL PURPOSE TRIODE AMPLIFIER WITH HIGH TRANSCONDUCTANCE. IT IS PARTICULARLY APPLICABLE IN ULTRA HIGH FREQUENCY CIRCUITS.

RATINGS

INTERPRETED ACCORDING TO RMA STANDARD MB-210

MAXIMUM PLATE VOLTAGE	300	VOLTS
MAXIMUM PLATE DISSIPATION	2.5	WATTS
MINIMUM GRID VOLTAGE	0	VOLTS
MAXIMUM DC HEATER-CATHODE POTENTIAL	100	VOLTS
MAXIMUM CATHODE CURRENT	20	MA.

DIRECT INTERELECTRODE CAPACITANCES

WITH EXTERNAL SHIELD CONNECTED TO CATHODE

GRID TO PLATE	4.0	$\mu\mu\text{f}$
INPUT	3.4	$\mu\mu\text{f}$
OUTPUT	3.0	$\mu\mu\text{f}$

TYPICAL OPERATING CONDITIONS AND CHARACTERISTICS

CLASS A_1 AMPLIFIER

PLATE VOLTAGE	90	250	VOLTS
GRID VOLTAGE ^A	0	-8	VOLTS
PLATE CURRENT	10	9.0	MA.
PLATE RESISTANCE	6 700	7 700	OHMS
TRANSCONDUCTANCE	3 000	2 600	μMHOS
AMPLIFICATION FACTOR	20	20	

^A THE DC RESISTANCE IN THE GRID CIRCUIT SHOULD NOT EXCEED 1 MEGOHM

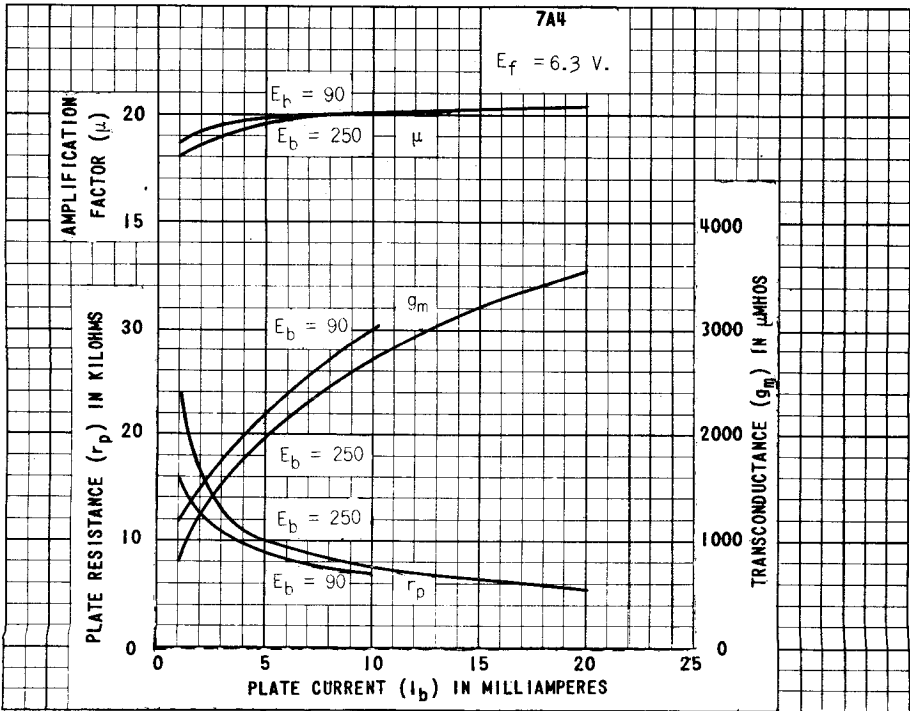
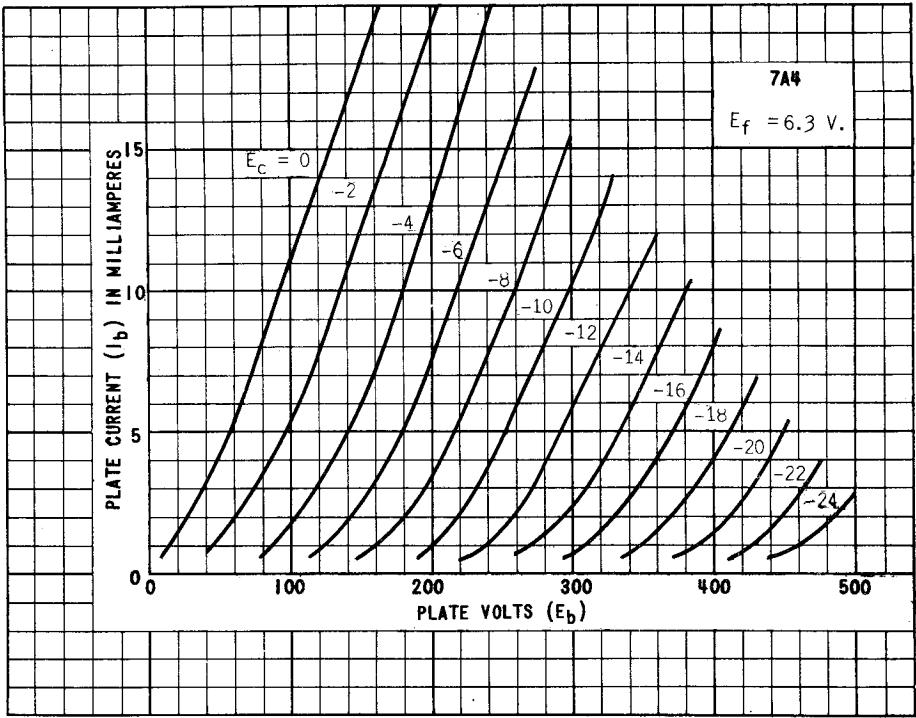

TUNG-SOL

BEAM POWER AMPLIFIER

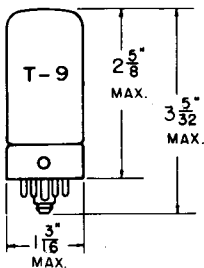

COATED UNIPOTENTIAL CATHODE

HEATER

6.3 VOLTS 0.75 AMPERE
AC OR DC

GLASS BULB

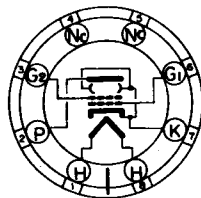

BOTTOM VIEW

LOCKING-IN 8 PIN

THE 7A5 IS A BEAM POWER AMPLIFIER DESIGNED PRIMARILY FOR SERVICE IN THE OUTPUT STAGE OF AUTOMOBILE OR HOUSEHOLD RECEIVERS. IT DELIVERS HIGH POWER OUTPUT WITH HIGH POWER SENSITIVITY AT LOW PLATE SUPPLY VOLTAGES.

RATINGS

INTERPRETED ACCORDING TO RMA STANDARD M8-210

MAXIMUM PLATE VOLTAGE	125	VOLTS
MAXIMUM SCREEN VOLTAGE	125	VOLTS
MAXIMUM PLATE DISSIPATION	5.5	WATTS
MAXIMUM SCREEN DISSIPATION	1.2	WATTS
MAXIMUM HEATER-CATHODE POTENTIAL	100	VOLTS

TYPICAL OPERATING CONDITIONS AND CHARACTERISTICS

CLASS A_1 AMPLIFIER

PLATE VOLTAGE	110	125	VOLTS
SCREEN VOLTAGE	110	125	VOLTS
CONTROL GRID VOLTAGE ^A	-7.5	-9.0	VOLTS
PEAK A-F GRID VOLTAGE	7.5	9.0	VOLTS
ZERO-SIG. PLATE CURRENT	40	44	MA.
ZERO-SIG. SCREEN CURRENT (APPROX.)	3.0	3.3	MA.
MAXIMUM-SIGNAL PLATE CURRENT	41	45	MA.
MAXIMUM-SIGNAL SCREEN CURRENT (APPROX.)	7.0	9.5	MA.
PLATE RESISTANCE (APPROX.)	14 000	17 000	OHMS
TRANSCONDUCTANCE	5 800	6 000	μMHOS
LOAD RESISTANCE	2 500	2 700	OHMS
TOTAL HARMONIC DISTORTION	10	10	PER CENT
MAXIMUM-SIGNAL POWER OUTPUT	1.5	2.2	WATTS

^A OBTAINED EITHER FROM A FIXED SOURCE OR SELF-BIAS FROM THE CATHODE CIRCUIT. WITH A FIXED BIAS SOURCE THE TOTAL GRID CIRCUIT RESISTANCE SHOULD NOT EXCEED 0.1 MEGOHM AND WITH SELF-BIAS THE GRID CIRCUIT RESISTANCE SHOULD NOT EXCEED 0.5 MEGOHM.



TUNG-SOL

TWIN DIODE

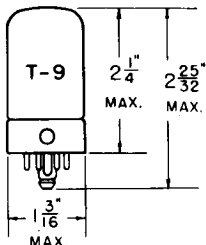

COATED UNIPOTENTIAL CATHODE

HEATER
6.3 VOLTS 0.15 AMPERE
AC OR DC

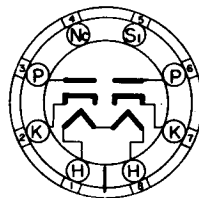

BOTTOM VIEW

GLASS BULB

LOCKING-IN 8-PIN BASE

THE 7A6 IS DESIGNED FOR USE AS A DIODE DETECTOR, AVC RECTIFIER AND POWER RECTIFIER IN LOW DRAIN APPLICATIONS. TWO SEPARATE RECTIFIER SECTIONS ALLOW CONSIDERABLE FLEXIBILITY IN THEIR APPLICATION. ITS RATINGS AND ELECTRICAL CHARACTERISTICS ARE SIMILAR TO THOSE OF THE 6H6, 6H6GT/G.

RATINGS

INTERPRETED ACCORDING TO RMA STANDARD M8-210.

MAXIMUM AC VOLTAGE PER PLATE (RMS)	150	VOLTS
MAXIMUM HEATER-CATHODE POTENTIAL	330	VOLTS
MAXIMUM PEAK INVERSE VOLTAGE	420	VOLTS
MAXIMUM STEADY STATE PEAK PLATE CURRENT		
PER PLATE	48	MA.
TUBE VOLTAGE DROP AT 16 MA. DC PER PLATE	11.0	VOLTS

DIRECT INTERELECTRODE CAPACITANCES

WITH EXTERNAL SHIELD CONNECTED TO CATHODE

PLATE TO PLATE	0.05 MAX.	μμf
----------------	-----------	-----

CONTINUED NEXT PAGE

PRINTED IN U.S.A.

PLATE
1478
AUG. 31
1944

TUNG-SOL

CONTINUED FROM PRECEDING PAGE

TYPICAL OPERATING CONDITIONS AND CHARACTERISTICS

HALF-WAVE RECTIFIER

HEATER VOLTAGE	6.4	6.3	VOLTS
AC VOLTAGE PER PLATE (RMS)	117	150	VOLTS
MAXIMUM DC OUTPUT CURRENT PER PLATE	8.0	8.0	MA.
MINIMUM TOTAL EFFECTIVE PLATE			
SUPPLY IMPEDANCE PER PLATE	15	40 ^A	OHMS

VOLTAGE DOUBLER

	HALF-WAVE	FULL-WAVE	
HEATER VOLTAGE	6.3	6.3	VOLTS
AC VOLTAGE PER PLATE (RMS)	117	117	VOLTS
MAXIMUM DC OUTPUT CURRENT	8.0	8.0	MA.
MINIMUM TOTAL EFFECTIVE PLATE			
SUPPLY IMPEDANCE PER PLATE	30	15	OHMS

^A WHEN FILTER CONDENSERS LARGER THAN 40 MFDS ARE USED IT MAY BE NECESSARY TO ADD ADDITIONAL PLATE SUPPLY IMPEDANCE.

TUNG-SOL

TRIPLE GRID
REMOTE CUT - OFF AMPLIFIER

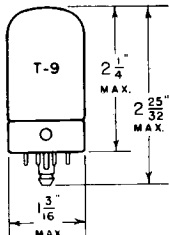

UNI-POTENTIAL CATHODE
HEATER
6.3 VOLTS 0.3 AMPERE
AC OR DC

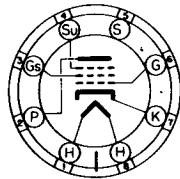

8V-L-5

GLASS BULB

LOCKING-IN 8 PIN BASE

THE TUNG-SOL 7A7 IS A TRIPLE GRID VARIABLE-MU AMPLIFIER. IT IS SUITABLE FOR USE WITH AVC IN RF AND IF AMPLIFIERS, AND IT MINIMIZES CROSS MODULATION. WITH THE EXCEPTION OF HEATER RATINGS AND CAPACITANCES, ITS RATINGS AND ELECTRICAL CHARACTERISTICS ARE IDENTICAL TO THOSE OF TYPES 6SK7, 6SK7GT/G, 12SK7, 12SK7GT/G AND 14A7/12B7.

RATINGS

NOMINAL HEATER VOLTAGE	7.0	VOLTS
NOMINAL HEATER CURRENT	0.32	AMPERE
MAXIMUM PLATE VOLTAGE	300	VOLTS
MAXIMUM SCREEN SUPPLY VOLTAGE	300	VOLTS
MAXIMUM SCREEN VOLTAGE	125	VOLTS
MINIMUM EXTERNAL GRID BIAS VOLTAGE	0	VOLT
MAXIMUM PLATE DISSIPATION	4.0	WATTS
MAXIMUM SCREEN DISSIPATION	0.4	WATT

DIRECT INTERELECTRODE CAPACITANCES^S

CONTROL GRID TO CATHODE	6	μμf
PLATE TO CATHODE	7	μμf
CONTROL GRID TO PLATE	0.005 MAX.	μμf

^S WITH AN EXTERNAL SHIELD CONNECTED TO CATHODE

FOR "INTERPRETATION OF RATINGS" REFER TO FRONT OF BOOK.

CONTINUED NEXT PAGE

TUNG-SOL

TYPICAL OPERATING CONDITIONS AND CHARACTERISTICS

CLASS A₁ AMPLIFIER

HEATER VOLTAGE	6.3	6.3	VOLTS
HEATER CURRENT	0.3	0.3	AMPERE
PLATE VOLTAGE	100	250	VOLTS
SCREEN VOLTAGE	100	100	VOLTS
CONTROL GRID VOLTAGE	-1	-3	VOLTS
SUPPRESSOR GRID AND PIN #5 CONNECTED TO CATHODE AT SOCKET			
PLATE CURRENT	13	9.2	MA.
SCREEN CURRENT	4.0	2.6	MA.
PLATE RESISTANCE APPROX.	0.12	0.8	MEGOHM
TRANSCONDUCTANCE	2350	2000	μMHOS
CONTROL GRID VOLTAGE APPROX.	-35	-35	VOLTS

FOR TRANSCONDUCTANCE = 10 μMHOS

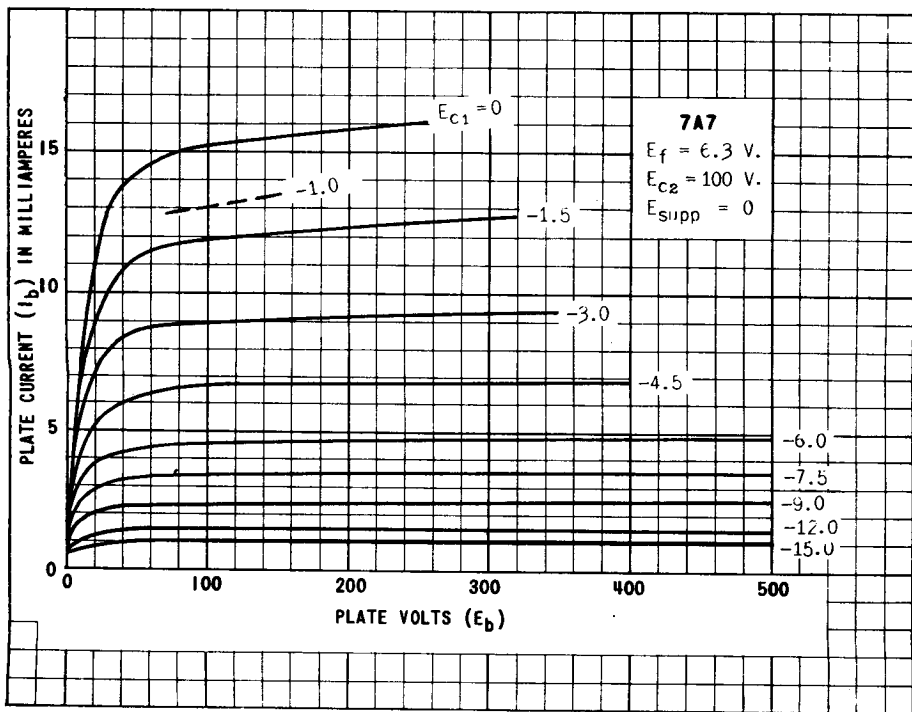
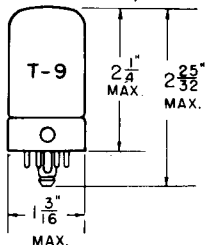

PLATE
1178-2

TUNG-SOL

OCTODE CONVERTER

COATED UNIPOTENTIAL CATHODE



HEATER
6.3 VOLTS 0.15 AMPERE
AC OR DC

GLASS BULB

LOCKING-IN 8-PIN BASE

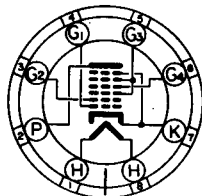

BOTTOM VIEW

THE 7A8 IS A PENTAGRID CONVERTER DESIGNED FOR SERVICE AS A COMBINED OSCILLATOR AND MIXER IN AC, STORAGE BATTERY, AND AC - DC OPERATED RECEIVERS.

RATINGS

INTERPRETED ACCORDING TO RMA STANDARD MB-210

CONVERTER SERVICE

MAXIMUM PLATE VOLTAGE	250	VOLTS
MAXIMUM SCREEN VOLTAGE (GRID #3 AND #5)	100	VOLTS
MAXIMUM SCREEN SUPPLY VOLTAGE	250	VOLTS
MAXIMUM PLATE DISSIPATION	1.0	WATT
MAXIMUM SCREEN DISSIPATION	0.3	WATT
MAXIMUM TOTAL CATHODE CURRENT	13	MA.
MAXIMUM ANODE-GRID VOLTAGE (GRID #2)	200	VOLTS
MAXIMUM ANODE-GRID SUPPLY VOLTAGE	250	VOLTS
MAXIMUM ANODE-GRID DISSIPATION	0.75	WATT
MINIMUM CONTROL-GRID (GRID #4) VOLTAGE	0	VOLTS
MAXIMUM HEATER-CATHODE POTENTIAL	100	VOLTS

DIRECT INTERELECTRODE CAPACITANCES

WITH CLOSE-FITTING SHIELD CONNECTED TO CATHODE

SIGNAL GRID TO MIXER PLATE (GRID #4 TO PLATE)	0.15 MAX.	$\mu\mu\text{f}$
SIGNAL GRID TO OSC. PLATE (GRID #4 TO GRID #2)	0.15 MAX.	$\mu\mu\text{f}$
SIGNAL GRID TO OSC. GRID (GRID #4 TO GRID #1)	0.15 MAX.	$\mu\mu\text{f}$
OSC GRID TO OSC. PLATE (GRID #1 TO GRID #2)	0.60	$\mu\mu\text{f}$
SIGNAL INPUT (GRID #4 TO ALL OTHER ELECTRODES= R-F INPUT)	7.5	$\mu\mu\text{f}$
OSC. INPUT (GRID #1 TO ALL OTHER ELECTRODES EXCEPT GRID #2)	3.8	$\mu\mu\text{f}$
OSC. OUTPUT (GRID #2 TO ALL OTHER ELECTRODES EXCEPT GRID #1)	3.4	$\mu\mu\text{f}$
MIXER OUTPUT (PLATE TO ALL OTHER ELECTRODES)	9.0	$\mu\mu\text{f}$

CONTINUED ON NEXT PAGE

TUNG-SOL

CONTINUED FROM PRECEDING PAGE

TYPICAL OPERATING CONDITIONS AND CHARACTERISTICS

PLATE VOLTAGE	100	250	VOLTS
SCREEN VOLTAGE	75	100	VOLTS
ANODE-GRID VOLTAGE	100	-	VOLTS
ANODE-GRID SUPPLY VOLTAGE ^A	-	250	VOLTS
CONTROL-GRID VOLTAGE	-3.0	-3.0	VOLTS
OSCILLATOR-GRID (GRID #1) RES.	50 000	50 000	OHMS
PLATE RESISTANCE	0.65	0.7 APPROX.	MEGOHM
CONVERSION TRANSCONDUCTANCE	375	550	μMHOS
CONVERSION TRANSCONDUCTANCE FOR GRID BIAS OF -30 VOLTS	-	2.0 APPROX.	μMHOS
PLATE CURRENT	1.8	3.0	MA.
SCREEN CURRENT	2.7	3.2	MA.
ANODE-GRID CURRENT	2.8	4.2	MA.
OSCILLATOR-GRID CURRENT	0.2	0.4	MA.
TOTAL CATHODE CURRENT	8.5	10.8	MA.

NOTE: THE TRANSCONDUCTANCE BETWEEN GRID #1 AND GRID #2 (NOT OSCILLATING) IS APPROXIMATELY 1600 MICROMHOS UNDER THE FOLLOWING CONDITIONS: PLATE VOLTS, 250; SCREEN VOLTS, 100; ANODE-GRID VOLTS, 180; OSCILLATOR-GRID VOLTS, 0; AND CONTROL-GRID CONNECTED TO CATHODE.

^A APPLIED THROUGH A PROPERLY BY-PASSED 20 000 OHM VOLTAGE-DROPPING RESISTOR.

PLATE
1481
AUG. 31
1944

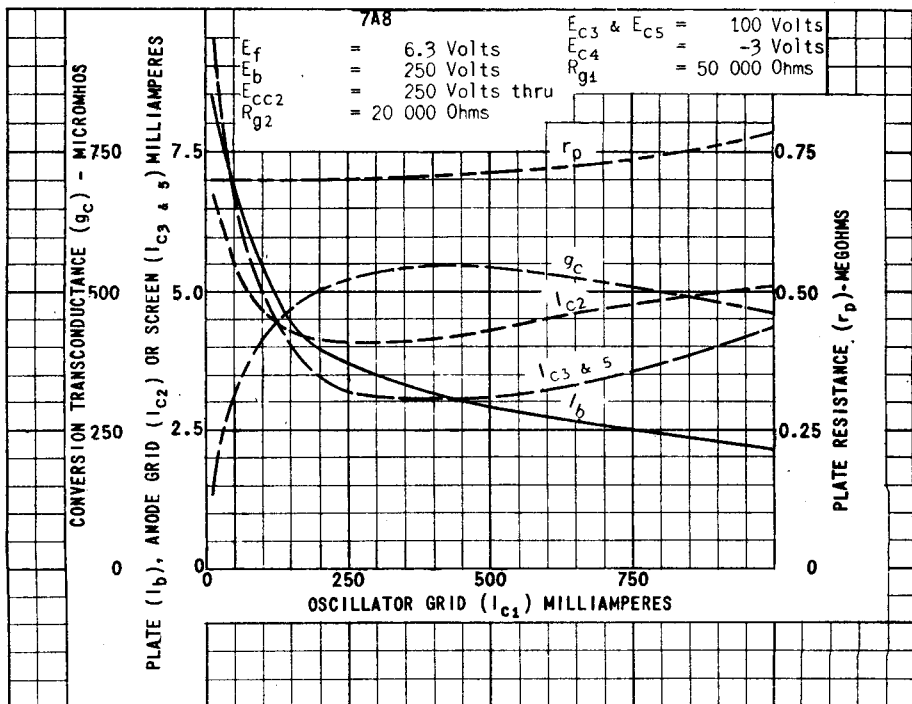
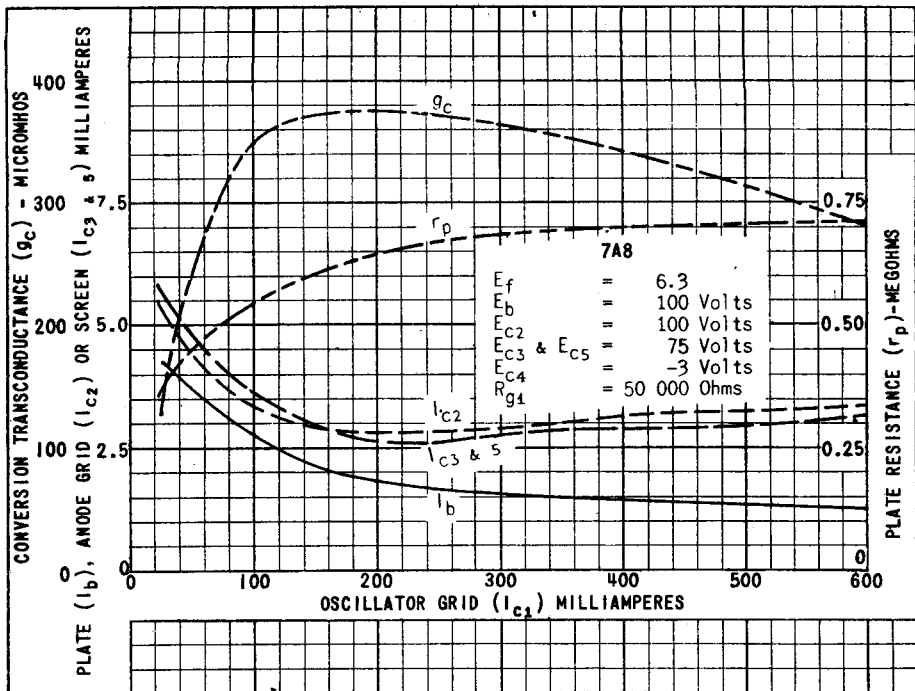
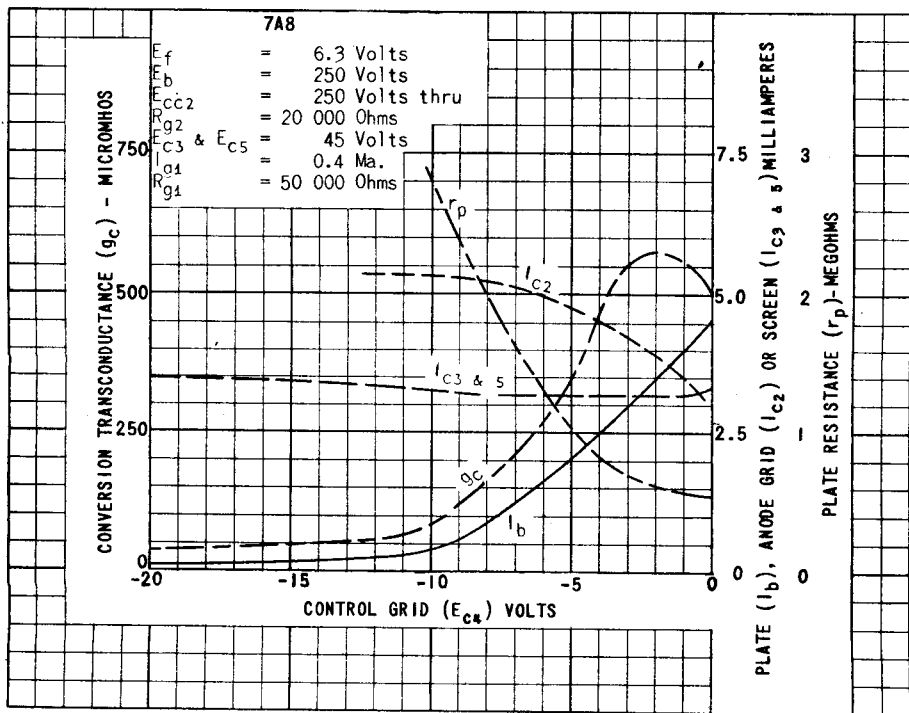
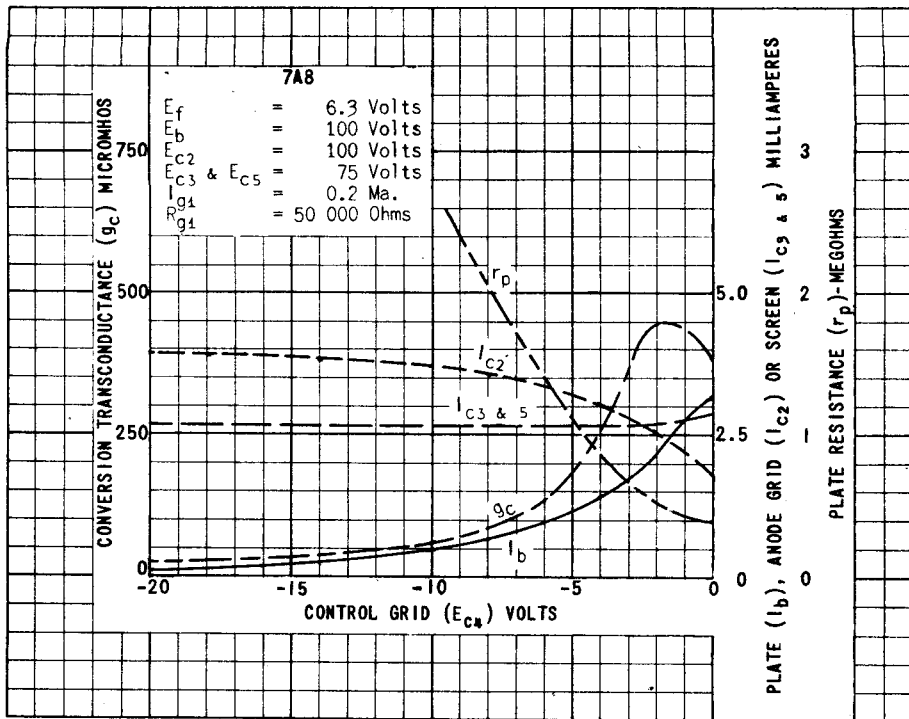

PLATE 1998 APRIL 1 1948

PRINTED IN U. S. A.



TUNG-SOL

SHARP CUT-OFF HIGH FREQUENCY RF PENTODE

PHYSICAL SPECIFICATIONS

EMITTER COATED UNIPOT. CATHODE		PIN CONNECTIONS	
BASE LOCK-IN 8-PIN		PIN 1 GRID 2	PIN 7 HEATER
CAP		PIN 2 HEATER	PIN 8 GRID 3, K
BULB SHORT T-9		PIN 3 PLATE	
MAXIMUM DIAMETER	1 3/16"	PIN 4 GRID 3, K	MOUNTING POS. ANY
MAXIMUM OVERALL LENGTH	2 1/32"	PIN 5 GRID 1	
MAXIMUM SEATED HEIGHT	1 1/2"	PIN 6 GRID 3, K	

RATINGS

INTERPRETED ACCORDING TO RMA STANDARD M8-210

HEATER OR FILAMENT VOLTAGE (NOMINAL)	7.0	VOLTS
HEATER OR FILAMENT CURRENT	0.160	AMP.
MAXIMUM PLATE VOLTAGE (DC)	300	VOLTS
MAXIMUM SCREEN VOLTAGE (DC)	100	VOLTS
MAXIMUM PLATE DISSIPATION	1.2	WATTS
MAXIMUM SCREEN DISSIPATION	0.15	WATT
MAXIMUM SCREEN SUPPLY VOLTAGE (DC)	100	VOLTS
MINIMUM EXTERNAL CONTROL GRID VOLTAGE (DC)	0	VOLTS

CAPACITANCES

WITH RMA SHIELD NO. M8-308 CONNECTED TO CATHODE

GRID NO. 1 - PLATE (MAX.)	0.06	μ f
INPUT	3.5	μ f
OUTPUT	4.0	μ f

TYPICAL OPERATING CONDITIONS AND CHARACTERISTICS

HEATER OR FILAMENT VOLTAGE	6.3	VOLTS
HEATER OR FILAMENT CURRENT	0.150	AMP.
PLATE VOLTAGE (DC)	250	VOLTS
SCREEN VOLTAGE (DC)	100	VOLTS
CONTROL GRID VOLTAGE (DC)	-2.0	VOLTS
PEAK AF SIGNAL VOLTAGE		VOLTS
PLATE CURRENT (DC)	4.0	MA.
SCREEN GRID CURRENT (DC)	1.3	MA.
MAXIMUM-SIGNAL PLATE CURRENT		MA.
MAXIMUM-SIGNAL SCREEN CURRENT		MA.
PLATE RESISTANCE	0.5	MEG OHM
TRANSCONDUCTANCE	1800	μ MHOS
AMPLIFICATION FACTOR		
LOAD RESISTANCE		OHMS
TOTAL HARMONIC DISTORTION		PER CENT
POWER OUTPUT		WATTS
CONTROL GRID VOLTAGE (DC) FOR $I_b = 10 \mu$ AMPS	-9.0	VOLTS



TUNG-SOL

PENTODE

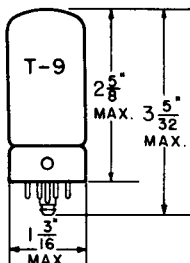

GLASS BULB

UNIPOTENTIAL CATHODE
 HEATER
 6.3 VOLTS 0.6 AMPERE
 AC OR DC
 ANY MOUNTING POSITION

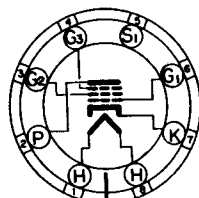

BOTTOM VIEW
 LOCK-IN 8 PIN BASE

THE 7AD7 IS A HEATER-CATHODE TYPE SHARP CUT-OFF PENTODE VOLTAGE AMPLIFIER USING THE LOCK-IN CONSTRUCTION. IT IS CHARACTERIZED BY A HIGH VALUE OF TRANSDUCANCE WHICH MAKES IT USEFUL IN WIDE-BAND INTERMEDIATE FREQUENCY OR VIDEO AMPLIFIERS.

DIRECT INTERELECTRODE CAPACITANCES
 WITH RMA SHIELD NO. 308 CONNECTED TO CATHODE

GRID TO PLATE: (G_1 TO P) MAX.	0.03	$\mu\mu\text{f}$
INPUT: G_1 TO ($H+K+G_2+G_3+IS$)	11.5	$\mu\mu\text{f}$
OUTPUT: P TO ($H+K+G_2+G_3+IS$)	7.5	$\mu\mu\text{f}$

RATINGS

INTERPRETED ACCORDING TO RMA STANDARD WB-210

HEATER VOLTAGE	6.3	VOLTS
MAXIMUM HEATER-CATHODE VOLTAGE	90	VOLTS
MAXIMUM PLATE VOLTAGE	300	VOLTS
MAXIMUM GRID #2 VOLTAGE	300	VOLTS
MINIMUM GRID #1 VOLTAGE	0	VOLTS
MAXIMUM PLATE DISSIPATION	10	WATTS
MAXIMUM GRID #2 DISSIPATION	1.2	WATTS
MAXIMUM GRID #1 CIRCUIT RESISTANCE (FIXED BIAS)	0.25	MEG.
MAXIMUM GRID #1 CIRCUIT RESISTANCE (SELF-BIAS)	1	MEG.

TYPICAL OPERATING CONDITIONS AND CHARACTERISTICS

CLASS A_1 AMPLIFIER

HEATER VOLTAGE	6.3	VOLTS
HEATER CURRENT	0.6	AMP.
PLATE VOLTAGE	300	VOLTS
GRID #3 VOLTAGE		PINS #4 AND #5 CONNECTED TO PIN #7 AT SOCKET
GRID #2 VOLTAGE	150	VOLTS
GRID #1 VOLTAGE ^A	-3	VOLTS
SELF BIAS RESISTOR	68	OHMS
PLATE RESISTANCE (APPROX.)	0.3	MEG.
TRANSDUCANCE	9 500	μMHOS
ZERO SIGNAL PLATE CURRENT	28	MA.
ZERO SIGNAL GRID #2 CURRENT	7	MA.

^AOBTAINED PREFERABLY BY SELF BIAS RESISTOR

CONTINUED ON FOLLOWING PAGE

PRINTED IN U. S. A.

PLATE
 2099
 NOV. 1,
 1948

TUNG-SOL

CONTINUED FROM PRECEDING PAGE

TYPICAL OPERATING CONDITIONS AND CHARACTERISTICS

CLASS A₁ TELEVISION AMPLIFIER

HEATER VOLTAGE	6.3	VOLTS
HEATER CURRENT	0.6	AMP.
PLATE SUPPLY VOLTAGE	300	VOLTS
GRID #3 VOLTAGE		
GRID #2 VOLTAGE	125	VOLTS
GRID #1 VOLTAGE	-3	VOLTS
SELF BIAS RESISTOR	68	OHMS
SIGNAL VOLTAGE (PEAK TO PLATE)	4	VOLTS
ZERO SIGNAL PLATE CURRENT	25	MA.
ZERO SIGNAL GRID #2 CURRENT	6	MA.
MAXIMUM SIGNAL VOLTAGE OUTPUT (PEAK TO PEAK)	135	VOLTS

PINS #4 AND #5 CONNECTED TO PIN #7 AT SOCKET

 PLATE
 2100
 NOV. 1,
 1948

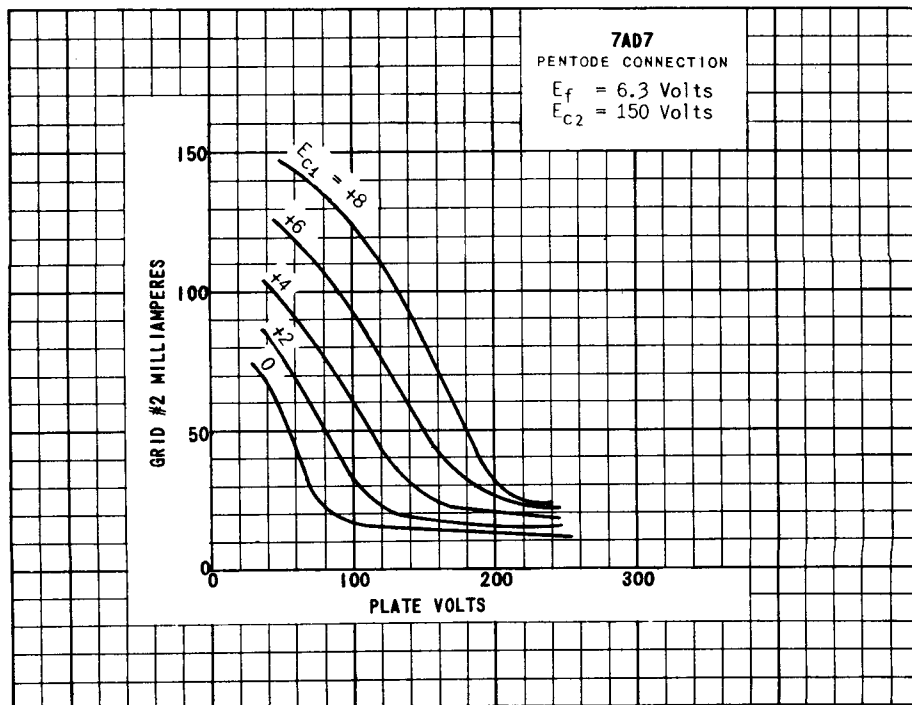
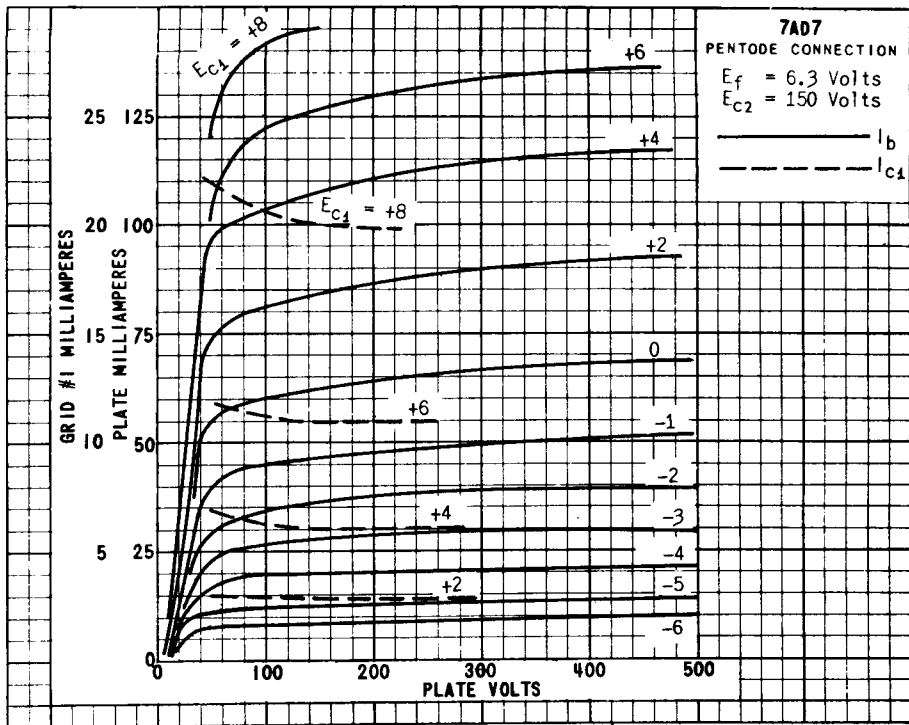

7AD7

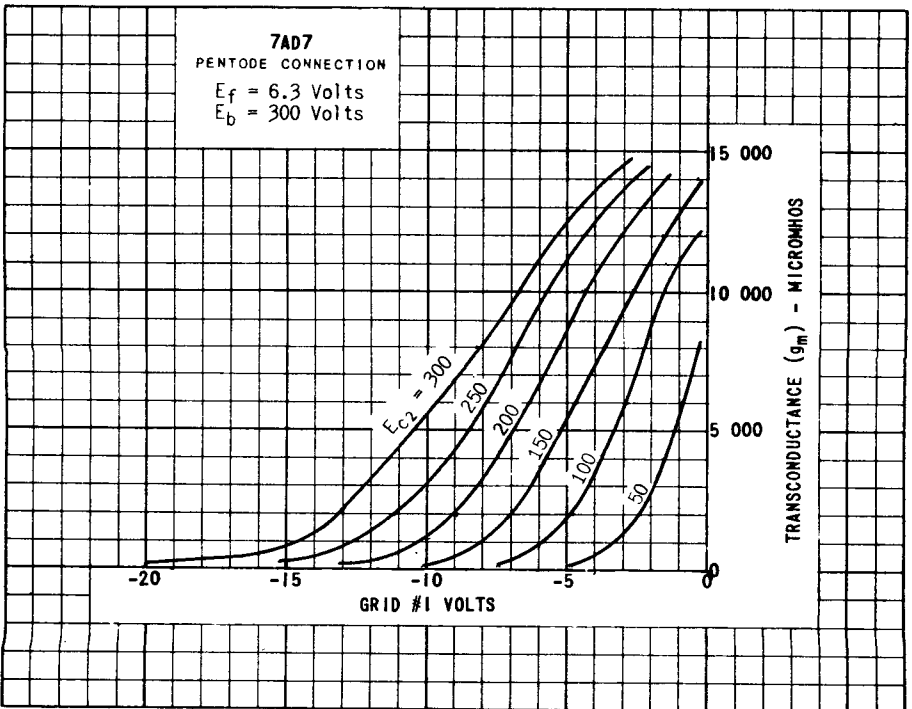
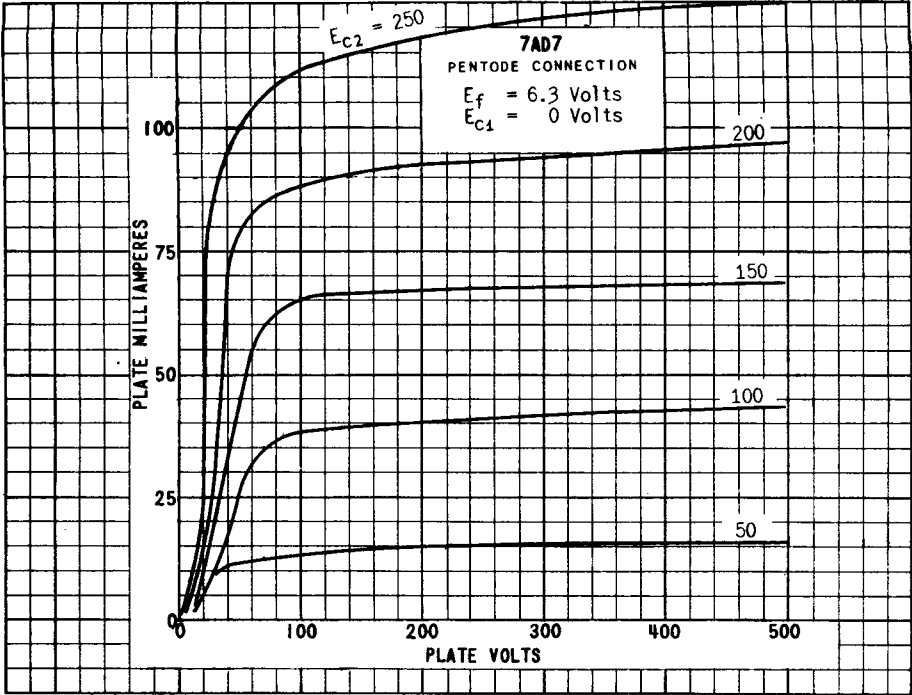

PLATE 2102
NOV. 1, 1948

TUNG-SOL

SHARP CUT-OFF PENTODE AMPLIFIER

PHYSICAL SPECIFICATIONS

EMITTER COATED UNIPOT. CATHODE	PIN CONNECTIONS	
BASE LOCK-IN 8 PIN	PIN 1 HEATER	PIN 7 CATHODE
CAP ---	PIN 2 PLATE	PIN 8 HEATER
BULB T-9	PIN 3 GRID 2	
MAXIMUM DIAMETER 1 3/16"	PIN 4 GRID 3	MOUNTING POS. ANY
MAXIMUM OVERALL LENGTH 2 25/32"	PIN 5 S ₁	
MAXIMUM SEATED HEIGHT 2 1/4"	PIN 6 GRID 1	

RATINGS

INTERPRETED ACCORDING TO RMA STANDARD MB-210

HEATER OR FILAMENT VOLTAGE (NOMINAL)	7.0	VOLTS
HEATER OR FILAMENT CURRENT (NOMINAL)	0.160	AMP.
MAXIMUM PLATE VOLTAGE (DC)	300	VOLTS
MAXIMUM SCREEN VOLTAGE (DC)	300	VOLTS
MAXIMUM PLATE DISSIPATION	2.0	WATTS
MAXIMUM SCREEN DISSIPATION	0.75	WATT
MINIMUM EXTERNAL CONTROL GRID VOLTAGE (DC)	-1.0	VOLTS

CAPACITANCES

RMA SHIELD MB-308 CONNECTED TO CATHODE

CONTROL GRID TO CATHODE	7.0	μf
PLATE TO CATHODE	6.0	μf
CONTROL GRID TO PLATE (MAX.)	0.005	μf

TYPICAL OPERATING CONDITIONS AND CHARACTERISTICS
CLASS A₁ AMPLIFIER

HEATER OR FILAMENT VOLTAGE	6.3	VOLTS
HEATER OR FILAMENT CURRENT	0.150	AMP.
PLATE VOLTAGE (DC)	250	VOLTS
SCREEN VOLTAGE (DC)	250	VOLTS
CONTROL GRID VOLTAGE		VOLTS
SUPPRESSOR VOLTAGE	CONNECTED TO CATHODE AT SOCKET	
CATHODE BIAS RESISTOR	250	OHMS
PLATE CURRENT (DC)	6.0	MA.
SCREEN CURRENT (DC)	2.0	MA.
MAXIMUM-SIGNAL SCREEN CURRENT		MA.
PLATE RESISTANCE	0.75	MEGOHM
TRANSCONDUCTANCE	4200	μMHOS
AMPLIFICATION FACTOR		
LOAD RESISTANCE		OHMS
TOTAL HARMONIC DISTORTION		PER CENT
POWER OUTPUT		WATTS
CONTROL GRID VOLTAGE (DC)		
FOR I _b = 10 μA (DC)	-10	VOLTS

PRINTED IN U. S. A.

PLATE
1707
APRIL 15
1946



TUNG-SOL

HIGH MU-TRIODE

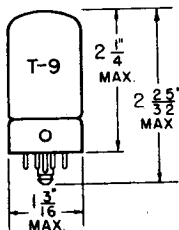

COATED UNIPOTENTIAL CATHODE
6.3 VOLTS 0.30 AMPERES
AC OR DC

IN CIRCUITS WHERE THE CATHODE IS NOT DIRECTLY CONNECTED TO THE HEATER, THE POTENTIAL DIFFERENCE BETWEEN HEATER AND CATHODE SHOULD BE KEPT AS LOW AS POSSIBLE.

GLASS BULB
ANY MOUNTING POSITION

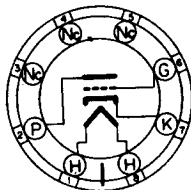

BOTTOM VIEW
LOCKING-IN 8 PIN BASE

THE 7B4 IS A GENERAL PURPOSE HIGH MU TRIODE USING THE LOCK-IN CONSTRUCTION AND IS SIMILAR TO THE 6F5GT SERIES. IT IS USEFUL AS A HIGH GAIN RESISTANCE COUPLED AUDIO AMPLIFIER.

RATINGS

INTERPRETED ACCORDING TO RMA STANDARD MB-210

HEATER VOLTAGE	7.0	VOLTS
HEATER CURRENT	0.32	AMPERE
MAXIMUM PLATE VOLTAGE	300	VOLTS

DIRECT INTERELECTRODE CAPACITANCES

WITH MB-308 TUBE SHIELD CONNECTED TO CATHODE

GRID PLATE	1.6	μF
INPUT	3.6	μF
OUTPUT	3.4	μF

TYPICAL OPERATING CONDITIONS AND CHARACTERISTICS

PLATE VOLTAGE	100	250	VOLTS
GRID VOLTAGE	-1	-2	VOLTS
PLATE CURRENT	0.4	0.9	MA.
PLATE RESISTANCE	85 000	66 000	OHMS
TRANSCONDUCTANCE	1 150	1 500	μMHOS
AMPLIFICATION FACTOR	100	100	

SIMILAR TYPE REFERENCE: Same ratings, characteristics and application as types 6F5, 6F5G, 6F5GT, 6SP5, 6SP5GT. Somewhat similar to triode section of type 75.



TUNG-SOL

PENTODE POWER AMPLIFIER

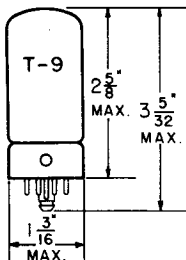

COATED UNIPOTENTIAL CATHODE

6.3 VOLTS 0.4 AMPERE

AC OR DC

IN CIRCUITS WHERE THE CATHODE IS NOT DIRECTLY CONNECTED TO THE HEATER, THE POTENTIAL DIFFERENCE BETWEEN HEATER AND CATHODE SHOULD BE KEPT AS LOW AS POSSIBLE.

GLASS BULB

ANY MOUNTING POSITION

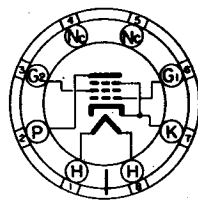

BOTTOM VIEW

LOCKING IN 8 PIN BASE

THE 7B5 IS A POWER AMPLIFIER PENTODE USING THE LOCK-IN CONSTRUCTION AND IS SIMILAR TO TYPE 6K6GT/G. IT IS PARTICULARLY USEFUL FOR SERVICE IN THE OUTPUT STAGE OF STORAGE BATTERY OF AC OPERATED RECEIVERS.

RATINGS

INTERPRETED ACCORDING TO RMA STANDARD NB-210

MAXIMUM PLATE VOLTAGE	315	VOLTS
MAXIMUM SCREEN VOLTAGE	285	VOLTS
MAXIMUM PLATE DISSIPATION	8.5	WATTS
MAXIMUM SCREEN DISSIPATION	2.8	WATTS

TYPICAL OPERATING CONDITIONS AND CHARACTERISTICS

CLASS A₁ AMPLIFIER

PLATE VOLTAGE	100	250	315	VOLTS
SCREEN VOLTAGE	100	250	250	VOLTS
CONTROL GRID VOLTAGE ^A	-7	-18	-21	VOLTS
PEAK AF SIGNAL VOLTAGE	7	18	21	VOLTS
ZERO SIGNAL PLATE CURRENT	9	32	25.5	MA.
ZERO SIGNAL SCREEN CURRENT	1.6	5.5	4	MA.
MAXIMUM SIGNAL PLATE CURRENT	9.5	33	28	MA.
MAXIMUM SIGNAL SCREEN CURRENT	3	10	9	MA.
PLATE RESISTANCE (APPROX.)	104 000	68 000	75 000	OHMS
TRANSCONDUCTANCE	1 500	2 300	2 100	μMHOS
LOAD RESISTANCE	12 000	7 600	9 000	OHMS
TOTAL HARMONIC DISTORTION	11	11	15	PER CENT
POWER OUTPUT (MAX. SIGNAL)	0.35	3.4	4.5	WATTS

^A FIXED BIAS MAY BE USED FOR A RESISTANCE IN THE GRID CIRCUITS UP TO .1 MEGOHM. WITH CATHODE BIAS THE GRID CIRCUIT MAY HAVE A RESISTANCE NOT EXCEEDING 1.0 MEGOHM.

SIMILAR TYPE REFERENCE: Same characteristics and operating conditions as types 41, 6K6G, 6K6GT, 6K6GT/G.

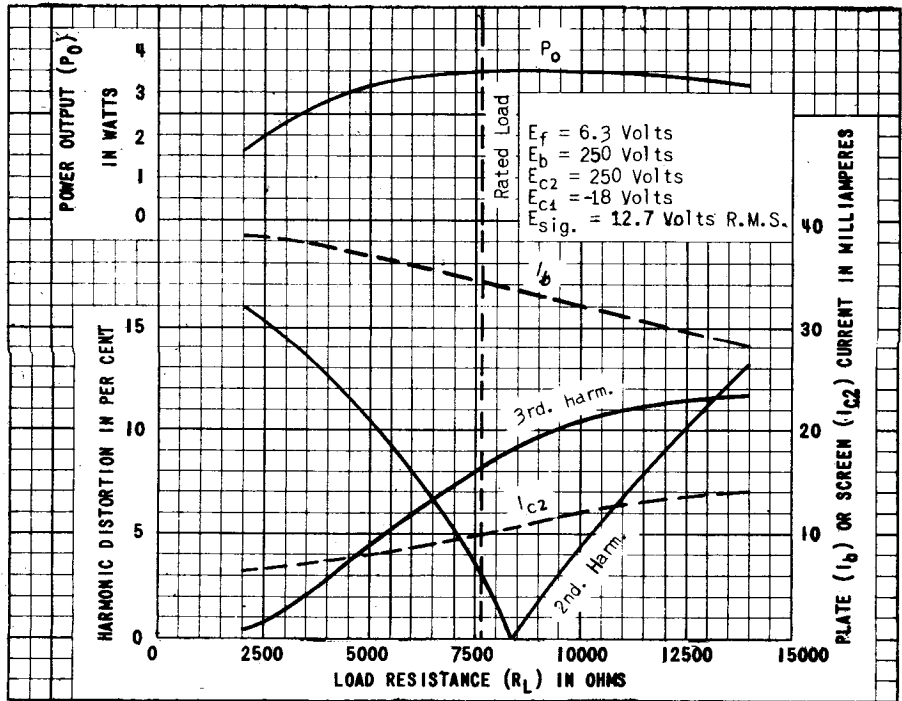
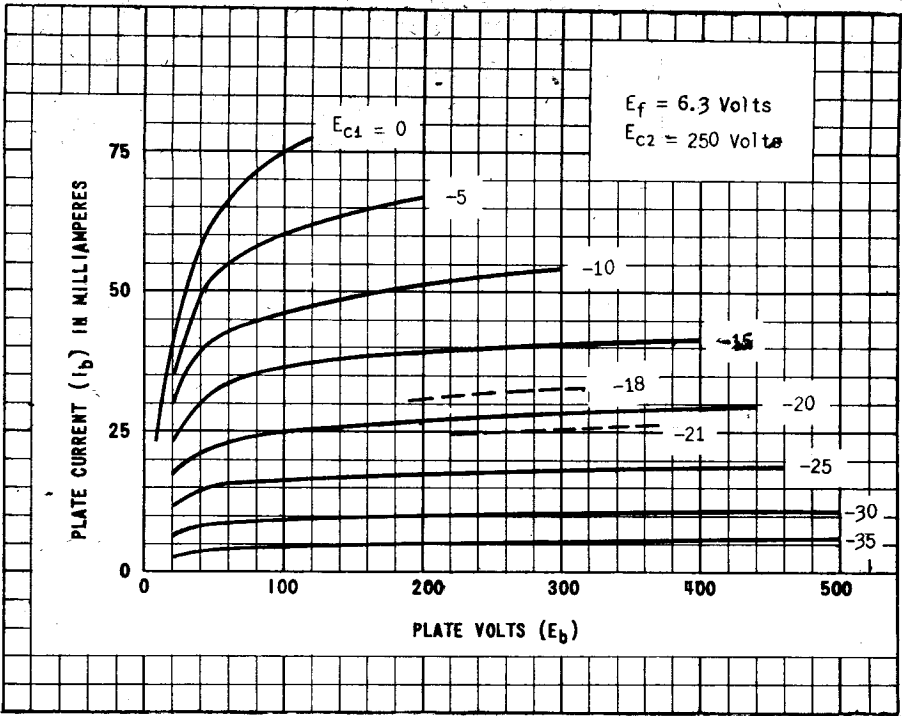
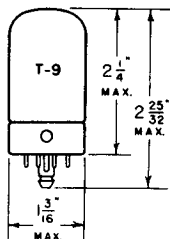

PLATE
 1989
 JULY 31,
 1945

TUNG-SOL

DUO - DIODE

HIGH-MU TRIODE AMPLIFIER



UNIPOTENTIAL CATHODE

HEATER

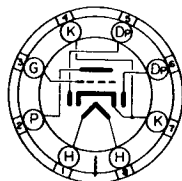
6.3 VOLTS 0.3 AMPERE
AC OR DC

8W

BOTTOM VIEW

GLASS BULB

8 PIN LOCKING - IN BASE

THE TUNG-SOL 7B6 CONSISTS OF TWO DIODES AND A HIGH-MU TRIODE WITH A COMMON CATHODE. IT IS DESIGNED FOR SERVICE AS A DIODE DETECTOR, AVC RECTIFIER AND AN IMPEDANCE OR RESISTANCE COUPLED AMPLIFIER. ITS RATINGS AND ELECTRICAL CHARACTERISTICS ARE SIMILAR TO THOSE OF THE 6SQ7GT, 12SQ7GT, 75 AND THE 2A6.

RATINGS

NOMINAL HEATER VOLTAGE	7.0	VOLTS
NOMINAL HEATER CURRENT	0.32	AMP.
MAXIMUM PLATE VOLTAGE	250	VOLTS

TYPICAL OPERATING CONDITIONS AND CHARACTERISTICS

CLASS A₁ AMPLIFIER

PLATE VOLTAGE	250	VOLTS
GRID VOLTAGE	-2	VOLTS
PLATE CURRENT	0.9	MA.
PLATE RESISTANCE	91000	OHMS
TRANSCONDUCTANCE	1100	μMHOS
AMPLIFICATION FACTOR	100	

DIODE UNITS - TWO

MINIMUM DIODE CURRENT PER PLATE WITH 10 VOLTS DC APPLIED	0.8	MA.
---	-----	-----

FOR "INTERPRETATION OF RATINGS" REFER TO FRONT OF BOOK.

CONTINUED NEXT PAGE

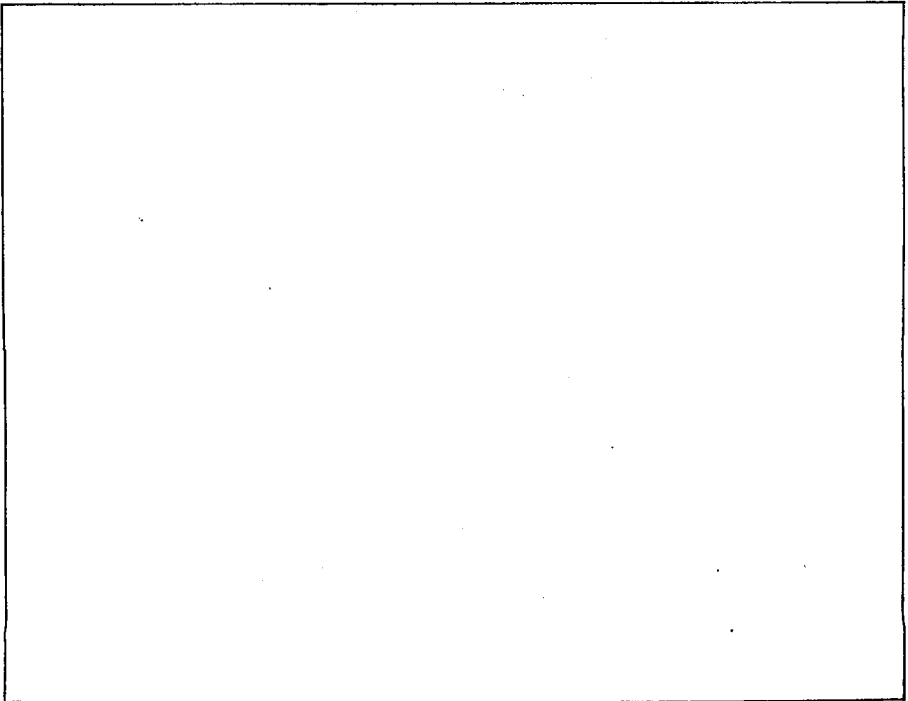
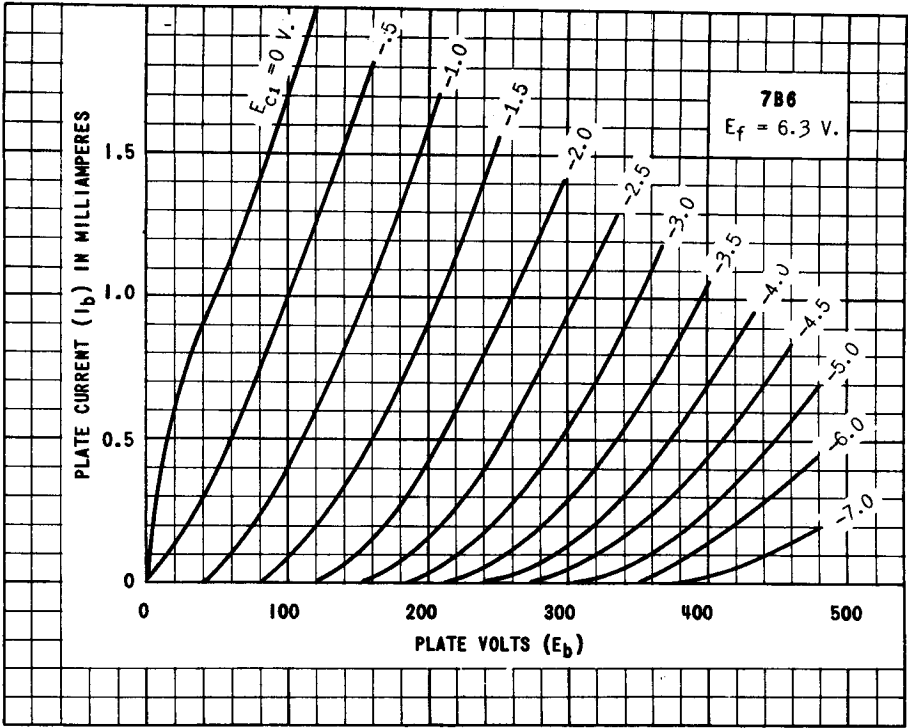

TUNG-SOL

TRIPLE GRID

REMOTE CUT-OFF AMPLIFIER

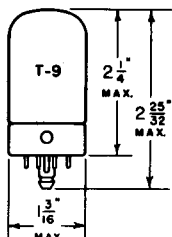

UNIPOTENTIAL CATHODE

HEATER

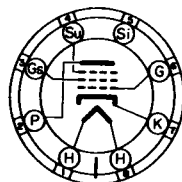
6.3 VOLTS 0.15 AMPERE
AC OR DC

8V

BOTTOM VIEW

GLASS BULB

8 PIN LOCKING-IN BASE

THE TUNG-SOL 7B7 IS A TRIPLE GRID REMOTE CUT-OFF AMPLIFIER. IT IS SUITABLE FOR USE WITH AVC IN RF AND IF AMPLIFIERS.

RATINGS

NOMINAL HEATER VOLTAGE	7.0	VOLTS
NOMINAL HEATER CURRENT	0.16	AMP.
MAXIMUM PLATE VOLTAGE	300	VOLTS
MAXIMUM SCREEN VOLTAGE	100	VOLTS
MAXIMUM PLATE DISSIPATION	2.25	WATTS
MAXIMUM SCREEN DISSIPATION	0.25	WATT
MINIMUM EXTERNAL GRID BIAS VOLTAGE	0	VOLT

DIRECT INTERELECTRODE CAPACITANCES⁵

CONTROL GRID TO CATHODE	5.0	μf
PLATE TO CATHODE	6.0	μf
CONTROL GRID TO PLATE	0.007 ^{MAX.}	μf

⁵ WITH AN EXTERNAL SHIELD CONNECTED TO CATHODE

FOR "INTERPRETATION OF RATINGS" REFER TO FRONT OF BOOK.

PLATE
822-1

AUG. 30
1940

CONTINUED NEXT PAGE

TUNG-SOL

TYPICAL OPERATING CONDITIONS AND CHARACTERISTICS

CLASS A₁ AMPLIFIER

PLATE VOLTAGE	100	250	VOLTS
SCREEN VOLTAGE	100	100	VOLTS
CONTROL GRID VOLTAGE	-3	-3	VOLTS
SUPPRESSOR GRID AND PIN #5 CONNECTED TO CATHODE AT SOCKET			
PLATE CURRENT	8.2	8.5	MA.
SCREEN CURRENT	1.8	1.7	MA.
PLATE RESISTANCE	0.3	0.75	MEGOHM
TRANSCONDUCTANCE	1675	1750	μMHOS
CONTROL GRID VOLTAGE	-40	-40	VOLTS
FOR TRANSCONDUCTANCE = 10 μMHOS			

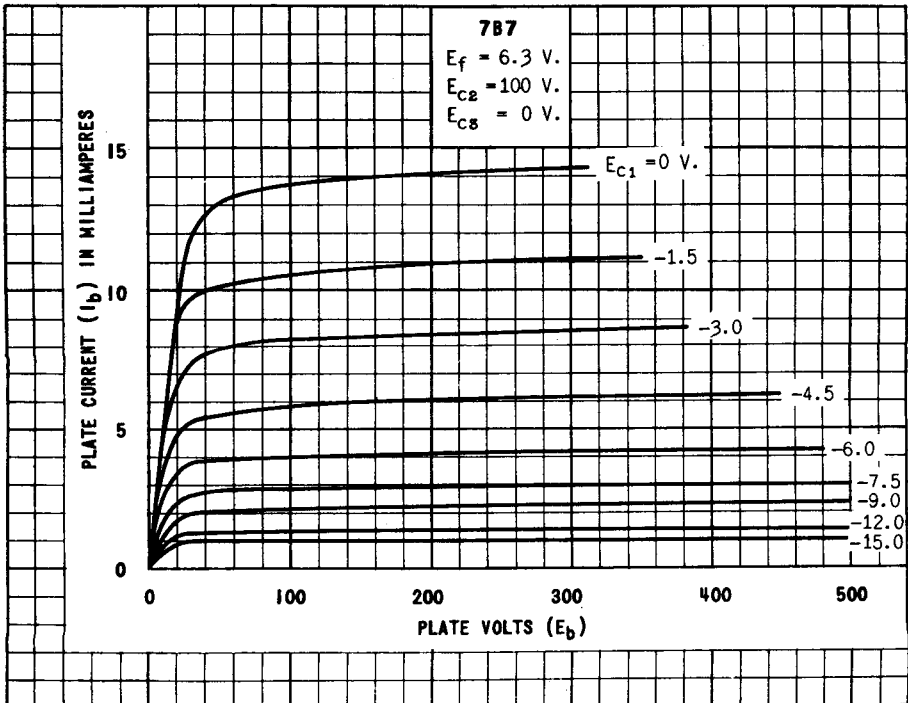

TUNG-SOL

PENTAGRID CONVERTER

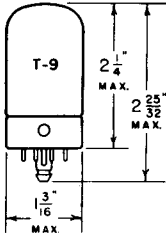

UNIPOTENTIAL CATHODE

HEATER

6.3 VOLTS 0.3 AMPERE

AC OR DC

GLASS BULB

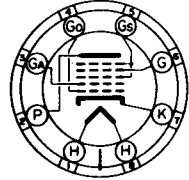

8X

BOTTOM VIEW

LOCKING-IN 8 PIN BASE

THE TUNG-SOL 7B8 IS A PENTAGRID CONVERTER DESIGNED FOR SERVICE IN AC, AC-DC AND STORAGE BATTERY OPERATED RECEIVERS. ITS APPLICATIONS AND ELECTRICAL CHARACTERISTICS ARE SIMILAR TO THOSE OF THE 6A8, 6A8G AND 6A8GT.

RATINGS

NOMINAL HEATER VOLTAGE	7.0	VOLTS
NOMINAL HEATER CURRENT	0.32	AMPERE
MAXIMUM PLATE VOLTAGE	300	VOLTS
MAXIMUM SCREEN (G _s) SUPPLY VOLTAGE	300	VOLTS
MAXIMUM SCREEN (G _s) VOLTAGE	100	VOLTS
MINIMUM EXTERNAL CONTROL GRID (G) BIAS VOLTAGE	0	VOLTS
MAXIMUM OSCILLATOR ANODE (G _A) SUPPLY VOLTAGE	300	VOLTS
MAXIMUM OSCILLATOR ANODE (G _A) VOLTAGE	200	VOLTS
MAXIMUM TOTAL CATHODE CURRENT	14	MA.
MAXIMUM PLATE DISSIPATION	1.0	WATT
MAXIMUM SCREEN DISSIPATION	0.3	WATT
MAXIMUM OSCILLATOR ANODE (G _A) DISSIPATION	.75	WATT

FOR "INTERPRETATION OF RATINGS" REFER TO FRONT OF BOOK.

CONTINUED NEXT PAGE

TUNG-SOL

DIRECT INTERELECTRODE CAPACITANCES⁵

CONTROL GRID (G) TO MIXER (P)	0.2 ^{MAX.}	μf
CONTROL GRID (G) TO OSCILLATOR ANODE (G _A)	0.2 ^{MAX.}	μf
CONTROL GRID (G) TO OSCILLATOR GRID (G ₀)	0.2 ^{MAX.}	μf
OSCILLATOR GRID (G ₀) TO OSCILLATOR ANODE (G _A)	0.9	μf
RF INPUT: CONTROL GRID (G) TO ALL OTHER ELECTRODES	10	μf
OSCILLATOR INPUT: OSCILLATOR GRID (G ₀) TO ALL OTHER ELECTRODES	5.0	μf
OSCILLATOR OUTPUT: OSCILLATOR ANODE (G _A) TO ALL OTHER ELECTRODES	3.4	μf
MIXER OUTPUT: MIXER PLATE (P) TO ALL OTHER ELECTRODES	9.0	μf

TYPICAL OPERATING CONDITIONS AND CHARACTERISTICS

CONVERTER SERVICE

HEATER VOLTAGE	6.3	6.3	VOLTS
HEATER CURRENT	0.3	0.3	AMPERE
PLATE (P) VOLTAGE	100	250	VOLTS
SCREEN (G _S) VOLTAGE	50	100	VOLTS
CONTROL GRID (G) VOLTAGE	-1.5	-3	VOLTS
OSCILLATOR ANODE (G _A) SUPPLY VOLTAGE ^A	-	250	VOLTS
OSCILLATOR ANODE (G _A) VOLTAGE	100	-	VOLTS
OSCILLATOR GRID (G ₀) RESISTOR	50 000	50 000	OHMS
PLATE CURRENT	1.1	3.5	MA.
SCREEN CURRENT	1.3	2.7	MA.
OSCILLATOR ANODE CURRENT	2.0	4.0	MA.
TOTAL CATHODE CURRENT	4.6	10.6	MA.
PLATE RESISTANCE ^{APPROX.}	0.6	0.36	MEGOHM
CONVERSION TRANSCONDUCTANCE			
FOR CONTROL GRID (G) VOLTAGE = -1.5 V.	360	-	μMHOS
CONVERSION TRANSCONDUCTANCE			
FOR CONTROL GRID (G) VOLTAGE = -3 V.	180	550	μMHOS
CONVERSION TRANSCONDUCTANCE			
FOR CONTROL GRID (G) VOLTAGE = -6 V.	50	325	μMHOS
CONVERSION TRANSCONDUCTANCE			
FOR CONTROL GRID (G) VOLTAGE = -10 V.	-	100	μMHOS
CONVERSION TRANSCONDUCTANCE ^{APPROX.}			
FOR CONTROL GRID (G) VOLTAGE = -20 V.	3	-	μMHOS
CONVERSION TRANSCONDUCTANCE ^{APPROX.}			
FOR CONTROL GRID (G) VOLTAGE = -35 V.	-	6	μMHOS

^A APPLIED THROUGH A PROPERLY BY-PASSED 20000 OHM DROPPING RESISTOR.

⁵ WITH EXTERNAL SHIELD CONNECTED TO CATHODE.

NOTE: THE TRANSCONDUCTANCE OF THE OSCILLATOR SECTION (NOT OSCILLATING) IS APPROXIMATELY 1150 μMHOS, THE AMPLIFICATION FACTOR IS 75 AND THE OSCILLATOR ANODE CURRENT IS 4.0 MA.
 CONDITIONS: PLATE VOLTAGE = 250 V., OSCILLATOR ANODE VOLTAGE = 100 V., SCREEN VOLTAGE = 55 V., CONTROL GRID VOLTAGE = -2.0 V., AND THE OSCILLATOR GRID VOLTAGE = -1.0 V.

PLATE
1131-1

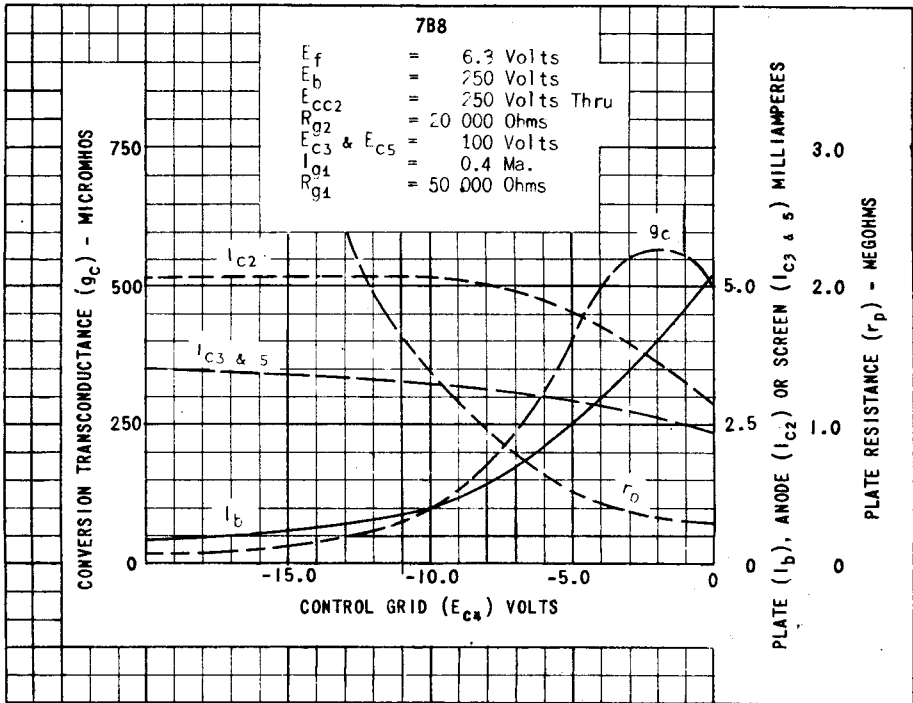
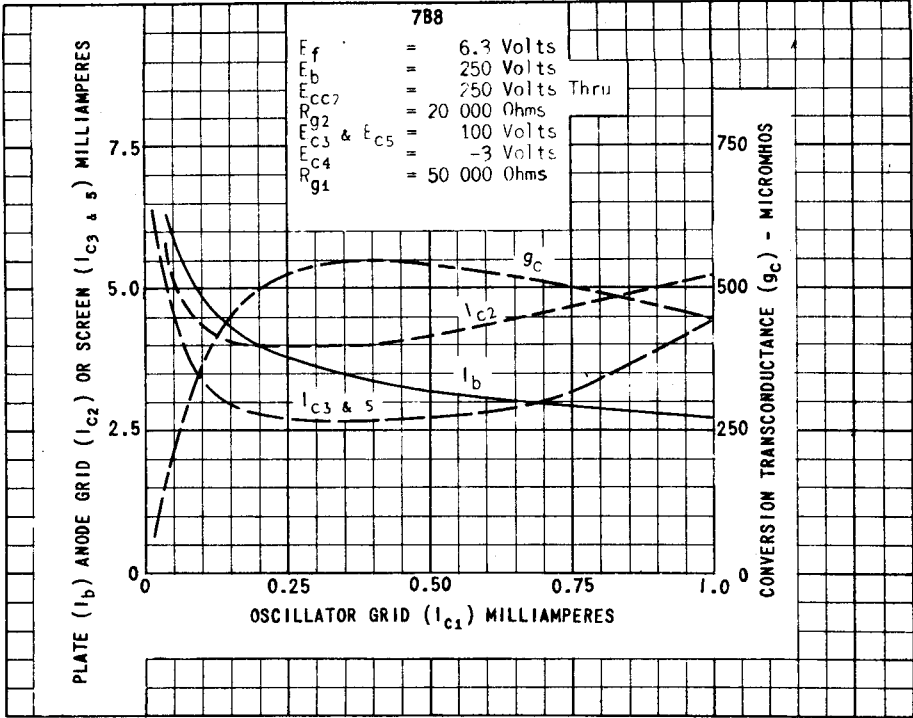

PRINTED IN U. S. A.

PLATE
2000
APRIL 1
1948

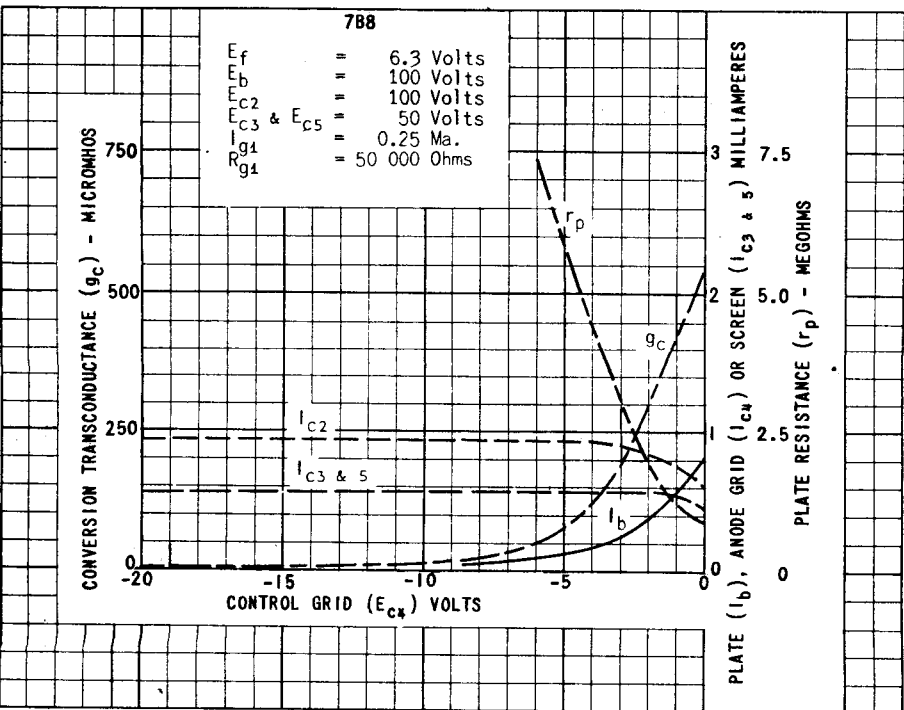
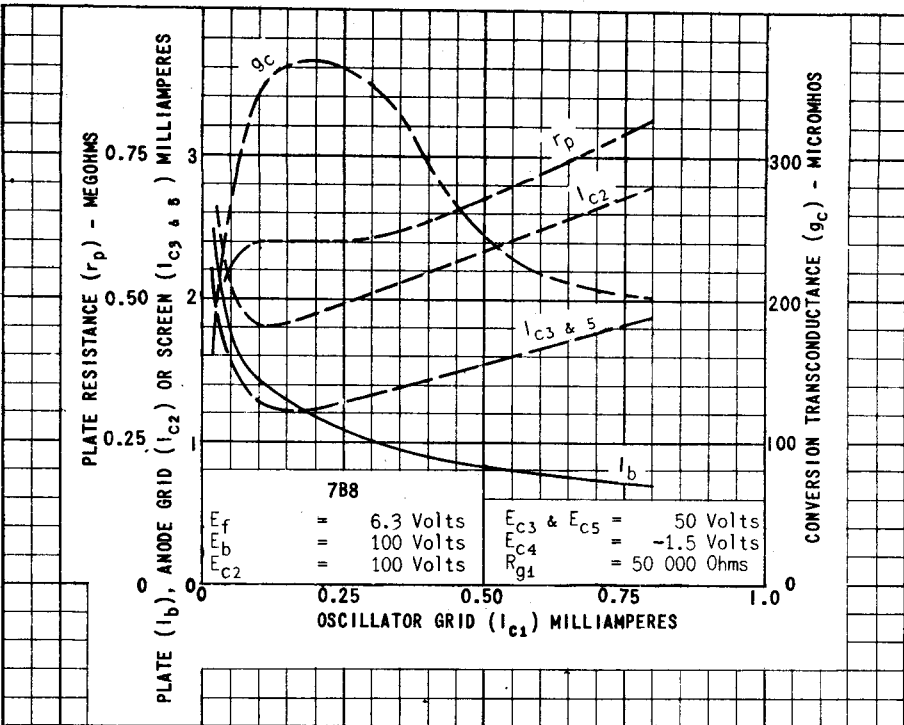
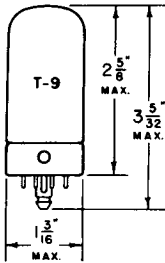

PLATE
 2001
 APRIL 1
 1948

TUNG-SOL



BEAM POWER AMPLIFIER

UNIPOTENTIAL CATHODE

HEATER
6.3 VOLTS 0.45 AMPERE
AC OR DC

GLASS BULB

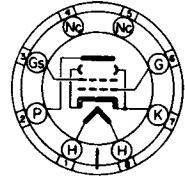

6AA

BOTTOM VIEW

LOCKING - IN 8 PIN BASE

THE TUNG-SOL 7C5 IS A BEAM POWER AMPLIFIER, DESIGNED FOR SERVICE IN THE OUTPUT STAGE OF AC AND STORAGE BATTERY OPERATED RECEIVERS. IT HAS HIGH POWER SENSITIVITY AND HIGH POWER OUTPUT WITH COMPARATIVELY LOW SUPPLY VOLTAGES.

RATINGS

NOMINAL HEATER VOLTAGE	7	VOLTS
NOMINAL HEATER CURRENT	0.48	AMPERE
MAXIMUM PLATE VOLTAGE	315	VOLTS
MAXIMUM SCREEN VOLTAGE	285	VOLTS
MAXIMUM PLATE DISSIPATION	12	WATTS
MAXIMUM SCREEN DISSIPATION	2	WATTS

FOR "INTERPRETATION OF RATINGS" REFER TO FRONT OF BOOK.

CONTINUED NEXT PAGE

PLATE
1088-2JULY 28
1941

TUNG-SOL

TYPICAL OPERATING CONDITIONS AND CHARACTERISTICS

SINGLE TUBE CLASS A₁ AMPLIFIER

HEATER VOLTAGE (AC OR DC)	6.3	6.3	6.3	VOLTS
HEATER CURRENT	0.45	0.45	0.45	AMPERE
PLATE VOLTAGE ^A	180	250	315	VOLTS
SCREEN VOLTAGE	180	250	225	VOLTS
CONTROL GRID VOLTAGE	-8.5	-12.5	-13	VOLTS
PEAK AF SIGNAL VOLTAGE	8.5	12.5	13	VOLTS
ZERO SIGNAL PLATE CURRENT	29	45	34	MA.
ZERO SIGNAL SCREEN CURRENT (NOMINAL)	3	4.5	2.2	MA.
MAXIMUM SIGNAL PLATE CURRENT	30	47	35	MA.
MAXIMUM SIGNAL SCREEN CURRENT (NOMINAL)	4	7	6	MA.
PLATE RESISTANCE APPROX.	58000	52000	77000	OHMS
TRANSCONDUCTANCE	3700	4100	3750	μMHOS
LOAD RESISTANCE	5500	5000	8500	OHMS
TOTAL HARMONIC DISTORTION	8	8	12	PER CENT
POWER OUTPUT	2.0	4.5	5.5	WATTS

PUSH PULL CLASS A₁ AMPLIFIER

VALUES FOR TWO TUBES UNLESS OTHERWISE SPECIFIED

PLATE VOLTAGE	250	285	VOLTS
SCREEN VOLTAGE	250	285	VOLTS
CONTROL GRID VOLTAGE ^A	-15	-19	VOLTS
PEAK AF SIGNAL VOLTAGE (GRID TO GRID)	30	38	VOLTS
ZERO SIGNAL PLATE CURRENT	70	70	MA.
ZERO SIGNAL SCREEN CURRENT (NOMINAL)	5.0	4.0	MA.
MAXIMUM SIGNAL PLATE CURRENT	79	92	MA.
MAXIMUM SIGNAL SCREEN CURRENT (NOMINAL)	13	13.5	MA.
PLATE RESISTANCE APPROX.	66000	65000	OHMS
TRANSCONDUCTANCE	3750	3600	μMHOS
EFFECTIVE LOAD RESISTANCE (PLATE TO PLATE)	10000	8000	OHMS
TOTAL HARMONIC DISTORTION	5	3.5	PER CENT
POWER OUTPUT	10	14	WATTS

^A THE DC RESISTANCE IN THE GRID CIRCUIT, UNDER MAXIMUM RATED CONDITIONS, SHOULD NOT EXCEED 0.5 MEGOHM FOR SELF BIAS OPERATION AND 0.1 MEGOHM FOR FIXED BIAS OPERATION.

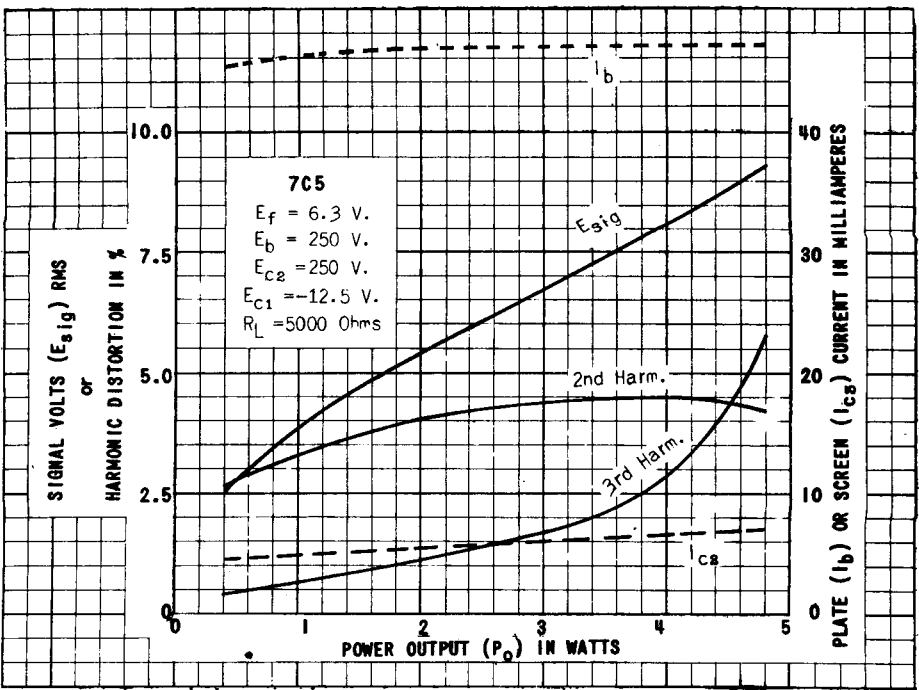
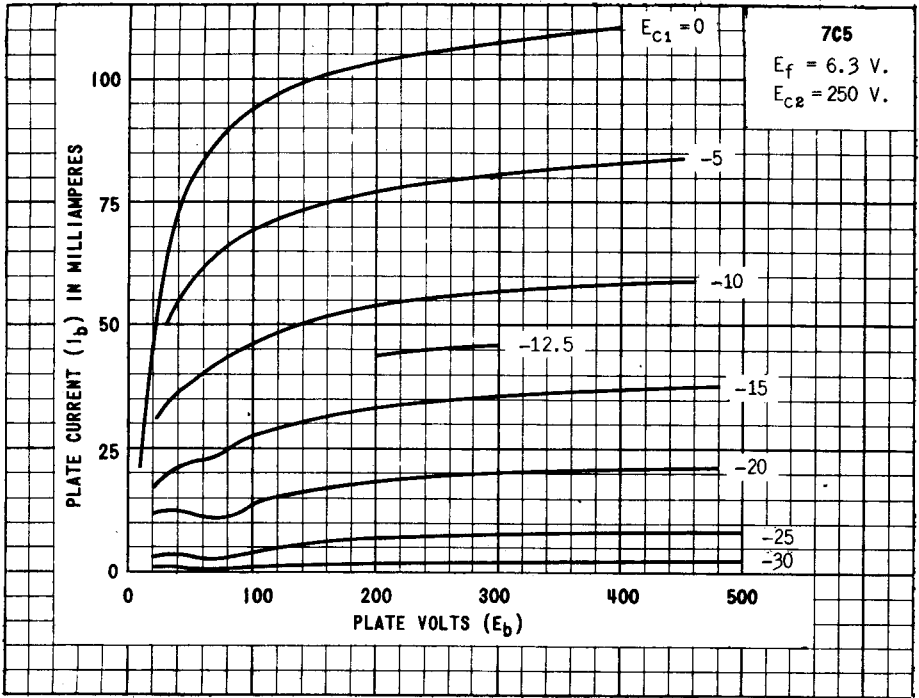

PRINTED IN U. S. A.

PLATE 1090-1
 JULY 28 1941

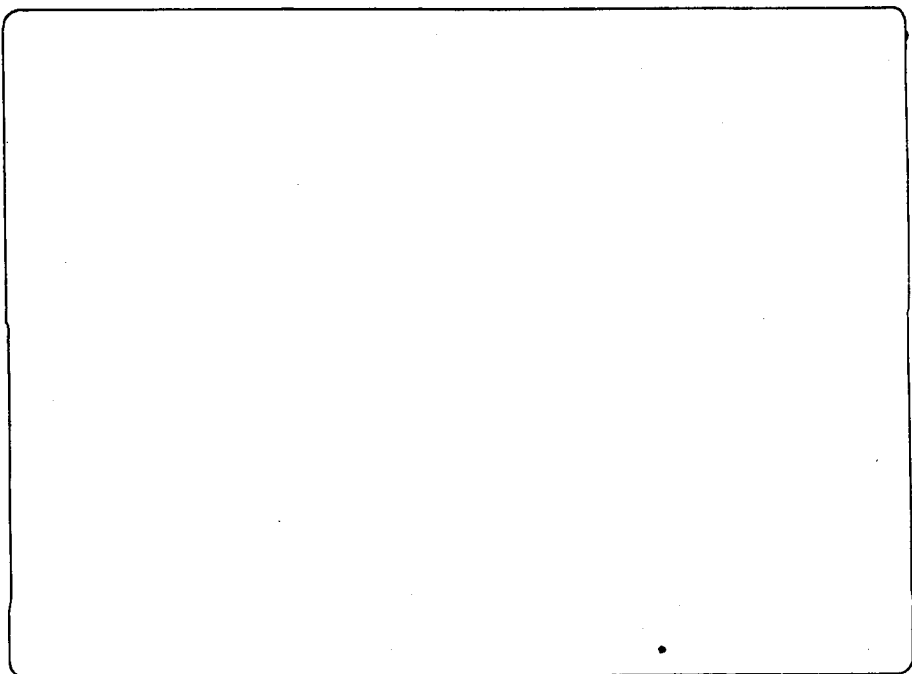
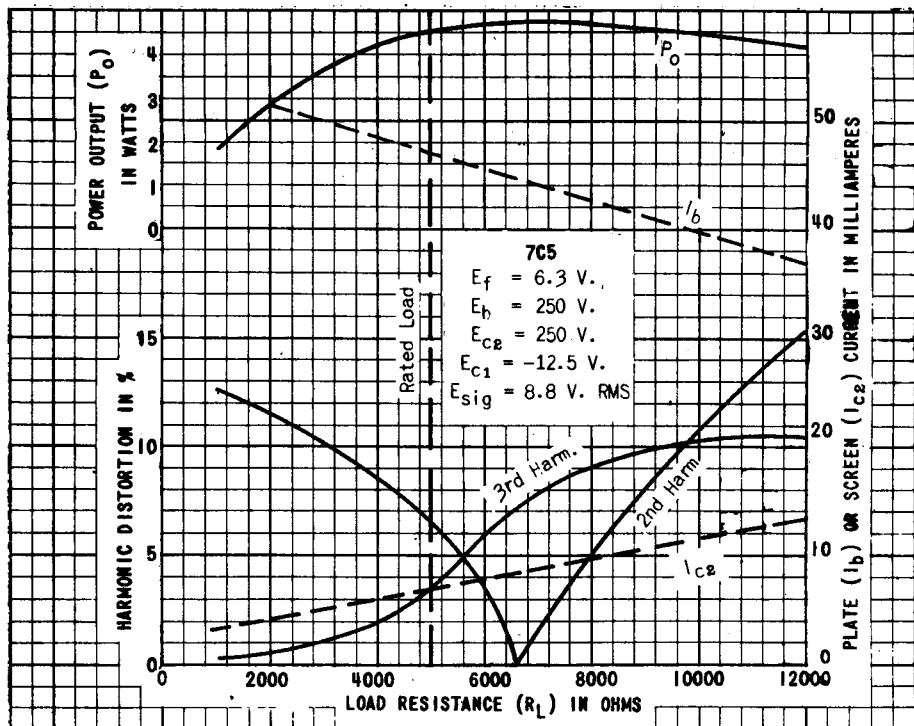

TUNG-SOL

DOUBLE DIODE TRIODE

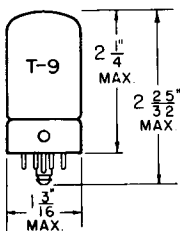

COATED UNIPOTENTIAL CATHODE

6.3 VOLTS 0.150 AMPERES
AC OR DC

IN CIRCUITS WHERE THE CATHODE IS NOT DIRECTLY CONNECTED TO THE HEATER, THE POTENTIAL DIFFERENCE BETWEEN HEATER AND CATHODE SHOULD BE KEPT AS LOW AS POSSIBLE.

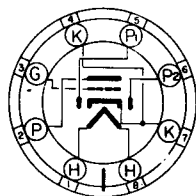

BOTTOM VIEW

LOCKING IN 8 PIN BASE

GLASS BULB

ANY MOUNTING POSITION

THE 7C6 IS A DOUBLE DIODE HIGH MU TRIODE USING THE LOCK-IN CONSTRUCTION. IT IS DESIGNED FOR SERVICE AS A DETECTOR AND HIGH GAIN AUDIO AMPLIFIER. IT FEATURES A LOW DRAIN HEATER.

RATINGS

INTERPRETED ACCORDING TO RMA STANDARD MB-210

MAXIMUM PLATE VOLTAGE	300	VOLTS
-----------------------	-----	-------

TYPICAL OPERATING CONDITIONS AND CHARACTERISTICS

CLASS A₁ AMPLIFIER

HEATER VOLTAGE	6.3	6.3	VOLTS
PLATE SUPPLY VOLTAGE	100	300	VOLTS
GRID LEAK	10	10	MEG OHMS
LOAD RESISTANCE	0.25	0.25	MEG OHM
COUPLING CAPACITOR	.01 TO .005	.01 TO .005	μF
GRID RESISTOR FOR FOLLOWING TUBE	.5	1.0	MEG OHM
EXTERNAL GRID CIRCUIT IMPEDANCE	0	0	MEG OHM
VOLTAGE GAIN	38	42	54
VOLTAGE OUTPUT (RMS)	5	6	37
TOTAL HARMONIC DISTORTION	2	5	2
			5 PER CENT

AVERAGE CHARACTERISTICS

TRIODE UNIT

PLATE VOLTAGE	100	250	VOLTS
GRID VOLTAGE	0	-1	VOLTS
AMPLIFICATION FACTOR	85	100	
PLATE RESISTANCE	0.1	0.1	MEG OHM
TRANSCONDUCTANCE	850	1,000	μMHOS
PLATE CURRENT	1.0	1.3	MA

CONTINUED ON FOLLOWING PAGE.

PLATE
1590
JULY 31,
1945

TUNG-SOL

CONTINUED FROM PRECEDING PAGE

DIODE UNITS

TWO

DIODE CURRENT PER PLATE WITH
10 VOLTS DC APPLIED

1.0 MA.

SIMILAR TYPE REFERENCE: Characteristics similar to type 75. Diode section similar to types 2B7, 6B7, 6B80, 85, 55.

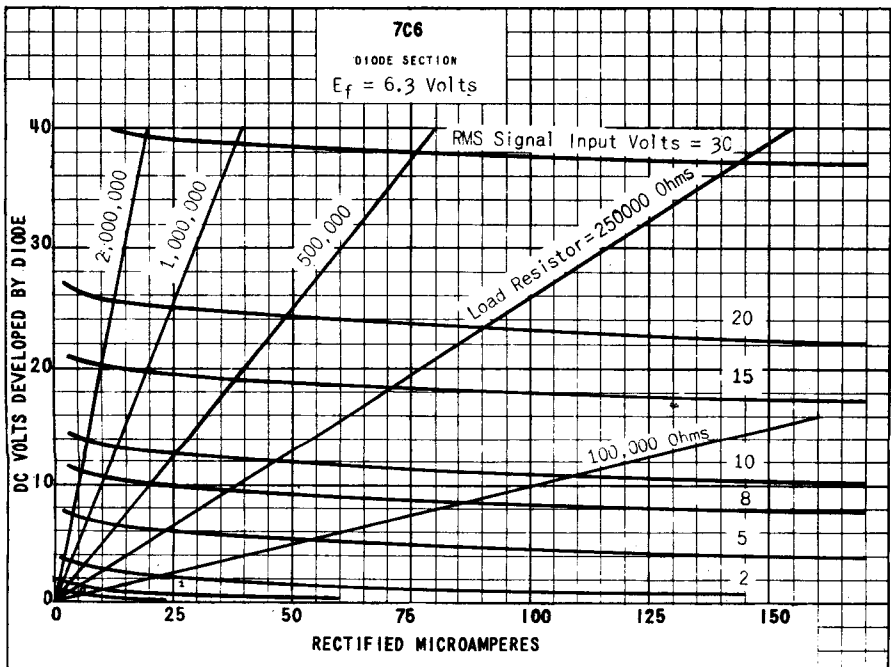
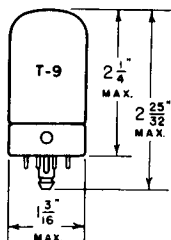

PLATE
1591
JULY 31,
1945

TUNG-SOL

TRIPLE GRID
DETECTOR AMPLIFIER



UNIPOTENTIAL CATHODE
HEATER
6.3 VOLTS 0.15 AMPERE
AC OR DC

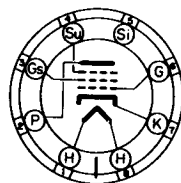

8V

BOTTOM VIEW

GLASS BULB

8 PIN LOCKING-IN BASE

THE TUNG-SOL 7C7 IS A TRIPLE GRID GENERAL PURPOSE DETECTOR AMPLIFIER. ITS RATINGS AND ELECTRICAL CHARACTERISTICS ARE SIMILAR TO THOSE OF THE 6W7G.

RATINGS

NOMINAL HEATER VOLTAGE	7.0	VOLTS
NOMINAL HEATER CURRENT	0.16	AMP.
MAXIMUM PLATE VOLTAGE	300	VOLTS
MAXIMUM SCREEN SUPPLY VOLTAGE	300	VOLTS
MAXIMUM SCREEN VOLTAGE	100	VOLTS
MINIMUM EXTERNAL GRID BIAS VOLTAGE	0	VOLT
MAXIMUM PLATE DISSIPATION	1.0	WATT
MAXIMUM SCREEN DISSIPATION	0.1	WATT

DIRECT INTERELECTRODE CAPACITANCES^S

CONTROL GRID TO CATHODE	5.5	μf
PLATE TO CATHODE	6.5	μf
CONTROL GRID TO PLATE	0.007 ^{MAX.}	μf

^S WITH AN EXTERNAL SHIELD CONNECTED TO CATHODE

FOR "INTERPRETATION OF RATINGS" REFER TO FRONT OF BOOK.

CONTINUED NEXT PAGE

TUNG-SOL

TYPICAL OPERATING CONDITIONS AND CHARACTERISTICS

CLASS A₁ AMPLIFIER

PLATE VOLTAGE	250	VOLTS
SCREEN VOLTAGE	100	VOLTS
CONTROL GRID VOLTAGE	-3	VOLTS
SUPPRESSOR GRID AND PIN #5 CONNECTED TO CATHODE AT SOCKET		
PLATE CURRENT	2.0	MA.
SCREEN CURRENT	0.5	MA.
PLATE RESISTANCE APPROX.	2.0	MEG OHMS
TRANSCONDUCTANCE	1300	μMHOS
CONTROL GRID VOLTAGE	-7	VOLTS

FOR CATHODE CURRENT CUT-OFF

TUNG-SOL

DUO-DIODE TRIODE AMPLIFIER

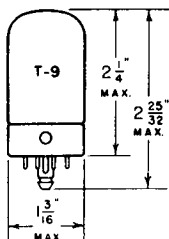

UNIPOTENTIAL CATHODE
 HEATER
 6.3 VOLTS 0.3 AMPERE
 AC OR DC

GLASS BULB

LOCKING-IN 8 PIN BASE

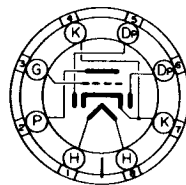

8W
 BOTTOM VIEW

THE TUNG-SOL 7E6 CONSISTS OF TWO DIODES AND A TRIODE IN A SINGLE BULB, WITH A COMMON CATHODE. IT IS DESIGNED FOR SERVICE AS A DIODE DETECTOR, AVC RECTIFIER AND AN AUDIO AMPLIFIER. ITS RATINGS AND ELECTRICAL CHARACTERISTICS ARE IDENTICAL WITH THOSE OF THE 6R7G AND THE 6R7GT.

RATINGS

HEATER VOLTAGE — NOMINAL	7.0	VOLTS
HEATER CURRENT — NOMINAL	0.32	AMPERE
MAXIMUM PLATE VOLTAGE	250	VOLTS
MAXIMUM PLATE DISSIPATION	2.5	WATTS
MINIMUM DIODE CURRENT PER PLATE	0.8	MA.

WITH 10 VOLTS DC APPLIED

TYPICAL OPERATING CONDITIONS AND CHARACTERISTICS

CLASS A₁ AMPLIFIER

PLATE VOLTAGE	250	VOLTS
GRID VOLTAGE	-9	VOLTS
PLATE CURRENT	9.5	MA.
PLATE RESISTANCE	8500	OHMS
TRANSCONDUCTANCE	1900	μMHOS
AMPLIFICATION FACTOR	16	

FOR "INTERPRETATION OF RATINGS" REFER TO FRONT OF BOOK.

CONTINUED NEXT PAGE

PLATE
 894-1

SEPT. 23
 1940

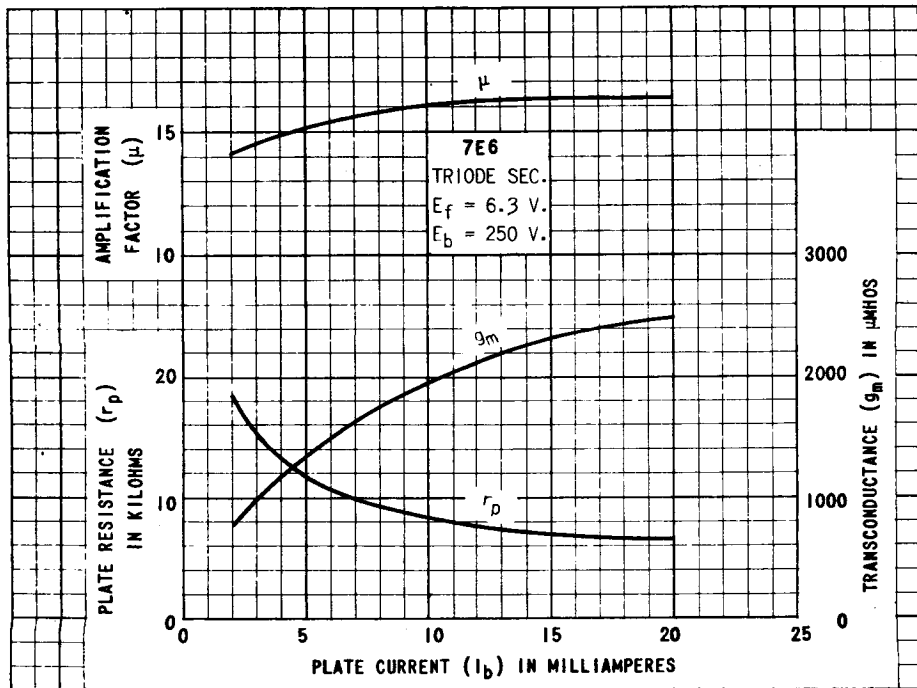
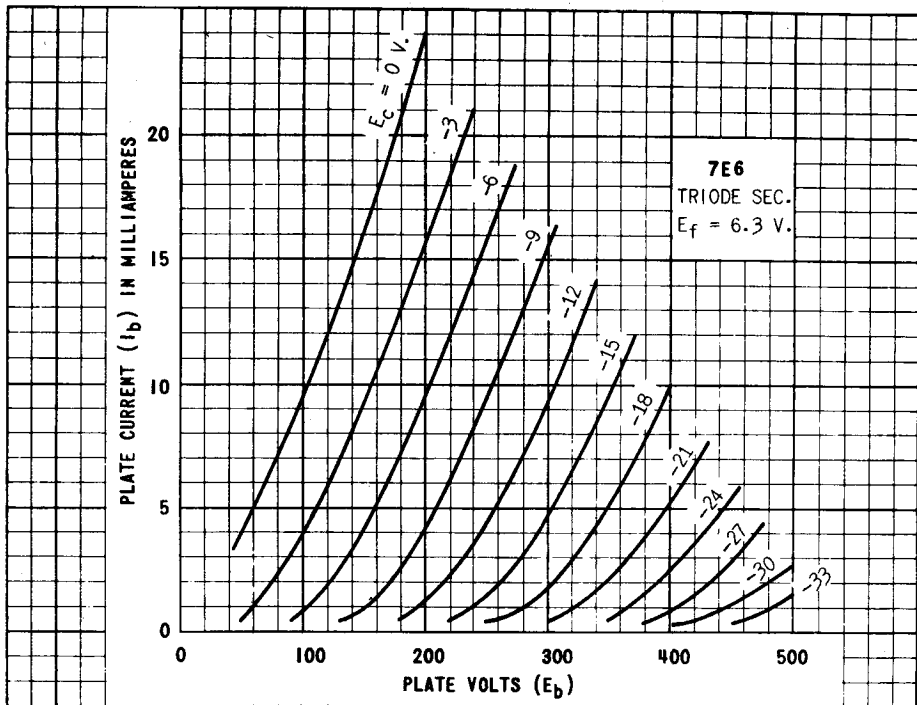

TUNG-SOL

DOUBLE DIODE PENTODE

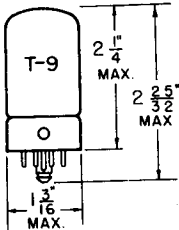

COATED UNIPOTENTIAL CATHODE

6.3 VOLTS 0.3 AMPERE

AC OR DC

IN CIRCUITS WHERE THE CATHODE IS NOT DIRECTLY CONNECTED TO THE HEATER, THE POTENTIAL DIFFERENCE BETWEEN HEATER AND CATHODE SHOULD BE KEPT AS LOW AS POSSIBLE.

GLASS BULB

ANY MOUNTING POSITION

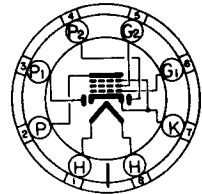

BOTTOM VIEW

LOCKING IN 8 PIN BASE

THE 7E7 IS A DOUBLE DIODE REMOTE CUT-OFF PENTODE USING THE LOCK-IN CONSTRUCTION WITH CHARACTERISTICS SIMILAR TO TYPE 6B8GT. IT IS USEFUL AS A COMBINED DETECTOR, AVC RECTIFIER, AND EITHER RF, IF, OR AUDIO AMPLIFIER.

RATINGS

INTERPRETED ACCORDING TO RMA STANDARD MB-210

MAXIMUM PLATE VOLTAGE	250	VOLTS
MAXIMUM SCREEN VOLTAGE	100	VOLTS
MAXIMUM SCREEN SUPPLY VOLTAGE	250	VOLTS
MAXIMUM PLATE DISSIPATION	2.0	WATTS
MAXIMUM SCREEN DISSIPATION	0.4	WATT
MINIMUM EXTERNAL CONTROL GRID BIAS VOLTAGE	0	VOLTS

DIRECT INTERELECTRODE CAPACITANCES

WITH MB-308 TUBE SHIELD CONNECTED TO CATHODE

GRID TO PLATE	0.005 MAX.	μμF
INPUT	4.6	μμF
OUTPUT	4.6	μμF
COUPLING: DIODE #1 TO GRID #1	0.013 MAX.	μμF
COUPLING: DIODE #2 TO GRID #1	0.003 MAX.	μμF

CONTINUED NEXT PAGE

PLATE
1592
JULY 31,
1945

TUNG-SOL

CONTINUED FROM PRECEDING PAGE

TYPICAL OPERATING CONDITIONS AND CHARACTERISTICS

PLATE VOLTAGE	100	250	VOLTS
SCREEN VOLTAGE	100	100	VOLTS
GRID VOLTAGE	-1.0	-3.0	VOLTS
PLATE RESISTANCE (APPROX.)	0.15	0.7	MEGOHMS
TRANSCONDUCTANCE	1 600	1 300	μMHOS
PLATE CURRENT	10	7.5	MA.
SCREEN CURRENT	2.7	1.6	MA.
GRID BIAS (FOR $S_M=2$ μMHOS)	-36	-42.5	VOLTS

DIODE UNITS: TWO

MINIMUM DIODE CURRENT PER PLATE WITH 10 VOLTS DC APPLIED	0.8	MA.
MAXIMUM DIODE CURRENT PER PLATE FOR CONTINUOUS OPERATION	1.0	MA.

SINILAR TYPE REFERENCE: Characteristics similar to types 2B7, 6B7, 6B8Q.
Application same in general as for other duo-diode
high gain pentodes.

TUNG-SOL

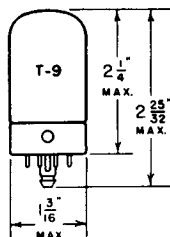
TWIN HIGH-MU
TRIODE AMPLIFIER

UNIPOTENTIAL CATHODE
HEATER
6.3 VOLTS 0.3 AMPERE
AC OR DC

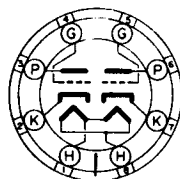

8AC
BOTTOM VIEW

GLASS BULB

LOCKING-IN 8 PIN BASE

THE TUNG-SOL 7F7 CONSISTS OF TWO INDEPENDENT HIGH-MU TRIODE SECTIONS. AS ALL ELECTRODES ARE BROUGHT OUT TO SEPARATE PIN CONNECTIONS, CONSIDERABLE FLEXIBILITY IS POSSIBLE IN ITS APPLICATION.

RATINGS

HEATER VOLTAGE - NOMINAL	7.0	VOLTS
HEATER CURRENT - NOMINAL	0.32	AMPERE
MAXIMUM PLATE VOLTAGE	250	VOLTS
MAXIMUM PLATE DISSIPATION PER SECTION	1	WATT
MINIMUM EXTERNAL GRID BIAS VOLTAGE	0	VOLT

TYPICAL OPERATING CONDITIONS AND CHARACTERISTICS

CLASS A₁ AMPLIFIER

VALUES ARE FOR EACH TRIODE SECTION

PLATE VOLTAGE	250	VOLTS
GRID VOLTAGE	-2	VOLTS
PLATE CURRENT	2.3	MA.
PLATE RESISTANCE APPROX.	44 000	OHMS
TRANSCONDUCTANCE	1600	μMHOS
AMPLIFICATION FACTOR	70	

FOR "INTERPRETATION OF RATINGS" REFER TO FRONT OF BOOK.



TUNG-SOL

TRIPLE GRID AMPLIFIER

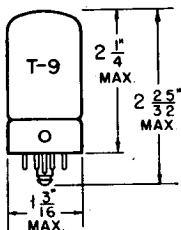

COATED UNIPOTENTIAL CATHODE

6.3 VOLTS 0.45 AMPERES

AC OR DC

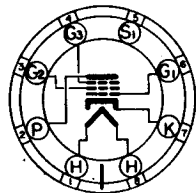

BOTTOM VIEW

LOCKING IN 8 PIN BASE

IN CIRCUITS WHERE THE CATHODE IS NOT DIRECTLY CONNECTED TO THE HEATER, THE POTENTIAL DIFFERENCE BETWEEN HEATER AND CATHODE SHOULD BE KEPT AS LOW AS POSSIBLE.

GLASS BULB

ANY MOUNTING POSITION

THE 7G7/1232 IS A TRIPLE GRID SHARP CUT-OFF HIGH TRANSCONDUCTANCE AMPLIFIER USING THE LOCK-IN CONSTRUCTION. IT IS PARTICULARLY ADAPTABLE FOR SERVICE AS A HIGH GAIN RF OR IF AMPLIFIER OR AS A LIMITER IN FM EQUIPMENTS.

RATINGS

INTERPRETED ACCORDING TO RMA STANDARD MB-210

MAXIMUM PLATE VOLTAGE	250	VOLTS
MAXIMUM SCREEN VOLTAGE	100	VOLTS
MAXIMUM SCREEN SUPPLY VOLTAGE	250	VOLTS
MAXIMUM PLATE DISSIPATION	1.5	WATTS
MAXIMUM SCREEN DISSIPATION	0.3	WATT

DIRECT INTERELECTRODE CAPACITANCES

WITH MB-308 TUBE SHIELD CONNECTED TO CATHODE

GRID TO PLATE	0.007 MAX.	$\mu\mu\text{F}$
INPUT	9.0	$\mu\mu\text{F}$
OUTPUT	7.0	$\mu\mu\text{F}$

TYPICAL OPERATING CONDITIONS AND CHARACTERISTICS

SUPPRESSOR VOLTAGE	0	VOLTS
INTERNAL SHIELD CONNECTED TO CATHODE		
PLATE VOLTAGE	250	VOLTS
SCREEN VOLTAGE	100	VOLTS
GRID VOLTAGE	-2	VOLTS
PLATE CURRENT	6.0	MA.
SCREEN CURRENT	2.0	MA.
PLATE RESISTANCE (APPROX.)	0.8	MEGOHM
TRANSCONDUCTANCE	4 500	μMHOS
GRID VOLTAGE FOR CATHODE CURRENT CUT-OFF (APPROX.)	-6	VOLTS

SIMILAR TYPE REFERENCE: Somewhat similar to types 1231 and 7L7.

PLATE
1994
JULY 31,
1945



TUNG-SOL

SHARP CUT-OFF DOUBLE TETRODE

PHYSICAL SPECIFICATIONS

EMITTER COATED UNIPOT. CATHODE		PIN CONNECTIONS		TETRODE NO.	TETRODE NO.
		PIN 1 HEATER	PIN 7 PLATE		
BASE	LOCK-IN 8-PIN	PIN 2 PLATE	2	PIN 8 HEATER	1
CAP	---	PIN 3 GRID 2	1&2		
BULB	SHORT T-9	PIN 4 GRID 1	2		
MAXIMUM DIAMETER	1 3/16"	PIN 5 GRID 1	1	MOUNTING POS.	ANY
MAXIMUM OVERALL LENGTH	2 1/32"	PIN 6 CATHODE	1&2		
MAXIMUM SEATED HEIGHT	1 1/2"				

RATINGS

INTERPRETED ACCORDING TO RMA STANDARD NB-210

HEATER OR FILAMENT VOLTAGE (NOMINAL) (AC OR DC)	7.0	VOLTS
HEATER OR FILAMENT CURRENT (NOMINAL)	0.320	AMP.
MAXIMUM PLATE VOLTAGE	300	VOLTS
MAXIMUM SCREEN VOLTAGE	100	VOLTS
MAXIMUM PLATE DISSIPATION (PER UNIT)	1.5	WATTS
MAXIMUM SCREEN DISSIPATION (PER UNIT)	.1	WATT
MAXIMUM SCREEN SUPPLY VOLTAGE	300	VOLTS
MINIMUM EXTERNAL CONTROL GRID BIAS VOLTAGE	0	VOLTS
MAXIMUM HEATER-CATHODE VOLTAGE	90	VOLTS

CAPACITANCES

WITH 1 5/16" DIAMETER SHIELD CONNECTED TO CATHODE

CONTROL GRID TO CATHODE	3.40	μ f
PLATE TO CATHODE	2.60	μ f
GRID TO PLATE (MAX.)	0.15	μ f

TYPICAL OPERATING CONDITIONS AND CHARACTERISTICS
PER UNIT

HEATER OR FILAMENT VOLTAGE	6.3	VOLTS
HEATER OR FILAMENT CURRENT	0.300	AMP.
PLATE VOLTAGE	250	VOLTS
SCREEN VOLTAGE	100	VOLTS
GRID VOLTAGE	-2.5	VOLTS
PLATE CURRENT	4.5	MA.
SCREEN CURRENT	0.8	MA.
ZERO-SIGNAL SCREEN CURRENT		MA.
MAXIMUM-SIGNAL PLATE CURRENT		MA.
MAXIMUM-SIGNAL SCREEN CURRENT		MA.
PLATE RESISTANCE	225 000	OHMS
TRANSCONDUCTANCE	2 100	μ MHOS
AMPLIFICATION FACTOR		
LOAD RESISTANCE		OHMS
TOTAL HARMONIC DISTORTION		PER CENT
POWER OUTPUT		WATTS
CONTROL GRID VOLTAGE FOR $I_b = 10 \mu$ A	-10	VOLTS



TUNG-SOL

PENTODE VOLTAGE AMPLIFIER

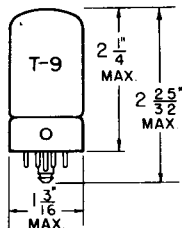

COATED UNIPOTENTIAL CATHODE

6.3 VOLTS 0.3 AMPERE
AC OR DC

IN CIRCUITS WHERE THE CATHODE IS NOT DIRECTLY CONNECTED TO THE HEATER, THE POTENTIAL DIFFERENCE BETWEEN HEATER AND CATHODE SHOULD BE KEPT AS LOW AS POSSIBLE.

GLASS BULB

ANY MOUNTING POSITION



BOTTOM VIEW

LOCKING-IN 8-PIN BASE

THE 7H7 IS A TRIPLE GRID SEMI-REMOTE CUT-OFF HIGH TRANSCONDUCTANCE AMPLIFIER USING THE LOCK-IN CONSTRUCTION. IT IS SIMILAR TO TYPES 6SD7GT AND 6SG7 AND IS USEFUL AS AN RF OR IF AMPLIFIER.

RATINGS

INTERPRETED ACCORDING TO RMA STANDARD MB-210

MAXIMUM PLATE VOLTAGE	300	VOLTS
MAXIMUM SCREEN SUPPLY VOLTAGE	300	VOLTS
MAXIMUM SCREEN VOLTAGE	150	VOLTS
MAXIMUM PLATE DISSIPATION	2.5	WATTS
MAXIMUM SCREEN DISSIPATION	0.5	WATT
MINIMUM EXTERNAL GRID BIAS VOLTAGE	0	VOLTS

DIRECT INTERELECTRODE CAPACITANCES

WITH MB-308 TUBE SHIELD CONNECTED TO CATHODE

GRID TO PLATE	0.007	$\mu\mu\text{f}$
INPUT	8.0	$\mu\mu\text{f}$
OUTPUT	7.0	$\mu\mu\text{f}$

TYPICAL OPERATING CONDITIONS AND CHARACTERISTICS

CLASS A₁ AMPLIFIER

PLATE VOLTAGE	100	250	VOLTS
SCREEN VOLTAGE	100	150	VOLTS
GRID VOLTAGE	1.0	-2.5	VOLTS
SUPPRESSOR AND INTERNAL SHIELD (CONNECTED TO CATHODE AT SOCKET)	0	0	VOLTS
PLATE RESISTANCE (APPROX.)	0.25	0.8	MEG OHM
TRANSCONDUCTANCE	3 800	3 800	μMHOS
PLATE CURRENT	8.2	9.5	MA.
SCREEN CURRENT	3.3	3.5	MA.
GRID VOLTAGE FOR TRANSCONDUCTANCE = 35 μMHOS (APPROX.)	-12	-19	VOLTS

SIMILAR TYPE REFERENCE: Somewhat similar to types 6SD7GT and 6SG7.



TUNG-SOL

TRIODE HEXODE CONVERTER

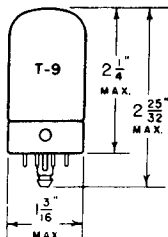

UNIPOTENTIAL CATHODE

HEATER

6.3 VOLTS 0.3 AMPERE

AC OR DC

GLASS BULB

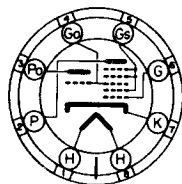

8AR

BOTTOM VIEW

LOCKING-IN 8 PIN BASE

THE TUNG-SOL 7J7 IS DESIGNED FOR SERVICE AS AN OSCILLATOR AND MIXER IN SUPERHETERODYNE CIRCUITS. IT CONSISTS OF A HEXODE MIXER AND A TRIODE OSCILLATOR WITH A COMMON CATHODE. THE INJECTOR GRID OF THE HEXODE IS INTERNALLY CONNECTED TO THE TRIODE GRID. ITS RATINGS AND ELECTRICAL CHARACTERISTICS ARE SIMILAR TO THOSE OF THE 6J8G

RATINGS

HEATER VOLTAGE - NOMINAL	7.0	VOLTS
HEATER CURRENT - NOMINAL	0.32	AMPERE
MAXIMUM HEXODE PLATE VOLTAGE (P)	300	VOLTS
MAXIMUM HEXODE SCREEN VOLTAGE (G _S)	100	VOLTS
MAXIMUM HEXODE SCREEN SUPPLY VOLTAGE	300	VOLTS
MAXIMUM TRIODE PLATE VOLTAGE (P _O)	150	VOLTS
MAXIMUM TRIODE PLATE SUPPLY VOLTAGE	300	VOLTS
MAXIMUM HEXODE PLATE DISSIPATION (P)	0.5	WATT
MAXIMUM HEXODE SCREEN DISSIPATION (G _S)	0.3	WATT
MAXIMUM TRIODE PLATE DISSIPATION (P _O)	1.25	WATTS
MAXIMUM TOTAL CATHODE CURRENT	14	MA.
MINIMUM EXTERNAL SIGNAL GRID BIAS VOLTAGE (G)	0	VOLT

DIRECT INTERELECTRODE CAPACITANCES⁵

HEXODE GRID (G) TO HEXODE PLATE (P)	0.01 ^{MAX.} μμf
HEXODE GRID (G) TO TRIODE PLATE (P _O)	0.1 ^{MAX.} μμf
HEXODE GRID (G) TO TRIODE GRID AND HEXODE GRID (G _O)	0.2 ^{MAX.} μμf
TRIODE GRID (G _O) TO TRIODE PLATE (P _O)	1.0 μμf
SIGNAL INPUT: HEXODE GRID (G) TO ALL OTHER ELECTRODES	5.5 μμf
OSC. INPUT: TRIODE GRID AND HEXODE GRID (G _O) TO ALL OTHER ELECTRODES EXCEPT TRIODE PLATE (P _O)	8.5 μμf
OSC. OUTPUT: TRIODE PLATE (P _O) TO ALL OTHER ELECTRODES EXCEPT TRIODE GRID AND HEXODE GRID (G _O)	2.0 μμf
MIXER OUTPUT: HEXODE PLATE (P) TO ALL OTHER ELECTRODES	7.5 μμf

⁵ WITH EXTERNAL SHIELD CONNECTED TO CATHODE

CONTINUED NEXT PAGE

TUNG-SOL

TYPICAL OPERATING CONDITIONS AND CHARACTERISTICS

CONVERTER SERVICE

HEXODE PLATE (P) VOLTAGE	100	250	VOLTS
HEXODE SCREEN (G_S) VOLTAGE	100	100	VOLTS
TRIODE PLATE (P_O) VOLTAGE	100	-	VOLTS
TRIODE PLATE (P_O) SUPPLY VOLTAGE	-	250 ^A	VOLTS
HEXODE CONTROL GRID (G) VOLTAGE	-3	-3	VOLTS
HEXODE PLATE CURRENT	1.1	1.3	MA.
HEXODE SCREEN CURRENT	3.1	2.9	MA.
TRIODE PLATE CURRENT	3.7	5.4	MA.
TRIODE GRID (G_O) CURRENT	0.3	0.4	MA.
TOTAL CATHODE CURRENT	8.2	10.0	MA.
TRIODE GRID (G_O) RESISTOR	50000	50000	OHMS
HEXODE PLATE RESISTANCE	0.3	1.5	MEG OHMS
CONVERSION TRANSCONDUCTANCE	260	300	μ MHOS
CONTROL GRID VOLTAGE	-20	-20	VOLTS

FOR CONVERSION TRANSCONDUCTANCE = 2 μ MHOS

^A THIS VALUE OF TRIODE PLATE SUPPLY VOLTAGE APPLIED THROUGH A 20 000 OHM DROPPING RESISTOR.

STATIC CHARACTERISTICS OF TRIODE SECTION ONLY

PLATE VOLTAGE	150	VOLTS
GRID VOLTAGE	-3	VOLTS
PLATE CURRENT	7.5	MA.
PLATE RESISTANCE	10400	OHMS
TRANSCONDUCTANCE	1350	μ MHOS
AMPLIFICATION FACTOR	14	

FOR "INTERPRETATION OF RATINGS" REFER TO FRONT OF BOOK.

PLATE
859-1

TUNG-SOL

PENTODE VOLTAGE AMPLIFIER

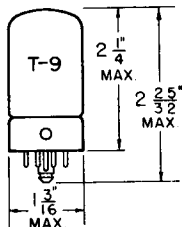

COATED UNIPOTENTIAL CATHODE
6.3 VOLTS 0.300 AMPERES
AC OR DC

IN CIRCUITS WHERE THE CATHODE IS NOT DIRECTLY CONNECTED TO THE HEATER, THE POTENTIAL DIFFERENCE BETWEEN HEATER AND CATHODE SHOULD BE KEPT AS LOW AS POSSIBLE.

GLASS BULB

ANY MOUNTING POSITION

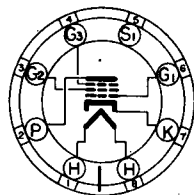

BOTTOM VIEW

LOCKING IN 8 PIN BASE

THE 7L7 IS A TRIPLE GRID SHARP CUT-OFF HIGH TRANSCONDUCTANCE AMPLIFIER USING THE LOCK-IN CONSTRUCTION. IT IS SIMILAR TO TYPE 6SH7GT AND IS USEFUL AS AN IF AMPLIFIER OR LIMITER IN FM EQUIPMENTS.

RATINGS

INTERPRETED ACCORDING TO RMA STANDARD W8-210

MAXIMUM PLATE VOLTAGE	300	VOLTS
MAXIMUM SCREEN SUPPLY VOLTAGE	300	VOLTS
MAXIMUM SCREEN VOLTAGE	125	VOLTS
MAXIMUM PLATE DISSIPATION	4.0	WATTS
MAXIMUM SCREEN DISSIPATION	0.4	WATT
MINIMUM EXTERNAL CONTROL GRID BIAS VOLTAGE	0	VOLTS

DIRECT INTERELECTRODE CAPACITANCES

WITH W8-308 TUBE SHIELD CONNECTED TO CATHODE

GRID TO PLATE	0.010	MAX.	μμF
INPUT	8.0		μμF
OUTPUT	6.5		μμF

CONTINUED ON FOLLOWING PAGE

TUNG-SOL

CONTINUED FROM PRECEDING PAGE

TYPICAL OPERATING CONDITIONS AND CHARACTERISTICS

CLASS A₁ AMPLIFIER

PLATE VOLTAGE	100	250	VOLTS
SCREEN VOLTAGE	100	100	VOLTS
GRID VOLTAGE	-1	-1.5	VOLTS
SUPPRESSOR AND INTERNAL SHIELD CONNECTED AT SOCKET	0	0	VOLTS
PLATE RESISTANCE (APPROX.)	0.1	1.0	MEGOHM
TRANSCONDUCTANCE	3 000	3 100	μMHOS
CONTROL GRID VOLTAGE FOR CATHODE CURRENT CUT-OFF	-5	-5	VOLTS
PLATE CURRENT	5.5	4.5	MA.
SCREEN CURRENT	2.4	1.5	MA.
CATHODE BIAS RESISTOR	125	250	OHMS

SIMILAR TYPE REFERENCE: Somewhat similar to type 707/1232 and type 63A7GT.

TUNG-SOL

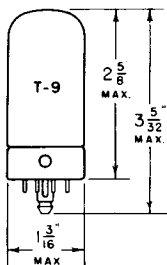

TWIN TRIODE AMPLIFIER

UNIPOTENTIAL CATHODE

HEATER

6.3 VOLTS 0.6 AMPERE

AC OR DC

GLASS BULB

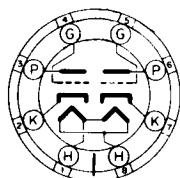

BAC-L-0

LOCKING-IN 8 PIN BASE

THE TUNG-SOL 7N7 IS A TWIN TRIODE VOLTAGE AMPLIFIER HAVING TWO COMPLETELY INDEPENDENT TRIODE UNITS IN ONE BULB. WITH THE EXCEPTION OF CAPACITANCES AND HEATER RATINGS, ITS ELECTRICAL CHARACTERISTICS ARE IDENTICAL TO THOSE OF THE 6F8G.

RATINGS

MAXIMUM PLATE VOLTAGE	300	VOLTS
MAXIMUM PLATE DISSIPATION PER UNIT	2.5	WATTS
MINIMUM CONTROL GRID VOLTAGE	0	VOLT

TYPICAL OPERATING CONDITIONS AND CHARACTERISTICS

CLASS A₁ AMPLIFIER (EACH UNIT)

PLATE VOLTAGE	90	250	VOLTS
CONTROL GRID VOLTAGE	0	-8	VOLTS
PLATE CURRENT	10.0	9.0	MA.
PLATE RESISTANCE	6700	7700	OHMS
TRANSCONDUCTANCE	3000	2600	μMHOS
AMPLIFICATION FACTOR	20	20	

DIRECT INTERELECTRODE CAPACITANCES⁵

	TRIODE UNIT 1	TRIODE UNIT 2	
GRID TO CATHODE	3.4	2.9	μf
PLATE TO CATHODE	2.0	2.4	μf
GRID TO PLATE	3.0	3.0	μf
GRID 1 TO GRID 2		0.4	μf
PLATE 1 TO PLATE 2		0.34	μf
GRID 2 TO PLATE 1		0.06	μf
GRID 1 TO PLATE 2		0.08	μf

⁵ WITH EXTERNAL SHIELD CONNECTED TO CATHODE

CONTINUED NEXT PAGE

PRINTED IN U. S. A.

PLATE
1179-1
FEB. 28
1942

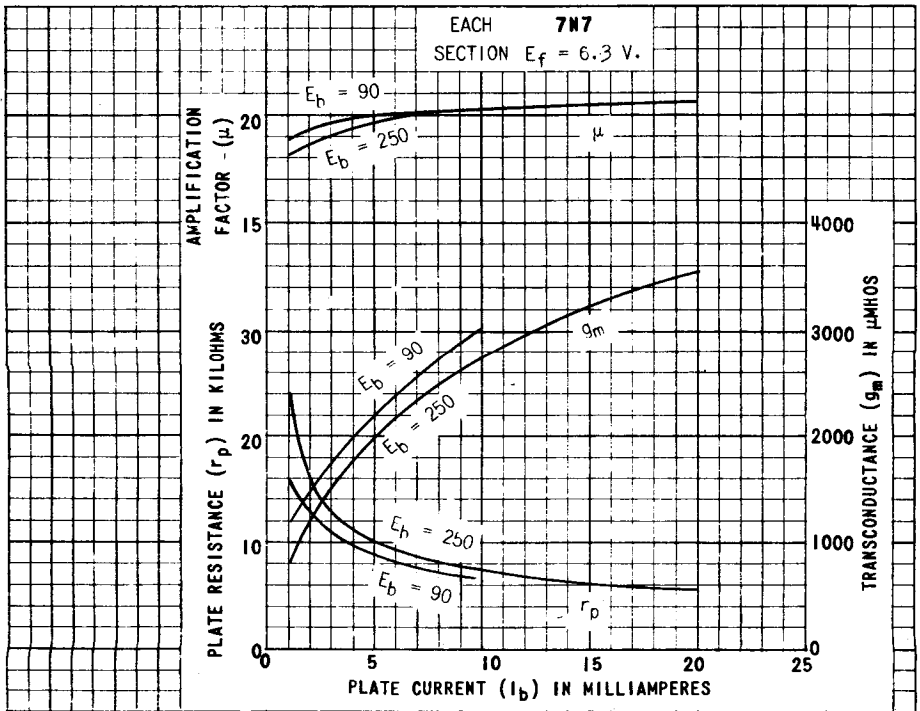
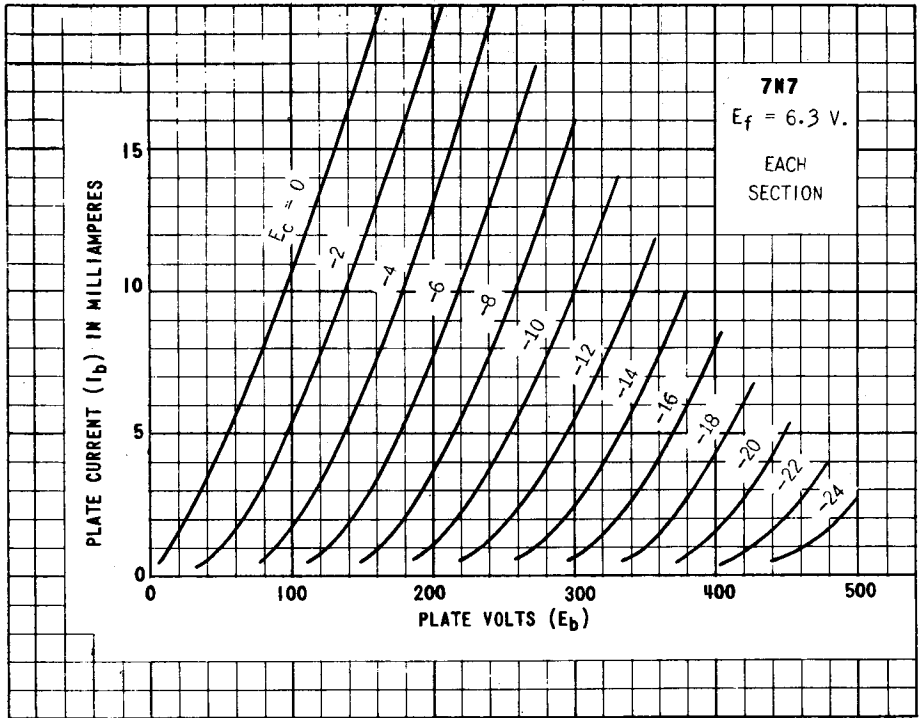

TUNG-SOL

PENTAGRID

PHYSICAL SPECIFICATIONS

EMITTER UNIPOTENTIAL CATHODE		PIN CONNECTIONS		
BASE	LOCKING-IN - 8 PIN	PIN 1	HEATER	PIN 7 CATHODE
CAP	NONE	PIN 2	PLATE	PIN 8 HEATER
BULB	T-9	PIN 3 GRIDS #2 & #4		
MAXIMUM DIAMETER 1 3/16"		PIN 4	GRID #1	
MAXIMUM OVERALL LENGTH 2 25/32"		PIN 5	GRID #5	TOP CAP NONE
MAXIMUM SEATED HEIGHT 2 1/4"		PIN 6	GRID #3	

RATINGS

HEATER OR FILAMENT VOLTAGE - NOMINAL (AC OR DC)	7.0	VOLTS
HEATER OR FILAMENT CURRENT - NOMINAL	0.32	AMP.
MAXIMUM PLATE VOLTAGE	300	VOLTS
MAXIMUM SCREEN VOLTAGE (GRIDS #2 & #4)	100	VOLTS
MAXIMUM SCREEN SUPPLY VOLTAGE	300	VOLTS
MAXIMUM PLATE DISSIPATION		WATTS
MAXIMUM SCREEN DISSIPATION	1.0	WATT
MAXIMUM TOTAL PLATE AND SCREEN DISSIPATION	2.0	WATTS
MAXIMUM TOTAL CATHODE CURRENT	14	MA.
MINIMUM EXTERNAL SIGNAL GRID BIAS VOLTAGE* (GRID #3)	0	VOLTS
MAXIMUM ANODE-GRID VOLTAGE		VOLTS
MAXIMUM ANODE-GRID SUPPLY VOLTAGE		VOLTS
MAXIMUM ANODE-GRID DISSIPATION		WATT

* WITH SELF-EXCITATED OSCILLATOR

CAPACITANCES⁵

SIGNAL GRID TO MIXER PLATE (GRID #3 TO PLATE)	0.20 MAX.	μf
SIGNAL GRID TO OSC. GRID (GRID #3 TO GRID #1)	0.20 MAX.	μf
SIGNAL INPUT (GRID #3 TO ALL OTHER ELECTRODES)	9.0	μf
OSC. GRID TO CATHODE (GRID #1 TO CATHODE)	2.2	μf
OSC. GRID TO PLATE (GRID #1 TO PLATE)	0.15 MAX.	μf
OSC. INPUT (GRID #1 TO ALL OTHER ELECTRODES)	7.0	μf
OSC. GRID TO ALL OTHER ELECTRODES EXCEPT CATHODE	5.0	μf
MIXER OUTPUT (PLATE TO ALL OTHER ELECTRODES)	9.0	μf
CATHODE TO ALL OTHER ELECTRODES EXCEPT GRID #1	6.0	μf

⁵ WITH EXTERNAL SHIELD CONNECTED TO BASE SHELL

TYPICAL OPERATING CONDITIONS AND CHARACTERISTICS

CONVERTER SERVICE

HEATER OR FILAMENT VOLTAGE	6.3	6.3	VOLTS
HEATER OR FILAMENT CURRENT	0.3	0.3	AMP.
PLATE VOLTAGE	100	250	VOLTS
SCREEN VOLTAGE	100	100	VOLTS
CONTROL GRID VOLTAGE	-2	-2	VOLTS
ANODE-GRID VOLTAGE			VOLTS
PLATE CURRENT	3.3	3.5	MA.
SCREEN CURRENT	8.5	8.5	MA.
ANODE-GRID CURRENT			MA.
OSCILLATOR-GRID CURRENT	0.5	0.5	MA.
TOTAL CATHODE CURRENT	12.3	12.5	MA.
OSCILLATOR-GRID RESISTOR	20000	20000	OHMS
PLATE RESISTANCE (APPROX.)	0.5	1.0	MEGOHM
CONVERSION TRANSCONDUCTANCE	525	550	μMHOS
FOR CONTROL GRID VOLTAGE = -2 VOLTS			
CONVERSION TRANSCONDUCTANCE	275	300	μMHOS
FOR CONTROL GRID VOLTAGE = -6 VOLTS			
CONVERSION TRANSCONDUCTANCE (APPROX.)	2	2	μMHOS
FOR CONTROL GRID VOLTAGE = -35 VOLTS			
SUPPRESSOR GRID (GRID #5)	0	0	VOLTS



TUNG-SOL

DOUBLE-DIODE PENTODE

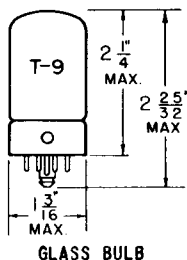

COATED UNIPOTENTIAL CATHODE

HEATER

6.3 VOLTS 300 MA.

AC OR DC

ANY MOUNTING POSITION

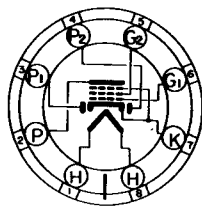

BOTTOM VIEW

LOCK-IN
8 PIN BASE

THE 7R7 COMBINES TWO DIODES AND ONE SEMI-REMOTE CUT-OFF PENTODE UNITS WITH A COMMON CATHODE IN ONE ENVELOPE. IT FEATURES LOW COUPLING CAPACITANCE BETWEEN THE DIODE AND PENTODE WHICH PERMITS USE OF THE TUBE AS A COMBINED INTERMEDIATE FREQUENCY AMPLIFIER, AVC RECTIFIER, AND DETECTOR. THE PENTODE UNIT MAY ALSO BE USED IN AUDIO AMPLIFIER SERVICE.

DIRECT INTERELECTRODE CAPACITANCES

WITH EXTERNAL SHIELD

GRID TO PLATE: (G_1 TO P)	0.004	μf
INPUT: G_1 TO ($H+K+G_3+G_2$)	5.6	μf
OUTPUT: P TO ($H+K+G_3+G_2$)	5.3	μf
DIODE #1 TO GRID #1: (P_1 TO G_1) MAX.	0.005	μf
DIODE #2 TO GRID #1: (P_2 TO G_1) MAX.	0.002	μf

RATINGS

INTERPRETED ACCORDING TO RMA STANDARD M8-210

HEATER VOLTAGE	6.3	VOLTS
MAXIMUM HEATER-CATHODE VOLTAGE	90	VOLTS
MAXIMUM PLATE VOLTAGE	300	VOLTS
MAXIMUM GRID #2 VOLTAGE	100	VOLTS
MAXIMUM GRID #2 SUPPLY VOLTAGE	300	VOLTS
MINIMUM NEGATIVE GRID #1 VOLTAGE	0	VOLTS
MAXIMUM PLATE DISSIPATION	2	WATTS
MAXIMUM GRID #2 DISSIPATION	0.25	WATT
MAXIMUM DIODE VOLTAGE DROP (MEASURED WITH DIODES CONDUCTING 0.8 MA. EACH PLATE)	10	VOLTS
MAXIMUM DIODE CURRENT EACH PLATE FOR CONTINUOUS OPERATION	1	MA.

TYPICAL OPERATING CONDITIONS AND CHARACTERISTICS

CLASS A_1 AMPLIFIER

HEATER VOLTAGE	6.3	6.3	6.3	6.3	VOLTS
HEATER CURRENT	300	300	300	300	MA.
PLATE VOLTAGE	100	100	250	250	VOLTS
GRID #2 VOLTAGE	100	100	100	100	VOLTS
GRID #1 VOLTAGE	-2	-1	-2	-1	VOLTS
CATHODE BIAS RESISTOR	450	130	450	130	OHMS
PLATE RESISTANCE (APPROX.)	0.5	0.35	1.8	1.0	MEG OHMS
TRANSCONDUCTANCE	2 100	3 000	2 200	3 400	μMHOS
PLATE CURRENT	3.4	5.5	3.5	6.2	MA.
GRID #2 CURRENT	1.0	2.2	1.0	1.6	MA.
GRID #1 VOLTAGE (APPROX.) FOR $G_m = 2 \mu\text{MHOS}$	-16	-16	-20	-20	VOLTS

7R7
 EACH DIODE UNIT
 $E_f = 6.3$ Volts

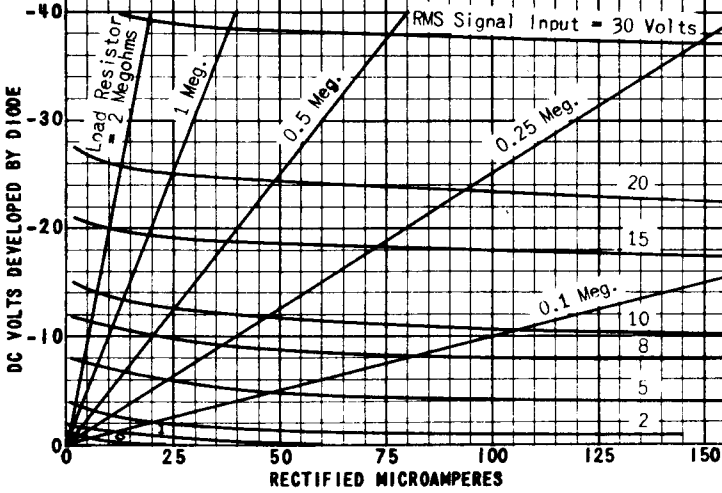

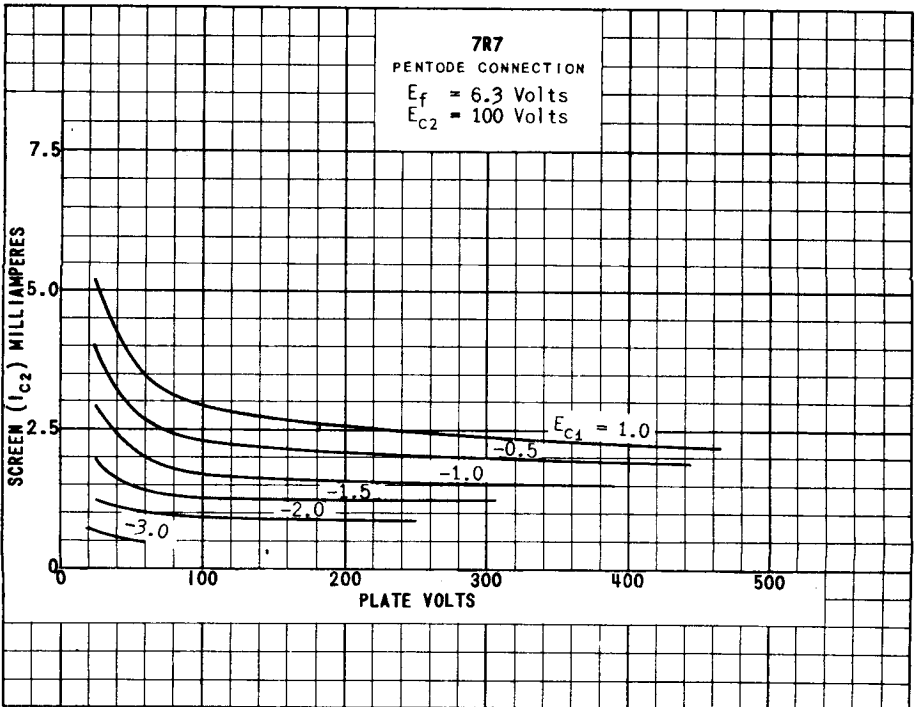
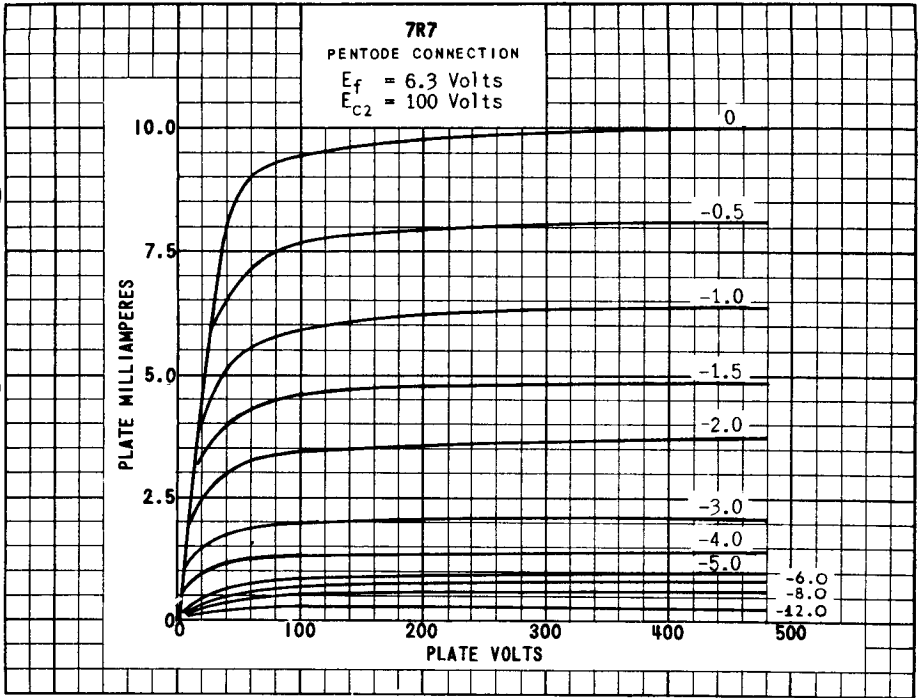

PRINTED IN U. S. A.

PLATE 2013
MAY 3 1948

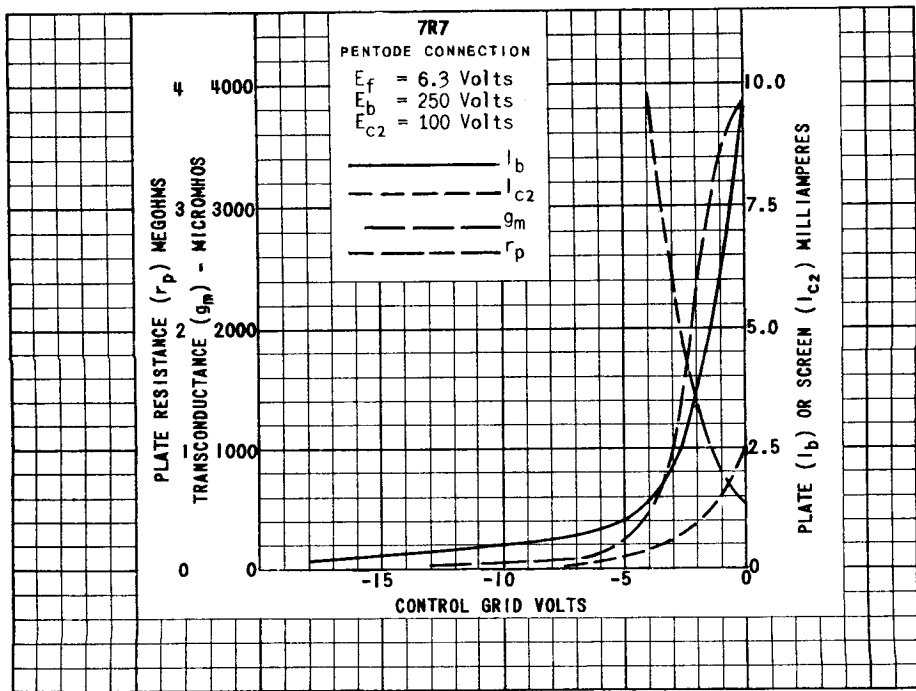
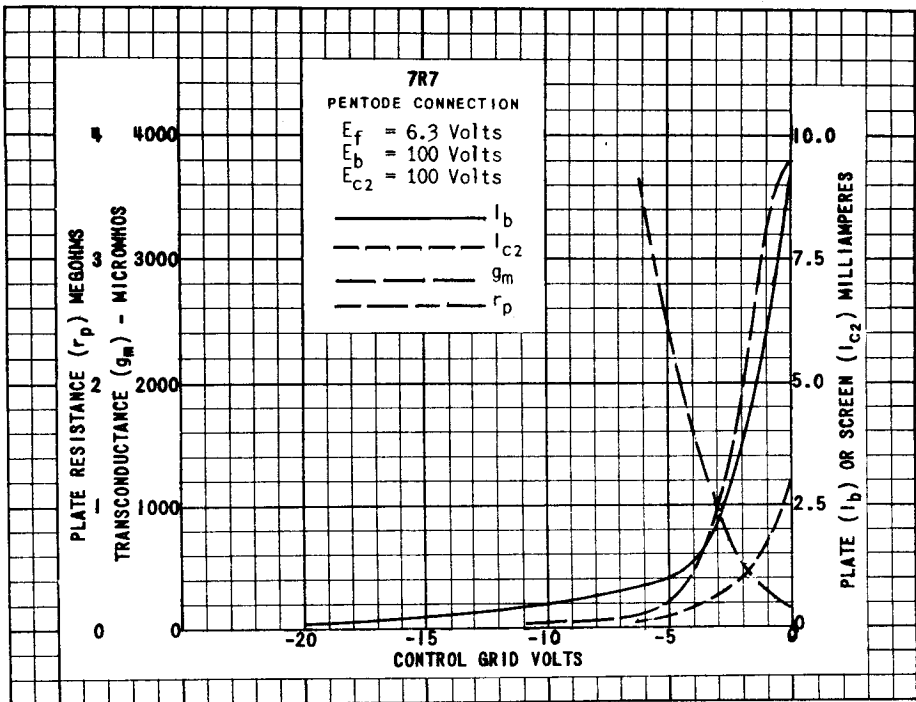
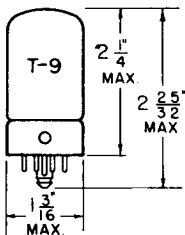

PLATE
2014
MAY 3
1948

TUNG-SOL

TRIODE-HEPTODE



GLASS BULB

COATED UNIPOTENTIAL CATHODE

HEATER

6.3 VOLTS 300 MA.

AC OR DC

ANY MOUNTING POSITION

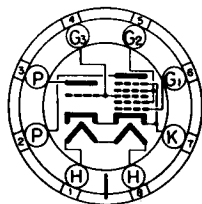

BOTTOM VIEW

LOCK-IN
8 PIN BASE

THE 7S7 IS A HEATER-CATHODE TYPE COMBINING A TRIODE AND A HEPTODE IN THE LOCK-IN-CONSTRUCTION. THE TWO SECTIONS ARE INTERCONNECTED INTERNALLY TO PROVIDE FOR EFFICIENT LOCAL OSCILLATOR-MIXER SERVICE WITH A MINIMUM OF FREQUENCY SHIFT WITH VARIATION OF CONTROL GRID BIAS.

DIRECT INTERELECTRODE CAPACITANCES
WITH EXTERNAL SHIELD CONNECTED TO CATHODE

HEPTODE GRID #1 TO PLATE: (G_1 TO P_h) MAX.	0.03	$\mu\mu f$
HEPTODE GRID #1 TO TRIODE PLATE: (G_1 TO P_t) MAX.	0.1	$\mu\mu f$
HEPTODE GRID #1 TO GRID #3: (G_1 TO G_3) MAX.	0.35	$\mu\mu f$
TRIODE GRID TO PLATE: (G_3 TO P_t)	1	$\mu\mu f$
SIGNAL INPUT: G_1 TO ($H+K+G_5+G_2+G_4+G_3$)	5	$\mu\mu f$
MIXER OUTPUT: P_h TO ($H+K+G_5+G_2+G_4+G_3$)	8	$\mu\mu f$
OSC. INPUT: G_3 TO ($H+K+G_5+G_2+G_4$)	7	$\mu\mu f$
OSC. OUTPUT: P_t TO ($H+K+G_5+G_2+G_4$)	3.5	$\mu\mu f$

RATINGS

INTERPRETED ACCORDING TO RMA STANDARD MB-210

HEATER VOLTAGE	6.3	VOLTS
MAXIMUM HEATER-CATHODE VOLTAGE	90	VOLTS
MAXIMUM HEPTODE PLATE VOLTAGE	300	VOLTS
MAXIMUM HEPTODE GRIDS #2 & #4 VOLTAGE	100	VOLTS
MAXIMUM HEPTODE GRIDS #2 & #4 SUPPLY VOLTAGE	300	VOLTS
MINIMUM HEPTODE GRID #1 VOLTAGE	0	VOLTS
MAXIMUM TRIODE PLATE VOLTAGE	175	VOLTS
MAXIMUM TRIODE PLATE SUPPLY VOLTAGE	300	VOLTS
MAXIMUM HEPTODE PLATE DISSIPATION	0.6	WATT
MAXIMUM HEPTODE GRIDS #2 & #4 DISSIPATION	0.4	WATT
MAXIMUM TRIODE PLATE DISSIPATION	1	WATT
MAXIMUM CATHODE CURRENT	14	MA.

PLATE
2038
JULY 1,
1948

CONTINUED ON FOLLOWING PAGE

TUNG-SOL

CONTINUED FROM PRECEDING PAGE

TYPICAL OPERATING CONDITIONS AND CHARACTERISTICS

CONVERTER SERVICE

HEATER VOLTAGE	6.3	6.3	VOLTS
HEATER CURRENT	300	300	MA.
HEPTODE PLATE VOLTAGE	100	250	VOLTS
HEPTODE GRIDS #2 & #4 VOLTAGE	100	100	VOLTS
TRIODE PLATE VOLTAGE	100	250 ^A	VOLTS
HEPTODE GRID #1 VOLTAGE	-2	-2	VOLTS
SELF BIAS RESISTOR	240	195	OHMS
GRID #3 RESISTOR	50 000	50 000	OHMS
HEPTODE PLATE CURRENT	1.9	1.8	MA.
HEPTODE GRIDS #2 & 4 CURRENT	3	3	MA.
TRIODE PLATE CURRENT	3	5	MA.
GRID #3 CURRENT	0.3	0.4	MA.
HEPTODE PLATE RESISTANCE	0.5	1.25	MEGOHMS
CONVERSION TRANSCONDUCTANCE	500	525	μMHMS
CONVERSION TRANSCONDUCTANCE WITH E _c = -21 VOLTS	2	2	μMHMS
TOTAL CATHODE CURRENT	8.2	10.2	MA.

^A APPLIED THROUGH 20,000 OHM DROPPING RESISTOR PROPERLY BY-PASSED.

TRIODE SECTION

HEATER VOLTAGE	6.3	VOLTS
HEATER CURRENT	300	MA.
PLATE VOLTAGE	100	VOLTS
GRID VOLTAGE	0	VOLTS
PLATE CURRENT	6.5	MA.
PLATE RESISTANCE	11 000	OHMS
TRANSCONDUCTANCE	1 650	μMHMS
AMPLIFICATION FACTOR	18	

SIMILAR TYPE REFERENCE: Ratings and Characteristics similar to type 7J7.

PLATE
2039
JULY 1,
1948

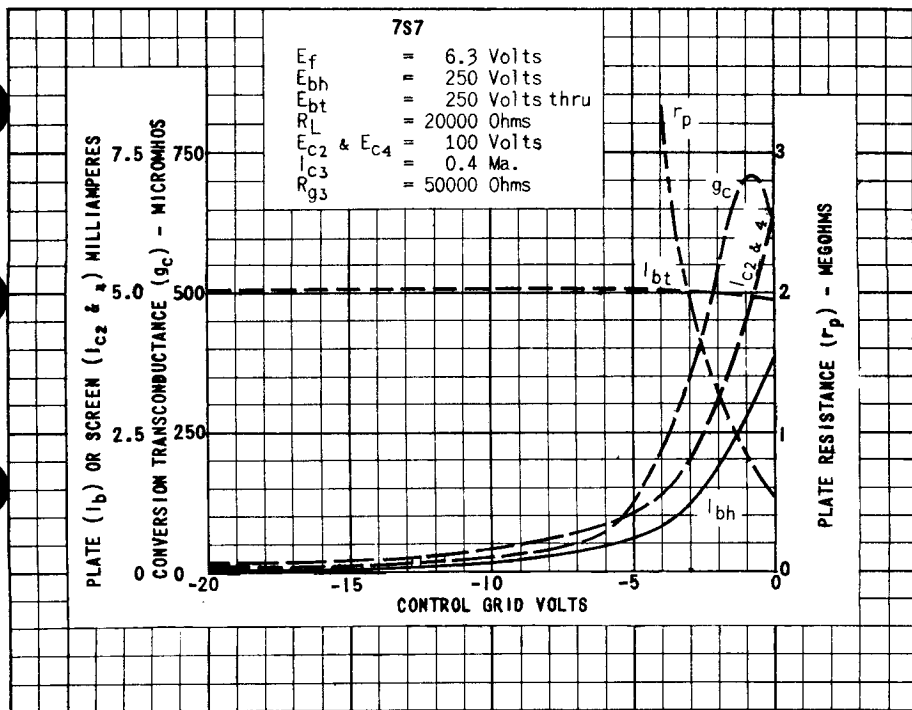
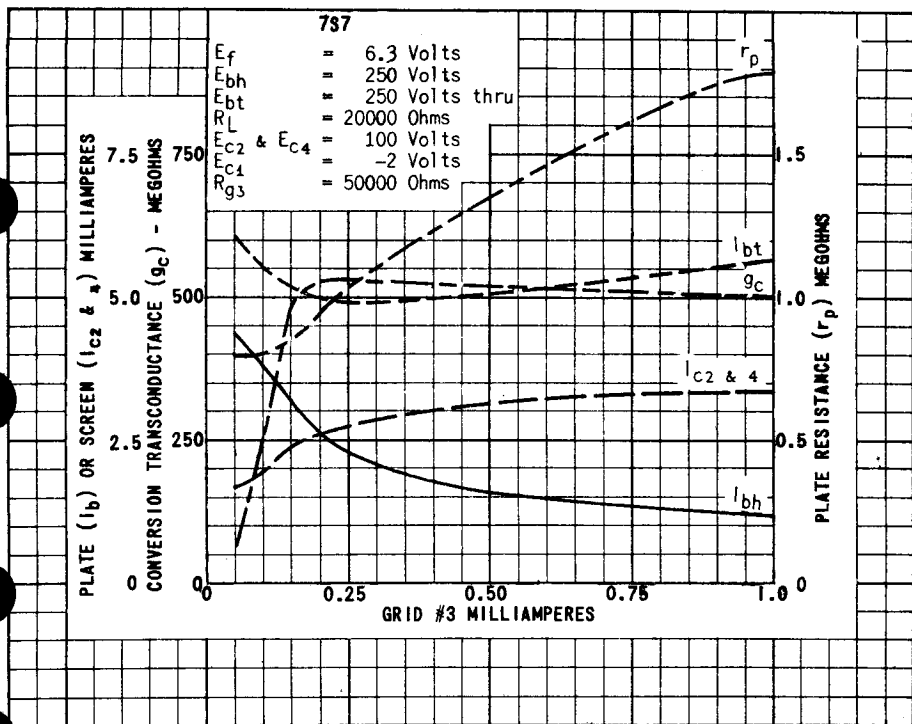
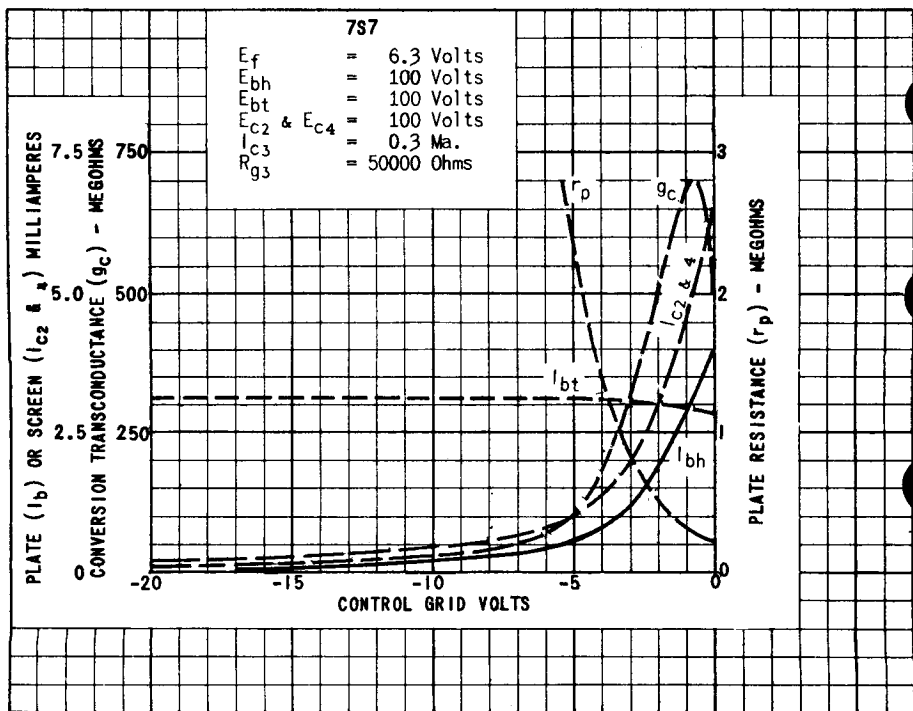
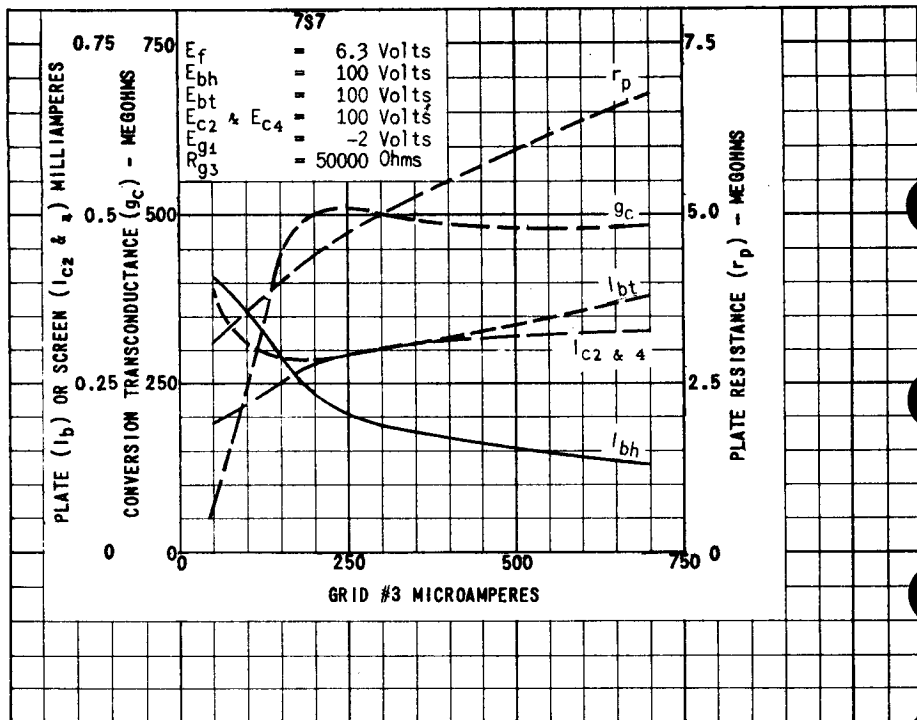
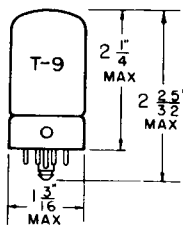

PLATE
2040
JULY 1,
1948



TUNG-SOL

PENTODE



GLASS BULB

UNIPOTENTIAL CATHODE
 HEATER
 6.3 VOLTS 450 MA.
 AC OR DC
 ANY MOUNTING POSITION

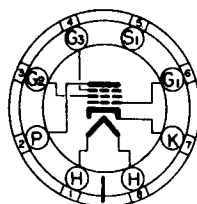

BOTTOM VIEW
 LOCK-IN 8 PIN BASE

THE 7V7 IS A HEATER-CATHODE TYPE SHARP CUT-OFF PENTODE VOLTAGE AMPLIFIER USING THE LOCK-IN CONSTRUCTION. IT IS CHARACTERIZED BY HIGH TRANSCONDUCTANCE AND LOW INTERELECTRODE CAPACITANCES WHICH ADAPT IT TO USE IN WIDE-BAND HIGH FREQUENCY AMPLIFIERS.

DIRECT INTERELECTRODE CAPACITANCES
 WITH RMA SHIELD #308 CONNECTED TO CATHODE

GRID TO PLATE: (G ₁ TO P) MAX.	0.004	μuf
INPUT: G ₁ TO (H+K+G ₂ +G ₃ +I _S)	9.5	μuf
OUTPUT: P TO (H+K+G ₂ +G ₃ +I _S)	6.5	μuf

RATINGS

INTERPRETED ACCORDING TO RMA STANDARD M8-210

HEATER VOLTAGE	6.3	VOLTS
MAXIMUM HEATER-CATHODE VOLTAGE	90	VOLTS
MAXIMUM PLATE VOLTAGE	300	VOLTS
MAXIMUM GRID #2 VOLTAGE	150	VOLTS
MAXIMUM GRID #2 SUPPLY VOLTAGE	300	VOLTS
MINIMUM CATHODE BIAS RESISTOR	160	OHMS
MAXIMUM PLATE DISSIPATION	4	WATTS
MAXIMUM GRID #2 DISSIPATION	0.8	WATT

CONTINUED ON FOLLOWING PAGE

PLATE
 2103
 NOV. 1,
 1948

TUNG-SOL

CONTINUED FROM PRECEDING PAGE

TYPICAL OPERATING CONDITIONS AND CHARACTERISTICS

CLASS A₁ AMPLIFIER

	CONDITION 1 ^A	CONDITION 2 ^B	
HEATER VOLTAGE	6.3	6.3	VOLTS
HEATER CURRENT	450	450	MA.
PLATE VOLTAGE	300	300	VOLTS
GRID #3 VOLTAGE			
GRID #2 SUPPLY VOLTAGE ^C	150	300	VOLTS
GRID #2 SERIES RESISTOR	---	40 000	OHMS
CATHODE BIAS RESISTOR	160	160	OHMS
PLATE RESISTANCE (APPROX.)	0.3	0.3	MEG.
TRANSCONDUCTANCE	5 800	5 800	μMHOS
PLATE CURRENT	10	10	MA.
GRID #2 CURRENT	3.9	3.9	MA.
GRID #1 VOLTAGE FOR $I_b = 10 \mu A$	-8	-16	VOLTS

^A CONDITION 1 WITH FIXED SCREEN SUPPLY.^B CONDITION 2 WITH SERIES SCREEN RESISTOR.^C SCREEN SUPPLY VOLTAGES IN EXCESS OF 150 VOLTS REQUIRE THE USE OF A SERIES-DROPPING RESISTOR TO LIMIT THE VOLTAGE AT THE SCREEN TO 150 VOLTS WHEN THE PLATE CURRENT IS AT ITS NORMAL VALUE OF 10 MA.

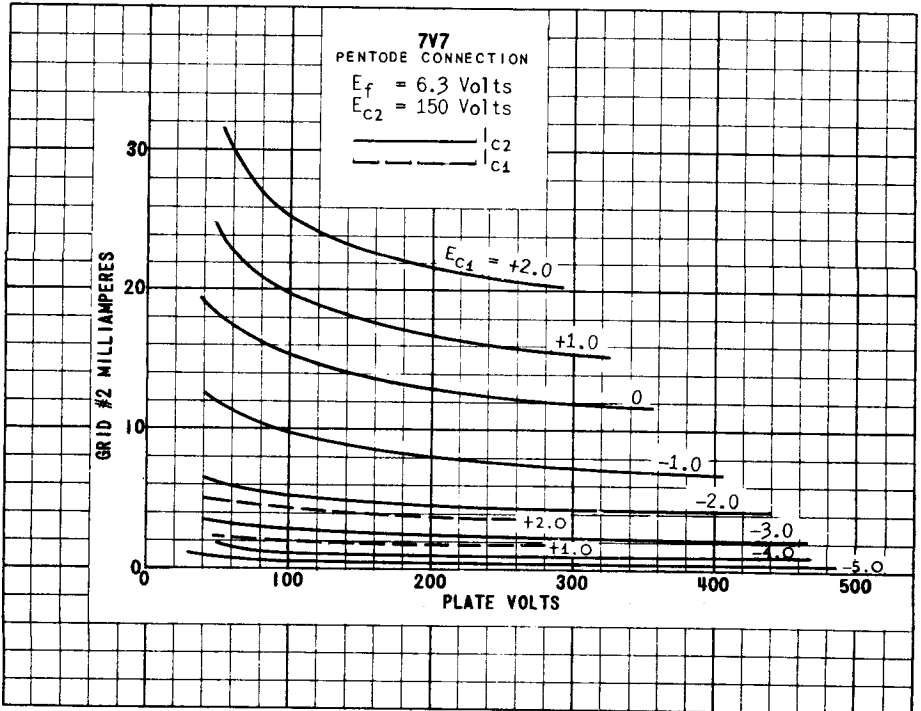
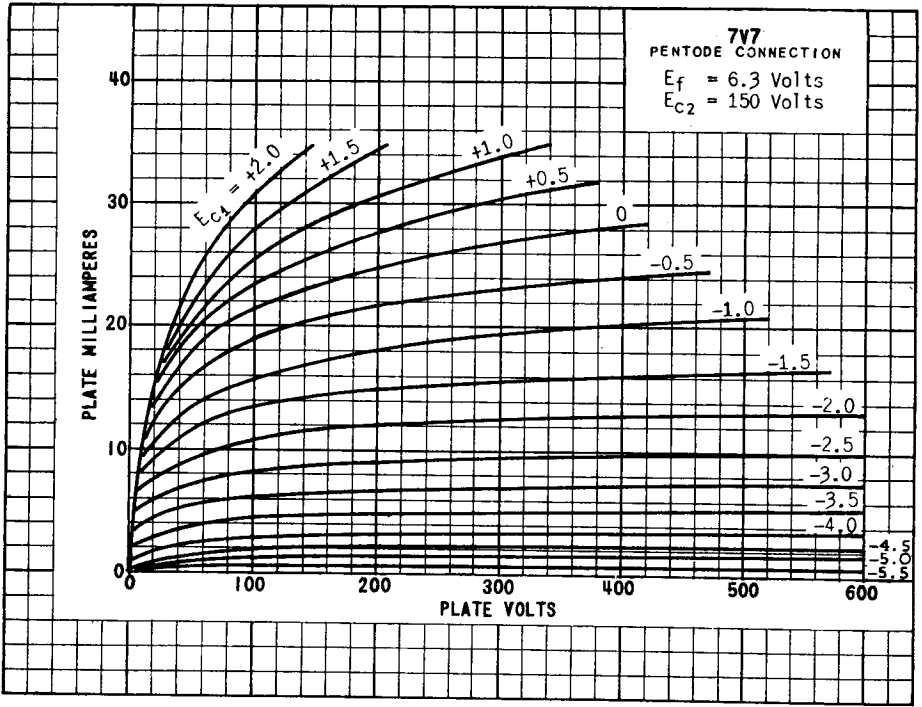

7V7
 PENTODE CONNECTION

$E_f = 6.3$ Volts
 $E_b = 300$ Volts
 $E_{c2} = 150$ Volts

————— I_b
 - - - - - I_{c2}
 ———— g_m
 - - - - - r_p

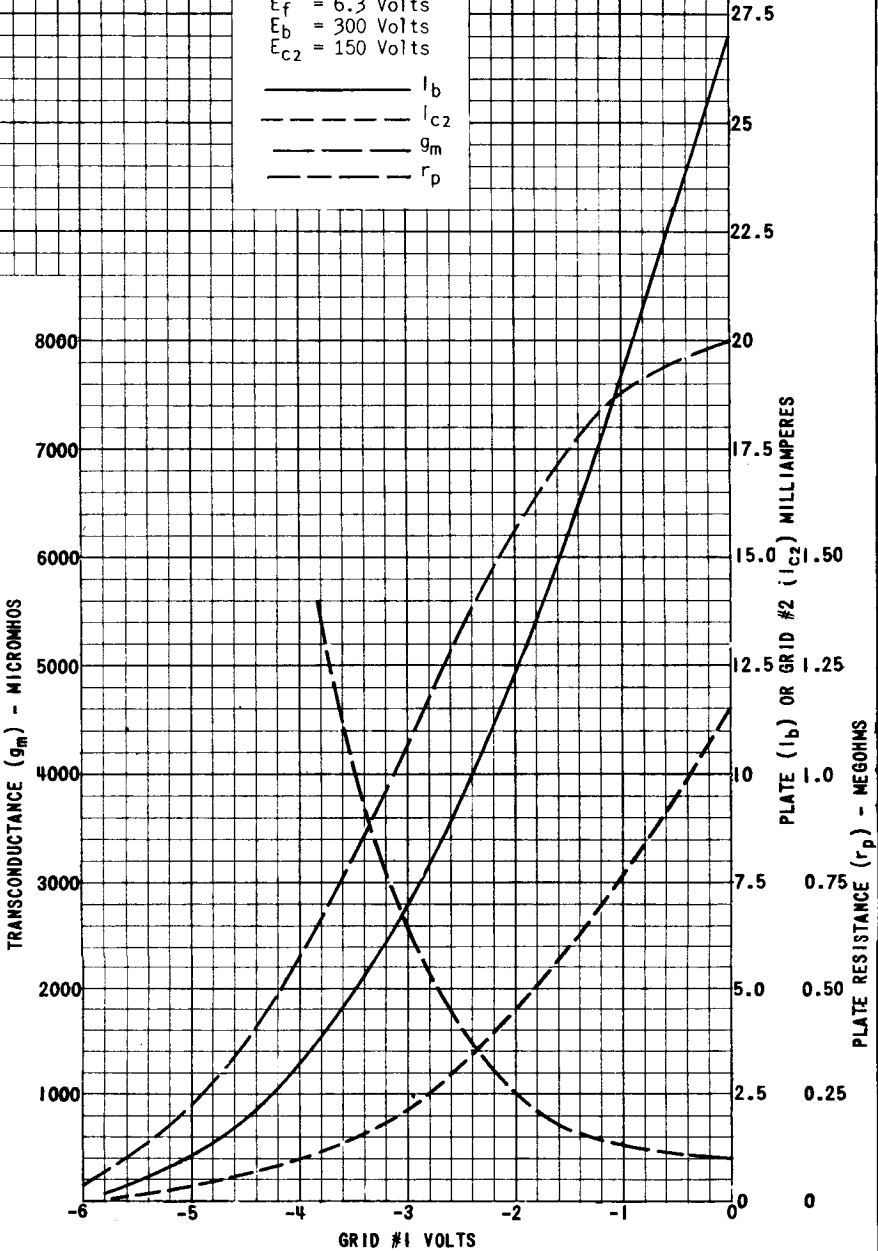

TUNG-SOL

PENTODE

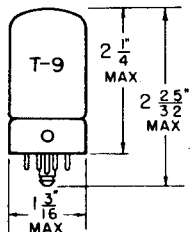

GLASS BULB

COATED UNIPOTENTIAL CATHODE

HEATER

6.3 VOLTS 450 MA.

AC OR DC

ANY MOUNTING POSITION

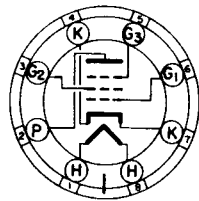

BOTTOM VIEW

LOCK-IN 8 PIN BASE

THE 7W7 IS A CATHODE TYPE SHARP CUT-OFF PENTODE VOLTAGE AMPLIFIER IN THE LOCK-IN CONSTRUCTION. IT IS CHARACTERIZED BY HIGH TRANSCONDUCTANCE AND LOW GRID-TO-PLATE CAPACITANCE WHICH MAKE IT USEFUL IN HIGH GAIN NARROW BAND AMPLIFIER SERVICE.

DIRECT INTERELECTRODE CAPACITANCES

WITH EXTERNAL SHIELD CONNECTED TO CATHODE

GRID TO PLATE: (G TO P) MAX.	0.0025	μmf
INPUT: G ₁ TO (H+K+G ₂ +G ₃)	9.5	μmf
OUTPUT: P TO (H+K+G ₂ +G ₃)	7.0	μmf

RATINGS

INTERPRETED ACCORDING TO RMA STANDARD M8-210

HEATER VOLTAGE	6.3	VOLTS
MAXIMUM HEATER-CATHODE VOLTAGE	90	VOLTS
MAXIMUM PLATE VOLTAGE	300	VOLTS
MAXIMUM GRID #2 VOLTAGE	150	VOLTS
MAXIMUM PLATE DISSIPATION	4	WATTS
MAXIMUM GRID #2 DISSIPATION	0.8	WATT

TYPICAL OPERATING CONDITIONS AND CHARACTERISTICS

CLASS A₁ AMPLIFIER

	WITH FIXED SCREEN SUPPLY	WITH SERIES SCREEN RESISTOR	
HEATER VOLTAGE	6.3	6.3	VOLTS
HEATER CURRENT	450	450	MA.
PLATE VOLTAGE	300	300	VOLTS
GRID #3 VOLTAGE	PIN #5 CONNECTED TO PIN #4 AT SOCKET		
GRID #2 VOLTAGE	150	---	VOLTS
GRID #2 SUPPLY VOLTAGE ^A	---	300	VOLTS
GRID #2 SERIES RESISTOR	---	40 000	OHMS
CATHODE BIAS RESISTOR	160	160	OHMS
PLATE RESISTANCE (APPROX.)	0.3	0.3	MEGOHM
TRANSCONDUCTANCE	5 800	5 800	μMHOS
PLATE CURRENT	10	10	MA.
GRID #2 CURRENT	3.9	3.9	MA.
GRID #1 VOLTAGE (APPROX.) FOR I _b = 10 μA.	-8	-16	VOLTS

^A WHEN A SCREEN SUPPLY VOLTAGE IN EXCESS OF 150 VOLTS IS USED, A SERIES SCREEN DROPPING RESISTOR MUST BE EMPLOYED TO LIMIT SCREEN VOLTAGE TO 150 VOLTS WITH PLATE CURRENT AT RATED VALUE OF 10 MA.

PLATE
2057
AUG. 2,
1948

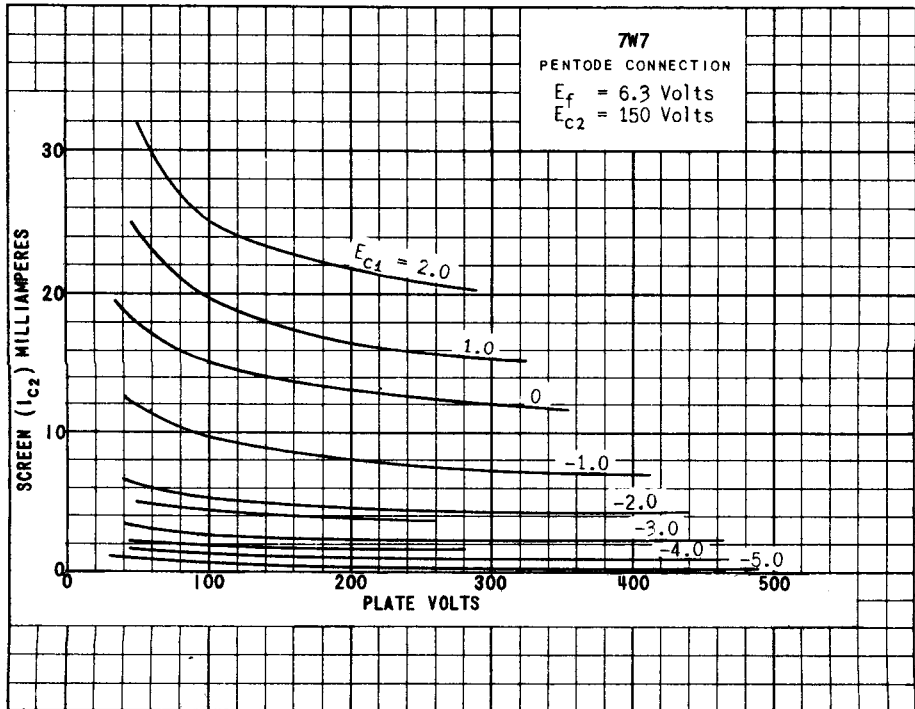
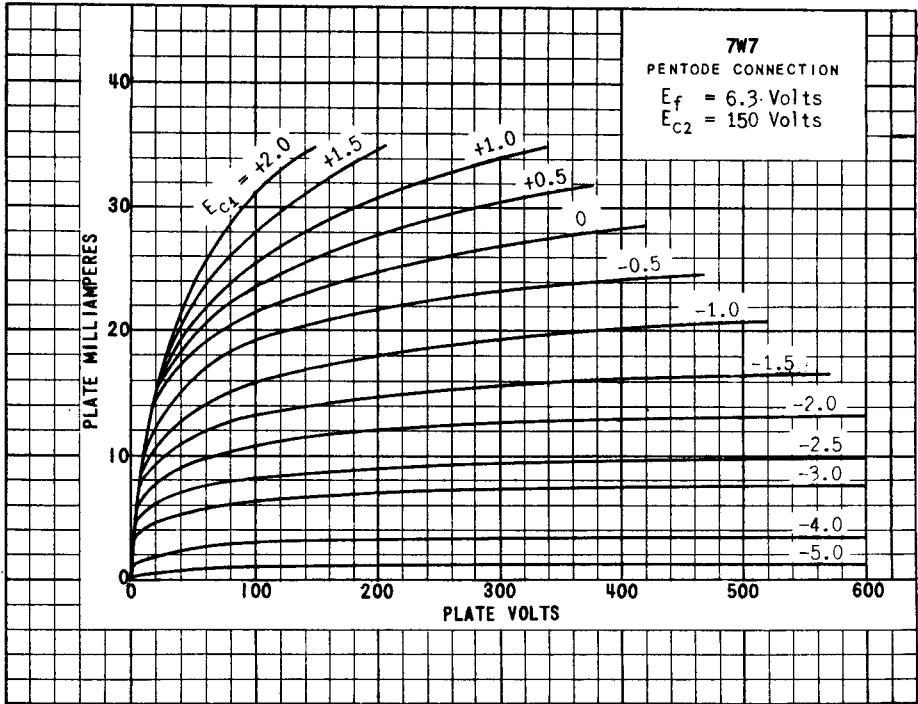

7W7
PENTODE CONNECTION

$E_f = 6.3$ Volts
 $E_b = 300$ Volts
 $E_{c2} = 150$ Volts

— I_b
 - - - I_{c2}
 — g_m
 - - - r_p

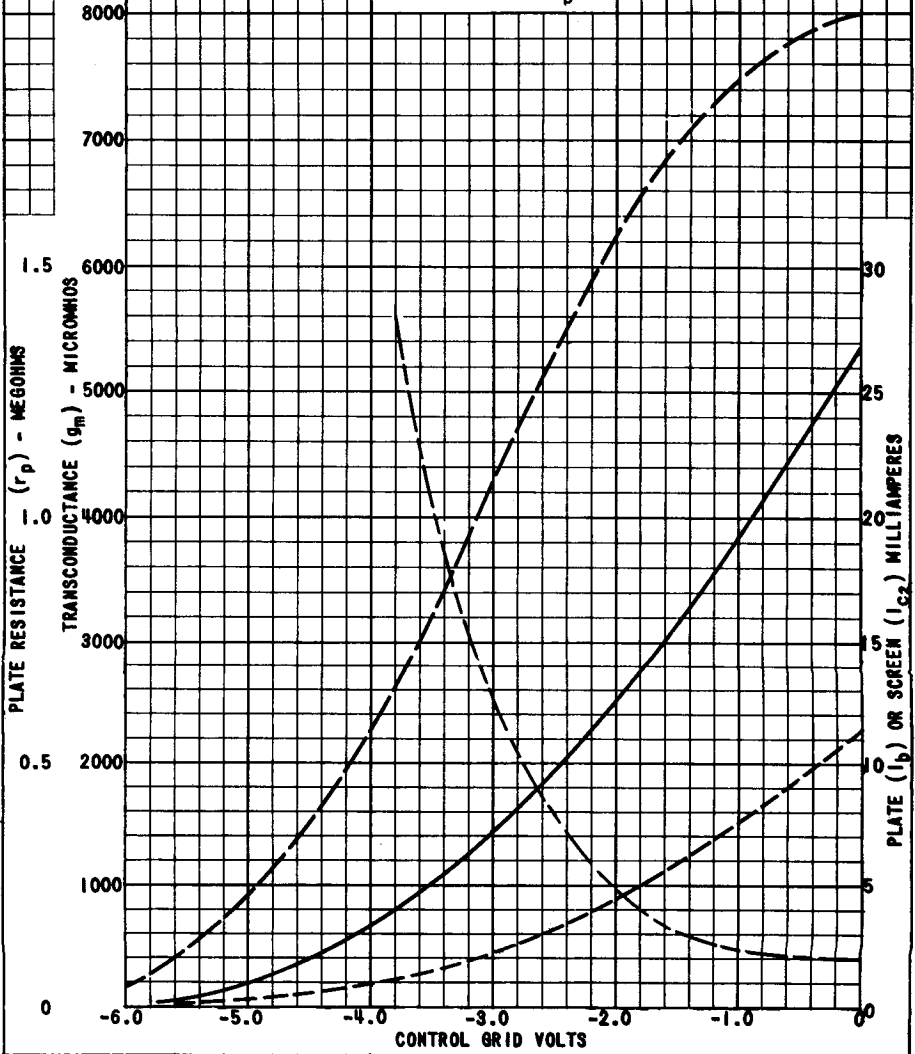

PRINTED IN U. S. A.

PLATE 2026
 JUNE 1, 1948



TUNG-SOL

DOUBLE DIODE

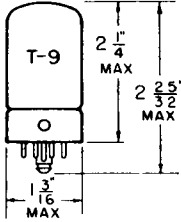

GLASS BULB

UNIPOTENTIAL CATHODE
 HEATER
 6.3 VOLTS 500 MA.
 AC OR DC
 ANY MOUNTING POSITION

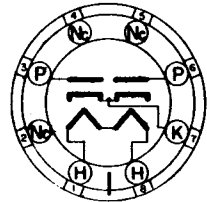

BOTTOM VIEW
 LOCK-IN 8 PIN BASE

THE 7Y4 IS A HEATER TYPE HIGH VACUUM TWIN DIODE USING THE LOCK-IN CONSTRUCTION. IT IS INTENDED FOR USE AS A FULL-WAVE RECTIFIER IN EITHER AC OR STORAGE BATTERY OPERATED EQUIPMENT WHERE ECONOMY OF HEATER POWER IS DESIRED.

RATINGS

INTERPRETED ACCORDING TO RMA STANDARD MB-210

HEATER VOLTAGE	6.3	VOLTS
MAXIMUM DC HEATER-CATHODE VOLTAGE	450	VOLTS
MAXIMUM PEAK INVERSE VOLTAGE	1 250	VOLTS
MAXIMUM AC PLATE VOLTAGE (RMS) CONDENSER INPUT	325	VOLTS
MAXIMUM AC PLATE VOLTAGE (RMS) CHOKE INPUT	450	VOLTS
MAXIMUM STEADY STATE PEAK PLATE CURRENT EACH PLATE	210	MA.
MAXIMUM OUTPUT CURRENT	70	MA.
TUBE VOLTAGE DROP (MEASURED WITH TUBE CONDUCTING 70 MA. EACH PLATE)	22	VOLTS

TYPICAL OPERATING CONDITIONS AND CHARACTERISTICS

FULL WAVE RECTIFIER
 CONDENSER INPUT TO FILTER

HEATER VOLTAGE	6.3	VOLTS
HEATER CURRENT	500	MA.
AC PLATE VOLTAGE EACH PLATE (RMS)	325	VOLTS
DC OUTPUT CURRENT	70	MA.
MINIMUM PLATE SUPPLY IMPEDANCE EACH PLATE ^A	150	OHMS

^A WHEN A FILTER CONDENSER LARGER THAN 40 μ F IS USED, IT MAY BE NECESSARY TO INCREASE THE SPECIFIED PLATE SUPPLY IMPEDANCE.

CHOKE INPUT TO FILTER

HEATER VOLTAGE	6.3	VOLTS
HEATER CURRENT	500	MA.
AC PLATE VOLTAGE EACH PLATE (RMS)	450	VOLTS
DC OUTPUT CURRENT	70	MA.
MINIMUM VALUE OF INPUT CHOKE	10	HENRYS

SIMILAR TYPE REFERENCE: Ratings and characteristics somewhat similar to types 6I50P and 84.

PLATE 2107
 NOV. 1, 1948

PRINTED IN U. S. A.

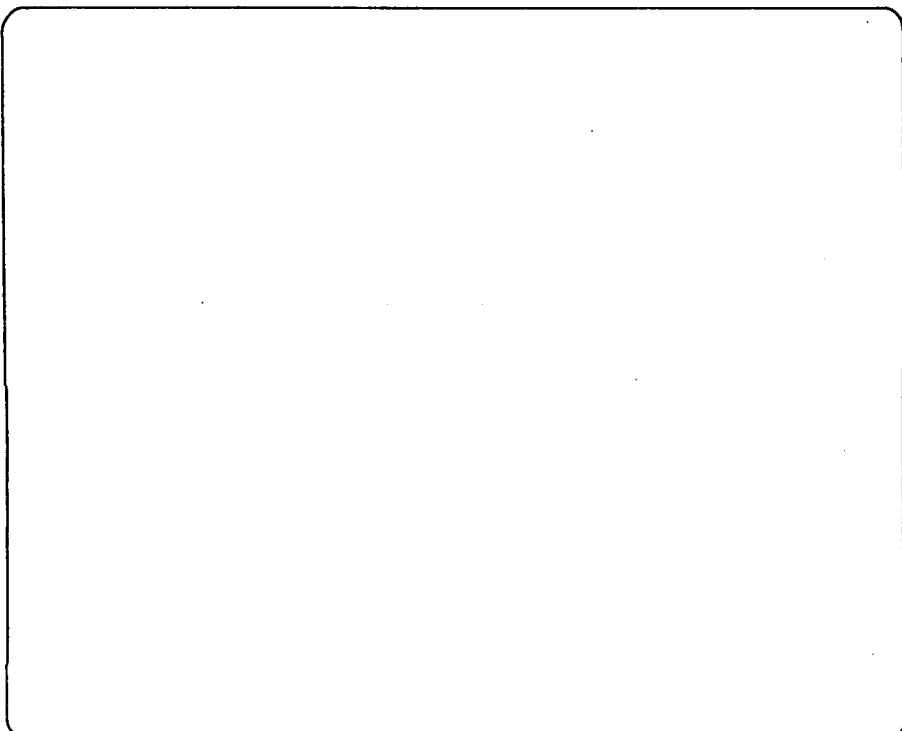
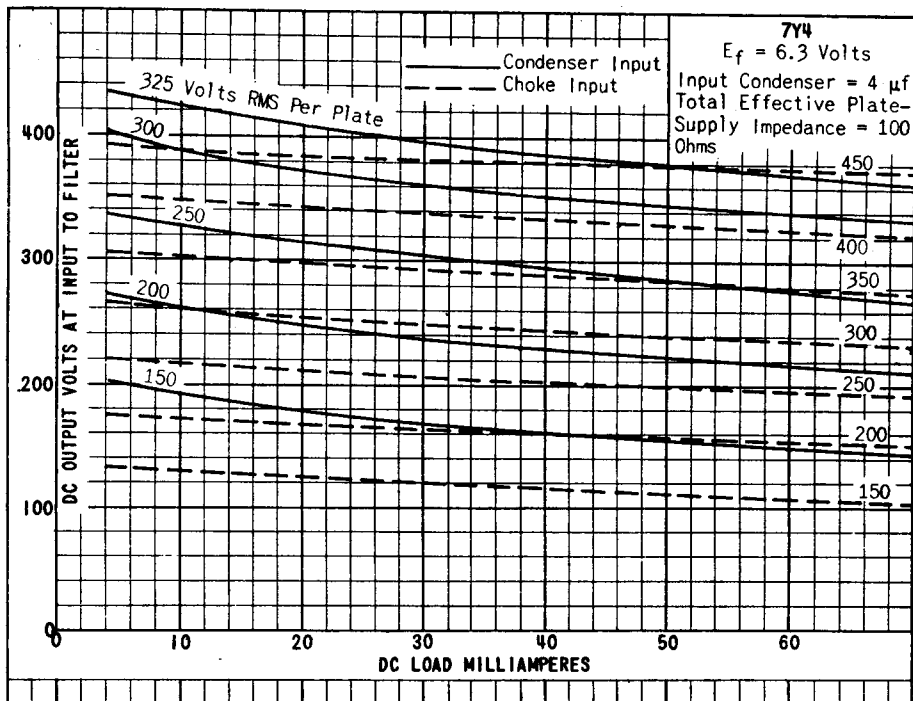
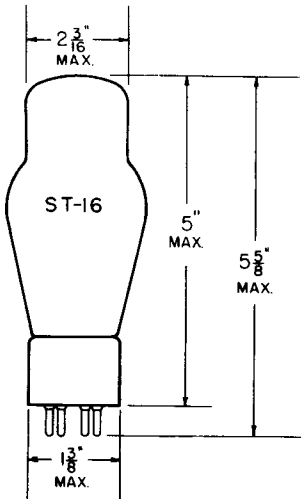

PLATE
 2108
 NOV. 1,
 1948

TUNG-SOL

TRIODE POWER AMPLIFIER



GLASS BULB

THORIATED TUNGSTEN FILAMENT

FILAMENT
7.5 VOLTS 1.25 AMPERES
AC OR DC

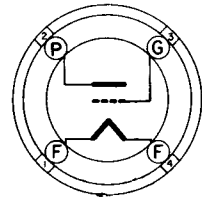

BOTTOM VIEW
MEDIUM 4-PIN BAYONET BASE

VERTICAL MOUNTING POSITION

TYPE 10 IS A HIGH-VACUUM, FILAMENT TYPE POWER AMPLIFIER TRIODE. IT MAY BE USED IN AUDIO STAGES AS A CLASS A AMPLIFIER OR, IN PUSH-PULL ARRANGEMENT, AS A CLASS B AMPLIFIER.

RATINGS

INTERPRETED ACCORDING TO RMA STANDARD MB-210

CLASS A AMPLIFIER

FILAMENT VOLTAGE (AC OR DC)	7.5	VOLTS
FILAMENT CURRENT	1.25	AMP.
MAX. DC PLATE VOLTAGE	425	VOLTS
MAX. PLATE DISSIPATION	12	WATTS

CLASS B AMPLIFIER

FILAMENT VOLTAGE (AC OR DC)	7.5	VOLTS
FILAMENT CURRENT	1.25	AMP.
MAX. DC PLATE VOLTAGE	425	VOLTS
MAX. PLATE DISSIPATION (AVERAGED OVER ANY AF CYCLE)	12	WATTS
MAX.-SIGNAL, MAX. DC PLATE CURRENT (PER TUBE)	60	MA.
MAX.-SIGNAL, MAX. PLATE INPUT (PER TUBE)	25	WATTS

DIRECT INTERELECTRODE CAPACITANCES (APPROX.)

GRID TO PLATE	7	μuf
INPUT	4	μuf
OUTPUT	3	μuf

CONTINUED ON FOLLOWING PAGE

PRINTED IN U. S. A.

PLATE
1628
NOV. 30
1945

TUNG-SOL

CONTINUED FROM PRECEDING PAGE

TYPICAL OPERATING CONDITIONS AND CHARACTERISTICS

CLASS A AMPLIFIER

AC FILAMENT VOLTAGE	7.5	7.5	7.5	VOLTS
DC PLATE VOLTAGE	250	350	425	VOLTS
DC GRID VOLTAGE ^A	-23.5	-32	-40	VOLTS
PEAK GRID SWING	18.5	27	35	VOLTS
DC PLATE CURRENT	10	16	18	MA.
CATHODE RESISTOR	2350	2000	2220	OHMS
PLATE RESISTANCE	6000	5150	5000	OHMS
LOAD RESISTANCE	13 000	11 000	10 200	OHMS
TRANSCONDUCTANCE	1330	1550	1600	μMHMS
AMPLIFICATION FACTOR	8	8	8	
UNDISTORTED POWER OUTPUT	0.4	0.9	1.6	WATTS

CLASS B AMPLIFIER TWO TUBES

AC FILAMENT VOLTAGE	7.5	7.5	7.5	VOLTS
DC PLATE VOLTAGE	250	350	425	VOLTS
DC GRID VOLTAGE ^A (APPROX.)	-28	-40	-50	VOLTS
PEAK AF GRID VOLTAGE (APPROX.)	110	120	130	VOLTS
ZERO-SIGNAL DC PLATE CURRENT (PER TUBE)	4	4	4	MA.
MAX.-SIGNAL DC PLATE CURRENT (PER TUBE)	55	55	55	MA.
LOAD RESISTANCE (PER TUBE)	1000	1500	2000	OHMS
EFFECTIVE PLATE-TO-PLATE LOAD RESISTANCE	4000	6000	8000	OHMS
MAX.-SIGNAL DRIVING POWER (APPROX.)	2.1	2.3	2.5	WATTS
MAX.-SIGNAL POWER OUTPUT (APPROX.)	13	20	25	WATTS

^A GRID-VOLTAGE MEASURED FROM MID-POINT OF AC OPERATED FILAMENT.

TUNG-SOL

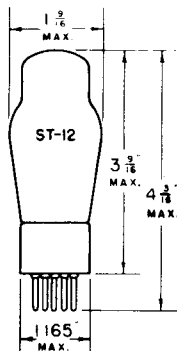

PENTODE POWER AMPLIFIER

UNIPOTENTIAL CATHODE

HEATER

6.3 VOLTS^A 0.6 AMPERE12.6 VOLTS^B 0.3 AMPERE

AC OR DC

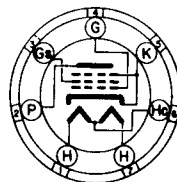

BOTTOM VIEW

GLASS BULB

SMALL 7 PIN BASE

THE TUNG-SOL 12A5 IS AN OUTPUT PENTODE WITH A CENTER TAPPED HEATER, SO THAT THE HEATER MAY BE OPERATED ON EITHER 6.3 VOLTS OR 12.6 VOLTS.

RATINGS

MAXIMUM PLATE VOLTAGE	180	VOLTS
MAXIMUM SCREEN VOLTAGE	180	VOLTS
MAXIMUM PLATE DISSIPATION	8.25	WATTS
MAXIMUM SCREEN DISSIPATION	2.5	WATTS

TYPICAL OPERATING CONDITIONS AND CHARACTERISTICS

CLASS A₁ AMPLIFIER

PLATE VOLTAGE	100	180	VOLTS
SCREEN VOLTAGE	100	180	VOLTS
CONTROL GRID VOLTAGE	-15	-25	VOLTS
PEAK AF SIGNAL VOLTAGE	15	25	VOLTS
ZERO-SIGNAL PLATE CURRENT	17	45	MA.
ZERO SIGNAL SCREEN CURRENT	3	8	MA.
MAXIMUM-SIGNAL PLATE CURRENT	19	48	MA.
MAXIMUM-SIGNAL SCREEN CURRENT	6.5	14	MA.
PLATE RESISTANCE ^{APPROX.}	50 000	35 000	OHMS
TRANSCONDUCTANCE	1700	2400	μMHOS
LOAD RESISTANCE	4500	3300	OHMS
TOTAL HARMONIC DISTORTION	12	11	PER CENT
SECOND HARMONIC DISTORTION	8.5	6.5	PER CENT
THIRD HARMONIC DISTORTION	8	8	PER CENT
POWER OUTPUT	0.8	3.4	WATTS

^A HEATERS CONNECTED IN PARALLEL^B HEATERS CONNECTED IN SERIES

FOR "INTERPRETATION OF RATINGS" REFER TO FRONT OF BOOK.

TUNG-SOL

BEAM POWER AMPLIFIER

PHYSICAL SPECIFICATIONS

EMITTER UNIPOTENTIAL CATHODE	PIN CONNECTIONS	
BASE INTER. SHELL OCTAL 7-PIN	PIN 1 NO CONN.	PIN 7 HEATER
CAP NONE	PIN 2 HEATER	PIN 8 CATH. & DEFL.
BULB T-9	PIN 3 PLATE	
MAXIMUM DIAMETER $1\frac{5}{16}$ "	PIN 4 GRID 2	
MAXIMUM OVERALL LENGTH $3\frac{1}{4}$ "	PIN 5 GRID 1	TOP CAP NONE
MAXIMUM SEATED HEIGHT $2\frac{11}{16}$ "	PIN 6 NONE	

RATINGS

HEATER OR FILAMENT VOLTAGE	12.6	VOLTS
HEATER OR FILAMENT CURRENT	0.15	AMPS.
MAXIMUM PLATE VOLTAGE	250	VOLTS
MAXIMUM SCREEN VOLTAGE	250	VOLTS
MAXIMUM PLATE DISSIPATION	7.5	WATTS
MAXIMUM SCREEN DISSIPATION	1.5	WATTS

RATINGS ARE TO BE INTERPRETED ACCORDING TO RMA STANDARD M8-210

CAPACITANCES

CONTROL GRID TO CATHODE	9.0	μ f
PLATE TO CATHODE	9.0	μ f
GRID TO PLATE	0.6	MAX. μ f

WITH STANDARD RMA SHIELD M8-308

TYPICAL OPERATING CONDITIONS AND CHARACTERISTICS
CLASS A₁ AMPLIFIER

HEATER OR FILAMENT VOLTAGE	12.6	VOLTS
HEATER OR FILAMENT CURRENT	0.15	AMPS.
PLATE VOLTAGE	250	VOLTS
SCREEN VOLTAGE	250	VOLTS
CONTROL GRID VOLTAGE	-12.5	VOLTS
PEAK AF SIGNAL VOLTAGE	12.5	VOLTS
ZERO-SIGNAL PLATE CURRENT	30	MA.
ZERO-SIGNAL SCREEN CURRENT	3.5	MA.
MAXIMUM-SIGNAL PLATE CURRENT	32	MA.
MAXIMUM-SIGNAL SCREEN CURRENT	5.5	MA.
PLATE RESISTANCE		MEGOHMS
TRANSCONDUCTANCE	3000	μ MOS
AMPLIFICATION FACTOR		
LOAD RESISTANCE	7500	OHMS
TOTAL HARMONIC DISTORTION	7	PER CENT
POWER OUTPUT	3.0	WATTS

THE DC RESISTANCE IN THE GRID CIRCUIT, UNDER RATED MAXIMUM CONDITIONS FOR THE TYPE 12A6GT SHOULD NOT EXCEED 0.5 MEGOHM FOR SELF-BIAS OPERATION AND 0.1 MEGOHM FOR FIXED BIAS OPERATION.

TUNG-SOL

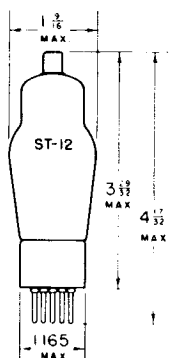

RECTIFIER
PENTODE POWER AMPLIFIER

UNIPOENTIAL CATHODES
 HEATER
 12.6 VOLTS 0.3 AMPERE
 AC OR DC

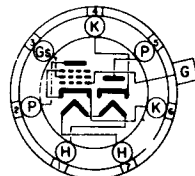

BOTTOM VIEW

GLASS BULB

SMALL 7 PIN BASE

THE TUNG-SOL 12A7 COMBINES A HALF-WAVE RECTIFIER AND OUTPUT POWER AMPLIFIER IN A SINGLE BULB. IT IS DESIGNED FOR SERVICE IN AC - DC RECEIVERS.

OPERATING CONDITIONS AND CHARACTERISTICS

PENTODE UNIT - CLASS A₁ AMPLIFIER

PLATE VOLTAGE	135	VOLTS
SCREEN VOLTAGE	135	VOLTS
CONTROL GRID VOLTAGE	-13.5	VOLTS
PLATE CURRENT	9.0	MA.
SCREEN CURRENT	2.5	MA.
PLATE RESISTANCE	102 000	OHMS
TRANSCONDUCTANCE	975	μMHOS
AMPLIFICATION FACTOR	100	
LOAD RESISTANCE	13 500	OHMS
POWER OUTPUT	0.55	WATT

RECTIFIER UNIT

AC VOLTAGE PER PLATE (RMS)	125 MAX.	VOLTS
DC OUTPUT CURRENT	30 MAX.	MA.



TUNG-SOL

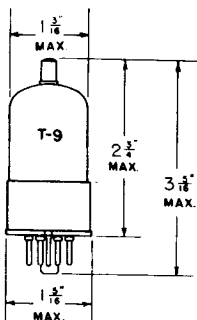

PENTAGRID CONVERTER

UNIPOENTIAL CATHODE

HEATER

12.6 VOLTS 0.15 AMPERE

AC OR DC

GLASS BULB

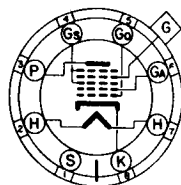

BOTTOM VIEW

SMALL WAFER 8 PIN OCTAL BASE WITH METAL SHELL

THE TUNG-SOL 12A8GT IS A PENTAGRID CONVERTER DESIGNED FOR SERVICE IN AC-DC OPERATED SUPERHETERODYNE RECEIVERS USING 150 MA. HEATER TUBES. WITH THE EXCEPTION OF HEATER RATINGS AND CAPACITANCES, ITS ELECTRICAL CHARACTERISTICS ARE IDENTICAL TO THOSE OF TYPES 7B8, 6A8, 6A8G AND 6A8GT.

RATINGS

MAXIMUM PLATE VOLTAGE	300	VOLTS
MAXIMUM SCREEN (Gs) SUPPLY VOLTAGE	300	VOLTS
MAXIMUM SCREEN (Gs) VOLTAGE	100	VOLTS
MINIMUM EXTERNAL CONTROL GRID (G) BIAS VOLTAGE	0	VOLTS
MAXIMUM OSCILLATOR ANODE (Ga) SUPPLY VOLTAGE	300	VOLTS
MAXIMUM OSCILLATOR ANODE (Ga) VOLTAGE	200	VOLTS
MAXIMUM TOTAL CATHODE CURRENT	14	MA.
MAXIMUM PLATE DISSIPATION	1.0	WATT
MAXIMUM SCREEN DISSIPATION	0.3	WATT
MAXIMUM OSCILLATOR ANODE (Ga) DISSIPATION	.75	WATT

FOR "INTERPRETATION OF RATINGS" REFER TO FRONT OF BOOK.

CONTINUED NEXT PAGE

TUNG-SOL

DIRECT INTERELECTRODE CAPACITANCES⁵

CONTROL GRID (G) TO MIXER PLATE (P)	0.26 ^{MAX.}	μμf
CONTROL GRID (G) TO OSCILLATOR ANODE (G _A)	0.19 ^{MAX.}	μμf
CONTROL GRID (G) TO OSCILLATOR GRID (G ₀)	0.16 ^{MAX.}	μμf
OSCILLATOR GRID (G ₀) TO OSCILLATOR ANODE (G _A)	1.1	μμf
RF INPUT: CONTROL GRID (G) TO ALL OTHER ELECTRODES	9.5	μμf
OSCILLATOR INPUT: OSCILLATOR GRID (G ₀) TO ALL OTHER ELECTRODES EXCEPT OSCILLATOR ANODE (G _A)	6.0	μμf
OSCILLATOR OUTPUT: OSCILLATOR ANODE (G _A) TO ALL OTHER ELECTRODES EXCEPT OSCILLATOR GRID (G ₀)	4.6	μμf
MIXER OUTPUT: MIXER PLATE (P) TO ALL OTHER ELECTRODES	12	μμf

TYPICAL OPERATING CONDITIONS AND CHARACTERISTICS

CONVERTER SERVICE

HEATER VOLTAGE	12.6	12.6	VOLTS
HEATER CURRENT	0.15	0.15	AMPERE
PLATE (P) VOLTAGE	100	250	VOLTS
SCREEN (G _S) VOLTAGE	50	100	VOLTS
CONTROL GRID (G) VOLTAGE	-1.5	-3	VOLTS
OSCILLATOR ANODE (G _A) SUPPLY VOLTAGE ^A	-	250	VOLTS
OSCILLATOR ANODE (G _A) VOLTAGE	100	-	VOLTS
OSCILLATOR GRID (G ₀) RESISTOR	50 000	50 000	OHMS
PLATE CURRENT	1.1	3.5	MA.
SCREEN CURRENT	1.3	2.7	MA.
OSCILLATOR ANODE CURRENT	2.0	4.0	MA.
OSCILLATOR GRID CURRENT	25	0.4	MA.
TOTAL CATHODE CURRENT	4.6	10.6	MA.
PLATE RESISTANCE ^{APPROX.}	0.6	0.36	MEGOHM
CONVERSION TRANSCONDUCTANCE			
FOR CONTROL GRID (G) VOLTAGE = -1.5 V.	360	-	μMHOS
CONVERSION TRANSCONDUCTANCE			
FOR CONTROL GRID (G) VOLTAGE = -3 V.	180	550	μMHOS
CONVERSION TRANSCONDUCTANCE			
FOR CONTROL GRID (G) VOLTAGE = -6 V.	50	325	μMHOS
CONVERSION TRANSCONDUCTANCE			
FOR CONTROL GRID (G) VOLTAGE = -10 V.	-	100	μMHOS
CONVERSION TRANSCONDUCTANCE ^{APPROX.}			
FOR CONTROL GRID (G) VOLTAGE = -20 V.	3	-	μMHOS
CONVERSION TRANSCONDUCTANCE ^{APPROX.}			
FOR CONTROL GRID (G) VOLTAGE = -35 V.	-	6	μMHOS

^A APPLIED THROUGH A PROPERLY BY-PASSED 20000 OHM DROPPING RESISTOR.

⁵ WITH EXTERNAL SHIELD CONNECTED TO CATHODE.

NOTE: THE TRANSCONDUCTANCE OF THE OSCILLATOR SECTION (NOT OSCILLATING IS APPROXIMATELY 1150 μMHOS; THE AMPLIFICATION FACTOR IS 75 AND THE OSCILLATOR ANODE CURRENT IS 4.0 MA. CONDITIONS: PLATE VOLTAGE = 250 V., OSCILLATOR ANODE VOLTAGE = 100 V., SCREEN VOLTAGE = 55 V., CONTROL GRID VOLTAGE = -2.0 V., AND THE OSCILLATOR GRID VOLTAGE = -1.0 V.

PLATE
1325-3
SEPT. 23
1943

TUNG-SOL

TWIN TRIODE

PHYSICAL SPECIFICATIONS

EMITTER	UNIPOTENTIAL CATHODE	PIN CONNECTIONS		
BASE	8-PIN OCTAL BAKELITE	PIN 1	GRID 1	PIN 7 HEATER
CAP	NONE	PIN 2	CATHODE 1	PIN 8 HEATER
BULB	T-9	PIN 3	PLATE 1	
MAXIMUM DIAMETER	1 5/16"	PIN 4	CATHODE 2	
MAXIMUM OVERALL LENGTH	3 1/16"	PIN 5	GRID 2	TOP CAP NONE
MAXIMUM SEATED HEIGHT	2 1/2"	PIN 6	PLATE 2	

RATINGS

HEATER OR FILAMENT VOLTAGE (AC OR DC)	12.6	VOLTS
HEATER OR FILAMENT CURRENT	.150	AMPS.
MAXIMUM PLATE VOLTAGE	300	VOLTS
MAXIMUM SCREEN VOLTAGE		VOLTS
MAXIMUM PLATE DISSIPATION	2.5	WATTS
MAXIMUM SCREEN DISSIPATION		WATTS

RATINGS ARE TO BE INTERPRETED ACCORDING TO RMA STANDARD M8-210

CAPACITANCES (WITH TIGHT FITTING SHIELD)

GRID TO CATHODE	3.2	2.9	MAX. $\mu\mu\text{f}$
PLATE TO CATHODE	3.0	2.6	MAX. $\mu\mu\text{f}$
GRID TO PLATE	2.2	3.0	MAX. $\mu\mu\text{f}$
PLATE TO PLATE	.4		MAX. $\mu\mu\text{f}$
GRID TO GRID	.06		MAX. $\mu\mu\text{f}$

TYPICAL OPERATING CONDITIONS AND CHARACTERISTICS
(EACH TRIODE SECTION)

HEATER OR FILAMENT VOLTAGE (AC OR DC)	12.6	VOLTS
HEATER OR FILAMENT CURRENT	.150	AMPS.
PLATE VOLTAGE	250	VOLTS
SCREEN VOLTAGE		VOLTS
GRID VOLTAGE	-9	VOLTS
PEAK AF SIGNAL VOLTAGE		VOLTS
PLATE CURRENT	12	MA.
ZERO-SIGNAL SCREEN CURRENT		MA.
MAXIMUM-SIGNAL PLATE CURRENT		MA.
MAXIMUM-SIGNAL SCREEN CURRENT		MA.
PLATE RESISTANCE	6600	Ω IMS
TRANSCONDUCTANCE	2400	μMHOS
AMPLIFICATION FACTOR	16	
PLATE CURRENT WITH E_c = -30 VOLTS	10	MMA

GENERAL DESCRIPTION

APPLICATION: The 12AH7GT is a cathode type of tube consisting of two triodes within a single envelope. It was designed for use in converter and audio applications. The 12AH7GT is a glass tube equipped with an octal base.

TUNG-SOL

TRIPLE GRID REMOTE CUT-OFF AMPLIFIER

PHYSICAL SPECIFICATIONS

EMITTER	UNIPOTENTIAL CATHODE	PIN CONNECTIONS			
BASE	LOCKING-IN 8 PIN	PIN 1	HEATER	PIN 7	CATHODE
CAP	NONE	PIN 2	PLATE	PIN 8	HEATER
BULB	T-9	PIN 3	GRID 2		
MAXIMUM DIAMETER	1 $\frac{3}{16}$ "	PIN 4	GRID 3		
MAXIMUM OVERALL LENGTH	2 $\frac{25}{32}$ "	PIN 5	INT. SHIELD	TOP CAP	NONE
MAXIMUM SEATED HEIGHT	2 $\frac{1}{4}$ "	PIN 6	GRID 1		

RATINGS

HEATER OR FILAMENT VOLTAGE (AC OR DC)	12.6	VOLTS
HEATER OR FILAMENT CURRENT	0.15	AMPS.
MAXIMUM PLATE VOLTAGE	250	VOLTS
MAXIMUM SCREEN VOLTAGE	100	VOLTS
MAXIMUM PLATE DISSIPATION		WATTS
MAXIMUM SCREEN DISSIPATION		WATTS

CAPACITANCES ⁴

CONTROL GRID TO CATHODE	5.5	μ f
PLATE TO CATHODE	7.0	μ f
GRID TO PLATE	0.005	MAX. μ f
4 WITH EXTERNAL SHIELD CONNECTED TO CATHODE		

TYPICAL OPERATING CONDITIONS AND CHARACTERISTICS

CLASS A₁ AMPLIFIER

HEATER OR FILAMENT VOLTAGE	12.6	12.6	VOLTS
HEATER OR FILAMENT CURRENT	0.15	0.15	AMPS.
PLATE VOLTAGE	100	250	VOLTS
SCREEN VOLTAGE (GRID 2)	100	100	VOLTS
CONTROL GRID VOLTAGE (GRID 1)	-3	-3	VOLTS
PEAK AF SIGNAL VOLTAGE			VOLTS
ZERO-SIGNAL PLATE CURRENT	8.9	9.2	MA.
ZERO-SIGNAL SCREEN CURRENT	2.6	2.4	MA.
MAXIMUM-SIGNAL PLATE CURRENT			MA.
MAXIMUM-SIGNAL SCREEN CURRENT			MA.
PLATE RESISTANCE (APPROX.)	0.25	0.8	MEG OHMS
TRANSCONDUCTANCE	1900	2000	μ MHOS
AMPLIFICATION FACTOR			
LOAD RESISTANCE			OHMS
TOTAL HARMONIC DISTORTION			PER CENT
POWER OUTPUT			WATTS
CONTROL GRID VOLTAGE			
FOR TRANSCONDUCTANCE	10 μ MHOS (APPROX.)	-35	VOLTS
SUPPRESSOR GRID VOLTAGE	0	0	VOLTS

TUNG-SOL

DOUBLE DIODE MINIATURE TYPE

COATED UNIPOTENTIAL CATHODE

HEATER

12.6 VOLTS 150 MA.

AC OR DC

ANY MOUNTING POSITION

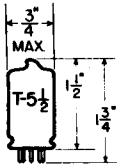

GLASS BULB

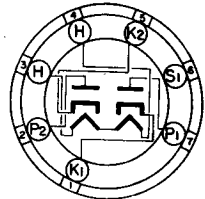

BOTTOM VIEW
MINIATURE BUTTON
7 PIN BASE

THE 12AL5 COMBINES TWO INDEPENDENT DIODE UNITS IN THE 7-PIN MINIATURE CONSTRUCTION. ITS HIGH PERVEANCE PERMITS HIGH EFFICIENCY IN EITHER FM OR AM DETECTOR SERVICE.

DIRECT INTERELECTRODE CAPACITANCES

	EXTERNAL SHIELD	NO EXTERNAL SHIELD	
PLATE TO CATHODE, HEATER AND INTERNAL SHIELD: P TO (H+K+IS) EACH UNIT	3.2 ^A	2.5	μmf
CATHODE TO PLATE, HEATER AND INTERNAL SHIELD: K TO (P+H+IS) EACH UNIT	3.6 ^B	3.6	μmf
PLATE #1 TO PLATE #2: (P ₁ TO P ₂)	0.02 ^C	0.08	μmf

^A CLOSE-FITTING EXTERNAL SHIELD CONNECTED TO CATHODE.

^B CLOSE-FITTING EXTERNAL SHIELD CONNECTED TO PLATE.

^C CLOSE-FITTING EXTERNAL SHIELD CONNECTED TO GROUND.

RATINGS

INTERPRETED ACCORDING TO RMA STANDARD M8-210

HEATER VOLTAGE	12.6	VOLTS
MAXIMUM HEATER-CATHODE VOLTAGE	330	VOLTS
MAXIMUM PEAK INVERSE PLATE VOLTAGE	330	VOLTS
MAXIMUM PEAK PLATE CURRENT EACH PLATE	54	MA.
MAXIMUM DC OUTPUT CURRENT EACH PLATE	9	MA.
TUBE VOLTAGE DROP (MEASURED WITH TUBE CONDUCTING 60 MA. EACH PLATE)	10	VOLTS

TYPICAL OPERATING CONDITIONS AND CHARACTERISTICS

HALF-WAVE RECTIFIER

IN HALF-WAVE SERVICE THE TWO UNITS MAY BE USED SEPARATELY OR IN PARALLEL.

HEATER VOLTAGE	12.6	VOLTS
HEATER CURRENT	150	MA.
AC PLATE VOLTAGE EACH PLATE (RMS)	117	VOLTS
MINIMUM TOTAL EFFECTIVE PLATE SUPPLY IMPEDANCE EACH PLATE	300	OHMS
DC OUTPUT CURRENT EACH PLATE	9	MA.

THE RESONANT FREQUENCY OF EACH UNIT IS 700 MC APPROX.

12AL5

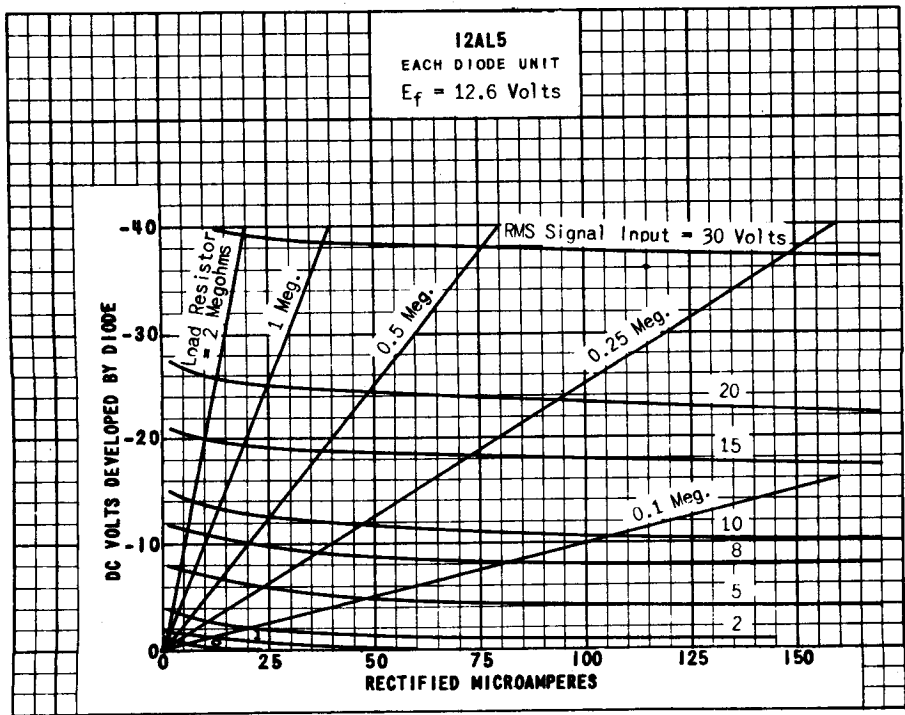
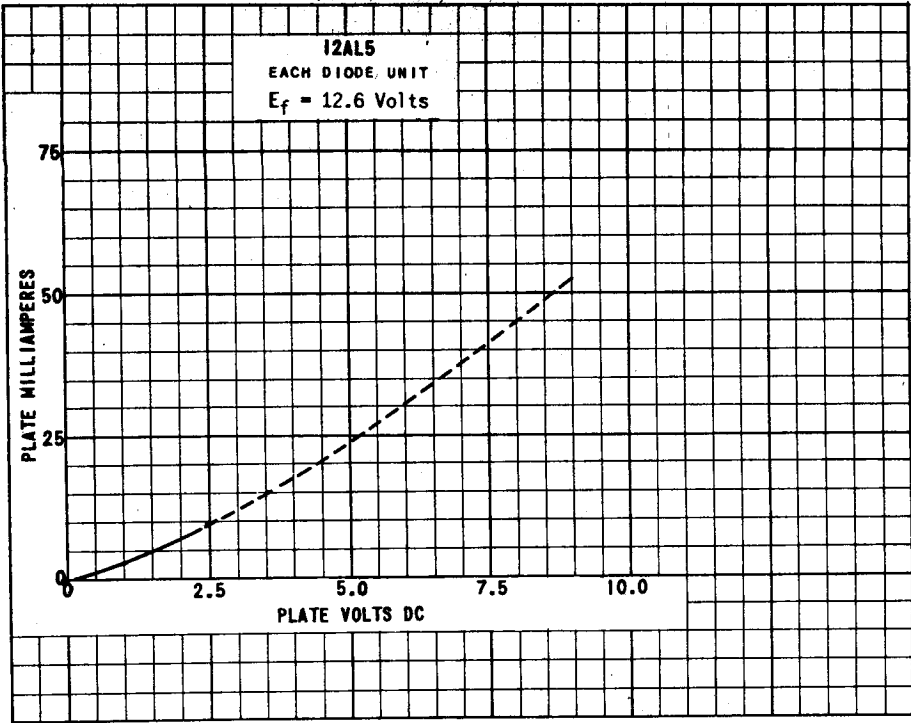

PLATE
1930
DEC. 1,
1947

TUNG-SOL

DOUBLE-DIODE TRIODE

MINIATURE TYPE

UNIPOTENTIAL CATHODE

HEATER

12.6 VOLTS 0.15 AMPERE

AC OR DC

ANY MOUNTING POSITION

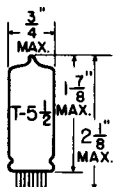

GLASS BULB

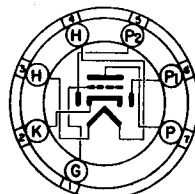

BOTTOM VIEW

MINIATURE BUTTON
7 PIN BASE

THE 12AT6 IS A COMBINED HIGH-MU VOLTAGE AMPLIFIER AND DOUBLE-DIODE DETECTOR USING THE 7-PIN MINIATURE CONSTRUCTION. IT IS INTENDED TO PROVIDE OUTPUT VOLTAGE ADEQUATE FOR FULL POWER OUTPUT OF MOST BEAM-POWER TUBES.

DIRECT INTERELECTRODE CAPACITANCES

WITH NO EXTERNAL SHIELD

GRID TO PLATE: (G TO P)	2.1	μmf
INPUT: G TO (H + K)	2.3	μmf
OUTPUT: P TO (H + K)	1.1	μmf
DIODE PLATE #2 TO TRIODE GRID: (P ₂ TO G) (MAX.)	0.025	μmf

RATINGS

INTERPRETED ACCORDING TO RMA STANDARD NB-210

HEATER VOLTAGE	12.6	VOLTS
MAXIMUM HEATER-CATHODE VOLTAGE	90	VOLTS
MAXIMUM PLATE VOLTAGE	300	VOLTS
MINIMUM DIODE CURRENT WITH 10 VOLTS DC APPLIED	0.8	MA.

TYPICAL OPERATING CONDITIONS AND CHARACTERISTICS

TRIODE UNIT - CLASS A₁ AMPLIFIER

HEATER VOLTAGE	12.6	12.6	VOLTS
HEATER CURRENT	0.15	0.15	AMP.
PLATE VOLTAGE	100	250	VOLTS
GRID VOLTAGE	-1	-3	VOLTS
PLATE CURRENT	0.8	1.0	MA.
PLATE RESISTANCE	54 000	58 000	OHMS
TRANSCONDUCTANCE	1 300	1 200	μMHOS
AMPLIFICATION FACTOR	70	70	

DIODE UNITS - TWO

THE DIODE UNITS ARE INDEPENDENT OF THE TRIODE UNIT EXCEPT FOR THE COMMON CATHODE SLEEVE.

SIMILAR TYPE REFERENCE: Except for heater ratings somewhat similar to 6Q7, 6Q7GT, 6SQ7, 6SQ7GT, 7B6, 7C6.

→ INDICATES A CHANGE OR ADDITION.

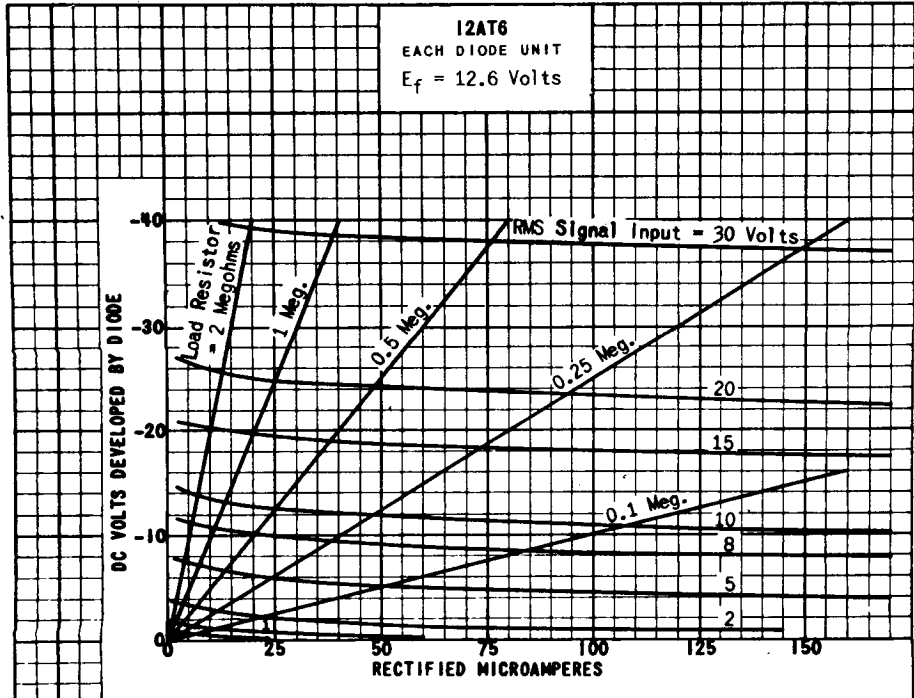
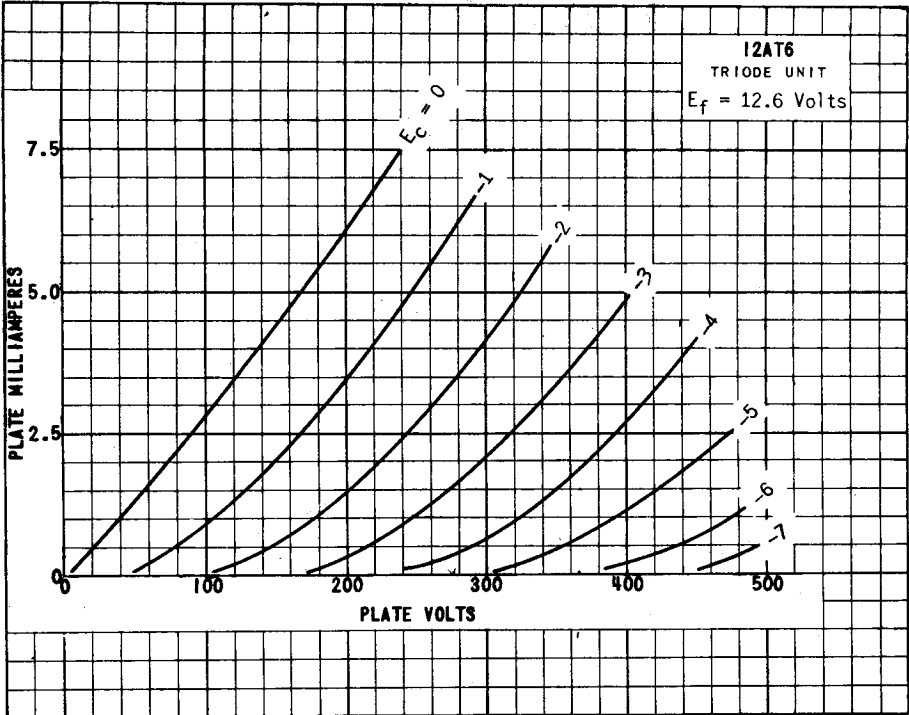

PLATE 1848
JULY 1, 1947

TUNG-SOL

DOUBLE TRIODE

MINIATURE TYPE

COATED UNIPOTENTIAL CATHODES

HEATER

SERIES

12.6 VOLTS
150 MA.

PARALLEL

6.3 VOLTS
300 MA.

AC OR DC

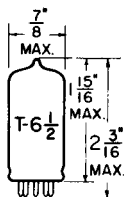

GLASS BULB

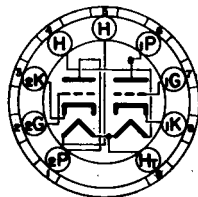
BOTTOM VIEW
SMALL BUTTON
9 PIN BASE

FOR 12.6 VOLT OPERATION APPLY HEATER VOLTAGE BETWEEN PINS #4 AND #5. FOR 6.3 VOLT OPERATION APPLY HEATER VOLTAGE BETWEEN PIN #9 AND PINS #4 AND #5 CONNECTED TOGETHER.

ANY MOUNTING POSITION

THE 12AT7 COMBINES TWO HIGH TRANSCONDUCTANCE TRIODES IN A 9 PIN MINIATURE CONSTRUCTION. ITS LOW CAPACITANCE AND HIGH RATIO OF PLATE CURRENT TO TRANSCONDUCTANCE ADAPT IT TO USE AS A HIGH FREQUENCY COMBINED OSCILLATOR AND MIXER OR AS A GROUNDED GRID RADIO FREQUENCY AMPLIFIER.

DIRECT INTERELECTRODE CAPACITANCES

	WITHOUT SHIELD	WITH SHIELD #316 ^A	
INPUT: G TO (H+K) (EACH SECTION)	2.2	2.2	μlf
OUTPUT: P TO (H+K) (SECTION #1)	0.5	1.2	μlf
(SECTION #2)	0.4	1.5	μlf
GRID TO PLATE: (G TO P) (EACH SECTION)	1.5	1.5	μlf
HEATER TO CATHODE: (H TO K) (EACH SECTION)	2.4	2.4	μlf

GROUNDED GRID

	WITHOUT SHIELD	WITH SHIELD #316 ^B	
INPUT: K TO (H+G) (EACH SECTION)	4.6	4.6	μlf
OUTPUT: P TO (H+G) (EACH SECTION)	1.8	2.6	μlf
PLATE TO CATHODE: (P TO K) (EACH SECTION)	0.2	0.2	μlf

^A CONNECTED TO CATHODE OF SECTION UNDER TEST.

^B CONNECTED TO GRID OF SECTION UNDER TEST.

RATINGS

INTERPRETED ACCORDING TO RMA STANDARD M8-210

EACH TRIODE UNIT

HEATER VOLTAGE	12.6	6.3	VOLTS
MAXIMUM HEATER-CATHODE VOLTAGE	90		VOLTS
MAXIMUM PLATE VOLTAGE	300		VOLTS
MAXIMUM NEGATIVE DC GRID VOLTAGE	-50		VOLTS
MAXIMUM PLATE DISSIPATION	2.5		WATTS

CONTINUED ON FOLLOWING PAGE

→ INDICATES A CHANGE OR ADDITION.

CONTINUED FROM PRECEDING PAGE

TYPICAL OPERATING CONDITIONS AND CHARACTERISTICS

CLASS A₁ AMPLIFIER - EACH TRIODE UNIT

HEATER VOLTAGE	12.6	6.3	12.6	6.3	VOLTS
HEATER CURRENT	150	300	150	300	MA.
PLATE VOLTAGE		100		250	VOLTS
CATHODE BIAS RESISTOR		270		200	OHMS
PLATE CURRENT		3.7		10	MA.
PLATE RESISTANCE		15 000		10 900	OHMS
TRANSCONDUCTANCE		4 000		5 500	μMHOS
AMPLIFICATION FACTOR		60		60	
GRID VOLTAGE (APPROX.) FOR I _b = 10 μA.		-5		-12	VOLTS

TYPICAL CIRCUIT FOR CONVERTER OPERATION AT 100 MEGACYCLES

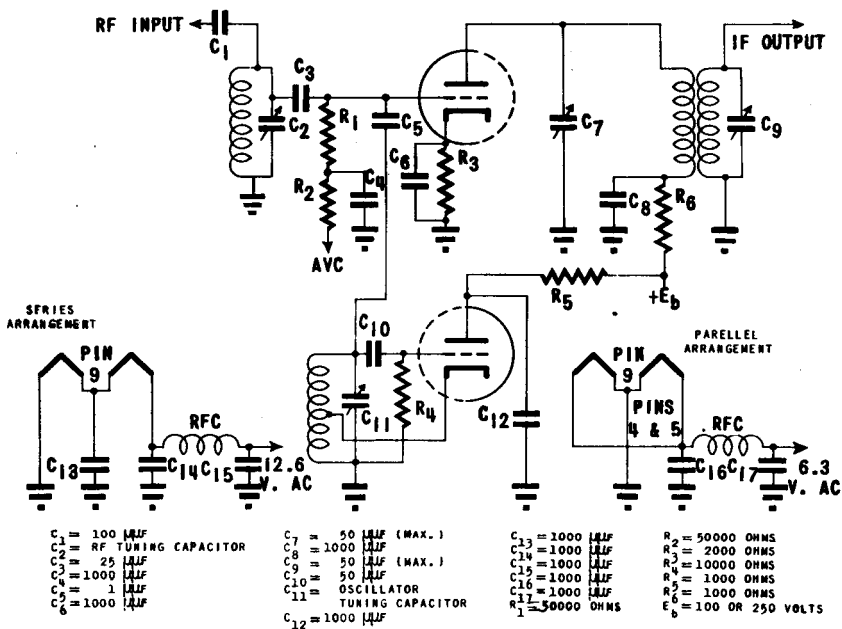

→ INDICATES A CHANGE OR ADDITION.

50000 | 250000 | 1000

12AT7

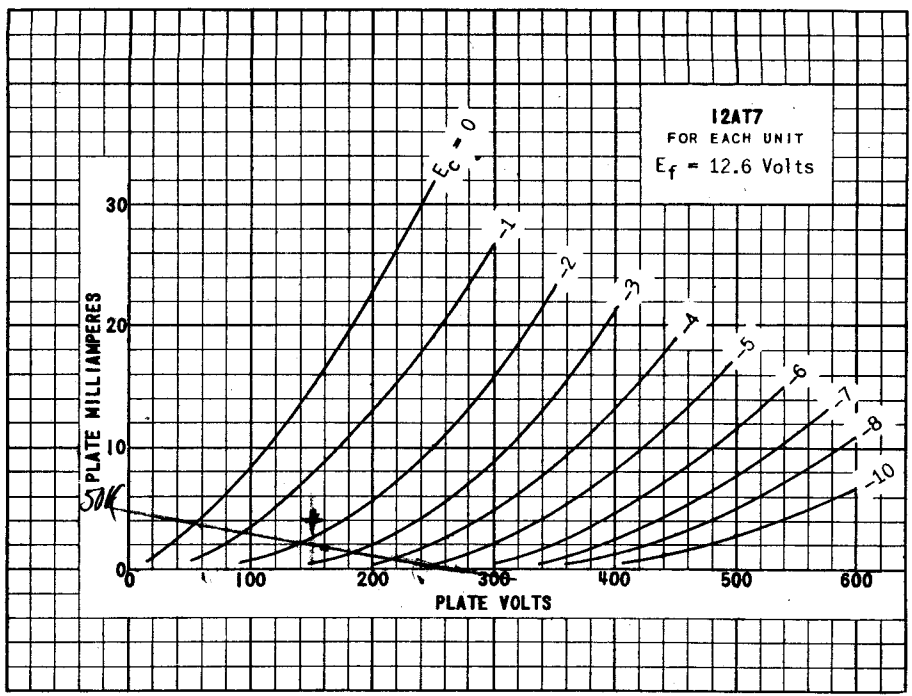

23780

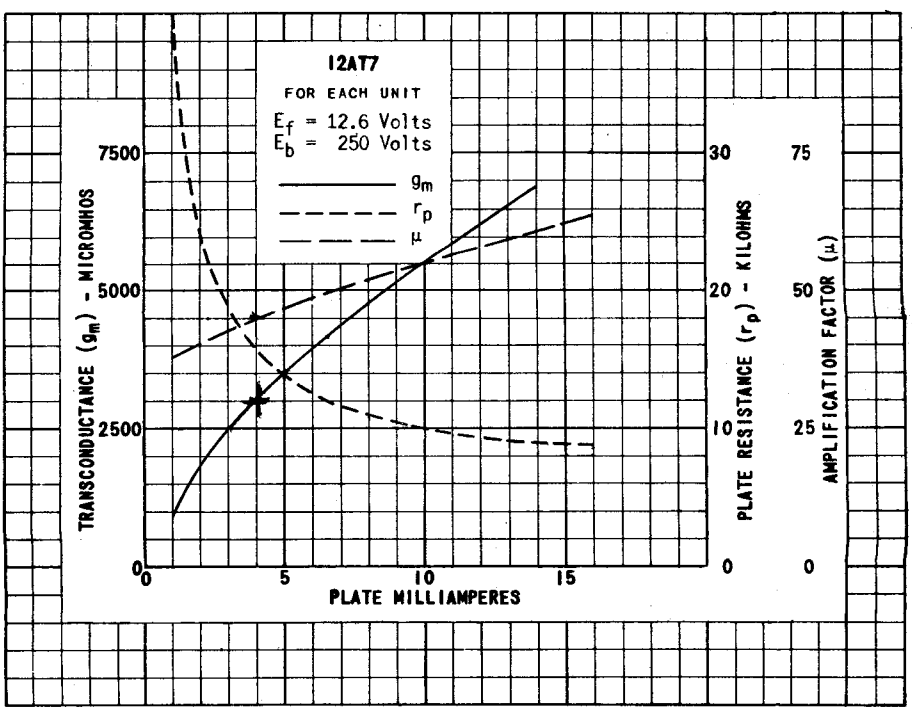

PRINTED IN U. S. A.

PLATE 1894
OCT. 1,
1947



TUNG-SOL

PENTODE

MINIATURE TYPE

UNIPOENTIAL CATHODE

HEATER

12.6 VOLTS 150 MA.

AC OR DC

ANY MOUNTING POSITION

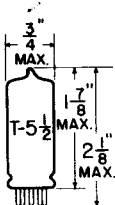

GLASS BULB

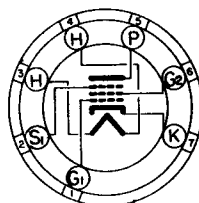

BOTTOM VIEW

MINIATURE BUTTON
7 PIN BASE

THE 12AU6 IS A PENTODE AMPLIFIER HAVING A SHARP CUT-OFF CONTROL CHARACTERISTIC USING THE MINIATURE CONSTRUCTION. WITH HIGH TRANSCONDUCTANCE, LOW GRID-PLATE CAPACITANCE, IT IS INTENDED FOR SERVICE AS EITHER AN AF OR RF AMPLIFIER.

RATINGS

INTERPRETED ACCORDING TO RMA STANDARD MB-210

HEATER VOLTAGE	12.6	VOLTS
HEATER CURRENT	150	MA.
MAXIMUM PLATE VOLTAGE	300	VOLTS
MAXIMUM SCREEN VOLTAGE	150	VOLTS
MAXIMUM SCREEN SUPPLY VOLTAGE	300	VOLTS
MAXIMUM GRID VOLTAGE:		
NEGATIVE BIAS	50	VOLTS
POSITIVE BIAS	0	VOLTS
MAXIMUM PLATE DISSIPATION	3	WATTS
MAXIMUM SCREEN DISSIPATION	0.65	WATTS
MAXIMUM HEATER-CATHODE VOLTAGE	90	VOLTS

DIRECT INTERELECTRODE CAPACITANCES

WITH NO EXTERNAL SHIELD

GRID TO PLATE (MAX.)	0.0035	μf
INPUT	5.5	μf
OUTPUT	5	μf

TYPICAL OPERATING CONDITIONS AND CHARACTERISTICS

CLASS A₁ AMPLIFIER

PLATE VOLTAGE	100	250	250	VOLTS
SCREEN VOLTAGE	100	125	150	VOLTS
GRID VOLTAGE	-1	-1	-1	VOLT
SUPPRESSOR VOLTAGE	0	0	0	VOLTS
PLATE CURRENT	5.2	7.6	10.8	MA.
SCREEN CURRENT	2.0	3.0	4.3	MA.
PLATE RESISTANCE (APPROX.)	0.5	1.5	1	MEG OHMS
TRANSCONDUCTANCE	3 900	4 450	5 200	μMHOS
GRID VOLTAGE FOR PLATE CURRENT = 40 μA .	-4.2	-5.2	-6.2	VOLTS

12AU6

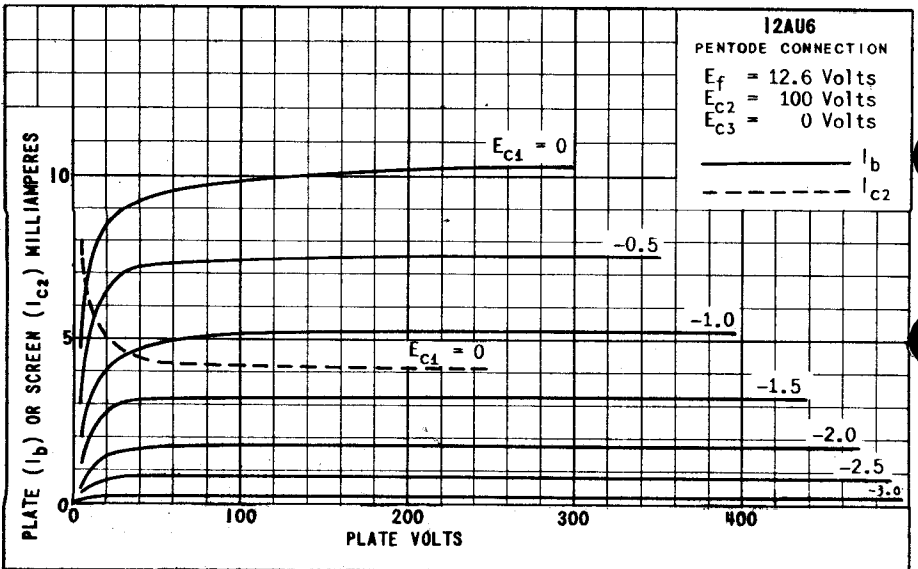
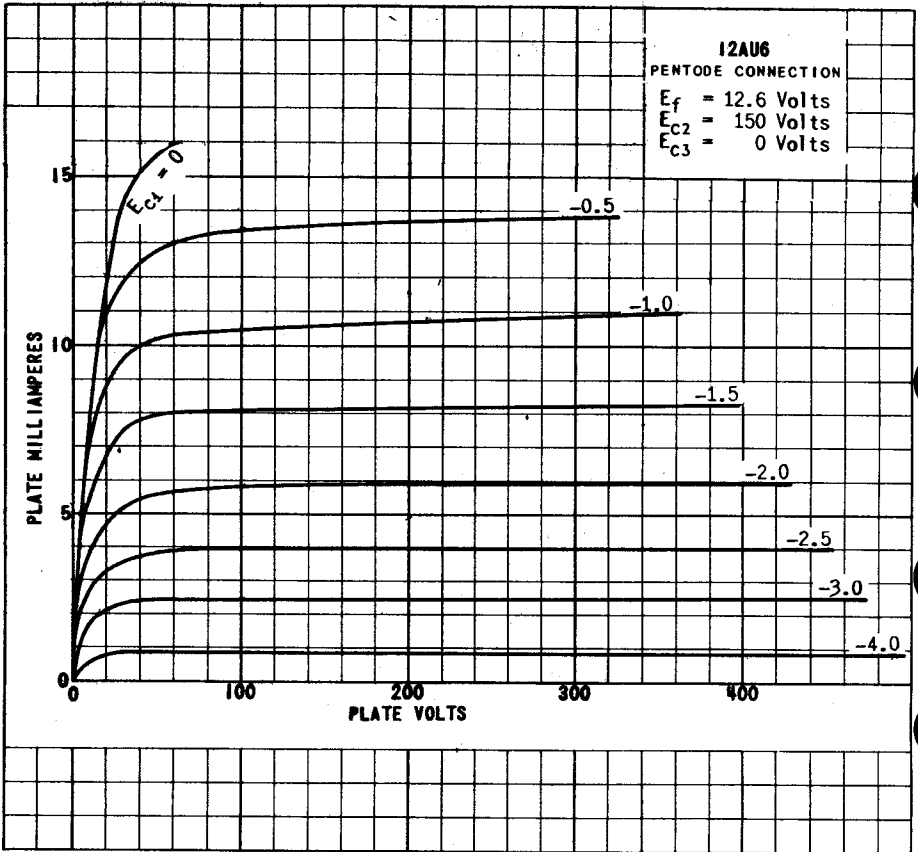
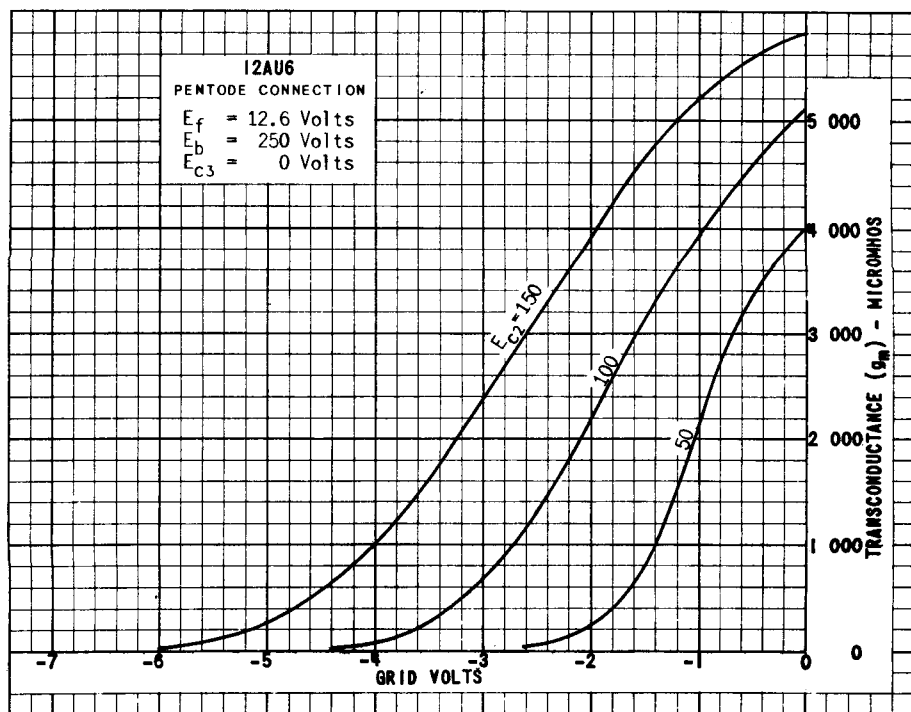
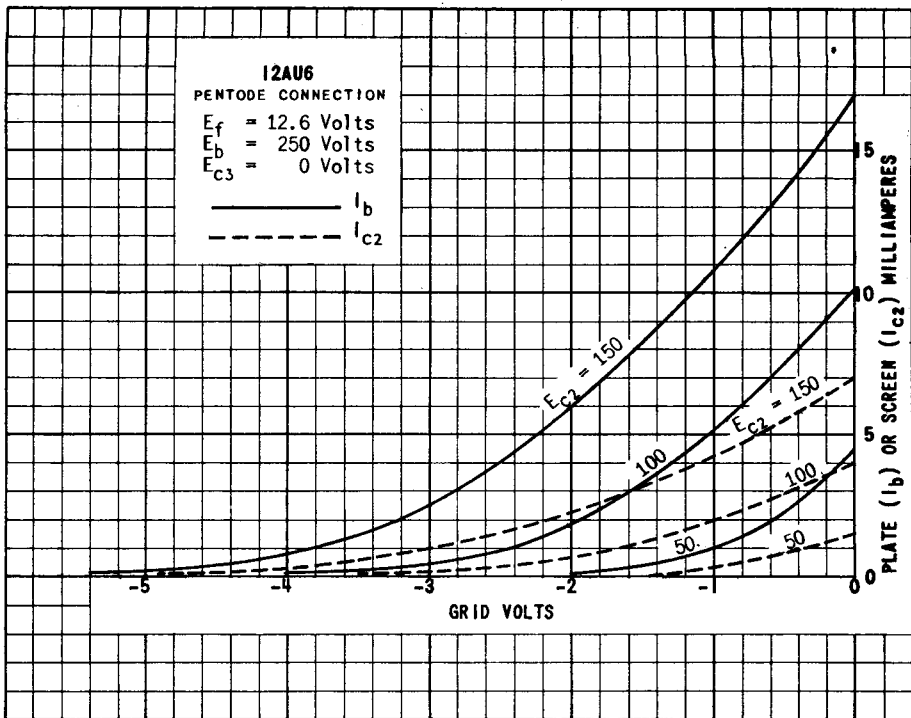

PLATE
 1859
 AUG. 1,
 1947



PRINTED IN U. S. A.

PLATE
1860
AUG. 1,
1947



TUNG-SOL

DOUBLE TRIODE

UNIPOTENTIAL CATHODES

HEATER

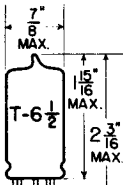

GLASS BULB

SERIES
12.6 VOLTS
150 MA.

PARALLEL
6.3 VOLTS
300 MA.

AC OR DC

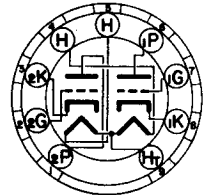

BOTTOM VIEW
SMALL BUTTON
9 PIN BASE

FOR 12.6 VOLT OPERATION APPLY HEATER VOLTAGE BETWEEN PINS #4 AND #5. FOR 6.3 VOLT OPERATION APPLY HEATER VOLTAGE BETWEEN PIN #9 AND PINS #4 AND #5 CONNECTED TOGETHER.

ANY MOUNTING POSITION

THE 12AU7 COMBINES TWO INDEPENDENT MEDIUM-MU INDIRECTLY HEATED CATHODE TYPE TRIODES IN THE SMALL 9 PIN BUTTON CONSTRUCTION. IT IS ADAPTABLE TO APPLICATION EITHER AS AN AUDIO FREQUENCY AMPLIFIER OR AS COMBINED OSCILLATOR AND MIXER.

DIRECT INTERELECTRODE CAPACITANCES

WITH NO EXTERNAL SHIELD

	TRIODE UNIT 1	TRIODE UNIT 2	
GRID TO PLATE: (G TO P)	1.5	1.5	μμf
INPUT: G TO (H + K)	1.6	1.6	μμf
OUTPUT: P TO (H + K)	0.50	0.35	μμf

RATINGS

INTERPRETED ACCORDING TO RMA STANDARD M8-210

EACH TRIODE UNIT

	12.6	6.3	
HEATER VOLTAGE	12.6	6.3	VOLTS
MAXIMUM HEATER-CATHODE VOLTAGE	180		VOLTS
MAXIMUM PLATE VOLTAGE	300		VOLTS
MAXIMUM PLATE DISSIPATION	2.75		WATTS
MAXIMUM CATHODE CURRENT	20		MA.
MAXIMUM GRID CIRCUIT RESISTANCE (FIXED BIAS)	0.25		MEGOHM
MAXIMUM GRID CIRCUIT RESISTANCE (SELF BIAS)	1.0		MEGOHM

TYPICAL OPERATING CONDITIONS AND CHARACTERISTICS

CLASS A₁ AMPLIFIER - EACH TRIODE UNIT

	12.6	6.3	12.6	6.3	
HEATER VOLTAGE	12.6	6.3	12.6	6.3	VOLTS
HEATER CURRENT	150	300	150	300	MA.
PLATE VOLTAGE	100		250		VOLTS
GRID VOLTAGE	0		-8.5		VOLTS
PLATE CURRENT	11.8		10.5		MA.
PLATE RESISTANCE	6 250		7 700		OHMS
TRANSCONDUCTANCE	3 100		2 200		μMHOS
AMPLIFICATION FACTOR	19.5		17		

SIMILAR TYPE REFERENCE: Each unit is identical to 804.

12AU7

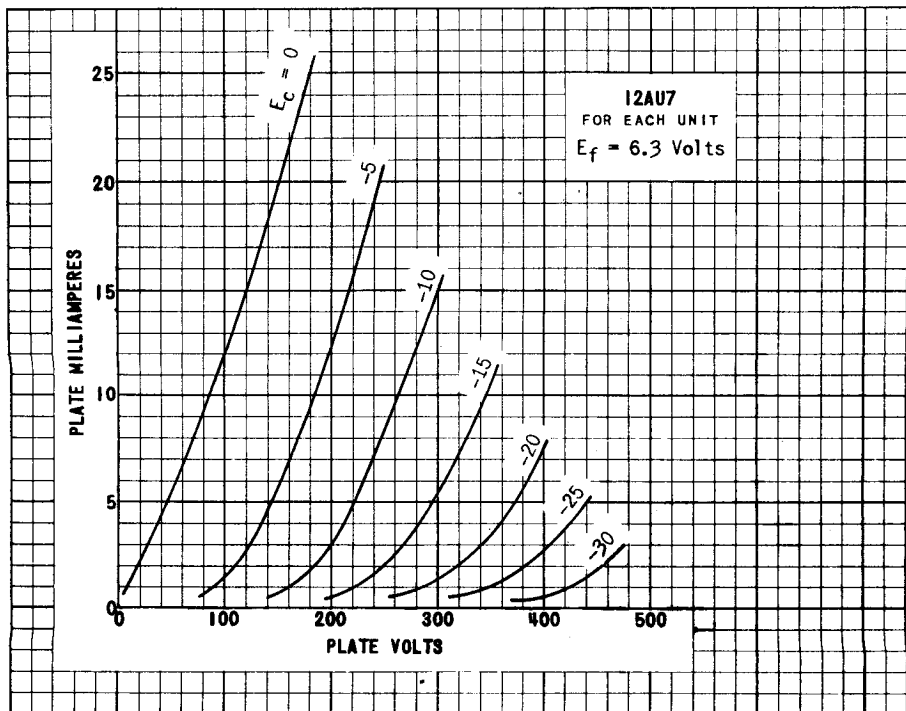
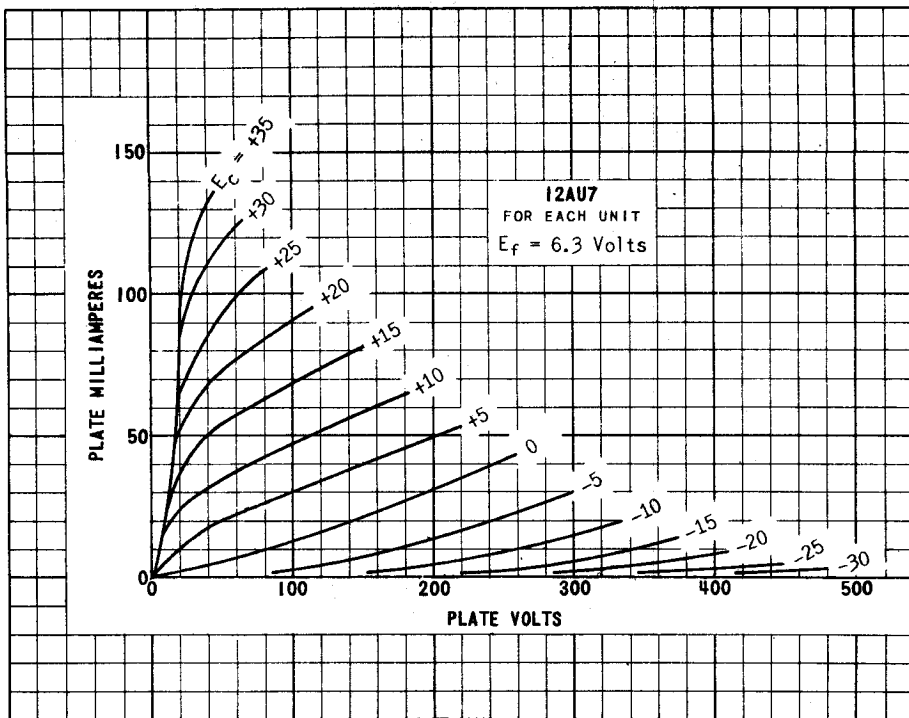

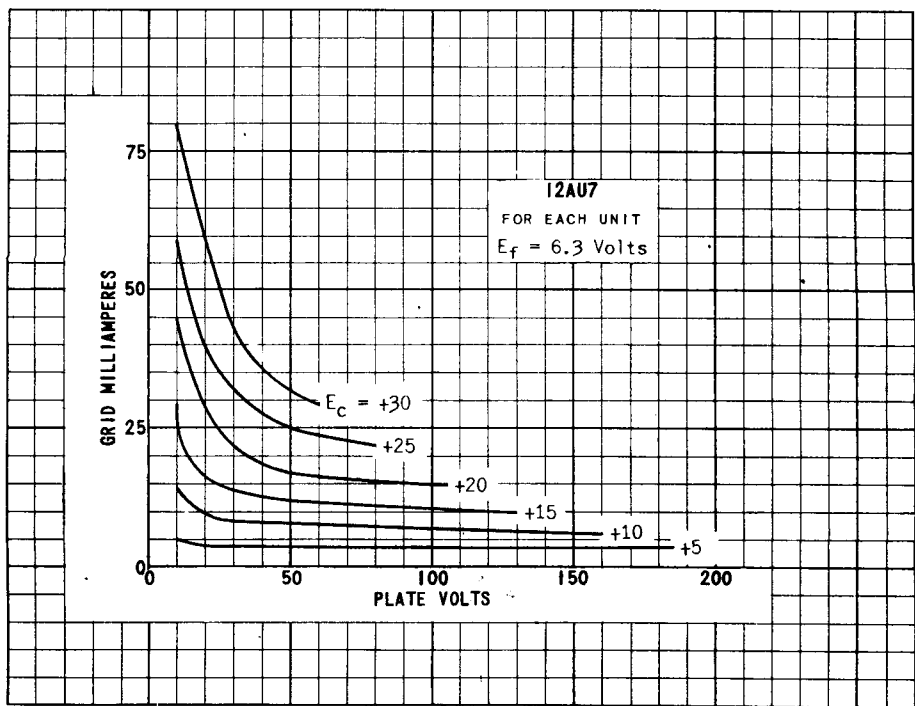
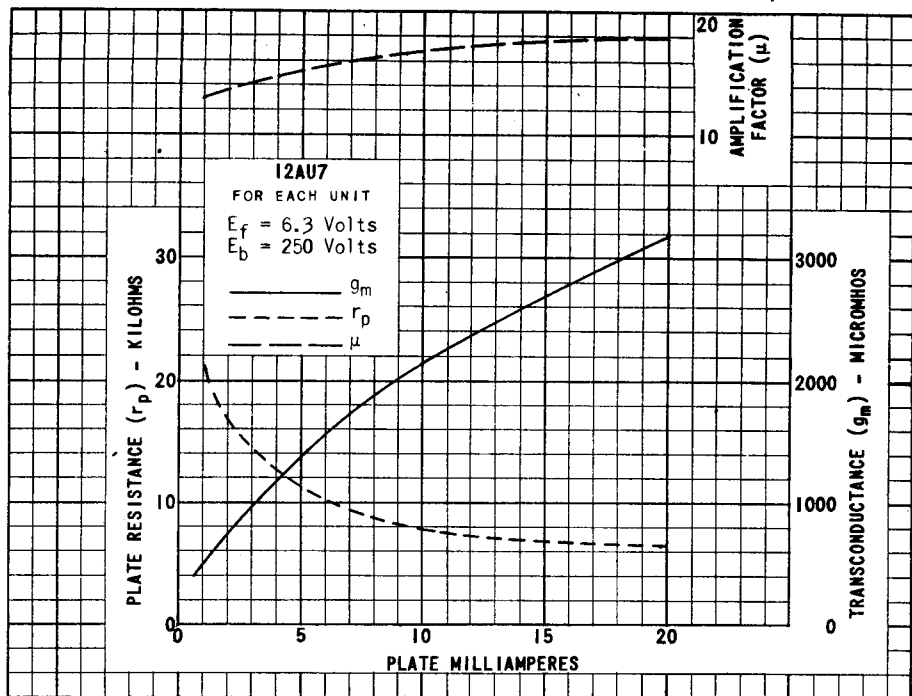

PRINTED IN U. S. A.

PLATE 1863
AUG. 1, 1947



TUNG-SOL

DOUBLE-DIODE TRIODE

MINIATURE TYPE

COATED UNIPOTENTIAL CATHODE

HEATER

12.6 VOLTS 150 MA.

AC OR DC

ANY MOUNTING POSITION

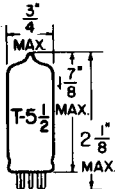

GLASS BULB

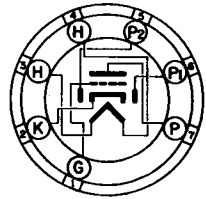

BOTTOM VIEW
MINIATURE BUTTON
7 PIN BASE

THE 12AV6 COMBINES A HIGH MU-TRIODE AND TWO INDEPENDENT DIODE UNITS IN THE 7-PIN MINIATURE CONSTRUCTION. IT PERMITS A SINGLE TUBE TO FUNCTION AS DETECTOR, AVC RECTIFIER, AND AUDIO AMPLIFIER. COUPLING BETWEEN THE DIODE AND TRIODE SECTIONS IS MINIMIZED BY THE USE OF INTERNAL SHIELDING.

RATINGS

INTERPRETED ACCORDING TO RMA STANDARD M8-210

FILAMENT VOLTAGE	12.6	VOLTS
MAXIMUM HEATER-CATHODE VOLTAGE	90	VOLTS
MAXIMUM PLATE VOLTAGE	300	VOLTS
MAXIMUM DIODE CURRENT EACH PLATE FOR CONTINUOUS OPERATION	1.0	MA.

TYPICAL OPERATING CONDITIONS AND CHARACTERISTICS

TRIODE UNIT - CLASS A₁ AMPLIFIER

FILAMENT VOLTAGE	12.6	12.6	VOLTS
FILAMENT CURRENT	150	150	MA.
PLATE VOLTAGE	100	250	VOLTS
GRID VOLTAGE	-1	-2	VOLTS
PLATE CURRENT	0.5	1.2	MA.
PLATE RESISTANCE	80 000	62 500	OHMS
TRANSCONDUCTANCE	1 250	1 600	μMHMS
AMPLIFICATION FACTOR	100	100	

DIODE UNITS - TWO

THE DIODE UNITS ARE INDEPENDENT OF THE TRIODE UNIT EXCEPT FOR THE COMMON CATHODE SLEEVE.

DIODE BIASING OF THE TRIODE UNIT IS NOT SUITABLE.

SIMILAR TYPE REFERENCE: Ratings and Characteristics somewhat similar to 12AT6 except for the use of more thorough shielding of the diode units from the triode.

CONTINUED ON FOLLOWING PAGE

PRINTED IN U. S. A.

PLATE
1969
FEB. 2,
1948

TUNG-SOL

CONTINUED FROM PRECEDING PAGE

RESISTANCE COUPLED AMPLIFIER

R_L MEG.	R_C MEG.	$E_{bb} = 90$ VOLTS			$E_{bb} = 180$ VOLTS			$E_{bb} = 300$ VOLTS		
		R_k	GAIN	E_o	R_k	GAIN	E_o	R_k	GAIN	E_o
0.1	0.22	4700	35 ^A	4	2000	47	18	1500	52	40
0.22	0.47	7400	45 ^B	6	3500	59	24	2800	65	49
0.47	1.0	13000	52 ^C	8	6700	66	28	5200	73	54

E_o IS RMS OUTPUT AT GRID CURRENT POINT.

GAIN MEASURED AT 5.0 VOLTS RMS OUTPUT EXCEPT AS INDICATED.

^A OUTPUT VOLTAGE OF 2 VOLTS RMS.

^B OUTPUT VOLTAGE OF 3 VOLTS RMS.

^C OUTPUT VOLTAGE OF 4 VOLTS RMS.

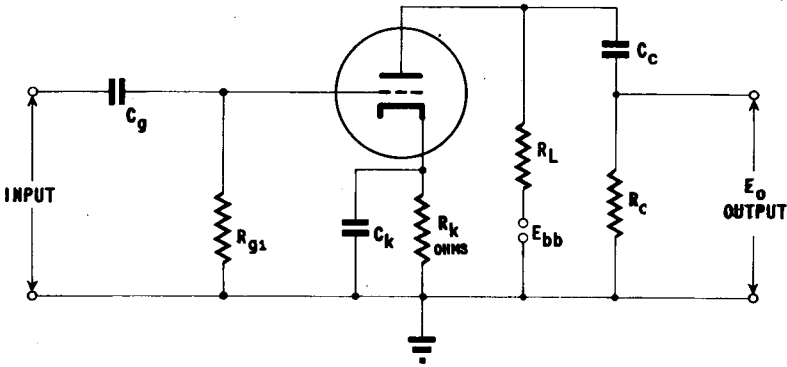

NOTE: COUPLING CAPACITORS C_g AND C_c SHOULD BE SELECTED TO GIVE DESIRED FREQUENCY RESPONSE. R_k SHOULD BE ADEQUATELY BY-PASSED BY CAPACITOR C_k .

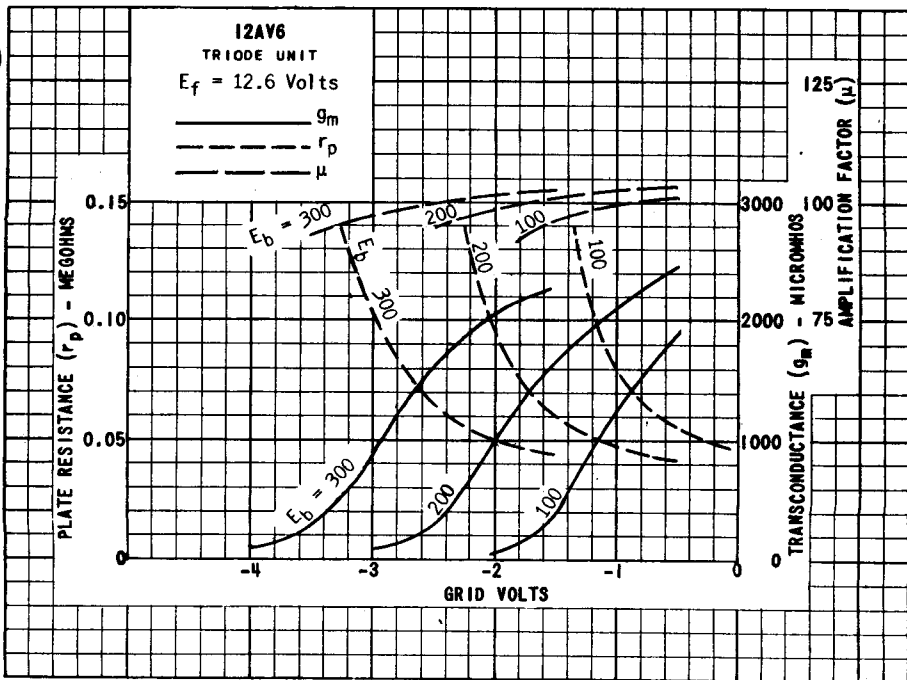
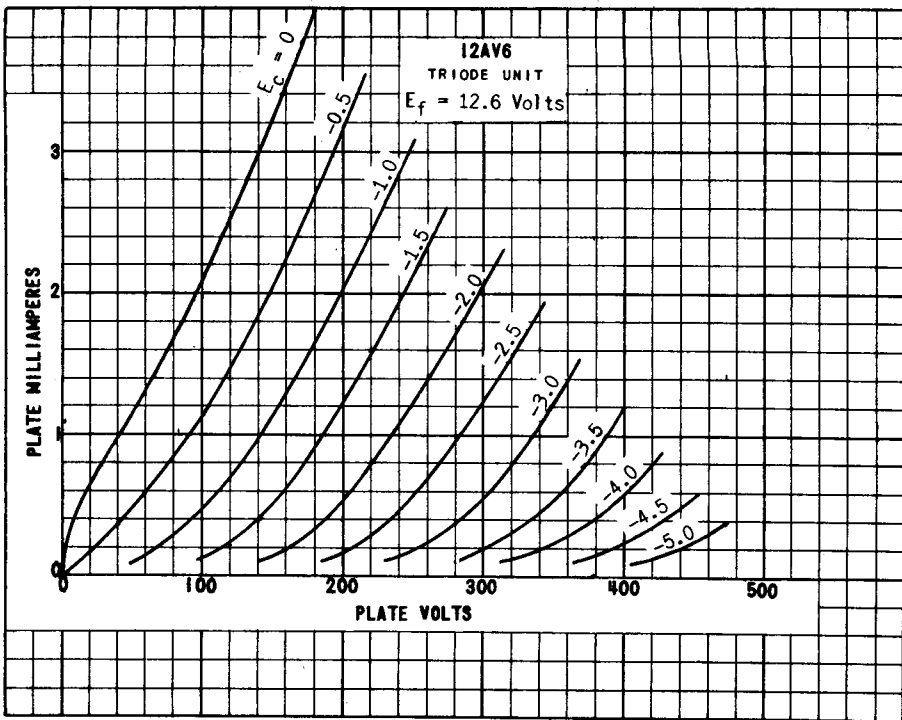

PRINTED IN U. S. A.

PLATE
1971
FEB. 2,
1948

12AV6

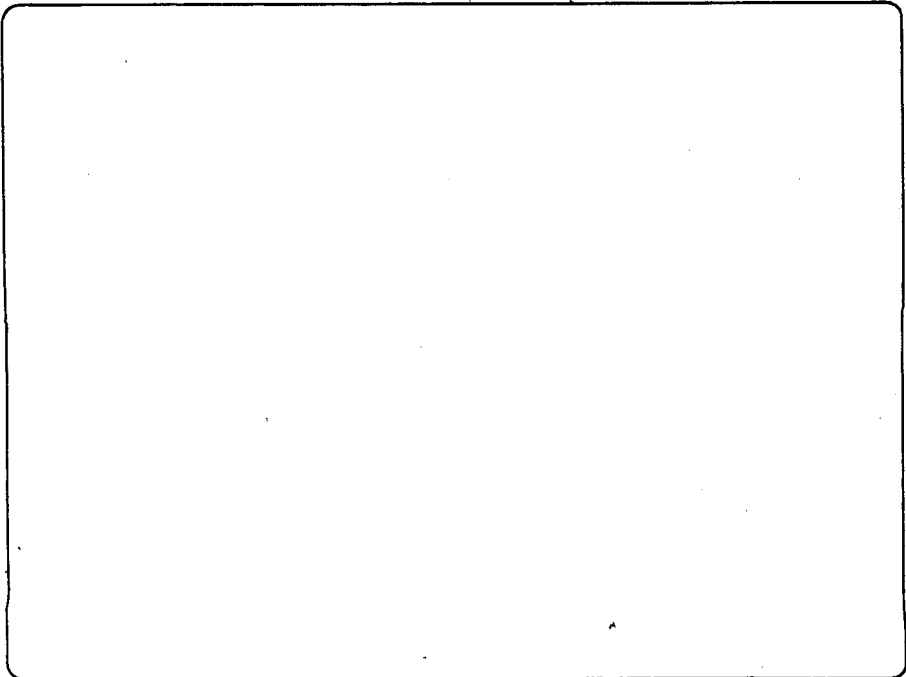
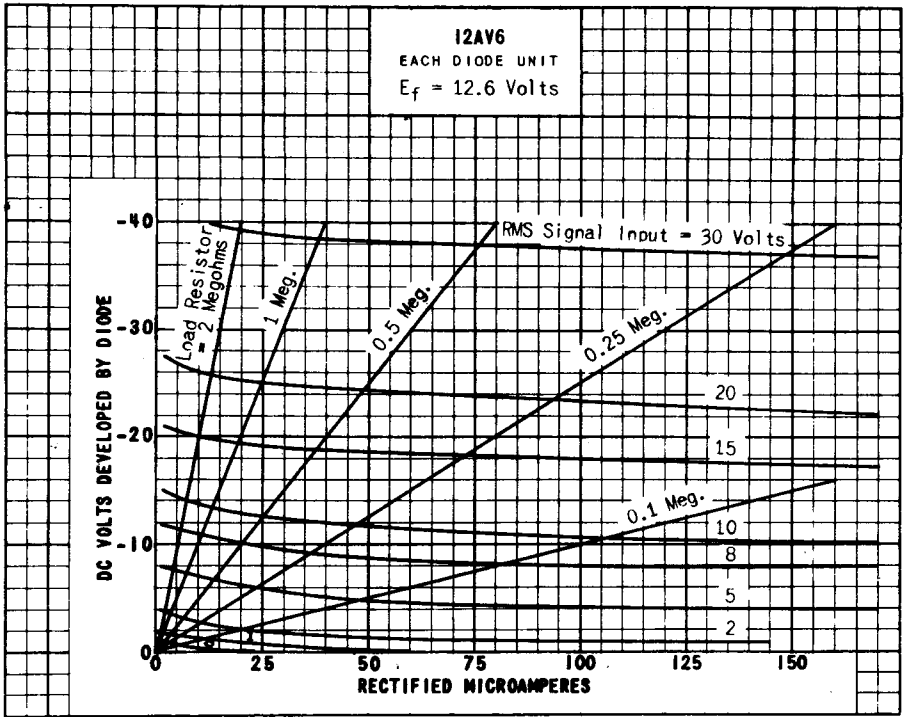
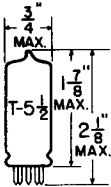

PLATE
1972
FEB. 2,
1948

TUNG-SOL

PENTODE

MINIATURE TYPE



GLASS BULB

UNIPOTENTIAL CATHODE

HEATER

12.6 VOLTS 150 MA.

AC OR DC

ANY MOUNTING POSITION

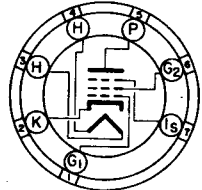

BOTTOM VIEW

MINIATURE BUTTON
7 PIN BASE

THE 12AW6 IS A MINIATURE TYPE RF PENTODE HAVING A SHARP CUT-OFF CHARACTERISTIC AND A HIGH VALUE OF TRANSCONDUCTANCE. IN COMPACT, LIGHT-WEIGHT EQUIPMENT IT IS USEFUL AS AN RF AMPLIFIER UP TO ABOUT 400 MEGACYCLES, AND AS A HIGH-FREQUENCY, INTERMEDIATE AMPLIFIER. IT HAS LOW INPUT AND OUTPUT CAPACITANCES AND A SEPARATE SUPPRESSOR CONNECTION ALL OF WHICH CONTRIBUTE TO ITS HIGH FREQUENCY PERFORMANCE. THE 12AW6 IS ELECTRICALLY EQUIVALENT TO TYPE 6AG5.

DIRECT INTERELECTRODE CAPACITANCES

WITH NO EXTERNAL SHIELD

GRID TO PLATE: (G ₁ TO P) MAX.	0.025	μmf
INPUT: G TO (H+K+G ₂ +G ₃ &IS)	6.5	μmf
OUTPUT: P TO (H+K+G ₂ +G ₃ &IS)	1.5	μmf

RATINGS

INTERPRETED ACCORDING TO RMA STANDARD MB-210

	TRIODE CONNECTION ^A	PENTODE CONNECTION	
HEATER VOLTAGE	12.6	12.6	VOLTS
MAXIMUM HEATER-CATHODE VOLTAGE	90	90	VOLTS
MAXIMUM PLATE VOLTAGE	300	300	VOLTS
MAXIMUM GRID #2 VOLTAGE	---	150	VOLTS
MAXIMUM GRID #2 SUPPLY VOLTAGE	---	-300	VOLTS
MAXIMUM NEGATIVE DC GRID #1 VOLTAGE	50	50	VOLTS
MAXIMUM POSITIVE DC GRID #1 VOLTAGE	0	0	VOLTS
MAXIMUM PLATE DISSIPATION	2.5	2	WATTS
MAXIMUM GRID #2 DISSIPATION	---	0.5	WATT

^A GRID #2 TIED TO PLATE AND GRID #3 TIED TO CATHODE.

PRINTED IN U. S. A.

PLATE
1912
NOV. 1,
1947

CONTINUED ON FOLLOWING PAGE

TUNG-SOL

CONTINUED FROM PRECEDING PAGE

TYPICAL OPERATING CONDITIONS AND CHARACTERISTICS

CLASS A₁ AMPLIFIER - PENTODE CONNECTION

HEATER VOLTAGE	12.6	12.6	12.6	VOLTS
HEATER CURRENT	150	150	150	MA.
PLATE VOLTAGE	100	125	250	VOLTS
GRID #3 VOLTAGE	CONNECTED TO CATHODE AT SOCKET			
GRID #2 VOLTAGE	100	125	150	VOLTS
CATHODE BIAS RESISTOR	100	100	200	OHMS
PLATE RESISTANCE (APPROX.)	0.3	0.5	0.8	MEGOHM
TRANSCONDUCTANCE	4 750	5 100	5 000	μMHOS
PLATE CURRENT	5.5	7.2	7	MA.
GRID #2 CURRENT	1.6	2.1	2	MA.
GRID #1 VOLTAGE (APPROX.) FOR $I_b = 10 \mu A$.	-5	-6	-8	VOLTS

CLASS A₁ AMPLIFIER - TRIODE CONNECTION

HEATER VOLTAGE	12.6	12.6	VOLTS
HEATER CURRENT	150	150	MA.
PLATE VOLTAGE	180	250	VOLTS
CATHODE BIAS RESISTOR	350	825	OHMS
PLATE RESISTANCE	7 900	11 000	OHMS
TRANSCONDUCTANCE	5 700	3 800	μMHOS
AMPLIFICATION FACTOR	45	42	
PLATE CURRENT	7.0	5.5	MA.

SIMILAR TYPE REFERENCE: Ratings and characteristics identical to 6AQ5.

PLATE
1913
NOV. 1,
.1947

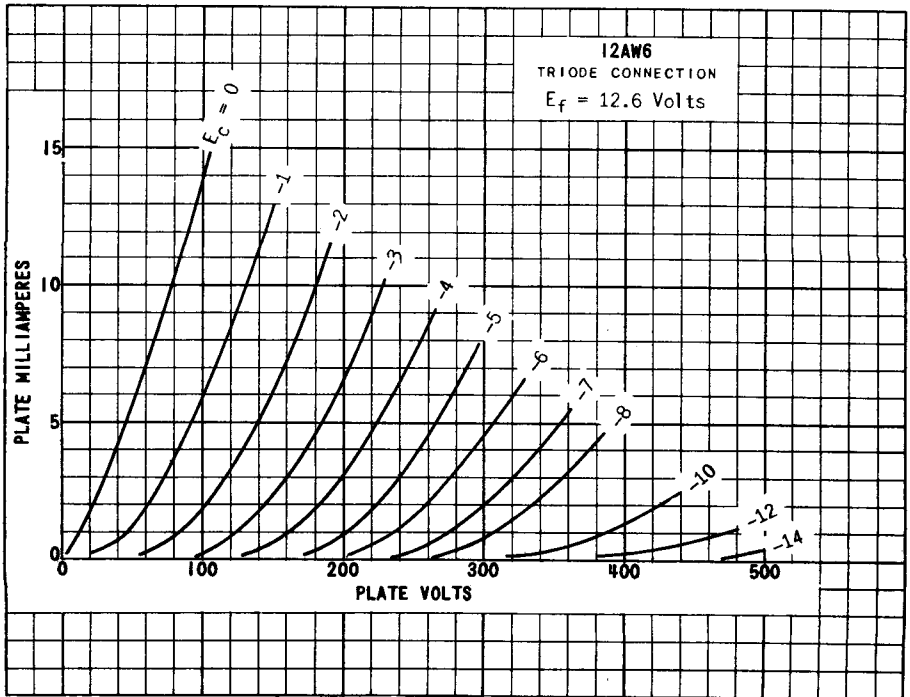
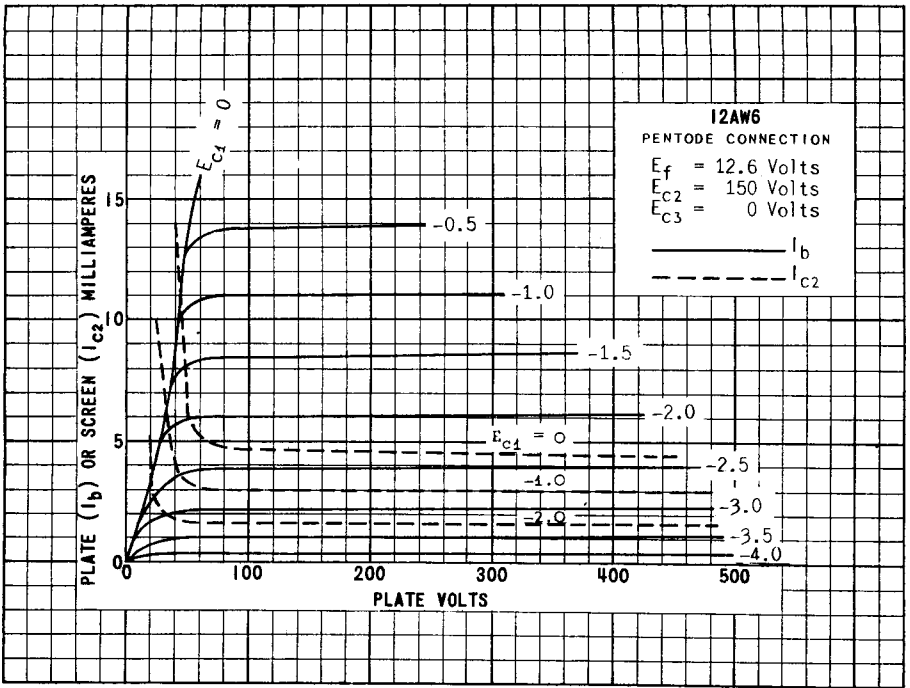

PRINTED IN U. S. A.

PLATE 1934
 NOV. 1,
 1947



TUNG-SOL

DOUBLE TRIODE

MINIATURE TYPE

UNIPOTENTIAL CATHODES

HEATER

SERIES
12.6 VOLTS
150 MA.

PARALLEL
6.3 VOLTS
300 MA.

AC OR DC

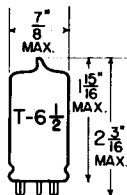

GLASS BULB

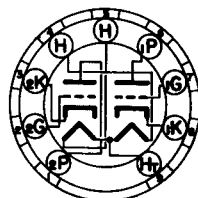

BOTTOM VIEW
SMALL BUTTON
9 PIN BASE

FOR 12.6 VOLT OPERATION APPLY HEATER VOLTAGE BETWEEN PINS #4 AND #5. FOR 6.3 VOLT OPERATION APPLY HEATER VOLTAGE BETWEEN PIN #9 AND PINS #4 AND #5 CONNECTED TOGETHER.

ANY MOUNTING POSITION

THE 12AX7 COMBINES TWO COMPLETELY INDEPENDENT HIGH-MU TRIODES IN THE SMALL 9 PIN BUTTON CONSTRUCTION. IT IS ADAPTABLE TO APPLICATIONS WHERE HIGH VOLTAGE GAIN AND LOW HEATER POWER ARE THE IMPORTANT CONSIDERATION, SUCH AS VOLTAGE AMPLIFIERS, PHASE INVERTERS AND MULTIVIBRATORS. THE CENTER TAPPED HEATER CONNECTION PERMITS OPERATION FROM EITHER A 6.3 VOLT OR 12.6 VOLT SUPPLY AND IN 300 MA. OR 150 MA. SERIES HEATER SERVICE.

DIRECT INTERELECTRODE CAPACITANCES

WITH NO EXTERNAL SHIELD

	TRIODE UNIT 1	TRIODE UNIT 2	
GRID TO PLATE: (G TO P)	1.7	1.7	μuf
INPUT: G TO (H + K)	1.6	1.6	μuf
OUTPUT: P TO (H + K)	0.46	0.34	μuf

RATINGS

INTERPRETED ACCORDING TO RMA STANDARD WB-210

EACH TRIODE UNIT

	12.6	6.3	VOLTS
HEATER VOLTAGE	12.6	6.3	VOLTS
MAXIMUM HEATER-CATHODE VOLTAGE	180		VOLTS
MAXIMUM PLATE VOLTAGE	300		VOLTS
MAXIMUM NEGATIVE DC GRID VOLTAGE	50		VOLTS
MAXIMUM POSITIVE DC GRID VOLTAGE	0		VOLTS
MAXIMUM PLATE DISSIPATION	1		WATT

TYPICAL OPERATING CONDITIONS AND CHARACTERISTICS

CLASS A₁ AMPLIFIER - EACH TRIODE UNIT

	12.6	6.3	12.6	6.3	
HEATER VOLTAGE	12.6	6.3	12.6	6.3	VOLTS
HEATER CURRENT	150	300	150	300	MA.
PLATE VOLTAGE	100		250		VOLTS
GRID VOLTAGE	-1		-2		VOLTS
PLATE CURRENT	0.5		1.2		MA.
PLATE RESISTANCE	80 000		62 500		OHMS
TRANSDUCTANCE	1 250		1 600		μMHOS
AMPLIFICATION FACTOR	100		100		

SIMILIAR TYPE REFERENCE: Characteristics somewhat similiar to types 6SL7GT and 12SL7GT.

CONTINUED FROM PRECEDING PAGE

RESISTANCE COUPLED AMPLIFIER

R ₁ MEG.	R _c MEG.	E _{bb} = 90 VOLTS			E _{bb} = 180 VOLTS			E _{bb} = 300 VOLTS		
		R _k	GAIN	E _o	R _k	GAIN	E _o	R _k	GAIN	E _o
0.1	0.22	4700	35 ^A	4	2000	47	18	1500	52	40
0.22	0.47	7400	45 ^B	6	3500	59	24	2800	65	49
0.47	1.0	13000	52 ^C	8	6700	66	28	5200	73	54

E_o IS RMS OUTPUT AT GRID CURRENT POINT.

GAIN MEASURED AT 5.0 VOLTS RMS OUTPUT EXCEPT AS INDICATED.

^A OUTPUT VOLTAGE OF 2 VOLTS RMS.

^B OUTPUT VOLTAGE OF 3 VOLTS RMS.

^C OUTPUT VOLTAGE OF 4 VOLTS RMS.

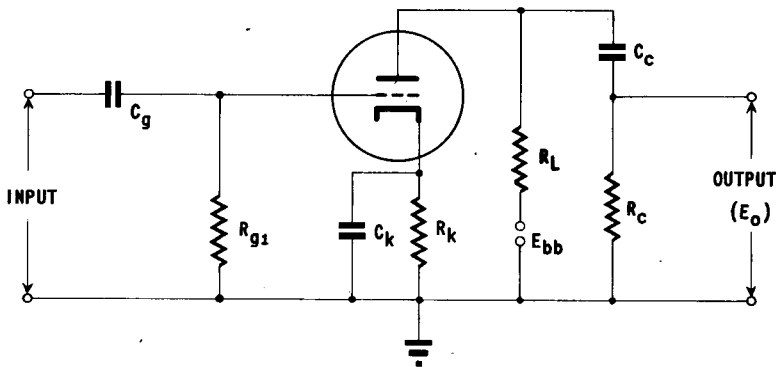

NOTE: COUPLING CAPACITORS C_g AND C_c SHOULD BE SELECTED TO GIVE DESIRED FREQUENCY RESPONSE. R_k SHOULD BE ADEQUATELY BY-PASSED BY CAPACITOR C_k.

12AX7

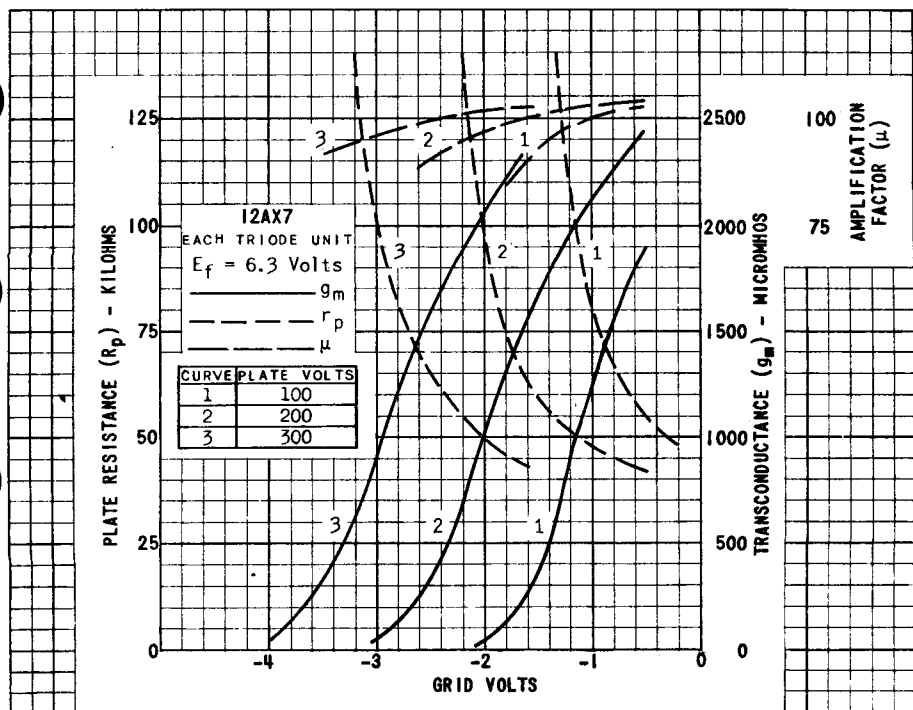
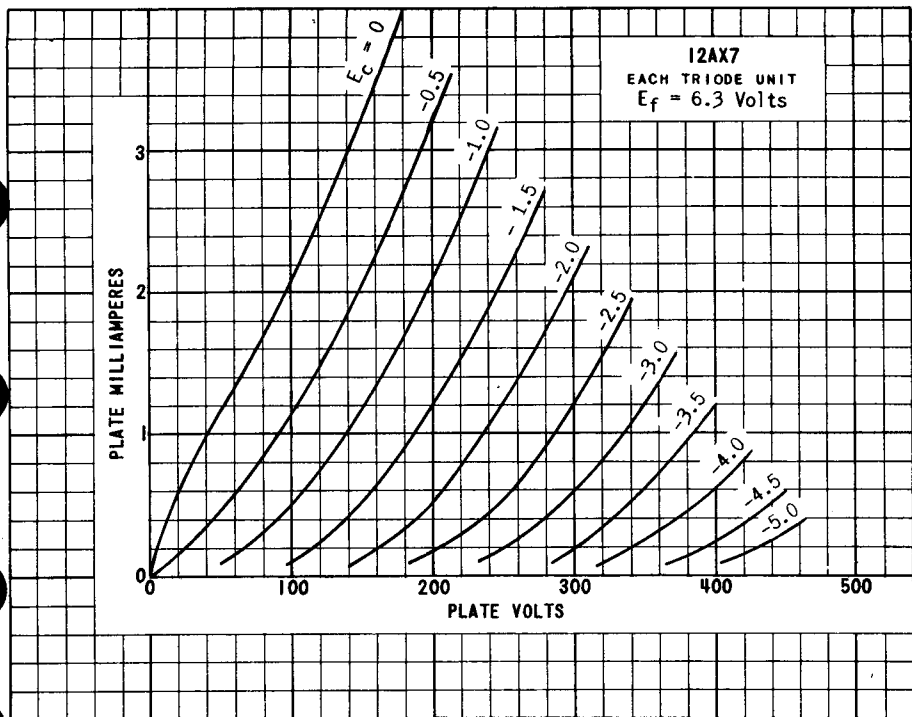

PRINTED IN U. S. A.

PLATE
1933
DEC. 1,
1947



TUNG-SOL

RF AMPLIFIER PENTODE

MINIATURE TYPE

UNIPOENTIAL CATHODE

HEATER

12.6 VOLTS 0.15 AMPERE

AC OR DC

ANY MOUNTING POSITION

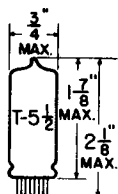

GLASS BULB

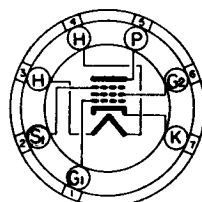

BOTTOM VIEW

MINIATURE BUTTON
7 PIN BASE

THE 12BA6 IS A PENTODE AMPLIFIER HAVING A REMOTE CONTROL GRID CHARACTERISTIC AND UTILIZING THE MINIATURE CONSTRUCTION. AS A RF AMPLIFIER IT IS CHARACTERIZED BY HIGH TRANSCONDUCTANCE AND LOW GRID-PLATE CAPACITANCE AND TRANSCONDUCTANCE.

RATINGS

. INTERPRETED ACCORDING TO RMA STANDARD MB-210

HEATER VOLTAGE	12.6	VOLTS
HEATER CURRENT	0.15	AMP.
MAXIMUM PLATE VOLTAGE	300	VOLTS
MAXIMUM SCREEN VOLTAGE	125	VOLTS
MAXIMUM SCREEN SUPPLY VOLTAGE	300	VOLTS
MAXIMUM GRID VOLTAGE:		
NEGATIVE BIAS	50	VOLTS
POSITIVE BIAS	0	VOLTS
MAXIMUM PLATE DISSIPATION	3	WATTS
MAXIMUM SCREEN DISSIPATION	0.6	WATTS
MAXIMUM PEAK HEATER-CATHODE VOLTAGE:		
HEATER NEG. WITH RESPECT TO CATHODE	90	VOLTS
HEATER POS. WITH RESPECT TO CATHODE	90	VOLTS

DIRECT INTERELECTRODE CAPACITANCES

WITH NO EXTERNAL SHIELD

GRID TO PLATE (MAX.)	0.0035	μmf
INPUT	5.5	μmf
OUTPUT	5.0	μmf

TYPICAL OPERATING CONDITIONS AND CHARACTERISTICS

CLASS A₁ AMPLIFIER

PLATE VOLTAGE	100	250	VOLTS
SCREEN VOLTAGE	100	100	VOLTS
CATHODE BIAS RESISTOR	68	68	OHMS
SUPPRESSOR VOLTAGE	0	0	VOLTS
PLATE CURRENT	10.8	11	MA.
SCREEN CURRENT	4.4	4.2	MA.
PLATE RESISTANCE (APPROX.)	0.25	1.5	MEGOMHS
TRANSCONDUCTANCE	4 300	4 400	μMHOS
GRID VOLTAGE (APPROX.) FOR TRANSCONDUCTANCE = 40 μMHOS	-20	-20	VOLTS

→ INDICATES A CHANGE OR ADDITION.

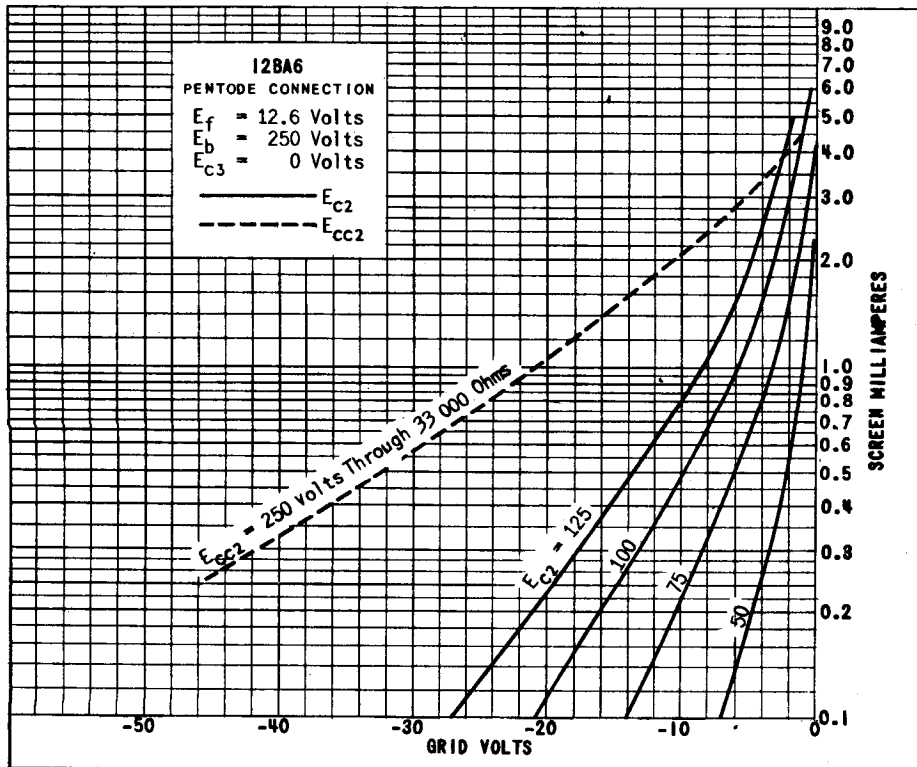
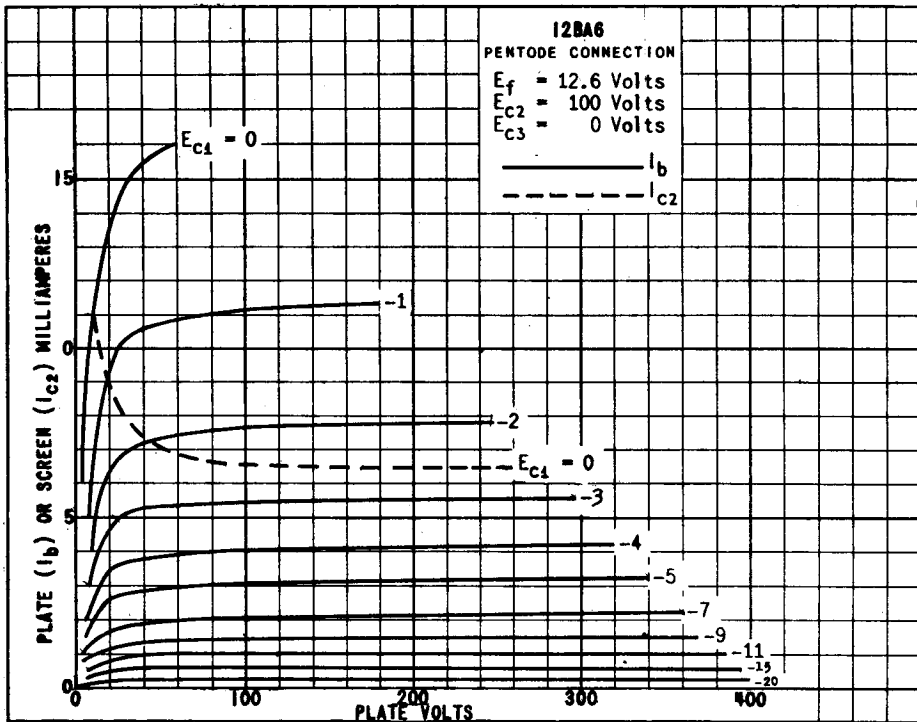
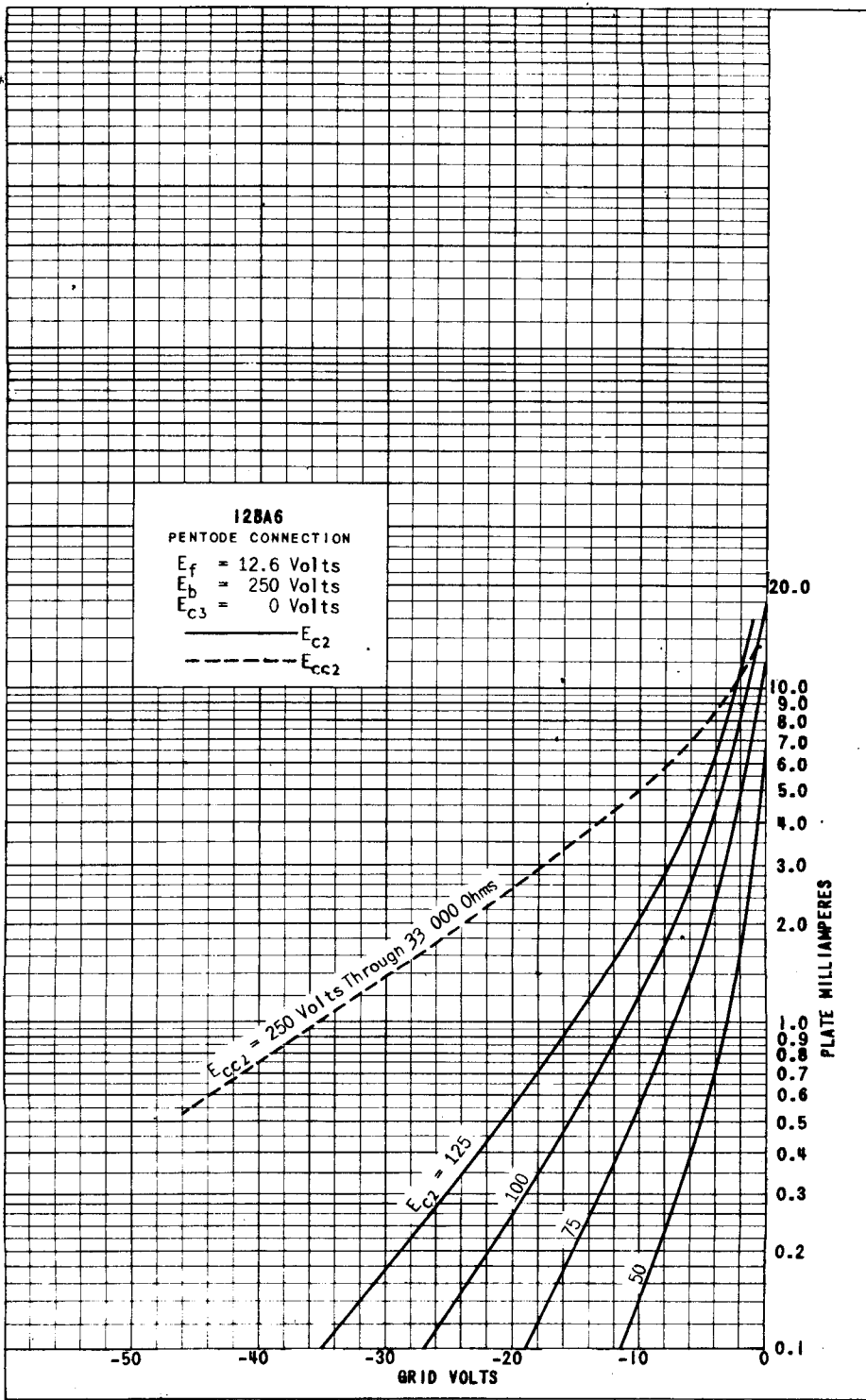

PLATE
1805
MAY 1
1947

12BA6
PENTODE CONNECTION

$E_f = 12.6$ Volts
 $E_b = 250$ Volts
 $E_{c3} = 0$ Volts

————— E_{c2}
 - - - - - E_{cc2}



PRINTED IN U. S. A.

PLATE
1806
MAY 1
1947

12BA6

12BA6
PENTODE CONNECTION

$E_f = 12.6$ Volts
 $E_b = 250$ Volts
 $E_{c3} = 0$ Volts

————— E_{c2}
 - - - - - E_{cc2}

$E_{cc2} = 250$ Volts Through 33,000 Ohms

$E_{c2} = 125$

100

75

25

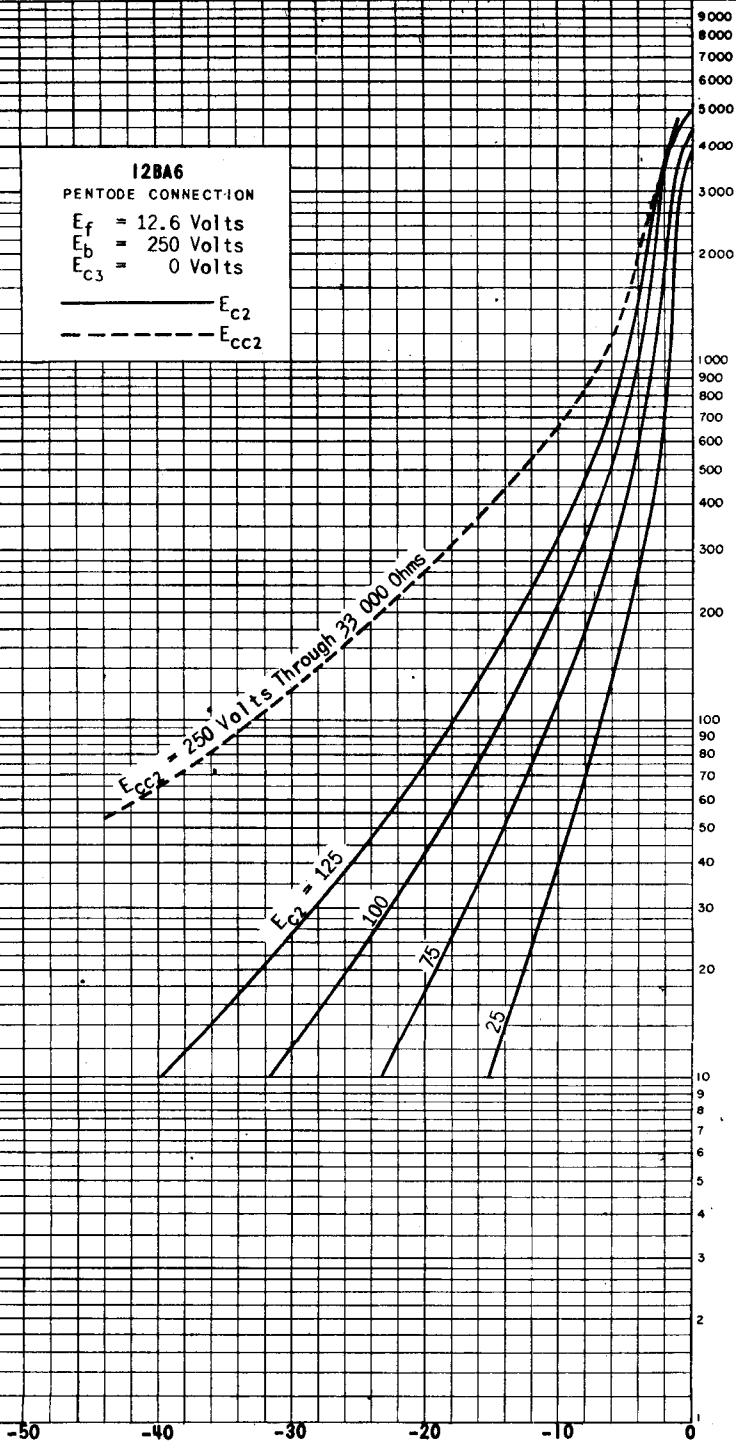

TRANSCONDUCTANCE (g_m) - MICROMHOS

-50 -40 -30 -20 -10 0

GRID VOLTS

PLATE
 1807
 MAY 1
 1947

TUNG-SOL

HEPTODE

MINIATURE TYPE

UNIPOTENTIAL CATHODE

HEATER

12.6 VOLTS 150 MA.

AC OR DC

ANY MOUNTING POSITION

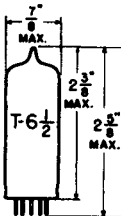

GLASS BULB

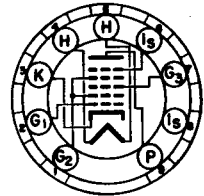

BOTTOM VIEW
SMALL BUTTON
9 PIN BASE

THE 12BA7 IS A CATHODE TYPE HIGH GAIN PENTAGRID CONVERTER IN THE SMALL 9-PIN BUTTON CONSTRUCTION. IT IS DESIGNED FOR SERVICE AS A COMBINED LOCAL OSCILLATOR AND MIXER AT HIGH FREQUENCIES, ESPECIALLY IN THE FM BROADCAST BAND.

DIRECT INTERELECTRODE CAPACITANCES
WITH NO EXTERNAL SHIELD

GRID #3 TO PLATE: (G ₃ TO P) MAX.	0.19	μf
GRID #1 TO GRID #3: (G ₁ TO G ₃) MAX.	0.1	μf
GRID #1 TO PLATE: (G ₁ TO P) MAX.	0.05	μf
GRID #1 TO CATHODE: (G ₁ TO K)	3.3	μf
GRID #1 TO ALL EXCEPT CATHODE: G ₁ TO (H+G ₂ +G ₄ +G ₃ +G ₅ +P+IS)	3.4	μf
CATHODE TO ALL EXCEPT GRID #1: K TO (H+G ₂ +G ₄ +G ₃ +G ₅ +P+IS)	4	μf
RF INPUT: G ₃ TO (H+K+G ₁ +G ₂ +G ₄ +G ₅ +P+IS)	9.5	μf
OSCILLATOR INPUT: G ₁ TO (H+K+G ₂ +G ₄ +G ₃ +G ₅ +P+IS)	6.7	μf
MIXER OUTPUT: P TO (H+K+G ₁ +G ₂ +G ₄ +G ₃ +G ₅ +IS)	8.3	μf

RATINGS

INTERPRETED ACCORDING TO RMA STANDARD MB-210

HEATER VOLTAGE	12.6	VOLTS
MAXIMUM HEATER-CATHODE VOLTAGE	90	VOLTS
MAXIMUM PLATE VOLTAGE	300	VOLTS
MAXIMUM GRIDS #2 & #4 VOLTAGE	100	VOLTS
MAXIMUM GRIDS #2 & #4 SUPPLY VOLTAGE	300	VOLTS
MAXIMUM NEGATIVE GRID #3 VOLTAGE	100	VOLTS
MAXIMUM POSITIVE GRID #3 VOLTAGE	0	VOLTS
MAXIMUM GRID #5 & INTERNAL SHIELD VOLTAGE ^A	0	VOLTS
MAXIMUM PLATE DISSIPATION	2	WATTS
MAXIMUM GRIDS #2 & #4 DISSIPATION	1.5	WATTS
MAXIMUM CATHODE CURRENT	22	MA.

^A INTERNAL SHIELD (PINS #6 AND #8) CONNECTED DIRECTLY TO GROUND.

PLATE
2086

OCT. 1,
1948

CONTINUED ON FOLLOWING PAGE

TUNG-SOL

CONTINUED FROM PRECEDING PAGE

TYPICAL OPERATING CONDITIONS AND CHARACTERISTICS

CONVERTER SERVICE - SEPARATE EXCITATION

THE CHARACTERISTICS SHOWN WITH SEPARATE EXCITATION
CORRESPOND VERY CLOSELY WITH THOSE OBTAINED IN A
SELF-EXCITED OSCILLATOR CIRCUIT OPERATING WITH ZERO
BIAS.

HEATER VOLTAGE	12.6	12.6	VOLTS
HEATER CURRENT	150	150	MA.
PLATE VOLTAGE	100	250	VOLTS
GRIDS #2 & #4 VOLTAGE	100	100	VOLTS
GRID #3 VOLTAGE	-1	-1	VOLTS
GRID #5 AND INTERNAL SHIELD ^A	CONNECTED DIRECTLY TO GROUND		
GRID #1 RESISTOR	20 000	20 000	OHMS
PLATE RESISTANCE (APPROX.)	0.5	1	MEGOHM
CONVERSION TRANSCONDUCTANCE	900	950	μMHOS
PLATE CURRENT	3.6	3.8	MA.
GRIDS #2 & #4 CURRENT	10.2	10	MA.
GRID #1 CURRENT	0.35	0.35	MA.
TOTAL CATHODE CURRENT	14.2	14.2	MA.
CONVERSION TRANSCONDUCTANCE WITH $E_{C3} = -20$ VOLTS	3.5	3.5	μMHOS

^A INTERNAL SHIELD (PINS #6 AND #8) CONNECTED DIRECTLY TO GROUND.

OSCILLATOR TRANSCONDUCTANCE
NOT OSCILLATING

GRID #3 VOLTAGE	0	VOLTS
GRID #1 VOLTAGE	0	VOLTS
GRIDS #2 & #4 CONNECTED TO PLATE	100	VOLTS
PLATE CURRENT	32	MA.
TRANSCONDUCTANCE BETWEEN GRID #1 & GRIDS #2 & #4 CONNECTED TO PLATE	8 000	μMHOS
AMPLIFICATION FACTOR	16.5	

SIMILAR TYPE REFERENCE: Except for heater ratings similar to 6SB7Y.

PLATE
2007
OCT. 1,
1948

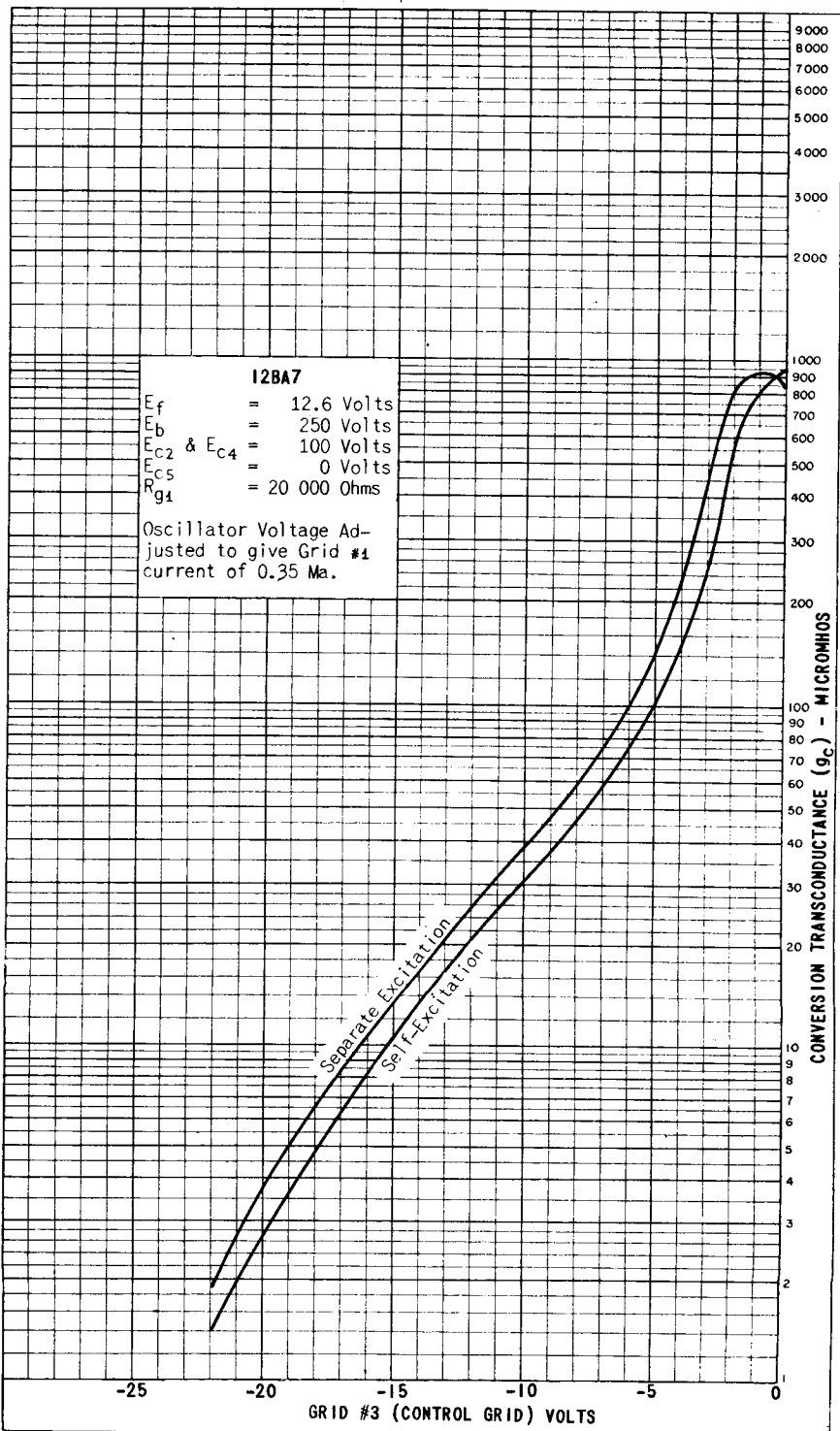

PRINTED IN U. S. A.

PLATE 2088
OCT. 1, 1948

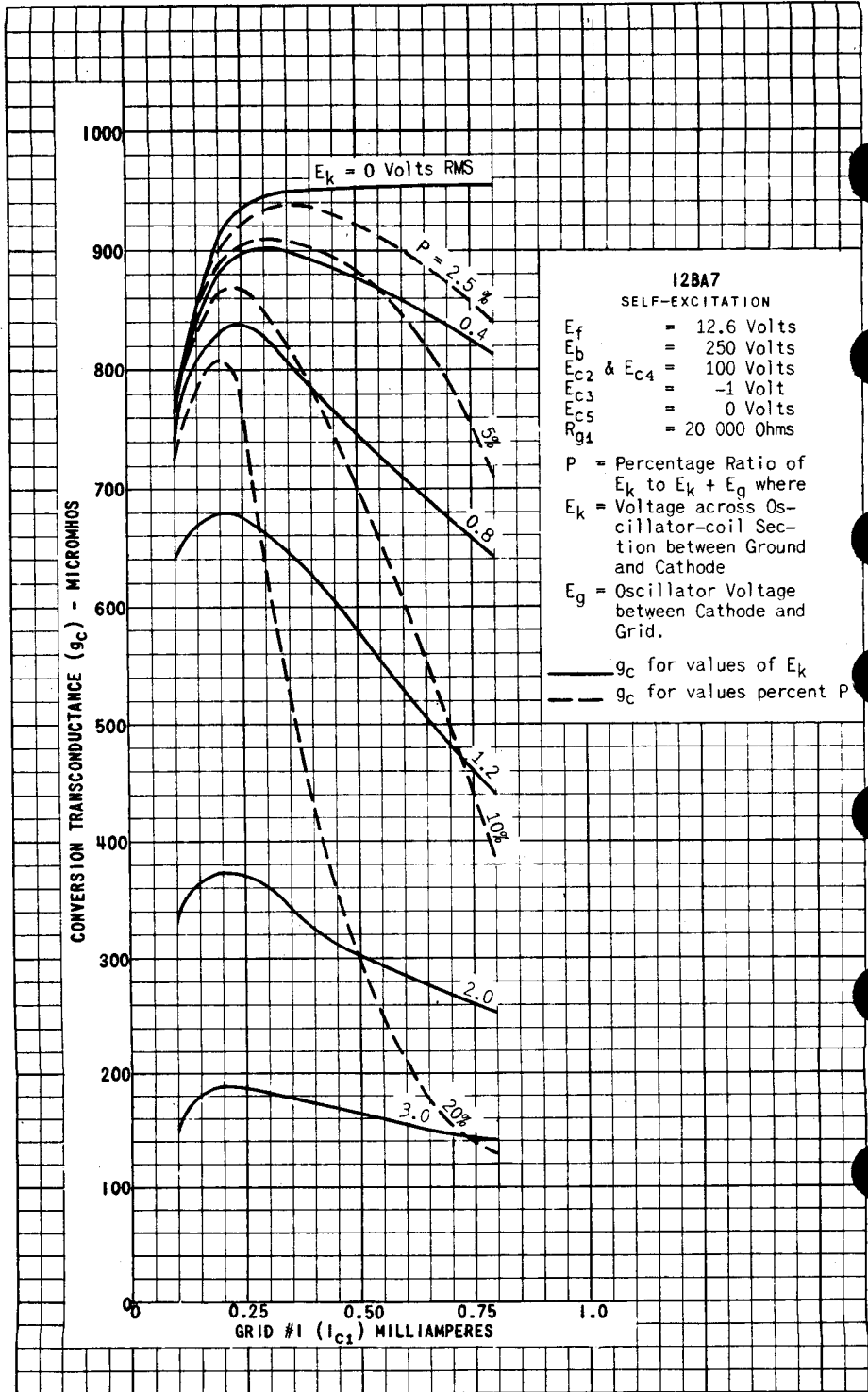

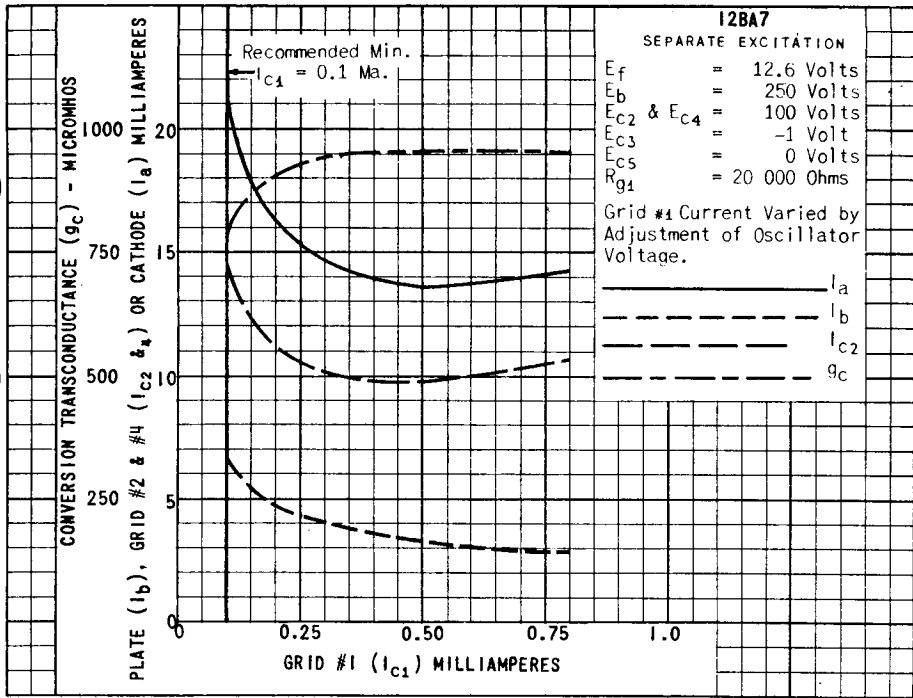

PRINTED IN U. S. A.

PLATE
2090
OCT. 1,
1948



TUNG-SOL

HEPTODE

MINIATURE TYPE

COATED UNIPOTENTIAL CATHODE

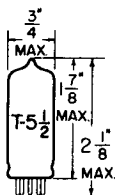

GLASS BULB

HEATER

12.6 VOLTS 0.15 AMPERE

ANY MOUNTING POSITION

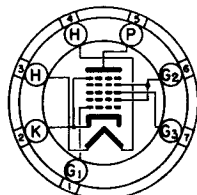
 BOTTOM VIEW
 MINIATURE BUTTON
 7 PIN BASE

THE 12BE6 IS A PENTAGRID CONVERTER USING THE MINIATURE CONSTRUCTION AND INTENDED FOR SERVICE AS COMBINED OSCILLATOR AND MIXER IN SUPERHETERODYNE RECEIVERS.

DIRECT INTERELECTRODE CAPACITANCES

WITH EXTERNAL SHIELD #316 CONNECTED TO PIN #2

SIGNAL GRID TO PLATE: (G_3 TO P) MAX. (WITHOUT SHIELD)	0.30	μuf
SIGNAL GRID TO OSC. GRID: (G_3 TO G_4) MAX.	0.15	μuf
OSC. GRID TO PLATE: (G_4 TO P) MAX.	0.05	μuf
RF INPUT: G_3 TO ($H+K+G_5+G_1+G_2+G_4+P$)	7.4	μuf
OSC. INPUT: G_4 TO ($H+K+G_5+G_2+G_4+G_3+P$)	5.7	μuf
MIXER OUTPUT: P TO ($H+K+G_5+G_1+G_2+G_4+G_3$)	13.6	μuf
OSC. GRID TO CATHODE: (G_4 TO K)	2.8	μuf
OSC. OUTPUT: K TO ($H+G_2+G_4+G_3+P+S$)	15.5	μuf

RATINGS

INTERPRETED ACCORDING TO RMA STANDARD M8-210

HEATER VOLTAGE	12.6	VOLTS
MAXIMUM HEATER-CATHODE VOLTAGE	90	VOLTS
MAXIMUM PLATE VOLTAGE	300	VOLTS
MAXIMUM GRID #2 AND #4 VOLTAGE	100	VOLTS
MAXIMUM GRID #2 AND #4 SUPPLY VOLTAGE	300	VOLTS
MAXIMUM NEGATIVE DC GRID #3 VOLTAGE	50	VOLTS
MAXIMUM POSITIVE DC GRID #3 VOLTAGE	0	VOLTS
MINIMUM GRID #3 EXTERNAL BIAS-VOLTAGE ^A	0	VOLTS
MAXIMUM PLATE DISSIPATION	1	WATT
MAXIMUM GRID #2 DISSIPATION	1	WATT
MAXIMUM CATHODE CURRENT	14	MA.

^A WITH SELF-EXCITED OSCILLATOR

CONTINUED ON FOLLOWING PAGE

→ INDICATES A CHANGE OR ADDITION

TUNG-SOL

CONTINUED FROM PRECEDING PAGE

TYPICAL OPERATING CONDITIONS AND CHARACTERISTICS

CONVERTER SERVICE - SEPARATE EXCITATION

CHARACTERISTICS SHOWN ARE OBTAINED IN THE STANDARD RMA CONVERSION CONDUCTANCE TEST SET WHICH USES SEPARATE EXCITATION. THE CHARACTERISTICS UNDER THESE CONDITIONS CORRESPOND VERY CLOSELY WITH THOSE OBTAINED IN A SELF-EXCITED OSCILLATORY CIRCUIT OPERATING AT ZERO-BIAS.

HEATER VOLTAGE	12.6	12.6	VOLTS
HEATER CURRENT	150	150	MA.
PLATE VOLTAGE	100	250	VOLTS
GRID #3 VOLTAGE	-1.5	-1.5	VOLTS
GRID #2 AND #4 VOLTAGE	100	100	VOLTS
PLATE RESISTANCE (APPROX.)	0.5	1	MEGOHM
OSCILLATOR (GRID #1) RESISTOR	20 000	20 000	OHMS
OSCILLATOR (GRID #1) CURRENT	0.5	0.5	MA.
CONVERSION TRANSCONDUCTANCE	455	475	μMHOS
PLATE CURRENT	2.8	3	MA.
GRID #2 AND #4 CURRENT	8	7.8	MA.
GRID #3 VOLTAGE (APPROX.) FOR G _c = 5 μMHOS	-30	-30	VOLTS

OSCILLATOR CHARACTERISTICS

BOOTON TYPE 10A STANDARD OSCILLATOR

PLATE VOLTAGE	100	250	VOLTS
GRIDS #2 AND #4 VOLTAGE	100	100	VOLTS
GRID #3 VOLTAGE	0	0	VOLTS
OSCILLATOR (GRID #1) RESISTOR	50 000	50 000	OHMS
OSCILLATOR (GRID #1) CURRENT FOR Z _{g-k} = 3100 OHMS	200	200	μA
OSCILLATOR (GRID #1) CURRENT FOR Z _{g-k} = 1250 OHMS	75	75	μA

OSCILLATOR TRANSCONDUCTANCE

NOT OSCILLATING

GRID #3 VOLTAGE	0	VOLTS
OSCILLATOR (GRID #1) VOLTAGE	0	VOLTS
GRID #2 AND #4 CONNECTED TO PLATE	100	VOLTS
PLATE CURRENT	25	MA.
TRANSCONDUCTANCE BETWEEN GRID #1 AND GRID #2 & #4 CONNECTED TO PLATE	7 250	μMHOS
AMPLIFICATION FACTOR	20	

→ INDICATES A CHANGE OR ADDITION

PLATE
2060
AUG. 2,
1948

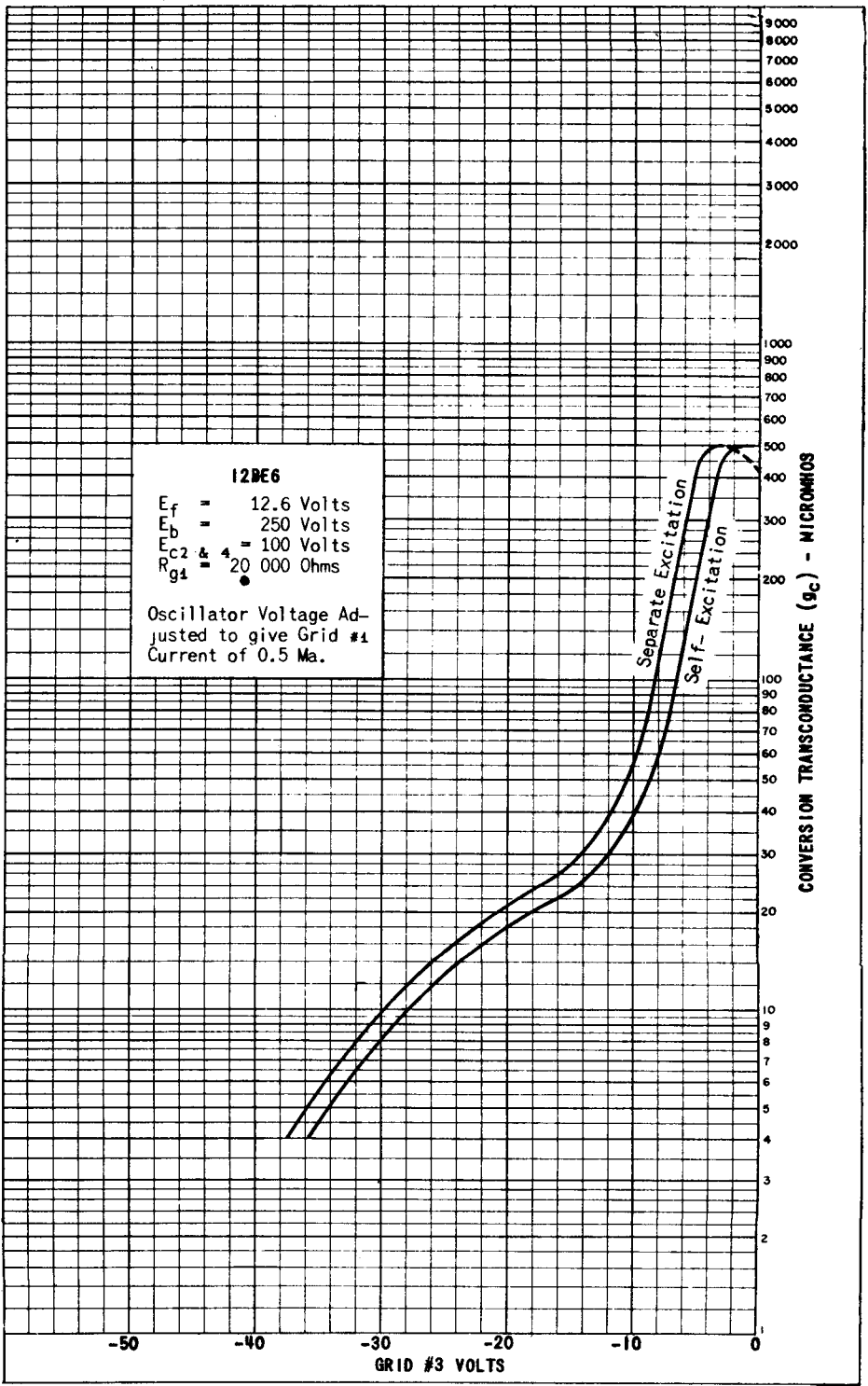

PRINTED IN U. S. A.

PLATE 2061
AUG. 2, 1948

12BE6 (6BE6)

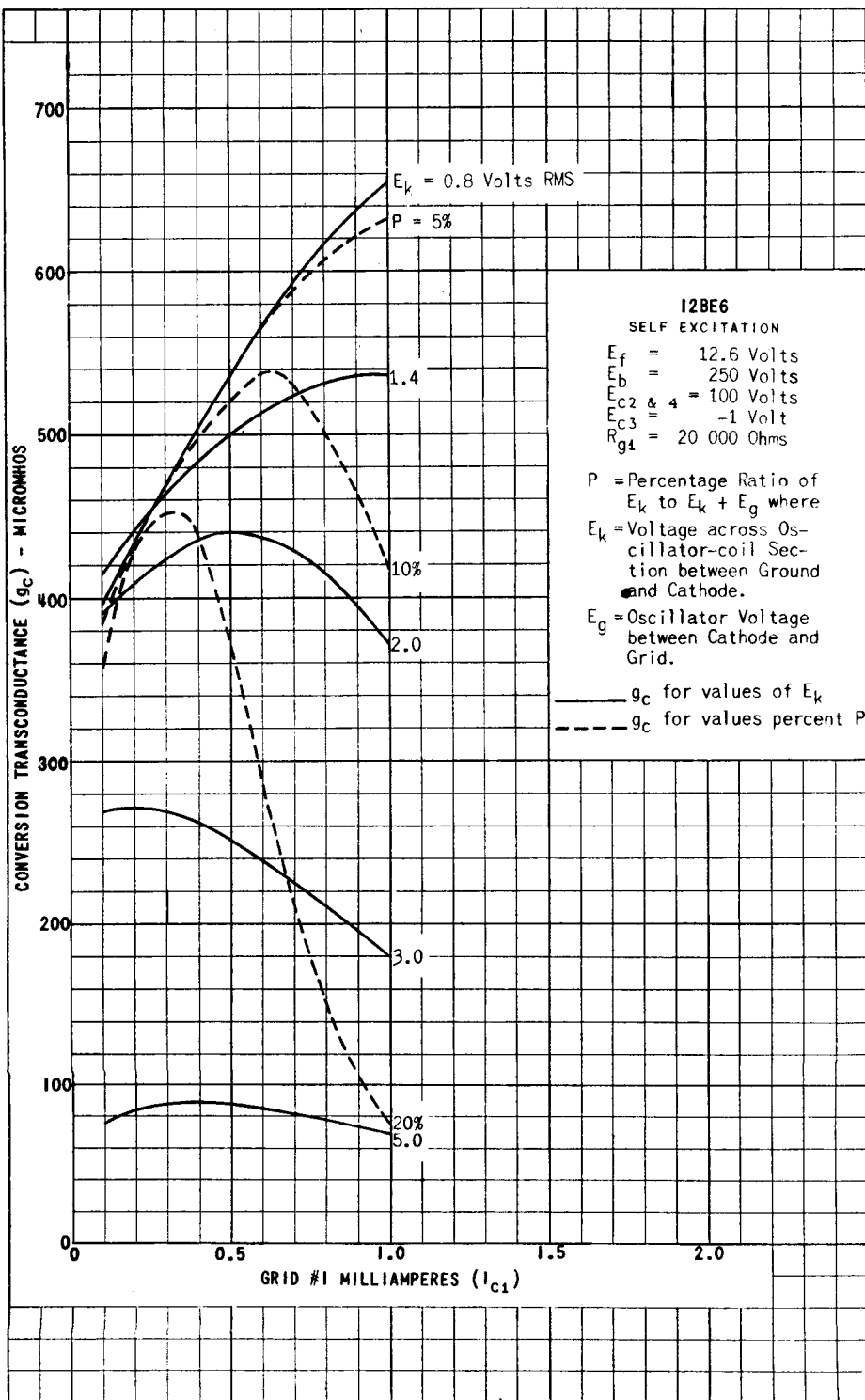

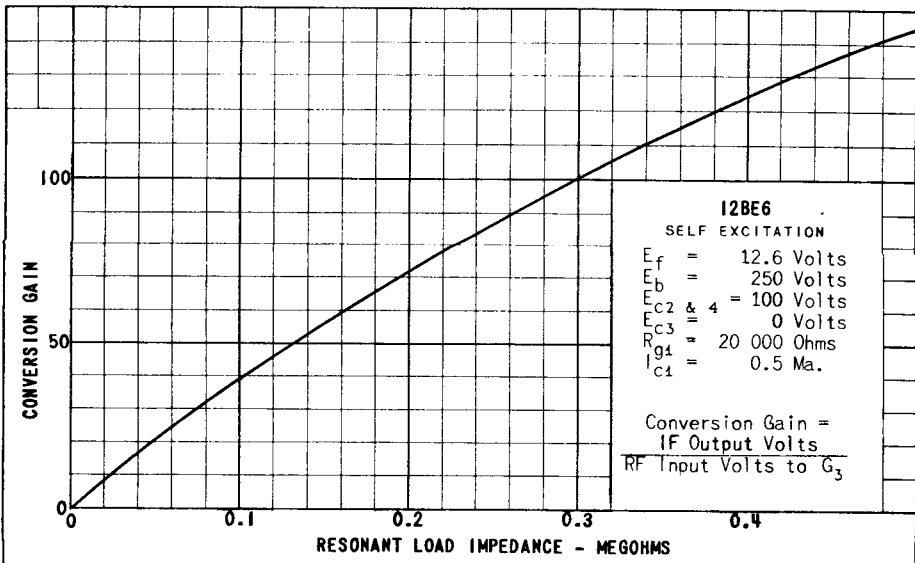
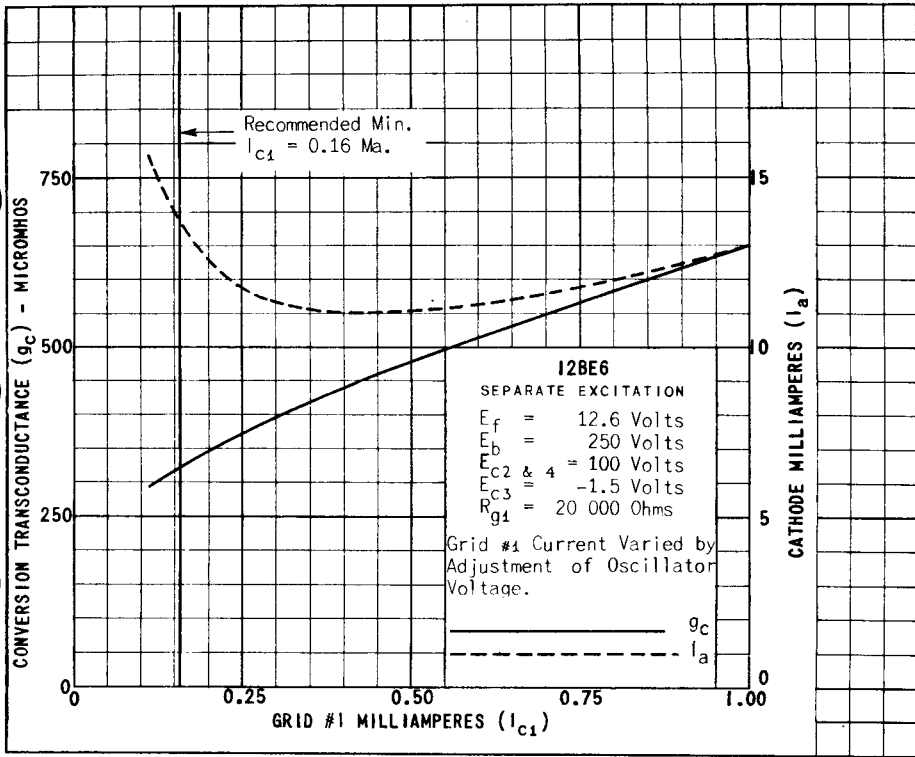

PRINTED IN U. S. A.

PLATE
2063
AUG. 2,
1948



TUNG-SOL

RF PENTODE AMPLIFIER

MINIATURE TYPE

PHYSICAL SPECIFICATIONS

EMITTER CATHODE		PIN CONNECTIONS	
BASE MINIATURE BUTTON 7-PIN	PIN 1 GRID 1	PIN 7 CATHODE	
CAP ---	PIN 2 SI, GRID 3	PIN 8 NONE	
BULB T-5 $\frac{1}{2}$	PIN 3 HEATER		
MAXIMUM DIAMETER 3/4"	PIN 4 HEATER	MOUNTING POS. ANY	
MAXIMUM OVERALL LENGTH 2 1/8"	PIN 5 PLATE		
MAXIMUM SEATED HEIGHT 1 7/8"	PIN 6 GRID 2		

RATINGS

INTERPRETED ACCORDING TO RMA STANDARD M8-210

HEATER OR FILAMENT VOLTAGE (AC OR DC)	12.6	VOLTS
HEATER OR FILAMENT CURRENT	0.150	AMP.
MAXIMUM PLATE VOLTAGE	300	VOLTS
MAXIMUM SCREEN VOLTAGE	125	VOLTS
MAXIMUM PLATE DISSIPATION	4.0	WATTS
MAXIMUM SCREEN DISSIPATION	0.4	WATT
MAXIMUM CATHODE CURRENT	14	MA.

CAPACITANCES

	WITH RMA MIN. SHIELD CONNECTED TO CATHODE	WITHOUT SHIELD
CONTROL GRID TO ALL OTHER ELECTRODES	4.3	4.3 μ lf
PLATE TO ALL OTHER ELECTRODES	5.0	5.0 μ lf
CONTROL GRID TO PLATE (MAX.)	0.005	0.004 μ lf

TYPICAL OPERATING CONDITIONS AND CHARACTERISTICS

HEATER OR FILAMENT VOLTAGE	12.6	12.6	VOLTS
HEATER OR FILAMENT CURRENT	0.150	0.150	AMP.
PLATE VOLTAGE	100	250	VOLTS
SCREEN VOLTAGE	100	100	VOLTS
CONTROL GRID VOLTAGE	-1	-3	VOLTS
PEAK AF SIGNAL VOLTAGE			VOLTS
PLATE CURRENT	13	9	MA.
SCREEN CURRENT	5	3.5	MA.
MAXIMUM-SIGNAL PLATE CURRENT			MA.
MAXIMUM-SIGNAL SCREEN CURRENT			MA.
PLATE RESISTANCE	0.12	0.7	MEGOHM
TRANSCONDUCTANCE	2350	2000	μ MHOS
AMPLIFICATION FACTOR			
LOAD RESISTANCE			OHMS
TOTAL HARMONIC DISTORTION			PER CENT
POWER OUTPUT			WATTS
CONTROL GRID VOLTAGE (APPROX.) FOR TRANSCONDUCTANCE = 10 μ MHOS	-35	-35	VOLTS

PLATE
1724
JUNE 17
1946



TUNG-SOL

PENTAGRID CONVERTER
MINIATURE TYPE

PHYSICAL SPECIFICATIONS

EMITTER UNIPOTENTIAL CATHODE		PIN CONNECTIONS	
BASE	MIN. BUTTON 7-PIN	PIN 1 GRID 1	PIN 7 GRID 3
CAP	NONE	PIN 2 GRID 5, CATHODE	PIN 8 NONE
BULB	T-5 $\frac{1}{2}$	PIN 3 HEATER	
MAX. DIAMETER	$\frac{3}{4}$ "	PIN 4 HEATER	MOUNTING POS. ANY
MAX. SEATED HEIGHT	1- $\frac{7}{8}$ "	PIN 5 PLATE	
MAX. OVERALL LENGTH	2- $\frac{1}{8}$ "	PIN 6 GRID 2, GRID 4	

RATINGS

INTERPRETED ACCORDING TO RMA STANDARD W8-210

HEATER OR FILAMENT VOLTAGE (AC OR DC)	12.6	VOLTS
HEATER OR FILAMENT CURRENT	0.15	AMPS.
MAXIMUM PLATE VOLTAGE	300	VOLTS
MAXIMUM PLATE DISSIPATION	1.0	WATT.
MAXIMUM TOTAL CATHODE CURRENT	14	MA.
MAXIMUM GRID VOLTAGE (G_2 & G_4)	100	VOLTS
MAXIMUM GRID SUPPLY VOLTAGE (G_2 & G_4)	300	VOLTS
MAXIMUM GRID DISSIPATION (G_2 & G_4)	1.0	WATT
MAXIMUM PEAK HEATER-CATHODE VOLTAGE:		
HEATER NEG. WITH RESPECT TO CATHODE	90	VOLTS
HEATER POS. WITH RESPECT TO CATHODE	90	VOLTS
MAXIMUM GRID 3 VOLTAGE:		
NEG. BIAS	50	VOLTS
POS. BIAS	0	VOLTS

CAPACITANCES

WITH NO EXTERNAL SHIELD

G_3 TO PLATE (C_{G3P}) (MAX.)	0.30	μ lf
G_4 TO PLATE (C_{G4P}) (MAX.)	0.05	μ lf
G_1 TO G_3 (C_{G1G3}) (MAX.)	0.15	μ lf
G_3 TO ALL OTHER ELECTRODES (RF INPUT)		
(C_{G3} ($H+K+G_1+G_2+G_4+G_5$))	7.2	μ lf
PLATE TO ALL OTHER ELECTRODES (MIXER OUTPUT)		
C_p ($H+K+G_1+G_2+G_3+G_4+G_5$)	8.6	μ lf
GRID NO. 1 TO ALL OTHER ELECTRODES		
(OSCILLATOR INPUT) C_{G1} ($H+K+G_2+G_3+G_4+G_5+P$)	5.5	μ lf
GRID NO. 1 TO ALL OTHER ELECTRODES EXCEPT		
CATHODE C_{G1} ($H+G_2+G_3+G_4+G_5+P$)	2.7	μ lf
GRID NO. 1 TO CATHODE (C_{G1K})		
CATHODE TO ALL OTHER ELECTRODES EXCEPT G_1	2.8	μ lf
C_K ($H+G_2+G_3+G_4+G_5+P$)	15	μ lf

CONTINUED ON FOLLOWING PAGE

TUNG-SOL

CONTINUED FROM PRECEDING PAGE

TYPICAL OPERATING CONDITIONS AND CHARACTERISTICS
 CONVERTER SERVICE - SEPARATE EXCITATION

PLATE VOLTAGE	100	250	VOLTS
SCREEN GRID VOLTAGE (G_2 & G_4)	100	100	VOLTS
CONTROL GRID VOLTAGE (G_3)	-1.5	-1.5	VOLTS
PLATE CURRENT	2.8	3.0	MA.
SCREEN GRID CURRENT (G_2 & G_4)	7.3	7.1	MA.
TOTAL CATHODE CURRENT	10.6	10.6	MA.
OSCILLATOR-GRID (G_1) RESISTOR	20 000	20 000	OHMS
CONVERSION TRANSCONDUCTANCE	455	475	UMHOS
PLATE RESISTANCE (APPROX.)	0.5	1.0	MEGOHM
CONVERSION TRANSCONDUCTANCE FOR G_3 BIAS OF -30 VOLTS (APPROX.)	4.0	4.0	UMHOS
GRID (G_1) CURRENT	0.5	0.5	MA.

NOTE: (1) THE CHARACTERISTICS SHOWN WITH SEPARATE EXCITATION CORRESPOND VERY CLOSELY WITH THOSE OBTAINED IN A SELF-EXCITED OSCILLATOR CIRCUIT OPERATING WITH ZERO BIAS.

(2) THE TRANSCONDUCTANCE BETWEEN GRID 1 AND GRIDS 2 & 4 CONNECTED TO PLATE (NOT OSCILLATING) IS APPROXIMATELY 7250 MICROMHOS UNDER THE FOLLOWING CONDITIONS: GRIDS NO. 1 & NO. 3 AT 0 VOLTS; GRIDS NO. 2 & NO. 4 AND PLATE AT 100 VOLTS. UNDER THE SAME CONDITIONS, THE PLATE CURRENT IS 25 MA., AND THE AMPLIFICATION FACTOR IS 20.

TUNG-SOL

DOUBLE-DIODE TRIODE

MINIATURE TYPE

UNIPOENTIAL CATHODE

HEATER

12.6 VOLTS 0.15 AMPERE

AC OR DC

ANY MOUNTING POSITION

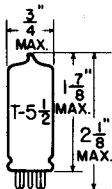

GLASS BULB

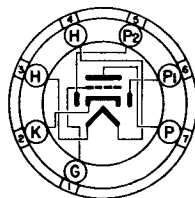

BOTTOM VIEW
MINIATURE BUTTON
7 PIN BASE

THE 12BF6 IS A COMBINED LOW-MU VOLTAGE AMPLIFIER AND DOUBLE-DIODE DETECTOR USING THE 7-PIN MINIATURE CONSTRUCTION. THE LOW AMPLIFICATION FACTOR OF THE TRIODE PERMITS LARGE VALUES OF OUTPUT SIGNAL WITH LOW DISTORTION.

DIRECT INTERELECTRODE CAPACITANCES

	WITH EXTERNAL SHIELD	WITH NO EXTERNAL SHIELD	
GRID TO PLATE: (G TO P)	2.0	2.0	μuf
INPUT: G TO (H + K)	1.8	1.8	μuf
OUTPUT: P TO (H + K)	1.4	1.1	μuf

RATINGS

INTERPRETED ACCORDING TO RMA STANDARD M8-210

HEATER VOLTAGE	12.6	VOLTS
MAXIMUM HEATER-CATHODE VOLTAGE	90	VOLTS
MAXIMUM PLATE VOLTAGE	300	VOLTS
MAXIMUM PLATE DISSIPATION	2.5	WATTS
MINIMUM DIODE CURRENT WITH 10 VOLTS DC APPLIED (EACH DIODE)	0.8	MA.

TYPICAL OPERATING CONDITIONS AND CHARACTERISTICS

CLASS A₁ AMPLIFIER - TRIODE UNIT

HEATER VOLTAGE	12.6	VOLTS
HEATER CURRENT	0.15	AMP.
PLATE VOLTAGE	250	VOLTS
GRID VOLTAGE	-9	VOLTS
PLATE CURRENT	9.5	MA.
PLATE RESISTANCE	8 500	OHMS
TRANSCONDUCTANCE	1 900	μMHOS
AMPLIFICATION FACTOR	16	
LOAD RESISTANCE	10 000	OHMS
TOTAL HARMONIC DISTORTION	6.5	PERCENT
POWER OUTPUT	0.3	WATTS

DIODE UNITS - TWO

THE CATHODE OF THE 12BF6 IS COMMON TO THE TWO DIODE PLATES AND THE TRIODE UNIT. DIODE BIASING OF THE TRIODE UNIT OF THE 12BF6 IS NOT SUITABLE.

SIMILAR TYPE REFERENCE: Ratings and characteristics identical to 12SR7. Except for heater ratings identical to 6R7, 6R7GT, 6SR7, 6SR7GT.

→ INDICATES A CHARGE OR ADDITION.

PRINTED IN U. S. A.

PLATE
1849
JULY 1,
1947

12BF6

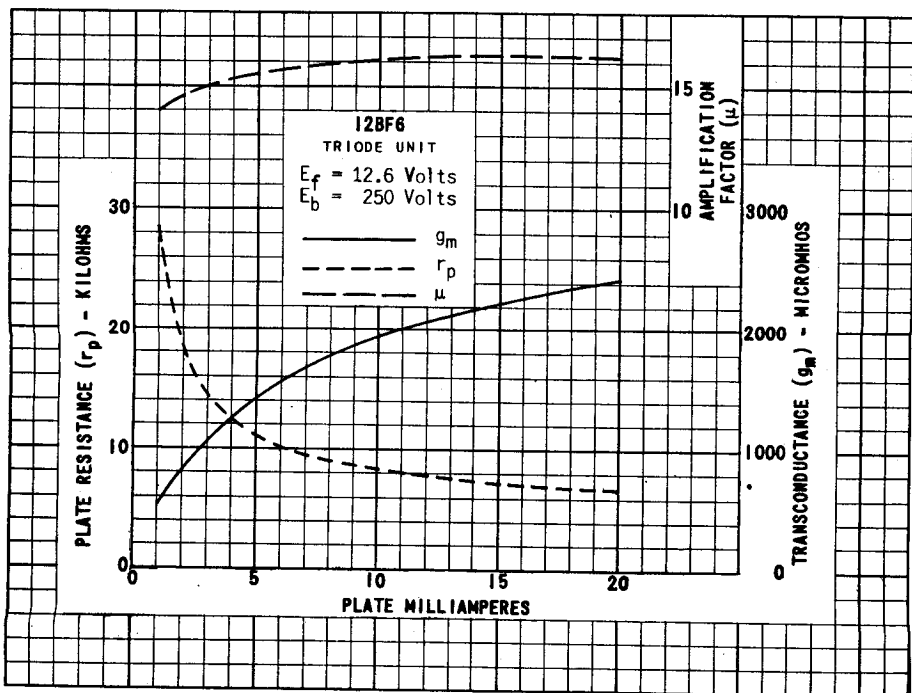
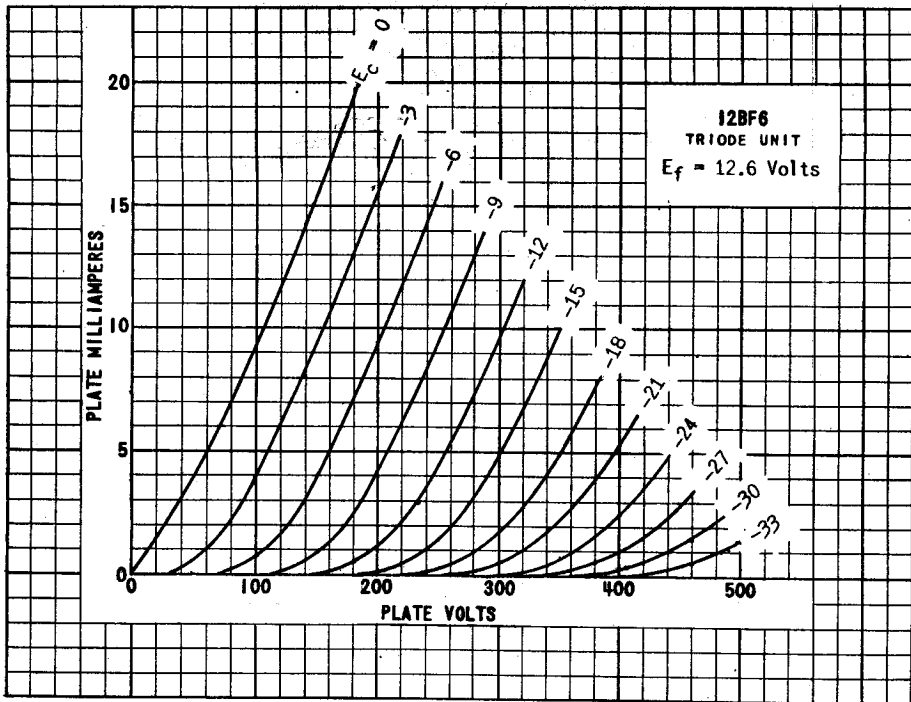
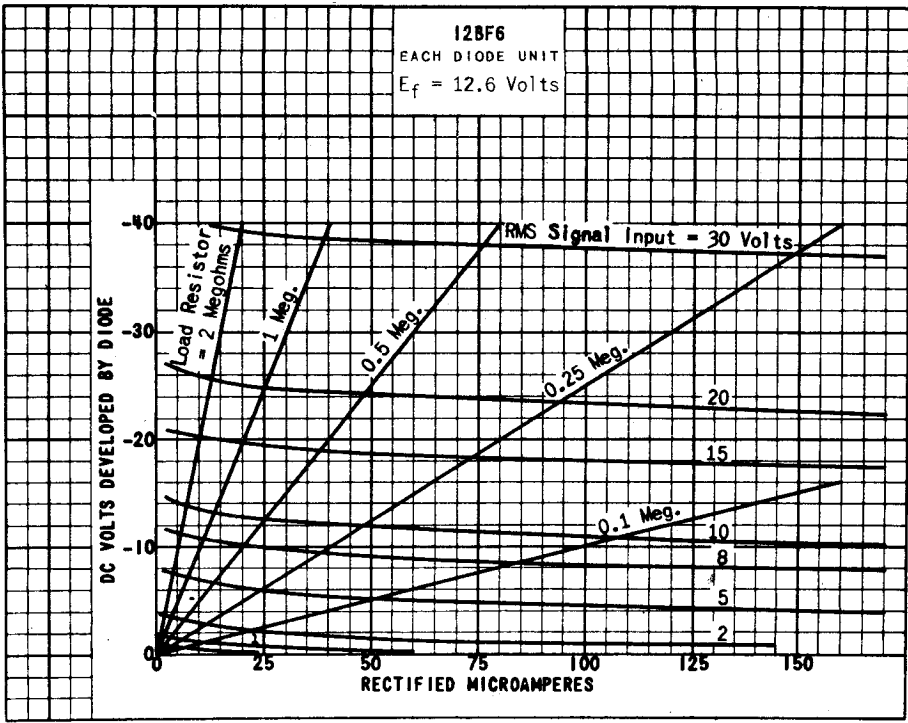

PLATE 1850
JULY 1, 1947



PRINTED IN U.S.A.

PLATE
1851
JULY 1,
1947



TUNG-SOL

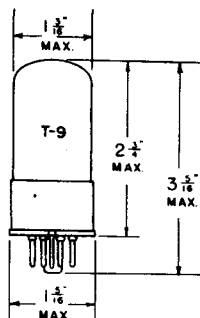

TRIODE AMPLIFIER

UNIPOENTIAL CATHODE

HEATER
12.6 VOLTS 0.15 AMPERE
AC OR DC

GLASS BULB

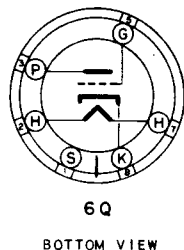

SMALL WAFER 6 PIN OCTAL BASE WITH METAL SHELL

THE TUNG-SOL 12E5GT IS A GENERAL PURPOSE TRIODE DESIGNED FOR SERVICE AS AN OSCILLATOR, DETECTOR OR AMPLIFIER. WITH THE EXCEPTION OF HEATER RATINGS, ITS ELECTRICAL CHARACTERISTICS ARE IDENTICAL WITH THOSE OF THE 76 AND THE 6P5GT.

OPERATING CONDITIONS AND CHARACTERISTICS

CLASS A₁ AMPLIFIER

PLATE VOLTAGE	100	250 ^{MAX.}	VOLTS
GRID VOLTAGE	-5	-13.5	VOLTS
GRID CIRCUIT RESISTANCE ^{MAX.}	1	1	MEGOHM
PLATE CURRENT	2.5	5.0	MA.
PLATE RESISTANCE	12 000	9500	OHMS
TRANSCONDUCTANCE	1150	1450	μMHOS
AMPLIFICATION FACTOR	13.8	13.8	

DETECTOR

	BIASED		GRID LEAK	
PLATE VOLTAGE	100	250	45	VOLTS
GRID VOLTAGE	-8	-20	RETURN TO CATHODE	VOLTS
PLATE CURRENT	ADJUST TO 0.2 MA. WITH NO INPUT SIGNAL		-	
GRID LEAK	-	-	1 TO 5	MEGOHMS
GRID CONDENSER	-	-	250	μμf

RESISTANCE COUPLED AMPLIFIER

PLATE SUPPLY VOLTAGE	100	100	250	250	VOLTS
PLATE LOAD RESISTOR	0.05	0.25	0.05	0.25	MEGOHM
CATHODE RESISTOR	3800	15 000	3800	15 000	OHMS
VOLTAGE GAIN	8.5	10	9	10	

DIRECT INTERELECTRODE CAPACITANCES

GRID TO CATHODE	3.6	μμf
PLATE TO CATHODE	2.6	μμf
GRID TO PLATE	2.8	μμf

12E5GT

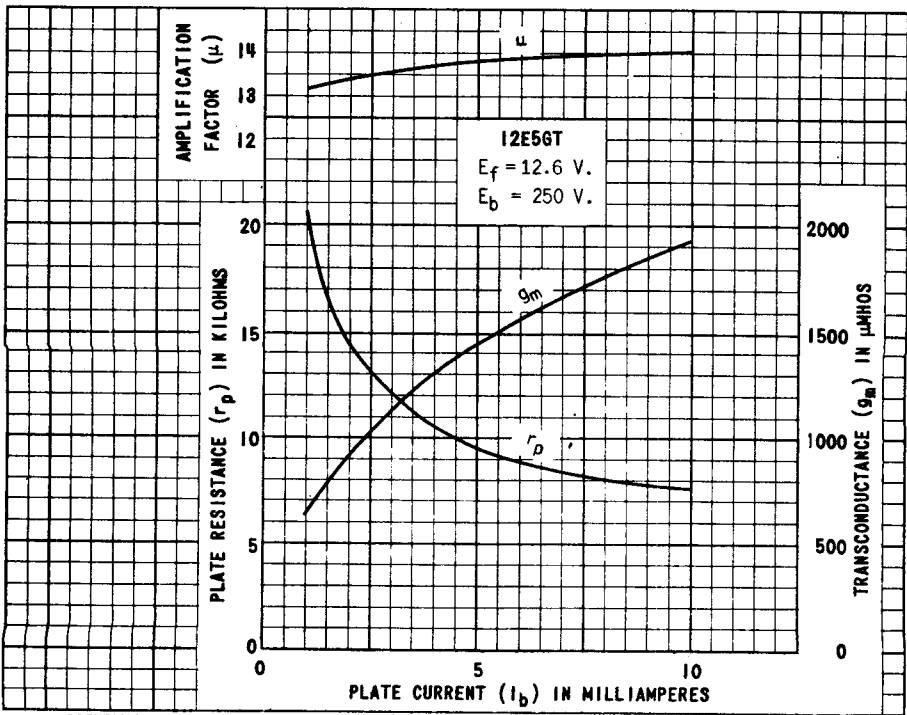
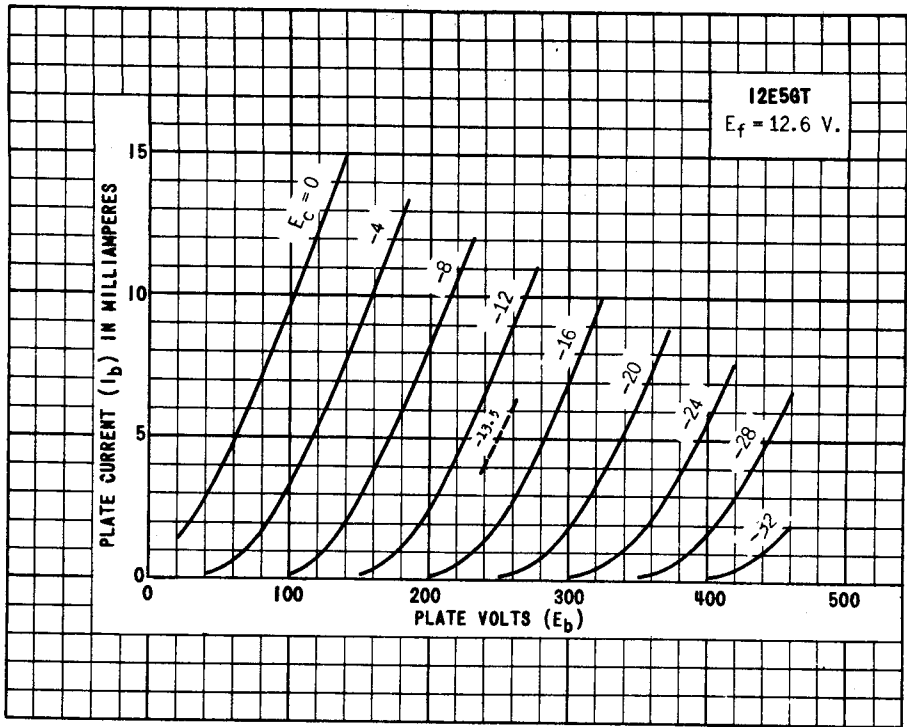

TUNG-SOL

HIGH-MU TRIODE AMPLIFIER

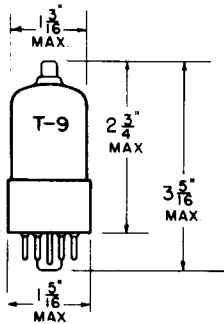

GLASS BULB

COATED UNIPOTENTIAL CATHODE

HEATER
12.6 VOLTS 0.15 AMPERE
AC OR DC

ANY MOUNTING POSITION

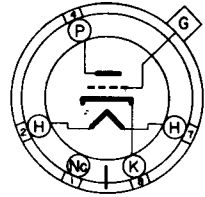

BOTTOM VIEW

INTERMEDIATE SHELL
5-PIN OCTAL

THE 12F5GT IS A GENERAL PURPOSE HIGH AMPLIFICATION FACTOR TRIODE. EXCEPT FOR THE HEATER RATING, ITS ELECTRICAL CHARACTERISTICS ARE IDENTICAL TO THOSE OF THE 6F5GT.

RATINGS

INTERPRETED ACCORDING TO RMA STANDARD W8-210

HEATER VOLTAGE	12.6	VOLTS
HEATER CURRENT	0.15	AMP.
MAX. PLATE VOLTAGE	300	VOLTS
HEATER-CATHODE VOLTAGE	AS LOW AS POSSIBLE	

DIRECT INTERELECTRODE CAPACITANCES (APPROX.)

WITH SHELL CONNECTED TO CATHODE

GRID TO PLATE	2.8	$\mu\mu\text{f}$
GRID TO CATHODE	2.2	$\mu\mu\text{f}$
PLATE TO CATHODE	3.2	$\mu\mu\text{f}$

TYPICAL OPERATING CONDITIONS AND CHARACTERISTICS

CLASS A₁ AMPLIFIER

PLATE VOLTAGE	100	250	VOLTS
GRID VOLTAGE	-1	-2	VOLTS
PLATE CURRENT	0.4	0.9	MA.
PLATE RESISTANCE	85 000	66 000	OHMS
TRANSCONDUCTANCE	1150	1500	μMHMS
AMPLIFICATION FACTOR	100	100	

CONTINUED ON FOLLOWING PAGE

TUNG-SOL

CONTINUED FROM PRECEDING PAGE

ZERO-BIAS RESISTANCE-COUPLED AMPLIFIER CLASS A₁

HEATER VOLTAGE	6.3	6.3			VOLTS		
PLATE SUPPLY VOLTAGE	100	300			VOLTS		
GRID LEAK	10	10			MEGOHM		
LOAD RESISTANCE	0.25	0.25			MEGOHM		
COUPLING CAPACITOR	0.01	TO	0.005	0.01	TO	0.005	μf
GRID RESISTOR FOR FOLLOWING TUBE	0.5	1.0	0.5	1.0	MEGOHM		
VOLTAGE GAIN	48	52	66	71			
VOLTAGE OUTPUT (RMS) AT 5 PER CENT HARMONIC DISTORTION	7.0	8.5	44	50	VOLTS		

SIMILAR TYPE REFERENCE: Except for heater ratings, same characteristics and application as types 6F5, 6F5G, 6F5GT, 6SF5, 6SF5GT; same characteristics as types 12SF5, 12SF5GT, 7B4.

TUNG-SOL

TRIODE

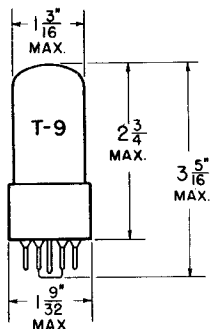

GLASS BULB

COATED UNIPOTENTIAL CATHODE

HEATER

12.6 VOLTS 150 MA.

AC OR DC

ANY MOUNTING POSITION

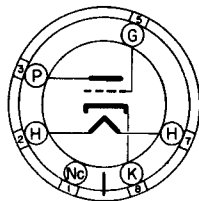
 BOTTOM VIEW
 INTERMEDIATE SHELL
 6 PIN OCTAL BASE

THE 12J5GT IS A GENERAL PURPOSE MEDIUM-MU TRIODE. IT IS USEFUL FOR SERVICE AS AN OSCILLATOR OR AUDIO-FREQUENCY AMPLIFIER.

 DIRECT INTERELECTRODE CAPACITANCES - APPROX.
 WITH CLOSE FITTING SHIELD CONNECTED TO CATHODE

GRID TO PLATE: (G TO P)	3.8	$\mu\mu\text{f}$
INPUT: G TO (H+K)	4.2	$\mu\mu\text{f}$
OUTPUT: P TO (H+K)	5	$\mu\mu\text{f}$

RATINGS

INTERPRETED ACCORDING TO RMA STANDARD NB-210

HEATER VOLTAGE	12.6	VOLTS
MAXIMUM HEATER-CATHODE VOLTAGE	90	VOLTS
MAXIMUM PLATE VOLTAGE	300	VOLTS
MINIMUM NEGATIVE DC GRID VOLTAGE	0	VOLTS
MAXIMUM GRID CIRCUIT RESISTANCE	1.0	MEG.
MAXIMUM PLATE DISSIPATION	2.5	WATTS
MAXIMUM CATHODE CURRENT	20	MA.

TYPICAL OPERATING CONDITIONS AND CHARACTERISTICS

CLASS A₁ AMPLIFIER

HEATER VOLTAGE	12.6	12.6	VOLTS
HEATER CURRENT	150	150	MA.
PLATE VOLTAGE	90	250	VOLTS
GRID VOLTAGE	0	-8	VOLTS
PLATE CURRENT	10	9	MA.
PLATE RESISTANCE	6 700	7 700	OHMS
TRANSCONDUCTANCE	3 000	2 600	μMHOS
AMPLIFICATION FACTOR	20	20	

SIMILAR TYPE REFERENCES: Ratings and characteristics are identical to 12AU4, except for heater ratings.

CONTINUED ON FOLLOWING PAGE

→ INDICATES A CHANGE OR ADDITION.

TUNG-SOL

CONTINUED FROM PRECEDING PAGE

RESISTANCE COUPLED AMPLIFIER

R_1 MEG.	R_{g1} MEG.	R_B MEG.	$E_{bb} = 90$ VOLTS			$E_{bb} = 180$ VOLTS			$E_{bb} = 300$ VOLTS		
			R_k	GAIN	E_o	R_k	GAIN	E_o	R_k	GAIN	E_o
0.10	A	0.10	3300	14	13	2200	14	26	1800	14	40
0.10	A	0.24	3600	14	16	2700	15	33	2200	15	51
0.24	A	0.24	7500	14	16	5100	15	30	4300	15	44
0.24	A	0.51	9100	14	19	6800	15	39	5100	15	54
0.51	A	0.51	13000	14	16	9100	15	30	6800	16	40
0.51	A	1.0	15000	14	19	10000	16	32	7500	16	45
0.24	10	0.24	---	15	13	---	16	33	---	17	46
0.24	10	0.51	---	16	17	---	17	38	---	18	62
0.51	10	0.51	---	16	14	---	18	32	---	18	53
0.51	10	1.0	---	17	18	---	18	41	---	19	68

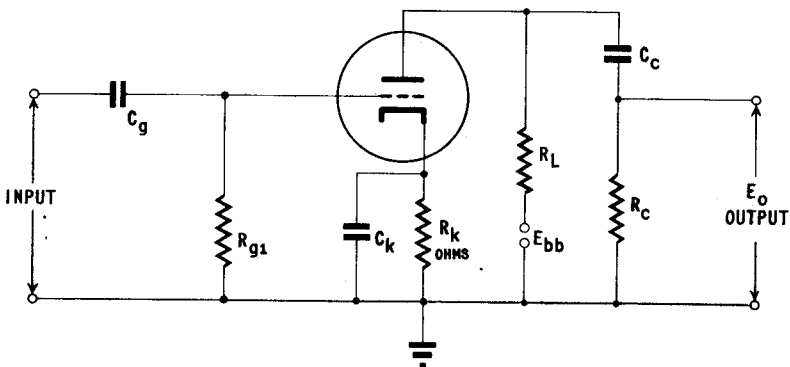
A VALUE OF R_{g1} IS NOT CRITICAL.GAIN MEASURED AT $E_o = 2.0$ VOLTS RMS OUTPUT. E_o IS RMS OUTPUT FOR 5% TOTAL HARMONIC DISTORTION.

NOTE: COUPLING CAPACITORS C_g AND C_c SHOULD BE SELECTED TO GIVE DESIRED FREQUENCY RESPONSE. R_k SHOULD BE ADEQUATELY BY-PASSED BY CAPACITOR C_k .

→ INDICATES A CHANGE OR ADDITION.

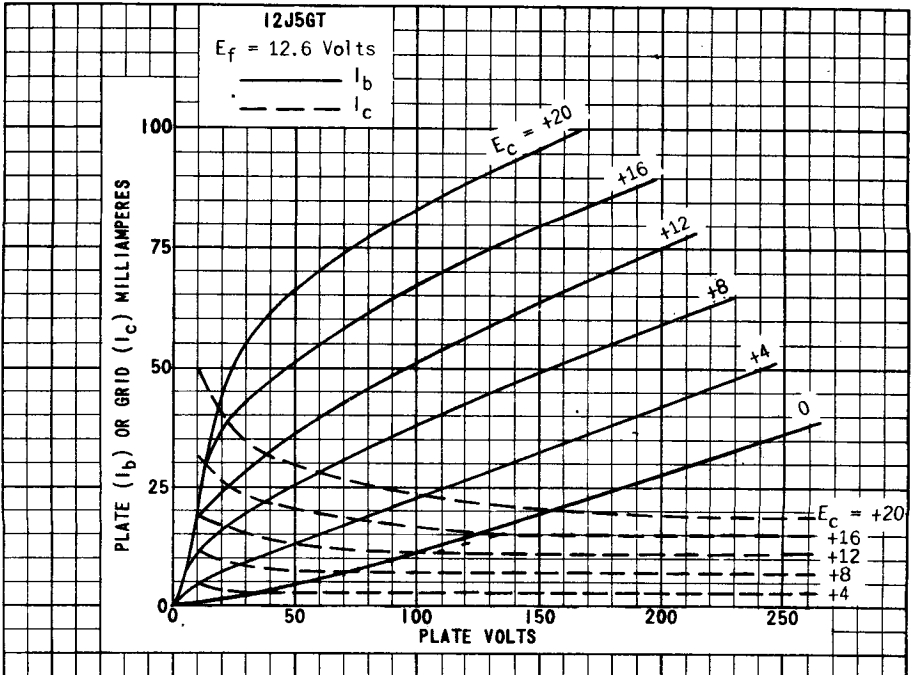
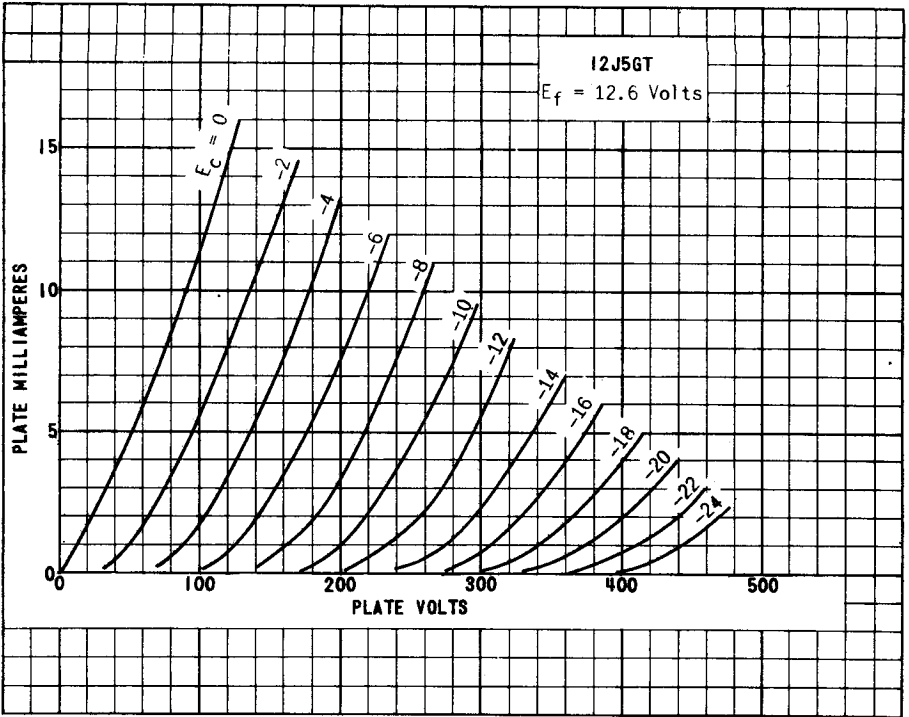

PRINTED IN U. S. A.

PLATE
 1950
 JAN. 2,
 1948

12J5GT

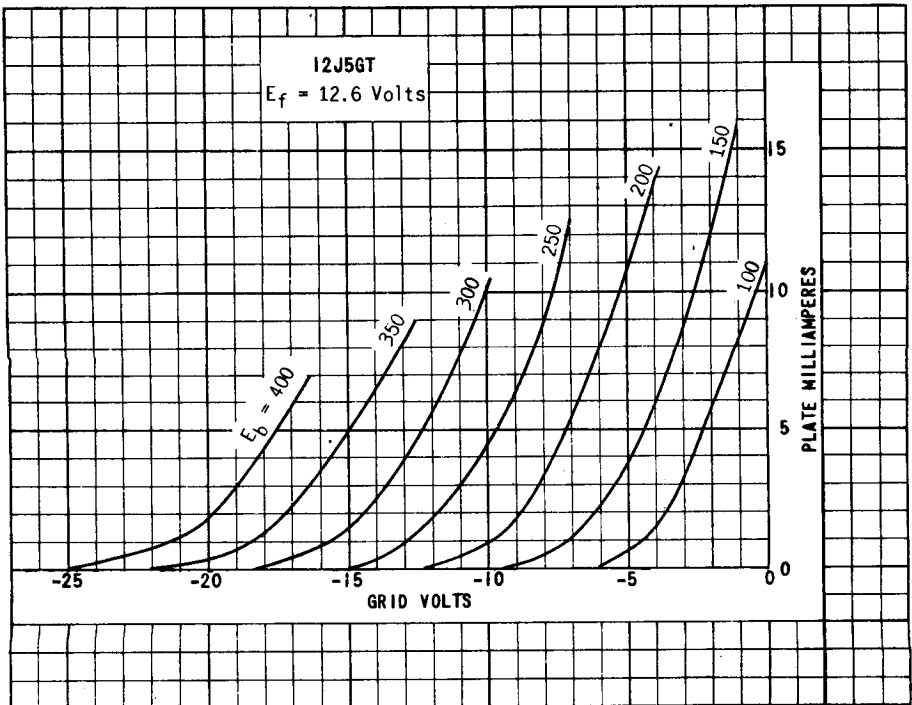
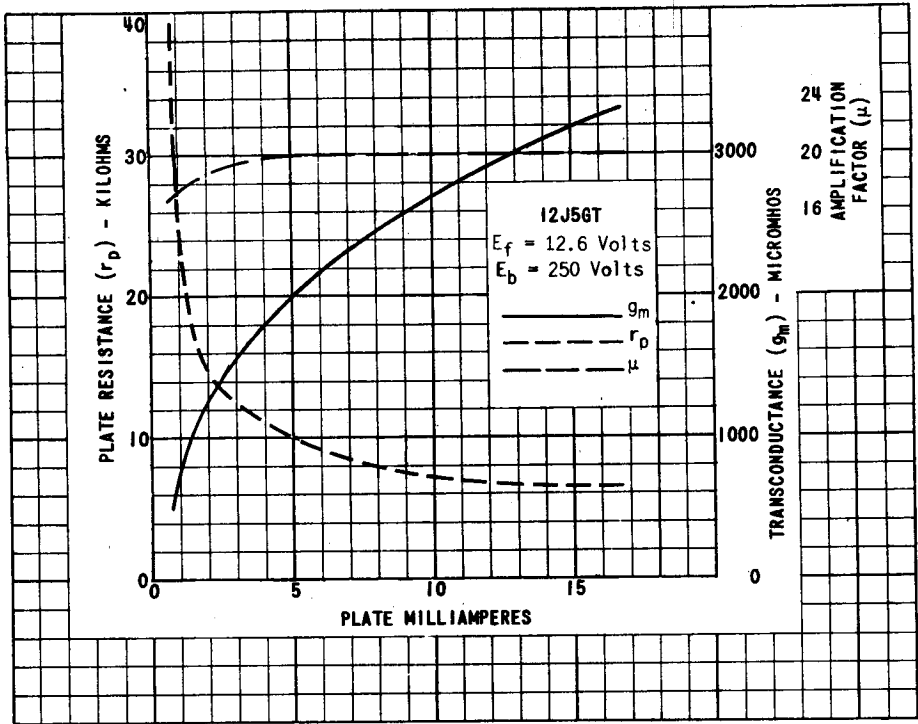

PLATE
 1951
 JAN. 2,
 1948

TUNG-SOL

TRIPLE GRID
DETECTOR AMPLIFIER

UNI-POTENTIAL CATHODE

HEATER
12.6 VOLTS 0.15 AMPERE
AC OR DC

SMALL 7 PIN OCTAL BASES

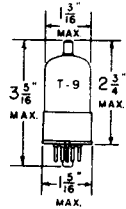
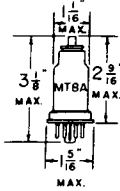

G-7Ra

BOTTOM VIEW

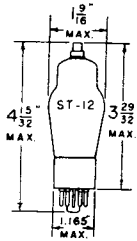

7R

BOTTOM VIEW

THE TUNG-SOL 6J7, 6J7G, 6J7GT AND THE 12J7GT ARE SHARP CUT-OFF GENERAL PURPOSE AMPLIFIERS. WITH THE EXCEPTION OF HEATER AND CAPACITANCE RATINGS, THEIR ELECTRICAL CHARACTERISTICS ARE SIMILAR TO THOSE OF THE 6C6.

RATINGS

	TRIODE ^A CONNECTION	PENTODE CONNECTION	
MAXIMUM PLATE VOLTAGE	250	300	VOLTS
MAXIMUM SCREEN SUPPLY VOLTAGE	-	300	VOLTS
MAXIMUM SCREEN VOLTAGE	-	125	VOLTS
MINIMUM EXTERNAL CONTROL GRID BIAS VOLTAGE	0	0	VOLTS
MAXIMUM PLATE DISSIPATION	1.75	0.75	WATT
MAXIMUM SCREEN DISSIPATION	-	0.10	WATT

^A SUPPRESSOR GRID AND SCREEN TIED TO PLATE

FOR "INTERPRETATION OF RATINGS" REFER TO FRONT OF BOOK.

CONTINUED NEXT PAGE

TUNG-SOL

DIRECT INTERELECTRODE CAPACITANCES

TRIODE CONNECTION

	6J7	6J7G	6J7GT 12J7GT
CONTROL GRID TO CATHODE	5 ^B	2.6 ^C	2.6 ^C
PLATE TO CATHODE	14	17	17
CONTROL GRID TO PLATE	2.0	1.8	1.8

PENTODE CONNECTION

CONTROL GRID TO CATHODE	7 ^B	4.6 ^D	4.6 ^D
PLATE TO CATHODE	12	12	12
CONTROL GRID TO PLATE ^{MAX.}	0.005	0.007	0.005

^B WITH SHELL CONNECTED TO CATHODE^C WITHOUT EXTERNAL SHIELD^D WITH EXTERNAL SHIELD CONNECTED TO CATHODE

TYPICAL OPERATING CONDITIONS AND CHARACTERISTICS

CLASS A₁ AMPLIFIER

	TRIODE CONNECTION		PENTODE CONNECTION		
PLATE VOLTAGE	180	250	100	250	VOLTS
SCREEN VOLTAGE	PLATE	PLATE	100	100	VOLTS
CONTROL GRID VOLTAGE ^E	-5.3	-8	-3	-3	VOLTS
SUPPRESSOR GRID	PLATE	PLATE	CONNECTED TO CATHODE AT SOCKET		
PLATE CURRENT	5.3	6.5	2.0	2.0	MA.
SCREEN CURRENT	-	-	0.5	0.5	MA.
PLATE RESISTANCE ^{APPROX.}	0.0110	0.0105	1.0	- ^F	MEGOHM
TRANSCONDUCTANCE	1800	1900	1185	1225	μMHOS
CONTROL GRID VOLTAGE	-	-	-7	-7	VOLTS

FOR CATHODE CURRENT CUT-OFF

^E THE DC RESISTANCE IN THE GRID CIRCUIT SHOULD NOT EXCEED 1.0 MEGOHM^F GREATER THAN 1 MEGOHMPLATE
1023-1APR. 21
1941

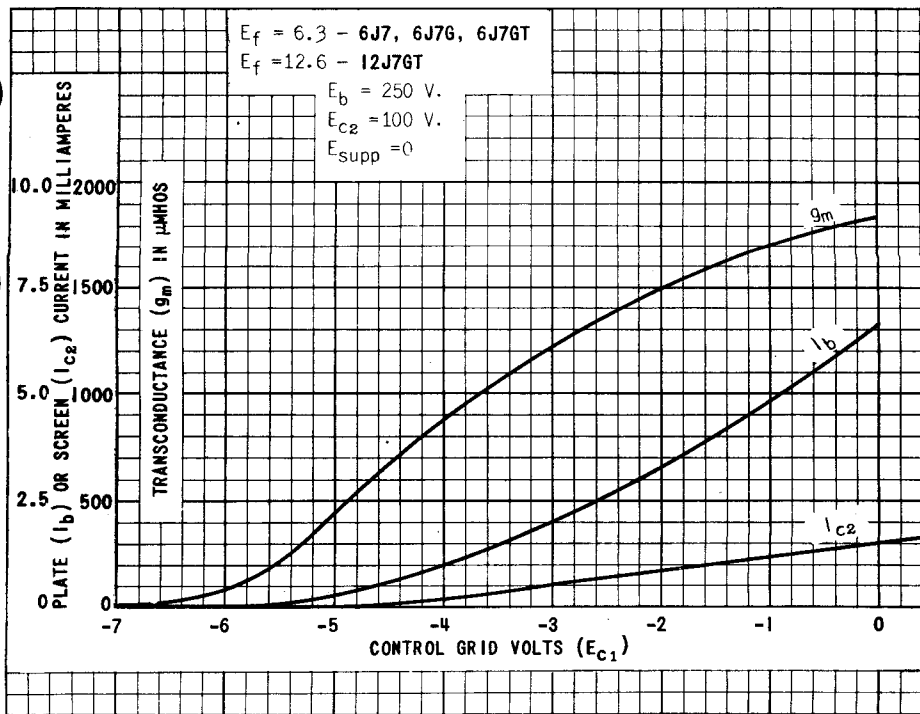
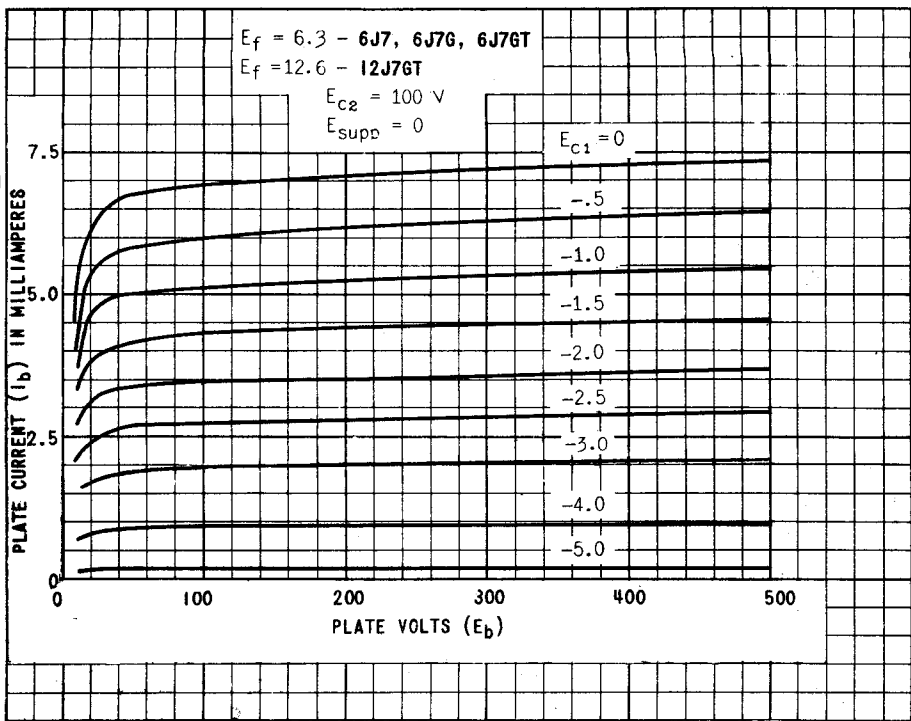

PRINTED IN U. S. A.

PLATE
 1024-1
 APR. 21
 1941

(6J7, 6J7G, 6J7GT) 12J7GT

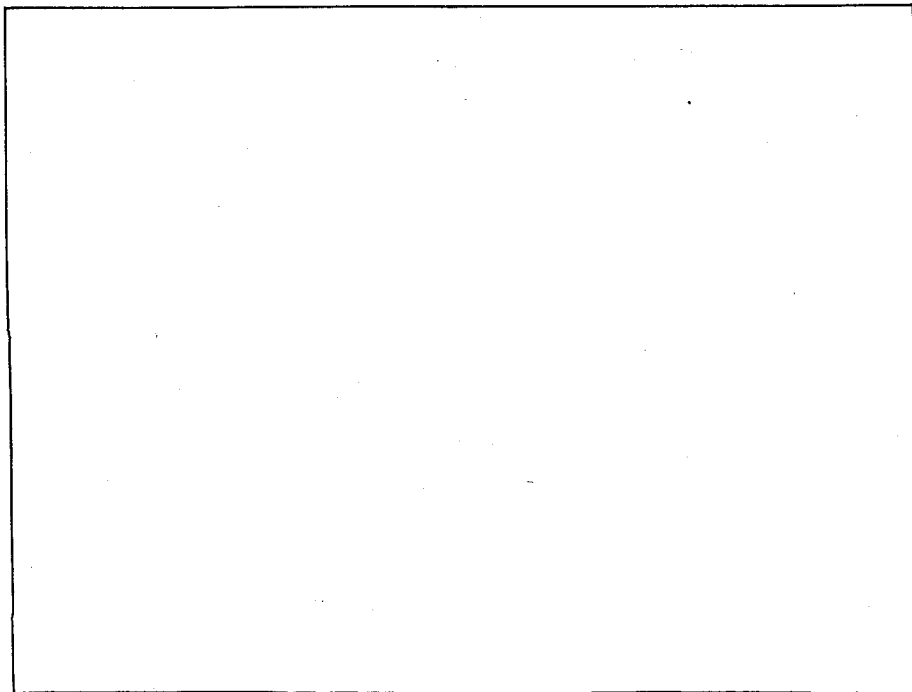
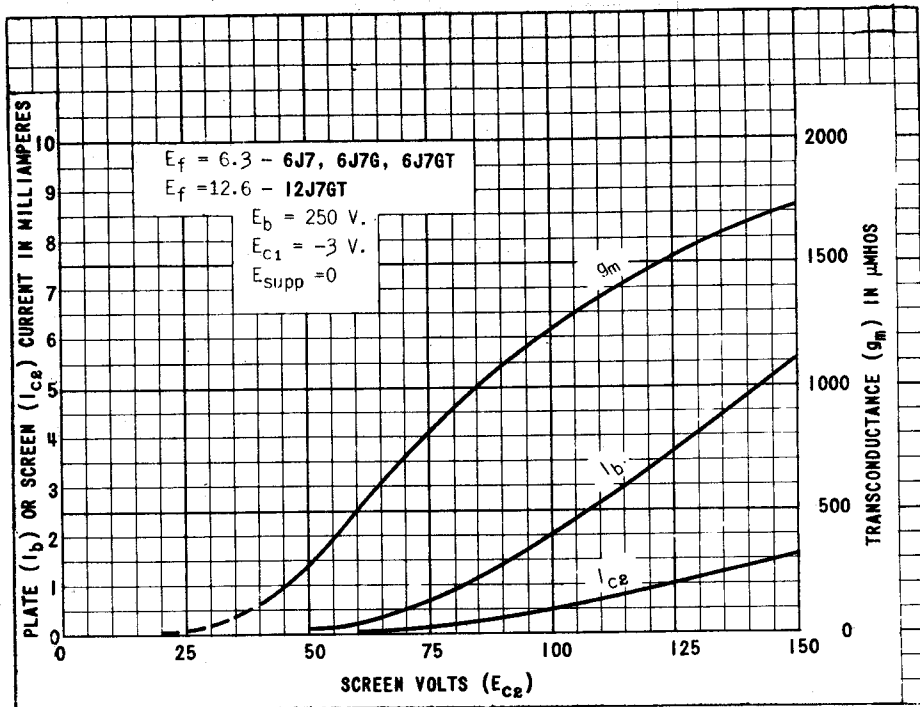
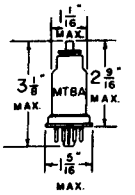

PLATE
 1025-1
 APR. 21
 1941

TUNG-SOL



METAL SHELL
7 PIN OCTAL BASE
6K7

**TRIPLE GRID
REMOTE CUT-OFF AMPLIFIER**

UNIPOTENTIAL CATHODE
HEATER
12.6 VOLTS 0.15 AMPERE
AC OR DC

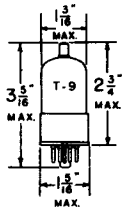

GLASS BULB
7 PIN OCTAL BASE
WITH METAL SHELL
6K7GT 12K7GT

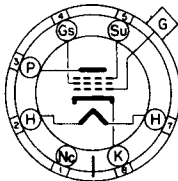

G-7R_a
BOTTOM VIEW
6K7G

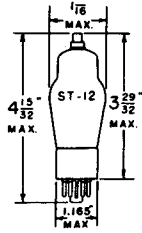

GLASS BULB
SMALL 7 PIN OCTAL BASE
6K7G

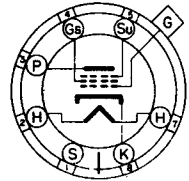

7R
BOTTOM VIEW
6K7 6K7GT 12K7GT

THE TUNG-SOL 6K7, 6K7G, 6K7GT AND THE 12K7GT ARE TRIPLE GRID VARIABLE MU AMPLIFIERS. THEY ARE SUITABLE FOR USE WITH AVC IN RF AND IF AMPLIFIERS, AND THEY MINIMIZE CROSS MODULATION. WITH THE EXCEPTION OF CAPACITANCES AND HEATER RATINGS THEIR ELECTRICAL CHARACTERISTICS ARE SIMILAR.

RATINGS

MAXIMUM PLATE VOLTAGE	300	VOLTS
MAXIMUM SCREEN SUPPLY VOLTAGE	300	VOLTS
MAXIMUM SCREEN VOLTAGE	125	VOLTS
MINIMUM EXTERNAL GRID BIAS VOLTAGE	0	
MAXIMUM PLATE DISSIPATION	2.75	WATTS
MAXIMUM SCREEN DISSIPATION	0.35	WATT

DIRECT INTERELECTRODE CAPACITANCES

	6K7 ^A	6K7G ^B	6K7GT ^A 12K7GT ^A	
CONTROL GRID TO CATHODE	7	5	5	μf
PLATE TO CATHODE	12	12	11	μf
CONTROL GRID TO PLATE	.005 ^{MAX.}	.007 ^{MAX.}	.007 ^{MAX.}	μf

^A SHELL IS CONNECTED TO THE CATHODE.

^B MEASURED WITH AN EXTERNAL SHIELD. THE INTERNAL SHIELD IN THE DOME IS CONNECTED TO THE CATHODE WITHIN THIS TUBE

CONTINUED NEXT PAGE

TUNG-SOL

TYPICAL OPERATING CONDITIONS AND CHARACTERISTICS

CLASS A₁ AMPLIFIER

PLATE VOLTAGE	90	180	250	250	VOLTS
SCREEN VOLTAGE	90	75	100	125	VOLTS
CONTROL GRID VOLTAGE	-3	-3	-3	-3	VOLTS
SUPPRESSOR GRID	CONNECTED TO CATHODE AT SOCKET				
PLATE CURRENT	5.4	4.0	7.0	10.5	MA.
SCREEN CURRENT	1.3	1.0	1.7	2.6	MA.
PLATE RESISTANCE APPROX.	0.3	1.0	0.8	0.6	MEGOHM
TRANSCONDUCTANCE	1275	1100	1450	1650	μMHOS
CONTROL GRID BIAS APPROX.	-38.5	-32.5	-42.5	-52.5	VOLTS
FOR TRANSCONDUCTANCE = 2 μMHOS					

TYPICAL OPERATING CONDITIONS WITH VARIABLE BIAS

MIXER IN SUPERHETERODYNE CIRCUITS

PLATE VOLTAGE	250	VOLTS
SCREEN VOLTAGE	100	VOLTS
CONTROL GRID VOLTAGE APPROX. A	-10	VOLTS
SUPPRESSOR GRID	CONNECTED TO THE CATHODE AT THE SOCKET	

^A THE GRID BIAS SHOWN IS MINIMUM FOR AN OSCILLATOR PEAK VOLTAGE OF 7 VOLTS. THESE VALUES ARE OPTIMUM.

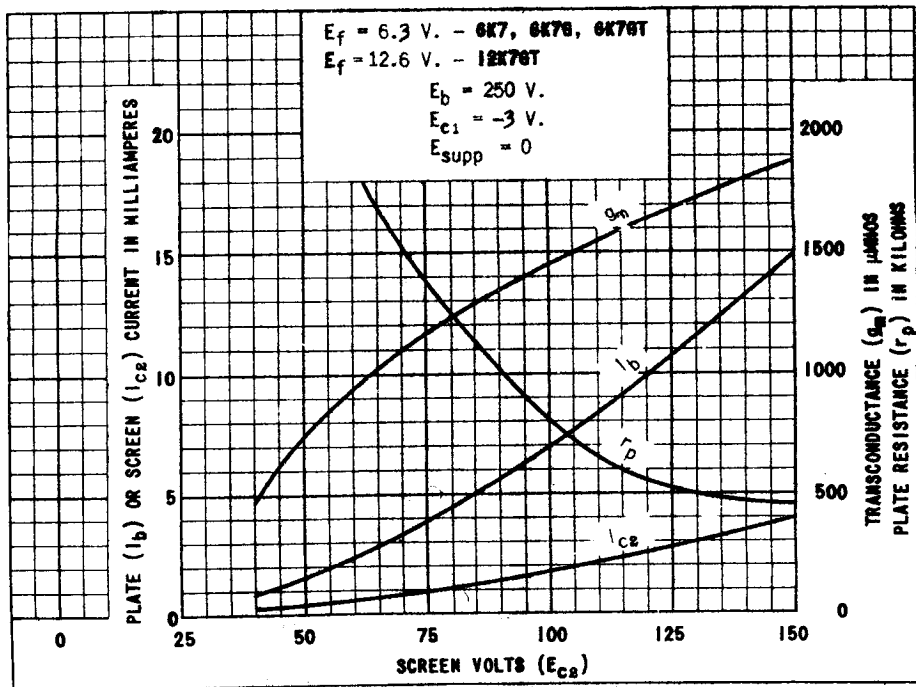
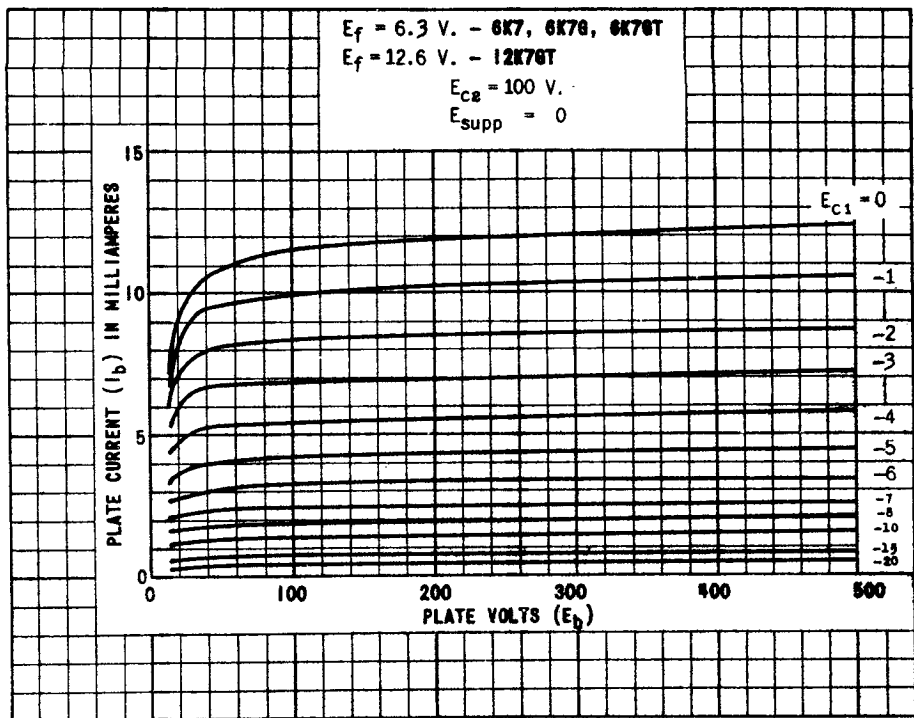

PRINTED IN U. S. A.
 PLATE 639-1
 NOV. 20 1939

12K7GT (6K7, 6K7G, 6K7GT)

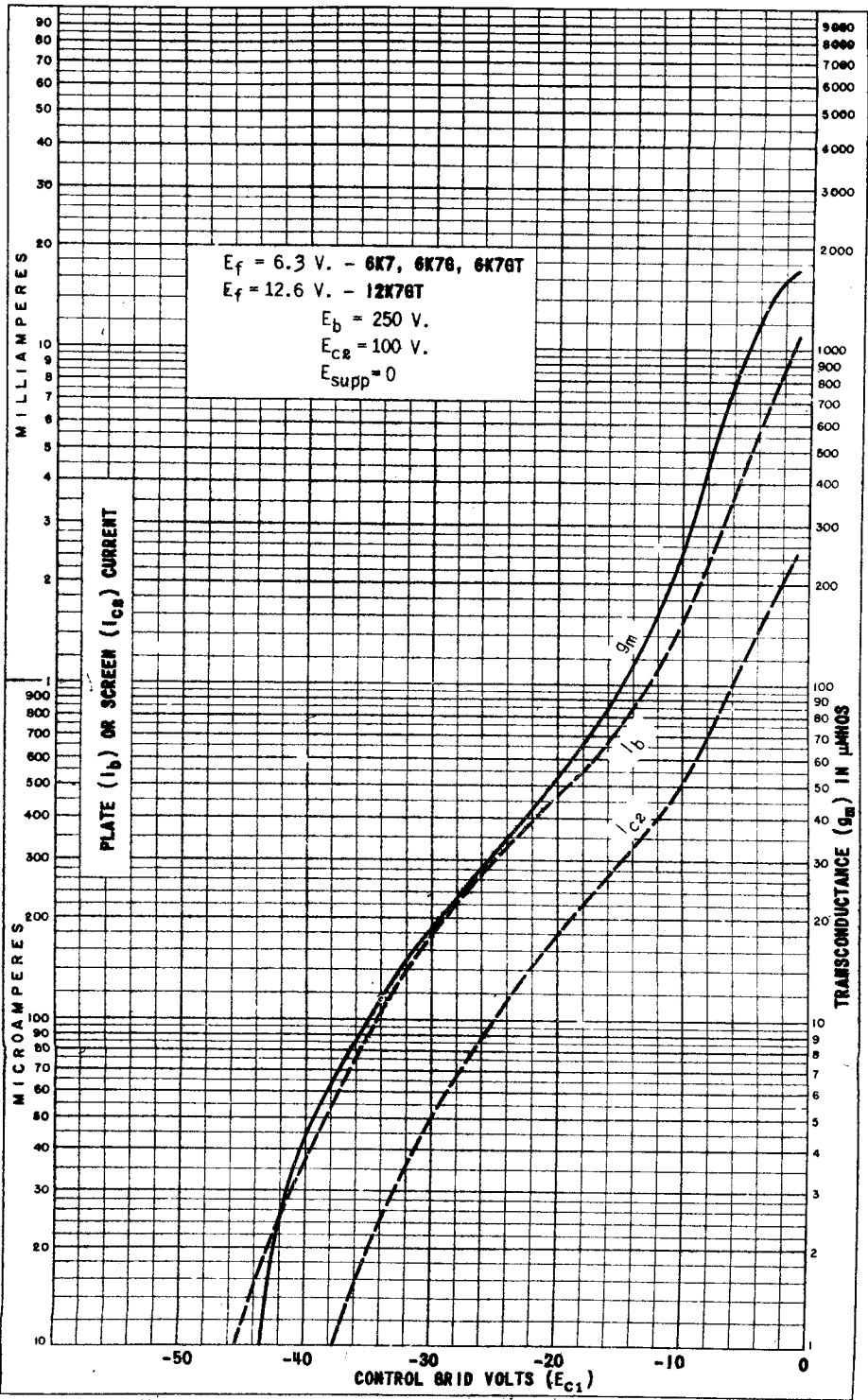
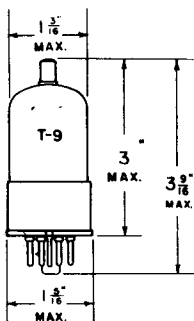

PLATE 640-1

TUNG-SOL



TRIODE HEXODE CONVERTER

UNIPOENTIAL CATHODE

HEATER

12.6 VOLTS 0.15 AMPERE
AC OR DC

GLASS BULB

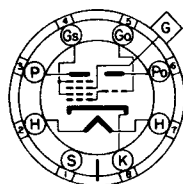

BK

BOTTOM VIEW

SMALL WAFER 8 PIN OCTAL BASE WITH METAL SHELL

THE TUNG-SOL 12K8GT CONSISTS OF A TRIODE OSCILLATOR AND A HEXODE MIXER IN A COMMON ENVELOPE. THE PHYSICAL DESIGN OF THIS TUBE REDUCES INTER-ACTION BETWEEN THE OSCILLATOR AND MIXER SECTIONS AND MAKES FOR STABLE OPERATION ON THE HIGH FREQUENCIES AS WELL AS THE BROADCAST BAND. IT IS USED IN AC-DC SUPERHETERODYNES USING 150 MA. HEATER TUBES.

RATINGS

MAXIMUM HEXODE PLATE (P) VOLTAGE	300	VOLTS
MAXIMUM HEXODE SCREEN (Gs) SUPPLY VOLTAGE	300	VOLTS
MAXIMUM HEXODE SCREEN (Gs) VOLTAGE	150	VOLTS
MAXIMUM HEXODE PLATE DISSIPATION	0.75	WATT
MAXIMUM HEXODE SCREEN DISSIPATION	0.7	WATT
MAXIMUM TOTAL CATHODE CURRENT	16	MA.
MINIMUM EXTERNAL SIGNAL GRID (g) BIAS VOLTAGE	0	VOLT
MAXIMUM OSCILLATOR ANODE (Po) VOLTAGE	125	VOLTS
MAXIMUM OSCILLATOR ANODE DISSIPATION	0.75	WATT

FOR "INTERPRETATION OF RATINGS" REFER TO FRONT OF BOOK.

CONTINUED NEXT PAGE

TYPICAL OPERATING CONDITIONS AND CHARACTERISTICS

CONVERTER SERVICE

HEXODE PLATE (P) VOLTAGE	100	250	VOLTS
HEXODE SCREEN (G_s) VOLTAGE	100	100	VOLTS
HEXODE CONTROL GRID (G) VOLTAGE	-3	-3	VOLTS
OSCILLATOR ANODE (P_o) VOLTAGE	100	100	VOLTS
HEXODE PLATE CURRENT	2.3	2.5	MA.
HEXODE SCREEN CURRENT	6.2	6.0	MA.
OSCILLATOR ANODE CURRENT	3.8	3.8	MA.
OSCILLATOR GRID (G_o) CURRENT	0.15	0.15	MA.
TOTAL CATHODE CURRENT	12.5	12.5	MA.
OSCILLATOR GRID RESISTOR	50 000	50 000	OHMS
CONVERSION TRANSCONDUCTANCE	325	350	μ MHOS
HEXODE PLATE RESISTANCE APPROX.	0.4	0.6	MEG OHM
HEXODE CONTROL GRID VOLTAGE APPROX.	-30	-30	VOLTS

FOR CONVERSION TRANSCONDUCTANCE = 2 μ MHOS

DIRECT INTERELECTRODE CAPACITANCES⁵

SIGNAL GRID TO MIXER PLATE (G TO P)	0.08 ^{MAX.}	μ f
SIGNAL GRID TO OSCILLATOR PLATE (G TO P_o)	0.05 ^{MAX.}	μ f
SIGNAL GRID TO OSCILLATOR GRID (G TO G_o)	0.2 ^{MAX.}	μ f
OSCILLATOR GRID TO OSCILLATOR PLATE (G_o TO P_o)	1.8	μ f
SIGNAL INPUT: G TO ALL OTHER ELECTRODES	4.6	μ f
OSCILLATOR INPUT: G_o TO ALL OTHER ELECTRODES EXCEPT P_o	6.5	μ f
OSCILLATOR OUTPUT: P_o TO ALL OTHER ELECTRODES EXCEPT G_o	3.4	μ f
MIXER OUTPUT: P TO ALL OTHER ELECTRODES	4.8	μ f
OSCILLATOR GRID TO MIXER PLATE (G_o TO P)	0.15 ^{MAX.}	μ f

^A WITH EXTERNAL SHIELD CONNECTED TO CATHODE.

NOTE: THE TRANSCONDUCTANCE OF THE OSCILLATOR SECTION (NOT OSCILLATING) IS APPROXIMATELY 3000 μ MHOS WHEN THE TRIODE PLATE VOLTAGE IS 100 VOLTS, AND THE TRIODE GRID VOLTAGE IS ZERO VOLTS.

TUNG-SOL

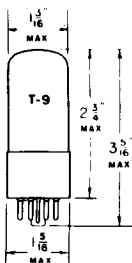

TWIN-PENTODE POWER AMPLIFIER

UNIPOTENTIAL CATHODE

HEATER

12.6 VOLTS 0.15 AMPERES

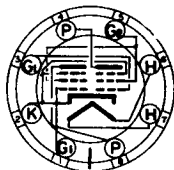

THE 12L8-GT IS A HEATER-CATHODE TYPE OF TWIN-UNIT TUBE WHICH CONTAINS TWO POWER-AMPLIFIER PENTODES WHICH HAVE A COMMON CATHODE. USING SINGLE-ENDED GT-CONSTRUCTION, THE 12L8-GT IS USEFUL IN THE OUTPUT STAGE OF COMPACT, LIGHTWEIGHT EQUIPMENT WHERE MODERATE POWER OUTPUT IS DESIRED. IN SUCH SERVICE, THE UNITS MAY BE CONNECTED IN PUSH-PULL OR IN PARALLEL DEPENDING ON THE REQUIREMENTS.

RATINGS

HEATER OR FILAMENT VOLTAGE (AC OR DC)		12.6	VOLTS
HEATER OR FILAMENT CURRENT		0.15	AMP.
MAXIMUM PLATE VOLTAGE	EACH UNIT	180	VOLTS
MAXIMUM SCREEN VOLTAGE	" "	180	VOLTS
MAXIMUM PLATE DISSIPATION	" "	2.5	WATTS
MAXIMUM SCREEN DISSIPATION	" "	1.0	WATT
MAXIMUM D-C HEATER-CATHODE POTENTIAL		100	VOLTS

DIRECT INTERELECTRODE CAPACITANCES (WITH NO EXTERNAL SHIELD)

	PENTODE UNIT P1	PENTODE UNIT P2	
CONTROL GRID TO CATHODE	5.0	5.0	$\mu\mu\text{f}$
PLATE TO CATHODE	6.0	6.0	$\mu\mu\text{f}$
GRID TO PLATE	0.7	0.7	$\mu\mu\text{f}$
GRID TO GRID		0.08	$\mu\mu\text{f}$
PLATE TO PLATE		1.5	$\mu\mu\text{f}$
GRID OF P1-PLATE OF P2		0.2	$\mu\mu\text{f}$
GRID OF P2-PLATE OF P1		0.1	$\mu\mu\text{f}$

TYPICAL OPERATING CONDITIONS AND CHARACTERISTICS

CLASS A AMPLIFIER (EACH SECTION)

HEATER OR FILAMENT VOLTAGE	12.6	VOLTS
HEATER OR FILAMENT CURRENT	0.15	AMP.
PLATE VOLTAGE	180	VOLTS
SCREEN VOLTAGE	180	VOLTS
CONTROL GRID VOLTAGE	-9	VOLTS
PEAK AF SIGNAL VOLTAGE	9	VOLTS
ZERO-SIGNAL PLATE CURRENT	13	MA.
ZERO-SIGNAL SCREEN CURRENT	2.8	MA.
MAXIMUM-SIGNAL PLATE CURRENT	13.5	MA.
MAXIMUM-SIGNAL SCREEN CURRENT	4.6	MA.
PLATE RESISTANCE	0.16	MEGOHM
TRANSCONDUCTANCE	2150	μMHOS
LOAD RESISTANCE	10000	OHMS
TOTAL HARMONIC DISTORTION	10	PER CENT
POWER OUTPUT	1	WATT

PLATE
1378-1
DEC. 15
1943



TUNG-SOL

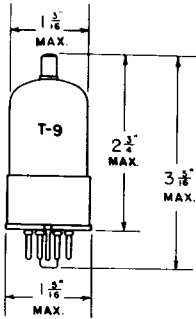

**DUO-DIODE
HIGH MU TRIODE AMPLIFIER**

UNIPOTENTIAL CATHODE

HEATER
12.6 VOLTS 0.15 AMPERE
AC OR DC

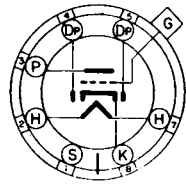

7 V
BOTTOM VIEW

GLASS BULB

SMALL WAFER 7 PIN OCTAL BASE WITH METAL SHELL

THE TUNG-SOL 12Q7GT COMBINES TWO DIODES AND A HIGH MU TRIODE IN A SINGLE BULB, USING A COMMON CATHODE. IT IS DESIGNED FOR SERVICE AS A DIODE DETECTOR, AVC RECTIFIER, AND A HIGH GAIN RESISTANCE COUPLED AMPLIFIER IN AC - DC OPERATED RECEIVERS USING 150 MA. HEATER TUBES.

RATINGS

MAXIMUM PLATE VOLTAGE	300	VOLTS
MINIMUM DIODE CURRENT WITH 10 VOLTS DC APPLIED PER PLATE	0.8	MA.

AVERAGE CHARACTERISTICS OF TRIODE UNIT

PLATE VOLTAGE	100	250	VOLTS
CONTROL GRID VOLTAGE	-1	-3	VOLTS
PLATE CURRENT	0.8	1.0	MA.
PLATE RESISTANCE	58000	58000	OHMS
TRANSCONDUCTANCE	1200	1200	μMHOS
AMPLIFICATION FACTOR	70	70	

FOR "INTERPRETATION OF RATINGS" REFER TO FRONT OF BOOK.

CONTINUED NEXT PAGE

PLATE
1118-2

SEPT. 17
1941

TUNG-SOL

TYPICAL OPERATING CONDITIONS AND CHARACTERISTICS

ZERO BIAS, RESISTANCE COUPLED, CLASS A₁ AMPLIFIER

PLATE SUPPLY VOLTAGE	100	300	VOLTS		
PLATE LOAD RESISTOR	0.25	0.25	MEGOHM		
GRID RESISTOR	10	10	MEGOHM		
COUPLING CONDENSER	.01 TO .005	.01 TO .005	μF		
GRID RESISTOR FOR FOLLOWING TUBE	.5 TO 1.0	.5 TO 1.0	MEGOHM		
EXTERNAL GRID CIRCUIT IMPEDANCE	0	0	MEGOHM		
VOLTAGE GAIN	40	42	50	56	
VOLTAGE OUTPUT (RMS) ^A	11	13	51	58	VOLTS

^A AT 5% TOTAL HARMONIC DISTORTION.

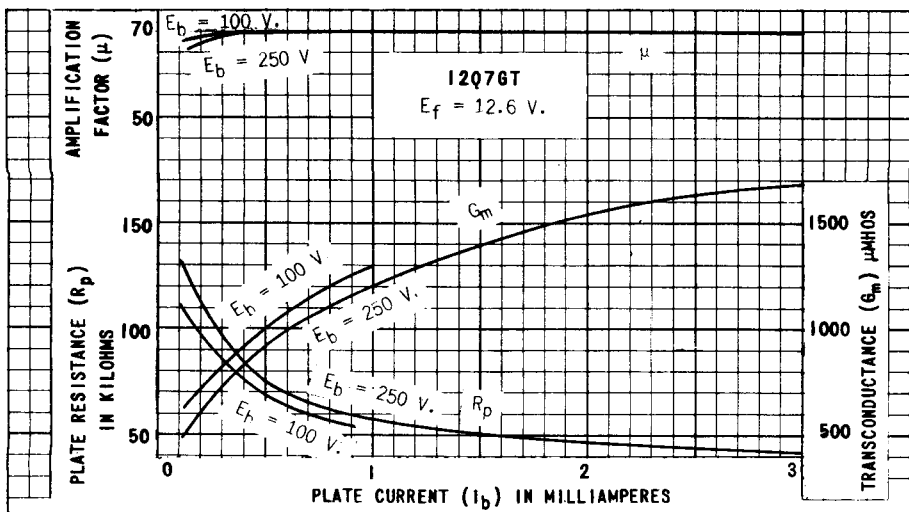
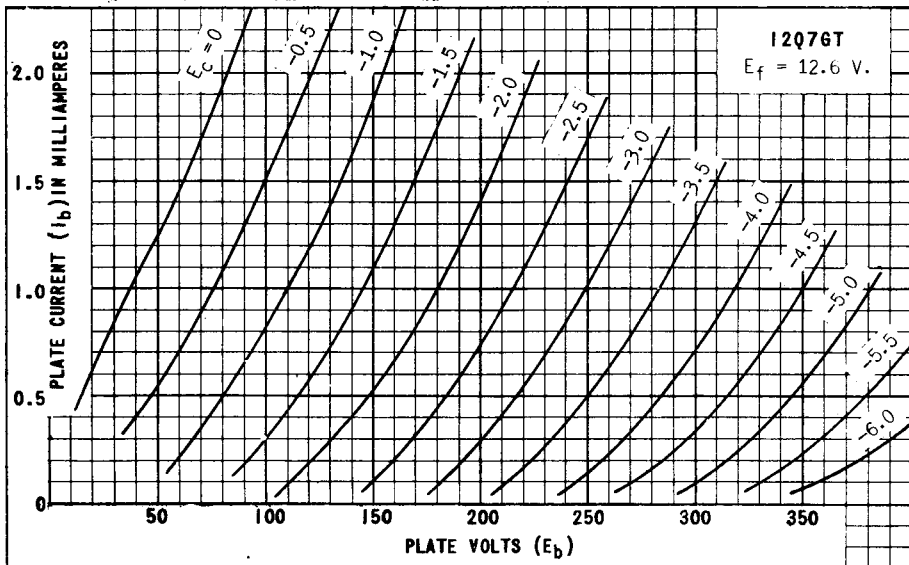
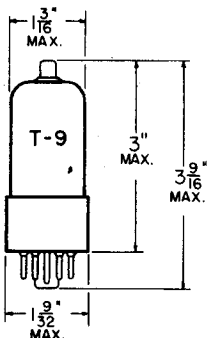

PLATE
1119-1

TUNG-SOL

TRIPLE-DIODE TRIODE



GLASS BULB
SKIRTED
MINIATURE CAP

COATED UNIPOTENTIAL CATHODES

HEATER

12.6 VOLTS 150 MA.

AC OR DC

ANY MOUNTING POSITION

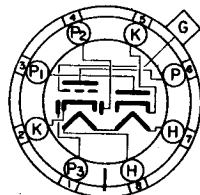

BOTTOM VIEW
INTERMEDIATE SHELL
8 PIN OCTAL BASE

THE 12S8GT COMBINES IN ONE ENVELOPE A HIGH-MU TRIODE AND THREE SEPARATE DIODES. ONE OF THE THREE DIODES HAS A SEPARATE CATHODE PERMITTING USE AS A BALANCED DISCRIMINATOR OR DETECTOR. IN COMBINATION FM/AM RECEIVERS THIS TUBE PROVIDES THE NECESSARY ELEMENTS FOR DETECTION OF BOTH TYPES OF SIGNAL WITHOUT NEED FOR ADDITIONAL SWITCHING.

DIRECT INTERELECTRODE CAPACITANCES

WITH EXTERNAL SHIELD MB-308 CONNECTED TO CATHODE

GRID TO PLATE: (G TO P)	1.2	μμf
INPUT: (G TO K)	2.0	μμf
OUTPUT: (P TO K)	3.8	μμf
DIODE INPUT (EACH DIODE) (APPROX.)	1.0	μμf

RATINGS

INTERPRETED ACCORDING TO RMA STANDARD MB-210

HEATER VOLTAGE	12.6	VOLTS
MAXIMUM HEATER-CATHODE VOLTAGE	150	VOLTS
MAXIMUM TRIODE PLATE VOLTAGE	300	VOLTS
MAXIMUM TRIODE PLATE DISSIPATION	0.5	WATT
MAXIMUM CONTINUOUS DIODE CURRENT (EACH DIODE)	1.0	MA.

TYPICAL OPERATING CONDITIONS AND CHARACTERISTICS

HEATER VOLTAGE	12.6	12.6	12.6	VOLTS
HEATER CURRENT	150	150	150	MA.
TRIODE PLATE VOLTAGE	50	100	250	VOLTS
GRID VOLTAGE	0	-1	-2	VOLTS
GRID CIRCUIT RESISTOR	10	0	0	MEG OHM
TRIODE PLATE CURRENT	0.07	0.4	0.9	MA.
PLATE RESISTANCE	285 000	110 000	91 000	OHMS
TRANSCONDUCTANCE	300	900	1 100	μMHOS
AMPLIFICATION FACTOR	85	100	100	
AVERAGE DIODE CURRENT WITH 40 VOLTS DC APPLIED (EACH DIODE)	2.5	2.5	2.5	MA.

ONE DIODE HAS A SEPARATE CATHODE, THE OTHER CATHODE IS COMMON TO TWO DIODES AND THE TRIODE UNIT.

IT IS RECOMMENDED THAT DIODE #1 (PIN 3) AND DIODE #3 (PIN 1) BE USED IN BALANCED DETECTOR CIRCUITS.

→ INDICATES A CHANGE OR ADDITION.

CONTINUED FROM PRECEDING PAGE

RESISTANCE COUPLED AMPLIFIER

R1 MEG.	Rg1 MEG.	Rc MEG.	Ebb = 90 VOLTS			Ebb = 180 VOLTS			Ebb = 300 VOLTS		
			Rk	GAIN	Eo	Rk	GAIN	Eo	Rk	GAIN	Eo
0.1	A	0.1	6800	25	6	4700	27	10	2200	36	29
0.1	A	0.27	8200	29	7	4700	35	15	2700	45	35
0.27	A	0.27	10000	35	9	6800	44	19	4700	53	42
0.27	A	0.47	12000	39	10	6800	48	21	5600	56	48
0.47	A	0.47	18000	39	10	10000	45	24	8200	58	51
0.47	A	1	18000	46	15	12000	54	29	9100	63	59
0.27	10	0.27	---	34	5	---	54	20	---	58	40
0.27	10	0.47	---	38	6	---	57	25	---	60	49
0.47	10	0.47	---	39	7	---	60	23	---	62	47
0.47	10	1	---	42	9.5	---	65	33	---	70	63

A VALUE OF Rg1 IS NOT CRITICAL.

Rk TAKEN TO NEAREST RMA VALUE FOR EACH CASE INSTEAD OF ABSOLUTE OPTIMUM VALUE.

Eo IS RMS OUTPUT AT 5% TOTAL HARMONIC DISTORTION.

GAIN MEASURED AT Eo = 2.0 VOLTS RMS OUTPUT.

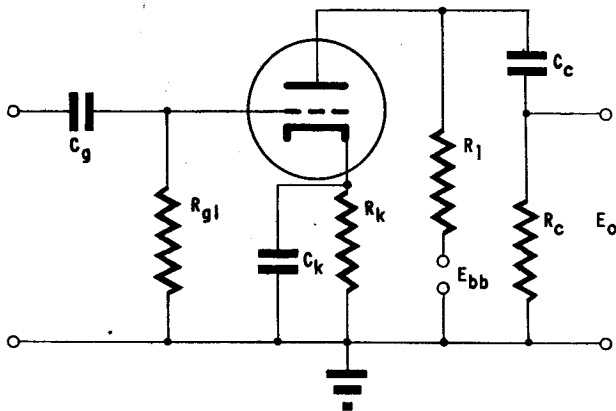

→ INDICATES A CHANGE OR ADDITION.

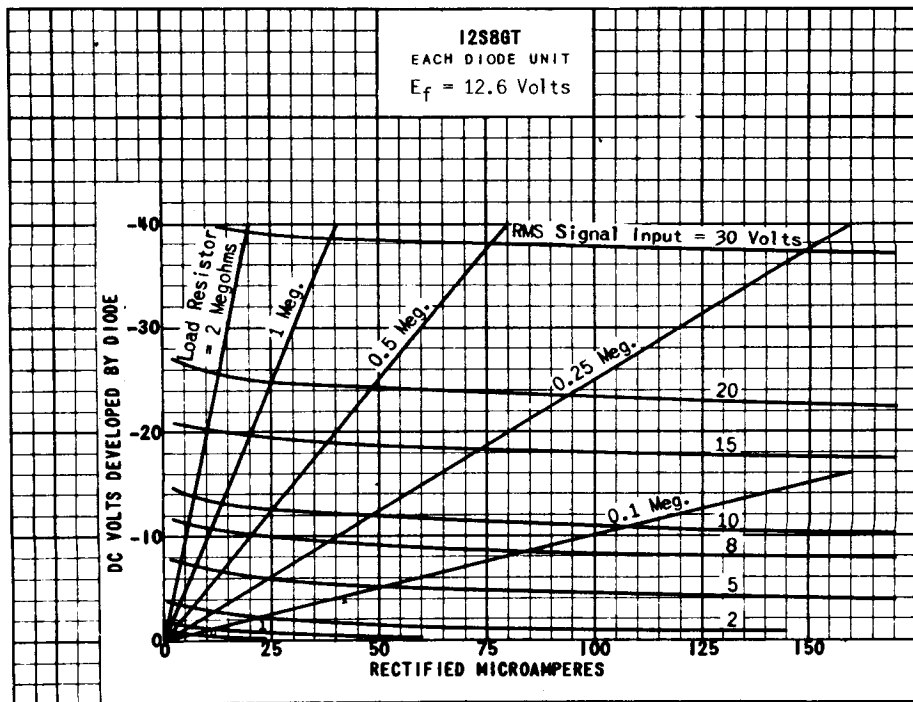
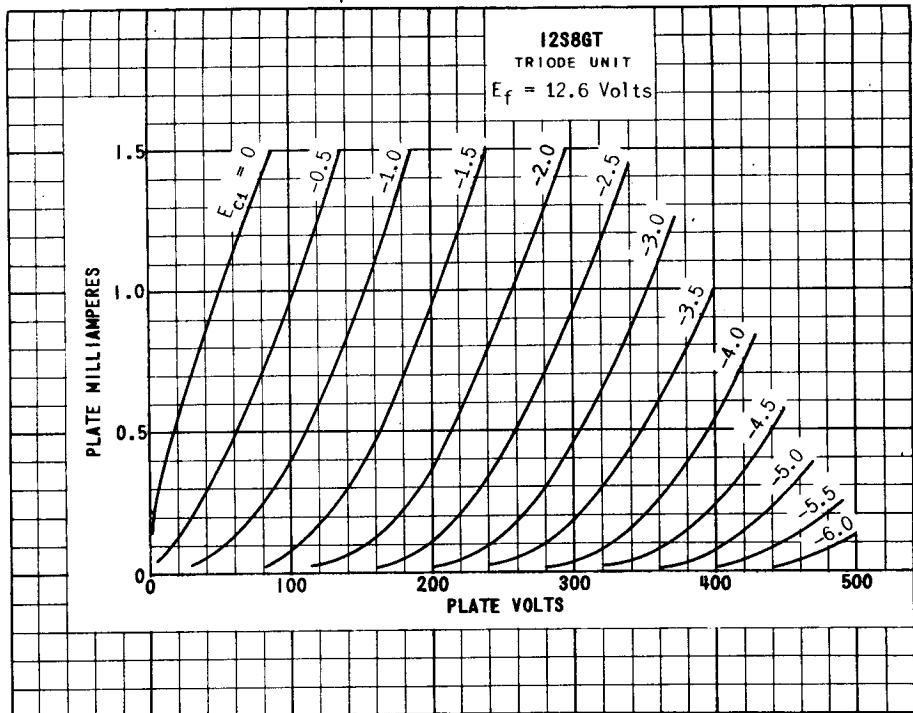

PRINTED IN U. S. A.

PLATE
1897
OCT. 1,
1947



TUNG-SOL

PENTAGRID CONVERTER

UNIPOTENTIAL CATHODE

HEATER

12.6 VOLTS 0.15 AMPERE
AC OR DC

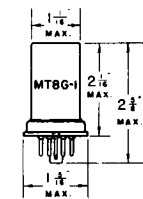

METAL TUBE
SMALL WAFER
8 PIN OCTAL BASE
12SA7

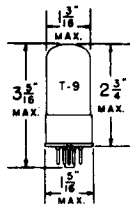

GLASS BULB
8 PIN OCTAL BASE
WITH METAL SHELL
12SA7GT/G

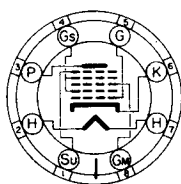

8R

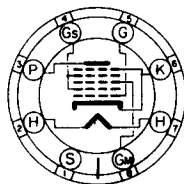

8AD

BOTTOM VIEWS

THE TUNG-SOL 12SA7 AND 12SA7GT/G ARE PENTAGRID CONVERTERS, DESIGNED TO MINIMIZE FREQUENCY DRIFT. THEY ARE INTENDED FOR SERVICE AS COMBINED OSCILLATORS AND MIXERS IN AC-DC OPERATED SUPERHETERODYNE RECEIVERS.

RATINGS

MAXIMUM PLATE VOLTAGE	300	VOLTS
MAXIMUM SCREEN (G _s) SUPPLY VOLTAGE	300	VOLTS
MAXIMUM SCREEN VOLTAGE	100	VOLTS
MINIMUM EXTERNAL CONTROL GRID (G) BIAS VOLTAGE ^A	0	VOLT
MAXIMUM TOTAL CATHODE CURRENT	14	MA.
MAXIMUM PLATE DISSIPATION	1.0	WATT
MAXIMUM SCREEN DISSIPATION	1.0	WATT

^A WITH SELF-EXCITED OSCILLATOR.

FOR "INTERPRETATION OF RATINGS" REFER TO FRONT OF BOOK.

CONTINUED NEXT PAGE

TUNG-SOL

DIRECT INTERELECTRODE CAPACITANCES

	12SA7	6SA7GT/G	
CONTROL GRID (G) TO MIXER PLATE (P) ⁵	0.13 MAX.	0.2 MAX.	μf
CONTROL GRID (G) TO OSCILLATOR GRID (G ₀) ⁵	0.15 MAX.	0.2 MAX.	μf
RF INPUT: CONTROL GRID (G) TO ALL OTHER ELECTRODES ⁵	9.5	11	μf
OSCILLATOR GRID (G ₀) TO PLATE (P) ⁵	0.06 MAX.	0.2 MAX.	μf
OSCILLATOR INPUT: OSCILLATOR GRID (G ₀) TO ALL OTHER ELECTRODES ⁵	7	8	μf
OSCILLATOR GRID (G ₀) TO ALL OTHER ELECTRODES EXCEPT CATHODE (K)	4.4	5	μf
OSCILLATOR GRID (G ₀) TO CATHODE (K)	2.6	3	μf
MIXER OUTPUT: PLATE (P) TO ALL OTHER ELECTRODES ⁵	12	12	μf
CATHODE (K) TO ALL OTHER ELECTRODES EXCEPT OSCILLATOR GRID (G ₀)	5	30	μf

⁵ WITH SHELL CONNECTED TO CATHODE.

TYPICAL OPERATING CONDITIONS AND CHARACTERISTICS

CONVERTER SERVICE - SEPARATE EXCITATION^A

PLATE (P) VOLTAGE	100	250	VOLTS
SCREEN (G _s) VOLTAGE	100	100	VOLTS
CONTROL GRID (G) VOLTAGE	-2	-2	VOLTS
OSCILLATOR GRID (G ₀) RESISTOR	20000	20000	OHMS
PLATE CURRENT	3.3	3.5	MA.
SCREEN CURRENT	8.5	8.5	MA.
OSCILLATOR GRID CURRENT	0.5	0.5	MA.
TOTAL CATHODE CURRENT	12.3	12.5	MA.
PLATE RESISTANCE	0.5	1.0	MEGOHM
CONVERSION TRANSCONDUCTANCE	425	450	μMHOS
FOR CONTROL GRID (G) VOLTAGE = -2 V.			
CONVERSION TRANSCONDUCTANCE	310	325	μMHOS
FOR CONTROL GRID (G) VOLTAGE = -6 V.			
CONVERSION TRANSCONDUCTANCE	75	80	μMHOS
FOR CONTROL GRID (G) VOLTAGE = -10 V.			
CONVERSION TRANSCONDUCTANCE APPROX.	2	2	μMHOS
FOR CONTROL GRID (G) VOLTAGE = -35 V.			

^A THE CHARACTERISTICS UNDER THESE CONDITIONS CORRESPOND VERY CLOSELY WITH THOSE OBTAINED IN A SELF-EXCITED OSCILLATORY CIRCUIT OPERATING WITH ZERO-BIAS.

TUNG-SOL

TWIN TRIODE AMPLIFIER

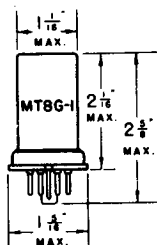

UNIPOTENTIAL CATHODE

HEATER

12.6 VOLTS 0.15 AMPERE

AC OR DC

METAL SHELL

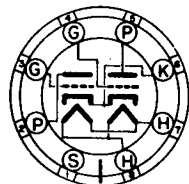

8S

BOTTOM VIEW

SMALL WAFER 8 PIN OCTAL BASE

THE TUNG-SOL 12SC7 IS A SINGLE-ENDED TWIN TRIODE AMPLIFIER IN A METAL SHELL. EACH SECTION IS DESIGNED WITH A HIGH AMPLIFICATION FACTOR. ITS PRIMARY APPLICATION IS AS A PHASE INVERTER AND AUDIO AMPLIFIER.

RATINGS

MAXIMUM PLATE VOLTAGE 250 VOLTS

TYPICAL OPERATING CONDITIONS AND CHARACTERISTICS

CLASS A₁ AMPLIFIER

VALUES ARE FOR EACH TRIODE SECTION

PLATE VOLTAGE	250	VOLTS
GRID VOLTAGE	-2	VOLTS
PLATE CURRENT	2	MA.
PLATE RESISTANCE	53000	OHMS
TRANSCONDUCTANCE	1325	μMHOS
AMPLIFICATION FACTOR	70	

FOR "INTERPRETATION OF RATINGS" REFER TO FRONT OF BOOK.

12SC7
 EACH TRIODE SECTION
 $E_f = 12.6 \text{ V.}$

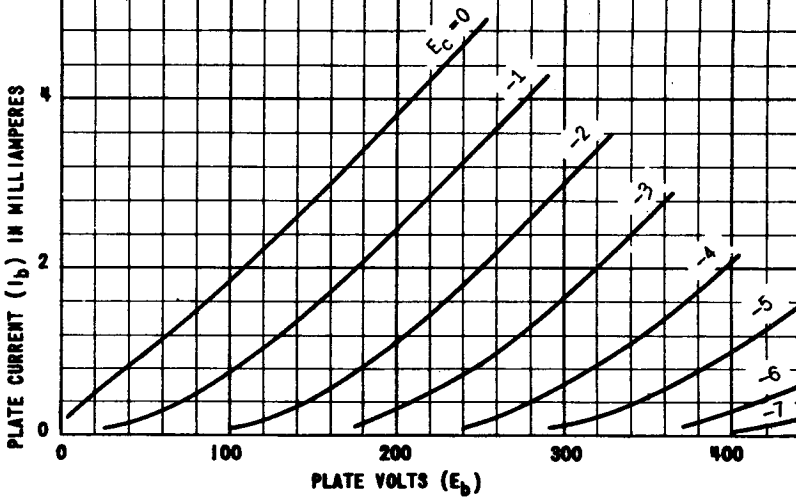

TUNG-SOL

HIGH MU TRIODE AMPLIFIER

UNIPOTENTIAL CATHODE

HEATER

12.6 VOLTS 0.15 AMPERE
AC OR DC

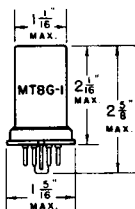

METAL SHELL
SMALL WAFER
6 PIN OCTAL BASE
12SF5

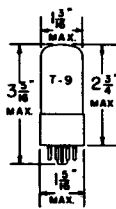

GLASS BULB
INTERMEDIATE
6 PIN OCTAL BASE
12SF5GT



6AB

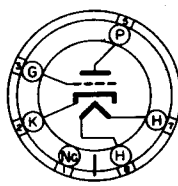

G-6AB

BOTTOM VIEWS

THE TUNG-SOL 12SF5 AND 12SF5GT ARE GENERAL PURPOSE HIGH MU TRIODES. THEY ARE DESIGNED FOR SERVICE AS HIGH GAIN RESISTANCE COUPLED AMPLIFIERS IN AC - DC OPERATED RECEIVERS USING 150 MA. HEATER TUBES.

RATINGS

HEATER VOLTAGE (AC OR DC)	12.6	VOLTS
HEATER CURRENT	0.15	AMPERE
MAXIMUM PLATE VOLTAGE	300	VOLTS

AVERAGE CHARACTERISTICS

PLATE VOLTAGE	100	250	VOLTS
CONTROL GRID VOLTAGE	-1	-2	VOLTS
PLATE CURRENT	0.4	0.9	MA.
PLATE RESISTANCE	85000	66000	OHMS
TRANSCONDUCTANCE	1150	1500	μMHOS
AMPLIFICATION FACTOR	100	100	

FOR "INTERPRETATION OF RATINGS" REFER TO FRONT OF BOOK.

CONTINUED NEXT PAGE

PLATE
1092-2

JULY 28
1941

12SF5, 12SF5GT

TUNG-SOL

TYPICAL OPERATING CONDITIONS AND CHARACTERISTICS

ZERO BIAS, RESISTANCE COUPLED, CLASS A₁ AMPLIFIER

PLATE SUPPLY VOLTAGE	100	300	VOLTS	
PLATE LOAD RESISTOR	0.25	0.25	MEGOHM	
GRID RESISTOR	10	10	MEGOHMS	
COUPLING CONDENSER	.01 to .005	.01 to .005	μf	
GRID RESISTOR FOR FOLLOWING TUBE	.5 to 1.0	.5 to 1.0	MEGOHM	
EXTERNAL GRID CIRCUIT IMPEDANCE	0	0	MEGOHM	
VOLTAGE GAIN	48	52	66	71
VOLTAGE OUTPUT (RMS) ^A	7.0	8.5	44	50
			VOLTS	

^A AT FIVE PER CENT TOTAL HARMONIC DISTORTION.

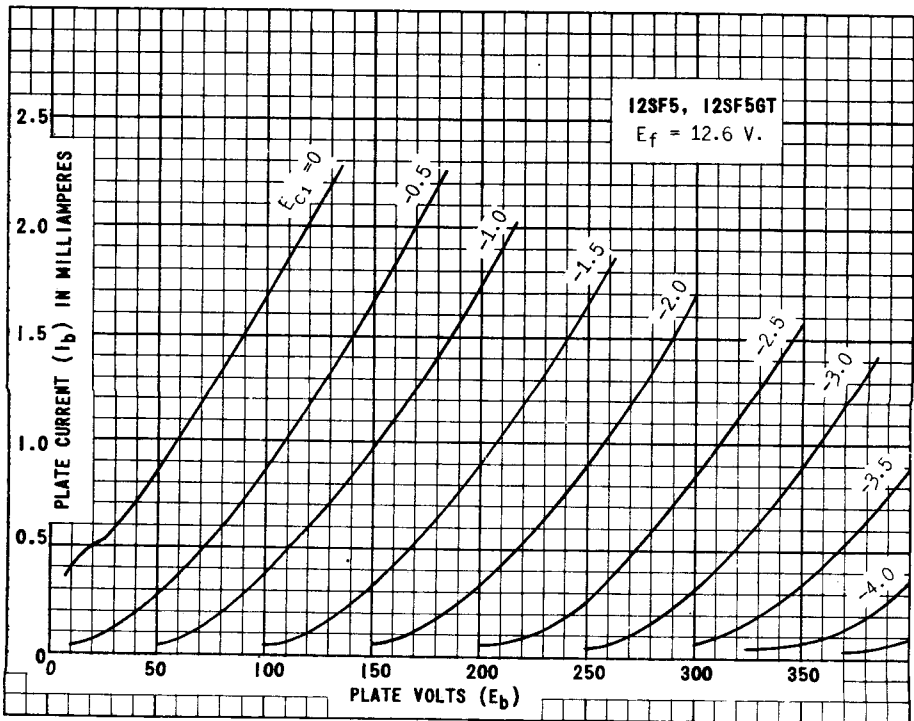

PLATE
1093-1

TUNG-SOL

DIODE AMPLIFIER PENTODE

PHYSICAL SPECIFICATIONS

EMITTER COATED UNIPOT. CATHODE		PIN CONNECTIONS	
BASE 8 PIN OCTAL WAFER WITH METAL SHELL		PIN 1 BASE SHELL, INTER-PIN SHIELD	
BULB T-9		PIN 2 GRID 1	PIN 7 HEATER
MAXIMUM DIAMETER 1 5/16"		PIN 3 G3, S1, K	PIN 8 HEATER
MAXIMUM OVERALL LENGTH 3 5/16"		PIN 4 GRID 2	
MAXIMUM SEATED HEIGHT 2 3/4"		PIN 5 DI. PLATE	MOUNTING POS. ANY
		PIN 6 PENT. PLATE	

RATINGS

INTERPRETED ACCORDING TO RMA STANDARD MB-210

HEATER OR FILAMENT VOLTAGE (AC OR DC)	12.6	VOLTS
HEATER OR FILAMENT CURRENT	0.15	AMP.
MAXIMUM PENTODE PLATE VOLTAGE	300	VOLTS
MAXIMUM SCREEN VOLTAGE	100	VOLTS
MAXIMUM PENTODE PLATE DISSIPATION	3.5	WATTS
MAXIMUM SCREEN DISSIPATION	0.5	WATT
MAXIMUM HEATER-CATHODE VOLTAGE	90	VOLTS
MAXIMUM SCREEN SUPPLY VOLTAGE	300	VOLTS
MINIMUM DIODE PLATE CURRENT WITH 10 VOLTS DC APPLIED	0.8	MA.

CAPACITANCES

WITH EXTERNAL SHIELD CONNECTED TO CATHODE

CONTROL GRID TO CATHODE	5.5	μ f
PENTODE PLATE TO CATHODE	6.0	μ f
GRID TO PENTODE PLATE	0.004	μ f (MAX.)
DIODE PLATE TO PENTODE GRID 1	0.002	μ f (MAX.)
DIODE PLATE TO PENTODE PLATE	1.3	μ f

TYPICAL OPERATING CONDITIONS AND CHARACTERISTICS
CLASS A₁ AMPLIFIER

HEATER OR FILAMENT VOLTAGE	12.6	12.6	VOLTS
HEATER OR FILAMENT CURRENT	0.15	0.15	AMP.
PLATE VOLTAGE	100	250	VOLTS
SCREEN VOLTAGE	100	100	VOLTS
CONTROL GRID VOLTAGE	-1	-1	VOLT.
PEAK AF SIGNAL VOLTAGE			VOLTS
PLATE CURRENT	12	12.4	MA.
SCREEN CURRENT	3.4	3.3	MA.
MAXIMUM-SIGNAL PLATE CURRENT			MA.
MAXIMUM-SIGNAL SCREEN CURRENT			MA.
PLATE RESISTANCE (APPROX.)	0.2	0.7	MEG OHM
TRANSCONDUCTANCE	1975	2050	μ MHOS
AMPLIFICATION FACTOR			
LOAD RESISTANCE			OHMS
TOTAL HARMONIC DISTORTION			PER CENT
POWER OUTPUT			WATTS
CONTROL GRID VOLTAGE (APPROX.) FOR TRANSCONDUCTANCE=10 μ MHOS	-35	-35	VOLTS

12SF7GT

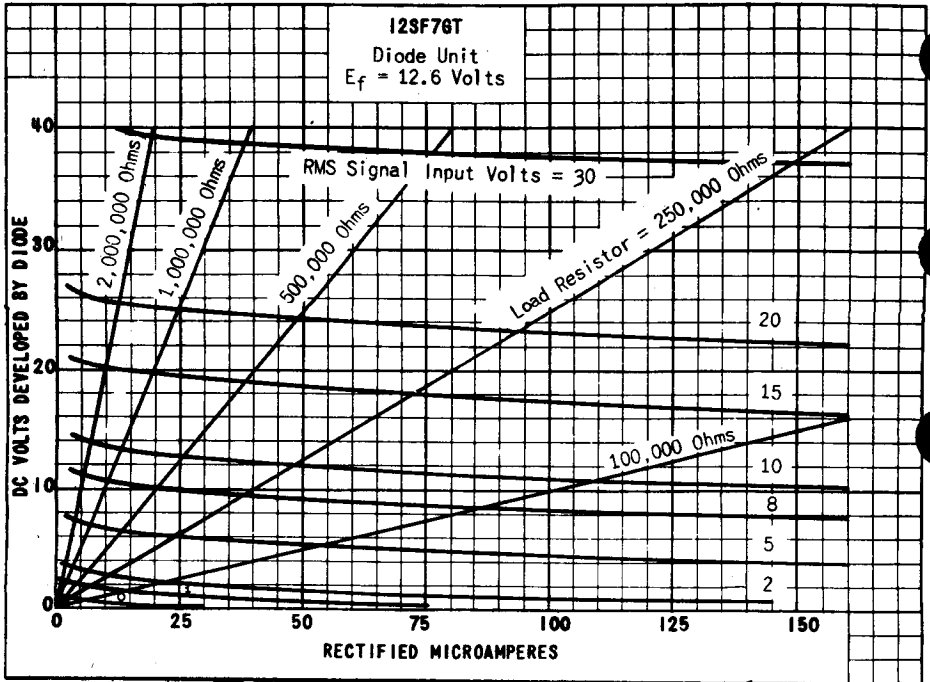
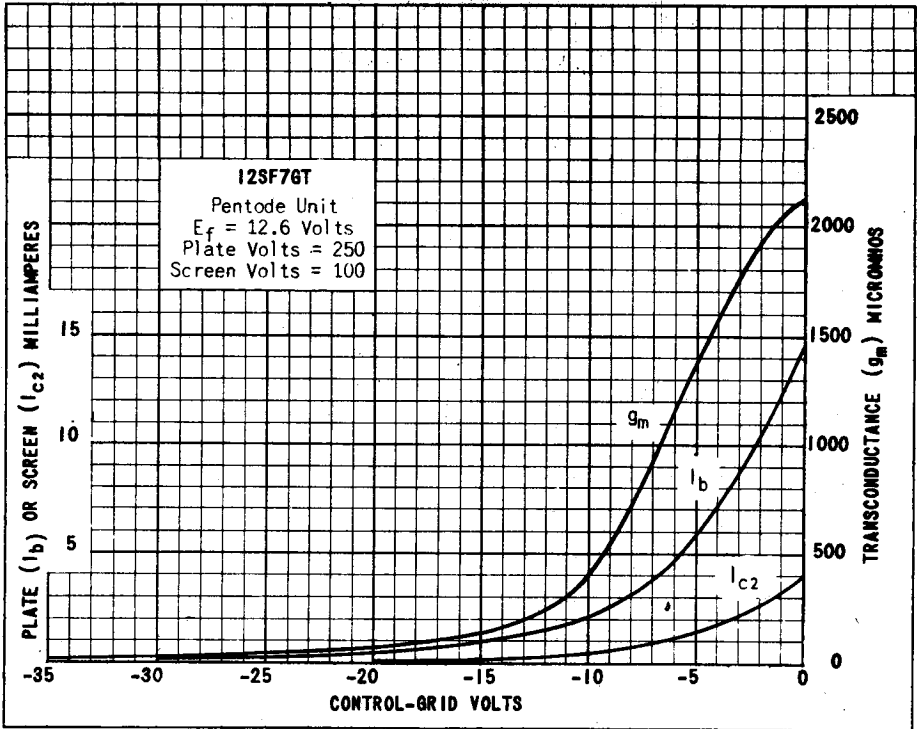
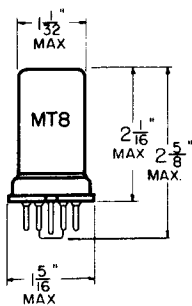

PLATE
 1710
 APRIL 1
 1946

TUNG-SOL

PENTODE



METAL SHELL

COATED UNIPOTENTIAL CATHODE

HEATER
12.6 VOLTS 150 MA.
AC OR DC

ANY MOUNTING POSITION

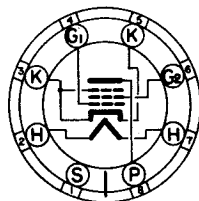

BOTTOM VIEW
SMALL WAFER
8 PIN OCTAL

THE 12SG7 IS A SEMI-REMOTE CUT OFF PENTODE VOLTAGE AMPLIFIER IN THE OCTAL METAL CONSTRUCTION. IT FEATURES HIGH TRANSCONDUCTANCE WITH LOW GRID-PLATE CAPACITANCE AND A DUAL CATHODE CONNECTION TO MINIMIZE EFFECTS OF COMMON CATHODE CIRCUIT COUPLING.

DIRECT INTERELECTRODE CAPACITANCES

	12sg7^A	
GRID TO PLATE: (G TO P) MAX.	0.003	μf
INPUT: G ₁ TO (H+K&G ₃ +G ₂)	8.5	μf
OUTPUT: P TO (H+K&G ₃ +G ₂)	7	μf

^A WITH SHELL CONNECTED TO CATHODE.

RATINGS

INTERPRETED ACCORDING TO RMA STANDARD M8-210

HEATER VOLTAGE	12.6	VOLTS
MAXIMUM HEATER-CATHODE VOLTAGE	90	VOLTS
MAXIMUM PLATE VOLTAGE	300	VOLTS
MAXIMUM GRID #2 VOLTAGE	200	VOLTS
MAXIMUM GRID #2 SUPPLY VOLTAGE	300	VOLTS
MINIMUM EXTERNAL GRID #1 VOLTAGE	0	VOLTS
MAXIMUM PLATE DISSIPATION	3	WATTS
MAXIMUM GRID #2 DISSIPATION	0.6	WATT

PLATE
2064
AUG. 2,
1948

CONTINUED ON NEXT PAGE

TUNG-SOL

CONTINUED FROM PRECEDING PAGE

TYPICAL OPERATING CONDITIONS AND CHARACTERISTICS

CLASS A₁ AMPLIFIER

HEATER VOLTAGE	12.6	12.6	12.6	VOLTS
HEATER CURRENT	150	150	150	MA.
PLATE VOLTAGE	100	250	250	VOLTS
GRID #2 VOLTAGE	100	125	150	VOLTS
GRID #1 VOLTAGE	-1	-1	-2.5	VOLTS
SELF BIAS RESISTOR	90	60	190	OHMS
PLATE RESISTANCE (APPROX.)	0.25	0.9	^c	MEGOHM
TRANSCONDUCTANCE	4100	4700	4000	μMHOS
PLATE CURRENT	8.2	11.8	9.2	MA.
GRID #2 CURRENT	3.2	4.4	3.4	MA.
GRID #1 VOLTAGE (APPROX.) FOR $g_m = 40 \mu\text{MHOS}$	-11.5	-14	-17.5	VOLTS

^c GREATER THAN 1.0 MEGOHM.

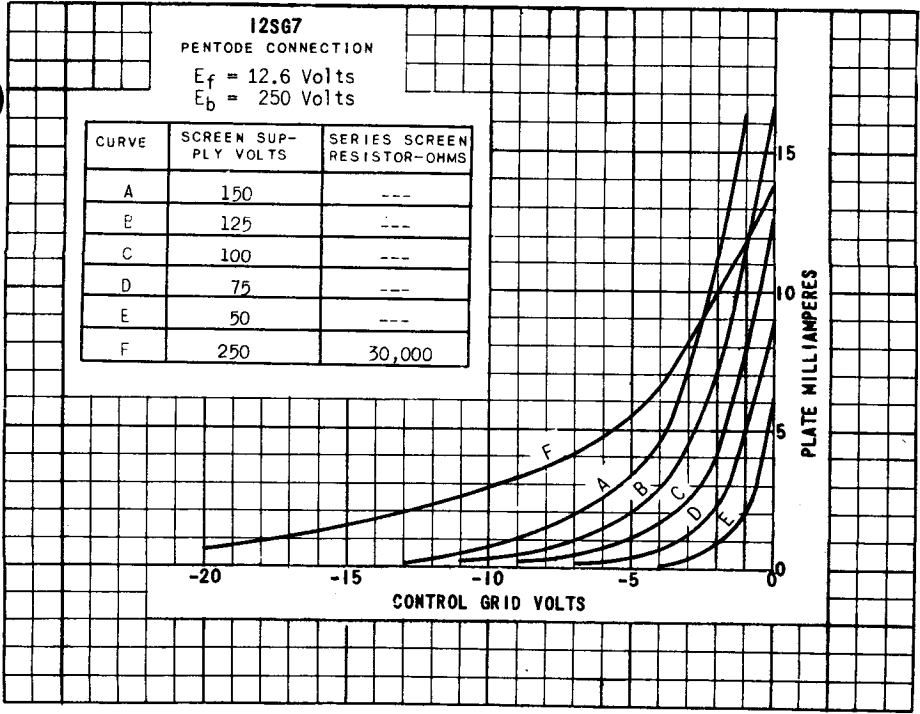
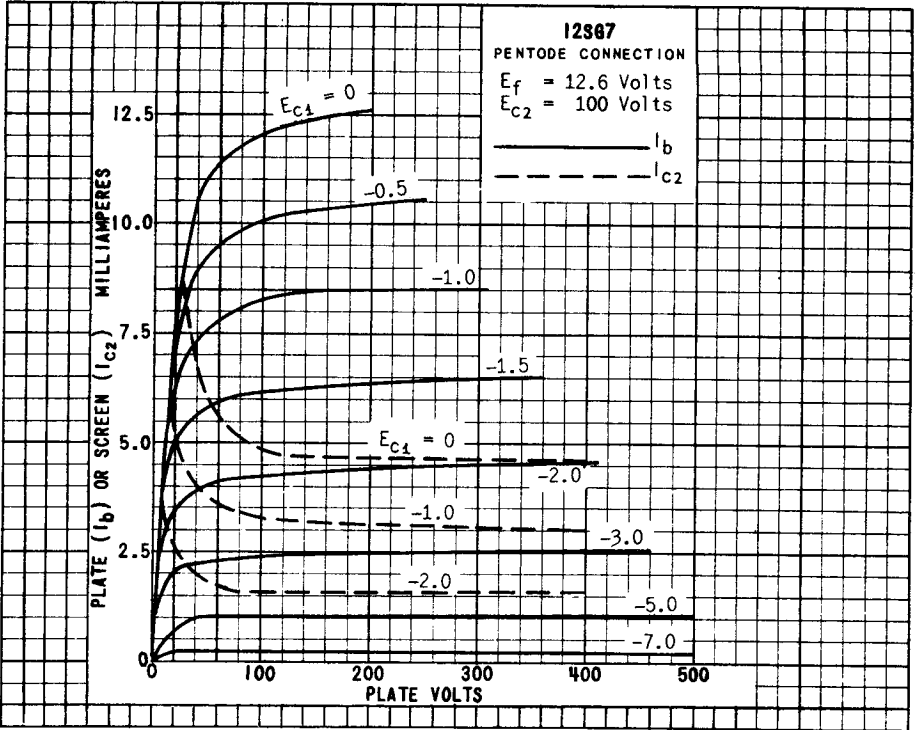

PLATE 2066
AUG. 2, 1948

12SG7(6SG7, 6SG7GT)

12SG7

PENTODE CONNECTION

$E_f = 12.6$ Volts

$E_b = 250$ Volts

CURVE	SCREEN SUPPLY VOLTS	SERIES SCREEN RESISTOR-OHMS
A	150	---
B	125	---
C	100	---
D	75	---
E	50	---
F	250	30,000

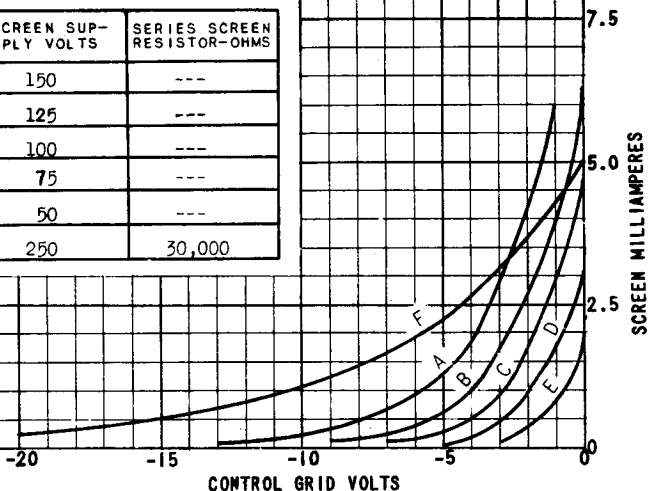

12SG7

PENTODE CONNECTION

$E_f = 12.6$ Volts

$E_b = 250$ Volts

CURVE	SCREEN SUPPLY VOLTS	SERIES SCREEN RESISTOR-OHMS
A	150	---
B	125	---
C	100	---
D	75	---
E	50	---
F	250	30,000

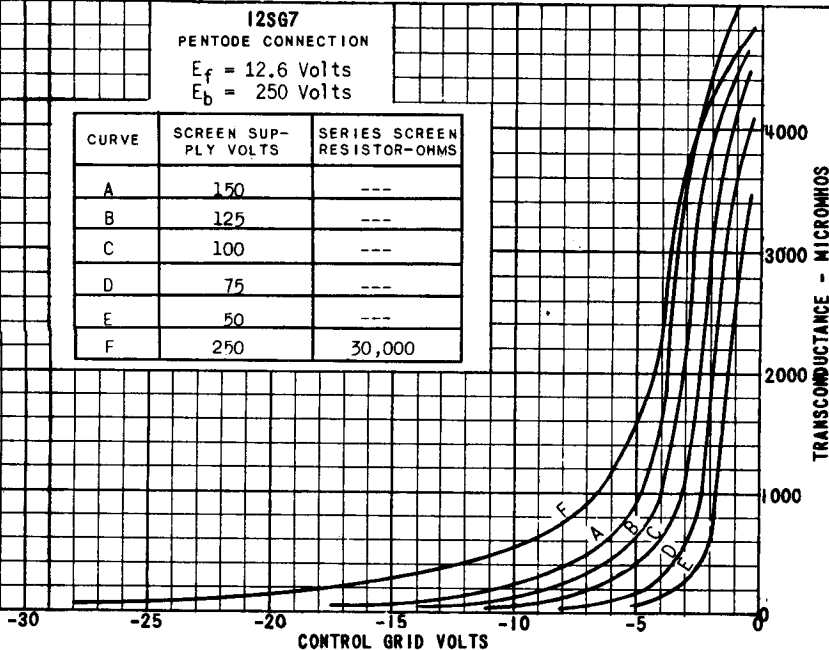
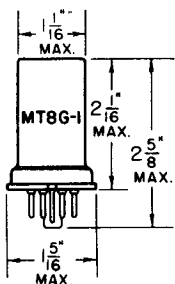

PLATE
2067
AUG. 2,
1948

TUNG-SOL

TRIPLE-GRID
DETECTOR AMPLIFIER



METAL SHELL
SMALL WAFER OCTAL
8 PIN BASE

6SJ7, 12SJ7

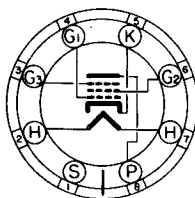

BOTTOM VIEW
6SJ7, 6SJ7GT
12SJ7, 12SJ7GT

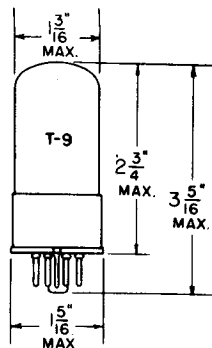

GLASS BULB
SMALL WAFER OCTAL 8 PIN
BASE WITH METAL SLEEVE

6SJ7GT, 12SJ7GT

UNIPOTENTIAL CATHODE

HEATER

6SJ7, 6SJ7GT - 6.3 V. 0.3 A.
12SJ7, 12SJ7GT - 12.6 V. 0.15 A.

AC OR DC

IN CIRCUITS WHERE THE CATHODE IS NOT DIRECTLY CONNECTED TO THE HEATER, THE POTENTIAL DIFFERENCE BETWEEN THE HEATER AND CATHODE SHOULD BE KEPT AS LOW AS POSSIBLE. UNDER NO CONDITIONS SHOULD IT EXCEED 100 VOLTS.

THESE TUBES ARE SINGLE ENDED PENTODES HAVING SHARP CUT-OFF CHARACTERISTICS. THEY MAY BE USED AS BIASED DETECTORS, RADIO FREQUENCY OSCILLATORS OR AS MIXER TUBES IN PROPERLY DESIGNED CIRCUITS. WITH THE EXCEPTION OF HEATER AND CAPACITANCE RATINGS, THEIR ELECTRICAL CHARACTERISTICS ARE IDENTICAL.

RATINGS

INTERPRETED ACCORDING TO RMA STANDARD MB-210

MAXIMUM PLATE VOLTAGE	300	VOLTS
MAXIMUM SCREEN VOLTAGE	125	VOLTS
MAXIMUM SCREEN SUPPLY VOLTAGE	300	VOLTS
MINIMUM GRID VOLTAGE	0	VOLTS
MAXIMUM PLATE DISSIPATION	2.5	WATTS
MAXIMUM SCREEN DISSIPATION	0.3	WATTS

CONTINUED NEXT PAGE

12SJ7, 12SJ7GT (6SJ7, 6SJ7GT)

TUNG-SOL

DIRECT INTERELECTRODE CAPACITANCES

SHELL CONNECTED TO CATHODE

	6SJ7-12SJ7	6SJ7GT-12SJ7GT	
GRID TO PLATE	0.005 MAX.	0.005 MAX.	$\mu\mu\text{f}$
INPUT	6.0	6.3	$\mu\mu\text{f}$
OUTPUT	7.0	10.0	$\mu\mu\text{f}$

TYPICAL OPERATING CONDITIONS AND CHARACTERISTICS

CLASS A₁ AMPLIFIER

	6SJ7-12SJ7	6SJ7GT-12SJ7GT	
PLATE VOLTAGE	100	250	VOLTS
SCREEN VOLTAGE	100	100	VOLTS
GRID VOLTAGE	-3	-3	VOLTS
SUPPRESSOR	TIE TO CATHODE		
PLATE CURRENT	2.9	3.0	MA.
SCREEN CURRENT	0.9	0.8	MA.
PLATE RESISTANCE (APPROX.)	0.7	1.5	MEGOHMS
TRANSCONDUCTANCE	1575	1650	μMHOS
GRID VOLTAGE	-9	-9	VOLTS

(FOR CATHODE CURRENT CUT-OFF)

PLATE
1442
JUNE 15
1944

(6SJ7, 6SJ7GT) 12SJ7, 12SJ7GT

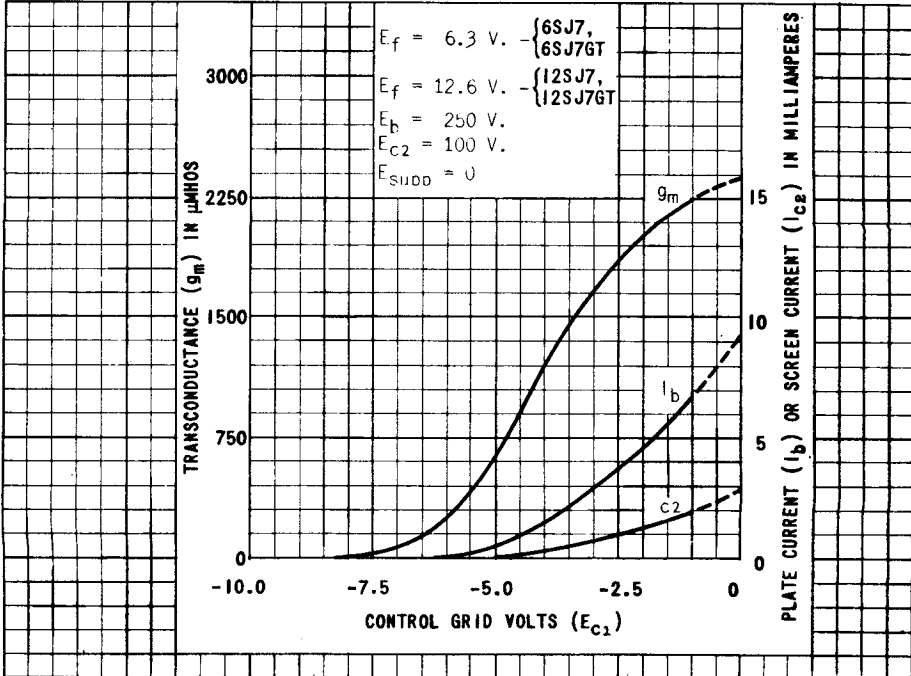
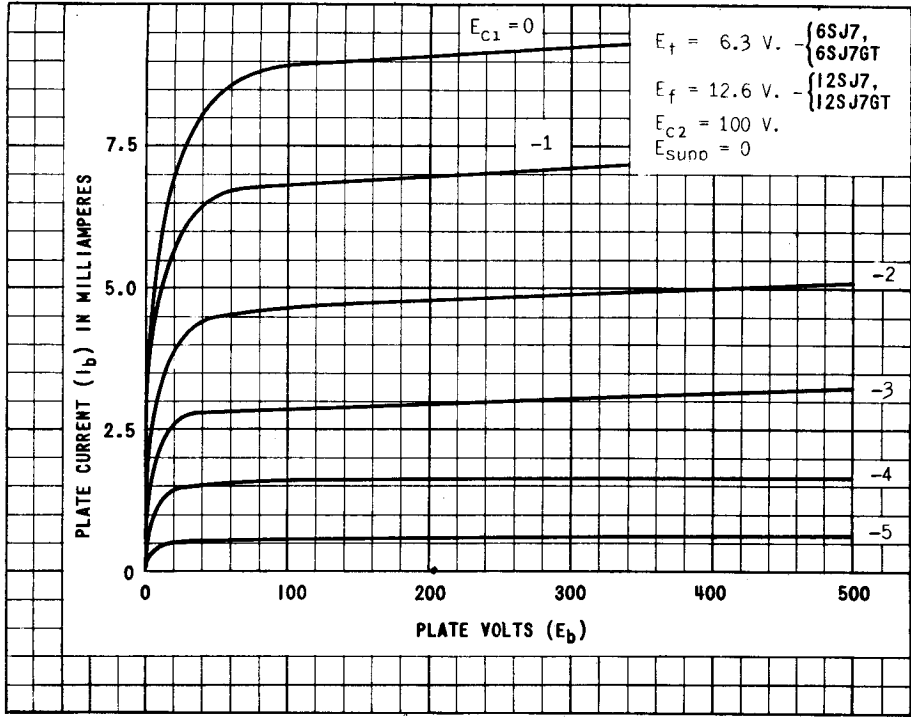

PRINTED IN U. S. A.

PLATE 1443
 JUNE 15 1944



TUNG-SOL

TRIPLE GRID

REMOTE CUT-OFF AMPLIFIER

UNIPOTENTIAL CATHODE

HEATER
12.6 VOLTS 0.15 AMPERE
AC OR DC

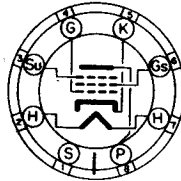
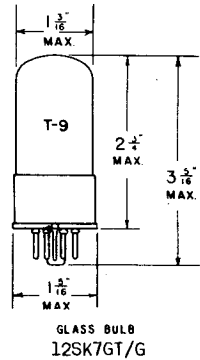
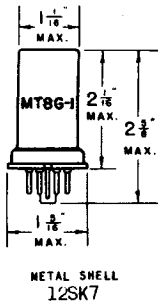

8N

BOTTOM VIEW

SMALL WAFER 8 PIN OCTAL BASE

THE TUNG-SOL 12SK7 AND 12SK7GT/G ARE TRIPLE GRID VARIABLE MU AMPLIFIERS. THEY ARE DESIGNED FOR USE WITH AVC IN RF AND IF AMPLIFIERS, AND THEY MINIMIZE CROSS MODULATION. WITH THE EXCEPTION OF HEATER RATINGS, THEIR RATINGS AND ELECTRICAL CHARACTERISTICS ARE IDENTICAL WITH THOSE OF THE 6SK7 AND 6SK7GT/G.

RATINGS

MAXIMUM PLATE VOLTAGE	300	VOLTS
MAXIMUM SCREEN SUPPLY VOLTAGE	300	VOLTS
MAXIMUM SCREEN VOLTAGE	125	VOLTS
MINIMUM EXTERNAL CONTROL GRID BIAS VOLTAGE	0	VOLTS
MAXIMUM PLATE DISSIPATION	4.0	WATTS
MAXIMUM SCREEN DISSIPATION	0.4	WATT

FOR "INTERPRETATION OF RATINGS" REFER TO FRONT OF BOOK.

CONTINUED NEXT PAGE

PLATE

1122-1

SEPT. 17
1941

12SK7, 12SK7GT/G

TUNG-SOL

DIRECT INTERELECTRODE CAPACITANCES⁵

	12SK7	12SK7GT/G	
CONTROL GRID TO CATHODE	6.0	6.5	μf
PLATE TO CATHODE	7.0	7.5	μf
CONTROL GRID TO PLATE	0.003 ^{MAX.}	0.005 ^{MAX.}	μf

⁵ WITH SHELL CONNECTED TO CATHODE.

TYPICAL OPERATING CONDITIONS AND CHARACTERISTICS

CLASS A₁ AMPLIFIER

PLATE VOLTAGE	100	250	VOLTS
SCREEN VOLTAGE	100	100	VOLTS
CONTROL GRID VOLTAGE	-1	-3	VOLTS
SUPPRESSOR GRID	CONNECTED TO CATHODE AT SOCKET		
PLATE CURRENT	15	9.2	MA.
SCREEN CURRENT	4.0	2.6	MA.
PLATE RESISTANCE ^{APPROX.}	0.12	0.8	MEGOHM
TRANSCONDUCTANCE	2350	2000	μMHOS
CONTROL GRID VOLTAGE	-35	-35	VOLTS

FOR TRANSCONDUCTANCE = 10 μMHOS

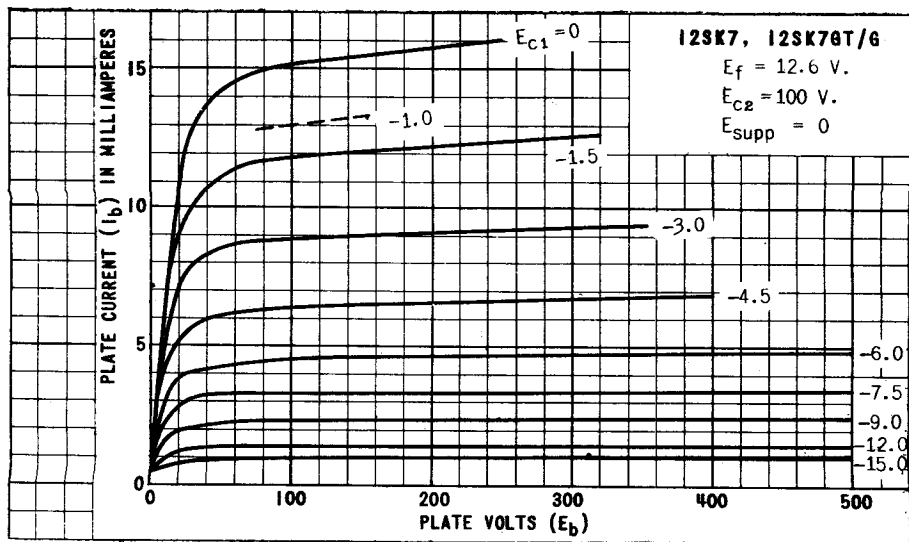
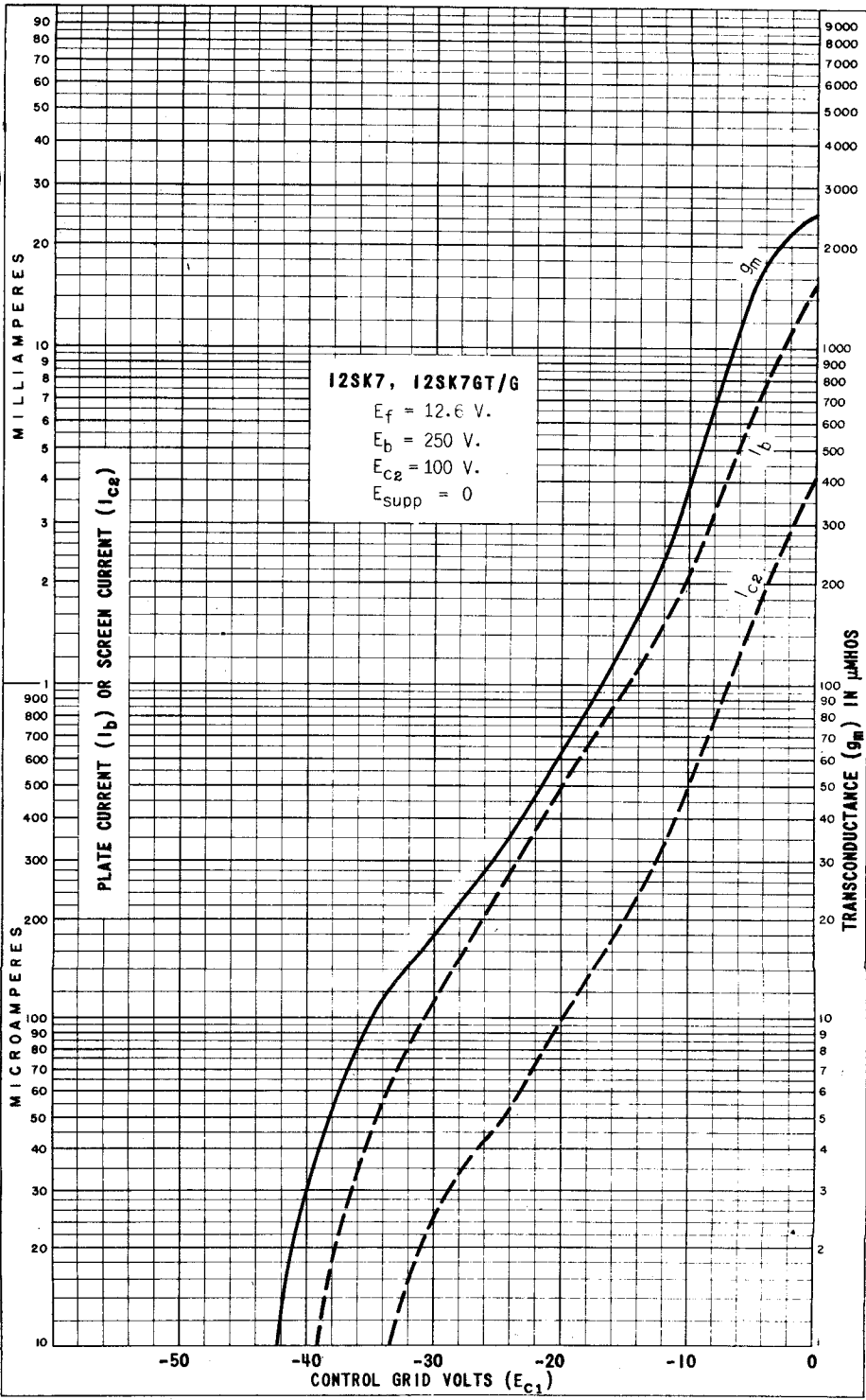

PLATE
1123-1

I2SK7, I2SK7GT/G



PRINTED IN U. S. A.

PLATE 1124-1
 SEPT. 17 1941

12SK7, 12SK7GT/G

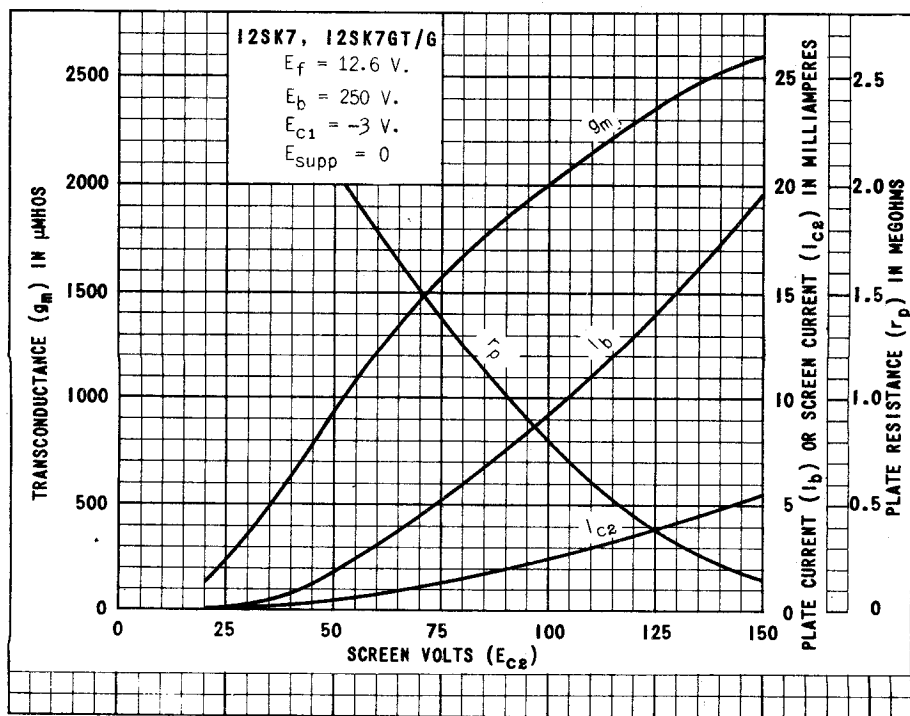
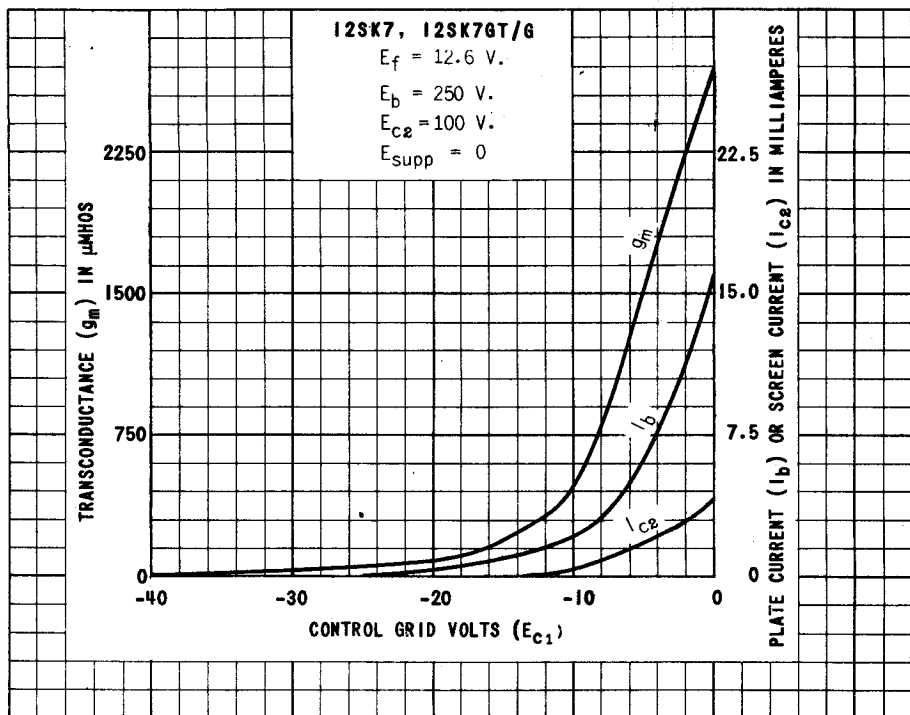

TUNG-SOL

TWIN-TRIODE AMPLIFIER

PHYSICAL SPECIFICATIONS

EMITTER UNIPOTENTIAL CATHODE	PIN CONNECTIONS	
BASE INTERMEDIATE SHELL OCTAL 8-PIN	PIN 1 GRID (T2)	PIN 7 HEATER
CAP NONF	PIN 2 PLATE (T2)	PIN 8 HEATER
BULB T-9	PIN 3 CATHODE (T2)	
MAXIMUM DIAMETER 1 5/16"	PIN 4 GRID (T1)	
MAXIMUM OVERALL LENGTH 3 5/16"	PIN 5 PLATE (T1)	TOP CAP NONE
MAXIMUM SEATED HEIGHT 2 3/4"	PIN 6 CATHODE (T1)	

RATINGS
AMPLIFIER - EACH UNIT

HEATER OR FILAMENT VOLTAGE (AC OR DC)	12.6	VOLTS
HEATER OR FILAMENT CURRENT	0.15	AMPS.
MAXIMUM PLATE VOLTAGE	250	VOLTS
MAXIMUM GRID VOLTAGE	0	VOLTS
MAXIMUM PLATE DISSIPATION	1	WATTS
MAXIMUM SCREEN DISSIPATION		WATTS

RATINGS ARE TO BE INTERPRETED ACCORDING TO RMA STANDARD M8-210

CAPACITANCES

	TRIODE UNIT T1	TRIODE UNIT T2	
GRID TO CATHODE	3.0	3.4	μf
PLATE TO CATHODE	3.8	3.2	μf
GRID TO PLATE	2.8	2.8	μf
PLATE TO PLATE	0.4		μf
GRID TO GRID	0.65		μf
GRID T2 TO PLATE T1	0.13		μf

TYPICAL OPERATING CONDITIONS AND CHARACTERISTICS
CLASS A₁ AMPLIFIER

HEATER OR FILAMENT VOLTAGE (AC OR DC)	12.6	VOLTS
HEATER OR FILAMENT CURRENT	0.15	AMPS.
PLATE VOLTAGE	250	VOLTS
GRID VOLTAGE	-2	VOLTS
CONTROL GRID VOLTAGE		VOLTS
PEAK AF SIGNAL VOLTAGE		VOLTS
ZERO-SIGNAL PLATE CURRENT	2.3	MA.
ZERO-SIGNAL SCREEN CURRENT		MA.
MAXIMUM-SIGNAL PLATE CURRENT		MA.
MAXIMUM-SIGNAL SCREEN CURRENT		MA.
PLATE RESISTANCE (APPROX.)	44000	OHMS
TRANSCONDUCTANCE	1600	μMHOS
AMPLIFICATION FACTOR	70	
LOAD RESISTANCE		OHMS
TOTAL HARMONIC DISTORTION		PER CENT
POWER OUTPUT		WATTS
CONTROL GRID VOLTAGE		
FOR TRANSCONDUCTANCE	μMHOS	VOLTS

TUNG-SOL

TWIN-TRIODE AMPLIFIER

PHYSICAL SPECIFICATIONS

EMITTER	UNIPOENTIAL CATHODE	PIN CONNECTIONS	
BASE	INTERMEDIATE SHELL OCTAL 8-PIN	PIN 1 GRID (T ₂)	PIN 7 HEATER
CAP	NONE	PIN 2 PLATE (T ₂)	PIN 8 HEATER
BULB	T-9	PIN 3 CATHODE (T ₂)	
MAXIMUM DIAMETER	1 5/16"	PIN 4 GRID (T ₁)	
MAXIMUM OVERALL LENGTH	3 5/16"	PIN 5 PLATE (T ₁)	TOP CAP NONE
MAXIMUM SEATED HEIGHT	2 3/4"	PIN 6 CATHODE (T ₁)	

RATINGS
AMPLIFIER-EACH UNIT

HEATER OR FILAMENT VOLTAGE (AC OR DC)	12.6	VOLTS
HEATER OR FILAMENT CURRENT	0.3	AMPS.
MAXIMUM PLATE VOLTAGE	300	VOLTS
MINIMUM GRID VOLTAGE	0	VOLTS
MAXIMUM PLATE DISSIPATION	2.5	WATTS

RATINGS ARE TO BE INTERPRETED ACCORDING TO RMA STANDARD M8-210

CHARACTERISTICS CLASS A₁ AMPLIFIER

PLATE VOLTAGE	90	250	VOLTS
GRID VOLTAGE	0	-8	VOLTS
AMPLIFICATION FACTOR	20	20	
PLATE RESISTANCE	6700	7700	OHMS
TRANSCONDUCTANCE	3000	2600	UMHOS
PLATE CURRENT	10	9	MA.

THE D-C RESISTANCE IN THE GRID CIRCUIT SHOULD NOT EXCEED 1.0 MEGOHM UNDER MAXIMUM RATED CONDITIONS PER UNIT.

TUNG-SOL

DOUBLE-DIODE TRIODE

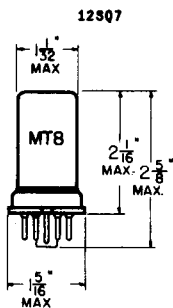

METAL SHELL

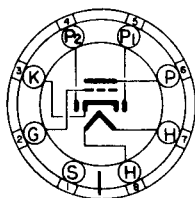

BOTTOM VIEW
SMALL WAFER
8-PIN OCTAL

COATED UNIPOTENTIAL CATHODE

HEATER

12.6 VOLTS 150 MA.

AC OR DC

ANY MOUNTING POSITION

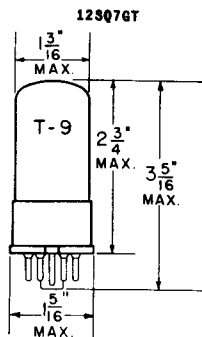

GLASS BULB

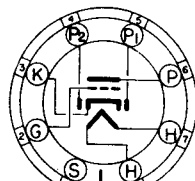

BOTTOM VIEW
SMALL WAFER
8-PIN OCTAL
METAL SLEEVE

THE 12SQ7 AND 12SQ7GT COMBINE TWO DIODE UNITS AND A HIGH-MU TRIODE IN A SINGLE ENVELOPE. EACH SECTION USES A COMMON CATHODE. IT IS INTENDED FOR SERVICE AS A COMBINED DETECTOR, AVC SOURCE, AND HIGH GAIN AUDIO AMPLIFIER.

DIRECT INTERELECTRODE CAPACITANCES - APPROX.

	12SQ7 ^A	12SQ7GT ^B	
GRID TO PLATE: (G TO P)	1.6	1.8	μuf
INPUT: G TO (H + K)	3.2	4.2	μuf
OUTPUT: P TO (H + K)	3.0	3.4	μuf

^A WITH SHELL CONNECTED TO CATHODE.

^B WITH NO EXTERNAL SHIELD.

RATINGS

INTERPRETED ACCORDING TO RMA STANDARD M8-210

HEATER VOLTAGE	12.6	VOLTS
MAXIMUM HEATER-CATHODE VOLTAGE	90	VOLTS
MAXIMUM PLATE VOLTAGE	300	VOLTS
MINIMUM DIODE CURRENT EACH PLATE WITH 10 VOLTS APPLIED	0.8	MA.
MAXIMUM DIODE CURRENT EACH PLATE FOR CONTINUOUS OPERATION	1.0	MA.

CONTINUED ON FOLLOWING PAGE

→ INDICATES A CHANGE OR ADDITION.

CONTINUED FROM PRECEDING PAGE

TYPICAL OPERATING CONDITIONS AND CHARACTERISTICS

CLASS A₁ AMPLIFIER - TRIODE UNIT

HEATER VOLTAGE	12.6	12.6	VOLTS
HEATER CURRENT	150	150	MA.
PLATE VOLTAGE	100	250	VOLTS
GRID VOLTAGE	-1	-2	VOLTS
PLATE CURRENT	0.4	0.9	MA.
PLATE RESISTANCE	110 000	91 000	OHMS
TRANSCONDUCTANCE	900	1 100	μMHMS
AMPLIFICATION FACTOR	100	100	

DIODE UNITS - TWO

THE TWO DIODE PLATES ARE PLACED AROUND THE CATHODE AND ARE INDEPENDENT OF THE TRIODE UNIT EXCEPT FOR THE COMMON CATHODE.

SIMILAR TYPE REFERENCE: Ratings and characteristics identical to 14BB.

R ₁ MEG.	R _{g1} MEG.	R _c MEG.	E _{bb} = 90 VOLTS			E _{bb} = 180 VOLTS			E _{bb} = 300 VOLTS		
			R _k	GAIN	E _o	R _k	GAIN	E _o	R _k	GAIN	E _o
0.10	A	0.10	4300	22	5.0	2400	29	15	2000	31	28
0.10	A	0.24	4700	27	7.0	2700	35	20	2200	38	37
0.24	A	0.24	7500	31	7.5	4300	42	20	3300	46	36
0.24	A	0.51	8200	40	10	4700	50	26	3900	52	50
0.51	A	0.51	13000	39	9.5	7500	53	24	5600	58	47
0.51	A	1.0	15000	43	11	8200	58	31	6200	62	56
0.24	10	0.24	---	39	4.5	---	45	19	---	49	38
0.24	10	0.51	---	45	6.5	---	52	24	---	57	48
0.51	10	0.51	---	48	7.0	---	59	22	---	62	42
0.51	10	1.0	---	52	8.5	---	62	25	---	66	55

^A VALUE OF R_{g1} IS NOT CRITICAL.

GAIN MEASURED AT E_o = 2.0 VOLTS RMS OUTPUT.

E_o IS RMS OUTPUT FOR 5% TOTAL HARMONIC DISTORTION.

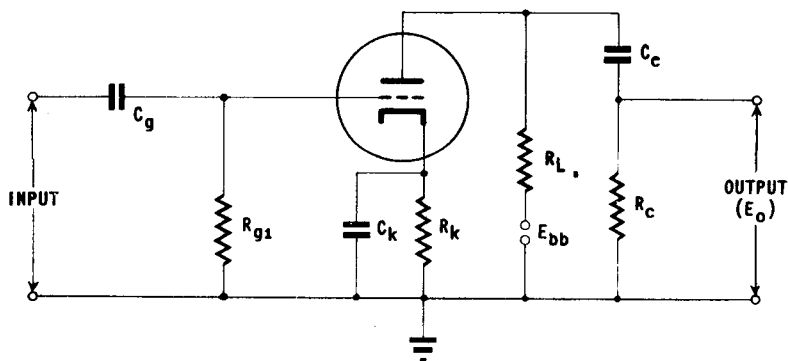

NOTE: COUPLING CAPACITORS C_g AND C_c SHOULD BE SELECTED TO GIVE DESIRED FREQUENCY RESPONSE. R_k SHOULD BE ADEQUATELY BY-PASSED BY CAPACITOR C_k.

→ INDICATES A CHANGE OR ADDITION

PLATE
1935
DEC. 1,
1947

12SQ7, 12SQ7GT

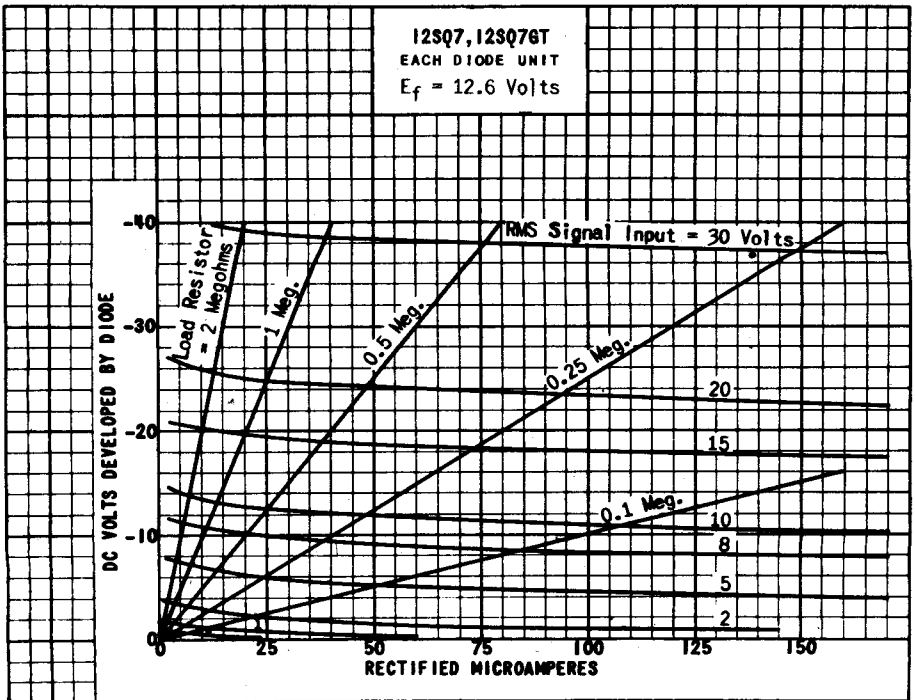
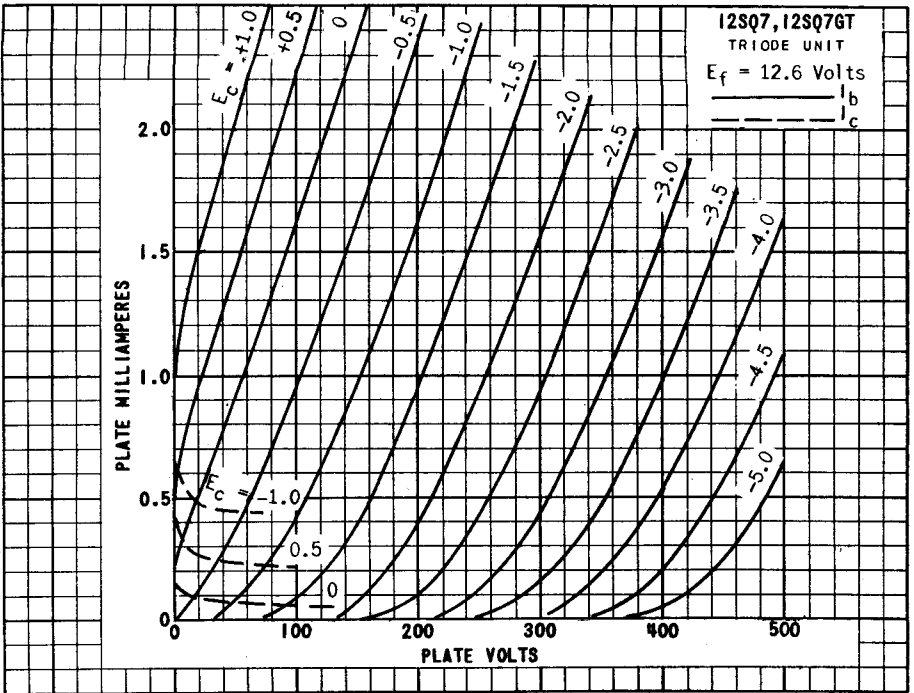

12SQ7, 12SQ7GT

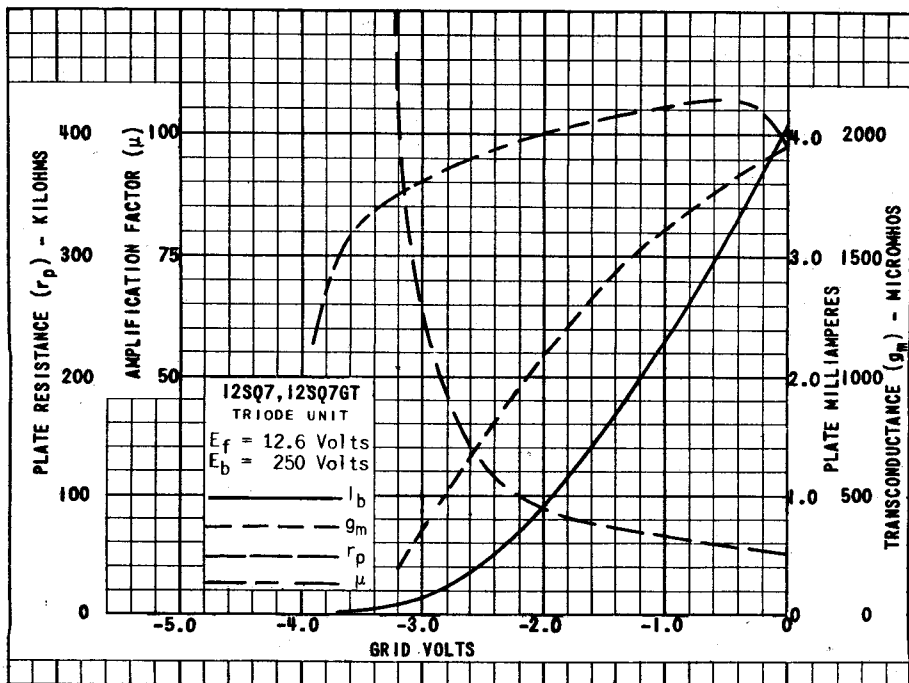
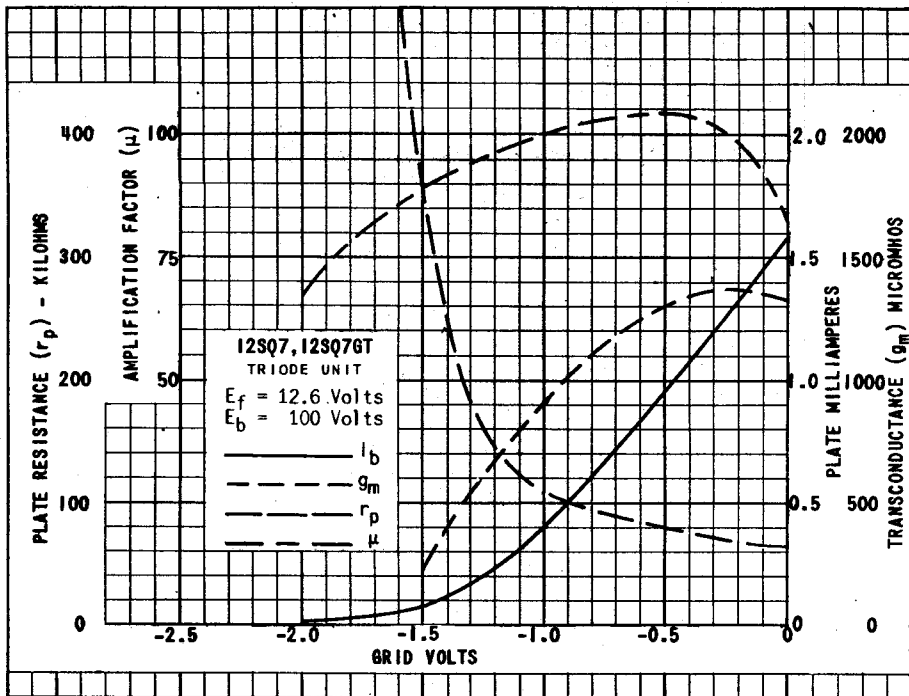

PLATE
1974
FEB. 2,
1948

TUNG-SOL

DUO-DIODE TRIODE
PHYSICAL SPECIFICATIONS

EMITTER	UNIPOTENTIAL CATHODE	PIN CONNECTIONS	
BASE	INTERMEDIATE SHELL OCTAL 8-PIN	PIN 1 NO CONN.	PIN 7 HEATER
CAP	NONE	PIN 2 TRIODE GRID	PIN 8 HEATER
BULB	T-9 GLASS	PIN 3 CATHODE AND DIODE SHIELD	
MAXIMUM DIAMETER	1 5/16"	PIN 4 DIODE PLATE-RIGHT	
MAXIMUM OVERALL LENGTH	3 3/16"	PIN 5 DIODE PLATE-LEFT	
MAXIMUM SEATED HEIGHT	2 3/4"	PIN 6 TRIODE PLATE	

RATINGS

HEATER OR FILAMENT VOLTAGE	12.6	VOLTS
HEATER OR FILAMENT CURRENT	0.15	AMPS.
MAXIMUM PLATE VOLTAGE	250	VOLTS
MAXIMUM SCREEN VOLTAGE		VOLTS
MAXIMUM PLATE DISSIPATION	2.5	WATTS
MAXIMUM SCREEN DISSIPATION		WATTS

FOR INTERPRETATION OF RATINGS, SEE "RECEIVING TUBE RATINGS" (CS-1800)

CAPACITANCES (WITH STANDARD RMA SHIELD M8-308)

CONTROL GRID TO CATHODE	3.5	μμf
PLATE TO CATHODE	3.8	μμf
GRID TO PLATE	2.3	μμf

TYPICAL OPERATING CONDITIONS AND CHARACTERISTICS
CLASS A₁ AMPLIFIER TRIODE SECTION

HEATER OR FILAMENT VOLTAGE	12.6	VOLTS
HEATER OR FILAMENT CURRENT	0.15	AMPS.
PLATE VOLTAGE	250	VOLTS
SCREEN VOLTAGE		VOLTS
GRID BIAS	-9	VOLTS
PEAK AF SIGNAL VOLTAGE		VOLTS
PLATE CURRENT	9.5	MA.
ZERO-SIGNAL SCREEN CURRENT		MA.
MAXIMUM-SIGNAL PLATE CURRENT		MA.
MAXIMUM-SIGNAL SCREEN CURRENT		MA.
PLATE RESISTANCE	8500	OHMS
TRANSCONDUCTANCE	1900	μMHOS
AMPLIFICATION FACTOR	16	

^A THE D-C RESISTANCE IN THE GRID CIRCUIT SHOULD NOT EXCEED 1.0 MEGOHM UNDER RATED MAXIMUM CONDITIONS.



TUNG-SOL

DUO-DIODE TRIODE

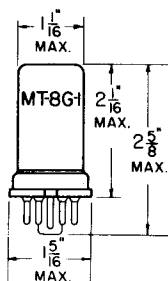

METAL SHELL

UNIPOENTIAL CATHODE

HEATER

12.6 VOLTS 0.15 AMPERE
AC OR DC

ANY MOUNTING POSITION

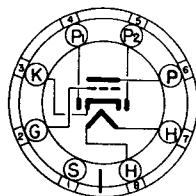

BOTTOM VIEW
SMALL WAFER
8 PIN OCTAL

THE 12SW7 HAS TWO DIODES AND A MEDIUM-MU TRIODE IN ONE ENVELOPE. IT IS DESIGNED ESPECIALLY FOR USE IN EQUIPMENT WHERE THE OPERATING VOLTAGES ARE OBTAINED FROM A 12 CELL STORAGE BATTERY AND FOR OPERATION AT A PLATE-SUPPLY VOLTAGE HAVING A DESIGN CENTER OF 26.6 VOLTS. IT MAY BE USED FOR SERVICE AS A DIODE DETECTOR, AVC RECTIFIER AND AS AN AUDIO AMPLIFIER IN AC, STORAGE BATTERY AND AC-DC OPERATED RECEIVERS.

RATINGS

INTERPRETED ACCORDING TO RMA STANDARD M8-210

HEATER VOLTAGE	12.6	VOLTS
HEATER CURRENT	0.15	AMP.
PLATE VOLTAGE	250	VOLTS
PLATE DISSIPATION	2.5	WATTS
PEAK HEATER-CATHODE VOLTAGE:		
HEATER NEG. WITH RESPECT TO CATHODE	90	VOLTS
HEATER POS. WITH RESPECT TO CATHODE	90	VOLTS

DIRECT INTERELECTRODE CAPACITANCES - TRIODE UNIT

WITH SHELL CONNECTED TO CATHODE

GRID TO PLATE (APPROX.)	2.4	$\mu\mu\text{f}$
INPUT (APPROX.)	3.0	$\mu\mu\text{f}$
OUTPUT (APPROX.)	2.8	$\mu\mu\text{f}$

TYPICAL OPERATING CONDITIONS AND CHARACTERISTICS

CLASS A₁ AMPLIFIER

PLATE VOLTAGE	26.5	250	VOLTS
GRID VOLTAGE:			
USING FIXED SUPPLY	---	-9	VOLTS
USING GRID RESISTOR	2	---	MEG OHMS
PLATE CURRENT	1.1	9.5	MA.
PLATE RESISTANCE	15 500	8 500	OHMS
TRANSCONDUCTANCE	1 100	1 900	μMHOS
AMPLIFICATION FACTOR	17	16	

CONTINUED ON FOLLOWING PAGE

TUNG-SOL

CONTINUED FROM PRECEDING PAGE

TYPICAL OPERATING CONDITIONS AND CHARACTERISTICS

RESISTANCE-COUPLED AMPLIFIER

PLATE SUPPLY VOLTAGE ^A	90	180	300	VOLTS
LOAD RESISTANCE	0.1	0.1	0.1	MEGOHM
GRID RESISTOR	0.25	0.25	0.25	MEGOHMS
CATHODE RESISTOR	4 400	4 100	3 800	OHMS
CATHODE BY-PASS CONDENSER	0.9	0.9	1.1	μ f
BLOCKING CONDENSER	0.01	0.01	0.015	μ f
PEAK VOLTAGE OUTPUT ^B	19	43	68	VOLTS
VOLTAGE GAIN (AT 5.0 VOLTS RMS)	10	10	10	

^AVOLTAGE AT PLATE EQUALS PLATE SUPPLY VOLTAGE MINUS VOLTAGE DROP IN LOAD RESISTANCE AND CATHODE RESISTOR.

^BVOLTAGE ACROSS GRID RESISTOR AT GRID-CURRENT POINT.

SIMILAR TYPE REFERENCE: Except for heater ratings, same ratings and characteristics as 6R7, 6R7D, 6R7D $\frac{1}{2}$, 6SR7, 6SR7D $\frac{1}{2}$, 280C. Same ratings and characteristics as 12SR7D.

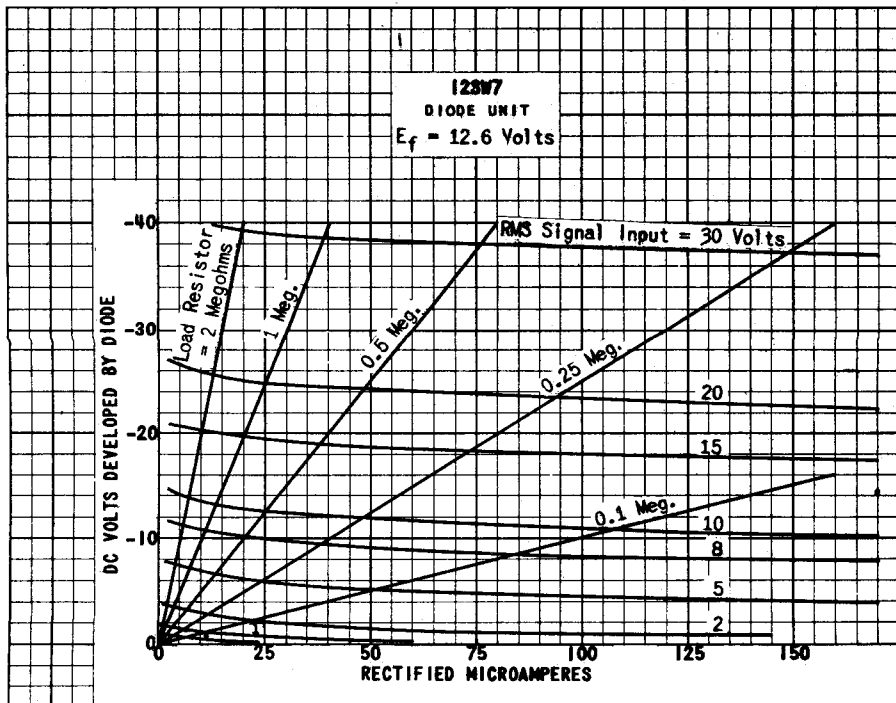

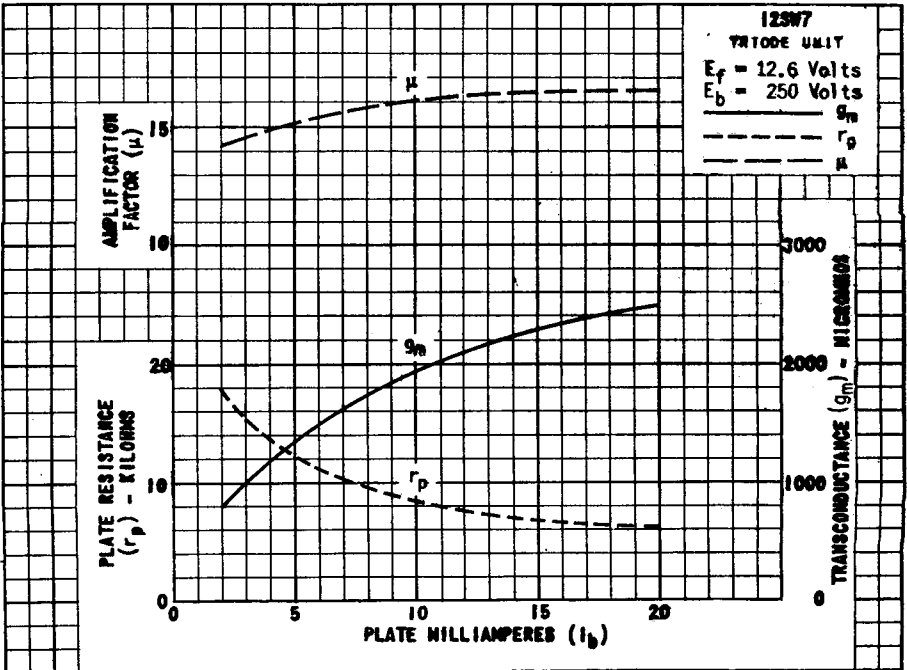
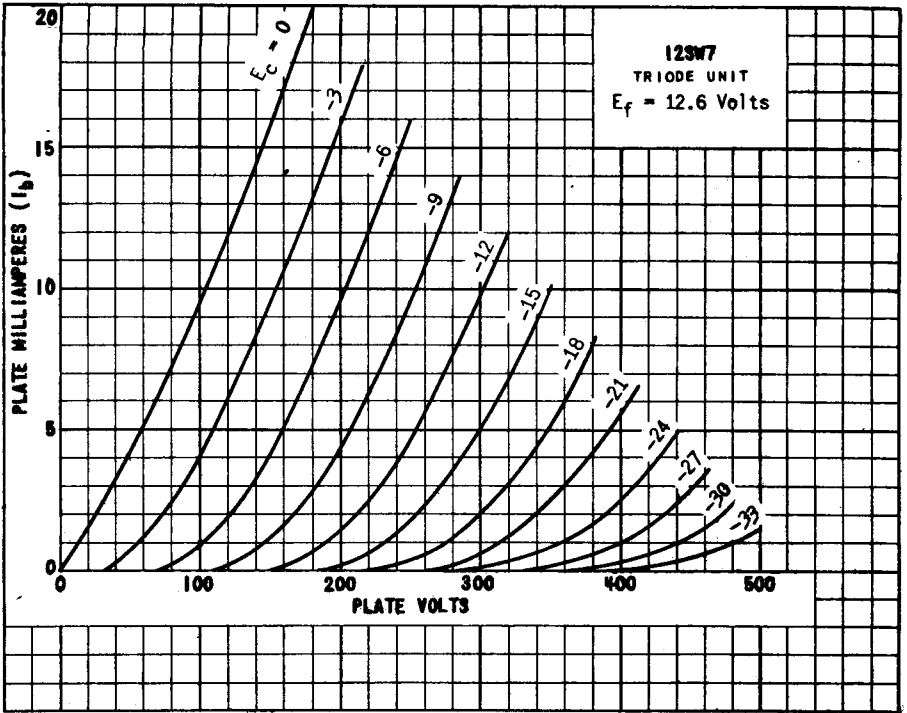

PRINTED IN U. S. A.

PLATE 1793
 NOV. 1, 1946



TUNG-SOL

TWIN TRIODE AMPLIFIER

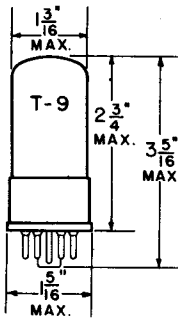

GLASS BULB

COATED UNIPOTENTIAL CATHODE

HEATER

12.6 VOLTS 0.3 AMPERE

AC OR DC

ANY MOUNTING POSITION

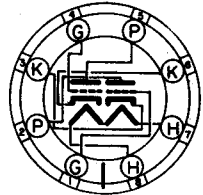

BOTTOM VIEW

INTERMEDIATE SHELL
8 PIN OCTAL BASE

THE 12SX7GT IS A TWIN MEDIUM MU TRIODE WHOSE SECTIONS ARE ELECTRICALLY INDEPENDENT EXCEPT FOR THE COMMON HEATER. IT IS DESIGNED ESPECIALLY FOR USE IN EQUIPMENT WHERE THE OPERATING VOLTAGES ARE OBTAINED FROM A 12 CELL STORAGE BATTERY AND FOR OPERATION AT A PLATE-SUPPLY VOLTAGE HAVING A DESIGN-CENTER OF 26.5 VOLTS. IT IS USEFUL AS AN AUDIO AMPLIFIER, OSCILLATOR, CONVERTER AND MULTI-VIBRATOR.

RATINGS

INTERPRETED ACCORDING TO RMA STANDARD MB-210

PER AMPLIFIER UNIT

HEATER VOLTAGE	12.6	VOLTS
HEATER CURRENT	0.3	AMP.
MAXIMUM PLATE VOLTAGE	300	VOLTS
MAXIMUM GRID VOLTAGE:		
NEG. BIAS VOLTAGE	50	VOLTS
POS. BIAS VOLTAGE	0	VOLTS
MAXIMUM CATHODE CURRENT	20	MA.
MAXIMUM PLATE DISSIPATION	2.5	WATTS
MAXIMUM PEAK HEATER-CATHODE VOLTAGE:		
HEATER NEG. WITH RESPECT TO CATHODE	90	VOLTS
HEATER POS. WITH RESPECT TO CATHODE	90	VOLTS

DIRECT INTERELECTRODE CAPACITANCES

WITH NO EXTERNAL SHIELD

	TRIODE UNIT 1	TRIODE UNIT 2	
GRID TO PLATE	3.6	3.6	μlf
INPUT	3.0	2.8	μlf
OUTPUT	0.8	1.2	μlf

TYPICAL OPERATING CONDITIONS AND CHARACTERISTICS

CLASS A₁ AMPLIFIER - PER UNIT

	26.5	90	250	
PLATE VOLTAGE				VOLTS
GRID VOLTAGE:				
USING FIXED SUPPLY	---	0	-8	VOLTS
USING GRID RESISTOR	0.05	---	---	MEGOHM
PLATE CURRENT	1.8	10	9.0	MA.
GRID CIRCUIT RESISTANCE (MAX.)	1.0	1.0	1.0	MEGOHM
PLATE RESISTANCE	11 500	6 700	7 700	OHMS
TRANSCONDUCTANCE	1 800	3 000	2 600	μMHOS
AMPLIFICATION FACTOR	21	20	20	

CONTINUED ON FOLLOWING PAGE

PLATE
1754
NOV. 1,
1946

PRINTED IN U. S. A.

TUNG-SOL

CONTINUED FROM PRECEDING PAGE

TYPICAL OPERATING CONDITIONS AND CHARACTERISTICS

RESISTANCE COUPLED AMPLIFIER - PER UNIT

PLATE SUPPLY-VOLTAGE ^A	90	180	300	VOLTS
LOAD RESISTANCE	0.1	0.1	0.1	MEGOMM
GRID RESISTOR	0.25	0.25	0.25	MEGOMM
CATHODE RESISTOR	3 940	2 830	2 440	OHMS
CATHODE BY-PASS CONDENSER	1.29	1.35	1.42	μf
BLOCKING CONDENSER	0.012	0.012	0.0125	μf
PEAK VOLTAGE OUTPUT ^B	17	34	56	VOLTS
VOLTAGE GAIN (AT 5.0 VOLTS RMS)	13	14	14	

^A VOLTAGE AT PLATE EQUALS PLATE-SUPPLY VOLTAGE MINUS VOLTAGE DROP IN LOAD RESISTANCE AND CATHODE RESISTOR.

^B VOLTAGE ACROSS GRID RESISTOR AT GRID CURRENT POINT.

SIMILAR TYPE REFERENCE: Except for heater ratings, same ratings and characteristics per unit as 6F8G, 6J5, 6J5G, 6J50F. Except for heater ratings, same ratings and characteristics as 6SN70F. Same ratings and characteristics per unit as 12J50F. Same ratings and characteristics as 12SN70F and 1633.

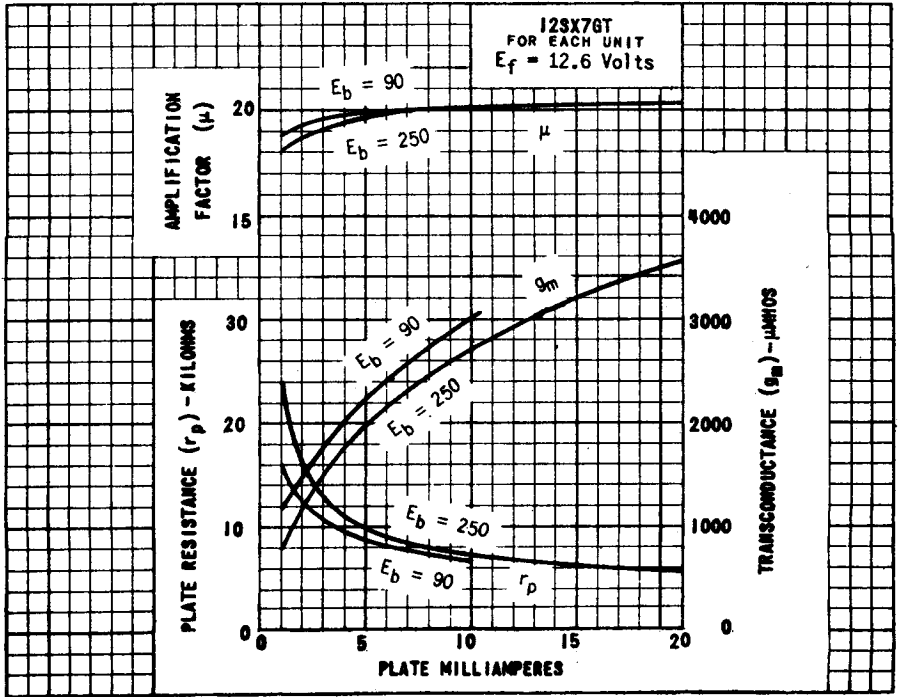
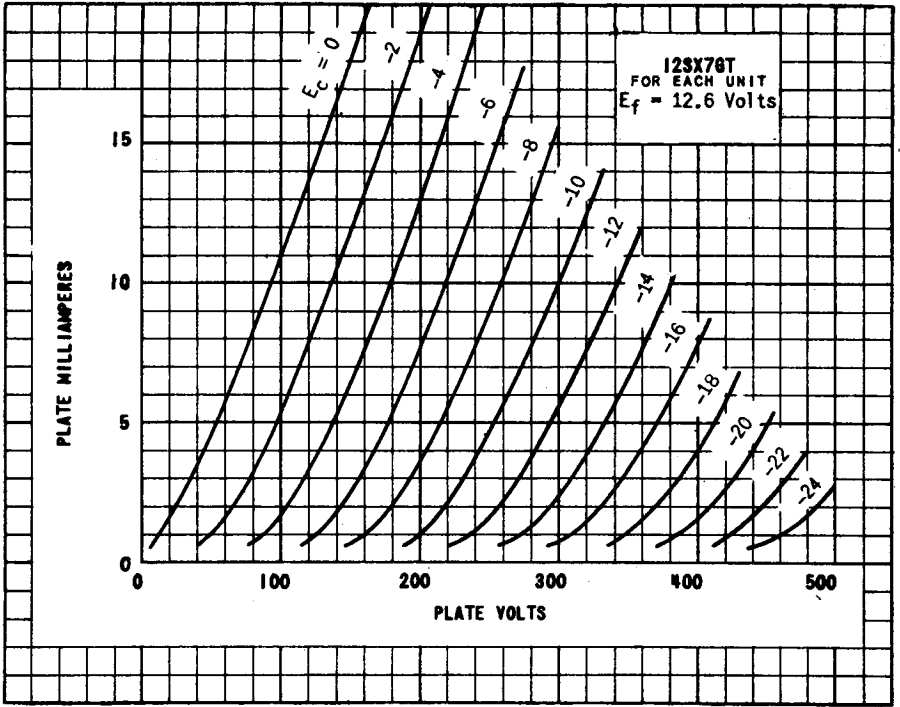

PLATE
1756
NOV. 1,
1946



TUNG-SOL

HEPTODE PENTAGRID CONVERTER

PHYSICAL SPECIFICATIONS

EMITTER	COATED UNIPOT. CATHODE	PIN CONNECTIONS	
BASE	SMALL WAFER OCTAL 8-PIN	PIN 1 SHELL, GRID 5	PIN 7 HEATER
	PHENOLIC	PIN 2 HEATER	PIN 8 SIGNAL GRID (G3)
BULB	MT-8 METAL	PIN 3 PLATE	
MAXIMUM DIAMETER	1 5/16"	PIN 4 SCR. (G2 & G4)	MOUNTING POS. ANY
MAXIMUM OVERALL LENGTH	2 5/8"	PIN 5 OSC. GRID (G1)	
MAXIMUM SEATED HEIGHT	2 1/16"	PIN 6 CATHODE	

RATINGS

INTERPRETED ACCORDING TO RMA STANDARD NB-210

HEATER OR FILAMENT VOLTAGE (AC OR DC)	12.6 VOLTS
HEATER OR FILAMENT CURRENT	0.15 AMP.
MAXIMUM PLATE VOLTAGE	300 VOLTS
MAXIMUM SCREEN VOLTAGE	100 VOLTS
MAXIMUM SCREEN SUPPLY VOLTAGE	300 VOLTS
MAXIMUM PLATE DISSIPATION	1.0 WATT
MAXIMUM SCREEN DISSIPATION	1.0 WATT
MAXIMUM TOTAL PLATE AND SCREEN DISSIPATION	WATTS
MAXIMUM TOTAL CATHODE CURRENT	14 MA.
MINIMUM EXTERNAL SIGNAL GRID BIAS VOLTAGE ^A	0 VOLTS
MAXIMUM ANODE-GRID VOLTAGE	VOLTS
MAXIMUM ANODE-GRID SUPPLY VOLTAGE	VOLTS
MAXIMUM ANODE-GRID DISSIPATION	WATT

^A WITH SELF-EXCITED OSCILLATOR

CAPACITANCES

SIGNAL GRID TO MIXER PLATE (G3 TO P) ^B	0.13 μf (MAX.)
K TO ALL OTHER ELECTRODES EXCEPT G1	5.0 μf
SIGNAL GRID TO OSC. GRID (G3 TO G1) ^B	0.15 μf (MAX.)
OSC. GRID TO MIXER PLATE (G1 TO P) ^B	0.06 μf (MAX.)
SIGNAL INPUT (G3 TO ALL OTHER ELECTRODES) ^B	9.5 μf
OSC. INPUT (G1 TO ALL OTHER ELECTRODES) ^B	7.0 μf
G1 TO ALL OTHER ELECTRODES EXCEPT K	4.4 μf
MIXER OUTPUT (P TO ALL OTHER ELECTRODES) ^B	12 μf
G1 TO K	2.6 μf

^B WITH SHIELD NO. 308 CONNECTED TO CATHODE

TYPICAL OPERATING CONDITIONS AND CHARACTERISTICS
CONVERTER SERVICE - SEPARATE EXCITATION

CHARACTERISTICS SHOWN ARE OBTAINED IN THE STANDARD RMA CONVERSION TRANSCONDUCTANCE TEST SET AND CORRESPOND VERY CLOSELY TO THOSE OBTAINED WITH ZERO BIAS IN A SELF-EXCITED OSCILLATOR CIRCUIT.

HEATER OR FILAMENT VOLTAGE	12.6	12.6	12.6 VOLTS
HEATER OR FILAMENT CURRENT	0.15	0.15	0.15 AMP.
PLATE VOLTAGE	28	100	250 VOLTS
SCREEN VOLTAGE	28	100	100 VOLTS
SIGNAL GRID BIAS	-1	-2	-2 VOLTS
ANODE-GRID VOLTAGE	0	0	0 VOLTS
PLATE CURRENT	0.5	3.3	3.5 MA.
SCREEN CURRENT	1.8	8.5	8.5 MA.
ANODE-GRID CURRENT			MA.
OSCILLATOR-GRID CURRENT	0.1	0.5	0.5 MA.
TOTAL CATHODE CURRENT	2.4	12.3	12.5 MA.
OSCILLATOR-GRID RESISTOR	20 000	20 000	20 000 OHMS
PLATE RESISTANCE (APPROX.)	---	0.5	1.0 MEGOHM

CONVERSION TRANSCONDUCTANCE

SIGNAL GRID BIAS = -1	250	---	---	μMHOS
SIGNAL GRID BIAS = -2	---	425	---	μMHOS
SIGNAL GRID BIAS = -6	8	310	325	μMHOS
SIGNAL GRID BIAS = -10	---	75	80	μMHOS
SIGNAL GRID BIAS = -35	---	2	2	μMHOS APPROX.

NOTE: WITH G2 & G4 CONNECTED TO PLATE (100 VOLTS), AND SIGNAL APPLIED TO G1 (0 VOLTS BIAS): THE TRANSCONDUCTANCE IS 4500 μMHOS, THE PLATE CURRENT IS 27 MA., AND THE AMPLIFICATION IS 13. G3 IS CONNECTED TO GROUND DURING THIS TEST.

TUNG-SOL

HEPTODE PENTAGRID CONVERTER

PHYSICAL SPECIFICATIONS

EMITTER COATED UNIPOT. CATHODE		PIN CONNECTIONS	
BASE SMALL WAFER OCTAL 8-PIN		PIN 1 BASE SHELL	PIN 7 HEATER
WITH METAL SHELL		PIN 2 HEATER	PIN 8 SIGNAL GRID (G ₃)
BULB	T-9 GLASS	PIN 3 PLATE	
MAXIMUM DIAMETER	1 5/16"	PIN 4 SCR. (G ₂ & G ₄)	MOUNTING POS. ANY
MAXIMUM OVERALL LENGTH	3 5/16"	PIN 5 OSC. GRID (G ₁)	
MAXIMUM SEATED HEIGHT	2 3/4"	PIN 6 K, G ₅ , S1	

RATINGS

INTERPRETED ACCORDING TO RMA STANDARD N6-210

HEATER OR FILAMENT VOLTAGE (AC OR DC)	12.6 VOLTS
HEATER OR FILAMENT CURRENT	0.15 AMP.
MAXIMUM PLATE VOLTAGE	300 VOLTS
MAXIMUM SCREEN VOLTAGE	100 VOLTS
MAXIMUM SCREEN SUPPLY VOLTAGE	300 VOLTS
MAXIMUM PLATE DISSIPATION	1.0 WATT
MAXIMUM SCREEN DISSIPATION	1.0 WATT
MAXIMUM TOTAL PLATE AND SCREEN DISSIPATION	WATTS
MAXIMUM TOTAL CATHODE CURRENT	14 MA.
MINIMUM EXTERNAL SIGNAL GRID BIAS VOLTAGE ^A	0 VOLTS
MAXIMUM ANODE-GRID VOLTAGE	VOLTS
MAXIMUM ANODE-GRID SUPPLY VOLTAGE	VOLTS
MAXIMUM ANODE-GRID DISSIPATION	WATT

^A WITH SELF-EXCITED OSCILLATOR

CAPACITANCES

SIGNAL GRID TO MIXER PLATE (G ₃ TO P) ^B	0.2 μ f (MAX.)
K TO ALL OTHER ELECTRODES EXCEPT G ₁	30 μ f
SIGNAL GRID TO OSC. GRID (G ₃ TO G ₁) ^B	0.2 μ f (MAX.)
OSC. GRID TO MIXER PLATE (G ₁ TO P) ^B	0.2 μ f (MAX.)
SIGNAL INPUT (G ₃ TO ALL OTHER ELECTRODES) ^B	11 μ f
OSC. INPUT (G ₁ TO ALL OTHER ELECTRODES) ^B	8.0 μ f
G ₁ TO ALL OTHER ELECTRODES EXCEPT K	5 μ f
MIXER OUTPUT (P TO ALL OTHER ELECTRODES) ^B	12 μ f
G ₁ TO K	3.0 μ f

^B WITH BASE SHELL AND STANDARD TUBE SHIELD CONNECTED TO CATHODE

TYPICAL OPERATING CONDITIONS AND CHARACTERISTICS CONVERTER SERVICE - SEPARATE EXCITATION

CHARACTERISTICS SHOWN ARE OBTAINED IN THE STANDARD RMA CONVERSION TRANSCONDUCTANCE TEST SET AND CORRESPOND VERY CLOSELY TO THOSE OBTAINED WITH ZERO BIAS IN A SELF-EXCITED OSCILLATOR CIRCUIT.

HEATER OR FILAMENT VOLTAGE	12.6	12.6	12.6 VOLTS
HEATER OR FILAMENT CURRENT	0.15	0.15	0.15 AMP.
PLATE VOLTAGE	28	100	250 VOLTS
SCREEN VOLTAGE	28	100	100 VOLTS
SIGNAL GRID BIAS	-1	-2	-2 VOLTS
ANODE-GRID VOLTAGE (G ₅)	0	0	0 VOLTS
PLATE CURRENT	0.5	3.3	3.5 MA.
SCREEN CURRENT	1.8	8.5	8.5 MA.
ANODE-GRID CURRENT			MA.
OSCILLATOR-GRID CURRENT	0.1	0.5	0.5 MA.
TOTAL CATHODE CURRENT	2.4	12.3	12.5 MA.
OSCILLATOR-GRID RESISTOR	20 000	20 000	20 000 OHMS
PLATE RESISTANCE (APPROX.)	---	0.5	1.0 MEGOHM

CONVERSION TRANSCONDUCTANCE:

SIGNAL GRID BIAS = -1	250	---	450 μ MHOS
SIGNAL GRID BIAS = -2	---	425	450 μ MHOS
SIGNAL GRID BIAS = -6	8	310	325 μ MHOS
SIGNAL GRID BIAS = -10	---	75	80 μ MHOS
SIGNAL GRID BIAS = -35	---	2	2 μ MHOS APPROX.

NOTE: WITH G₂ & G₄ CONNECTED TO PLATE (100 VOLTS), AND SIGNAL APPLIED TO G₁ (0 VOLTS BIAS): THE TRANSCONDUCTANCE IS 4500 μ MHOS, THE PLATE CURRENT IS 2.7 MA., AND THE AMPLIFICATION IS 13. G₃ IS CONNECTED TO GROUND DURING THIS TEST.

TUNG-SOL

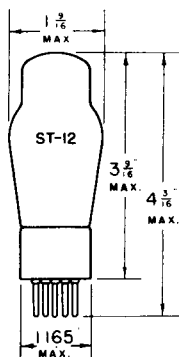

HALF WAVE
HIGH VACUUM RECTIFIER

UNIPOTENTIAL CATHODE
HEATER
12.6 VOLTS 0.3 AMPERE
AC OR DC

GLASS BULB

SMALL 4 PIN BASE

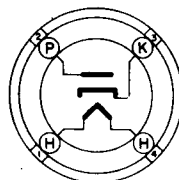

4G

BOTTOM VIEW

THE TUNG-SOL 1223 IS DESIGNED FOR SERVICE AS A POWER RECTIFIER IN AC-DC RECEIVERS.

RATINGS

MAXIMUM DC HEATER TO CATHODE POTENTIAL	350	VOLTS
MAXIMUM PEAK INVERSE VOLTAGE	700	VOLTS
MAXIMUM STEADY-STATE PEAK PLATE CURRENT	330	MA.

OPERATING CONDITIONS AND CHARACTERISTICS

HALF WAVE RECTIFIER WITH CONDENSER INPUT TO FILTER

AC PLATE VOLTAGE (RMS)	117	150	235 ^{MAX.}	VOLTS
DC OUTPUT CURRENT ^{MAX.}	55	55	55	MA.
TOTAL EFFECTIVE PLATE SUPPLY IMPEDANCE ^{MIN. A}	0	30	75	OHMS
TUBE VOLTAGE DROP AT 110 MA. PLATE CURRENT	17			VOLTS

^A WHEN FILTER CONDENSERS LARGER THAN 40 MFDS ARE USED, IT MAY BE NECESSARY TO ADD ADDITIONAL PLATE SUPPLY IMPEDANCE.

FOR "INTERPRETATION OF RATINGS", REFER TO FRONT OF BOOK.

CONTINUED NEXT PAGE

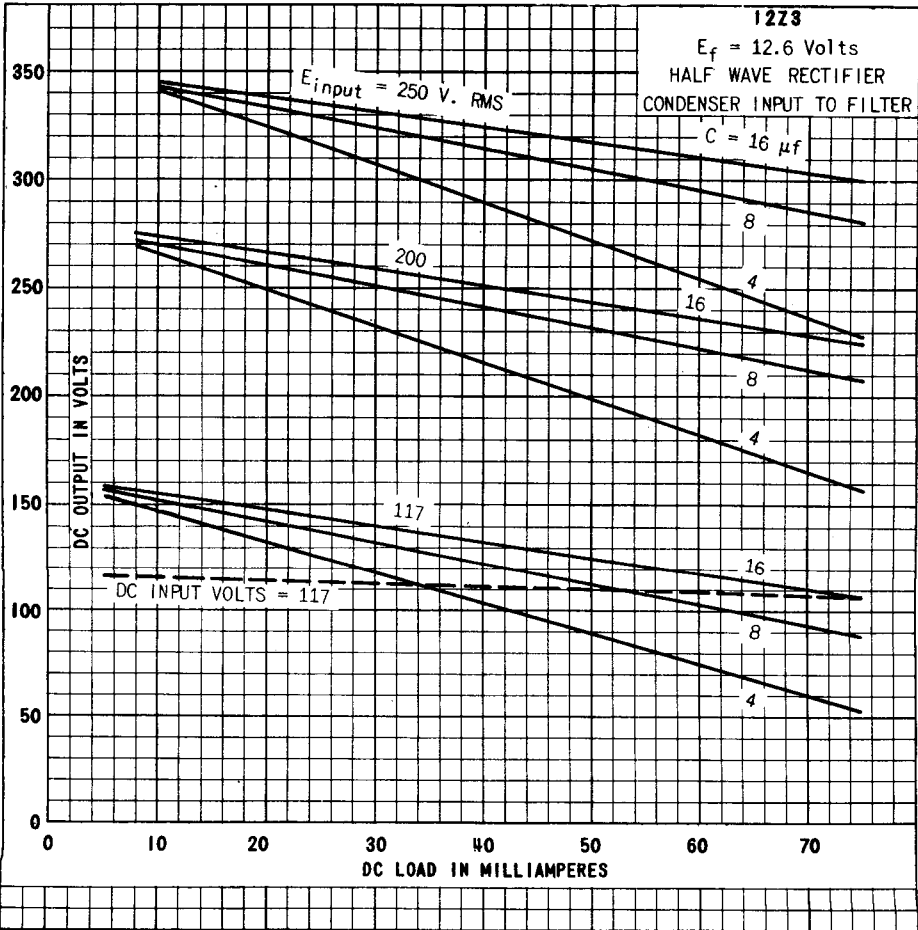
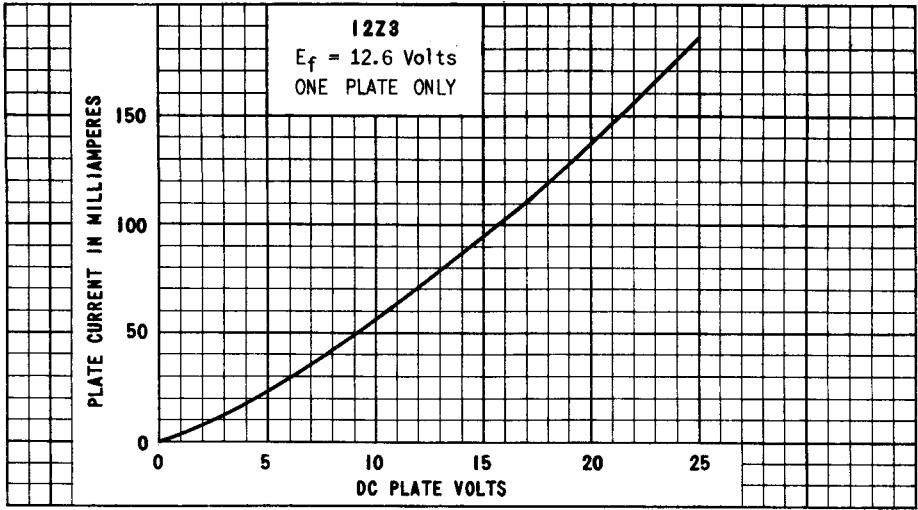

TUNG-SOL

TRIPLE GRID

DETECTOR AMPLIFIER

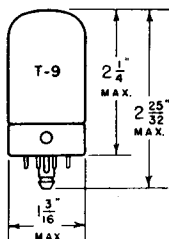

UNIPOTENTIAL CATHODE

HEATER
12.6 VOLTS 0.15 AMPERE
AC OR DC

GLASS BULB

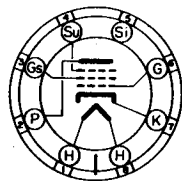

8V

BOTTOM VIEW

LOCKING-IN 8 PIN BASE

THE TUNG-SOL 14C7 IS A TRIPLE GRID GENERAL PURPOSE DETECTOR, DESIGNED FOR SERVICE IN AC-DC RECEIVERS USING 150 MA. HEATER TUBES. WITH THE EXCEPTION OF HEATER RATINGS ITS ELECTRICAL CHARACTERISTICS ARE IDENTICAL TO THOSE OF THE 7C7.

RATINGS

NOMINAL HEATER VOLTAGE	14.0	VOLTS
NOMINAL HEATER CURRENT	0.16	AMP.
MAXIMUM PLATE VOLTAGE	300	VOLTS
MAXIMUM SCREEN SUPPLY VOLTAGE	300	VOLTS
MAXIMUM SCREEN VOLTAGE	100	VOLTS
MINIMUM EXTERNAL GRID BIAS VOLTAGE	0	VOLT
MAXIMUM PLATE DISSIPATION	1.0	WATT
MAXIMUM SCREEN DISSIPATION	0.1	WATT

DIRECT INTERELECTRODE CAPACITANCES^S

CONTROL GRID TO CATHODE	6.0	μf
PLATE TO CATHODE	6.5	μf
CONTROL GRID TO PLATE	0.007 ^{MAX.}	μf

^S WITH EXTERNAL SHIELD CONNECTED TO CATHODE.

FOR "INTERPRETATION OF RATINGS" REFER TO FRONT OF BOOK.

PLATE
1153-1
NOV-17
1941

CONTINUED NEXT PAGE

TUNG-SOL

TYPICAL OPERATING CONDITIONS AND CHARACTERISTICS

CLASS A₁ AMPLIFIER

PLATE VOLTAGE	100	250	VOLTS
SCREEN VOLTAGE	100	100	VOLTS
CONTROL GRID VOLTAGE	-1	-3	VOLTS
SUPPRESSOR GRID AND PIN #5	0	0	VOLT
PLATE CURRENT	5.7	2.2	MA.
SCREEN CURRENT	1.8	0.7	MA.
PLATE RESISTANCE APPROX.	.325	1.0	MEGOHM
TRANSCONDUCTANCE	2275	1575	μMHOS

TUNG-SOL

TRIPLE GRID

SEMI-REMOTE CUT-OFF AMPLIFIER

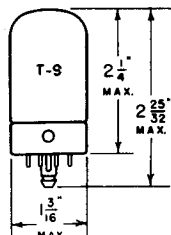

UNI-POTENTIAL CATHODE

HEATER

12.6 VOLTS 0.16 AMPERE
AC OR DC

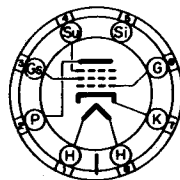

8V

BOTTOM VIEW

GLASS BULB

LOCKING IN 8 PIN BASE

THE TUNG-SOL 14H7 IS A SEMI-REMOTE CUT-OFF AMPLIFIER. IT IS SUITABLE FOR USE WITH AVC AS RF AND IF AMPLIFIERS IN AC-DC OPERATED RECEIVERS USING 150 MA. HEATER TUBES.

RATINGS

NOMINAL HEATER VOLTAGE	14.0	VOLTS
NOMINAL HEATER CURRENT	0.16	AMPERE
MAXIMUM PLATE VOLTAGE	300	VOLTS
MAXIMUM SCREEN SUPPLY VOLTAGE	300	VOLTS
MAXIMUM SCREEN VOLTAGE	150	VOLTS
MINIMUM EXTERNAL GRID BIAS VOLTAGE	0	VOLTS
MAXIMUM PLATE DISSIPATION	2.5	WATTS
MAXIMUM SCREEN DISSIPATION	.5	WATT

FOR "INTERPRETATION OF RATINGS" REFER TO FRONT OF BOOK.

CONTINUED NEXT PAGE

TUNG-SOL

TYPICAL OPERATING CONDITIONS AND CHARACTERISTICS

CLASS A₁ AMPLIFIER

HEATER VOLTAGE	12.6	12.6	VOLTS
HEATER CURRENT	0.15	0.15	AMPERE
PLATE VOLTAGE	100	250	VOLTS
SCREEN VOLTAGE	100	150	VOLTS
CONTROL GRID VOLTAGE	-1	-2.5	VOLTS
SUPPRESSOR AND INTERNAL SHIELD	0	0	VOLT
PLATE CURRENT	8.2	9.5	MA.
SCREEN CURRENT	3.3	3.5	MA.
PLATE RESISTANCE ^{APPROX.}	0.25	0.8	MEGOHM
TRANSCONDUCTANCE	3800	3800	μMHOS
CONTROL GRID VOLTAGE ^{APPROX.}	-12	-19	VOLTS

FOR TRANSCONDUCTANCE = 35 μMHOS

DIRECT INTERELECTRODE CAPACITANCES⁵

INPUT: CONTROL GRID TO ALL OTHER ELECTRODES EXCEPT PLATE	8.0	μf
OUTPUT: PLATE TO ALL OTHER ELECTRODES EXCEPT CONTROL GRID	7.0	μf
CONTROL GRID TO PLATE	0.007 ^{MAX.}	μf

⁵ WITH EXTERNAL SHIELD CONNECTED TO CATHODE.

TUNG-SOL

PENTAGRID

PHYSICAL SPECIFICATIONS

EMITTER UNIPOTENTIAL CATHODE		PIN CONNECTIONS			
BASE	LOCKING-IN - 8 PIN	PIN 1	HEATER	PIN 7	CATHODE
CAP	NONE	PIN 2	PLATE	PIN 8	HEATER
BULB	T-9	PIN 3 GRIDS #2 & #4			
MAXIMUM DIAMETER 1 3/16"		PIN 4	GRID #1		
MAXIMUM OVERALL LENGTH 2 25/32"		PIN 5	GRID #5	TOP CAP NONE	
MAXIMUM SEATED HEIGHT 2 1/4"		PIN 6	GRID #3		

RATINGS

HEATER OR FILAMENT VOLTAGE - NOMINAL (AC OR DC)	14.0	VOLTS
HEATER OR FILAMENT CURRENT - NOMINAL	0.16	AMP.
MAXIMUM PLATE VOLTAGE	300	VOLTS
MAXIMUM SCREEN VOLTAGE (GRIDS #2 & #4)	100	VOLTS
MAXIMUM SCREEN SUPPLY VOLTAGE	300	VOLTS
MAXIMUM PLATE DISSIPATION		WATTS
MAXIMUM SCREEN DISSIPATION	1.0	WATT
MAXIMUM TOTAL PLATE AND SCREEN DISSIPATION	2.0	WATTS
MAXIMUM TOTAL CATHODE CURRENT	14	MA.
MINIMUM EXTERNAL SIGNAL GRID BIAS VOLTAGE* (GRID #3)	0	VOLTS
MAXIMUM ANODE-GRID VOLTAGE		VOLTS
MAXIMUM ANODE-GRID SUPPLY VOLTAGE		VOLTS
MAXIMUM ANODE-GRID DISSIPATION		WATT

* WITH SELF-EXCITATED OSCILLATOR

CAPACITANCES⁵

SIGNAL GRID TO MIXER PLATE (GRID #3 TO PLATE)	0.20 MAX.	μf
SIGNAL GRID TO OSC. GRID (GRID #3 TO GRID #1)	0.20 MAX.	μf
SIGNAL INPUT (GRID #3 TO ALL OTHER ELECTRODES)	9.0	μf
OSC. GRID TO CATHODE (GRID #1 TO CATHODE)	2.2	μf
OSC. GRID TO PLATE (GRID #1 TO PLATE)	0.15 MAX.	μf
OSC. INPUT (GRID #1 TO ALL OTHER ELECTRODES)	7.0	μf
OSC. GRID TO ALL OTHER ELECTRODES EXCEPT CATHODE	5.0	μf
MIXER OUTPUT (PLATE TO ALL OTHER ELECTRODES)	9.0	μf
CATHODE TO ALL OTHER ELECTRODES EXCEPT GRID #1	6.0	μf

⁵ WITH EXTERNAL SHIELD CONNECTED TO BASE SHELL

TYPICAL OPERATING CONDITIONS AND CHARACTERISTICS

CONVERTER SERVICE

HEATER OR FILAMENT VOLTAGE	12.6	12.6	VOLTS
HEATER OR FILAMENT CURRENT	0.15	0.15	AMP.
PLATE VOLTAGE	100	250	VOLTS
SCREEN VOLTAGE	100	100	VOLTS
CONTROL GRID VOLTAGE	-2	-2	VOLTS
ANODE-GRID VOLTAGE			VOLTS
PLATE CURRENT	3.3	3.5	MA.
SCREEN CURRENT	8.5	8.5	MA.
ANODE-GRID CURRENT			MA.
OSCILLATOR-GRID CURRENT	0.5	0.5	MA.
TOTAL CATHODE CURRENT	12.3	12.5	MA.
OSCILLATOR-GRID RESISTOR	20000	20000	OHMS
PLATE RESISTANCE (APPROX.)	0.5	1.0	MEG OHM
CONVERSION TRANSCONDUCTANCE	525	550	μMHOS
FOR CONTROL GRID VOLTAGE = -2 VOLTS			
CONVERSION TRANSCONDUCTANCE	275	300	μMHOS
FOR CONTROL GRID VOLTAGE = -6 VOLTS			
CONVERSION TRANSCONDUCTANCE (APPROX.)	2	2	μMHOS
FOR CONTROL GRID VOLTAGE = -35 VOLTS			
SUPPRESSOR GRID (GRID #5)	0	0	VOLTS



TUNG-SOL

DUO-DIODE PENTODE AMPLIFIER

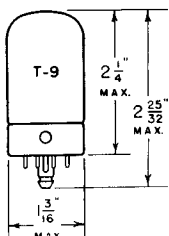

UNIPOTENTIAL CATHODE

HEATER

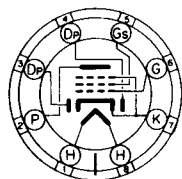
12.6 VOLTS · 0.15 AMPERE
AC OR DC

8AE-L-7

GLASS BULB

LOCKING-IN 8 PIN BASE

THE TUNG-SOL 14R7 COMBINES TWO DIODES AND A PENTODE IN A SINGLE BULB, USING A COMMON CATHODE. IT IS DESIGNED FOR SERVICE AS A DIODE DETECTOR, AVC RECTIFIER AND PENTODE AMPLIFIER IN AC-DC RECEIVERS USING 150 MA. HEATER TUBES.

RATINGS

NOMINAL HEATER VOLTAGE	14.0	VOLTS
NOMINAL HEATER CURRENT	0.16	AMPERE
MAXIMUM PLATE VOLTAGE	250	VOLTS
MAXIMUM SCREEN VOLTAGE	100	VOLTS
MAXIMUM SCREEN SUPPLY VOLTAGE	250	VOLTS
MINIMUM EXTERNAL GRID BIAS VOLTAGE	0	VOLT
MAXIMUM PLATE DISSIPATION	2.0	WATTS
MAXIMUM SCREEN DISSIPATION	0.25	WATT
MINIMUM DIODE CURRENT PER PLATE WITH 10 VOLTS DC APPLIED	0.8	MA.
MAXIMUM DIODE CURRENT PER PLATE FOR CONTINUOUS OPERATION	1.0	MA.

FOR "INTERPRETATION OF RATINGS" REFER TO FRONT OF BOOK.

CONTINUED NEXT PAGE

TUNG-SOL

DIRECT INTERELECTRODE CAPACITANCES⁵

INPUT: CONTROL GRID (G) TO ALL OTHER ELECTRODES EXCEPT PLATE (P)	5.6	μf
OUTPUT: PLATE (P) TO ALL OTHER ELECTRODES EXCEPT CONTROL GRID (G)	5.3	μf
CONTROL GRID (G) TO PLATE (P)	0.004 ^{MAX.}	μf
DIODE #1 TO CONTROL GRID (G)	0.005 ^{MAX.}	μf
DIODE #2 TO CONTROL GRID (G)	0.002 ^{MAX.}	μf

TYPICAL OPERATING CONDITIONS AND CHARACTERISTICS

PENTODE UNIT - CLASS A₁ AMPLIFIER

HEATER VOLTAGE	12.6	12.6	VOLTS
HEATER CURRENT	0.15	0.15	AMPERE
PLATE (P) VOLTAGE	100	250	VOLTS
SCREEN (G _s) VOLTAGE	100	100	VOLTS
CONTROL GRID (G) VOLTAGE	-1	-1	VOLTS
PLATE CURRENT	5.5	5.7	MA.
SCREEN CURRENT	2.2	2.1	MA.
PLATE RESISTANCE ^{APPROX.}	0.35	1.0	MEGOHM
TRANSCONDUCTANCE	3000	3200	μMHOS
CONTROL GRID VOLTAGE FOR	-16	-20	VOLTS

TRANSCONDUCTANCE = 2 μMHOS

⁵ WITH EXTERNAL SHIELD CONNECTED TO CATHODE.

TUNG-SOL

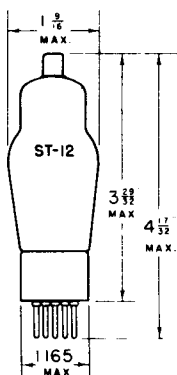

PENTODE AMPLIFIER

UNIPOTENTIAL CATHODE

HEATER

2.0 VOLTS 0.220 AMPERE

DC

GLASS BULB

SMALL 5 PIN BASE

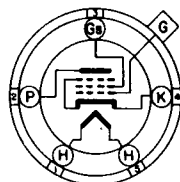

5F

BOTTOM VIEW

THE TUNG-SOL 15 IS A SHARP CUT-OFF PENTODE WITH A HEATER OF LOW POWER DRAIN.

OPERATING CONDITIONS AND CHARACTERISTICS

CLASS A₁ AMPLIFIER

PLATE VOLTAGE	67.5	135 ^{MAX.}	VOLTS
SCREEN VOLTAGE ^{MAX.}	67.5	67.5	VOLTS
CONTROL GRID VOLTAGE	-1.5	-1.5	VOLTS
PLATE CURRENT	1.85	1.85	MA.
SCREEN CURRENT	0.30	0.30	MA.
PLATE RESISTANCE	0.63	0.8	MEG OHM
TRANSCONDUCTANCE	710	750	μMHOS
AMPLIFICATION FACTOR	450	600	

DIRECT INTERELECTRODE CAPACITANCES

GRID TO CATHODE	2.35	μf
PLATE TO CATHODE	7.8	μf
GRID TO PLATE ^S	0.01 ^{MAX.}	μf

^S WITH SHIELD



TUNG-SOL

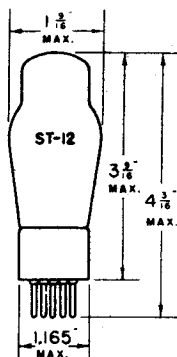

TWIN TRIODE POWER AMPLIFIER

COATED FILAMENT

2.0 VOLTS 0.26 AMPERE
DC

GLASS BULB

SMALL 6 PIN BASE

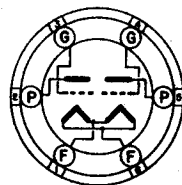

6C

BOTTOM VIEW

THE TUNG-SOL 19 IS DESIGNED FOR SERVICE AS A CLASS B POWER AMPLIFIER IN THE OUTPUT STAGE OF BATTERY OPERATED RECEIVERS. EXCEPT FOR FILAMENT CURRENT ITS RATINGS AND CHARACTERISTICS ARE IDENTICAL WITH THOSE OF THE 1J6G.

OPERATING CONDITIONS AND CHARACTERISTICS

MAXIMUM PLATE VOLTAGE	135	VOLTS
MAXIMUM PEAK PLATE CURRENT PER PLATE	50	MA.

CLASS B₂ AMPLIFIER

PLATE VOLTAGE MAX.	135	135	135	VOLTS
GRID VOLTAGE ^A	-6	-3	0	VOLTS
ZERO-SIG. PLATE CURRENT PER PLATE	0.5	2	5	MA.
LOAD RESISTANCE PER PLATE	2500	2500	2500	OHMS
EFFECTIVE LOAD RESISTANCE ^{PLATE TO PLATE}	10 000	10 000	10 000	OHMS
AVERAGE POWER INPUT GRID TO GRID APPROX.	0.095	0.13	0.17	WATT
POWER OUTPUT APPROX.	1.6	1.9	2.1	WATTS

^A RETURN TO NEGATIVE FILAMENT (PIN #6)

TUNG-SOL

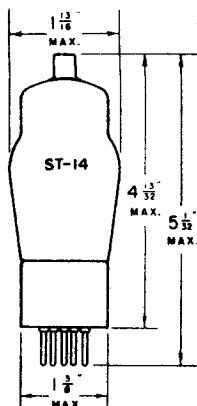

TETRODE AMPLIFIER

UNIPOTENTIAL CATHODE

HEATER

2.5 VOLTS 1.75 AMPERES
AC OR DC

GLASS BULB

MEDIUM 5 PIN BASE

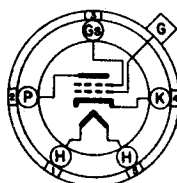

5 E

BOTTOM VIEW

THE TUNG-SOL 24 IS A SCREEN-GRID AMPLIFIER EMPLOYED PRIMARILY IN RF APPLICATIONS.

OPERATING CONDITIONS AND CHARACTERISTICS

CLASS A₁ AMPLIFIER

PLATE VOLTAGE ^A	180	250	VOLTS
SCREEN VOLTAGE ^{MAX.}	90	90	VOLTS
CONTROL GRID VOLTAGE	-3	-3	VOLTS
PLATE CURRENT	4	4	MA.
SCREEN CURRENT	1.7	1.7	MA.
PLATE RESISTANCE	0.4	0.6	MEGOHM
TRANSCONDUCTANCE	1000	1050	μMHOS
AMPLIFICATION FACTOR	400	630	

^A MAXIMUM PLATE V. = 275 V.

DIRECT INTERELECTRODE CAPACITANCES

CONTROL GRID TO CATHODE	.53	μf
PLATE TO CATHODE	10.5	μf
CONTROL GRID TO PLATE ^S	.007 ^{MAX.}	μf

^S WITH SHIELD

TUNG-SOL

TRIPLE-DIODE TRIODE

MINIATURE TYPE

COATED UNIPOTENTIAL CATHODES

HEATER

18.9 VOLTS 150 MA.

AC OR DC

ANY MOUNTING POSITION

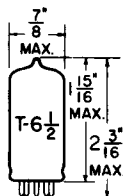

GLASS BULB

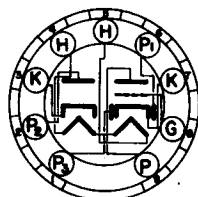
 BOTTOM VIEW
 SMALL BUTTON
 9 PIN BASE

THE 19T8 COMPRISES THREE HIGH PERVEANCE DIODES AND A HIGH MU TRIODE IN ONE ENVELOPE WITH THE 9 PIN MINIATURE CONSTRUCTION. ONE OF THE THREE DIODE PLATES HAS AN INDEPENDENT CATHODE PROVIDING SATISFACTORY OPERATION IN BALANCED LOW IMPEDANCE DETECTOR CIRCUITS. THIS TUBE STRUCTURE PERMITS THE CONSTRUCTION OF AM/FM RECEIVERS WITH A MINIMUM OF SWITCHING.

 DIRECT INTERELECTRODE CAPACITANCES - APPROX.
 WITH NO EXTERNAL SHIELD

GRID TO EACH DIODE PLATE (MAX.)	0.035	μμf
DIODE #1 INPUT: P ₁ TO (H+K)	3.8	μμf
DIODE #2 INPUT: P ₂ TO (H+K)	4.5	μμf
DIODE #3 INPUT: P ₃ TO (H+K)	3.8	μμf
DIODE CATHODE TO ALL: K TO (H+K+P ₁ +P ₂ +P ₃ +P+G)	8.5	μμf

RATINGS

INTERPRETED ACCORDING TO RMA STANDARD M8-310

HEATER VOLTAGE	18.9	VOLTS
MAXIMUM HEATER-CATHODE VOLTAGE	90	VOLTS
MAXIMUM PLATE VOLTAGE	300	VOLTS
MAXIMUM POSITIVE DC GRID VOLTAGE	0	VOLTS
MAXIMUM DIODE CURRENT EACH PLATE FOR CONTINUOUS OPERATION	5	MA.

TYPICAL OPERATING CONDITIONS AND CHARACTERISTICS

CLASS A₁ AMPLIFIER

HEATER VOLTAGE	18.9	18.9	VOLTS
HEATER CURRENT	150	150	MA.
PLATE VOLTAGE	100	250	VOLTS
GRID VOLTAGE	-1	-3	VOLTS
PLATE CURRENT	0.8	1	MA.
PLATE RESISTANCE	54 000	58 000	OHMS
TRANSCONDUCTANCE	1 300	1 200	μMHOS
AMPLIFICATION FACTOR	70	70	
AVERAGE DIODE CURRENT WITH 5 VOLTS DC APPLIED	20	20	MA.

ONE DIODE HAS A SEPARATE CATHODE, THE OTHER CATHODE IS COMMON TO TWO DIODES AND THE TRIODE UNIT.

IT IS RECOMMENDED THAT DIODE #2 (PIN 2) AND DIODE #3 (PIN 1) BE USED IN A RADIO-DETECTOR CIRCUIT FOR FM.

CONTINUED ON FOLLOWING PAGE

→ INDICATES A CHANGE OR ADDITION

 PLATE
 2091
 OCT. 1,
 1948

TUNG-SOL

CONTINUED FROM PRECEDING PAGE

RESISTANCE COUPLED AMPLIFIER

R1 MEG.	Rg1 MEG.	Rc MEG.	Ebb = 90 VOLTS			Ebb = 180 VOLTS			Ebb = 300 VOLTS		
			Rk	GAIN	Eo	Rk	GAIN	Eo	Rk	GAIN	Eo
0.10	A	0.10	5700	21	7	2400	29	18	1800	33	35
0.10	A	0.24	6100	26	9	2700	34	23	2000	38	42
0.24	A	0.24	9100	30	10	4300	40	24	3000	44	43
0.24	A	0.51	10000	34	13	4700	45	31	3300	49	52
0.51	A	0.51	15000	37	14	7500	47	28	5600	51	50
0.51	A	1	16000	40	16	8200	50	35	6200	55	60
0.24	10	0.24	---	31	5	---	44	19	---	48	40
0.24	10	0.51	---	37	7	---	49	25	---	52	52
0.51	10	0.51	---	39	7.5	---	51	22	---	54	44
0.51	10	1	---	42	10	---	54	28	---	58	56

^A VALUE OF Rg1 IS NOT CRITICAL.

Rk TAKEN TO NEAREST RMA VALUE FOR EACH CASE INSTEAD OF ABSOLUTE OPTIMUM VALUE.

Eo IS RMS OUTPUT AT 5% TOTAL HARMONIC DISTORTION.

GAIN MEASURED AT Eo = 2.0 VOLTS RMS OUTPUT.

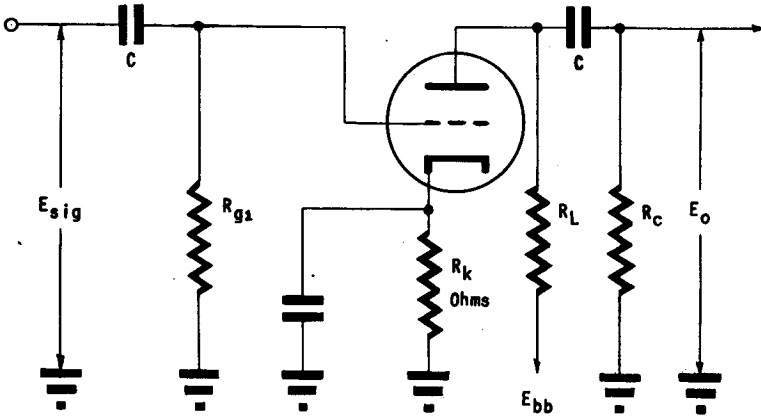

NOTE: COUPLING CAPACITORS (C) SHOULD BE SELECTED TO GIVE DESIRED FREQUENCY RESPONSE. Rk SHOULD BE ADEQUATELY BY-PASSED.

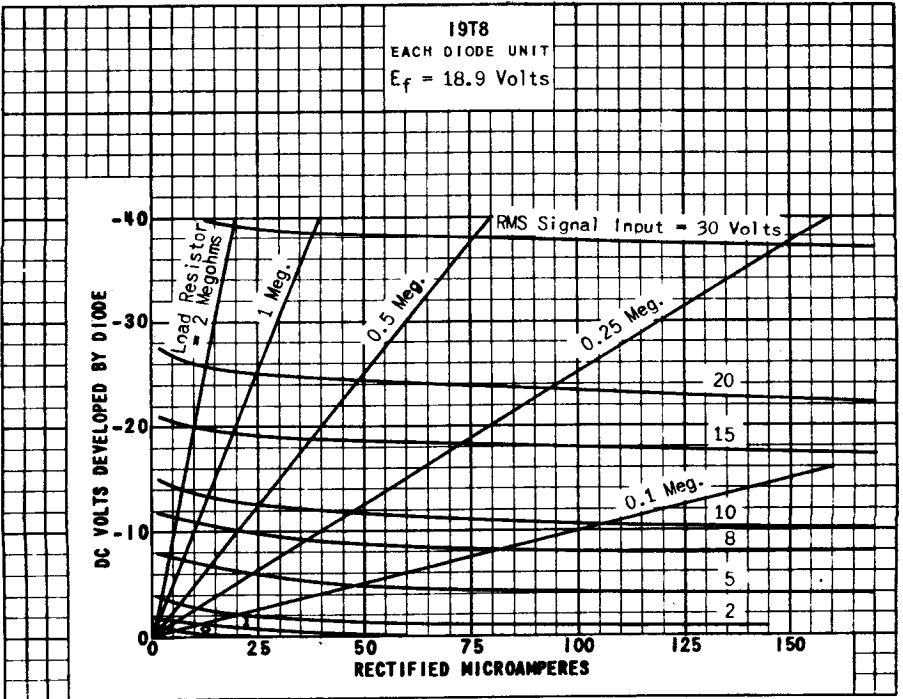
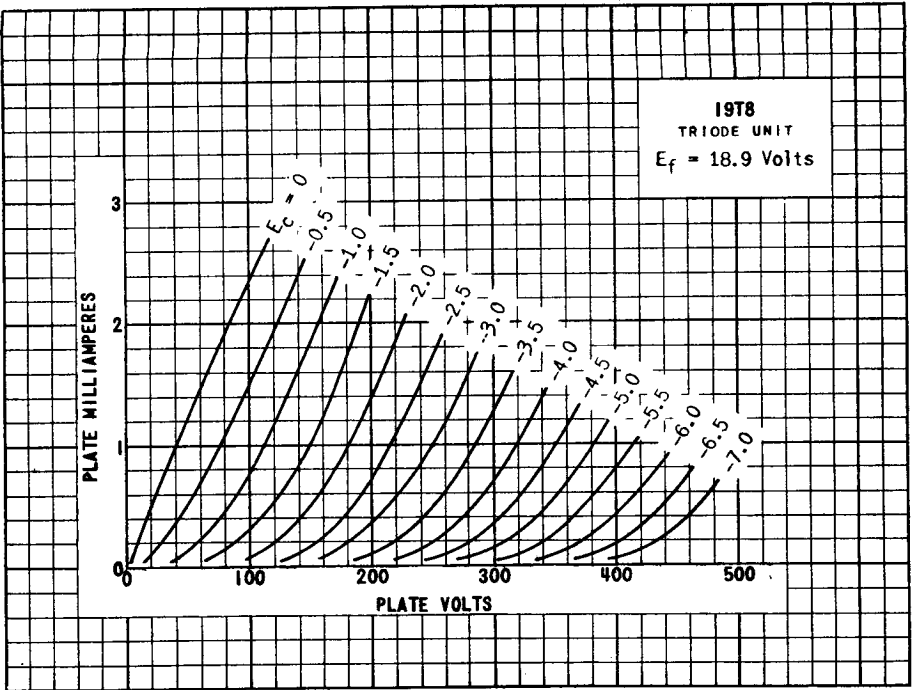



TUNG-SOL

PENTODE POWER AMPLIFIER

UNI-POTENTIAL CATHODE

HEATER

25 VOLTS 0.3 AMPERE

AC OR DC

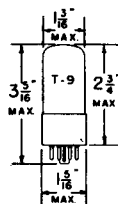
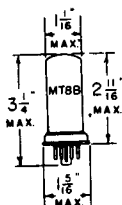

METAL SHELL
SMALL WAFER
7-PIN OCTAL BASE

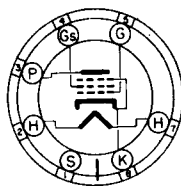

7S

25A6 BOTTOM VIEW

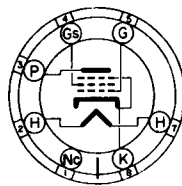

G-7S *

25A6GT/G BOTTOM VIEW

GLASS BULB
INTERMEDIATE
7-PIN OCTAL BASE

THE TUNG-SOL 25A6 AND 25A6GT/G ARE DESIGNED FOR SERVICE IN THE POWER OUTPUT STAGES OF AC - DC RECEIVERS. THEIR RATINGS AND ELECTRICAL CHARACTERISTICS ARE IDENTICAL WITH THOSE OF THE TYPE 43

RATINGS

MAXIMUM PLATE VOLTAGE	160	VOLTS
MAXIMUM SCREEN VOLTAGE	135	VOLTS
MAXIMUM PLATE DISSIPATION	5.3	WATTS
MAXIMUM SCREEN DISSIPATION	1.9	WATTS

TYPICAL OPERATING CONDITIONS AND CHARACTERISTICS

CLASS A₁ AMPLIFIER

PLATE VOLTAGE	95	135	160	VOLTS
SCREEN VOLTAGE	95	135	120	VOLTS
CONTROL GRID VOLTAGE ^A	-15	-20	-18	VOLTS
PEAK AF SIGNAL VOLTAGE	15	20	18	VOLTS
ZERO-SIGNAL PLATE CURRENT	20	37	33	MA.
ZERO-SIGNAL SCREEN CURRENT	4	8	6.5	MA.
MAXIMUM-SIGNAL PLATE CURRENT	22	39	36	MA.
MAXIMUM-SIGNAL SCREEN CURRENT	8	14	12	MA.
PLATE RESISTANCE APPROX.	45000	35000	42000	OHMS
TRANSCONDUCTANCE	2000	2450	2375	μMHOS
LOAD RESISTANCE	4500	4000	5000	OHMS
TOTAL HARMONIC DISTORTION	11	9	10	PER CENT
POWER OUTPUT	0.9	2	2.2	WATTS

^A THE DC RESISTANCE IN THE GRID CIRCUIT, UNDER MAXIMUM RATED CONDITIONS, SHOULD NOT EXCEED 0.5 MEGOHM FOR SELF BIAS OPERATION AND 0.1 MEGOHM FOR FIXED BIAS OPERATION.

CONTINUED NEXT PAGE

25A6, 25A6GT/G

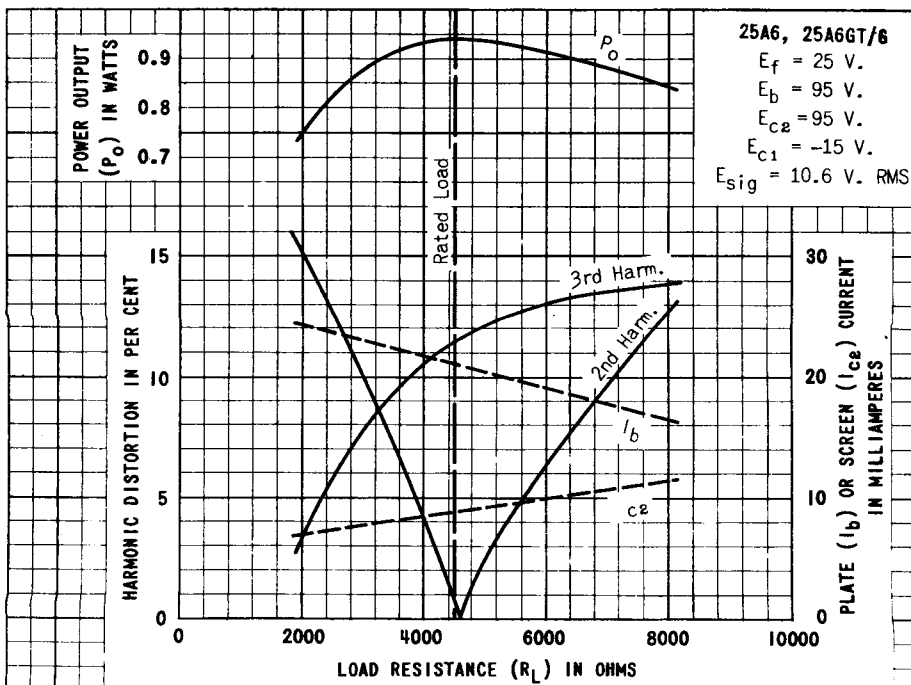
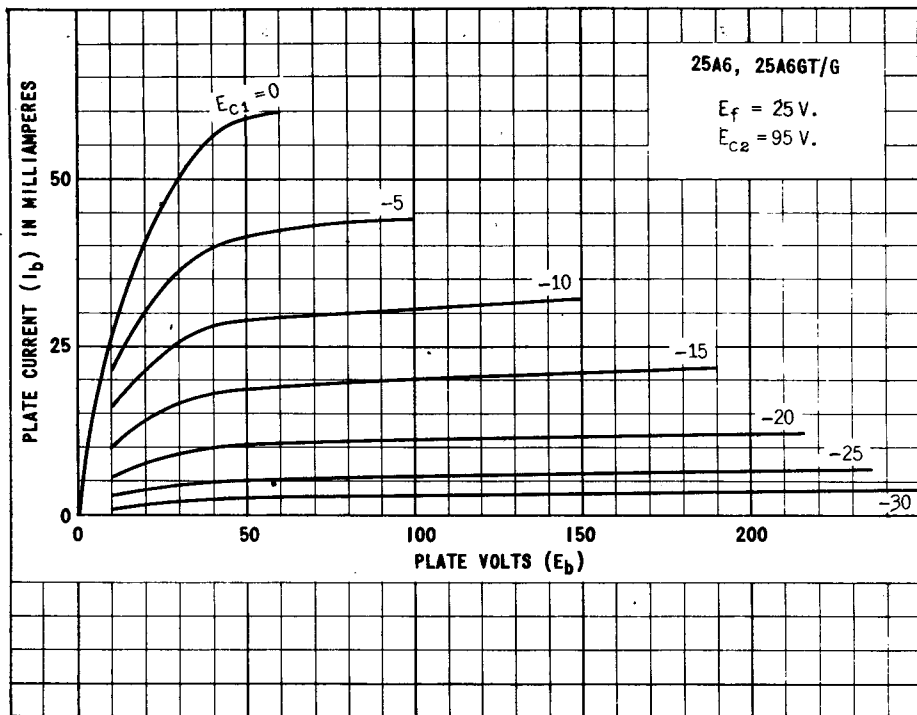

TUNG-SOL

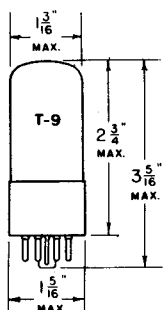

RECTIFIER

PENTODE POWER AMPLIFIER

UNIPOTENTIAL CATHODES

HEATER

25 VOLTS 0.3 AMPERE
AC OR DC

GLASS BULB



G-8F

BOTTOM VIEW

INTERMEDIATE 8 PIN OCTAL BASE

THE TUNG-SOL 25A7GT/G COMBINES A HALF WAVE RECTIFIER AND A PENTODE POWER AMPLIFIER IN A SINGLE BULB. IT IS DESIGNED FOR SERVICE IN AC-DC OPERATED RECEIVERS.

RATINGS

PENTODE POWER AMPLIFIER UNIT

MAXIMUM PLATE VOLTAGE	117	VOLTS
MAXIMUM SCREEN VOLTAGE	117	VOLTS
MAXIMUM PLATE DISSIPATION	2.25	WATTS
MAXIMUM SCREEN DISSIPATION	0.8	WATT

RATINGS

RECTIFIER UNIT

MAXIMUM AC PLATE VOLTAGE (RMS)	117	VOLTS
MAXIMUM DC HEATER TO CATHODE POTENTIAL	175	VOLTS
MAXIMUM PEAK INVERSE VOLTAGE	350	VOLTS
MAXIMUM STEADY STATE PEAK PLATE CURRENT	450	MA.
TUBE VOLTAGE DROP: MEASURED WITH APPLIED DC AT 150 MA. PLATE CURRENT	23	VOLTS
MAXIMUM DC OUTPUT CURRENT	75	MA.
MINIMUM EFFECTIVE PLATE SUPPLY IMPEDANCE	15	OHMS

CONTINUED NEXT PAGE

TYPICAL OPERATING CONDITIONS AND CHARACTERISTICS

CLASS A₁ AMPLIFIER

PLATE VOLTAGE	100	VOLTS
SCREEN VOLTAGE	100	VOLTS
CONTROL GRID VOLTAGE ^A	-15	VOLTS
ZERO-SIGNAL PLATE CURRENT	20.5	MA.
ZERO-SIGNAL SCREEN CURRENT	4	MA.
PLATE RESISTANCE	50 000	OHMS
TRANSCONDUCTANCE	1800	μMHOS
LOAD RESISTANCE	4500	OHMS
TOTAL HARMONIC DISTORTION	9	PER CENT
POWER OUTPUT	0.77	WATT

^A THE DC RESISTANCE IN THE GRID CIRCUIT, UNDER MAXIMUM RATED CONDITIONS, SHOULD NOT EXCEED 0.5 MEGOHM FOR SELF BIAS OPERATION AND 0.1 MEGOHM FOR FIXED BIAS OPERATION.

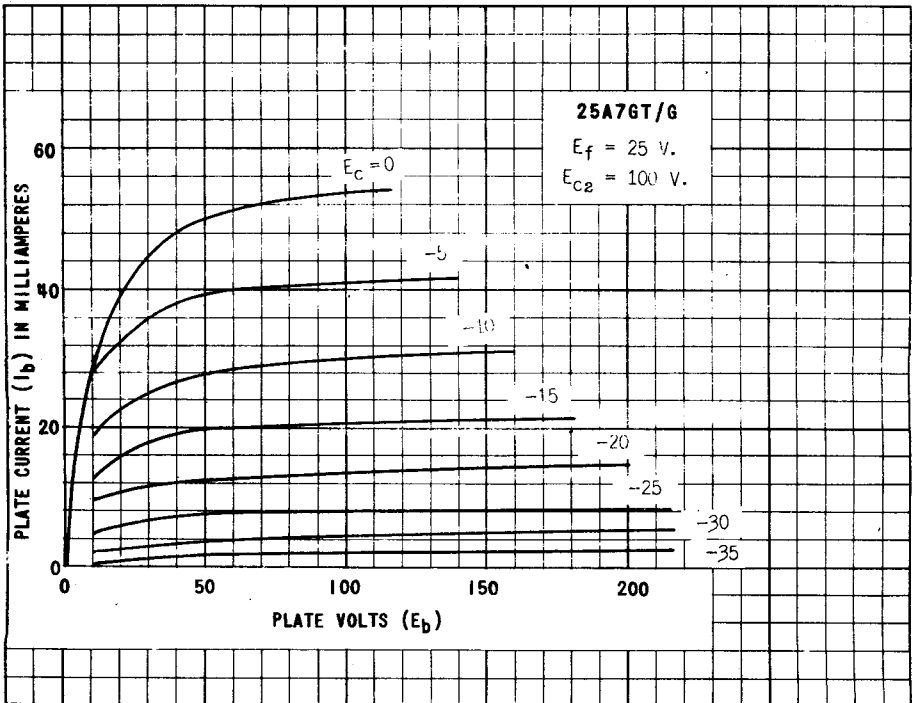

TUNG-SOL

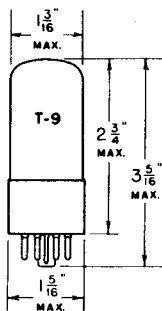

TRIODE POWER AMPLIFIER

UNIPOTENTIAL CATHODE

HEATER

25 VOLTS 0.3 AMPERE

AC OR DC

GLASS BULB

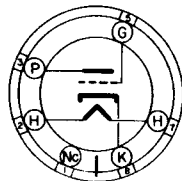

G-6Qa

BOTTOM VIEW

INTERMEDIATE 6 PIN OCTAL BASE

THE TUNG-SOL 25AC5GT/G IS A HIGH-MU POWER OUTPUT TRIODE DESIGNED FOR SERVICE WITH POSITIVE GRID BIAS IN DYNAMIC COUPLED CIRCUITS EMPLOYING A TYPE 6AE5GT/G, TYPE 6P5GT/G, TYPE 76, OR A TYPE 37 AS A DRIVER.

RATINGS

MAXIMUM PLATE VOLTAGE	180	VOLTS
MAXIMUM PLATE DISSIPATION	10	WATTS

AVERAGE CHARACTERISTICS

PLATE VOLTAGE	110	VOLTS
CONTROL GRID VOLTAGE	+15	VOLTS
PLATE CURRENT	45	MA.
GRID CURRENT	7	MA.
PLATE RESISTANCE	15 200	OHMS
TRANSCONDUCTANCE	3800	μMMS
AMPLIFICATION FACTOR	58	

TYPICAL OPERATING CONDITIONS AND CHARACTERISTICS

DYNAMIC-COUPLED CLASS A₁ AMPLIFIER

DRIVER TUBE TYPE	6AE5GT/G	6P5GT/G	37	
PLATE SUPPLY VOLTAGE	110	180	180	VOLTS
CONTROL GRID VOLTAGE	A	A	A	VOLTS
DRIVER GRID RESISTOR MAX.	1.0	1.0	1.0	MEGOHM
POWER TUBE PLATE CURRENT	45	27	37	MA.
DRIVER TUBE PLATE CURRENT	7	4	5.3	MA.
INPUT SIGNAL TO DRIVER VOLTAGE (RMS) ^B	22	12	17	VOLTS
LOAD RESISTANCE	2000	8000	5000	OHMS
TOTAL HARMONIC DISTORTION	10	10	10	PER CENT
POWER OUTPUT	2.0	2.0	2.7	WATTS

^A BIAS VOLTAGE FOR BOTH THE 25AC5GT/G AND THE DRIVER ARE AUTOMATICALLY DEVELOPED BY THE "DYNAMIC COUPLED" CIRCUIT.

^B DRIVER GRID CURRENT DOES NOT FLOW DURING ANY PART OF THE INPUT CYCLE.

25AC5GT/G

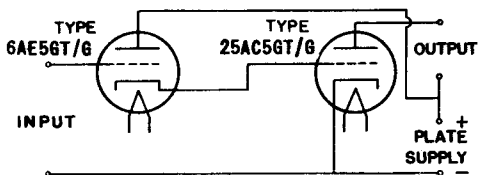
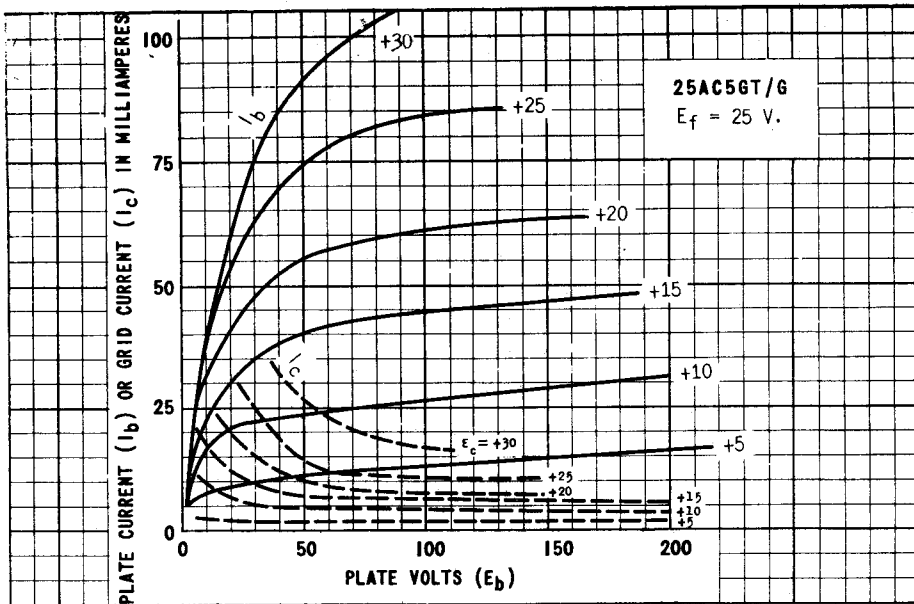

THE DATA SHOWN HEREIN IS FOR YOUR INFORMATION. TUNG-SOL LAMP WORKS INC. ASSUMES NO LIABILITY WITH RESPECT TO ITS USE IN THE INFRINGEMENT OF ANY PATENT.

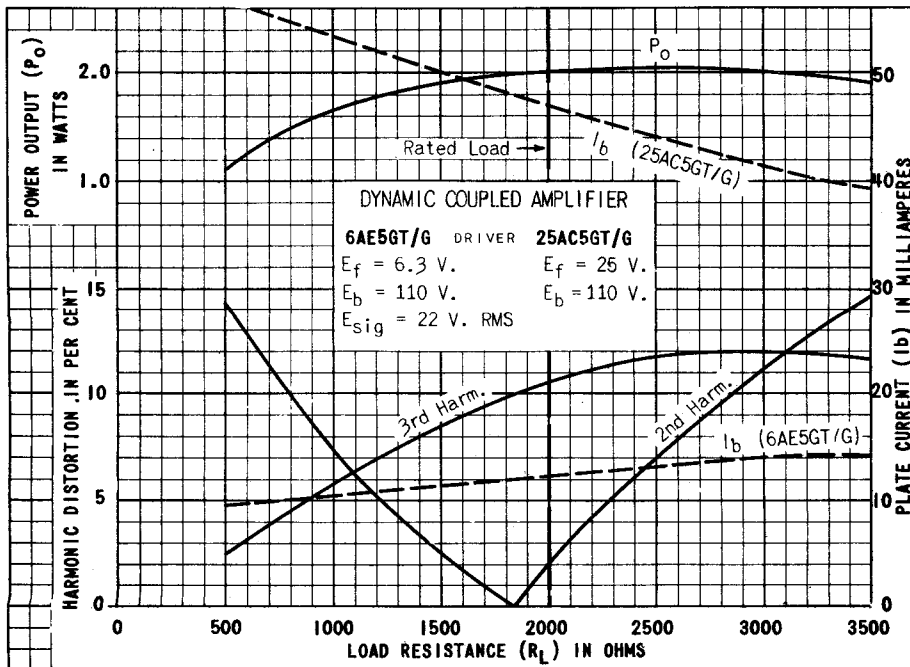
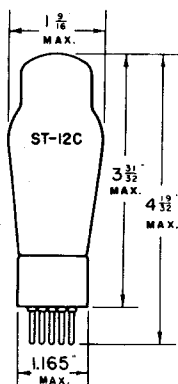

PLATE 1160-1

TUNG-SOL



DYNAMIC COUPLED POWER AMPLIFIER

UNIPOTENTIAL CATHODES

HEATER

25 VOLTS 0.3 AMPERE

AC OR DC

GLASS BULB

SMALL 6 PIN BASE

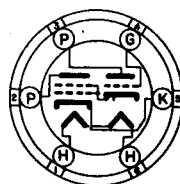

6Da

BOTTOM VIEW

THE TUNG-SOL 25B5 CONSISTS OF TWO DYNAMICALLY COUPLED TRIODES AND IS DESIGNED FOR SERVICE IN THE POWER OUTPUT STAGE OF AC-DC RECEIVERS. ALL NECESSARY BIASES ARE SUPPLIED INTERNALLY. IT RATINGS AND CHARACTERISTICS ARE IDENTICAL WITH THOSE OF THE 25N6G.

OPERATING CONDITIONS AND CHARACTERISTICS

CLASS A₁ AMPLIFIER

OUTPUT PLATE (2) VOLTAGE	110	180 ^{MAX.}	VOLTS
INPUT PLATE (3) VOLTAGE	110	100 ^P	VOLTS
INPUT GRID (4) VOLTAGE	0	0	VOLTS
GRID CIRCUIT RESISTANCE ^{MAX.}	1	1	MEG OHM
OUTPUT PLATE CURRENT	45	46	MA.
INPUT PLATE CURRENT	7	5.8	MA.
TRANSCONDUCTANCE	2200	2300	UMHOS
AMPLIFICATION FACTOR	25	35	
LOAD RESISTANCE	2000	4000	OHMS
SIGNAL VOLTAGE (RMS) ^S	21	21	VOLTS
TOTAL HARMONIC DISTORTION	9	9	PER CENT
POWER OUTPUT	2.0	3.8	WATTS

(2) BASE PIN #2

(3) BASE PIN #3

(4) BASE PIN #4

^S FOR RATED POWER OUTPUT

^P BOTH PLATES MAY BE OPERATED AT 180 VOLTS IF THE GRID IS BIASED TO -20 VOLTS. FIXED OR SELF BIAS MAY BE USED. FOR SELF BIAS THE CATHODE RESISTOR SHOULD BE 400 OHMS.

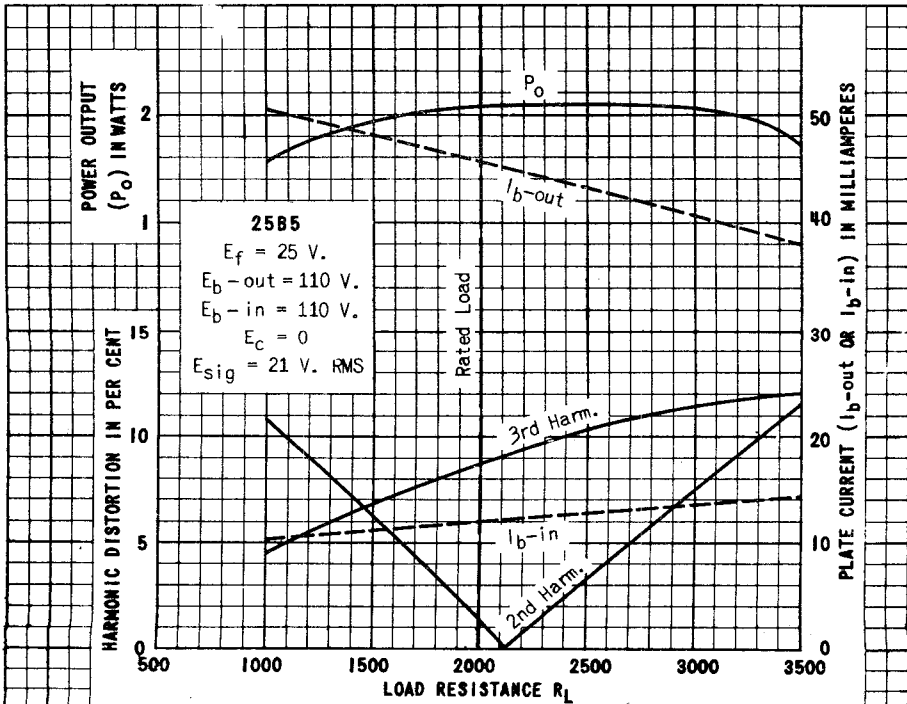
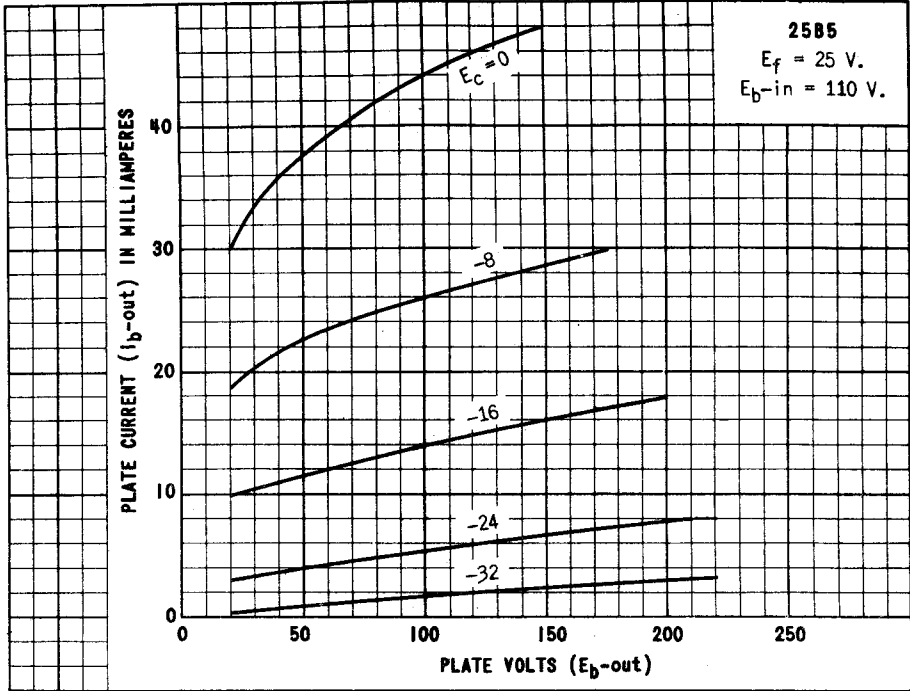

TUNG-SOL

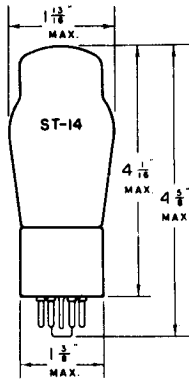

PENTODE POWER AMPLIFIER

UNIPOTENTIAL CATHODE

HEATER

25.0 VOLTS 0.3 AMPERE
AC OR DC

GLASS BULB

MEDIUM 7 PIN OCTAL BASE

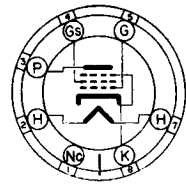

G-7S

BOTTOM VIEW

THE TUNG-SOL 25B6G IS A POWER OUTPUT PENTODE, WHICH IS DESIGNED FOR SERVICE IN SERIES OPERATED HEATER CIRCUITS THAT REQUIRE A HIGH POWER OUTPUT.

RATINGS

MAXIMUM PLATE VOLTAGE	200	VOLTS
MAXIMUM SCREEN VOLTAGE	135	VOLTS
MAXIMUM PLATE DISSIPATION	12.5	WATTS
MAXIMUM SCREEN DISSIPATION	2.0	WATTS

TYPICAL OPERATING CONDITIONS AND CHARACTERISTICS

CLASS A₁ AMPLIFIER

PLATE VOLTAGE	105	135	200	VOLTS
SCREEN VOLTAGE	105	135	135	VOLTS
CONTROL GRID VOLTAGE	-16	-22	-23	VOLTS
PEAK AF SIGNAL VOLTAGE	16	22	23	VOLTS
ZERO-SIGNAL PLATE CURRENT	48	61	62	MA.
ZERO-SIGNAL SCREEN CURRENT	2.0	2.5	1.8	MA.
MAXIMUM-SIGNAL PLATE CURRENT	55	69	71	MA.
MAXIMUM-SIGNAL SCREEN CURRENT	10	14.5	13	MA.
PLATE RESISTANCE	15 500	15 000	18 000	OHMS
TRANSCONDUCTANCE	4800	5000	5000	μMHOS
LOAD RESISTANCE	1700	1700	2500	OHMS
TOTAL HARMONIC DISTORTION	12.5	14	15	PER CENT
SECOND HARMONIC DISTORTION	7	8	8.5	PER CENT
THIRD HARMONIC DISTORTION	10	11	11	PER CENT
POWER OUTPUT	2.4	4.3	7.1	WATTS

FOR "INTERPRETATION OF RATINGS" REFER TO FRONT OF BOOK.

CONTINUED NEXT PAGE

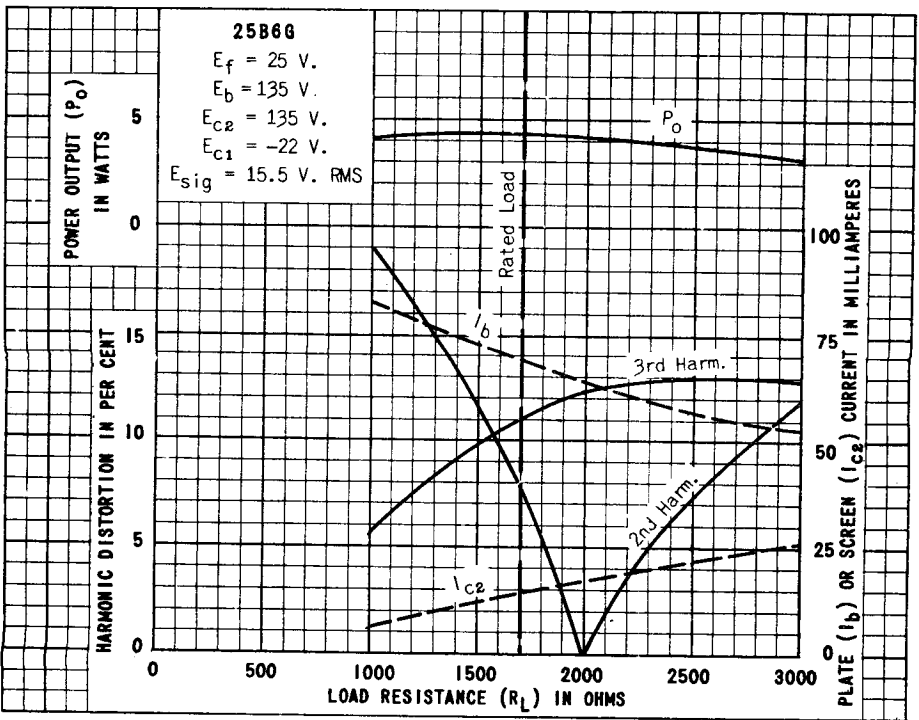
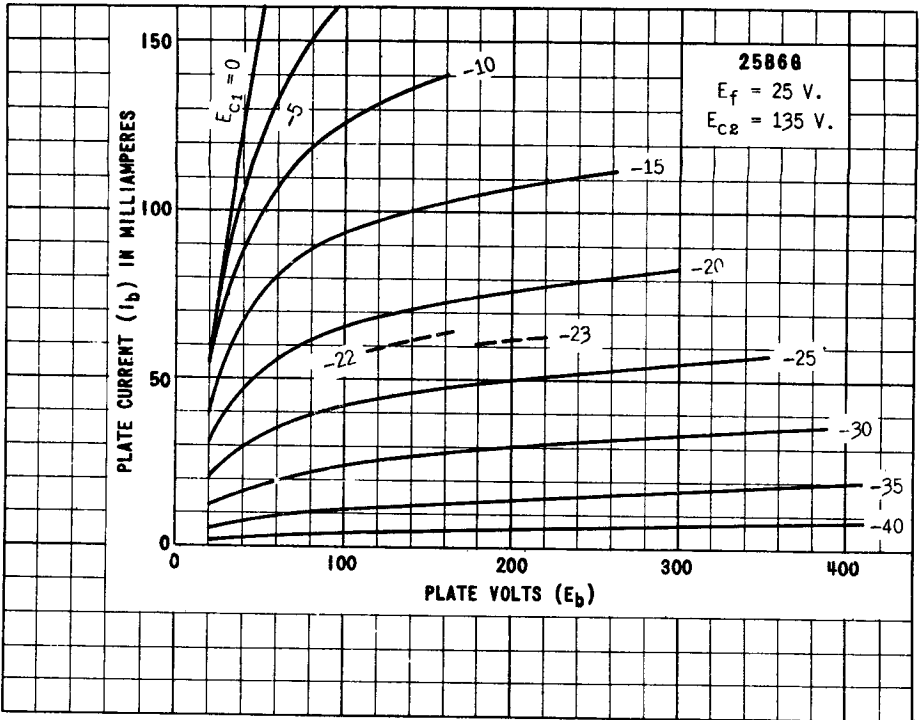

TUNG-SOL

TRIODE-PENTODE AMPLIFIER

PHYSICAL SPECIFICATIONS

EMITTER UNIPOTENTIAL CATHODE	PIN CONNECTIONS	
BASE INTERMEDIATE-8 PIN OCTAL	PIN 1 PENT. CATH. *	PIN 7 PENT. HEATER
CAP SKIRTED MINIATURE-STYLE C	PIN 2 TRIODE HTR.	PIN 8 TRIODE GRID
BULB T-9	PIN 3 PENT. PLATE	
MAXIMUM DIAMETER 1 5/16"	PIN 4 PENT. GRID #2	
MAXIMUM OVERALL LENGTH 3 5/16"	PIN 5 TRIODE PLATE	TOP CAP PENT. GRID #1
MAXIMUM SEATED HEIGHT 2 3/4"	PIN 6 TRIODE CATH.	

*AND GRID #3

RATINGS

HEATER OR FILAMENT VOLTAGE (AC OR DC)	25	VOLTS
HEATER OR FILAMENT CURRENT	0.15	AMP.

DIRECT INTERELECTRODE CAPACITANCES

	PENTODE	TRIODE	
CONTROL GRID TO CATHODE	5.5	5.0	μf
PLATE TO CATHODE	10.0	4.6	μf
CONTROL GRID TO PLATE	0.02	2.2	μf
PENTODE CONTROL GRID TO TRIODE GRID		0.02	μf
PENTODE CONTROL GRID TO TRIODE PLATE		0.009	μf
PENTODE PLATE TO TRIODE GRID		0.075	μf

OPERATING CONDITIONS AND CHARACTERISTICS

PENTODE SECTION-CLASS A₁ AMPLIFIER

PLATE VOLTAGE	100	VOLTS
SCREEN VOLTAGE (GRID #2)	100	VOLTS
CONTROL GRID VOLTAGE (GRID #1)	-3	VOLTS
PLATE CURRENT	7.6	MA.
SCREEN CURRENT	2.0	MA.
PLATE RESISTANCE	0.185	MEGOHM
TRANSCONDUCTANCE	2000	μMHOS
AMPLIFICATION FACTOR	370	
CONTROL GRID VOLTAGE	-41	VOLTS
FOR TRANSCONDUCTANCE = 2 μMHOS		

TRIODE SECTION-CLASS A₁ AMPLIFIER

PLATE VOLTAGE	100	VOLTS
GRID VOLTAGE	-1	VOLT
PLATE CURRENT	0.6	MA.
PLATE RESISTANCE	0.075	MEGOHM
TRANSCONDUCTANCE	1500	μMHOS
AMPLIFICATION FACTOR	112.5	
GRID VOLTAGE (APPROX.)	-2.5	VOLTS
FOR PLATE CURRENT CUT-OFF		

PLATE
T857-1

SEPT. 23
1940



TUNG-SOL

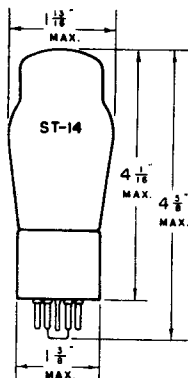

BEAM POWER AMPLIFIER

UNIPOTENTIAL CATHODE

HEATER
25.0 VOLTS 0.3 AMPERE
AC OR DC

GLASS BULB

MEDIUM 7 PIN OCTAL BASE

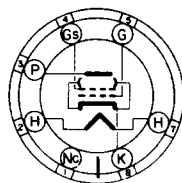

G-7AC

BOTTOM VIEW

THE TUNG-SOL, 25C6G IS A BEAM POWER AMPLIFIER, DESIGNED FOR SERVICE IN THE OUTPUT STAGE OF AC-DC RECEIVERS. IT FEATURES HIGH POWER OUTPUT WITH LOW SUPPLY VOLTAGES.

RATINGS

MAXIMUM PLATE VOLTAGE	200	VOLTS
MAXIMUM SCREEN VOLTAGE	135	VOLTS
MAXIMUM PLATE DISSIPATION	12.5	WATTS
MAXIMUM SCREEN DISSIPATION	1.75	WATTS

TYPICAL OPERATING CONDITIONS AND CHARACTERISTICS

CLASS A₁ AMPLIFIER

PLATE VOLTAGE	135	200	VOLTS
SCREEN VOLTAGE	135	135	VOLTS
CONTROL GRID VOLTAGE ^A	-13.5	-14	VOLTS
PEAK AF SIGNAL VOLTAGE	13.5	14	VOLTS
ZERO-SIGNAL PLATE CURRENT	58	61	MA.
ZERO-SIGNAL SCREEN CURRENT (NOMINAL)	3.5	2.2	MA.
MAXIMUM-SIGNAL PLATE CURRENT	60	66	MA.
MAXIMUM-SIGNAL SCREEN CURRENT (NOMINAL)	11.5	9	MA.
PLATE RESISTANCE ^{APPROX.}	9300	18 300	OHMS
TRANSCONDUCTANCE	7000	7100	μMHOS
LOAD RESISTANCE	2000	2600	OHMS
TOTAL HARMONIC DISTORTION	10	10	PER CENT
POWER OUTPUT	3.6	6.0	WATTS

^A THE DC RESISTANCE IN THE GRID CIRCUIT, UNDER MAXIMUM RATED CONDITIONS, SHOULD NOT EXCEED 0.5 MEGOHM FOR SELF-BIAS OPERATION AND 0.1 MEGOHM FOR FIXED BIAS OPERATION.

FOR "INTERPRETATION OF RATINGS" REFER TO FRONT OF BOOK.

CONTINUED NEXT PAGE

25C6G

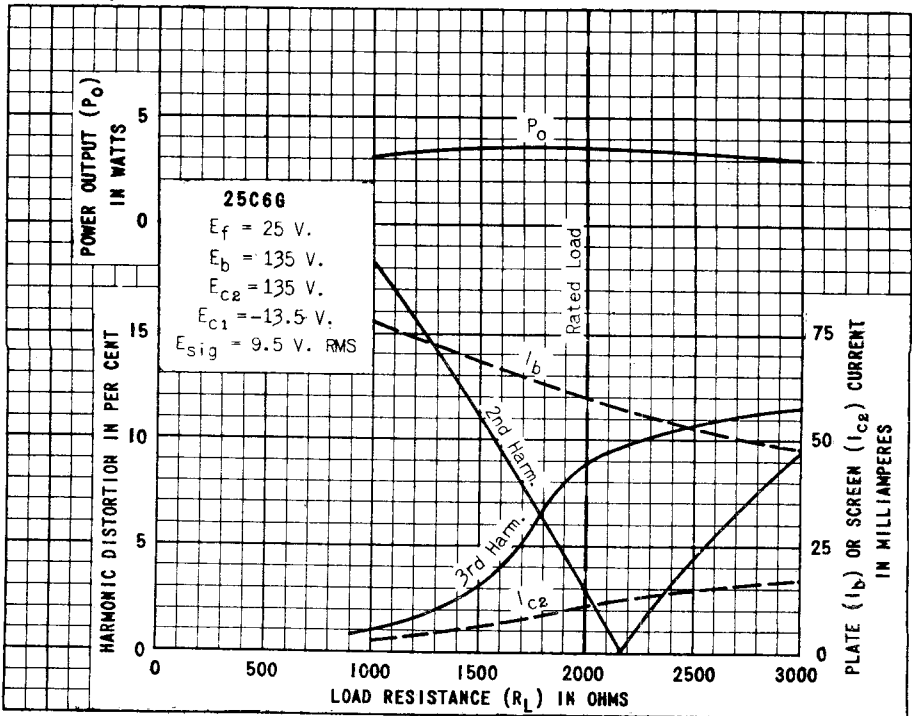
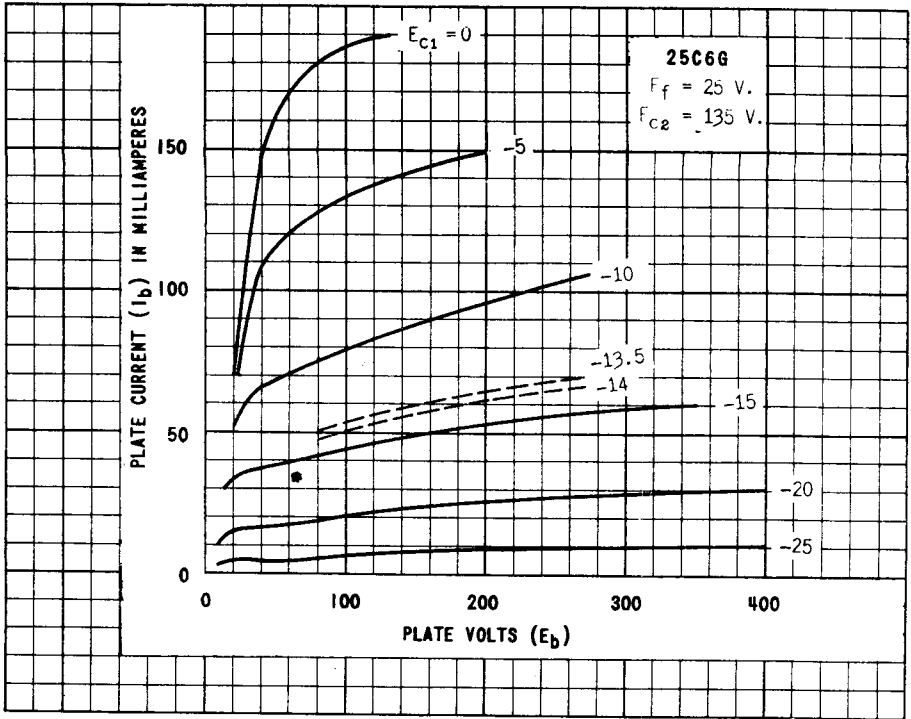

PLATE 1095-1

TUNG-SOL

**DIODE TRIODE
REMOTE CUT-OFF PENTODE**

PHYSICAL SPECIFICATIONS

EMITTER UNIPOTENTIAL CATHODE	PIN CONNECTIONS	
BASE INTERMEDIATE-8 PIN OCTAL	PIN 1 CATHODES*	PIN 7 TRIODE HEATER
CAP SKIRTED MINIATURE-STYLE C	PIN 2 PENT.HEATER	PIN 8 DIODE PLATE
BULB T-9	PIN 3 PENT.PLATE	
MAXIMUM DIAMETER 1 5/16"	PIN 4 PENT.GRID #2	
MAXIMUM OVERALL LENGTH 3 9/16"	PIN 5 TRIODE GRID	TOP CAP PENT.GRID #1
MAXIMUM SEATED HEIGHT 3"	PIN 6 TRIODE PLATE	

* DIODE-TRIODE CATHODE TIED TO PENTODE CATHODE

RATINGS

HEATER OR FILAMENT VOLTAGE (AC OR DC)	25.0	VOLTS
HEATER OR FILAMENT CURRENT	0.15	AMP
MAXIMUM PLATE VOLTAGE		VOLTS

DIRECT INTERELECTRODE CAPACITANCES

	PENTODE	TRIODE	
CONTROL GRID TO CATHODE	5.2	3.7	μf
PLATE TO CATHODE	10.0	4.5	μf
CONTROL GRID TO PLATE	0.015 ^{MAX.}	2.5	μf
PENTODE CONTROL GRID TO TRIODE GRID		0.01 ^{MAX.}	μf
PENTODE CONTROL GRID TO TRIODE PLATE		0.02 ^{MAX.}	μf
PENTODE PLATE TO TRIODE GRID		0.10 ^{MAX.}	μf

OPERATING CONDITIONS AND CHARACTERISTICS

TRIODE SECTION - CLASS A₁ AMPLIFIER

PLATE VOLTAGE	100	VOLTS
GRID VOLTAGE	-1	VOLT
PLATE CURRENT	0.5	MA.
PLATE RESISTANCE	91000	OHMS
TRANSCONDUCTANCE	1100	μMHOS
AMPLIFICATION FACTOR	100	

PENTODE SECTION - CLASS A₁ AMPLIFIER

PLATE VOLTAGE	100	VOLTS
SCREEN VOLTAGE (GRID #2)	100	VOLTS
CONTROL GRID VOLTAGE (GRID #1)	-3	VOLTS
PLATE CURRENT	8.5	MA.
SCREEN CURRENT	2.7	MA.
PLATE RESISTANCE APPROX.	200 000	OHMS
TRANSCONDUCTANCE	1900	μMHOS
CONTROL GRID VOLTAGE	-35	VOLTS
FOR TRANSCONDUCTANCE = 2 μMHOS APPROX.		

PLATE
T842-1

SEPT-9
1940

Handwritten scribble or mark at the top of the page.



TUNG-SOL

BEAM POWER AMPLIFIER

UNIPOTENTIAL CATHODE

HEATER

25 VOLTS 0.3 AMPERE
AC OR DC

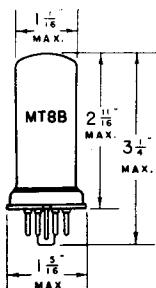

SMALL
7 PIN OCTAL
BASE

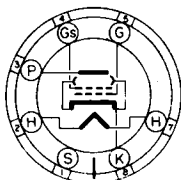

7AC
BOTTOM VIEW

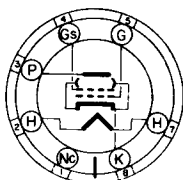

G-7AC
BOTTOM VIEW

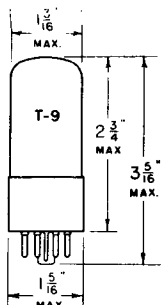

INTERMEDIATE
7 PIN OCTAL
BASE

THE TUNG-SOL 25L6 AND 25L6GT/G ARE DESIGNED FOR SERVICE IN THE OUTPUT STAGE OF AC-DC RECEIVERS. THEY DELIVER A HIGH POWER OUTPUT WITH HIGH POWER SENSITIVITY FROM LOW SUPPLY VOLTAGES.

RATINGS

MAXIMUM PLATE VOLTAGE	200	VOLTS
MAXIMUM SCREEN VOLTAGE	117	VOLTS
MAXIMUM PLATE DISSIPATION	10	WATTS
MAXIMUM SCREEN DISSIPATION	1.25	WATTS

TYPICAL OPERATING CONDITIONS AND CHARACTERISTICS

CLASS A₁ AMPLIFIER

PLATE VOLTAGE	110	200	VOLTS
SCREEN VOLTAGE	110	110	VOLTS
CONTROL GRID VOLTAGE ^A	-7.5	-8	VOLTS
PEAK AF SIGNAL VOLTAGE	7.5	8	VOLTS
ZERO-SIGNAL PLATE CURRENT	49	50	MA.
ZERO-SIGNAL SCREEN CURRENT - NOMINAL	4	1.5	MA.
MAXIMUM-SIGNAL PLATE CURRENT	50	55	MA.
MAXIMUM-SIGNAL SCREEN CURRENT - NOMINAL	11	6	MA.
PLATE RESISTANCE ^{APPROX.}	10 000	35 000	OHMS
TRANSCONDUCTANCE	8200	8250	μMHOS
LOAD RESISTANCE	2000	3000	OHMS
TOTAL HARMONIC DISTORTION	10	10	PER CENT
POWER OUTPUT	2.2	4.7	WATTS

^A THE DC RESISTANCE IN THE GRID CIRCUIT, UNDER MAXIMUM RATED CONDITIONS, SHOULD NOT EXCEED 0.5 MEGOHM FOR SELF-BIAS OPERATION AND 0.1 MEGOHM FOR FIXED BIAS OPERATION.

FOR "INTERPRETATION OF RATINGS" REFER TO FRONT OF BOOK.

CONTINUED NEXT PAGE

25L6, 25L6GT/G

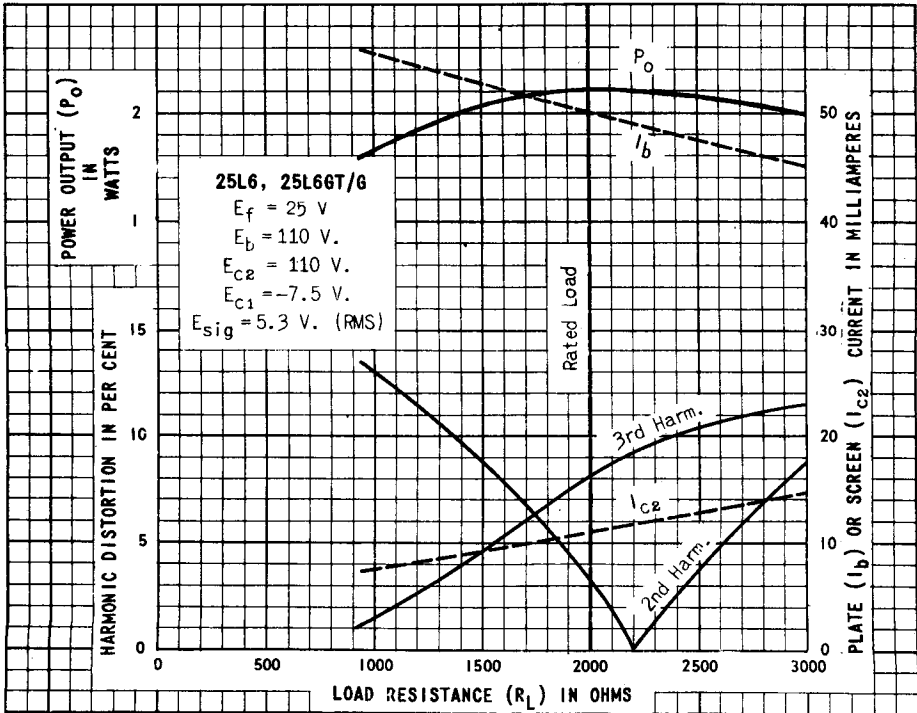
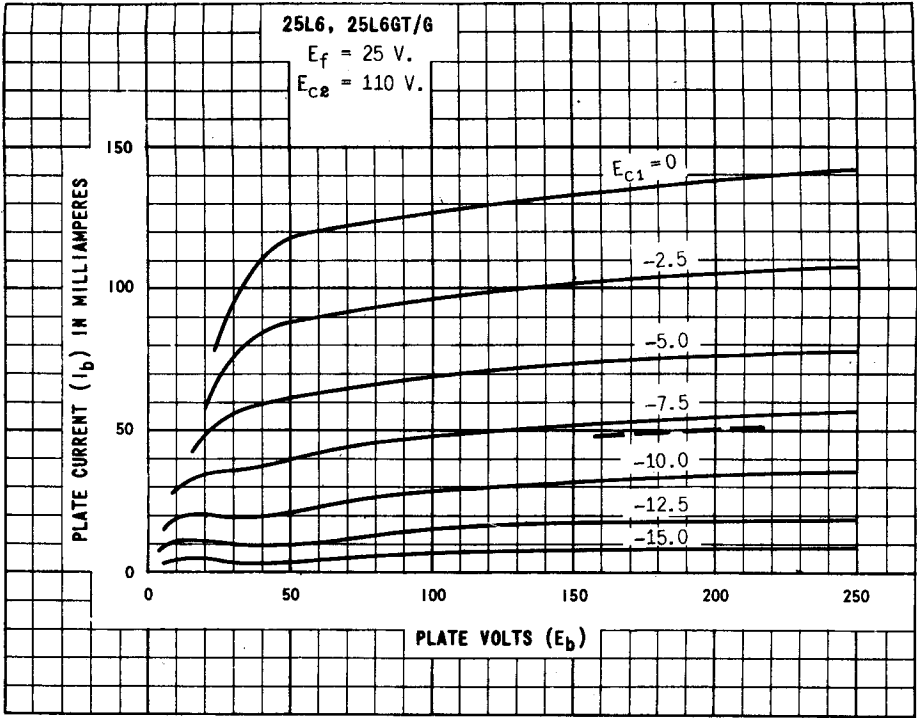
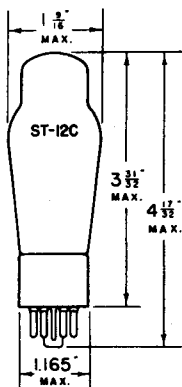

PLATE
 1017-2
 APR. 2
 1941

TUNG-SOL



DYNAMIC COUPLED POWER AMPLIFIER

UNI-POTENTIAL CATHODES

HEATER

25 VOLTS 0.3 AMPERE

AC OR DC

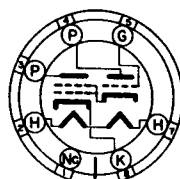

G-7W_a

GLASS BULB

SMALL 7 PIN OCTAL BASE

THE TUNG-SOL 25N6G CONSISTS OF TWO DYNAMICALLY COUPLED TRIODES AND IS DESIGNED FOR SERVICE IN THE POWER OUTPUT STAGE OF AC-DC RECEIVERS. ALL NECESSARY BIASES ARE SUPPLIED INTERNALLY. ITS RATINGS AND CHARACTERISTICS ARE IDENTICAL WITH THOSE OF THE 25B5.

OPERATING CONDITIONS AND CHARACTERISTICS

CLASS A₁ AMPLIFIER

OUTPUT PLATE (3) VOLTAGE	110	180 ^{MAX.}	VOLTS
INPUT PLATE (4) VOLTAGE	110	100 ^F	VOLTS
INPUT GRID (5) VOLTAGE	0	0	VOLTS
GRID CIRCUIT RESISTANCE ^{MAX.}	1	1	MEGOHM
OUTPUT PLATE CURRENT	45	46	MA.
INPUT PLATE CURRENT	7	5.8	MA.
TRANSCONDUCTANCE	2200	2300	μMHOS
AMPLIFICATION FACTOR	25	35	
LOAD RESISTANCE	2000	4000	OHMS
SIGNAL VOLTAGE (RMS) ^S	21	21	VOLTS
TOTAL HARMONIC DISTORTION	9	9	PER CENT
POWER OUTPUT	2.0	3.8	WATTS

(3) BASE PIN #3

(4) BASE PIN #4

(5) BASE PIN #5

^S FOR RATED POWER OUTPUT

^F BOTH PLATES MAY BE OPERATED AT 180 VOLTS IF THE GRID IS BIASED TO -20 VOLTS. FIXED OR SELF BIAS MAY BE USED. FOR SELF BIAS THE CATHODE RESISTOR SHOULD BE 400 OHMS.



TUNG-SOL

TWIN DIODE HIGH VACUUM RECTIFIER
VOLTAGE DOUBLER

UNIPOTENTIAL CATHODES

HEATER

25 VOLTS 0.3 AMPERE
AC OR L^*

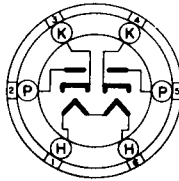
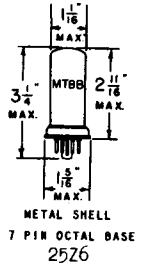
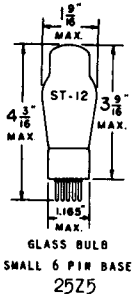

6E
BOTTOM VIEW
25Z5

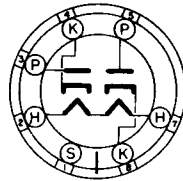

7Q
BOTTOM VIEW
25Z6

THE TUNG-SOL 25Z5 AND 25Z6 ARE DESIGNED PRIMARILY FOR SERVICE AS POWER RECTIFIERS IN AC-DC RECEIVERS. TWO SEPARATE RECTIFIER SECTIONS PERMIT USING THE TUBE AS A VOLTAGE DOUBLER, FULL WAVE RECTIFIER OR HALF WAVE RECTIFIER. FOR HALF WAVE OPERATION THE TWO SECTIONS MAY BE OPERATED SEPARATELY, OR IN PARALLEL TO REDUCE TUBE DROP. THEIR RATINGS AND ELECTRICAL CHARACTERISTICS ARE IDENTICAL TO THOSE OF THE 25Z6GT/G.

RATINGS

MAXIMUM AC PLATE VOLTAGE PER PLATE (RMS)	235	VOLTS
MAXIMUM DC HEATER TO CATHODE POTENTIAL	350	VOLTS
MAXIMUM PEAK INVERSE VOLTAGE	700	VOLTS
MAXIMUM STEADY-STATE PEAK PLATE CURRENT PER PLATE	450	MA.
TUBE VOLTAGE DROP	22	VOLTS
AT 150 MA. PER PLATE		

TYPICAL OPERATING CONDITIONS AND CHARACTERISTICS

VOLTAGE DOUBLER

	HALF WAVE	FULL WAVE	
AC VOLTAGE PER PLATE (RMS) MAX.	117	117	VOLTS
DC OUTPUT CURRENT MAX.	75	75	MA.
TOTAL EFFECTIVE PLATE SUPPLY IMPEDANCE PER PLATE MIN. ^A	30	15	OHMS

^A WHEN FILTER CONDENSER LARGER THAN 40 μ FDS ARE USED, IT MAY BE NECESSARY TO ADD ADDITIONAL PLATE SUPPLY IMPEDANCE.

FOR "INTERPRETATION OF RATINGS" REFER TO FRONT OF BOOK.

CONTINUED NEXT PAGE

PRINTED IN U. S. A.

TUNG-SOL

HALF-WAVE RECTIFIER

AC VOLTAGE PER PLATE (RMS) ^{MAX.}	117	150	235 ^{MAX.}	VOLTS
DC OUTPUT CURRENT PER PLATE ^{MAX.}	75	75	75	MA.
TOTAL EFFECTIVE PLATE SUPPLY IMPEDANCE PER PLATE ^{MIN.-A}	15	40	100	OHMS

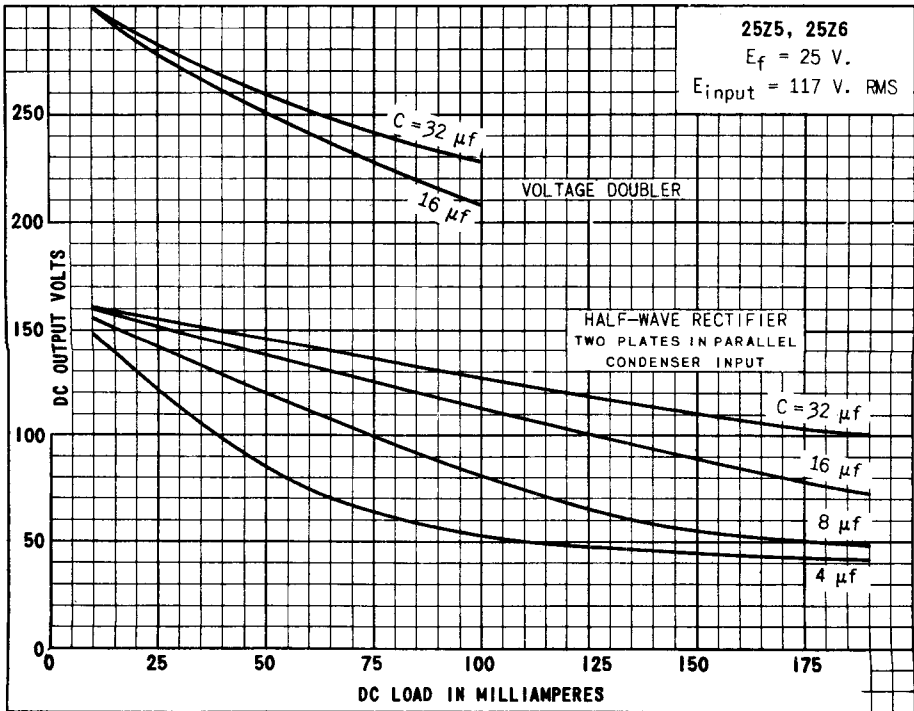
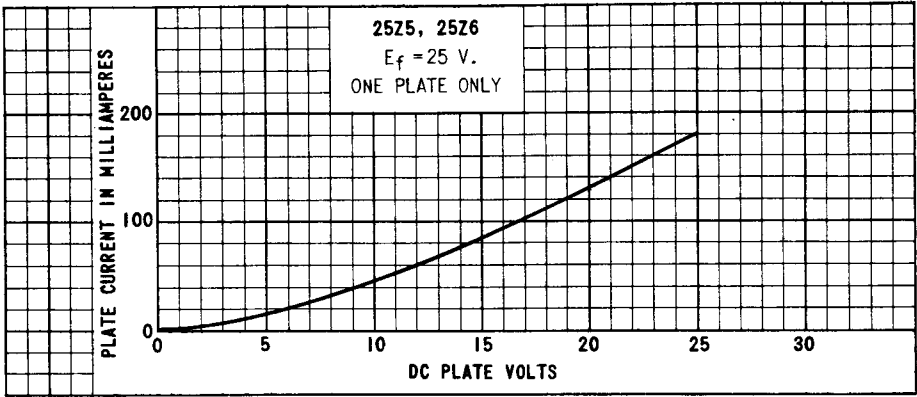

PLATE 929-3

TUNG-SOL

TWIN DIODE HIGH VACUUM RECTIFIER

VOLTAGE DOUBLER

UNIPOTENTIAL CATHODES

HEATER

25 VOLTS 0.3 AMPERE

AC OR DC

GLASS BULB

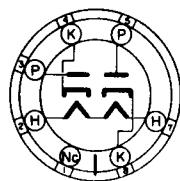

G-7Qa

BOTTOM VIEW

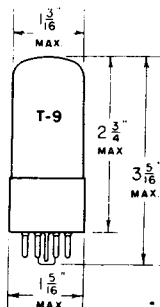

INTERMEDIATE 7 PIN OCTAL BASE

THE TUNG-SOL 25Z6GT/G IS DESIGNED PRIMARILY FOR SERVICE AS A POWER RECTIFIER IN AC - DC RECEIVERS. TWO SEPARATE RECTIFIER SECTIONS PERMIT USING THE TUBE AS A VOLTAGE DOUBLER, FULL WAVE RECTIFIER OR HALF WAVE RECTIFIER. FOR HALF-WAVE OPERATION THE TWO SECTIONS MAY BE OPERATED SEPARATELY, OR IN PARALLEL TO REDUCE TUBE DROP. ITS RATINGS AND ELECTRICAL CHARACTERISTICS ARE IDENTICAL TO THOSE OF THE 25Z5 AND 25Z6.

RATINGS

MAXIMUM AC PLATE VOLTAGE (RMS)	235	VOLTS
MAXIMUM DC HEATER TO CATHODE POTENTIAL	350	VOLTS
MAXIMUM PEAK INVERSE VOLTAGE	700	VOLTS
MAXIMUM STEADY-STATE PEAK PLATE CURRENT PER PLATE	450	MA.
TUBE VOLTAGE DROP	22	VOLTS
AT 150 MA. PER PLATE		

TYPICAL OPERATING CONDITIONS AND CHARACTERISTICS

VOLTAGE DOUBLER

	HALF WAVE	FULL WAVE	
AC VOLTAGE PER PLATE (RMS) MAX.	117	117	VOLTS
DC OUTPUT CURRENT MAX.	75	75	MA.
TOTAL EFFECTIVE PLATE SUPPLY IMPEDANCE PER PLATE MIN. ^A	30	15	OHMS

NOTE: THIS DOUBLE-BRANDED TUBE, 25Z6GT/G, REPLACES EITHER THE 25Z6G OR THE 25Z6GT.

^A WHEN FILTER CONDENSERS LARGER THAN 40 μ FDS ARE USED, IT MAY BE NECESSARY TO ADD ADDITIONAL PLATE SUPPLY IMPEDANCE.

FOR "INTERPRETATION OF RATINGS" REFER TO FRONT OF BOOK.

CONTINUED NEXT PAGE

25Z6GT/G

TUNG-SOL

HALF-WAVE RECTIFIER

AC VOLTAGE PER PLATE (RMS)	117	150	235 ^{MAX.}	VOLTS
DC OUTPUT CURRENT PER PLATE ^{MAX.}	75	75	75	MA.
TOTAL EFFECTIVE PLATE SUPPLY IMPEDANCE PER PLATE ^{MIN.A}	15	40	100	OHMS

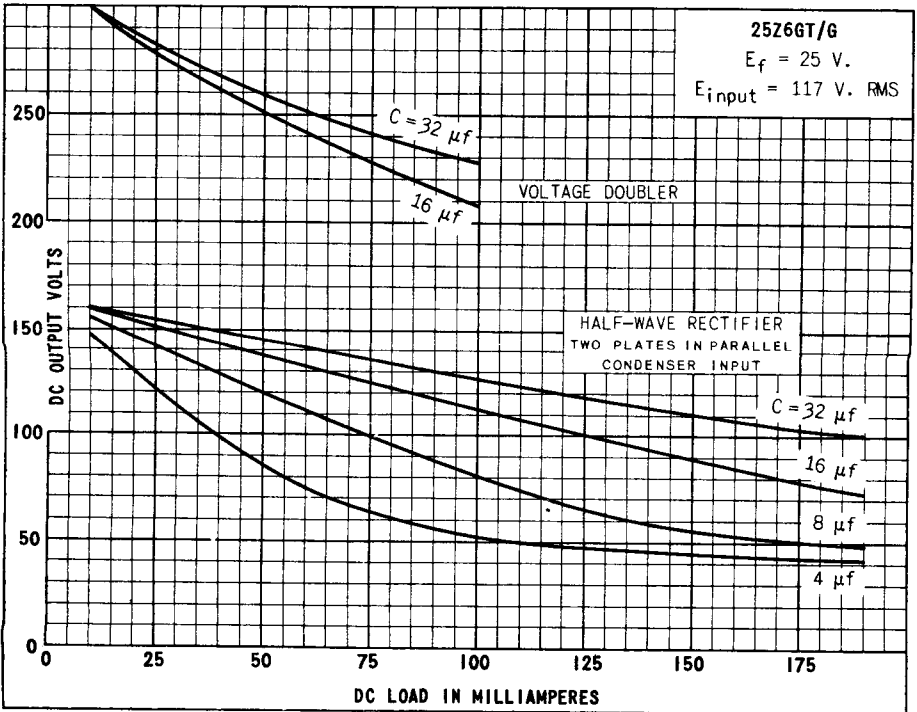
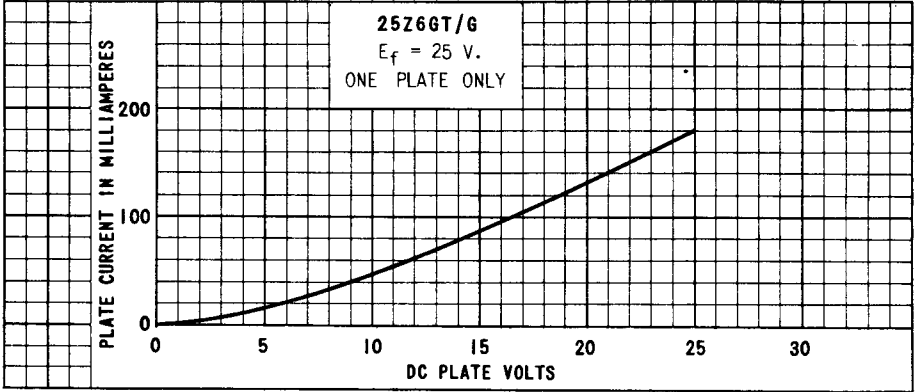
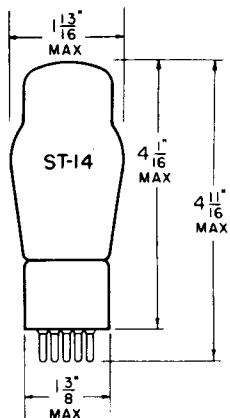

PLATE 931-4

TUNG-SOL

TRIODE AMPLIFIER



GLASS BULB

COATED FILAMENT

FILAMENT

1.5 VOLTS 1.05 AMPERES

AC OR DC

ANY MOUNTING POSITION

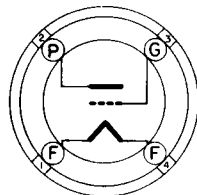
BOTTOM VIEW
MEDIUM
4 PIN BASE

THE 26 IS A TRIODE AMPLIFIER INTENDED PRIMARILY FOR USE IN RF AND AF STAGES OF AC OPERATED RECEIVERS.

RATINGS

INTERPRETED ACCORDING TO RMA STANDARD M8-210

FILAMENT VOLTAGE	1.5	VOLTS
FILAMENT CURRENT	1.05	AMP.
MAXIMUM PLATE VOLTAGE	180	VOLTS

DIRECT INTERELECTRODE CAPACITANCES

WITH NO EXTERNAL SHIELD

GRID TO PLATE	8.1	μf
INPUT	2.8	μf
OUTPUT	2.5	μf

TYPICAL OPERATING CONDITIONS AND CHARACTERISTICS

CLASS A AMPLIFIER

PLATE VOLTAGE	90	135	180	VOLTS
GRID VOLTAGE ^A	-7	-10	-14.5	VOLTS
PLATE CURRENT	2.9	5.5	6.2	MA.
PLATE RESISTANCE	8900	7600	7300	OHMS
TRANSCONDUCTANCE	935	1100	1150	μMHOS
AMPLIFICATION FACTOR	8.3	8.3	8.3	

^A MEASURED FROM MIDPOINT OF AC OPERATED FILAMENT.

→ INDICATES A CHANGE OR ADDITION.

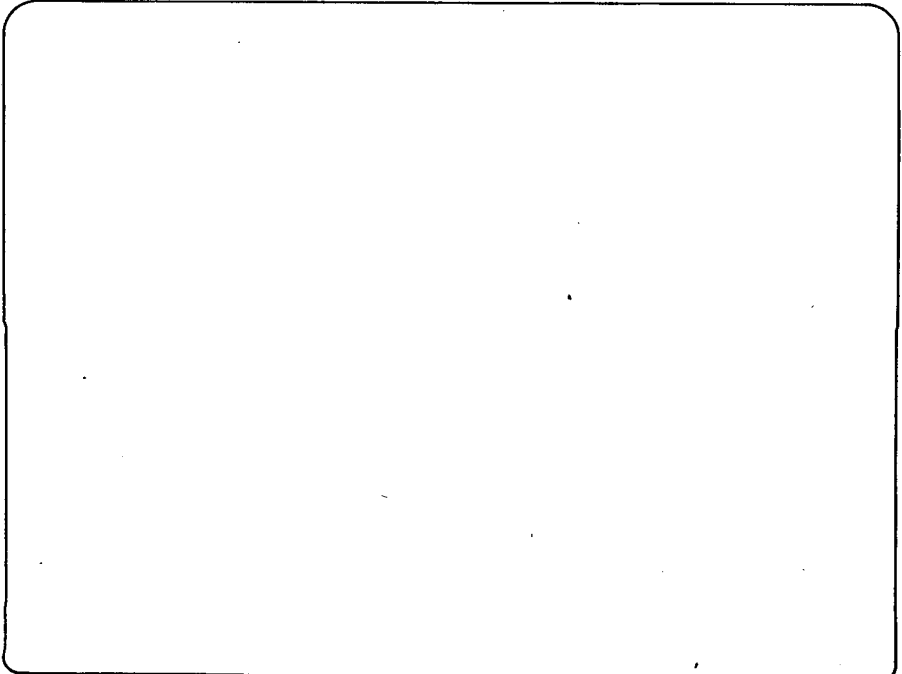
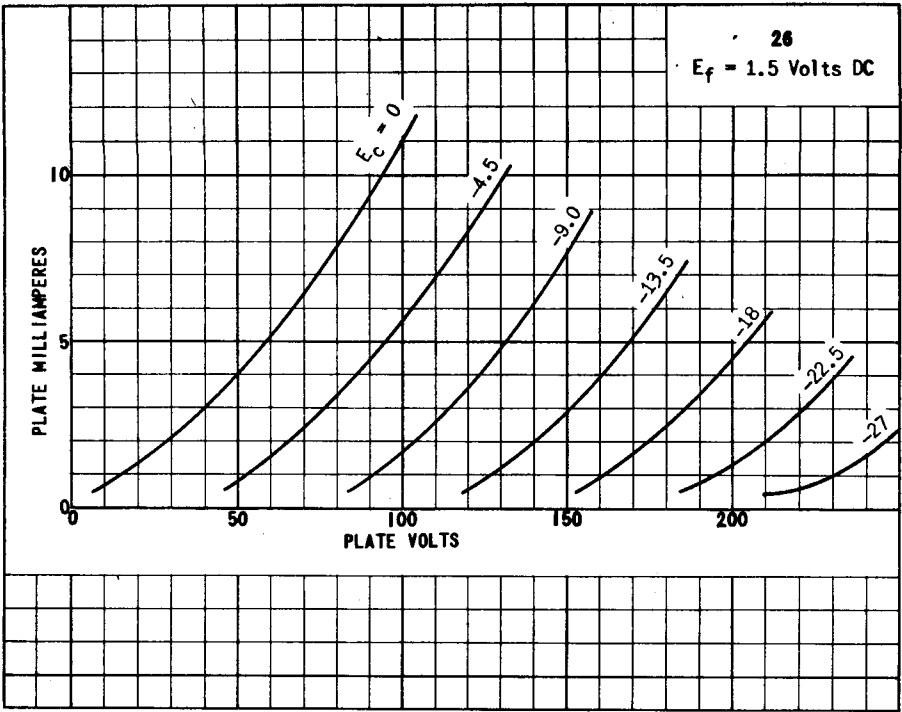
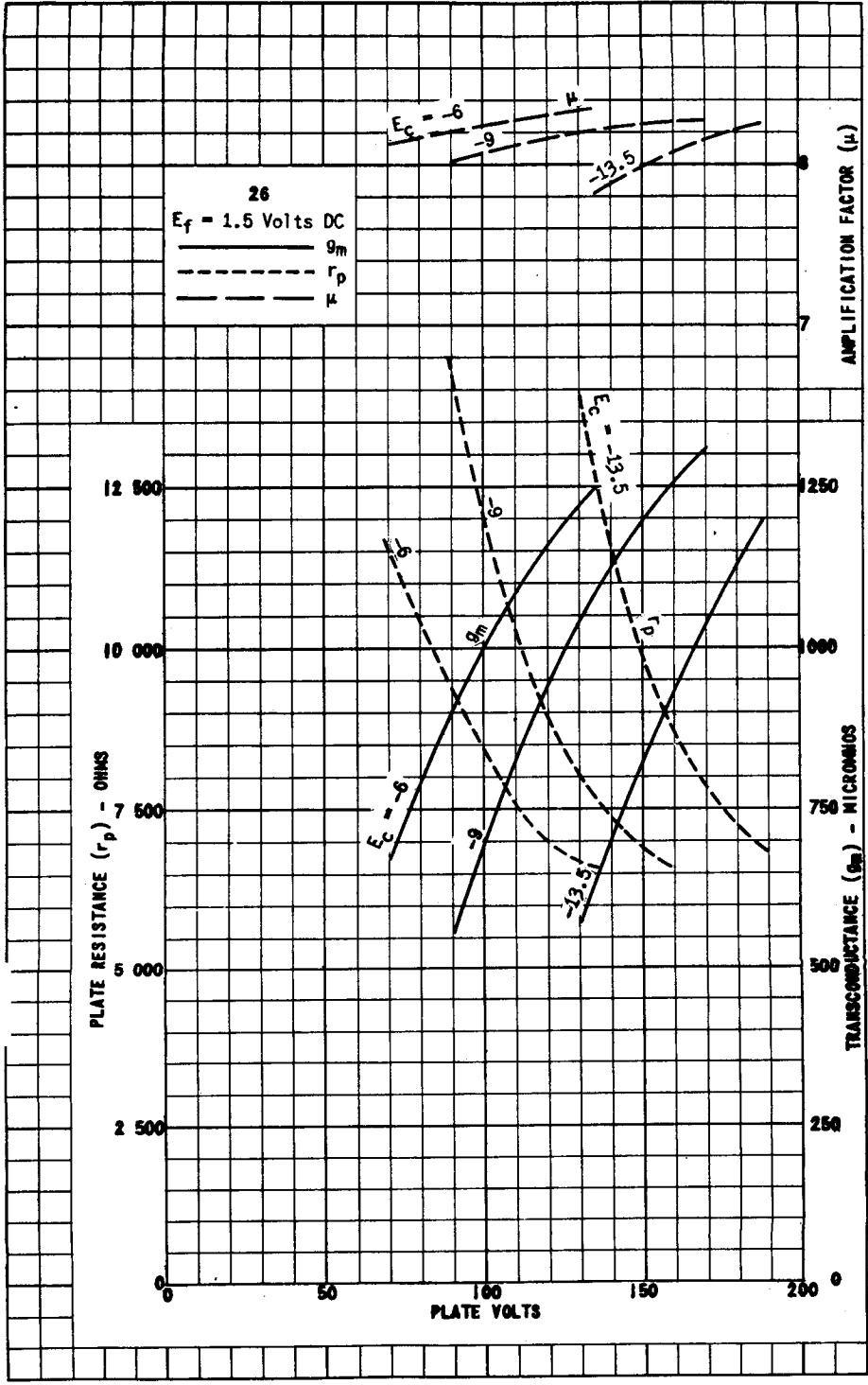

PLATE
 1758
 NOV. 1,
 1946

PRINTED IN U. S. A.

PLATE
1759
NOV. 1,
1946





TUNG-SOL

DOUBLE BEAM PENTODE

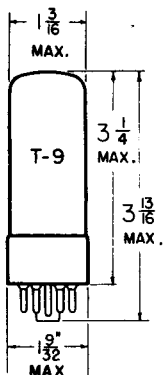

GLASS BULB

COATED UNIPOTENTIAL CATHODE

HEATER

26.5 VOLTS 0.6 AMPERE

AC OR DC

ANY MOUNTING POSITION

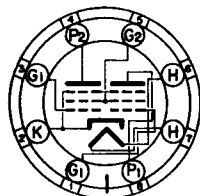

BOTTOM VIEW
INTERMEDIATE SHELL
8 PIN OCTAL

THE 26A7GT IS A CATHODE TYPE TWIN BEAM POWER AMPLIFIER USING THE OCTAL BASE CONSTRUCTION. IT IS INTENDED FOR USE AS A PUSH-PULL OR PARALLEL CONNECTED POWER OUTPUT TUBE IN AIRCRAFT OR MOBILE SERVICE WHERE BOTH THE PLATE AND HEATER SUPPLY IS LIMITED TO 28 VOLTS.

DIRECT INTERELECTRODE CAPACITANCES - APPROX. WITH NO EXTERNAL SHIELD

	EACH UNIT	
GRID TO PLATE: (G TO P)	1.2	μuf
INPUT: G ₁ TO (H+K&G ₃ +G ₂)	16	μuf
OUTPUT: P TO (H+K&G ₃ +G ₂)	13	μuf

RATINGS

INTERPRETED ACCORDING TO RMA STANDARD M8-210

HEATER VOLTAGE	26.5	VOLTS
MAXIMUM HEATER-CATHODE VOLTAGE	90	AMP. VOLTS
MAXIMUM PLATE VOLTAGE	50	VOLTS
MAXIMUM GRID #2 VOLTAGE	50	VOLTS
MAXIMUM PLATE DISSIPATION	2	WATTS
MAXIMUM GRID #2 DISSIPATION	0.5	WATT
MAXIMUM GRID #1 CIRCUIT RESISTANCE (FIXED BIAS) ^A	0.1	MEGOHM
MAXIMUM GRID #1 CIRCUIT RESISTANCE (SELF BIAS)	0.5	MEGOHM

^A WHEN THE PLATE VOLTAGE AND THE GRID #2 VOLTAGE DO NOT EXCEED THE MAXIMUM DESIGN VALUE OF 26.5 VOLTS, THE DC RESISTANCE IN THE GRID CIRCUIT MAY BE AS HIGH AS 0.5 MEGOHM WITH GRID-RESISTOR BIAS.

TUNG-SOL

CONTINUED FROM PRECEDING PAGE

TYPICAL OPERATING CONDITIONS AND CHARACTERISTICS

CLASS A₁ AMPLIFIER - EACH UNIT

HEATER VOLTAGE	26.5	VOLTS
HEATER CURRENT	0.6	AMP.
PLATE VOLTAGE	26.5	VOLTS
GRID #2 VOLTAGE	26.5	VOLTS
GRID #1 VOLTAGE	-4.5	VOLTS
PEAK AF SIGNAL VOLTAGE	4.5	VOLTS
ZERO-SIGNAL PLATE CURRENT	20	MA.
ZERO-SIGNAL GRID #2 CURRENT (NOMINAL)	2	MA.
MAXIMUM-SIGNAL PLATE CURRENT	20.5	MA.
MAXIMUM-SIGNAL GRID #2 CURRENT (NOMINAL)	5.5	MA.
PLATE RESISTANCE (APPROX.)	2 500	OHMS
TRANSCONDUCTANCE	5 500	μMHOS
LOAD RESISTANCE	1 500	OHMS
TOTAL HARMONIC DISTORTION	7	PERCENT
MAXIMUM-SIGNAL POWER OUTPUT	200	MW

PUSH-PULL CLASS AB₁ AMPLIFIER - BOTH UNITS

HEATER VOLTAGE	26.5	VOLTS
HEATER CURRENT	0.6	AMP.
PLATE VOLTAGE	26.5	VOLTS
GRID #2 VOLTAGE	26.5	VOLTS
GRID #1 VOLTAGE	-7	VOLTS
PEAK AF GRID TO GRID VOLTAGE	14	VOLTS
ZERO-SIGNAL PLATE CURRENT	19	MA.
ZERO-SIGNAL GRID #2 CURRENT (APPROX.)	2	MA.
MAXIMUM-SIGNAL PLATE CURRENT	30	MA.
MAXIMUM-SIGNAL GRID #2 CURRENT (APPROX.)	8.5	MA.
EFFECTIVE LOAD RESISTANCE (PLATE TO PLATE)	2 500	OHMS
TOTAL HARMONIC DISTORTION	5	PERCENT
MAXIMUM-SIGNAL POWER OUTPUT	500	MW

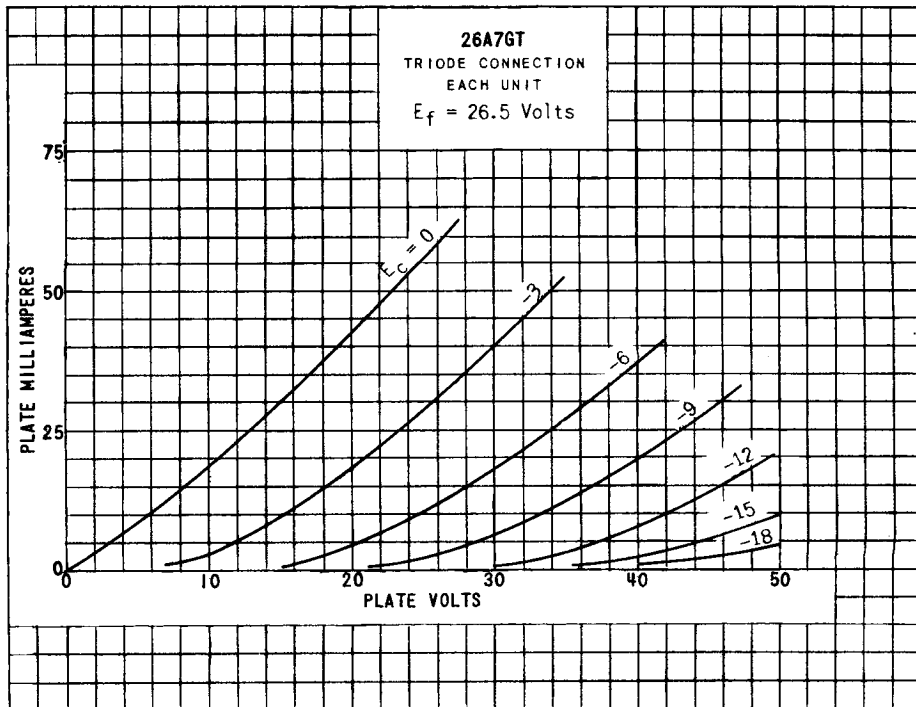
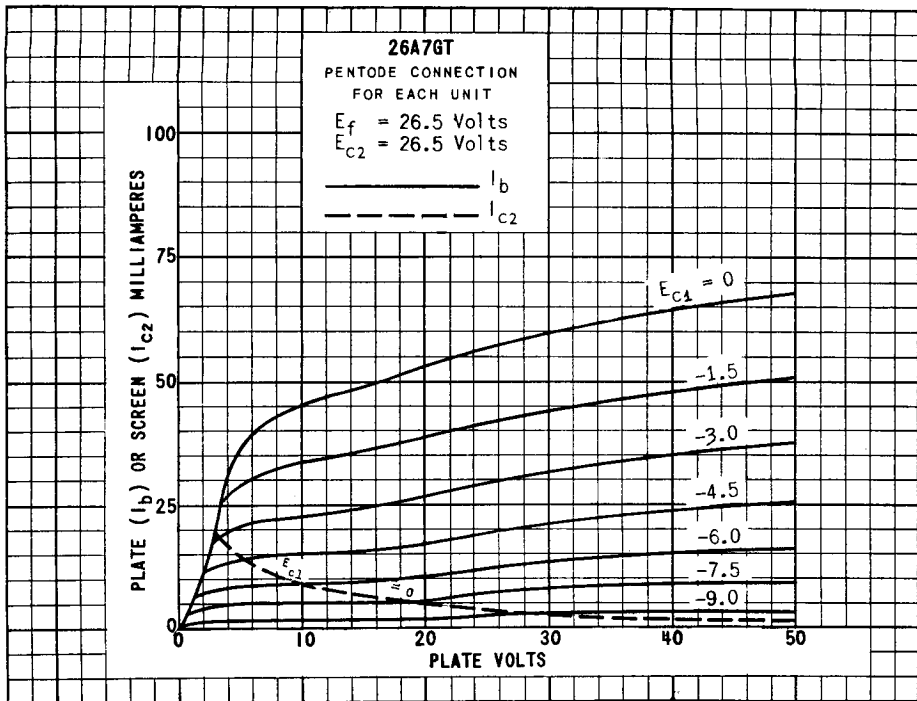

PRINTED IN U. S. A.

PLATE
2029
JUNE 1,
1948

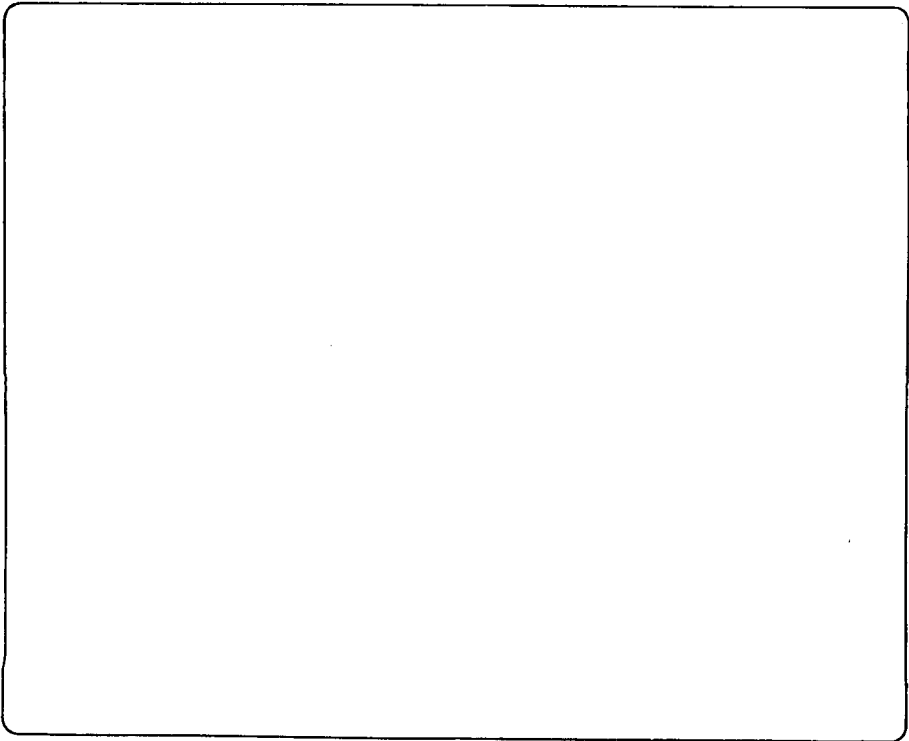
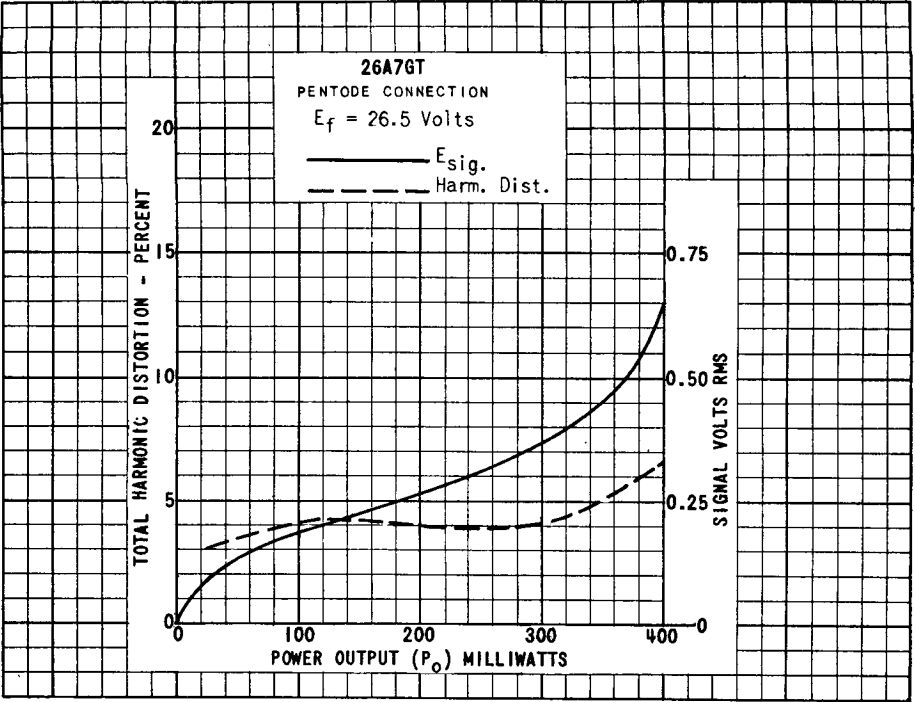

TUNG-SOL

TRIODE DETECTOR AMPLIFIER

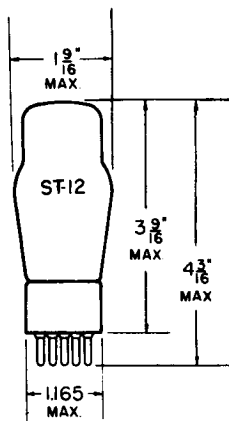

GLASS BULB

COATED UNIPOTENTIAL CATHODE

HEATER

2.5 VOLTS 1.75 AMPERES

AC OR DC

ANY MOUNTING POSITION

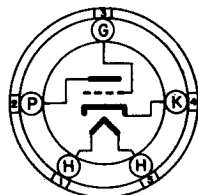

BOTTOM VIEW

SMALL
5 PIN BASE

THE 27 IS A GENERAL PURPOSE TRIODE DESIGNED FOR SERVICE AS AN OSCILLATOR, DETECTOR OR AMPLIFIER.

RATINGS

INTERPRETED ACCORDING TO RMA STANDARD MB-210

HEATER VOLTAGE	2.5	VOLTS
HEATER CURRENT	1.75	AMP.
MAXIMUM PLATE VOLTAGE	275	VOLTS
MAXIMUM HEATER-CATHODE VOLTAGE	90	VOLTS

DIRECT INTERELECTRODE CAPACITANCES

WITH NO EXTERNAL SHIELD

GRID TO PLATE	3.3	$\mu\mu\text{f}$
INPUT	3.1	$\mu\mu\text{f}$
OUTPUT	2.3	$\mu\mu\text{f}$

TYPICAL OPERATING CONDITIONS AND CHARACTERISTICS

CLASS A AMPLIFIER

PLATE VOLTAGE	90	135	180	250	VOLTS
GRID VOLTAGE	-6	-9	-13.5	-21	VOLTS
PLATE CURRENT	2.7	4.5	5.0	5.2	MA.
PLATE RESISTANCE	11 000	9 000	9 000	9 250	OHMS
TRANSCONDUCTANCE	820	1 000	1 000	975	μMHMS
AMPLIFICATION FACTOR	9	9	9	9	

DETECTOR

BIASED

GRID LEAK

PLATE VOLTAGE	250	275	45	VOLTS
GRID VOLTAGE (APPROX.)	-30	-35	RETURN TO CATHODE	VOLTS
PLATE CURRENT ^A	ADJUSTED TO 0.2 MA. WITH NO INPUT SIGNAL			---
GRID RESISTORS				---
MINIMUM	---	---	1	MEGOHM
MAXIMUM	---	---	5	MEGOHMS
GRID CONDENSER	---	---	250	$\mu\mu\text{f}$

^A MAXIMUM DC PLATE CURRENT SHOULD BE LIMITED TO 5.0 MA.

→ INDICATES A CHANGE OR ADDITION.

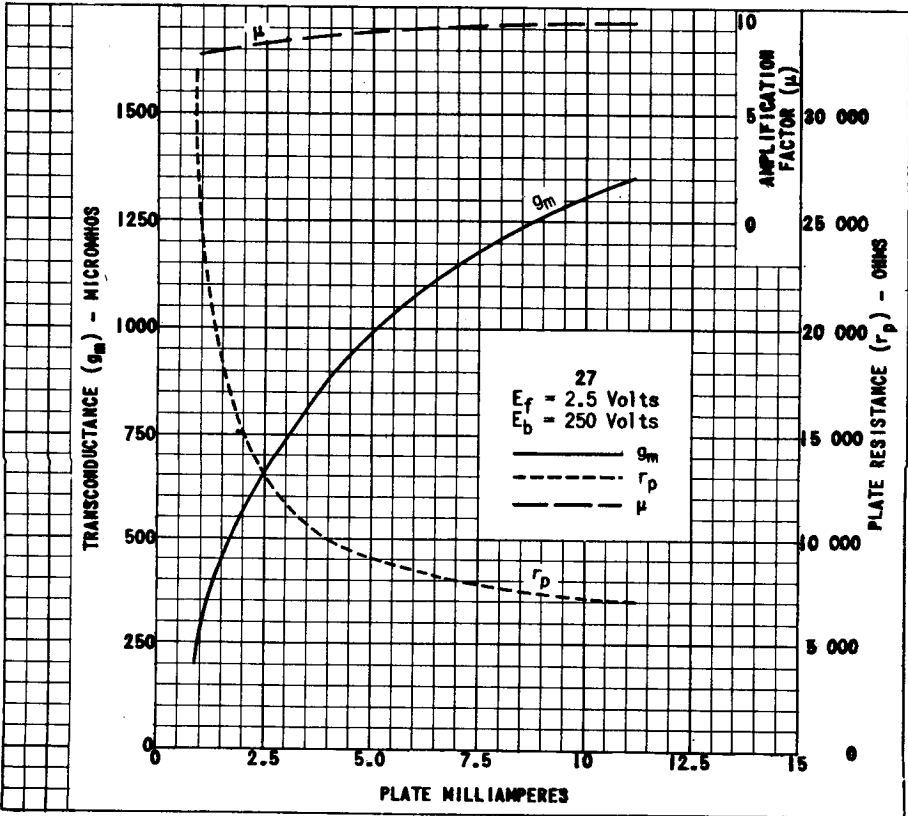
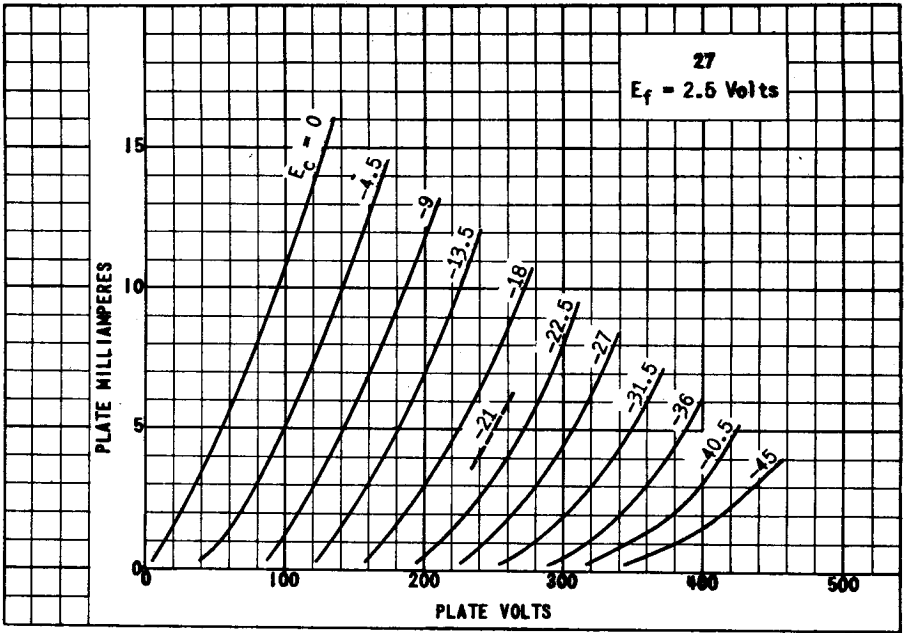

TUNG-SOL

TRIODE AMPLIFIER

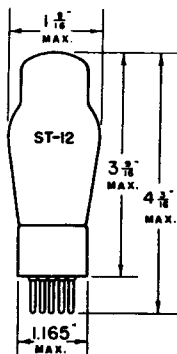

COATED FILAMENT

2.0 VOLTS 0.06 AMPERE
DC

GLASS BULB

SMALL 4 PIN BASE

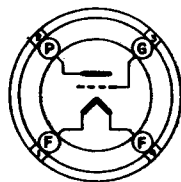

4D

THE TUNG-SOL 30 IS A GENERAL PURPOSE FILAMENT TYPE TRIODE DESIGNED FOR SERVICE IN BATTERY OPERATED RECEIVERS. WITH THE EXCEPTION OF CAPACITANCES ITS RATINGS AND CHARACTERISTICS ARE IDENTICAL WITH THOSE OF THE 1H4G.

OPERATING CONDITIONS AND CHARACTERISTICS

CLASS A₁ AMPLIFIER

PLATE VOLTAGE	90	135	180 ^{MAX.}	VOLTS
GRID VOLTAGE	-4.5	-9.0	-13.5	VOLTS
GRID CIRCUIT RESISTANCE ^{MAX.}	2	2	2	MEGOHMS
PLATE CURRENT	2.5	3.0	3.1	MA.
PLATE RESISTANCE	11 000	10 300	10 300	OHMS
TRANSCONDUCTANCE	850	900	900	μMHOS
AMPLIFICATION FACTOR	9.3	9.3	9.3	

DETECTOR

	BIASED			GRID LEAK	
PLATE VOLTAGE	90	135	180 ^{MAX.}	45 ^{MAX.}	VOLTS
GRID VOLTAGE	-9 ^A	-13.5 ^A	-18 ^A	RETURN TO (+) FILAMENT	VOLTS
PLATE CURRENT ^P	ADJUST TO 0.2 MA. WITH NO INPUT SIGNAL			-	
GRID LEAK ^A	-	-	-	1 TO 5	MEGOHMS
GRID CONDENSER	-	-	-	250	μf.

^A APPROXIMATE GRID RETURN TO NEGATIVE END OF FILAMENT.

^P WITH MAXIMUM SIGNAL THE AVERAGE DC PLATE CURRENT SHOULD NOT EXCEED 2.0 MA.

CONTINUED NEXT PAGE

TUNG-SOL

CLASS B₂ AMPLIFIER

PLATE VOLTAGE	180 MAX.	VOLTS
PEAK PLATE CURRENT PER TUBE	50 MAX.	MA.
ZERO-SIGNAL PLATE CURRENT PER TUBE	1.5 MAX.	MA.

TYPICAL OPERATING CONDITIONS

VALUES ARE FOR TWO TUBES

PLATE VOLTAGE	157.5	VOLTS
GRID VOLTAGE	-15	VOLTS
ZERO-SIGNAL PLATE CURRENT	1	MA.
LOAD RESISTANCE PER TUBE	2000	OHMS
EFFECTIVE LOAD RESISTANCE ^{PLATE TO PLATE}	8000	OHMS
PEAK POWER INPUT ^{GRID TO GRID}	260 MAX.	MILLIWATTS
POWER OUTPUT ^D (6% TO 7% DISTORTION)	2.1	WATTS

^D WITH ONE TYPE 30 AS DRIVER, OPERATED WITH PLATE VOLTAGE = 157.5 VOLTS, GRID VOLTAGE = -11.3 VOLTS, PLATE LOAD OF APPROXIMATELY 18,000 OHMS, AND INPUT TRANSFORMER RATIO, PRIMARY TO ONE HALF SECONDARY = 1.165.

DIRECT INTERELECTRODE CAPACITANCES

GRID TO FILAMENT	3.0	μf
PLATE TO FILAMENT	2.2	μf
GRID TO PLATE	6.0	μf

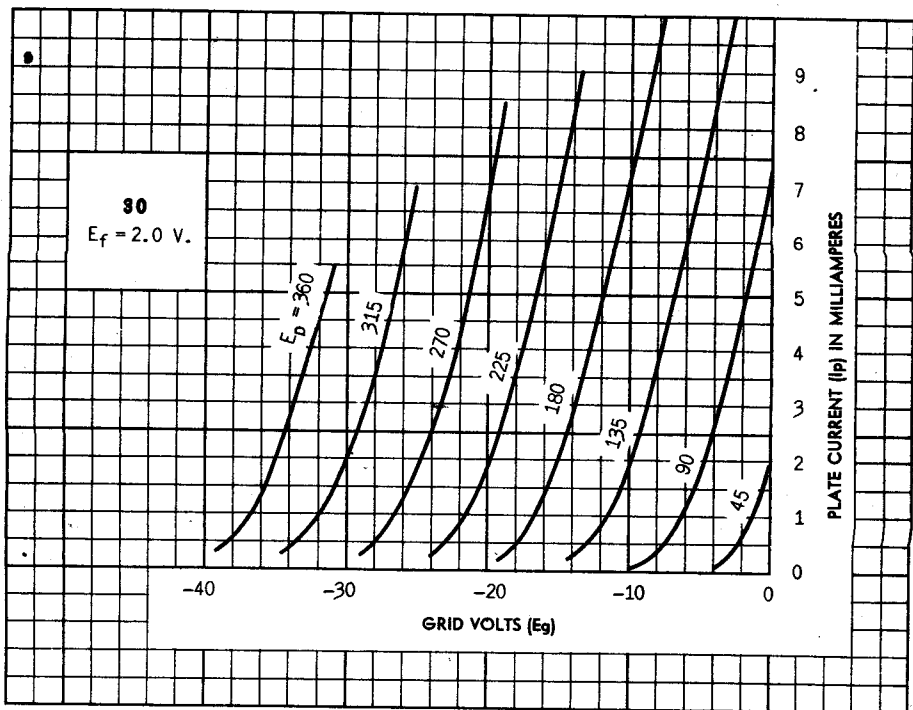
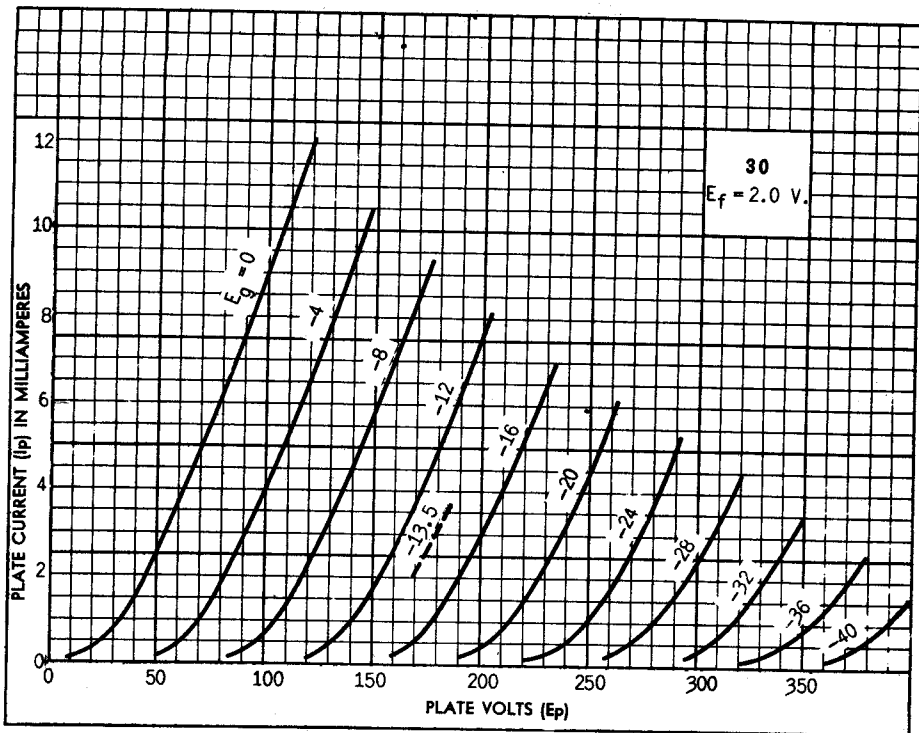

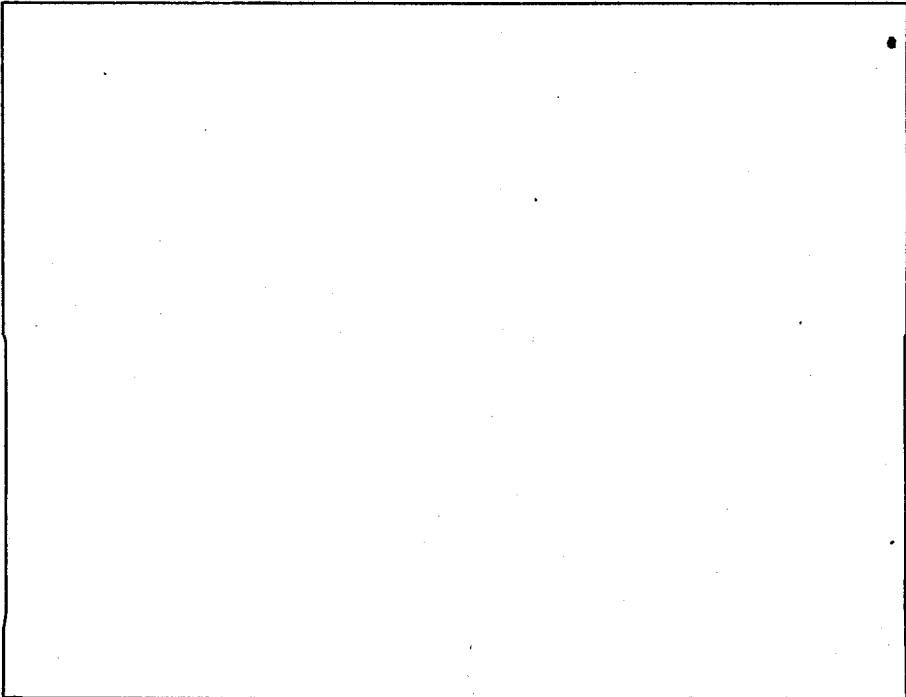
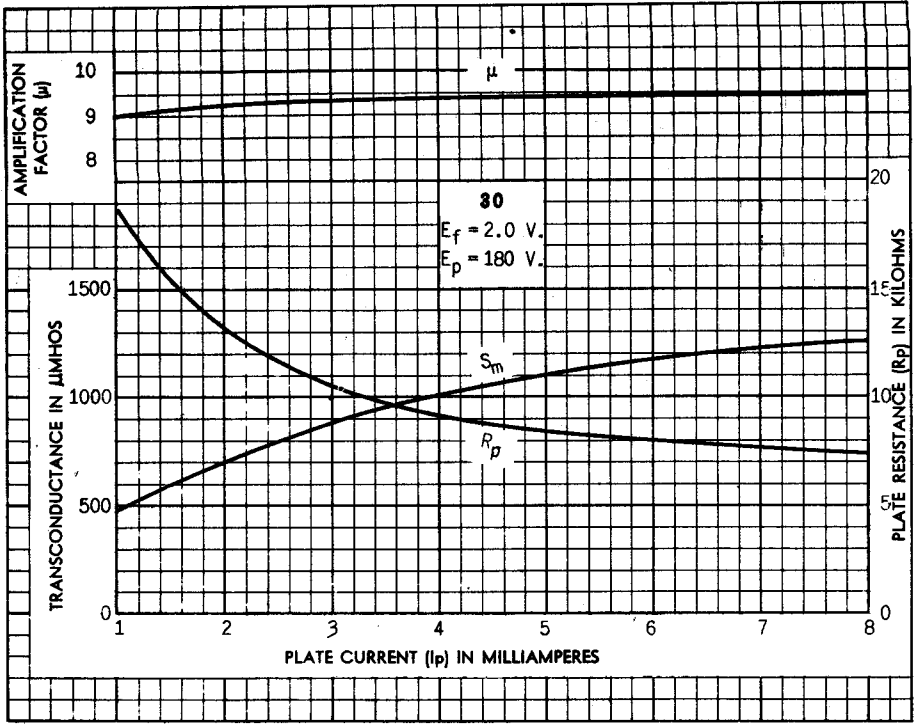

TUNG-SOL

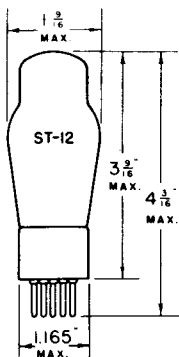

TRIODE POWER AMPLIFIER

COATED FILAMENT

2.0 VOLTS 0.13 AMPERE
DC

GLASS BULB

SMALL 4 PIN BASE

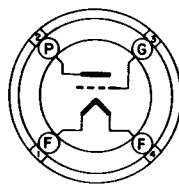

4D

BOTTOM VIEW

THE TUNG-SOL 31 IS A TRIODE POWER AMPLIFIER DESIGNED FOR BATTERY OPERATION.

OPERATING CONDITIONS AND CHARACTERISTICS

CLASS A₁ AMPLIFIER

PLATE VOLTAGE	135	180	VOLTS
GRID VOLTAGE ^A	-22.5	-30	VOLTS
GRID CIRCUIT RESISTANCE ^G	0.5 MAX.	0.5 MAX.	MEGOHM
PLATE CURRENT	8	12.3	MA.
PLATE RESISTANCE	4100	3600	OHMS
TRANSCONDUCTANCE	925	1050	μMHOS
AMPLIFICATION FACTOR	3.8	3.8	
LOAD RESISTANCE	7000	5700	OHMS
POWER OUTPUT	0.185	0.375	WATT

^A RETURN TO NEGATIVE FILAMENT (PIN #4)^G WITH FIXED BIAS

DIRECT INTERELECTRODE CAPACITANCES

GRID TO FILAMENT	3.6	μμf
PLATE TO FILAMENT	2.8	μμf
GRID TO PLATE	5.5	μμf

PLATE

544-2

AUG. 14
1939

TUNG-SOL

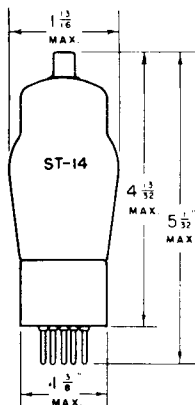

TETRODE AMPLIFIER

COATED FILAMENT

2.0 VOLTS 0.06 AMPERE
DC

GLASS BULB

MEDIUM 4 PIN BASE

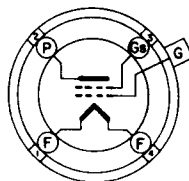

4K

BOTTOM VIEW

THE TUNG-SOL 32 IS DESIGNED FOR SERVICE AS A GENERAL PURPOSE SHARP CUT-OFF TETRODE VOLTAGE AMPLIFIER IN BATTERY OPERATED RECEIVERS.

OPERATING CONDITIONS AND CHARACTERISTICS

CLASS A₁ AMPLIFIER

PLATE VOLTAGE	135	180 ^{MAX.}	VOLTS
SCREEN VOLTAGE ^{MAX.}	67.5	67.5	VOLTS
CONTROL GRID VOLTAGE ^A	-3	-3	VOLTS
GRID CIRCUIT RESISTANCE ^{MAX.}	2	2	MEG OHMS
PLATE CURRENT	1.7	1.7	MA.
SCREEN CURRENT ^{MAX.}	0.4	0.4	MA.
PLATE RESISTANCE ^{APPROX.}	0.95	1.2	MEG OHMS
TRANSCONDUCTANCE ^{APPROX.}	640	650	μMHOS
AMPLIFICATION FACTOR ^{APPROX.}	610	780	

DETECTOR

	BIASED		GRID LEAK	
PLATE SUPPLY VOLTAGE	135	180	135	VOLTS
SCREEN VOLTAGE	45	67.5 ^{MAX.}	45 ^{MAX.}	VOLTS
PLATE RESISTOR ^P	0.1	0.1	0.1	MEG OHM
GRID VOLTAGE	-4.5 ^A	-6 ^A	RETURN TO + FIL. (PIN #1)	VOLTS
PLATE CURRENT	ADJUST TO 0.2 MA. WITH NO INPUT SIGNAL			
GRID LEAK	-	-	1 TO 5	MEG OHMS
GRID CONDENSER ^P OR EQUIVALENT IMPEDANCE	-	-	250	μμf

DIRECT INTERELECTRODE CAPACITANCES

CONTROL GRID TO FILAMENT	5.5	μμf
PLATE TO FILAMENT	11	μμf
CONTROL GRID TO PLATE ⁵	0.015 ^{MAX.}	μμf

⁵ WITH SHIELD^A RETURN TO NEGATIVE FILAMENT (PIN #0)PLATE
345-2

TUNG-SOL

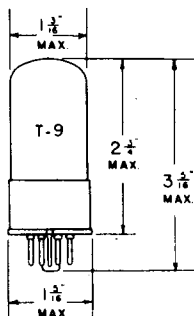

**RECTIFIER
BEAM POWER AMPLIFIER**

UNIPOTENTIAL CATHODES

 HEATER
 32.5 VOLTS 0.3 AMPERE
 AC OR DC

GLASS BULB

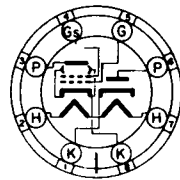
8-PIN OCTAL BASE



8F

BOTTOM VIEW

THE TUNG-SOL 32L7GT COMBINES A HALF WAVE POWER RECTIFIER AND OUTPUT POWER AMPLIFIER IN A SINGLE BULB. IT IS DESIGNED FOR SERVICE IN AC-DC RECEIVERS.

OPERATING CONDITIONS AND CHARACTERISTICS

AMPLIFIER SECTION - CLASS A₁

PLATE VOLTAGE	90	90	VOLTS
SCREEN VOLTAGE	90	90	VOLTS
CONTROL GRID VOLTAGE	-5	-7	VOLTS
PLATE CURRENT	38	27	MA.
SCREEN CURRENT	3.0	2.0	MA.
PLATE RESISTANCE	15 000	17 000	OHMS
TRANSCONDUCTANCE	6800	4800	μMHOS
AMPLIFICATION FACTOR	90	81	
LOAD RESISTANCE	2600	2600	OHMS
TOTAL HARMONIC DISTORTION	5.3	9.0	PER CENT
SECOND HARMONIC DISTORTION	2.2	6.5	PER CENT
THIRD HARMONIC DISTORTION	4.6	5.5	PER CENT
POWER OUTPUT	0.8	1.0	WATT

NOTE: THE GRID CIRCUIT RESISTANCE SHOULD NOT EXCEED 0.5 MEGOHM.

RECTIFIER SECTION

AC PLATE VOLTAGE	125 MAX.	VOLTS
DC OUTPUT CURRENT	60 MAX.	MA.



TUNG-SOL

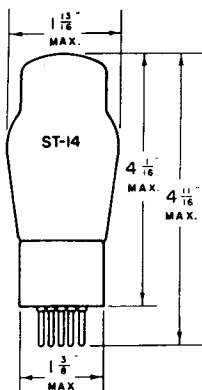

PENTODE POWER AMPLIFIER

COATED FILAMENT

2.0 VOLTS 0.26 AMPERE
DC

GLASS BULB

MEDIUM 5 PIN BASE

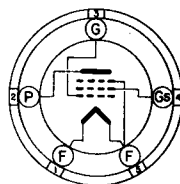

5K

BOTTOM VIEW

THE TUNG-SOL 33 IS A FILAMENT TYPE POWER AMPLIFIER DESIGNED FOR SERVICE IN THE OUTPUT STAGE OF BATTERY AND DC OPERATED RECEIVERS.

OPERATING CONDITIONS AND CHARACTERISTICS

CLASS A₁ AMPLIFIER

PLATE VOLTAGE	135	180 ^{MAX.}	VOLTS
SCREEN VOLTAGE	135	180 ^{MAX.}	VOLTS
CONTROL GRID VOLTAGE ^A	-13.5	-18	VOLTS
GRID CIRCUIT RESISTANCE ^G	0.5 ^{MAX.}	0.5 ^{MAX.}	MEGOHM
PLATE CURRENT	14.5	22	MA.
SCREEN CURRENT	3	5	MA.
TRANSCONDUCTANCE	1450	1700	μMHOS
AMPLIFICATION FACTOR	70	90	
LOAD RESISTANCE	7000	6000	OHMS
TOTAL HARMONIC DISTORTION	7	7	PER CENT
POWER OUTPUT	0.7	1.4	WATTS

DIRECT INTERELECTRODE CAPACITANCES

CONTROL GRID TO FILAMENT	8	μμf
PLATE TO FILAMENT	12	μμf
CONTROL GRID TO PLATE	1	μμf

^A RETURN TO NEGATIVE FILAMENT (PIN #5)^G WITH FIXED BIAS

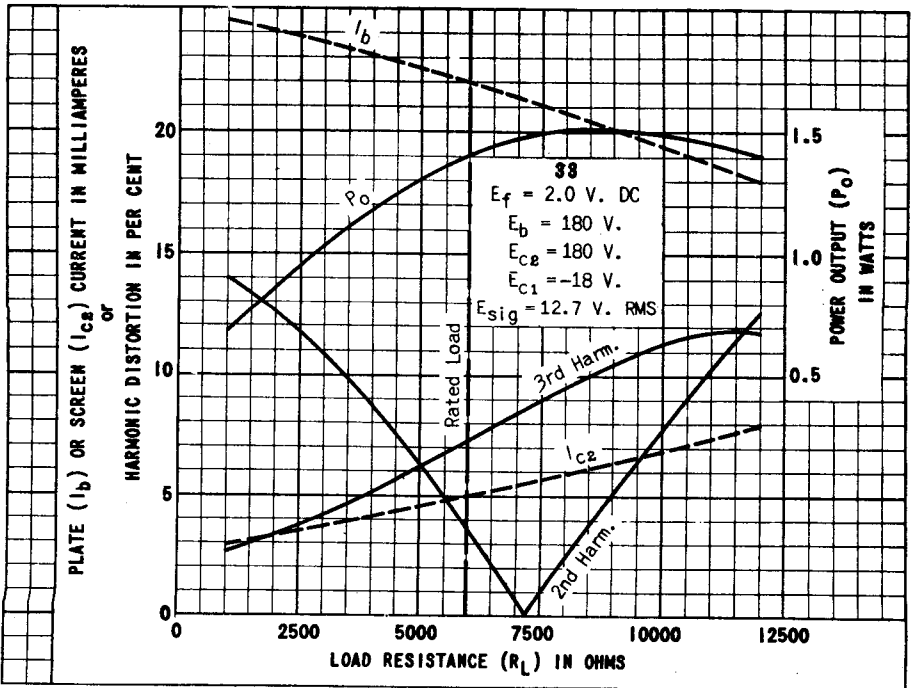
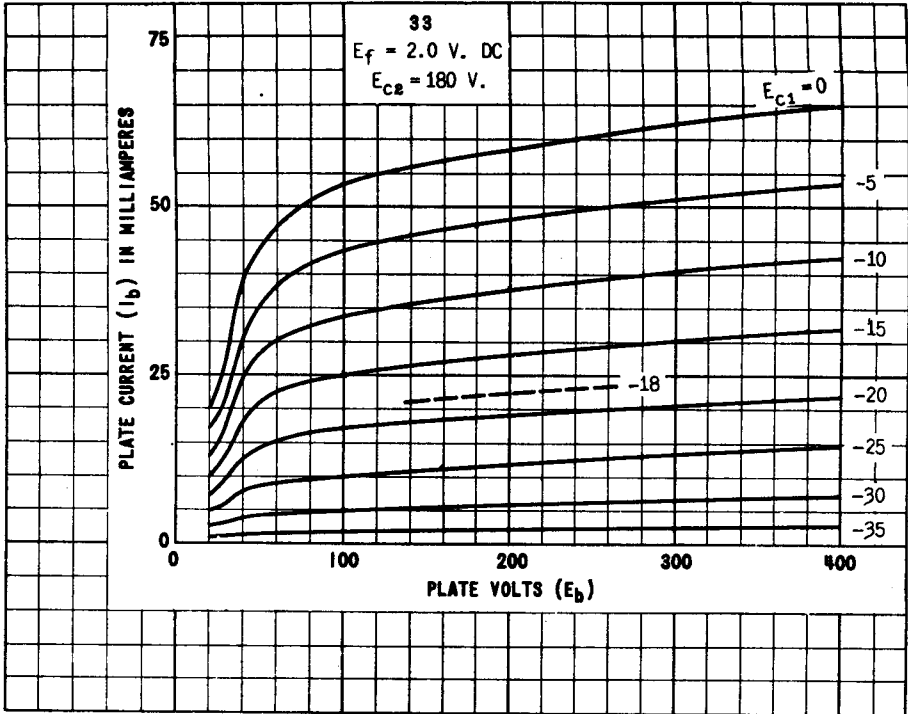

TUNG-SOL

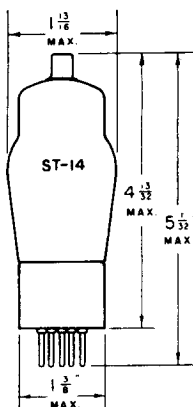

FIG. 7

**REMOTE CUT - OFF
PENTODE AMPLIFIER**

COATED FILAMENT
2.0 VOLTS 0.06 AMPERE
DC

GLASS BULB

MEDIUM 4 PIN BASE

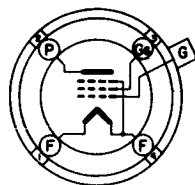

4M

THE TUNG-SOL 34 IS A REMOTE CUT-OFF PENTODE AMPLIFIER DESIGNED FOR USE IN BATTERY OPERATED RECEIVERS. IT IS SUITABLE FOR USE WITH AVC IN RF AND IF AMPLIFIERS AND MINIMIZES CROSS MODULATION.

OPERATING CONDITIONS AND CHARACTERISTICS

CLASS A₁ AMPLIFIER

PLATE VOLTAGE	67.5	135	180 ^{MAX.}	VOLTS
SCREEN VOLTAGE ^{MAX.}	67.5	67.5	67.5	VOLTS
CONTROL GRID VOLTAGE ^{MIN.}	-3	-3	-3	VOLTS
PLATE CURRENT	2.7	2.8	2.8	MA.
SCREEN CURRENT	1.1	1.0	1.0	MA.
PLATE RESISTANCE ^{APPROX.}	0.4	0.6	1.0	MEG OHM
TRANSCONDUCTANCE	560	600	620	μMHOS
AMPLIFICATION FACTOR ^{APPROX.}	224	360	620	
CONTROL GRID VOLTAGE	-22.5	-22.5	-22.5	VOLTS
FOR TRANSCONDUCTANCE = 15 μMHOS				

AS MIXER IN SUPERHETERODYNE CIRCUIT

PLATE VOLTAGE	67.5	135	180 ^{MAX.}	VOLTS
SCREEN VOLTAGE ^{MAX.}	67.5	67.5	67.5	VOLTS
CONTROL GRID VOLTAGE ^{APPROX. G}	-5	-5	-5	VOLTS

⁶ THIS GRID BIAS IS MINIMUM FOR AN OSCILLATOR PEAK VOLTAGE OF 4.0 VOLTS.

DIRECT INTERELECTRODE CAPACITANCES

CONTROL GRID TO FILAMENT	6.0	μμf
PLATE TO FILAMENT	11.5	μμf
CONTROL GRID TO PLATE ⁵	0.015 ^{MAX.}	μμf

⁵ WITH SHIELD

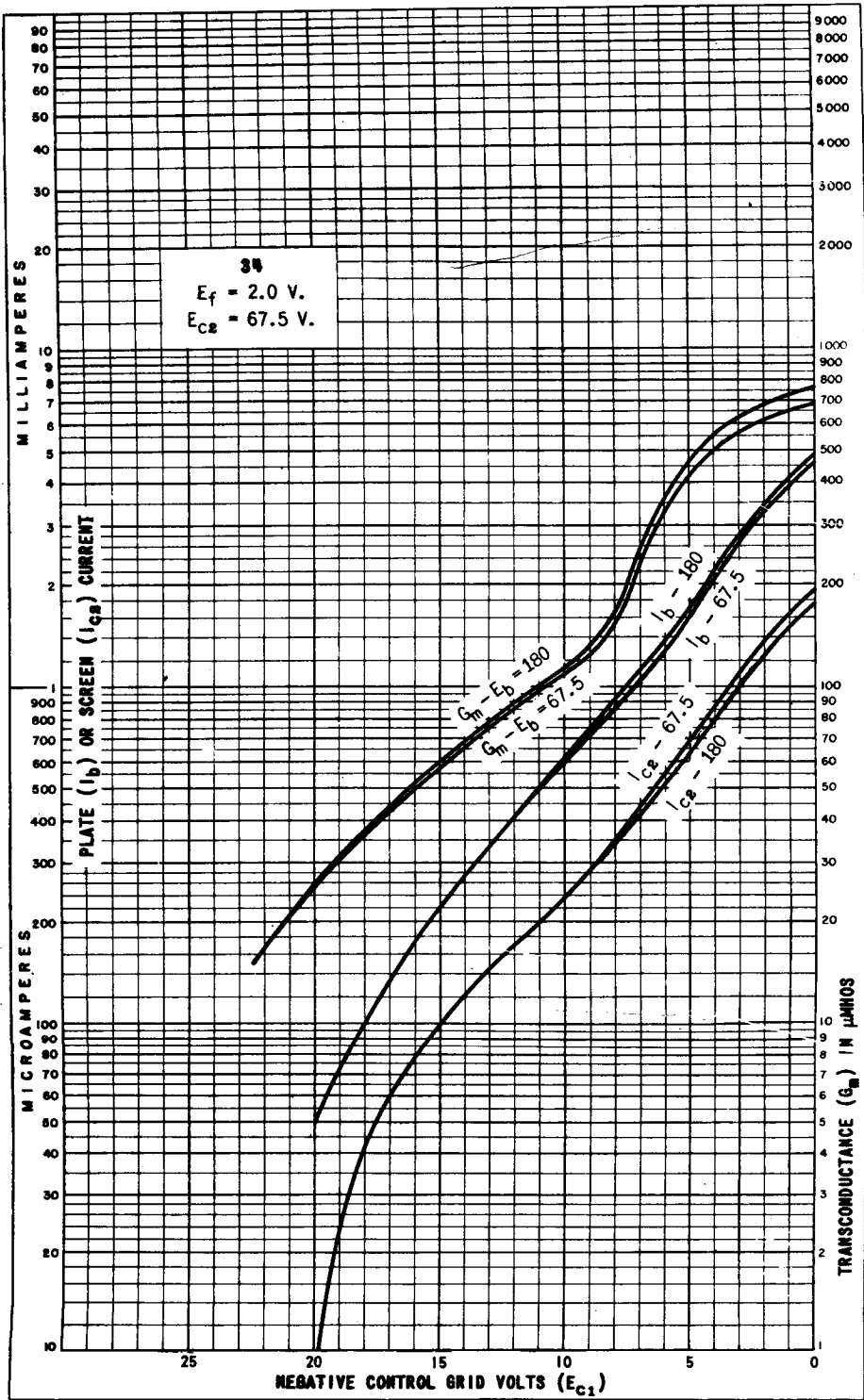

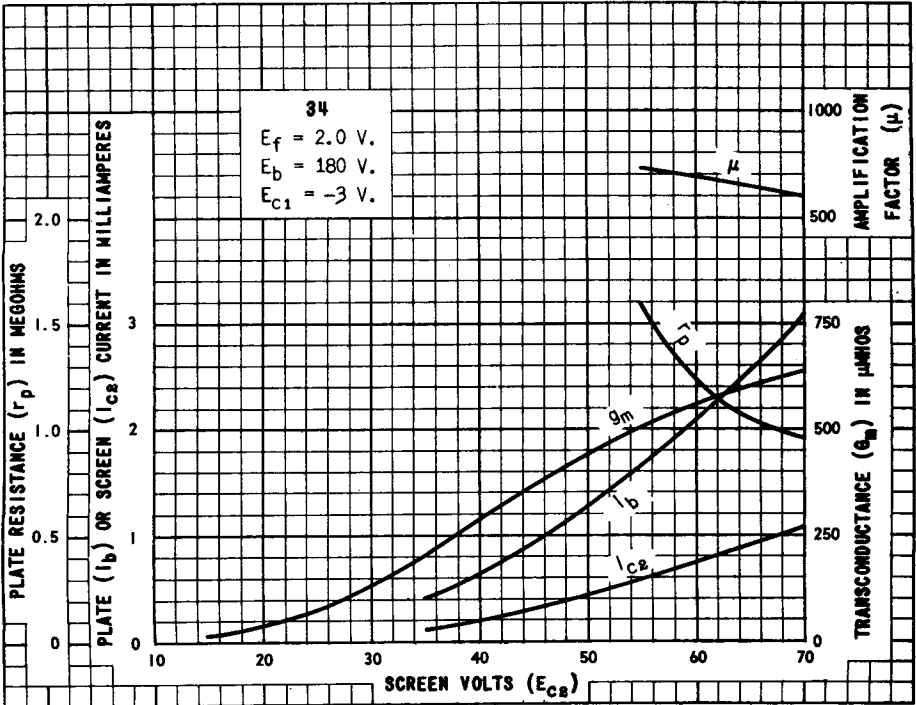
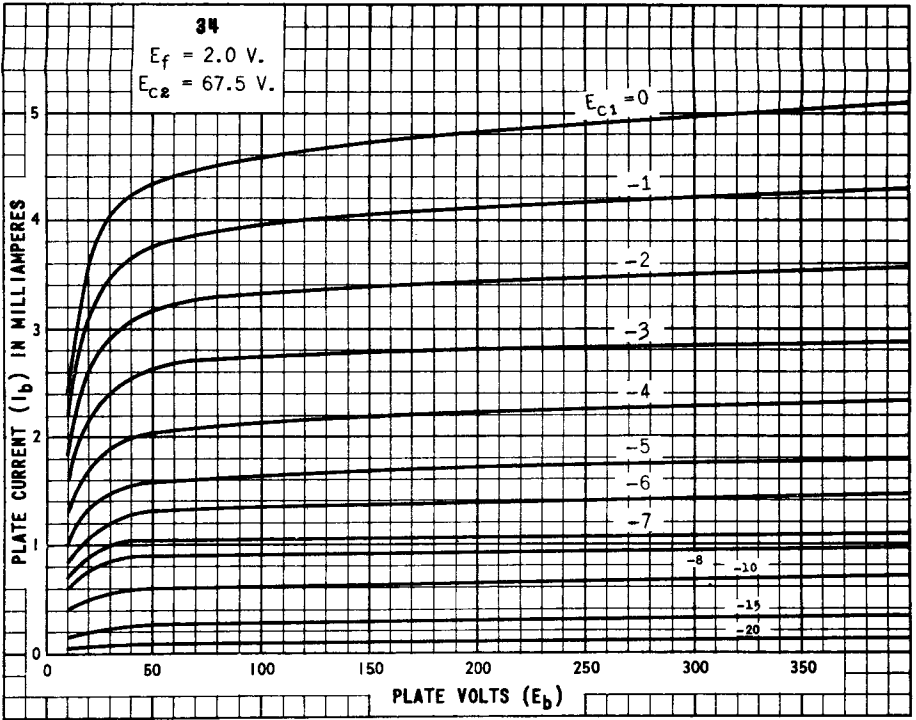

PRINTED IN U. S. A.

PLATE 224-1

DE. 12 1938

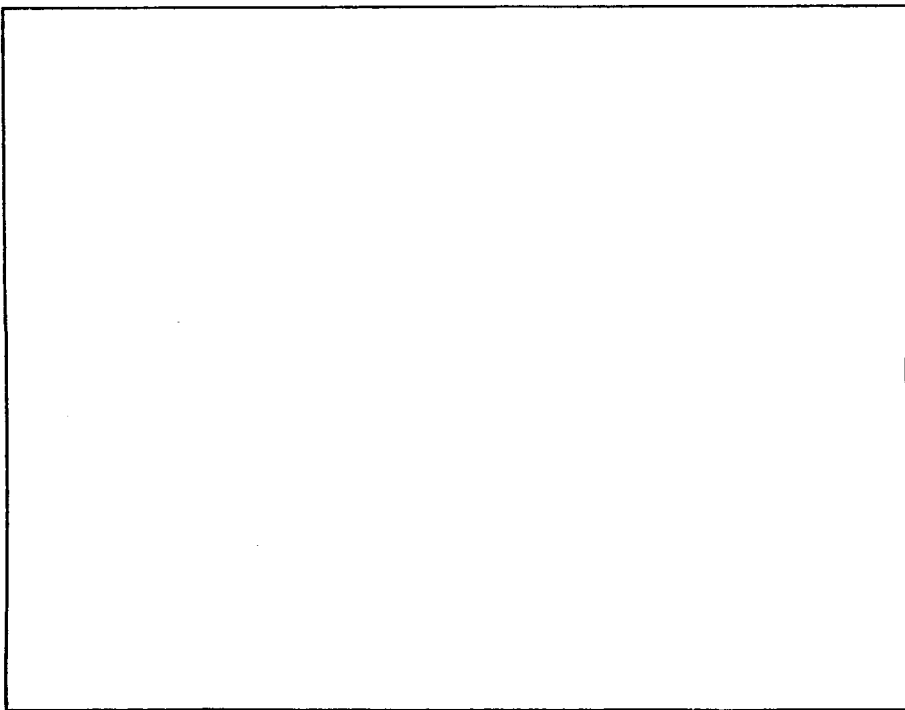
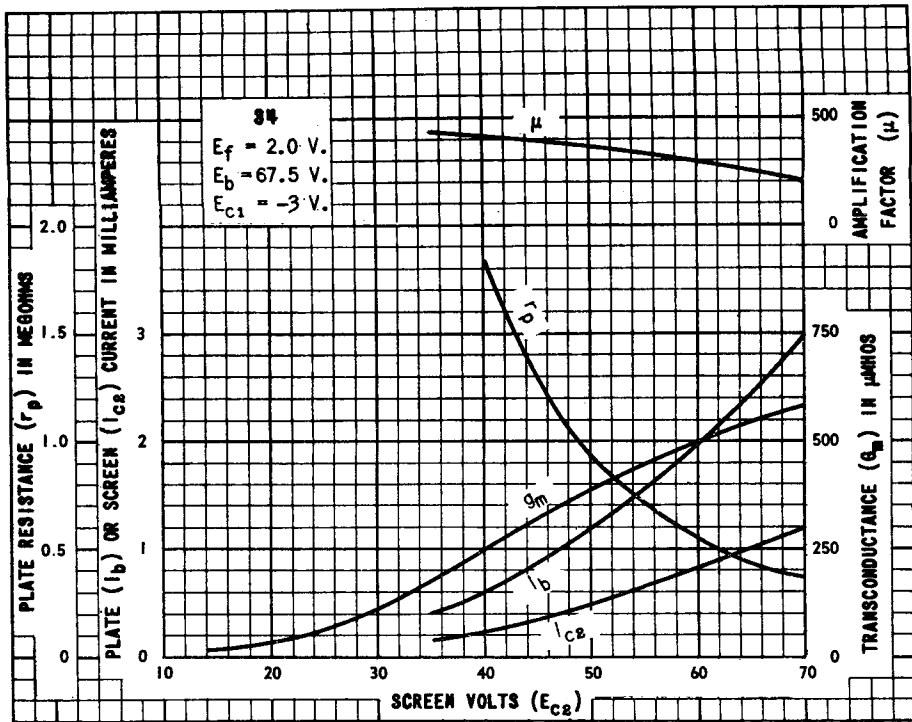

TUNG-SOL

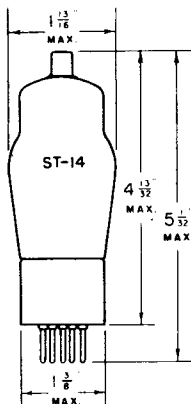

REMOTE CUT-OFF TETRODE AMPLIFIER

UNIPOTENTIAL CATHODE

HEATER

2.5 VOLTS 1.75 AMPERES

AC OR DC

GLASS BULB

MEDIUM 5 PIN BASE

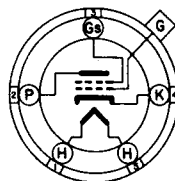

5 E

BOTTOM VIEW

THE TUNG-SOL 35 IS DESIGNED FOR USE AS AN AMPLIFIER OR MIXER IN SUPERHETERODYNE RECEIVERS.

OPERATING CONDITIONS AND CHARACTERISTICS

CLASS A AMPLIFIER

PLATE VOLTAGE	180	250	VOLTS
SCREEN VOLTAGE ^{MAX.}	90	90	VOLTS
CONTROL GRID VOLTAGE	-3	-3	VOLTS
PLATE CURRENT	6.3	6.5	MA.
SCREEN CURRENT	2.5	2.5	MA.
PLATE RESISTANCE	0.3	0.4	MEGOHM
TRANSCONDUCTANCE	1020	1050	μMHOS
AMPLIFICATION FACTOR	305	420	
CONTROL GRID VOLTAGE	-40	-40	VOLTS

FOR TRANSCONDUCTANCE = 15 μMHOS

AS MIXER IN SUPERHETERODYNE CIRCUIT

PLATE VOLTAGE	250	VOLTS
SCREEN VOLTAGE ^{MAX.}	90	VOLTS
CONTROL GRID VOLTAGE ^{APPROX. G}	-7	VOLTS

^G THIS GRID BIAS IS MINIMUM FOR AN OSCILLATOR PEAK VOLTAGE OF 6.0 VOLTS

DIRECT INTERELECTRODE CAPACITANCES

CONTROL GRID TO CATHODE	5.3	μμf
PLATE TO CATHODE	10.5	μμf
CONTROL GRID TO PLATE ^S	.007 ^{MAX.}	μμf

^S WITH SHIELD

PLATE
486-1

JUNE 26
1939



TUNG-SOL

BEAM POWER AMPLIFIER

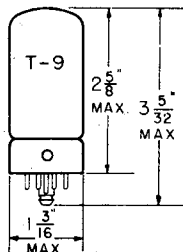

GLASS BULB

COATED UNIPOTENTIAL CATHODE

HEATER
35 VOLTS 0.15 AMPERE
AC OR DC

ANY MOUNTING POSITION

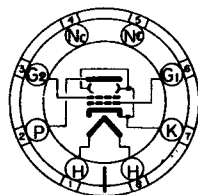

BOTTOM VIEW

LOCKING-IN
8 PIN BASE

THE 35A5 IS A BEAM POWER AMPLIFIER OF THE HEATER-CATHODE TYPE USING THE LOCK-IN CONSTRUCTION. IT IS DESIGNED FOR SERVICE IN THE OUTPUT STAGE OF AC AND AC-DC RECEIVERS.

RATINGS

INTERPRETED ACCORDING TO RMA STANDARD MB-210

HEATER VOLTAGE (AC OR DC)	35	VOLTS
HEATER CURRENT	0.15	AMP.
MAX. PLATE VOLTAGE	200	VOLTS
MAX. SCREEN VOLTAGE	117	VOLTS
MAX. PLATE DISSIPATION	8.5	WATTS
MAX. SCREEN DISSIPATION	1	WATT
HEATER-CATHODE VOLTAGE	AS LOW AS POSSIBLE	

TYPICAL OPERATING CONDITIONS AND CHARACTERISTICS

CLASS A₁ AMPLIFIER

PLATE VOLTAGE	110	200	VOLTS
SCREEN VOLTAGE	110	110	VOLTS
GRID VOLTAGE	7.5	-8	VOLTS
PEAK AF GRID VOLTAGE	7.5	8	VOLTS
ZERO-SIGNAL PLATE CURRENT	40	41	MA.
ZERO-SIGNAL SCREEN CURRENT (APPROX.)	3	2	MA.
MAX.-SIGNAL PLATE CURRENT	41	44	MA.
MAX.-SIGNAL SCREEN CURRENT (APPROX.)	7	7	MA.
PLATE RESISTANCE (APPROX.)	14 000	40 000	OHMS
GRID RESISTOR (MAX.)			
FIXED BIAS	0.1	0.1	MEGOHM
CATHODE BIAS	0.5	0.5	MEGOHM
LOAD RESISTANCE	2500	4500	OHMS
TRANSCONDUCTANCE	5800	5900	UMHOS
MAX.-SIGNAL POWER OUTPUT	1.5	3.3	WATTS
TOTAL HARMONIC DISTORTION	10	10	PER CENT

SIMILAR TYPE REFERENCE: Same characteristics as type 35L8G; somewhat similar to type 25L8G, amplifier unit of type 70L78F.



TUNG-SOL

BEAM POWER AMPLIFIER

MINIATURE TYPE

UNIPOTENTIAL CATHODE

HEATER

35 VOLTS 0.015 AMPERE

AC OR DC

ANY MOUNTING POSITION

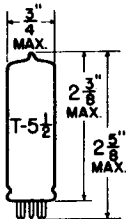

GLASS BULB

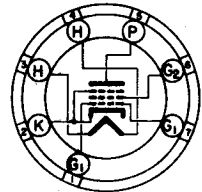

BOTTOM VIEW
MINIATURE BUTTON
7 PIN BASE

THE 35B5 IS A BEAM POWER AMPLIFIER IN THE MINIATURE CONSTRUCTION. BECAUSE OF ITS HIGH POWER SENSITIVITY AT LOW PLATE-SCREEN VOLTAGE, IT IS PARTICULARLY ADAPTABLE TO AC/DC RECEIVER APPLICATIONS.

RATINGS

INTERPRETED ACCORDING TO RMA STANDARD M8-210

HEATER VOLTAGE	35	VOLTS
HEATER CURRENT	0.15	AMP.
MAXIMUM PLATE VOLTAGE	117	VOLTS
MAXIMUM SCREEN VOLTAGE	117	VOLTS
MAXIMUM PLATE DISSIPATION	4.5	WATTS
MAXIMUM SCREEN DISSIPATION	1.0	WATTS
MAXIMUM HEATER-CATHODE VOLTAGE	150	VOLTS

DIRECT INTERELECTRODE CAPACITANCES - APPROX. WITH NO EXTERNAL SHIELD

GRID TO PLATE	0.4	$\mu\mu\text{f}$
INPUT	11	$\mu\mu\text{f}$
OUTPUT	6.5	$\mu\mu\text{f}$

TYPICAL OPERATING CONDITIONS AND CHARACTERISTICS

CLASS A_1 AMPLIFIER

PLATE VOLTAGE	110	VOLTS
SCREEN VOLTAGE	110	VOLTS
CONTROL GRID VOLTAGE	-7.5	VOLTS
PEAK AF GRID VOLTAGE	7.5	VOLTS
ZERO-SIGNAL PLATE CURRENT	40	MA.
ZERO-SIGNAL SCREEN CURRENT (APPROX.)	3	MA.
MAXIMUM SIGNAL PLATE CURRENT	41	MA.
MAXIMUM SIGNAL SCREEN CURRENT (APPROX.)	7	MA.
GRID CIRCUIT RESISTANCE (MAX.): FOR FIXED BIAS FOR CATHODE-BIAS	0.1 0.5	MEGOHM MEGOHM
LOAD RESISTANCE	2 500	OHMS
PLATE RESISTANCE	14 000	OHMS
TRANSCONDUCTANCE	5 800	μMHOS
MAXIMUM SIGNAL POWER OUTPUT	1.5	WATTS
TOTAL HARMONIC DISTORTION	10	PERCENT

SIMILAR TYPE REFERENCE:

Within its ratings identical to 35L6GT. Except for heater ratings, somewhat similar to types 745, 50B5.

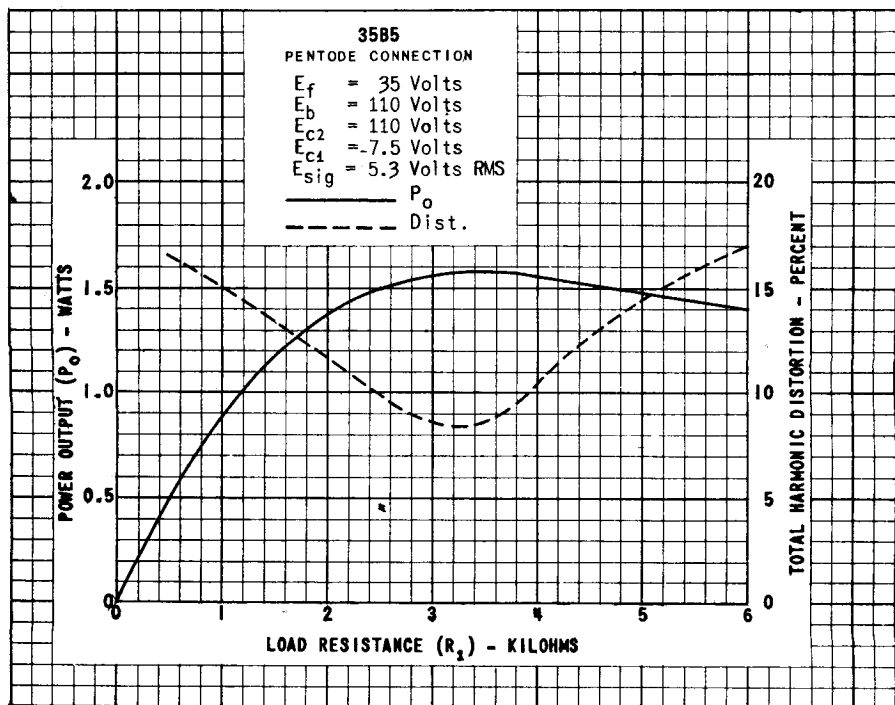
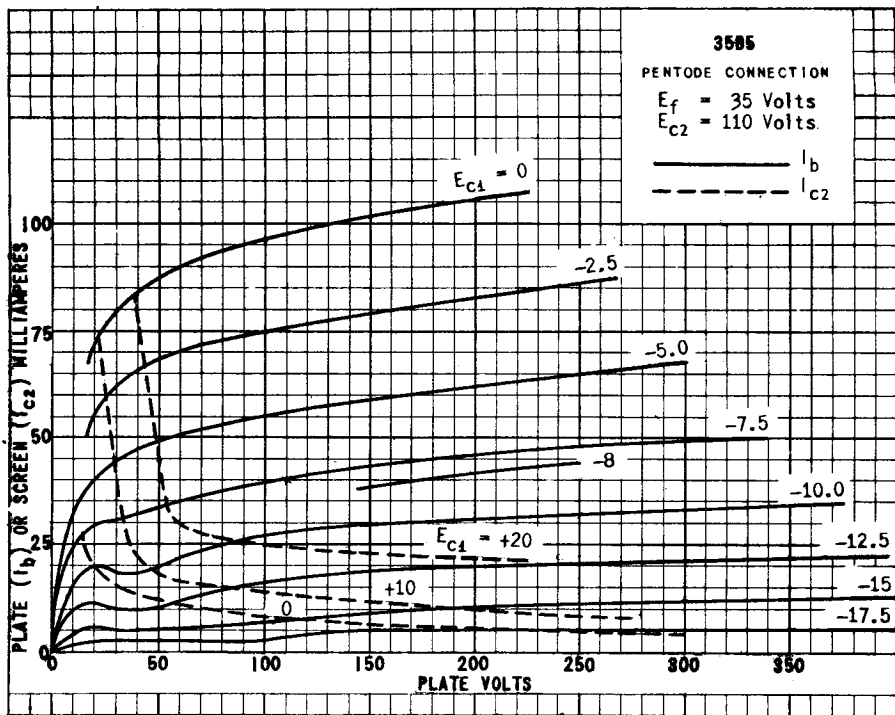

TUNG-SOL

BEAM PENTODE

MINIATURE TYPE

UNIPOENTIAL CATHODE

HEATER

35 VOLTS 150 MA.

AC OR DC

ANY MOUNTING POSITION

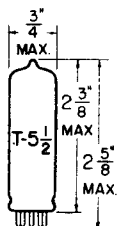

GLASS BULB

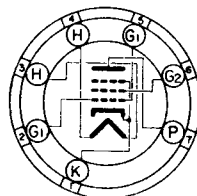

BOTTOM VIEW

MINIATURE BUTTON
7 PIN BASE

THE 35C5 IS A BEAM POWER AMPLIFIER IN THE MINIATURE CONSTRUCTION. BECAUSE OF ITS HIGH POWER SENSITIVITY AT LOW PLATE-SCREEN VOLTAGE, IT IS PARTICULARLY ADAPTABLE TO AC/DC RECEIVER APPLICATIONS.

DIRECT INTERELECTRODE CAPACITANCES - APPROX.
WITH NO EXTERNAL SHIELD

GRID TO PLATE: (G ₁ TO P)	0.57	μuf
INPUT: G ₁ TO (H+K+G ₃ +G ₂)	12	μuf
OUTPUT: P TO (H+K+G ₃ +G ₂)	6.2	μuf

RATINGS

INTERPRETED ACCORDING TO RMA STANDARD M8-210

HEATER VOLTAGE	35	VOLTS
MAXIMUM HEATER-CATHODE VOLTAGE	180	VOLTS
MAXIMUM PLATE VOLTAGE	135	VOLTS
MAXIMUM GRID #2 VOLTAGE	117	VOLTS
MAXIMUM PLATE DISSIPATION	4.5	WATTS
MAXIMUM GRID #2 DISSIPATION	1	WATT
MAXIMUM GRID #1 CIRCUIT RESISTANCE (FIXED BIAS)	0.1	MEGOHM
MAXIMUM GRID #1 CIRCUIT RESISTANCE (SELF BIAS)	0.5	MEGOHM
MAXIMUM BULB TEMPERATURE (AT HOTTEST POINT ON BULB SURFACE)	250	°C

TYPICAL OPERATING CONDITIONS AND CHARACTERISTICS

CLASS A₁ AMPLIFIER

HEATER VOLTAGE	35	VOLTS
HEATER CURRENT	150	MA.
PLATE VOLTAGE	110	VOLTS
GRID #2 VOLTAGE	110	VOLTS
GRID #1 VOLTAGE	-7.5	VOLTS
PEAK AF GRID #1 VOLTAGE	7.5	VOLTS
ZERO-SIGNAL PLATE CURRENT	40	MA.
ZERO-SIGNAL GRID #2 CURRENT (NOMINAL)	3	MA.
MAXIMUM SIGNAL PLATE CURRENT	41	MA.
MAXIMUM SIGNAL GRID #2 CURRENT	7	MA.
TRANSCONDUCTANCE	5 800	MICROMHOS
LOAD RESISTANCE	2 500	OHMS
TOTAL HARMONIC DISTORTION	10	PERCENT
MAXIMUM SIGNAL POWER OUTPUT	1.5	WATTS

SIMILAR TYPE REFERENCE: Ratings and characteristics somewhat similar to type 35B5.

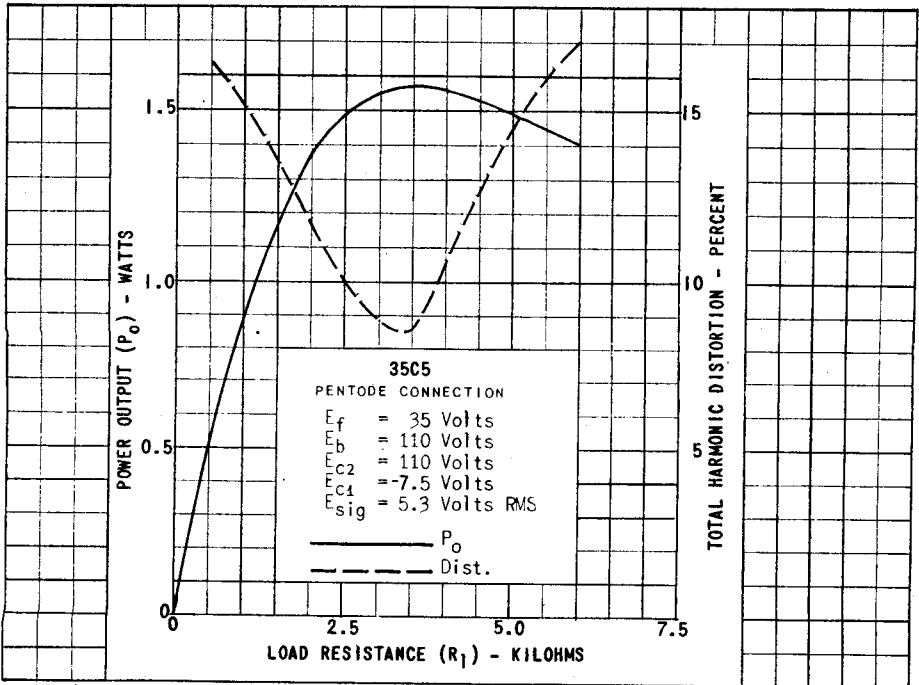
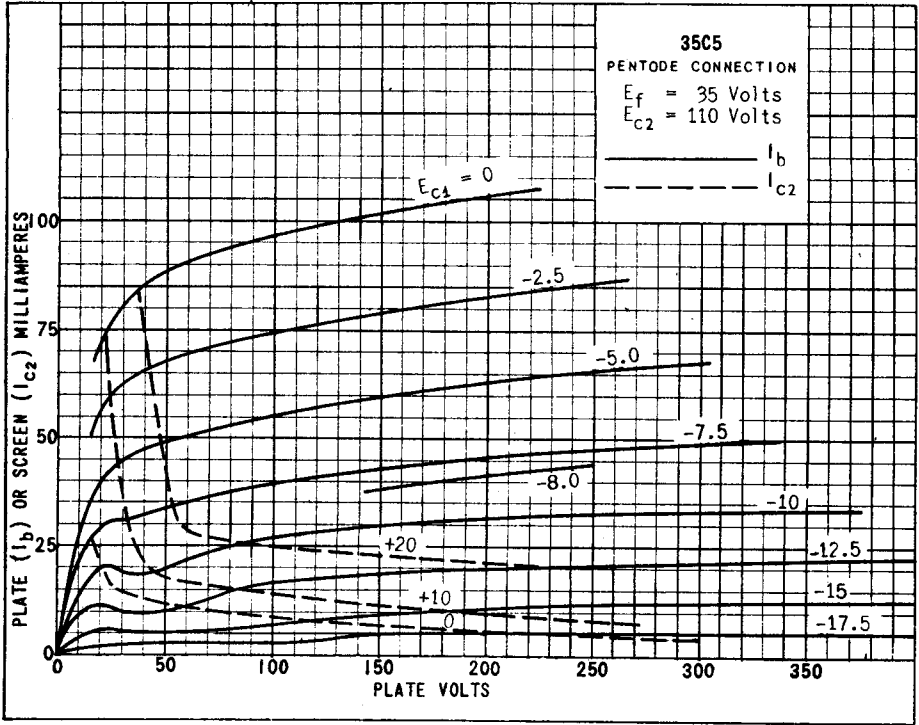
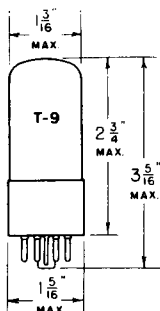

PLATE
 2003
 APRIL 1
 1948

TUNG-SOL

BEAM POWER AMPLIFIER



UNI-POTENTIAL CATHODE

HEATER
35 VOLTS 0.150 AMPERE
AC OR DC

GLASS BULB

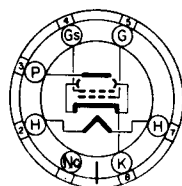

7AC

BOTTOM VIEW

INTERMEDIATE 7 PIN OCTAL BASE

THE TUNG-SOL 35L6GT/G IS A BEAM POWER AMPLIFIER, DESIGNED PRIMARILY FOR SERVICE IN THE OUTPUT STAGE OF AC-DC RECEIVERS EMPLOYING 150 MA. HEATER TUBES. IT DELIVERS HIGH POWER OUTPUT WITH HIGH POWER SENSITIVITY FROM LOW SUPPLY VOLTAGES.

RATINGS

HEATER VOLTAGE (AC OR DC)	35.0	VOLTS
HEATER CURRENT	0.150	AMPERE
MAXIMUM PLATE VOLTAGE	200	VOLTS
MAXIMUM SCREEN VOLTAGE	117	VOLTS
MAXIMUM PLATE DISSIPATION	8.5	WATTS
MAXIMUM SCREEN DISSIPATION	1	WATT

TYPICAL OPERATING CONDITIONS AND CHARACTERISTICS

CLASS A₁ AMPLIFIER

PLATE VOLTAGE	110	200	VOLTS
SCREEN VOLTAGE	110	110	VOLTS
GRID VOLTAGE ^A	-7.5	-8	VOLTS
PEAK AF SIGNAL VOLTAGE	7.5	8	VOLTS
ZERO-SIGNAL PLATE CURRENT	40	41	MA.
ZERO-SIGNAL SCREEN CURRENT - NOMINAL	3	2	MA.
MAXIMUM SIGNAL PLATE CURRENT	41	44	MA.
MAXIMUM SIGNAL SCREEN CURRENT - NOMINAL	7	7	MA.
PLATE RESISTANCE ^{APPROX.}	14000	40000	OHMS
TRANSCONDUCTANCE	5800	5900	μMHOS
LOAD RESISTANCE	2500	4500	OHMS
TOTAL HARMONIC DISTORTION	10	10	PER CENT
POWER OUTPUT	1.5	3.3	WATTS

^A THE DC RESISTANCE IN THE GRID CIRCUIT UNDER MAXIMUM RATED CONDITIONS SHOULD NOT EXCEED 0.5 MEGOHM FOR SELF-BIAS OPERATION AND 0.1 MEGOHM FOR FIXED BIAS OPERATION.

FOR "INTERPRETATION OF RATINGS" REFER TO FRONT OF BOOK.

CONTINUED NEXT PAGE

35L6GT/G

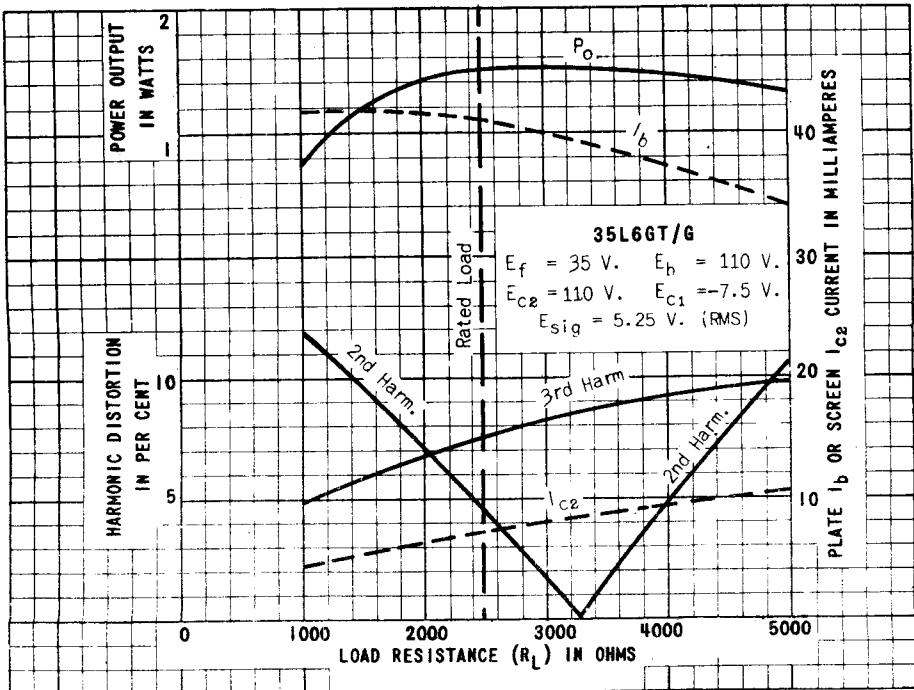
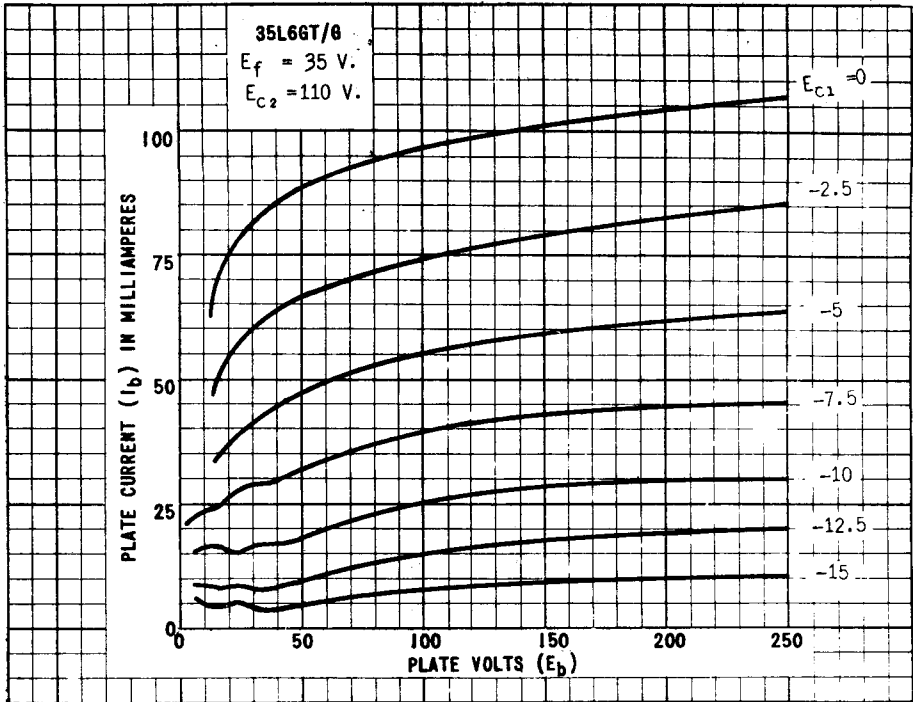

PLATE
1059-1

TUNG-SOL

· HALF-WAVE HIGH-VACUUM RECTIFIER
MINIATURE TYPE

PHYSICAL SPECIFICATIONS

EMITTER UNIPOT. CATHODE		PIN CONNECTIONS			
BASE	MIN. BUTTON 7-PIN	PIN 1	NONE	PIN 7	CATHODE
CAP	NONE	PIN 2	NONE	PIN 8	NONE
BULB	T-5 $\frac{1}{2}$	PIN 3	HEATER	PANEL LAMP	HEATER
MAX. DIAMETER	3/4"	PIN 4	HEATER	SECTION BETWEEN	
MAX. SEATED HEIGHT	2-3/8"	PIN 5	PLATE	PINS 4 & 6	
MAX. OVERALL LENGTH	2-5/8"	PIN 6	HEATER TAP	MOUNTING POS. ANY	

RATINGS

INTERPRETED ACCORDING TO RMA STANDARD MB-210

	WITHOUT PANEL LAMP	WITH NO. 40 OR NO. 47 PANEL LAMP	
HEATER VOLTAGE AC OR DC:			
ENTIRE HEATER (PINS 3 & 4)	35	32	VOLTS
PANEL-LAMP SECTION (PINS 4 & 6)	7.5	5.5	VOLTS
HEATER CURRENT:			
BETWEEN PINS 3 & 4	0.15	—	AMPERE
BETWEEN PINS 3 & 6	—	0.15	AMPERE
TUBE VOLTAGE DROP WITH APPLIED DC			
AT 200 MA. PLATE CURRENT	18	18	VOLTS
MAXIMUM PEAK INVERSE PLATE VOLTAGE		330	VOLTS
MAXIMUM PEAK PLATE CURRENT		600	MA.
MAXIMUM DC OUTPUT CURRENT:			
WITH PANEL LAMP — NO SHUNTING RESISTOR		60	MA.
WITH PANEL LAMP — SHUNTING RESISTOR ^A		90	MA.
WITHOUT PANEL LAMP		100	MA.
MAXIMUM PANEL-LAMP SECTION VOLTAGE (RMS):			
WHEN PANEL LAMP FAILS		15	VOLTS
MAXIMUM PEAK HEATER-CATHODE VOLTAGE:			
HEATER POS. WITH RESPECT TO CATHODE		330	VOLTS
HEATER NEG. WITH RESPECT TO CATHODE		330	VOLTS
^A SEE MAXIMUM CIRCUIT VALUES.			

MAXIMUM CIRCUIT VALUES

MAXIMUM PANEL-LAMP SHUNTING RESISTOR ^B		
FOR DC OUTPUT CURRENT OF 70 MA.	800	OHMS
FOR DC OUTPUT CURRENT OF 80 MA.	400	OHMS
FOR DC OUTPUT CURRENT OF 90 MA.	250	OHMS
^B REQUIRED WHEN DC OUTPUT CURRENT IS GREATER THAN 60 MA.		

CONTINUED ON FOLLOWING PAGE

TUNG-SOL

CONTINUED FROM PRECEDING PAGE

TYPICAL OPERATING CONDITIONS AND CHARACTERISTICS

WITH NO. 40 OR NO. 47 PANEL LAMP IN CIRCUIT
WITH CONDENSER-INPUT FILTER

AC PLATE-SUPPLY VOLTAGE (RMS)	117	117	117	117	VOLTS
FILTER-INPUT CAPACITOR	40	40	40	40	μ f
TOTAL EFFECTIVE PLATE-SUPPLY IMPEDANCE (MIN.)	15	15	15	15	OHMS
PANEL-LAMP SHUNTING RESISTOR	-	300	150	100	OHMS
DC OUTPUT CURRENT	60	70	80	80	MA.

WITHOUT PANEL LAMP IN CONVENTIONAL HALF
WAVE CIRCUIT WITH CONDENSER-INPUT FILTER

AC PLATE-SUPPLY VOLTAGE (RMS)	117	VOLTS
FILTER-INPUT CAPACITOR	40	μ f
TOTAL EFFECTIVE PLATE-SUPPLY IMPEDANCE (MIN.)	15	OHMS
DC OUTPUT CURRENT	100	MA.
DC OUTPUT VOLTAGE AT INPUT TO FILTER (APPROX.):		
AT HALF-LOAD CURRENT (50 MA.)	140	VOLTS
AT FULL-LOAD CURRENT (100 MA.)	120	VOLTS
VOLTAGE REGULATION (APPROX.):		
HALF-LOAD TO FULL-LOAD CURRENT	20	VOLTS

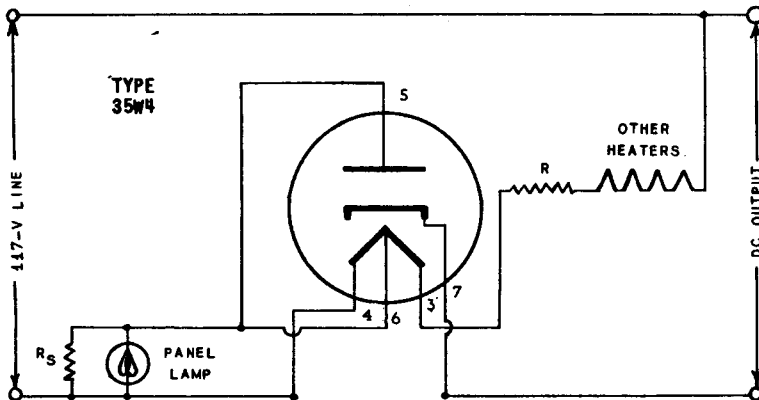
DROP ACROSS R AND ALL HEATERS (WITH PANEL LAMP) SHOULD EQUAL 117
VOLTS AT 0.15 AMPERE. R_s = SHUNTING RESISTOR REQUIRED WHEN DC OUTPUT CURRENT EXCEEDS 60
MA.PLATE
1662
DEC. 15
1945

TUNG-SOL

DIODE

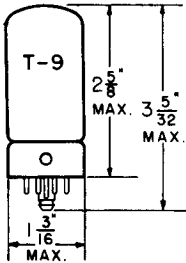

GLASS BULB

COATED UNIPOTENTIAL CATHODE

HEATER

35 VOLTS 150 MA.

AC OR DC

ANY MOUNTING POSITION

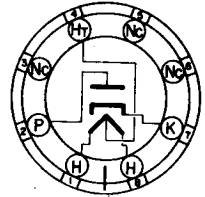

BOTTOM VIEW
8 PIN LOCK-IN

THE 35Y4 IS A SINGLE DIODE IN THE LOCK-IN CONSTRUCTION INTENDED FOR HALF-WAVE POWER RECTIFIER SERVICE. IT FEATURES A TAPPED HEATER SECTION PROVIDING A BALLAST ACTION AND SOURCE OF VOLTAGE FOR A PANEL LAMP.

RATINGS

INTERPRETED ACCORDING TO RMA STANDARD MB-210

HEATER VOLTAGE	35	VOLTS
MAXIMUM DC HEATER-CATHODE VOLTAGE	300	VOLTS
MAXIMUM PEAK INVERSE VOLTAGE	700	VOLTS
MAXIMUM AC PLATE VOLTAGE (RMS)	235	VOLTS
MAXIMUM STEADY STATE PEAK PLATE CURRENT	600	MA.
MAXIMUM DC OUTPUT CURRENT:		
WITHOUT PANEL LAMP	100	MA.
WITH PANEL LAMP AND SHUNTING RESISTOR	90	MA.
WITH PANEL LAMP AND NO SHUNTING RESISTOR	60	MA.
MAXIMUM VALUE OF PANEL LAMP SHUNTING RESISTOR:		
FOR 70 MA. DC OUTPUT CURRENT	800	OHMS
FOR 80 MA. DC OUTPUT CURRENT	400	OHMS
FOR 90 MA. DC OUTPUT CURRENT	250	OHMS
TAPPED SECTION VOLTAGE (BETWEEN PINS #1 & #4)		
WITH 150 MA. FLOWING BETWEEN PINS #1 & #8	7.5	VOLTS
MAXIMUM VOLTAGE ACROSS TAPPED SECTION WHEN PANEL LAMP FAILS (RMS)	15	VOLTS
TUBE VOLTAGE DROP (MEASURED WITH TUBE CONDUCTING 200 MA.)	20	VOLTS

CONTINUED ON FOLLOWING PAGE

TUNG-SOL

CONTINUED FROM PRECEDING PAGE

TYPICAL OPERATING CONDITIONS AND CHARACTERISTICS

WITH 40 MFD. INPUT CONDENSER AND #40 OR #47 PANEL LAMP

HEATER VOLTAGE (PINS #1 & #8)	32	32	32	32	32	VOLTS
HEATER CURRENT (PINS #4 & #8)	150	150	150	150	150	MA.
VOLTAGE ACROSS TAPPED SECTION OF HEATER (PINS #1 & #4)	5.5	5.5	5.5	5.5	5.5	VOLTS
AC PLATE VOLTAGE (RMS)	117	117	117	117	235	VOLTS
DC OUTPUT CURRENT	60	70	80	90	60	MA.
MINIMUM EFFECTIVE PLATE SUPPLY IMPEDANCE	15	15	15	15	100	OHMS
PANEL LAMP SHUNT RESISTOR	—	300	150	100	—	OHMS

WITH 40 MFD. INPUT CONDENSER AND NO PANEL LAMP

HEATER VOLTAGE (PINS #1 & #8)	35	35	VOLTS
HEATER CURRENT (PINS #4 & #8)	150	150	MA.
VOLTAGE ACROSS TAPPED SECTION OF HEATER (PINS #1 & #4)	7.5	7.5	VOLTS
AC PLATE VOLTAGE (RMS)	117	235	VOLTS
DC OUTPUT CURRENT	100	100	MA.
MINIMUM EFFECTIVE PLATE SUPPLY IMPEDANCE	15	100	OHMS

SIMILAR TYPE REFERENCE: Ratings and characteristics somewhat similar to types 35W4 and 35Z50F.

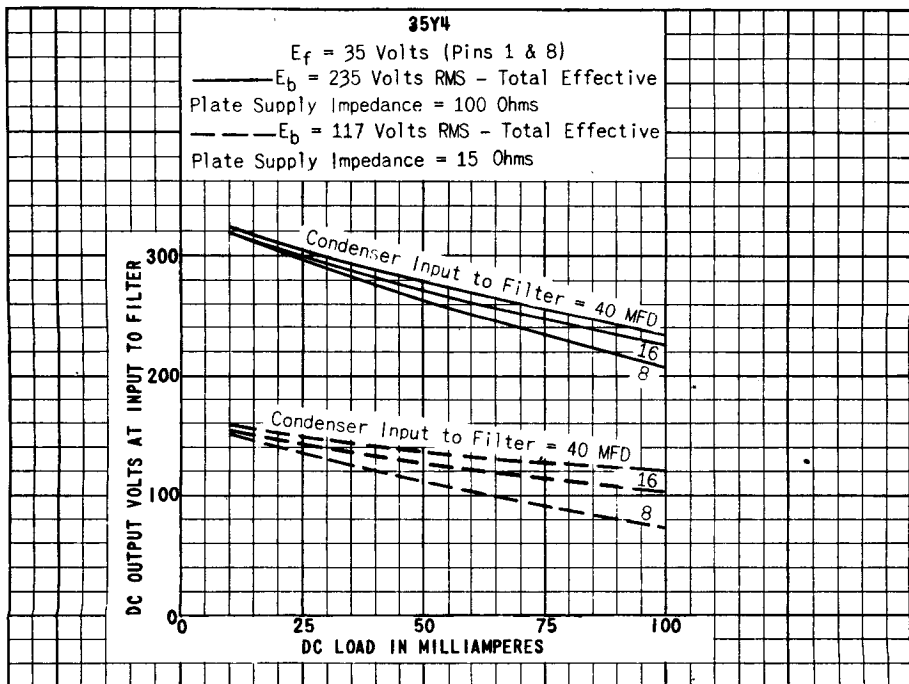

TUNG-SOL

HALF WAVE
HIGH VACUUM RECTIFIER

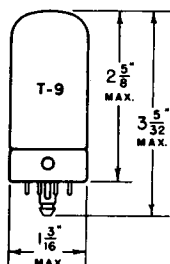

UNIPOTENTIAL CATHODE
HEATER
32.0 VOLTS 0.15 AMPERE
AC OR DC

GLASS BULB

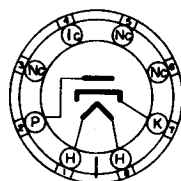

4Z

BOTTOM VIEW

NOTE: 1C DENOTES
INTERNAL CONNECTION

8 PIN LOCKING-IN BASE

THE TUNG-SOL 3523 IS DESIGNED PRIMARILY FOR SERVICE AS A POWER RECTIFIER IN AC-DC RECEIVERS WHICH EMPLOY 150 MA. HEATER TUBES.

RATINGS

NOMINAL HEATER VOLTAGE	35.0	VOLTS
NOMINAL HEATER CURRENT	0.16	AMP.
MAXIMUM AC PLATE VOLTAGE (RMS)	235	VOLTS
MAXIMUM PEAK INVERSE VOLTAGE	700	VOLTS
MAXIMUM DC HEATER TO CATHODE POTENTIAL	350	VOLTS
MAXIMUM STEADY-STATE PEAK PLATE CURRENT	600	MA.
TUBE VOLTAGE DROP - AT 200 MA.	20	VOLTS

TYPICAL OPERATING CONDITIONS AND CHARACTERISTICS

HALF WAVE RECTIFIER WITH CONDENSER INPUT TO FILTER

AC PLATE VOLTAGE (RMS)	117	150	235 MAX.	VOLTS
DC OUTPUT CURRENT ^{MAX.}	100	100	100	MA.
TOTAL EFFECTIVE PLATE SUPPLY IMPEDANCE ^{MIN. A}	15	40	100	OHMS

^A WHEN FILTER CONDENSERS LARGER THAN 40 μ FDS. ARE USED, IT MAY BE NECESSARY TO ADD ADDITIONAL PLATE SUPPLY IMPEDANCE.

FOR "INTERPRETATION OF RATINGS", REFER TO FRONT OF BOOK.

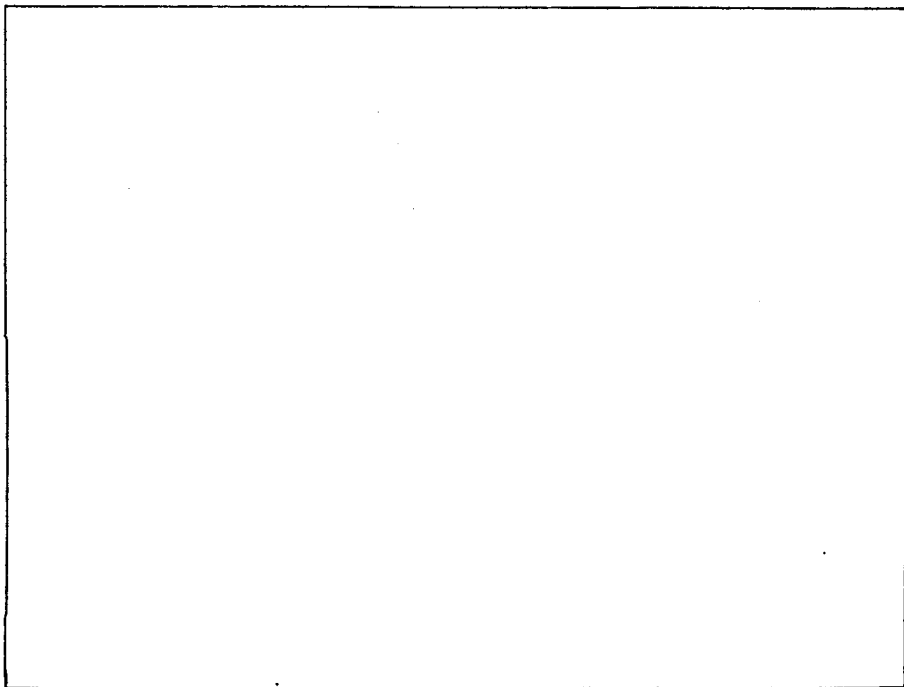
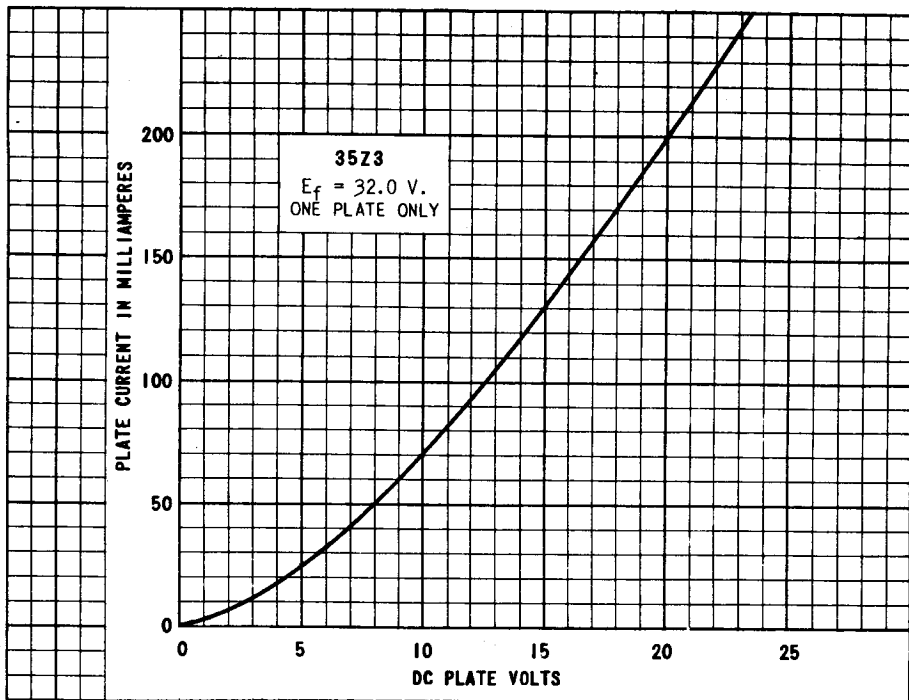
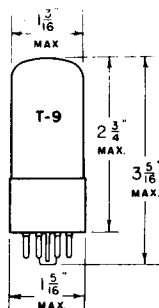

PLATE
827-1

TUNG-SOL



HALF WAVE

HIGH VACUUM RECTIFIER

UNIPOTENTIAL CATHODE

HEATER

35 VOLTS 0.15 AMPERE

AC OR DC

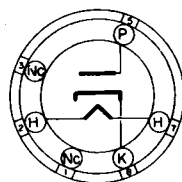

5AA

BOTTOM VIEW

GLASS BULB

INTERMEDIATE 6 PIN OCTAL BASE

THE TUNG-SOL 35Z4GT IS DESIGNED PRIMARILY FOR SERVICE AS A POWER RECTIFIER IN AC-DC RECEIVERS EMPLOYING 150 MA. HEATER TUBES.

RATINGS

MAXIMUM AC PLATE VOLTAGE (RMS)	235	VOLTS
MAXIMUM PEAK INVERSE VOLTAGE	700	VOLTS
MAXIMUM DC HEATER TO CATHODE POTENTIAL	350	VOLTS
MAXIMUM STEADY-STATE PEAK PLATE CURRENT	600	MA.
TUBE VOLTAGE DROP - AT 200 MA.	18	VOLTS

TYPICAL OPERATING CONDITIONS AND CHARACTERISTICS

HALF WAVE RECTIFIER WITH CONDENSER INPUT TO FILTER

AC PLATE VOLTAGE (RMS)	117	235 ^{MAX.}	VOLTS
DC OUTPUT CURRENT ^{MAX.}	100	100	MA.
TOTAL EFFECTIVE PLATE SUPPLY IMPEDANCE ^{MIN. A}	15	100	OHMS

^A WHEN FILTER CONDENSERS LARGER THAN 40 μ FDS ARE USED, IT MAY BE NECESSARY TO ADD ADDITIONAL PLATE SUPPLY IMPEDANCE.

FOR "INTERPRETATION OF RATINGS" REFER TO FRONT OF BOOK.

PLATE
932-3DEC-30
1940

CONTINUED NEXT PAGE

35Z4 GT

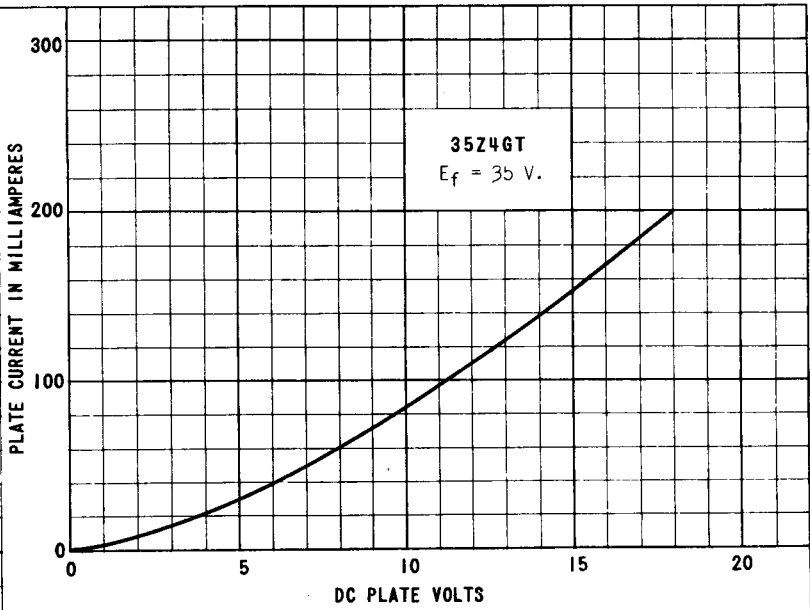
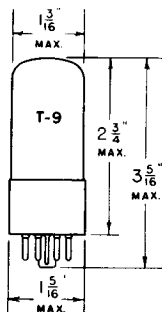

PLATE
933-5

TUNG-SOL



HALF WAVE
HIGH VACUUM RECTIFIER

UNIPOTENTIAL CATHODE

HEATER

35.0 VOLTS 0.150 AMPERE

AC OR DC

WITHOUT PANEL LAMP

GLASS BULB

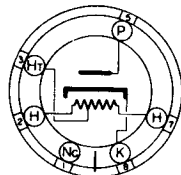

6AD-0-0

INTERMEDIATE 6 PIN OCTAL BASE

THE TUNG-SOL 35Z5GT/G IS DESIGNED FOR USE AS A RECTIFIER IN AC-DC RECEIVERS. IT FEATURES A 35 V. 150 MA. HEATER HAVING A TAP BROUGHT OUT SO THAT, WITH PROPER EXTERNAL CONNECTIONS, THE TAPPED SECTION OF THE HEATER SERVES AS A BALLAST RESISTOR FOR A PANEL LAMP. IT IS RECOMMENDED THAT THE PLATE CURRENT OF THE RECTIFIER BE PASSED THROUGH THE PANEL LAMP AND THE TAPPED SECTION OF THE HEATER, WHICH IS ACCOMPLISHED BY CONNECTING THE PLATE OF THE RECTIFIER TO THE TAP ON THE HEATER.

RATINGS

MAXIMUM AC PLATE VOLTAGE (RMS)	235	VOLTS
MAXIMUM PEAK INVERSE VOLTAGE	700	VOLTS
MAXIMUM DC HEATER TO CATHODE POTENTIAL	350	VOLTS
MAXIMUM STEADY STATE PEAK PLATE CURRENT	600	MA.
MAXIMUM DC OUTPUT CURRENT:		
NO PANEL LAMP	100	MA.
WITH PANEL LAMP AND SHUNTING RESISTOR	90	MA.
WITH PANEL LAMP AND NO SHUNTING RESISTOR	60	MA.
MAXIMUM VALUE OF PANEL LAMP SHUNTING RESISTOR:		
FOR 70 MA. DC OUTPUT CURRENT	800	OHMS
FOR 80 MA. DC OUTPUT CURRENT	400	OHMS
FOR 90 MA. DC OUTPUT CURRENT	250	OHMS
TAPPED HEATER SECTION VOLTAGE (BETWEEN #2 AND #3)	7.5	VOLTS
WITH 150 MA. FLOWING BETWEEN PINS #2 AND #3		
MAXIMUM VOLTAGE ACROSS TAPPED HEATER SECTION	15.0	VOLTS
WHEN PANEL LAMP FAILS (RMS)		
TUBE VOLTAGE DROP AT 200 MA. DC	18	VOLTS

CONTINUED NEXT PAGE

TUNG-SOL

TYPICAL OPERATING CONDITIONS AND CHARACTERISTICS

WITH #40 OR #47 PANEL LAMP

HEATER VOLTAGE (BETWEEN PINS #2 AND #7)	32	32	32	32	32	VOLTS
HEATER CURRENT (BETWEEN PINS #3 AND #7)	.150	.150	.150	.150	.150	AMPERE
VOLTAGE ACROSS TAPPED SECTION OF HEATER (PINS #2 AND #3)	5	5	5.5	5.5	5.5	VOLTS
AC PLATE VOLTAGE (RMS)	117	117	117	117	235	VOLTS
DC OUTPUT CURRENT	60	70	80	90	60	MA.
MINIMUM EFFECTIVE PLATE SUPPLY IMPEDANCE	15	15	15	15	100	OHMS
PANEL LAMP SHUNT RESISTANCE	-	300	150	100	-	OHMS

WITHOUT PANEL LAMP

HEATER VOLTAGE (BETWEEN PINS #2 AND #7)	35-0	35-0	VOLTS
HEATER CURRENT (BETWEEN PINS #3 AND #7)	.150	.150	AMPERE
VOLTAGE ACROSS TAPPED SECTION OF HEATER (PINS #2 AND #3)	7.5	7.5	VOLTS
AC PLATE VOLTAGE (RMS)	235	117	VOLTS
DC OUTPUT CURRENT	100	100	MA.
MINIMUM EFFECTIVE PLATE SUPPLY IMPEDANCE	100	15	OHMS

^A WHEN FILTER CONDENSERS LARGER THAN 40 UFDS. ARE USED, IT MAY BE NECESSARY TO ADD ADDITIONAL PLATE SUPPLY IMPEDANCE.

THE DROP ACROSS THE SERIES RESISTANCE, IF ANY, AND ALL HEATERS SHOULD TOTAL 117 V. AT 0.15 AMPERE.

⁶ VOLTAGES SHOULD NOT BE APPLIED TO THE SOCKET WHEN TUBES ARE INSTALLED OR REMOVED.

FOR "INTERPRETATION OF RATINGS" REFER TO FRONT OF BOOK.

CONTINUED NEXT PAGE

TUNG-SOL

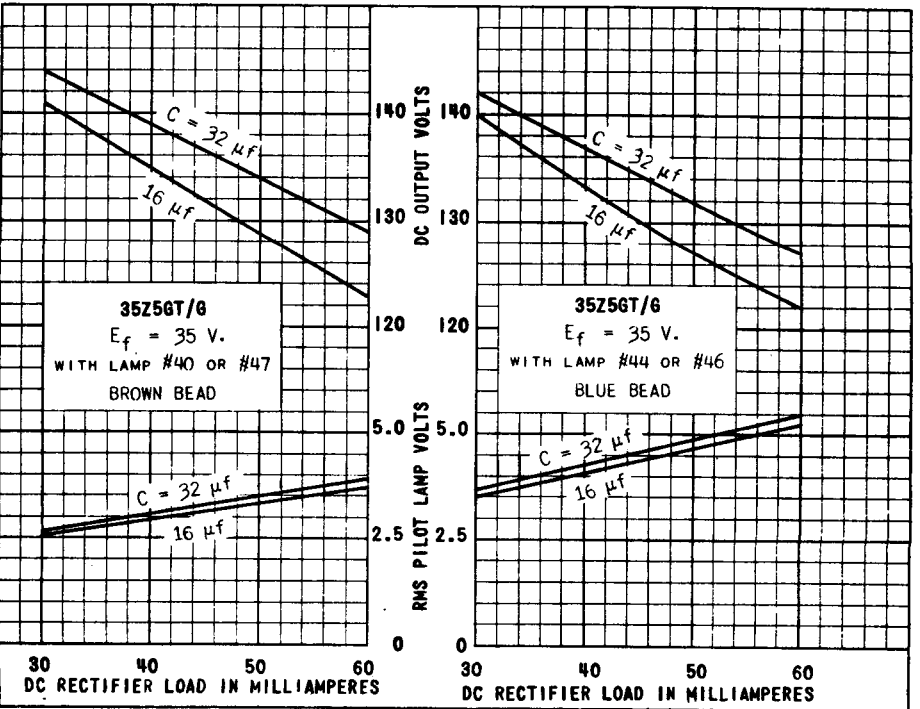
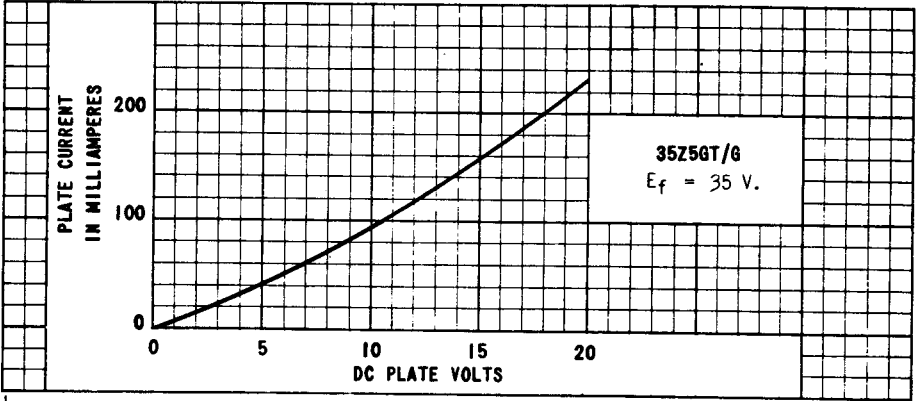
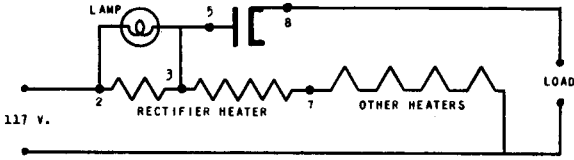

PRINTED IN U. S. A.

PLATE 1186-1
FEB. 28 1942

TUNG-SOL

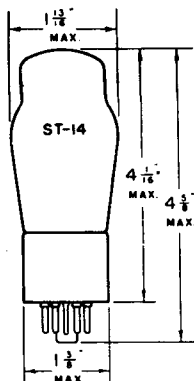

TWIN-DIODE HIGH VACUUM RECTIFIER

VOLTAGE DOUBLER

UNIPOTENTIAL CATHODES

HEATER

35 VOLTS 0.3 AMPERE

AC OR DC

GLASS BULB

MEDIUM 7 PIN OCTAL BASE

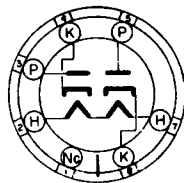

7Q-0-0

THE TUNG-SOL 3526G IS DESIGNED PRIMARILY FOR HEAVY DUTY SERVICE AS A POWER RECTIFIER IN AC-DC CIRCUITS. TWO SEPARATE RECTIFIER SECTIONS PERMIT USING THE TUBE AS A VOLTAGE DOUBLER, FULL WAVE RECTIFIER OR HALF WAVE RECTIFIER. FOR HALF WAVE OPERATION THE TWO SECTIONS MAY BE USED SEPARATELY, OR IN PARALLEL TO INCREASE THE OUTPUT CURRENT AND REDUCE TUBE DROP.

RATINGS

MAXIMUM AC PLATE VOLTAGE (RMS)	235	VOLTS
MAXIMUM DC HEATER TO CATHODE POTENTIAL	350	VOLTS
MAXIMUM PEAK INVERSE VOLTAGE	700	VOLTS
MAXIMUM STEADY-STATE PEAK PLATE CURRENT PER PLATE	660	MA.
TUBE VOLTAGE DROP AT 220 MA. DC PER PLATE	20	VOLTS

TYPICAL OPERATING CONDITIONS AND CHARACTERISTICS

VOLTAGE DOUBLER

	HALF WAVE	FULL WAVE	
AC PLATE VOLTAGE PER PLATE (RMS)	117	117	VOLTS
DC OUTPUT CURRENT ^{MAX.}	110	110	MA.
MINIMUM EFFECTIVE PLATE SUPPLY IMPEDANCE ^{PER PLATE}	30	15	OHMS

HALF WAVE RECTIFIER

CONDENSER INPUT TO FILTER

AC PLATE VOLTAGE PER PLATE (RMS)	117	150	235	VOLTS
DC OUTPUT CURRENT PER PLATE ^{MAX.}	110	110	110	MA.
MINIMUM EFFECTIVE PLATE SUPPLY IMPEDANCE ^{PER PLATE}	15	40	100	OHMS

FOR "INTERPRETATION OF RATINGS" REFER TO FRONT OF BOOK.

PLATE
1187-2
FEB. 28
1942

TUNG-SOL

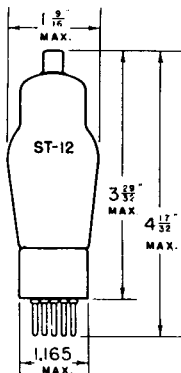

TETRODE AMPLIFIER

UNIPOTENTIAL CATHODE

HEATER
6.3 VOLTS 0.3 AMPERE
AC OR DC

GLASS BULB

SMALL 5 PIN BASE

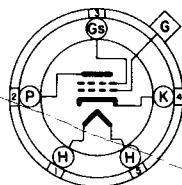

5E

BOTTOM VIEW

THE TUNG-SOL 36 IS DESIGNED FOR USE AS AN RF AMPLIFIER OR DETECTOR.

OPERATING CONDITIONS AND CHARACTERISTICS

CLASS A AMPLIFIER

PLATE VOLTAGE	100	135	180	250 MAX.	VOLTS
SCREEN VOLTAGE	55	67.5	90 MAX.	90 MAX.	VOLTS
CONTROL GRID VOLTAGE	-1.5	-1.5	-3	-3	VOLTS
PLATE CURRENT	1.8	2.8	3.1	3.2	MA.
SCREEN CURRENT	-	-	-	1.7 MAX.	MA.
PLATE RESISTANCE	0.55	0.475	0.50	0.55	MEG OHM
TRANSCONDUCTANCE	850	1000	1050	1080	μMHOS
AMPLIFICATION FACTOR	470	475	525	595	

DETECTOR

	BIASED			GRID LEAK	
PLATE SUPPLY VOLTAGE	100	180	250 MAX.	135	VOLTS
SCREEN VOLTAGE	55	67.5	90 MAX.	45 MAX.	VOLTS
CONTROL GRID VOLTAGE	-5 ^A	-6 ^A	-8 ^A	RETURN TO CATHODE	VOLTS
PLATE RESISTOR	0.25 ^B	0.25 ^B	0.25 ^B	0.25 ^B	MEG OHM
PLATE CURRENT	ADJUSTED TO 0.1 MA. WITH NO INPUT SIGNAL				
GRID LEAK	-	-	-	2 TO 5	MEG OHMS
GRID CONDENSER	-	-	-	250	μf

^A APPROXIMATE^B OR EQUIVALENT IMPEDANCE

DIRECT INTERELECTRODE CAPACITANCES

CONTROL GRID TO CATHODE	3.7	μf
PLATE TO CATHODE	9.2	μf
CONTROL GRID TO PLATE ^S	.007 MAX.	μf

^S WITH SHIELD

TUNG-SOL

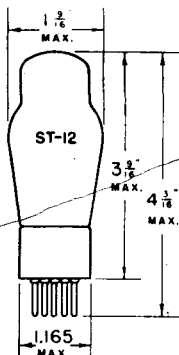

TRIODE AMPLIFIER

UNIPOTENTIAL CATHODE

HEATER

6.3 VOLTS 0.3 AMPERE
AC OR DC

GLASS BULB

SMALL 5 PIN BASE

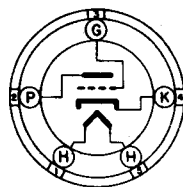

5A

BOTTOM VIEW

THE TUNG-SOL 37 IS A GENERAL PURPOSE TRIODE DESIGNED FOR SERVICE AS AN OSCILLATOR, DETECTOR OR AMPLIFIER.

OPERATING CONDITIONS AND CHARACTERISTICS

CLASS A AMPLIFIER

PLATE VOLTAGE	90	135	180	250 ^{MAX.}	VOLTS
GRID VOLTAGE	-6	-9	-13.5	-18	VOLTS
PLATE CURRENT	2.5	4.1	4.3	7.5	MA.
PLATE RESISTANCE	11 500	10 000	10 200	8400	OHMS
TRANSCOND TANCE	800	925	900	1100	μMHOS
AMPLIFICATION FACTOR	9.2	9.2	9.2	9.2	

DETECTOR

	BIASED				GRID LEAK	
PLATE VOLTAGE	90	135	180	250 ^{MAX.}	45	VOLTS
GRID VOLTAGE	-10	-15	-20	-28	RETURN TO CATHODE	VOLTS
PLATE CURRENT	ADJUST TO 0.2 MA. WITH NO INPUT SIGNAL					
GRID LEAK	-	-	-	-	1 TO 5	MEGOHMS
GRID CONDENSER	-	-	-	-	250'	μμf

RESISTANCE COUPLED AMPLIFIER

PLATE SUPPLY VOLTAGE	250	VOLTS
PLATE RESISTOR	0.1	MEGOHM
CATHODE RESISTOR	11 000	OHMS
VOLTAGE GAIN	7	

DIRECT INTERELECTRODE CAPACITANCES

GRID TO CATHODE	3.5	μμf
PLATE TO CATHODE	2.9	μμf
GRID TO PLATE	2.0	μμf

PLATE
473-1

TUNG-SOL

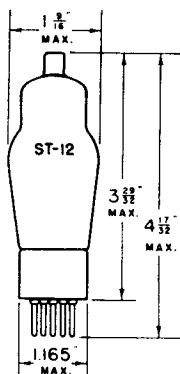

PENTODE POWER AMPLIFIER

UNIPOTENTIAL CATHODE

HEATER

6.3 VOLTS 0.3 AMPERE

AC OR DC

GLASS BULB

SMALL 5 PIN BASE

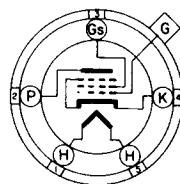

5 F

BOTTOM VIEW

THE TUNG-SOL 38 IS A PENTODE POWER AMPLIFIER DESIGNED FOR SERVICE IN THE OUTPUT STAGE OF AC OR STORAGE BATTERY OPERATED RECEIVERS.

OPERATING CONDITIONS AND CHARACTERISTICS

CLASS A AMPLIFIER

PLATE VOLTAGE	100	135	180	250 ^{MAX.}	VOLTS
SCREEN VOLTAGE	100	135	180	250 ^{MAX.}	VOLTS
CONTROL GRID VOLTAGE	-9	-13.5	-18	-25	VOLTS
PLATE CURRENT	7	9	14	22	MA.
SCREEN CURRENT	1.2	1.5	2.4	3.8	MA.
PLATE RESISTANCE	0.14	0.13	0.11	0.10	MEGOHM
TRANSCONDUCTANCE	875	925	1050	1200	μMHOS
AMPLIFICATION FACTOR	120	120	120	120	
LOAD RESISTANCE	15 000	13 500	11 600	10 000	OHMS
TOTAL HARMONIC DISTORTION	8	10	8	8	PER CENT
POWER OUTPUT	0.27	0.55	1.0	2.5	WATTS

NOTE: THE POTENTIAL DIFFERENCE BETWEEN HEATER AND CATHODE SHOULD BE KEPT AS LOW AS POSSIBLE.

DIRECT INTERELECTRODE CAPACITANCES

CONTROL GRID TO CATHODE	3.5	μμf
PLATE TO CATHODE	7.5	μμf
CONTROL GRID TO PLATE	0.3	μμf

PLATE
470-1JUNE 26
1939

TUNG-SOL

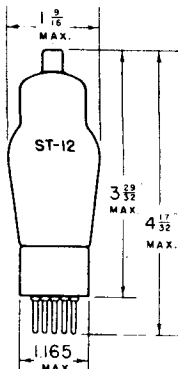

REMOTE CUT - OFF
PENTODE AMPLIFIER

UNIPOTENTIAL CATHODE

HEATER

6.3 VOLTS 0.3 AMPERE
AC OR DC

GLASS BULB

SMALL 5 PIN BASE

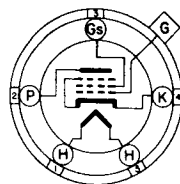

5 F

BOTTOM VIEW

THE TUNG-SOL 39/44 IS DESIGNED FOR USE AS AN RF AMPLIFIER OR MIXER
IN AC AND STORAGE BATTERY OPERATED SUPERHETERODYNE RECEIVERS.

OPERATING CONDITIONS AND CHARACTERISTICS

CLASS A AMPLIFIER

PLATE VOLTAGE	90	180	250 ^{MAX.}	VOLTS
SCREEN VOLTAGE ^{MAX.}	90	90	90	VOLTS
CONTROL GRID VOLTAGE ^{MIN. A}	-3	-3	-3	VOLTS
PLATE CURRENT	5.6	5.8	5.8	MA.
SCREEN CURRENT	1.6	1.4	1.4	MA.
PLATE RESISTANCE	0.375	0.75	1.0	MEG OHM
TRANSCONDUCTANCE	960	1000	1050	μMHOS
AMPLIFICATION FACTOR	360	750	1050	
CONTROL GRID VOLTAGE	-42.5	-42.5	-42.5	VOLTS

FOR TRANSCONDUCTANCE = 2 μMHOS

^A THE DC RESISTANCE IN THE GRID CIRCUIT SHOULD NOT EXCEED 3 MEGOHMS.

AS MIXER IN SUPERHETERODYNE CIRCUIT

PLATE VOLTAGE	90	180	250 ^{MAX.}	VOLTS
SCREEN VOLTAGE ^{MAX.}	90	90	90	VOLTS
CONTROL GRID VOLTAGE	-7	-7	-7	VOLTS

THIS GRID BIAS IS MINIMUM FOR AN OSCILLATOR PEAK VOLTAGE OF 6 VOLTS.

DIRECT INTERELECTRODE CAPACITANCES

CONTROL GRID TO CATHODE	3.5	μμf
PLATE TO CATHODE	10	μμf
CONTROL GRID TO PLATE ^S	.007 ^{MAX.}	μμf

^S WITH SHIELD

TUNG-SOL

PENTODE POWER AMPLIFIER

UNI-POTENTIAL CATHODE

HEATER

6.3 VOLTS 0.4 AMPERE

AC OR DC

GLASS BULB

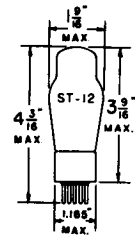
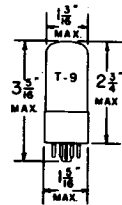
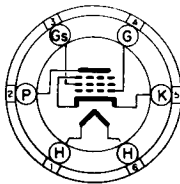
SMALL 6 PIN BASE
417 PIN OCTAL BASE
6K6GT

6B

BOTTOM VIEW

41

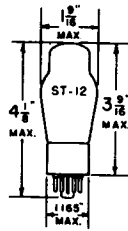
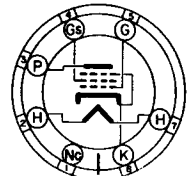
SMALL 7 PIN OCTAL BASE
6K6G

G-7S

BOTTOM VIEW

6K6G 6K6GT

THE TUNG-SOL 6K6G, 6K6GT AND 41 ARE DESIGNED FOR SERVICE IN THE POWER OUTPUT STAGES OF AC OR STORAGE BATTERY OPERATED RECEIVERS. THEIR ELECTRICAL CHARACTERISTICS ARE IDENTICAL.

MAXIMUM RATINGS

MAXIMUM PLATE VOLTAGE	315	VOLTS
MAXIMUM SCREEN VOLTAGE	285	VOLTS
MAXIMUM PLATE DISSIPATION	8.5	WATTS
MAXIMUM SCREEN DISSIPATION	2.8	WATTS

CONTINUED NEXT PAGE

TUNG-SOL

TYPICAL OPERATING CONDITIONS AND CHARACTERISTICS

CLASS A₁ AMPLIFIER

PLATE VOLTAGE	100	250	315	VOLTS
SCREEN VOLTAGE	100	250	250	VOLTS
CONTROL GRID VOLTAGE	-7	-18	-21	VOLTS
PEAK AF SIGNAL VOLTAGE	7	18	21	VOLTS
ZERO-SIGNAL PLATE CURRENT	9.0	32	25.5	MA.
ZERO-SIGNAL SCREEN CURRENT	1.6	5.5	4.0	MA.
MAXIMUM-SIGNAL PLATE CURRENT	9.5	33	28	MA.
MAXIMUM-SIGNAL SCREEN CURRENT	3	10	9	MA.
PLATE RESISTANCE	104 000	68 000	75 000	OHMS
TRANSCONDUCTANCE	1500	2300	2100	μMHOS
LOAD RESISTANCE	12 000	7600	9000	OHMS
TOTAL HARMONIC DISTORTION	11	11	15	PER CENT
POWER OUTPUT	0.35	3.4	4.5	WATTS

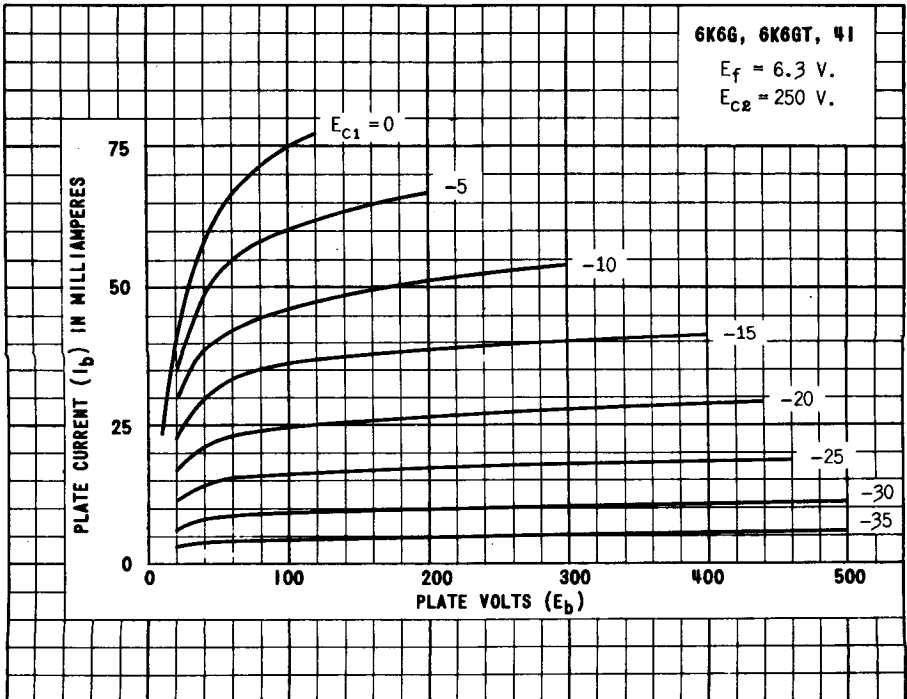
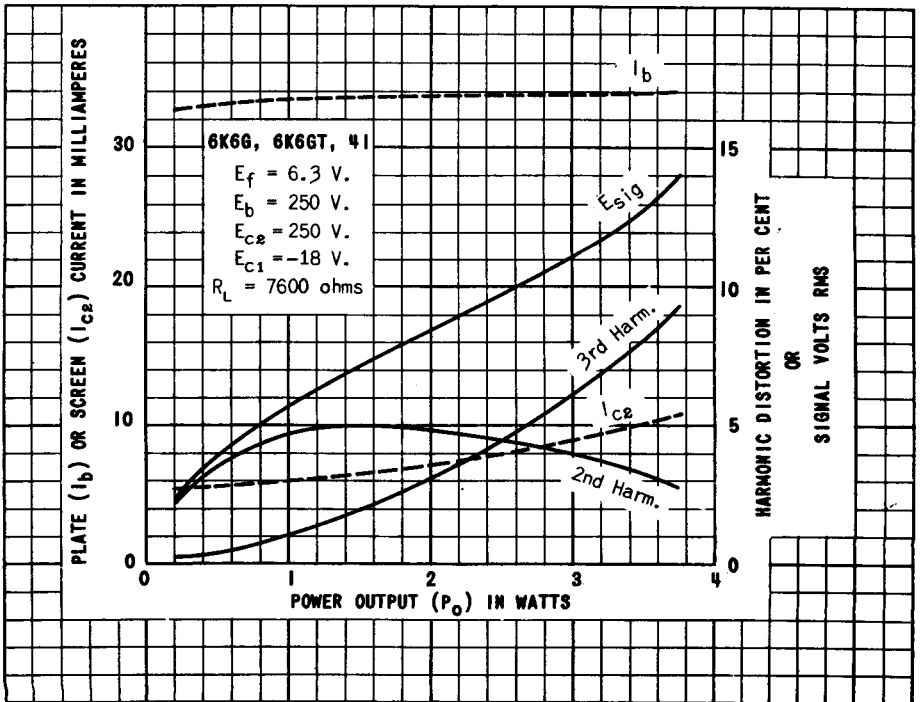
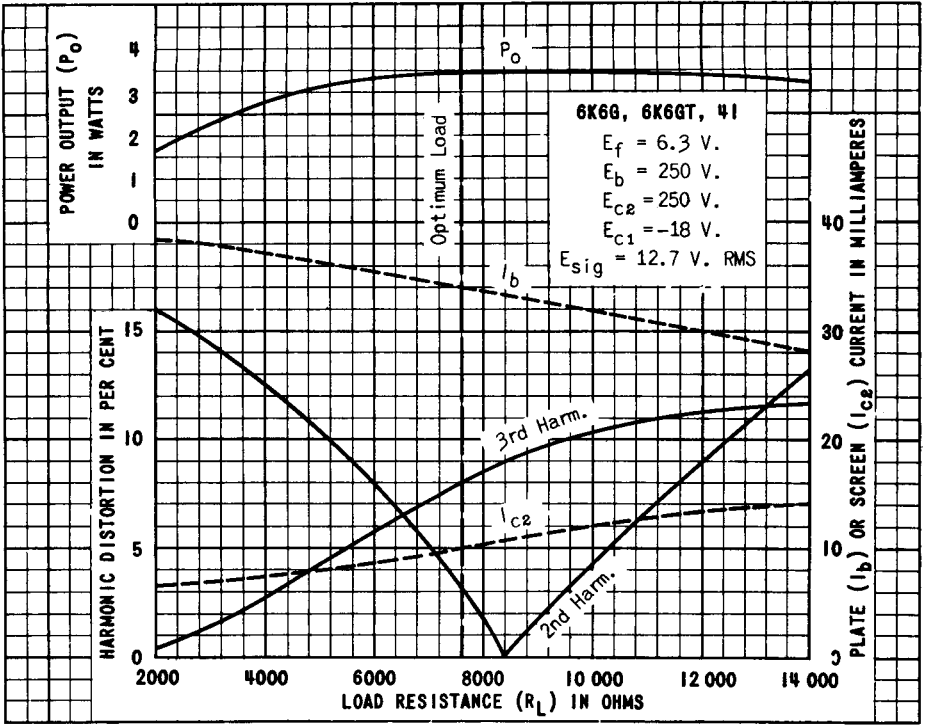

PLATE 670-2





TUNG-SOL

PENTODE POWER AMPLIFIER

COATED UNIPOTENTIAL CATHODE

HEATERS

6F6, 6F6GT/G, 42 - 6.3 V., 0.7 AMPERE
2A5 - 2.5 V., 1.75 AMPERES

TYPES 6F6, 6F6GT/G, 2A5 AND 42 ARE PENTODE AMPLIFIERS DESIGNED FOR APPLICATION IN POWER OUTPUT STAGES OF RECEIVERS. WITH THE EXCEPTION OF HEATER RATINGS, THEIR ELECTRICAL CHARACTERISTICS ARE IDENTICAL.

MAXIMUM RATINGS

	PENTODE CONNECTION	TRIODE CONNECTION	
MAXIMUM PLATE VOLTAGE	375	390	VOLTS
MAXIMUM SCREEN VOLTAGE	285	-	VOLTS
MAXIMUM PLATE DISSIPATION	11	-	WATTS
MAXIMUM SCREEN DISSIPATION	3.75	-	WATTS
MAXIMUM TOTAL PLATE AND SCREEN DISSIPATION	-	10	WATTS

TYPICAL OPERATING CONDITIONS AND CHARACTERISTICS

CLASS A₁ AMPLIFIER - SINGLE TUBE ^C

	PENTODE CONNECTION	PENTODE CONNECTION	TRIODE CONNECTION	
PLATE VOLTAGE	250	285	250	VOLTS
SCREEN VOLTAGE	250	285	-	VOLTS
CONTROL GRID VOLTAGE ^A	-16.5	-20	-20	VOLTS
PEAK AF SIGNAL VOLTAGE	16.5	20	20	VOLTS
ZERO-SIGNAL PLATE CURRENT	34	38	31	MA.
ZERO-SIGNAL SCREEN CURRENT	6.5	7	-	MA.
MAXIMUM-SIGNAL PLATE CURRENT	36	40	34	MA.
MAXIMUM-SIGNAL SCREEN CURRENT	10.5	13	-	MA.
PLATE RESISTANCE (APPROX.)	80000	78000	2600	OHMS
TRANSCONDUCTANCE	2500	2550	2600	UMHO
AMPLIFICATION FACTOR	-	-	6.8	
LOAD RESISTANCE	7000	7000	4000	OHMS
TOTAL HARMONIC DISTORTION	8	9	6.5	PER CENT
POWER OUTPUT	3.2	4.8	0.85	WATTS

PUSH-PULL AMPLIFIER - TWO TUBES ^F

CLASS A₁ AMPLIFIER ^C CLASS AB₂ AMPLIFIER ^D

	PENTODE CONNECTION	PENTODE CONNECTION	TRIODE CONNECTION	
PLATE VOLTAGE	315	375	350	VOLTS
SCREEN VOLTAGE	285	250	-	VOLTS
CONTROL GRID VOLTAGE	-24 ^A	-26	-38	VOLTS
PEAK AF SIGNAL VOLTAGE (GRID TO GRID)	48	82	123	VOLTS
ZERO-SIGNAL PLATE CURRENT	62	34	48	MA.
ZERO-SIGNAL SCREEN CURRENT	12	5	-	MA.
MAXIMUM-SIGNAL PLATE CURRENT	80	82	92	MA.
MAXIMUM-SIGNAL SCREEN CURRENT	19.5	19.5	-	MA.
EFFECTIVE LOAD RESISTANCE (PLATE TO PLATE)	10000	10000	6000	OHMS
TOTAL HARMONIC DISTORTION	4	3.5	2	PER CENT
POWER OUTPUT	11	18.5	13	WATTS

(CONTINUED NEXT PAGE)

TUNG-SOL

TYPICAL OPERATING CONDITIONS FOR CATHODE BIAS

CLASS A₁ AMPLIFIER ^CCLASS AB₂ AMPLIFIER ^D

	SINGLE TUBE AMPLIFIER				PUSH-PULL AMPLI.		
	Pentode Conn.	Triode Conn.	Pentode Conn.	Pentode Conn. ^F	Triode Conn. ^F		
Plate	250	285	250	315	375	350	Volts
Screen	250	285	-	285	250	-	Volts
Cathode Resistor	410	-	650	380	340 ^B	730 ^F	Ohms
Peak A-F Grid Voltage	16.5	20	20	-	-	-	Volts
Peak A-P Grid-to-Grid Voltage	-	-	-	58	94	132	Volts
Zero-Sig. Plate Cur.	34	38	31	62	54	50	Ma.
Max.-Sig. Plate Cur.	35	38	32	73	77	60	Ma.
Zero-Sig. Screen Cur.	6.5	7	-	12	8	-	Ma.
Max.-Sig. Screen Cur.	9.7	12	-	18	18	-	Ma.
Load Resistance	7000	7000	4000	-	-	-	Ohms
Effective Load Resis. (plate to plate)	-	-	-	10000	10000	10000	Ohms
Total Harmonic Dist.	8.5	9	6.5	3	5	3	%
Max.-Sig. Power Output	3.1	4.5	0.8	10.5	19	9	Watts

^A THE DC RESISTANCE IN THE GRID CIRCUIT, UNDER RATED MAXIMUM CONDITIONS, SHOULD NOT EXCEED 0.5 MEGOHM FOR SELF-BIAS OPERATION AND 0.1 MEGOHM FOR FIXED-BIAS OPERATION.

^B THE VALUE GIVEN FOR THE CATHODE RESISTOR IS DETERMINED FOR A GRID BIAS OF -21 VOLTS.

^C SUBSCRIPT 1 INDICATES THAT GRID CURRENT DOES NOT FLOW DURING ANY PART OF INPUT CYCLE.

^D SUBSCRIPT 2 INDICATES THAT GRID CURRENT FLOWS DURING SOME PART OF INPUT CYCLE.

^E THE VALUE GIVEN FOR THE CATHODE RESISTOR IS DETERMINED FOR A GRID BIAS OF -36.5 VOLTS.

^F UNLESS OTHERWISE SPECIFIED, VALUES ARE FOR 2 TUBES.

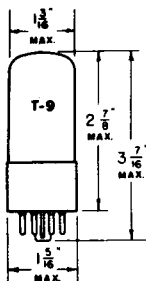

GLASS BULB

6F6GT/G

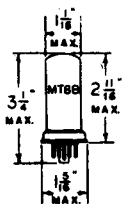

METAL SHELL

6F6

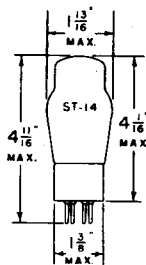

GLASS BULB

2A5 - 42

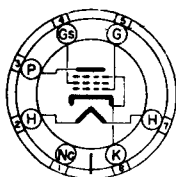

MEDIUM 7 PIN OCTAL BASE

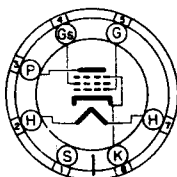

7 PIN OCTAL BASE

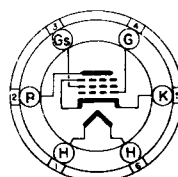

MEDIUM 6 PIN BASE

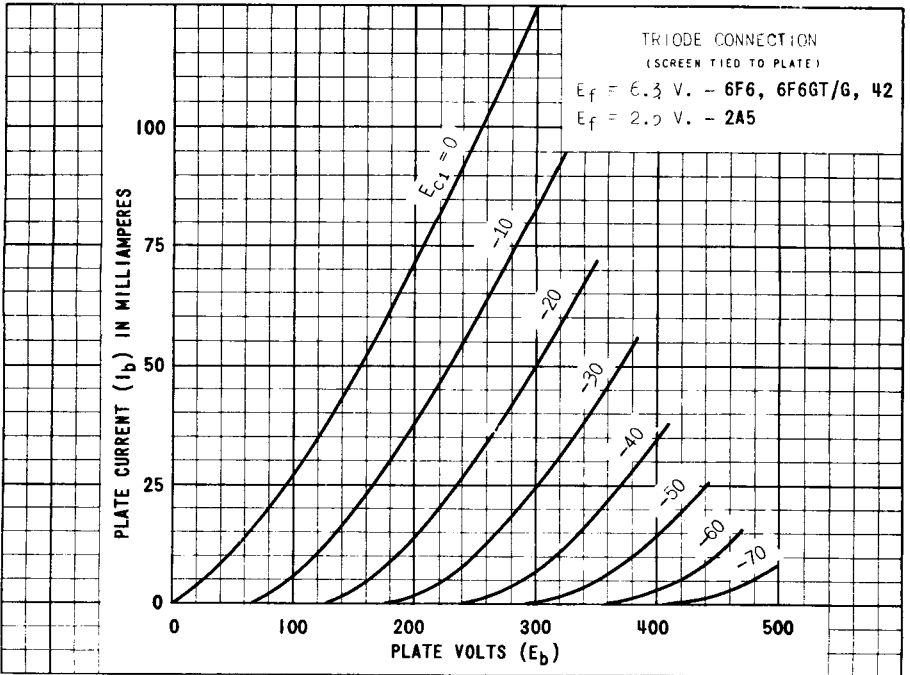
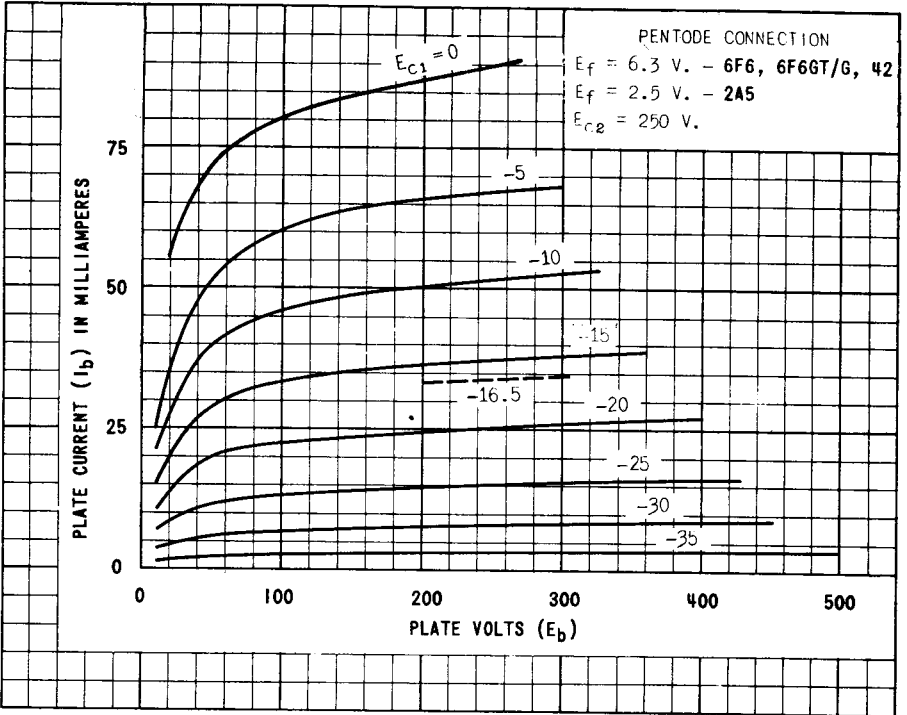

PRINTED IN U. S. A.

PLATE 1372-1
OCT. 25 1943

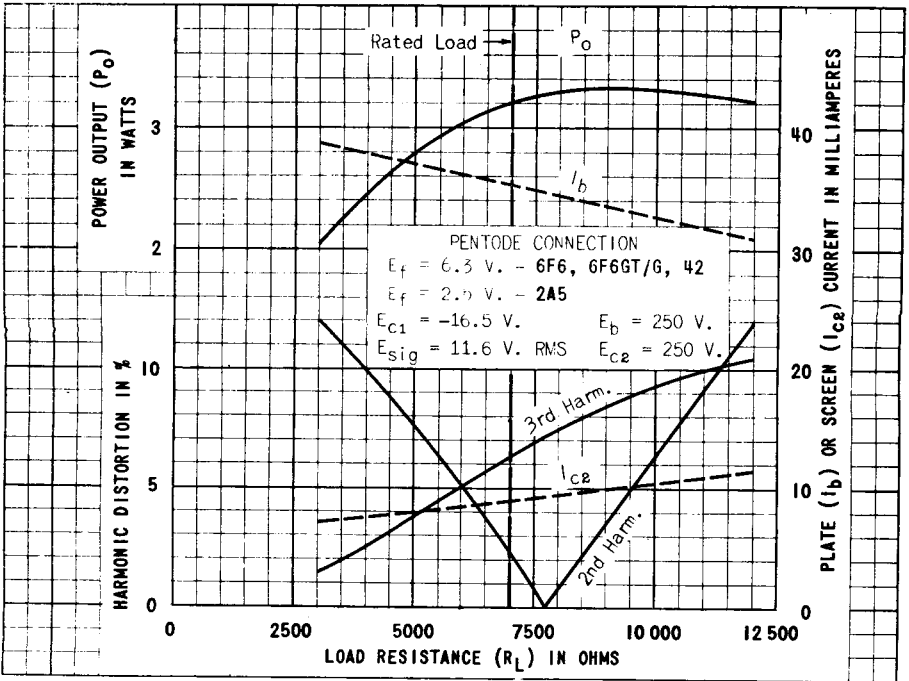
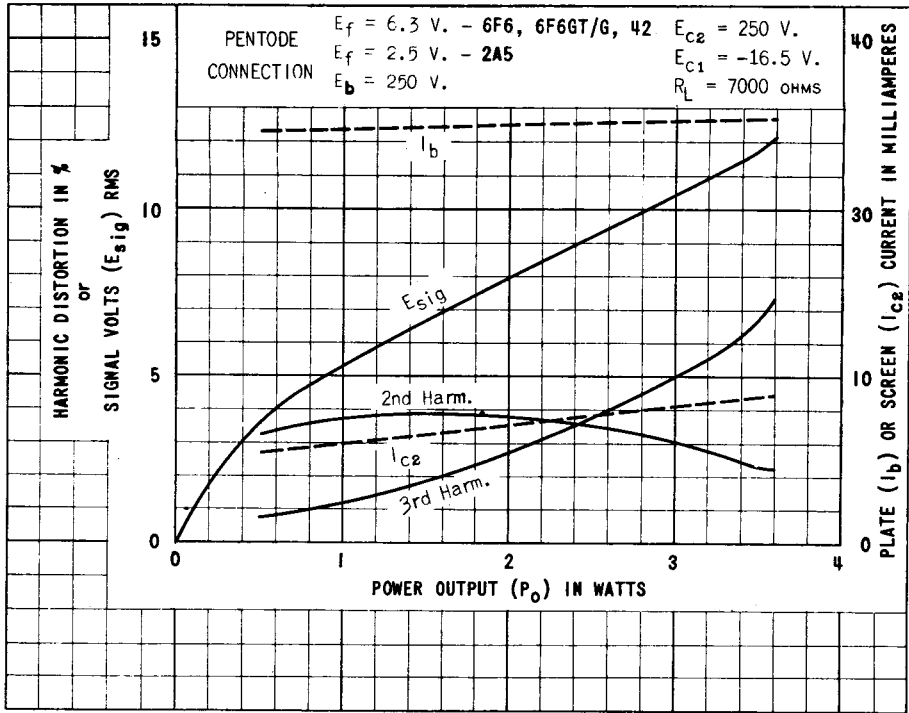
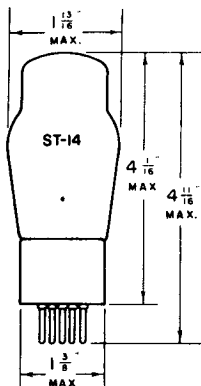

PLATE 1373-1
OCT. 25 1943

TUNG-SOL



PENTODE POWER AMPLIFIER

UNIPOTENTIAL CATHODE

HEATER

25 VOLTS 0.3 AMPERE

AC OR DC

GLASS BULB

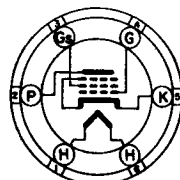

6B

BOTTOM VIEW

MEDIUM 6 PIN BASE

THE TUNG-SOL 43 IS DESIGNED FOR SERVICE IN THE POWER OUTPUT STAGE OF AC-DC RECEIVERS. ITS CHARACTERISTICS ARE IDENTICAL WITH THOSE OF THE 25A6G.

MAXIMUM RATINGS

MAXIMUM PLATE VOLTAGE	160	VOLTS
MAXIMUM SCREEN VOLTAGE	135	VOLTS
MAXIMUM PLATE DISSIPATION	5.3	WATTS
MAXIMUM SCREEN DISSIPATION	1.9	WATTS

OPERATING CONDITIONS AND CHARACTERISTICS

CLASS A₁ AMPLIFIER

PLATE VOLTAGE	95	135	160	VOLTS
SCREEN VOLTAGE	95	135	120	VOLTS
CONTROL GRID VOLTAGE	-15	-20	-18	VOLTS
PEAK AF SIGNAL VOLTAGE	15	20	18	VOLTS
ZERO-SIG. PLATE CURRENT	20	37	33	MA.
ZERO-SIG. SCREEN CURRENT	4	8	6.5	MA.
MAX.-SIG. PLATE CURRENT	22	39	36	MA.
MAX.-SIG. SCREEN CURRENT	8	14	12	MA.
PLATE RESISTANCE	45 000	35 000	42 000	OHMS
TRANSCONDUCTANCE	2000	2450	2375	μMHOS
LOAD RESISTANCE	4500	4000	5000	OHMS
TOTAL HARMONIC DISTORTION	11	9	10	PER CENT
POWER OUTPUT	0.9	2	2.2	WATTS

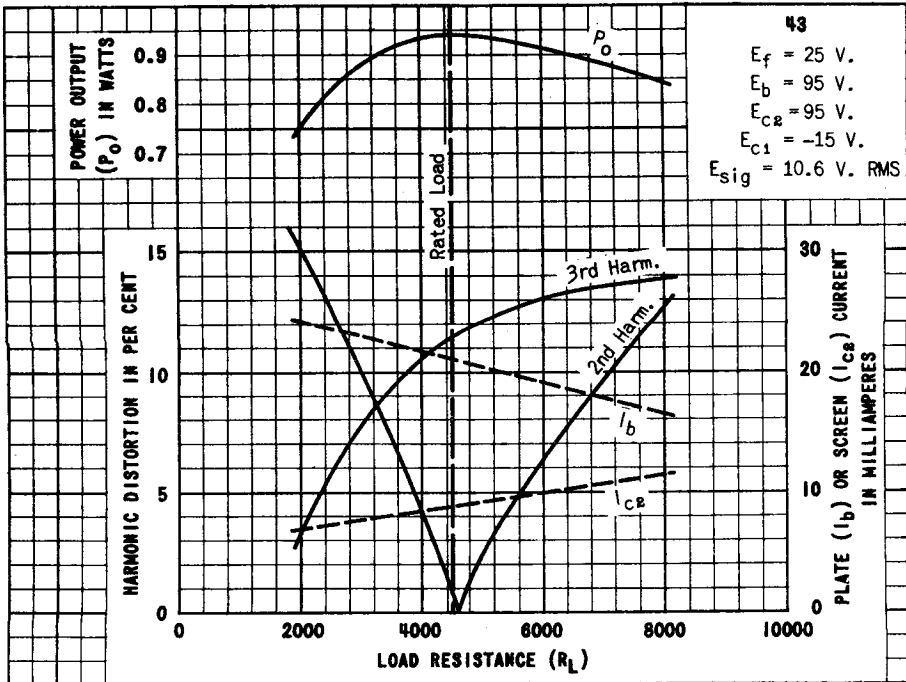
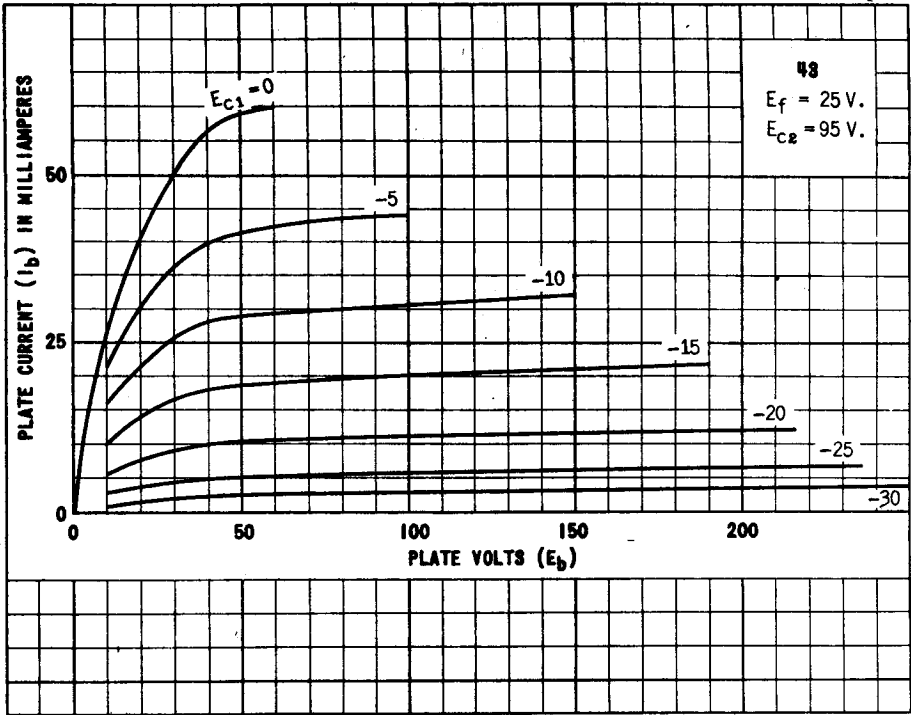

TUNG-SOL

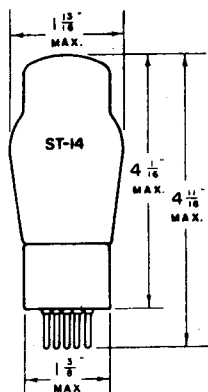

TRIODE POWER AMPLIFIER

COATED FILAMENT

2.5 VOLTS 1.5 AMPERES
AC OR DC

GLASS BULB

MEDIUM 4 PIN BASE

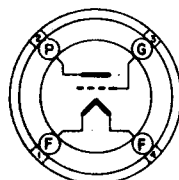

4D

BOTTOM VIEW

THE TUNG-SOL 45 IS A FILAMENT TYPE TRIODE POWER AMPLIFIER DESIGNED FOR SERVICE IN THE OUTPUT STAGE OF AUDIO AMPLIFIERS WHERE HIGH OUTPUT AND LOW HARMONIC DISTORTION ARE DESIRED.

OPERATING CONDITIONS AND CHARACTERISTICS

CLASS A₁ AMPLIFIER

PLATE VOLTAGE	180	250	275 ^{MAX.}	VOLTS
GRID VOLTAGE ^G	-31.5	-50	-56	VOLTS
GRID CIRCUIT RESISTANCE ^{MAX.}				
SELF BIAS	1	1	1	MEGOHM
FIXED BIAS	0.1	0.1	0.1	MEGOHM
PLATE CURRENT	31	34	36	MA.
PLATE RESISTANCE	1650	1610	1700	OHMS
TRANSCONDUCTANCE	2125	2175	2050	μMHOS
AMPLIFICATION FACTOR	3.5	3.5	3.5	
LOAD RESISTANCE	2700	3900	4600	OHMS
POWER OUTPUT	0.825	1.6	2.0	WATTS

PUSH-PULL CLASS AB₂ AMPLIFIER^T

	FIXED BIAS	SELF BIAS	
PLATE VOLTAGE	275 ^{MAX.}	275 ^{MAX.}	VOLTS
GRID VOLTAGE ^G	-68		VOLTS
SELF BIAS RESISTOR		775	OHMS
ZERO-SIG. PLATE CURRENT	28	36	MA.
MAX.-SIG. PLATE CURRENT	138	90	MA.
LOAD RESISTANCE PLATE TO PLATE	3200	5060	OHMS
TOTAL HARMONIC DISTORTION	5	5	PER CENT
AVERAGE POWER INPUT GRID TO GRID	656	460	MILLIWATTS
POWER OUTPUT	18	12	WATTS

(CONTINUED NEXT PAGE)

COPYRIGHT OCT. 1, 1938

TUNG-SOL

^G GRID VOLTAGE MEASURED FROM MID-POINT OF AC OPERATED FILAMENT.

^T VALUES SPECIFIED FOR TWO TUBES.

DIRECT INTERELECTRODE CAPACITANCES

GRID TO FILAMENT	4	$\mu\mu\text{f}$
PLATE TO FILAMENT	3	$\mu\mu\text{f}$
GRID TO PLATE	7	$\mu\mu\text{f}$

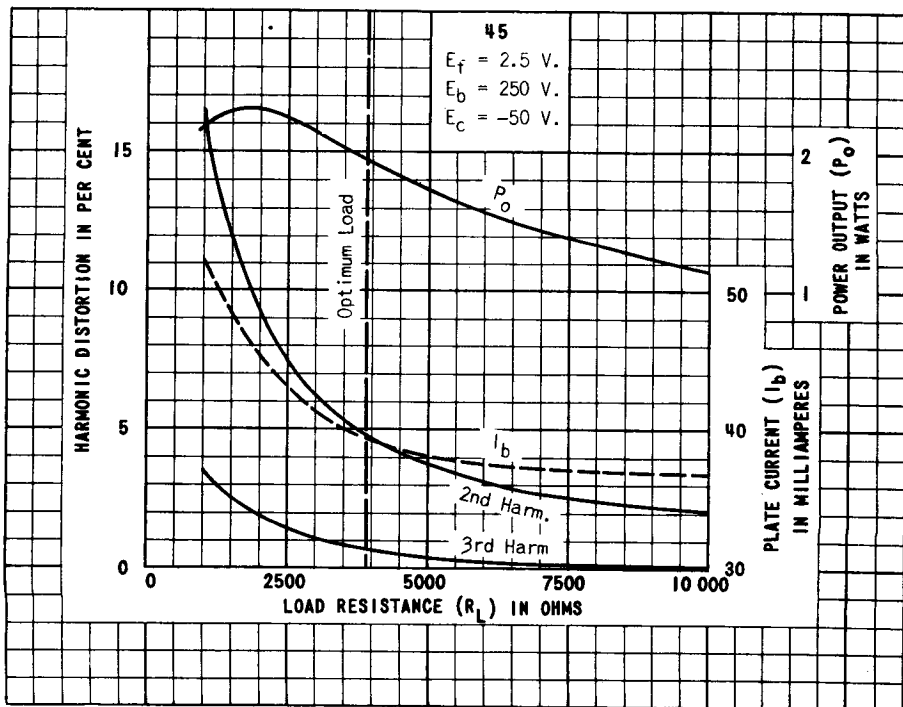
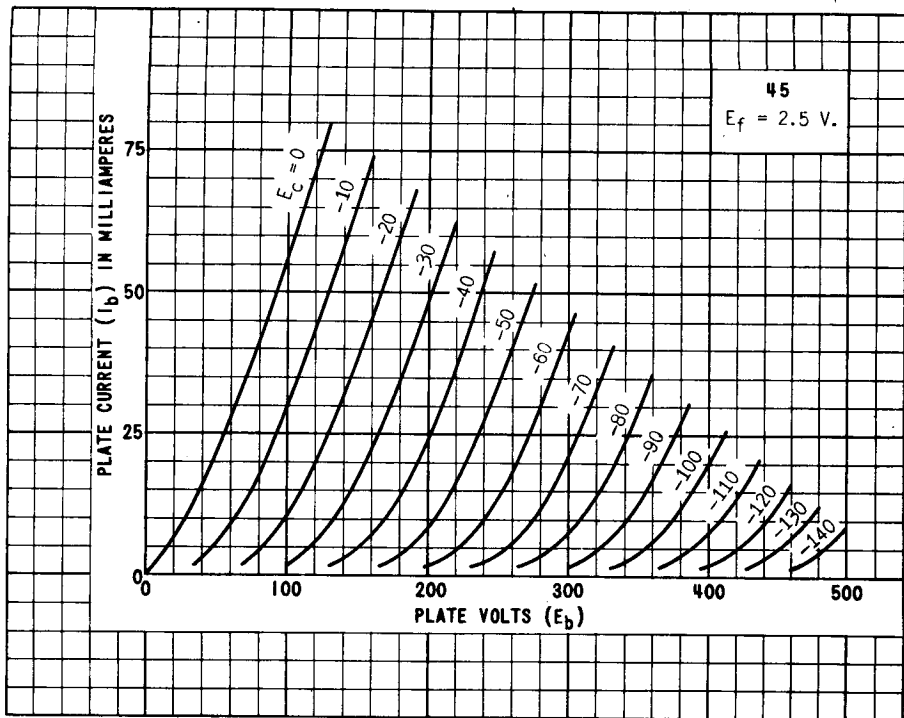

PRINTED IN U. S. A.

PLATE 301-1

JAN. 23 1939

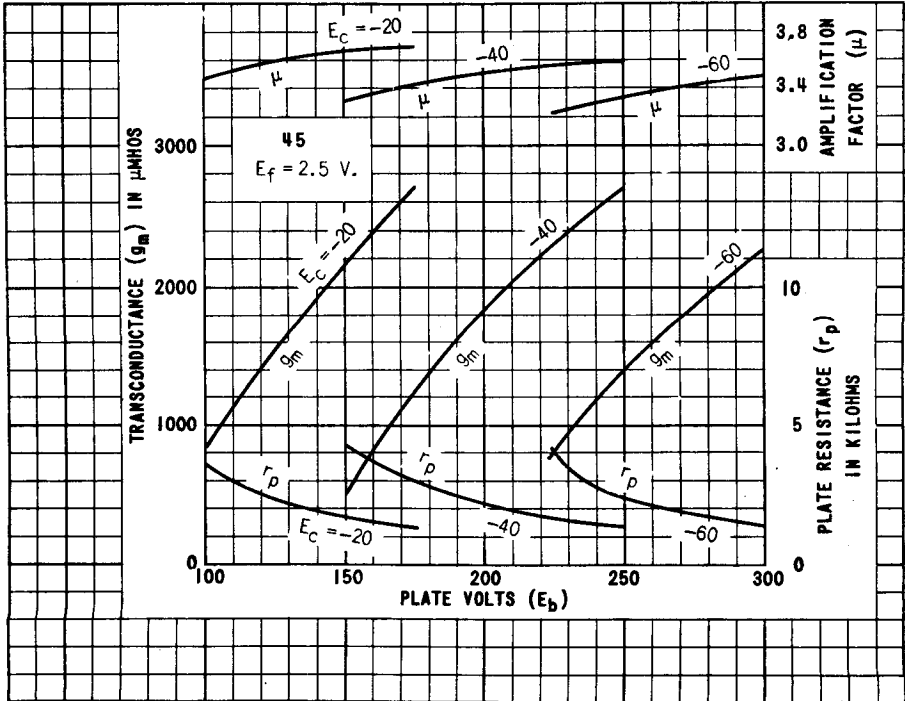
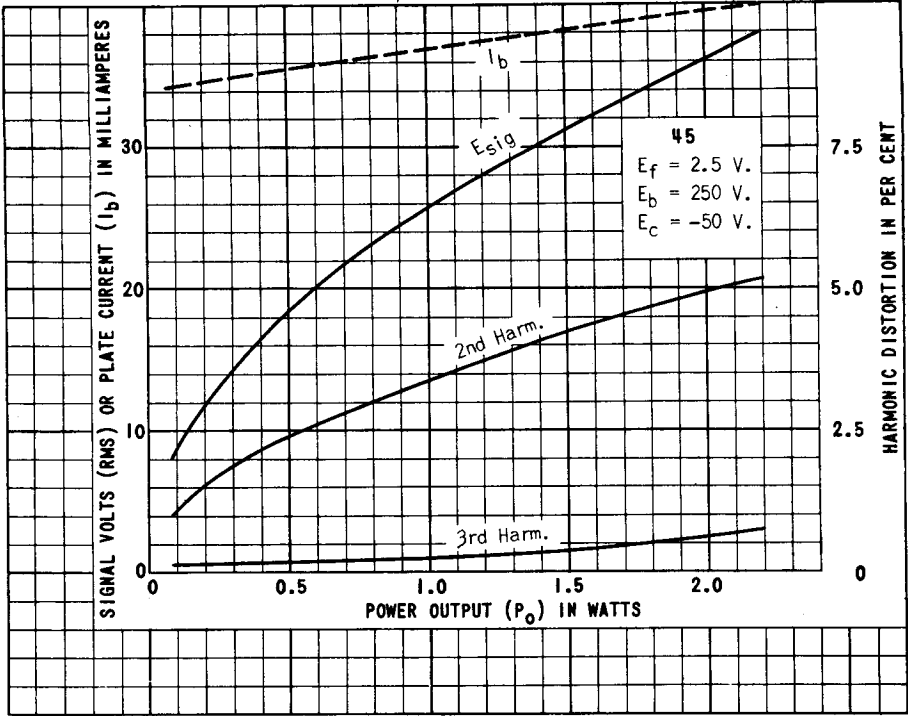

TUNG-SOL

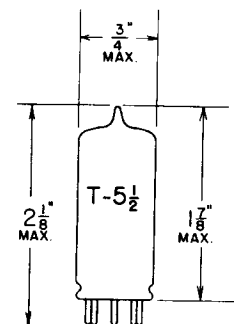

HALF-WAVE
HIGH VACUUM RECTIFIER

UNI POTENTIAL CATHODE

HEATER

45 VOLTS 0.075 AMPERE

AC OR DC

GLASS BULB

BUTTON 7 PIN BASE

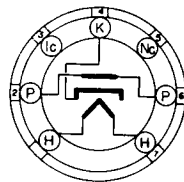

5AM-0-0

THE TUNG-SOL 45Z3 IS A MINIATURE TYPE HALF WAVE POWER RECTIFIER DESIGNED FOR SERVICE IN COMPACT THREE WAY PORTABLE RECEIVERS USING MINIATURE TYPE TUBES. IT IS MADE WITHOUT A SEPARATE BASE, USING THE ELECTRODE LEADS THROUGH THE "BUTTON" STEM FOR BASE PINS.

RATINGS

MAXIMUM AC PLATE VOLTAGE (RMS)	117	VOLTS
MAXIMUM PEAK INVERSE VOLTAGE	350	VOLTS
MAXIMUM DC HEATER TO CATHODE POTENTIAL	175	VOLTS
MAXIMUM STEADY-STATE PEAK PLATE CURRENT	390	MA.
TUBE VOLTAGE DROP - AT 130 MA. DC	23	VOLTS

TYPICAL OPERATING CONDITIONS AND CHARACTERISTICS

HALF WAVE RECTIFIER

AC PLATE VOLTAGE (RMS)	117	VOLTS
DC OUTPUT CURRENT MAX.	65	MA.
MINIMUM TOTAL EFFECTIVE PLATE SUPPLY IMPEDANCE	15	OHMS

FOR "INTERPRETATION OF RATINGS" REFER TO FRONT OF BOOK.

CONTINUED NEXT PAGE

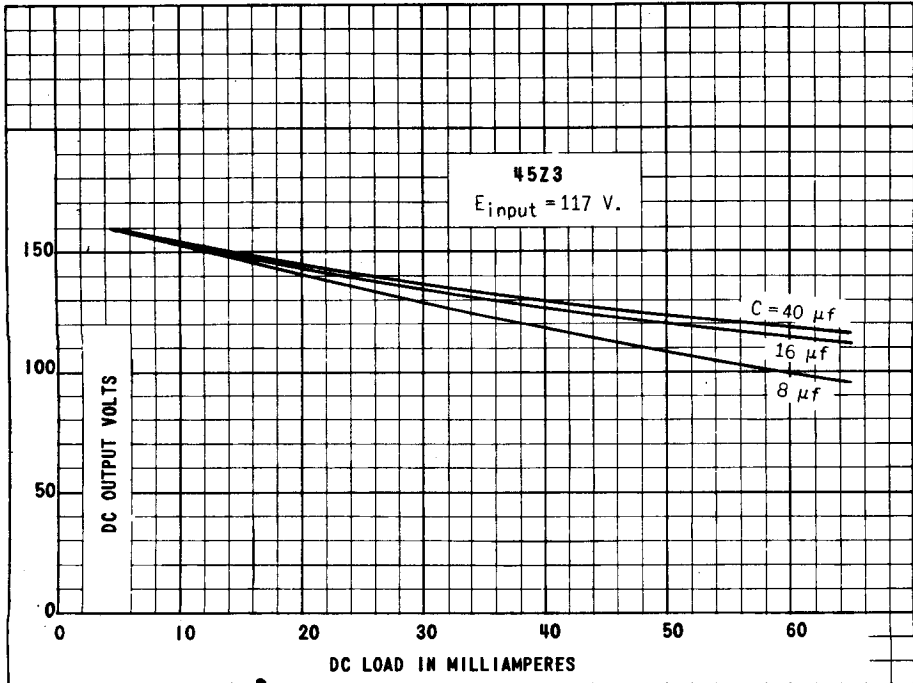
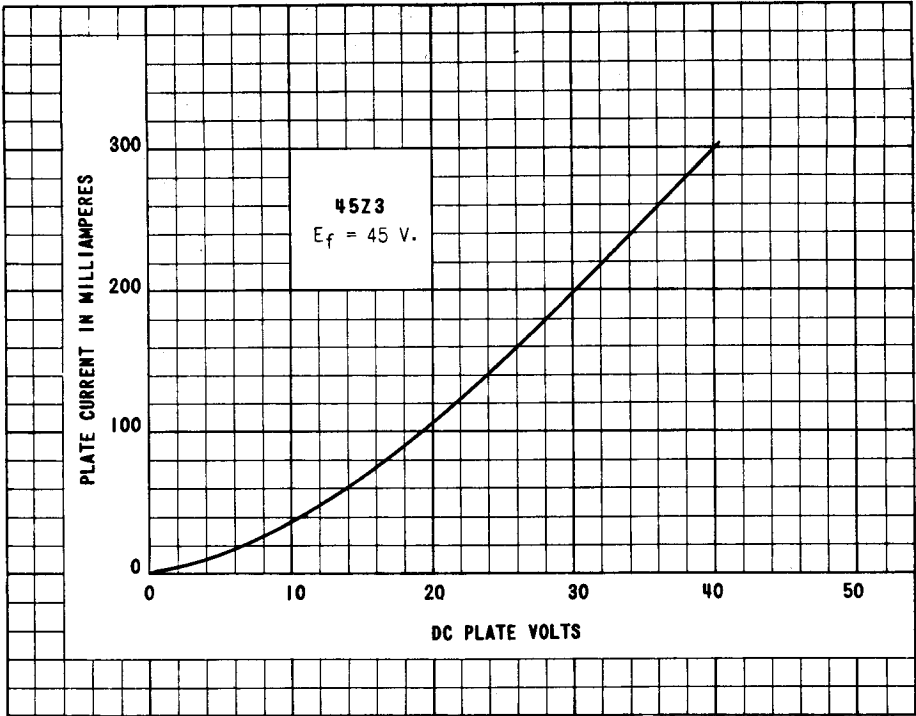

TUNG-SOL

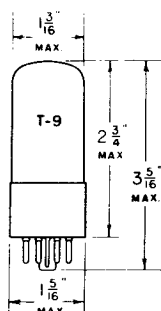

HALF WAVE
HIGH VACUUM RECTIFIER

UNIPOTENTIAL CATHODE

HEATER
45 VOLTS 0.15 AMPERE

AC OR DC
WITHOUT PANEL LAMP

GLASS BULB

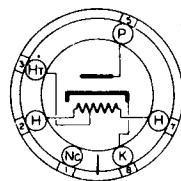

6AD

BOTTOM VIEW

INTERMEDIATE 6 PIN OCTAL BASE

THE TUNG-SOL 45Z5GT IS DESIGNED PRIMARILY AS A POWER RECTIFIER FOR AC-DC RECEIVERS. IT FEATURES A 45 V. 150 MA. HEATER HAVING A TAP BROUGHT OUT SO THAT, WITH PROPER EXTERNAL CONNECTIONS, THE TAPPED SECTION OF THE HEATER SERVES AS A BALLAST RESISTOR FOR A PANEL LAMP. IT IS RECOMMENDED THAT THE PLATE CURRENT OF THE RECTIFIER BE PASSED THROUGH THE PANEL LAMP AND THE TAPPED SECTION OF THE HEATER, WHICH IS ACCOMPLISHED BY CONNECTING THE PLATE OF THE RECTIFIER TO THE TAP ON THE HEATER.

RATINGS

MAXIMUM AC PLATE VOLTAGE (RMS)	235	VOLTS
MAXIMUM PEAK INVERSE VOLTAGE	700	VOLTS
MAXIMUM DC HEATER TO CATHODE POTENTIAL	350	VOLTS
MAXIMUM STEADY-STATE PEAK PLATE CURRENT	600	MA.
MAXIMUM DC OUTPUT CURRENT*		
NO PANEL LAMP	100	MA.
WITH PANEL LAMP AND SHUNTING RESISTOR	90	MA
WITH PANEL LAMP AND NO SHUNTING RESISTOR	60	MA.
MAXIMUM VALUE OF PANEL LAMP SHUNTING RESISTOR:		
FOR 70 MA. DC OUTPUT CURRENT	800	OHMS
FOR 80 MA. DC OUTPUT CURRENT	400	OHMS
FOR 90 MA. DC OUTPUT CURRENT	250	OHMS
TAPPED HEATER SECTION VOLTAGE BETWEEN PINS #2 AND #3)	7.5	VOLTS
WITH 0.150 AMPERES FLOWING BETWEEN PINS #2 AND #7		
MAXIMUM VOLTAGE ACROSS TAPPED HEATER SECTION	15.0	VOLTS
WHEN PANEL LAMP FAILS (RMS)		
TUBE VOLTAGE DROP	16	VOLTS
AT 200 MA. DC		

CONTINUED NEXT PAGE

TUNG-SOL

TYPICAL OPERATING CONDITIONS AND CHARACTERISTICS

WITH #40 OR #47 PANEL LAMP

HEATER VOLTAGE (BETWEEN PINS #2 & #7)	42.0	42.0	42.0	42.0	42.0	VOLTS
HEATER CURRENT (BETWEEN PINS #3 & #7)	0.15	0.15	0.15	0.15	0.15	AMP.
VOLTAGE ACROSS TAPPED SECTION OF HEATER (PINS #2 & #3)	5.5	5.5	5.5	5.5	5.5	VOLTS
AC PLATE VOLTAGE (RMS)	117	117	117	117	235	VOLTS
DC OUTPUT CURRENT	60	70	80	90	60	MA.
EFFECTIVE PLATE SUPPLY IMPEDANCE ^{MIL-A}	15	15	15	15	100	OHMS
PANEL LAMP SHUNT RESISTANCE	-	300	150	100	-	OHMS

WITHOUT PANEL LAMP

HEATER VOLTAGE (BETWEEN PINS #2 & #7)	45.0	45.0	VOLTS
HEATER CURRENT (BETWEEN PINS #3 & #7)	0.15	0.15	AMP.
VOLTAGE ACROSS TAPPED SECTION OF HEATER (PINS #2 & #3)	7.5	7.5	VOLTS
AC PLATE VOLTAGE (RMS)	235	117	VOLTS
DC OUTPUT CURRENT	100	100	MA.
EFFECTIVE PLATE SUPPLY IMPEDANCE ^{MIL-A}	100	15	OHMS

^A WHEN FILTER CONDENSERS LARGER THAN 40 μ FDS ARE USED, IT MAY BE NECESSARY TO ADD ADDITIONAL PLATE SUPPLY IMPEDANCE.

THE DROP ACROSS THE SERIES RESISTANCE, IF ANY, AND ALL HEATERS SHOULD TOTAL 117 V. AT 0.15 AMPERE.

VOLTAGES SHOULD NOT BE APPLIED TO THE SOCKET WHEN TUBES ARE INSTALLED OR REMOVED.

FOR "INTERPRETATION OF RATINGS" REFER TO FRONT OF BOOK.

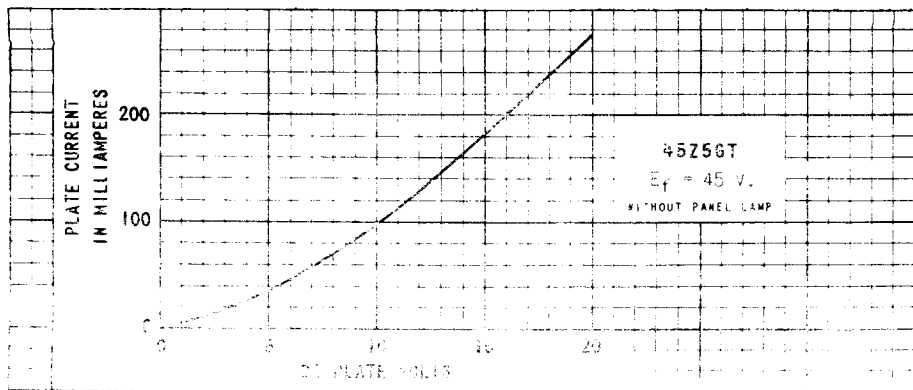
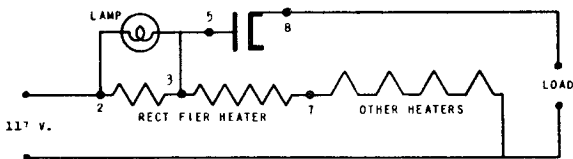

TUNG-SOL

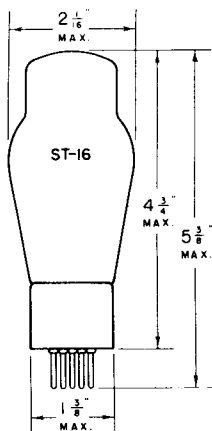

DUAL GRID POWER AMPLIFIER

COATED FILAMENT

2.5 VOLTS 1.75 AMPERES
AC OR DC

GLASS BULB

MEDIUM 5 PIN BASE

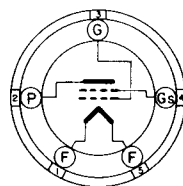

5C

BOTTOM VIEW

THE TUNG-SOL 46 IS A DUAL GRID POWER TUBE DESIGNED FOR USE IN A CLASS A OR CLASS B OUTPUT STAGE.

OPERATING CONDITIONS AND CHARACTERISTICS

CLASS A₁ AMPLIFIERGRID G₂ CONNECTED TO PLATE AT SOCKET

PLATE VOLTAGE	250	VOLTS
GRID VOLTAGE ^A	-33	VOLTS
PLATE CURRENT	22	MA.
PLATE RESISTANCE	2380	OHMS
TRANSCONDUCTANCE	2350	μMHOS
AMPLIFICATION FACTOR	5.6	
LOAD RESISTANCE	6400	OHMS
POWER OUTPUT ^B	1.25	WATTS

^A MEASURED FROM MIDPOINT OF AC OPERATED FILAMENT.^B APPROXIMATELY TWICE THIS VALUE IS RECOMMENDED FOR LOAD WHEN THIS TUBE IS USED AS DRIVER FOR CLASS B STAGE.

CLASS B AMPLIFIER - TWO TUBES

GRIDS CONNECTED TOGETHER AT SOCKET

PLATE VOLTAGE	300	400 ^{MAX.}	VOLTS
GRID VOLTAGE	0	0	VOLTS
ZERO-SIGNAL PLATE CURRENT	8	12	MA.
PEAK PLATE CURRENT ^{PER TUBE}	200 ^{MAX.}	200 ^{MAX.}	MA.
MAXIMUM PLATE DISSIPATION	10	10	WATTS
LOAD RESISTANCE ^{PLATE TO PLATE}	5200	5800	OHMS
AVERAGE POWER INPUT ^{GRID TO GRID}	0.95	0.65	WATT
POWER OUTPUT	16	20	WATTS

PLATE

474-1

JUNE 26
1939

TUNG-SOL

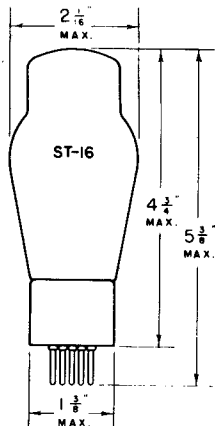

PENTODE POWER AMPLIFIER

COATED FILAMENT

2.5 VOLTS 1.75 AMPERES
AC OR DC

GLASS BULB

MEDIUM 5 PIN BASE

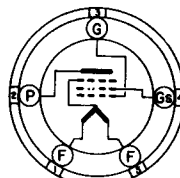

5B

BOTTOM VIEW

THE TUNG-SOL 47 IS A FILAMENT TYPE OUTPUT POWER PENTODE.

OPERATING CONDITIONS AND CHARACTERISTICS

CLASS A AMPLIFIER

PLATE VOLTAGE	250 MAX.	VOLTS
SCREEN VOLTAGE	250 MAX.	VOLTS
CONTROL GRID VOLTAGE ^A	-16.5	VOLTS
PLATE CURRENT	31	MA.
SCREEN CURRENT	6	MA.
PLATE RESISTANCE	60 000	OHMS
TRANSCONDUCTANCE	2500	μMHΩS
AMPLIFICATION FACTOR	150	
LOAD RESISTANCE	7000	OHMS
POWER OUTPUT ^B	2.7	WATTS

^A MEASURED FROM MIDPOINT OF AC OPERATED FILAMENT.^B 6% TOTAL HARMONIC DISTORTION.

TUNG-SOL

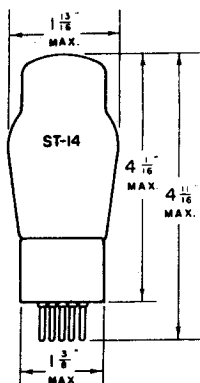

DUAL GRID POWER AMPLIFIER

COATED FILAMENT

2.0 VOLTS 0.12 AMPERE
DC

GLASS BULB

MEDIUM 5 PIN BASE

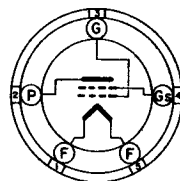

5C

BOTTOM VIEW

THE TUNG-SOL 49 IS A DUAL GRID POWER TUBE DESIGNED FOR USE IN A CLASS A OR CLASS B OUTPUT STAGE.

OPERATING CONDITIONS AND CHARACTERISTICS

CLASS A₁ AMPLIFIERGRID G_s CONNECTED TO PLATE AT SOCKET

PLATE VOLTAGE	135 ^{MAX.}	VOLTS
GRID VOLTAGE ^A	-20	VOLTS
PLATE CURRENT	6.0	MA.
PLATE RESISTANCE	4175	OHMS
TRANSCONDUCTANCE	1125	μMHOS
AMPLIFICATION FACTOR	4.7	
LOAD RESISTANCE	11000 ^B	OHMS
POWER OUTPUT	0.170	WATT

^A RETURN TO NEGATIVE FILAMENT (PIN #5)^B APPROXIMATELY TWICE THIS VALUE IS RECOMMENDED FOR LOAD AS DRIVER FOR CLASS B STAGECLASS B₂ AMPLIFIER - TWO TUBES - PUSH-PULL

GRIDS CONNECTED TOGETHER AT SOCKET

PLATE VOLTAGE	135	180 ^{MAX.}	VOLTS
GRID VOLTAGE ^E	0	0	VOLTS
PEAK AF SIGNAL VOLTAGE ^C PER TUBE	35	35	VOLTS
ZERO-SIGNAL PLATE CURRENT ^D PER TUBE	1.3	2	MA.
EFFECTIVE LOAD RESISTANCE ^C PLATE TO PLATE	8000	12000	OHMS
POWER OUTPUT ^C APPROX.	2.3	3.5	WATTS

^C FOR POWER OUTPUT SHOWN^D MAXIMUM PEAK PLATE CURRENT IS 50 MA.^E RETURN TO NEGATIVE FILAMENT (PIN #5)

FOR "INTERPRETATION OF RATINGS" REFER TO THE FRONT OF BOOK.

TUNG-SOL

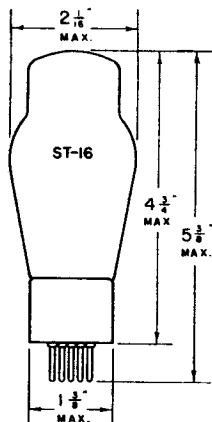

TRIODE POWER AMPLIFIER

COATED FILAMENT

7.5 VOLTS 1.25 AMPERES
AC OR DC

GLASS BULB

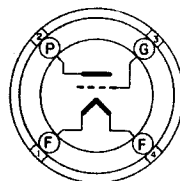

4D

BOTTOM VIEW

MEDIUM 4 PIN BASE

THE TUNG-SOL 50 IS A FILAMENT TYPE POWER OUTPUT TUBE.

OPERATING CONDITIONS AND CHARACTERISTICS

CLASS A₁ AMPLIFIER

PLATE VOLTAGE	300	350	400	450	VOLTS
GRID VOLTAGE ^A	-54	-63	-70	-84	VOLTS
PLATE CURRENT	35	45	55	55	MA.
PLATE RESISTANCE	2000	1900	1800	1800	OHMS
TRANSCONDUCTANCE	1900	2000	2100	2100	μMHOS
AMPLIFICATION FACTOR	3.8	3.8	3.8	3.8	
LOAD RESISTANCE	4600	4100	3670	4350	OHMS
POWER OUTPUT	1.6	2.4	3.4	4.6	WATTS

^A GRID VOLTAGE MEASURED FROM MID-POINT OF AC OPERATED FILAMENT.

SELF BIAS IS RECOMMENDED IN ALL CASES. THE GRID CIRCUIT RESISTANCE SHOULD NOT EXCEED 10 000 OHMS.

DIRECT INTERELECTRODE CAPACITANCES

GRID TO FILAMENT	4.2	μμf
PLATE TO FILAMENT	3.4	μμf
GRID TO PLATE	7.1	μμf

PLATE
908-2

TUNG-SOL

BEAM PENTODE

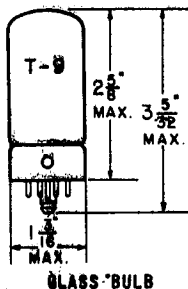

COATED UNIPOTENTIAL CATHODE

HEATER

50 VOLTS 150 MA.

AC OR DC

ANY MOUNTING POSITION

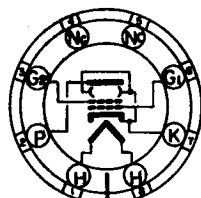

BOTTOM VIEW
LOCKING-IN
8 PIN BASE

THE 50A5 IS DESIGNED FOR SERVICE IN THE OUTPUT STAGE OF AC/DC RECEIVERS. IT DELIVERS HIGH POWER OUTPUT WITH HIGH POWER SENSITIVITY FROM LOW SUPPLY VOLTAGES.

RATINGS

INTERPRETED ACCORDING TO RMA STANDARD W8-210

HEATER VOLTAGE	50	VOLTS
MAXIMUM PLATE VOLTAGE	200	VOLTS
MAXIMUM GRID #2 VOLTAGE	117	VOLTS
MAXIMUM PLATE DISSIPATION	10	WATTS
MAXIMUM GRID #2 DISSIPATION	1.25	WATTS

TYPICAL OPERATING CONDITIONS AND CHARACTERISTICS

CLASS A₁ AMPLIFIER

HEATER VOLTAGE	50	50	VOLTS
HEATER CURRENT	150	150	MA.
PLATE VOLTAGE	110	200	VOLTS
GRID #2 VOLTAGE	110	110	VOLTS
GRID #1 VOLTAGE	-7.5	-8	VOLTS
PEAK AF SIGNAL VOLTAGE	7.5	8	VOLTS
GRID CIRCUIT RESISTANCE (MAX.):			
FOR FIXED BIAS	0.1	0.1	MEGOHM
FOR CATHODE BIAS	0.5	0.5	MEGOHM
ZERO SIGNAL PLATE CURRENT	49	50	MA.
ZERO SIGNAL GRID #2 CURRENT (NOMINAL)	4	1.5	MA.
MAXIMUM SIGNAL PLATE CURRENT	50	55	MA.
MAXIMUM SIGNAL GRID #2 CURRENT (NOMINAL)	11	6	MA.
PLATE RESISTANCE (APPROX.)	10 000	35 000	OHMS
TRANSCONDUCTANCE	8 200	8 250	μMHOS
LOAD RESISTANCE	2 000	3 000	OHMS
TOTAL HARMONIC DISTORTION	10	10	PERCENT
POWER OUTPUT	2.2	4.7	WATTS

SIMILAR TYPE REFERENCE: Ratings and characteristics identical to 50L6GT. Except for heater ratings identical to 25L6GT, somewhat similar to 35L6GT.

PLATE
1864

AUG. 1,
1947



TUNG-SOL

BEAM POWER AMPLIFIER

MINIATURE TYPE

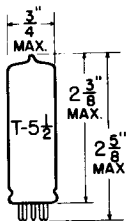

GLASS BULB

UNIPOTENTIAL CATHODE

HEATER

50 VOLTS 0.15 AMPERE

AC OR DC

ANY MOUNTING POSITION

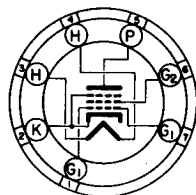
 BOTTOM VIEW
 MINIATURE BUTTON
 7 PIN BASE

THE 50B5 IS A BEAM POWER AMPLIFIER IN THE MINIATURE CONSTRUCTION. BECAUSE OF ITS HIGH POWER SENSITIVITY AT LOW PLATE-SCREEN VOLTAGE, IT IS PARTICULARLY ADAPTABLE TO AC/DC RECEIVER APPLICATIONS.

RATINGS

INTERPRETED ACCORDING TO RMA STANDARD M8-210

HEATER VOLTAGE	50	VOLTS
HEATER CURRENT	0.15	AMP.
MAXIMUM PLATE VOLTAGE	117	VOLTS
MAXIMUM SCREEN VOLTAGE	117	VOLTS
MAXIMUM PLATE DISSIPATION	5.5	WATTS
MAXIMUM SCREEN DISSIPATION	1.25	WATTS
MAXIMUM HEATER-CATHODE VOLTAGE	90	VOLTS

 DIRECT INTERELECTRODE CAPACITANCES - APPROX.
 WITH NO EXTERNAL SHIELD

GRID TO PLATE	0.5	$\mu\mu\text{f}$
INPUT	13	$\mu\mu\text{f}$
OUTPUT	6.5	$\mu\mu\text{f}$

TYPICAL OPERATING CONDITIONS AND CHARACTERISTICS

CLASS A₁ AMPLIFIER

PLATE VOLTAGE	110	VOLTS
SCREEN VOLTAGE	110	VOLTS
GRID VOLTAGE	-7.5	VOLTS
PEAK AF GRID VOLTAGE	7.5	VOLTS
ZERO-SIGNAL PLATE CURRENT	49	MA.
ZERO-SIGNAL SCREEN CURRENT (APPROX.)	4	MA.
MAXIMUM-SIGNAL PLATE CURRENT	50	MA.
MAXIMUM-SIGNAL SCREEN CURRENT (APPROX.)	8.5	MA.
GRID CIRCUIT RESISTANCE (MAX.):		
FOR FIXED BIAS	0.1	MEG OHM
FOR CATHODE BIAS	0.5	MEG OHM
LOAD RESISTANCE	2 500	OHMS
PLATE RESISTANCE (APPROX.)	14 000	OHMS
TRANSCONDUCTANCE	7 500	μMHOS
MAXIMUM-SIGNAL POWER OUTPUT	1.9	WATTS
TOTAL HARMONIC DISTORTION	9	PERCENT

SIMILAR TYPE REFERENCE: Within its ratings similar to 50L6GT. Except for heater ratings somewhat similar to 25B5, 35B5, 35L6GT.

→ INDICATES A CHANGE OR ADDITION.

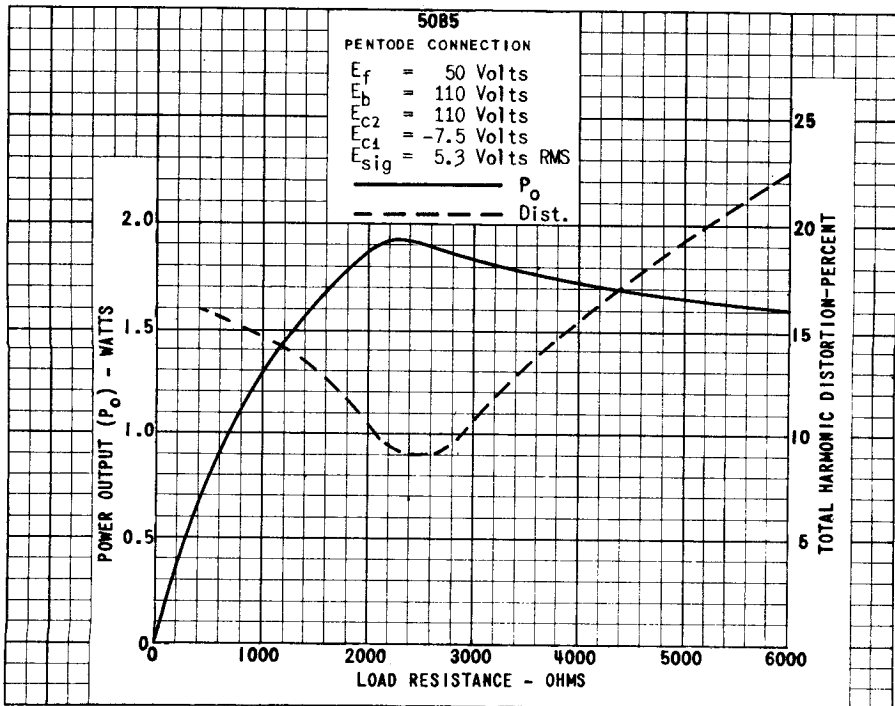
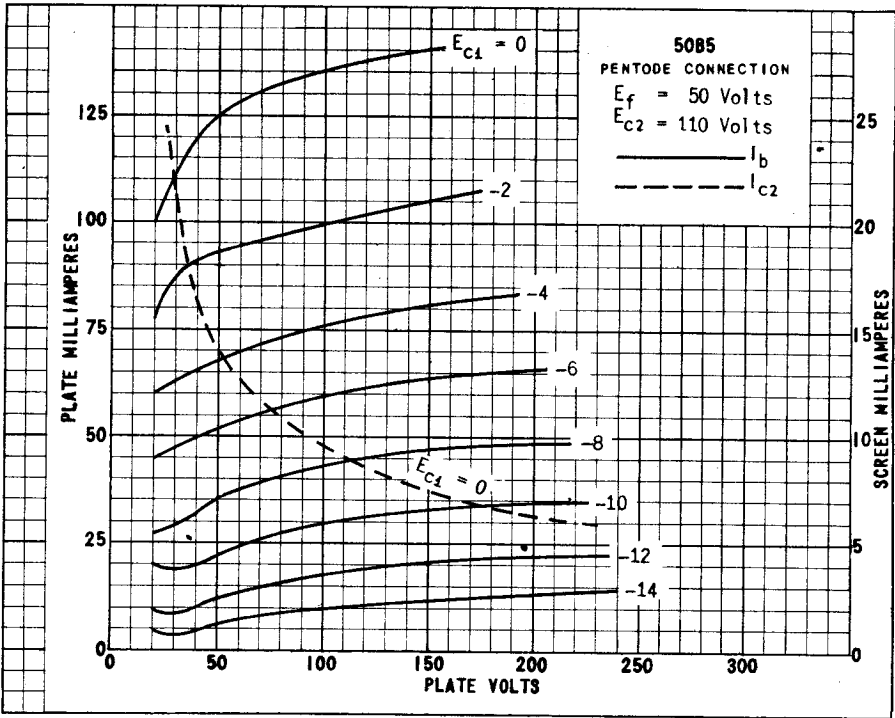

TUNG-SOL

BEAM PENTODE

MINIATURE TYPE

UNIPOENTIAL CATHODE

HEATER

50 VOLTS 150 MA.

AC OR DC

ANY MOUNTING POSITION

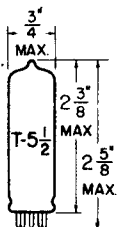

GLASS BULB

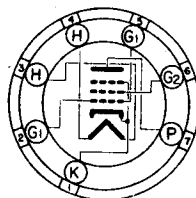

BOTTOM VIEW

MINIATURE BUTTON
7 PIN BASE

THE 50C5 IS A BEAM POWER AMPLIFIER IN THE MINIATURE CONSTRUCTION. BECAUSE OF ITS HIGH POWER SENSITIVITY AT LOW PLATE-SCREEN VOLTAGE, IT IS PARTICULARLY ADAPTABLE TO AC/DC RECEIVER APPLICATIONS.

DIRECT INTERELECTRODE CAPACITANCES - APPROX.

WITH NO EXTERNAL SHIELD

GRID TO PLATE: (G_1 TO P)	0.64	$\mu\mu\text{f}$
INPUT: G_1 TO ($H+K+G_3+G_2$)	13	$\mu\mu\text{f}$
OUTPUT: P TO ($H+K+G_3+G_2$)	6.1	$\mu\mu\text{f}$

RATINGS

INTERPRETED ACCORDING TO RMA STANDARD MB-210

HEATER VOLTAGE	50	VOLTS
MAXIMUM HEATER-CATHODE VOLTAGE	180	VOLTS
MAXIMUM PLATE VOLTAGE	135	VOLTS
MAXIMUM GRID #2 VOLTAGE	117	VOLTS
MAXIMUM PLATE DISSIPATION	5.5	WATTS
MAXIMUM SCREEN DISSIPATION	1.25	WATTS
MAXIMUM GRID #1 CIRCUIT RESISTANCE (FIXED BIAS)	0.1	MEGOHM
MAXIMUM GRID #1 CIRCUIT RESISTANCE (SELF BIAS)	0.5	MEGOHM
MAXIMUM BULB TEMPERATURE (AT HOTTEST POINT ON BULB SURFACE)	250	$^{\circ}\text{C}$

TYPICAL OPERATING CONDITIONS AND CHARACTERISTICS

CLASS A_1 AMPLIFIER

HEATER VOLTAGE	50	VOLTS
HEATER CURRENT	150	VOLTS
PLATE VOLTAGE	110	VOLTS
SCREEN VOLTAGE	110	VOLTS
GRID #1 VOLTAGE	-7.5	VOLTS
PEAK AF GRID #1 VOLTAGE	7.5	VOLTS
ZERO-SIGNAL PLATE CURRENT	49	MA.
ZERO-SIGNAL GRID #2 CURRENT (NOMINAL)	4	MA.
MAXIMUM SIGNAL PLATE CURRENT	50	MA.
MAXIMUM SIGNAL GRID #2 CURRENT (NOMINAL)	8.5	MA.
PLATE RESISTANCE	10 000	OHMS
TRANSCONDUCTANCE	7 500	μMHOS
LOAD RESISTANCE	2 500	OHMS
TOTAL HARMONIC DISTORTION	9	PERCENT
MAXIMUM SIGNAL POWER OUTPUT	1.9	WATTS

SIMILAR TYPE REFERENCE: Ratings and characteristics somewhat similar to type 50B5.

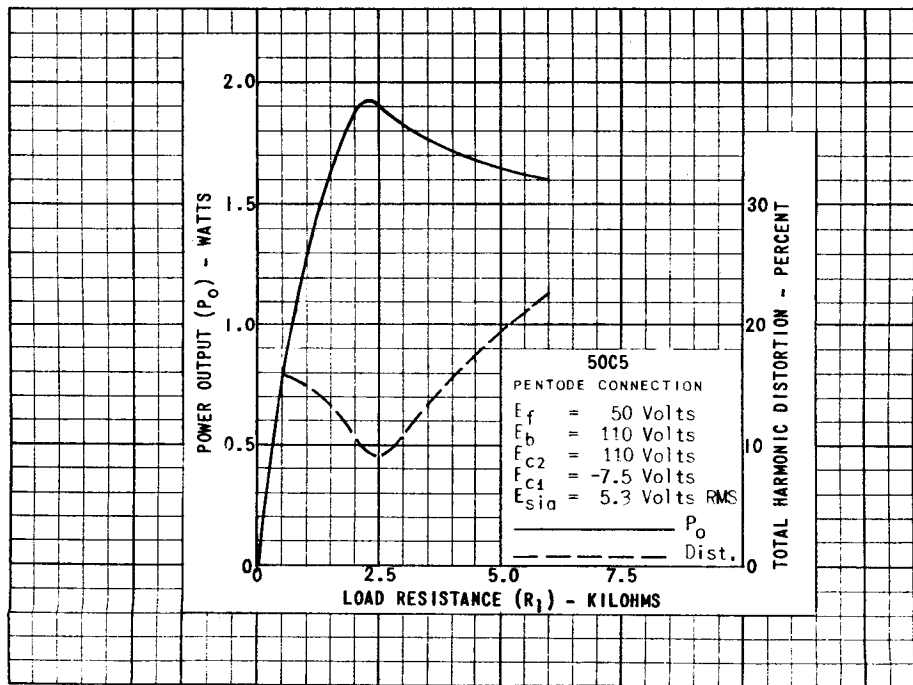
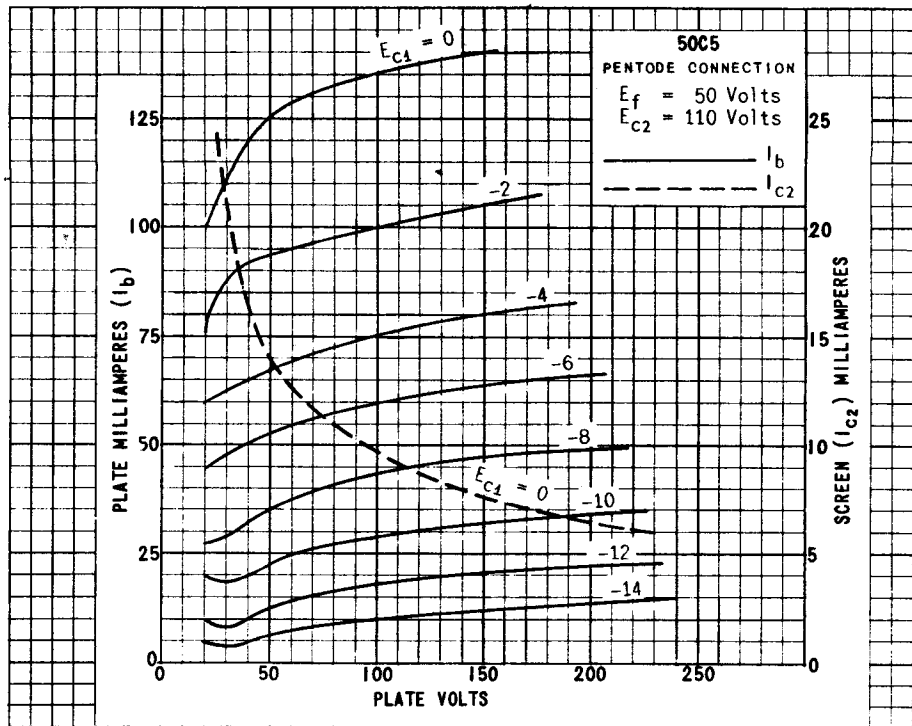

TUNG-SOL

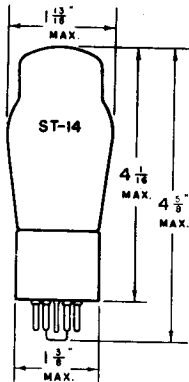

BEAM POWER AMPLIFIER

U. POTENTIAL CATHODE

HEATER

50.0 VOLTS 0.15 AMPERE
AC OR DC

GLASS BLLB

MEDIUM 7 PIN OCTAL BASE

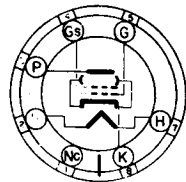

G-7AC

BOTTOM VIEW

THE TUNG-SOL 50C6G IS A BEAM POWER AMPLIFIER, DESIGNED FOR SERVICE IN THE OUTPUT STAGE OF AC-DC RECEIVERS. IT FEATURES HIGH POWER OUTPUT WITH LOW SUPPLY VOLTAGES.

RATINGS

MAXIMUM PLATE VOLTAGE	200	VOLTS
MAXIMUM SCREEN VOLTAGE	135	VOLTS
MAXIMUM PLATE DISSIPATION	12.5	WATTS
MAXIMUM SCREEN DISSIPATION	1.75	WATTS

TYPICAL OPERATING CONDITIONS AND CHARACTERISTICS

CLASS A₁ AMPLIFIER

PLATE VOLTAGE	135	200	VOLTS
SCREEN VOLTAGE	135	135	VOLTS
CONTROL GRID VOLTAGE ^A	-13.5	-14	VOLTS
PEAK-TO-PEAK SIGNAL VOLTAGE	13.5	14	VOLTS
ZERO-SIGNAL PLATE CURRENT	58	61	MA.
ZERO-SIGNAL SCREEN CURRENT (NOMINAL)	3.0	2.2	MA.
MAXIMUM-SIGNAL PLATE CURRENT	60	66	MA.
MAXIMUM-SIGNAL SCREEN CURRENT (NOMINAL)	10.5	9	MA.
PLATE RESISTANCE APPROX.	9300	18300	OHMS
TRANSCONDUCTANCE	7000	7100	μMHOS
LOAD RESISTANCE	2000	2600	OHMS
TOTAL HARMONIC DISTORTION	10	10	PER CENT
POWER OUTPUT	3.6	6.0	WATTS

^A THE DC RESISTANCE IN THE GRID CIRCUIT, UNDER MAXIMUM RATED CONDITIONS, SHOULD NOT EXCEED 0.5 MEGOHM FOR SELF-BIAS OPERATION AND 0.1 MEGOHM FOR FIXED BIAS OPERATION.

FOR "INTERPRETATION OF RATINGS" REFER TO FRONT OF BOOK.

CONTINUED NEXT PAGE

JUNE 6
1941

PLATE
1061-1

50C6G

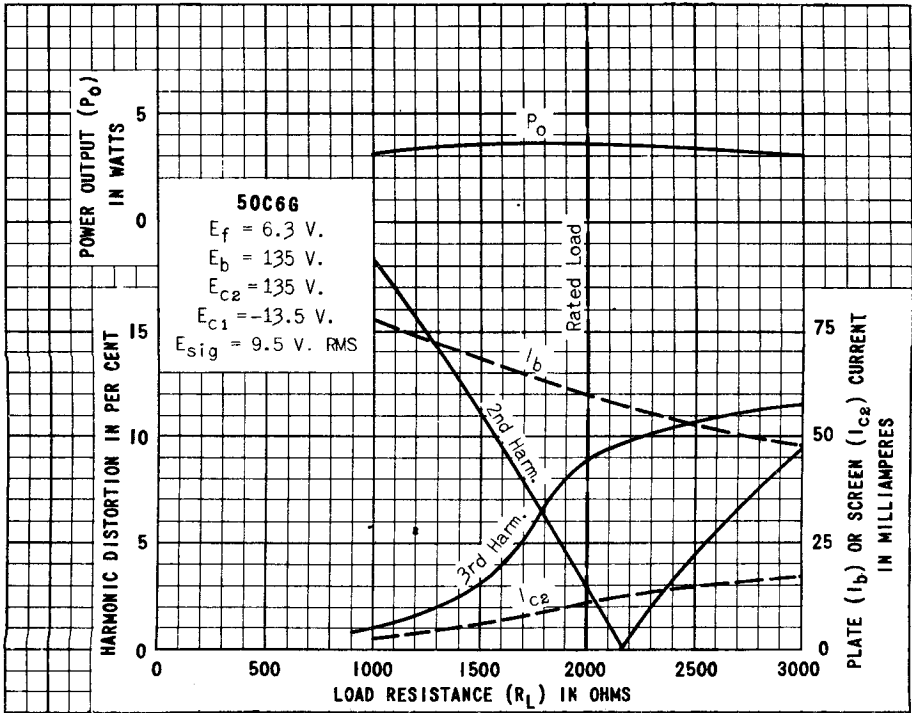
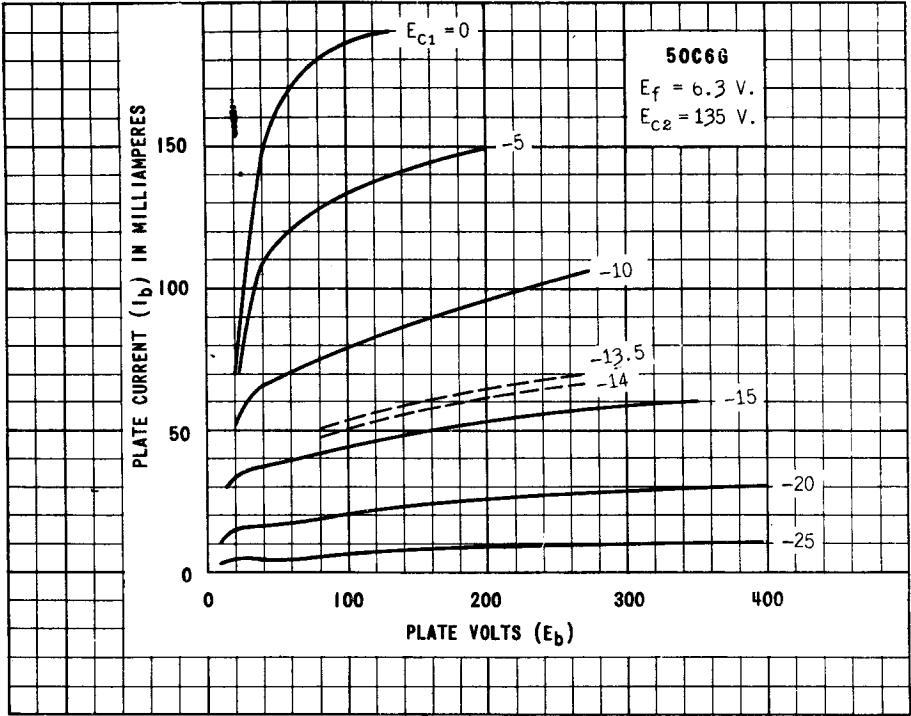
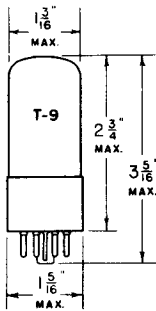

PLATE
1062-1

TUNG-SOL

BEAM POWER AMPLIFIER



UNIPOTENTIAL CATHODE

HEATER
50 VOLTS 0.15 AMPERE
AC OR DC

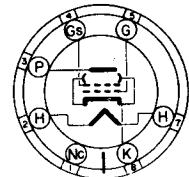

G-7AC

BOTTOM VIEW

CLASS BULB

INTERMEDIATE 7 PIN OCTAL BASE

THE TUNG-SOL 50L6GT IS DESIGNED FOR SERVICE IN THE OUTPUT STAGE OF AC-DC RECEIVERS. IT DELIVERS A HIGH POWER OUTPUT WITH HIGH POWER SENSITIVITY FROM LOW SUPPLY VOLTAGES.

RATINGS

MAXIMUM PLATE VOLTAGE	200	VOLTS
MAXIMUM SCREEN VOLTAGE	117	VOLTS
MAXIMUM PLATE DISSIPATION	10	WATTS
MAXIMUM SCREEN DISSIPATION	1.25	WATTS

TYPICAL OPERATING CONDITIONS AND CHARACTERISTICS

CLASS A₁ AMPLIFIER

PLATE VOLTAGE	110	200	VOLTS
SCREEN VOLTAGE	110	110	VOLTS
CONTROL GRID VOLTAGE ^A	-7.5	-8	VOLTS
PEAK AF SIGNAL VOLTAGE	7.5	8	VOLTS
ZERO-SIGNAL PLATE CURRENT	49	50	MA.
ZERO-SIGNAL SCREEN CURRENT - NOMINAL	4	1.5	MA.
MAXIMUM-SIGNAL PLATE CURRENT	50	55	MA.
MAXIMUM-SIGNAL SCREEN CURRENT - NOMINAL	11	6	MA.
PLATE RESISTANCE APPROX.	10 000	35 000	OHMS
TRANSCONDUCTANCE	8200	8250	μMHOS
LOAD RESISTANCE	2000	3000	OHMS
TOTAL HARMONIC DISTORTION	10	10	PER CENT
POWER OUTPUT	2.2	4.7	WATTS

^A THE DC RESISTANCE IN THE GRID CIRCUIT, UNDER MAXIMUM RATED CONDITIONS, SHOULD NOT EXCEED 0.5 MEGOHM FOR SELF-BIAS OPERATION AND 0.1 MEGOHM FOR FIXED BIAS OPERATION.

FOR "INTERPRETATION OF RATINGS" REFER TO FRONT OF BOOK.

50L6GT

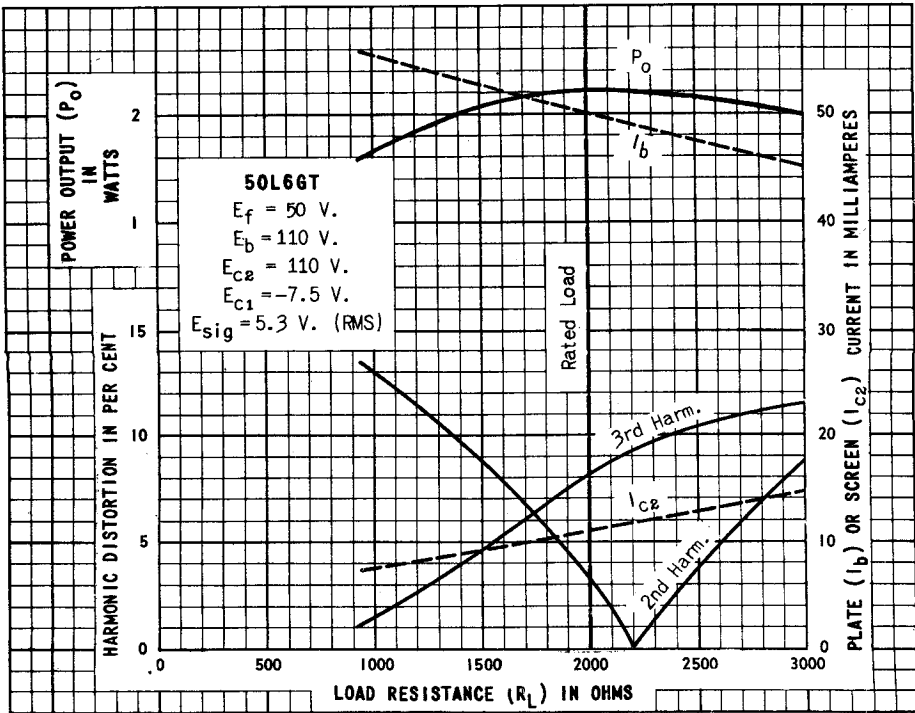
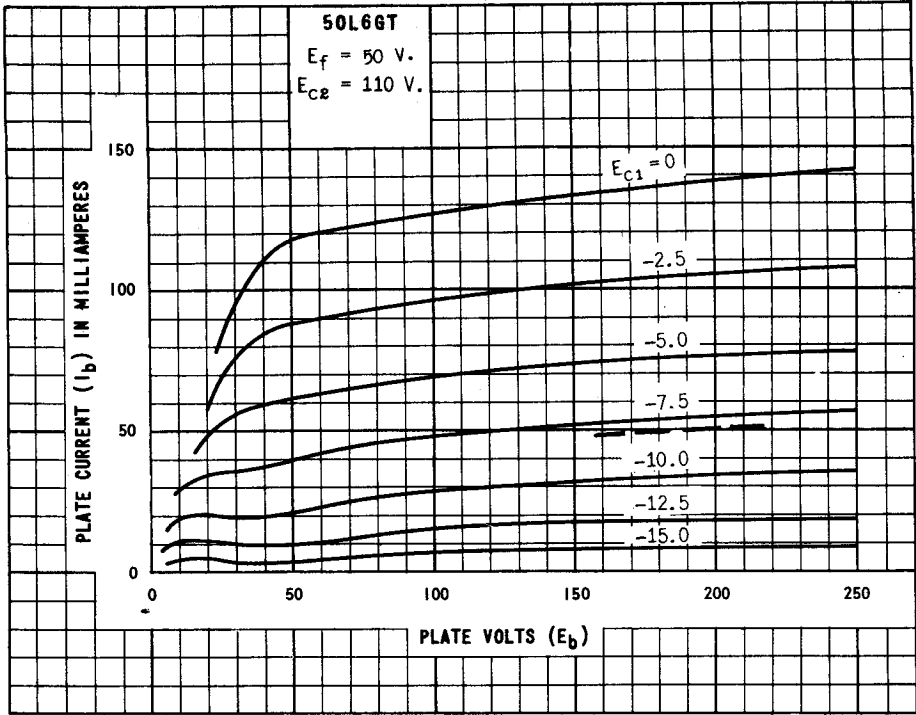

TUNG-SOL

DOUBLE DIODE

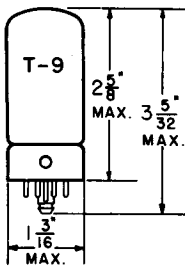

GLASS BULB

COATED UNIPOTENTIAL CATHODE

HEATER

50 VOLTS 150 MA.

AC OR DC

ANY MOUNTING POSITION

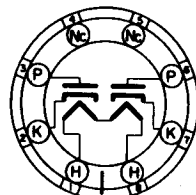

BOTTOM VIEW
LOCK-IN
8 PIN BASE

THE 50X6 COMBINES TWO INDEPENDENT DIODES IN THE LOCK-IN CONSTRUCTION PERMITTING THE TUBE TO BE USED AS A POWER RECTIFIER IN EITHER HALF-WAVE, FULL-WAVE, OR VOLTAGE DOUBLER APPLICATIONS.

RATINGS

INTERPRETED ACCORDING TO RMA STANDARD M8-210

HEATER VOLTAGE	50	VOLTS
MAXIMUM HEATER-CATHODE VOLTAGE	350	VOLTS
MAXIMUM INVERSE PLATE VOLTAGE	700	VOLTS
MAXIMUM STEADY STATE PEAK PLATE CURRENT PER PLATE	450	MA.
MAXIMUM DC OUTPUT CURRENT PER PLATE	75	MA.
TUBE VOLTAGE DROP (MEASURED WITH TUBE CONDUCTING 150 MA. AT PLATE)	22	VOLTS

TYPICAL OPERATING CONDITIONS AND CHARACTERISTICS

VOLTAGE DOUBLER

	HALF WAVE	FULL WAVE	
HEATER VOLTAGE	50	50	VOLTS
HEATER CURRENT	150	150	MA.
AC PLATE VOLTAGE, EACH PLATE RMS	117	117	VOLTS
FILTER INPUT CONDENSER	16	16	μ f
MINIMUM TOTAL EFFECTIVE PLATE SUPPLY IMPEDANCE	30	15	OHMS
DC OUTPUT CURRENT	75	75	MA.

HALF-WAVE RECTIFIER

	SINGLE SECTION	CONDENSER INPUT FILTER		
HEATER VOLTAGE	50	50	50	VOLTS
HEATER CURRENT	150	150	150	MA.
AC PLATE SUPPLY VOLTAGE RMS	117	150	235	VOLTS
FILTER INPUT CONDENSER	16	16	16	μ f
MINIMUM TOTAL EFFECTIVE PLATE SUPPLY IMPEDANCE	15	40	100	OHMS
DC OUTPUT CURRENT	75	75	75	MA.

SIMILAR TYPE REFERENCE: Electrically equivalent to 50Y78F without pilot lamp.

PRINTED IN U. S. A.

PLATE 2074
SEPT. 1 1948

50X6

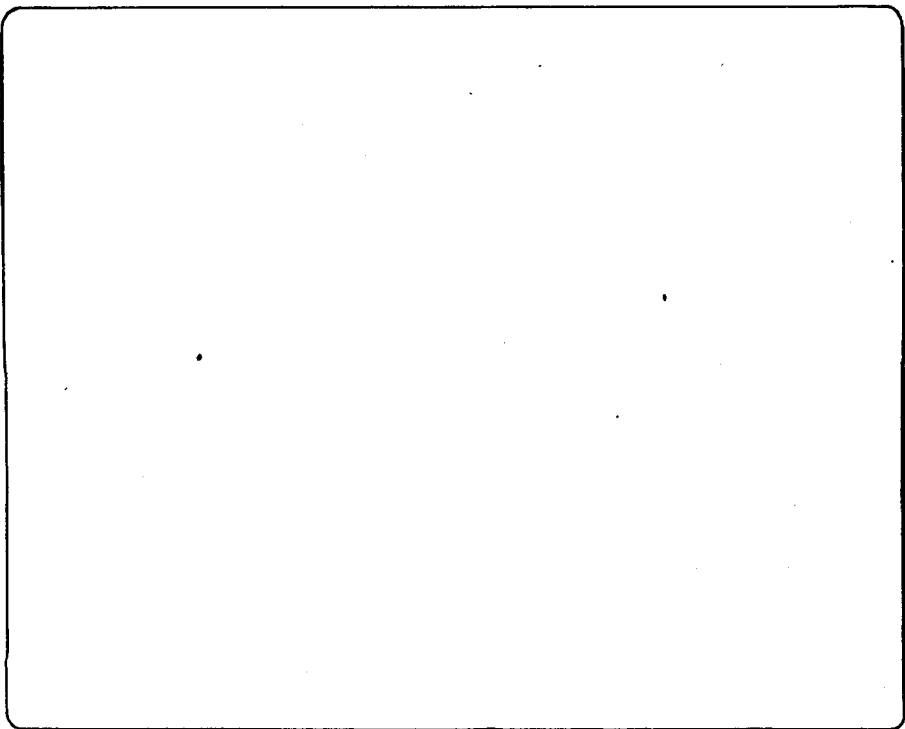
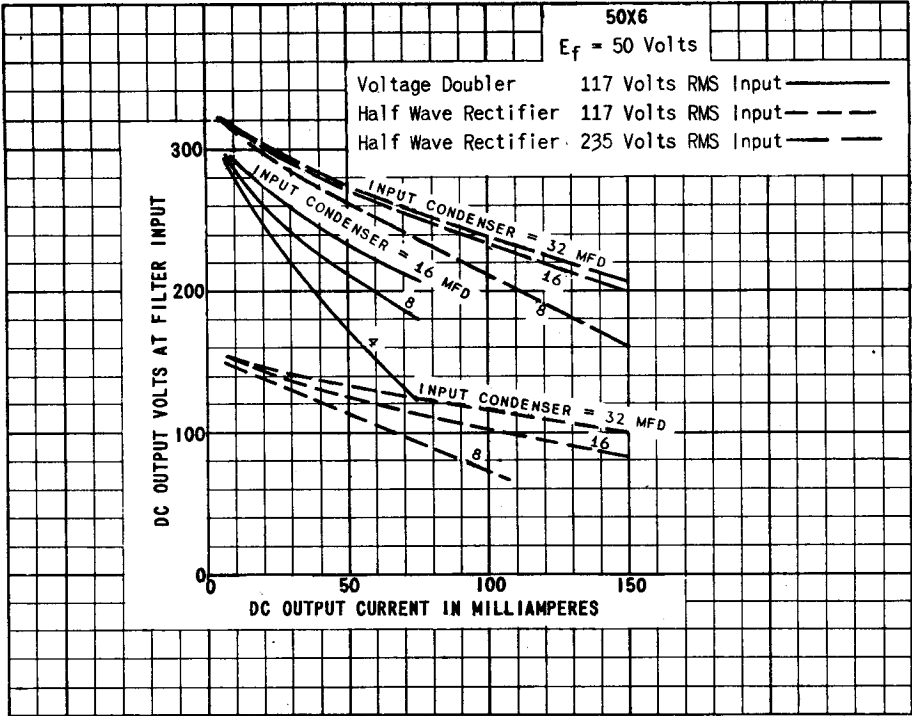
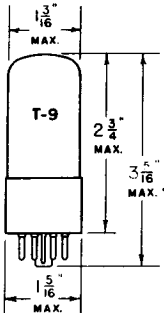

PLATE
2075
SEPT. 1
1948

TUNG-SOL

TWIN DIODE HIGH VACUUM RECTIFIER

VOLTAGE DOUBLER



UNI-POTENTIAL CATHODE

HEATER

50 VOLTS 0.15 AMPERE

AC OR DC

GLASS BULB

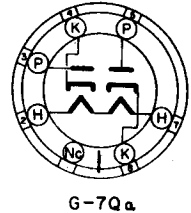

G-7Qa

BOTTOM VIEW

INTERMEDIATE 7 PIN OCTAL BASE

THE TUNG-SOL 50Y6GT/G IS DESIGNED PRIMARILY FOR SERVICE AS A POWER RECTIFIER IN AC - DC RECEIVERS. TWO SEPARATE RECTIFIER SECTIONS PERMIT USING THE TUBE AS A VOLTAGE DOUBLER, FULL WAVE RECTIFIER OR HALF WAVE RECTIFIER. FOR HALF WAVE OPERATION THE TWO SECTIONS MAY BE OPERATED SEPARATELY, OR IN PARALLEL TO REDUCE TUBE DROP. ITS RATINGS AND ELECTRICAL CHARACTERISTICS ARE IDENTICAL TO THOSE OF THE 25Z5 AND THE 25Z6GT/G.

RATINGS

MAXIMUM AC PLATE VOLTAGE (RMS)	235	VOLTS
MAXIMUM DC HEATER TO CATHODE POTENTIAL	350	VOLTS
MAXIMUM PEAK INVERSE VOLTAGE	700	VOLTS
MAXIMUM STEADY-STATE PEAK PLATE CURRENT PER PLATE	450	MA.
TUBE VOLTAGE DROP	22	VOLTS
AT 150 MA. PER PLATE		

TYPICAL OPERATING CONDITIONS AND CHARACTERISTICS

VOLTAGE DOUBLER

	HALF WAVE	FULL WAVE	
AC VOLTAGE PER PLATE (RMS) ^{MAX.}	117	117	VOLTS
AC OUTPUT CURRENT ^{MAX.}	75	75	MA.
TOTAL EFFECTIVE PLATE SUPPLY IMPEDANCE PER PLATE ^{MIN.}	30	15	OHMS

^A WHEN FILTER CONDENSERS LARGER THAN 40 UFDS ARE USED IT MAY BE NECESSARY TO ADD ADDITIONAL PLATE SUPPLY IMPEDANCE.

FOR "INTERPRETATION OF RATINGS" REFER TO FRONT OF BOOK.

CONTINUED NEXT PAGE

PLATE
1063-2

JUNE 6
1941

TUNG-SOL

HALF WAVE RECTIFIER

AC PLATE VOLTAGE PER PLATE (RMS)	117	150	235 ^{MAX.}	VOLTS
DC OUTPUT CURRENT PER PLATE ^{MAX.}	75	75	75	MA.
TOTAL EFFECTIVE PLATE SUPPLY	15	40	100	OHMS
IMPEDANCE PER PLATE ^{MIN.}				

^A WHEN FILTER CONDENSERS LARGER THAN 40 UFDS ARE USED IT MAY BE NECESSARY TO ADD ADDITIONAL PLATE SUPPLY IMPEDANCE.

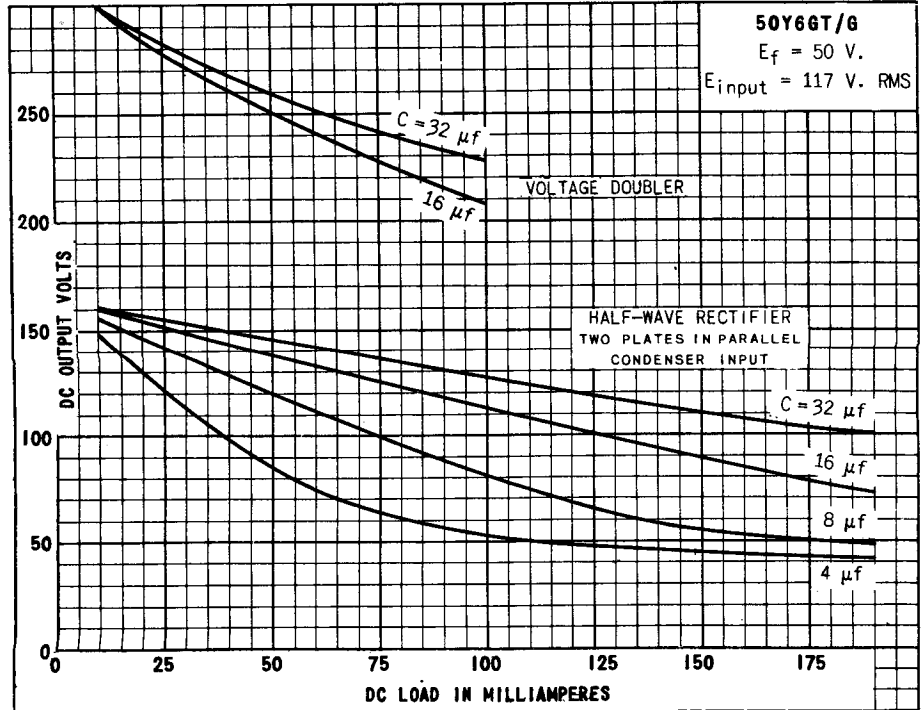
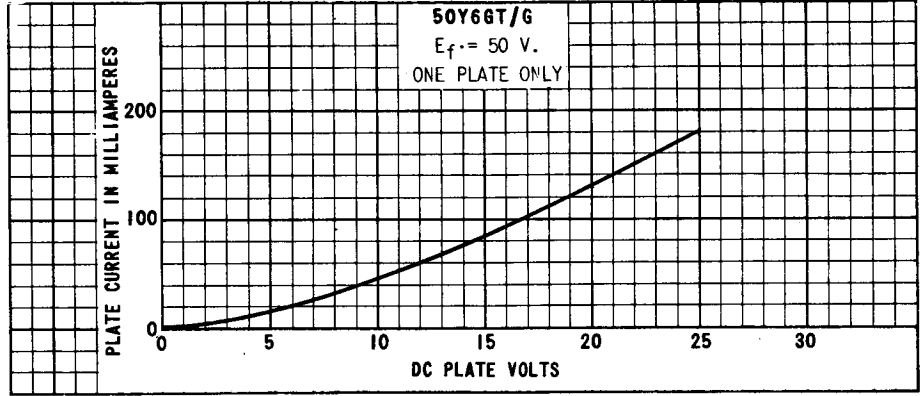

TUNG-SOL

DOUBLE DIODE

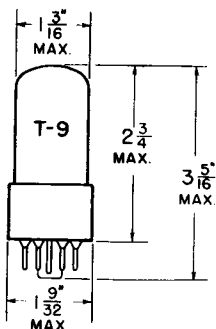

GLASS BULB

COATED UNIPOTENTIAL CATHODE

HEATER

50 VOLTS 150 MA.

AC OR DC

ANY MOUNTING POSITION

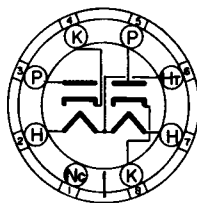

BOTTOM VIEW
INTERMEDIATE SHELL
8 PIN OCTAL

THE 50Y7GT IS A TWIN DIODE POWER RECTIFIER TUBE USING THE LOCK-IN CONSTRUCTION. EACH DIODE UNIT IS INDEPENDENT WHICH PERMITS OPERATION AS EITHER HALF-WAVE, FULL-WAVE, OR VOLTAGE DOUBLER. THE HEATER IS COMMON TO THE TWO UNITS AND PROVIDES A TAP CONNECTION FOR PILOT LIGHT OPERATION.

RATINGS

INTERPRETED ACCORDING TO RMA STANDARD MB-210

HEATER VOLTAGE	50	VOLTS
MAXIMUM HEATER-CATHODE VOLTAGE	350	VOLTS
MAXIMUM PEAK INVERSE PLATE VOLTAGE	700	VOLTS
MAXIMUM AC PLATE VOLTAGE EACH PLATE (RMS)		
VOLTAGE DOUBLER	117	VOLTS
HALF-WAVE RECTIFIER	235	VOLTS
MAXIMUM STEADY STATE PEAK PLATE CURRENT EACH PLATE	450	MA.
TAPPED SECTION VOLTAGE (PINS #6 & #7)	7.5	VOLTS
MAXIMUM DC OUTPUT CURRENT EACH PLATE	75	MA.
MAXIMUM DC OUTPUT CURRENT EACH PLATE WITH PANEL LAMP	65	MA.
TUBE VOLTAGE DROP (MEASURED WITH TUBE CONDUCTING 150 MA. EACH PLATE)	22	VOLTS

TYPICAL OPERATING CONDITIONS AND CHARACTERISTICS

VOLTAGE DOUBLER

HEATER VOLTAGE	46	VOLTS
HEATER CURRENT	150	MA.
AC PLATE SUPPLY VOLTAGE (RMS)	117	VOLTS
DC PLATE CURRENT TOTAL	65	MA.
MINIMUM TOTAL EFFECTIVE PLATE SUPPLY IMPEDANCE EACH PLATE	15	OHMS
PANEL LAMP SHUNTING RESISTOR	250	OHMS

HALF-WAVE RECTIFIER

SINGLE SECTION CONDENSER INPUT FILTER
WITH #40 OR #47 PANEL LAMP

HEATER VOLTAGE (PINS #2 & #7)	46	46	46	VOLTS
HEATER CURRENT	150	150	150	MA.
AC PLATE SUPPLY VOLTAGE (RMS)	117	150	235	VOLTS
MINIMUM TOTAL EFFECTIVE PLATE SUPPLY IMPEDANCE EACH PLATE	15	40	100	OHMS
DC OUTPUT CURRENT PER PLATE	65	65	65	MA.

SIMILAR TYPE REFERENCE: Without pilot lamp electrically equivalent to type 50Y6.

PRINTED IN U. S. A.



TUNG-SOL

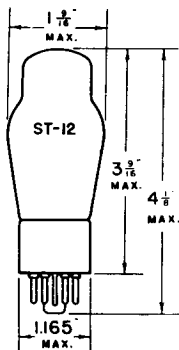

TWIN DIODE HIGH VACUUM RECTIFIER

VOLTAGE DOUBLER

UNIPOTENTIAL CATHODES

HEATER

50 VOLTS 0.15 AMPERE

AC OR DC

GLASS BULB

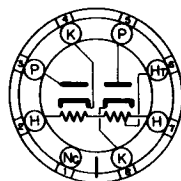

G-8AN

BOTTOM VIEW

SMALL 8 PIN OCTAL BASE

THE TUNG-SOL 50Z7G IS DESIGNED FOR SERVICE AS A POWER RECTIFIER IN AC-DC RECEIVERS. TWO SEPARATE RECTIFIER UNITS ALSO PERMIT THE USE OF THE TUBE AS A VOLTAGE DOUBLER, FULL WAVE RECTIFIER OR HALF WAVE RECTIFIER. WITH THE PROPER EXTERNAL CONNECTIONS, THE TAPPED SECTION OF THE HEATER SERVES AS A BALLAST RESISTOR FOR THE PANEL LAMP.

RATINGS

HEATER VOLTAGE (BETWEEN PINS #2 AND #7)	50.0	VOLTS
HEATER CURRENT (BETWEEN PINS #2 AND #7)	0.15	AMP.
MAXIMUM AC PLATE VOLTAGE PER PLATE (RMS)	235	VOLTS
MAXIMUM PEAK INVERSE VOLTAGE	700	VOLTS
MAXIMUM DC HEATER TO CATHODE POTENTIAL	350	VOLTS
MAXIMUM STEADY-STATE PEAK PLATE CURRENT PER PLATE	400	MA.
MAXIMUM DC OUTPUT CURRENT PER PLATE WITH PANEL LAMP	65	MA.
TAPPED SECTION OF HEATER VOLTAGE (BETWEEN PINS #6 & #7) WITH 0.15 AMP. FLOWING BETWEEN PINS #2 & #7	2.0	VOLTS
TUBE VOLTAGE DROP - AT 130 MA. DC PER PLATE	21	VOLTS

FOR "INTERPRETATION OF RATINGS" REFER TO FRONT OF BOOK.

CONTINUED NEXT PAGE

TUNG-SOL

TYPICAL OPERATING CONDITIONS AND CHARACTERISTICS

 HALF WAVE RECTIFIER
 WITH #292 OR #292A PANEL LAMP^A

HEATER VOLTAGE (BETWEEN PINS #2 AND #7) APPROX-	50.0	50.0	VOLTS
HEATER CURRENT (BETWEEN PINS #2 AND #6)	0.15	0.15	AMP.
MAXIMUM VOLTAGE ACROSS TAPPED SECTION OF HEATER (BETWEEN PINS #6 AND #7)	2.5	2.5	VOLTS
AC PLATE VOLTAGE PER PLATE (RMS)	117	235 ^{MAX}	VOLTS
DC OUTPUT CURRENT PER PLATE ^{MAX-}	65	65	MA.
TOTAL EFFECTIVE PLATE SUPPLY IMPEDANCE PER PLATE ^{MIN. B}	15	100	OHMS

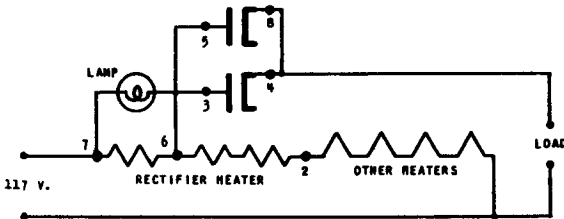
 VOLTAGE DOUBLER
 WITH #292 OR #292A PANEL LAMP^A

HEATER VOLTAGE (BETWEEN PINS #2 AND #7)	50.0	VOLTS
AC PLATE VOLTAGE PER PLATE (RMS) ^{MAX-}	117	VOLTS
DC OUTPUT CURRENT PER PLATE ^{MAX-}	65	MA.
TOTAL EFFECTIVE PLATE SUPPLY IMPEDANCE PER PLATE ^{MIN. B}	15	OHMS

^A IT IS RECOMMENDED THAT THE PLATE CURRENT OF THE RECTIFIER BE PASSED THROUGH THE PANEL LAMP AND THE TAPPED SECTION OF THE HEATER.

^B WHEN FILTER CONDENSERS LARGER THAN 40 μ FDS ARE USED, IT MAY BE NECESSARY TO ADD ADDITIONAL PLATE SUPPLY IMPEDANCE.

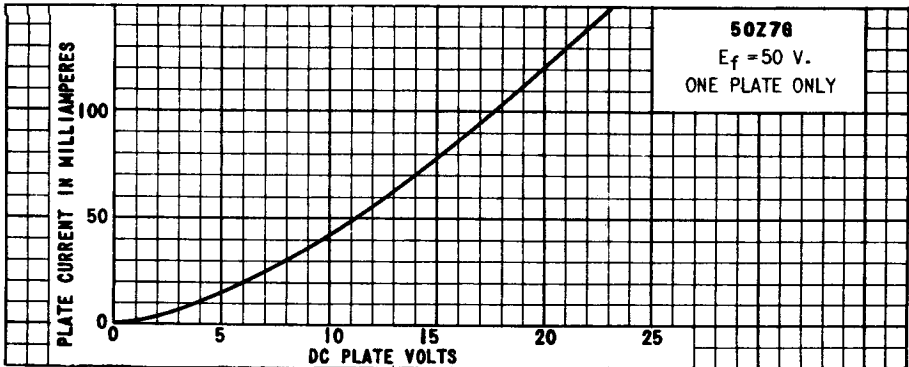

TUNG-SOL

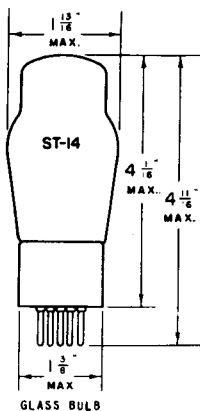

TWIN TRIODE POWER AMPLIFIER

UNIPOTENTIAL CATHODE

HEATER

2.5 VOLTS 2.0 AMPERES

AC OR DC

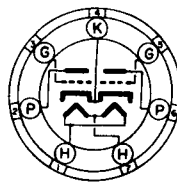
7B
BOTTOM VIEW
MEDIUM 7 PIN BASE

THE TUNG-SOL 53 IS A TWIN TRIODE DESIGNED PRIMARILY FOR SERVICE AS A CLASS B POWER AMPLIFIER. EXCEPT FOR CAPACITANCES AND HEATER RATINGS, ITS RATINGS AND ELECTRICAL CHARACTERISTICS ARE IDENTICAL TO THOSE OF THE 6N7, 6N7G AND THE 6A6.

RATINGS

MAXIMUM PLATE VOLTAGE	300	VOLTS
MAXIMUM PEAK PLATE CURRENT PER PLATE	125	MA.
MAXIMUM AVERAGE DISSIPATION PER PLATE	5.5	WATTS

OPERATING CONDITIONS AND CHARACTERISTICS

CLASS A₁ AMPLIFIER

TRIODES CONNECTED IN PARALLEL

PLATE VOLTAGE	250	294	VOLTS
GRID VOLTAGE	-5	-6	VOLTS
PLATE CURRENT	6	7	MA.
PLATE RESISTANCE	11300	11000	OHMS
TRANSCONDUCTANCE	3100	3200	μMHOS
AMPLIFICATION FACTOR	35	35	

CLASS B₂ AMPLIFIER - PUSH-PULL

UNLESS STATED OTHERWISE, VALUES ARE FOR TWO TUBES

	IDEAL	TYPICAL	
ZERO-SIGNAL PLATE VOLTAGE	300	300	VOLTS
DC GRID VOLTAGE	0	0	VOLT
AF-PEAK SIGNAL VOLTAGE PER GRID ^A	29	41	VOLTS
MAXIMUM PEAK-SIGNAL GRID CURRENT PER GRID	20	22	MA.
ZERO-SIGNAL PLATE CURRENT PER PLATE	17.5	17.5	MA.
MAXIMUM-SIGNAL DC PLATE CURRENT PER PLATE	35	35	MA.
GRID IMPEDANCE AT 400 CYCLES	0	516 ^B	OHMS
PLATE SUPPLY IMPEDANCE	0	1000	OHMS
EFFECTIVE LOAD RESISTANCE ^{PLATE-TO-PLATE}	8000	8000	OHMS
TOTAL HARMONIC DISTORTION	4	8	PER CENT
THIRD HARMONIC	3.5	7.5	PER CENT
FIFTH HARMONIC	1.5	2.5	PER CENT
POWER OUTPUT	10	10	WATTS

^A FOR POWER OUTPUT SHOWN^B 500 OHMS AND 50 MH.

FOR "INTERPRETATION OF RATINGS" REFER TO FRONT OF BOOK



TUNG-SOL

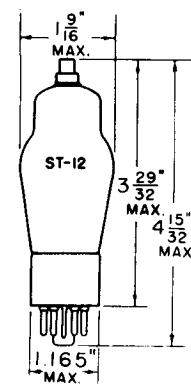

6V7G
SMALL 7 PIN
OCTAL BASE

DUPLEX-DIODE TRIODE

UNIPOTENTIAL CATHODE

HEATER

6V7G, 85 55
6.3 V. 2.5 V.
0.3 A. 1.0 A.

AC OR DC

IN CIRCUITS WHERE THE CATHODE IS NOT DIRECTLY CONNECTED TO THE HEATER, THE POTENTIAL DIFFERENCE BETWEEN HEATER AND CATHODE SHOULD BE KEPT AS LOW AS POSSIBLE. UNDER NO CONDITIONS SHOULD IT EXCEED 100 VOLTS.

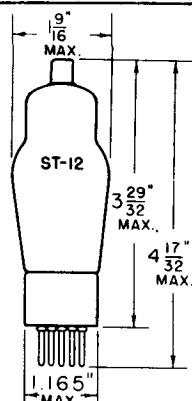

55, 85
SMALL 8 PIN
BASE

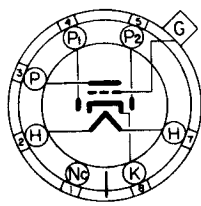

6V7G

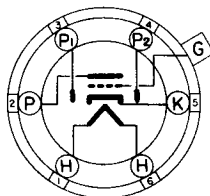

55, 85

BOTTOM VIEWS

THE 6V7G, 55 AND 85 ARE HEATER CATHODE TYPE TUBES CONSISTING OF TWO DIODES AND A TRIODE IN A SINGLE BULB. THEY ARE DESIGNED FOR USE AS COMBINED DETECTORS, AMPLIFIERS AND AUTOMATIC VOLUME CONTROL TUBES.

RATINGS

INTERPRETED ACCORDING TO RMA STANDARD M8-210

MAXIMUM PLATE VOLTAGE	250	VOLTS
MAXIMUM PLATE DISSIPATION	2.0	WATTS

DIRECT INTERELECTRODE CAPACITANCES

GRID TO PLATE	1.5	μmf
INPUT	1.5	μmf
OUTPUT	4.3	μmf

TYPICAL OPERATING CONDITIONS AND CHARACTERISTICS

CLASS A AMPLIFIER

PLATE VOLTAGE	135	180	250	VOLTS
GRID VOLTAGE	-10.5	-13.5	-20	VOLTS
PLATE CURRENT	3.7	6.0	8.0	MA.
PLATE RESISTANCE	11000	8500	7500	OHMS
TRANSCONDUCTANCE	750	975	1100	μMHOS
AMPLIFICATION FACTOR	8.3	8.3	8.3	
LOAD RESISTANCE	25000	20000	20000	OHMS
POWER OUTPUT	75	160	350	MW.

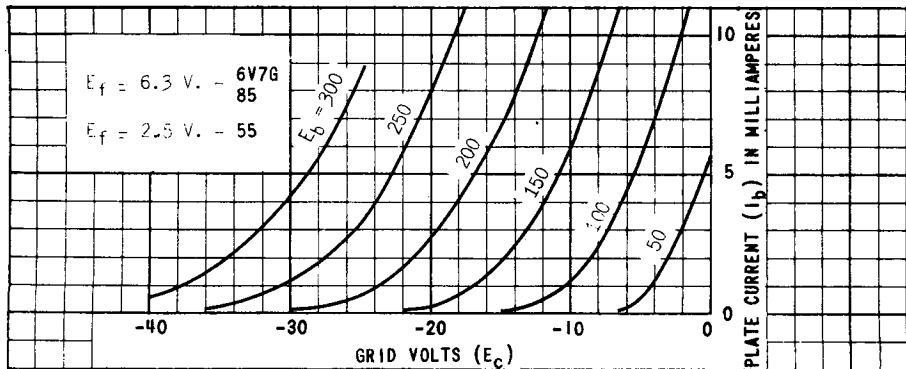
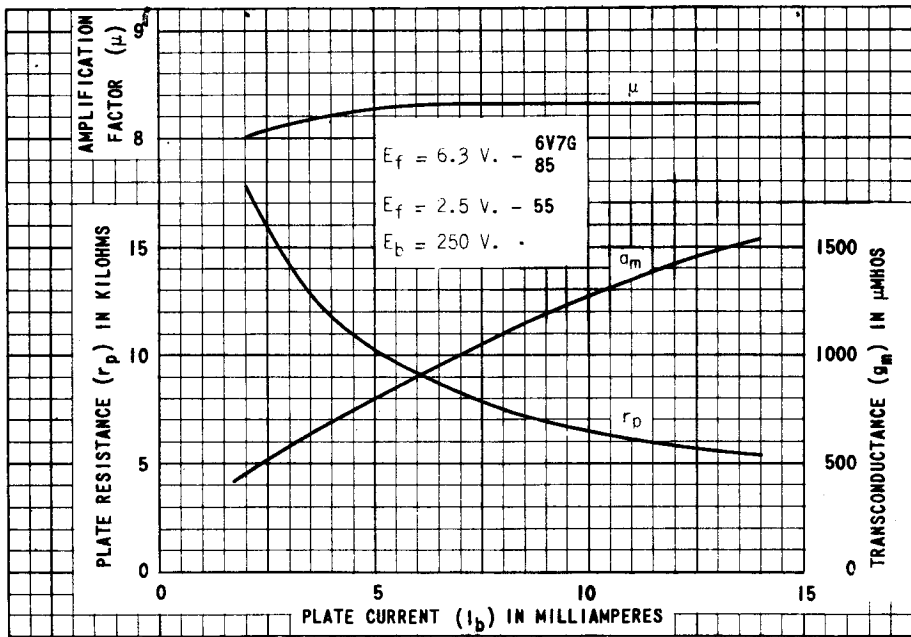
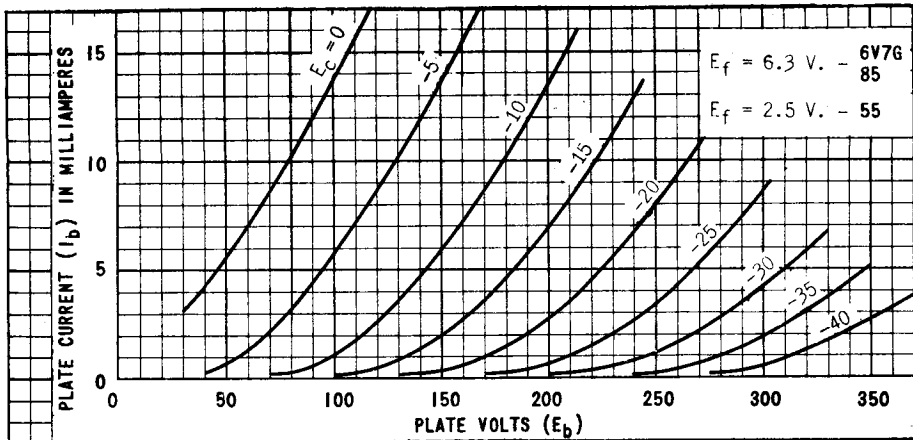
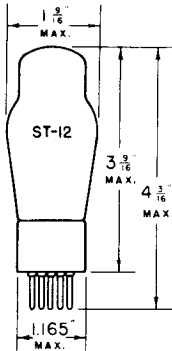

PLATE
1445
JUNE 15
1944

TUNG-SOL



TRIODE AMPLIFIER

UNIPOTENTIAL CATHODE

HEATER

2.5 VOLTS 1.0 AMPERE

AC OR DC

GLASS BULB

SMALL 5 PIN BASE

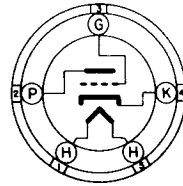

BOTTOM VIEW

THE TUNG-SOL 56 IS A GENERAL PURPOSE TRIODE DESIGNED FOR SERVICE AS AN OSCILLATOR, DETECTOR OR AMPLIFIER. EXCEPT FOR HEATER RATINGS AND CAPACITANCES, ITS RATINGS AND CHARACTERISTICS ARE IDENTICAL WITH THOSE OF THE 76.

OPERATING CONDITIONS AND CHARACTERISTICS

CLASS A₁ AMPLIFIER

PLATE VOLTAGE	100	250 ^{MAX.}	VOLTS
GRID VOLTAGE	-5	-13.5	VOLTS
GRID CIRCUIT RESISTANCE ^{MAX.}	1	1	MEGOHM
PLATE CURRENT	2.5	5	MA.
PLATE RESISTANCE	12 000	9500	OHMS
TRANSCONDUCTANCE	1150	1450	μMHOS
AMPLIFICATION FACTOR	13.8	13.8	

DETECTOR

	BIASED		GRID LEAK	
PLATE VOLTAGE	100	250	45	VOLTS
GRID VOLTAGE	-8	-20		VOLTS
PLATE CURRENT	ADJUST TO 0.2 MA. WITH NO INPUT SIGNAL			
GRID LEAK			1 TO 5	MEGOHMS
GRID CONDENSER			250	μf

RESISTANCE COUPLED AMPLIFIER

PLATE SUPPLY VOLTAGE	100	100	250	250	VOLTS
PLATE LOAD RESISTOR	0.05	0.25	0.05	0.25	MEGOHM
CATHODE RESISTOR	3800	15 000	3800	15 000	OHMS
VOLTAGE GAIN	8.5	10	9	10	

DIRECT INTERELECTRODE CAPACITANCES

GRID TO CATHODE	3.2	μf
PLATE TO CATHODE	2.2	μf
GRID TO PLATE	3.2	μf

PLATE
1446
JUNE 15
1944



TUNG-SOL

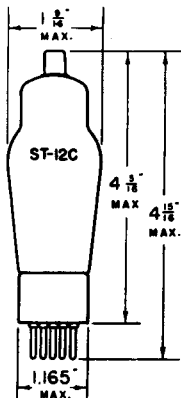

TRIPLE GRID
DETECTOR AMPLIFIER

UNIPOTENTIAL CATHODE

HEATER
2.5 VOLTS 1.0 AMPERE
AC OR DC

GLASS BULB

SMALL 6 PIN BASE

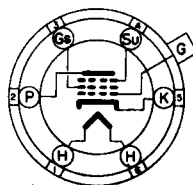

6F

BOTTOM VIEW

THE TUNG-SOL 57 IS A TRIPLE GRID GENERAL PURPOSE DETECTOR AMPLIFIER. EXCEPT FOR HEATER RATINGS, ITS ELECTRICAL CHARACTERISTICS ARE IDENTICAL WITH THOSE OF THE 6C6.

OPERATING CONDITIONS AND CHARACTERISTICS

CLASS A₁ AMPLIFIER

PLATE VOLTAGE	100	250	250	335	VOLTS
SCREEN VOLTAGE	100	100	125	110	VOLTS
CONTROL GRID VOLTAGE	-3	-3	-3	-3	VOLTS
SUPPRESSOR GRID	CONNECTED TO CATHODE AT SOCKET				
PLATE CURRENT	2	2	3.7	2.7	MA.
SCREEN CURRENT	0.5	0.5	1	0.7	MA.
PLATE RESISTANCE ^{APPROX.}	1.0	1.5	1.7	2.6	MEG OHMS
TRANSCONDUCTANCE	1185	1225	1510	1325	μMHOS
AMPLIFICATION FACTOR ^{APPROX.}	1185	1850	2500	3500	
CONTROL GRID VOLTAGE FOR CATHODE CURRENT CUT-OFF	-7	-7	-9	-7.5	VOLTS

BIASED DETECTOR

PLATE SUPPLY VOLTAGE	100	100	250	VOLTS
SCREEN SUPPLY VOLTAGE	16	100	100	VOLTS
PLATE RESISTOR	1	1	0.5	MEG OHM
SCREEN RESISTOR	0	2	0	MEG OHMS
CATHODE RESISTOR	30 000	25 000	10 000	OHMS
SUPPRESSOR GRID	CONNECTED TO CATHODE AT SOCKET			

DIRECT INTERELECTRODE CAPACITANCES

CONTROL GRID TO CATHODE	5	μμf
PLATE TO CATHODE	6.5	μμf
CONTROL GRID TO PLATE ³	.007 ^{MAX.}	μμf

³ WITH SHIELD

TUNG-SOL

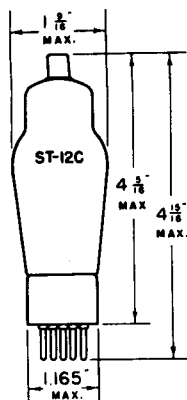

TRIPLE GRID
REMOTE CUT-OFF AMPLIFIER

UNIPOTENTIAL CATHODE
HEATER
2.5 VOLTS 1.0 AMPERE
AC OR DC

GLASS BULB

SMALL 6 PIN BASE

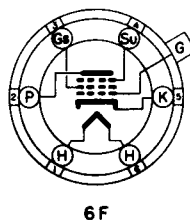

BOTTOM VIEW

THE TUNG-SOL 58 IS A TRIPLE GRID VARIABLE MU AMPLIFIER. EXCEPT FOR HEATER RATINGS, ITS ELECTRICAL CHARACTERISTICS ARE IDENTICAL WITH THOSE OF THE 6D6.

OPERATING CONDITIONS AND CHARACTERISTICS

CLASS A₁ AMPLIFIER

PLATE VOLTAGE	100	250	VOLTS
SCREEN VOLTAGE	100	100	VOLTS
CONTROL GRID VOLTAGE	-3	-3	VOLTS
SUPPRESSOR GRID	CONNECTED TO CATHODE AT SOCKET		
PLATE CURRENT	8	8.2	MA.
SCREEN CURRENT	2.2	2	MA.
PLATE RESISTANCE	0.25	0.8	MEG OHM
TRANSCONDUCTANCE	1500	1600	μMHOS
AMPLIFICATION FACTOR	375	1280	
CONTROL GRID VOLTAGE	-50	-50	VOLTS
FOR TRANSCONDUCTANCE = 2 μMHOS			

AS MIXER IN SUPERHETERODYNE CIRCUIT

PLATE VOLTAGE	100	250 ^{MAX.}	VOLTS
SCREEN VOLTAGE ^{MAX.}	100	100	VOLTS
CONTROL GRID VOLTAGE	-10	-10	VOLTS
SUPPRESSOR GRID	CONNECTED TO CATHODE AT SOCKET		

DIRECT INTERELECTRODE CAPACITANCES

CONTROL GRID TO CATHODE	4.7	μμf
PLATE TO CATHODE	6.3	μμf
CONTROL GRID TO PLATE ⁵	.007 ^{MAX.}	μμf

⁵ WITH SHIELD

PLATE
320-1

TUNG-SOL

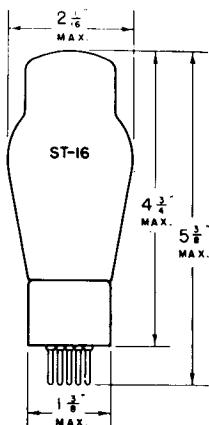

TRIPLE GRID POWER AMPLIFIER

UNIPOTENTIAL CATHODE

HEATER

2.5 VOLTS 2.0 AMPERES

AC OR DC

GLASS BULB

MEDIUM 7 PIN BASE

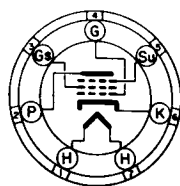

7A

BOTTOM VIEW

THE TUNG-SOL 59 IS A TRIPLE GRID OUTPUT POWER TUBE WHICH MAY BE USED AS A CLASS A TRIODE, CLASS B TRIODE OR CLASS A PENTODE.

OPERATING CONDITIONS AND CHARACTERISTICS

CLASS A₁ AMPLIFIER

	TRIODE ^A	PENTODE ^B	
PLATE VOLTAGE ^{MAX.}	250	250	VOLTS
SCREEN (G _s) VOLTAGE	-	250 ^{MAX.}	VOLTS
CONTROL GRID (G) VOLTAGE	-28	-18	VOLTS
PLATE CURRENT	26	35	MA.
SCREEN CURRENT	-	9	MA.
PLATE RESISTANCE	2300	40 000	OHMS
TRANSCONDUCTANCE	2600	2500	μMHOS
AMPLIFICATION FACTOR	6	100	
LOAD RESISTANCE	5000 ^C	6000	OHMS
POWER OUTPUT	1.25	3.0	WATTS

^A GRIDS G_s AND S_u TIED TO PLATE

^B GRID S_u TIED TO CATHODE

^C APPROXIMATELY TWICE THIS VALUE IS RECOMMENDED FOR THE LOAD OF THIS TUBE WHEN USED AS A DRIVER FOR A CLASS B₂ STAGE.

CLASS B₂ AMPLIFIER - TWO TUBESGRID S_u TIED TO PLATE, GRIDS G AND G_s TIED TOGETHER

PLATE VOLTAGE	300	400 ^{MAX.}	VOLTS
GRID (G & G _s) VOLTAGE	0	0	VOLTS
ZERO-SIGNAL PLATE CURRENT	20	26	MA.
LOAD RESISTANCE ^{PLATE TO PLATE}	4600	6000	OHMS
POWER OUTPUT	15	20	WATTS

NOTE: MAXIMUM PLATE DISSIPATION IS 10 WATTS. MAXIMUM PEAK PLATE CURRENT IS 200 MA.



TUNG-SOL

BEAM POWER AMPLIFIER

HALF-WAVE RECTIFIER WITH TAPPED HEATER

PHYSICAL SPECIFICATIONS

EMITTER UNIPOTENTIAL CATHODE	PIN CONNECTIONS	
BASE INTERMEDIATE 8 PIN OCTAL	PIN 1 RECT. CATHODE	PIN 7 RECT. HEATER*
CAP NONE	PIN 2 AMP. HEATER	PIN 8 AMP. CATHODE**
BULB T-9	PIN 3 AMP. PLATE	
MAXIMUM DIAMETER 1 5/16"	PIN 4 GRID #2	
MAXIMUM OVERALL LENGTH 3 5/16"	PIN 5 GRID #1	TOP CAP NONE
MAXIMUM SEATED HEIGHT 2 3/4"	PIN 6 RECT. PLATE*	

* PILOT LAMP CONNECTION

** AND BEAM PLATES

RATINGS

HEATER OR FILAMENT VOLTAGE (AC OR DC)	70.0	VOLTS
HEATER OR FILAMENT CURRENT	0.15	AMP
MAXIMUM PLATE VOLTAGE (AMPLIFIER SECTION)	110	VOLTS
MAXIMUM SCREEN VOLTAGE (AMPLIFIER SECTION)	110	VOLTS
MAXIMUM AC PLATE VOLTAGE (RMS) (RECTIFIER SECTION)	125	VOLTS
TUBE VOLTAGE DROP AT 120 MA. DC (RECTIFIER SECTION)	14	VOLTS

OPERATING CONDITIONS AND CHARACTERISTICS

AMPLIFIER SECTION - CLASS A₁ AMPLIFIER

PLATE VOLTAGE	110	VOLTS
SCREEN VOLTAGE	110	VOLTS
CONTROL GRID VOLTAGE	-7.5	VOLTS
PLATE CURRENT	40	MA.
SCREEN CURRENT	3.0	MA.
TRANSCONDUCTANCE	5800	μMHOS
AMPLIFICATION FACTOR (APPROX.)	80	
LOAD RESISTANCE	2500	OHMS
TOTAL HARMONIC DISTORTION	6.5	PER CENT
POWER OUTPUT	1.5	WATTS

RECTIFIER SECTION - HALF WAVE RECTIFIER

WITH CONDENSER INPUT TO FILTER

MAXIMUM AC PLATE VOLTAGE (RMS)	125	VOLTS
MAXIMUM DC OUTPUT CURRENT	60	MA.

NOTE: THIS TUBE IS USED WITH A 0.15 AMPERE PILOT LAMP, WHICH IS CONNECTED BETWEEN PINS #6 AND #7. SINCE THE DC OUTPUT CURRENT OF THE RECTIFIER SECTION FLOWS THROUGH THE PILOT LAMP SECTION OF THE HEATER, THIS TUBE SHOULD NEVER BE USED IN CIRCUITS WITHOUT A PILOT LAMP.

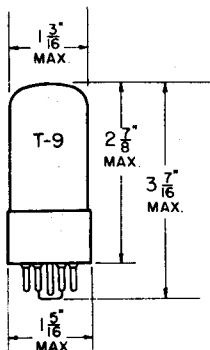

TUNG-SOL

COMBINED HALF WAVE RECTIFIER
AND BEAM POWER AMPLIFIER

GLASS BULB

COATED UNIPOTENTIAL CATHODES

HEATER
70 VOLTS 0.15 AMPERE
AC OR DC

ANY MOUNTING POSITION

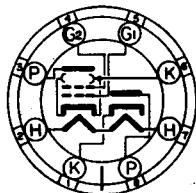

BOTTOM VIEW

INTERMEDIATE SHELL
8-PIN OCTAL

THE 70L7GT IS A COMBINED RECTIFIER AND POWER OUTPUT BEAM TETRODE DESIGNED FOR SERVICE IN AC-DC RECEIVERS.

RATINGS

INTERPRETED ACCORDING TO RMA STANDARD MB-210

HEATER VOLTAGE (AC OR DC)	70	VOLTS
HEATER CURRENT	0.15	AMP.

RECTIFIER UNIT

MAX. PEAK INVERSE PLATE VOLTAGE	350	VOLTS
MAX. PEAK PLATE CURRENT	420	MA.
MAX. DC HEATER-CATHODE POTENTIAL	175	VOLTS

WITH CONDENSER-INPUT FILTER:

MAX. AC PLATE VOLTAGE (RMS)	117	VOLTS
MAX. DC OUTPUT CURRENT	70	MA.
MIN. TOTAL EFFECTIVE PLATE SUPPLY IMPEDANCE ^A	15	OHMS

AMPLIFIER UNIT

MAX. PLATE VOLTAGE	117	VOLTS
MAX. SCREEN VOLTAGE	117	VOLTS
MAX. PLATE DISSIPATION	5.0	WATTS
MAX. SCREEN DISSIPATION	1.0	WATT
HEATER-CATHODE VOLTAGE	AS LOW AS POSSIBLE ^B	

^A WHEN A FILTER-INPUT CONDENSER EXCEEDING 40 μ F IS USED, MORE PLATE SUPPLY IMPEDANCE MAY BE NECESSARY TO LIMIT THE PEAK PLATE CURRENT TO THE RATED VALUE.

^B OBTAINED BY CONNECTING PIN #2 TO THE SIDE OF THE LINE OPPOSITE THAT TO WHICH PINS #7 AND #8 ARE CONNECTED.

TUNG-SOL

CONTINUED FROM PRECEDING PAGE

TYPICAL OPERATING CONDITIONS AND CHARACTERISTICS

CLASS A₁ AMPLIFIER

PLATE VOLTAGE	110	VOLTS
SCREEN VOLTAGE	110	VOLTS
GRID VOLTAGE	7.5	VOLTS
PEAK AF GRID VOLTAGE	7.5	VOLTS
ZERO-SIGNAL PLATE CURRENT	40	MA.
ZERO-SIGNAL SCREEN CURRENT (APPROX.)	3	MA.
MAX.- SIGNAL PLATE CURRENT	43	MA.
MAX.- SIGNAL SCREEN CURRENT (APPROX.)	6	MA.
GRID RESISTOR (MAX.)		
FIXED BIAS	0.1	MEGOHM
CATHODE BIAS	0.5	MEGOHM
PLATE RESISTANCE	15 000	OHMS
LOAD RESISTANCE	2000	OHMS
TRANSCONDUCTANCE	7500	μMHOS
MAX.- SIGNAL POWER OUTPUT	1.8	WATTS
TOTAL HARMONIC DISTORTION	10	PER CENT

SIMILAR TYPE REFERENCE: Rectifier unit similar to types 117E3 and 117E40; amplifier unit somewhat similar to types 25100, 3515, 35100.

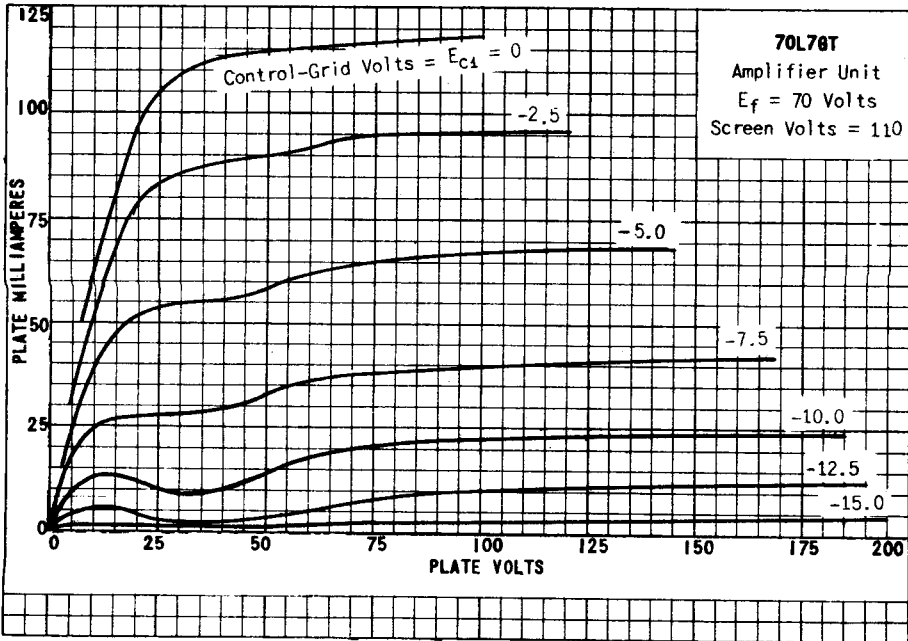
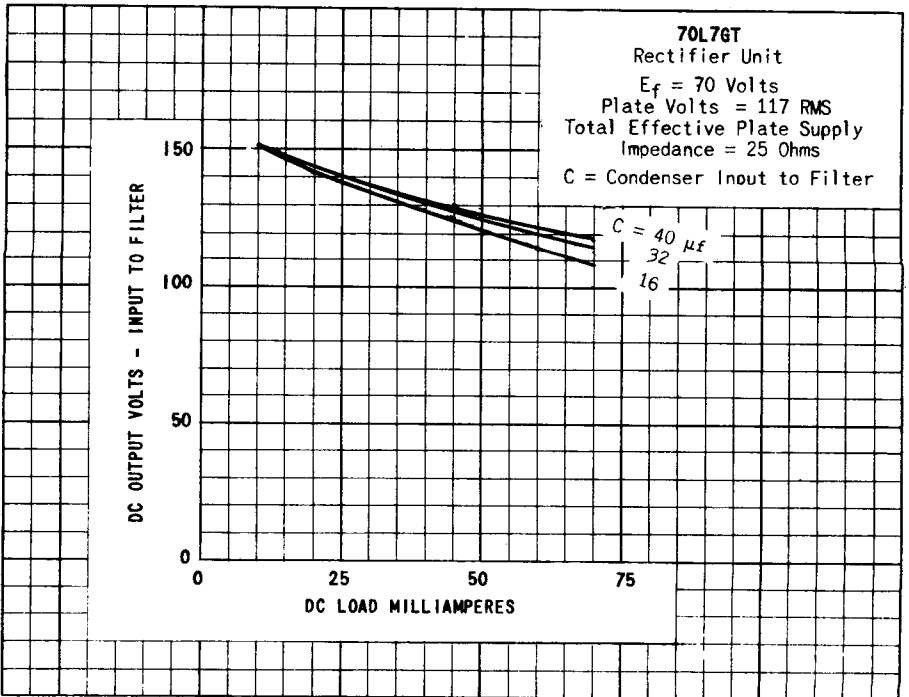
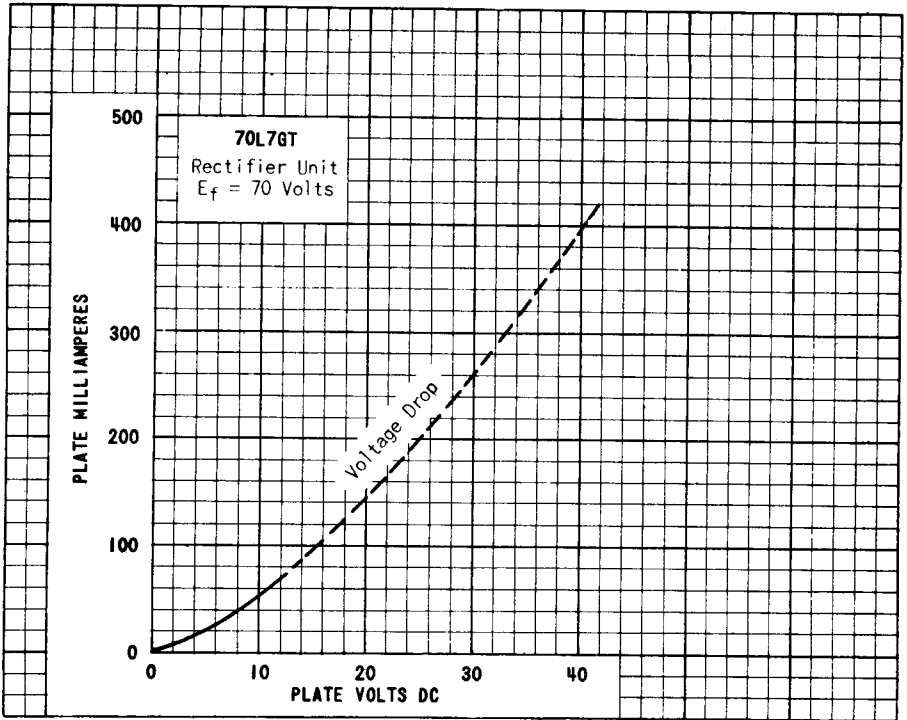

PLATE
1634
NOV. 30
1945



70L7GT

70L7GT

Amplifier Unit
 $E_f = 70$ Volts Plate Volts = 110
 Screen Volts = 110 Control Volts = -7.5
 Signal (RMS) = 5.3

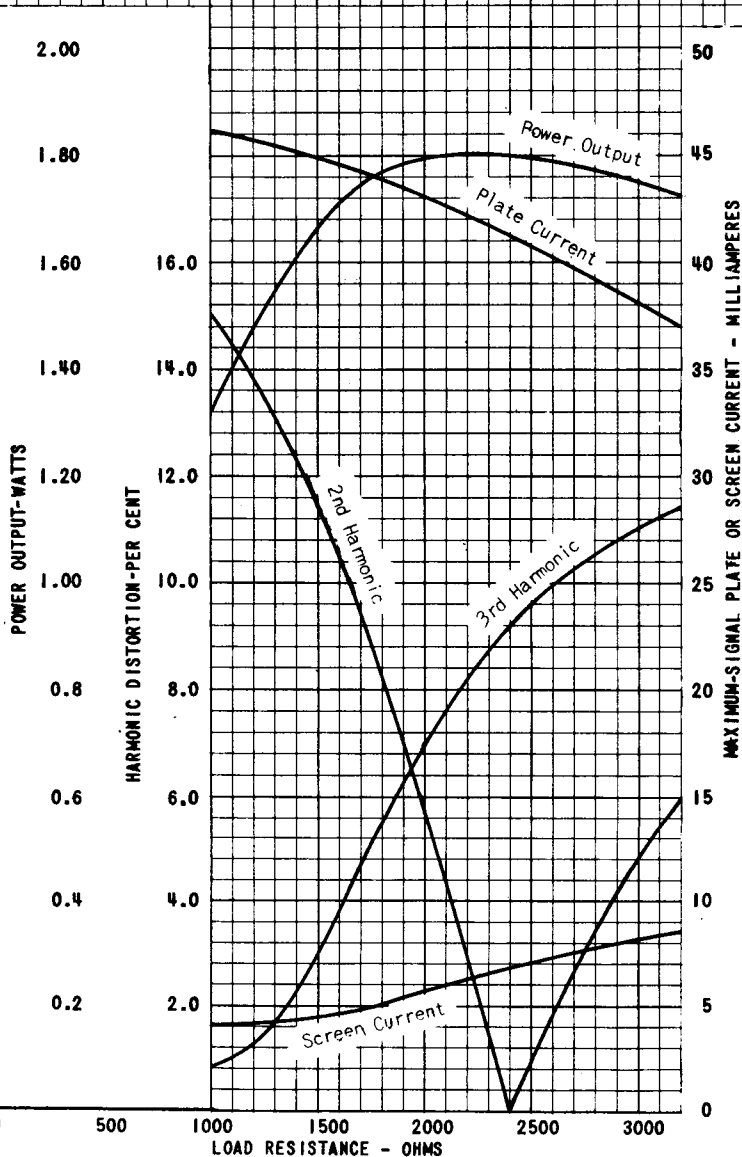
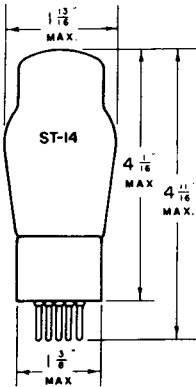

PLATE
 1636
 NOV. 30
 1945

TUNG-SOL



TRIODE POWER AMPLIFIER

COATED FILAMENT

5.0 VOLTS 0.25 AMPERE
AC OR DC

GLASS BULB

MEDIUM 4 PIN BASE

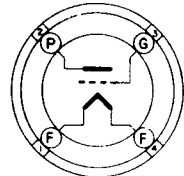

4 D

BOTTOM VIEW

THE TUNG-SOL 71A IS A FILAMENT TYPE POWER AMPLIFIER HAVING LOW PLATE RESISTANCE.

OPERATING CONDITIONS AND CHARACTERISTICS

CLASS A₁ AMPLIFIER

PLATE VOLTAGE	90	135	180 ^{MAX.}	VOLTS
GRID VOLTAGE ^A	-16.5	-27	-40.5	VOLTS
PLATE CURRENT	10	17.3	20	MA.
PLATE RESISTANCE	21 0	1820	1750	OHMS
TRANSCONDUCTANCE	1400	1650	1700	μMHOS
AMPLIFICATION FACTOR	3	3	3	
LOAD RESISTANCE	3000	3000	4800	OHMS
TOTAL HARMONIC DISTORTION	5	5	5	PER CENT
POWER OUTPUT	0.125	0.4	0.79	WATT

^A RETURN TO NEGATIVE FILAMENT (PIN #4)

DIRECT INTERELECTRODE CAPACITANCES

GRID TO FILAMENT	3.2	μf
PLATE TO FILAMENT	2.9	μf
GRID TO PLATE	7.5	μf

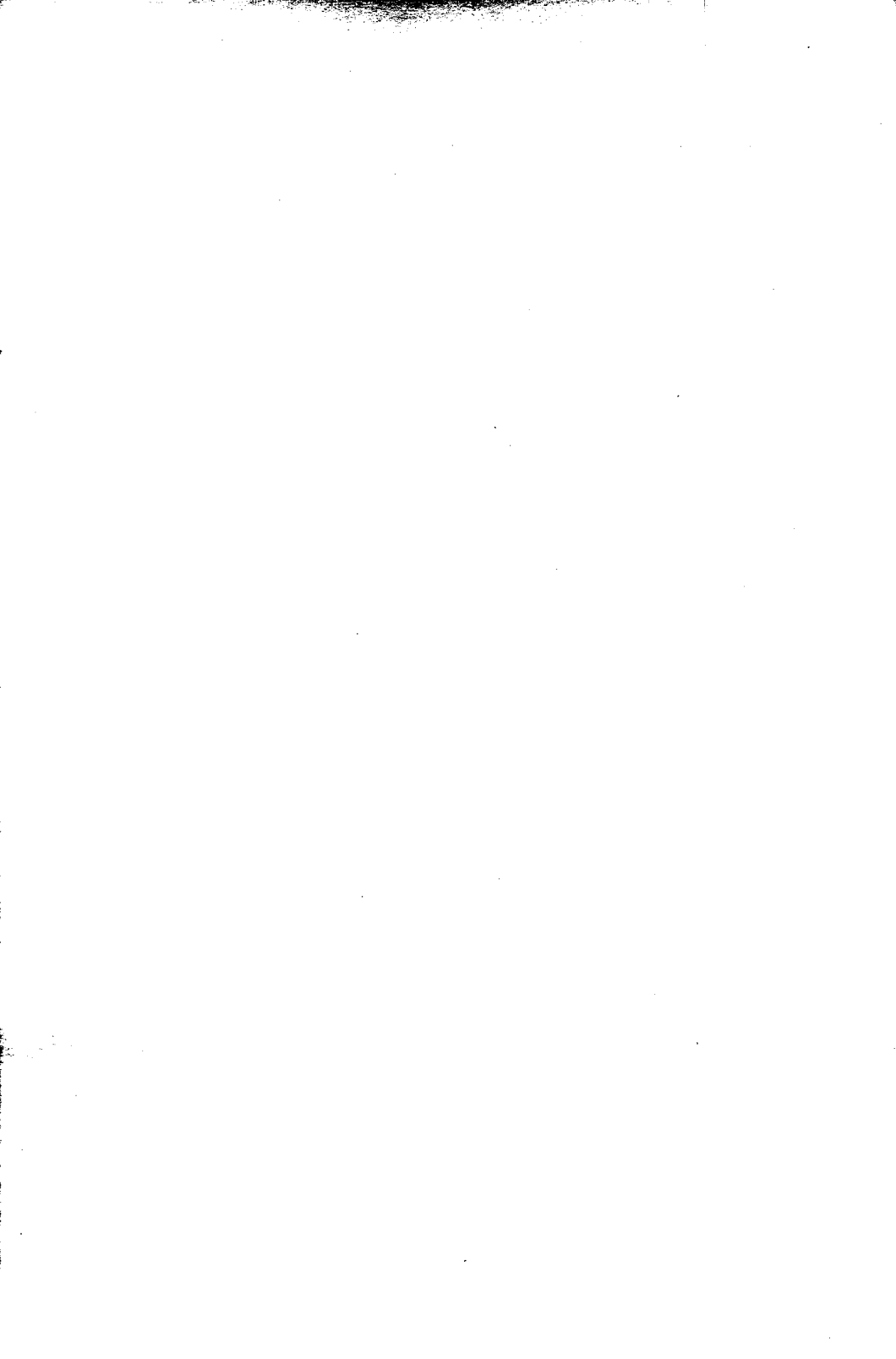

TUNG-SOL

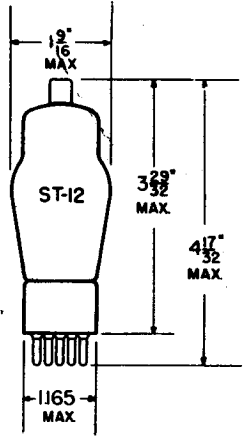

2A6, 75

SMALL METAL
CAP

**DUO-DIODE
HIGH-MU TRIODE AMPLIFIER**

COATED UNIPOTENTIAL CATHODE

2A6	2.5 VOLTS	0.8 AMPERE
75	6.3 VOLTS	0.3 AMPERE
6B6G	6.3 VOLTS	0.3 AMPERE
	AC OR DC	

GLASS BULB

ANY MOUNTING POSITION

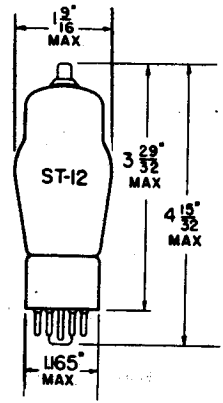

6B6G

SKIRTED MINIATURE
CAP

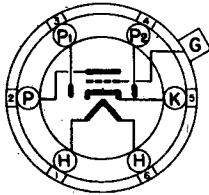

BOTTOM VIEW

SMALL
6-PIN BASE

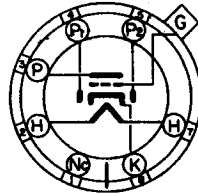

BOTTOM VIEW

SMALL
7-PIN OCTAL BASE

THE 2A6, 6B6G AND 75 COMBINE TWO DIODES AND A HIGH-MU TRIODE IN A SINGLE BULB, USING A COMMON CATHODE. THEY ARE DESIGNED FOR USE AS DIODE DETECTORS, AVC RECTIFIERS AND RESISTANCE COUPLED AMPLIFIERS.

RATINGS

INTERPRETED ACCORDING TO RMA STANDARD M8-210

MAXIMUM PLATE VOLTAGE	250	VOLTS
MINIMUM DIODE CURRENT PER PLATE WITH 10 VOLTS DC APPLIED	0.8	MA.
MAXIMUM CATHODE VOLTAGE	100	VOLTS

CONTINUED ON NEXT PAGE

PRINTED IN U. S. A.

PLATE
1555
JAN. 15
1945

TUNG-SOL

CONTINUED FROM PRECEDING PAGE.

DIRECT INTERELECTRODE CAPACITANCES (APPROX.)

TRIODE UNIT

GRID TO PLATE	1.7	μmf
INPUT	1.7	μmf
OUTPUT	3.8	μmf

TYPICAL OPERATING CONDITIONS AND CHARACTERISTICS

CLASS A₁ AMPLIFIER

TRIODE UNIT

PLATE VOLTAGE	250	VOLTS
GRID VOLTAGE	-2.0	VOLTS
PLATE CURRENT	0.9	MA.
PLATE RESISTANCE	91 000	OHMS
TRANSCONDUCTANCE	1 100	μMHOS
AMPLIFICATION FACTOR	100	

RESISTANCE COUPLED AMPLIFIER

PLATE SUPPLY VOLTAGE	100	100	250	VOLTS
PLATE LOAD RESISTOR	0.25	0.25	0.25	MEGOHM
CATHODE RESISTOR	0.0	10 000	4 000	OHMS
GRID CIRCUIT RESISTOR	6.0	1.0	1.0	MEGOHMS
GRID COUPLING CONDENSER	0.01	0.05	0.05	μf
VOLTAGE GAIN	35	35	52	

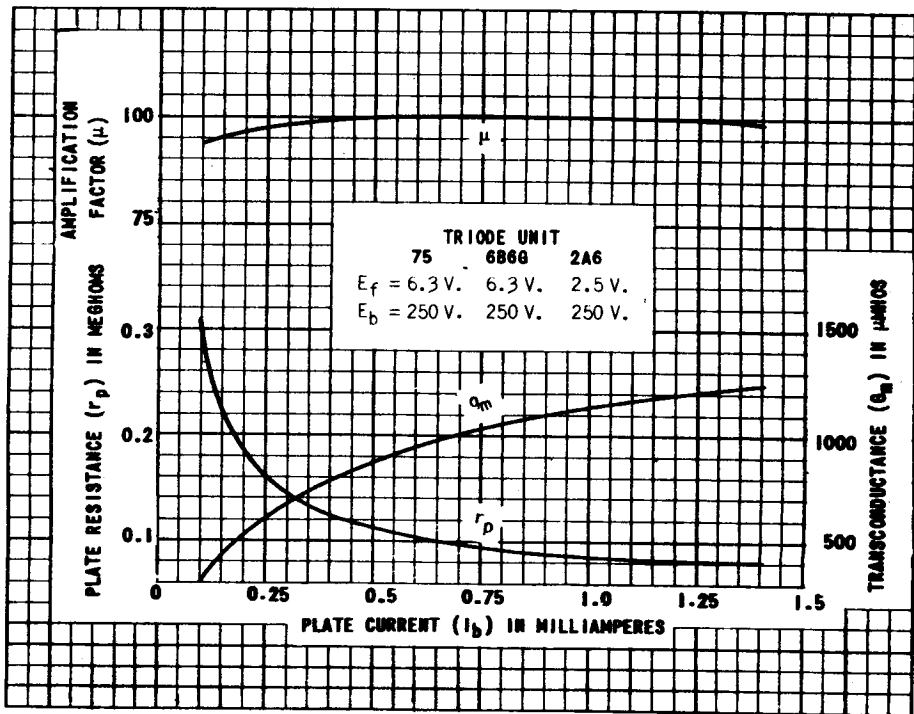
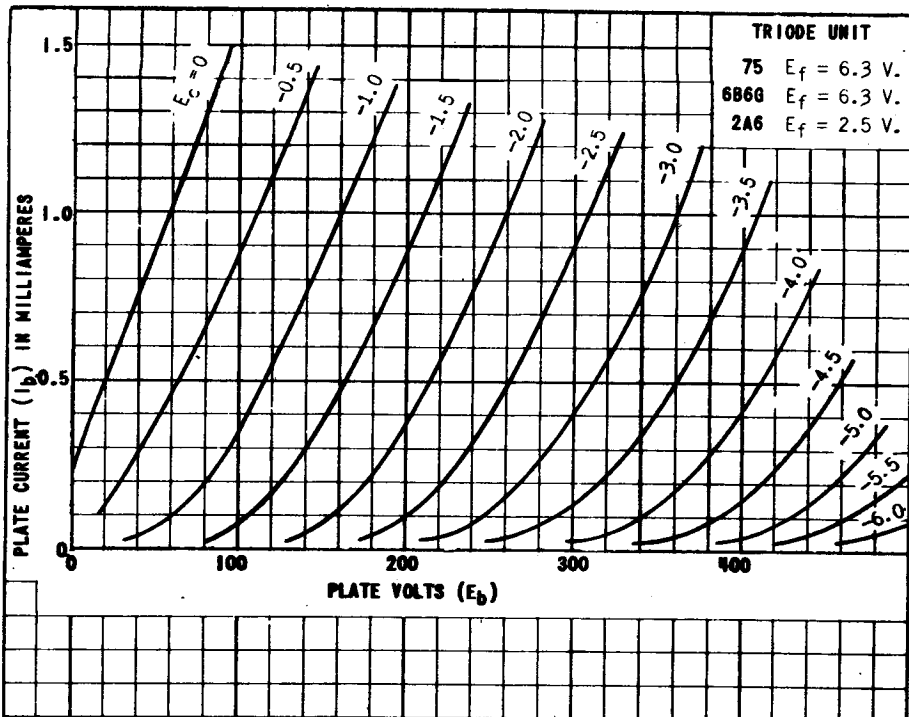

PRINTED IN U.S.A.

PLATE 1557
JAN. 15 1945



TUNG-SOL

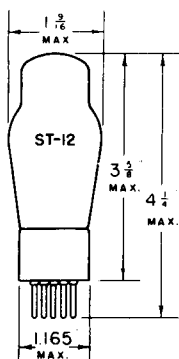

TRIODE AMPLIFIER

UNIPOTENTIAL CATHODE

HEATER

6.3 VOLTS 0.3 AMPERE

AC OR DC

GLASS BULB

SMALL 5 PIN BASE

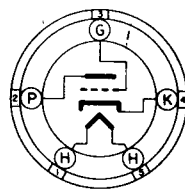

5A

THE TUNG-SOL 76 IS A GENERAL PURPOSE TRIODE DESIGNED FOR SERVICE AS AN OSCILLATOR, DETECTOR OR AMPLIFIER. EXCEPT FOR HEATER VOLTAGE AND CURRENT ITS CHARACTERISTICS ARE IDENTICAL WITH THOSE OF THE 56.

OPERATING CONDITIONS AND CHARACTERISTICS

CLASS A₁ AMPLIFIER

PLATE VOLTAGE	100	250 ^{MAX.}	VOLTS
GRID VOLTAGE	-5	-13.5	VOLTS
GRID CIRCUIT RESISTANCE ^{MAX.}	1	1	MEG OHM
PLATE CURRENT	2.5	5	MA.
PLATE RESISTANCE	12000	9500	OHMS
TRANSCONDUCTANCE	1150	1450	μMHOS
AMPLIFICATION FACTOR	13.8	13.8	

DETECTOR

BIASED

GRID LEAK

PLATE VOLTAGE	100	250	45	VOLTS
GRID VOLTAGE	-8	-20	RETURN TO CATHODE	VOLTS
PLATE CURRENT	ADJUST TO 0.2 MA. WITH NO INPUT SIGNAL			
GRID LEAK			1 TO 5	MEG OHMS
GRID CONDENSER			250	μf

RESISTANCE COUPLED AMPLIFIER

PLATE SUPPLY VOLTAGE	100	100	250	250	VOLTS
PLATE LOAD RESISTOR	0.05	0.25	0.05	0.25	MEG OHM
CATHODE RESISTOR	3800	15 000	3800	15 000	OHMS
VOLTAGE GAIN	8.5	10	9	10	

DIRECT INTERELECTRODE CAPACITANCES

GRID TO CATHODE	3.6	μf
PLATE TO CATHODE	2.6	μf
GRID TO PLATE	2.8	μf



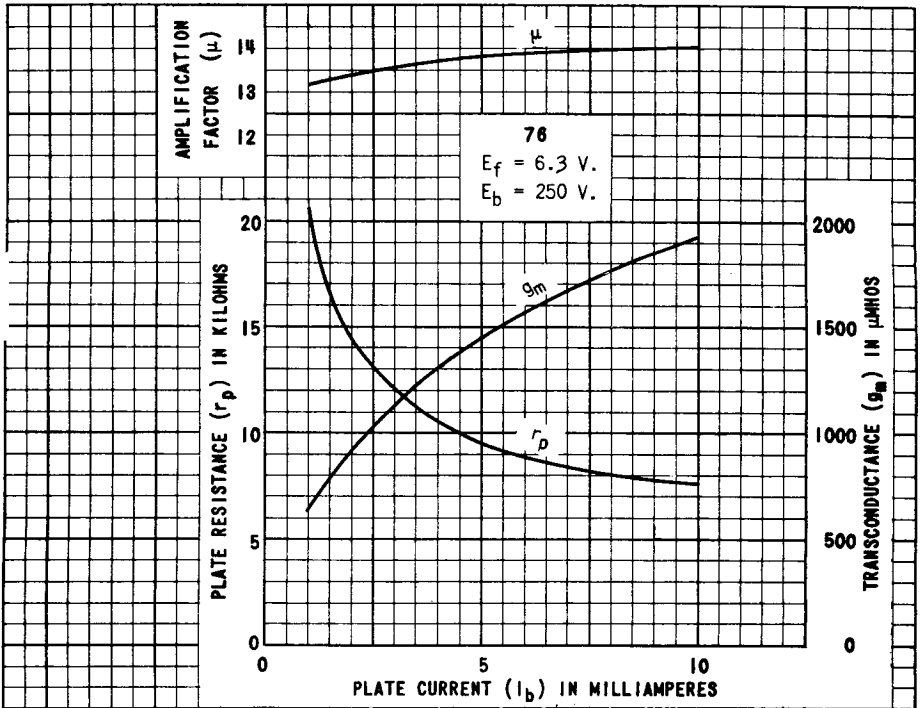
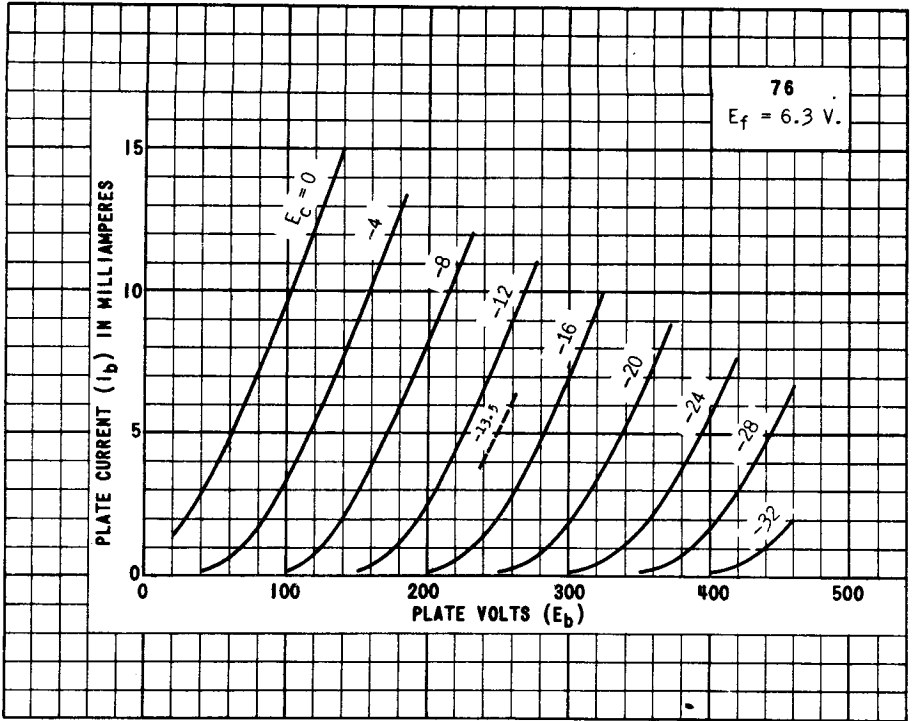
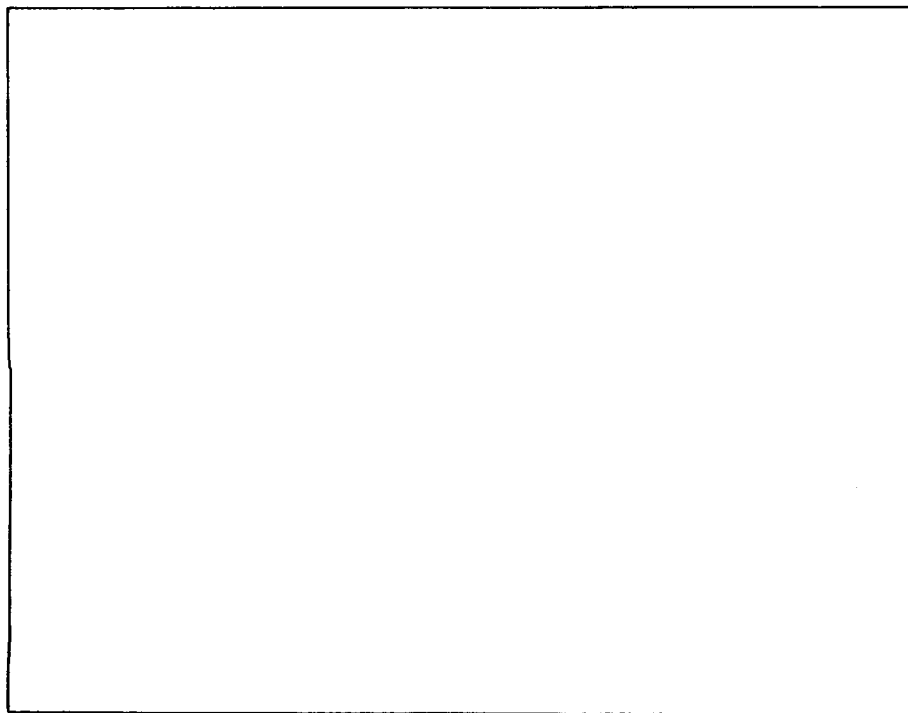
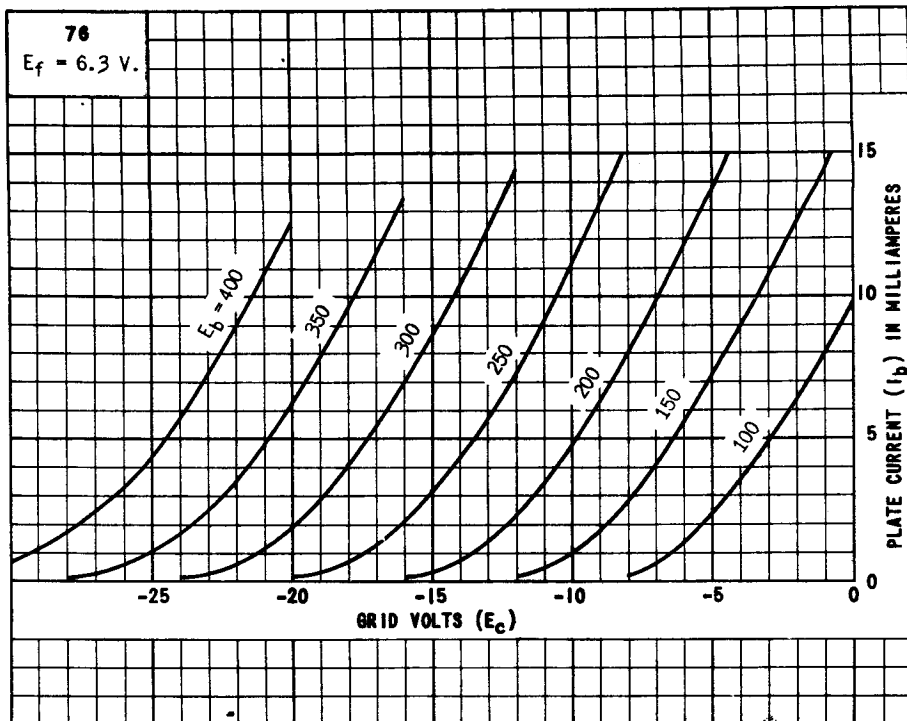
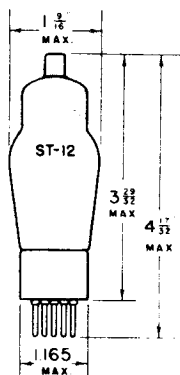

PLATE 332-1
 JAN. 23 1939



TUNG-SOL



**TRIPLE GRID
DETECTOR AMPLIFIER**

UNIPOTENTIAL CATHODE
HEATER
6.3 VOLTS 0.3 AMPERE
AC OR DC

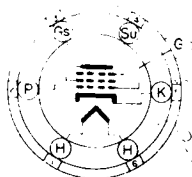

6F
BOTTOM VIEW

GLASS BULB

SMALL 6 PIN BASE

THE TUNG-SOL 77 IS A TRIPLE GRID GENERAL PURPOSE DETECTOR AMPLIFIER.

RATINGS

MAXIMUM PLATE VOLTAGE	300	VOLTS
MAXIMUM SCREEN SUPPLY VOLTAGE	300	VOLTS
MAXIMUM SCREEN VOLTAGE	100	VOLTS
MINIMUM EXTERNAL GRID BIAS VOLTAGE	0	
MAXIMUM PLATE DISSIPATION	.75	WATT
MAXIMUM SCREEN DISSIPATION	.10	WATT

TYPICAL OPERATING CONDITIONS AND CHARACTERISTICS

CLASS A₁ AMPLIFIER

PLATE VOLTAGE	100	250	VOLTS
SCREEN VOLTAGE	60	100	VOLTS
CONTROL GRID VOLTAGE	-1.5	-3	VOLTS
GRID CIRCUIT RESISTANCE ^{MAX.}	1	1	MEGOHM
SUPPRESSOR GRID	CONNECTED TO CATHODE AT SOCKET		
PLATE CURRENT	1.7	2.3	MA.
SCREEN CURRENT	0.4	0.5	MA.
PLATE RESISTANCE ^{APPROX.}	.6	1.0 ^{MIN.}	MEGOHM
TRANSCONDUCTANCE	1100	1250	μMHOS
CONTROL GRID VOLTAGE	-5.5	-7.5	VOLTS

FOR CATHODE CURRENT CUT-OFF

PLATE
655-2

NOV. 20
1939

CONTINUED NEXT PAGE

TUNG-SOL

BIASED DETECTOR

PLATE SUPPLY VOLTAGE	100	100	250	VOLTS
SCREEN SUPPLY VOLTAGE	16	100	100	VOLTS
PLATE RESISTOR	1	1	0.5	MEGOHM
SCREEN RESISTOR	0	2	0	MEGOHMS
CATHODE SELF BIASING RESISTOR	30 000	25 000	10 000	OHMS
SUPPRESSOR GRID	CONNECTED TO CATHODE AT SOCKET			

DIRECT INTERELECTRODE CAPACITANCES

CONTROL GRID TO CATHODE	4.7	μmf
PLATE TO CATHODE	11	μmf
CONTROL GRID TO PLATE ⁵	0.007 MAX.	μmf

⁵ MEASURED WITH AN EXTERNAL SHIELD. THE INTERNAL SHIELD WITHIN THE DOME IS CONNECTED INTERNALLY TO THE SCREEN GRID (PIN #3).

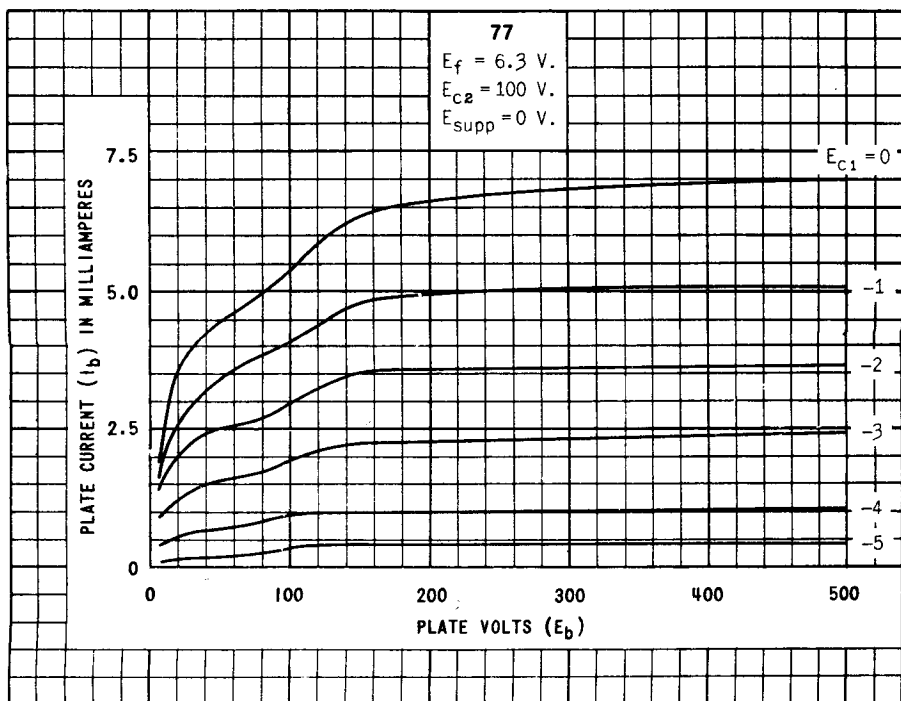

TUNG-SOL

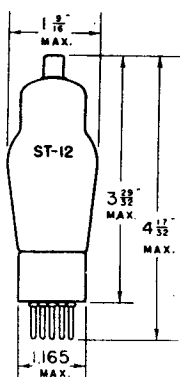

TRIPLE GRID
REMOTE CUT-OFF AMPLIFIER

UNIPOTENTIAL CATHODE

HEATER

6.3 VOLTS 0.3 AMPERE
AC OR DC

GLASS BULB

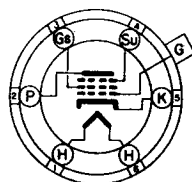

6F

BOTTOM VIEW

SMALL 6 PIN BASE

THE TUNG-SOL 78 IS A TRIPLE GRID REMOTE CUT-OFF AMPLIFIER. IT IS SUITABLE FOR USE WITH AVC IN RF AND IF AMPLIFIERS AND MINIMIZES CROSS MODULATION. WITH THE EXCEPTION OF CAPACITANCES, ITS RATINGS AND ELECTRICAL CHARACTERISTICS ARE IDENTICAL WITH THOSE OF THE 6K7G, THE 6K7G AND THE 6K7GT.

RATINGS

MAXIMUM PLATE VOLTAGE	300	VOLTS
MAXIMUM SCREEN SUPPLY VOLTAGE	300	VOLTS
MAXIMUM SCREEN VOLTAGE	125	VOLTS
MINIMUM EXTERNAL GRID BIAS VOLTAGE	0	VOLTS
MAXIMUM PLATE DISSIPATION	2.75	WATTS
MAXIMUM SCREEN DISSIPATION	0.35	WATT

TYPICAL OPERATING CONDITIONS AND CHARACTERISTICS

CLASS A₁ AMPLIFIER

PLATE VOLTAGE	90	180	250	250	VOLTS
SCREEN VOLTAGE	90	75	100	125	VOLTS
CONTROL GRID VOLTAGE	-3	-3	-3	-3	VOLTS
SUPPRESSOR GRID	CONNECTED TO CATHODE AT SOCKET				
PLATE CURRENT	5.4	4.0	7.0	10.5	MA.
SCREEN CURRENT	1.3	1.0	1.7	2.6	MA.
PLATE RESISTANCE ^{APPROX.}	0.3	1.0	0.8	0.6	MEGOHM
TRANSCONDUCTANCE	1275	1100	1450	1650	μMHOS
CONTROL GRID BIAS	-38.5	-38.5	-42.5	-52.5	VOLTS

FOR TRANSCONDUCTANCE = 2 μMHOS

CONTINUED NEXT PAGE

TUNG-SOL

TYPICAL OPERATING CONDITIONS WITH VARIABLE BIAS

MIXER IN SUPERHETERODYNE CIRCUITS

PLATE VOLTAGE	250	VOLTS
SCREEN VOLTAGE	100	VOLTS
CONTROL GRID VOLTAGE APPROX. A	-10	VOLTS
SUPPRESSOR GRID	CONNECTED TO CATHODE AT SOCKET	

^A THE GRID BIAS SHOWN IS MINIMUM FOR AN OSCILLATOR PEAK VOLTAGE OF 7 VOLTS. THESE VALUES ARE OPTIMUM.

DIRECT INTERELECTRODE CAPACITANCES^S

CONTROL GRID TO CATHODE	4.5	$\mu\mu\text{f}$
PLATE TO CATHODE	11	$\mu\mu\text{f}$
CONTROL GRID TO PLATE	.007 ^{MAX.}	$\mu\mu\text{f}$

^S MEASURED WITH AN EXTERNAL SHIELD. THE INTERNAL SHIELD IN THE DOME IS CONNECTED TO THE CATHODE WITHIN THE TUBE.

TUNG-SOL

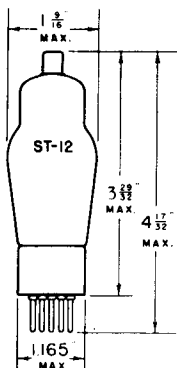

CLASS B TWIN TRIODE AMPLIFIER

UNIPOTENTIAL CATHODE

HEATER
6.3 VOLTS 0.6 AMPERE
AC OR DC

GLASS BULB

SMALL 6 PIN BASE

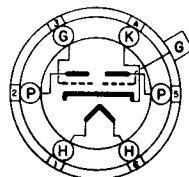

6H

BOTTOM VIEW

THE TUNG-SOL 79 COMBINES TWO TRIODES WITH A COMMON CATHODE IN A SINGLE BULB. IT IS DESIGNED FOR SERVICE AS A CLASS B POWER AMPLIFIER, VOLTAGE AMPLIFIER OR PHASE INVERTER. WITH THE EXCEPTION OF CAPACITANCES ITS RATINGS AND CHARACTERISTICS ARE IDENTICAL WITH THOSE OF THE 6Y7G.

OPERATING CONDITIONS AND CHARACTERISTICS

PLATE VOLTAGE	MAX.	250	VOLTS
PEAK PLATE CURRENT PER PLATE	MAX.	90	MA.
AVERAGE PLATE DISSIPATION	MAX.	11.5	WATTS

CLASS B₂ AMPLIFIER

PLATE VOLTAGE	180	250 MAX.	VOLTS
GRID BIAS	0	0	VOLTS
ZERO-SIGNAL PLATE CURRENT PER PLATE	3.8	5.3	MA.
EFFECTIVE LOAD RESISTANCE	7000	14 000	OHMS
AVERAGE POWER INPUT	380	380	MILLIWATTS
POWER OUTPUT	5.5	8.0	WATTS

RESISTANCE COUPLED AMPLIFIER AND PHASE INVERTER

PLATE SUPPLY VOLTAGE	100	100	250	250	VOLTS
PLATE LOAD RESISTOR	0.1	0.5	0.1	0.5	MEGOHM
CATHODE RESISTOR	2000	6000	1200	3000	OHMS
VOLTAGE GAIN	30	35	35	43	

PRINTED IN U. S. A.

PLATE
373-2

APR. 14
1939



TUNG-SOL

FULL WAVE HIGH VACUUM RECTIFIER

COATED FILAMENT

THE TUNG-SOL 5Y3GT/G, 5Y4G AND 80 ARE DESIGNED FOR USE AS POWER RECTIFIERS IN AC OPERATED RECEIVERS. THEIR RATINGS AND ELECTRICAL CHARACTERISTICS ARE IDENTICAL.

HORIZONTAL OPERATION PERMITTED ONLY IF PLANE OF THE FILAMENTS IS VERTICAL.

RATINGS

FILAMENT VOLTAGE	5.0 AC	VOLTS
FILAMENT CURRENT	2.0	AMPS.
MAXIMUM PEAK INVERSE VOLTAGE	1400	VOLTS
MAXIMUM STEADY-STATE PEAK PLATE CURRENT PER PLATE	375	MA.
MAXIMUM AC PLATE VOLTAGE PER PLATE (RMS)		
CONDENSER INPUT	350	VOLTS
MAXIMUM AC PLATE VOLTAGE PER PLATE (RMS)		
CHOKE INPUT	500	VOLTS
TUBE VOLTAGE DROP: MEASURED WITH APPLIED DC AT 125 MA. PER PLATE	60	VOLTS

FOR INTERPRETATION OF RATINGS REFER TO RMA STANDARD M8-210

OPERATING CONDITIONS AND CHARACTERISTICS FULL WAVE RECTIFIER

	CONDENSER INPUT	CHOKE INPUT	
FILAMENT VOLTAGE	5.0 AC	5.0 AC	VOLTS
AC PLATE VOLTAGE PER PLATE (RMS) MAX.	350	500	VOLTS
DC OUTPUT CURRENT MAX.	125	125	MA.
TOTAL EFFECTIVE PLATE SUPPLY IMPEDANCE PER PLATE MIN.	50		OHMS
MINIMUM VALUE OF INPUT CHOKE		5	HFNR-5

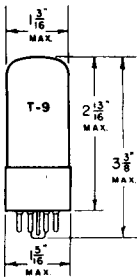

5Y3GT/G - MEDIUM 5 PIN OCTAL BASE

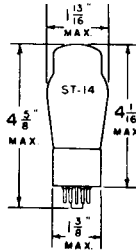

5Y4G - MEDIUM 8 PIN OCTAL BASE

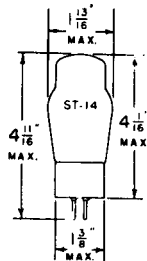

80 - MEDIUM 4 PIN BASE

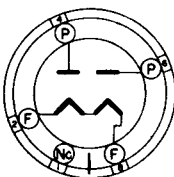

5Y3GT/G

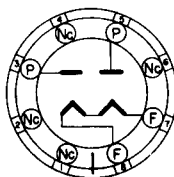

5Y4G

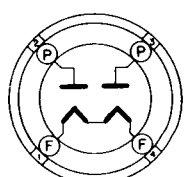

80

SEE OTHER SIDE OF SHEET FOR CURVES

PRINTED IN U. S. A.

PLATE
1364-1
OCT. 25
1943

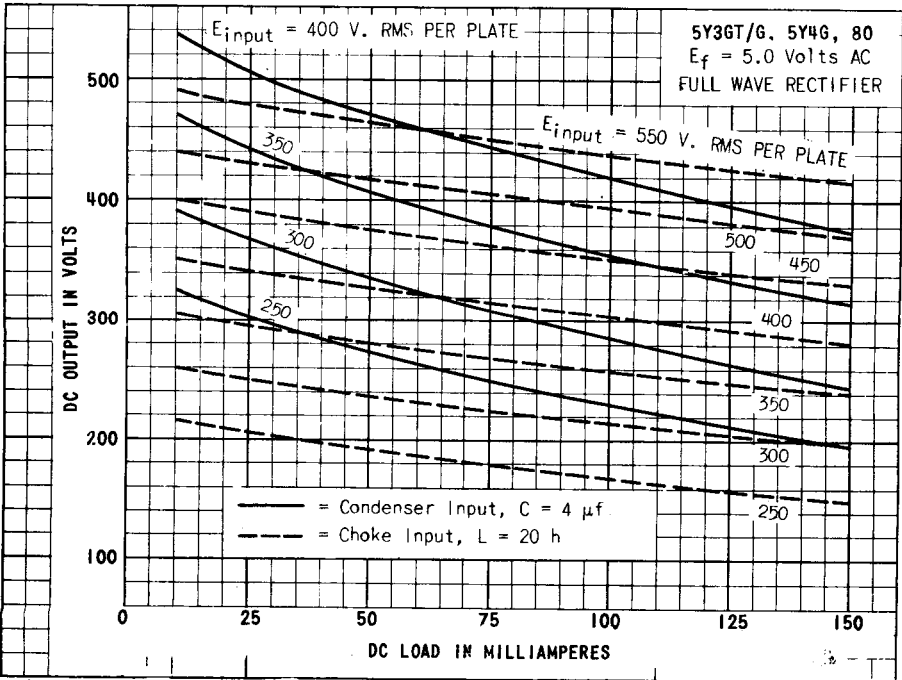
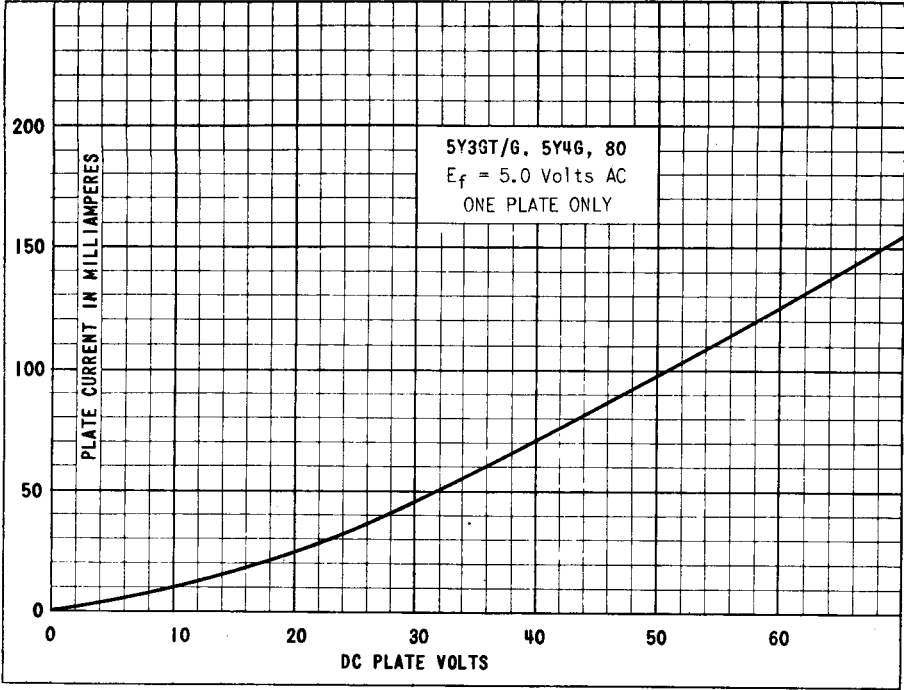
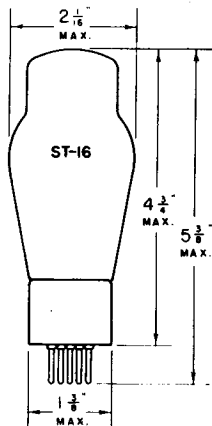

PLATE
 1365-1
 OCT. 25
 1943

TUNG-SOL



**HALF-WAVE
HIGH VACUUM RECTIFIER**

COATED FILAMENT

7.5 VOLTS 1.25 AMPERES
AC

GLASS BULB

MEDIUM 4 PIN BAYONET BASE

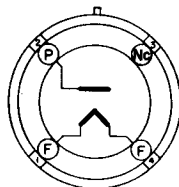

4B

BOTTOM VIEW

THE TUNG-SOL 81 IS A HALF-WAVE RECTIFIER WHICH MAY BE USED WITH EITHER CHOKE OR CONDENSER INPUT TO THE FILTER.

OPERATING CONDITIONS AND CHARACTERISTICS

HALF-WAVE RECTIFIER - SINGLE TUBE
CONDENSER OR CHOKE INPUT TO FILTER

AC PLATE VOLTAGE (RMS)	700 ^{MAX.}	VOLTS
DC OUTPUT CURRENT	85 ^{MAX.}	MA.

FULL-WAVE RECTIFIER - TWO TUBES

CONDENSER OR CHOKE INPUT TO FILTER

AC PLATE VOLTAGE (RMS)	700 ^{MAX.}	VOLTS
DC OUTPUT CURRENT	170 ^{MAX.}	MA.
AVERAGE TUBE VOLTAGE DROP AT 170 MA. DC	91	VOLTS



TUNG-SOL

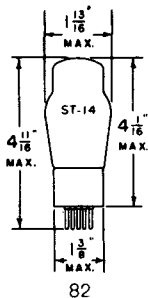

**FULL WAVE
MERCURY VAPOR RECTIFIER**

COATED FILAMENT

82 - 2.5 VOLTS 3.0 AMPERES

83 - 5.0 VOLTS 3.0 AMPERES

AC

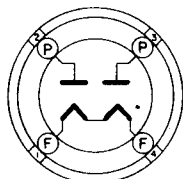
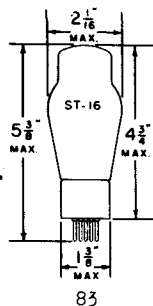

4C

RATINGS

MEDIUM 4 PIN BASE BOTTOM VIEW

82 83

	82	83	
MAXIMUM PEAK INVERSE VOLTAGE	1550	1550	VOLTS
MAXIMUM STEADY-STATE PEAK PLATE CURRENT PER PLATE	345	675	MA.

OPERATING CONDITIONS AND CHARACTERISTICS

FULL WAVE RECTIFIER WITH CONDENSER INPUT TO FILTER

	82	83	
AC PLATE VOLTAGE PER PLATE (RMS) ^{MAX.}	450	450	VOLTS
DC OUTPUT CURRENT ^{MAX.}	115	225	MA.
TOTAL EFFECTIVE PLATE SUPPLY IMPEDANCE PER PLATE ^{MIN. A}	50	50	OHMS
CONDENSED MERCURY TEMPERATURE OPERATING RANGE	24°-60°	20°-60°	CENTIGRADE

FULL WAVE RECTIFIER WITH CHOKE INPUT TO FILTER

	82	83	
AC PLATE VOLTAGE PER PLATE (RMS) ^{MAX.}	550	550	VOLTS
DC OUTPUT CURRENT ^{MAX.}	115	225	MA.
VALUE OF INPUT CHOKE ^{MIN.}	6	3	HENRYS
CONDENSED MERCURY TEMPERATURE OPERATING RANGE	24°-60°	20°-60°	CENTIGRADE
APPROXIMATE TUBE VOLTAGE DROP	15	15	VOLTS

^A WHEN FILTER CONDENSERS LARGER THAN 40 μFDS ARE USED, IT MAY BE NECESSARY TO ADD ADDITIONAL PLATE SUPPLY IMPEDANCE. THE 82 AND 83 MAY BE OPERATED WITH PLATES CONNECTED IN PARALLEL. TO EQUALIZE THE CURRENT DISTRIBUTION BETWEEN PLATES, WHEN SO CONNECTED, IT IS NECESSARY TO ADD RESISTANCE IN SERIES WITH EACH PLATE LEAD (TYPE 82: 100 OHMS, TYPE 83: 50 OHMS). FOR PARALLEL OPERATION IN A FULL-WAVE CIRCUIT, IT IS DESIRABLE THAT BOTH PLATES WITHIN THE SAME TUBE BE CONNECTED TO THE SAME TERMINAL OF THE PLATE TRANSFORMER.

FULL LOAD SHOULD NOT BE APPLIED TO THIS TUBE UNTIL THE FILAMENTS HAVE REACHED THEIR NORMAL OPERATING TEMPERATURE. UNDER NORMAL OPERATING CONDITIONS, THE FILAMENTS HEAT QUICKLY WHEN THE SET IS "TURNED ON" AND ARE READY TO SUPPLY FULL-LOAD CURRENT BEFORE THE TUBES IN THE RECEIVER REQUIRE IT.

FOR "INTERPRETATION OF RATINGS", REFER TO FRONT OF BOOK.

CONTINUED NEXT PAGE

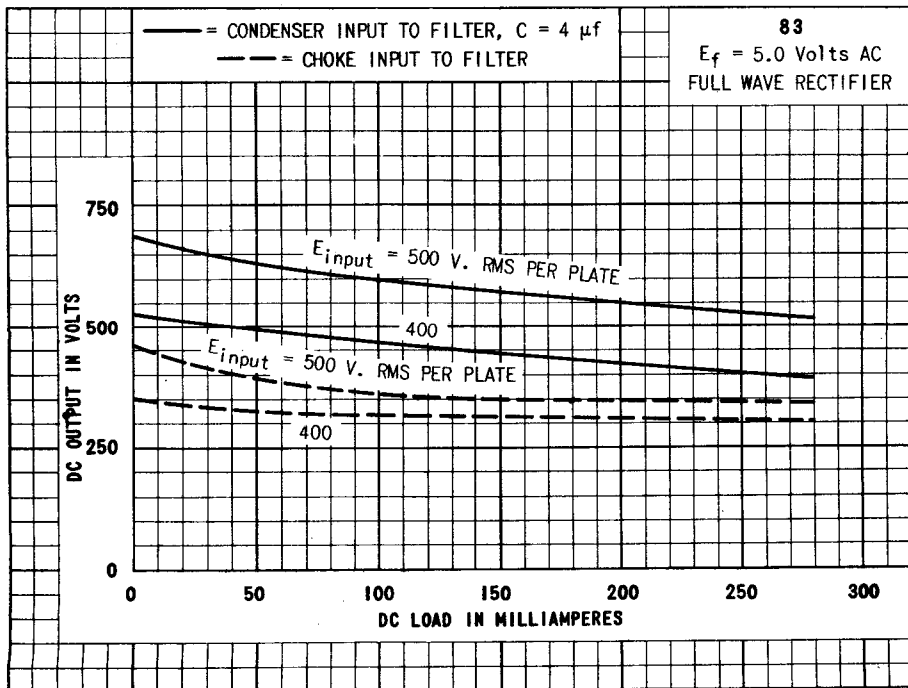
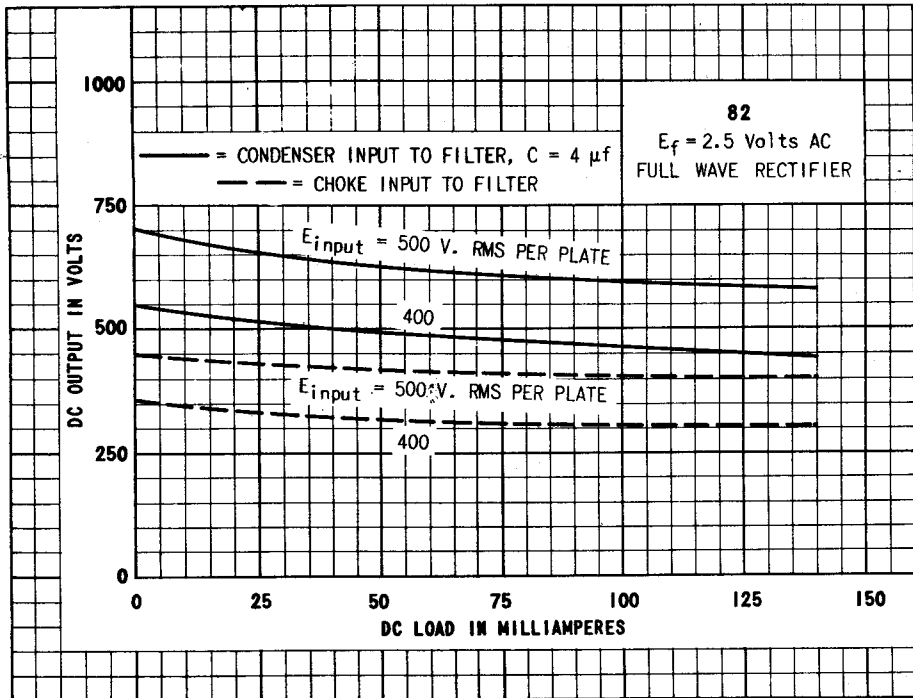

TUNG-SOL

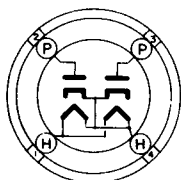
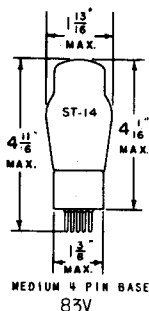

4L

BOTTOM VIEW

FULL WAVE
HIGH VACUUM RECTIFIER

UNIPOTENTIAL CATHODE

HEATER

5.0 VOLTS 2.0 AMPERES
AC

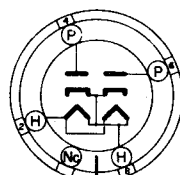
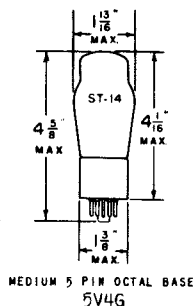

G-5L

BOTTOM VIEW

THE TUNG-SOL 5V4G AND 83V ARE POWER RECTIFIERS WITH LOW INTERNAL VOLTAGE DROPS. THEY ARE DESIGNED FOR SERVICE IN AC OPERATED RECEIVERS THAT REQUIRE HIGH CURRENTS. THEIR RATINGS AND ELECTRICAL CHARACTERISTICS ARE IDENTICAL.

RATINGS

MAXIMUM PEAK INVERSE VOLTAGE	1400	VOLTS
MAXIMUM STEADY-STATE PEAK PLATE CURRENT PER PLATE	525	MA.

OPERATING CONDITIONS AND CHARACTERISTICS

FULL WAVE RECTIFIER WITH CONDENSER INPUT TO FILTER

AC PLATE VOLTAGE PER PLATE (RMS) ^{MAX.}	375	VOLTS
DC OUTPUT CURRENT ^{MAX.}	175	MA.
TOTAL EFFECTIVE PLATE SUPPLY IMPEDANCE PER PLATE ^{MIN. A}	65	OHMS

FULL WAVE RECTIFIER WITH CHOKE INPUT TO FILTER

AC PLATE VOLTAGE PER PLATE (RMS) ^{MAX.}	500	VOLTS
DC OUTPUT CURRENT ^{MAX.}	175	MA.
VALUE OF INPUT CHOKE ^{MIN.}	4.0	HENRYS
TUBE VOLTAGE DROP	23	VOLTS

AT 175 MA. PER PLATE

^A WHEN FILTER CONDENSERS LARGER THAN 40 μ FDS ARE USED, IT MAY BE NECESSARY TO ADD ADDITIONAL PLATE SUPPLY IMPEDANCE.

FOR "INTERPRETATION OF RATINGS", REFER TO FRONT OF BOOK.

CONTINUED NEXT PAGE

83V (5V4G)

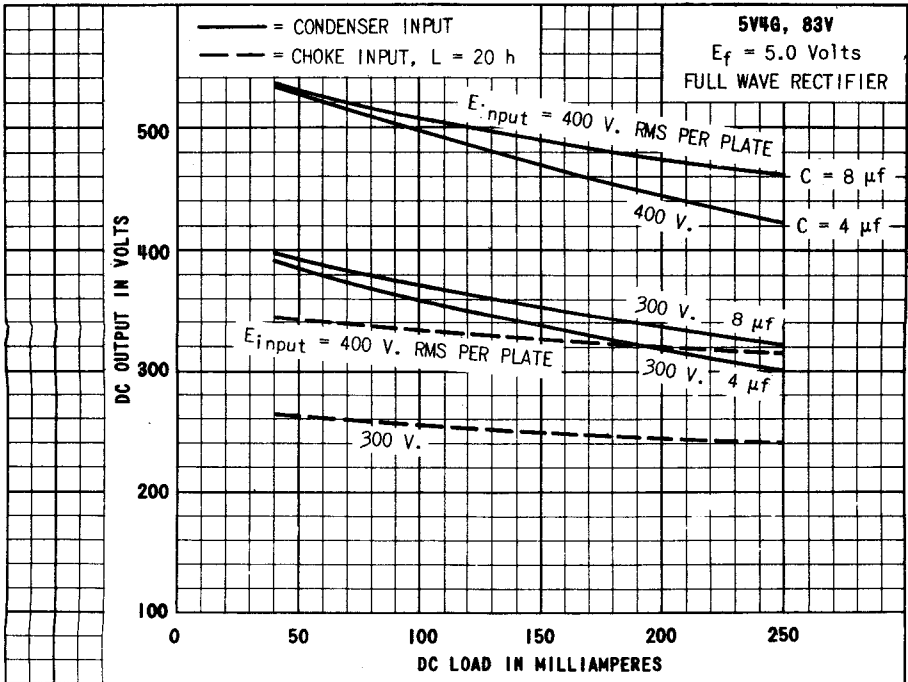
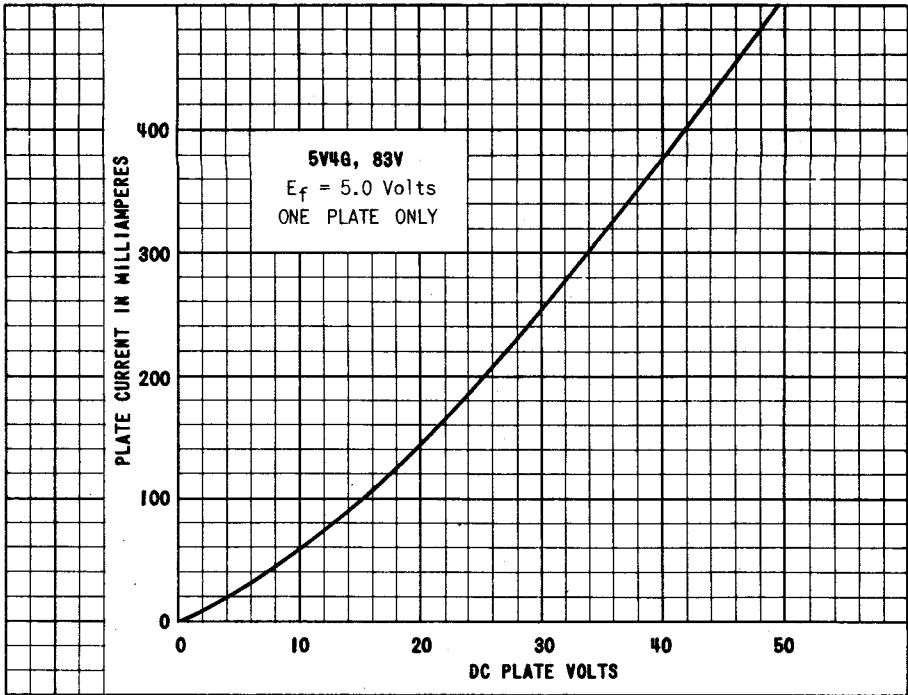
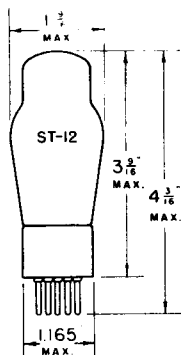

PLATE
702-1

TUNG-SOL



**FULL WAVE
HIGH VACUUM RECTIFIER**

UNIPOTENTIAL CATHODE

HEATER

6.3 VOLTS 0.5 AMPERE

AC OR DC

GLASS BULB

SMALL 5 PIN BASE

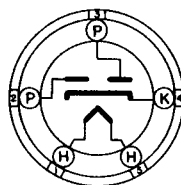

5D

BOTTOM VIEW

THE TUNG-SOL 84/6Z4 IS DESIGNED FOR USE AS A POWER RECTIFIER IN STORAGE BATTERY AND AC OPERATED RECEIVERS.

RATINGS

MAXIMUM PEAK INVERSE VOLTAGE	1250	VOLTS
MAXIMUM DC HEATER TO CATHODE POTENTIAL	450	VOLTS
MAXIMUM STEADY-STATE PEAK PLATE CURRENT PER PLATE	180	MA.

OPERATING CONDITIONS AND CHARACTERISTICS

FULL WAVE RECTIFIER WITH CONDENSER INPUT TO FILTER

AC PLATE VOLTAGE PER PLATE (RMS) ^{MAX.}	325	VOLTS
DC OUTPUT CURRENT ^{MAX.}	60	MA.
TOTAL EFFECTIVE PLATE SUPPLY IMPEDANCE PER PLATE ^{MIN-A}	65	OHMS

FULL WAVE RECTIFIER WITH CHOKE INPUT TO FILTER

AC PLATE VOLTAGE PER PLATE (RMS) ^{MAX.}	450	VOLTS
DC OUTPUT CURRENT ^{MAX.}	60	MA.
VALUE OF INPUT CHOKE ^{MIN.}	10	HENRYS
TUBE VOLTAGE DROP	20	VOLTS
AT 60 MA. PER PLATE		

^A WHEN FILTER CONDENSERS LARGER THAN 40 μ FDS ARE USED, IT MAY BE NECESSARY TO ADD ADDITIONAL PLATE SUPPLY IMPEDANCE.

FOR "INTERPRETATION OF RATINGS", REFER TO FRONT OF BOOK.

CONTINUED NEXT PAGE

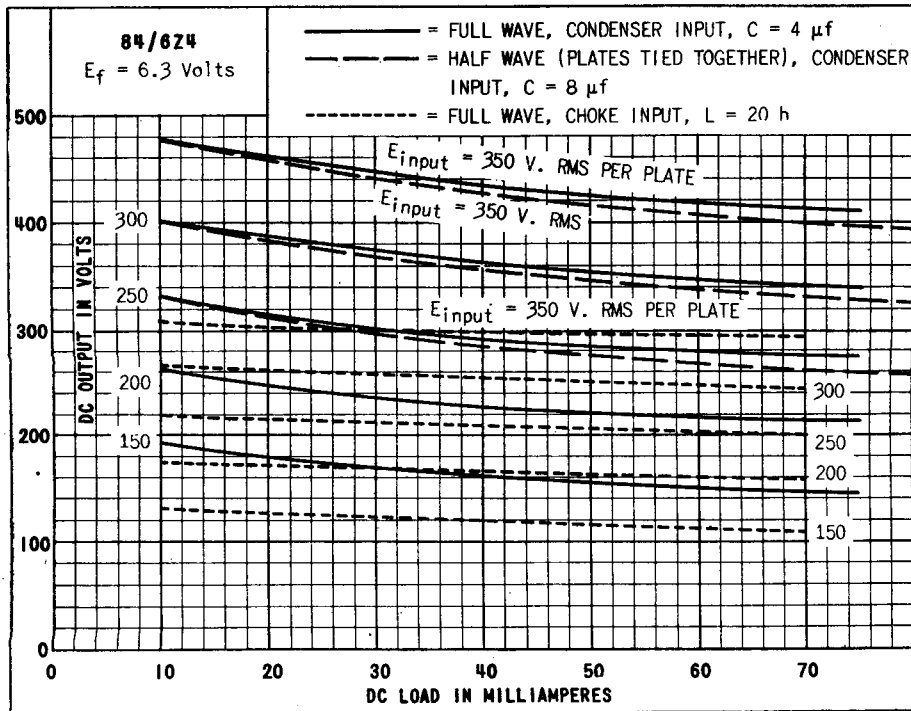
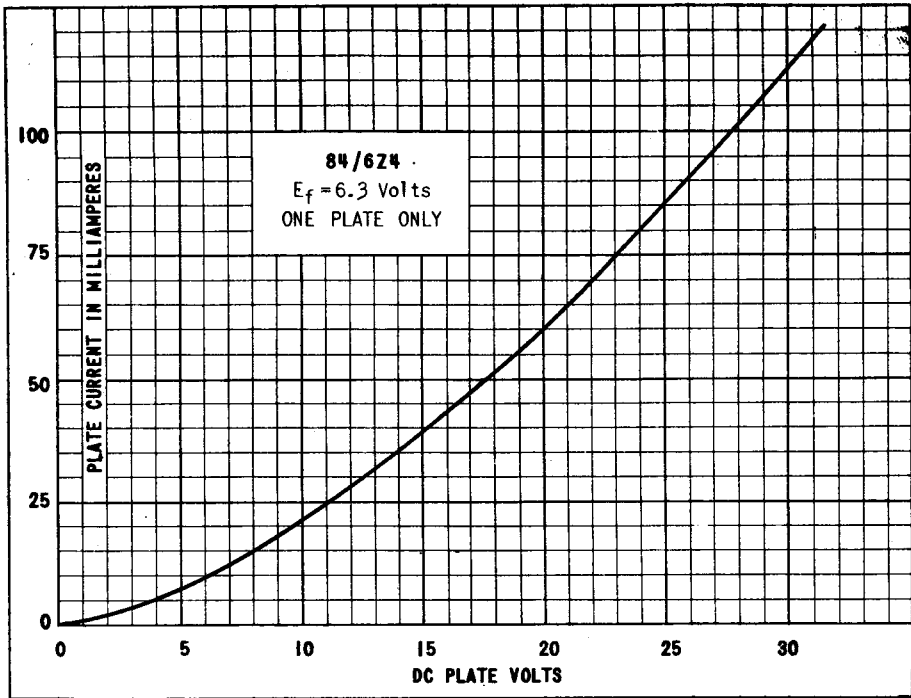

TUNG-SOL

DUPLEX-DIODE TRIODE

UNIPOENTIAL CATHODE

HEATER

6V7G, 85 55
 6.3 V. 2.5 V.
 0.3 A. 1.0 A.

AC OR DC

IN CIRCUITS WHERE THE CATHODE IS NOT DIRECTLY CONNECTED TO THE HEATER, THE POTENTIAL DIFFERENCE BETWEEN HEATER AND CATHODE SHOULD BE KEPT AS LOW AS POSSIBLE. UNDER NO CONDITIONS SHOULD IT EXCEED 100 VOLTS.

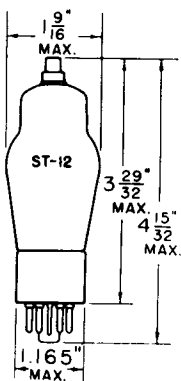

6V7G
 SMALL 7 PIN
 OCTAL BASE

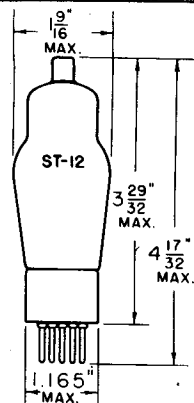

55, 85
 SMALL 8 PIN
 BASE

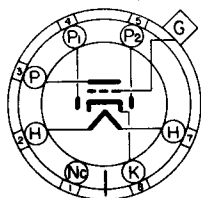

6V7G

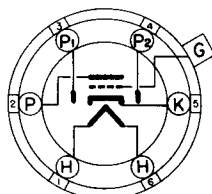

55, 85

BOTTOM VIEWS

THE 6V7G, 55 AND 85 ARE HEATER CATHODE TYPE TUBES CONSISTING OF TWO DIODES AND A TRIODE IN A SINGLE BULB. THEY ARE DESIGNED FOR USE AS COMBINED DETECTORS, AMPLIFIERS AND AUTOMATIC VOLUME CONTROL TUBES.

RATINGS

INTERPRETED ACCORDING TO RMA STANDARD MB-210

MAXIMUM PLATE VOLTAGE	250	VOLTS
MAXIMUM PLATE DISSIPATION	2.0	WATTS

DIRECT INTERELECTRODE CAPACITANCES

GRID TO PLATE	1.5	μμf
INPUT	1.5	μμf
OUTPUT	4.3	μμf

TYPICAL OPERATING CONDITIONS AND CHARACTERISTICS

CLASS A AMPLIFIER

PLATE VOLTAGE	135	180	250	VOLTS
GRID VOLTAGE	-10.5	-13.5	-20	VOLTS
PLATE CURRENT	3.7	6.0	8.0	MA.
PLATE RESISTANCE	11000	8500	7500	OHMS
TRANSCONDUCTANCE	750	975	1100	μMHOS
AMPLIFICATION FACTOR	8.3	8.3	8.3	
LOAD RESISTANCE	25000	20000	20000	OHMS
POWER OUTPUT	75	160	350	MW.

PLATE
 1447
 JUNE 15
 1944

85 (6V7G, 55)

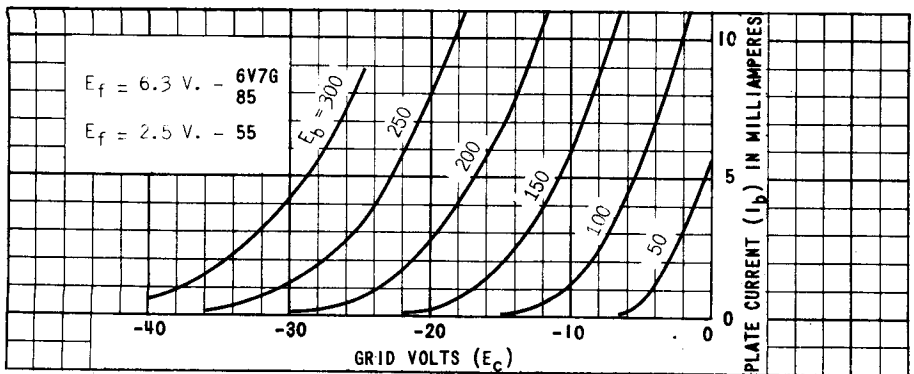
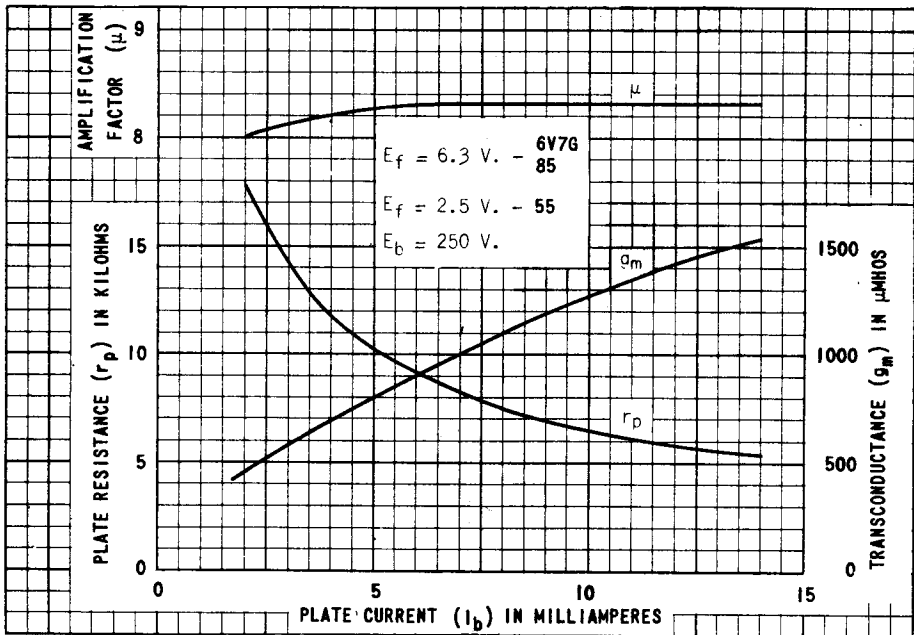
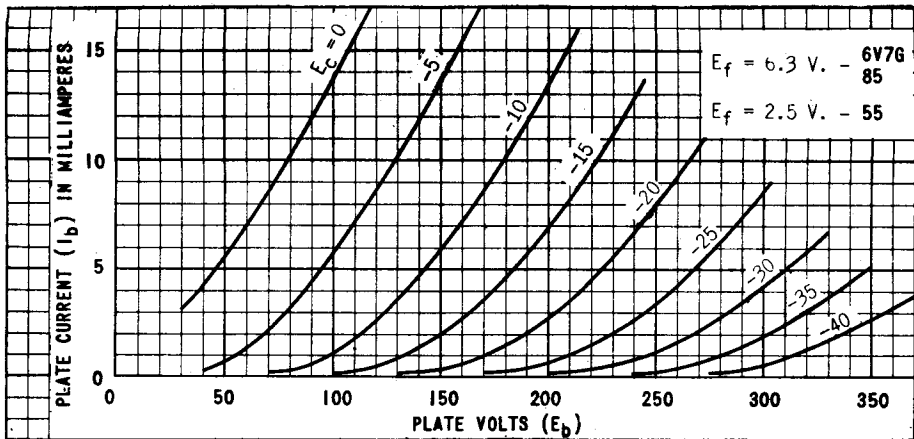
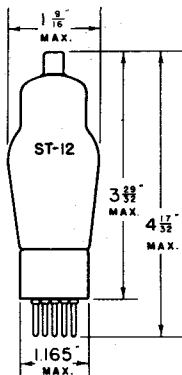

PLATE
1448
JUNE 15
1944

TUNG-SOL



TRIPLE GRID POWER AMPLIFIER

UNIPOTENTIAL CATHODE

HEATER

6.3 VOLTS 0.4 AMPERE

AC OR DC

GLASS BULB

SMALL 6 PIN BASE

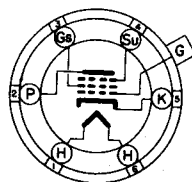

6F

THE TUNG-SOL 89 IS DESIGNED FOR SERVICE AS A PENTODE, CLASS A TRIODE, OR CLASS B TRIODE, IN THE OUTPUT STAGE OF AC OPERATED AND STORAGE BATTERY OPERATED RECEIVERS.

OPERATING CONDITIONS AND CHARACTERISTICS

CLASS A₁ AMPLIFIER—TRIODE CONNECTEDGRIDS G₂ AND S_U CONNECTED TO PLATE

PLATE VOLTAGE	160 ²	180	250 MAX.	VOLTS
CONTROL GRID VOLTAGE	-20	-22.5	-31	VOLTS
GRID CIRCUIT RESISTANCE MAX.	1	1	1	MEG OHM
PLATE CURRENT	17	20	32	MA.
PLATE RESISTANCE	3300	3000	2600	OHMS
TRANSCONDUCTANCE	1425	1550	1800	μMHOS
AMPLIFICATION FACTOR	4.7	4.7	4.7	
LOAD RESISTANCE ^P	7000	6500	5500	OHMS
TOTAL HARMONIC DISTORTION MAX.	5	5	5	PER CENT
POWER OUTPUT	300	400	900	MW.

^P WHEN USED AS A DRIVER FOR A CLASS B STAGE, APPROXIMATELY TWICE THIS VALUE OF LOAD RESISTANCE IS RECOMMENDED.

CLASS A₁ AMPLIFIER—PENTODE CONNECTED

PLATE VOLTAGE	100	135	180	250 MAX.	VOLTS
SCREEN GRID VOLTAGE	100	135	180	250 MAX.	VOLTS
CONTROL GRID VOLTAGE	-10	-13.5	-18	-25	VOLTS
GRID CIRCUIT RESISTANCE MAX.	1	1	1	1	MEG OHM
SUPPRESSOR	CONNECTED TO CATHODE AT SOCKET				
PLATE CURRENT	9.5	14	20	32	MA.
SCREEN CURRENT	1.6	2.2	3.0	5.5	MA.
TRANSCONDUCTANCE	1200	1350	1550	1800	μMHOS
AMPLIFICATION FACTOR	125	125	125	125	
LOAD RESISTANCE	10 700	9200	8000	6750	OHMS
TOTAL HARMONIC DISTORTION	9	9	9	9	PER CENT
POWER OUTPUT	0.33	0.75	1.5	3.4	WATTS

CONTINUED NEXT PAGE

TUNG-SOL

CLASS B₂ AMPLIFIER - TRIODE CONNECTION(GRID G₂ TIED TO PLATE; GRIDS G AND G₃ CONNECTED TOGETHER)

PLATE VOLTAGE ^{MAX.}	250	VOLTS
PEAK PLATE CURRENT ^{MAX.}	90	MA.
AVERAGE GRID DISSIPATION (GRIDS G AND G ₃) ^{MAX.}	0.35	WATTS

TWO TUBES PUSH-PULL

PLATE VOLTAGE	180	180	VOLTS
GRID VOLTAGE	0	0	VOLTS
ZERO-SIGNAL PLATE CURRENT PER TUBE	3	3	MA.
LOAD RESISTANCE PER TUBE	3400	2350	OHMS
EFFECTIVE LOAD RESISTANCE PLATE TO PLATE	13600	9400	OHMS
POWER OUTPUT (TWO TUBES) ^{APPROX.}	2.5	3.5	WATTS

DIRECT INTERELECTRODE CAPACITANCES^S

CONTROL GRID TO CATHODE	3.4	μf
PLATE TO CATHODE	7.5	μf
CONTROL GRID TO PLATE	0.5	μf

^S WITH SHIELD

TUNG-SOL

BOLOMETER

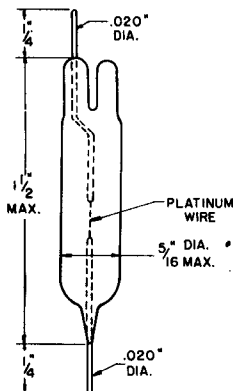
HOT WIRE RESISTOR
FOR MEASURING HIGH FREQUENCY CURRENTS

THE BOLOMETER B-100 CONSISTS OF A VERY FINE PLATINUM WIRE MOUNTED IN AN EVACUATED GLASS ENVELOPE. IT IS USED IN THE MEASUREMENT OF SMALL HIGH FREQUENCY CURRENTS.

RATINGS

RESISTANCE ^A	200 ($\pm 25\%$)	OHMS
MAXIMUM CURRENT	1.50	MA.
OPTIMUM BIAS CURRENT	0.5	MA.
SENSITIVITY	4.0	MICRO WATTS PER 1% CHANGE IN RESISTANCE
THERMAL TIME CONSTANT	0.025 APPROX.	SEC.

^A MEASURED AT A CURRENT OF 0.5 MA. THE INCREASE IN RESISTANCE DUE TO SKIN EFFECT IS LESS THAN 1% FOR FREQUENCIES UP TO 10,000 MEGACYCLES.

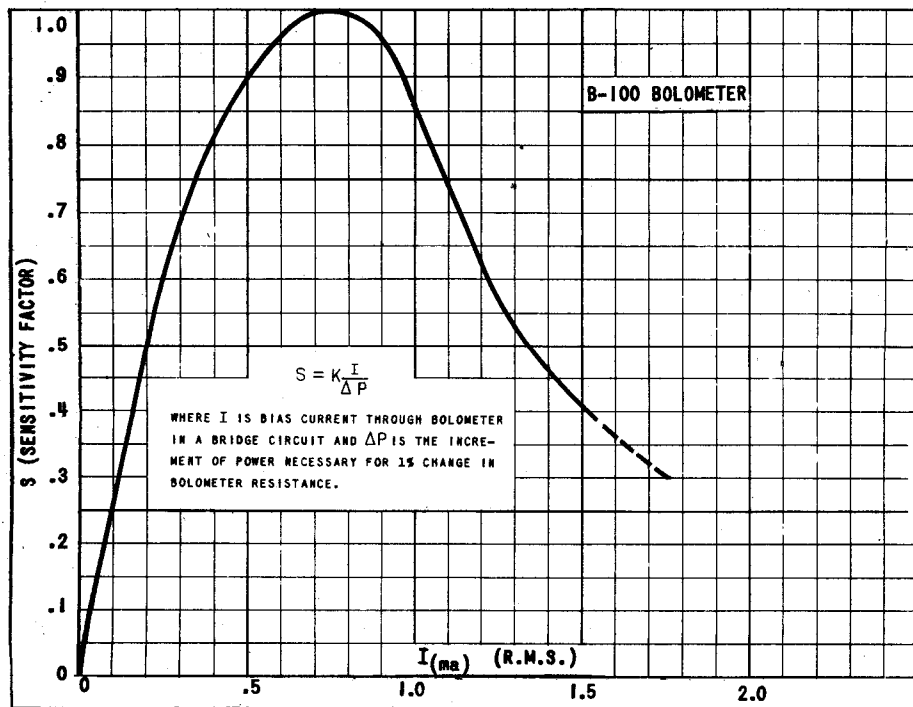
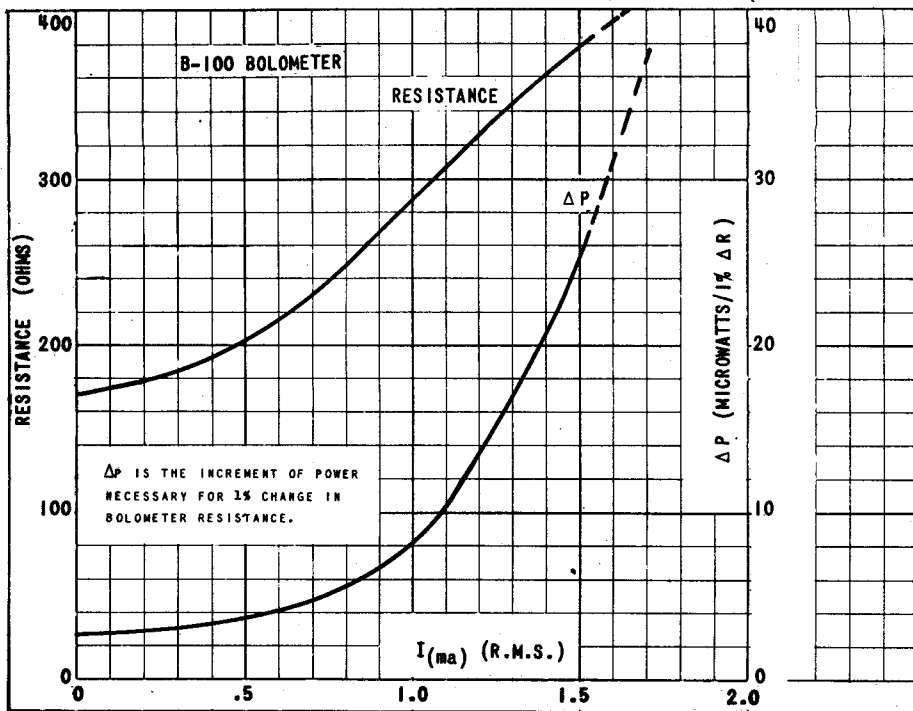

TUNG-SOL

BEAM POWER AMPLIFIER
 HALF WAVE RECTIFIER

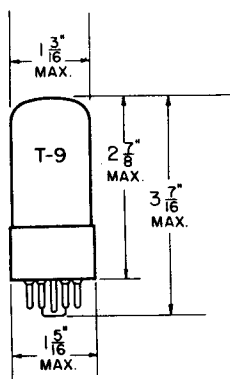

GLASS BULB

COATED UNIPOTENTIAL CATHODES

HEATERS

117 VOLTS 0.09 AMPERE

AC OR DC

ANY MOUNTING POSITION

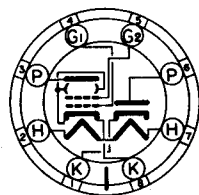

BOTTOM VIEW

INTERMEDIATE SHELL
8 PIN OCTAL BASE

THE 117L7/M7GT COMBINES A HALF-WAVE RECTIFIER AND A BEAM POWER AMPLIFIER IN THE SAME ENVELOPE. IT IS DESIGNED FOR AC-DC SERVICE FROM A 117 VOLT LINE IN THREE WAY PORTABLE RECEIVERS.

RATINGS

INTERPRETED ACCORDING TO RMA STANDARD M8-210

AMPLIFIER UNIT

MAXIMUM HEATER VOLTAGE	117	VOLTS
MAXIMUM HEATER CURRENT	0.090	AMP.
MAXIMUM PLATE VOLTAGE	117	VOLTS
MAXIMUM SCREEN VOLTAGE	117	VOLTS
MAXIMUM PLATE DISSIPATION	6.0	WATTS
MAXIMUM SCREEN DISSIPATION	1.0	WATTS

RECTIFIER UNIT

MAXIMUM HEATER VOLTAGE	117	VOLTS
MAXIMUM HEATER CURRENT	0.090	AMP.
MAXIMUM AC PLATE VOLTAGE (RMS)	117	VOLTS
MAXIMUM PEAK INVERSE VOLTAGE	350	VOLTS
MAXIMUM STEADY STATE PEAK PLATE CURRENT	450	MA.
TUBE VOLTAGE DROP AT 150 MA. PLATE CURRENT	16	VOLTS
MAXIMUM DC HEATER-CATHODE VOLTAGE	175	VOLTS

CONTINUED ON FOLLOWING PAGE

→ INDICATES A CHANGE OR ADDITION.

TUNG-SOL

CONTINUED FROM PRECEDING PAGE

TYPICAL OPERATING CONDITIONS AND CHARACTERISTICS

AMPLIFIER UNIT

CLASS A₁ AMPLIFIER

PLATE VOLTAGE	105	VOLTS
SCREEN VOLTAGE	105	VOLTS
GRID VOLTAGE	-5.2	VOLTS
PEAK AF GRID VOLTAGE	5.2	VOLTS
ZERO-SIGNAL PLATE CURRENT	43	MA.
ZERO-SIGNAL SCREEN CURRENT	4	MA.
MAXIMUM-SIGNAL PLATE CURRENT	43	MA.
MAXIMUM-SIGNAL SCREEN CURRENT	5.5	MA.
LOAD RESISTANCE	4 000	OHMS
PLATE RESISTANCE (APPROX.)	17 000	OHMS
TRANSCONDUCTANCE	5 300	μMHOS
MAXIMUM-SIGNAL POWER OUTPUT	0.85	WATT
TOTAL HARMONIC DISTORTION	5.0	PERCENT

HALF WAVE RECTIFIER,
WITH CONDENSER-INPUT FILTER

AC PLATE VOLTAGE (RMS)	117	VOLTS
DC OUTPUT CURRENT	75	MA.
MINIMUM TOTAL EFFECTIVE PLATE SUPPLY IMPEDANCE	15	OHMS

SIMILAR TYPE REFERENCE: Characteristics for the amplifier unit are identical to 117P7GT, somewhat similar to 117N7GT. Except for heater ratings somewhat similar to 70L7GT.

→ INDICATES A CHANGE OR ADDITION

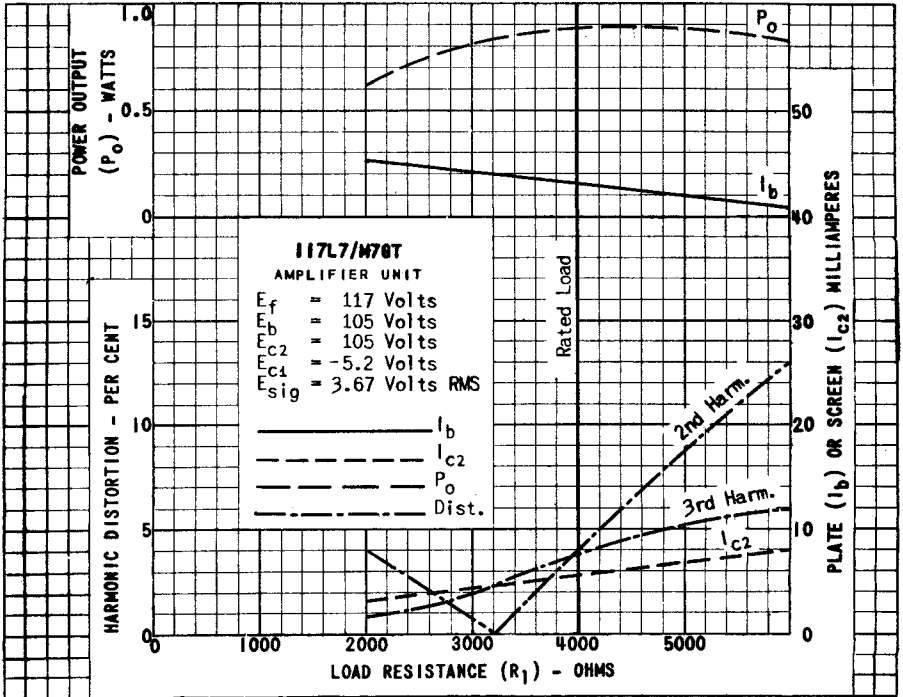
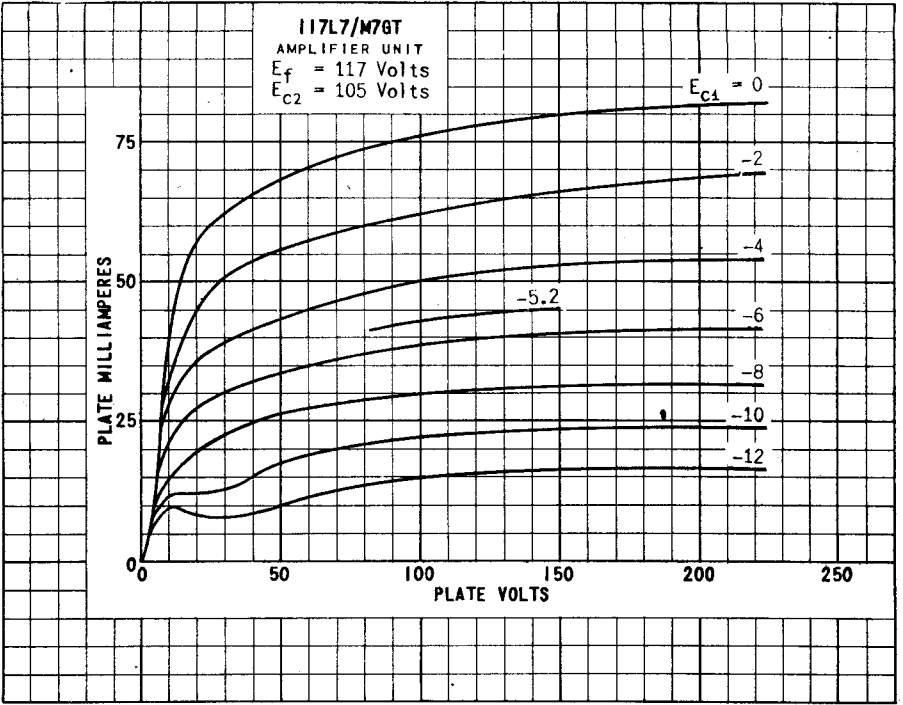

PRINTED IN U. S. A.

PLATE
1817
JUNE 2,
1947

117L7/M7GT

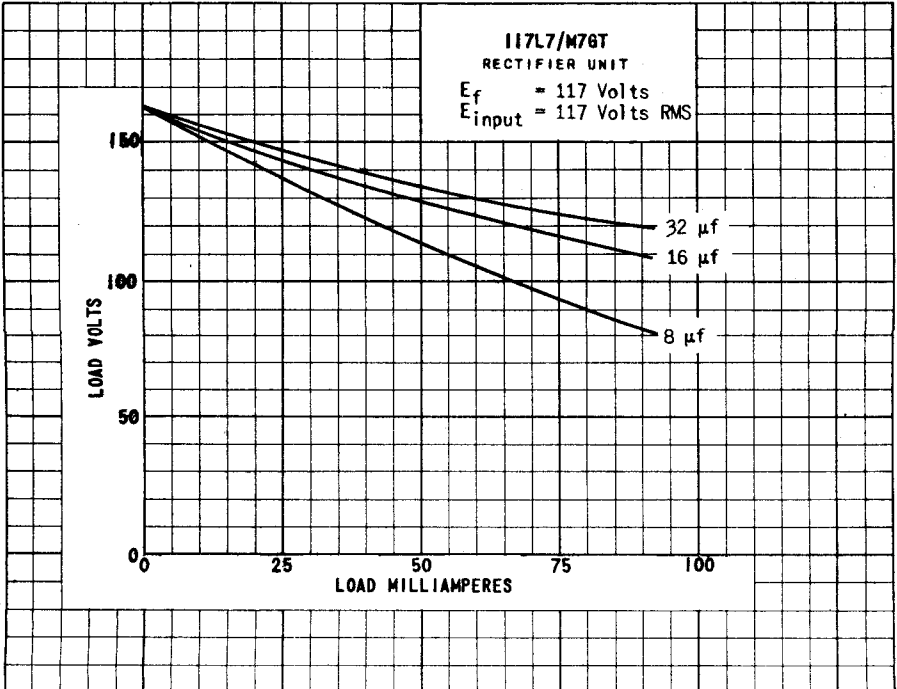
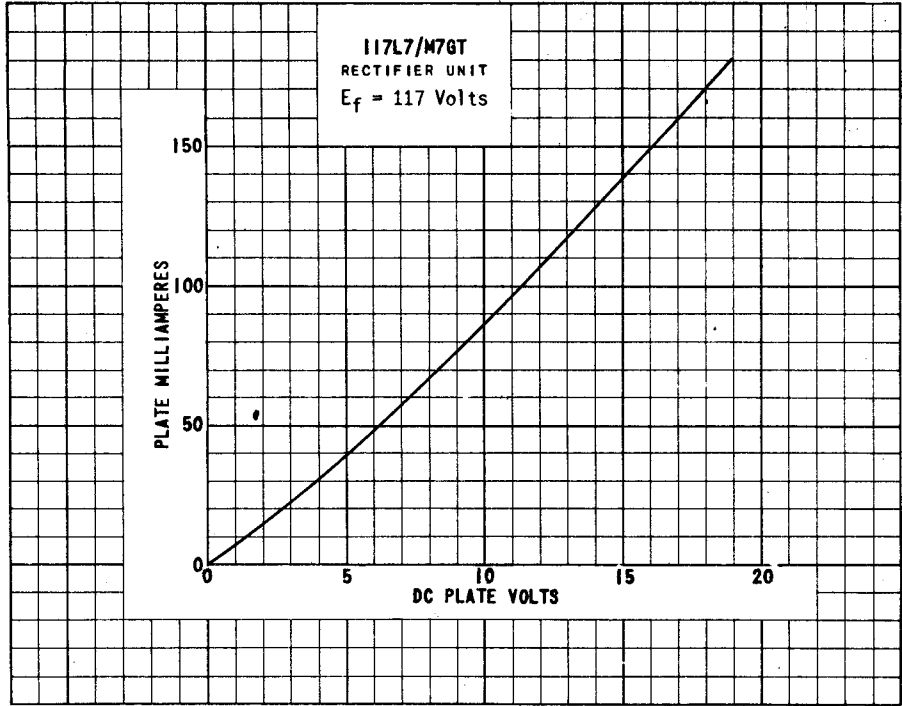
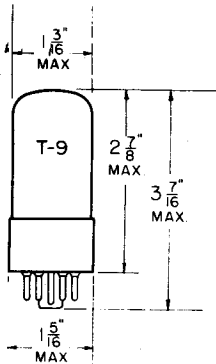

PLATE
1818
JUNE 2,
1947

TUNG-SOL

COMBINED HALF WAVE RECTIFIER
AND BEAM POWER AMPLIFIER

COATED UNIPOTENTIAL CATHODES

HEATER
117 VOLTS 0.09 AMPERE
AC OR DC

ANY MOUNTING POSITION

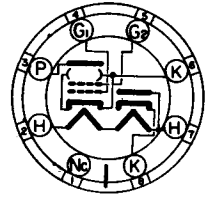

BOTTOM VIEW

INTERMEDIATE SHELL
8-PIN OCTAL

GLASS BULB

THE 117N7GT IS A MULTI-UNIT TUBE CONTAINING A HALF-WAVE RECTIFIER AND A BEAM POWER AMPLIFIER IN THE SAME ENVELOPE. IT IS DESIGNED WITH A HEATER FOR CONNECTION DIRECTLY ACROSS A 117-VOLT SUPPLY LINE.

RATINGS

INTERPRETED ACCORDING TO RMA STANDARD M8-210

HEATER VOLTAGE (AC OR DC)	117	VOLTS
HEATER CURRENT	0.09	AMP.

RECTIFIER UNIT

MAX. PEAK INVERSE PLATE VOLTAGE	350	VOLTS
MAX. PEAK PLATE CURRENT	450	MA.
MAX. DC HEATER-CATHODE POTENTIAL	175	VOLTS

WITH CONDENSER-INPUT FILTER:

MAX. AC PLATE VOLTAGE (RMS)	117	VOLTS
MAX. DC OUTPUT CURRENT	75	MA.
MIN. TOTAL EFFECTIVE PLATE SUPPLY IMPEDANCE ^A	15	OHMS

^A WHEN A FILTER-INPUT CONDENSER LARGER THAN 40 μ F IS USED, IT MAY BE NECESSARY TO USE ADDITIONAL PLATE-SUPPLY IMPEDANCE TO LIMIT THE PEAK PLATE CURRENT TO RATED VALUE.

CONTINUED ON FOLLOWING PAGE

TUNG-SOL

CONTINUED FROM PRECEDING PAGE

AMPLIFIER UNIT

MAX. PLATE VOLTAGE	117	VOLTS
MAX. SCREEN VOLTAGE	117	VOLTS
MAX. PLATE DISSIPATION	5.5	WATTS
MAX. SCREEN DISSIPATION	1	WATT

TYPICAL OPERATING CONDITIONS AND CHARACTERISTICS

CLASS A₁ AMPLIFIER

PLATE VOLTAGE	100	VOLTS
SCREEN VOLTAGE	100	VOLTS
GRID VOLTAGE ^B	-6	VOLTS
PEAK AC GRID VOLTAGE	6	VOLTS
ZERO-SIGNAL PLATE CURRENT	51	MA.
ZERO-SIGNAL SCREEN CURRENT	5	MA.
PLATE RESISTANCE (APPROX.)	16 000	OHMS
LOAD RESISTANCE	3000	OHMS
TRANSCONDUCTANCE	7000	μMHOS
TOTAL HARMONIC DISTORTION	6	PER CENT
MAX. SIGNAL POWER OUTPUT	1.2	WATTS

^B TYPE OF INPUT COUPLING USED SHOULD NOT INTRODUCE TOO MUCH RESISTANCE IN THE GRID CIRCUIT. RESISTANCE SHOULD NOT EXCEED 0.25 MEGOHM WITH FIXED BIAS, NOR 1.0 MEGOHM WITH CATHODE BIAS.

TUNG-SOL

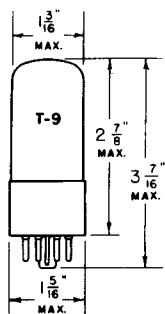

BEAM POWER AMPLIFIER

HALF WAVE RECTIFIER

UNI-POTENTIAL CATHODES

HEATERS

117 VOLTS 0.090 AMPERE

AC OR DC

GLASS BULB

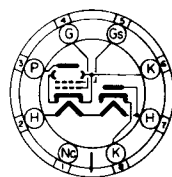

8AV

BOTTOM VIEW

INTERMEDIATE 8 PIN OCTAL BASE

THE TUNG-SOL 117P7GT COMBINES A HALF WAVE RECTIFIER AND A BEAM POWER AMPLIFIER IN THE SAME BULB. IT IS DESIGNED FOR AC - DC SERVICE FROM A 117 VOLT LINE IN THREE WAY PORTABLE RECEIVERS.

RATINGS

BEAM POWER AMPLIFIER UNIT

MAXIMUM PLATE VOLTAGE	117	VOLTS
MAXIMUM SCREEN VOLTAGE	117	VOLTS
MAXIMUM PLATE DISSIPATION	6.0	WATTS
MAXIMUM SCREEN DISSIPATION	1.0	WATT

RATINGS

RECTIFIER UNIT

MAXIMUM AC PLATE VOLTAGE (RMS)	117	VOLTS
MAXIMUM DC HEATER TO CATHODE POTENTIAL	175	VOLTS
MAXIMUM PEAK INVERSE VOLTAGE	350	VOLTS
MAXIMUM STEADY STATE PEAK PLATE CURRENT	450	MA.
TUBE VOLTAGE DROP AT 150 MA. PLATE CURRENT	16	VOLTS

FOR "INTERPRETATION OF RATINGS" REFER TO FRONT OF BOOK.

CONTINUED NEXT PAGE

TUNG-SOL

TYPICAL OPERATING CONDITIONS AND CHARACTERISTICS

BEAM POWER AMPLIFIER UNIT

CLASS A₁ AMPLIFIER

PLATE VOLTAGE	105	VOLTS
SCREEN VOLTAGE	105	VOLTS
CONTROL GRID VOLTAGE ^A	-5.2	VOLTS
PEAK AF SIGNAL VOLTAGE	5.2	VOLTS
ZERO SIGNAL PLATE CURRENT	43	MA.
MAXIMUM SIGNAL PLATE CURRENT	43	MA.
ZERO SIGNAL SCREEN CURRENT	4	MA.
MAXIMUM SIGNAL SCREEN CURRENT	5.5	MA.
PLATE RESISTANCE APPROX.	17000	OHMS
TRANSCONDUCTANCE	5300	μMHOS
LOAD RESISTANCE	4000	OHMS
TOTAL HARMONIC DISTORTION	5.0	PER CENT
MAXIMUM SIGNAL POWER OUTPUT	0.85	WATT

TYPICAL OPERATING CONDITIONS

HALF WAVE RECTIFIER

AC PLATE VOLTAGE (RMS)	117	VOLTS
DC OUTPUT CURRENT	75 ^{MAX.}	MA.
MINIMUM TOTAL EFFECTIVE PLATE SUPPLY IMPEDANCE	15	OHMS

^A THE DC RESISTANCE IN THE GRID CIRCUIT UNDER MAXIMUM RATED CONDITIONS, SHOULD NOT EXCEED 1.0⁷ MEGOHM FOR FULL SELF BIAS AND SERIES SCREEN RESISTOR OPERATION AND 0.25 MEGOHM FOR FIXED BIAS OPERATION.

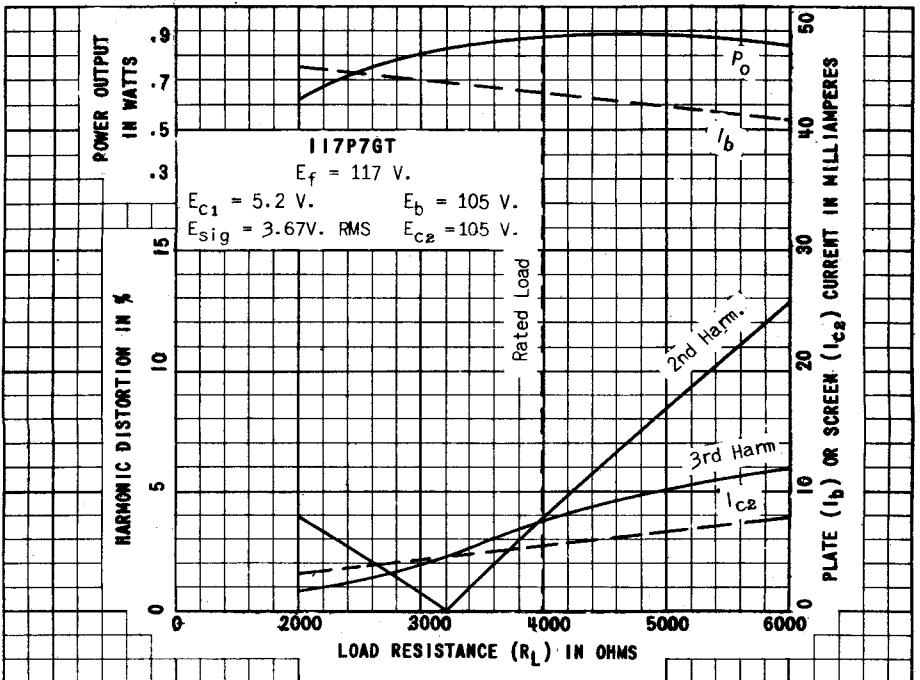
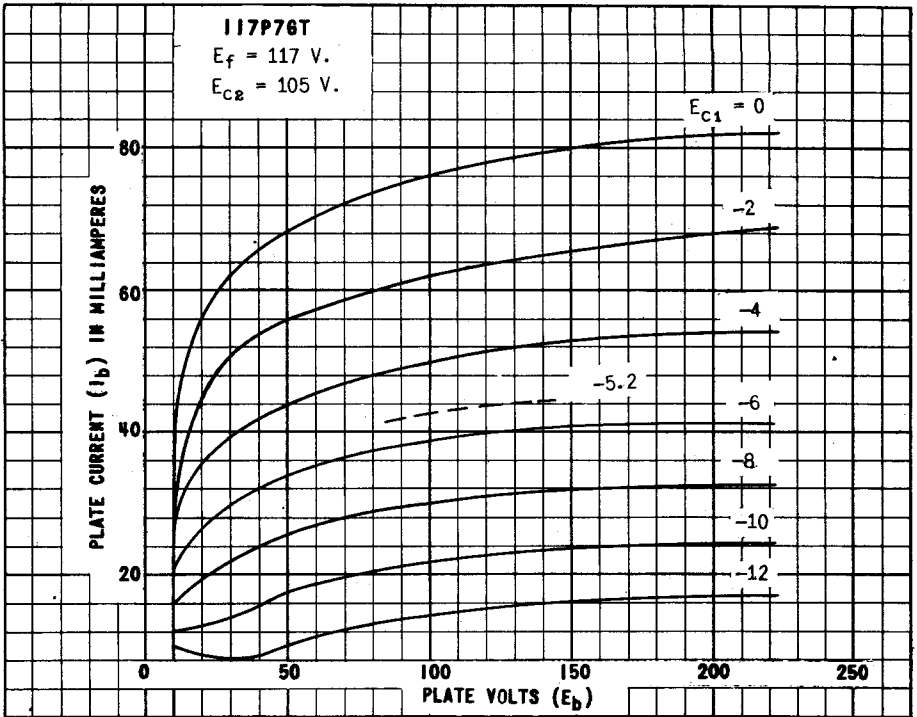

117P7GT

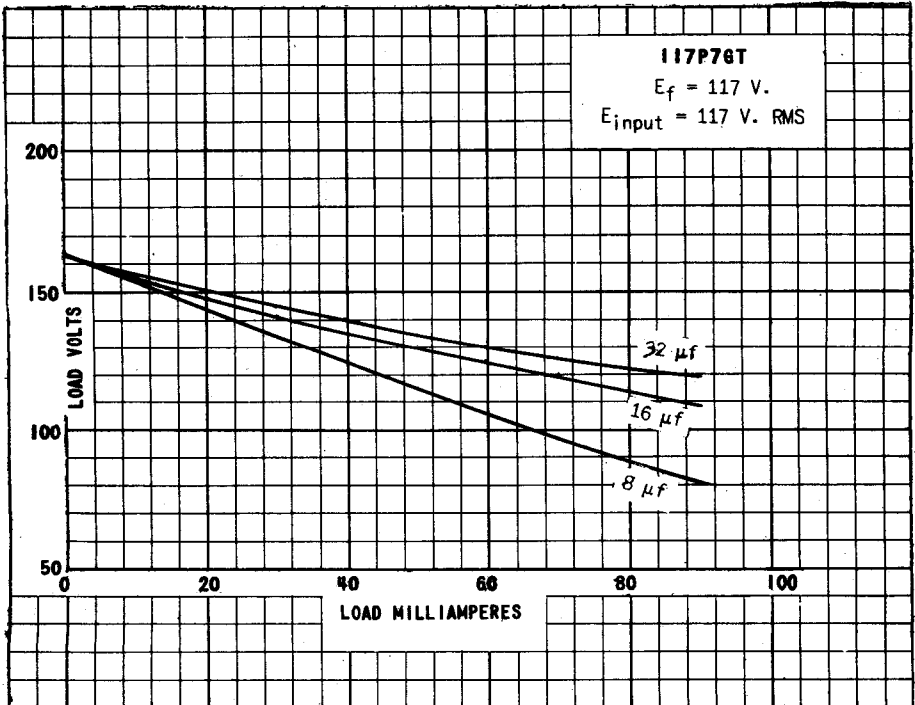
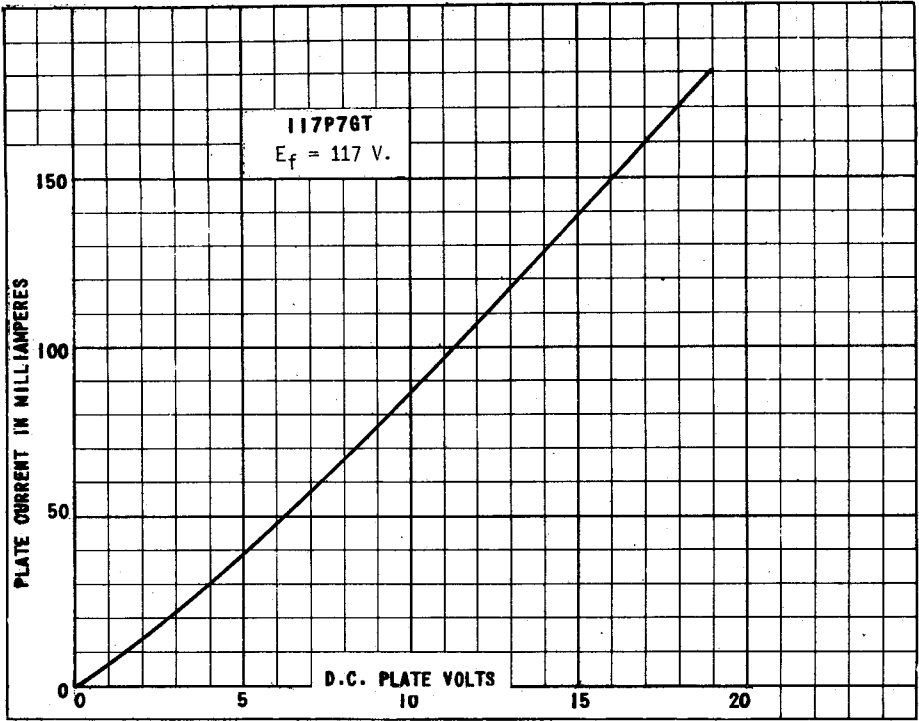

PLATE 1164-1

TUNG-SOL

DIODE

MINIATURE TYPE

COATED UNIPOTENTIAL CATHODE

HEATER

117 VOLTS 40 MA.

AC OR DC

ANY MOUNTING POSITION

NOTE: DO NOT USE PIN #1 ON SOCKET AS TIE POST.

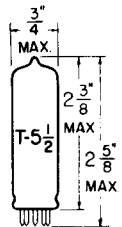

GLASS BULB



BOTTOM VIEW
MINIATURE BUTTON
7 PIN BASE

THE 11723 IS A MINIATURE CATHODE-TYPE, CLOSE-SPACED HALF-WAVE RECTIFIER DESIGNED FOR SERVICE IN THREE-WAY PORTABLE RECEIVERS. THE 117 VOLT HEATER PERMITS DIRECT, ACROSS THE LINE, HEATER OPERATION WITHOUT NEED FOR A DROPPING RESISTOR.

RATINGS

INTERPRETED ACCORDING TO RMA STANDARD M8-210

HEATER VOLTAGE	117	VOLTS
MAXIMUM DC HEATER-CATHODE VOLTAGE		
CATHODE POSITIVE	175	VOLTS
CATHODE NEGATIVE	100	VOLTS
MAXIMUM AC PLATE VOLTAGE [RMS]	117	VOLTS
MAXIMUM PEAK INVERSE VOLTAGE	330	VOLTS
MAXIMUM STEADY-STATE PEAK PLATE CURRENT	540	MA.
MAXIMUM STEADY-STATE DC OUTPUT CURRENT	90	MA.
MAXIMUM TRANSIENT PEAK PLATE CURRENT	2.5	AMP.
TUBE VOLTAGE DROP: MEASURED WITH TUBE CONDUCTING 180 MA. PLATE CURRENT	22.5	VOLTS

TYPICAL OPERATING CONDITIONS AND CHARACTERISTICS

HALF-WAVE RECTIFIER

HEATER VOLTAGE	117	VOLTS
HEATER CURRENT	40	MA.
AC PLATE SUPPLY VOLTAGE (RMS)	117	VOLTS
DC OUTPUT VOLTAGE	110	VOLTS
DC OUTPUT CURRENT	90	MA.
EFFECTIVE PLATE SUPPLY IMPEDANCE	20	OHMS
INPUT CONDENSER	30	μf

SIMILAR TYPE REFERENCE: Same general characteristics as type 11724GT; somewhat similar to the rectifier unit of type 70L7GT.

→ INDICATES A CHANGE OR ADDITION.

PRINTED IN U.S.A.

PLATE 2093
OCT. 1, 1948

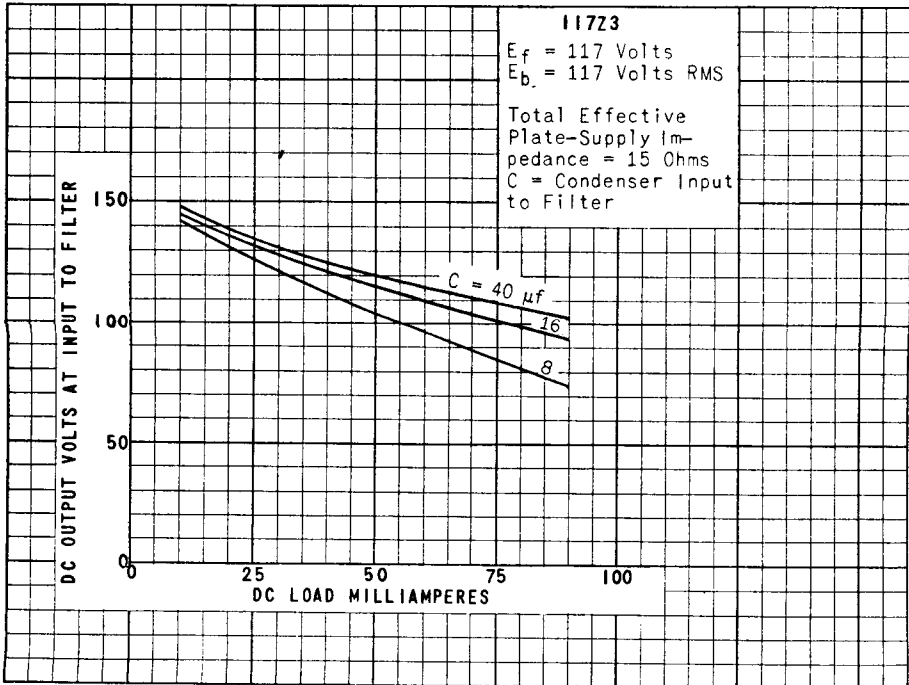
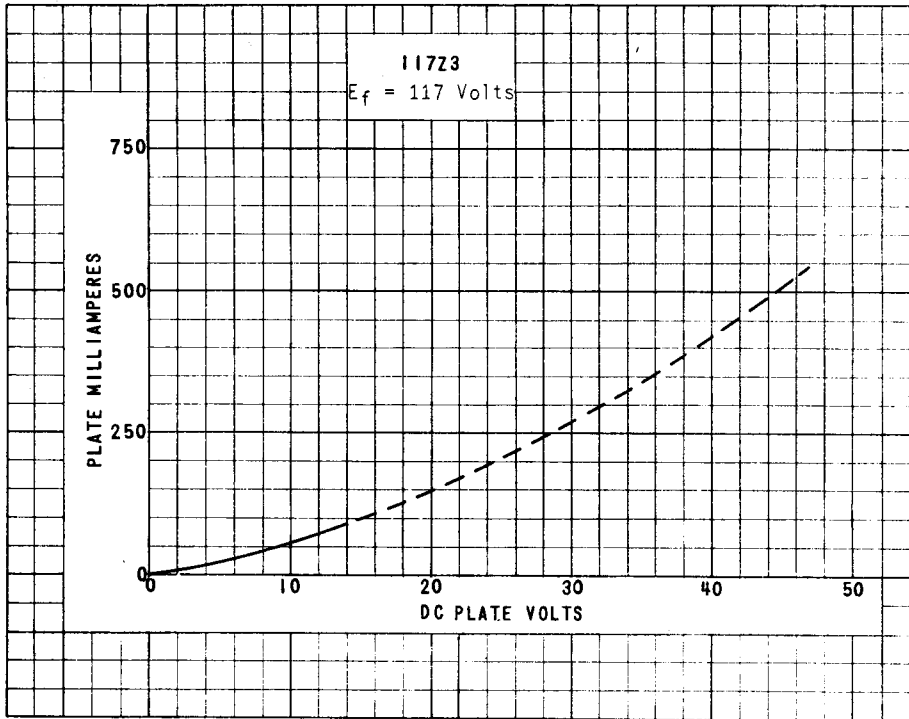

10 TUBE AC SUPERHETERODYNE RECEIVER

TUNG-SOL

TYPICAL CIRCUIT

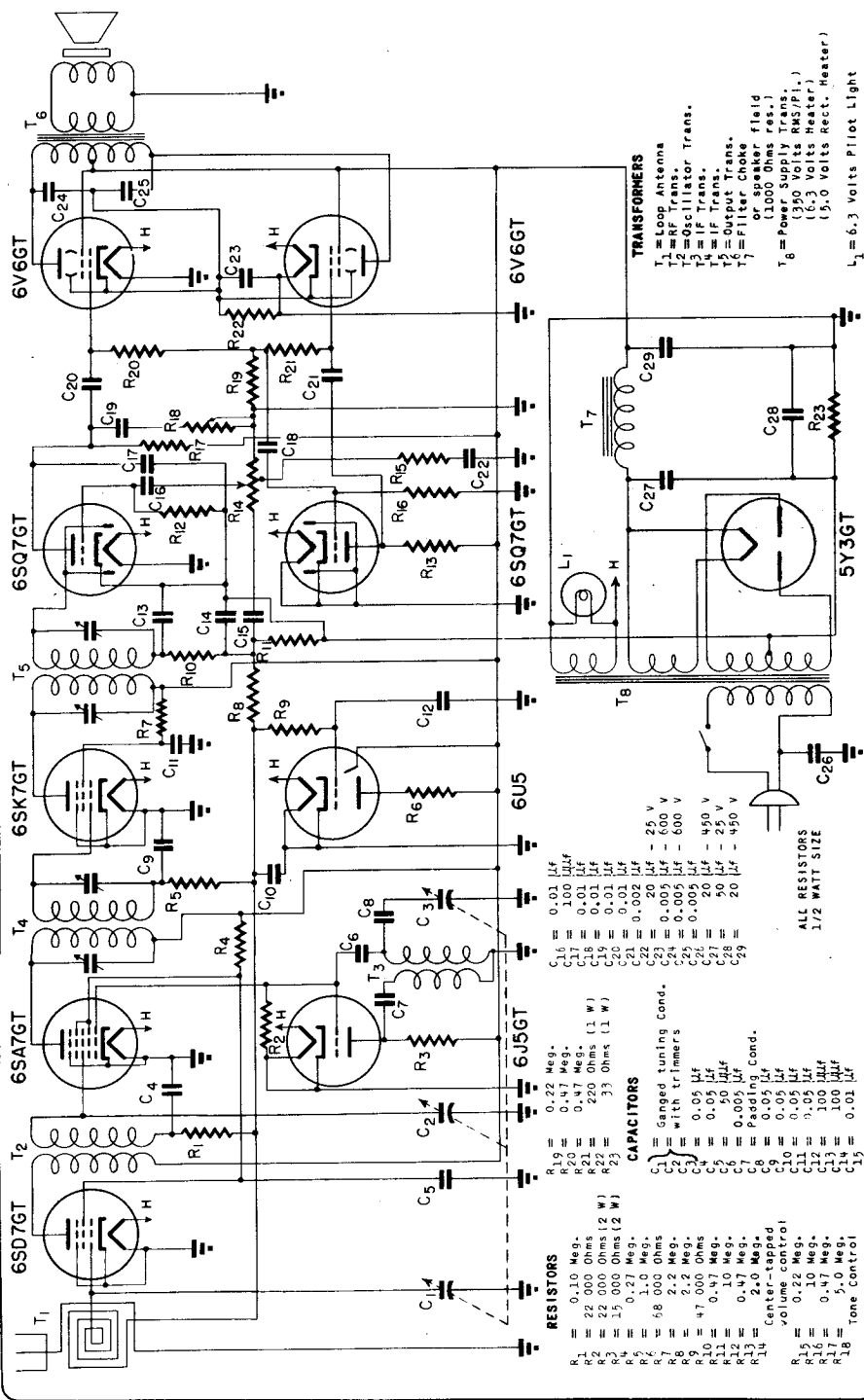

- TRANSFORMERS**
- T₁ = Loop Antenna
 - T₂ = AF Trans.
 - T₃ = Oscillator Trans.
 - T₄ = IF Trans.
 - T₅ = IF Trans.
 - T₆ = Output Trans.
 - T₇ = Filter Choke (fil. 1.000 Ohms res.)
 - T₈ = Power Supply Trans. (390 Volts RMS/Pri.) (16.3 Volts Heater) (15.0 Volts Rect. Heater)
- L₁ = 6.3 Volts Pilot Light

- RESISTORS**
- R₁ = 0.10 Meg.
 - R₂ = 22,000 Ohms
 - R₃ = 22,000 Ohms (2 W)
 - R₄ = 15,000 Ohms (2 W)
 - R₅ = 0.20 Meg.
 - R₆ = 68,000 Ohms
 - R₇ = 2.2 Meg.
 - R₈ = 2.2 Meg.
 - R₉ = 47,000 Ohms
 - R₁₀ = 10 Meg.
 - R₁₁ = 0.47 Meg.
 - R₁₂ = 2.0 Meg.
 - R₁₃ = Center-tapped volume control
 - R₁₄ = 0.22 Meg.
 - R₁₅ = 10 Meg.
 - R₁₆ = 0.47 Meg.
 - R₁₇ = 5.0 Meg.
 - R₁₈ = Tone Control
- CAPACITORS**
- C₁ = Ganged tuning Cond. with trimmers
 - C₂ = 0.05 μ F
 - C₃ = 0.05 μ F
 - C₄ = 0.05 μ F
 - C₅ = 0.05 μ F
 - C₆ = 0.005 μ F
 - C₇ = Passing Cond.
 - C₈ = 0.05 μ F
 - C₉ = 0.05 μ F
 - C₁₀ = 0.05 μ F
 - C₁₁ = 0.22 Meg.
 - C₁₂ = 10 Meg.
 - C₁₃ = 0.47 Meg.
 - C₁₄ = 100 μ F
 - C₁₅ = 1.0 μ F
 - C₁₆ = 0.01 μ F
 - C₁₇ = 1.00 μ F
 - C₁₈ = 0.01 μ F
 - C₁₉ = 0.01 μ F
 - C₂₀ = 0.01 μ F
 - C₂₁ = 0.02 μ F
 - C₂₂ = 20 μ F - 25 V
 - C₂₃ = 0.005 μ F - 600 V
 - C₂₄ = 0.005 μ F - 600 V
 - C₂₅ = 0.02 μ F - 490 V
 - C₂₆ = 50 μ F - 25 V
 - C₂₇ = 20 μ F - 450 V
 - C₂₈ = 20 μ F - 450 V
- ALL RESISTORS 1/2 WATT SIZE

PRINTED IN U. S. A.

PLATE 1839
JULY 1, 1947

FREQUENCY MODULATION TUNER

TYPICAL CIRCUIT

TUNG-SOL

CAPACITORS

- C₁, C₃, C₁₈ = 50 μF
- C₂, C₅, C₆ = 500 μF
- C₂₀, C₂₄ = 500 μF
- C₆ To C₁₄ inclusive, C₂₁ = 0.003 μF
- C₁₅, C₁₆ = 250 μF
- C₁₇ = 5 μF 50 V.
- C₁₉ = 1 μF
- C₂₂, C₂₃ = 0.02 μF
- C₂₅ = 0.0005 μF
- C_P = OSCILLATOR PADDER
- C₂₆ } = 3 GANG TUNING CONDENSER
- C₂₇ }
- C₂₈ }

TRANSFORMERS

- T₁ = Antenna Transformer
- T₂ = RF Transformer
- T₃, T₄ = 10.7 MC IF Transformer
- T₅ = 10.7 MC Ratio Detector Transformer
- L₁, L₂ = 100 MC RF Chokes
- L₃ = Oscillator Coil

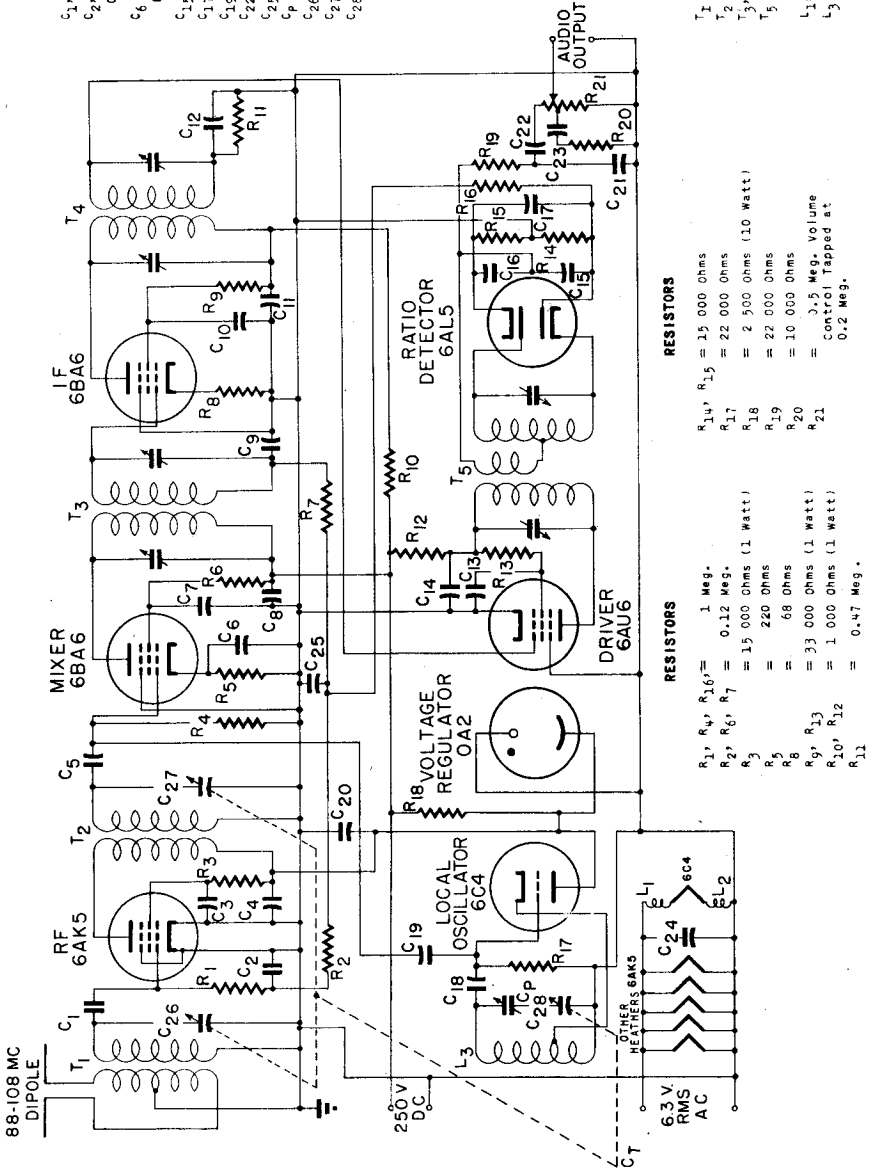

RESISTORS

- R₁₄, R₁₅ = 15 000 Ohms
- R₁₇ = 22 000 Ohms
- R₁₈ = 2 500 Ohms (10 Watt)
- R₁₉ = 22 000 Ohms
- R₂₀ = 10 000 Ohms
- R₂₁ = 3.5 Meg. Volume Control Tapped at 0.2 Meg.
- R₁, R₄, R₁₆ = 1 Meg.
- R₂, R₆, R₇ = 0.12 Meg.
- R₃ = 15 000 Ohms (1 Watt)
- R₅ = 220 Ohms
- R₈ = 68 Ohms
- R₉, R₁₃ = 33 000 Ohms (1 Watt)
- R₁₀, R₁₂ = 1 000 Ohms (1 Watt)
- R₁₁ = 0.47 Meg.

ALL RESISTORS 1/2 WATT SIZE EXCEPT AS NOTED

TUNG-SOL

HALF-WAVE RECTIFIER

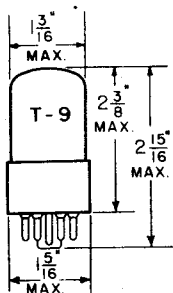

COATED UNIPOTENTIAL CATHODE

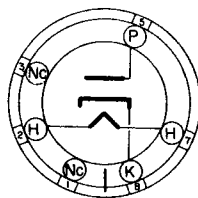
117 VOLTS .040 AMPERE
AC OR DC

ANY MOUNTING POSITION

GLASS BULB

BOTTOM VIEW

INTERMEDIATE SHELL
6-PIN OCTAL

THE 117Z4GT IS A HALF-WAVE RECTIFIER DESIGNED FOR SERVICE IN THREE-WAY PORTABLE RECEIVERS.

RATINGS

INTERPRETED ACCORDING TO RMA STANDARD M8-210

HEATER VOLTAGE (AC OR DC)	117	VOLTS
HEATER CURRENT	.040	AMP.
MAX. AC PLATE VOLTAGE	117	VOLTS
MAX. DC HEATER CATHODE POTENTIAL	175	VOLTS
MAX. PEAK INVERSE PLATE VOLTAGE	350	VOLTS
MAX. STEADY STATE PEAK PLATE CURRENT	540	MA.
TUBE VOLTAGE DROP FOR 180 MA. DC	22.5	VOLTS

TYPICAL OPERATING CONDITIONS AND CHARACTERISTICS

WITH CONDENSER-INPUT FILTER

HALF-WAVE RECTIFIER

AC PLATE VOLTAGE (RMS)	117	VOLTS
DC OUTPUT CURRENT	90	MA.
MIN. TOTAL EFFECTIVE PLATE SUPPLY IMPEDANCE ^A	30	OHMS

^A WHEN FILTER CONDENSERS LARGER THAN 40 μ F ARE USED, IT MAY BE NECESSARY TO USE ADDITIONAL PLATE SUPPLY IMPEDANCE.



TUNG-SOL

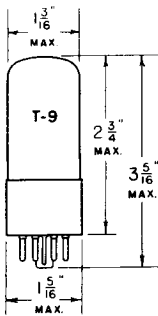

**FULL WAVE
HIGH VACUUM RECTIFIER**

UNI-POTENTIAL CATHODES

HEATER
117 VOLTS 0.075 AMPERE
AC OR DC

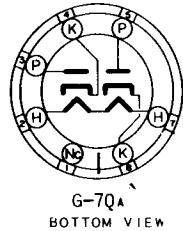

GLASS BULB

INTERMEDIATE 7 PIN OCTAL BASE

THE TUNG-SOL 117Z6GT/G IS DESIGNED FOR SERVICE AS A POWER RECTIFIER IN THREE WAY PORTABLE RECEIVERS.

RATINGS

MAX. AC PLATE VOLTAGE PER PLATE (RMS)	235	VOLTS
MAX. PEAK INVERSE VOLTAGE	700	VOLTS
MAX. DC HEATER TO CATHODE POTENTIAL	350	VOLTS
MAX. STEADY-STATE PEAK PLATE CURRENT PER PLATE	360	MA.
TUBE VOLTAGE DROP - AT 120 MA. DC PER PLATE	15.5	VOLTS

TYPICAL OPERATING CONDITIONS AND CHARACTERISTICS

VOLTAGE DOUBLER

	HALF WAVE	FULL WAVE	
AC PLATE VOLTAGE PER PLATE (RMS) ^{MAX.}	117	117	VOLTS
DC OUTPUT CURRENT	60	60	MA.
TOTAL EFFECTIVE PLATE SUPPLY IMPEDANCE PER PLATE ^{MIN.-A}	30	15	OHMS

HALF WAVE RECTIFIER WITH CONDENSER INPUT TO FILTER

AC PLATE VOLTAGE PER PLATE (RMS)	117	150	235 ^{MAX.}	VOLTS
DC OUTPUT CURRENT PER PLATE ^{MAX.}	60	60	60	MA.
TOTAL EFFECTIVE PLATE SUPPLY IMPEDANCE PER PLATE ^{MIN.-A}	15	40	100	OHMS

^A WHEN FILTER CONDENSER LARGER THAN 40 UFDS ARE USED, IT MAY BE NECESSARY TO ADD ADDITIONAL PLATE SUPPLY IMPEDANCE.

FOR "INTERPRETATION OF RATINGS" REFER TO FRONT OF BOOK.

CONTINUED NEXT PAGE

117Z6GT/G

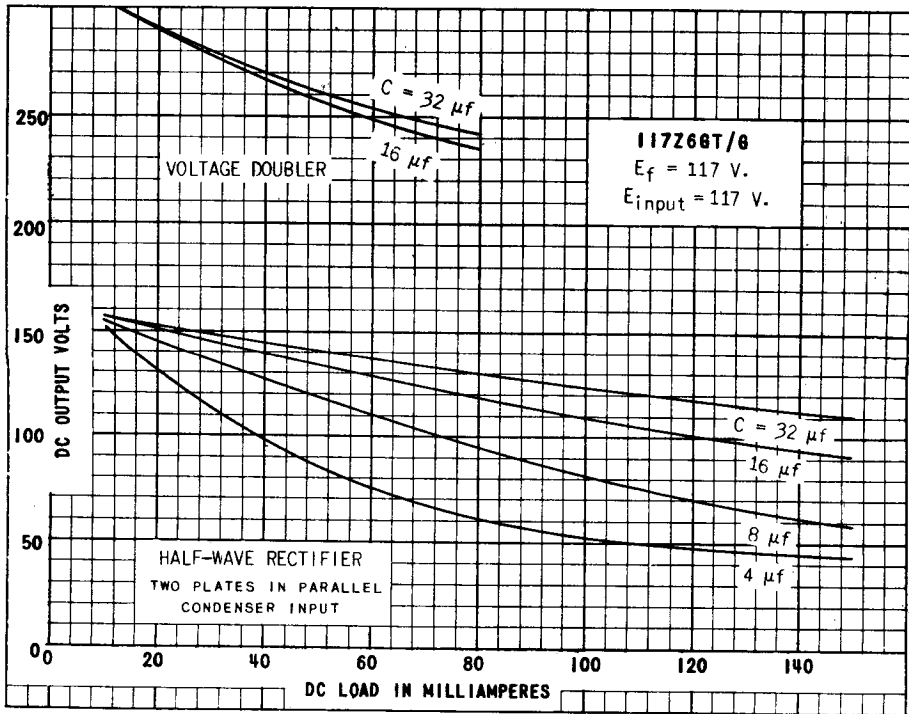
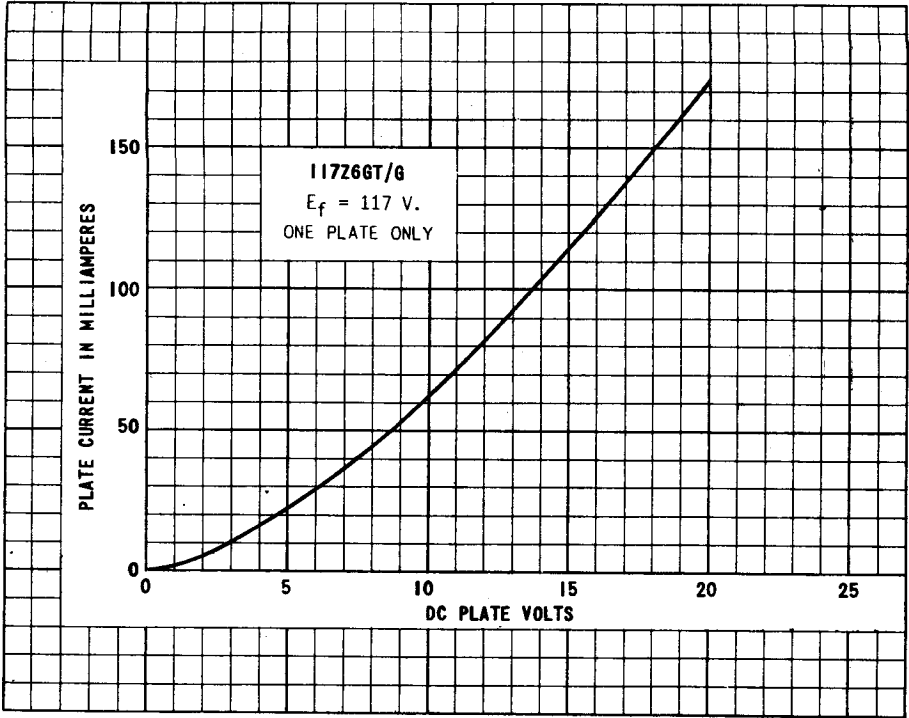
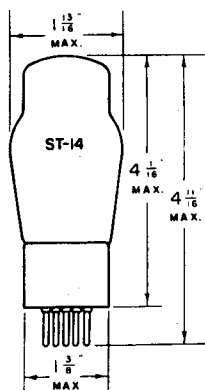

PLATE
1129-1

TUNG-SOL



TRIODE POWER AMPLIFIER

COATED FILAMENT

5.0 VOLTS 1.25 AMPERES
AC OR DC

GLASS BULB

MEDIUM 4 PIN BASE

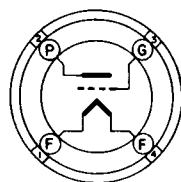

4D

BOTTOM VIEW

THE TUNG-SOL 183 IS A FILAMENT TYPE POWER TRIODE SUITABLE FOR SERVICE IN THE OUTPUT STAGE OF AC OPERATED RECEIVERS.

OPERATING CONDITIONS AND CHARACTERISTICS

CLASS A₁ AMPLIFIER

PLATE VOLTAGE	250	VOLTS
GRID VOLTAGE	-60	VOLTS
PLATE CURRENT	25	MA.
PLATE RESISTANCE	1800	OHMS
TRANSCONDUCTANCE	1800	μMHOS
AMPLIFICATION FACTOR	3.2	
LOAD RESISTANCE	4500	OHMS
POWER OUTPUT	2.0	WATTS

TUNG-SOL

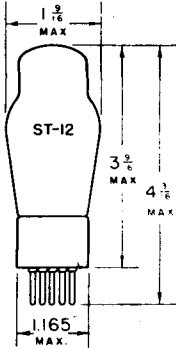

TRIODE AMPLIFIER

UNIPOTENTIAL CATHODE

HEATER

3.0 VOLTS 1.3 AMPERES
AC OR DC

GLASS BULB

SMALL 5 PIN BASE

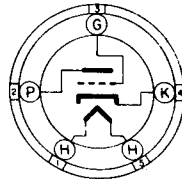

5A

BOTTOM VIEW

THE TUNG-SOL 485 IS A GENERAL PURPOSE TRIODE DESIGNED FOR SERVICE AS AN OSCILLATOR, DETECTOR OR AMPLIFIER.

OPERATING CONDITIONS AND CHARACTERISTICS

CLASS A₁ AMPLIFIER

PLATE VOLTAGE	180	VOLTS
GRID VOLTAGE	-9	VOLTS
PLATE CURRENT	6.0	MA.
PLATE RESISTANCE	9300	OHMS
TRANSCONDUCTANCE	1350	μMHOS
AMPLIFICATION FACTOR	12.5	

TUNG-SOL

ULTRA-HIGH FREQUENCY TRANSMITTING TRIODE

THORIATED TUNGSTEN FILAMENT

2.0 VOLTS

3.65 AMPERES

RATINGS

FILAMENT VOLTAGE ^A	2.0 ± 5%	VOLTS
MAXIMUM PLATE VOLTAGE	450	VOLTS
MAXIMUM GRID VOLTAGE	-250	VOLTS
MAXIMUM PLATE DISSIPATION	30	WATTS
MAXIMUM PLATE INPUT POWER	26	WATTS
MAXIMUM PLATE CURRENT	90	MA.
MAXIMUM GRID CURRENT	15	MA.
MAXIMUM FREQUENCY FOR ABOVE RATING	500	MC.
TRANSCONDUCTANCE (I _b = 67 MA)	2400	μMHOS

DIRECT INTERELECTRODE CAPACITANCES

GRID TO PLATE	1.6	μf
GRID TO FILAMENT	1.2	μf
PLATE TO FILAMENT	0.8	μf

TYPICAL OPERATION CLASS C AMPLIFIER OR OSCILLATOR^B

PLATE VOLTAGE	450	VOLTS
PLATE CURRENT	80	MA.
MAXIMUM GRID CURRENT	12	MA.
POWER OUTPUT	7.5	WATTS

^A FILAMENT VOLTAGE SHOULD BE ADJUSTED FOR OVER-ALL OPTIMUM OPERATION WITHIN THE 5% FILAMENT VOLTAGE TOLERANCE.

^B THE ABOVE TYPICAL OPERATING CONDITIONS APPLY AT 500 MC. FOR OPERATION AT HIGHER FREQUENCIES THE MAXIMUM PLATE INPUT POWER SHOULD BE REDUCED. FURTHERMORE, THE PLATE EFFICIENCY WILL DECREASE.

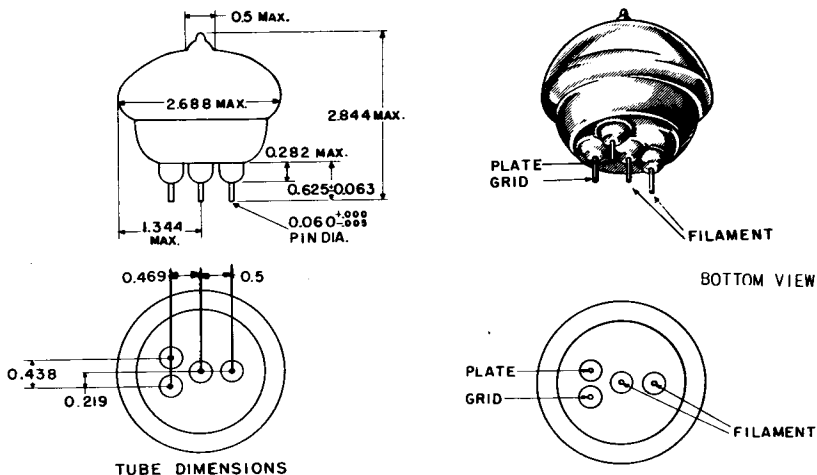

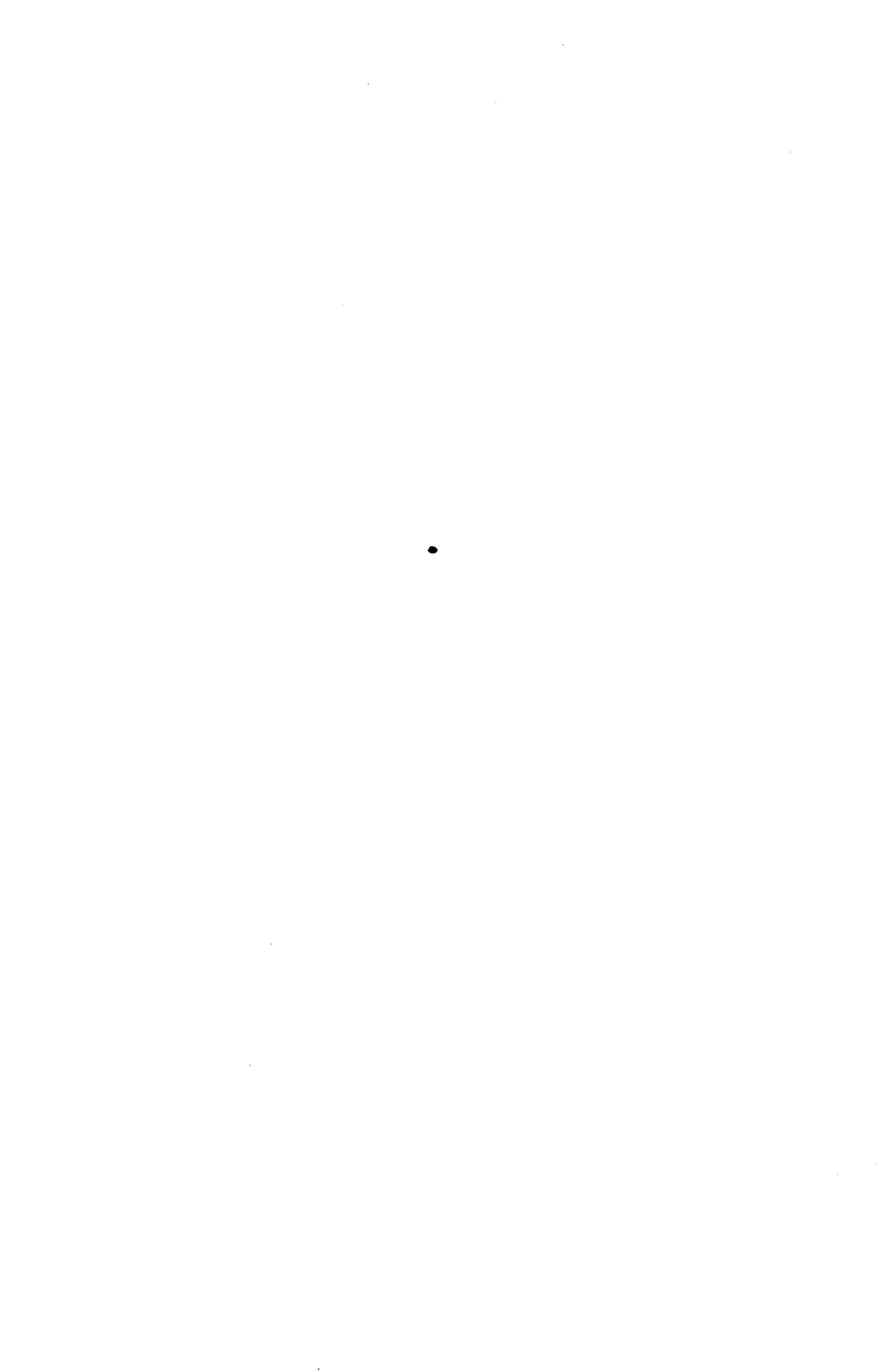

TUNG-SOL

ULTRA-HIGH FREQUENCY TRIODE

THORIATED TUNGSTEN FILAMENT

1.15 VOLTS

4.5 AMPERES

THE TYPE 703A IS ULTRA-HIGH FREQUENCY TRIODE IN A GLASS ENVELOPE WITH SHORT AND DIRECT LEADS TO THE ELEMENTS. CLOSE ELECTRODE SPACING AND LOW CAPACITANCES MAKE THE TUBE SUITABLE FOR OSCILLATOR, AMPLIFIER, OR MIXER SERVICE AT FREQUENCIES AS HIGH AS 1500 MEGACYCLES.

RATINGS

FILAMENT VOLTAGE ⁴	1.15 ± 5%	VOLTS
MAXIMUM PLATE VOLTAGE	350	VOLTS
MAXIMUM PLATE DISSIPATION	20	WATTS
TRANSCONDUCTANCE (I _P = 45 MA)	2075	μMHOS

DIRECT ELECTRODE CAPACITANCES

GRID TO PLATE	0.90	μμf
GRID TO FILAMENT	0.85	μμf
PLATE TO FILAMENT	0.60	μμf

⁴ FILAMENT VOLTAGE SHOULD BE ADJUSTED FOR OVER-ALL OPTIMUM OPERATION WITHIN THE 5% FILAMENT VOLTAGE TOLERANCE.

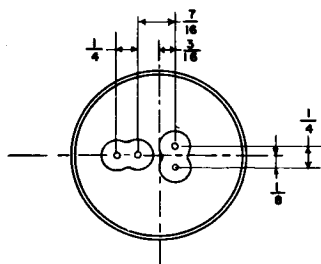
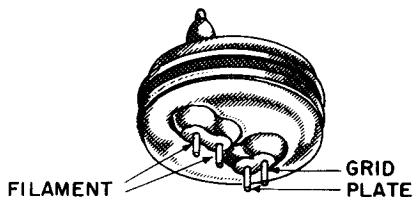
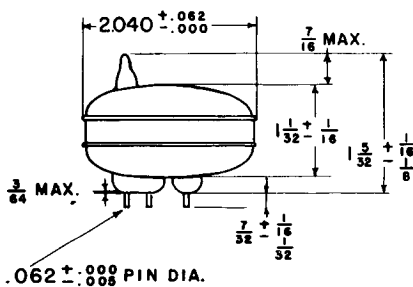

TUBE DIMENSIONS

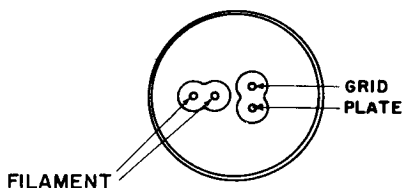

BOTTOM VIEW

TUNG-SOL

HALF-WAVE HIGH VACUUM RECTIFIER

THORIATED TUNGSTEN FILAMENT

5.0 VOLTS

5 AMPERES

RATINGS

FILAMENT VOLTAGE ^A	5.0 ± 5%	VOLTS
MAXIMUM PEAK INVERSE PLATE VOLTAGE	35	KV.
MAXIMUM AVERAGE RECTIFIED PLATE CURRENT	100	MA.
MAXIMUM PEAK PLATE CURRENT	500	MA.
VOLTAGE DROP (I _b = 365 MA)	300	VOLTS

^A FILAMENT VOLTAGE SHOULD BE ADJUSTED FOR OVER-ALL OPTIMUM OPERATION WITHIN THE 5% FILAMENT VOLTAGE TOLERANCE.

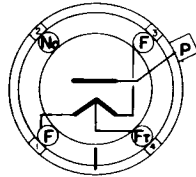
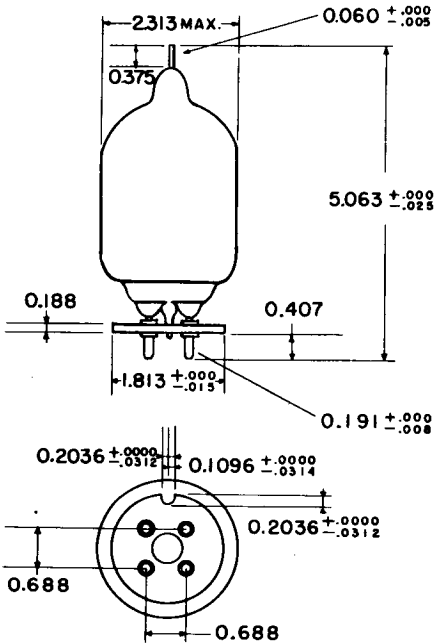

TUBE DIMENSIONS

TUNG-SOL

HIGH FREQUENCY PENTODE

UNI-POTENTIAL CATHODE

HEATER

6.3 VOLTS 175 MA.

RATINGS

MAXIMUM PLATE VOLTAGE	180	VOLTS
MAXIMUM SCREEN VOLTAGE	120	VOLTS
MAXIMUM CATHODE CURRENT	10.1	MA.

TYPICAL OPERATING CONDITIONS AND CHARACTERISTICS

HEATER VOLTAGE	6.3	VOLTS
HEATER CURRENT	175	MA.
PLATE VOLTAGE	120	VOLTS
SCREEN VOLTAGE	120	VOLTS
GRID VOLTAGE	-2	VOLTS
PLATE CURRENT	7.5	MA.
SCREEN CURRENT	2.5	MA.
MUTUAL CONDUCTANCE	4000	μ MHOS
PLATE RESISTANCE	.25	MEG OHMS
GRID VOLTAGE ($I_p = 10 \mu A$, APPROX.)	-9	VOLTS

THE 713A AND 717A ARE IDENTICAL WITH THE EXCEPTION OF THE BASES AS SHOWN BELOW.

THE 713A HAS A SEVEN PIN OCTAL BAKELITE BASE AND THE 717A HAS A MICANOL WAFER WITH METAL SHELL AS SHOWN BELOW.

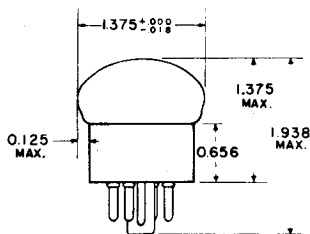

TUBE DIMENSIONS

713A

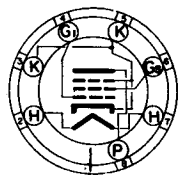

PIN 3: BASE SHIELD

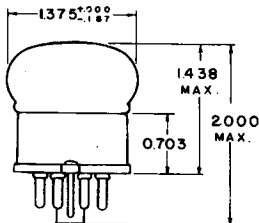

TUBE DIMENSIONS

717A

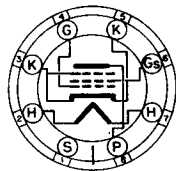



TUNG-SOL

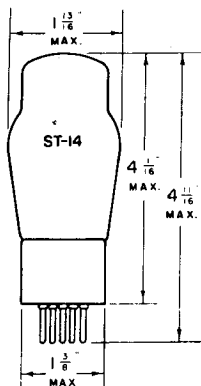

PENTODE POWER AMPLIFIER

COATED FILAMENT

2.0 VOLTS 0.12 AMPERE
DC

GLASS BULB

MEDIUM 5 PIN BASE

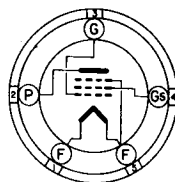

5K

BOTTOM VIEW

THE TUNG-SOL 950 IS A FILAMENT TYPE PENTODE POWER AMPLIFIER DESIGN-
ED FOR SERVICE IN THE OUTPUT STAGE OF BATTERY OPERATED RECEIVERS.
ITS RATINGS AND CHARACTERISTICS ARE IDENTICAL WITH THOSE OF THE 1J5G.

OPERATING CONDITIONS AND CHARACTERISTICS

CLASS A₁ AMPLIFIER

PLATE VOLTAGE	135	VOLTS
SCREEN VOLTAGE	135	VOLTS
CONTROL GRID VOLTAGE ^A	-16.5	VOLTS
GRID CIRCUIT RESISTANCE WITH FIXED BIAS ^{MAX.}	0.5	MEG OHM
PLATE CURRENT	7	MA.
SCREEN CURRENT	2	MA.
TRANSCONDUCTANCE	950	μMHOS
AMPLIFICATION FACTOR	100	
LOAD RESISTANCE	13500	OHMS
POWER OUTPUT	0.45	WATT

^A RETURN TO NEGATIVE FILAMENT (PIN #5)PLATE
578-1OCT. 20
1939



TUNG-SOL

DETECTOR AMPLIFIER-PENTODE

ACORN TYPE

COATED UNIPOTENTIAL CATHODE ^B

HEATER

6.3 VOLTS ^D 0.15 AMPERE
AC OR DC

RATINGS

RF OR AF AMPLIFIER CLASS A

MAXIMUM PLATE VOLTAGE	250	VOLTS
MAXIMUM SCREEN (GRID 2) VOLTAGE	100	VOLTS
MAXIMUM SUPPRESSOR (GRID 3) VOLTAGE	100	VOLTS
MINIMUM CONTROL GRID VOLTAGE (GRID 1)	-3	VOLTS
MAXIMUM PLATE DISSIPATION	0.5	WATT
MAXIMUM SCREEN DISSIPATION	0.1	WATT

DIRECT INTERELECTRODE CAPACITANCES

CONTROL GRID TO CATHODE	3	μf
PLATE TO CATHODE	3.4	μf
GRID TO PLATE (WITH SHIELD BAFFLE)	0.007 (MAX.)	μf

TYPICAL OPERATION AND CHARACTERISTICS

CLASS A₁ AMPLIFIER

HEATER VOLTAGE	6.3	6.3	VOLTS
PLATE VOLTAGE	90	250	VOLTS
SCREEN VOLTAGE (GRID 2)	90	100	VOLTS
CONTROL GRID VOLTAGE (GRID 1)	-3	-3	VOLTS
AMPLIFICATION FACTOR	1100	> 2000	
PLATE RESISTANCE	1.0	> 1.5	MEGOHMS
MUTUAL CONDUCTANCE	1100	1400	μMHOS
PLATE CURRENT	1.2	2.0	MA.
SCREEN CURRENT	0.5	0.7	MA.

SUPPRESSOR CONNECTED TO CATHODE AT SOCKET (GRID 3)

RESISTANCE COUPLED A-F VOLTAGE AMPLIFIER

HEATER VOLTAGE	6.3	VOLTS
PLATE-SUPPLY VOLTAGE ^A	250	VOLTS
SCREEN VOLTAGE (GRID 2)	50	VOLTS
CONTROL GRID VOLTAGE (GRID 1) ^C	-2.1	VOLTS
LOAD RESISTANCE	0.25	MEGOHM
PLATE CURRENT	0.5	MA.
VOLTAGE OUTPUT (5% SECOND HAR.)	40 TO 50	VOLTS (RMS)
VOLTAGE AMPLIFICATION (APPROX.)	100	

SUPPRESSOR CONNECTED TO CATHODE AT SOCKET (GRID 3)

(CONTINUED NEXT PAGE)

TUNG-SOL

BIASED DETECTOR

HEATER VOLTAGE	6.3	VOLTS
PLATE-SUPPLY VOLTAGE	250	VOLTS
SCREEN VOLTAGE (GRID 2)	100	VOLTS
CONTROL GRID VOLTAGE (GRID 1) (APPROX.)	-6	VOLTS
LOAD RESISTANCE	0.25	MEGOHM
PLATE CURRENT	ADJUSTED TO 0.1 MA. WITH NO INPUT SIGNAL	
SELF-BIAS RESISTOR	20000 TO 50000	OHMS
SUPPRESSOR CONNECTED TO CATHODE AT SOCKET (GRID 3)		

A THIS IS A PLATE-SUPPLY VOLTAGE VALUE. THE VOLTAGE EFFECTIVE AT THE PLATE WILL BE THE PLATE-SUPPLY VOLTAGE MINUS THE VOLTAGE DROP (IN THE LOAD RESISTOR) CAUSED BY THE PLATE CURRENT.

B IN CIRCUITS WHERE THE CATHODE IS NOT DIRECTLY CONNECTED TO THE HEATER, THE POTENTIAL DIFFERENCE BETWEEN HEATER AND CATHODE SHOULD BE KEPT AS LOW AS POSSIBLE. IF THE USE OF A LARGE RESISTOR BETWEEN HEATER AND CATHODE IS NECESSARY BECAUSE OF CIRCUIT CONSIDERATIONS, IT IS ESSENTIAL THAT THIS RESISTOR BE BY-PASSED BY A SUITABLE FILTER NETWORK OR OBJECTIONABLE HUM MAY DEVELOP.

C THE D-C RESISTANCE IN THE GRID CIRCUIT SHOULD NOT EXCEED 1.0 MEGOHM.

D SHOULD NOT DEVIATE MORE THAN $\pm 10\%$ FROM RATED VALUE.

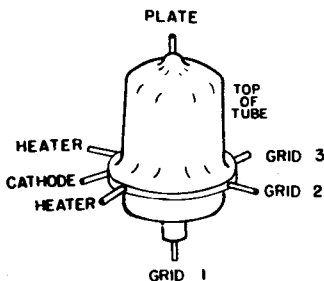
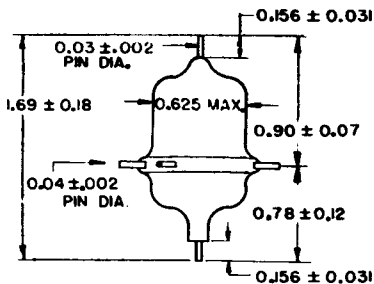

954-956

PIN CONNECTIONS

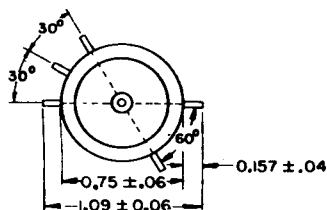

ALL LINEAR DIMENSIONS ARE SPECIFIED IN INCHES

PLATE
1352-1
OCT. 25
1943

TUNG-SOL

DETECTOR, AMPLIFIER, OSCILLATOR
ACORN TYPECOATED UNIPOTENTIAL CATHODE ^B

HEATER

6.3 VOLTS ^E 0.15 AMPERE
AC OR DC

RATINGS

RF OR AF AMPLIFIER CLASS A

MAXIMUM PLATE VOLTAGE	250	VOLTS
MAXIMUM PLATE DISSIPATION	1.6	WATTS

DIRECT INTERELECTRODE CAPACITANCES

GRID TO PLATE	1.4	μf
GRID TO CATHODE	1.0	μf
PLATE TO CATHODE	0.6	μf

TYPICAL OPERATION AND CHARACTERISTICS

CLASS A₁ AMPLIFIER

HEATER VOLTAGE	6.3	6.3	6.3	6.3	VOLTS
PLATE VOLTAGE	90	135	180	250	VOLTS
GRID VOLTAGE ^A	-2.5	-3.75	-5	-7	VOLTS
AMPLIFICATION FACTOR	25	25	25	25	
PLATE RESISTANCE	14700	13200	12500	11400	OHMS
TRANSCONDUCTANCE	1700	1900	2000	2200	μMHOS
PLATE CURRENT	2.5	3.5	4.5	6.3	MA.
LOAD RESISTANCE	-	-	20000	-	OHMS
U.P.O. (5% SECOND HAR.)	-	-	135	-	MW

TYPICAL CONDITIONS FOR RESISTANCE COUPLED A-F VOLTAGE AMPLIFIER

HEATER VOLTAGE	6.3	VOLTS
PLATE-SUPPLY VOLTAGE ³	180	VOLTS
GRID VOLTAGE ^A	-3.5	VOLTS
LOAD RESISTANCE	250000	OHMS
PLATE CURRENT	0.42	MA.
VOLTAGE OUTPUT (5% SECOND HAR.)	45 (RMS)	VOLTS
VOLTAGE AMPLIFICATION (APPROX.)	20	

R-F POWER AMPLIFIER & OSCILLATOR - CLASS C

PLATE MODULATED OR C.W.

MAXIMUM PLATE VOLTAGE	180	VOLTS
MAXIMUM PLATE CURRENT	8	MA.
MAXIMUM GRID CURRENT	2	MA.

TYPICAL OPERATION

HEATER VOLTAGE	6.3	VOLTS
PLATE VOLTAGE	180	VOLTS
GRID VOLTAGE (APPROX.)	-3.5	VOLTS
PLATE CURRENT	7	MA.
GRID CURRENT (APPROX.)	1.5	MA.
POWER OUTPUT ^D (APPROX.)	0.5	WATT

TUNG-SOL

DETECTOR

TYPICAL OPERATION

	BIASED	GRID LEAK	
HEATER VOLTAGE	6.3	6.3	VOLTS
PLATE-SUPPLY VOLT ^C	180	45	VOLTS
GRID VOLTAGE (APPROX.)	-7	GRID RETURN TO CATHODE	VOLTS
LOAD RESISTANCE	0.25	-	MEGOHM
PLATE CURRENT	ADJUSTED TO 0.2 MA. APPROX. WITH NO INPUT SIGNAL	-	MA.
SELF-BIAS RESISTOR (APPROX.)	50000	-	OHMS
GRID LEAK	-	1 TO 5	MEGOHMS
GRID CONDENSER	-	0.00025	μ f

- ^A THE D-C RESISTANCE IN THE GRID CIRCUIT SHOULD NOT EXCEED 1.0 MEGOHM.
- ^B IN CIRCUITS WHERE THE CATHODE IS NOT DIRECTLY CONNECTED TO THE HEATER, THE POTENTIAL DIFFERENCE BETWEEN HEATER AND CATHODE SHOULD BE KEPT AS LOW AS POSSIBLE. IF THE USE OF A LARGE RESISTOR BETWEEN HEATER AND CATHODE IS NECESSARY BECAUSE OF CIRCUIT CONSIDERATIONS, IT IS ESSENTIAL THAT THIS RESISTOR BE BY-PASSED BY A SUITABLE FILTER NETWORK OR OBJECTIONABLE HUM MAY DEVELOP.
- ^C THIS IS A PLATE-SUPPLY VOLTAGE VALUE. THE VOLTAGE EFFECTIVE AT THE PLATE WILL BE THE PLATE-SUPPLY VOLTAGE MINUS THE VOLTAGE DROP (IN THE LOAD RESISTOR) CAUSED BY THE PLATE CURRENT.
- ^D AT 5 METERS. ONLY MODERATE REDUCTION IN THIS VALUE WILL BE FOUND FOR WAVELENGTHS AS LOW AS 1 METER. BELOW 1 METER, THE POWER OUTPUT DECREASES AS THE WAVELENGTH IS DECREASED.
- ^E SHOULD NOT DEVIATE MORE THAN $\pm 10\%$ FROM RATED VALUE.

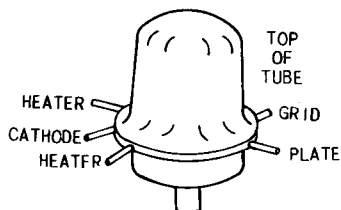
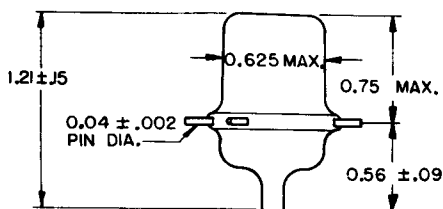

PIN CONNECTIONS

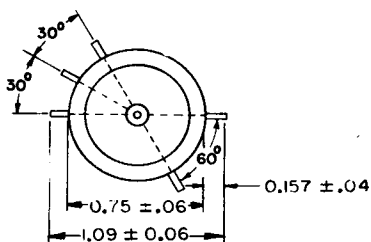

ALL LINEAR DIMENSIONS ARE
SPECIFIED IN INCHES

PLATE
1354-1
OCT. 25
1943

TUNG-SOL

REMOTE CUT-OFF RF AMPLIFIER PENTODE

ACORN TYPE

COATED UNIPOTENTIAL CATHODE

HEATER

6.3 VOLTS^C 0.15 AMPERE

AC OR DC

RATINGS

RF OR AF AMPLIFIER CLASS A₁

MAXIMUM PLATE VOLTAGE	250	VOLTS
MAXIMUM SCREEN (GRID 2) VOLTAGE	100	VOLTS
MAXIMUM PLATE DISSIPATION	1.7	WATTS
MAXIMUM SCREEN DISSIPATION	.3	WATT

TYPICAL OPERATION AND CHARACTERISTICS

HEATER VOLTAGE	6.3	VOLTS
HEATER CURRENT	.15	AMP.
PLATE VOLTAGE	250	VOLTS
SCREEN VOLTAGE (GRID 2)	100	VOLTS
CONTROL GRID VOLTAGE (GRID 1) ^B	-3	VOLTS
PLATE RESISTANCE (APPROX.)	.70	MEGOHM
TRANSCONDUCTANCE	1800	μMPOS
GRID VOLTAGE FOR GM = 10 μMPOS	-3.5	VOLTS
PLATE CURRENT	6.7	MA.
SCREEN CURRENT	2.7	MA.
SUPPRESSOR CONNECTED TO CATHODE AT SOCKET (GRID 3)		

^A IN CIRCUITS WHERE THE CATHODE IS NOT DIRECTLY CONNECTED TO THE HEATER, THE POTENTIAL DIFFERENCE BETWEEN HEATER AND CATHODE SHOULD BE KEPT AS LOW AS POSSIBLE. IF THE USE OF A LARGE RESISTOR BETWEEN HEATER AND CATHODE IS NECESSARY BECAUSE OF CIRCUIT CONSIDERATIONS, IT IS ESSENTIAL THAT THIS RESISTOR BE BY-PASSED BY A SUITABLE FILTER NETWORK OR OBJECTIONABLE HUM MAY DEVELOP.

^B THE D-C RESISTANCE IN THE GRID CIRCUIT SHOULD NOT EXCEED 1.0 MEGOHM.

^C SHOULD NOT DEVIATE MORE THAN $\pm 10\%$ FROM RATED VALUE.

SEE OTHER SIDE OF PAGE FOR PIN CONNECTIONS AND BULB DIMENSIONS

PLATE
1355-1
O.T. 25
1943

TUNG-SOL

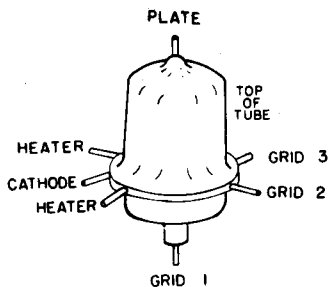
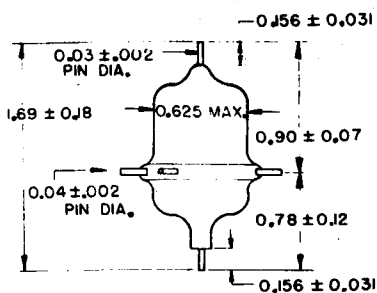

954-956

PIN CONNECTIONS

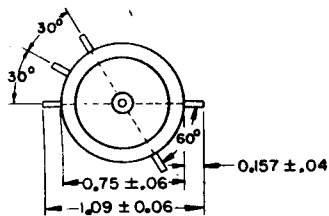

ALL LINEAR DIMENSIONS ARE SPECIFIED IN INCHES

PLATE
1356-1
OCT. 25
1943

TUNG-SOL

TRANSMITTING BEAM POWER AMPLIFIER 1625

UNIPOTENTIAL CATHODE

HEATER

12.6 VOLTS 0.45 AMPERES

RATINGS

HEATER VOLTAGE (AC/DC)	12.6	VOLTS
MAXIMUM PLATE VOLTAGE	750	VOLTS
MAXIMUM SCREEN VOLTAGE	350	VOLTS
MAXIMUM PLATE DISSIPATION	30	WATTS
MAXIMUM SCREEN DISSIPATION	3.5	WATTS

DIRECT INTERELECTRODE CAPACITANCES (WITH EXTERNAL SHIELD)

CONTROL GRID TO CATHODE	11	μf
PLATE TO CATHODE	7	μf
MAXIMUM GRID TO PLATE	.2	μf

TYPICAL OPERATING CONDITIONS AND CHARACTERISTICS

RF CLASS C AMPLIFIER OR OSCILLATOR

HEATER VOLTAGE (AC/DC)	12.6	VOLTS
HEATER CURRENT	0.45	AMP.
PLATE VOLTAGE	600	VOLTS
SCREEN VOLTAGE	200	VOLTS
GRID CURRENT	6.0	MA.
SCREEN CURRENT	10	MA.
PLATE CURRENT	100	MA.
POWER OUTPUT	35	WATTS
GRID RESISTOR	10000	OHMS

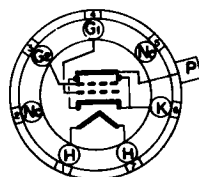
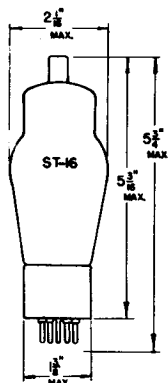

TRANSMITTING TRIODE 1626

UNIPOTENTIAL CATHODE

HEATER

12.6 VOLTS 0.25 AMPERES

RATINGS

HEATER VOLTAGE (AC OR DC)	12.6	VOLTS
MAXIMUM PLATE VOLTAGE	250	VOLTS
MAXIMUM GRID VOLTAGE	-150	VOLTS
MAXIMUM PLATE DISSIPATION	5	WATTS

TYPICAL OPERATING CONDITIONS AND CHARACTERISTICS

HEATER VOLTAGE (AC OR DC)	12.6	VOLTS
HEATER CURRENT	0.25	AMP.
PLATE VOLTAGE	250	VOLTS
GRID VOLTAGE	-32	VOLTS
PLATE CURRENT	25	MA.
PLATE RESISTANCE	2500	OHMS
MUTUAL CONDUCTANCE	2500	μMHOS

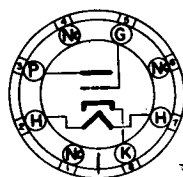
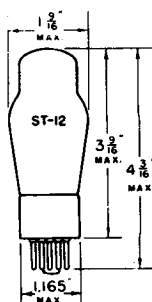

TUNG-SOL

CATHODE RAY TUNING INDICATOR

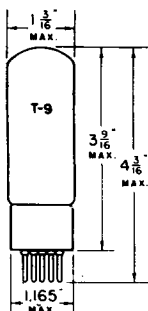

6E5

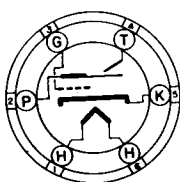

UNIPOENTIAL CATHODE

HEATERS

6E5 - 6.3 V., 0.3 AMPERE

1629 - 12.6 V., .15 AMPERE

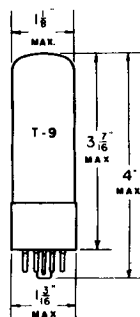

1629

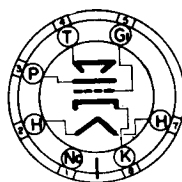

THE 1629 AND 6E5 ARE IDENTICAL WITH THE EXCEPTION OF THE HEATER RATINGS. THIS TUBE IS A CATHODE RAY TUNING INDICATOR WITH A CIRCULAR FLOURESCENT TARGET. THE DEGREE OF SHADOW ANGLE IS VARIED BY THE AVC OR OTHER CONTROLLING GRID VOLTAGE.

RATINGS

MAXIMUM PLATE SUPPLY VOLTAGE	250	VOLTS
MAXIMUM TARGET VOLTAGE	250	VOLTS
MINIMUM TARGET VOLTAGE	100	VOLTS

TYPICAL OPERATING CONDITIONS AND CHARACTERISTICS

PLATE AND TARGET SUPPLY VOLTAGE	100	200	250	VOLTS
TRIODE GRID VOLTAGE (0° SHADOW ANGLE)	-3.3	-6.5	-8.0	VOLTS
TRIODE GRID VOLTAGE (90° SHADOW ANGLE)	0	0	0	VOLTS
SERIES TRIODE PLATE RESISTOR	0.5	1	1	MEGOHM
TRIODE PLATE CURRENT (TRIODE GRID $V_g=0$)	0.19	0.19	0.24	MA.
TARGET CURRENT (TRIODE GRID $V_g=0$) ^A	1	3	4	MA.

^A SUBJECT TO WIDE VARIATIONS

FOR "INTERPRETATION OF RATINGS" REFER TO FRONT OF BOOK

TUNG-SOL

**HALF-WAVE HIGH-VACUUM RECTIFIER
MINIATURE TYPE**

PHYSICAL SPECIFICATIONS

EMITTER COATED FILAMENT	PIN CONNECTIONS	
BASE MINIATURE BUTTON 7-PIN	PIN 1 FILAMENT-	PIN 7 FILAMENT +
CAP	PIN 2 C-DO NOT USE	PIN 8 NONE
BULB T- 5 $\frac{1}{2}$	PIN 3 C-DO NOT USE	BULB TERMINAL PLATE
MAX. DIAMETER $\frac{3}{4}$ "	PIN 4 NO CONNECTION	
MAX. SEATED HEIGHT $2\frac{3}{16}$ "	PIN 5 NO CONNECTION	MOUNTING POS. ANY
MAX. OVERALL LENGTH $2\frac{7}{16}$ "	PIN 6 C-DO NOT USE	

RATINGS^A

INTERPRETED ACCORDING TO RMA STANDARD M8-210

HEATER OR FILAMENT VOLTAGE (AC OR DC)	1.4	VOLTS
HEATER OR FILAMENT CURRENT	0.05	AMP
MAXIMUM PEAK INVERSE PLATE VOLTAGE	7000	VOLTS
MAXIMUM PEAK PLATE CURRENT ^B	6	MA.
MAXIMUM AVERAGE PLATE CURRENT	1	MA.
^A THESE RATINGS APPLY TO THE 1654 WHEN IT IS OPERATED FROM A POWER SUPPLY HAVING A FREQUENCY UP TO 500 CYCLES PER SECOND.		
^B A PEAK VALUE OF 20 MA. FOR 0.1 SECOND IS PERMITTED UNDER CONDITIONS OF "HOT-SWITCHING", I.E., SWITCHING THE PLATE CIRCUIT "ON" WHILE THE FILAMENT IS HOT.		

DIRECT INTERELECTRODE CAPACITANCE (APPROX.)

WITH NO EXTERNAL SHIELD

PLATE TO FILAMENT	1.4	μ f
-------------------	-----	---------

TYPICAL OPERATING CONDITIONS AND CHARACTERISTICS

HALF-WAVE RECTIFIER

AC PLATE-SUPPLY VOLTAGE	2500	VOLTS
FILTER INPUT CONDENSEN ^W	0.025	μ f
TOTAL EFFECTIVE PLATE-SUPPLY IMPEDANCE	175 000	OHMS
DC OUTPUT VOLTAGE (APPROX.) - AT INPUT TO FILTER	2350	VOLTS
DC OUTPUT CURRENT	1	MA.

CIRCUIT VALUES

A PLATE-SUPPLY IMPEDANCE OF 175000 OHMS IS REQUIRED SO THAT THE "HOT-SWITCHING" CURRENT WILL NOT EXCEED THE 20 MA. ALLOWABLE UNDER CONDITIONS OF NORMAL LINE-VOLTAGE FLUCTUATIONS.

THE PLATE-SUPPLY IMPEDANCE MAY BE DECREASED FOR PLATE-SUPPLY VOLTAGES LESS THAN 2500 VOLTS IF THE RESULTANT PEAK-CURRENT RATING OF 6 MA. AND THE "HOT-SWITCHING" CURRENT OF 20 MA. ARE NOT EXCEEDED.

NOTE: THE 1654 IS A MINIATURE, HALF-WAVE, HIGH VACUUM TUBE DESIGNED FOR HIGH VOLTAGE, LOW-CURRENT OPERATION WHERE THE POWER-SUPPLY FREQUENCY DOES NOT EXCEED 500 CYCLES PER SECOND. IT IS ESPECIALLY USEFUL IN EQUIPMENT DESIGN WHERE SPACE AND LOW FILAMENT DRAIN ARE HIGHLY SIGNIFICANT FACTORS.

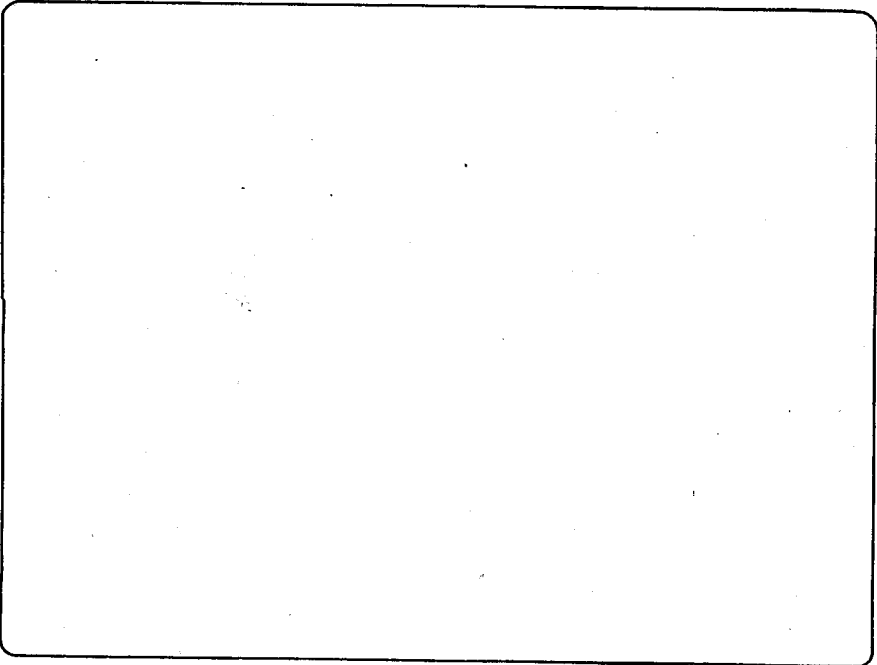
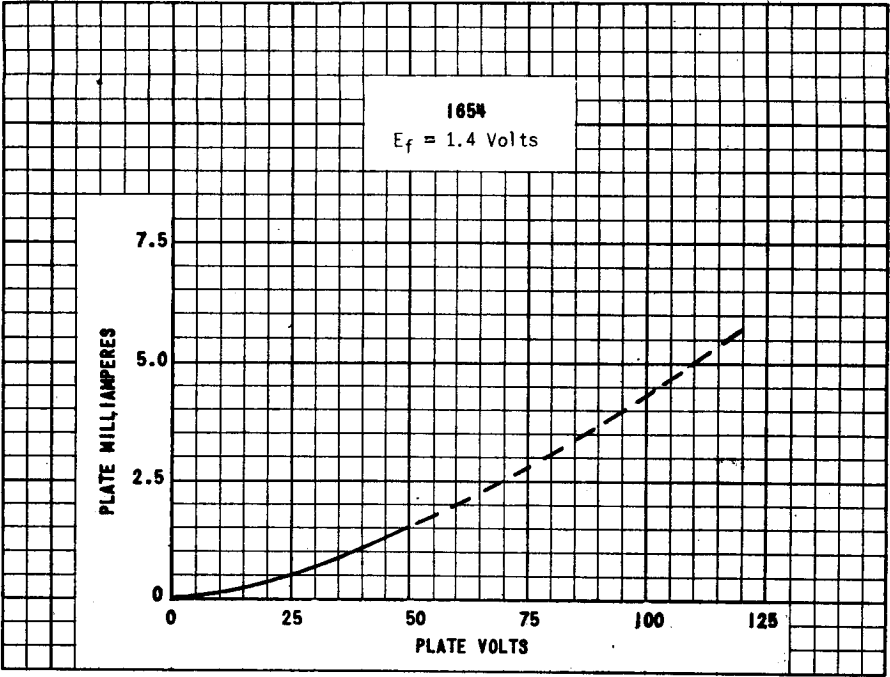

PLATE
1689
FEB. 15
1946

TUNG-SOL

DETECTOR AMPLIFIER PENTODE

MIDGET TYPE

COATED UNIPOTENTIAL CATHODE

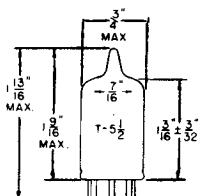

HEATER^A
6.3 VOLTS 0.15 AMPERE
AC OR DC

GLASS BULB

MINIATURE BUTTON 7 PIN BASE

MOUNTING POSITION - ANY

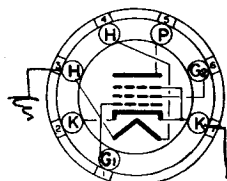

BOTTOM VIEW

THE 9001 IS A SHARP CUT-OFF MIDGET TYPE PENTODE INTENDED FOR USE AS A DETECTOR AND AMPLIFIER AT ULTRA HIGH FREQUENCIES. ITS CONSTRUCTION, INCLUDING DOUBLE CATHODE LEADS, PERMITS CIRCUITS TO BE DESIGNED WITH EXTREMELY SHORT LEADS AND WITH MINIMUM INTER-CIRCUIT COUPLING. ELECTRICALLY ITS CHARACTERISTICS ARE IDENTICAL WITH TYPE 954.

RATINGS*

MAXIMUM PLATE VOLTAGE	250	VOLTS
MAXIMUM SCREEN VOLTAGE	100	VOLTS
MINIMUM GRID VOLTAGE	-3	VOLTS
PLATE DISSIPATION	0.5	WATT
SCREEN DISSIPATION	0.1	WATT

*INTERPRETED ACCORDING TO RMA STANDARD M8-210

DIRECT INTERELECTRODE CAPACITANCES

MAXIMUM GRID TO PLATE (WITH EXTERNAL SHIELD)	0.01	μf
INPUT (WITH NO EXTERNAL SHIELD)	3.6	μf
OUTPUT (WITH NO EXTERNAL SHIELD)	3.0	μf

TYPICAL OPERATING CONDITIONS AND CHARACTERISTICS

CLASS A_1 AMPLIFIER

PLATE VOLTAGE	90	250	VOLTS
SCREEN VOLTAGE	90	100	VOLTS
GRID VOLTAGE	-3	-3	VOLTS
PLATE RESISTANCE (APPROX.)	1.0	GREATER THAN 1.0 MEGOHM	
TRANSCONDUCTANCE	1100	1400	μMHOS
PLATE CURRENT	1.2	2.0	MA.
SCREEN CURRENT	0.5	0.7	MA.

CONTINUED NEXT PAGE

TUNG-SOL

CONTINUED FROM PRECEDING PAGE

MIXER IN SUPERHETERODYNE CIRCUIT

PLATE VOLTAGE	250	VOLTS
SCREEN VOLTAGE	100	VOLTS
GRID VOLTAGE (APPROX.) ^B	-5	VOLTS
CONVERSION TRANSCONDUCTANCE (APPROX.)	550	μMHOS

^A WHEN THE CATHODE IS NOT CONNECTED DIRECTLY TO THE HEATER THE POTENTIAL DIFFERENCE BETWEEN HEATER AND CATHODE SHOULD BE KEPT AS LOW AS POSSIBLE.

^B VALUES INDICATED ARE OPTIMUM. FOR AN OSCILLATOR PEAK VOLTAGE OF 4 VOLTS, THE GRID BIAS IS MINIMUM.

TO PROVIDE THE SHORTEST POSSIBLE CIRCUIT RETURNS AND TO PREVENT INTER-STAGE COUPLING AT ULTRA HIGH FREQUENCIES, EACH RF AMPLIFIER STAGE MAY REQUIRE RF BY-PASSING AND SHIELDING. THIS CAN BE ACCOMPLISHED BY PLACING SMALL CONDENSERS CLOSE TO THE TUBE TERMINALS. IN ADDITION RF CHOKES MAY BE REQUIRED IN THE SUPPLY OF RETURN LEADS OF THE TUBE ELEMENTS.

THIS TUBE HAS TWO CATHODE LEADS. IF THE GRID RETURN IS CONNECTED TO ONE CATHODE TERMINAL AND THE PLATE AND SCREEN RETURNS ARE CONNECTED TO THE OTHER CATHODE TERMINAL, THE PLATE AND SCREEN RF CIRCUITS WILL BE COMPLETED WITH A MINIMUM OF INDUCTANCE IN COMMON WITH THE GRID CIRCUIT.



TUNG-SOL

SUPER CONTROL RF AMPLIFIER PENTODE

MIDGET TYPE

COATED UNIPOTENTIAL CATHODE

HEATER^A6.3 VOLTS 0.15 AMPERE
AC OR DC

GLASS BULB

MINIATURE BUTTON 7 PIN BASE

MOUNTING POSITION - ANY

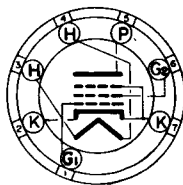
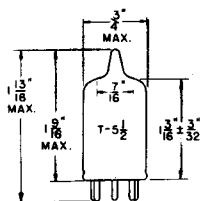

BOTTOM VIEW

THE 9003 IS A REMOTE CUT-OFF MIDGET TYPE PENTODE INTENDED FOR USE AS AN AMPLIFIER AND MIXER AT ULTRA HIGH FREQUENCIES. ITS CONSTRUCTION, INCLUDING DOUBLE CATHODE LEADS, PERMITS CIRCUITS TO BE DESIGNED WITH EXTREMELY SHORT LEADS AND WITH MINIMUM INTER-CIRCUIT COUPLING. ELECTRICALLY ITS CHARACTERISTICS ARE IDENTICAL WITH TYPE 956.

RATINGS*

MAXIMUM PLATE VOLTAGE	250	VOLTS
MAXIMUM SCREEN VOLTAGE	100	VOLTS
MINIMUM GRID VOLTAGE	-3	VOLTS
MAXIMUM PLATE DISSIPATION	1.7	WATTS
MAXIMUM SCREEN DISSIPATION	0.3	WATT

* INTERPRETED ACCORDING TO RMA STANDARD MB-210

DIRECT INTERELECTRODE CAPACITANCES

MAXIMUM GRID TO PLATE (WITH EXTERNAL SHIELD)	0.01	μmf
INPUT (WITH NO EXTERNAL SHIELD)	3.4	μmf
OUTPUT (WITH NO EXTERNAL SHIELD)	3.0	μmf

TYPICAL OPERATING CONDITIONS AND CHARACTERISTICS

CLASS A₁ AMPLIFIER

PLATE VOLTAGE	250	VOLTS
SCREEN VOLTAGE	100	VOLTS
GRID VOLTAGE	-3	VOLTS
PLATE RESISTANCE (APPROX.)	0.7	MEG OHM
TRANSCONDUCTANCE	1800	μMHOS
GRID BIAS FOR TRANSCONDUCTANCE OF 15 μMHOS	-35	VOLTS
GRID BIAS FOR TRANSCONDUCTANCE OF 2 μMHOS	-45	VOLTS
PLATE CURRENT	6.7	MA.
SCREEN CURRENT	2.7	MA.

TUNG-SOL

CONTINUED FROM PRECEDING PAGE

MIXER IN SUPERHETERODYNE CIRCUIT

PLATE VOLTAGE	250	VOLTS
SCREEN VOLTAGE	100	VOLTS
GRID VOLTAGE (APPROX.) ^B	-10	VOLTS
CONVERSION TRANSCONDUCTANCE (APPROX.)	600	μMHOS

^A WHEN THE CATHODE IS NOT DIRECTLY CONNECTED TO THE HEATER THE POTENTIAL DIFFERENCE BETWEEN HEATER AND CATHODE SHOULD BE KEPT AS LOW AS POSSIBLE.

^B VALUES INDICATED ARE OPTIMUM. FOR AN OSCILLATOR PEAK VOLTAGE OF 9 VOLTS THE GRID BIAS IS MINIMUM.

TO PROVIDE THE SHORTEST POSSIBLE CIRCUIT RETURNS AND TO PREVENT INTER-STAGE COUPLING AT ULTRA HIGH FREQUENCIES, EACH RF AMPLIFIER STAGE MAY REQUIRE RF BY-PASSING AND SHIELDING. THIS CAN BE ACCOMPLISHED BY PLACING SMALL CONDENSERS CLOSE TO THE TUBE TERMINALS. IN ADDITION RF CHOKES MAY BE REQUIRED IN THE SUPPLY OF RETURN LEADS OF THE TUBE ELEMENTS.

THIS TUBE HAS TWO CATHODE LEADS. IF THE GRID RETURN IS CONNECTED TO ONE CATHODE TERMINAL AND THE PLATE AND SCREEN RETURNS ARE CONNECTED TO THE OTHER CATHODE TERMINAL, THE PLATE AND SCREEN RF CIRCUITS WILL BE COMPLETED WITH A MINIMUM OF INDUCTANCE IN COMMON WITH THE GRID CIRCUITS.

PLATE
1406
MARCH 15
1944

TUNG-SOL

ULTRA HIGH FREQUENCY DIODE

ACORN TYPE

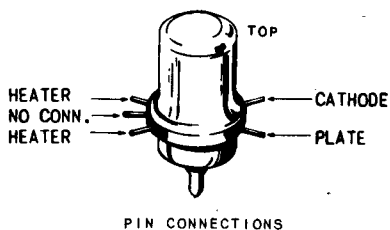

COATED UNIPOTENTIAL CATHODE

HEATER.
6.3 VOLTS 0.15 AMPERE
AC OR DC

GLASS BULB

MOUNTING POSITION - ANY

THE 9004 IS AN ACORN TYPE DIODE INTENDED FOR USE AS AN ULTRA HIGH FREQUENCY DETECTOR.

RATINGS*

MAXIMUM AC PLATE VOLTAGE (RMS)	117	VOLTS
MAXIMUM DC OUTPUT CURRENT	5	MA.

*INTERPRETED ACCORDING TO RMA STANDARD MB-210

DIRECT INTERELECTRODE CAPACITANCES

(WITH NO EXTERNAL SHIELD)

PLATE TO CATHODE	1.3	μf
PLATE TO HEATER (APPROX.)	0.3	μf
HEATER TO CATHODE (APPROX.)	2.2	μf

RESONANT FREQUENCY APPROXIMATELY 850 MC.

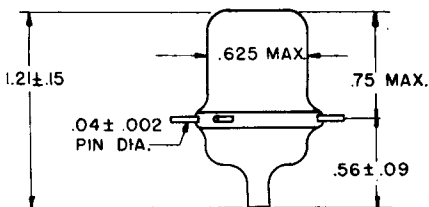
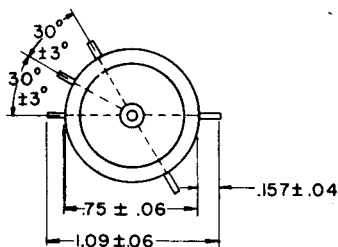

TUBE DIMENSIONS

TUNG-SOL

ULTRA HIGH FREQUENCY DIODE

ACORN TYPE

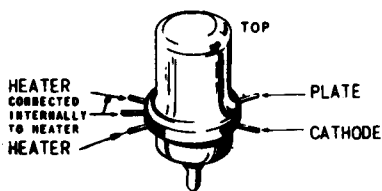

PIN CONNECTIONS

COATED UNIPOTENTIAL CATHODE

HEATER
3.6 VOLTS 0.165 AMPERE
AC OR DC

GLASS BULB

MOUNTING POSITION - ANY

THE 9005 IS AN ACORN TYPE DIODE INTENDED FOR USE AS AN ULTRA HIGH FREQUENCY DETECTOR.

RATINGS*

MAXIMUM AC PLATE VOLTAGE (RMS)	117	VOLTS
MAXIMUM DC OUTPUT CURRENT	1.0	MA.

* INTERPRETED ACCORDING TO RMA STANDARD MB-210

DIRECT INTERELECTRODE CAPACITANCES

(WITH NO EXTERNAL SHIELD)

PLATE TO CATHODE	0.8	μ mf
PLATE TO HEATER (APPROX.)	0.2	μ mf
HEATER TO CATHODE (APPROX.)	1.1	μ mf

RESONANT FREQUENCY APPROXIMATELY 1500 MC.

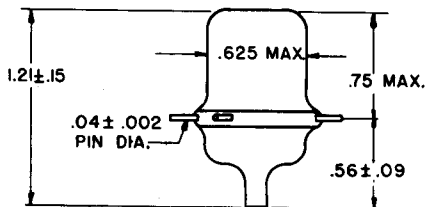
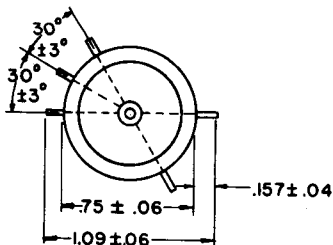

TUBE DIMENSIONS

PLATE
1408
MARCH 15
1944

TUNG-SOL

ULTRA HIGH FREQUENCY DIODE

MIDGET TYPE

COATED UNIPOTENTIAL CATHODE

HEATER
6.3 VOLTS 0.15 AMPERE
AC OR DC

GLASS BULB

MINIATURE BUTTON 7 PIN BASE

MOUNTING POSITION - ANY

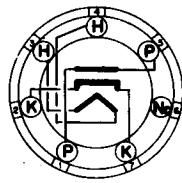
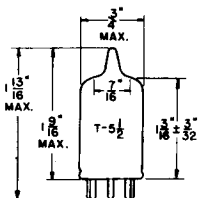

BOTTOM VIEW

THE 9006 IS A MIDGET TYPE DIODE INTENDED FOR USE AS AN ULTRA HIGH FREQUENCY DETECTOR.

RATINGS*

MAXIMUM PEAK INVERSE PLATE VOLTAGE	750	VOLTS
MAXIMUM PEAK PLATE CURRENT	15	MA.
MAXIMUM DC OUTPUT CURRENT	5	MA.
MAXIMUM DC HEATER CATHODE POTENTIAL	100	VOLTS

* INTERPRETED ACCORDING TO RMA STANDARD MB-210

DIRECT INTERELECTRODE CAPACITANCES

(WITH NO EXTERNAL SHIELD)

PLATE TO CATHODE	1.4	$\mu\mu\text{f}$
PLATE TO HEATER	0.2	$\mu\mu\text{f}$
CATHODE TO HEATER	2.2	$\mu\mu\text{f}$

TYPICAL OPERATING CONDITIONS AND CHARACTERISTICS

AC PLATE SUPPLY VOLTAGE (RMS)	270	VOLTS
MINIMUM TOTAL EFFECTIVE PLATE SUPPLY IMPEDANCE	100	OHMS
DC OUTPUT CURRENT	5	MA.

RESONANT FREQUENCY APPROXIMATELY 700 MC.

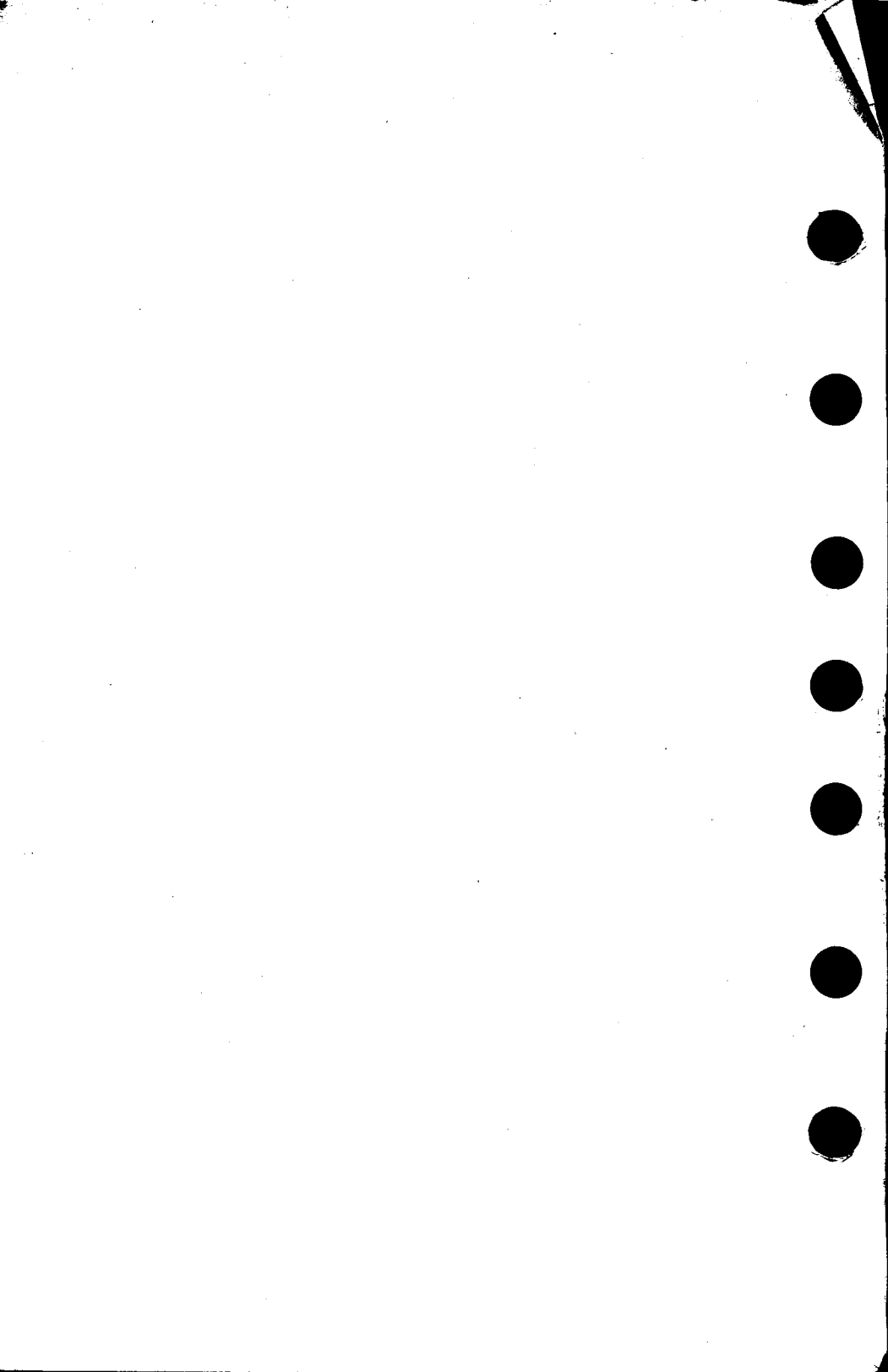

TUNG-SOL

TWIN TRIODE AMPLIFIER

PHYSICAL SPECIFICATIONS

EMITTER UNIPOTENTIAL CATHODE		PIN CONNECTIONS		
BASE	LOCKING-IN 8 PIN	PIN 1	HEATER	PIN 7 CATHODE #1
CAP	NONE	PIN 2	CATHODE #2	PIN 8 HEATER
BULB	T-9	PIN 3	PLATE #2	
MAXIMUM DIAMETER	1 3/16"	PIN 4	GRID #2	
MAXIMUM OVERALL LENGTH	2 25/32"	PIN 5	GRID #1	TOP CAP NONE
MAXIMUM SEATED HEIGHT	2 1/4"	PIN 6	PLATE #1	

RATINGS

HEATER OR FILAMENT VOLTAGE (NOMINAL)	14.0	VOLTS
HEATER OR FILAMENT CURRENT (NOMINAL)	0.160	AMP.
MAXIMUM PLATE VOLTAGE		VOLTS

TYPICAL OPERATING CONDITIONS AND CHARACTERISTICS

CLASS A₁ AMPLIFIER

HEATER VOLTAGE	12.6	VOLTS
HEATER CURRENT	0.15	AMPERE
PLATE VOLTAGE	250	VOLTS
CONTROL GRID VOLTAGE	-10	VOLTS
PLATE CURRENT	9.0	MA.
PLATE RESISTANCE	7600	OHMS
TRANSCONDUCTANCE	2100	μMHOS
AMPLIFICATION FACTOR	16	

DIRECT INTERELECTRODE CAPACITANCES⁵

	TRIODE UNIT 1	TRIODE UNIT 2	
GRID TO CATHODE	2.2	2.2	μμf
PLATE TO CATHODE	1.6	1.6	μμf
GRID TO PLATE	2.3	2.3	μμf
GRID #1 TO GRID #2	0.20		μμf
PLATE #1 TO PLATE #2	0.60		μμf
GRID #1 TO PLATE #2	0.06		μμf
GRID #2 TO PLATE #1	0.10		μμf

⁵ WITH BASE SHELL GROUNDED.

PLATE
1165-1
NOV. 17
1941

TUNG-SOL

TRIODE AMPLIFIER

PHYSICAL SPECIFICATIONS

EMITTER, UNIPOTENTIAL CATHODE		PIN CONNECTIONS			
BASE	LOCKING-IN 6 PIN	PIN 1	HEATER	PIN 7	CATHODE
CAP	NONE	PIN 2	PLATE	PIN 8	HEATER
BULB	T-9	PIN 3	NO CONN.		
MAXIMUM DIAMETER	1 3/16"	PIN 4	NO CONN.		
MAXIMUM OVERALL LENGTH	2 25/32"	PIN 5	NO CONN.	TOP CAP	NONE
MAXIMUM SEATED HEIGHT	2 1/4"	PIN 6	GRID		

RATINGS

HEATER OR FILAMENT VOLTAGE (NOMINAL)	7	VOLTS
HEATER OR FILAMENT CURRENT (NOMINAL)	0.32	AMP.
MAXIMUM PLATE VOLTAGE		VOLTS

TYPICAL OPERATING CONDITIONS AND CHARACTERISTICS

CLASS A₁ AMPLIFIER

HEATER VOLTAGE	6.3	6.3	VOLTS
HEATER CURRENT	0.3	0.3	AMPERE
PLATE VOLTAGE	100	250	VOLTS
CONTROL GRID VOLTAGE	0	-8	VOLTS
PLATE CURRENT	10.0	8.0	MA.
PLATE RESISTANCE	7000	8700	OHMS
TRANSCONDUCTANCE	3600	2300	μMHOS
AMPLIFICATION FACTOR	25	20	

DIRECT INTERELECTRODE CAPACITANCES⁵

CONTROL GRID TO CATHODE	3.4	μf
PLATE TO CATHODE	2.6	μf
GRID TO PLATE	2.0	μf

⁵ WITH BASE SHELL GROUNDED.

TUNG-SOL

PRINTED IN U. S. A.

PLATE
1331-3
SEPT. 23
1943

NOTES

TUNG-SOL