

LTC3220/LTC3220-1 User's Guide

by Marty Merchant

INTRODUCTION

This application note illustrates how to program and use the unique features of the LTC3220/LTC3220-1 Universal LED (ULED) Driver. These features include individually controlling, gradually turning on and off, or blinking up to 18 LEDs. This device may also be used to provide digital signal(s) to other devices while in shutdown using a strong pull-down general purpose output (GPO) and an external

power source. Current limited GPO mode may also be used to control other devices using the charge pump output (CPO) of the device or an external supply. A programmable shutdown feature allows the device to go into and out of shutdown returning to its pre-shutdown state. These features give the user vast flexibility and control of LEDs and other devices while saving memory space, programming time, I²C traffic, and even battery power.

LT, LT, LTC and LTM are registered trademarks of Linear Technology Corporation. All other trademarks are the property of their respective owners.

Table 1. Features of LTC3220

FEATURE	BENEFITS
18 Separate Outputs	18 Individually Controlled 20mA Current Sources with 64-Step Linear Dimming Control
Blink Mode	Blinks One of Four Blinking Patterns
Gradation	Gradually Turns On and Off LEDs
GPO Mode (Strong)	<ul style="list-style-type: none"> I²C Controlled Open Drain Drivers Operates in Shutdown, Low Q Current
GPO Mode (Current Limited)	I ² C Controlled Open Drain Drivers with Adjustable Current Limit
External Reset	Resets All Internal Registers and Forces Part into Shutdown
Programmable Shutdown	<ul style="list-style-type: none"> I²C Controlled Shutdown Data Registers Retain Data and Outputs Return to Previous State when Shutdown Terminates
Auto Switching Charge Pump	Automatically Switches to 1x, 1.5x, or 2x Modes for Better Efficiency
Forced Charge Pump Mode	May Be Programmed to Remain in 1x, 1.5x, or 2x Mode

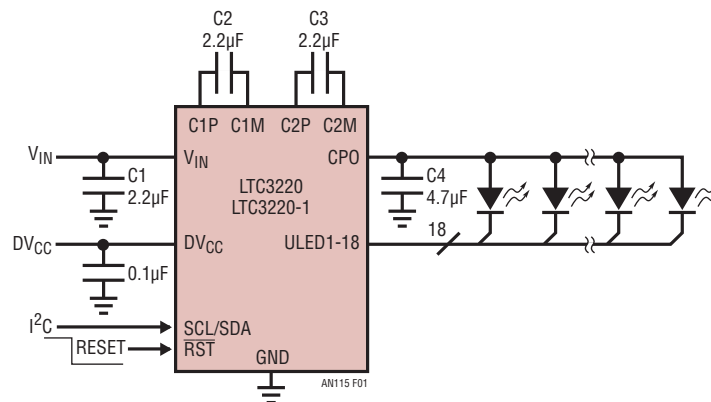
Figure 1. Typical LTC3220 Application

Application Note 115

Table 2. Write Word Protocol Used By the LTC3220/LTC3220-1

1	7	1	1	8	1	8	1	1
S	Slave Address	Wr	A	*Sub-Address	A	Data Byte	A	P**

S = Start Condition, Wr = Write Bit = 0, A = Acknowledge, P = Stop Condition

*The sub-address uses only the first 5 bits, D0, D1, D2, D3 and D4.

**Stop can be delayed until all of the data registers have been written.

Table 3. Sub-Address Byte Assignment

MSB							LSB			
7	6	5	4	3	2	1	0	Register	Function	
0	0	0	0	0	0	0	0	REG0	COMMAND	
0	0	0	0	0	0	0	1	REG1	ULED1	
0	0	0	0	0	0	1	0	REG2	ULED2	
0	0	0	0	0	0	1	1	REG3	ULED3	
0	0	0	0	0	1	0	0	REG4	ULED4	
0	0	0	0	0	1	0	1	REG5	ULED5	
0	0	0	0	0	1	1	0	REG6	ULED6	
0	0	0	0	0	1	1	1	REG7	ULED7	
0	0	0	0	1	0	0	0	REG8	ULED8	
0	0	0	0	1	0	0	1	REG9	ULED9	
0	0	0	0	1	0	1	0	REG10	ULED10	
0	0	0	0	1	0	1	1	REG11	ULED11	
0	0	0	0	1	1	0	0	REG12	ULED12	
0	0	0	0	1	1	0	1	REG13	ULED13	
0	0	0	0	1	1	1	0	REG14	ULED14	
0	0	0	0	1	1	1	1	REG15	ULED15	
0	0	0	1	0	0	0	0	REG16	ULED16	
0	0	0	1	0	0	0	1	REG17	ULED17	
0	0	0	1	0	0	1	0	REG18	ULED18	
0	0	0	1	0	0	1	1	REG19	GRAD/ BLINK	

I²C Control

The LTC3220/LTC3220-1 has 20 data registers, each with its own sub-address as shown in Table 3. The data is loaded into the registers when the device receives a Stop bit. This device is written using the standard I²C protocol (a 7-bit slave address and write bit, followed by the 8-bit sub-address byte and an 8-bit data byte) as illustrated in Table 2. This device is a slave I²C device that can only receive data.

The only difference between the LTC3220 and the LTC3220-1 is the 7-bit I²C address. The LTC3220 I²C address is 0011100 and the LTC3220-1 I²C address is 0011101.

DATA BYTES

Register 0 (Table 4 and Table 5) is used to enter or exit shutdown, set the charge pump to Auto, Force 1x, Force 1.5x, or Force 2x modes, and to parallel write to the part using the Quick Write bit. Register 1 through register 18 set the intensity and mode for each of the eighteen individual ULED outputs (Table 6). Register 19 is separated into three portions as illustrated in Table 7, Table 8 and Table 9. The blink bits, D4 and D3, are used to select the blinking on-time and period. The gradation timer bits, D2 and D1, are used to control the gradation time while the Up bit, D0, is used to control the gradation ramp direction.

Table 4. REG0, Command Byte

MSB							LSB
D7	D6	D5	D4	D3	D2	D1	D0
Unused	Unused	Unused	Unused	Shutdown	Force2x	Force1p5x	Quick Write

Table 5. Command Byte Bit Functions

Quick Write	0	Serial Write to Each Register
	1	Parallel Write, REG1 Data Is Written to All Eighteen Universal Registers
Force1p5x	1	Forces Charge Pump into 1.5x Mode
	0	Enables Mode Logic to Control Mode Changes Based on Dropout Signal
Force2x	1	Forces Charge Pump into 2x Mode
	0	Enables Mode Logic to Control Mode Changes Based on Dropout Signal
Force1x		D1 (Force1p5x) = 1 D2 (Force2x) = 1 } Forces Charge Pump into 1x Mode
Shutdown	1	Shuts Down Part, While Preserving Data in Registers
	0	Normal Operation

Table 6. REG1 to REG18, Universal LED 6-Bit Linear DAC Data with Blink/Gradation/GPO Modes

	BLINK/GRADATION/GPO MODE BITS		LED CURRENT DATA					
	MSB		LSB					
	Bit 7	Bit 6	Bit 5	Bit 4	Bit 3	Bit 2	Bit 1	Bit 0
Normal	0	0	D5	D4	D3	D2	D1	D0
Blink Enabled	0	1	D5	D4	D3	D2	D1	D0
Gradation Enabled	1	0	D5	D4	D3	D2	D1	D0
GPO Mode*								
Strong Pull-Down Mode	1	1	0	0	0	0	0	0
Current Limited Mode	1	1	D5	D4	D3	D2	D1	D0
High Impedance/OFF	0	0	0	0	0	0	0	0

*(Gradation/Blink/Dropout Disabled)

Application Note 115

Table 7. REG19, Gradation and Blinking Register

MSB							LSB
D7	D6	D5	D4	D3	D2	D1	D0
Unused	Unused	Unused	GB4	GB3	GB2	GB1	UP

Table 8. Gradation Up Bit

UP	0	Gradation Counts Down
	1	Gradation Counts Up

Table 9. Gradation and Blinking Register Bit Functions

BLINK TIMES AND PERIOD				GRADATION TIMES AND PERIOD			
D4	D3	Blink	Period	D2	D1	Times	Period
0	0	0.625s	1.25s	0	0	Disabled	Disabled
0	1	0.156s	1.25s	0	1	0.24s	0.313
1	0	0.625s	2.5s	1	0	0.48s	0.625
1	1	0.156s	2.5s	1	1	0.96s	1.25

DEVICE SETUP AND OPERATION

This device requires an input supply of 2.9V to 5.5V and a DV_{CC} supply of 1.5V to 5.5V. Refer to the LTC3220/LTC3220-1 data sheet for electrical connections and specifications. Although the power on reset clears all the data registers, it is good practice to reset the part using the \overline{RST} pin to make sure all data registers are reset after V_{IN} and/or DV_{CC} power up. The Quick Write feature may also be used to clear all ULED registers with few I^2C writes.

SET ONE OR MORE ULED OUTPUT(S)

To set one or more ULED output(s) using the I^2C bus, write the intensity setting to the desired ULED registers with the mode enable bits (Bit 7 and Bit 6) low, followed by a Stop bit. The following example illustrates how to set ULED1 and ULED2 to 5mA. Since the full-scale current is 20mA, use the following formula to determine the number of steps needed to acquire 5mA.

$$\text{Steps} = \text{ILED} \cdot \text{StepsFullScale} / \text{IFullScale} \quad (1)$$

$$5\text{mA} \cdot 63\text{Steps} / 20\text{mA} = 15.75 \text{ Steps}$$

The number of steps is rounded to 16 and converted to the hexadecimal value 10H. Setting the ULED register to 10H will set the ULED output to approximately 5mA. In Example 1, the “S” designates the Start Bit and 38H designates the LTC3220 7-bit I^2C address plus the write bit to form the 8-bit hexadecimal byte of 38. For the LTC3220-1, substitute 3AH in place of 38H for the I^2C address. The second hexadecimal bytes, 01 and 02, are the sub-address bytes. The third hexadecimal byte is the register data byte. The “P” designates the Stop bit. The Stop bit was set after the last write to load ULED1 and ULED2 registers and set the ULED outputs simultaneously. A Stop bit may be used after each I^2C write, however it is not desired in some cases while gradating. All of the following examples will use the same format used in Example 1.

Example 1. Setting ULED1 and ULED2 to 5mA.

S 38H 01H 10H* ‘Set ULED1 to 5mA, No Stop bit needed

S 38H 02H 10H P ‘Set ULED2 to 5mA, Stop bit loads data

*A Stop bit may be used here if desired.

USING THE GPO FEATURE

This device has two GPO modes: the Current Limited GPO mode limits the output current from 0.4mA to 20mA in 63 steps and the Strong Pull-Down GPO mode acts like a switch. The GPO modes may be used as an open drain output to drive a logic signal to a microprocessor or some other device. This is accomplished by allowing the ULED pin to be driven to 0V without causing the charge pump to change modes.

If the device is forced into shutdown while in Current Limited GPO mode, the output is disabled and the supply current will be reduced to a few hundred microamps. This mode is useful for driving other devices which are not to be controlled during shutdown, or to control the current to other devices which would otherwise cause the LTC3220/LTC3220-1 to go into dropout. When a Current Limited GPO is used as an open drain output, the current setting should be set greater than the maximum current needed. However a current setting greater than 10 times the maximum current may increase the quiescent current by more than 10%.

To set one or more ULED output(s) to Current Limit GPO mode, write the intensity setting greater than 0mA to the desired ULED registers with the GPO mode enable bits (Bit 7 and Bit 6) high, followed by a Stop bit. It was determined using formula (1) that 3 steps are required to provide 1mA, therefore the hexadecimal code needed to provide 1mA of current in GPO mode is C3H. Example 2 illustrates how to set ULED1 and ULED2 to 1mA Current Limited GPO mode.

Application Note 115

Example 2. Set ULED1 and ULED2 to 1mA in Current Limited GPO mode.

S 38H 01H C3H* 'Set ULED1 to 1mA in GPO mode

S 38H 02H C3H P 'Set ULED2 to GPO mode, Stop bit loads data

*A Stop bit may be used here if desired.

In Strong Pull-Down GPO mode, the current is not limited by the device and needs to be limited externally to 25mA or less. The advantage of this mode is that it only uses 3 μ A of quiescent current and may be used while the part is in shutdown. CPO should not be used for supplying current to a Strong Pull-Down GPO during shutdown since CPO is limited by a weak pull-up current source. To set one or more ULED output(s) to Strong Pull-Down GPO mode, write the intensity setting of 0mA to the desired ULED registers with the GPO enable bits high as illustrated in Table 6. A Stop bit loads the data and sets the output. Example 3 illustrates how to set ULED1 and ULED2 into Strong GPO mode.

Example 3. Set ULED1 and ULED2 to Strong GPO mode.

S 38H 01H C0H* 'Set ULED1 to Strong GPO mode

S 38H 02H C0H P 'Set ULED2 to Strong GPO mode, Stop bit loads data

*A Stop bit may be used here if desired.

USING THE BLINKING FEATURE

Blinking LEDs may be used to indicate voicemail messages, missed calls, low battery, or other messages. The LTC3220/LTC3220-1 has a blinking feature that allows the user to choose between one of four different blinking rates as illustrated in Table 9. This feature reduces processor time and I²C traffic. The blinking times are controlled by a single free running counter. When one or more ULED outputs are set to blink, they will synchronously blink with the blinking timer. The ULED outputs may start blinking in the "on" or the "off" state except when the part is coming out of shutdown. When the device starts blinking out

of shutdown, the ULED outputs will start blinking in the "off" state. To set one or more ULED output(s) blinking, set the blinking rate in register 19, and then set the ULED register(s) and blinking bit with the desired intensity. Send a Stop bit to start the ULED output(s) blinking. The blink rate may be changed at any time by changing the blink bits in register 19. Example 4 shows how to start ULED1 and ULED2 blinking.

Example 4. Setting ULED1 and ULED2 to blink at 5mA with a 2.5s period and a 0.625s on-time.

S 38H 13H 10H* 'Set blinking time to 0.625s on, 2.5s period

S 38H 01H 50H* 'Set ULED1 to blink at 5mA

S 38H 02H 50H P 'Set ULED2 to blink, Stop bit loads all data

*A Stop bit may be used here if desired.

USING GRADATION

It is sometimes desirable to gradually turn on and off LEDs or displays. Normally substantial I²C bus time is required to gradually turn on and off LEDs. The LTC3220/LTC3220-1 has a gradation feature that allows the user to smoothly turn on and off LEDs with little I²C interaction. This device uses a single gradation ramp to gradate one or more LED(s) from off-to-on or from on-to-off simultaneously. Ideally the ULED gradation enable bit and the gradation timer are enabled at the same time as described in the following procedures. If the gradation mode bit is set in the ULED register prior to starting the gradation timer, the ULED outputs will provide a 100 μ A current which will cause the LEDs to turn on.

Gradation consists of a gradation time and a gradation period. The gradation period is the time that the gradation timer is running. The gradation timer starts running as soon as the gradation timer bits are loaded into register 19 and stops after a set amount of time. The gradation time is when the LED current starts to change to when it stops changing. This typically starts 40ms after the gradation timer has started and is approximately 80% of the

gradation period. The gradation period can be observed on the down gradation ramp as shown in Figure 2. The gradation period shown in Figure 2 is 670ms and the gradation time is about 570ms.

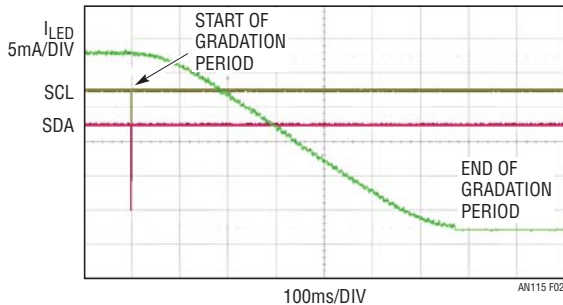

Figure 2. 625ms Gradation Period

GRADATING ONE OR MORE ULED OUTPUT(S) UP FROM OFF-TO-ON

To gradate one or more ULED output(s) from the off-to-on state via the I²C bus, the gradation timer bits in register 19 (D2 and D1) should be initialized to 0. Set the ULED register to the desired intensity with the gradation bit (Bit 7) set without sending a Stop bit. Then set the gradation time and the gradation Up bit (D0) high in register 19. The Stop bit loads the registers and starts the gradation process. Example 5 illustrates how to gradate ULED1 and ULED2 from 0mA to 5mA. Figure 3 illustrates how a ULED output current is ramped from 0mA to 5mA at 0.48s.

Example 5. Gradating ULED1 and ULED2 from 0mA to 5mA at 0.48s:

- S 38H 13H 00H P 'Clear gradation timer if not already clear
- S 38H 01H 90H** 'Set ULED1 to gradate to 5mA
- S 38H 02H 90H** 'Set ULED2 to gradate to 5mA
- S 38H 13H 05H P 'Set gradation time to 0.48s and set the Up Bit, Stop bit starts gradation

** A Stop bit may be used here but is not desired

Prior to disabling the gradation timer or gradating up any other ULED outputs, the gradation bits in the ULED register must be cleared. This is accomplished by writing an intensity value with the gradation bit cleared as illustrated in Example 6

Example 6. Disabling gradation with ULED1 and ULED2 at 5mA.

- S 38H 01H 10H* 'Set ULED1 to 5mA with gradation bit low
- S 38H 02H 10H* 'Set ULED2 to 5mA with gradation bit low
- S 38H 13H 00H P 'Disable gradation, Stop bit loads all data

* A Stop bit may be used here if desired.

GRADATING ONE OR MORE ULED OUTPUT(S) DOWN FROM ON-TO-OFF

The gradating down procedure is similar to the gradating up procedure except the initial state of the ULED output and the state of the Up bit in register 19. One advantage of the LTC3220/LTC3220-1 compared to its predecessors is that the ULED registers are automatically set to 0 when the gradation down ramp completes. This allows the ULED outputs to turn off and the part to go into shutdown without any additional I²C interaction. To gradate one or more ULED output(s) from the on-to-off state via the I²C bus, the gradation timer in register 19 (D2 and D1) should be initialized to 0. Set the ULED register to the initial intensity with the gradation bit (D7) set without sending a Stop bit. Then set the gradation time and the gradation Up bit (D0) low in register 19 followed by a Stop bit as shown in Example 7. The Stop bit loads the registers and starts the gradation process. Figure 4 illustrates how the ULED current gradates down from 5mA to 0mA in 0.48s.

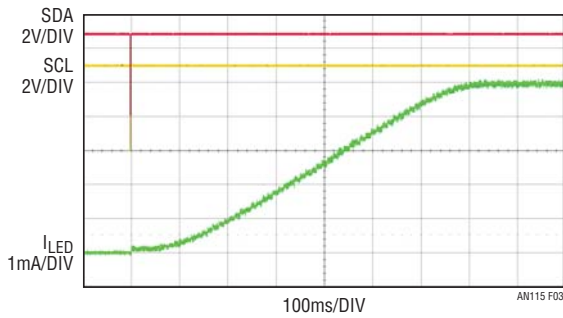

Figure 3. Gradation from 0mA to 5mA in 0.48s

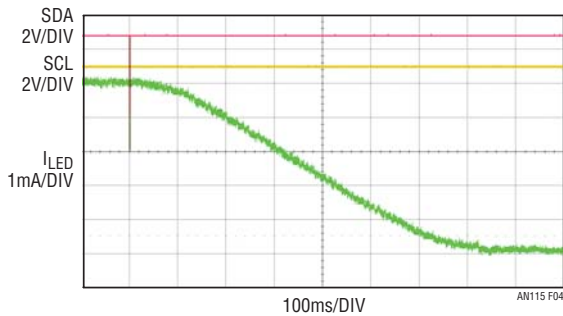

Figure 4. Gradation from 5mA to 0mA in 0.48s

Example 7. Gradating ULED1 and ULED2 from 5mA to 0mA at 0.48s (ULED1 and ULED2 previously set to 10H, 5mA).

- S 38H 13H 00H P 'Clear gradation timer if not already clear
- S 38H 01H 90H** 'Set ULED1 with gradation bits
- S 38H 02H 90H** 'Set ULED2 with gradation bits
- S 38H 13H 04H P 'Set gradation timer with Up bit low and start gradation

** A Stop bit may be used here but is not desired

See Appendix A for more information on gradation and gradation programming techniques.

USING QUICK WRITE

The Quick Write feature allows the user to control all 18 ULED outputs simultaneously with few I²C commands by parallel writing the 18 ULED registers. This feature may be used to set, clear, blink, gradate, or set the ULED outputs into GPO mode. To set (or clear) all ULED outputs using the Quick Write feature, first set the Quick Write bit in the Command register. Then set the ULED1 register to the desired value. When done using the Quick Write feature, clear the Quick Write bit. Example 8 illustrates how to clear all of the ULED registers using the Quick Write feature.

Example 8. Clear all ULED registers using the Quick Write Feature.

- S 38H 00H 01H* 'Set the Quick Write Bit
- S 38H 01H 00H P 'Load the ULED1 Register with 00H
- S 38H 00H 00H P*** 'Clear Quick Write Bit, Stop bit Sets all Registers to 0

* A Stop bit may be used here if desired.

*** This step is only needed if the Quick Write feature is no longer needed.

All ULED outputs may be set to blink or GPO mode using the Quick Write feature by setting the mode enable bits when loading the ULED1 register as shown in Example 8. However, the desired blinking time should be selected prior to enabling all ULED outputs in blink mode.

USING PROGRAMMABLE SHUTDOWN

The programmable shutdown allows the user to shutdown the device at anytime while maintaining the data in all of the data registers. During shutdown, all ULED outputs not in Strong GPO mode will turn off, CPO will connect to V_{IN} via a weak switch, and the LTC3220/LTC3220-1 will only consume about 3 μ A. When the device comes out of shutdown, all ULED outputs and the charge pump will return to their pre-shutdown state. If the ULED output was set to blink, it will start blinking starting with the off cycle at the previously selected on-time and period. If a ULED output was set to gradate up, it will gradate up at the previously selected gradation time. If shutdown was programmed after a ULED output has completed a gradation down cycle, the output will remain off when shutdown ends. If shutdown was programmed while a ULED output was gradating down, the gradation ramp will reset and the ULED output will go to the previous set intensity and then

gradate down at the set gradation time. Figure 5 shows how a gradation down cycle is reset if shutdown is set before the gradation cycle completes.

CONCLUSION

The LTC3220/LTC3220-1 features are designed to give the user more control of LEDs or other devices while minimizing I²C bus time and battery power. The blinking and gradation features allow the user to provide visual effects without extensively using the I²C bus. The Strong GPO mode allows the user to control other devices while using only 3 μ A of quiescent current when the part is in shutdown. The Quick Write feature allows all of the outputs to be changed at once with little I²C interaction. The shutdown feature puts the device into shutdown and will return the device to its pre-shutdown state. All these features make controlling complex illumination schemes easier.

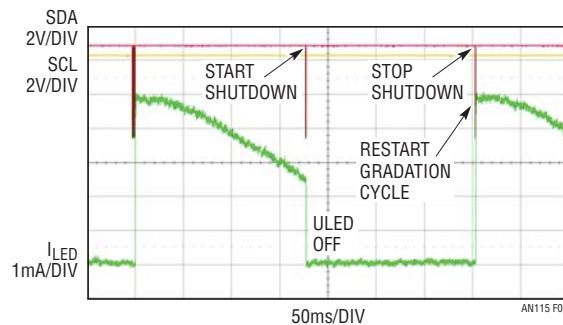

Figure 5. Shutdown Set During a Gradation Down Cycle

APPENDIX A: MORE GRADATION TECHNIQUES

CONTINUOUSLY GRADATING ONE OR MORE ULED OUTPUT(S) UP AND DOWN

It may be desired to continuously gradate a ULED output up and down. This may be achieved by first initiating the gradation as in Example 5 or Example 7. To gradate down again after gradating up, clear the Up bit in register 19. Do not clear the gradation timer bits in register 19 or the gradation enable bit in the ULED register. If it is desired to change the gradation ramp time, the gradation timer bits may be changed when clearing the Up bit in register 19. Example 9 illustrates how to gradate back down again without resetting the gradation enable bit or gradation timer bits.

Example 9. Gradating down after gradating up as illustrated in Example 5.

```
S 38H 13H 04H P 'Clear Up bit, Stop bit starts
                    gradation ramp down
```

To gradate back up after gradating down is similar to gradating one or more ULED outputs up. The only difference is that the gradation timer does not have to be reset as in Example 5. Gradating back up is done by setting the ULED intensity and the gradation bit without a Stop bit. Then set the gradation Up bit and gradation timer in register 19, as illustrated in Example 10. If a different gradation rate is desired, the gradation time may be changed when the Up bit is set in register 19.

Example 10. Gradating ULED1 and ULED2 back up to 5mA after gradating down.

```
S 38H 01H 90H** 'Set ULED1 to gradate to 5mA
S 38H 02H 90H** 'Set ULED2 to gradate to 5mA
S 38H 13H 05H P 'Set Up bit, Stop bit starts
                    gradation
```

**A Stop bit may be used here but is not desired

CONTINUOUSLY GRADATING ONE OR MORE ULED OUTPUT(S) UP AND DOWN WITH STOP BITS AFTER EVERY I²C WRITE

If a Stop bit must be set after the ULED registers are written when gradating up and prior to setting the gradation timer and Up bit, one of two results will occur. If the device went into shutdown after gradating down, then the ULED output(s) will jump to the destination gradation current after the ULED register data and Stop bit are received. The ULED will remain at this setting until the gradation timer is set. This may cause an LED to flash briefly. Figure 6 illustrates how a ULED output current jumps after loading the ULED register until the gradation timer is set with a clock speed of 100KHz. This flash may be reduced to tens of microseconds by using a 400KHz I²C clock and reducing the delay between bytes and start and stop bits.

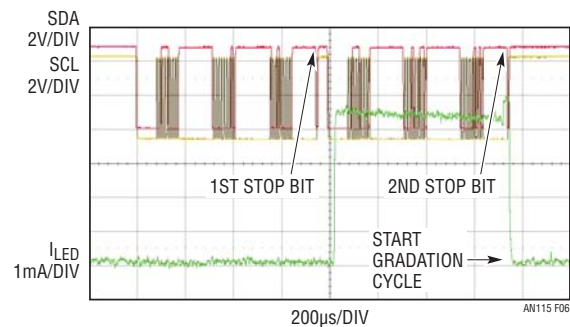

Figure 6. Gradating Up After Gradating Down and Going Into Shutdown. Stop Bit After 1st Stop Bit Causes ULED Output to Jump Until Gradation Timer Is Set with 2nd Stop Bit

When a part is not in shutdown after the gradating down and the ULED register data and a Stop bit were received, the ULED output will provide a 100 μ A current until the gradation timer is loaded. This 100 μ A output state may be reduced by using a 400KHz I²C clock and reducing the delay between bytes, Start, and Stop bits. Figure 7 illustrates how a ULED output provides 100 μ A after loading the ULED register until the gradation timer is set with a clock speed of 100kHz.

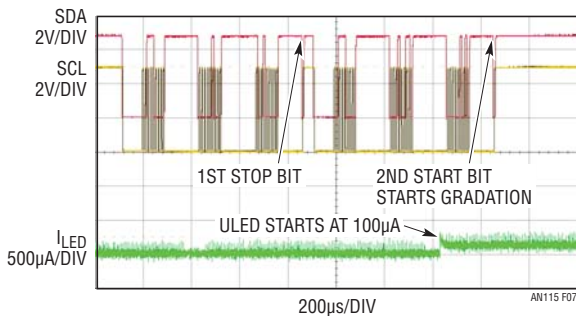

Figure 7. Gradating Up After Gradating Down and Device Does Not Go into Shutdown

GRADATING MULTIPLE ULED OUTPUTS IN SAME DIRECTION CONSECUTIVELY

It may be desired to gradate a number of ULED outputs in the same direction consecutively. This is easily done,

however since there is only one gradation ramp one gradation cycle must be completed prior to starting the next. To gradate multiple ULED outputs up consecutively, first initiate gradation as done in Example 5. After the gradation cycle has completed, disable gradation as done in Example 6, then start the next ULED output gradating as done in Example 5.

Gradating down consecutive ULED outputs is even less complicated since the ULED registers are cleared automatically after the gradation cycle has completed. To do this, gradate the first ULED output down as illustrated in Example 7. Wait until the gradation down cycle has completed and then clear the gradation timer. Now gradate the next ULED down again as shown in Example 7.

GRADATING USING QUICK WRITE

The Quick Write feature may also be used to gradate up or down. This process is similar to setting the ULED outputs in normal mode using the Quick Write feature except the gradation time is set prior to sending a Stop bit. The ULED outputs may also be gradated up and down consecutively by leaving the Quick Write bit set, changing the Up bit in register 19, and reloading the ULED1 register prior to the up gradation. Example 11 illustrates how to consecutively gradate all ULED outputs up and down using the Quick Write feature.

Application Note 115

Example 11. Gradate all ULEDs Up and Down using the Quick Write Feature.

- S 38H 00H 01H* 'Set the Quick Write Bit
- S 38H 01H 90H** 'Load the ULED1 Register with 90H
- S 38H 13H 05H P 'Set the Gradation Timer and Up Bit, Stop Bit starts gradation

Wait for gradation period to finish.

- S 38H 13H 04H P 'Clear the gradation Up Bit, Stop Bit starts gradation

Wait for gradation period to finish.

- S 38H 01H 90H** 'Load the ULED1 Register with 90H
- S 38H 13H 05H P 'Set the Gradation Timer and Up Bit, Stop Bit starts gradation
- S 38H 00H 00H P*** 'Clear Quick Write Bit

*A Stop bit may be used here if desired.

**A Stop bit may be used here but is not desired

***This step is only need if the Quick Write feature is no longer needed.

GRADATING WITH STOP BITS AFTER EVERY I²C WRITE

If it is not possible to delay the Stop bit until after the data is loaded when gradating up, set the ULED registers with a Stop bit and then set the gradation timer and Up bit in register 19 with as little delay as possible between writes. Although the ULED outputs will turn on at 100µA within several hundreds of microseconds, all of the ULED outputs will gradate together after the gradation timer is loaded. Figure 8 shows the ULED output current at 100µA until the gradation timer is set in register 19 using a 100kHz I²C clock. The duration of this 100µA current state may be reduced by using a 400kHz I²C clock and reducing the delay between bytes and start and stop bits.

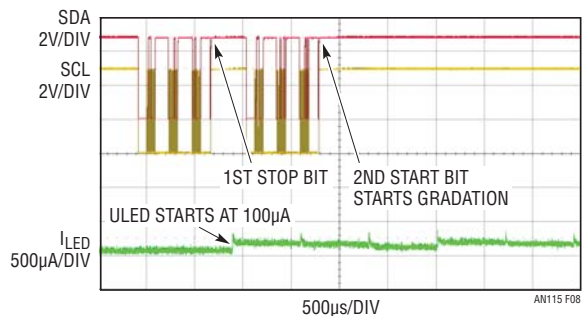

Figure 8. Start of Up Gradation when a Stop Bit Is Received After the ULED Register Data Is Received

If it is not possible to delay the Stop bit until after the data is loaded when gradating down, set the ULED registers with a Stop bit and then set the gradation timer and clear the Up bit in register 19 with as little delay as possible between writes. Although the ULED outputs will provide 100µA within tens of microseconds of the corresponding Stop bit, all of the ULED outputs will return to their initial state and gradate down together after the gradation timer is loaded. Figure 9 illustrates how the ULED output current will behave when a Stop bit is sent after the ULED register is written to using a 100kHz clock speed with a 400µs delay between writes. This 100µA state may be reduced by using a 400kHz clock and by reducing the delay between bytes and start and stop bits.

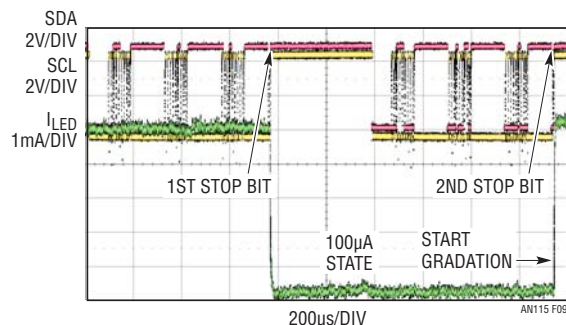

Figure 9. Start of Gradation from 5mA to 0mA with A Stop Bit After Writing the ULED Register