

THE RADIO ENGINEERING HANDBOOK

PREPARED BY A STAFF OF
TWENTY-EIGHT SPECIALISTS

KEITH HENNEY, EDITOR-IN-CHIEF
*Member, The Institute of Radio Engineers; Author, "Principles
of Radio," "Electron Tubes in Industry";
Editor, "Electronics"*

SECOND EDITION

McGRAW-HILL BOOK COMPANY, INC.
NEW YORK AND LONDON
1935

COPYRIGHT, 1933, 1935, BY THE
MCGRAW-HILL BOOK COMPANY, INC.

PRINTED IN THE UNITED STATES OF AMERICA

*All rights reserved. This book, or
parts thereof, may not be reproduced
in any form without permission of
the publishers.*

THE MAPLE PRESS COMPANY, YORK, PA.

PREFACE

For several years prior to the publication of the first edition of this handbook the need had been felt for a compilation of design data pertaining to radio engineering. Although many of the fundamental principles of electrical engineering apply to radio, the whole task of designing, manufacturing, and operating equipment for radio communication is vastly different from that for electrical-power apparatus. A handbook for the radio engineer became essential.

Since 1933, however, the radio art, as always, has moved ahead rapidly. New tubes, new circuits, new services, new frequencies, even new concepts have appeared. What was visioned in 1933 has not only come to pass, but in some cases has gone out of the art already. A new edition of the handbook, therefore, has become necessary.

Much of the fundamental material appearing in the first edition remains. Many of the practical design data have been changed, some discarded for more recent material. A section on antennas has been added, television has been entirely rewritten, and other new material to the extent of nearly 300 pages will be found in this second edition.

The extent to which the first edition has found its way into schools, as well as into the libraries of practicing engineers for whom it was designed, has been most encouraging; although the emphasis is on practice rather than theory, instructors and students will find an essential amount of fundamental discussion. The technician will find here many man-hours of effort compiled into the form of tables and curves by the twenty-eight engineers and physicists who have aided the editor in preparing this new edition.

KEITH HENNEY.

NEW YORK, N. Y.,
October, 1935.

CONTENTS

	PAGE
PREFACE	V
SECTION 1	
MATHEMATICAL AND ELECTRICAL TABLES	1
Greek alphabet—Decimal equivalents—Trigonometric functions—Wave length-frequency tables—Wire tables—Decibel chart—Logarithms—Standard graphic symbols—Inductance charts—Communication band widths—Frequency separations—Broadcast station day and night separation tables—Harmonic content calculations—Shunt and multiplier data for meters.	
SECTION 2	
ELECTRIC AND MAGNETIC CIRCUITS, <i>by</i> E. A. UEHLING	30
Electric charges—Coulomb's law—Electrons and protons—Nature of current—Concept of e.m.f.—Ohm's law—Inductance—Capacitance—Wave form—Direct-current circuits—Alternating-current circuits—Kirchhoff's laws—Transients—Logarithmic decrement—Magnetic circuits—Core materials—Radiation—Antenna radiation formulas—Electromagnetic and electrostatic fields.	
SECTION 3	
RESISTANCE, <i>by</i> JESSE MARSTEN.	51
Units of resistance—Temperature coefficient—Series and parallel resistors—Skin effect—High-frequency resistance tables—Wire-wound resistors—Composition-type resistors—Resistor testing—Variable resistors—Tapers.	
SECTION 4	
INDUCTANCE, <i>by</i> GOMER L. DAVIES	72
Magnetic flux—Inductance, definition and units—Time constant—Reactance—Impedance—Power in inductive circuits—Measurement of inductance at low frequencies—Iron-core coil measurements—High-frequency inductance measurements—Radio-frequency inductors—Coil capacity—Inductor types—Inductance-coil design—Iron-core r-f coils—Calculation of inductance of air-core coils—Inductance standards—Mutual inductance.	
SECTION 5	
CAPACITY, <i>by</i> E. L. HALL	102
Units—Dielectric materials—Dielectric-constant tables—Dielectric power loss—Power-factor tables—Dielectric strength—	

	PAGE
Calculation of capacity—Condenser types—Electrolytic condensers—Capacity motors—Variable condensers—Gang condensers—Variable-condenser design—Standards of capacity—Capacity measurements.	
SECTION 6	
COMBINED CIRCUITS OF L, C, AND R, by W. F. LANTERMAN	130
Impedance—Vector diagrams—Complex notation—Equivalent-impedance charts— Q tables—Insertion loss—Resonance—Resonant-circuit design—Resonant-circuit properties—Oscillator tracking-circuit design—Split-tank circuits—Decoupling filters—Recurrent networks—Transmission lines—Resistance pads—R-f lines—Tapered lines—Impedance transformers—Wave filters—Filter design formulas.	
SECTION 7	
ELECTRICAL MEASUREMENTS, by R. F. FIELD AND JOHN H. MILLER	182
Standards—Current-measuring instruments—High-frequency current meters—Rectifier meters—Voltage-measuring instruments—Resistance measurements—Capacity, frequency, power-factor, etc., measurements—Moving-diaphragm meters—Vacuum-tube voltmeters—Cathode-ray tube measurements—Comparison measurements—D-c measurements—A-c bridge measurements.	
SECTION 8	
VACUUM TUBES, by J. M. STINCHFIELD	231
Electron velocity—Space charge—Electron emission—Contact potential—Work function—Filament calculations—Schottky effect—Two-electrode tubes—Three-electrode tubes—Triode characteristics—Space-current calculation—Amplification factor—Plate resistance—Mutual conductance—Mechanism of amplification—Detector-amplifier triodes—Power-amplifier triodes—Power tetrodes and pentodes—Triple-grid power amplifiers—Class B amplifiers—Calculation of power output and distortion—Screen-grid amplifiers—Super-control amplifiers—Combination tubes—Pentagrid converters—Metal tubes—Ultrahigh-frequency tubes—Interelectrode capacitance.	
SECTION 9	
OSCILLATION, by W. W. WALTZ	277
Conditions for oscillation—Fundamental circuits—Frequency control—Quartz-crystal cuts—Crystal mountings—Frequency-stabilizing circuits—Magnetostriction oscillators—Tuning-fork oscillators—Resonant lines—Beat-frequency oscillators—High-frequency oscillators—Oscillator design.	
SECTION 10	
DETECTION AND MODULATION, by K. W. JARVIS	320
Detection characteristic—Detector equations—Triode as detector—Plate detection—Grid detection—High-amplitude detection—Linear detection—Heterodyne detection—Rectification	

diagrams—Screen-grid as detector—Modern detector practice
—Diode detection—Detector-oscillators—Frequency converters
—Modulation—Side-band theory—Plate modulation—Heising
modulation—Balanced modulator—Frequency inversion
—Modulation measurements—Frequency multipliers—Band
widths required—Frequency modulation.

SECTION 11

- AUDIO-FREQUENCY AMPLIFIERS**, by GLENN KOEHLER 359
Amplifier classifications—Class A amplifiers—Voltage amplification—Power output—Methods of coupling—Amplifier design—Transformer calculations—Impedance-matching transformers—Push-pull amplifiers—Pentode power amplifiers—Frequency-response equalization—Power supply—Direct-coupled amplifiers—Class B amplifiers—Class AB amplifiers—Frequency-response measurements.

SECTION 12

- RADIO-FREQUENCY AMPLIFIERS**, by R. S. GLASGOW 393
Interstage coupling—Tuned amplifiers—Cascade amplifiers—Band-pass amplifiers—Regeneration—Neutralizing circuits—Pentode amplifiers—Power amplifiers—Design calculations—Modulated amplifiers—Frequency multipliers.

SECTION 13

- RECEIVING SYSTEMS**, by G. L. BEERS 422
Types of receiver circuits—T-r-f receivers—Superheterodyne receivers—Regenerative receivers—Superregenerative receivers—Methods of rating and testing—Antenna input systems—Untuned amplifiers—Intermediate-frequency amplifiers—Frequency converters—Tone control—Volume control—Automatic volume control—Tuning silencer—Receiving-circuit noise—Shielding and filtering—Superheterodyne interference—Choice of intermediate frequency—All-wave receivers—Automobile radio receivers—High-fidelity receivers—Universal receivers—Direction finders—Single-signal receivers.

SECTION 14

- RECTIFIERS AND POWER-SUPPLY SYSTEMS**, by R. C. HITCHCOCK . . . 462
Power-supply design—Voltage regulation—Voltage dividers—Filter design—Filter-choke design—Voltage-doubling circuits—Mercury-vapor and vacuum rectifiers—Battery chargers—Mercury-arc rectifiers—Dry-contact rectifiers—Vibrators—Motor generators—Transformer design.

SECTION 15

- LOUD-SPEAKERS AND ACOUSTICS**, by IRVING WOLFF 496
Sound waves in air—Velocity of sound—Electrical, mechanical, acoustical impedance—Room acoustics—Absorption coefficients—Reverberation time—Sound transmission—Characteristics of the ear—Loud-speakers—Calculation of loud-speaker efficiency—Loud-speaker baffles—Loud-speaker motors—Loud-

speaker impedance—Horns—Directional characteristics—
Acoustic measurements.

SECTION 16

- HIGH-FREQUENCY TRANSMISSION AND RECEPTION, by A. HOYT
TAYLOR AND ROBERT KRUSE. 527**
History—Peculiarities of high frequencies—Kennelly-Heaviside
layer—Fading—Propagation theory—High-frequency usage
—Skip-distance and range table—Band width required—
Frequency stability—Frequency allocation—High-frequency
circuits—Ultrahigh-frequency oscillators—High-frequency su-
perheterodyne receivers—Superregenerative receivers—Multi-
range receivers—Secrecy methods—Carrier suppression—
Short-wave services.

SECTION 17

- CODE TRANSMISSION AND RECEPTION, by JOHN B. MOORE. 557**
Printing-telegraph equipment—Codes—Character formation—
Required frequency range—Speeds attainable—Transoceanic
code services—Short-wave transmission—Ship-to-shore com-
munications—Transmitting equipment—High-frequency al-
ternators—Frequency multipliers—Arc transmitters—Tube
transmitters—Long-wave antennas—Marine transmitters—
Short-wave technique—Receiving equipment—Long-wave re-
ceivers—Directional antennas—Ship-to-shore equipment—
Short-wave receivers—Central office organization—Automatic
transmitters—Tone-control circuits—Transcribing methods—
Ink recorder.

SECTION 18

- TELEVISION, by VICTOR J. ANDREW. 582**
Program sources—Scanning theory—Scanning methods—Icono-
scope—Electron multiplier—Variable-velocity scanning—Re-
ceiving transducers—Kerr effect—Cathode-ray systems—
Screen materials—Electron scanning—Amplifiers—Synchroni-
zation—Saw-toothed wave generator—Frame frequency—As-
pect ratio—Ghosts—Chain broadcasting—Television definitions
—Television stations.

SECTION 19

- RADIO BROADCASTING, by CARL G. DIETSCH. 600**
Broadcasting-system elements—Audio-frequency range—Vol-
ume range—Microphones—Studio technique—Microphone
placement—Studio characteristics—Faders—Speech-input am-
plifiers—Volume indicators—Wire lines—Transmitting equip-
ment—Modulators—High-fidelity design—Class B amplifiers
—Power supply—Parasitic oscillations—Transmission lines.

SECTION 20

- FACSIMILE TRANSMISSION, by R. H. RANGER. 663**
General requirements—Scanning systems—Photocell ampli-
fiers—Dot-dash system—Carrier systems—Light valves—
Recording methods—Synchronization—Systems in use.

SECTION 21

AIRCRAFT RADIO, *by* HARRY DIAMOND 685
 Government aircraft radio facilities—Weather broadcast stations—Range beacon equipment—Radio marker beacons—Government radio aids—Ground-station equipment—Airplane equipment—Aircraft power equipment—Antennas—Shielding and bonding—Direction finders—Homing systems—Rotating radio beacons—Goniometer—Visual course indications—Blind-landing aids—Landing beams—Army landing aids—Altimeters.

SECTION 22

ANTENNAS, *by* EDMUND A. LAPORT. 724
 Terminology—Fundamental radiation formulas—Current and potential distribution—Impedances of linear conductors—Radiation resistance—Distribution of field intensity—Electrical images of antennas—Directivity diagrams—Antenna array calculations—Broadcast antennas—Ground systems—Antenna-resistance measurement—Antenna terminations—Concentric transmission lines—Lightning protection—Directive broadcast antennas—Marine transmitters—High-frequency non-directional antennas—Directive high-frequency antennas—Receiving antennas—Directional antennas—Beverage antennas—Diversity reception.

SECTION 23

PHOTOCELLS, *by* H. C. RENTSCHLER 792
 Photoelectric emission—Color sensitivity—Vacuum and gas phototubes—Choice of phototubes—Phototube circuits—Photoelectric measurements—Photo-conductivity—Selenium cells—Photovoltaic effect—Grid-controlled rectifiers.

SECTION 24

SOUND MOTION PICTURES, *by* FRANKLIN S. IRBY AND AARON NADELL. 806
 Methods of recording—Microphones—Amplifiers—Film recorders—Motor systems—Disk records—Wax preparation and equipment—Rerecording—Noise reduction—Sound-film standards—Theater reproducing equipment—Loud-speaker systems—Reproducing-equipment troubles.

INDEX 833

THE RADIO ENGINEERING HANDBOOK

SECTION 1

MATHEMATICAL AND ELECTRICAL TABLES

1. Greek Alphabet.

Name	Letters		Commonly used to designate
	Cap.	Small	
Alpha.....	A	α	Angles. Coefficients. Area
Beta.....	B	β	Angles. Coefficients
Gamma.....	Γ	γ	Angles. Specific gravity. Conductivity
Delta.....	Δ	δ	Decrements. Increments. Variation. Density
Epsilon.....	E	ϵ	E.m.f. Base of natural logarithms. Very small quantity
Zeta.....	Z	ζ	(Cap.) Impedance. Coordinates
Eta.....	H	η	Hysteresis coefficient. Efficiency
Theta.....	Θ	θ, ϑ	Angular phase displacement. Time constant
Iota.....	I	ι	Current in amperes
Kappa.....	K	κ	Dielectric constant. Susceptibility. Visibility
Lambda.....	Λ	λ	(Small) Wave length
Mu.....	M	μ	Permeability. Amplification factor. Prefix micro-
Nu.....	N	ν	Reluctivity
Xi.....	Ξ	ξ	
Omicron.....	O	\omicron	
Pi.....	Π	π	Circumference divided by diameter 3.1416
Rho.....	P	ρ	Resistivity
Sigma.....	Σ	σ, ς	(Cap.) Sign of summation
Tau.....	T	τ	Time constant. Time-phase displacement
Upsilon.....	T	υ	
Phi.....	Φ	ϕ, φ	Flux. Angle of lag or lead
Chi.....	X	χ	(Cap.) Reactance
Psi.....	Ψ	ψ	Angular velocity in time. Phase difference. Dielectric flux. Angles
Omega.....	Ω	ω	Resistance in ohms. Resistance in megohms. $2\pi F$. Angular velocity

2. Decimal Equivalents of Parts of One Inch.

$\frac{1}{16}$	0.015625	$\frac{1}{8}$	0.125000	$\frac{3}{16}$	0.187500	$\frac{1}{2}$	0.500000
$\frac{3}{32}$	0.031250	$\frac{5}{16}$	0.250000	$\frac{1}{4}$	0.250000	$\frac{5}{8}$	0.625000
$\frac{1}{8}$	0.046875	$\frac{3}{8}$	0.375000	$\frac{3}{8}$	0.375000	$\frac{3}{4}$	0.750000
$\frac{3}{16}$	0.062500	$\frac{1}{2}$	0.500000	$\frac{1}{2}$	0.500000	$\frac{7}{8}$	0.875000
$\frac{5}{16}$	0.078125	$\frac{5}{8}$	0.625000	$\frac{5}{8}$	0.625000	$\frac{15}{16}$	0.937500
$\frac{3}{8}$	0.093750	$\frac{3}{4}$	0.750000	$\frac{3}{4}$	0.750000	$\frac{15}{16}$	0.937500
$\frac{7}{16}$	0.109375	$\frac{7}{8}$	0.875000	$\frac{7}{8}$	0.875000	$\frac{15}{16}$	0.937500
$\frac{1}{4}$	0.125000	$\frac{15}{16}$	0.937500	$\frac{15}{16}$	0.937500	$\frac{15}{16}$	0.937500
$\frac{5}{8}$	0.140625	$\frac{15}{16}$	0.937500	$\frac{15}{16}$	0.937500	$\frac{15}{16}$	0.937500
$\frac{3}{4}$	0.156250	$\frac{15}{16}$	0.937500	$\frac{15}{16}$	0.937500	$\frac{15}{16}$	0.937500
$\frac{15}{16}$	0.171875	$\frac{15}{16}$	0.937500	$\frac{15}{16}$	0.937500	$\frac{15}{16}$	0.937500
$\frac{15}{16}$	0.187500	$\frac{15}{16}$	0.937500	$\frac{15}{16}$	0.937500	$\frac{15}{16}$	0.937500
$\frac{15}{16}$	0.203125	$\frac{15}{16}$	0.937500	$\frac{15}{16}$	0.937500	$\frac{15}{16}$	0.937500
$\frac{15}{16}$	0.218750	$\frac{15}{16}$	0.937500	$\frac{15}{16}$	0.937500	$\frac{15}{16}$	0.937500
$\frac{15}{16}$	0.234375	$\frac{15}{16}$	0.937500	$\frac{15}{16}$	0.937500	$\frac{15}{16}$	0.937500
$\frac{1}{4}$	0.250000	$\frac{15}{16}$	0.937500	$\frac{15}{16}$	0.937500	$\frac{15}{16}$	0.937500

3. Trigonometric Functions.

°	'	sin	tan	cot	cos	°	'	sin	tan	cot	cos
0	0	0.0000	0.0000	infin.	1.0000	0	90	0.1392	0.1405	7.1154	0.9903
10	0	0.0029	0.0029	343.7737	1.0000	50	10	0.1421	0.1435	6.9682	0.9899
20	0	0.0058	0.0058	171.8854	1.0000	40	20	0.1449	0.1465	6.8269	0.9894
30	0	0.0087	0.0087	114.5887	1.0000	30	30	0.1478	0.1495	6.6912	0.9890
40	0	0.0116	0.0116	85.9398	0.9999	20	40	0.1507	0.1524	6.5606	0.9886
50	0	0.0145	0.0145	68.7501	0.9999	10	50	0.1536	0.1554	6.4348	0.9881
1	0	0.0175	0.0175	57.2900	0.9998	0	89	0.1564	0.1584	6.3138	0.9877
10	0	0.0204	0.0204	49.1039	0.9998	50	10	0.1593	0.1614	6.1970	0.9872
20	0	0.0233	0.0233	42.9641	0.9997	40	20	0.1622	0.1644	6.0844	0.9868
30	0	0.0262	0.0262	38.1885	0.9997	30	30	0.1650	0.1673	5.9758	0.9863
40	0	0.0291	0.0291	34.3678	0.9996	20	40	0.1679	0.1703	5.8708	0.9858
50	0	0.0320	0.0320	31.2416	0.9995	10	50	0.1708	0.1733	5.7694	0.9853
2	0	0.0349	0.0349	28.6363	0.9994	0	88	0.1736	0.1763	5.6713	0.9848
10	0	0.0378	0.0378	26.4316	0.9993	50	10	0.1765	0.1793	5.5764	0.9843
20	0	0.0407	0.0407	24.5418	0.9992	40	20	0.1794	0.1823	5.4845	0.9838
30	0	0.0436	0.0437	22.9038	0.9990	30	30	0.1822	0.1853	5.3955	0.9833
40	0	0.0465	0.0466	21.4704	0.9989	20	40	0.1851	0.1883	5.3093	0.9829
50	0	0.0494	0.0495	20.2056	0.9988	10	50	0.1880	0.1914	5.2257	0.9822
3	0	0.0523	0.0524	19.0811	0.9986	0	87	0.1908	0.1944	5.1446	0.9816
10	0	0.0552	0.0553	18.0750	0.9985	50	10	0.1937	0.1974	5.0658	0.9811
20	0	0.0581	0.0582	17.1693	0.9983	40	20	0.1965	0.2004	4.9894	0.9805
30	0	0.0610	0.0612	16.3499	0.9981	30	30	0.1994	0.2035	4.9152	0.9799
40	0	0.0640	0.0641	15.6048	0.9980	20	40	0.2022	0.2065	4.8430	0.9793
50	0	0.0669	0.0670	14.9244	0.9978	10	50	0.2051	0.2095	4.7729	0.9787
4	0	0.0698	0.0699	14.3007	0.9976	0	86	0.2079	0.2126	4.7046	0.9781
10	0	0.0727	0.0729	13.7267	0.9974	50	10	0.2108	0.2156	4.6382	0.9775
20	0	0.0756	0.0758	13.1969	0.9971	40	20	0.2136	0.2186	4.5736	0.9769
30	0	0.0785	0.0787	12.7062	0.9969	30	30	0.2164	0.2217	4.5107	0.9763
40	0	0.0814	0.0816	12.2505	0.9967	20	40	0.2193	0.2247	4.4494	0.9757
50	0	0.0843	0.0846	11.8262	0.9964	10	50	0.2221	0.2278	4.3897	0.9750
5	0	0.0872	0.0875	11.4301	0.9962	0	85	0.2250	0.2309	4.3315	0.9744
10	0	0.0901	0.0904	11.0594	0.9959	50	10	0.2278	0.2339	4.2747	0.9737
20	0	0.0929	0.0934	10.7119	0.9957	40	20	0.2306	0.2370	4.2193	0.9730
30	0	0.0958	0.0963	10.3854	0.9954	30	30	0.2334	0.2401	4.1653	0.9724
40	0	0.0987	0.0992	10.0780	0.9951	20	40	0.2363	0.2432	4.1126	0.9717
50	0	0.1016	0.1022	9.7882	0.9948	10	50	0.2391	0.2462	4.0611	0.9710
6	0	0.1045	0.1051	9.5144	0.9945	0	84	0.2419	0.2493	4.0108	0.9703
10	0	0.1074	0.1080	9.2553	0.9942	50	10	0.2447	0.2524	3.9617	0.9696
20	0	0.1103	0.1110	9.0098	0.9939	40	20	0.2476	0.2555	3.9136	0.9689
30	0	0.1132	0.1139	8.7769	0.9936	30	30	0.2504	0.2586	3.8667	0.9681
40	0	0.1161	0.1169	8.5555	0.9932	20	40	0.2532	0.2617	3.8208	0.9674
50	0	0.1190	0.1198	8.3450	0.9929	10	50	0.2560	0.2648	3.7760	0.9667
7	0	0.1219	0.1228	8.1443	0.9925	0	83	0.2588	0.2679	3.7321	0.9659
10	0	0.1248	0.1257	7.9530	0.9922	50	10	0.2616	0.2711	3.6891	0.9652
20	0	0.1276	0.1287	7.7704	0.9918	40	20	0.2644	0.2742	3.6470	0.9644
30	0	0.1305	0.1317	7.5958	0.9914	30	30	0.2672	0.2773	3.6059	0.9636
40	0	0.1334	0.1346	7.4287	0.9911	20	40	0.2700	0.2805	3.5656	0.9628
50	0	0.1363	0.1376	7.2687	0.9907	10	50	0.2728	0.2836	3.5261	0.9621
8	0	0.1392	0.1405	7.1154	0.9903	0	82	0.2756	0.2867	3.4874	0.9613
		cos	cot	tan	sin			cos	cot	tan	sin

°	'	sin	tan	cot	cos	°	'	sin	tan	cot	cos	
16	0	0.2756	0.2867	3.4874	0.9613	0	74	24	0.4067	0.4452	2.2460	0.9135
	10	0.2784	0.2899	3.4495	0.9605			10	0.4094	0.4487	2.2286	0.9124
	20	0.2812	0.2931	3.4124	0.9596			20	0.4120	0.4522	2.2113	0.9112
	30	0.2840	0.2962	3.3759	0.9588			30	0.4147	0.4557	2.1943	0.9100
	40	0.2868	0.2994	3.3402	0.9580			40	0.4173	0.4592	2.1775	0.9088
	50	0.2896	0.3026	3.3052	0.9572			50	0.4200	0.4628	2.1609	0.9075
17	0	0.2924	0.3057	3.2709	0.9563	0	73	25	0.4226	0.4663	2.1445	0.9063
	10	0.2952	0.3089	3.2371	0.9555			10	0.4253	0.4699	2.1283	0.9051
	20	0.2979	0.3121	3.2041	0.9546			20	0.4279	0.4734	2.1123	0.9038
	30	0.3007	0.3153	3.1716	0.9537			30	0.4305	0.4770	2.0965	0.9026
	40	0.3035	0.3185	3.1397	0.9528			40	0.4331	0.4806	2.0809	0.9013
	50	0.3062	0.3217	3.1084	0.9520			50	0.4358	0.4841	2.0655	0.9001
18	0	0.3090	0.3249	3.0777	0.9511	0	72	26	0.4384	0.4877	2.0503	0.8988
	10	0.3118	0.3281	3.0475	0.9502			10	0.4410	0.4913	2.0353	0.8975
	20	0.3145	0.3314	3.0178	0.9492			20	0.4436	0.4950	2.0204	0.8962
	30	0.3173	0.3346	2.9887	0.9483			30	0.4462	0.4986	2.0057	0.8949
	40	0.3201	0.3378	2.9600	0.9474			40	0.4488	0.5022	1.9912	0.8936
	50	0.3228	0.3411	2.9319	0.9465			50	0.4514	0.5059	1.9768	0.8923
19	0	0.3256	0.3443	2.9042	0.9455	0	71	27	0.4540	0.5095	1.9626	0.8910
	10	0.3283	0.3476	2.8770	0.9446			10	0.4566	0.5132	1.9486	0.8897
	20	0.3311	0.3508	2.8502	0.9436			20	0.4592	0.5169	1.9347	0.8884
	30	0.3338	0.3541	2.8239	0.9426			30	0.4617	0.5206	1.9210	0.8870
	40	0.3365	0.3574	2.7980	0.9417			40	0.4643	0.5243	1.9074	0.8857
	50	0.3393	0.3607	2.7725	0.9407			50	0.4669	0.5280	1.8940	0.8843
20	0	0.3420	0.3640	2.7475	0.9397	0	70	28	0.4695	0.5317	1.8807	0.8829
	10	0.3448	0.3673	2.7228	0.9387			10	0.4720	0.5354	1.8676	0.8816
	20	0.3475	0.3706	2.6985	0.9377			20	0.4746	0.5392	1.8546	0.8802
	30	0.3502	0.3739	2.6746	0.9367			30	0.4772	0.5430	1.8418	0.8788
	40	0.3529	0.3772	2.6511	0.9356			40	0.4797	0.5467	1.8291	0.8774
	50	0.3557	0.3805	2.6279	0.9346			50	0.4823	0.5505	1.8165	0.8760
21	0	0.3584	0.3839	2.6051	0.9336	0	69	29	0.4848	0.5543	1.8040	0.8746
	10	0.3611	0.3872	2.5826	0.9325			10	0.4874	0.5581	1.7917	0.8732
	20	0.3638	0.3906	2.5605	0.9315			20	0.4899	0.5619	1.7796	0.8718
	30	0.3665	0.3939	2.5386	0.9304			30	0.4924	0.5658	1.7675	0.8704
	40	0.3692	0.3973	2.5172	0.9293			40	0.4950	0.5696	1.7556	0.8689
	50	0.3719	0.4006	2.4960	0.9283			50	0.4975	0.5735	1.7437	0.8675
22	0	0.3746	0.4040	2.4751	0.9272	0	68	30	0.5000	0.5774	1.7321	0.8660
	10	0.3773	0.4074	2.4545	0.9261			10	0.5025	0.5812	1.7205	0.8646
	20	0.3800	0.4108	2.4342	0.9250			20	0.5050	0.5851	1.7090	0.8631
	30	0.3827	0.4142	2.4142	0.9239			30	0.5075	0.5890	1.6977	0.8616
	40	0.3854	0.4176	2.3945	0.9228			40	0.5100	0.5930	1.6864	0.8601
	50	0.3881	0.4210	2.3750	0.9216			50	0.5125	0.5969	1.6753	0.8587
23	0	0.3907	0.4245	2.3559	0.9205	0	67	31	0.5150	0.6009	1.6643	0.8572
	10	0.3934	0.4279	2.3369	0.9194			10	0.5175	0.6048	1.6534	0.8557
	20	0.3961	0.4314	2.3183	0.9182			20	0.5200	0.6088	1.6426	0.8542
	30	0.3987	0.4348	2.2998	0.9171			30	0.5225	0.6128	1.6319	0.8526
	40	0.4014	0.4383	2.2817	0.9159			40	0.5250	0.6168	1.6212	0.8511
	50	0.4041	0.4417	2.2637	0.9147			50	0.5275	0.6208	1.6107	0.8496
24	0	0.4067	0.4452	2.2460	0.9135	0	66	32	0.5299	0.6249	1.6003	0.8480
		cos	cot	tan	sin			cos	cot	tan	sin	

4. Functions of Angles in Various Quadrants.

Function	$-x$	$90^\circ \pm x$	$180^\circ \pm x$	$270^\circ \pm x$	$360^\circ \pm x$
Sin.....	$-\sin x$	$+\cos x$	$\mp \sin x$	$-\cos x$	$\pm \sin x$
Cos.....	$+\cos x$	$\mp \sin x$	$-\cos x$	$\pm \sin x$	$+\cos x$
Tan.....	$-\tan x$	$\mp \cot x$	$\pm \tan x$	$\mp \cot x$	$\pm \tan x$
Cot.....	$-\cot x$	$\mp \tan x$	$\pm \cot x$	$\mp \tan x$	$\pm \cot x$
Sec.....	$+\sec x$	$\mp \operatorname{cosec} x$	$-\sec x$	$\pm \operatorname{cosec} x$	$+\sec x$
Cosec.....	$-\operatorname{cosec} x$	$+\sec x$	$\mp \operatorname{cosec} x$	$-\sec x$	$\pm \operatorname{cosec} x$

5. Mathematical and Physical Constants.

$\pi = 3.14159$	$\log_{10} \pi = 0.49714$
$1/\pi = 0.31830$	$\log_e \pi = 1.14472$
$\pi^2 = 9.86960$	$\log_{10} 2 = 0.30102$
$\sqrt{\pi} = 1.77245$	$\log_{10} e = 0.43429$
$e = 2.71828$	$\log_e 10 = 2.30258$
	$\log_e 2 = 0.69314$

Velocity of light = 2.99796×10^{10} cm per second

Electron charge = $\begin{cases} 1.5911 \times 10^{-20} \text{ abs. c.m.u.} \\ 4.770 \times 10^{-10} \text{ abs. e.s.u.} \end{cases}$

Planck's constant = $h = 6.547 \times 10^{-27}$ erg-sec.

6. Table of Circuit Constants.

Values of ω , $1/\omega$, inductive and capacitive reactance, wave length, and LC products for frequencies from 10 cycles to 100 Mc for inductance in henrys and capacity in microfarads.

The following table, in conjunction with the multiplying factors given below, gives the values of circuit constants, for any frequency between 10 cycles and 100 mc:

MULTIPLYING FACTORS

For frequencies between	Mult. ω by	Mult. $1/\omega$ by	Mult. λ (wave length) by	Mult. LC by
10.5 cycles and 100 cycles.....	1.0	10^{-4}	10^5	10^{-8}
105 cycles and 1,000 cycles.....	10.0	10^{-5}	10^4	10^{-9}
1,050 cycles and 10,000 cycles.....	10^2	10^{-6}	10^3	10^{-10}
10.5 kc and 100 kc.....	10^2	10^{-7}	10^2	10^{-12}
105 kc and 1,000 kc.....	10^4	10^{-8}	10^1	10^{-14}
1,050 kc and 10,000 kc.....	10^6	10^{-9}	1.0	10^{-16}
10.5 mc and 100 mc.....	10^8	10^{-10}	0.1	10^{-18}

Inductive Reactance. To obtain the inductive reactance of an inductance of L henrys at any frequency:

a. Apply the proper multiplying factor to column 2.

b. Multiply by L , the number of henrys.

Capacitive Reactance. To obtain the capacitive reactance of a condenser of $C \mu\text{f}$ at any frequency:

a. Apply the proper multiplying factor to column 3.

b. Divide the result by C , the number of microfarads.

c. Multiply by 10^6 .

If C is in micromicrofarads instead of microfarads, multiply by 10^{12} instead of 10^6 .

Example. Thus an inductance of 250 mh at 2,500 cycles has a reactance of $250 \times 10^{-3} \times 157.08 \times 10^2 = 3,940$ ohms. A capacity of 250 μf at 2,500 kc has a reactance of $10^{-9} \times 63.665 \times 10^{12} \div 250 = 254$ ohms.

Frequency	$\omega = 2\pi f$ or $X_L = \omega L$	$1/\omega = 1/2\pi f$ or $X_c = 1/\omega c$	λ Wave length	LC
105	65.974	151.57	285.71	229.75
110	69.115	144.79	272.73	209.34
115	72.257	138.49	260.87	191.52
120	75.398	132.63	250.00	175.90
125	78.540	127.33	240.00	162.18
130	81.682	122.43	230.77	149.88
135	84.823	117.89	222.22	138.99
140	87.965	113.68	214.28	129.23
145	91.106	109.76	206.90	120.48
150	94.248	106.10	200.00	112.58
155	97.389	102.60	193.55	105.44
160	100.53	99.472	187.50	98.945
165	103.67	96.459	181.82	93.040
170	106.81	93.624	176.47	87.646
175	109.96	90.983	171.43	82.708
180	113.10	88.418	166.67	78.179
185	116.24	86.030	162.16	74.011
190	119.38	83.766	157.90	70.167
195	122.52	81.618	153.85	66.615
200	125.66	79.562	150.00	63.325
205	128.81	77.633	146.35	60.274
210	131.95	75.785	142.85	57.637
215	135.09	74.024	139.54	54.796
220	138.23	72.395	136.36	52.335
225	141.37	70.736	133.33	50.035
230	144.51	69.245	130.43	47.880
235	147.65	67.727	127.66	45.866
240	150.80	66.315	125.00	43.975
245	153.94	64.959	122.45	42.198
250	157.08	63.665	120.00	40.545
255	160.22	62.415	117.65	38.954
260	163.36	61.215	115.38	37.470
265	166.50	60.060	113.20	36.068
270	169.65	58.995	111.11	34.747
275	172.89	57.841	109.09	33.494
280	175.93	56.840	107.14	32.307
285	179.07	55.844	105.26	31.185
290	182.21	54.880	103.45	30.120
295	185.35	53.952	101.70	29.107
300	188.47	53.050	100.00	28.145
305	191.64	52.181	98.36	27.229
310	194.78	51.300	96.77	26.360
315	197.92	50.525	95.238	25.528
320	201.06	49.736	93.700	24.736
325	204.20	48.977	92.308	23.981
330	207.35	48.229	90.910	23.260
335	210.49	47.508	89.559	22.571
340	213.63	46.812	88.245	21.911
345	216.77	46.132	86.956	21.281
350	219.91	45.491	85.715	20.677
355	223.05	44.833	84.390	20.099
360	225.20	44.209	83.335	19.565
365	229.34	43.602	82.192	19.013
370	232.48	43.015	81.080	18.503
375	235.62	42.440	80.000	18.013

Frequency	$\omega = 2\pi f$ or $X_L = \omega L$	$1/\omega = 1/2\pi f$ or $X_C = 1/\omega c$	λ Wave length	LC
380	238.76	41.883	78.950	17.542
385	241.90	41.339	77.922	17.089
390	245.04	40.809	76.975	16.654
395	248.19	40.293	75.948	16.234
400	251.33	39.781	75.000	15.831
405	254.47	39.298	74.073	15.442
410	257.61	38.816	73.175	15.068
415	260.75	38.355	72.288	14.707
420	263.89	37.892	71.425	14.409
425	267.04	37.448	70.588	14.023
430	270.18	37.012	69.770	13.699
435	273.32	36.587	68.965	13.386
440	276.46	36.197	68.180	13.084
445	279.60	35.764	67.416	12.788
450	282.74	35.368	66.666	12.509
455	285.89	34.980	65.934	12.238
460	288.03	34.622	65.215	11.970
465	292.17	34.227	64.516	11.715
470	295.31	33.863	63.830	11.466
475	298.45	33.505	63.161	11.227
480	301.59	33.157	62.500	10.994
485	304.74	32.815	61.856	10.768
490	307.88	32.479	61.225	10.549
495	311.02	32.152	60.604	10.337
500	314.16	31.832	60.000	10.136
505	317.30	31.516	59.406	9.9322
510	320.44	31.207	58.825	9.7380
515	323.59	30.903	58.251	9.5524
520	326.73	30.607	57.690	9.3675
525	329.87	30.317	57.142	9.1898
530	333.01	30.030	56.600	9.0170
535	336.15	29.748	56.075	8.8498
540	339.29	29.497	55.555	8.6867
545	342.43	29.203	55.045	8.5276
550	345.58	28.920	54.545	8.3735
555	348.72	28.676	54.054	8.2234
560	350.86	28.420	53.570	8.0767
565	355.00	28.169	53.097	7.9348
570	358.14	27.922	52.630	7.7962
575	361.28	27.679	52.174	7.6610
580	364.43	27.440	51.725	7.5296
585	367.57	27.207	51.280	7.4013
590	370.71	26.976	50.850	7.2767
595	373.85	26.749	50.420	7.1547
600	376.99	26.525	50.000	7.0362
605	380.13	26.308	49.586	6.9200
610	383.28	26.090	49.180	6.8072
615	386.42	25.878	48.780	6.6968
620	389.56	25.650	48.385	6.5900
625	392.70	25.468	48.000	6.4844
630	395.84	25.262	47.619	6.3820
635	398.98	25.063	47.244	6.2819
640	402.12	24.868	46.850	6.1840
645	405.27	24.674	46.511	6.0885
650	408.41	24.488	46.154	5.9952

Frequency	$\omega = 2\pi f$ or $X_L = \omega L$	$1/\omega = 1/2\pi f$ or $X_c = 1/\omega c$	λ Wave length	LC
655	411.55	24.298	45.801	5.9040
660	413.69	24.114	45.455	5.8150
665	417.83	23.933	45.113	5.7279
670	420.97	23.754	44.779	5.6425
675	424.12	23.578	44.445	5.5466
680	427.26	23.406	44.122	5.4777
685	430.39	23.238	43.796	5.3982
690	433.54	23.066	43.478	5.3202
695	436.68	22.900	43.166	5.2441
700	439.82	22.745	42.857	5.1492
705	442.97	22.575	42.553	5.0962
710	446.11	22.416	42.195	5.0247
715	449.25	22.259	41.957	4.9546
720	452.39	22.104	41.667	4.8912
725	455.53	21.953	41.379	4.8189
730	458.67	21.801	41.096	4.7532
735	461.82	21.655	40.817	4.6887
740	464.96	21.507	40.540	4.6257
745	468.10	21.363	40.268	4.5636
750	471.24	21.220	40.000	4.5032
755	474.38	21.080	39.735	4.4436
760	476.52	20.941	39.475	4.3855
765	480.67	20.804	39.215	4.3282
770	483.81	20.669	38.961	4.2722
775	486.95	20.536	38.710	4.2173
780	490.09	20.404	38.487	4.1635
785	493.23	20.275	38.216	4.1105
790	496.37	20.146	37.974	4.0585
795	499.51	20.019	37.735	4.0076
800	502.66	19.891	37.500	3.9577
805	505.80	19.770	37.267	3.9087
810	508.94	19.649	37.036	3.8605
815	512.08	19.528	36.810	3.8134
820	515.22	19.408	36.587	3.7670
825	518.36	19.292	36.364	3.7216
830	521.51	19.177	36.144	3.6767
835	524.65	19.060	35.927	3.6337
840	527.79	18.946	35.712	3.6022
845	530.93	18.835	35.502	3.5474
850	534.07	18.724	35.294	3.5062
855	537.21	18.614	35.087	3.4657
860	539.36	18.506	34.885	3.4242
865	543.50	18.399	34.682	3.3852
870	546.64	18.293	34.487	3.3465
875	549.78	18.189	34.285	3.3082
880	552.92	18.098	34.090	3.2710
885	556.06	17.988	33.898	3.2341
890	558.92	17.882	33.708	3.1970
895	562.35	17.783	33.520	3.1622
900	565.49	17.689	33.333	3.1272
905	568.63	17.586	33.150	3.0926
910	571.77	17.490	32.967	3.0595
915	574.91	17.378	32.787	3.0254
920	578.05	17.311	32.607	2.9925
925	581.20	17.206	32.432	2.9604

Frequency	$\omega = 2\pi f$ or $X_L = \omega L$	$1/\omega = 1/2\pi f$ or $X_c = 1/\omega c$	λ Wave length	LC
930	584.34	17.113	32.258	2.9287
935	587.48	17.022	32.086	2.8974
940	590.62	16.931	31.915	2.8665
945	593.76	16.842	31.746	2.8364
950	596.90	16.752	31.580	2.8067
955	600.05	16.665	31.414	2.7774
960	602.19	16.578	31.250	2.7485
965	606.33	16.492	31.088	2.7200
970	609.47	16.407	30.928	2.6920
975	612.61	16.324	30.770	2.6646
980	615.75	16.239	30.617	2.6372
985	618.90	16.158	30.456	2.6106
990	622.04	16.071	30.302	2.5842
995	625.18	15.995	30.150	2.5586
1000	628.32	15.916	30.000	2.5330

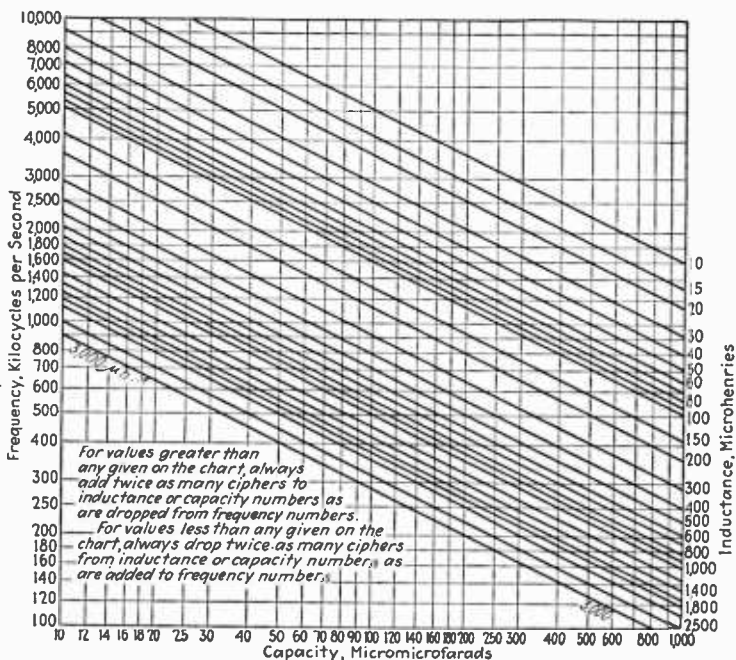
7. L, C, λ Chart.

8. Dimensions, Weights, and Resistances of Pure, Solid, Bare Copper Wire.

(Copper-wire Tables, *Circ.* 31, Bur. Standards.)

B. & S. or American wire gage	Diam. in mils at 20°C. (68°F.)	Cross-sectional area at 20°C. (68°F.)		Carrying capacities			Weight	
		Circular mils (d ²), 1m = 0.001 in.	Square inches	Rubber insul. amps. A	Varn. cloth insul. amps. B	Other insul. amps. C	Pounds per 1,000 ft.	Pounds per mile
0000	460.0	211,600.0	0.166.2	225	270	325	640.5	3,381.840
000	409.6	167,800.0	0.131.8	175	210	275	507.9	2,681.712
00	364.8	133,100.0	0.104.5	150	180	225	402.8	2,126.784
	324.9	105,500.0	0.082.89	125	150	200	319.5	1,686.960
	1289.3	83,690.0	0.065.73	100	120	150	253.3	1,337.424
	2257.6	66,370.0	0.052.13	90	110	125	200.9	1,060.752
	3229.4	52,640.0	0.041.34	80	95	100	159.3	841.104
	4204.3	41,740.0	0.032.78	70	85	90	126.4	667.392
	5181.9	33,100.0	0.026.00	55	65	80	100.2	529.056
	6162.0	26,250.0	0.020.62	50	60	70	79.46	419.548.8
	7144.3	20,820.0	0.016.35	38	...	54	63.02	332.745.6
	8128.5	16,510.0	0.012.97	35	40	50	49.98	263.894.4
	9114.4	13,090.0	0.010.28	28	...	38	39.63	209.246.1
	10101.9	10,380.0	0.008.155	25	30	30	31.43	165.950.4
11	90.74	8,234.0	0.006.467	20	...	27	24.02	131.577.6
12	80.81	6,530.0	0.005.129	20	25	25	19.77	104.385.6
13	71.96	5,178.0	0.004.067	17	15.08	82.790.4
14	64.08	4,107.0	0.003.225	15	18	20	12.43	65.630.4
15	57.07	3,257.0	0.002.558	9.858	52.050.24
16	50.82	2,583.0	0.002.028	6	...	10	7.818	41.279.04
17	45.26	2,048.0	0.001.609	6.200	32.736.00
18	40.30	1,624.0	0.001.276	3	...	6	4.917	25.961.76
19	35.89	1,288.0	0.001.012	3.899	20.586.72
20	31.96	1,022.0	0.000.802.3	The above values are those specified in the 1931 National Electrical Code. In lighting work, no wire smaller than No. 14 is used, except in fixtures			3.092	16.325.70
21	28.46	810.1	0.000.636.3				2.452	12.946.56
22	25.35	642.4	0.000.504.6				1.945	10.269.60
23	22.57	509.5	0.000.400.2				1.542	8.141.76
24	20.10	404.0	0.000.317.3				1.223	6.457.44
25	17.90	320.4	0.000.251.7				0.969.9	5.121.072
26	15.94	254.1	0.000.199.6				0.769.2	4.061.376
27	14.20	201.5	0.000.158.3				0.610.0	3.220.800
28	12.64	159.8	0.000.125.5				0.483.7	2.553.936
29	11.26	126.7	0.000.099.53				0.383.6	2.025.408
30	10.03	100.5	0.000.078.94				0.304.2	1.608.176
31	8.928	79.70	0.000.062.60				0.241.3	1.274.060
32	7.950	63.20	0.000.049.64				0.191.3	1.010.064
33	7.080	50.13	0.000.039.37				0.151.7	0.800.976
34	6.305	39.75	0.000.031.22				0.120.3	0.635.184
35	5.615	31.52	0.000.024.76				0.095.42	0.513.717.6
36	5.000	25.00	0.000.019.64				0.075.68	0.399.590.4
37	4.453	19.83	0.000.015.57				0.060.01	0.316.852.8
38	3.965	15.72	0.000.012.35				0.047.59	0.251.275.2
39	3.531	12.47	0.000.009.793				0.037.74	0.199.267.2
40	3.145	9.888	0.000.007.766				0.029.93	0.158.030.4

Length, 25°C. (77°F.)		Resistance at 25°C. (77°F.)			B. & S. or American wire gage
Feet per pound	Feet per ohm	R ohms per 1,000 ft.	Ohms per mile	Ohms per pound	
1.561	20,010.0	0.049,98	0.263,894.4	0.000,078,03	0000
1.968	15,870.0	0.063,02	0.332,745.6	0.000,124,1	000
2.482	12,580.0	0.079,47	0.419,501.6	0.000,197,3	00
3.130	9,980.0	0.100,2	0.529,056	0.000,313,7	0
3.947	7,914.0	0.126,4	0.667,392	0.000,498,8	1
4.977	6,270.0	0.159,3	0.841,104	0.000,793,1	2
6.276	4,977.0	0.200,9	1.060,752	0.001,261	3
7.914	3,947.0	0.253,3	1.337,424	0.002,005	4
9.980	3,130.0	0.319,5	1.686,960	0.003,188	5
12.58	2,482.0	0.402,8	2.126,784	0.005,069	6
15.87	1,969.0	0.508,0	2.682,240	0.008,061	7
20.01	1,561.0	0.640,5	3.381,840	0.012,82	8
25.23	1,238.0	0.807,7	4.264,656	0.020,38	9
31.82	981.8	1.018	5.375,04	0.032,41	10
40.12	778.7	1.284	6.779,52	0.051,53	11
50.59	617.5	1.619	8.548,32	0.081,93	12
63.80	489.7	2.042	10.781,76	0.130,3	13
80.44	388.3	2.575	13.596,00	0.207,1	14
101.4	308.0	3.247	17.144,16	0.329,4	15
127.9	244.2	4.094	21.616,32	0.523,7	16
161.3	193.7	5.163	27.260,64	0.832,8	17
203.4	153.6	6.510	34.372,80	1.324	18
256.5	121.8	8.210	43.348,80	2.105	19
323.4	96.60	10.35	54.648,0	3.348	20
407.8	76.61	13.05	68.904,0	5.323	21
514.2	60.75	16.46	86.908,8	8.464	22
648.4	48.18	20.76	109.612,8	13.46	23
817.7	38.21	26.17	138.177,6	21.40	24
1,031.0	30.30	33.00	174.240,0	34.03	25
1,300.0	24.03	41.62	219.753,6	54.11	26
1,639.0	19.06	52.48	277.094,4	86.03	27
2,067.0	15.11	66.17	349.377,6	136.8	28
2,607.0	11.98	83.44	440.563,2	217.5	29
3,287.0	9.504	105.2	555.456	345.9	30
4,145.0	7.537	132.7	700.656	549.9	31
5,227.0	5.977	167.3	883.344	874.4	32
6,591.0	4.740	211.0	1,114.080	1,390.0	33
8,310.0	3.759	266.0	1,404.480	2,211.0	34
10,480.0	2.981	335.5	1,771.440	3,515.0	35
13,210.0	2.364	423.0	2,233.440	5,590.0	36
16,600.0	1.875	533.4	2,816.352	8,888.0	37
21,010.0	1.487	672.6	3,551.328	14,130.0	38
26,500.0	1.179	848.1	4,477.968	22,470.0	39
33,410.0	0.935	1,069.0	5,644.32	35,730.0	40

9. Tensile Strength of Pure Copper Wire in Pounds.

Size, B. & S. gage	Hard drawn		Annealed		Size, B. & S. gage	Hard drawn		Annealed	
	Actual	Average per square inch	Actual	Average per square inch		Actual	Average per square inch	Actual	Average per square inch
0000	8.260	49.700	5.320	32.000	7	1050.0	64.200	556.0	34.000
000	6.550	49.700	4.220	32.000	8	843.0	65.000	441.0	34.000
00	5.440	52.000	3.340	32.000	9	678.0	66.000	350.0	34.000
0	4.530	54.600	2.650	32.000	10	546.0	67.000	277.0	34.000
1	3.680	56.000	2.100	32.000	12	343.0	67.000	174.0	34.000
2	2.970	57.000	1.670	32.000	14	219.0	68.000	110.0	34.000
3	2.380	57.600	1.323	32.000	16	138.0	68.000	68.9	34.000
4	1.900	58.000	1.050	32.000	18	86.7	68.000	43.4	34.000
5	1.580	60,800	884	34.000	19	68.8	68.000	34.4	34.000
6	1.300	63,000	700	34.000	20	54.7	68,000	27.3	34.000

10. Insulated Copper Wire.

Size, B. & S. gage	Enamel wire			Single-silk covered			Double-silk covered		
	Outside diam- eter, mils	Turns per linear inch	Pounds per 1,000 ft.	Outside diam- eter, mils	Turns per linear inch	Pounds per 1,000 ft.	Outside diam- eter, mils	Turns per linear inch	Pounds per 1,000 ft.
8	130.6	7.7	50.6						
9	116.5	8.6	40.2						
10	104.0	9.6	31.8						
11	92.7	10.8	25.3						
12	82.8	12.1	20.1						
13	74.0	13.5	15.90						
14	66.1	15.1	12.60						
15	59.1	16.9	10.00						
16	52.8	18.9	7.930	52.8	18.9	7.89	54.6	18.3	8.00
17	47.0	21.3	6.275	47.3	21.1	6.26	49.1	20.4	6.32
18	42.1	23.8	4.980	42.4	23.6	4.97	44.1	22.7	5.02
19	37.7	26.5	3.955	37.9	26.4	3.94	39.7	25.2	3.99
20	33.7	29.7	3.135	34.0	29.4	3.13	35.8	28.0	3.17
22	26.9	37.2	1.970	27.3	36.6	1.98	29.1	34.4	2.01
24	21.5	46.5	1.245	22.1	45.3	1.25	23.9	41.8	1.27
26	17.1	58.5	0.785	17.9	55.9	0.791	19.7	50.8	0.810
28	13.6	73.5	0.494	14.6	68.5	0.498	16.4	61.0	0.514
30	10.9	91.7	0.311	12.0	83.3	0.316	13.8	72.5	0.333
32	8.7	115	0.196	9.9	101	0.210	11.8	84.8	0.217
34	6.9	145	0.123	8.3	121	0.129	10.1	99.0	0.141
36	5.5	180	0.078	7.0	143	0.082	8.8	114	0.092
38	4.4	227	0.049	6.0	167	0.053	7.8	128	0.062
40	3.5	286	0.031	5.1	196	0.035	6.9	145	0.043

11. Insulated Copper Wire.

Size, B. & S. gauge	Ohms per 1,000 ft.	Single-cotton covered			Double-cotton covered		
		Outside diameter, mils	Turns per linear inch	Pounds per 1,000 ft.	Outside diameter, mils	Turns per linear inch	Pounds per 1,000 ft.
0000	0.0500	467	2.14	477	2.10	
000	0.0630	418	2.39	428	2.34	
00	0.0795	373	2.68	382	2.62	
0	0.100	334	3.00	343	3.00	
1	0.128	300	3.33	308	3.25	
2	0.159	267	3.75	275	3.64	
3	0.201	239	4.18	248	4.03	
4	0.253	214	4.67	222	4.51	
5	0.319	192	5.21	200	5.00	
6	0.403	170	5.88	175	5.62	
7	0.508	153	6.54	160	6.25	
8	0.641	136	7.35	50.6	142	7.05	51.2
9	0.808	121	8.26	40.2	127	7.87	40.6
10	1.02	108	9.25	31.9	113	8.85	32.2
11	1.28	97	10.3	25.3	102	9.80	25.6
12	1.62	87	11.5	20.1	92	10.9	20.4
13	2.04	78	12.8	16.0	82	12.2	16.2
14	2.58	70	14.3	12.7	74	13.5	12.9
16	4.1	56	17.9	8.03	60	16.7	8.21
18	6.5	45	22.2	5.08	49	20.4	5.24
20	10.4	37	27	3.22	41	24.4	3.37
22	16.6	29.5	33.9	2.05	33.3	30.0	2.17
24	26.2	24.1	41.5	1.3	28.1	35.6	1.4
26	41.6	19.9	50.2	0.834	23.9	41.8	0.914
28	66.2	16.6	60.2	0.533	20.6	48.6	0.608
30	105	14	71.4	0.340	18.0	55.6	0.400
32	167	12	83.4	0.223	16.0	62.9	0.270
34	266	10.3	97.1	0.148	14.3	70.0	0.193
36	423	9.0	111	0.099	13.0	77.0	0.136
38	673	8.0	125	0.070	12.0	83.3	0.105
40	1,070	7.1	141	0.052	11.1	90.9	0.084

12. Approximate Wave Lengths of 4-ft. Coil Antennas with Various Values of Condenser Capacity across the Coil Terminals.

Number of turns	Condenser capacity, microfarads						Distribution in slots $\frac{1}{2}$ in. apart, turns per slot
	0.00005	0.0001	0.0005	0.001	0.002	0.003	
1	65	128	178	250	310	1
3	130	155	290	400	550	675	1
6	230	280	500	710	1,000	1,200	1
12	430	490	920	1,250	1,700	2,050	1
24	760	880	1,600	2,100	3,000	3,600	1
48	1,550	1,775	3,150	4,300	6,000	7,000	2
72	2,200	2,650	4,800	6,400	8,800	11,000	3
120	3,930	4,500	7,900	10,000	14,700	17,700	5
240	7,600	9,000	15,650	20,500	27,200	32,900	10

13. Wire Table Chart.

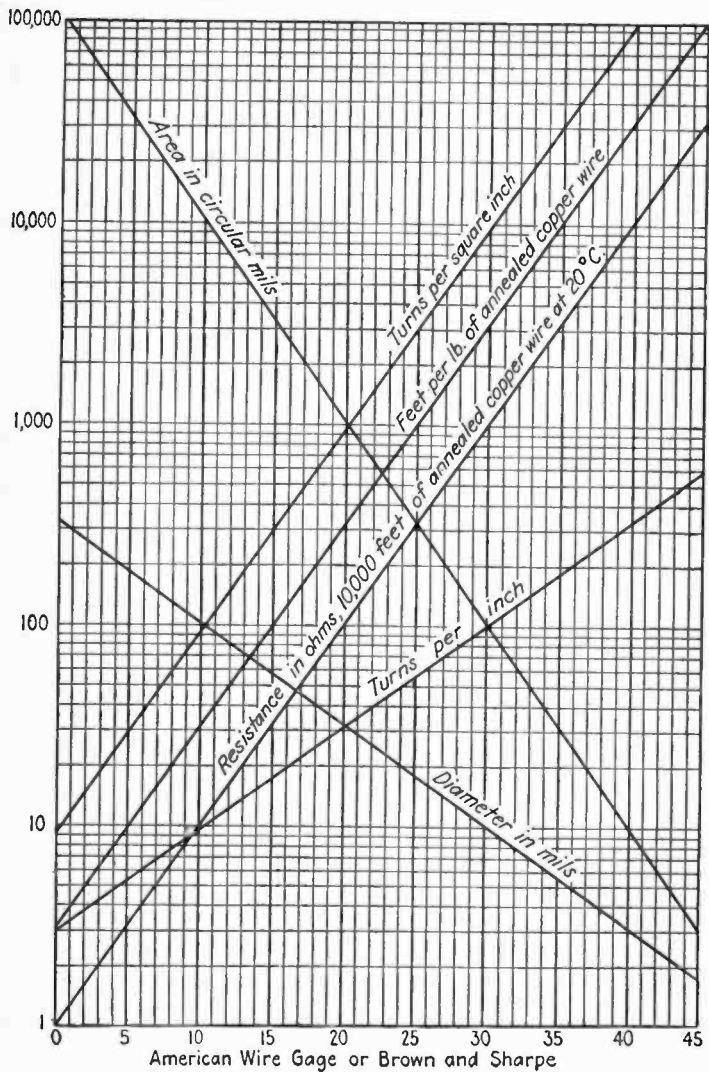

14. Chart for Converting Loss or Gain into Decibels.

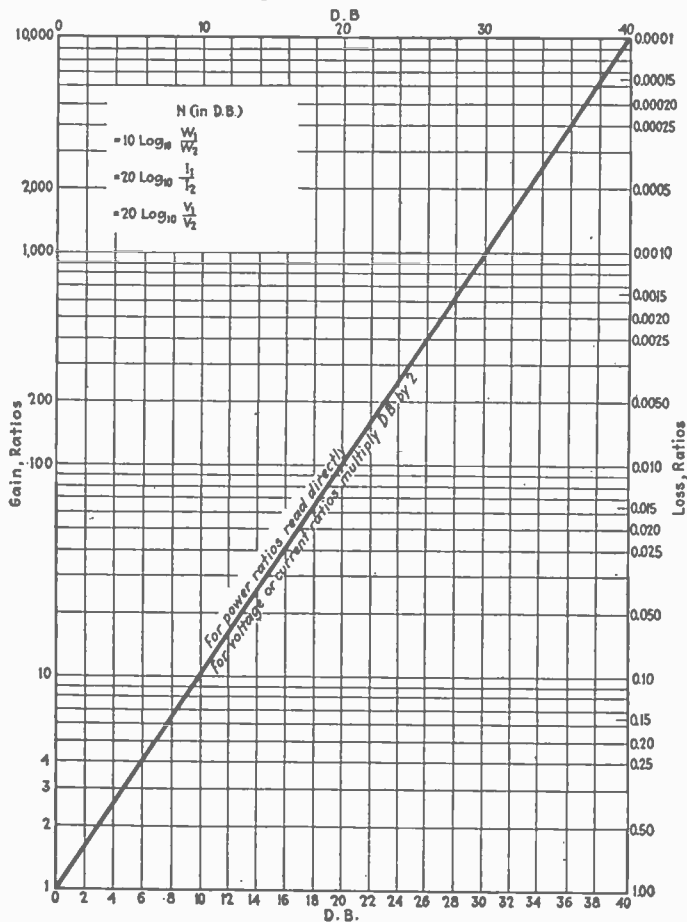

15. Logarithms of Numbers.

N	0	1	2	3	4	5	6	7	8	9
10	0000	0043	0086	0128	0170	0212	0253	0294	0334	0374
11	0414	0453	0492	0531	0569	0607	0645	0682	0719	0755
12	0792	0828	0864	0899	0934	0969	1004	1038	1072	1106
13	1139	1173	1206	1239	1271	1303	1335	1367	1399	1430
14	1461	1492	1523	1553	1584	1614	1644	1673	1703	1732
15	1761	1790	1818	1847	1875	1903	1931	1959	1987	2014
16	2041	2068	2095	2122	2148	2175	2201	2227	2253	2279
17	2304	2330	2355	2380	2405	2430	2455	2480	2504	2529
18	2553	2577	2601	2625	2648	2672	2695	2718	2742	2765
19	2788	2810	2833	2856	2878	2900	2923	2945	2967	2989
20	3010	3032	3054	3075	3096	3118	3139	3160	3181	3201
21	3222	3243	3263	3284	3304	3324	3345	3365	3385	3404
22	3424	3444	3464	3483	3502	3522	3541	3560	3579	3598
23	3617	3636	3655	3674	3692	3711	3729	3747	3766	3784
24	3802	3820	3838	3856	3874	3892	3909	3927	3945	3962
25	3979	3997	4014	4031	4048	4065	4082	4099	4116	4133
26	4150	4166	4183	4200	4216	4232	4249	4265	4281	4298
27	4314	4330	4346	4362	4378	4393	4409	4425	4440	4456
28	4472	4487	4502	4518	4533	4548	4564	4579	4594	4609
29	4624	4639	4654	4669	4683	4698	4713	4728	4742	4757
30	4771	4786	4800	4814	4829	4843	4857	4871	4886	4900
31	4914	4928	4942	4955	4969	4983	4997	5011	5024	5038
32	5051	5065	5079	5092	5105	5119	5132	5145	5159	5172
33	5185	5198	5211	5224	5237	5250	5263	5276	5289	5302
34	5315	5328	5340	5353	5366	5378	5391	5403	5416	5428
35	5441	5453	5465	5478	5490	5502	5514	5527	5539	5551
36	5563	5575	5587	5599	5611	5623	5635	5647	5658	5670
37	5682	5694	5705	5717	5729	5740	5752	5763	5775	5786
38	5798	5809	5821	5832	5843	5855	5866	5877	5888	5899
39	5911	5922	5933	5944	5955	5966	5977	5988	5999	6010
40	6021	6031	6042	6053	6064	6075	6085	6096	6107	6117
41	6128	6138	6149	6160	6170	6180	6191	6201	6212	6222
42	6232	6243	6253	6263	6274	6284	6294	6304	6314	6325
43	6335	6345	6355	6365	6375	6385	6395	6405	6415	6425
44	6435	6444	6454	6464	6474	6484	6493	6503	6513	6522
45	6532	6542	6551	6561	6571	6580	6590	6599	6609	6618
46	6628	6637	6646	6656	6665	6675	6684	6693	6702	6712
47	6721	6730	6739	6749	6758	6767	6776	6785	6794	6803
48	6812	6821	6830	6839	6848	6857	6866	6875	6884	6893
49	6902	6911	6920	6928	6937	6946	6955	6964	6972	6981
50	6990	6998	7007	7016	7024	7033	7042	7050	7059	7067
51	7076	7084	7093	7101	7110	7118	7126	7135	7143	7152
52	7160	7168	7177	7185	7193	7202	7210	7218	7226	7235
53	7243	7251	7259	7267	7275	7284	7292	7300	7308	7316
54	7324	7332	7340	7348	7356	7364	7372	7380	7388	7396

N	0	1	2	3	4	5	6	7	8	9
55	7404	7412	7419	7427	7435	7443	7451	7459	7466	7474
56	7482	7490	7497	7505	7513	7520	7528	7536	7543	7551
57	7559	7566	7574	7582	7589	7597	7604	7612	7619	7627
58	7634	7642	7649	7657	7664	7672	7679	7686	7694	7701
59	7709	7716	7723	7731	7738	7745	7752	7760	7767	7774
60	7782	7789	7796	7803	7810	7818	7825	7832	7839	7846
61	7853	7860	7868	7875	7882	7889	7896	7903	7910	7917
62	7924	7931	7938	7945	7952	7959	7966	7973	7980	7987
63	7993	8000	8007	8014	8021	8028	8035	8041	8048	8055
64	8062	8069	8075	8082	8089	8096	8102	8109	8116	8122
65	8129	8136	8142	8149	8156	8162	8169	8176	8182	8189
66	8195	8202	8209	8215	8222	8228	8235	8241	8248	8254
67	8261	8267	8274	8280	8287	8293	8299	8306	8312	8319
68	8325	8331	8338	8344	8351	8357	8363	8370	8376	8382
69	8388	8395	8401	8407	8414	8420	8426	8432	8439	8445
70	8451	8457	8463	8470	8476	8482	8488	8494	8500	8506
71	8513	8519	8525	8531	8537	8543	8549	8555	8561	8567
72	8573	8579	8585	8591	8597	8603	8609	8615	8621	8627
73	8633	8639	8645	8651	8657	8663	8669	8675	8681	8686
74	8692	8698	8704	8710	8716	8722	8727	8733	8739	8745
75	8751	8756	8762	8768	8774	8779	8785	8791	8797	8802
76	8808	8814	8820	8825	8831	8837	8842	8848	8854	8859
77	8865	8871	8876	8882	8887	8893	8899	8904	8910	8915
78	8921	8927	8932	8938	8943	8949	8954	8960	8965	8971
79	8976	8982	8987	8993	8998	9004	9009	9015	9020	9025
80	9031	9036	9042	9047	9053	9058	9063	9069	9074	9079
81	9085	9090	9096	9101	9106	9112	9117	9122	9128	9133
82	9138	9143	9149	9154	9159	9165	9170	9175	9180	9186
83	9191	9196	9201	9206	9212	9217	9222	9227	9232	9238
84	9243	9248	9253	9258	9263	9269	9274	9279	9284	9289
85	9294	9299	9304	9309	9315	9320	9325	9330	9335	9340
86	9345	9350	9355	9360	9365	9370	9375	9380	9385	9390
87	9395	9400	9405	9410	9415	9420	9425	9430	9435	9440
88	9445	9450	9455	9460	9465	9469	9474	9479	9484	9489
89	9494	9499	9504	9509	9513	9518	9523	9528	9533	9538
90	9542	9547	9552	9557	9562	9566	9571	9576	9581	9586
91	9590	9595	9600	9605	9609	9614	9619	9624	9628	9633
92	9638	9643	9647	9652	9657	9661	9666	9671	9675	9680
93	9685	9689	9694	9699	9703	9708	9713	9717	9722	9727
94	9731	9736	9741	9745	9750	9754	9759	9763	9768	9773
95	9777	9782	9786	9791	9795	9800	9805	9809	9814	9818
96	9823	9827	9832	9836	9841	9845	9850	9854	9859	9863
97	9868	9872	9877	9881	9886	9890	9894	9899	9903	9908
98	9912	9917	9921	9926	9930	9934	9939	9943	9948	9952
99	9956	9961	9965	9969	9974	9978	9983	9987	9991	9996

16. Standard Graphic Symbols Used in Radio Communication.

1. Aerial (antenna)		19. Inductor, iron core	
2. Ammeter		20. Inductor, variable	
3. Arc		21. Jack	
4. Battery (the positive electrode is indicated by the long line)		22. Key	
5. Coil antenna		23. Lightning arrester	
6. Condenser fixed		24. Loud-speaker	
7. Condenser, fixed, shielded		25. Microphone (telephone transmitter)	
8. Condenser, variable		26. Photoelectric cell	
9. Condenser, variable (with moving plate indicated)		27. Piezoelectric plate	
10. Condenser, variable shielded		28. Resistor	
11. Counterpoise		29. Resistor, adjustable	
12. Crystal detector		30. Resistor, variable	
13. Frequency meter (wave meter)		31. Spark gap, rotary	
14. Galvanometer		32. Spark gap, plain	
15. Glow lamp		33. Spark gap, quenched	
16. Ground		34. Telephone receiver	
17. Inductor		35. Thermoelement	
18. Inductor, adjustable		36. Transformer, air core	

37. Transformer, iron core		44. Triode (with directly heated cathode)	
38. Transformer with variable coupling		45. Triode (with indirectly heated cathode)	
39. Transformer, with variable coupling (with moving coil indicated)		46. Screen-grid tube (with directly heated cathode)	
40. Voltmeter		47. Pentode tube	
41. Wires, joined		48. Rectifier tube, full wave (filamentless)	
42. Wires, crossed, not joined		49. Rectifier tube, full wave (with directly heated cathode)	
43. Diode (or half-wave rectifier)		50. Rectifier tube, half wave (filamentless)	

17. Inductance of Various Windings.

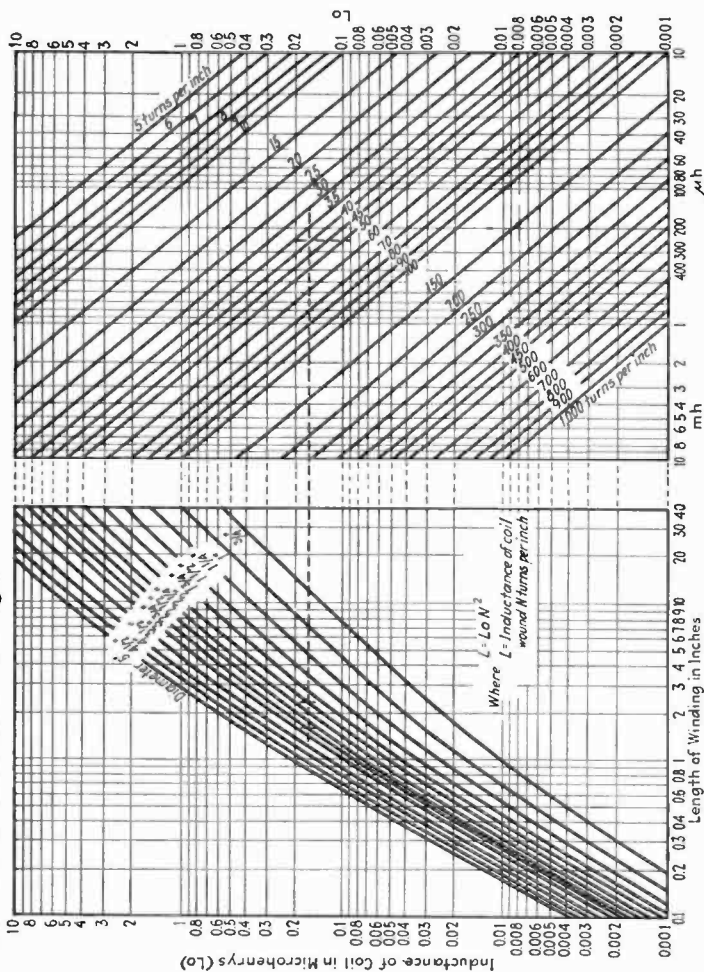

18. Systems of Electrical Units.

Practical	E.m.u.	E.s.u.	R.f.	A.f.
Volt(v).....	10^{-8} v	300 v	v	v
Ampere(a).....	10 a	3.33×10^{-10} a	ma	ma
Second.....	sec.	sec.	μ sec.	msec.
Cycle.....	cycle	cycle	Mc	kc
Ohm.....	10^{-9} ohm	0.9×10^{12} ohm	k-ohm	k-ohm
Mho.....	10^9 mho	1.11×10^{-12} mho	m-mho	m-mho
Henry(h).....	10^{-9} h (cm)	0.9×10^{12} h	mh	h
Farad(f).....	10^9 f	$1.1 \mu\mu$ f (cm)	$m\mu$ f	μ f
Watt(w).....	10^{-7} w	10^{-7} w	mw	mw
Joule(j).....	10^{-7} j (erg)	10^{-7} j	$m\mu$ j	μ j
Coulomb(c).....	10 c	3.33×10^{-10} c	$m\mu$ c	μ c

$\mu = 10^{-6}$; m = 10^{-3} ; k = 10^3 ; M = 10^6 ; $m\mu = 10^{-9}$.

19. Width of Authorized Communication Bands.

From Rules and Regulations of the Federal Communications Commission.

Type of emission	Frequency range, kilocycles	Normal width of communication band, kilocycles
A-1: C. W. Morse telegraphy; printer and slow-speed facsimile	10 to 100	0.100
	100 to 550	0.250
	1,500 to 6,000	0.500
	6,000 to 12,000	1.000
	12,000 to 28,000	2.000
		(To be specified in instrument of authorization)
A-2: Tone modulated cw and icw..	10 to 100	1.500
	100 to 550	2.000
	1,500 to 6,000	3.000
	6,000 to 12,000	4.000
A-3: Commercial telephony: Single side band.....		3.000
		6.000
A-3, A-4: Visual broadcasting: Double side band.....	550 to 1,500	10.000
Special: High-speed facsimile; picture transmission; high-quality telephony; television, etc.....	{ 10 to 550 1,500 to 28,000	The authorized width of the communication band for special types of transmission shall be specified in the instrument of authorization

20. Tolerance Table.

The licensee of every station, except amateur stations, shall be required to maintain frequency within the tolerance as provided by the following table:

Frequency range, kilocycles	Frequency tolerance, per cent	
	A Applicable to stations licensed and authorized by construction permits prior to effective date of this order	B Applicable to all equipment authorized subsequent to effective date of this order
A. 10 to 550:	Plus or minus	Plus or minus
a. Fixed stations.....	0.1	0.1
b. Land stations.....	0.1	0.1
c. Mobile stations except those using damped waves or simple oscillator transmitters.....	0.5	0.5
d. Mobile stations using damped wave or simple oscillator transmitters.....	1.0 ¹	0.5
B. 550 to 1,500:		
a. Broadcasting stations.....	1	1
C. 1,500 to 6,000:		
a. Fixed stations.....	0.05	0.03
b. Land stations.....	0.05	0.04
c. Mobile stations using frequencies not normally used for ship radiotelegraph transmissions.....	0.04	0.04
d. Other mobile stations.....	0.05	0.04
D. 6,000 to 28,000:²		
a. Fixed stations.....	0.05	0.02
b. Land stations.....	0.05	0.04
c. Mobile stations using frequencies not normally used for ship radiotelegraph transmissions.....	0.05	0.04
d. Other mobile stations.....	0.1	0.1
e. Broadcasting stations.....	0.03	0.01

¹ This tolerance is applicable to previous licensed simple oscillator transmitters transferred to other mobile stations.

² See Part III, paragraph 144, Rules and Regulations, Federal Communications Commission.

³ For licenses in experimental stations operating on frequencies of 30,000 kc and above, the commission's policy is to require as near a tolerance of 0.05 as the state of the art permits to be maintained.

21. Separation between Assigned Frequencies.

Frequency range, kilocycles	Frequency separation, kilocycles	Frequency range, kilocycles	Frequency separation, kilocycles
10 to 15	0.15	390 to 550	2
15 to 20	0.2	550 to 1,500	10
20 to 25	0.25	1,500 to 3,000	4
25 to 30	0.3	3,000 to 6,000	5
30 to 40	0.4	6,000 to 11,000	10
40 to 50	0.5	11,000 to 16,400	15
50 to 60	0.6	16,400 to 21,550	20
60 to 100	0.8	21,550 to 28,000	25
100 to 390	1		

NOTE. The separation between assignments may be greater than those indicated where this is required by the type of emission authorized.

22. Average Day Separation between Broadcast Stations.

The separations below are recommended by Engineering Division, Federal Communications Commission, as of July 1932, based on frequency maintenance of plus or minus 50 cycles.¹

Classification and power	Freq. diff., kilo-cycles	Local		Regional, limited time and day			Clear		
		100 w	250 w	500 w	5 kw	10 kw	5 kw	10 kw	50 kw
Local	0	80	100						
	10	34	41	103	153	171	153	171	220
	20	16	21	71	121	139	121	139	190
	30	12	17	58	108	126	108	126	176
100 w	40	11	16	54	104	122	104	122	172
	0	100	100						
	10	41	46	115	165	183	165	183	233
	20	21	24	79	129	147	129	147	197
250 w	30	17	18	61	111	129	111	129	179
	40	16	16	55	105	123	105	123	173
	0	260	400	450	700	800	1000
	10	103	115	150	200	220	200	220	277
Regional, limited, time and day 500 w	20	71	79	100	150	167	150	167	217
	30	58	61	72	122	140	122	140	190
	40	54	55	60	111	129	111	129	179
	0	400	400	450	700	800	1000
5 kw	10	153	165	200	250	270	250	270	325
	20	121	129	150	182	200	182	200	250
	30	108	111	122	143	161	143	161	211
	40	104	105	111	123	141	123	141	191
10 kw	0	450	450	450	700	800	1000
	10	171	183	220	270	290	270	290	345
	20	139	147	167	200	213	200	213	263
	30	126	129	140	161	170	161	170	219
Clear	40	122	123	129	141	147	141	147	197
	0	700	700	700			
	10	153	165	200	250	270	250	270	325
	20	121	129	150	182	200	182	200	250
5 kw	30	108	111	122	143	161	143	161	211
	40	104	105	111	123	141	123	141	191
	0	800	800	800			
	10	171	183	220	270	290	290	290	345
10 kw	20	139	147	167	200	213	200	213	263
	30	126	129	140	161	170	161	170	219
	40	122	123	129	141	147	141	147	197
	0	1,000	1,000	1,000			
50 kw	10	220	233	277	325	345	325	345	395
	20	190	197	217	250	263	250	263	300
	30	176	179	190	211	219	211	219	242
	40	172	173	179	191	197	191	197	212

¹ These separations are calculated to minimize objectionable interference in the good service areas of stations about 90 per cent of the time.

23. Average Night Separation between Broadcast Stations.

The same conditions as to frequency stability, etc., as under daytime separation table.

Classification and power	Freq. diff., kilo-cycles	Local 100 w	Regional			Clear		
			500 w	5 kw	10 kw	10 kw	50 kw	
Local	0	185						
	10	53	106	183	225	237	350	
	100 w	20	21	54	90	105	156	206
		30	13	40	76	91	131	181
	40	11	36	72	87	124	174	
Regional	0	...	800					
	10	106	180	300	355	355	505	
	500 w	20	54	74	127	150	188	235
		30	40	46	82	97	142	192
	40	36	39	75	90	128	178	
5 kw	0	1,600	2,000			
	10	183	300	335	390	500	550	
	20	90	127	163	187	268	320	
	30	76	82	102	117	175	225	
	40	72	75	83	98	143	193	
10 kw	0	2,000	2,000			
	10	225	355	390	405	570	620	
	20	105	150	187	203	305	350	
	30	91	97	117	128	192	243	
	40	87	90	98	102	150	200	
Clear	0							
	10	237	355	500	570	570	750	
	20	156	188	268	305	305	420	
	30	131	142	175	192	192	247	
	40	124	128	143	150	150	200	
50 kw	0							
	10	350	505	550	620	750	800	
	20	206	235	320	350	420	470	
	30	181	192	225	243	247	297	
	40	174	178	193	200	200	218	

24. Computing the Harmonic Content of Any Given Periodic Complex Wave Form. When an oscillogram (or other graphical representation) of a periodic complex wave is available, it is possible to compute the percentage of each harmonic up to and including the sixth, by means of the following scheme:¹

The oscillogram must contain at least one complete period of the wave, that is, from any given point on the wave to the corresponding point at the left or right at which the form of the wave begins to repeat itself. In Fig. 1 the complete period is given by the distance *OX*, a distance of 360 electrical degrees. With a compass or dividers, divide this com-

¹ This method is known as the *twelve ordinate scheme*, and is a convenient form for solving the equations of the Fourier analysis. The form given here has been adapted from "Graphical and Mechanical Computation," Part II, Experimental Data, by Joseph Lipka, published by John Wiley and Sons, Inc., New York, pp. 181-185. See also Terebesi, "Rechenablonen für harmonische Analyse und Synthese," Julius Springer, Berlin, 1930.—Donald G. Fink.

plete period into 12 equal parts, and erect the 12 equally spaced ordinates $y_0, y_1, y_2, \dots, y_{11}$. Each of these vertical lines is drawn from the horizontal time axis to the curve. With a rule (preferably one divided into tenths of inches or a millimeter rule, so that the lengths can be expressed in decimal form), measure the length of each of these ordinates. It makes no difference whether inches, millimeters or any other

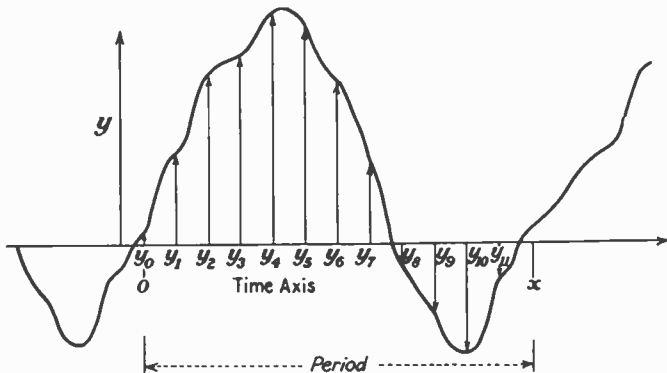

FIG. 1. Example of complex wave for analysis.

arbitrary unit is used, so long as all ordinates are measured with the same unit. Record the length of each ordinate in the spaces given in the table below:

Ordinate number.	y_0	y_1	y_2	y_3	y_4	y_5	y_6	y_7	y_8	y_9	y_{10}	y_{11}
Length of ordinate	5.5	37.0	68.6	76.4	93.2	89.6	66.7	34.3	-8.8	-28.4	-44.1	-15.0

The lengths given are the lengths taken from Fig. 1.

The computation consists in substituting these lengths in the following schedule of additions, subtractions, and multiplications, and in performing the indicated operations. First set down the values of the ordinates in the following arrangement, adding and subtracting as indicated:

	y_0	y_1	y_2	y_3	y_4	y_5	y_6	y_7	y_8	y_9	y_{10}	y_{11}
Sum:	s_0	s_1	s_2	s_3	s_4	s_5	s_6					
Difference:		d_1	d_2	d_3	d_4	d_5						

Then take the sum terms in the following arrangement:	s_0	s_1	s_2	s_3	s_4	s_5	s_6
	s_6	s_5	s_4	s_3	s_2	s_1	s_0
Sum:	S_0	S_1	S_2	S_3			
Difference:	D_0	D_1	D_2				

Take the difference terms in this arrangement:	d_1	d_2	d_3
	d_5	d_4	
	S_4	S_5	S_6
	D_3	D_4	

Finally:

$$\frac{S_0}{S_2} \quad \frac{S_1}{S_3}$$

and

$$\frac{S_4}{S_6} \quad \frac{D_0}{D_2}$$

$$\text{Sum: } S_7 \quad S_8$$

$$\text{Difference: } D_3 \quad D_4$$

We are now in a position to find the coefficients in the equation of the complex wave. This equation is written:

$$y = A_0 + A_1 \cos \omega t + A_2 \cos 2\omega t + A_3 \cos 3\omega t + A_4 \cos 4\omega t + A_5 \cos 5\omega t \\ + A_6 \cos 6\omega t + B_1 \sin \omega t + B_2 \sin 2\omega t + B_3 \sin 3\omega t + B_4 \sin 4\omega t \\ + B_5 \sin 5\omega t$$

where A and B are the coefficients of the cosine and sine terms, respectively.

The formulas for the A 's and B 's are as follows:

$$A_0 = \frac{S_7 + S_8}{12}; A_1 = \frac{D_0 + 0.866D_1 + 0.5D_2}{6}; A_2 = \frac{S_0 + 0.5S_1 - 0.5S_2 - S_3}{6}$$

$$A_3 = \frac{D_3}{6}; A_4 = \frac{S_0 - 0.5S_1 - 0.5S_2 + S_3}{6}; A_5 = \frac{D_0 - 0.866D_1 + 0.5D_2}{6}$$

$$A_6 = \frac{S_7 - S_8}{12}; B_1 = \frac{0.5S_4 + 0.866S_5 + S_6}{6}; B_2 = \frac{0.866(D_3 + D_4)}{6}$$

$$B_3 = \frac{D_3}{6}; B_4 = \frac{0.866(D_3 - D_4)}{6}; B_5 = \frac{0.5S_4 - 0.866S_5 + S_6}{6}$$

There are several checks which may be made on the arithmetic of the above computations:

$$y_0 = A_0 + A_1 + A_2 + A_3 + A_4 + A_5 + A_6 \\ y_1 - y_{11} = (B_1 + B_5) + \sqrt{3}(B_2 + B_4) + 2B_3$$

For computing the percentage harmonic content of the wave, it is convenient to express the equation of the wave in somewhat simpler form, reducing the cosine terms to sine terms in the following manner:

$$y = A_0 + \sqrt{A_1^2 + B_1^2} \sin(\omega t + \alpha_1) + \sqrt{A_2^2 + B_2^2} \sin(2\omega t + \alpha_2) + \\ \sqrt{A_3^2 + B_3^2} \sin(3\omega t + \alpha_3) + \sqrt{A_4^2 + B_4^2} \sin(4\omega t + \alpha_4) + \\ \sqrt{A_5^2 + B_5^2} \sin(5\omega t + \alpha_5) + A_6 \sin(6\omega t + \alpha_6)$$

The coefficient of each sine term in the above equation is proportional to the magnitude of the harmonic, that is, $\sqrt{A_1^2 + B_1^2}$ is the amplitude of the fundamental, $\sqrt{A_2^2 + B_2^2}$ the amplitude of the second harmonic (double frequency), $\sqrt{A_3^2 + B_3^2}$ the amplitude of the third harmonic (triple frequency), and so on. A_0 is the d-c component of the wave, ω is equal to $2\pi f$, where f is the fundamental frequency. The angles $\alpha_1, \alpha_2, \alpha_3$, etc., are equal to $\tan^{-1} \frac{A_1}{B_1}, \tan^{-1} \frac{A_2}{B_2}$, etc. These angles do not enter into the computation, unless the phase displacements between the various harmonics are desired.

To find the percentages of the various harmonics, in terms of the magnitude of the fundamental, use the following expressions:

Per cent second harmonic:

$$\text{Per cent} = \frac{\sqrt{A_2^2 + B_2^2}}{\sqrt{A_1^2 + B_1^2}} \times 100 \text{ per cent}$$

For the third harmonic:

$$\text{Per cent} = \frac{\sqrt{A_3^2 + B_3^2}}{\sqrt{A_1^2 + B_1^2}} \times 100 \text{ per cent}$$

and so on. For all harmonics up to the sixth taken together, the total harmonic content expressed as a percentage is:

$$\text{Per cent} = \frac{\sqrt{A_2^2 + A_3^2 + A_4^2 + A_5^2 + A_6^2 + B_2^2 + B_3^2 + B_4^2 + B_5^2 + B_6^2}}{\sqrt{A_1^2 + B_1^2}} \times 100 \text{ per cent}$$

It is sometimes useful to compare the r-m-s value of the fundamental with the d-c component, expressed as a percentage. To obtain this percentage from above figures, substitute in the following expression:

D-c component, expressed as a per cent of r-m-s fundamental,

$$= \frac{A_0}{0.707\sqrt{A_1^2 + B_1^2}} \times 100 \text{ per cent}$$

Example (see Fig. 1 and values in table above):

	5.5	37.0	68.6	76.4	93.2	89.6	66.7
		-15.0	-44.1	-28.4	-8.8	34.3	
Sum:	5.5	22.0	24.5	48.0	84.4	123.9	66.7
Difference:	s_0	s_1	s_2	s_3	s_4	s_5	s_6
		52.0	112.7	104.8	102.0	55.3	
		d_1	d_2	d_3	d_4	d_5	
	5.5	22.0	24.5	48.0		52.0	112.7
	66.7	123.9	84.4			55.3	102.0
	72.2	145.9	108.9	48.0	Sum,	107.3	214.7
	S_0	S_1	S_2	S_3		S_4	S_5
	-61.2	-101.9	-59.9		Difference:	-3.3	10.7
	D_0	D_1	D_2			D_3	D_4
	72.2	145.9				107.3	-61.2
	108.9	48.0				104.8	-59.9
Sum:	181.1	193.9			Difference:	2.5	-1.3
	S_7	S_8				D_5	D_6

$$A_0 = \frac{181.1 + 193.9}{12} = +31.3$$

$$A_1 = \frac{-61.2 + 0.866(-101.9) + .5(-59.9)}{6} = -29.6$$

$$A_2 = \frac{72.2 + .5(145.9) - .5(108.9) - 48.0}{6} = +7.1$$

$$A_3 = \frac{-1.3}{6} = -0.2$$

$$A_4 = \frac{72.2 - 0.5(145.9) - 0.5(108.9) + 48.0}{6} = -1.2$$

$$A_5 = \frac{-61.2 - 0.866(-101.9) + 0.5(-59.9)}{6} = -0.4$$

$$A_6 = \frac{181.1 - 193.9}{12} = -1.1$$

$$B_1 = \frac{0.5(107.3) + 0.866(214.7) + 104.8}{6} = +57.3$$

$$B_2 = \frac{0.866(-3.3 + 10.7)}{6} = +1.1$$

$$B_3 = \frac{2.5}{6} = +0.4$$

$$B_4 = \frac{0.866(-3.3 - 10.7)}{6} = -2.0$$

$$B_5 = \frac{0.5(107.3) - 0.866(214.7) + 104.8}{6} = -4.5$$

Result:

$$y = 31.3 - 29.6 \cos \omega t + 7.1 \cos 2\omega t - 0.2 \cos 3\omega t \\ - 1.2 \cos 4\omega t - 0.4 \cos 5\omega t - 1.1 \cos 6\omega t \\ + 57.3 \sin \omega t + 1.1 \sin 2\omega t + 0.4 \sin 3\omega t \\ - 2.0 \sin 4\omega t - 4.5 \sin 5\omega t$$

Percentage of various harmonics:

$$\text{Second: Per cent} = \frac{\sqrt{(7.1)^2 + (1.1)^2}}{\sqrt{(29.6)^2 + (57.3)^2}} \times 100 \text{ per cent} = 11.1 \text{ per cent}$$

$$\text{Third: Per cent} = \frac{\sqrt{(0.2)^2 + (0.4)^2}}{64.5} \times 100 \text{ per cent} = 0.7 \text{ per cent}$$

$$\text{Fourth: Per cent} = \frac{\sqrt{(1.2)^2 + (2.0)^2}}{64.5} \times 100 \text{ per cent} = 3.6 \text{ per cent}$$

$$\text{Fifth: Per cent} = \frac{\sqrt{(0.4)^2 + (4.5)^2}}{64.5} \times 100 \% = 7.0 \text{ per cent}$$

$$\text{Sixth: Per cent} = \frac{1.1}{64.5} \times 100 \% = 1.7 \text{ per cent}$$

Total harmonic content:

Per cent =

$$\frac{\sqrt{(7.1)^2 + (0.2)^2 + (1.2)^2 + (0.4)^2 + (1.1)^2 + (1.1)^2 + (0.4)^2 + (2.0)^2 + (4.5)^2}}{64.5} \\ = 13.8 \text{ per cent}$$

Percentage d-c component:

$$\text{Per cent} = \frac{31.3}{0.707(64.5)} = 68.9 \text{ per cent}$$

25. Evaluation of Square Root of the Sum of the Squares of Two Numbers. In the calculation of impedance as the square root of the sum of the squares of a reactance and a resistance, a useful and convenient method of solution consists in rewriting the equation as follows.

$$\sqrt{a^2 + b^2} = b\sqrt{1 + \frac{a^2}{b^2}}$$

where a is the larger number.

The operations can now be carried out fairly simply with the slide rule. If the right-hand side of this equation be multiplied and divided by a/b the solution becomes simply one of multiplying the larger number a by a factor which is a function of the ratio of a/b .

A table may be worked out for this function. W. J. Seeley of Duke University, Durham, N. C., has copyrighted such a table in which the factor has been worked out to five decimal places for various values of a/b from 0.001 to 30. Curves may be drawn from calculations of this nature which will be useful in graphically determining the value of the function a/b .

26. Shunt and Multiplier Data for Meters. It is often useful to convert a low-reading current meter to a voltmeter or a current meter of higher maximum current reading. The following table will cover the usual situations arising in the average laboratory. The values of shunt are calculated from the equation for meter shunts,

$$R_s = \frac{R_m \times I_m}{I - I_m}$$

where R_m = meter resistance in ohms
 I_m = full-scale current of meter
 I = current desired to be read

SHUNT AND MULTIPLIER VALUES
 27-ohm (0-1) Milliammeter

Scale	Use as	Resistance in ohms of multiplier or shunt		Multiply old scale by
0-10	Voltmeter	10.000	<i>M</i>	10
0-50	Voltmeter	50.000	<i>M</i>	50
0-100	Voltmeter	100.000	<i>M</i>	100
0-250	Voltmeter	250.000	<i>M</i>	250
0-500	Voltmeter	500.000	<i>M</i>	500
0-1000	Voltmeter	1,000.000	<i>M</i>	1000
0-10	Milliammeter	3	<i>S</i>	10
0-50	Milliammeter	0.551	<i>S</i>	50
0-100	Milliammeter	0.272	<i>S</i>	100
0-500	Milliammeter	0.0541	<i>S</i>	500

35-ohm (0-1.5) Milliammeter

0-15	Voltmeter	10.000	<i>M</i>	10
0-150	Voltmeter	100.000	<i>M</i>	100
0-750	Voltmeter	500.000	<i>M</i>	500
0-15	Milliammeter	3.89	<i>S</i>	10
0-75	Milliammeter	0.714	<i>S</i>	50
0-150	Milliammeter	0.354	<i>S</i>	100
0-750	Milliammeter	0.0701	<i>S</i>	500

SECTION 2

ELECTRIC AND MAGNETIC CIRCUITS

BY E. A. UEHLING¹

FUNDAMENTALS OF ELECTRIC CIRCUITS

1. Nature of Electric Charge. According to modern views all natural phenomena may be explained on the basis of fundamental postulates regarding the nature of electric charge. In the neighborhood of an electric charge is postulated the existence of an electric field to explain such phenomena as repulsion and attraction. The force which acts between electric charges by virtue of the electric fields surrounding them is expressed by Coulomb's law which states that

$$F = \frac{q_1 q_2}{r^2}$$

The value of the unit charge in the electrostatic system is based on this law and is defined, therefore, as that value of electric charge which when placed at 1 cm distance from an equal charge repels it with a force of 1 dyne.

2. Electrons and Protons. There are two types of electricity: positive and negative. The electron is representative of the latter and the proton of the former. All matter is made up simply of electrons and protons. Exhaustive experiment has proved that all electrons, no matter how derived, are identical in nature. They are easily isolated and as a consequence have been thoroughly studied. Among the most important results of this study are the following facts:²

Charge of the electron.....	4.770 × 10 ⁻¹⁰ e.s.u.
Mass.....	9.04 × 10 ⁻²⁸ g
Radius.....	2 × 10 ⁻¹³ cm, approx.

The proton has not been so thoroughly studied. It is not so easily isolated, and the effects of electric and magnetic fields on its motion are considerably smaller than similar effects obtained when electrons are studied. The proton apparently has a mass of about 1,838 times that of the electron and a considerably smaller radius.

The mass of electrons and protons is purely inertial in character. In other words these fundamental units of electric charge consist simply of pure electricity. For the sake of completeness it should be added that this mass is not independent of velocity and that the values given for both the electron and proton assume velocities which are small in comparison with that of light.

¹ Department of Physics, California Institute of Technology.

² MILLIKAN, R. A., "The Electron."

3. Atomic Structure. The atoms of matter consist of a central positive nucleus surrounded by such a number of electrons as will neutralize the nuclear charge. The central positive nucleus consists of both electrons and protons with an excess of the latter. This excess determines the chemical characteristics of the atom by determining the number of electrons outside the nucleus, while the total number of protons determines the atomic weight of the element. According to one view the electrons outside the nucleus move in planetary elliptic orbits about it. The radius of the different orbits varies within a single atom, and as a consequence the strength of the bond existing between the nucleus and the different electrons varies.

4. Ionization. The outer electrons are in general loosely bound to the nucleus and under favorable conditions may be completely disassociated from the remainder of the atom. This process of the removal of an electron is known as *ionization*. It is the process by which electrons are removed from a heated filament in a vacuum tube, from an alkali metal surface in the photoelectric cell, and from the plate and grid of vacuum tubes when bombarded by the filament electrons giving rise to the secondary emission so commonly experienced.

5. The Nature of Current. The modern view of electricity regards a current as a flow of negative charge in one direction plus a flow of positive charge in the opposite direction. In electrolytic conduction the unit of negative charge is an atom with one or more additional electrons called a *negative ion*, and the unit of positive charge is an atom with one or more electrons less than its normal number known as the *positive ion*.

In conduction through gases, as, for example, through the electric arc, the negative ion is usually a single electron, whereas the positive ion is as before an atom with one or more electrons removed.

In conduction through solids, however, the current is strictly electronic and is not made up of two parts as in the previous cases. The electrons constituting the current are the outer orbital electrons of the atoms. Since these electrons are less tightly bound to the atom than the other electrons they are comparatively free and are often spoken of as *free electrons*. These electrons move through the solid under the influence of an electric field colliding with the atoms as they move and continuously losing energy gained from the field. As a consequence the motion of the electrons in the direction of the field is of a comparatively small velocity¹ (of the order of 1 cm per second), whereas the velocity of thermal agitation of the free electrons is high (about 10^7 cm per second). According to this view of the electric current in solids, conductors and insulators differ only in the relative number of free electrons possessed by the substance.

Since current consists of a motion of electric charges, it may be defined as a given amount of charge passing a point in a conductor per unit time. In the electrostatic system the unit of current is defined to be a current such that an electrostatic unit of electricity crosses any selected cross section of a conductor in unit time. In the practical system the unit of current is the ampere which is approximately equal to 3×10^9 electrostatic units of current and is defined on the basis of material constants as that current which will deposit 0.00111800 g of silver from a solution of silver nitrate in 1 sec.

¹ JEANS, J. H., "Electricity and Magnetism," p. 306.

6. The Nature of Potential. An electric charge that is resident in an electric field experiences a force of repulsion or attraction depending on the nature of the charge. Its position in the field may be considered as representing a certain quantity of potential energy which may be taken as the amount of work which is capable of being done when the electric charge moves from the point in question to an infinite distance. If the convention of considering a unit positive charge as the test charge is adopted, the potential energy at a point may be taken as characteristic of the field and consequently will be regarded simply as the potential.

In a similar manner the difference of potential of two points may be described as the amount of work required to move a unit positive test charge from one point to another. More specifically a difference of potential in a conductor may be spoken of as equal to the energy dissipated when an electron moves through the conductor from the point of low potential to the point of high potential. This energy is dissipated in the form of heat caused by the bombardment of the molecules of the conductor by the electrons as they proceed from one point to another.

7. Concept of E.M.F. The idea of potential leads directly to a conception of an electromotive force. If a difference of potential between two points of a conductor is maintained by some means or other, electrons will continue to flow, giving rise to a continuous current. A difference in potential maintained in this way while the current is flowing is known as an *electromotive force*. Only two important methods of maintaining a constant e.m.f. exist: the battery and the generator. Other methods, as, for example, the thermocouple, are not primarily intended for the purpose of maintaining a current.

The unit of e.m.f. in the practical system is the *volt*. It is defined as 10^9 e.s.u. of potential or as $1.0000/1.0183$ of the voltage generated by a standard Weston cell.

8. Ohm's Law and Resistance. The free electrons which contribute to the electric current have a low drift velocity in the negative direction of the field within the conductor. In moving through the metal in a common general direction they enter into frequent collisions with the molecules of the metal, and as a consequence they are continually retarded in their forward motion and are not able to attain a velocity greater than a certain terminal velocity u , which depends on the value of the field and the nature of the substance. The collisions which tend to reduce the drift velocity of the electrons act as a retarding force. When a current is flowing, this retarding force must be exactly equal to the accelerating force of the field. The retarding force is proportional to N , the number of free electrons per unit length of conductor, and to u , their drift velocity. It may be designated as kNu . The accelerating force is proportional to the field E per unit length of conductor, to the number N of electrons per unit length, and to the electronic charge e and may be represented as NEe . Then $NEe = kNu$. Since the current i has been given as

$$i = Neu$$

$$NEe = k \frac{i}{e}$$

$$E = \frac{k}{Ne^2} i = Ri$$

where

$$R = \frac{k}{Ne^2}$$

The statement $E = Ri$ is known as Ohm's law. R is here defined as the *resistance* per unit length. The unit of resistance is the *ohm*. It may be obtained from Ohm's law when the e.m.f. is expressed in volts and the current in amperes.

9. Inductance. Circuits possess inductance by virtue of the electromagnetic field which surrounds a conductor carrying a current. The coefficient of self-inductance is defined as the total number of lines of force passing through a circuit and due entirely to one c.g.s. unit of current traversing the circuit. If N is the number of lines of force linked with any circuit of inductance L and conveying C c.g.s. units of current, $N = LC$.

The practical unit of inductance is the *henry*. It is equal to 10^9 c.g.s. units of inductance. If the number of lines of force N through a circuit is changed, an e.m.f. due to this change of flux is induced in the circuit. This e.m.f. is given by the equation

$$e = -\frac{dN}{dt} = -L\frac{dC}{dt}$$

The inductance of a circuit is equal to 1 henry if an opposing e.m.f. of 1 volt is set up when the current in the circuit varies at the rate of 1 amp. per second.

10. Mutual Inductance. The coefficient of mutual inductance is defined in the same way as that of self-inductance and is given in c.g.s. units as the total magnetic flux which passes through one circuit when the other is traversed by one c.g.s. unit of current, or

$$N = MC$$

$$e = -\frac{dN}{dt} = -M\frac{dC}{dt}$$

The practical unit is the henry as in self-inductance.

11. Energy in Magnetic Field. Energy is stored in the electromagnetic field surrounding a circuit representing the energy accumulated during the time when the free electrons were initially set in motion and the current established. This energy is given by the equation, $W = \frac{1}{2}LI^2$, where, if L is in henrys and I in amperes, the energy is in *joules*.

12. Capacitance. The ratio of the *quantity* of charge on a conductor to the *potential* of the conductor represents its *capacity*. If one conductor is at zero potential and another at the potential V , the capacity is given as the ratio of the charge stored to the potential difference of the conductors

$$C = \frac{Q}{V}$$

If Q is in coulombs (the quantity of charge carried by 1 amp. flowing for 1 sec.) and V is in volts, C is known as the *farad*.

The energy stored in a condenser is given by the equation, $W = \frac{1}{2}CV^2$, where, if V is in volts and C is in farads, W is in joules.

The force acting per unit area on the conductors of the condenser tending to draw them together is

$$F = \frac{E^2}{8\pi} = \frac{V^2}{8\pi d^2}$$

where d is the distance separating the condenser plates, and V is the potential difference.

Other expressions relating charge or current to capacity and potential difference are

$$V = \frac{fidt}{C}$$

and

$$i = C \frac{dV}{dt}$$

13. Units. The practical units that have been described are related to the electrostatic units as shown by the following table. A third set of units, known as the electromagnetic, is also related to the practical units, the ratios of which are given in this table.

Quantity	Name of unit	Measure in electromagnetic units	Measure in electrostatic units
Charge of electricity.....	Coulomb	10^{-1}	3×10^9
Potential.....	Volt	10^8	$\frac{1}{300}$
Capacity.....	Farad	10^{-9}	9×10^{11}
Current.....	Ampere	10^{-1}	3×10^9
Resistance.....	Ohm	10^9	$\frac{1}{9} \times 10^{-11}$
Inductance.....	Henry	10^9	

14. Continuous and Alternating Currents. If the free electrons of a conductor move with a constant drift velocity under the impelling force of an invariant electric field, the electric current in the conductor is spoken of as being *continuous*, or *direct*. If, however, the impressed electric field is varying in both direction and magnitude, the drift velocity of the electrons will vary in both direction and magnitude, since electrons always flow in a direction opposite to that of the electric field. A current of this kind which varies periodically with the time is known as an *alternating* current.

15. Wave Form. The current or the e.m.f. may be represented graphically as a function of the time by assigning to successive values of the latter variable the value of the former. There is an infinite variety of functional relationships between current and time, but of all the laws by which these two variables may be connected there is one that can be differentiated from all others. This law is that of the *sine* or *cosine* function. All other relationships can be resolved into a linear combination of functions of this simple type.

The form of the sine function is shown in Fig. 1a. It is represented analytically by the following type of equations

$$i = I_0 \sin \omega t$$

$$e = E_0 \sin \omega t$$

where i and e are the instantaneous values of the current and voltage, I_0 and E_0 are the maximum values, and ω is 2π times the frequency with

which the current or voltage alternates. The sine wave is the ideal toward which practical types approach more or less closely. Since it cannot be resolved into other types, it is the pure wave form.

16. Harmonics. Current and voltage waves, in practice, are not pure and may therefore be resolved into a series of sine or cosine functions. One of the functions into which the original wave is resolved will have a frequency term equal to that of the original wave. All of the other functions will have frequency terms of higher value, which will in general be designated as *harmonics* of the lowest or fundamental frequency. A few types of complex waves which may be resolved into two or more pure sine waves are shown in Fig. 1b and c. The resolution of a complex wave into its component parts may be accomplished physically as well as mathematically. This may be demonstrated by means of high- and low-pass filters in the output circuit of an ordinary vacuum-tube oscillator.

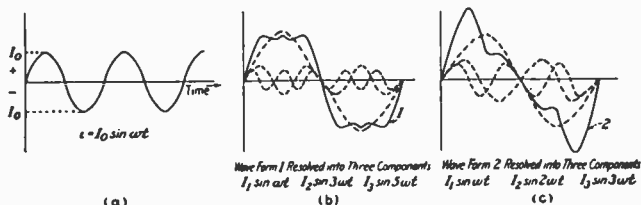

FIG. 1.—Sine wave and complex waves.

17. Effective and Average Values. The *effective value* of an a-c wave is the value of continuous current which gives the same power dissipation as the a. c. in a resistance. For a sine wave this value of continuous current is equal to the maximum value divided by $\sqrt{2}$. The *average value* of an alternating current is equal to the integral of the current over the time for one-half period divided by the elapsed time. For a sine wave the average value is equal to the maximum value of the current divided by $\pi/2$. The ratio of the effective value of the current to the average value is often taken as the *form factor* of the wave. Thus all types of waves may be simply characterized by means of this ratio.

Direct-current meters read average values of currents over a complete period. Such meters therefore read zero in an a-c circuit. Thermocouple and hot-wire-type meters read effective values. Such meters are therefore used for making a-c measurements at radio- as well as at audio-frequencies.

18. Phase. The current in a circuit may have its maximum and zero values at the same time as those of the e.m.f. wave, or these values may occur earlier or later than those of the latter. These three cases are illustrated in Fig. 2. When the corresponding values of the current and e.m.f. occur at the same time they are said to be in phase. If the current values occur before the corresponding values of the voltage wave, the current is said to be in *leading* phase, and if these values occur after the corresponding values of the voltage wave, it is said to be in *lagging* phase.

19. Power. The power consumed in a continuous-current circuit is $W = EI = I^2R$, where R is the *effective resistance* of the circuit. The power consumed in an a-c circuit having negligible inductance and

capacitance is given by the same equation with the necessary restrictions on I so that it represents the effective value of the current and not the average value. The power consumed in an inductive or capacitive circuit is $W = EI \cos \varphi$, where φ is the *phase angle*, that is, the angle of lag or lead of current. The term " $\cos \varphi$ " is commonly referred to as the *power factor* of the circuit.



FIG. 2.—Phase in a-c circuits.

DIRECT-CURRENT CIRCUITS

20. Direction of Current Flow. An electric current is a flow of electric charges. Electric charges will move through a medium of finite resistance if a difference of electric potential exists between two points of that medium. In metallic conductors there is but one type of charge which is free to move, the negative charge or the free electrons of the conductor. The current in a metallic conductor then consists solely of an electron current. The convention arose historically of speaking of an electric current as flowing from the high potential (positive) to the low potential (negative) point, while, as a matter of fact, the electrons of the conductor actually move in the opposite direction. It is necessary to distinguish, therefore, between the direction of current flow in the historical sense and the direction of flow of electrons.

21. Constant Positive Resistance, Negative Resistance, and Infinite Resistance. In a d-c circuit the relationship between voltage and current is governed solely by the resistance of the circuit and all equivalent resistances such as counter e.m.f.s. Some knowledge regarding the nature of this resistance is needed. Three cases present themselves. In the first case are those circuits in which

$$\frac{de}{di} = R$$

where R is positive and is constant in value over a rather large range. Conduction in solids and electrolytes is of this type. In the second class are those circuits in which de/di has a value which is negative and is usually not constant. Conduction in arcs and glow discharges is generally of this type. In the third class are those circuits in which

$$\frac{de}{di} = \infty$$

Conduction in the plate circuit of a vacuum tube under saturation conditions is of this type.

Circuits of the first class, in which the differential coefficient de/di has a positive value, may be subdivided into two other classes. If the

value of de/di is constant over the entire range of voltage and current from zero to the maximum value, and if this value is designated by the quantity R , then Ohm's law may be used and $e = iR$. In this case, R is both the d-c and a-c resistance. If, however, R is not constant over this range of values, the value of R given at a particular value of e and i given by the equation

$$R = \frac{de}{di}$$

is only the a-c resistance of the circuit at the particular value of e and i chosen. The a-c resistance given by this equation may be quite different from the d-c value as given by the equation

$$R = \frac{e}{i}$$

In a vacuum-tube plate circuit the d-c value of the resistance is frequently about twice as high as the a-c value.

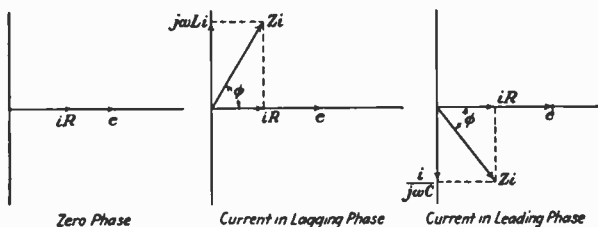

FIG. 3.—Vector representation of a-c circuits.

ALTERNATING-CURRENT CIRCUITS

22. Impedance. The resistance to the flow of an electric current having the value $i = I_0 \sin \omega t$ depends on the circuit element through which the current is passing. In a pure resistance the potential fall would be $E_1 = I_0 R \sin \omega t$, which is seen to be in phase with the current passing through it. In an inductance the potential fall would be

$$E_2 = L \frac{di}{dt} = \omega L I_0 \cos \omega t = j\omega L I_0 \sin \omega t = j\omega L i$$

and therefore leads the current by a phase angle of 90 deg. In a capacitance the potential fall would be

$$\begin{aligned} E_3 &= \frac{1}{C} \int i dt = -\frac{I_0}{\omega C} \cos \omega t = -\frac{j I_0}{\omega C} \sin \omega t \\ &= -\frac{j i}{\omega C} \\ &= \frac{i}{j\omega C} \end{aligned}$$

and is therefore led by the current by a phase angle of 90 deg. The potential fall through all three elements taken together is equal to

$$E = \left(R + j\omega L + \frac{1}{j\omega C} \right) i$$

The coefficient of i is termed the *impedance* of the circuit. It is written, in general, as

$$z = R + j\omega L + \frac{1}{j\omega C} = R + j\left(\omega L - \frac{1}{\omega C}\right)$$

where R is the total series resistance of the circuit, L is the total series inductance, and C is the effective series capacitance. The term involving j is of special importance, for it is this term which gives to the current its leading or lagging characteristics depending on whether ωL is smaller or larger than $1/\omega C$. This quantity is known as the circuit *reactance*

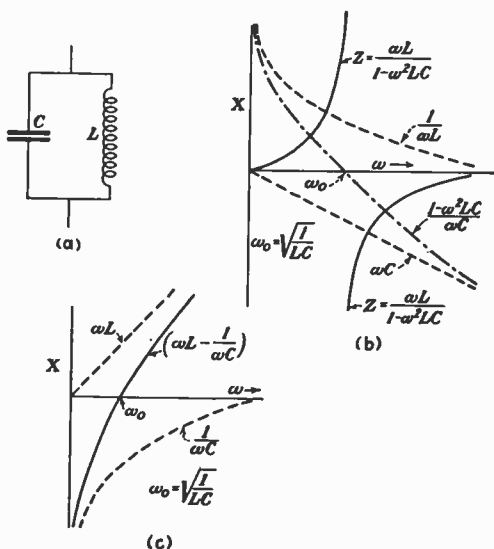

FIG. 4.—Reactance and impedance of parallel circuit.

and is designated by the letter X . The impedance may be written, therefore, -

$$z = R + jX$$

Occasionally the absolute value of the circuit impedance is required. It is then written in the following form

$$z = Ze^{i\phi}$$

$$Z = \sqrt{R^2 + X^2}$$

$$\phi = \arctan \frac{X}{R}$$

where

In this expression Z represents the absolute value of the impedance, z the complex value, and ϕ the phase angle.

The impedance of a single circuit will be given to illustrate the method of obtaining this quantity for any circuit. For a parallel combination of circuit elements, such as illustrated in Fig. 4a, it would be obtained as follows:

$$z = \frac{1}{\frac{1}{j\omega C} + \frac{1}{j\omega L}} = \frac{j\omega L}{1 - \omega^2 LC}$$

This equation shows that when $\omega^2 = 1/LC$ the impedance is infinite. It may be represented graphically as a function of ω as shown in Fig. 4b. The figure and the equation illustrate the case of parallel resonance. The case of series resonance is illustrated in Fig. 4c, and the equation is

$z = j\left(\omega L - \frac{1}{\omega C}\right)$, which holds for a circuit having only an inductance L and capacitance C in series with the e.m.f. In the series case, the impedance is zero at resonance; that is, when $\omega^2 = 1/LC$ and in the parallel case the impedance is infinite at resonance.

23. Circuit Parameters. Every electric circuit, no matter how complicated, is made up of a particular combination of inductances, capacitances, and resistances. These parameters and the manner in which they are combined with one another completely govern the performance of a circuit and determine the value of the current at any point of the circuit at any time for any given value of the impressed e.m.f. or combination of e.m.f.s.

Inductances, capacitances, and resistances may be lumped or distributed in nature. They are regarded as of the former type if their values are more or less concentrated at one or a finite number of points in a circuit. For example, the inductance of a circuit would be considered as lumped if a definite number of places in the circuit is found where inductance exists, and at all other points a comparative non-existence of inductance. On the other hand the inductance of a uniform telephone line is considered as distributed since it exists along the entire line and may, at no point in the line, be neglected.

24. Circuit Equations. Every circuit may be completely expressed by a system of simultaneous equations. Having expressed a particular circuit in this manner, a solution may be obtained frequently without difficulty. Since the equations are of primary importance, methods of obtaining them will be given.

There are two distinct cases. When a sinusoidal voltage or combination of sinusoidal voltages is impressed on a circuit, a.c. flows in every branch of the circuit as a consequence of the impressed e.m.f. This current may be divided into two parts. One part is known as the *transient current*, and the other as the current of the *steady state*. The transient current disappears very shortly after the voltage has been impressed. The steady state continues as long as the e.m.f. continues in its initial state of voltage, frequency, and wave form. Often only the steady state is of interest. Examples of this are to be found in studies of r-f transformer performance and in studies of electric filters of the low-pass, high-pass, or band-pass types and in the studies of the various characteristics of different antenna-coupling methods. At other

times the transient condition may be of primary interest; as, for example, in the study of the fidelity of reproduction with regard to wave form of an electromagnetic or electrodynamic loud-speaker motor.

If interest centers only in the steady state the following method is to be used: Apply Kirchhoff's second law which states that the sum of all the e.m.fs. around any circuit is zero, writing one equation for each branch of the circuit, and using as the potential falls the values $j\omega L$ for each inductance, $1/j\omega C$ for each capacitance, and IR for each resistance. If inductances, capacitances, and resistances occur that are common to two or more branches, they will be used once for each of the common branches paying due regard to the sign of the term.

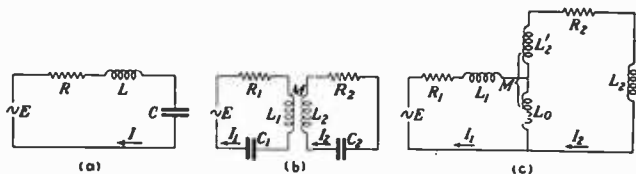

FIG. 5.—Circuits illustrating use of Kirchhoff's laws.

This method may be illustrated by the examples of Fig. 5 and the following equations:

For circuit a:

$$E = IR + j\omega LI + \frac{I}{j\omega C} = I \left[R + j \left(\omega L - \frac{1}{\omega C} \right) \right]$$

$$= I(R + jX)$$

$$I = \frac{E}{R + jX}$$

For circuit b:

$$E = I_1 R_1 + j\omega L_1 I_1 + \frac{I_1}{j\omega C_1} - j\omega M I_2 = I_1 z_1 - j\omega M I_2$$

$$0 = I_2 R_2 + j\omega L_2 I_2 + \frac{I_2}{j\omega L_2} - j\omega M I_1 = I_2 z_2 - j\omega M I_1$$

where z_1 is the total complex impedance of circuit 1, and z_2 is the total complex impedance of circuit 2.

For circuit c:

$$E = I_1 R_1 + j\omega L_1 I_1 + j\omega L_0 I_1 - j\omega M I_2 - j\omega L_0 I_2$$

$$= I_1 z_1 - j\omega I_2 (M + L_0)$$

$$0 = I_2 R_2 + j\omega L_2 I_2 + j\omega L_0 I_2 + j\omega L_2 I_2 - j\omega M I_1 - j\omega L_0 I_1$$

$$= I_2 z_2 - j\omega I_1 (M + L_0)$$

In these equations I is the maximum value of the sinusoidal current, and E is the maximum value of the sinusoidal e.m.f. These equations may be solved for any of the currents by the method of simultaneous equations.

In the transient values of the various currents, Kirchhoff's second law may be used as before, but instead of using the values of potential fall as given in the preceding equations, use the instantaneous values. The equation for circuit a of Fig. 5 is then written

$$e = iR + L \frac{di}{dt} + \frac{1}{C} \int i dt$$

or

$$\frac{de}{dt} = L \frac{d^2i}{dt^2} + R \frac{di}{dt} + \frac{i}{C}$$

where e and i are the instantaneous values of the impressed e.m.f. and current respectively. For circuit b ,

$$e = i_1 R_1 + L_1 \frac{di_1}{dt} + \frac{1}{C_1} \int i_1 dt - M \frac{di_2}{dt}$$

$$0 = i_2 R_2 + L_2 \frac{di_2}{dt} + \frac{1}{C_2} \int i_2 dt - M \frac{di_1}{dt}$$

To obtain the transient solution, e and de/dt are replaced by zero and the equation solved by the methods used for linear, homogeneous equations of the first degree.

25. General Characteristics of A-c Circuits. The general equations applied to a number of the more important radio circuits yield the following results.

Current Flow in an Inductive Circuit:

$$i = \frac{E}{R} \left(1 - e^{-\frac{Rt}{L}} \right)$$

where E is the constant impressed e.m.f.

Time Constant of an Inductive Circuit: The time required for a current to rise to $\left(1 - \frac{1}{e} \right)$ or to about 63 per cent of its final value. This time is equal to L/R .

Current Flow in a Capacitive Circuit:

$$i = \frac{E}{R} e^{-\frac{t}{RC}}$$

where E is the constant impressed e.m.f.

Time Constant of a Capacitive Circuit. The time required for the current to fall from its initial value to $1/e$ or about 0.37 of this value. This time is equal to RC .

Current Flow in an Inductive-capacitive Circuit:

$$i = \frac{E}{\omega L} e^{-\frac{Rt}{2L}} \sin \omega t, \text{ if } R^2 < \frac{4L}{C}$$

$$i = \frac{E}{\omega L} e^{-\frac{Rt}{2L}}, \text{ if } R^2 = \frac{4L}{C}$$

where ω is 2π times the natural frequency of the circuit which is given by the equation

$$f = \frac{1}{2\pi} \sqrt{\frac{1}{LC} - \frac{R^2}{4L^2}}$$

Logarithmic Decrement. Ratio of successive maxima of the current in an oscillatory discharge is equal to

$$\frac{RT}{e^{2L}} = e^{\frac{R}{2Lf}}$$

where $R/2Lf$ is called the log. dec. of the circuit, T is the natural period, and f the natural frequency of the circuit.

Currents in Two Circuits Coupled by a Mutual Impedance, M , when a Sinusoidal E.M.F., E , Exists in Circuit 1:

$$I_1 = \frac{E}{z_1 + \frac{\omega^2 M^2}{z_2}}$$

$$I_2 = \frac{j\omega M I_1}{z_2} = \frac{j\omega M E}{z_1 z_2 + \omega^2 M^2}$$

where z_1 and z_2 are the complex impedances of circuits 1 and 2 respectively.
Effective Reactance of One Circuit Coupled to a Second Circuit:

$$X' = X_1 - \frac{\omega^2 M^2}{Z_2^2} X_2$$

where X_1 and X_2 are the actual reactances of circuits 1 and 2 respectively and Z_2 is the absolute value of the complex impedance of circuit 2.

Effective Resistance of One Circuit Coupled to a Second Circuit:

$$R' = R_1 + \frac{\omega^2 M^2}{Z_2^2} R_2$$

where R_1 and R_2 are the actual resistances of circuits 1 and 2 respectively.
Effective Total Impedance of One Circuit Coupled to a Second Circuit:

$$z' = z_1 + \frac{\omega^2 M^2}{z_2} = R_1 + jX_1 + \frac{\omega^2 M^2}{R_2 + jX_2}$$

$$= R_1 + \frac{\omega^2 M^2}{Z_2^2} R_2 + j \left\{ X_1 - \frac{\omega^2 M^2}{Z_2^2} X_2 \right\}$$

Partial Resonance Relation Obtained When Only the Reactance of Circuit 1 is Variable:¹

$$X_1 = \frac{\omega^2 M^2}{Z_2^2} X_2$$

Partial Resonance Relation Obtained when only the Reactance of Circuit 2 is Variable:¹

$$X_2 = \frac{\omega^2 M^2}{Z_1^2} X_1$$

Total Optimum Resonance Relation when the Reactance of Both Circuits 1 and 2 Are Variable:¹

Case I: If $\omega^2 M^2 < R_1 R_2$

Resonance relation $X_1 = 0$ and $X_2 = 0$

Case II: If $\omega^2 M^2 > R_1 R_2$

$$\text{Resonance relation } \frac{R_2}{R_1} = \frac{\omega^2 M^2}{Z_1^2} = \frac{X_2}{X_1}$$

Case III: If $\omega^2 M^2 = R_1 R_2$

Resonance relation $X_1 = 0, X_2 = 0$

$$\frac{R_2}{R_1} = \frac{\omega^2 M^2}{Z_1^2}$$

Total Secondary Current at Total Optimum Resonance Relation, the E.M.F., E , Being Impressed in Circuit 1.

Case I: If $\omega^2 M^2 < R_1 R_2$

$$I_2 = \frac{\omega M E}{R_1 R_2 + \omega^2 M^2}$$

¹ PIERCE, G. W., "Electric Oscillations and Electric Waves," Chap. XI.

Cases II and III: If $\omega^2 M^2 \geq R_1 R_2$

$$I_2 = \frac{E}{2\sqrt{R_1 R_2}}$$

I_2 for cases II and III is seen to be greater than for case I and is independent of ωM .

MAGNETIC CIRCUITS

26. The Fundamental Quantities of Magnetic Circuits. The first fundamental quantity is the *magnetic flux or induction*. The unit of flux is known as the *maxwell* and is defined by the statement that from a unit magnetic pole, 4π maxwells, or lines of force, radiate.

The second fundamental quantity is the *reluctance*. It is analogous to the resistance of electric circuits, as the flux is analogous to the current. The unit of reluctance is the *oersted* and is defined as the reluctance offered by 1 cm cube of air.

The third fundamental quantity is the *magnetomotive force* (m.m.f.). It is analogous to the e.m.f. of electrical circuits. The unit of m.m.f. is the *gilbert* and is defined as the m.m.f. required to force a flux of 1 maxwell through a reluctance of 1 oersted. Thus the fundamental equation in which these three quantities are related to one another is:

$$M = \phi R$$

Other important quantities of magnetic currents may be defined as follows: the *magnetic field strength* is represented by the quantity H and is equal to the number of maxwells per unit of area when the medium through which the flux is passing is air. This unit is known as the *gauss* if the unit of area is the square centimeter.

In any medium other than air the lines of force are known as *lines of induction* and the symbol B is used instead of H to represent them. In air the induction B and the field strength H are equal to one another, but in other mediums this is not true.

The *permeability* μ is the ratio between the magnetic induction B and the field strength H . In air this ratio is unity. In *paramagnetic* materials the permeability is greater than unity, in *ferromagnetic* materials it may have a value of several thousand, and in *diamagnetic* materials it has a value of less than unity.

The intensity of magnetization I is the *magnetic moment* per unit volume or the *pole strength* per unit area. The unit of magnetic pole strength is a magnetic pole of such a value that when placed 1 cm from a like pole, a force of repulsion of 1 dyne will exist between them. The magnetic pole strength per unit area of any pole is measured in terms of this unit. The magnetic moment of a magnet is the product of the pole strength and the distance between the poles.

The *susceptibility* K of a material is equal to the ratio of the magnetization I produced in the material to the field strength H producing it. All of these quantities are connected by the following equations

$$\begin{aligned} B &= \mu H \\ I &= KH \\ B &= 4\pi I + H \\ \mu &= 4\pi K + 1 \end{aligned}$$

Magnetization curves are of great importance in the design of magnetic structures and should be immediately available for all materials with which one intends to work. These curves may give either the values of

B as a function of H for the material, or the values of I as a function of H . A typical B - H curve is shown in Fig. 6.

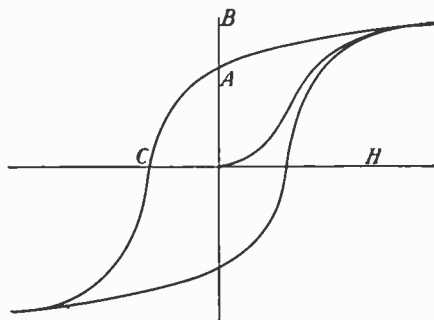

FIG. 6.—Typical B - H curve.

The ratio of the coordinates of a B - H curve gives the value of μ for the material at the particular value of H chosen. The ratio of the coordinates in an I - H curve similarly gives the value of the susceptibility K .

Magnetic saturation is a phenomenon occurring at large values of H when the induction B increases at a much lower rate with increase of H than is the case for small values of H .

The retentivity of a substance is the value of B in the material when the field H is reduced to zero after having

first been raised to above its saturation value. It is given by the point A of the B - H curve of Fig. 6.

The coercivity of a material is the minimum negative value of H required to just reduce the induction to zero after the field strength H has first been raised to a positive value sufficiently large to saturate the material. It is given by the point C of the B - H curve of Fig. 6.

27. Magnetic Properties of Iron and Steel.

Material	Coercivity	Retentivity	Maximum permeability	$4\pi I$ at saturation
Electrolytic iron.....	2.83	11,400	1,850	21,620
Annealed.....	0.36	10,800	14,400	21,630
Annealed electrical iron in sheets.....	1.30	9,400	3,270	20,500
Cast steel.....	1.51	10,600	3,550	21,420
Annealed.....	0.37	11,000	14,800	21,420
Steel hardened.....	52.4	7,500	110	18,000
Cast iron.....	11.4	5,100	240	16,400
Annealed.....	4.6	5,350	600	16,800
Tungsten magnet steel.....	64.0	9,600	105	13,600
Chrome magnet steel.....	64.0	9,000	94	12,600
Cobalt steel (15 per cent)....	192.0	8,000		

28. Electromagnetic Structures. In this type of structure the magnetic material is usually very soft; its coercivity is very low; and as a consequence the m.m.f. must be supplied by a continuous electric current. The m.m.f., M , due to an electric current, is given by the equation $M = 0.4\pi NI$, where I is the current in amperes, and N is the number of turns on the electromagnet.

By our most fundamental relation for magnetic circuits

$$\begin{aligned} M &= \phi R \\ 0.4\pi NI &= R\phi \\ NI &= \frac{R\phi}{0.4\pi} \end{aligned}$$

The design of a magnetic structure is usually begun by a consideration of the flux requirements in a particular air gap. The size and shape of the air gap are generally given, and the flux density desired in the air gap is known. From these data one can compute R and ϕ . For the quantity ϕ , $\phi = BA$, where A is the area of the air gap and B is the flux density desired. This equation assumes no leakage flux, and since this is a condition never realized in practice and from which there may be a far from negligible departure, one must add to the value of ϕ given by this equation a correction the value of which is dictated by experience. For the quantity R , $R = L/A$, where L is the length of the air gap and A is the area. This equation neglects the reluctance of the magnet itself and of all other iron parts of the magnetic circuit. Since all reluctances but that residing in the air gap are very small in comparison, this procedure is usually justified, although there are cases in which additional reluctance must be taken into account. In such cases the reluctance of the other parts of the circuit is computed in the same manner as that of the air gap, except that an estimate of the permeability of the part in the circuit in question must be made and its equivalent air-gap reluctance computed by dividing by this permeability. Finally,

$$NI = \frac{R\phi}{0.4\pi} = \frac{LBA}{0.4\pi A} = \frac{LB}{0.4\pi}$$

This equation then completely determines the value of the ampere-turns NI from the original data. This is the important quantity in the design of the electromagnet. The separate values of N and I are undetermined by this equation, other considerations such as the nature of the current supply, the size of the coil, the heat dissipation that can be permitted and the cost being of paramount importance.

29. Core Materials for Receiver Construction (The Editor). Since such materials operate under widely different conditions each material must be properly selected for its particular task. For example, materials used in economical audio transformers are too expensive to be used in power transformers.

Power Transformers. Material for cores of transformers supplying energy for plate and filament circuits is selected as for any power transformer upon a watt-loss basis. This information is reliably supplied by manufacturers of such material, and measurements of this factor are not generally made by the user of the material. Loss tests are made on complete transformers to determine the suitability of the material under consideration.

The mechanical properties of the sheets submitted by various suppliers are important. By causing injury to or premature loss of a die, poor mechanical properties may tie up a production schedule. Wavy irregular sheets necessitate scrapping wide strips from both sides of each sheet and introduce an unexpected cost.

Permeability of the core material is of importance where limited space or weight requirements make necessary the use of flux densities of 14,000 gauss or higher. Here a high permeability is indicated to avoid high exciting copper losses and poor voltage regulation.

Audio Transformers: Filter Reactors. Here the permeability is of importance. The factor to be used is the *working permeability* or *apparent*

a-c permeability instead of the theoretical value obtained from *B-H* or μ -*B* curves. This useful value must be obtained from the working inductance of some definite design of choke or transformer. Such values will take care of the fact that in audio transformers and chokes the core material is polarized by a relatively high unidirectional magnetizing force (plate current or load current through the filter).

The apparent *a-c* permeability may be determined from the following expression taken from the Allegheny Steel Company's book, "Magnetic Core Materials for Radio."

$$\mu a = \frac{La \times l \times 10^8}{1.256 \times AK_1N^2} = \frac{l \times 10^8}{1.256AN^2} \times \frac{La}{K_1}$$

where *La* = apparent inductance in henrys

A = cross-sectional area of core in square centimeters

*K*₁ = core stacking factor

N = number of turns in the winding

l = length of magnetic path in centimeters.

The quantity ($l \times 10^8 \div AN^2$) is a constant determined by the physical dimensions of the core and the number of turns in the coil. The quantity (La/K_1) indicates the way in which the stacking factor as affected by the punching characteristics enters into the determination of the permeability. Material which acts badly mechanically results in burrs in punching and gives a reduced number of pieces in a given design. This gives lower inductance but does not affect the permeability determination.

The value of the stacking factor for any design is given by dividing the product of the core volume (cubic centimeters) and the specific gravity of the core material into the actual measured weight of the core material in grams. Thus,

$$K_1 = \frac{W}{Vg}$$

where *W* = weight of core in grams; *V* = volume in cubic centimeters; *g* = specific gravity of the core material.

The value of *g* may vary as follows:

Silicon steel with silicon content 2 per cent or less..... 7.7

Silicon steel with silicon content more than 2 per cent.... 7.5

Allegheny electric metal..... 8.3

Manufacturers of transformer iron supply curves from which a designer may learn the incremental or apparent *a-c* permeability of the iron he proposes to use. From these curves the inductance of a core winding may be determined by using the above formula.

To determine the inductance of a winding on a core with an air gap use the following schedule:

$$\text{Total m.m.f.} = 1.256 \times I \times N = H_1l_1 + H_2l_2 = H_1l_1 + B_0l_2$$

where

I = current (d-c)

N = number of turns in the winding

*l*₁ and *l*₂ = the iron and air paths

*H*₁ and *H*₂ = magnetic potential gradients along these paths

*H*₂ = *B*₀ in air

This equation is that of a straight line intersecting the vertical axis of a *B-H* curve at a point corresponding to *H*₁ = 0 and *B*₀ = m.m.f./*l*₂ and intersecting the horizontal axis at a point corresponding to *B*₀ = 0 and *H*₁ = m.m.f./*l*₁. Thus the d-c flux density in the core and the magnetic

potential gradient in the iron part of the circuit and the a-c permeability ($\mu_{a-c} = BH$) may be determined. The a-c reluctance is the reciprocal of the a-c permeability. The *apparent reluctance* is equal (in cases where the air gap is 1 per cent or less of the iron path) to the a-c reluctance plus the ratio of the air gap to the length of the mean iron path. The reciprocal of this value of apparent reluctance is the apparent permeability which, substituted in the formula above, determines the inductance.

RADIATION

30. Nature of Radiation. Electromagnetic energy may arise from continuously varying electronic currents in a conductor, displacement currents, or oscillating dipoles. In order that this energy may be appreciable it is necessary that the system of conductors be of such a form that the electromagnetic field will not be confined in any way and that the frequency of oscillation of the current or charges be high. The various forms of antennas and the employment of radio frequencies satisfy these requirements.

The nature of radiation may be understood only after a complete examination of Maxwell's equations and the various transformations of the wave equation. Any attempt to give a simple yet accurate picture of the phenomenon of radiation must be fruitless, though such pictures may aid in an understanding of the subject. Such descriptions may be found in any text on radio. An exact analysis of Maxwell's equations shows that whenever an electric wave moves through space an associated magnetic wave having its vectors at right angles to that of the electric wave must accompany it. Both vectors, furthermore, are at right angles to the direction of propagation. This analysis also shows that an electromagnetic field due to an oscillating dipole or to an oscillating current in a conductor has two components. One of these varies inversely as the first power of the distance from the source and is, furthermore, directly proportional to the frequency, and the other varies inversely as the second power of the distance. The former is known as the *radiation field* and the latter as the *induction field*. Though indistinguishable physically, the induction and radiation fields have a separate mathematical existence accounting completely for the phenomenon of energy radiation. The energy of the induction field returns to the conductor with the completion of each cycle. Its existence is confined, as one might expect, to the neighborhood of the conductor, whereas the radiation field may be thought of as a detached field traveling outward into space with the velocity of light and varying much more slowly in intensity with distance from the conductor than the other.

31. Vertical Antenna. The most simple form of antenna is the vertical wire. The electromagnetic radiation field depends on the strength of the current in the wire, and as a consequence its intensity is increased if the current throughout the vertical wire is uniform. It is for this reason that a counterpoise is usually attached to the lower end of the antenna and a horizontal aerial to the upper end. The capacity of the counterpoise and aerial may be made so high that the current throughout the vertical portion of the wire is practically uniform.

Under these conditions the magnetic field at any distant point is given by the equation

$$H = -\frac{\omega h I_0}{10cl} \cos \omega \left(t - \frac{l}{c} \right) \text{ gauss}$$

where $\omega = 2\pi f$

f = frequency of oscillation

I_0 = maximum value of the current in the antenna

c = velocity of light in centimeters per second in vacuum

l = distance from the source in centimeters

h = height of antenna or length of vertical wire in centimeters

and

$$E = -\frac{300\omega h I_0}{10cl} \cos \omega \left(t - \frac{l}{c} \right) \text{ volts}$$

These equations¹ are derived by considering the antenna as an oscillating Hertzian doublet of separation h . The effective values of the magnetic and electric fields are

$$H_e = -\frac{\omega h I_e}{10cl} = -\frac{2\pi h I_e}{10\lambda}$$

$$E_e = -\frac{300\omega h I_e}{10cl} = -\frac{600\pi h I_e}{10\lambda}$$

where I_e is the effective value of the antenna current, and λ is the wave length of the electromagnetic wave.

32. Loop Antenna. The field due to a loop antenna is given by the equations

$$H_e = \frac{4\pi h I_e}{10\lambda} \sin \frac{\pi s}{\lambda}$$

$$E_e = \frac{1,200\pi h I_e}{10\lambda} \sin \frac{\pi s}{\lambda}$$

where s is the distance of separation of the vertical portions of the loop in centimeters.

33. Coil Antenna. For a coil of N turns having negligible capacity between turns at the frequency considered so that the current in all turns is substantially the same, the field is given by the equations

$$H_e = \frac{4\pi N h I_e}{10\lambda} \sin \frac{\pi s}{\lambda}$$

$$E_e = \frac{1,200\pi N h I_e}{10\lambda} \sin \frac{\pi s}{\lambda}$$

34. The fundamental and harmonic frequencies of oscillation in an antenna may be calculated in many cases. If the inductance and capacity of the vertical wire of the antenna are neglected, the low frequency capacity and inductance are given by the equations²

$$C = lC_i$$

$$L = \frac{l}{3}L_i$$

where C_i and L_i are the capacity and inductance per unit length of conductor, and l is the length of conductor. These equations may be calculated by means of accurate formulas which are available.³

Then the low-frequency reactance of the antenna is

$$X_i = \frac{\omega L_i}{3} - \frac{1}{\omega C_i}$$

¹ BERG, "Electrical Engineering," Advanced Course, pp. 278 *f.*; MORSE-CROFT, "Principles of Radio Communication," p. 706.

² Bur. Standards Circ. 74, pp. 72 *f.*

³ Bur. Standards Circ. 74, pp. 237-243.

The high-frequency reactance of the antenna is given by the equation

$$X_h = -\sqrt{\frac{L_i}{C_i}} \cot \omega l \sqrt{L_i C_i}$$

The reactance of the antenna becomes zero when

$$\omega l \sqrt{C_i L_i} = n \frac{\pi}{2} (n = 1, 3, 5 \dots)$$

that is, when

$$f = \frac{\omega}{2\pi} = \frac{n}{4l \sqrt{C_i L_i}}$$

The reactance becomes infinite when

$$\omega l \sqrt{C_i L_i} = m \frac{\pi}{2} (m = 0, 2, 4 \dots)$$

that is, when

$$f = \frac{\omega}{2\pi} = \frac{m}{4l \sqrt{C_i L_i}}$$

If the inductance of the vertical wire is to be considered, or if a series inductance is used with the antenna

$$X = \omega L_s - \sqrt{\frac{L_i}{C_i}} \cot \omega l \sqrt{C_i L_i}$$

where L_s is the total inductance of the vertical wire and any coils in series with the antenna.

The harmonic frequencies of the antenna at which the reactance is zero do not differ by multiples of π as before. The natural frequency of oscillation is given, however, quite generally by the equation

$$\omega L_s - \sqrt{\frac{L_i}{C_i}} \cot \omega l \sqrt{C_i L_i} = 0$$

$$\frac{\cot \omega l \sqrt{C_i L_i}}{\omega \sqrt{C_i L_i}} = \frac{L_s}{L_i}$$

35. Antenna Resistance. The resistance of an antenna may be divided into three parts in which the power dissipation is of the following kinds:

1. Radiation.
2. Joule heat.
3. Dielectric absorption.

The power radiated depends on the form of the antenna. It is proportional to the square of the frequency of oscillation and to the square of the current flowing in the antenna. Due to the latter consideration one may write $P = AI^2$, where A is a constant factor depending on the form of the antenna and the frequency. It may be called the radiation resistance. For a given antenna the radiation resistance varies inversely as the square of the wave length. The ohmic resistance to which the joule heat is due is approximately constant, the skin effect and other factors being comparatively small. The resistance due to dielectric absorption is directly proportional to the wave length. When these three components of resistance are added to obtain the total resistance, one finds that for every antenna there is a wave length for which the total resistance is a minimum.

36. Energy in the Field. The energy of an electromagnetic field at any point is given by the equation¹

$$U = \frac{1}{8\pi}(\epsilon E^2 + \mu H^2)$$

where E is in electrostatic units instead of volts as in the previous equations, ϵ is the dielectric constant, and μ the permeability of the medium. In free space

$$U = \frac{1}{8\pi}(E^2 + H^2)$$

But, in general,

$$H = \sqrt{\frac{\epsilon}{\mu}}E$$

$$\begin{aligned} U &= \frac{\epsilon}{4\pi}E^2 = \frac{\mu}{4\pi}H^2 \\ &= \frac{E^2}{4\pi} = \frac{H^2}{4\pi} \text{ in free space.} \end{aligned}$$

The energy flux through 1 sq cm of surface, perpendicular to the direction of propagation, is given by the equation

$$\begin{aligned} S &= vU = \frac{c}{\sqrt{\epsilon\mu}}U = \frac{c}{4\pi} \sqrt{\frac{\epsilon}{\mu}}E_s^2 = \frac{c}{4\pi} \sqrt{\frac{\mu}{\epsilon}}H_s^2 \\ &= \frac{c}{4\pi}E_s^2 = \frac{c}{4\pi}H_s^2 \\ &= \frac{c}{8\pi}E_m^2 = \frac{c}{8\pi}H_m^2 \end{aligned} \left. \vphantom{\begin{aligned} S &= vU \\ &= \frac{c}{4\pi}E_s^2 \\ &= \frac{c}{8\pi}E_m^2 \end{aligned}} \right\} \text{ in free space.}$$

where E_s and H_s represent effective values, and E_m and H_m the maximum values of the electric and magnetic fields respectively. Therefore, for the effective values of the electric and magnetic fields due to a vertical wire antenna,

$$E_s = -\frac{2\pi h I_s}{10\lambda l} \text{ c.s.u.}$$

$$H_s = -\frac{2\pi h I_s}{10\lambda l}$$

$$S = \frac{c}{4\pi} \left(\frac{2\pi h I_s}{10\lambda l} \right)^2 = \frac{c\pi h^2 I_s^2}{10^2 \lambda^2 l^2}$$

Then the total radiation from a vertical antenna, assuming that H has its maximum value in the equatorial plane of the antenna and that its variation in a vertical plane at a distance l from the antenna follows a sine law, is given by the expression

$$2\pi l^2 \left(\frac{c\pi h^2 I_s^2}{10^2 \lambda^2 l^2} \right) \text{ ergs per second}$$

or

$$\frac{60\pi^2 h^2 I_s^2}{\lambda^2} \text{ watts}$$

¹ JEANS, J. H., "Mathematical Theory of Electricity and Magnetism," p. 518.

SECTION 3

RESISTANCE

BY JESSE MARSTEN, B.S.¹

1. General Concepts. In any electrical conductor or system in which there is a flow of current there is a certain amount of energy continually being lost or converted into forms not readily available for use. As far as is known at present this dissipation of energy may take one of two forms: there may be an evolution of heat, and there may be radiation of energy into space. Such energy dissipation is attributed to a property of electric conductors or systems termed *resistance*.

When dealing with continuous currents, the resistance of a conductor or network, R , is adequately defined by *Ohm's law*,

$$E = iR \quad (1)$$

where E is the voltage drop across the conductor or network and i is the current through it. This assumes no back e.m.f. due to polarization or other causes. In this case the dissipation of energy takes place entirely in the form of heat generation, and the rate at which electrical energy is thus converted into heat is given by *Joule's law*,

$$P = i^2R \quad (2)$$

where P is the power or rate at which electrical energy is being dissipated in the form of heat, i is the continuous current in the circuit, and R the resistance of the circuit.

Ohm's law is insufficient to define resistance in a-c circuits. It is found experimentally that the rate at which heat is evolved in a circuit exceeds that which would be necessitated by the resistance of the circuit as determined by Ohm's law. This is due to the fact that the electromagnetic and electrostatic fields around the circuit vary with time and introduce effects which increase the losses in the circuit. Among these effects may be enumerated the following major ones:

1. *Eddy-current losses* in conductors and other masses of metals in and near the circuit.
2. *Hysteresis losses* in magnetic materials.
3. *Dielectric losses* in the insulating mediums.
4. *Absorption of energy* by neighboring conductors or circuits by induction.
5. *Radiation of electromagnetic energy* into space.
6. *Skin Effect*. Increase of conductor resistance due to non-uniform current density.

¹ Member, Institute of Radio Engineers; associate member, American Institute of Electrical Engineers, chief engineer, International Resistance Company.

All these effects result in an increase in energy loss in the circuit over and above that given by Ohm's law. It therefore becomes necessary to introduce the concept of *a-c resistance* or *effective resistance*, which is defined by the more general joulean relationship,

$$P = i^2 R \text{ effective} \quad (3)$$

where P is the power loss in the circuit due to all causes and i is the effective current in the circuit. Ohm's law for continuous currents follows directly from this more general definition.

2. Units of Resistance. The practical unit of resistance is the *ohm* and is defined by Ohm's law when the voltage and current are unity in the practical system. It has, however, been arbitrarily defined as the resistance at 0°C. of a column of mercury having a uniform cross section, a height of 106.3 cm, and weighing 14.4521 g. Owing to the increasing use of resistors having resistances of the order of millions of ohms, the *megohm* unit is also employed. The megohm is equal to 10^6 ohms.

3. Specific Resistance. It is found experimentally that the resistance of an electric conductor is directly proportional to its length and inversely to its cross section:

$$R = \rho \frac{l}{A} \quad (4)$$

The proportionality factor ρ is called the *specific resistance* of the conductor and is a function of the material of the conductor.

From this definition of specific resistance it is apparent that any number of units may be derived for specific resistance, depending upon the units chosen for l and A . The unit generally employed in practical engineering is the *ohms per circular mil foot*, and is the resistance of a 1 ft. length of the conductor having a section of 1 cir. mil (diameter 1 mil for a circular conductor).

4. Volume Resistivity. If, in the above definition, l and A are both unity, in the same system of units, then ρ is the resistance of a unit cube of the material and may be defined as the *volume resistivity* of the material. It should be noted that volume resistivity is not the resistance of any unit volume of the material but is specifically the resistance of unit volume measured across faces whose areas are each unity.

With a knowledge of the dimensions of a conductor and its specific resistance the resistance of the conductor to d.c. may be computed from Eq. (4). Consistent units must be employed. The resistance thus computed will be correct at the temperature for which the specific resistance applies. To obtain the resistance of the conductor at any other temperature a correction will have to be applied.

5. Temperature Coefficient. The resistance of a conductor is a function not only of the material and dimensions of the conductor but also of its temperature. Within the temperature limits generally encountered in practice the change in resistance due to temperature variation is directly proportional to the change in temperature:

$$R_{t_2} = R_{t_1}[1 + \alpha(t_2 - t_1)] \quad (5)$$

R_{t_1} and R_{t_2} are the conductor resistances at temperature t_1 and t_2 respectively.

The proportionality factor α is defined as the *temperature coefficient of resistance* of the material and is the change in resistance of any material per ohm per degree rise in temperature.

All conductors do not react alike to changes in temperature. Metals, for example, have a positive temperature coefficient. Some alloys, such as manganin and constantan, have practically zero temperature coefficient and are therefore used primarily for resistance standards.

A knowledge of the temperature coefficient of conductor materials enables one at times to make more accurate determinations of temperature change than is possible by thermometer measurements, especially in cases where parts to be measured are not readily accessible. Resistance determinations of the conductor are made at both temperatures and the temperature change computed from Eq. (5).

6. Properties of Materials as Conductors.

Material	Specific resistance at 0°C., ohms per cir. mil ft.	Temperature coefficient per °C. between 20° to 100°C., ohms per °C.
Silver.....	9.75	0.004
Copper.....	10.55	0.004
Aluminum.....	17.3	0.0039
Nickel (pure).....	58.0	0.0041
Iron (pure).....	61.1	0.0062
Phosphor bronze.....	70.0	0.004
Lead.....	114.7	0.0041
Nickel silver, 18 per cent (German silver).....	180 to 190	0.00027
Manganin (copper, 82 per cent; manganese, 14 per cent; nickel, 4 per cent).....	290	0.00002
Constantan (Advance, Cupron, Ideal, Ia-Ia) (copper, 55 per cent; nickel, 45 per cent).....	294	0.00002
Nichrome (nickel, 60 per cent; chromium, 15 per cent; iron, balance).....	650 to 675	0.0001 to 0.00017

7. Resistors in Series and Parallel. Simple and complex networks of resistors may be represented by an equivalent resistor which may be expressed in terms of the individual resistances making up the network.

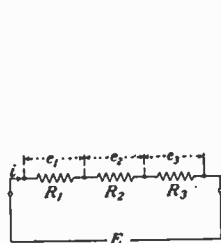

FIG. 1.—Simple series circuit.

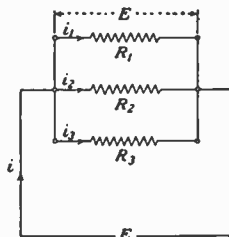

FIG. 2.—Parallel circuit.

The equivalent resistance of a number of resistors connected in series is equal to the sum of the individual resistances. Referring to Fig. 1:

$$E = iR_{\text{equiv.}} = e_1 + e_2 + \dots + e_n = R_1i + R_2i + \dots + R_ni = i(R_1 + R_2 + \dots + R_n)$$

$$\frac{E}{i} = R_{\text{equiv.}} = (R_1 + R_2 + \dots + R_n)$$

$$R_{\text{equiv.}} = \sum_1^n R$$

The reciprocal of the equivalent resistance of a number of resistors connected in parallel is equal to the sum of the reciprocals of the individual resistances. Referring to Fig. 2:

$$i = i_1 + i_2 + \dots + i_n = \frac{E}{R_1} + \frac{E}{R_2} + \dots + \frac{E}{R_n}$$

$$\frac{i}{E} = \frac{1}{R_{\text{equiv.}}} = \frac{1}{R_1} + \frac{1}{R_2} + \dots + \frac{1}{R_n}$$

$$\frac{1}{R_{\text{equiv.}}} = \sum_1^n \frac{1}{R}$$

RESISTANCE AS FUNCTION OF FREQUENCY

8. Skin Effect. It may be shown that the resistance of a conductor is a minimum when the current density is uniformly distributed over the cross section of the conductor. This condition obtains for d.c. The resistance increases for non-uniform distribution of current density over the cross section of the conductor. This latter condition obtains in conductors carrying a.c. This is a result of the distribution of magnetic flux lines, outside and inside the conductor. If the conductor is assumed to be made up of a number of conducting elements in parallel, then the interior elements, being surrounded by more flux lines than the exterior, will have greater reactance and, therefore, the current in the interior elements will be less than that in the exterior elements. As a result the current crowds toward the surface of the conductor, giving a non-uniform current density. This imperfect penetration of current in a conductor, resulting in an increase in resistance, is termed *skin effect*.

Skin effect in a conductor is a function of the following factors:

$$t \sqrt{\frac{\mu f}{\rho}} \quad (6)$$

where t = thickness of the conductor

f = frequency of current

μ = permeability of the conductor

ρ = specific resistance of the conductor in microhm-centimeters.

It is possible to compute accurately the h-f resistance of simple round cylindrical conductors from involved functions of the above factor. To facilitate these computations tables have been prepared from which the ratio of h-f resistance R_f to d-c resistance R_0 may be quickly determined. From this factor and the easily measured d-c resistance the h-f resistance may be computed.

The table below gives the values of R_f/R_0 for different values of the factor

$$x = \pi d \sqrt{\frac{2\mu f}{\rho}}$$

where d is the diameter of the wire in centimeters, ρ is the volume resistivity in microhm-centimeters (1.724 at 10°C. for copper), x may be computed for any particular case, and R_0 may be measured at d.c. or computed.

9. Ratio of H-f Resistance to the D-c Resistance for Different Values of $x = \pi d \sqrt{2\mu f/\rho}$.

x	R_f/R_0	x	R_f/R_0	x	R_f/R_0
0	1.0000	5.2	2.114	14.0	5.209
0.5	1.0003	5.4	2.184	14.5	5.386
0.6	1.0007	5.6	2.254	15.0	5.562
0.7	1.0012	5.8	2.324		
0.8	1.0021	6.0	2.394	16.0	5.915
0.9	1.0034	6.2	2.463	17.0	6.268
				18.0	6.621
1.0	1.005	6.4	2.533	19.0	6.974
1.1	1.008	6.6	2.603	20.0	7.328
1.2	1.011	6.8	2.673		
1.3	1.015	7.0	2.743	21.0	7.681
1.4	1.020	7.2	2.813	22.0	8.034
1.5	1.026	7.4	2.884	23.0	8.387
				24.0	8.741
1.6	1.033	7.6	2.954	25.0	9.094
1.7	1.042	7.8	3.024		
1.8	1.052	8.0	3.094	26.0	9.447
1.9	1.064	8.2	3.165	28.0	10.15
2.0	1.078	8.4	3.235	30.0	10.86
				32.0	11.57
2.2	1.111	8.6	3.306	34.0	12.27
2.4	1.152	8.8	3.376		
2.6	1.201	9.0	3.446	36.0	12.98
2.8	1.256	9.2	3.517	38.0	13.69
3.0	1.318	9.4	3.587	40.0	14.40
				42.0	15.10
3.2	1.385	9.6	3.658	44.0	15.81
3.4	1.456	9.8	3.728		
3.6	1.529	10.0	3.799	46.0	16.52
3.8	1.603	10.5	3.975	48.0	17.22
4.0	1.678	11.0	4.151	50.0	17.93
				60.0	21.47
4.2	1.752	11.5	4.327	70.0	25.00
4.4	1.826	12.0	4.504		
4.6	1.899	12.5	4.680	80.0	28.54
4.8	1.971	13.0	4.856	90.0	32.07
5.0	2.043	13.5	5.033	100.0	35.61

It is frequently useful to know the largest diameter of wire of different materials which will give a ratio of R_f/R_0 of 1.01 for different frequencies. For a ratio of R_f/R_0 equal to 1.001, the diameters given below should be multiplied by 0.55; and for R_f/R_0 equal to 1.1, the diameters should be multiplied by 1.78.

10. Maximum Diameter of Wires for H-f Resistance Ratio of 1.01.

Material	Diameter, centimeters										
	100 3,000	400 750	1,000 300	1,600 187.5	2,000 150	3,000 100	6 Mc 50	10 Mc 30	20 Mc 10	60 Mc 5	300 Mc 1
Copper.....	0.0358	0.0177	0.0112	0.0089	0.0079	0.0065	0.00457	0.00355	0.00251	0.00145	0.00065
Silver.....	0.0345	0.0172	0.0109	0.0086	0.0077	0.0063	0.00445	0.00346	0.00267	0.00141	0.00063
Gold.....	0.0420	0.0210	0.0133	0.0105	0.0094	0.0077	0.00543	0.00422	0.00298	0.00172	0.00077
Platinum.....	0.1120	0.0560	0.0354	0.0280	0.0250	0.0205	0.01445	0.0112	0.00783	0.00456	0.00205
Mercury.....	0.264	0.132	0.0836	0.0661	0.0591	0.0483	0.03416	0.0265	0.0187	0.0108	0.00485
Manganin.....	0.1784	0.0892	0.0584	0.0446	0.0399	0.0325	0.02300	0.0179	0.0126	0.0073	0.00326
Constantan.....	0.1862	0.0946	0.0598	0.0473	0.0423	0.0345	0.02400	0.019	0.0134	0.00775	0.00346
German silver.....	0.1942	0.0970	0.0614	0.0485	0.0434	0.0354	0.02500	0.0195	0.0138	0.00784	0.00354
Graphite.....	0.765	0.383	0.242	0.191	0.171	0.140	0.0988	0.0767	0.0542	0.0312	0.0140
Carbon.....	1.60	0.801	0.506	0.400	0.358	0.292	0.2065	0.16	0.1135	0.0655	0.0292
Iron $\mu = 1,000$ $\mu = 500$ $\mu = 100$	0.00263 0.00373 0.00838	0.00131 0.00187 0.00418	0.00083 0.00118 0.00264	0.00066 0.00093 0.00209	0.00059 0.00084 0.00186	0.00048 0.00068 0.00132	0.000339 0.00049 0.001075	0.000263 0.000374 0.000836	0.000186 0.000284 0.000591	0.000107 0.000152 0.000341	0.000048 0.000068 0.000153

11. Reduction of Skin Effect. In view of the tendency of the current to crowd to the surface of the conductor at high frequencies, the remedies which have been found practical in effecting an improvement in the resistance ratio R_f/R_0 have been those in which the conductor has been designed so that it presents a skin to the current flow. These are:

1. *Use of Flat Copper Strip.* While skin effect is present, for the same cross-sectional area a flat strip gives a lower resistance ratio than do round conductors.

2. *Use of Tubular Conductors.* Here the external magnetic field is much greater than the internal field, and therefore all parts of the conductor are affected alike by the field, thus reducing the skin effect.

3. *Use of Litzendraht.* According to Eq. (6) the smaller the diameter of the wire the less the skin effect. Litzendraht is a braided cable made up of a large number of fine strands of wire. When certain precautions are taken this braid shows a very much lower resistance ratio than does a solid copper wire of equal section. These precautions are:

a. Each strand must be thoroughly insulated from every other strand to avoid contact resistance.

b. Braiding must be such that each strand passes from the center to the outside of the conductor at regular intervals—a sort of transposition. This insures that all strands are affected alike by the magnetic flux.

c. Each strand must be continuous.

12. Types of Resistors. Resistors generally used in radio and allied applications may be broadly classified as:

1. Fixed resistors.
2. Variable resistors.

Each of these groups may be further classified on the basis of the nature of the conducting material of the resistor, as:

1. Wire wound.
2. Composition (employing carbon).

13. Fixed Wire-wound Resistors. As commonly employed, these are wound on strips of fiber or bakelite, and on ceramic forms. The former are used where the power-dissipation requirements are generally negligible, for example, as center-tapped resistors across vacuum-tube filaments for hum balancing. Resistors wound on ceramic forms are generally used where the power requirements exceed 2 or 3 watts. Such resistors are made with a protective coat of enamel or cement baked over the winding, thus affording a measure of protection against mechanical injury and penetration of moisture. The characteristics of the wire-wound resistor are those of the particular wire employed and generally show a negligible or slight temperature coefficient and no voltage coefficient, that is, the resistance is independent of the applied voltage.

14. Protective Coatings for Wire-wound Resistors. Coatings on wire are employed to protect the windings from mechanical injury, to prevent electrolytic effects and consequent corrosion due to penetration of moisture, and to provide an insulating covering for the winding. Coatings most widely used in practice are:

- A. Vitreous enamel coatings.
- B. Cement coatings employing inorganic binders.
- C. Cement coatings employing asphaltic binders.

Coatings in the first two classifications are capable of withstanding temperatures in excess of 250°C. without deterioration. They afford a high measure of protection against humidity. Exceptions to the latter statement are coatings employing sodium silicate (water glass) binders which are highly hygroscopic and, therefore, unsuitable where resistance to humidity is an important factor.

Coatings in the last classification are capable of withstanding temperatures up to about 175°C., this varying with the nature of the binder. Resinous binders stand lower temperatures than asphaltic binders. They are, however, superior to the higher temperature coatings in their moisture-resistant properties.

15. Rating Wire-wound Resistors. In view of the low temperature coefficient of the resistance wires generally employed in radio wire-wound resistors, the resistance change with loads normally encountered is small. The rating is, therefore, primarily determined by the power the resistor can dissipate continuously for an unlimited time without excessive temperature rise or deterioration of the resistor. Some manufacturers rate resistors on the basis of the power that will produce a temperature rise of 250°C. in an ambient temperature of 40°C., when the resistor is mounted in free air. Such perfect ventilation conditions are seldom encountered. As a result, it is generally recommended that such resistors be used at one-fourth to one-half the nominal rating, which results in a temperature rise of 100°C. to 150°C. In practice even these temperature rises may be excessive owing to such factors as poor ventilation, proximity of resistors to parts which may not be subjected to elevated temperatures, and Fire Underwriter's approval. The specific application therefore limits the practical use of a resistor rather than any nominal rating.

16. Factors Influencing Rating of Wire-wound Resistors.

A. Heat-resistant properties of protective coating.

B. Heat-resistant properties of winding core. (Ceramic cores are most widely used, which withstand very high temperatures.)

C. Use of intermediate taps. Taps reduce effective winding space, resulting in less active cooling surface, reducing the nominal rating. The extent of reduction depends upon length of the resistor, being smaller for long units than for short ones. On short units 2 in. long, the rating may be reduced by as much as 15 to 20 per cent, whereas on long units 6 in. long the reductions may be 3 to 5 per cent.

17. Flat Iron-clad Resistors. Flat resistors have attained a wide vogue in radio-receiver design because of definite advantages. Such resistors are wound on a flat bakelite strip. The winding is covered with a sheet of thin fiber, and the entire assembly is enclosed in a sheet steel punching with mounting holes. The design permits the resistor to be mounted flat on a steel chassis which helps conduct the heat away from the resistor, permitting somewhat higher ratings than would otherwise be permissible. The bakelite form and fiber insulation limit the rating to about 1 watt per square inch as against a nominal rating of 2 to 6 watts per square inch for the cement and vitreous-enamel types.

18. Temperature Rise of Wire-wound Resistors. Figure 3 shows the temperature rise to be expected at various loadings of wire-wound resistors wound on ceramic forms, with vitreous-enamel and cement coverings. The 100 per cent rating is based on manufacturers' rating

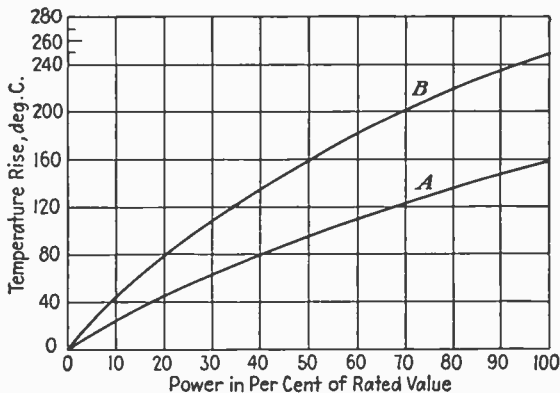

FIG. 3.—Temperature rise of wire-wound resistors. A, vitreous enamel; B, cement covering.

of 250°C. rise in open air for class A and B coatings (Paragraph 14) and 160°C. rise in open air for class C coating. Temperature is measured at the center of the outer surface of the resistor.

19. Variable Wire-wound Resistors. These are usually of the continuously variable type, made by winding resistance wire on a flat strip of fiber, bakelite, or other insulating material. This strip may be formed into an arc and placed in a protecting container. A metallic

sliding arm is arranged to travel over the winding, thus making contact with each turn as it is rotated. The choice of wire and size is determined by the range and space requirements.

In general, wire-wound continuously variable resistors are wound so that the resistance changes uniformly with the motion of the sliding contact. For certain uses, as, for example, antenna-type volume controls, it is desirable that the resistance change be non-uniform. In this case the form on which the wire is wound is sometimes tapered so that the resistance per degree rotation is not constant. Other methods of tapering employed are winding with variable pitch, winding sections of the control with different sizes of wire, and copper plating start and finish of the winding.

Some of the factors to be considered in design are:

1. Contact between slider and resistor element should be positive.
2. Winding should not become loose on the form.
3. Sliding contact should not wear away resistance wire.
4. Resistance change per turn should be as small as possible.
5. Slider material should be such that it will not oxidize.

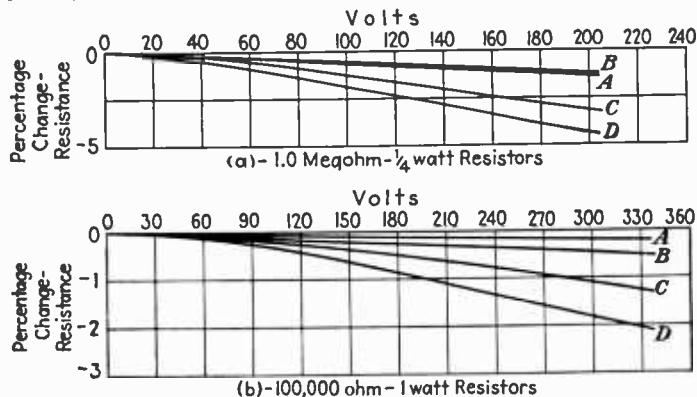

FIG. 4.—Voltage characteristic of various resistors. Curves A are metallized-filament type; others are carbon type.

20. Composition-type (Radio) Resistors. The term *composition-type* resistor is employed to cover that group of resistors in which a conductor is mixed with binder in definite proportions and suitably treated to produce a resistor material. This type of resistor has attained a wide popularity because of the following advantages: (1) Flexibility in range—it may be made in any value up to several megohms; (2) compactness—its physical dimensions are small for any range; they may be made in sizes down to $\frac{3}{16}$ by $\frac{1}{2}$ in. or smaller.

Numerous types of these resistors have been produced, but they take two general forms:

1. *Solid-body Resistor.* In this type the resistor material is extruded, pressed or molded into its final physical form, which generally is a solid rod,

after which it may be subjected to some form of heat treatment. The so-called *carbon resistors* are examples of this type.

2. *Filament-coated Resistors.* In this type a conducting coat or film is baked on the surface of a continuous glass filament or other form. In the case of the glass filament this is completely enclosed in an insulating tube. The so-called *metallized-filament resistors* are examples of this type.

21. **Characteristics of Composition-type Resistors.** Composition-type (commercially known as *radio*) resistors possess properties differing very markedly from those of metallic resistors. The most important ones are as follows, and are possessed by all these types in varying degree:

a. *Voltage Characteristics.* The resistance is not independent of the applied voltage and generally falls with increasing voltage. Typical curves showing the manner in which the resistance varies with voltage (heating effect due to load not present or corrected for) are shown in Fig. 4.

The percentage change of resistance at a given voltage measurement referred to its resistance at some low voltage such as $1\frac{1}{2}$ volts has arbitrarily

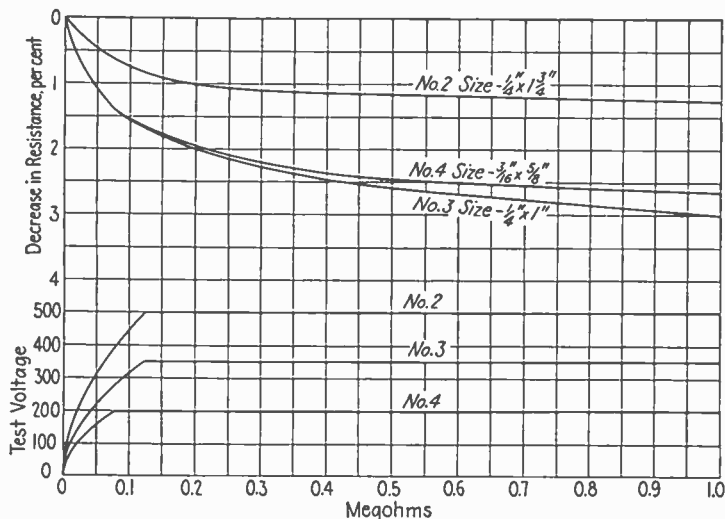

FIG. 5.—Voltage coefficient of carbon resistors.

been called the *voltage coefficient*. This coefficient increases as the physical size of the resistor decreases and increases with the resistance value. It is also a function of the ingredients or mix employed in the resistor. Figure 5 shows for a given type of carbon resistor the relationship between voltage coefficient and size and value of the resistor. The test voltage at which each measurement was made is indicated for each value of resistance.

b. *Radio-frequency Characteristics.* Unlike wire-wound resistors, composition-type resistors decrease in value with increasing frequency. This effect is very marked in the high-valued resistors such as 1 megohm but is absent, or very small, in the low values such as 100,000 ohms and under. The effect decreases with the diameter of the active resistor element. Skin

effect is not the factor which determines this characteristic. Two factors play a prominent part here. First, the shunting effect of the individual

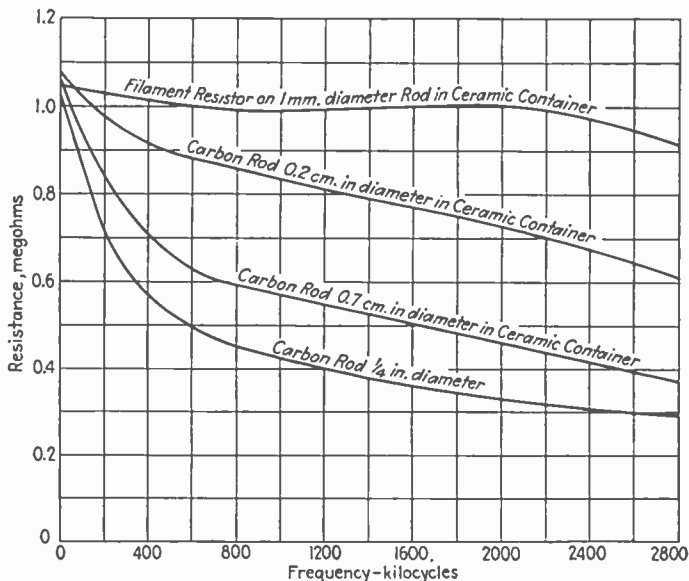

FIG. 6a.—Resistance-frequency characteristics of various types of 1 megohm resistors up to 3 megacycles (University of Wisconsin CWA project E-16-5).

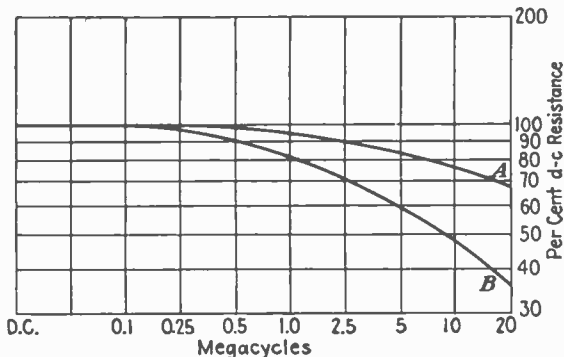

FIG. 6b.—Characteristic for filament-type resistor, carried to 20 megacycles, in two different insulating housings.

capacities between conducting masses in the resistor element tends to reduce the effective resistance. Second, the dielectric in binder and fillers of these

resistors and their housings introduces losses with increasing frequency which likewise act to reduce the resistance.

c. Humidity Characteristics. The effect of humidity in general is to cause a rise of resistance. This effect may sometimes be reduced by suitable treatment.

d. Noise. These types of resistors all show, in varying degree, the presence of microphonic noise. The degree of noise is a function of the load, size of the

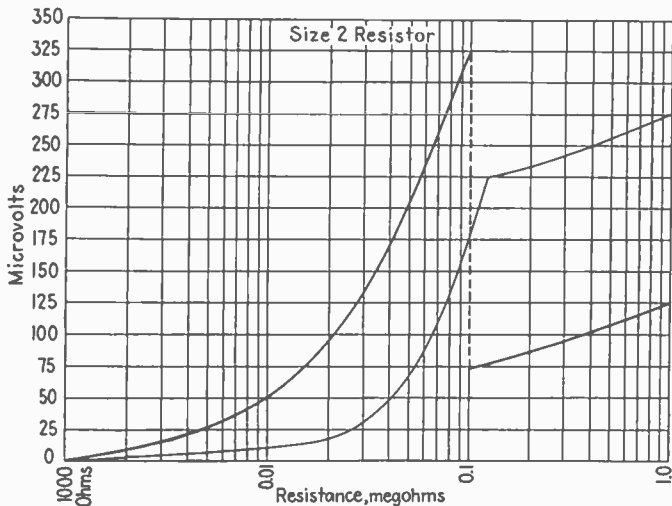

Fig. 7a.—Noise characteristics of carbon resistor.

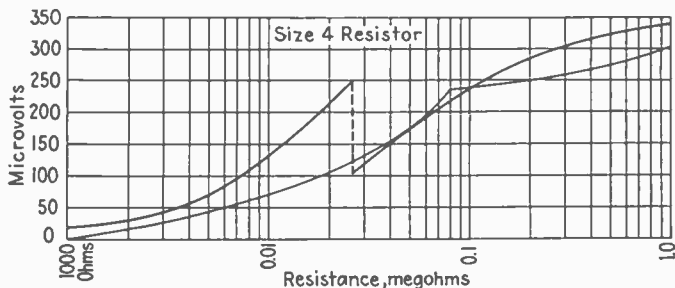

Fig. 7b.—Noise characteristics of smaller sized unit than in Fig. 7a.

resistor, and the nature of the materials used in the resistor. In general, for a given set of materials in the resistor, the noise level increases with increasing resistance and decreasing size of the resistor. Figures 7a and b show typical noise-level curves for two makes of resistors. The change in each curve or the point of discontinuity shows where a change of mix or materials was

made. The curves also show the increase in noise for a given value as the resistor size decreases. Noise measurements were made in accordance with the method described in paragraph 25.

22. Rating Composition-type Resistors. The rating of composition-type resistors is a more complicated matter. The temperature coefficient of this type of resistor being larger, it is possible for a resistance change to become quite appreciable, before a temperature limitation is exceeded. Furthermore, with the higher ranges, such as 0.25 megohm and over, in which the power dissipation may be very low, the voltage characteristics may be a determining factor instead of the load-carrying characteristics. It is therefore customary to rate this type of unit on the basis of the maximum load it can carry, or the maximum voltage which can be applied to it, without exceeding prescribed resistance changes.

The prescribed changes generally accepted are 5 per cent for intermittent rated-load operation, and 10 per cent for 50 per cent overload operation. Designs are such that power dissipations of the order of 0.5 to 1 watt per square inch of radiating surface are employed. Generally accepted standard ratings and sizes are here given.

Rating	Diameter of resistor, inches	Over-all length of resistor, inches
$\frac{1}{10}$	$\frac{3}{8}$	$\frac{3}{8}$
$\frac{1}{4}$	$\frac{3}{8}$ to $\frac{3}{16}$	$1\frac{1}{16}$
$\frac{1}{2}$	$\frac{3}{16}$ to $\frac{3}{4}$	1
1	$\frac{1}{4}$	$1\frac{3}{4}$
2	$\frac{3}{16}$	2

There is a tendency toward increasing the rating of the smaller sizes of resistors. This is because of the finding that the temperature rise of the very short resistors is appreciably lower for a given power dissipation than would be expected from its reduced cooling surface. This is because the metal end terminals, which, because of shortness of unit, cover a substantial portion of the entire resistor and are very close to the center hot section, act to cool the resistor by conducting the heat away. The above $\frac{1}{4}$ -watt size and even $\frac{1}{10}$ -watt sizes are, therefore, being recommended for use at $\frac{1}{2}$ watt.

23. Composition of Resistors. Radio resistors of the carbon and filament types generally employ a conducting material of high specific resistance mixed with a filler and binder. The most widely used conducting material is some form of carbon or graphite. The fillers or binders employed vary with the type of resistor. Examples of these are clay, rubber, and bakelite. The filler and conductor are mixed in various proportions to obtain resistors with different ranges. The method of making the resistor varies also with its type. The solid-body types are generally either molded or extruded. The filament resistor is made by baking the resistance material on a glass rod which is sealed in a ceramic or bakelite container.

24. R.M.A. Color Code. The use of resistors has increased to such an extent and so many are employed in a radio set that it has become desirable to identify each resistor for range in a quick and simple manner.

Such identification simplifies assembly of these units in radio sets and helps in servicing. A color code has therefore been adopted by the Radio Manufacturers' Association as follows:

Ten colors shall be assigned to the figures as shown in the table below in which cable designations indicate the color shades as shown on the Standard Color Card of America, 8th ed., 1928, issued by the Textile Color Card Association of the United States.

Figure	Color	Color to be equivalent to
0	Black	
1	Brown	Cable 60113
2	Red	Cable 60149
3	Orange	Cable 60041
4	Yellow	Cable 60187
5	Green	Cable 60105
6	Blue	Cable 60102
7	Violet	Cable 60010
8	Gray	Cable 60034
9	White	

The body *A* of the resistor shall be colored to represent the first figure of the resistance value. One end *B* of the resistor shall be colored to represent the second figure. A band, or dot, *C*, of color, representing the number of ciphers following the first two figures, shall be located within the body



FIG. 8.—Standard resistor of R.M.A.

color. Two diagrams (Fig. 8) illustrate two interpretations of this standard, both of which are deemed to be in accordance with the standard.

Examples illustrating the standard are as follows:

Ohms	A	B	C
10	Brown 1	Black 0	Black, no ciphers
200	Red 2	Black 0	Brown, one cipher
3,000	Orange 3	Black 0	Red, two ciphers
3,400	Orange 3	Yellow 4	Red, two ciphers
40,000	Yellow 4	Black 0	Orange, three ciphers
44,000	Yellow 4	Yellow 4	Orange, three ciphers
43,000	Yellow 4	Orange 3	Orange, three ciphers

25. Test Specifications. Over the last few years, a series of tests have been developed which are designed to establish the performance merit of composition resistors. These tests have been tentatively recommended by the Radio Manufacturers' Association and have gradually been adopted by the leading manufacturers as the basis of specifications for composition resistors. These tests are:

Resistance Measurements. Unless otherwise specified it shall be standard to measure the resistance under the same voltage drop as normally exists across the resistor in the application for which it is intended.

The readings are to be made as quickly as possible at 20°C., preferably with a limit bridge-circuit arrangement so that the resistors do not have an opportunity of undergoing an appreciable temperature rise due to the current passing through them under the conditions of the test.

Normal-load Life Test. It shall be standard to make normal-load life tests by placing the resistors on load intermittently 1½ hr. on and ½ hr. off at an ambient temperature of 40°C., for 1,000 cycles or 2,000 hr. at the voltage representing the rating of the resistor as specified by the resistor manufacturer. Any readings taken should be made by uniform method at the end of a half hour off period. The results of this test shall be plotted, showing the per cent permanent change in resistance *vs.* time in hours.

Either direct or alternating voltage may be used in the foregoing tests depending on how the resistors are intended to be used.

It shall be standard for the resistor manufacturer to state the rated potential in direct voltage with a supplementary rating on alternating voltage when requested.

Load Characteristics. It shall be standard to plot these characteristics, showing the per cent change in resistance values *vs.* loads in watts, making readings at 10 per cent intervals up to 100 per cent overload value or up to the maximum rated voltage as specified by the resistor manufacturer, conducting the tests at an ambient temperature of 40°C., and allowing a minimum of 15 min. at constant load immediately preceding each reading, so that the resistor comes up to equilibrium temperature conditions after each change in load. The resistors are to be exposed 1 hr. at 40°C., before starting the test. Each reading is to be made under steady-state hot conditions at the voltage drop existing for the particular wattage setting.

Voltage Characteristics. It shall be standard to plot voltage-characteristic curves, making readings with uniform voltage increments up to a maximum voltage representing 100 per cent overload in watts on the resistor or up to the maximum voltage rating of the resistor. The resistors are to be at 40°C., for 1 hr. before starting the test, and readings are to be made as quickly as possible so that the resistors do not have an opportunity to heat under the conditions of the test. The resistors are to be connected in the circuit only during a period of time sufficient for making resistance determinations.

Humidity Test. It shall be standard to expose resistors to a relative humidity of 32 per cent at an ambient temperature of 40°C., for 150 hr. at which time the resistance value is recorded. Following this, the resistors are to be exposed to a relative humidity of 90 per cent for 300 hr. with an ambient temperature of 40°C., and the final resistance value is to be recorded. Finally, the resistors are again subjected for 150 hr. to a relative humidity of 32 per cent at 40°C., and a final reading taken at the end of this period. The readings are to be made at 20°C. by uniform method not later than 30 min. and not less than 15 min. after the resistors have been removed from the humidity chamber.

It is recommended that the resistors be suspended in an enclosed chamber over a saturated solution of cupric chloride or sodium tartrate for the 90 per cent relative humidity condition, and over a saturated solution of magnesium chloride for the 32 per cent relative humidity condition.

On account of the difficulty in obtaining quantitative results on humidity tests, it is recommended that the various resistors involved should be tested together at the same time under exactly the same conditions.

Overload Tests. It shall be standard to make overload tests with a 50 per cent overload on the resistors for 100 hr. at an ambient temperature of 40°C. Resistance measurements are to be made by uniform method before commencing the test after the resistors have been at 40°C., for ½ hr. Resistance measurements are again to be made, under the same conditions, ½ hr. following the completion of the test. The differences between the initial

readings and final readings are to be expressed as per cent permanent changes in resistance.

Aging Tests. It shall be standard to make an aging test wherein the resistors are kept under standard conditions of 40°C., ambient temperature and 32 per cent relative humidity for a period of 90 days. Readings are to be taken at intervals by uniform method so that a curve can be plotted showing the per cent change in resistance versus time in days.

It is recommended that the standard conditions in the foregoing be attained by means of an enclosed chamber containing a saturated solution of magnesium chloride, further, that the resistors be suspended over the solution as specified under humidity test.

If shelf tests are made, it shall be standard to test all the resistors together under identical conditions. Results of one test should not be compared with another unless the time, temperature, and humidity cycles are precisely the same.

"Noise" Test. It shall be standard to test resistors for noise, using resistors having the same value tested under the voltage drop normally existing in the application for which they are intended. A resistance-type amplifier is to be used with a resistance input circuit, the entire combination to be as independent of frequency as is possible. A visual instrument, such as an r-m-s vacuum-tube voltmeter, shall be used on the output of the amplifier. An aural test, using a loud-speaker on the output of the amplifier, should also be used in conjunction with the foregoing.

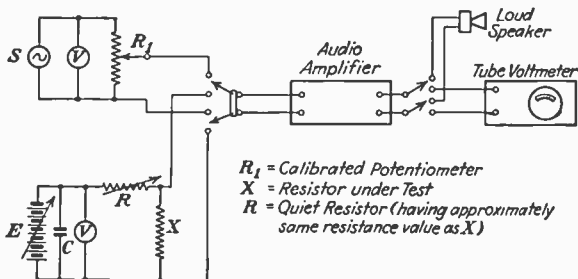

FIG. 9.—Circuit for resistor noise measurement.

A circuit arrangement, such as shown in Fig. 9 shall be used. In this circuit arrangement E represents an adjustable voltage source of constant value, C a large by-pass condenser; R represents an adjustable, standard, quiet resistor, such as a laboratory decade box; X represents the unknown under test; R_1 is a calibrated potentiometer; and S is a source of a-c supply of 1,000 cycles; V in both cases represents an indicating voltmeter. In operation it shall be standard to first connect the resistor as shown, adjusting R to have approximately the same resistance value as the unknown under test. E is then adjusted until the voltage normally existing across the resistor in the application for which it is used is placed across the terminals of X . This voltage is, of course, one-half that shown on the voltmeter when R is adjusted to be exactly the same as X . The switch on the output of the amplifier is placed on the tube voltmeter setting and the switch on the input is connected across the unknown resistor. The gain of the amplifier is adjusted to obtain a definite deflection on the vacuum-tube voltmeter after which it is not changed. The input switch is then thrown to the calibrated potentiometer setting, and the setting of the potentiometer is adjusted until the reading of the tube voltmeter on the output of the amplifier is the same as before. The setting of the calibrated potentiometer, which is calibrated in microvolts,

shows the equivalent r-m-s voltage variation existing across the particular unknown resistor being tested. It can then be stated that the *noise* of the resistor is equivalent to so many microvolts r-m-s for the particular voltage drop existing across the same.

26. Acceptable Performance. On the basis of these specified tests the following is considered acceptable performance:

1. Life Test.....	5 per cent change or less
2. Overload.....	10 per cent change or less
3. Humidity.....	10 per cent change or less
4. Noise.....	500 μ v or less
5. Voltage characteristic.	

27. Representative Values of Resistors Employed in Radio Sets. The range of resistors usually employed in radio sets extends from 1 ohm up to 10 megohms. These resistors are used for various purposes, such as providing grid bias to radio, audio, and detector tubes; plate coupling, voltage dividers, and filters. Typical values employed for these various applications are enumerated below:

1. Detector bias resistors.....	5,000 to 50,000 ohms
2. Power bias resistors.....	200 to 3,000 ohms
3. Voltage dividers.....	1,000 to 100,000 ohms
4. Plate-coupling resistors.....	50,000 to 250,000 ohms
5. Grid leaks.....	100,000 to 10 megohms
6. Filter resistors.....	100 to 100,000 ohms

28. Variable Carbon-type Resistors. In numerous radio applications high variable resistors are required, for example, for controlling the sensitivity of a receiver by varying the C-bias on the r-f tubes a variable resistor up to 50,000 ohms maximum is commonly employed. For adjusting the audio signal level in automatic volume control sets a variable resistor up to 0.5 megohm is not uncommon. From the point of view of cost, wire-wound resistors of this order of magnitude are prohibitive. Furthermore it is desirable to have a non-uniform rate of change of resistance with respect to angular rotation, which is very difficult to secure with wire-wound resistors. Carbon or graphitic types of variable resistors which are capable of being made to meet these requirements at reasonable cost are therefore widely used. Such resistors generally consist of a resistive solution applied to some flat form, such as paper, bakelite or ceramic, and baked on. A rotating slider or some other form of contact travels over this resistive element producing a continuous variation of resistance. Since the resistor is essentially painted on the form, its geometrical form may be varied by design. Also different concentrations of the resistor ink or paint may be employed at different positions of the resistor element. By the use of these two expedients the resistor may be designed to give any variation of resistance desired.

29. Uses for Variable Carbon Resistors. Within their power limitation, these resistors may be used wherever a continuously variable resistor is required. They may be used as either potentiometers or rheostats. They find their widest use as volume controls and tone controls in radio receivers. Some of their specific uses are here listed, and the basic circuits illustrating these uses are shown in Fig. 10.

a. Sensitivity control for radio receivers, by varying control-grid or screen-grid potentials of r-f tubes (Fig. 10a).

- b. Antenna control for varying r-f input to antenna tube (Fig. 10b).
 c. Sensitivity and antenna input control, combination of *a* and *b* (Fig. 10c).
 d. Audio-level control (Fig. 10d).
 e. Combination load-resistor and audio-level control in diode rectifier circuit.
 f. Tapped volume control for acoustic compensation at low levels. Tuned circuits are shunted across one or more taps to produce varying degrees of a-f compensation at different levels.
 g. Gain controls and faders for phonograph and a-f amplifiers.
 h. Tone control in a-f amplifiers for varying a-f frequency characteristics.
 i. High-frequency variable resistor when nonreactive feature is essential, as in signal generator attenuators.

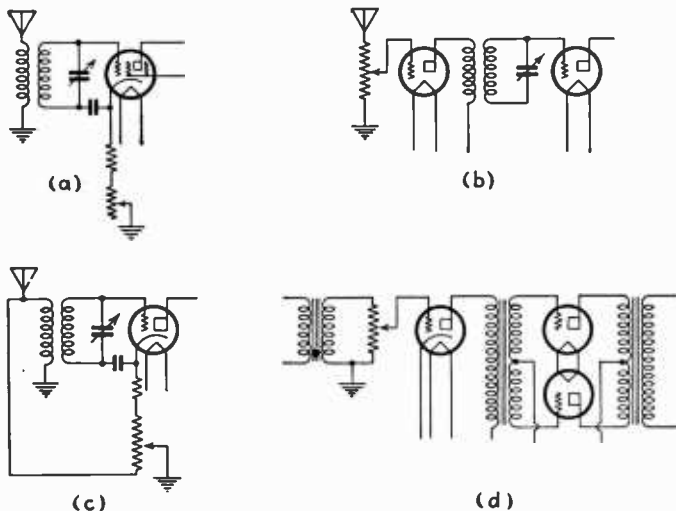

FIG. 10.—Typical uses of variable resistors.

30. Tapers. The circuit considerations involved in these applications are discussed elsewhere in the Handbook, particularly in the section on Receiving Systems. However, each of these applications calls for a resistance curve, or *taper* as it is termed, which is most suitable for it. This taper defines the law of resistance change *vs.* angular rotation of the variable arm. Some widely used curves are given in Fig. 11.

A suitable specification defining the taper should include:

a. Curve showing resistance variation against active angular rotation of the contactor. Where a switch is incorporated in the variable resistor, the angle taken up for operation of the switch is considered inactive. Curve should indicate whether resistance increases with clockwise or counterclockwise rotation.

b. Resistance at extreme counterclockwise end between variable arm and left terminal; this is generally called *left terminal minimum* and is specified as "less than so many ohms."

c. Resistance at extreme clockwise end between contactor and right terminal; this is generally called *right terminal minimum* and is specified as "less than so many ohms."

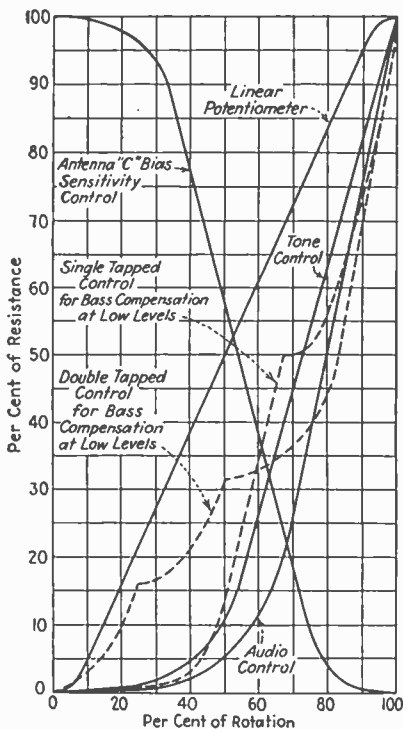

FIG. 11.—Taper curves of variable resistors.

d. When a tap is specified, the angular location and resistance of the tap should be given. The resistance between the tap terminal and the variable arm when located at the tap is sometimes specified.

31. Choice of Volume-control-resistance Curve.¹ In an audio amplifier in which the maximum output is 40 db above the minimum output, the volume control should be so made that each $\frac{1}{40}$ of the rotation should correspond to an attenuation of 1 db. If the volume control has a total attenuation of 80 db, more than is necessary on this particular amplifier, each $\frac{1}{40}$ of the rotation will correspond to 2 db attenuation since only half of the total rotation can be used. In the second case the control would be more critical than in the first case.

¹ By the editor.

In a radio receiver the design of the volume control differs widely depending upon whether the receiver has automatic volume control or not. If not, the entire voltage gain of the receiver must be under control, perhaps 120 db. The tendency for the volume control to become noisy or to be difficult to adjust without producing violent jumps of volume change increases with the total gain that must be controlled.

The fact that a.v.c. systems cannot deliver a uniform voltage to the audio detector because of the wide variations of input voltage (ranging from a microvolt to several volts) makes necessary a different shape of attenuation curve than would be used on an audio amplifier used by itself. A type of curve (Centralab) useful in the a.v.c receiver is shown. Here, approximately uniform attenuation of 40 db is secured in 80 per cent rotation from the maximum volume. This is the range most often used. The departure from linearity in the first 15 per cent of rotation is to keep the resistance gradient within limits representing low noise.

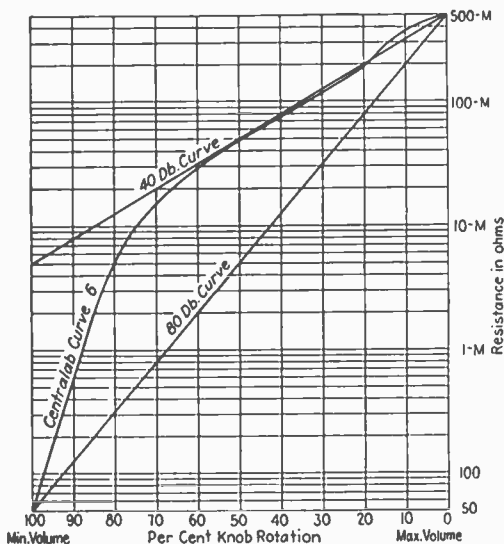

FIG. 12.—Advantage of special taper for volume control.

Between 80 and 100 per cent rotation, the curve changes rapidly to provide a total attenuation of 80 db. Rapid attenuation in this region is accomplished without noise because the resistance change per decibel is small. Such a curve is much more satisfactory than a straight logarithmic line (note the 80-db curve). In addition they are simpler to build. A tapered resistance curve such that equal increments in rotation produce equal increments in attenuation (a straight line when plotted against the logarithm of the resistance) requires that a change of 300,000

ohms take place in the first 10 per cent, 120,000 ohms in the second 10 per cent, and so on till the last 10 per cent rotation produces a change of only 75 ohms. This is true of a 500,000-ohm control with a total attenuation of 80 db.

32. Wear Characteristics. Variable carbon resistors necessarily have the same general electrical characteristics as fixed carbon resistors. In addition, due to the motion of the slider on the resistance element, there is a certain amount of wear on the resistance element. This produces a change in resistance value and noise. Factors influencing these changes are:

1. Hardness of resistance element which determines ability to withstand abrasion.

2. Pressure of moving contact on resistance element.

3. Smoothness of moving contact surface.

33. Specifications for Variable Resistors. No standard specifications have been established for variable resistor performance. A typical specification, however, representative of acceptable performance is here given.

1. *Endurance or wear.* Life Test: Units shall not fail before 10,000 complete operations when operated without electrical load. The unit shall be operated over its full range including operation of switch at a rate of approximately 1,000 operations per hour. Failure shall be considered as a change in resistance of greater than 15 per cent of the initial resistance or mechanical fracture of the switch.

2. *Noise.* Units shall be of such a nature as to produce no audible sound in the loud-speaker of the apparatus in which the unit is used.

3. *Humidity.* The resistance of units shall not show a temporary change of more than 25 per cent when conditioned 100 hr. at a temperature of 40°C. and a relative humidity of 90 per cent. Units shall be conditioned 24 hr. in a desiccator before placing in the humidity chamber.

4. *Resistance Curve.* The resistance curve and permissible variations over the entire resistance range of effective electrical rotation shall be in accordance with the drawing (as supplied by the purchaser). These curves shall be within the required limits and must conform in general shape to the nominal curve of the drawing.

References

- Bur. Standards Circ. 74.*
DRIVER-HARRIS COMPANY: *Bull. R-28.*
GILBY WIRE COMPANY: "Resistance Handbook."
KENNELLY, LAWS, and PIERCE: *Experimental Research in Skin Effect in Conductors, Trans. A.I.E.E., 1915.*
MORECROFT: "Principles of Radio Communication."
PENDER: "Handbook for Electrical Engineers."

SECTION 4

INDUCTANCE

BY GOMER L. DAVIES, B.S.¹

1. Magnetic Flux. The property of electrical circuits called *inductance* depends upon the magnetic effects associated with a flow of electric current. In a magnetic system the magnitude of the force of magnetic attraction or repulsion is proportional to the product of the strengths of the poles and inversely proportional to the square of the distance between them. A *unit magnetic pole* is defined as that pole which repels a similar pole at a distance of 1 cm with a force of 1 dyne. The force between two poles acts along the line joining the poles. Consequently a unit north pole in the vicinity of a magnet is acted upon by two forces: one of repulsion, due to the north pole of the magnet; and one of attraction, due to the south pole. The resultant is the total force exerted by the magnet upon the unit pole. Thus the magnet is surrounded by a *field of force* or *magnetic field* whose direction and magnitude at any point are defined as the direction and magnitude of the force acting upon a unit north pole at that point.

If a unit north pole is allowed to move freely in a magnetic field, it will move in the direction of the field at each point and will trace out a path which is called a *line of force*. The total field is considered to be made up of a large number of such lines. In any region of space the total of all the lines of force in that region is called the *magnetic flux* in that region, and the number of lines of force passing through a unit area of a surface perpendicular to the direction of the field is the *flux density* and is determined by the strength of the field.

2. Magnetic Effects of Current-carrying Conductors. Magnetic effects are exhibited not only by magnets but also by wires carrying electric currents. The magnetic field near a straight current-carrying conductor consists of circular lines of force surrounding the conductor; the flux density at any point outside the wire is proportional to the current and inversely proportional to the distance of the point from the axis of the conductor. If the wire carrying the current is wound in one or more layers on a cylindrical form, the field inside of this coil is parallel to the axis of the cylinder and is proportional to the product of the current and the number of turns on the coil. This product of current (in amperes) and number of turns is called the *ampere-turns* of the coil. The flux density along the axis of the coil may be expressed as the product of the ampere-turns by a constant. If the winding is of infinite length, this constant is 4π .

¹ Engineer, Washington Institute of Technology, Washington, D. C.

3. Inductance—Definition and Units.¹ When the current in a circuit varies Ohm's law in the form in which it is stated for constant-current circuits, no longer serves to define the current.

The magnetic flux associated with the circuit varies with the current and induces a voltage in the circuit which is given by the equation

$$e = -\frac{d\phi}{dt} \quad (1)$$

where e is the induced voltage, ϕ the flux, and t the time. As the flux is proportional to the current, it may be written

$$\phi = Li \quad (2)$$

where L is a constant and i the current. Then

$$e = -\frac{d}{dt}(Li) = -L\frac{di}{dt} \quad (3)$$

If the current is increasing, the induced e.m.f. opposes the current, and work must be done to overcome this e.m.f. If the work is W ,

$$\frac{dW}{dt} = ei = -Li\frac{di}{dt} \quad (4)$$

and

$$W = -\int_0^{i_0} Lidi = -\frac{Li_0^2}{2} \quad (5)$$

i_0 being the final value of the current, the initial value being taken as zero.

The quantity L in these equations is the *coefficient of self-induction*, *self-inductance*, or simply *inductance* of the circuit. It may be defined in three ways: from Eq. (2), as the flux associated with the circuit when unit current is flowing in it; from Eq. (3), as the back e.m.f. in the circuit caused by unit rate of change of current; and from Eq. (5), as twice the work done in establishing the magnetic flux associated with unit current in the circuit. These three definitions give identical and constant values of L provided there is no material of variable permeability near the circuit, and provided the current does not change so rapidly that its distribution in the conductors differs materially from that of a constant current. If these conditions do not hold, L is not constant and the values obtained from the three definitions will in general be different.

The units used for inductance must conform to the units used for the other quantities used in the defining equations. The practical unit is the *henry*, which is the inductance of a circuit when a back e.m.f. of 1 volt is induced in the circuit by a current changing at the rate of 1 amp. per second. The relations between units are as follows:

$$\begin{aligned} 1 \text{ henry} &= 10^9 \text{ c.m.u.} \\ &= 1.1124 \times 10^{-12} \text{ c.s.u.} \end{aligned}$$

The henry is subdivided into two smaller units, the millihenry and the microhenry. The millihenry is one-thousandth of a henry, and the microhenry is one-millionth of a henry. The millihenry and microhenry are abbreviated mh and μ h respectively. Thus

$$1 \text{ henry} = 1,000 \text{ mh} = 1,000,000 \mu\text{h}$$

¹ STARLING, S. G., "Electricity and Magnetism," Chap. XI, 1926.

The term "inductance" refers to a property of an electrical circuit or piece of apparatus but not to any material object. A piece of apparatus used to introduce inductance into a circuit is properly called an *inductor* or coil.

4. Current in Circuits Containing Inductance. If a circuit containing a source of constant e.m.f. and pure resistance only is closed, the current rises instantly to its full value as determined by Ohm's law. If the circuit contains inductance, a back e.m.f. of the value $L\frac{di}{dt}$ acts during the time the current is changing, so that, if the e.m.f. of the source is E , the actual e.m.f. available to force current through the resistance is $E - L\frac{di}{dt}$.

The equation for the current in the circuit is

$$E - L\frac{di}{dt} = Ri \quad (6)$$

or

$$L\frac{di}{dt} + Ri = E \quad (7)$$

The solution of this equation is

$$i = \frac{E}{R} \left(1 - e^{-\frac{Rt}{L}} \right) \quad (8)$$

The time t is reckoned from the instant at which the switch is closed, and e is the base of natural logarithms.

At a time $t = L/R$ after the circuit is closed, the current has a value equal to $I_0 \left(1 - \frac{1}{e} \right)$, or about 63 per cent of its final value. The quantity L/R is called the *time constant* of the circuit. The time constant, or the time required for the current to rise to a value of $1 - \frac{1}{e}$ times its final value, does not depend upon the actual values of inductance and resistance but only upon their ratio.

The current in such a circuit is shown in Fig. 1 for several values of L/R . Theoretically the current does not reach its maximum value I_0

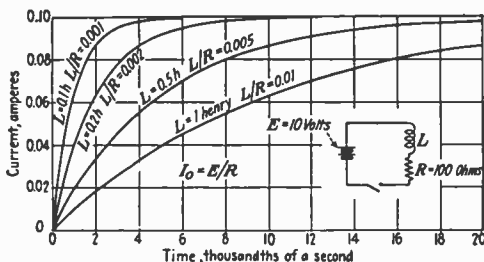

FIG. 1.—Rise of current in inductive circuit.

except at an infinite time after the circuit is closed, but practically the difference between the actual current and the value I_0 becomes negligible after a relatively short time.

If, after the steady current I_0 has been established in the circuit, the source of the e.m.f. is short-circuited, the current does not fall to zero instantly but decreases according to the equation

$$i = \frac{E}{R} \epsilon^{-\frac{Rt}{L}} \quad (9)$$

This equation is plotted in Fig. 2 for the same values of the circuit constants as were used in Fig. 1. In this case the time constant L/R

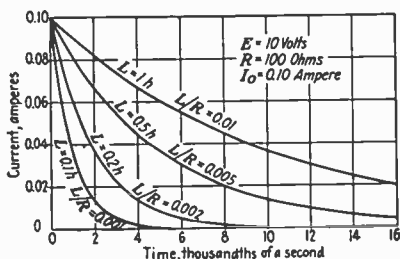

FIG. 2.—Fall of current in inductive circuit.

represents the time required for the current to fall to $1/e$ or about 37 per cent of its initial value.

If, instead of the source of e.m.f. being short-circuited, the circuit is opened, the resistance becomes extremely large and the current falls to zero almost instantly. As a result of this rapid change of current, a large e.m.f. is induced in the circuit, causing a spark or arc at the point at which the circuit is opened.

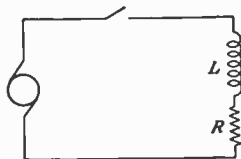

FIG. 3.—Series circuit containing resistance and inductance.

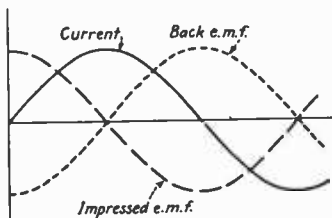

FIG. 4.—Phase relations in inductive circuit.

When the current in an inductive circuit is changing, a back e.m.f. other than that due to resistance acts in the circuit. This back e.m.f. is proportional to the current and to the quantity ωL , which is called the *inductive reactance* and usually written X_L . Also, the phase of the back e.m.f. is 90 deg. behind that of the current. To force a current through a pure inductance, therefore, requires an impressed e.m.f. 180 deg. out of phase with the back e.m.f., or one leading the current by 90 deg. (Fig. 4).

Now, if a sinusoidal e.m.f. is impressed on a circuit containing resistance and inductance in series (Fig. 3), the current in the circuit will also be sinusoidal, provided the resistance and inductance are independent of the current. The portion of the impressed e.m.f. required to force current through the resistance will be in phase with the current, while the portion required to force current through the inductance will lead the current by 90 deg. The resultant phase of the impressed e.m.f. with respect to the current will have some value between zero and 90 deg., depending upon the values of resistance and inductance in the circuit.

To determine mathematically the behavior of the circuit described above, it is necessary to set up and solve the differential equation for the circuit. This equation will have the same form as Eq. (7) with E replaced by $E_M \sin \omega t$; that is,

$$L \frac{di}{dt} + Ri = E_M \sin \omega t \quad (10)$$

The solution is

$$i = \frac{E_M}{\sqrt{R^2 + \omega^2 L^2}} \sin(\omega t - \phi) + c e^{-\frac{Rt}{L}} \quad (11)$$

where $\tan \phi = \omega L/R$, and c is a constant to be determined. The first term is the only one of importance after the current has been flowing for a short time. Thus the current has a peak or maximum amplitude of $E_M/\sqrt{R^2 + \omega^2 L^2}$ and lags the impressed e.m.f. by the phase angle ϕ whose tangent is $\omega L/R$. The quantity $\sqrt{R^2 + \omega^2 L^2}$ is called the *impedance* of the circuit and is denoted by Z . In terms of the effective values of current and e.m.f. I and E , the equation for the current may be written

$$I = \frac{E}{Z} \text{ or } I_M = \frac{E_M}{Z} \quad (12)$$

In complex notation this form is

$$i = \frac{E_M \sin \omega t}{R + j\omega L} \quad (13)$$

or, in terms of the instantaneous e.m.f.,

$$i = \frac{e}{R + j\omega L} = \frac{e}{z} \quad (14)$$

The quantity z is called the *complex* or *vector impedance*. It is a vector

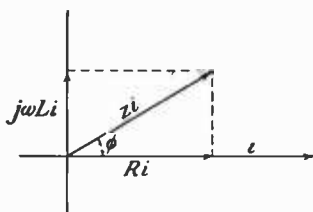

FIG. 5.—Vector relations of inductive circuit.

with a magnitude $\sqrt{R^2 + \omega^2 L^2}$ or Z , and an angle ϕ whose tangent is $\omega L/R$. A vector diagram showing these relations is given in Fig. 5. Thus the relation between current and e.m.f. in an a-c circuit containing resistance and inductance in series may be expressed in the same form as Ohm's law for d-c circuits, provided instantaneous values of current and voltage and vector impedance are used [Eq. (14)]. A similar relation may be written using effective values of current and voltage and the magnitude of

the vector impedance. Both the vector impedance z and its magnitude Z

are generally referred to simply as impedance, the context usually indicating which quantity is meant.

The impedance Z increases as the frequency is increased. Consequently, for constant values of E , R , and L , the current I will decrease

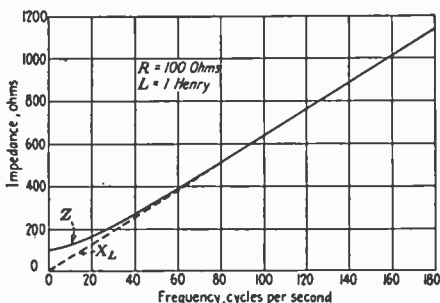

FIG. 6.—Impedance of inductive circuit with frequency.

as the frequency increases. Figure 6 shows values of Z plotted against frequency, and Fig. 7 shows how the current in the circuit of Fig. 3 varies with the frequency of the impressed voltage.

Consider Eq. (11). After the switch has been closed for some time, the values of current and voltage bear a definite relation to each other at each instant during a cycle, and this series of relations is repeated during every cycle. The circuit is now said to be in the steady-state condition, and the first term of the right-hand side of Eq. (11) completely defines the current in terms of the voltage and impedance. However, for a short interval of time after the switch is closed, the second or transient term generally has an appreciable value and must be considered. By comparison with Eq. (9) it is seen that this transient current has the form shown in Fig. 2. It is evident that the duration of the transient current will depend upon the time constant L/R . The initial value of the current, which is equal to the constant c , must, however, be determined. Now the current must be zero at the instant the switch is closed (since it cannot rise to some finite value instantaneously because of the inductance in the circuit) and, therefore, if t is taken as zero at the instant of closing the switch, the value of c may be found mathematically to be defined by the equation

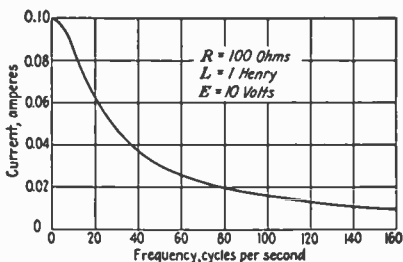

FIG. 7.—Current vs. frequency in inductive circuit.

$$c = \frac{EM}{Z} \sin \phi = I_M \sin \phi \quad (15)$$

The physical significance of this equation is most readily seen by reference to Fig. 8.¹ In *a* of this figure, the curve *e* represents the voltage impressed upon the circuit and the curve marked "Steady state current" indicates the value the current would have if the switch had been closed at a time much earlier than the time represented in the figure. Accord-

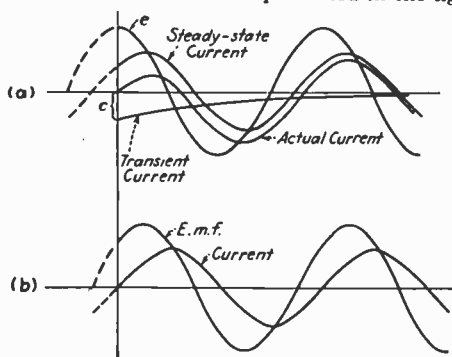

FIG. 8.—Effect on transient current of closing circuit at different times in the cycle.

ingly, at the instant of closing the switch, the current should have the value given by the intersection of the steady-state current curve with the vertical axis in the figure. But the actual current must be zero at this instant; therefore, the transient current must have the value *c*, just neutralizing the fictitious steady-state current. This

transient current then decreases according to the curve labeled "transient current," and the actual current is the sum of the steady-state current and the transient current. If the switch should be closed at an instant at which the steady-state current would be zero, as in Fig. 8*b*, the constant *c* would be equal to zero and there would be no transient term. Consequently the quantity ϕ in Eq. (15) represents the phase angle of the instant of closing the switch with reference to the nearest time at which

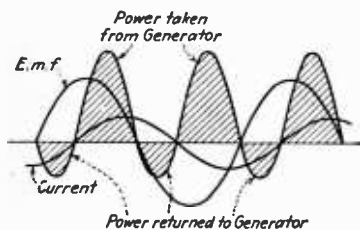

FIG. 9.—Power in inductive circuit.

the steady-state current crosses the zero axis in passing from negative to positive values. In Fig. 8*a*, the switch was assumed to be closed shortly after the steady-state current passed through such a zero value; therefore, in this case, the so-called "phase angle" is a lag angle, and $\sin \phi$ is negative, making *c* negative as shown.

5. Power in Inductive Circuit. The instantaneous power used in the circuit of Fig. 3 is the product of the instantaneous values of current and voltage. Figure 9² shows this power at times to be negative because

¹ MORECROFT, J. H., "Principles of Radio Communication," 2d ed., 1927.

² *Ibid.*

the current and voltage have opposite signs. Such negative power represents a restoration to the source of some of the energy stored in the magnetic field. In a circuit containing inductance only, the current and voltage are 90 deg. out of phase and the negative loops of the instantaneous-power curve are exactly equal to the positive loops, so that the average power taken by the inductance is zero.

In general, the instantaneous power is given by¹

$$\begin{aligned} p &= E_M \sin \omega t \times I_M \sin (\omega t - \phi) \\ &= E_M I_M (\sin^2 \omega t \cos \phi - \sin \omega t \cos \omega t \sin \phi) \\ &= \frac{E_M I_M}{2} (\cos \phi - \cos 2\omega t \cos \phi - \sin 2\omega t \sin \phi) \end{aligned} \quad (16)$$

The average value of the second and third terms in the last parenthesis is zero, so that the average power taken by the circuit is that expressed by the first term, or

$$P = \frac{E_M I_M}{2} \cos \phi = EI \cos \phi \quad (17)$$

where, as before, E_M and I_M are maximum values, and E and I are effective values of the voltage and current. Since

$$E = IZ$$

and

$$\begin{aligned} \cos \phi &= \frac{R}{Z} \\ P &= IZ \times I \times \frac{R}{Z} = I^2 R \end{aligned} \quad (18)$$

This last equation is often used to define the effective resistance of an a-c circuit.

As a consequence of Eq. (17), the power in an a-c circuit containing inductance and resistance cannot be determined by measuring the current and voltage unless the value of the phase angle ϕ can also be measured. As this is usually difficult, the power must generally be measured with a wattmeter.

The quantity $\cos \phi$ is called the *power factor* of the circuit. In a circuit containing only resistance, the power factor is unity; in a circuit containing only inductance, the power factor would be zero. As applied to a coil used as an inductor, the power factor at a given frequency gives the ratio of the resistance of the coil to its impedance and may be used as a figure of merit for the coil. As the ideal inductor would have zero power factor, a good coil should have a very small power factor.

6. Measurements of Inductance at Low Frequencies. The measurement of the inductance of air-core coils at low frequencies is relatively simple, as the inductance is sensibly constant with change in frequency and current. Iron-core inductors, for reasons which will be examined in detail later, do not have a fixed inductance under all conditions, and measurements on them must be made under conditions which duplicate as nearly as possible the conditions under which the inductor is used.

¹ *Ibid.*

A simple method of approximate measurement uses the circuit of Fig. 10. An a-c voltage of known frequency is applied at E , and the current and voltage read on the meters. The voltmeter reading divided by the ammeter reading gives the impedance and, if the resistance is measured by a d-c-bridge or voltmeter-ammeter method,

$$L = \frac{Z^2 - R^2}{4\pi^2 f^2} = 0.025 \frac{Z^2 - R^2}{f^2} \quad (19)$$

The method is usable for iron-core coils that carry a.c. only, provided the measuring current is adjusted to the value that the coil carries in use.

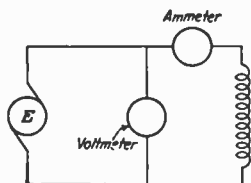

FIG. 10.—Circuit for measurement of inductance.

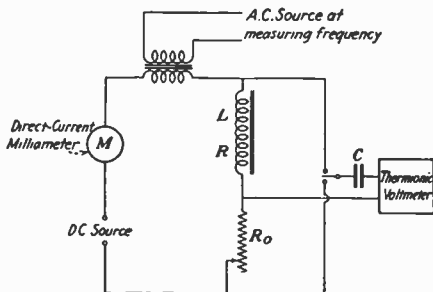

FIG. 11.—Measurement of iron core carrying a.c. and d.c.

If measurements are made at a number of current values, the curve of inductance against current may be plotted. The results obtained by this method are generally slightly larger than the true values of inductance because the a-c resistance, particularly in iron-core coils, is greater than the d-c resistance.

7. Measurement of Inductance of Iron-core Coils. When an iron-core coil must carry relatively large d.c. upon which is superimposed a small value of a.c., its inductance is dependent upon the magnitudes of the two currents flowing through it, and other methods must be used.

The impedance of an iron-core coil carrying d.c. and a.c. may be measured by the circuit of Fig. 11. The d.c. through the circuit is adjusted to the value carried by the coil during operation, and the a-c source adjusted to impress a voltage across the coil (measured by the thermionic voltmeter) equal to the a-c voltage across it under operating conditions. The resistance R_0 is then varied until the alternating voltage across it is equal to that across the coil, as measured by the thermionic voltmeter. Then the impedance of the coil at the measuring frequency is equal to R_0 . Readjustments of the impressed direct and alternating voltages may be necessary as R_0 is changed. The condenser C prevents the direct voltages across the coil and resistor from affecting the thermionic voltmeter. From the impedance and the resistance of the coil, the inductance may be calculated by Eq. (19).

In Fig. 12 is a simple method of arriving at the impedance of an iron-core coil based on the supposition that the inductance is high compared

to the resistance. The voltage across R and X is measured with a vacuum-tube voltmeter, for example. Then $E_r/R = I$ and $E_x/I = X = (E_x/E_r) \times R$, whence

$$X = R/E_r \quad (20)$$

In the general case in which M represents the total losses of the coil, the power factor of the inductance is $\cos \theta$ and

$$\cos \theta = \frac{E_{2-3} - E_x - E_r}{2E_x E_r} \quad (21)$$

and the total losses in the core and winding may be thus obtained.

Once the impedance, reactance, and inductance of a coil have been determined, the permeability and finally the magnetizing force and flux density of an iron-core coil may be obtained. Thus the a-c flux density

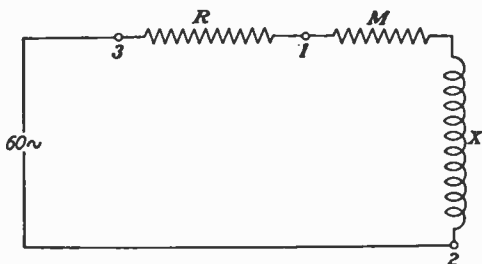

FIG. 12.—Circuit for determining inductance of iron-core coil.

$$B_{\max.} = \frac{E_{\text{eff.}} \times 10^8}{4.44 \times f \times N \times A \times K} \text{ gaussess} \quad (21a)$$

where $E_{\text{eff.}}$ = r.m.s. voltage across the coil

f = frequency in cycles per second

N = number of turns in the winding

A = cross section of the core in square centimeters

K = core-stacking factor (see Sec. 2, Art. 29).

The polarizing m.m.f. resulting from the d.c. in the winding, in gilberts per centimeter is given by

$$H_0 = \frac{1.256NI}{l} \quad (21b)$$

where N = number of turns in the winding

I = d.c. in amperes

l = length of magnetic circuit in centimeters.

To get m.m.f. in ampere-turns per inch, multiply H_0 by 2.032.

The following table (Allegheny Steel Company) gives values of $B_{\max.}$ and H_0 found in practice.

Coil	$B_{\max.}$, gaussses	H_0 , gilberts/cm
Detector-stage audio transformer.....	0.5 to 10	0.6 to 1.2
Second-stage a-f transformer.....	250	1.5
Push-pull output transformer with two primaries...	7,000	0
Polarized output transformer.....	4,200	6.7
Heavy-duty filter reactor (80 ma).....	300	27

8. Turner Constant-impedance Method. For measurements involving a.c. only, the constant-impedance method (of Turner¹), shown in Fig. 13, is used. The method is based upon the fact that, when $1 - \omega^2 LC = 0$, the impedance of the parallel circuit is equal to ωC and is independent of the resistance in the inductive branch. Consequently the line current will have the same magnitude with the switch open or closed. To measure any value of inductance, then, it is only necessary to adjust the capacity so that the reading of the ammeter A is the same for both positions of the switch. Then

$$L = 1/(2\omega^2 C) \quad (22)$$

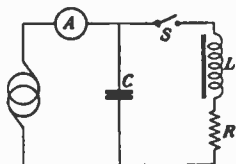

FIG. 13.—Turner constant-impedance method.

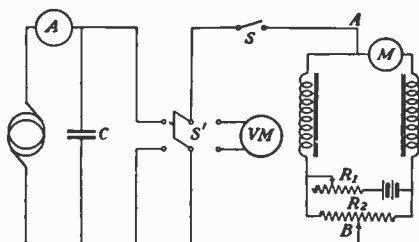

FIG. 14.—Measuring circuit for coils carrying a.c. and d.c.

When the coil must carry d.c. as well as a.c., the circuit of Fig. 14 may be used for the inductance measurement. Two similar inductors are used, the d.c. through them being adjusted to the proper value by means of the resistor R_1 and measured by means of the d-c ammeter M . The switch S' is then thrown to the right and the resistor R_2 adjusted to make the constant-potential difference between the points A and B zero. Then, with S' thrown to the left, the inductance measurement may be carried out in the manner already described. The result is the inductance of the two coils in parallel, which is one-half the inductance of one coil.

9. Measurements of Inductance at High Frequencies. Very often the low-frequency inductance of a coil, determined by one of the methods already given, may also be used as the high-frequency inductance. In

¹ TURNER, H. M., Constant Impedance Method for Measuring Inductance of Choke Coils, *Proc. I.R.E.*, 16, 1559, 1928.

some instances it is desirable to determine the inductance at the operating frequency. Bridge methods are not suitable for measurements at high frequencies. Two other methods are commonly used: comparison of the coil with a standard, and measurement of the capacity required to tune the coil to resonance with a known frequency, from which the inductance may be calculated. Both methods give the apparent inductance.

In the comparison method, a standard inductor, having an apparent inductance L_s at the measuring frequency, is connected in parallel with a calibrated variable condenser, coupled to an oscillator and the coil-condenser circuit tuned to resonance, the capacity C_s of the condenser being noted at the resonance setting. The coil to be measured, whose inductance is denoted by L_x , is then substituted for L_s , the circuit retuned, and the condenser capacity C_x again observed. Since the frequency is the same in both cases,

$$L_x C_x = L_s C_s \quad (23)$$

If the low-frequency inductance L_0 and internal capacity C_0 of the standard coil are known,

$$L_x C_x = L_0 (C_s + C_0) \quad (24)$$

In the second method, it is necessary to determine accurately the frequency of the source. The coil to be measured is connected to a calibrated variable condenser, coupled loosely to the generator and tuned to resonance. If f is the frequency of the source, L_x the apparent inductance of the coil, and C_x the condenser capacity at resonance,

$$L_x = \frac{1}{39.48 f^2 C_x} = \frac{0.02533}{f^2 C_x} \quad (25)$$

In this equation, L_x is expressed in henrys and C_x in farads. For L_x in μh and C_x in $\mu\mu\text{f}$, the equation becomes

$$L_x = \frac{25.33 \times 10^{16}}{f^2 C_x} \quad (26)$$

If the capacity necessary to tune the coil to resonance at a number of different frequencies is determined, a graph of the squares of the wavelengths corresponding to the several measuring frequencies against the measured values of capacity will be a straight line whose slope is the pure inductance and whose intercept with the negative-capacity axis is the internal capacity of the coil. This is illustrated in Fig. 15.

10. Inductance of Iron-core Coils. Iron-core coils are mainly useful at relatively low frequencies, and their use is generally confined to circuits carrying currents within the a-f range. (But see Art. 16.)

The inductance of a circuit is not constant if any material of variable permeability is within the magnetic field of the circuit. Consequently,

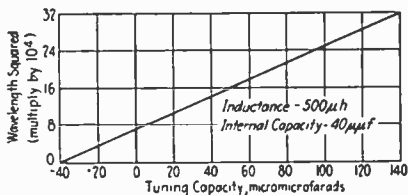

FIG. 15.—Method of determining inductance and distributed capacity of a coil.

when a coil is wound on an iron core, its inductance is dependent upon the circumstances under which it is used. Accordingly, to use iron-core coils most advantageously, it is necessary to study their characteristics under varying conditions. Three important cases must be distinguished: the current through the coil is a.c. of single frequency; the current consists of a d-c component upon which is superimposed a single-frequency a-c component; the current is comprised of two a-c components of different frequencies.

The average inductance of an iron-core coil carrying a.c. of single frequency is dependent upon the magnitude of the current. Also, the a-c resistance of such a coil is higher than that of an air core coil with an identical winding. Therefore all inductance measurements of iron-core coils should be made with the measuring current equal to the current which will flow through the coil in operation, or the inductance may be measured for a number of different currents and a curve of inductance against current plotted.

In many radio applications a coil carries a relatively large d.c. with a small a-c component superimposed. The inductance of an iron-core coil under such conditions is a function of the magnitudes of the d-c and a-c components of the current. This is illustrated by Fig. 16. The constant magnetizing force (due to the d.c.) may be such as to cause the core to be magnetized to the point A.

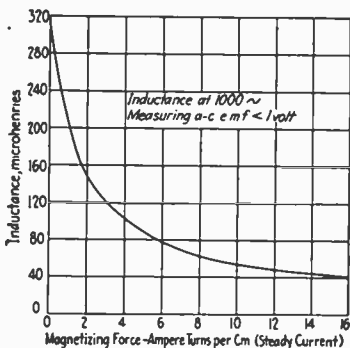

FIG. 17.—Effect of d.c. on inductance of coil.

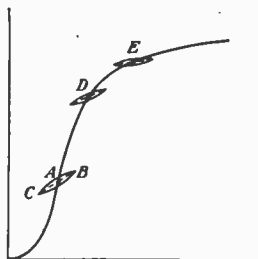

FIG. 16.—Characteristic of coil carrying large value of d.c. and small value of a.c.

The alternating component of the magnetizing force (due to the a.c.) will then carry the iron through the small hysteresis loop *CB* whose slope is not the same as the slope of the magnetization curve. The permeability represented by the slope of this small hysteresis loop is called the *incremental permeability*. As the constant component of the magnetizing force or current is increased, the point *A* moves farther up the magnetization curve and the incremental permeability decreases, as indicated by the small loops at *D* and *E*. As saturation of the core is approached, the incremental permeability, and hence the inductance, becomes very small. As the magnitude of the a-c component is increased, the slope of the

hysteresis loop, and accordingly the incremental permeability, increases, thus increasing the inductance. Consequently the inductance of an iron-core coil under these conditions decreases with increase of the d-c component of the current, and increases with increase of the a-c component. Figure 17 shows the decrease in inductance with increase in constant magnetizing force.

If an *air gap* is introduced in the magnetic circuit of an iron-core coil, the inductance of the coil is generally diminished. If, however, the coil is carrying both d.c. and a.c., the air gap may so decrease the constant flux that the incremental permeability is actually increased, so that the effective inductance for the a-c component is increased. The effective resistance of the inductor is also decreased by the introduction of an air gap. These effects are illustrated in Fig. 18.¹ As a consequence of these characteristics, iron-core inductors that are intended for use in circuits where they must carry d.c. as well as a.c. are usually made with an air gap in the magnetic circuit of the core.

When the inductor carries two alternating currents of different frequencies, the effects of the variable permeability of the iron are somewhat more complicated and of relatively less practical importance than in the cases already treated.²

11. Inductors at Radio Frequencies.

When inductors are used at radio frequencies, many factors affecting their performance come into prominence. The h-f resistance of a coil is much larger than its d-c resistance because of a number of losses which come into existence with the operation of the coil in h-f circuits. The factors causing this increase are skin effect, eddy currents, dielectric losses, and internal capacity.

When the wire is wound into a coil, the effect of the magnetic field of the coil is such as to concentrate the current on the inner surfaces of the turns. Figure 19 illustrates this effect, the depth of shading indicating the current density. This concentration of current causes a further increase in the

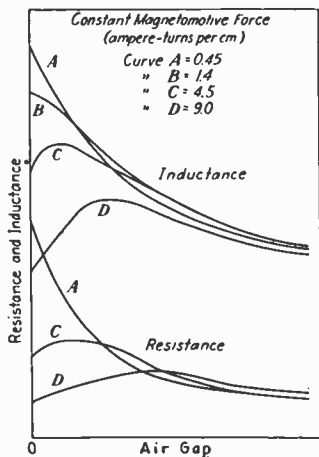

FIG. 18.—Effect of air gap on coil characteristics.

effective resistance of the coil, and also causes a decrease in the inductance as the frequency increases. However, the variation of inductance with frequency is generally small in comparison with the variation caused by internal capacity.

Eddy currents in the conductors composing the coil constitute a serious source of loss at frequencies over 3,000 kc. These losses are minimized by the use of wire as small as possible without unduly increasing the conductor resistance, or by the use of tubing instead of wire. Because of these losses at frequencies higher than 3,000 kc there is an optimum wire size giving a minimum resistance in inductance coils.

Any dielectric in the field of the coil also introduces losses which become important at

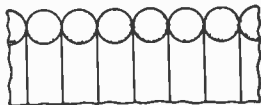

FIG. 19.—Concentration of current at surface at high frequencies.

¹ MORECROFT, J. H., "Principles of Radio Communication," 2d ed., 1927.

² TURNER, H. M., Inductance as Affected by Initial Magnetic State, Air Gap, and Superposed Currents, *Proc. I.R.E.*, 17, 1822, 1929.

these frequencies, so that the type and amount of dielectric within the field of the coil must be carefully regulated. The dielectric should be of the best quality and its volume must be kept at a minimum. The conductors of the coil should, in general, come in contact with the dielectric as little as possible. Coils are often wound upon skeleton or ribbed winding forms so that each turn touches the supporting insulating material at only a few points and is surrounded for the greater part of its length solely by air.

12. Effect of Coil Capacity. Every inductor behaves not as a pure inductance and resistance in series but as an inductance and resistance shunted by a small capacity. This behavior is caused by the self- or internal capacity of the coil. The resistance and inductance of the equivalent parallel circuit at any frequency are called the *apparent resistance* and *apparent inductance* of the coil at that frequency. The apparent resistance is given approximately¹ by the equation

$$R_A = \frac{R}{(1 - \omega^2 LC_0)^2} \quad (27)$$

and the apparent inductance by

$$L_A = \frac{L}{1 - \omega^2 LC_0} \quad (28)$$

where R and L are the resistance and inductance the coil would have at the frequency $\omega/2\pi$ if the internal capacity C_0 were absent. These equations do not hold for frequencies near the natural frequency of the coil; that is, the frequency for which $1 - \omega^2 LC_0 = 0$. These equations are derived on the assumption that the e.m.f. in the circuit is introduced in some manner other than by induction in the coil itself. If the e.m.f. is induced in the coil, the internal capacity is merely added to any other capacity which may be connected in parallel with the coil. Since a coil is practically always used at frequencies for which $1 - \omega^2 LC_0$ is positive, the apparent resistance and inductance of the coil will increase as the frequency increases, the apparent resistance becoming very large as $1 - \omega^2 LC_0$ approaches zero. The percentage change in resistance for a given change in frequency is about twice as great as the change in inductance. At frequencies for which $1 - \omega^2 LC_0$ is negative, the coil behaves as a capacity rather than an inductance.

It has been found² that the internal capacity of a single-layer coil is roughly proportional to the radius and practically independent of the number of turns and the length. For a closely wound solenoid, the internal capacity in $\mu\mu\text{f}$ is very approximately equal to six-tenths of the radius in centimeters.

13. Types of Inductors. A straight wire has a certain amount of inductance, but to make inductors small enough to be convenient it is necessary to wind the wire in the form of a coil thus utilizing a great length of wire in a small space and also increasing the interlinkages of flux and wire.

The simplest inductor consists of a single square turn of wire. The inductance of this arrangement may be calculated accurately, but it has

¹ Radio Instruments and Measurements, *Bur. Standards Circ. 74*.

² Howe, G. W. O., *Jour. I.E.E.* (London), 60, 63, 1922; also MOLLIN, E. B., "Radio Frequency Measurements," p. 340, 1931.

few other advantages. This type is sometimes used as a fundamental standard.

The *single-layer solenoid* consists of one layer of wire on a cylindrical form, the turns either adjacent to one another or spaced. Sometimes the coil is made self-supporting by means of a binder, such as collodion, and the form removed after winding.

Multilayer coils must be used when a single-layer coil of the required inductance would be inconveniently large. The multilayer coil may take one of three forms: *layer wound*, *bank wound*, and *honeycomb or duolateral*.

The *layer-wound coil* is useful only at low frequencies because of its high internal capacity caused by the proximity of turns of greatly differing potentials. The wire is wound on the coil in layers, each layer being completed before another is begun. Iron-core coils are usually wound in this manner. If a very large number of turns must be used, it is better for the whole coil to be made up of a number of "pies," each pie being a short layer-wound coil. The pies are assembled side by side to form the complete coil. Insulation is



FIG. 20.—Bank winding.

greatly facilitated by this type of construction, and the internal capacity is somewhat reduced.

Bank winding is one result of the attempt to devise a multilayer coil with relatively low internal capacity. The turns are wound in the order shown by the cross-sectional view in Fig. 20.

Honeycomb and *duolateral* windings are further results of the same effort. The wire zigzags back and forth from one side of the winding space to the other, adjacent turns of the same layer being spaced from each other by several times the wire diameter. The effect of this type of winding is to cause turns of adjacent layers to cross each other at an angle and to separate parallel turns by at least the diameter of the wire. A coil of this type is self-supporting and quite compact.

Basket-weave and *spider-web* windings were developed also to minimize the internal capacity. In the basket-weave coil the wire is wound in and out of a number of pegs set in a circle. Adjacent turns cross at an angle. The pegs are usually removed after the winding is completed and the coil is self-supporting. This is essentially a single-layer coil. The spider web, on the other hand, is primarily a multilayer coil of one turn per layer. The wire is wound back and forth between a series of pegs fastened radially in a circular form. This coil may also be self-supporting.

The *toroidal* coil is wound around a doughnut-shaped form. Its field is almost entirely internal, so that it may be placed close to other coils and apparatus.

The *flat spiral* type of coil is self-explanatory—the wire being wound in the form of a spiral, each turn having a greater radius than the preceding one.

14. Variable Inductors. Any of the previous types of coils may be tapped and the number of turns in circuit varied with a tap switch or clip. This method gives only a step-by-step variation, and considerable loss may be introduced by the unused portions of the coil.

A continuously variable inductor may be made by connecting in series or parallel two coils having a variable mutual inductance. The coils may be single-layer or multilayer solenoids and their mutual inductance may be varied by changing the distance between the coils or by rotating one with respect to the other. The most common form of variable inductor, however, is the arrangement commonly called a *variometer*, a cross section of which is

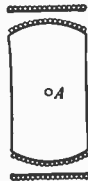

FIG. 21. Variable inductor.

shown in Fig. 21. The inner coil is rotatable about the axis *A*, which is perpendicular to the plane of the figure. The two coils may be connected in either series or parallel, thus increasing the range of the instrument considerably. The mutual inductance between the coils may be increased by winding the outer coil upon the interior of a spherical surface, instead of using the cylindrical form shown.

If a slight increase of resistance of a coil is not objectionable, and the desired range of inductance variation is small, a copper disk slightly smaller than the inside of the coil form may be mounted on a shaft perpendicular to the axis of the coil. The inductance of the coil will be appreciably decreased when the plane of the disk is perpendicular to the coil axis, the decrease of inductance becoming less as the disk is rotated away from this position.

15. Design of Inductance Coils. It is desirable that the inductance should be as large as possible, while the resistance is kept at a minimum. There are some cases in which a relatively high resistance is permissible or even desirable. Choke coils for use at high frequencies must have a high impedance with a minimum internal capacity.

To determine a basis for comparison between coils of different characteristics, a factor of merit for an inductor must be defined. Coils for use at frequencies above 300 or 400 kc are usually small in size, so that volume is relatively unimportant and the desirable characteristics are high inductance (and, therefore, high reactance) and low resistance. The ratio of inductance (or reactance) to resistance may then be taken as a factor of merit, the ideal coil having a large ratio. Sometimes the power factor of the coil, which is equal to the ratio of resistance to impedance, is taken as a factor of merit, an ideal coil having zero power factor. The ratio of reactance to resistance ($L\omega/R$) is sometimes called the *Q* of the coil. (See Table I, Sec. 6.)

A coil to be used at frequencies below 300 kc is likely to be somewhat large if wound in a manner that would be entirely appropriate at higher frequencies. Consequently the factor of merit for coils designed for use at the lower radio frequencies should include the volume of the inductor and may be defined as the inductance-resistance ratio divided by the volume of the coil.

For a given length of wire, maximum inductance is obtained when the wire is wound as compactly as possible; that is, in a bank-wound coil with a winding cross section as nearly square as possible. The bank-wound type is mentioned because the simple multilayer coil is practically useless at radio frequencies because of its high internal capacity. A closely wound single-layer coil made up of the same length of wire has a considerably lower inductance than the bank-wound coil. However, at radio frequencies, the resistance of the single-layer coil is so much lower than that of the multilayer coil that the L/R ratio of the former is much larger than that of the latter. In view of its simplicity of construction, the single-layer solenoid wound with solid wire would appear to be the most desirable coil type at medium and high radio frequencies, even though within certain ranges of frequency some other types have certain advantages. At high frequencies (above 3,000 kc), the single-layer solenoid, either closely wound or spaced, is used almost exclusively.

For a given wire length, this type of coil has a maximum inductance when the ratio of diameter to length of coil is 2.46,¹ although this value

¹ Radio Instruments and Measurements, *Bur. Standards Circ.* 74.

is not critical. The inductance decreases somewhat rapidly as this ratio becomes much smaller than 2.46, while the decrease is only slight for larger values of the ratio. Since the internal capacity of the coil is approximately proportional to the diameter, it is advantageous to use a ratio of diameter to length somewhat smaller than 2.46, provided that the coil is to be used under such conditions that the decrease in internal capacity effected in this way more than compensates for the slightly lower inductance-resistance ratio.

A multilayer coil has a maximum inductance when the cross section of the winding is a square. It has also been shown¹ that, with a square cross section given, the inductance of this type of coil is maximum when the mean diameter is 3.02 times the depth of the winding.

Below 300 kc the volume of the coil must be included in the factor of merit. In these circumstances, the honeycomb and bank-wound coils outstrip all others, the honeycomb type being somewhat superior to the bank wound. Table I gives the characteristics of honeycomb coils.

TABLE I.—HONEYCOMB-COIL DATA

Turns on coil	Size of wire, B. & S. gage	Inductance, mh	Distributed capacity, μf	Natural wave length, meters	Wave lengths with the following shunt-condenser capacities, μf			
					0.001	0.0005	0.00025	0.0001
25	24	0.038	26.8	60	372	267	193	131
35	24	0.076	30.8	91	528	378	277	188
50	24	0.150	36.4	139	743	534	391	270
75	24	0.315	28.6	179	1,007	770	560	379
100	24	0.585	36.1	274	1,470	1,055	771	532
150	24	1.29	21.3	313	2,160	1,546	1,110	746
200	25	2.27	18.9	391	2,870	2,050	1,470	980
250	25	4.20	22.9	585	3,910	2,800	2,020	1,355
300	25	6.60	19.0	669	4,900	3,490	2,510	1,670
400	25	10.5	17.4	806	6,160	4,400	3,160	2,095
500	25	18.0	17.3	1,052	8,070	5,750	4,140	2,740
600	28	37.5	19.2	1,600	11,600	8,300	5,980	3,980
750	28	49.0	18.3	1,785	13,300	9,500	6,830	4,540
1,000	28	85.3	16.8	2,260	17,600	12,500	9,000	5,950
1,250	28	112.0	15.5	2,490	20,100	14,300	10,250	6,780
1,500	28	161.5	15.8	3,000	24,200	17,200	12,350	8,150

16. Coils for Various Frequency Ranges. A study of the characteristics of various types of inductors in the frequency range of 300 to 1,500 kc has been made by Hund and De Groot.² Their results show that in this frequency band the single-layer solenoid and the loose basket-weave coils have the highest inductance-resistance ratios of the coils wound with solid wire, with the radial basket weave or spider web a close third. Coils wound with 32-38 Litz wire were found to be somewhat better in all respects than solid-wire coils. Contrary to a somewhat generally accepted belief, a few broken strands in the Litz wire made only a slight difference in the r-f resistance of a coil.

¹ Radio Instruments and Measurements, *Bur. Standards Circ. 74*.

² HUND, AUGER, and H. B. DE GROOT, Radio Frequency Resistance and Inductance of Coils Used in Broadcast Reception, *Bur. Standards Tech. Paper 298*, Vol. 19, p. 651, 1925.

In solid-wire coils, little is gained by using a wire size larger than No. 24-AWG, although No. 16 gives a slightly lower resistance between 300 and 1,200 kc. Spacing the turns does not decrease the resistance appreciably—not enough to compensate for the extra length necessary. A number of binders were tried on single-layer coils, all of them causing a slight increase in the r-f resistance of the coil. Collodion appeared to be the best of these binders.

At frequencies above 3,000 kc, dielectric losses, eddy currents, and internal capacity are important. The first two cause relatively large increases in the coil resistance. The third increases both the resistance

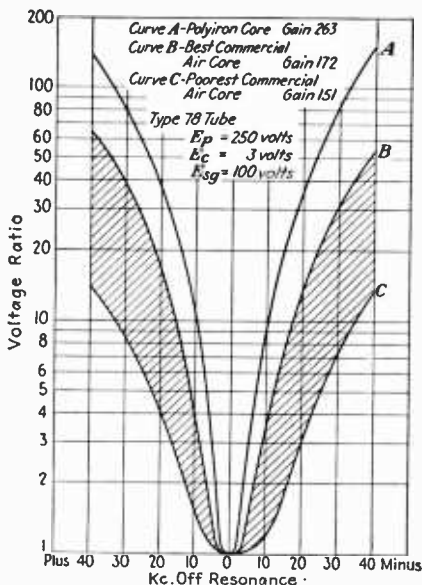

FIG. 22.—Iron-core coil characteristics.

and inductance of the coil if the voltage in the circuit is not induced in the coil itself. If the circuit e.m.f. is introduced by induction in the coil, the internal capacity, acting as a parallel condenser, determines the highest frequency to which the coil can be tuned. As the upper limit of parallel tuning capacity is not very large (in order that the L/C ratio be not too small), a large internal capacity seriously restricts the range over which the coil may be tuned efficiently. It is for these reasons that the single-layer solenoid is used almost exclusively at such frequencies.

Coils for Short-wave Receivers. A considerable study of coils of various sizes made from wire of various sizes and for use at frequencies of the order of 15 Mc was made by W. S. Barden and David Grimes.¹

¹ *Electronics*, June, 1934, p. 174. (This material and that on iron-core inductances are by the Editor.)

It was determined that maximum value of Q for such coils, of the order of $1 \mu\text{h}$ inductance, could be realized when wire diameter and spacing between turns were of the same order of magnitude. Very large wire (long coils) was not superior to medium-size wire, say No. 20 or No. 22. Using wire of No. 14 size, 1-in.-diameter coils were superior to $\frac{1}{2}$ -in.-diameter coils for any winding length.

It was determined that shielding the coil does not reduce the Q to a serious extent, provided proper spacing is observed. In reasonable practice Q need not be decreased by more than 10 per cent or L by more than 15 per cent. Bakelite winding forms have some effect upon Q . Thus a $1\text{-}\mu\text{h}$ coil of No. 10 wire (0.104 in.) was wound on a 2-in. length of 1.5-in.-diameter bakelite having a 0.125-in. wall. This coil had 0.333-in. winding pitch. At 15 mc, $Q = 212$. Upon removing the winding form it remained self-supporting, and Q increased to 229.

Coils made of No. 14 wire on a 1-in.-diameter form with 0.111 in. between turns ($0.88 \mu\text{h}$, $5\frac{3}{4}$ turns) were found to be good compromise coils. These would have a Q of 184. Coils made on 0.5-in. forms wound with small wire, say No. 24, have values of Q in the region from 75 to 100.

Iron-core R-f Inductances. From 1931 to 1935 considerable headway was made in the use of ferro inductors at broadcast and intermediate frequencies. The advantages offered by iron coils over air coils are the small size and high Q . They have been especially useful where it is necessary to get high gain, or high selectivity, in small space, or with a minimum number of tuned circuits. Some attempt has been made to use coils with variable iron cores so that in tuning a circuit the inductance would be varied instead of the capacity.

One such material (Polyiron) has an iron content of 95 per cent. The remainder of the pressed core is bakelite and insulating varnish. Permeability measured with toroidal cores is of the order of 12; its specific gravity is 4.8 against 7.0 for solid iron; its conductivity is 100 mhos per cubic centimeter against 10^{-6} for solid iron. Permeability remains constant from 50 to 2,000,000 cycles. Variation of magnetic force from 0.01 to 10 gauss makes no appreciable change.¹

Another iron which has come into use in this country is Ferrocort, already widely used in Europe. Intermediate-frequency transformers for 456, 370, 360 and 175 kc have been designed from Ferrocort and Polyiron as have transformers coupling an i-f stage to a diode detector. For automobile and other receivers where high initial gain is required, to reduce the noise to signal ratio, iron coils seem to offer considerable advantages.

In a typical receiver of the characteristics given below, the table shows the advantages to be gained by using iron instead of air-core coils.

This receiver was a six-tube a-c export tube, employing 370-kc i-f transformers. It used a type 57 first detector, type 27 oscillator, a type 58 i-f amplifier, a type 2A6 diode-triode, a type 2A5 output tube and a type 80 rectifier. The high impedance of the plate-cathode circuit of the first detector is partially responsible for the excellent selectivity of the receiver.

¹ LANGLEY, RALPH H., Tuning by Permeability Variation, *Electronics*, July, 1931; CROSSLEY, ALFRED, Iron Core Intermediate Frequency Transformers, *Electronics*, November, 1933; POLYDOROFF, W. J., Further Notes on Iron-core Coils, *Electronics*, January, 1934; and Ferro-inductors and Permeability Tuning, *Proc. I.R.E.*, May 1933; FILL, J. V., Ferrocort and Its Applications, *Electronics*, November, 1934.

Care was taken to align the receiver properly at each frequency in order that each test be made under the best conditions.

WITH AIR-CORE TRANSFORMERS

Frequency, kilocycles	Band width 10 times, kilocycles	Band width 100 times, kilocycles	Band width 1,000 times, kilocycles	Sensitivity, microvolts
1,400	18	37	62	5
1,000	13	28	46	4
600	13	26	42	5

WITH IRON-CORE UNITS

1,400	7	16	31	5
1,000	7	15	27	4
600	7	14	26	6

The advantages from the standpoint of gain are as follows.

In a five-tube a-c d-c set of the better type employing 456-kc i-f transformers, the tube complement was as follows: 6C6, 6D6, 75, 43, and 25Z5. The type 6C6 was employed as a composite oscillator-first detector. In this receiver the two i-f transformers and also the antenna coupler were replaced with iron-core units. The sensitivity at 1000 kc increased from 100 to 20 μ V.

17. Calculation of Inductance of Air-core Coils. The inductance of many types of air-core coils may be calculated by means of formulas involving the dimensions of the coil and the number of turns.¹ Several formulas from *Circular 74* of the Bureau of Standards are given here. Few of the available corrections to inductance formulas are included, since they apply only to the calculation of the l-f inductance. The h-f inductance of a coil cannot be calculated with a high degree of accuracy because of the skin effect and coil capacity.

In the following formulas all dimensions are expressed in centimeters and the inductance is in microhenrys.

18. Straight Round Wire. If l is the length of the wire, d is the diameter of the cross section, and μ is the permeability of the material of the wire,

$$L_0 = 0.002l \left[\log_e \frac{4l}{d} - 1 + \frac{\mu}{4} \right] \quad (29)$$

$$= 0.002l \left[2.303 \log_{10} \frac{4l}{d} - 1 + \frac{\mu}{4} \right] \quad (30)$$

If $\mu = 1$ (for all materials except iron),

$$L_0 = 0.002l \left[2.303 \log_{10} \frac{4l}{d} - 0.75 \right] \quad (31)$$

The return conductor is assumed to be remote. These formulas give the low-frequency inductance.

¹ ROSA, E. B., and F. W. GROVER, *Bur. Standards Sci. Paper* 169; GROVER, F. W., *Bur. Standards Sci. Papers* 320, 1917; 455, 1922; 468, 1923. See for coil design and calculation, especially at low frequencies, MORGAN BROOKS and H. M. TURNER, *Inductance of Coils, Bull. 53, Univ. Ill. Eng. Exper. Sta., Jan. 8, 1912.*

As the frequency increases, the inductance decreases, its value at infinite frequency being

$$L_{\infty} = 0.002l \left[2.303 \log_{10} \frac{4l}{d} - 1 \right] \quad (32)$$

A general expression for the inductance at any frequency is

$$L = 0.002l \left[2.303 \log_{10} \frac{4l}{d} - 1 + \mu\delta \right] \quad (33)$$

The quantity δ is obtained from the table below, as a function of the argument x , where

$$x = 0.1405d \sqrt{\frac{\mu f}{\rho}} \quad (34)$$

and f is the frequency and ρ is the volume resistivity of the wire in microhm-centimeters. For copper at 20°C.,

$$x_c = 0.1071d\sqrt{f}$$

This quantity δ will be used in several of the following formulas without further definition.

VALUE OF δ IN INDUCTANCE FORMULAS

x	δ	x	δ	x	δ	x	δ	x	δ	x	δ
0	0.250	2.5	0.228	6.0	0.116	12.0	0.059	25.0	0.028	70.0	0.010
0.5	0.250	3.0	0.211	7.0	0.100	14.0	0.050	30.0	0.024	80.0	0.009
1.0	0.249	3.5	0.191	8.0	0.088	16.0	0.044	40.0	0.0175	90.0	0.008
1.5	0.247	4.0	0.1715	9.0	0.078	18.0	0.039	50.0	0.014	100.0	0.007
2.0	0.240	5.0	0.139	10.0	0.070	20.0	0.035	60.0	0.012	∞	0.000

19. Two Parallel Round Wires—Return Circuit. The current is assumed to flow in opposite directions in two parallel wires of length l and diameter d , the distance between centers of wires being D . Then

$$L = 0.004l \left[2.303 \log_{10} \frac{2D}{d} - \frac{D}{l} + \mu\delta \right] \quad (35)$$

This neglects the inductance of the wires connecting the two main wires. If these wires are long, their inductance may be calculated by Eq. (33) and added to the result from Eq. (35), or the whole system may be treated as a rectangle and the inductance calculated by Eq. (37).

20. Square of Round Wire. The length of one side of the square is denoted by a ; other letters have already been defined.

$$L = 0.008a \left[2.303 \log_{10} \frac{2a}{d} + \frac{d}{2a} - 0.774 + \mu\delta \right] \quad (36)$$

21. Rectangle of Round Wire. The sides of the rectangle are a and a_1 and the diagonal $g = \sqrt{a^2 + a_1^2}$. Then

$$L = 0.00921 \left[(a + a_1) \log_{10} \frac{4aa_1}{d} - a \log_{10} (a + g) - a_1 \log_{10} (a_1 + g) \right] \\ + 0.004 \left[\mu\delta(a + a_1) + 2 \left(g + \frac{d}{2} \right) - 2(a + a_1) \right] \quad (37)$$

22. Grounded Horizontal Wire. The wire is assumed to be parallel to the earth which acts as the return circuit. In addition to symbols already used, h denotes the height of the wire above ground. Then

$$L = 0.004605l \left[\log_{10} \frac{4h}{d} + \log_{10} \left\{ \frac{l + \sqrt{l^2 + \frac{d^2}{4}}}{l + \sqrt{l^2 + 4h^2}} \right\} \right] + 0.002 \left[\sqrt{l^2 + 4h^2} - \sqrt{l^2 + \frac{d^2}{4}} + \mu\delta - 2h + \frac{d}{2} \right] \quad (38)$$

23. Circular Ring of Circular Section. If a is the mean radius of the ring,

$$L = 0.01257a \left[2.303 \log_{10} \frac{16a}{d} - 2 + \mu\delta \right] \quad (39)$$

provided that $d/2a \leq 0.2$.

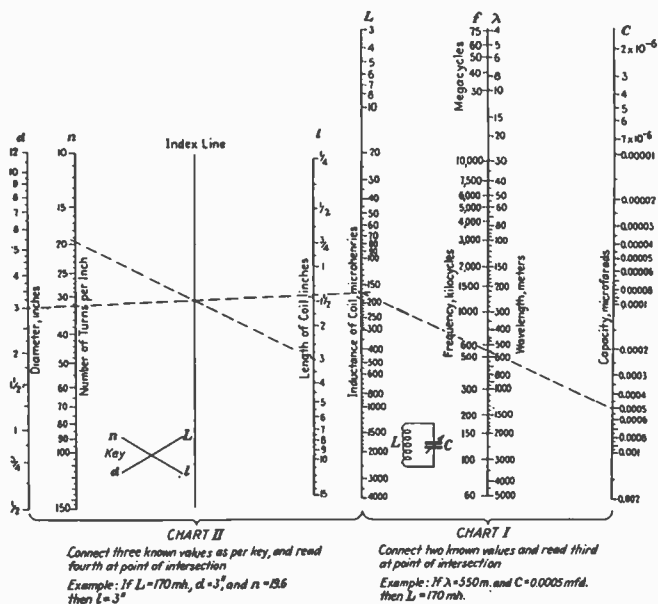

FIG. 23.—Inductance-design chart.

24. Single-layer Coil or Solenoid.

$$L = \frac{0.0395a^2n^2}{b} K \quad (40)$$

where n is the number of turns, a is the radius of the coil measured from the axis to the center of the wire, b is the length of the coil, and K is a function of $2a/b$, the value of which may be determined by means of the table below.

VALUE OF K IN FORMULA 40

Diameter to length	K	Difference	Diameter to length	K	Difference	Diameter to length	K	Difference
0.00	1.0000	-0.0209	2.00	0.5255	-0.0118	7.00	0.2584	-0.0047
.05	.9791	203	2.10	.5137	112	7.20	.2537	45
.10	.9588	197	2.20	.5025	107	7.40	.2491	43
.15	.9391	190	2.30	.4918	102	7.60	.2448	42
.20	.9201	185	2.40	.4816	97	7.80	.2406	40
0.25	0.9016	-0.0178	2.50	0.4719	-0.0093	8.00	0.2366	-0.0094
.30	.8838	173	2.60	.4626	89	8.50	.2272	86
.35	.8665	167	2.70	.4537	85	9.00	.2185	79
.40	.8499	162	2.80	.4452	82	9.50	.2106	73
.45	.8337	156	2.90	.4370	78	10.00	.2033	
0.50	0.8181	-0.0150	3.00	0.4292	-0.0075	10.0	0.2033	-0.0133
.55	.8031	146	3.10	.4217	72	11.0	.1903	113
.60	.7885	140	3.20	.4145	70	12.0	.1790	98
.65	.7745	136	3.30	.4075	67	13.0	.1692	87
.70	.7609	131	3.40	.4008	64	14.0	.1605	78
0.75	0.7478	-0.0127	3.50	0.3944	-0.0062	15.0	0.1527	-0.0070
.80	.7351	123	3.60	.3882	60	16.0	.1457	63
.85	.7228	118	3.70	.3822	58	17.0	.1394	58
.90	.7110	115	3.80	.3764	56	18.0	.1336	52
.95	.6995	111	3.90	.3708	54	19.0	.1284	48
1.00	0.6884	-0.0107	4.00	0.3654	-0.0052	20.0	0.1236	-0.0085
1.05	.6777	104	4.10	.3602	51	22.0	.1151	73
1.10	.6673	100	4.20	.3551	49	24.0	.1078	63
1.15	.6573	98	4.30	.3502	47	26.0	.1015	56
1.20	.6475	94	4.40	.3455	46	28.0	.0959	49
1.25	0.6381	-0.0091	4.50	0.3409	-0.0045	30.0	0.0910	-0.0102
1.30	.6290	89	4.60	.3364	43	35.0	.0808	80
1.35	.6201	86	4.70	.3321	42	40.0	.0728	64
1.40	.6115	84	4.80	.3279	41	45.0	.0664	53
1.45	.6031	81	4.90	.3238	40	50.0	.0611	43
1.50	0.5950	-0.0079	5.00	0.3198	-0.0076	60.0	0.0528	-0.0061
1.55	.5871	76	5.20	.3122	72	70.0	.0467	48
1.60	.5795	74	5.40	.3050	69	80.0	.0419	38
1.65	.5721	72	5.60	.2981	65	90.0	.0381	31
1.70	.5649	70	5.80	.2916	62	100.0	.0350	
1.75	0.5579	-0.0068	6.00	0.2854	-0.0059			
1.80	.5511	67	6.20	.2795	56			
1.85	.5444	65	6.40	.2739	54			
1.90	.5379	63	6.60	.2685	52			
1.95	.5316	61	6.80	.2633	49			

25. Multilayer Coils: Circular Coils of Rectangular Cross Section. For long coils of a few layers, the following formula may be used:

$$L = L_s - \frac{0.0126n^2ac}{b}(0.693 + B_s) \quad (41)$$

where L_s is the inductance calculated by Eq. (40), n and b are the same as in Eq. (40), a is the radius of coil measured from axis to center of winding cross section, c is the radial depth of winding, and B_s is the correction given on p. 73.

VALUE OF B_s IN FORMULA 43

b/c	B_s	b/c	B_s	b/c	B_s	b/c	B_s	b/c	B_s	b/c	B_s
1	0.0000	6	0.2446	11	0.2844	16	0.3017	21	0.3116	26	0.3180
2	0.1202	7	0.2563	12	0.2888	17	0.3041	22	0.3131	27	0.3190
3	0.1753	8	0.2656	13	0.2927	18	0.3062	23	0.3145	28	0.3200
4	0.2076	9	0.2730	14	0.2961	19	0.3082	24	0.3157	29	0.3209
5	0.2292	10	0.2792	15	0.2991	20	0.3099	25	0.3169	30	0.3218

For short multilayer coils, the dimensions shown in Fig. 24 are used. Two formulas are required, one for use when $b > c$, and the other for use when $b < c$. In the first case:

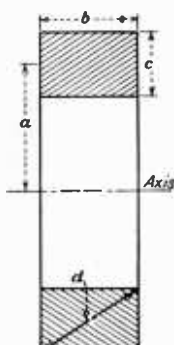

$$L = 0.01257an^2 \left[\left(1 + \frac{b^2}{32a^2} + \frac{c^2}{96a^2} \right) \log_e \frac{8a}{d} - y_1 + \frac{b^2}{16a^2} y_2 \right]$$

$$= 0.01257an^2 \left[2.303 \left(1 + \frac{b^2}{32a^2} + \frac{c^2}{96a^2} \right) \log_{10} \frac{8a}{d} - y_1 + \frac{b^2}{16a^2} y_2 \right] \quad (42)$$

When $b < c$:

$$L = 0.01257an^2 \left[\left(1 + \frac{b^2}{32a^2} + \frac{c^2}{96a^2} \right) \log_e \frac{8a}{d} - y_1 + \frac{c^2}{16a^2} y_2 \right]$$

$$= 0.01257an^2 \left[2.303 \left(1 + \frac{b^2}{32a^2} + \frac{c^2}{96a^2} \right) \log_{10} \frac{8a}{d} - y_1 + \frac{c^2}{16a^2} y_2 \right] \quad (43)$$

FIG. 24.—Multilayer coil.

y_1 , y_2 , and y_3 may be obtained from the table shown below. These formulas are quite accurate as long as the diagonal of the cross section (d Fig. 24) does not exceed the mean radius. The accuracy decreases considerably as b becomes large in comparison with a .

For very accurate results, a correction must be added if the insulation of the wire occupies a considerable percentage of the winding space. This correction is given by

$$\Delta L = 0.01257an \left[2.303 \log_{10} \frac{D}{d} + 0.155 \right] \quad (44)$$

where D is the distance between the centers of adjacent wires, and d is the diameter of the bare wire.

26. Multilayer Square Coil. If n is the number of turns and a is the side of the square measured to the center of the rectangular cross section which has length b and depth c , then

$$L = 0.008an^2 \left[2.303 \log_{10} \frac{a}{b+c} + 0.2235 \frac{b+c}{a} + 0.726 \right] \quad (45)$$

If the cross section is square ($b = c$), this becomes

$$L = 0.008an^2 \left[2.303 \log_{10} \frac{a}{b} + 0.447 \frac{b}{a} + 0.033 \right] \quad (46)$$

VALUE OF CONSTANTS IN FORMULAS (42) AND (43)

b/c or c/b	y_1	c/b	y_2	b/c	y_3
0	0.5000	0	0.125	0	0.597
0.025	0.5253				
0.05	0.5490	0.05	0.127	0.05	0.599
0.10	0.5924	0.10	0.132	0.10	0.602
0.15	0.6310	0.15	0.142	0.15	0.608
0.20	0.6652	0.20	0.155	0.20	0.615
0.25	0.6953	0.25	0.171	0.25	0.624
0.30	0.7217	0.30	0.192	0.30	0.633
0.35	0.7447	0.35	0.215	0.35	0.643
0.40	0.7645	0.40	0.242	0.40	0.654
0.45	0.7816	0.45	0.273	0.45	0.665
0.50	0.7960	0.50	0.307	0.50	0.677
0.55	0.8081	0.55	0.344	0.55	0.690
0.60	0.8182	0.60	0.384	0.60	0.702
0.65	0.8265	0.65	0.427	0.65	0.715
0.70	0.8331	0.70	0.474	0.70	0.729
0.75	0.8383	0.75	0.523	0.75	0.742
0.80	0.8422	0.80	0.576	0.80	0.756
0.85	0.8451	0.85	0.632	0.85	0.771
0.90	0.8470	0.90	0.690	0.90	0.786
0.95	0.8480	0.95	0.752	0.95	0.801
1.00	0.8483	1.00	0.816	1.00	0.816

Formula (43) may be used to correct for insulation by replacing the factor 0.01257 by 0.008.

For a single-layer square coil,

$$L = 0.008an^2 \left[2.303 \log_{10} \frac{a}{b} + 0.2231 \frac{b}{a} + 0.726 \right] - 0.008an(A + B) \quad (47)$$

A and B are given below, where d is the diameter of the bare wire and D is the distance between turns, measured to the centers of the wires.

VALUE OF A IN FORMULA (47)

d/D	A	d/D	A	d/D	A
1.00	0.557	0.40	-0.359	0.15	-1.340
0.95	0.506	0.38	-0.411	0.14	-1.409
0.90	0.452	0.36	-0.465	0.13	-1.483
0.85	0.394	0.34	-0.522	0.12	-1.563
0.80	0.334	0.32	-0.583	0.11	-1.650
0.75	0.269	0.30	-0.647	0.10	-1.746
0.70	0.200	0.28	-0.716	0.09	-1.851
0.65	0.126	0.26	-0.790	0.08	-1.969
0.60	0.046	0.24	-0.870	0.07	-2.102
0.55	-0.041	0.22	-0.957	0.06	-2.256
0.50	-0.136	0.20	-1.053	0.05	-2.439
0.48	-0.177	0.19	-1.104	0.04	-2.662
0.46	-0.220	0.18	-1.158	0.03	-2.950
0.44	-0.264	0.17	-1.215	0.02	-3.355
0.42	-0.311	0.16	-1.276	0.01	-4.048

VALUE OF B IN FORMULA (47)

Number of turns, n	B	Number of turns, n	B
1	0.000	40	0.315
2	0.114	45	0.317
3	0.166	50	0.319
4	0.197	60	0.322
5	0.218	70	0.324
6	0.233	80	0.326
7	0.244	90	0.327
8	0.253	100	0.328
9	0.260	150	0.331
10	0.266	200	0.333
15	0.286	300	0.334
20	0.297	400	0.335
25	0.304	500	0.336
30	0.308	700	0.336
35	0.312	1,000	0.336

27. Inductance Standards. Like all other standards, inductance standards must be rugged, permanent, and constant. The simplest fundamental standard is a single square turn of round wire. The inductance of such a standard can be calculated with great accuracy.

When a standard having a large value of inductance is desired, the single square turn becomes too large for use, and it is necessary to design some more compact form. The resistance and internal capacity must be kept to a minimum. Furthermore the turns must be held rigidly in place so they cannot change their relative positions. The dielectric in the field of the coil must have a minimum volume and be of such material that the losses in it are as small as possible.

These requirements are best met by a single-layer solenoid with a spaced winding. For a minimum conductor resistance, the ratio of diameter to length should be 2.46, but a somewhat smaller value of this ratio is desirable to reduce the internal capacity, this being proportional to the radius.

One excellent form of standard inductor is made by winding silk-covered Litz wire in slots in the edges of strips of hard rubber, the ends of which are supported by hard-rubber rings. With this skeleton type of winding form, the cross section of the coil is polygonal rather than circular. In order that the proper ratios of diameter to length may be maintained, the coils must be of large size, their diameters ranging from 10 to 40 cm. for inductance values that are necessary in the frequency range from 15 to 1,500 kc. Such a coil must be given relatively careful handling, however, since jolts might cause some of the wires to change their positions. A more rugged coil consists of bare wire wound upon a threaded cylindrical form, the turns being cemented in place with a very little cement, preferably collodion. The form should be as thin as is consistent with adequate strength. Glass forms may also be used, although it is then necessary to cement the turns more thoroughly than in the case of a threaded form.

With recent advances in the precision of frequency determination and improvement in standard condensers, the temperature coefficient of a

standard inductance may become an important factor. It is possible, in this case, to reduce the temperature coefficient by a special design of the winding form.

28. Mutual Inductance. As the changing magnetic field due to a varying current in a circuit induces an e.m.f. in the circuit itself, so may it induce an e.m.f. in any neighboring circuit. The e.m.f. induced in the first circuit depends upon the self-inductance of that circuit, and, in the same way, the e.m.f. induced in the second circuit depends upon the *mutual inductance* between the two circuits. Mutual inductance is defined in three ways exactly analogous to the three ways of defining self-inductance: (1) as the magnetic flux linking the second circuit when unit current flows in the first circuit; (2) as the e.m.f. induced in circuit 2 when the current in circuit 1 changes at the rate of one unit per second; (3) as twice the work done in establishing the magnetic flux, linking circuit 2, associated with unit current in circuit 1. These three definitions give constant and equal values for the mutual inductance if there is no material of variable permeability near the circuits and if the current does not vary so rapidly that its distribution in the cross section of the conductors differs greatly from a uniform one. The change in current distribution at high frequencies, however, has a very slight effect upon the mutual inductance.

The units of mutual inductance are the same as those of self-inductance: in the practical system they are the henry and its subdivisions, the millihenry (mh) and microhenry (μ h).

29. Measurement of Mutual Inductance. When two inductors, having a mutual inductance, are connected in series so that their magnetic fields aid each other, the total inductance of the combination is

$$L' = L_1 + L_2 + 2M \quad (48)$$

where L' is the inductance of the combination, L_1 and L_2 are the inductances of the coils, and M is their mutual inductance. If the connections to one of the coils are reversed, the total inductance becomes

$$L'' = L_1 + L_2 - 2M \quad (49)$$

Then, from these two equations,

$$M = \frac{L' - L''}{4} \quad (50)$$

These relations furnish a convenient method for the measurement of mutual inductance. The inductance of the two coils connected in series is measured by any suitable method, the connections to one coil reversed, and the inductance again measured. The larger of the two measured values is then denoted by L' and the smaller by L'' , and M is calculated by means of Eq. (50). This method is applicable at any frequency, provided the inductance-measurement method is appropriate at that frequency. It is not very accurate when M is small in comparison with the inductance of the larger of the two coils.

A method applicable for all values of M is illustrated in Fig. 25.¹ V represents a voltage-measuring device of high impedance, preferably a thermionic voltmeter. A voltage source of frequency $\omega/2\pi$ is connected to

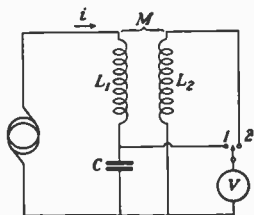

FIG. 25.—Circuit for measuring mutual inductance.

¹ MOULLIN, E. B., "Radio Frequency Measurements," p. 383, 1932.

VALUES OF F FOR FORMULA 56

r_2/r_1	F	Difference	r_2/r_1	F	Difference	r_2/r_1	F	Difference
0	∞							
0.010	0.05016	-0.00120	0.30	0.008844	-0.000341	0.80	0.0007345	-0.0000604
.011	4897	109	.31	8503	328	.81	6741	579
.012	4787	100	.32	8175	314	.82	6162	555
			.33	7861	302	.83	5607	531
0.013	4687	-0.00093	.34	7559	290	.84	5076	507
.014	4594	87						
.015	4507	81	0.35	0.007269	-0.000280	0.85	0.0004569	-0.0000484
.016	4426	148	.36	6989	270	.86	4085	460
.018	4278	132	.37	6720	260	.87	3625	437
			.38	6460	249	.88	3188	413
0.020	0.04146	-0.00119	.39	6211	241	.89	2775	389
.022	4027	109						
.024	3918	100	0.40	0.005970	-0.000232	0.90	0.0002386	-0.0000365
.026	3818	93	.41	5738	225	.91	2021	341
.028	3725	86	.42	5514	217	.92	1880	316
			.43	5297	210	.93	1364	290
0.030	3639	-0.00081	.44	5087	202	.94	1074	263
.032	3558	76						
.034	3482	71	0.45	0.004885	-0.000195	0.95	0.00008107	-0.00002351
.036	3411	68	.46	4690	189	.96	5756	2046
.038	3343	64	.47	4501	183	.97	3710	1706
			.48	4318	178	.98	2004	1301
0.040	0.03279	-0.00061	.49	4140	171	.99	703	703
.042	3218	58				1.00	0	
.044	3160	55	0.50	0.003969	-0.000166			
.046	3105	53	.51	3803	160	0.950	0.00008170	-0.00000494
.048	3052	51	.52	3643	156	.952	7613	482
			.53	3487	150	.954	7131	470
0.050	0.03001	-0.00226	.54	3337	146	.956	6661	458
.060	2775	191				.958	6202	446
.070	2584	164	0.55	0.003191	-0.000141			
.080	2420	144	.56	3050	137	0.960	0.00005756	-0.00000436
.090	2276	128	.57	2913	133	.962	5320	421
			.58	2780	128	.964	4899	409
0.100	0.02148	-0.00116	.59	2652	125	.966	4490	397
.11	2032	104				.968	4093	383
.12	1928	96	0.60	0.002527	-0.000120			
.13	1832	89	.61	2407	117	0.970	0.00003710	-0.00000370
.14	1743	82	.62	2290	113	.972	3340	356
			.63	2177	109	.974	2984	341
0.15	0.01661	-0.00075	.64	2069	106	.976	2643	327
.16	1586	71				.978	2316	312
.17	1515	66	0.65	0.001962	-0.000103			
.18	1449	62	.66	1859	99	0.980	0.00002004	-0.00000296
.19	1387	59	.67	1760	96	.982	1708	278
			.68	1664	93	.984	1430	262
0.20	0.01328	-0.00055	.69	1571	90	.986	1168	242
.21	1273	52				.988	926	223
.22	1221	50	0.70	0.001481	-0.000087			
.23	1171	47	.71	1394	84	0.990	0.00000703	-0.00000201
.24	1124	45	.72	1310	81	.992	502	177
			.73	1228	78	.994	326	148
0.25	0.010792	-0.000425	.74	1150	76	.996	177	115
.26	10366	408				.998	062	62
.27	0.009958	388	0.75	0.0010741	-0.0000731			
.28	9570	371	.76	10010	704			
.29	9199	355	.77	9306	680			
			.78	8626	653			
			.79	7973	628			

the terminals *A* and *B*, the current being denoted by *i*. When the switch is connected to point 1, the voltage measured is

$$e_1 = \frac{i}{\omega C} \quad (51)$$

With the switch on point 2, the measured voltage

$$e_2 = \omega Mi = \omega^2 M C e_1 \quad (52)$$

Then

$$M = \frac{e_2}{e_1} \cdot \frac{1}{\omega^2 C} \quad (53)$$

The capacity *C* may be replaced by a resistance *R*. Then

$$M = \frac{e_2 R}{e_1 \omega} \quad (54)$$

If a variable standard of mutual inductance is available, any other mutual inductance whose value falls within the range of the standard may be readily measured. The primaries are connected in series to a voltage source, the secondaries in opposition to a telephone receiver or other indicating device, and the standard is varied until a null indication is obtained. The unknown mutual inductance then has the value indicated by the standard.

30. Calculation of Mutual Inductance.¹ The mutual inductance of two parallel coaxial circles may be calculated by the following method: first, calculate

$$\frac{r_2}{r_1} = \sqrt{\frac{\left(1 - \frac{a}{A}\right)^2 + \frac{D^2}{A^2}}{\left(1 + \frac{a}{A}\right)^2 + \frac{D^2}{A^2}}} \quad (55)$$

where *a* is the radius of the smaller circle, *A* the radius of the larger circle, and *D* the distance between the planes of the two circles. From the table shown on page 77 the value of *F* corresponding to the calculated value of *r*₂/*r*₁ is obtained. Then

$$M = F\sqrt{Aa} \quad (56)$$

The units are the same as in the formulas for self-inductance already given.

For two parallel coaxial multilayer coils of square or nearly square cross section, a good approximation is given by

$$M = n_1 n_2 M_0 \quad (57)$$

where *n*₁ and *n*₂ are the numbers of turns on the two coils, and *M*₀ is the mutual inductance of two circles located at the centers of the cross sections of the two coils.

The same formula may be used as a rough approximation for the mutual inductance of two coaxial single-layer solenoids.

References

- BUTTERWORTH, S.: The High-frequency Copper Losses in Inductance Coils, *Exp. Wireless*, 2, 613, 1925.
 COURSEY, P. R.: Calculation and Design of Inductances, *Electrician*, 75, 841, 1915.
 GRIFFITHS, W. H. F.: Notes on Standard Inductances for Wave Meters and Other Radio-frequency Purposes, *Exp. Wireless and Wireless Eng.*, 6, 543, 1929.
 MAXWELL: "Electricity and Magnetism," Vol. II.
 PERNOT, F. E.: Formulae and Tables for Design of Air-Core Inductance Coils, *Univ. Calif. Pub., Eng.*, 1, 117, 1916.
 WHITTEMORE, L. E., and G. BREIT: Inductance, Capacity, and Resistance of Coils at Radio Frequency, *Phys. Rev.*, 14, 170, 1919.
 WILMOTTE, R. M.: Parasitic Losses in Inductance Coils at Radio Frequency, *Exp. Wireless*, 2, 451 and 477, 1925.

¹ ROSA, E. B., and F. W. GROVER, *Bur. Standards Sci. Paper* 169; GROVER, F. W., *Bur. Standards Sci. Papers* 320 and 498.

SECTION 5

CAPACITY

BY E. L. HALL,¹ E.E.

1. Capacity. Capacity is one of the three electrical quantities present in all radio circuits. The radio engineer endeavors to concentrate capacity in definite well-known forms at definite points in the circuits, but capacity exists between different conductors in the circuits and between the various conductors and the ground. Such capacities, usually small, are ordinarily of no importance in the case of low or audio-frequency currents but may be of great consequence in radio-frequency circuits.

A *condenser* is an electrical device in which capacity plays the main role. While some inductance and some resistance may be present, these quantities are usually of such minor importance that they are negligible.

A condenser has three essential parts, two of which are usually metal plates separated or insulated by the third part called the *dielectric*.

The amount of electricity which the condenser will hold depends on the voltage applied to the condenser. This may be expressed as $Q = C \times V$. The *capacity* of the condenser is the ratio of the quantity of electricity and the potential difference or voltage, or $C = Q/V$ where Q is given in coulombs, C in farads, and V in volts. The capacity of a condenser is dependent on the size and spacing of the plates and the kind of dielectric between the plates.

2. Units of Capacity. The unit of capacity is the *farad*. A condenser has a capacity of one farad when one coulomb of electricity can be added to it by an applied voltage of one volt. This unit is too large for practical use so that a smaller unit, the microfarad, abbreviated μf , or one-millionth of a farad, is used. A condenser having a capacity of one microfarad is much larger than is used in radio circuits. Condensers for such circuits usually have capacities between a few thousandths and a few millionths of a microfarad. Another unit, the micromicrofarad, is often used. It is abbreviated $\mu\mu\text{f}$.

Another unit of capacity sometimes used is the *centimeter*. The centimeter is equal to 1.1124 micromicrofarads.

3. Electrical Energy of Charged Condenser. Work is done in charging a condenser because the dielectric opposes the setting up of the electric strain or displacement of the electric field in the dielectric. The energy of the charging source is stored up as electrostatic energy in the dielectric.

The work done in placing a charge in the condenser is

$$W = \frac{1}{2}Q \times V = \frac{1}{2}CV^2 = \frac{Q^2}{2C}$$

¹ Radio Section, Bureau of Standards.

where W is expressed in joules
 Q is expressed in coulombs
 V is expressed in volts.

The work done in charging the condenser is independent of the time taken to charge it.

4. **Power Required to Charge Condenser.** The average power required to charge a condenser is given by the equation

$$P = \frac{1}{2} \frac{CV^2}{t}$$

where P is expressed in watts
 C is expressed in microfarads
 V is expressed in volts
 t is expressed in seconds.

If the condenser is charged and discharged N times per second the above equation becomes

$$P = \frac{1}{2} CV^2 N$$

If an alternating e.m.f. of frequency f is used in charging the condenser, the equation may be written

$$P = CE_0^2 f$$

where P = power in watts
 C = capacity in farads
 E_0 = maximum value of voltage
 f = frequency in cycles per second.

5. **Dielectric Materials.** The dielectric of a condenser is one of the three essential parts. It may be found in solid, liquid, or gaseous form or in combinations of these forms in a given condenser.

The simplest form of condenser consists of two electrodes or plates separated by air. This represents a condenser having a gaseous dielectric. If this imaginary condenser has the air between the plates replaced by a non-conducting liquid, such as transformer oil, and if the distance between the plates is the same as in the first case, it would be found that the capacity was increased several times because the oil has a higher value of dielectric constant than air which is usually taken as 1.

If the space between the plates is occupied by a solid insulator, a condenser would result, which would be practical, as far as the possibility of constructing it is concerned. It would be found, in this case also, that the capacity of the condenser was several times larger than when air was the dielectric.

The mechanical construction of either air or liquid dielectric condensers requires the use of a certain amount of solid dielectric for holding the two sets of plates.

There are a great many dielectric or insulating materials available for the engineer to choose from. It often is found that a material which is very good from the electrical standpoint is poor mechanically, or *vice versa*. Air is the only gas generally used as a dielectric. Compressed air has been used in some high-voltage condensers, and compressed nitrogen and carbon dioxide are also in use.

Several kinds of oil have been used in condensers, such as castor oil, cottonseed oil, and transformer oil. More recently electrolytic condensers have come into use in radio equipment for use as filters and bypass

condensers where a large capacity is required and either a direct current or pulsating direct current is applied.

Among the solids used as the condenser dielectric are mica, glass, and paper. Solid insulators used as mechanical supports in condensers include quartz, glass, Isolantite, porcelain, Bakelite, mica, amber, hard rubber, Victron, etc.

6. Dielectric Properties of Insulating Materials. Such properties as surface and volume resistivity, dielectric strength or puncture voltage, dielectric constant, and absorption, are often considered in direct-current and commercial-frequency applications. Such data are of little value if the insulating material is to be used at radio frequencies. For the latter application r-f measurements of various properties of the material are essential. A material which may be a satisfactory insulator for low frequencies may be worthless as an insulator at radio frequencies.

One of the most important properties of an insulator for radio frequencies is its power loss. This includes several factors which are difficult to separate, but together indicate its suitability for radio purposes. The general idea of the imperfection of a condenser is brought out in several names such as "power loss," "power factor," and "phase difference," but they are not identical terms.

Dielectric constant is another important property of a material which has a definite bearing upon its use at radio frequencies.

Neither power loss nor dielectric constant alone can be used in selecting the best insulator for a particular application at radio frequencies. Some investigators have published results in which a product of the power loss and dielectric constant appears. This factor has no recognized name as yet but has certain merits in use for indicating more completely the suitability of an insulating material for radio uses.

7. Dielectric Constant. The *dielectric constant* K of an insulating material is the ratio of the capacity C_x of a condenser using the material as the dielectric, to the capacity C_a of the condenser using air as the dielectric, or $K = C_x/C_a$. This property of the material is sometimes called *inductivity* or *specific inductive capacity*.

The dielectric constant of a material is not a constant in the true sense of the word, but varies with the frequency, moisture content, temperature, voltage applied, and manner of applying it.

8. Values of Dielectric Constant for Electrical Insulating Materials at Radio Frequencies.

Material	Frequency, kilocycles	Dielectric constant	Source	
Celluloid, photographic film.....	A	6.7	} 1	
Cellulose nitrate, laboratory product.....	A	3.8		
Cement, de Khotinski, medium hard.....	A	3.9		
Fiber, black.....	A	7.6		
red.....		4.8		
oil impregnated).....		5.8		
Fused quartz.....	{ 18,000	3.4	6	
		100	4.2	8
Glass.....		30	5.1 to 7.9 ^a	3

Material	Frequency, kilocycles	Dielectric constant	Source
borosilicate.....	18,000	5.1	6
crown.....	800	6.2	4
cobalt.....	500	7.3	2
electrical.....	100	5.7	8
flint.....	890	7.0	2
heat resisting.....	A	5.7	}
photographic, with gelatin coating.....	A	7.5	
without gelatin coating.....	A	7.5	
plate, American.....	A	7.6	}
plate.....	500	6.8	
Pyrex.....	{ 30	4.8	3
window.....	{ 500	4.9	2
	{ A	8.0	1
	{ 210	3.0	}
Hard rubber.....	{ 1,126	3.0	
	{ 18,000	2.9	6
Isolantite.....	B	6.1	5
Marble.....	{ 44	8.4	}
	{ 1,400	7.3	
white.....	A	9.3	}
gray.....	A	11.6	
blue.....	A	9.4	
Mica, clear, U. S. muscovite.....	100 to 1,000	{ 8.69 to 6.57	}
clear, India muscovite.....		{ 7.90 to 7.07	
clear, India.....	A	6.4	1
built-up, shellac binder.....	A	5.6	1
Mycalex.....	100	8.0	8
Phenolic insulation, laminated (bakelite).....	{ 190	5.4 to 5.8	}
	{ 1,000	5.1 to 5.6	
black.....	18,000	{ 4.7	}
natural brown.....		{ 4.4	
Porcelain.....	100	7.0	8
	{ A	30.0	1
Slate, electrical.....	{ 44	20.5	}
	{ 2,650	8.95	
Varnish, spar.....	A	5.5	}
insulating.....	A	4.8	
Victron resin, clear.....	446 to 877	2.96	9
Vitrolex.....	1,100	6.4	9
Vulcanized rubber.....	18,000	3.9	6
Wax, beeswax.....	A	3.2	}
ceresin.....	A	2.5	
paraffin.....	A	2.6	
Wood, basswood, dry.....	}	2.0	}
baywood, dry.....		2.4	
cypress, dry.....		2.0	
fir, dry.....		3.1	
maple, dry.....		2.6	
oak, dry.....		3.1	
birch.....		500	
maple.....	500	4.4	}
oak.....	425	3.3	
whitewood, dry.....	18,000	1.7	6

* range of nine samples of various chemical compositions reported.

⁴ measurements made between 80 and 1,875 kc.

⁵ average of a number of values between 1 kc and 3,130 kc.

¹ PRESTON, J. L., and E. L. HALL, Radio-frequency Properties of Insulating Materials, *QST*, 9, 26-28, February, 1925.

² HOCH, E. T., Power Losses in Insulating Materials, *Bell System Tech. Jour.* 1, November, 1922.

³ DECKER, WILLIAM C., Power Losses in Commercial Glasses, *Elec. World*, 89, 601-603, Mar. 19, 1927.

⁴ BAIRSTO, G. E., Conductivity and Dielectric Constant of Dielectrics for High-frequency Oscillations, *Proc. Roy. Soc. (London) A*, 96, 363-382, January, 1920.

⁵ *Isolantite circular*.

⁶ CHAFFEE, J. G., The Determination of Dielectric Properties at Very High Frequencies, *Proc. I.R.E.*, 22, 1020, August, 1934.

⁷ LEWIS, A. B., E. L. HALL, and F. R. CALDWELL, Some Electrical Properties of Foreign and Domestic Micas and the Effect of Elevated Temperatures on Micas, *Bur. Standards Jour. Research*, 7, 409, August, 1931.

⁸ BROWN, W. W., Properties and Applications of Mycalex to Radio Apparatus, *Proc. I.R.E.*, 18, 1307-1315, August, 1930.

⁹ *Dielectric Products Corp. circular*.

9. Power Loss, Phase Difference, and Power Factor. Electrical insulating materials are not perfect in their insulating qualities and there is a certain amount of power absorbed in them when used in an a-c circuit. A measurement of the power loss is the best single property that gives an indication of the suitability of an insulating material for use in radio circuits. Power loss can be expressed by a number of quantities, the most commonly used being resistance, power factor, phase difference, and phase angle.

When a.c. flows in a condenser, the voltage across the condenser lags somewhat less than 90 deg. behind the current as shown by the angle θ (Fig. 1), called the *phase angle*. The complement ψ of the phase angle, is called the *phase difference*. The cosine of the phase angle is called the *power factor*. The power loss in the insulating material is

$$P = EI \cos \theta$$

or

$$P = EI \sin \psi$$

where E = voltage across the condenser

I = current in amperes through the condenser

θ plus $\psi = 90$ deg. as shown in Fig. 1. From the above, $\sin \psi = \cos \theta$, or the sine of the phase difference is equal to the power factor.

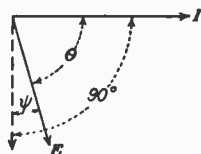

FIG. 1.—Phase in a capacitive circuit.

When considering a condenser having dielectric losses, such as current leakage, brush discharge or corona, dielectric absorption or resistance in the plates, joints, contacts, leads, etc., it is customary to think of it as a perfect condenser C with a resistance R in series as shown in Fig. 2.

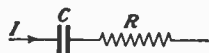

FIG. 2.—Condenser with dielectric losses.

The voltage vectors may be shown as in Fig. 3, where the resultant voltage E flowing in the circuit is obtained by completing the vector diagram. The angle ψ is quite small for materials suitable for radio-frequency insulators. For small angles the angle $\psi = \tan \psi$. In Fig. 3

$$\tan \psi = \frac{RI}{I/\omega C} = R\omega C = 2\pi fRC.$$

If the resistance, capacity, and frequency can be measured, the phase difference can be calculated from

$$\psi = 2\pi fRC,$$

where ψ = phase difference in radians

f = frequency in cycles per second

R = resistance in ohms

C = capacity in farads.

The following equation is sometimes convenient when wave length in meters is given

$$\psi = 0.1079 \frac{RC}{\lambda},$$

where ψ = phase difference in degrees

R = resistance in ohms

C = capacity in micromicrofarads

λ = wave length in meters.

For small angles, phase difference in radians is equal to power factor (nearly).

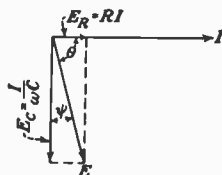

FIG. 3.—Vector relations in a condenser with dielectric losses.

Power factor in per cent is 1.745 times phase difference in degrees. Power factor in per cent is given by the following equation:

$$\cos \theta = 2\pi fRC \times 10^{-7}$$

where $\cos \theta$ = power factor in per cent

f = frequency in kilocycles

R = resistance in ohms

C = capacity in micromicrofarads.

The leakage of electricity by conduction through the dielectric or along its surface contributes to the phase difference but is generally negligible at high frequencies. A condenser having leakage may be represented by a perfect condenser with a resistance in parallel as shown in Fig. 4. The current

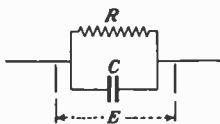

FIG. 4.—Equivalent of condenser with leakage.

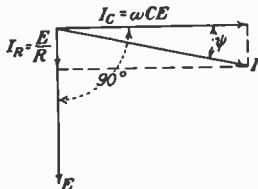

FIG. 5.—Vectors in condenser with leakage.

divides between the capacity and the resistance, I_R through the resistance being in phase with the applied voltage E , and I_C through the capacity leading E by 90° as shown in Fig. 5. The resultant current I leads E by $(90^\circ - \psi)$, where ψ is the phase difference. In Fig. 5

$$\tan \psi = \frac{E/R}{\omega CE} = \frac{1}{\omega RC}$$

or

$$\psi = \frac{1}{\omega RC}$$

Power factor is a term that involves all the power losses in a condenser. If the total power loss in a condenser is W watts, the voltage applied to it is V volts (r-m-s), and the current flowing through it is I amperes (r-m-s) the power factor, of the condenser is W/VI . The relation between I (amperes) and V (volts) for a condenser of capacity C (microfarads) operating at a frequency f is

$$I = \frac{2\pi fCV}{10^8} = \frac{\omega CV}{10^6}$$

The power factor of a condenser in per cent may be written

$$\cos \theta = \frac{W \times 10^6}{2\pi fCV^2} = \frac{W \times 10^6}{\omega CV^2}$$

Referring again to Fig. 2 showing the perfect condenser C and resistance R replacing the actual condenser, the value of R can be calculated from the equation $W = I^2R$. The quantity R is known as the *equivalent resistance* of the condenser at the given frequency.

The expression $W \times 10^6 / \omega CV^2$ for power factor can be changed into the expression involving resistance, capacity and ω by substituting I^2R for W and then substituting $\omega CV / 10^6$ for I , giving power factor equal to $RC\omega \times 10^{-6}$.

10. Values of Power Factor for Electrical Insulating Materials at Radio Frequencies.

Material	Frequency, kilocycles	Power factor, per cent	Source	
Amber.....	187.5	0.459	1	
	300	0.476		
	429	0.478		
	600	0.495		
	1,000	0.513		
Calan.....	300	0.036	11	
	1,000	0.032		
	3,000	0.028		
	10,000	0.026		
	50,000	0.025		
Calit.....	300	0.041	11	
	1,000	0.038		
	3,000	0.037		
	10,000	0.034		
	50,000	0.032		
Celluloid, photographic film.....	A	4.2	5	
Cellulose nitrate, laboratory product.		2.8		
Cement, de Khotinski, medium hard.		3.68		
Condensa.....	300	0.097	11	
	1,000	0.08		
	3,000	0.072		
	10,000	0.061		
	50,000	0.057		
Condensa C.....	300	0.072	11	
	1,000	0.06		
	3,000	0.041		
	10,000	0.032		
	50,000	0.028		
Fiber, black.....	A	4.55	5	
		red.....		4.89
		oil impregnated.....		3.68
Frequentia.....	300	0.047	11	
	1,000	0.038		
	3,000	0.030		
	10,000	0.028		
	50,000	0.026		
Frequentia D.....	1,000	0.038	11	
	10,000	0.019		
	50,000	0.019		
Glass.....	30	0.35 to 2.98 ^a	4	
	600	0.04 to 0.65 ^b		
	borosilicate.....	18,000	0.59	8
	cobalt.....	500	0.70	2
	electrical.....	100	0.4	9
	flint.....	500	0.42	2
		720	0.42	
		890	0.40	
	heat resisting.....	A	0.61	5
	photographic, with gelatin coating.		1.00	
photographic, without gelatin coating.	0.86			

Material	Frequency, kilocycles	Power factor, per cent	Source			
plate	{ 14 100 500 1,000	{ 0.97 0.77 0.66 0.62	} 3			
				500	0.70	} 2
				American plate.....	14	0.88
100	0.74					
Pyrex.....	500	0.67	} 4			
	750	0.68				
	30	0.56				
window.....	500	0.26	} 2			
	A	0.42				
Hard rubber.....	210	0.87	} 5			
	440	0.88				
	710	0.88				
	1,128	1.05				
	600	0.62				
	1,000	0.68				
	18,000	0.76				
	300	0.65				
	1,000	0.64				
	3,000	0.61				
Isolantite.....	10,000	0.57	} 11			
	50,000	0.53				
Marble, white.....	B	0.18	} 6			
	A	0.52				
Marble, white.....	A	4.2	} 5			
		1.22				
Mica.....	300 to 50,000	0.017	} 11			
	100 to 1,000	{ 0.04 to 0.01				
clear, U. S. Muscovite.....	}	{ 0.02 to 0.01	} 7			
clear, India Muscovite.....						
clear, India.....	600	0.017	1			
built-up, shellac binder.....	A	1.75	5			
Mycalex.....	100	0.2	} 8			
	300	0.19				
	1,000 to 50,000	0.18				
Phenolic insulation, laminated (bake- lite).....	190	3.85 to 7.35	} 2			
	1,100	4.20 to 6.65				
	black.....	6.0				
natural brown.....	18,000	5.6	8			
Porcelain.....	100	0.7	} 9			
	300	0.70				
	1,000	0.55				
	3,000	0.49				
	10,000	0.63				
	50,000	0.85				
Quartz.....	300 to 10,000	0.010	} 11			
	50,000	0.011				
transparent, fused.....	100	0.02	9			
Slate, electrical.....	A	63.0	} 5			
	800	0.20				
Steatite.....	45,000	0.16	} 10			
	300	0.21				
	1,000	0.20				
	3,000	0.18				
Ultra-Calan.....	10,000	0.17	} 11			
	50,000	0.15				
	1,000 to 10,000	0.010				
	50,000	0.011				

Material	Frequency, kilocycles	Power factor, per cent	Source
Ultra-Steatite.....	{ 1,000 50,000	{ 0.1 0.06	10
Varnish, spar.....	A	{ 3.15 5.25	
insulating.....		446 to 877	{ 0.03
Victron resin, clear.....	1,100		0.3 to 0.4
Vitrolex.....	18,000	2.9	
Vulcanized rubber.....	A	{ 1.63 0.04	5
Wax, beeswax.....		14 100 500	
ceresin.....	500		{ 0.026
paraffin.....		A	{ 1.92 2.45
Wood, basswood, dry.....	A		{ 2.1 3.5
baywood, dry.....		500	{ 2.45 2.97
cypress, dry.....	500		{ 6.48 3.33
fir, dry.....		300	{ 3.68
maple, dry.....	425		{ 3.50
oak, dry.....		635	{ 3.85
birch.....	1,060		{ 4.20
maple.....		18,000	{ 2.3
oak.....			
whitewood, dry.....			

^a Range of nine samples of various chemical compositions reported.

^b Range of 27 samples of various chemical compositions reported.

^c Measurements made between 80 and 1,875 kc.

^d Between 250 and 1,500 kc.

¹ SCHOTT, ERICH, Hochfrequenzverluste von Gläsern und einigen anderen Dielektrics, *Jahrb. drahtlosen Tele. Tele.*, 18, 82-122, August, 1921.

² HOCH, E. T., Power Losses in Insulating Materials, *Bell System Tech. Jour.*, 1, November, 1922.

³ MACLEOD, H. J., Power Losses in Dielectrics, *Phys. Rev.*, 21, 53-73, 1923.

⁴ DECKER, WILLIAM C., Power Losses in Commercial Glasses, *Elec. World*, 69, 601-603, Mar. 19, 1927.

⁵ PRESTON, J. L., and E. L. HALL, Radio-frequency Properties of Insulating Materials, *QST*, 9, 26-28, February, 1925.

⁶ *Isolanite circular.*

⁷ LEWIS, A. B., E. L. HALL, and F. R. CALDWELL, Some Electrical Properties of Foreign and Domestic Micas and the Effect of Elevated Temperatures on Micas, *Bur. Standards Jour. Research*, 7, 409, August, 1931.

⁸ CHAFFEE, J. G., The Determination of Dielectric Properties at very High Frequencies, *Proc. I.R.E.*, 22, 1020, August, 1934.

⁹ BROWN, W. W., Properties and Applications of Mycalex to Radio Apparatus, *Proc. I.R.E.*, 18, 1307-1315, August, 1930.

¹⁰ *Dielectric Products Corp. circular.*

¹¹ HANDEK, H., Keramische Spezialmassen, *Archiv für tech. Messen*, 44, 28, 29, February, 1935.

POWER FACTOR OF VARIOUS INSULATING MATERIALS AT 1,000,000 CYCLES
(General Electric Company)

Material	Power factor	Dielectric constant
Clear linseed-oil varnish film.....	0.012	2.2
Black asphaltic varnish film.....	0.008	2.0
Shellac film.....	0.025	4.1
Clear gum varnish film.....	0.011	3.2
Mineral oil.....	0.0008	2.7
Rosin.....	0.0026 to 0.0037	3.3 to 4.7
Paraffin wax.....	0.0097	2.5
Ceresin wax.....	0.0012 to 0.0021	2.5 to 2.6
Beeswax.....	0.025	2.9
Portland cement.....	0.018 to 0.029	6.8 to 8.0
Porcelain (wet process).....	0.006 to 0.008	6.5 to 7.0
Plate glass.....	0.01	8.4
Fused quartz.....	0.0002	4.1
Mycalex.....	0.002	8.0
Hard rubber.....	0.015 to 0.02	3.0 to 5.0
Phenolic resin laminated compound (highest grade, paper base).....	0.035	5.0
Phenolic resin laminated compound (highest grade, cloth base).....	0.045	5.0
Phenolic resin molded compound (wood-flour filler)...	0.035	5.5
Phenolic resin molded compound (mica filler).....	0.01	6.0
Hard fiber (dry).....	0.05	5.0
Mica (clear muscovite).....	0.0001 to 0.0006	6.5 to 8.0
Mica (amber).....	0.0004 to 0.071	5.4 to 5.8
Varnished cloth, (yellow).....	0.03	2.5
(black).....	0.02	2.0
Slate.....	0.45 to 0.63	12.4 to 19.0

11. Dielectric Strength. The *dielectric strength* of an insulating material is the minimum value of electric field intensity required to rupture it. Dielectric strength is usually expressed in kilovolts per centimeter of dielectric thickness. The fall in insulation resistance with rise in temperature is a factor of great importance in connection with the breakdown of a dielectric under the applied voltage. Insulating materials are not strictly homogeneous. The current leak through an insulating material may perhaps be concentrated in a few small paths through the material, and the energy loss due to the leakage, while small, may be large compared with the area through which it is flowing. The paths of the current flowing through the dielectric become heated with a resulting lowering of the resistance of the path and an increase in the current leakage. The heating of the dielectric may lead to rapid deterioration, particularly if moisture is present, and ultimate breakdown. The length of time of the application of the voltage has a definite bearing upon the breakdown voltage. Most dielectrics will withstand for a

very brief period a much higher voltage than they can when the voltage is applied for a longer period.

These effects have dictated two tests for condensers, a high flash-test voltage of very brief duration, and the application of a much lower voltage for a longer period.

The dielectric strength of a material is usually found to be lower for r-f voltages than for a-f or d-c voltages. The rupturing voltage at radio frequencies depends on the rapidity with which the voltage is raised and is not nearly so definite a phenomenon as low-frequency puncture voltage. Dielectric strength of solid insulators is difficult to measure because of the complexity of the experimental effects. As the r-f currents flow in the material, heating, corona, flash-over, and possible deterioration, blistering, or charring may result with consequent changing of voltage and current as the time of application elapses.

If high r-f voltages are applied to an air condenser, a corona discharge may be set up which appears as a visible glow around high potential metal parts, points and sharp edges, and is usually distinctly audible. These corona effects represent a power loss in the condenser. Hence, the construction of air condensers for high voltages requires the rounding of all edges and corners and the avoiding of sharp points which encourage the formation of corona and flash-over.

12. Dielectric Absorption. When a condenser is connected to a d-c source of e.m.f. the instantaneous charge is followed by the flow of a small and steadily decreasing current into the condenser. The additional charge is absorbed by the dielectric. Similarly, the instantaneous discharge of a condenser is followed by a continuously decreasing current. The condenser does not become fully charged immediately, nor does it completely discharge immediately when its terminals are shorted, but several discharges may be secured when the condenser possesses dielectric absorption. The maximum charge in a condenser cyclically charged and discharged varies with the frequency of charge.

If a condenser evidencing dielectric absorption is used at radio frequencies, a power loss occurs which appears as heat in the condenser. The existence of power loss indicates a component of e.m.f. in phase with the current as though a resistance were in series with the condenser as shown in Fig. 2. The effect of dielectric absorption can be measured along with other losses in the condenser, although dielectric absorption represents the chief power loss in solid dielectrics.

13. Calculation of Capacity. Formulas are available for use in calculating the capacity for a large number of geometrical shapes of conducting surfaces such as spheres, and cylinders, either separated or concentric, and flat surfaces of various shapes. The usual type of condenser calculations are concerned with two or more flat conductors.

When two conducting plates are parallel, close together and of large area, the capacity of the condenser is given by

$$C = 0.0885 \times \frac{KS}{t}$$

where C = capacity in micromicrofarads
 K = dielectric constant (which is 1 for air)
 S = area of one plate in square centimeters
 t = distance between plates in centimeters.

When more than two plates are used in the condenser, the formula becomes

$$C = 0.0885 \times \frac{KS(N - 1)}{t}$$

where N = number of plates

The actual capacity of a parallel plate condenser is slightly larger than the value as calculated from the above formula, because of the fringing of the electric lines of force beyond the space between the plates. A correction can be made for this fringing by slightly increasing the dimensions of the plates. A narrow strip of width w can be added to the actual plate dimensions. In the case of circular plates $w = 0.4413t$ and for plates with straight edges $w = 0.110t$, where t is the distance between the plates in centimeters.

14. Combinations of Condensers. Combinations of two or more condensers in a circuit are often arranged in either series or parallel. Condensers connected in parallel give a total capacity equal to the sum of the capacities of the individual condensers. Condensers connected in series give a resulting capacity which may be calculated from the following:

$$C = \frac{1}{\frac{1}{C_1} + \frac{1}{C_2} + \frac{1}{C_3} + \dots}$$

This formula gives the following expression in the case of two condensers in series

$$C = \frac{C_1 \times C_2}{C_1 + C_2}$$

The various elements such as tubes, sockets, mountings, wiring, etc., in radio apparatus contain many small capacities by virtue of the difference of potential existing between the numerous conductors insulated from one another. These small capacities are known as stray capacities. While they are unimportant in some kinds of work, in other types of work, such as in amplifier design they must be taken into account. In the case of resistance-coupled amplifiers, for example, these capacities reduce the amplification at the higher audio frequencies and make a flat characteristic with high overall gain impossible.

The effect of stray capacities is eliminated in the case of condensers used as capacity standards by shielding the insulated plates and grounding the shield. In this manner a definite capacity is always assured for a given scale setting.

15. Effect of Frequency on Condenser Capacity. One of the most important considerations is the effect of frequency upon the capacity value of a condenser. In the best condensers this effect is nil. In fact, one of the criterions of a suitable condenser for a capacity standard is that its capacity shall be the same for two different sets of charging and discharging conditions. A variable air condenser, such as the Bureau of Standards type described on page 120 of the Bureau's *Circ. 74*, gives the same capacity at 100 and at 1,000 charges and discharges per second. A condenser having considerable solid dielectric in its make-up will show a difference in capacity with frequency. The quantity of electricity which flows into a condenser during a finite charging period is greater than would flow in during an infinitely short charging period. Conse-

quently, the measured or apparent capacity with a.c. of any finite frequency is greater than the capacity on infinite frequency, the latter being called the geometric capacity. The capacity of a condenser decreases as the frequency increases.

The length of the internal leads of a condenser should be kept as short and direct as possible to minimize the inductance of the leads which acts to give an apparent change of capacity with frequency. The amount of this change can be calculated from $C_a = C[1 + \omega^2 CL \times 10^{-12}]$ where C_a is the apparent or measured capacity, C is in μf , and L in μh .

16. Types of Condensers. There are many ways in which condensers might be classified, having to do with their construction, size, voltage rating, use, dielectric, or whether the capacity is fixed or variable. The condensers used in various radio applications are found in innumerable sizes, shapes, and uses. The two simplest divisions into which condensers may be classified have to do with their capacity: *i.e.*, whether it is fixed or variable.

17. Types of Fixed Condensers.—Fixed condensers are available in all capacity ranges from a few $\mu\mu\text{f}$ to several μf , for any voltage rating up to 45,000 volts or higher, and in innumerable shapes and sizes, all depending upon the use for which the condenser is intended.

Paper formerly was used as the dielectric for condensers for use on lower voltages, while mica was used in condensers for higher voltages. More recently as the art of condenser manufacture has progressed, an oil-impregnated paper dielectric is used in condensers for the higher voltages, the whole condenser being mounted within an oil-filled container.

For paper dielectric, 100 per cent pure linen paper is used, which must meet severe requirements as to thickness, porosity, uniformity, width, freedom from conducting particles, alkalinity, and acidity. Two or more layers of paper are used between the metal foil plates, depending upon the voltage for which the condenser is designed. Paper condensers are impregnated with special high melting point waxes and sealed within metal containers, thus being protected from moisture.

Paper condensers are formed by winding two metal foil electrodes or ribbons in conjunction with the paper ribbons. There are two types of winding, *inductive* and *non-inductive*. The latter type is recommended for r-f and for the higher a-f work. The inductive type is satisfactory for low-frequency work.

In winding the inductive type of condenser, the foil used is narrower than the paper and the contact is made with the foils by tinned copper strips inserted in the winding. The non-inductive type of winding is made with the foils about the same width as the paper. The foil is staggered so that the condenser plates project over the ends of the paper. The terminals are soldered to the extending foil at the opposite ends and thus make contact with every turn of the foil. The latter type of construction makes for minimum plate resistance and minimum power loss.

Mica has been used very extensively for condensers for use at radio frequencies. India mica has been used almost exclusively as it has been generally considered as of superior quality for radio use.

Selected mica is split into sheets of definite thickness, gauged and tested for punctures or other defects. A condenser is built up of alternating mica and metal foil sheets, the sets of plates of opposite polarity being brought out at opposite ends where they are soldered together, forming the two terminals. The whole stack of plates is rigidly clamped together in such a way as to firmly grip the plates in the center and expel all dielectric other than mica. The condenser may be mounted in a suitable container.

If a condenser is to be used with higher voltages, the practice is to construct the condenser with two or more condenser sections in series, rather than to increase the thickness of the mica. The former method is more flexible than the latter, permitting the construction of condensers for 45,000 volts or higher.

It is customary to mount the large high-voltage condensers in steel tanks which are filled with a high flash-point insulating oil which serves to prevent access of dirt and moisture, prevents flash-over along the condenser sections, insulates the condenser from the tank and conducts heat away from the condenser elements.

18. Electrolytic Condensers. Another type of fixed condenser of high capacity for use on voltages not exceeding about 600 volts has come into wide use, known as the *electrolytic condenser*. The chief advantage of the electrolytic condenser is its low cost and its small size for its large capacity as compared to other older types of fixed condensers. For example, an 8- μ f 500-volt condenser is about $1\frac{3}{8}$ in. in diameter and $4\frac{1}{2}$ in. long.

These condensers, however, are not always interchangeable with condensers using paper or mica dielectric, because some can be used only in direct or pulsating direct-current circuits, and must be correctly connected with respect to polarity.

Electrolytic condensers can be obtained for operation in low-voltage filament circuits, for use as filter condensers in "B" power supply units and "A" eliminators. The capacities available run as high as 4,000 μ f for the low-voltage types. Other electrolytic condensers are available for voltages of 100 and 180 volts with capacities from 10 to 100 μ f, while the condensers for 350 to 400 volts have capacities of from 1 to 32 μ f.

Electrolytic condensers have small leakage currents which increase with the operating temperature of the condenser and with the voltage applied. This leakage is less than 0.2 milliamp per microfarad at 400 or 500 volts.

19. Electrolytic Condenser Characteristics. The electrolytic condenser has found general use in the filter circuits of radio receivers and has made possible the design of compact but effective filter systems. In addition to the advantages mentioned above, the electrolytic is also self-healing, momentary overloads of voltage simply causing a temporary rupture of the dielectric, the rupture healing itself as soon as the voltage is reduced to normal.

Electrolytic condensers may be divided into two distinct types, the *wet* and the *dry*. "The wet type has been replaced to a very great extent by the dry type. A very large quantity of the wet types are, however, still being produced and used, because in certain capacities and voltages they are more easily and economically produced. In the higher voltage ratings the wet-type condenser will stand higher voltage surges without injury than will the dry type. On the other hand the wet type is very limited in both voltage and capacity ratings because of economical reasons and manufacturing difficulties. The wet type also has a high power factor compared to the dry type and is subject to wide variations in characteristics under extreme temperature variations.

"The dry-type electrolytic condenser is not handicapped by any of the limitations of the wet type. Dry types can be produced in any capacity from a fraction of a microfarad to millions of microfarads and from

6 volts to 600 volts in single units. They can be produced for operation on alternating current as well as for operation on direct or pulsating current. They can be produced in multiple capacities and for operation on different voltages in the same winding or section. The dry type has a comparatively low power factor and will stand operation under conditions of wide temperature variations. Another distinct advantage of the dry type is that it can be made into almost any desired physical shape." (Treatise on Electrolytic Condensers, Paul MacKnight Deeley.)

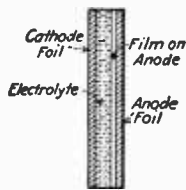

FIG. 6.—Electrolytic condenser construction.

While the liquid condenser contains a considerable quantity of water none of the condensers is entirely without moisture.

The electrolytic condenser consists of four essential parts: the anode, the cathode, the electrolyte, and the dielectric film formed electrochemically usually on the surface of the anode (Fig. 6). The anode is almost invariably made of aluminum, the cathode of either copper or aluminum, and the electrolytic composition depends upon the type of condenser and the service for which it is intended.

"At the present stage of development in the art of electrolytic condensers only two types of electrolytes are in general use for the formation of anodic films. These are: first, an aqueous solution of ammonium or sodium borate and boric acid, and, second, an aqueous solution of sulphuric acid. In many instances processes are in use which involve the utilization of both of these types of electrolytes in a multiple-step procedure. That is, an initial anodic formation takes place first in one type of electrolyte and is then completed in another type of electrolyte." (Deeley.)

20. Characteristics of Dielectric Film. The properties of the electrolytic condenser are due to the film formed on the anode, the composition of which is not accurately known. The extreme thinness of the film makes it possible to obtain high capacities per unit area and its dielectric strength enables it to withstand high voltages. The unit functions as a condenser only so long as a positive potential is applied to the anode. Ordinary electrolytic condensers can therefore be used only on d.c. or on pulsating d.c. This characteristic does not limit the application of the condenser to radio or audio circuits since most of the currents in such systems are pulsating d.c.

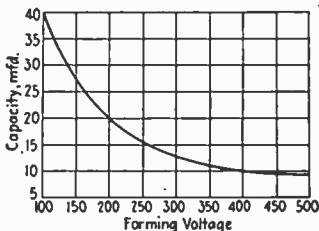

FIG. 7.—Electrolytic condenser characteristic.

Commercial electrolytic condensers for radio applications have been made in ratings up to 600 volts peak; by a series arrangement of two or more condensers the voltage rating may be increased in direct proportion to the number of units connected in series. Experiments with several 500-volt condensers have indicated that when using a series arrangement of electrolytic condensers, shunting resistors to equalize the voltages are not required as is the case when several paper condensers are connected in series.

The capacity per unit area depends upon the thickness of the film on the anode which in turn is an inverse function of the voltage to which the film is formed in manufacture. For a constant anode area the capacity is therefore inversely proportional to the forming voltage. If the anode area is such as to give $8 \mu\text{f}$ if the forming voltage is 500 volts d.c. then the same anode area formed to any lower voltage will give a capacity as indicated by the curve of Fig. 7.

21. Leakage Current. If an unformed electrolytic unit is connected across a d-c circuit the initial current is limited only by the resistance of the electrolyte. An anode film rapidly forms however and the current drops, finally reaching values in the order of 0.2 per μf in the case of condensers such as are generally used in the filter circuits of radio receivers. If the condensers are left on a d-c voltage for a long period (several hundred hours) the d-c current through the unit will drop to but a few microamperes per microfarad.

Condensers which have not been in use for some time will give a high leakage current: when voltage is again applied, this current rapidly decreases.

22. Effect of Temperature. Figure 8 shows how the capacity of a typical electrolytic condenser varies with temperature; all electrolytic

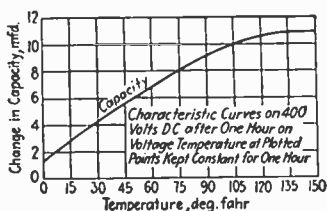

FIG. 8.—Temperature coefficient, electrolytic condenser.

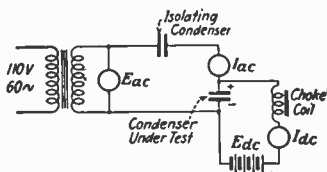

FIG. 9.—Production testing circuit for electrolytic condenser.

condensers show a similar dependence of capacity upon temperature. Subjecting such condensers to temperatures below 0°F . causes a temporary change in characteristics, but the condensers regain the normal characteristics after the return to room temperature.

Testing. The circuit of Fig. 9 is generally used to test electrolytics in production. E_{ac} supplies a polarizing voltage so that the voltage across the condenser will be pulsating d. c. The isolating condenser prevents short-circuiting the polarizing voltage. If E_{ac} is maintained at a constant value the a-c milliammeter may be calibrated in terms of the capacity of the condenser under test. I_{dc} reads the d-c leakage current through the condenser.

For the accurate measurement of capacity and power factor bridge systems such as those shown in Fig. 10a or b should be used. They are essentially standard bridge systems rearranged to permit the application of a polarizing voltage.

23. Use of Electrolytic Condensers for Condenser-start Motors (Aerovox.) Recent years have witnessed the growing demand for high-quality fractional-horsepower motors, for use in refrigerators, washing machines, oil burners, office appliances, small shop equipment, etc. These motors must be quiet, have good operating characteristics, high starting torque, and must create no radio interference. Of all types of single-phase

fractional-horsepower motors, the capacitor motor is by far the best. It possesses the desired characteristics and is the simplest and most reliable of all high-quality single-phase motors. The capacitor motor is not new in conception, but for many years its commercial development was impossible because of the lack of suitable condensers. This problem has now been eliminated by the use of electrolytic condensers.

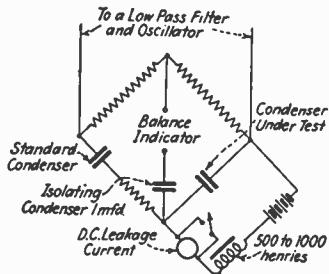

FIG. 10a.—Circuit for measuring electrolytic condenser capacity.

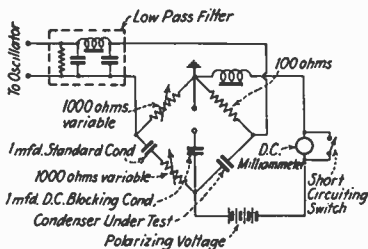

FIG. 10b.—Capacity and power factor measurement.

Various circuit arrangements can be employed in the design of capacitor motors. The three most generally employed are shown. In all three circuits S represents an automatic switch which functions when the motor reaches a sufficiently high speed.

In Fig. 11a the condenser is connected in series with the starting phase, to provide the starting torque. Through the use of such a condenser, starting torques of the order of several hundred per cent or more of full-load torque can be obtained. Such a motor has high starting torque, is simple in design and reliable in operation. The power factor under running conditions is low, because at running speed the condenser is disconnected.

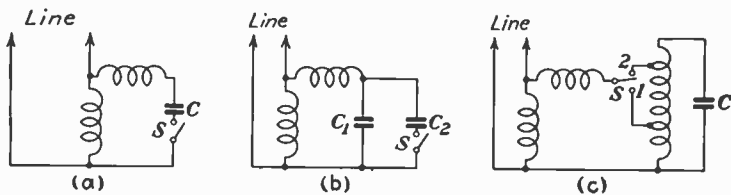

FIG. 11.—Capacitor motor circuits.

Figure 11b employs two condensers in parallel. At start switch S is closed and the total capacity is sufficient to provide high starting torque. At high speeds condenser C_2 is automatically disconnected and the remaining condenser C_1 has a value such as to make the motor run at nearly unity power factor and to operate practically as a two-phase motor, the condenser functioning to convert the single-phase supply into a two-phase supply.

A single condenser in conjunction with an auto transformer can be used as shown in Fig. 11. At start the switch is in position 1 and the effective capacity for starting is equal to CN^2 (turns ratio). At running speed (or slightly lower) the switch S automatically connects to contact 2 and the effective capacity is thereby reduced to the proper value to give high efficiency under running conditions.

The circuit of Fig. 11a makes use of a single electrolytic starting condenser which is only in the circuit during the starting period. In the circuit, Fig. 11b, the condenser C_2 may be an electrolytic type while C_1 which is in circuit during running must be an oil-filled oil-impregnated condenser. The circuit in Fig. 11c uses a single oil-filled oil-impregnated condenser. Where high starting torque is important, Fig. 11a may be followed; where high starting torque combined with high efficiency under running conditions is required, the circuits of Figs. 11b and 11c must be followed.

24. Types of Variable Condensers. The most common type of variable condenser consists of a series of parallel metal plates fastened to a shaft capable of rotation so that the moving plates intermesh with a set of fixed plates. Air is the main dielectric in such condensers, although some solid insulating material is required to insure that the two sets of plates are correctly located with respect to each other. Many ways of insulating the plates from each other have been devised, using one or more pieces of the insulating material in sheet, rod, or bar form. Bakelite, hard rubber, Pyrex, porcelain, fused quartz, and Isolantite are some of the materials used for such insulators.

The most common use of a variable condenser is in association with a coil, the combination forming a circuit resonant to a band of radio frequencies depending upon the coil constants and the capacity range of the condenser. For a number of applications it is more convenient to have the capacity change in a different way than proportional to the angle of rotation of the plates. This first resulted in the "decimeter" plate and the straight-line wave-length plate. As the use of frequency rather than wave length became common, the straight-line frequency plate came into use and later the "mid-line" plate. There are other possibilities such as straight-line percentage wave length and straight-line percentage frequency, the latter being of advantage in frequency measurements. In any of the above shapes or classifications, the movable plates formerly were so shaped as to give the desired frequency or wave-length curve. This resulted in an ill-shaped plate difficult to balance or to hold to a desired setting. In some cases semicircular rotating plates were used with the fixed plates cut away so as to obtain the desired curve. In any of the special forms of plates, the plate shape may vary. The minimum and maximum capacities of the condenser play a large part in determining the outline of the plate.

Brass or aluminum plates and steel shafts are ordinarily used. If the condenser is intended for use on high voltages, the spacing between opposite plates must be sufficient to avoid a flash-over or arcing between plates. It is customary to round off all sharp edges and corners in such condensers to avoid flash-over.

Condensers of the air type are often filled with oil, which increases the voltage that they can stand and increases the capacity from two to five times depending on the dielectric constant of the oil used.

Compressed-air condensers were formerly used in some radio transmitting stations. The voltage which such a condenser will stand is increased without changing the capacity.

Compressed Gas Condensers. Recently, condensers filled with nitrogen or carbon dioxide at pressures from 100 to 200 lb. per square inch have been employed in some of the high-powered broadcast transmitters. A typical condenser was 17 in. in diameter, 3 ft. high and weighed 185 lb. Its maximum voltage rating was 40,000 r.m.s., and maximum current rating 100 amp. at 1000 kc. The condenser plates were placed within a copper or copper-plated steel container made to withstand the pressure of the gas. Corona or other discharges within the condenser were eliminated because of the high pressure, thus reducing losses. One cylinder of compressed nitrogen will supply a condenser for a year or more. The condenser was variable from 0.0011 to 0.0015 μ f.

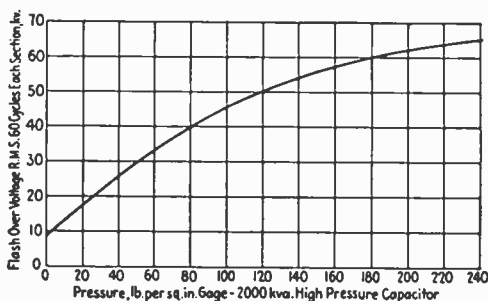

FIG. 12.—Flash-over voltage (60 cycles) of 2000 kva. capacitor.

25. Gang Condensers. The single-dial control radio receiver brought problems to the designer in how to tune two to five circuits accurately using a corresponding number of similar coils and variable condensers operating on the same shaft. As it is practically impossible conveniently to manufacture two condensers exactly alike, to say nothing of three or four alike, so that their capacities shall be exactly the same throughout the complete rotation of the condenser plates and accurately tune the condensers with the same number of similar coils which differ slightly in value, it has been customary to balance or equalize these tuned circuits by the addition of small paralleling condensers sometimes called trimming condensers. Such condensers can be obtained matched to one-half of 1 per cent. It is possible to obtain two to four condensers called gang condensers for radio receivers arranged with their shafts in line and operated by one dial, matched to one-half of 1 per cent. The individual condensers may be separated from one another by metal shields if desired.

26. Design Equations for Variable Air Condensers. The capacity of a condenser made up of three plates as indicated in Fig. 13 can be obtained by determining the area of the overlapping plates, the distance between the adjacent plates, and substitution of these values in the general equation given in Art. 13. The area of the shaded portion of Fig. 13 is $\frac{1}{2}\pi(r_1^2 - r_2^2)$. The distance between the plates is $\frac{1}{2}(s - t)$.

Substituting these values in the general equation, the capacity of the condenser is given by

$$C = \frac{0.0885 \frac{1}{2} \pi (r_1^2 - r_2^2) \times (3 - 1)}{\frac{1}{2} (s - t)}$$

The maximum capacity of a condenser with N plates can be obtained by using a similar equation which may be written

$$C = \frac{0.278 (r_1^2 - r_2^2) (N - 1)}{(s - t)}$$

In the above equations C is in micromicrofarads and the dimensions r_1 , r_2 , s , and t in centimeters. These equations neglect the capacity through the solid insulation which is used in the condenser and the fringing effect, the correction for which is in Art. 13. Many condensers are made to have as small a minimum capacity as possible, giving a large ratio of maximum to minimum capacity, but this is of doubtful advantage, as slight changes of capacity due to warping of plates or wear in bearings will cause a relatively large error at the lower end of the scale but practically no noticeable effect at the maximum capacity end of the scale.

A semicircular plate condenser gives a capacity calibration curve similar to C shown in Fig. 14. With the exception of the portions near the ends of the curve, it is practically a straight line. In practice, the lower ten and upper five or ten degrees of a 180-deg. scale are not used, so as to avoid the curvature in the calibration curve in these regions. Zero setting does not give zero capacity.

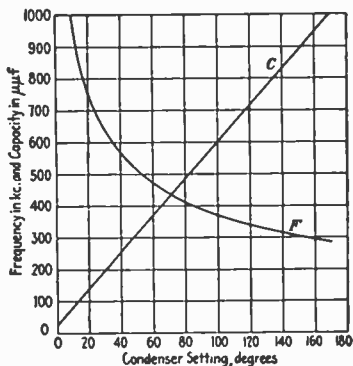

FIG. 14.—Semicircular plate condenser characteristic.

if L is assumed to be constant, $\lambda \propto \sqrt{C}$ and \sqrt{C} is proportional to the square root of the setting θ . For a uniform wave-length condenser it is necessary to have C vary as the square of the setting θ , or $C \propto \theta^2$.

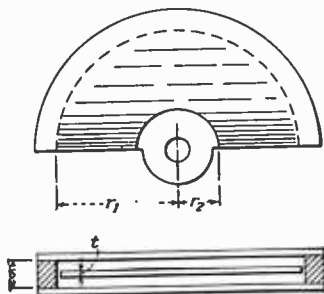
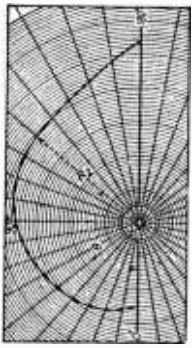
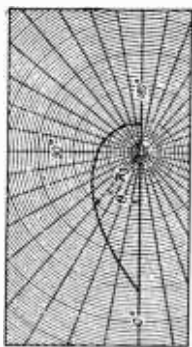
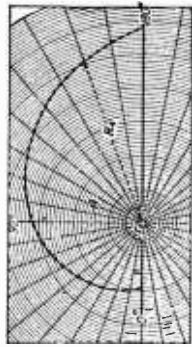

FIG. 13.—Dimensions useful in determining condenser capacity.

A curve for such a condenser used with a coil is shown at F in Fig. 14. The frequency changes very rapidly on the lower part of the scale. A slight capacity change would make a large frequency change. Therefore, when using frequency meters having semicircular plate condensers which constitute the main capacity of the circuit, the coils should be so designed as to give overlaps without resort to the low-capacity end of the scale.

As the wave length λ of a wave-meter circuit is proportional to \sqrt{LC} ,

Straight-line wave length	Straight-line frequency	Straight-line percentage wave length or frequency
		
$C_1 = (a_1\theta + b_1)^2$ $A_1 = k[(a_1\theta + b_1)^2 - \text{resid. cap.}] + K\theta$ $R_1 = [114.6(2ka_1(a_1\theta + b_1) + K)]^{1/2}$ <p>Constants:</p> $a_1 = \frac{\sqrt{\text{max. cap.}} - \sqrt{\text{resid. cap.}}}{180}$ $b_1 = \sqrt{\text{resid. cap.}}$	$C_2 = \frac{1}{(a_2\theta + b_2)^2}$ $A_2 = k\left\{\frac{1}{(a_2\theta + b_2)^2} - \text{resid. cap.}\right\} + \frac{K(180 - \theta)}{K(180 - \theta) + K}$ $R_2 = [114.6\left\{\frac{2ka_2}{(a_2\theta + b_2)^2} + K\right\}]^{1/2}$ <p>Constants:</p> $a_2 = \frac{1}{180} \left\{ \frac{1}{\sqrt{\text{resid. cap.}}} - b_2 \right\}$ $b_2 = \frac{1}{\sqrt{\text{max. cap.}}}$	$C_4 = a_4\theta^2$ $A_4 = k[a_4\theta^2 - \text{resid. cap.}] + K\theta$ $R_4 = [114.6(ka_4\theta^2 + K)]^{1/2}$ <p>Constants:</p> $a_4 = \text{resid. cap.}$ $b_4 = \frac{\log(\text{max. cap.}) - \log(\text{resid. cap.})}{78.174}$

Common constants $k = \frac{\text{total plate area} - 180 K}{\text{max. cap.} - \text{resid. cap.}}$

$$K = \frac{r^2}{114.6}$$

Again, it may be desirable that the percentage change in capacity for a given angle of rotation of the plates be the same for all parts of the scale as in the Kolster decimeter.¹ The polar equation for the boundary curve is

$$r = \sqrt{2C_0 a \epsilon^{a\theta} + r_2^2}$$

where C_0 = capacity when angle $\theta = 0$

a = constant = percentage change of capacity per scale division

$\epsilon = 2.71828$

r_2 = radius of cut-out portion to clear washers separating variable plates.

The equations and tables on the previous page have been compiled by Griffiths.² The four types of plates given are for equivalent condensers having a capacity at zero setting of 36 μmf and a maximum of 500 μmf , with a plate area of 20 sq. cm.

The paper mentioned above gives the following data for the radii at different angles for the condensers mentioned in the table of equations.

θ , degrees	Radius, centimeters		
	R_2	R_3	R_4
0	2.49	8.25	1.93
5	2.56		
10	2.60	6.70	2.02
20	2.76	5.62	2.13
30	2.89	4.80	2.24
40	...	4.17	2.36
60	3.18	3.32	2.64
80	...	2.75	2.98
90	3.56		
100	...	2.37	3.38
120	3.86	2.10	3.85
140	...	1.90	4.40
150	4.12	...	4.71
160	...	1.76	5.04
170	5.40
180	4.38	1.65	5.80

27. Effect of Putting Odd-shaped Plate Condensers in Series or Parallel. If any of the above condensers are placed in parallel or in series with another condenser, the straight-line calibration will be altered. If paralleling condensers are used, the plate shape would require recalculation, after which the plate would become more nearly semicircular. If a condenser is added in series, the calculation of the plate shape is more difficult. Griffiths³ gives complete equations for a number of series

¹ *Bur. Standards Circ. 74*, p. 117. *Bur. Standards Sci. Paper 235*.

² GRIFFITHS, W. H. F., Notes on the Laws of Variable Air Condensers, *Exp. Wireless and Wireless Eng.*, 3, 3-14, January, 1926.

³ GRIFFITHS, W. H. F., Further Notes on the Laws of Variable Air Condensers, *Exp. Wireless and Wireless Eng.*, 3, 743-755, December, 1926.

combinations, the following table applying to the cases indicated where maximum capacity of variable condenser = 500 $\mu\mu\text{f}$, minimum capacity of variable condenser = 36 $\mu\mu\text{f}$, series fixed capacity = 500 $\mu\mu\text{f}$, total plate area = 20 sq. cm., r = radius of inactive semicircular area of moving plate = 1.2 cm.

θ , degrees	Radius, centimeters			
	R_3	R_4	R_7	R_8
0	2.74	2.16	9.25	1.82
10	2.80	6.95
20	2.35	5.57	1.96
30	2.92	4.65
40	2.56	2.15
50	3.06
60	2.78	3.32	2.38
70	3.22
90	3.40	2.42	2.85
100	3.37
110	3.66
120	2.02	3.57
130	3.88
140	4.25
150	4.18	1.78	4.74
160	4.85
170	4.52
180	4.73	5.66	1.62	7.16

R_3 , straight-line capacity with series fixed capacity.

R_4 , corrected square law of capacity with series fixed capacity.

R_7 , inverse square law of capacity with series fixed capacity.

R_8 , exponential law of capacity with series fixed capacity.

28. Important Considerations in Design. It is not difficult to find a large number of condensers on the market which will answer the needs of any condenser application in radio receivers. The manufacture of condensers for such use has been brought to a high stage of development, both electrically and mechanically. The design problems here are simpler in that low power and low voltage are to be handled.

When condensers for radio transmitters are considered, high power and high voltage are to be provided for. More recently the use of very high radio frequencies was added to the problem by requiring better insulating materials. Insulators which were satisfactory at low radio frequencies have been found to heat up and be unsuited for frequencies such as 30,000 kc.

The following classification shows how condensers for transmitting sets could be divided with respect to the voltages to which they are subjected:

Those subjected to steady d-c voltages only.

Those subjected to low-frequency voltages only.

Those subjected to damped r-f voltages only (obsolete).

Those subjected to steady CW r-f voltages only.

Those subjected to modulated CW r-f voltages only.

Those subjected to d-c voltages with superimposed r-f voltage.

Those subjected to low-frequency voltage and superimposed r-f voltage.

The last four of the above divisions could be further subdivided into those for use on frequencies up to about 3,000 kc, those for use on frequencies from

3,000 to about 25,000 kc, and those for use on frequencies of 30,000 kc and above. The two latter classes require special construction.

In specifying the rating of condensers for use in radio transmitters, the following data should be given: capacity, current, frequency, nature of voltage to be applied. A knowledge of the maximum radio-frequency voltage and maximum current permissible is important. A condenser should never be operated at more than half the breakdown voltage. In the case of radio-frequency voltages, this fraction should be much smaller.

29. Standards of Capacity. Fixed condensers using the best grade of mica or fixed air condensers are used as capacity standards for radio frequencies. For some work a variable air condenser is essential as a standard.

An important requirement of a standard condenser is that the capacity remain constant, the prerequisite of which is rigidity of construction, which is more difficult to secure in a variable than in a fixed condenser. There should be no relative motion possible between the movable plates and the pointer. There should be no stops against which the pointer or movable plates may strike and thus destroy the calibration. The manner of insulating the two sets of plates is of great importance not only in fulfilling the rigidity requirement but in minimizing the power loss. An insulating material having a low temperature coefficient of expansion should be used, so that the capacity will not change perceptibly with temperature. As small an amount of solid insulating material as possible should be employed, keeping it well out of the electric field. This field is quite intense near the high-potential post. All insulation should be avoided in the vicinity of that terminal if power factor is to be kept low.

The condenser should be provided with a metal shield, which may be grounded during measurements, if the capacity is to remain constant. The leads inside the condenser should be as short and direct as possible. The resistance of leads, plates and contacts should be kept to the minimum. Flexible connection to the moving plates should not be used in a standard.

Mica condensers can be employed as standards after calibration as to capacity and power factor over the range of frequencies at which they are to be used.

30. Methods of Measuring Capacity. There are two general methods of capacity measurement: (1) absolute measurements in terms of other electrical or physical units; (2) comparison methods, where a condenser of unknown capacity is compared with a known calibrated condenser. The absolute methods are not carried out at radio frequencies. Approximate calibrations of condensers for r-f use can be obtained using some form of bridge operating at 1,000 cycles. A very convenient instrument for rapid checking work is found in the direct-reading microfarad meter which operates on 60-cycle current.

Condenser calibrations at radio frequencies are conveniently made by a substitution method in a resonance circuit. The standard used must be one which is constructed for use as a standard at radio frequencies. It should give the same calibration at two widely different charge and discharge rates, such as 100 and 1,000 charges and discharges per second. If it fills this requirement, it may be assumed to give the same calibration at radio frequencies.

A simple tuned circuit consisting of a coil and the condenser under test is arranged with a double-throw switch so that the standard condenser may be readily substituted. Resonance may be indicated by a

sensitive meter coupled to the main coil by a few turns of wire. A crystal detector and 1-ma d-c meter makes a very convenient indicating device. Power is supplied electromagnetically by a small vacuum tube oscillator. The measurement circuit is shown in Fig. 15. The shielded side of the condenser should be grounded. It is essential that the leads connecting the switch points to each condenser be of the same length in

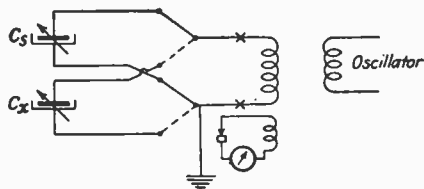

FIG. 15.—Measurement of condenser capacity.

each case as otherwise the circuits will not have the same amount of inductance when one condenser is substituted for the other, which will result in an error in the calibration. The coupling between the test circuit and the oscillator should be kept quite loose, which will be necessary if a sensitive resonance indicating instrument is used.

If in the circuit shown in Fig. 15 a fixed inductor is used, the calibration will be made at various frequencies depending upon the capacity for the different condenser settings. A variable air condenser of suitable size could be connected across the coil at XX and used to keep the resonance frequency the same for any setting of C_x . If such a circuit is carefully set up, no errors will result if the two circuits connected to C_x and C_s are similar. The frequency at which the measurements are made can be measured with a frequency meter. The frequency or frequency range over which a calibration is made should always be stated.

For rougher calibration work, the circuit shown in Fig. 16 may be used where C_s is tuned both with and without C_x in the circuit. It should be noted that the leads and switch connecting C_x to the circuit will introduce errors in the calibration.

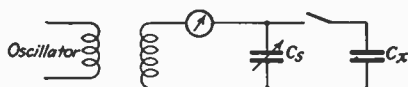

FIG. 16.—Simple scheme for measuring capacity.

31. Precautions in Measurement of Very Small Capacities. It is difficult to get agreement between different laboratories in the measurement of capacities of the order of 15 or 20 μmf or less. The reasons for this are several and include differences in methods of measurement, different lengths of leads used, different sizes and spacing of leads, stray capacities to neighboring objects, and differences of a few micro-microfarads in the capacity standards of the various laboratories. Hence, it is not unusual to find a disagreement as much as 30 per cent or more in the measurement of a capacity of the order of 10 μmf .

For measurements of small capacities it is essential to keep all connecting leads of minimum length, and have them occupy definite positions, so that corrections for their inductance and capacity can be applied if desired. Apparatus not actually needed should be kept away from the measuring circuit. A standard having a finely graduated scale is essential for such measurements. It should be capable of repeating its capacity value for any given setting. Its capacity curve should preferably be a straight line without

any crooks in it, so that interpolations can be accurately made from calibrated points.

32. Methods of Measuring Condenser Resistance and Power Factor and Dielectric Constant of Insulating Materials at Radio Frequencies. Measurements of condenser resistance and power factor of insulating materials are made in practically the same manner, as the sample of insulating material is prepared so as to form a condenser. Methods of measuring condenser resistance¹ and power factor of insulating materials² have been given in publications of the Bureau of Standards. The American Society for Testing Materials has one or more standard methods of testing electrical insulating materials for power factor and dielectric constant.³

The circuit shown in Fig. 17 may be used for measurements of resistance, power factor and dielectric constant. Assuming that the power factor of a sample of insulating material is to be measured, the sample in sheet form is made into a condenser of capacity between 100 and 1,000 $\mu\mu\text{f}$, as represented by C_x (Fig. 17). The remainder of the circuit consists of the coil L , thermoelement T , and double-pole double-throw switch S , in which radio-frequency resistors R may be inserted. The galvanometer G gives deflections which are proportional to the square of the current flowing in the circuit LTC_xR , as electromagnetically induced from the radio-frequency oscillator O .

The deflections of galvanometer G are noted for several values of inserted resistance R and for the case when R is a link of practically zero resistance. Using the "zero resistance" deflection and the deflection for a known value r of resistance inserted in switch S , the resistance R_T of the total circuit LTC_xR is given by

$$R_T = \frac{r}{\sqrt{\frac{d_0}{d_1}} - 1}$$

The average of the values of R_T calculated for various values of r should be taken as the resistance of the complete circuit. The resistance R_s of the circuit when C_s is substituted for C_x should be obtained in the same manner. The resistance R_x of the condenser C_x is then given by $R_x = R_T - R_s$. It is essential for this measurement that the two parts of the circuit which are interchanged should be as nearly identical as possible.

After the resistance R_x of the insulating material condenser is obtained, the power factor or phase difference can be calculated from the equations given above. The dielectric constant K can be calculated from the

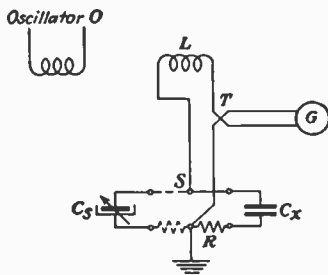

Fig. 17.—Circuit for measuring properties of insulators.

¹ Radio Instruments and Measurements, *Bur. Standards Circ. 74*, pp. 190-193.

² Methods of Measurement of Properties of Electrical Insulating Materials, *Bur. Standards Sci. Paper 471*.

³ Tentative Methods of Testing Electrical Insulating Materials for Power Factor and Dielectric Constant at Frequencies of 100 to 1,500 kc., serial designation D150-34T, American Society for Testing Materials, 260 South Broad Street, Philadelphia, Pa.

equation $K = Ct/0.0885S$, where C = capacity of sample in micromicrofarads, t = thickness of sample in centimeters, and S = area of smaller plate in square centimeters. The capacity is known, as given by C_s , and the area of one plate and the thickness of the sample can easily be measured.

The method described above operates satisfactorily at frequencies from 100 to 1,500 kc.

A bridge method is sometimes used for these measurements although the apparatus is considerably more complicated than that described above.

A comparative method for testing insulating materials at very high radio frequencies has been used by certain laboratories. In this method the insulating material sample is placed in an intense electric field produced by a 30-megacycle transmitter, and the temperature rise in the sample measured for a definite time interval. While such results have not as yet been definitely tied up with power factor, dielectric constant, etc., yet they represent in a very practical manner a means for determining the suitability of different types of materials for use at very high radio frequencies. An insulator which is entirely satisfactory at lower radio frequencies such as 1,000 or 2,000 kc may prove to be unusable at 20 or 30 megacycles. Hence data on power factor and dielectric constant are meaningless without a statement of the frequency at which the data were obtained.

Some of the German technical periodicals¹ have reported the production of improved ceramic insulators in Germany. One type of material is claimed to have extremely low power loss at very high frequencies. Another type of material having moderate power loss possesses very high values of dielectric constant which can be made to have values as high as 100. The latter material would appear to have advantages in condenser manufacture for use at ultra-high frequencies where very small parts and extremely short connections are required. These materials have several names and differ in their properties. The names are: Calit, Ultra-Calit, Calan, Ultra-Calan, Frequentit, Frequenta, Condensa, and Condensa C. The last two materials have the high dielectric constants, and the ones with the prefix "Ultra" have very low losses and are intended for ultra-high frequency work.

33. Life Tests on Paper Condensers (Dubilier). Accelerated life tests of paper condensers can be made with d-c voltages only. Excessive alternating voltages produce heating, which in turn so alters the characteristics of the dielectric of the condensers that no definite relationship between these voltages and life has yet been obtained.

Tests with alternating voltages of higher than rated value have so far produced results that cannot be coordinated. High d-c voltages have given fairly consistent results—so much so, that it has been possible to express the life of condensers in terms of impressed voltage.

Engineers of the Dubilier laboratories have taken samples of all kinds of paper condensers and subjected them to voltages ranging from that rated to four times rated voltage, keeping them on until the condensers broke down. A record of the kind of condenser, voltage, and life at the particular voltage was kept. When enough data were accumulated—which represented the test results of thousands of condensers,

¹ Calit und Calan, zwei neue hochwertige Isolierstoffe der Hochfrequenztechnik. *Hochfrequenztechnik und Elektroakustik*, 43, 33, 34, January, 1934; HANDREK, H., Neue Hochfrequenz-Isolierstoffe, *Hochfrequenztechnik und Elektroakustik*, 43, 73-75, March, 1934.

with dielectric thicknesses of from 0.8 to 6.0 mils, and voltages of 200 to 2,000—it was found that the life could be expressed conservatively in terms of the fifth power of voltage. In other words, the life of paper condensers on d.c. was found to vary inversely as the fifth power of the impressed voltage.

Expressed mathematically:

$$L = K \left\{ \frac{V_1}{V_2} \right\}^5$$

where L = life in hours

K = a constant depending upon the design of the condenser
(usually 10,000)

V_1 = rated voltage

V_2 = applied voltage

It is therefore clear that if a proper sample is taken from a lot of condensers and is subjected to a higher voltage to hasten its breakdown, in a very short time the sample will reveal the quality of the entire lot. As an example, twice the rated voltage will reduce the life to only about 3 per cent, and hence, instead of waiting about 10,000 hr. to find the life of a condenser, only about 300 hr. are required at the accelerated life test of twice rated voltage.

In this as in any other test, a sufficiently large sample must be taken to be really representative of the entire lot. This is governed by the well known probability laws of sampling.

The fifth power relationship is a conservative one, and in well constructed condensers, as high as a seventh power relation between life and voltage holds. At no time, even with the poorest of condensers has a lower than fifth power been obtained.

SECTION 6

COMBINED CIRCUITS OF L, C, AND R

BY W. F. LANTERMAN¹

GENERAL IMPEDANCES

1. Impedances in A-c Circuits. The *impedance* of a circuit carrying alternating current is the ratio of the voltage impressed across its terminals to the current flowing through it. If the circuit consists of resistance only, the current is in phase with the impressed voltage and the impedance is resistive. If the circuit consists solely of inductance, the current lags one-fourth cycle in phase behind the voltage, or if the circuit is made up of pure capacitance, the current leads the voltage by one-fourth cycle. In the latter two cases, the impedance is said to be reactive.

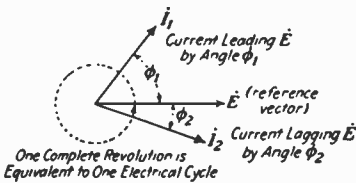

2. Vector Diagrams. Vector diagrams are graphical representations showing both magnitudes and phase angles of currents and voltages with respect to some known voltage or current called the *reference vector* (Fig. 1). Leading vectors are displaced from the reference vectors by counterclockwise angles equal to the time phase angle; lagging vectors are similarly displaced in the clockwise direction.

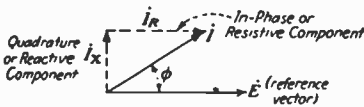

The two projections of a vector upon lines parallel to and perpendicular to the reference vector are, respectively, the in-phase (resistive) and the quadrature (reactive) components of the projected vector. The algebraic sum of any two vectors is the resultant of the algebraic sum of the in-phase components and the sum of the quadrature components, added vectorially, as shown in Fig. 1.

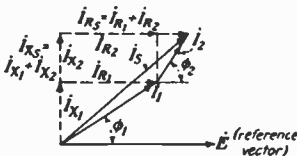

FIG. 1.—Vector diagrams of typical circuits.

the sum of the quadrature components, added vectorially, as shown in Fig. 1.

3. Complex Notation. Algebraic vector notation requires the use of a vector operator j as a factor in each expression for a quadrature vector.

¹ National Broadcasting Co., Chicago, Ill.

to distinguish such quantities from in-phase vectors. Thus, a vector is written

$$\dot{I} = I_R + jI_X$$

where I_R and I_X are the magnitudes of the in-phase and quadrature components, respectively. The operator j signifies that I_X , the reactive component, is leading the reference vector (and the in-phase component, I_R) by 90 electrical degrees, or one-fourth cycle. If the reactive component is *lagging*, the expression is written with a negative operator ($-j$):

$$\dot{I} = I_R - jI_X$$

A vector operated on twice by the operator j —a double operation written $j \times j$, or j^2 —is rotated twice through 90 deg., or 180 deg. This amounts merely to reversing the original direction of the vector, which is denoted by $j^2\dot{I} = -\dot{I}$; hence $j \times j$ or $j^2 = -1$ and j is sometimes considered equivalent to $\sqrt{-1}$. In vector notation, however, the radical $\sqrt{-1}$ is real and signifies an operation, which, if performed twice, reverses the direction of a vector; this usage is in contradistinction to the purely algebraic conception of the radical $\sqrt{-1}$, wherein it is an imaginary numeric.

4. Impedance in Form of a Vector. Instead of writing the magnitude of current due to each resistance and reactance, it is often convenient to write the resistances and reactances themselves in the form of a vector (such expressions are not true vectors; they are a form of vector operator). Thus a resistance R in series with a reactance X may be expressed as $Z = R + jX$. The current when a voltage \dot{E} is impressed is

$$\dot{I} = \frac{\dot{E}}{Z} = \frac{\dot{E}}{R + jX} \quad (1)$$

From this it follows that $\dot{I}R + j\dot{I}X = \dot{E}$. $\dot{I}R$ is the voltage across the resistor and is in phase with \dot{E} while $j\dot{I}X$ is the voltage across the reactance and is leading \dot{E} by 90 deg.

To convert (1) into an expression of the form $\dot{I} = I_R + jI_X$, both numerator and denominator are multiplied by $(R - jX)$. Since j^2 is equivalent to -1 ,

$$\dot{I} = \frac{\dot{E}(R - jX)}{(R + jX)(R - jX)} = \frac{\dot{E}R}{R^2 + X^2} - j\frac{\dot{E}X}{R^2 + X^2} \quad (2)$$

5. Values of the Reactance X of Coils and Condensers. In the above expressions, reactances have been symbolized by X . If the reactance is a coil having an inductance of L henrys, $X = \omega L$ ohms, where $\omega = 2\pi f$; if it is a condenser having a capacitance of C farads, $X = -\frac{1}{\omega C}$ ohms;

if it is composed of both L and C , $X = \left(\omega L - \frac{1}{\omega C}\right)$ ohms. Capacitance always has negative reactance, and inductance always has positive reactance.

6. Equivalent Impedance. The equivalent impedance of a network of impedances is the ratio of voltage to current at the terminals of the network.

7. Equivalent Impedance of Impedances in Series. If two impedances Z_1 and Z_2 are in series, the resistance component of their equivalent impedance is the sum of their resistances, and the reactance component is the sum of their reactances:

$$Z_0 = Z_1 + Z_2 = (R_1 + jX_1) + (R_2 + jX_2) = (R_1 + R_2) + j(X_1 + X_2) \quad (3)$$

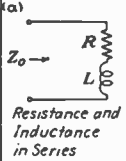
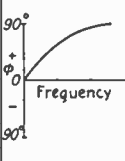
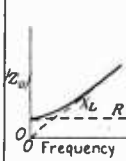
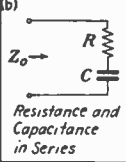
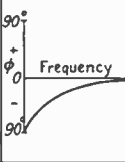
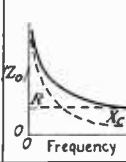
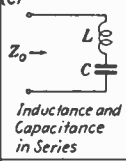
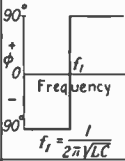
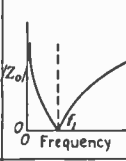
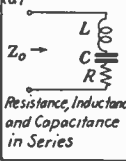
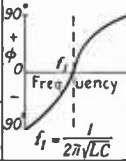
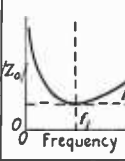
Formula:		$X_L = 2\pi fL$ ohms when L is in henries	
$Z_0 = Z_1 + Z_2 + Z_3 + \dots + Z_n$ $= R_1 + R_2 + R_3 + \dots + j(X_1 + X_2 + X_3 + \dots)$		$X_C = \frac{10^6}{2\pi fC}$ ohms when C is in mfd.	
Circuit	Phase Angle	Magnitude of Z_0	Algebraic Formulae
(a)  Resistance and Inductance in Series			$Z_0 = R + jX_L$ $ Z_0 = \sqrt{R^2 + X_L^2}$ $\phi = \tan^{-1} \frac{X_L}{R}$
(b)  Resistance and Capacitance in Series			$Z_0 = R - jX_C$ $ Z_0 = \sqrt{R^2 + X_C^2}$ $\phi = \tan^{-1} \frac{X_C}{R}$
(c)  Inductance and Capacitance in Series			$Z_0 = j(X_L - X_C)$ $ Z_0 = X_L - X_C $ $= 0$ when $X_L = X_C$ $\phi = \tan^{-1} \infty \cdot (X_L - X_C)$ $= 0$ when $X_L = X_C$ $= -90^\circ$ when $X_L > X_C$ $= +90^\circ$ when $X_L < X_C$
(d)  Resistance, Inductance and Capacitance in Series			$Z_0 = R + j(X_L - X_C)$ $ Z_0 = \sqrt{R^2 + (X_L - X_C)^2}$ $= R$ when $X_L = X_C$ $\phi = \tan^{-1} \frac{X_L - X_C}{R}$ $= 0$ when $X_L = X_C$

Equivalent impedances of series combinations of L , C , and R .



8. Equivalent Impedance of Impedances in Parallel. If two impedances, Z_1 and Z_2 , are in parallel, their equivalent impedance is

$$Z_0 = \frac{Z_1 Z_2}{Z_1 + Z_2} = \frac{(R_1 + jX_1)(R_2 + jX_2)}{(R_1 + jX_1) + (R_2 + jX_2)}$$

$$= \frac{[(R_1 + R_2)(R_1R_2 - X_1X_2) - (X_1 + X_2)(X_1R_2 - R_1X_2)]}{(R_1 + R_2)^2 + (X_1 + X_2)^2} + j \frac{[(R_1 + R_2)(X_1R_2 + X_2R_1) + (X_1 + X_2)(R_1R_2 - X_1X_2)]}{(R_1 + R_2)^2 + (X_1 + X_2)^2} \quad (4)$$

This expression, while somewhat involved, is seen still to be of the form

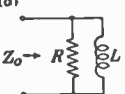
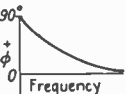
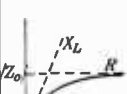
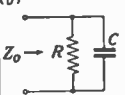
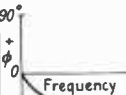
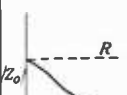
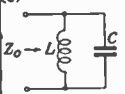
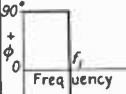
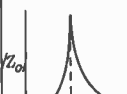
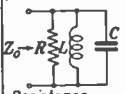
$$Z_0 = R_0 + jX_0$$

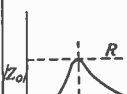
Circuit	Phase Angle	Magnitude of Z_0	Algebraic Formulae
<p>(a)</p>  <p>$Z_0 \rightarrow R$ and L in parallel</p> <p>Inductance and Resistance in Parallel</p>			$Z_0 = \frac{RX_L(X_L + jR)}{R^2 + X_L^2}$ $ Z_0 = \frac{RX_L}{\sqrt{R^2 + X_L^2}}$ $\phi = \tan^{-1} \frac{R}{X_L}$
<p>(b)</p>  <p>$Z_0 \rightarrow R$ and C in parallel</p> <p>Resistance and Capacitance in Parallel</p>			$Z_0 = \frac{RX_C(X_C - jR)}{R^2 + X_C^2}$ $ Z_0 = \frac{RX_C}{\sqrt{R^2 + X_C^2}}$ $\phi = \tan^{-1} -\frac{R}{X_C}$
<p>(c)</p>  <p>$Z_0 \rightarrow L$ and C in parallel</p> <p>Inductance and Capacitance in Parallel</p>	 <p>$f_1 = \frac{1}{2\pi\sqrt{LC}}$</p>		$Z_0 = -jC \frac{L}{X_L - X_C}$ $ Z_0 = \frac{L}{C X_L - X_C }$ $= \infty$ when $X_L = X_C$ $\phi = \tan^{-1} \infty \cdot \left(-\frac{X_L X_C}{X_L - X_C}\right)$ $= 0$ when $X_L = X_C$
<p>(d)</p>  <p>$Z_0 \rightarrow R, L, C$ in parallel</p> <p>Resistance, Capacitance and Inductance in Parallel</p>	 <p>$f_1 = \frac{1}{2\pi\sqrt{LC}}$</p>		$Z_0 = \frac{RX_L X_C (X_L X_C - j(RX_L - RX_C))}{(RX_L - RX_C)^2 + X_L^2 X_C^2}$ $ Z_0 = \frac{RX_L X_C}{\sqrt{(RX_L - RX_C)^2 + X_L^2 X_C^2}}$ $= R$ when $X_L = X_C$ $\phi = \tan^{-1} -\frac{RX_L - RX_C}{X_L X_C}$ $= 0$ when $X_L = X_C$

Equivalent impedance of parallel combinations of L, C, and R.

9. Equivalent Impedance of Networks Having More than Two Impedances. By applying the foregoing principles as many times as necessary in

a step-by-step process, it is possible to reduce any network to a single equivalent impedance. Thus in Fig. 2,

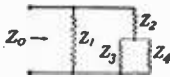

FIG. 2.—Network with branch impedances.

and finally,

$$Z_{34} = \frac{Z_3 Z_4}{Z_3 + Z_4}$$

$$Z_{234} = Z_2 + Z_{34}$$

$$Z_0 = \frac{Z_1(Z_2 + Z_{34})}{Z_1 + Z_2 + Z_{34}}$$

Circuit	Phase Angle	Magnitude of Z_0	Algebraic Formulae
$X_L = 2\pi fL$ ohms when L is in henries $X_C = \frac{10^6}{2\pi fC}$ ohms when C is in mfd.			
$Z_0 = \frac{Z_1 Z_2}{Z_1 + Z_2} = \frac{(R_1 R_2 - X_1 X_2)(R_1 + R_2) + (R_1 X_2 + R_2 X_1)(X_1 + X_2) + j[(R_1 X_2 + R_2 X_1)(R_1 + R_2) - (R_1 R_2 - X_1 X_2)(X_1 + X_2)]}{(R_1 + R_2)^2 + (X_1 + X_2)^2}$			
(e)	<p>Resistance and Inductance in Series and in Parallel with Capacitance</p> <p>$f_1 = \frac{1}{2\pi\sqrt{LC}}$</p> <p>Max. ϕ angle occurs when $f = 0.577f_1$, $Q > 1$</p> <p>Not valid for $Q \leq 1$</p>		$Z_0 = \frac{RX_C - j[X_L(X_L - X_C) + R^2]}{R^2 + (X_L - X_C)^2}$ $ Z_0 = X_C \sqrt{\frac{R^2 + X_L^2}{R^2 + (X_L - X_C)^2}}$ $= \frac{1}{RC}$ when $X_L = X_C$ $\phi = \tan^{-1} \frac{X_L(X_L - X_C) + R^2}{RX_C}$ $= 0$ when $X_L = X_C$ and R is small
(f)	<p>Resistance and Inductance in Series and in Parallel with Capacitance and Resistance in Series</p> <p>$f_1 = \frac{1}{2\pi\sqrt{LC}}$</p> <p>$Q > 1$</p> <p>Not valid for $Q \leq 1$</p>		$Z_0 = \frac{M + N}{(R_L^2 + R_C^2) + (X_L - X_C)^2}$ $ Z_0 = \frac{\sqrt{M^2 + N^2}}{\sqrt{(R_L + R_C)^2 + (X_L - X_C)^2}}$ $= \frac{L}{(R_L + R_C)X_C}$ when $X_L = X_C$ and R_L and R_C are small $\phi = \tan^{-1} \frac{N}{M}$ $= 0$ when $X_L = X_C$ and R_L and R_C are small $M = (R_L R_C + X_L X_C)(R_L + R_C) + (R_C X_L - R_L X_C)(X_L - X_C)$ $N = (R_C X_L - R_L X_C)(R_L + R_C) - (R_L R_C + X_L X_C)(X_L - X_C)$

Equivalent impedance of parallel combinations of L , C , and R .

10. Absolute Values of an Impedance. In many cases the magnitude of an impedance is all that it is required to know; this is given by

$$|Z_0| = \sqrt{R_0^2 + X_0^2} \tag{5}$$

11. Dissipation Factor Q . The ratio Q of reactance to resistance has significance as a figure of merit of a coil or condenser and is called the *dissipation constant*.

$$\text{For a coil,} \quad Q = \frac{\omega L}{R} \quad (6)$$

$$\text{For a condenser,} \quad Q = \frac{1}{\omega RC} \quad (7)$$

TABLE I.—REPRESENTATIVE VALUES OF Q FOR VARIOUS COILS AND CONDENSERS

Frequency, cycles	Coils with powdered iron cores	Air-cored coils	Condensers with paper dielectric	Condensers with mica dielectric
100	25 to 50	3 to 10	1,000	
1,000	50 to 75	25 to 50	500	3,000
10,000	100 to 150	100 to 300	100 to 200	500
100,000	150 to 200	100 to 300	50 to 100	200 to 300
1,000,000	100 to 200	100 to 300	50 to 200

The following data are quoted from Franks:¹

Item	Frequency, kilo-cycles	Q	Item	Frequency, kilo-cycles	Q
100 μf molded bakelite fixed condenser.....	1,000	40	Broadcast band bank-wound litz solenoid $\frac{3}{4}$ in. diam. in $1\frac{1}{2}$ in. square shield can.....	1,000	110
Typical gang condenser; bakelite stator insulation	100	2,000	Broadcast band universal-wound litz coil with iron core in same can.....	1,000	185
	1,000	700			
	10,000	200			
Same with ceramic stator insulation.	100	8,000	Transmitter coil, $4\frac{1}{2}$ in. diam. and 5 in. long, 11 turns of $\frac{1}{4}$ in. copper tubing.....	5,000	650
	1,000	3,000			
	10,000	1,000			
Single-section litz-wound universal coil; 456-ke intermediate frequency, in can.....	456	80	Transmitter coil $1\frac{1}{2}$ in. diameter and $1\frac{1}{2}$ in. long, 12 turns of No. 10 wire.....	10,000	400

12. Loss Due to Inserting Series or Shunt Impedance in Audio Circuits. In audio circuits, attenuation-frequency characteristics are often purposely modified by the insertion of corrective impedances as equalizers, "tone controls," and scratch filters. The following formulas give the loss in decibels.

a. Shunt Impedance. The loss due to inserting a shunt impedance Z_2 (Fig. 3a and b) is

$$L = 20 \log_{10} \left(1 + \frac{Z_1 Z_2}{Z_s (Z_1 + Z_2)} \right) \text{ db} \quad (8)$$

The shunting impedance can usually be located at a point in the circuit where the impedances Z_1 and Z_2 are matched, and where each is substantially

¹ FRANKS, C. J., *Electronics*, p. 126, April, 1935.

a pure resistance through the range of frequencies involved. Then, letting $Z_1 = Z_2 = R_0$, the loss is

$$L = 20 \log_{10} \left| \frac{2Z_s + R_0}{2Z_s} \right| \text{ db} = 20 \log_{10} \sqrt{1 + \frac{\cos \phi}{K} + \frac{1}{4K^2}} \text{ db} \quad (9)$$

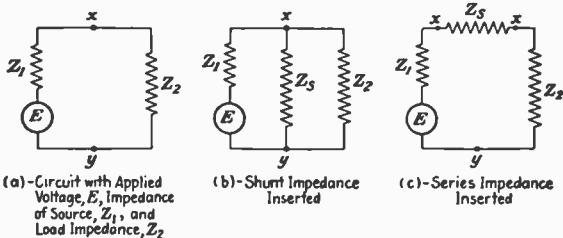

FIG. 3.—Shunt and series impedances inserted in audio-frequency circuits.

where $K = |Z_s|/R_0$ and ϕ is the phase angle of Z_s . For various values of K and ϕ , the loss can be read from the curve (Fig. 4).

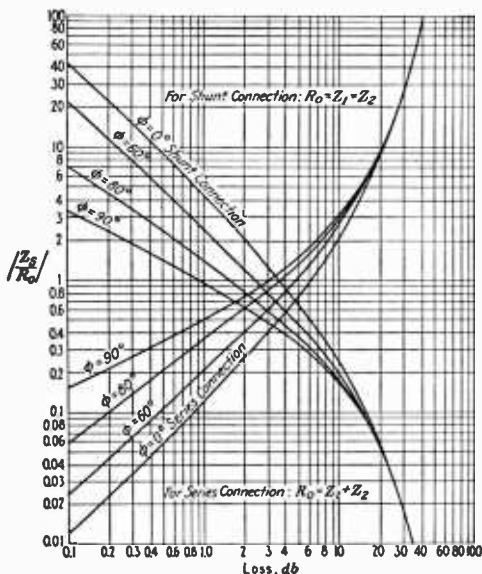

FIG. 4.—Transmission loss due to insertion of shunt or series impedance.

b. Series Impedance. The loss in decibels due to inserting a series impedance Z_s (Fig. 3a and c) is

$$L = 20 \log_{10} \left(\frac{Z_1 + Z_2 + Z_s}{Z_1 + Z_2} \right) \text{ db} \quad (10)$$

The series impedance can usually be inserted at a point in the circuit where the impedances Z_1 and Z_2 are matched, and where each is substantially a pure resistance through the range of frequencies involved. Then, letting $Z_1 + Z_2 = R_0$, the loss is

$$\begin{aligned} L &= 20 \log_{10} \left| \frac{R_0 + Z_s}{R_0} \right| \text{ db} \\ &= 20 \log_{10} \sqrt{1 + 2K \cos \phi + K^2} \text{ db} \end{aligned} \quad (11)$$

where $K = |Z_s|/R_0$ and ϕ is the phase angle of Z_s . The loss can be read from Fig. 4 for various values of K and ϕ .

RESONANCE

13. Definition. In circuits containing both inductive and capacitive reactances, the current drawn from the source may be in phase with the e.m.f., under which condition the reactance component of the equivalent impedance becomes equal to zero. At such frequencies the circuit is in *phase resonance*, or merely in *resonance*.

Physically, resonance depends upon the periodic shift of stored energy from the magnetic field of the coil to the electrostatic field of the condenser, in the form of a circulating current. If the coil and condenser are in series the phenomenon is called *series resonance* and the circulating current I_0 flows through the source and line. The impedance of this arrangement is low at resonance and the line current is large. If the coil and condenser are in shunt the phenomenon is called *parallel resonance* (or *anti-resonance*). The impedance at resonance is large in this case. The value of the circulating current in the case of parallel resonance depends inversely on the L/C ratio and the resistance and is usually large compared to the current flowing in the external supply circuit. Because of its ability to store energy a parallel resonant circuit is often referred to as a *tank* circuit.

14. Series Resonance. The impedance of a coil is

$$Z_L = R_L + jX_L$$

where R_L is the resistance and X_L the reactance of the coil. If the coil is carrying a current I , the countervoltage due to the impedance of the coil is $I Z_L$ or

$$\dot{E}_L = I Z_L = I R_L + j I X_L$$

This is shown graphically by the vector diagram (Fig. 5a).

In many condensers the resistance is negligible compared to X_C , so that the impedance of a condenser is very nearly equal to the reactance, or

$$Z_C \approx -jX_C \approx -j \frac{1}{2\pi f C}$$

If the value of the current is I amperes, the countervoltage across the condenser is

$$\dot{E}_C = I Z_C \approx -j I X_C \approx -j \frac{I}{2\pi f C}$$

This is shown graphically by the vector diagram (Fig. 5b).

If the coil and condenser are connected in series, the same current flows through both. The voltage across the system is $\dot{E}_0 = \dot{E}_L + \dot{E}_C = I(R + j(X_L - X_C))$ and the countervoltages developed by the reactances are in phase opposition to each other (Fig. 5c). If $X_L = X_C$, the reactance term becomes zero and $\dot{E}_0 = IR$. This occurs when $2\pi fL = 1/2\pi fC$ or when the frequency is

$$f_r = \frac{1}{2\pi\sqrt{LC}} \quad (12)$$

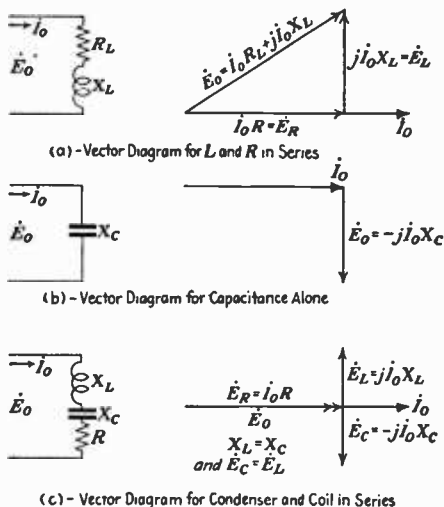

FIG. 5.—Vectors in series circuits.

Under these conditions, the circuit is in *series resonance*. The resonance frequency f_r depends only upon the product of L and C . The vector diagram for this condition is shown by Fig. 5c.

15. Impedance of Series Resonant Circuit at Frequencies Other than Resonant Frequency. At frequencies other than f_r , the impedance of the circuit is greater than the resistance, due to the reactive component, which at any frequency f_1 is

$$X_1 = 2\pi L \left(\frac{f_1^2 - f_r^2}{f_1} \right) \quad (13)$$

With X_1 and R known, the absolute value of impedance is

$$|Z_1| = \sqrt{R^2 + X_1^2} \quad (14)$$

16. Design of Series Resonant Circuits. The magnitude of Z_0 (looking into a series circuit) is $|Z_0| = \sqrt{R^2 + (X_L - X_C)^2}$ which can be written

$$\frac{|Z_0|}{\omega_r L} = \sqrt{Q^2 + n^2 + \frac{1}{n^2} - 2} \quad (15)$$

where $\omega_r = 2\pi \times$ resonance frequency

$\omega_1 = 2\pi \times$ any frequency f_1

$$n = \frac{\omega_1}{\omega_r}$$

$$Q = \frac{\omega_r L}{R}$$

The phase angle of Z_0 is given by $\phi = \tan^{-1} \frac{X_0}{R_0}$

$$= \tan^{-1} Q \left(n - \frac{1}{n} \right) \quad (16)$$

Values of $|Z_0|/\omega_r L$ and ϕ for various values of Q and n may be read from the curves (Figs. 6 and 7). Since (15) is symmetrical with regard to n and

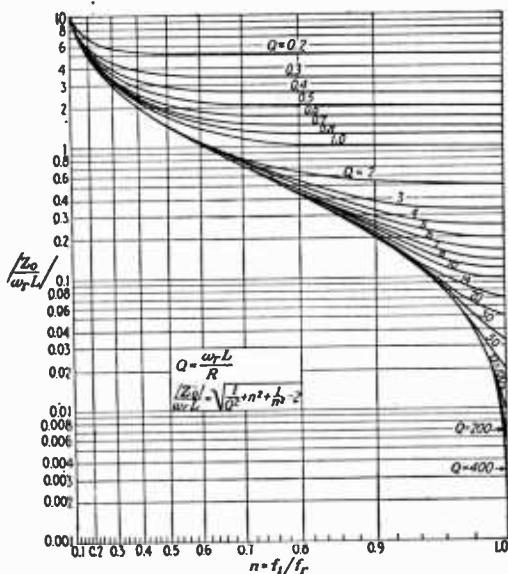

FIG. 6. $\frac{|Z_0|}{\omega_r L}$ vs. n for series circuits.

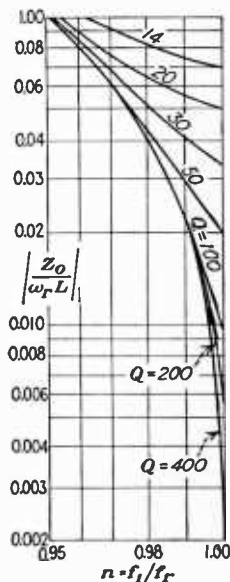

FIG. 6a.

$1/n$, and (16) is also symmetrical except for a reversal of sign, the same curves (Figs. 6 and 7) may be used when $n = f_1/f_r$, or when $n = f_r/f_1$. Thus the resonance curve may be plotted for frequencies above and below resonance.

Example of Design of Series Resonant Circuit. Assume that a series resonant circuit is to be designed to have an impedance, Z_0 , of 100 ohms at a resonant frequency of 1,000 cycles, and of 500 ohms at 0.9 resonance frequency. At resonance, the impedance is the resistance, so $R = 100$ ohms.

At $n = 0.9$, the impedance is to be five times the impedance at $n = 1.0$. From Fig. 6 we find that to secure the desired 5/1 ratio between $|Z_0|/\omega_r L$ at $n = 1.0$ and at $n = 0.9$, Q must be 23, giving $|Z_0|/\omega_r L = 0.043$ and $|Z_0|/\omega_r L = 0.215$.

Then

$$\omega_r L = QR = 2,300$$

For

$$f_r = 1,000$$

$$\omega_r = 6,280$$

and

$$L = \frac{\omega_r L}{\omega_r} = 0.366 \text{ henry}$$

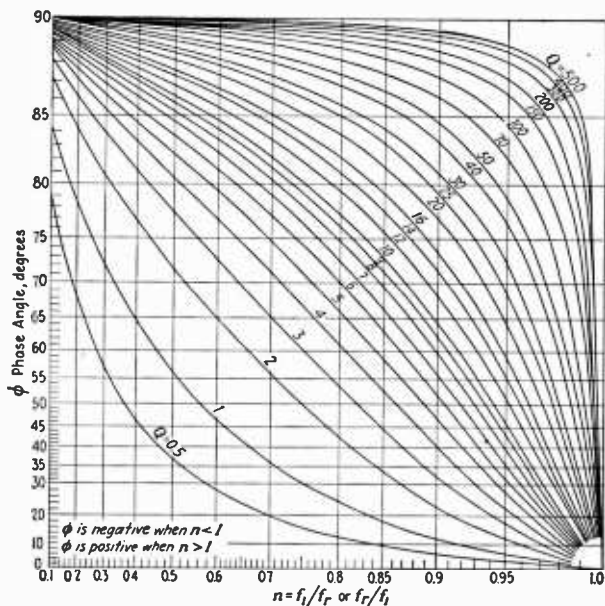

FIG. 7.—Phase angles in terms of n and Q , series circuits.

$$\phi = \tan^{-1} \left[Q \left(n - \frac{1}{n} \right) \right].$$

From the table in Section 1,

$$LC = 25.33 \times 10^{-6}$$

and

$$C = \frac{LC}{L} = 0.692 \times 10^{-6} \text{ farad}$$

Then we have $R = 100$ ohms, $L = 0.366$ henry, and $C = 0.692 \times 10^{-6}$ farad as the constants of the circuit.

The impedance of the circuit at other frequencies can be found from the ratio $|Z_0|/\omega_r L$ read from Fig. 6 along the curve $Q = 23$, and the phase angles can be read from the corresponding curve of Fig. 7.

17. Table of Circuit Constants and Impedances at Various Frequencies.

The table in Section 1 gives frequently used constants in impedance and resonance calculations, for frequencies from 10 cycles to 100 megacycles.

18. Properties of Series Resonant Circuits. A series resonant circuit has the following properties at resonance: (1) The current flowing is in phase with the impressed voltage; (2) the current is limited only by the resistance of the coil; (3) the countervoltage across the coil is always greater than the impressed voltage, if the resistance of the coil is the only resistance in the circuit; (4) the countervoltage across the condenser may or may not be greater than the impressed voltage, depending upon the ratio between X_C and R ; (5) the reactance and impedance of the circuit vary in magnitude and sense with the frequency as shown in Fig. 8.

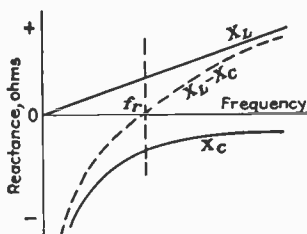

FIG. 8.—Series circuit reactance.

Items 3 and 4 are of importance in cases where iZ_L and iX_C are several times higher than the impressed voltages, under which conditions such high voltages may occur across L and C as to endanger their insulation.

19. Amplifier Using Series Resonant Circuits.

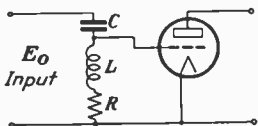

FIG. 9.—Use of series resonance circuit as voltage amplifier.

The fact that the countervoltages may be made to exceed the impressed voltage is useful as a voltage amplification scheme in vacuum tube circuits, such as that shown in Fig. 9. If C and R are small and L is large, the voltage E_o applied to the grid of the tube at resonance may be several times the impressed voltage E_o . If C and L are calibrated and one or both are made variable, the plate current is proportional to E_L , the circuit can be used as a frequency meter.

The phase relation of E_L and E_C is determined by the values of L , R , and C , so that the circuit is also useful as a phase changing device. At resonance the input impedance of the circuit viewed from the source is equal to R , and since a small value of R must be used to secure voltage amplification and sharpness of resonance, the circuit is essentially "current operated" and works efficiently only out of low impedance sources.

20. Use of Series Resonant Circuit for Frequency Regulation.

Another application of a series resonant circuit is shown in Fig. 10. At resonance, the excitation voltages applied to the grids are the reactance drops iX_C and iX_L . The tubes are biased to the cut-off point so that rectification takes place. As long as the frequency of the applied voltage E_o is $f = 1/2\pi\sqrt{LC}$, the excitation voltages and therefore the plate cur-

rents of the two tubes will be equal, but if the frequency varies, the voltage drop across one reactance will increase and that across the other will decrease, causing the plate current of one tube to exceed the other. This difference in plate currents may be read on a meter to indicate the frequency of applied voltage, or may be utilized through a differential relay to operate an automatic frequency controlling device.

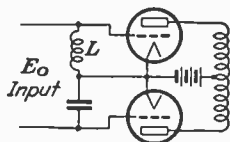

FIG. 10.—Use of series resonance circuit for frequency regulation.

22. Scratch Filters. Resonant circuits are also used as filters for reducing needle scratch in electrical phonograph reproducers and for reducing carbon hiss in microphone circuits. In this case the resonance frequency is usually about 4,500 cycles. In the circuit below, the value of R may be adjusted to give the desired attenuation of the high frequency. The loss-frequency characteristic of such a filter is shown. A low-pass filter with cut-off frequency equal to 5,000 cycles is also frequently employed as a scratch filter (see Art. 57).

23. Tone Control. A series-resonant circuit tuned to 5,000 or 6,000 cycles is also applied as a "tone control" in audio systems, where it is desired to accentuate the low-frequency reproduction at the expense of the higher frequencies. For this purpose, a smaller L/C ratio than that used in scratch filters is desirable; L may be about 20 mh, $C = 0.5 \mu\text{f}$ and R variable to obtain the desired effect.

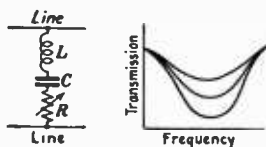

FIG. 11.—Series resonant equalizer.

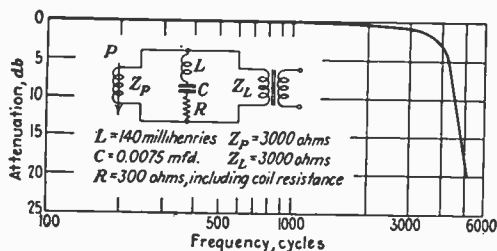

FIG. 12.—Transmission characteristic of scratch filter used with magnetic phonograph pick-up.

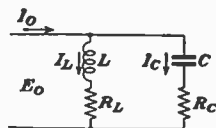

FIG. 13.—Parallel resonance.

24. General Parallel Circuits. The parallel circuit shown in Fig. 13 is widely used in audio and radio circuits. The resistance R_L is principally that of the coil; the resistance R_C of the condenser is usually small.

The equivalent impedance is

$$Z_0 = \frac{Z_L Z_C}{Z_L + Z_C} = (R_L + R_C)(R_L R_C + X_L X_C) + (R_C X_L - R_L X_C)(X_L - X_C) \\ + j[(R_L + R_C)(R_C X_L - R_L X_C) - (X_L - X_C)(R_L R_C + X_L X_C)] \\ (R_L + R_C)^2 + (X_L - X_C)^2 \quad (17)$$

25. Resonance Relations in Parallel Circuits. The reactive component of the equivalent impedance is

$$X_0 = \frac{(R_L + R_C)(R_C X_L - R_L X_C) - (X_L - X_C)(R_L R_C + X_L X_C)}{(R_L + R_C)^2 + (X_L - X_C)^2} \quad (18)$$

If X_0 is equal to zero, Z_0 becomes pure resistance, I_0 is in phase with E_0 , and the circuit is in resonance.

This condition exists if

$$\omega_r = \frac{1}{\sqrt{LC}} \sqrt{\frac{L - R_L^2 C}{L - R_C^2 C}}$$

or

$$f_r = \frac{1}{2\pi\sqrt{LC}} \sqrt{\frac{L - R_L^2 C}{L - R_C^2 C}} \quad (19)$$

When, also, $R_L = R_C$,

$$f_r = \frac{1}{2\pi\sqrt{LC}} \quad (19a)$$

Increasing the ratio of R_L/R_C in (19) tends to decrease the frequency of resonance.

Equation (19a) gives the condition under which the frequency of parallel resonance exactly equals that of a series circuit of the same L and C —that is, when the resistances of the branches are equal.

26. Special Case Where $R_L = R_C$ and $X_L = X_C$.

If

$$R_L = R_C = R \text{ and } X_L = X_C = X,$$

$$Z_0 = \frac{R^2 + X^2}{2R} \quad (20)$$

But if $X_L = X_C$ ($\omega L = \frac{1}{\omega C}$), $\omega_r = \frac{1}{\sqrt{LC}}$ or $f_r = \frac{1}{2\pi\sqrt{LC}}$.

Then $X^2 = (\omega L)^2 = L/C$, and (20) becomes

$$Z_0 = \frac{R^2 + \frac{L}{C}}{2R} \quad (21)$$

When the resistances of the two parallel branches are equal, the equivalent impedance is a pure resistance at the frequency $f = 1/2\pi\sqrt{LC}$ and has the value shown in (20). If also $R^2 = L/C$, (20) reduces to

$$Z_0 = R \quad (22)$$

Thus if $R_L = R_C = R$ and $R = \sqrt{L/C}$, the circuit is resonant at all frequencies (i.e., the current and voltage are in phase), and the impedance is equal to R .

27. Approximate Value of Resonance Frequency When R_C and R_L Are Small. In many actual circuits the resistance R_C is negligible, and R_L consists principally of the resistance of the coil, in which case (19) becomes

$$f_r \approx \frac{1}{2\pi\sqrt{LC}} \sqrt{1 - \frac{R_L^2 C}{L}}$$

If, also the quantity $R_L^2 C/L$ is small compared with 1, then

$$f_r \approx \frac{1}{2\pi\sqrt{LC}} \quad (23)$$

The latter relation is identical with the Eq. (12) for series resonance and is sufficiently accurate for most circuit calculations.

28. Properties of Parallel Resonant Circuits. At its resonant frequency, a parallel circuit has the following properties: (1) The current in the external circuit is in phase with the impressed voltage; (2) the current circulating in the parallel circuit itself is generally much larger than the current flowing in the external circuit; (3) as far as the external circuit is concerned, the parallel circuit behaves as a resistance approximately equal to L/RC , which is usually large.

29. Absolute Value of Impedance at Resonance in Parallel Resonant Circuit. Letting $\omega = 1/\sqrt{LC}$ in (17) gives for the impedance of a parallel circuit at resonance

$$Z_0 \approx \frac{(R_L R_C + X_L X_C) + j(R_C X_L - R_L X_C)}{R_L + R_C} \quad (24)$$

The absolute value of this impedance is

$$|Z_0| \approx \sqrt{\frac{(R_L R_C + \omega^2 L^2)^2 + \omega^2 L^2 (R_C R_L)^2}{(R_L + R_C)^2}} \quad (25)$$

30. Absolute Value of Impedance in General Parallel Circuit, with Negligible Resistance in Capacity Branch. In this case $R_C \approx 0$, and from (17),

$$Z_0 \approx X_C \left[\frac{R_L X_C - j[R_L^2 + X_L^2 - X_L X_C]}{R_L^2 + (X_L - X_C)^2} \right] \quad (26)$$

The absolute magnitude of Z_0 is

$$|Z_0| \approx \frac{X_C \sqrt{R_L^2 + X_L^2}}{\sqrt{R_L^2 + (X_L - X_C)^2}} \quad (27)$$

If R_L is small compared with X_L ,

$$|Z_0| \approx \frac{X_L X_C}{\sqrt{R_L^2 + (X_L - X_C)^2}} \approx \frac{L}{C} \frac{1}{\sqrt{R_L^2 + (X_L - X_C)^2}} \quad (28)$$

At resonance, $X_L = X_C$ (R_L and R_C being assumed negligible), and

$$|Z_0| \approx \frac{L}{RC} \quad (29)$$

The equivalent impedance of a low-resistance parallel circuit is therefore very nearly a pure resistance at the resonant frequency and has the value L/RC .

31. Design of Parallel Resonant Circuits. The magnitude of Z_0 is

$$|Z_0| = X_C \frac{\sqrt{R_L^2 + X_L^2}}{\sqrt{R_L^2 + (X_L - X_C)^2}} \quad (27)$$

which can be written

$$\frac{|Z_0|}{\omega_r L} = \left[\frac{1 + Q^2}{nQ^2} \right] \frac{\sqrt{\frac{1}{Q^2} + n^2}}{\sqrt{\frac{1}{Q^2} + \left(n - \frac{1 + Q^2}{nQ^2} \right)^2}} \quad (30)$$

where $Q = \frac{\omega_r L}{R}$ and $n = \frac{f_1}{f_r}$.

For values of $Q = 10$ or larger, this reduces to

$$\frac{|Z_0|}{\omega_r L_0} = \frac{\sqrt{\frac{1}{Q^2} + n^2}}{n \sqrt{\frac{1}{Q^2} + n^2 + \frac{1}{n^2} - 2}} \quad (30a)$$

From the latter expression, it can be shown that $|Z_0| = 1.414\sqrt{L/C}$ at $f_1 = 0.707f_r$. Hence the L/C ratio of a parallel resonant circuit is expressible as a function of its impedance at 70.7 per cent of resonance frequency, or *vice versa*. The ratio of $|Z_0|$ at 70.7 per cent resonance frequency to $|Z_0|$ at resonance is

$$\frac{|Z_0| \text{ at } 70.7\% f_r}{|Z_0| \text{ at } f_r} = \frac{1.414}{Q} \quad (31)$$

The phase angle of Z_0 is given by

$$\begin{aligned} \phi &= \tan^{-1} \left[- \left(\frac{R_L^2 \times X_L^2 - X_L X_C}{R X_C} \right) \right] \\ &= \tan^{-1} \left[-nQ \left(\frac{1}{Q^2} + n^2 - 1 \right) \right] \\ &\approx \tan^{-1} [-nQ(n^2 - 1)] \end{aligned} \quad (32)$$

when $Q \geq 10$, say.

Values of $|Z_0|/\omega_r L$ and ϕ for various values of n and Q can be read from the curves (Figs. 14 and 14a).

Examples of Design of Parallel Resonant Circuit. Assume that a parallel circuit (Fig. 13) is to be resonant at 5,000 cycles, with an impedance of 4,000 ohms at resonance ($n = 1$) and an impedance of 100 ohms at 3,000 cycles ($n = 0.6$). From Fig. 14, $|Z_0|/\omega_r L = 0.9$ for all values of Q when $n = 0.6$.

At resonance $|Z_0|/\omega_r L$ is to be $\frac{4,000}{100} \times 0.9 = 36$. From the curves it is found that $Q = 36$ gives $|Z_0|/\omega_r L = 36$ at $n = 1$ where $\omega_r = 31,416$. Then for $n = 1$,

$$Z_0 = 36\omega_r L = 4,000, \text{ or } L = \frac{4,000}{36 \times 31,416} = 0.00354 \text{ henry}$$

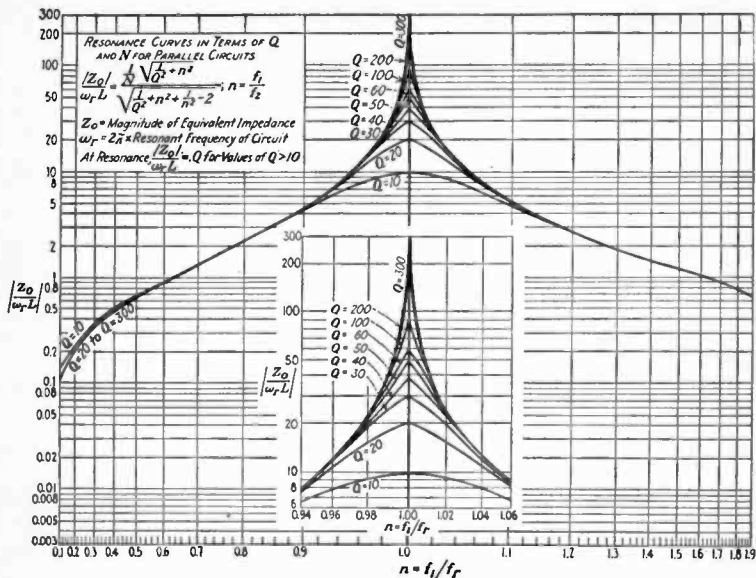

FIG. 14.—Parallel resonance curves.

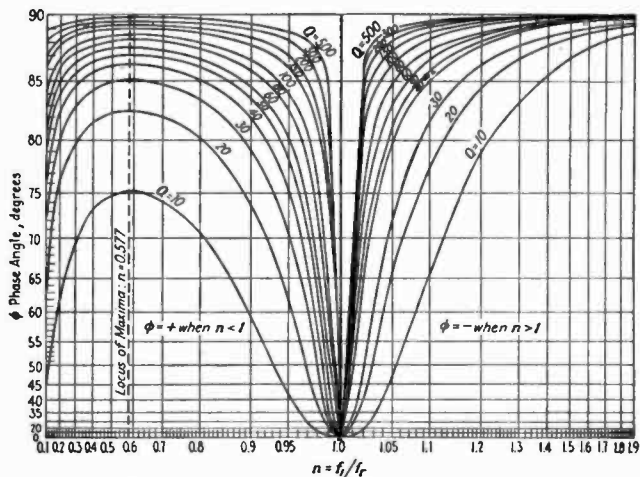

FIG. 14a.—Phase angle of parallel LC circuit in terms of n and Q .

LC for 5,000 cycles = 10.136×10^{-10} . Then $C = LC/L = 0.286 \times 10^{-6}$ farad, and $R = \omega_r L/Q = 3.08$ ohms.

As a second example, suppose that a parallel circuit resonant at 1,000 kc is to have an impedance of 10,000 ohms at that frequency, and 100 ohms at 707 kc (70.7 per cent resonance frequency). By (32),

$$\frac{|Z_0| \text{ at } 70.7 \% f_r}{|Z_0| \text{ at } f_r} = \frac{1.414}{Q} = 0.01$$

or

$$Q = 141.4$$

From Fig. 14, $|Z_0|/\omega_r L = 141.4$ when $Q = 141.4$ and $n = 1$; and

$$\begin{aligned} \omega_r L &= \frac{|Z_0|}{141.4} \\ &= 70.7 \text{ ohms} \end{aligned}$$

Then

$$L = \frac{\omega_r L}{\omega_r} = 0.0112 \times 10^{-3} \text{ henry}$$

$$C = \frac{LC}{L} = 2,260 \times 10^{-12} \text{ farad}$$

and

$$R = \frac{\omega_r L}{Q} = 0.5 \text{ ohm}$$

The impedances at other frequencies can be computed from $|Z_0|/\omega_r L$ and the phase angles can be read from Fig. 14.

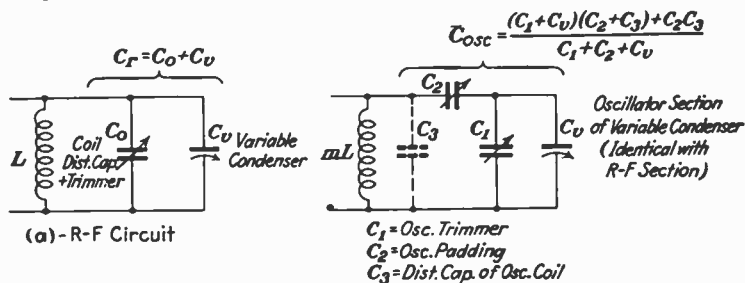

FIG. 15a and b.—Oscillator circuits for superheterodyne.

32. Design of Oscillator Tracking Circuits. In superheterodyne receivers employing single-dial tuning controls, an important problem is that of "tracking" the oscillator so that a constant frequency difference is maintained between it and the r-f amplifiers. In practice, three methods of obtaining this spacing between r-f and oscillator circuits have been used:

1. One section of the gang condenser has smaller and especially shaped plates.

2. A "straight-line frequency" condenser is used with the rotor in the oscillator section set ahead on the shaft by an angle sufficient to give the required frequency difference.

3. A condenser having identical sections is used, with a semifixed padding condenser in series with the oscillator section.

The last method is best adapted to quantity-production methods and has been most widely used in broadcast receivers. A generalized oscillator tank circuit of this type is shown with the corresponding r-f circuit in Fig. 15. The factor m is the ratio of the oscillator to r-f coil inductances. C_v is the variable condenser section; C_0 is the r-f trimmer capacity plus the distributed capacity of the r-f coil; C_1 is the distributed capacity of the oscillator coil; C_2 is the padding condenser, and C_1 is

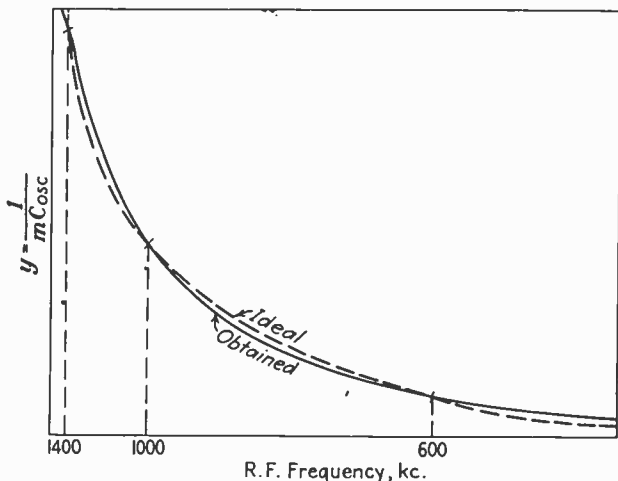

FIG. 15c.—Closeness of tracking secured by formulas.

the oscillator trimmer. The manner in which C_v varies with dial setting is immaterial to the solution of the tracking problem, so long as the sections are identical. It can be shown¹ that any network of semifixed capacities which might be connected between the variable condenser C_v and the coil mL may be reduced to an equivalent π network such as that formed by C_1 , C_2 , and C_3 , thus establishing Fig. 15b as the general circuit covering all cases.

No combination of values for C_1 , C_2 , and C_3 will give perfect alignment at more than three points on the dial. In broadcast receivers, exact alignment is usually made at signal frequencies of 1,400, 1,000, and 600 kc. At other frequencies within the tuning range, slight errors in tracking exist, which at any given signal frequency are approximately proportional to the intermediate frequency: the higher the intermediate frequency, the larger is the tracking error. In a well-designed circuit using an intermediate frequency of 175 kc, the maximum deviations from true alignment occur at the extreme ends of the dial and are about 2 kc. A

¹ JOHNSON, K. S., "Transmission Circuits for Telephonic Communication," Chap. VIII; D. Van Nostrand Company, New York; EVERITT, W. L., "Communication Engineering," Chap. III, McGraw-Hill Book Company, Inc., New York.

typical tracking curve is plotted in Fig. 15c, with the errors purposely exaggerated to display the effect.

The values of C_1 , C_2 , and C_3 may be determined by calculation or by experimental methods. Either method involves a considerable amount of labor. The following design procedure, due to Roder,¹ is probably the most direct method of solution:

Step 1. Known Constants:

- Three frequencies of perfect alignment ($= f_r$). (Usually 1,400, 1,000, and 600 kc for broadcast receivers.)
- R-f circuit inductance ($= L$).
- R-f circuit trimmer capacity ($= C_0$). (Including distributed capacity of r-f coil.)
- Intermediate frequency ($= f_i$).
- Distributed capacity of oscillator coil ($= C_3$).

Solution to Yield: Values of C_1 , C_2 , and m .

Units: All constants are measured in the following units:

- f = frequency in kilocycles.
 L = inductance in microhenries.
 C = capacitance in micromicrofarads.

Step 2. Compute

$$x_n = \frac{253.3 \times 10^8}{L f_r^2} \quad \text{and} \quad y_{11} = \frac{f_{osc}^2 L}{253.3 \times 10^8}$$

for each alignment frequency.

Step 3. Compute

$$X = \frac{y_2 - y_3 + x_2 B - x_1 A}{B - A}; \quad Y = \frac{y_1 B - y_3 A}{B - A}$$

where

$$A = \frac{y_1 - y_2}{x_2 - x_1} \quad \text{and} \quad B = \frac{y_2 - y_3}{x_3 - x_2}$$

Step 4. Compute

$$K = (x_1 - X)(y_1 - Y) \equiv (x_2 - X)(y_2 - Y) \equiv (x_3 - X)(y_3 - Y)$$

(The truth of these identities is a check on the accuracy of the calculations thus far.)

Step 5. Compute

$$m = \frac{1}{K}(1 - v)$$

where

$$v = 0.5u - 0.3125u^2 + 0.2188u^3$$

and

$$u = \frac{4C_3 Y}{K}$$

Step 6. Compute

$$C_1 = C_0 - X - \frac{Kv}{2Y} \{1 + 0.75v + 0.625v^2 + 0.547v^3\}$$

and

$$C_2 = \frac{1}{Y} \sqrt{\frac{K}{m}}$$

¹ Roder, HANS, Oscillator Padding, *Radio Engineering*, March, 1935, p. 7.

Example:

Step 1. Let

$$\begin{aligned}
 f_{r_1} &= 1,400 \text{ kc} & L &= 200 \mu\text{h} \\
 f_{r_2} &= 1,000 \text{ kc} & C_0 &= 30 \mu\mu\text{f} \\
 f_{r_3} &= 600 \text{ kc} & C_3 &= 15 \mu\mu\text{f} \\
 f_i &= 175 \text{ kc.}
 \end{aligned}$$

Step 2.

	f_r	$f_{\text{osc.}}$	x	y
1	1,400	1,575	64.62	0.4742×10^{-2}
2	1,000	1,175	126.65	1.0901×10^{-2}
3	600	775	351.81	1.9586×10^{-2}

Step 3.

$$A = \frac{(0.4742 - 1.0901) \times 10^{-2}}{(126.65 - 64.62)} = -99.29 \times 10^{-6}$$

$$B = \frac{(1.0901 - 1.9586) \times 10^{-2}}{(351.81 - 126.65)} = -38.57 \times 10^{-6}$$

$$X = \frac{(1.0901 - 1.9586) \times 10^{-2} + (126.65)(-99.29 \times 10^{-6}) - (64.62)(-38.57 \times 10^{-6})}{[(-38.57) - (-99.29)] \times 10^{-6}} = -5.23$$

$$Y = \frac{[(0.4742)(-38.57) - (1.9586)(-99.29)] \times 10^{-2}}{[(-38.57) - (-99.29)] \times 10^{-6}} = 0.113 \times 10^{-2}$$

Step 4.

$$K = \left\{ \begin{array}{l} (64.62 + 5.23)(0.4742 - 0.113) \times 10^{-2} \\ (126.65 + 5.23)(1.0901 - 0.113) \times 10^{-2} \\ (351.81 + 5.23)(1.9586 - 0.113) \times 10^{-2} \end{array} \right\} = 1.287$$

Step 5.

$$u = \frac{4 \times 15 \times 0.113 \times 10^{-2}}{1.287} = 0.0528$$

$$v = (0.5)(0.0528) - (0.312)(0.0528)^2 + (0.219)(0.0528)^3 = 0.02567$$

$$m = \frac{1}{1.287}(1 - 0.02567) = 0.761$$

$$L_{\text{osc.}} = 0.761 \times 200 = 152.2 \mu\text{h}$$

$$\begin{aligned}
 C_1 &= 30 + 5.23 - \frac{(1.287) \times (0.02567)}{(0.113 \times 10^{-2}) \times 2} \\
 &\quad \times \{1 + (0.75)(0.02567) + (0.625)(0.02567)^2 + (0.547)(0.02567)^3\} \\
 &= 20.38 \mu\mu\text{f}
 \end{aligned}$$

$$C_2 = \frac{1}{0.113 \times 10^{-2}} \sqrt{\frac{1.287}{0.761}} = 1,150 \mu\mu\text{f}$$

33. Split Tank Circuits. Parallel resonant circuits are high-impedance circuits; this property makes them peculiarly suitable for use with vacuum tubes, where the relatively high-impedance grid and plate circuits necessary to high amplification are easily realized. In other

instances, however, the reverse is true and the high impedance of a resonant circuit is a disadvantage, as for instance, at the end of a transmission line, where the termination circuit must offer a low impedance equal to that of the line (about 500 ohms). In such cases an impedance adjustment may be made by the insertion of a transformer, or by using a "split" form of the resonant circuit itself. The latter is equivalent to "tapping" off at a midpoint of the tank circuit and may be done in either the inductance or capacitance branch, as illustrated in Fig. 16. The result is a coupled circuit, that part of the reactance between points B and C in each case being the mutual impedance.

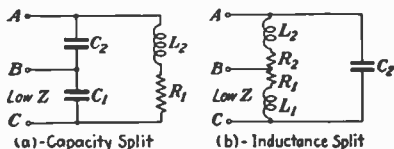

FIG. 16.—Split tank circuits for matching low-impedance to high-impedance circuits.

The result is a coupled circuit, that part of the reactance between points B and C in each case being the mutual impedance.

a. Capacity Split. In Fig. 16a, the impedance at B-C is

$$|Z_{BC}| = \frac{\sqrt{L_2^2 C_2^2 \left(\frac{1}{C_1(C_1 + C_2)} \right)^2 + \frac{R_2^2 L_2 C_2}{C_1(C_1 + C_2)}}}{R_2} \quad (33)$$

If R_2 is small,

$$|Z_{BC}| \approx \frac{L_2 C_2}{R_2 C_1 (C_1 + C_2)} \quad (34)$$

and its ratio to the impedance Z_{AC} is

$$\frac{|Z_{BC}|}{|Z_{AC}|} = \frac{C_2^2}{(C_1 + C_2)^2} \quad (35)$$

The resonant frequency is

$$f_r = \frac{1}{2\pi \sqrt{L \frac{C_1 C_2}{C_1 + C_2}}} \quad (36)$$

and the impedances Z_{AC} and Z_{BC} are both purely resistive at resonance.

The ratio of C_1 to C_2 for a given ratio between Z_{AC} and Z_{BC} is

$$\frac{C_1}{C_2} = \left[\sqrt{\frac{Z_{AC}}{Z_{BC}}} - 1 \right] \quad (37)$$

In terms of the resonant frequency, inductance, and the impedance ratio,

$$C_1 = \frac{1}{4\pi^2 f_r^2 L} \sqrt{\frac{Z_{AC}}{Z_{BC}}} \quad (38)$$

$$C_2 = \frac{1}{4\pi^2 f_r^2 L \left(1 - \sqrt{\frac{Z_{BC}}{Z_{AC}}} \right)} \quad (39)$$

b. Inductance Split. In Fig. 16b the inductance is split, and the impedance at B-C is (assuming no mutual inductance between L_1 and L_2)

$$|Z_{BC}| = \frac{\sqrt{\left(R_1 R_2 - \frac{L_1 L_2}{(L_1 - L_2) C_2} + \frac{L_2}{C_2}\right)^2 + \left(\frac{R_2 L_1}{\sqrt{(L_1 + L_2) C_2}} + \frac{R_1 L_2}{\sqrt{(L_1 + L_2) C_2}} - \frac{R_1 \sqrt{(L_1 + L_2) C_2}}{C_2}\right)^2}}{R_1 + R_2} \quad (40)$$

If R_1 and R_2 are small,

$$|Z_{BC}| = \frac{L_2}{C_2(R_1 + R_2)} \cdot \frac{L_2}{(L_1 + L_2)} \quad (41)$$

and its ratio to the total impedance Z_{AC} is

$$\frac{|Z_{BC}|}{|Z_{AC}|} = \frac{L_2^2}{(L_1 + L_2)^2} \quad (42)$$

The resonant frequency is

$$f_r = \frac{1}{2\pi \sqrt{(L_1 + L_2) C_2}} \quad (43)$$

and the impedances Z_{AC} and Z_{BC} are both resistive at resonance.

The ratio of L_1 to L_2 for a given ratio between Z_{AC} and Z_{BC} is

$$\frac{L_1}{L_2} = \sqrt{\frac{Z_{AC}}{Z_{BC}}} - 1 \quad (44)$$

In terms of the frequency, capacity, and the impedance ratio,

$$L_1 = \frac{1}{4\pi^2 f_r^2 C_2} \left(1 - \sqrt{\frac{Z_{BC}}{Z_{AC}}}\right) \quad (45)$$

$$L_2 = \frac{1}{4\pi^2 f_r^2 C_2} \sqrt{\frac{Z_{BC}}{Z_{AC}}} \quad (46)$$

34. Measurement of Parallel Resonance Impedance. A convenient method of experimentally determining the resonance impedance of a parallel circuit is shown in Fig. 17. LC is the circuit to be measured. This method is based on the fact that the circuit just commences to oscillate when the "negative resistance" of the tube characteristic is numerically equal to the impedance of the LC place circuit. In practice, a type 22 or 24 tube is satisfactory, in which case B should be about 120 volts and C about 25 volts. The potentiometers G and P control the grid bias and plate voltages, respectively. The latter should be between 60 and 80 volts for the B voltage mentioned. A receiver or other indicating device is loosely coupled to LC to detect the point where oscillation starts. G and P are adjusted until the circuit is on the verge of oscillation. The LC is short-circuited by closing the key S , and P is varied a few volts above and below the setting at which oscillation occurred and the values of plate current noted. The values of G and B

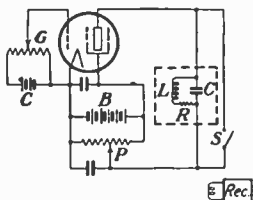

FIG. 17.—Circuit for measuring resonant impedance of parallel circuit.

are of course unchanged during this latter adjustment. The slope of the $e_p - i_p$ curve through the value of e_p where oscillation occurred is the negative resistance and is numerically equal to the impedance $|Z_0|$. If L and C are known, R can be computed from Eq. (29):

$$|Z_0| = \frac{L}{RC} \quad (29)$$

or

$$R = \frac{L}{|Z_0|C}$$

This also suggests the use of the above circuit for measuring r-f resistance, by inserting an unknown resistance in series in the LC circuit and measuring its impedance before and after the insertion is made. By a similar process, capacity or inductance may also be measured. The method as outlined is limited by tube characteristics to impedances of about 10,000 ohms and over.

COUPLED CIRCUITS

35. Coupling. If two circuits have one or more common impedances, they are said to be electrically coupled. A common impedance is any impedance so situated that it causes the current in one circuit to influence the current in the other. The impedance may be resistive, reactive, or both.

36. Coefficient of Coupling. The coefficient of coupling is

$$K = \frac{X_m}{\sqrt{X_1 X_2}} \quad (47)$$

where X_m is any one component of the mutual impedance (resistance, capacitive reactance or inductive reactance) and X_1 and X_2 are the total impedance components of the same kind in the respective circuits. K varies in value between zero and 1; if it is nearly 1, the coupling is *close* or *tight*; if near zero, the coupling is *loose*.

Coupled Circuits: Direct Capacitive

Impedance:

$$Z_0 = j \frac{\frac{1}{\omega C_m} \left(\omega L_1 - \frac{1}{\omega C_1} \right) - \left(\omega L_1 - \frac{1}{\omega C_1} \right) \left(\omega L_2 - \frac{1}{\omega C_2} \right) + \frac{1}{\omega C_m} \left(\omega L_2 - \frac{1}{\omega C_2} \right)}{\frac{1}{\omega C_m} - \omega L_2 + \frac{1}{\omega C_2}}$$

General case: L_1, L_2, C_1, C_2 and C_m unrestricted.

$$f_1 = \sqrt{\frac{f_a^2 + f_b^2 - \sqrt{(f_a^2 - f_b^2)^2 + 4k^2 f_a^2 f_b^2}}{2}}$$

$$f_2 = \sqrt{\frac{f_a^2 + f_b^2 + \sqrt{(f_a^2 - f_b^2)^2 + 4k^2 f_a^2 f_b^2}}{2}}$$

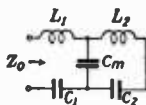

Circuit

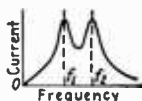

Resonance Curve

$$\text{where } f_a = \frac{1}{2\pi \sqrt{L_1 \frac{C_1 C_m}{C_1 + C_m}}}$$

$$f_b = \frac{1}{2\pi \sqrt{L_2 \frac{C_2 C_m}{C_2 + C_m}}}$$

Coefficient of coupling:

$$k = \sqrt{\frac{C_1 C_2}{(C_1 + C_m)(C_2 + C_m)}}$$

Special cases:

a Both circuits tuned to same frequency ($f_a = f_b$)

$$f_1 = f_a \sqrt{1 - k} \qquad f_2 = f_b \sqrt{1 + k}$$

b Loose coupling ($f_a = f_b$ and $C_m \gg C_1$ and C_2 ; $k \neq 0$).

$$f_1 \neq f_2 \neq f_a \neq \frac{1}{2\pi \sqrt{L_1 C_1}} \neq \frac{1}{2\pi \sqrt{L_2 C_2}}$$

c Close coupling ($f_a = f_b$ and $C_m \ll C_1$ and C_2 ; $k \neq 1$).

$$f_1 \neq 0 \text{ and } f_2 \neq \sqrt{2} f_a \neq \frac{\sqrt{2}}{2\pi \sqrt{L_1 C_m}} \neq \frac{\sqrt{2}}{2\pi \sqrt{L_2 C_m}}$$

d Both circuits identical

$$\begin{cases} f_a = f_b \\ L_1 = L_2 \\ C_1 = C_2 \end{cases}$$

$$f_1 = \frac{1}{2\pi \sqrt{L_1 C_1}} \qquad f_2 = \frac{1}{2\pi \sqrt{L_1 \frac{C_1 C_m}{2C_1 + C_m}}}$$

Coupled Circuits: Indirect Capacitive

Equivalent impedance

$$Z_0 = j \left[\omega L_1 - \frac{1}{\omega C_d} \left(\frac{\omega L_2 - \frac{1}{\omega C_d}}{\omega C_d} \frac{1}{\omega C''} + \frac{L_2}{C_d} \right) \right]$$

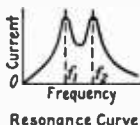
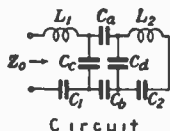

where

$$C' = \frac{C_a C_b}{C_a + C_b}$$

$$C'' = \frac{C_a C_b C_c}{C_a C_b + C_a C_c + C_b C_c}$$

General case: $L_1, L_2, C_a, C_b, C_c,$ and C_d unrestricted.

$$f_1 = \sqrt{\frac{f_a^2 + f_b^2 - \sqrt{(f_a^2 - f_b^2)^2 + 4k^2 f_a^2 f_b^2}}{2}}$$

$$f_2 = \sqrt{\frac{f_a^2 + f_b^2 + \sqrt{(f_a^2 - f_b^2)^2 + 4k^2 f_a^2 f_b^2}}{2}}$$

where $f_a = \frac{1}{2\pi \sqrt{L_1 \left(C_c + \frac{C_d C'}{C_d + C'} \right)}}$ $f_b = \frac{1}{2\pi \sqrt{L_2 \left(C_d + \frac{C_c C'}{C_c + C'} \right)}}$

Coefficient of coupling:

$$k = \frac{C'}{\sqrt{(C_c + C')(C_d + C')}}}$$

Special cases:

a Both circuits tuned to same frequency ($f_a = f_b$).

$$f_1 = f_a \sqrt{1 - k} \qquad f_2 = f_a \sqrt{1 + k}$$

b Loose coupling ($C_a + C_b \ll C_c$ and C_d ; $k \neq 0$; $f_a = f_b$).

$$f_1 \neq f_2 \neq f_a \neq \frac{1}{2\pi\sqrt{L_1 C_c}} \neq \frac{1}{2\pi\sqrt{L_2 C_d}}$$

c Close coupling ($f_a = f_b$) ($C_a + C_b \gg C_c$ and C_d ; $k = 1$).

$$f_1 \neq 0$$

$$f_2 \neq \sqrt{2} f_a \neq \frac{1}{\pi\sqrt{2L_1(C_c + C_d)}} \neq \frac{1}{\pi\sqrt{2L_2(C_c + C_d)}}$$

d Both circuits identical.

$$\begin{cases} f_a = f_b \\ L_1 = L_2 \\ C_1 = C_2 \end{cases}$$

$$f_1 \neq \frac{1}{2\pi\sqrt{L_1(C_c + 2C')}}}$$

$$f_2 \neq \frac{1}{2\pi\sqrt{L_1 C_c}}$$

$$k = \frac{C'}{C_c + C'}$$

Coupled Circuits: Direct Inductive

Equivalent impedance:

$$Z_0 = j \frac{\omega L_m \left(\omega L_1 - \frac{1}{\omega C_1} \right) + \left(\omega L_1 - \frac{1}{\omega C_1} \right) \left(\omega L_2 - \frac{1}{\omega C_2} \right) + \omega L_m \left(\omega L_2 - \frac{1}{\omega C_2} \right)}{\omega L_m + \omega L_2 - \frac{1}{\omega C_2}}$$

General case: L_1, L_2, L_m, C_1 and C_2 unrestricted.

$$f_1 = \sqrt{\frac{f_a^2 + f_b^2 - \sqrt{(f_a^2 - f_b^2)^2 + 4k^2 f_a^2 f_b^2}}{2(1 - k^2)}}$$

$$f_2 = \sqrt{\frac{f_a^2 + f_b^2 + \sqrt{(f_a^2 - f_b^2)^2 + 4k^2 f_a^2 f_b^2}}{2(1 - k^2)}}$$

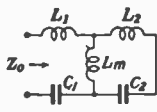

Circuit

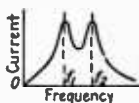

Resonance Curve

where

$$f_a = \frac{1}{2\pi\sqrt{(L_1 + L_m)C_1}}$$

$$f_b = \frac{1}{2\pi\sqrt{(L_2 + L_m)C_2}}$$

Coefficient of coupling

$$k = \frac{L_m}{\sqrt{(L_1 + L_m)(L_2 + L_m)}}$$

Special cases:

a Both circuits tuned to same frequency ($f_a = f_b$).

$$f_1 = \frac{f_a}{\sqrt{1 + k}} \quad f_2 = \frac{f_a}{\sqrt{1 - k}}$$

b Loose coupling ($f_a = f_b$ and $L_m \ll L_1$ and L_2) $k \neq 0$.

$$f_1 \neq f_2 \neq f_a \neq \frac{1}{2\pi\sqrt{L_1 C_1}} \neq \frac{1}{2\pi\sqrt{L_2 C_2}}$$

c Close coupling ($f_a = f_b$ and $L_m \gg L_1$ and L_2 ; $k \neq 1$).

$$f_1 \neq \frac{f_a}{\sqrt{2}} \neq \frac{1}{2\pi\sqrt{2L_m C_1}}$$

$$f_2 \neq \infty$$

d Both circuits identical.

$$\begin{cases} f_a = f_b \\ L_1 = L_2 \\ C_1 = C_2 \end{cases}$$

$$f_1 = \frac{1}{2\pi\sqrt{(L_1 + 2L_m)C_1}}$$

$$f_2 = \frac{1}{2\pi\sqrt{L_1C_1}}$$

$$k = \frac{L_m}{L_1 + L_m}$$

37. Direct and Indirect Coupling. If the common impedance is a resistance, inductance or capacitance connected directly between the

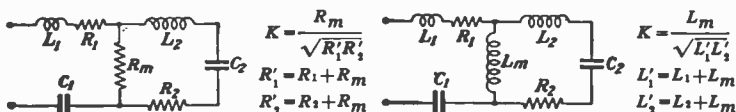

FIG. 18.—Direct resistive coupling. FIG. 19.—Direct inductive coupling.

two circuits, the coupling is *direct*. Such circuits are shown in Figs. 18, 19, and 20. If the common impedance is a transformer, the coupling

Coupled Circuits: Indirect Inductive

Equivalent impedance:

$$Z_0 = j \left[\left(\omega L_1' - \frac{1}{\omega C_1} \right) - \frac{(\omega M)^2}{\left(\omega L_2' - \frac{1}{\omega C_2} \right)} \right]$$

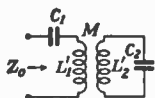

Circuit

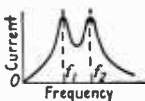

Resonance Curve

Equivalent direct-coupled circuit: Indirect inductive coupling is equivalent to direct inductive coupling if

$$\begin{aligned} L_1 &= L_1' - M \\ L_2 &= L_2' - M \\ L_m &= M \end{aligned}$$

where L_1' and L_2' are the self-inductances of the coils.

$$f_1 = \sqrt{\frac{f_a^2 + f_b^2 - \sqrt{(f_a^2 - f_b^2)^2 + 4k^2 f_a^2 f_b^2}}{2(1 - k^2)}} \qquad f_a = \frac{1}{2\pi\sqrt{L_1'C_1}}$$

$$f_2 = \sqrt{\frac{f_a^2 + f_b^2 + \sqrt{(f_a^2 - f_b^2)^2 + 4k^2 f_a^2 f_b^2}}{2(1 - k^2)}} \qquad f_b = \frac{1}{2\pi\sqrt{L_2'C_2}}$$

$$k = \frac{M}{\sqrt{L_1'L_2'}}$$

Special cases:

a Both circuits tuned to the same frequency ($f_a = f_b$)

$$f_1 = \frac{f_a}{\sqrt{1 + k}} \qquad f_2 = \frac{f_a}{\sqrt{1 - k}}$$

b Loose coupling ($f_a = f_b$ and $M \ll L_1'$ and L_2' ; $k \approx 0$).

$$f_1 \approx f_2 \approx f_a \approx \frac{1}{2\pi\sqrt{L_1'C_1}} \approx \frac{1}{2\pi\sqrt{L_2'C_2}}$$

c Close coupling ($f_a = f_b$ and $M \gg L_1'$ and L_2' ; $k = 1$).

$$f_1 \approx \frac{f_a}{\sqrt{2}} \approx \frac{1}{2\pi\sqrt{2MC_1}}$$

$$f_2 \approx \infty$$

d Both circuits identical

$$\begin{cases} f_a = f_b \\ L_1' = L_2' \\ C_1 = C_2 \end{cases}$$

$$f_1 = \frac{1}{2\pi\sqrt{(L_1' + M)C_1}}$$

$$f_2 = \frac{1}{2\pi\sqrt{(L_1' - M)C_1}}$$

$$k = \frac{M}{L_1'}$$

is indirect, and is usually called merely *inductive coupling*. This type of coupling is illustrated in Fig. 21. Indirect capacitive coupling is illustrated in Fig. 22.

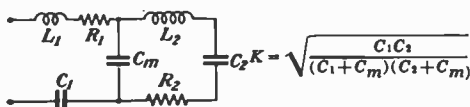

FIG. 20.—Direct capacitive coupling.

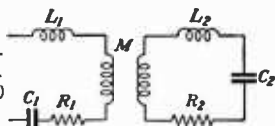

FIG. 21.—Indirect or inductive coupling.

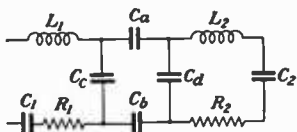

FIG. 22.—Indirect capacitive coupling.

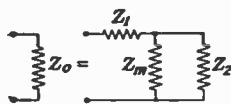

FIG. 23.—Equivalent impedance of direct-coupled circuits.

From Figs. 18 to 20 it is apparent that direct-coupled circuits may be considered as networks of impedances in series and parallel, as in Fig. 23. The notion of "equivalent impedance" (Art. 6) is a useful concept in the treatment of such circuits. In the present treatment of coupled circuits the equivalent impedance is determined by combining the various impedance elements of the circuits according to the laws of parallel and series combination as discussed in Arts. 7 and 8.

The equivalent impedance of the network of Fig. 23 is

$$Z_0 = Z_1 + \frac{Z_m Z_2}{Z_m + Z_2}$$

$$= \frac{Z_1 Z_m + Z_1 Z_2 + Z_m Z_2}{Z_m + Z_2} \tag{48}$$

Coupled Circuits: Inductive or Transformer with Resistance

Equivalent Impedance:

$$Z_0 = R_0 + jX_0 = \left(R_1 + \frac{\omega^2 M^2 R_2^2}{|Z_2|^2} \right) + j \left(X_1 - \frac{\omega^2 M^2 X_2^2}{|Z_2|^2} \right)$$

where

$$|Z_2|^2 = R_2^2 + X_2^2$$

$$X_1 = \omega L_1' - \frac{1}{\omega C_1}$$

$$X_2 = \frac{\omega L_2' - 1}{\omega C_2}$$

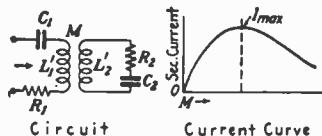

Special case:

If M is variable, and both circuits tuned to the same frequency, the current in the secondary varies with M as shown in the figure.

The maximum secondary current occurs at

$$\omega M = \sqrt{R_1 R_2}$$

38. Use of Resistanceless Circuits in Calculations. Each impedance in (48) is in general of the form $R_0 + jX_0$, so that the expression becomes somewhat involved if an exact solution is made. In many actual applications, however, coupled circuits are also sharply tuned, which is tantamount to saying that their resistances are small compared with their reactances. For such cases, computations are much simplified without undue sacrifice of accuracy if the circuits are assumed to be resistanceless.

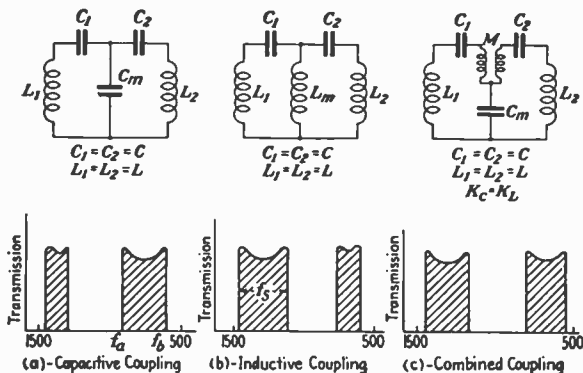

FIG. 24.—Coupled circuits as band-pass filters.

39. Combined Inductive and Capacitive Coupling in Radio-frequency Selector Circuits. A combination of inductive and capacitive coupling has been utilized in a radio-frequency "preselector" circuit designed by E. A. Uehling.¹ The circuit functions as a band-pass filter and has, as the name implies, especial application as the coupling link between the antenna and first tube of a broadcast receiver. For this purpose it is required to transmit a band of frequencies about 10 kc wide and to allow

¹ *Electronics*, p. 279, September, 1930.

this band to be shifted over the broadcast range (500 to 1,500 kc) by tuning, without substantial change in its width.

The band-pass characteristic is obtained by use of the double resonance phenomenon in coupled circuits, the difference between the two frequencies determining the width of the transmission band. If the two coupled circuits are identical these resonant frequencies are functions of $\sqrt{X_m^2 - R^2}$ where X_m is the mutual impedance and R the resistance of each circuit. The band width is approximately

$$f_s = f_1 - f_2 \approx \frac{\sqrt{X_m^2 - R^2}}{2\pi L} \quad (49)$$

Since both X_m and R vary with frequency, the band width will in general also vary with frequency, as shown in Fig. 24. However, the variation with inductive coupling is opposite in effect to that with capacitive coupling, as shown by the figure, so that a combination of both can be obtained which will give a practically constant band width.

Uehling has shown that this condition obtains when

$$X_{m_n} = \pm \sqrt{R_n^2 + 4\pi^2 L^2 f_s^2} \quad (50)$$

where R_n is the resistance and L the total inductance of each branch and f_s is the band width. With X_m computed for the two boundary frequencies f_a and f_b of the tuning range, the values of M and C_m required are given by

$$M = \frac{X_{m_b} f_b - X_{m_a} f_a}{2\pi(f_a^2 - f_b^2)} \quad (51)$$

$$C_m = \frac{f_a^2 - f_b^2}{2\pi f_a f_b (X_{m_b} f_b - X_{m_a} f_a)} \quad (52)$$

Representative values of M and C_m for $f_a = 1,500$ kc, $f_b = 550$ kc, $R_a = 30$ ohms, $R_b = 10$ ohms, $L = 200 \times 10^{-6}$ henry, and $f_s = 10$ kc, which are typical constants of broadcast circuits, are

$$M = 3.2 \times 10^{-6} \text{ henry}$$

and

$$C_m = 0.06 \text{ mfd}$$

The inductive coupling M must be negative so that its effect will be additive to that of C_m . This may be obtained by winding the coils M (Fig. 24) of two wires side by side, and connecting the "start" ends of the coils to C_1 and C_2 and the "finish" ends to C_m .

40. Stray Coupling. Because of the apparent increase in resistance of a circuit when another circuit is coupled to it, spurious and unintentional coupling due to stray fields and the proximity of other apparatus may appreciably affect the resistance of r-f circuits and introduce unnecessary losses unless precautions are taken to avoid it. Stray effects are due principally to capacity coupling and stray inductive coupling. The former varies with the areas of conductors and a-c voltages involved, and inversely with the distances between the conductors, while the latter varies with ampere turns, the diameter of the heavy current path in the circuit and inversely with the distance between the circuit and other conductors in which induced currents flow.

41. Decoupling Filters. When the plate current for several tubes of a high-gain amplifier is obtained from a single source, the internal resistance

of the source is common to all the plate circuits and is likely to act as a coupling between stages. Similar couplings may exist through a bleeder circuit when screen voltage for two or more tubes is taken from a common tap, or through a bias resistor common to the control-grid circuits of several tubes. To reduce such stray couplings to negligible amounts, decoupling filters are generally inserted in the circuits of each tube and separate bias resistors are used.

A typical application of decoupling filters is shown in Fig. 25, the filter elements being indicated by heavy lines. The condensers C furnish

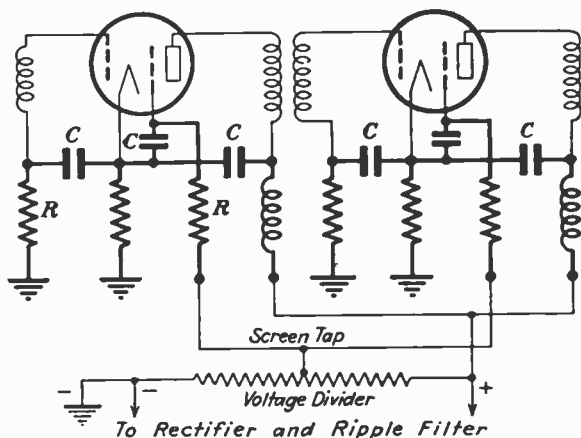

FIG. 25.—Capacity-resistance filter usage.

low-impedance paths back to the cathodes for the signal currents flowing in the grid, screen-grid, and plate circuits, while the high-impedance resistors R and chokes in the leads to the voltage divider prevent any appreciable flow of signal currents in that direction. The choice of values for these resistors and chokes depends principally upon the currents in the leads and the permissible d-c voltage drop in each filter. The impedance of each by-pass condenser should be not more than 10 per cent of that of the associated resistor or choke, at any frequency for which the amplifier is designed to operate. On the other hand, the value of C should not be so large in any filter that "blocking" or motor boating occurs due to too high a time constant.

The impedance of a choke coil (neglecting its resistance) is

$$X_L = 6.28fL \text{ ohms,}$$

and that of a condenser is

$$X_C = \frac{10^6}{6.28fC} \text{ ohms}$$

where f = frequency in cycles per second

L = inductance in henries

C = capacity in microfarads.

The value of each cathode resistor, when separate biasing resistors are used, is equal to the bias required, divided by the total cathode d.c. of that tube. The screen-grid filter resistors serve as voltage-dropping resistors as well as filters, and their values are determined by the IR drops required for correct screen voltages.

RECURRENT NETWORKS

42. General Types. *Recurrent networks* are iterative combinations of L , C , and R , such as those shown in Fig. 26.

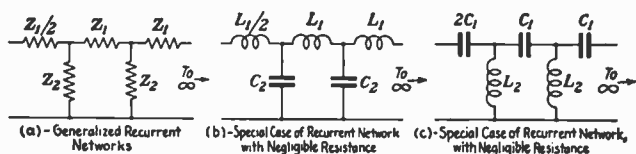

FIG. 26.—Types of infinitely long recurrent network structures.

The transmission characteristics of such structures vary with frequency in a singular manner and introduce both useful and detrimental effects in radio- and audio-frequency circuits. Examples of recurrent networks are transmission lines (actual and artificial) and wave filters.

43. Terminating Conditions for No Reflection and Maximum Power Transfer. If a recurrent network is terminated at the n th section in an impedance equal to its image impedance, there is no reflection at the termination, and the network behaves as though it had an infinite number of sections, in so far as its input terminals are concerned.

A long line so isolates its terminating impedances (the source and load impedances) that the apparent value of each as measured from the opposite end of the line is very nearly equal to the line impedance and practically independent of the terminations. Consequently, to obtain a maximum transfer of power from source to line and from line to load, the source and load impedances must equal the characteristic impedance of the line, or be matched to the line by transformers whose turns ratios are equal to the square root of the ratio of termination and line impedances. A line terminated in its characteristic impedance at both ends also has a minimum reflection from its terminals, and in general a line thus operated has the lowest total transmission loss.

In a structure having lumped constants, and terminated at one of its series elements, the series impedance in each end section is one-half the value of the series impedance in the internal sections (Fig. 26). If the termination is at a shunt element, the shunt impedance at each end is made twice the shunt impedance in the internal sections.

44. Transmission Lines. Transmission lines are recurrent structures having continuously distributed impedances. Two wires in space have, besides their ohmic resistance, shunt capacity and series inductance and are thus equivalent to the recurrent structure of Fig. 27, where L , C ,

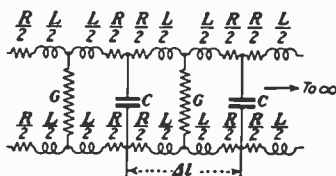

FIG. 27.—Line constants.

and R are the constants of a very short length (Δl) of the line and G is the conductance due to leakage between the wires in the same length.

45. General Properties of a Transmission Line. The characteristic impedance is

$$Z_0 = \sqrt{\frac{R + j\omega L}{G + j\omega C}} \text{ ohms} \quad (53)$$

or

$$|Z_0| = \sqrt{\frac{(R^2 + \omega^2 L^2)}{(G^2 + \omega^2 C^2)}} \text{ ohms} \quad (54)$$

or

$$Z_0 = \sqrt{Z_{\infty} Z_{sc}} \text{ ohms} \quad (55)$$

where Z_{∞} and Z_{sc} are the input impedances with the far end open- and short-circuited, respectively.

The propagation constant is

$$P = \sqrt{(R + j\omega L)(G + j\omega C)} = A + jB \quad (56)$$

R , L , G , and C being the resistance, inductance, leakage, and capacitance per unit length of the line.

Attenuation Constant. The real part (A) of P is the attenuation constant and is

$$A = 6.141 \sqrt{\sqrt{(R^2 + \omega^2 L^2)(G^2 + \omega^2 C^2)} + RG - \omega^2 LC} \text{ db per unit length} \quad (57)$$

Wave-length Constant. The quadrature part (B) of P is the wave-length constant and is

$$B = 0.707 \sqrt{\sqrt{(R^2 + \omega^2 L^2)(G^2 + \omega^2 C^2)} - RG + \omega^2 LC} \text{ radians per unit length} \quad (58)$$

The velocity of propagation is

$$V = \frac{\omega}{B} = \frac{2\pi f}{B} \text{ unit lengths per second} \quad (59)$$

The wave length is

$$\lambda = \frac{2\pi}{B} \text{ unit lengths} \quad (60)$$

The retardation time is

$$t = \frac{B}{\omega} = \frac{B}{2\pi f} \text{ sec. per unit length} \quad (61)$$

Input Impedance of a Line Terminated at Its Far End by an Impedance Z_a .

Let Z_i = input impedance of the line

Z_0 = characteristic impedance of the line

Z_a = terminating impedance at the far end

θ = propagation factor.

The input impedance of a line so terminated is

$$Z_i = Z_0 \left[\frac{Z_a \cosh \theta + Z_0 \sinh \theta}{Z_0 \cosh \theta + Z_a \sinh \theta} \right] \quad (62)$$

The propagation factor is

$$\theta = lP \tag{63}$$

where l = length

P = propagation constant per unit length

In the communication field, transmission lines may be classified according to the frequencies they are used to transmit, as *audio-* or *radio-frequency* lines. Simplified forms of the general transmission line formulae result from the introduction of approximations appropriate to each case.

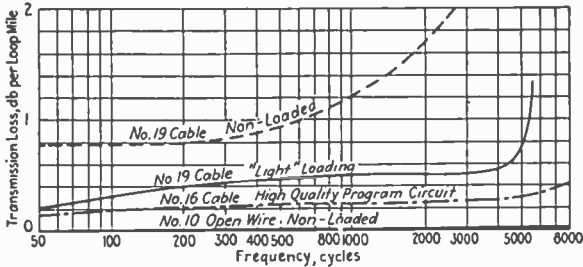

FIG. 28.—Transmission-loss characteristics of various audio-frequency circuits.

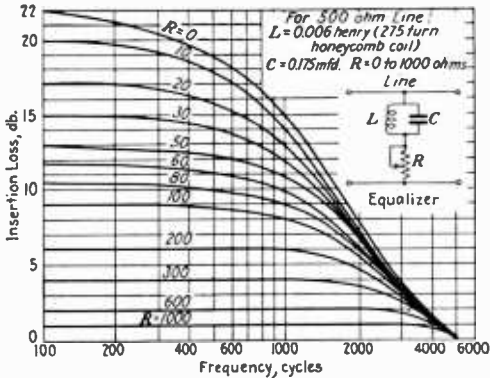

FIG. 29.—Attenuation-frequency characteristic of equalizer shunted across a 500-ohm circuit.

46. Audio-frequency Lines. In open-wire lines and large-gage cables, G is negligible, so that

$$A \approx 6.14 \sqrt{\omega C \sqrt{R^2 + \omega^2 L^2} - \omega^2 LC} \text{ db per unit length} \tag{64}$$

and

$$B \approx 0.707 \sqrt{\omega C \sqrt{R^2 + \omega^2 L^2} + \omega^2 LC} \text{ radians per unit length} \tag{65}$$

In small-gage cables, both L and G become negligibly small, and

$$A \approx 15.39\sqrt{fRC} \text{ db per unit length} \quad (66)$$

and

$$B \approx 1.772\sqrt{fRC} \text{ radians per unit length} \quad (67)$$

In both cases, the attenuation is seen to vary with frequency. The transmission-loss frequency characteristics of various kinds of a-f circuits

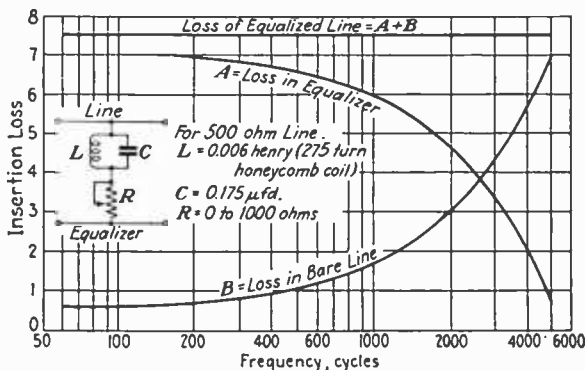

FIG. 30.—Attenuation equalizer for short cable circuits.

are shown in Fig. 28, and other characteristics of typical audio lines are shown in Table II.

47. Equalization of Transmission-loss Characteristic. From the curves in Fig. 28 it is evident that if a band of frequencies is transmitted over a line, the higher frequencies will suffer more attenuation than the low frequencies, resulting in distortion. The prevention of this condition necessitates the use of attenuation equalizers in high quality circuits. A typical 5,000-cycle equalizer for this purpose and its transmission-loss curves are illustrated in Fig. 29, and the curves for the bare line, equalizer alone, and the equalized line are shown in Fig. 30. The equalizer is usually connected in shunt across the receiving end of the line, preceding other apparatus.

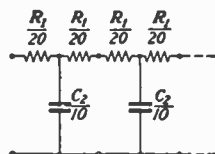

FIG. 31.—Artificial non-loaded cable.

48. Artificial Lines. An artificial line is a compact network of lumped impedances to simulate the electrical characteristics of an actual line. Such a network having approximately the characteristics of an unloaded cable or open-wire circuit may be constructed as shown in Fig. 31 and is useful in laboratory measurements and investigations.

The constants R_1 and C_2 are the loop resistance and capacity of the full length of the line to be represented. For standard cable, $R_1 = 88$ ohms and $C_2 = 0.054 \mu\text{f}$ per loop mile; values for various other lines are given in Table II. As the similarity between the artificial and the actual line increases with the number of sections in the former, it is preferable to use

at least ten sections, and not more than one mile of cable or ten miles of open wire should be represented by one section. The end sections should be "mid-series" terminated—i.e., their series impedances should be one-half that of the internal sections.

49. Resistance Pads. Resistance pads are artificial lines whose series and shunt elements are pure resistances and are used principally as attenuators in a-f circuits. The amount of loss caused by insertion of a pad in a circuit may be accurately computed and is independent of frequency if the terminating impedances are resistances.

Either π or T structures may be used as pads, as shown in Fig. 32a. Both are electrically equivalent, but for identical values of loss and impedance one type may require resistors of more convenient values than the other. A pad which is to be used in a circuit that is balanced to ground should be of the balanced π or T type; otherwise the unbalanced network is satisfactory and requires several less resistors to build.

50. Pad Design. To design a pad, three constants must be known: the input and output impedances and the loss in decibels. The input and output impedances of a pad are usually made equal to those of the circuit to be connected to it. The design procedure depends upon whether these are equal or are different from each other.

a. Equal Input and Output Impedances. In this case, the value of each element is found by multiplying the proper constants, selected from Table III in connection with Fig. 32a, by the value of the input or output impedance Z in ohms.

Example: To design a 10-db, 500/500-ohm pad of the balanced T type: From Table III, for 10-db attenuation, $a = 0.5195$ (hence $a/2 = 0.2597$) and $b = 0.7027$. Then the required resistances are $0.2597 \times 500 = 129.85$ for the series elements and $0.7027 \times 500 = 351.35$ ohms for the shunt element.

b. Unequal Input and Output Impedances. In this case, the design involves more computation. The value of each element is indicated by Fig. 32b, the constants of which are to be found in Table III. The ratio of input to output impedance (or *vice versa*) of a pad of given loss is limited by the fact that for

TABLE II.—CHARACTERISTICS OF NON-LOADED AUDIO-FREQUENCY CIRCUITS
(Per loop mile at 1,000 cycles)

Type of circuit	R Ohms	L Henrys	G μ mhos	C Microfarads	Z Ohms	λ Miles	V Miles per second	A db per mile	B Radians per second
No. 10 open-wire NL.....	10.4	0.00394	0.8	0.0078	739	177	176,600	0.65	0.0356
No. 16 cable NL.....	42.2	0.001	0.87	0.062	331	64.5	64,500	0.73	0.0975
No. 19 cable NL.....	83.2	0.001	0.87	0.062	462	47.5	47,500	1.065	0.1322
No. 22 cable NL.....	171	0.001	1.75	0.073	610	31.7	31,700	1.72	0.198

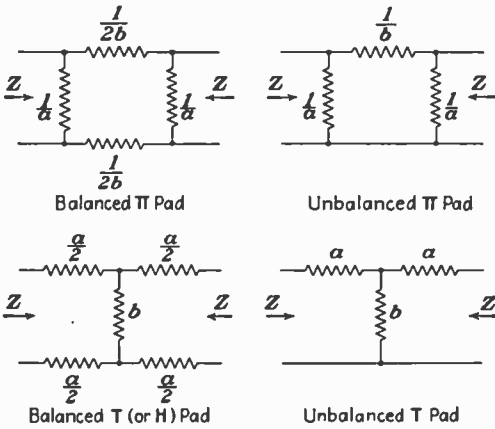

$Z = \text{Input Impedance} = \text{Output Impedance}$

FIG. 32a.—Equivalent balanced and unbalanced pads.

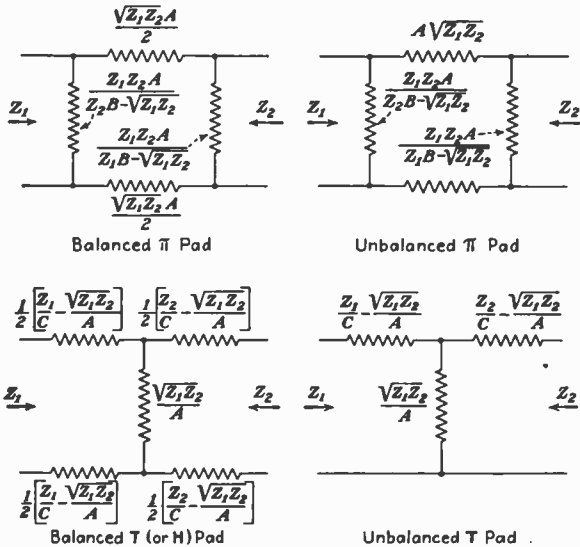

FIG. 32b.—Pads to be used between unequal impedances.

large values of the impedance ratio, certain of the pad resistors would have to be negative in value if the loss of the pad were to be below a certain minimum value. The maximum impedance ratio which a 10-db pad can have, for instance, is 3.018. Stated in another way, this means that if the impedance ratio of a pad is to be 3.018, its loss must be at least 10 db. The maximum impedance ratios for various values of pad losses are also given in Table III. These are the same for both π and T pads.

TABLE III.—CONSTANTS FOR PADS OF FIG. 32

Loss, decibels	A	B	C	a	b	1/b	1/a	1/2b	Maximum ratio Z_1/Z_2 or Z_2/Z_1
1	0.1154	1.007	0.1150	0.0575	8.664	0.1154	17.39	0.0577	1.014
2	0.2323	1.027	0.2263	0.1146	4.305	0.2323	8.724	0.1161	1.055
3	0.3523	1.060	0.3325	0.1710	2.838	0.3523	5.848	0.1761	1.124
4	0.4770	1.108	0.4305	0.2263	2.097	0.4770	4.419	0.2385	1.228
5	0.6084	1.170	0.5192	0.2801	1.645	0.6084	3.570	0.3042	1.369
6	0.7472	1.248	0.5986	0.3323	1.339	0.7472	3.009	0.3736	1.557
7	0.8960	1.343	0.6673	0.3825	1.116	0.8960	2.615	0.4480	1.804
8	1.0570	1.455	0.7264	0.4305	0.9482	1.0570	2.323	0.5285	2.117
9	1.2320	1.586	0.7763	0.4762	0.8118	1.2320	2.100	0.6160	2.515
10	1.4218	1.738	0.8181	0.5195	0.7027	1.4218	1.925	0.7109	3.018
11	1.6324	1.914	0.8527	0.5601	0.6127	1.6324	1.785	0.8162	3.663
12	1.8659	2.117	0.8814	0.5986	0.5359	1.8659	1.670	0.9329	4.482
13	2.1223	2.346	0.9046	0.6343	0.4712	2.1223	1.576	1.0611	5.504
14	2.4067	2.605	0.9235	0.6672	0.4155	2.4067	1.498	1.2033	6.786
15	2.7230	2.901	0.9387	0.6981	0.3672	2.7230	1.432	1.3615	8.415
20	4.9522	5.052	0.9802	0.8182	0.2020	4.9522	1.222	2.4761	25.52
25	8.8612	8.918	0.9940	0.8932	0.1128	8.8612	1.119	4.4306	79.52
30	15.800	15.830	0.9980	0.9387	0.06331	15.800	1.065	7.900	250.5
35	28.094	28.112	0.9994	0.9649	0.03560	28.094	1.036	14.047	790.2
40	50.000	49.997	0.9998	0.9802	0.02000	50.000	1.020	25.000	2,500
45	88.928	88.933	0.9999	0.9888	0.01124	88.928	1.011	44.464	7,909
50	158.1	158.05	1.0000	0.9937	0.006325	158.10	1.006	79.050	24,980
60	500	500	1.0000	0.9980	0.002000	500	1.002	250	
70	1,581	1,581	1.0000	0.9994	0.000632	1,581	1.001	790	
80	5,000	5,000	1.0000	0.9998	0.000200	5,000	1.000	2,500	
90	15,810	15,810	1.0000	0.9999	0.0000632	15,810	1.000	7,905	
100	50,000	50,000	1.0000	1.0000	0.0000200	50,000	1.000	25,000	

$$A = \sinh \theta$$

$$B = \cosh \theta$$

$$C = \tanh \theta$$

$$\theta = \frac{\text{loss in decibels}}{8.686}$$

$$a = \frac{1}{C} - \frac{1}{A}$$

$$b = \frac{1}{A}$$

$$\text{Maximum ratio } \frac{Z_1}{Z_2} \text{ or } \frac{Z_2}{Z_1} = B^2$$

Example: To design a 20-db 500/200-ohm pad of the unbalanced π type:

$$Z_1 = 500 \text{ ohms, } Z_2 = 200 \text{ ohms}$$

From Table III, $A = 4.9522$ and $B = 5.0522$. Then,

$$\text{the input shunt element} = \frac{Z_1 Z_2 A}{Z_2 B - \sqrt{Z_1 Z_2}} = 713 \text{ ohms;}$$

the series element = $\sqrt{Z_1 Z_2 A} = 1,567$ ohms;

the output shunt element = $\frac{Z_1 Z_2 A}{Z_1 B - \sqrt{Z_1 Z_2}} = 430$ ohms.

51. Characteristic Impedance of R-F Line. At high frequencies R and G usually become negligible as compared with ωL and ωC respectively. The characteristic impedance of a line at radio frequencies is then

$$Z_0 = \sqrt{\frac{L}{C}} \text{ ohms} \quad (68)$$

where L and C are in henrys and farads per unit length.

a. Special Case: Line of Two Parallel Wires. In terms of the dimensions of the line

$$Z_0 = 277 \log_{10} \frac{2s}{d} \text{ ohms} \quad (69)$$

for parallel wire where s is the spacing from center to center of the wires, and d the diameter, both being measured in the same units. Equation (69) is based on the assumption that s is at least ten times d and that the

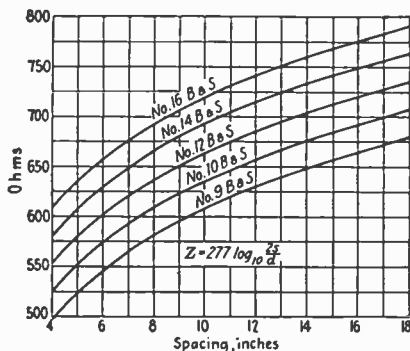

FIG. 33.—Characteristic impedance of open-wire r-f transmission line.

height of the line above the ground is at least ten times s . The characteristic impedances of open-wire r-f lines of commonly used dimensions are shown in Fig. 33.

b. Special Case: Line of Two Coaxial Conductors. Radio-frequency lines are often constructed with one conductor in the form of a metal tube, and the other a coaxially placed wire or tube of smaller diameter. The advantage of such construction lies principally in the effective shielding which can be obtained by grounding the outer tube.

The characteristic impedance of a line having such coaxial conductors is

$$Z_0 = 138.5 \log_{10} \frac{r_o}{r_i} \text{ ohms} \quad (70)$$

where r_o is the inside radius of the outer tube, and r_i is the outside radius of the inner conductor. For a line whose outer and inner conductors are respectively $\frac{3}{4}$ and $\frac{1}{4}$ in. in diameter, $Z = 65$ ohms.

52. Other Properties of R-F Lines.

Velocity of propagation is

$$V = \frac{1}{\sqrt{L_1 C_2}} = 186,000 \text{ miles per second} \quad (71)$$

(the speed of light)

Wave-length constant is

$$B = \omega \sqrt{L_1 C_2} \text{ radians per unit length} \quad (72)$$

$$= \frac{\omega}{186,000} \text{ radians per mile} \quad (73)$$

Wave length is

$$\lambda = \frac{2\pi}{\omega \sqrt{L_1 C_2}} = \frac{1}{f \sqrt{L_1 C_2}} \text{ unit lengths} \quad (74)$$

$$= \frac{186,000}{f} \text{ miles} \quad (75)$$

$$= \frac{3,000,000,000}{f} \text{ m} \quad (76)$$

Retardation time is

$$t = \sqrt{L_1 C_2} \text{ sec. per unit length} \quad (77)$$

$$= 5.39 \times 10^{-6} \text{ sec. per mile} \quad (78)$$

Attenuation constant is

$$A = 4.346R \sqrt{\frac{C}{L}} \text{ db per unit length} \quad (79)$$

For *parallel wires* this becomes

$$A = \frac{0.0157R}{\log_{10} \frac{2s}{d}} \text{ db per unit length} \quad (80)$$

where R = loop resistance per unit length

s = spacing of wires, center to center

d = diameter of each wire, s and d being measured in the same units

For *coaxial conductors*, the attenuation is

$$A = \frac{0.0314R}{\log_{10} \frac{r_o}{r_i}} \text{ db per unit length} \quad (81)$$

where R = loop resistance (sum of the resistance of the two conductors)

r_o = radius of outer tube

r_i = radius of inner conductor, r_o and r_i being measured in the same units.

53. Input Impedance of Line Terminated in Impedance Z_a at Its Far End. *Special Cases for Radio Frequencies.* At high frequencies, the

attenuation constant A of a line approaches zero and the propagation constant is nearly equal to the wave-length constant B :

$$P \approx jB \approx j\omega\sqrt{LC} \quad (82)$$

and from (63)

$$\theta = lP = j l B = j\omega l\sqrt{LC} \quad (83)$$

Then Eq. (62) becomes:

$$Z_i = Z_0 \left[\frac{Z_a \cos lB + jZ_0 \sin lB}{Z_0 \cos lB + jZ_a \sin lB} \right] \text{ ohms} \quad (84)$$

This input impedance has certain interesting and useful values when the length of the line is a multiple of a quarter- or half-wave length.

a. Lines Quarter-wave Length Long. In this case,

$$l = \frac{\lambda}{4}, B = \frac{2\pi}{\lambda}, \text{ and } lB = \frac{\pi}{2}.$$

Then (84) reduces to

$$Z_i = \frac{Z_0^2}{Z_a} \text{ ohms} \quad (85)$$

Due to this property, quarter-wave lines are made use of as impedance-matching transformers. If, for instance, a line whose characteristic impedance is Z_1 is to be connected to an antenna system whose input impedance is Z_2 , a quarter-wave line having characteristic impedance $Z_0 = \sqrt{Z_1 Z_2}$ is inserted.

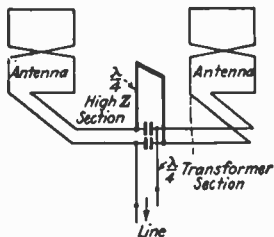

FIG. 34.—Use of quarter-wave short-circuited line to by-pass low-frequency currents for sleet melting without disturbing the r-f impedance of the system.

Since $Z_2 = Z_a$ the impedance facing the line is $Z_i = Z_1 Z_2 / Z_2 = Z_1$ ohms, and the impedance facing the antenna is $Z_i' = Z_1 Z_2 / Z_1 = Z_2$ ohms, which results in a perfect impedance match at each junction.

Quarter-wave Line Short-circuited at Far End. In this case $Z_a = 0$ and $Z_i = \infty$. Such a line is thus anti-resonant at the radio frequency corresponding to four times its length and is often used in antenna systems to by-pass low-frequency current around large radio-frequency impedances, for melting sleet. Such a use is illustrated in Fig. 34.

Quarter-wave Line Open-circuited at the Far End. In this case, $Z_a = \infty$ and $Z_i = 0$. Such a line thus has practically no impedance at the radio frequency which corresponds to four times its length.

Half-wave line Terminated in Impedance Z at Far End. Here, $l = \lambda/2$ and $lB = \pi$. Consequently, (84) becomes

$$Z_i = Z_a \quad (86)$$

Thus the input impedance of a half-wave line is equal to the termination impedance at its far end and is independent of the characteristic impedance of the line.

Lines Whose Lengths Are Integral Multiples of Quarter- or Half-wave Lines. Such lines can be shown to have the same properties as quarter- or half-wave lines, due to the periodicity of the sine and cosine functions in (84).

54. Termination Impedances at Radio Frequencies. At radio frequencies, proper termination of lines is even more important than at audio frequencies, since reflection resulting from mismatched impedances at the junctions produces standing waves which in turn cause radiation along the line and a decrease in efficiency. Impedance irregularities in a line also tend to set up reflections, and bends in the line should therefore be gradual, with a minimum radius of about one-fourth wave length. For the same reason, the line should be kept free (at least one-fourth wave length) from large masses of conducting or dielectric materials.

55. Efficiency of Lines at Radio Frequencies. In a properly constructed and terminated line the power losses are practically all due to the inherent ohmic resistance of the line, and the efficiency may be fairly high. For ordinary designs, the efficiency is approximately

$$(100 - 2l) \text{ per cent} \quad (87)$$

where l is the length of the line in wave lengths.

56. Tapered Lines as Impedance Transformers. A gradual smooth change with length in the inductance and capacity of a line causes the characteristic impedance to vary along the line, and can be shown to introduce no reflections. Consequently, a section of line with variable spacing or diameter of the wires is, like the quarter wave-length line, a useful impedance matching transformer, the dimensions being so chosen that the end impedances of the line equal their respective terminating impedances.

WAVE FILTERS

57. Wave filters are forms of artificial lines, such as those of Fig. 26b and c, purposely designed to transmit efficiently current in a desired band of frequencies and more or less completely to suppress all other frequencies. The boundary frequencies between transmission bands and attenuation bands are called *cut-off frequencies*.

The following brief discussion of wave-filter design is intended to serve as a guide to the design of simple filters for use where the requirements are not very severe. For complete information concerning the design of filter to meet more exacting specifications, the references listed in the bibliography at the end of this section should be consulted.

Filters are divided into four classes, according to the frequency bands which they are intended to transmit, namely, *low pass*, *high pass*, *band pass*, and *band elimination*.

58. Losses in Filters, and Effects of Dissipation. The elements of ideal wave filters are always pure reactances; practically, however, some dissipation must always be tolerated due to the resistance of coils and condensers, but this is made as small as possible by employing high- Q elements.

The terminating impedances of a filter are usually resistances equal in value to the image impedances of the filter. Then the loss within the transmitted bands (except near the cut-off frequency) is mainly due to dissipation in the elements and is usually small. In the vicinity of cut-off

and the point of maximum attenuation, the total insertion loss of a filter involves the reflection and interaction losses as well as the attenuation. The loss elsewhere in the attenuated bands is very nearly the sum of the attenuation constants of the various sections, minus a gain of approximately 6 db which is due to reflections resulting from impedance

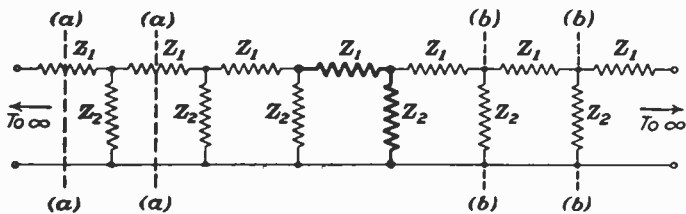

(a)-L-Section, showing Relation to Infinite Line

(a-a) is symmetrical T section

(b-b) is symmetrical π section

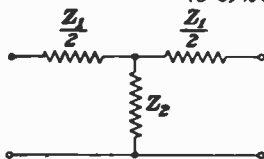

(b)-Symmetrical T-Section cut from infinite line of (a) at (a-a). This section is "mid-series terminated"

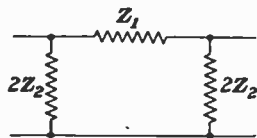

(c)-Symmetrical π -Section cut from infinite line of (a) at (b-b). This section is "mid-shunt terminated"

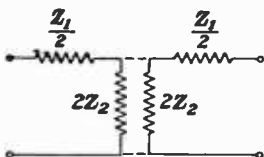

(d)-Symmetrical T-Section divided into two half-sections by replacing Z_2 with two parallel impedances each of value $2Z_2$

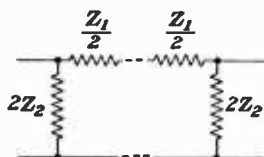

(e)-Symmetrical π -Section divided into two half-sections by replacing Z_1 with two series impedances each of value $Z_1/2$

FIG. 35.—Equivalence of T and π networks.

mismatches occurring in these regions. Methods for the exact calculation of filter losses are beyond the scope of this handbook but are available in the published works of Zobel, Johnson and Shea.

59. The Basic Filter Section. The basis of filter design is the full L section, consisting of a series element Z_1 and a shunt element Z_2 as shown at a in Fig. 35. The relation of such a section to an infinite line is also indicated. In a wave filter, where the number of sections is finite and

small instead of infinite, symmetrical sections are used. These are either T or π networks as shown at *b* and *c* in Fig. 35. The T section may be considered as being cut from the infinite line, Fig. 35*a*, at the mid-points (*a-a*) of two consecutive series elements Z_1 , and is said to be "mid-series terminated." The π section may be considered as being cut at the mid-points (*b-b*) of two consecutive shunt elements and is said to be "mid-shunt terminated." (To form a mid-shunt termination, each full-shunt element is replaced by an equivalent two impedances in parallel, each of value $2Z_2$.) Either a T or π section may be divided into pairs of equivalent half sections as shown at *d* and *e* in Fig. 35.

60. Types of Sections. *a. Constant-K Sections.* The simplest and most common type of filter section is that in which the impedances Z_1 and Z_2 are so related that their product is a constant

$$Z_1 \times Z_2 = K^2$$

at all frequencies. From this it derives its name "constant- K " section. The configuration and circuit constants of the four classes of constant- K sections are shown in the filter-design formulas in Art. 64. The image impedances of mid-series and mid-shunt terminated constant- K sections within the transmission bands are functions of frequency, but each approaches the value K at some frequency within the band. The value K is therefore taken as the nominal resistance of the constant- K section for design purposes. If a constant- K section is used with one or both of its terminals connected to a pure resistance of value $R = K$, the impedances will be mismatched for all frequencies within the transmitted band except one, and the actual insertion or transmission loss of the filter will be increased by reflection losses at the terminations. This causes an even more gradual cut-off for the constant- K section than its attenuation curve would indicate.

b. m -Derived Sections. In many filters, a sharper cut-off than that given by a constant- K type of structure is required. Such a characteristic may be realized in the so-called " m -derived section," which is due to Otto J. Zobel.¹ This type of section is derived from the constant- K section as a prototype but is made to have sharper cut-off than the prototype by the addition of impedance elements in either the shunt or series arms so that infinite attenuation occurs at some frequency beyond cut-off. Each impedance of the m -type section is related to those of the constant- K section by a factor which is a function of a constant m . The latter is in turn a function of the ratio between the frequency of infinite attenuation and the cut-off frequency and may have any value between

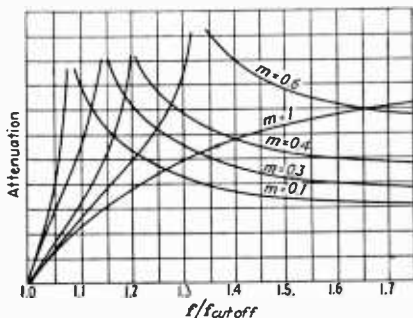

FIG. 36.—Effect of m upon sharpness of cut-off in a low-pass filter structure.

¹ Bell System Tech. Jour., January, 1923.

0 and plus 1. The sharpness of cut-off increases as m approaches 0. This effect is illustrated in Fig. 36 for various values of m . It will be noted that when m is equal to 1, the structure is identical with the constant- K structure. Also, from Fig. 36, it appears that from the viewpoint of obtaining a uniform degree of attenuation throughout the attenuated band the combination of a constant- K section ($m = 1$) (having gradual cut-off but large attenuation remote from cut-off) with one having a small value of m and sharp cut-off ($m = 0.3$, for instance) would be desirable. This principle is valuable in the design of composite filters.

c. Shunt-derived and Series-derived m Sections. Two forms of m -derived sections exist; if the extra impedance is added to the shunt arm, the

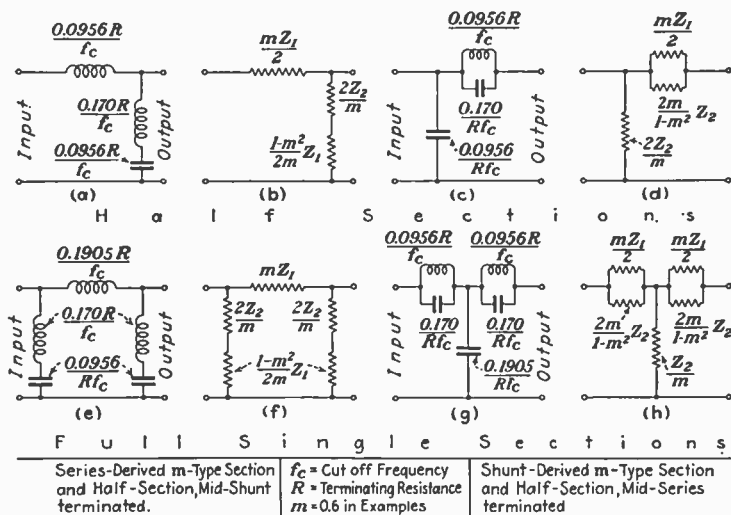

FIG. 37.—Half-section compared with full-section structures.

section is called *series derived*, while if it is added to the series arm, the section is called *shunt derived*. (See illustrations of derived sections under Filter-design Formulas, Art. 64.)

61. Assembly of Sections into Filters. A filter may consist of any number of sections from a single one-half section to five or six full sections, depending on the amount of attenuation of unwanted frequencies required. The *amount* of attenuation in the rejected band depends upon the number of filter sections used, while the *shape* of the transmission curve depends upon the types of sections employed.

62. One-half- and One-section Filters. If a half section or one full section is used alone as a filter, and the requirements regarding the cut-off are not too sharp, an m -derived section is usually preferable, with $m = 0.6$. This will provide the best impedance match with resistance

terminations. Either of the structures shown in Fig. 37 is suitable for use with terminations of resistance R .

63. Multi-section Filters. Filters having more than one section are of two types:

A *uniform* filter is one in which all sections are identical with the exception of the end sections. The latter are ordinarily half sections suitable for connecting the filter to its terminating resistances.

A *composite* filter is one made up of two or more sections having different characteristics, each of which is designed to contribute some especial property to the characteristic of the filter as a whole. For example, one section which has sharp cut-off but a diminishing attenuation beyond cut-off may be combined with another section having a gradual cut-off and increasing attenuation beyond, as shown at I and II in Fig. 38.

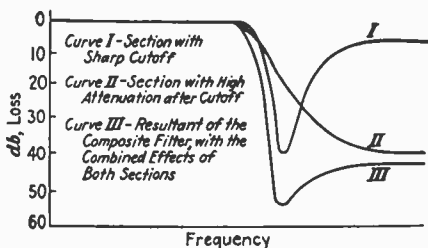

FIG. 38.—Transmission curves for composite low-pass filter.

The resulting composite structure will then have both sharp cut-off and high attenuation beyond, as shown at III. In general, constant- K sections have gradual cut-offs with increasing attenuation beyond, while m -sections with small values of m have the sharpest cut-off characteristics. Still other types of sections may be added to match impedances at the junctions of the filter and its terminating resistances, or to further alter the transmission characteristics.

In a composite filter it is essential that the image impedances be matched at each junction of the component sections, to avoid reflection losses which would impair the transmission curve of the filter. Likewise, the end terminations of the filter should as nearly as possible match the terminating resistances. One of the principal advantages of the m -type structure is that its image impedances can be made identical with other m -type sections or with constant- K sections; or they can be made to approximate resistances over the transmission band for terminating purposes. A complete analysis of the impedance conditions within a wave filter is not possible in the limited space available here but may be found in the References listed at the end of the section. The following will suffice as working rules in designing simple filters for ordinary requirements:

End Terminations. Resistance. A mid-shunt termination of a series-derived m -type section or half section, or a mid-series termination of a shunt-derived section or half section, with $m = 0.6$ in either case.

For Parallel or Series Connection with Other Filters. An 0.8-series constant- K section or half section (i.e., one terminated in a series arm equal to 0.8 of a full series arm, Z_1 .)

Here, as well as in the two preceding paragraphs, the image impedance of the internal section next to the end section in either case must match the image impedance at the inner terminals of the latter, in accordance with the following.

Internal Junctions. The following terminations of the types of filter sections for which formulas are given in Art. 64 may be joined together without impedance mismatches at the junction points:

Mid-series termination of constant- K type to mid-series termination of series-derived m type.

Mid-shunt termination of constant- K type to mid-shunt termination of shunt-derived m type.

Mid-series termination of constant- K , series-derived m type or shunt-derived m type, to mid-series termination of another section of the same type.

Mid-shunt termination of constant- K , series-derived m type or shunt-derived m type, to mid-shunt termination of another section of the same type.

(NOTE. In the latter two cases, the values of m in the two sections to be joined, if they are of the m type, may be, and frequently are, different. Both sections must be of the same type and termination, however.)

64. Filter-design Formulas. Formulas for calculating the capacities and inductances of constant- K , series-derived m -type and shunt-derived m -type basic sections are given in the following pages. These are expressed in terms of R , the terminating resistances, the factor m , and the values of f_c , the cut-off frequency, and other critical frequencies. These factors must be predetermined on the basis of the filter requirements and the considerations outlined above.

I. LOW PASS FILTERS

(a) - Constant K Type

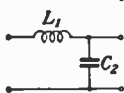

$$L_1 = \frac{R}{\pi f_2}$$

$$C_2 = \frac{1}{\pi f_2 R}$$

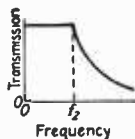
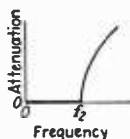

(b) m - Derived Type

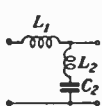

Series

$$L_1 = \frac{mR}{\pi f_2}$$

$$L_2 = \frac{(1-m^2)R}{4m\pi f_2}$$

$$C_2 = \frac{m}{\pi f_2 R}$$

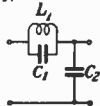

Shunt

$$L_1 = \frac{mR}{\pi f_2}$$

$$C_1 = \frac{(1-m^2)}{4m\pi f_2 R}$$

$$C_2 = \frac{m}{\pi f_2 R}$$

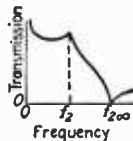
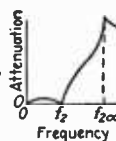

$$m = \sqrt{1 - \frac{f_2^2}{f_{200}^2}}$$

II - HIGH PASS FILTERS

(a) - Constant K Type

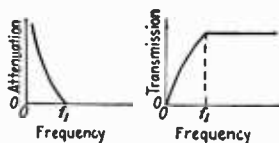
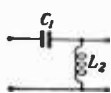

$$C_1 = \frac{1}{4\pi f_1 R}$$

$$L_2 = \frac{R}{4\pi f_1}$$

(b) - m - Derived Types

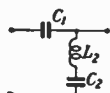

Series
Series

$$C_1 = \frac{1}{4\pi f_1 m R}$$

$$L_2 = \frac{R}{4\pi f_1 m}$$

$$C_2 = \frac{m}{(1-m^2)\pi f_1 R}$$

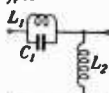

Shunt
Shunt

$$L_1 = \frac{mR}{(1-m^2)\pi f_1}$$

$$C_1 = \frac{1}{4\pi f_1 m R}$$

$$L_2 = \frac{R}{4\pi f_1 m}$$

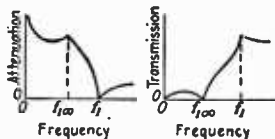

$$m = \sqrt{1 - \frac{f_{100}^2}{f_1^2}}$$

III - BAND ELIMINATION FILTERS

(a) - Constant K Type

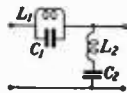

$$L_1 = \frac{(f_1 - f_0)R}{\pi f_0 f_1}$$

$$C_1 = \frac{1}{4\pi(f_1 - f_0)R}$$

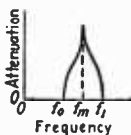

$$L_2 = \frac{R}{4\pi(f_0 - f_1)}$$

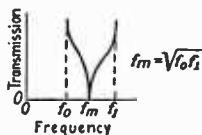

$$C_2 = \frac{f_1 - f_0}{\pi R f_0 f_1}$$

III - BAND ELIMINATION FILTERS (continued)

(b) - *m*-Derived Types

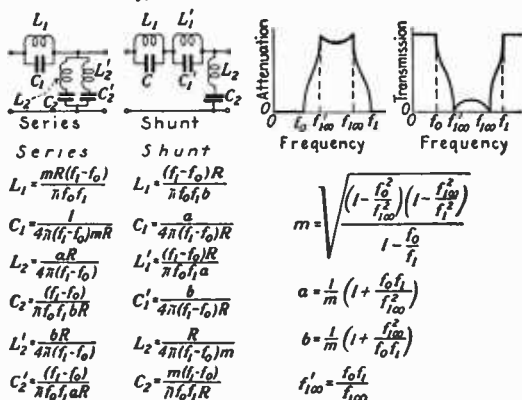

IV. BAND PASS FILTERS

(a) - Constant *K* Type

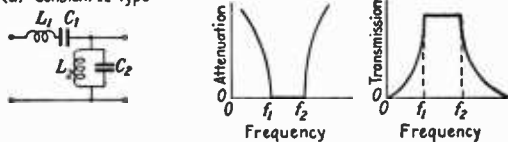

$$L_1 = \frac{R}{\pi(f_2 - f_1)}$$

$$C_1 = \frac{(f_2 - f_1)}{4\pi f_2 f_1 R}$$

$$L_2 = \frac{(f_2 - f_1)R}{4\pi f_2 f_1}$$

$$C_2 = \frac{1}{\pi(f_2 - f_1)R}$$

IV. BAND PASS FILTERS (continued)

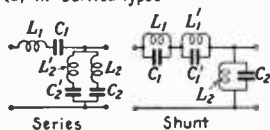
(b)-*m*-Derived Types

Series

Shunt

$$L_1 = \frac{mR}{\pi(f_2 - f_1)}$$

$$L_1' = \frac{(f_2 - f_1)R}{4\pi f_1 f_2 b}$$

$$C_1 = \frac{(f_2 - f_1)}{4\pi f_1 f_2 m R}$$

$$C_1' = \frac{a}{\pi(f_2 - f_1)R}$$

$$L_2 = \frac{aR}{\pi(f_2 - f_1)}$$

$$L_1' = \frac{(f_2 - f_1)R}{4\pi f_1 f_2 a}$$

$$C_2 = \frac{(f_2 - f_1)}{4\pi f_1 f_2 b R}$$

$$C_1' = \frac{b}{\pi(f_2 - f_1)R}$$

$$L_2' = \frac{bR}{\pi(f_2 - f_1)}$$

$$L_2 = \frac{(f_2 - f_1)R}{4\pi f_1 f_2 m}$$

$$C_2' = \frac{(f_2 - f_1)}{4\pi f_1 f_2 a R}$$

$$C_2 = \frac{m}{\pi(f_2 - f_1)R}$$

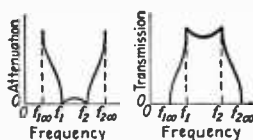

$$m = \frac{h}{1 - \frac{f_1^2}{f_{200}^2}}$$

$$h = \sqrt{\left(1 - \frac{f_1^2}{f_{200}^2}\right) \left(1 - \frac{f_2^2}{f_{200}^2}\right)}$$

$$a = \frac{(1 - m^2) f_1 f_2}{4h f_{100}^2} \left(1 - \frac{f_2^2}{f_{200}^2}\right)$$

$$b = \frac{(1 - m^2)}{4h} \left(1 - \frac{f_{100}^2}{f_{200}^2}\right)$$

$$f_{100} = \frac{f_1 f_2}{f_{200}}$$

Examples of Filter Design: a. Single-section Filter. Required: High-pass single-section filter to be connected between resistance terminations of $R = 1,000$ ohms, with a cut-off frequency of 1,000 cycles and maximum attenuation occurring at 800 cycles.

To secure the attenuation peak at 800 cycles, an *m*-type filter section is required. Either the shunt- or series-derived type may be used. Choosing the latter, we have from the filter formulas II (b), Art. 64, in which $f_1 = 1,000$ cycles, $f_{100} = 800$ cycles, $R = 1,000$ ohms, and $m = 0.6$,

$$C_1 = 0.1325 \times 10^{-6} \text{ farads}$$

$$L_2 = 0.1325 \text{ henry}$$

$$C_2 = 0.298 \times 10^{-6} \text{ farads}$$

From the considerations involving impedance matching at the end terminals, a mid-shunt termination facing each resistance termination is seen to be desirable for a series-derived section. Hence the structure of Fig. 37f is indicated. One full-series element (C_1) will be required, with a double-impedance shunt arm ($2L_2 + C_2/2$) at each end. The completed filter will then be as shown in Fig. 39.

b. Multi-section Composite Filter. Required: Low-pass filter to be connected between resistance terminations of $R = 600$ ohms, with sharp cut-off at 1,000 cycles and high attenuation beyond.

There is no unique solution or "best" filter design for this problem. A large number of filters might be designed to meet these requirements, each of which would serve as well as any of the others. The relative merits of different designs will depend upon their economy of coils and condensers in accomplishing the required results. One suitable design is shown here:

Let the input-end section be a half-section mid-series-derived *m* type, with its mid-shunt termination facing the input to match impedances at that point. Let $m = 0.4$ for this half section to give a sharp cut-off.

This will be followed by a symmetrical full section of the series-derived m type, mid-series terminated, with $m = 0.75$. Then a half section of the constant- K type with mid-series termination facing the full section and mid-shunt termination facing the end-terminating half section, which will be shunt-derived m type, with $m = 0.6$. The latter will have a mid-shunt

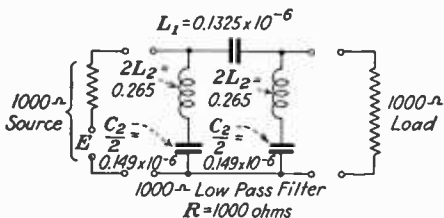

FIG. 39.—Example of single-section filter.

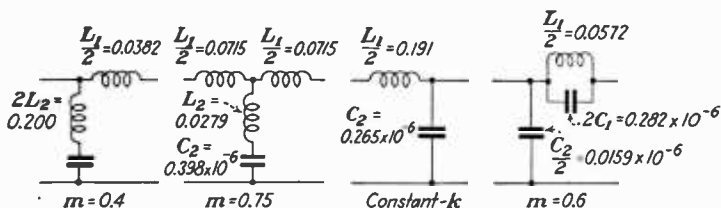

FIG. 40.—Low-pass filter for use between 600 ohms with sharp cut-off at 1,000 cycles.

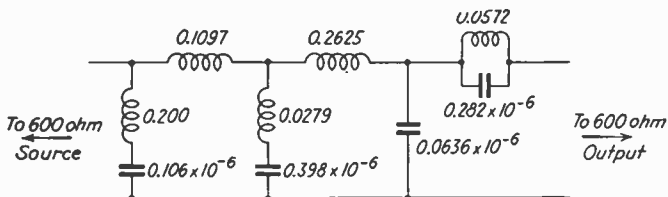

FIG. 41.—Final filter as designed by Fig. 40.

termination facing the constant- K half section and a mid-series termination facing the output termination.

References

Circuit Theory:

BRYANT and CORRELL: "Alternating Current Circuits," McGraw-Hill Book Company, Inc.

COLEBROOK: "Alternating Currents and Transients," McGraw-Hill Book Company, Inc.

EVERITT: "Communication Engineering," McGraw-Hill Book Company, Inc.

JOHNSON: "Transmission Circuits for Telephonic Communication," D. Van Nostrand Company, Inc.

KENNELLY: "Electric Lines and Nets," McGraw-Hill Book Company, Inc.

MORECROFT: "Principles of Radio Communication," John Wiley & Sons, Inc.

SHEA: "Transmission Networks and Wave Filters," D. Van Nostrand Company, Inc.

TERMAN: "Radio Engineering," McGraw-Hill Book Company, Inc.

Wave Filters:

CAMPBELL: Physical Theory of Electric Wave Filters, *Bell System Tech. Jour.*, vol. 1, No. 2, p. 1.

—: Cisoidal Oscillations, *Trans. A.I.E.E.*, April, 1911.

CARSON and ZOBEL: Transient Oscillations in Electric Wave Filters, *Bell System Tech. Jour.*, July, 1923.

DELLENBAUGH: Electric Filters, *QST*, July and August, 1923.

JOHNSON: "Transmission Circuits for Telephonic Communication," Chaps. XVI and XVII, D. Van Nostrand Company, Inc.

JOHNSON and SHEA: Mutual Inductance in Wave Filters, with an Introduction on Filter Design, *Bell System Tech. Jour.*, vol. 4, No. 1, p. 52.

PIERCE: "Electric Oscillations and Electric Waves," Chap. XVI, McGraw-Hill Book Company, Inc.

SHEA: "Transmission Networks and Wave Filters," D. Van Nostrand Company, Inc.

ZOBEL: Theory and Design of Uniform and Composite Wave Filters, *Bell System Tech. Jour.*, vol. 2, No. 1, p. 1.

—: Transmission Characteristics of Electric Wave Filters, *Bell System Tech. Jour.*, vol. 3, No. 4, p. 567.

Transmission Lines:

EVERITT: "Communication Engineering," McGraw-Hill Book Company, Inc.

FELDMAN and STERBA: Transmission Lines for Short-Wave Radio Systems, *Bell System Tech. Jour.*, vol. 9, No. 3, p. 411, and *Proc. I.R.E.*, vol. 20, No. 7.

FRANKLIN and TERMAN: "Transmission Line Theory," Franklin and Charles.

TERMAN: "Radio Engineering," McGraw-Hill Book Company, Inc.

SECTION 7

ELECTRICAL MEASUREMENTS

BY R. F. FIELD¹ AND JOHN H. MILLER²

True basic measurements of electrical quantities are rarely made except in standardizing laboratories, owing to the inherent difficulties in the procedure. Ordinary measurements are made by comparison devices of one form or another. Direct-reading instruments, having an electrical torque-producing means functioning against a spring, are calibrated against accurate standards which are in turn calibrated against basic measuring devices. Such torque-producing instruments are used for measuring current, voltage, power, and resistance. Instruments for measuring phase relations, frequencies, and other factors may have two torque-producing systems, each torque varying with the position of the moving element and bearing different functional relations to the quantity measured. The result is for the moving system carrying the pointer to take up a position where the torques balance, this being different for each different value of the quantity in question, and the scale may be marked accordingly.

STANDARDS

1. Current. Current is measured, absolutely, in terms of the force of attraction or repulsion between two coils connected in series and carrying that current, and the various dimensions of the coils. This current is then used to deposit silver in the *silver voltammeter* to determine the electrochemical equivalent of silver. The silver voltammeter is thus the standard of current. One ampere of continuous unvarying current will deposit 0.001118 g of silver per second when following the standard procedure. The use of this standard is tedious and time consuming, and it is generally used only for the exact calibration of a standard cell and a known resistance.

2. Resistance. Resistance is measured absolutely by a number of methods in terms of a speed of revolution of a disk or coil and its various dimensions. The resistance is then compared with a mercury column of uniform cross section by a suitable bridge method. Such a column of mercury, having a mass of 14.4521 g, a uniform cross section (practically equivalent to 1 sq mm) of a length of 106.3 cm, and at the temperature of melting ice, has a resistance of 1 ohm. Practical secondary standards are coils of manganin wire immersed in oil and sealed in metal containers. Such sealed standards built by Leeds & Northrup Company to the specifications of the U. S. Bureau of Standards are

¹ General Radio Company, Inc., Cambridge, Massachusetts.

² Weston Electrical Instrument Company, Newark, N. J.

adjusted to an accuracy of 0.01 per cent and may be relied upon to hold their calibration to 1 part in 100,000 for considerable periods of time. The sealing of the containers is important to prevent the absorption, by the oil, of moisture from the atmosphere and the deposit, in turn, of this moisture upon the shellac or other insulating material on the wire which, in turn, will cause mechanical strains to distort the values beyond normal expectancy.

3. Voltage. Voltage measurements cannot be measured absolutely with an accuracy sufficient to make the measurement desirable, on account of the smallness of the electrostatic forces involved. The secondary standard of voltage is the saturated cadmium or Weston cell.

These cells, as built by Weston and by the Eppley Laboratory, are correct to 0.01 per cent. They may be depended upon to hold their voltage to 1 part in 100,000 when proper correction for temperature is made. The unsaturated cadmium cell must be compared with the saturated type for its initial calibration. Its temperature coefficient is negligible. Its voltage is constant to 1 part in 10,000.

As stated above, the cell is calibrated basically in terms of the standard mercury ohm and the standard ampere as obtained by the *silver-volt-ammeter* method.

4. Reactance. The self and mutual inductance of single-layer air-core coils and the capacitance of two-plate air condensers having guard rings may be calculated from their dimensions, with an accuracy of better than 2 parts in 100,000.

5. Frequency. The absolute standard of frequency is the mean solar day as measured by astronomical observations. The mechanical vibrations of piezo-electric quartz crystals or of tuning forks made from carefully stabilized metals provide standards of frequency, when permanently connected into suitable vacuum-tube circuits and allowed to oscillate continuously at constant temperature. Over long periods of time their frequency is constant to better than 1 part in 1,000,000; recent advances indicate a stability of 2 parts in 10,000,000 is obtainable. The frequency of the crystal with which such accuracy may be attained is restricted to the neighborhood of 100 kc. Tuning-fork standards usually operate at 1,000 cycles. By means of suitable frequency multipliers and dividers all other frequencies from 1 cycle to 100 megacycles may be obtained with the same accuracy.

Quartz crystals whose frequencies remain constant to 5 parts in 1,000,000 may be made for the frequency range 20 kc to 10 Mc. Metals, such as nickel and certain iron alloys, having the property of magnetostriction, may be used as oscillators in suitable vacuum-tube circuits. Their frequency range extends from 5 to 100 kc. Their stability is about 2 parts in 100,000. For the lower frequencies tuning forks and metal bars are used. Their frequency range is 25 to 1,000 cycles.

CURRENT-MEASURING INSTRUMENTS

6. Moving-coil permanent-magnet instruments of the pointer type, or reflecting galvanometers, consist of a coil, usually wound on a metal frame for damping purposes, which can rotate in an intense uniform magnetic field produced by a permanent magnet.

The current I flowing through the turns N of the coil reacts with the magnetic field H in the air gap to produce a force F acting on each conductor

proportional to the product IHl of the current, magnetic field, and length of conductor in the field. If the coil is pivoted at its center, a torque will be exerted, tending to rotate the coil about an axis parallel to the sides of the coil and perpendicular to the magnetic field. Some kind of restoring torque is provided which is proportional to the angle θ through which the coil rotates. Expressing the sensitivity S of the instrument as the angular deflection per unit current, it is given by

$$S = \frac{\theta}{I} = \frac{HNlb}{\tau} \quad (1)$$

where b is the diameter of the coil and τ is the restoring torque per unit angular displacement. For maximum sensitivity as a galvanometer, the permanent magnet should be very strong and the restoring force very weak. However, for pointer-type indicating instruments swung on pivots between sapphire V jewels, there is a minimum torque which may be used for a given moving element weight for frictional effects to be unobservable. For instruments mounted on a switchboard and having a horizontal axis, the ratio of the torque in millimeter-grams for 90 deg. to the weight in grams should not be



FIG. 1.—Moving-coil galvanometer.

below 40. For portable instruments having a vertical axis it has been found that heavy elements, over 1 g, show greater friction than given by the above equation and lighter elements, under 1 g, show less friction. Hence for such vertical-axis instruments the three-halves power of the weight is used. For portable instruments, therefore, the torque to weight 3:2 ratio is used and should be over 40 for unobservable friction.

The magnetic field obtained from the permanent magnet must be constant so that the electrical characteristics of the instrument may remain unchanged. The constancy of a magnetic system is determined by the ratio K , which is equal to the product of the effective length of the magnet times the effective cross section of one of the air gaps, divided by the product of the cross section of the magnet and the total air-gap length. This constant should be over 25 to 30 for high-cobalt steels and over 75 to 100 for chrome and tungsten magnet steels. Tungsten and chrome steels are most generally used and will give the most flux per unit cost; high-cobalt steels will cost two to three times as much for the same effective flux but will be much smaller and are widely used for airplane instruments and where the utmost in sensitivity is required in a moderate-sized instrument.

The flux density in the air gap is between 500 and 2,500 gauss. The structure of a pole piece and a core is used to decrease the length of the air gap and to make the magnetic flux uniform and radial. Where distorted d-c scales are required to balance other factors such as decibel relations, the pole tips may be cut away to produce a markedly distorted field resulting in a more uniform scale for the quantity measured.

The deflection of any sensitive galvanometer is indicated by the angular rotation of a beam of light, the so-called optical lever, which is reflected from a mirror, either plane or convex, mounted above the moving coil. The older form of telescope and scale is now being replaced by a spot of light containing cross hairs which moves along a scale. The use of a spot of light is much less fatiguing than observation through a telescope, and a wider range of view is obtained. The usual scale length is 50 cm

with zero in the center. The standard distance from mirror to scale is 1 meter. The maximum angular deflection is about 14 deg. Practically all pivot instruments use pointers. Full-scale deflection corresponds to approximately 90 deg. This is increased to 120 deg. in some central-station meters by careful shaping of the pole pieces. It may be increased to 270 deg. by a radical change in design.

The moving element of every deflection instrument provided with a restoring torque proportional to the angular deflection is in effect a torsional pendulum. As such it has a moment of inertia P , a period T , and a damping factor. If the damping factor is low, the instrument will oscillate several times about its position of rest, each oscillation being less than the preceding one in accordance with the decrement of the system. For most rapid indication it is desirable that the instrument be not quite aperiodic or dead beat but rather that it overswing from 3 to 5 per cent. (For a complete discussion of this see Drysdale and Jolley, "Conditions of Rapid Indication," Volume I.)

Normal ammeters and voltmeters may be expected to have a period of the order of 1 to 2 sec. The smaller instruments, if equipped with magnets for very high gap densities and extremely light moving elements may have a period as short as 0.2 sec. (Weston high-speed power-level indicators). Instruments of ultra-high sensitivity, where very little energy is available, may have a period as high as 5 sec. Sensitive suspension galvanometers may have a period as long as 12 sec.

The period of an instrument is important because the time necessary for any deflection instrument to attain a new position when its deflecting force is altered cannot be less than its period. High-speed indication in indicating instruments is very desirable, particularly when the phenomena being observed are rapidly changing, as in the monitoring of voice-frequency circuits; instruments with a long period will integrate the energy while high-speed instruments will give indications of peaks.

The friction of the suspension and the surrounding air is not sufficient to prevent the moving coil oscillating back and forth about its equilibrium position when a deflecting force is applied. The amount of damping is measured by the rate at which the amplitude of the oscillations decreases. The ratio of any two successive swings is constant. The Napierian or hyperbolic logarithm of this ratio is called the *logarithmic decrement* of the instrument. The smallest amount of damping which will cause the coil to come to rest with no oscillation whatever is called the *critical damping*, and the coil is said to be critically damped. Increasing the damping beyond this point increases the time necessary for the coil to come to rest and produces overdamping. The shortest time in which the coil can come within a given small distance of its position of rest occurs when the coil is slightly underdamped. It has a value of about 1.5 times the period of the coil. The extra damping necessary to critically damp a coil is usually obtained magnetically from the motion of the coil in the field of the permanent magnet, which sets up counter electromotive forces. The amount of damping produced by the current in the coil depends upon the total resistance of the coil and connected circuit. That resistance which produces critical damping is called the *critical damping resistance*. A galvanometer is usually so designed that its critical damping resistance is at least five times its coil resistance so that it may be shunted for critical damping without losing much sensitivity. All but the most sensitive pivot instruments are critically damped on

open circuit by the current set up in the metal winding form, and resistance of the connected circuit has little effect on the damping.

The *current sensitivity* of any galvanometer varies directly as the number of turns on its moving coil and as the square of its period. For a given winding space on the coil, its resistance varies as the square of the number of turns, assuming that the portion of the winding space occupied by insulation remains constant. The deflection is proportional to the current and to the square root of the resistance, *i.e.*, to the square root of the power dissipated in the coil.

TABLE I.—CHARACTERISTICS OF D-C GALVANOMETERS

Make	Type	$E, \mu v$	$I, \mu a$	$T, \text{sec.}$	$R \text{ coil, } \Omega$	$RC.D., \Omega$	$W, \mu\mu w$
Suspended coil type with mirror							
L. & N.....	2285a	0.032	0.0027	7.5	12	37	0.00009
	2285b	0.046	0.0038	5	12	52	0.00017
	2285f	0.032	0.00004	20	800	71,000	0.0000013
	2290	0.008	0.00001	40	800	101,000	0.00000008
	2500b	0.25	0.0005	6	500	10,500	0.00012
	2500e	1.5	0.003	3	500	2,500	0.0045
	2500f	0.05	0.0001	14	500	14,500	0.000005
	2239a	1.7	0.014	8	115	10,000	0.022
	2239b	1.0	0.001	14	1,000	10,000	0.001
	2239f	1.6	0.0002	18	8,000	54,000	0.00032
L. & N.....	2270	0.008	0.0002	5	40	0.0000016
Suspended coil type with self-contained scale							
L. & N.....	2400c	10	0.01	3	1,000	16,000	0.1
	2420c	25	0.025	3	1,000	16,000	0.62
	2310d	125	0.125	3.5	1,000	11,000	15.6
Double-pivot type with pointer and scale							
Weston.....	440	37	0.25	2.7	150	1,150	9.4
	322	38	0.20	190	1,890	7.6

Values of voltage E , current I , and power W are for a scale deflection of 1 mm at a scale distance of 1 m for the galvanometers having mirrors; for those having self-contained scales the values given are for a deflection of the smallest division, usually 1 mm. The voltage drop in the external critical damping resistance is not included in the voltage given.

In the selection of galvanometers it should be noted that in general those of high sensitivity will also be slow in action, and in general the natural period and critical damping resistance for a galvanometer as listed by the several makers should be considered as carefully as the sensitivity. Further, galvanometers of highest sensitivity will require great care in leveling; they will be responsive to minor vibrations and in many installations may require special supports.

Where vibration in a building is a factor, the Julius suspension may be used, a somewhat complex system of weights supported by springs with oil-damping vessels. A simpler method although not so perfect is to rest a 200-lb. block (of concrete) on an air cushion; this will absorb all vibration usually encountered in factories, at least for galvanometers of moderate sensitivity. Galvanometers with a single suspension have the greatest sensitivity, those with a taut suspension less, and those with double pivots least. For the most sensitive type of galvanometer, increasing the period from 5 to 40 sec. allows the power to be decreased

from 11 to $0.005 \mu\mu\text{w}$. The minimum current sensitivity is 10^{-11} amp. per millimeter. The smallest current sensitivity for a taut suspension is 10^{-8} amp. per millimeter, and for a double-pivot, pointer instrument, 2×10^{-7} amp. per scale division.

Galvanometers of the suspended type are used mainly as null indicators for d-c bridges and potentiometers and as deflection instruments in comparison methods. In the latter case a *differential galvanometer* is sometimes used. This is a galvanometer having two separate insulated windings on the suspended coil. They have equal numbers of turns and are so connected that, when equal currents flow through the two coils, no deflection is produced.

The sensitivity of a galvanometer is most easily reduced by shunting, and, since it is desirable to keep the galvanometer critically damped, the Ayrton-Mather universal shunt shown in Fig. 2 is most convenient. This arrangement is also used in multiple-range ammeters and milliammeters and is frequently known as a series shunt. The total resistance of the shunt is made approximately equal to the critical damping resistance of the galvanometer or indicating instrument with which it is used.

Pointer-type instruments of the pivot type are used as ammeters and voltmeters of all ranges and as the indicating portions of thermocouple, rectifier, and various vacuum-tube instruments. The minimum range of the ammeters extends from $5 \mu\text{a}$ to an upper limit determined only by the size of shunt desired, commercial shunts having been made to 50,000 amp. Above 15 to 30 ma the movements are shunted, in which case the copper or aluminum winding of the moving coil must have sufficient manganin swamping resistance in series with it to give a good temperature coefficient when shunted by the manganin resistance. Voltmeters may be made with a full-scale range from 1 mv to as high as series resistance can be arranged to care for the requirements. Instruments are made with self-contained series resistance up to a few hundred volts; higher ranges usually require an external resistor with the instrument placed in the grounded or low-potential side of the circuit for the sake of safety and to reduce electrostatic effects on the moving system.

Voltmeter sensitivity may be from 10 ma down to very low values, but at present a 1-ma sensitivity, *i.e.*, 1,000 ohms per volt, is finding wide acceptance because of its usefulness in the analysis of electronic circuits. *Voltammeters* are combinations wherein the moving element may be connected in shunt or in series with resistance networks for the measurement of current or potential of the ranges desired.

In general, pointer-type indicating instruments can be made to give full-scale deflection on as little as $0.1 \mu\text{w}$, although for a rugged instrument from 1 to $5 \mu\text{w}$ is required. Moving-element resistances may be made from about 1 ohm to 10,000 ohms. Low-resistance elements are limited by the spring or suspension resistance which becomes a very appreciable part of the total, reducing the energy available for torque; high-resistance elements are limited by the available wire, and many are now being wound of enameled copper wire 0.001 in. in diameter.

As in the output circuits of vacuum-tube amplifiers, the resistance of the instrument or galvanometer should be matched to the circuit

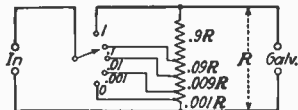

FIG. 2.—Ayrton-Mather universal shunt.

in which it is placed for maximum energy transfer, and this is particularly important where the energy is limited. On the other hand, this will frequently result in overdamping galvanometers of ultra-high sensitivity, and a compromise must usually be made between speed of response and sensitivity requirements. It should be noted, however, that this matching is not of vital importance since the loss by a very approximate match in error by as much as 20 per cent is very small.

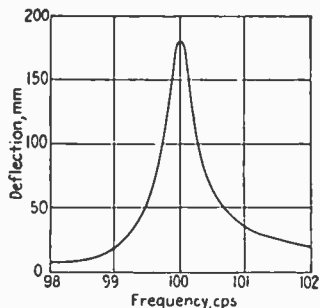

FIG. 3.—Resonance curve of vibration galvanometer.

never less than 1 sec., while the frequencies at which measurements are made are rarely less than 30 cycles. The upper limit for a taut single suspension is around 300 cycles. This limit may be raised to 1,000 by the use of a taut bifilar suspension. Electrical characteristics of commercial vibration galvanometers are given in Table II. At 60 cycles their sensitivity is equal to that of a good d-c galvanometer. A resonance curve when tuned to a frequency of 100 cycles is shown in Fig. 3.

The natural frequency may be raised still further by eliminating the coil entirely and using the single-turn loop formed by the bifilar suspension. The mirror is then placed at the center of the taut wires. The general method of construction is shown in Fig. 4. By this means a natural frequency of 12 kc may be obtained. The sensitivity decreases inversely as the first power of the frequency. On this account it is as sensitive at 10 kc as the bifilar-coil galvanometer was at 1 kc. In comparison with other null detectors at these frequencies, its sensitivity is so low that it is not much used in this form.

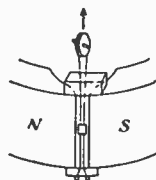

FIG. 4.—Bifilar suspension.

8. The Einthoven string galvanometer uses the simplest possible moving system for a galvanometer. A single conducting string moves in the narrow air gap of the magnetic system, which may be a permanent magnet or an electromagnet depending on the sensitivity desired. Its motion is observed through a microscope or by its shadow thrown on a screen from a point light source. Electrical characteristics of the Einthoven string galvanometer built by the Cambridge Instrument Company are given in Table II, using a silvered glass string and a magnification of six-hundred times. The string galvanometer may also be used as an oscillograph. The shadow of the string is observed on a

translucent screen as reflected from a revolving mirror. The motion of the string may also be photographed on film or bromide paper. The usual paper speed is 10 in. per second, but this may be increased to a maximum of 100 in. per second. At this latter speed, phenomena lasting a millisecond appear 0.1 in. long. Electrical characteristics of a string oscillograph built by the General Radio Company, using a 0.0004-in. tungsten string, are also shown in Table II. It may be equipped with a motor-driven camera and a synchronous shutter for producing 0.01-sec. timing lines.

TABLE II.—CHARACTERISTICS OF A-C GALVANOMETERS

Make	Type	f , cycles	E , μv	I , μa	R , Ω	W , $\mu\mu\text{w}$
		Vibrating-coil type				
Cambridge.....	Campbell bifilar	50	8.5	0.017	500	0.14
		100	17.5	0.05	350	0.88
		350	53	0.33	160	17
		750	104	2.0	52	200
		1,000	175	5.0	35	800
	Campbell unifilar	30	1.5	0.05	30	0.075
		50	1.2	0.04	50	0.080
		100	3.0	0.025	120	0.075
		200	7.0	0.10	70	0.70
L. & N.....	2350a	60	17.5	0.025	700	0.44
Cambridge.....	Duddell oscillograph	100	5.0	0.02	250	0.10
		1,000	50	0.2	250	10
		2,000	100	0.4	250	40
Cambridge.....	Einthoven	Vibrating-string type				
		100	100	0.025	4,000	2.5
		300	800	0.2	4,000	160
G. R. Co.....	338-L	60	110	2.5	45	280
		250	590	13	45	7,600
		500	1,350	30	45	40,000
		1,000	5,000	110	45	550,000
		Suspended-coil type with electromagnet				
L. & N.....	2570	60	0.06	0.005	12	0.0003
L. & N.....	2440	Electromagnet type				
		60	16	0.05	325	800,000
W. E. Co.....		Vibrating-diaphragm type (telephone)				
		800	400	0.02	6,000	2.4

Values of voltage E , current I , and power W are for a scale deflection of 1 mm at a scale distance of 1 m for all galvanometers except the telephone, for which the threshold of audibility is used. The moving system is tuned to the frequencies given for all instruments except the suspended coil galvanometer with electromagnet.

9. Moving-coil A-C Instruments. If a steady deflection is desired with a.c., the magnetic field must change in direction with the current in the coil and must have the same phase. This requires that the field be an electromagnetic one. In the case of galvanometers and particularly null indicators, a field of laminated iron may be used excited at the same frequency as the moving coil. When used as a null indicator in a bridge network, the field is connected across the same supply as the bridge while the moving coil is connected to the detector terminals. Since the current through the field and the flux produced will be nearly 90 deg. out of phase with the voltage applied to the bridge, the gal-

vanometer will be most sensitive to the reactance balance and will be little affected by the resistance balance. These conditions may be equalized or reversed by the introduction of resistance in series with the field, or reactance in series with the bridge, to make the field current and bridge current differ in phase by 45 deg. or be in phase. The phase selectivity of the a-c galvanometer may be of advantage in certain special cases, but in general it is a considerable disadvantage. The electrostatic field of the main field winding exerts a considerable force on the moving coil so that it must be carefully shielded. Its sensitivity is very high and it compares favorably with the best d-c galvanometers.

10. Electrodynamometer. When the iron core is omitted from the field winding, the moving coil and field coil may be connected in series. The deflection is then proportional to the square of the current flowing in the windings, and the instrument is called an *electrodynamometer*. Instruments of this type read the same on both a.c. and d.c. and are suitable as transfer instruments, provided certain precautions are taken. Protection from external magnetic fields is most important. This is usually accomplished in pivot-type instruments by shielding with soft iron. It may also be effected by making the instrument *astatic*. When a.c. is used, an error is introduced if the distribution of current in the coils is affected by eddy currents in the conductors themselves—the so-called *skin effect*—or by capacitance between the windings. The former effect is minimized by the use of conductors with insulated strands—so-called *litzendraht*—the latter by careful spacing and by electrostatic shielding.

Electrodynamometers may be used as galvanometers, ammeters, voltmeters, and wattmeters. Their sensitivity as galvanometers is so low compared with vibration galvanometers and other meters that they are now rarely used. As ammeters, voltmeters, and wattmeters, they are the standard instruments for use at commercial frequencies. In general the sensitivity of a-c instruments is of the order of 1/1,000 of that of d-c instruments, this being due to the difference in field intensity of the electromagnetic field as compared with that which can be obtained from a permanent magnet. Electrodynamometer instruments of the highest precision will take from 1 to 3 watts full scale, the total energy varying with the square of the deflection. Suspension-type electro-dynamometers may have sensitivities 100 times as great.

Electrodynamometer ammeters have their fields and moving coils in series up to several hundred milliamperes above which the moving element is shunted across a resistor in series with the fixed coils. Above 50 amp., or so, current transformers are used and these are now available with special alloy cores which will give accuracies of the order of $\frac{1}{10}$ of 1 per cent. Electrodynamometer instruments are ordinarily made to function up to 133 cycles without correction but may be used on frequencies up to several thousand cycles if especially designed or if corrections are made. Note that low-range voltmeters have very low resistance in order to get the required energy; dynamometer voltmeters with full-scale values of 2 volts may draw as much as 0.5 amp. High voltages above 1,000 volts are measured with potential transformers.

Electrodynamometer instruments are also used as wattmeters where the field is excited in series with the load and the moving coil is across the load in series with suitable resistance, the readings being proportional for $EI \cos \theta$. For polyphase circuits a multiplicity of similar elements

may be arranged on a single shaft, the most usual variety being the two-element instrument for three-phase circuits. Such an instrument gives true power without relation to phase angle.

TABLE III.—CHARACTERISTICS OF A-C AMMETERS

Make	Type	E , v	I , amp.	R , Ω	W , w	
Electrodynamometer type						
Weston.....	} 326	2.6	1.0	2.6	2.6	
		341	1.0	0.5	2.0	0.5
		370	21	0.015	1,400	0.31
Moving-iron type						
Weston.....	} 155	31	0.02	1,540	0.62	
		433	14	0.03	460	0.41
		476	30	0.015	2,000	0.45
		517	30	0.015	2,000	0.45
		528	30	0.015	2,000	0.45
Hot-wire type						
Hartmann & Braun.....		0.6	0.1	6	0.06	
G. R. Co.....	} 127	2.3	0.1	23	0.23	
		0.9	1	0.9	0.90	
		0.52	10	0.052	5.2	
Thermocouple type						
G. R. Co.....	} 493	0.8	0.008	100	0.0064	
		0.2	0.10	2	0.020	
Cambridge.....	}	0.24	0.008	30	0.0019	
		0.12	0.12	1	0.014	
		0.08	0.70	0.12	0.059	
Weston.....	} 412	0.25	0.01	25	0.0025	
		} 425	0.13	0.10	1.35	0.0135
			0.62	0.12	5.2	0.075
0.59	0.50		1.18	0.295		
Cambridge.....	} Duddell	1.5	0.01	150	0.015	
		1.5	0.10	1.5	0.015	
Rectifier type						
Weston.....	301	1	0.001	1,000	0.001	
G. R. Co.....	} 488	3	0.00075	4,000	0.00225	
		2	0.0005	4,000	0.001	
		2	0.00025	8,000	0.0005	
		2	0.0001	20,000	0.0002	
Westinghouse.....	} PY-4	13.4	0.010	1,270	0.13	
		NA	13.6	0.010	1,300	0.13
		NA	13.6	0.010	1,300	0.13

Values of voltage E , current I , and power W are for full-scale deflection.

11. Moving Iron Instruments. Galvanometers may be constructed with a stationary coil and a moving iron vane or magnet. The moving system consists of small permanent magnets placed at the center of the coil at right angles to the axis of suspension. To avoid the effect of outside magnetic fields, the system is duplicated with the magnets pointing in the opposite direction to make it astatic and the whole galvanometer is surrounded by multiple soft-iron shields. Its sensitivity (see Table I) is nearly equalled by the best moving-coil galvanometers so that it is very little used.

Soft iron may also be used in the moving element, either alone or in conjunction with a fixed piece of soft iron, both of which are magnetized by the fixed coil.

Soft-iron meters are much used as a-c ammeters and voltmeters in a wide variety of ranges and sizes. They may also be used on d.c. Electrical characteristics are given in Table III. The range of the ammeters is from 20 ma to 500 amp. The upper limit is ten times that of dynamometer-type meters, because the current coil is fixed. Currents up to 5,000 amp. are measured by the use of current transformers. Frequencies to 500 cycles may be used. The range of the voltmeters is from 1 to 750 volts. Their resistances are such as to give from 3 to 200 ohms per volt, the values increasing with the voltage. Higher voltages are measured by the use of either multipliers or potential transformers. Frequencies up to 500 cycles may be used, the normal limit being 133.

In general the sensitivity of pointer-type indicating instruments using the moving iron principle will be from 0.1 to 1 watt full scale. Instruments using short vanes, usually of the arcuate type, take about 1 watt full scale. Instruments with long radial vanes are more sensitive with a minimum of 0.1 watt full scale but in general are more sensitive to external fields and must be well shielded and kept away from strong external fields. Moving iron instruments in general are less satisfactory on badly distorted wave forms as the hysteresis loop of the iron is represented in the measurement. They are, however, widely used on power circuits and are generally available in all sizes from the small 2-in. instruments up to the larger switchboard types.

HIGH-FREQUENCY CURRENT METERS

12. For the measurement of currents of high frequency, the only satisfactory means is through the heat developed in a resistor, which heat may be measured by the expansion of a wire, by measuring the thermoelectric voltage developed by a thermocouple adjacent to the resistor wire, by bolometer methods, and by other heat-measuring systems.

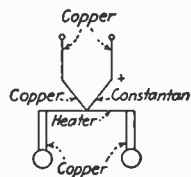

FIG. 5.—Thermocouple meter.

13. The hot-wire expansion type of instrument is today practically obsolete. Its defects of varying in indication with ambient temperature, the lack of perfect resiliency in the heated expansion wire, and its low overload capacity together with the advent of the thermocouple instrument have practically made this type obsolete.

14. A thermocouple meter consists of a heater wire, a thermocouple adjacent to it, and a d-c galvanometer or millivoltmeter. Figure 5 shows the basic diagram of the device. Such a simple assembly, however, does not compensate for variations in temperature of the terminals or for ambient temperature variations.

The Weston thermal ammeter as developed by W. N. Goodwin, Jr., is as shown in Fig. 6. The heater is a wire or strip of platinum alloy of very short length whereby most of the heat is conducted to the terminals thus wiping out largely the effect of convection currents of air. The temperature of the heater strip may be represented as a parabola in its gradient from center to each terminal lug, and it is this temperature

difference or gradient from the center of the heater to its end which is measured by the thermocouple. The couple proper consists of a pair of wires, usually of constantan and a platinum alloy, permanently welded to the center of the heater at the junction end, with the effective

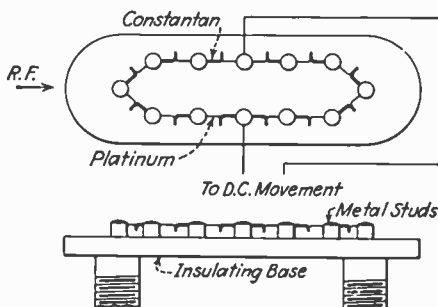

FIG. 6.—Galvanometer or bridge-type couple.

cold ends soldered to a pair of copper strips which are thermally connected to, but electrically insulated from, the terminal lugs. Their heat capacity is such that the difference in temperature between the center of the heater strip and the center of the two copper compensating strips is always the same as from the center of the heater strip to the terminal lug, regardless of ambient temperature changes or general rise in temperature of the surroundings due to heating of the lugs themselves or temperature rise due to the total heat generated. The thermo-electric voltage from the couple is, therefore, strictly proportional to the temperature difference between the center and ends of the heater strip which in turn is proportional to the square of the current causing this temperature rise, and a d-c instrument connected to the couple may be calibrated in terms of this current.

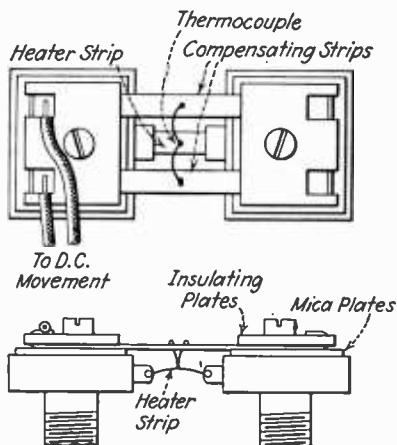

FIG. 7.—Compensated thermocouple.

Couples may be designed to give suitable indication on instruments of commercial types from 200 ma up to 1,000 amp.; the higher ranges require larger heater strips, and above 100 amp. several may be placed in multiple in a cylindrical structure. Instruments having a range up to 3 amp. have sufficiently small heaters so that the skin effect which produces the most noticeable error will not come into play

in currents up to some 20 Mc; for larger currents at high frequencies current transformers or capacity shunts are desirable.

For low ranges so-called bridge-type couples are used, as shown in Fig. 7, whereby a number of couples are arranged in series parallel to give a higher thermal e.m.f. The impedance of these couples is higher than for a single couple, and for the common current-squared galvanometer the effective resistance is 4.5 ohms. The indicating instrument for the standard single couples has a sensitivity of 12 mv and a resistance of about 5 ohms.

For still higher sensitivities the couple may be placed *in vacuo*. Such couples show no increase in sensitivity until the vacuum is better than 0.01 mm of mercury; but above this point a great increase in sensitivity is obtained up to as much as 25 times that obtained in air for certain extremely fine wire couples. The heaters for such couples may be carbon or graphitized wire. Commercial vacuum couples are intended to function with a 12-ohm, 200- μ a d-c instrument and may be obtained in ranges down to as low as 2 ma in the heater circuit for full-scale deflection on the instrument with a heater resistance of from 700 to 1,000 ohms. Vacuum couples are rarely used for currents higher than a few hundred milliamperes, and the air couples are quite satisfactory for these higher ranges.

Thermocouple instruments in general are calibrated on commercial frequency a.c., and, if used on d.c., the mean of reversed readings should be taken to make certain that any d-c drop in the heater picked up by the couple is canceled out.

Thermocouple instruments may be obtained with separate couples for use in indicating at a distance as where a couple is placed in the antenna of a transmitting station and the leads brought back to an instrument in the transmitting building. The couple should be placed in the high-frequency circuit at a point of ground potential or very close to it, and under certain conditions choke coils are necessary to keep r-f currents out of the instrument circuit.

The ratio of the power available to operate the indicating meter to that put into the heater is about 1 to 2,000 for the most efficient couples, hence a very sensitive d-c instrument is required for low r-f energies.

Thermocouple voltmeters are constructed by using one of the more sensitive couples with sufficient series resistance to give the desired voltage range. Their range is from 0.3 to 150 volts with resistances of 125 ohms per volt above 1 volt, and 500 ohms per volt above 10 volts, if desired. Their frequency range is determined by that of the series resistance. The small resistance spools which must be used in meters with self-contained resistors change their resistance rapidly with frequency so that their frequency limit is 3 kc. Frequencies of 1 megacycle may be attained with an error of 1 per cent with special high-frequency resistors.

Since the e.m.f. produced by the thermocouple is proportional to the power input and hence to the square of the current, this meter will read correctly on both d.c. and a.c. and may therefore be used as a transfer instrument. It is necessary, however, to take the average of the readings for both directions when using direct current.

RECTIFIER METERS

15. An alternating current may be changed to a pulsating current having a steady component by the process of rectification. If the

current-voltage characteristic is as shown in Fig. 8a the effect is called *half-wave rectification*. The negative half cycles are eliminated and the positive half cycles reproduced undistorted. The value of the steady component is half the average value of a half sine wave. The ratio of the d.c. to the effective value of an a-c current having a sine wave form

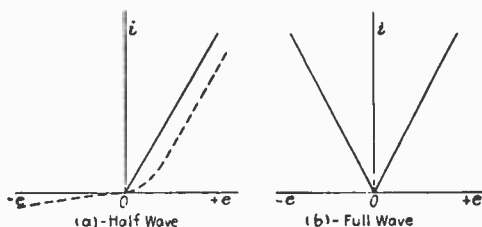

FIG. 8.—Rectifier characteristics.

which would flow if the rectifier were replaced by a pure resistance of the same value as that of the rectifier is $\sqrt{2/\pi}$, or 0.450. By a combination of rectifiers, it is possible to obtain the characteristic shown in Fig. 8b, which gives full-wave rectification. The d.c. is then 0.900 of the a.c. Actual rectifiers have a curved characteristic as shown by the dotted line in Fig. 8a. For negative voltages the resistance is not infinite. The ratio of the positive and negative half-cycle resistances is sometimes as low as 8. Because of the curvature of the characteristic, the ratio of d.c. to a.c. is a function both of the magnitude of the current and of wave form.

The crystal rectifiers used with early radio receivers may be used with a sensitive d-c meter for rectifying an alternating current. Carborundum, galena, silicon, and many other crystals may be used. The crystal is cast in a low melting-point alloy and the top contact made with a fine copper wire. Rectification occurs at the points of contact of copper and crystal.

16. Commercial rectifier instruments contain a full-wave rectifier consisting of four copper oxide rectifier disks connected in bridge relation as shown in Fig. 9. The rectification is by virtue of the oxide film formed on the copper disk. Current flows readily from the oxide to the copper and much less readily in the reverse direction.

For instrument use, the rectifier consists of four small plates about $\frac{3}{16}$ in. square or round, arranged in a stack with suitable terminals between adjacent disks for connection to the instrument and the external circuit. Contact with the oxide is made through the use of lead or graphite intermediate plates,

or the surface oxide on the rectifier disks themselves may be reduced to metallic copper in the firing process. Such a stack is rated at about 2.5 volts and may be used up to 15-ma maximum. The circuit shown puts two rectifiers in series and gives full-wave rectification.

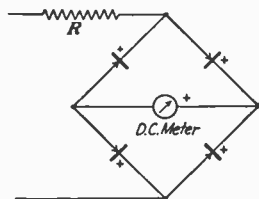

FIG. 9.—Copper-oxide rectifier loop.

The sensitivity¹ of the device depends upon the resistance and full-scale current of the d-c instrument. The d-c instrument measures the average value of a rectified wave, while a.c. is usually measured by methods which give the r-m-s value of the wave. It is customary to calibrate rectifier

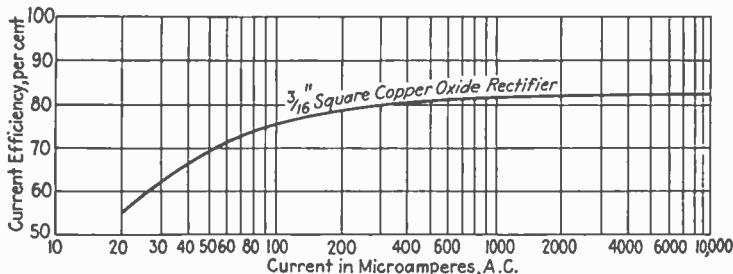

FIG. 10.—Current-efficiency characteristic.

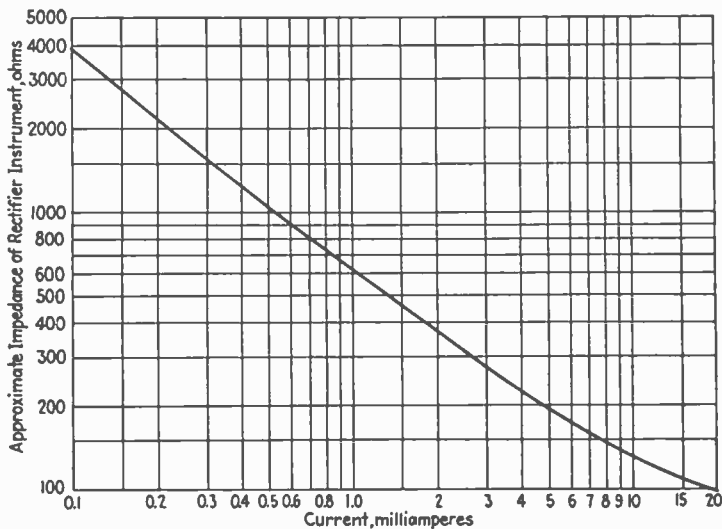

FIG. 11.—Impedance characteristic.

instruments in terms of the r-m-s value, of a stated wave form, usually a sine wave. If a rectifier instrument is used on a wave form differing widely from the wave for which it is calibrated, an error proportional to the form factor will result. Calibration also corrects an error due to imperfect rectification, which varies with current, temperature, and frequency.

¹ The following several paragraphs and Tables IV and V have been contributed by F. S. Stickney of the Westinghouse Electric & Mfg. Co.

The performance of rectifier instruments can be best expressed by considering the d-c instrument and the rectifier as a unit according to Fig. 9.

The current efficiency, $F = \frac{\text{average d-c current}}{\text{r-m-s a-c current}}$, is 80 to 85 per cent for a sinusoidal a-c current in the order of 0.001 amp. It is therefore impossible to use an a-c rectifier instrument for d.c. without first making a suitable change in circuit or calibration. Figure 10 shows the effect of current on current efficiency for a sinusoidal wave. This variation is corrected in calibrating.

The 60-cycle impedance of rectifier instruments is shown approximately by Fig. 11. This curve is plotted from a number of commercial instruments and includes the resistance of the d-c instrument.

Temperature variations have considerable effect on both the impedance and accuracy of rectifier instruments. Figure 12 shows temperature-voltage variations from which impedance can be determined. Figure 13 shows temperature-efficiency relations at various current values. In general, rectifier instruments are reasonably accurate below 25°C., but microammeters will begin to read slightly low above 25°C., and all rectifier instruments may become erratic at temperatures in excess of 45°C. High-temperature locations should be avoided in application.

Frequency errors are largely the result of capacity between disks. With high current density, good accuracy is obtainable somewhat above audio frequencies. With low current density (microammeters), frequency errors may become large at audio frequencies. For example, at 0.005 amp. a.c. the frequency error is about 3 per cent between 60 and 16,000 cps, while at 0.0005 amp. a rectifier instrument may read 13 per cent low at 10,000 cps. Higher errors can be expected at lower current values.

In general, low-range voltmeters are more subject to temperature and frequency errors than high-range voltmeters. Low-range voltmeters have scales which are compressed at the lower end due to variations of impedance with current. High-range voltmeters and milliammeters have nearly uniform scale distribution.

The following tables give approximate constants of commercial rectifier instruments.

TABLE IV.—MILLIAMMETERS AND MICROAMMETERS

Full Scale, Milliamperes	Approximate 60-Cycle Impedance at Full Scale ¹
15	100
10	130
5	190
2	370
1	600
0.5	1,140
0.2	1,950
0.1	4,200
0.05	6,300
0.02	10,000

¹ Individual copper oxide rectifiers vary considerably from the average in characteristics. Impedance values given may vary ± 15 per cent, and efficiency values vary ± 3 per cent for the product of one manufacturer. Much greater variations may be expected between the products of different manufacturers.

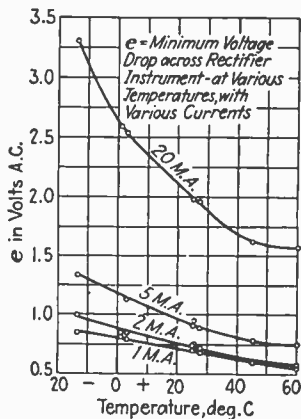

FIG. 12.—Effect of ambient temperature on the voltage drop across a rectifier instrument at various currents.

TABLE V.—VOLTMETERS

Full scale, volts	Full scale, approximate ohms per volt	Approximate fixed resistance, ohms ¹	Approximate 60-cps impedance of rectifier and d-c instrument at full scale, ohms ¹
150	1,000	149,400	600
50	1,000	49,400	600
10	1,000	9,400	600
4	1,000	3,400	600
3	2,000	4,860	1,140
2	2,000	3,860	1,140
1.5	2,000	1,860	1,140
1.	5,000	33,050	1,950
0.5	5,000	550	1,950

¹ Individual copper oxide rectifiers vary considerably from the average in characteristics. Impedance values given may vary ± 15 per cent, and efficiency values vary ± 3 per cent for the product of one manufacturer. Much greater variations may be expected between the products of different manufacturers.

17. Power-level instruments used in the monitoring of voice-frequency currents make use of the rectifier

type of instrument almost exclusively. While some special types use vacuum-tube voltmeters of one sort or another, the simplicity and direct sensitivity of the rectifier instrument make it very nearly ideal. Such instruments have scales usually marked in decibels above or below an established zero level. They are essentially voltmeters with their markings having reference to the power passing into a line or load of definite impedance.

The most usual instrument has a scale from minus 10 db, through 0, to plus 6 db. Since the instrument is a voltmeter, and since its scale is nearly linear, with plus 6 db at full scale, zero level is practically at the center of the scale (see Fig. 14). For a 500-ohm line, a zero level of 6 mw represents 1.73 volts and the instrument is calibrated to this value; full scale or plus 6 db is thus 3.46 volts. For purposes of standardization and so that external resistors may readily be calculated when the instrument is to be used on a higher level, it is normally adjusted to 5,000 ohms at zero level. Both voltage and resistance adjustments are made at this center-scale

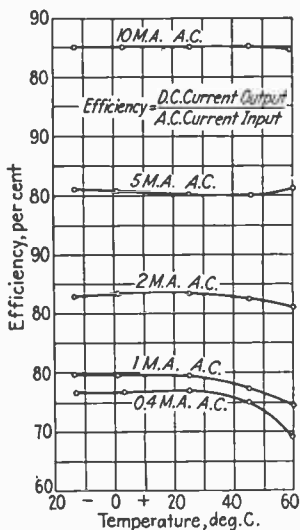

FIG. 13.—Ambient temperature-efficiency relation.

point where the instrument is most used; the effective resistance is approximately 7 per cent low at full scale and 10 per cent high at minus 10 db.

Special instruments are also furnished with a scale as above but calibrated down 10 db, equivalent to 0.89 volt at the center-scale zero-

level mark and for use where the additional resistance to bring them to higher levels is switched in and out as required. Instruments may also be calibrated for some other line resistance such as 600 ohms or 50 ohms and for other zero levels such as 1 or $12\frac{1}{2}$ mw both of which are in use to some degree.

While instruments having normal response characteristics are usually furnished having a period of approximately 0.6 sec. and with some overthrow, both high-speed and low-speed instruments are used for special purposes. High-speed instruments with a period of approximately 0.2 sec. and aperiodic action are made for monitoring and will indicate peaks of short duration, even though they do not show instantaneous crashes. Much overmodulation can be avoided by monitoring with an instrument of this type. Slow-speed instruments with a period of approximately 1.5 sec. are also used to obtain an integrated average of the energy in the system and may be used to keep the general level well up in conjunction with a high-speed instrument, the indications of which are used to monitor the top level.

Table VI gives values for power level, resulting voltage ratios, voltages for commonly used loads and total power-level indicator resistance on the basis of the instruments described above.

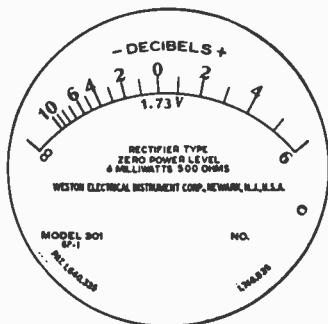

FIG. 14.—Scale of db meter.

MEASUREMENTS OF PULSATING CURRENTS AND POTENTIALS

In making measurements of current and voltage which are neither true a.c. or d.c., care must be taken to make the measurement with the correct type of instrument in order that a measurement be had of the actual value required.

18. Rectified current, which may or may not be filtered, should in general be measured with a moving-coil permanent-magnet type of d-c instrument. This gives the average value. It is the value of current or voltage of interest when charging a battery and in general is the value of interest in vacuum-tube technique. Iron-vane and electro-dynamometer instruments indicate the r-m-s value which is used for determining the heating effect.

Direct-current instruments, particularly voltmeters, have a sufficiently large heat-overload capacity so that they may ordinarily be used on pulsating currents without danger.

To measure the a-c component of voltage, a condenser may be placed in series with an a-c voltmeter of suitable range; the d-c component is blocked and the a-c value only is measured. The impedance of the condenser at the frequency used (120 cycles for a full-wave rectifier system) should not be greater than 10 per cent of the instrument resistance; the impedances being in quadrature, the resulting error will be under 1 per cent. This is the simplest method of measuring hum in

TABLE VI.—USEFUL TECHNICAL DECIBEL DATA

Power level, db	Power ratio to 0 db	Power 6 mw at 0 db, watts	Voltage ratio to 0 db	Volts, based on 6 mw. at 0 db in		Voltmeter resistance 5,000 at 0 db	
				500 ohms	600 ohms	Total	Unit
-10	0.1000	0.0006000	0.31623	0.5477	0.6000	1,581	
-9	0.1259	0.0007553	0.35481	0.6145	0.6732	1,774	193
-8	0.1585	0.0009509	0.39811	0.6895	0.7554	1,991	217
-7	0.1995	0.0011972	0.44668	0.7737	0.8475	2,233	242
-6	0.2512	0.0015071	0.50119	0.8681	0.9509	2,506	273
-5	0.3162	0.0018975	0.56234	0.9740	1.0670	2,812	306
-4	0.3981	0.0023886	0.63096	1.0928	1.1972	3,155	343
-3	0.5012	0.0030071	0.70795	1.2262	1.3433	3,540	385
-2	0.6310	0.0038737	0.79433	1.3758	1.5071	3,972	432
-1	0.7943	0.0047660	0.89125	1.5437	1.6910	4,456	484
0	1.0000	0.0060000	1.00000	1.7321	1.8974	5,000	544
+1	1.2589	0.0075535	1.1220	1.9434	2.1289	5,610	610
+2	1.5849	0.0095093	1.2589	2.1805	2.3886	6,294	684
+3	1.9953	0.0119716	1.4125	2.4466	2.6801	7,062	768
+4	2.5119	0.0150713	1.5849	2.7451	3.0071	7,924	862
+5	3.1623	0.0189747	1.7783	3.0801	3.3741	8,891	967
+6	3.9811	0.0238865	1.9953	3.4559	3.7867	9,976	1,085
+7	5.0119	0.030071	2.2387	3.8776	4.2477	11,193	1,217
+8	6.3096	0.038737	2.5119	4.3507	4.7660	12,559	1,366
+9	7.9433	0.047660	2.8184	4.8816	5.3475	14,091	1,532
10	10.0000	0.060000	3.1623	5.4772	6.0000	15,811	1,720
11	12.589	0.075535	3.5481	6.1455	6.7321	17,740	1,929
12	15.849	0.095093	3.9811	6.8954	7.5536	19,905	2,165
13	19.953	0.119716	4.4668	7.7368	8.4752	22,334	2,429
14	25.119	0.150713	5.0119	8.6808	9.5094	25,059	2,725
15	31.623	0.189747	5.6234	9.7400	10.670	28,117	3,058
16	39.811	0.238865	6.3096	10.9285	11.972	31,548	3,431
17	50.119	0.30071	7.0795	12.2620	13.433	35,397	3,849
18	63.096	0.38737	7.9433	13.7582	15.071	39,716	4,319
19	79.433	0.47660	8.9125	15.4369	16.910	44,562	4,846
20	100.000	0.60000	10.0000	17.3205	18.974	50,000	5,438
21	125.89	0.75535	11.220	19.434	21.289	56,105	6,105
22	158.49	0.95093	12.589	21.805	23.886	62,945	6,840
23	199.53	1.19716	14.125	24.466	26.801	70,625	7,680
24	251.19	1.50713	15.849	27.451	30.071	79,240	8,615
25	316.23	1.89747	17.783	30.801	33.741	88,915	9,675
26	398.11	2.38865	19.953	34.559	37.867	99,765	10,850
27	501.19	3.0071	22.387	38.776	42.477	111,935	12,170
28	630.96	3.8737	25.119	43.507	47.660	125,595	13,660
29	794.33	4.7660	28.184	48.816	53.475	140,915	15,320
30	1,000.00	6.0000	31.623	54.772	60.000	158,110	17,195
31	1,258.9	7.5535	35.481	61.455	67.321	177,405	19,295
32	1,584.9	9.5093	39.811	68.954	75.536	199,055	21,650
33	1,995.3	11.9716	44.668	77.368	84.752	223,340	24,285
34	2,511.9	15.0713	50.119	86.808	95.094	250,595	27,255
35	3,162.3	18.9747	56.234	97.400	106.70	281,170	30,575
36	3,981.1	23.8865	63.096	109.285	119.72	315,480	34,310
37	5,011.9	30.071	70.795	122.620	134.33	353,970	38,490
38	6,309.6	38.737	79.433	137.582	150.71	397,160	43,190
39	7,943.3	47.660	89.125	154.369	169.10	445,620	48,460
40	10,000.0	60.000	100.000	173.205	189.74	500,000	54,380
41	12,589.2	75.535	112.20	194.34	212.89	561,050	61,050
42	15,848.9	95.093	125.89	218.05	238.86	629,450	68,400
43	19,952.6	119.716	141.25	244.66	268.01	706,250	76,800
44	25,118.9	150.713	158.49	274.51	300.71	792,460	86,150
45	31,622.8	189.747	177.83	308.01	337.41	889,150	96,750
46	39,810.7	238.865	199.53	345.59	378.67	997,650	108,500
47	50,118.7	300.71	223.87	387.76	424.77	1,119,350	121,700
48	63,095.7	387.37	251.19	435.07	476.60	1,255,950	136,600
49	79,432.7	476.60	281.84	488.16	534.75	1,409,150	153,200
50	100,000.0	600.00	316.25	547.72	600.00	1,581,100	171,950

a rectified plate supply. Because of its high resistance, the rectifier voltmeter described previously is most satisfactory for this purpose.

Peak voltages and currents are best measured through the use of a vacuum-tube voltmeter with a large capacity shunted by an extremely high resistance d-c voltmeter (see Articles on Vacuum-tube Voltmeters). A cathode-ray oscillograph is also useful in such studies.

VOLTAGE-MEASURING INSTRUMENTS

19. Use of Current Meters to Indicate Voltage. All current-measuring instruments having a sensitivity in milliamperes, may, with the addition of suitable series resistance, be used to indicate potential. The current drain of the instrument must be sufficiently low to abstract negligible energy from the circuit, as otherwise corrections must be made. With modern instruments of high sensitivity this requirement can usually be met.

20. Direct measurements of voltage are obtainable through electrostatic means, but the instruments are of limited utility because of their low torque and because the minimum ranges are rarely under several hundred volts. They are essentially instruments for the research laboratory.

Electrostatic voltmeters depend on the attractive force which exists between two conducting plates between which a difference of potential exists. In their simplest form, the force of attraction between a stationary and a movable disk is balanced by a calibrated spring. The *Kelvin absolute electrometer* is constructed in this manner. The force of attraction is proportional to the square of the difference of potential between the plates. Such meters give the same indication on steady and alternating voltages and have neither waveform nor frequency error.

One type of construction, used in suspended-vane meters, is shown in Fig. 15. The stationary plates are sections of two concentric cylinders, into which the cylindrical rotor turns. With the opposite poles of a magnet placed outside the stator plates, satisfactory damping is obtained from the currents induced in the loop. This type of construction is that used in the *Ayrton-Mather electrostatic voltmeter* built by the Cambridge Instrument Company.

Electrostatic voltmeters are very useful because of their high resistance and low power consumption at low frequencies. They cannot be used on high voltage at frequencies much above a megacycle, because of the rapid increase of the power loss in the necessary insulation. This loss increases directly as the first power of the frequency and the square of the voltage. A hard-rubber insulator with a power factor of 0.004 and capacitance of $10 \mu\mu f$ will have, at a frequency of 10 megacycles and voltage of 2.5 kv, a charging current of 1.5 amp. and a power loss of 15 watts, both of which values are excessive.

MEASUREMENT OF RESISTANCE

21. While bridge measurements of resistance give greatest accuracy (Art 36 *et seq.*) direct-reading instruments are much used because there is no requirement for the manipulation of the controls, and they are widely

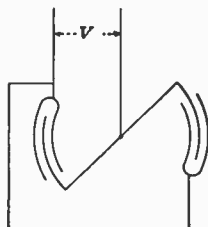

FIG. 15.—Suspended-vane meter.

used in production testing of resistance units as well as in general laboratory practice where the highest accuracy is not essential.

The simplest *direct-reading ohmmeter* consists of an ammeter and battery as shown in Fig. 16. Two readings are made, one with the terminals shorted, the other with the unknown resistance R connected. The fixed resistance S limits the current to about full-scale reading of the ammeter. The deflection is made exactly full scale by adjustment of the ammeter shunt B . The range of this type of meter is usually taken as that resistance which gives a deflection which is 5 per cent of full scale. On this basis the usual ranges are 1,000, 10,000, and 100,000 ohms.

Through the use of more complex networks, instruments with still wider ranges of capacity can be made available. The upper limit of resistance measurements by this means depends upon the instrument sensitivity and battery voltage; a 50- μ a instrument at 15 volts gives an excellent deflection on several megohms. The lower limit, since a minimum battery voltage of 1.5 volts must be used, is dependent only on the current capacity of the battery and the resistance of the leads. In general, for accurate work, the effective battery resistance must be calculated into the circuit as a part of the total series resistance.

Note that in all series-type ohmmeters the center- or half-scale resistance value is exactly equal to the total effective ohmmeter resistance at its terminals.

The readings of an ohmmeter may be made independent of the applied voltage by dispensing with the controlling springs and obtaining the controlling torque from a separate coil connected across the supply voltage. Figure 17 shows the circuit used by Evershed and Vignole in their ohmmeters of this type.

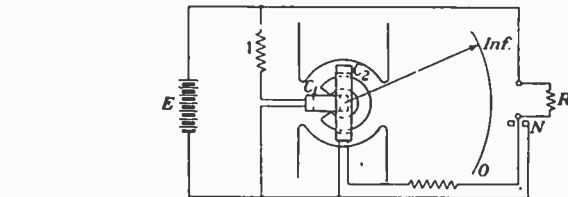

FIG. 17.—Ohmmeter of Evershed and Vignole.

This construction was first used by Evershed for an ohmmeter designed to measure high resistances up to 100 megohms. The source of voltage was a self-contained high-voltage magneto generator, giving voltages up to 500 volts. It was called a *megger*. The same principle has now been applied to ohmmeters of lower range using battery voltages. The resistance range extends from 1 ohm to 5,000 megohms.

22. Measurement of Impedance. When the voltmeter-ammeter method is used with a source of alternating voltage, the ratio of voltage to current gives the impedance of the load

$$Z = \frac{E}{I} \quad (2)$$

With the usual a-c instruments the corrections for the instruments are larger and more difficult to make because of their reactance. The high-resistance rectifier voltmeter and vacuum-tube voltmeter eliminate this difficulty.

The separation of impedance into its components requires the use of a wattmeter. The connections of Fig. 18a are usually used when no correction for instrument errors is to be made, while those of Fig. 18b allow the correction to be made quite easily. For this distinction the current coil of the wattmeter

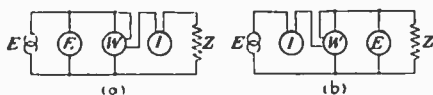

FIG. 18.—Measurement of impedance.

is grouped with the ammeter and its potential coil with the voltmeter. As before, the impedance of the load is given by Eq. (2). Its power factor is the ratio of the wattmeter readings to the product of voltage and current.

$$\text{P.f.} = \cos \theta = \frac{W}{EI} \quad (3)$$

where θ is the phase angle between voltage and current. The resistance of the load is

$$R = \frac{W}{I^2} \quad (4)$$

and the reactance

$$X = \sqrt{W^2 - R^2} \quad (5)$$

With the knowledge as to whether the load is inductive or capacitive, its inductance or capacitance may be calculated from

$$X = \omega L = -\frac{1}{\omega C} \quad (6)$$

where $\omega = 2\pi f$.

23. Measurement of Capacitance. Since the power factor of the usual condenser is small, its reactance is approximately equal to its impedance. This may be measured directly by the voltmeter-ammeter method and the capacitance calculated from Eq. (6). At a given voltage and frequency, a single ammeter reading is sufficient and the ammeter may be calibrated to read capacitance directly.

Capacitance may also be measured on a single indicating meter whose readings are independent of the applied voltage. The moving element consists of two coils set at right angles to each other. There are no controlling springs. The connections used in the high-frequency Weston microfarad meter are shown in Fig. 19.

The C_1 and C_2 are connected across the supply voltage, one in series with a fixed capacitance S , the other in series with the unknown C . The stationary field coils F are directly connected across the line voltage. With no condenser

connected in circuit with coil C_2 , the coil C_1 sets itself in the plane of the field coils F and determines the zero of the scale. The introduction of C allows current to flow in the coil C_1 and provides an opposing torque which is proportional to the capacitance added. The resulting deflection is of course just as dependent on frequency as on capacitance, so that any particular instrument must be used on the exact frequency for which it was calibrated. The low-frequency Weston microfarad meter has the moving coils connected in series instead of in parallel with the field coils.

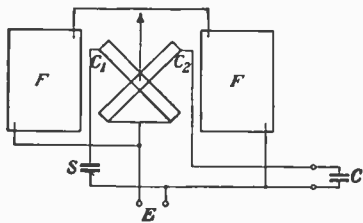

FIG. 19.—High-frequency microfarad meter. (Weston.)

from 0.05 to 10 μf at 60 cycles, 0.001 to 0.05 μf at 500, and 0.0005 μf at 1,000 cycles. The applied voltage sufficient torque to give a definite reading.

24. Measurement of Power Factor. Instruments for measuring power factor are very similar to the moving-coil capacitance meters described above. The connections used in the Weston power-factor meter are shown in Fig. 20.

25. Measurement of Frequency. Frequency may be measured with an indicating instrument similar to the capacitance meter shown in Fig. 19, in which the capacitance C is fixed and the capacitance S is replaced by a resistance. The scale is, of course, calibrated in terms of frequency.

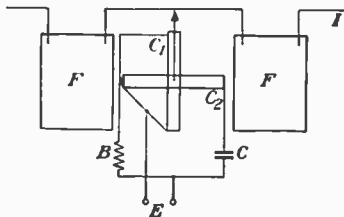

FIG. 20.—Power-factor meter. (Weston.)

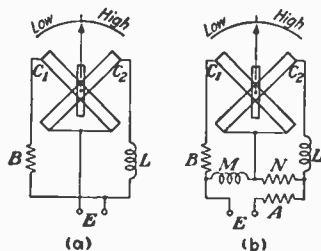

FIG. 21.—Frequency meter. (Weston.)

The functions of the moving and fixed coils may be transposed, the stationary part now consisting of two coils set at right angles to each other. The moving part is simply a vane of soft iron, since its sole function is to indicate the direction of the resultant magnetic field set up by the two stationary coils. The connections of such a frequency meter are shown in Fig. 21a. The tendency of the vane toward rotation is overcome in the Weston frequency meter by decreasing the phase difference between the currents in the two coils as shown in Fig. 21b. The rotation of the magnetic field is no longer uniform. The vane, being long and narrow, takes up a definite position, its inertia preventing it from following the irregular rotation of the magnetic field. The frequency range of the instrument is about 30 per cent of the mid-scale reading. These meters are usually built for the commercial frequencies

venting it from following the irregular rotation of the magnetic field. The frequency range of the instrument is about 30 per cent of the mid-scale reading. These meters are usually built for the commercial frequencies

25 and 60 cycles. The General Electric Company has built them for higher frequencies, up to 2,000 cycles.

Frequency meters are also constructed, which make use of *vibrating reeds*. A series of reeds, whose natural frequencies of vibration differ by regular intervals, are arranged in a line or in a circular arc in the order of ascending frequency. They are mounted on a suitably shaped electromagnet, whose winding is connected across the supply voltage of unknown frequency. That reed, having a natural frequency nearest to the supply frequency, will vibrate with an easily visible amplitude, and the frequency intervals between adjacent reeds are sufficiently small, compared to their damping, so that at least one will always vibrate.

MOVING DIAPHRAGM METERS

26. The telephone¹ is a very sensitive galvanometer, in which the indication of motion is acoustic. It is essentially a moving iron vibration galvanometer, polarized with a permanent magnet. Its construction is shown in Fig. 22. The amplitude of vibration is proportional to the product of the steady flux in the air gap produced by the permanent magnet and the alternating flux produced by the coils carrying the alternating current. The latter flux is much increased by placing the coils on laminated soft-iron pole pieces. The reluctance of the hardened steel magnet to the alternating flux is so great that most of the a-c flux passes across the gap at the base of the pole pieces. This gap is

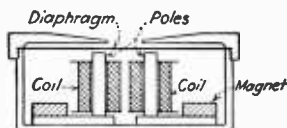

FIG. 22.—Construction of telephone.

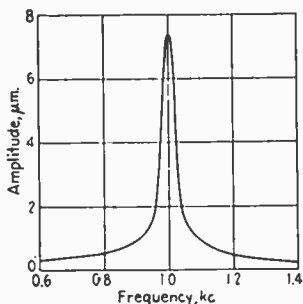

FIG. 23.—Resonance curve of Western Electric telephone.

The variation of amplitude with frequency is a sharp resonance curve. Figure 23 shows such a curve for a Western Electric telephone. The damping is little affected by changes in stiffness and natural frequency. The impedance of a telephone winding increases with frequency in a regular way, except around the resonance frequencies. The resistance and reactance are generally of the same order of magnitude,

¹In 1935 the Brush Development Company introduced a telephone based on the piezo-electric effect. At the time of writing sensitivity data were not available. THE EDITOR.

so that its lag angle is about 45 deg. At a frequency of 1,000 cycles they are about 10 times the d-c resistance of the winding. Near resonance the motion of the diaphragm introduces a counter e.m.f. into the circuit which is usually interpreted as additional resistance and reactance. These terms are referred to as *motional values*. In telephones of low damping, they may be as much as 70 per cent of the normal values. The actual numerical value of the resistance and reactance depends on the number of turns with which the magnets are wound. The d-c resistance varies from 30 to 1,000 ohms. The sensitivity of telephones is somewhat indefinite because it depends on the acuteness of hearing of the observer. It is usual to express it as the current necessary to produce a just audible response. Because of the existence of a threshold of hearing, this minimum current is reasonably definite and reproducible, at least for any one person. Values of this minimum current, together with the corresponding voltage, resistance, and power are given in Table II for a Western Electric receiver. It is much more sensitive than any vibration galvanometer and at its resonant frequency is not far behind a good d-c galvanometer.

27. Mica-diaphragm Telephone. It is possible to use non-magnetic materials for the diaphragm by providing a separate steel armature so shaped and clamped that its natural frequency is higher than that of the diaphragm, to which it is attached by a stiff rod. The *Baldwin telephone* uses a mica diaphragm very similar to that of a phonograph pickup. Both its sensitivity and selectivity are very high. Other modifications are the use of corrugated diaphragms to broaden the resonance curve and the use of a balanced armature in which the polarity of the permanent magnet is so arranged that the armature is not under tension due to them but is attracted only by the alternating flux.

28. Dynamic Telephone. The present type of dynamic speaker is a moving-coil galvanometer, in which a light paper cone attached to the moving coil acts as a diaphragm. There is no single natural frequency, so that over a wide frequency range the sensitivity is essentially constant. A head telephone has been developed by the Bell Telephone Laboratory with a moving coil and very light conical diaphragm. Its sensitivity is reasonably constant over a wide range of frequencies and holds up remarkably at frequencies as low as 100 cycles.

29. Thermophones. When a fine wire is heated by the passage of a.c., sound waves are produced in the surrounding air if the heat capacity of the wire is so small that the temperature of the surface of the wire follows the cyclic variations of the current. Instruments of this sort have been constructed, using gold foil as the heater. They are called *thermophones*. Their sensitivity in terms of sound energy is low. But they can be made small enough to be placed in the ear, so that their overall sensitivity is quite satisfactory. Their response decreases slowly as the frequency is increased. The theory of this instrument has been studied in considerable detail, because of its use as a standard in the production of sound.

ELECTRON TUBE METERS

30. Vacuum-tube Voltmeters. The three-electrode vacuum tube is used as the basis of a number of different types of meters. It is used as a rectifier in the manner discussed above. Its great advantage over

the two-electrode tube lies in the fact that its input resistance is practically infinite so that it is essentially a potential-operated device. The simplest type of connections is shown in Fig. 24. The grid bias E_c is so chosen that maximum plate rectification occurs, the relation between plate current and grid voltage being as shown in Fig. 25. When an alternating voltage e is applied between grid and filament, the average plate current increases from I_P to $I_{P'}$. This change in plate current is the quantity in

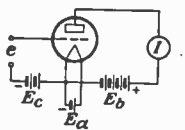

FIG. 24.—Vacuum-tube voltmeter.

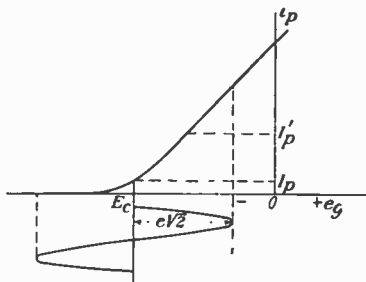

FIG. 25.—Vacuum-tube voltmeter characteristic.

terms of which the instrument is calibrated. The upper limit of applied voltage e is that for which the peak voltage equals the grid bias.

The zero of the plate-current meter may be suppressed mechanically so that the zero of the voltage scale may coincide with its electrical zero. This suppression may also be attained electrically as shown in Fig. 26. Part of the filament voltage taken from the potentiometer P_F sends a current through the resistance R and the ammeter equal and opposite to the zero plate current.

Its success depends upon the fact that the rectifying property of a three-electrode tube is nearly independent of plate voltage, provided that the grid voltage is simultaneously adjusted so as to keep the plate current constant. With the suppressor switch K open, the grid bias is adjusted by the grid

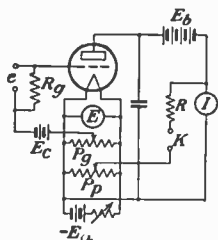

FIG. 26.—Circuit for bucking-out plate current.

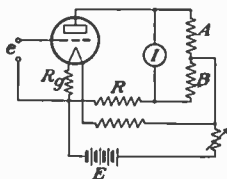

FIG. 27.—Single-battery type of voltmeter.

potentiometer P_g to give the value of plate current for which the calibration was made, the filament voltage having been previously adjusted. This determines the correct grid bias for the plate voltage then existing. Switch K is then closed and the zero suppressed electrically. With mechanical suppression this procedure reduces to setting the meter to zero by the potentiometer P_p .

The use of three separate batteries is a great disadvantage. A method whereby a single 22.5-volt battery supplies all three voltages was suggested by Hoare¹ and is shown in Fig. 27. The zero of the meter is suppressed electrically by the balance of the bridge formed by the three resistances A , B , and R and the plate resistance of the tube. The grid bias is obtained from the potential drop in the resistance R_0 due to the filament current.

The grid bias for the voltmeters shown in Figs. 24 and 26 may also be obtained by connecting the grid return to a resistance R_b in the plate circuit as shown in Fig. 28. This method of obtaining the grid bias causes the bias to increase with the applied voltage. The relation resulting between meter deflection and signal voltage, while nearly a square-law relation for small voltages, becomes nearly linear for large voltages of from 20 to 100 volts. For a large grid bias plate current flows only during the positive peak so that the error due to wave form may become serious.

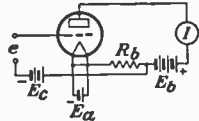

FIG. 28.—Grid bias from plate circuit.

Wave-form error is not serious for low voltages and vanishes if the law followed by the meter is strictly the square.

The *sensitivity* obtainable with a vacuum-tube voltmeter depends mainly upon that of the indicating meter. The detection coefficients of the various tubes available are not widely different and are not much affected by the value of plate voltage. A full-scale reading of 3 volts is usual with a d-c meter showing full-scale deflection on 200 μ a. A 20- μ a meter would show a full-scale deflection on 1 volt. Wall galvanometers may be used to obtain increased sensitivity but the difficulty in maintaining the zero setting increases greatly.

The *input resistance* of a vacuum-tube voltmeter is high, being either the insulation resistance of the input terminals or the resistance R_0 of Fig. 26 shunted between grid and filament to maintain the grid bias. This may be as high as 10 megohms. The plate load of the tube is sufficiently low so that it does not affect the input resistance. The input capacitance is essentially that of the terminals, socket, and grid-filament capacitance. By careful design this may be made as low as 5 μ f.

The *calibration* of a vacuum-tube voltmeter is usually independent of frequency over a wide range. At low frequencies an error appears when the reactance of the plate by-pass condenser, connected between plate and filament to provide a low-impedance path for the alternating component of the plate current, becomes comparable with the plate load. If this condenser is omitted, in order that the meter may be calibrated and used at commercial frequencies, errors may appear at frequencies below 100 kc due to natural frequencies in the meter and resistances of the plate circuit. Finally natural frequencies in the grid circuit, either in the resistance R_0 of Fig. 26 or in the combination of resistance R_0 of Fig. 27 and the grid-filament capacitance of the tube, set a definite upper limit below 10 Mc.

The sensitivity of the vacuum-tube voltmeter may be increased by the method suggested by Turner² in which two voltages are impressed on two balanced tubes connected as shown in Fig. 29. Equal voltages e_2 are applied

¹ HOARE, *Jour. A. I. E. E.*, 46, 541-545, 1927.

² TURNER and McNAMARA, *Proc. I. R. E.*, 18, No. 10, 1743-1747, October, 1930.

to the two grids in opposite phase across resistances R and a separate voltage e_1 of the same frequency and the same phase as either is introduced into the common grid lead across the resistance R_c . With the grid bias adjusted for plate rectification, the differential current through the meter connected between the two plates is proportional to the product $e_1 e_2$ of the two voltages. The voltage e_2 applied to each grid is usually the small voltage to be measured and voltage e_1 is a high voltage which gives increased sensitivity. A special phase shifting network is generally necessary for the adjustment of voltage e_1 . An effective amplification of 100 may be obtained.

If the two voltages are not in phase, the current through the ammeter is proportional to $e_1 e_2 \cos \theta$, where θ is the phase angle between e_1 and e_2 . This is the form for the expression for power in an a-c circuit. Hence if e_1 is proportional to the voltage across any load, and e_2 is proportional to the current through that load, obtained as the fall of potential due to the flow of this current through resistances R , the ammeter deflection is proportional to the power dissipated in the load. Full-scale deflection may be obtained with powers as small as $20 \mu\text{w}$. The frequency limits are those of the regular vacuum-tube voltmeter.

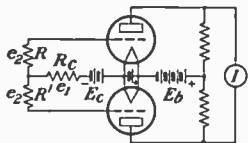

FIG. 29.—Balanced vacuum-tube voltmeter.

31. Tube Amplifier Voltmeter. The sensitivity of any a-c voltmeter may be increased by the use of a calibrated amplifier. This should be resistance coupled so as to give a constant voltage amplification over a wide frequency range. The electrical connections for such an amplifier as manufactured by the General Radio Company are shown in Fig. 30. A voltage amplification of 100 may be obtained with a voltmeter having a resistance of $5 \text{ k}\Omega$, 200 for one of $20 \text{ k}\Omega$, over a frequency range from 25 cycles to 50 kc. By suitably changing coupling condensers and grid

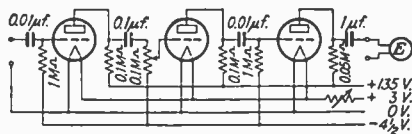

FIG. 30.—Amplifier-detector circuit.

resistances, increasing them for lower frequencies and decreasing them for higher resistances, this range may be extended to 1 cps and to 200 kc. With a voltmeter giving a full-scale deflection on 2 volts, an input voltage of 20 mv will produce a full-scale deflection and 2 mv may be detected.

The amplifier may be calibrated by means of an attenuator or potentiometer, adjusted to decrease the voltage applied to it in the ratio of 100 to 1. The attenuator is connected directly to the voltmeter and its deflection set to some convenient value. It is then connected to the input terminals of the amplifier, and the volume control adjusted to give the same voltmeter deflection. The effect of the attenuator on the voltage of the source may be equalized for the two observations by connecting across the input terminals a resistance equal to that of the voltmeter.

32. Electron-stream Meters. A stream of moving electrons is used in the *cathode-ray tube* to indicate and measure an electric or magnetic field.

Electrons emitted from a hot cathode *C* are accelerated by a positive potential applied to the anode *A* as shown in Fig. 31. Most of the electrons strike the anode and form the anode or plate current. The remainder pass through a small hole in the center of the anode and continue at constant velocity to a fluorescent screen *S* of willemite or zinc sulfide, which is usually the enlarged end of the glass tube in which the various parts are mounted. The beam is naturally divergent because of the mutual repulsion of the individual electrons comprising it and must be focused on the screen in some manner in order to obtain a small sharp spot. In the earlier tubes this was accomplished by leaving enough residual gas in the tube to give a pressure of about 0.001 mm of mercury. The positive ions produced by the electron stream exert a repulsive force on the electrons and prevent their divergence. Satisfactory focusing by this means demands a constant gas pressure, which

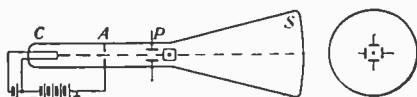

FIG. 31.—Electron-stream meter.

is difficult to maintain throughout the life of a tube. There is also an upper limit of perhaps 100 kc to the frequency for which sharp focusing can be obtained because of the relative slowness of the ionization process.

The beam may also be focused by a longitudinal magnetic field or a radial electric field, the latter being the more convenient. For this type of focusing, the gas pressure is reduced to the minimum necessary to prevent an accumulation of negative charge on the screen. Between the anode *A* and screen *S* there is placed a second anode having a positive potential between four and five times that of the first anode. In some designs the enlarged conical end of the tube is lined with a conducting layer and serves as this second anode. In others the second anode is a short cylinder or ring of larger diameter than the first anode. The cathode is usually of the oxide-coated type with a separate heater which, aside from its high efficiency in producing electrons, operates at a temperature sufficiently low so that light from it does not illuminate the screen. It is surrounded by a focusing cylinder with a partially closed outer end, which is connected directly to the cathode when the second anode is used. In tubes with residual gas the exact focusing of the beam is attained by varying the negative voltage applied to this cylinder.

The electron stream may be deflected by a transverse magnetic or electric field, applied beyond the first anode in the region where the electrons have a constant velocity. The losses inherent in the coils necessary to produce a transverse magnetic field limit their use to special cases. The transverse electric field is applied through four deflecting plates symmetrically disposed around the tube axis. When a difference of potential is applied to either pair of opposite plates, the stream of electrons is deflected toward the positive plate through an angle proportional to the strength of the electric field. The bright spot on the fluorescent screen, which marks where the electrons strike the screen, then moves proportionally. A voltage applied between the other pair of plates produces a deflection of the spot in a direction at

right angles to the first deflection. The deflection at the screen is inversely proportional to the higher anode voltage. It is of the order of 2 in. per 100 volts for an anode voltage of 1,000 volts.

When an alternating voltage is applied to a pair of plates, the electric field set up between the plates is continually varying in magnitude and direction. The stream of electrons is deflected back and forth between the plates, and the spot of light is drawn out into a line symmetrically disposed about the undeflected spot, provided the pair of plates is grounded at a point midway in potential between them. An alternating voltage applied to the other pair of plates will produce a line at right angles to the first. If the two voltages are applied to the two pairs of plates simultaneously the electron stream follows the instantaneous resultant force exerted by both fields and traces on the screen a pattern which is closed, and therefore appears stationary, when the frequencies used bear a simple relation to one another. These patterns are called *Lissajous*¹ figures. For two equal frequencies the pattern is an ellipse of varying eccentricity which at the extremes becomes a straight line or a circle. The exact figure is determined by the phase difference of the two voltages. For other ratios of the two frequencies the patterns become reentrant. For the general case the ratio of the number of loops formed on adjacent sides of the pattern is that of the two frequencies.

32a. Timing Axis. Since the electron stream can follow accurately all variations in applied voltage, it is only necessary to spread out the line of light which it produces on the screen into a two-dimensional picture to make visible its exact wave form. The second voltage of the same frequency giving the elliptical pattern just described does this but in such a manner that the whole pattern must be redrawn to be easily interpreted. The time axis, which the second voltage must provide, should be linear, not sinusoidal and its return to zero value should be instantaneous.

A very convenient circuit for this purpose employs a neon tube as shown in Fig. 32. The potential across the condenser C builds up according to an exponential law determined by the time constant CR of the circuit, which over the first part of its range is nearly linear. At some potential between 100 and 300 volts, dependent on the shape of the electrodes and the pressure of the gas, the neon tube breaks down and the condenser discharges very rapidly. At some lower voltage the neon tube goes out and the charging process is resumed. If the resistance R is replaced by a two-electrode vacuum tube, the curvature of the exponential law of charging may be partially compensated for by the changing resistance of the vacuum tube as the voltage across it is varied. The frequency at which the condenser charges and discharges depends on the time constant CR of the charging circuit, and is controlled by varying these quantities. Frequencies covering the range from 1 to 20,000 cycles are attainable. The waveform thus spread out on the screen will drift along the time axis unless the two frequencies are exactly equal or are simple multiples. It is very convenient to have the pattern stationary. The two frequencies may be synchronized by using a thyatron or three-electrode gas-filled tube in place of the two-electrode neon tube. Some voltage from the source of the waveform under observation is applied to the grid of the thyatron. When the control circuit is adjusted to produce approximately the correct frequency, this added voltage is sufficient to trigger off the discharge and maintain exact synchronism.

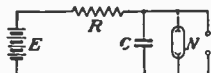

FIG. 32.—Timing circuit for cathode-ray tube.

¹ BARTON, "Textbook on Sound," pp. 555-557.

A time axis may also be obtained by viewing the screen on a *revolving mirror*. The pattern will be stationary when the speed of revolution of the mirror is an exact multiple of the frequency of the given wave.

Transient phenomena may be studied by photographing the single trace of the electron stream as spread out by any of the methods of obtaining a time axis described in Art. 21. The time axis may also be obtained by moving the photographic film itself. In this case, and also for the revolving-mirror method, the screen must be of the type in which the fluorescence does not persist, else the trace on the film will be blurred. Screens with persistence times as short as 25 microsec. and as long as 50 millisecc. are available. The latter are useful in viewing very low frequency phenomena and in television, where it is helpful in reducing flicker.

COMPARISON MEASUREMENTS

33. Comparison of Voltages. A steady voltage may be compared with the difference of potential across a resistance carrying current by the use of the simple potentiometer shown in Fig. 33a.

A battery E_1 causes a current I to flow in a resistance R . The unknown voltage E is connected to this resistance through a galvanometer G , and the resistance is adjusted to give no deflection of the galvanometer.

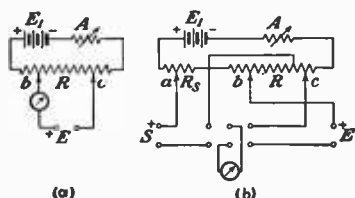

FIG. 33.—Potentiometer types. (a) simple; (b) with standard cell resistance.

order to obtain balance. The unknown voltage is then connected through the galvanometer and balance is restored by adjustment of resistance R , which may now be calibrated directly in volts. Connections for this type of measurement are shown in Fig. 33b.

Two alternating voltages may be compared by the potentiometer principle only when they have the same frequency and the same phase. They must at every instant be equal and opposite in order that the galvanometer in series with them shall show no deflection. Hence the potentiometer current must be taken from the same source as the voltage to be measured and some form of phase-shifting device must be provided for which the output current is independent of its phase.

Drysdale used a two-phase induction regulator, feeding one phase through a resistance and the other through a capacitance in order to obtain the two currents in quadrature. Such a device P is shown in Fig. 33c connected to a d-c potentiometer. The galvanometer G_A is an a-c galvanometer having a sensitivity comparable to that of the d-c galvanometer G_D . Since there is no standard of a-c voltage, a standard cell is used to adjust the potentiometer

current to its proper value. This value is read on a transfer ammeter I , which may be either of the electro-dynamometer or insulated heater thermocouple type. Its zero may be suppressed mechanically to give the effect of a longer scale and hence a greater accuracy of reading. Switches K and K_1 are then thrown to connect the potentiometer to the a-c voltages and the a-c current adjusted to produce the same deflection in ammeter I . Vacuum-tube voltmeters and rectifier voltmeters whose resistances are large compared with the resistance of the potentiometer may be calibrated directly without using the phase shifter, by connecting them directly to the terminals E . The

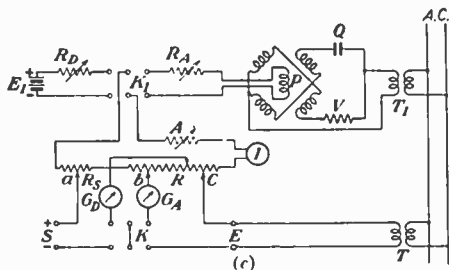

FIG. 33(c).—Drysdale potentiometer.

voltage applied to them may be calculated from the settings of the contacts b and c .

34. Comparison of Impedances. An unknown resistance may be compared with a known resistance in a number of different ways. When the known resistance is variable, a *substitution method* may be employed.

The unknown resistance X is connected in series with a battery and shunted galvanometer g , the shunt resistance M having been adjusted to allow a full-scale deflection. The known variable resistance S is then substituted for X and the same current allowed to flow. Its value as thus determined is that of the resistance R . When the known resistance is not continuously variable, the value of the unknown resistance may be interpolated from the two readings of the meter. This method is frequently used for the measurement of very high resistances, such as insulation resistances from a megohm up. The known resistance is rarely larger than 1 megohm so that under these conditions different values of the shunt M are used for the two measurements. The method is not applicable to measurements with alternating current because the phase angles of the source and load are indeterminate.

Two resistances may be compared by connecting them in series and measuring the voltage drops across them by means of a high-resistance voltmeter. Since the same current flows in both resistances, the value of the unknown resistances is

$$R = S \frac{E_R}{E_S} \quad (7)$$

where E_R and E_S are the voltages across the unknown and known resistances respectively. Except for the case of equal resistances, the resistance of the galvanometer must be either very large compared with the resistances being measured or a correction must be made for the current taken by the galvanometer. This method may be used with alternating current to compare all kinds of impedances. Either a vacuum-tube voltmeter or a high-resistance

rectifier voltmeter must be used, since correction for the current taken by the voltmeter is difficult. The polarity of the voltmeter should be maintained as in d-c measurements in order to eliminate the errors of these voltmeters due to even harmonics. The upper limit for frequency is that imposed by the frequency characteristics of the known standard and by the capacitances to ground of the voltmeter in its two positions.

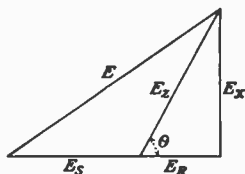

FIG. 34.—Vectorial relations in three-voltmeter circuit.

The power factor of an unknown impedance may be determined by the *three-voltmeter method*, in which the voltages across the unknown and known impedances and that applied to the two in series are read. The same precautions concerning polarity and capacitances to ground apply as in the two-voltmeter method. The vectorial relations between the three voltmeter readings together with the voltage components of the unknown impedance are shown in Fig. 34.

The expressions giving the unknown impedance Z , its resistance R , reactance X , and power factor $\cos \theta$ are

$$\begin{aligned} Z &= S \frac{E_z}{E_s} \\ R &= S \frac{E^2 - E_z^2 - E_s^2}{2E_s^2} \\ X &= \sqrt{Z^2 - R^2} \\ \cos \theta &= \frac{R}{Z} = \frac{E^2 - E_z^2 - E_s^2}{2E_z E_s} \end{aligned} \quad (8)$$

The total resistance of a circuit may be measured by the *added resistance method*. Since with a constant applied voltage, the current flowing in the circuit is inversely proportional to the total resistance, the circuit resistance is given by

$$R = S \frac{I'}{I - I'} \quad (9)$$

where I is the initial current and I' the current which flows when the resistance S is added. A plot of the reciprocal of the current flowing for different values of the added resistance against that resistance gives a straight line whose negative intercept on the resistance axis is the circuit resistance. The added resistance necessary to halve the current is also the circuit resistance. This method is sometimes used to measure the resistance of a sensitive galvanometer.

The added-resistance method may be used with alternating current provided the circuit is tuned to resonance. The necessary connections are shown in Fig. 35. By reducing the reactance of the circuit to zero the same equations and procedure may be used as for direct current. The ammeter used is usually of the thermocouple type. Halving the current on such a meter quarters the deflection, so that this type of measurement is sometimes called the *quarter-deflection method*. The ammeter may be replaced by a vacuum-tube voltmeter connected across the condenser. This arrangement is much more sensitive than

the thermocouple ammeter, so that the source of alternating current may be of lower power. The upper limit for frequency is set by the frequency characteristic of the known resistance and the capacitances to ground of the different parts of the circuit. This method is the one usually adopted for the measurement of the resistance of inductors at high frequencies.

The total resistance of the tuned circuit may also be measured by detuning the circuit. The added reactance necessary to halve the squared current (deflection of a thermocouple meter) is equal to the resistance of the circuit. This method is sometimes called the *added-reactance method*.

Two reactances may be compared in a tuned circuit by a substitution method. The circuit is tuned to resonance both when the unknown reactance is connected in circuit and when it is disconnected. The change in reactance of the variable standard, with which the circuit is tuned, is equal to the unknown reactance. When the unknown and known reactances are both inductive or both capacitive, the value of the unknown inductance or capacitance is obtained directly, independent of frequency, the two reactances being connected in series if inductive, and in parallel if capacitive. For these pairs of measurements it is unnecessary that the currents be kept of the same value.

The resistance of the unknown reactance may be determined by noting the current at resonance when it is connected in circuit and then by adjusting the current to this same value by adding sufficient resistance when it is disconnected. This added resistance, corrected for the change in resistance of the standard reactance with setting, is the resistance of the unknown reactance. The resistance of variable reactors must in general be measured by the added-resistance method described above or by one of the bridge methods. The resistance of a variable air condenser follows a definite law and this fact may be used in this type of resistance measurements.

35. Comparison of Frequencies. Two nearly equal frequencies may be compared by measuring in a suitable manner their difference in frequency. When the two frequencies are in the audible range, this difference will appear as an audible beat—a waxing and waning in intensity—which may be counted if it is less than 10 beats per second. If the beats are faster than this or if the beating frequencies are above audibility, the beat must be rectified and a beat frequency produced. This beat frequency may then be measured by a suitable frequency meter. The accuracy of the comparison depends both on the accuracy of measurement of the beat frequency and on the ratio of this frequency to the original frequencies. The beat frequency is usually kept in the audible range.

If the two frequencies to be compared are not nearly equal, so that their frequency difference is large and above audibility, audible beats may usually be obtained between some of their harmonics. For a beat frequency b between the m th harmonic of a known frequency f and the n th harmonic of an unknown frequency f' , the expression giving f' is

$$f' = \frac{mf \pm b}{n} \quad (10)$$

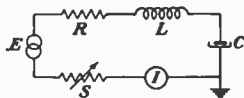

FIG. 35.—Added-resistance method.

the sign of b being determined by considering which harmonic, mf or nf' is the larger. Sufficient harmonics are usually present in most frequency sources for the purpose of this comparison, especially when emphasized and isolated by the use of tuned circuits. They can always be produced by the use of a rectifier tube.

In the most precise measurements the known frequency is a multiple or submultiple of a standard crystal frequency, obtained from the various multi-vibrators driven by the standard. For less precise work a variable standard may be used. The beat frequency is then made zero. Such a variable frequency oscillator, called a heterodyne oscillator, will have a limited frequency range, even though provided with multiple coils. Properly chosen for range, it may be used to measure a super-audio beat frequency, such as might be obtained when comparing two very high frequencies.

Frequency is measured in terms of inductance and capacitance by means of a tuned-circuit frequency meter consisting of a variable capacitance and a set of fixed inductances. The frequency range allotted to each coil determines the accuracy of setting, which ranges from 0.1 per cent to 0.001 per cent. Resonance is indicated in a variety of ways; thermocouple ammeter, heterodyne zero beat, or reaction on an oscillator, these being arranged in the order of their accuracy. In the third method the frequency meter is coupled closely enough to the oscillator whose frequency is being measured so that either the amplitude of its oscillations is affected or its frequency is altered. The frequency alteration is the more precise method, but demands for greatest accuracy a second oscillator set at zero beat with the first. When the frequency meter is in exact resonance, the zero beat note of the two oscillators will be unaffected. In the second method a vacuum-tube oscillator is connected to the wavemeter so that it really becomes a heterodyne oscillator. A screen-grid tube, operating as a dynatron oscillator, may be connected to a frequency meter without the addition of extra coils or taps and converts it into a heterodyne-frequency meter.

D-C BRIDGE MEASUREMENTS

36. Whenever two resistances or impedances are compared by matching or comparing the deflections of any deflecting instrument, the accuracy of the measurement is determined by the accuracy of reading of the deflections themselves. This accuracy may be greatly increased by adopting a null method, in which a certain relation of the resistances being compared is indicated by a zero deflection. As this condition is approached, the sensitivity of the indicating instrument may be increased.

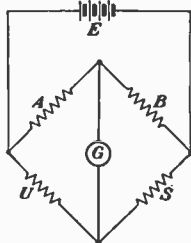

FIG. 36.—Wheatstone bridge.

37. Four-resistance Network. The simple four-resistance network invented by Christie in 1833 and exploited by Wheatstone ten years later is shown in Fig. 36.

Two paths are provided for the current, one through the ratio arms A and B , the other through the unknown and known resistances U and S . The galvanometer G is connected between the junctions of these pairs of resistances. The condition for a null deflection of the galvanometer is that these two junctions are at the same potential. Equating the voltage drops

$$AI_A = UI_U \text{ and } BI_B = SI_S \quad (11)$$

or, since no current flows in the galvanometer,

$$\frac{A}{B} = \frac{U}{S} \text{ or } U = \frac{A}{B}S \quad (12)$$

The ratio arms are usually only variable in steps of ten so that the bridge is balanced by varying the known resistance S .

In commercial bridges the accuracy ranges from 0.1 to 0.02 per cent. In the complete bridges of high accuracy all switching is by taper plugs and the ratio arms are reversible. There are five decades in the known resistance, tenths to thousands, and nine ratios, 0.0001 to 10,000. Comparisons of resistances on the best bridges using sealed standards, flat mercury contacts, and a temperature-controlled oil bath, may be made to 1 part in 1,000,000, which is beyond the accuracy with which the primary standard of resistance is known.

38. The sensitivity of the null detector necessary to attain a given accuracy of bridge balance is determined by the relative magnitude of the resistances of the bridge arms and the voltage applied to the bridge. The ratio of the output voltage e to the input voltage E is given by

$$\frac{e}{E} = \frac{G/B}{1 + \frac{A}{B}} \cdot \frac{A/B}{\frac{A}{B}\left(1 + \frac{S}{B}\right) + \frac{G}{B}\left(1 + \frac{A}{B}\right)} d \quad (13)$$

where G is the resistance of the null detector and d is the fractional accuracy of balance demanded. For an equal-arm bridge

$$\frac{e}{E} = \frac{1}{4} \frac{G/B}{1 + \frac{G}{B}} d \quad (14)$$

This ratio lies between $\frac{1}{8}d$ and $\frac{1}{4}d$ for ratios of detector and bridge-arm resistances between one and infinity. In general, its value decreases rapidly when the bridge arms are made unequal and when the detector resistance is low compared to them. On this account resistances above a megohm cannot be accurately measured when a d-c galvanometer is used as a null detector.

For a very high resistance detector, Eq. (13) becomes

$$\frac{e}{E} = \frac{A/B}{\left(1 + \frac{A}{B}\right)^2} d \quad (15)$$

which is independent of the ratio S/B . This condition may be realized by the use of a vacuum-tube voltmeter as described in Art. 30. Thus for greatest sensitivity the detector should be connected from the junction of the highest resistances to the junction of the lowest. The battery, on the other hand, should be connected across the higher and lower resistance pairs, so that the amount of power drawn by the bridge is a maximum.

39. Slide-wire Bridges. When the known resistance is fixed, the bridge must be balanced by varying one or both of the ratio arms. In the slide-wire bridge shown in Fig. 37a the ratio arms A and B are parts of a single uniform resistance along which the contact of the lead from galvanometer may slide. The position of the contact is read as a distance

measured from one end, the whole length of the scale being L divisions. The value of the unknown resistance in terms of these distances is

$$U = \frac{l}{L-l}S \quad (16)$$

When the known and unknown resistances are nearly equal the accuracy of measurement may be increased by placing extension coils in series

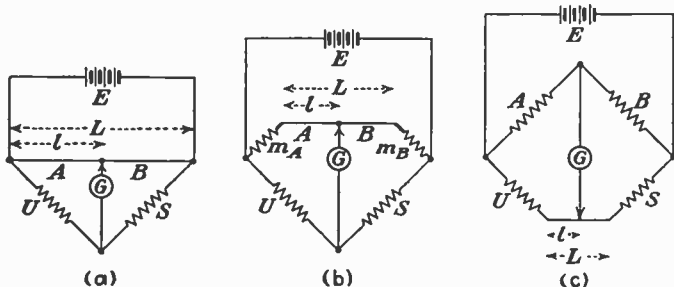

FIG. 37.—(a) Slide-wire bridge; (b) bridge with extension arms; (c) Carey Foster bridge.

with the slide wire as shown in Fig. 37b. The slide wire may be calibrated to read directly the percentage error of the unknown resistance U in terms of the standard resistance S .

Two nearly equal resistances may also be compared by means of the Carey Foster bridge shown in Fig. 37c. This is a slide-wire bridge in which the slide wire is placed between the two resistances being compared. Two settings of the slide wire l and l' are made with the resistances U and S as shown in Fig. 38 and transposed.

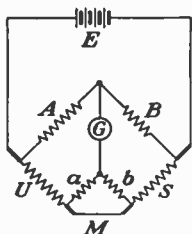

FIG. 38.—Kelvin double bridge.

The value of the unknown resistance is

$$U = S - (l - l')\rho \quad (16a)$$

where ρ is the resistance per unit length of the slide wire.

40. Kelvin Bridge. In the measurement of a tenth ohm or less, the variation in contact resistance at its terminals and the consequent variation in the lines of current flow near the terminals may produce appreciable errors. To overcome this difficulty, low-resistance standards are always built as four-terminal resistances. All ammeter shunts are so constructed. The two potential terminals are placed between the current terminals and the resistance proper. The value of the resistance is that between the potential terminals.

Such four-terminal resistances cannot be compared on the ordinary Wheatstone bridge. They may be measured on the Kelvin double bridge shown in Fig. 38. The two four-terminal conductors U and S are connected in series, leaving an unknown resistance M between

their adjacent potential terminals. The bridge is balanced by adjustment of the standard resistance S . The value of the unknown resistance U is given by

$$U = \frac{A}{B}S \quad (17)$$

when the double ratio arms are proportional, satisfying the condition $A/B = a/b$.

A-C BRIDGE MEASUREMENTS

41. Four-impedance Network. When an alternating voltage is applied to the simple Wheatstone bridge of Fig. 36, the conditions for balance of the bridge involve the impedances of the four arms, as shown in Fig. 39.

For a null deflection of the a-c galvanometer or telephones the two junctions, across which it is connected, must be at the same potential at all instants of the a-c cycle. Equating the voltage drops along the two parallel paths offered to the flow of the alternating current

$$Z_A I_A = Z_U I_U \text{ and } Z_B I_B = Z_S I_S \quad (18)$$

where Z_A, Z_B , etc., replace A, B , etc., in Fig. 37.

The four impedances are vectors of the form

$$Z = R + jX \quad (19)$$

Hence, since no current flows in the galvanometer,

$$\frac{Z_A}{Z_B} = \frac{Z_U}{Z_S} \quad (20)$$

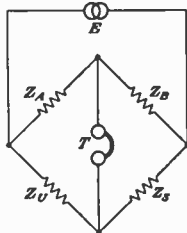

FIG. 39.—A-c bridge.

Expanding these vectors into their rectangular components the two conditions of balance are

$$\frac{A}{B} = \frac{U}{S} + \frac{X_A X_S - X_B X_U}{BS} = \frac{X_U}{X_S} + \frac{U X_B - S X_A}{B X_S} \quad (21)$$

where the resistance components of the four arms are represented by the four letters A, B, U, S without subscripts. If the ratio arms have no reactance, so that $X_A = X_B = 0$, these conditions reduce to

$$\frac{A}{B} = \frac{U}{S} = \frac{X_U}{X_S} \quad (22)$$

The two reactances must have the same ratio as their resistances and as the ratio arms. Considering the reactances as both inductive or both capacitive, Eq. (22) becomes

$$\frac{A}{B} = \frac{U}{S} = \frac{L_U}{L_S} \text{ and } \frac{A}{B} = \frac{U}{S} = \frac{C_S}{C_U} \quad (23)$$

respectively. These equations cover all the types of bridge measurements in which similar impedances are compared.

42. Power Supply and Null Detector. The power source at audio and radio frequencies is usually a vacuum-tube oscillator, capable of supplying several hundred milliwatts of power at varying potentials

up to 100 volts. At the low audio frequencies, a-c generators with rotating parts may be used, as well as the commercial power supplies at 60 and 25 cycles. The null detector used throughout the a-f range is almost always the head telephone. For the lower frequencies, vibration galvanometers and a-c moving-coil galvanometers are frequently used. Rectifier voltmeters are used for frequencies up to 20 kc, vacuum-tube voltmeters at all frequencies. At super-audio frequencies a heterodyne oscillator and detector may be used to produce an a-f beat note, which can then be observed by any of the methods described. Radio-frequency oscillators may be modulated at an audio frequency, usually 1 kc, and the bridge output observed on a radio receiver. All-wave receivers cover the frequency range from 150 kc to 20 Mc.

Vacuum-tube amplifiers are used with all types of null detectors to give increased sensitivity. The amount of amplification necessary to give any desired accuracy of balance may be approximately determined by Eqs. (14) and (15). For an equal-arm bridge and an amplifier with a high-resistance input the value of e/E is $\frac{1}{4}d$ for the larger component of impedance, provided that the square of the ratio of the small to the large component is negligible compared to unity. The value of e/E for the smaller component is then less than that for the larger component by their ratio. The minimum voltage detectable on a rectifier voltmeter is 0.2 volt and on a high-grade head telephone at its resonant frequency 0.0004 volt. In Table VII are given the values of the input voltage E needed to obtain an accuracy of balance of 1 and 0.1 per cent for the larger impedance component with the telephones at various frequencies and with the rectifier at any frequency. The ratio of the input voltage given to the voltage available or safe for use is the amplification needed.

TABLE VII.—INPUT VOLTAGE ON AN EQUAL-ARM RESISTANCE BRIDGE

Detector	E , volts, for		
	f , kc	$d = 1$ per cent	$d = 0.1$ per cent
Telephone.....	0.1	80	800
	0.2	8	80
	0.5	1.0	10
	1.0	0.4	4
	2.0	0.8	8
	5.0	12	120
	10.0	80	800
Voltmeter.....	Any	80	800

43. Bridge Transformers. Transformers are used to match the impedance of a bridge to that of the oscillator or detector and to isolate the bridge electrostatically. One junction point of the bridge, usually that between the two impedances being compared, is grounded, except when direct impedances are measured (see Art. 46). The capacitances to ground of the transformer, oscillator, or detector not connected to this grounded junction are placed across the two bridge arms whose junction point is grounded. The effect of the ground capacitances

of the oscillator or detector connected to the transformer may be removed by placing a grounded shield between the primary and secondary windings. An impedance bridge with such a transformer connected across its ratio arms is shown in Fig. 40. The terminal capacitances C_{TU} and C_{TS} are placed across the bridge arms U and S . They are usually of the order of several hundred micromicrofarads and may therefore introduce serious errors. The direct capacitance between the two windings may be reduced to a few tenths of $1 \mu\mu\text{f}$.

The effect of the terminal capacitances C_{TU} and C_{TS} may be reduced or either one made zero by the addition of a second shield. The two shields are symmetrically placed around the two windings, as shown in Fig. 41. The capacitance C_n between the

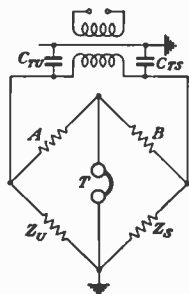

FIG. 40.—Impedance bridge with transformer.

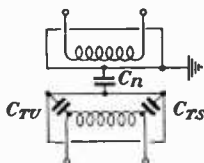

FIG. 41.—Bridge-transformer capacities.

two shields may be made much smaller than the terminal capacitances and is in series with them. The resultant terminal capacitances may be placed across either bridge arm U or S by connecting the shield around the secondary winding to one terminal of that winding. The effect of the terminal capacitances may be removed entirely from the arms U and S and placed across the ratio arms A and B by introducing a third shield between the two winding shields and connecting it to the junction of the ratio arms.

44. Bridge Errors. Reactances introduced into the arms of a bridge by the wiring of the bridge and by the oscillator and detector cause the more serious errors in bridge measurements. These residual reactances may be inductances in series with the bridge arms and capacitances in parallel with them. The effect of such residuals in the ratio arms may be seen by rewriting Eq. (21) of Art. 41 in the approximate form

$$\frac{A}{B} = \frac{U}{S} \left[1 + (Q_A - Q_B) \frac{1}{D_U} \right] = \frac{X_U}{X_S} \left[1 - (Q_A - Q_B) D_U \right] \left\{ \begin{array}{l} (24) \\ D_S - D_U = Q_A - Q_B \end{array} \right.$$

where the *storage factors*¹ Q_A and Q_B and the *dissipation factors* D_U and D_S are of the form

$$Q = \frac{X}{R} \quad \text{and} \quad D = \frac{R}{X} \quad (25)$$

¹ EDITOR'S NOTE. There is no uniformity at present in the usage of the term *dissipation factor* and similar terms, or of the expressions defined by a ratio of an impedance (or reactance) and a resistance or the reciprocal. The expression here differs from that used in Sec. 6 on Circuits involving R , L , and C . It is felt, however, that this apparent discrepancy should not be confusing and that the present is not the time to attempt bringing these terms into line. Power factor is, in all usages, the ratio of resistance to impedance and becomes equal to the ratio of R/X when its value is small.

The errors introduced are proportional to the difference of the storage factors of the ratio arms, multiplied by the dissipation factor of the impedance arms for the reactance component, and divided by that dissipation factor for the resistance component. For impedances with small dissipation factors the error is confined to the resistance component; for impedances with large dissipation factors to the reactance component.

Residual reactances in the impedance arms produce at low frequencies errors proportional to their ratio with similar reactances in these arms. Series inductance introduces large errors in measurements of small inductances; parallel capacitance in measurements of small capacitances.

The effect of residual reactances increases with frequency, the storage factor of the ratio arms being of the form $Q = \omega L/R$ for series inductance and $Q = R\omega C$ for parallel capacitance. Hence bridges designed for operation at frequencies much above 10 kc should have equal ratio arms. When residual inductance in the impedance arms is in series with a large capacitance, the effective capacitance of the combination is

$$\hat{C} = \frac{C}{1 - \omega^2 LC} \quad (26)$$

which increases indefinitely as the resonant frequency is approached. Such resonance limits the use of a direct reading bridge to about 5 Mc. Variable resistances used in the impedance arms must be so constructed that their inductance is independent of resistance setting.

The errors introduced into bridge measurements by reactances in the ratio arms may be minimized by the use of substitution methods. The effect of capacitances to ground, when a Wagner ground is not used, and the effect of the reactance of the leads to the known and unknown reactances may also be thus greatly reduced. Both reactances are connected in the same arm of the bridge, a similar reactance being placed in the other arm. Two bridge balances are obtained, one with the unknown reactance in circuit, the second with it disconnected and its impedance replaced by the known variable reactance and the added resistance. Inductances are connected in series, placing them far enough apart to reduce their mutual inductance to a negligible amount, and the unknown is removed by shorting. Capacitances are connected in parallel and the unknown is removed by disconnecting its high-potential terminal. Both condensers must be completely shielded and their grounded terminals connected together.

Distinguishing the values for the second balance, when the unknown reactance has been removed, by primes, the values of the unknown reactances are given by the change in reactance of the variable standards.

$$\begin{aligned} L_u &= L_s' - L_s & C_u &= C_s' - C_s \\ &= \Delta L_s & &= \Delta C_s \end{aligned} \quad (27)$$

The corresponding expressions for the resistances are

$$\begin{aligned} U &= S' - S + R' - R & U &= (R' - R) \left(\frac{C_s'}{C_u'} \right)^2 \\ &= \Delta S + \Delta R & &= \Delta R \left(\frac{C_s'}{C_u'} \right)^2 \end{aligned} \quad (28)$$

The squared terms appearing in the expression for the condenser resistance result from the law by which the series resistance of condensers connected in parallel is found.

$$R = \frac{R_1 C_1^2 + R_2 C_2^2 + \dots}{(C_1 + C_2 + \dots)^2} = \frac{\sum_1^n R_m C_m^2}{\left(\sum_1^n C_m\right)^2} \quad (29)$$

The terms containing the resistance of the standard condenser have disappeared because the quantity RC^2 for an air condenser is a constant, independent of the setting of the condenser. This follows from the more general law that, for an air condenser, in which the losses occurring in the solid dielectric are independent of the setting of the plates and for which the power factor of the solid dielectric is independent of frequency, the quantity $R\omega C^2$ is constant. This law holds with increasing frequency until the losses due to skin effect in the plates and supports and to ionization of the air between and on the plates become appreciable.

45. Resistance Balance. When two impedances are compared on a four-impedance bridge, the conditions of balance [Eq. (23) of Art. 41]

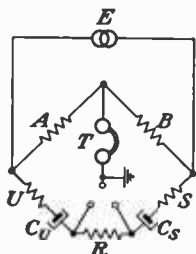

FIG. 42.—Series-resistance bridge.

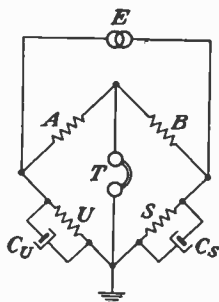

FIG. 43.—Parallel-resistance bridge.

demand that their dissipation factors be equal. Since this will not in general be the case, means must be provided for attaining the resistance balance. The simplest method is that of adding a resistance in series with that impedance having the lower dissipation factor. The connections for a capacitance bridge with the added resistance so arranged that it may be placed in either impedance arm is shown in Fig. 42. This method gives the series resistance and reactance of the unknown impedance and can be used for dissipation factors less than unity. Neither of the impedances, although essentially at ground potential, can be grounded.

Added resistances may be placed in parallel with the two impedance arms as shown in Fig. 43. This method gives the parallel resistance and reactance of the unknown impedance and is best adapted to the measurement of impedances having dissipation factors greater than unity. For small dissipation factors the shunting effect of the parallel resistances is such as to markedly reduce the sensitivity of the bridge balance. One terminal of each impedance is grounded.

The resistance balance may also be made by adding suitable reactances to the ratio arms. Grover's method of adding series inductances is shown in Fig. 44.

The balance equations are

$$C_U = \frac{B}{A} C_S \text{ (approx.) and } U = \frac{A}{B} S + \frac{1}{B} \left(\frac{L_A}{C_S} - \frac{L_B}{C_U} \right) \quad (30)$$

whence

$$D_U = D_S - (Q_A - Q_B)$$

The method of adding parallel capacitances across the ratio arms shown in Fig. 45 was suggested by Thomas. The balance equations are

$$C_U = \frac{B}{A} C_S \text{ (approx.) and } U = \frac{A}{B} S + A \left(\frac{C_B}{C_S} - \frac{C_A}{C_U} \right) \quad (31)$$

whence

$$D_U = D_S + Q_A - Q_B$$

In any particular case the reactance needs to be placed in only one arm in order to obtain the resistance balance. The Schering bridge is such a modification of Fig. 44 in which the parallel condenser is placed

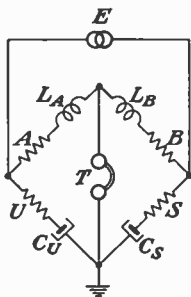

FIG. 44.—Grover's method.

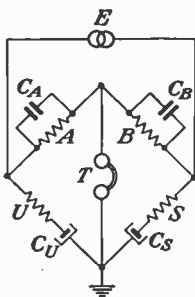

FIG. 45.—Thomas' method.

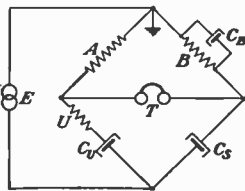

FIG. 46.—Schering bridge.

only across one ratio arm. This bridge is used for measuring the power factor of cables and other small condensers at high voltages. The connections are shown in Fig. 46. The input and output terminals are transposed so that the high voltage may be placed across the two condensers in parallel, while keeping the two resistors and the null detector at practically ground potential. The standard condenser C_S has a small capacitance and is so mounted that its losses are reduced to a minimum.

The balance equations are

$$C_U = \frac{B}{A} C_S \text{ and } U = \frac{C_B}{C_S} A \quad (31a)$$

whence

$$D_U = Q_B$$

46. Direct Capacitance. Any capacitance having terminal capacitances to a surrounding shield or to ground may be represented as a

three-terminal capacitance, as shown in Fig. 47. The capacitance C_D between the terminals 1 and 2 is called the *direct capacitance*. The total capacitance between these terminals is the sum of the direct capacitance C_D , and the two terminal capacitances C_{T1} and C_{T2} in series. The direct capacitance may be measured on a bridge by connecting the shield to either of the junction points of the bridge, to which the direct capacitance is not connected. These two connections are shown in Fig. 48. Errors due to placing the terminal capacitances across the bridge arms greatly limit the usefulness of these connec-

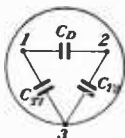

FIG. 47.—Three-terminal capacitance.

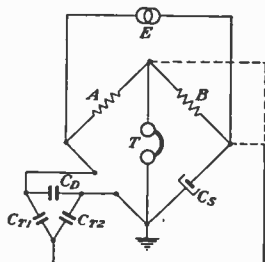

FIG. 48.—Measurement of direct capacitance.

tions. When the shield is connected to the junction of the ratio arms, the terminal capacitance C_{T1} is placed across the arm A and produces an error $A\omega C_{T1}$ in the determination of the dissipation factor of the direct capacitance C_D . The terminal capacitance C_{T2} and any capacitance of the shield to ground are placed across the telephones T .

When the shield is connected to the junction of the arms B and S , the terminal capacitance C_{T2} is placed across the impedance arm S and produces an error in the determination of the direct capacitance C_D unless the standard capacitance C_S is very large compared to C_{T2} . Any capacitance of the shield to ground is also placed across C_S , while the terminal capacitance C_{T1} is placed across the oscillator E . If the direct capacitance C_D is not surrounded by a shield, the terminal capacitances C_{T1} and C_{T2} are to ground and this method is inapplicable.

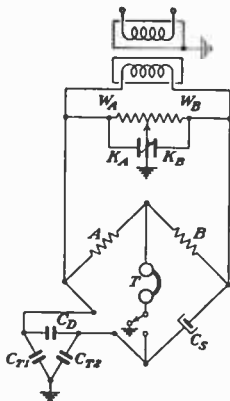

FIG. 49.—Wagner ground.

47. Wagner Ground. The use of a Wagner ground enables both direct capacitance and its dissipation factor to be measured correctly, because the terminal capacitances are not connected across any of the bridge arms. A capacitance bridge with Wagner ground and shielded input transformer is shown in Fig. 49. The terminal capacitance C_{T1} to the shield or to ground is placed across half of the Wagner ground. The other terminal capacitance C_{T2} is placed across the junction of the impedance arms and ground. The terminal capacitances of the input transformer are also removed from the bridge arms and placed across the Wagner ground. The Wagner ground is balanced by simultaneous adjustment of its resistances and capacitances with the bridge telephones connected between the junction of the ratio arms and

ground. The precision of these adjustments must be comparable to that of the impedance arms U and S , in order that the errors introduced into the bridge balance shall be negligible. Successive balances of the bridge and Wagner ground must be made until the correct balance for each is attained. The necessary precision of the Wagner-ground balance may be reduced by the use of a second Wagner ground connected across the telephones, as shown in Fig. 50. Balsbaugh¹ has shown that the use of either of the two Wagner grounds is sufficient for correct bridge balance and that with both the precision of adjustment of both may be decreased.

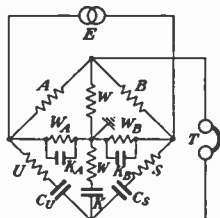

FIG. 50.—Double Wagner ground.

Whenever a Wagner ground is used with a bridge, direct impedances are always measured. In general its use should be reserved for that purpose. The fact that it removes all ground capacitances from the bridge arms and thereby eliminates the errors which these capacitances produce does not justify its use in general impedance measurements except in special instances.

48. Comparison of Inductances and Capacitances. An inductance and a capacitance may be compared directly by suitably placing them

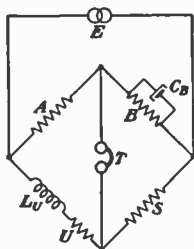

FIG. 51.—Maxwell bridge.

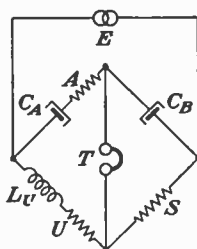

FIG. 52.—Owen bridge.

in the four-impedance network. The connections for the Maxwell bridge are shown in Fig. 51.

The balance equations are

$$L_U = ASC_B \text{ and } U = \frac{A}{B}S \quad (32)$$

whence

$$Q_U = Q_B$$

Losses in the condenser C_B enter only into the resistance balance and may be made negligible by suitable choice of resistance A . The resistance and reactance balances are not independent unless condenser C_B is continuously variable.

In the Owen bridge an inductance is compared with a capacitance in the manner shown in Fig. 52.

¹ BALSBAUGH and HERZENBERG, *Jour. Franklin Inst.*, 218, No. 1, 49-97.

The balance equations are

$$L_U = ASC_B \quad \text{and} \quad U = \frac{C_B}{C_A} S \quad (32a)$$

whence

$$Q_U = Q_A$$

The resistance balance is made either by having condenser C_A continuously variable or by adding resistance in series with the unknown inductor.

The Hay bridge is similar to the Owen bridge with one of the condensers omitted. On this account, however, it is not independent of frequency. The connections are shown in Fig. 53. The conditions of balance are

$$L_U = \frac{ASC_B}{1 + B^2\omega^2 C_B^2} \quad \text{and} \quad U = \frac{ABS\omega^2 C_B^2}{1 + B^2\omega^2 C_B^2} \quad (33)$$

whence

$$Q_U = \frac{1}{D_B}$$

The two bridge balances are not independent.

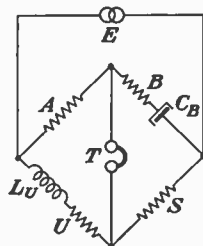

FIG. 53.—Hay bridge.

49. The resonance bridge shown in Fig. 54 is the simplest bridge in which inductance, capacitance, and frequency enter. At balance the arm containing the reactances is resonated to the applied frequency and becomes a pure resistance. The bridge is then an all-resistance equal-arm bridge. For this reason it may be used at high frequencies to measure the resistance and inductance of a reactor.

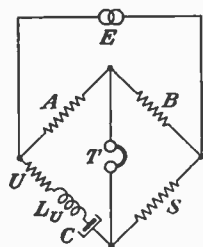

FIG. 54.—Resonance bridge.

The balance equations are

$$\omega^2 = \frac{1}{L_U C_U} \quad \text{and} \quad U = \frac{A}{B} S \quad (34)$$

This bridge is frequently used to measure frequency, usually in the audio-frequency range. A variable inductor is used and the condenser may be varied in steps. A range from 200 cycles to 4 kc may be covered in three ranges. The frequency scale is irregular, due to the characteristics of variable inductors and the various ranges cannot be made multiples of one another. Due to the large stray field of the variable inductor, its magnetic pickup is considerable. A resistance balance

must be provided to allow for the variation of the resistance of the tuned arm with frequency.

50. Wien Bridge. Capacitances may be measured in terms of resistance and frequency with the Wien bridge, shown in Fig. 55. The balance equations expressed in their simplest form are

$$\omega^2 = \frac{1}{USC_U C_S} \quad \text{and} \quad \frac{C_U}{C_S} = \frac{B}{A} - \frac{S}{U} \quad (35)$$

Solving for the two capacitances,

$$C_U^2 = \frac{BU - AC}{AU^2S\omega^2} \text{ and } C_S^2 = \frac{A}{(BU - AS)S\omega^2} \quad (36)$$

The bridge is valuable because the standards of frequency and resistance are known to a greater accuracy than the standard of capacitance. Ferguson and Bartlett¹ have developed this method to its greatest precision. Their estimated accuracy for the determination of capacitance by this method, is 0.003 per cent.

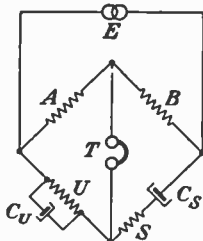

FIG. 55.—Wien bridge.

The Wien bridge also furnishes a very convenient means for measuring frequency in the audio-frequency range. The two capacitances are made equal, while the two ratio arms are made such that B is twice A . The two resistances U and S are made variable over a suitable range but are also kept equal. Thus the resistance balance is always satisfied and the reactance balance reduces to

$$f = \frac{1}{2\pi UC_U} \quad (37)$$

In the frequency meter built by the General Radio Company the resistances U and S are wound on tapered cards so shaped that the frequency scale is logarithmic. This gives a constant fractional accuracy of reading. There are three frequency ranges, obtained from three different pairs of condensers, each covering a range of 10 to 1 in frequency. The same calibration serves for all ranges. The frequency limits attained are 20 cycles and 20 kc.

51. Six-impedance Network. The six-impedance network was developed by Anderson to provide a modification of the Maxwell bridge which would render the two balance conditions independent even with a fixed capacitance. The connections are shown in Fig. 56.

The general balance condition for the six-impedance network is

$$Z_Q(Z_B Z_U - Z_A Z_S) = Z_P[Z_P(Z_A + Z_B) + Z_A Z_B] \quad (38)$$

For the Anderson bridge this reduces to

$$L_U = SC_Q \left[P \left(1 + \frac{A}{B} \right) + A \right] \text{ and } U = \frac{A}{B} S \quad (39)$$

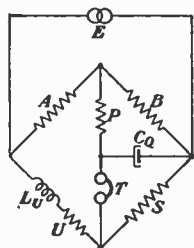

FIG. 56.—Anderson bridge.

The effect of losses in the condenser C_Q is usually small.

52. Mutual-inductance Balances. Two mutual inductances may be compared by means of the *Felici mutual-inductance balance* shown in Fig. 57. The known mutual inductance must be variable. For the

¹ FERGUSON and BARTLETT, *Bell System Tech. Jour.*, 7, No. 3, 420-437.

usual condition of balance, zero voltage across the null detector, the two mutual inductances are equal.

$$M_U = M_S \tag{40}$$

They must be so connected that their induced secondary voltages are in opposition. Mutual inductance between them should be avoided.

53. Four-impedance Network with Mutual Inductances. A mutual inductance may be compared with a self-inductance on a four-impedance bridge by placing it between one arm and either an input or output lead of the bridge, as shown in Fig. 58.

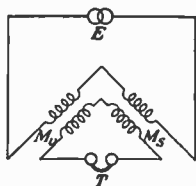

FIG. 57.—Felici mutual-inductance balance.

The general balance equation for this network is

$$Z_A Z_S - Z_B Z_U - j\omega M(Z_A + Z_B) = 0 \tag{41}$$

For Campbell's arrangement of this bridge the two conditions of balance become

$$L_U = \frac{A}{B} L_S - \left(1 + \frac{A}{B}\right) M$$

and

$$U = \frac{A}{B} S \tag{42}$$

A substitution method is usually adopted so that the inductance and resistance of that portion of the mutual inductance connected in the *S* arm need

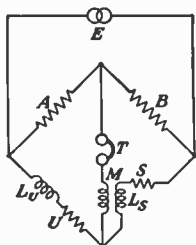

FIG. 58.—Comparison of mutual with self-inductance.

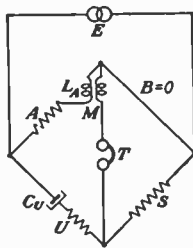

FIG. 59.—Carey Foster mutual-inductance bridge.

not be known. When the ratio arms are equal the extra balancing inductance represented by L_U of Fig. 58 may be eliminated by providing a center tap in one branch of the mutual inductance. This connection is usually referred to as the Heaviside equal-arm bridge.

A mutual inductance may be compared with a capacitance by means of the *Carey Foster bridge*, shown in Fig. 59. The conditions of balance are

$$C_U = \frac{M}{AS} \text{ and } U = S \left(\frac{L_A}{M} - 1 \right) \tag{43}$$

The impedance of the *B* arm is made zero in order to make the balance independent of frequency. The method suffers because the resistance and self-inductance of the mutual inductance enter into the expressions for the

unknown capacitance and its resistance respectively. Capacitance between the two windings of the mutual inductance causes the voltage induced in its secondary to have a phase angle with reference to the primary current different from 90 deg. This reduces the calculated resistance of the condenser and frequently yields negative values, especially for large mica condensers. The method is perhaps better suited for the measurement of a mutual inductance in terms of a known condenser.

References

- BOLTON, E. P.: "Electrical Measuring Instruments," E. P. Dutton & Co., Inc., New York, 1923.
- BROWN, H. A.: Radio Frequency Electrical Measurements, "McGraw-Hill Book Company, Inc., New York.
Cambridge Instrument Company, Catalogue.
General Radio Company, Catalogue.
- HAGUE, B.: "Alternating-current Bridge Methods," Sir Isaac Pitman & Sons, Ltd., London, 1923.
- HUND, A.: "High-frequency Measurements," McGraw-Hill Book Company, Inc., New York, 1933.
- JANSKY, C. M.: "Electrical Meters," McGraw-Hill Book Company, Inc., New York.
- KENNELLY, A. E.: "Electrical Vibration Instruments," The Macmillan Company, New York.
- LAW, F. A.: "Electrical Measurements," McGraw-Hill Book Company, Inc., New York.
Leeds & Northrup Company, Catalogue.
- MOULLIN, E. B.: "Radio Frequency Measurements," 2d ed., Charles Griffin & Company, Ltd., London, 1931.
- STARLING, S. G.: "Electricity and Magnetism," Longmans, Green & Company, London, 1924.
- Weston Electrical Instrument Corporation, Catalogue.

SECTION 8

VACUUM TUBES

By J. M. STINCHFIELD, B.S.¹

1. Electrons. The electron is a negatively charged particle of electricity. In 1897 J. J. Thomson discovered that the cathode rays passing from the cathode to the anode in a gaseous discharge, were moving, negatively charged, particles. He measured the ratio of the charge e to the mass m of these particles and termed them corpuscles. Thomson's corpuscles are now commonly known as electrons. The cathode rays or streams of electrons are deflected by either magnetic or electrostatic fields. They exert mechanical force sufficient to turn a vane in a vacuum or to heat the object they strike.

2. Electrons in an Electrostatic Field. An electrostatic field exerts a force upon an electron. If the field intensity is X and the charge on the electron e , the force f acting on the electron is

$$f = Xe \quad (1)$$

If the mass of the electron is m , the acceleration a will be

$$a = \frac{Xe}{m} \quad (2)$$

The force and acceleration on the electron will change if the field intensity changes. The force is in the direction of the field at the point considered, the electron tending to move toward the positive.

In a uniform field the work W done on an electron in moving between two points distance s apart will be

$$\begin{aligned} W &= fs \\ &= Xes \end{aligned} \quad (3)$$

Since Xs is also the potential difference between the two points, calling this potential difference V , the work done on the electron is

$$W = Ve$$

If the field is not uniform the line integral of the force and distance regardless of the path between the two points will give the work done. The work done on a unit charge moved between two points defines the potential difference between the two points. The work done on an electron moved between two points of potential difference V will be

$$W = Ve \quad (4)$$

¹ Engineering Department, RCA Manufacturing Co., Inc., Radiotron Division.

If the velocity of an electron is changed by an amount v in passing between two points, the change in kinetic energy will be

$$\frac{mv^2}{2} \quad (5)$$

The change in potential energy or work done in passing between the two points will be

$$Ve$$

The change in kinetic energy is equal to the change in potential energy, and

$$Ve = \frac{mv^2}{2} \quad (6)$$

The velocity acquired by an electron in passing between two points of potential difference V is

$$v = \sqrt{\frac{2Ve}{m}} \quad (7)$$

The potential V is in absolute e.s.u. in the relations above. The potential difference in volts divided by 300 is the potential difference in absolute e.s.u.

The ratio of the charge e to the mass m of the electron is

$$\frac{e}{m} = \frac{4.774 \times 10^{-10}}{8.999 \times 10^{-28}} = 5.305 \times 10^{17} \text{ e.s.u. per gm}$$

The electron velocities corresponding to various potential differences are shown in the table. When the velocity becomes greater than about one-tenth the velocity of light, the apparent mass of the electron increases enough to cause a small error. The error in using Eq. (7) is less than one-half of 1 per cent for potential differences less than 300 volts.

Volts	Velocity, Centimeters per Second
1	0.00595×10^{10}
5	0.0133
10	0.0188
20	0.0266
30	0.0326
40	0.0376
50	0.0421
60	0.0461
70	0.0498
80	0.0532
90	0.0564
100	0.0595
200	0.0841
300	0.103
400	0.119
500	0.133
1,000	0.188

Volts	Velocity, Centimeters per Second
10,000	0.586×10^{10}
100,000	1.64
1,000,000	2.82

3. Electrons in an Electromagnetic Field. An electron moving with a velocity v in an electromagnetic field of intensity H is acted on by a force

$$f = Hev \quad (8)$$

The direction of the force is at right angles to both the direction of the field H and the direction of motion of the electron.

The force f is effective in producing an acceleration:

$$a = \frac{Hev}{m} \quad (9)$$

The acceleration is at right angles to the direction of motion. If the electron moves unimpeded and the field H is uniform, the path will be circular and of radius

$$r = \frac{v^2}{a} = \frac{mv}{eH} \quad (10)$$

4. Current Due to a Stream of Electrons. A current i is defined by the quantity of electricity q flowing per unit of time. If there are n electrons per unit of volume in a certain space, the quantity of electricity q in this space is ne per unit of volume. If these electrons are moved with a velocity v , the quantity flowing per unit of time is the current

$$i = nev \quad (11)$$

This is the current per unit of area at right angles to the direction of flow.

5. Space Charge Due to a Cloud of Electrons. If in a given space there are n electrons per unit of volume, the volume density of electrification is

$$\rho = ne \quad (12)$$

The potential distribution in the given space due to the electrons is given by

$$\frac{\partial^2 V}{\partial x^2} + \frac{\partial^2 V}{\partial y^2} + \frac{\partial^2 V}{\partial z^2} = -4\pi\rho \quad (13)$$

For the case of large parallel plates, only the distance x between plates need be considered. Equation (13) simplifies to

$$\frac{\partial^2 V}{\partial x^2} = -4\pi\rho \quad (14)$$

If a current i is flowing and the electrons move with uniform velocity v the space charge or volume density of electrification is

$$\rho = \left(\frac{i}{v} \right) \quad (15)$$

6. Emission of Electrons. Certain internal forces existing at the surfaces of substances prevent the escape of the free electrons unless a

certain amount of energy is supplied to the surface. In the usual type of radio tube, the electron-emitting filament material is supplied with the heat energy of an electrical current sufficient to cause the desired electron emission. Emission excited by heat energy is known as *thermionic emission*.

Electron emission may be produced by electrons impinging upon substances with sufficient velocity. For example the electrons emitted by the hot filament of a radio tube may be accelerated toward the plate by a positive voltage. If a great enough velocity is reached each electron will have sufficient energy to release one or more electrons from the plate. This is known as *secondary emission*.

The energy supplied by light is sufficient to cause emission from some substances. This is the type of emission employed in photoelectric cells and is known as *photoelectric emission*.

Strong electric fields acting on gases or vapors may cause the gas particles to collide with sufficient energy to release electrons from the gas. This process is known as *ionization*. In this case both the electron and the remaining positively charged gas ion are mobile, so that the electron moves toward the positive and the gas ion toward the negative electrodes from which the field originates.

7. Thermionic Emission. The emission of electrons from metals heated to a certain temperature is a characteristic property of the metal. From consideration of thermodynamics and the kinetic theory of gases Richardson obtained an equation for thermionic emission.

$$I_s = A_1 T^{3/2} \epsilon^{-\frac{b_1}{T}} \quad (16)$$

where I_s = emission current in amperes per square centimeter

A_1 = a constant for the emitting substance

T = absolute temperature in degrees Kelvin

ϵ = base of Napierian logarithms

b_1 = a constant depending upon the nature of the emitting surface

A similar equation giving equivalent results was derived by Dushman:

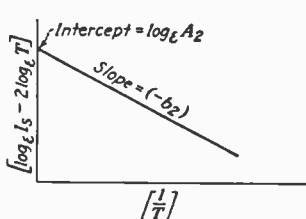

$$I_s = A_2 T^2 \epsilon^{-\frac{b_2}{T}} \quad (17)$$

where I_s = electron emission in amperes per square centimeter

T = absolute temperature of the emitter in degrees Kelvin ($C + 273$)

ϵ = base of Napierian logarithms (2.718)

b_2 = a constant for the material

FIG. 1.—Determination of constants in emission equation.

The constants A_2 and b_2 of Eq. (17) can be determined for a given material in the following manner:

$$\log_e [I_s] = \log_e \left[A_2 T^2 \epsilon^{-\frac{b_2}{T}} \right]$$

$$[\log_e I_s - 2 \log_e T] = \left[\log_e A_2 - \frac{b_2}{T} \right]$$

Readings of the emission current from the substance at different temperatures are obtained. Values of $[\log I_s - 2 \log_e T]$ are plotted against $[1/T]$. The result should be a straight line. The intercept of this line with the vertical axis gives the value of $\log_e A_2$, the slope gives the value of $(-b_2)$.

Equations (16) and (17) are experimentally indistinguishable within the usual range of temperatures. When the constants are known for Eq. (16) the constants for Eq. (17) may be calculated from the following approximate relations.

$$b_2 = \left[b_1 - 1.5 \frac{T_1 + T_2}{2} \right] \quad (18)$$

$$A_2 = [0.223 A_1 T^{-1.5}] \quad (19)$$

For Non-homogeneous Emitters. For thoriated tungsten and oxide-coated emitters the emission constants depend to a considerable extent on the processing as well as on the materials. The curves below show typical data relative to pure metallic emitters.¹

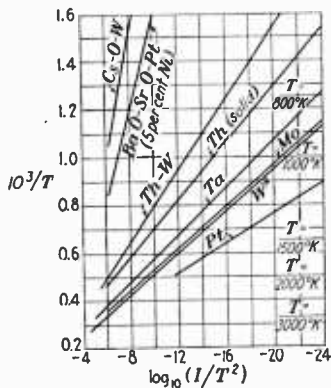

FIG. 1a.

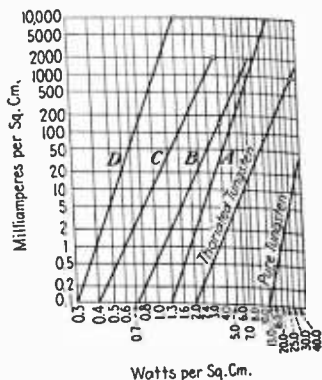

FIG. 1b.

FIG. 1a.—Emission of coated filament compared to that from pure metals. (*A.I.E.E. reprint.*)

FIG. 1b.—Emission from coated filament vs. power input. A to D represent different examples from several sources. (*"A Science Series for Engineers," A.I.E.E. reprint.*)

A filament coated with a mixture of the oxides of barium and strontium on a core of 95 per cent platinum and 5 per cent nickel has the following characteristics:

Electrical Resistivity of the Core.

$$= 0.000022(1 + 0.00208t - 0.000,000,46t^2) \text{ ohm cm}$$

t = temperature in degrees centigrade

Thermal Emissivity (Ratio to Black Body).

$$= [0.4 + 0.00025T]$$

where T = degrees Kelvin lies between 800° and 1200°K .

¹ DUSHMAN, SAUL, "A Science Series for Engineers," *A.I.E.E.*, reprint.

The electron emission in zero field is given by the equation

$$I_s = 0.01T^2\epsilon \frac{11,600}{T}$$

where T = degrees Kelvin
 I_s = emission current in amperes per square centimeter

For an anode potential of 150 volts and a current limited by space charge to 0.010 amp. per square centimeter the average life is

$$= \frac{22,000}{T} \text{ hr.} = 0.000015\epsilon \text{ hr.}$$

The following values are those most probable when the anode potential equals 150 volts and the electric field is zero:

T	I_s	p_r	p_a	Life
900	20	2.3	0.02	730,000
950	45	3.0	0.045	170,000
1,000	90	3.7	0.09	55,000
1,050	170	4.6	0.17	20,000
1,100	310	5.6	0.31	7,400

T = temperature in degrees Kelvin

I_s = emission current in milliamperes per square centimeter

p_r = power thermally radiated in watts per square centimeter

p_a = power absorbed by electron emission in watts per square centimeter

Life = most probable average life in hours

8. Contact Potential. The rate of emission of electrons from different substances and the contact differences of potential are closely related.

The contact potential depends only upon the materials of the electrodes and their temperature, but not upon size, shape, or position of the electrodes.

For example, an electron in escaping from the inner to the outer surface of substance A will do work equal to W_A so that its potential is changed to V_A . Similarly the work for an electron to escape from the surface B is W_B and the potential change V_B . Hence in moving an electron from substance A across a space to substance B the work done will be

$$[W_A + (V_A - V_B)e - W_B] \quad (20)$$

This is the algebraic summation of the work done and would be equal to zero, except for the work done at the junction of the two substances in the return connection. This later potential difference is known as the *Peltier effect* and is negligible in comparison with the other effects

$$W_A = \phi_A e \quad (21)$$

$$W_B = \phi_B e \quad (22)$$

$$(V_A - V_B)e = W_B - W_A = (\phi_B - \phi_A)e \quad (23)$$

$$(V_A - V_B) = (\phi_B - \phi_A) \quad (24)$$

$(V_A - V_B)$ is called the *contact potential difference* between the two substances, and by Eq. (24) it is equal to the difference in the *work function*, or electron affinity ϕ of the two substances.

9. Work Function. When a quantity of electricity q is moved through a potential difference V the work done equals qV . Work must be done when an electron is removed from a surface. If the work done per electron is W_1 , the electron charge e , and the potential difference ϕ is required to supply an amount of energy equal to W_1 , then,

$$W_1 = \phi e \quad (25)$$

$$\phi = \frac{W_1}{e} = \frac{k\phi b}{e} = (8.62 \times 10^{-5}b) \text{ volts} \quad (26)$$

ϕ is called the *electron affinity* of the substance and is equal to the work function (W_1/e). The smaller the quantity ϕ the easier it will be for an electron to escape from the cathode. A low value of ϕ indicates a large electron emission for a given temperature.

The following table gives the electron affinity or work function of several substances expressed in volts:

Substance	ϕ
Tungsten.....	4.52
Platinum.....	4.4
Tantalum.....	4.3
Molybdenum.....	4.3
Carbon.....	4.1
Silver.....	4.1
Copper.....	4.0
Bismuth.....	3.7
Tin.....	3.8
Iron.....	3.7
Zinc.....	3.4
Thorium.....	3.4
Aluminum.....	3.0
Magnesium.....	2.7
Nickel.....	2.8
Titanium.....	2.4
Lithium.....	2.35
Sodium.....	1.82
Mercury.....	4.4
Calcium.....	3.4

10. Filament Calculations. The dimensions of filaments designed to operate at a given voltage and temperature, and to furnish a certain total emission current are related to the physical properties of the material.

Suppose that the required total emission current is I_B ma. From the power-emission chart for the type of filament material being used, find I_s the emission current in milliamperes per square centimeter for a given power input p watts per square centimeter corresponding to good life performance, or to temperature T .

The total surface area of the required filament: $A = (I_B/I_s)$.

The total power input to the filament: $pA = E_f I_f = P_f$ watts.

At a voltage E_f the filament current $I_f = (pA/E_f)$.

Filament resistance at the operating temperature: $R_f = (E_f/I_f)$.

The resistance of a circular filament: $R = \left[\rho \frac{A}{2\pi^2 r^3} \right]$

where A = area of the filament surface

r = radius of the filament

ρ = specific resistance of the filament material. ρ must be known as a function of the temperature.

The resistance of a rectangular filament is given by

$$R = \left[\rho \frac{A}{2S_1S_2(S_1 + S_2)} \right]$$

where A = area of the filament surface

S_1 = thickness of the filament

S_2 = width of the filament

ρ = specific resistance of the filament material at temperature T

11. Filament-current Filament-radius Relation. For a given type of filament material operating at a specified temperature and filament voltage, the radius or filament cross section is uniquely related to the filament current.

For a circular filament: $I_f = [(2p/\rho)^{1/2} \pi r^{3/2}]$

For a rectangular filament: $I_f = (2p/\rho)^{1/2} \cdot [S_1S_2(S_1 + S_2)]^{1/2}$.

For a square filament: $I_f = (2p/\rho)^{1/2} \cdot 2^{1/2} \cdot S_1^{3/2}$.

12. Filament-voltage Filament-dimensions for a Constant Temperature. For a given filament material to be operated at a given temperature, the filament voltage is related to the filament length and sectional dimensions as follows:

Circular filament: $E_f = (2p\rho)^{1/2} \frac{l}{r^{1/2}}$

Rectangular filament: $E_f = (2p\rho)^{1/2} \left(\frac{1}{S_1} + \frac{1}{S_2} \right)^{1/2} \cdot l$

13. Lead-loss Correction. The cooling effect of the leads connected to a filament decreases the emission from the parts near the junction. The voltage drop in these parts of the filament is also less.

Langmuir and Dushman give the following correction formulas for a V-shaped filament cooled by large leads. The decrease in voltage due to the cooling effect of the two end leads is

$$\Delta V = 0.00026(T - 400) \text{ volts}$$

T = degrees Kelvin of the central portion of the filament.

The correction for the effect on the electron emission is given in terms of the voltage of a length of uncooled filament which would give the same effect as the decrease caused by the cooling of the leads. The correction for the two leads is $\Delta V_H = 2(0.00017T\phi - 0.05)$ volts. ϕ is a number which depends upon the temperature coefficient of the quantity H , which may represent any property of the metal, such as candlepower, electron emissivity, etc. For the case of electron emission the exponent

of the temperature coefficient is $N = \left(2 + \frac{b_0}{T} \right)$

Dushman's coefficient for the material b_0 and the temperature T in degrees Kelvin being known, N is calculated.

N	0.5	1.0	2.0	2.5	5.0	10.	20.	30.	50.
ϕ	0.48	0.85	1.23	1.44	1.72	2.10	2.47	2.69	2.95

N is related to ϕ as shown by the data above which may be plotted as a curve knowing ϕ the correction ΔV_H is determined.

The electron emission per unit area after taking into account the lead-loss correction is

$$I = \left(\frac{i}{S} f \right)$$

where i = observed total emission from any given filament

S = total filament area

The correction factor f is given by

$$f = \left[\frac{V + \Delta V}{V + \Delta V - \Delta V_H} \right]$$

Dushman gives curves of ΔV and ΔV_H plotted against temperature for different values of b_0 .

$V + \Delta V$ corresponds to the corrected voltage drop along the filament.

14. Effect of Space Charge. The equations of Richardson and Dushman for thermionic emission give the total electron current, with

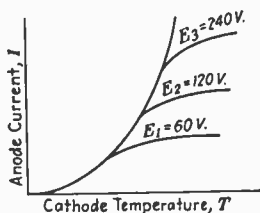

FIG. 2.—Space-charge effect in limiting emission.

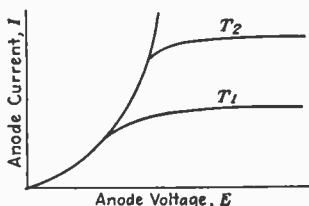

FIG. 3.—Saturation at constant temperatures.

zero field strength at the surface of the cathode. If the electrons are allowed to accumulate just outside the surface they form a negative cloud. If the electrons are drawn to a positive electrode both the negative cloud and to a less degree the cathode surface fields are changed.

Langmuir found that if the voltage applied to the anode was not sufficiently high a temperature increase of the cathode did not increase the current indefinitely. This effect is shown in Fig. 2. It is due to the repelling effect of the negative cloud of electrons surrounding the cathode and is known as the *space-charge effect*, or volume density of electrification. Figure 3 shows this effect with constant-cathode temperatures and variable-anode voltage.

The theory of these effects is as follows: The distribution of the potential between two large parallel plates is directly proportional to the distance starting from the low and increasing to the high potential plate. If plate A emits low-velocity electrons (assumed zero) spontaneously, and if plate B is positive with respect to A , electrons will be drawn over

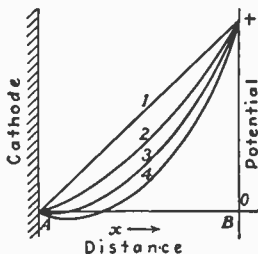

FIG. 4.—Distribution of potential in cathode-plate space.

to B . Starting with a low temperature T , the distribution of potential between A and B will be uniform as shown by the straight line 1 in Fig. 4. Increasing the temperature of A will cause an electron current of I amp. per square centimeter to flow to B . Laplace's equation connecting the potential distribution with the volume density of electrification ρ is

$$\Delta V = \frac{\partial^2 V}{\partial x^2} + \frac{\partial^2 V}{\partial y^2} + \frac{\partial^2 V}{\partial z^2} = -4\pi\rho \quad (27)$$

For large parallel planes Eq. (27) may be simplified to

$$\frac{d^2 V}{dx^2} = -4\pi\rho \quad (28)$$

If ρ is constant and negative, the potential distribution will be a parabolic curve as shown by curve 2 in Fig. 4. A further increase in the temperature of A will cause the parabola to take the form of curve 3 having a horizontal tangent at A . In this case the potential gradient at the cathode is zero ($dV/dx = 0$), and a further increase of temperature will not increase the electron current to B . This accounts for the effect shown in Fig. 2.

In the above discussion the electrons were assumed to be emitted with no initial velocity. Usually small initial velocities exist, so that a slightly negative gradient is necessary at A in order to prevent an increase in current. Curve 4 of Fig. 4 shows the effect of the initial velocities of emission on the potential distribution at the temperature for which a further increase in temperature will not increase the anode current.

15. Schottky Effect. Richardson's and Dushman's equations for the thermionic emission from a substance at a given temperature assumes that the electric field strength is zero at the cathode. In actual practice a definite potential is used. This effect of the potential gradient at the cathode on the observed emission current is called the *Schottky effect*.

Dushman gives the correction for the Schottky effect as follows:

$$\begin{aligned} I_0 &= \text{electron emission in zero field} \\ I_v &= \text{observed emission at an anode voltage } V \end{aligned}$$

Then

$$I_v = I_0 e^{\frac{4.39\sqrt{kV}}{T}}$$

where k = a constant whose value depends upon the relative geometrical arrangement of anode and cathode

T = temperature in degrees Kelvin

e = base of Napierian logarithms

16. Electron Current between Parallel Plates. When the cathode is a large flat surface A and the plate, or anode, B is a parallel surface, the plate current per square centimeter of surface not too near the edges of the plates is given by the equation

$$i = 2.34 \times 10^{-6} \frac{V^{3/2}}{x^2} \quad (29)$$

where i = maximum current density in amperes per square centimeter

x = distance between plates in centimeters

V = potential difference between A and B in volts

This equation assumes that the initial velocities of the electrons leaving *A* are zero. If the potential of *B* is large relative to one or two volts, the initial velocities of the electrons can be neglected.

Equation (29) assumes that the anode potential is positive with respect to *A* so that some current is flowing but that the anode potential is below the value necessary to give the full current emitted at *A*. When the anode potential is great enough to draw over all of the electrons emitted at *A*, the current (saturation current) I_s is given by the Richardson-Dushman equation.

17. **Electron Current between Concentric Cylinders.** Given two concentric cylinders *A* and *B* (Fig. 6) having radii of a and r cm and of infinite length. Langmuir's equation for the electron current to the plate *B* is given by the relation

$$i = 14.7 \times 10^{-6} \frac{V^{3/2}}{r\beta^2}$$

where i = current in amperes per centimeter length
 V = potential between *A* and *B* in volts
 r = radius of the anode in centimeters
 a = radius of the cathode in centimeters
 β = a factor which varies with the ratio of (r/a)

r/a	β^2	r/a	β^2
1.00	0.000	20	1.072
2.00	0.279	50	1.094
3.00	0.517	100	1.078
4.00	0.667	200	1.056
5.00	0.767	500	1.031
10.00	0.978	1,000	1.017
		∞	1.000

When the inner cylinder is a small wire of less than one-tenth the diameter of the plate, the error is small if β is neglected, and the approximate equation is

$$i = \left[14.7 \times 10^{-6} \frac{V^{3/2}}{r} \right]$$

18. **Electron Current with Any Shape Electrodes.** Langmuir has demonstrated that under the assumption on which the above equations were derived the current will vary as the three-halves power of the potential difference V regardless of the shape of the electrodes. The derivation of the equations neglects the initial velocities of the electrons and the potential gradient at the cathode.

19. **Two-electrode Vacuum Tubes.** The three-halves power equation for the plate current of a two-electrode tube is quite accurate when the voltage between cathode and plate is large with respect to the effects of (1) initial velocities of emission; (2) voltage drop in the filament or cathode; (3) contact potential between cathode and plate and the emission of electrons from the cathode is large and the plate voltage well below the value for saturation current. The electrodes are assumed to be in good vacuum, so that the effects of gas are negligible.

In the case of thoriated-tungsten or oxide-coated filaments only a fraction of the total cathode surface is active so that the saturation current may be reached at a plate voltage below the theoretical.

The current is calculated from the formula

$$i = kV^{3/2}$$

where k is the space-charge constant of the tube for a given type of tube structure and depends only upon the geometrical configuration without regard to the dimensions of the tube. The value of k for

infinite parallel plates is $\left(2.34 \times 10^{-6} \frac{A}{x^2}\right)$

where A = the area of the plate in square centimeters

x = the distance from the cathode plate to the anode plate in centimeters.

For concentric cylinders, $k = \left(14.7 \times 10^{-6} \frac{l}{r\beta^2}\right)$

l = length of the cylinders

r = radius of the outer cylinder or anode

β = a function of (r/a) (see table on page 241)

20. Effect of Initial Velocities—Parallel Plates. If the effect of the initial velocity of the electrons is included and they have a Maxwellian distribution,

$$i = 2.34 \frac{A}{(x_a - x_m)^2} (V_a - V_m)^{1.5} \left(1 + 0.0247 \sqrt{\frac{T}{V_a}}\right)$$

Cathode... B Anode

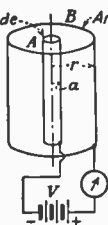

FIG. 6.—Cylindrical structure.

where i = total plate current in amperes

A = area of one surface of the anode in square centimeters

T = temperature of the cathode in degrees Kelvin

V_a = potential of the anode above that of the cathode volts

V_m = minimum potential of the space between cathode and anode with respect to the cathode

x_a = distance from cathode to anode in centimeters

x_m = distance from cathode to V_m in centimeters

21. Effect of Magnetic Field. Initial velocities = 0
For coaxial cylinders,

$$i = kV_a^{1.5}, \text{ if } V_a > V'$$

$$i = 0, \text{ if } V_a < V'$$

k = same as above

$$V' = \left[0.0221 H^2 r_o^2 + 0.0188 I^2 \left(\log_{10} \frac{r_o}{r_i} \right)^2 \right]$$

H = strength of magnetic field externally applied parallel to axis of cylindrical electrodes

I = current flowing through the inner cylindrical electrode parallel to its axis

r_o = radius of the outer electrode

r_i = radius of the inner electrode

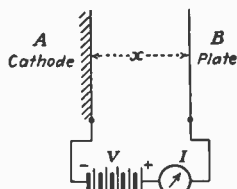

FIG. 5.—Electron current between parallel plates.

22. Characteristics of Typical Commercial Diodes.

Type	i_f	E_f	E_m	i_m	P_n	k
ThW.....	1.25	7.5	550	0.065	0.0075	1.2
ThW.....	3.25	10	1,500	0.20	0.050	1.7
ThW.....	3.85	11	2,500	0.25	0.250	1.1
PW.....	14.7	11	16,000	0.166	1.00	0.5
PW.....	24.5	22	17,500	0.833	5.00	1.0
PW.....	52	22	18,000	3.0	20.00	1.1
PW.....	10	10	20,000	0.10	0.10
PW.....	10	10	85,000	0.10	0.11
PW.....	32	9	75,000	0.25	0.25
PW.....	10	10	150,000	0.100	0.11
PW.....	32	12.5	150,000	0.25	0.11

i_f , E_f = filament current, voltage (amperes and volts)

E_m = maximum effective a-c input voltage (volts)

i_m = maximum rectified tube current (amperes)

P_n = nominal power rating (kilowatts)

ThW, PW = thoriated tungsten, and pure tungsten, filament

k = 0.0001 amp. per volt^{1,5}

THREE-ELECTRODE TUBES

23. Effect of the Grid. When a wire mesh or similar electrode having openings through which electrons may pass is placed between the cathode and the plate of a two-electrode tube it exerts a large controlling effect on the flow of electrons to the plate. The meshlike electrode between cathode and plate is termed a *grid*. The tube is then known as a *triode*, or three-electrode tube.

When the grid is connected to a battery or other source of voltage the electrons are attracted if the grid is positive with respect to the cathode and repelled if it is negative. The close proximity of the grid to the space charge surrounding the cathode increases its effectiveness in controlling the electron flow.

In most useful applications the tubes are operated with sufficient electron emission and with plate and grid voltages low enough so that the space charge surrounding the cathode is ample to permit large momentary increases in the electron flow to the plate.

The effect of a large positive plate voltage in drawing the electrons to the plate can be reduced by a relatively small negative voltage applied to the grid. The electrons being negative will avoid the negative grid so that no current will flow in the grid circuit. If the negative grid voltage is not too large with respect to the plate voltage, electrons will be drawn through the openings in the grid mesh to the positive plate.

The resulting plate current is controlled by the grid although no current flows in the grid circuit. The power is equal to the product of the current times the voltage. Zero power in the grid circuit can thus control a considerable amount of power in the plate circuit. Voltage variations of the grid produce corresponding variations of the plate current. The extent to which the plate-current variations are faithful reproductions of the grid-voltage variations depends upon the steady polarizing voltages (A , B , and C voltages) applied to the tube and the range of the voltage variations.

CHARACTERISTICS OF THE THREE-ELECTRODE TUBE

24. Static Characteristics. The effects of various d-c voltages applied to the electrodes of a tube are shown by curves called the *static characteristics* of the tube. The vertical scale of these curves usually shows the plate current, grid current, total emission current, or filament current of the tube. The horizontal scale shows a range of voltages

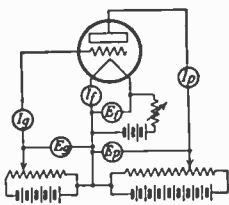

FIG. 7.—Circuit for measuring static characteristics.

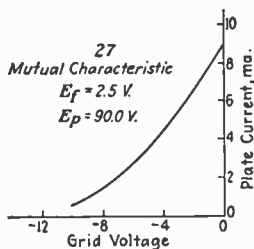

FIG. 8.—Typical grid-voltage plate-current characteristic.

effective on one electrode. The voltage on the other electrodes are held constant at some value specified on the curve.

The circuit for obtaining the static characteristic curve data is shown in Fig. 7. The meters marked I_p , I_g , and I_f read the plate current, grid current, and filament current respectively. Potentiometers connected across batteries permit adjusting the plate and grid voltages.

25. Mutual or Transfer Characteristic. The mutual characteristic, or transfer characteristic of the tube, shows the effect of the grid voltage upon the plate current. The term mutual or transfer indicates that the

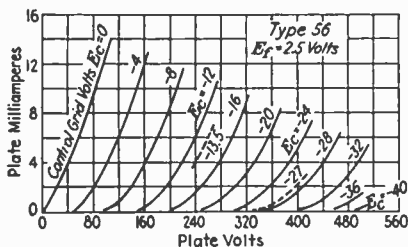

FIG. 9.—Plate characteristics of typical triode tubes.

voltage in one circuit controls the current in another circuit. Figure 8 shows this characteristic for a 27 triode tube.

26. Plate Characteristic. The plate characteristic represents the relation between plate current and plate voltage. These curves for a type 56 tube are shown in Fig. 9. Each curve is for a specified voltage.

27. Grid Characteristic. The grid characteristic shows the grid current-grid voltage relation. Electron flow to the grid starts in the region of zero grid voltage. The exact point at which grid current starts is determined by the initial velocities of emission, and the contact potential of the grid to cathode. The net effect is equivalent to a small positive or negative bias usually not greater than one volt.

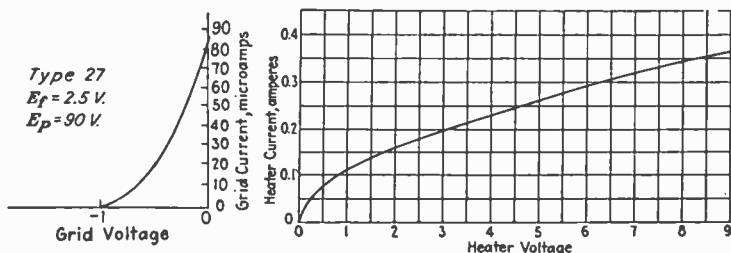

FIG. 10.—Grid-current grid-voltage characteristic.

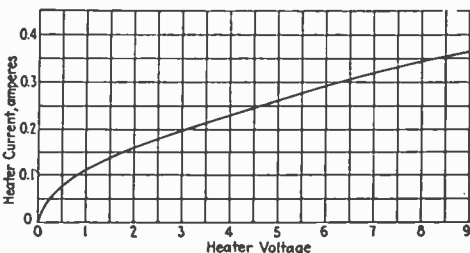

FIG. 11.—Filament characteristic of 6C6.

The grid characteristic of a 27 tube is shown in Fig. 10. The inherent bias in the tube is nearly 0.9 volt positive so that the grid must be biased negative by 0.9 volt to secure an effective zero grid voltage.

28. Filament, or Heater, Characteristic. The filament-voltage filament-current curve obtained with plate and grid terminals disconnected is termed the filament characteristic. The characteristic refers to the heater filament when the tube is of the indirectly heated cathode type.

29. Normal Emission and Emission Characteristic. The *normal emission current* is ordinarily obtained as a single reading at rated filament voltage. The circuit arrangement for this test is shown in Fig. 13. A definite voltage (50 volts is commonly used) is applied between the cathode and all other electrodes as the anode. A switch is arranged in the circuit so that the voltage is applied only long enough to obtain the emission-current reading. This test should not be made at rated filament voltages on large power tubes where the heating would be excessive; on the low-filament-current types 99, 30, 31, 32, etc.; or on the oxide-coated 0.25-amp.-filament-current tubes, such as types 112A and 71A. An emission check on all these types can be made by observing the filament voltage required to give a certain small value of emission current (values of 3 or 5 ma are generally used).

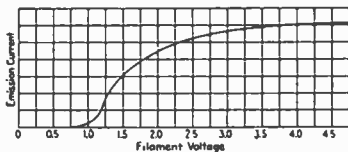

FIG. 12.—Filament characteristics of 1C6.

The normal emission test, even though applied only momentarily usually causes some liberation of gas and heating of the electrodes.

Hence it is desirable to complete other tests before this test is made or to allow sufficient time after this test, operating with normal voltages, to clear up gas and to return the temperature to normal.

When the effect of filament voltage on normal emission current is of interest, readings, obtained as above but for different filament voltages, are plotted as a curve.

The *emission characteristic* shows the true (total) emission current for a range of cathode heating power.

To avoid the effects of space charge, heating of grids and anode, liberation of gas and such extraneous effects, the readings are taken only with low cathode-heating power and the emission for normal heating power is obtained by extrapolation. A usual procedure is to read the cathode heating power for emission currents of 0.1, 0.2, 0.5, 1.0, 2.0, and 5.0 ma with 50 volts positive on the common electrode connection with respect to the cathode. The data are plotted on a special coordinate paper devised by C. J. Davisson. If the emission follows Richardson's temperature equation and the power is radiated according to the Stefan-Boltzmann law of radiation, the curve appears as a straight line. The extension of this straight line shows the emission current for normal or other values of cathode heating power.

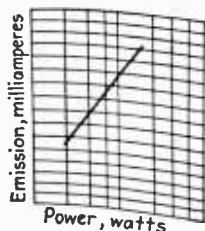

FIG. 14.—Emission curve.

and in tungsten-filament tubes where the work function is large.

4. Poor vacuum (gas ionization effects) (bends upward).
5. Heating of the anode by the emission current (bends upward).
6. Progressive change in activity of the cathode.

A method for reading emission currents which is applicable in general consists in the use of a commutator for applying the voltage recurrently for only a small time interval. By means of an oscillograph the emission current is read as the peak current during the interval the voltage is applied. By this method the heating effects can be kept low.

CALCULATION OF THE SPACE CURRENT OF THE THREE-ELECTRODE TUBE

30. The space current I of a three-electrode tube is equal to the sum of the plate current I_p and the grid current I_g ; $I = (I_p + I_g)$. The three-electrode tube is calculated as an equivalent diode $I = k(E_p +$

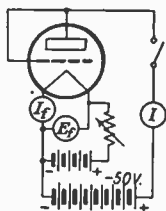

FIG. 13.—Measurement of emission characteristic.

μE_g)^{3/2}. The grid voltage E_g is equivalent to a plate voltage μE_g . μ is the amplification factor of the tube.

31. Plane-parallel Elements. For a structure with plane-parallel elements with the filament symmetrically placed between grids and plates:

$$k = 2.34 \times 10^{-6} \times \frac{A}{(\alpha + \beta)^{1/2} [\alpha + \beta(\mu + 1)]^{3/2}}$$

$$\mu = \frac{2\pi\alpha n}{\log_e \frac{1}{2\pi r n}}$$

$$I = 2.34 \times 10^{-6} \frac{A}{(\alpha + \beta)^{1/2}} \left[\frac{E_p + \mu E_g}{\alpha + \beta(\mu + 1)} \right]^{3/2}$$

where I = total space current in amperes

α = distance from plate to grid in centimeters

β = distance from grid to filament in centimeters

n = number of grid wires per centimeter length of the structure

r = radius of the grid wires

A = effective plate area

32. Concentric Elements. For a structure with a cylindrical anode and grid and a coaxial strand of filament,

$$k = 14.7 \times 10^{-6} \frac{LR_p^{1/2}}{[(R_p - R_g) + R_g(\mu + 1)]^{3/2}}$$

$$\mu = \frac{2\pi n R_g^2 \left(\frac{1}{R_g} - \frac{1}{R_p} \right)}{\log_e \frac{1}{2\pi r n}}$$

$$I = 14.7 \times 10^{-6} \frac{L}{R_p} \left[\frac{(R_p - R_f)(E_p + \mu E_g)}{(R_p - R_f) + (R_g - R_f)(\mu + 1)} \right]^{3/2}$$

If R_f is very much smaller than R_p and R_g the equation can be written approximately

$$I = 14.7 \times 10^{-6} LR_p^{1/2} \left[\frac{E_p + \mu E_g}{(R_p - R_g) + R_g(\mu + 1)} \right]^{3/2}$$

where L = length of the structure in centimeters

R_f = radius of the filament in centimeters

R_p = radius of the plate in centimeters

R_g = radius of the grid in centimeters

The above relations are useful in the design of the structures. The k should be determined for the type of tube structure. The μ and the current-voltage characteristics remain the same if all dimensions are changed proportionately. The plate current equals the space current when the grid current is zero.

33. Amplification Factor. The amplification factor is a measure of the effectiveness of the grid voltage relative to that of the plate voltage upon the plate current. It is the ratio of the change in plate voltage to a change in grid voltage in the opposite polarity, under the condition that the plate current remains unchanged. As most precisely used,

the term refers to infinitesimal changes as indicated by the defining equation:

$$\mu = -\frac{\partial e_p}{\partial e_g}; i_p = \text{constant}$$

The amplification factor is indicated by the horizontal spacing of the plate characteristic or mutual characteristic curves of the tube. Since horizontal lines represent constant plate current the plate voltage spacing divided by the grid voltage spacing of the curve is the amplification factor. The amplification factor of three-electrode tubes is nearly constant for a constant plate current. In the region near zero plate current or near the full emission current of the filament, the amplification factor changes greatly with voltage. It is necessary to use smaller increments in regions where the amplification factor changes rapidly.

34. Measurement of Amplification Factor. The amplification factor is measured conveniently with an alternating-current bridge circuit shown schematically in Fig. 15. The resistance R_1 is adjusted for zero sound in the phones. The amplification factor is given by

$$= \frac{R_2}{R_1}$$

Due to tube capacities or other reactances in the circuit it is usually necessary to provide a means for adjusting the phase of the grid and plate a-c voltages for complete balancing out of the sound in the phones. This phase balance is secured with condenser C in Fig. 15. The d-c voltage drop in R_2 should be allowed for when setting the plate voltage. The adjustable ground connection is convenient in eliminating the unbalancing effects of capacity to ground. The a-c tone voltage should be as small as practical.

The phones can be preceded by a suitable amplifier.

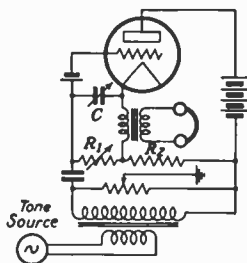

FIG. 15.—Measurement of amplification factor.

CALCULATION OF THE AMPLIFICATION FACTOR

35. Plane-parallel Electrodes. When the diameter of the grid wires is large compared to their spacing the formula derived by Vodges and Elder is most accurate. Figure 16 shows a cross section of the electrodes. The amplification factor is

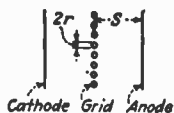

FIG. 16.—Tube with plane-parallel electrodes.

$$\mu = \left[\frac{2\pi ns - \log_e \frac{1}{2}(\epsilon^{2\pi nr} + \epsilon^{-2\pi nr})}{\log_e (\epsilon^{2\pi nr} + \epsilon^{-2\pi nr}) - \log_e (\epsilon^{2\pi nr} - \epsilon^{-2\pi nr})} \right]$$

where r = radius of the grid wire in centimeters
 n = number of grid wires per centimeter length of structure
 s = distance from plate to grid in centimeters

When the diameter of the grid wires is small compared to their spacing the equation above simplifies to

$$\mu = \frac{2\pi ns}{\log_e (1/2\pi nr)}$$

36. Concentric Cylindrical Electrodes. The amplification factor of the cylindrical structure shown in Fig. 17 is given by

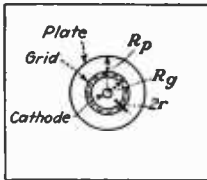

$$\mu = \frac{2\pi n R_g \log_e (R_p/R_g) - \log_e \frac{1}{2}(\epsilon^{2\pi nr} + \epsilon^{-2\pi nr})}{\log_e (\epsilon^{2\pi nr} + \epsilon^{-2\pi nr}) - \log_e (\epsilon^{2\pi nr} - \epsilon^{-2\pi nr})}$$

where R_p = radius of the anode in centimeters
 R_g = radius of the grid in centimeters
 r = radius of the grid wires in centimeters
 n = number of grid wires (turns) per centimeter length of structure.

FIG. 17.

When the diameter of the grid wires is small compared with their spacing the equation simplifies to

$$\mu = \frac{2\pi n R_g \log_e (R_p/R_g)}{\log_e \left(\frac{1}{2\pi nr} \right)}$$

37. Plate Resistance and Plate Conductance. The plate resistance r_p is defined by the equation,

$$r_p = \frac{1}{S_p} = \frac{\partial e_p}{\partial i_p}$$

It is the reciprocal of the plate conductance S_p .

The plate conductance is the ratio of the change in plate current to the change in plate voltage producing it, all other electrode voltages being maintained constant. As most precisely used, the term refers to infinitesimal changes as indicated by the defining equation

$$S_p = \frac{\partial i_p}{\partial e_p}$$

The plate conductance is given by the slope of the plate-characteristic curves of the tube. When readings are taken on the characteristic curves the current and voltage increments should be made as small as convenient. The plate resistance is the reciprocal slope of the plate-characteristic curve. For example, at the point on the plate characteristics corresponding to the d-c operating voltages, the plate current rises 1.0 ma when the plate voltage increases 10 volts. The conductance is then

$$S_p = \frac{0.001}{10} = 0.0001 \text{ mho} = 100 \text{ micromhos}$$

The plate resistance is

$$r_p = \frac{10}{0.001} = 10,000, \text{ ohms}$$

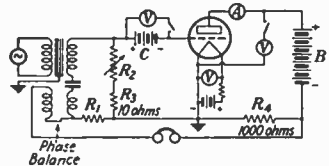

FIG. 18.—Measurement of plate resistance.

The numerical value of the plate resistance changes with the applied d-c operating voltages.

38. Measurement of the Plate Resistance. The plate resistance or plate conductance can be measured directly with the aid of a bridge

type of circuit. Figure 18 illustrates a circuit suitable for this purpose. When the bridge is balanced for minimum sound in the phones the plate resistance of the tube is

$$r_p = \frac{R_2 R_3}{R_1}$$

The alternating voltage (tone) applied to the bridge should be as small as practical. The use of an amplifier preceding the phones increases the sensitivity and accuracy of these measurements. The effects of small capacities are sometimes troublesome in circuits of this type. The electrode capacity of the tube causes some phase shift resulting in a poor balance. The phase balance variometer balances the small out-of-phase component permitting a closer adjustment to the null point. The capacity to ground can be balanced by suitable shielding or by means of a Wagner earth connection.

39. Calculation of the Plate Resistance. The plate resistance of a tube depends upon the operating voltages as well as the structural parameters. It is within certain limits inversely proportional to the area of the anode and also to the area of the cathode. Decreasing the distance between filament and plate decreases the plate resistance. Since it is desirable to make (μ/r_p) large, the grid to plate distance controlling μ should not be decreased too much. This requires that the grid be placed near the filament to lower the plate resistance. When the grid is too near to the filament it will be heated. Small amounts of grid emission current resulting from too high grid temperature have an objectionable effect on the operation of the tube.

The plate resistance of a tube may be calculated from the plate-current plate-voltage relation. For a structure with plane-parallel elements in which the filament is symmetrically placed between grids and plates the plate resistance is,

$$r_p = \frac{(\alpha + \beta)^{1/2} [\alpha + \beta(\mu + 1)]^{3/2}}{A(E_p + \mu E_g)^{1/2}} \times 10^6$$

where r_p = plate resistance in ohms

α = distance from plate to grid in centimeters

β = distance from grid to filament in centimeters

μ = amplification factor

E_p = plate voltage

E_g = grid voltage

A = a constant depending on the cathode area, or anode area, and type of structure. For typical filament-type tubes $A = 1.8L$, where L is the length of the filament in centimeters.

The grid voltage E_g is conveniently made zero and the plate voltage taken equal to the value giving normal plate current.

40. Mutual Conductance. The mutual conductance (or grid-plate transconductance) of a tube is defined by the relation

$$S_m = S_{gp} = \frac{\partial i_p}{\partial e_g}$$

It is the ratio of the change in plate current to the change in grid voltage, under the condition that all other voltages remain constant. It is also

equal to the ratio of the amplification factor μ to the plate resistance r_p of the tube:

$$S_m = \frac{\mu}{r_p}$$

The mutual conductance determines the plate current change per volt applied to the grid. It is evident that this is the most important characteristic of a tube. It is a figure of merit of the tube and enters into the calculations of the performance of the tube. It is a direct measure of the amplifying properties of the tube operating into a load impedance which is small with respect to the plate resistance.

With high impedance loads the amplification factor and plate resistance are considered separately in determining the tube performance. The mutual conductance may be determined graphically from the slope of the mutual characteristic curve of the tube. Direct measurements are usually most convenient when many readings are required. The bridge circuit described in the following section balances readily with either three-electrode or screen-grid tubes.

41. Measurement of Mutual Conductance. The mutual conductance can be measured directly in the circuit shown in Fig. 19. The resistance R_1 and the phase balance C are adjusted until the sound in the phones is balanced out. The mutual conductance is given by

$$S_m = \frac{R_1}{R_2 R_3} \left(1 + \frac{R_3}{r_p} \right) = \frac{R_1}{R_2 R_3} \text{ (approx.)}$$

42. Calculation of the Mutual Conductance. The mutual conductance S_m is equal to the ratio of the amplification factor μ to the plate resistance r_p . Each of these factors can be calculated with a fair degree of accuracy for certain types of structures. The amplification factor depends almost entirely upon the structure of the grid and the grid-plate distance. The plate resistance depends upon the amplification factor, the surface areas of the cathode and anode, the grid-filament distance, and the applied d-c operating voltages. The mutual conductance depends upon all of these factors.

43. Grid-current Coefficients. When the grid of a tube is not biased with sufficient negative voltage and the tube operation extends into the positive range of grid voltage, an electron current will flow to the grid. Under these conditions the current in the grid circuit may change the effective grid voltage. When it is desirable to include these effects in determining the performance of the tube the coefficients relative to the grid current are useful.

The *grid conductance* S_g , or its reciprocal the *grid resistance* r_g , is defined by the equation

$$S_{gg} \equiv S_g = \frac{\partial i_g}{\partial e_g}$$

$$r_g = \frac{1}{S_g} = \frac{\partial e_g}{\partial i_g}$$

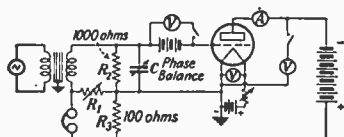

FIG. 19.—Measurement of mutual conductance.

The grid conductance S_g is the ratio of the change in the grid current to the change in grid voltage producing it, other electrode potentials being maintained constant. As most precisely used the term refers to infinitesimal changes, as indicated by the defining equation.

The coefficient showing the relative effectiveness of grid and plate voltages on the grid current has been variously termed reflex factor, inverse amplification factor, and inverse factor. Recent I.R.E. standards term this coefficient the *plate-grid mu factor*. It is the ratio of the change in grid voltage to the change in plate voltage required to maintain a constant value of grid current. As most precisely used the term refers to infinitesimal changes as indicated by the defining equation

$$\mu_{gp} \equiv \mu_n = -\frac{\partial e_g}{\partial e_p}; i_g = \text{constant}$$

The coefficient showing the effect of plate voltage on the grid current has been termed *inverse mutual conductance*, or the *plate-grid transconductance* (note that this is not the grid-plate transconductance which is the mutual conductance. The difference in these terms can be easily remembered, since the words grid and plate appear in the same order as the direction of action in the tube). It is the ratio of the change in grid current to the change in plate voltage producing it, all other electrode voltages being maintained constant. As most precisely used the term refers to infinitesimal changes, as indicated by the defining equation

$$S_{gp} \equiv S_n = \frac{\partial i_g}{\partial e_p}$$

The grid-current coefficients of the tube may be determined graphically from the static characteristic curves or measured directly in bridge circuits similar to those employed for the plate current coefficients.

44. Higher-order Coefficients. The tube coefficients in most common use are the amplification factor, plate resistance or conductance, and mutual conductance. These are the first-order plate-current coefficients of a triode. They determine the amplifying properties of the tube and enter into nearly all applications of the tube.

When the tube is operated so that detection, modulation, distortion, cross modulation, frequency conversion, and such effects are of importance, it is necessary to use second-order, third-order, and higher-order coefficients in addition to the first-order coefficients to determine the performance of the tube. For example, in the case of plate circuit detection the tube coefficient determining this effect is the second derivative of the plate current with respect to the grid voltage. The first derivative, or first-order coefficient, is the mutual conductance which is

$$\frac{\partial i_p}{\partial e_g} = S_m$$

The second derivative, or second-order coefficient, is

$$\frac{\partial^2 i_p}{\partial e_g^2} = \frac{\partial S_m}{\partial e_g}$$

The d-c plate-current change with signal voltage and second-harmonic distortion are also determined by the second-order coefficient.

Cross-modulation and modulation distortion in the r-f stages of a receiver are determined by the third-order coefficient

$$\frac{\partial^3 i_p}{\partial e_g^3} = \frac{\partial^2 S_m}{\partial e_g^2}$$

The third-harmonic distortion in a tube is also determined by the third-order coefficient. The fifth-harmonic distortion would be determined by the fifth-order coefficient,

$$\left(\frac{\partial^5 i_p}{\partial e_g^5} \right)$$

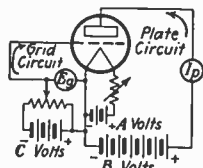

FIG. 20.—Triode circuit.

Higher-order coefficients are usually obtained graphically from the current-voltage characteristics of the tube. When the analytical expression for the current is known the coefficients may be obtained by differentiation. The measurement of an effect depending principally on one coefficient may be used as a measure of the coefficient.

45. Mechanism of the Three-electrode Amplifier. Figure 20 represents a triode connected to a suitable source of A , B , and C voltage. A meter I_p is connected in the plate circuit of the tube for reading the plate current. A potentiometer is connected across the C voltage. The grid voltage E_g will be changed as the slider is changed on the potentiometer. If the slide moves toward the positive, the plate current increases; if toward the negative, the plate current decreases. The plate currents corresponding to different grid voltages are plotted as in curve 1 in Fig. 21. This is a mutual characteristic curve of the tube.

Suppose that the slide is varied in some definite manner. For example, start to count time from zero on curve 2 in Fig. 21. With the slider initially at 5 volts the plate current is 3 ma. Move the slider steadily in the negative direction, until say, in three seconds the grid voltage is 9 volts. The plate current will be 0.5 ma. Now start the slider in the positive direction, moving at the same steady rate. At the end of 6 sec. the slider has returned to its original position. Continuing the motion of the slider in the positive direction at the end of 9 sec. the grid voltage is -1.0 volt and the plate current is 6.5 ma. If the slider is started in the negative direction at the same rate, the grid voltage will be -5 volts at the end of 12 sec., thus completing the cycle.

Curve 3 shows the plate-current change corresponding to the grid-voltage change with time. If the slider is connected to a mechanism arranged to continue this motion, the plate current would contain an alternating current of 1 cycle in 12 seconds or 5 cycles per minute. The waveform of the a.c. will be as shown in curve 3. It is superimposed upon the d-c plate current.

The positive and negative peaks of the plate current as measured from the initial 3-ma point are not equal although the grid-voltage peaks are

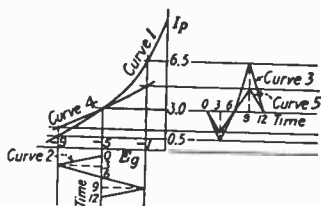

FIG. 21.—Mechanism of amplification.

equal. In this case the plate current is not a faithful reproduction of the input voltage.

If a resistance is connected in the plate circuit, the effective plate voltage is reduced as the plate current increases. The plate current at E_c equals -5 volts can be brought to the initial 3-ma point by a suitable increase in the B voltage to compensate for the voltage lost in the resistance. Starting with the same initial 3-ma point, the resulting characteristic with a resistance load is shown by the curve 4 in Fig. 21. The same alternating grid-voltage curve 2 produces the plate current curve 5. The positive and negative plate-current peaks of curve 5 as measured from the initial point are almost identical. The distortion has been eliminated and the voltage developed across the resistance can be used to operate a succeeding stage of amplification or other device.

The potentiometer and slider of Fig. 20 can be replaced with a fixed grid-bias voltage and an a-c voltage. The tube will operate as described above except that a-c cycles usually occur so rapidly that the plate-current (d.c.) meter cannot follow them. A meter showing the effective value (r-m-s) of the a.c. can be used to measure the current. The alternating current can be heard when connected to a loud-speaker, if it is within the audible range of frequencies. The waveform of the a.c. can be seen when connected to an oscillograph.

46. Detector Amplifier Triodes. Types of tubes designated as detector amplifier triodes, or general-purpose triodes, are used for detection, for voltage amplification, and in general in circuits where a low-power triode tube is needed.

The electrodes of the detector, amplifier triode are cathode, grid, and plate (anode). The cathode may be of the filament- or heater-cathode type, the grid of a medium or high amplification-factor type, and the plate designed for various characteristics depending on the principal use for which the tube is intended.

Some of the available types of cathodes are as follows: A filament type with low current suitable for operation with dry-cell batteries; a filament type with higher current used with storage batteries (filament types of tubes requiring relatively high current and operated with a-c supply are used in the power output stage and an amplifier type, the type 26, has been used in r-f and some a-f circuits); a heater-cathode type operating on 2.5 volts a-c supply; a heater-cathode type operating on 6.3 volts for direct connection to the storage battery of an automobile, for use in series-connected d-c line or universal a-c, d-c circuits, and for use with 6.3 volts a-c supply.

A medium amplification factor (6 to about 15 or 20) is characteristic of the general-purpose type. The high-amplification-factor tubes are especially suitable for use in resistance-coupled a-f circuits. The plate characteristics are relatively low plate current and medium or high plate resistance. The grid-plate transconductance is usually not so high as obtained with power amplifier triodes.

The medium-plate-resistance types are suitable for use in transformer-coupled a-f amplifier circuits, in grid-leak detector circuits, and in general in circuits where a medium-plate-resistance, medium-amplification-factor triode tube is suitable.

The high-amplification-factor type having high plate resistance can be used with resistance-coupled (or impedance-coupled) circuits for

a-f voltage amplification. This type is suitable for use as a grid-biased detector with resistance-coupled output. The medium-amplification-factor types also can be used as grid-biased detectors when a resistance-coupled or high-impedance output circuit is used.

Operating plate voltages below 250 volts are usual unless exceptionally large amplitude output voltages are required. The operating plate voltage must be large enough to accommodate this maximum output voltage. The grid-bias voltage and the plate load impedance are usually chosen to give low distortion and maximum output.

The following tabulation shows the characteristics of several typical detector amplifier triode tubes.

TYPICAL DETECTOR AMPLIFIER TRIODES

Type	E_f	I_f	Type cathode	E_p	E_c	I_p	R_p	μ	S_m	P_o	Capacitance in μmf			Bulb	Base
											G-P	F-C	P-C		
99	3.3	0.063	F	90	- 4.5	2.5	15,500	6.6	425	3.3	2.5	2.5	T-8	V99 4 nub
01A	5.0	0.25	TT	135	- 9	3.0	10,000	8.0	800	8.1	3.1	2.2	ST-14	X99 4 nub
40	5.0	0.25	F	180	- 3	0.2	150,000	30.0	200	8.0	2.8	2.2	ST-14	Med. 4
112A	5.0	0.25	TT	180	-13.5	7.7	4,700	8.5	1,800	0.285	8.5	4.0	2.0	ST-14	Med. 4
26	1.5	1.05	O	180	-14.5	6.2	7,300	8.3	1,158	8.1	2.8	2.5	ST-14	Med. 4
27	2.5	1.75	F	180	-14.5	6.2	7,300	8.3	1,158	8.1	2.8	2.5	ST-14	Med. 4
27	2.5	1.75	H-C	250	-21	5.2	9,250	9.0	975	3.3	3.1	2.3	ST-12	Med. 5
30	2.0	0.060	O	180	-13.5	3.1	10,300	9.3	900	6.0	3.0	2.1	ST-12	Small 4
37	6.3	0.3	F	250	-18	7.5	8,400	9.2	1,100	2.0	3.5	2.9	ST-12	Small 5
56	2.5	1.0	O	250	-13.5	5.0	9,500	13.8	1,450	3.2	3.2	2.2	ST-12	Small 5
76	6.3	0.3	H-C	150	-13.5	5.0	9,500	13.8	1,450	2.8	3.5	2.5	ST-12	Small 5

NOTE: Here and in the following tables the following symbols are used: F = filament
TT = thoriated tungsten
O = oxide coated
H-C = heater-cathode

47. Power Amplifier Triodes. Power amplifier triodes are used in applications where more power is needed than can be obtained from the ordinary amplifier triodes or where lower plate resistance or higher transconductance is desired. For the power output stage in radio receivers, for operating relays, lighting small signal lamps, and in general for delivering voltages and power in low-resistance loads these types are used. The low plate resistance is an advantage when a flat amplification characteristic over a wide range of frequencies is desired. In some instances, for example, in operating a low-resistance relay where a large plate-current change per volt on the grid is desired a power triode with high transconductance is used. When adequate signal voltage is available and an insensitive relay is used, or when positive action is of first importance, a tube with maximum plate current would be more important than a high transconductance.

For operating loud-speakers the transformer primary carries the d-c plate current plus the alternating current due to the signal. In this case a low d-c plate current causes less tendency to saturate the core when a single tube is used, and less loss in the winding resistance when a push-pull stage is used. For loud-speaker and other applications where appreciable power with low distortion is desired, a power amplifier triode is used.

An important characteristic of the power amplifier triode is that the distortion decreases to a low value and the power output decreases only at a slow rate as the load resistance increases beyond a value equal to the plate resistance of the tube. For low distortion (about 5 per cent second harmonic), it is usual to operate with a load resistance equal to twice the plate resistance of the tube.

Power amplifier triodes are characterized by high plate current, low plate resistance, low amplification factor, high transconductance, and moderate to high power output depending on the maximum plate voltage and plate current or the power dissipation permissible in the tube.

The tabulation below of typical power amplifier triode tubes shows a range of plate current for the various types from 12.3 to 60 ma, plate resistances from 800 to 5,000 ohms; amplification factor from 3.0 to 8.0; transconductance from 1,050 to 5,250 micromhos. The rated maximum plate voltage ranges from 180 to 450 volts. The bias voltage which is a measure of the signal voltage required for full output ranges from minus 30 volts to minus 84 volts. The power output ranges from 0.375 to 4.6 watts.

For higher power output per tube either pentodes, class B tubes, or the larger high-voltage power tubes are used.

TYPICAL POWER AMPLIFIER TRIODES

Type	E_f	I_f	Type cathode	E_p	E_c	I_p	R_p	μ	S_m	P_0	Capacitance in $\mu\mu\text{f}$			Bulb	Base
											G-P	G-C	P-C		
71A	5.0	0.25	FT	100	-40.5	20	1,700	3	1,700	0.79	7.5	3.2	2.9	ST-14	M 4
45	2.5	1.5	FO	275	-56	36	1,700	3.5	2,050	2.0	7	4	3	ST-14	M 4
50	7.5	1.25	FO	450	-84	55	1,800	3.8	2,100	4.6	ST-19	M 4B
31	2.0	0.130	FO	180	-30	12.3	3,600	3.8	1,050	0.375	5.7	3.5	2.7	ST-12	S 4
10	7.5	1.25	FT	425	-39	18	5,000	8.0	1,600	1.6	7	4	3	ST-16	M 4
2A3	2.5	2.5	FO	250	-45	60	800	4.2	5,250	3.5	13	9	4	ST-16	M 4

48. Power Amplifier Tetrodes and Pentodes. A power amplifier tetrode is similar to a power output pentode except that the tetrode does not have a suppressor grid. The electrodes are cathode, control grid, screen grid, and plate. The construction is such that the secondary emission from the plate cannot reach the screen grid. The plate characteristic curves are similar to those for a pentode tube without the

secondary emission dip which is characteristic of amplifier (screen-grid) tetrodes. The operating conditions are similar to those used for power output pentodes.

The characteristics of a typical tube intended for use in circuits using 120 volts d-c supply are as follows:

TYPICAL POWER AMPLIFIER TETRODE

Type	E_f	I_f	Type cathode	E_p	E_{c_2}	E_{c_1}	I_p	I_{c_2}	R_p	μ	S_m	P_o	Bulb	Base
48	30	0.4	{H-C O	125	100	-20	56	9.5	3,900	2.5	ST-16	M 6

Power amplifier pentodes are high-efficiency power output tubes. They are capable of higher power output with less plate voltage, less power input, and less signal voltage than are triode power amplifier tubes. Circuits using pentode power amplifier tubes must be more carefully designed to obtain low distortion than are circuits using triode power amplifier tubes.

The electrodes in a power amplifier pentode are cathode, control grid, screen grid, suppressor grid, and plate. The cathode may be either a filament or a unipotential heater type. The control grid connects to a negative bias and the signal voltages. The screen grid connects to the plus B voltage usually of the same value as used on the plate. The screen grid is by-passed with a condenser between it and the cathode. The suppressor grid is usually connected to the cathode inside of the tube. This grid prevents the screen grid from collecting secondary emission electrons from the

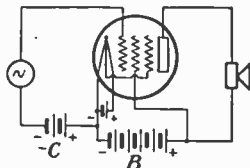

FIG. 22.—Connections of pentode for power-output tube.

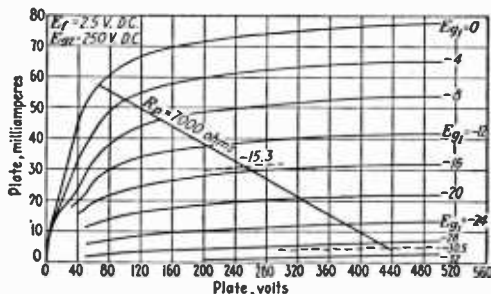

FIG. 23.—Load characteristic of 47 pentode.

plate and thus eliminates the dip in the plate-characteristic curves which appear in the screen-grid types of tubes.

Power amplifier pentodes are used in the power-output stage of radio receivers, and for operating relays and other devices where high mutual conductance and high plate resistance are desired. Due to its high plate resistance it is useful in circuits requiring a constant-current characteristic. For example, for distortionless magnetic deflection of a cathode-ray tube at all frequencies, the current through the deflecting coils should be directly proportional to the signal voltage. When a pentode power amplifier is used, a distortionless pattern results over a range of frequencies for which the deflecting coil impedance is low enough to utilize the pentode constant-current characteristic.

For several typical power amplifier pentodes listed below the range of characteristics of the various types shows plate current from 22 to 34 ma, transconductance from 1,200 to 2,500 micromhos, plate resistance from 35,000 to 100,000 ohms, amplification factor from 80 to 220, and power output from 1.4 to 3.4 watts. The maximum plate voltage ratings range from 135 to 250 volts. The grid-bias voltage which is approximately equal to the peak signal voltage for full output ranges from minus 12 to minus 25 volts.

TYPICAL POWER AMPLIFIER PENTODE

Type	E_c	I_f	Type cathode	E_p	E_{c_1}	E_{c_2}	I_p	I_{c_2}	R_p	μ	S_m	P_o	Capacitance in μmf			Bulb	Base
													G-P	In-put	Out-put		
47	2.5	1.75	F O F O	250	250	-16.5	31	6	60,000	150	2,500	2.7	1.2	8.6	13.0	ST-16	M 5
33	2.0	0.26	F O F O	180	180	-18	22	5	55,000	90	1,700	1.4	1.0	8.0	12.0	ST-14	M 5
38	6.3	0.3	H-C O	250	250	-25	22	3.8	100,000	120	1,200	2.5	0.3	3.5	7.5	ST-12	S 5
41	6.3	0.3	H-C O	250	250	-18	32	5.5	68,000	150	2,200	3.4	ST-12	M 6
42	6.3	0.7	H-C O	250	250	-16.5	34	6.5	100,000	220	2,200	3.0	ST-14	M 6
2A5	2.5	1.75	H-C O	250	250	-16.5	34	6.5	100,000	220	2,200	3.0	ST-14	M 6
43	2.5	0.3	H-C O F O	135	135	-20	34	7	35,000	80	2,300	2.0	ST-14	M 6
6A4	6.3	0.3	H-C O F O	180	180	-12	22	3.9	45,500	100	2,200	1.4	ST-14	M 5

49. Dual-grid Power Amplifiers. Tubes of this class have a cathode, two grids, and a plate. When the two grids are connected together and used as a single grid, the resulting characteristics are suitable for use as a class B power output tube. When the inner grid is used as the control grid and the outer grid is connected to the plate the resulting characteristics are suitable for class A power amplification, suitable for driving the class B stage.

The characteristics of typical tubes have for class B operation a quiescent plate current of 2 and 6 ma, plate-voltage ratings of 180 and 400 volts, class B a-f power output for two tubes of 3.5 and 20 watts. For class A operation the maximum plate-voltage ratings are 135 and

250 volts. The corresponding grid-bias voltages are -20 and -33 volts, the amplification factors 4.7 and 5.6, plate resistance 4,175 and 2,380 ohms, the transconductance 1,125 and 2,350 micromhos, the class A power output 0.17 and 1.25 watts.

TYPICAL DUAL-GRID POWER AMPLIFIERS

Type		E_f	I_f	E_p	E_c	I_p	R_p	μ	S_m	P_o	Bulb	Base
46	{Tri.	250	-33	22	2,380	5.6	2,350	1.25	S-17	{M 5
	{Cl. B	2.5	1.75	400	0	6	20		
49	{Tri.	135	-20	6.0	4,175	4.7	1,125	0.17	ST-14	{M 5
	{Cl. B	2.0	0.12	180	0	2	3.5		

50. Triple-grid Power Amplifiers. The triple-grid power amplifier tube is a universal type of power amplifier tube. With various connections of the grids it may be used as a class A triode, class B triode, or class A pentode power amplifier.

Using the inner grid for the control grid, with the two outer grids connected to the plate, it operates as a class A power amplifier suitable for driving a class B power amplifier.

With the two inner grids connected together as the control grid and the outer grid connected to the plate, operation as a class B power amplifier is obtained.

For pentode operation the inner grid is used as the control grid, the second grid as the screen, and the outer grid as the suppressor. Two typical tubes of this type have characteristics as follows:

TRIPLE-GRID POWER AMPLIFIERS

Type		E_f	I_f	E_p	E_{c_2}	E_{c_1}	I_p	I_{c_2}	R_p	μ	S_m	P_o	Bulb	Base
59	{Tri.	2.5	2.0	250	...	-28	26	...	2,300	6	2,600	1.25	ST-16	{M 7
	{Pent.	250	250	-18	35	9	40,000	100	2,500	3.0		
	{Cl. B	400	...	0	13	20		
89	{Tri.	6.3	0.4	250	...	-31	32	...	2,600	4.7	1,800	0.9	ST-12	{S 16
	{Pent.	250	250	-25	32	5.5	70,000	125	1,800	3.4		
	{Cl. B	250	...	0	3	3.5		

51. Class B Twin Amplifiers. Class B twin-amplifier tubes as the name implies consist of two triode class B a-f amplifier structures in a single bulb.

Like other special class B tubes these tubes operate in a push-pull circuit with zero control-grid bias voltage. The initial plate current of typical tubes listed below ranges from 10 to 17.5 ma. For maximum plate voltages ranging from 135 to 300 volts, the power output of these small-sized tubes ranges from 2.1 to 10 watts. A small power amplifier tube is used to drive the class B tube.

TYPICAL CLASS B TWIN AMPLIFIERS

Type		E_f	I_f	Type cathode	E_p	E_c	I_p	R_p	μ	S_m	P_o	Bulb	Base
19	Cl. B	2.0	0.26	F O	135	...	10	2.1	ST-12	{S 6
53	Tri.	2.5	2.0	H-C O	294	-6	7	11,000	35	3,200	0.400		
	Cl. B	2.5	2.0	H-C O	300		17.5	10	ST-14	{M 7
6A6	Cl. B	6.3	0.8	H-C O	300	...	17.5	10	ST-14	
79	Cl. B	6.3	0.6	H-C O	250	...	10.5	8.0	ST-12	{S 6

52. Calculation of Power Output and Distortion. To calculate the power output and distortion of a power tube, draw a line on the $I_p - E_p$ characteristic curves representing the load resistance. The line is drawn through the operating point with the reciprocal slope (voltage to current ratio) equal to the resistance of the load.

A pure sine wave (or cosine wave) signal voltage is assumed to be effective on the grid. At certain values of bias voltage E_c corresponding to selected points on the signal voltage wave, the plate current is noted. With these values of plate current the power output and distortion are calculated as shown by the following example for the type 47 tube.

$$\begin{array}{ll}
 E_c = 0 & = 0 & I_{\max.} & = .0585 \\
 E_c = .293E & = -4.47 & I_x & = .0527 \\
 E_c = E & = -15.25 & I_{po} & = .0320 \\
 E_c = 1.707E & = -26.03 & I_y & = .0107 \\
 E_c = 2E & = -30.50 & I_{\min.} & = .0052
 \end{array}$$

Static operating point is $E_B = E_{c2} = 250$ volts, $E_{c1} = -15.25$ volts, $E_f = 2.5$ volts d.c., $I_{po} = 32.0$ ma. Load resistance = 7,000 ohms. The plate current corresponding to values of bias voltage not shown on the $I_p - E_p$ curves can be obtained by plotting a curve of the known values of I_p vs. E_c from which intermediate points may be read.

$$\begin{aligned}
 e_g &= E \cos \omega t \\
 i_p &= I_0 + I_1 \cos \omega t + I_2 \cos 2 \omega t + I_3 \cos 3 \omega t \\
 I_0 &= +\frac{1}{8}[I_{\max.} + I_{\min.} + 2(I_x + I_{po} + I_y)] \\
 I_1 &= +\frac{1}{4}[I_{\max.} - I_{\min.} + \sqrt{2}(I_x - I_y)] \\
 &= \frac{1}{4} [.0585 - .0052 + 1.414(.0527 - .0107)] = .0282 \\
 I_2 &= +\frac{1}{4}[I_{\max.} + I_{\min.} - 2I_{po}] \\
 &= \frac{1}{4} [.0585 + .0052 - 2 \times .0320] = -.00007 \\
 I_3 &= +\frac{1}{4}[I_{\max.} - I_{\min.} - \sqrt{2}(I_x - I_y)] \\
 &= \frac{1}{4} [.0585 - .0052 - 1.414(.0527 - .0107)] = -.0015
 \end{aligned}$$

$$\text{Power output} = \frac{1}{2} I_1^2 R = \frac{1}{2} (.0282)^2 \times 7,000 = 2.77 \text{ watts}$$

$$\text{Percentage second harmonic} = \frac{I_2}{I_1} \times 100 \text{ per cent} = \frac{.00007}{.0282} \times 100$$

$$\text{per cent} = 0.25 \text{ per cent}$$

$$\text{Percentage third harmonic} = \frac{I_3}{I_1} \times 100 \text{ per cent} = \frac{.0015}{.0282} \times 100$$

$$\text{per cent} = 5.3 \text{ per cent}$$

The power output and distortion with various load impedances are shown in Fig. 24. The second harmonic distortion is a minimum near the rated 7,000-ohm load. The harmonic distortion increases with the load. The total distortion is the vector sum of the second and third harmonics, since the magnitude of the higher-frequency components is small. The power output for minimum distortion is near the maximum obtainable.

53. Screen-grid Amplifiers. The screen-grid amplifier tube possesses properties which make it markedly superior to a triode for amplification of r-f or a-f voltages. It is also a good detector tube.

Prior to the advent of screen-grid tubes r-f circuits using triode tubes had to be stabilized by special circuit arrangements to avoid feed-back through the grid-plate capacitance which caused oscillation. Due to the low value of control grid to plate capacitance in a screen-grid tube (about 0.01 μmf) the feed-back is negligible and stable operation results without the use of critically balanced circuits. Also the screen grid has the effect of greatly increasing the plate resistance and, since the mutual conductance is not decreased, the effective value of amplification factor ($\mu = R_p S_m$) is very large. In use, the high plate resistance puts less shunt-load resistance across any tuned circuit to which it is connected. The result is a more sharply tuned circuit with higher over-all impedance. The net result is higher voltage amplification and greater selectivity. For example, with triode tubes a voltage amplification of 20 per stage is considered high at broadcast frequencies, while with screen-grid tubes a gain in excess of 100 per stage is easily obtained. At intermediate frequencies a gain of 200 to 400 per stage is readily obtained.

The screen-grid tube has a cathode, two grids, and a plate. The inner grid is used as the control grid, to which signal and bias voltages are applied. The outer grid serves as an electrostatic screen between the plate and the inner structure. It is operated at a fixed positive potential ordinarily not higher than about one-half to one-third of the plate voltage.

The characteristics of typical tubes show plate currents ranging from 1.7 to 4.0 ma, plate resistance from 0.3 to 1.2 megohms, transconductance from 500 to 1,080 micromhos, and grid to plate capacitance from 0.02 to 0.007 μmf .

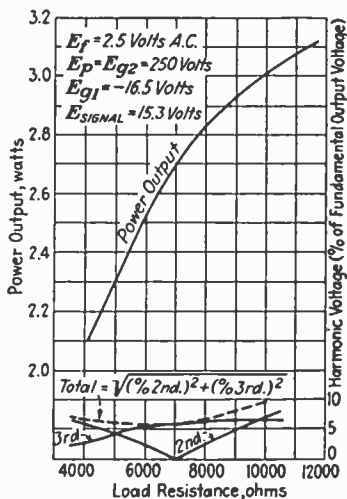

Fig. 24.—Output characteristics of pentode power tube.

TYPICAL SCREEN-GRID AMPLIFIERS

Type	E_f	I_f	Type cathode	E_p	E_{s1}	E_{s2}	I_p	I_{c2}	R_p megohms	μ	S_m	Capacitance in μmf			Bulb	Base
												G-P	In- put	Out- put		
22	3.3	0.132	F O	135	67.5	-1.5	3.7	1.3	0.325	160	500	0.02	3.5	10	ST-14	M 4
24A	2.5	1.75	H-C O F O	250	90	-3.0	4.0	1.7	0.600	630	1,050	0.007	5.3	10.5	ST-14	M 4
32	2.0	0.060	F O	180	67.5	-3.0	1.7	0.4	1.2	780	650	0.015	5.3	10.5	ST-14	M 4
36	6.3	0.3	H-C O	250	90	-3.0	3.2	1.7	0.55	595	1,080	0.007	3.7	9.2	ST-12	S 5

54. Triple-grid Detector Amplifiers. Triple-grid detector amplifier types have, as the name implies, three grids, a cathode, and a plate. Although the three grids all have external terminals to permit various connections in circuits, these tubes are most frequently operated as pentode voltage amplifiers. With this connection the inner grid functions as the control grid, the second grid as the screen grid, and the outer grid as the suppressor grid.

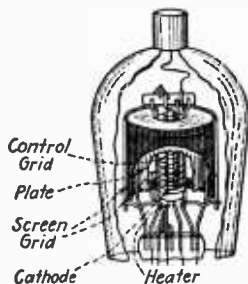

FIG. 25.—Structure of screen-grid tube.

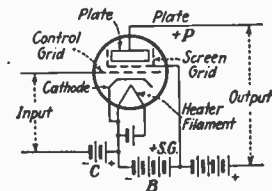

FIG. 26.—Circuit for screen-grid tube.

The operating characteristics are like those of a screen-grid tube except that certain improvements in performance result. The plate resistance is higher and the grid-plate capacitance is lower than for screen-grid tubes. Due to the presence of the suppressor grid, the same voltage can be used on the plate and screen grid. This is possible because there is no secondary emission kink in the plate-characteristic curves. This is an advantage, for example, when operating with a 100-volt supply since the use of 100 volts on the screen grid produces high transconductance and also permits higher signal voltages on the control grid. When large amplitude output voltages are required, this connection permits utilization of nearly the entire range of plate voltage. In some r-f circuits the suppressor grid is used for modulation. In one circuit, that of an electron-coupled oscillator, the suppressor grid is grounded so that it functions as an electrostatic screen.

When used as a voltage amplifier for audio frequencies, high gain, large amplitude output, and low distortion can be obtained with this type of

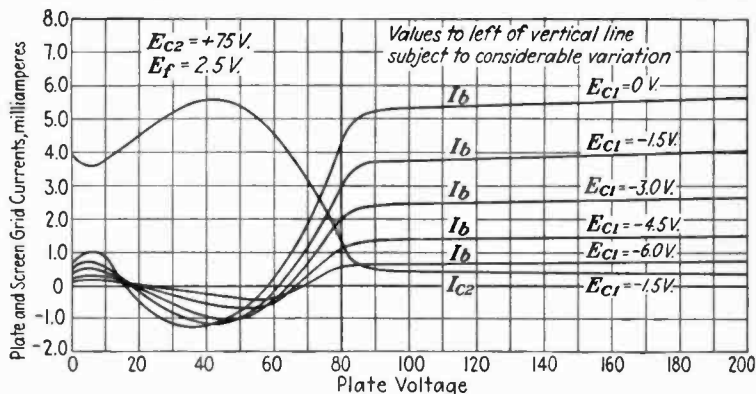

FIG. 27.—Type-24 screen-grid characteristics.

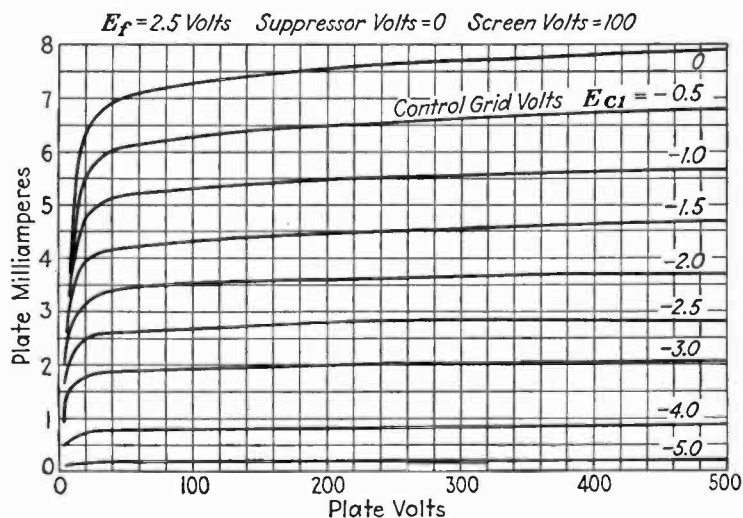

FIG. 28.—Average plate characteristics, type 57.

tube. Operating characteristics of the 57, for example, are as follows: plate-supply voltage, 250 volts; screen voltage, 50 volts; grid bias, minus 2.1 volts; self-bias resistor, 3,500 ohms; plate-load resistor,

250,000 ohms; grid resistor of following stage, 0.5 megohm; plate current 0.48 ma, peak output, 60 to 70 volts, voltage amplification, 100.

As a detector, owing to the sharp cut-off, the sensitivity is high and the distortion low. A high-resistance plate load is used. A suitable con-

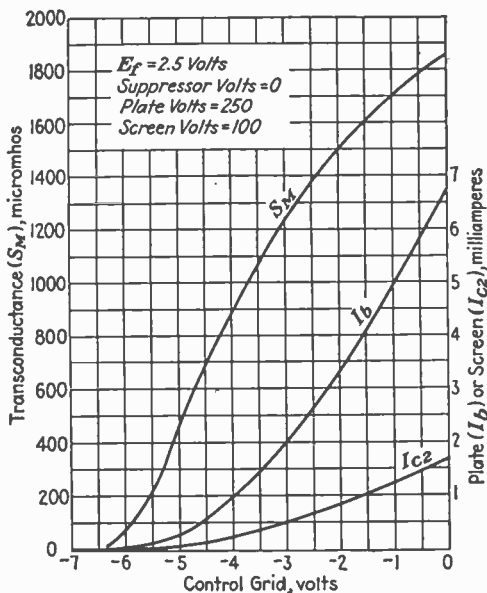

FIG. 29.—Average characteristics, type 57.

dition for operating the type 57 is the same as shown above for a-f amplification.

As shown below, typical tubes of this class operate with 250 volts on the plate, 100 volts on the screen grid and minus 3 volts on the control

TYPICAL TRIPLE-GRID DETECTOR AMPLIFIERS

Type	E_f	I_f	Type cathode	E_p	E_{s2}	E_{c1}	I_p	I_{c2}	E_p	μ	S_m	Capacitance in μmf			Bulb	Base
												G-P	In-put	Out-put		
57	2.5	1.0	{ H-C O	250	100	-3	2.0	0.5	71.5	71,500	1,225	0.007	5.0	6.5	ST-12	{ S 6
77	6.3	0.3	{ H-C O	250	100	-3	2.3	0.5	1.5	1,500	1,250	0.007	4.7	11.0	ST-12	{ S 6
6C6	6.3	0.3	{ H-C O	250	100	-3	2	0.5	71.5	71,500	1,225	0.010	5.0	6.5	ST-12	{ S 6

grid. Operating conditions for small r-f voltages have a plate resistance of 1.5 megohms or more, plate current of 2.0 to 2.3 ma, transconductance of 1,225 to 1,250 micromhos, and grid-plate capacitance of 0.007 to 0.010 $\mu\mu\text{f}$.

55. Screen-grid Supercontrol Amplifiers. The screen-grid supercontrol amplifier tube differs from the ordinary screen-grid amplifier type in that it has a remote plate-current cut-off characteristic (variable-mu effect) instead of the usual cut-off characteristic of the detector amplifier type of tube. The supercontrol type is designed for use in radio- and intermediate-frequency amplifier circuits where the stage gain is to be controlled by means of grid-bias voltage. It is effective in reducing

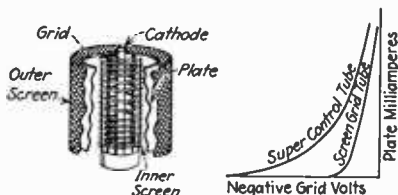

FIG. 30.—Variable-mu or supercontrol tube.

cross-modulation and modulation distortion over a large range of signal voltages. A change in grid-bias voltage from minus 3 volts to minus 40 volts changes the transconductance from 1,050 to 15 micromhos. This corresponds to a change in gain of approximately 70 to 1 per stage. At the minus 40-volt bias point a signal amplitude of approximately 10 volts can be accommodated without serious distortion.

As a mixer tube or first detector in superheterodyne circuits the following voltages are suitable (for type 35 tube): plate voltage, 250 volts; screen voltage 90 volts; and grid bias minus 4 volts, with a 6-volt peak swing from the oscillator. By increasing the grid bias on the mixer in conjunction with that on the radio- and intermediate-frequency stages, some additional control (should be less than on other stages) of volume may be accomplished.

Characteristics of a typical tube are as follows:

TYPICAL SCREEN-GRID SUPERCONTROL AMPLIFIER

Type	E_f	I_f	Type cathode	E_p	E_{c_2}	E_{c_1}	I_p	I_{c_2}	R_p	μ	S_m	Capacitance in $\mu\mu\text{f}$			Bulb	Base
												G-P	In-put	Out-put		
35	2.5	1.75	$\begin{cases} \text{H-C} \\ \text{O} \end{cases}$	250	90	-3.0	6.5	2.5	0.4	420	1,050	0.007	5.3	10.5	ST-14	$\begin{cases} \text{M} \\ 5 \end{cases}$

Supercontrol r-f amplifier pentodes with internally connected suppressor grids are operated the same as screen-grid supercontrol amplifier tubes. The plate resistance of this type is somewhat higher. The

secondary emission kink in the plate characteristics is eliminated so that screen grid and plate may be operated on the same voltage when low-voltage operation is desired.

The characteristics of typical tubes are as follows:

TYPICAL SUPERCONTROL R-F PENTODE AMPLIFIER

Type	E_f	I_f	Type cathode	E_p	E_{c_2}	E_{c_1}	I_p	I_{c_2}	R_p	μ	S_m
34	2.0	0.060	$\left\{ \begin{array}{l} \text{F} \\ \text{O} \\ \text{H-C} \\ \text{O} \end{array} \right.$	180	67.5	-3.0	2.8	1.0	1.0	620	620
39-44	6.3	0.3		250	90	-3.0	5.8	1.4	1.0	1.050	1,050

56. Triple-grid Supercontrol Amplifiers. The triple-grid supercontrol amplifier types like the triple-grid detector amplifier types have three grids, a cathode, and a plate. This type is particularly suited for use as a radio- and intermediate-frequency amplifier. With the usual connection of the three grids a pentode type of characteristic results. The operating characteristics are similar to the triple-grid detector amplifier types except for somewhat lower plate resistance, higher mutual conductance, higher plate current, and a remote plate-current cut-off characteristic. The remote cut-off characteristic permits a large range of control of amplification of r-f voltages without cross-modulation or modulation distortion. It is useful also as a first detector in superheterodyne circuits, but is not generally satisfactory for use as the second detector or for use as an a-f amplifier. For these latter applications the sharp plate-current cut-off detector amplifier type should be used.

The characteristics of typical tubes of this type show higher plate current for low bias voltages than for the detector amplifier triple-grid tubes. The plate-characteristic curves show a continuously decreasing effect of grid-bias voltage on plate current as the negative bias voltage is increased (variable-mu effect). This gradual decrease in plate-current and large bias voltage required for plate-current cut-off permits the use of large signal voltages while the tube is biased to reduce amplification without distortion or cross-modulation of the radio- and intermediate-frequency voltages. The plate resistance of this type tends to be less than for the sharp cut-off type. The values of 0.6 to 0.8 megohm are high enough to prevent excessive loading of the tuned circuits. Voltage amplification greater than 100 at broadcast frequencies and from 200 to 400 at intermediate frequencies is readily obtained.

In operation with voltages as shown in tabulation on page 267, the grid-bias voltage (E_{c_1}) can be made variable from minus 3 volts to minus 40 volts for gain control of radio- or intermediate-frequency stages. As a mixer tube a grid bias of minus 10 volts is used for an oscillator voltage of 7 peak volts. Consideration should be given to the amplitude of the signal voltages to be expected in each stage and the bias-voltage range should be limited accordingly. The signal voltage should never cause the grid to swing far enough in the positive direction to permit grid current to flow, nor far enough in the negative direction to exceed the plate-current cut-off point.

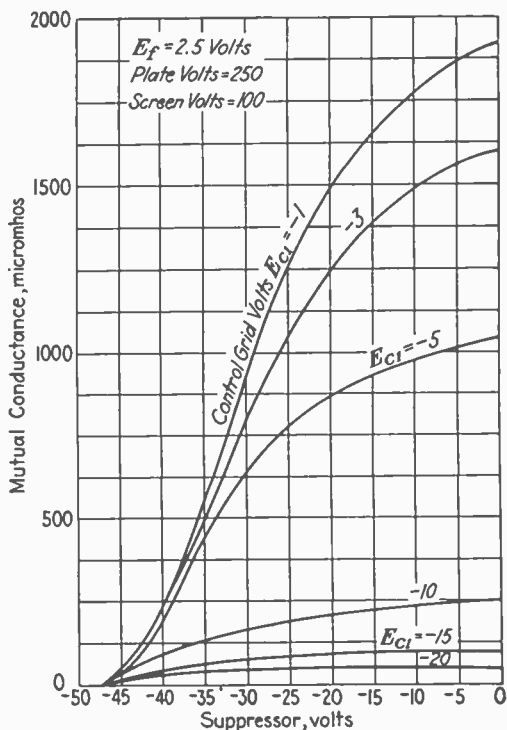

FIG. 31.—Suppressor-grid characteristic, type 58.

TYPICAL TRIPLE-GRID SUPERCONTROL AMPLIFIERS

Type	E_f	I_f	Type cathode	E_p	E_{c2}	E_{c1}	I_p	I_{c2}	R_p	μ	S_m	Capacitance in $\mu\mu\text{f}$			Bulb	Base
												G-P	In-put	Out-put		
58	2.5	1.0	H-C O	250	100	-3	8.2	2.0	0.8	1,280	1,600	0.007	4.7	6.5	ST-12	$\begin{Bmatrix} 8 \\ 6 \end{Bmatrix}$
78	6.3	0.3	H-C O	250	125	-3	10.5	2.6	0.6	990	1,650	0.007	4.5	11.0	ST-12	$\begin{Bmatrix} 8 \\ 6 \end{Bmatrix}$
6D6	6.3	0.3	H-C O	250	100	-3	8.2	2.0	0.8	1,280	1,600	0.010	4.7	6.5	ST-12	$\begin{Bmatrix} 8 \\ 6 \end{Bmatrix}$

57. Duplex-diode Triodes. The duplex-diode triode tubes have an amplifier triode and two small diodes in a single bulb. Usually the cathode of all units has a common connection. The diodes are small units used with high-resistance loads (peak currents less than approximately 0.5 ma) for detection and gain-regulating circuits. The triode is of the general type of detector amplifier triodes.

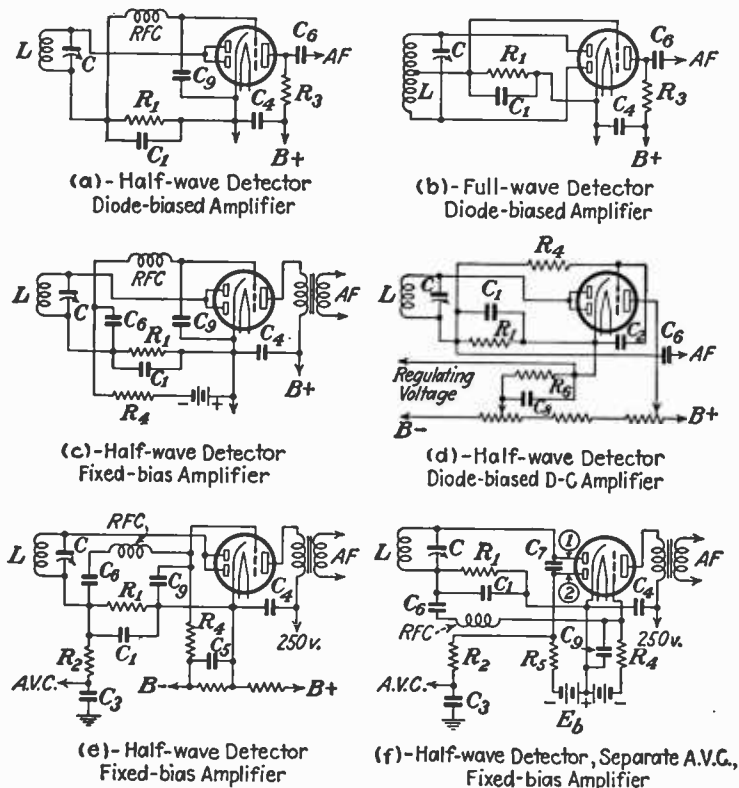

FIG. 32.—Typical duplex-diode triode circuits.

Typical tubes of this type have triodes with amplification factors of 8.3 and 100, plate resistance of 7,500 and 91,000 ohms, transconductance of 1,100 micromhos. The medium-amplification-factor type can be used as a transformer-coupled a-f amplifier, with one diode for detection and the other as an automatic volume control. Various other uses in circuits will be evident. The high-amplification-factor type is suitable for use as a resistance-coupled a-f amplifier, with one diode as a detector and the other for gain control or various other circuit arrangements.

TYPICAL DUPLEX-DIODE TRIODES

Type	E_f	I_f	E_p	E_{c1}	I_p	R_p	μ	S_m	P_o mw	Capacitance in $\mu\mu\text{f}$			Bulb	Base
										G-P	Input	Output		
55	2.5	1.0	250	-20	8.0	7,500	8.3	1,100	350	1.5	1.5	4.3	ST-12	{ 8 6 8 6 8 6 8 6
85	6.3	0.3	250	-20	8.0	7,500	8.3	1,100	350	1.5	1.5	4.2	ST-12	
75	6.3	0.3	250	-2	0.8	91,000	100	1,100	ST-12	
2A6	2.5	0.8	250	-2	0.8	91,000	100	1,100	..	1.7	1.7	3.8	ST-12	

58. Duplex-diode Pentodes. These types like the duplex-diode triode types have two small diodes for use as detectors or gain control, and a pentode voltage amplifier unit in a single bulb. The pentode unit may be used for either r-f or a-f amplification. Thus the pentode may operate as an intermediate-frequency amplifier supplying signal to the diode units functioning as detector and gain-control units, or the pentode may function as a resistance-coupled a-f amplifier following the diode units.

TYPICAL DUPLEX-DIODE PENTODES

Type	E_f	I_f	Type cathode	E_p	E_{c2}	E_{c1}	I_p	I_{c2}	R_p	μ	S_m	Capacitance in $\mu\mu\text{f}$			Bulb	Base
												G-P	In-put	Out-put		
2B7	2.5	0.8	{H-C O	250	125	-3	9	2.3	0.65	730	1,125	0.007	3.5	9.5	ST-12	{ 8 7 8
6B7	6.3	0.3	{H-C O	250	125	-3	9	2.3	0.65	730	1,125	0.007	3.5	9.5	ST-12	

59. Triode Pentode. This tube exemplified by the type 6F7 has a pentode voltage amplifier unit and a small triode unit in a single bulb. The two units operate independently except that a common cathode connection is used.

Various uses for this multi-unit tube will be evident to the reader. The principal advantage is economy of space; the disadvantage is that failure of one unit requires replacement of the entire tube.

The characteristics of the two sections of this tube are as follows:

TYPICAL TRIODE PENTODE

Type	E_f	I_f	Type cathode	E_p	E_{c2}	E_{c1}	I_p	I_{c2}	R_p	μ	S_m	Capacitance in $\mu\mu\text{f}$			Bulb	Base	
												G-P	In-put	Out-put			
6F7	6.3	0.3	{H-C O	Pent. Triode	250 100	100 ...	-3 -3	6.5 3.5	1.5 ...	0.85 17,800	900 8	1,100 450	0.008 2.0	3.2 2.5	12.5 3.0	ST-12 ST-12	{ 8 7

60. Pentagrid Converters. The pentagrid-converter tube has a cathode, five grids, and an anode. It is designed to perform the combined functions of oscillator and first detector in a superheterodyne circuit. The electrode starting from the cathode, and counting outward (the usual method for designating grids by number) are first (No. 1 grid) the oscillator control grid; next (No. 2 grid) the oscillator anode; grids 3 and 5, connected together within the tube, are used to accelerate the electron stream from the cathode (similar to the operation of the screen

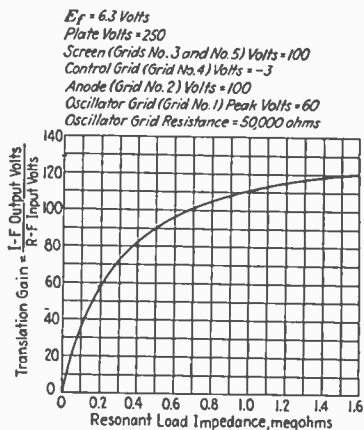
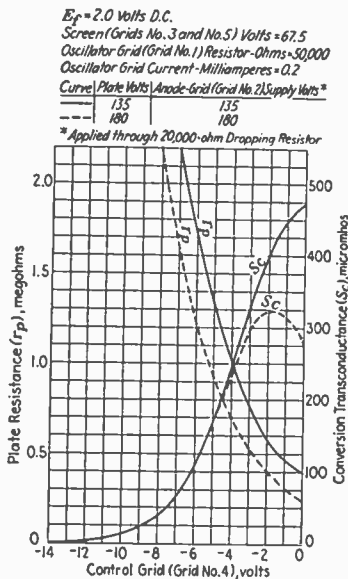

FIG. 33.—Characteristics of pentagrid converters 1C6, left; 6A7, right.

grid in screen-grid and pentode tubes); and grid 4 operates as the signal control grid. The grids 3 and 5 shield grid 4 from the inner and the plate electrodes and give the tube a high plate resistance. The high plate resistance permits the use of high-impedance loads resulting in high gain and selectivity.

In operation the electron stream is initially modulated at oscillator frequency by the inner electrodes. The incoming r-f signal, applied to grid 4 further modulates the electron stream, thus producing components of plate current, the frequencies of which are the various combinations of the oscillator and signal frequencies. Since the primary circuit of the first intermediate-frequency stage is designed for resonance at the intermediate frequency (equal to the difference between the oscillator and signal frequencies), only the desired intermediate frequency will be present in the secondary of the intermediate-frequency transformer.

In use, the oscillator coils are designed with a little greater coupling between grid and oscillator anode coils than is commonly used with triode

oscillators. A ratio of mutual inductance between these coils to the inductance of the grid coil (tuned coil) of 0.25 to 0.40 is satisfactory. Higher values of coupling may cause difficulty in tracking the oscillator frequency to the signal frequency.

The translation gain is given by the relation

$$A = \frac{aS_c Z r_p}{(Z + r_p)}$$

where a = voltage ratio of the I_f transformer

S_c = conversion transconductance

Z = effective impedance of I_f transformer across input terminals

r_p = plate resistance of the tube.

With transformers ordinarily used a translation gain of approximately 60 or with special high-impedance transformers a gain of 100 can be readily obtained.

The characteristics of typical tubes of this type are as follows:

TYPICAL PENTAGRID CONVERTERS

Type	E_f	I_f	E_p	$E_{c_{1-3}}$	E_{c_2}	E_{c_4}	E_{c_1}	I_p	I_{1-3}	I_{c_2}	I_{c_1}	R_p	S_c
1A6	2.0	0.06	180	67.5	135	-3	50,000 Ω	1.3	2.4	2.3	0.2	0.5	300
1C6	2.0	0.12	180	67.5	135	-3	50,000 Ω	1.5	2.0	3.3	0.2	0.75	325
2A7	2.5	0.8	250	100	200	-3	50,000 Ω	3.5	2.2	4.0	0.7	0.36	520
6A7	6.3	0.3	250	100	200	-3	3.5	2.2	4.0	0.7	0.36	520

61. Metal Tubes. Metal radio tubes employ a metallic envelope instead of a glass envelope for maintaining a vacuum in the space surrounding the electrodes of the tube. The structure of the tube electrodes is similar to that used in glass-bulb tubes. The metallic envelope offers the following advantages: Elimination of additional tube shields; better shielding of tube electrodes from stray fields than with metal-coated glass bulbs or shield cans; greater mechanical strength; and a smaller size.

This construction also permits better dissipation of the heat developed at the anode.

The metal radio tubes have the octal type of base having a central lug which aids in locating the tube in the socket. There are eight pin positions on the base, the same spacings being used on all types except that pins are omitted or included as needed. This permits the use of one type of socket for a greater number of tube types. This is of considerable advantage, for example, in testing tubes where the large number of sockets and electrode combinations unduly complicates the equipment.

The characteristics of the metal radio tubes are similar to other tubes of the same general type.

The following are some typical metal radio tubes:

Type	Type Function
6C5	Detector amplifier triode
6D5	Power amplifier triode
6H6	Twin diode (for detection, a.v.c., etc)
6J7	Triple-grid detector amplifier
6K7	Triple-grid supercontrol amplifier
6A8	Pentagrid converter
6L7	Pentagrid mixer amplifier

62. Ultra-high Frequency Tubes. At frequencies above 60 Mc (wave lengths below 5 meters) conventional tubes and circuits give poor performance. By means of tubes specially designed for ultra-high frequencies, the performance can be greatly improved. For low-power circuits and for receiving circuits, these special tubes of unusually small dimensions are used. These tubes, known as *acorn* types, because of their appearance, permit the use of conventional circuits in the frequency range of 60 to 300 Mc and higher.

A small glass bulb with the electrode connections sealed directly through the center and end portions of the bulb is used. There is no base on these tubes. The electrode terminals appear directly on the bulb and

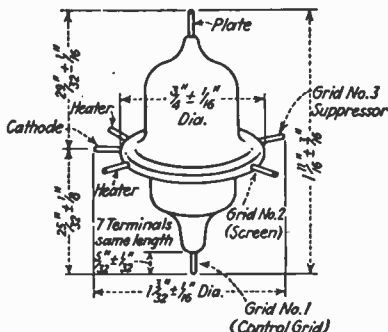

FIG. 34.—Acorn pentode.

are made strong enough for insertion in a socket. The electrodes are similar to those in other types of tubes except that, owing to the unusually small dimensions, special design and construction are required. A cathode of the indirectly heated type operating on 6.3 volts and a low value of current is used.

Some of the advantages of this type of tube are low electrode capacitance, low electrode connecting lead inductance, small electron transit time, and small space requirement.

The type 955 detector, amplifier, oscillator triode tube can, for example, be used as follows:

As a resistance-coupled a-f amplifier: Plate-supply voltage, 180 volts; grid bias, minus 3.5 volts; plate-load resistor, 250,000 ohms; and plate current, 0.42 ma. The grid resistor may be made as high as 0.5 megohm. With these voltages, an undistorted voltage output of 45 volts may be obtained. The voltage amplification is approximately 20.

As a grid-leak detector a plate voltage of 45 volts, a grid leak of 1 to 5 megohms, and condenser of 0.00025 μ f is used.

As a grid-biased detector a bias of minus 7 volts is suitable for use with a plate-supply voltage of 180 volts. The initial plate current should be a little less than 0.2 ma. For self-bias a resistor of approximately 50,000 ohms should be used.

As an oscillator or r-f (Class C) amplifier, a grid resistor of 20,000 to 25,000 ohms in series with choke coil is used. Conventional circuits can be employed except that special care in making connections and in providing by-pass

condensers directly at the point required with a minimum of connecting leads should be used.

The type 954, detector amplifier pentode may be operated in any circuits requiring this type tube.

As a *r-f amplifier* of frequencies up to approximately 400 Mc operating conditions may be as follows:

Plate voltage.....	250 volts	Screen voltage.....	100 volts
Grid bias.....	-3 volts	Suppressor grid connected to cathode	
Plate current.....	2.0 ma	Screen current.....	0.7 ma
Transconductance.....	1,400 micromhos		
Plate resistance greater than	1.5 megohms		

As an *a-f amplifier* typical operating conditions are as follows:

Plate-supply voltage.....	250 volts	Suppressor, connected to cathode at socket	
Screen voltage.....	50 volts	Plate-load resistor.....	250,000 ohms
Grid bias.....	-2.1 volts	Plate current.....	0.5 ma

The grid resistor may be made as high as 1.0 megohm. Under these conditions, an undistorted voltage output of 40 to 50 volts root-mean-square may be obtained. The voltage amplification is approximately 100.

INTERELECTRODE CAPACITANCE

63. Tube-equivalent Network. The capacitances between the grid, plate, and filament of a triode are illustrated in Fig. 35 and also the equivalent mesh network. These are the direct interelectrode capacitances of the tube. In general, an n -electrode tube has N direct interelectrode capacitances, where

$$N = \frac{n}{2}(n - 1)$$

The direct interelectrode capacitance is the standard method of specifying the tube capacitances. It is preferred to the older methods of measurement with one electrode floating or, between one electrode and the other electrodes connected together. Either of these methods leads to results

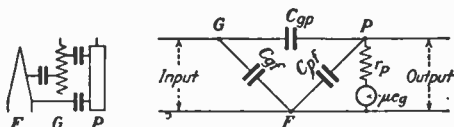

FIG. 35.—Interelectrode capacity network.

which are not independent of the particular arrangement of apparatus. The direct interelectrode capacitance is the same regardless of the type of measuring circuit. The capacitance of the socket and socket connections is not included. The tube is usually measured with the cathode cold. When the cathode is heated and voltages applied the capacitance may change a small amount.

The three direct capacitances of a triode are grid-plate capacitance (C_{gp}), grid-cathode capacitance (C_{gf}), and plate-cathode capacitance (C_{pf}). The grid-plate capacitance allows energy feed-back from the plate to the grid circuit having an important effect on the stability and input impedance. The grid-cathode capacitance and the plate-cathode

capacitance shunt the input and output load impedances having some effect on the tuning or frequency characteristics.

The direct interelectrode capacitances of a tetrode are represented in Fig. 36. The six direct capacitances form a three-mesh network. When

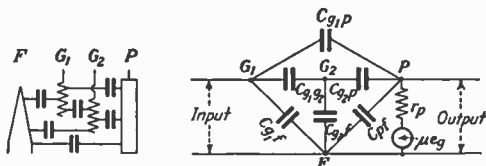

FIG. 36.—Tetrode network.

the tetrode is connected as a screen-grid tube the screen grid G_2 is effectively grounded. The three-mesh network is reduced to an equivalent single-mesh triode network.

The screen-grid cathode capacitance (C_{g2f}) is effectively short-circuited by a large by-pass condenser. The control-grid to screen-grid capacitance (C_{g1g2}) is in parallel with the control-grid to cathode capacitance (C_{g1f}). The screen-grid to plate capacitance (C_{g2p}) is in parallel with the plate to cathode capacitance (C_{pf}). The equivalent network is shown in Fig. 37.

FIG. 37.—Equivalent network of screen-grid tube.

The capacitances of a screen-grid tube are usually stated as the maximum grid-plate capacitance (C_{g1p}), the average input capacitance ($C_{g1f} + C_{g1g2}$), and the average output capacitance ($C_{pf} + C_{g2p}$).

64. Measurement of Interelectrode Capacitance. The direct interelectrode capacitance can be measured with the bridge circuit of Fig. 38. The electrodes to be measured are connected to terminals AB . The remaining electrodes and any shields are connected to the ground terminal G .

When the bridge is balanced the capacitance is

$$C_{AB} \equiv C_{gp} = \frac{R_1 C}{R_2}$$

The resistance R corrects the phase and balances the effect of the capacitance across R_2 .

Any leakage resistance R_{AB} across C_{AB} will cause an error. If the leakage resistance R_{AB} is known, the capacitance C_{AB} is given by the relation

$$C_{AB} = \frac{R_1 C}{R_2} \sqrt{1 - \frac{1}{\omega^2 \left(\frac{R_1 C}{R_2} \right)^2 R_{AB}^2}}$$

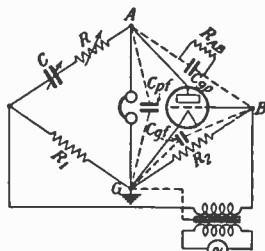

FIG. 38.—Measurement of tube capacitances.

For example if $(R_1C/R_2) = 5.0 \mu\mu f$, the frequency is 1,000 cycles, and R_{AB} is 100 megohms, the correction factor is approximately 0.95 and $C_{AB} = 4.75 \mu\mu f$.

65. Radio-frequency Method. An r-f method of measuring the direct interelectrode capacitances is shown schematically in Fig. 39. The r-f oscillator supplies sufficient voltage to cause a current through C_2 which can be measured with the thermocouple TC . The capacitance C_1 does not affect the measured current if the voltage E is held constant. The reactance of capacitance C_3 is high with respect to the low-resistance thermocouple. The indicating microammeter I has one side grounded. An r-f choke L and by-pass condenser C keep r-f currents out of the capacitance C_2 is given by

$$C_2 = \frac{I}{\omega E}$$

If a standard variable capacitance of slightly greater range than C_2 is available, a substitution method can be used. The standard capacitance is connected across C_2 . It should be enclosed in a grounded shield. The small capacitance to the shield is in parallel with C_1 and C_3 .

In use the meter reading I is noted with the tube in place. The tube is then removed and the standard capacitance is increased until the same meter reading I is obtained. The difference in the two readings of the standard capacitance is the value of the tube capacitance C_2 . The r-f voltage E should be constant. The absolute value of the voltage and current need not be known. A thermocouple with a filter and meter connected in series with a small capacitance across the oscillator terminals can be used as the voltage indicator.

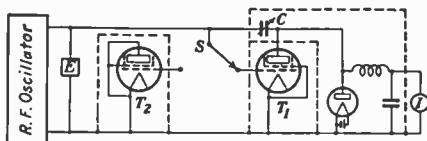

FIG. 40.—Measurement of screen-grid plate-grid capacitance.

66. Grid-plate Capacitance of Screen-grid Tubes. The direct grid-plate capacitance of screen-grid tubes is a small fraction of a micro-microfarad. Bridge measurements are not generally satisfactory. The radio-frequency substitution method is convenient for this purpose. Figure 40 is the schematic circuit. C is a standard capacitance having a range equal to the range of capacitances to be measured. Coaxial cylinder capacitors can be constructed accurately covering an extremely small capacitance range. The thermocouple current indicator should be replaced with a sensitive indicator such as a tube rectifier or carborundum crystal. The plate of the tube should be shielded from the grid. A

balancing tube T_2 of the same type as the tube T_1 being measured serves to maintain the tube input capacitance load on the oscillator. The low-capacity switch S is first thrown to the tube T_1 under test, and the reading of the meter noted. The switch is then thrown to the balance tube T_2 and the standard condenser C adjusted to give the same reading on the meter. The grid-plate capacitance is equal to the change in the standard capacitance.

References

- CARSON, J. R.: A Theoretical Study of the Three-element Vacuum Tube, *Proc. I. R. E.*, April, 1919.
- DUSHMAN, S.: *Gen. Elec. Rev.*, **18**, 156, 1915.
- : Thermionic Emission, *Rev. Modern Phys.*, **2**, October, 1930.
- , and J. W. EWALD: Graphs for Calculation of Electron Emission from Tungsten, Thoriated Tungsten, Molybdenum, and Tantalum, *Gen. Elec. Rev.*, **26**, No. 3, March, 1923.
- , H. N. ROWE, J. EWALD, and C. A. KIDNER: *Phys. Rev.*, **25**, 343, 1925.
- FRY, T. C.: Potential Distribution between Parallel Plane Electrodes, *Phys. Rev.*, **17**, 441, 1921; **22**, 445, 1923.
- GROSZKOWSKI, J.: "Les lampes à plusieurs électrodes," Étienne Chiron, éditeur, Paris, 1927.
- "International Critical Tables," McGraw-Hill Book Company, Inc.
- KING, R. W.: Calculation of the Constants of the Three-electrode Vacuum Tube, *Phys. Rev.*, **15**, No. 4, p. 256, 1920.
- KUSUNOSE, Y.: Calculation of Characteristics and the Design of Triodes, *Proc. I. R. E.*, October, 1929.
- LANGMUIR, I.: Emission from Thoriated Tungsten Filaments, *Phys. Rev.*, **22**, 357, 1923.
- : *Phys. Rev.*, **7**, 154, 302, 1916.
- : *Phys. Rev.*, **34**, 401, 1912.
- : The Effect of Space Charge and Residual Gases on Thermionic Currents in High Vacuum, *Phys. Rev.*, **2**, No. 6, 1913.
- , and KARL T. COMPTON: Electrical Discharges in Gases, *Rev. Modern Phys.*, **3**, April, 1931.
- LLEWELLYN, F. B.: Operation of Thermionic Vacuum Tube Circuits, *Bell System Tech. Jour.*, **5**, July, 1926.
- PETERSON, E., and H. P. EVANS: Modulation in Vacuum Tubes Used as Amplifiers, *Bell System Tech. Jour.*, **6**, July, 1927.
- RICHARDSON, O. W.: "The Emission of Electricity from Hot Bodies," Longmans, Green & Co., 1921.
- "Smithsonian Physical Tables," 1927, p. 403.
- THOMSON, J. J.: "Conduction of Electricity through Gases," 3d ed., Cambridge University Press, 1928.
- VAN DER BIJL, H. J.: "The Thermionic Vacuum Tube," McGraw-Hill Book Company, Inc., 1920.
- VODGES, F. B., and F. R. ELDER: Formulas for the Amplification Constant for Three-electrode Tubes in Which the Diameter of Grid Wires Is Large Compared to the Spacing, *Phys. Rev.*, **24**, December, 1924.
- WARNER, J. C.: Some Characteristics and Applications of Four-electrode Tubes. *Proc. I. R. E.*, April, 1928.

SECTION 9

OSCILLATION

BY W. W. WALTZ¹

1. Conditions for Oscillation. The mathematics of oscillating circuits have been ably demonstrated by many writers.² The discussion which follows is the general mathematical treatment of conditions for oscillation for three-electrode tubes.³ The same method of procedure can be used to show the condition for oscillation for a device having only two electrodes, although the final result will be different in that the

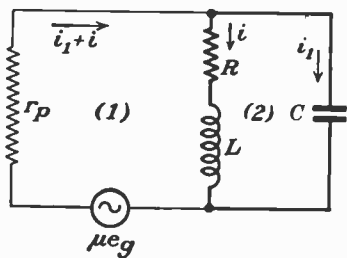

FIG. 1.—Fundamental oscillator circuit.

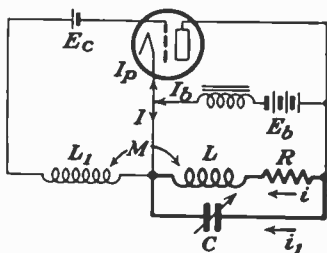

FIG. 2.—Tuned-plate oscillator.

two-electrode device will be shown to possess a negative resistance characteristic.

Consider the fundamental circuit of Fig. 1 in which the heavy lines represent an oscillatory circuit connected across the plate and filament of a vacuum tube having a plate resistance r_p . Figure 2 shows the circuit from which this fundamental schematic was derived.

Because of the mutual inductance between L and L_1 , variations in the current through L cause varying e.m.fs. to be impressed upon the grid. If R is small, any current flowing in the plate circuit will establish an e.m.f. in the circuit LC which is 90 deg. out of phase with the plate current. LC is, theoretically, non-reactive, hence the current through this circuit is in phase with the voltage across it. The current through L , therefore, induces an e.m.f. in L_1 90 deg. out of phase. Thus it is seen

¹ Consulting Engineer, Staten Island, New York.

² HAZELTINE, L. A., *Proc. I.R.E.* April, 1918; HULL, L. M., *Bur. Standards Sci. Paper* 355, December, 1919; PRINCE, D. C., *Proc. I.R.E.*, June, August, October, 1923.

³ VAN DER BIJL, H. J., "The Thermionic Vacuum Tube," McGraw-Hill Book Company Inc., 1920.

that the varying e.m.f. impressed on the grid of the tube is in phase with the plate-current variations.

Certain assumptions are made by Van der Bijl¹ to simplify the discussion; it will be assumed that the grid is sufficiently negative to prevent the flow of grid current; all interelectrode capacities will be neglected; the LC circuit is non-reactive at the oscillation frequency.

A current i in the coil L induces a voltage e_g in the coil L_1 . This is given by

$$e_g = M \frac{di}{dt} = jM\omega i \quad (1)$$

Since a voltage e_g on the grid of a tube introduces a voltage equal to μe_g in the plate circuit, the above equation becomes

$$\mu c_g = \mu jM\omega i \quad (2)$$

The solution of the circuit now involves only the application of Kirchhoff's laws to the network of Fig. 1, leading to a differential equation whose solution gives, as the condition of oscillation,

$$r_p = \frac{\mu M}{CR} - \frac{L}{CR} \quad (3)$$

Equation (3) shows that in a three-electrode tube circuit the resistance need not be negative, provided the term $\mu M/CR$ is great enough. The amplification constant appearing in this expression shows that the ability of a three-electrode tube to oscillate is directly dependent upon its ability to amplify.

Equation (3) may be written in the forms,

$$S_m = \frac{\mu}{r_p} \geq \frac{L}{r_p M} + \frac{CR}{M} \quad \text{or} \quad S_m = \frac{\mu}{r_p} \geq \frac{CR}{M - \frac{L}{\mu}} \quad (4)$$

in which $S_m (= \mu/r_p)$ is the tube transconductance. For small oscillations S_m is given by the slope of the e_g/i_p characteristic; for large oscillations S_m is approximately equal to the slope of a line joining the points of maximum and minimum current on the characteristic curve. As the intensity of the oscillations increases, more and more of the e_g-i_p characteristic is utilized and the slope of this line decreases. Equation (4) shows that S_m must be greater than some quantity involving the constants of the external circuit in order that oscillations be sustained. Since S_m is approximately proportional to the plate voltage, $\mu/r_p (= S_m)$ and r_p can be replaced by E_p and some constant. Since, for the tube to oscillate, S_m must be larger than some minimum value, it can be seen that the tube will not oscillate until E_p reaches a certain minimum value. This value is fixed, if the other quantities (coupling, etc.) are fixed. These remarks indicate the desirability of having S_m as large as possible.

The frequency of oscillation is controlled largely by L and C , but the plate resistance of the tube and the resistance of the oscillatory circuit also play a part. In a well-designed circuit the resistance is small, so that the frequency is given by the well-known expression $f = 1/2\pi\sqrt{LC}$.

¹ *Loc. cit.*

In an oscillating circuit the plate current and grid voltage should be in phase, as nearly as possible. The phase relations are shown in Fig. 3. Since the plate characteristic of the tube is not a straight line but is curved, sinusoidal voltages on the grid will not produce sinusoidal oscillations of plate current but will produce harmonics. These cause a wastage of power. In general, these harmonics will not appear in the

load circuit which is usually tuned to the oscillatory circuit. Since such a tuned circuit has low impedance to frequencies higher (and lower) than its own natural frequency, these harmonic currents in the plate circuit will not induce high harmonic voltages in the load circuit. In cases where a particularly pure output

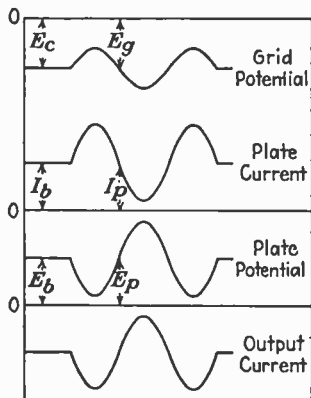

FIG. 3.—Oscillator phase relations.

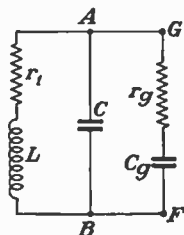

FIG. 4.—Input capacitances.

is desired, special means must be taken to restrict the development of harmonic voltages.

Thus far no consideration has been given to the effect of the inter-electrode capacities of the tube. These can result in oscillations, even if there is no mutual inductance between the output and input coils. Because of these capacities there is an effective impedance between the grid and filament of the tube. The value of this impedance depends upon the load conditions of the output circuit as well as the capacity between grid and plate. This impedance, which in Fig. 4 is represented by a resistance r_g and reactance C_g (the effective input capacity), is given by

$$Z = \frac{1 + j\omega r_g C_g}{-\omega^2 r_g C_g C + j\omega(C + C_g)} \tag{5}$$

in which, in addition to the quantities already mentioned, C is the capacity shunted across the input by whatever circuit may be connected thereto. The real component is

$$r = \frac{r_g}{r_g^2 \omega^2 C^2 + \left(\frac{C + C_g}{C_g}\right)^2} \tag{6}$$

The first term of the denominator of Eq. (6) is generally negligible giving, as the total resistance of the circuit,

$$r_1 + \left(\frac{C_o}{C + C_o} \right)^2 r_o \quad (7)$$

If r_o should be negative, the total resistance will be reduced and the tube will have a greater gain. If, when r_o is negative, the effective resistance of the circuit to the right of AB is equal to zero, sustained oscillations will be produced. This increase in gain, caused by a reduction of the resistance, gives rise to the effect known as *regeneration*.

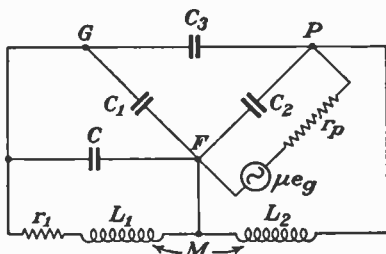

FIG. 5.—Capacities affecting oscillator action.

r_o is negative when the reactance in the plate circuit is inductive. Curves showing the relation between r/r_p and the regeneration effect indicate that the maximum regeneration is obtained when the external impedance in the plate circuit is equal to the plate resistance.

The factor C_o in the above discussion represents only one of the inter-electrode capacities; there are others, as shown by Fig. 5. This diagram represents, fundamentally, one type of oscillating circuit. As can readily be seen, there are several paths for the oscillating current to take, the most important of these being through the grid-plate capacity C_3 , thence through L_1 and L_2 . Obviously, the addition of the capacity C_3 makes the fundamental frequency of the tuned circuit vary somewhat from the value which might be expected. This can be seen from the reactance curves of Fig. 6, in which the reactance of the circuit L_1C is given by the line X_1 . The point of resonance for this circuit alone is at A . Line X_2 gives the reactance of L_2 and its coupling with L_1C . The reactance added to the circuit by C_3 is shown by the line X_3 , and this results in a shift of the fundamental frequency of the entire circuit from point A to point F .

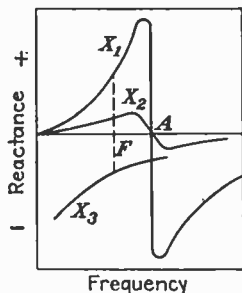

FIG. 6.—Tuned-circuit reactance.

The above analysis is perfectly general and can be applied (with appropriate changes in nomenclature and due regard to phase relations) to any type of vacuum-tube oscillator.

2. Fundamental Vacuum-tube Circuits. The two most familiar circuits for oscillators are those shown in Fig. 7a and b, known respectively as the *Hartley* and *Colpitts* circuits. For grid excitation, the Hartley

circuit employs the mutual inductance between two coils (which in actual practice may be a single coil; the degree of coupling between the two sections being determined by the location of the filament tap).

In the Colpitts circuit the same result is obtained by the use of two condensers, the ratio between them determining the grid excitation.

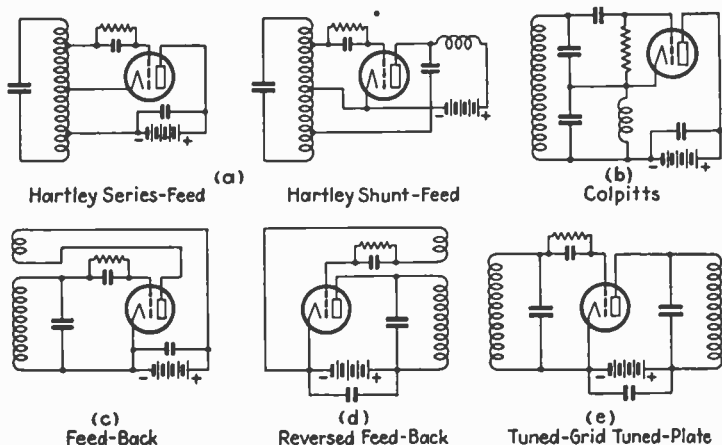

FIG. 7.—Fundamental oscillator circuits.

In the *feed-back* circuit (Fig. 7c), energy from the plate circuit is fed back to the grid; in this oscillator the tuned circuit is connected between grid and filament.

As the name implies, the *reversed feed-back* oscillator (Fig. 7d) functions the same as the feed-back circuit, the difference being that the tuned circuit is in this case connected between plate and filament.

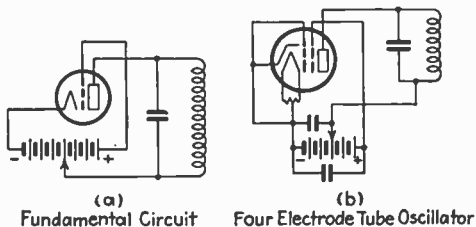

FIG. 8.—Dynatron oscillator circuits.

The *tuned-grid tuned-plate* circuit (Fig. 7e) has both input and output circuits tuned to approximately the frequency of oscillation, the grid-plate capacity providing the feed-back coupling impedance.

In the *dynatron*,¹ use is made of the fact that a circuit having negative resistance can be made to oscillate. The action of this circuit can be

¹ HULL, A. W., *Proc. I.R.E.*, February, 1918.

explained by reference to Fig. 8a, in which it will be seen that the grid of the tube is at a positive potential with respect to the plate. Having the grid more positive than the plate results in a flow of electrons to the grid, which in turn results in what is known as *secondary emission*, i.e., the electrons from the filament striking the grid release other electrons from that element; these secondary electrons are then drawn to the plate. When the number of secondary electrons becomes large enough, the current flowing into the grid decreases and the tube characteristic assumes a negative slope.

FIG. 9.—Barkhausen-Kurz oscillator.

This circuit has found rather wide application in some fields, and its usefulness increased with the advent of the four-electrode tube.¹

Another circuit which is of considerable interest, especially in the high-frequency range, is that known as the *Barkhausen-Kurz* type.² This circuit (Fig. 9), like the dynatron, operates with a positive grid, although in this case the frequency of oscillation is determined by the transit time of the electron between the tube elements. Since the transit time of the electrons depends upon the potential difference of the elements between which they are moving, the frequency is largely determined by the grid voltage and the tube geometry. This frequency is given approximately by

$$\frac{E_g}{f^2} = \text{constant} \quad (8)$$

where E_g is the grid potential, f the frequency, and the constant is a function of the tube geometry.

The *Gill-Morell* oscillator (Fig. 10) is a modification of the above type, in which the external circuits are adjusted to the frequency of oscillation and exert a certain influence upon the

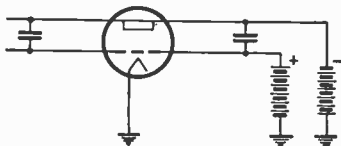

FIG. 10.—Gill-Morell oscillator.

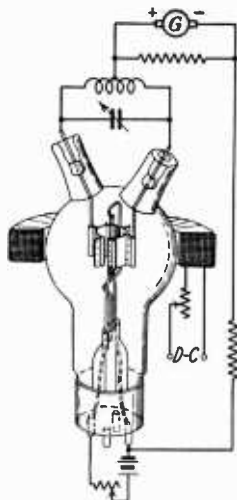

FIG. 11.—Magnetron.

potential of the grid.³ In this circuit the generated frequency is a function of the adjustment of the tuned circuit as well as of the grid potential and tube geometry.

¹ WORTHEN, *General Radio Experiments*, vol. 4, May, 1930. See also TATUO HAYASI, *Jour. I.E.E. Japan*, 54, 7, July, 1934, for a dynatron frequency doubler; and *Radio Research Japan*, vol. 4, No. 2, 1934, same author, for a screen-grid tube oscillator with inductance in screen and plate and positive control grid used as a source of sharply peaked oscillations for stroboscope and oscillograph use.

² BARKHAUSEN and KURZ, *Phys. Zeits.*, vol. 21, 1920.

³ GILL and MORELL, *Phil. Mag.*, vol. 44, 1922.

The *magnetron* oscillator (Fig. 11) depends for its operation upon the curvature of the electron orbits produced by a magnetic field.¹ Oscillators of this type are more efficient at the ultra-high frequencies; they apparently possess the ability to oscillate at frequencies much higher than any other type.

The frequency of oscillation of this circuit is a function of the magnetic field, the anode radius, and the anode potential; it is given approximately by²

$$\lambda H = 13,100 \quad (9)$$

in which λ is the wave length in centimeters, and H , the field strength, is given by

$$H = \frac{6.72}{R} \sqrt{V} \quad (10)$$

where R is the anode radius, and V the anode potential.

Tubes for magnetron circuits have no grids but are constructed with two plates.

FREQUENCY CONTROL

3. Conditions Contributing to Frequency Change. It has been demonstrated by several writers that the conditions which contribute to a shift in the frequency of oscillators may be classified roughly as follows:³

- A. Tube characteristics.
- B. Temperature.
- C. Vibration.
- D. External coupling.

Gunn has shown that the changes in the internal impedance of a tube generally result from the following:

- a. Changes in plate potential.
- b. Changes in mean grid potential.
- c. Changes in filament potential.
- d. Changes in emission due to causes other than c.
- e. Changes in spacing of the tube elements.
- f. Interruption (keying) of the circuit.

A consideration of vacuum-tube mathematics, with regard to the causes enumerated above, makes it quite obvious that these variations affect the operating parameters of the tube most of which play a role in controlling the fundamental frequency generated by the tube and its associated circuits.

It has been pointed out by Llewellyn that, in general, the frequency of oscillation is rigorously determined by three characteristics of the tube (disregarding for the moment the external circuits). These are the plate resistance r_p , the grid resistance r_g , and the amplification factor μ . Of these quantities, r_p and r_g are principally responsible for whatever changes in frequency there may be. It can be seen that r_g has the same

¹ HULL, A. W., *Phys. Rev.*, vol. 18, 1921.

² KELLY and SAMUEL, *Bell System Tech. Jour.*, vol. 14, January, 1935.

³ LLEWELLYN, F. B., *Bell System Tech. Jour.*, vol. 11, January, 1932; GUNN, ROSS, *I.R.E., Proc.*, September, 1930.

relation to the static values of grid current and potential that r_p has to the plate current and potential. The effect of varying the applied potential of the grid or plate, or of changing the filament current, is directly to cause r_p and r_g to vary, usually in opposite directions. When the amplitude of oscillation varies, for which variations of the battery voltages are again principally responsible, both r_g and r_p vary.

The effect of temperature variation is not quite so pronounced, being chargeable almost exclusively to changes of spacing in such elements as condensers and coils. In extreme cases, as was also demonstrated by Gunn, means must be employed to counteract these effects.

Frequency shift due to vibration is also a matter which chiefly concerns the circuit external to the tube, although it is conceivable that vibration might be the cause of frequency shift from causes listed under *e*, above.

External coupling as a cause of frequency shift can be either mechanical or electrical. Mechanical coupling would undoubtedly come under the same general classification as vibration. Electrical coupling, on the other hand, arises from such matters as improper shielding, impedances common to two or more circuits, insufficient filtering of power supply leads, etc.

4. Crystal Control. The theoretical study of the vibrating crystal is much too involved, and its mathematics of too great a complexity, to be covered here.

The occurrence of quartz crystals—the most commonly used of the piezo-electric materials—in the natural state is quite generally known. Suffice it to say that

FIG. 12.—Quartz crystal cross section.

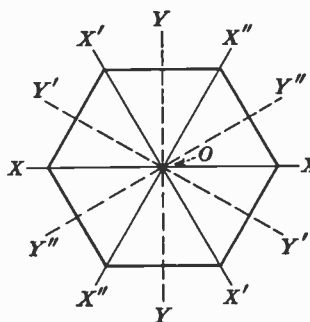

the crystals, while rarely symmetrical in form, have the general form of a hexagonal prism, sometimes surmounted on the ends by a hexagonal pyramid. Assuming, for the sake of simplicity, a symmetrical crystal, a cross section would appear as shown in Fig. 12. In this diagram the *electric axes*—so called by reason of the fact that the greatest piezo-electric activity is noticed in the direction of these axes—are represented by the lines XX , $X'X'$, and $X''X''$. The other axes, YY , $Y'Y'$, and $Y''Y''$, have been given the name *mechanical axes*. Through the point O , perpendicular to the plane of the page, passes the optic axis of the crystal. Sections—plates—cut from the crystal, with due regard to the proper orientation with respect to these axes, are those employed for frequency control.

The most commonly known cuts are those called the X -cut and the Y -cut, so named because they have certain orientations with respect either to an X -axis or to a Y -axis. Figure 13a shows the X -cut orientation, and *b*, of the same figure, is that for the Y -cut. It should be realized that, although the diagram shows the section taken from the center of the crystal, this is of no significance. The determining factor is the angle at which the section is cut with respect to either an X -axis or a Y -axis; the plate could, if desired, be cut from any part of the crystal provided the proper orientation is maintained.

Both the X-cut and the Y-cut plates have been used extensively, although vagaries which both exhibit leave much to be desired from a performance standpoint. However, their wide application makes it desirable to consider these cuts before entering into any discussion of more recent developments in the art.

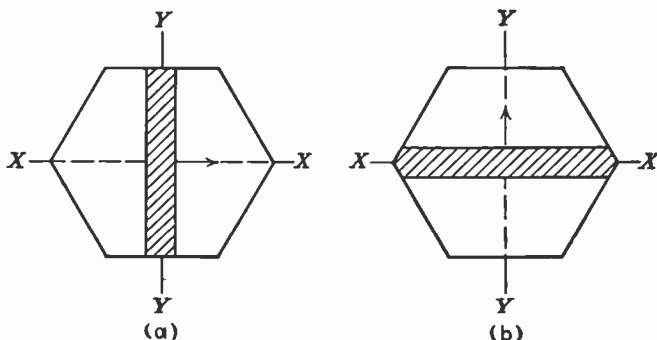

FIG. 13.—X- and Y-cuts.

5. X-cut Characteristics. The X-cut plate enjoys a wide popularity in some services—the U. S. Navy is a large user. This plate, with a temperature coefficient of frequency amounting to -10 to -25 parts per million (p.p.m.) per degree centigrade requires careful temperature control.

Two major response frequencies are found in the X-cut plate; one high and one low. The plate is operated at the higher of the two frequencies; this frequency is given as a function of the thickness of the plate (the dimension parallel to the X-axis) by

$$f = \frac{K}{t} \quad (11)$$

where t = thickness in millimeters

$$K = 2.860 \times 10^6.$$

One of the chief objections to the X-cut plate lies in the discontinuities which its frequency-temperature coefficient curve exhibits. If the frequency of vibration of the plate is plotted as a function of its temperature coefficient, a curve results in which there appear occasional abrupt "hops" in the frequency. These have been explained by Lack and others¹ to be caused by the coupling of various modes of vibration within the crystal; in this sense the curve is similar to a curve which would be obtained by plotting the frequencies of several separately tuned coupled circuits.

At the points of discontinuity there may occur either of two effects: the crystal might be entirely non-oscillatory, or there might exist two frequencies of vibration which would be so close together as to make the plate useless. If the fundamental frequency to which the crystal is being

¹ LACK, F. R., *Bell System Tech. Jour.*, vol. 8, July, 1929; MASON, W. P., *Bell System Tech. Jour.* vol. 13, July, 1934.

ground happens to fall at one of these points, there is no available remedy. Further grinding, *i.e.*, thickness grinding, will result only in overshooting the desired frequency. Edge grinding is inefficacious.

6. Y-cut Characteristics. The Y-cut plate also has high and low fundamental frequencies, with the high frequency often appearing as a doublet, *i.e.*, two response frequencies only a kilocycle or so apart. For relatively thin plates, the high frequency is given by

$$f = \frac{K}{t} \quad (12)$$

where t = thickness in millimeters

$$K = 1.96 \times 10^6.$$

The low frequency is a function of the dimension parallel to the X-axis (width) and is given by Eq. (11).

At the frequency given by Eq. (12) the Y-cut plate has a temperature-frequency characteristic which varies widely. It is usually positive and lies between 25 and 100 p.p.m. per degree centigrade. Some investigators report temperature-frequency characteristics, for this cut, which vary from +100 to -20 p.p.m. per degree centigrade.

Like the X-cut, the temperature-coefficient-frequency curve of a Y-cut plate exhibits discontinuities. These can often be removed by edge grinding, however, and this fact seems to establish the greater usefulness of the Y-cut plate. If the fundamental frequency is not one of a doublet, any discontinuities can be removed from the working range without disturbing the fundamental frequency.

7. Other Crystal Cuts. From the statement above regarding the range, from +100 to -20 p.p.m. per degree of temperature centigrade which might be found in Y-cut plates, it might seem possible to get a plate having a zero coefficient. Marrison¹ has found this to be the case for the so-called ring (doughnut or "Life Saver") plates in which the temperature coefficient, while not strictly zero, is only about 1 p.p.m. per degree centigrade.

More recent work has resulted in the discovery of plates which apparently have few if any of the effects (large temperature-frequency characteristics; secondary spectra; etc.) which tend to limit the usefulness of the more familiar X- and Y-cut plates.² Diminution of these effects is attained by cutting plates at different angles of rotation about the X-axis. These angles, with the arbitrary designations given to the plates, are listed below:

Plate	Angle of Rotation about X-axis, Degrees
BC	-60
BT	-49
AC	31
AT	35

The curve of Fig. 14 shows the temperature coefficient of frequency plotted as a function of the angle of rotation about the X-axis. From this curve it will be seen that two of the cuts, the BT (-49°) and the

¹ MARRISON, W. A., *Bell System Tech. Jour.*, vol. 8, July, 1929.

² LACK, F. R., W. G. WILLARD, and I. E. FAIR, *Bell System Tech. Jour.*, vol. 13, July, 1934.

AT (35°), have zero temperature coefficients. The other cuts, *BC* and *AC*, certainly appear to be better than the *Y*-cut plate in so far as temperature characteristic is concerned.

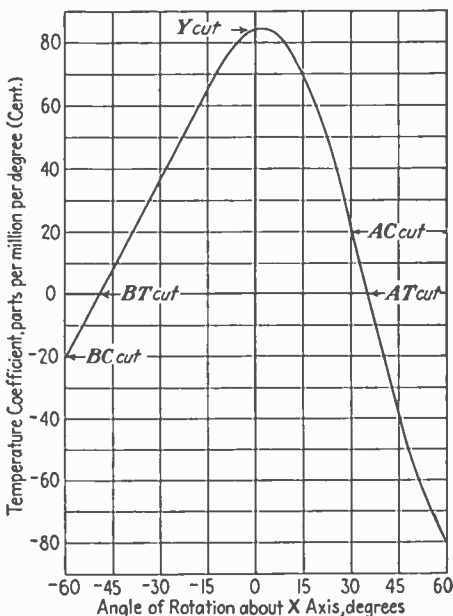

FIG. 14.—Temperature coefficient *versus* rotation about the *X*-axis.

The fundamental frequency of vibration for any of these cuts is given by

$$f = \frac{1}{2t} \sqrt{\frac{c_{66}}{\rho}} \quad (13)$$

where c_{66} = the elastic constant for quartz. This varies from 28×10^{10} to 70×10^{10} , depending upon the angle of rotation about the *X*-axis

t = thickness in centimeters

ρ = the density of quartz (2.65 g/cm^3).

This expression has been plotted (Fig. 15) to show the frequency in kilocycles per millimeter thickness of the crystal as a function of the angle of rotation about the *X*-axis.

From the theory derived in connection with the development of these plates, it was expected that the so-called secondary spectra which result in the discontinuities described under the *X*- and *Y*-cuts would be eliminated, at least over the workable temperature range. This has been

found experimentally to be the case. Furthermore, plates cut with these new orientations, especially the *AT*-cut plates, have been found to possess all of the favorable characteristics of the *Y*-cut. Tests on the *AT*-cut plates indicate the possibility of using them to control moderate amounts of power. At 2 Mc, 50-watt oscillators appear to be feasible; some experimental circuits have been operated up to 200 watts without destroying the plate. Altogether, these plates seem to be at least one answer to future problems of high-frequency generation and stabilization.

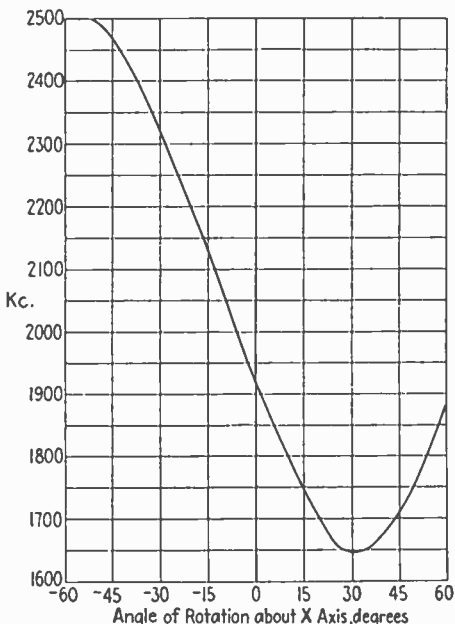

FIG. 15.—Frequency in kilocycles per millimeter thickness *versus* rotation about the *X*-axis (see Fig. 14).

There is no definitely established frequency limit for quartz plates; the practical limits are being constantly extended. Plates have been used at 20 Mc, and a 1-kc quartz bar has been reported. Quartz plates are rarely called upon to control more than a few watts directly; higher powers are controlled by amplifying the output of the crystal stage.

Several other materials which assume a more or less well defined crystalline form have been investigated as possibilities for piezo-electric elements. Among these may be mentioned tourmaline and Rochelle salt (sodium potassium tartrate). The Rochelle salt crystals have in general been discarded, although they have found applications in the so-called crystal speakers and phonograph pickups.

Tourmaline, while it is practically as good as quartz over a great frequency range—and somewhat better than quartz in the range from about 3 Mc to 30 Mc—has the disadvantage of being a semi-precious stone; its cost is, in consequence, out of proportion to its usefulness.

Beyond the range where crystals exert satisfactory control, *i.e.*, about 30 Mc at the present state of the art, the concentric conductor as a frequency-control element appears to offer the best possibilities. (See Art. 14.)

8. Temperature Control. Present-day requirements of carrier-frequency stability necessitate that radio transmitters have their frequency-control device (quartz plate) under accurately controlled temperature conditions; this is because of the fact that practically all of the quartz plates now in use are *X* and *Y* cut.

The general practice is to construct the entire oscillator assembly in such a manner as to maintain nearly constant temperatures within the housing of the circuit; this helps to avoid frequency drift which might be caused by expansion or contraction of the coils and condensers of the oscillator circuit.

In addition, the quartz plate is operated in a constant-temperature oven. This oven, electrically heated, is usually designed after the principles given by Marrison.¹ These principles involve the thermal conductivity of the material of which the oven is made, the ambient temperature range, and the temperature coefficient of the quartz plate.

Briefly stated, the problem is one of accurately determining the temperature of the plate and of causing any slight variation of this temperature to actuate suitable thermostatic devices, which in turn cause more or less current to flow through the heater associated with the oven.

An example of such a control chamber is given by Marrison as follows:

It consists of a cylindrical aluminum shell with a wall about one inch thick, with a heater, and with a temperature-responsive element in the wall to control the rate of heating. The aluminum shell has a metal plug that screws into the open end forming a chamber for the crystal which is then completely closed except for a small hole for electrical connections.

Since aluminum is a good thermal conductor the shell equalizes the temperature throughout the chamber and thus avoids the use of a fluid bath. The main heating coil is wound in a single layer over the whole curved surface of the aluminum cylinder, being separated from it only by the necessary electrical insulation. Auxiliary heating coils are wound also on the ends so as to distribute the heating as uniformly as possible. This, in effect, makes the short cylinder behave like a section from an infinite cylinder. To protect the thermostat from the effect of ambient temperature gradients the heating coil has an outside covering consisting of four layers each of thin felt and sheet copper spirally wound so that alternate layers are of copper and felt, the innermost layer being of felt and the outer one of copper. . . . This covering is very effective in reducing surface gradients since the conductivity in directions parallel to, and perpendicular to, the surface differ by a large ratio.

The thermostat used with these constant-temperature chambers is generally the mercury-column type. This is simply a thermometer in which contact wires have been fused. At the point on the scale where the operating temperature is located, the glass stem has been drawn out; *i.e.*, if the device is to function at, say 35°C., the stem of the thermometer

¹ *Loc. cit.*

is constricted and elongated between about 34.5° and 35.5° . One of the contact wires is fused through the glass at the 35° point, the other wire making contact with the mercury at the bulb. This elongation of the stem over a range of one degree or so causes the mercury column to move an appreciably greater distance per fraction of a degree change in temperature.

This type of regulator is very sensitive to minute temperature changes, but it has several disadvantages. Among these, the most important are: the mercury-wire contact is fixed and cannot be changed to meet different conditions; the regulator cannot carry any appreciable current. For this latter reason, it is customary to utilize the regulator simply to change the grid bias on a vacuum tube; the tube plate circuit includes the winding of a relay which operates with small changes of plate current. This relay, which is generally too small to handle the heater current, actuates still another relay to open or close the heater circuit.

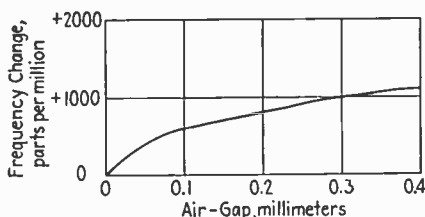

FIG. 16.—Frequency change versus air gap.

With the advent of the constant-temperature-coefficient crystals, the need for this complicated and delicate temperature-control device has been dispensed with. Some types of service, notably aircraft radio, where ambient temperatures may range from -40° to $+40^\circ\text{C}$., still require some kind of temperature regulation, but the requirements are satisfactorily met with a more or less conventional heating chamber and an ordinary bimetallic thermostat.

9. Crystal Mountings. There are, in general, but two types of crystal holders: those in which the crystal plate is firmly clamped, and those employing an air gap between the plate and one or both electrodes. Some plates, especially those used in crystal-filter networks where there is no great amount of vibration, may have the contact electrodes directly sputtered upon the faces.

The use of a holder with an adjustable air gap permits slight adjustments in frequency to be made. Figure 16 indicates the change in frequency for different air gaps for a representative crystal and holder. For plates which are to control appreciable amounts of power, however, the holder which firmly clamps the plate seems to be preferable; this is particularly true where the oscillator frequency is fixed definitely, *e.g.*, radio transmitters, especially those in services which require the minimum of attention on the part of the operator.

For laboratory use in frequency standards, however, an air gap may be of considerable value. Some holders are made with a fixed air gap, and the final calibration of the crystal is made by slightly changing this gap,

after which the entire assembly is sealed. Figure 17 shows several types of holder which have been developed.

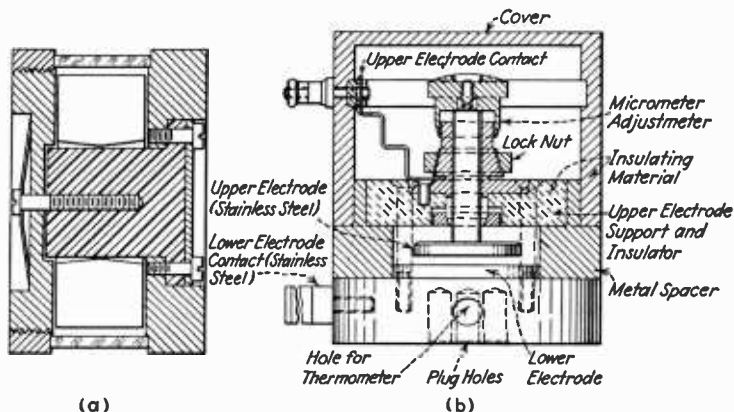

FIG. 17.—Types of crystal holders; (a) for ring plates,¹ (b) holder with adjustable air gap.²

While the actual construction of crystal holders is beyond the scope of this discussion, it may be pertinent to point out some of the requirements which must be met by the holder.

These may be enumerated briefly as follows:

- a. The electrode surfaces must be lapped perfectly flat and must be entirely free of oil and dirt.
- b. The electrodes must be made from metal which will not corrode.
- c. Where an air gap is employed, means should be provided for clamping the movable electrode after the final adjustment has been made.
- d. Some type of construction is generally necessary which will prevent lateral motion of the plate; this may be accomplished by enclosing the plate and electrodes in close-fitting cases of suitable insulating material.
- e. The entire assembly should be made dust proof.

10. Crystal Circuits. The circuit schematics shown in Fig. 18 are representative of accepted practice.

Since the frequency of a crystal-controlled oscillator is dependent upon circuit conditions as well as upon the fundamental frequency of the plate itself, curves showing the output frequency as a function of these circuit variables are given in Fig. 19.

11. Frequency-stabilizing Circuits. It was pointed out above that the chief factors in unsteady frequency were tube characteristics and operating voltages; the first of these is, of course, to a great extent a function of the second. Consequently any plan to stabilize frequencies by means of reducing the effect of these components must necessarily start with a consideration of frequency *vs.* operating voltage.

¹ MARRISON, W. A., *Bell System Tech. Jour.*, 8, 493-514, July, 1929.

² BOOTH, and DIXON, *Jour. I.E.E. London.*

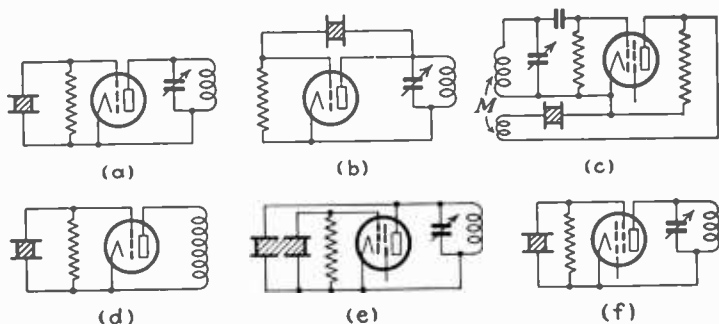

FIG. 18.—Representative oscillator circuits; (a) the most generally used circuit, (b) the Pierce circuit, (c) a high stability circuit (*General Radio Company*), (d) circuit employed in crystal calibrator—output exceptionally rich in harmonics, (e) Cady circuit adapted (*J. R. Harrison*) to four-electrode tube, (f) Hull space-charge grid circuit.

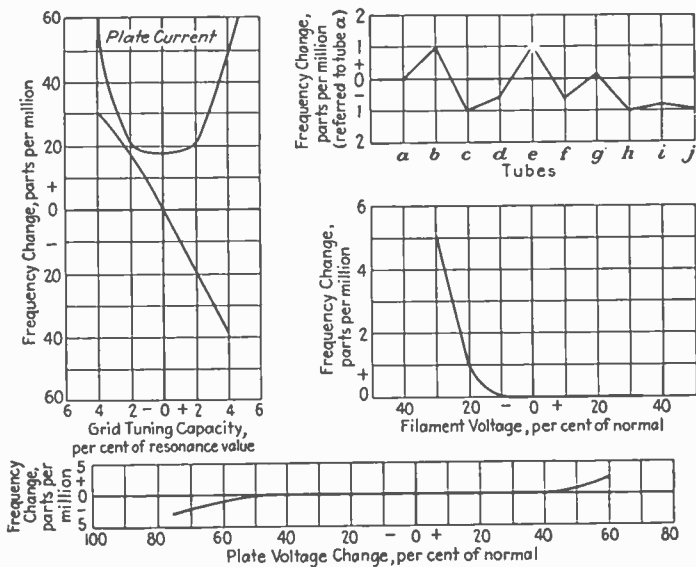

FIG. 19.—Frequency versus circuit variables.

A satisfactory means of accomplishing this result was described by Llewellyn.¹

His method of attack is as follows:

In Fig. 20 is shown the equivalent circuit network of a Hartley or Colpitts oscillator. In this diagram the tuned circuit is the network made up of the impedances Z_1 , Z_2 , and Z_3 , plus the mutual impedance Z_m . Z_4 and Z_5 are in the circuit to effect the independence of the frequency and operating voltages; the values which they must assume are to be determined. When

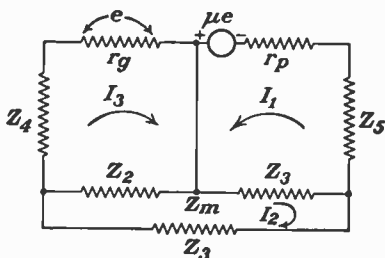

FIG. 20.—Circuit used by Llewellyn for analysis.

currents are flowing as indicated by the arrows the following circuit equations will hold.

$$\mu e = I_1(r_p + Z_1 + Z_5) + I_2(Z_1 + Z_m) - I_3 Z_m \tag{14}$$

$$0 = I_1(Z_1 + Z_m) + I_2 Z_0 - I_3(Z_2 + Z_m) \tag{15}$$

$$0 = -I_1 Z_m - I_2(Z_2 + Z_m) + I_3(r_g + Z_2 + Z_4) \tag{16}$$

$$e = I_3 r_g \tag{17}$$

Z_0 in these equations is the impedance of the tuned circuit, as previously described, and is equal to

$$Z_0 = Z_1 + Z_2 + Z_3 + 2Z_m \tag{18}$$

Because the network has only three meshes, Eqs. (14) to (17) comprise actually only three simultaneous equations. These may be rewritten in determinant form:

$$\begin{vmatrix} (r_p + Z_1 + Z_5) & +(Z_1 + Z_m) & -(Z_m + \mu r_g) \\ +(Z_1 + Z_m) & Z_0 & -(Z_2 + Z_m) \\ -Z_m & -(Z_2 + Z_m) & (r_g + Z_2 + Z_4) \end{vmatrix} = 0 \tag{19}$$

From the determinant (19) may be found the conditions necessary for oscillation and the frequency of oscillation. These are given by

$$(r_p + Z_1 + Z_5)Z_0(r_g + Z_2 + Z_4) + (Z_1 + Z_m)(Z_2 + Z_m)(\mu r_g + 2Z_m) = Z_0 Z_m (\mu r_g + Z_m) + (Z_1 + Z_m)^2 (r_g + Z_2 + Z_4) + (Z_2 + Z_m)^2 (r_p + Z_1 + Z_5) \tag{20}$$

Each of the impedance (Z) in the above may be replaced by the equivalent form $(R + jX)$ in which j is the vector operator and R and X are real quantities, resistance and reactance, respectively. Since practically all of the losses in the circuit are caused by tube resistances r_g and r_p , these two are

¹ Loc. cit.

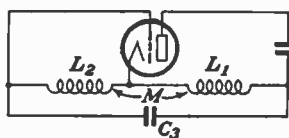

(a)

FIG. 21(a).—Hartley oscillator, plate stabilization.

$$C_4 = C_3 \left(\frac{L_0}{L_1 + L_2 A^2 - 2MA} \right)$$

where $L_0 = L_1 + L_2 + 2M$,

$$A = \frac{L_1 + M}{L_2 + M}$$

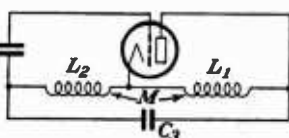

(b)

FIG. 21(b).—Hartley oscillator, grid stabilization.

$$C_4 = C_3 A^2 \left(\frac{L_0}{L_1 + L_2 A^2 - 2MA} \right)$$

where $L_0 = L_1 + L_2 + 2M$

$$A = \frac{L_1 + M}{L_2 + M}$$

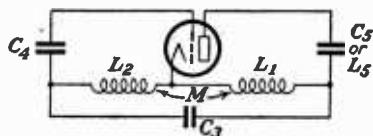

(c)

FIG. 21(c).—Hartley oscillator, plate and grid stabilization.

$$\frac{1}{C_5} + \frac{A^2}{C_4} = \frac{1}{C_3} \left(\frac{L_1 + L_2 A^2 - 2MA}{L_0} \right)$$

$$L_5 = L_0 \frac{C_3}{C_4} A^2 - L_1 - L_2 A^2 + 2MA$$

where $L_0 = L_1 + L_2 + 2M$

$$A = \frac{L_1 + M}{L_2 + M}$$

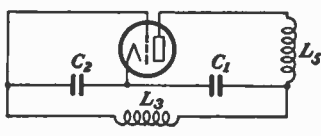

(d)

FIG. 21(d).—Colpitts oscillator, plate stabilization.

$$L_5 = L_3 \frac{C_1^2}{C_4}$$

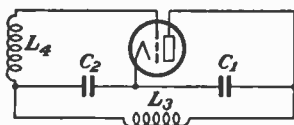

(e)

FIG. 21(e).—Colpitts oscillator, grid stabilization.

$$L_4 = L_3 \frac{C_1}{C_2}$$

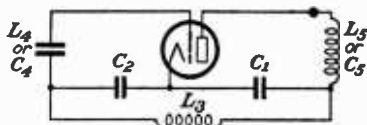

(f)

FIG. 21(f).—Colpitts oscillator, plate and grid stabilization.

$$L_3 = L_4 \left(\frac{C_2}{C_1} \right) + L_5 \left(\frac{C_1}{C_2} \right)$$

$$L_5 = L_3 \frac{C_2}{C_1} \left[1 + \frac{C_2}{C_4} \left(\frac{C_2}{C_1 + C_2} \right) \right]$$

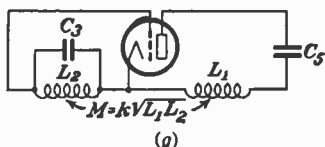

FIG. 21(g).—Feed-back oscillator, plate stabilization.

$$C_3 = C_2 \frac{L_2}{L_1} \left(\frac{1}{1 - k^2} \right)$$

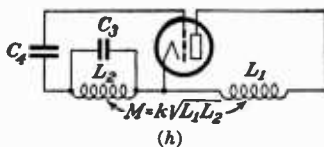

FIG. 21(h).—Feed-back oscillator, grid stabilization.

$$C_4 = C_2 \left(\frac{k^2}{1 - k^2} \right)$$

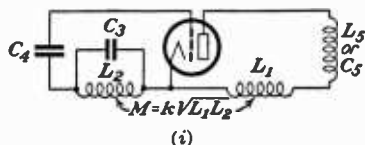

FIG. 21(i).—Feed-back oscillator, plate and grid stabilization.

$$L_5 = L_1 \left[k^2 \left(1 + \frac{C_3}{C_4} \right) - 1 \right]$$

$$C_5 = C_2 \frac{L_2}{L_1} \left[\frac{1}{1 - k^2 \left(1 + \frac{C_3}{C_4} \right)} \right]$$

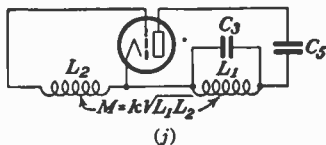

FIG. 21(j).—Reversed feed-back oscillator, plate stabilization.

$$C_5 = C_2 \left(\frac{k^2}{1 - k^2} \right)$$

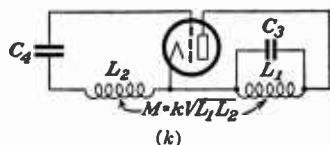

FIG. 21(k).—Reversed feed-back oscillator, grid stabilization.

$$C_4 = C_2 \frac{L_1}{L_2} \left(\frac{1}{1 - k^2} \right)$$

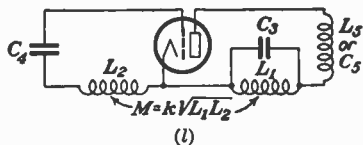

FIG. 21(l).—Reversed feed-back oscillator, plate and grid stabilization.

$$L_5 = L_1 \left[1 + \frac{1}{k^2} \left(\frac{L_1 C_2}{L_2 C_4} - 1 \right) \right]$$

$$C_5 = \frac{C_3}{\frac{1}{k^2} \left(1 - \frac{L_1 C_2}{L_2 C_4} \right) - 1}$$

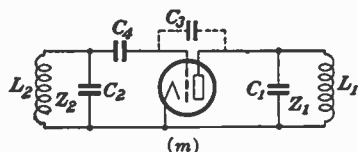

FIG. 21(m).—Tuned-plate, tuned-grid oscillator with no magnetic coupling.

$$C_1 = \frac{L_2}{L_1} \left[C_2 + \frac{(1 + \mu) C_3 C_4}{C_4 + (1 + \mu) C_3} \right] - C_3$$

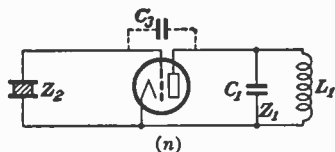

FIG. 21(n).—Piezo-electric oscillator which is equivalent to the circuit of (m), and may be stabilized similarly, provided the impedance Z_2 of the crystal is equal to Z_1 in (m).

the only resistances with which this analysis need be concerned. In this case, Eq. (20) becomes

$$[r_p + j(X_1 + X_s)]jX_0[r_0 + j(X_2 + X_4)] - (X_1 + X_m)(X_2 + X_m) \\ [\mu r_0 + 2jX_m] = -X_0X_m[\mu r_0 + jX_m] - (X_1 + X_m)^2[r_0 + j(X_2 + X_4)] \\ - (X_2 + X_m)^2[r_p + j(X_1 + X_s)] \quad (21)$$

If Eq. (21) is separated into real and imaginary portions and each of these equated to zero, the resulting equations must be simultaneous and must express the frequency and the values which r_p and r_0 must assume for oscillations to exist. As was mentioned previously, the problem is to find values of X_4 and X_s which will allow the frequency to be expressed in terms of the oscillatory circuit regardless of how the tube characteristics might vary.

$$-X_0[r_p(X_2 + X_4) + r_0(X_1 + X_s)] - \mu r_0(X_1 + X_m)(X_2 + X_m) = \\ -X_0X_m\mu r_0 - (X_1 + X_m)^2r_0 - (X_2 + X_m)^2r_p \quad (22)$$

$$X_0[r_p r_0 - (X_1 + X_s)(X_2 + X_4)] - 2X_m(X_1 + X_m)(X_2 + X_m) = \\ -X_0X_m^2 - (X_1 + X_m)^2(X_2 + X_4) - (X_2 + X_m)^2(X_1 + X_s) \quad (23)$$

Equation (23) shows that if X_4 and X_s assume values which satisfy the equation

$$2X_m(X_1 + X_m)(X_2 + X_m) = (X_1 + X_m)^2(X_2 + X_4) + (X_2 + X_m)^2(X_1 + X_s) \quad (24)$$

the frequency will be exactly that which causes X_0 to become zero, and this frequency will remain so, irrespective of values which may be assumed by the tube constants. This means that the frequency of oscillation is independent of the tube and is equal to the resonant frequency of the oscillatory circuit. By the same line of reasoning it will be seen that a variable load resistance, provided it is connected in parallel with r_p or r_0 , would have no effect upon the frequency of oscillation; hence, the same method may be followed where a changing load resistance has to be contended with.

Consider the circuit of Fig. 21a, which is a Hartley oscillator in which the stabilizing reactance is in the plate circuit. As applied to Eq. (24) the terms have the following values:

$$X_1 = \omega L_1 \\ X_2 = \omega L_2 \\ X_m = \omega M$$

Either X_4 or X_s is to be determined. However, in Fig. 21a the stabilization is on the plate side so that X_4 is set equal to zero and Eq. (24) is solved for X_s . This gives

$$X_s = 2\omega M \left(\frac{L_1 + M}{L_2 + M} \right) - \omega L_2 \left(\frac{L_1 + M}{L_2 + M} \right)^2 - \omega L_1 \quad (25)$$

From this it can be seen that X_s must be negative; i.e., a capacity reactance is necessary for plate stabilization of the Hartley oscillator. Setting

$$X_s = -\frac{1}{\omega C_s}$$

and, since $X_0 = 0$, the angular frequency is given by

$$\omega^2 = \frac{1}{C_s(L_1 + L_2 + 2M)} \quad (27)$$

and

$$C_s = C_3 \frac{L_1 + L_2 + 2M}{L_1 + L_2 \left(\frac{L_1 + M}{L_2 + M} \right)^2 - 2M \left(\frac{L_1 + M}{L_2 + M} \right)} \quad (28)$$

This is the value of capacity which is to be inserted between the plate and the tuned circuit of a Hartley oscillator in order that the frequency may be independent of operating voltage; this assumes, however, that there is no reactance between the grid and the tuned circuit. In practice a d-c path for the plate current may be arranged by shunting C_5 with a high-impedance choke.

If for any reason it should be desired to have a blocking condenser between the grid and the tuned circuit, the condenser may be given a value which will insure stability and at the same time function as a blocking condenser. The proceeding to determine the size of this condenser is similar to that in the demonstration above given, except that X_5 is set equal to zero and Eq. (24) solved for X_4 .

Exactly the same principle applies to other oscillating circuits for either plate or grid stability or a combination of both. The accompany-

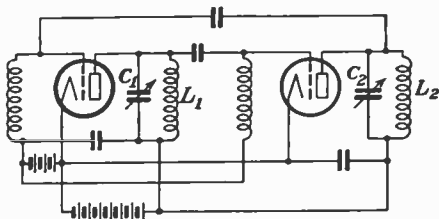

FIG. 22.—Stabilized oscillator of Gunn.

ing diagrams give the various reactance values necessary for stabilization of these circuits.

Another method of generating stabilized frequency has been described by Ross Gunn of the Naval Research Laboratories.¹ In brief, this method, which is shown in Fig. 22, employs the well-known principle that a filter having a great number of sections can be made to approach single-frequency transmission as closely as may be desired by the use of as many filter sections as are necessary.

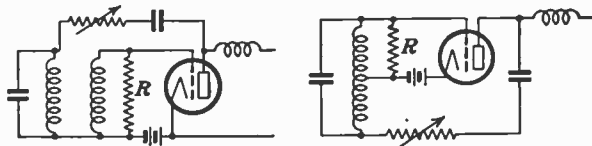

FIG. 23.—Stabilizing networks of Terman.

Referring to Fig. 22, the circuits L_1C_1 and L_2C_2 are, in effect, filter sections. The potential on the grid of the first tube is made to vary, this variation is amplified, its phase changed 180 deg., and it is passed on to the second tube. The second tube likewise amplifies and reverses the phase of the voltage and returns it to the first tube through the coupling condenser. This process repeats itself indefinitely and, since the tuned circuits L_1C_1 and L_2C_2 are effectively across the grids of the two tubes, the only frequency which reaches the grid of either tube will be

¹ GUNN, ROSS, *Proc. I.R.E.*, *loc. cit.*

that to which these tuned circuits are antiresonant. Thus it can be seen that this circulatory path through what are, in effect, two filter sections becomes a filter with an almost impossibly large number of sections.

Terman has also described a frequency-stabilizing system employing resistances.¹ His circuits are shown in Fig. 23.

12. Magnetostriction Oscillators. The control of the oscillating frequency of a circuit by the magnetostrictive effect was first described by Pierce.² Magnetostriction in metals is somewhat analogous to the piezoelectric effect in crystals, *i.e.*, there is a physical distortion due to an external field, in this case a magnetic field. The inverse effect also obtains; a mechanical stress in magnetostrictive material changes the magnetic permeability.

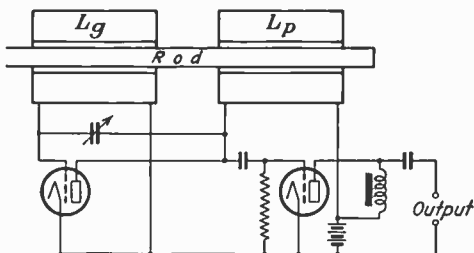

FIG. 24.—Magnetostriction oscillator.

If a rod of magnetostrictive material is placed in an alternating magnetic field, the rod will vibrate longitudinally at a frequency which is twice that of the alternating current producing the field. If, however, the rod is magnetically polarized the frequency of vibration will be that of the applied alternating current. Under this condition the rod may be clamped or pivoted at its exact center, this being a nodal point. For this condition the resonant frequency of the rod (usually in the range from 1,000 cycles to several hundred thousand cycles) is given by

$$f = \frac{v}{2l} \quad (29)$$

where v = the velocity of sound in the rod
 l = length of the rod.

The circuit of Fig. 24 is the one usually employed with the magnetostriction rod. This circuit is different from that employed in the usual oscillator in that the coils are so connected that, if there were filament-emission currents flowing in the grid and plate circuits, the rod would be magnetized by the coils with the same polarity; this is the opposite of the conditions which exist in the Hartley circuit.

Pierce has given extensive data on this oscillator,³ including such matters as temperature coefficients and values of the function v in Eq. (29), for various magnetostrictive materials.

¹ TERMAN, F. E., *Electronics*, July, 1933.

² PIERCE, G. W., *Amer. Acad. Sci.*, vol. 63, 1928.

³ *Ibid.*; see also *Proc. I.R.E.*, 17, 42, January, 1929.

13. Mechanically Coupled Circuits (Tuning-fork Oscillators). The choice of a particular type of tuning fork depends largely upon the requirements of the problem at hand and upon the degree of frequency stability desired. Simplest and least precise are the contact-driven forks which are capable of supplying considerable power output of approximately square-top wave form. When a sinusoidal output of good precision is desired, the single-microphone drive serves admirably. Still greater precision, more power, and purer wave form are to be had

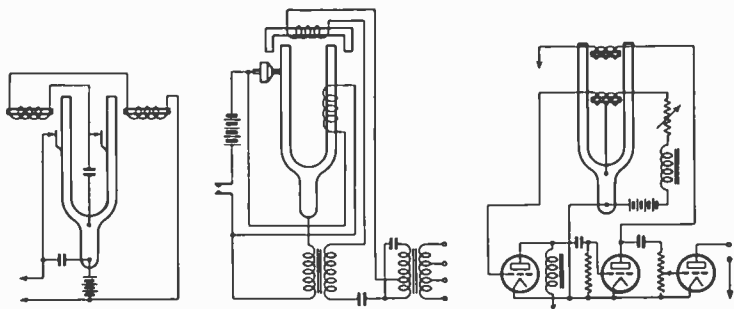

FIG. 25.—Circuits for various types of tuning-fork oscillators (Hummers).

from the somewhat more complicated double-button fork. A high-precision standard demands the use of a freely vibrating fork, such as is exemplified by the vacuum-tube driven type. The ultimate in precision so far attained is to be found in the freely vibrating fork with suitable provision for eliminating its temperature error. Typical circuits employing these features are shown in Fig. 25.¹

Tuning forks, suitable for use in oscillators of this type, are available in various degrees of accuracy of adjustment and temperature coefficient. The highest commercially feasible accuracy appears to be about 0.05 per cent of the fundamental frequency. Forks of this type have a temper-

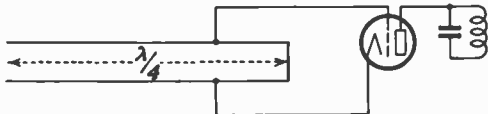

FIG. 26.—Resonant lines as the oscillatory circuit of an oscillator. (Terman, *Electrical Engineering*, vol. 53, July 1934.)

ature coefficient of 0.00023 per degree centigrade. Precision forks of the kind described are of non-magnetic material; this requires that soft-iron armatures be dovetailed into the prongs if they are to be used with a magnetic drive circuit.

14. Resonant Lines. Resonant transmission lines may be used as circuit elements in the ultra-high frequency range as a means of obtaining high impedance with low loss. The lines may be of either the two-wire variety or the concentric-conductor (coaxial cable) type (Fig. 26). For

¹ LAMSON, H., *General Radio Experimenter*, vol. 5, September, 1930.

ultra-high frequencies, the lines are small enough to be included within the apparatus. These circuits can be made highly selective and will give stability comparable to that of a crystal.¹

15. Carrier- and Audio-frequency Oscillators. Frequencies in the audio or carrier range may be conveniently generated by any one of several types of oscillators most of which employ vacuum tubes. Among the earlier investigators of constant-frequency oscillator circuits, Horton published considerable data on oscillators for the audio- and carrier-frequency ranges.² One of the results of Horton's investigations is the circuit shown in Fig. 27. This oscillator has enjoyed a wide popularity,

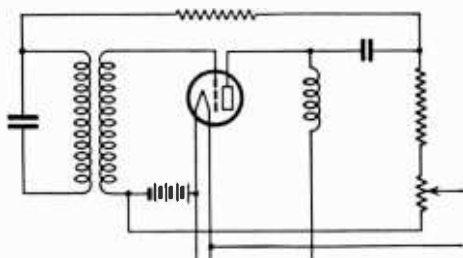

FIG. 27.—Fundamental schematic of a circuit which has been widely used for the generation of audio and carrier frequencies.

being the fundamental circuit of many of the telephone system's oscillators; it is also the basis of a well-known commercial oscillator.

16. Beat-frequency Oscillators. Chief among the objections to vacuum-tube oscillators, as discussed above, for audio frequency is that unduly large coils (with their attendant low Q) and condensers are necessary. This objection has been met by the so-called beat-frequency oscillator in which, as the name implies, the desired audio frequency is obtained by the reaction between the two high frequencies which are generated by oscillators with moderately sized circuit components.

Beating two radio-frequency oscillators to obtain a desired audio frequency seems on first thought to be a simple matter. That it is not is due to the necessity of eliminating all reaction between the two r-f oscillators. For instance, the fixed frequency oscillator must not change frequency when the variable oscillator is tuned; likewise, the variable oscillator must not lock in step (synchronize) with the fixed oscillator at the low frequencies. This means that the frequency of the two oscillators must be independent of load conditions. In practically all oscillators the output circuit forms, directly or by some kind of coupling, a part of the oscillating circuit; changes in load cause a variation in the constants of the oscillating circuit.

One method of meeting this difficulty in the beat-frequency oscillator is to provide a buffer amplifier between each oscillator and the detector.

¹ Terman, F. E., *Elec. Eng.*, vol. 53, July, 1934; see also Conklin, Finch, and Hansell, *Proc. I.R.E.*, November, 1931.

² Horton, J. W., *Bell System Tech. Jour.*, vol. 3, July, 1924; see also F. E. Terman, *Electronics*, July, 1933.

This is the method employed in Fig. 28 which is the circuit schematic of a beat-frequency oscillator designed by the U. S. Bureau of Standards.¹

Examination of this circuit will show rather conventional oscillator circuits which are coupled, by means of the coils L_1 and L_2 , to the buffer amplifiers. These amplifiers in turn feed into the detector, the output of which contains a low-pass filter which cuts off at about 30,000 cycles.

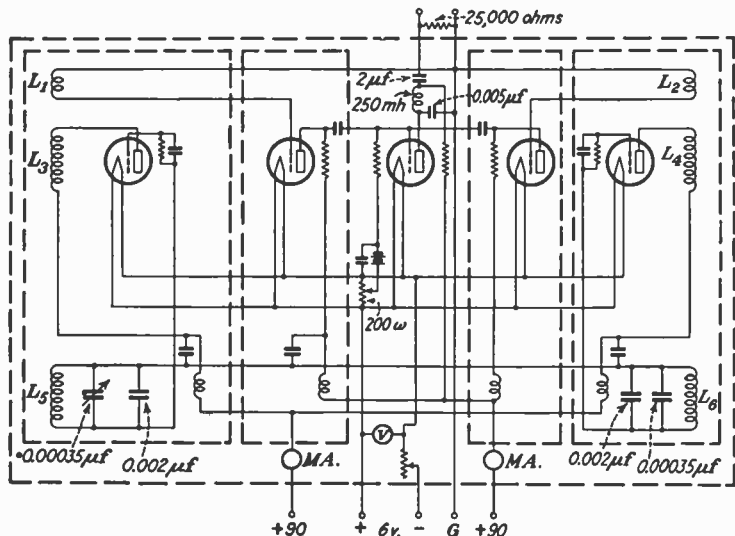

FIG. 28.—Schematic diagram of beat-frequency oscillator used by the Bureau of Standards in acoustic research. (From Bureau of Standards Research Paper 242.)

The coils in the oscillatory circuits are wound on $3\frac{1}{2}$ -in. diameter tubing about 6 in. long and are spaced about 2 in. on centers. The three coils for each oscillator are wound with No. 26 wire. The grid coils (L_3 , L_4) have 55 turns; the plate coils (L_1 , L_2), 40 turns; the coupling coils (L_1 , L_2), 18 turns.

Figure 29 shows the circuit schematic of a commercial beat-frequency oscillator in which the buffer-amplifier stages are included in the same tubes which produce the oscillations. This results in an electron-coupled circuit in which the second grid of each of the oscillator tubes acts as the oscillator plate and amplifier-control grid; the third grid of these tubes is, then, a shielding grid.

The secondary winding of the output transformer of this oscillator is tapped to match circuits up to 10,000 ohms impedance. The auxiliary circuit, connected across a portion of this output winding, is a magnetic

¹ CHRISLER and SNYDER, *Bur. Standards Jour. Research*, vol. 5, October, 1930.

reproducer which carries a reed on its armature. With the switch closed and the main frequency control set to a predetermined point, an auxiliary condenser can then be adjusted for maximum vibration of the reed, thus providing a reasonably accurate calibration point for the oscillator.

Beat-frequency oscillators are prone to develop harmonics which, of course, result in a distorted output wave form. This distortion is a function of, among other things, the load impedance and the frequency of the audio-beat note; it is most pronounced at the lower frequencies. Careful adjustment of the oscillator and its load is the chief method of

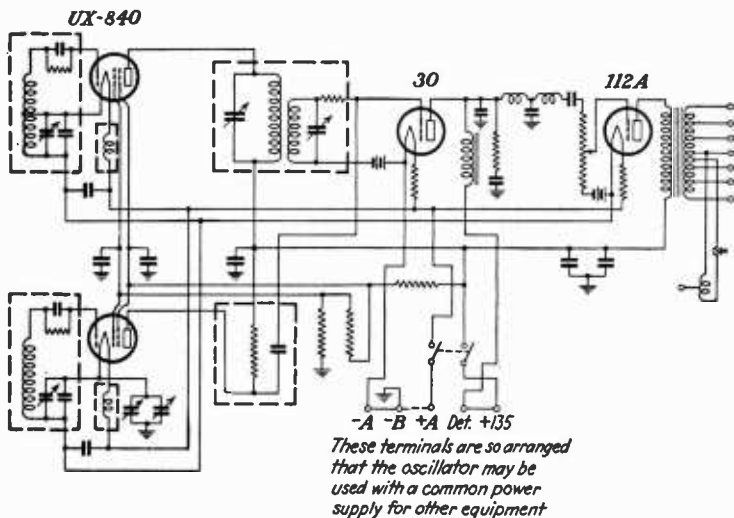

FIG. 29.—Beat frequency oscillator circuit. (RCA Manufacturing Company.)

meeting this difficulty. The oscillator of Fig. 29 will, without special adjustment, have a maximum harmonic output of 5 per cent or less over the entire audio range (20 — 17,000 cps). At frequencies above 100 cps, the harmonic content will be less than 2.5 per cent provided proper termination is maintained. A low harmonic content presupposes a pure resistance load.

17. Multivibrators. The multivibrator is perhaps best described as a two-stage resistance-coupled amplifier in which the output voltage is fed back to the input. Since each tube introduces a phase shift of 180 deg., the voltage applied to the first tube from the second has the correct phase to produce sustained oscillations.

Figure 30 shows the fundamental schematic of this type of oscillator, along with curves of the various current and voltage relations in the circuit.¹

¹ HUND, AUGUST, "High-frequency Measurements," McGraw-Hill Book Company, Inc., 1933.

The approximate frequency of oscillation of the multivibrator is given by

$$f = \frac{1}{R_1 C_1 + R_2 C_2} \quad (30)$$

The wave form of the output of the multivibrator is highly distorted, but this results in one of the most useful features of this circuit, i.e., it is

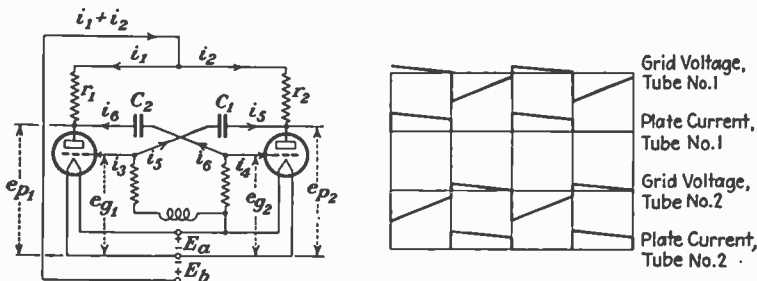

FIG. 30.—Fundamental circuit of the multivibrator and the voltage and current relations of the various branches.

used as a submultiple generator. If the circuit is set up as shown in Fig. 31 and the output from a high-frequency oscillator connected to the terminal marked "In," the output will give frequencies which are exact submultiples of that applied to the input; submultiple frequencies as low as $f/40$ are easily found.

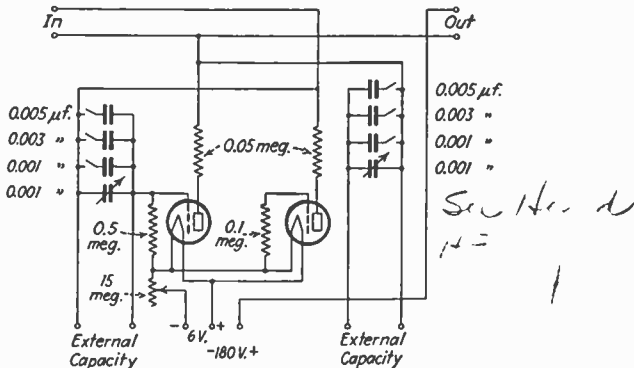

FIG. 31.—Generator of submultiple frequencies.

If the input and output terminals are short-circuited (a small coil may be connected between the low-potential ends of the grid resistances for coupling to an external circuit), frequencies as low as 1 cycle per 10 sec. and as high as 50,000 cycles per second can be obtained.

18. Glow-discharge-tube Oscillators. This type of oscillator is of the so-called relaxation type, *i.e.*, circuits where the oscillations are due to condenser charges and discharges through a resistance. The product of C and R determines the frequency, although it should be pointed out that the positive and negative loops of the cycle are sometimes of different duration; this, of course, results in a distorted wave shape, although the richness in harmonics makes this a valuable feature for some applications.

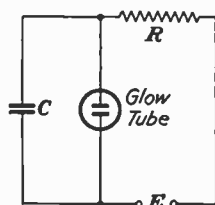

FIG. 32.—Glow-tube oscillator.

Figure 32 is the simplest form of the relaxation oscillator and consists of a variable capacity C , a variable resistance R , and the so-called glow tube, all connected, as shown, across a d-c voltage supply.¹ Oscillations take place because of differences between the starting and extinction potentials of the tubes. The d-c voltage charges the condenser through the resistance until the voltage across the tube reaches the starting value. The glow discharge then takes place, and the condenser discharges through the tube until the voltage drops to the extinction point. The cycle then repeats at a frequency which is given by

$$f = \frac{1}{RC \log \frac{E - E_s}{E - E_e}} \quad (31)$$

in which E is the supply voltage, E_s the extinction potential, and E_e the starting potential.

If an inductance is inserted in series with the condenser, there will be no sudden surge of current through this branch of the circuit. The net effect is that the condenser charges and discharges more smoothly, and the combination of capacity and inductance begins to exert a control over the frequency of oscillation.²

Figure 33 is the circuit diagram for an inductive glow-discharge oscillator. For this circuit the frequency is given by

$$f = \frac{1}{2\pi\sqrt{L'C'}} \quad (32)$$

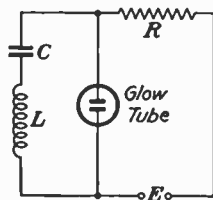

FIG. 33.—Inductive glow-tube oscillator.

In this expression, L' and C' include the effective inductance and capacity of the tube itself.

At the resonant frequency of this circuit the discharge through the tube lasts throughout the entire cycle, so that a reasonably sinusoidal current wave results. Figure 34 shows this circuit with more refinements.

HIGH-FREQUENCY OSCILLATORS

19. Limiting Frequencies of Vacuum-tube Oscillators. The three-electrode tube can be dependent upon to generate frequencies as high as

¹ *Ibid.*

² Kock, W. E., *Electronics*, March, 1935.

about 30 Mc without a great loss of power from this high-frequency operation. Beyond this range, while the tube may oscillate, the power output and hence the efficiency decrease seriously. The obvious answer to this difficulty is a radical redesign of the tube, paying particular attention to the interelectrode capacities and the inductance of the lead wires, both of which enter into the determination of the upper frequencies at which a tube will oscillate.

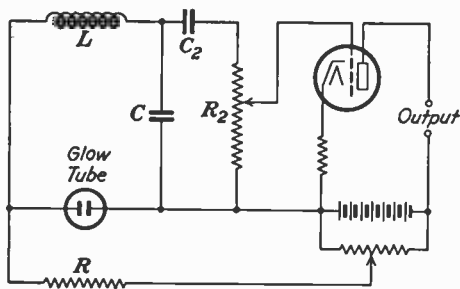

FIG. 34.—Circuit for glow-tube oscillator.

In 1927, Englund, of the Bell Telephone Laboratories, Inc., reported satisfactory operation at 1.67 meters using conventional tubes (WE 215A). Removing the base from the tubes resulted in a further decrease in wave length to 1.42 meters. The circuit employed is shown in Fig. 35. This particular type of tube represents about the most compact commercially available triode; the lead wires are extremely short, and the maximum interelectrode capacity, i.e., plate to grid, is only 2.6 $\mu\text{f.}$ ¹

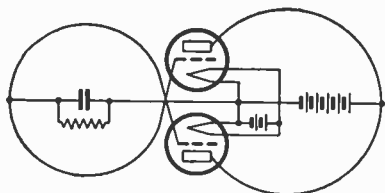

FIG. 35.—Short-wave oscillator of Englund.

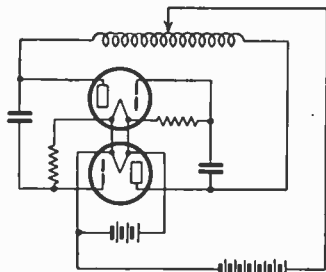

FIG. 36.—Symmetrical short-wave oscillator.

For wave lengths above 5 meters ($f = 60 \text{ Mc}$), some tubes appear to be satisfactory provided certain precautions are taken. It seems best, in order to shorten the length of the leads, to operate two tubes in a symmetrical circuit as is shown in Fig. 36. This "back-to-back" arrangement may also be used with the conventional Lecher wire system as shown in Fig. 37.

¹ ENGLUND, C. R., *Proc. I.R.E.*, vol. 15, November, 1927.

More recent investigations have shown that a conventional circuit, for instance, the Colpitts oscillator, can be made to function at ultra-high frequencies by using nothing but the interelectrode capacities and the lead inductances of the tube as the elements of the oscillating circuit. In this case the only part of the oscillating circuit external to the tube itself is a short-circuiting link between the grid and plate terminals.

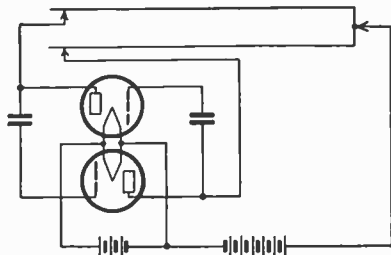

FIG. 37.—“Back-to-back” Lecher wire circuit.

Figure 38a shows the standard Colpitts oscillator circuit, while b, of the same figure, is the limiting circuit.¹

Since the fundamental frequency of oscillation of any circuit is given by

$$f = \frac{1}{2\pi\sqrt{LC}} \quad (33)$$

it can be seen that the frequency of oscillation of the circuit of Fig. 38b is determined by substituting for L in this equation the quantity

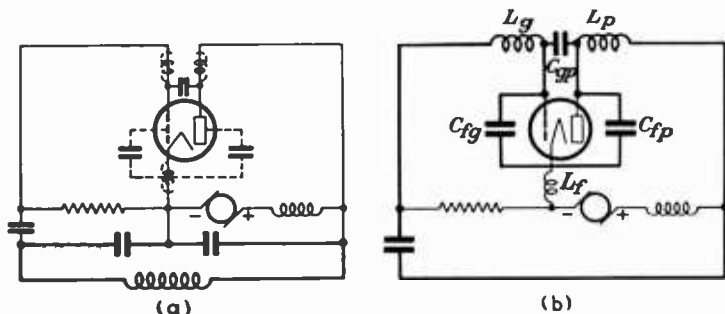

FIG. 38.—Colpitts high-frequency oscillator.

$(L_g + L_p)$, in which L_g and L_p are the inductances of the grid and plate leads as indicated in the figure. C in the equation is a function of the interelectrode capacities of the tube and may be expressed as

$$C_{gp} + \frac{C_{fg}C_{fp}}{C_{fg} + C_{fp}}$$

¹ KELLEY and SAMUEL, *loc. cit.*

While this circuit oscillates at extremely high frequencies, the power output is seriously reduced and there is a total loss of control over the amplitude and phase of the grid and plate potentials.

20. Special Tubes for High Frequencies. The next step in pushing the frequency range upward is in the construction of special tubes. McArthur and Spitzer¹ have described a tube which is effective in the range from 60 to 150 Mc. This tube departs from conventional design chiefly in the ratio of the plate diameter to plate length and in the special arrangement whereby the grid and plate leads are brought out through separate presses. Compared with a conventional tube of the same plate dissipation, this tube has its interelectrode capacities reduced by a factor of about 4.

At still higher frequencies, the transit time of an electron from cathode to plate becomes of importance, and in the design of tubes for use above about 200 Mc it becomes justifiable to increase the interelectrode capacities in order to reduce the transit time of the electrons. Fay and Samuel² have recently described tubes for use at 300 Mc in which the electrode spacing is somewhat closer than that in the tubes described by McArthur and Spitzer, although the interelectrode capacities actually prove to be slightly lower. The length of the leads has been decreased, and, in order to decrease the inductance and resistance, the leads have been made larger in diameter.

It is interesting to note, while the tube described by McArthur and Spitzer refuses to oscillate at 300 Mc, this latter tube functions at that frequency with an efficiency of 18 per cent.

Fay and Samuel² report on a tube with an output of 6 watts at 500 Mc and a frequency limit of 740 Mc. As made, the tube presents a rather unusual appearance including among other things the total absence of the usual press and the peculiar construction of the grid, it being in the form of a number of straight wires, parallel and equidistant from the filament, supported by cooling collars at the ends. Despite its small size, the plate can dissipate 40 watts.

In a paper by Kelly and Samuel,³ a tube is described which functions at 1,200 Mc with an efficiency of 10 per cent. While the authors point out that the tubes are in no sense a commercial product, it is reasonable to assume that with further advances in the art the frequency range of the negative-grid triode may be extended beyond 1,200 Mc.

Other methods of generating ultra-high frequencies have been described above.

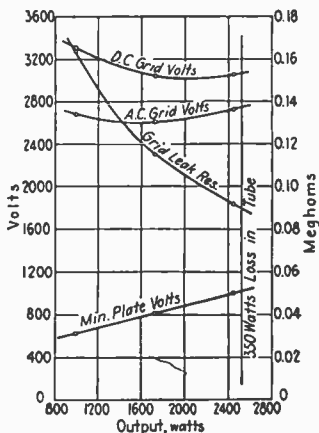

FIG. 39.—Optimum operating conditions.

¹ McARTHUR and SPITZER, *Proc. I.R.E.*, vol. 19, November, 1931.

² FAY, C. E., and A. L. SAMUEL, *Proc. I.R.E.*, vol. 23, March, 1935.

³ *Loc. cit.*

Tubes developed by Thompson¹ and associates will be found described in Sec. 8 on Vacuum Tubes. These tubes, known as *acorn* tubes are very small, and are effective at wave lengths of the order of 1 meter and less. At 3 meters they produce about the same voltage amplification as modern receiving tubes produce at broadcast wave lengths. At 3 meters none of the present broadcasting tubes is effective.

OSCILLATOR DESIGN

21. Design of the Simpler Vacuum-tube Circuits.² A vacuum-tube oscillating circuit must contain stored energy to maintain oscillations. The energy leaves the circuit as output at a different instantaneous rate than it enters as input and, consequently, some flywheel effect is necessary.

Consider a circuit having an inductance L , a capacity C , and oscillating at a frequency f and voltage V with W watts loss. At a point in the cycle when the current is zero, the instantaneous voltage will be $\sqrt{2}V$; all the energy is stored in the condenser; and its amount is CV^2 . The r-m-s current in this circuit is $2\pi fCV$, and the joules lost per cycle are W/f . Dividing energy stored by joules lost per cycle gives

$$\frac{\text{Energy stored}}{\text{Energy lost per cycle}} = \frac{CV^2}{W/f} = \frac{fCV^2}{W} = \frac{2\pi fCV^2}{2\pi W} = \frac{VI}{2\pi W}$$

which shows that the ratio of energy stored to energy dissipated per cycle is $1/2\pi$ times the ratio of reactive power to watts. Circuits having less than twice as much energy stored in them as they dissipate per cycle have been found by actual test to have a tendency to erratic operation. Circuits having a greater relative amount of stored energy give excellent operation but require more condenser capacity and more expensive inductance coils, and the useless power losses in the oscillating circuit are higher. Unless, therefore, there is some other determining factor, circulating volt-amperes should approximate 4π times the total power output in watts as a desirable minimum value. Another way of saying this is that the power factor should not be over 8 per cent or, in the older radio nomenclature, that the decrement should not exceed 0.25. This circulating energy has the same effect as the flywheel of a single-acting engine and must be coupled closely to the plate; *i.e.*, the circuit must be so arranged that the sinusoidal voltage wave of the oscillating circuit is available at the tube terminals without distortion due to the current passing between the two. As a mechanical analogue, consider the value of a flywheel driven through a spring—an oscillating circuit connected to a vacuum tube through a loose coupling of any sort would be equally ineffective.

After assurance is obtained that the circulating energy is adequate, the design of an oscillating circuit becomes a matter of obtaining the proper voltages and phase relations for the leads to the tube. Two general types of circuit are in common use and in either of these the production of the desired values is quite simple.

¹ THOMPSON, B. J., Tubes to Fit the Wavelength, *Electronics*, August, 1933; and SALZBERG, B., *Electronics*, September, 1934.

² The editor and author wish to acknowledge their indebtedness to D. C. Prince for permission to use the material which appears as Arts. 21 to 32 inclusive, and which constituted an appreciable portion of the section on Oscillation in the first edition of this handbook.

22. Design of a Hartley Circuit. Figure 40 shows a form of the Hartley circuit. The oscillating current is made to flow through two inductances or one inductance with a tap. The voltage drops across the two windings are used as the alternating components of the plate and grid voltages. Energy is supplied at constant potential from the blocking condenser C_2 . This condenser supplies the pulses of current drawn through the tube at the frequency of the oscillating circuit. The charge is replaced at a more uniform rate from the direct-current source G through the choke L_c . The oscillating circuit consists of the plate inductance L_p , the grid inductance L_g , the condenser C_1 , and the load resistance r_L . It will be noticed that the triode, the oscillating circuit and the immediate source of energy C_2 are connected in series.

We shall assume that the impedance of the load resistance will be quite small compared with the other impedances in the oscillating circuit, and its effect on the voltage distribution may be neglected in an approximate calculation. The function of the grid-leak resistance r_g and bias condenser C_3 is to maintain a bias for the grid voltage. The condenser has sufficient capacity to pass the current pulses through to the grid without distorting the voltage wave, but the average current thus passed is discharged at a uniform rate through the resistance, thereby providing a steady bias voltage.

The first step in design is to determine the volt-amperes in the oscillating circuit, which value should be at least 4π times the watts output. The voltages across L_p and L_g are obtained from the curves giving optimum operating conditions for the tube and this fixes the current and impedance of the various parts of the oscillating circuit. The value of the grid-leak resistance is also obtained from the optimum operating conditions curves. This leaves only the plate choke L_c , blocking condenser C_2 and grid-leak condenser C_3 to be determined. In general, if the choke has enough inductance so that it passes only a very small current and the condensers have sufficient capacity to present no appreciable impedance to the currents which they carry, the circuit will operate satisfactorily. There are certain refinements to be considered if the best design practice is to be followed, but consideration of these will be deferred.

23. Design of Colpitts Oscillator. Figure 41 shows a form of the Colpitts circuit which differs from the Hartley circuit in that the plate and grid alternating voltages are obtained by taking the voltage drop across two condensers instead of across two inductances. The oscillating

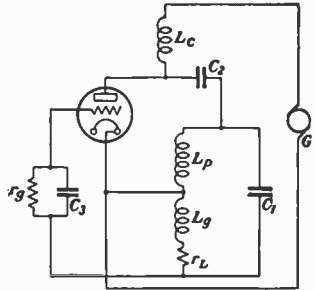

FIG. 40.—Form of Hartley circuit.

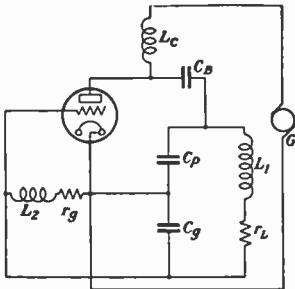

FIG. 41.—Colpitts oscillator.

circuit, therefore, consists of the plate condenser C_p , the grid condenser C_g , the inductance L_1 , and effective resistance r_L . A plate choke L_c and blocking condenser C_B are used as in the Hartley circuit. The capacity C_g serves also as the grid-leak condenser. In order to prevent a loss in the grid-leak resistance r_g , due to the alternating voltage across the condenser, the former has in series with it a substantial choke coil L_2 . The Colpitts circuit offers practically the same design problems as the Hartley circuit and will therefore not be considered separately.

24. Design Calculations. An example will serve to illustrate the methods of calculation just described. Assume a Hartley circuit, as in Fig. 40, driven by a one-kilowatt triode operating at 15,000 volts direct potential. The curves of optimum operating conditions are given in Fig. 39. The output is to be one kilowatt at 10^6 cycles.

For an output of one kilowatt, the circulating volt-amperes immediately available in the oscillating circuit will be 4π , or about 12.5 kva.

From Fig. 39 the minimum instantaneous plate volts should be 630. Deducting this from 15,000 volts leaves 14,370 for the peak value of the plate alternating voltage, which corresponds to 10,160 volts r-m-s. Figure 39 gives also the grid alternating voltage, which is 2,690 volts in this case. Adding the plate and grid voltages together gives 12,850 volts as the total a-c drop across the oscillating circuit.

TABLE I

Element of circuit	Volts	Amperes	Impedance	Value at 10^6 cycles
Plate coil L_p	10,160	1.23	8,270	1.32 mh
Grid coil L_g	2,690	1.23	2,185	0.348 mh
Tuning condenser C_1	12,850	1.23	10,450	0.000,152 μ f

To be conservative, it will be assumed that only that part of the energy stored in the oscillating circuit which corresponds to the volt-amperes in the plate coil is coupled closely enough with the vacuum tube to be useful as flywheel effect. This means that the plate coil must carry a current corresponding to the 12,500 volt-amp. at 10,160 volts, or 1.23 amp., and this is the circulating current of the oscillating circuit. Hence, there results the accumulation of the data in Table I.

The grid-leak resistance should be approximately 165,000 ohms, and a condenser of a few thousandths of a microfarad capacity representing an impedance of less than a hundred ohms should operate nicely as a grid-leak condenser C_3 . A condenser of similar capacity, but insulated for a higher voltage, should be satisfactory as a plate-blocking condenser C_2 . It is very desirable to keep the high-frequency current out of the supply source because of the damage it can do there. As far as the r. f. is concerned, the choke coil L_c is in parallel with the plate coil L_p , for there will be enough capacity in the leads and windings of the generator G to make sure that it will present very little impedance to high frequency. Hence, if the choke coil has an inductance of several hundred or a thousand times that of the plate coil the operation will probably be altogether satisfactory. As a practical precaution, however, it is advisable to shunt G with a condenser to by-pass any high-frequency current reaching its terminals.

25. Effect of Load Resistance. A point of the greatest importance, which is sometimes overlooked, is the fact that the effective resistance of the oscillating circuit is absolutely fixed. Since the voltages in the circuit permit only slight variation without greatly disturbing the efficiency, it is necessary that the load absorb the correct power at the current fixed by this condition. In this case in hand, the current is 1.23 amp. and the output 1 kw, which means the effective resistance of the oscillating circuit must be 660 ohms. If the load itself does not have this actual resistance, it must be coupled into the oscillating circuit in such a way that it presents the effective resistance. Considerations which follow, dealing with more complicated circuits, will illustrate some of the ways in which this can be accomplished.

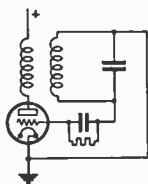

FIG. 42.—Grid-circuit oscillator.

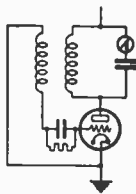

FIG. 43.—Plate-circuit oscillator.

The two simple circuits of Figs. 42 and 43 are calculated as in the foregoing cases but require the calculation of mutual inductance in determining the anode voltage in Fig. 42 and the grid voltage in Fig. 43.

26. Grid Phase-angle Corrections. In dealing with the design of oscillating circuits the effects of the load resistance, the plate choke, and the blocking condenser were described as though only their primary functions were fulfilled and, this accomplished, they exerted no other influence on the circuit. All three parts of the circuit can, however, affect its operation; and, though the changes produced are usually small, it is satisfying to know just what may be expected. In general, the effects consist of the introduction of small voltages or currents into the simple scheme of things first described. This results in a small change in magnitude of practically all of the various quantities, combined with a slight change in the phase relations.

To simplify the discussion, only the fundamental frequency component of the current supplied to the oscillating circuit through the blocking condenser will be considered. The harmonics are relatively much less important, and their omission will entail no serious error. The value of the fundamental component can be obtained by dividing the watts input to the oscillating circuit by the voltage between the leads to the plate and filament of the tube.

Figure 44 illustrates the effect of the load resistance in a Hartley circuit. The oscillating circuit itself *AOBC* is drawn in such a way that the angles between various parts of the circuit correspond to the electrical phase differences of the voltages across them. Thus the grid coil *OB* and the condenser *AC* are in geometrically parallel sections of circuit, for they carry the same current, and both are pure reactances. The load resistance is drawn at right angles to them for similar reasons. Part of the load resistance might be located in the plate coil section *AO*, but this

would not affect the diagram, so far as the object in hand is concerned, which is to show the relation between plate and grid voltages. It will be observed that the grid current has been neglected. This is not the case with the plate current, which may be represented by a sinusoidal current flowing between the leads to the circuit at *A* and *O*. For this reason the plate coil in Fig. 44 is not drawn parallel with the grid coil, but

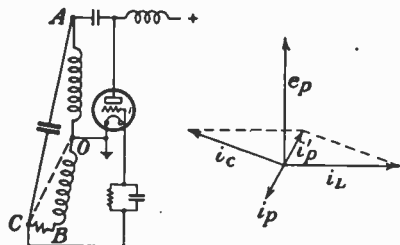

FIG. 44.—Effect of load resistance in Hartley circuit.

instead there is a phase difference between their voltages. For the present it will be assumed that there is no drop across the blocking condenser and no current passed by the plate choke. Hence, *OA* will be the alternating component of the plate voltage.

The grid voltage will be represented by the dotted line *OC* in Fig. 44 and the plate current will be in phase with it. Thus, in the vector diagram the plate current i_p is drawn parallel with *OC*. The currents through the condenser and plate coil are 90 deg. out of phase with the corresponding voltages and are represented by i_c and i_L perpendicular to *AC* and *OA* respectively. Adding the two vectorially results in i_p' which must be equal and opposite to the alternating component of the plate current i_p . It will be seen that i_p' must always lag behind e_p , or, in

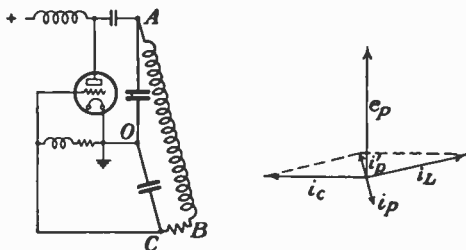

FIG. 45.—Colpitts circuit.

other words, the oscillating circuit absorbs power not as a perfect resistance but as a resistance in connection with an inductance. The circuit itself produces this effect by running slightly below the resonant frequency, thus drawing the lagging component of current by increasing the current through the inductance and decreasing the current through the capacity. The deviation of the frequency from that corresponding

to the natural frequency of oscillation can be calculated by applying numerical values to the vectors.

The corresponding phenomena in a Colpitts circuit are shown in Fig. 45. In this case i_p' leads e_p by an angle which requires that the oscillating circuit operate slightly above its natural frequency in order to produce this power factor. This self-adjustment of the simpler types of circuit is a very valuable property under many conditions, as it automatically insures against serious losses due to the grid excitation being out of phase.

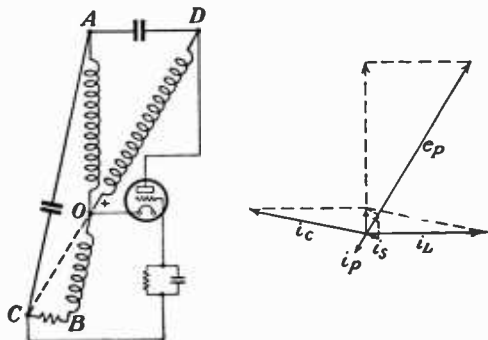

FIG. 46.—Effect of plate choke and blocking condenser on Hartley circuit.

27. Effect of Imperfect Chokes and Condensers. Figure 46 indicates the effect of the plate choke and the blocking condenser upon the operation of the circuit. This is the same Hartley circuit as shown in Fig. 44, but the blocking condenser and plate choke are no longer considered to be perfect in operation. The alternating component of the plate voltage is, therefore, no longer represented by OA but by a vector OD displaced from OA by the addition of AD , the drop in the blocking condenser. The plate choke may be considered to be grounded on the side next to the high voltage generator as far as the high frequency is concerned, so this choke appears as an inductance connected between O and D .

By choosing a blocking condenser of the correct impedance, it is possible to bring the plate voltage OD exactly 180 deg. out of phase with the grid voltage, the conditions to be desired for efficient operation. This will result in the oscillating circuit plus the blocking condenser drawing a load with a leading current component. This component may then be neutralized by arranging the choke so that it will draw a lagging current of equal magnitude. In the vector diagram of Fig. 46 the current through AC is represented by i_c and that through AO by i_L . These combine to form a short vertical current vector to which is added the choke current i_s to form a total current equal and opposite to i_p supplied by the tube. The voltage across OA has been taken to be vertical and, if the sum of i_c and i_L is vertical, the drop which this current causes in the blocking condenser must be represented by a horizontal line. This, when added to that representing the voltage across OA , results in the alternating component of the plate voltage e_p . This voltage can, by this means, be

made opposite to i_p and e_o , i.e., by control of the drop in the blocking condenser.

To make a complete calculation of a circuit including the points just discussed, the circuit $OBCA$ is treated as though the choke and blocking condenser were not present. This circuit may be equivalent either to a pure resistance between A and O (as shown in the vector diagram) or the equivalent load may contain some reactance. Let it be so proportioned that it will be equivalent to a resistance. The angle COA and its supplement AOD can then be calculated. The equivalent resistance between A and O is known since it represents a given load at a given voltage. The capacity reactance AD can, therefore, be selected so that $AD/OA = \tan(180^\circ - AOC)$.

The alternating voltage is impressed at D and the circuit DAO will draw some leading current, the amount being easily ascertainable. It is then only necessary to choose the choke DO of such a value that it will draw the same amount of lagging current.

28. Absolute Values of Choke and Condensers. The procedure in arriving at the proper values of blocking condenser and line choke will be clearer if the solution of a numerical example is carried through. The first item to be determined is the ratio of the inductances on which the alternating components of the plate and grid voltage depend. In Fig. 46 the plate voltage is represented by OD and the drop across the inductance by OA , and it will be noticed that the two may be considered equal in magnitude unless the circuit is far from normal in design. The effect of the resistance in the grid inductance on the magnitude of the grid voltage can also be neglected. The two inductances will then be in the same ratio as the alternating components of plate and grid potentials E_p and E_o respectively, as determined from the data on optimum operating conditions.

Assume that this gives

$$\frac{E_p}{E_o} = \frac{OA}{OC} = 4$$

Let $OA = 100$ ohms inductance with 5 ohms resistance

$OB = 25$ ohms inductive reactance

$BC = 2.5$ ohms resistance

$CA = 125$ ohms capacity reactance

Then angle $OAC = \sin^{-1} \frac{2.5}{100} = 1 \text{ deg. } 27 \text{ min.}$

If 100 volts be impressed across OA ,

$$i_L = 1, \text{ watts in } OA = (i_L)^2 \times 5 = 5.0$$

$$i_c = 1, \text{ watts in } BC = (i_c)^2 \times 2.5 = 2.5$$

$$\text{Total watts} = \underline{7.5}$$

Equivalent resistance = $\frac{E^2}{W} = \frac{100^2}{7.5} = 1,333$ ohms. It will be arranged to have this circuit operate at the resonant points so that its reactance between O and A is zero.

In the triangle *AOC*

$$\frac{OA}{\sin ACO} = \frac{OC}{\sin OAC} = \frac{AC}{\sin AOC}$$

$$\frac{100}{\sin ACO} = \frac{25}{0.025}, \sin ACO = 0.1$$

Angle *ACO* = 4° 45 min.

Angle *AOD* = angle *OAC* + angle *ACO* = 7 deg. 12 min.

AD = impedance between *A* and *O* × tan *AOD*

$$= 1,333 \times 0.126 = 168 \text{ ohms capacitance.}$$

The total impedance between *O* and *D* through *A* is 1,343 ohms, so that the ratio between the plate and grid voltages suffers no appreciable change due to the presence of the plate-blocking condenser. If 100 volts are impressed between *D* and *O*, the current is

$$\frac{100}{1,343} = 0.0745 \text{ amp.}$$

and the wattless volt-ampere component is, then,

$$0.0745^2 \times 168 = 0.933 \text{ volt amp.}$$

In order to correct for these leading volt amperes, the choke should draw the same amount lagging, thus giving

$$DO = \frac{100^2}{0.933} = 10,700 \text{ ohms}$$

If the impedance of the plate-blocking condenser had been high, the desired ratio between grid and plate voltages would not have been obtained. It would then have been necessary to assume an initial value somewhat larger than desired for the final result, proceeding by a series of approximations. However, for other reasons, it is not likely that a high-impedance blocking condenser would be desirable. A high-impedance blocking condenser corresponds to a low-impedance choke which would allow radio-frequency currents to flow in circuits with high effective resistance and thus, possibly damage power generating apparatus.

29. To Secure Proper Phase Relations. Proportioning the plate-blocking condenser and line choke is not the only method of bringing plate voltage and current into the 180-deg. phase relation. The angle *OAC* may be compensated for by de-phasing the grid in such a way as to cause the oscillations to occur at the natural resonant frequency and the plate current and voltage to be properly related.

In Fig. 47 diagrams of two methods are shown by which a Hartley circuit may be restored to operation at the natural resonant frequency of the circuit with proper phase relations, while at the right are two equivalent methods for the Colpitts circuit. In the first diagram the phasing is accomplished by connecting resistance *CG* and inductance *GO* in series. The grid is attached at *C*. The same result is accomplished in the second drawing by a resistance from *O* to *G* and a condenser from *G* to *C*. The elements are reversed in the third and fourth to produce lag instead of lead.

Although grid phasing may correct the various angles, it is probable that adjustments of the choke and the blocking condenser are to be

preferred since these devices are normally present and so do not constitute added complication.

30. Grid-bias Condenser. It will be noted that no criteria have yet been developed governing the choice of a grid-blocking condenser. Since the function of this condenser is to pass the alternating-current component of grid excitation without the occasion of serious voltage drop while forcing the direct component to flow through the grid leak or biasing resistance, its value is not critical. Its value should be large enough to make the grid-plate capacity small by comparison. The

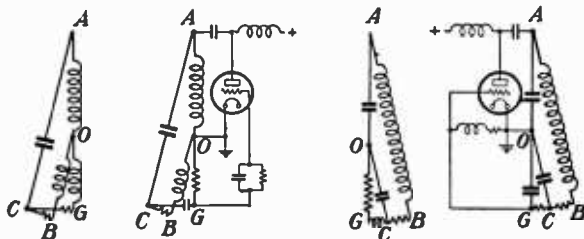

FIG. 47.—Hartley (left) and Colpitts (right) circuits.

values of tube capacity are normally so small that this requirement causes no concern. The individual pulse of direct current should cause no considerable change in the bias, but this requirement also causes small concern. Too large a value of condenser will produce intermittent oscillations because of the time required to charge and discharge.

31. Use of Tubes in Parallel and Push Pull. In case more power is desired than one tube can furnish, it is possible to parallel two tubes. However, it is often more desirable to connect the two tubes at opposite ends of the oscillating circuit in what is called the push-pull arrangement.

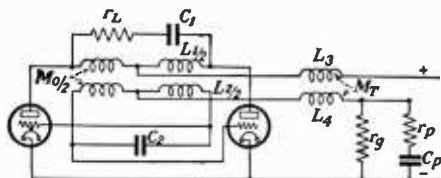

FIG. 48.—Push-pull oscillator with square current waves through each tube per half cycle.

The oscillator efficiencies determined in the foregoing paragraphs are all on the assumption that substantially sine waves of voltage are employed. By modifying the voltage wave in such a way as to maintain the potential drop across the tube at a minimum for a considerable time, it is possible to secure considerably increased outputs from a given pair of tubes while still maintaining high efficiency.

In Fig. 48 is shown a circuit of the push-pull type in which, by proper design, it is possible to have approximately square current waves drawn through each tube for a half cycle. While the calculations are somewhat

more involved, they are not too difficult and here, as before, comparison of practice with theory has shown that performance can be estimated with a high degree of accuracy.

32. Output and Efficiency of Operation. In calculating the performance of a tube, the energy delivered to the oscillating circuit is its output. In general, this circuit will have two effective resistances, one representing useful energy, and the other representing losses. The first resistance is used in calculating the output of the entire apparatus, but the second should also be included when calculating the tube performance; for it is not right to charge any device with losses dependent on another part of the apparatus.

The energy delivered to the oscillating circuit by the tube may be calculated directly by integrating the instantaneous product of plate current and oscillating circuit voltage for a complete cycle. As in many other devices of good efficiency, however, it is found desirable to calculate the input to the tube and losses connected with it and take the difference between the two for the output.

The input is obtained by multiplying the average plate current by the potential of the d-c source of energy.

The losses are of two kinds: those inside the tube and those dependent upon the tube's grid requirements. The losses in the tube are obtained by integration of the products of instantaneous values of the plate and grid voltages and the corresponding currents. The only other loss to be charged against the tube is that occurring in the grid-leak resistance. This is obtained by multiplying the average grid current by the bias voltage.

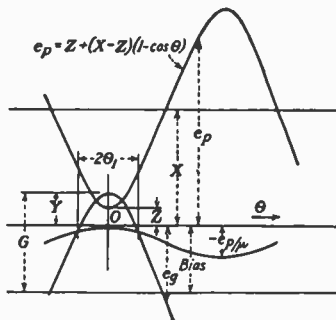

FIG. 49.—Curves for calculating tube performance.

Figure 49 shows the plate and grid voltages with the nomenclature to be used in calculating tube performance; X is the direct potential of the supply source (often termed direct plate voltage) and Z is the minimum instantaneous plate voltage. This gives for the instantaneous plate voltage

$$e_p = Z + (X - Z)(1 - \cos \theta)$$

in which angular displacement θ is measured from the point of minimum voltage.

The maximum amplitude of the alternating component of the grid potential is G and it is superimposed on the bias voltage B . The maximum positive value of the grid voltage is Y and its instantaneous value is

$$e_g = Y - G(1 - \cos \theta)$$

In making calculations of tube performance it is convenient to assume a given angle for plate-current flow and, likewise, given values for minimum plate and maximum grid voltages and then to calculate from these assumed values the required grid excitation. Figure 49 shows how the grid excitation, operating angle, and plate and grid voltages are related. When the grid

voltage is equal to $-e_p/\mu$ the tube is at the point of cut-off. Letting θ_1 be the corresponding phase angle gives

$$G(1 - \cos \theta_1) = Y + \frac{e_p}{\mu}$$

or

$$G = \frac{Y + \frac{1}{\mu}(Z + (X - Z)(1 - \cos \theta_1))}{1 - \cos \theta_1}$$

and, of course,

$$B = G - Y$$

33. Adjustment and Control. The main considerations in the adjustment of an oscillator circuit are those which make for maximum power output and, except in the case of oscillators used as harmonic generators, the reduction or elimination of all frequencies other than the fundamental.¹

Article 32, above, discussed the output and efficiency of operation, and it will be necessary only to point out that, once the tuned circuit has been adjusted to the operating frequency, the coupling of this resonant circuit to the plate circuit of the tube is varied until the desired value of oscillating current is obtained in the resonant circuit. Very frequently this adjustment of the coupling results in a change of fundamental frequency, which change must, of course, be compensated for by retuning the resonant circuit; the adjustment of the oscillator then becomes a matter of "cut and try" to find the point of maximum oscillating current at the desired frequency. Occasionally it will be found that, as discussed above, adjustment of the grid leak will have some effect upon the efficiency of operation.

In the conventional oscillator the power output is under control within the limits set by the maximum permissible tube voltages. Obviously, at the maximum tube voltages, the greatest power output will be obtained at an optimum value of coupling between the plate and grid circuits of the tube and between the oscillator and the load.

Power can be taken from the oscillating circuit by either direct or indirect coupling; however, it must be kept in mind that the effective resistance of the load circuit is *reflected* into the oscillatory circuit to a degree determined by the coupling factor between the two circuits, and this reflected resistance must be considered in the design of the oscillatory circuit.

Operation of the oscillator tube at reduced voltages (plate and grid) is another method of controlling the power output, although this results in a loss of efficiency, especially when it is remembered that the operating voltages are design parameters of great significance.

References

Oscillators, General:

- ARGUMBAAU, L. B.: *I. R. E.*, **21**, January, 1933.
 BENIOFF, H.: *I. R. E.*, **19**, July, 1931.
 DOW, J. B.: *I. R. E.*, **15**, May, 1927; **19**, December, 1931.
 ELLER, K. B.: *I. R. E.*, **16**, December, 1928.
 GROSKOWSKI, JANUSZ: *I. R. E.*, **22**, February, 1934.
 HAMBURGER, F., JR.: *I. R. E.*, **22**, January, 1934.
 JEN, C. K.: *I. R. E.*, **19**, December, 1931.
 JIMBO, S.: *I. R. E.*, **17**, November, 1929.
 KING, R. W.: *B. S. T. J.*, **2**, October, 1923.

¹ TERMAN, F. E., "Radio Engineering," McGraw-Hill Book Company, Inc., 1932.

- KRUSE, R. S.: *Q. S. T.*, December, 1926; January, February, March, 1927.
 MODEL, S. J.: *I. R. E.*, **21**, December, 1933.
 ROSENSTEIN, H. O.: *I. R. E.*, **19**, October, 1931.
 STONE, J. S.: *I. R. E.*, **19**, August, 1931.
 VAN DER POL, BALH: *I. R. E.*, **22**, September, 1934.
 VECCHIACCHI, F.: *I. R. E.*, **19**, May, 1931.

Frequency-control Crystals:

- BOELLA, M.: *I. R. E.*, **19**, July, 1931.
 CADY, W. G.: *I. R. E.*, **10**, April, 1922.
 CLAYTON, J. M.: *Q. S. T.*, September, 1926.
 COLWELL, R. C.: *I. R. E.*, **20**, May, 1932.
 DAWSON, Q. S. T., September, 1926.
 DYE, D. W.: *Phys. Soc.*, **36**, August, 1926.
 HARRISON, J. R.: *I. R. E.*, December, 1927; **16**, November, 1928.
 HEATON, V. E., and E. G. LAPHAM: *I. R. E.*, **20**, February, 1932.
 HORTON, J. W., and W. A. MARRISON: *I. R. E.*, **16**, February, 1928.
 KOGA, I.: *I. R. E.*, **19**, June, 1931.
 LAPHAM, E. G.: *I. R. E.*, **22**, January, 1934.
 MACKINNON, K. A.: *I. R. E.*, **20**, November, 1932.
 MEAHL, H. R.: *I. R. E.*, **22**, June, 1934.
 MUELLER, E. L.: *Q. S. T.*, May, 1927.
 PIERCE, G. W.: *Am. Acad.*, **59**, October, 1923.
 TERRY, E. M.: *I. R. E.*, **16**, November, 1928.
 VAN DYKE, K. S.: *I. R. E.*, **16**, June, 1928.
 VIGOUREUX, P.: *Phil. Mag.*, December, 1928.
 ———: "Quartz Resonators and Oscillators."
 WATTS, W. A.: *Q. S. T.*, January, 1928.
 WHEELER, L. P.: *I. R. E.*, **19**, April, 1931.
 WILLIAMS, N. H.: *I. R. E.*, **21**, July, 1933.
 WORRALL, R. H., and R. B. OWENS: *I. R. E.*, **16**, June, 1928.
 WRIGHT, J. W.: *I. R. E.*, **17**, January, 1929.

High-frequency Oscillators (including magnetrons, electron coupling, etc.):

- DYRTT, L. F.: *I. R. E.*, **23**, March, 1935.
 HOAG, J. B.: *I. R. E.*, **21**, August, 1933.
 HOLLMANN, H. E.: *I. R. E.*, **17**, February, 1929.
 KARPLUS: *Gen. Rad. Exp.*, **8**, May, 1931.
 KILGORE, G. R.: *I. R. E.*, **20**, November, 1932.
 KOZANOWSKI, H. N.: *I. R. E.*, **20**, June, 1932.
 LOEBER, C. W.: *Electronics*, November, 1930.
 McNAMARA, F. T.: *I. R. E.*, **22**, August, 1934.
 MEGAW, E. C. S.: *I. R. E.*, **21**, December, 1933.
 MOORE, W. H.: *I. R. E.*, **22**, August, 1934.
 MOUROMTSEFF, I. E., and NOBLE: *I. R. E.*, **20**, August, 1932.
 OKABE, KINJIRO: *I. R. E.*, **21**, November, 1933.
 THOMPSON, B. J., and P. O. ZOTTU: *I. R. E.*, **22**, December, 1934.
 WENSTROM, W. H.: *I. R. E.*, **20**, January, 1932.
 WHITE, W. C.: *Electronics*, April, 1930.

SECTION 10

DETECTION AND MODULATION

BY KENNETH W. JARVIS¹

DETECTION

1. Demodulation, usually called *detection*, is the process necessary to obtain from the incoming signal the initial modulation frequency. The instantaneous signal voltage for the detection processes discussed in this chapter, unless otherwise noted, is as follows:

Instantaneous signal voltage =

$$e = E_A(1 + m \cos Bt) \cos At \quad (1)$$

This may also be written as

$$e = E_A \cos At + mE_A \cos At \cos Bt \quad (2)$$

or as

$$e = E_A \cos At + \frac{mE_A}{2} \cos (A + B)t + \frac{mE_A}{2} \cos (A - B)t \quad (3)$$

where E_A = peak value of the carrier-frequency voltage

m = modulation factor

$B = 2\pi f_B$, where f_B is the low-modulation frequency

$A = 2\pi f_A$, where f_A is the carrier frequency

(1) is the expression derived as the standard type of modulation signal by customary modulation processes.

(2) represents the normal carrier voltage plus a voltage of the carrier frequency which varies at the modulation frequency.

(3) represents the sum of three individual frequencies termed the carrier and the side bands respectively, which adds to give (at least mathematically) the standard signal.

In the analysis of detection (or demodulation) all three types of equations are occasionally used. For simplicity of expression and ease and accuracy of calculation (3) is customarily employed. The problem of detection is to obtain, from the standard-type signal, currents and voltages of frequency f_B .

2. **Detection Characteristic.** An *asymmetrical* current voltage characteristic is necessary for detection. Figure 1 shows a standard-type signal applied to such a characteristic and the resulting current wave form. For illustration some of the more important frequency components of the current are shown in approximately correct amplitude. The subscripts refer to corresponding frequencies. Such asymmetrical characteristics may be obtained in certain mineral crystals, both natural

¹ The author's indebtedness to Marvin Hobbs for considerable mathematical work is gratefully acknowledged.

and artificial. Electronic devices, such as vacuum tubes, are more commonly used due to greater stability and sensitivity. Figure 2 shows

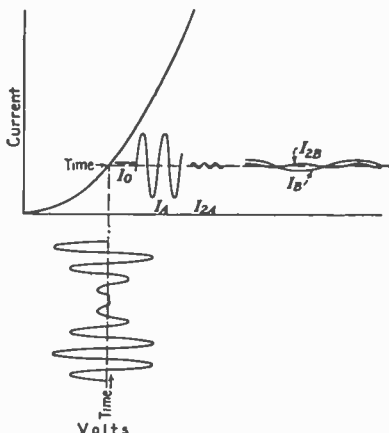

FIG. 1.—Standard detection characteristic.

such a characteristic of a crystal detector, and Figure 3 that of a vacuum tube. In the use of crystals much depends on the pressure of the metallic contact. Galena (PbS) requires a fine contact with light pressure and a sensitive operating point. Under these conditions it is a very sensitive detector. Silicon crystals require

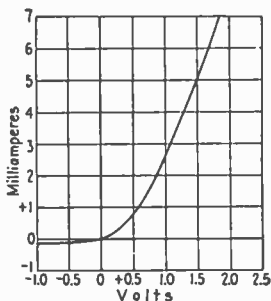

FIG. 2.—“Perikon” Crystal detector characteristic.

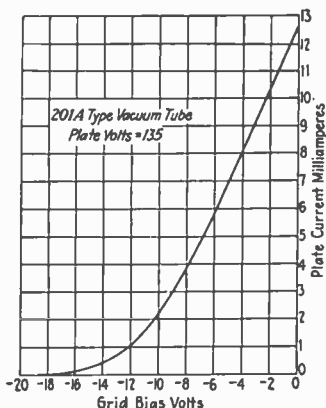

FIG. 3.—Characteristic suitable for detection.

greater contact pressure but are somewhat less sensitive. Carborundum, requiring a high-pressure contact, is less sensitive than silicon but is very stable in operation. The maximum sensitivity is obtained at the point

of greatest change in curvature. With some crystals, such as carborundum, a biasing potential is necessary to bring the operating point to this maximum sensitivity.

Copper oxide rectifiers exhibit such a curve as Fig. 1 but have not been commonly used as detectors owing to the action of the rectifier capacity at high carrier frequencies. They are used in Europe to some extent.

3. Detector Equations. The equations relating to the asymmetrical characteristic of Fig. 1 are developed as follows:

$$I = f(E) \quad (4)$$

$$I = I_0 + i = P_0 + P_1e + \frac{P_2e^2}{2!} + \frac{P_3e^3}{3!} + \dots \quad (5)$$

where P_1, P_2 , etc., are the first, second, etc., derivatives of I with respect to E evaluated under the circuit operating conditions and at the chosen operating point. Substituting Eq. (1) into (5) and reducing to first-order terms to determine the amplitude of the various frequency components resulting gives a series of terms representing d-c, fundamental, second, third, etc., harmonics of both carrier and modulation frequencies as well as combinations of carrier and side band of the form of

$$\begin{aligned} I = P_0 &+ \left(\frac{P_2EA^2}{4} + \frac{P_4E^4}{64} + \dots \right) \\ &+ \left(\frac{P_2m^2EA^2}{8} + \frac{3P_4m^2EA^4}{64} + \frac{3P_4m^4EA^4}{512} \dots \right) \\ &+ \left(P_1EA + \frac{P_2EA^3}{8} + \frac{3P_3m^2EA^3}{16} + \dots \right) \cos At \\ &+ \left(\frac{P_2mEA^2}{2} + \frac{P_4mEA^4}{16} + \frac{3P_4m^3EA^4}{64} + \dots \right) \cos Bt \\ &+ (\text{terms}) \cos 2At + (\text{terms}) \cos 2Bt \\ &+ (\text{terms}) \cos 3At + (\text{terms}) \cos 3Bt + \dots \\ &+ (\text{terms}) [\cos (A+B)t + \cos (A-B)t] \end{aligned} \quad (6)$$

The coefficient of any term in (6) may be found from the double summation indicated below:

$$i_{(pA \pm qB)} = \sum_{s=0}^{\infty} \sum_{r=0}^{\frac{p-q+2s}{2}} \frac{(p+2s)! P_{p+2s} m^{q+r} E A^{p+2s}}{2^{(p+2s+q+2r-n)} (p+2s-q-2r)! (p+s)! (q+r)! s! r!} \cos (pA \pm qB)t \quad (7)$$

When $p = q = 0, n = 0$. For all other values of p or $q, n = 1$. The expression (7) holds for all values of p and q including zero. The only restriction

is in the term $\frac{p-q+2s}{2}$. In case

the values of p, q , and the chosen s make this term a fraction, the next integer below the fraction is used to terminate the r summation.

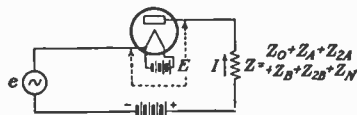

Fig. 4.—Detection circuit.

4. Detector Derivative. The series in Art. 3 is given in terms of P_n , the derivative of I with respect to E , for the entire circuit. This is often difficult to evaluate, especially when a complex wave such as

the standard radio signal is applied. The derivative of the detector alone can usually be determined satisfactorily. Determining P and using the circuit constants enable the detector operation to be calculated. Figure 4 shows the circuit where e is the voltage of Eq. (3) and Z is the circuit impedance to any frequency as indicated by the subscript.

Only two terms of the power series

$$i = a_1 e_0 + a_2 e_0^2 + \quad (8)$$

will be retained. For simplicity the total current i is given as the sum of the individual frequency components.

$$\begin{aligned}
 i = i_0 = & \frac{1}{4} \left\{ \frac{P_2}{1 + P_1 Z_0} \left[1 - \frac{Z_A P_2}{1 + P_1 Z_A} - \frac{\bar{Z}_A P_2}{1 + P_1 \bar{Z}_A} \right. \right. \\
 & \left. \left. + \frac{Z_A \bar{Z}_A P_2^2}{(1 + P_1 Z_A)(1 + P_1 \bar{Z}_A)} \right] \right\} E_A^2 \\
 & + \frac{1}{4} \left\{ \frac{P_2}{1 + P_1 Z_0} \left[1 - \frac{Z_{A+B} P_2}{1 + P_1 Z_{A+B}} - \frac{\bar{Z}_{A+B} P_2}{1 + P_1 \bar{Z}_{A+B}} \right. \right. \\
 & \left. \left. + \frac{Z_{A+B} \bar{Z}_{A+B} P_2^2}{(1 + P_1 Z_{A+B})(1 + P_1 \bar{Z}_{A+B})} \right] \right\} E_{A+B}^2 \\
 & + \frac{1}{4} \left\{ \frac{P_2}{1 + P_1 Z_0} \left[1 - \frac{Z_{A-B} P_2}{1 + P_1 Z_{A-B}} - \frac{\bar{Z}_{A-B} P_2}{1 + P_1 \bar{Z}_{A-B}} \right. \right. \\
 & \left. \left. + \frac{Z_{A-B} \bar{Z}_{A-B} P_2^2}{(1 + P_1 Z_{A-B})(1 + P_1 \bar{Z}_{A-B})} \right] \right\} E_{A-B}^2 \\
 & + i_A = \left(\frac{P_1}{1 + P_1 Z_A} \right) E_A \cos At \\
 & + i_{2A} = \frac{1}{4} \left\{ \frac{P_2}{1 + P_1 Z_{2A}} \left[1 - \frac{2Z_{2A} P_2}{1 + P_1 Z_{2A}} \right. \right. \\
 & \left. \left. + \frac{Z_{2A}^2 P_2^2}{(1 + P_1 Z_{2A})^2} \right] \right\} E_A^2 \cos 2At \\
 & + i_B = \frac{1}{2} \left\{ \frac{P_2}{1 + P_1 Z_B} \left[1 - \frac{Z_A P_2}{1 + P_1 Z_A} - \frac{Z_{A-B} \bar{P}_2}{1 + P_1 \bar{Z}_{A-B}} \right. \right. \\
 & \left. \left. + \frac{Z_A \bar{Z}_{A-B} P_2^2}{(1 + P_1 Z_A)(1 + P_1 \bar{Z}_{A-B})} \right] \right\} E_A E_{A-B} \cos Bt \\
 & + \frac{1}{2} \left\{ \frac{P_2}{1 + P_1 Z_B} \left[1 - \frac{Z_{A+B} P_2}{1 + P_1 Z_{A+B}} - \frac{\bar{Z}_A P_2}{1 + P_1 \bar{Z}_A} \right. \right. \\
 & \left. \left. + \frac{Z_{A+B} \bar{Z}_A P_2^2}{(1 + P_1 Z_{A+B})(1 + P_1 \bar{Z}_A)} \right] \right\} E_A E_{A+B} \cos Bt \\
 & + i_{2B} = \frac{1}{2} \left\{ \frac{P_2}{1 + P_1 Z_{2B}} \left[1 - \frac{Z_{A+B} P_2}{1 + P_1 Z_{A+B}} - \frac{Z_{A-B} \bar{P}_2}{1 + P_1 \bar{Z}_{A-B}} \right. \right. \\
 & \left. \left. + \frac{Z_{A+B} \bar{Z}_{A-B} P_2^2}{(1 + P_1 Z_{A+B})(1 + P_1 \bar{Z}_{A-B})} \right] \right\} E_{A+B} E_{A-B} \cos 2Bt \quad (9)
 \end{aligned}$$

If the circuit conditions ahead of the detector input do not change the initial side-band ratio (due to asymmetrical amplification or side-band cutting),

$$E_{A+B} = E_{A-B} = \frac{m}{2} E_A \quad (10)$$

and if the radio frequency is by-passed so that

$$Z_A = Z_{A+B} = Z_{A-B} = 0$$

the audio currents and resulting voltages IZ are

$$\left. \begin{aligned} i_B &= \frac{P_2}{1 + P_1 Z_B} m E_A^2; & e_B &= \frac{P_2 Z_B}{1 + P_1 Z_B} m E_A^2 \\ i_{2B} &= \frac{P_2}{1 + P_1 Z_{2B}} \frac{m^2}{4} E_A^2; & e_{2B} &= \frac{P_2 Z_{2B}}{1 + P_1 Z_{2B}} \frac{m^2}{4} E_A^2 \end{aligned} \right\} \quad (11)$$

If good fidelity is required so that $Z_B = Z_{2B}$, the ratio between second harmonic and fundamental is

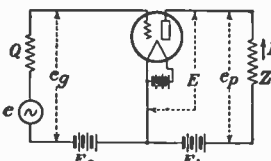

Percentage distortion = $\frac{m}{4}$ (12)

where

$$Z_A = R + jX_A$$

$$\bar{Z}_A = R - jX_A$$

$$P_1 = \frac{dI}{dE} = \frac{1}{R_p}$$

$$P_2 = \frac{d^2 I}{dE^2} = \frac{dR_p}{dE} = R_p'$$

FIG. 5.—Triode as detector.

R_p = detector resistance while detecting

5. Triode as Detector. The three-element tube also may serve as a detector, and its performance in terms of the tube parameters and circuit constants developed exactly as in the previous paragraph. More complicated expressions result, for grid current and grid impedances affect the plate current as well as plate impedances. The plate voltage affects the grid current; the grid voltage affects the plate current. Figure 5 shows the circuit conditions. The plate current at any frequency may be determined by substituting the a and b coefficients given by (14) and (15) into (13).

$$i_p = \left\{ \begin{aligned} i_0 &= \frac{1}{2} [(1 - b_{1(A)} Q_A)(1 - \bar{b}_{1(A)} \bar{Q}_A) a_{2(0A)} - a_{1(0A)} Q_0 b_{2(0A)}] E_A^2 \\ &+ \frac{1}{2} [(1 - b_{1(A+B)} Q_{A+B})(1 - \bar{b}_{1(A+B)} \bar{Q}_{A+B}) a_{2(0(A+B))} - a_{1(0(A+B))} Q_0 \\ &\quad \frac{b_{2(0(A+B))}}{b_{2(0(A+B))}}] E^2_{A+B} \\ &+ \frac{1}{2} [(1 - b_{1(A-B)} Q_{A-B})(1 - \bar{b}_{1(A-B)} \bar{Q}_{A-B}) a_{2(0(A-B))} - a_{1(0(A-B))} Q_0 \\ &\quad \frac{b_{2(0(A-B))}}{b_{2(0(A-B))}}] E^2_{A-B} \\ i_A &= [a_{1(A)}(1 - b_{1(A)} Q_A)] E_A \cos At \\ i_{2A} &= \frac{1}{2} [(1 - b_{1(A)} Q_A)^2 a_{2(2A)} - a_{1(2A)} Q_{2A} b_{2(2A)}] E_A^2 \cos 2At \\ i_B &= [(1 - b_{1(A+B)} Q_{A+B})(1 - \bar{b}_{1(A)} \bar{Q}_A) a_{2(A+B)} - a_{1(A+B)} Q_{(A+B)} b_{2(A+B)}] \\ &\quad \frac{E_A E_{A+B} \cos Bt}{E_A E_{A+B} \cos Bt} \\ &+ [(1 - b_{1(A-B)} Q_{A-B})(1 - \bar{b}_{1(A-B)} \bar{Q}_{A-B}) a_{2(A-B)} - a_{1(A-B)} Q_{(A-B)} b_{2(A-B)}] \\ &\quad \frac{E_A E_{A-B} \cos Bt}{E_A E_{A-B} \cos Bt} \\ i_{2B} &= [(1 - b_{1(A+B)} Q_{A+B})(1 - \bar{b}_{1(A-B)} \bar{Q}_{A-B}) a_{2(2B)} - a_{1(2B)} Q_{2B} b_{2(2B)}] \\ &\quad \frac{E_{A+B} E_{A-B} \cos 2Bt}{E_{A+B} E_{A-B} \cos 2Bt} \end{aligned} \right. \quad (13)$$

$$a_{1(A)} = \frac{\mu}{R_p + Z_A}; \quad a_{1(A-B)} = \frac{\mu}{R_p + Z_{A-B}}; \quad a_{1(A+B)} = \frac{\mu}{R_p + Z_{A+B}}$$

$$a_{2(B)} = \frac{\frac{1}{2} \left[-\mu^2 R_p R_p' + \mu \frac{\partial \mu}{\partial E_p} (R_p^2 - Z_A \bar{Z}_{A-B}) + \frac{\partial \mu}{\partial E_\theta} (R_p + Z_A)(R_p + \bar{Z}_{A-B}) \right]}{(R_p + Z_A)(R_p + \bar{Z}_{A-B})(R_p + Z_B)}$$

$$a_{2(2B)} = \frac{\frac{1}{2} \left[-\mu^2 R_p R_p' + \mu \frac{\partial \mu}{\partial E_p} (R_p^2 - Z_{A+B} \bar{Z}_{A-B}) + \frac{\partial \mu}{\partial E_\theta} (R_p + Z_{A+B})(R_p + \bar{Z}_{A-B}) \right]}{(R_p + Z_{A+B})(R_p + \bar{Z}_{A-B})(R_p + Z_{2B})} \quad (14)$$

$$b_{1(A)} = \frac{1 - \frac{\mu}{\nu} \frac{Z_A}{R_p + Z_A}}{R_\theta + \left(1 - \frac{\mu}{\nu} \frac{Z_A}{R_p + Z_A} \right) Q_A}$$

$$b_{2(B)} = \left\{ \frac{\frac{1}{2} \left[-R_\theta R_\theta' \left(1 - \frac{\mu}{\nu} \frac{Z_A}{R_p + Z_A} \right) \left(1 - \frac{\mu}{\nu} \frac{\bar{Z}_{A-B}}{R_p + \bar{Z}_{A-B}} \right) - 2a_{2(B)} \frac{R_\theta^2}{\nu} Z_B \right. \right. \\ \left. \left. - \frac{\partial}{\partial E_\theta} \left(\frac{1}{\nu} \right) \left(\frac{\mu Z_A R_\theta^2}{R_p + Z_A} + \frac{\mu \bar{Z}_{A-B} R_\theta^2}{R_p + \bar{Z}_{A-B}} - \frac{\mu^2 Z_A \bar{Z}_{A-B} R_\theta^2}{(R_p + Z_A)(R_p + \bar{Z}_{A-B})} \right) \right. \right. \\ \left. \left. + \frac{\partial}{\partial E_p} \left(\frac{1}{\nu} \right) \left(\frac{\mu^2 Z_A \bar{Z}_{A-B} R_\theta^2}{(R_p + Z_A)(R_p + \bar{Z}_{A-B})} \right) \right]}{\left[R_\theta + \left(1 - \frac{\mu}{\nu} \frac{Z_A}{R_p + Z_A} \right) Q_A \right] \left[R_\theta + \left(1 - \frac{\mu}{\nu} \frac{\bar{Z}_{A-B}}{R_p + \bar{Z}_{A-B}} \right) \bar{Q}_{A-B} \right]} \right. \\ \left. \left[R_\theta + \left(1 - \frac{\mu}{\nu} \frac{Z_B}{R_p + Z_B} \right) Q_B \right] \right\}$$

$$b_{2(2B)} = \left\{ \frac{\frac{1}{2} \left[-R_\theta R_\theta' \left(1 - \frac{\mu}{\nu} \frac{Z_{A+B}}{R_p + Z_{A+B}} \right) \left(1 - \frac{\mu}{\nu} \frac{\bar{Z}_{A-B}}{R_p + \bar{Z}_{A-B}} \right) - 2a_{2(2B)} \frac{R_\theta^2}{\nu} Z_{2B} \right. \right. \\ \left. \left. - \frac{\partial}{\partial E_\theta} \left(\frac{1}{\nu} \right) \left(\frac{\mu Z_{A+B} R_\theta^2}{R_p + Z_{A+B}} + \frac{\mu \bar{Z}_{A-B} R_\theta^2}{R_p + \bar{Z}_{A-B}} - \frac{\mu^2 Z_{A+B} \bar{Z}_{A-B} R_\theta^2}{(R_p + Z_{A+B})(R_p + \bar{Z}_{A-B})} \right) \right. \right. \\ \left. \left. + \frac{\partial}{\partial E_p} \left(\frac{1}{\nu} \right) \left(\frac{\mu^2 Z_{A+B} \bar{Z}_{A-B} R_\theta^2}{(R_p + Z_{A+B})(R_p + \bar{Z}_{A-B})} \right) \right]}{\left[R_\theta + \left(1 - \frac{\mu}{\nu} \frac{Z_{A+B}}{R_p + Z_{A+B}} \right) Q_{A+B} \right] \left[R_\theta + \left(1 - \frac{\mu}{\nu} \frac{\bar{Z}_{A-B}}{R_p + \bar{Z}_{A-B}} \right) \bar{Q}_{A-B} \right]} \right. \\ \left. \left[R_\theta + \left(1 - \frac{\mu}{\nu} \frac{Z_{2B}}{R_p + Z_{2B}} \right) Q_{2B} \right] \right\}$$

$$b_{2(2A)} = \left\{ \frac{\frac{1}{2} \left[-R_\theta R_\theta' \left(1 - \frac{\mu}{\nu} \frac{Z_A}{R_p + Z_A} \right)^2 - 2a_{2(2A)} \frac{R_\theta^2}{\nu} Z_{2A} \right. \right. \\ \left. \left. - \frac{\partial}{\partial E_\theta} \left(\frac{1}{\nu} \right) \left(\frac{2\mu Z_A R_\theta^2}{R_p + Z_A} - \frac{\mu^2 Z_A^2 R_\theta^2}{(R_p + Z_A)^2} \right) + \frac{\partial}{\partial E_p} \left(\frac{1}{\nu} \right) \left(\frac{\mu^2 Z_A^2 R_\theta^2}{(R_p + Z_A)^2} \right) \right]}{\left[R_\theta + \left(1 - \frac{\mu}{\nu} \frac{Z_A}{R_p + Z_A} \right) Q_A \right]^2 \left[R_\theta + \left(1 - \frac{\mu}{\nu} \frac{Z_{2A}}{R_p + Z_{2A}} \right) Q_{2A} \right]} \right\} \quad (15)$$

The barred symbol is the conjugate of the unbarred symbol.

$$\mu = \frac{\Delta E_p}{\Delta E_g} \text{ for equal increments of plate current.}$$

$$\nu = \frac{\Delta E_p}{\Delta E_g} \text{ for equal increments of grid current.}$$

μ is inherently positive; ν is inherently negative.

6. Plate Detection. The modulation frequency qB components of (13) are derived from both grid and plate-current curvature. To simplify the case for plate detection assume μ constant and that the grid is maintained negative with respect to the cathode.

Then

$$i_B = \frac{-\frac{1}{2}\mu^2 R_p R_p'}{(R_p + Z_A)(R_p + \bar{Z}_{A-B})(R_p + Z_B)} E_A E_{A+B} - \frac{\frac{1}{2}\mu^2 R_p R_p'}{(R_p + Z_{A+B})(R_p + \bar{Z}_A)(R_p + Z_B)} E_A E_{A-B} \quad (16)$$

$$\left. \begin{array}{l} \text{When the plate is by-passed, the usual case, } Z_{A+B} = Z_A = Z_{A-B} = 0 \\ \text{With a standard signal, } E_{A+B} = E_{A-B} = \frac{m}{2} E_A \end{array} \right\} \quad (17)$$

Substituting (17) in (16) gives

$$i_B = -\frac{\frac{1}{2}\mu^2 R_p'}{R_p(R_p + Z_B)} m E_A^2 \quad (18)$$

Similarly,

$$i_{2B} = -\frac{\frac{1}{2}\mu^2 R_p'}{R_p(R_p + Z_{2B})} \frac{m^2}{4} E_A^2 \quad (19)$$

The similarity of (18) and (19) is apparent. As in (11),

$$\text{Per cent distortion} = \frac{m}{4} \quad (11)$$

In the foregoing analysis R_p and R_p' must be measured under the operating conditions of bias voltage, plate voltage, E_A , etc. When the signal E_A is introduced a change in plate current i_0 takes place, and if an impedance Z_0 is present, the plate voltage at the tube terminals will decrease, increasing R_p , and probably decreasing R_p' . This decreases the audio output as based on measurements of R_p and R_p' with $E_A = 0$. For calculation purposes it is necessary to have a series of curves of R_p and R_p' with E_p and E_A as variables. E_p and the expression for i_0 being known,

$$i_0 = \frac{1}{2} a_2(a_A) E_A^2 + \frac{1}{2} a_2[0(A+B)] \frac{m^2}{4} E_A^2 + \frac{1}{2} a_2[1(A-B)] \frac{m^2}{4} E_A^2 \quad (20)$$

usually neglected

the plate voltage drop $i_0 Z_0$ may be calculated, assuming R_p and R_p' . The determined plate voltage in this way will give wrong values of R_p and R_p' , but observation of the R_p and R_p' curves will show the probable correction. This process of trial and error may be repeated, two checks usually giving the current within 5 or 10 per cent of the correct value. R_p may be conveniently determined by direct measurement of the plate resistance with a Wheatstone bridge using a 1,000-cycle tone source, while the

carrier voltage E_A is applied to the grid of the tube. Correct bias and plate potentials must be applied. R_p' can be most accurately determined graphically by drawing tangents to the curve of R_p vs. E_p .

The fidelity curve can be calculated when the characteristics of Z_B are known. With the most sensitive operating point, R_p usually decreases with increase in E_A , giving better fidelity for high input signal voltages. Figure 6 shows a fidelity curve of a radio receiver with three values of input, using a reactive load.

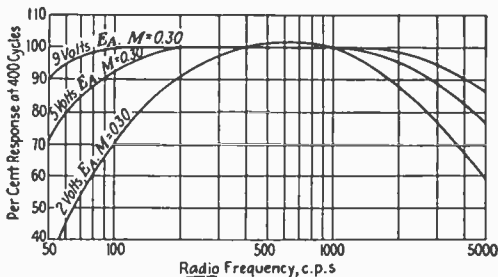

FIG. 6.—Fidelity as function of input voltage.

7. Grid-current detection is more complex. Assume a plate impedance of Z_p which is resistance only, and μ and ν as constants. The grid circuit contains a resistance Q_g shunted by a condenser of negligible impedance to r.f. and infinite impedance to a.f. The plate current then is

$$i_B = \frac{\frac{1}{2}\mu Q_g \left[R_g R_g' - \frac{\mu^2 R_p R_p'}{(R_p + Z_p)^2} \left(\frac{R_g^2 Z_p}{\nu} \right) \right]}{(R_p + Z_p) R_g^2 (R_g + Q_g)} m E_A^2 \quad (21)$$

As in the case of plate detection, R_g and R_g' must be evaluated under the operating conditions with all voltages, including signal, applied. The second term of the numerator shows that the change in plate current curvature, as expressed by R_p' affects the sensitivity. As ν is inherently negative, this second term aids the detection. As the plate battery is varied the value of the second term changes, reaching a maximum with a rather low plate voltage. This detection action is in addition to that due to plate curvature. As the sign of i_B in (18) is negative, the currents of (18) and (21) are in opposition and the modulation frequency current is less as a result.

Since ν is usually numerically large, terms with ν in the denominator may be dropped. Considering the actual impedance of the grid circuit network, with this simplification the plate current is

$$i_B = \frac{\mu Q_B}{R_p + Z_B} \left\{ \frac{\frac{1}{2} R_g R_g'}{(R_g + Q_A)(R_g + \bar{Q}_{A-B})(R_g + Q_B)} + \frac{\frac{1}{2} R_g R_g'}{(R_g + Q_{A+B})(R_g + \bar{Q}_A)(R_g + Q_B)} \right\} m E_A^2 \quad (22)$$

Substituting the P terms of (12) in (10) gives an i_B of the form in the brackets of (22), which is the a-f current of a two-element detector. Multiplying this current by the a-f grid impedance Q_B gives the audio voltage impressed on the grid of the tube, which as an amplifier produces a plate current $\mu(R_p + Z_B)$ times the grid voltage. Grid-leak and condenser detectors are more sensitive than the plate curvature detectors because d^2I_q/dE_g^2 is greater than d^2I_p/dE_g^2 , and because of the additional audio amplification. Several disadvantages are evident. The finite value of R_g forms an undesired load on the circuit ahead. The additional audio amplification adds to microphonic and filter problems. To gain sensitivity a low plate voltage is used, with a resulting high value of R_p and poor fidelity if using reactive loads.

Substituting the impedance of the leak-condenser combination $Q_B, Q_A, Q_{A+B}, Q_{A-B}$ in (22) enables the a-f current to be calculated for any value of A and B . If R_q is the leak resistance and C_q the shunt capacity, the maximum current i_B is approximately obtained when

$$C_q^2 = \frac{\sqrt{2}(R_q + R_g)}{ABR_qR_g^2} \quad (23)$$

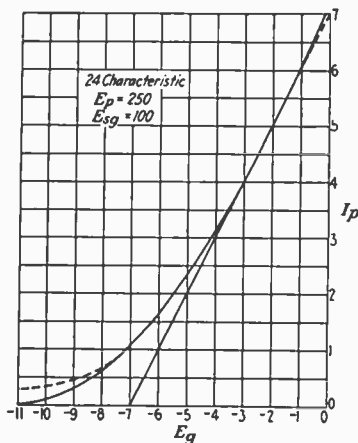

FIG. 7.—Hyperbolic detector characteristic.

and 7 above are valid only for small signals. For higher amplitude signals more than two terms of Eq. (6) must be used. The complete series may be reduced to terms containing the tube and circuit parameters, but the computation is laborious and without value for inspection purposes. In many cases the equation suiting the $E-I$ curve may be obtained under operating conditions. Consider Fig. 7. The solid curve is the I_p, E_g of a 24 or 57 tube under the conditions stated. The dashed line is the equation of the hyperbola

$$I_p = \frac{b}{a} \sqrt{a^2 + (E_g + c)^2} + \frac{b}{a} (E_g + c) \quad (24)$$

where $a = 2.69, b = 1.41, c = 6.35$.

The two curves coincide within reasonable limits. Using Eq. (24) and successively differentiating to determine P_2, P_4, P_6 , etc., gives values

If $R_q = 10^6, R_g = 5 \times 10^4, A = 2\pi \times 10^6, B = 2\pi \times 10^3$, then $C_q = 125 \mu\text{f}$. Decrease of R_g (as due to greater signal or lower plate voltage) means a larger condenser is desirable. Increasing the a. f. means decreasing C_q for maximum i_B . Occasionally the equivalent grid impedance due to tube capacitances and circuit elements is more important than R_g . In this case other tube input impedance equations will give an approximate value to use for R_g .

8. High-amplitude Detectors.

The conclusions reached in Arts. 6

to be substituted into Eq. (6) to determine i_B and i_{2B} . Determining the maximum value of i_B as a function of E_g gives

$$I_{B(\max.)}, E_g = -c \quad (25)$$

To determine the minimum second-harmonic distortion, the coefficient of i_{2B} is divided by the coefficient of i_B , and the minimum value determined.

$$\frac{i_{2B}}{i_B}(\min.), E_g = -c \quad (26)$$

The maximum sensitivity and minimum distortion are obtained with the same bias condition, a fortunate circumstance. In case the cut-off of the tube does not match the assumed hyperbola as in Fig. 7 (hyperbola above tube characteristic) the best operating point is with a slightly greater negative bias. If the straight-line portion of the curve be extended, as shown by the light line of Fig. 7, the intercept on the E_g axis provides approximately the correct operating point. In this case $E_g = -c = 6.35$ volts, while the intercept gives $E_g = -7.0$ volts. Experimentally this tube gave a maximum sensitivity with $E_g = -6.5$ volts, the values not being critical to ± 1 volt.

The straight-line extension method has been used in various comparisons and gives a uniformly satisfactory means of determining the best bias voltage. It should be noted that Fig. 7 is determined under the operating conditions. The value of E_A will affect the shape of the characteristic curve, giving an intercept indicating a required higher bias for large values of E_A . It can be shown that the distortion decreases for increasing values of E_A . As this case is merely intermediate between the restricted input square-law detector and the linear detector, no discussion is necessary.

9. The linear detector characteristic shown in Fig. 8 is ideal for detector operation. This exact characteristic has never been produced, yet a study of its detection operation leads to helpful conclusions. The curve itself may be expressed by a Fourier series.

$$i_p = K \left[\frac{c}{4} + \frac{\theta}{2} - \frac{2c}{\pi^2} \cos \frac{\pi\theta}{c} - \frac{2c}{3^2\pi^2} \cos \frac{3\pi\theta}{c} \cdots - \frac{2c}{(2n-1)^2\pi^2} \cos (2n-1) \frac{\pi\theta}{c} \right] \quad (27)$$

where

$$\theta = e_g = E_A(1 + m \cos Bt) \cos At \quad (1)$$

Substituting (1) in (27) gives a series involving Bessel functions. For detection purposes the i_o , i_B , and i_{2B} components of i only need be considered. Tabulating the Bessel functions for these frequencies shows that for all values of E_A and m

$$i_o = \frac{KE_A}{\pi} \quad (28)$$

$$i_B = \frac{KmE_A}{\pi} \cos Bt \quad (29)$$

$$i_{2B} = 0 \quad (30)$$

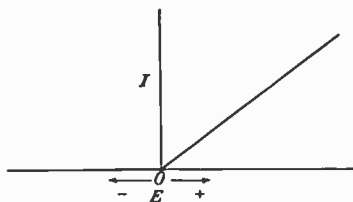

FIG. 8.—Linear detection characteristic.

Equation (29) shows the linear detector to be truly linear in output, both with respect to m and with respect to E_A . Equation (30) shows the entire lack of distortion. (Calculations for i_{3B} , i_{4B} , etc., show all harmonic terms to be zero.) In the current i_B of (29) is the short-circuit audio-frequency plate current of the tube. The equivalent plate-circuit audio-frequency generator voltage is $i_B R_p$, and therefore the voltage across an external impedance Z_B , assuming $Z_A = Z_{A+B} = 0$, is

$$e_B = \frac{K m E_A}{\pi} \frac{R_p Z_B}{R_p + Z_B} \cos Bt \quad (31)$$

Assuming μ holds constant over the entire operating range,

$$R_p = \frac{2\mu}{K} \quad (32)$$

and therefore

$$e_B = \frac{2\mu K m E_A}{\pi} \frac{Z_B}{2\mu + K Z_B} \cos Bt \quad (33)$$

In case the operating point is not at the cut-off point but is biased below cut-off, these equations may be written

$$i_B = \left[\frac{K m E_A}{\pi} \sin \alpha \right] \cos Bt \quad (34)$$

$$e_B = \left[\frac{K m E_A Z_B \mu}{\mu \pi + K Z_B \alpha} \sin \alpha \right] \cos Bt \quad (35)$$

where α is one-half the angle during which current flows. If Eq. 31 is used, R_p must be measured, as previously, with E_A , or the equivalent, on the grid and with other operating conditions normal.

The theoretical advantages of linear detection have led to many attempts to make such a device. The simplest expedient is to operate at the point indicated in Fig. 7 and apply such a large value of E_A that the device is operating on the straight-line portions the major part of the cycle. Linear detection methods need not be confined to the plate circuit, as the input to a grid current curvature detector may be sufficient to approximate linear grid rectification.

10. The heterodyne detector is more properly a modulation device, although in this, as in other similar units, the distinction is a matter of viewpoint. A signal of the type of Eq. (1) is impressed simultaneously with a heterodyne voltage E_H of a frequency $H/2\pi$ upon an asymmetrical device. New frequencies are produced, each of which may be considered as a new carrier frequency. These new carrier frequencies are all possible sum and difference combinations of integer multiples of A and H . With each of these carriers are associated other frequencies differing therefrom by the modulation frequency B (and for higher-order curvature, $\pm 2B$, $\pm 3B$, etc.). Thus the heterodyne voltage $e_{(H \pm A)}$ is of the form

$$e_{(H \pm A)} = P \frac{E_A E_H}{4} (1 + m \cos Bt) \cos (H \pm A)t \quad (36)$$

The voltage $E_{(H-A)}$ is the one commonly used. In general the external impedance of the heterodyne detector is zero to both frequencies A and H and finite at the frequency $(H - A)$. As in (10) the heterodyne voltage may directly be written. For a square-law characteristic, $i = KE^2$, and operation above cut-off,

$$e_H = \left[\frac{\mu K Z_{(H-A)}}{\mu + 2K Z_{(H-A)} E_0} \right] E_A E_H [1 + m \cos Bt] \cos (H - A)t \quad (37)$$

where E_0 is the initial bias voltage measured above the current cut-off. In case the magnitude of E_H swings the instantaneous voltage off the square-law curve and below cut-off

$$e_{(H-A)} = \frac{\mu K Z_{(H-A)} \frac{1}{\pi} \left(\alpha - \frac{1}{2} \sin 2\alpha \right)}{\mu + 2 K Z_{(H-A)} E_H \frac{1}{\pi} (\sin \alpha - \alpha \cos \alpha)} E_A E_H [1 + m \cos Bt] \cos (H - A)t \quad (38)$$

where α is as defined for (35) and is one-half the angle during which current flows.

For a linear detector characteristic $i = KE$ and operation entirely above cut-off, no detection or heterodyne voltage results. The action is as if several frequencies be simultaneously applied to a linear amplifier. Amplification of each frequency results, but no modulation is produced, hence no new frequencies.

When, in the linear detector, the voltage E_H swings the operation below cut-off, a heterodyne voltage results:

$$e_{(H-A)} = \frac{\mu K Z_{(H-A)} \frac{1}{\pi} \sin \alpha}{\mu + K Z_{(H-A)} \frac{1}{\pi} \alpha} E_A [1 + m \cos Bt] \cos (H - A)t \quad (39)$$

Notice that E_H does not appear in (39). Its only effect is to determine α . Equations (37), (38) and (39) assume that E_A is very small compared with E_H , quite generally the case.

11. Two modulated signals of the type given by Eq. (1) are often impressed simultaneously upon a detector. The response ratio of the desired and undesired stations and the magnitude of the spurious new frequencies depend upon the type of detector used, relative carrier

Frequency	Amplitude-square law	Amplitude linear characteristic, first terms
B	$E_A^2 M$	$E_A M$
$2B$	$E_A^2 M^2/4$	0
b	$E_a^2 m$	$m E_a - E_a k \left(a_0 m - \frac{a_1 m}{2} - \frac{m E_a k}{E} \right) - \frac{3 E_a^2 k^2 b_0 m}{2 E}$
$2b$	$\frac{E_A^2 m^2}{4}$	$\frac{m^2 E_a^2 k^2}{2 E} - \frac{b_0 E_a^2 k^2 m^2}{4 E}$
D	$E_A E_a$	$E_a k \left(a_0 - \frac{a_1 M}{2} - \frac{m^2 E_a k}{2 E} \right) + \frac{b_0 E_a^2 k^2}{2 E} (2 + m^2)$
$2D$	0	$b_0 E_a^2 k^2/4 E$
$B \pm D$	$\frac{E_A E_a M}{2}$	$E_a k \left(\frac{a_0 M}{2} - \frac{a_1}{2} + \frac{a_2 M}{4} - \frac{m^2 M E_a k}{4 E} \right)$
$b \pm D$	$\frac{E_A E_a m}{2}$	$E_a k \left(\frac{a_0 m}{2} - \frac{a_1 M m}{4} - \frac{m E_a k}{2 E} \right) + \frac{b_0 E_a^2 k^2 m}{E}$
$B \pm b \pm D$	$E_A E_a M m$	0

amplitudes and degrees of modulation. The mathematical computation may be made by the use of a sum of infinite series, or with the somewhat more rapidly convergent Bessel series. The relative amplitude terms

indicated in the preceding table were obtained from the infinite-series solution.

The voltage e impressed on the detector is of the form

$$e = E_A(1 + M \cos Bt) \cos At + E_a(1 + m \cos bt) \cos at \quad (40)$$

where A, B, M refer to the desired station signal and a, b, m refer to the interfering station signal. For simplicity of representation let $A - a = D$. The various important frequency components and their amplitudes are noted in the table on page 255. The first terms of the infinite series given may be considered as representing almost completely the amplitude of the frequency components under the following restrictions:

$$E_a \approx 0.1E_A, \quad 0.1 < m < 0.5, \quad 0.1 < M < 0.5$$

The constants in the table are

$$a_0 = 1 + \frac{M^2 k^2}{2} + \frac{3M^4 k^4}{8} \qquad b_0 = 1 + 3M^2 k^2$$

$$a_1 = Mk + \frac{3M^3 k^3}{4} + \frac{5M^5 k^5}{8}$$

$$a_2 = \frac{M^2 k^2}{2} + \frac{M^4 k^4}{2}$$

$$k = \frac{E_A}{E_A + E_a}$$

12. Demodulation of One Signal by Another. The audio component b of the undesired signal is reduced due to the presence of E_A . This is an important and interesting phenomenon. The linear detector in the presence of more than one signal discriminates against the weaker signal. This ratio has been investigated by means of Bessel functions. Assuming a low and equal percentage of modulation, for convenience in calculation, this gives the following ratio of the audio components of b and B .

Carrier ratio	Acoustic ratio	Carrier ratio	Acoustic ratio
1.0	1.0	0.5	0.137
0.9	0.630	0.4	0.0956
0.8	0.430	0.3	0.0470
0.7	0.308	0.2	0.0202
0.6	0.209	0.1	0.0052

13. Rectification diagrams are experimentally determined curves very useful in deriving detector characteristics. For a two-element detector (including such devices as grid-leak and condenser detector in a screen-grid tube or in a neutralized triode) the only variables considered are direct current, direct voltage, and alternating voltage, and the resulting series of curves is called a *rectification diagram*. For triodes, etc., where the signal is applied to the grid circuit of a plate-current curvature detector, the series of curves is known as a *transrectification diagram*. Figure 9 is a transrectification diagram for a 201-A tube. The plate current is shown as a function of plate voltage for various r-f voltages (r-m-s values) on the grid. Two load-resistance lines for 100,000 and 200,000 ohms are shown. The d-c voltage change across the load resistance for values of r-f voltage is shown in Fig. 10. These curves are derived from Fig. 9.

Considering the standard signal of Eq. (1) to be a voltage E_A varied in magnitude $\pm mE_A$, the output voltage change across the load impedance may be calculated. This voltage change, divided by two, gives the peak value of audio output. Thus in Fig. 10, an r-f voltage of 5

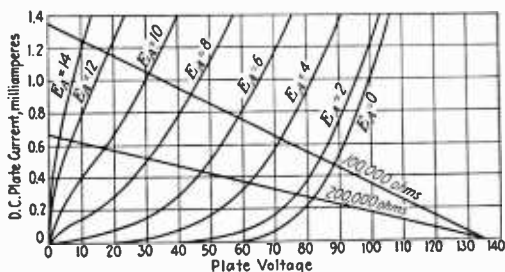

FIG. 9.—Transrectification diagram of 201-A tube. Curves for 27 and 56 are very similar. The 56 is slightly better than the others.

volts r-m-s, modulated 30 per cent gives 9.3 and 10.4 volts peak, across the 100,000- and 200,000-ohm loads, respectively.

Rectification diagrams need not be taken at radio frequencies. A voltage source such as the 60-cycle supply is satisfactory. The plate impedance to the frequencies E_A , E_{A-B} , E_{A+B} must be approximately zero.

The rectification diagrams may also be used with reactive loads. The slope of the load line through the operating point must correspond to the impedance of the reactance at the audio frequency under consideration. The actual current-voltage relations form an ellipse about this load line, the extremities of which approximate the peak-voltage swings. Complete fidelity curves may be plotted in this manner. In this case, as with the resistance load, the external impedance to E_A , E_{A-B} , and E_{A+B} must be approximately zero. An r-f voltage of 10, r-m-s, modulated 30 per cent to a 27 tube properly biased gives 29 audio, peak volts across 200,000 ohms.

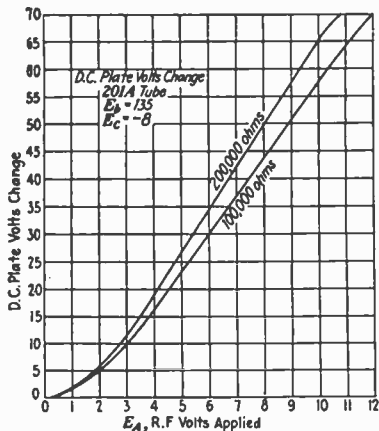

FIG. 10.—Curves derived from characteristic of Fig. 9.

14. Other Detection Characteristics. For simplicity in reference, all voltages given on the curves as E_A are given in r-m-s values. Figure 11 shows detection characteristics of a 27 used as a two-element detector. Figure 12 shows the equivalent detection resistance for the same tube.

In using various tubes for grid-leak and condenser detectors several factors are evident. The grid-leak resistance should be high to increase the tube initial bias, reducing the tube grid conductance and so the loss on the r-f circuit. A high leak resistance also increases the sensitivity. It has a major disadvantage in that in combination with the correct capacity for detection, considerable loss in high modulation frequencies results. Figure 13 shows a series of fidelity curves using different grid-

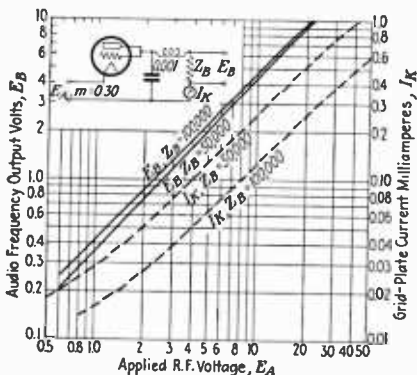

FIG. 11.—Diagram for 27 or 56 tube as a two-element detector.

leak resistances. It has become almost standard practice to use a grid condenser of $250 \mu\text{f}$ and a leak resistance of one megohm for all tubes used as grid-leak detectors. Better individual compromises for specific uses are often helpful. Figure 14 shows the r-f input a-f output of a 227 tube used as a grid-leak and condenser detector.

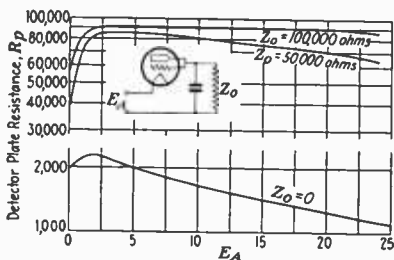

FIG. 12.—Equivalent resistance of 27 or 56 as two-element detector.

The plate resistance R_p while detecting, and the change in plate resistance R_p' , have been repeatedly used in detection equations. Figure 15 gives values of R_p and Fig. 16 gives values of R_p' for various conditions of a 27 tube.

15. Screen-grid Tube as Detector. Screen-grid tubes are extensively used as detectors. Figure 17 gives a series of curves, plotting a-f output

against r-f input for various bias conditions. The total harmonic distortion introduced by this detector is also shown. With a low

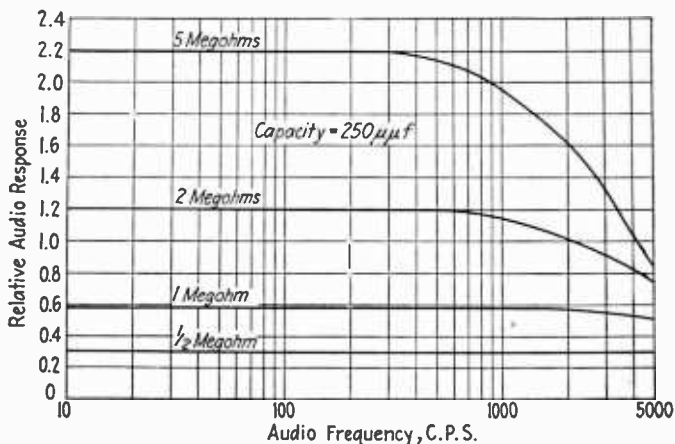

FIG. 13.—Fidelity of grid-leak detector as function of leak resistance.

battery bias (7 volts) the distortion is initially $m/4$ and decreases with increase in voltage, increasing when grid current begins to flow. With successively increasing bias voltages b, c, d the distortion percentage

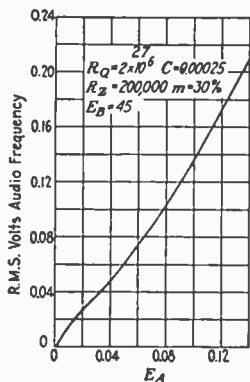

FIG. 14.—Grid leak and condenser detector.

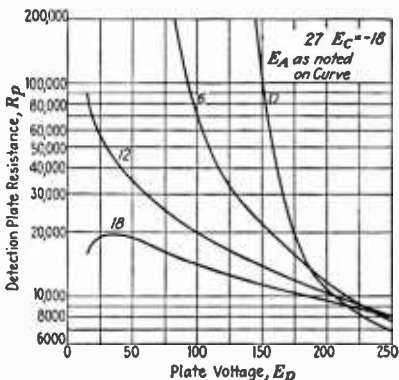

FIG. 15.—Value of plate resistance while detecting, for various input voltages.

increases rapidly from the $m/4$ condition, and the sensitivity decreases. Higher outputs are possible, however. With sufficient r-f input, the

second harmonic for these extreme bias voltages will decrease as shown by the descending curves of *b*, *c*, and *d*.

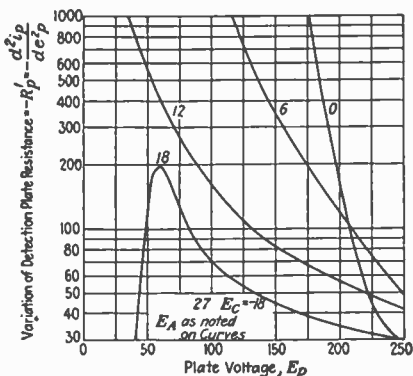

FIG. 16.—Values of change in plate resistance.

For resistance loads, where full battery voltage does not reach the plates, the conditions shown do not differ much so long as the plate

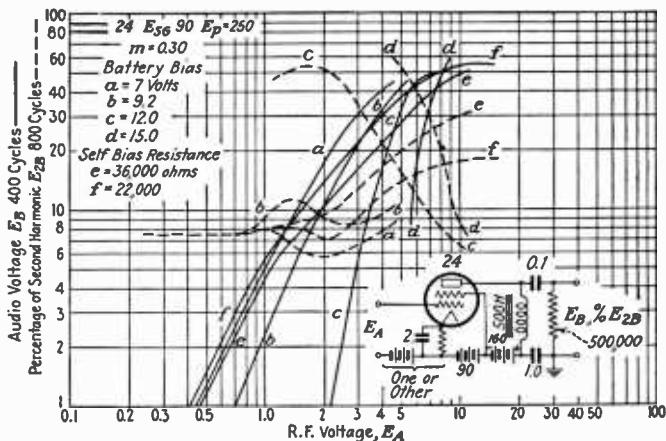

FIG. 17.—Screen-grid detector characteristics.

voltage minus the signal peak voltage is greater than the screen voltage. The suppressor in the 57 permits slighter higher plate a-c voltages.

The slope of the input-output curve is often considered as a means of estimating if the detector action is square law, linear or intermediate, and guessing the corresponding harmonic distortion. In such a self-bias arrangement the increasing bias voltage with increasing r-f input may modify the output-input curve to indicate a linear detector characteristic without the distortion conforming. In a sense the output-input curves as shown are static; distortion is due to a dynamic characteristic. It is significant to note that the *e, f* output curves cross the *c, d* output curves at the same r-f input as the corresponding distortion curves, indicating that a given r-f input and bias voltage produce a definite output and distortion regardless of how obtained.

Figure 18 shows another series of curves giving output and distortion as a function of bias conditions. These bias resistances range from values

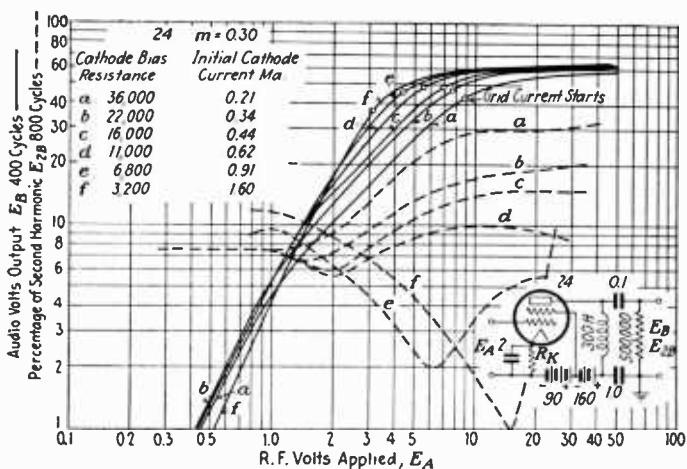

FIG. 18.—Output and distortion as function of bias resistance.

too low to those too high. *a* with 36,000 ohms gives an input-output curve of high initial sensitivity and almost linear characteristic. In spite of this apparent linear characteristic, the distortion, except for the initial $m/4$ value, is high. Decreasing the bias resistance below the optimum value results in an initial increase in distortion, a later decrease in distortion but only after grid current starts, making this decrease of doubtful value. Third harmonic distortion becomes serious only after grid current starts and when feeding from a high-impedance circuit so it is not shown in Figs. 17 and 18.

Other factors greatly influence the sensitivity and distortion of the 24. The output circuit for the curves of Figs. 17 and 18 is an extremely high reactance shunted by a 500,000-ohm resistance. For resistance coupling, higher supply voltages must be used to make up for the IR drop, or other compromises, such as lower plate resistance, be utilized. With signal voltages applied, the plate current increases and the net

voltage on the tube plate electrode decreases. When the instantaneous plate potential reaches a value as low as the screen potential serious distortion results. Actual design must insure high plate voltage in addition to correct bias conditions as portrayed in Figs. 17 and 18.

16. Values of C Bias for Various Tubes as Detectors.

27 or 56		77				6C6 or 57			
E_b	E_{c_1}	E_b	E_{c_2}	E_{c_1}	RL megs.	E_b	E_{c_2}	E_{c_1}	RL megs.
45	- 5.0	100	36	- 1.95	0.25	250	50	- 1.95	0.25
90	- 10.0	250	50	- 1.95	0.25	250	33	- 1.7	0.50
135	- 15.0	250	100	- 4.3	0.50	250	100	- 3.86	0.25
180	- 20.0	Input signal = 1.18 to 1.88				250	100	- 4.3	0.50
250	- 30.0	Output signal = 14 to 17 volts				Input signal = 1.18 to 1.38			
275	- 33	Modulation percentage = 20				Output signal = 17 volts			
						Modulation percentage = 20			
					30				
		E_b	E_{c_1}			E_b	E_{c_1}		
		45	- 3.5			90	- 10		
		90	- 9			135	- 15		
		135	- 13.5			180	- 20		
		180	- 20			250	- 28		

E_{c_1} , control-grid voltage; E_{c_2} , screen-grid voltage.

These bias values are all slightly higher than those required for optimum sensitivity. Greater output can be obtained using these values, however.

17. Modern Detector Practice. It has become common practice to use diodes as detectors, either by connecting two or more elements of a triode or pentode together to form a two-element tube or to use diodes in tubes especially made for this purpose. Frequently these are combination tubes, as diode-triodes, diode-pentodes, or they may be simply diodes. The all-metal diode of 1935, for example, contained two diodes with separate cathodes, each distinct from the other.

The diodes may be used in parallel, or one of the plates may be used to supply a.v.c. voltage, or both may be used as detectors in a push-pull circuit. The latter delivers half the voltage from a given input that is delivered by a single diode, but because of the balanced input delivers no r-f voltage to the grid of the following amplifier.

The output load of a diode is a resistor. A-c voltages developed across this resistor are applied to the grid of a following tube or to the control grid of the triode, tetrode, or pentode contained in the same envelope with the diodes. Across this resistor also appears a d-c voltage. The end of the resistor nearest the diode plate is negative. This negative voltage is utilized directly, or after amplification, as the a.v.c. control voltage and is applied to the grid of amplifiers or frequency changers.

The input-output characteristics of a typical diode-tetrode are shown in Fig. 19a. The d-c voltages developed in another typical tube (6B7) are shown in Fig. 19b.

The diode makes a good detector because of its low resistance in the conducting direction, making it easy to provide a load that gives linearity. Care must be taken, however, not to shunt down this load resistance with the grid-leak resistances of the following tube so that a low a-c resistance load is worked into.

If the triode, tetrode, or pentode in the combination tubes is biased by the voltage developed by the diode, there will be zero (or nearly zero)

bias on the tube at no-signal conditions. Therefore sufficient resistance must be in the plate circuit of this amplifier to prevent excessive plate current. Furthermore on strong signals it is possible that sufficient diode d-c voltage will be developed to bias the amplifier section to cut-off.

The diode, of course, draws current on the conducting half-cycle. Therefore it loads the input circuit feeding it. This loading is equal, quantitatively, to about one-half the value of the diode resistance used. Thus with a diode load of 0.5 megohm, it may be considered that the input is shunted by one-half this value. At low input r-f voltages,

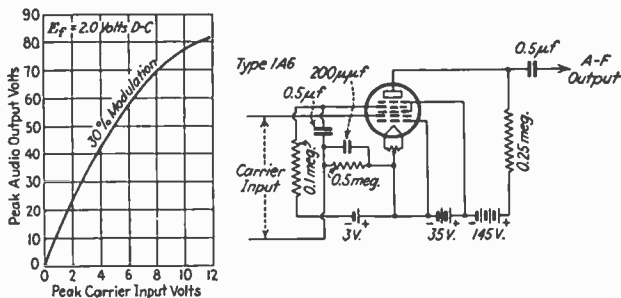

FIG. 19a.—Typical detection characteristics diode-tetrode.

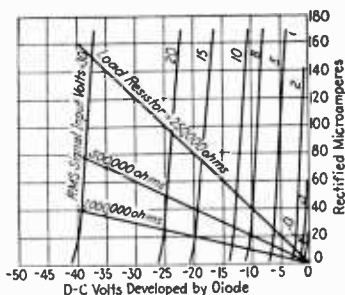

FIG. 19b.—Half-wave rectification; single 6B7 diode.

however, the diode does not develop any bias, and therefore rectification does not take place on a linear characteristic but on a curve. Some current may flow on both portions of the cycle, due to the initial velocity of the electrons. Thus a diode with a 0.5-megohm load automatically adjusts itself to be about 0.5 volt negative under the no-signal conditions. Therefore the diode is passing about 1 μ A of current. Now the diode equivalent resistance, which is presented to the input circuit as loading, is equal to $R = V_1/i$ where V_1 is a constant equal to about 0.1 for most

oxide-coated diodes under the usually imposed conditions and i is the current being passed.¹

The load is approximately 100,000 ohms under conditions of weak-signal detection. The loading is therefore more severe than under heavy-signal input conditions.

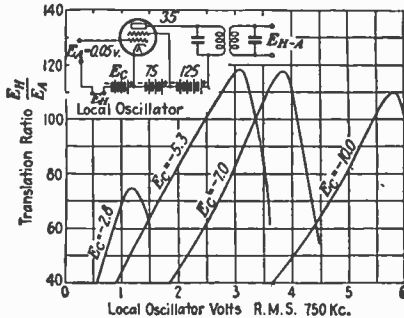

FIG. 20.—Superheterodyne oscillator characteristic.

18. Superheterodyne Translation Ratio. The sensitivity of the first detector, or heterodyne detector, of a superheterodyne system is expressed as the translation ratio. This is the ratio of the intermediate frequency voltage across the i-f impedance in the plate circuit of the detector, and the r-f voltage applied to the grid of the detector. Figure 20 gives typical translation ratio characteristics for a 35 tube under various oscillator voltages. The sudden drops are due to grid current on the r-f tuned circuit.

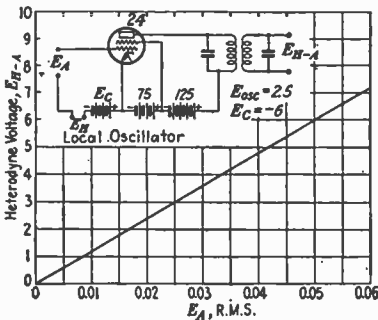

FIG. 21a.—I-f output versus r-f input.

Fig. 21a where the linearity is clearly evident.

18a. Combination Detector and Oscillator. The functions of 1st detector and oscillator of a superheterodyne may be simultaneously carried on in a single tube. The grid circuit is tuned to the applied signal E_A , and a plate circuit is made resonant to the resultant intermediate frequency. In addition, the plate circuit is coupled back to the

the r-f voltage applied to the grid of the detector. Figure 20 gives typical translation ratio characteristics for a 35 tube under various oscillator voltages. The sudden drops are due to grid current on the r-f tuned circuit.

The 35-type tubes were not designed as detectors, or modulators; but as large voltages from a local oscillator can be applied to the grid, this type may be used as first detectors.

With a constant oscillator voltage, the i-f output is linear with respect to the r-f input voltage within operating limits. This condition for a 24 is shown in

¹ PHILIPS. *Setmakers' Bull.* 20, February, 1935.

grid circuit by means of a third circuit resonant at the frequency of the applied signal plus the intermediate frequency. The result is that an oscillator voltage E_H (at the frequency $H/2\pi$) is simultaneously applied on the grid with the signal E_A , and a heterodyne voltage $E_{(H-A)}$ will be developed across the resonant plate circuit. A typical circuit is shown in Fig. 21b. Several limitations are necessary in practice. The heterodyne voltage E_H applied to the grid should not be high enough to draw grid current, or distortion will result. This calls for low oscillation voltages. Satisfactory operation to date has resulted from use of a 24-type and similar tubes. The actual voltage conditions vary with design. Bias voltages may range from 5 to 10 volts with the r-m-s heterodyne voltages on the grid about one half of this bias voltage. Translation ratios from 15 to 50 may be obtained.

Electron-coupled Frequency Converters. Introduction of tubes known as *pentagrid converters* simplified the problem of the first detector in superheterodynes. Unwanted couplings in the circuits described above cause trouble between oscillator, signal, and mixer circuits. The newer converter tubes eliminate this difficulty by eliminating capacitive or inductive feedback as the means of coupling the oscillator and mixer circuits. Instead the electron stream is used as the mixing agent.

In these tubes the electrons, first, come under the influence of a grid acting as control grid of an oscillator, then they are accelerated toward a grid on which are the incoming signal voltages. The electrons, therefore, are further modulated by this grid. Thus, on arrival at the plate, they carry components of the two frequencies as well as sum and difference frequencies. The plate circuit is tuned to the desired (usually the difference) frequency as in any other frequency changer. There are 5- and 6-grid tubes of this type.

MODULATION

19. Modulation is the process or result of modifying an energy carrier, the changes conforming to the modulating signal. The simplest form of modulation consists in the intermittent transmission of energy, producing an instantaneous change in energy from zero to maximum amplitude. Such a modulation process is customarily produced by keying and breaks the power supply, disconnects the carrier medium, or diverts the energy carrier into a power-dissipating unit when transmission is undesired. The energy carrier might be direct current in the case of a telegraph wire line, medium or high frequency currents in the cases of carrier current or radio telegraphy transmission. Suitable devices responsive to the modulation are assumed to be at the receiving end of the system.

20. Absorption modulation is typical of modulation processes. With a given impressed voltage in a circuit the current is determined by the

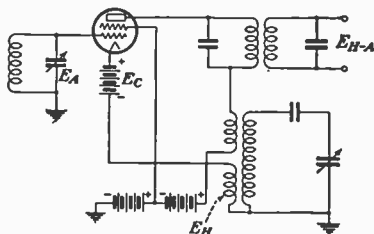

FIG. 21b.—Combined detector-oscillator circuit.

resistance of the circuit. In an absorption modulation circuit the resistance comprises the load impedance R_L and a resistance R_0 which varies in amplitude at the modulation frequency and to a degree represented by m and determined by circuit conditions.

The frequency of the impressed voltage is $A/2\pi$ and that of the modulation frequency $B/2\pi$. The voltage across the load impedance R_L is

$$e_L = \frac{E_0 R_L \sin At}{R_L + R_0(1 + m \sin Bt)} \quad (41)$$

Expanded, this gives

$$e_L = E_0 \left\{ \sin At - \frac{R_0}{R_L} (1 + m \sin Bt) \sin At + \dots \right\} \quad (42)$$

The successive terms dropped from this expansion represent harmonic or distortion terms and may be neglected for this analysis. Combining,

$$e_L = E_0 \left\{ \left(1 - \frac{R_0}{R_L}\right) \sin At - \frac{R_0}{R_L} m \sin At \sin Bt \right\} \quad (43)$$

Equation (43) represents a voltage $E_0 \left(1 - \frac{R_0}{R_L}\right) \sin At$ at the impressed

frequency, and a second voltage $E_0 \frac{R_0}{R_L} m \sin At \sin Bt$ at the frequency $\frac{A}{2\pi}$

but modulated by the frequency $B/2\pi$. The amplitude of the modulated component is proportional to the variation in resistance R_0 as expressed by m and the ratio R_0/R_L .

21. Circuits for Absorption Modulation. The absorption-modulation circuits of Fig. 22 *a, b, c* are illustrative of common methods. *a* is a telephone transmitter modulating a current of zero (d-c) frequency; *b* and *c* are methods applied to low-power r-f transmitters for voice-frequency modulation. The coupling ratios used are such as to provide the maximum modulation within the power capacity of the microphone.

22. The power rating of the device used to produce the resistance variation largely determines the modulated output. The greater R_0 with respect to R_L the greater will be the modulated output component,

but a smaller percentage of total power supplied will be transmitted. The current of carrier frequency flowing through the modulating unit causes power loss and resultant heat. In the case of a carbon-grain transmitter as shown in Fig. 22, sticking and poor operation will result. The correct relation-

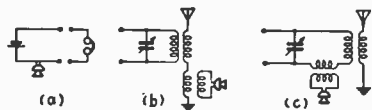

FIG. 22.—Absorption modulation circuits.

ship between R_0 and R_L is rather a compromise between opposing factors of decreased modulation and increased transmission. Maximum modulated output (maximum signal response) will generally be obtained between the values R_0 equals R_L and R_0 equals $\frac{1}{2}R_L$ depending somewhat on m . The power rating of well designed carbon-grain type microphones is approximately 5 watts, giving reasonable modulation control of from 5 to 20 watts. Special water-cooled micro-

phones have been used multiplying the above power values by about five times.

23. Analysis of Modulation. The mathematical expression for an energy carrier of a frequency $A/2\pi$ modulated by a signal of frequency $B/2\pi$ is shown to be a product, as $(1 + m \sin Bt) \sin At$. This means that the per cycle amplitude of the carrier voltage varies as the amplitude of the modulation signal, being greatest when $\sin Bt$ is $+1$ and least when $\sin Bt$ is -1 . Such a variation can be obtained by impressing simultaneously voltages of frequencies $A/2\pi$ and $B/2\pi$ upon a device

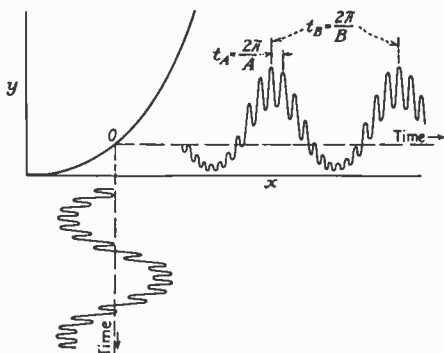

FIG. 23.—Modulation process.

whose response is not proportional to the voltage applied. Figure 23 shows how this result is obtained; x is the applied voltage and y the corresponding response. An initial operating point o is indicated. Time is measured along the dashed lines through o and parallel to the x and y axes. On the vertical time axis is shown the instantaneous sum of the applied voltages. On the horizontal time axis is shown the instantaneous response. Due to the changing slope of the asymmetrical x, y characteristic the per cycle amplitude of the response at the frequency $A/2\pi$ varies as the value of $\sin Bt$ varies. This is the desired relation for a modulated signal, and so indicates that such an asymmetrical characteristic does produce a modulated response.

The response y to an input x can be expressed as a general function

$$y = f(x) \quad (44)$$

Expanding by Maclaurin's theorem

$$y = ax + \frac{bx^2}{2!} + \frac{cx^3}{3!} + \frac{dx^4}{4!} \dots \quad (45)$$

Let

$$x = E_A \sin At + E_B \sin Bt \quad (46)$$

where E_A is the peak voltage of the carrier frequency input ($f = A/2\pi$) and E_B is the peak voltage of the modulation signal input ($f = B/2\pi$). Substituting (46) in (45) and tabulating vertically, with equivalent first-order trigonometric functions,

$$\begin{aligned}
 & a(E_A \sin At + E_B \sin Bt) + \\
 & \frac{b}{2}(E_A \sin At + E_B \sin Bt)^2 + \\
 & \frac{c}{6}(E_A \sin At + E_B \sin Bt)^3 + \\
 & \frac{d}{24}(E_A \sin At + E_B \sin Bt)^4 + \\
 & + \dots \dots \dots
 \end{aligned}
 \left. \vphantom{\begin{aligned} a \\ b \\ c \\ d \end{aligned}} \right\} = \left. \begin{aligned}
 & aE_A \sin At + aE_B \sin Bt + \\
 & \frac{bE_A^2}{4} + \frac{bE_B^2}{4} - \frac{bE_A^2}{2} \cos 2At - \\
 & \frac{bE_B^2}{4} \cos 2Bt + bE_A E_B \sin At \sin Bt \\
 & \frac{cE_A}{4} \left(\frac{E_A^2}{2} + \frac{E_B^2}{3} \right) \sin At + \\
 & \frac{cE_B}{4} \left(\frac{E_B^2}{2} + \frac{E_A^2}{3} \right) \sin Bt - \\
 & \frac{cE_A^3}{24} \sin 3At - \frac{cE_B^3}{24} \sin 3Bt - \\
 & \frac{cE_A^2 E_B}{12} (1 - \cos 2At) \sin Bt - \\
 & \frac{cE_A E_B^2}{12} (1 - \cos 2Bt) \sin At \\
 & \frac{dE_A^4}{192} \cos 4At - \frac{dE_A^2}{48} (E_A^2 + 3E_B^2) \\
 & \cos 2At + \frac{d}{64} (E_A^4 + E_B^4) + \\
 & \frac{dE_A E_B}{8} (E_A^2 + E_B^2) \sin At \sin Bt - \\
 & \frac{dE_A^3 E_B}{24} \sin 3At \sin Bt - \\
 & \frac{dE_A E_B^3}{24} \sin 3Bt \sin At - \\
 & \frac{dE_B^2}{48} (E_B^2 + 3E_A^2) \cos 2Bt + \\
 & \frac{d}{16} E_A^2 E_B^2 \cos 2At \cos 2Bt + \\
 & \frac{dE_B^4}{192} \cos 4Bt \\
 & + \dots \dots \dots
 \end{aligned} \right\} \quad (47)$$

The values of a , b , c , d , etc., represent successive differentials of the function y with respect to x , evaluated at the operating point x . It is to be noted that the functional relationship between x and y is based on the *complete* operating circuit and not merely the asymmetrical characteristic of the modulating device. Due to load impedances straightening out the curve between x and y of the modulating device itself, the differentials indicated will in general be smaller in magnitude than those based upon the x , y characteristic of the modulating device. If the actual value of this function is known, the values of these differentials may be obtained. Two typical curves of $y = f(x)$ are expressed below and the differentials evaluated:

$$\begin{array}{ll}
 y = C_1 + K_1 x^2 & y = C_2 + K_2 X_0^{3/2} \\
 a = \frac{dy}{dx} & = 2K_1 X_0 & = \frac{3}{2} K_2 X_0^{1/2} \\
 b = \frac{d^2 y}{dx^2} & = 2K_1 & = \frac{3}{4} K_2 X_0^{-1/2}
 \end{array}$$

$$c = \frac{d^2y}{dx^2} = 0 = -\frac{3}{8}K_2X_0^{-3/2}$$

$$d = \frac{d^4y}{dx^4} = 0 = \frac{9}{16}K_2X_0^{-3/2}$$

In the equations the product of two trigonometric values such as $\sin rAt \sin sBt$ represents a carrier of frequency $rA/2\pi$ modulated by a signal of $sB/2\pi$. If s is not unity, higher frequencies than the desired modulation signal frequency are transmitted and in general distortion results. If r is not unity, the modulation signal is also transmitted as a modulated carrier of higher frequency than that desired. The magnitudes of such undesired components may be reduced by keeping E_A and E_B small (in comparison with the operating characteristic of the x, y function) or by using such a function as indicated above where all differentials beyond the second have a value of zero.

For analytical purposes, the instantaneous amplitude of y may be expressed as an equation and written as follows:

$$y = aE_A \sin At + aE_B \sin Bt + \frac{bE_A^2}{4} + \frac{bE_B^2}{4} - \frac{bE_A^2}{4} \cos 2At - \frac{bE_B^2}{4} \cos 2Bt + bE_A E_B \sin At \sin Bt \quad (48)$$

The desired transmission is at a frequency $A/2\pi$. Dropping other terms,

$$y = aE_A \sin At + bE_A E_B \sin At \sin Bt \quad (49)$$

The second component of Eq. (49) represents a variable amplitude carrier at the frequency $A/2\pi$ and varying in amplitude at the frequency $B/2\pi$. This variable amplitude adds to and subtracts from the first term of Eq. (49), giving an average peak value of aE_A . The percentage of modulation may be expressed as a percentage change in value of this average peak, due to the second term of Eq. (49).

$$m = \frac{bE_B}{a} \quad (50)$$

where m is the modulation factor. The percentage of modulation is usually the value discussed, which is $100m$. The factor b/a represents the ability of the device to produce modulation and is termed its modulation efficiency. The percentage of modulation varies directly as the modulation voltage E_B . Substituting (50) in (49) gives

$$y = aE_A \left[\sin At + \frac{m}{2} \cos (A - B)t - \frac{m}{2} \cos (A + B)t \right] \quad (51)$$

Equation (51) indicates that the desired result of modulation is equivalent to three components, having frequency characteristics of $\frac{A}{2\pi}$, $\frac{A - B}{2\pi}$, $\frac{A + B}{2\pi}$ and having corresponding amplitudes of 1, $m/2$, $m/2$ and initial corresponding phases of 0, +90, -90 deg. respectively. The frequency $A/2\pi$ is referred to as the carrier frequency and the frequencies $\frac{A - B}{2\pi}$ and $\frac{A + B}{2\pi}$ as the lower and upper side bands.

24. Carrier and Side Band Physical Picture. Three viewpoints may be taken of the relations between the carrier and the side bands. The

first is illustrated in Fig. 24, where a , b , and c respectively represent instantaneous amplitudes of the carrier, lower and upper side-band components plotted against time; d gives the instantaneous sum of a , b , and c and represents exactly the form of the modulated output. The modulation factor is indicated.

A second viewpoint is shown in Fig. 25, which represents the peak (or effective) voltage amplitude of the carrier and side bands plotted

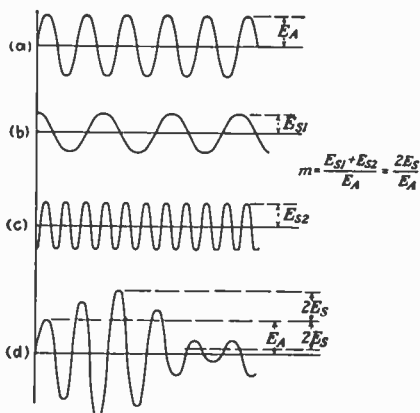

FIG. 24.—Relations between carrier and side bands.

against their corresponding frequencies. The modulation factor is indicated. Its value is obtained by noting that the maximum and minimum amplitudes occur when the sum of the side-band amplitudes adds to and subtracts from the carrier.

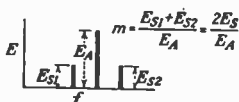

FIG. 25.—Carrier and side bands on a frequency scale.

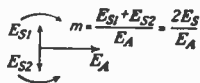

FIG. 26.—Vector diagram of carrier and side bands.

A third viewpoint is shown in Fig. 26, where the vectors indicate peak (or effective) voltage amplitudes of the carrier and side bands and their respective initial phase conditions. With respect to the carrier vector the lower side band rotates clockwise while the upper side band rotates counterclockwise, the relative angular velocities being $+B$ and $-B$. The maximum and minimum amplitudes occur when the side-band vectors are in phase or exactly out of phase with the carrier. The modulation factor is indicated.

25. Modulation Due to Iron Saturation. An asymmetrical characteristic occurs near the saturation point of an iron core reactor. If such a

reactor, so operated, be used as a transmission element in a carrier frequency system and if a modulating signal be impressed through an auxiliary winding, modulation will result. Such a system was used for modulating arc-type radio transmitters or those of the Alexanderson or Goldschmidt type. Due to nonpenetration of the flux into the iron such schemes are effective only at frequencies up to 100,000 cycles.

26. Plate-circuit Modulation. The plate-current characteristic of a three-element vacuum tube with respect to its grid and plate voltages may be approximately expressed as

$$I_p = \left(E_g + \frac{E_p}{\mu} + e \right)^2 \tag{52}$$

x , in the range in which the tube is effective as a modulation device, is approximately $\frac{3}{2}$. The voltages at the carrier frequency and at the modulation frequency may be independently impressed in the grid or plate circuits of the vacuum tube with resultant modulation. If both voltages are impressed in the grid circuit, smaller amplitudes are necessary to produce an equivalent plate circuit output than if one or both are impressed in the plate circuit. Here μ represents the amplification factor of the tube. It is not constant but varies as I_p cut-off is approached at high negative grid voltages. The result is that in obtaining high percentages of modulation, a greater amount of distortion will be produced when the carrier and modulation voltages are impressed in the grid circuit than when impressed in the plate circuit. Best results may be obtained when the carrier voltage is impressed in the grid circuit and the modulation voltage in the plate circuit. Tubes operating in the manner outlined above are called *modulated amplifiers*.

27. Modulation Quantities. Certain quantitative values are often needed in the solution of modulation problems. These are indicated as follows:

In terms of the grid and plate incremental voltages the power series for the three-element vacuum tube is

$$i_p = F_1 e_g + F_2 e_p + \frac{1}{2} F_3 e_g^2 + F_4 e_g e_p + \frac{1}{2} F_5 e_p^2 \dots \tag{53}$$

$$F_1 = \frac{\mu}{R_p}; \quad F_2 = \frac{1}{R_p}; \quad F_3 = \frac{1}{R_p} \frac{d\mu}{dE_g} + \frac{\mu}{R_p} \frac{d\mu}{dE_p} - \mu^2 \frac{R_p'}{R_p^2}; \quad F_4 = \left. \begin{aligned} & \frac{1}{R_p} \frac{d\mu}{dE_p} - \mu \frac{R_p'}{R_p^2}; \quad F_5 = -\frac{R_p'}{R_p^2} \end{aligned} \right\} \tag{54}$$

where
$$\mu = -\frac{dE_p}{dE_g}; \quad \frac{1}{R_p} = \frac{dI_p}{dE_p}; \quad R_p' = \frac{dR_p}{dE_p} \tag{55}$$

With a resistance R_L in the plate circuit the series of (53) may be expressed as

$$i_p = \frac{\mu e_g}{R_p + R_L} - \frac{1}{2} e_g^2 \left[\frac{\mu^2 R_p R_p'}{(R_p + R_L)^2} - \frac{2R_p \frac{d\mu}{dE_g}}{(R_p + R_L)^2} \right] + \dots \tag{56}$$

$$e_p = -i_p R_L \tag{57}$$

Maximum modulated voltage across R_L is obtained when

$$R_L(\text{approx.}) = \frac{\mu}{2} \frac{1}{\frac{d\mu}{dE_g}} \left[R_p' + \sqrt{(\mu R_p')^2 - 2R_p R_p' \frac{d\mu}{dE_g}} \right] \tag{58}$$

$$R_L = \frac{R_p}{2} \left(\text{when } \frac{d\mu}{dE_g} = 0 \right) \tag{59}$$

Maximum modulated power in R_L is obtained when

$$R_L = \frac{R_p}{5} \left(\text{when } \frac{d\mu}{dE_g} = 0 \right) \quad (60)$$

Effective voltage E_f of modulated carrier is

$$E_f = \frac{1}{2} E_A \sqrt{m^2 + 2} \quad (61)$$

where E_A is the peak voltage of the unmodulated carrier and m is the modulation factor.

Maximum peak voltage of modulated carrier is

$$E_{p \text{ max.}} = E_A(1 + m) \quad (62)$$

Minimum peak voltage of modulated carrier is

$$E_{p \text{ min.}} = E_A(1 - m) \quad (63)$$

Maximum peak voltage of modulated carrier is

$$E_{p \text{ max.}} = E_f \frac{2(m + 1)}{\sqrt{m^2 + 2}} \quad (64)$$

28. Heising modulation, named after its inventor, is based on the relationship between the amplitude of the carrier frequency voltage from an oscillator and the voltage of the plate power supply to that oscillator. Figure 27 shows the relationship between the voltage across the tuned circuit in a low-power oscillator with respect to the supply voltage applied to the plate. The output is practically linear with respect to the supply voltage. In operation the modulating voltage is added to and subtracted from the plate supply voltage. If the peak

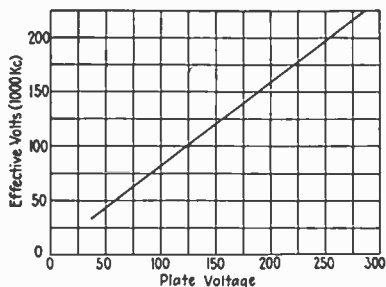

FIG. 27.—Voltage across tuned circuit as function of oscillator plate voltage.

of the modulating voltage is equal to the plate supply voltage the oscillator carrier voltage varies between zero and twice the average value, which is equivalent to 100 per cent modulation. The transmitted power from the oscillator varies as the square of the voltage and, therefore, during this maximum voltage period is four times its normal value. At the minimum voltage period no power is radiated. The increased power supply to the oscillator tube must come from the modulation signal source. The modulation supply is generally from a vacuum tube used as a modulation-frequency amplifier. For 100 per cent modulation the undistorted power output of this modulation amplifier must be twice the normal power rating of the oscillator.

29. Oscillator-modulator System. Figure 28 shows a complete oscillator-modulator system comprised of a Hartley oscillator and a Heising modulator. The plate power supply for the oscillator and modulator

tubes is from a common source, the plates being fed through the choke L . The modulation-frequency voltage developed across this choke is added to and subtracted from the supply voltage impressed on the plate of the oscillator tube, giving the resultant modulation as previously indicated. The radio-frequency choke K prevents the effective grounding of the plate of the oscillator tube and prevents radio-frequency energy from being fed back into the modulator tube. To maintain fidelity at low frequencies, the choke L must be of high inductance. About 95 per cent of the 400-cycle voltage amplitude across this choke will be maintained at 60 cycles, if the choke inductance in henrys is $0.008 R_p$, where R_p is the plate resistance of the modulator tube. To maintain fidelity

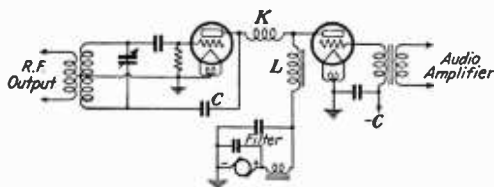

FIG. 28.—Hartley oscillator—Heising modulator.

at high frequencies the feed-back condenser C (plus any equivalent capacity due to wiring) must be kept small. At 5,000 cycles 95 per cent transmission will be maintained if this capacity in microfarads is not greater than $10/R_p$.

30. Oscillation Control. The amplitude of oscillation in a carrier-frequency oscillator may be controlled by varying the grid voltage in a manner similar to the Heising modulator. One effective way of accomplishing this is to control the value of the grid leak used. With proper adjustment the amplitude of oscillation is proportional to the impedance of the grid leak, the current through which is used to provide bias for the oscillator tube. If the plate-filament circuit of a vacuum tube be

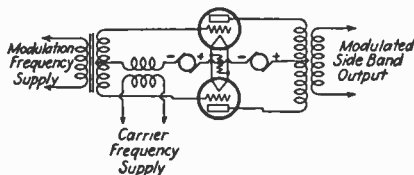

FIG. 29.—Modulated balanced amplifier.

used in place of the customary grid leak, this modulation tube will draw current whenever its plate is positive, thereby giving an equivalent grid-leak resistance. The magnitude of this resistance is determined by the type of tube used, etc., and by the potential impressed upon its grid. If this applied grid potential is in the nature of a modulation signal, the leak resistance and consequently the carrier-frequency output will vary in accordance with this signal.

31. Power Tubes as Modulators.

General information									
Model	Main use	Socket mounting	Type of cooling	Max. over-all length, inches	Max. over-all dia., inches	Filament			Average voltage amplification factor
						Types	Volts	Amperes	
UX-171A.....	Power amplifier	UX	Air	4½	1½ ¹⁶	Thoriated	5.0	0.25	3
UX-210.....	General purpose	UX	Air	5½	2½ ¹⁶	Thoriated	7.5	1.25	8
UV-211.....	General purpose	UT-541	Air	7½	2½ ¹⁶	Thoriated	10.0	3.25	12
UX-245.....	Power amplifier	UX	Air	5½	2½ ¹⁶	Thoriated	2.5	1.75	3.5
UX-250.....	A-f power amplifier or modulator only	UX	Air	6¼	2½ ¹⁶	Coated	7.5	1.25	3.8
UX-841.....	Voltage amplifier only	UX	Air	5½	2½ ¹⁶	Thoriated	7.5	1.25	30
UX-842.....	A-f power amplifier or modulator only	UX	Air	5½	2½ ¹⁶	Thoriated	7.5	1.25	3
UV-845.....	A-f power amplifier or modulator only	UT-541	Air	7½	2½ ¹⁶	Thoriated	10.0	3.25	5
UV-848.....	General purpose	Water jacket	Water	20¼	4¼	Tungsten	22.0	52.0	8
UV-849.....	General purpose	UT-501 & UT-502	Air	14¾	4½ ¹⁶	Thoriated	11.0	5.00	19
UV-851.....	General purpose	UT-501 & UT-502	Air	17¾	6¾	Thoriated	11.0	15.50	20
DE-520M.....	Modulator	Water jacket	Water	16	4¼	Tungsten	22.0	30.0	10
WE-205D.....	General purpose	115B	Air	4½	2¾	Coated	4.5	1.60	7.3
WE-211D.....	General purpose	112A 118A	Air	7½ ¹⁶	2½ ¹⁶	Coated	10.0	3.00	12.0
WE-212D.....	Oscillator or modulator	113A	Air	13¾	3¾	Coated	14.0	6.00	16.0

32. Modulated Balanced Amplifier. Figure 29 shows the circuit commonly known as a modulated balanced amplifier. Both the carrier voltage and the modulating signal are impressed on the grids of the amplifier tubes. The voltage on the upper tube is $[E_A \sin At + E_B \sin Bt]$, and the voltage on the lower tube is $[E_A \sin At - E_B \sin Bt]$. The currents in the plate circuit are transferred to a third circuit, the sign of the mutual inductance being positive for one plate circuit and negative for the other. The net result is to cause a cancellation of the carrier frequency in the third circuit, while the side-band components add, giving two components $E_{AM} \cos (A - B)t$ and $E_{AM} \cos (A + B)t$.

The radiated energy is concentrated in the side bands and for this reason is often called the *carrier-suppression* method. When E_B is zero; that is, no modulation signal impressed; there is no radiation. This method of operation presupposes the addition of an equivalent carrier frequency voltage at the receiving end. Its principal advantages

Oscillator or r-f power amplifier						A-f power amplifier or modulator						
Max. operating d-c volts modulated	Max. operating d-c volts non-modulated	Max. operating a-c (r-m-s) volts	Max. plate dissipation, watts	Max. r-f grid amperes	Max. operating plate volts	Max. plate dissipation watts	Normal plate, volts*	Grid bias, volts†	Plate, amperes	Normal output, watts	Average a-c plate resistance, ohms	Average mutual conductance, micromhos
135	180	180	5	...	180	3.5	180	- 40.5	0.020	0.7	2,000	1,500
350	450	450	15	5	425	12	425	- 39	0.018	1.7	5,000	1,600
1,000	1,250	1,500	100	7.5	1,250	75	1,000	- 55	0.072	10.0	3,400	3,530
200	250	250	10	...	250	7.5	250	- 50	0.030	1.7	2,000	1,750
.....	450	30	450	- 84	0.055	4.5	1,800	2,100
.....	425	12	425	- 8	0.0075	21,500	1,400
.....	425	12	425	- 100	0.028	3.0	2,500	1,200
.....	1,250	75	1,000	- 147	0.075	20.0	1,800	3,000
12,000	15,000	15,000	10,000	30	12,000	7,500	10,000	- 1,000	0.750	2,400	3,300
2,000	2,500	2,500	400	10	3,000	300	3,000	- 132	0.100	100	3,200	6,000
2,000	2,500	2,500	750	10	2,500	600	2,000†	- 73	0.150	65	2,800	6,800
2,000	2,500	2,500	750	10	2,500	600	2,000	- 65	0.300	100	1,400	15,000
8,000	10,000	10,000	5,000	20.0	10,000	5,000	8,000	- 500	0.65
275	350	350	20	350	15	350	- 22.5	0.033	1.0	3,500	2,000
750	1,000	1,000	65	1,000	65	750	- 30	0.065	3,200	3,900
1,300	520	2,000	250	1,500	- 60	0.015	2,150	7,500

* These voltages are maximum values for usual broadcast transmitting uses.

† Measured from mid-point of filament.

‡ At 2,000 volts modulator output is greater than that from UV-204A at 2,000 volts.

lie in the efficiency of operation and in the fact that the service area of the transmitter and its interference area practically coincide. For perfect balance the effective m is infinite.

33. Single Side-band Transmission. If suitable filters be arranged to prevent the transmission of all frequencies below the carrier frequency, the upper side band only will be transmitted. Its principal advantage over the carrier-suppression method is that at the receiving end the supplied carrier frequency does not have to be so nearly identical in frequency with the original carrier frequency for the same degree of distortion. With single side-band transmission the signal may be completely lost due to selective frequency fading, while in the carrier-suppression method at least one of the two side bands may get through, providing half-amplitude response.

34. Frequency Inversion; Scrambling. To insure secrecy of transmission, frequency inversion or frequency scrambling methods are used.

The modulation signal modulates an oscillator of approximately 50,000 cycles. If the modulation frequencies range between 100 and 3,000 cycles, filters are arranged in the output of the modulated oscillator to pass only those frequencies between 47,000 and 49,900 cycles. The frequencies in this selected range are made to heterodyne with an oscillator at a frequency of 42,000 cycles. A second filter system is arranged to pass only those frequencies between 5,000 and 7,900 cycles, which are the resulting beat frequencies. It may be observed that the original 3,000-cycle modulation signal frequency now has a corresponding amplitude at 5,000 cycles. The original 100-cycle modulation frequency signal now has a corresponding amplitude at a frequency of 7,900 cycles. The frequency scale of the original modulation signal has been inverted by the process. These frequencies may, if desired, be further lowered by a second heterodyning step against a 4,900-cycle oscillator which would produce the inverted scale of frequencies ranging from 100 to 3,000 cycles. This inverted modulation frequency is then impressed as the normal modulation upon a carrier-frequency oscillator. To obtain an intelligible signal at the receiving end, it is necessary to again invert the modulation frequencies by the reverse process. To anyone not having at hand the proper equipment and not knowing the correct frequency at which the inverting was done the transmission would be indecipherable.

METHODS OF MEASURING MODULATION

35. Inferential Methods. Percentage of modulation is a most important factor in modulation problems. Its value may be determined in two general ways, the first based on the process of producing the modulation, and the second on measurements of the modulated carrier itself.

The factor of modulation is given in Eq. (50). Determining the values of a and b under the operating conditions and measuring E_B enables m to be calculated.

Another inferential method is based on the oscillator amplitude characteristic as shown in Fig. 27. If the plate supply voltage increased 10 per cent, the output voltage will also increase 10 per cent. This simple relation indicates that

$$m = \frac{E_B}{E_p} \quad (65)$$

where E_B represents the peak value of the modulation signal voltage and E_p represents the applied plate voltage. Occasionally the function shown in Fig. 27 will be a straight line, but its intercept on the E_p axis will not be at the point 0, 0. In this case the value of E_p in Eq. (65), will not be the actual plate voltage but the indicated voltage along the E_p axis, between the straight-line intercept and the applied plate voltage.

Another inferential method is to produce an equivalent modulated signal, not by the actual process of modulation, but by the simultaneous transmission of two or more frequencies differing by the desired modulation signal frequency. The factor of modulation is equal to the amplitude of the transmitted frequency component corresponding to the side band divided by the amplitude of the frequency chosen as the carrier. Independent measurement of the voltage amplitudes of these components enables m to be calculated.

36. Methods Based on Shape of Modulated Output. The first method based on the shape of the modulated output as indicated in *d* (Fig. 24). Before modulation, the peak voltage of the carrier-frequency component is measured with a peak voltmeter. After modulation, the positive peak voltage is again measured. The increase in peak voltage divided by the carrier peak voltage gives the percentage of modulation. The principal disadvantage in this method is that, due to improper adjustment in the oscillator-modulator system, the effective carrier may change in

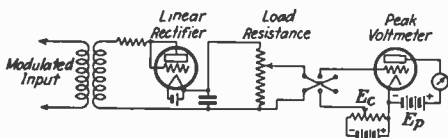

FIG. 30.—Circuit for measuring modulation.

amplitude from its unmodulated value when modulated. This error may be avoided by measuring the amplitude of the maximum and minimum peaks. The factor of modulation is then given by

$$m = \frac{E_{\max.} - E_{\min.}}{E_{\max.} + E_{\min.}} \quad (66)$$

A circuit diagram for such a measuring arrangement is shown in Fig. 30. The rectifier is linear, giving a voltage (d.c. and at the modulation frequency) across the load corresponding (in proportion) to the carrier plus and minus the modulation component. The positive peak is first measured with the peak voltmeter, and then by reversing, the negative peak is measured, both with reference to zero load voltage. Substituting in (66) gives *m*.

37. Use of Detector to Measure Modulation. A simple way of measuring the percentage of modulation is to apply the modulated signal to the grid of a detector tube, and observing the d-c change in plate current and the alternating component at the modulation frequency. The change in d.c. may be read with a d-c meter while the alternating component may be calculated by measuring the modulation-frequency voltage across a known resistance in the plate circuit. Figure 31 shows a curve between percentage of modulation and the ratio between the effective value of the a.c. and change in the d-c plate circuit.

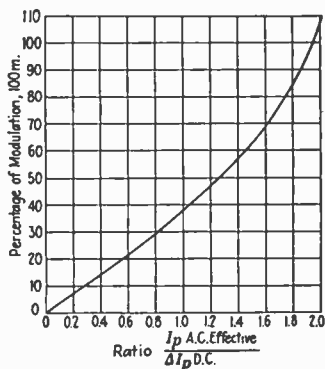

FIG. 31.—Use of change in detector plate current as measure of modulation.

38. Use of Cathode-ray Oscilloscope. The modulated signal is applied to one pair of control plates while the modulation frequency obtained by rectifying a portion of the modulated carrier frequency is

applied to the other pair of control plates. The resulting figure, with proper adjustment of phase, will be an isosceles trapezoid. The greater of the parallel lines is the peak amplitude, while the lesser of the two corresponds to the minimum amplitude of the applied voltage.

$$m = \frac{l_1 - l_2}{l_1 + l_2} \quad (67)$$

where l_1, l_2 are the lengths of the parallel sides referred to above. Another method of using an oscilloscope or oscillograph to obtain the value of m is as follows: As in the positive and negative peak measurement method, a linear rectifier is necessary to supply the oscillograph. Instead of measuring peak values of the rectified signal, the curves are actually observed in the image glass or measured from a photograph and calculated as in (66). Customarily a second line image, initially coinciding with the zero input line of the vibrating element, is used to indicate the zero condition. If the negative peaks reach this zero line, 100 per cent modulation is being obtained.

39. Change of Modulation Due to Resonance Characteristic. When a modulated carrier is impressed on a circuit having resonance characteristics the percentage of modulation is changed. The action may be considered from either the frequency amplitude response characteristic of the resonant circuit or from the energy storing and decrement properties of the circuit. If the circuit resonance frequency is made to coincide with the carrier frequency the new factor of modulation is

$$m' = m \left(\frac{R}{\sqrt{R^2 + \frac{4L}{C} \left(\frac{f_m}{f_c} \right)^2}} \right) \quad (68)$$

where $L, R,$ and C are the inductance, series resistance, and capacity of the circuit at resonance to the carrier frequency f_c , and f_m is the modulation frequency. In Eq. (68) the effect of R is to decrease the change in percentage of modulation. In transmitters resistance is often added to the resonance circuits to prevent change in modulation percentage at high modulation frequencies.

40. Frequency Multipliers. It is often desired to produce frequency multiplication by an asymmetrical characteristic such as illustrated in Fig. 23. A further expansion of (47) shows various components having frequencies $2A/2\pi, 3A/2\pi, 4A/2\pi,$ etc. If double carrier frequency is desired, there are four components having the frequency $2A/2\pi$ in the expansion indicated. Two of these may be considered as the new carrier. The second is a term involving $\cos 2At \sin Bt$, indicating side bands with respect to the new carrier at a frequency difference corresponding to the desired modulation frequency. The fourth component involving $\cos 2At \cos 2Bt$ indicates double-frequency modulation and is undesired. The desired modulation frequency is due to third-order curvature, while the undesired double frequency is due to fourth-order curvature. If two identical tubes are used, the third-order components may be increased by push-pull connection in the grid circuits and by connecting the plate circuits in parallel. This method of connection also tends to cancel the fourth-order effect and so produces a substantially undistorted modulated carrier of twice the initial carrier frequency.

41. Change in Percentage Modulation. If a modulated signal such as given in Eq. (51) be applied as x in the function of Fig. 23 and the components at a frequency corresponding to the carrier frequency only be considered the response will be

$$y = ax + \frac{1}{8}cx^3 + \frac{1}{192}cx^5 + \dots \quad (69)$$

where a, c, e , etc., are the first, third, fifth, etc., differentials of y with respect to x . In case of a triode,

$$\left. \begin{aligned} a &= \frac{di_p}{de_0} \\ b &= \frac{d^3i_p}{de_0^3} \\ e &= \frac{d^5i_p}{de_0^5} \end{aligned} \right\} \begin{aligned} y &= i_p \\ x &= E_A(1 + m \sin Bt) \sin At \end{aligned} \quad (70)$$

Equation (70) shows that the percentage of modulation has been increased so that

$$m' = m \left(1 + \frac{1}{8}x^2 \frac{c}{a} + \dots \right) \quad (71)$$

This change in modulation is undesired, as it destroys a linear input-output relation and introduces 2nd and higher harmonics of the modulation frequency and consequent distortion. It may be reduced by decreasing the value of c . Vacuum tubes having a value of c small under any voltage conditions are used for variable gain control amplifier tubes. The 235 type is such a tube.

42. Cross modulation results when two modulated signals are impressed simultaneously upon an asymmetrical amplifier. This means that the modulation of both signals may be obtained when tuned on either carrier. The effective percentage of modulation for the interfering signal with respect to the desired carrier is

$$m' = m_i \frac{E_i^2 c}{2a} \quad (72)$$

where m' is the effective modulation of the desired carrier E_c , by the undesired modulation frequency, m_i is the modulation factor of the interfering carrier E_i , c and a are the third and first differentials of the x, y function (see Fig. 23) respectively, evaluated under operating conditions. In the case both signals are impressed on the grid of a triode,

$$a = \frac{di_p}{de_0}, \quad c = \frac{d^3i_p}{de_0^3}$$

43. Band Width Necessary. The transmission of intelligence by modulated carrier frequencies requires a definite portion of the frequency spectrum and implies a limit to the number of such carrier channels available. In the case of wire lines the total number of channels is given by the available frequency spectrum divided by the band width, times the number of pairs of wires, times the multiplexing factor. In the case of a radiated wave the total band width required is the sum of three items: (1) the total band width required by the side bands necessary to the type of transmission being used; (2) a certain tolerance to allow for drift of transmitter frequencies; and (3) a guard band required by the limitations of practical receivers which have frequency characteristics which are more trapezoidal than rectangular in shape.

Modulation intelligence symbol	Character or rate	Single side band width	
		Necessary by best known methods	Desirable for high quality
Telegraph.....	English, Continental code, 200 words per minute	40	120 to 200
Telephony.....	Speech	2,500	6,500
Telephony.....	Music	4,500	15,000
Picture.....	1 sq. in. 60 lines per inch, per second	1,800	7,200 to 9,000
Television.....	1 sq. in. 50 lines per inch, 16 pictures per second	15,000	40,000

44. **Frequency modulation** is the term applied to that type of modulation where the carrier is varied in frequency rather than in amplitude by the modulation signal. If the carrier is wobbled plus and minus $B/2\pi$ times a second, and a device proportionally responsive to the frequency be used at the receiver, an effective response at the frequency $B/2\pi$ will be obtained as a demodulated signal. The response amplitude is supposed to be directly proportional to the carrier-frequency variation, a wobble of 500 cycles giving ten times the response of a 50-cycle wobble. Mathematical considerations for sine-wave frequency modulation give an equation for the various frequency components having Bessel function coefficients as follows:

$$\begin{aligned}
 q = & J_0 n \cos At \\
 & - J_1 n [\cos (A - B)t - \cos (A + B)t] \\
 & + J_2 n [\cos (A - 2B)t - \cos (A + 2B)t] \\
 & + J_3 n [\cos (A - 3B)t - \cos (A + 3B)t] \\
 & + \dots \dots \dots
 \end{aligned}
 \quad \left. \vphantom{q} \right\} \quad (73)$$

where $n = \frac{\Delta A}{B}$.

With n having the following values, the respective side-band amplitudes are:

n	Unmodulated carrier amplitude	Modulated carrier amplitude	$\frac{B}{2\pi}$	$\frac{2B}{2\pi}$	$\frac{3B}{2\pi}$	$\frac{4B}{2\pi}$
0.1	1	0.998	0.058			
1.0	1	0.763	0.440	0.115	0.020	0.003

This analysis shows that frequency modulation occupies not less but more of the frequency spectrum.

45. **Square-top Waves.** For intermittent frequency modulation by keying, the coefficients of the Fourier series are those resulting from the square-top wave. For this case the equation similar to (73) is

$$\begin{aligned}
 q = & \frac{2}{\pi} \left[\frac{n}{n^2} \sin \left(\frac{\pi}{2} n \right) \cos At \right. \\
 & + \frac{n}{n^2 - 1^2} \cos \left(\frac{\pi}{2} n \right) \{ \cos (A - B)t - \cos (A + B)t \} \\
 & - \frac{n}{n^2 - 2^2} \sin \left(\frac{\pi}{2} n \right) \{ \cos (A - 2B)t - \cos (A + 2B)t \} \\
 & - \frac{n}{n^2 - 3^2} \cos \left(\frac{\pi}{2} n \right) \{ \cos (A - 3B)t - \cos (A + 3B)t \} \\
 & + \dots \dots \dots \left. \right] \quad (74)
 \end{aligned}$$

Bibliography on Detection

AIKEN, C. B.: Detection of Two Modulated Waves Which Differ Slightly in Carrier Frequency, *Proc. I.R.E.*, January, 1931.

BAILEY, AUSTIN, and T. A. McCANA: Application of Printing Telegraph to Long Wave Radio Circuits, *Bell System Tech. Jour.*, October, 1931.

BALLANTINE, STUART: Detection at High Signal Voltages—Plate Rectification with the High-vacuum Triode, *Proc. I.R.E.*, July, 1929.

———: Detection by Grid Rectification with the High-vacuum Triode, *Proc. I.R.E.*, May, 1928.

BARCLAY, W. A.: The Numerical Estimation of Grid Rectification for Small Signal Amplitudes, *Exper. Wireless and Wireless Eng.*, November, 1929.

BROWN, H. A., and C. T. KNIPP: Behavior of Alkali Vapor Detector Tubes, *Proc. I.R.E.*, January, 1927.

BUTTERWORTH, S.: Note on the Apparent Demodulation of a Weak Station by a Stronger One, *Exper. Wireless and Wireless Eng.*, November, 1929.

CHAFFEE, E. L.: Voltage Detection Coefficient, *Proc. I.R.E.*, November, 1927.

———, and G. H. BROWNING: A Theoretical and Experimental Investigation of Detection for Small Signals, *Proc. I.R.E.*, February, 1927.

COLEBROOK, F. M.: The Theory of the Straight-line Amplifier, *Exper. Wireless and Wireless Eng.*, November, 1930.

CULVER, C. A.: An Improved System of Modulation in Radio Telephony, *Proc. I.R.E.*, October, 1923.

DONLE, H. P.: New Applications of the Sodion Detector, *Proc. I.R.E.*, April, 1924.

FREEMAN, H. M.: Detecting Characteristics of Electron Tubes, *Proc. I.R.E.*, October, 1925.

HARRIS, SYLVAN: Notes on the Detection of Large Signals, *Proc. I.R.E.*, October, 1929.

NELSON, J. R.: Detection with the Four-electrode Tube, *Proc. I.R.E.*, June, 1928.

———: Grid Circuit Power Rectification, *Proc. I.R.E.*, March, 1931.

———: Notes on Grid Circuit Detection, *Proc. I.R.E.*, March, 1929.

ROBERTS, W. VAN B.: Note on Detection by Grid Condenser and Leak, *Proc. I.R.E.*, September, 1927.

ROBINSON, G. D.: Test Procedure for Detectors with Resistance Coupled Output, *Proc. I.R.E.*, May, 1931.

RODER, HANS: Amplitude, Phase, and Frequency Modulation, *Proc. I.R.E.*, December, 1931.

SMITH, L. P.: Theory of Detection in a High-vacuum Thermionic Tube, *Proc. I.R.E.*, October, 1926.

TERMAN, F. E.: Some Principles of Grid-leak Grid-condenser Detection, *Proc. I.R.E.*, October, 1928.

———, and BIRNEY DYSART: Detection Characteristics of Screen-grid and Space-charge-grid Tubes, *Proc. I.R.E.*, May, 1929.

———, and THOMAS M. GOOIN: Detection Characteristics of Three-element Vacuum Tubes, *Proc. I.R.E.*, January, 1929.

WHEELER, H. A.: Discussion on W. A. MacDonald Paper, *Proc. I.R.E.*, April, 1927.

Bibliography on Modulation

AFFEL, H. A., C. S. DEMAREST, and C. W. GREEN: Carrier Systems on Long-distance Telephone Lines, *Bell System Tech. Jour.*, July, 1928.

ARNOLD, H. D., and LLOYD ESPENSCHIED: Transatlantic Radio Telephony, *Bell System Tech. Jour.*, October, 1923.

BALLANTINE and SNOW: Variable Mu Tetrodes, Contribution 22 from the Radio-frequency Laboratories.

BOWN, RALPH, DE LOSS K. MARTIN, and R. K. POTTER: Some Studies in Radio Broadcast Transmission, *Proc. I.R.E.*, February, 1926.

- BYRNES, I. F.: Recent Developments in Low Power and Broadcasting Transmitters, *Proc. I.R.E.*, May, 1928.
- CARSON, J. R.: *Proc. I.R.E.*, February, 1922.
- CLOKEY, A. A.: Automatic Printing Equipment for Long Loaded Submarine Telegraph Cables, *Bell System Tech. Jour.*, July, 1927.
- CULVER, C. A.: An Improved System of Modulation in Radio Telephony, *Proc. I.R.E.*, October, 1923.
- CURTIS: The Application of Vacuum-tube Amplifiers to Submarine Cable, *Bell System Tech. Jour.*, July, 1927.
- FARNHAM, P. O., and A. W. BARBER: Problems Involved in the Design and Use of Apparatus for Testing Radio Receivers, *Proc. I.R.E.*, August, 1930.
- GRAY, FRANK, J. W. HORTON, and R. C. MATHES: The Production and Utilization of Television Signals, *Bell System Tech. Jour.*, October, 1927.
- HARRIS, SYLVAN: Cross Modulation in R-f Amplifiers, *Proc. I.R.E.*, February, 1930.
- HARTLEY, R. V. L.: Relations of Carrier and Side Bands in Radio Transmission, *Proc. I.R.E.*, February, 1923.
- : Transmission of Information, *Bell System Tech. Jour.*, July, 1928.
- HEISING, R. A.: Production of Single Side Band for Transatlantic Radio Telephony, *Proc. I.R.E.*, June, 1925.
- HENNEY, KEITH: "Principles of Radio," John Wiley & Sons, Inc.
- HOMBALD, N. E.: Frequency Modulation, *Exper. Wireless and Wireless Eng.*, May and August, 1929.
- HORTON, J. W.: Vacuum-tube Oscillator, A Graphical Method of Analysis, *Bell System Tech. Jour.*, July, 1924.
- IVES, HORTON, PARKER, and CLARK: Transmission of Pictures over Telephone Lines, *Bell System Tech. Jour.*, April, 1925.
- JARVIS, K. W.: Radio Receiver Testing Equipment, *Proc. I.R.E.*, April, 1929.
- JOLLIFFE, C. B.: The Uses of the Electron-tube Peak Voltmeter for the Measurement of Modulation, *Proc. I.R.E.*, April, 1929.
- JONES, W. C.: Condenser and Carbon Microphones, Their Construction and Use, *Bell System Tech. Jour.*, January, 1931.
- KING, R. W.: Thermionic Vacuum Tubes and Their Applications, *Bell System Tech. Jour.*, October, 1923.
- LAUER, H.: *Exper. Wireless and Wireless Eng.*, August, 1929.
- LLEWELLYN, F. B.: Operation of Thermionic Vacuum-tube Circuits, *Bell System Tech. Jour.*, July, 1926.
- MAKEY: *Exper. Wireless and Wireless Eng.*, July, 1929.
- MARTIN, W. H., and W. F. DAVIDSON: The Trend in Design of Telephone Transmitters and Receivers, *Bell System Tech. Jour.*, October, 1930.
- Measurement of Percentage Modulation, *R.C.A. Broadcast Bull.* 3; G. R. Experimentor, March, 1931.
- MILNOR: Submarine Cable Telegraphy, *Trans. A.I.E.E.*, p. 20, 1922.
- MORECROFT, J. H.: "Principles of Radio Communication," John Wiley & Sons, Inc.
- MOULIN: "High-frequency Measurements," J. B. Lippincott Company.
- NELSON, E. L.: Radio Broadcasting Transmitters and Related Transmission Phenomena, *Bell System Tech. Jour.*, January, 1930.
- : Radio Transmission System for Television, *Bell System Tech. Jour.*, October, 1927.
- PETERSON, EUGENE, and CLYDE R. KEITH: Grid-current Modulation, *Bell System Tech. Jour.*, January, 1928.
- and HERBERT P. EVANS: Modulation in Vacuum Tubes used as Amplifiers, *Bell System Tech. Jour.*, July, 1927.
- and F. B. LLEWELLYN: The Operation of Modulators from a Physical Standpoint, *Proc. I.R.E.*, January, 1930.
- RAVENHART, R.: Discussion of F. K. Vreeland's "On the Distortionless Reception of a Modulated Wave and Its Relation to Selectivity," *Proc. I.R.E.*, October, 1928.
- SHACKELTON, W. J., and J. G. FERGUSON: Electrical Measurement of Communication Apparatus, *Bell System Tech. Jour.*, January, 1928.
- TERMAN, F. E.: Discussion on Some Possibilities of Intelligence Transmission when Using a Limited Band of Frequencies, *Proc. I.R.E.*, July, 1930.
- : Some Possibilities of Intelligence Transmission When Using a Limited Band of Frequencies, *Proc. I.R.E.*, January, 1930.
- VAN DER BIJL, H. J.: "The Thermionic Vacuum Tube and Its Applications," McGraw-Hill Book Company, Inc.
- VAN DER POL, B.: Frequency Modulation, *Proc. I.R.E.*, July, 1930.
- WRIGHT, S. B., H. C. SILENT: The New York-London Telephone Circuit, *Bell System Tech. Jour.*, October, 1927.

SECTION 11

AUDIO-FREQUENCY AMPLIFIERS

BY GLENN KOEHLER¹

1. Classification of A-F Amplifiers. An a-f amplifier is usually defined as one which is to work in the range of frequencies from 20 to 20,000 cps. Amplifiers for this purpose may be either selective or non-selective; *i.e.*, they may be made to amplify substantially a single frequency or a range of frequencies. Ordinarily the terminology implies that the amplifier will work over a range of frequencies.

There are four general classifications of vacuum-tube amplifiers. These classifications relate to the manner in which the tube is operated with respect to its I_p - E_g characteristics. They are class A, class AB, class B, and class C.

A class A amplifier operates in such a manner that the output wave form for a single tube and any kind of output impedance is substantially the same as the input wave form. In a class A amplifier, operation must take place such that the dynamic characteristic is nearly a straight line over the complete cycle of the input e.m.f. Ordinarily the grid in a class A amplifier is not driven positive.

A class AB amplifier is operated with more grid bias than a class A, and the grid is driven positive with respect to the cathode. In this class of amplifiers the a-c plate current for each tube flows for less than the full 360 electrical degrees of the input cycle. This type usually requires some driving power. It requires two tubes in push-pull to give an output wave form that is nearly like the input wave form.

A class B amplifier is operated with sufficient grid bias to reduce the plate current almost to zero when no input voltage is applied. For a single tube the a-c plate current flows for only 180 electrical degrees of the input cycle. It requires two tubes in push-pull to produce an output wave form that is nearly like the input wave form.

A class C amplifier is operated with more than sufficient grid bias to reduce the plate current to zero when no input voltage is applied. Plate current flows for less than 180 electrical degrees of the input cycle. It requires the use of a selective circuit in the plate circuit in order to give an output wave form that is comparatively free from distortion.

2. General Requirements of an A-F Amplifier. An a-f amplifier must satisfy the following general requirements:

1. The gain of the amplifier must conform to a certain amplification-frequency characteristic.

2. The output wave form must not contain more than a certain amount of distortion that is generated in the amplifier itself.

¹ Department of Electrical Engineering, University of Wisconsin.

3. The gain of the amplifier must be such that a certain output power is obtained from a given input voltage.

4. The noise and "hum" level of the amplifier should be within a pre-assigned limit.

5. The gain should not vary much with the usual variations in d-c operating voltage, temperature of filaments, etc.

6. The input and output conditions should be such as to work the amplifier out of a certain source impedance into a certain load impedance.

3. Elements of an A-F Amplifier. The a-f amplifier tube acts as a power converter taking continuous power from the battery or d-c source in the plate circuit and converting this power into a-c power. The converted power is used to set up a voltage across an impedance in the plate circuit for the case of a voltage amplifier, or to supply power to a load for the case of a power amplifier. For carrying out this function, each stage of an amplifier must be furnished with an input coupling device, an output coupling device, and the necessary sources of power to actuate the tube. For the case of a multistage amplifier the input coupling device of one tube may be the output coupling device of the tube ahead of it.

CLASS A AMPLIFIERS

4. Voltage Amplification per Stage. a. Simple Theory. A single triode amplifier is shown in Fig. 1. The voltage-amplification theory given below applies to a tube of three elements or more when operated as a class A amplifier without external impedances in any of the elements other than the anode or plate circuit. In the simple theory the interelectrode capacitances of the tube and socket are neglected.

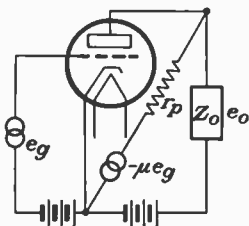

FIG. 1.—Triode amplifier.

The two important constants of the amplifier tube are the amplification constant μ and the plate resistance r_p . The tube acts as a source of alternating e.m.f. which is controlled by the input voltage e_g . This equivalent source which has a voltage $-\mu e_g$ and an internal impedance r_p sets up a.c. in the external impedance Z_o . The a.c. through Z_o produces an alternating voltage across Z_o which is the output voltage e_o . The voltage amplification, or voltage gain of the amplifier is

$$A_v = \frac{\dot{E}_o}{\dot{E}_g} = \frac{-\mu \dot{Z}_o}{r_p + \dot{Z}_o} \quad (1)$$

In this expression $\dot{Z}_o = R_o + jX_o$ and \dot{E}_o and \dot{E}_g are the vector values of e_o and e_g . Voltage amplification is also a vector quantity. The voltage \dot{E}_g is used as the reference vector. Figure 2 shows the voltage amplification in per cent of μ plotted against ratios of output impedance to plate resistance: for cases where, \dot{Z}_o is a resistance R_o , or a reactance X_o .

Because of the approximate way in which the ear responds to sound, i.e., logarithmically, it is convenient to express the gain of an amplifier logarithmically. The unit is the decibel, which is equal to 20 times the common logarithm of the absolute value of the voltage ratio. Hence the

gain in decibels is $20 \log_{10} |A_v|$. The power gain in decibels can be determined from the voltage in decibels, only when the input and output impedances are known. Strictly speaking the power gain in decibels is the more fundamental quantity.

b. *Effects of the Interelectrode Capacitance.* The location of the interelectrode capacitances for a triode are shown in Fig. 3. These capacitances should include the tube itself and the socket. The capacitances given in the tube handbooks and manuals are usually for the tube alone. In many cases the socket interelectrode capacitances are as large as for the tube alone. When the socket capacitances are not known it is good practice to add about $4 \mu\mu\text{f}$ for adjacent electrodes and $3 \mu\mu\text{f}$ for all others except in the case where the grid comes out the top which requires

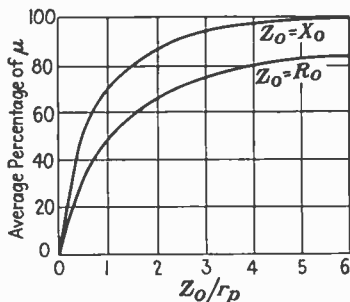

FIG. 2.—Voltage amplification of a triode.

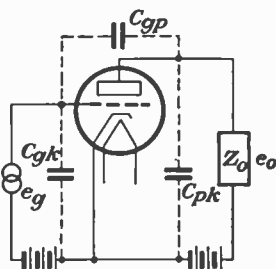

FIG. 3.—Triode amplifier showing interelectrode capacitances.

no change from that given in the handbook. Multigrid tubes used as class A triode amplifiers are treated similar to the triode when there are no impedances in any of the other grid circuits.

The voltage amplification \dot{A}_v for the circuit of Fig. 3 is

$$\dot{A}_v = \frac{\dot{E}_o}{\dot{E}_g} = \frac{j\omega C_{gp} - G_{pg}}{G_p + \dot{Y}_o + j\omega(C_{gp} + C_{pk})} \quad (2)$$

in which $\dot{Y}_o = 1/\dot{Z}_o$, $G_{pg} = \mu/r_p$, and $G_p = 1/r_p$.

Usually the interelectrode capacitances are not very effective upon \dot{A}_v over the a-f range and the susceptances $j\omega C_{gp}$ and $j\omega C_{pk}$ are negligible. Under these conditions Eqs. (2) and (1) are identical.

5. The Input Impedance. The input impedance of the tube shown in Fig. 3 is the voltage \dot{E}_g divided by the current \dot{I}_g that would flow in the external grid circuit. For a high vacuum tube, when operated so that the grid never goes positive, the current \dot{I}_g would be the vector sum of the currents through the capacitances C_{gp} and C_{gk} . Since these two branches are effectively in parallel, it is better to consider input admittances. The expression for the input admittance is

$$\dot{Y}_i = j\omega C_{gk} + j\omega C_{gp}(1 - \dot{A}_v) \quad (3)$$

The impedance \dot{Z}_i is the reciprocal of \dot{Y}_i . The voltage amplification \dot{A}_v is a vector quantity and is obtained from Eq. (2) or (1) when the inter-electrode capacitances are negligible in their effects upon \dot{A}_v . When the output impedance is a resistance, the value of \dot{A}_v is usually a negative real quantity, and the capacitance C_{op} is multiplied by $(1 + |\dot{A}_v|)$. Under certain conditions when the impedance \dot{Z}_o has an inductive reactance, the input impedance \dot{Z}_i is made up of a capacitive reactance and negative resistance. This is an important consideration in an a-f amplifier because it may cause sustained oscillations which in turn may cause very bad distortion.

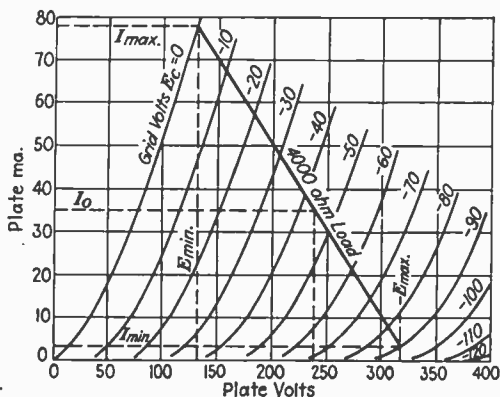

FIG. 4.—Load characteristics of a triode.

The input impedance of an amplifier tube is an important consideration when designing multistage amplifiers. As a general rule this impedance plays a part in the performance of a voltage amplifier for all frequencies above about 3,000 cps.

6. The Power Amplifier. The tube that is used to deliver power to a utilization device such as a loud-speaker is generally called a *power amplifier*. For this tube the voltage amplification is not a consideration, but the power sensitivity and the amount of power that can be converted without appreciable distortion are important. The power sensitivity is the power output in watts for a unit volt impressed on the grid.

The power sensitivity is given by the expression,

$$\text{Power sensitivity} = \frac{\mu^2 R_o}{(R_o + r_p)^2} \quad (4)$$

when the output impedance is a pure resistance R_o . The power sensitivity is a maximum and equal to $\mu^2/4r_p$ when $R_o = r_p$. However, this is not the best value of R_o for maximum undistorted power output. From theoretical considerations maximum undistorted power output is obtained when $R_o = 2r_p$ and when the peak a-c input voltage is equal to the grid-bias voltage. When $R_o = 2r_p$,

$$P_o = \frac{\mu^2 E_o^2}{9r_p}$$

where E_g is the r-m-s value of the a-c input voltage. For maximum undistorted power output $E_g\sqrt{2}$ is equal to the grid-bias voltage. Because the current-voltage characteristics of a tube are not straight lines, the output resistance R_o should usually be greater than $2r_p$ to limit the second-harmonic current to 5 per cent of the fundamental.

The maximum power output and second-harmonic distortion¹ can be calculated approximately for assumed values of load resistance by applying the following relations and referring to Fig. 4:

$$\text{Power output} = \frac{(I_{\max.} - I_{\min.}) \times (E_{\max} - E_{\min.})}{8} \quad (5)$$

$$\text{Per cent second-harmonic distortion} = \frac{\frac{I_{\max.} + I_{\min.}}{2} - I_o}{I_{\max.} - I_{\min.}} \times 100 \quad (6)$$

CLASS A MULTISTAGE AMPLIFIER THEORY AND DESIGN

7. Methods of Coupling. Multistage class A voltage amplifiers are usually divided into three classes as follows:

1. Resistance-capacitance coupled amplifier, illustrated in Fig. 5.

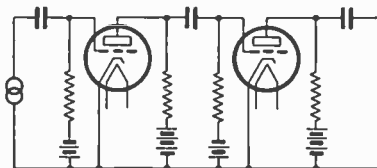

FIG. 5.—Resistance-capacitance coupled amplifier.

2. Impedance-capacitance coupled amplifier, illustrated in Fig. 6.

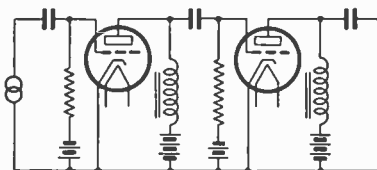

FIG. 6.—Impedance-capacitance coupled amplifier.

3. Transformer-coupled amplifier, illustrated in Fig. 7.

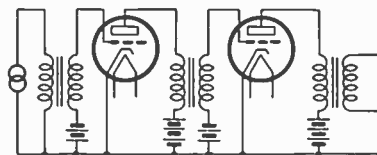

FIG. 7.—Transformer-coupled amplifier.

There are several variations of the class 2 type. The resistances in the grid circuits may be replaced by inductive impedances. In general

¹ See also Art. 52, Sec. 8.

the elements in both the plate and grid may be any type of impedances as long as they pass d-c. The more common types are the one shown and the one with simple inductive impedances in both the plate and grid. A single multistage amplifier may be a combination of these different fundamental types.

8. The Resistance-capacitance Coupled Amplifier. This class of multistage amplifiers is illustrated in Fig. 8, with the interelectrode capacitances of the tubes shown in dotted line. Consider the voltage amplification of stage 1, i.e., E_{g2}/E_{g1} . Over a middle range of frequencies the voltage amplification is substantially independent of the frequency; neither the coupling condenser nor the interelectrode capacitances have

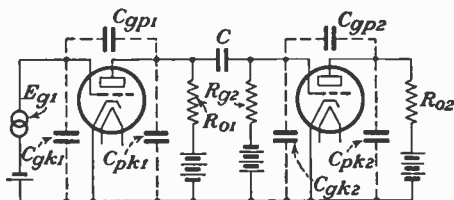

FIG. 8.—Resistance-capacitance coupled amplifier showing tube capacitances.

any effect. At the low frequencies the coupling condenser C causes the amplification to decrease with decrease in frequency, because there is a voltage drop, in C , from the plate of tube 1 to the grid of tube 2 which increases with decrease in frequency. At the high frequencies the interelectrode capacitances cause the amplification to decrease with increase in frequency because these capacitances lower the impedance in the external plate circuit of tube 1.

Frequency Characteristic. The medium-frequency gain A_M of stage 1 is

$$\frac{E_{g2}}{E_{g1}} = A_M = \frac{G_{p01}}{G_{g2} + G_o + G_{p1}} \quad (7)$$

in which

$$G_{p01} = \frac{\mu_1}{r_{p1}}, G_{g2} = \frac{1}{R_{g2}}, G_o = \frac{1}{R_{o1}}, \text{ and } G_{p1} = \frac{1}{r_{p1}}$$

$20 \log_{10} A_M$ will be used as the reference level, or zero level, to show what happens at low and high frequencies. The low-frequency gain, A_L , in terms of medium-frequency gain is

$$A_L = \frac{A_M}{\sqrt{1 + (G_o/\omega C)^2}} \quad (8)$$

in which $G_o = \frac{G_{g2}(G_o + G_{p1})}{G_o + G_{p1} + G_{g2}}$ and C is the capacitance of the coupling condenser between stages 1 and 2. The loss at low frequencies, due to C , is equal to $20 \log_{10} \sqrt{1 + (G_o/\omega C)^2}$. The curves of Fig. 9 show the relation between C and G_o for particular decibel losses at a frequency of 50 cps. The curves may be used to predict the decibel loss due to C at any other frequency f_x by multiplying the ordinates by $50/f_x$ and locating the known value of C on the new scale. Both scales may be changed simultaneously by multiplying by a

factor x in order to provide a more convenient range for G_s . To illustrate the use of the curves, suppose $r_{p1} = 100,000$, $R_{o1} = 200,000$, and $R_{o2} = 500,000$,

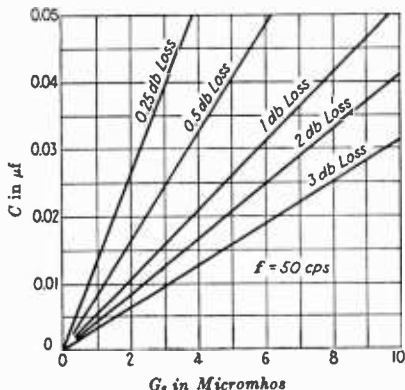

FIG. 9.—Loss in low-frequency amplification due to coupling condenser.

then $G_s = 1.76 \times 10^{-6}$. For 0.5 db loss at 50 cps. it requires a coupling condenser C equal to $0.0125 \mu f$.

The high-frequency gain, A_H , is

$$A_H = \frac{A_M}{\sqrt{1 + (\omega C_s / G_s')^2}} \tag{9}$$

in which $C_s \cong C_{gp1} + C_{pk1} + C_{ok2} + C_{gp2}(1 + |A_{v2}|)$ (see Fig. 8), and $G_s' = G_{p1} + G_o + G_{o2}$.

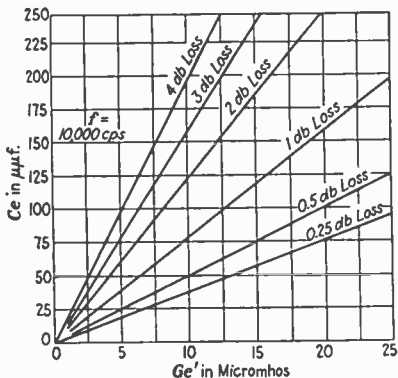

FIG. 10.—Loss in high-frequency amplification due to interelectrode capacitances.

The loss due to the shunting action of the effective capacitance C_s at the high frequencies is $20 \log_{10} \sqrt{1 + (\omega C_s / G_s')^2}$. The curves of Fig. 10 show the

relation between C_e and G_e' for various decibel losses at a frequency of 10,000 cps. For a frequency f_z , multiply the present ordinates by $10,000/f_z$ and locate the capacitance C_e on the new scale. Suppose C_e is equal to $84 \mu\mu f$, then for the values given in the example above $G_e' = 17 \times 10^{-6}$ and the loss at 10,000 cps is about 0.5 db.

In an amplifier of this type there is some phase distortion at both the highest and the lowest frequencies which the amplifier will pass without appreciable loss. The change in the phase angle of the voltage amplification with the frequency is, at low frequencies $\theta_L = \tan^{-1} G_e/\omega C$, and at high frequencies it is $\theta_H = \tan^{-1} \omega C_e/G_e'$.

9. Design of a Resistance-capacitance Coupled Amplifier. When considering the proposition of using a certain tube in stage 1 (Fig. 8), to drive tube 2 and also give a preassigned amount of gain for stage 1, the first question is what will be the response at the highest frequency to be amplified. This question is settled by determining the effective capacitance C_e (it is assumed that A_{v2} is known) and using the curves of Fig. 10 to find the value of G_e' for the allowable loss at the highest frequency. This value of G_e' will determine the medium-frequency gain of stage 1 [see Eq. (7)]. In calculating C_e the interelectrode capacitances given in the tube handbooks and manuals must be increased by 3 to 5 $\mu\mu f$ to include the interelectrode socket and other stray capacitances except for the electrode that comes out the top of the tube.

To determine the size of the coupling condenser C for a preassigned response at the lowest frequency, it is necessary at this point in the design to fix the size of G_{g2} , or R_{g2} , and G_o , or R_o . The following considerations are pertinent to fixing the sizes of these resistors. It is always well to use as small a coupling condenser as possible. Hence, because of the way that C depends upon G_{g2} , R_{g2} should be as large as possible but should not exceed the maximum recommended value given in the tube tables. In any event the product of $R_{g2}C$ should not exceed approximately 0.05 because of the tendency of C to become charged from a very small grid current and thereby cause the grid bias to become shifted. For a given value of $G_o + G_{g2}$, and this is fixed when G_e' is fixed for a given tube, it is well to make R_o somewhat higher than the plate resistance r_{p1} to reduce distortion if the tube is worked very hard. On the other hand R_o consumes d-c voltage which must be supplied by the plate-voltage source.

10. Impedance-capacitance Coupled Amplifier. Under this classification of multistage amplifiers would fall almost any type of coupling except transformer coupling. Resistance-capacitance coupling has special characteristics and is therefore treated under Art. 8. The usual accepted types of the classification herein discussed are the two shown in Figs. 11a and 11b. The type shown in Fig. 11b is sometimes called double impedance coupled. These types have frequency characteristics inferior to the resistance-capacitance coupled amplifier but possess some other advantages. For example, it requires less B supply voltage to give the same plate voltage because of the much lower d-c voltage drop in the plate circuit. By a double-impedance scheme the gain at the low frequencies can be made higher than the gain at intermediate frequencies. This is sometimes useful in frequency-response equalization.

For the type shown in Fig. 11a the voltage amplification for stage 1 at medium frequencies is

$$A_M = \frac{E_{g2}}{E_{g1}} = \frac{G_{p01}}{G_{p1} + G_{g2}} = \frac{\mu_1 R_{g2}}{r_{p1} + R_{g2}} \quad (10)$$

TABLE I.—OPERATING CONDITIONS FOR RESISTANCE-COUPLED A-F AMPLIFIER SERVICE¹

	100			135			180			250		
Plate supply* (volts).....	100	100	100	135	135	135	180	180	180	250	250	250
Screen supply (volts).....	100	100	100	135	135	135	180	180	180	250	250	250
Grid bias (volts).....	-1.05	-1.10	-1.10	-1.05	-1.10	-1.10	-1.05	-1.10	-1.10	-1.30	-1.30	-1.35
Cathode resistor (ohms).....	10,500	15,400	11,550	6,200	9,150	5,850	10,000	4,900	7,100	5,450	9,000	3,170
Plate resistor (megohm).....	0.25	0.50	0.25	0.25	0.50	0.25	0.50	0.25	0.50	0.25	0.50	0.25
Grid resistor† (megohm).....	0.25	0.25	0.50	0.25	0.50	0.25	0.50	0.25	0.50	0.25	0.50	0.25
Plate current (milliamp.).....	0.10	0.07	0.09	0.17	0.12	0.18	0.11	0.25	0.17	0.24	0.14	0.41
Voltage output‡ (peak volts).....	11-16	10-14	15-19	17-23	17-21	20-30	18-27	26-33	24-30	32-40	30-38	33-38
Voltage amplification.....	30	29	36	42	38	50	48	48	46	56	55	48
Plate supply* (volts).....	100	100	100	135	135	135	180	180	180	250	250	250
Screen supply (volts).....	100	100	100	135	135	135	180	180	180	250	250	250
Grid bias (volts).....	-2.00	-2.50	-2.15	-2.60	-1.80	-2.25	-1.95	-2.40	-2.10	-2.60	-2.10	-2.60
Cathode resistor (ohms).....	5,550	12,200	9,350	19,250	3,800	8,300	4,850	10,900	3,700	7,600	3,500	7,300
Plate resistor (megohm).....	0.25	0.50	0.25	0.50	0.25	0.50	0.25	0.50	0.25	0.50	0.25	0.50
Grid resistor† (megohm).....	0.25	0.25	0.50	0.50	0.25	0.50	0.25	0.50	0.25	0.50	0.25	0.50
Plate current (milliamp.).....	0.27	0.15	0.23	0.13	0.35	0.20	0.30	0.16	0.43	0.26	0.65	0.35
Voltage output‡ (peak volts).....	28-30	25-27	36-38	32-33	38-40	32-35	48-50	42-44	50-53	45-48	65-68	55-65
Voltage amplification.....	35	36	47	46	36	38	53	56	53	63	70	54
Plate supply* (volts).....	100	100	100	135	135	135	180	180	180	250	250	250
Screen supply (volts).....	100	100	100	135	135	135	180	180	180	250	250	250
Grid bias (volts).....	-4.75	-3.75	-5.00	-5.50	-6.80	-4.75	-7.00	-7.00	-7.50	-7.00	-7.50	-11.00
Cathode resistor (ohms).....	16,800	25,800	21,200	46,000	21,200	24,300	22,000	42,500	16,300	28,000	14,900	31,200
Plate resistor (ohms).....	0.25	0.50	0.25	0.50	0.25	0.50	0.25	0.50	0.25	0.50	0.25	0.50
Grid resistor† (megohm).....	0.25	0.25	0.50	0.50	0.25	0.50	0.25	0.50	0.25	0.50	0.25	0.50
Plate current (milliamp.).....	0.28	0.14	0.23	0.12	0.32	0.19	0.31	0.16	0.46	0.25	0.47	0.24
Voltage output‡ (peak volts).....	24-26	17-22	27-29	26-27	34-36	27-30	38-42	36-40	38-40	36-38	40-44	40-45
Voltage amplification.....	6.1	6.0	6.6	6.2	6.1	6.1	6.5	6.3	6.4	6.7	6.5	6.4
Plate supply* (volts).....	100	100	100	135	135	135	180	180	180	250	250	250
Screen supply (volts).....	100	100	100	135	135	135	180	180	180	250	250	250
Grid bias (volts).....	-1.10	-1.25	-1.05	-1.25	-1.20	-1.35	-1.25	-1.40	-1.25	-1.50	-1.30	-1.55
Cathode resistor (ohms).....	3,760	6,450	3,400	7,250	3,100	5,600	3,750	6,300	2,180	4,550	2,600	4,850
Plate resistor (megohm).....	0.25	0.50	0.25	0.50	0.25	0.50	0.25	0.50	0.25	0.50	0.25	0.50
Grid resistor† (megohm).....	0.25	0.25	0.50	0.50	0.25	0.50	0.25	0.50	0.25	0.50	0.25	0.50
Plate current (milliamp.).....	0.22	0.14	0.23	0.13	0.29	0.18	0.25	0.17	0.43	0.25	0.38	0.24
Voltage output‡ (peak volts).....	15-23	17-22	16-29	18-28	21-32	27-31	29-37	34-38	31-43	36-41	36-52	45-52
Voltage amplification.....	40	39	54	53	54	52	61	62	76	65	92	93

¹ These data are taken from the RCA Radiotron Handbook.

* Voltage at plate will be plate-supply voltage minus voltage drop in plate resistor caused by plate current.

† For the following amplifier tube. The tabulated values illustrate design practice. For any particular set of conditions, however, the grid resistor for the following amplifier tube should conform to the recommendations given on the type involved.

‡ Developed across plate resistor of interstage coupling circuit including grid resistor of following tube. Value to left is maximum undistorted output voltage obtainable; value to right is maximum output voltage obtainable with some distortion.

Note: In the above data, the use of a coupling condenser between the plate resistor and the grid resistor of the following tube is assumed. A 0.1 µf condenser is usually adequate to insure good low-frequency response.

in which $G_{p01} = \mu_1/r_{p1}$ and $G_{p1} = 1/r_{p1}$ for the tube of stage 1 and $G_{g2} = 1/R_{g2}$. In some cases it may be necessary to add the core-loss conductance for L_{o1} to G_{g2} . The voltage amplification at low frequencies in terms of A_M is rather involved. It is

$A_L =$

$$\frac{A_M}{\sqrt{1 + \left(\frac{r_{p1}R_{g2}}{r_{p1} + R_{g2}}\right)^2 \left[\frac{1}{\omega^2 L_{o1}^2} \left(1 + \frac{1}{R_{g2}^2 \omega^2 C^2}\right) - \frac{2}{R_{g2}^2 \omega^2 L_{o1} C} + \frac{1}{r_{p1}^2 R_{g2}^2 \omega^2 C^2} \right]}} \quad (11)$$

When $C \bar{\geq} 0.05 \mu f$ and $R_{g2} \bar{\geq} 0.5$ megohm and $f \bar{\geq} 50$ cps, this equation reduces to

$$A_L \cong \frac{A_M}{\sqrt{1 + \frac{1}{\omega^2 L_{o1}^2} \left(\frac{r_{p1}R_{g2}}{r_{p1} + R_{g2}}\right)^2}} \quad (12)$$

From Eq. (12) it is seen that there is a loss in amplification at the low frequencies. The loss in amplification in decibels due to insufficient reactance in choke L_{o1} is equal to

$$20 \log_{10} \sqrt{1 + \frac{1}{\omega^2 L_{o1}^2} \left(\frac{r_{p1}R_{g2}}{r_{p1} + R_{g2}}\right)^2}$$

The curves in Fig. 20 in Art. 16 may be used to get the relation between L_{o1} and $r_{p1}R_{g2}/(r_{p1} + R_{g2})$ for a given decibel loss at 50 cps by substituting

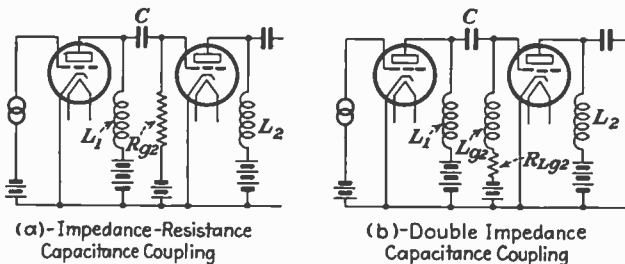

FIG. 11.—Impedance-capacitance coupled amplifier.

L_{o1} for L_m and $r_{p1}R_{g2}/(r_{p1} + R_{g2})$ for R_4 . This holds true as long as the loss is not less than 0.5 db.

At the high frequencies the voltage amplification, A_H , is

$$A_H = \frac{A_M}{\sqrt{1 + \left(\frac{\omega C_e}{G_e}\right)^2}} \quad (13)$$

in which C_e is the effective capacitance due to the tubes (see Art. 8), plus the distributed capacitance of the choke, and G_e equals $G_{p1} + G_{g2}$ plus a conductance $1/R_c$ due to the core loss of the choke. The relation between C_e and G_e at 10,000 cps is the same as that given by the curves of Fig. 10. (See explanation in Art. 8 for extending the range of the curves.)

The type of amplifier illustrated in Fig. 11b has some interesting characteristics. The medium-frequency amplification is $A_M = \mu_1$, neglecting the core losses of the two coils. For the case in which ωL_{o1} is several times $R_{L_{o2}}$ and is at least three times r_{p1} , the amplification per stage at low frequencies in terms of that at medium frequency is

$$A_L = \frac{A_M}{\sqrt{\left(\frac{f_r}{f} \frac{1}{Q}\right)^2 + \left(1 - \frac{f_r^2}{f^2}\right)^2}} \quad (14)$$

in which $f_r = \frac{1}{2\pi\sqrt{L_{o2}C}}$ and $Q = \frac{\omega_r L_{o2}}{r_{p1} + R_{L_{o2}}}$. Using the medium-frequency gain as the reference and plotting $20 \log_{10} \sqrt{\left(\frac{f_r}{f} \frac{1}{Q}\right)^2 + \left(1 - \frac{f_r^2}{f^2}\right)^2}$ as ordinates and f/f_r as abscissas for various values of Q , the curves of Fig. 12 result.

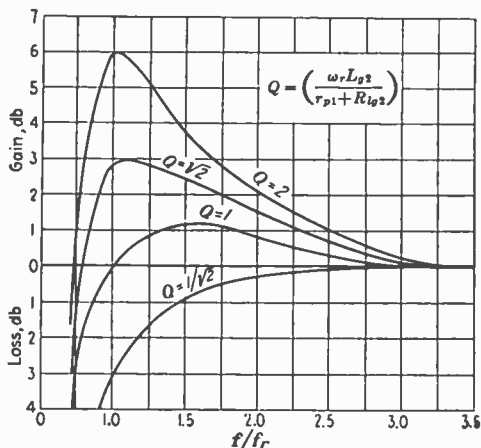

FIG. 12.—Low-frequency characteristic of a double impedance-capacitance coupled amplifier.

These curves explain the characteristics of this type of coupling and furnish quantitative information on how to fix the values of L_{o2} and C for a particular performance at the low frequencies. At the frequency f_r , the gain, or loss, in decibels is equal to $20 \log_{10} Q$. The curves also show how the gain, or loss, varies with the frequency f for a particular case. The phase distortion at low frequencies would be very bad for an amplifier of this type.

At the high frequencies the amplification per stage, A_H , is

$$A_H = \frac{A_M}{\sqrt{1 + (\omega C_e' / G_e')^2}} \quad (15)$$

in which $G_e' = 1/r_{p1}$ plus the conductances due to the core losses in the two chokes, and $C_e = C_{pk1} + C_{gp1} + C_{pk2} + C_{gp2}(1 + |A_{s2}|)$ plus the effective distributed capacitances of the two chokes. The quantitative relation between C_e and G_e' for different decibel losses at 10,000 cps can be obtained

from the curves of Fig. 10. (See explanation in Art. 8 for extending the ranges or finding values at another frequency.)

11. Design of Impedance-capacitance Coupled Amplifiers. The application of the type of coupling shown in Fig. 11a to tubes of high plate resistance is limited principally by the amount of inductance that can be obtained in choke L_{01} without a large amount of distributed capacitance. The distributed capacitance of the choke adds to the tube capacitance and therefore helps to lower the amplification at the high frequencies. Chokes for this purpose are sometimes wound in pie sections in order to reduce the distributed capacitance. Of course for tubes having high plate resistance some of the maximum possible gain can be sacrificed by lowering R_{02} to have a small variation in gain over the frequency range. This will make it easier to satisfy the requirements at both the highest and lowest frequency.

For tubes that have low plate resistance, the design procedure is to fix the value of R_{02} so that it will not be greater than the maximum recommended value or the value which will keep the highest frequency response within the desired limit. The curves of Fig. 10 are useful for determining the limit to R_{02} so far as frequency response is concerned. In this figure for this purpose G_e is equal to $G_{p1} + G_{02}$ plus a conductance allowed for the core loss of L_{01} . After R_{02} is fixed the value of L_{01} is determined tentatively by the use of the curves in Fig. 19. For this purpose R_4 on the graph becomes $r_{p1}R_{02}/(r_{p1} + R_{02})$. The last step is to determine C such that the loss due to it is not more than 0.25 db. In some cases it may be necessary to check the results by applying Eq. (11).

For tubes that have high plate resistance, the design procedure is about the same as the above except it may be necessary to work back and forth from high-frequency consideration to low-frequency consideration in order to obtain the desired characteristics.

In designing an amplifier of the type shown in Fig. 11b the general procedure is the same as above. In some cases the medium-frequency amplification may be less than μ_1 because of the core losses of the two chokes. These core losses are equivalent to two resistances in parallel from the grid to the cathode of tube 2 and their effect is similar to R_{02} in Fig. 11a.

The following example will illustrate how to apply Eq. (14) and the curves of Fig. 12. The plate resistance r_{p1} of the tube is 10,000 ohms, the allowed resistance for R_{L02} is 1,000 ohms, the desired gain at 50 cps is 3 db over the gain at medium frequencies. From the curves of Fig. 12, Q must be $\sqrt{2}$ to give the desired gain. From the expression for Q ,

$$L_{02} = Q \frac{(r_{p1} + R_{L02})}{\omega_r}$$

L_{02} is equal to $11,000/2\pi 50$ which gives 35 henrys. The size of the coupling condenser is given by $C = 1/\omega_r^2 L_{02}$ and is equal to 0.29 μf .

12. The Equivalent Circuit of a Transformer-coupled Amplifier. The complete equivalent circuit of one stage of a transformer-coupled amplifier comprises the plate resistance of the tube ahead of the transformer, the input capacitance of the tube after the transformer, and the equivalent circuit of the transformer itself. Figure 13 illustrates

the complete equivalent circuit for one stage. This circuit does not apply to all types but represents the condition quite accurately for a great many.

In this diagram the symbols shown represent the following: μE_{g1} is the voltage generated in the tube source and r_{p1} is the plate resistance of the tube source. R_p and R_s are the primary and secondary winding resistances.

L_p and L_s are the primary and secondary leakage inductances. These inductances are due to the magnetic fluxes that link with each coil and not the other, i.e., the fluxes that are not mutual to the two coils.

C_p and C_s are the effective distributed capacitances of the primary and secondary windings. C_m is the effective mutual capacitance between the windings. C_m may not be present in certain transformers. Sometimes C_m is of a complicated nature and difficult to estimate. C_L is the input capacitance of the tube load.

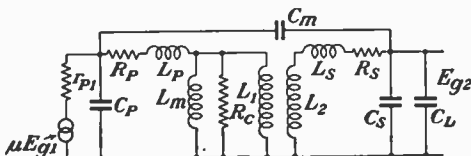

FIG. 13.—Equivalent circuit of a transformer-coupled amplifier.

L_m and R_c are the magnetizing inductance and core-loss resistance of the transformer. The magnetizing current and the equivalent core-loss current of a transformer are nearly proportional to the induced voltage.

L_1 and L_2 are fictitious inductances necessary to transfer the current and voltage to the load and to provide the proper phase change from primary to secondary. The phase of the secondary voltage with respect to the primary is important when the mutual capacitance C_m is equal to or greater than 25 per cent of C_s and C_L . The ratio of the primary turns to the secondary turns is equal to $\sqrt{L_1/L_2}$. This ratio is called N , the ratio of transformation.

In Arts. 14 and 15 it is shown how the equivalent circuit is modified in order to simplify matters. This simplification is possible for a transformer which is intended to cover a range of frequencies like 50 to 5,000 cps and when the variation in amplification over the range is not more than 6 db.

13. Calculation of Transformer Constants. The material under this article applies to both interstage transformers and impedance-matching transformers. The most important constants required in a given design are the magnetizing inductance L_m and the leakage inductances L_p and L_s .

The magnetizing inductance L_m is given by the expression

$$L_m \text{ in henrys} = \frac{4\pi 10^{-9} N_p^2 \mu_r A}{l} \quad (16)$$

in which N_p is the number of turns on the primary; μ_r is the relative permeability; if the primary carries d.c., μ_r is the apparent incremental permeability; A is the net area of the core in square centimeters and l is the mean length of path in centimeters. When A is not the same for the entire length of the path, the total reluctance must be calculated from the sum of the reluctances of the paths over which the net area is constant. To evaluate L_m when the winding carries d-c current there must be available curves of μ_r plotted against the d-c magnetizing

ampere turns per centimeter for various flux a-c densities on the particular magnetic material.¹

The leakage inductances L_p and L_s depend upon the configuration of the windings. These inductances are due to the fluxes that link with one coil and not the other. For the type illustrated by Fig. 14, when the space between the coils is small compared to D_i or D_o ,

$$L_t = L_p + N^2L_s = \frac{16\pi N_p^2}{10^9 W} \left[(D_1 + D_2 + 2D_o) \frac{Dt}{3} + \frac{1}{2}(D_i^2 - D_o^2) + (D_1 + D_2 + 2D_i + D_b)D_b \right], \quad (17)$$

where $D_t = D_1 + D_b + D_o$.

For an interspaced winding of this type, *i.e.*, one in which one coil is placed between the two halves of the other coil, $L_p + N^2L_s$ is approxi-

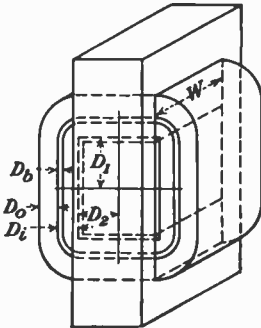

FIG. 14.—Simple winding scheme for a transformer.

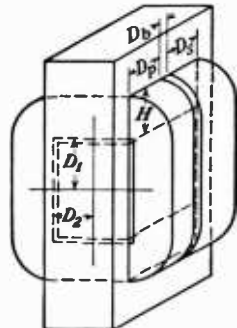

FIG. 15.—Winding scheme for low effective capacitance.

mately one-fourth of that given by Eq. (17). All dimensions are in centimeters and are indicated in the figure.

The leakage inductance for a winding of the type shown in Fig. 15 is approximately

$$L_t = L_p + N^2L_s = \frac{16\pi N_p^2}{10^9 H} \left[(D_1 + D_2 + H) \left(\frac{D_p}{3} + \frac{D_s}{3} + D_b \right) \right] \quad (18)$$

For an interspaced winding of this type the total leakage inductance is approximately one-fourth of the value given by Eq. (18).

For interstage and impedance-matching transformers the core losses under most ordinary circumstances are usually small compared to the copper losses, but for the sake of completeness the expression for the core-loss resistance R_c is given. It is

$$R_c = \frac{2\pi^2 10^{-16} f^2 N_p^2 A}{K_c l} \quad (19)$$

¹ See also Sec. 2, article on Magnetic Circuit.

in which $K_c = \frac{\text{total core loss per c.c.}}{B^2}$ at the operating conditions. B is the flux density in gausses. It is assumed that the hysteresis losses as well as the eddy-current losses are proportional to B^2 . It has been found by the author that the hysteresis losses at low flux densities are nearly proportional to B^2 , but sometimes the exponent of B is even greater than 2.

The distributed capacitance of transformer windings is due mainly to the layer-to-layer capacitances. The effective capacitance of a winding is approximately equal to the capacitance between the two mean layers divided by the number of layers. In most cases the layers may be treated as parallel plates having a dielectric equal to thickness of paper between layers plus 2 times the thickness of the insulation on the wire. If the dielectric constants of the paper and insulation are much different they must be treated accordingly.

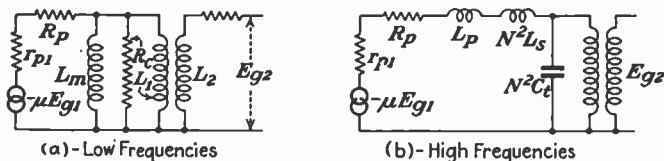

FIG. 16.—Equivalent circuits of a transformer-coupled amplifier.

14. Theory of Transformer-coupled Amplifiers. The characteristics of this type of amplifier are best explained by dividing the frequency range into the low frequencies, the medium frequencies, and the high frequencies. The equivalent circuits of Figs. 16a and 16b apply to the low and the high frequencies. At the medium frequencies the core-loss resistance R_c is usually so large compared to $r_{p1} + R_p + N^2R_s$, that the voltage amplification per stage, *i.e.*, $E_{o2}/E_{o1} = A_M$ is practically equal to μ_1/N . Hence $20 \log_{10} (\mu_1/N)$ will be used as the reference level in decibels, and the performance at the low and high frequencies will be termed a loss, or gain, in decibels measured from this reference level (see Art. 13 for definition of terms).

At the low frequencies the magnetizing inductance is effective and the low-frequency amplification A_L , in terms of A_M , is

$$A_L = \frac{A_M}{\sqrt{1 + \left(\frac{1}{\omega L_m} \frac{(R_p + r_{p1})R_c}{R_c + R_p + r_{p1}} \right)^2}} \quad (20)$$

The loss at the low frequencies due to L_m is

$$20 \log_{10} \sqrt{1 + \left(\frac{1}{\omega L_m} \frac{(R_p + r_{p1})R_c}{R_c + R_p + r_{p1}} \right)^2}$$

This case is so similar to the one illustrated by the equivalent circuit of Fig. 18a for an impedance-matching transformer that the curves given in Fig. 19 may be used to see the relation between L_m and

$\frac{(R_p + r_{p1})R_c}{R_c + r_{p1} + R_p}$ for various decibel losses at 50 cps. In many cases R_c is so large compared with r_{p1} and R_p that the quantity

$$\frac{(R_p + r_{p1})R_c}{R_c + R_p + r_{p1}} \cong R_p + r_{p1}.$$

Hence in most cases $R_p + r_{p1}$ can be substituted for R_4 when using the curves in Fig. 19 to determine L_m for a given loss in decibels. The curves of Fig. 19 can be used for any other frequency f_x by multiplying the ordinates by $50/f_x$ and locating L_m on the new scale.

At the high frequencies the leakage inductances and the tube and distributed capacitances affect the voltage amplification. For cases

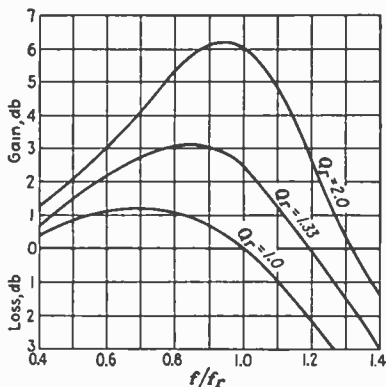

FIG. 17.—High-frequency characteristics of a transformer-coupled amplifier.

in which C_m is small compared to $C_s + C_L$, the amplification at the high frequencies in terms of A_M is

$$A_H = \frac{A_M}{\sqrt{\left(1 - \frac{f^2}{f_r^2}\right)^2 + \frac{f^2}{f_r^2} \frac{1}{Q_r^2}}} \quad (21)$$

The gain, or loss, = $20 \log_{10} \sqrt{\left(1 - \frac{f^2}{f_r^2}\right)^2 + \frac{f^2}{f_r^2} \frac{1}{Q_r^2}}$, in which $Q_r = \frac{\omega_r L_i}{R_s}$, $\omega_r = 1/\sqrt{L_i C_s}$, $C_s = (C_m + C_s + C_L)/N^2$, $R_s = r_{p1} + R_p + N^2 R_e$, $L_i = L_p + N^2 L_s$, $C_L = C_{ok2} + C_{op2}(1 + |A_{v2}|)$ and is the ratio of primary turns to secondary turns. The curves of Fig. 17 show how the loss, or gain, varies around the frequency f_r for different values of $\omega_r L_i / R_s$. The best results are obtained when $\omega_r L_i / R_s$ is approximately equal to 1. This can be accomplished to some extent by controlling L_i and C_s in the design.

When C_m is not small compared to $C_s + C_L$, the voltage amplification is approximately the value given by Eq. (21) times

$$1 + \frac{NC_m}{C_m + C_s + C_L},$$

in which N may be either positive or negative in numerical value. N is positive if the two coils form a single winding in one direction about the common core when connected together at the cathode ends, and negative when the windings are in opposite directions. The mutual capacitance may be avoided by the use of static shields.

15. Design of Transformer-coupled Amplifiers. Usually transformer coupling is used with voltage amplifier tubes that have a comparatively low plate resistance. This is necessary to obtain the desirable characteristics at the low frequencies because the magnetizing inductance for a given low-frequency response is almost directly proportional to the plate resistance of the tube. It is essential also that the d-c plate current be as small as possible so that it will not saturate the core of the transformer. The magnetizing inductance L_m is the first consideration in the design of an interstage transformer. The curves of Fig. 19 can be used for determining the value of L_m for a given decibel loss at the lowest frequency. In the preliminary procedure the core loss can be neglected and $R_p + r_{p1}$ can be substituted for R_4 in Fig. 19. An allowance of 8 to 10 per cent of r_{p1} is made for the primary winding resistance.

The amount of voltage amplification per stage required at the medium frequencies is nearly equal to the amplification constant μ_1 times the ratio of secondary turns to primary turns; in the theory this is μ_1/N . Practical values for this ratio are 2 to 4. If higher, difficulty is experienced at the high frequencies because of the tube load and distributed capacitance of the secondary windings, even though the leakage inductance is very small.

The performance of the transformer at the high frequencies depends largely upon the leakage inductance and the capacitance of the secondary winding and tube load. This is illustrated in Fig. 17. For practically constant gain up to any frequency f_h either the frequency f_r must be at least two times f_h or else the winding must be so designed that $f_r = f_h$ and the quantity $\omega_r L_l / R_r = Q_r$ is approximately equal to 1.

Interspersing the windings of a transformer, placing one winding between the two halves of the other, lowers the total leakage inductance by a factor of one-fourth but generally results in a much higher effective capacitance. Therefore the net result of interspersing is not to raise the frequency f_r by a factor of 2. Even if f_r were raised by a factor of 2 the quantity Q_r might be reduced below 1 at f_r , and the gain of the amplifier would not be constant up to f_r .

Winding the transformer like Fig. 15 except with interspaced coils is very effective in reducing the capacitance of the windings, but this is very uneconomical as to space.

The theory and design given here apply to input transformers as well as interstage transformers. The input transformer must be designed for a particular source impedance and a particular tube load.

16. Impedance-matching Transformers. When a given load resistance R_L is not of the proper magnitude to result in maximum power into the load from a source which has a resistance R_s , a transformer is interposed between the source and the load. Because of the resistances of the transformer windings and the losses in the magnetic core the

transformer will consume a certain amount of energy itself. In addition to the energy lost in the transformer the magnetizing current causes a loss of power to the load at the low frequencies, and the leakage inductance causes a loss at the high frequencies. For a transformer of this type, intended to cover a range of frequencies, it is convenient to divide the theory and design into three phases, namely: low frequency, medium

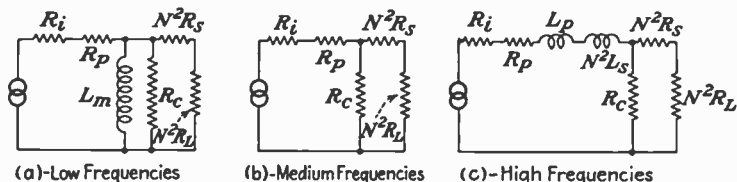

FIG. 18.—Equivalent circuits of an impedance-matching transformer.

frequency, and high frequency. Figures 18a, 18b, and 18c represent the equivalent circuits that apply to each of these phases of discussion.

In the figures R_i is the internal resistance of the source; R_p and R_s are the primary and secondary winding resistances; L_p and L_s are the leakage-flux inductances of the primaries and secondaries; L_m and R_c are the magnetizing inductance and core-loss resistance; and N is the ratio of primary turns to secondary turns.

The current in the transferred load resistance at the medium frequency is used as the reference level. Referring to Fig. 18b and letting $R_1 = R_i + R_p$,

$$R_2 = (R_s + R_l)N^2, R_3 = \frac{R_2}{1 + \frac{R_c}{R_2}}, \text{ and } R_4 = \frac{R_2 R_1}{R_3 + R_1},$$

$$I_M = \frac{E}{R_2(R_3 + R_1)/R_3} \quad (22)$$

In many cases R_2/R_c is so small compared to 1 that $I_M = E/(R_2 + R_1)$.

For the low frequencies Fig. 18a applies and the current I_L in terms of I_M is

$$I_L = \frac{I_M}{\sqrt{1 + \frac{R_4^2}{\omega^2 L_m^2}}} \quad (23)$$

Then $20 \log_{10} \sqrt{1 + \frac{R_4^2}{\omega^2 L_m^2}}$ is the loss due to L_m . Figure 19 shows the relation between L_m and R_4 for various losses at a frequency of 50 cps. For any other frequency multiply the ordinates by $50/f_z$ and locate L_m on the new scale. Also, because of the linear relation between L_m and R_4 , both scales may be changed simultaneously by any factor x in order to provide a more convenient range for R_4 . For most cases, since R_c is several times R_2 , the quantity R_4 is equal to $R_1/(1 + R_1/R_2)$.

For the high frequencies Fig. 18c applies and the current I_H in terms of I_M is

$$I_H = \frac{I_M}{\sqrt{1 + \frac{\omega^2 L_l^2}{(R_1 + R_2)^2}}} \quad (24)$$

Then $20 \log_{10} \sqrt{1 + \frac{\omega^2 L_l^2}{(R_1 + R_2)^2}}$ is the loss due to the leakage inductance. Figure 20 shows the relation between the total leakage inductance

$$L_l = L_p + N^2 L_s$$

and the resistance $R_1 + R_2$ for different decibel losses at 10,000 cps. For any other frequency f_x , multiply the ordinates by $10,000/f_x$ and read L_l on the new

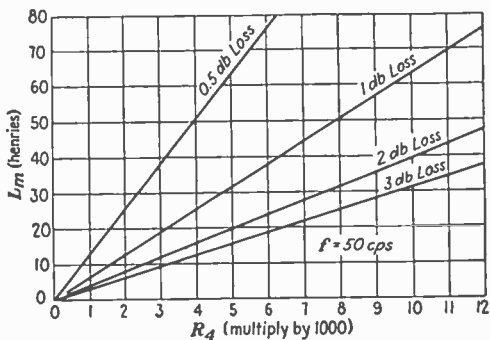

FIG. 19.—Loss at low frequency due to magnetizing inductance.

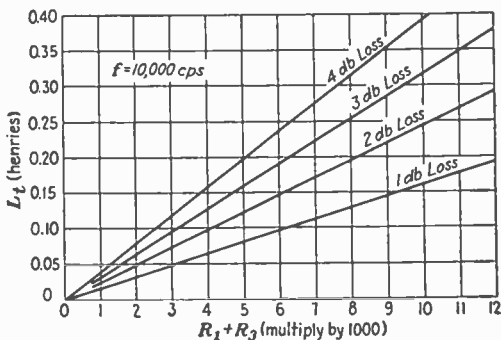

FIG. 20.—Loss at high frequency due to leakage inductance.

scale. Also both scales may be changed simultaneously by a factor x in order to provide a more convenient range for $R_1 + R_2$.

The procedure in designing a transformer of this kind is to first determine the size of core and number of primary turns in order to obtain a value of L_m which will limit the loss to a preassigned amount. In this procedure it is necessary to allow for the winding resistances R_p and R_s . The expression for L_m is given in Art. 13. The next step is to fix the ratio of turns and the number of secondary turns for the desired value

of transferred load resistance. The final step is to determine the style of winding that will keep the leakage inductance within the limit which is allowed for a given loss at the highest frequency.

17. Class A Push-pull Amplifier. Whenever possible the power stage of a class A amplifier should be operated in push-pull. There are several advantages of push-pull operation over the same two tubes in parallel or a single larger tube. Because of the non-linear character of the I_p - E_g curves of a triode the tube generates harmonics which are supplied to the load. The second harmonic is usually the largest. In a push-pull arrangement, as shown in Fig. 21, the even harmonic currents

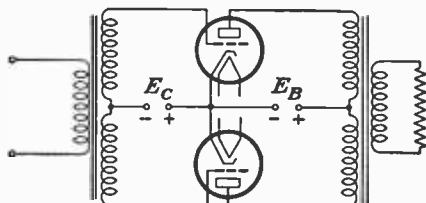

FIG. 21.—Schematic of a push-pull amplifier.

in the two sides of the primary bear such phase relation to each other that there is no voltage set up across the secondary winding by them. Hence for a given amount of over-all distortion the push-pull tubes can be made to deliver more power to a load than the same two tubes in parallel. The optimum grid bias for push-pull operation is somewhat greater than for a single tube, and consequently the input voltage is also higher. The optimum plate-to-plate load resistance is less than twice the optimum load resistance for a single triode. Consequently each tube will deliver more power to the load than a single tube would deliver to its optimum load. To reduce the odd harmonic distortion the plate-to-plate load resistance should be somewhat higher than twice the plate resistance of either tube.

The power output in a balanced class A push-pull amplifier is

$$P_o = \left(\frac{2\mu E_g}{R_o + 2r_p} \right)^2 R_o \quad (25)$$

where R_o is the plate-to-plate load resistance and μ and r_p are the constants of either tube.

Another advantage of push-pull tubes is that there is no d-c saturation of the core of the output transformer. Hence less iron and copper are required for the output transformer.

For a balanced push-pull system there is no fundamental or odd harmonic current through the d-c power supply to the cathodes. However, the even harmonics add up in the common return to the cathodes. This should be recognized when using self-bias resistors for the C bias. The self-biasing resistor should be shunted with sufficient capacitance to eliminate any even harmonic voltage across the resistor, or otherwise there will be even harmonics in the output.

For push-pull operation the plate supply does not need to be so well filtered. Disturbances coming from this source cancel out in the output transformer.

It is usually more difficult to design an input transformer for a push-pull amplifier than for a single tube. The difficulty arises in keeping the secondary voltages equal in magnitude and opposite in phase for all frequencies. At the high frequencies one side may deliver a higher voltage than the other. This effect can be reduced by winding the transformer so that the two secondaries are symmetrical in their leakage inductance, winding resistances, and distributed capacitances.

18. The Pentode Power Amplifier. The power sensitivity and the efficiency of power conversion for a power pentode tube are usually much higher than for a triode. For example a type 89 tube as a pentode will deliver 3.4 watts for a peak grid voltage of 25 whereas it will deliver only 0.9 watt for a peak voltage of 31 when used as a triode. The efficiency of conversion for the pentode connection is 32 per cent and only 8.9 per cent for the triode connection. The expression for the power sensitivity of a pentode power amplifier is the same as the expression for the triode amplifier as given in Art. 6. A method for determining the power output and distortion from the E_p - I_p characteristics is given in Sec. 8, Art. 52.

The load resistor for a pentode power amplifier should be such that the instantaneous plate current does not fall below the knee of the I_p - E_p curve taken for the grid voltage reached on the maximum value of the positive half of the input cycle. If the load resistor is higher than this value there will be serious distortion for the maximum grid swing. This limits the load resistor to a value considerably below the plate resistance of the tube. Consequently for load impedances that change with the frequency there is apt to be distortion, unless care is taken to insure that the impedance never rises above the optimum value for a limited amount of distortion. For this reason pentode tubes should be used to deliver power to devices that have a fairly constant impedance. The optimum load resistor for a pentode amplifier is that which results in the smallest amount of second-harmonic distortion. Because of the greater sensitivity and greater efficiency of the pentode over the triode some of the power output possible can be sacrificed in order to obtain good wave form.

19. Frequency-response Equalization in Amplifier Systems. By the use of certain expedients it is possible to construct multistage amplifiers that will work with certain kinds of input and output devices and give an over-all frequency-response characteristic of a desired type. Much can be done along this line when phase distortion is not a consideration. A stage of transformer coupling with a specially designed transformer may be used to raise the high-frequency response of the amplifier to compensate for a loss at the high frequencies in a given input or output device. A stage of double impedance coupling may be used to raise the low-frequency response of the amplifier. Condensers shunted across a part of the plate-coupling resistors in a resistance-capacitance coupled amplifier will result in higher gain at the low than at the high frequencies. Shunting the same resistors with choke coils will lower the low-frequency response. Simple and more complicated networks in the form of series and shunt combinations of coils and condensers are used to raise, or lower, the gain over a band of frequencies. There are

so many combinations of methods that may be employed to give frequency-response equalization in amplifier systems that it is impossible to cover all of them. However, the equalization method is a systematic way of designing an entire system.

The subject of controlled-frequency characteristics, or so called tone control, in radio receivers is treated in Sec. 13.

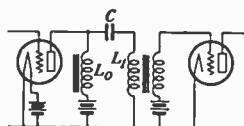

FIG. 22.—Series-resonant coupling circuit.

The following material up to Art. 23 on Frequency-response Equalization written by J. G. Aceves is taken from the first edition of this handbook.

20. Parallel-feed, Series-resonance Circuit.

Figure 22 shows diagrammatically the simplest form of parallel plate-feed, series-resonant

circuit coupling. The inductance L_0 may have any value such that its reactance is large in comparison with that of the primary of the transformer L_1 with the condenser C in series, at any frequency.

It will be noted that the impedance of the primary of the transformer at very low audio frequencies is practically ωL_1 . The voltage across the secondary will be $n^2\omega L$ times the current in which n is the turns ratio.

By substituting the values of the impedance in Eq. (1) the gain per stage may be obtained. To see more clearly how the gain varies with frequency, let ω_0 be the frequency (in radians) for which $\omega L_1 - \frac{1}{\omega C} = 0$ and the ratio of any frequency ω to ω_0 will be designated by N ; so that $\omega = N\omega_0$. Let Q be the ratio $\omega_0 L_1 / r_p$ and assume that the resistance of the primary is small in comparison with r_p ; then in terms of these quantities

$$A_s = \gamma = \mu \frac{nNQ}{\sqrt{1 + Q^2 \left(N - \frac{1}{N}\right)^2}} \quad (26)$$

Analyzing this equation, it will be apparent that if Q is large, say over 4, and N is more than 3 or 4, the amplification or gain γ is practically equal to μn . For frequencies near ω_0 the gain will be greater, and at ω_0 the gain will be $\gamma = nQ$. Hence, the maximum amplification takes place at ω_0 and is Q times as large as it is at all other frequencies far removed from ω_0 , say two or more octaves. Figure 23 shows the variation of γ with frequency for different values of Q and ω_0 . Graph A shows the gain at various frequencies for $Q = 10$ and $\omega_0 = 314$ radians (50 cycles). It is altogether too sharp for good low-frequency compensation. With $Q = 5$ curves B and C were calculated for $\omega_0 = 314$ and 377 radians respectively (50 and 60 cycles). If one of the stages is tuned to 50 cycles and the next to 60, the combined amplification will be represented by curve D. By shunting the primary of the transformer with a variable resistance, the rise will be controllable even

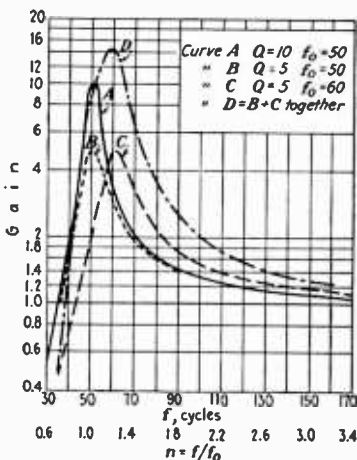

FIG. 23.—Variation of gain (γ) with frequency.

to a point of actually depressing the amplification curve at the frequencies around or below ω_0 , and the amplifier will offer the characteristics of a resistance-coupled circuit.

21. Increasing Amplification at High Frequencies. There are cases when it is desirable to increase the amplification at the higher frequencies—for example, in ultraselective superheterodynes, in phonograph reproduction, or in sound moving pictures with film recording where the audio amplifier is far away from the light cell. Among the various schemes used in this connection, two of the simplest expedients will be mentioned. One method consists of utilizing the capacity coupling between windings of the audio-frequency transformers which, combined with the leakage reactance and the capacity of the tube input circuit,

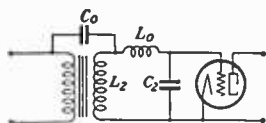

FIG. 24.—Utilizing capacity between windings to raise gain at high frequencies.

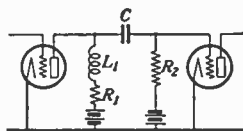

FIG. 25.—Choke and resistance frequency-control circuit.

form a network similar to the schematic diagram of Fig. 24. It is rather difficult to calculate the gain at various frequencies even if the values of C_0 , C_2 , L_2 , and L_0 were known. It is better to connect the audio-frequency transformer windings with such "polarity" that the capacity coupling C_0 will have an additive effect with the mutual induction between windings, and to choose a suitable type of audio transformer with the required leakage reactance. There are many such transformers on the market, particularly of old design.

A second method lends itself to predetermination of the gain and consists of a combination of choke and resistance in the feed circuit of the anode as shown in Fig. 25. The resistance R_2 may be replaced by a choke or by the primary of an a-f transformer.

If, for simplicity, this resistance or impedance is assumed to be large in comparison with the impedance $Z_1 = R_1 + j\omega L_1$ it will be noted that the gain per stage will be given by substituting the value of Z_1 in the fundamental Eq. (1):

$$\gamma = \mu \frac{R_1 + j\omega L_1}{R_1 + r_p + j\omega L_1}$$

or rationalizing,

$$\gamma = \mu \sqrt{\frac{R_1^2 + \omega^2 L_1^2}{(R + r_p)^2 + \omega^2 L_1^2}} \quad (27)$$

It will be noted that as ω increases, $(\omega L_1)^2$ will be large in comparison with R^2 and $(R + r_p)^2$ and the fraction inside the radical will approach unity. For low frequencies, however, $(\omega L_1)^2$ will be small compared to R^2 and to $(R + r_p)^2$ and the gain will tend to the value of

$$\gamma = \mu \frac{R_1}{R_1 + r_p}$$

which would be the gain had there been no choke in the circuit. If we make $R_1 = r_p$, the gain at low frequencies will be nearly one-half the corresponding value at high frequencies, and the effect of duplicating this circuit in two of the stages will make the net ratio between low- and high-frequency gain nearly four, or 12 db. The value of the inductance L_1 should be such that ωL_1 will be sensibly equal to $R_1 + r_p$ at the frequency at which it is desired to begin the boosting, for example, 700 cycles.

There is nothing to prevent the combination of both low- and high-frequency boosting in each stage; all that is necessary is to substitute the resistance R_2 of Fig. 25 for an inductance of the proper value according to previous discussion and Eq. (26).

22. Frequency-band Suppression. There are cases where it is desirable to amplify the low frequencies, the high frequencies, or some intermediate-frequency band to a smaller extent than the rest or even to eliminate them altogether. Low-, high-, and band-elimination filters can be employed, but in the majority of cases a simple device is quite

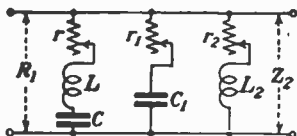

FIG. 26.—Series equalizing circuits.

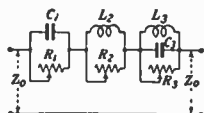

FIG. 27.—Shunt-connected equalizing circuits.

suitable, and it may be secured at hand from standard parts. A combination of a variable resistance of about 100 to 100,000 ohms, a fixed condenser, and a multi-tap inductance, such as commercial variable-ratio transformers, will be quite effective in reducing a frequency band. The resistance with the condenser only will reduce high frequencies; and the resistance with the inductance alone, the low. The place to connect these elements may be either the grid or the anode circuit of any of the stages, according to the values of the resistance, inductance and capacity of these parts and the impedance of the circuit to which they are to be attached. They may be connected in series or in shunt as per Figs. 26 and 27. If the output impedance Z_2 is infinite, as when connecting the circuit to the grid of a tube, the calculation for the voltage reduction at various frequencies is very simple. Representing by Q , as in previous sections, the ratio of the reactance to the resistance of the source (vacuum tube or phonograph pick-up, etc.) and q the ratio of the reactance of the coil to the total resistance of the shunt circuit r, l, c (Fig. 26):

$$Q = \frac{\omega_0 L}{R} \quad \text{and} \quad q = \frac{\omega_0 L}{r}$$

where

$$\omega_0 = \frac{1}{\sqrt{LC}} \quad \text{and} \quad \frac{\omega}{\omega_0} = N$$

The gain will be

$$\gamma = \mu \sqrt{\frac{Q^{-2} + (N - N^{-1})^2}{(Q^{-1} + q^{-1})^2 + (N - N^{-1})^2}} \quad (28)$$

Figure 28 gives some graphs calculated for various values of Q and q , for $\mu = 1$. It will be noted that the sharpness of the peak is mostly controlled by the selection of Q , while the reduction is governed by the choice of q .

If the impedance Z_2 is not large in comparison with the impedance of the shunt, the results will be only approximate but sufficiently so to enable the designer to make a good choice of parts for an experimental trial from which the final circuit constants can easily be selected. The similarity of the circuits containing inductance or capacity only with resistance (Fig. 26) to the circuit of Fig. 25 will be apparent, and the calculations will be almost identical. In Fig. 27 the circuits in series with the line are quite well known, and only the fact need be pointed out that they are not suitable for operation in connection with a high-impedance load such as the grid circuit of a tube except perhaps in one instance—when the

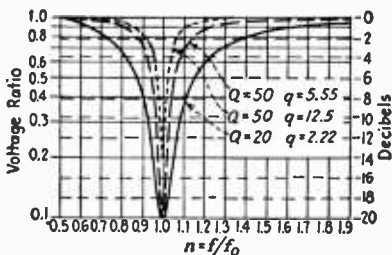

FIG. 28.—Filter cut-off characteristics.

capacity reactance of the grid to filament is low. An inductance with a resistance in shunt with it, such as L_2R_2 (Fig. 27), may work very well in surface-noise elimination in phonograph-record reproduction. The inductance together with the electrode capacity of the tube will act as a single stage of low-pass filter that should be designed to cut off just below 3,500 cycles, as the "scratch" predominant frequency seems to be around 3,700 cycles. The shunt resistance will permit the control of the sharpness and the extent of the cutting off of the upper frequency band so as not to interfere unnecessarily with the reproduction of the overtones and at the same time sufficiently to reduce the obnoxious needle scratch.

23. Power Supply to Tubes of an Amplifier. The design of the power supply is not included here. This is taken up in Sec. 14 of the handbook. Only the things pertinent to the operation of the amplifier are given here.

Filament-power supply whether a.c. or d.c. should have good regulation. When using a.c., the leads should be low in resistance and twisted to avoid setting up disturbing magnetic fields.

For the B supply the importance of regulation depends upon the class of the amplifier, the class B type requiring the best regulation. It is important that the internal impedance of the supply, such as a rectifier, be small at the lowest a.f. as compared to the load impedance, particularly if the load impedance is somewhat inductive.

When using a common rectifier and also low-capacity batteries for the B supply of a multistage amplifier, it is necessary to use decoupling

impedances and condensers to avoid regeneration through the common impedance of the plate supply. Figure 29 illustrates the use of decoupling resistors and condensers. These are the resistors and condensers marked R_2 , R_4 , C_2 , and C_4 . Decoupling resistor R_4 and condenser C_4 may not be necessary. The voltage set up across the common impedance of the B supply by the third tube is of the same phase as the voltage output of the first tube. Hence decoupling resistor R_2 and capacitance C_2 should at least be of such size that the voltage set-up across the grid of the second tube by the current in the plate of the third tube is less than the voltage required to produce the same plate current when there is no regenerative effect at any frequency. The reactance of C_2 at the lowest frequency should be small compared to R_{o1} , so that the voltage

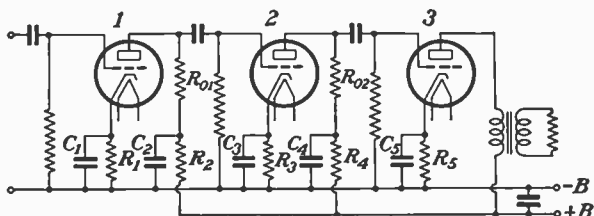

FIG. 29.—The use of decoupling circuits to prevent feed-back.

amplification of the first stage will not vary appreciably with the frequency. Resistance R_2 may also be a choke or a combination of choke and resistance in series.

Self-bias resistors must be by-passed by condensers that have a reactance, at the lowest frequency to be amplified, small compared to the resistor, or otherwise degeneration will result and the gain of the stage will be reduced.

24. Direct-coupled Amplifiers. Under this classification are included all types of amplifiers in which the grid of one tube is connected to the plate of the preceding tube in such a manner that changes in d-c potential on the grid of the input tube will be amplified through the system. There are two important applications of such amplifiers. One application is an amplifying system for d-c purposes. The other application is an amplifier for a-c purposes when phase distortion at low frequencies is a consideration. It is difficult to obtain much amplification at low frequencies without phase distortion by the usual types of a-c amplifiers. Direct-coupled amplifiers have high-frequency characteristics like a well-designed resistance-capacitance coupled amplifier. The tube capacitances shunt the coupling resistor and cause the amplification to decrease with increase in frequency above the frequency at which the effective shunt-capacitance susceptance is about three times the combined conductance of the coupling resistor and plate conductance.

The one common fault with many of the direct-coupled amplifiers when used for d-c work is instability. Small changes in the filament-, plate- and grid-supply voltages cause false results in the output device. For amplifying low-frequency a.c. this particular characteristic is not so objectionable. Another common objection is the nature of the plate- and filament-supply voltages that are required.

The types of direct-coupled amplifiers that have been proposed are too numerous to discuss here. One type which seems to be free of some of the bad features enumerated above is a push-pull arrangement of tubes. This type possesses several advantages over ordinary single-tube-per-stage types. A two-stage push-pull type is shown in Fig. 30. For a balanced system, changes in plate current due to changes in the

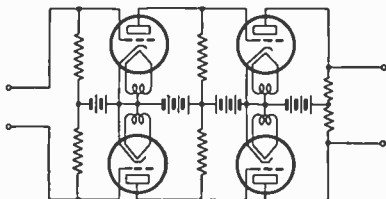

FIG. 30.—Direct-coupled push-pull amplifier.

plate-supply voltage or to variation in cathode temperature are not amplified through the system. For balanced-output tubes there is no d-c component in the output device when no voltage is applied to the input. The output of the amplifier can be adapted to a high-impedance device such as the cathode-ray oscillograph or to a low-impedance device such as a milliammeter or the Duddell oscillograph. With the advent of twin tubes that have comparatively high transconductances the push-pull arrangement becomes quite feasible. The main objection to push-pull input is that a device of high impedance must have balanced capacitances between its terminals and ground if the system is used at very high frequencies.

24a. High-gain Amplifiers. Ingenious methods such as the one proposed by Schmitt¹ for obtaining practically the maximum possible

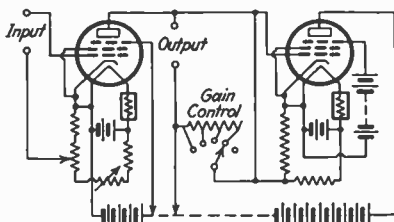

FIG. 31.—Direct-coupled high-gain amplifier.

voltage amplification from a high- μ pentode such as the 57 have merit. The d-c plate potential is supplied to the pentode through a similar pentode which acts as a very high a-c impedance. The arrangement is shown in Fig. 31. The full gain of the tube is obtained only by a load of very high impedance.

¹ SCHMITT, OTTO H. A., A Method of Realizing the Full Amplification Factor of High-Mu Tubes, *Rev. Sci. Instruments*, December, 1933.

CLASS B AMPLIFIERS

25. Class B Amplifier. This type of audio amplifier is a power amplifier which is operated at such a grid bias that there is practically no d-c plate current when the signal voltage is zero. It requires two tubes as shown in Fig. 32 to give a wave form in the load resistor R_L that is nearly like the input wave form to the grids of the tubes. The two tubes working in a balanced system as class B produce in some respects what a single larger tube would do as class A. The only difference of any importance is that in the class B amplifier there is a very small d-c plate current with no signal voltage compared to the d-c plate current in a class A circuit. This results in higher efficiency and much lower energy consumption from the plate supply. Also the grids of class B amplifiers are driven positive whereas they are not in class A. Because of grid current a class B amplifier requires some power to drive it.

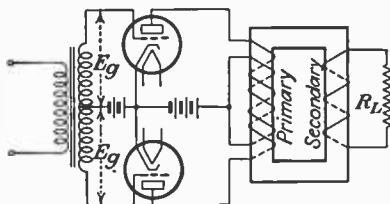

FIG. 32.—Class B amplifier unit.

Upon carrying out the analogy with a class A amplifier and referring to the circuit diagram of Fig. 32 the following points are brought out. The two windings of the primary of the output transformer serve the same purpose as a single winding for a class A amplifier. One of the windings carries a.c. in one direction during one half of the input cycle and the other winding carries current in the opposite direction during the other half of the input cycle. The effect is the same as one winding of the same number of turns carrying currents in alternate directions during the two halves of the cycle. This is exactly the same state of affairs except for d-c current that would result if the two class B tubes were replaced by one larger class A tube and only one primary winding used. Hence the two tubes are considered as a unit, and, because of the similarity to class A conditions, the power output in the fundamental wave can be calculated approximately under certain conditions.

For an ideal transformer, if N is the ratio of the turns of the primary winding to the secondary winding, the load resistance R_L acts as a resistance $R_L N^2$ to the two tubes as a unit or to the equivalent class A tube. This is the impedance that determines the dynamic characteristics and the power output of the unit and not the so-called plate-to-plate impedance. To calculate the power delivered to the load by the unit it is convenient to replace the effect of the tubes by a generator which has an equivalent voltage and internal impedance. This procedure is exactly similar to the way in which it is done for the analogous class A tube because it takes two tubes as class B to simulate one tube as class A. Hence by analogy to the class A amplifier the power in the fundamental wave is

$$P_o = \frac{\mu^2 E_g^2 R_L N^2}{(R_L N^2 + r_p)^2} \quad (29)$$

in which μE_g is the equivalent generated voltage and r_p is the internal impedance of the unit acting as an a-c source of power.

The constants μ and r_p have the same significance for the class B unit as they do for the single class A tube. The only difference is that they are not so constant over the range of operation as for the class A tube. This is mainly because r_p varies some. However in some cases r_p is usually much larger than $R_L N^2$ and some error in the value of r_p produces very little error in calculating P_o by Eq. (29). The quantity μ is equal to $G_{pp} r_p$. Hence it is necessary to determine only G_{pp} and r_p from the characteristic curves of the tube or μ and r_p by direct measurement. The transconductance G_{pp} is the slope of the line that coincides with straighter parts of the static I_p-E_g characteristics of the two tubes for the operating d-c plate potential when plotted as shown for curve A in Fig. 33. The plate resistance of the unit is the reciprocal of the slope of the line that coincides with the straighter parts of the static I_p-E_p characteristics of the two tubes when drawn in a similar manner to the I_p-E_g characteristic of Fig. 33. The quantity r_p must be evaluated for some particular grid potential because the slope of the characteristic changes with the grid potential. For this reason r_p must be evaluated at the average value of the grid swing.

The above expression for P_o is not very accurate for small values of E_g . It gives only the power in the fundamental of the output wave. The expression is quite accurate for tubes operated with negative grid bias like the type 45. The amount of power in the harmonics is probably more easily obtained by actual measurement, although it might be obtained approximately from the I_p-E_p characteristics by a process similar to the one applied to the pentode given in Sec. 8, Art. 52. To avoid serious distortion, the grid swing and load impedance to the unit, *i.e.*, $R_L N^2$, for a given d-c plate voltage must be such that the plate current does not fall below the knee of the I_p-E_p characteristic for the highest value of the grid swing. This can be determined by drawing the load line on the I_p-E_p curve sheet.

The table below shows the values of the constants to be used in the expression for P_o , and P_o for a given load and grid voltage for some of the tubes that are used as class B audio amplifiers.

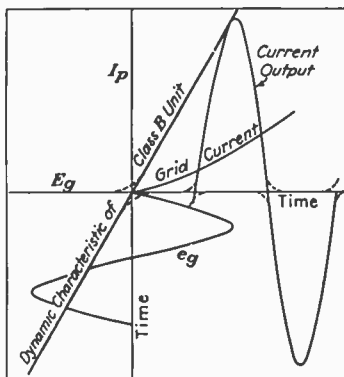

FIG. 33.—Graphical analysis of class B unit.

TABLE II

Tube	D-C voltages		G_{pp} , 10^{-3}	r_p	μ	Load, $R_L N^2$	E_g , r.m.s.	P_o , watts	
	Plate	Grid						Calc.	Meas.
45	275	-76	1,070	3.2	875	85	17.1	16.5
46	300	0	4,000	17,500	70	900	35.5	16.3	14.5
59	400	0	3,810	12,000	45.7	1,500	30	15.5	
89	180	0	2,500	20,000	50	3,400	14.1	3.1	

26. Design of Input and Output Transformers for Class B Amplifiers.

The design of either of these transformers is essentially the design of an impedance-matching transformer which is treated in Art. 16. For the input transformer there is one feature that must be given special attention. For those tubes which do not draw grid current over the complete positive half of the cycle the magnetizing inductance of the transformer must be determined on the basis that the secondary is open. Because of the non-linear character of the grid current, it is essential that the drop in voltage through the input transformer be very small. This means low resistances for the windings and low leakage inductance. Because only one half of the secondary is active at a time, the two secondary windings should be interspaced between the two halves of the primary.

The maximum grid voltage divided by the maximum grid current as obtained from the I_g-E_g characteristics of one tube is a measure of the load impedance for which the input transformer is designed. The load impedance transferred from one secondary to the primary should be two or more times the plate resistance of the driver tube in order that the grid voltage may not be distorted because of the variable nature of the load on the transformer. The exact ratio of the transformer is determined largely by experiment because of the non-linear character of the grid current.

The theory in Art. 25 gives the conditions as to the source impedance to be met in designing the output transformer. This transformer must be large enough to handle the power that is transferred. The resistances of the windings and the leakage inductance must be made as small as possible. The ratio of turns of one primary winding to the turns of the secondary winding must be such as to transfer the load resistance to whatever resistance is necessary for the class B unit. This resistance is determined largely by experiment and depends upon the allowable harmonic distortion. Because it takes two windings on the primary for the class B unit to simulate a single primary winding in a class A amplifier and since only one of these windings carries current at a time, it is good practice to interspace these two windings with each other as much as possible so that they will be balanced as to resistance and leakage inductance. The more detailed procedure in the design of the output transformer is the same as an impedance-matching transformer and is given in Art. 16.

CLASS AB AMPLIFIERS

27. Class AB Amplifiers. This type of amplifier is essentially a power amplifier. It is operated with grid bias intermediate to class A and class B and so driven that plate current in each tube flows for more than 180 deg but less than 360 deg. of the input cycle. Hence it requires two tubes in a balanced push-pull circuit to give a wave form in the load nearly like the input wave form. Since the grids of the tubes are driven positive it requires some driving power for the amplifier.

Referring to Art. 25 on the class B amplifiers and Fig. 32, the same analogy may be carried out between class AB and class A. For a class B amplifier the power output is given by Eq. (29). If the quantity r_p in Eq. (29) is divided by 2, the resulting expression can be used for determining the power output of a class A push-pull amplifier. The power

output for a class AB amplifier is intermediate to class A and class B, for the same tubes and driving voltages. Consequently, on a unit basis, as explained in Art. 25, the two class AB tubes may be replaced by a single source having μE_o volts and an internal impedance somewhere in between the values r_p and $r_p/2$ depending upon the angle of the input cycle at which the plate current ceases flowing in either tube when its

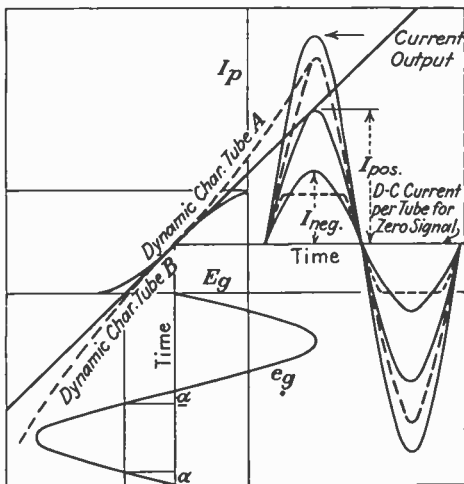

FIG. 34.—Graphical analysis of class AB unit.

input grid voltage is negative. If this angle is known or can be predetermined the power output in the fundamental wave is approximately

$$P_o = \left(\frac{\mu E_o}{R_o + \frac{r_p}{1+k}} \right)^2 R_L N^2 \quad (30)$$

in which R_L is the load resistance, N is the ratio of the turns of one primary winding to the secondary turns, and k is the ratio $I_{neg.}/I_{pos.}$. $I_{neg.}$ is the peak value of the fundamental component of the plate current for the two tubes as a unit when their grids swing negative with respect to the cathode, and $I_{pos.}$ is taken in a similar manner for the positive swing of the grid potential. Figure 34 gives a picture of the plate currents in the two tubes as derived from the I_p - E_o dynamic characteristics. The equivalent sine values of the fundamental components of current are shown in full line. The instantaneous fundamental component of current in the load resistor is $N(I_{pos.} + I_{neg.}) \sin \omega t$.

In terms of α , the angle in radians at which plate-current cut-off takes place on the negative half of the cycle

$$I_{neg.}/I_{pos.} = \frac{2}{\pi} \left(\alpha + \frac{\sin 2\alpha}{2} \right)$$

The value of α is determined by drawing the load line on the I_p - E_p characteristic after the scale of I_p has been changed by the quantity $1 + k$. Obviously this requires a cut-and-try process because k is not known until α is known. However, since k lies between 0 and 1, two load lines can be drawn on the original curves, one for $k = 0$ and one for $k = 1$. Then an estimate of the angle for cut-off can be made. From this estimated value of α , k is determined. The I_p scale is then changed by $1 + k$ and the new load line drawn, and the corrected value of α is obtained. In determining the cut-off point, straight lines coinciding with most of I_p - E_p characteristics should be extended to the plate-voltage axis.

28. Design of Input and Output Transformers for Class AB Amplifiers. The input-transformer requirements for a class AB amplifier are not quite so severe as they are for class B. However, since the grids swing positive on the highest input voltage, it is necessary to design the transformer on the basis that power is delivered to the secondary. Because of the non-linear character of the load current, the transformer should have low resistance and low leakage inductance. The ratio of transformation should be such that the load resistance transferred to the primary should be somewhat higher than the optimum load resistance for the particular driver tube. An approximate value for the equivalent impedance of the load is the peak grid voltage divided by the grid current as determined from the I_g - E_g characteristic for the peak grid voltage. The ratio of primary turns to the turns of one secondary winding can be determined for this approximate value of impedance. The exact ratio is determined largely by experiment because of the difficulty in estimating the amount of distortion due to grid current. The magnetizing inductance is determined on the basis that the secondary is open, or that there is no load impedance. This is necessary to insure low-frequency response when the input voltage is not sufficient to drive the grids of the class AB tubes positive. The magnetizing inductance for a given low-frequency response can be determined by the method given in Art. 16 by assuming an infinite load resistance.

The output transformer should have low resistance and low leakage inductance. The impedance of the equivalent source $r_p/(1 + k)$ is explained in Art. 27. The impedance into which the tubes should work as a unit is determined mainly by experiment because of the limitation placed on the harmonic distortion. Then, for a given load, the ratio of the primary turns to the turns of one secondary winding should be such as to transfer the load impedance equal to the experimentally determined impedance. The effect of the magnetizing inductance and leakage inductance can be determined for a given amount of response at the lowest and highest frequency by using the material in Art. 16.

TESTING AND MEASUREMENTS

29. Frequency-response Measurements. A universal arrangement of equipment for making gain, or loss, measurements over a range of frequencies is shown in Fig. 35. The method is simply one of measuring the ratio of the output voltage to the input voltage. A calibrated potential divider or two calibrated resistors R_1 and R_2 , so arranged that R_1 plus R_2 is constant, facilitates in making these measurements. For making gain measurements, S_1 is thrown in the position indicated by the full lines; for loss measurements in the dotted-line position.

When the divider is so adjusted that the reading of the vacuum-tube voltmeter is the same for the two positions of S_2 ,

$$\text{Gain, or loss, in db} = 20_{10} \frac{R_1 + R_2}{R_2}$$

For the full-line position of S_1 the resistance R_2 must always be small compared to the input impedance of the equipment under test plus R_1 . To get the true gain, or loss, characteristic of a piece of equipment as

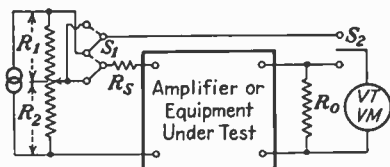

FIG. 35.—Method for making frequency-response measurements.

it is actually used, it must be terminated as used and the termination included in the test. For example R_i and R_o represent the input and output resistance of the amplifier under test. These may also be any kind of impedances. When testing an input or interstage transformer it should be terminated in the tubes for which it is intended. Care must also be taken to limit the voltage applied to the equipment to the proper value.

30. Measuring Distortion in Amplifiers. The simplest method for measuring the total harmonic distortion in the voltage across the output impedance in a power amplifier is shown in Fig. 36. For a given voltage impressed upon the grid of the amplifier, the vacuum-tube voltmeter is made to read a minimum by adjusting slide C of R_2 and the mutual inductance M . Then the reading of V.T.M. is a measure of the square

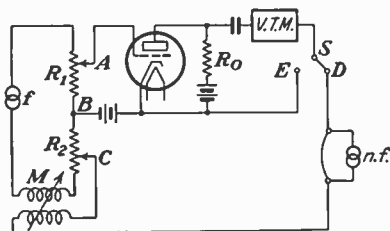

FIG. 36.—Circuit for measuring distortion.

root of sums of the squares of all the harmonic voltages across R_o . Mutual inductance M provides for a phase shift from 180 deg. through the amplifier tube. The vacuum-tube voltmeter must be as nearly an r-m-s meter as possible. The source should be reasonably free from harmonics. Switch S provides for measuring the total a-c voltage across R_o when V.T.M. has a multiplier to extend its range. A vacuum-tube voltmeter using a type 56 or 76 tube and operated over a region

in which the square root of the plate current plotted against grid voltage is nearly a straight line makes an excellent meter for this purpose.

When it is desired to know the separate harmonics in the output impedance a voltage having a frequency nf almost equal to the harmonic sought may be introduced into the connection up to contact d , as illustrated. The voltage of nf will be equal to the particular harmonic voltage when the swing of the needle of V.T.M. is a maximum. The measurements may be carried out by means of a laboratory oscillator for nf and some filtering for the voltage obtained from the 60-cycle lighting circuit for f .

For the more refined measurements of distortion there are various types of wave analyzers on the market. These have a wider range of application than the simple method described above.

31. Measuring the Impedances of a Transformer and an Iron-core Reactance.¹ One of the simplest methods for measuring the impedance of an iron-core reactance at low frequencies and preferably the power

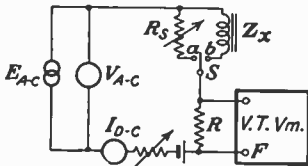

FIG. 37.—Circuit for measuring the impedance of iron-core coils.

frequency of 60 cycles is illustrated in Fig. 37. The circuit is arranged, when necessary, so that d.c. can be sent through the iron-core coil. When R_s is so adjusted that the reading of the vacuum-tube voltmeter is the same for both positions, a and b , of switch S , the absolute value of the impedance Z_x is equal to R_s , provided R_s is at least 20 times R . The error is less than 5 per cent. Oftentimes it is necessary to use an amplifier ahead of the vacuum-tube voltmeter. It is

essential that the vacuum-tube voltmeter or amplifier be connected as shown, or false readings may result if the meter places too much stray shunt capacitance across Z_x .

The method of Fig. 36 may be used for measuring the impedances of the primary and secondary of a transformer. It is not possible, of course, to obtain the resistance and reactance separately by this method. Methods that place the standard resistance R_s in series with Z_x and require balancing the voltage drop across R_s against that across Z_x for the same current are objectionable except for quite low values of impedance. By such a method the d.c. through and a-c potential across Z_x are disturbed while adjusting R_s .

It is not generally safe to use the method described to measure the leakage inductance of a transformer. Leakage inductance is measured by shorting the secondary and measuring the impedance of the primary. Generally this measurement requires an inductance bridge because of the high value of R compared with X .

¹ See also Art. 29, Sec. 2.

SECTION 12

RADIO-FREQUENCY AMPLIFIERS

BY R. S. GLASGOW, M. S.¹

1. Class A Amplifier. Amplifiers are divided into three general classes, A, B, and C, depending on the type of service in which they are to be used.

A class A amplifier is one which operates so that the plate output wave shapes of current are practically the same as those of the exciting grid voltage.

This is accomplished by operating the tube with sufficient negative grid bias such that some plate current flows at all times, and by applying an alternating excitation voltage to the grid of such value that the dynamic operating characteristic is essentially linear. The grid must not go positive on excitation peaks and the plate current must not fall low enough at its minimum to cause distortion due to curvature of the characteristic.

The characteristics of class A operation are freedom from distortion and relatively low power output. Practically all a-f amplifiers are operated in this manner. Radio-frequency amplifiers of the type used in receiving sets to amplify the signal voltage prior to detection are also of this class.

Class B and C amplifiers will be discussed under Power Amplifiers.

2. Radio-frequency amplifiers for receiving sets are usually classified as to the type of coupling employed between stages. This coupling means can be either a resistance, an impedance, a transformer, or any combination of these elements. The circuit constants of the coupling means may be adjustable or fixed, giving rise to a further classification of a tuned or an untuned amplifier. In the latter the circuits are essentially the same as those employed for a-f amplifiers, and are in general unsatisfactory except for the lower radio frequencies.

3. Resistance-coupled Amplifier. This type of amplifier is occasionally used where uniform amplification is desired over a moderate band in the lowest range of radio frequencies. In Fig. 1 the output voltage E_2 is given by

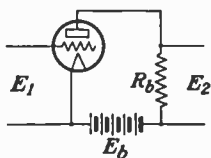

FIG. 1.—Resistance-coupled amplifier.

$$E_2 = \frac{\mu R_b}{r_p + R_b} E_1 \quad (1)$$

¹ Associate professor of Electrical Engineering, Washington University, St. Louis.

where μ and r_p are respectively the amplification factor and plate resistance of the tube used. Defining the voltage amplification per stage G as the ratio of the output voltage to the input voltage, we have

$$G = \frac{E_2}{E_1} = \frac{\mu R_b}{r_p + R_b} \quad (2)$$

As R_b is made very large compared to r_p the value G approaches μ as a limit so that tubes having a large value of μ are necessary if reasonably high gain per stage is desired. Equation (2) presumes that the input impedance of the next stage which is shunted across R_b is enormously large, so that R_b is not appreciably reduced as a result of being shunted by this input impedance.

In a typical cascade amplifier as shown in Fig. 2, R_b is in effect shunted by the grid leak R_c in parallel with C_g , the input capacity of the tube. The reactance of the blocking condenser C in series with them is negligibly small in comparison. For frequencies lower than 500 kc with a pure resistance in its plate circuit C_g may be regarded as constant and independent of the frequency, and is given by

$$C_g = C_{gf} + C_{gp} \left(1 + \frac{\mu R_b}{r_p + R_b} \right) \quad (3)$$

where C_{gf} = capacity between grid and filament

C_{gp} = capacity between grid and plate

These interelectrode capacities will be from 4 to 10 μmf depending on the type of tube and socket used so that C_g may lie anywhere from 40 to 80 μmf . Thus at 1,000 cycles the input impedance of the tube alone will be about 3 megohms while at 100 kc it has dropped to about 30,000 ohms. As a result the gain per stage diminishes as the frequency increases due to the reduction of the effective value of R_b by the short-circuiting effect of C_g . In addition to these limitations, a-f disturbances and tube noises are readily amplified so that resistance-coupled amplifiers are usually not very satisfactory for radio frequencies.

4. Impedance-coupled Amplifier. The simplest amplifier of this type merely employs a choke coil in the plate circuit as shown in Fig. 3. The voltage amplification per stage is given by

$$G = \frac{E_2}{E_1} = \frac{\mu \sqrt{R_b^2 + \omega^2 L_b^2}}{\sqrt{(r_p + R_b)^2 + \omega^2 L_b^2}} \quad (4)$$

where R_b and L_b are respectively the resistance and inductance (in henrys) of the choke coil and $\omega = 2\pi \times$ frequency. If the resistance of the coil is small compared to its reactance, ωL_b , and to the plate resistance r_p of the tube, the expression for the amplification becomes

$$G = \frac{\mu \omega L_b}{\sqrt{r_p^2 + \omega^2 L_b^2}} \quad (5)$$

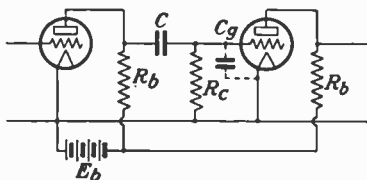

FIG. 2.—Cascade amplifier.

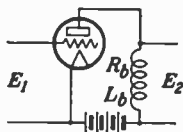

FIG. 3.—Impedance-coupled amplifier.

If ωL_b is very large compared to r_p , G approaches μ of the tube as a limiting value, as was the case with the resistance-coupled amplifier. By choosing L_b large enough so that the reactance of the coil is large compared to the plate resistance of the tube at the lowest frequency we are interested in, the gain will be constant for all higher values of frequency. Owing to distributed capacity effects and the shunting of the coil by the input capacity of the next tube it is not possible to obtain uniform amplification as predicted above except at low frequencies. For high frequencies such as the present broadcast band the effect of this capacity is to produce a parallel resonant circuit whose impedance is high at the resonant frequency, but which drops off rapidly for frequencies higher than resonance. This results in a reduction of the gain for frequencies above resonance. To avoid this, it becomes necessary to use a value of choke-

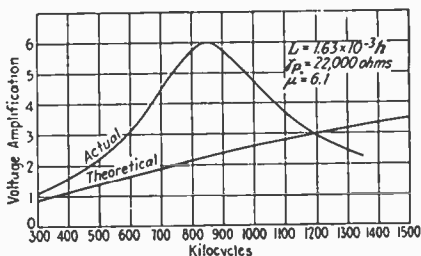

FIG. 4.—Amplification of a choke-coupled amplifier tube.

coil inductance such that resonance occurs somewhat below the highest frequency to be amplified. This value of inductance is governed chiefly by the input capacity of the next tube which may be of the order of 10 to 20 $\mu\mu\text{f}$, depending on the type of tube used and the nature of the load in its plate circuit. For this reason there is little to be gained by reducing the distributed capacity of the coil if it is already small compared to the tube input capacity. At broadcast frequencies the value of inductance thus obtained results in too low a reactance to give good amplification for frequencies much below resonance.

This is illustrated in Fig. 4. The coil used was a single layer solenoid closely wound with 173 turns of No. 28 wire having an inductance of 1.63×10^{-3} henry and about 10 ohms d-c resistance. The distributed capacity of the coil was 3.5 $\mu\mu\text{f}$. The curve shows the measured amplification¹ using a Western Electric 215-A "peanut" tube which had an amplification factor of 6.1 and a plate resistance of 22,000 ohms. The input capacity of the vacuum-tube voltmeter which used a tube of the same type was 18 $\mu\mu\text{f}$, including leads, which lowered the natural period of the choke coil to 850 kc. The lower curve shows the theoretical amplification that would be obtained if these shunting capacities were absent.

If C represents the total capacity shunting the coil in Fig. 3, the expression for the amplification becomes

$$G = \frac{\mu Z}{\sqrt{(r_p + R)^2 + X^2}} \quad (6)$$

¹ FRIIS and JENSEN, *Bell System Tech. Jour.*, 3, 187.

where

$$R = \frac{R_b}{\omega^2 C^2 R_b^2 + (\omega^2 L_b C - 1)^2} \quad (7)$$

$$X = \frac{L_b - C(R_b^2 + \omega^2 L_b^2)}{\omega^2 C^2 R_b^2 + (\omega^2 L_b C - 1)^2} \quad (8)$$

$$Z = \sqrt{R^2 + X^2} \quad (9)$$

The above expression for Z is the resultant impedance of the coil in the plate circuit when shunted by the capacity C under the assumption that this capacity has no appreciable resistance associated with it. The voltage amplification will be a maximum when Z is a maximum, which will occur at resonance. When Z is a maximum the apparent reactance as given by (8) becomes zero, and

$$Z_{\max.} = \frac{R_b^2 + \omega^2 L_b^2}{R_b} \quad (10)$$

the expression for maximum gain thus becomes

$$G_{\max.} = \frac{\mu}{1 + \frac{r_p R_b}{R_b^2 + \omega^2 L_b^2}} \quad (11)$$

If the shunting capacity C has an effective resistance R_c in series with it, the expressions for R and X in (7) and (8) become

$$R = \frac{\omega^2 C R_c [R_b (R_b + R_c) + \omega^2 L_b^2] + R_b}{\omega^2 C^2 (R_b + R_c)^2 + (\omega^2 L_b C - 1)^2} \quad (12)$$

$$X = \frac{L_b - C [R_b^2 + \omega^2 L_b (L_b - C R_c^2)]}{\omega^2 C^2 (R_b + R_c)^2 + (\omega^2 L_b C - 1)^2} \quad (13)$$

5. Use at Low Frequencies. At frequencies in the vicinity of 50 kc much higher values of inductance can be secured and while the distributed capacities of such coils will be greater, the total capacity shunted across

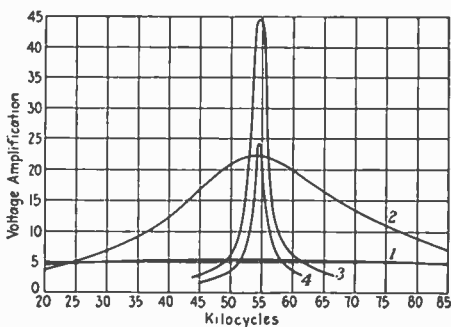

FIG. 5.—Amplification as a function of turn ratio.

the coil will not be more than two or three times the value that would obtain at broadcast frequencies. Since the voltage amplification will be approximately constant and equal to the μ of the tube as long as the impedance of the coil in the plate circuit is large compared to r_p , uniform

amplification can be readily obtained for a wide band at the lower radio frequencies. This is shown by curve 1 in Fig. 5. In order to secure the high inductance needed at the lower frequencies without unduly increasing the distributed capacity a multilayer winding of "honeycomb" type is often used. Another method is to subdivide the coil into a number of thin, closely adjacent, random-wound pancake sections by using a coil form with a number of narrow grooves turned in it. Such coils can be made astatic by reversing the direction of the winding in each alternate section so that their magnetic fields are in opposition. This form of construction requires a greater number of turns to secure a given inductance, but it possesses the advantage of being immune from stray magnetic couplings with the other coils in the amplifier.

At the lower radio frequencies suitable iron cores can be profitably employed, enabling high values of inductance to be obtained with a nominal number of turns on the coil. The iron must be very well laminated to reduce the eddy currents, or an objectionable increase in the resistance of the coil will result. The iron commonly used for this purpose has a thickness of only one to two mils. Dust cores of iron and its magnetic alloys¹ are very satisfactory for this purpose. However, as the frequency increases the advantages of an iron core diminish. The resistance of the coil rapidly increases while the apparent permeability of the iron becomes less, so that at high frequencies the iron contributes comparatively little to the inductance. This results in a ratio of $\omega L/R$, which is lower than would be obtained with a suitable air core inductance. For this reason iron cores are seldom used for frequencies above 500 kc.

In 1931, Polydoroff² developed a method for tuning a circuit by variations in the inductance by inserting a core of finely powdered iron. Because of the high specific resistance of the core material, the losses in the tuned circuit were kept low, and sufficient change in permeability of the core was secured to tune a circuit over a 3 to 1 variation in frequency.

6. Transformer-coupled Amplifiers. The problems in an untuned transformer-coupled amplifier are much the same as those just discussed. The primary of the transformer is merely a choke coil in the plate circuit of the tube so that the secondary voltage may be obtained by multiplying the primary voltage by the ratio of transformation. The expression for the voltage amplification can then be obtained by multiplying (4) or (6) by this ratio.

If the impedance into which the transformer is working is enormously large so that the secondary may be assumed to be on open circuit the ratio of transformation is given by

$$a = \frac{M}{L_p} = K \sqrt{\frac{L_s}{L_p}} \quad (14)$$

where M = mutual inductance

L_p = primary inductance

L_s = secondary inductance

K = coefficient of coupling = $M/\sqrt{L_p L_s}$

From (14) it is seen that the ratio of transformation is only equal to the turns ratio if the coupling between primary and secondary is unity and if

¹ SHACKELTON and BARBER, Compressed Powered Permalloy, *Trans. A.I.E.E.*, pp. 429-436, April, 1928.

² Ferro-inductors and Permeability Tuning, *Proc. I.R.E.*, p. 690, May, 1933.

the inductances are proportional to the square of the number of turns. These conditions are usually obtained only if an iron core is used.

The assumption that the secondary of the transformer is working into an open circuit is seldom valid due to the input capacity of the following tube. The effect of this capacity becomes more pronounced as the step-up ratio of the transformer is increased. At low ratios of transformation the response curve is relatively flat, but as the ratio is increased the tuning effect of the tube capacity across the secondary becomes quite pronounced resulting in a sharply defined resonance curve. This is illustrated in Fig. 5. The transformer used was a coil of 2,400 turns wound on an iron dust core which had an inductance of 0.33 henry. Taps were brought out so that the coil could be used as an auto transformer of adjustable ratio by connecting the plate of the amplifier tube across any portion of the total inductance. The same tube was used as in Fig. 4. Curve 1 was for a 1:1 ratio, the coil being used as an impedance-coupled amplifier. Curves 2, 3, and 4 are for step-up ratios of 1:4, 1:16 and 1:48 respectively.

The general vector expressions for the currents in the primary and secondary of a transformer-coupled amplifier are given by

$$i_p = \frac{\mu e_g (Z_s + Z_2)}{(r_p + Z_p)(Z_s + Z_2) - Z_m^2} \quad (15)$$

$$i_s = \frac{-\mu e_g Z_m}{(r_p + Z_p)(Z_s + Z_2) - Z_m^2} \quad (16)$$

The circuit is shown in Fig. 6, *a* being the actual connection and *b*, the electrical equivalent. The negative sign in (16) indicates that the secondary

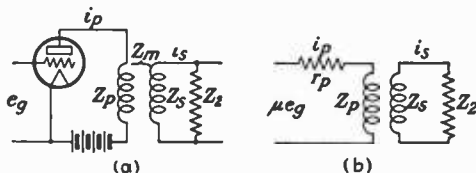

FIG. 6.—Transformer-coupled amplifier.

current is flowing in a direction opposite to that in the primary and can be disregarded if we are interested only in the magnitude of the current. Substituting the following vector expressions for the various impedances and assuming that Z_2 is a condenser having a capacity, C_2 , we have

$$Z_p = R_p + j\omega L_p$$

$$Z_s + Z_2 = R_s + j\left(\omega L_s - \frac{1}{\omega C_2}\right)$$

$$Z_m = j\omega M$$

where R_s is the resistance of the transformer secondary and includes any resistance that may be associated with C_2 . The vector expression for the secondary current is then

$$i_s = \frac{-\mu e_g j\omega M}{\left[(r_p + R_p)R_s + \frac{L_p}{C_2} - \omega^2(L_p L_s - M^2) \right] + j\left[r_p\left(\omega L_s - \frac{1}{\omega C_2}\right) + \omega L_p R_s \right]} \quad (17)$$

and the voltage amplification at any frequency is given by

$$G = \frac{i_s Z_2}{e_g} = \frac{\mu \frac{M}{C_2}}{\sqrt{\left[(r_p + R_p)R_s + \frac{L_p^2}{C_2} - \omega^2(L_p L_s - M^2) \right]^2 + \left[r_p \left(\omega L_s - \frac{1}{\omega C_2} \right) + \omega L_p R_s \right]^2}} \quad (18)$$

Equations (17) and (18) neglect the effects of distributed capacity of the primary and possible capacity coupling between primary and secondary. These items, if appreciable, will modify the expression for the gain as given by (18).¹

The voltage amplification will be a maximum at resonance, or when the j term in (17) is zero. This will occur when

$$\omega = \frac{1}{\sqrt{C_2 \left(L_s + L_p \frac{R_s}{r_p + R_p} \right)}} \quad (19)$$

and the gain will be given by

$$G_{\max.} = \frac{\mu \frac{M}{C_2}}{(r_p + R_p)R_s + \omega^2 \left(M^2 + L_s^2 \frac{R_s}{r_p + R_p} \right)} \quad (20)$$

At high frequencies the tube input capacity is a complex function of the frequency and of the constants in the output circuit. By using a coil in the output circuit whose natural period is slightly lower than the lowest frequency to be amplified, the input capacity of that tube can be made to increase as the frequency is lowered. Since C_2 in the above equations is composed largely of tube input capacity it is possible by proper design to have C_2 increase automatically as the frequency of the incoming signal decreases, and at the proper rate so as to tune the transformer secondary to approximate resonance for a reasonable range of frequencies. This automatic tuning effect results in a much broader and more uniform response curve than would be obtained if C_2 were fixed in value.

7. Tuned Amplifiers. The circuits discussed in the preceding sections are employed when it is desired to amplify a fixed band of frequencies. The width of this band and the uniformity of the amplification therein are governed by design limitations. The majority of receiving sets must be capable of amplifying a selected narrow band of frequencies and excluding all others. The *selectivity* of the receiving set is dependent upon how thoroughly this latter item is carried out. In receivers designed for entertainment purposes, the *fidelity* is also of importance and depends upon the uniformity of the amplification within the selected band. The type of detector used and the characteristics of the a-f amplifier also affect the fidelity.

¹ DIAMOND and STOWELL, Note on Radio-frequency Transformer Theory, *Proc. I.R.E.*, 16, 1194, September, 1928.

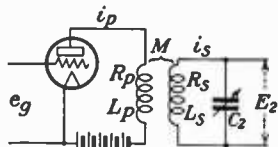

FIG. 7.—Typical tuned r-f transformer.

A typical tuned r-f transformer connection is shown in Fig. 7. The current in the secondary and the voltage amplification per stage at any frequency with C_2 fixed in value are given by (17) and (18) respectively.

At resonance,

$$\omega \left(L_s + L_p \frac{R_s}{r_p + R_p} \right) = \frac{1}{\omega C_2} \quad (21)$$

and the gain will be a maximum and is given by (20). The resistance of the primary is usually negligible in comparison with r_p , and since $\frac{L_p R_s}{r_p + R_p}$ is also small, (21) becomes

$$\omega L_s = \frac{1}{\omega C_2} \quad (22)$$

and the expression for the gain at resonance to a sufficiently close degree of approximation becomes

$$G_{\max.} = \frac{\mu \omega M}{r_p R_s + \omega^2 M^2} \omega L_s = \frac{\mu M}{r_p R_s + \omega^2 M^2} \quad (23)$$

If the mutual inductance M in (23) is adjusted to satisfy the condition

$$\omega M = \sqrt{r_p R_s} \quad (24)$$

the optimum value of voltage amplification will be obtained, and (23) reduces to

$$G_{\text{opt}} = \frac{\mu \omega L_s}{2\sqrt{r_p R_s}} \quad (25)$$

Equation (25) gives the maximum amplification it is possible to obtain with a given tube and coil.

When M is adjusted to its optimum value it will be noted that the figure of merit of the tube is $\mu/\sqrt{r_p}$. Therefore if two tubes have equal values of transconductance the one having the highest amplification factor will give the greatest gain. For this reason tetrodes and pentodes are capable of giving very high amplification. With M less than optimum the gain becomes more nearly proportional to the mutual conductance. When optimum coupling is employed the amplification is directly proportional to the ratio of the coil reactance to the square root of its resistance. Consequently, secondary coils using relatively small wire of comparatively high resistance can be used without seriously reducing the amplification. In this respect the r-f transformer differs from a coil aerial as in the latter the gain falls off directly with the coil resistance. For values of M considerably below optimum the gain will fall off at a rate more nearly proportional to the first power of the coil resistance. It is interesting to note that the turn ratio between primary and secondary does not enter into the expression for the amplification, the mutual inductance between them being the criterion. When optimum amplification is obtained the impedance looking into the primary of the transformer is equal to the plate resistance of the tube. This condition differs from the impedance-coupled amplifier in that in the latter optimum amplification is obtained only when the impedance in

the plate circuit is enormous compared to r_p of the tube. The impedance looking into the primary of the circuit in Fig. 7 is

$$Z_p' = R_p + j\omega L_p + \frac{\omega^2 M^2}{R_s + j\left(\omega L_s - \frac{1}{\omega C_2}\right)} \quad (26)$$

The preceding equations are all applicable to screen-grid tetrodes and pentodes. The circuit of a tuned amplifier using a pentode is shown in Fig. 8. These tubes have values of r_p approaching a megohm and values of μ varying from 400 to over 1,000. The coupling used in the transformer is always considerably below the optimum value, so that $\omega^2 M^2$ can usually be neglected in the denominator of Eq. (23). The approximate expression for the gain at resonance then becomes

$$G_{\text{max.}} = \frac{\mu\omega M}{r_p R_s} \omega L_s = S_m Q_s \omega M \quad (27)$$

where S_m is the transconductance of the tube, and $Q_s = \omega L_s / R_s$ the figure of merit of the secondary coil.

These tubes enable values of amplification per stage to be obtained which are considerably greater than with the ordinary triode. This advantage, together with their freedom from oscillation without the use of neutralizing circuits, has caused the use of triodes as r-f amplifiers to be virtually abandoned.

8. Effect of Mutual Inductance. The effect of the magnitude of M on the resonant amplification for four different frequencies is shown in Fig. 9.¹ The secondary circuit resistance varied from 4 ohms at 500 kc to 25 ohms at 1,500 kc. It will be observed that a fixed value of mutual inductance of about 45 μ h would give approximately optimum amplification for the entire range of frequencies included in the curves. There is therefore little to be gained in sensitivity by adjusting the coupling in this type of amplifier for various frequencies providing sufficient coupling has been initially employed. There is, however, considerable advantage to be obtained by increasing M as the frequency is lowered in order to secure more uniform selectivity and better fidelity. The mechanical complications involved in automatically varying the amount of coupling with tuning have prevented its use in commercial receiving sets up to the present.

The effect of the value of M on selectivity is shown in Fig. 10, using the same tube and transformer as in Fig. 9. It will be noted that these curves have the same characteristics as those in the Fig. 5, curve 3 of that figure having the proper turn ratio to produce the optimum value of M . If the ordinates of Fig. 10 are reduced to a percentage basis as in Fig. 11 the increased broadening of tuning with increased M is clearly apparent. As M approaches zero the response curve approaches the resonance curve of the secondary circuit. Therefore if good selectivity is desired M must be fairly small—usually well under its optimum value—so that some

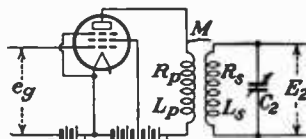

FIG. 8.—Tuned r-f amplifier using a pentode.

¹ GLASGOW, R. S., Tuned Radio-frequency Amplifiers, *Jour. A.I.E.E.*, p. 327, May, 1928.

sacrifice must be made in sensitivity. A further difficulty presents itself when the selectivity at various frequencies is investigated, as illustrated in Fig. 12. At the lowest frequency the response curve is so sharp that

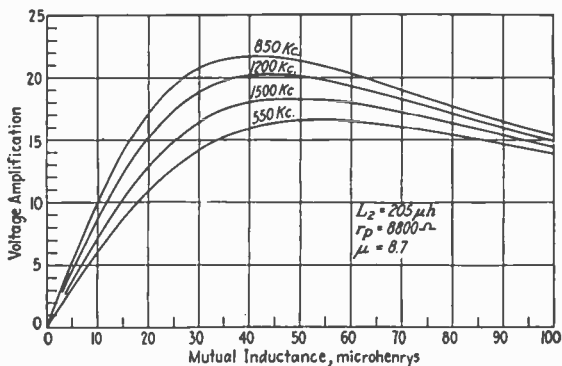

FIG. 9.—Effect of M on resonant amplification.

the gain for side-band frequencies 5 kc off resonance is only 36 per cent of the resonant amplification. The fidelity is therefore impaired. At the highest frequency the fidelity is good but the selectivity is very poor.

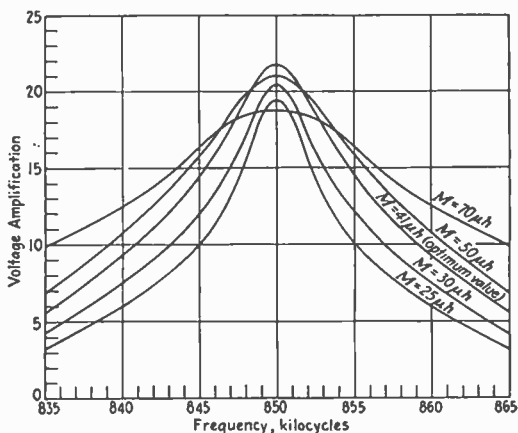

FIG. 10.—Effect of varying M on selectivity.

Reducing the value of M would sharpen the tuning at high frequencies but would cause it to become still sharper at the low frequencies with further impairment of fidelity in this region. This reduction in M would

also cause a serious loss in sensitivity at the lower frequencies. Consequently the design of a tuned r-f receiving set for entertainment purposes represents a compromise between good fidelity and sensitivity at the long waves, and fair selectivity at the short waves. Any attempt to improve the performance at one end of the tuning range results in impaired performance at the other. This has resulted in the introduction of various modifications in the circuit of Fig. 7.

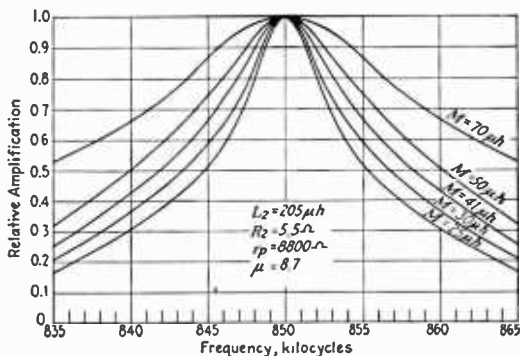

FIG. 11.—Figure 10 platted on a percentage basis.

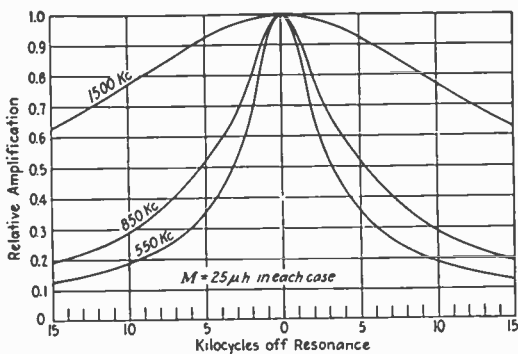

FIG. 12.—Selectivity as a function of frequency.

9. Combinations of Inductive and Capacitive Coupling. To secure better performance in tuned amplifiers without resorting to moving parts other than the tuning condensers, combinations of inductive and capacitive coupling between stages have been used.¹ By a proper choice of circuit elements it is possible to make the effective coupling

¹ WHEELER, H. A., and W. A. McDONALD, Theory and Operation of Tuned Radio-frequency Coupling Systems, *Proc. I.R.E.*, 19, 738, May, 1931.

vary with the frequency in a predetermined manner. In this way the variation of gain with frequency can be given almost any desired characteristic.

Two examples of such circuits are shown in Fig. 13. In 13a the coil L_b has a large value of inductance so that its distributed capacitance C_1 , augmented by C_{pf} of the tube, resonates it to a frequency somewhat

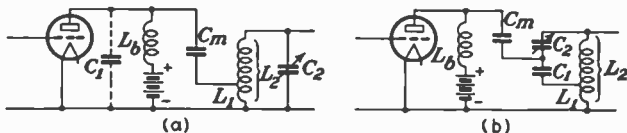

FIG. 13.—Tuned amplifiers using combinations of inductive and capacitive coupling.

below the tuning range of the set. The output current of the tube divides between L_b and the path through the coupling condenser C_m . At low frequencies a larger portion of the output current flows through this second path because of the high impedance offered by L_b as parallel resonance is approached in the latter. This causes the voltage induced in L_2 to remain more nearly constant over the tuning range.

The circuit of Fig. 13b accomplishes the same results in a somewhat different manner. The coil L_b and condenser C_m merely serve as choke coil and blocking condenser of an amplifier using parallel feed. The amplified output current divides between C_1 and C_2 and then recombines to flow through the primary L_1 of the autotransformer. The capacity

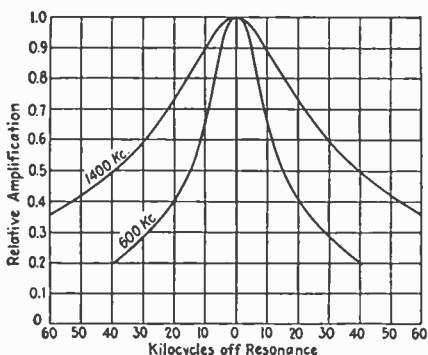

FIG. 14.—Variation in selectivity in t-r-f amplifier having high-inductance primary.

of the tuning condenser C_2 is increased as the signal frequency is lowered, which causes a progressive increase in the effective coupling. C_1 is about twenty times larger than the maximum value of C_2 , while L_1 includes about a turn or two of the coil L_2 .

The advantages of the circuits just described can be approached by that of Fig. 8 if the primary inductance is increased to a large value

so that L_p , in conjunction with its distributed capacity and the output capacity of the tube used, has a resonant frequency somewhat below the tuning range of the circuit. A similar result may be had by using a smaller primary coil shunted by a fixed condenser. The capacity between primary and secondary coils functions in a manner similar to C_m in Fig. 13a. Response curves for a transformer-coupled amplifier of this type are shown in Fig. 14. The variation in selectivity is considerably less over the tuning range than in Fig. 12.

The use of a primary operated above its resonant frequency results in a plate-load impedance which has capacitive reactance. A load of this nature results in *negative feed-back* in the case of triodes, so that neutralizing circuits have to be employed to prevent the gain from being reduced to a fraction of its theoretical value. Ordinarily, these circuits are used to balance out the effects of positive feed-back and prevent oscillation. Screen-grid tubes are free from these troubles.

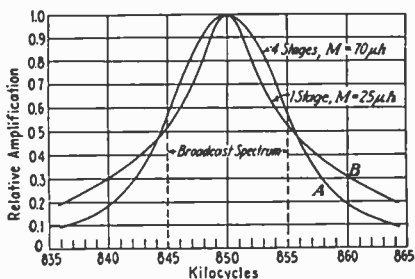

FIG. 15.—Increase in selectivity with cascading.

10. Cascade Amplifiers. If two or more identical stages of amplification are connected in cascade the over-all voltage amplification is given by

$$G = G^n \quad (28)$$

where n = number of stages

G = amplification per stage

This expression presumes that the various stages do not react on each other, which is not always the case in practice due to small unavoidable couplings between input and output circuits. If the various stages are not all identical the over-all amplification will be the product of the individual values of G per stage. The response curve of a multi-stage amplifier composed of identical stages is readily obtained from the curve of an individual stage by raising its ordinates to the n th power, where n is the number of stages.

The use of several stages of cascade tuned r-f amplification enables both the selectivity and fidelity of the amplifier to be increased, provided the tuning of each stage is made broader as the number of stages is increased. This is illustrated in Fig. 15 where A is the response curve of a four-stage amplifier, each stage having the constants of the top curve of Fig. 11. Curve B is a single stage and is the bottom curve of this same figure. The necessity for broader tuning per stage in multi-stage

amplifiers in order to avoid too great a sacrifice in fidelity permits the use of coils of rather compact dimensions wound with relatively small wire. The increased coil resistance thus produced will reduce the gain per stage but this can be offset if necessary by increasing the mutual inductance to more nearly the optimum value. At frequencies sufficiently remote from resonance such that the gain per stage becomes less than unity a cascade amplifier acts as an *attenuator* of the signal. An increase in the number of stages will therefore actually decrease the strength of interfering signals whose frequencies are above or below the band where the gain per stage is equal to or greater than one. All signals whose frequencies lie within this band will be strengthened by an increase in the number of stages. For this reason two types of selectivity may be recognized; the *adjacent-channel selectivity*, and the *distant-channel selectivity*. It is therefore possible in a comparative test of two amplifiers of equal sensitivity to find that the first will produce less interference from interfering signal of, say, 30 kc away from resonance than the second; while for a signal of, say, 60 kc away there may be more interference present than in the second amplifier.

The attenuation of signals remote from the resonant frequency requires that the amplifier be well shielded in order to prevent short portions of the lead wires and circuits of the output stage from acting as aeri- als and picking up energy. Thus a few inches of exposed wire running to the grid of the detector tube might have a voltage induced in it from an interfering powerful local station which is much greater in magnitude than these same signals after passing through the amplifier.

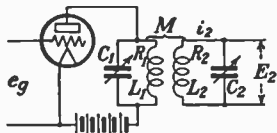

FIG. 16.—Transformer with primary and secondary tuned.

appearance of the resultant response curves is given in Fig. 17. Due to the more uniform amplification obtained over a wider band of frequencies, these circuits are often referred to as band-pass filters. This form of circuit is commonly used in the i-f amplifier of superheterodynes.

When the primary and secondary are both tuned to the same frequency the width of the transmitted band depends upon the magnitude of the coupling between them. A double-humped response curve results if M is greater than the critical value, and, as M is increased, the two peaks move farther apart and the hollow between them becomes deeper, particularly if the resistance of the two coils is low.

The expression for the voltage amplification is rather complicated and is given by

$$G = \frac{\mu M}{C_2 \sqrt{A^2 + B^2}} \quad (29)$$

where

$$A = R_2[R_1 + r_p(1 - \omega^2 L_1 C_1)] - \omega(L_1 + r_p R_1 C_1) \left(\omega L_2 - \frac{1}{\omega C_2} \right) + \omega^2 M^2$$

$$B = \omega R_2(L_1 + r_p R_1 C_1) + [R_1 + r_p(1 - \omega^2 L_1 C_1)] \left(\omega L_2 - \frac{1}{\omega C_2} \right) + \omega^3 M^2 C_1 r_p$$

The value of M in Fig. 16 is usually made equal to or slightly greater than the critical value. In addition to the flatter top, the sides of the curve fall off more rapidly than with a single tuned circuit, resulting in better selectivity.

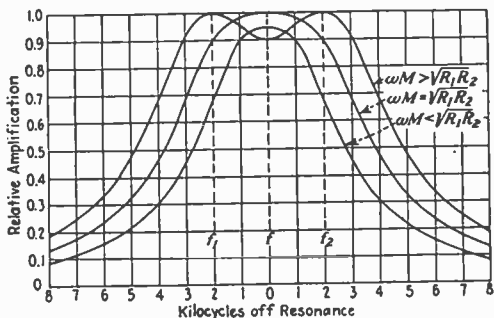

FIG. 17.—Response curves of doubly-tuned r-f stage.

When the primary and secondary circuits are both tuned alike so that $\omega L_1 = 1/\omega C_1$ and $\omega L_2 = 1/\omega C_2$, Eq. (29) becomes

$$G = \frac{\mu M}{C_2 \sqrt{(R_1 R_2 + \omega^2 M^2)^2 + \left(\omega L_1 R_2 + r_p \frac{R_1 R_2 + \omega^2 M^2}{\omega L_1} \right)^2}} \quad (30)$$

With fixed coupling between primary and secondary the width of the response curve becomes greater as the frequency increases, which causes a progressive reduction in selectivity in much the same manner as with a single tuned circuit. In i-f amplifiers in superheterodynes the frequency of the band to be amplified is fixed and the problem of varying selectivity is not encountered.

12. Regeneration in Amplifiers.

The three-electrode vacuum tube is not a perfect unilateral device but permits the amplified output energy to react upon the input circuit. The grid-to-plate capacity of the tube serves to electrostatically couple the input and output circuits as shown in Fig. 18. If some of the output voltage is fed back into the input circuit so as to be in phase with e_g , the total, or regenerative amplification, may be expressed by

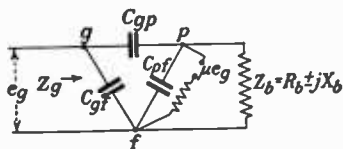

FIG. 18.—Interelectrode capacity network.

$$G_r = G \frac{1 - S}{1 - GS} \quad (31)$$

where S is the fraction of the output which is fed back into the input circuit and G is the gain of the amplifier if feed-back were absent. If the quantity GS is unity, the total amplification becomes infinite and a continuous oscillation will result. In addition to feed-back due to C_{gp} which almost always has to be balanced out to secure stability, feed-back due to coupling resulting from the use of a common B or C battery may be sufficient to cause instability. Small electrostatic or electromagnetic couplings between the input and output circuits of the amplifier can also give rise to oscillation even if each stage has been perfectly neutralized. For example, a four-stage amplifier having a gain of 10 per stage will oscillate if as much as 0.01 per cent of the output voltage succeeds in getting into the input circuit in the proper phase. Consequently multi-stage amplifiers of high over-all gain must be carefully shielded to avoid instability, particularly at the higher frequencies.

The oscillation of a single stage amplifier can occur only if the plate circuit is sufficiently inductive. If the impedance in the plate circuit is pure resistance or a condensive reactance, no oscillations can take place, although in the latter case anti-regenerative feed-back may occur of sufficient magnitude to greatly reduce the resultant gain. The effect of feed-back may be looked upon as being due to the input impedance Z_g of the grid-filament terminals of the tube. This impedance is of the form

$$Z_g = \pm r_g - j\frac{1}{\omega C_g} \quad (32)$$

When the plate circuit is inductive the sign of r_g is negative so that the tube is then capable of annulling part or all of the positive resistance of the associated input circuit. In the latter event, oscillations occur. The effect of the various circuit elements of Fig. 18 on Z_g is given by

$$Z_g = \frac{C_{gp} + C_{pf} - j\frac{1}{\omega}\left(\frac{1}{R_b \pm jX_b} + \frac{1}{r_p}\right)}{\frac{\mu C_{gp}}{r_p} + (C_{gf} + C_{gp})\left(\frac{1}{R_b \pm jX_b} + \frac{1}{r_p}\right) + j\omega(C_{gf}C_{gp} + C_{gp}C_{pf} + C_{pf}C_{gf})} \quad (33)$$

When Z_b is capacitive and has sufficient resistance associated with it, r_g is positive and the tube may introduce rather large losses into the input circuit, even though the grid is biased sufficiently negative so that no conductive grid current flows.

13. Methods of Avoiding Oscillation. Circuits designed to combat the effects of regeneration are of two general types. Either sufficient resistance is introduced into the input circuit to offset the negative resistance introduced by the tube, or else a suitable network of circuit elements is employed so as to electrically isolate the input and output circuits by making them two pairs of opposite points of an a-c bridge. The most common method of the first mentioned group is to insert a resistance of several hundred ohms in series with the grid of the tube. In a tuned amplifier designed to cover a range of frequencies this resistance must be sufficiently large to secure stability at the highest frequency, which means that it is much larger than necessary at the lower frequencies. This results in loss of amplification at these frequencies. In a number of instances where this method was used in commercial

receiving sets, only a part of the stability was secured in this fashion—the balance was obtained by utilizing some stray coupling, between the parts so that a bridge circuit in effect was produced. Another, although rather inefficient method, applies an adjustable positive bias to the grid of the tube by connecting the grid return lead to the arm of a potentiometer connected across the filament-heating battery.

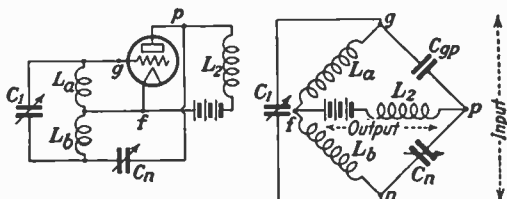

FIG. 19.—Rice neutralized amplifier.

14. Neutralizing Circuits. One form of bridge circuit due to C. W. Rice is shown in Fig. 19 where are given the actual circuit and the electrical equivalent with the tube electrodes omitted. The filament terminal of the tube, instead of being connected to the lower end of the input circuit, is connected to an intermediate point which divides the inductance into two parts, L_a and L_b . The lower terminal n of the input circuit is connected to the plate through a small balancing condenser C_n . The terminals g and n of the input circuit and f and p of the output circuit constitute two pairs of opposite points of a bridge. An inspection of the latter figure indicates that no voltage can exist across the input terminals gn due to a voltage between fp if the arms are balanced. Hence the energy which is fed back through C_{gp} is opposed in phase by that which flows through C_n . The conditions for a balance are

$$\frac{L_a}{L_b} = \frac{C_n}{C_{gp}} \quad (34)$$

This balance is not entirely independent of frequency as (34) would indicate unless the coupling between L_a and L_b is substantially unity. This

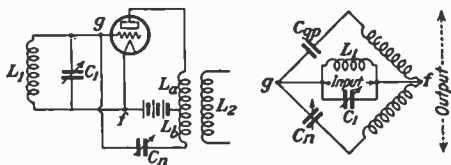

FIG. 20.—Hazeltine neutralized amplifier.

is because L_a is shunted by the input capacity of the tube. With certain arrangements a high-frequency parasitic oscillation may take place which will impair the performance of the amplifier at the frequencies for which it was designed. A small capacity of about the size of C_n shunted across L_2 will often prevent such parasites in receiving circuits.

The Rice circuit is commonly used in neutralizing r-f power amplifier circuits in transmitted sets.

Another form of balancing circuit due to L. A. Hazeltine known as the *Neurodyne* is shown in Fig. 20. This type of circuit applies the same principle to the output circuit as the previous method did to the input. The conditions for balance are the same as (34). The coupling between L_a and L_b should again be approximately unity if the circuit is to remain balanced for a wide range of frequencies with a fixed adjustment of C_n ,

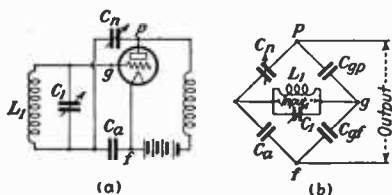

FIG. 21.—Capacity bridge neutralization of grid-plate capacity.

as L_a is shunted by the output impedance of the tube. This circuit has the advantage over the Rice circuit for receiving sets in that one set of plates of the tuning condenser is at filament or ground potential. This enables the rotors of the condensers to be mounted directly on a common shaft without requiring insulating bushings or couplings. A modification of this circuit has the neutralizing condenser C_n connected to a tap at some intermediate point in L_2 thus dispensing with the coil L_b . Lack of tight coupling between L_a and L_2 with this arrangement makes it more difficult to secure complete neutralization for a wide range of frequencies.

A circuit wherein all four of the bridge arms are condensers is shown in Fig. 21. The grid-plate capacity as well as the grid-filament capacity of the tube is involved, these two capacities serving as a pair of ratio arms. The conditions for a balance are

$$\frac{C_n}{C_a} = \frac{C_{gp}}{C_{gf}} \quad (35)$$

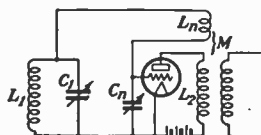

FIG. 22.—Mutual inductance bridge circuit.

The value of C_a is usually about $100\mu\mu\text{f}$, which requires a value of C_n somewhat larger in size than the neutralizing condensers of the preceding circuits. In order to avoid the accumulation of a charge on the grid which may cause the tube to "block," C_a is usually shunted by a 250,000-ohm grid leak. The distributed capacity of a suitable choke coil whose natural frequency is below the frequency to be amplified can also be substituted for the condenser C_a .

Another form of circuit involving the principle of a mutual inductance bridge is illustrated in Fig. 22. The conditions for a balance are

$$\frac{M}{L_2} = \frac{C_{gp}}{C_{gf} + C_n} \quad (36)$$

Since C_n is in parallel with the grid-filament capacity of the tube it is possible to utilize C_{gf} in place of an actual neutralizing condenser, C_n ,

and balance by proper adjustment of the mutual inductance between L_n and L_2 .

15. Neutralizing Adjustments. The most convenient method of neutralizing the above circuits is to tune the amplifier to a signal in the high-frequency range of the receiving set. The tube filament of the stage to be neutralized is then opened, usually by slipping a piece of paper between the filament pin and the filament terminal in the tube socket. This destroys the repeater action of the tube and converts that portion of the circuit into its equivalent electrical network. The neutralizing condenser is then adjusted until the signal disappears. The filament is then lighted and the procedure is repeated with the next stage.

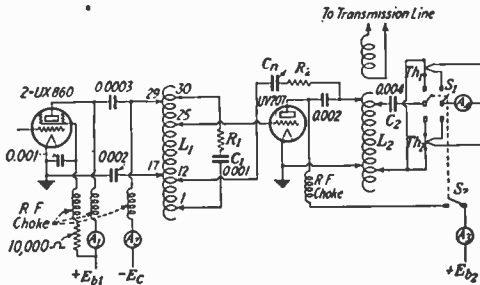

FIG. 23.—Broadcast transmitter power amplifier.

When stray couplings are present the value of balancing capacity required may vary with the frequency so that when exact neutralization is obtained at one frequency the stage may be sufficiently unbalanced at some other frequency so that oscillations occur. In this case a compromise adjustment of C_n must be found which will hold the stage out of oscillation for the entire tuning range. This may not be possible if considerable stray coupling is present together with high gain per stage.

16. Neutralizing Power Amplifiers. Radio-frequency power amplifiers such as are used in transmitting sets where sufficient power is available can be neutralized by means of a suitable r-f ammeter in the output tank circuit. In these circuits provision is usually made to remove the plate voltage from the tube to be neutralized rather than to switch off the filament.

Figure 23 shows the last two stages of power amplification of a typical 1-kw broadcast transmitter. The first stage consists of two 75-watt screen-grid tubes in parallel which require no neutralization. The second stage is neutralized by means of the condenser C_n which connects to the input tank circuit L_1C_1 at the point shown. The principle is the same as that of Fig. 17. The turns to which the various taps on L_1 are connected are indicated by the numbers. A 30-ohm resistance R_2 is connected in series with C_n to secure a more exact phase balance, since C_{op} of the tube will have some losses associated with it and will therefore have a phase angle of less than 90 degrees.

The neutralizing adjustment is made as follows: The switch S_1 is thrown to the top position inserting a low-range thermocouple Th_1 in the output

tank circuit L_2C_2 . At the same time the galvanometer A_1 is connected to the thermocouple and the plate circuit is opened by S_2 which is mechanically connected with S_1 . With excitation applied to the grid the balancing condenser C_n is then adjusted until A_1 reads zero. The switch S_1 is then thrown to the lower position, closing the plate circuit and inserting a high range thermocouple Th_2 in the tank circuit, and at the same time transferring A_1 .

17. Pentodes as Radio-frequency Amplifiers.

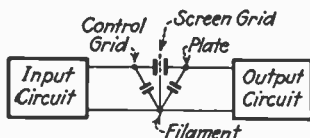

FIG. 24.—Elimination of coupling between input and output circuits by means of screen-grid tube.

are concerned, as will be seen from Fig. 24.

In r-f pentodes the suppressor grid is of further assistance in reducing this capacity and values of C_{gp} of $0.01 \mu\mu\text{f}$, or less, are obtained. Feedback of amplified output energy through the tube is thereby reduced to the point where stable operation with fair gain can be obtained at wave lengths of a few meters. These tubes may oscillate, if too high a value of gain per stage is attempted. Capacitive coupling between grid and plate leads external to the tube must be carefully avoided by the use of adequate shielding.

The majority of these tubes for receiving purposes are of the remote cut-off or variable- μ type.¹ This feature enables a variable negative bias to be impressed on the control grid as a means of volume control without producing cross-modulation and distortion when strong local signals are being received. With the conventional type of tube on strong signals the bias would have to be adjusted almost to cut-off in order to reduce the mutual conductance sufficiently to avoid overloading the last stage. Serious distortion of the modulated envelope would result if the tube were operated in this region of high curvature.

18. Radio-frequency Power Amplifiers. The low output and plate efficiency of class A amplifiers preclude their use in transmitters, and class B or class C operation is employed.

Class B amplifiers are operated with a negative bias approximately equal to cut-off so that the plate current is almost zero when the alternating grid excitation is removed. With a sinusoidal voltage applied to the grid the plate current consists of a series of half-sine waves, similar to the output of a half-wave rectifier. The load impedance is adjusted so as to obtain an approximately linear dynamic characteristic, as shown in Fig. 25. The grid swings positive on excitation peaks, causing grid current to flow. Class B amplifiers are used in radio-telephone transmitters following the modulated stage. The power output obtainable from a given tube is much greater than with class A

¹ BALLANTINE and SNOW. Reduction of Distortion and Cross-talk in Radio Receivers by Means of Variable- μ Tetrodes. *Proc. I.R.E.*, 18, 2102, December, 1930.

operation and the plate efficiency is much higher, having a theoretical maximum value of 78.54 per cent. As with a-f power amplifiers, tubes operating as class B r-f amplifiers may also be operated in push-pull.

A class C amplifier is one in which high output and plate efficiency are the primary considerations. The grid is negatively biased to a

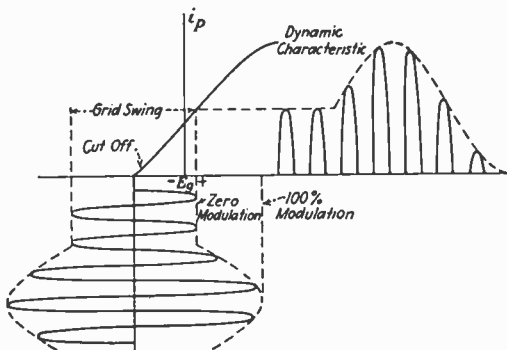

FIG. 25.—Characteristics of class B amplification.

point considerably beyond cut-off, as shown in Fig. 26, so that the plate current is zero with no grid excitation. The latter is quite large and is often sufficient to cause the plate current to reach saturation on positive swings. Plate efficiencies in the vicinity of 90 per cent may be obtained with the larger tubes. These high efficiencies are made possible by allowing the plate current to flow during less than 180 deg. of the cycle, and only at a time when the plate potential is comparatively low. In radio-telegraph transmitters all stages are operated class C, while with radio telephony only the modulated amplifier and the stages preceding it are so operated.

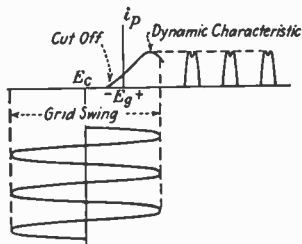

FIG. 26.—Class C operation.

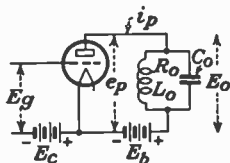

FIG. 27.—Schematic circuit of r-f power amplifier.

The plate-current wave shapes in both cases are badly distorted, particularly with class C operation, and the output contains both odd and even harmonics. However, the tank circuit L_oC_o in Fig. 27 is resonant to the fundamental to which it offers a high impedance of the

nature of a pure resistance. The impedance offered to the plate-current harmonics diminishes rapidly with the order of the latter so that the voltage drop E_o across the tank circuit is very nearly sinusoidal in shape. The instantaneous plate voltage e_p will be the algebraic difference between the plate-supply voltage E_b and the drop E_o across the load.

Either triodes or screen-grid tetrodes may be used as power amplifiers. The latter have the advantage of not requiring neutralization. The screen-grid voltage in transmitting tubes is usually about 15 per cent of the plate-supply voltage, which is proportionally much lower than in receiving tubes. These tubes are difficult to construct for power outputs much greater than 500 watts, and, where larger outputs are required, triodes must be used.

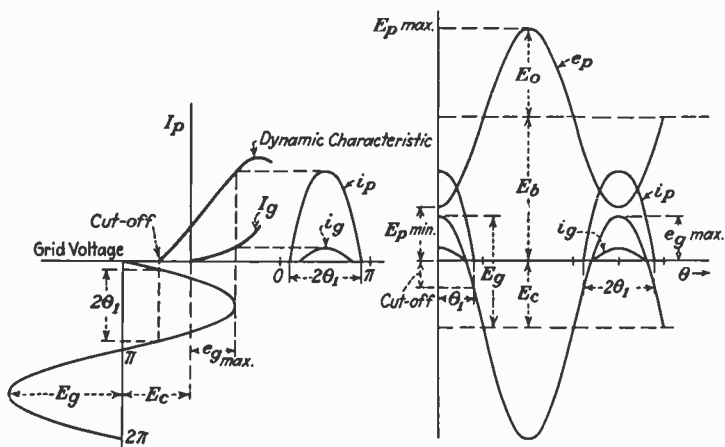

FIG. 28.—Instantaneous values of current and voltage in Class C amplifier.

19. Current and Voltage Relations. The instantaneous current and voltage relations for a class C amplifier are shown in Fig. 28. The potential e_p of the plate with respect to the filament is at a minimum during the time plate current is actually flowing. The power loss within the tube will be equal to the product of e_p and i_p averaged over a complete cycle. It is evident from Fig. 28 that this loss can be kept small by limiting the angle $2\theta_1$ during which time plate current actually flows. This will vary from 180 deg. in the case of a class B amplifier to perhaps as low as 60 deg. for class C operation. It will also be noted that the grid-excitation voltage E_g is at its positive maximum when the plate voltage is a minimum. The minimum plate voltage should not be allowed to fall below the value of $e_{g \text{ max}}$, if excessive grid current is to be avoided. Ordinarily $e_{g \text{ max}}$ is limited to about 80 per cent $E_{p \text{ min}}$.

20. Circuit Calculations. In the design of a power amplifier the given data will include the frequency, the type of tube to be used, and the plate-supply voltage. The minimum plate voltage and the maximum positive value of

the grid voltage are then selected, also the angle θ_1 . The required grid-excitation voltage will be

$$E_g = \frac{E_b}{\mu} + \frac{1}{1 - \cos \theta_1} \left(\frac{E_p \text{ min.} \cos \theta_1}{\mu} + e_g \text{ max.} \right) \quad (37)$$

The required C bias will be

$$E_c = E_g - e_g \text{ max.} \quad (38)$$

and the voltage across the tank circuit is given by

$$E_0 = E_b - E_p \text{ min.} \quad (39)$$

Corresponding pairs of plate and grid voltages can then be computed for increments of 5 or 10 deg. over the time interval $2\theta_1$ during which plate current flows. Since the various current and voltage waves are symmetrical on either side of the vertical axis, it is only necessary to do this from zero to θ_1 . A suitable table for this purpose is given below.

TABLE I

Given data:		Assumed values:			Computed values:		
Tube.....		$E_p \text{ min.}$			E_g		Eq. (37)
μ		$e_g \text{ max.}$			E_c		Eq. (38)
E_b		θ_1			E_0		Eq. (39)

	θ	0°	10°	20°	30°	40°	θ_1
1	θ						
2	$\cos \theta$	1	0.9848	0.9397	0.8660	0.7660	
3	$E_0 \cos \theta$						
4	$e_p = E_b - E_0 \cos \theta$						
5	$E_g \cos \theta$						
6	$e_g = E_g \cos \theta - E_c$						
7	i_p	y_0	y_1	y_2	y_3	y_4	0
8	i_p	0
9	$i_p \cos \theta$	y_0'	y_1'	y_2'	y_3'	y_4'	0
10	$i_p \cos \theta$	0

The values of plate and grid currents in lines 7 and 8 are obtained from the static characteristics of the tube for the computed pairs of instantaneous values of e_p and e_g in lines 4 and 6. The grid-current characteristic will also be necessary if the power required for grid excitation is to be determined.

The d-c component of plate current I_b will be the average value of i_p over a complete cycle and is given by

$$I_b = \frac{1}{18} \left(\frac{y_0}{2} + y_1 + y_2 + \dots + y_{n-1} \right) \quad (40)$$

using the trapezoidal rule to determine the area under the curve for i_p . If 5-deg. intervals are used in Table I the coefficient of Eq. (40) would be $\frac{1}{18}$.

The d-c component of grid current I_c can be found in a similar manner by substituting as ordinates the items of line 8 in Eq. (40).

The maximum amplitude of the fundamental component of the plate current is given by

$$\begin{aligned} I_{p1} &= \frac{2}{\pi} \int_0^\pi i_p \cos \theta d\theta \\ &= \frac{1}{9} \left(\frac{y_0'}{2} + y_1' + y_2' + \dots + y_{n-1}' \right) \end{aligned} \quad (40a)$$

using the trapezoidal rule to evaluate the definite integral. If 5-deg. intervals are used in Table I the coefficient of Eq. (40a) becomes $\frac{1}{18}$.

The maximum amplitude of the fundamental component I_{g1} of the grid current can be obtained in the same way by substituting the items of line 10 in Eq. (40a).

21. Power Relations. The d-c power supplied to the circuit from the source of E_b is

$$P_{\text{input}} = E_b I_b \quad (41)$$

The power output to the tank circuit at the fundamental frequency is

$$P_{\text{tank}} = \frac{E_o I_{p1}}{2} \quad (42)$$

since the tank impedance is of the nature of a pure resistance R_b at resonance. The required value of R_b is evidently

$$R_b = \frac{E_o}{I_{p1}} \quad (43)$$

and is related to the constants of the tank circuit by

$$R_b = \frac{L_o}{C_o R_o} \quad (44)$$

where R_o is the apparent resistance of the tank coil and includes coupled resistance introduced by the useful load which is either inductively or conductively coupled to the tank coil. In the circuit of Fig. 27 the value of coupled resistance reflected into the tank coil would be the power absorbed from the tank divided by the square of the oscillatory tank current.

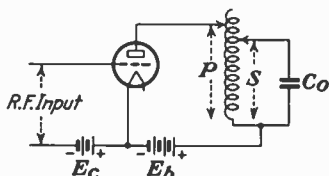

FIG. 29.—Tank-circuit inductance used as autotransformer to vary load impedance.

impedance of the tank circuit may be varied by varying the ratio of L_o to C_o . As the latter item is often a mica condenser of fixed capacity, a variation may be made in the value of R_b by using the tank inductance as an autotransformer, as illustrated in Fig. 29. The ratio of transformation will be approximately the turns ratio P/S , and, by moving the plate tap so as to alter the number of turns included in P , it is possible to change the load impedance as viewed from the tube by the square of the transformation ratio.

The power input to the grid is

$$P_{\text{grid input}} = \frac{E_g I_{g1}}{2} \quad (45)$$

The power amplification will be Eq. (42) divided by Eq. (45) and is

$$G_p = \frac{E_o I_{p1}}{E_g I_{g1}} \quad (46)$$

Power amplifiers are practically always operated with a fixed-bias voltage E_c instead of being self-biased by means of a grid leak and condenser, as with oscillators. This is because in the event of failure of the excitation voltage the self-bias would no longer function and the tube would be injured. A portion of the power input to the grid would be consumed across E_c and would charge the bias battery, if one were used. This power lost across the bias is $E_c I_c$, and the power consumed within the tube due to the flow of grid current is

$$P_g = \frac{E_g I_{g1}}{2} - E_c I_c \quad (47)$$

Since the grid is enclosed by the plate, the heating of the grid by P_g must be radiated by the plate in addition to its own losses.

The power loss within the tube which is to be dissipated at the plate in the form of heat, exclusive of the power loss in the filament, is

$$\text{Tube loss} = E_b I_b - \frac{E_o I_{p1}}{2} + \frac{E_g I_{g1}}{2} - E_c I_c \quad (48)$$

This expression may be used to check the assumed operating conditions from the standpoint of allowable plate dissipation.

The plate efficiency is defined as the ratio of the output to the tank circuit, to the power supplied to the plate, and is given by

$$\text{Plate efficiency} = \frac{E_o I_{p1}}{2 E_b I_b} \quad (49)$$

With the allowable plate dissipation fixed, a moderate improvement in the plate efficiency will materially increase the useful output and the maximum output will be obtained when the plate efficiency is made a maximum.

The effective value of the oscillatory current in the tank will be

$$I_L = \frac{E_o}{\sqrt{2(R_o^2 + \omega^2 L_o^2)}} \quad (50)$$

Where the effective value of Q for the coil is high, the currents in the coil and condenser are approximately the same and will be given with sufficient accuracy for most purposes by

$$I_L = I_c = E_o \omega C_o = \frac{E_o}{\omega L_o} \quad (51)$$

The preceding discussion has been based upon the series-fed circuit of Fig. 27, but the same equations and method of analysis will likewise apply to the case of parallel-feed in Fig. 23. This latter arrangement is the one usually employed.

22. Class B Amplifiers. In order not to distort the envelope of the applied modulated wave in Fig. 25 the dynamic characteristic must be essentially linear and the operating conditions are chosen so as to bring this about. When this is the case, the maximum amplitude of the fundamental component of the plate current is given by

$$I_{p1} = \frac{\mu E_0}{2r_p + R_b} \quad (52)$$

to a fair degree of approximation. The d-c component of plate current will then be

$$I_b = \frac{2}{\pi} I_{p1} = 0.637 I_{p1} \quad (53)$$

The plate efficiency, from Eq. (49), becomes

$$\text{Plate efficiency} = \frac{E_0 I_{p1}}{2 E_b I_b} = \frac{\pi E_0}{4 E_b} \quad (54)$$

Since E_0 approaches E_b as a limiting value, it follows that the plate efficiency of a class B amplifier approaches 78.54 per cent as a limiting value. In actual practice it is usually about 70 per cent on excitation peaks at 100 per cent modulation, and falls to about 33 per cent when the applied excitation voltage is unmodulated.

23. Tuning Adjustments. The tank circuit should always be adjusted to unity power factor so that minimum plate voltage may coincide with maximum plate current. A departure from this relation will lower the plate efficiency. This adjustment is usually made by tuning the tank circuit for minimum d-c plate current. Strictly speaking, minimum I_b may be used as an accurate measure of unity power factor only when C_0 of the tank is the element varied. The usual tuning adjustment is L_0 , which is varied by means of a copper or aluminum disk rotated within the tank coil and acts as a single short-circuited turn. In this case maximum impedance will not occur at unity power factor, and L_0 should be adjusted to a value slightly lower than that which produces minimum I_b . If the effective value of Q for the tank is fairly high, the adjustments for maximum impedance and unity power factor practically coincide, in which case the circuit may be adjusted for minimum plate current with either tuning element the variable.

24. Modulated Amplifiers. If an a-f voltage is superimposed upon the d-c plate-supply voltage E_b of a class C amplifier having constant r-f excitation applied to its grid, the tank current I_0 may be made to rise and fall in amplitude as illustrated in Fig. 30. The schematic diagram of the circuit is shown in Fig. 31. A linear relation must exist between tank current and plate voltage if distortion is to be avoided. The relation between the plate voltage and I_b should also be fairly linear so that the modulator tube supplying the a-f power shall work into a constant load resistance, which will be equal to E_b/I_b , or, in general, $\Delta E_b/\Delta I_b$.

The grid excitation, grid bias, and tank-circuit impedance are adjusted so as to obtain the desired linear relations. The adjustments may be checked by varying E_b from zero to twice normal value and plotting I_0 and I_b against E_b as in Fig. 30. The value of plate-supply voltage impressed upon the modulated amplifier is somewhat lower than the normal value used for unmodulated operation in order to avoid excessive plate heating on modulation peaks. The grid bias E_c required is approximately twice the value of cut-off for the tube and the tank impedance is usually higher than with unmodulated operation. The plate efficiency

is lower than with unmodulated amplifiers and is usually in the neighborhood of 60 per cent, depending upon the size of the tube used. Either triodes or tetrodes may be used.

The continuous power output with 100 per cent modulation is 1.5 times the power at zero modulation. The output on modulation peaks

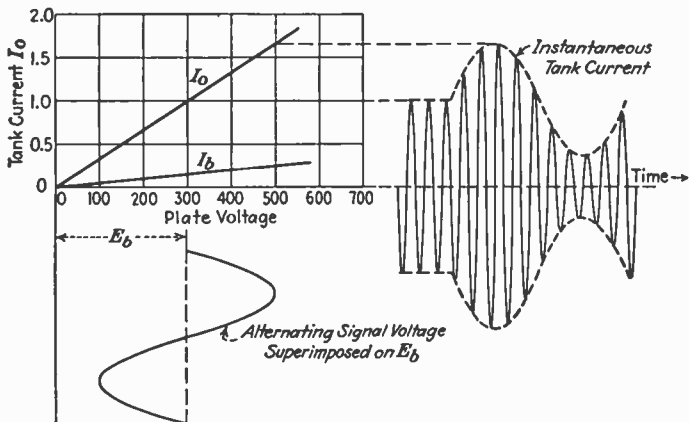

FIG. 30.—Modulation of Class C amplifier by superimposing a-f signal-voltage on plate-supply voltage.

will be four times the unmodulated carrier output. This increase in the power output when modulated must be furnished by the a-f input from the modulator tubes. The amount of a-f power required varies with the square of the modulating factor, so that the modulator tubes must be capable of furnishing a sizable amount of audio power if 100 per cent modulation is to be attained.

While the plate-modulated amplifier has been the most widely used, other methods requiring very much less audio power can be employed. Instead of varying the voltage applied to the plate of the modulated amplifier, it is possible to secure similar results by varying the magnitude of the C bias at an a-f rate. The schematic circuit is shown in Fig. 32, together with the details of operation. The signal voltage cyclically adds to and subtracts from the fixed biasing voltage E_c , causing the amplitude of the plate-current impulses to rise and fall. The plate-current wave shapes will be similar to those of the class B amplifier of Fig. 25, except that the angle 2θ , during which plate current flows will vary with the modulation. The mode of operation changes from an underexcited class C amplifier when unmodulated to a class B amplifier

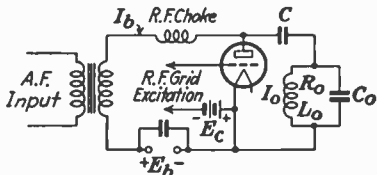

FIG. 31.—Plate-modulated Class C amplifier.

on modulation peaks, assuming complete modulation. The advantage of this method over plate modulation is that very little a-f energy is required for complete modulation. The modulating source is only required to furnish a portion of the grid-excitation losses of the amplifier

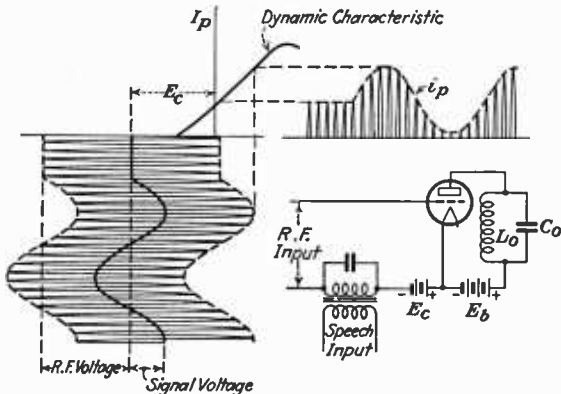

FIG. 32.—Schematic circuit and operation details of grid-modulated amplifier.

in this case. The plate efficiency is somewhat lower and freedom from distortion is more difficult to secure.

Another method is to insert the modulating voltage in the suppressor-grid circuit of a screen-grid type of power pentode operating as a class C amplifier, as shown in Fig. 33. The suppressor grid is biased negatively by a moderate amount and swings positive on modulation peaks, during which time suppressor-grid current flows. The power represented by this current has to be furnished by the modulating source, but it is negligible in comparison to the demands of a plate-modulated

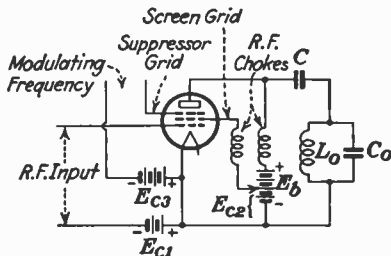

FIG. 33.—Screen-grid pentode used as modulated Class C amplifier.

amplifier. The distortion is low with moderately high percentages of modulation but becomes appreciable at 100 per cent.

25. Frequency Multipliers. The plate current of a class C amplifier is badly distorted and contains a large percentage of harmonics. It

is possible to resonate the tank circuit to one of these harmonics and cause it to absorb power at the harmonic frequency. The impedance offered to the fundamental and the balance of the harmonics will be small so that little power will be absorbed at these frequencies.

Frequency multipliers are used to obtain higher frequencies than can be readily produced by crystal-controlled oscillators. Quartz crystals for high frequencies become rather fragile and are apt to crack in service. To secure crystal control of the frequency in the case of short-wave transmitters, the crystal is ground to oscillate at some low-frequency multiple of the transmitted frequency. The output of the crystal-controlled oscillator is then impressed on one or more amplifiers connected in cascade and adjusted to multiply the frequency. The usual practice is to double the frequency with each stage, and, while greater multiplications than this can be obtained, the output falls off rapidly as higher multiplications per stage are attempted. A class C amplifier having a plate efficiency of 80 per cent would show an efficiency of about 70 per cent when used as a frequency doubler. The instantaneous current and voltage relations in a frequency doubler will be similar to Fig. 28 except that the frequency of e_p will be twice as great and will therefore be low in value for a shorter time interval. This requires a smaller value of θ_1 in order to keep the losses within the tube small. These losses are proportional to the product of the instantaneous values of e_p and i_p and can be minimized by restricting the flow of plate current to a smaller interval of time. This calls for values of E_b and E_c somewhat higher than with the conventional type of class C amplifier. Either triodes or tetrodes can be used. The former will not need to be neutralized, as the input and output circuits are tuned to different frequencies and hence will not oscillate.

SECTION 13

RECEIVING SYSTEMS

BY G. L. BEERS, B.S.¹

1. Classification. The following is a classification of radio receivers according to their operating principle.

1. Tuned-radio-frequency.
2. Superheterodyne.
3. Regenerative.
4. Superregenerative.

2. Tuned-radio-frequency Receivers. Tuned-radio-frequency (t-r-f) receivers are those which obtain their selectivity and r-f amplification through the use of circuits which function at the frequency of the incoming signal.

Tuned r-f receivers use from two to six circuits which are tuned simultaneously by means of a single tuning control. A gang condenser which consists of several variable condensers assembled in a single unit is used to vary the frequency of the tuned circuits. The series resistance of a conventional tuned circuit, whose frequency is varied by means of a variable condenser, increases with frequency. The selectivity of t-r-f broadcast receivers varies in a ratio of about three to one from one end of the broadcast range to the other. One or two of the tuned circuits in a t-r-f receiver are generally used in the antenna-input system and the remainder are used to provide the coupling between the stages of the radio-frequency amplifier. Screen-grid tubes are used almost universally in the r-f amplifier. A grid-leak and condenser detector or negatively biased detector and one or two stages of audio-frequency amplification are used in the audio portion of the receiver. Tuned r-f receivers are best suited for use where the selectivity requirements are not extreme.

3. Superheterodyne Receivers. In the superheterodyne receiver the received voltage is combined with a voltage from a local oscillator and converted into a voltage of a lower or intermediate frequency which is then amplified and detected to reproduce the original signal wave.

The superheterodyne receiver utilizes the essential components of a t-r-f receiver, and in addition, a frequency converter and intermediate-frequency (i-f) amplifier. The frequency converter consists of a variable-frequency oscillator and a detector. The function of the frequency converter is to change the frequency of the received signal to the intermediate frequency. The oscillator and t-r-f circuits in superheterodyne receivers are usually tuned simultaneously by means of a gang con-

¹ Engineering Department, RCA Manufacturing Company, RCA Victor Division, Camden, N. J.

denser. Through the use of a combination of fixed shunt and series condensers the oscillator is made to maintain a constant-frequency difference from the r-f circuits although the variable condensers for tuning each of these circuits are identical in capacity. The i-f amplifier uses two or three transformers, which usually contain two coupled circuits with the coupling adjusted to provide the so-called band-pass filter characteristics. The i-f amplifier provides the major portion of the amplification and selectivity. Since the characteristics of this amplifier are independent of the frequency to which the receiver is tuned, the sensitivity and selectivity of a superheterodyne receiver are usually very uniform throughout its tuning range. The r-f circuits are used primarily for eliminating certain types of interference which are common to this type of receiver. The performance of the superheterodyne receiver is in general superior to that of any other type of receiver in use today.

4. Regenerative Receivers. In a regenerative receiver the following action takes place: The received voltage is impressed on the grid of a vacuum tube. A portion of the resultant voltage which appears in the plate circuit of the tube is fed back to the grid circuit in the proper phase relation to increase the applied grid voltage. The effect of this action is to reduce the effective resistance of the resonant circuit to which the signal is applied and, thereby, provide considerable amplification of the received signal.

Regenerative receivers are usually provided with two controls, one for tuning the receiver and the other for controlling the amount of feed-back energy. If the feed-back is increased beyond a certain value, sustained oscillations are produced. It is common practice to tune regenerative receivers while sustained oscillations are being produced, as the beat frequency produced between the carrier wave of the transmitting station and the locally produced oscillations indicates when the receiver is properly tuned. This method of tuning is called the "zero-beat" method as the tuning of the receiver is adjusted so that the beat note decreases in frequency till it is no longer audible. When a conventional regenerative receiver is tuned in this way interference is produced in nearby receivers which are tuned to the same station. A stage of tuned r-f amplification is sometimes used between the antenna and the regenerative circuit to reduce the possibility of producing this type of interference. The regenerative receiver is quite sensitive considering the number of tubes which are used. It is not very selective since only a single tuned circuit is generally used. They are now practically obsolete as broadcast receivers, although they are still used to a limited extent in short-wave work.

5. Superregenerative Receivers. A superregenerative receiver is a regenerative receiver in which sustained oscillations are prevented by the periodic variation of the effective resistance of the resonant circuit to which the received signal is applied.

In the superregenerative receiver oscillations are permitted to build up at a periodic rate in a resonant circuit tuned to the frequency of the received signal wave. Sustained oscillations in this circuit are prevented by the application of a quenching frequency potential to the grid of the superregenerative tube which periodically affects the tube characteristics in such a way as to stop the oscillations. The quenching frequency may be supplied either by a separate oscillator or by the super-

regenerative tube itself. The audio system of this type of receiver is usually provided with an a-f filter to remove the quenching frequency from the audio output. An r-f stage is frequently used ahead of the detector to prevent energy being transferred from the superregenerative circuit to the antenna. The superregenerator is used in police automobile receivers for frequencies near 30 Mc. A signal input of 50 to 100 μv will give an intelligible signal, although an input of 500 to 1000 μv is generally necessary to reduce the noise to a satisfactory value. Harmonics of the quench frequency beating with the received signal make a source of interference if the ratio between signal and quench frequencies is not 100:1 or more.

6. Method of Rating. Receiving sets are generally rated on the basis of the following characteristics: (1) sensitivity; (2) selectivity; (3) fidelity; (4) overload level; (5) power consumed.

1. The *sensitivity* is that characteristic which determines to how weak a signal it is capable of responding. It is measured quantitatively in terms of the input voltage required to give a standard output.

2. The *selectivity* is the degree to which the receiver is capable of differentiating between the desired signal and signals of other carrier frequencies. This characteristic is not expressible by a single numerical value but requires one or more graphs for its expression.

3. The *fidelity* of a radio receiver is the degree to which it accurately reproduces at its output terminals the signal which is impressed upon it. As applied to a radio receiver, fidelity is measured by the accuracy of reproduction at the output terminals of the modulation of the received wave.

4. The *overload level* of a receiver is the maximum power output which can be obtained from it when the output voltage does not contain more than ten per cent of total harmonics.

7. Method of Testing. A standardized method of testing radio receivers has been established by the Institute of Radio Engineers and is described in detail in the Year Book of the Institute. The following is a brief summary of the procedure.

1. *Definition of Terms.*

a. Sensitivity, selectivity, fidelity and maximum undistorted output (see Method of Rating).

b. Normal test output: An a-f power output of 0.05 watt in a non-inductive resistor connected across the output terminals of the receiver is the normal test output for a broadcast radio receiver. The output resistor should have the value recommended by the tube manufacturer to obtain maximum undistorted output power for the type of output tube used.

c. Normal radio-input voltage: This term represents the r-m-s r-f voltage modulated 30 per cent at 400 cycles which results in normal test output at resonance.

d. Standard test frequencies: In the testing of a broadcast radio receiver, the five standard carrier frequencies are 600, 800, 1,000, 1,200, and 1,400 kc. When tests at only three carrier frequencies are required, the carrier frequencies of 600, 1,000, and 1,400 kc are used.

2. *Equipment Required.*

a. A signal generator: This consists of a shielded vacuum-tube oscillator whose frequency can be varied from 500 to 1,500 kc. An a-f oscillator is provided to modulate the r-f oscillator by a known amount at any frequency from 40 to 10,000 cycles. A calibrated resistance-type attenuator is used to impress a known potential on the standard antenna connected to the receiver. The attenuator system should be such as to allow a range of voltage impressed on the standard antenna unit from 1 μv to 200,000 μv .

b. Standard antenna: The standard antenna for a broadcast radio receiver not having a self-contained antenna is an antenna having in series a capacity of 200 μmf and a self-inductance of 20 μh and a resistance of 25 ohms.

c. Output-measuring circuit: This consists of a load resistor, output filter and vacuum-tube voltmeter. The output resistor should be adjustable to any desired value between 1 and 20,000 ohms and capable of dissipating 10 watts. An output filter is provided for preventing the flow of d.c. through the load resistor when testing sets which normally have d.c. in their output circuit. A vacuum-tube voltmeter or equivalent device is used for determining accurately the r-m-s voltage across the load resistor.

d. Harmonic-measuring circuit: For this purpose a harmonic analyzer capable of measuring frequencies up to 15,000 cycles is recommended. The instrument should have sufficient frequency discrimination to measure harmonics which are 0.5 per cent or less of the fundamental.

3. Tests.

a. Sensitivity: The sensitivity is determined by impressing an r-f voltage, with 400 cycles, 30 per cent modulation, in series with a standard antenna and adjusting the intensity of the input voltage until normal test output is obtained for carrier frequencies between 550 and 1,500 kc.

b. Selectivity: The selectivity of a receiver is determined by tuning it to each test frequency in succession with the receiver in the same condition as in the sensitivity test and measuring the r-f input necessary to give normal test output at steps not greater than 10 kc at least up to 100 kc on either side of resonance or until the radio-input voltage has increased to ten thousand times or more if the measuring equipment permits.

d. Fidelity: This is determined by tuning the radio receiver to each standard test frequency in succession with the receiver in the same condition as in the sensitivity and selectivity tests, adjusting the impressed voltage to the normal radio-input voltage and then varying the modulation frequency from 40 to 10,000 cycles at 30 per cent modulation and constant r-f input voltage throughout, taking readings of relative output voltage at convenient modulation frequencies.

4. Additional Tests.

a. Determination of the overload level: This is determined by increasing in successive steps the r-f input to the receiver (with modulation adjusted to 30 per cent at 400 cycles) and measuring both the power output and the percentage harmonics. The overload level of the receiver is the maximum power output obtained from it when the output voltage does not contain more than 10 per cent of total harmonics.

b. Volume-control tests: This test is a determination of the effect of the volume control on the sensitivity, selectivity, and fidelity.

c. Test for hum: For determining the hum voltage, a filter is connected between the output of the receiver and the voltmeter. This filter has a characteristic which evaluates the various hum components according to their quantitative effect on the human ear.

8. Design of Receiving Systems. The majority of receiving sets in use today are broadcast receivers designed to cover the frequency range of from 550 to 1,500 kc. The essential electrical elements of a modern broadcast receiver may be classified as follows:

1. Radio-frequency system.
2. Audio-frequency system.
3. Volume-control system.
4. Power-supply system.
5. Loud-speaker.

9. Radio-frequency System. Antenna-input Systems. The antenna-input system transfers the signal wave intercepted by the antenna to

the grid of the first tube in the receiver. The antenna-input system also contributes to the over-all performance as follows:

1. One or more t-r-f circuits in the antenna-input system provide selectivity for the separation of stations as well as the prevention of cross modulation.
2. A reduction in tube noise for a given sensitivity is obtained through the step-up in voltage provided by the use of tuned circuits in antenna-input systems.

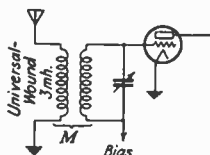

FIG. 1.—Antenna-input system.

A typical antenna-input system is illustrated in Fig. 1. Since there is considerable variation in the characteristics of receiving antennas used the value of the antenna-coupling inductance is chosen so that the antenna system is always tuned to a frequency below the tuning range of the receiver. If the antenna circuit becomes resonant in the tuning range of the receiver, the first tuned circuit in a uncontrolled receiver will be thrown out of alignment with the remainder of the receiver and the over-all performance will be seriously affected. Figure 2 shows the voltage step-up between the antenna and the

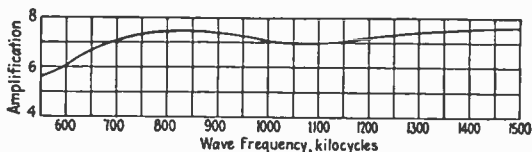

FIG. 2.—Amplification of input system of Fig. 1.

grid of the first tube which is obtained from such an arrangement. Two coupled tuned circuits are sometimes used between the antenna and the grid of the first tube. This reduces the voltage gain to approximately half that obtained with the single tuned circuit but increases the selectivity and therefore reduces the possibility of cross modulation in the first tube of the receiver. An antenna-input system is shown in Fig. 3, which provides considerably greater coupling between the antenna and the first tuned circuit. This system is employed in automobile receivers where the signal intercepted by the antenna is usually quite small. By connecting a small inductance in series with the antenna so that a series-tuned circuit is formed which is resonant at approximately 2,000 kc this system will provide a voltage gain which varies from 10 at 600 kc to 20 at 1,400 kc.

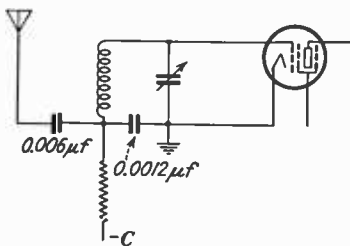

FIG. 3.—Closely coupled antenna-input system.

10. Radio-frequency Amplifiers. The types of r-f amplifiers in use in broadcast receivers may be classified as tuned, fixed-tuned, and untuned.

Tuned r-f amplifiers are those which amplify a narrow band of frequencies and are provided with a control by which the position of this band of frequencies may be moved over a wide frequency range.

Untuned r-f amplifiers are not provided with a tuning control and are designed to amplify a wide band of frequencies.

Fixed-tuned r-f amplifiers are those which pass a narrow band of frequencies and whose resonant frequency is not varied with the tuning of the receiver. The intermediate-frequency amplifier of a superheterodyne receiver is an amplifier of this type.

11. Single-tuned Circuit T-R-F Amplifiers. The selectivity and amplification which can be obtained from a conventional t-r-f amplifier stage are a function of the effective resistance of the tuned circuit used in the interstage transformer. Since the selectivity provided by a t-r-f amplifier cannot be increased beyond a certain limit without serious attenuation of the high-modulation frequencies, the useful amplification which can be obtained from an amplifier stage is therefore limited. The selectivity and amplification which a t-r-f amplifier will provide can be calculated. From a practical standpoint of receiver design, however, it usually requires less time and is more accurate to determine the characteristics of a particular transformer experimentally by laboratory measurements since a determination of the effective resistance of the tuned circuit is necessary even if the characteristics of the transformer are to be calculated. It is likewise difficult to take into consideration the effects of regeneration and the proximity of shielding, etc., in a mathematical consideration of r-f transformer characteristics. The ratio of reactance to effective resistance or $\omega L/R$ of the tuned circuits used in r-f transformers for broadcast receivers is usually between 100 and 150 throughout the broadcast frequency range. The diameter of the coils used in the t-r-f circuits of broadcast receivers varies from $\frac{5}{8}$ to 2 in. and the size of the copper wire used for winding the coils is usually between Nos. 20 and 35 B. & S., the larger wire being used in the short-wave coils of "all-wave" receivers.

12. Screen-grid Tubes. All modern broadcast receivers employ screen-grid tubes in the r-f amplifiers and the following advantages are gained through their use:

1. No neutralization of grid-plate capacity is required, since the grid-plate capacity of the screen-grid tube is usually less than $0.01 \mu\text{mf}$.

2. The high plate impedance (500,000 ohms) of this type of tube produces a negligible effect on the selectivity of the tuned circuits used in t-r-f amplifiers.

3. Higher amplification per stage can be obtained due to the high impedance and high transconductance of this type of tube.

Considerable shielding is required in screen-grid r-f amplifiers to prevent coupling between circuit elements and wiring which may likewise cause oscillations. It is common practice to locate the grid circuits and plate circuits associated with each tube in separate metal compartments to prevent coupling between them.

Figure 4 illustrates the type of t-r-f transformer which is used in the majority of broadcast receivers. The primary of the transformer is a small "universal-wound" coil which is either wound on a form of small

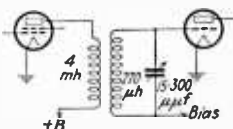

FIG. 4.—T-r-f interstage transformer.

diameter so that it can be mounted inside the secondary or is wound directly on the end of the same form as the secondary. The secondary is wound on a piece of tubing made of bakelite or some similar material.

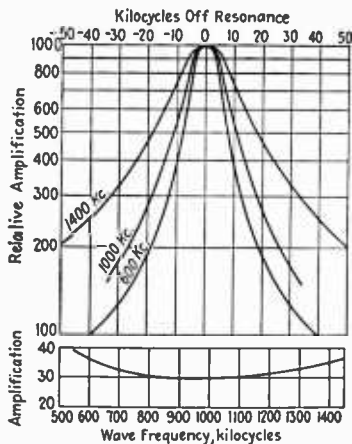

FIG. 5.—Characteristics of transformer in Fig. 4.

The primary is coupled electromagnetically to the secondary. The amplification and selectivity characteristics obtained with this transformer when used with an r-f pentode, having a transconductance of 1,000 micromhos, are shown in Fig. 5.

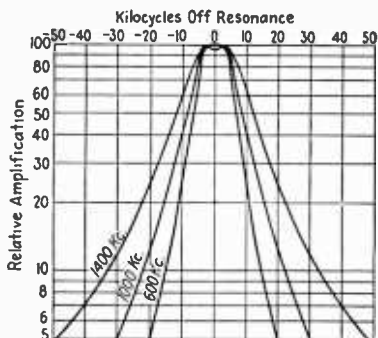

FIG. 7.—Selectivity characteristics of coupled tuned-circuit t-r-f transformer.

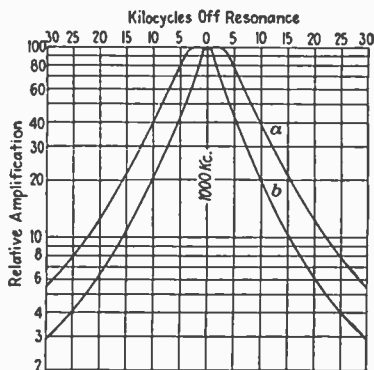

FIG. 6.—Selectivity comparison of single and coupled tuned circuits.

tuned-circuit transformer depends on the coupling between the two circuits. The flatness of the top of the curve depends on the effec-

13. Coupled Tuned-circuit T-R-F Amplifiers. A number of broadcast receivers use one or more transformers in which two tuned circuits are used. The two circuits are coupled near the point of critical coupling. The advantage obtained through the use of this type of transformer is that a considerable improvement is obtained in the shape of the selectivity characteristic. Figure 6 illustrates this improvement. Curve *a* shows the characteristic obtained with two coupled tuned circuits, and curve *b* shows the characteristic obtained with two similar tuned circuits in cascade. The width of the top of the resonance curve of a coupled

tive resistance of the tuned circuits. By using slightly greater than critical coupling at the low-frequency end of the broadcast range and less at the high-frequency end of the range, the selectivity of this type of transformer can be made more uniform over the broadcast range than one using a single tuned circuit. Figure 7 shows the selectivity characteristic obtained from a transformer of this type. The voltage gain provided by a coupled tuned-circuit t-r-f transformer is approximately one-half that which can be obtained from a transformer using a single tuned circuit.

14. Untuned R-F Amplifiers. A stage of fixed-tuned r-f amplification is sometimes used in receivers where additional gain is desired without the need for the additional selectivity which would be provided by a stage of t-r-f amplification. A transformer of this type is frequently used to provide a receiver with a more uniform over-all sensitivity characteristic throughout its tuning range.

Figure 8 shows a fixed-tuned r-f transformer which provides a fair degree of amplification over the broadcast band. The transformer consists of a primary of 160 turns and secondary of 130 turns of No. 40 E.C. wire. Both windings are wound on a separate piece of $\frac{1}{2}$ -in. paper tubing. Each winding is assembled on an L-shaped core built up of 120 three-mil silicon-steel laminations. The air gap between the two sections of the core shown in Fig. 10 is $\frac{1}{16}$ in. The secondary of the transformer is tuned by a capacity of $25 \mu\text{mf}$. The voltage gain provided by a stage of fixed-tuned r-f amplification using this transformer and an r-f pentode is shown in Fig. 9.

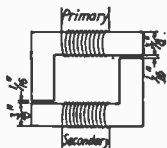

FIG. 8.—Untuned transformer.

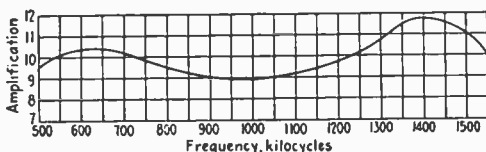

FIG. 9.—Amplification characteristic of untuned r-f transformer.

15. The i-f amplifier in a superheterodyne is the major factor in determining the receiver sensitivity and selectivity.

Modern superheterodyne receivers use an intermediate frequency at or near either 175 or 460 kc. One hundred seventy-five kilocycles is generally used in receivers which are designed to cover only the tuning range from 550 to 1,500 kc, while 460 kc is used in receivers whose tuning range includes the international short-wave bands. Nearly all i-f amplifiers make use of transformers employing two coupled tuned circuits. The selectivity characteristic provided by a transformer of this type may be made substantially flat-topped if the coupling between the two tuned circuits is adjusted to near the critical value.

The two characteristics which are given the most consideration in the design of an i-f amplifier are gain and selectivity. These characteristics may

either be calculated or determined experimentally. The gain in a coupled tuned-circuit i-f stage with both circuits tuned to resonance is equal to

$$\left| \frac{E_1}{E_2} \right| = S_m \times \frac{\omega M}{r_1 r_2 + \omega^2 M^2} \times \frac{1}{\omega^2 C_1 C_2}$$

The selectivity characteristic may be determined by

$$\left| \frac{E_1}{E_2} \right| = S_m \times \frac{\omega M}{r_1 r_2 [1 - 4Q_1 Q_2 B^2 + j_2(Q_1 + Q_2)B] + \omega^2 M^2} \times \frac{1}{\omega^2 C_1 C_2}$$

where E_1 is the voltage developed across the secondary of the transformer; E_2 is the voltage applied to the grid of the amplifier tube; S_m is the trans-conductance of the amplifier tube; M is the mutual inductance between primary and secondary; r_1 and r_2 are the effective series resistances of the primary and secondary; Q_1 and Q_2 are the $\omega L/r$ of the primary and secondary, respectively; B is $\frac{f - f_0}{f_0}$, where f_0 is the common resonant frequency and f is any other frequency; and C_1 and C_2 are the primary and secondary capacities.

To obtain maximum gain in an i-f amplifier stage, the L/C ratio should be the maximum which will give the desired frequency stability and the Q necessary to give the required selectivity characteristic. If the L/C ratio of the tuned circuits is made too high, the variations in the inter-electrode capacity of the tubes may cause a serious misalignment of the tuned circuits. The capacity used to tune the intermediate frequency circuits is therefore seldom less than 30 or 40 $\mu\mu\text{f}$.

The width of the frequency band which a coupled tuned-circuit transformer will pass is controlled by the coupling between the two tuned circuits and the effective resistance of the circuits. If increasing the coupling between the circuits until the transformer passes the desired frequency band causes the top of the selectivity characteristic to become double-peaked it can be made flat by increasing the effective resistance of one or both of the tuned circuits. To obtain the same selectivity characteristic in kilocycles at 460 kc as at 175 kc the Q of the tuned circuits must be approximately 2.5 times as great. To secure compact tuned circuits having the Q required (80 to 100) to give satisfactory selectivity at 460 kc the coils are frequently wound in sections using Litz wire. A two-to-one improvement in the Q of coils suitable for a 460-kc i-f transformer can generally be obtained through the use of cores molded of finely divided iron particles and an insulating binder.

A typical i-f transformer consists of two universal-wound coils assembled on an insulating support such as a wooden rod or piece of bakelite tubing. These two coils constitute the inductive elements of two tuned coupled circuits. One of the tuned circuits is connected in the plate circuit of the amplifier tube and the other in the grid circuit of the succeeding tube. The electromagnetic coupling between these circuits is determined by the spacing between the coils. The tubing or rod on which the coils are wound is mounted on a plate of insulating material such as porcelain or isolantite. On this plate are also mounted the two small adjustable condensers which are used to tune the two coupled tuned circuits. Care must be exercised in the design of these condensers to insure that the capacity of the condensers remains constant after adjustment. The entire transformer assembly is enclosed in a

metal container which serves both to protect the unit and shield it electrically. The two adjustable condensers are usually so located that the screws for adjusting their capacity are accessible through holes in either the top or bottom of the container.

The selectivity characteristic provided by a typical i-f transformer is shown in curve A (Fig. 10). A voltage amplification of several hundred can readily be obtained with a single i-f transformer and a modern r-f pentode having a transconductance in excess of 1,500. The voltage gain for the usual i-f amplifier consisting of three transformers and two amplifier tubes when measured from the grid of the first detector to the grid of the second detector is usually from 15,000 to 30,000. The voltage gain in the amplifiers using two transformers and one amplifier tube is 5,000 or less. The amplification in the three-transformer amplifiers is usually held considerably below the optimum value to prevent instability.

16. Frequency Converters. In a superheterodyne receiver the received signal wave is changed to a signal wave of an intermediate frequency. This change is accomplished through the medium of a frequency converter, which consists of a detector and variable-frequency oscillator. The detector is frequently called the *first detector* due to its position in the circuit.

In some receivers the first detector is a negatively biased r-f pentode and operates due to the curvature of the E_p-I_p characteristic. The received signal voltage and a voltage from the local oscillator are both impressed on the grid of this detector. The beat-frequency potential produced by the rectification of these two currents is impressed on a tuned circuit connected in the plate circuit of the detector. The majority of receivers, however, employ a pentagrid converter as the combined oscillator and first detector. The coupling between the oscillator and first detector, when this tube is used, is obtained through the electron stream in the tube. The reaction which is frequently encountered with two-tube frequency converters which employ electromagnetic or electrostatic coupling between the oscillator and first detector circuits is thus avoided. This freedom from direct coupling between the oscillator and first detector resulting from the use of a pentagrid converter makes it possible to prevent the radiation of the oscillator energy by the antenna system without employing an r-f amplifier stage ahead of the first detector. The efficiency of a frequency converter is a function of the conversion transconductance of the tube employed as the first detector. Conversion transconductance is defined as the ratio of the i-f current through the i-f transformer primary in the plate circuit of the first detector to the r-f signal applied to its grid. The conversion transconductance of a typical pentagrid converter is generally somewhat higher than that obtained from an r-f pentode used as a first detector and may

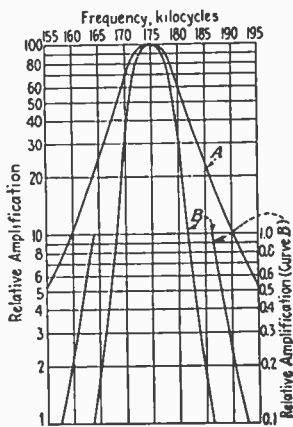

FIG. 10.—Intermediate-frequency selectivity characteristics: Curve A, one stage; curve B, three stages.

vary from 300 to 500 micromhos, depending on the potentials applied to the several electrodes.

In several receivers a separate oscillator tube is used in conjunction with a pentagrid converter. Greater flexibility in the design of the oscillator circuit is thus permitted since the separate tube has a considerably higher transconductance than the triode portion of the pentagrid converter. This advantage is particularly important in receivers designed to cover frequency ranges up to 30 Mc, owing to the difficulty of obtaining a stable oscillator with the desired output and frequency stability at such frequencies.

The major problems in the design of the frequency converter for a uncontrolled superheterodyne receiver are:

1. To maintain a constant-frequency difference between the oscillator and radio-frequency circuits.
2. To minimize variations in the oscillator frequency with variations in the supply voltage and variations in tubes, etc.
3. To maintain a constant oscillator voltage on the detector grid throughout the tuning range of the receiver.
4. To minimize radiation from the oscillator in order to prevent interference in nearby receivers.

17. Methods of Maintaining Constant-frequency Difference. Three methods have been used to maintain a constant-frequency difference between the oscillator and first detector in uncontrolled superheterodyne receivers.

The *first method* makes use of straight-line-frequency condensers and requires that the oscillator rotor be displaced with respect to the radio-frequency circuit rotors by an amount sufficient to give the proper frequency difference. This arrangement has the disadvantage that the useful tuning range of the condensers is reduced by the amount that the rotors are displaced. For this reason this method cannot be used where the intermediate frequency is high.

The *second method* uses a gang condenser in which the oscillator condenser plates have a special shape. The problem of test and alignment for condensers of this type is somewhat complicated and more costly than for condensers in which all the elements are alike.

The *third method* which is the one in general use makes use of condensers of equal capacity for both the t-r-f and oscillator circuits. The constant-frequency difference between the t-r-f and oscillator circuits is obtained through the use of a combination of shunt and series condensers in the oscillator circuit. The oscillator in superheterodyne receivers is generally tuned to a higher frequency than the t-r-f circuits, since a smaller percentage change in frequency is required and a smaller change in capacity is therefore necessary to produce the desired variation in the oscillator frequency. The oscillator tuning inductance is therefore smaller than that of the r-f circuits and its value is such that the correct frequency difference between the oscillator and t-r-f is obtained at the middle of the tuning range with equal capacity in each circuit. The combination of shunt and series condensers used in the tuned oscillator circuit maintains the frequency difference constant throughout the tuning range of the receiver.

These condensers are shown in Fig. 11. Condenser *A* is the main tuning condenser. Condenser *B* is the fixed-series capacity. Condenser *C* is a small adjustable condenser for accurately adjusting the total series capacity. Condenser *D* is the small adjustable shunt condenser.

Typical values to maintain a frequency difference of 175 kc are:

Main tuning capacity <i>A</i>	15 μf to 350 μf
T-r-f tuning inductance.....	270 μh
Oscillator tuning inductance.....	215 μh
Fixed-series capacity <i>B</i>	750 μf
Adjustable-series capacity <i>C</i>	15 μf to 70 μf
Adjustable-shunt capacity <i>D</i>	5 μf to 40 μf

The effect of these condensers is shown in Fig. 12. Curve *A* shows the relation between frequency and dial reading for the r-f circuits. Curve *B* shows the same relations for the oscillator circuit without the shunt and series condensers. Curve *C* shows the effect of the shunt condenser and curve *D* shows the effect of both shunt and series condensers. Similar treatment can be applied to gang condensers of the straight-line-frequency, mid-line or straight-line-capacity types. The equations for calculating the circuit constants in a system of this type are given in Sec. 6.

Figure 11 shows a typical oscillator circuit used in superheterodyne receivers. It will be noted that the tube is connected across only a portion of the tuned circuit so as to minimize the effect of tube variations on the oscillator frequency.

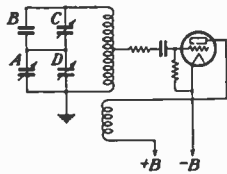

FIG. 11.—Typical superheterodyne oscillator circuit.

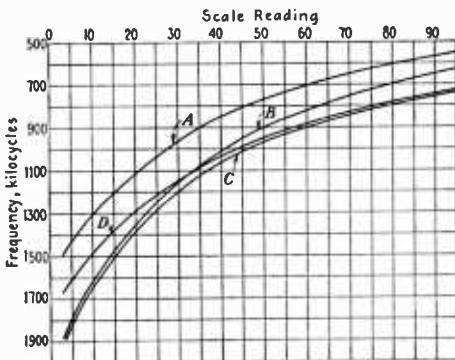

FIG. 12.—Effect of shunt and series condensers in oscillator circuit.

18. Tone Controls. A considerable number of broadcast receivers are equipped with a high-frequency tone control, which is a device which enables the user of a receiver to vary the over-all fidelity characteristic of the receiver. The usual tone control operates on some portion of the a-f system in such a manner as to vary the high-frequency response. Figure 13 shows the most general method of accomplishing this result.

The advantages of a high-frequency tone control are:

1. Noise encountered when receiving distant stations can be reduced considerably by decreasing the high-frequency response of a receiver through the use of a tone control.

2. All broadcast transmitters do not have the same fidelity characteristics and a tone control permits the user to compensate for some of these variations.

3. The frequency-response characteristic of the ear varies with the intensity of the sound. A tone control compensates for this characteristic.

A low-frequency tone control is used in some receivers so that low-frequency interference can be minimized. Such interference can be caused by a low-frequency hum on the carrier wave of a transmitter or by the beat note between two transmitters operating on the same channel. The intelligibility of the speech reproduced by a broadcast receiver is frequently improved by decreasing the receiver's low-frequency response. Figure 13 shows a low-frequency tone control

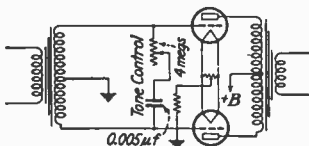

FIG. 13.—Tone control circuit.

which has been used in broadcast receivers. A switch having two or more positions is sometimes used instead of the potentiometer.

Acoustically Compensated Volume Control. A volume-control arrangement has been used in a number of broadcast receivers in which the

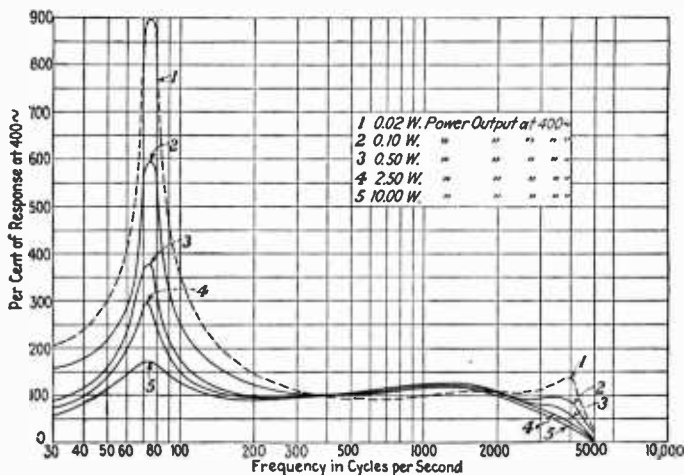

FIG. 14.—Variation of low-frequency response with volume.

over-all frequency-response characteristic of the receiver varies with the audio output level. This type of volume control has been called an acoustically compensated volume control and is intended to compensate for the variation in the frequency-response characteristic of the ear with amplitude. Reducing the audio output of a receiver to a low value with a typical volume-control system gives the listener the impression that the very low and high frequencies have been attenuated and the middle frequency range has been correspondingly accentuated. The acoustically

compensated volume control was devised to correct this effect. Figure 15 shows one of the arrangements which has been used to accomplish this result. This volume-control system makes use of a resonant circuit which attenuates the middle frequency range more than the high and low frequencies when the audio output is reduced. The effect of this

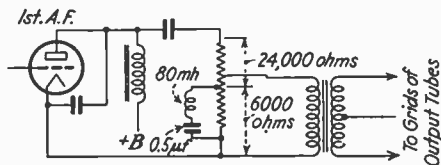

FIG. 15.—Tone-compensated volume control.

type of control is illustrated by the curves in Fig. 14, which show the relation between the audio output and frequency-response characteristic of the receiver. The low-frequency compensation shown by these curves was used not only to compensate for the variation in the frequency-response characteristic of the ear with amplitude, but also to correct for the acoustic deficiencies of the cabinet in which the receiver was installed. Since a definite relation should exist between the audio output level and the frequency-response characteristic of a receiver equipped with an acoustically compensated volume control, it is necessary that the audio output for a given setting of the volume control be independent of the strength of the received signal. Some form of a.v.c. is necessary to meet this requirement.

19. Volume-control System.
The two types of volume control which are used in broadcast receivers are manual and automatic.

The control of volume in both types is generally accomplished by varying the transconductance of the amplifier tubes through a change in the potential applied to the control grids. This method makes it possible to apply volume control to a number of tubes simultaneously using a single potentiometer or variable resistor. The source of the variable-control grid potential does not need to supply power which is a prerequisite of any simple a.v.c. system.

Serious distortion and cross-modulation may be introduced through the use of this type of volume control if an amplifier tube is biased near the cut-off point and the applied signal potential is large. This distortion and cross-modulation are functions of the third and higher derivatives of the E_g-I_p characteristic of the tube. To minimize this distortion it is advisable to proportion the volume-control potential applied to the grid of the individual tubes inversely with the signal voltage on each tube.

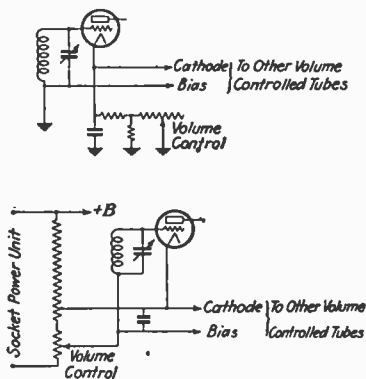

FIG. 16.—Volume-control circuits.

The use of "variable-mu" or "exponential-type" amplifier tubes is desirable in a control-grid-bias volume-control system which must take care of a wide variation in the strength of received signals. Two arrangements which are frequently used to obtain manual volume control are illustrated by Fig. 16.

20. Automatic Volume Control. Automatic volume control is used almost universally in broadcast receivers. It has the advantage that practically the same audio output is obtained from the receiver irrespective of the input. This is an advantage in tuning from one station to another where a considerable difference exists in the relative field strength of the stations. It also has the advantage of compensating for some of the more serious effects of fading. Automatic volume control also makes the manual adjustment of volume less critical since the entire range of the manual control is used only to vary the actual audio output. With the manual type of volume control only a small fraction of the total variation of the control may be required to change the sound

output from minimum to maximum. The manual type of control is therefore likely to be very critical to adjust.

Figures 17 and 18 show two a.v.c. arrangements. In each system the d-c component of the rectified output of a detector is used as additional control grid bias for the r-f and i-f amplifier tubes. In the first arrangement a separate volume-control tube provides the additional bias voltage. In the second system a single tube performs the dual function of providing the control grid bias and demodulating the received signal.

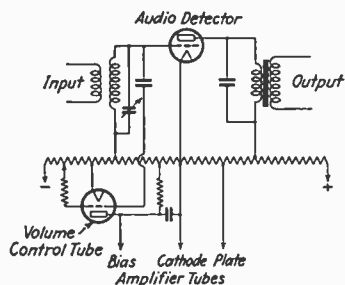

FIG. 17.—Automatic volume-control circuit.

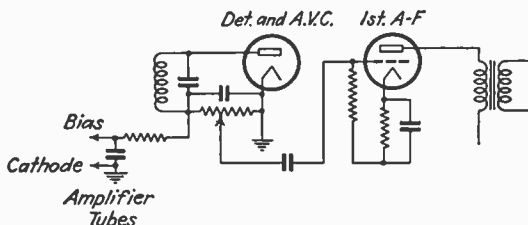

FIG. 18.—Combination detector—volume-control tube circuit.

In the first arrangement the output level is controlled by varying the bias on the grid of the control tube. In the second system the output level is controlled by varying the audio amplification. For the receiver to reproduce faithfully the dynamic range of a received program the rectifier from which the a.v.c. control potential is derived must have a substantially linear input-output characteristic. A diode rectifier, with a load resistance of several hundred thousand ohms, provides a rectifier

which is sufficiently linear for this purpose. The negatively biased triode a.v.c. arrangement illustrated by Fig. 17 will cause the dynamic range of the received program to be compressed, since the output of this rectifier increases as the percentage modulation of the received signal is increased.

Response and Recovery Characteristic. A resistance-capacity filter is usually used in the output circuit of an a.v.c. rectifier. This filter prevents the a-f components in the output circuit of the rectifier from being applied to the amplifier grids. The time constant of the a.v.c. rectifier output circuit should be such that the lowest modulation frequencies will not cause variations in the amplifier grid bias. It should not be so slow, however, as to give a noticeable delay when the system recovers from a crash of static. A time constant between $\frac{1}{10}$ and $\frac{1}{5}$ sec. is usually considered satisfactory. The response and recovery of the system are influenced by the characteristics of the rectifier. For example, the system illustrated by Fig. 17 will have a quick response and slow recovery, because the condenser shunting the output resistor is charged through the relatively low impedance of the rectifier but discharges through the high resistance of the output resistor.

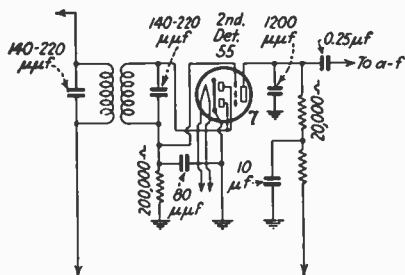

FIG. 19.—Diode-biased triode.

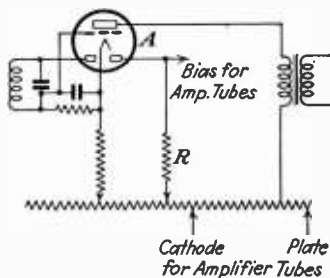

FIG. 20.—Double-diode triode as a.v.c. tube.

21. Delayed Automatic Volume Control. The system illustrated by Fig. 17 is an example of delayed a.v.c. in which no control potential is derived until the signal level at the a.v.c. rectifier has reached a predetermined value. The negatively biased triode used in this arrangement is biased beyond the point of plate current cut-off, and, therefore, no potential will be developed across the resistor in its plate circuit until the signal amplitude is sufficient to swing the grid positive with respect to the plate-current cut-off point. An a.v.c. of this delayed type is used to prevent the receiver sensitivity from being reduced before the desired output level is obtained. It therefore results in a flatter receiver-input to audio-output characteristic. When the delay for this type of control is secured by preventing the rectifier tube from functioning until the received signal has reached a desired value, the linear rectifier requirement is not fulfilled and dynamic range distortion results. This type of distortion is avoided by the delayed a.v.c. system shown in Fig. 19 in which the change in potential derived from the rectifier is first amplified before it is applied to the amplifier grids. In this system the delay is inserted between the rectifier and the amplifier, and a linear rectifier can

thus be used which will give a d-c component which is independent of the percentage modulation of the received signal. In Fig. 20 the control grid of the double-diode triode is directly connected to the diode output resistor so that its bias becomes more negative with an increase in the amplitude of the signal applied to the diode. When no signal is applied to the diode the control grid is at cathode potential, and a d-c drop of between 50 and 100 volts occurs across the cathode resistor. The diode anode *A* is connected through a suitable resistor to the plate-supply system at a point sufficiently negative with respect to the cathode to give the desired delay. When a signal is applied to the signal diode, the control grid becomes negative and the drop across the cathode resistor decreases. When the amplitude of the received signal exceeds the predetermined level, the cathode of the tube becomes negative with respect to the anode *A* and current flows through resistor *R* causing an increase in the negative bias on the amplifier grids.

22. Selectivity Ahead of A.V.C. System. In some receivers employing a separate a.v.c. rectifier this rectifier is connected to a point in the receiver which is preceded by less selectivity than is used ahead of the audio detector. The advantage of this system is that, when the receiver is tuned off resonance with a desired signal, the noise which is normally encountered is reduced. Under this condition the a.v.c. potential is proportionately greater than the signal potential at the audio detector, and the receiver sensitivity and audio output are less than would have been obtained if the same selectivity was used ahead of the a.v.c. rectifier and audio detector. This difference in selectivity should not exceed 10 to 1, otherwise the reduction in sensitivity, when tuned off resonance from a strong signal, will be so great as to prevent the reception of a weak signal on the adjacent channel.

23. Biasing the Amplifier Tubes at Different Rates. To minimize the type of distortion frequently encountered in volume-control systems due to the curvature of the E_g-I_p characteristic, it is desirable to proportion the volume-control grid bias for each amplifier tube inversely as the signal potential applied to the tube. The method generally used for approximating this relation is to provide one or more taps on the a.v.c. bias resistor. The r-f amplifier tube is connected to the resistor so that the entire potential drop is applied to its grid. The i-f amplifier tubes are connected to the tap or taps on the resistor so that they receive one-half or less of the total a.v.c. voltage.

24. Separate Channel or Parallel A.V.C. Systems. In some receivers a separate i-f amplifier stage is used to feed the a.v.c. diode. The use of the separate channel, which is usually designed to have higher gain than the normal signal channel, makes it possible to provide a delayed a.v.c. having a very flat characteristic. The use of the separate channel also makes it easy to provide less selectivity in the a.v.c. channel than in the signal channel and still provide a high signal voltage at the a.v.c. rectifier. Another expedient which can be used with the separate channel a.v.c. system to give a very flat a.v.c. characteristic is to apply a part of the a.v.c. potential to the amplifier tube in the signal channel following the point at which the additional a.v.c. amplifier tube is connected. Care must be exercised in determining the control potential to be applied to an amplifier stage following the point in the normal signal channel from which the control potential is derived. If the control potential applied to such a stage is too great, the a.v.c. system may be overcompensated

and the receiver output may actually decrease as the strength of a received signal increases. Figure 21 illustrates an a.v.c. system employing a separate amplifier stage. In this arrangement a portion of the control potential is applied to the signal amplifier tube subsequent to the point to which the separate a.v.c. amplifier tube is connected.

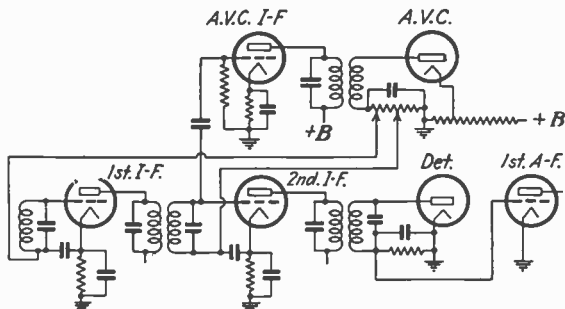

FIG. 21.—Amplified a.v.c. arrangement.

Manual Output Control. The manual control of the output of an a.v.c. receiver is usually obtained by varying the gain in the a-f portion of the receiver.

25. Noise Suppressor or Tuning Silencer. Two of the objectionable characteristics of a receiver equipped with a conventional a.v.c. system are the accentuation of noise when tuning between stations and the seeming lack of selectivity when a station is being tuned in. Several arrangements have been devised to overcome these objections. One of the systems is illustrated in Fig. 23. This a.v.c. system makes use of a noise-suppressor tube A, the bias of which is controlled by the detector

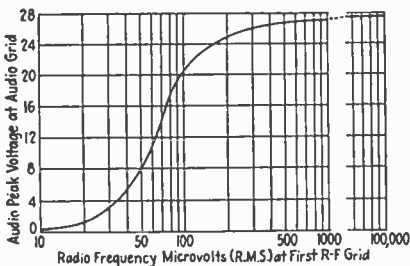

FIG. 22.—Automatic volume-control characteristic.

and a.v.c. tube B. The d-c drop across a resistor in the plate circuit of tube A is used to control the bias on the a-f amplifier tube C. When the receiver is tuned between stations, the bias on tube A is such that sufficient plate current flows through the resistor in its plate circuit to increase the negative bias on tube C to the point where the amplifier is

inoperative. When a signal of a predetermined strength is tuned in, tube *B* increases the negative bias on tube *A* so that its plate current is greatly reduced and the bias on the audio-amplifier tube *C* is restored to its normal value and the amplifier then functions in the conventional manner. The signal level at which the receiver will respond is controlled by varying the screen-grid voltage on the noise-suppressor tube. Another scheme of this type makes use of a very selective circuit which controls the noise-suppressor tube. This selective circuit is tuned to the center of the frequency band passed by the intermediate frequency amplifier. A separate control tube that causes the noise-suppressor tube to operate

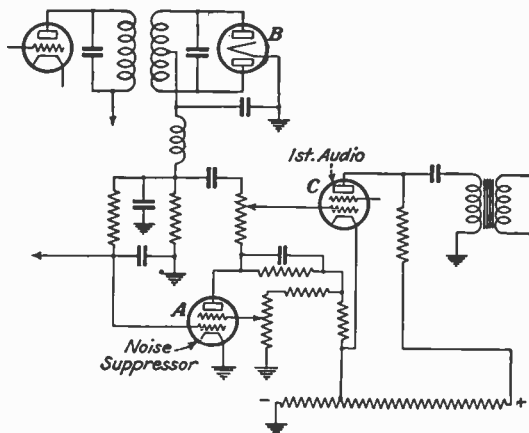

FIG. 23.—Circuit for keeping between-carrier noise out of a receiver.

is connected to the i-f amplifier through this selective circuit. Through the use of the additional tube and selective circuit the receiver is made to respond to received signals only when tuned to almost exact resonance. This type of arrangement, therefore, makes it impossible to tune a receiver so as to give the disagreeable distortion which is obtained when the carrier wave of a station is being received on the side of the receiver resonance curve.

26. Noise in Receiving Systems. The source of the noise which is frequently obtained in the output circuit of a receiving system may either be located external to or within the receiving system. The two general sources of noise which are external to the receiver are

1. Atmospheric static.
2. Man-made static.

The expedients which are employed in receiving systems to minimize noise due to these types of interference without sacrificing the fidelity of the system are to employ an antenna system which will provide as favorable a signal to noise ratio as possible and to use sufficient shielding on the receiver chassis to prevent the noise being picked up by the receiver circuits.

The two chief sources of noise which are located within a receiving system are thermal-agitation and *shot effect*.

Thermal-agitation noise is due to the random motion of the electrons within a conductor. The noise voltage introduced into a circuit by this cause may be calculated from the equation,

$$\bar{e}^2 = 5.49 \times 10^{-23} TZ df$$

where \bar{e}^2 = the mean square thermal-agitation voltage; T is the absolute temperature of the conductor ($273 + ^\circ\text{C}.$); Z is the resistance of the conductor or the resonant impedance of a tuned circuit; and df is the frequency band width factor.

The number of electrons emitted by the cathode of a thermionic tube varies from instant to instant, and this variation in emission introduces a voltage in the circuit through which these electrons pass. This variation in electron emission has been called *shot effect*.

The following equation gives the voltage introduced in a circuit by this cause:

$$\bar{E}^2 = 3.18 \times 10^{-19} IZ df$$

where \bar{E}^2 = the mean-square shot-effect voltage (without space charge)

I = the electron current

Z = the resonant impedance of the tuned circuit

df = the frequency band width factor.

The space charge obtained in a vacuum tube under normal operating conditions reduces the shot-effect voltage to about one-half the above value.

The thermal-agitation and shot-effect noise found in the output circuit of a receiver usually originates in the grid and plate circuits, respectively, of the first tube. Where the gain in this tube is very low, the second tube may also contribute to the noise.

Since both types of noise are introduced as a series of pulses, the circuits in which the noise is introduced are excited at the frequency to which they are tuned.

The shot-effect voltage developed in the plate circuit of a tube varies in proportion to the square root of the plate current. Changing the plate load impedance has no direct effect on the signal-to-noise ratio since both factors are changed in the same ratio. High gain in the first tube with low plate current is therefore desirable to minimize shot-effect noise.

Thermal-agitation noise varies as the square root of the impedance across which the noise is developed. The merit of an antenna-input system from the thermal-agitation noise standpoint may be expressed as the ratio of g/\sqrt{Z} , where g is the voltage gain between the antenna and the grid of the first tube and Z is the effective impedance in the grid circuit of this tube.

27. Complete Receiving System. The usual broadcast receiver consists of the following elements.

1. The receiver chassis.
2. The loud-speaker.
3. The cabinet.

In the majority of receivers the r-f, i-f, a-f and power supply circuits are assembled as a single unit. In a few receivers the power supply

rectifier and filter system and the power output tubes are mounted on a separate base.

The tuning condenser in a large number of broadcast receivers is flexibly mounted, with respect to the chassis, by means of soft rubber washers. The complete chassis in many receivers is also flexibly mounted in the cabinet. These precautions are used to prevent acoustic feedback in receivers which are capable of producing a high power output. Acoustic feed-backs are caused by the loud-speaker vibrations being transmitted through the cabinet to the receiver chassis and thence to tuning condenser or some other circuit element which is caused to vibrate sufficiently to intermittently detune the receiver at an audio-frequency rate. If the proper phase relations exist between the loud-speaker vibrations and the variations in signal intensity which result from the vibration of the condenser plates, sustained oscillations may be produced.

28. Shielding and Filtering. It is common practice to confine the r-f and i-f circuits in metal containers which provide both electromagnetic and electrostatic shielding. Tube shields are used to prevent coupling between tubes and between the grid and plate portions of individual tubes. In some instances shielded leads are used to provide the connections to the grids or plates of amplifier tubes but in general the necessity for such shielding is avoided by so locating these leads that they are electrically isolated by the tube shields and the metal containers for the r-f and i-f circuits.

Care must be exercised in locating the power transformer and filter reactor on the receiver chassis, otherwise the electromagnetic field produced by these units may induce an appreciable hum voltage in the a-f circuits. It is desirable to keep these units separated from the a-f circuits as much as possible and it is frequently necessary to determine experimentally the best location for these components by connecting them into the circuit with flexible leads and orienting them until a position is established which reduces the hum to the desired minimum.

Resistance-capacity filters are frequently used in the voltage supply leads for the tube electrodes. These filters are employed to prevent coupling between points in the system which differ in signal potential and to provide additional filtering for the voltage fluctuations which may exist at the output of the B supply filter. The d-c drop which can be tolerated in a given circuit is frequently a limiting factor in the use of such filters. When r-c filters are used in circuits in which the average current varies during the operation of the receiver, it is essential that the recovery characteristic of the filter be such that the voltage on the electrode can return to its normal value in approximately $\frac{1}{10}$ sec., otherwise noticeable interruptions in the received program will be obtained when sudden changes in the average current occur. This problem is most frequently encountered when r-c filters are used in the plate or screen circuits of tubes which are controlled by the a.v.c. system.

29. Loud-speaker. The electrodynamic loud-speaker is used in substantially all the broadcast receivers which are produced today.

30. Cabinet. The cabinet for a broadcast radio receiver must fulfill three requirements.

1. It must house and protect the receiver chassis and loud-speaker mechanism.

2. It must provide sufficient baffle area for the loud-speaker to give the desired low-frequency response (see Chap. 16).

3. It must serve as a piece of furniture which will harmonize with the furnishings in the room in which it is to be placed.

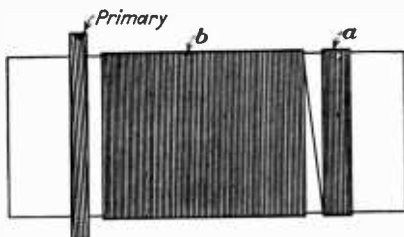

FIG. 24.—Method of varying inductance slightly for tracking purposes.

31. Single-dial Tuning Problem. One of the major problems in the design of a uncontrolled broadcast receiver is the maintenance of the proper alignment of the tuned circuits throughout the broadcast frequency range. To maintain such alignment normally requires that the inductances and variable condensers be made very uniform. It is common practice to sort the coils in groups so that the variation in inductance between them is less than 0.5 per cent. Coils are also employed which are wound in two sections, such as *a* and *b* in Fig. 24. One or more of the turns in section *a* can be moved with respect to section *b* so as to increase or decrease the spacing between the two coil sections. The total inductance of the coil can thereby be adjusted to any desired value. Receivers are equipped with gang condensers in which an outside plate on each rotor is slotted into a number of segments. In the process of the alignment of the circuits, these segments are bent so as to compensate for variations in both the coils and variable condensers. One type of receiver, which has been produced commercially, made use of a cam arrangement by which the position of one element of the tuning capacitor could be adjusted with relation

to the other element at a number

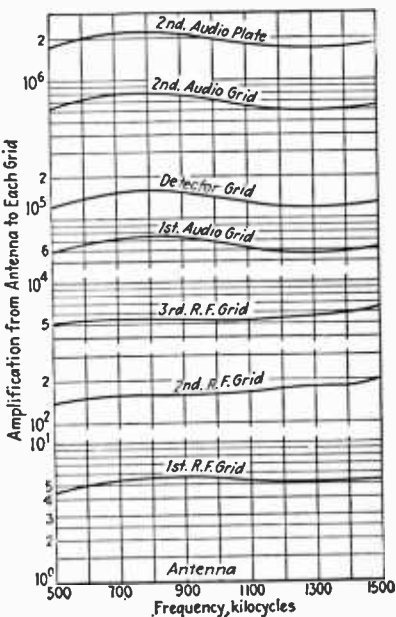

FIG. 25.—Sensitivity curves of voltage gain in t-r-f receiver.

of points in the tuning range of the receiver. Such an arrangement provides greater compensation for variations in the inductance of the

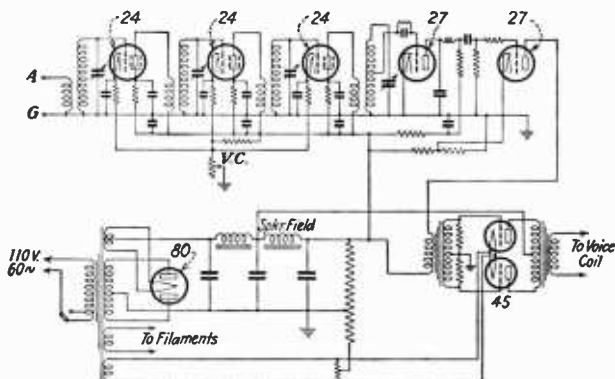

FIG. 26.—Typical t-r-f receiver.

coils and capacity of the variable condensers than can be obtained with the slotted-end plate condensers.

32. Tuned-radio-frequency Receivers.

The general performance characteristics of a t-r-f receiver can be determined readily from the characteristics of the various components. Figure 25 shows the voltage gain between the antenna and the grid of each tube in a t-r-f receiver. The gain in the detector is determined for a carrier modulated 30 per cent of sufficient amplitude to produce a receiver output of 0.05 watt across the normal output impedance. Fig. 26 shows the circuit diagram of the receiver. It utilizes four t-r-f circuits.

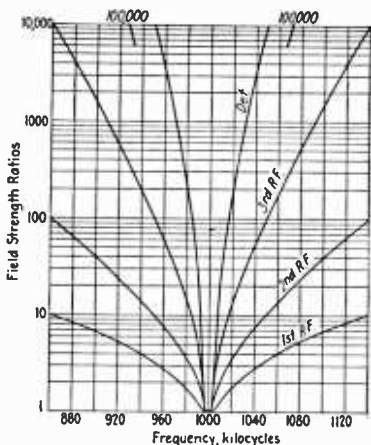

FIG. 27.—Over-all selectivity of t-r-f receiver.

curves the selectivity curves of the individual circuits are plotted to the same scale on logarithmic coordinates. The over-all selectivity-characteristic curves are then obtained by laying off for each frequency

33. Over-all Selectivity.

Figure 27 illustrates a graphic method of determining the over-all selectivity of the receiver from the selectivity characteristics of the individual tuned circuits. The curves in this figure show the selectivity contributed by the tuned circuits in the receiver from the antenna to the grid of each tube. To obtain these

a distance which is equal to the sum of the distances which represent the ordinates of the individual selectivity characteristics for the same frequency. This procedure may be reversed and the selectivity characteristics which a given number of individual circuits must have to give a particular over-all selectivity characteristic can be determined. Such a determination is made by dividing the distance which represents the ordinate for a given frequency on the over-all selectivity characteristic by the number of tuned circuits. The distances obtained in this way then determine the ordinates of the individual selectivity-characteristic curve. In this case it is assumed that the selectivity characteristics of all the tuned circuits are alike.

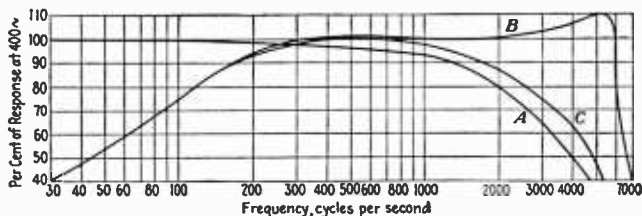

FIG. 28.—A, Side-band attenuation due to r-f circuits; B, frequency-response characteristic of detector and a-f amplifier; C, over-all frequency-response characteristic.

The attenuation of the r-f system for the high-frequency side bands at 1,000 kc is shown in Fig. 28A. This is simply one-half of the top of the selectivity-characteristic curve of the receiver plotted on an enlarged scale. The frequency-response characteristic of the detector and a-f system is shown in Fig. 28B. The ordinates for each frequency in the over-all fidelity characteristic curve of the receiver are obtained by multiplying the corresponding ordinates of these two curves. The over-all fidelity characteristic of the receiver is shown in Fig. 28C. Compensation for the attenuation of the higher modulation frequencies in the r-f system by a corresponding accentuation of the high-frequency response of the audio system is occasionally used. This method of obtaining a flat over-all fidelity characteristic in a t-r-f receiver is not entirely satisfactory due to the difference in the high-frequency side-band attenuation at the high-frequency and low-frequency ends of the broadcast range.

34. Superheterodyne Receivers. The ease of obtaining high amplification and a high degree of selectivity with a minimum of shielding allows considerable flexibility in the design of a superheterodyne receiver. Sufficient amplification can be obtained in the r-f and i-f circuits so that a power detector and single stage of a-f amplification are sufficient to provide the desired sensitivity. The general tendency in the design of superheterodyne receivers has been to take advantage of the high degree of selectivity which this type of receiver can provide at a corresponding sacrifice in fidelity. The superheterodyne receiver, however, lends itself just as well to the design of a high-fidelity receiver since the advantages of coupled tuned circuits can readily be realized in this type of receiver.

35. Superheterodyne Characteristics. The adjacent-channel selectivity and fidelity of a superheterodyne receiver can be determined readily from the characteristics of the individual components of the receiver.

Figure 29 shows the gain from the antenna to the grid of each tube. Figure 30 shows similar curves giving the total selectivity contributed

by the tuned circuits between the antenna and the grid of each tube. These curves are determined in the same manner as that described under the design of t-r-f receivers. From these two sets of curves it is possible to determine the voltage on the grid of each tube from a local station when the receiver is tuned to a distant station on an adjacent channel. Such a determination is frequently desirable in this type of receiver where the selectivity contributed by the circuits between each tube is not uniform. This relation between gain and selectivity between each tube must be properly proportioned; otherwise, the signal from a local station may be sufficient to draw grid current on one of the tubes even if the over-all selectivity of the receiver is sufficient to separate the signals from the local and distant stations before they reach the second detector. Figure 31 shows (A) the side-band attenuation in the radio-frequency circuits of the receiver and (B) the over-all fidelity characteristic.

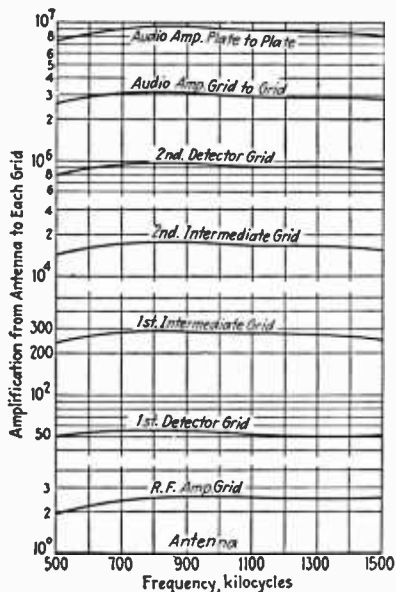

FIG. 29.—Voltage gain in superheterodyne receiver.

36. Superheterodyne Interference Problems. The selectivity of a superheterodyne receiver as determined in Fig. 30 is not a true indication of the actual selectivity of the receiver under all conditions, as this type of receiver is susceptible to certain types of interference which are not encountered with a t-r-f receiver. The susceptibility to these interferences is a result of converting the received signal to an intermediate frequency. The following classification gives the more important possible sources of interference common to a superheterodyne receiver in which the intermediate frequency is lower than any frequency in the tuning range of the receiver.

1. *Image-frequency interference:* If f is the oscillator frequency in a superheterodyne and IF the intermediate frequency, signals impressed on the first detector, having frequencies of either $f + IF$ or $f - IF$, will be heterodyned

to the intermediate frequency and pass through the receiver. It is therefore necessary to prevent one of these signals from reaching the first detector; otherwise, *image-frequency* interference will result. R-f circuits, tuned to the signal which it is desired to receive, are the usual arrangement for preventing image-frequency interference. Since the oscillator in superheterodyne receivers is usually tuned to a higher frequency than the radio-frequency circuits, a signal which can produce image-frequency interference must have a frequency of $f_1 + 2IF$ where f_1 is the frequency of the desired station.

When a received signal is successively heterodyned to two intermediate frequencies, as is the case in some superheterodyne receivers used in communication work, there is more than one signal that can cause image-frequency interference with any desired signal. For example, if f_1 is the frequency of the desired signal and IF_1 and IF_2 the two intermediate frequencies, then interference can be caused by signals whose frequencies are $f_1 + 2IF_1$ and $f_1 - 2IF_2$. It is assumed that both oscillators are tuned to a higher frequency than the signal frequency. The circuits ahead of the second heterodyne oscillator and associated detector must provide the selectivity necessary to avoid interference by the $f_1 - 2IF_2$ signals.

2. *Interference due to harmonics of the oscillator heterodyning undesired stations:* If a signal having a frequency of $2f \pm IF$ is impressed on the first detector, it will cause interference with the signal being heterodyned by the fundamental oscillator frequency f . Tuned

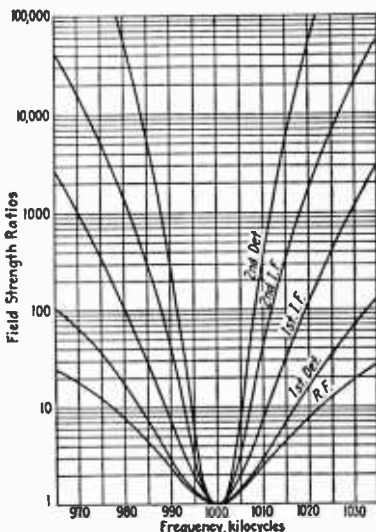

FIG. 30.—Superheterodyne selectivity characteristics.

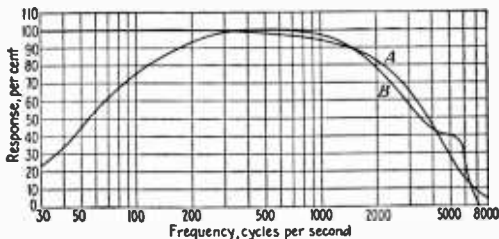

FIG. 31.—A, Side-band attenuation due to r-f circuits of superheterodyne; B, over-all fidelity characteristic.

r-f circuits ahead of the first detector likewise reduce the possibility of this type of interference.

3. *Interference due to stations which are separated by the intermediate frequency:* Combinations of signals are sometimes encountered which are

separated by the intermediate frequency and if such signals are permitted to reach the first detector, interference will result. Tuned r-f circuits ahead of the first detector are also used to prevent this type of interference.

4. *Interference due to harmonics of the intermediate frequency produced by the second detector:* When the intermediate frequency is lower than any frequency in the tuning range of the receiver, certain harmonics of the intermediate frequency fall in the broadcast frequency band. If these harmonics, which are produced by the second detector, are of sufficient amplitude and are fed back to the input system of the receiver, they will cause interference when a station is received whose frequency is equal to a particular harmonic of the intermediate frequency. With an intermediate frequency of 175 kc this type of interference is likely to be encountered at 700, 875, 1,050, 1,225, and 1,400 kc. This type of interference is eliminated by careful shielding of the second-detector circuits.

5. *Responses when the difference frequency is less than the i-f:* When the frequency difference between the oscillator and the signal impressed on the first detector is one-half or one-third the i-f a second or third harmonic of the beat frequency may be produced in the first detector which will be amplified by the I-f amplifier. Interference with a desired signal may be produced in this way. If sufficient selectivity is used ahead of the first detector to prevent image-frequency interference, interference of this type will also be avoided.

37. Sources of Interference When the I-f Is Higher Than the Signal Frequency. In some all-wave receivers the intermediate frequency is higher than the signal frequency throughout one tuning range. When this condition exists the potential sources of interference differ from those enumerated above. Interference may result from the following causes:

1. *Interference due to harmonics of the received signal.* If the tuning range includes a signal frequency equal to one-half or one-third the r.f., such a signal may produce harmonics in the first detector which will be amplified by the i-f amplifier. I-f signals are thus produced without the use of the heterodyne oscillator. The frequency of the signals produced in this way does not vary as the receiver is tuned. The local oscillator also heterodynes the signal to the intermediate frequency but the i.f. thus produced varies as the receiver is tuned. When the receiver is tuned through such a signal, a beat note is produced by the two i-f signals. Selectivity ahead of the first detector will restrict the tuning range over which this interference is encountered but cannot eliminate it when the desired signal is the signal causing the interference.

2. *Interference due to two signals whose sum frequency equals the i.f.* When two signals are impressed on the first detector and produce a sum frequency equal to the i.f., a beat note is produced as the receiver is tuned through a desired signal. Under this condition two i-f signals are produced, one of which remains fixed in frequency while the other varies as the receiver tuning is changed. Since the signals which can produce this interference may be on adjacent channels, the selectivity which must be used ahead of the first detector to entirely avoid this interference is equivalent to that normally used in the complete receiver.

38. Choice of the Intermediate Frequency. The choice of the intermediate frequency for a superheterodyne receiver is a compromise between the following factors:

1. With a given t-r-f system ahead of the first detector, the possibility of encountering image-frequency interference is reduced as the intermediate frequency is increased.

2. Under the above conditions, the possibility of interference due to two stations separated by the intermediate frequency is also reduced as the intermediate frequency is raised.

3. The possibility of interference due to harmonics of the intermediate frequency being fed back from the second detector to the input of the receiver increases as the intermediate frequency is raised, since lower harmonics appear in the broadcast band and the amplitude of the harmonics which can cause interference is therefore increased.

4. The difficulty of obtaining a high degree of selectivity and amplification in an i-f amplifier is increased as the intermediate frequency is raised.

The majority of broadcast receivers employ intermediate frequencies at or near either 175 or 460 kc. The higher intermediate frequency is used in all-wave receivers to minimize image-frequency interference and reduce reaction between the oscillator and first detector circuits when the receiver is tuned to high signal frequencies. With an intermediate frequency of 175 kc, the fourth harmonic is the first to appear in the broadcast range from 550 to 1,600 kc. The second and third harmonics of a 460-kc i.f. appear in this tuning range.

39. Tuned-radio-frequency Circuits. The t-r-f circuits ahead of the first detector in a superheterodyne receiver are used primarily for

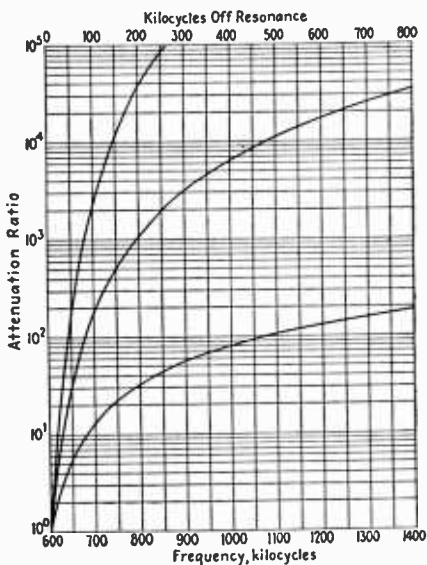

Fig. 32.—Attenuation of one, two, and three t-r-f circuits.

eliminating certain types of interference common to the superheterodyne type of receiver. Figure 32 shows the attenuation of one, two, and three t-r-f circuits for frequencies up to 800 kc off resonance when tuned to 600 kc. From curves of this type it is possible to obtain the image-frequency ratio for any given r-f system which may be used ahead of the first

detector. *Image-frequency ratio* has been termed the ratio between the field strength necessary to produce standard output from a superheterodyne at the image frequency and that necessary to produce standard output at the frequency to which the receiver is tuned. The image-frequency ratio provided by modern broadcast receivers is usually about 20,000 to 1 in the tuning range from 540 to 1,600 kc. With an image frequency of 460 kc this ratio can be obtained with two tuned r-f

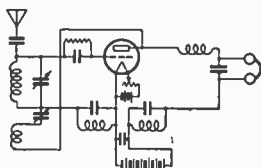

FIG. 33.—“Tickler”-type regenerative receiver.

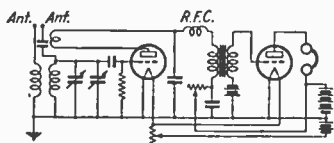

FIG. 34.—Regenerative circuit with resistance control.

circuits. This combination provides an image-frequency ratio of between 100 to 1 and 200 to 1 in the tuning range from 10 to 20 Mc. Care must be exercised in the design of a superheterodyne receiver to use sufficient shielding so that the actual selectivity of the t-r-f circuits is realized. If a reasonable amount of shielding is not used, signals which will cause image-frequency interference may be picked up directly on the first detector circuits and the benefit of the t-r-f circuits between the antenna and this detector will be lost.

40. Regenerative Receivers. Two typical regenerative-receiver circuits are shown in Figs. 33 and 34. In the first arrangement the regeneration is controlled by varying the coupling between the “tickler” coil, which is connected in the plate circuit of the regenerated tube, and the inductance of the tuned grid circuit. A variable resistance is used in the plate circuit of the regenerated tube in the second receiver. This variable resistance is used to vary the plate potential on the tube and thereby control the regeneration. The coupling between the tickler

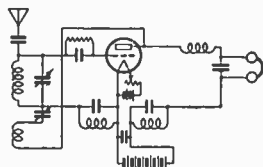

FIG. 35.—Single-tube superregenerator.

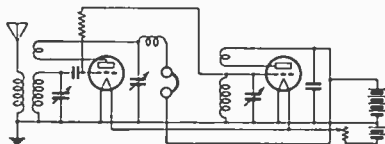

FIG. 36.—Superregenerative circuit with separate quenching tube.

coil and the inductance of the tuned circuit in the second receiver is fixed. This arrangement is generally used in receivers which make use of plug-in coils to cover a wide frequency range since the tickler coil can then be wound on the same form as the tuned circuit inductance.

41. Superregenerative Receivers. Two typical superregenerative circuits are shown in Figs. 35 and 36. Figure 35 shows a single-tube arrangement in which the quenching frequency is produced by the same

tube which provides the superregeneration. In the circuit shown in Fig. 36 a separate tube is used to provide the quenching frequency which is usually between 5,000 and 20,000 cycles. A filter is generally used in the output circuit of the superregenerative tube to eliminate the quenching frequency so that it does not appear in the receiver output.

In Fig. 37 is shown the complete circuit diagram of a superregenerative receiver used in police cars for the reception of signals on frequencies between 30 and 40 Mc. This receiver employs a tuned r-f stage ahead of the superregenerative detector to prevent radiation. The 20-kc quench frequency is provided by a separate oscillator. Two stages of a-f amplification are employed. Amateur practice on 56 Mc is to use a single tube in which the periodic blocking of the tube is produced by the proper choice of grid leak and condenser.

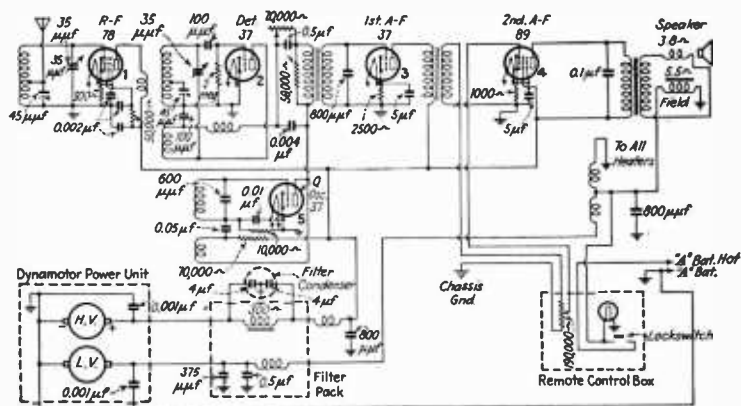

FIG. 37.—Superregenerator receiver for police cars.

42. All-wave Receivers. A large number of the broadcast receivers being produced at the present time cover one or more short-wave ranges in addition to the normal broadcast frequency band (540 to 1,600 kc). These short wave ranges include frequencies up to 48,000 kc. Some receivers are also designed to tune through a long wave band from 150 to 400 kc.

In the majority of all-wave receivers separate coils are employed in the r-f system for each tuning range. A few receivers use a tapped coil for each tuned circuit. When such coils are utilized, the unused portion of the coil is always short-circuited. When separate coils are employed, the coils for two or more of the frequency bands are frequently wound on a single form. The coil windings differ considerably with the frequency range which the coils are designed to cover. Wire as small as No. 35 Brown and Sharpe is used in the inductances for the tuning range from 540 to 1,600 kc, while wire as large as No. 22 Brown and Sharpe is used in some of the short-wave coils. The turns on the short-wave coils are usually spaced to minimize the coil losses.

All-wave receivers are provided with a gang switch for simultaneously connecting the coils used for each tuning range to the associated tuning

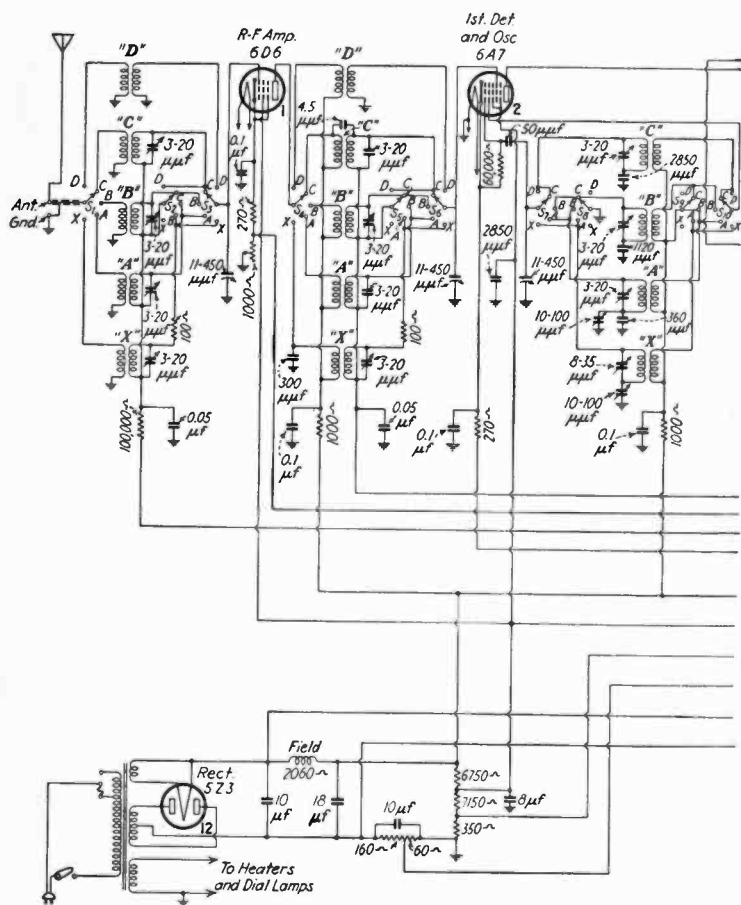
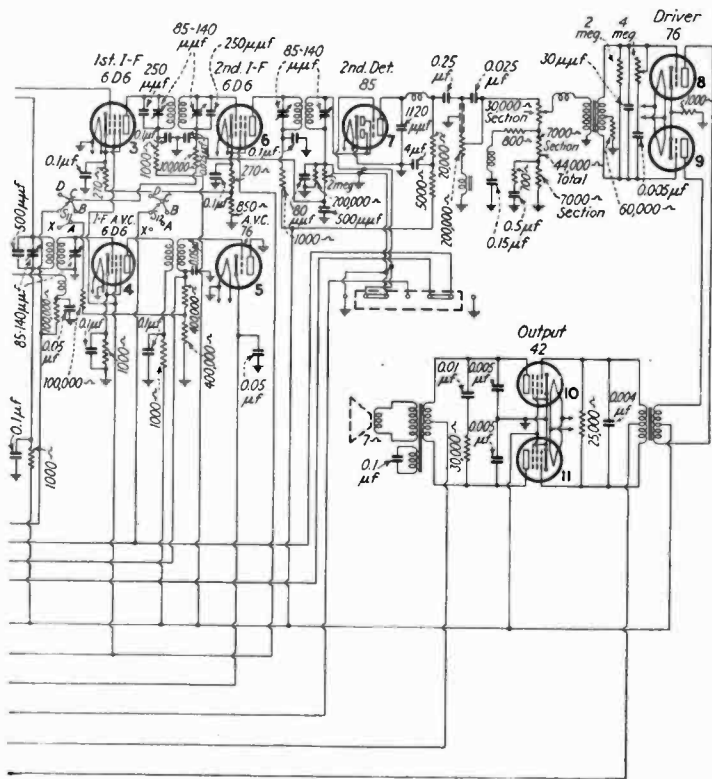

FIG. 38.—Circuit diagram

condensers and tubes. Such a switching arrangement is illustrated by Fig. 38, which shows the complete circuit diagram of a typical all-wave receiver.

Receivers of this type are usually equipped with tuning mechanisms which permit the user to change the drive ratio between the tuning



of 1935 all-wave receiver.

knob and the variable condenser from 10 to 1 to 50 to 1. The 50 to 1 ratio is necessary to tune the receiver accurately to a short-wave station since the frequency band covered in a single high-frequency tuning

range may be over ten times that covered in the range from 540 to 1,600 kc.

Special tuning dials are necessary on all-wave receivers since a separate scale is required for each tuning range. In some receivers all the scales are visible to the user regardless of the tuning range which is being used, and an indicator which is actuated by the range switch knob is used to designate the correct scale. In the dials used on other receivers of this type only the scale corresponding to the tuning range being used is visible. With this arrangement the dial scales are movable with respect to the dial opening and the range switch is mechanically connected with the dial scales so that as the tuning range is switched from one frequency band to another the proper scale is moved into place.

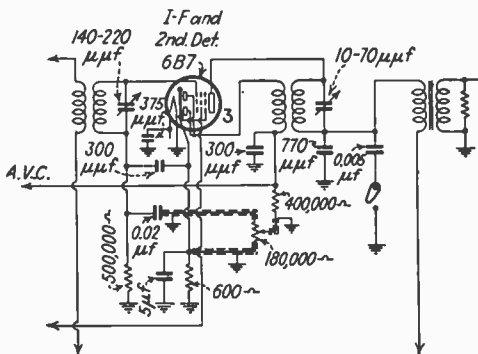

FIG. 39.—Reflexed amplifier.

43. Automobile Radio Receivers. Compactness and ruggedness are two of the essential requirements of an automobile radio receiver. Compactness is required because of the small space which is usually available in which to mount the receiver and ruggedness is necessary because of the vibration and road shocks to which the receiver is subjected. Reflex circuits have been used in automobile receivers to minimize the number of tubes required to give satisfactory performance. A circuit of this type is illustrated by Fig. 39. In this diagram a 6B7 tube functions as an i-f amplifier, a diode detector, and an a-f amplifier. The i-f signals impressed on the grid of this tube are amplified and impressed on the diode portion of the tube by means of an i-f transformer, the primary of which is connected in the plate circuit of the pentode. The a-f potential developed across the diode output resistor is impressed on the grid of the pentode through a coupling condenser and grid leak. The a-f component of the pentode plate current develops a voltage across the primary of the a-f transformer which is connected in series with the primary of the i-f transformer associated with the diode. The switch shown in the diagram for connecting a by-pass condenser across the primary of the a-f transformer is used as a two-position high-frequency tone control.

Since the strength of the signals intercepted by an automobile antenna varies greatly with the location of the car, it is essential that an automobile radio receiver be equipped with an effective a.v.c. system.

The plate and bias potentials for the tubes in automobile receivers are generally obtained from vibrator B-supply systems. Two arrangements which are frequently used are illustrated by Fig. 40. In the system shown by diagram (a), a vibrator and transformer are used to derive a high-voltage alternating potential from the 6-volt storage battery. This voltage is rectified by a vacuum-tube rectifier and supplied to the receiver circuits through a conventional filter. In diagram (b) the vibrator is not only used to provide the high voltage, but also performs

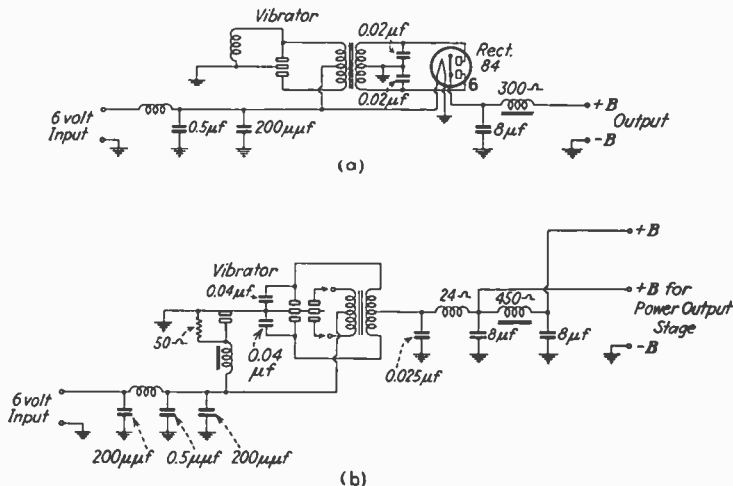

FIG. 40.—Vibrator B-supply systems.

the function of rectification. The filter shown in this diagram was designed to supply the potentials for a receiver using a class B output stage and the second filter section was used to minimize fluctuations in the plate potential for the r-f and i-f amplifier tubes.

The chassis of an automobile radio receiver is generally completely shielded to prevent the pickup of ignition interference on the receiver circuits. Two methods have been employed for preventing the ignition systems of automobiles from causing excessive interference in automobile radio receivers. In the first method the interference radiated by the ignition system is minimized through the use of suppressor resistors in the spark plug and distributor leads. An r-f filter is used in the leads connecting the receiver to the storage battery. All portions of the automobile electrical system which may radiate the interference such as leads to the dome light, etc. are by-passed with a suitable by-pass condenser. The objection to this method is that the resistors which are used to suppress the high-frequency oscillations may decrease the effec-

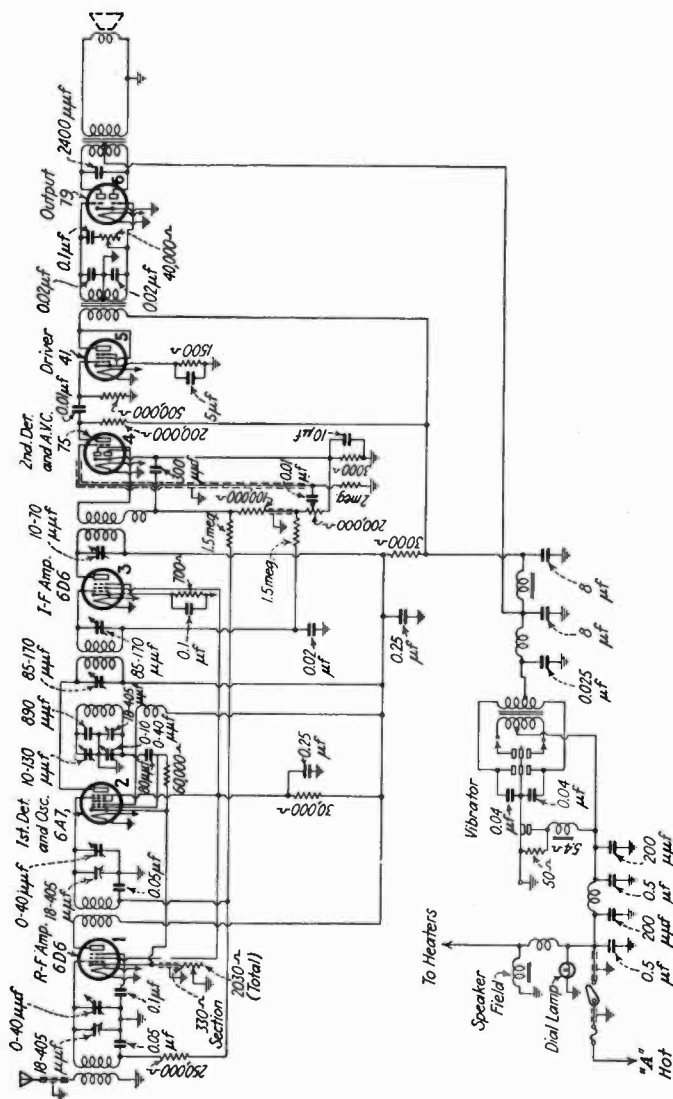

FIG. 41.—Automobile radio receiver.

tiveness of the ignition system to the point where a loss in engine efficiency occurs. In the second method which has been used to minimize this type of interference, a special antenna system is employed which discriminates between high-frequency ignition interference and the desired signal (see Sec. 22).

In a large number of automobile radio receivers all the receiver elements with the exception of the tuning controls are assembled in a single unit. This unit is arranged for mounting to the fire wall by means of one or more bolts. The unit containing the station selector dial and tuning control knob is either mounted on the instrument panel or attached to the steering column. The tuning control unit is mechanically connected to the receiver chassis by means of a flexible shaft.

The circuit diagram of a typical automobile radio receiver is shown in Fig. 41.

HIGH-FIDELITY RECEIVERS

44. Audio-frequency Response Range. The term "high fidelity" has been associated with broadcast receivers which provide reasonably uniform reproduction of frequencies from 50 to 8,000 cycles. It is impractical to exceed the 8,000 cycle high-frequency limit as long as the 10-kc spacing between broadcasting stations is maintained. When the range of high frequencies reproduced by a broadcast receiver is extended, a corresponding increase in low-frequency response range must be made to maintain a proper acoustic balance.

45. Variable Selectivity. To obtain reasonable freedom from cross-talk and high-frequency interference when receiving weak signals, it is necessary that a high-fidelity receiver be provided with some means whereby its selectivity can be increased over that required for the reception of high-fidelity programs from local transmitters. This change in selectivity is generally secured by altering the effective coupling between the primary and secondary of one or more of the i-f transformers. This is accomplished by moving one i-f coil with respect to the other, by the use of a transformer employing a third winding which is shunted by a variable resistor, or by varying the coupling between two windings of a variometer which contains a portion of the primary and secondary inductance of the i-f transformer.

46. Tuning Meter. The broad selectivity characteristic required to give high-fidelity receivers the desired a-f response range makes it very difficult to tune such a receiver properly by ear. To facilitate tuning, a tuning meter is employed. In some high-fidelity receivers this meter is connected in the plate circuit of a rectifier which is preceded by a very selective i-f circuit. This i-f circuit is tuned to the center of the frequency band passed by the i-f amplifier and the deflection of the tuning meter thus accurately indicates when the receiver is in resonance with a desired signal.

47. "Monkey Chatter" Interference. Receivers reproducing high audio frequencies are susceptible to "monkey chatter" interference. This interference is produced either by the side bands of an undesired signal beating with the desired carrier wave or by the side bands of the desired signal beating with an undesired carrier wave. A large percentage of the energy in this interference is found in the frequency band from 8,000 to 10,000 cycles. A low-pass filter giving an attenuation of

at least 40 db for frequencies above 8,000 cycles is generally employed in high-fidelity receivers to minimize this interference. Such a filter is also effective in reducing other high-frequency interference such as man-made static, tube hiss and beat notes caused by carrier waves on adjacent channels.

48. Minimizing Distortion in High-fidelity Receivers. As the range of frequencies reproduced by a broadcast receiver is increased the distortion which can be tolerated is reduced. The most important source of distortion in such receivers is the detector and audio-frequency

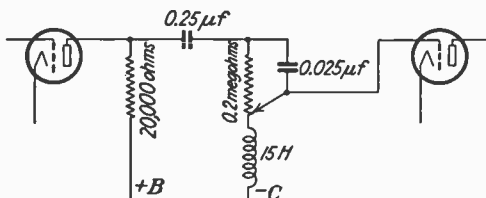

FIG. 42.—Input to a-f amplifier to avoid detector distortion.

amplifier. The diode is the most satisfactory of the detectors used in broadcast receivers from the standpoint of distortion. To minimize the distortion when receiving signals having a high percentage modulation with a diode detector, it is necessary that the a-f impedance of the diode output circuit be the same as its d-c resistance. This condition may be obtained through the circuit shown in Fig. 42, in which the grid of the a-f amplifier tube is directly connected to the diode output resistor thus avoiding the shunt a-c path formed by the conventional coupling condenser and leak. The distortion introduced by this detector and a-f amplifier stage can be kept well under 5 per cent when the percentage modulation of the received signal is approximately 100 per cent. A push-pull Class A output stage is generally used where minimum distortion is desired.

The precautions for minimizing distortion as outlined under Automatic Volume Control must also be observed.

49. High-fidelity Loud-speakers. Special loud-speakers are employed in high-fidelity receivers to reproduce the wide range of frequencies. In some receivers a special cone speaker is used employing a voice coil wound with aluminum wire. In other receivers two loud-speakers are utilized to reproduce the desired frequency range. One of these speakers is designed to reproduce frequencies from 50 to 2,500 cycles and the other, frequencies from 2,500 to 8,000 cycles. The high-frequency energy radiated by the usual cone loud-speaker is concentrated in a relatively narrow beam. Sound diffusers are used in a number of high-fidelity receivers to disperse this beam and produce a more uniform distribution of high-frequency energy. These devices consist of a number of vertical or horizontal slats placed in front of the loud-speaker at various angles with respect to its axis.

50. Universal or A-c-D-c Receivers. Figure 43 shows the circuit diagram of a five-tube superheterodyne receiver which may be operated from either alternating or direct current. The heaters of the tubes used in receivers of this type are connected in series. Since the voltage

required for the heaters is considerably less than the line voltage, the heaters are connected to the supply line through a series resistor which

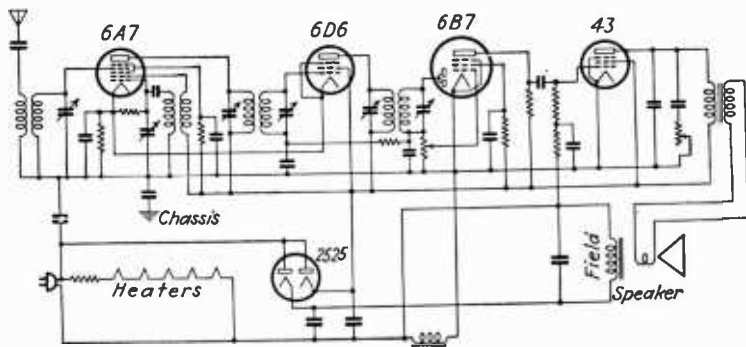

FIG. 43.—A-c-d-c receiver circuit.

provides the desired voltage drop. This resistor must usually dissipate considerable heat. In a number of the smaller universal receivers the series heater resistor is included as a third conductor in the power cord thus facilitating the dissipation of heat. The rectifier tube prevents the electrolytic condensers from being damaged in case the power plug is not inserted correctly in a d-c outlet.

SPECIAL RECEIVERS

51. Commercial Receivers. The principles underlying the design of commercial receivers are the same as those employed in the design of broadcast receivers.

Ruggedness and reliability are among the chief considerations in the design of commercial receivers, since such receivers must usually remain in continuous operation for long periods of time. Simplicity of tuning is not so important in this type of receiver as in broadcast radio receivers, since commercial receivers are generally used by skilled operators. Commercial radio receivers are generally designed to use battery-operated tubes. The plate potential for such receivers is supplied from either batteries or a motor generator. In some transatlantic receiving systems, three complete receiver and antenna combinations are used to overcome the effects of fading. In an installation of this type the antennas

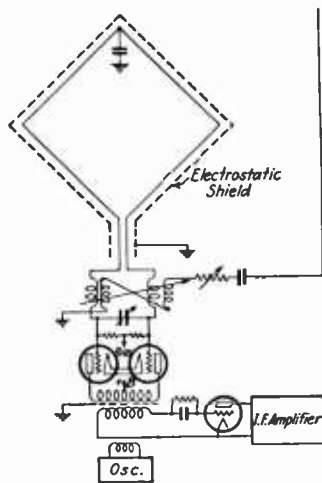

FIG. 44.—Direction-finder circuit.

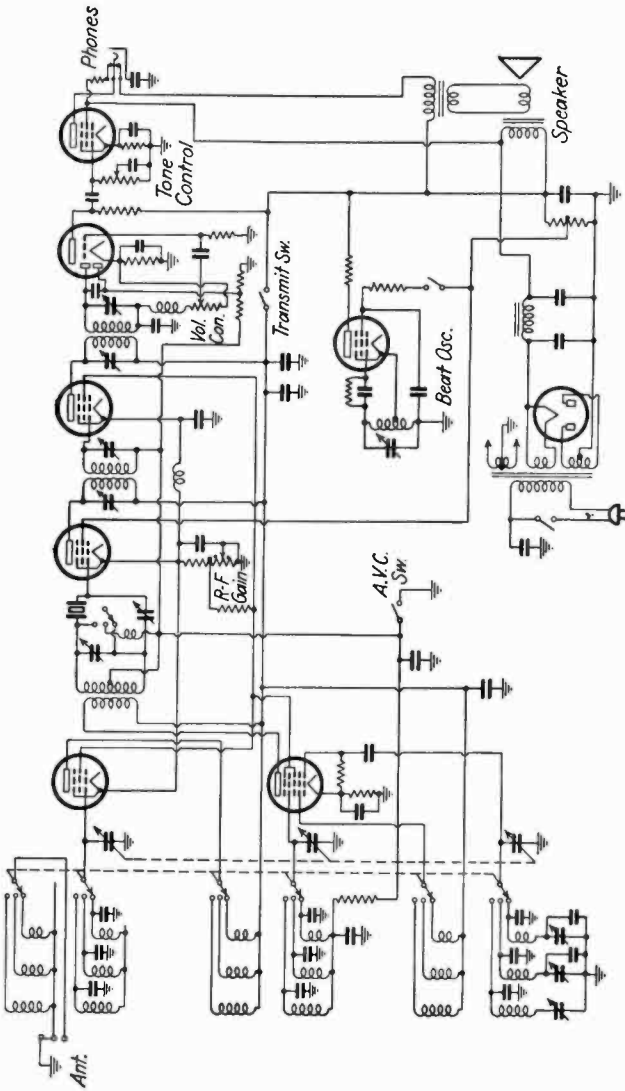

FIG. 45.—Single-signal receiver using quartz crystal.

are separated by several wave lengths. An automatic volume-control arrangement is provided so that only the output of the receiver which is receiving the strongest signal is used.

52. Direction Finders. The directional property of a loop antenna is utilized in direction finders to determine the plane in which the radio transmitter and the direction finder are located. The circuit diagram of a typical finder is shown in Fig. 44. The loop antenna in this receiver is enclosed in an electrostatic shield. The center tap on the loop is grounded. These precautions are taken to eliminate the electrostatic effect of the loop antenna. If this effect is present, a broad minimum is obtained as the loop antenna is rotated and it is impossible to obtain an accurate bearing. The diagram shows an arrangement for compensating for the effect of a nearby metal object which might distort the field around the loop. A small antenna having characteristics as similar to the metal object as possible is erected and connected through a resistor to the variometer shown in the diagram. By proper adjustment of the variometer the signals introduced by the nearby metal object and the compensating antenna and variometer arrangement are made to balance so that they produce no effect on the inherent directional properties of the loop antenna. The superheterodyne circuit is usually employed in direction finders. Both the loop antenna and oscillator circuits are tuned through the use of a single control. Bearings can be determined to within about 1 deg.

53. Single-signal Receivers. Many of the receivers used by amateur radio operators are of the single-signal type which is characterized by its extreme selectivity. The high degree of selectivity is frequently obtained through the use of a quartz crystal as a coupling element in one of the i-f stages. The selectivity characteristic of a 460-kc quartz crystal may have band widths at 90 per cent and 10 per cent of 10 and 100 cycles respectively. The limited frequency band required for code communication permits the use of receivers having such a selectivity characteristic.

Figure 45 shows the circuit diagram of a receiver employing a quartz crystal. As indicated by this diagram the crystal is used as a coupling element between the secondary of the first i-f transformer and the grid of the first i-f amplifier tube. A neutralizing arrangement is employed to counteract the effect of the crystal holder capacity. This capacity limits the selectivity contributed by the crystal, and in conjunction with the inductance of the crystal, forms a parallel-resonant circuit which introduces considerable attenuation for a narrow band of frequencies near the frequency to which the crystal is resonant. A switch is provided for removing the crystal from the circuit when desired thereby decreasing the receiver selectivity. A switch is also employed for rendering the a.v.c. system inoperative when code signals are received. The receiver gain is then adjusted by means of a manual control. An i-f oscillator is used to heterodyne c-w signals.

SECTION 14

RECTIFIERS AND POWER-SUPPLY SYSTEMS

By R. C. HITCHCOCK, M.A.¹

1. Power-supply Design. The main elements in a unit whose input is a.c. and whose output is d.c., in the order of current flow are: (1) transformer, (2) rectifier, (3) filter, and (4) voltage divider. The filter and voltage divider are also used in *B* and *C* supply units from

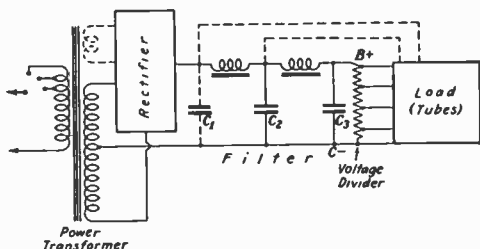

FIG. 1.—Typical a-c powered unit for furnishing *B* and *C* voltages.

d-c supply lines, in which case the rectifier and transformer are not needed. Although the main application of the design of the above items 1 to 4 is for *B* and *C* power supply, they may also be applied to filament *A* supply systems.

It is usually advisable to start the design with the tubes (or with the d-c load requirement), to determine what plate and grid voltages are needed, and then to take up the design of the filter, its rectifier and transformer. It is also possible to start the solution by beginning with the rectifier, thereby determining the maximum output voltages which are reasonable with good filtering and regulation. If any one particular item (1 to 4 above) must be used, the other three can be designed to work with that item.

Beginning with the load is quite logical, because the filter-choke design requires the knowledge of the load current, and the ratio of choke inductance to the filter capacity depends on the load resistance. If, in starting with the desired voltages, it is found when the rectifier is reached that no standard tube will supply a sufficiently high voltage or current, it may be advisable to make the necessary percentage cut in voltage or current, and to use a standard rectifier, thus reducing the

¹ Electronics Section, Meter Engineering, Westinghouse Electric and Manufacturing Company, Newark, N. J.

output by the percentage mentioned. It is usually easy to design a suitable power transformer, the rating being increased by using a thicker stack of standard punchings, the spool size being increased accordingly.

A voltage divider usually is designed for a definite load on each of several voltage taps. If the load is increased on a certain tap, that voltage decreases and all the other voltages, too, are decreased, the amount depending on the amount of the increase in load, and the fraction of total voltage supplied to that certain tap.

1a. Adjustable Voltage Dividers. This section is mainly for those who are not particularly interested in solving equations. A high-resistance (1,000 ohms per volt) voltmeter of suitable range and an *adjustable voltage divider* are required. First-class dividers are available commercially, both of the vitreous enamel type with a bared portion on which sliders may be moved, and also the bare wire type, wound in insulating grooves. Either type is quite satisfactory, and after the voltages are set with the tube loads connected, by using the voltmeter, the sliders may be clamped securely in place.

It will be necessary to perform one simple calculation to secure a voltage divider of suitable wattage capacity. To do this two things must be known: the total voltage (E) to be used, and the circulating current (I). These two factors determine the ohmage of a resistor, neglecting tube loads, and to a safe approximation this will determine the wattage rating of the divider. Assuming 300 volts for E and 10 ma for I_0 (the E corresponds to $B_2 + C_2$ of Art. 2). The resistance in ohms is:

$$\frac{1,000 \times E \text{ volts}}{I \text{ ma}} = \frac{300,000}{10} = 30,000 \text{ ohms.}$$

The wattage is:

$$\frac{E^2 \text{ volts}}{R \text{ ohms}} = \frac{300 \times 300}{30,000} = 3 \text{ watts}$$

The standard wattage rating of resistors is for the unit to be mounted with 1 ft. of free air in each direction. In actual use the resistors must be more confined, and a safe factor is to divide the standard rating by three. Hence, a 10-watt resistor under actual (confined) use, can dissipate $\frac{10}{3} = 3.3$ watts.

A different current will flow between each slider of the voltage divider. To allow for this unequal current distribution (see Art. 1b) the wattage rating should be multiplied by an additional factor of 3. The result is that the 3-watt value must be multiplied by 3×3 . Thus, a 27-watt resistor or larger will be satisfactory for the circuit calculated above.

A final consideration must also be made; that of the maximum allowable voltage which the resistor can withstand. Manufacturers give these data, but, as an approximate guide for continuous duty at 300 volts, the resistor should be 3 to 4 in. long.

The complete calculations for voltage dividers is given in the following articles, 1b to 6.

1b. Wattage Rating of Resistor Sections in Voltage Dividers. In voltage dividers, as in every other electrical circuit, the radiating surface of the resistors must be adequate. In Arts. 2 to 6, as well as in the preceding Art. 1a, the wattage for *each section* can be found by dividing the voltage squared by the resistance in ohms. For enclosed spaces, the wattage should be three times the standard rating (Art. 1a). In general, each section of the voltage divider carries a different current, and a complete calculation must be made

for each. For example, the parallel voltage divider of Fig. 2 requires six calculations, one each for R_A , R_B , R_C , R_D , R_E , R_F .

2. Parallel Voltage Divider.¹ The simplest form of parallel voltage divider is shown in Fig. 2. To start with, the resistance of the coupling devices between the tube plates and the B supply will be neglected. In the series voltage divider these will be taken up in detail.

The voltage applied from $B+$ to $C-$ comprises the total B , plus C , voltage that needs to be supplied to the load. For example, a 45 tube with a B voltage of 250 means that the plate is 250 volts positive with respect to the filament. The corresponding grid voltage is 50, meaning that the grid is 50 volts negative with respect to the filament. Thus, the filament can be considered as at an intermediate potential between $B+$ and $C-$. On the voltage divider as shown in Fig. 2, $B+$ will be on the upper part of the resistor, $B-$ lower down, and $C-$ still lower down than $B-$.

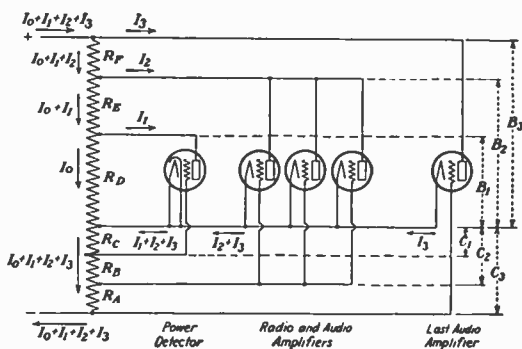

FIG. 2.—Parallel voltage divider.

The tube plates take current from the voltage divider, and the use of Ohm's law gives the resistor values. The grids take no appreciable current, so from $B-$ to $C-$ no allowance need be made for currents entering or leaving, the total current passing through the voltage divider from $B-$ to the lowest $C-$ used. The filament returns are schematic, without showing the potentiometers which adjust for minimum hum. As shown there are three B voltages, noted at the extreme right of the figure, B_1 for the detector, B_2 for the radio and audio amplifiers, and B_3 for the last audio tube. The subscripts on the C voltages correspond with those on the B voltages. For instance, C_2 is the grid voltage for the power tube using B_2 plate volts.

The power detector takes B_1 plate volts and C_1 grid volts. If the grid-leak type of detector is used there is no grid voltage required, and $C_1 = 0$. The plate currents are I_1 , I_2 , and I_3 . If, as in the case of I_2 , there are several tubes being supplied with the same voltage, the individual plate currents are multiplied by the number of tubes. For example, I_2 in Fig. 2 is made up of three equal parts, one part supplying each of three identical tubes. The

¹ See Voltage Dividers, Their Application and Design, *Aerovox Research Worker*, December, 1934.

current I_0 , flowing in parallel with I_1 , is known as the circulating or waste current.

The resistance of the voltage divider has been divided into six sections denoted by the letter R , with subscripts A to F , to avoid confusion by using the same numerical subscripts on B and C voltages. Thus, the voltage drops from B_3 to B_2 through the resistor R_F , from B_2 to B_1 through R_E , etc.

The currents and their directions are shown by arrows, the amounts being indicated by the letter I with appropriate subscripts.

In calculating the resistors of Fig. 2, the equations are:

$$R_F = \frac{B_3 - B_2}{I_0 + I_1 + I_2} \quad (1)$$

$$R_E = \frac{B_2 - B_1}{I_0 + I_1} \quad (2)$$

$$R_D = \frac{B_1}{I_0} \quad (3)$$

$$R_C = \frac{C_1}{I_0 + I_1 + I_2 + I_3} \quad (4)$$

$$R_B = \frac{C_2 - C_1}{I_0 + I_1 + I_2 + I_3} \quad (5)$$

$$R_A = \frac{C_3 - C_2}{I_0 + I_1 + I_2 + I_3} \quad (6)$$

The equivalent resistance of the voltage divider and tube load is used in calculating the filter, and for Fig. 2 the equivalent resistance is equal to the total voltage divided by the total current:

$$R_{\text{equiv.}} = \frac{B_3 + C_3}{I_0 + I_1 + I_2 + I_3} \quad (7)$$

In this equation, as in Eqs. (1) to (6) the absolute values of the B and C voltages are used.

3. Voltage Regulation. The parallel voltage divider has good voltage regulation when the circulating current I_0 is large compared to the other currents. For reasons of economy, however, it is inadvisable to make I_0 very large. First, the increase in I_0 causes the equivalent load resistance to go down, which requires (see Fig. 6) larger filter condensers. The extra I_0 , in the second place, causes extra heat in the voltage divider which in turn means that the power transformer must be supplied a heavy current and the operating cost is increased.

The formula for determining the $B + C$ voltage is, to a good approximation:

$$B + C = E - (I_0 + I_1 + \dots)R_t \quad (8)$$

where $B + C$ are the voltages across the load and voltage divider, E the r-m-s voltage of one high-voltage winding of the transformer, and R_t the combined resistance of the chokes, transformer winding and tube resistance.

From Eq. (8) it will be seen that, if any of the individual I 's increase, the total $B + C$ voltage decreases, and from Eqs. (1) to (7), written in the form

$$R_F(I_0 + I_1 + I_2) = B_3 - B_2 \text{ rewriting (1)} \quad (9)$$

it is seen that the voltage drop between taps is greater; for example, less voltage is supplied at B_2 if I_1 is increased. For good regulation it is essential that the R_t of Eq. (8) be small compared to the load resistance, and that the circulating current I_0 be large. For reasons of economy in manufacture as well as operating cost I_0 should be small so that the filter can be cheaper.

4. Series-parallel Voltage Divider. By putting $I_0 = 0$ ($R_D =$ open circuit) in Fig. 2 a series-parallel voltage divider is made. The C

voltages are, as before, taken from resistors R_A , R_B , and R_C . The equations of (1) to (8) still hold by putting $I_0 = 0$ wherever it appears.

5. Series Voltage Divider. Figure 3 shows the series voltage divider, the currents and their directions being shown by arrows. The currents for the tubes are the same as for Fig. 2, I_1 being the power-detector plate current, B_1 and C_1 the plate and grid voltages for the power-detector tube, etc.

The series voltage divider is simpler to figure than the parallel, because there is no circulating current, each B voltage has only one set of tube currents flowing through it, and the grid-bias resistors are separate for each group of tubes. A further simplification results in the calculation of the plate resistors, as the resistance of the coupling device is easily

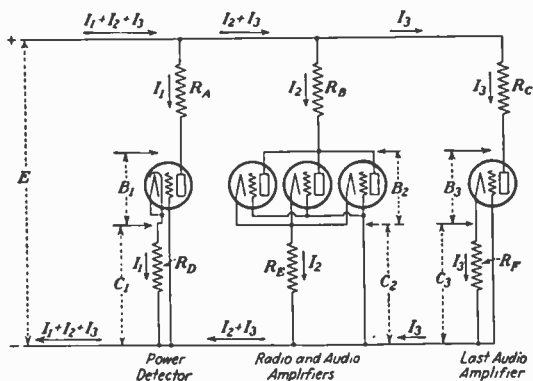

FIG. 3.—Series voltage divider.

included in the plate-resistor calculation. That is, the resistance of the transformer-coil choke or coupling resistor between $B+$ and a particular tube plate is considered as incorporated in the resistor incorporated in the plate circuits of Fig. 3. The last audio stage requires the most voltage and therefore the B and C voltage which it requires is the main factor in determining the maximum B and C voltages needed. The total voltage from the filter is not applied to the plate directly but through a coupling device, as indicated by the resistor R_C . This resistor is not a means of decreasing the voltage to a proper value but represents the coupling device only.

The total voltage supplied at the left of Fig. 3 is larger than the B_3 plus C_3 used by the last audio tube by an amount equal to the drop in the coupling device. The voltage at the end of the filter is

$$E = I_3 R_C + B_3 + C_3 \quad (10)$$

R_C determines the supply voltage; if R_C is large, the required E is large, and *vice versa*. The equations for the other resistors are:

$$R_A = \frac{E - B_1 - C_1}{I_1} \quad (11)$$

$$R_D = \frac{C_1}{I_1} \tag{12}$$

$$R_B = \frac{E - B_2 - C_2}{I_2} \tag{13}$$

$$R_B = \frac{C_2}{I_2} \tag{14}$$

$$R_F = \frac{C_3}{I_3} \tag{15}$$

In the power detector and radio and audio amplifiers the R_A and R_B include the resistance values of the coupling devices. For example, if a choke coil of 1,000 ohms feeds the plate of the power detector then the actual resistance to use will be $(R_A - 1,000 \text{ ohms})$.

6. Voltage Divider with Graded Filter. A voltage divider of a graded form is shown in Fig. 4. The output stage comprises two similar tubes

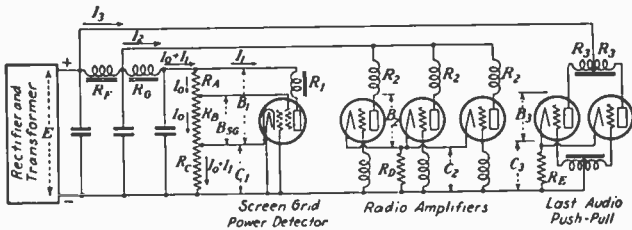

FIG. 4.—Voltage divider with graded filter.

in push pull, an arrangement which requires a minimum of filtering. The B_3 comes directly from the positive side of the rectifier. Note the filter condenser across from B_3 to the negative terminal. Sometimes, as in Fig. 1, the first condenser shown dotted is omitted. When taking the B voltage for a push-pull stage directly from the receiver it is necessary that this first condenser be retained.

The "grading" of this arrangement is apparent; the output stage receives the least filtering, push pull requiring practically no filter when the tubes are matched; the radio amplifiers have one stage of filtering in their B supply; and the power detector has two stages of filtering for its B . This grading is economical; the heavy output-tube currents do not flow through any of the filter chokes. This reduces heat losses and allows the design of a smaller choke, or a better one of the same physical size. The voltage drop of the choke is eliminated, thus the power-transformer voltage can be lower. Many of the feed-back difficulties are also avoided. When common resistors supply several tubes which are in cascade, it is often found that a small variation in the output-tube current will change the grid voltage of a preceding tube, which by virtue of its amplification and coupling, causes a larger variation in the output-tube circuit. This process may be cumulative and continue to build up and "howl" or "motor boat." This feed-back is avoided by separate resistors, and is especially well eliminated by having a full stage of filtering between the output tube, radio amplifiers, and detector, as in Fig. 4.

It should again be noted that only with a push-pull output stage is it possible to supply $B+$ directly from a filter. If a single output tube is used, the plate voltage must have at least one stage of filtering (*i.e.*, a series choke and its accompanying condenser).

Figure 4 gives the coupling units as R_1 for the detector, R_2 for each radio amplifier, and R_3 for each half of the push-pull output choke. The voltage for the screen grid of the detector tube is furnished by a parallel connection across the B resistor after the second stage of the filter. The screen-grid current is small and may be neglected if I_0 , the circulating current, is, say, 10 to 20 ma.

The chokes of Fig. 4 may have a very high resistance, over 1,500 ohms each for R_F and R_G , because no very heavy currents flow through them. In fact, it may be desirable to have some high series resistance in the circuit to reduce the voltage from that required by the last audio stage to that needed by the radio amplifiers and detector. For this reason, it should be borne in mind that the values of R_F and R_G for the chokes and R_1 and R_2 , the plate-coupling units for detector and radio tubes, should be considered as including any voltage-reducing resistor which is needed.

As before, I_1 is the detector plate current, I_2 includes three-tube plate currents, and I_3 now has two plate currents, the equations for Fig. 4 being:

$$R_A = \frac{B_1 - B_{sg}}{I_0} \quad (16)$$

$$R_B = \frac{B_{sg}}{I_0} \quad (17)$$

$$R_C = \frac{C_1}{I_0 + I_1} \quad (18)$$

$$R_D = \frac{C_2}{I_2} \quad (19)$$

$$R_E = \frac{C_3}{I_3} \quad (20)$$

The equations determining the choke and coupling resistors are:

$$B_1 + C_1 = E - R_F(I_2 + I_1 + I_0) - R_G(I_0 + I_1) - I_1 R_1 \quad (21)$$

$$B_2 + C_2 = E - R_F(I_2 + I_1 + I_0) - \frac{I_2 R_2}{3} \quad (22)$$

$$B_3 + C_3 = E - \frac{I_3 R_3}{2} \quad (23)$$

By substituting values either for the choke resistances or for the coupling coils, Eqs. (21) to (23) simplify into useful working formulas.

If screen-grid radio tubes are used, their screen-grid voltages may be obtained from the same supply as shown in Fig. 4 for the detector.

The equivalent resistances of the first and second filter load are not the same, due to the different load currents. For the first filter section the equivalent load is:

$$R_{\text{equiv.}} = \frac{E}{I_2 + I_1 + I_0} - R_F \quad (24)$$

and that for the second is:

$$R_{\text{equiv.}} = \frac{E}{I_1 + I_0} - R_F \frac{(I_2 + I_1 + I_0)}{I_1 + I_0} - R_G \quad (25)$$

6a. Filter Condensers. The advent of reliable electrolytic condensers has greatly simplified the construction of adequate filter systems at a low cost. The untuned low-pass filter¹ can readily be made by using a very few high-capacity electrolytic units. The one thing to note carefully is that electrolytic condensers are suitable only for direct current² and must be connected correctly. Condensers mounted in metal cans usually have the can negative. Cardboard units always have colored tracers, the red lead usually being plus. Wrongly connecting electrolytic condensers will ruin not only the condenser but is likely to damage the transformer and the rectifier tube. Mercury-vapor rectifiers, with their low voltage drop, are especially susceptible to such wrong connections.

Electrolytic condensers may be considered as comprising two general classes: low voltage, high capacity, from 1.0 to 50 μf , for grid filtering; and high voltage (up to 450 volts d.c.) for plate filtering, from 1 to 16 μf . Higher voltages are available by using several 450-volt units in series.

While electrolytic condensers are constantly being improved, there probably will always be a characteristic current which flows through the condenser.³ This current rises with temperature and may be a considerable fraction of a milliamperere per microfarad at the temperature of radio set operation.

There is a lower limit of temperature at which electrolytic condensers lose an appreciable portion of their capacity to store electrical energy. This limit is invariably below freezing (32°F.), and is usually of little consequence in radio-set use.

6b. Voltage-doubling Circuits. For low-voltage receiving circuits, there is now available a tube, 25Z5, comprising two rectifier elements in a single glass envelop. In a suitable circuit (see Figs. 24 and 25) as much as 250 volts and 30 ma d.c. can be obtained from a 115-volt a.-c. line without a transformer.

As the available output voltage, Art. 8, depends largely on the first condenser value, electrolytic condensers are frequently used because of their high capacity per unit volume. As already noted in Art. 6a such condensers must be connected correctly. Note that the positive lead of one condenser is connected to the negative of the other. *It is not possible to use a dual electrolytic condenser for voltage doubling if the negative lead is common.*

The voltage-doubling scheme can be used for higher voltage circuits using two standard half-wave rectifier tubes and a transformer with separate filament windings. The high voltage is supplied from an appropriate secondary instead of from the line.

In designing filters, Arts. 7 to 11, the value of the first condenser is found by using half the value of one doubler-condenser. If two 16- μf condensers are used, the "first condenser" value of the filter is one-half of 16 or 8 μf .

Although the 25Z5 was designed for use as a voltage-doubler tube, many other uses have been found. For example each cathode and plate may be used to supply a portion of a load.

¹ See Art. 7.

² For capacitor-type motors on a.c., two electrolytic condensers are used in series so that at all times one is connected correctly.

³ See Sec. 5, Arts. 18 to 23; also *The Influence of Power Factor and Capacity on Filtering Efficiency*, *Aerovox Research Worker*, October and November, 1934.

7. Filters. The filters used to give d.c. from rectified a.c. are known as low-pass filters.¹ Low-pass filters are divided into two classes, tuned and untuned filters. The tuned filter offers a maximum impedance or attenuation to the frequency of the supply, but the impedance at nearby higher or lower frequencies, is not quite so great (see Fig. 5b), although the general trend of the curve is a rising attenuation as the frequency increases.

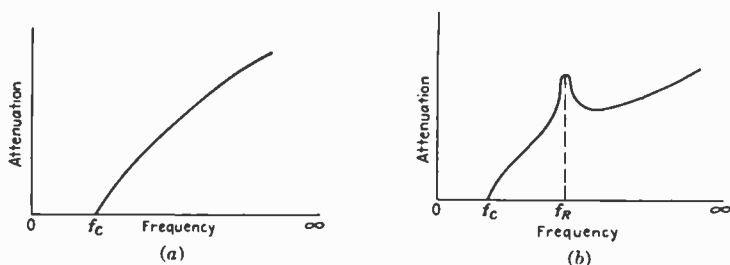

FIG. 5.—(a) Low-pass filter. (b) Tuned low-pass filter.

The usual form of untuned low-pass filter is that of Figs. 1 and 4, using three condensers and two chokes. This filter (Fig. 5a) has a continuously rising curve of impedance as the frequency increases. To obtain good filtering with this filter it is desirable to choose f_c , the frequency at which attenuation begins, as low as possible. The equations for determining the proper inductance and capacity for this filter are:

$$C = \frac{1}{\pi f_c R} = \frac{0.3183}{f_c R} \text{ farads} \quad (26)$$

$$L = \frac{R}{\pi f_c} = \frac{0.3183 R}{f_c} \text{ henrys} \quad (27)$$

where f_c = frequency at which attenuation begins

C = capacity in farads

R = resistance in ohms

L = inductance in henrys

As this is an often-used type of filter, Fig. 6 is devised to give the data of Eqs. (26) and (27) in a convenient chart form. The four columns from left to right are f_c in cycles per second; L in henrys; R in load ohms; and C in microfarads. Thus with any two of the factors fixed, the corresponding two are determined from this chart by a straightedge across the two known factors. For use on 60 cycles half-wave rectification, it is necessary that f_c be below 60, and for the double-wave rectifier f_c should be below 120 cycles, and the lower the f_c the better will be the filtering at the desired frequency, as shown by the rising attenuation curve of Fig. 5a.

The third column R is the usual starting place for finding the filter values, when the voltage divider and tube load have been calculated

¹ The theory of filters is admirably covered in the following books: K. S. Johnson and T. S. Shea, "Transmission Circuits for Telephone Circuits"; G. W. Pierce, "Electric Waves and Oscillations."

first. When the point on the R column is fixed, and f_c , say, 50 cycles per second, the values of L and C are quickly determined. It is seen

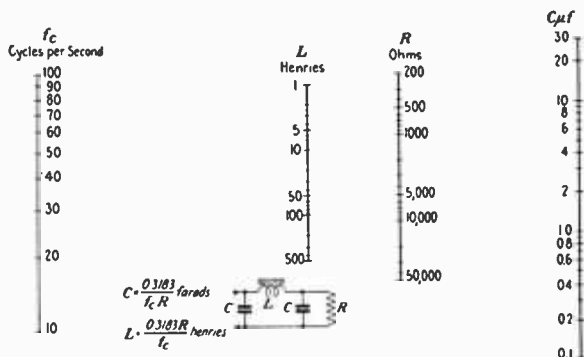

FIG. 6.—Low-pass filter design chart, Pi section.

from Fig. 6 that, for a given cut-off frequency f_c , as the load resistance increases the L increases, while the C value goes down. Very high load resistances require chokes of large inductance values, but as high-resistance loads mean small currents, the use of large inductances is feasible.

By assuming that the load resistance, R , does not affect the values of L or C , a useful approximation¹ can be secured, concerning the amount of filtering needed in each stage for the circuit shown in Fig. 4. Suppose the output stage is supplied with plate power which is filtered x per cent, so that its hum is reduced to x per cent of its unfiltered value, and at this value it gives no noticeable hum in the loud-speaker. Suppose further that the amplification between the plate of this last tube, and the preceding tube plate is A . Then the preceding stage must have its power supply filtered x/A per cent. This means that the ripple in the plate supply of the next to the output stage must be $1/A$ as much as the output stage, because of its amplification. Figure 7 gives this relation in useful graphic form. If a stage of amplification has a gain of 25, it is essential that the

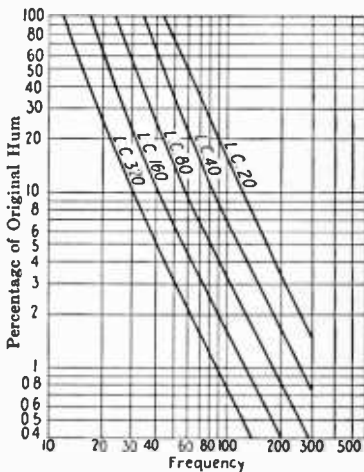

FIG. 7.—Smoothing effected by various products of inductance (henrys) and capacity (microfarads).

¹ COCKING, W. T., *Wireless World*, Nov. 19, 1930, pp. 565-568.

preceding tube be supplied with plate power with one twenty-fifth the ripple, or 4 per cent. An LC product of 56 will give this degree of filtering at 100 cycles, according to Fig. 7, and this means a 28-henry choke and a $2\text{-}\mu\text{f}$ condenser which are close to standard values.

A similar circuit to Fig. 4, using resistors instead of chokes, is frequently used to provide an extra degree of filtering for stages preceding a power stage (see Fig. 8). This is especially useful when the output stage requires a high voltage, and the voltage for the other stages must be materially reduced. The reason chokes are used is that they have high impedance to the unwanted rectified a.c., but low resistance to the desired d.c. Now if the amount of d.c. is no great object, a resistance of as great a value

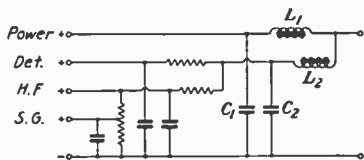

FIG. 8.—Circuit which minimizes feed-back.

as the impedance can be employed, and this is quite useful in some cases where the voltage is to be reduced. If, as in Fig. 8, two stages of choke and condenser filtering are used, the additional resistance and condenser filter stages simply increase the amount of filtering, without the extra cost of chokes which are more expensive than resistors. The RC values and the degree of filtering are given in Fig. 9 and the use is the same as that of Fig. 7. The circuit of Fig. 8 is quite similar to Fig. 4, in eliminating the undesired feed-back effects.

The use of the chart (Fig. 6), based on Eqs. (26) and (27), gives very satisfactory

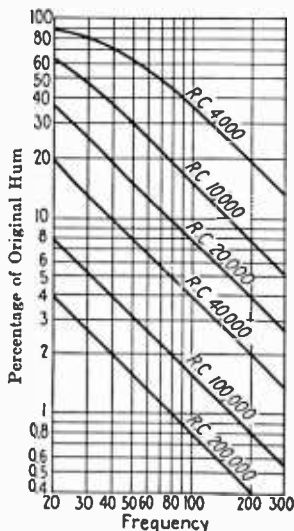

FIG. 9.—Filtering effected by resistance (ohms)-capacity (microfarads) circuit.

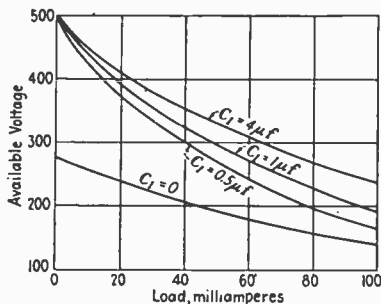

FIG. 10.—Effect of C_1 on voltage available.

results, but the experimental curves¹ showing the effects of load, and

¹ The curves (Figs. 10 to 13) are experimental curves taken from the *Aerovox Res. Worker*, articles by Sidney Fishberg, research engineer.

different condenser values are quite interesting, and will give a clearer idea of the validity of the chart.¹

8. First Filter Condenser. The effect of the first filter condenser, shown dotted in Fig. 1, is to raise the available output voltage. Figure 10 gives the output voltage available as the first condenser C_1 is changed, as a function of the load current.

Figure 11 gives the per cent ripple in output as the capacity of C_1 is varied. This curve shows that the use of a single condenser C_1 can never reduce the ripple much below 10 per cent with a reasonable value of capacity. Much less than one-half of 1 per cent is needed in a good filter, and as at least two condensers must be used to provide a single filter section, Fig. 11 agrees with the theory.

9. Second and Third Filter Condensers. Figure 12 gives the per cent ripple as a function of C_2 and C_3 for a given current drain. It will be seen that when $C_2 = C_3$, the most economical

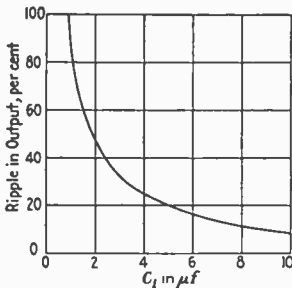

FIG. 11.—Effect of C_1 on ripple in output.

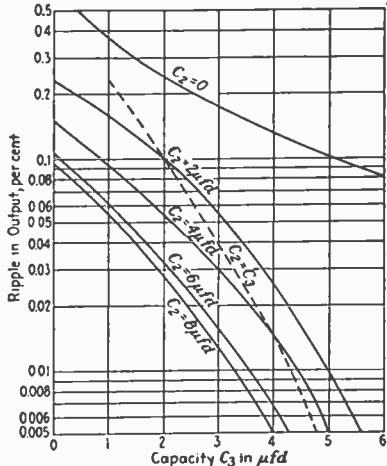

FIG. 12.—Percentage ripple as a function of C_2 and C_3 .

filter results. For example, suppose the ripple permissible to be 0.1 per cent. This can be supplied with $C_2 = 0$ if $C_3 = 5 \mu\text{fd}$, a total of $5 \mu\text{fd}$. But this can also be met with $C_2 = 2 \mu\text{fd}$, and $C_3 = 2 \mu\text{fd}$, a total of only $4 \mu\text{fd}$. The dotted line gives the ripple value where C_2 and C_3 are equal. The per cent ripple figures of course apply only to a specific filter, but the relations between the condenser values hold for similar filter circuits.

Figure 13 gives the percentage hum as a function of the current drain. This shows that the higher the values of C_2 and C_3 , the lower the percentage hum. It should be remembered that increasing current means a decreasing load resistance. From Fig. 6, assuming f_c is constant, the capacity should increase and the inductance decrease as the load resistance decreases. Thus, as Fig. 13 was taken using the same inductance coils throughout, larger values for C_2 and C_3 are needed as the current

¹ A theoretical calculation of the effects of C_1 , C_2 , and C_3 on the output voltage is given in *Gen. Elec. Rev.*, 19, 177, 1916.

drain increases. It is almost certain that the inductance values of the chokes decreased as the current through them increased. To a certain extent this inductance decrease does not interfere with the filtering, especially if the capacity is increased, as, referring again to Fig. 6, when the resistance decreases to half a certain value, the capacity should be doubled, while the inductance need be only half its former value, if f_c be kept the same. Thus in Fig. 13, as in the other figures, the experimental facts agree with the theoretical chart (Fig. 6) and Eqs. (26) and (27) for this type of filter.

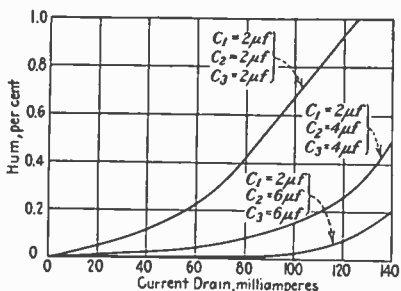

FIG. 13.—Percentage hum as a function of current drain.

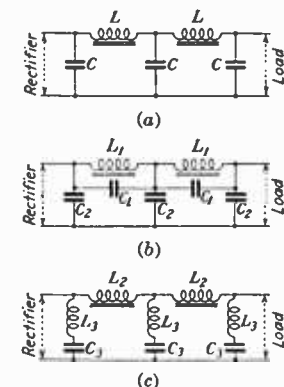

FIG. 14.—(a) Low-pass filter. (b) and (c) Tuned low-pass filters.

10. Tuned Low-pass Filter. Two tuned low-pass filter circuits are given in Fig. 14, *b* and *c*, whose attenuation characteristics were given in Fig. 5*b*. For comparison, Fig. 14*a* gives the ordinary low-pass filter.

For the tuned filter of Fig. 14*b*, having the series chokes shunted by small condensers, the equations are

$$C_1 = \frac{1}{4\pi f_c R a \sqrt{a^2 - 1}} = \frac{0.07858}{f_c R a \sqrt{a^2 - 1}} \text{ farads} \quad (28)$$

$$C_2 = 4C_1(a^2 - 1) \text{ farads} \quad (29)$$

$$L = R^2 C \text{ henrys} \quad (30)$$

$$a = \frac{f_R}{f_c} \quad (31)$$

For the tuned filter of Fig. 14*c* having small chokes in series with the condensers, the equations are

$$C_3 = \frac{\sqrt{a^2 - 1}}{f_c R a} = \frac{0.3183 \sqrt{a^2 - 1}}{f_c R a} \text{ farads} \quad (32)$$

$$L_2 = R^2 C_3 \text{ henrys} \quad (33)$$

$$L_3 = \frac{L_2}{4(a^2 - 1)} \text{ farads} \quad (34)$$

$$a = \frac{f_R}{f_c} \quad (35)$$

If wide variations in the supply frequency were likely to occur, this type of filter would not be advisable. As a rule, the frequency of most power companies is now kept constant enough to run synchronous electric clocks, and this is quite good enough for this type of tuned circuit. However, the values of C_1 , L_1 , and C_3 , L_2 have to be accurately maintained in order fully to secure the advantages of the tuned filter. Due to these closer manufacturing limits, the use of the tuned filter is not so wide in large production as its advantages would seem to warrant. A combination of tuned low-pass filter and the regular-type filter is sometimes used with very good results.

11. Filter Chokes Having Mutual Inductance. An interesting type of filter is one in which the first and second choke are magnetically

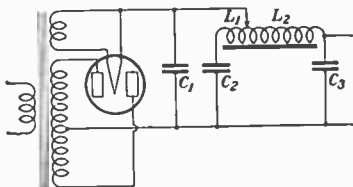

FIG. 15.—Tapped choke-filter circuit.

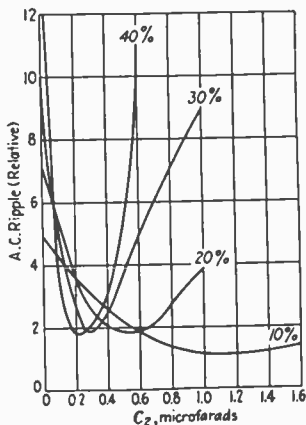

FIG. 16.—Tapped choke. Percentage of total turns (Fig. 15) used in L_1 .

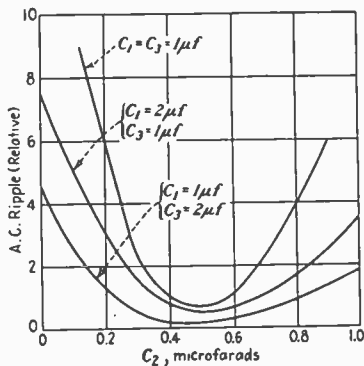

FIG. 17.—Condenser values for tapped choke filter (Fig. 15).

coupled.¹ Figure 15 shows a tap on the first choke² to which the positive rectifier lead and a filter condenser are connected. The a-c component,

¹ This type of filter is manufactured under Clough patents and is sold by Silver Marshall under the trade name Unichoke.

² *Proc. I.R.E.*, January, 1930, p. 161, from which Figs. 15 to 17 are taken.

flowing through the L_1 section of the choke, neutralizes to a large degree the a-c component of L_2 , so that the output ripple is reduced. Figure 16 shows the relative a-c output ripple with a variable C_2 as the tap on the choke is changed so that L_1 uses from 10 to 40 per cent of the total turns of the choke.

Figure 17 shows how the values of C_1 and C_2 affect the relative a-c ripple as a function of C_2 . These curves indicate that the best C_2 value is fairly independent of C_1 and C_4 .

12. Design of Filter Chokes. It is important that the filter choke be designed to carry the desired direct current and at the same time to offer the necessary reactance to the a-c component. A direct method of design¹ has been derived using both the normal and incremental permeability curves for the core material.

The derivation gives two working equations:

$$\frac{LI^2}{V} = \frac{B^2 \left(\frac{1}{\mu} + \frac{a}{l} \right)^2 \times 10^{-8}}{0.4 \left(\frac{1}{\mu\Delta} + \frac{a}{l} \right)} \quad (36)$$

$$\frac{NI}{l} = \frac{B}{0.4\pi} \left(\frac{1}{\mu} + \frac{a}{l} \right) \quad (37)$$

where L = henrys

I = d-c amperes

V = core volume in cubic centimeters (cm³)

N = turns

l = magnetic path in centimeters

a = air gap in centimeters

B = steady flux density on iron and air gap in gaussses

μ = normal permeability B/H

$\mu\Delta$ = incremental permeability $\Delta B/\Delta H$ for a minor hysteresis loop

The original curves were plotted with a/l as a parameter, LI^2/V being the ordinate, and NI/l as the abscissa for both 4 per cent silicon steel and hypernik. Figures 18 and 19 are alignment charts which include the data of the original curves. LI^2/V is the left column, and NI/l and a/l are on the right column. A straightedge passing through a given LI^2/V and tangent to the curve in the central part of the chart will cut the right column at the corresponding value of NI/l and a/l . The reverse procedure, beginning with NI/l , is also possible.

Figure 19a gives typical permeability curves for three grades of magnetic material which is commercially available.² A chart for calculating chokes, using Arceo Radio 4 is Fig. 19b, the values of LI^2/V and NI/l being the same as for Figs. 18 and 19. In Fig. 19b either the desired value of LI^2/V is followed over the curve and then down to NI/l or the reverse procedure can be followed. The gap ratio a/l shown opposite the curve has exactly the same significance as before.

13. Designing a Choke to Carry D-c. A small choke to carry 80 ma and have 14 henrys is desired. The left column of Fig. 18 is LI^2/V , and this is calculated first. L is 14 henrys, I is 0.08 amp.; I^2 is 64×10^{-4} amp.² V is the volume of the core, which was calculated to be 83.6 cm.³

¹ HANNA, C. R., *Jour. A.I.E.E.*, 46, p. 128, February, 1927.

² These curves were supplied by C. W. Rust, electrical engineer, American Rolling Mill Company, Middletown, Ohio.

$$\frac{LI^2}{V} = \frac{14 \times 64 \times 10^{-4}}{83.6} = 10.7 \times 10^{-4} = 0.00107$$

Lining up this value with a straightedge which is tangent to the central curve (Fig. 18) the value of NI/l is found to be 18. The core used has $l = 14$ cm

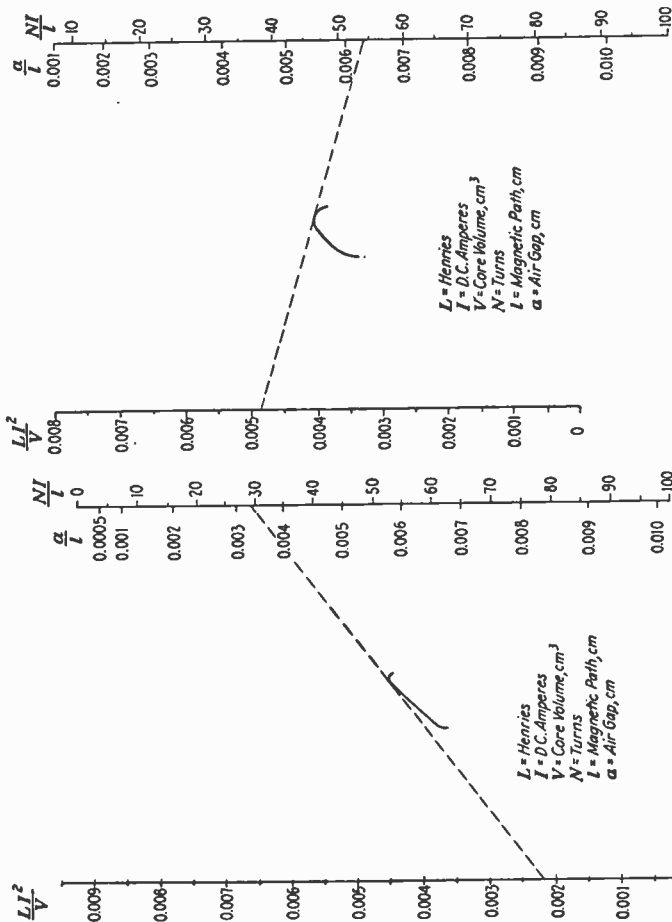

Fig. 19.—Choke design; hipernik core.

Fig. 18.—Choke design; 4 per cent silicon core.

so $N = 18 \times l/I = 18 \times 14/0.08 = 3,150$ turns. Thus to get 14 henrys, 3,150 turns are wound on the core given. To have this inductance at 80 ma an air gap is needed, as shown in Fig. 18, the a/l (gap ratio) being 0.0021. As l is 14 cm, $a = l \times 0.0021$ or $14 \times 0.0021 = 0.029$ cm (equivalent to

0.029/2.54 = 0.011 in.). This required air gap is made by inserting paper sheets of the proper thickness between the punchings, and then clamping them firmly in position.

The inductance of a choke depends to some degree on the frequency. For use with low frequencies in a filter circuit the inductance remains practically

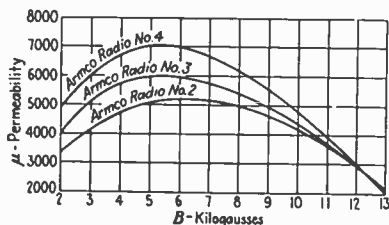

FIG. 19a.—Typical permeability curves of radio grades of Armco iron.

constant. Both the hysteresis loss and eddy-current loss are of importance in choosing a core material for chokes and transformers. The hysteresis loss is directly proportional to the frequency if the maximum flux density remains constant; and to the 1.6 power of the maximum flux density if the frequency remains constant.

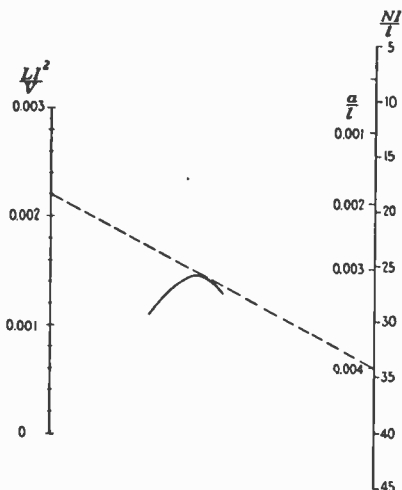

FIG. 19b.—Choke design; Armco Radio 4.

The eddy-current loss can be kept low by using thin sheets of core material. A usual standard thickness is 0.014 in., and this is quite satisfactory for filter choke and transformers for 60 cycles. The insulation between laminations does not need to be very thick, the usual oxide layer on the sheet being sufficient.

14. Filter-condenser Ratings. Some rectifiers begin supplying rectified voltage before the tubes in the load heat up sufficiently to take their rated currents. (This is especially true of the slow indirect-heated tubes.) For this reason it is often desirable, especially from a factor of safety viewpoint, to use peak voltages in calculating all condenser ratings.

The first condenser should, then, be able to stand the peak voltage of the power-transformer secondary. For a 400-volt secondary the peak is 564 volts. For reliable continuous use, the rating of the first filter condenser should be 564 volts. If no current flows, the voltage on both the second and third condensers will also be within a few per cent of the peak value 564 volts.

Assuming that an appreciable percentage of the total load current flows in the voltage divider as a "waste" or "circulating" current (I_0 in Figs. 2 and 4) the second and third condenser ratings do not have to be so high as that of the first condenser, by the amount of the voltage drop in the chokes. This drop is figured by the usual $E = IR$ formula, where the circulating current is I and the resistance is that of the respective chokes.

If an appreciable load of resistors, or fast-heating tubes is always in the circuit, the IR drop through the chokes can be subtracted from the voltage applied to the first condenser. For instance, if a current of 60 ma flows through the first choke having $R = 400$ ohms, the voltage drop is $0.06 \times 400 = 24$ volts. Assuming the r-m-s voltage (neglecting the tube drop), at the first condenser is 400 volts, the steady voltage component at the second condenser is $400 - 24 = 376$ volts. To this should be added 10 per cent to allow for the ripple, so that $376 \times 1.1 = 413.6$ volts should be the d-c rating for the second condenser.

It is true that a good filter condenser will stand, for a time, voltages greater than its d-c rating, but the practice of applying these higher voltages is seldom advisable.

15. Rectifiers. The general types of rectifiers are:

- Vacuum-tube rectifier with filament cathode.
- Gas-filled tube with filament cathode.
- Glow rectifier, gas filled.
- Dry-disk metal rectifier.
- Electrolytic rectifier.
- Mechanical or vibrating rectifier.

Any of these can be used as either half- or full-wave rectifiers, although some of the units are half-wave devices, two being required to give full-wave rectification.

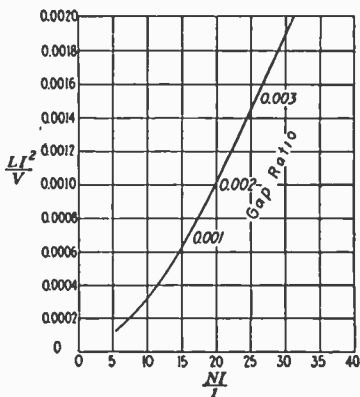

FIG. 19c.—Typical reactor design curve; V in cubic centimeters and l in centimeters. Armco Radio 4.

16. Vacuum-tube Rectifier with Filament Cathode. This type of rectifier is used in nearly all a-c powered radio receivers, and has numerous

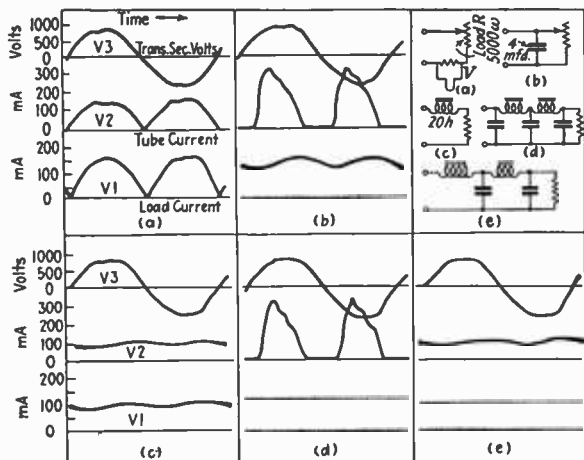

FIG. 20.—Half-wave rectifier, different load circuits.

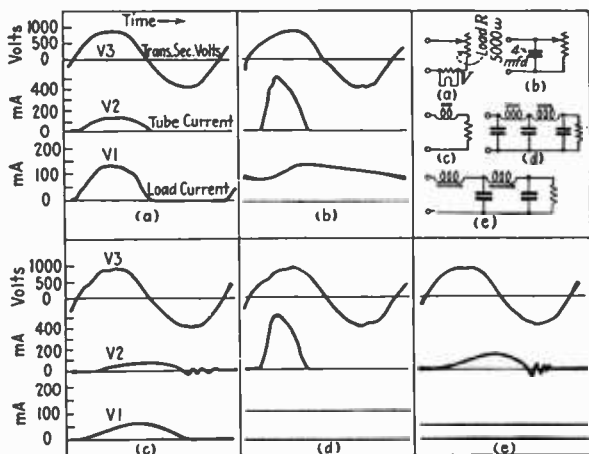

FIG. 21.—Full-wave rectifier, different load circuits.

applications in higher powered units. Some oscillograms¹ showing the effect of different load circuits are given in Figs. 20 and 21. In both

¹ WISE, ROGER, *Radio Broadcast*, April, 1929, pp. 394-395.

figures, the letters *a* to *e* refer to similar load circuits, *a* being a simple resistor load, *b* a 4- μ f condenser across the resistance, *c* a 20-henry choke in series with the resistor, *d* a standard three-condenser, two-choke filter with load resistance, *e* the same as *d* with the first condenser omitted.

For each load three factors are shown, the *V* letters denoting the oscillograph vibrators, the transformer secondary voltage being V_2 , the tube current V_2 , and the load current V_1 . The curves of special interest are those of *d* and *e* in Figs. 20 and 21. In both figures *d* shows a severe load current being drawn from the rectifier tube, the peak current from the half-wave tube being 540 ma, and the output current 102 ma, a ratio of 5.3:1. The full-wave tube peak current is 290 ma, while the output current is 118 ma, a ratio of 2.5:1. For the *e* section of these two figures, the half-wave tube peak current is 130 ma and the load 45 ma, a ratio of 2.9:1 while the full-wave peak current is 110 ma, and the load 96 ma, a ratio of 1.5:1. In all these curves the power transformer was the same, and an idea of the relative output voltages and currents can be secured by comparing the desired circuits of Figs. 20 and 21.

From the standpoint of the rectifier tube, these figures show that the omission of the first filter condenser will decrease the high periodic loads which are required by the standard filter having an input condenser. By referring to Fig. 10 it will be seen that the omission of C_1 decreases the available voltage, and this is verified by the curves in Figs. 20 and 21, as the same transformer supplied the voltages to both *d* and *e* circuits in turn.

Figure 22¹ gives the load current, through several cycles, for several forms of filter. The letters are made the same as for Figs. 21 and 20 wherever possible for convenient reference. Curve *B* of Fig. 22 corresponds to the *b* curve of the full-wave rectifier of Fig. 21 while *B'* is the same as *b* with the condenser capacity approximately six times as large. *B''* is the same as *B'*, for a half-wave rectifier, and *B'''* has about six times as much capacity as *B''* but is otherwise the same. Curve *C* corresponds to the regular *c* of the former figures, and *C'* is the same as *c* with a 2.13 mfd condenser across the rectifier side of the choke. Curve *C''* is like *C'* with the condenser increased to nearly six times its original value. Curve *D* resembles the *d* of the former figures, except that it comprises only one filter section instead of two as in Fig. 21.

17. Characteristics of Rectifiers for Receivers. The table (p. 482) gives the characteristics of rectifiers commonly used in radio receivers and in higher power installations. The types generally used are the 80, the 5Z3, the 25Z5 and the 1-v for receivers. The 25Z5, designed as a voltage-doubler tube, is generally used in a-c d-c receivers with the plates connected in parallel to reduce the internal drop in the tube and thus to increase its output from a low-voltage line. On d.c., the tube merely acts as a resistance but forces the user of the set to plug it into the d-c line with the proper polarity.

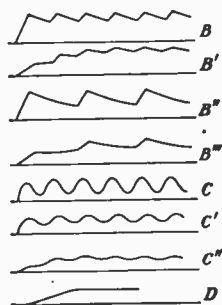

FIG. 22.—Load currents for several forms of filter.

¹ KUHLMAN and BARTON, *Jour. A.I.E.E.*, January, 1928, p. 17.

TABLE I.—VACUUM-TYPE RECTIFIERS

Type	Filament		Heater		Maximum voltage heater-cathode, volts	Maximum a-c supply, volts per plate	Peak inverse volts	Maximum direct-current load current, milliamperes
	Volts	Amperes	Volts	Amperes				
80*	5.0	2.0	350	125
81	7.5	1.25	700	85
5Z3*	5.0	3.0	500	250
1-v	6.3	0.3	500	350	1,000	50
84*	6.3	0.5	500	350	1,000	50
12Z3	12.6	0.3	350	250	700	80
25Z5*,†	25.0	0.3	125	100
217-A	10.0	3.25	3,500	600
217-C	10.0	3.25	7,500	600

* Full wave.

† Voltage doubler.

In the voltage doubler, two half-wave rectifiers are operating on their respective half cycles of input. One diode is reversed with respect to the other. While one diode is rectifying, the condenser across the other is discharging through the load and the conducting diode. The output voltage is the sum of these voltages, roughly twice the line voltage. The ripple frequency is double the line frequency.

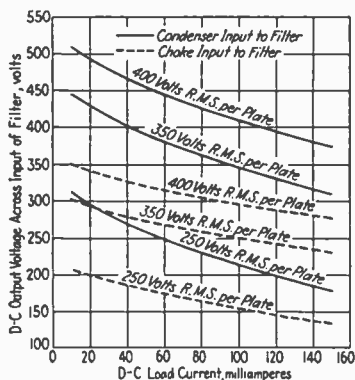

FIG. 23.—Output characteristics of Type 80 tube.

18. Hot-cathode Mercury-vapor Rectifier. The hot-cathode mercury-vapor rectifier¹ differs from the mercury-arc tube in two respects. First, it operates at a relatively low temperature, so that the vapor pressure is low. This low mercury pres-

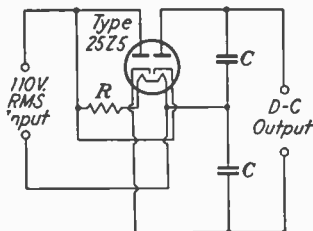

FIG. 24.—Voltage-doubler circuit.

sure gives a useful characteristic, a high breakdown voltage in the inverse direction. Second, the electrons are emitted from the filament and not from a pool of mercury. In the second respect this tube resembles the vacuum-tube rectifier, but the difference lies in the much lower potential drop due to the neutralizing of the filament space charge by the positively charged mercury ions.

¹ PIKE and MASER, *QST*, February, 1929, p. 20.

The filament-to-plate drop of the mercury-vapor tube is about 15 volts, and is practically independent of the load current. This low drop helps regulation as well as increasing the available d-c output. This tube

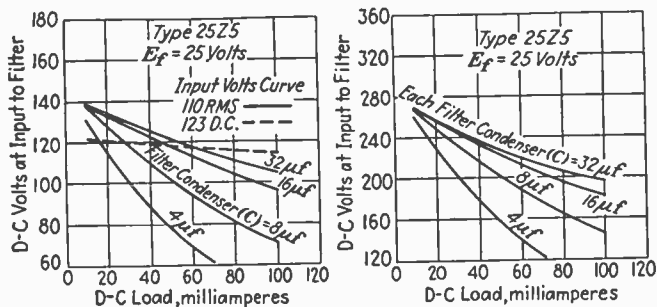

FIG. 25.—Output of voltage doubler (right) and half-wave rectifier (left).

is self-igniting, and does not require the starting mechanism of the mercury-arc rectifier. Table VI gives tube characteristics.

TABLE II.—HOT-CATHODE MERCURY-VAPOR RECTIFIERS

Type	Filament		Time the filament must be heated before applying plate voltage	Maximum peak inverse volts	Maximum peak plate amperes	Average plate current, single phase, amperes (full wave)	Frequency range, cycles per second	Temperature range, degrees centigrade	Approximate drop in tube, volts
	Volts	Amperes							
82*	2.5	3.0	1,400	0.4	0.125	15
83*	5.0	3.0	1,400	0.8	0.25	15
857	5.0	30.0	{ 10 min.	22,000	40.0	10.0	Up to 150	30 to 40	10
			{ 10 min.	10,000	40.0	10.0	Up to 150	15 to 50	10
866	2.5	5.0	30 sec.	7,500	0.6	0.3	Up to 150	0 to 50	15
866-A	2.5	5.0	30 sec.	{ 10,000	0.6	0.3	Up to 150	15 to 50	10
				{ 5,000	0.6	0.3	Up to 150	50 to 60	10
				{ 5,000	0.6	0.3	Up to 1,000	15 to 60	10
869-A	5.0	18.0	60 sec.	20,000	10.0	2.5	Up to 150	15 to 50	10
870	5.0	65.0	30 min.	{ 16,000	450.0	75.0	Up to 150	35 to 40	10
				{ 7,500	450.0	75.0	Up to 150	35 to 50	10
				{ 5,000	0.3	0.2	Up to 150	0 to 50	15
871	2.5	2.0	10 sec.	5,000	0.3	0.2	Up to 150	0 to 50	15
872	5.0	10.0	30 sec.	7,500	5.0	1.25	Up to 150	0 to 50	15

* Full wave.

19. Battery Chargers. Although this section is primarily devoted to the supplying of high voltages and low currents, there is a definite field for a low-voltage high-current rectifier. The argon-filled, tungsten-filament Rectigon and Tungsar bulbs fill this need. The use is largely that of charging storage batteries and no filter is needed for this application.

Filters have been designed for use with these rectifiers, so that the output can be fed directly to the filaments of d-c radio tubes. To design

a proper low-pass filter for d-c tube filament currents, Eqs. (26) and (27) should be used, as the chart of Fig. 6 does not cover this range. The condenser has to have a large capacity, and the low voltage "dry" electrolytic condensers are often used. In using these condensers it is important to connect the correct polarity to the rectifier.

TABLE III.—RECTIGON-BULB CHARACTERISTICS

Number	Filament		Load, amperes	Approximate drop in tube, volts	d-c load, volts
	Volts	Amperes			
289415*	2.75	17	2	10	75
289416†*	2.75	19	6	10	75†

* Style number of Westinghouse Electric and Manufacturing Company.

† Often used up to 100 volts.

20. Mercury-arc Rectifiers. Formerly, mercury-arc rectifiers were most used¹ in the field lying between the argon tube and the filament-vacuum rectifier. With the introduction of the mercury-vapor tubes, many of the advantages of the mercury-arc rectifier—low voltage drop, high efficiency—were duplicated. The mercury-arc tube requires a starting electrode, and usually a mechanical tilting device for starting.

21. Glow Rectifier. The Raytheon tube uses a cold cathode, with two rod-shaped anodes, giving full-wave rectification. Helium gas at low pressure fills the bulb. With both electrodes cold, a small current flows in the reverse direction in Raytheon tubes. Another characteristic is

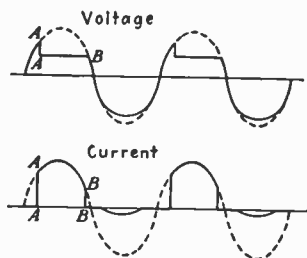

FIG. 26.—Voltage and current waves. Raytheon gaseous rectifier.

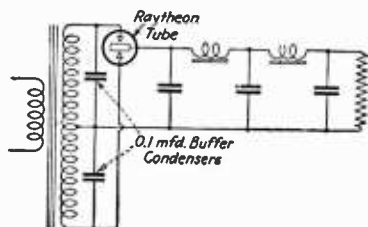

FIG. 27.—Raytheon rectifier circuit.

the abrupt current rise of the output of this type of tube. No current flows until the glow discharge takes place, and this requires a voltage of several hundred volts, the actual value depending on the electrode shape, spacing, material, gas, and pressure. When the current starts, it does so abruptly until the steady-glow voltage is reached (see Fig. 26). Filter circuits using the Raytheon tube have a buffer condenser from each anode to cathode (see Fig. 27).

¹ PRINCE and VOGDES, "Principles of Mercury Arc Rectifiers and Their Circuits," p. 23, McGraw-Hill Book Company, Inc.

These tubes are more sensitive to voltage overload than to current overload,¹ the high voltages causing insulation troubles. The guaranteed life at full load is 1,000 hours, but this is frequently more than doubled in practice. The maximum efficiency of the tube itself is about 55 per cent.¹

TABLE IV.—RAYTHEON RECTIFIER TUBES

Type	Rated output, volts	Rated output d-c milliamperes	Maximum rated r-m-s volts per plate
BH.....	300	125	350
BA.....	200	350	350

It is usually desirable to use filter condensers with a large safety factor of voltage rating, as the glow rectifier supplies *B* and *C* voltages before tube filaments can heat up sufficiently to take their rated plate currents.

22. Dry-contact Rectifiers. The crystal detector is a familiar example of a dry-contact rectifier. The most important dry-contact rectifier for power supply is the copper-cuprous oxide type. The theory of these rectifiers is not completely understood, and the assembly of a unit which has long life and good properties requires special engineering information. Cooling is especially important in these rectifiers, the rating being increased by the use of cooling fins, or by drafts of air directed on the unit. The proper current densities are important in securing a desirable ratio of forward to inverse resistance.

The usual rating of a 1½-inch diameter Rectox disk is ¼ amp. and 3 volts, but in some cases where the operating conditions are favorable, the current and voltage can be nearly doubled.

These rectifiers allow an appreciable reverse current to pass, this current increasing with temperature rise. The operating temperature should be preferably below 100°F. The leakage current is usually of the order of milliamperes, when the load current is amperes. A typical current-voltage curve is Fig. 28.²

23. Circuits for Dry-contact Rectifiers. One large use of dry rectifiers is battery chargers. Even for this low voltage several disks in series have to be used. With this in mind, a simplification of the transformer can be made; *i.e.*, no center tap need be supplied. Figure 29 shows the circuit, a bridge form. This circuit is not used with tube rectifiers, as it requires four rectifying arms, which would mean four half-wave tube rectifiers. With the Rectox this is no disadvantage, as the series disks are simply grouped in four sections.

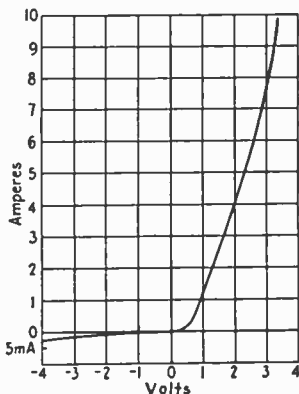

FIG. 28.—Typical Rectox current-voltage curve.

¹ KRYTER, R. J., *QST*, May, 1929, p. 33.² *Wireless World*, Dec. 19, 1928, p. 825.

In Fig. 29 when A is positive, the path of the current is $ADBC$; and when C is positive, the current path is $CDBA$. During the time that A is positive, nearly the entire transformer voltage is applied across the bridge arm DC and across AB . It is this voltage which is the limiting factor—the 3 volts per disk, as mentioned previously.

24. Vibrator-Interrupter. There are two methods in general use for securing high-voltage d-c from a low-voltage d-c source. The vibrator or interrupter type has found extensive use for radios on motor vehicles. In principle, the vibrator type includes all of the typical a-c power unit shown in Fig. 1; with one important addition. The primary of the transformer of Fig. 1 is wound for low voltage and includes a vibrator which periodically breaks the d-c circuit to the low-voltage primary. The pulsating voltage is stepped up, rectified, and filtered.

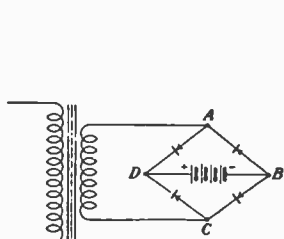

FIG. 29.—Bridge circuit for Rectox rectifier.

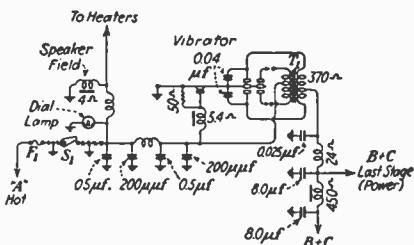

FIG. 30.—Vibrator power supply.

The high voltage is usually rectified in one of two ways.¹ A vacuum or mercury-filled rectifier can be used, the cathode being heated by the low-voltage d-c source (as contrasted with a cathode winding on the power transformer when a-c power is used). The second way is to have a separate set of (insulated) contacts on the vibrator arm, so that the high voltage is rectified synchronously as the low voltage is made and broken. Both of these rectifying methods are widely used. A schematic circuit diagram of the synchronous mechanical rectifier and the associated filters, for both low and high voltage, is shown in Fig. 30.

25. Motor Generator. A straightforward method of securing high-voltage d.c. from a low-voltage d-c source is the *motor generator*. Separate units have been available for some time, but commercial units in a single compact case are now being built which are as compact as vibrator units. These motor generators have a single field winding and are provided with sealed ball bearings which require no lubrication over a period of years.

¹ P. R. Mallory Co. See also G. W. Blessing, Applications of the Generator Type Auto "B" Power Unit, *Radio Craft*, February, 1935, pp. 479, 499; W. W. MacDonald, Auto-Radio "B" Eliminators, *Radio Retailing*, March, 1932, pp. 40-41; V. C. MacNab, Power Transformers for Automobile Radio Vibrators, *Electronics*, May, 1934, p. 149; C. W. Palmer, A Tubeless "B" Supply, *Radio Craft*, December, 1934, pp. 344, 377; Walter Van B. Roberts, Vibrator Power Supply from Dry Cells, *Electronics*, July, 1934, pp. 214-215; Roy Slawson, "B" Supply for Farm or Auto Sets, *Radio Craft*, November, 1934, pp. 280, 300, 301. (See note to Table VI, p. 488.)

For heavy-duty and continuous service, such as police squad cars, this type of high-voltage supply is especially suited. High-efficiency units are available for devices which must be employed for long periods of time. There are various voltages suitable for 2-volt air-cell or 2-volt storage batteries: 6.3 volts for the standard three-cell car battery; 12 volts for trucks, and 32 volts for farm-lighting plants. Other input voltages can also be obtained.

Characteristics of low-voltage d-c motor generators with high-voltage d-c outputs suitable for radio B power supply are given in Tables V and VI.

26. Alternating-current Generator. The use of an a-c generator will allow the utilization of standard a-c equipment, up to the rating of the generator. The a-c generator is usually driven either mechanically by the gasoline engine in the car, or coupled to a d-c motor actuated by the source of low voltage (storage battery).

When driven directly by the car motor, a generator gives a frequency which changes with the car speed, but above a certain minimum speed (depending on the ratio of the mechanical drive) the voltage can be kept fairly constant, and most a-c radio equipment is not critical as to frequency if it is above a specified minimum. Most radios operate on 50 to 60 cycles but will work satisfactorily from fifty up to several hundred cycles per second, if the voltage is normal. One manufacturer (Powerack Company, New York, New York) supplies models of a-c generators to be driven by the car fan belt, giving 50, 100, 175, or 250 watts output at 115 volts a.c. The last model is the largest made for driving by a fan belt, as this is the maximum wattage obtainable without the belt slipping.

These units can actuate a-c radios, and in the larger sizes can successfully do things which the smaller motor generators or vibrators are not

TABLE V¹

Input volts, d.c.	Input amperes, d.c.	Remarks	Output volts, d.c.	Output milli-amperes, d.c.	Intermediate tap, volts	Size, inches
2	2	Air cell or one-cell (storage battery)	125	10	67½	4½ × 5½ × 3½
2	1.5	90	10	4½ × 5½ × 3½
6.3	2.2	Storage battery	180	30	90
6.3	1.8	three-cell	135	30	67½	2¾ × 4 × 5
6.3	3	200	40	90
6.3	1.7	Police-duty low A drain	180	30	90	4½ × 5½ × 3½
6.3	1.1	Special high efficiency	135	30	67
6.3	2.2	200	40	90
6.3	4.2	250	50	90
6.3	11.3	Sound trucks and transmitters	350	100	4½ × 5½ × 3½
6.3	10.5	300	100
6.3	6.0	275	75
6.3	4.5	250	50
12	10	Dual unit sound truck or transmitter	500	150	5½ × 4 × 7
12	12	400	200

¹ Carter Motor Co.

TABLE VI¹

Input volts, d.c.	Input amperes, d.c.	Remarks	Output volts, d.c.	Output milli-amperes, d.c.	Intermediate tap, volts	Size, inches
6.3	1.94	Three-cell storage battery	180	30	$2\frac{3}{8} \times 5\frac{7}{16} \times 5\frac{3}{16}$
6.3	1.94	180	30	90	
6.3	1.42	135	30	67½	
6.3	2.75	200	40		
6.3	3.80	225	50		
6.3	4.20	250	50		
6.3	1.65	Police squad cars (high efficiency)	180	30	90	
6.3	1.10	135	30	67½	
6.3	5.00	Sound trucks	265	75		
6.3	8.75	300	100		
6.3	Farm-lighting systems	180	...	22½, 45, 67½, 90, 135	
6.3	180	...	90	
6.3	135	...	67½	
32	Farm-lighting systems	180	...	22½, 45, 67½, 90, 135	
32	180	...	90	
32	135	...	90	
32	300	100		

¹ Pioneer Gen-E-Motor Co. On the prior art in connection with vibrator rectifiers see U. S. Patents 550,782; 522,986; 1,296,269; 1,819,617; and *The Wireless Engineer*, M. G. Scroggie, February, 1924 and R. Mines, September, 1924; *QST*, September, 1920; *Radio News*, November, 1921, p. 406.

designed to do. For instance, small electric stoves, soldering irons, as well as standard 110-volt electric lights, up to the wattage of the generator, can be supplied from the a-c generator while the engine is running.

If power must be supplied when the motor is not running, the a-c generator can be operated by a d-c motor supplied from the car battery (see Tables VII and VIII).

27. Transformers. The design of a reliable power transformer, having high efficiency, requires fairly elaborate calculations,¹ and to take into account the d.c. which flows in a transformer secondary when a half-wave rectifier is used, some interesting equations have been derived.²

A simple approximate-design method will be given here, for the construction of single-phase low-powered transformers up to 180 volt-amp., or 180 watts for approximately unity power factors. This design is especially suited to transformers which supply a full-wave rectifier and filament energy to an a-c powered radio receiver, three factors making it possible to secure a satisfactory transformer without complicated design methods, these factors being:

1. There is no urgent need for high efficiency. An 80 per cent efficient transformer which takes 60 watts to supply 48 output watts is fairly satisfactory, if it can radiate the heat which it generates.

¹ "Standard Handbook for Electrical Engineers," McGraw-Hill Book Company, Inc., by Charles L. Fortescue.

² HARDER, E. L., *Elec. Jour.*, October, 1930, p. 601.

VII.¹—D-C TO A-C CONVERTERS, A.C. = 110 VOLTS

Sec. 14)

Input volts, d.c.	Input amperes, d.c.	Output volt-amperes, a.c.
6	13.3	40
6	19.0	60
12	7.5	40
12	11.8	80
12	17.5	120
12	20.0	160
32	2.78 to 15	40 to 300
110	0.8 to 3.85	40 to 300
220	0.4 to 1.92	40 to 300

¹ Pioneer Gen-E-Motor Co.TABLE VIII.¹—D-C TO A-C CONVERTERS, A.C.-115 VOLTS 60 CYCLES

Input volts, d.c.	Output volt-amperes, a.c.	R.p.m.
6	40	3,600
12	80	3,600
12	80	1,800
12	150	1,800
32	80 to 400	3,600
32	100 to 2,000	1,800
115	90 to 2,500	3,600 and 1,800
230	90 to 2,500	3,600 and 1,800

¹ Electric Specialty Co.

2. These transformers are operated at a fairly constant load. This improves the maintenance of the various output voltages as each secondary winding will have a constant *IR* drop.

3. The load on the transformer secondary is nearly of unity power factor. The filament power load is essentially a resistance load, with unity power factor. The current supplied to the filter has slightly less than unity power factor, but this can be disregarded in low-powered transformers. The indirect heated receiving tubes, such as the 227 require less than half as much d-c power in their plate and grid circuits, as that which is needed to heat their cathodes. This would mean a unity power-factor heater supply and (assuming a series voltage divider) less than half as many additional watts for plate and grid supply, at a lower power factor. It is true that a power tube, such as 250 at its maximum rating, uses slightly over three times the wattage in its *B + C* circuit than in its filament. It is rare, however, to have more than two power tubes in a receiver, and the assumption that the power factor of the secondary is unity is usually not over 20 per cent off. This means

that the wire of the high-voltage secondary and of the primary be increased to allow for this added current.

28. Small Transformer Details. Economy in a transformer is seen when the winding encloses a maximum of core area with a minimum wire, and the magnetic path should be as short as possible.

The core form of a small transformer can be of several shapes, but it is usual to use standard punchings shaped like capital letter E's. As a rule, two punchings are used, one having longer legs than the other so that the magnetic circuit "breaks joints" in stacking the iron. Another convention usually followed in small transformers is the use of a single-winding form, all secondaries and primary being on the middle leg of the E core.

The spool form is usually an insulating tube, and side pieces may be fitted on which terminals are placed, or, if the coil is to be machine wound with interwoven cotton, the side pieces can be omitted, and flexible leads provided.

29. Ten Steps in Designing a Small Power Transformer. 1. *Determine the Volts and Amperes Needed for Each Secondary.*

a. Find the total maximum secondary watts = $W_s = E_1I_1 + E_2I_2 + \dots$

b. Find the total watts needed for primary = W_p

Assuming 90 per cent efficiency $W_p = W_s/0.9$

c. Find primary amperes assuming 90 per cent power factor

$$I_p = \frac{W_p}{E_p \times 0.9} = \frac{W_s}{0.81E_p}$$

and for $E_p = 110$ volts, $I_p = W_s/89.1$ amp.

2. *Size of Wire.* Knowing the current for each winding, the wire size is determined by the circular mils per ampere which it is desired to use. A safe rule is to use 1,000 cir. mils per ampere for transformers under 50 watts, and 1,500 cir. mils per ampere for higher powers.

3. *Core Considerations.* A curve showing core areas for different powers is Fig. 31 which shows the area for 40 watts to be 1 sq. in., 70 watts 1.5 sq. in., 2 sq. in. for 120 watts. The area of the core is the same as the inside dimensions of the spool, making a 10 per cent allowance for stacking; for example, a spool 1 by 2 in. inside would enclose 2 sq. in., but, allowing for a 10 per cent loss, only 90 per cent or $0.9 \times 2 = 1.8$ sq. in. is the net core area. The core area is needed to determine the turns per volt.

4. *Core Loss and Induction.* The flux density at which the core is to be worked determines the iron (core) loss. Figure 32 gives several curves of different core materials, watts per pound being plotted against flux densities in kilolines per square inch. Sixty-five kilolines per square inch is an average value of the induction. The making of a curve such as Fig. 32 depends largely on experimental data, not directly on a theoretical basis. For this reason, no definite value of the core loss can be given; it depends on the quality of core material which is available. It should be noted that better and better core material is constantly being made, having lower loss per pound, so that the use of higher flux densities is becoming possible. Up to 15 kilolines is not uncommon, but unusual for this application. The core loss increases with frequency, a typical curve being Fig. 33.

5. *Induced-voltage Equation, Turns per Volt.* The elementary definition, that 10^8 magnetic lines cut, per second, will induce one volt pressure, is the basis of the equation

$$E = \frac{BANf}{10^8} \times 4.44$$

where E is the voltage, A the area of the core, B the flux density in the same units as A , f the cycles per second, and N the number of turns. A more

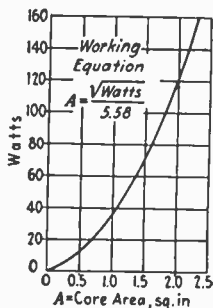

FIG. 31.—Small power transformer core area as a function of watts.

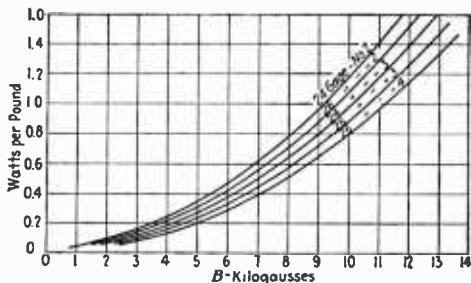

FIG. 32.—Core-loss curves Armco Radio grades (60 volts).

useful working equation for small power transformers is obtained by solving for N/E in turns per volt:

$$\frac{N}{E} = \frac{10^8}{BAf4.44}$$

Figure 34 is an alignment chart of this equation. The left column is B the flux density, in both kilolines per square inch and kilogausses (kilolines per square centimeter), the center column is the net core area in both square inches and square centimeters, the right column giving the turns per volt for both 25 and 60 cycles per second.

Using a flux density of 65 kilolines per square inch and the net core area mentioned in step 3 (1.8 sq. in.), the turns per volt for 60 cycles are found to be 3.1 turns per volt. Thus for each volt on the transformer, there must be 3.1 turns. It is customary to change the turns per volt to an even number so that the proper center taps can be made. In this case, by using 4 turns per volt, with the same core area, the induction will be lower, with a corresponding lower core loss. It is also quite possible, and sometimes advisable, to change the core area so that an even number of turns per volt is given. For example, by increasing the core area to 2.8 sq. in. 2 turns per volt could be used, or decreased to 1.4 sq. in. so that 4 turns per volt would be used. The reason for desiring the even numbers of turns per volt is to supply the $\frac{1}{2}$ -volt steps for receiving tubes, such as $7\frac{1}{2}$ volts, which would require an integral number of turns when the turns per volt are used.

The voltage drop in the transformer winding should be mentioned here, and it will be again taken up in detail in the example. For instance, the load voltage at a tube filament is lower than the no-load voltage by the amount of IR drop in the winding and the connecting wires to the tube. Thus, it may be that to secure $7\frac{1}{2}$ volts at the tube filament, the transformer no-load

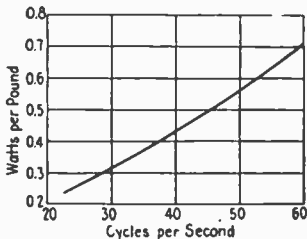

FIG. 33.—Core loss vs. frequency $B = 10,000$.

voltage will have to be 8. In this case, any integral number of turns per volt, either odd or even, will suit the design.

6. *Turns for Each Winding.* In step 1 the desired voltages were given, $E_1, E_2,$ etc. Using the value of turns per volt in step 5, the total turns for each winding are found. For example, with 4 turns per volt, a 110-volt winding should have $4 \times 110 = 440$ turns.

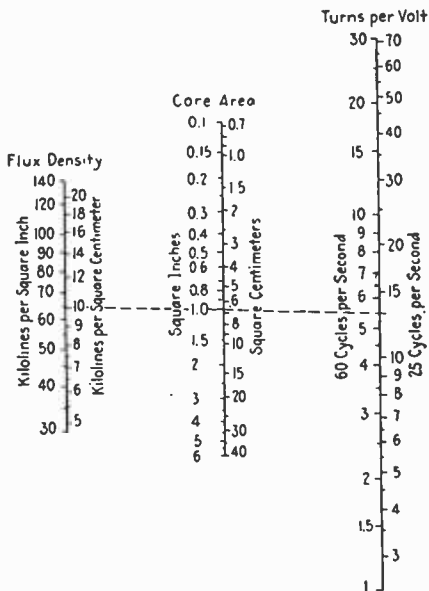

FIG. 34.—Transformer design chart based on $E = \frac{BANf \times 4.44}{10^8}$.

7. *Winding Space Required.* From the total turns for each winding, and the wire size, the total area of winding space is calculated. Different wires and insulations have definite turns per square inch. The method of insulation, however, may have these values vary by factors of as much as three to one. That is, a 900-turn coil wound in layers with enamel wire may take up one square inch of cross-section area. By interleaving thin insulating paper between layers, only 600 turns can be wound in a square-inch area; and by using a certain size of cotton interwoven between turns, only 400 turns can be wound in a square inch. Thus, the space of winding depends to a large degree on the kind and thickness of insulation. Double cotton-covered wire takes up considerably more space than enameled wire. Yet, if the extra-needed insulating space for the interlayer protection is considered, the space ratio may not be so great.

After adding up the winding space of all the windings the area should be compared with that of the core. If the winding will go in the core space, this part of the design is finished.

If the wires will not go in the available space, the winding may be redesigned, or the core area increased. Using thinner coverings for wire, fewer

secondaries or fewer circular mils per ampere will decrease the space needed for the wire. A larger iron size or a thicker stack of the same sized iron will increase the core area and allow a smaller number of turns per volt, thus decreasing the cross section of the winding.

8. *Copper Loss.*
 - a. Find the length of the mean (average) turn in feet.
 - b. Find the length of each winding in feet by multiplying the number of turns by the mean turn length.
 - c. From wire tables find the ohms per 1,000 ft. for the size wire used, and then from 8-b the actual ohms for this length.
 - d. Multiply the current squared for each winding by the ohms for that winding.
 - e. Add the I^2R 's for each winding to get the copper loss L_1 .
9. *Core Loss.* The core loss in watts L_2 is found from the weight of the core and flux density and kind of core used in step 4. A useful factor is that 4 per cent silicon steel weighs 0.27 lb. per cubic inch.

10. The approximate percentage efficiency is $\frac{W_s \times 100}{W_s + L_1 + L_2}$, W_s being the secondary watts (see step 1).

NOTE. If step 10 shows about 90 per cent efficiency, the design is complete. If much less than 90 per cent, step 1a must be modified, a new larger value of I_p being used in finding a larger primary wire. This will not change the efficiency, but will prevent overloading the primary winding due to its carrying a greater current than that for which it was designed.

It is desirable, as a rule, to keep the efficiency above 90 per cent, and this can be done by reducing L_1 and L_2 , by using larger wires, or larger cores.

30. *Typical Small Transformer Design.* This transformer gives a full-wave rectifier supply, filament supply for rectifier and receiver, and works on a primary voltage of 110, at a frequency of 60 cycles.

1. The desired secondary voltages and currents are:

E , volts	I , amperes	Use	Watts = EI
330	0.05	B and C supply	16.5
330	0.05	B and C supply	16.5
5.0	2.0	Rectifier filament	10.0
2.5	2.5	Filament	6.25
2.5	3.0	Filament	7.5

- a. Total secondary watts W_s 55.75
- b. Primary watts $W_p = W_s/0.9 = 55.75/0.9 = 61.9$
- c. Primary amperes $I_p = W_p/89.1 = 55.75/89.1 = 0.69$

2. This transformer is over 50 watts, so 1,500 circ. mils per ampere is the current density to use in finding the proper-sized wire. The wire sizes, with

Volts	Amperes	Size wire
110	0.69	20
330	0.05	30
330	0.05	30
5	2.0	14
2.5	2.5	14
1.5	3.0	12

the identifying current and voltages, are listed in table above. The use of larger wires of even numbers keeps the IR drop lower than when using a

smaller wire. However, if the use of these larger wires makes too large a winding cross section, smaller wires must be used.

3. The core area available is $1\frac{3}{8} \times 2$ inches, the net area being $1\frac{3}{8} \times 2.0 \times 0.9 = 2.48$ in. This is larger than necessary as shown by Fig. 35, but allows the design, in this case, of a transformer with good efficiency and good regulation.

4. The flux density used is 65 kilolines per square inch, and 4 per cent silicon iron with a loss of 0.6 watt per pound.

5. The turns per volt for 65 kilolines per square inch and core area of 2.48 sq. in. give three turns per volt.

6. The turns for each winding are:

Volts	Turns
110	330
330	990
330	990
5	15
2.5	7.5(8)*
1.5	4.5(5)

* It is usual to add $\frac{1}{2}$ turn to filament windings for 2.5, and 1.5 to allow for the IR drop in the winding and leads to the tube filaments. An even number like 8 also makes taps easier.

7. Winding space, in square inches, using enamel wire:

Turns	Feet	Ohms per 1,000 ft.	Actual ohms	IR volts drop	I^2R , watts
330	320	10	3.02	0.14
990	906	105	95	0.25
990	906	105	95	0.25
15	13.7	2.6	0.035	0.07	0.14
8	7.3	2.6	0.019	0.05	0.12
5	4.6	1.8	0.008	0.024	0.07
Total.....	0.97

a. The mean turn is 11 in. = $1\frac{1}{2}$ ft.

b. The space needed is 1.2 sq. in. and the space available is $1 \times 2 = 2$ sq. in., so the extra space can be used for the spool and for insulation between windings and layers.

c.

Turns	Size wire	Turns per square inch	Actual space, square inch
330	20	590	0.56
990	30	4,000	0.25
990	30	4,000	0.25
15	14	190	0.08
8	14	190	0.04
5	12	135	0.04
Total.....	1.22

d. The copper loss L_1 is 0.97 watt.

8. The core weighs approximately 5 lb., which at 0.6 watt per pound gives $5 \times 0.6 = 3.0$ watts = L_2 .

9. Watts output = $55.75 = W$.

$$\text{Losses} = L_1 + L_2 = 3.0 + 0.97 = 3.97 \text{ watts}$$

$$\text{Per cent efficiency} = \frac{55.75 \times 100}{55.75 + 3.97} = \frac{5,575}{59.72} = 93 \text{ per cent}$$

NOTE. It is seen that the copper losses are about one-third the iron loss; this means that a smaller core could be used. A higher efficiency could be obtained, if there were enough winding space, by using higher induction with more turns per volt, thus decreasing the core loss, without increasing the copper loss very much.

10. *Volts Drop.* It is seen by the *IR* column that the drop in the winding is not serious.

SECTION 15

LOUD-SPEAKERS AND ACOUSTICS

BY IRVING WOLFF, B.S., PH.D.¹

1. Symbols.

- a* Instantaneous displacement of air particle in sound wave.
b Flare factor of exponential horn.
c Velocity of sound.
d Diameter of disk.
e Napierian base.
f $\sqrt{-1}$
l Length of conductor; thickness of wall.
m Mass.
p Sound pressure.
r Distance from center of a sphere.
s Stiffness.
t Time
u Instantaneous velocity of particle in sound wave.
v Voltage.
x Distance from an axis of coordinates.
z Mechanical impedance.
z_r Mechanical resistance.
z₁ Impedance per unit area at throat of horn.
z₂ Impedance per unit area at mouth of horn.

A Strength of small sound source.
E Energy density in sound field.
H Magnetic or electric field strength.
H₀ Polarizing magnetic or electric field strength.
I Current.
J Energy flux density in sound wave.
M Vector force factor or electromechanical coupling coefficient.
R Electrical resistance.
R_s Electrical resistance of supply source.
S Surface or cross-sectional area.
S₁ Cross-sectional area of throat of horn.
S₂ Cross-sectional area of mouth of horn.
T Reverberation time.
U Maximum velocity of air particles in sound wave.
V Volume of an enclosure.
W Acoustic power emission of sound source.
Z Electrical impedance.

 $\bar{\alpha}$ Average absorption coefficient $\bar{\alpha} = \frac{S_1\alpha_1 + S_2\alpha_2 \cdots S_n\alpha_n}{S_1 + S_2 \cdots S_n}$
 γ Angle between line joining point of observation to the center of a sound radiator and line perpendicular to the radiator.
dS Small surface element.

 λ Wave length.
 ρ Density.
 ρ_0 Density of air when undisturbed.
 θ Temperature.
 μ Magnetic permeability.
 ω 2π frequency.

¹ Research Division, R.C.A. Manufacturing Co., Camden, N. J.

2. Sound Waves in Air. A sound wave in air is a compressional wave which is characterized by a to-and-fro motion of the air particles and an increase and decrease of sound pressure above and below atmospheric in the path of the wave. In the interest of conciseness when the term "pressure of a sound wave" is used, the difference in pressure between atmospheric and the pressure which occurs when the sound wave is present is what is referred to.

The following equations give the relations between amplitude of motion of the air particles, velocity of motion of the particles, and pressure in a *plane* sound wave, where u represents the instantaneous velocity of an air particle, U is the maximum velocity, λ is the wave length of the sound wave in air, c is the velocity of propagation of the sound wave, x is a coordinate taken in the direction of propagation of the plane sound wave, a is the displacement of the air particles, p is the pressure of the sound wave, and ρ_0 is the density of air. If the wave is simple harmonic,

$$u = U \cos \frac{2\pi}{\lambda}(ct - x) \quad (1)$$

$$a = \frac{\lambda U}{2\pi c} \sin \frac{2\pi}{\lambda}(ct - x) \quad (2)$$

$$p = c\rho_0 U \cos \frac{2\pi}{\lambda}(ct - x) \quad (3)$$

The next equations give the same relations for a *spherical* sound wave where all symbols are the same as above; A represents the strength of a small source considered to be at the center of the sphere as represented by the maximum rate of emission of air, and r is the distance from the center of the sphere.

$$u = \frac{A}{2\lambda r} \cos \frac{2\pi}{\lambda}(ct - r) + \frac{A}{4\pi r^2} \sin \frac{2\pi}{\lambda}(ct - r) \quad (4)$$

$$a = \frac{A}{4\pi r c} \sin \frac{2\pi}{\lambda}(ct - r) - \frac{\lambda A}{8\pi^2 r^2 c} \cos \frac{2\pi}{\lambda}(ct - r) \quad (5)$$

$$p = \frac{c\rho_0 A}{2\lambda r} \cos \frac{2\pi}{\lambda}(ct - r) \quad (6)$$

In a plane sound wave of simple harmonic type the maximum of pressure takes place at the same time that the velocity of the particles (air molecules) is a maximum in the direction of propagation of the wave. That is, suppose we are observing at a certain position in space a sound due to a source which is vibrating with simple harmonic motion at some distance from us so that the wave front is almost a plane. If we were just able to observe pressure at this position in space where we are stationed, we would note that the pressure varies in a simple harmonic fashion about atmospheric pressure. If we were just able to follow velocity, we would see the air molecules moving back and forth. If,

however, both factors can be observed at the same time, we shall note that as the air particles move forward the pressure becomes greatest at the time that the air particles are moving fastest. In analytical terms, the pressure and velocity are in phase.

On the other hand, the equations show, that in a spherical sound wave, the pressure and velocity are no longer in phase except when the radius of the sphere is very great and the wave approximates to a plane wave. When the radius of the sphere is very small, the pressure and velocity are almost 90 deg. out of phase. It will also be noted that although the pressure dies down at a rate inversely proportional to the distance away from the source or center of the spherical wave, the velocity reduces at a much greater rate when a point is taken close to the center of the spherical wave. It is only in plane waves that the pressure and velocity are in phase and always proportional to each other in magnitude. In the plane wave, the pressure is always equal to $\rho_0 c$ times the velocity.

In the spherical wave it is equal to $\rho_0 c \sqrt{1 + \frac{\lambda^2}{4\pi^2 r^2}}$ times the velocity

in absolute magnitude. In other shapes of waves still different relations hold which will not be considered here.

Imagine a large plane sheet vibrating and sending out a sound wave. Work has to be done to move this sheet back and forth against the air resistance. This work generates a sound wave which gives a means for transferring the energy from the sheet to some distant point. The energy transfer through any small area in space is determined by taking the product of the root-mean-square force and the velocity. In addition to the transfer of energy due to the sound wave (the value of this transfer through a square centimeter of surface is called the *energy flux density*) there also exists, due to presence of the sound wave, a certain amount of kinetic and potential energy in any small region in the path of the wave. This energy is known as the *energy density* in the wave. By means of the relations connecting pressure and velocity in the sound wave given in the previous equations the energy density and flux can be expressed in terms of the pressure alone. The equations connecting energy flux and density and sound pressure, and which hold for both plane and spherical sound waves, are:

$$J = \frac{p^2}{\rho_0 c} \quad (7)$$

$$\text{and } E = \frac{p^2}{\rho_0 c^2} \quad (8)$$

where J is the energy flux in ergs/sq cm/sec and E is the energy density in ergs/cc.

3. Velocity of Sound in Common Materials. (From International Critical Tables) Velocity of sound in air at different temperatures is given by means of the equation:

$$C = 330.6 \sqrt{1 + 0.003707\theta - 1.256\theta^2 10^{-7}}$$

where θ is expressed in degrees centigrade and the velocity is in meters per second. If the velocity is in feet per second and the temperature, theta, is in degrees Fahrenheit, this equation is

$$C = 1,047 \sqrt{1 + 0.002207\theta - 0.415\theta^2 10^{-7}}$$

The density of air is 0.00129 g/cc at 0°C. and 760-mm mercury pressure. The velocity of sound in other materials is given below.

VELOCITY OF SOUND AND IMPEDANCE IN MATERIALS

Material	Temperature, °C.	Speed (C), meters/sec.	Density (ρ), g/cc.	$\rho c \times 10^{-2}$ sec-cm ²
Air.....	20	344	0.00120	0.41
Aluminum.....		5,105	2.7	14,000
Argon.....		308	0.00178	0.55
Beeswax.....	16	863	0.97	830
Brass.....		3,479	8.5	30,000
Brick.....		3,652	2.0	7,300
Cadmium.....		2,307	8.6	20,000
Chlorine.....		208	0.00321	0.67
Cobalt.....		4,724	8.9	42,000
Copper.....	20	3,560	8.9	37,000
Cork.....		430 to 530	0.24	1,000 to 1,300
Ebonite.....	15	1,573	1.2	1,900
Gelatin.....		1,364	1.3	1,800
Gold (soft).....	20	1,743	19.3	34,000
Glass.....	16	5,202	2.5	13,000
Granite.....		3,950	2.7	11,000
Helium.....		971	0.000178	0.17
Hydrogen.....		1,262	0.000089	0.11
Iron.....		5,000	7.9	38,000
Lead.....	18	1,229	11.3	14,000
Magnesium.....		4,602	1.7	7,800
Marble.....		3,810	2.7	10,000
Mercury.....	20	1,407	13.6	19,000
Nickel.....		4,973	8.9	44,000
Nitrogen.....		338	0.00125	0.42
Oxygen.....		316	0.00143	0.45
Palladium.....	10	3,074	12.0	36,000
Paraffin.....	6	1,522	0.9	1,400
Paraffin.....	35	250	0.9	220
Platinum.....	20	2,690	21.4	57,000
Rubber (vulcanised, black).....	0	54	1.4	75
Rubber (vulcanised, black).....	50	30.7	1.4	43
Silver.....	20	2,678	10.4	28,000
Slate.....		4,510	2.7	12,000
Steel.....		5,000	7.9	38,000
Tin.....	13	2,490	7.3	18,000
Water (distilled air free).....	4	1,419	1.0	1,400
Water (distilled air free).....	15	1,447	1.0	1,400
Water (distilled air free).....	21.5	1,484	1.0	1,500
Water (ocean, 3 % salt).....	14.5	1,503	1.0	1,500
Woods: *				
Ash (parallel to grain).....		4,670	0.55	2,600
Ash (across grain).....		1,260	0.55	690
Beech.....		3,340	0.65	2,200
Cedar.....		3,975	0.40	1,600
Cherry.....		4,410	0.50	2,200
Elm (parallel to grain).....		4,120	0.55	2,200
Elm (across grain).....		1,013	0.55	550
Fir.....		5,256	0.45	2,400
Mahogany.....		4,135	0.60	2,500
Maple.....		4,110	0.55	2,300
Oak.....		3,381	0.65	2,200
Pine.....		3,320	0.45	1,500
Poplar.....		4,280	0.40	1,700
Sycamore.....		4,460	0.50	2,200
Walnut.....		4,781	0.55	2,600
Zinc.....	13	2,681	7.13	19,000

4. Electrical, Mechanical, and Acoustical Impedance. In electrical engineering, the concept of electrical impedance is very useful. The impedance of any part of an electrical circuit is the complex quantity obtained by taking the complex quotient of the voltage in the circuit to the current flowing through it. In acoustical and mechanical work, analogous concepts are equally useful. The Institute of Radio Engineers has defined the mechanical impedance of a mechanical system as follows: "The *mechanical impedance* of a mechanical system is the complex quotient of the alternating force applied to the system by the resulting alternating linear velocity in the direction of the force at its point of application." Furthermore, in analogy to the electrical quantities, the *mechanical resistance* has been defined as the real component of the mechanical impedance and the *mechanical reactance* as the imaginary component of the mechanical impedance.

Another useful concept is the *acoustic impedance* of a sound medium. The definition given by the Institute of Radio Engineers for this quantity is as follows: "The acoustic impedance of a sound medium on a given surface is the complex quotient of the pressure (force per unit area) on the surface by the flux (volume velocity or linear velocity multiplied by the area) through that surface. The acoustic impedance may be expressed in terms of mechanical impedance, acoustic impedance being equal to the mechanical impedance divided by the square of the area of the surface considered." The *acoustic resistance* has been defined as the real component of the acoustic impedance and the *acoustic reactance* as the imaginary component.

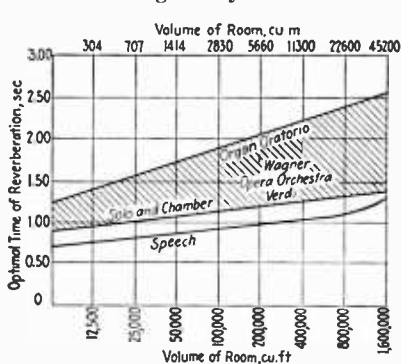

FIG. 1.—Optimal reverberation times as a function of room size and type of sound as given by V. O. Knudsen.

The apparently conflicting definitions for mechanical and acoustic impedance may at first seem needlessly confusing, but practice has found the definitions which are given to be the most practical. In mechanical systems, we deal with the motion under the influence of certain forces and, therefore, the force and motion have been taken as the quantities in terms of which the impedance is to be defined. In electrical systems, we deal with voltage and current. The acoustic systems are quite analogous to electrical systems. The analogous quantities are pressure and total flow, and it is found that the consideration of complex acoustic circuits is simplified by the use of these quantities.

5. Acoustics of Rooms. When a source of sound is in a room or auditorium the sound waves leaving the source are reflected many times by the walls before they are absorbed. These successive reflections of the sound are known as *reverberation*. Architects and designers of theatres and auditoriums have found the reverberation characteristics of the room of great importance in reference to its effect on the quality of music and intelligibility of speech.

To have a quantitative measure of this reverberation, Wallace Sabine defined the *reverberation time* of a room as the time necessary for the average sound energy in the room to drop to one-millionth of its original value after all sources of sound are shut off. He also determined by numerous psychological experiments the values of the reverberation time which observers found most pleasant. This time was found to depend on the size of the auditorium, a longer time being permissible in a larger room. A curve giving the relation between optimum reverberation time and room size is shown in Fig. 1.

The factors which influence the reverberation time can be determined both theoretically and experimentally. A very good check has been found between experiment and theory. The fundamental equation governing the building up of the average sound energy density in a room due to a source having a power emission W started at time $t = 0$, where α is the average absorption of surfaces and objects in the room obtained by summing all the products of absorption coefficients and areas and where the absorption of the air itself is neglected is:

$$\bar{\alpha} = \frac{S_1\alpha_1 + S_2\alpha_2 + S_3\alpha_3 + \dots}{S_1 + S_2 + S_3 + \dots}$$

S is the total absorbing area,

$$S = S_1 + S_2 + S_3$$

V is the volume of the room and c is the velocity of sound:

$$E = \frac{4W}{cS\bar{\alpha}} \left(1 - e^{-\frac{cS \log_e (1 - \bar{\alpha})t}{4V}} \right) \quad (9)$$

Inspection of the above equation shows that for large t its value approaches $4W/cS\bar{\alpha}$, which is the steady-state sound energy.

For the decay of the sound energy after the source has been shut off,

$$E = \frac{4W}{cS\bar{\alpha}} e^{-\frac{cS \log_e (1 - \bar{\alpha})t}{4V}} \quad (10)$$

From the latter equation the reverberation time as defined by Sabine may be calculated. Evaluating all constants,

$$T = \frac{0.16V}{-S \log_e (1 - \bar{\alpha})} \quad \text{if all dimensions are in meters} \quad (11)$$

It has been customary to express absorption coefficients of objects in square feet of perfect absorption in this country, and a great many measurements of rooms are given in English units. The following equation gives the reverberation time when feet are used for all measurements:

$$T = \frac{0.05V}{-S \log_e (1 - \bar{\alpha})} \quad (12)$$

If the average absorption is less than 0.5 Eqs. (11) and (12) may be simplified approximately to:

$$T = \frac{0.16V}{S\bar{\alpha}} \quad (13)$$

and

$$T = \frac{0.05V}{S\bar{\alpha}} \quad (14)$$

(Text continued on page 506.)

6. Absorption Coefficient for Common Materials.

Material	Absorption coefficients for frequency						Auth.	Date
	64	128	256	512	1,024	2,048		
Open window, Theoretical.....	1.0	1.0	1.0	1.0	1.0	1.0	1.0	
Masonry, Plasters, and Tiles:								
Brick wall, 18 in., unpainted.....	0.021	0.024	0.025	0.081	0.042	0.049	0.070	06
18 in., painted.....	0.011	0.012	0.013	0.017	0.020	0.023	0.025	06
Concrete, porous breeze, 2-in. blocks, set in 1:3 cement-sand mortar.....	0.15	0.21	0.43	0.37	0.39	0.51	26
Plaster, Akoustolith, $\frac{1}{2}$ in., on $\frac{1}{4}$ -in. thick lime water.....	0.21	0.24	0.29	0.33	0.37	0.42	23
Ambler, sound absorbing.....	0.03	0.06	0.14	0.17	0.19	0.11	26
Calacoustic, $\frac{1}{4}$ in.....	0.12	0.13	0.16	0.21	0.35	27
Gypsum, on hollow tile.....	0.012	0.013	0.020	0.028	0.040	0.050	14
Lime, on wood lath.....	0.048	0.020	0.034	0.030	0.028	0.043	14
Lime, on wood lath with finishing coat.....	0.036	0.012	0.013	0.018	0.045	0.055	14
Sabinite, $\frac{1}{4}$ in. acoustical plaster.....	0.166	0.214	0.29	0.34	27
Sabine, $\frac{1}{4}$ in., fixed as tiles.....	0.07	0.07	0.23	0.43	0.27	0.41	26
1 in. (as modified by BRS), trowel applied.....	0.11	0.11	0.29	0.47	0.29	0.38	26
Rumford, 1 in.....	0.06	0.12	0.36	0.52	0.52	0.36	147
Sabine, acoustical.....	0.09	0.18	0.29	0.34	0.34	0.30	147
Sabine, West Point (ceramic tile).....	0.064	0.068	0.12	0.19	0.25	0.22	14
.....	0.012	0.013	0.018	0.029	0.040	0.053	14
Building boards and panel:								
Acoustex, 1 in.....	0.10	0.25	0.55	0.73	0.64	0.56	PS
1½ in.....	0.14	0.34	0.68	0.82	0.63	0.52	PS
Armstrong corkboard, 1 in., 0.875 lb. per sq. ft.....	27
1 in., sprayed with cold-water paint.....	0.08	0.30	0.31	0.28	27
2 in., 1.6 lb. per sq. ft.....	0.07	0.30	0.28	0.29	27
Acoustic Zenitherm, 1.14 in., cork granules cemented into a porous, stiff tile.....	0.17	0.35	0.27	0.34	27
Acousti-Celotex, Type A, 1½ in., 1.11 lb. per sq. ft., perforated with 441 small holes per sq. ft. on back of material.....	0.03	0.13	0.33	0.42	0.15	26
Type B, as above, with perforations exposed on front, painted or unpainted.....	0.13	0.28	0.25	0.23	0.23	0.23	29
Type BB, 1½ in., 1.67 lb. per sq. ft., perforated on front as above, painted or unpainted.....	0.22	0.28	0.47	0.53	0.62	0.62	29
.....	0.28	0.42	0.70	0.74	0.77	0.77	29

Type C, $\frac{3}{8}$ in., 0.48 lb. per sq. ft., completely perforated, painted or unpainted.....	0.14	0.16	0.30	0.45	0.57	0.55	CEL	29
Celotex, $\frac{1}{2}$ in., standard building board.....	0.17	0.18	0.20	0.20	0.19	0.19	CEL	29
Cork (coarse), 1 in., slab $3\frac{1}{4}$ ft. by 1 ft., $7\frac{1}{2}$ in., 1 in. from wall, framed in wood.....	0.14	0.25	0.40	0.25	0.34	0.21	BR	26
Insulte, $\frac{1}{2}$ in., standard building board.....	0.23	0.26	0.28	0.29	0.32	VK	287
Acoustile, single layer.....	0.24	0.26	0.30	0.36	0.38	VK	277
Acoustile, double layer, $\frac{1}{2}$ -in. air space.....	0.30	0.31	0.34	0.37	0.40	VK	277
Masonite, $\frac{7}{16}$ in., building board, bare.....	0.19	0.25	0.32	0.36	0.36	VK	28
$\frac{7}{16}$ in., on 2 by 1-in. furring.....	0.17	0.24	0.28	0.295	0.30	0.28	PS	27
$\frac{7}{16}$ in., on 2 by 4-in. studding.....	0.18	0.245	0.31	0.34	0.30	0.24	PS	27
Wood, sheathing, 0.8-in. pine.....	0.064	0.11	0.10	0.081	0.082	0.11	WS	06
3-ply teak panels, 3 ft. by 2 ft. 2 in., 1 in. from wall, framed in wood.....	0.09	0.17	0.17	0.15	0.15	0.15	BR	26
Felts and membranes:								
Asbestos felt, $\frac{3}{8}$ in., 33 per cent of volume is solid material	0.06	0.14	0.32	0.25	0.19	0.18	WS	12
$\frac{5}{8}$ in. felted to asbestos cloth.....	0.07	0.17	0.35	0.30	0.23	0.20	WS	12
Balsam wool, $\frac{1}{2}$ in., paper and cloth covering, weight 0.20 lb. per sq. ft.....	0.05	0.22	0.41	0.58	0.52	0.39	PS	24
1 in., paper and cloth covering, 0.265 lb. per sq. ft.....	0.06	0.30	0.56	0.70	0.58	0.46	PS	24
1 in., paper on under side, other side bare, 0.233 lb. per sq. ft.....	0.09	0.24	0.45	0.64	0.55	0.42	PS	24
1 in., loosely felted quilt of wool fiber, 0.26 lb. per sq. ft. 1 in., covered with steel tile perforated with $64\frac{1}{16}$ -in. holes per sq. in., 0.93 lb. per sq. ft.....	0.18	0.44	0.62	0.62	FW	27
Cabot quilt, 3 ply, 2 layers $1\frac{1}{2}$ in. from wall plus canvas cover 1 in. distant.....	0.19	0.47	0.64	0.66	FW	27
Flax-li-num, $\frac{9}{16}$ in. 1-in. felted flax fibers, 1.17 lb. per sq. ft., bare.....	0.22	0.42	0.74	0.77	0.69	0.44	PB	26
1 in., with unpainted decorative membrane (0.1 lb. per sq. ft., mesh 10 per in.) mounted $\frac{3}{4}$ in. distant.....	0.08	0.14	0.31	0.54	0.51	0.45	PS	27
Hair and asbestos felt, 19% volume solid.....	0.49	0.61	0.67	0.66	FW	27
Hair felt, 12% volume is solid 1 in. thick.....	0.30	0.61	0.60	0.55	FW	27
Same covered with burlap attached with silicate of soda	0.04	0.11	0.38	0.55	0.46	0.39	WS	12
Same with light membrane (0.87 oz. per sq. ft.) stretched near surface.....	0.09	0.20	0.52	0.71	0.66	0.44	WS	12
	0.13	0.33	0.74	0.76	0.49	0.18	WS	12
	0.17	0.40	0.65	0.27	0.14	0.11	WS	12

6. Absorption Coefficient for Common Materials. (Continued)

Material	Absorption coefficients for frequency						Auth.	Date	
	Absorption coefficients for frequency								
	64	128	256	512	1,024	2,048			4,096
Same with heavy membrane (2.58 oz. per sq. ft.) stretched near surface.....	0.25	0.29	0.41	0.32	0.19	0.11	0.08	WS	12
1 in., in contact with wall.....	0.09	0.10	0.23	0.58	0.72	0.66	0.46	WS	12
1 in., spaced 2 in. from wall.....	0.11	0.11	0.26	0.62	0.73	0.66	0.45	WS	12
1 in., spaced 4 in. from wall.....	0.10	0.13	0.30	0.66	0.74	0.66	0.45	WS	12
1 in., spaced 6 in. from wall.....	0.12	0.15	0.35	0.68	0.75	0.66	0.45	WS	12
1 in., located at center of room with barrel ceiling.....	0.14	0.15	0.32	0.96	1.27	1.02	0.62	WS	12
1 in., located at sides of room with barrel ceiling.....	0.11	0.20	0.25	0.54	0.43	0.48	0.20	WS	12
Jute felt, ½ in.....	0.038	0.049	0.076	0.17	0.48	0.52	0.51	WS	06
1 in.....	0.12	0.15	0.22	0.54	0.63	0.57	0.52	WS	06
1½ in.....	0.19	0.24	0.38	0.63	0.65	0.57	0.52	WS	06
2 in.....	0.27	0.34	0.50	0.69	0.67	0.58	0.52	WS	06
2½ in.....	0.34	0.43	0.59	0.75	0.67	0.58	0.52	WS	06
3 in.....	0.40	0.50	0.66	0.77	0.68	0.58	0.52	WS	06
J-M asbestos akoustikos felt, ½ in. bare.....	0.07	0.14	0.31	0.51	0.51	0.43	PS	28
¾ in. bare.....	0.08	0.23	0.45	0.65	0.56	0.46	PS	28
1 in. bare.....	0.11	0.31	0.59	0.68	0.58	0.46	PS	28
1½ in. bare.....	0.13	0.41	0.73	0.73	0.58	0.46	PS	28
2 in. bare.....	0.21	0.46	0.79	0.75	0.58	0.46	PS	28
3 in. bare.....	0.33	0.56	0.79	0.77	0.58	0.46	PS	28
J-M Nashkote, Type AX, ½ in. (J-M asbestos Akoustikos felt with batiste membrane cemented to felt, surface painted with one coat of No. 3000 paint).....	0.10	0.22	0.34	0.41	0.32	0.17	PS	28
Type AX ¾ in.....	0.13	0.24	0.38	0.45	0.35	0.17	PS	28
1 in.....	0.15	0.38	0.43	0.40	0.29	0.18	PS	28
1½ in.....	0.22	0.38	0.41	0.39	0.29	0.20	PS	28
2 in.....	0.34	0.38	0.44	0.4	0.30	0.23	PS	28
3 in.....	0.40	0.47	0.48	0.45	0.31	0.24	PS	28
Membrane, light, 0.87 oz. per sq. ft.....	0.01	0.01	0.04	0.10	0.10	0.07	0.01	WS	12
Heavy, 2.58 oz. per sq. ft.....	0.05	0.06	0.16	0.16	0.10	0.07	0.06	WS	12
Canvas, 6 in. from wall.....	0.10	0.12	0.25	0.33	0.15	0.36	BR	26

Rock wool, banner, 1 in.	0.35	0.49	0.63	0.80	0.83	VK	28
2 in.	0.44	0.59	0.68	0.82	0.84	VK	28
4 in., granulated, packed loosely between 2 by 4 in., 16 in. o.c.	0.43	0.52	0.57	0.65	0.64	VK	28
1 in., 2 layers separated by 1½-in. air space.	0.53	0.64	0.71	0.87	0.90	VK	28
Rock wool, Gimco, 1¼ in., silicate fibers felted between metal lath, 1.44 lb. per sq. ft.	0.46	0.57	0.56	0.72	FW	27
Slagbestos, 1½-in. slabs, ¾ in. from wall.	0.32	0.38	0.65	0.73	0.30	BR	26
1½ in., plus canvas 1 in. distant.	0.42	0.49	0.80	0.78	0.47	BR	26
Floor coverings:							
Carpet, 0.4-in. pile, on concrete.	0.09	0.08	0.21	0.26	0.27	BR	26
0.4-in. pile, on felt, ½ in. on concrete.	0.11	0.14	0.37	0.43	0.27	BR	26
0.4-in. pile, on felt, on ¾ in. polished cork on concrete.	0.17	0.13	0.35	0.42	0.23	BR	26
0.4-in. pile, on felt, on ¾ in. pitch pine blocks on concrete.	0.11	0.13	0.38	0.45	0.29	BR	26
Amritza, 0.43 in., on concrete.	0.09	0.06	0.24	0.28	0.11	BR	26
Cardinal Batala, 0.43 in. on concrete.	0.12	0.10	0.28	0.42	0.21	BR	26
¾ in., rubber on concrete.	0.04	0.04	0.08	0.12	0.03	BR	26
¾ in., rubber on polished cork on concrete.	0.09	0.04	0.15	0.11	0.10	BR	26
Cork, ¾-in. flooring slabs, glued down.	0.08	0.02	0.08	0.18	0.21	BR	26
¾-in. flooring slabs, waxed and polished.	0.04	0.03	0.05	0.11	0.07	BR	26
Wood, ¾-in. pine blocks, laid in mastic.	0.05	0.03	0.06	0.09	0.10	BR	26
¾-in. Gurjan, laid in mastic.	0.03	0.04	0.07	0.14	0.09	BR	26
Individual objects:							
Audience, per person.	1.7	3.6	4.3	4.7	5.0	WS	06
Cushions, cotton, 2¾ sq. ft., under canvas and short nap plush.	0.99	1.7	1.9	2.0	2.0	WS	06
Hair, 2¾ sq. ft., under canvas and plush.	0.86	1.1	1.8	1.7	1.4	WS	06
Hair, under canvas and thin leatherette.	0.67	1.1	1.3	1.3	0.73	WS	06
Vegetable fiber, under canvas and damask.	0.64	0.75	1.0	1.6	1.4	WS	06
Chairs, bent ash.	0.15	0.15	0.16	0.17	0.20	WS	06

The abbreviations employed are: Auth., authority; W.S., W.C. Sabine; P.S., P.E. Sabine; F.W., F.R. Watson; V.K., V.O. Knudsen; B.R., Building Research Station, England; CEL, average of results by P.S., F.W. and V.K.

Using Eq. (12), (14) (14a) or (14b) and the tables (pp. 502-505) giving absorption coefficients of some common materials and objects, the reverberation time of a room can be calculated.

Equations (9) to (14) assume that the energy density in the room averaged over regions large compared to the wave length is uniform during the decay and that all directions of sound energy flux at each point in the space are equally probable. Unfortunately these conditions are rather difficult to fulfill in measuring rooms, and great difficulty has been encountered in determining the absorption coefficients of materials, the values obtained on the same material in different laboratories varying widely. For this reason the coefficients given in the preceding table which have been determined by the best authorities on the subject, but under a wide variety of conditions, should not be taken as representing definitely the relative merits of different materials but merely as giving an indication of the absorption to be expected.

At the higher frequencies the absorption of the air itself in rather reverberant rooms may be important, particularly in dry atmosphere. An experimental determination of the absorption to be expected has been made by Knudsen.¹ The general reverberation time equation corrected for the absorption of the air is:

$$T = \frac{0.16 V}{-S \log_e (1 - \bar{\alpha}) + 4KV} \text{ in meters} \quad (14a)$$

$$T = \frac{0.05 V}{-S \log_e (1 - \alpha) + 4KV} \text{ in feet} \quad (14b)$$

A table showing the experimentally determined values of K at 21°C. for use in these equations follows:

Relative humidity, %	K per foot				K per meter			
	2,000~	3,000~	4,000~	6,000~	2,000~	3,000~	4,000~	6,000~
20	0.00065	0.00125	0.00270	0.00480	0.000215	0.000410	0.000885	0.00160
30	0.00055	0.00115	0.00240	0.00420	0.000180	0.000375	0.000785	0.00140
40	0.00045	0.00105	0.00210	0.00365	0.000150	0.000340	0.000690	0.00120
50	0.00040	0.00095	0.00185	0.00315	0.000130	0.000315	0.000605	0.00105
60	0.00035	0.00090	0.00165	0.00275	0.000115	0.000295	0.000540	0.000900
70	0.00035	0.00085	0.00150	0.00240	0.000115	0.000280	0.000490	0.000785

Sound Transmission. The fraction of sound transmitted through a partition or wall depends primarily on the area of the wall and the mass of the wall material but is influenced to a great extent by possible flexural (bending) modes of vibration of the wall at the frequency being considered. A formula for the fractional transmission through partitions, neglecting the flexural vibrations has been given by A. H. Davis.²

$$\frac{\text{Transmitted sound}}{\text{Incident sound}} = \frac{1}{1 + \frac{\omega^2 \rho^2 l^2}{6,700}}$$

¹ *Jour. Acoustical Soc. America*, 3, 126, 1931.

² *Phil. Mag.*, 15, 309, 1933.

where ρ is the density of the material making up the wall or partition in grams per cubic centimeter and l is the thickness in centimeters. This formula should not be relied upon to give an exact result, since the sound transmission is considerably greater when the wall can resonate, as is most often true. It may be used to give a lower limit to the transmission. In most cases the transmitted sound will not exceed that calculated by this formula by more than 10 db.

CHARACTERISTICS OF THE EAR

7. Frequency and Intensity Limits. The normal ear recognizes tonal qualities in sounds varying in frequency from 16 to 20,000 cycles and with pressures from 0.0004 to 3,000 bars. These limits are of course approximate and vary from ear to ear. Above this pressure a sensation of feeling sets in. The minimum value of the sound pressure which gives a sensation of tone is called the *threshold of audibility*, the minimum value which will stimulate a sensation of feeling is called the *threshold*

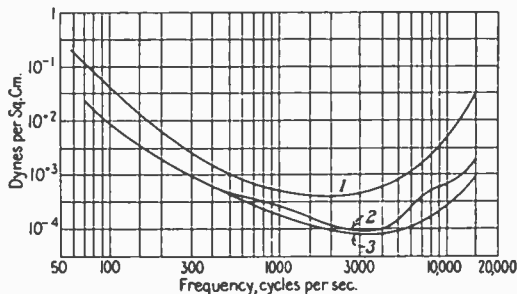

FIG. 2.—Threshold of audibility as given by Sivian and White (*Jour. of Acoustical Soc. America*, 4, 313, 1933). (1) In terms of pressure on ear drum for single ear; (2) in terms of pressure in free undisturbed sound wave, two ears, observer facing sound source; (3) in terms of pressure in free undisturbed sound wave, two ears, random horizontal incidence.

of feeling. Both thresholds vary with the frequency. The values of these thresholds as functions of frequency are shown in Fig. 2.

8. Relation between Loudness and Intensity. The loudness of a sound is measured by the psychological effect of the sound on the ear, while the intensity is measured in physical units. Experiments have been performed with pure tones which show that equal additions of physical intensity do not increase the loudness by the same amount at all intensities, but that the *minimum change in intensity which is noticeable is roughly proportional to the intensity*. For this reason a logarithmic scale for expressing the physical quantities which affect the ear has been found convenient, and the *sensation level* of a sound has been defined as the logarithm of the ratio of the physical intensity of the sound to the intensity of sound at the threshold of audibility. It is usually expressed in decibels. The relations between sensation level at 1,000 cycles, pressure, energy flux, and energy density for a free sound wave are shown in Fig. 3.

9. Relation between Loudness and Frequency. As has been noted above the threshold of audibility varies with the frequency. The physical intensity which will cause the same loudness effect on the ear varies

in an analogous manner. The effective loudness of a pure tone of any frequency has been determined by comparing it with a 1,000-cycle tone on a throw-over test. The results of these experiments are shown in Fig. 4. The low tones require a much smaller increase in intensity for an equivalent increase in loudness than do the tones of higher frequencies.

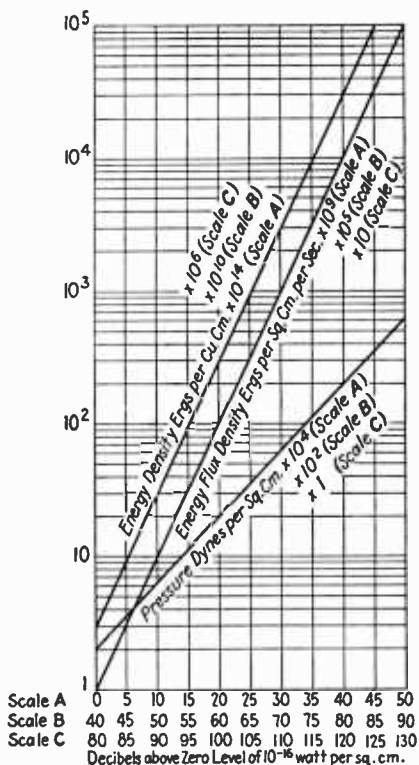

FIG. 3.—Relation between zero level of 10^{-6} watt per square centimeter pressure, energy density, and energy flux density. This zero level for a thousand-cycle sound wave in free space will probably be adopted as the standard for calibration of noise instruments by the American Standards Association. A great many of the older noise measurements were made with a zero level of 0.005 dyne per sq. cm., which corresponds closely to the threshold of hearing when the pressure is measured in the ear canal for a thousand-cycle pure tone. In comparing noise measurements always take care to ascertain the zero level which was used and convert to some standard.

LOUD-SPEAKERS

10. Desirable Characteristics. The loud-speaker should, when used in conjunction with an ideal microphone and transfer system (which

may contain electrical lines and a number of stages of recording), reproduce the sound wave which would have reached the ear of the listener if he had been present in the place where the original music or speech was produced. There is a certain amount of argument as to just how much allowance should be made in the psychology of listening for the acoustics of the place where the original should be imagined to take place and the room in which the observer listened to the reproduction. No definite evidence has been brought forward to give a definite decision as to just what weight should be given to these factors, although the preponderance of opinion among broadcasters and those connected with the recording of motion pictures is that the attempt should be made in the reproduction to reproduce as accurately as possible the acoustic

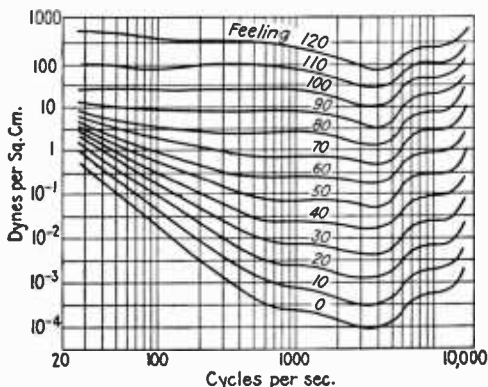

FIG. 4.—Relation between pressure in free wave and loudness for 10 db steps above threshold, observer facing sound source as given by Fletcher and Munson. (*Jour. Acoustical Soc. America*, 5, 91, 1933.)

characteristics of the place in which the sound was picked up, and the loud-speaker should be designed to fit the location in which it will be placed, so that it will balance whatever acoustic peculiarities there are in the reproducing room.

On this basis, the loud-speaker should give a constant sound pressure output at the position of the listener in the room in which the loud-speaker is to be used for a sound wave having the same pressure at the microphone at all frequencies. Assuming that the remainder of the system does its work properly, the loud-speaker should reproduce constant pressure under the conditions specified above for constant voltage input to the last tube of the audio amplifier.

Loud-speakers can be designed so as to radiate sound in a beam similar to that sent out by a headlight of an automobile or to radiate sound uniformly in all directions. Whether the uniform radiation or the beam radiation is desired will depend on the condition of use. The loud-speaker which is used in the radio set or phonograph at home should not be too sharply directional, as the listeners would normally be scattered over a wide angle in front of the loud-speaker, and those not directly

in front will suffer under conditions of directional radiation. Radiation in the form of a hemisphere in front of the radio set is most desirable for this use. When loud-speakers are used in theaters, the reverberation characteristics of the theater are usually injurious to the best intelligibility and various devices have been resorted to, such as cutting off the low frequencies to improve the results. The best effects have been obtained by making the loud-speaker radiation directional and pointing it toward the audience, so that the maximum radiation will strike them directly before reflections from any other surfaces.

The loud-speaker must handle whatever energy it is required to reproduce without distortion. Distortion noticeable in loud-speaker reproduction is probably most often due to overloading in the electrical system but can be due to non-linear effects in the loud-speaker or more often to rattles and buzzes due to parts which are set into vibration when the loud-speaker is subject to violent motion. The buzz due to loud-speaker rattle is so similar to that noticed due to amplifier overloading that the listener should always be careful to make sure that no distortion is taking place in the electrical or recording system before blaming the loud-speaker.

11. Calculation of Loud-speaker Efficiency. At first sight it might seem most useful to define loud-speaker efficiency in the same manner as the efficiency of other generators is defined, *viz.*, in terms of the ratio of the power delivered to the power which is supplied to it. Due to the conditions under which a loud-speaker is used, however, another definition of efficiency which has been called the *absolute efficiency* has been found of more value.

In practice, a loud-speaker is supplied from either a vacuum tube or a transformer attached to a vacuum tube. The impedance of this vacuum tube or the effective impedance of the transformer when placed in the circuit is very nearly a pure resistance independent of the frequency. If the loud-speaker motor has a large reactive component of impedance, or if its impedance varies greatly as the frequency is changed, it will be impossible to supply electrical power to the loud-speaker which is equal to that which could be delivered to a resistance having the same resistance as the supply source (the condition for maximum power transfer from a supply source to an external unit). Even though the loud-speaker might, therefore, have a high efficiency in the usual sense, under the conditions of use, it would not be possible to deliver a large amount of power to it and it would, therefore, from a practical standpoint, not be an efficient loud-speaker.

The definition of loud-speaker efficiency which has been adopted by the Institute of Radio Engineers has been worded so as to allow for the ability of the loud-speaker to absorb energy from the supply source as well as the ability of the loud-speaker to convert that electrical energy into acoustic output.

The general definition which the Institute of Radio Engineers has given for the absolute efficiency of electro-acoustic apparatus when applied to loud-speakers can be interpreted as follows:

The *absolute efficiency* of a loud-speaker for a given circuit condition is the *ratio of the acoustic output of the loud-speaker to the maximum power which can be drawn from the supply source.*

Based on this definition, the absolute efficiency of a loud-speaker not of the relay type is given by the following formula:

$$\text{Eff.} = \frac{\frac{4z_r}{|z^2|} |M^2| R_s}{\left| \frac{M^2}{z} + Z + R_s \right|^2} \quad (15)$$

where z_r is the mechanical resistance due to acoustic radiation, z is the total mechanical impedance, including reactance due to air reaction and masses and stiffnesses in the drive system; also resistance due to radiation and any other energy losses, M is the vector force factor, *i.e.*, complex quotient of force developed in the mechanical system per unit current in the electrical system, Z is the impedance of the electrical system excluding the impedance due to the motion of the mechanical system which is included in the M^2/z term, R_s is the electrical impedance of the supply source, and the bars indicate absolute values. When using the formula in the form in which it stands, all mechanical quantities must be expressed in c.g.s. absolute units; and electrical quantities in absolute electromagnetic units when the force action is electromagnetic and in absolute electrostatic units when the force action is electrostatic.

12. Sample Calculation of Efficiency of a Dynamic Loud-speaker on a Large Baffle. In the next succeeding paragraphs an illustration showing how formula (15) can be used to calculate the efficiency of a loud-speaker is given. The determination of a number of the quantities which are required for the calculation is discussed in the succeeding sections, and reference will be made to these sections as required.

It is usually not possible to calculate the efficiency of a loud-speaker with mathematical precision, but information may be obtained by making approximations, which allow an analysis to be made of the factors that are important in determining its efficient operation, and which permit the engineer to determine the most economical manner in which he can improve the design.

To simplify the illustration, a dynamic cone loud-speaker will be chosen having the following characteristics:

An 8-in. diameter paper cone, with $\frac{1}{2}$ -in. suspension. Mass of cone plus coil 14.7 g. Mechanical system, due to the stiffness of the suspension and the centering means, resonant at 100 cycles. Diameter of the air gap 4 cm. Number of turns in the coil 120. Flux in the gap 9,000 gauss. The transformer feeding the loud-speaker is so designed that it reflects the output tube impedance into the secondary as 11 ohms.

To simplify the calculation, the assumption can be made that the radiation from the front and rear is equal and the same as that from a vibrating disk in an infinite baffle.

Referring to Eq. (15) we must first calculate the mechanical impedance due to radiation z_r and the total impedance z . z_r is obtained directly from curve 8a by multiplying the values given on that curve by the area of the disk. The diameter of the disk plus the vibrating part of the suspension is approximately 22 cm, giving an area of 380 sq cm. The values of z_r for a series of frequencies are shown in column 3 of the table (p. 420). The frequencies are given in column 1, and values of d/λ corresponding to each frequency, where d is the diameter of the disk and λ is the wave length of sound at that frequency, are shown in column 2. The total mechanical reactance is made up of a mass component due to the mass of the cone plus drive coil, a stiffness component due to the stiffness of suspension and centering device, and an additional

mass component due to reaction of the air, the value of which is obtained by referring to curve 8b and multiplying by the area of the disk. The values of the latter at a series of frequencies are shown in column 4, while the component due to the mass of the cone itself, which is equal to ω times the mass, is shown in column 5.

Since the system is resonant at 100 cycles the total mass component must be equal to the total stiffness component at that frequency and the stiffness component therefore equals 13.4×10^3 mechanical ohms at 100 cycles, and has values inversely proportional to the frequency, as shown in column 6 for the other frequencies. The total reactive component of the mechanical impedance, which is obtained by subtracting the total stiffness component from the total mass component, is shown in column 7. It will be noted that any frictional or heat losses in the vibrating system have not been included as they are negligibly small compared to the other quantities. Columns 3 and 7 determine the total vector mechanical impedance.

We next require the force factor M . A discussion of the determination of the force factor for a dynamic loud-speaker is given in paragraph 16 under the discussion of Moving Conductor Motor, and it is equal to the product of the length of conductor in the gap times the magnetic field strength. In the case of the loud-speaker under discussion, this is equal to $\pi \times 4 \times 120 \times 9,000$ and is the same at all frequencies. Its value is shown in column 8.

The supply impedance must be expressed in electromagnetic absolute units and is equal to 11×10^9 abohms, as shown in column 9. The electrical impedances of the system, as measured with the mechanical system clamped so that it cannot vibrate, and expressed in abohms are shown in columns 10 and 11; 10 gives the resistive component and 11 the reactive component. The efficiencies calculated by means of formula 15 and the values which have been given in the preceding columns of the table are shown in column 12. Care must be taken in using formula 15 to use absolute values and components in the proper place as indicated by the double bars.

The calculation of the efficiency has been carried to only 1,600 cycles, as the simple assumptions which have been made no longer hold for frequencies above this value. The fact that the vibrating body is a cone rather than a disk affects the radiation at frequencies where the depth of the cone becomes comparable with the wave length. The cone also fails to vibrate as if it were moving all in phase at the higher frequencies so that the assumption of a vibrating piston is no longer valid. The calculation of the efficiency where the more complicated phenomena take place is beyond the scope of this simple example and reference can be made to an article by M. J. O. Strutt¹ for additional information. The effect of the use of a finite baffle has also been excluded as this calculation usually involves a consideration of the cabinet which is used to surround the loud-speaker and must be considered as a separate problem.

The response of the loud-speaker in any direction may also be obtained by means of the efficiency values which have just been calculated and the directional radiation curves shown in Fig. 10. The response of a

¹ *Ann. Physik*, 11, 129, 1931.

loud-speaker as defined by the Institute of Radio Engineers¹ is expressed in terms of the quantity $\frac{p}{v/\sqrt{R}}$, where p is the resultant sound pressure

in the medium expressed in bars, R is a resistance equal to that of the source to which the loud-speaker is designed to be connected expressed in ohms, and v is the voltage supplied to the loud-speaker in series with a resistance R . The calculation of the response as thus defined by means of the efficiency values and the directional curves is made in the following manner:

The absolute efficiency has been defined in the paragraph preceding Eq. (15) of this section. The acoustic output of the loud-speaker expressed in ergs per second may be obtained by integrating the sound-energy flux density over a sphere with the loud-speaker as center. The energy flux density through any small area dS is equal to JdS , where J is the energy flux density through that area. Expressed in terms of solid angle, this is $Jr^2d\Omega$, where r is the radius of the sphere with the loud-speaker as center and $d\Omega$ is the solid angle subtended by the area dS . Referring to Eq. (7), the energy flux density may be expressed in terms of the pressure produced by the loud-speaker. The product of the density of air by the velocity of sound in air in the denominator of this equation is approximately equal to 40, and the energy flux density

through the area dS is therefore equal to $\frac{p^2r^2}{40}d\Omega$. The total energy

flux is obtained by integrating this over the surface of the sphere. If p_0 equals the sound pressure directly in front of the loud-speaker, the sound pressure at any other point at the same distance from the loud-speaker is equal to $p_0\phi$, where ϕ is the relative pressure, as shown on Fig.

11. The total sound energy flux is thus equal to $\frac{p_0^2r^2}{40} \int \phi^2 d\Omega$. The

maximum power which can be drawn from the supply source is $v^2/4R \times 10^7$ expressed in ergs per second.

The efficiency is therefore

$$\frac{\frac{p_0^2r^2}{40} \int \phi^2 d\Omega}{v^2/4R \times 10^7} = \frac{p_0^2}{v^2/R} \times 10^{-8} \times r^2 \int \phi^2 d\Omega$$

and

$$\frac{p_0}{v/\sqrt{R}} = \frac{10^4}{r} \sqrt{\frac{\text{efficiency}}{\int \phi^2 d\Omega}}$$

An expression is thus given for the response directly in front of the loud-speaker in terms of the efficiency and the integral of ϕ^2 taken over the whole sphere. The values of this integral, as determined from Fig. 10, integrating by quadrature, are given in column 13, and the values of the response directly in front of the loud-speaker, calculated by means of the

¹ See Section 12 on Acoustic Measurements in Report of the Committee on Standardization of the I.R.E. sections on Definitions of Electro-acoustic Devices and Tests of Electro-acoustic Devices, 1931.

CALCULATION OF LOUD-SPEAKER EFFICIENCY

(1) Frequency	(2) d/λ	(3) z_r	Reactive component of mechanical impedance			(8) M
			(4) Air loading	(5) Mass of cone	(6) Stiffness of suspension	
50	0.032	0.16×10^3	2.0×10^3	4.6×10^3	-26.8×10^3	13.6×10^6
75	0.049	0.35×10^3	3.0×10^3	7.0×10^3	-17.9×10^3	13.6×10^6
100	0.065	0.62×10^3	4.1×10^3	9.3×10^3	-13.4×10^3	13.6×10^6
200	0.13	2.5×10^3	8.2×10^3	18.5×10^3	-6.7×10^3	13.6×10^6
400	0.26	9.5×10^3	16.4×10^3	37.0×10^3	-3.3×10^3	13.6×10^6
800	0.52	26.8×10^3	23.0×10^3	74.0×10^3	-1.6×10^3	13.6×10^6
1,600	1.04	32.6×10^3	4.6×10^3	148.0×10^3	-0.8×10^3	13.6×10^6

Frequency	(9) R_s abohms	Electrical impedance $X + jY$		(12) Absolute efficiency, per cent	(13) $\int \phi^2 d\Omega$	(14) Response directly in front $\frac{p_0}{v/\sqrt{R}}$
		(10) X abohms	(11) Y abohms			
50	11×10^8	10.7×10^8	1.0×10^8	0.6	12.5	$220 \times 1/r$
75	11×10^8	10.7×10^8	1.5×10^8	4.7	12.5	$610 \times 1/r$
100	11×10^8	10.8×10^8	2.0×10^8	12.7	12.5	$1,010 \times 1/r$
200	11×10^8	11.0×10^8	3.6×10^8	9.9	12.3	$900 \times 1/r$
400	11×10^8	12.0×10^8	7.0×10^8	5.6	11.4	$700 \times 1/r$
800	11×10^8	13.9×10^8	12.6×10^8	2.9	7.8	$610 \times 1/r$
1,600	11×10^8	17.6×10^8	22.0×10^8	0.9	2.5	$600 \times 1/r$

Note: r expressed in centimeters.

last equation, are given in column 14. It will be noted that the response is more uniform as a function of frequency than the efficiency due to the fact that the radiation is encompassed in a smaller solid angle as the frequency is increased. The response in any other direction may be determined by reference to Fig. 11 and the values in column 14 of the table.

This discussion illustrates some of the methods which can be employed to evaluate theoretically, with a fair degree of accuracy, the results which can be expected from a loud-speaker. As in the case which was chosen for illustration, it is usually necessary to make simplifying assumptions in order to limit the complexity of the problem and reduce the variables which affect the response and the efficiency to the simplest terms. Even though an exact solution is not obtained, methods similar to the above will be found very useful in efficient design of loud-speakers.

The calculations which are shown above have been checked experimentally in a number of instances, showing that the dynamic cone is not a very efficient loud-speaker. The efficiency of a dynamic driving mechanism may be considerably improved by the use of a directional baffle or a horn and air chamber. By these means the efficiency can be increased to 30 per cent or more.¹

THE LOUD-SPEAKER MOTOR

13. Determination of Force Factors. Three types of loud-speaker motors have been in common use for obtaining the motion required to produce a sound wave from an electrical wave. The first loud-speakers

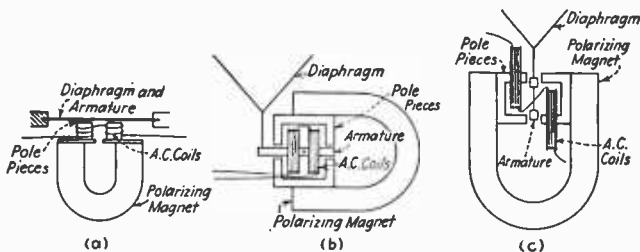

FIG. 5.—Types of magnetic-armature loud-speaker motors: (a) Bipolar; (b) balanced; (c) fringing flux.

which were built were of the *magnetic armature* type. More recently these have practically been superseded by the *moving conductor* drive (principally electrodynamic) and the larger portion of all loud-speakers in use today are of this type. The *condenser* loud-speaker is one of the oldest forms, having been proposed when singing condensers were first noticed and has a number of ardent exponents at this time but has never reached the popular favor that the magnetic types have assumed. Other types of drive, such as *magnetostriction* and *piezo-electric* have been proposed, but have never had wide usage.

¹ WENTE, E. C., and A. L. THURAS: *Bell System Tech. Jour.*, 8, p. 140, 1928; H. F. OLSON, *Jour. Acoustical Soc. America*, 2, 485, 1931.

14. Magnetic Armature Motor. Magnetic armature motors are characterized by a ferromagnetic armature or diaphragm in a polarizing magnetic field and some means for superposing an alternating field on the fixed field. The polarizing field is always required if non-linear distortion is to be avoided, since the force due to a magnetic field is proportional to the square of the field strength with the result that the use of an alternating field alone would lead to total absence of fundamental reproduction.

Several types of unit are shown in Fig. 5. Type *a* was quite common in older loud-speakers and in telephone receivers, due to its simplicity and low cost. Type *b* is called a *balanced unit*, since the magnetic circuit is such as to balance the magnetic flux in the armature when in its rest position. This driver has been very popular, as it permits the use of a very light armature and efficient magnetic circuit in which the variable magnetic flux does not have to pass through the higher-reluctance fixed magnetic field circuit. Type *c* is a *fringing flux type* and has the advantage of having the armature motion parallel to the pole piece faces, thus eliminating the possibility of the armature striking the pole faces on high amplitude of motion. It has the disadvantage of being wasteful of magnetic flux.

The force developed by a magnetic field on a portion of a ferromagnetic armature in air in which the magnetism is induced is

$$\frac{H^2}{8\pi} \left(1 - \frac{1}{\mu} \right) dS \quad (16)$$

where H is the component of field strength in the air perpendicular to the armature surface, μ is the permeability of the armature material and dS is the surface element. This formula assumes that the iron is not saturating so that the permeability can be taken as constant throughout the armature. In all practical loud-speakers, μ is so large compared to 1 that $1/\mu$ can be neglected.

In types *a* and *b* the total magnetic flux entering the armature can be considered without much error as parallel to the direction of motion and therefore useful in developing force. In type *c* considerable flux exerts force components on the armature which are not in the direction of motion.

15. Necessity for Polarizing Field. A consideration of the formula given for the force on the armature shows the necessity for polarizing field. Calling the polarizing field strength H_0 and the instantaneous value of the alternating field $H \sin \omega t$, the force on a small armature section moving a negligible distance in the air gap is

$$\frac{1}{8\pi} (H_0^2 + 2H_0H \sin \omega t + H^2 \sin^2 \omega t) dS \quad (17)$$

The first term exerts a steady pull which, it will be seen, tends to attract the armature to the pole piece, the second term leads to a force proportional to the product of fixed field and alternating field, and the third term leads to second harmonic production. To make the second harmonic distortion negligible, H must always be kept small compared to H_0 particularly in units of type *a* where the tendency to balance the second harmonic distortion as in types *b* and *c* is not present. The

second term in the above expression is the one which determines the alternating force and therefore the force factor. Since H is proportional to the current through the voice-coil winding, the computation of the relation between H and the current, as explained in the chapter on magnetic circuits, is all that is required for the force-factor determination.

Due to the change in air-gap length as the armature vibrates, with resultant change in reluctance of the magnetic circuit, an additional alternating force in phase with the displacement is set up which for small displacements is proportional to the displacement of the armature from its equilibrium position and in the direction to increase the displacement. This force has the general characteristics of a stiffness but is opposite in sign and is therefore called a negative stiffness. In

magnitude it is equal to $\frac{1}{4\pi} H_0^2 dS$

times the relative change in reluctance. It is subtracted from the mechanical stiffness in determining the mechanical impedance of the unit. Contrary to popular belief, the balanced units types b and c do not reduce this negative stiffness. As a matter of fact, it is twice as large due to the reduction of force on one side while that on the other side is increased.

16. Moving Conductor Motor. In the moving conductor motor a non-magnetic conductor is placed in a magnetic field whose lines of force are transverse to the direction in which motion is desired. In the dynamic type shown in Fig. 6 the conductor takes the form of a coil of one or more turns of cylindrical shape to which a diaphragm is attached in a ring-shaped air gap. In the ribbon type shown in Fig. 6

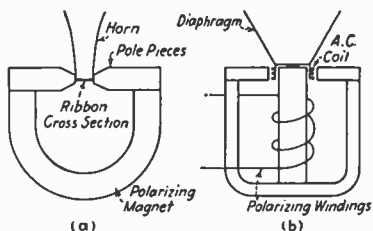

FIG. 6.—Types of moving-conductor loud-speaker motors. (a) Ribbon; (b) dynamic.

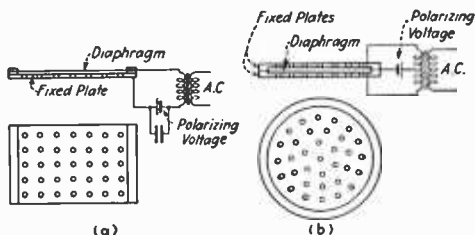

FIG. 7.—Condenser loud-speakers. (a) Unilateral; (b) bilateral.

the conductor is usually a thin strip of aluminum which acts at the same time as diaphragm. Numerous other modifications have been proposed, all of which operate by the force developed in a conductor through which a current is flowing in a transverse field.

The force in dynes developed on the conductor when current flows through it is lIH_0 where I is the current in absolute electromagnetic units, l is the total length of conductor and H_0 is the polarizing field.

The force factor for the moving conductor type of unit is thus lH_0 . If the field is not perpendicular to the conductor in the air gap, the component of magnetic field perpendicular to the conductor should be taken for H_0 . If the field is non-uniform, the integral of lH_0 over the length of the conductor is taken.

17. Condenser Loud-speaker. In the condenser loud-speaker the force on the diaphragm is developed by direct electrostatic attraction. It has the theoretical advantage of the possibility of driving the diaphragm with a uniform force at all points on the surface. Both unidirectional and balanced electrostatic fields have been proposed and tried on the condenser loud-speaker as is shown diagrammatically in Fig. 7.

The attractive force in dynes per square centimeter of diaphragm pulling the diaphragm toward the fixed electrode is $H^2/8\pi$ with air as dielectric, where H is the electric field strength in electrostatic units. In constructing electrostatic loud-speakers, a polarizing electric field is required similar to the polarizing magnetic field which is used in the magnetic armature type. Without the presence of this polarizing field, no fundamental reproduction is obtained. Calling the strength of the polarizing field H_0 and the variable field which is superposed on this $H \sin \omega t$, the total attractive force per square centimeter becomes

$$\frac{1}{8\pi}(H_0^2 + 2H_0H \sin \omega t + H^2 \sin^2 \omega t) \quad (18)$$

By making the polarizing field strong compared to the alternating field, the second harmonic distortion which is included in the last term can be made negligible compared with the fundamental reproduction due to the second term, which is

$$\frac{H_0H \sin \omega t}{4\pi} \quad (19)$$

The force factor is determined by obtaining the ratio of electric field strength to current through the loud-speaker and then by the use of the last equation determining the ratio of force to current. Since the force on the diaphragm, electric field, and voltage are all in phase and in quadrature with the current, the force factor will, in general, be multiplied by j , and M^2 in Eq. (15) will be negative.

Similarly to the magnetic armature type, the electrostatic loud-speaker has a negative stiffness component due to the tendency of the diaphragm to be attracted more strongly towards the fixed electrode as it approaches it. It is equal to $H_0^2/4\pi$ times the relative change in air-gap length, per square centimeter of surface. In the balanced unit, although the static forces due to the polarizing field are balanced out approximately, the negative stiffness force which arises due to motion away from the equilibrium position is double as large as for the single-sided type, due to the decrease in attractive force on one side corresponding to the increase in attractive force on the other.

18. Mechanical Impedance of Loud-speaker Elements. The mechanical impedance of loud-speakers is due to the masses and stiffnesses in the loud-speaker armatures, coils, connecting links, and diaphragms and the loading due to air. The loading due to the air will be considered below. Assuming that a force is applied to a simple system consisting

of a mass attached to a spring and that the mass is in some viscous material, such as oil, which damps its motion, the mechanical impedance due to the mass is $j\omega m$, where m is the mass in grams, ω is 2π times the frequency and j is the square root of -1 ; that due to the stiffness is equal to $s/j\omega$, where s is the stiffness in dynes per centimeter of displacement.

The total impedance of the system is $j\omega m + \frac{s}{j\omega} + z_r$, where z_r is the mechanical resistance. These impedances are all in series since all parts of the system are moving with the same velocity which corresponds to having the same current in electrical circuits. When the same force is applied to a number of mechanical impedances which move with velocities determined by the force, then the same equations hold as if they were impedances in parallel in electrical circuits.

In the common forms of loud-speakers, the impedances of the motor, diaphragm, and air loading are usually in series when the frequency of agitation is low enough so that the flexing of the members may be neglected. At the higher frequencies, where the flexing must be taken into account, the relations become more complicated and must be worked out for each individual case.

LOUD-SPEAKER RADIATOR

19. One Single Diaphragm. The simplest type of loud-speaker radiator to consider, and one which is closely approximated in many

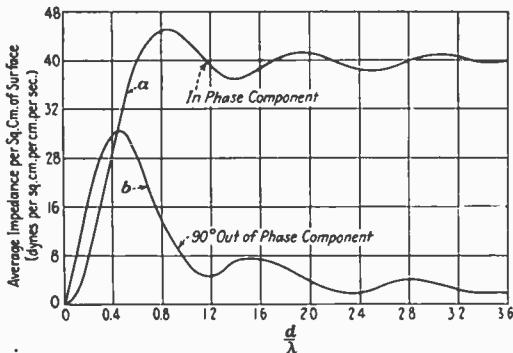

FIG. 8.—Load on a vibrating circular diaphragm set in an infinite baffle.

loud-speakers, is a piston vibrating back and forth in an infinite wall. The sound radiation from a source of this kind has been considered by Lord Rayleigh and completely solved in mathematical terms. At the lower frequencies, where the wave length is comparable with the size of the piston, it is not a very efficient radiator of sound waves. A curve showing the force developed per unit area of a piston per unit velocity (mechanical impedance per unit area) as a function of the ratio of piston size to wave length is given in Fig. 8. The force developed may be divided into two components, one of which is in phase with the velocity,

and the other one in quadrature with the velocity and of such sign as to act as if the mass of the piston were increased. At the higher frequencies, the quadrature component becomes negligible compared to the component in phase with the velocity which approaches a value of approximately 41 dynes per square centimeter per centimeter per second of velocity.

20. A System of Diaphragms. By making the diaphragm larger, the efficiency of low-frequency radiation can be increased but other defects arise which make this procedure impractical for most purposes. As the diaphragm is made larger, it becomes necessary to make it thicker to obtain sufficient rigidity. The added mass which is thus introduced makes reproduction of high frequencies difficult. It has, therefore, been found most practical to use a number of small diaphragms placed adjacent to each other when good reproduction of low frequencies is desired. By means of this procedure, each vibrating diaphragm reacts

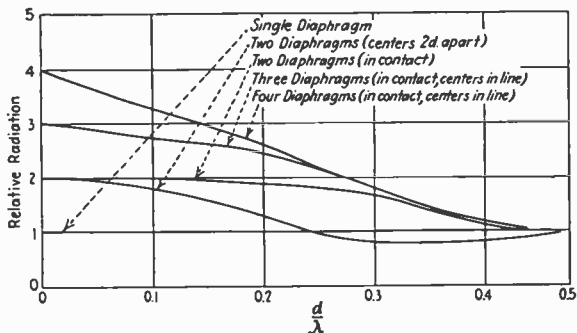

FIG. 9.—Radiation from a system of vibrating diaphragms all vibrating in phase, compared with that from a single diaphragm, as a function of diaphragm size and wave length.

on the others to increase the resistive low-frequency loading with consequent increase in radiation. A curve showing the relative radiation from a system of one, two, three and four diaphragms placed adjacent to each other and in line is shown in Fig. 9. It will be noted that at low enough frequencies the radiation is proportional to the number of diaphragms which are used, while at high frequencies the increase in the number of diaphragms does not improve the efficiency of radiation. For a more detailed consideration of the radiation from a combination of diaphragms reference can be made to the original articles.

21. Horns. A second method which has been widely used for many centuries for obtaining increased low-frequency radiation is the device known as a horn. Up to recent times a conical horn and some type of flaring horn have been employed.

At present, the exponential-type horn is used almost exclusively, that is, one whose cross-sectional area is given by a formula of the type:

$$S = S_1 \epsilon^{bx}$$

where S_1 is the cross-sectional area of the throat, ϵ is the Napierian base and

b is a constant which determines the rate of flare. By means of a horn having a certain length and flare, it is theoretically possible, excluding frictional losses, to load a diaphragm so that a resistance loading of 41 mechanical units per square centimeter can be obtained at any frequency. The formula for the resistive force per square centimeter on a diaphragm for unit velocity (resistive impedance per square centimeter) for an exponential horn of infinite length is given in Eq. (20).

$$z_r = \rho_0 c \sqrt{1 - \frac{b^2 c^2}{4\omega^2}} \quad (20)$$

When $bc/2\omega$ is greater than 1, that is, for frequencies less than $bc/4\pi$, the expression above becomes imaginary and no energy is rated (the impedance is entirely reactive).

22. Effect of Flare and Length. It will be noted that the flare of the horn, as determined by the constant b , is the factor which determines to how low a frequency the loading on the diaphragm caused by the horn becomes effective. From a practical standpoint, there is a limit to the use of a very small flare, since it is found necessary to make the mouth opening of the horn of the same order of magnitude as the wave length of sound being radiated in order to secure efficient radiation. To obtain the large mouth opening with a very small flare, the horn length becomes excessive and impractical. It is this factor of size which places a practical limit on the low-frequency radiation possible from horns.

When the horn is finite in length, it is necessary to make a correction for the reflection from the open end in order to obtain the radiation characteristic. The formula for the loading per unit area due to a finite horn is as follows:

$$z_1 = \rho_0 c \left[\frac{z_2 \cos (ql - \phi) + j\rho_0 c \sin (ql)}{\rho_0 c \cos (ql + \phi) + z_2 \sin (ql)} \right] \quad (21)$$

where z_1 is the impedance per square centimeter due to the horn, z_2 is the impedance per square centimeter at the mouth of the horn, l is the length of the horn,

$$q \text{ is } \frac{1}{2} \sqrt{\frac{16\pi^2}{\lambda^2} - b^2}$$

b is the flare constant, and

$$\phi = \tan^{-1} \left[\frac{-1}{\frac{16\pi^2}{\lambda^2 b^2} - 1} \right]$$

In choosing the impedance at the open end, a value sufficiently accurate for most purposes is obtained by assuming that the loading at the open end is the same as for a piston of size equal to the mouth opening of the horn (see Fig. 8).

23. Increasing Loading to Obtain Greater Efficiency. In the preceding paragraph, the assumption has been made that the horn throat opening is the same size as the diaphragm. As has been stated, under these conditions the maximum loading of the diaphragm by the air is approximately 41 dynes per square centimeter per centimeter per second velocity. It is very often desirable to increase this loading to obtain more efficient loud-speaker action. See Eq. (15) for loud-speaker efficiency. This

increased loading can be obtained by using a so-called *air chamber* adjacent to the diaphragm and using a horn mouth opening which is smaller than the diaphragm size. Assuming that the chamber is small enough so that the compression of the air can be neglected, the impedance per unit area on the diaphragm for any fixed velocity is increased by the ratio of the area of the diaphragm to the area of the mouth opening of the horn. Further details for the case where the compression of the air in the chamber cannot be neglected can be found in original articles.

24. Directional Characteristics of Loud-speakers. The directional characteristics of loud-speakers are very important in determining their performance. For loud-speakers to be used in small rooms (home entertainment), a non-directional characteristic is to be desired. For

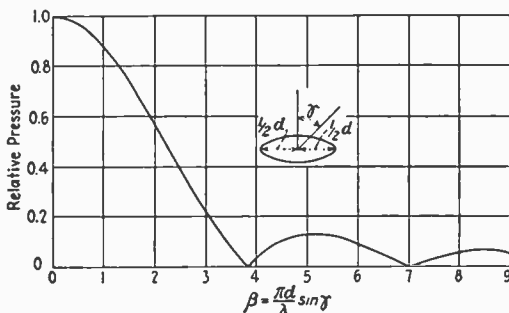

FIG. 10.—Directional radiation characteristics of vibrating disk in infinite baffle.

loud-speakers to be used in auditoriums, a rather sharply defined directional characteristic, such that the loud-speaker sprays sound over the audience and nowhere else, is most desirable for maximum intelligibility. For loud-speakers to be used out of doors, a directional characteristic in which the loud-speaker directs the sound toward the places where it is to be heard and nowhere else is of great importance in order to obtain maximum efficiency.

A non-directional characteristic is obtained from a source of sound (single radiator) which is small compared to the wave length. When the source is a double radiator, such as a loud-speaker on a baffle, a maximum of radiation is obtained directly in front and in back with zero intensity in the plane of the baffle where the sound wave from the front and rear interferes.

The directional radiation characteristic due to a circular disk is shown in Fig. 10. Along the ordinate axis is plotted the ratio of the pressure at any point in space to the pressure at a point the same distance away from the center of the disk but on the axis. Along the axis of abscissas is a function β defined by

$$\beta = \left(\frac{\pi d}{\lambda} \right) \sin \gamma$$

where d is the diameter of the disk, λ is the wave length of sound being

radiated, and γ is the angle between the perpendicular to the disk at its center and the direction under consideration.

This directional characteristic will be found useful in making approximate estimates of the directivity of numerous loud-speakers. When the loud-speaker is of the cone type, the diameter of the base of the cone can be taken as the diameter of the disk up to frequencies where the wave length of radiated sound becomes smaller than the base diameter. Above that frequency, the cone shape must be taken into account as well as the fact that most cones no longer vibrate with their whole surface in phase at the high frequencies. Experiment has shown that the directional characteristic is more accurately represented by taking that of a disk with diameter three-fourths to one-half that of the cone base at the higher frequencies.

When the loud-speaker is of the horn or directional baffle type, the mouth opening of the horn can be taken as the diameter of the disk. In the case of these loud-speakers, the directional characteristic as thus determined will usually be somewhat too sharp, particularly at the higher frequencies, due to the fact that the sound intensity over the mouth of the horn is not uniform and the wave which leaves the mouth is more spherical than plane. A somewhat more accurate picture is obtained by taking the value approximately three-fourths the diameter of the mouth opening with further reduced size as the frequency is increased.

ACOUSTIC MEASUREMENTS

25. Loud-speaker Measurements. To determine the performance of a loud-speaker, the following quantities should be known:

1. The frequency response and directional characteristics of the loud-speaker.

2. The power-handling capacity of the loud-speaker.

3. The efficiency of the loud-speaker.

The frequency response and directional characteristics of the loud-speaker are usually measured by actuating the loud-speaker with a simple-harmonic current and measuring the sound output by means of some form of calibrated microphone-amplifier system. The measurements must be carefully made, and attention must be paid to all details so that the results may not be in error or influenced by surroundings which are not connected with the loud-speaker. For details of methods which have been found most suitable for making these measurements, reference should be made to the 1931 report of the Institute of Radio Engineers Standardization Committee in the chapter on "Performance Indexes and Tests on Electro-acoustic Devices" and to the references which are given at the end of this chapter.

The response of the loud-speaker is measured in terms of a quantity

$\frac{p}{v\sqrt{R}}$, where p is the resultant sound pressure in the medium (at the

specified frequency) at a specified point or the average of the resultant pressure at specified points relative to the loud-speaker, R is a resistance equal to that of the source to which the loud-speaker is designed to be connected, and v is the voltage (at the specified frequency) supplied to the loud-speaker in series with the resistance R . This quantity gives a measure of the pressure developed at the specified point in space by

the loud-speaker, taking into account its ability to draw energy from the electric circuit as well as its ability to convert such energy into sound waves.

When the loud-speaker is to be used in the home, a fair approximation to the performance to be expected can be obtained by taking a frequency-response characteristic with the microphone placed almost directly in front of the loud-speaker, and another one with the microphone at an angle 45 deg. to the axis of the loud-speaker. When it is to be used in auditoriums or outdoors, it is important that the directional as well as the frequency response characteristic be obtained, and the response should be measured at a number of positions around the loud-speaker.

26. The determination of the power-handling capacity is somewhat difficult due to the psychological factors involved in determining when the overload point has been reached. The most important factors in determining overload are the production of extraneous tones which were not present in the original input. The annoyance of such tones will be a function of the frequency. It is known that the higher-pitched tones are much more unpleasant and a greater source of annoyance than those of lower pitch having the same physical intensity or even the same loudness.

The most common source of overloading is rattles in the loud-speaker, due to vibration of loose parts, or very often the so-called "oil-can" effect, an unstable impulsive vibration due to excessive amplitudes. It may also happen that the loud-speaker diaphragm motion is not a linear function of the impressed voltage, leading to production of harmonics, sum tones, and difference tones in the sound output similar to the distortion present in an overloaded vacuum tube.

Whether the loud-speaker is able to handle sufficient energy is best determined by a listening test. Precautions must be taken to be sure that the electric wave which is impressed on the loud-speaker is undistorted, as it is very difficult to distinguish between rattles in the loud-speaker and non-linear distortion in a vacuum tube. A variety of musical selections should be used for test purposes. Rattles are particularly likely to show up on impulse tones such as are generated in a piano or on complicated waves like those produced by an orchestra having a large number of instruments. After it has been determined that rattles are present in the loud-speaker, the output from a continuously variable oscillator having sufficient power should be impressed on the voice coil, while a listening test is made to determine at what frequency the buzz is the most prominent. This will usually disclose the reason for the rattle and steps can be taken to attempt to eliminate it.

27. The effective efficiency of a loud-speaker also depends on psychological factors. No two loud-speakers of different design have the same frequency response, and without a definite weighting system to be applied to the individual frequencies an estimate of the relative efficiencies of the two loud-speakers is not possible. In practice, a listening test in which the loudness of the loud-speakers is compared when listened to by an observer in a position relatively the same with respect to the loud-speakers gives a good indication of their relative efficiencies. The louder-speaker should have its output attenuated until the apparent volume of the two is the same. The amount of the attenuation introduced gives a measure of the increased efficiency of the more intense loud-speaker over the less sensitive one.

References

General:

- AIGNER: "Unterwasserschalltechnik."
 CRANDALL: "Theory of Vibrating Systems and Sound."
 GEIGER, H., and KARL SCHEEL: "Handbuch der Physik" (vol. 8, Akustik), 1927.
 LAMB: "Dynamic Theory of Sound."
 OLSON and MASSA: "Applied Acoustics."
 RAYLEIGH, J. W. S. LORD: "Theory of Sound."
 RICHARDSON, E. G.: "Sound."
 STEWART and LINDSAY: "Acoustics."
 WAGNER, K. W.: "Die wissenschaftlichen Grundlagen des Rundfunkempfangs," Chaps. 1-4.
 WOOD, A. B.: "Sound."

Acoustics of Rooms:

- Articles on Sound Transmission and Measurement of Sound-transmission Coefficients, *Jour. Acoustical Soc. America*, 1, January, 1930.
 DAVIS and KAYE: "The Acoustics of Buildings."
 EYRING, CARL F.: Reverberation Time in "Dead" Rooms, *Jour. Acoustical Soc. America*, 1, 217, 1930.
 KNUDSEN, V. O.: Acoustics of Music Rooms, *Jour. Acoustical Soc. America*, 2, 435, 1931.
 ———: "Architectural Acoustics."
 SCHUSTER, K., and E. WAETZMANN: Reverberation in an Enclosed Space, *Ann. Physik*, 1, 5, 671, 1929.
 WATSON, F. R.: "Acoustics of Buildings."

Characteristics of the Ear:

- Bell System Tech. Jour.*, 3, 375, 1925.
 FLETCHER, H.: "Speech and Hearing."
 FLETCHER and MUNSON: *Jour. Acoustical Soc. America*, 5, 82, 1933.
 KINGSBURY, B. A.: Direct Comparison of the Loudness of Pure Tones, *Phys. Rev.*, 29, 588, 1927.
 SIVIAN and WHITE: *Jour. Acoustical Soc. America*, 4, 288, 1933.

Loud-speakers:

- McLACHLAN: "Elements of Loudspeaker Practice (Elementary)."
 ———: "Loudspeakers."
 MONCH, W.: "Mikrophon und Telephon." Also certain chapters in references Stewart and Lindsay, Crandall, Wagner, Geiger and Scheel.

Dynamic Loud-speakers:

- OLSON, H. F.: *Proc. I.R.E.*, 22, 33, 1934.
 RICE and KELLOGG: *Jour. A.I.E.E.*, 44, 982, 1925.

Ribbon Loud-speaker:

- GERLACH, E.: *Physik. Zeits.*, 25, 675, 1924.
 SCHOTTKY, W.: *Physik. Zeits.*, 25, 672, 1924.

Condenser Loud-speakers:

- EDELMAN, P. E.: Condenser Loud-speakers with Flexible Electrodes, *Proc. I.R.E.*, 19, 256, 1931.
 GREAVES, V. F., L. W. KRANZ, and W. D. KROZIER: The Kyle Condenser Loud-speaker, *Proc. I.R.E.*, 17, 1142, 1929.
 HANNA, C. R.: Theory of the Electrostatic Loud-speaker, *Jour. Acoustical Soc. America*, 2, 143, 1930.
 Vogt Electrostatic Loud-speaker, *Wireless World*, 24, 553, 1929.

Loud-speaker Characteristics:

- BOSTWICK, L. G.: *Jour. Acoustical Soc. America*, 2, 242, 1930.
 HANNA, C. R.: *Jour. Acoustical Soc. America*, 2, 150, 1930.
 WOLFF, IRVING: Sound Measurements and Loud-speaker Characteristics, *Proc. I.R.E.*, 16, 1729, 1928.

Horn Loud-speakers:

- BOSTWICK: *Jour. Acoustical Soc. America*, 2, 242, 1931.
 HANNA and SLEPIAN, *Trans. A.I.E.E.*, 43, 393, 1924.
 OLSON, H. F.: *Jour. Acoustical Soc. America*, 2, 485, 1931.
 WENTE and THURAS: *Bell System Tech. Jour.*, January, 1928.

Sound Radiation from a System of Vibrating Diaphragms:

- WOLFF and MALTER: *Phys. Rev.*, 33, 1061, 1929.

Directional Characteristics of Loud-speakers:

STENZEL, H.: *Elektrische Nachr. Tech.*, June, 1927, May, 1929.

WOLFF and MALTER: *Jour. Acoustical Soc. America*, 2, 201, 1930.

Loud-speaker Measurements:

KENNELLY: "Electrical Vibration Instruments."

Report of the Committee on Standardization of the I.R.E., sections on Definition of Electro-acoustic Devices and Tests of Electro-acoustic Devices, 1931.

Loud-speaker Testing:

BOSTWICK, L. G.: *Bell System Tech. Jour.*, 8, 135, 1929.

KELLOGG, E. W.: *Jour. Acoustical Soc. America*, 2, 157, 1930.

MEYER, ERWIN: *Elektrische Nachr. Tech.*, 3, 290, 1926; 4, 86, 203, 1927; *Zeits. Tech. Physik*, 10, 309, 1929.

OLNEY, BENJAMIN: *Proc. I.R.E.*, 19, 1113, 1931.

WOLFF and A. RINGEL: *Proc. I.R.E.*, 15, 363, 1927.

Calibration of Microphones for Loud-speaker Measurements:

BALLANTINE, STUART: Effect of Diffraction around the Microphone on Sound Measurements, *Phys. Rev.*, 32, 988, 1928; *Proc. I.R.E.*, December, 1928.

—: Theoretical and Experimental Determination of the Correction Due to the Resonance in the Microphone Cavity and Obstacle Effect to be Made in Comparing Free Wave and Pressure Calibrations of a Condenser Microphone, *Contributions from Radio-frequency Laboratories*, No. 18.

BARNES, E. J., and WEST: Calibration and Performance of Rayleigh Disk, *Jour. I.E.E.*, 66, 871.

OLIVER, D. A.: An Improved Condenser Microphone for Sound Pressure Measurements, *Jour. Sci. Instruments*, 7, 113, 1930.

SECTION 16

HIGH-FREQUENCY TRANSMISSION AND RECEPTION

BY ALBERT HOYT TAYLOR, PH.D.¹ AND ROBERT S. KRUSE²

1. **Historical.** High-frequency transmission may be said to have begun with the laboratory work of Heinrich Hertz in 1886. He was dealing with damped waves of the order of 1 to 3 m in wave length produced by spark discharge and detected by similar means, namely, micrometer spark set. Naturally with such crude methods of detection the range of the transmissions was not beyond the limits of the laboratory in Berlin. Nevertheless, the essential nature of the phenomena as an electromagnetic wave motion was demonstrated and the facility with which these very short waves permitted themselves to be reflected, focussed by parabolic mirrors, etc., was clearly proved. In spite of the later introduction of thermocouples in receiving gear, little progress had been made with short-wave transmission and reception outside of laboratory experiments at still a much later date. It was very natural, after the discoveries of Lodge and Marconi as to the action of elevated antennae, that the size of the radiating structure should be increased, which meant a corresponding increase in wave length. This was all the more certain to happen because in the search for means of producing energy at higher levels, the physical dimensions of the circuits had to be increased, which also tended to raise the wave length or lower the frequencies with which experiments were undertaken. So, in the early part of this century, we witnessed the steady progress toward longer and longer waves with higher and higher power levels. It was not until after the advent of vacuum-transmitting tubes of considerable power that it was possible to produce such high frequencies as, say 100,000-kc or 3-m waves, with any great amount of energy and even yet at this date extremely high energies have not been produced on those frequencies.

By the year 1920 there were long-wave stations in existence with frequencies as low as 12 kc and powers running into many hundreds of kilowatts. Nevertheless, it is worthy of note that some of Marconi's experiments in 1899 showed the transmission of intelligible signals through space over a distance of $1\frac{3}{4}$ miles using a directive system for waves of 1 m in length. In 1916 Marconi and Franklin demonstrated the feasibility of using high-frequency waves between 2 and 15 m in length (150,000 to 20,000 kc) up to distances of about 100 miles. Again here the great utility of reflectors or other devices for concentrating the energy was proven. The same two investigators in 1923 carried out similar experiments for frequencies in the neighborhood of 3,000 kc with a power of 12 kw in the aerial, giving a daylight range of 1,250 miles. In the

¹ Commander, U. S. Naval Reserve; superintendent, Radio Division, Naval Research Laboratory; past president, Institute of Radio Engineers.

² Guilford, Conn.

meantime other investigators, too numerous to mention individually by name, had entered into the picture in this and other countries. The noteworthy contributions of American amateurs to the field of high-frequency transmission and reception cannot, however, be passed by without notice, because these amateurs brought about results which had been generally believed to be impossible without the use of extraordinary equipment, and yet they did the work with the simple means available to amateur experimenters of very limited financial resources. Naturally, the government agencies (particularly the United States Navy) took an important part in this program and developed the first high power, crystal-controlled set in the high-frequency band in 1924. Since 1923 there has been a steady increase in the practically useable portions of the radio-frequency spectrum. Prior to 1923 there were very few stations making any practical use of frequencies higher than 3,000 kc. Now there are hundreds of stations using frequencies above 3,000 kc, and practical uses are being found for frequencies as high as 100,000 kc and in 1931 successful telephone conversations were carried on across the English Channel in a wave length of 18 cm (1,670,000 kc).

2. Peculiarities of High Frequencies. It may seem strange that so many years elapsed after the introduction of vacuum tubes for transmitters and receivers before much practical use was made of the upper frequencies. One reason for this was the fact that very extensive investigation had been carried out on the attenuations of various radio frequencies in transmissions of considerable distance and it was known to be the general rule that attenuation increased rapidly as the frequency was raised, especially for daylight communication. It was recognized that freak transmissions could occur during the dark hours when abnormally high level signals were received. They were, however, erratic and unreliable. The work of Marconi in 1916, working over distances of the order of 100 miles, had apparently created little impression upon other engineers, probably for the reason that the success of these experiments (as far as they went) was ascribed to the use of concentrating (reflecting) devices at the transmitting and receiving end. Certainly it was not recognized by anyone at that time that frequencies above 3,000 kc showed properties radically different from these at the lower frequencies. Some use of the higher frequencies between 3,000 and 7,000 kc was made during the World War with simple transmitters of very low power with crude receivers. Soon after the war, low-power vacuum-tube transmitters operated by American amateurs began to cover considerable overland distances with agreeable dependability, employing frequencies between 2,000 and 6,000 kc. Little attention was paid to this work, but when Westinghouse commenced their experiments in the 3,000-kc band and when amateurs on low power succeeded in spanning the Atlantic to some degree of regularity, engineers everywhere began to realize that the higher frequencies followed a different attenuation law from the lower frequencies.

From 1923, progress was very rapid, but it brought with it some noteworthy perplexities, the most important of these being the fact that signals above 6,000 kc in frequency would frequently dwindle away to an extremely low level a few miles away from the transmitting station, skip a zone of territory, and come in again later on receivers located hundreds of miles distant. Investigation of this phenomenon by Reinartz and other amateurs, and by the Naval Research Laboratory, resulted in the determination of skip distances for many frequencies, for both night-

and daytime conditions, and with some regard to seasonal variations which were even then recognized to be of importance. The most striking peculiarity of the high frequencies is their extraordinary carrying power compared with the energy of the transmitter. The second most important peculiarity is the *skip-distance* effect just referred to. The fact that the skip distance was much greater at night than in the daytime at first led to erroneous conclusions that some of the higher frequencies traveled better in the daytime than they did at night; that is, were less attenuated. This, however, is not the case. Skip distance is merely increased during the dark hours. Correlated with this effect is a third and equally important one which is known as the *limiting-frequency effect*. For a given atmospheric condition, which will vary with the time of year and time of day, there is a limiting frequency beyond which dependable reception over long distances is no longer possible.

3. Status of Facts and Theory in 1925. About the year 1925 or 1926, the known facts were about as follows:

Frequencies between 10 kc and about 2,300 kc followed, during the daytime at least, a very regular law of attenuation especially in transmission over water, with the attenuation a function of the wave length such that the extrapolation of the formula to still higher frequencies indicated that it was hopeless to expect these frequencies to be useful in long-haul communication.

Frequencies above 3,000 kc showed a value in long-haul communication (especially in the daytime) which rapidly increased with the frequency instead of decreasing, and which gave observed values of received signal thousands of times greater than that which could be calculated from extrapolation of the long-wave formula.

Frequencies above 6,000 kc or thereabouts showed a skip-distance effect which was greater at night than it was in the daytime and greater in the winter than it was in the summer time.

The limiting frequency, or highest frequency, useful for long-haul communication, was distinctly lower at night than it was in the daytime and in general (with certain exceptions which will be noted later on) lower in the winter time than it was in the summer time. It was therefore apparent that: (1) the attenuation theory was all wrong, or (2) it was applicable only to the lower frequencies, or (3) the higher frequencies did not follow the ordinary law of radio communication at all.

This aspect of affairs caused a great many investigators in the field of pure science to become interested in wave-propagation phenomena and led to a development which showed that the second of these possibilities was more nearly correct. As shown by publications of A. Hoyt Taylor and E. O. Hulburt in *Physical Review*, February, 1926, the long-wave theory could be amended in such a way as not to damage its usefulness in the long-wave field and yet could take account in a fairly reasonable way of the properties of the higher frequencies.

4. Theoretical Considerations—Kennelly-Heaviside Layer. Since radio waves are known to be electromagnetic in character and are of the same general properties as the waves of radiant heat and light, there is no reason why they should not travel in a straight line with no more than the customary deviations due to diffraction, reflection, and refraction. One of the earliest problems in radio theory after the success of Marconi's first transoceanic signal in 1901-1902 was to account for the manner in which the waves emanating from Clifden, Ireland, progressed to Glace

Bay, Nova Scotia, where Marconi picked them up. One had three choices here:

1. To assume that the wave penetrated through the earth's crust.
2. To assume that the diffraction effects caused them to bend around the surface and follow the curvature of the globe.
3. To assume that something happened in the upper layers of the earth's atmosphere to refract the waves back to the earth's surface. A ray of energy sent out tangentially from Clifden, for instance, would otherwise pierce the sky in a straight line and be lost as far as further usefulness was concerned.

The first of these possibilities was easily thrown out. The electrical constants of average earth and sea water were well known. The absorption of a wave which would be obliged to travel through the earth's crust would be so enormous that there would be no possibility of getting across the Atlantic. Calculations made on the pure diffraction effect indicated that this also is not sufficient to account for the bending of the waves around the contour of the globe. Kennelly, in this country, had suggested a reflecting medium in the upper layers of the earth's atmosphere, and simultaneously Heaviside, in England, had made the same suggestion with the additional idea that the reflecting medium was ionized, that is, contained positive and negative ions. The theoretical possibilities of such a layer were analyzed by a great number of different investigators and a satisfactory explanation for the return of the rays to the earth was arrived at when it was found that the properties of such a layer could easily be such as to cause an advance in the phase of velocity of that portion of the wave front which extended up into the upper regions of the earth's surface. This caused a change in direction of this advancing wave, which continually bent it back again towards the earth. In case the bending is more than sufficient to equal the earth's curvature, the ray will return to the earth at some point at a distance from the transmitter which will depend upon the frequency. The higher the frequency, the more difficult it will be for the ionized layer to bend the ray, and therefore the farther it will travel before coming down to the earth. After coming down to earth the ray is no doubt reflected again and proceeds upward where it encounters the Kennelly-Heaviside layer at a certain time and is returned to the earth at a point approximately twice as far away from the transmitter as the point of its first return.

Considering any single ray then, we would have possible points of reception at regular distances at recurring intervals, from the transmitter outward, assuming for the purposes of argument a similar condition in the Kennelly-Heaviside layer over a considerable stretch of territory. Actually, however, we do not have points of reception but rather zones of reception, which we familiarly refer to as first, second, third, etc., zones of reception, corresponding to the first, second, third, etc., regions where the rays are returned from the layer. Excepting at the limiting frequency, there is always a cone of rays available for communication purposes. The ray which is most nearly horizontal will strike the Kennelly-Heaviside layer at the flattest angle and will therefore be most certain to be turned down, but it will (from the nature of its path) travel long distances before coming down again. A ray which more nearly approaches the vertical will, if returned at all, come back much closer to the transmitter, but if the frequency is high enough it will have such penetrating power and so little deviation that it will never be returned at all.

For any given frequency then, there is, under ideal conditions, a limiting angle of uptake from the transmitting antenna above which radiation is no longer useful because it penetrates the layer and does not return to the earth. Now, as the frequency is increased and the rays become more penetrating and less easily deviated, they have to strike the layer at flatter and flatter angles in order to have any chance of returning to earth at all, and therefore as the frequency is increased the rays which angle sharply upward are eliminated as far as useful communication is concerned and only the very low-angle rays are of any use to us, until finally, the useful cone of radiation, which is included between the horizontal ray and the ray proceeding upwards to the critical angle with the horizontal, has become a very small angle indeed and with still further increase of frequency this angle vanishes altogether. Thus, for a given condition of the layer there is a critical frequency above which it is not possible to get long-distance communication. Immediately below this critical frequency we get a very narrow cone of rays available, perhaps up to 3 or 4 deg. above the horizontal ray, and naturally when these are turned back down to earth they come back a long distance away from the transmitter, thus showing very large skip-distance effect and after they rebound again from the earth and are turned back a second time there is a second zone of reception, but between the two zones there is a wide region over which reception is not feasible and this region (the existence of which was experimentally verified in the spring and summer of 1926 by the Naval Research Laboratory) has been called the *secondary skip-distance region*. Occasional instances of tertiary skip distances have also been found.

5. Changes in Layer Height. If the effective height or density of the Kennelly-Heaviside layer is altered, the whole picture changes. If the layer is higher or less dense in electrons, the picture will be essentially the same except that all frequencies will be somewhat lower than when dealing with the low layer or a very dense layer. Thus, even at fairly moderate frequencies secondary skip zones may open up at night and, as is well known, critical frequencies are much lower at night in general than they are in the daytime. Obviously the frequencies most suitable for general communication purposes are those for which a fairly wide cone of rays is available, so that the first zone of reception is wide enough to overlap with the second zone and the second with the third zone, etc., in order that there may be no missing regions intervening other than the first skip-distance zone.

It is far more necessary to understand the properties of wave propagation when attacking practical communication problems with the aid of high frequencies than it is even in the case of low frequencies. There are marked seasonal variations, as far as optimum frequencies are concerned, in those circuits which pass through the regions of the earth's surface subject to wide differences in climate from summer to winter. This is particularly true in such circuits as pass close to the polar regions. During summer the polar regions are exposed to long periods of sunlight, and the presumption is that the production of electrons is at a high rate. The equivalent height of the layer is low, and successful communication is best obtained with relatively high frequencies. This has been more or less substantiated by work with polar and Alaskan expeditions. During the long polar night, however, the situation is reversed and the effective height of the layer is very high, making it necessary to use much

lower frequencies than can be used in the summer time. On the other hand, the low frequencies thus used in the winter time are not satisfactory also in the summertime because of the high absorption at that period. Aside from what may be called geographical variations and seasonal variations, there is a possibility that there is a connection between general radio conditions, especially in the very high frequency band, and sun-spot activities. If that be true, we may expect a long period of variation in perhaps an eleven-year cycle corresponding somewhat to the rise and fall of sun-spot activities. This idea has some foundation in fact, but observations have not yet been continued long enough to make the matter certain. Theoretically, it seems very plausible that sun spots should certainly be the source of very intense ultra-violet radiation. It is well known that on the upper frequencies, particularly above 12,000 kc the effect of magnetic disturbances is extremely violent.

Magnetic disturbances in general have a very disastrous effect upon east and west communication and a somewhat less disastrous effect upon north and south communication. In general, it seems necessary that the circuit in question must be exposed to the magnetic storm during the daylight hours; otherwise it will not be seriously affected.

6. Multiple Reflections. One curious result of the ability of high-frequency waves to reach a distant point by a series of alternate reflections from the earth's surface and refractions from the Kennelly-Heaviside layer is that a given receiver at a distance may be affected simultaneously by several different waves originating at the same transmitter but arriving over entirely different paths. For instance, in getting across the north Atlantic, one wave at a low angle may make the trip in three hops, touching the surface of the Atlantic only twice on the way over, whereas another one from the same transmitter at a higher angle (provided it does not exceed the critical angle) may make a much larger number of hops and still arrive with sufficient energy. Eckersley, in England, has shown six possible signals from telephone transmitters on the American side which may arrive at the English receiving stations over six different paths of different lengths. A splendid chance for interference results from this condition, and a certain dragging out of the signal even in moderate speed-code work is often noticeable from this cause. In telephony it might be quite disastrous, especially as the Kennelly-Heaviside layer is known not to be at rest but usually in the grip of uneasy movement which can quite rapidly alter the path conditions of the rays and shift their relative phases on arriving at the receiver.

7. Fading. Fading at frequencies high enough to produce audible modulation has frequently been observed. With the aid of highly directive receiving gear and by confining its attention (so to speak) only to a limiting cone of arriving rays, this effect can naturally be somewhat reduced, but it is still at times exceedingly troublesome. Another form of high-frequency interference which has an interesting theoretical bearing and which does not occur on the lower frequencies, is the round-the-world signal; and under certain conditions, depending upon the time of year, time of day, and geographical location of the station in question, a station *A* may communicate with station *B* either by the direct great-circle path or reversed one, although the reversed one may be much longer than the direct path.

8. Theory of High-frequency Wave Propagation. For purposes of reducing the problem to a more elementary form, the refractions in the

upper layer of the earth's atmosphere may be theoretically replaced by reflections at a height which may be designated as the equivalent height of the Kennelly-Heaviside layer. Thus the problem may be treated as a reflection problem with a fair degree of accuracy, always keeping in mind, however, that the real process is not an abrupt reflection but a more gradual turning down brought about by refraction. Still, it often simplifies matters to think of things in this way.

Figure 1 shows how matters would be represented on a basis of the reflection theory. The transmitter is at T and the case represented is for an effective layer height of 500 miles. We see that the tangent ray comes back to earth at R_2 and that rays of higher elevation than the tangent ray are turned down closer in, until finally we reach the limiting ray, which is the last one turned down, and it reaches the earth again at R_1 . The first zone of reception is therefore a region between R_1 and R_2 , the skip distance is the region between T and R_1 (neglecting the short ground-wave range out from T), and the cone of rays actually useful to communication purposes is contained between the tangent ray, (which is ultimately reflected to R_2) and that other ray which is ultimately reflected to R_1 . It is interesting to note that even the tangent ray, although

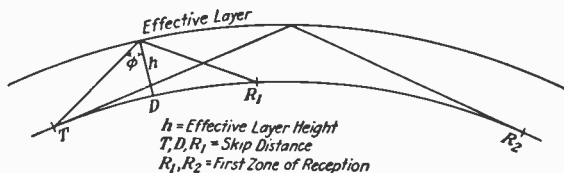

FIG. 1.—Reflection of a wave from ionized layer.

making a zero angle at the transmitter with the earth's surface, cuts the Kennelly-Heaviside layer at an appreciable angle and that even this angle may be too great or may exceed the critical angle if the frequency is sufficiently high. In that case the ray penetrates the layer and is not reflected down from it.

Figure 2 shows the difference in behavior of two radiations starting at W , one at 30 m or 10,000 kc, and the other at 15 m or 20,000 kc. At 30 m the critical angle may be much larger and therefore a relatively large cone of rays is available. This cone of rays first reaches the earth at 500 miles from the transmitter W , this 500 miles being the skip distance. The tangent ray reaches the earth at 2,000 miles for this particular case, where the Kennelly-Heaviside layer equivalent height is assumed to be 150 miles, a winter daytime average. The first zone of reception therefore lies between 500 and 2,000 miles for this frequency. After a second reflection from the layer a new zone is begun at 1,000 miles which extends from 1,000 to 2,500 miles. Again a third zone, after a third reflection from the layer, is begun at 1,500 so that between 0 and 500 miles we have no waves except a feeble ground wave which only goes a few miles out from the transmitter; between 500 and 1,000 miles we have rays which have suffered a single reflection. Between 1,000 and 1,500 miles we have rays of two sorts, some of which have suffered one reflection and some two. Between 1,500 and 2,000 miles we have rays which have suffered one, two, and three reflections. Thus, we see that the different zones of reception

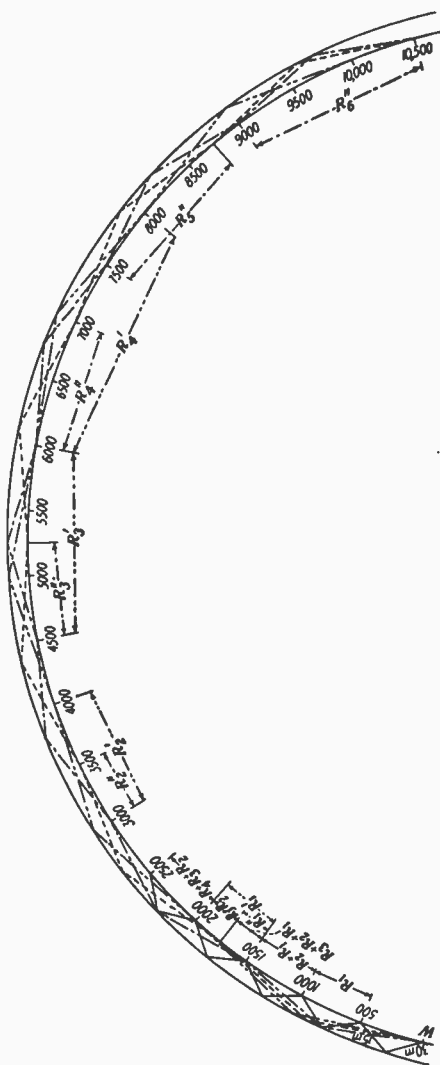

FIG. 2.—Successive reflections of a 15-m and a 30-m wave.

overlap. Also, it is evident that there is ample chance for interference patterns to develop in zones at a moderate distance. At great distances, however, so many zones overlap that likelihood of a complete fade-out due to interference is not so great. Now, if we consider the 15-m or 20,000-kc wave, we see that the first zone of reception due to the narrower cone of rays available (the critical angle being much smaller) will be between 1,500 and 2,000 miles, with a skip distance of 1,500 miles. This region is marked R_1' . Now, after a second reflection this wave comes down again between 3,000 and 4,000 miles giving a second zone of reception marked R_2' but these two zones do not overlap, there being a gap between 2,000 and 3,000 miles. The third zone marked R_3' also shows a gap between it and the second zone of 500 miles, but after the third zone there are no more gaps, the fourth zone marked R_4' meeting the third zone, and all the zones thereafter (not shown in the diagram) overlapping. If now we considered a still higher frequency with a still smaller critical angle we would find a first zone of reception similar to that marked R_1'' . The corresponding second zone is marked R_2'' , the third zone R_3'' , the fourth R_4'' , the fifth R_5'' , and the sixth R_6'' . So that we see, even if the waves have traveled halfway around the earth, there are still missing skip distances of a higher order than the first. They are, however, gradually closing up. It is easy to see that if the frequency is increased further, the zones of reception rapidly diminish to the vanishing point. Of course, this picture does not fit the actual case but is for the ideal case of a perfectly uniform layer distribution together with perfectly uniform reflections from the surface of the earth. It does, however, give us a general guide to what we may expect.

9. Use of Ultra-high Frequencies. The ranges of different high frequencies and their serviceability for different purposes are given in Table

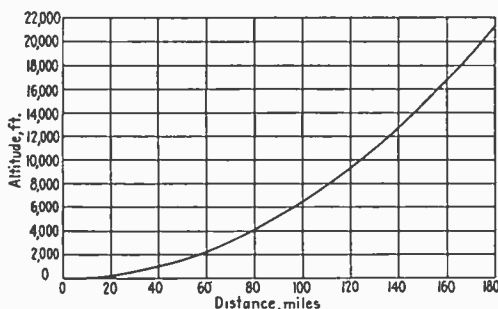

FIG. 3.—Necessary altitude above earth to receive direct ray from ground station.

I, which also gives approximate or average skip-distance effects based on data of various sorts accumulated over a period of years. Frequencies too high to be useful for long-distance communication may nevertheless be extremely valuable for certain other types of work where the points between which communication is to be established are of perhaps some altitude or are close enough together so that the curvature of the earth does not intervene and cut off the direct rays. This type of communica-

TABLE I.—SKIP-DISTANCE AND RANGE TABLE¹
(For frequencies between 1500 and 30,000 kc.)

Frequency, kilocycles	Approximate wave length, meters	Range of ground wave	Skip distances						Maximum reliable range						Services (International Radiotelegraph Convention)	Remarks
			Summer		Winter		Summer		Winter		Summer		Winter			
			Day	Night	Day	Night	Day	Night	Day	Night	Day	Night	Day	Night		
			Day	Night	Day	Night	Day	Night	Day	Night	Day	Night	Day	Night		
1,500-1,575	200-175	100	100	100	150	300	Mobile	Police, television, aviation, etc. U. S. Entirely amateur.			
1,715-2,000	175-150	90	120	175	170	600	600	Mobile—Fixed— Amateur				
2,000-2,250	150-133	85	130	250	200	750	750	Mobile—Fixed	U. S. 2000 to 2300 Experimental visual broadcast.			
2,250-2,750	133-109	80	150	350	220	1,500	220	Mobile	2398 Experimental.			
2,750-2,850	109-105	70	170	500	300	2,500	300	Fixed	2750 to 2850 Experimental visual broad- cast.			
2,850-3,500	105-85	65	200	900	350	3,000	350	Mobile—Fixed	Aviation, government, etc.			
3,500-4,000	85-75	60	230	1,500	400	4,500	400	Amateur	Amateurs and government.			
4,000-5,500	75-54	55	300	4,000	500	7,000	500	Mobile—Fixed	Point-to-point, etc.			
5,500-6,700	54.0-52.7	50	400	4,000	600	8,000	600	Mobile.	<p>Notes</p> <p>Mobile: Ships and coastal stations, aircraft, railroad stock, etc. Fixed: Permanent stations handling point-to-point traffic.</p> <p>Ship Distance: Shortest distance be- yond the ground wave at which commu- nication is possible, or the point where the sky wave first comes to earth. On certain frequencies and at certain seasons communication is possible within the skip distance due to echoes and around- the-world signals.</p>			
5,700-6,000	52.7-50.0	50	50	50	60	450	5,000	4,000	650	8,000	650	Fixed.				
6,000-6,150	50.0-48.8	50	60	60	90	500	5,500	5,000	700	8,000	700	Broadcast.				
6,150-6,675	48.8-45.0	45	70	115	80	175	550	6,500	750	8,000	750	Mobile.				
6,675-7,000	45.0-42.8	45	80	185	100	290	650	7,000	820	8,000	820	Fixed.				
7,000-7,300	42.8-41.0	45	90	220	115	360	700	7,500	900	8,000	900	Amateurs.				
7,300-8,200	41.0-36.6	40	140	200	175	465	750	8,000	1,100	8,000	1,100	Fixed.				
8,200-8,550	36.6-35.1	40	170	370	200	570	800	8,000	1,300	8,000	1,300	Mobile.				
8,550-8,900	35.1-33.7	40	170	420	230	630	800	8,000	1,460	8,000	1,460	Fixed.				
8,900-9,500	33.7-31.2	40	200	485	270	710	950	8,000	1,680	8,000	1,680	Broadcast.				
9,500-9,600	31.2-27.3	35	260	530	280	740	1,000	8,000	1,820	8,000	1,820	Fixed.				
11,000-11,400	27.3-26.3	35	300	625	325	860	1,200	8,000	2,460	8,000	2,460	Mobile.				
11,400-11,700	26.3-25.6	35	315	800	400	1,080	1,300	8,000	2,700	8,000	2,700	Broadcast.				
11,700-11,900	25.6-25.2	35	335	835	420	1,120	1,500	8,000	3,000	8,000	3,000	Fixed.				
11,900-12,300	25.2-24.4	30	356	870	430	1,170	1,550	8,000	3,000	8,000	3,000	Fixed.				

TABLE I.—SKIP-DISTANCE AND RANGE TABLE. 1.—(Continued)

Frequency, kilocycles	Approximate wave length, meters	Range of ground wave	Skip distance				Maximum reliable range				Services (International Radiotelegraph Convention)	Remarks
			Summer		Winter		Summer		Winter			
			Day	Night	Day	Night	Day	Night	Day	Night		
12,300-12,825	24.4-23.4	30	370	940	460	1,240	1,600	8,000	3,200	Mobile.	The table was obtained from the general average of a large number of observations. For the night ranges given it is assumed that the greater part of the path between the transmitting and receiving stations is in darkness. As the distances given in this table are general averages many discrepancies may be found in practice due to seasonal changes, sun-spot activities, geographical location, local weather conditions, etc.	
12,825-13,350	23.4-22.4	30	390	1,000	485	1,700	8,000	3,440	Mobile-Fixed.			
13,350-14,000	22.4-21.4	30	430	1,075	510	1,800	8,000	3,660	Fixed.			
14,000-14,400	21.4-20.8	30	440	1,150	545	1,950	8,000	4,060	Amateurs.			
14,400-15,100	20.80-19.85	30	460	1,230	580	2,200	8,000	4,360	Fixed.			
15,100-15,350	19.85-19.55	30	475	1,300	610	2,300	8,000	4,640	Broadcast.			
15,350-16,400	19.55-18.30	30	500	1,370	640	2,500	8,000	5,060	Fixed.			
16,400-17,100	18.30-17.50	25	550	700	700	3,000	8,000	5,600	Mobile.			
17,100-17,750	17.50-16.90	25	580	740	740	3,500	8,000	6,200	Mobile-Fixed.			
17,750-17,800	16.90-16.85	25	600	755	755	4,000	8,000	6,450	Broadcast.			
17,800-21,450	16.85-14.00	20	660	835	835	5,000	8,000	7,000	Fixed.			
21,450-21,550	14.00-13.90	20	750	1,050	1,050	6,000	8,000	7,000	Broadcast.			
21,550-22,300	13.90-13.45	20	780	1,080	1,080	7,000	8,000	7,000	Mobile.			
22,300-23,000	13.45-13.10	20	835	1,130	1,130	7,000	8,000	7,000	Mobile-Fixed.			
23,000-28,000	13.10-10.70	15	900	Not reflected	1,200	Un- known	Un- known	Un- known	Un- known			
28,000-30,000	10.70-10.00	10	1,000	1,400	1,400	Un- known	Un- known	Un- known	Un- known			

¹ Prepared by L. C. Young, Naval Research Laboratory.

NOTE: Frequencies higher than 30,000 kc (wave lengths shorter than 10 m) at present find their greatest use over "quasi-optical ranges; i.e., to the horizon or slightly beyond. Low power and directional radiators are frequently employed.

tion would be called communication by the direct ray. It has some marked advantages and naturally some disadvantages also. Figure 3 shows the altitude at which an airplane would have to fly in order to get direct-ray communication with a ground station. Especially this figure shows that a plane at an altitude of 2,000 ft. could expect direct-ray communication up to about 60 miles, and at 10,000 ft. up to about 125 miles, the range increasing to 175 miles at 20,000-ft. altitude.

Among the advantages of these very high frequencies, say from 40 megacycles up, may be mentioned the following:

1. They can be confined into concentrated beams like a searchlight, since the necessary antenna or radiating structures, being commensurate with the wave length, are relatively small and therefore not too costly. These radiating structures are of many different forms, but they all depend more or less on what might be called, roughly, the diffraction-grating theory. In other words, they depend upon simultaneous in-phase radiation from a large number of properly spaced conductors. Such beams on various frequencies, from 3,000 to 75,000 kc, are finding much use for both telegraphy and telephony. Usually a network similar to the radiating network is placed one-fourth wave length behind it, that network acting as a tuned reflector, thus more or less effectively cutting out the radiation to the rear of the beam in question.

2. Waves are possible in the upper-frequency bands where no ground waves exist on account of high absorption and no sky waves on account of critical angle. The direct ray is free from fading, which is a very great advantage indeed.

3. These upper frequencies are practically free from atmospheric disturbances.

4. Where it is desired to modulate the carrier wave with a very wide band of frequencies, in television for instance, the ultra-high frequencies lend themselves very well to the solution of the problem, since the percentage variation from the carrier is, even with 200- or 300-kc modulation frequency, small.

5. The small antennas permit mobile transmission. The disadvantages of these upper frequencies are as follows:

1. It is difficult to build transmitters of high power and receivers with a high degree of sensitivity due to limitations within the vacuum tubes used for these purposes. These difficulties are being rapidly overcome. Certainly much progress has been made even in the last two years along these lines, and frequencies as high as 1,500 Mc have actually been produced in the laboratory, although to date not in any great amount of energy. Suitable receivers for such frequencies are as yet undeveloped. Practically satisfactory transmitters are available, however, up to 100 Mc (perhaps higher), and fairly satisfactory receivers up to about the same point.

2. Man-made radio disturbances, particularly from ignition systems on automobiles and airplane engines, as well as induction from transmission lines, telephone lines, X-ray machines, trolleys, etc., are very annoying on these upper frequencies. They do not, however, up to at least 100,000 kc constitute an insuperable barrier to progress.

3. These higher frequencies are very easily reflected from buildings and other objects near or on the path of transmission, resulting sometimes in complicating interference patterns or standing waves (shadows). Experiments, particularly with television in our large cities, are showing peculiarities of this nature.

10. Band Width Required. For any frequency to be useful for practical communication purposes, the agency operating it must be allowed a certain channel or band within which to operate. The width of this channel depends upon the type of service in question. Television, for instance, requires a very wide band; high-grade sound broadcasting,

a fairly wide band; satisfactory speech, a somewhat narrower band; while high-speed telegraphy is notably narrower than speech telephony, and low-speed telegraphy a very narrow band indeed. Facsimile transmission requires a band, depending upon the speed of transmission, which generally lies somewhere between high-speed telegraphy and telephony. In addition to the band of frequencies which the station must actually transmit to accomplish its mission, a certain tolerance for the frequency stability must be allowed. This is an extremely important matter. The closer a group of stations can stay on their assigned frequencies the more likely they are to operate without mutual interference. It has been proved possible to operate a station day after day within a few parts in a million of its assigned frequency, but it is naturally difficult for many stations in the world, on account of financial and patent limitations, to come up to the same standard. Moreover, the same standard cannot very well be required of an airplane as would be required for a first class fixed station where initial costs are not so important.

As the art stands today (1935), a station which holds its frequency to better than one part in 100,000 of its assigned frequency is doing very well indeed. One which does not hold its frequency to better than 10 parts in 10,000 is doing very poor work. As was predicted in 1932 the tolerance permitted on frequency stability has been rapidly tightened up. In addition, then, to the actual band of frequencies necessary for service, we must add a small tolerance band and then a small guard band to be sure that the neighboring assignments do not result in interference. These, then, are the basic principles underlying allocations of frequency by practically all civilized nations.

11. Attainment of Frequency Stability. The wonderful development in piezo-electrically controlled circuits has set a standard for frequency stability of a very high order and is still indicating further possibilities of refinements. It is not to be overlooked, however, that there are many promising self-oscillating circuits of a very fair degree of stability, which, when handled with exactly the proper precaution, are capable of giving a very high order of stability. (See Art. 16, Lecher-stabilized transmitters.)

12. Allocation of Frequencies. The national aspect of frequency allocation in this country is handled by the Federal Communications Commission. Internationally it is handled by such conferences as the Washington Conference of 1927 and the Madrid Conference held late in 1932, assisted by the work of the International Technical Consulting Committee (C.C.I.R.) which has had one meeting at The Hague and another meeting at Copenhagen.

The present international allocation of frequencies for various services is herewith appended as Table II. No doubt some slight rearrangements of this table will be made in the near future. At the present time, it being not considered safe to allocate frequencies generally closer together than one-tenth of 1 per cent, it can be seen that in spite of the tremendous spread of frequencies opened up for public use by the exploitation of the high bands of frequencies, there are after all only a limited number of frequencies for everyone's use. Fortunately many of these frequencies can be duplicated in different parts of the world for simultaneous operation, if due account is taken of the time of day and geographical location of the stations. There is no harm for instance, in operating a station in the 6,000-kc band in this country on a frequency used in Europe

provided that operation is not carried on later in the day than within an hour or two of the time when total darkness covers the path between here and Europe. During the dark hours, of course, interference will result, but during the hours of full daylight this frequency will not cross the Atlantic with sufficient intensity to cause interference. The super-frequencies, or limited-range frequencies, of course, can even be duplicated within our own country from city to city. Such duplications as these, however, have generally to be worked out through regional agreements such as we have with Canada at the present time, as Canada is close enough so that interference might result if the frequencies were

TABLE II

Frequency band, kilocycles	Services as given in Washington General Regulations, Art. 5	Frequency band, kilocycles	Services as given in Washington General Regulations, Art. 5
550 to 1,300	Broadcasting	9,600 to 11,000	Fixed
1,300 to 1,500	a. Broadcasting	11,000 to 11,400	Mobile
	b. Maritime mobile, waves of 1,365 kc exclusively	11,400 to 11,700	Fixed
		11,700 to 11,900	Broadcasting
1,500 to 1,715	Mobile	11,900 to 12,300	Fixed
1,715 to 2,000	Mobile, fixed, and amateurs	12,300 to 12,825	Mobile
		12,825 to 13,350	Mobile and fixed
2,000 to 2,250	Mobile and fixed	13,350 to 14,000	Fixed
2,250 to 2,750	Mobile	14,000 to 14,400	Amateur
2,750 to 2,850	Fixed	14,400 to 15,100	Fixed
2,850 to 3,500	Mobile and fixed	15,100 to 15,350	Broadcasting
3,500 to 4,000	Mobile, fixed, and amateurs	15,350 to 16,400	Fixed
		16,400 to 17,100	Mobile
4,000 to 5,500	Mobile and fixed	17,100 to 17,750	Mobile and fixed
5,500 to 5,700	Mobile	17,750 to 17,800	Broadcasting
5,700 to 6,000	Fixed	17,800 to 21,450	Fixed
6,000 to 6,150	Broadcasting	21,450 to 21,550	Broadcasting
6,150 to 6,675	Mobile	21,550 to 22,300	Mobile
6,675 to 7,000	Fixed	22,300 to 23,000	Mobile and fixed
7,000 to 7,300	Amateurs	23,000 to 28,000	Not reserved
7,300 to 8,200	Fixed	28,000 to 30,000	Amateurs and experimental
8,200 to 8,550	Mobile		Not reserved
8,550 to 8,900	Mobile and fixed	30,000 to 56,000	Amateurs and experimental
8,900 to 9,500	Fixed	56,000 to 60,000	Amateurs and experimental
9,500 to 9,600	Broadcasting	Above 60,000	Not reserved

not properly divided between the two countries. Any scheme that will permit a greater exploitation of the given channels or bands assigned to a station is worth developing. A good many such schemes have been tried out, and some of them have had a considerable degree of success. Most of them depend either upon the operation of a number of frequencies within a very narrow band all very accurately held in place, or on the multiple modulation at audio or supersonic frequencies of a single carrier.

TECHNICAL ITEMS PECULIAR TO HIGH-FREQUENCY DEVELOPMENTS

13. Circuit Precautions. In both transmitters and receivers, increasing care is necessary as the frequency rises lest there be introduced excessive stray couplings or shunts through intercomponent capacitances

induced by the designer's desire to group his equipment closely to minimize conductor lengths. It is frequently possible to avoid close grouping of tuned amplifier stages (r.f. or i.f.) by joining the tuned output circuit of one to the tuned input of the next through a "link" circuit, which may ordinarily be untuned and if not over $\frac{1}{8}$ wave length long may be operated at a high power factor, without standing waves. The insulation requirements of such a circuit are modest, making transposition or shielding practical. The coupling is principally magnetic, minimizing the interlocking of tuning.

To minimize capacitive couplings at the cost of increased capacity to chassis or earth, electric screens of parallel conductors, connected at one end only to avoid circulating currents, are frequently utilized.

Shielding must be more carefully designed, not only because of the need for small shunting capacitances, but also because of the increased inductive reactance offered by a given length of sheet metal considered as a coupling conductor common to several circuits. In some applications it is desirable to make only one contact with the shield and in turn to connect the shield to the main frame or chassis at but one (the same) point. Where the shield encloses a tuned coil or an r-f choke, it is well to measure the performance *in situ*. With a proper shield, tuned coils may frequently be given an improved Q rather than the reverse, because the decrease in resistance overtakes the decrease in inductance.

Particular care is necessary to insure that by-pass condensers with their connecting leads do not pass through resonance and become inductive before arriving at the working frequency. Quick determinations of the resonance frequencies of condensers with various lengths of conductor of different type may be made with a low-power calibrated test oscillator and charted for future use.

Insulation, though "low loss" has been greatly overadvertised, is important whenever high field intensities arise, especially in the presence of heat and moisture. The more homogeneous ceramics, despite mechanical shortcomings, provide great permanence of form and size where retention of calibration is important. Care must be exercised to avoid overly elastic clamps or fastenings for such material, lest structural instability follow. Other materials are very satisfactory for most uses, those of good homogeneity, good surface smoothness, freedom from aging effects, and small affinity for moisture tending to give lower losses. Such generalities should not be used as guides. An inquisitive frame of mind among designers is desirable.

Conductor losses are very frequently increased by eddy currents in excessively large wire or tubing, particularly in coils. The use of copper-tube coils with turns spaced by a fraction of the conductor diameter is bad practice, though the increased loss is concealed by the large heat radiation from such a coil.

Where multiple tuning ranges are involved in either sending or receiving equipment, the tuned coils are sometimes exchanged bodily as are vacuum tubes. Like switching devices, such arrangements should be tested for the maintenance of dependable contacts of low resistance; also for the ability of the coils to endure unaltered the rough use involved.

At the higher radio frequencies, it is not possible to regard a coil as even approximating the behavior of a pure inductance. If wound with many turns of small wire, it will certainly display multiple resonances

at frequencies which are easily altered by adjacent or connected conductors through the introduction of capacitances of magnitudes comparable to, or greater than, those of the coil. Every attempt should be made to minimize the responsibility of r-f chokes by rearranging the circuit so that they may be connected at points of low r-f potential. If this is impractical, the circuit must be inspected carefully for irregularities of operation due to the choke, several samples of which should be tested, the great effect of moisture not being neglected.

14. Transmitters. In the case of transmitters for telegraphic purposes, especially continuous wave telegraphy involving beat-tone reception, it is necessary for the transmitter frequency to have a very high degree of stability that there shall not be too much variation in tones of received signal. If, for instance, beat-tone reception is employed on a frequency of 20,000 kc and this tone is not allowed to vary more than 100 cycles, it will require that the transmitters be held at a frequency constant to within one part in 200,000. It is, of course, extraordinarily difficult to do this without the use of master-oscillator circuits which are followed by suitable amplifiers to bring the power up to the required level. In case piezo-electric control is used, it is highly desirable to keep the controlling crystal at a constant temperature, generally chosen at 50°C., and since it is not economical to grind crystals accurately for frequencies higher than 6,000 kc it is necessary to follow the crystal master with amplifiers which act as frequency multipliers.

It is common practice to design a 1-kw set with a tube line-up somewhat as follows:

1. Master oscillator $7\frac{1}{2}$ watt, triode, tetrode, or pentode worked at low power in order not to overheat the crystal.
2. Buffer stage on same frequency as master, also $7\frac{1}{2}$ -watt, tetrode or pentode worked at approximately full power.
3. 75-watt tetrode or pentode stage which also acts as a multiplier, doubling or trebling the frequency.
4. A pair of 75-watt tetrodes or pentodes which may single, double, or treble the frequency as the case may be, and which in turn feed into:
5. A pair of 500-watt tetrode tubes which always act as amplifiers without frequency multiplication in the best type of design.

It is always desirable to avoid frequency multiplication in the last stage in order to prevent emission on sub-harmonics and to reduce as far as possible harmonic emission, since the singling operation can be carried out without the use of the excessive negative C which is necessary for frequency multiplication. The tube is thus worked more nearly on the linear portion of the characteristic, giving less harmonic development. Unless such transmitters have their individual stages carefully shielded, the stages prior to the final amplifier are extremely liable to have sufficient coupling to the antenna through the set to give off strong sub-harmonics which may cause objectionable interference. In fact, in spite of the most careful shielding a certain amount of this emission always does seem to take place so that it is sometimes necessary to add a tunable tank circuit or some kind of filtering system between the last stage and the radiating structure. Moreover, to reduce the negative bias in the last stage too far would result in an abnormally low efficiency of the final power amplifier, so that a compromise has to be effected between efficiency and the tendency to produce harmonics. In some cases it is

better to work the tubes with a somewhat higher negative bias and at higher efficiency and add the tank circuit.

15. Telephone Transmitters. In the case of transmitters intended for telephony the situation is far more complicated. It is not possible to work the modulated stage (and later stages, if any) at very high efficiency. Otherwise distortion will result. Here the same general rules apply as for any high-grade broadcast transmitter, except that it is extremely inadvisable to modulate in the earlier stages subject to frequency multiplication because here we will certainly have distortion occurring. While the necessity for frequency control would not appear to be so great for telephonic communication, yet in reality it is of the same order of magnitude, since it has been found that wobbling in frequency gives rise to abnormal fading effects which have a very disastrous effect in distorting the received signal. Where the master oscillator is not piezo-electrically controlled or controlled by some mechanical or magnetostriction oscillator of similar precision, a self-oscillating master circuit may be used provided suitable precautions are complied with.¹ Circuits must be chosen which are inherently stable and which show the smallest variation in frequency with changes in filament and plate voltage. Such master oscillators must have their supply voltages for filament, plate, and negative *C* (if such be used) very carefully filtered to avoid frequency modulation by such effects. Moreover, special precautions must be taken to hold all these voltages very constant. However, when these things are rigidly complied with it is possible to get excellent results almost comparable with those obtained from piezo-electric control. Such circuits, however, generally require much more careful attention and more supervision and checking than piezo-electrically controlled master circuits. An example of a non-crystal controlled circuit follows.

16. Lecher-stabilized Transmitters. Piezo-electric quartz-crystal plates being less practical at frequencies materially above 7,000 kc, they can stabilize high-frequency transmission only through cascaded harmonic amplifier stages. Piezo-electric tourmaline-crystal plates, though operable three octaves higher, are costly and have other shortcomings.

Since highly stable tuned circuits, with lumped capacity sufficient to swamp tube variations, become impractical at very high frequencies, such as used in horizon-range low-power radio telephony, refuge is occasionally taken in tuned systems of the Lecher wire form, that is, parallel linear conductors (usually joined at their distant ends) of a length such that standing waves will occur on them when one end is connected to a source of radio frequency as, for example, the plates of a push-pull pair of vacuum tubes whose grids are connected to a similar system. Many variations are possible.

The advantage of such a system over a tuned circuit with lumped capacitance (condenser) and inductance (coil) is that a change in oscillator frequency not only produces phase changes but reinforces the effect of such changes by the shifting of nodes *along* the conductor. If the "tuned line" is made into a "long line," on which stand many quarter waves, the shifting becomes proportionately greater and stability improves

¹ GUNN, ROSS, A New Frequency-stabilized Oscillator System, *Proc. I.R.E.*, September, 1930, p. 1560.

further, providing it is possible to avoid dimensional changes in the line due to temperature, wind, or vibration.

17. Ultrahigh-frequency Oscillators. By making a tube smaller, with unchanged geometry, its upper frequency limit as an amplifier or regenerative oscillator may be raised. Other means are structural changes to provide a minimum of solid insulation near the elements and to provide very short connecting leads of low inductance. In both air- and water-cooled tubes it is common also to minimize interelement capacitances by increased interelement spacing. The larger diameter of the elements increases radiating area per unit length, permitting short elements with minimum phase difference from end to end. The less fortunate consequences are tendencies toward low transconductance and less complete grid control.

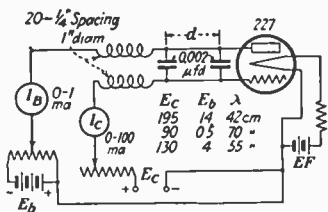

FIG. 4.—Barkhausen oscillator.

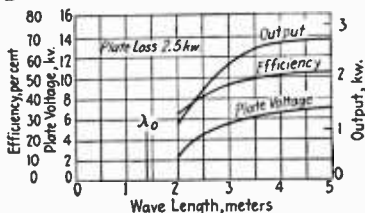

FIG. 5.—Characteristics of water-cooled triode tube for short waves (RCA-846).

At a wave length of about 50 cm (frequency 600,000 kc), the output of even very small regenerative oscillators has become very small and unstable. (Effect similar to that of larger tube at 2 m, as shown in Fig. 5.) The "centimeter waves" are accordingly generated more easily by oscillators typified by that of Barkhausen and Kurz, in which the electron cloud between a triode's grid and plate is caused to pulsate rapidly after going forward through the highly positive grid (except electrons captured by the grid) toward the less positive, or actually negative, plate. The frequency is determined largely by the (highly stable) filament, plate, and grid voltages and the tube dimensions but may be reinforced by Lecher wires (standing wave line), as in Fig. 4. Length d is adjustable. Although the diagram shown resembles an "ultraudion" regenerative oscillator the d-c potentials and the mode of oscillation are different. The d-c and r-f grid currents are large, making grid heating the limitation of the tube, which works at very low efficiency. Generation at wave lengths of a few centimeters is practical, though the power output is very low. This is unimportant since a large share of the output may be fed to a very small half-wave antenna placed in the focus of a reflector which projects it as a narrow beam toward any desired unscreened point above the horizon. Amplification in the receiver being not at present possible, save at audio frequencies after detection, a strong received signal is obtained by another reflector focused on the receiving antenna, which may be a miniature array. Ranges of 20 miles and more have been attained between elevated stations, working at wave lengths below 20 cm, *i.e.*, at frequencies above 1,500,000 kc.

Because of the bad frequency stability, such oscillators may be keyed by an interposed key-controlled beam barrier, rather than keying the oscillator electrically. Voice modulation applied to the circuit causes frequency modulation, hence voice control of the beam has been used, as for example by a grille of gaseous conduction tubes lighted by d.c. and voice modulated to vary their conductivity and their absorption of the beam.

Other generators of high radio frequencies are variants of the Barkhausen-Kurz triode device, and forms of the magnetron diode oscillator, in which a linear filament is surrounded by a cylindrical plate split into segments joined by tuned circuits or standing-wave lines, the whole being immersed in a magnetic field whose direction assists in determining which of several modes of oscillation may result.

Frequencies beyond those of any vacuum-tube device have been obtained by "mass oscillation" of a quantity of metallic particles of uniform size, excited as half-wave Hertzian oscillators by sparks passed through the mass. As far as is known no communication applications of this generator have been made.

18. "Transceivers." Transceiver is a name originally applied by R. H. G. Mathews to low-power equipment using the same tubes alternately for sending or receiving. Lately the term has been in use principally as regards two-, three-, or four-tube devices working in the 30,000- to 100,000-kc range as modulated oscillator transmitters and superregenerative receivers of low selectivity. Low transmitter-frequency stability and a tendency toward receiver radiation, both productive of interference, are undesirable characteristics of these equipments where a number are operated "inside the horizon." It is probable that these shortcomings will be corrected sufficiently to permit extensive use of transceivers, or some other type of highly compact radio-telephone equipment in this or a higher frequency range.

There has been some agitation for waiving the usual requirements of a federal station license and operator's license for transceivers, presumably because of limited range and the virtual impossibility of enforcing compliance for equipment so easily moved or concealed.

19. Peculiarities of High-frequency Transmitters. For very high frequencies, operation of amplifiers in the push-pull arrangement is very effective. This is indeed absolutely imperative at the present time for the last stage of a high-power transmitter since it is necessary to have this amplifier work on the same frequency as the preceding stage. It must be balanced or neutralized against the preceding stages. Such balance or neutralization at very high frequencies is extremely unsatisfactory unless a symmetrical push-pull arrangement is used. Automatically neutralized (screen-grid tetrode or pentode) tubes are now commercially available up to 500 watts in this country, and some experimental screen-grid tubes in the water-cooled class have been made but are not yet commercially available.

Another peculiarity of h-f transmitters is the fact that it is much easier to design such transmitters with high-impedance tubes which have relatively low grid capacity than it is to design them for low voltage, low impedance tubes with high inter-element capacity. It is easier to get excitation and efficiency with a high-impedance tube and is much easier to carry out balancing operations. Such tube layouts as are

commonly used, for instance in many broadcast transmitters, would be almost impossible to work with at very high frequencies.

In the case of transmitters having to cover a wide range of frequencies another difficulty is encountered; namely, dead-end effects in variable-coil systems. These must be carefully taken care of by short-circuiting certain turns or cutting them out. These dead-end effects may even be troublesome when the coil in question is disconnected entirely from the transmitter but is in the immediate vicinity of the particular coil that happens to be used for the transmission at that time.

Another peculiarity of the h-f transmitter is the fact that it is required to work into radiating systems of very unusual impedances. In the case of transmitters working on one or two fixed frequencies and into a transmission line, this difficulty is not so important since a transmission line of fixed characteristic impedance of, say, 600 to 800 ohms, can be generally adopted and adhered to, but in cases where they work more directly into an antenna (especially if that antenna be fixed for a wide range of frequencies), the impedance of the radiating system may vary from a few ohms up to several thousand. Therefore, it is often necessary to provide for an extremely wide range in coupling between the last stage of the transmitter and its radiating system. This does not hold where the transmitter is designed for one frequency and operating into a standard transmission line, feeding a radiating structure. For frequencies above 2,000 kc it is not only unnecessary to use Litzendraht for coils but is a disadvantage, hence the almost universal use of either solid conductor or water-cooled hollow conductor for coil windings. It is also necessary to avoid many forms of insulation that are perfectly adequate at lower frequencies, such as those used in the broadcast band. Many insulators which give excellent service at low frequencies show rapid development of heat and breakdowns within a few seconds when used in high-power h-f transmitters. Fortunately there have been developed within the last few years a number of types of insulators, some of which seem to be suitable even for frequencies as high as 100,000 kc and perhaps higher. Among them are Pyrex, Isolantite, Mycalex, Victron, and Sillimanite.

The perfect insulator for these frequencies, namely, an insulator which has the requisite electric properties combined with strength and machinability, has not yet been discovered.

20. Receivers. Many h-f receivers are more or less of the same general type as those of low frequencies. They may have one or two stages of tuned tetrode or pentode amplification followed by a detector which can regenerate or oscillate, as needs be, and then by suitable audio amplification. The difficulty with this type of receiver is that the gain in r-f amplification per tube is very small as the frequency gets very high, until in many cases the gain is actually negative. Better tube design is gradually extending the frequency range of such receivers. In the case of a receiver for continuous wave reception it is necessary to have a beat oscillator which may be a separate heterodyne or the detector itself may oscillate. The push-pull arrangement for both r-f amplification and oscillating detection has here some marked advantages. The amplification per stage will hold up better at higher frequencies with push-pull than without it, and the detector will oscillate at much higher frequencies in the push-pull arrangement than in the single-tube arrangement.

Receivers for very high frequencies often have considerable trouble from tube noises and differ radically from ordinary receivers in one particular, namely, susceptibility to microphonic disturbances. The receiver box must have absolutely no loose contacts between bits of metal anywhere, and the tubes themselves must be non-microphonic if possible. Many a receiver which is sufficiently sensitive for its purpose fails utterly because of its microphonic properties. This is particularly true for receivers designed for shipboard work and still more so for aircraft receivers. It is also extremely good practice to put r-f filters in all supply leads, telephone cords, etc., to such receivers to keep signals from coming in by the wrong channel. When such receivers are provided with automatic volume control, they have a marked advantage in the presence of fading signals. Fading is, of course, one of the greatest drawbacks to high-frequency work.

21. High-frequency Superheterodynes. The h-f superheterodyne differs from the ordinary superheterodyne in that the intermediate or transfer frequency is usually higher than that of the simple broadcast receiver. It may be anywhere from 400 to 1,500 kc depending on the frequency range to be covered (5,000 kc in some recent designs for quasi-optical waves). One very sensitive type of receiver which is used to a considerable extent at the present time is a combination of these first two types. It uses two or three stages of r-f amplification preceding the first detector which is usually made regenerative. The rest of the receiver is of the superheterodyne type. The use of ganged controls is possible at fairly high frequencies but naturally more difficult. It is highly desirable, especially in aviation work where simplicity of operation is essential. For extremely high frequencies, say above 60,000 kc, the first type of receiver, namely, r-f, detector, and audio, is of very little use and the superheterodyne is far less effective than at somewhat lower frequencies. The fact that it is impossible to get adequate r-f amplification ahead of the detector is no doubt the reason for the ineffectiveness of both receivers. Nevertheless, with specially constructed tubes some progress is being made in this field with superheterodynes.

22. Superregenerative Receivers. Until recently the most sensitive receiver for these very high frequencies would seem to have been the superregenerative receiver, but it has the great drawback that it is not relatively as effective for continuous wave signals as for modulated signals. For modulated signals, however, it is extremely sensitive but unfortunately not any too selective. It is, however, largely used for work in these very high bands. Recent advances in receiver and tube design have produced superheterodyne sensitivity at least equal to that of the present 5 to 10 m superregenerators, with the advantage that selectivity may be used as soon as transmitters in this region are well stabilized. Unfortunately a receiver of poor selectivity will receive much more strongly from a modulated transmitter of bad frequency stability than will a receiver of good selectivity, the latter only "seeing the signal as it goes by" the frequency to which the receiver is adjusted. Thus bad transmitters and bad receivers are mutually prolonging each other's existence. For still higher frequencies, for example, well above 100,000 kc, there is no known receiver that has at the present time any great amount of sensitivity. In fact, for experimental work we see the investigators turning back to the old crystal or diode detectors followed by audio amplification.

23. Multirange Receivers. Many communication services are compelled to use several frequencies, differing considerably, each suited to some requirement of time and distance. Multirange receivers are, therefore, necessary. In addition to the usual design considerations, these receivers encounter problems arising purely from higher signal frequency or the multiplicity of tuning ranges.

It is ordinarily necessary to provide such receivers, at the input, with one, two, or even three selective signal-frequency amplifying stages of good gain for the purpose of depressing cross-talk and noise early in the system. (Several tuned circuits, without tubes, would depress cross-talk but not noise.) This holds true whether the receiver thereafter employs the superheterodyne principle or uses additional signal-frequency amplifiers.

For a single tuning range it is relatively easy to provide such pre-selecting amplification. In multirange receivers it is frequently not practical to exchange both the coils and the variable condensers which tune them. If the same tuning condensers are used for all tuning ranges, the L/C ratio of the tuned circuits, and the possible stage gain, fall as the frequency rises. To obtain some amplification in the first stage, as well as to avoid excessive cramping of the tuning scale on the higher frequency ranges, it is necessary to limit the size of the tuning condenser. Any given size obviously produces approximately the same tuning ratio (highest frequency divided by lowest frequency) for all tuning ranges unless resort is had to tapped coils or loading condensers (or both) which tend to damage the selectivity and gain. In its worst form this problem arises in the all-wave entertainment receiver which is required to cover nearly the whole short-wave spectrum, and also the normal American 550- to 1,600-kc broadcast spectrum whose width dictates the size of the tuning condenser. Cost compels such receivers to use the superheterodyne principle to limit the number of tunable circuits to be aligned. A single i-f amplifier being required to serve all ranges, it follows that the percentage difference between signal frequency and oscillator frequency varies widely in the different ranges. In consequence, heavy fixed-capacity loading of some circuits is unavoidable. The intermediate frequency chosen must avoid the tuning range of the receiver unless a gap is to be left and should also avoid strong commercial signals. At present a compromise frequency near 460 kc is customary. The rest of the bad compromise which results will, in a typical case, be about as follows:

TUNING CONDENSERS

12 to 450 μf range (capacity ratio, 37.5/1; ideal tuning ratio, 6.1/1)

Range	Kilocycles	Tuning ratio
1	140 to 410	2.93/1
2	540 to 1,720	3.18/1
3	1,720 to 5,400	3.14/1
4	5,400 to 18,000	3.33/1
5	18,000 to 36,000	2.0/1

The gap (410 to 540 kc) across the intermediate frequency of 460 is typical, as is the apparently irrational relation of the tuning ranges, which are determined by the composite circuit capacity; also the loading

capacitors required to secure tracking of the oscillator and the signal-frequency tuned circuits.

Neglecting range 1, we find range 2 to be employing inductances about 400 times as large as those of range 5, although retaining the same tuning condenser. The designer has no hope of maintaining uniform performance, especially as his worst conditions are in the frequency ranges normally offering weaker signals.

Better performance becomes possible if the tuning ranges are made narrower, at the cost of making them more numerous or dropping some ranges.

For entertainment reception the 540- to 1,600-kc region must be covered as one range to avoid confusing non-technicians; hence the only obvious simplification is to drop some ranges, for example ranges 3 and 5. This gives a "skip-band" receiver or "dual-band" receiver.

In services other than entertainment reception, it is not essential to provide wide tuning ranges; hence the tuning-capacity maximum may be decreased to give both improved L/C ratio and less cramped tuning scales. With care in chassis design, it is possible to provide a 2:1 tuning ratio with a variable-condenser maximum of about 100 $\mu\mu\text{f}$, but this leaves little margin for alignment trimmer capacity and is commercially inconvenient unless each condenser has its own tuning control, which is possible where frequency changes are infrequent. Smaller condensers, or tapped coils, are at times used where narrow bands or single channels are to be covered, particularly where communication is at the higher frequencies. The selectivity of such receivers is not exceptional, though their very open tuning scales tend to produce an illusion to that effect.

In multirange receivers of the superheterodyne type the frequency-converting or translating device requires particular attention in order that the various ranges may find the oscillator injecting nearly the same r-f voltage into the system, the tendency being toward decreased output at higher frequencies, especially with temporary subnormal supply-line voltages. Noisy operation results, especially as regards superheterodyne "shush" noises. In the estimation of some engineers the most effective remedy is to avoid the multipurpose (pentagrid, hexode, etc.) tubes in favor of a relatively powerful independent oscillator, well isolated and very loosely coupled to the translator or first detector.

Oscillator stability as regards temperature, aging drift, line-voltage changes, strong-signal loading, or alterations of the d-c voltages through operation of manual or automatic volume controls, require relatively greater care. The means of attacking these problems are fairly evident, but the cure is frequently tedious.

The circuits employed do not differ materially from those at longer waves, except as regards the smaller inductances and the relatively large loadings. At frequencies above 60,000 kc, corresponding to a wave length of 5 m, other types of circuits come into play, but the superheterodyne may be regarded as thoroughly practical at frequencies up to 100,000 kc.

CIRCUIT DEVICES OF SHORT-WAVE IMPORTANCE

24. Short-wave Automatic Volume Control—Diversity Reception. The requirements of automatic volume control for short-wave receivers usually differ from those at standard waves because of the more rapid

changes in signal strength and the relatively low signal strength. For satisfactory performance on all ranges it is sometimes considered desirable to provide two independent a.v.c. systems, the short-wave one being relatively rapid in action and actuated by weaker carriers.

In commercial-channel reception, fading is sometimes further reduced by receiving simultaneously with three or more antennas geographically separated, so that interference patterns will probably not affect them equally at an instant. The received signals are combined after passing through independent receivers, each of which may have a.v.c. and also a cut-off tube or circuit to remove from the system any receiver which at that moment is contributing little but noise. The receivers may be located at the antennas and the audio outputs sent by wire to a central point, or the antenna energy may be sent along r-f transmission lines to a central point and there fed to receivers which may have a common oscillator if desired.

Where intense interference is encountered, and intelligibility rather than uniform signal level is essential, it is at times desirable to dispense with a.v.c. to avoid depression of the receiver sensitivity by an interfering signal, or by noise. In telegraphic communication, where the incoming stream of energy is interrupted, or in systems of telephony, where the carrier is suppressed or varied, the normal a.v.c. systems are unsatisfactory since they are based on the assumption that a constant carrier is to be delivered to the detector or demodulator of the receiver and will vary the receiver sensitivity widely in attempting to produce such a result.

25. The "Comparator." If deep (high-percentage) modulation at all instants were possible, it would be relatively easy for radio-telephony signals to override short-wave noise. To provide this effect in a degree is the purpose of the "comparator" (compressor-expander) circuits of the American Telegraph and Telephone Company. By utilizing non-linear amplification these circuits at the transmitter produce modulation which is *less* than proportional to speech intensity. The range of speech-sound intensity is thus compressed. Consequently the speech level may be raised to bring the numerous weak speech sounds to a higher level without at the same time producing overload distortion on the relatively infrequent strong sounds. Thus the signal is enabled to override noise and at the receiver is passed through another device which responds *more* than proportionately and is so dimensioned as to expand the speech to its original form.

Viewed from another standpoint, a given tube equipment is enabled to transmit more speech power in this manner.

26. Secrecy Methods. The prevalence of eavesdropping on long-distance radio-telephony channels has made secrecy methods necessary. Though differing in detail and in complexity, these schemes are based on a few principles. One is that of *frequency inversion*, in which the original carrier and one sideband of a modulated signal are erased, the remaining sideband then being grafted on a new carrier placed at its other side, so that high frequencies become low ones, and low ones become high ones. By use of suitable filters the sideband may first be split and only one part inverted; then placed on the same or another carrier as the un-inverted part. Another scheme causes the voice modulation to appear as a *secondary modulation*, i.e., as an intelligence-frequency modulation of a previous non-audible modulation. Other

schemes provide for *irregular variation* of one of the frequencies involved in the transmission. Combinations of these schemes are possible.

The object in all cases is to compel the use of a special receiver presumably not available to eavesdroppers and usually also to provide some feature which is adjustable at intervals so that even the proper receiver will not avail unless adjusted in the same way at the same time.

Another method productive of a degree of secrecy is the use of waves sufficiently short to permit employment of full metallic-sheet reflectors productive of a very narrow beam. This (unless relayed) seems limited to a distance not greatly beyond the horizon because of the transmission effects encountered at wave lengths for which it is physically possible to make such reflectors. The communication secured resembles that possible with a beam of invisible light, modulated by voice or key, with the added merit that fog, smoke, or dust does not interfere in the same measure and that an eavesdropper must have knowledge of both the beam course and the frequency.

27. Carrier Suppression and Single-sideband Transmission. Short-wave transmitters cannot at present be made to handle as much power as long-wave transmitters, because of tube limitations. Thus there is no insuperable difficulty about a 500-kw carrier at 700 kc, and it is merely necessary to use an adequate number of 100-kw tubes in the output stage. Though costly, the system is practical. At short waves it becomes inoperative. The anode of such a tube is about 3 ft. long, as are grid and filament. Thus at the higher frequencies the various parts of the same element are not sufficiently closely in phase to produce efficient operation. Furthermore the grid-filament capacitance per tube is about 50 μmf , through which capacitance a destructive charging current can flow at a frequency such as 15,000 kc, were the attempt made to drive the tubes to full output. Furthermore, if one attempted to assemble several of them into a 500-kw output stage, even in push-pull parallel the input capacitance of the stage would be large compared to any tuning condenser practical at this frequency. The frequency control exercised by the tuned circuit then becomes indefinite, and intertube oscillations at unwanted frequencies are prevented with difficulty, especially if the stage is in any way modulated or supplied with modulated input, whether the modulation be by key or voice. Tubes of the size mentioned are for the moment regarded as limited to frequencies of 1,500 kc or lower.

Smaller tubes, with ratings in the vicinity of 20 kw are resorted to, but at frequencies higher than about 1,500 kc the use of more than about six in one stage becomes difficult for reasons just cited. Furthermore the tubes must be operated at reduced input, say 50 per cent of the 1,500-kc rating when working near 15,000 kc. The reasons for this have been partially stated. Beyond 15,000 kc, the tube size and safe input for any given size continue to decrease as one proceeds toward 60,000 kc, at which frequency ordinary means do not now conveniently produce outputs of more than 10 kw, even with special low-capacitance water-cooled tubes having short lead-in conductors of small inductance.

It is fortunate that this is the vicinity in which quasi-optical transmission with limited power requirements is encountered, since the output available with normal tubes decreases rapidly beyond this point. Tube dimensions must be decreased progressively until at a frequency of perhaps 800,000 kc only a watt or two of output can be produced, and

this at low efficiency. The duration of an r-f cycle has become so short as to be comparable to the transit time of electrons from emitter to absorber, *i.e.*, from cathode to anode; hence the "shutter" or "valve" action of the grid is no longer valid. This leads to the use of other types of oscillators.

With the progressive decrease in power rating of tubes when going from 1,500 toward 60,000 kc, it becomes important to operate the tubes in the most effective manner, even by use of devices not economically justifiable at longer waves. Particularly in telephone or other modulated service (facsimile, etc.), all legitimate means are resorted to for reducing the percentage of the tube rating occupied by the "carrier," and therefore wasted as regards the production of intelligence-frequency power at the receiver. In average speech a sideband represents not more than perhaps $\frac{1}{6}$ of the carrier power. Therefore the equipment can be made to transmit more speech power if the output stage is relieved of the carrier, and preferably of one sideband, which may be done in the familiar manner of using a low-power balanced modulator and filtering out one sideband before final amplification. The necessity of restoring the carrier at proper frequency and strength in the receiver limits such a device to commercial circuits with trained receiving operators. The Compondor, described above, though primarily an antinoise device, serves a similar purpose without necessarily resorting to carrier elimination.

Finally, h-f tube limitations have at least contributed toward the desire to use highly directive antennas with which to make up power deficiencies.

28. Controlled Carrier. Another circuit device for accomplishing a reduction in power consumption, and tube heating is *controlled carrier*, *i.e.*, any circuit arrangement attempting to provide at any instant only so much carrier as may be necessary to fill the speech envelope. Various possible schemes exist and are of course equally applicable to long-wave transmitters as their operation takes place in the d-c and a-f circuits. Their chief drawback appears to be that they impose severe load variations upon the plate-supply system of the modulated stage and subsequent stages, if any. The voltage regulation of this device must accordingly be very good.

This is in some degree characteristic of all schemes for making the final amplifier stage do a bigger job (or saving power in doing the same job). Accordingly it is advisable to consider relative costs, comparing larger tubes and perhaps higher plate voltage against the cost of a more complex circuit and a plate supply of improved regulation. Regulation of more than about 5 per cent from the resting condition to the condition of full modulation may damage fidelity.

Some carrier-control systems involve circuits with time constants such that the *recovery time*, during which the carrier rises to a required level, may be so long as to clip loud sounds following fainter sounds. When received with a receiver having a.v.c., a controlled carrier produces a varying noise background and the time constants of the a.v.c. system produce delays productive of distortion. To avoid this by making the a.v.c. action prompter would logically lead to an a.v.c. as rapid as the changes in the carrier. Since these are theoretically as rapid as the modulation itself, the system becomes absurd.

29. Voice Relays. A long-distance two-way radio-telephone circuit operated in connection with the public telephone system may easily

fall into oscillation at an audio frequency through acoustic feed-back at the subscriber's telephone instrument. To avoid destructive consequences, such circuits are sometimes so equipped as to permit transmission in one direction only at any given time, control being taken by the end at which speech begins first and consisting of a speech-controlled lockout relay. A slight delay is provided to prevent chattering or loss of control between words. Longer pauses block the transmitter and permit control to pass to the distant correspondent. The practical system includes additional equipment to guard against wide changes in noise level.

The major shortcoming of such a device is the confusion created in the subscriber's mind upon discovering his inability to interrupt the distant speaker.

SHORT-WAVE SERVICES INVOLVING SPECIAL PROBLEMS

30. Police Patrol and Similar Radio Services. In services involving one-way or two-way communication between a fixed station and a land-going automotive vehicle, abnormally severe conditions are encountered because of the mechanical noise of the vehicle, the electrical noise due to the electrical equipment in the vehicle, surrounding vehicles, power lines, buildings, and railways. The very small antenna, shadows cast by buildings, hills, etc., and finally the physical abuse of the equipment through vibration, moisture, and temperature changes are sources of trouble.

In the case of two-way communication a further limitation is the small power available at a voltage which varies widely with engine speed, temperature, and sometimes the condition of a storage battery.

Highly dependable one-way voice communication to the vehicles is obtainable in city areas at distances of 5 miles or more with fixed-station antenna power of 500 watts at a frequency of the order of 2,000 kc, but the "answer-back" range of the vehicle is unsatisfactory as a proper 2,000-kc sending antenna is not practical. (In open country the ranges are materially greater, two-way voice communication having in some cases been obtained at such frequencies up to distances of 50 miles, using an extremely low resistance one-turn loop antenna on a steel-body car carefully rebonded.)

For frequencies up to 15,000 kc the equipment continues to resemble that of fixed stations except as to size and power, while the radiation efficiency of the mobile antenna rises gradually and transmission from the vehicle improves except as interfered with by skip and interference-pattern effects. In city areas reception in the vehicle becomes noisier above 7,000 kc, as the fundamental frequencies of electrical devices, notably the ignition equipment of automobiles, are approached. The latter, depending on design, peak at frequencies from 15,000 to 150,000 kc, averaging perhaps 60,000 kc, but are very "broad." Above 30,000 kc quasi-optical transmission enters, skipping disappears, and interference patterns become nearly stationary so that fading is minimized and two-way communication is materially easier. Very primitive modulated-oscillator transmitters and unselective receivers have given these frequencies a bad name. If proper crystal-stabilized transmitters and selective (superheterodyne) receivers are used there is little interference.

Prompt dependability being the first requirement of police and similar systems, all mobile equipment should undergo severe acceptance tests, routing service tests, and periodical overhaul. It should be possible to exchange a receiver, loud-speaker, or power supply in 1 to 5 min. upon arrival of a service car.

The fixed station should have protection against accident and attack, also dual telephone lines, dual power-supply lines, duplicate transmitters, adequate maintenance crew and equipment, and a system of operation designed to reduce to *seconds* the delay in handling a message, while permitting its recording, checking, and repeating, also instant detection of any irregularity in acting upon it, as indicative of a service failure due to defective apparatus or armed resistance. To maintain alertness and fast cooperation between station, patrol cars, and precinct houses is vital.

Other public safety services, such as those of fire departments, present similar requirements.

31. International Telephony and Entertainment Broadcasting. International broadcasting and international commercial radio telephony are in a state of very rapid flux, rendering obsolete details of present equipment shortly after they are described. In general the tendency is toward higher powers, the use of more highly developed directive sending antennas, and (for the point-to-point channels) of equally good receiving antennas. The latter are not practical where the reception is to be accomplished by individual citizens whose antennas must lie above their dwellings and who are not interested in one transmitting station to the exclusion of others.

It is not possible to predict whether international entertainment broadcasts (at this time frequently loaded with political propaganda) will continue to be directed toward the individual receiver, or whether this practice will be superseded by the rival practice of transmission toward specialized commercial receiving stations equipped to feed the signals to a telephone network and thence to the local or semilocal broadcasting stations. The former method is more flexible and less costly, the latter delivers a better signal because of the superior receiving equipment and because of the possibility of using types of transmission unsuited for a household receiver.

The powers employed at this time (1935) range from about 3 to 15 kw (carrier power) for stations delivering useful international entertainment-value programs. The commercial-channel international or transoceanic stations are of similar powers or of more specialized types whose ratings cannot be given directly in carrier power because they work with special signals as noted elsewhere under "Compondor," Carrier Suppression, Single Sideband, and the like. The *equivalent carrier* of such stations is in a few cases about 50 kw. These stations are invariably equipped for operation as extensions of the wire telephone system of the country and in many cases are operated by the same management, which in some countries is governmental.

Channels of this type are customarily kept open continuously, even when not in use. One circuit may be provided with several channels differing sufficiently in frequency to make synchronism of adverse conditions improbable. These are frequently kept open at the same time, as the cycles of noise, fading, and the like are not completely predictable, making quick shifts in frequency desirable.

Since, inevitably, there are some changes in frequency at either sending or receiving end, it is necessary that a *tuning watch* be main-

tained at the receiving end. On radio telegraphic long-distance circuits this is commonly facilitated by an automatic transmitting device making some characteristic signal continuously whenever the circuit is idle. A radio-telephone channel may similarly be marked by a tone modulation, manually or automatically interrupted when talking begins, or operators may at short intervals call or carry on casual conversation. It has also been found possible to cause a receiver to tune itself so as to follow any reasonable frequency variation of the distant transmitter. In one transoceanic circuit this is accomplished by imposing a tone, outside the voice sidebands, and at the receiver using the radio frequency representing this tone to beat with a highly stable local oscillator, the resulting beat frequency, or rather the variations thereof, being used to operate through differently tuned circuits upon a pair of balanced detectors whose output is utilized to provide for the beating oscillator of the receiver (the translation oscillator) a wandering bias. This wandering bias causes frequency changes in the oscillator. By proper choice of constants the oscillator is thus made to pursue the frequency changes of the transmitter. Such a system assumes that the transmitter frequency is known and that variations in it and in the receiver will be small. With temperature-controlled quartz-crystal oscillators, these are proper assumptions.

The international radio-telephone service available at any time may best be determined from the pages of a current land-line telephone directory.

32. Short-wave Television. One aspect of television is to be outlined here. Our present concepts of high-speed analysis of a view by consecutive photoelectric inspection of elementary areas all result in the production of a band of electrical frequencies far too wide for transmission over a wire telephone circuit or as a sideband of a long- or medium-wave radio carrier. Transmission to the horizon, or somewhat beyond, is practical at carrier frequencies of the order of 30 Mc to either side of which there is ample space for wide sidebands. However, any considerable extension of the service area involves either radio relaying or a special type of metallic circuit capable of transmitting a wide range of frequencies. Such circuits are so costly at present that the limitation of television broadcasting is economic rather than electrical.

While discrete city areas can be covered by individual stations, each one is then limited to local studio or "spot" pickups, of limited variety. A network including only a few major cities would be a solution but would create a tendency toward many highly diverse independent transmitters in other areas. It remains to be seen what is economically feasible.

33. Aviation Aids. Long-range radio beacons are not ordinarily operated at short waves, but concentrated beams at wave lengths ranging from a fraction of 1 m to perhaps 20 m are being experimentally employed to indicate landing-field boundaries and (when inclined) to mark the path down which the approaching plane should glide. There is no generally employed standard practice as yet. Two-way voice communication with planes, also two-way telegraphic communication at frequencies suited to long distances by day and night is very extensively employed with powers at the plane ranging from 1 to 500 watts, the latter being quite unusual. Noise, vibration, weight and power limitations, wide ranges of temperature, and the undesirability of large

antennas because of wind resistance make this a difficult service to design for, especially as the diversity of types of communication required demands that both receiver and transmitter be capable of quick retuning to widely different frequencies by a pilot who can spare little attention. Wind-driven generators have to a large extent been replaced by engine-driven devices, operable in emergency even on the ground. Crystal control of transmitters, or other high-stability circuits, with selective superheterodyne receivers of high mechanical excellence, combined with the lack of all screening of the antenna, commonly results in ranges greater than those of ground stations, power considered. In military services and some long commercial airlines, requiring extremely light weight or long-range continuous wave, or modulated continuous wave, telegraphy is used extensively, but in the more ordinary air services voice is preferred because of its speed. Ignition disturbances from the plane motors are suppressed by shielding rather than by the use of resistors, as in automobiles. Contact noises are reduced by bonding metallic parts of the ship together and, in the case of moving control members, by flexible bonding plus avoidance of metal-to-metal rubbing contacts.

Radio altimeters, usually based on systems of standing waves between plane and ground, have been used experimentally and give promise as additional safety devices to give warning in the event that a barometric altimeter has, through atmospheric change, changed its reference pressure dangerously during a flight.

34. Immediate Problems of High-frequency Work. The following are the most urgent problems to be overcome in advancing the development of the upper frequencies. Though progress has been made, the list resembles that given in the 1932 edition of this book.

1. Reduction of harmonics and sub-harmonics in transmitters.
2. Improvement of frequency control at frequencies above 50,000 kc.
3. The further development of receivers of high-frequency range.
4. Further development of diversity reception for reduction of fading.
5. A general attack on all types of electrical device noises and rubbing metallic-contact noises.

A vast number of new frequencies may still be added to the radio spectrum in the "centimeter-wave" region. Naturally, radiation of this kind must be handled as a searchlight is handled. There is very little bending around structures and very little tendency to follow the curvature of the earth.

For certain special cases of limited-range communication these applications may hope to be quite successful, since the very low power in the oscillations is apparently more than offset, by virtue of the fact that they may be concentrated in a very narrow pencil of radiation. On account of the difficulty of exact control of frequency, most of the work so far done has dealt with modulated waves.

SECTION 17

CODE TRANSMISSION AND RECEPTION

BY JOHN B. MOORE, B.S.¹

1. **Radio communication**, as distinguished from radio broadcasting of educational and entertainment programs, is carried on chiefly by means of some one of the recognized telegraph codes. Radiotelegraph signals are, therefore, made up of short and long periods of constant signal strength separated by idle periods of proper duration to correspond to the combinations of dots, dashes, and spaces comprising the characters of the code being used. The design of the entire system must be such that the lengths of the dots, dashes, and spaces in the signal supplied to the receiving operator are substantially the same as they were made by the transmitting operator. In a simple system operated at slow speeds no special difficulties are encountered in meeting this requirement. Present day commercial systems, however, which utilize remote control from a central traffic office, and which are operated at high keying speeds, impose severe requirements on all of the equipment used.

2. **Standard Codes.** In international communication the International Morse Code is used. Specially marked and accented letters such as are used in German, French, and the Scandinavian languages have special characters which are used when working a station in the same country or its possessions. When communicating with a foreign station these letters are either replaced by a combination of unaccented letters or in some cases the unaccented letter is transmitted alone. Some countries such as Japan and Egypt having alphabets differing radically from the Latin alphabet use special codes for working within the country or to ships. Nationals of such countries desiring to transmit a message in their own language to a foreign country must spell out the sounds of their words in one of the languages using the Latin alphabet.

3. **Business Codes.** Business concerns that have a large volume of telegraph communication use so-called five-letter or ten-letter codes. Standard codes for such use are available and consist of groups of letters arranged alphabetically; each group standing for a complete sentence or part of a sentence. Special and private codes are also used, and large concerns often have a department for the coding and decoding of coded telegraphic messages.

4. **Printing telegraph equipment** has found a very limited use in the radio communication systems of the world. On short-distance circuits where the received signals are strong and steady, and where atmospheric disturbances are well below the signal level, such equipment can be operated satisfactorily.

¹ Research receiving engineer, R.C.A. Communications, Inc.

A . _ _ _	Period _____
B - -	Semicolon _____ . - - - - .
C - - - . . .	Comma _____ . - . - - . -
D - - . . .	Colon _____ - - - -
E .	Interrogation _____ . . . - - . .
F	Exclamation point _____ - - . . - - -
G - - . . .	Apostrophe _____ . - - - - .
H	Hyphen _____ - -
I	Bar indicating fraction _____ - -
J	Parenthesis _____ - - . - - - -
K - - . . .	Inverted commas _____
L - - . . .	Underline _____ . . - - - - -
M - - . . .	Double dash _____ - -
N	Distress Call _____
O - - . . .	Attention call to precede every trans-
P - - . . .	mission _____
Q - - . . .	General inquiry call _____
R	From (de) _____
S	Invitation to transmit (go ahead) _____
T - - . . .	Warning - high power _____
U	Question (please repeat after) -
V	interrupting long messages _____
W - - . . .	Wait _____
X	Break (Bk.) (double dash) _____
Y - - . . .	Understand _____
Z - - . . .	Error _____
Ä (German),	Received (O.K.) _____
Å or Å (Spanish-Scandinavian)	Position report (to precede all position
.	messages) _____
CH (German-Spanish)	End of each message (cross) _____
.	Transmission finished (end of work)
É (French)	(conclusion of correspondence) _____
Ñ (Spanish) - - - - -	
Ö (German) - - - - -	
Ü (German),	
1 . - - - - -	
2 . . - - - -	
3 . . . - - -	
4 - -	
5	
6 -	
7 - -	
8 - - - . . .	
9 - - - - .	
0 - - - - -	

FIG. 1.—The Continental code.

One type of printer equipment operates from the regular telegraph code; a tape being perforated by a machine actuated from the incoming signal, and then fed into the actual printer. This types the letters on a paper tape which is cut and pasted on message blanks. Another type of automatic printer utilizes a code in which six impulses comprise the total number of elements in any one character. A different number or combination of impulses, up to the maximum of six consecutive ones, is used for each character.

This latter type of printer equipment has found application on certain short wave transoceanic circuits over which unusually stable conditions exist. It is of use chiefly where, or when, traffic conditions are such as to permit a speed of some 40 to 50 words per minute being employed.

5. Character Formation. The unit used in code characters, and in figuring speeds of transmission, is the dot. Present practice, based on automatic transmitting equipment, is to speak of dots per second. On this basis the time required to transmit one dot includes the duration of the space separating the dot from the next element of the character. As the duration of the dot itself and of the following space are equal, they constitute a cycle. Keying speeds are, therefore, commonly stated in dots, or (square) cycles, per second. The equivalent time required for the transmission of the other elements of the code are: a dash, two dots; space between letters, one dot; space between words, three dots. For traffic purposes speeds are generally stated in words per minute. The ratio of words per minute to dots or cycles per second is generally accepted as being 2.5:1 for usual commercial traffic, 100 words per minute being equivalent to 40 cycles keying frequency.

In the Baudot code used for printing telegraph equipment, the duration of the character is divided into five equal periods. For any one of these periods either a marking, or a spacing (no current or reverse current) impulse may be transmitted. One impulse is required between letters, and in the non-synchronous type of equipment an additional impulse is required at the start of each character to set the receiving mechanism in motion. The total number of elements per character is, then, either six or seven depending on the type of equipment used. The space between words is a full-length character. The code consists of a different combination of marking and spacing impulses for each character, there being a total of 32 possible combinations for the five periods utilized. For calculation of keying frequency the single period or element, which is the shortest impulse required to be transmitted, corresponds to the marking portion of a dot in the Morse Code. This is one half cycle. For the non-synchronous printer equipment each letter requires, for its transmission, seven half cycles or three and one-half full cycles. On the basis of five letters per word, and a space between words, the ratio of words per minute to keying cycles per second is 2.86 to 1. This is the figure realizable with automatic tape transmission. Where the impulses go directly from the keyboard-operated machine to the line, the dot speed will remain unchanged, but the number of words per minute that can be transmitted will be reduced on account of the unavoidable irregularities in the speed of the typist.

6. Required Frequency Range. A square wave shape such as a succession of dots, where the value of the current or voltage rises instantly to a steady value at which it remains for one half cycle and then instantly drops to zero, can be analyzed into the fundamental and all of its odd

harmonics. The equation of the voltage wave is:

$$e = \frac{4E}{\pi} \left(\sin x + \frac{1}{3} \sin 3x + \frac{1}{5} \sin 5x + \dots \right) \quad (1)$$

which holds for values of x between $-\pi$ and $+\pi$. For most practical telegraphic purposes it is only necessary for the system to pass the fundamental, third, and fifth in their proper intensity and phase, as terms of higher order do not add sufficiently to the fidelity to warrant building the equipment to handle them. The frequency range required by a sufficient number of higher order harmonics to give appreciable improvement can often be used to better advantage for additional channels.

For any service where the received signal strength rises to the same maximum value on every dot and dash it is not necessary to pass even the third harmonic of the keying frequency. A system which will pass the second harmonic of the fundamental keying frequency is satisfactory. The receiving equipment can be adjusted to operate at a fairly definite level on the building up and decaying of the current or voltage wave so as to give characters which are neither too heavy (long) nor too light (short) as compared to the spaces. However, in a system where the received signal may vary by 2:1 or more in intensity at fairly short and frequent intervals it is necessary to have quite a steep rise and fall of the received signal at make and break in order to obtain a constant "weight" of keying. This applies particularly to automatic reception, where the signal operates a recording device either directly from amplifiers or through a relay of either the mechanical or vacuum-tube types. For aural reception it is desirable to retain the harmonics of the keying frequency as the signal then sounds cleaner cut, and more definite, making it easier to read.

Cases of interference, in both the radio and the land-line portions of a system, are sometimes encountered where it is necessary slightly to round off the sharp, square envelopes of the dots, in order to reduce or eliminate the interference or cross talk caused by the too sudden rise and fall of current.

Where the exact effect of a given circuit on the shape of a square input wave is desired, the range of frequencies passed by the system must be considered as a continuous band rather than dealing with only odd harmonics of the keying frequency.

The usual modulation and sideband theory of radio telephony is applied to code transmission by considering the fundamental keying frequency, and such of its harmonics as are passed, to modulate the carrier 100 per cent. The total band width required to be passed by the entire system is equal to twice the frequency of the highest harmonic of the keying speed that it is desired to retain. (See Arts. 30 to 33 for actual values.)

7. Speeds Attainable. Speeds of transmission range from about 15 up to 300 words per minute; the corresponding keying frequencies being 6 to 120 square cycles per second. Work with ships, and with aircraft, is carried on mainly at speeds up to about 35 words per minute. Transmission is by means of a manually operated telegraph key. Reception is by ear. In point-to-point service, such as transoceanic, traffic speeds normally range from 30 up to 250 words per minute depending upon the type of equipment used, transmission conditions and the amount of

traffic to be handled. Keying is done by machine almost entirely, hand-operated keys being used only for minor service communications. Reception is generally by means of an ink recorder, the telegraphic characters on the tape being transcribed on a typewriter by the operator. Aural reception is resorted to only under adverse conditions.

8. **Fidelity of the mark-to-space ratio**, while important at all speeds, requires special attention when automatic operation at speeds in excess of 100 words per minute is to be maintained. Where the duration of the mark portion of a dot is only one-eightieth of a second, or less, factors that are disregarded at slow speeds become of primary importance. Automatic transmitters, relays, and electrical circuits should be fast enough so that the signal supplied to the recording equipment will not be heavier than 60/40 or lighter than 40/60 in mark-to-space ratio at the highest speed used. At 200 words per minute, which is not exceptional in present-day short-wave work, this means a variation of not more than 1.25 millisecc. in the duration of a dot. While it is sometimes possible to compensate for heavy or light keying characteristics by means of relay adjustments in another portion of the system, this should not be depended upon for obtaining the desired over-all fidelity. Each unit of the system should be capable of giving the required fidelity at a speed in excess of the maximum operating speed, the margin required depending on the number of elements in the over-all system and the fidelity of each.

9. **Checking the keying characteristics** of portions of, and of the entire, system is done by means of keying wheels which send out either a single word over and over, or a succession of dots of 50/50 mark-to-space ratio. For speeds up to about 100 words per minute the usual high-speed ink recorder can be used for checking character formation quite satisfactorily. For accurate information, especially at higher speeds, some form of oscilloscope or oscillograph must be used. The low-voltage type of cathode-ray oscilloscope is admirably suited to this work where photographic records are often not required. Associated amplifiers must be better than the equipment being tested.

10. **Requirements for Facsimile.** Facsimile service requires equipment capable of handling keying frequencies up to about 500 square dots per second. This speed is possible only on short-wave equipment and requires a band width of about 5,000 cycles. In the transmission of facsimile halftones higher keying speeds may require a total band width of 10,000 cycles.

RADIOTELEGRAPHIC SERVICES

11. **Services.** Code-communication channels and equipment can be classified, according to the type of service rendered by them, under the general headings of transoceanic, shorter distance point to point, ship to shore, aircraft, special mobile services, and military.

12. **Transoceanic (long wave),** long distance communications were, prior to 1928, handled almost exclusively on frequencies ranging from about 14 to about 30 kc. Great circle distances covered on such commercial circuits range from 2,000 to 5,000 miles, roughly. To cover distances greater than this with commercial reliability requires so much power to be radiated from the transmitter that it becomes uneconomical.

Approximate values of signal strength to be expected are calculated from the Austin-Cohen transmission formula

$$E = 120\pi \frac{HI}{\lambda D} \sqrt{\frac{\theta}{\sin \theta}} \times e^{-u} \quad (2)$$

where

$$u = \frac{0.0014D}{\lambda^{0.6}}$$

HI = effective height times current for transmitting antenna in meter amperes

λ = wave length in kilometers

D = great-circle distance in kilometers

θ = arc of great circle between transmitter and receiver

E = received field strength in microvolts per meter

or the slightly different expression

$$E \text{ in } \frac{\mu V}{m} = \frac{377HI}{\lambda D} e^{-u} \quad (3)$$

where

$$u = \frac{0.005D}{\lambda^{1.25}}$$

which is derived from data taken on the New York to London circuits at frequencies ranging from 17 to 60 kc.¹

13. Field Strength Required (Long Wave). For successful operation the received field strength must be sufficiently above the level of atmospheric disturbances and other local sources of noise to give fully readable signals. Automatic recording requires a signal to noise ratio of at least two to one. This is based on the general, or average, noise level. Moderately severe atmospheric disturbances such as "crashes" and "clicks" will be from several to perhaps ten times as strong as a normally satisfactory signal. Field strengths obtained on transoceanic circuits range from 10 or less up to 250 μv per meter. A value of 20 is about the minimum for satisfactory communication under average conditions. Modern high-powered transmitting stations have an antenna input power of from 40 to 500 kw with output ratings up to some 130,000 meter amp.

14. Short Wave. During the last few years "short waves" have assumed increasing importance in long-distance radio communication of all types. Frequencies used range from about 7,500 to 23,000 kc, depending upon distance, season of year, time of day, and path traversed. Proper choice of frequency allows of reliable communication between any two points on the earth with transmitters of modern design. Power output of the equipment ranges from 1 to 40 kw. Due to the extreme variations in transmission conditions encountered at these frequencies it is necessary to have available at least 10 kw output from the transmitters, for high-speed automatic operation over the longer distances. Even with the maximum output of present transmitters, and with directive antennas for both transmission and reception, communication is slowed down or even stopped, at times, by severe disturbances in transmission conditions. Normal field strengths obtained at the receiving antennas range from 0.1 up to 100 or more $\mu v/m$, depending on transmitter radiation, path, and transmission conditions. The minimum

¹ ESPENSCHIED, ANDERSON, and BAILEY, *Proc. I.R.E.*, February, 1926.

signal required for reliable, commercial operation depends partly on the noise level at the receiving point. Atmospheric disturbances (static), while troublesome at times, are not so serious as in the case of long waves. Fading requires the use of a greater signal-to-noise ratio on short waves. Utilization of either space, frequency, polarization, or time diversity of fading will overcome, to a great extent, the bad effects of static and permit successful operation on much weaker signals. A very rough estimate of the minimum field strength ordinarily required for code communication, with automatic recording, is $5 \mu\text{v}$ per meter. Slow-speed aural reception can be carried on with field strengths of as low as $0.1 \mu\text{v}$ per meter.

Minimum field strength required is determined by (1) directional distribution of noise at the receiving point; (2) directivity and pick-up of the antenna system, which are both effective in determining the gain of the antenna in signal to noise ratio as compared with a standard vertical doublet; (3) the noise equivalent of the receiver itself.

15. Short Waves versus Long Waves. Advantages of short waves for transoceanic code communication are: (1) lower first cost of equipment and antennas, (2) smaller power consumption, (3) higher keying speeds of which the equipment is capable, (4) less trouble from static, (5) directive transmission, (6) greater distances can be covered with a reasonable and practicable transmitter power. Disadvantages are: (1) interruption of service due to severe magnetic disturbances, (2) effects of fading, (3) necessity of having several frequencies, a separate antenna being required for each, for 24-hr. service the year round.

Advantages of long-wave operation are: (1) freedom from interruption of service by magnetic disturbances, (2) comparative reliability and steadiness of signal strengths. Long-wave arcs, alternators, and tube sets are used. Tube transmitters, only, are used for short-wave operation.

16. Point-to-point communication for distances up to some 2,000 miles is carried on at frequencies ranging from approximately 30 kc up to 100 kc. These stations are used for domestic service and also for the shorter international circuits. Certain bands in the 6,000-kc to 23,000-kc portion of the spectrum are also used for these shorter circuits.

Types of equipment used for 30- to 100-kc work include: spark (obsolete), arc, frequency multipliers, and tube transmitters. For short-wave operation tube transmitters are used exclusively.

17. Ship-to-shore and ship-to-ship communication is an entirely different class of service, in all respects, from point to point. Except at the larger coastal stations, and on a very few ships, transmission is entirely by hand and copying is by ear. This is because of the nature of the service; a coast station usually having not more than ten to twenty messages for one ship at a time, and *vice versa*. Automatic transmission and reception are used only when traffic on hand amounts to some forty messages or more. The same operator generally handles both transmission and reception, which is not the case in point-to-point work. Due to the great number of ships, and to the intermittent nature of their traffic, the marine frequency bands must be shared by all ships. This creates interference and traffic handling problems that are not encountered in point-to-point work. A marine operator must be located at the receiving equipment. Remote control is used only on the transmitters of coastal stations, the transmitting and receiving stations being separated by distances of up to 50 miles to permit of simultaneous transmission and reception.

Frequencies utilized lie within the 100- to 550-kc band; those around 150 kc being used for long-distance work to the larger ships, while those from 400 to 550 kc are for shorter-distance work mainly to the smaller ships, and for distress calls (500 kc). Coastal stations using efficient 5- to 10-kw transmitters and directive reception can normally work ships about 1,500 miles and up to 3,000 miles under favorable conditions, at the lower frequencies. Operation in the 400- to 550-kc band is more variable, a 5-kw transmitter having a normal daytime range of around 500 miles and a night range of several thousand under favorable conditions.

Spark (obsolete), arc, and tube transmitters are used at the lower frequencies. On the higher frequencies tube sets are replacing the old spark equipment. These operate either cw or icw as desired.

Short waves are coming into some use for the handling of ship-to-shore traffic and for special brokerage service to some of the larger ships. Short-wave equipment in the present state of the art is not so well adapted for general marine use as is the 100- to 550-kc equipment. For small craft, where space for equipment and antennas is limited, such equipment has the advantage of being able to work over long distances with comparatively small power.

TRANSMITTING SYSTEMS AND EQUIPMENT

18. The high-frequency alternator is one of the most used types of transmitter for long-wave transoceanic code communication. The *Alexanderson alternator* used in this country is a high-speed inductor-type machine having a large number of poles so that frequencies up to 30 kc and higher may be obtained directly. These machines have an output of 200 kw and are driven by a 600-hp. two-phase induction motor through a set of gears to give the desired alternator speed. The stator is built in sections to facilitate dismantling for repairs and maintenance and has 64 separate windings which are connected to separate windings on the antenna-input transformer. One winding is used to supply a tuned circuit the output of which is rectified and used for automatic speed control. Forced lubrication and water cooling are used on account of the high speed and relatively high losses as compared with commercial power-frequency machinery. Such an alternator intended for operation at 27,200 cycles is driven at a speed of 2,675 r.p.m., has 1,220 poles and requires a field current of 2 amp. at about 120 volts.

To maintain the frequency constant to approximately 0.1 per cent and to have it the same under conditions of full load and practically no load, elaborate compensating means are provided as shown on the schematic diagram. Primary compensation saturation transformers each have an a-c and a d-c winding so connected that the voltage at the motor depends upon the impedance of these transformers which, in turn, depends upon the value of current in the d-c winding. Connected to the slip rings of the wound rotor are two banks of liquid rheostats, the "running" bank being connected at all times and the compensation bank being thrown on or off by the contactors. These contactors, and the contactor in the primary compensation d-c control circuit, are operated from a master relay which is controlled from the central traffic office. Compensation adjustments are made to maintain the machine at the same speed with the control key open or closed.

19. **Method of Keying.** Keying the output is accomplished by means of a magnetic modulator which is a special transformer having an a-c

winding and a differentially connected d-c saturation winding. When the control key is open, a relay closes this d-c circuit, and the resulting drop in impedance of the a-c winding detunes the antenna and reduces the alternator output voltage so that practically no current circulates in the antenna circuit. For key closed the d-c winding is deenergized and the antenna circuit now becomes resonant to the alternator frequency so that normal antenna current is obtained. Due to the low frequency

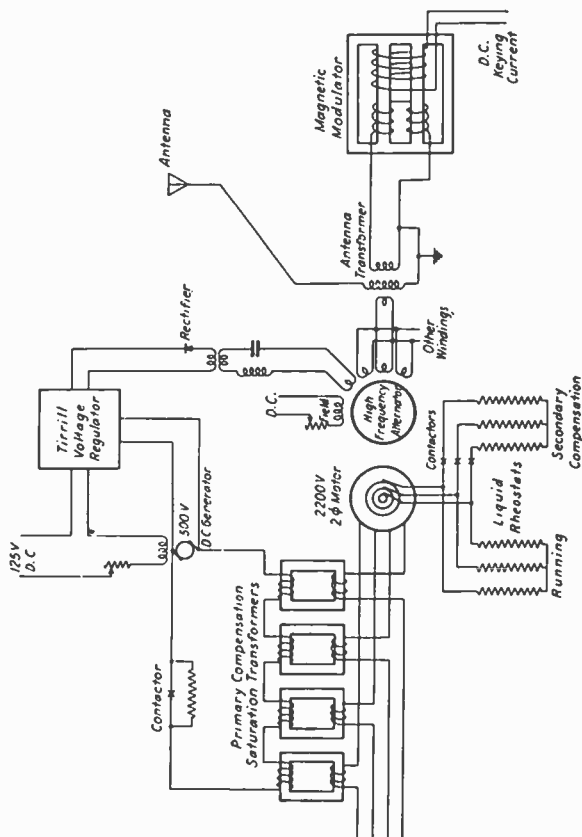

FIG. 2.—Alexanderson alternator equipment.

of the system and the low resistance of the antenna circuit, also on account of the large contactors required in the compensation circuits, keying speeds are limited to about 120 words per minute on long-wave transmitters.

20. Goldschmidt Alternator. Another type of high-frequency machine that has been used to some extent is the Goldschmidt alternator. The

fundamental frequency generated is usually one-fourth of that desired. This is then changed successively to the second, third, and fourth multiples by utilizing the e.m.f. generated in one winding by the rotating field due to current of the next lower order frequency which is flowing in the other winding. The heavy circulating currents are obtained by tuning the respective windings, the output circuit being arranged to deliver energy to the antenna at the desired multiple frequency. The object of this method of obtaining radio frequencies is to use a comparatively low-speed machine rather than to attempt direct generation at the desired frequency, which requires the use of a high-speed machine having a large number of poles.

21. Static Frequency Multipliers. Present practice favors the use of static frequency multipliers where it is desired to use an alternator of comparatively low frequency. Two general methods, both of which depend upon the use of special transformers having d-c saturation windings, are employed. The first utilizes either two or three transformers connected in such a manner that the second or the third harmonic of the fundamental is in phase in the several output windings. The second may utilize but a single transformer, with a d-c saturation winding. The output winding is tuned to the desired harmonic frequency and receives its energy by "shock excitation." This is accomplished by so adjusting the d-c and a-c supply currents that voltage is induced in the secondary winding for only a small portion of a cycle of the supply frequency. In this manner harmonics of the fifth, and higher, orders may be obtained.

22. Arc transmitters are used, to some extent, for long-wave transoceanic work. There have been two main objections, however, to the

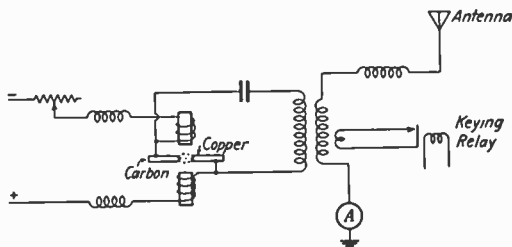

FIG. 3.—Arc transmitter.

use of such equipment. Most arc transmitters emit two frequencies, one for mark and the other for space. As there must be a sufficient frequency difference between these to allow of their being separated in the receiving equipment, one such transmitter really requires two communication channels for its operation. The other objection has been that most arc sets emitted strong harmonics. These can, however, be prevented from radiating strongly by proper shielding and the use of properly arranged circuits for feeding the antenna. Elimination of the space wave or "back wave" is rather difficult in transmitters of this type, especially when the output may be as high as 1,000 kw in large installations. The actual power output of the arc can not be keyed as the arc, to be stable, must draw a fairly constant current while in opera-

tion. Keying is generally accomplished by changing the inductance of the resonant circuit associated with the arc, thereby changing the frequency of the emitted wave. This is done by short-circuiting a few turns that are coupled to the main tuning inductance.

Methods have been proposed for shifting the output of the arc to a dummy antenna, or absorbing circuit, for keying the actual power radiated on but one frequency. Such methods have not come into general use.

The arc is operated from a direct-current source, usually motor generators, at a voltage of from 300 to 3,500 volts depending upon the power rating of the unit. It burns in an atmosphere rich in hydrogen, which is supplied by gas or by the vaporization of some such liquid as alcohol which is fed into the arc chamber. For the efficient production of undamped oscillations the arc must burn in a transverse magnetic field. This is supplied by a large electromagnet the poles of which are respectively above and below the arc chamber and the coils of which are energized by passing the arc current through them. The intensity of magnetic field required for optimum results is inversely proportional to wave length and also depends upon the material used to furnish the hydrogenous atmosphere in the arc chamber. Values normally range from about 2 to 20 kilo-gausses. A water-cooled copper anode is used with a carbon cathode which is slowly rotated by means of a motor while the arc is in operation. A current-limiting resistor, normally used while striking the arc, is shorted out when the arc is running.

23. **Tube transmitters** have been used but little at frequencies between 14 and 30 kc for long-distance communication. Tubes to handle the power required have not been available until quite recently. This meant that a number of tubes had to be operated in parallel in the power-amplifier stage. Such transmitters have rated outputs of from 40 to 500 kw and are of the usual master-oscillator, power-amplifier type.

24. **Long-wave antennas** of the various familiar types such as the T, inverted L, and umbrella have been used. Masts for these structures have, in some cases, been as high as 1,000 ft. Ordinarily they range from 400 to 800 ft. high. The technical problem is to get as many amperes in an antenna of as great an effective height as possible with a given power input. Voltages from antennas to ground may easily be 100 kv or more so that corona and insulation considerations place a limitation on the design. Of the total power supplied to the antenna the useful portion is that radiated. The remainder is accounted for by conductor losses, coil losses, leakage and corona (if present), and by loss in the resistance of the ground-return path. In a structure where most of the capacity is from the flat top to earth, and where the dimensions are considerably less than a wave length, the radiation resistance is given approximately by the relation $R = 1600 \frac{H^2}{\lambda^2}$ where H is the effective

height of the antenna and λ the length of the radiated wave. Approximate calculation of H is possible in simple cases by summing up the products HI for all sections of the structure and dividing by the total current. This is done by calculating the capacities to earth of the various sections, and by measurement of the total value. Experimental methods of determining the capacity from small-size models are described by Lindenblad and Brown.¹

¹ LINDENBLAD, N., and W. W. BROWN, Main Consideration in Antenna Design, *Proc. I. R. E.*, June, 1926.

26. The multiple-tuned antenna, consists of a long, flat top supported by towers and having downloads at a number of points which pass through tuning inductances to earth. The total antenna current is the sum of all the currents measured at the base of the tuning coils. A system of buried wires, and overhead conductors connected to them through current-equalizing coils, is laid out to give a uniform distribution of current in the earth under the antenna. This is approximately the condition for minimum earth resistance. This uniform distribution is sometimes altered, by experiment, to still further reduce the losses. Such antenna and ground systems often have a total resistance of less than $\frac{1}{2}$ ohm. Total antenna currents of 700 amp. and more are obtained, by this means, from a transmitter output of 200 kw. For N tuning points the inductance of each download and coil is approximately N times that which would resonate with the total antenna capacity at the desired

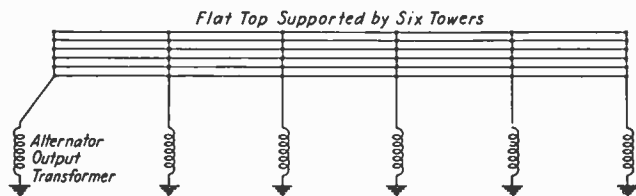

FIG. 4.—Multiple-tuned antenna.

frequency. The physical length of such an antenna for operation at 17 kc, or thereabouts, may be a mile or mile and a half, with as many as six tuning points.

26. Removal of Ice. In climates where sleet is experienced the antenna wires should be counterweighted, rather than solidly anchored, in order to lessen the chances of breakage. A heavy coating of sleet on the wires, with the attendant increase in sag, throws the antenna out of tune as well as endangering it mechanically. When this becomes serious it is necessary to melt the sleet from the wires in order to get normal antenna current. For this purpose break insulators and by-pass condensers are so arranged in the antenna wires that a series circuit of all (or part) of the wires is obtained at the low power-supply frequency. Special transformers supply power at about 2,000 volts for the purpose. This is sent through the antenna conductors just long enough to heat them sufficiently to melt off the sleet or ice.

27. Marine Transmitters. For marine work tube transmitters are replacing the older spark and arc equipment. The radiated energy is confined more to a single frequency, which is essential for reducing interference, and systems for simultaneous transmission and reception, for break-in operation, and for remote control are much more easily built up by the use of tube transmitters. With a well-filtered plate supply the beat note obtained by use of a heterodyne or autodyne receiver is fairly pure, and its pitch can be changed at will by the receiving operator to suit conditions. For attracting the attention of ships standing by on a calling wave, or for working ships not equipped for heterodyne reception, the radiated energy can be interrupted at an a-f rate.

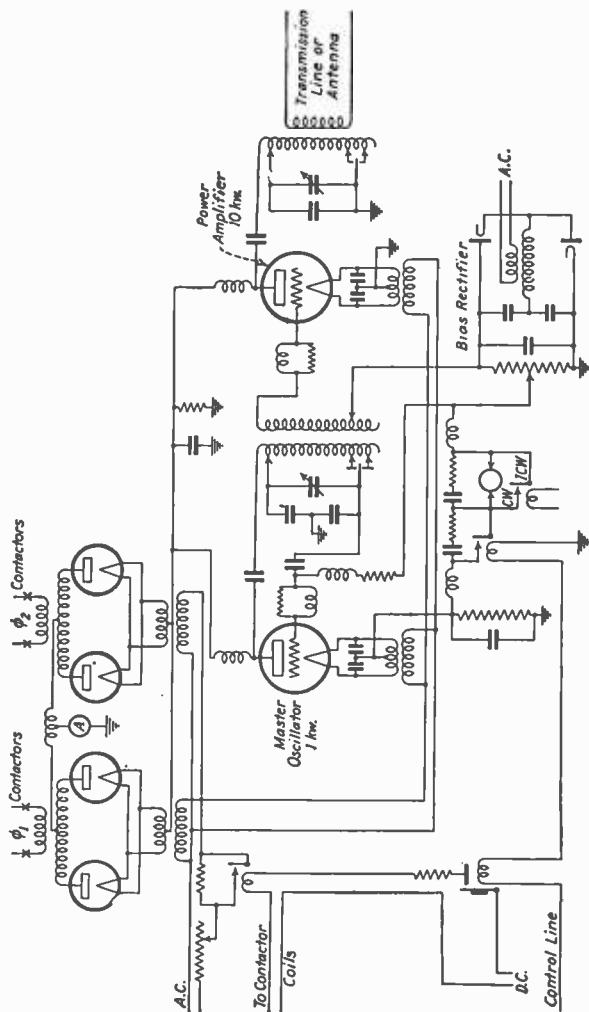

FIG. 5.—Marine coastal transmitter.

Transmitters for coastal stations usually have an output of from 5 to 10 kw. An air-cooled 1-kw tube functions as master oscillator and drives the 10-kw power-amplifier tube, which is of the water-cooled type. Plate supply is obtained from a full-wave kenotron rectifier, the output of which is filtered to some extent. Bias voltages are normally obtained from a

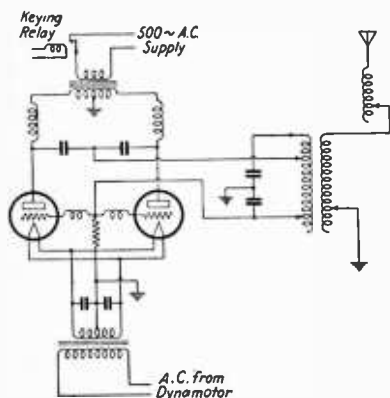

FIG. 6.—Essential circuit of icw marine transmitter with a-c plate supply.

and antenna-circuit impedances at transformers.

To make the transmitter instantly available the tube filaments are operated at reduced voltage, with plate supply off, when not in actual use. The "starting" relay operates contactors which apply full voltage to the filaments and close the low-voltage circuit to the plate-supply transformers. For remote control, the starting and keying relays can be operated from a single line by using double-current keying with a polar "keying" relay and a neutral line relay with weighted armature for "starting." The chopper, for production of icw, may also be relay operated. Wave change can be arranged by relay-operated contactors which change taps on the tuning inductances, these contactors being operated by a polar relay controlled from the operator's table.

28. Transmitters for shipboard use are generally of smaller power output than are those for coastal stations. Cost and space requirement are also important factors which must be kept down. The usual equipment is, therefore, more simple and compact than that treated above:

a small rectifier, to eliminate as much rotating machinery as possible. Filament supply is alternating current from step-down transformers. Because of the nature of the service, interruptions due to equipment trouble must be reduced to a minimum. For this reason two power-amplifier tubes are mounted so that either one can be used. Cooling water systems are provided in duplicate and equipped with pressure- or flow-operated relays which will shut down the transmitter in case of water failure. In some cases it is advisable to locate the antenna at a distance from the transmitter proper. A two-wire transmission line is used for this purpose, being matched to the power-amplifier its ends by means of air-core

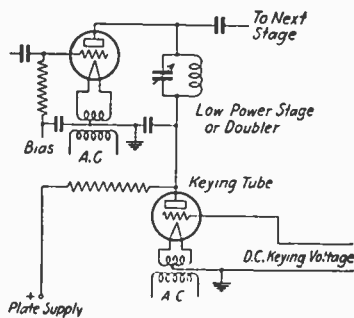

FIG. 7.—Tube keyer for transmitter.

The master-oscillator power-amplifier arrangement with direct-current plate supply, or alternating current at a frequency of 350 cycles, meets the requirements very well in the intermediate frequency bands. The master oscillator holds the frequency steady regardless of changes in antenna capacity due to rolling of the ship, and the elimination of a separate rectifier saves space. Where space permits, a high-voltage direct-current generator is used for plate supply. Medium power tubes require about a 2,000-volt supply. Change of wave is accomplished by changing taps on the tuning inductances. Choice of several frequencies in the band is provided by means of a multi-point switch operated from the front of the panel. The normal power-supply mains being direct current, a motor generator is required to furnish the plate-supply voltage. Another machine may furnish alternating current for the filaments. On small transmitters satisfactory keying can be effected in the low-voltage alternating-current plate supply by means of a relay controlled from the operator's key.

29. Short-wave Technique. In the 6,000- to 23,000-kc band the demand for channels, and the comparatively narrow band required for a communication channel, has necessitated the use of transmitting equipment which will maintain its assigned frequency within very small limits. Channel spacing of one-tenth of 1 per cent requires a maximum tolerance of only 0.025 per cent or 1 part in 4,000 under all operating conditions of temperature and power supply. To do this requires the use of either a carefully stabilized and compensated tube oscillator or some control device, such as a quartz crystal, which, when kept at a constant temperature, will maintain the desired frequency within small limits. Crystal control has found most favor in this country, to date.

Commercial short-wave code transmitters used for long-distance communication have an output of from 20 to 40 kw. The crystal is kept at a constant temperature, and operates at one-eighth or one-fourth of the final frequency desired. The oscillator stage is followed by a screen-grid "buffer" stage, to isolate it from feed-back and detuning effects, then by two or three frequency-doubling stages before the first amplifier stage operating at the signal frequency. Screen-grid tubes used in these stages, with proper shielding of tubes and circuits, and filtering of supply leads, eliminate troublesome feed-back effects without the use of neutralization. Water-cooled triodes used in the final power amplifier must be employed in a balanced stage with proper neutralization of feed-back through the tube capacities. The tank circuit of the power amplifier is coupled either directly, or through a transmission line, to the antenna.

For high-speed telegraphic operation the voltage regulation of all plate and bias supplies must be small. If poor regulation exists the envelope shape of the characters will be triangular or irregular, instead of rectangular. (A small amount of lag may be introduced intentionally, in some cases, to round off the corners in order to eliminate trouble from keying clicks in nearby receivers.) For this reason hot-cathode mercury-vapor rectifiers are used for supplying the high direct-current potentials required. These tubes, together with the high-voltage transformers, have very good voltage regulation at high values of output voltage.

For continued operation at keying speeds up to 250 words per minute (100 cycles per second) it is inadvisable to use a system of keying which

employs electromechanical relays. A vacuum-tube keying stage is therefore used to key one of the low-power stages of the transmitter.

Where a plate supply having good regulation is not available the load on it can be held constant by using two power amplifiers one of which supplies the antenna and the other a resistance load. Keying is accomplished by shifting the load from the main amplifier to the absorbing tube by biasing the amplifier grids below cut-off and bringing the absorbing tube grid bias up to such a value that the load drawn from the plate supply is the same as when the amplifier is supplying energy to the antenna. For receiving systems which rely partly upon frequency diversity of fading it is desirable to modulate the wave radiated from the transmitter at an audio frequency of something under 1,000 cycles per second. To prevent interference with signals on adjacent channels this modulation should be reasonably free of harmonics. Otherwise, the higher order side bands will extend over into the adjacent channels and cause interference.

RECEIVING SYSTEMS AND EQUIPMENT

30. Long-wave Receivers. Long-wave receiving equipment must be designed to reduce trouble from static to a minimum, and to separate transmitters differing in frequency by only about 200 cycles, which is the approximate spacing of assigned channels. The use of four efficient tuned circuits provides the required selectivity together with moderate ease of handling. For commercial work it has been the practice to obtain the h-f selectivity ahead of an aperiodic amplifier, then to go to a heterodyne detector of either the single-tube or balanced-modulator type which is followed by as much a-f amplification as is required. The final selectivity may, if necessary, be obtained by the use of narrow a-f band-pass filters. For complete separation of signals on adjacent channels this is often necessary. Due to the difficulty of obtaining complete shielding, at these comparatively low radio frequencies, it is generally advisable to use astatic pairs of coils in all tuned circuits, couplers, oscillators, etc., in addition to the use of a reasonable amount of shielding. Transformers and couplers are built with electrostatic shields to prevent capacity coupling, where this is undesirable.

In a multiplex receiving station, where it may be necessary to receive from ten to twenty signals from approximately the same direction, a single aperiodic antenna system is the most economical and practical. The individual receivers are fed by means of "coupling tubes" operated from a common, or from individual, antenna-output transformers. All tuning is done beyond these coupling tubes so that operation of the individual receivers is entirely independent of all others.

31. Directional Antennas. Reduction of static is accomplished by the use of directive-antenna systems. Arrays of large loops, or of loop and vertical combinations, are one means of obtaining directivity. Where the nature of the soil is such as to produce a considerable tilt of the wave front, the Beverage wave antenna is used to advantage. This antenna consists of one or two wires strung on poles at a height of about 20 ft. and extending in the direction of the desired signal for a distance of approximately one wave length. The antenna is highly directional, and small signal voltages obtained from stations to the rear can be compensated for by feeding into the signal circuit a small voltage of

proper amplitude and phase obtained from the damping resistance connected between antenna and ground, or by setting up reflections in the antenna itself.

As keying speeds on long-wave transoceanic circuits seldom exceed 100 words per minute (40 cycles/per second), and signal strengths are steady, such a channel requires only a total band width of about 160 cycles. Frequency variations of the transmitters can be kept within

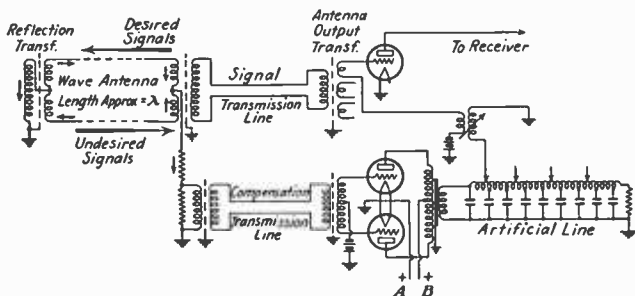

FIG. 8.—Wave antenna and output circuits.

about 0.1 per cent or 20 cycles in 20,000, and heterodyne oscillators used for reception should have as good stability.

32. Ship-to-shore Receivers. Receiving equipment for ship-to-shore service must cover the frequency range of 500 down to 14 kc in order to operate in the regular marine bands and also to receive broadcasts and time signals from high-powered long-wave stations. Receivers for shipboard use are of the autodyne type embodying a tuned antenna circuit coupled to the oscillating detector, which latter has a "tickler coil" for regeneration control, and generally two stages of audio-frequency amplification. By means of tapped inductances the receiver may tune from about 1,000 down to 60 kc. For the lower frequencies a set of loading inductances is used. One of the chief requirements is ease of operation and rapidity of tuning. Regeneration control allows the receiver to be operated oscillating for cw reception or non-oscillating for reception of spark, icw or modulated signals. Provision is made for disconnecting the receiver from the antenna when transmitting.

Important coastal stations have separate receivers to cover the lower and higher frequency marine bands of approximately 115 to 171 kc and 375 to 500 kc respectively. Such receivers should have but a single

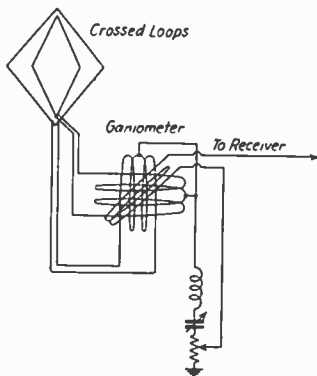

FIG. 9.—Loop-vertical antenna for directive reception.

tuning control and, to obtain the required selectivity, should be of the superheterodyne type. An intermediate-frequency oscillator, which can be used at will by the operator, must be provided for cw reception. The over-all selectivity should be such that a total band width of not more than 1 kc is passed at 80 per cent peak response.

As in long-wave reception, reduction of static and interference is accomplished by the use of directive antennas. For the lower frequency band the Beverage wave antenna has the advantage of relatively large pick-up, good directivity with compensation, and the ability to supply a number of receivers operating at the same or different frequencies. Where reception from all directions is required, and for the higher-frequency bands where the wave antenna is unsuitable for night reception, antennas of the flat top, inverted L, T, vertical, or loop types are employed. The loop and vertical combination, giving a cardioid directive diagram, can be arranged with crossed loops and a goniometer so that the operator can rotate his antenna reception diagram at will.

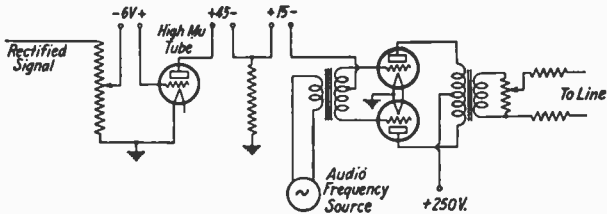

FIG. 10.—Tone keyer for receivers.

33. Short-wave receiving equipment, for the reception of commercial radio-telegraph signals, comprises two general classes, namely, (a) point to point and (b) mobile.

For commercial point-to-point service the receiving equipment must deliver a signal which is as nearly perfect as is possible. This requires a high degree of frequency stability, the best practicable over-all selectivity, and means for reducing the effects of fading to a minimum. The receiver should have a total band width such that it will provide an attenuation of from 40 to 60 db at the frequencies of the channels adjacent to that on which reception is being carried on. In calculating selectivity requirements, the assigned channel spacing must be reduced by twice the frequency tolerance permitted on each channel. This gives the frequency spacing between two signals on adjacent channels, when the frequencies of the two transmitters have drifted toward each other. Protection against all other types of interference, such as those encountered in superheterodyne receivers should be not less than 70 db. At the same time, the useful band width must be sufficiently great so that no undue amount of attention will be required to keep signals fairly well centered in the pass band of the receiver. With present-day stability of transmitter frequencies, and of receivers, this means a useful band width of from 1 to 4 kc depending upon the carrier frequency.

Present-day receivers, to provide the required performance, are generally of the multiple-detection, or superheterodyne, type in which one or two intermediate-frequency systems are employed. It is only

by the use of a relatively low final intermediate frequency that the necessary selectivity and useful band widths can be obtained. The required i-f characteristics are obtained by use of either a band-pass filter or a number of stages of amplification employing one or more tuned transformers per stage. Choice of more than one band width in the i-f system is highly desirable and often necessary.

In equipment used for high-speed automatic operation the signal is amplified, beat down to a lower frequency, and then rectified. The rectified output, consisting of short and long pulses of direct current, is used to operate a relay of either the electro-mechanical or vacuum-tube type. The former operates into a simplex, duplexed, or quadruplexed direct-current telegraph line to the central traffic office. The tube relay, or "keyer," controls the signal fed to the tone line from a local audio-frequency source. The receiving operator is thus supplied with an audio signal of constant frequency and intensity regardless of any changes in the actual radio signal which are not great enough to make it drop out of the receiver. By means of a-f filters six or more keyed tones of this sort may be handled over a single, two-wire tone line.

To minimize the effects of fading, receiving equipment is arranged to take advantage of the diversity of fading existing, at a given instant, either on slightly different frequencies at the same location or on the same frequency at points separated ten wave lengths or more apart. Frequency diversity, in practice, is most economically obtained by modulating the carrier with an a.f. of not higher than 1,000 cycles, and preferably of not higher than 500 cps, in order to minimize interference to signals on adjacent channels. This results in radiation on the carrier and on an upper and a lower frequency. If the band width of the receiver is sufficient to pass these three frequencies, and if the normal signal strength on any one of these frequencies is sufficient to operate the keying device, considerable diverse fading on the several frequencies received can be tolerated. In spite of the fact that a lesser peak voltage can be obtained from a modulated signal than from a pure cw signal considerable improvement is obtained, under practical conditions of fading, by its use. Where space diversity is utilized a pure, unmodulated signal is to be preferred. In this case two or three separate receivers are fed from separate directive antennas spaced ten wave lengths or more apart. The rectified outputs from these receivers are combined and made to operate the keying device. Confining the radiated energy to a single frequency means greater signal strength for a given transmitter power, and combination after rectification eliminates the consideration of instantaneous phase relations which might be such as to cancel rather than add.

34. Use of Limiting Circuits. Under conditions of high signal-to-noise ratio and violent fading, the use of considerable limiting in the receiving equipment is desirable. This should be done following the final selectivity, and must be in a system having small enough time constants so that the decaying transients occurring after each overload do not occupy an appreciable portion of the interval between characters. In order to use such limiting successfully it is essential, as stated before, to pass up to about the fifth harmonic of the keying frequency. If this is not done, wide variations in mark-to-space ratio of the final signal will occur as the degree of limiting varies with the signal strength.

Character formation can be maintained, in some cases of overloaded systems, by the use of a so-called "sliding bias" on the rectifier. The

signal may be amplified up to some 30 or 40 volts maximum value and applied to the grid circuit of a rectifier tube which begins to take grid current at a relatively low applied signal voltage. By proper choice of grid- and plate-circuit resistors, and the use of a condenser across the grid-circuit resistor to give a relatively large time constant, only the tops of the character envelopes will be effective. In using such a system, however, reliance must be placed upon some form of diversity reception to prevent splitting of characters, and drop-outs, due to rapid fading.

Recent practice has been to use some system of automatically controlling the gain (A.G.C.) of the r-f amplifier stages. The circuits are similar to those used in broadcast receivers and are superior to those which operate on the final detectors, because they minimize overloading r-f and i-f amplifiers and first detectors.

35. Commercial Receiving-center Problems. In a large receiving station for long-distance communication there may be from 10 to 100 individual receivers installed and intended for simultaneous operation. To do this requires that each unit be effectively shielded and that all battery-supply leads be well filtered for the frequencies at which the respective units operate. High-frequency equipment must also be protected from low-frequency voltages which might be present on the battery supply buses, as such voltages may cause undesirable modulation of signals if allowed to get to the tube circuits. Transmission lines, where used, must be of a type which has negligible stray pick-up and radiation. Satisfactory types of line, depending upon the equipment with which it is to be used, are (a) the balanced four-wire line, (b) the two-wire transposed line, and (c) the concentric-pipe line. The first consists of four wires arranged at the corners of an imaginary square, diagonally opposite wires being connected together at both ends of the line. The four-wire and two-wire types are used where the system is to be kept balanced with respect to earth. Antenna systems which operate against earth generally use the concentric-pipe line in which the outer pipe is grounded. The two types of systems are sometimes connected together by means of suitable tuned transformers.

To obtain the full benefits of good shielding stray feed-back through the battery-supply leads must be eliminated by means of properly proportioned, and located, filter circuits. This is of especial importance in short-wave equipment, and in medium-wave equipment for marine coastal station use.

36. Power supply for commercial receiving equipment must be absolutely reliable and not subject to interruption. Storage batteries operated either on a floating, or on a charge and discharge, basis are used for this service.

Charging equipment consists of motor-generator sets for filament batteries, where relatively heavy currents are required, and either motor generators or rectifiers for batteries of smaller rating such as used for plate and bias supply. Where receiving antennas may be located fairly close to the building that houses the charging equipment, this must be located in a specially shielded room to prevent direct radiation into the antennas. Equipment used for floating batteries that are in service must be provided with effective filtering between it and the battery and load bus.

CONTROL METHODS AND EQUIPMENT

37. Central Office. In commercial radiotelegraphic systems the transmitters are controlled from a central traffic office, and received signals are conveyed to this central office from the receiving station by land lines. Transmitting and receiving stations are, in some cases, as much as 500 miles distant from the central office. The tendency, however, is to keep this distance below 100 miles to reduce initial and maintenance costs, or rentals, of land lines. Long control and tone lines are justified only if a distant location of the transmitter will effect a considerable saving in the power required to obtain satisfactory service, or if the distant receiving site is considerably superior to nearby ones in signal-to-noise ratio. In long-wave transoceanic and medium-wave marine work the use of long land lines is often well worth while. In short-wave work the over-all results are not so dependent upon geographical location. Suitable sites are generally available within 100 miles of the city to be served.

38. Automatic Transmitters. In "automatic" operation of code circuits a tough paper tape is perforated by means of a machine which has a keyboard similar to that of standard typewriters. This tape is then fed through the "automatic transmitter" in which two cam-operated steel rods come up against the tape at every point where a perforation might exist. Where one is, the rod goes on through, and a contact operated by a lever on the lower end of the rod is closed. These two rods controlling the "make" and "break" contacts alternate in coming against the tape and are sufficiently offset in the direction of travel of the tape so that perforations in the upper (make) and lower (break) rows, when opposite the same center hole, give a dot and when opposite adjacent center holes give a dash. (Sample tape appears below.)

The two contacts supply current, in opposite directions, to a polar relay which, in turn, keys the control circuit going to the transmitting station. For speeds much above 100 words per minute it is desirable to have as few mechanical relays as possible between this main polar relay and the keying circuit of the radio transmitter. The time required for a relay armature to travel from one contact to the other, while short, becomes important when the duration of a dot is less than 0.010 sec.

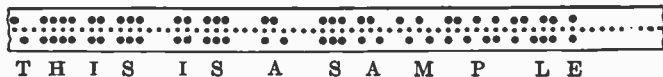

39. Tone-control Circuits. Where only a few transmitters are to be controlled from one point, direct-current double-current keying is the most economical and satisfactory. A complete metallic circuit is to be preferred to a single wire with ground return, although the latter is entirely satisfactory in many cases.

In a large central-office system the number of control lines required can be greatly reduced by the use of multiplex tone, or "voice-frequency carrier," control. By the use of a number of different frequencies, and band-pass filters at both ends of the circuit, as many as ten channels can be obtained on a two-wire line which will pass frequencies from about

400 cycles up to 2,500 cycles with approximately equal attenuation. In one such type of equipment the audio-frequency supply is a multi-frequency inductor-type alternator having a separate winding and rotor for each frequency. Energy from this machine is keyed by means of either electromechanical or vacuum-tube relays which are controlled by the automatic tape transmitter and supply current to the control line. Band-pass filters in the individual control channels reduce the harmonic content of the signal supplied to the line to a low value and also round off the corners of the square keying envelopes.

The band width required in filters for tone-control work depends (1) upon the maximum keying speed which must be handled and (2) upon the fidelity of envelope shape required for the particular application. Where great fidelity is not required, or where the over-all transmission gain of line and associated equipment does not vary more than about 20 per cent, it is sufficient to pass the second harmonic of the keying frequency. This means a total band width of four times the keying frequency. To obtain fairly square envelope shape, with a mark-to-space ratio of about 60/40, it is necessary to pass up to the third harmonic or a total band of six times the keying frequency, at least.

For the lengths of line normally used between central offices and outlying stations, and present-day code keying speeds, the matter of phase distortion due to the line is of relatively small importance.

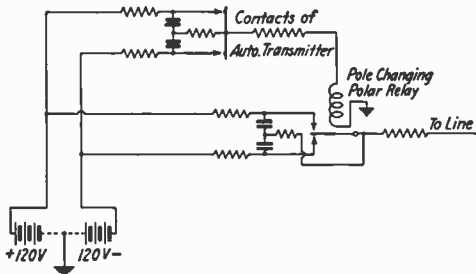

Fig. 11.—Double-current control circuits.

40. Control equipment used at transmitting stations may be of either the d-c or tone-operated type, depending upon the system used at the central office. In a double-current d-c system, the conventional polarized telegraph relay is used as a main-line relay for speeds up to some hundred words per minute. Where normal operating speeds run much above one hundred words per minute special high-speed relays of the polarized type must be used. Large keying and compensation relays and contactors used in long-wave transmitters are controlled by the line relay or a heavier intermediate relay. In tube sets—especially short-wave equipment—higher keying speeds are possible and require the use of a minimum number of mechanical relays. For d-c control the main line relay may operate directly into a tube keyer incorporated in the transmitter.

In tone-control systems the equipment at the transmitting station comprises band-pass filters and amplifier-rectifier units. Two stages

of transformer-coupled amplification, with manual volume control, suffice. The rectified output may be used to operate either electromechanical relays or tube keyers. Where such equipment is used at a large, high-powered transmitting station it must be thoroughly protected from the stray fields of the transmitters, transmission lines, and antennas. It is generally necessary to locate it in a well-shielded room and effectively to filter all control lines and power-supply cables that enter or leave the room.

Tube keyers, while more elaborate than the usual mechanical relays, are capable of operating at practically any speed desired. They also eliminate relay maintenance and adjustment. In the simpler arrangements the control tone is amplified, rectified by either a two-element or a three-element tube rectifier, then passed through a smoothing circuit or low-pass filter. The d-c pulses thus obtained are applied to the control elements of the keying-stage tube or tubes. Grid-glow tubes have found some favor in such work due to the fact that, once triggered off, the plate current remains at a constant value until the plate voltage is removed, or reduced to a low value. This permits the squaring up of badly distorted envelope shapes without resorting again to mechanical relays.

41. Received Signal Transfer. Systems for transferring signals from the receiving station to the central office are similar to the transmitter-control systems. In short-wave work the actual radio signal, after heterodyne detection, is amplified and rectified and applied to a tube keyer. This may be arranged to supply direct current, or tone, for transfer to the traffic office. Audio-frequency filters, of the same type used for tone control, allow a number of channels to be handled over one line.

Where tone lines are long enough to require the use of one or more repeaters, care must be taken that the sum of the voltages of all channels is not high enough to cause any overloading of the repeaters. If this takes place, intermodulation between channels will be caused, which results in mutilated signals at the central office. With repeated lines, and the usual band-pass filters, it is essential that all channels be kept at approximately the same signal level. A maximum difference of 2/1 between any two channels should not be exceeded. Large differences in channel levels are apt to cause interference on the weaker ones.

In medium-wave and short-wave receiving stations the contacts of all telegraph keys and relays must be prevented from sparking, and the wires to and from the contacts must be properly filtered. If these precautions are not taken serious click interference will be experienced in the receiving equipment. The same applies to commutator-type electric motors. Circuit breakers should preferably be located in a shielded room.

TRANSCRIBING METHODS AND EQUIPMENT

42. High-speed Reception. As the average operator copies at a rate of only about 40 words per minute, aural reception must be replaced by some method in which a record is made of the signal, on the high-speed

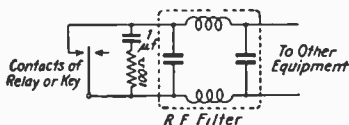

FIG. 12.—Spark absorber and click filter.

circuits, the recorded signal then being copied off at a slower speed by one or more operators. The older dictaphone and photographic methods of recording were not entirely satisfactory. Most systems now use some form of "ink recorder" in which the movement of a pen is controlled by the incoming signal and makes short and long characters on a moving paper tape.

Reception by tape has the double advantage of speed and of there being a record to which the operator may refer or which may be looked up later in case any question arises.

43. Ink Recorder. One commonly used type of ink recorder consists of a small coil suspended in a strong unidirectional magnetic field supplied by an electromagnet. The signal is amplified and rectified and the d-c pulses sent through the recorder coil which, in turn, moves the pen arm up against an upper stop. With no signal current flowing the pen is held against the lower stop by the spring of the pen arm and coil suspension. To improve the action of the device at high speeds the coil is suspended midway between the stops and current reversals are used, in place of pulsating direct current, to operate the coil. This is obtained from a pole-changing relay operated by the rectified signal, or from a

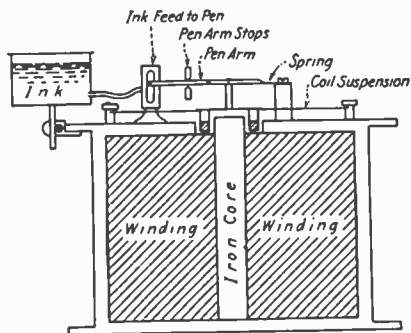
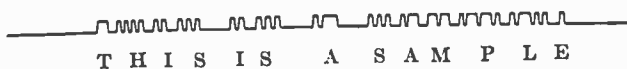

FIG. 13.—Ink recorder. Paper tape and tape guide not shown.

special amplifier-rectifier unit which gives an output direct current in opposite directions for "mark" and "space."



References

- AUSTIN, L. W.: *Proc. I. R. E.*, June, 1926.
 BEVERAGE, RICE, and KELLOGG: The Wave Antenna, a New Type of Highly Directive Antenna, *Proc. A. I. E. E.*, March, 1923.
 BYRNES and COLEMAN: 20- to 40-kw High-frequency Transmitters, *Proc. I. R. E.*, March, 1930.
 CARSON, JOHN R.: "Electric Circuit Theory and the Operational Calculus," McGraw-Hill Book Company, Inc., New York.
 ESPENSCHIED, ANDERSON, and BAILEY: Transatlantic Radio Telephone Transmission, *Proc. I. R. E.*, February, 1926.

- FULLER, L. F.: The Design of Poulsen Arc Converters for Radio Telegraphy, *Proc. I. R. E.*, October, 1919.
- SHEA, T. E.: "Transmission Networks and Wave Filters," D. Van Nostrand Company, New York.
- STEINER and MASER: Hot-cathode Mercury-vapor Rectifier Tubes, *Proc. I. R. E.* January, 1930.

SECTION 18

TELEVISION

BY VICTOR J. ANDREW, PH. D.¹

1. Program Sources. The common sources of television programs are (1) a motion picture film, (2) an indoor studio especially prepared, and (3) an outdoor event not primarily intended for television. Transmission from a film is the easiest, although the second and third kinds are considered necessary for a useful service.

The greater part of present television development work is aimed toward transmission of action in a studio comparable to studio programs used in sound broadcasting. While transmission of outdoor events is much desired, it is probable that technical difficulties will postpone this until indoor methods are fairly well developed.

Transmission from a film is sometimes used with a very short interval elapsing between taking the picture and transmitting it. The film is developed but not dried. The interval is reported to be as short as 7 sec. in a method used in Germany. In public demonstrations in Germany an interval of $1\frac{3}{4}$ min. has been used. Thirty seconds is claimed for the *Baird cine-televisor* in England.

2. Scanning Theory. The only way in which three-dimensional information (two space dimensions and brilliancy) can be transmitted by a one-dimensional agent (carrier amplitude) is to break the three dimensions into small arbitrary elements and transmit the information in each element successively. The process of dividing the two space dimensions into elements and recombining the elements at the receiver is known as *scanning*. The variations in the third dimension, brilliancy, are converted into proportional electrical currents by the transmitting transducer, and again into light by the receiving transducer.

A round or square element depends primarily on the size of the elements. With rectilinear scanning, only a square element gives complete coverage with no overlap. This is not an important requirement however. Mertz and Gray² have considered the effect of various-shaped elements and find that the production of extraneous images varies greatly.

The effect of the finite size of the scanning elements in limiting resolution may be expressed in terms of blur or of production of extraneous

¹ Chief engineer, Doolittle and Falknor, Inc.; member, Institute of Radio Engineers.

² MERTZ and F. G. GRAY, A Theory of Scanning and Its Relation to the Characteristics of the Transmitted Signal in Telephotography and Television, *Bell System Tech. Jour.*, 13, 464, July, 1934.

video frequencies.¹ The possibility of using correcting networks in the amplifier has been considered.

3. Scanning Methods in the Transmitter. The photoelectric effect is always used for the transmitting transducer, either in the form of a phototube or a photoelectric surface in a tube employing electron scanning. There are three points in the system at which scanning may be accomplished: (1) between the source of light and the scene, (2) between the scene and the phototube, and (3) between the photoactive surface and the electrical circuit

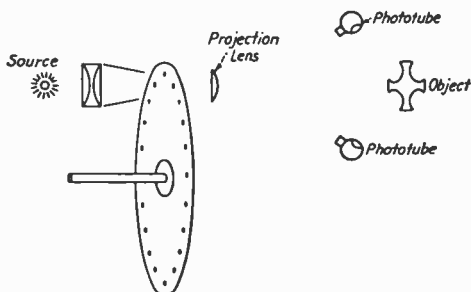

FIG. 1.—“Flying spot” method of scanning.

The first two methods employ the Nipkow disk or a mechanical or optical equivalent. A series of spirally arranged apertures in a rotating disk serves to break the image into a series of strips which provide a continuous scanning of the scene. Both methods are limited by the amount of light available at the phototube. The “flying spot” is the more satisfactory of the two and is illustrated in Fig. 1. The available light varies inversely as the number of elements. RCA² have found this method satisfactory for 120 line pictures, but not for 240 lines. It is always used when the picture is taken from a film.

Much of the recent development in transmitting has been devoted to obtaining greater initial video currents, by using method 3. The methods of Zworykin and Farnsworth are best known in the United States.

The Iconoscope. Zworykin³ makes the entire scene act continuously in producing a photoelectric effect. The energy obtained from each element during the entire period of one frame is stored and then all released during the short period in which the element is scanned. To accomplish this, the optical image is focused on the photoelectric surface composed of a mosaic of small, separated conductors. The photo-

¹ HORTON, J. W., F. J. GRAY, and R. C. MATHES: *Bell System Tech. Jour.*, **6**, 551; HORTON, J. W., *The Electrical Transmission of Pictures and Images*, *Proc. I.R.E.*, **17**, 1540, September, 1929.

² An Experimental Television System, *Proc. I.R.E.*, **22**, 1241, November, 1934; ENGSTROM, E. W., Introduction, KELL, R. D., BEDFORD, A. V., and TRAINER, M. A., *The Transmitter*, HOLMES, R. S., CARLSON, W. L., and TOLSON, W. A., *The Receivers*, YOUNG, C. J., *The Radio Relay Link for Television Signals*.

³ ZWORYKIN, V. K., *The Iconoscope—A Modern Version of the Electric Eye*, *Proc. I.R.E.*, **22**, 16, January, 1934.

electrons emitted are drawn to a near-by positive electrode, leaving the service positively charged. The surface is then scanned by a beam of electrons which are emitted and focused by an electron gun and deflected horizontally and vertically by two independent perpendicular electro-magnetic or electrostatic fields at the line frequency and the frame frequency, respectively. The deflecting current or voltage has a saw-toothed wave form. Those parts of the surface which were illuminated and have emitted electrons are consequently so charged as to receive electrons from the scanning beam, whereas the dark parts of the screen receive no electrons. The reception of electrons on the screen is registered by the induced charge on a plane electrode just back of the screen. This tube, called an *iconoscope*, is shown in Fig. 2. It delivers 0.001 volt into a 10,000-ohm load. This permits operation under conditions similar to those required for motion picture photography.

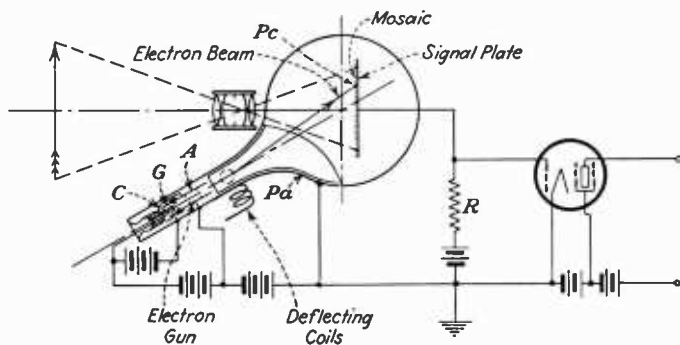

FIG. 2.—The iconoscope and its circuit.

The resolution with the iconoscope is said to be ample for 500-line television. It is so high in fact that excellent pictures may be obtained when only a portion of the screen is used. The size of the part used is determined by the magnitude of the sweeping voltages, and its location is determined by the d-c bias superimposed on the sweeping voltages. It is possible therefore by electrical adjustments to give the impression that the camera is approaching the scene or turning with respect to it.

Farnsworth System. A tube developed by Farnsworth¹ for television transmission called an *image dissector* appears in cross section in Fig. 3. An optical image of the scene is projected on to the transparent and photoelectrically active left end of the tube which is 4 in. in diameter. The electrons emitted at this surface form an image of the scene. They are accelerated toward the other end of the tube by a uniform electric field produced by applying 700 volts. The component of initial electron velocity which is perpendicular to the axis of the tube tends to introduce blur in the electron image. To overcome this, a uniform magnetic field is directed along the axis of the tube to focus the electrons. The field

¹ FARNSWORTH, P. T., Television by Electron Image Scanning, *Jour. Franklin Inst.*, 218, 411, October, 1934.

is produced by a coil of 500 ampere-turns and must be kept constant within 2 per cent.

In its simplest form, this tube has a very small target at the point marked "scanning aperture" in Fig. 3. The entire electron beam, which in cross section is an image of the scene, is deflected horizontally and vertically in rectilinear scanning by magnetic fields. Scanning the beam is equivalent to moving the small target in the usual scanning path through the scene. The two vertical deflection coils require from 5,000 to 10,000 turns each. The horizontal deflection coils for 240-line pictures contain 65 turns each. An illumination of 15 to 25 lumens in the image in the tube is required to give 0.0001 volt across a 15,000-ohm output load. This type of dissector is used for motion picture film transmission.

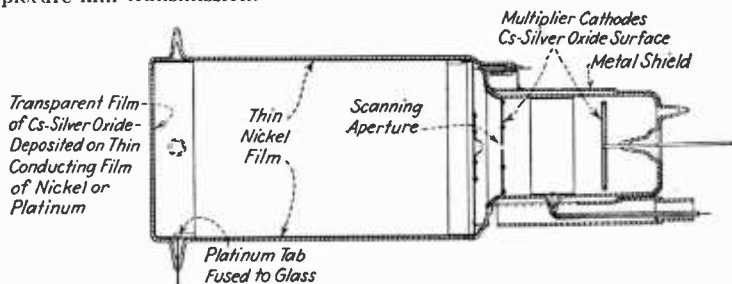

FIG. 3.—Image-dissector tube.

When a scene is to be picked up directly, the dissector is combined with another invention of Farnsworth, the *electron multiplier*. This serves the same purpose as a conventional amplifier, but it operates on such weak electron currents that they would be below background noise in an amplifier. It is an arrangement whereby one initial electron is accelerated and strikes an electrode which is especially prepared to produce a maximum of secondary emission. The number of secondary electrons per primary electron is said to be as many as ten experimentally and five or six in practical tubes. The secondary electrons may in turn be accelerated and used to liberate a still larger number of electrons. One way of accomplishing this is to accelerate the electrons back and forth across the same space, applying an a-c field to the space which has a frequency corresponding to the time required for the electron transit. Farnsworth has developed the electron multiplier for other purposes than the dissector, one of them being a cold-cathode oscillator.

In Fig. 3 the electron multiplier is shown combined with the image dissector. The small target previously described in the dissector is replaced by a 0.015-in. aperture which admits electrons into the multiplier. The circuit of the multiplier is shown in Fig. 4. The multiplier increases the output of the dissector by a factor of several thousand and makes possible scanning outdoors without direct sunlight.

Variable-velocity Scanning. Bedford and Puckle¹ in England have developed a method whereby the brilliancy of an element in the receiving

¹ BEDFORD and PUCKLE, A Velocity-modulation Television System, *Jour. Inst. Elec. Engrs.* (London), 75, 63, July, 1934.

cathode-ray tube is controlled by varying the velocity with which an electron beam scans the element, rather than by varying the intensity of the scanning beam as is more commonly done. The greatest difficulties in this system are found in the transmitting scanning method and transducer. Their solution is to use a cathode-ray tube in the transmitter, similar to the one in the receiver. The image created on the screen of this tube is focused on a film bearing the picture which is being transmitted. As the picture is scanned, the light which passes through the film is modulated by the varying density of the film. This light is converted into an electric current by a phototube, amplified, and integrated by charging a condenser with it. The condenser voltage is used for deflecting the electron beam in the cathode-ray tube. In this way the progress of the scanning electron beam depends on the

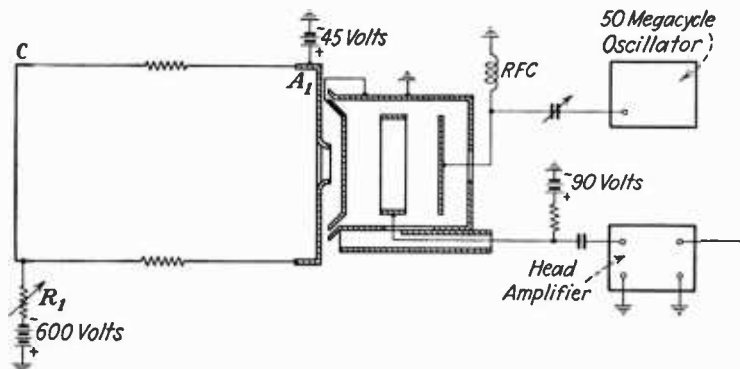

FIG. 4.—Circuit of image dissector—electron multiplier.

opacity of the film at the point being scanned. The beam moves faster over dark than over light portions of the scene. Since the scene is formed on the screen of the transmitting cathode-ray tube by varying the two deflecting voltages only, all that is necessary at the receiving point is to operate a cathode-ray tube with the two deflecting circuits effectively in parallel with the corresponding circuits in the transmitting tube. No synchronization is required. Fundamentally two communication channels are required for the two directions of deflection. A method has been developed whereby a single channel can be used, but one synchronizing frequency must then be used.

The advantages claimed for this system are:

1. Simplification of synchronization.
2. Elimination of the problem of obtaining linear modulation of the electron beam in the receiving transducer.
3. Reduction in the width of channel required to transmit a given amount of intelligence.
4. Greater average brilliancy in reproduction.
5. A debatable advantage due to increasing resolution in the bright portions and decreasing resolution in the dark portions of the scene. This is the result of slower scanning in the brighter portions.

4. Receiving Transducers. The receiving transducer may consist either of a variable light source or of a constant light source followed by a light valve. In either case, the requirement of extremely rapid variation severely limits the kind of transducer which may be used.

The transducer in earlier receivers was a discharge in a tube containing neon. A large plane cold cathode the size of the image emitted light proportional to the current through the tube. A Nipkow disk or equivalent was used for scanning between the transducer and the eye of the observer.

When a constant point source of light (an exciter lamp) followed by a light valve is used, the beam passes through scanning apparatus similar to that used for flying-spot scanning in transmission. The light falls on a white screen such as is used for home motion pictures. Screen illuminations in the order of 5 footcandles are obtained, and general room illumination is held down to 0.5 footcandle or less. For comparison we may note that illumination from moonlight is 0.02, in an average interior is 10, and from sunlight is, 5,000 footcandles.

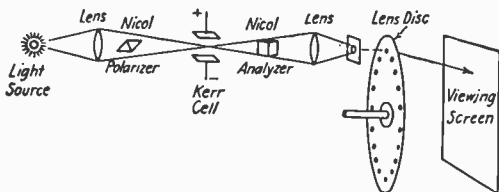

FIG. 5.—Nicol-prism Kerr-cell light-valve system.

The **Kerr effect** is used in the light valve. The light is focused and passed through a nicol prism, a complex unit of Iceland spar which has the property of polarizing light. When the light next passes through a second nicol prism rotated 90 deg. with respect to the first, the second attempt to polarize the light results in total extinction of it. The amount of light that can pass through this combination increases proportionately as the angle of the second nicol prism varies from 90 deg. By inserting something between the two nicol prisms which can rotate the plane of polarization of the light, the effect is the same as rotating the second nicol prism. By varying the amount of rotation of polarization, the light passing through the system can be controlled. A Kerr cell has the property of rotating the plane of polarization an amount which depends on the voltage applied to the cell. The cell consists of nitrobenzene, carbon bisulfide, or certain other liquids between two plate electrodes. A system using the Kerr cell is illustrated in Fig. 5.

Cathode-ray-tube Transducers. The transducers most generally used at present are cathode-ray tubes, named *kinescopes* by RCA and *oscillights* by Farnsworth. Figures 6 and 7 show a Farnsworth oscillight and the control circuit for a cathode-ray tube, respectively. The light is fluorescence from a screen bombarded by electrons. The variation in brilliancy is accomplished by controlling the current of electrons to the screen by a control grid in the electron gun. Scanning is applied

to the electron stream, after it is modulated in intensity and before it reaches the screen.

Screen Materials. Various substances may be used for the fluorescent screen, with various light-producing efficiency, color, and persistence of light after the bombardment ceases. The brilliancy of a screen is given by $ai(v-b)$, where i and v are the current and voltage between the cathode and the screen, and a and b are constants characteristic of the screen material.

Willemite (zinc orthosilicate) is the screen material most commonly used. Its brilliancy falls to half in about 0.01 sec. after bombardment ceases. This is approximately the maximum persistence which can be tolerated without producing objectionable tails after bright moving objects in the scene. Willemite has an efficiency of 1.8 to 2.7 per cent, as compared with 2.5 to 4 per cent for incandescent lamps. The light emitted by willemite is a maximum at 5,230 angstroms (green), which is close to 5,560 angstroms, the wave length to which the eye is most sensitive.

Cadmium tungstate is used by von Ardenne and others in Europe. It emits yellow light, with an efficiency slightly less than that of willemite and with much less persistence. *Calcium tungstate*, which emits a bluish white light, is also used for very fast screens. It appears less brilliant than willemite to the eye but registers much brighter photographically. *Magnesium tungstate* produces a fast efficient screen and emits white light.

Television in natural colors has been given some consideration. The most obvious way to accomplish this is by using three complete television systems, each responding to and reproducing a different color. The transmitting and receiving transducers may be inherently color selective or may be used with suitable color filters.

It has been found practical to have the electron current reaching the fluorescent screen pass away from it in the form of secondary electrons which go to the highest potential anode in the tube.

Cathode-ray tubes have been designed with a water jacket outside the screen end of the tube to cool it.

Since the amplifiers in television transmitters and receivers have a low-frequency cut-off above zero, the average brilliancy of a picture is never transmitted. The receiver maintains a constant average brilliancy regardless of changes in the scene.

5. Scanning Methods in the Receiver. The methods of scanning in the receiver are: (1) between a luminous surface and the eye, (2) between a point source of light and a screen where the image is formed, and (3) between a point source of electrons and a screen which fluoresces when bombarded by the electrons. The first two methods employ the Nipkow disk or an equivalent. The following equivalents are equally applicable to scanning in transmitting or receiving.

Lens Disk. Jenkins has used a disk with lenses in the apertures. Instead of a spiral arrangement the lenses may be tilted, each a little more than the previous one; or a rotating circular prism may be used. The *Weiller wheel* has a series of mirrors mounted perpendicular to the spokes, each tilted a little more than the preceding one. Zworykin has used two circular prisms rotating at different speeds to effect spiral scanning. The German Tekade receiver employs a *rotating mirror* shaped like a screw. Priess uses a *vibrating mirror* moving sinusoidally

with mechanical resonance at 24 cycles vertically and 4,800 cycles horizontally. Feeble synchronizing signals coupled magnetically to the vibrator maintain the motion.

Electron Scanning. Scanning on the electron beam is employed when a cathode-ray tube is used for the receiving transducer. When progressive rectilinear scanning is used, the beam is deflected across the screen at a uniform speed to form one line and then is quickly returned to start the next line. It is also moving down the screen at a uniform speed, and, when it reaches the bottom, it is quickly returned to the top to start the next frame. The beam may be deflected either electrostatically

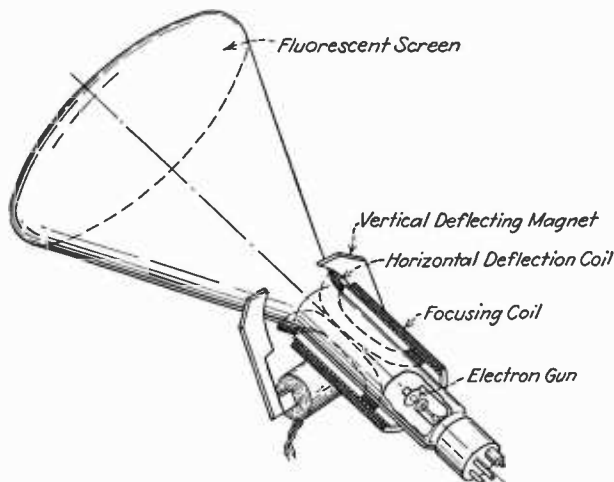

FIG. 6.—Oscillite tube and coil system.

or electromagnetically. In RCA receivers it has been found most satisfactory to use electrostatic deflection for the higher frequency horizontal (line-frequency) sweep, and magnetic deflection for the lower frequency vertical (frame-frequency) sweep. Farnsworth¹ uses magnetic deflection in both directions. The line-frequency deflecting coils are nearer the electron gun. The frame-frequency deflectors use an iron core. Figure 6 shows the construction of one of these tubes. The voltage or current used for deflection must have a saw-toothed wave form. The cathode-ray tube has an advantage in eliminating noise and wear resulting from using moving parts in the scanning system.

6. Receiver Circuits. The receiver must be capable of passing the wide frequency band with the freedom from distortion which is discussed under Amplifiers. Selectivity prior to the first r-f tube must be sufficient to exclude signals which might produce harmonics or cross-modulation. When positive modulation is used, the phase of the output must be such that the observed illumination reaches a maximum brilliancy when

¹ *Loc. cit.*

the carrier is a maximum. This is accomplished by employing an even number of video-frequency stages when plate detection is used, and an odd number when grid detection is used.

In the RCA system, a superheterodyne receiver is used which tunes over the proposed television band from 40 to 80 Mc. The r-f amplifier

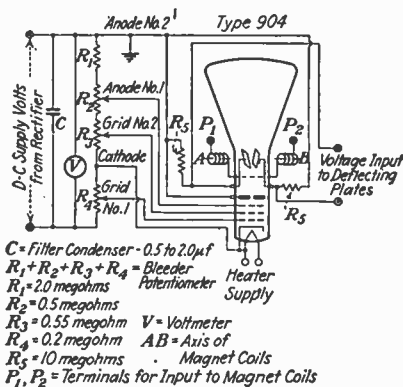

FIG. 7.—Cathode-ray tube control circuit.

is broad enough to pass both audio- and video-signal carriers, which are on 50 and 49 Mc, respectively. The beating oscillator on 56 Mc translates the video to 7 Mc and the audio to 6 Mc. The receivers are separated starting with the first detector. The audio i-f amplifier is broad enough for high-fidelity reception but sharp enough to reject the video i-f signal. The video i-f amplifier is necessarily very broad, and a trap is required to reject the audio i-f signal. A single tuning control operates both audio and video receivers, and in this way the sharp tuning necessary for good audio reception insures proper tuning to the video signal. Automatic volume control is used on both receivers, which makes response flat for signals above 100 μ v. Because of ignition and other interference, signals in excess of 1,000 μ v are needed for good reception. A vertical half-wave antenna is used, usually located indoors.



FIG. 8.—Figure for judging television fidelity.

7. Amplifiers. The design of amplifiers in both the transmitter and the receiver is much more of a problem than in other forms of communication because of the wide band to be transmitted and the close limitations on phase shift. The response must be flat within plus or minus 2 db over the video-frequency range, which is in the order of 25 to 2,000,000 cycles. Resistance-coupled amplifiers are used almost exclusively. Phase shift must be limited so that the time delay of different frequencies does not vary more than about 10 microsec. Resonance in the video-frequency system must be avoided because it produces phase shift. The design shown in Fig. 8 is transmitted to indicate the visual

excellence of a television channel. Blurring of the points indicates loss of the higher frequencies. Curvature or a sharp bend in the figure indicates a gradual or abrupt change in the propagation time of certain frequencies.

Figure 9 shows an amplifier equalized for a wide band of frequencies¹ to give uniform response and negligible phase distortion. The plate

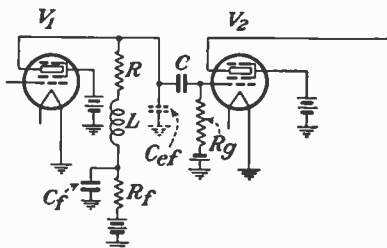

FIG. 9.—Wide-band equalized amplifier.

resistor in an amplifier stage should be equal in ohms to the effective reactance of the tube and distributed capacity C_{eff} , at the highest frequency which it is desired to pass. The reactance of the inductance in the plate circuit at this frequency should be equal to one-half the value of the plate resistor. To obtain a flat frequency response at the low-frequency end, plate filters are used. Each plate supply is filtered through a resistor R_f by-passed by a condenser C_f . The circuit constants are so selected that, as the resistance of the coupling condenser between stages rises as the signal frequency is lowered, tending to cause a loss in the voltage applied to the grid of the following stage,

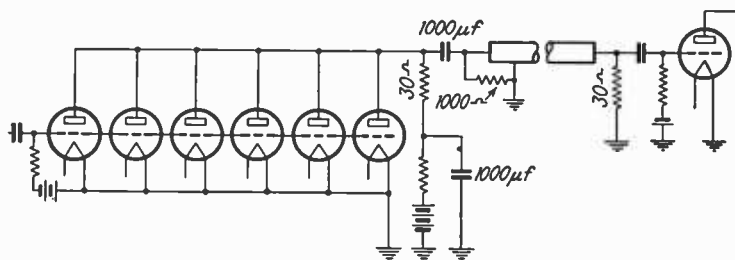

FIG. 10.—Amplifier for use with 1,500-ft. television line.

the reactance of the by-pass condenser on the plate filter rises, increasing the effective plate-circuit impedance.

When video frequencies must be transmitted for a considerable distance, as from the pickup to the transmitter, a wire of extremely low capacity is needed. Since the capacity of a concentric conductor is proportional to the ratio of the diameter of the inner conductor to the

¹ See *Proc. I.R.E.*, **22**, 1241, November, 1934; ROBINSON, T. D., *Theoretical Notes on Certain Features of Television Receiving Circuits*, *Proc. I.R.E.*, **21**, 833, June, 1933.

diameter of the outer conductor, the capacity may be decreased indefinitely by making the diameter of the inner conductor small. Figure 10 shows the amplifier circuit used in conjunction with a 1,500-ft. transmission line. The 1,000- μ f condensers and 30-ohm resistors are worthy of note.

The phototube amplifier must be noise-free except for the unavoidable thermal noise in the phototube-coupling resistance. The magnitude of this noise in volts is $7.4 \times 10^{-12} \sqrt{TRf}$, where T is the absolute temperature, R is the resistance in ohms, and f is the width of the frequency band in cycles. Bedford and Puckle¹ assume from this that the necessary phototube output is 10^{-3} volt and 10^{-9} amp. when a transparent film is scanned.

8. Synchronization. It is essential that the scanning equipment at the receiving end operate in exactly the same frequency and phase as that at the transmitting end. Maintenance of synchronization is practically impossible unless a synchronizing frequency from one source is used to control scanning at both ends. When a common source of a-c power is available, it may be used for synchronization. A Nipkow scanning disk is driven or controlled by a synchronous motor.

In the RCA system² the synchronizing signal is transmitted along with the video signal. In video frequency, the negative peaks are limited to the amplitude corresponding to total darkness. Of the time required for scanning one line, 10 per cent is set aside for the return to start scanning the next line. A blocking signal in the transmitter makes this period black, so the returning beam does not register in the kinescope. During this interval a sharp synchronizing impulse is transmitted. Negative modulation is used, with total darkness producing positive 100 per cent modulation. The impulse modulates the transmitter positive 125 per cent. The synchronizing impulse originates in a disk at the transmitter, driven 1,440 r.p.m. by a motor. Apertures in the disk admit light to a phototube.

At the receiving end, this peak is separated from the video signal by passing the signal through an amplifier adjusted to respond only to peaks in excess of those corresponding to black. The signal is then used to synchronize a relaxation oscillator.

For synchronizing the vertical sweep, a similar signal is used which occupies the interval between frames, a much longer interval than that between lines. Tuned circuits are used to separate the horizontal and the vertical synchronizing signals.

Farnsworth³ uses a similar method of transmitting synchronizing impulses in the intervals, and on the same carrier frequency, but he uses a separate transmitter for the purpose.

9. Saw-toothed-wave Generator. A saw-toothed wave form of voltage or current is required for the linear sweep used in scanning with a cathode-ray tube. The simplest form of linear-voltage source is a potentiometer driven continuously by a motor. The simplest non-mechanical source is a condenser charged by a constant current and abruptly discharged at intervals. The constant charging current is obtained by a relatively high voltage and a resistor, by a high-vacuum hot-cathode diode with limited emission, or by a tetrode in which the

¹ *Loc. cit.*

² See *Proc. I.R.E.*, **22**, 1241, November, 1934.

³ *Loc. cit.*

plate current varies little with plate voltage. The discharge may occur in a simple gas tube with two cold electrodes, or in a thyratron such as the 885. Figure 11 shows a circuit for sweeping one axis.

In such an oscillator the frequency is $f = \frac{10^3 i}{c(e_1 - e_2)}$, where f is the frequency in cycles per second, i is the charging current in milliamperes, c is the capacity of the condenser in microfarads, e_1 is the voltage at which the tube breaks down and carries plate current (determined by the tube, and, in a tube with a control grid, by the grid potential), and e_2 is the voltage at which the plate ceases to carry current (determined by the tube construction). If a resistance instead of a tube is used to control the charging current, the frequency is $f = \frac{500,000(2e - e_1 - e_2)}{rc(e_1 - e_2)}$, where e is the supply voltage (which is large compared to e_1) in volts and r is the resistance through which the charging current flows, in ohms.

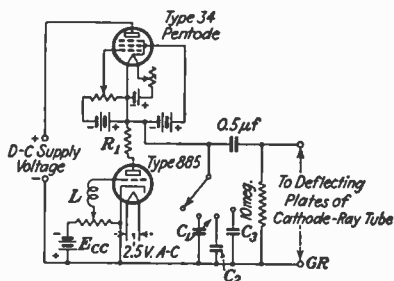

Ecc = Battery, Bleeder Circuit, or Self-Biasing Resistor Suitably By-Passed

R₁ = 700 ohms, or Less, Depending on Requirements

C₁, C₂, C₃ = Different Shunt Condensers

L = Synchronizing Pick-Up Coil Having as Low an Impedance as Practical

GR = Connection to Ground as Well as to Anode No. 2 of Cathode-Ray Tube

FIG. 11.—Time axis circuit.

Another kind of sweeping oscillator is a conventional oscillator circuit, using a grid condenser and a high-resistance grid leak. The grid current charges up the grid condenser beyond cut-off, and oscillations then cease until the condenser discharges through the leak. The cycle then repeats. The useful oscillations are the frequency of charging and discharging the condenser. This type of oscillator is used for horizontal and vertical scanning in the RCA receivers.¹

Any of these types of oscillators, sometimes called *relaxation* oscillators, may be easily controlled to operate in synchrony with an external frequency by introducing a small amount of the control frequency into the oscillating circuit. When the tube has a control grid, the control frequency is introduced into the grid circuit. The control frequency may be the same as the oscillator frequency or any frequency bearing a close integral relation, such as a third, four times, or two-thirds the

¹ See *Proc. I.R.E.*, **22**, 1241, November, 1934.

oscillator frequency. The closer the relation between the two frequencies, the more variation in the natural frequency of the oscillator can occur without losing control.

The equation of a saw-tooth oscillator wave is

$$e = a(\sin \omega t + \frac{1}{2} \sin 2\omega t + \dots + 1/n \sin n\omega t).$$

To keep distortion of the image small enough to not be objectionable, it is necessary to preserve frame-frequency harmonics as high as the twentieth and line-frequency harmonics as high as the tenth.

A current wave of saw-toothed form can be produced in an inductance by closing the circuit through a constant resistance (which may be zero) and periodically introducing a high voltage in series with the circuit for a short interval.

10. Frame Frequency. The number of frames per second must be sufficiently high to produce the illusion of motion and also to prevent the appearance of an objectionable amount of flicker. Motion pictures are taken at a speed of 24 per second which is sufficient to produce apparent motion, but not sufficient to prevent flicker. In projection a speed of 48 is used, and each picture is projected twice.

Engstrom¹ has made a careful study of the necessary frame frequency for television and has concluded that 24 pictures per second is unsatisfactory, but 48 pictures per second is entirely satisfactory. Because a certain amount of 60-cycle energy from the power supply is sure to get into the receiving transducer, he believes that a frame frequency of 30 or 60 should be used. He recommends interlaced scanning instead of progressive scanning. During the first half of one frame period all of the even-numbered lines are traced successively, and during the last half all of the odd lines are traced. This gives an effect comparable with the extra interruption in motion picture projection, if the observer is not close enough to distinguish individual lines. Farnsworth² also believes that interlaced scanning will be the correct solution to flicker, and he describes suitable sweeping circuits to produce it.

The frequency required to prevent flicker decreases as the fraction of the time illuminated increases. The scanning-disk method is at a great disadvantage in this respect since each element is illuminated for a very short period. The cathode-ray transducer is much more satisfactory because illumination does not disappear instantly when excitation ceases.

The frequency range required for transmission is proportional to the frame frequency, and consequently the frame frequency should be kept to a minimum. The recent work in the United States has used a frequency of 24, while that in England and Germany has used 25.

11. Number of Lines. The effect of various numbers of lines in television pictures has been studied carefully by Wenstrom³ and Engstrom.² The average perfect eye can resolve two points separated by an angle of 1 min. of arc. Television lines subtending an angle of 2 min. are reported to be entirely satisfactory. Assuming this resolution, the required number of lines is given by $l = 1,700h/d$, where h is the

¹ ENGSTROM, E. W., A Study of Television Image Characteristics, Pt. I, *Proc. I.R.E.*, **21**, 1631, December, 1933; Pt. II, *Proc. I.R.E.*, **23**, 295, April, 1935.

² *Loc. cit.*

³ WENSTROM, W. H., Notes on Television Definition, *Proc. I.R.E.*, **21**, 1317, September, 1933.

height of the picture and d is the viewing distance, both measured in the same units.

Aspect Ratio. The ratio h/d is important in determining the satisfaction that the picture will give the observer. In motion pictures, 1 to 4 is the optimum ratio. Engstrom believes that a ratio from 1 to 4 to 1 to 8 is necessary to give satisfaction comparable to that from home moving pictures. This indicates that a picture of about 300 lines is necessary.

Aspect ratios from 1.00 to 1.50 have been used. Present indications are that 1.33 will be standard in the United States and England and 1.20 in Germany.

It is usually assumed that with rectilinear scanning, to obtain the same resolution vertically and horizontally, a horizontal distance equal to the height of a scanning line must be capable of generating $\frac{1}{2}$ cycle. On this assumption, the number of elements is the square of the number of lines l times the aspect ratio r , and the maximum frequency which must be transmitted is $f = \frac{1}{2}l^2rn$, where n is the frame frequency. If it is assumed that 10 per cent of the time is consumed by control functions, rather than picture reproduction, then we obtain $f = 0.55l^2rn$.

The preceding assumption is subject to further correction due to the fact that the horizontal scanning is continuous, while the vertical scanning is along predetermined strips. This decreases the resolution in the vertical direction and has been found experimentally to require 25 per cent more lines to compensate for it. The required frequency then becomes $f = 0.36l^2rn$.

Sixty-line television is the least detail which has been seriously considered and offers only low-quality reproduction of portraits and similar objects not requiring detail. Groups of persons, stage scenes, and large outdoor scenes such as football games require progressively more elements, up to about 200,000 lines for most satisfactory reproduction.

12. Propagation in Space. A little early work on television was done on broadcast frequencies. The extremely high modulation frequencies required for high-quality television occupy such a wide communication band that the service obviously must be on a high carrier frequency. Bands up to 20 Mc are practically all occupied by other services. At present, television is confined almost exclusively to the region between 40 and 80 Mc.

The propagation characteristics of frequencies in excess of 30 Mc are such that they are useful for only relatively short distances, approaching more nearly a line of sight as the frequency increases. At present distances up to 25 miles for broadcasting and 100 miles for beam transmission seem to be the maximum limit for dependable operation. This distance is satisfactory for broadcasting in a metropolitan area which is comparable with the area primarily served by most aural broadcast stations.

The British Television Committee recommends service in a 25-mile radius with a frequency above 30 Mc.

Ghosts. When transmission occurs under such conditions that the signal travels over two or more paths of different lengths between the transmitter and the receiver, considerably more distortion occurs in the received image than would be observed under similar conditions with a sound program. A second path brings a second complete image, ordinarily of less brilliancy than the first and with a constant displacement on the screen.

13. Chain Broadcasting. To develop television along the lines of sound broadcasting, stations in different cities require circuits which will permit them to carry the same program simultaneously. Since the pickup apparatus and production of programs are likely to be much more expensive than for sound broadcasting, the operation of stations in several cities from one studio is particularly important. The problem is being approached both by radio connecting circuits and by metallic lines.

In 1933 RCA operated an experimental system which transmitted programs from New York to Camden, N. J. The New York transmitter operated on 44 Mc with a non-directional antenna at a height of 1,200 ft. above ground level. One relay station was located 63 miles from New York and 23 miles from Camden. Directive antennas were used for both reception and transmission. The relay transmitter operated on 79 Mc with a power of 100 watts. The station was located on a hill 130 ft. above the surrounding ground. The receiving antenna was 165 ft. and the transmitting antenna 70 ft. above the hill. The transmitting and receiving antennas for the first link (from New York) were vertical. Those for the second link (to Camden) were horizontal. A directive antenna 120 ft. above ground level was used for reception at Camden. Superheterodyne receivers were used.

A radio transmitter of 30 watts power was also used to transmit a program from an outdoor pickup a mile from the main station.¹

The metallic circuit which is most likely to prove serviceable in television network broadcasting is a concentric line. Such a line offers an impedance and velocity of propagation which are independent of frequency. The loss² in decibels per 1,000 ft. in concentric copper transmission line having the optimum ratio (3.6 to 1) of diameters of conductors and negligible insulation loss is $0.256\sqrt{f}/d$, where f is the frequency in megacycles and d is the inside diameter of the outer conductor.

Because of the difficulty of making an amplifier which will perform uniformly over an extremely wide frequency range, the frequencies may be shifted to a different part of the spectrum where the ends of the band will still have the same separation in cycles but much less in per cent. An experimental line of the Bell Telephone Laboratories³ carried a band which had been raised by 100,000 cycles from the original video currents. The video frequencies from 20 to 500,000 cycles were first beat with a 2,000,000-cycle frequency. The lower sideband, extending from 1,999,980 to 1,500,000 cycles, was isolated by filters and then was beat against a 2,100,000-cycle carrier. The beat extending from 100,020 to 600,000 cycles was isolated and then transmitted over a concentric line. At the receiving end, these processes were reversed.

In Germany, both methods of connecting transmitters are being considered. A 10-mile concentric transmission line 2 in. in diameter has been installed between the studio and the transmitter in Berlin. On Mt. Brocken,⁴ at an elevation of 3,700 ft. and 125 miles from Berlin,

¹ See *Proc. I.R.E.*, **22**, 1241, November, 1934.

² STERBA, E. J., and C. B. FELDMAN: *Transmission Lines for Short-wave Radio Systems*, *Proc. I.R.E.*, **20**, 1163, July, 1932.

³ ESPENSHIED and STRIEBY: *Systems for Wide-band Transmission over Coaxial Lines*, *Bell System Tech. Jour.*, p. 654, October, 1934.

⁴ The Brocken is the highest peak in the Harz mountains.

the Berlin television transmitter is received well. It is believed that a central transmitter on Mt. Brocken would deliver a program suitable for rebroadcasting in most German cities.

A much simpler method of distributing programs from a central studio to transmitters in various cities is to record them on motion picture film and maintain a system of rapid distribution by airplane.

14. Accompanying Sound. When television is used for entertainment purposes, an accompanying audio channel is considered necessary. Early experimental television transmitters in the United States have often been accompanied by the program of a broadcast station between 550 and 1,500 kc.

RCA is transmitting video on a 49-Mc carrier and audio on a 50-Mc carrier. They recommend that it be standard practice to have the audio carrier 1 Mc higher in frequency than the video carrier. German television¹ on 44.8 Mc is accompanied by audio on 43.35 Mc.

DEFINITIONS

Aspect Ratio. The aspect ratio of a frame is the numerical ratio of the frame width to the frame height.

Brightness. The brightness of a luminous object is the number of candlepower per square inch of the object.

Candlepower. A candlepower is the unit of luminous intensity of a light source, as measured in a given direction. It is equal to the intensity of a standard candle.

Electron Multiplier. An electron multiplier is a vacuum tube in which an electron current is amplified by producing secondary electrons by impact.

Facsimile Transmission. Facsimile transmission is the electrical transmission of a picture having a limited number of shade values.

Footcandle. A footcandle is the amount of illumination on a surface 1 ft. from a source of one candlepower.

Frame. A frame is a single complete picture.

Frame Frequency. Frame frequency is the number of times per second that the picture area is completely scanned.

Framing. Framing is the adjustment of the picture to a desired position with respect to the field of view.

Iconoscope. An iconoscope is a cathode-ray tube used for television transmission (named by Zworykin).

Image Dissector. An image dissector is a cathode-ray tube used for television transmission (named by Farnsworth).

Kinescope. A kinescope is a cathode-ray tube used for television reception (named by Zworykin).

Line Frequency. Line frequency, in rectilinear scanning, is the number of scanning lines traced in 1 sec. It is equal to the number of lines in the frame times the frame frequency.

Lumen. A lumen is the amount of light emitted in a unit solid angle by a source of 1 candlepower. The number of lumens is equal to the area times the footcandles.

Negative Modulation. Negative modulation occurs when a decrease in initial light intensity causes an increase in the radiated power.

Oscillight. An oscillight is a cathode-ray tube used for television reception (named by Farnsworth).

Phototube. A phototube is a vacuum tube in which electron emission is produced directly by the radiation falling upon an electrode. (This is also called a photoelectric tube.)

¹ German Government Aids Television, *Electronics*, 8, 11, January, 1935.

Picture Element. A picture element is the smallest subdivision defined by the process of scanning. The number of elements is normally equal to the aspect ratio times the square of the number of lines.

Picture Transmission. Picture transmission is the electrical transmission of a picture having a gradation of shade values.

Positive Modulation. Positive modulation occurs when an increase in initial light intensity causes an increase in the radiated power.

Progressive Scanning. Progressive scanning is rectilinear scanning in which scanning lines trace one dimension substantially parallel to the side of the frame and in which successively traced lines are adjacent.

Rectilinear Scanning. Rectilinear scanning is the process of scanning an area in a predetermined sequence of narrow parallel strips.

Scanning. Scanning is the process of analyzing an area according to a predetermined method.

Scanning Line. A scanning line is a single continuous narrow strip determined by rectilinear scanning.

Staggered Scanning. Staggered scanning is rectilinear scanning in which scanning lines trace one dimension of the frame, and in which successively traced lines are separated by an integral number of line widths.

Synchronizing. Synchronizing of images is the maintaining of the time and space relations between the transmitted and reproduced pictures.

Television. Television is the electrical transmission and reception of transient visual images.

Transducer. A transducer is a device actuated by power from one system and supplying power in the same or any other form to a second system. Either of these systems may, for example, be electrical, mechanical, acoustical, or optical.

Video Frequency. Video frequencies are those frequencies which must be transmitted in television. Approximately 15 to 2,000,000 cycles.

TELEVISION SYSTEMS

System	Frame frequency	Lines	Aspect ratio
RCA (New York)	24	60	1.33
RCA (New York)	24	120	1.33
RCA (Camden)	24	240	1.33
Farnsworth	24	300	1.00
British	25	240	1.33
German	25	180	1.20
Don Lee	15	80	1.00
Heintz and Kauffman	24	300	1.00
General Television Corp.	30	360	1.20
First National Television Inc.	..	45	1.00
Bedford and Puckle	25	120	1.33
Kansas State College	20	60	1.20
W6XAI	20	90	1.20

TELEVISION-RECEIVER CHARACTERISTICS

Manufacturer	Frame frequency	Lines	Picture size, cm.	Method
Telefunken	25	180	23 × 26	Cathode ray
Telefunken	25	180	15 × 17	Cathode ray
Loewe	25	180	10 × 15	Cathode ray
Tekade	25	180	12 × 15	Mirror screw
Fernseh A.G.	25	180	24 × 30	Cathode ray
Von Ardenne	25	180	15 × 17	Cathode ray
(Theatre)	25	180	305 × 369	
(British)	25	240	15 × 20	Cathode ray

TELEVISION STATIONS (June, 1935)

Call	Location	Carrier frequency, megacycles	Frame frequency	Lines	Aspect ratio
W2XDR	Long Island City, N. Y.	2.05			
W8XAN	Jackson, Mich.	2.05			
W9XK	Iowa City, Iowa	2.05			
W9XAK	Manhattan, Kan.	2.05	20	60	1.20
W9XAO	Chicago, Ill.	2.05			
W6XAH	Bakersfield, Calif.	2.05			
W9XAP	Chicago, Ill.	2.8	20	90	1.20
W2XBS	Bellmore, N. Y.	2.8	24	60	
W9XAL	Kansas City, Mo.	2.8		45	1.00
W6XS	Los Angeles, Calif.	2.8	15	80	1.00
W9XG	West Lafayette, Ind.	2.8			
W2XAB	New York, N. Y.	2.8			
W2XF	New York, N. Y.	44.0			
W3XAD	Camden, N. J.	44.0			
W2XAX	New York, N. Y.				
W6XAO	Los Angeles, Calif.	44.5	15	80	1.00
W9XD	Milwaukee, Wis.				
W2XD	New York, N. Y.				
W2XAG	New York, N. Y.				
DJG	Berlin, Germany	44.8	25	180	1.20
	Munich, Germany	44.8	25	180	1.20
	Frankfort, Germany	44.8	25	180	1.20
	Cologne, Germany	44.8	25	180	1.20
W1XG	Boston, Mass.	47.16	30	360	1.20
W1XG	Boston, Mass.	48.32	30	360	1.20
W6XAO	Los Angeles, Calif.	49.4	15	80	1.00
	San Francisco, Calif.	60.0	24	300	1.00
W2XF	New York, N. Y.	61.0			
W3XE	Philadelphia, Pa.	66.0			
W1OXX	Camden, N. J.				
W6XAO	Los Angeles, Calif.	66.75	15	80	1.00
W2XDR	Long Island City, N. Y.				
W8XAN	Jackson, Mich.				
W9XAL	Kansas City, Mo.				
W9XK	Iowa City, Iowa				

Bibliography

- ZWORYKIN, V. K.: On Electron Optics, *Jour. Franklin Inst.*, **215**, 535, March, 1933.
- IAMS, H., and B. SALZBERG: The Secondary Emission Phototube, *Proc. I.R.E.*, **23**, 55, January, 1935.
- "Technical Information on Cathode Ray Tubes, High Voltage Rectifier, Gas Triode," RCA, 1933.
- ENGSTROM, E. W.: An Experimental Television System; ZWORYKIN, V. K.: Description of an Experimental Television System and Kinescope; KELL, R. D.: Description of Experimental Television Transmitting Apparatus; BEERS, G. L.: Description of Experimental Television Receivers; *Proc. I.R.E.*, **21**, 1652, December, 1933.
- WATT, HERD, and BAINBRIDGE-BELL: "Applications of the Cathode Ray Oscilloscope in Radio Research," His Majesty's Stationery Office, London.
- FARNSWORTH, P. T.: U. S. Patent 1,773,980.

SECTION 19

RADIO BROADCASTING

BY CARL G. DIETSCH, B. Sc.¹

1. **Broadcasting** is a direct outgrowth of exceptional advances made in the development of radio-telephone communication during the closing years of the World War. Because of its usefulness as a medium for providing entertainment and educational and religious information for the public, radio broadcasting has established itself as a leading form of radio transmission of direct value to a large percentage of the public.

In its usual form, broadcasting is a prearranged scheduled service on a daily basis² of radio transmissions intended for general reception. Programs are of either a musical, educational, religious or special-events nature.

2. **Principal Elements of a Broadcasting System.** All of the equipment of a broadcasting system extending from the microphone to the radiating antenna of the radio transmitting station will be considered as part of the system. A general circuit layout of typical facilities of the kind as used in the larger broadcasting centers for supplying a network of stations with program service is represented by the simplified diagram, Fig. 1. Equipment of a single studio is represented; that of other studios of the usual group would be similar and would be at the point marked on the program bus. Inasmuch as many programs, such as the broadcasting of special events, originate at remote points, in most cases a great distance from the studio, the layout of the facilities for remote pickups, sometimes termed "nemo" programs, has been included to illustrate the use of telephone lines as well as point-to-point radio-telephone communication to complete the circuits necessary.

A list of the essential elements of the system is as follows:

1. Microphones:
 - A. Studio
 - B. Remote pickups
2. Apparatus for controlling and conveying microphone output:
 - A. Studio control booth:
 - (1) Preliminary amplifier
 - (2) Microphone mixers
 - (3) Studio amplifier
 - (4) Volume control or faders
 - (5) Volume indicator
 - (6) Monitoring speaker
 - B. Remote pickups:
 - (1) Preliminary amplifier
 - (2) Volume controls or faders

¹ Engineering Department National Broadcasting Company.

² HOAN, C. W., Ten Years of Broadcasting, *Proc. I.R.E.*, 19, 356, March, 1931.

- (3) Volume indicator
 - (4) Monitoring equipment
 - (5) Radio telephone or wire-line facilities for intercommunication.
3. Master control room apparatus:
- A. Volume controls
 - B. Studio amplifiers
 - C. Relays and switching apparatus
 - D. Network channel amplifiers
 - E. Volume indicator
 - F. Monitoring facilities
4. Telephone line facilities to local radio transmitting stations and to distant radio transmitters connected to networks
5. Radio transmitter:
- A. Line amplifier
 - B. Volume controls
 - C. Volume indicator
 - D. Radio transmitter
 - E. Monitoring equipment:
 - (1) Monitoring rectifier and speaker
 - (2) Modulation-percentage indicator
 - (3) Carrier-frequency monitor
 - F. Antenna

3. Audio-frequency Range. Perfect reproduction of a sound transmitted through an electro-acoustical system requires that the system pass all of the audible frequencies of the sound in their relative intensities. Under these conditions of reproduction, the listener would be conveyed acoustically from his loud-speaker to a point near by the sound source.

A correlated acoustic chart of the frequency range of various musical instruments within the orchestral range and the different voices which constitute the vocal range is shown in Fig. 2. The shaded keys are not included on a standard piano keyboard. The extreme organ range not shown on the chart is from 16 to 16,384 cycles physical pitch. The extreme frequency-transmission ranges necessary to produce perfect naturalness of speech and orchestral music are shown in Fig. 3. These ranges extend considerably above those of Fig. 2 because they include overtones and noise accompaniment additional to the fundamental tones. These curves were secured as a result of listening tests by a group of observers upon sounds transmitted through an electro-acoustic system equipped with electrical filters by means of which frequencies above and below any desired cut-off could be suppressed. Extensive research¹ made during recent years indicates that for perfect reproduction of speech and music a frequency range between 30 to 15,000 cycles is desirable in order that the average ear may appreciate fully all of the frequencies produced by the sound sources.

The curves shown in Fig. 4 are an indication of the relative qualities of reproduced orchestral music the frequency range of which was limited by electrical filters. It is apparent from these curves that where a transmission system has a limited frequency range, such as that which exists in broadcasting technique, an acceptable reproduction of the sound sources may be secured within a band width of between 50 to 8,000 cycles.

The engineering and economic limitations of the frequency range used for broadcasting lie in restrictions of the use of the upper audio fre-

¹ SNOW, W. B., *Jour. Acous. Soc. Am.*, July, 1931, p. 61.

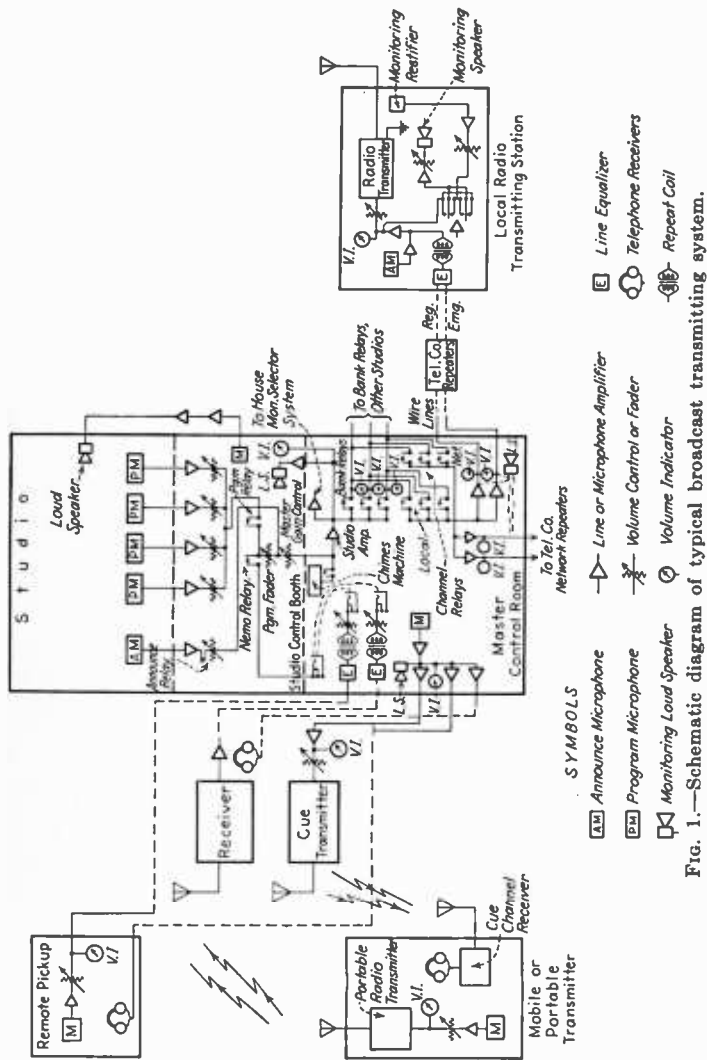

Fig. 1.—Schematic diagram of typical broadcast transmitting system.

ACOUSTIC CHART

WIND INSTRUMENTS

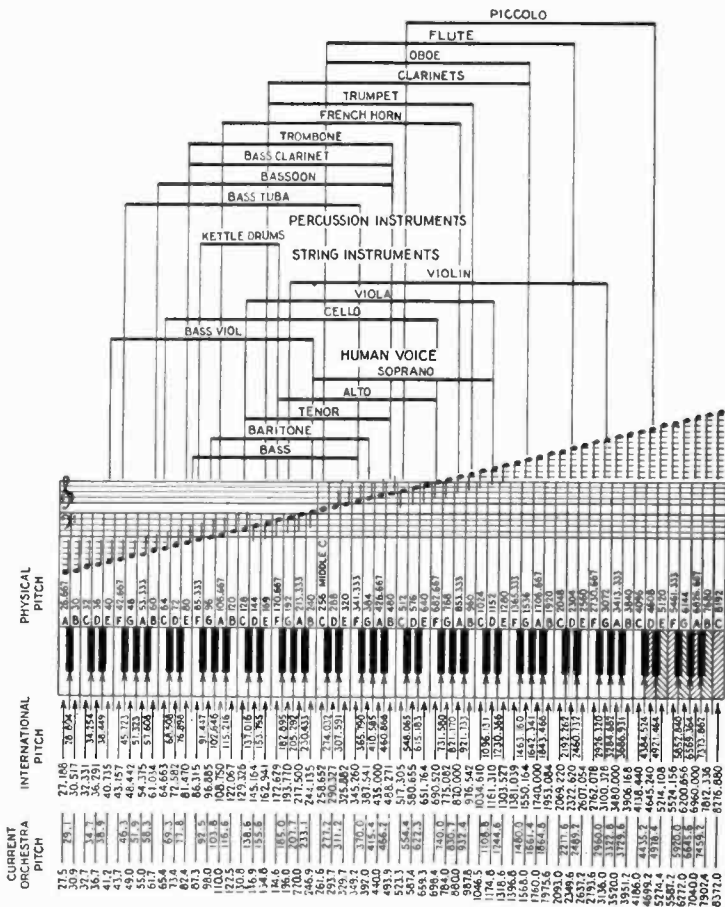

FIG. 2.—Correlated acoustic chart showing the scientific or philosophical scale generally used by physicists, the international equally tempered scale based on A = 435 complete vibrations per second. This scale was formerly used by musicians. The current orchestra or symphony scale based on A = 440 complete vibrations per second is at present generally used by musicians.

quencies due largely to a limited band width of the modulation spectrum contained between the presently assigned carrier frequencies of 10-ke separation.¹

An overlapping of the modulation frequencies of a "wanted" station by those of an "unwanted" station of 10,000-cycle separation restricts

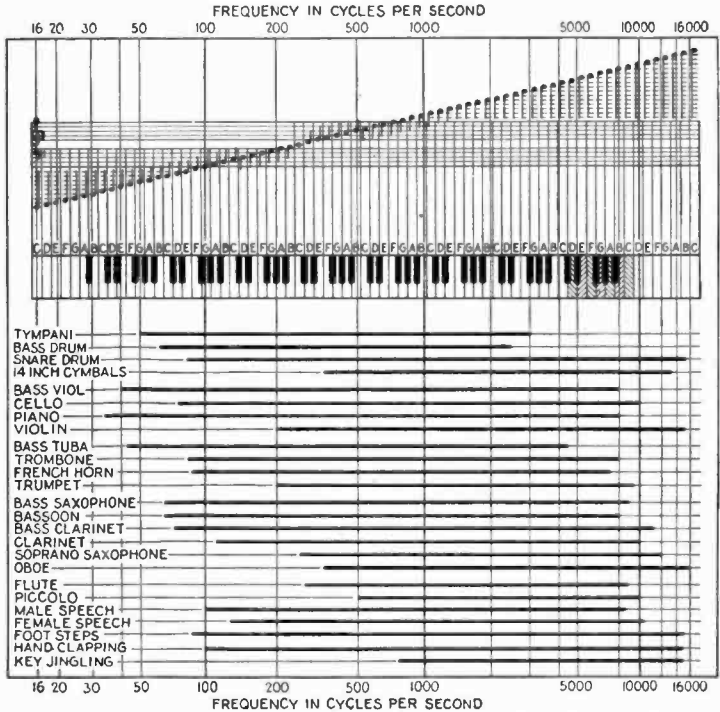

FIG. 3.—Frequency range required for the reproduction of musical instruments, voice, and noise without noticeable distortion.

the range of frequencies to a broadcast listener usually considerably below that which is passed by the broadcasting system itself. The high quality of programs available from broadcasting facilities which have an over-all uniform frequency response from the microphone to the antenna within 4 db from 30 to 8,000 cycles and above cannot therefore be appreciated by the average listener because of limitations in the average broadcasting-receiver frequency response and restrictions in the band width which can be received free from cross-talk and "monkey chatter."

¹ ECKERSLEY, P. P., Minimum Frequency Separation, *Proc. I.R.E.*, February, 1933, p. 195.

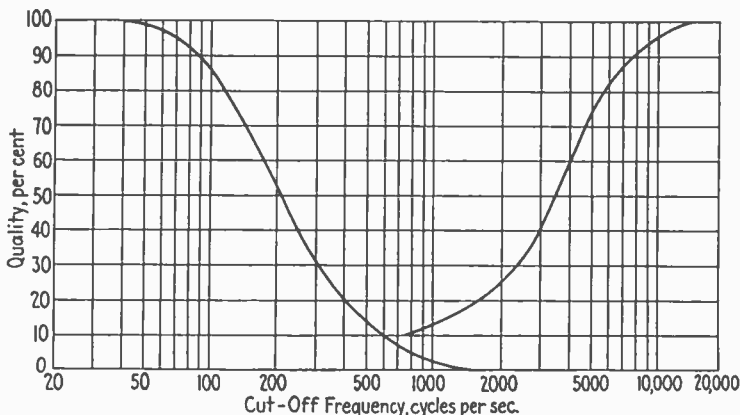

FIG. 4.—Quality of orchestra music as a function of cut-off frequency.

Note	Cycles per second	Organ pipe	Remarks
C ₁₀	33,488		Beyond limit of audibility for average person.
C ₉	16,744		Considered ideal upper limit for perfect transmission of speech and music.
	15,000		Considered as upper limit for high-quality transmission of speech and music.
	10,000		Highest note on fifteenth stop.
C ₈	8,372	¾ in.	Considered as satisfactory upper limit for high-quality transmission of speech and music.
	7,500		Highest note of pianoforte.
C ₇	4,186		Approximate resonant frequency of ear cavity.
G ₆	3,136		Considered as satisfactory upper limit for good-quality transmission of speech.
E ₆	2,637.2		
	3,000		
C ₆	2,093		Maximum sensitivity of human ear.
	2,000		Mean speech frequency from articulation standpoint.
	1,500		
A ₄	880		Representative frequency of telephone currents.
	800		
E ₄	659.3		Orchestral tuning (see note below).
A ₃	440		
C ₃	261.6		Considered as satisfactory lower limit for good-quality transmission of speech.
	200		
C ₂	130.8		Considered as satisfactory lower limit of high-quality transmission of speech and music.
	100		
E ₂	82.4		
C	65.4	8 ft.	Lowest note of cello.
B ₀	61.7		
C ₀	32.7	16 ft.	Lowest note of average church organ.
			Considered ideal lower limit for perfect transmission of speech and music.
A ₁	27.5		Lowest note of pianoforte.
G ₁	24.5		
C ₁	16.35		Lowest audible sound. Longest pipe of largest organ.

Notes of the "Gamut".....	C	D	E	F	G	A	B	C
Vibration frequencies proportional to.....	1	¾	5/4	¾	¾	5/4	15/8	2
Intervals between successive notes.....	¾	1/8	1/15	1/8	1/8	1/8	1/15	

NOTE: Nearest note is indicated. Scale A = 440 cycles per second based on middle C₁ (symphony pitch) = 261.6 cycles per second.

FIG. 5.—Frequencies to be transmitted on a high-quality system.

4. Volume Range. Table I below gives the peak power of various musical instruments playing triple forte. A violin playing very softly

TABLE I.—PEAK POWER OF MUSICAL INSTRUMENTS
(Fortissimo Playing)

Instrument	Peak Power, Watts
Heavy orchestra.....	70
Large base drum.....	25
Pipe organ.....	13
Snare drum.....	12
Cymbals.....	10
Trombone.....	6
Piano.....	0.4
Trumpet.....	0.3
Bass saxophone.....	0.3
Bass tuba.....	0.2
Bass viol.....	0.16
Piccolo.....	0.08
Flute.....	0.06
Clarinet.....	0.05
French horn.....	0.05
Triangle.....	0.05

has an output of about 4 mw, whereas that of a full orchestra has a peak value of 70 watts. The intensity range of the sound sources in

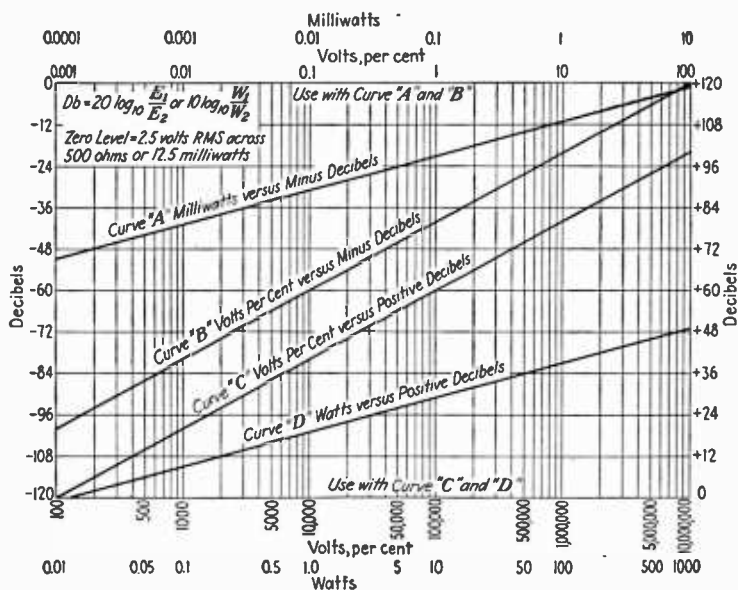

FIG. 6.—Relation of db to watts or volts.

this case is about 43 db. Due to limitations in broadcasting circuits and the modulation capabilities of the transmitter this volume range

must be compressed within the limits which can be handled by the wire lines, their associated equipment as well as the radio broadcasting transmitter wherein there is caused serious amplitude distortion if modulation peaks except those of extremely short time duration exceed the modulation capabilities of the transmitter.

5. The Decibel or db. In referring to levels of r-m-s voltage across a known impedance, or rather the energy level delivered or received by a system, especially where audio power is concerned, frequent mention is made of the term *decibel* or *db*. As used in broadcasting technique, the level in decibels is based upon a zero energy level of 12.5 mw. Where a definite line impedance or pure resistance of say 500 ohms is involved, at the terminals of a piece of apparatus, zero level would be the equivalent of $\sqrt{.0125 \times 500}$ or 2.5 volts r-m-s. Figure 6 may be used as a means for readily determining relative decibel levels with respect to energy in watts and milliwatts and voltage in terms of percentage where 100 per cent is the equivalent of a zero level of voltage.

While the 12.5-mw zero level is the one commonly used in broadcasting technique, zero levels of 6 and 1 mw are used in other lines of work such as in telephone practice. In referring to energy levels hereafter, the decibel will be considered as being based upon a zero energy level of 12.5 mw.

THE AUDIO FACILITIES

6. Microphone Requirements. It is by means of the microphone that the acoustic energy of sound waves produced for broadcasting purposes is converted into those of electric energy; the wave shape of one conforming with that of the other. The principal requirements of a microphone which will produce high-quality conversion are a relatively high sensitivity with respect to its inherent noise level, a uniform wave¹ response over the high-quality frequency range, a substantially uniform frequency response over the angles included by its directivity characteristic, and mechanical and electrical ruggedness.

In considering six types of microphones commonly used for broadcasting, the principal features of each will be discussed. Inasmuch as the quality of reproduction of speech and music is dependent upon the acoustic properties of the room² containing the sound sources and the placement of the microphone with respect to them, satisfactory results while using even the best instruments requires a knowledge of the technique of microphone placement. For this reason, the article on studio technique should be consulted before a thorough understanding of the relative merits of any of the instruments can be gained.

7. The Velocity Microphone. This instrument, illustrated by Fig. 7, gets its name quite appropriately from the movement of a metallic ribbon under the motion of air particles impinging upon it, thus setting up by electromagnetic induction an e.m.f. corresponding to the amplitude variations of an incident sound wave.

The commercial form of the RCA Victor type 44A brought out through the development work of Olson,³ consists of a thin metallic ribbon suspended between the poles of a powerful permanent magnet with its

¹ BALLANTINE, STUART, *Proc. I.R.E.*, **18**, 1206, July, 1930.

² HANSON, O. B., and R. M. MORRIS, *Design and Construction of Broadcast Studios*, *Proc. I.R.E.*, **19**, January, 1931.

³ OLSON, H. F., *Jour. Soc. Mot. Pict. Engrs.*, **16**, 695, 1931; *Jour. Acous. Soc. Am.*, **3**, 56, 1931.

length perpendicular to, and its width in the plane of, the magnetic lines of force. It is moved from its position of equilibrium by the difference of pressure between its two sides. This pressure difference between the front and back of the ribbon is the same as that produced in a sound

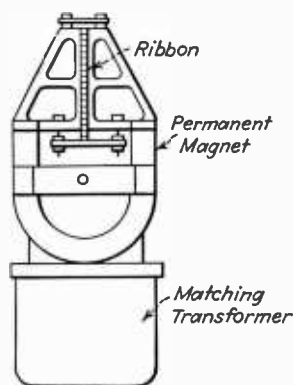

FIG. 7.—Front view of velocity microphone; cover screens removed.

field between two points in space separated by this distance. The pressure difference between the front and back of the ribbon is proportional to frequency. Since the acoustic impedance of the system is also proportional to the frequency, and the velocity in a mechanical system is the ratio of the pressure to the acoustic impedance, the velocity of the ribbon is independent of frequency.

a wide range of frequencies. A curve of frequency response taken on this type of microphone is shown in Fig. 8.

One of the interesting features of the velocity type is its marked directional characteristics. With a plane-progressive wave, the response in front and back of the instrument varies with the cosine of the angle between the direction of the sound wave and the normal to the ribbon. The directional characteristics are shown in the polar diagram, Fig. 9. Since these directional properties are practically independent of frequency, they become useful in discriminating against undesired sounds

With a ribbon constructed so as to have a natural period below the audible range, the frequency response of this microphone is free from severe irregularities prominent in the condenser and carbon types because of cavity and diaphragm resonance and from pressure-doubling effects at the higher frequencies produced in most electrodynamic types. The ribbon is made light enough so that its motion will conform with the motion of air particles even at very high frequencies with a result that the response of the velocity microphone is uniform over

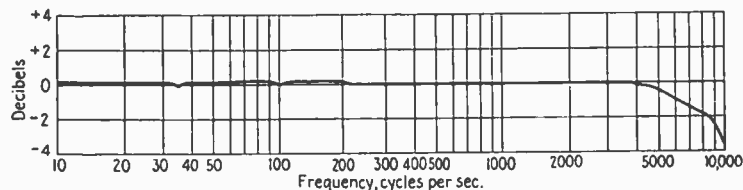

FIG. 8.—Velocity-microphone characteristics.

and for obtaining a desired relation between the sounds from different sources and from reverberant sound in a studio. Olson¹ has pointed out that its response to reverberant or reflected sound is one-third that of a non-directive system, with a result that it can be used at a distance from

¹ OLSON, H. F., *Jour. Soc. Mot. Pict. Engrs.*, 16, 695, 1931; *Jour. Acous. Soc. Am.*, 3, 56, 1931.

a sound source, of 1.7 times the distance of a non-directional type and still give the same results with respect to undesired reverberant sounds.

Because of the directional properties of the instrument, its sensitivity is a maximum in directions in front and back perpendicular to the plane

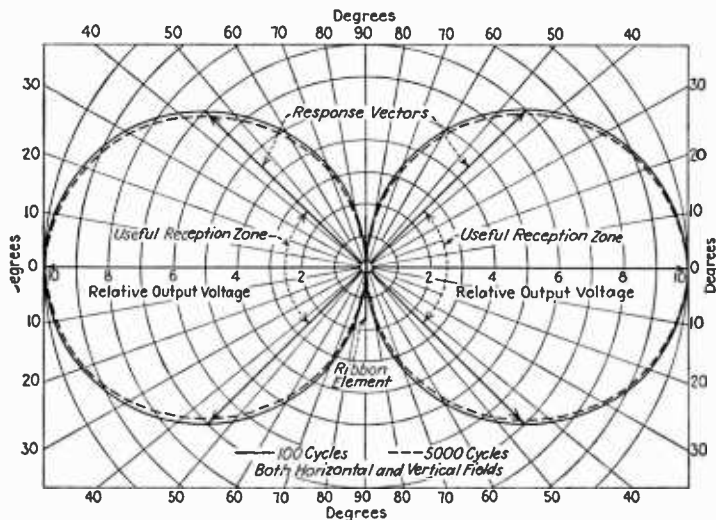

FIG. 9.—Directional characteristics of RCA velocity microphone.

of the ribbon. With an input sound pressure of 10 dynes per square centimeter the unit will normally deliver an output level of -72 db as compared to a zero level of 12.5 mw.

The microphone is equipped with a matching transformer. This is required to match the impedance of the ribbon to either a 250- or 25-ohm line in a manner shown in Fig. 10.

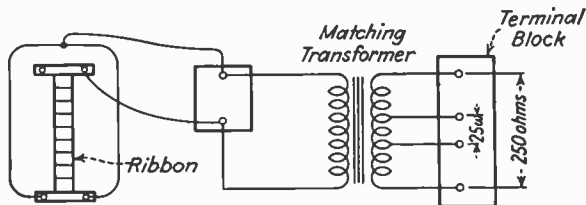

FIG. 10.—Internal connections of velocity microphone.

8. The Moving-coil or Dynamic Microphone. This type of instrument, a well-known model of which is the Western Electric 618A¹ utilizes a light movable coil contained in a magnetic field to produce an e.m.f.

¹ THURAS, A. L., *Bell. Lab. Record*, 10, 314, May, 1932.

which conforms with the sound waves impinging upon the dome-shaped diaphragm.

The assembly is composed essentially of a coil of fine aluminum ribbon edge-wound and attached rigidly to a duralumin diaphragm of low mechanical stiffness which supports the coil in a radial magnetic field of a

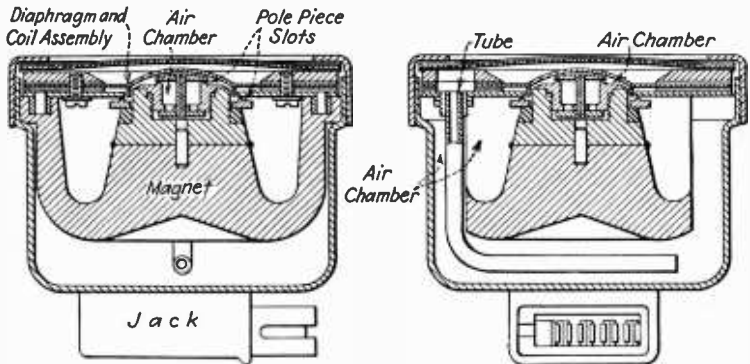

FIG. 11.—Type 618A dynamic microphone. (Western Electric.)

permanent magnet made from high-grade cobalt-steel alloy. The diaphragm is clamped rigidly around its outer edge. When the diaphragm is caused to vibrate in response to the sound waves impinging upon its surface, the coil is caused to vibrate in a like manner and cuts the magnetic lines of force. The e.m.f. generated in the coil is substantially proportional to the sound vibrations which cause the diaphragm movement.

Uniform response of the instrument over a wide frequency range is accomplished by the use of a diaphragm of proper stiffness¹ together with a

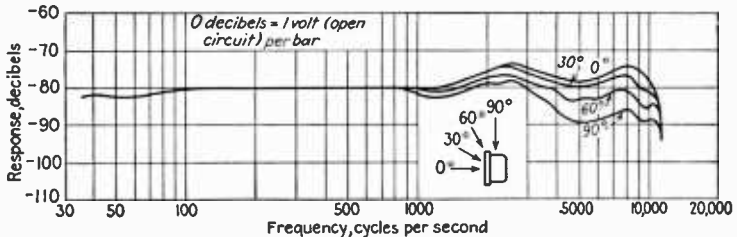

FIG. 12.—Field calibration of dynamic microphone showing effect of angle of incidence of the sound wave.

suitable system of acoustical reactions within the air chambers beneath the diaphragm by means of an arrangement of slots and tubes. The air chambers and slot openings connecting them are associated with the characteristics of the diaphragm in order to obtain a substantially uniform response over a frequency range of from 35 to 7,900 cps. In Fig. 11

¹ WENTE, E. C., and A. L. THURAS, *Jour. Acous. Soc. Am.*, 3, 44, July, 1931.

are illustrated details of these acoustic elements, one of which is a metal tube. In addition to exerting control over the motion of the diaphragm so as to improve the response at low frequencies, this tube allows air to be transferred from the front to the back of the same and thus eliminates effects upon the diaphragm due to barometric pressure changes.

Wave-response calibration curves on this type of instrument indicate that the frequency characteristics are influenced by the angle from

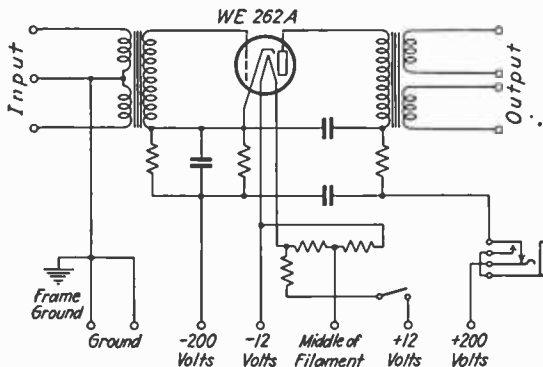

FIG. 13.—Schematic of microphone amplifier. (Western Electric 80A.)

which the sound waves approach the diaphragm. In referring to the curves of Fig. 12 it may be noticed that, as the angle between the wave direction and the normal to the face of the diaphragm is increased, there is a falling off of the response at the higher frequencies.

The sensitivity of the 618A microphone is somewhat greater than the conventional form of condenser microphone. For the condition of a person speaking with normal conversational intensity at a distance of 3 ft. from the instrument, the output is normally about -87 db as based on a zero level of 12.5 mw.

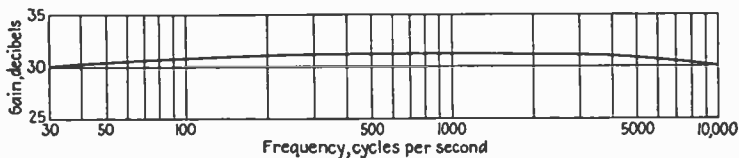

FIG. 14.—Gain-frequency characteristic of amplifier of Fig. 13.

Figure 13 is a schematic diagram of an amplifier which was designed particularly for use with the dynamic microphone and Fig. 14 its gain characteristic. It operates from an impedance of 30 ohms into either a 200- or 50-ohm circuit and has a gain of approximately 31 db.

9. The Crystal Microphone. This type of microphone depends for its operation upon the piezo-electric effect, produced in plates cut from Rochelle-salt crystals, in converting sound energy into electric energy.

Most of recent models of this type of instrument involve the use of a Brush Development Company assembly termed the *sound cell*. The elements primarily essential for its operation are plates having dimensions of $\frac{1}{4}$ by $\frac{1}{4}$ by .01 in. cut from Rochelle-salt crystals along axes in such a manner that their inherent characteristics tend to cause elongation or contraction when they are subject to an electric field provided by foil electrodes.

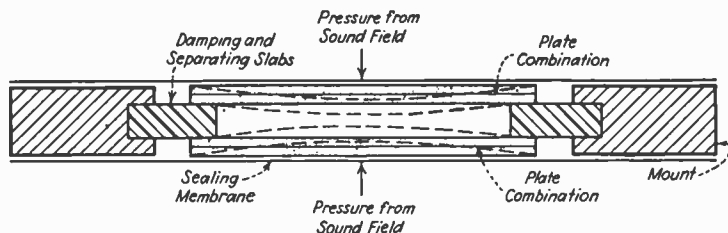

FIG. 15.—Cross-section view of single-cell crystal microphone.

By cementing together two such piezo-active plates which have tendencies to act in opposition to each other when a voltage is applied, an assembly analogous in the mechanical motion of bending to a bimetallic thermostatic strip acted upon by variation of temperature is produced. Figure 15 is a magnified cross-sectional view of a single cell. The assembly consists of two plate combinations mentioned above, separated by an air space and held in position by a suitable mounting.

The cell is covered over with a membrane which serves to seal the crystals from the outside atmosphere. When the cell is placed in a sound field, pressure acting normal to the outer surfaces of the plates tends to cause bending with a result that an e.m.f. is generated between the foil

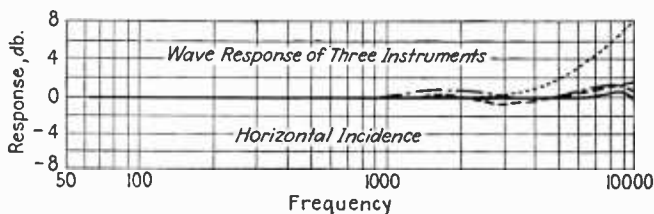

FIG. 16.—Response of crystal microphones.

electrodes. The two plate combinations are connected in parallel. The wave form of this e.m.f. conforms with that of sound waves. Because of the small physical dimensions of the plates the frequency of mechanical resonance of the system is rather high, with the result that frequency response is quite uniform over a wide frequency range. The curves of Fig. 16 due to Ballantine¹ show the free space calibration of three commercial models of these microphones.

¹ *Proc. I.R.E.*, 18, 1206, July, 1930.

Commercial models contain series-parallel groups of these sound cells totaling as many as 24. The sensitivity of a single sound cell is approximately -90 db while a multi-cell microphone has a sensitivity as great as -68 db.

The output impedance of these instruments is quite high. This requires them to be operated directly into the grid of an amplifier tube having a grid leak of about 5 megohms. The small physical dimensions of a

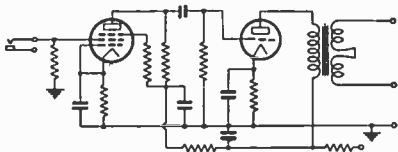

FIG. 17.—Amplifier for use with crystal microphone.

single cell make it practically non-directionive. This property is also characteristic of multi-cell units. Figure 17 shows a resistance-capacity-coupled amplifier¹ suitable for use with such a microphone.

10. The Inductor Microphone. The generation of an e.m.f. by virtue of electromagnetic induction is the principle upon which the inductor microphone (RCA Victor type 50A is a typical type) transforms energy contained in sound waves mechanically impressed upon its moving conductor into corresponding waves of electrical energy. The moving element in which the e.m.f. is generated consists of a straight aluminum conductor having a length of approximately 2 in. and diameter of 0.01 in. It is rigidly coupled to a thin concave aluminum diaphragm approximately

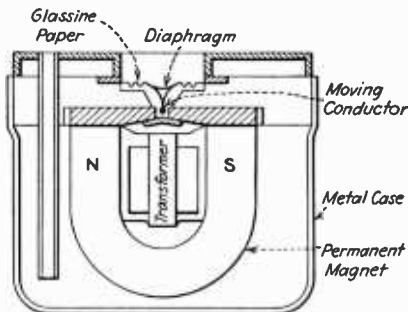

FIG. 18.—Cross section of RCA 50A inductor microphone.

$\frac{1}{4}$ by 2 in. by means of a V-shaped structure made of glassine paper. A cross-sectional diagram of the instrument is shown in Fig. 18. The voltage-generating element or moving conductor is mounted with its length perpendicular to the magnetic lines of force of a powerful permanent magnet.

Sound waves impressed upon the diaphragm cause a corresponding movement of the conductor within the field of the permanent magnet.

¹ WILLIAMS, A. L., Piezo-Electric Microphones, *Jour. Soc. Mot. Pict. Engrs.*, Spring, 1934.

Vibration of the conductor is therefore in accord with the sound waves and by virtue of its position in the magnetic field, an alternating e.m.f. of similar wave shape as the sound is produced across the primary of a microphone transformer contained within the open portion of the permanent horseshoe magnets. The minute voltage produced on the secondary

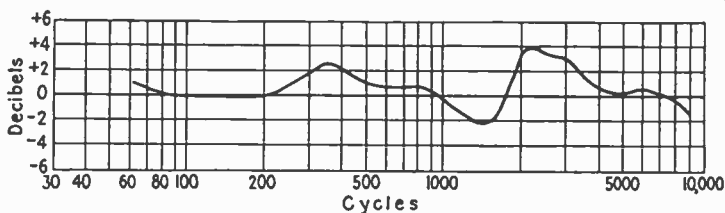

FIG. 19.—Characteristics, type 50A microphone.

of the transformer when impressed upon the grid of the first tube of a suitable amplifier is increased to a level required for broadcasting.

As this microphone is a pressure-operated type, most of which are subject to cavity and diaphragm resonance effects, an ingenious complex acoustic-damping assembly is contained within the instrument case to mechanically control the moving system resistance over a wide range of frequencies for a constant driving force over this range. It is by means of this acoustic-damping assembly that the resonance frequencies are

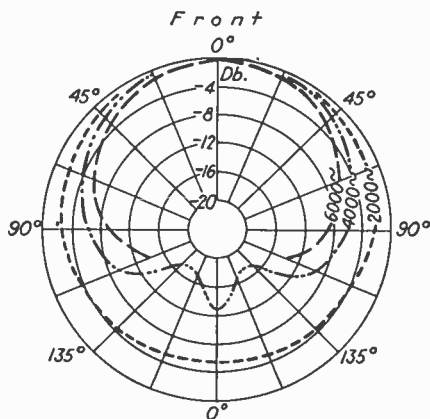

FIG. 20.—Directional characteristics of inductor microphone.

equalized sufficiently to flatten out its frequency-response characteristic. Figure 19 is a response curve of this type of microphone. The response is limited to 60 cycles to equalize pressure between the front and back of the diaphragm. This assists in elimination of wind noises and thus permits its use out of doors.

Its directional characteristics as shown in Fig. 20 are practically spherical for frequencies below 1,000 cycles. Like other pressure-operated instruments of comparable size, the variation of the frequency response to the higher frequencies is attenuated as the angle between the direction of incident sound and the plane of the diaphragm is decreased.

The sensitivity of the instrument is quite high in comparison to its size. This is made possible by the use of a straight conductor in creating

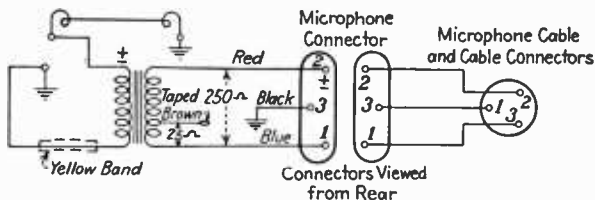

FIG. 21.—Inductor-microphone connections.

very efficient magnetic circuit. With an input sound pressure of 10 dynes per square centimeter perpendicular to the plane of the diaphragm, the inductor microphone will deliver an output level of -67 db as compared with a zero level of 12.5 mw. On an open-circuit basis of measurement with an input of 1 dyne per square centimeter (1 bar), its open-circuit output is equivalent to -81 db with reference to the above zero level.

The instrument has quite rugged properties as well as freedom from shock-excitation troubles. This is made possible by the acoustic-dampening assembly.

11. Condenser Microphones.

The condenser microphone involves the variation in thickness of the air dielectric of an electrical condenser as a medium for changing energy of sound waves into electrical energy having a corresponding wave shape. It consists essentially of a thin tightly stretched duralumin diaphragm spaced approximately 0.002 in. from a flat brass disk called the *back plate*, the plate and diaphragm forming the electrodes of an air condenser. Figure 22 gives a cross-sectional view of the RCA UZ 4083A, also called the 4AA condenser microphone. The varying pressure upon the very thin diaphragm caused by the sound waves causes the electrostatic capacity of the condenser to vary by an amount in the order of 0.01 per cent of its normal value of 200 μmf , and the slight voltage thereby produced can be impressed on the grid of a vacuum tube and thus amplified.

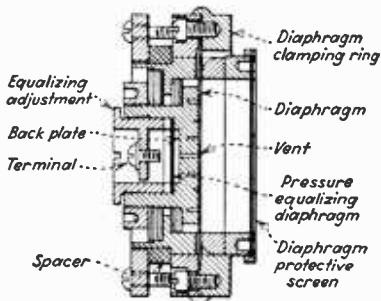

FIG. 22.—Condenser microphone.

The microphone illustrated has a diaphragm of aluminum alloy 0.001 in. in thickness. The edges are clamped between threaded rings, the

requisite stiffness being obtained by advancing the stretching ring until the desired resonant frequency, usually about 5,000 cycles, is obtained. The space between the diaphragm and back plate is hermetically sealed in assembly to prevent dust or moisture from entering and resulting in the unit becoming noisy. The thin rubber auxiliary diaphragm

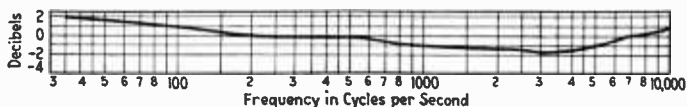

FIG. 23.—Pressure calibration of microphone.

together with a small air vent hole in the center of the back plate is provided as an equalizing system for changes in atmospheric pressure.

In the past in determining the response characteristics of a condenser microphone, use has frequently been made of the thermophone method, the thermophone consisting of two strips of gold foil mounted on a plate and fitted into the recess in the front of the microphone, the recess being entirely

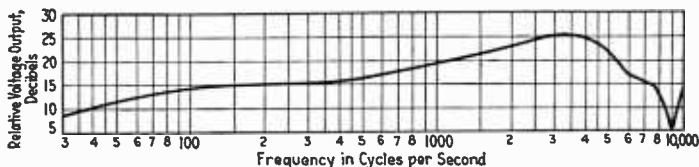

FIG. 24.—Microphone response for sounds normal to diaphragm.

enclosed and filled with hydrogen. A direct current upon which is superimposed an alternating current is passed through the foil and causes fluctuations in the temperature of the foil and the gas immediately surrounding it. These fluctuations in temperature cause changes in the pressure on the microphone diaphragm, and the magnitude of the pressure developed on the diaphragm can be computed from the constants of the system. Thermophone calibration is often referred to as a *pressure calibration*, since it depends entirely upon the actual pressure developed on the diaphragm and hence does

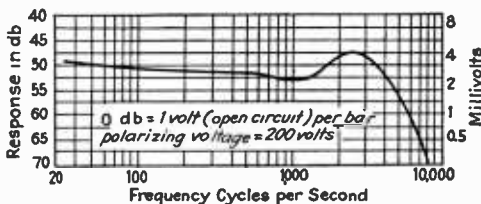

FIG. 25.—Studio characteristics of microphone.

not take into account any effects which may occur when the microphone is used for actual pickup purposes. The response obtained by placing the instrument in a sound field of constant pressure is termed a *field calibration*.

The effect of the diffusion of the sound field and the tendency for most acoustic materials to be more absorbent at high frequencies appear to cause

the average response of such a microphone to conform closely to the characteristics shown in Fig. 25. This, perhaps, accounts in part at least for the instances in which a corrective network designed to compensate for the field calibration normal to the diaphragm failed to effect a noteworthy improvement in quality.

The sensitivity of the instrument on the basis of a zero level of 12.5 mw is approximately -96 db at 1,000 cycles with an input sound pressure of 10 dynes per square centimeter. It will generate an open-circuit voltage of approximately 5 mv at 1,000 cps with a polarizing potential of 180 volts. Under these conditions it should feed into a load of not less than 10 megohms.

On account of its inherent high-impedance characteristics, it is usual to incorporate an amplifier in the microphone housing to reduce to a

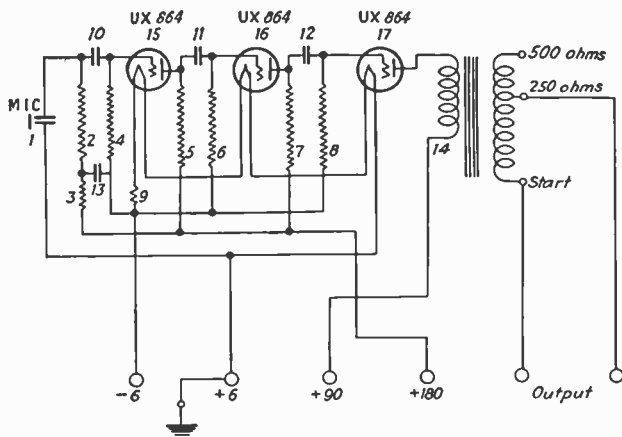

FIG. 26.—Amplifier for condenser microphone.

minimum the length of lead between the microphone and the grid of the first tube of its associated amplifier. Sometimes a compact amplifier is placed on the floor alongside of the microphone, the two being connected with a length of low-capacity cable. A d-c polarizing potential in excess of 180 volts has in some cases been used, but this should never exceed 500 volts.

In 1917 E. C. Wentz published an account of the work done on an improved condenser microphone having a stretched diaphragm and a back plate so located that in addition to serving as one plate of a condenser, it added sufficient air damping to reduce greatly the effect of diaphragm resonance. This was followed by additional developments upon the early Wentz¹ models by using duralumin as a substitution for steel as a diaphragm material with a result that the sensitivity of modern instruments is about ten times that of the early models.

12. Carbon Microphones. A carbon microphone is one utilizing the variation resistance of carbon granules. A typical example of the pres-

¹ WENTZ, E. C., *Phys. Rev.*, 19, 498, 1922.

ent day "double-button" carbon microphone is shown in Fig. 27; this gives a cross-sectional view of the type-387 Western Electric carbon

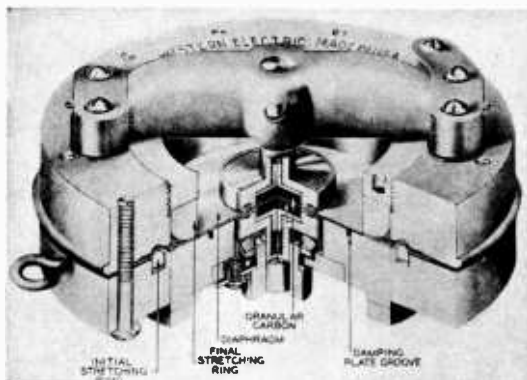

FIG. 27.—Carbon microphone.

microphone. The diaphragm of this microphone is made from duralumin 0.0017 in. in thickness and is clamped securely around its outer edge.

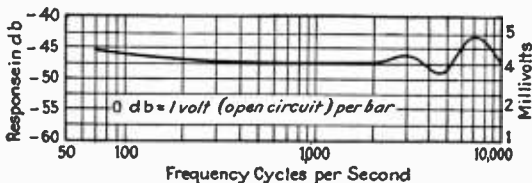

FIG. 28.—Response of air-damped duralumin diaphragm.

The stretching of the diaphragm to give the desired resonant frequency, usually about 5,700 cycles, is done in two steps by means of two stretching rings. In order to insure uniformly low contact resistance, the portions of the diaphragm which are in contact with the granular carbon are covered with a thin film of gold deposited by cathode sputtering. The size of the carbon granules is such that they will pass through a screen having 60 meshes per inch but will be retained on a screen having 80 meshes per inch. Each button

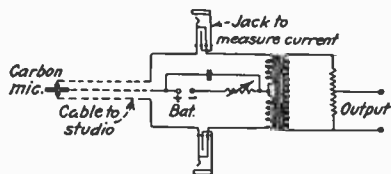

FIG. 29.—Carbon microphone connections.

contains about 0.06 cc of carbon corresponding to about 3,000 granules.

Referring to Fig. 28, it will be noted that the use of an air-damped stretched duralumin diaphragm has resulted in a carbon microphone having a substantial uniform response over a wide range of frequencies.

The operation of a carbon microphone may be effected by cohering (sometimes called "caking") of the granules. Severe cohering causes a large reduction in resistance and sensitivity which persists for an extended period unless the instrument is tapped so as to agitate mechanically the granules. One of the common causes of cohering is breaking the circuit when current is flowing through the microphone. Experience has shown that the use of a simple filter consisting of two $0.02 \mu\text{f}$ condensers and three coupled coils, each having a self-inductance of 0.0014 henry, will effectively protect the microphone button without introducing an

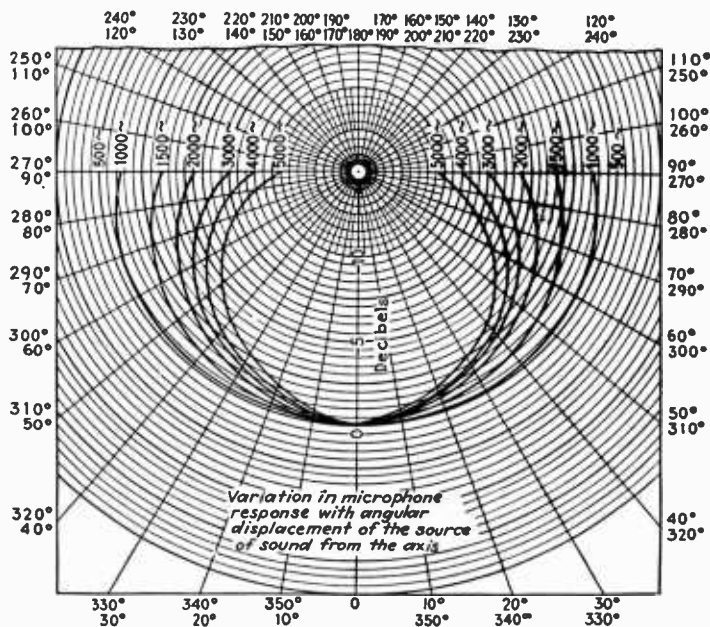

FIG. 30.—Directional characteristic of microphone.

appreciable transmission loss; a potentiometer switch also serves to prevent caking.

The quality of transmission obtained with a double-button carbon microphone compares favorably with that secured with a condenser microphone; the carbon microphone has the disadvantage however of a high noise level or "microphone hiss." Figure 29 shows the manner in which the carbon microphone is connected to its associated amplifier. Jacks are used to measure the current flowing through each button, these currents being usually in the neighborhood of 10 to 20 ma.

The sensitivity of the carbon microphone is somewhat higher than the other types. The average sensitivity is in the neighborhood of -46 db as compared with a zero level of 12.5 mw.

Wave-response curves exhibited by Ballantine¹ show that response at normal incidence is quite uniform, between a frequency range from 60 to 1,000 cycles. Above 1,000 cycles, it increases rapidly becoming about 15 db higher at 2,500 cycles than at 1,000 cycles. This increase extends rather uniformly from 2,500 to 6,000 cycles, where there is a marked falling off.

13. Parabolic reflector Microphone. The use of a large concave reflecting surface mounted behind a condenser microphone has been found to give the instrument pronounced directional characteristics. The system gets its name quite appropriately from the shape of the

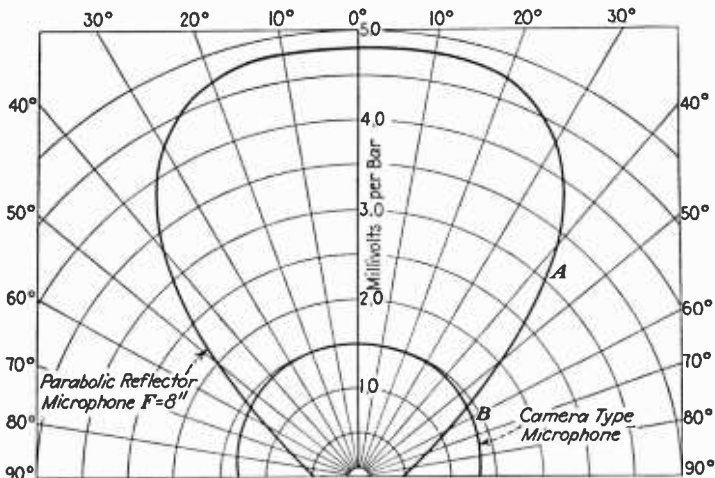

FIG. 31.—Comparative axial response at 1,000 cycles per second in millivolts per bar. A, parabolic reflector; B, camera-type microphone.

reflecting surface, a cross section of which contains a section of a parabola. By virtue of the microphone placement at the focus of the parabola, the sound waves which strike the reflecting surface are concentrated upon that microphone diaphragm, resulting in increased sensitivity of the instrument in line with the axis of the parabola.

The use of the reflector, therefore, makes possible the placement of the instrument sufficiently far from the sound source so that it is practically equidistant from all of the instruments or voices, with a result that the problem of securing proper balance and volume control is simplified. The directional characteristic makes it possible to swing the microphone and its reflector as one would a searchlight and in this manner follow the action on the stage of an auditorium or on the field of a sporting event. Curve B, Fig. 31, shows the directional characteristics at 1,000 cycles of an ordinary camera-type condenser microphone, while curve A shows the response of a similar microphone with a parabolic reflector. It may

¹ BALLANTINE, STUART, High-Quality Broadcasting, *Proc. I.R.E.*, 22, 576, May, 1934.

be noted that there is an increase in sensitivity along the line of axis of about 4 to 1, due to the use of the parabolic reflector.

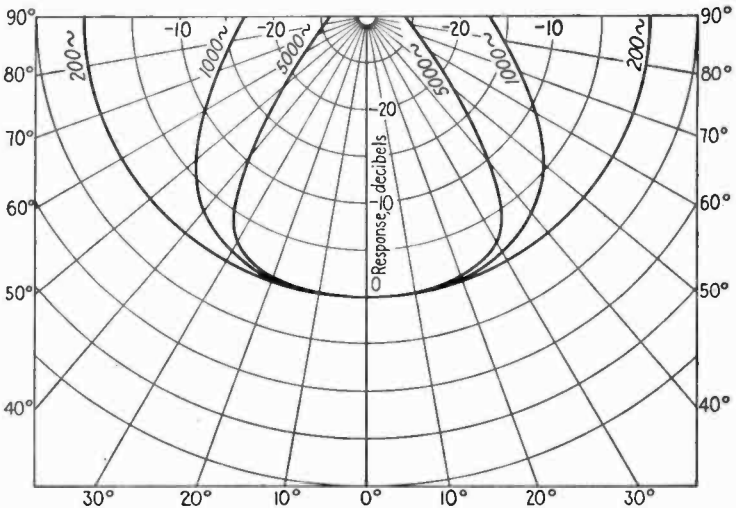

FIG. 32.—Axial frequency response of parabolic microphone with a focal length of 8 in.

Since the reflector increases the sensitivity and makes it possible to locate the microphone at a greater distance from the source of sound, it is

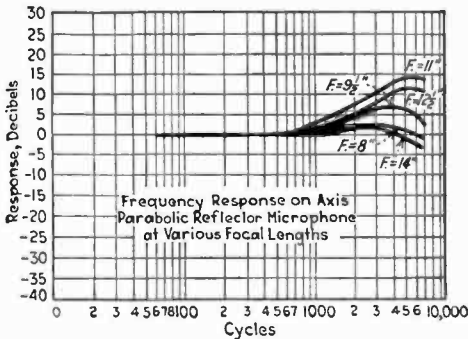

FIG. 33.—Variation of high-frequency response by changing position of microphone in reflector.

desirable that the output of the microphone fall off rapidly if the sound originate at a point displaced more than 30 deg. from the axis of the

instrument; if this characteristic is obtained, reverberation and reflections in the studio or auditorium will have very little effect.

Figure 32 shows that a uniform response is obtained over a range of about 30 deg. either side of the microphone axis. Figure 33 shows how the frequency response at the high-frequency end can be altered by changing the position of the microphone in the reflector. By this arrangement the response can be made sensibly flat up to 7,000 cycles or, if desired, the high-frequency response may be increased by as much as 15 db over the response at low frequencies. In certain instances where the high-frequency absorption is considerable, the ability to accentuate the highs by refocusing proves very helpful. The directional microphone can be placed at a point sufficiently far from an orchestra so that it is essentially equidistant from all the instruments, and the problems of balance and volume control are thereby greatly reduced.

Another distinct advantage of the directional microphone is its ability largely to disregard the acoustics of the room as it responds only to the sounds upon which it is directly focused. In some instances this effect may be so marked as to make it necessary to use another microphone without any reflector to pick up some of the reverberation and make the reproduction more realistic.

STUDIO TECHNIQUE AND MICROPHONE PLACEMENT

14. Studio Problems. A problem of vital concern to a broadcasting system is that of providing favorable acoustic conditions within its studio or auditorium facilities in order that the effects of reverberant sound from the walls of the enclosures may be kept within desirable proportions in comparison to the sound reaching the microphones directly from the source. Of even greater concern are the problems involving correct placement of microphones with respect to the sound sources within the enclosures, so as to assure faithful reproduction of each voice or musical instrument, their significant overtones, and a pleasant blending of the groups of voices or instruments.

It is, therefore, by virtue of the selection of a microphone which will faithfully transmit all of the actual sounds that occur within its range as well as the correct placement of it within a studio or auditorium having suitable acoustic characteristics that high-quality programs can be produced. Under optimum conditions of reproduction, a broadcast listener would hear the same acoustic naturalness of the program from his loud-speaker as he would if he were to be transported to a spot in the studio or auditorium where the sounds originating therein would afford a sensation to the listener most agreeable to his ear.

The major considerations involved in proper studio design such as sound proofing, ventilation, optimum dimensions, and suitable acoustical treatment of the walls have been given in numerous articles.¹ Here we shall be concerned with only the problems of microphone placement assuming that favorable studio or auditorium conditions exist such as adequate sound proofing that would prevent undesired extraneous noises from entering a given enclosure and suitable acoustical treatment of the walls and floor to provide equal absorption over a wide frequency range and give the enclosure in itself a uniform frequency characteristic.

¹ HANSON, O. B., and R. M. MORRIS: Design and Construction of Broadcast Studios, *Proc. I.R.E.*, 19 January, 1931; SIVIAN, L. J., *Bell System Tech. Jour.*, 10, 108, 1931.

It is of considerable importance that the frequency characteristic of the studio or enclosure be considered for high-quality transmission because this characteristic is actually superimposed upon that of the microphone under conditions where the reverberant sound received by the microphone is appreciable as compared with that received directly from the source.

15. Single vs. Multiple Microphone Usage. During the first years of broadcasting it was a usual procedure to use more than one microphone to pick up a program, especially under conditions where the broadcasting group was rather large. This was necessary on account of an inherently high noise level of the carbon microphones used during that period requiring a placement of those instruments sufficiently close to the sound sources to overcome the inherent background noise of these carbon types. The combination of more than a single microphone for making a pickup had a disadvantage in that the outputs from the several microphones used were not in proper phase relation with respect to the sound sources. This resulted in considerable distortion from such a set-up when the microphone outputs were combined and fed into a common amplifier.

Improvements in the carbon-type microphone as well as the development of others having higher sensitivity as compared to inherent noise level permitted the placement of a single microphone at sufficient distance from the sound sources so that more than one microphone was not necessary to obtain a good acoustic balance from a group. The practice of using more than one microphone at a time has, therefore, been almost entirely discontinued because of the phase distortion resulting therefrom.

16. Microphone Placement. The carbon microphone, while still used on rare occasions, for some forms of broadcasting, field-pickup work, etc., retains the disadvantage of a high inherent noise level requiring placement of the sound sources close to the "live" face of the instrument. Its directive characteristics at the higher frequencies make necessary the placement of the broadcasting group within an area contained within an angle of 30 deg. either side of the microphone axis. A prearrangement of musical instruments within this area is quite similar to other diaphragm types.

The frequency characteristics of any diaphragm type of microphone are dependent upon the relative positions of the microphone and the sources of sound. When the sounds approach at right angles to the plane of the microphone diaphragm, a uniform response over the desired range might be obtained. But, if the sounds approach from any other point, it will be

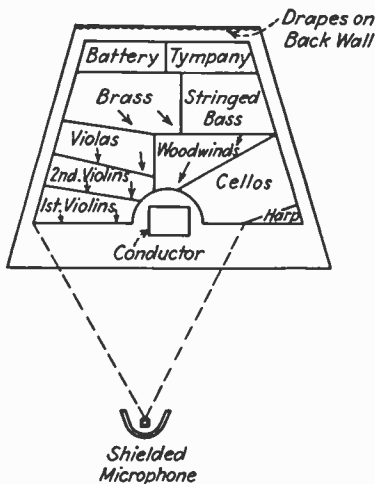

FIG. 34.—Set-up of 110-piece symphony orchestra.

found in general that the response will fall off with frequency. This characteristic is illustrated by Figs. 20 and 30, which indicate how response varies with the angular displacement of the sound source from the microphone axis. It will be noted that there is a high loss at the higher frequencies for high angular displacements. Since the majority of musical instruments depend for their quality or timbre upon the

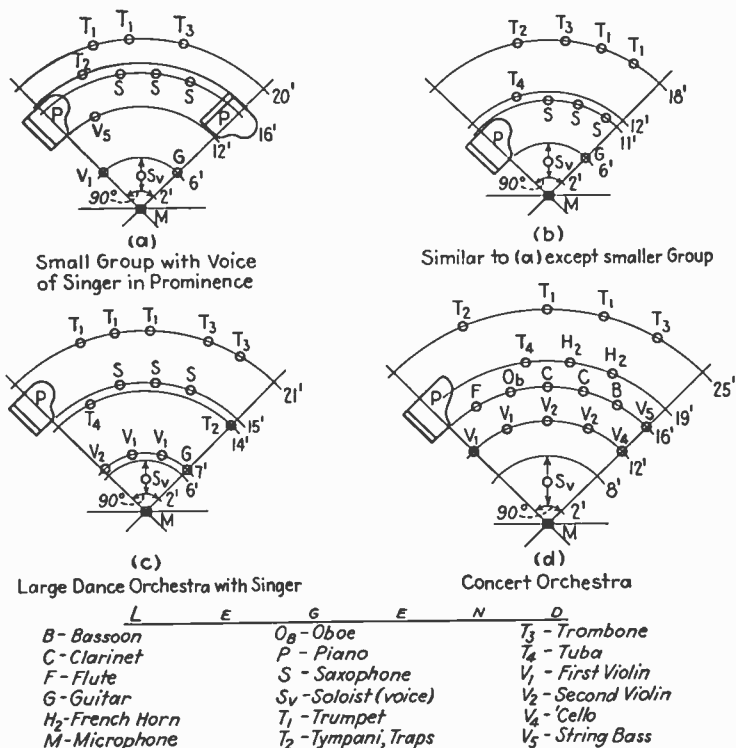

FIG. 35.—Orchestra arrangements for use with a single type 50A inductor microphone.

presence of overtones, it is obvious that, if these overtones are discriminated against, the quality will be changed materially. If, in considering this loss in the higher frequencies with angular displacement, we apply the limitation that the loss at 5,000 cycles shall not be more than 2 db, then Fig. 30 indicates that in using a single microphone of the condenser type all of the musical instruments of a group should be kept within an angle of 30 deg. either side of the microphone axis.

There are many factors involved in securing a proper placement of vocal sound sources or of musical instruments before a pressure or diaphragm type of microphone. While certain rules have been set up, they may serve only as a guide. Most satisfactory results are obtained by a combined study of the instruments as well as an actual set-up of them before a microphone in a given enclosure. The results of actual listening tests by means of a high-fidelity speaker and monitoring system performed by one who has a trained ear for music or sound naturalness is a final check upon the proper placement.

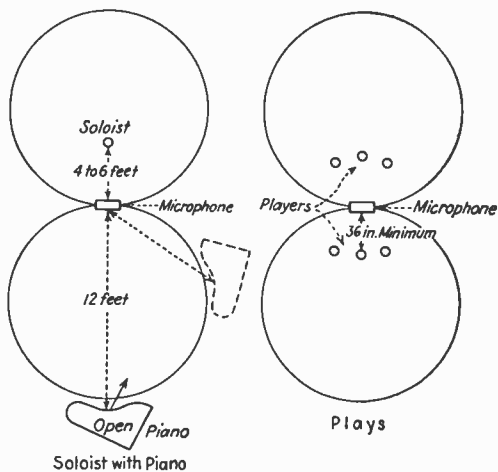

FIG. 36.—Microphone arrangements.

17. Typical Studio Arrangement. A typical set-up of a large symphony orchestra before a condenser microphone is shown in Fig. 34.¹ It will be noted that the instruments are placed so as to not only obtain the desired balance for theater work but also to obtain the proper harmonic balance allowing for the microphone directional characteristics on the higher frequencies. The microphone is acoustically shielded to prevent reverberation from the auditorium behind it. The string instruments in this set-up, being the least powerful ones, are concentrated in the foreground of the group. The woodwinds are next in line followed in the background by the powerful brass and percussion instruments. In the arrangement it may be noted that the string tone of the orchestra is given a favorable position in order to produce a softness to the music which will not be overpowered acoustically by the heavy brasses and percussion instruments. For this reason they are placed a sufficient distance in the background.

Figure 35 shows various arrangements of instruments and voices before the inductor type of microphone. The characteristic of this type permits

¹ HANSON, O. B., *Microphone Technique in Radio Broadcasting*, Jour. Acou. Soc. Am., 3, No. 1, July, 1931.

the placement of the musical instruments within an area contained by an angle of 45 deg. on either side of the microphone axis. In using this type of instrument the source of sound, speaker, announcer, or musical instrument should not be placed closer than 1 ft. from the face of the microphone.

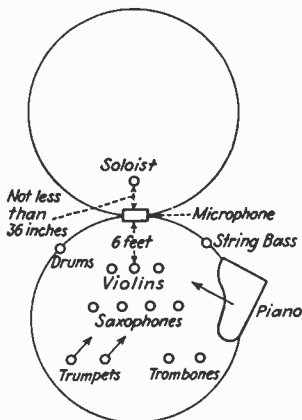

Dance Orchestra

FIG. 37.—Dance orchestra microphone arrangement.

The bidirectional characteristics of the velocity microphone are advantageous in that the performers can be distributed on both sides of the instrument in a manner shown in Figs. 36 and 37. The uniform frequency-response characteristic of the instrument with directivity is an advantage in that the intensity of some instruments may be decreased without discriminating against their higher frequencies, simply by moving them at a larger angle with respect to the microphone axis.

An orchestral arrangement involving the use of a velocity microphone as suggested by LaPrade¹ is shown in Fig. 38.

The orchestral group in this arrangement was conveniently located on one face of the instrument. To prevent reflection from a wall directly in back of the microphone, the instrument is tilted at an angle of approximately 30 deg. toward the orchestra. An

exceedingly well-balanced pickup has been accomplished by this method.

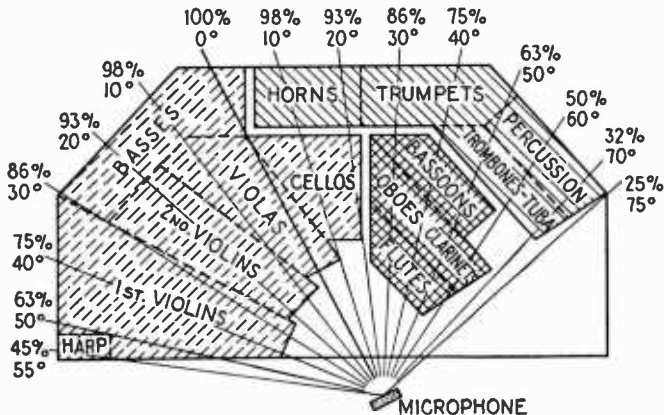

FIG. 38.—Velocity-microphone set-up for large orchestra group.

¹ LA PRADE, ERNEST, National Broadcasting Co., The Technique of Broadcasting Instrumental Groups, address at North Central Music Educators Conference, Indianapolis, March, 1935. See Proc. Music Educators National Conference, 1935 (in preparation).

18. Increasing Reverberation. Inasmuch as most musical instruments, especially the strings, depend upon their overtones to produce a richness to the music, a definite amount of reverberation from the walls of the studio or auditorium is necessary to accentuate the string tone and to afford a pleasant naturalness to the music. The amount of reverberant sound received from the walls of the enclosure as well as the proper height of the microphone to receive the reverberant sound can be determined only by experiment. If an enclosure, such as an auditorium containing a large group or audience of people which have the tendency of causing great sound absorption conditions, is not "live" enough, sufficient reverberation may be picked up by raising the microphone. Under conditions where excessive reverberation prevails, the amount picked up by the microphone may generally be reduced by lowering the instrument.

The size of the studio used to enclose a broadcasting group is an important consideration in securing a correct balance of reverberant sound to direct sound reaching the microphone. If the volume from a group of voices or musical instruments is too great for a given enclosure, the effect of reverberation from the walls becomes excessive. Correct balance of the reverberant sound as compared to direct sound is therefore dependent upon the dimensions of the enclosure as well as the sound-absorption properties of walls. Proper selection of a suitable studio for a given broadcasting group is usually secured through actual listening tests on a high-fidelity monitoring system by persons qualified through their ability to judge the proper relations between direct and reverberant sound required to produce a most pleasing balance of the sounds produced in the studio. Such persons are usually those who have had long experience as musicians or orchestra conductors. This enables them to determine the proper relationships and balance of the tones from various instruments and voices, and also to sense the ideals of the composer of the musical selections.

19. Volume Controls or Faders. It is quite essential that volume controls or faders used in high-quality broadcasting circuits should have inherent frequency characteristics which are uniform over a range of between 30 and 15,000 cycles to prevent them from causing frequency distortion. Also essential is a very low noise level. This is normally -150 db or better. Proper shielding for protection against dust and dirt is necessary to maintain a low noise level, as well as to act as a shield against any stray r-f electromagnetic fields.

In Figs. 39 are shown various types of attenuating structures used in broadcasting technique. The type shown in Fig. 39A is frequently used as a microphone fader and is commonly known as the *LT structure*. When used in multiple such as for mixing several microphone outputs, sufficient resistance is inserted in one output lead from each attenuator to maintain correct circuit matching. This combination is shown in Fig. 39B. The single-ladder type of attenuator is shown in Fig. 39C, while 39D shows the balanced-ladder type. The ladder attenuators maintain an impedance that remains practically constant in both directions through the middle of the attenuation range. Important features

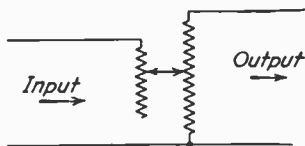

FIG. 39A.—LT attenuator.

of this type of attenuator are its simplicity of design requiring fewer contacts and switches. The minimum attenuation setting of a ladder pad normally corresponds to its insertion loss which amounts to approxi-

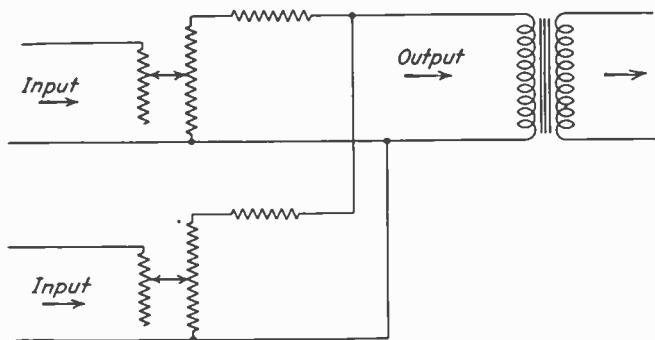

FIG. 39B.—Multiple-type LT attenuator.

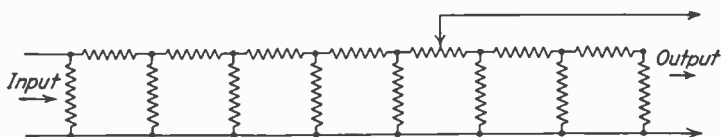

FIG. 39C.—Single-ladder attenuator.

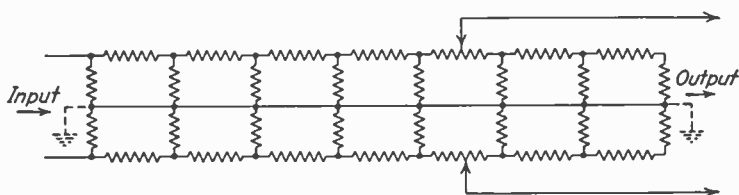

FIG. 39D.—Balanced-ladder attenuator.

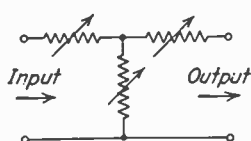

FIG. 39E.—Type-T attenuator.

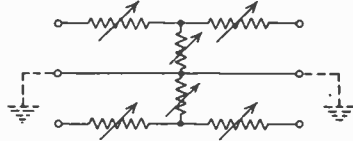

FIG. 39F.—Balanced-H attenuator.

mately 2.5 db. Where an attenuation range is required extending from zero upward, the H or T structures are used. They are usually constructed with a minimum attenuation setting of zero.

The T and balanced-H structures are shown in Figs. 39E and 39F, respectively. Both of these types maintain a constant impedance in both directions when properly terminated. The balanced-H and ladder structures are used where the transmission circuits must be balanced to ground. They are frequently used in broadcasting circuits as master gain controls. Figure 39G shows a high-impedance voltage divider usually in the form of a gain control in the input circuit of a vacuum tube. This is a common type of gain control used on speech amplifier units.

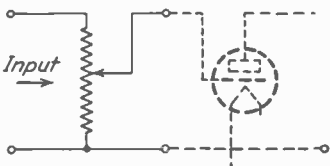

FIG. 39G.—Voltage divider.

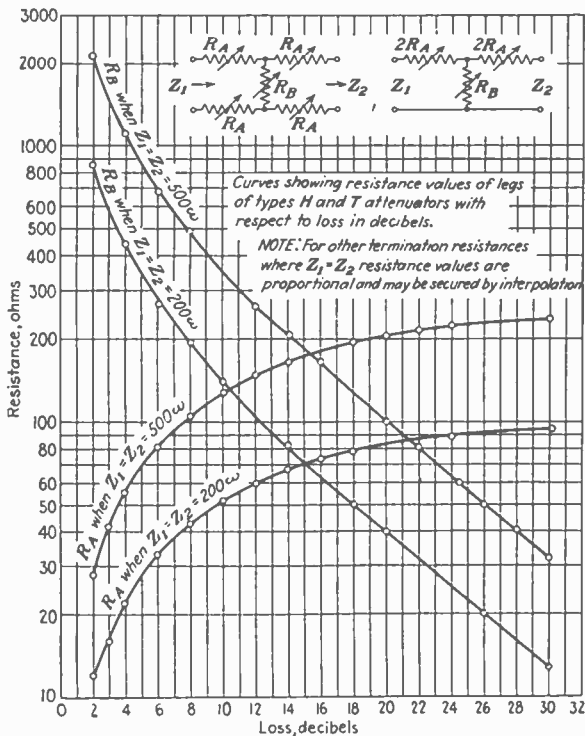

FIG. 40.—Chart for H and T attenuator design.

The curves in Fig. 40 give resistance values of the branches of an H-pad suitable for a channel having an impedance of 200 or 500 ohms, the range of attenuation being between 2 and 30 db. Similar curves for

other impedances may be determined from the formulas¹ given in articles² published.

20. Speech-input Amplifiers. These amplifiers sometimes termed *preamplifiers* or *microphone amplifiers* and *line amplifiers* are here considered. They comprise the apparatus necessary to increase the electrical

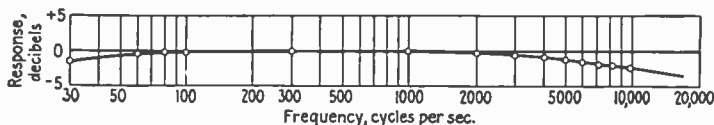

FIG. 41.—Speech amplifier at full gain.

energy output of the microphone to a sufficient level to permit its transfer by means of wire lines, to the broadcast transmitting station. The normal energy level of programs entering the wire lines is approximately +2 db. In Fig. 1 is shown the arrangement of preamplifiers and line amplifiers between the microphone and the wire lines. Other equipment shown is the microphone controls, volume indicators, monitoring amplifiers, and relay-switching systems.

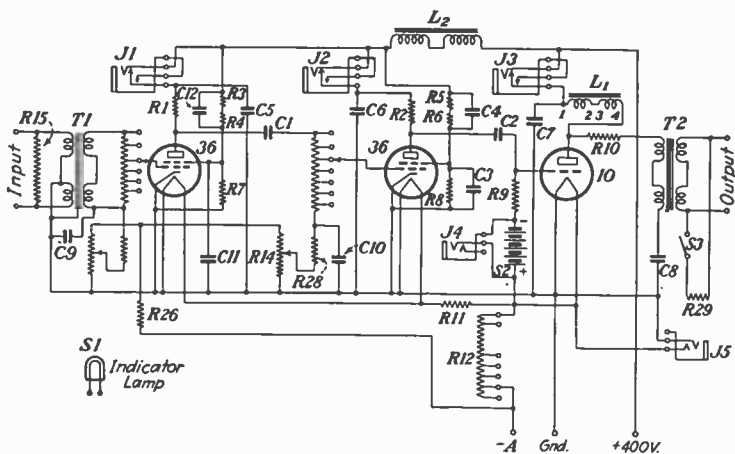

FIG. 42.—Studio amplifier circuit.

Speech-input equipment is designed usually to have a substantially uniform frequency-response characteristic from about 30 to 15,000 cycles. The frequency characteristic of a speech-input amplifier is given in Fig. 41. In Fig. 42 is shown the circuit diagram of a typical three-stage amplifier. The maximum gain of such an amplifier from input to output

¹ JOHNSON, K. S. "Transmission Circuits for Telephone Communication," D. Van Nostrand Company, Inc.

² LANTERMAN, W. F., The Design of Attenuating Networks, *Electronics*, February, 1931.

is usually about 70 db, and the maximum output without overloading is about +16 db above a zero level of 12.5 mw.

21. Volume Indicators. These instruments are essentially voltmeters having relatively high internal resistance as compared to the terminal resistances of the audio buses to be measured so that they may be bridged across an audio circuit without causing any noticeable change in the circuit characteristics. A volume indicator as used in broadcasting technique is calibrated to read decibel units directly. These units are based on a zero energy level of 12.5 mw. The corresponding r-m-s voltage for a given decibel energy level as read by a volume indicator, of course, is dependent upon the terminal impedance of the audio circuit. The curves of Fig. 6 show relative levels of decibels as compared with voltage percentages based upon a zero level of 2.5 volts across a resistance of 500 ohms, which is the characteristic impedance of most wire lines used for broadcasting.

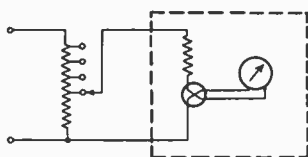

FIG. 43.—Bimetallic rectifier type of volume indicator.

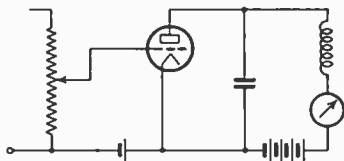

FIG. 44.—Volume indicator, vacuum-tube type.

To prevent the existence of distortion such as that produced by transmitter overmodulation the program level leaving the studio as well as that entering the transmitter speech amplifier must be carefully watched. It is by means of the volume indicator that the operator is able to adjust the program level to a proper value by means of volume controls provided for that purpose. In Fig. 43 is shown a diagram of a common type of volume indicator. It consists essentially of a high-resistance voltmeter of the copper oxide rectifier type, calibrated to read energy level in decibel units. The range of the instrument is extended by the use of a potentiometer, taps upon which are fixed by relative decibel-level settings.

The vacuum-tube voltmeter type of volume indicator, a diagram of which is shown in Figure 44, is a kind used by some broadcasting installations. Owing to a variation of input impedance of such a measuring stage due to the grid-current changes, it is preceded by a class A stage. In recent years an effort¹ has been made to determine correct volume-indicator characteristics to suit broadcasting requirements. This has been accomplished by means of integrating meters and modulation peak counters.

22. Wire Lines. Wire telephone systems are employed almost exclusively for the national distribution² of programs to the various stations connected on a network. As of June, 1932, programs were distributed over five basic networks to which ten additional groups of stations are

¹ BALLANTINE, STUART, High-Quality Radio Broadcasting, *Proc. I.R.E.*, **22**, 605, May, 1934.

² CLARK, A. B., Wire Line Systems for National Broadcasting, *Proc. I.R.E.*, **17**, 1998, November, 1929.

added as occasion demands. These networks involve some 179 stations which are connected together by approximately 35,000 miles of wire or twice this number of wire miles for programs alone. Telegraph circuits for interstation connections involve other thousands of miles of wire circuits. One of the groups involves a radio link to the Hawaiian Islands for re-broadcasting American programs.

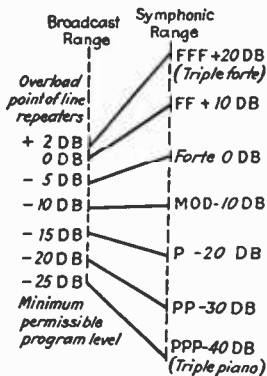

FIG. 45.—Compression of dynamic range in broadcasting system.

It should be pointed out, however, that the listener may obtain an impression of greater dynamic range than is indicated by the above figures due to the fact that the harmonic content of the notes produced by various musical instruments varies with the loudness of the tone and

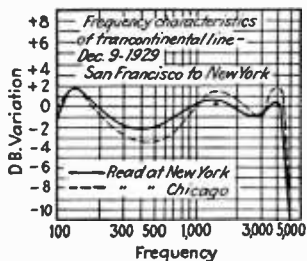

FIG. 46.—Transcontinental line as of 1929.

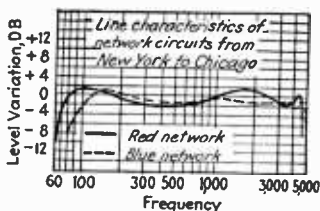

FIG. 47.—New York to Chicago circuit characteristic.

since these harmonic frequencies are transmitted, the listener gets the impression of volume from the character of the sound as well as from the actual volume. Figures 46 and 47 show respectively the frequency characteristics of the transcontinental line and the New York to Chicago circuit.

The frequency band which is transmitted over long-distance program circuits extends from about 100 cycles to about 5,000 cycles; to transmit music with improved fidelity a wider band than the above is desirable. A few circuits are at present available which extend the band down to 30 or 50 cycles and extend the higher range by 2,000 or 3,000 cycles. Program transmission circuits must be designed to handle wide ranges of volume. At present the volume range is limited to some 25 or 30 db, from about plus 2 or 4 db down to about minus 25 db. Obviously, since the dynamic range of a symphony orchestra is about 60 db, the wire line circuit necessitates some compression of the dynamic range. The chart of Fig. 45 indicates the manner in which the dynamic range of a symphony orchestra is compressed within the range that can be handled by the line.

RADIO FACILITIES

23. Audio-frequency Equipment. The process of transferring programs from the main control room of the studios to the broadcast transmitting station is generally accompanied by a considerable reduction in the program signal level. Attenuation caused by the wire line upon which is added that caused by the line equalizer lowers the signal intensity as much as 25 db. A line equalizer consists of a specially designed network containing correctly proportioned values of L , R , and C . Irregularities in the wire-line frequency characteristics are smoothed out by the equalizer so as to produce a uniform frequency response of the wire line over as wide a range as practicable.

To increase the level of the incoming signals to a sufficient intensity to drive the first tube of the speech amplifier of a broadcasting transmitter, a line amplifier is required. This amplifier is usually of a high-quality type having sufficient gain to raise the audio program signal to a level of approximately +4 db. At this level it enters the first speech-amplifier stage. The line equalizers, line amplifiers, variable attenuators, volume indicators, monitoring amplifiers, microphone for making local announcements, together with their switching equipment and jack panels, are normally mounted on racks in a shielded room called the *control room*. The shielding consists of an outside-grounded copper screen containing within it a floating copper screen.

A schematic wiring diagram of a simple layout of speech-input equipment is shown in Fig. 48. The most essential items necessary to produce a sufficient gain in program level for supplying the speech equipment of a radio transmitter are given, as well as a means for making local announcements at the station. An actual set of equipment necessary for radio broadcasting-station operation is considerably more complex than that shown in this diagram.

24. Typical Transmitting Equipment. In Fig. 49 is shown a simplified diagram of a 5-kw. broadcasting transmitter of recent design. It is known as the RCA type 5C. The carrier frequency of this transmitter is maintained well within the FCC tolerance of plus or minus 50 cycles by a crystal-controlled oscillator unit. Modulation is accomplished by the low-level method, the modulated amplifier being a push-pull stage employing 203-A tubes. The modulating voltage is secured from a class B audio stage. This is coupled by means of a transformer to the plate-voltage supply of the modulated amplifier. The final r-f amplifier stage contains two 863 water-cooled tubes operated in a push-pull circuit and adjusted to operate as a class B r-f amplifier.

Features of this transmitter which merit consideration are its simplicity brought about through the use of a-c filament supply for all tubes thus eliminating filament motor-generator sets. This points toward a considerable saving in power and vacuum-tube operating costs as well as on transmitter space requirements and initial installation costs. Reduction of carrier noise level of this transmitter to an extremely low level is accomplished through the use of indirectly heated cathodes of tubes in the low-level stages and the use of push-pull operation in the others. In the water-cooled power-tube stage the hum caused by the magnetron effect from the large current carrying power-tube filaments is reduced by supplying the filament of one tube with 60-cycle power, 90

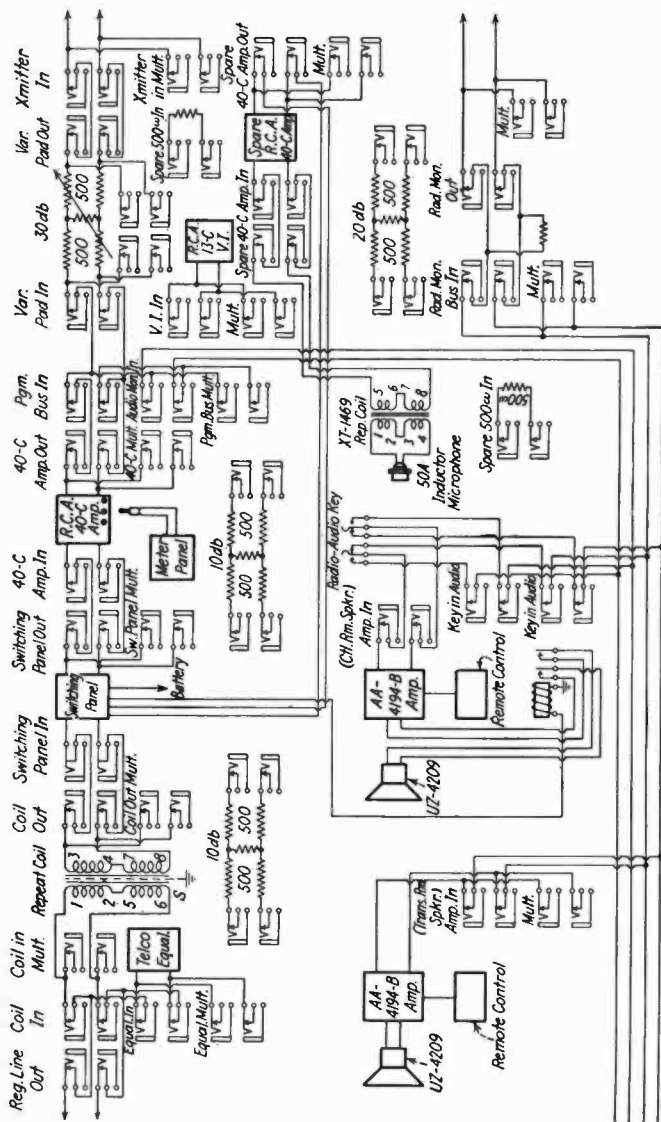

Fig. 48.—Layout of speech-input equipment.

deg. out of phase with the other, by the use of a Scott-connected filament transformer. Residual hum is balanced out through the use of a device known as the *hum compensator*. This consists essentially of a phase and amplitude control for a frequency-multiplying network for each of the harmonic components of the hum-voltage wave. The hum frequencies at proper phase and amplitude are fed into the input of the audio system of the transmitter as a counter-modulation 180 deg. out of phase with the hum, with a result that the hum generated in the transmitter, mostly due to the magnetron effect of the filaments of the large tubes, is balanced to zero.

A class B r-f power amplifier capable of delivering 50 kw of carrier power and modulation capabilities of 100 per cent has been recently produced. The 5-kw transmitter described above is normally used as an exciter for the output stage of the 50-kw transmitter. The 50-kw stage also utilizes a push-pull circuit employing two 898 power tubes. These power tubes are each equipped with filaments connected three phase to reduce their magnetron effects to a minimum. The complete 50-kw transmitter consisting of a main-rectifier, control-equipment power amplifier and its exciter unit is known as the RCA type 50 C.

A simplified circuit diagram of a 50-kw transmitter as used in many broadcasting stations at present is shown in Fig. 50. In this transmitter known as the RCA 50 B low-level modulation is used; the modulated amplifier being a 350-watt tube operating at 1,800 volts through a voltage reducer from 3,000 volts and supplied with an a-f modulating voltage from a constant-current modulator employing two 350-watt power tubes operating at a plate voltage of 3,000 volts. The modulator unit supplies adequate audio voltage and current through this arrangement to produce 100 per cent modulation with negligible distortion.

The last two stages of r-f amplification consist of push-pull stages utilizing cross-neutralizing connections. The final or power-amplifier stage employs a push-pull arrangement of two tubes feeding into a r-f transmission line.

The filaments of all vacuum tubes with exception of the rectifier tubes are heated by direct current. This is supplied by a motor-generator set. A filter is provided across the output of the d-c generator to insure a pure d-c supply. Plate power for the various stages is supplied from hot-cathode mercury-vapor rectifier units. These are provided with adequate filtering to insure also a very low carrier-noise level.

The transmitter is crystal-controlled. This insures maintenance of the carrier frequency continuously constant well within the tolerance of plus or minus 50 cycles. The most recent quartz plates utilized for controlling the frequency are ground on a crystalline axis so as to produce a desired carrier frequency regardless of the crystal temperature, as long as it is kept above 32°F. A constant-temperature control is provided to maintain the temperature within very close limits on crystals subject to frequency change with temperature.

The transmitter is normally provided with a phantom antenna for use during transmitter "warm-up" and test periods rather than to use the transmitter radiating system. Switches are provided for transferring r-f carrier power from the output stage of the transmitter to either the station radiating antenna or the phantom antenna. The phantom antenna is designed to act as an effective resistance load equivalent to the characteristic impedance of the transmission line. It must neces-

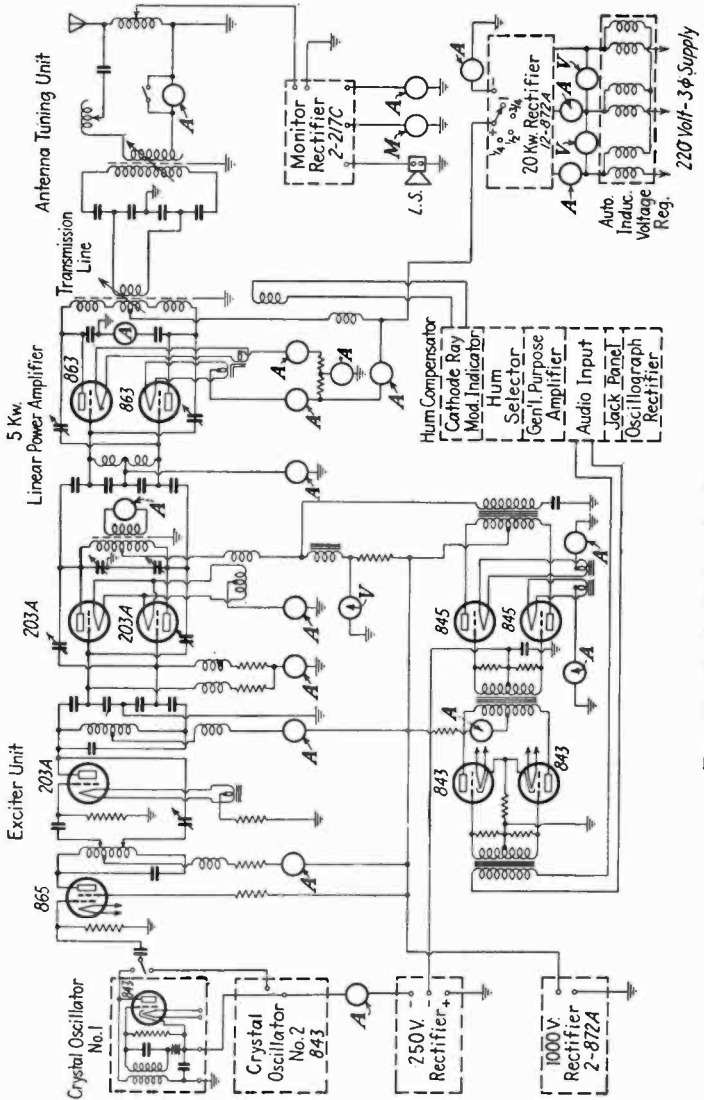

FIG. 49.—Typical 5-kw. circuit arrangement.

sarily be capable of dissipating 75 kw of r-f energy which is the full power output of a 50-kw transmitter when modulated 100 per cent with a sustained audio signal having sinusoidal wave shape.

MODULATION EQUIPMENT

25. The Speech Amplifier. An audio-amplifier unit employing power tubes is usually necessary as the preliminary part of the audio system of a transmitter. This unit is required to raise the audio-signal intensity to a sufficient amount to swing the grids of the modulator tubes. Resistance coupling is frequently used in speech-amplifier circuits. In Figs. 49 and 50 are shown circuit connections of typical transmitter speech amplifiers.

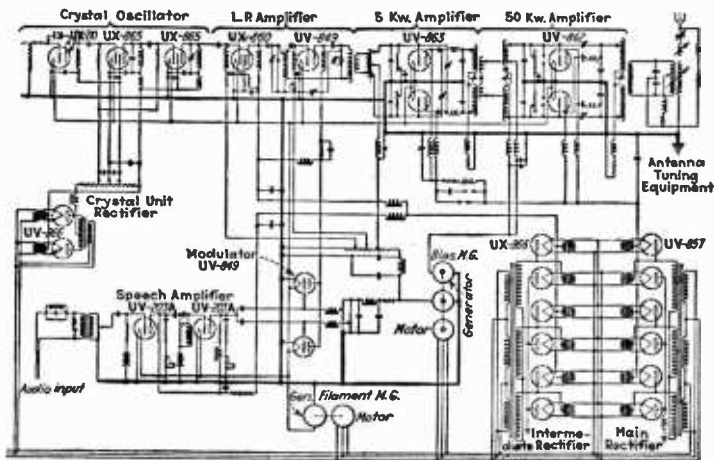

FIG. 50.—Circuit diagram of modern 50-kw transmitter.

Production of a broadcasting signal that will afford a means for conveying speech and music to the receiving set of a broadcast listener involves the generation of a constant r-f carrier upon which there are superimposed audio frequencies the intensities of which conform as nearly as possible with those contained in the sound produced in the studio. The production of such a signal may be accomplished by several methods¹ of modulation.

In American broadcasting technique the amplitude system of modulation is used exclusively. The advantage of amplitude modulation lies in the production of a modulation envelope containing but a single pair of sidebands, as compared to the phase and frequency methods which produce an infinite number of sidebands with a result that a considerable amount of distortion becomes apparent as the modulation is increased above 60 per cent.

¹ RODER, HANS, Amplitude, Phase and Frequency Modulation, *Proc. I.R.E.*, 19, 2145, December, 1931.

Amplitude modulation provides a means for reproducing an audio signal containing, under favorable conditions, a distortion not exceeding a few per cent with the carrier fully modulated. In broadcasting transmitters it can be effected by either plate or grid modulation. When grid modulation is applied to a power amplifier tube, either by means of a bias-voltage or r-f grid-voltage change, the efficiency of the power amplifier is rather low, ranging from 30 to 35 per cent. A plate-modulated radio stage operating as class C amplifier has a comparatively high efficiency ranging from 60 to 75 per cent. This advantage of higher efficiency, however, is offset by the low efficiency of the plate modulator unless a class B audio amplifier is used for modulating. Therefore, there is not much difference in the two systems in so far as efficiency is concerned with respect to power and vacuum-tube costs except under conditions where modulating power for a class C r-f output stage is supplied from a modulator of rather high efficiency.

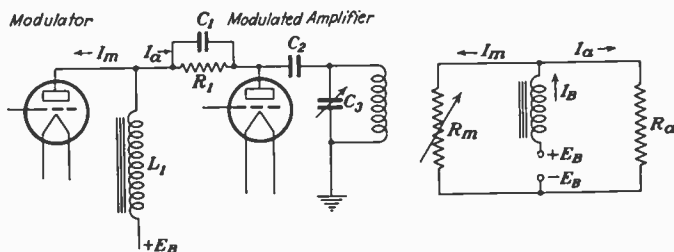

FIG. 51.—Heising constant-current modulator and equivalent.

When the last or power-amplifier stage of the transmitter is plate-modulated, the set-up is commonly called a *high-level system* of modulation whereas a transmitter modulated in a low power stage of the transmitter and followed by a class B r-f power amplifier is termed the *low-level system* of modulation.

26. Modulators and Modulated Amplifiers. In Fig. 51 is shown a constant-current system of modulation due to Heising.¹ The modulator and modulated amplifier of the system are connected in parallel with a constant-current source of supply. This is connected to the common plate lead through a large inductance L_1 called the *modulation choke*.

The dynamic modulating characteristics of such a system can be determined with a fair degree of accuracy from the static characteristics of the modulator tubes in a method illustrated in Fig. 52. The modulated amplifier is assumed to be a pure resistance load in parallel with the plate resistance of the modulator tubes and both assumed to be supplied with power through a modulation choke of infinite impedance. The sum of the instantaneous currents in the amplifier and modulator in this case is a constant. An approximation is made of the number of modulator tubes required to modulate a given r-f amplifier. The plate-current ordinate for a single tube must be multiplied by the number of modulator tubes before the load line BA can be plotted, the slope of which depends upon the load resistance produced by the amplifier. Line BA was chosen for two modulator tubes operating at 3,000 volts plate into an amplifier of 2,000 volts and 150 ma or

¹ HEISING, R. A., Modulation in Radio Telephony, *Proc. I.R.E.*, 9, 365, August, 1921.

an effective resistance of 13,333 ohms. The mean modulator plate current I_0 is chosen from allowable plate dissipation and load line BA drawn in about operating point C . The modulator grid voltage swings from $-\frac{1}{2}E_1$ (filament voltage) to equal grid voltage on the other side of the operating point.

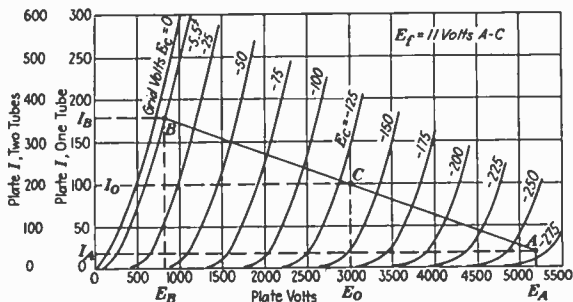

FIG. 52.—Method of determining modulator characteristics.

By taking readings of plate current and voltage from end points of the load line, the following information becomes available.

$$\text{Modulation factor} = \frac{E_A - E_B}{2E_0}$$

where E_A = maximum plate-voltage swing
 E_B = minimum plate-voltage swing
 E_0 = d-c plate voltage at operating point C

$$\text{Per cent distortion} = \frac{\frac{1}{2}(I_A + I_B) - I_0 \times 100}{(I_B - I_A)}$$

where I_A = maximum plate-current swing
 I_B = minimum plate-current swing
 I_0 = plate current at operating point C

$$\text{Power output in watts} = \frac{1}{6}(E_A - E_B)(I_B - I_A)$$

27. Design for High Audio Fidelity. In the design of the modulated amplifier circuit of the above system certain elements of the circuit must be properly proportioned to afford a uniform frequency characteristic. The capacity of C_1 , Fig. 51, should necessarily be large enough so that its impedance at the lowest frequency to be transmitted is less than one-third of R_1 , or the plate-dropping resistor.

The capacitor C_2 is provided to permit an r-f path from plate to filament of the amplifier tube and at the same time break the path for the direct current. It must also break the path for higher frequency a-f current and permit it to flow through the amplifier tube. It should, therefore, be no larger than necessary to conduct the r-f plate current without producing excessive phase shift in the plate current under conditions where C_2 is less than $2C_3$.

Sufficient impedance of the modulation choke over the a-f range is another important factor in circuit design. Its impedance at the lowest audio frequency should be at least two times the effective resistance load produced by the r-f amplifier tube. The choke should be free from inherent self-capacitance defects over the frequency range to maintain a sufficiently uniform high impedance at the higher frequencies of the range.

The design features mentioned above concern some principles involved in modulated-amplifier circuit design to prevent the existence of a-f distortion of a modulated signal. High-quality signal reproduction requires that amplitude distortion should also be kept at a minimum. A common cause of amplitude distortion is due to underexcitation of the grid of a modulated amplifier tube when plate modulation is applied. This results in insufficient driving voltage during periods of high plate-voltage swing and consequently peak-output limiting. Trouble from this cause shows up quite clearly upon an amplitude curve or upon an oscillograph in the form of chopped-off positive peaks. In Fig. 53 are

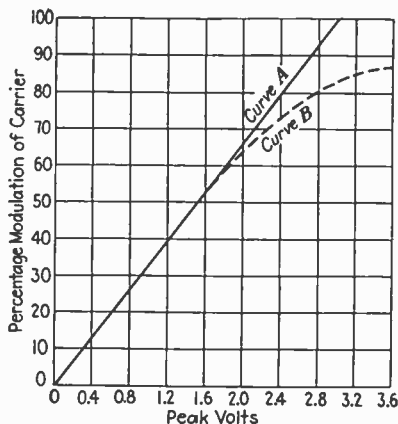

FIG. 53.—Amplitude curves taken on a modulated amplifier. Curve A taken on stage with sufficient driving power applied to saturate grid. This shows negligible amplitude distortion. Curve B taken on stage with insufficient grid excitation to cover positive peaks. Amplitude distortion becomes noticeable at 60 % modulation and increases with higher levels.

shown amplitude curves taken on the modulated carrier of a stage the grid of which was excited to saturation as shown in A and underexcited in B. In broadcast transmitter design it is a custom to have available a surplus of driving power for a modulated amplifier to prevent any possible occurrence of amplitude distortion.

The constant-current or Heising system of plate modulation described above is often designated as a class A system, since the modulator tube performs under conditions similar to those encountered in a class A amplifier. Conditions of operation of a tube in a class A system may be defined as those under which the plate current of the tube does not pass through zero at any time during a grid-voltage cycle.

A vacuum tube performing as a class B amplifier or modulator operates with a negative bias voltage fixed at a condition approaching plate-current cut-off. Therefore, plate current of the tube increases with a positive grid-voltage swing but as the grid voltage passes through the positive half of the cycle and swings negative, the plate current is cut off and remains so until the grid again swings positive.

Operation of a tube as a class B amplifier may be defined therefore as that under which the plate current for the tube flows for one-half of a grid-voltage cycle. By virtue of a push-pull circuit arrangement shown in Fig. 54 it is possible to develop a combined output plate current from two tubes which conforms with the grid-driving voltage throughout the cycle.¹

It is quite evident, therefore, that a properly designed class B system permits a much higher plate efficiency to be secured from a given set of tubes and correspondingly a much greater output from them than with a class A system. This efficiency has been made to reach as high as 66.6 per cent with a small percentage of audio harmonic distortion.

Inasmuch as it is often necessary to drive the grids of class B audio amplifiers into their positive grid-current region to obtain maximum

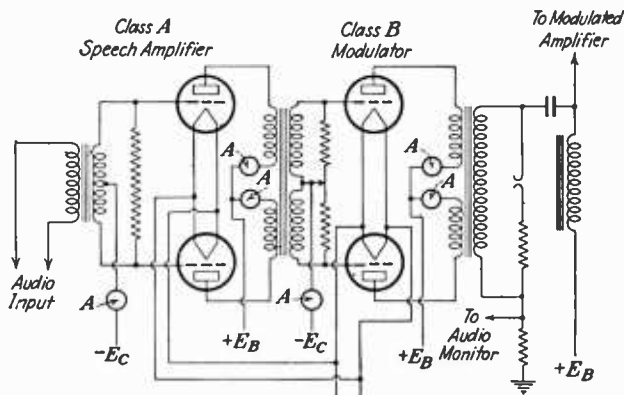

FIG. 54.—Class B push-pull modulator.

power output, it is important that the driver-amplifier stage for the modulator stage should have a good output-voltage regulation. This calls for driver tubes having a sufficient output capacity to deliver an undistorted voltage to the grids of the class B stage, even though there is a non-uniform increase of load on the driver stage caused by the class B tubes as they are driven through the positive grid-current region of their dynamic operating characteristics.

RADIO-FREQUENCY CIRCUIT

28 Class B Linear R-f Amplifiers. The operation of a Class B r-f amplifier may be understood by a study of Fig. 55A. Here it is shown that plate current drawn by the tube is very closely a linear function of the grid-voltage swing. The associated output-circuit loading is adjusted so as to realize from the tube a maximum conversion efficiency. Some curves showing how plate-current efficiency varies with effective load impedance are shown in Fig. 55B. The crest positions on these curves

¹ HUTCHERSON, J. A., Application of Transformer-coupled Modulators, *Proc. I.R.E.*, 21, July, 1933.

depend upon the tube characteristics and the power factor of the circuit into which it operates. These curves were taken at a broadcast frequency by varying the load upon the output circuit of a linear amplifier stage and measuring the efficiency of the stage at various d-c plate voltages.

Under conditions where the conversion efficiency is a linear function of the grid swing, the power output is necessarily proportional to the

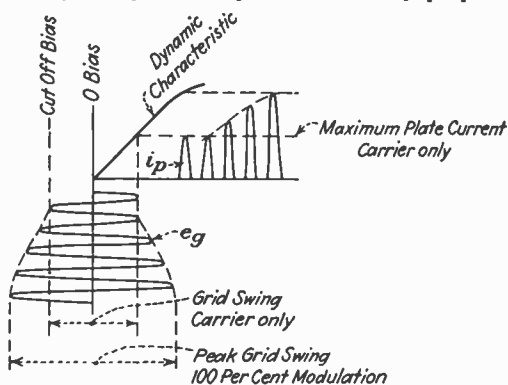

FIG. 55A.—Theoretical curves showing class B r-f amplifier operation.

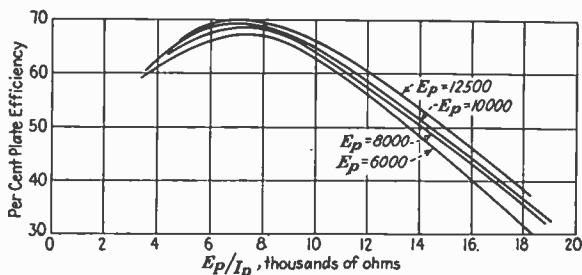

FIG. 55B.—Load curves for class B linear amplifier from which suitable adjustments may be selected.

square of the grid swing. Hence, the peak power output at 100 per cent modulation is four times that at which the modulation is zero. The steady power output under conditions of sustained 100 per cent modulation is 1.5 times the output of zero modulation. Therefore in considering power-tube requirements for a Class B linear-amplifier stage provision must be made with respect to filament emission and plate dissipation so that the tubes are capable of supplying peak power outputs of four times that of the nominal carrier power output rating of the transmitter. This, of course, assumes that the modulation capability of the transmitter is 100 per cent.

29. Water-cooled Tubes. For tubes of low power artificial cooling during operation is usually not necessary, radiation into the air being sufficient. For the larger tubes, however, artificial cooling is usually accomplished by means of a circulating water system which causes a sheet of water to pass over the anode surface at very high velocity.

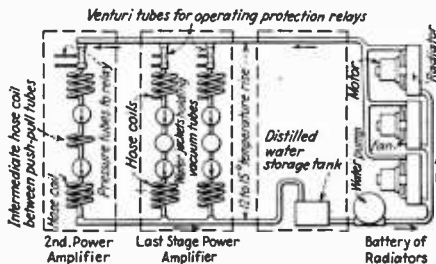

FIG. 56.—Water-cooling and circulation system.

To restrict leakage of current from the anodes to the grounded pipes of the water system, connection is made between the anodes and the water system through a long length of coiled hose or porcelain tubing. This interposes between the anode and ground columns of water long enough to make the electrical resistance to ground very high; as much as one hundred feet of coiled hose may be used giving resistances to ground in the order of 0.5 up to several megohms.

In many cases distilled water is used, the water being maintained at a satisfactory temperature by an artificial cooler since for economical reasons it is desirable that the same water be used indefinitely.

The water-cooling and circulating system is automatically started when the transmitter is turned on and the transmitter is automatically turned off in the event of any failure in the water-cooling system. One method of doing this is shown in Fig. 56, where the water system contains a Venturi tube whose inlet and output orifices are connected to a device operated by the difference in pressure established between the two orifices by the flow of water. If the flow is interrupted or falls below its normal value, a contactor through additional relays causes the power supply to be disconnected.

Sometimes a milliammeter is provided on the transmitter panel which indicates the magnitude of the current leaking through one of the closed coils, the amount of current serving to indicate the relative purity of the water, and indicating when it is advisable to change the water supply.

Table II indicates the chemical contents of cooling water used at four different radio stations for cooling tubes. The first three samples are unsatisfactory and would form scale. Tube prices being what they

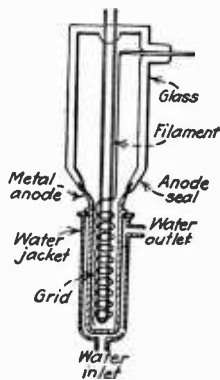

FIG. 57.—Water-cooled tube.

are, it is best to use a closed circulatory system with distilled water. Figure 57 is a diagram of a water-cooled tube.

TABLE II

Substance	Grains per gallon			
	1	2	3	4
Calcium carbonate.....	4.73	0.26	3.85	None
Calcium sulphate.....	None	2.76	Trace	0.45
Sodium carbonate.....	3.91	None	None	None
Sodium sulphate.....	3.09	0.28	0.24	None
Sodium chloride.....	1.02	1.02	0.85	0.67
Sodium and potassium nitrates.....	0.41	None	None	None
Magnesium carbonate.....	1.37	0.13	1.68	None
Magnesium sulphate.....	None	0.76	0.19	0.47
Aluminum and iron oxides.....	0.36	Trace	Trace	Trace
Silica.....	1.22	0.17	0.81	0.15
Total.....	16.11	5.38	7.62	1.74

30. Power Supply. Plate-voltage supply for transmitters may be obtained from d-c generators, high-vacuum tube rectifiers, mercury-vapor rectifiers, or hot-cathode mercury-vapor rectifiers. Direct-current generators are generally used for moderate voltages, but hot-cathode mercury-vapor tubes for rectification of high voltages have found rapidly increasing favor because of their reliability of operation and performance.

The hot-cathode mercury-vapor rectifier is one of the newest and evidently the best method of supplying high voltages to transmitter plate circuits. The operation of the hot-cathode mercury-vapor rectifier is similar in several respects to that of a mercury-vapor rectifier.

The most striking difference between mercury-vapor tubes and high-vacuum tubes is the internal-voltage drop between plate and cathode. In the high-vacuum tube, the voltage drop may vary from a few volts to several thousand volts, depending upon the current, element spacing, etc. In the mercury-vapor tube, the space charge is limited by the arc-drop of the vapor which is practically constant at values between 12 and 17 volts regardless of the current.

TABLE III.—COMPARISON OF HIGH-VACUUM AND MERCURY-VAPOR TUBE RECTIFIERS*

No. of tubes	Tube type	Circuit	D-c output			Tube-drop		Losses, kilowatts		Efficiency, per cent
			Volts	Amperes	Kilo-watts	Volts	At amperes	Fila-ment	Tube-drop	
6	UV-214	3 ϕ double Y	15,000	12	180	1,560	6	6.9	18.7	87.5
6	UV-857	3 ϕ full wave	15,000	12	180	15	12	1.5	0.36	98.8
†6	UV-857	3 ϕ full wave	21,000	30	630	15	30	1.5	0.9	99.4

* I. R. E., Vol. 18, No. 1, January, 1930.

† Maximum rating.

Table III gives a direct comparison of the relative efficiency of a high-vacuum tube and two mercury-vapor tubes. Note that the mercury-vapor tubes give very low internal-voltage drop and have considerably higher efficiencies.

There are two fundamental limits which determine the power output that can be obtained from any number of tubes operated in any type of circuit. These ratings are (a) the maximum peak inverse voltage at which the tube can operate without flashing back and (b) the maximum peak plate current which the cathode can supply with a reasonably long life.

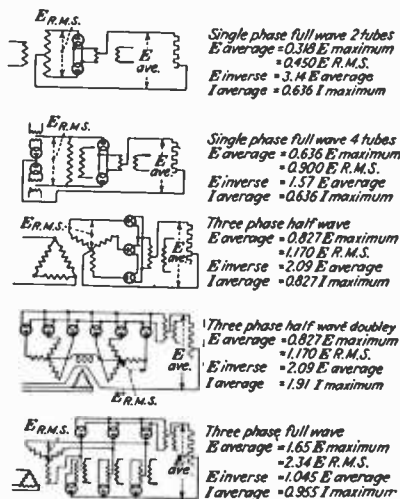

FIG. 58.—Hot-cathode mercury-vapor power circuits.

The maximum peak inverse voltage which can exist across a tube in any of the usual types of circuits is equal to the line-to-line peak or crest voltage of the power transformer less the voltage drop of the conducting tube.

The peak plate current depends upon the type of circuit, tube, filter, and load. In a single-phase full-wave circuit, each tube must carry the full load current for half the time. In the three-phase half- and full-wave circuit, each tube carries the load current for one-third of the time. If the rectifier feeds into an inductance, square blocks of current are drawn from the rectifier and the peak plate current approaches the d-c value. If the rectifier feeds into a capacity load plate, current is drawn for only a part of each half cycle and the peak current may reach values of from three to five times that of the d-c load current.

Table IV gives data on several typical hot-cathode mercury-vapor tubes designed for radio-power supply purposes. The circuits most commonly used with these types of tubes are shown in Fig. 58. The single-phase full-wave and the three-phase and half-wave circuits are

quite generally used. The three-phase full-wave circuit was suggested by D. C. Prince as being particularly applicable to the half-wave mercury-vapor tube, since it gives a peak inverse voltage whose magnitude is only 4.5 per cent greater than the average output voltage; the wave form is that of a six-phase rectifier.

TABLE IV.—HOT-CATHODE MERCURY-VAPOR TUBE RATINGS

Tube type	Filament		Peak inverse voltage	Peak anode current, amperes
	Volts	Amperes		
UX-866.....	2.5	5	7,500	0.6
UV-872.....	5	10	7,500	5.0
UV-869.....	5	20	25,000	10.0
UV-857.....	5	30	22,000	40.0

31. Parasitic Oscillations in Broadcasting Transmitters. One of the most important design features of a transmitter is to provide for adequate suppression of parasitic oscillations. Such spurious oscillations are usually caused by regeneration in an amplifier stage. They have frequencies different from the fundamental or its harmonics. While modern transmitters generally contain inherent design and construction features having a tendency to suppress all undesired parasitic oscillations, the various forms of these spurious oscillations as encountered, especially in transmitters of early design, are here considered.

All classes of amplifiers are subject to these kinds of oscillations. The problem of suppressing them in a Class C amplifier is not usually so difficult as in the Class B types where the grids of the tubes are driven positive for a considerable portion of the cycle. Before reliable and economical service can be realized from a transmitter of any type all tendencies for parasitic oscillation must be suppressed to prevent serious lessening in the life of vacuum tubes or program interruptions because of arc-overs in the transmitter. Such oscillations may exist in an otherwise normal amplifier stage and may not be evident to casual inspection owing to their disappearance entirely when grid excitation is removed.

A typical Class B power amplifier stage of the push-pull type is shown in Fig. 59. This amplifier contains some inherent design features which have a tendency to suppress spurious oscillations. The capacitors C_6 and C_7 assist in this respect by acting as a very low reactance path for all parasitics of a frequency higher than the fundamental with a result that they effectively load the parasitic circuit. Connections between these capacitors and the tube grids are kept at an absolute minimum. The grid loading resistors R_1 and R_2 whose real purpose is to improve the regulation of the grid circuit as the grids swing positive also act as a resistor load to damp out parasitic oscillations. The tank-circuit capacitors C_8 and C_9 with their midpoint grounded act as a low reactance path to ground for frequencies above the fundamental.

The frequency of parasitic oscillations may be anything from the very low end of the frequency spectrum to the ultra-high frequency region. Parasitics of very low frequencies, in the neighborhood of less than one cycle to ten cycles per second, are sometimes set up by the dynatron

action of the tubes at the natural period of the power-supply filter circuit C_1 , C_2 , and L_1 .

The existence of these parasitics of very low frequencies usually becomes apparent in the form of a severe irregularity in the saturation

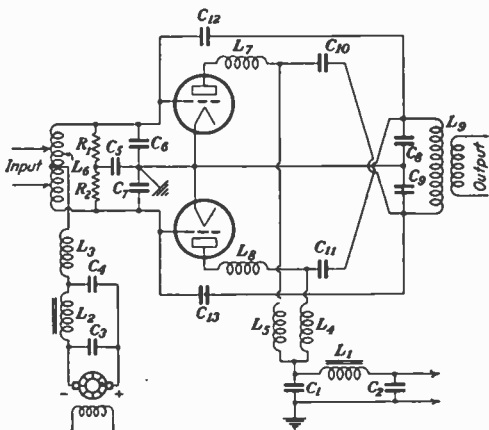

FIG. 59.—Class B amplifier with characteristics to suppress parasitics.

curve of the linear amplifier. Such a curve is shown in Fig. 60. The point X shows the beginning of this parasitic condition and Y the point where it ceases. It is caused by the dynatron characteristics of the

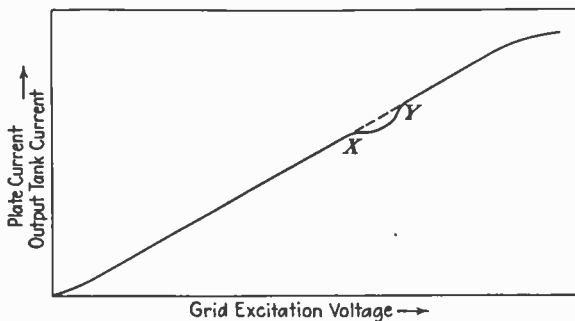

FIG. 60.—Typical saturation curve of class B r-f linear amplifier showing dynatron effect of power tube grids with E_b and E_c constant.

amplifier tube grids and occurs at a point on their operating characteristic just before they are driven positive. A solution for such a condition is to use amplifier tubes whose amplification factor is such that the region XY falls below the carrier operating point. For this reason high-mu

tubes have on some occasions been found to be more satisfactory than low- μ tubes.

Low-frequency parasitic oscillations of approximately one-third to one-fifth of the fundamental frequency are sometimes caused by tuned grid-tuned plate regeneration with the plate chokes L_3 and L_4 in combination with the blocking condensers C_{10} and C_{11} forming an output-tank circuit. A similar grid-tank circuit is formed by C_6 , C_7 , and L_3 . Inasmuch as all tubes are effectively in parallel for this combination the neutralizing capacitors tend to aggravate the condition rather than to prevent it. In Fig. 61 is shown an equivalent parasitic circuit of the combination as formed from the circuit in Fig. 59. The remedy for this condition is to change the values of inductance and capacity in either the

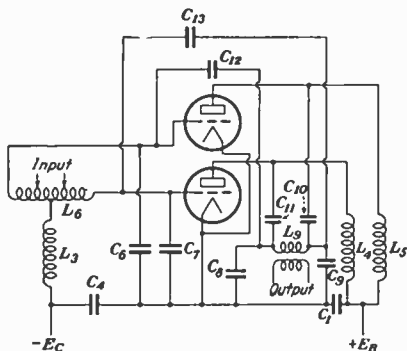

FIG. 61.—Equivalent parasitic circuit of Fig. 59.

parasitic grid or plate circuits so as to cause their natural periods to depart substantially from a near resonance condition. It is usually possible to suppress such oscillation by tuning the parasitic grid circuit to a higher frequency than the corresponding plate circuit.

The existence of these oscillations may usually be detected by applying excitation at the fundamental frequency to a stage with reduced plate voltage and grid-bias voltage until the tubes draw plate current. If oscillation of the stage continues after fundamental grid excitation is removed, as indicated by neon lamps attached to the tube plates, the frequency of the parasitic may be determined by means of a wave meter and thus steps can be taken to eliminate it.

Oscillations within an amplifier stage at frequencies near the fundamental are usually caused by regeneration within an amplifier stage due to improper neutralization causing tuned-grid tuned-plate circuit oscillations. Improper circuit design or too close coupling between the inductances of the input and output circuits or chokes is also liable to cause this condition.

Parasitic oscillations of frequencies in the neighborhood of from five to twenty times the fundamental result in cases where the leads from the tube grids and the condensers C_6 and C_7 form a grid tank circuit the resonance frequency of which is determined by various distributed capacities and the inductance of the leads. Oscillations are made

possible by the existence of a similar plate-tank circuit formed by leads from the tube plates to capacitors C_8 and C_9 together with various stray capacities. The form of parasitic oscillation is seldom sustained but shows itself most prominently when the stage is subject to high peaks of modulation. The trouble may usually be corrected by insertion in the plate leads at a point adjacent to the tube plates choke coils L_7 and L_8 .

These parasitic choke coils L_7 and L_8 together with a shortening of grid leads to an absolute minimum may also assist in suppressing parasitic oscillations of ultra-high frequencies in amplifier stages employing two tubes in parallel. The grid leads of the two tubes although connected may combine with stray capacities, thus forming a push-pull oscillation of a very high frequency. Such oscillations in some cases cause high r-f voltages to build up which may result in serious arc-overs from various parts of the tube output circuits.

While it is beyond the scope of this section to cover entirely the causes and remedies for parasitic or spurious oscillations in transmitters, the general information given herein should assist in determining unstable or parasitic conditions within a given amplifier stage. Careful circuit study and extensive tests upon a stage suspected of producing parasitic oscillations are necessary before troubles of this kind can be completely eliminated.

32. Suppression of Broadcasting Transmitter R-f Harmonics. Since it is the inherent characteristic of a vacuum tube while functioning at a reasonably high efficiency in an amplifier circuit to generate harmonic frequencies of the fundamental, vacuum-tube transmitters are frequently a source of harmonic interference. For example, a station broadcasting on 600 kc, if second and third harmonics were not suppressed, would produce interference with other stations operating on 1,200 kc and 1,800 kc. It is, therefore, essential that a modern broadcasting station should be so designed and adjusted as to suppress to the greatest extent possible the radiation of all harmonic frequencies.

Inasmuch as the only method of determining how effectively a station radiates is by means of a field-intensity survey, it is evident that field intensity measurements about a station are necessary to determine how much harmonic energy is radiated and to show the progress of work done toward reducing radiation to an absolute minimum. In Fig. 62 is shown the results of such a survey taken in the vicinity of a high-powered broadcasting station.

In specifying the allowable harmonic radiation from a broadcasting station the IRE Committee on Broadcasting as of January, 1930, recommended that the maximum radio field intensity of a harmonic component measured at a distance of one mile from a station should not exceed 0.05 per cent of the field intensity of the fundamental.

A field strength of $500 \mu\text{v}/\text{m}$ at a distance of one mile is recommended as a maximum allowable intensity from a high-powered transmitting station. If in the case of a 50-kw station a circular field pattern and equal attenuation is assumed for both a harmonic and the fundamental in the immediate vicinity of the station, a field strength of $500 \mu\text{v}$ at one mile would correspond to approximately seven milliwatts of radiated power at a harmonic frequency. The effect of directivity (illustrated in curve *B*), may cause a field intensity of a number of times the value of $500 \mu\text{v}$ to be projected in a given direction with a very small fraction of one watt of harmonic power in the transmission line and antenna circuits.

Such a concentration of radiated power may form very objectionable interference. Considering the factors involved, therefore, it is evident that harmonic suppression must be attacked from a number of angles. These may be briefly outlined as follows:

1. Design of the transmitter circuits to reduce the harmonic content of the power delivered to the antenna circuits to a minimum.
2. Thorough and effective shielding of the entire transmitter or building.
3. Effectively grounding all harmonic drain circuits and elimination of long conductors near the transmitter coupled to it inductively or capacitatively.
4. Reduction of directivity of harmonic radiation to a minimum.
5. Installation of shielded band- or low-pass filters at the input end of the transmission line, to the antenna.

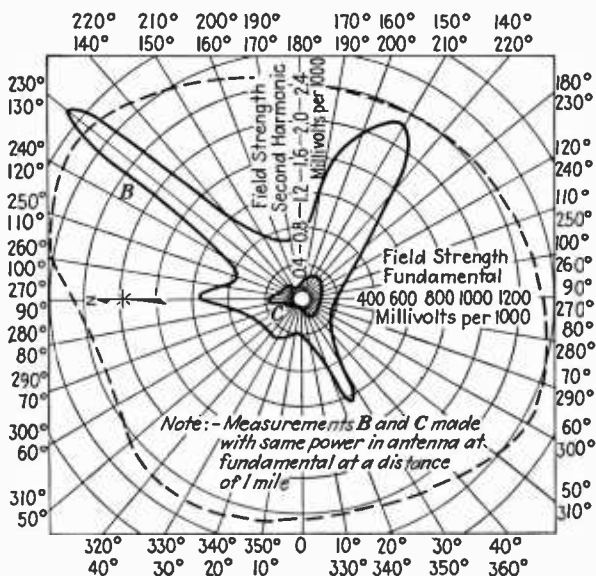

FIG. 62.—Radio field-intensity survey. The dotted curve gives fundamental frequency field strength; B and C are second harmonic intensity before and after reduction.

Some commonly used triode amplifier circuits are shown in Figs. 63 and 64. The push-pull amplifier is superior to the single-ended circuit as it is capable of producing a sum plate current of the two tubes which is symmetrical in wave shape and therefore contains no even harmonics. Individual plate currents, of course, contain even harmonics which are drained to ground through C_3 and C_4 resulting in identical instantaneous even harmonic potentials being set up on each side of L_2 but no actual even harmonic current through it. Under these conditions, an electrostatically shielded inductive coupling permits transfer of only fundamental and odd harmonic frequencies to the coupled circuit. For a

condition of symmetrical plate current it is evident that the tube characteristics must match closely, $C_1 = C_2$ and $C_3 = C_4$. The neutralizing bridge must be balanced not only for the fundamental frequency but for even harmonics. This requires that the internal capacities of the tubes should match. As will be shown later, a high ratio of circulating kilovolt-ampere in the tank circuit to the kilowatt delivered from the amplifier

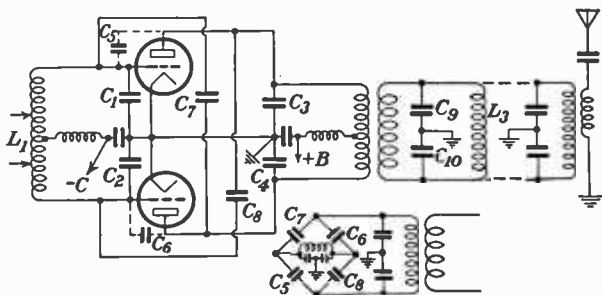

FIG. 63.—Push-pull amplifier with high kilovolt-ampere tank circuit in transmission line.

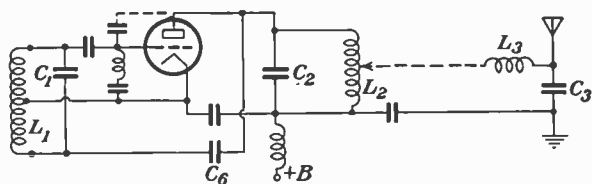

FIG. 64.—Line termination effecting reduced harmonic radiation.

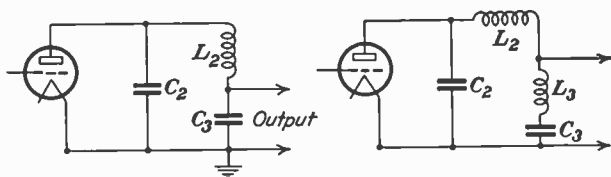

FIG. 65.—Improved tank circuits for suppressing harmonic radiation.

reduces the output of harmonics from a single-ended amplifier to a very low value. This is also true in the push-pull circuit.

The circuit shown in Fig. 64 will give a very small amount of harmonic output by proper design of the circuit constants. The curves in Fig. 66 show the filtering effect of a high kilovolt-ampere tank circuit in suppressing harmonic components of current generated in the tube. These curves show actual harmonic transferred to a given load circuit Z_L with a constant output at the fundamental and various kilovolt-ampere to kilowatt ratios of L_1 and C_2 . Fig. 65 shows improvement in tank circuits so as to increase the normal filtering action of an ordinary tank circuit.

A high kilovolt-ampere to kilowatt ratio applied to these circuits is capable of reducing harmonic output to an extremely small amount. There are some limitations in the amount of filtering which can be secured by a high kilovolt-ampere tank circuit, however, since the I^2R losses in the circuit increase in proportion to the circulating kilovolt-ampere and the cost of apparatus for increasing kilovolt-ampere in a circuit without increasing losses is considerable. In broadcasting transmitters there is the limitation of too low a decrement in a circuit attenuating too greatly the high frequencies of a modulated envelope. In Fig. 65 the series of trap L_2C_2 is tuned to a particular harmonic to be eliminated. The use of antiresonant circuits (parallel traps) in the plate lead of an amplifier while reducing to some extent a single harmonic has a tendency

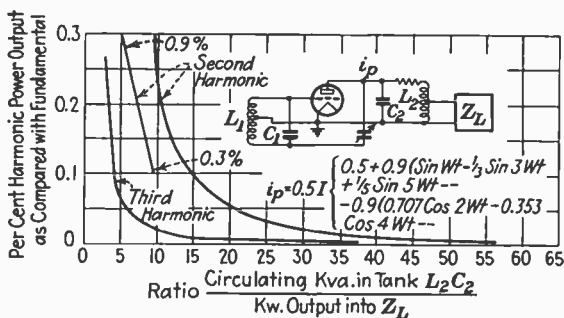

FIG. 66.—Effectiveness of high kilovolt-ampere-kilowatt ratio in reducing harmonic output with constant power output at fundamental.

to allow considerable voltage to build up at others. Most satisfactory results are usually secured by designing a minimum impedance path for harmonics to ground as compared with a given high impedance at the fundamental.

The effectiveness of the shielding of a transmitter may be determined by operating the transmitter with full power output into a shielded phantom antenna. Measurement of the harmonic field strengths produced from the transmitter itself is direct evidence of how well it is shielded. Such radiation can usually be traced to a long conductor near the transmitter coupled to it through a common ground return or capacitively. Ground conductors serving to drain harmonic frequency power to ground therefore should be as direct as possible and should not be extended so as to have a free end which might attain a high potential at resonant frequencies. This is particularly true of the harmonic drains near the antenna itself. These should have a separate ground to prevent coupling of harmonic frequencies into the antenna.

A sensitive wave meter is very useful in determining the relative harmonic field intensities near the various circuits of a transmitter. When tuned to the frequencies of various harmonics, and coupled to various circuits of the transmitter or placed at positions along nearby open conductors, this instrument will indicate proportionate amounts of the harmonic components of the current flow. By effectively grounding a long open conductor either directly or through large capacity

condensers at a number of distributed points harmonic radiation can usually be eliminated.

The push-pull amplifier when coupled to a long transmission line has often become a source of undesirable even-harmonic radiation because of sufficient electrostatic capacity existing between the coupled circuits to permit a transfer of even-harmonic energy from the amplifier output circuit to the line. Unless this electrostatic capacity is reduced to an extremely low value, i.e., by installation of a well-grounded electrostatic screen between the two coils, even harmonics usually find a path along the transmission line with a ground return to the generating source. An unshielded transmission line serves in this case as an effective directive radiator in the form of a large loop. Its effective height will be dependent upon the height of the transmission line above ground. Parallel flow of even-harmonic currents along the line, therefore, makes it a much more effective radiator in some directions than the push-pull flow of harmonic currents in the line.

A circuit which has been found to be very effective in reducing both the parallel as well as the push-pull flow of harmonic currents in a transmission line is shown in Fig. 63 in the form of a high kilovolt-ampere floating tank circuit $L_3C_9C_{10}$ tuned to the fundamental component of current flowing in the line. This tank circuit, while offering an impedance to the fundamental approaching an infinitely high value, offers a relatively low impedance path to ground for the parallel flow of even harmonics equivalent to

$$Z_{ne} = \frac{-1}{4\pi f_{ne} C_9} = \frac{-1}{4\pi f_{ne} C_{10}}$$

where resistance of circuit is negligible

Z_{ne} = impedance to n^{th} even harmonic

f_{ne} = frequency of n^{th} even harmonic

and for the push-pull flow of odd harmonics between transmission-line conductors

$$Z_{no} = \frac{-2\pi f_{no} L_3}{(2\pi f_{no})^2 L_3 C - 1}$$

where resistance of circuit is negligible

Z_{no} = impedance to n^{th} odd harmonic

f_{no} = frequency of n^{th} odd harmonic

$$C = \frac{C_9}{2} = \frac{C_{10}}{2}$$

where $C_9 = C_{10}$

It is evident that as C_9 and C_{10} are increased in capacity the effectiveness of the circuit in reducing harmonics is increased. Since the transmission-line termination impedance is usually made to match the line impedance for the fundamental frequency it usually happens that the line impedance is matched for this frequency only and as a result harmonic components of current and voltage in the line appear as standing waves along the line. In such a case the above tank circuit is most effective for eliminating a particular harmonic if it is placed at a point along the line of maximum voltage. This circuit alone was effective in one case

in reducing second-harmonic radiation from a station to one-fifth of its former value.

Antiresonant circuits installed in a transmission line at current antinodes have been found very effective in reducing to a great extent a single harmonic to which they were tuned. Extreme care should be taken in shielding these antiresonant circuits to secure best results. A combination of antiresonant circuits and a low-pass filter is shown in Fig. 67. This combination has been used successfully in severe cases of harmonic radiation from a very long transmission line and antenna system. The filter in design matches the surge impedance of the line and has a cut-off frequency between the fundamental and second harmonic. Antiresonant circuits have been found useful to sharpen the cut-off so as to attenuate sufficiently the second-harmonic frequency. Considerable experience in filter design and adjustment is required to secure optimum results from such an arrangement.

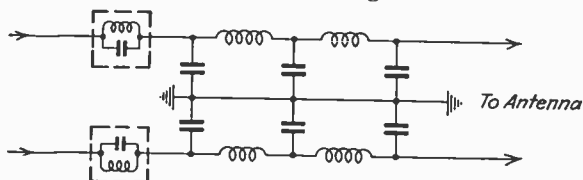

FIG. 67.—Low-pass filter combined with antiresonant circuits in transmission line.

The methods of line termination shown in Figs. 63 and 64 are effective in reducing the possibility of harmonics reaching the antenna circuit. The termination shown in Fig. 64 may be improved by use of a multi-section low-pass filter.

33. Antenna Circuit Terminations for R-f Transmission Lines. In the early days of broadcasting it was common practice to construct a station with an antenna system quite close to the station building so that the antenna could be coupled either directly or with a short-link circuit to the output tank circuit of the transmitter. Such an arrangement had disadvantages, the most serious of which were:

1. Distortion of the antenna field pattern due to the station building, nearby power lines and other structures.
2. Reduced antenna efficiency due to circulating currents in the structure as well as imperfect ground system caused by same.
3. Hazards caused to the station staff and building by falling ice formed by sleet as well as parts of the antenna in case of mechanical failure.
4. Broadcast signal distortion caused by the high radio-frequency field intensity present at the base of the antenna in entering station audio circuits.
5. Difficulties experienced in preventing r-f harmonic transfer from the transmitter output stage to the antenna.

As advancements were made in broadcast station design it became more apparent that considerable improvements in antenna efficiency could be secured from an antenna located some distance from the station so as to approach the ideal condition of an antenna radiating in free space. The r-f transmission line was found to be very efficient for conveying the energy from the transmitter to the antenna. A simple form of such a

transmission line is the parallel two-conductor type, each conductor having a diameter of approximately $\frac{1}{2}$ in. The spacing of the conductors is normally about 15 in.

The fundamental properties of such a radio-frequency transmission line may be most easily comprehended by considering its electrical properties under conditions where it would appear to be a transmission line of infinite length. In this case, a wave of electrical energy advancing along the line from the transmitter end would not be interfered with by reflections from the end of the line. There would be a progressive reduction in the voltage vector as it moved away from the transmitter end. At any point X , the magnitude of the voltage vector may be expressed as:

$$E_x = E_0 e^{-\alpha x} \quad (1)$$

where α is the attenuation constant.

Since the phase position of the voltage vector is shifted backwards as the distance from the transmitter end is increased it may be expressed as:

$$E_x = E_0 e^{-i\beta x} \quad (2)$$

where β is the wave-length constant.

At any point X along the line, therefore, a complete expression for the line voltage may be expressed as:

$$E_x = E_0 e^{-x(\alpha + j\beta)} = E_0 e^{-Px} \quad (3)$$

where P is the propagation constant equal to $(\alpha + j\beta)$. It may be expressed as:

$$P = \sqrt{R + j\omega L} \sqrt{G + j\omega C} \quad (4)$$

where R = line resistance in ohms per unit length

L = line inductance in henrys per unit length

G = line leakage conductance in mhos per unit length

C = line capacitance in farads per unit length.

An infinite line as measured at the transmitter end would have a vector impedance of

$$Z_0 = \frac{\sqrt{R + j\omega L}}{\sqrt{G + j\omega C}} \quad (5)$$

This is known as the *characteristic impedance* of an infinite line measured at the transmitter end. It is also equal to the characteristic impedance of a line of finite length terminated in its characteristic impedance. It shows that to provide a line termination that will prevent wave reflections it should be a real quantity in the form of an effective resistance.

Normally the values of R and G are negligible at high frequencies in comparison to the reactive components. The characteristic impedance for practical purposes can, therefore, be calculated from the formula

$$Z_0 = \sqrt{\frac{L}{C}} \quad (6)$$

It is equivalent to a pure resistance. For the uniform parallel two-conductor line mentioned above the characteristic impedance

$$Z_0 = 276 \log_{10} \left(\frac{S}{d} + \sqrt{\frac{S^2}{d^2} - 1} \right) \quad (7)$$

where S is the distance between conductors and d is the diameter of the conductor.

Where S is relatively great in comparison to d , the formula is sufficiently accurate when expressed as

$$Z_0 = 276 \log_{10} \left(\frac{2S}{d} \right) \quad (8)$$

For a concentric-tube transmission line the characteristic impedance is

$$Z_0 = 138 \log_{10} \frac{S}{d} \quad (9)$$

The curves of Fig. 68 show the characteristic impedance values with respect to spacing and conductor size of both the parallel conductor line and the concentric-tube type.

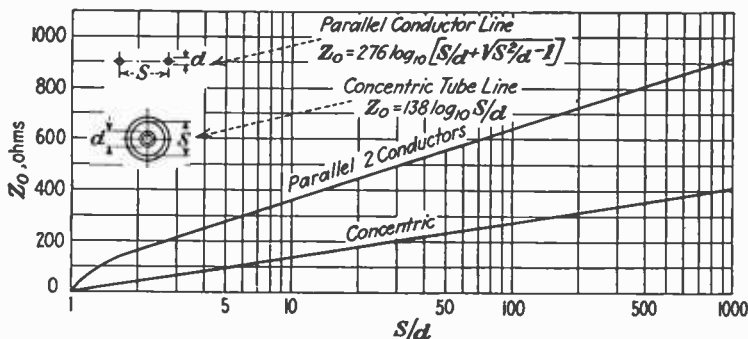

FIG. 68.—Impedance of parallel and concentric-tube lines.

34. Transmission-line Calculations.¹ There are diverse methods of measuring the characteristic impedance of a transmission line. A simple but effective method is illustrated in Fig. 69. With the set-up shown and the switch thrown to the line position a trial value of resistance R_2 is inserted. C is adjusted for maximum I_2 . Then with switch thrown in the opposite position and R_1 set to equal R_2 the capacitor C is adjusted for maximum I_1 . By trial, a combination may be found where there is a maximum value of I_1 and I_2 for the same setting of C with R_1 equal to R_2 . This value of R is the characteristic or surge impedance of the line.

¹ See also Sec. 22 on Antennas.

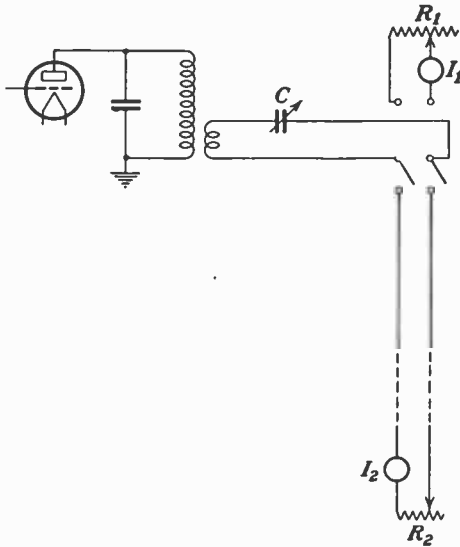

FIG. 69.—Measuring impedance of transmission line.

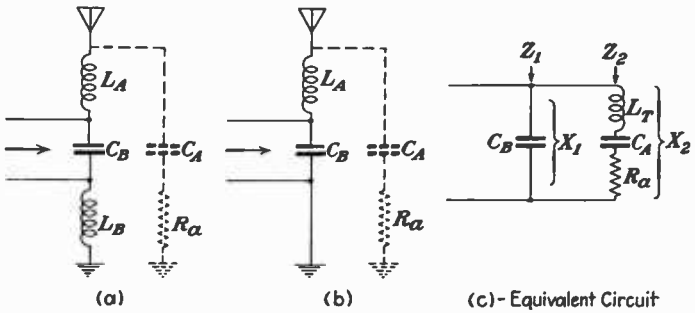

FIG. 70.—Terminations for transmission lines.

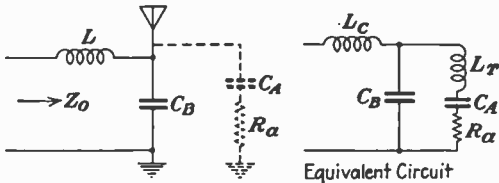

FIG. 71.—Transmission-line termination.

When r-f power is transmitted over a transmission line to an antenna load, the line termination may be adjusted to afford a condition where there are no wave reflections by making the effective resistance of the termination equal to the characteristic impedance of the line. Several circuits used for terminating transmission lines are shown in Figs. 70 to 72 together with their equivalent circuits.

A formula for calculating the value of capacitor C_B for an effective resistance value Z_0 equal to the characteristic impedance of a two-conductor transmission line balanced to ground as shown in Fig. 72 as well as for a

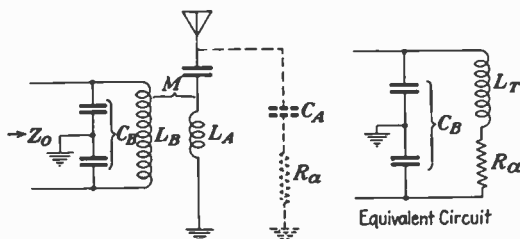

FIG. 72.—Balanced transmission-line termination.

transmission line having one conductor grounded has been developed as follows:

- Let Z_0 = effective resistance of transmission-line termination
 R_a = antenna resistance consisting of radiation resistance plus equivalent loss resistance
 L_T = combined inductance-balance coils plus equivalent antenna inductance

C_A = equivalent antenna capacity

C_B = line-termination capacity

X_1 = reactance of C_B

X_2 = reactance of $X_L - X_{CA}$

Z_1 = impedance branch 1 = $-jX_1$

Z_2 = impedance branch 2 = $R_a + jX_2$

$$Z_0 = \frac{Z_1 Z_2}{Z_1 + Z_2} = \frac{-jX_1(R_a - jX_2)}{-jX_1 + R_a + jX_2} = \frac{-jX_1(R_a - jX_2)}{R_a + j(X_2 - X_1)}$$

$$= \frac{R_a X_1^2 - j(X_2^2 - X_1 X_2 + R_a^2)}{R_a^2 + (X_2 - X_1)^2}$$

For a condition of non-reflection from the line termination Z_0 must be a real quantity. Therefore, the reactive component equals zero or

$$\frac{-j(X_2^2 - X_1 X_2 + R_a^2)}{R_a^2 + (X_2 - X_1)^2} = 0 = X_2^2 - X_1 X_2 + R_a^2$$

and

$$Z_0 = \frac{R_a X_1^2}{R_a^2 + (X_2 - X_1)^2} \quad (10)$$

Whence $Z_0 = \frac{R_a^2 + X_2^2}{R_a}$ (11)

and $X_2 = \pm \sqrt{Z_0 R_a - R_a^2}$

and $X_1 = \frac{R_a^2 + Z_0 R_a - R_a^2}{\pm \sqrt{Z_0 R_a - R_a^2}} = \frac{Z_0 R_a}{\pm \sqrt{Z_0 R_a - R_a^2}}$ (12)

This shows the value of C_B to be dependent only on values of Z_0 and R_a where Z_0 is equivalent to a pure a-c resistance.

$$X_1 = \frac{Z_0 R_a}{\pm \sqrt{R_a(Z_0 - R_a)}} = \frac{1}{2\pi f C_B}$$

$$C_B = \sqrt{\frac{Z_0 - R_a}{4\pi^2 f^2 Z_0^2 R_a}} \quad (13)$$

Formula (12) shows that unless Z_0 exceeds the value of R_a an effective resistance equivalent to the characteristic impedance of the line cannot be secured.

When low impedance lines are used, such as the concentric-tube type, the termination shown in Fig. 71 is useful since it affords a condition where correct termination may occur in the form of an effective resistance even though R_a equals or exceeds Z_0 .

In Figure 72 is shown a transmission in the form of a tank circuit. The tank condenser C_B across the line is selected so as to provide a suitable kilovolt-ampere ratio of the tank circuit with respect to the kilowatts transferred to the antenna circuit; this kilovolt-ampere to kilowatt ratio is normally about ten and should never be less than two.

From Eq. (12) above,

$$X_1 = \frac{Z_0 R_a}{\pm \sqrt{R_a(Z_0 - R_a)}}$$

$$X_1^2 = \frac{Z_0^2 R_a}{(Z_0 - R_a)}$$

from which

$$R_a = \frac{X_1^2 Z_0}{Z_0 + X_1^2} \quad (14)$$

where R_a in this case is the effective value of resistance reflected into the tank circuit from the antenna circuit.

The value of R_a in this case can be readily calculated from the formula

$$R_a = \frac{\omega^2 M^2 R_a}{R_a^2 + X_a^2} \quad (15)$$

where the inherent resistance of the tank circuit is negligible,

M = mutual inductance between L_A and L_B

X_A = reactance of antenna circuit

R_a = resistance of antenna circuit.

For a condition of proper termination X_a approaches zero and may be neglected and

$$\frac{\omega^2 M^2}{R_a} = \frac{X_1^2 Z_0}{Z_0^2 + X_1^2}$$

$$M = \sqrt{\frac{X_1^2 Z_0 R_a}{\omega^2 (Z_0^2 + X_1^2)}} \quad (16)$$

In Fig. 73 are shown values of M required for a transmission impedance of 400, 500, and 600 ohms and a line-termination capacitor of between 0.001 and 0.004 μf . The transmitter frequency was assumed as 670 kc and the antenna resistance 30, 70, and 140 ohms. In the design of a tank circuit termination for a given line the value of C_B across the line is selected so as to provide a proper kilovolt-ampere in the tank circuit with respect to the power transferred to the antenna circuit. This kilovolt-ampere to kilowatt ratio is normally about ten.

The usual procedure in adjusting a transmission-line termination for a condition of no-wave reflection on the line is as follows:

1. The number of coupling turns is calculated so as to give the proper value of M . With the tank circuit open, the antenna is tuned to exact resonance by means of an external oscillator until loosely coupled to it at the fundamental frequency.

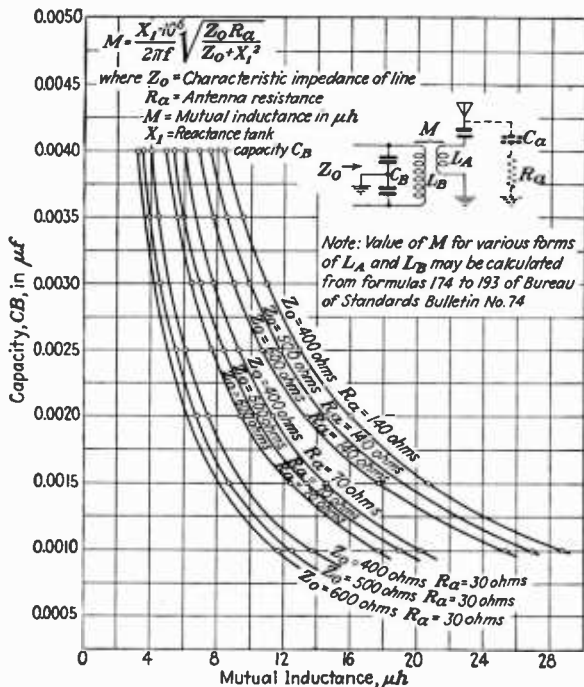

FIG. 73.—Values of M required for proper termination.

2. The tank circuit is now connected into the circuit and tuned to resonance. This is indicated by a condition where the current in the antenna circuit becomes a minimum.

3. The transmission line is then connected across the tank circuit without making any changes in previous adjustments.

4. Correct termination may be checked by measuring the transmission-line currents at the ends and quarter-wave points along the line by means of suitable meters. When proper termination has been effected the transmission-line currents will be identical at all points along the line.

35. Broadcast Station Coverage. The service area of a given broadcasting station consists essentially of two distinct regions. That region in close proximity to the station as served by the direct ray or ground

wave is called the *primary coverage area* of a broadcasting station while the region at some distance from the station and served by virtue of indirect ray or sky-wave reflections is called the *secondary coverage area*. During daylight hours of broadcast transmission on frequencies between 550 and 1500 kc a broadcast listener is concerned with the primary coverage area signals of nearby stations for programs since there is very

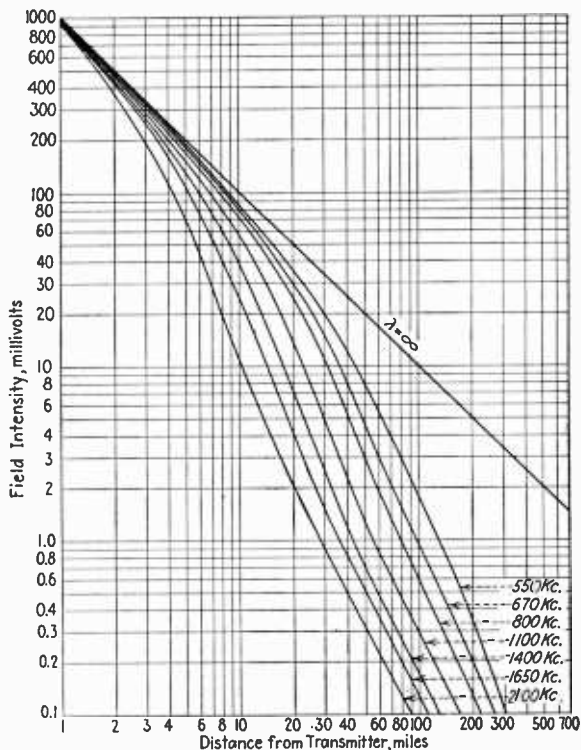

FIG. 74.—Field intensity at various distances from an antenna radiating an equivalent power of 1,000 millivolts at one mile over soil having conductivity of $\sigma = 60 \times 10^{-12} \epsilon = 15$.

little sky-wave energy reflected during this period under normal conditions. The daylight service area of such a broadcasting station therefore consists almost entirely of that region served by the direct ray. During hours of twilight and darkness, the secondary coverage areas of stations in the broadcast band between 550 kc and 1500 kc become apparent. The secondary coverage area begins at a considerable distance from a given station and is served by the predominant sky wave. The received signal therefore usually fades or fluctuates in intensity. (Report of Committee on Radio Propagation Data. *Proc. I.R.E.*, Vol. 21, No. 10,

October, 1933.) The primary and secondary coverage areas of a broadcasting station are separated by a region known as the *fading area* of the station. In this area the signal intensities of the direct and indirect rays approach an equality with a result that violent fluctuations in signal intensities are apparent. The fading areas of stations are dependent upon a number of factors such as frequency of transmission, antenna radiation characteristics, conductivity of intervening terrain, time of day and season, and are normally contained within radii of between 20 and several hundred miles.

Considering a broadcasting station radiating equally in all directions, and assuming equal ground attenuation the service area would consist of a primary coverage area or circular area near the station and served by a steady ground-wave signal. Outside of this would exist the fading area consisting of a ring about the primary area. Beyond the fading ring the secondary coverage area would exist. Inasmuch as broadcast reception is rather uncertain in the fading region and in the secondary coverage area, the real value of a given station is dependent normally upon its primary coverage area.

In its fifth annual report to the Congress of the United States the Federal Communications Committee tabulated values of field strength considered necessary for reliable broadcast service in three areas: (1) a business city area where a field strength of 10 mv/m is recommended, (2) a residential district of a city where a field intensity of 2 mv/m is recommended, and (3) a rural area where 0.5 mv/m is considered sufficient. In addition, it is stated that for fair service a signal intensity of one-half the above values is needed and for poor service one-fourth of these values. These figures are based upon the average signal intensity necessary to override the noise levels of these districts.

The service area of a broadcasting station is dependent upon a number of factors such as the frequency of transmission, ground conductivity, radiated power, antenna design, and the conditions of interference to signal reception. The published results of rather extensive surveys¹ have indicated that the frequency of transmission greatly determines the service area of a given station. From results published in the Ohio State Bulletin No. 71 the following table is given. These results are based on a given soil.

SERVICE RADIUS FOR 1-KW RADIATED POWER MILES

Frequency	5 mv	2 mv	1 mv	½ mv	0.1 mv
550	25	45	63	88	180
700	22	39	56	77	140
1070	15	26	37	52	97
1450	11	18	23	32	60

¹ KIRBY, S. S. and K. A. NORTON, Field Intensity Measurements, Bur. Standards Jour. Research, April, 1932.

BYRNE, J. F., Radio Transmission Characteristics of Ohio at Broadcast Frequencies, Bull. 71, Ohio State University Engineering Service.

ROLF, Numerical Discussion of Sommerfeld's Attenuation Formula, Proc. I.R.E., Vol. 18, No. 3, March, 1930.

ECKERSLEY, P. P., The Calculation of the Service Area of Broadcast Stations, Proc. I.R.E., 18 (7), July, 1930.

ECKERSLEY, T. L., Direct Ray Broadcast Transmission. Proc. I.R.E., 20 (10), October, 1932.

SECTION 20

FACSIMILE TRANSMISSION

By R. H. RANGER¹

1. General Requirements. Elementary dots in a half-tone picture, printed in a newspaper, illustrate how a picture must be analyzed in photo units in order to transmit it electrically to a distance. There is no known way that a picture may be transmitted in its entirety electrically from one point to another; the process consists first in tracing across the original picture point by point in consecutive lines; second in sending a representation of the values of each such traced point over the communication system; and third in putting down the point representations in the proper places on the recording sheet to build up the picture at the receiving station.

The finer these picture elements are taken in the analysis the finer will be the resultant detail in the recorded picture as compared with the original. The number of such photo units to the picture therefore indicates the resolving power of the system.

It takes 50 dots in a line across a picture and 50 lines down a picture to represent a face in good shape. This means 2,500 dots or photo units total. Photo units to the number of 300,000 are required to get across a scene that would normally be required in newspaper work.

It makes no difference as to the size of the finished picture, the resolving power is entirely a question of the number of photo units transmitted in good shape. It takes just as many tiny photo units to represent a face well on a postage stamp as it takes to represent a face in larger photo units on a 10-ft. enlargement. Naturally it will be necessary to stand back from the large pictures to get the effect, but the detail will be equal in each case.

The maximum possible difference between two consecutive photo units would be that one was white and the next was dark. As the normal representations of this transition would be from a positive value of current for one and a negative or minimum value for the next, a complete electrical cycle would be represented by the two successive photo units. Therefore, the modulation impressed on the carrier in picture transmission is anything up to a frequency one-half the number of photo units being handled.

Photo units may be handled over normal telephone lines at the rate of 800 a second corresponding to a maximum modulation rate of 400 cycles. This will cover a 5-by-7 picture of a scene in 7 min. It must be borne in mind that a band width considerably in excess of the modulation rate should be allowed for picture transmission. The third harmonic of the

¹ Fellow, I. R. E., Royal Society of London; Member, A. I. E. E., American Physical Society, Optical Society, President, Rangertone; Inc.

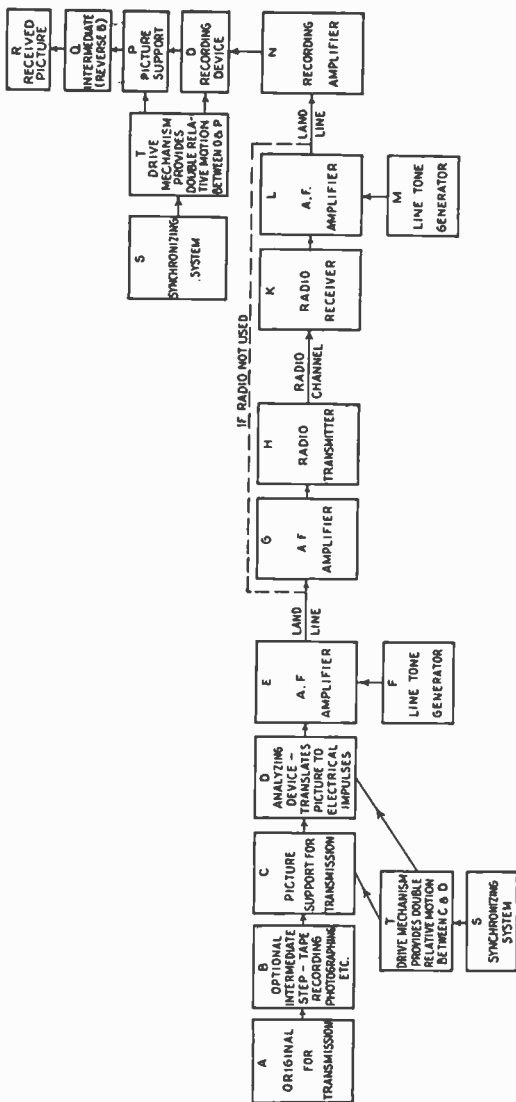

Fig. 1.—Block diagram of steps in picture transmission and reception.

modulation rate should be planned for; this means that a single side-band width of 1,200 cycles or a complete band width of 2,400 is generally necessary for the transmission of a 5-by-7 picture in 7 min. A carrier at least ten times the modulation rate is recommended.

TABLE OF UNITS IN CODE AND FACSIMILE

Average Values

(1 word = 5 letters + 1 space)

Code Transmission (Continental):

1 word requires 24 cycles modulation. 50 $\frac{\text{words}}{\text{minute}}$ require 20 $\frac{\text{cycles}}{\text{second}}$ modulation

and therefore require at least a 200 cycle carrier and 60-cycle band width.

Facsimile Transmission:

6 lines typewriting to vertical inch

12 letters or 2 words to 1 in. of line

12 words per square inch

1 letter requires 60 photo units or 30 cycle modulation

1 word requires 360 photo units or 180 cycle modulation. 50 $\frac{\text{words}}{\text{minute}}$ require

300 $\frac{\text{photo units}}{\text{second}}$ or 150 $\frac{\text{cycles}}{\text{second}}$ and thus require a band width of 450 cycles and a carrier of at least 1,500 cycles

Synchronism involves the timing of the tracing or scanning means at the transmitting and receiving points such that they are tracing corresponding points of the picture at the same time to prevent distortions between adjacent lines. This synchronism should be accurate to one half of a photo unit to prevent noticeable jiggles between lines; and between the start and finish of a picture it should be accurate to 1 part in 30,000. This means, for example, that in the traversing of the 5-by-7 picture, mentioned above, the tracing point will cover 3,500 linear inches in going over the picture line at a time, when those lines are 100 to the inch. And at the bottom of the picture, the accuracy of synchronism should be such that the final dot is no more than $\frac{1}{10}$ in. out. Further inaccuracy would objectionably skew the picture out of plumb.

As a matter of practice, each end of an independently synchronized picture station tries to hold its synchronism to 1 part in 100,000 so that the over-all synchronism will not be out more than 1 part in 50,000.

2. Scanning Methods. To pick up these elemental photo units that make up the transmitted picture, it is necessary to have some sort of a tracing pencil which goes over the entire picture. In the very first picture-transmission method of over 90 years ago an actual fine metal brush was suggested. This was fastened to the end of a swinging pendulum which therefore described an arc across the picture being transmitted. The picture consisted of a drawing in shellac on a piece of tin foil. At the end of each pendulum swing the table on which the foil was mounted would space down a small amount, corresponding to the next line of the picture, and the brush would then swing across again. This is one form of an analyzing head; but by far the most popular method has been some sort of a cylinder mounted in the manner of a lathe with the cylindrical drum carrying the picture to be sent and a point picking up the picture values, or, as has now become the method, of a fine point of light illuminating the picture, a point at a time. As the

cylinder turns, the tracing point travels down the length of the cylinder, so that at the end of a certain time, the entire picture will have been traced.

All of these motions are relative; either the drum may rotate or the point of light, or one may be rotating and the other moving axially to accomplish the resolution at right angles to the first. In any event, the picture is covered line after line, and these lines may be curved or straight. Each method has certain values of its own.

Reciprocating motions may be used for the scanning, in which the tracing points move back and forth horizontally by means of a right and left worm, and the paper is advanced forward for each successive line. This means that the tracing is done first from left to right, and then from

right to left. It has the advantage of working for continuous feed of paper, but it has the disadvantage of requiring greater accuracy in order that the successive lines may be very accurately framed so that the right and left scanning registers accurately at each end.

3. Inherent Accuracy. A word on inherent accuracy may here be given. This means that the system which does not require split thousandths for accuracy but instead a tendency to cancel out what errors there may be in the operation will have therefore by far the greater chance of successful operation. It is inherently accurate. At least its operation is such as to minimize inaccuracies in mechanical motion and electric timing, which are found to exist in any system.

A way of overcoming the inherent inaccuracy of the reciprocating motion, and still maintain the advantage of continuous motion, is provided in the spiral and bar recording equipment. The

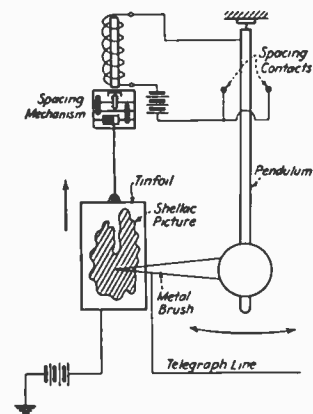

FIG. 2.—Alexander Bain's original picture apparatus (1843).

spiral rotates on one side of the paper, and the bar moves to and from the other side of the paper energized by the picture signals so that the point at which they will contact at successive intervals moves from one side of the sheet to the other, and then starts over again at the original side. It is used in carbon recording and chemical recording.

The lens disk accomplishes the same purpose at the transmitting station by moving a beam of light optically from one side to the other of a picture, and immediately starting again from the original side. It may be realized that it is inherently easier to get optical systems to register moving as a radius, as indicated for the stationary cylinders, than it is to have the beam cross a flat object.

In one method of scanning, the analysis is in two directions. First, a line is traced at an angle downward from left to right, and then a line downward from right to left starting at the same general height.

The net result is a cross-screen analysis of the picture. The analysis between successive lines of a picture is always far sharper than the analysis between successive points of the same line, due to the slower

changes in value found in progressing from one line to the next. The cross screen takes advantage of this in that it tackles each photo unit from two different angles and therefore gives a better average definition between points. But it does require far greater machine precision for the actual structure. A simpler method of accomplishing the same result is to transmit the same picture twice and place it in the machine first so that the lines are vertical, and second so that they are horizontal. The pictures are then made into a composite print at the receiving point. This method averages out faults and provides pleasing results.

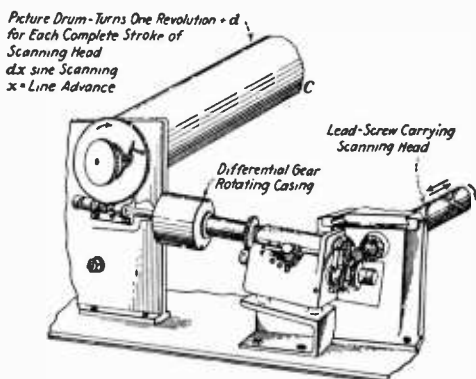

FIG. 3.—Cross-screen analyzing scanner.

4. Photo Analyzers. To pick up each photo element in terms of current value, so that it may be transmitted electrically, there must be some electric identification of the element. The first method was to construct the original picture in such form that it had in itself different electric characteristics. This was done by writing on tin foil with an insulating medium such as shellac. Then, when a metallic brush swept over the untouched part of the picture, electric contact was made between the metallic brush and the metal of the foil. When the brush came upon the shellac the circuit would be broken. This then constituted the differentiation between the two parts of the picture.

5. Photo-engraving Method. Instead of making the picture by drawing with shellac, it is possible to take advantage of the photo-engraving art in which a raised metal replica of the picture is made in dots which normally would take printer's ink. Instead of this, however, they are made to establish the electric contact for the tracing point. And instead of the usual dots of the half tone, it was proposed to use line screens in which the picture is etched in straight lines of varying width across the picture. The tracing point was then made to cut across these lines at right angles such that it made contact for greater or shorter duration as it crossed. This line method required much less accuracy of adjustment between the contact point and the lines of the picture than if the dots were used. The engraved lines of the picture were usually filled in with some insulating material so that the tracer rode across

either the insulation or the live metal. The difficulties with this method were in the contact. Working with larger originals made the problem easier.

6. Potassium Bichromate Method. The engraving art was also adapted to the picture art in the use of bichromate prints. Potassium bichromate dissolved in a gelatine has the property of being light sensitive in such manner that where the light strikes the combination, the gelatine will be hardened and made quite impervious to water. Therefore, if a plate covered with such prepared gelatine be exposed to strong light through a negative (or positive) of the picture transmitted, the gelatine will be correspondingly hardened where the light passes through to greater or less degree. Subsequent treatment with water will make the parts less struck by light to rise. The result is that an impression in relief of the desired picture is produced. This relief print may then be placed under the scanning point which will rise and fall as it passes over the relief picture and either turn on and off a current for a black-and-white picture, or increase and decrease the current by a microphone contact for a photograph.

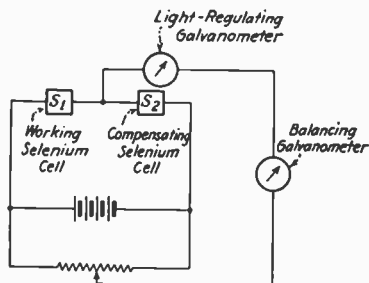

FIG. 4.—Compensating selenium cell lag. (Korn.)

Attempts have been made to interpret picture values electrically, by the variation in resistance of the different amounts of silver suspended in the usual photographic film, but the differences are not sufficiently regular to work out nicely, electrically.

7. "Pencil-of-light" Method.

All of the above mechanical methods have been most carefully worked out and many pictures have been transmitted by them, but the inability of such means to

pick up the fine detail of photographs has had to give way to the inherently easier methods of using a light pencil for the scanning device. But a pencil of light has limits of definition far beyond the requirements for picture transmission. This was early recognized, but the means for interpreting the light changes electrically were not so readily accomplished. The first useful tool in this direction was selenium, which by accident showed its

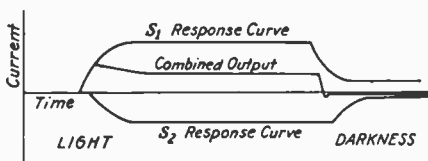

FIG. 5.—Compensation effect of circuit shown in Fig. 4.

change in resistance with change in illumination. This change is really quite large, but it has the drawback of not being immediately self-restoring. Some ingenious compensators have been arranged for this sluggishness

which is a form of polarization. The compensation usually takes the form of two selenium cells working at a different time rate such that the quick one precedes the slow and establishes a new base line for subsequent changes by the fast one. Wonderful technique was established in this direction and excellent pictures were transmitted.

But again inherent simplification was welcomed in the true photoelectric cell in which the sluggishness is beyond the normal means of detection. Such cells are not so sensitive as selenium cells, so they in turn became of use only when the vacuum-tube art produced the efficient amplifier.

8. Photocell Amplifiers. Unless very excessive light values are used, the change in illumination of a normal photocell is not such as to give more than $\frac{1}{2}\mu$ a change from the black to white parts of the picture. Care must be taken to see that as much light change as possible comes from the picture to the photocell. This means that as great light efficiencies as possible are required. An easy rule is to keep the number of optical elements in the light system to a minimum. A good prism may reflect 95 per cent of the incident light; a metal mirror cannot do much better than 60 per cent; but both these percentages will be completely vitiated by a little dust on the surface. Every lens surface reflects wastefully some of the light supposed to pass through it; so inherently more light is passed by reducing the number of elements in the system.

9. Direct-current Amplification. Two general methods of amplification are valuable for photocells: so-called d-c amplification and a-c amplification. D-c amplification means that the coupling between the photocell and the successive stages of amplification will be such as to pass all changes of any frequency, from zero up. In other words, the average illumination of the picture will be effective through the amplifier. An a-c amplifier means one in which the coupling is such as to pass only changes which occur at a rate exceeding a certain minimum. D-c amplification is usually accomplished by means of some resistance or reactive and resistance coupling between stages. A-c amplification is accomplished by capacity coupling between stages or by transformer coupling. It should be pointed out that d-c amplification may still be accomplished as far as the picture is concerned if the original photocell current changes are made to modulate a tone which is then in turn amplified as a.c.

10. Modulated D-c Amplification. The more general way of accomplishing the same result is by means of a chopper wheel interposed somewhere in the optical system. A chopper wheel is a rotating disk with symmetrical holes to break up the light into individual pulses passing through the optical system, and giving rise to a characteristic tone throughout the electric system. The modulation for this tone should be proportional to the changes in density of the picture being transmitted as the successive elements are traced by the analyzing point of light. The changes in intensity of the tone should be linear with respect to the changes in light density of the picture. There are so many places where the transpositions are apt to follow the square law that care must be exercised to use inherently linear arrangements. It is obviously very bad if the square law happens in the same direction in two parts of the system making the resultant interpretations of the picture changes follow the fourth power of the original. The result of such distortion is to lose much

of the detail of the picture; the eye is not capable of following many changes in density anyway, ten perhaps at most, so if some of these changes are crowded into either the light or dark parts of the picture by non-linearity in the operation of the system as a whole, the resolving power of the system is materially reduced.

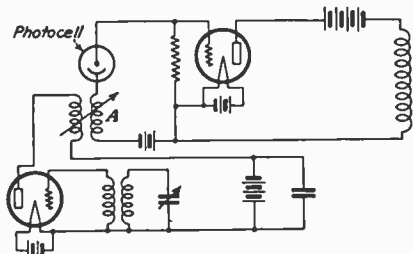

FIG. 6.—Tube-generated tone is fed into photocell circuit at A to permit a-c amplification of photo currents.

11. Necessary Accuracy. It may seem that such accuracy is only necessary for photograph transmission, and that for the black and whites of printed matter and diagrams such distortions may be tolerated. This is of course true where extreme simplicity may permit it, but generally speaking this is only an excuse, and good linear response is as advantageous in black and whites as it is on photographs. It means that truer resolution of the lines of black-and-white matter will be made by a certain density of photo units when the response is linear, than would be made by the same number of photo units per square inch of the paper if the response is not linear. Where the response is not linear, the reproduced picture will take on the built-up brick structure. It is of course likewise possible to reduce the effect of the square law in one part of the system by interposing another square law in the opposite direction somewhere else. But as usual no two wrongs can make a complete right. True design consists in replacing the square law by inherent linearity.

12. Balanced Circuits. In the same manner that the push-pull amplifier balances out some non-linearities in ordinary amplification, some of the defects in photocell amplification may be accomplished by balanced arrangements. One of these consists in using two photocells, which receive the light alternately from a mirrored chopper wheel. This reduces general interference from extraneous disturbances. One of its chief advantages lies in the fact that it balances out the actual light chopping by the picture elements.

This may seem a curious desideratum, but the reason is that the relative low-frequency impulses coming from the original picture will distort the beginning and end of the tone impulses. What is desired is a true modulation of the communication system in terms of the density of the picture. After the carrier has been so modulated it is not necessary to carry through the frequencies which caused such modulation, and to do so may easily cause distortion due to the fact that the frequencies are so far apart that they will be handled differently by all parts of the system, in both intensity and rate of response, and the result with all

such intermodulations present is to widen out the markings on the picture, making them muddy and even producing shadows and ghost images, which look like echoes.

Take, for example, the 150-cycle modulations corresponding to 50-words-a-minute facsimile; assume that this is put on a 2,500-cycle carrier. Then the side bands will be 450 cycles either side of this, allowing for the third harmonic of the modulation frequency. This brings the lower side band down approximately to 2,000 cycles. Now all the essentials for getting the facsimile across are in the band from 2,000 to 3,000 cycles. If at the same time, the system attempts to handle all the straight modulation around 150 cycles, it is obvious that it will require special treatment to handle this in exactly the same manner that it does the higher frequencies. "Retlifts" may be used to correct phase lags, or filters may be used to pass only the desired upper band, but again the simpler method is inherently to cancel out the lower modulation frequencies before they are formed electrically. This is done by balancing the two photocells with their associated amplifier tubes such that they receive equal response from each half of the chopped light and by then connecting the two amplifier tubes in push pull.

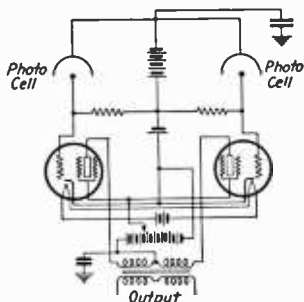

FIG. 7.—Balanced push-pull photocell amplifier.

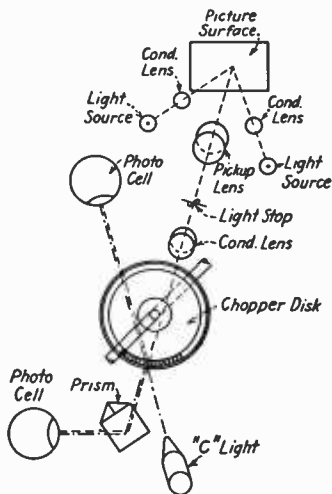

FIG. 8.—Balanced photocell optical system with chopper mirror and biasing C light.

13. Reproduction of Dark Portions. It is always harder to get good modulation in the darker parts of the picture. The photo currents are so low that the variations are around the threshold values of the cell and amplifier set-up. A convenient method of raising the tone above this noise level is to use a C light. This light acts to move the response to a more effective portion of the curve, just as a C battery does for an

amplifier tube. In this case, it consists of a small light which is always shining through the chopper wheel to produce a tone with the photocells. Its light path must be adjusted so that it will be in phase with light projected from the picture. Under these conditions, it is seen that there is a definite minimum value to the tone in the push-pull output of the amplifier, and this tone is added to by the picture light values. This method is particularly useful if rectification of the tone is to be used later in the system, and the power capacity of the system is such as to handle the full value of the C tone plus the picture tone, for then the rectified response is moved well up on the square-law curve where it becomes quite linear for the picture changes. Likewise, the output is greatly increased by this process as the picture change has become a product function with the C light. For example, with a C light tone four times as strong as the average picture tone, the output will be eight times the output without the C light tone. The limit to such methods is the power capacity of the last tube in the amplification and rectification.

It may be noted that if the C light is adjusted 180 deg. out of phase with the picture tone, the output will be 180 deg. out of phase with the input; *i.e.*, stronger light from the picture decreases the tone. This is particularly useful in case the tone is to modulate a radio transmitter directly in which case the dark part gives maximum tones and the light part minimum, and even no tone for pure white if such adjustment is desired.

14. Use of Triggered Oscillators. A very interesting possibility in photocell amplification is the use of triggered oscillators. Of course straight modulation of an oscillator may be accomplished after d-c amplification of the photocell currents, but likewise a balanced system may be set up with two tubes as two arms of a Wheatstone balance. One of these tubes will be merely an adjustment for the other active one which is operated by the photocell currents. The tone may be introduced as normally in a Wheatstone bridge between the outer ends of the balance, or it may be introduced into the screens of both tubes using the new screen-grid tubes. In passing, it may be noted that suppressed carrier modulation may be obtained by acting on both tubes in the bridge push pull.

15. Electric Retouching. Finally, mention should be made of the use of electric retouching in photocell amplifiers. This consists in over-emphasizing the intensity of quick changes. That is, where a sharp change in picture density occurs, the amplifier will overaccentuate the change. This is done by inserting resistance in a d-c amplifier stage and then shunting that resistance with a capacity. The same thing may be accomplished by reducing the gain in the center of the frequency band of the modulated carrier. The effect on the picture is to give a deeper black line at a quick change from white to black and a cleaner white line next to a change from black to white. This increases the snap to pictures which is especially desired by newspapers.

16. Changing Intensity to Time Values. There are two general methods by means of which the picture densities may be made to change electric values. One is to represent the density changes directly in current intensity changes. If the communication system is such as to maintain such intensity changes proportional throughout from transmitter to receiver, it is by far the best method. But a uniformity corresponding to 0.1 db is found necessary in order that objectionable streaks

do not result in pictures. This is obviously difficult over any but the best lines, and quite impossible over present long-distance radio circuits. Fortunately, another method is possible; this consists in changing the picture density changes into interrupted current of uniform intensity. It is called the *telegraphic method*. Obviously a very short dot on the received picture, although it be printed absolutely black, will appear gray against a white background in the finished picture. Therefore the problem consists in changing the picture densities into dots or dashes of different lengths to make the appropriate imprint on the received picture. The method in which a tracer point went over a line engraving is one method of obtaining this change from intensity to dots and dashes. The half-tone screen has already interpreted intensity valuations into area valuations in the half-tone engraving process. The making of such an engraving before transmitting is expensive and time consuming. A more direct method builds up similar dots by adding some form of pulsating circuit to the electric response from the photocell. If a sensitive relay is included somewhere in the intensity-change electrical circuit, and this relay will turn on and off at well-defined limiting values, it is possible to add to the picture signal in alternating current preferably of a saw-tooth characteristic, and then the relay will trigger at times dependent upon the sum of the voltages from the alternating current and the picture currents.

17. Use of Revolving Commutator. An old method is to make use of a revolving commutator which revolves once for every photo unit and is raised vertically by the picture changes. It has been suggested that even the relief picture would be sufficient to accomplish this. As the commutator rotates it will strike an inclined segment such that for raised parts of the picture the commutator will be closed around a longer arc of the commutator rotation.

18. Marginal-relay Method. Another simple method is the use of several marginal relays, the relays being set at successive values such that one will close at a low value of current from the picture, the next will close at a slightly higher value, and so on. Then a commutator picks up the relays in succession and will therefore deliver a longer impulse to the line if more of these relays are closed. Another method consists in making several black-and-white engravings of the picture. These engravings are purposely made to be either black or white at different densities of the original picture, by methods well known in the engraving art. Then these engravings are all mounted on a common axis on a cylinder and are rotated under separate tracing points, one for each separate plate. These points act exactly as the marginal relays mentioned above, in that a rotating commutator closes through each tracer point in succession and the more of these points that are in contact with their respective plates, the longer will be the contact on any given

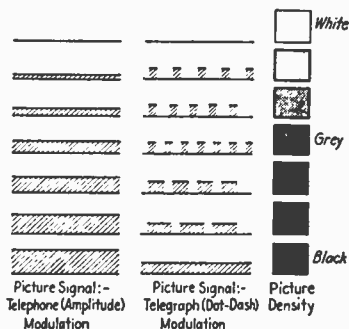

FIG. 9.—Telephonic and telegraphic interpretation of photo densities.

rotation of the commutator. In spite of the seeming complexity of this method, many successful pictures have been sent by cable in this manner.

19. Change of Marginal Setting. Another method has been to change the marginal setting of the photo current on each complete revolution of the drum carrying the single picture. Then every time the picture value crosses the marginal limit, the current is closed to the transmitter. The scanning lines are necessarily taken much closer together so that the picture is built up of what look, on enlargement of them, like very long relief sections of the picture.

The very fact that the successive lines of the latter method must be made one-fifth as wide in order that the individual lines will be unresolved by the eye and that a smooth series of tone values be given the picture show that it takes much more effort to give half-tone values than it does black and white. If modulation may be used as in the telephone method, it is not necessary to break up the picture into separate photo units, as the intensity changes are maintained over the complete communication system; but if such an intensity change has to be registered in time element changes, it is obvious that those time elements must be definite divisions of the photo unit. That is, if five different tone values are to be registered for each successive photo unit, the communication channel must be capable of differentiating to one-fifth the size of the photo unit. This means that the keying rate of the system will have to be able to modulate at five times the rate that it did for black-and-white alternate photo units. And only five different values is rather a limited possible valuation for true picture work. Ten would be a better figure, so that the modulation rate is anything from five to ten times more severe for picture work as it is for black and whites if the variable-size dot method of picture representation is to be used.

20. Dot-dash System. In the face of this dilemma, a new method of telegraphic modulation was devised known as the dot-dash method of building up the picture values synthetically. It consists of establishing a tie-up between the picture values and the marking and spacing lengths of a vibrating relay. Assume a relay that is oscillating back and forth in marking-to-spacing at around 300 cycles. This condition is to represent the middle value of the picture in the grays. Then for lighter values of the picture, the relay circuits will be changed such that the contact will stay on spacing for longer and longer periods although it will stay on the marking side for the same quite short period. The net result will be that for lighter parts of the picture, dots will be made farther and farther apart. Now for parts of the picture darker than the middle gray value, the spacing interval will be maintained the same, and the marking interval will be gradually increased in duration. This means that longer and longer dashes will be produced. These changes are accomplished in the electric circuits of the tube relay by the change of the rate of charge of condensers associated with the marking and spacing reactions respectively.

21. Double-modulation Method. Any of the picture-response methods may be improved in their operation by ways known as double modulation. This arises from the fact that none of the methods is very good at the extreme white or extreme black ends of the scale. Therefore, if the setting between the picture values and the current response is altered between successive lines, the black end will be brought down nearer the gray values on one traversal of the scanning, and on the next the white

will be brought up into the gray setting where it will be given more faithful interpretation. The net result is a widening of the picture ranges over which the response will be more linearly faithful. The ways this may be accomplished are legion. One is to change a potentiometer affecting the gain of the photocell amplifier at the end of each scanning stroke, and then return it to the previous setting for the next after. A contact or commutator on the scanning drum makes this possible. Instead of making it at the end of every stroke it may be done at a rate slower than the modulation rate, say at 50 cycles a second, and this will give a definite line-up of the modulation setting at this 50-cycle rate.

22. Intermediate Records. Instead of building up the finished picture directly from the current values obtained by scanning the original picture, intermediary processes may be used, for example, separate engraved plates. Other means are to record the picture variations by the normal punched tape common in telegraph practice. The tape punches may be made to represent different picture values.

For example, five dots across the tape will represent a darker part of the picture than one dot would represent. Not only this, but the dots may be used in different sequence so that much wider range of picture values may be obtained. Likewise, it would be possible to represent the number of times a given picture value was to be repeated. The more complete the ability of the tape to convey intelligence the more quickly will the transmission be accomplished; but by the same token the more of a thinking machine the tape puncher and tape reproducer have to be to get pictures out of the combination. Therefore there is a practical limit to automatic artists. The punched tape is made by marginal relays setting the proper punches. The perforated tape is then sent over the regular telegraphic systems by land wire, cable, or radio, and a duplicate tape is re-perforated at the receiving end. This tape is then placed before a photo-recording drum which rapidly puts down light, controlled through the dots, on sensitive paper. This tape method has the distinct advantage that it may be sandwiched in with regular telegraphic traffic and that it may even be handled in sections.

23. Radio-transmitter Keying. The picture modulations must be put on a communication system. In the case of the telephone method the only requirement is to maintain the gain constant throughout the picture to 0.2 db. Otherwise the picture will be streaked. The smoothness of the telephone method of intensity recording makes this even more imperative.

For telegraphic modulation, the requirements are less severe. It is essential that the characteristics of the signals be kept as near their original form as possible. As they start as square waves, they should be kept near this form. This requirement is met fairly well if the third harmonic of the modulation rate is allowed to pass. These signals may be put over a regular telegraph line in what are termed direct-current pulses. This is the best way to do it for short distances over open wires, especially up to, say, 50 miles in length. But for greater distances, various

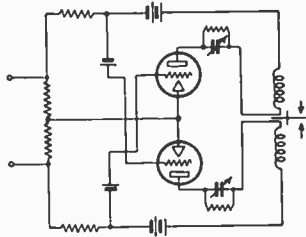

FIG. 10.—Timed push-pull relay for re-forming telegraphic impulses.

serious distortions in the signals come in, due to the fact that the 150 cycles, for example, will not travel so fast as the 450 cycles. This is particularly noticeable where long intervals of solid white may be interposed between short sections of black, as in typewriting.

The steady stationary current is approached for the white, which far exceeds the value received in a normal modulation cycle. This effect may be reduced considerably by the use of the Reading condenser, familiar for years to telegraphic engineers. This consists of nothing more or less than a condenser shunted by a resistance in series with the line. Its position is at the receiving end of the line; but it helps at both ends. It means that short pulses are favored against long ones, as the short pass through the condenser more readily. A vacuum-tube arrangement has been devised which is of very great help in this direction especially where the lines are long and the received currents small. It is called the *push-pull relay* and consists generally of two tubes arranged in differential balance as regards signals coming over the line. They have Reading condensers in their plate circuits timed to the average rate of the signal pulses, and by this means have a tendency to reshape the incoming signals to their original square-cut characteristic.

24. Use of Neon Tubes. The introduction of neon tubes in such telegraphic signal circuits has also been of help. They require a certain minimum voltage impressed across them before they give any response. With such tubes inserted either directly in the line or more usually in the plate circuit of an amplifier of the line currents, (1) they will not respond to small line disturbances under the normal signal level, and (2) they will give a very sharp building up of the incoming waves when they do break down. They do not have this characteristic on the end of a signal; but by the use of two such tubes in differential arrangement, one for the positive current going on, and the other for the negative going off, the squaring action may be accomplished on both ends of the signals.

25. Carrier Systems. For long lines, the time of arrival of the signal components at the receiving end of the line becomes so different that the signals cannot be corrected by any general means. It is usual therefore to resort to tone carrier for the keying. This means that a tone preferably ten times the normal modulation rate should be used. If this modulation rate is 150 cycles, this would mean a carrier tone of 1,500 cycles. Now the band width, as previously pointed out, should include the third harmonic of the modulation. This means that a band width of 450 cycles should be passed either side of this 1,500 cycles. However, it is possible to use only one side band and the carrier. If the line, for example, does not pass signals up to 1,900 cycles nicely, no difficulty will be noticed if the carrier and perhaps the first harmonic above are passed. The only reason for suggesting that the upper side band also be retained is that some 25 per cent of the energy is in that side band. If it is desired to limit the band width of a carrier system, so that more channels may be crowded into the same total space, it is possible to insert filters after the carrier is modulated by the picture signals and before the tone is put on the line. This filter will pass the carrier and one set of side bands, say the lower.

26. Modulation Circuit. The actual modulation of a carrier by the modulation keying, is best accomplished in a balanced tube circuit. In this circuit, the tone is placed on two tubes in push-pull. The grids of these tubes however, are kept negative below cut-off during non-signal periods and the keying is then made to raise the grids in push-push to

the operating point. This method balances out the objectionable click at the start and finish of such keying, if only one tube were used. The net effect of such clicks is to lengthen out the picture signals and produce muddy copies. As pointed out in the photocell modulation methods, this push-pull method is inherently better.

Finally, mention should be made of the phase correctors which are used to correct the phase of received signal frequency components. They consist of series-tuned circuits in the basic form, placed across the terminus of the line, a position in which they have the ability to retard the phase of the frequencies approaching the frequency for which the circuit is tuned.

At the end of a land line, if the signals are to be used to key a radio transmitter, care must be taken that lines are kept as free as possible from r-f pick-up as they come into the station. Shielding is of course the answer here. In practically all radio-transmitter keying circuits condensers are used in various portions. They must be kept to a minimum size in order that the transmitter may key quickly. The keying becomes quite an engineering problem in class *B* and class *C* transmitters especially.

27. Wave Lengths Used in Radio Transmission. Rigorous uniformity is demanded of the entire radio circuit to insure that streaks are not caused on radio pictures. For long waves the only general requirement is that the decrement of the circuit be not so low that the signals do not build up and decrease quickly. The long-wave antenna helps materially in giving directional selectivity to the signals reducing interference from static or other signals as well as giving much more energy on the desired signal. This means that the decrement of the tubing circuits may be worked at a higher value, thus giving faster keying to handle the picture signals.

The first long-wave transmission of pictures was handled on wave lengths of the order of 15,000 m, and 60-cycle modulation was generally the highest that could be handled well. Short waves opened up tremendous possibilities as to keying speeds. Keying speeds of 300 cycles may be successfully handled now over short waves, and higher speeds are being planned.

28. Necessity for Uniform Signal Strength. The great bugbear with short waves is the variation in intensity and actual fading out of the signal. It is obvious that telegraphic modulation is all that may be used where such fading exists. (For the very short wave lengths and searchlight distances telephonic modulation may well be used, due to the constancy of the signals.) One form of promoting constancy of signal strength is to have the incoming radio signals key audio oscillators. This keying is so arranged that a rectifier stage works down to cut-off in keying the audio oscillator.

One of the greatest developments is in *diversity reception* for short waves. In this, three antennas with their respective receivers control a common audio-tone carrier. If one signal fades, the chances are that one of the others will still be giving sufficient energy to key the full tone to the line. Directional set-up of the antennas themselves improves likewise the geographical selectivity of the system. The precaution to be made is that the time constants of the rectifiers accomplishing the keying of the audio oscillator by the radio signals shall be fast enough to follow the modulation.

29. Recording Methods. The photographic method exposes elementary areas of photographic paper to light in varying amounts corresponding to the modulated signals. It has the great advantage of the wonderful technique available coupled to the fact that no mechanical movements are necessary. Extremely light movements of mirrors or light valves may accomplish the exposure of the sensitive paper to light. The disadvantage is the requirement of dark room or box operation with no knowledge of the actual performance until the exposure and development of the complete picture are accomplished.

The basic principle of many photographic systems is to turn a light on and off. The usual filament light is slow in response but this response may be speeded up by cooling the filament with a gas in the bulb, such as hydrogen, and by placing the filament near the wall of the tube. Quicker

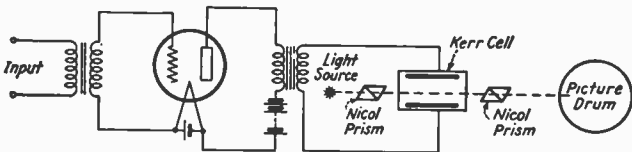

FIG. 11.—Photo recording by polarized light.

filament lighting may be accomplished by making it as fine as possible, or by using an auxiliary current which will keep the filament at incipient operation just below the heat value which would record on the paper, (this auxiliary current is better removed after the filament is lighted to speed up the cooling), or by the use of Reading condensers in series with the supply to the lamp such that the initial voltage will be higher than the working voltage. Much higher light operation is obtained by the use of a ribbon galvanometer.

30. Light Valves. A speedy method of light control is accomplished by electric bi-refringence in the Kerr cell, which alters polarized light so that it passes through a nicol prism system with current applied to

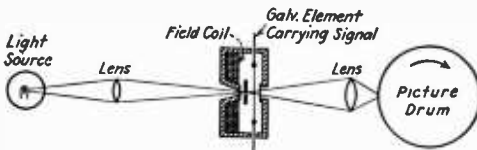

FIG. 12.—Photo recording with electro galvanometer.

the cell. The Kerr cell requires about 900 volts for good operation with a separation of the order of 1 mm between the plates in the nitrotoluol. Magnetic rotation of polarized light has also been tried, but the rather strong magnetic fields necessary, together with the slow reaction of such magnetic systems, has militated against their use. Mirror galvanometers have always been used, of course.

31. Glow Lamps. One of the simplest lights for recording is the gas-discharge tube in which ionization of a gas, such as neon, is quickly accomplished. When this discharge is limited to a crater, a very highly

actinic beam is developed, efficient in power consumption and speed. Various gases have been used, perhaps the more successful being a mixture of helium with just a trace of argon. A pressure of about 15 mm with 0.1 per cent of argon gives an idea of the general values for such a tube. General voltage range for such a lamp is of the order of 200 volts.

32. Corona-discharge Exposure. An interesting method of recording on photographic paper is furnished by the corona discharge from a coil set-up of the Tesla variety in which a great step-up ratio is used. The discharge from a needle point to the sensitive paper gives interesting results when the discharge does not spread too much. It is particularly useful on half tones. As the discharge is virtually entirely in the ultra-violet, a paper especially sensitive to that region may be used. Yellow celluloid will make it possible to screen the operation and work in only a slightly darkened room.

33. Starch-iodine Paper. The oldest form of visible recording consists in utilizing the starch-iodine reaction, known for three-quarters of a century. Paper is moistened with a dilute solution of starch and potassium iodide. The cathode is the recording point, and iodine is liberated when very minute values of current pass from the cathode through the paper to the anode cylinder. Ferrocyanide solutions may likewise be used which have the advantage of greater sensitivity and greater permanence, but they always have the drawback of the poisonous characteristic of the solutions.

34. Mechanical and Liquid Recorders. Mechanical recorders have been in general use throughout the half century of picture development. The aim has always been to make them as light as possible so that they will be sensitive and respond accurately to the necessarily high frequencies.

A very free-flowing and instantly drying fluid is made of heated paraffin. It flows very readily when heated along metal, so that a very small stylus made about the size and shape of the bill of a bird may be mounted upon a very sensitive magnetic system. A string wick will carry the heated paraffin to the pen, which is likewise kept warm by being in the proximity of a small electric resistor. The paraffin is colored by an oil-soluble dye; the reds are particularly effective.

Carbon paper has been another great recording favorite. A stylus is used to record through the carbon paper into the white paper beneath. Heating the stylus makes it work even faster. One of the most ingenious suggestions in this direction was the thought of making an envelope of two pieces of paper with the carbon tissue inside and sealed before recording. The record was then made on the receiving instrument and the envelope delivered unopened to the addressee; in which case the latter is the first to see the traced message when he opens the envelope and removes the carbon paper.

35. Heat Methods. Heat has been used in many ways for recording. Air may be heated as it passes through an electrically heated tube leading to a fine jet. This heated jet of air is prevented from hitting the heat-sensitive paper by means of a very small electrically deflected vane. Or a jet of cold air may be used to deflect the hot air away from the paper, and the vane may act on the cold air. The vane is operated by the incoming signals.

Many forms of heat-sensitive paper have been made. Ordinarily, scorching of the paper requires too high temperatures. An endothermic reaction is generally used, in which two chemicals, non-reactive at normal temperatures, are broken down under the heat and then react with each other to produce a colored compound. For example, nickel sulphide is produced by the endothermic reaction of sodium hypo-sulphite and nickel sulphate. A thin coating of red mercuric iodide becomes white on the application of heat. One arrangement uses the heat to melt away a thin coating of paraffin laid on paper from a colloidal solution. Very little heat is required for this purpose. Then the paper so recorded may be inked with any color by rolling it up with a roller holding a water ink. By using a paint brush, such a wax record may be colored to correspond to the original.

Straight vapors may likewise be keyed by the vane. One such vapor is an alcoholic solution of an oil-soluble aniline dye, such as purple. This vapor will record very rapidly at a quarter of an inch distance from the nozzle, so that close operation is not essential. But at greater distance, the recording power falls off rapidly. This is a prime necessity, for otherwise the entire paper might be covered by the vapor. This is the general trouble with any of the gas reactions of, say, ammonia and a mercury salt in the paper. The entire paper at once becomes fogged.

36. Synchronizing Methods. Two general methods of synchronizing are extant: step by step and independent time control. The first consists

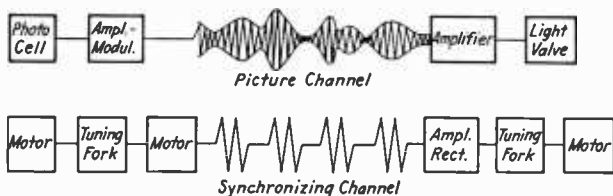

FIG. 13.—Superposition of motor control and picture signals on communication circuits.

in advancing the scanning at the receiver in step with the scanning at the transmitter by means of signals sent from the transmitter to the receiver. The signals may either be special signals on separate channels from the picture signals, or at the end of each line of scanning, or by the actual picture signals themselves. For the separate channel, it is usual to transmit a low frequency (40 cycles) either directly or by modulating a higher frequency, say 400 cycles, which in turn is transmitted over the channel. This frequency is obtained from some part of the transmitting apparatus, or it may be the frequency which likewise controls the transmitters.

Synchronous motors are generally used for the actual driving of the equipment. The motors are themselves synchronous or they are made into synchronous motors by having applied to them additional control energy which is synchronous to their rotation. For example, a direct-current motor may be turned into a synchronous motor, by putting an extra commutator on its shaft which has two segments and two slip rings on it. This commutator then makes alternate connections through the ensuing half revolutions of the shaft between the brush which bears against the segments and alternately with each of the slip-ring brushes which correspond to the two segments. By connecting the slip-ring brushes, to the two opposite contacts of a vibrat-

ing tuning fork, current may then be led from the fork prong through the contacts through the segments to the segment brush. This current may then be added to the field of the motor. If the motor is rotating synchronously with the fork, a large value of current will be carried through this hook-up, as the fork will change from one fork contact to the other, at the same time that the commutator segments change. This current will tend to slow down the motor. If the motor is exactly out of phase with the fork, so that its contacts change exactly opposite to the changes in the brushes, then no current will be added to the field of the motor. This will tend to speed up the motor again. The net result is that the motor will come to a position somewhere between these two values, depending upon its load. It is seen that the motor will not operate exactly in phase with the fork, but it will operate in synchronism, holding a position always at constant phase difference with the fork. Such phase difference means that the picture will be a little to the right or left of the exact correct position, but it will be perfectly straight up and down, if the motors remain synchronous. Such phase difference may be compensated by "framing" the picture. With such a device as just described, this is done by providing the brush which makes contact with the segments with a rotatable arm, which may be turned by hand until the picture is in exactly the proper position.

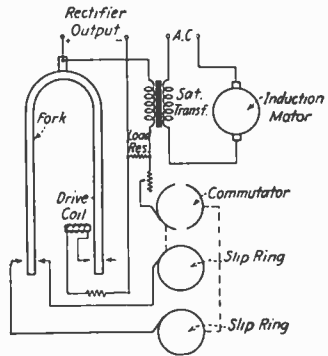

FIG. 14.—Fork control of induction motor speed, a-c supply.

37. Induction Motor-Tuning Fork System. The same synchronizing arrangement may be used to connect an induction motor with a tuning fork to make the motor synchronous with the fork.

In this case, direct current obtained from a rectifier is led through the same contacts and segments as previously described, and this direct current operates to change the reactance in a saturation transformer. Such a transformer has two windings, one of high resistance for the direct current and the other of high reactance and low resistance for the a.c. it is to control. If the d.c. saturates the transformer, the reactance will be quite low, so that if the secondary of such a transformer is in series with the supply to an induction motor, this motor will receive more current and have a tendency to speed up.

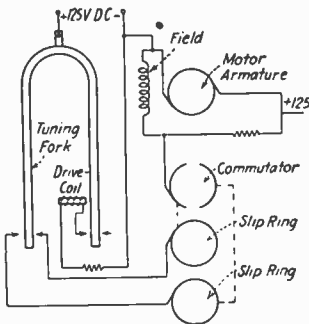

FIG. 15.—Fork control of shunt motor, d-c supply.

38. Motor-generator Control. Another method of control consists in directly connecting a motor and a generator mechanically. The generator has the same frequency as the fork which is to control it. In this case it is usual to use higher frequencies for control, say 500 cycles. The energy

from the generator may be applied to the plates of two vacuum tubes, the grids of which are operated by the energy from an electric pick-up on the fork. If the generator is supplying voltage to the plates of the tubes, synchronous with the grid excitation from the fork, it will have to do more work; if it is exactly out of step it will have to do no work. The system adjusts to a middle position.

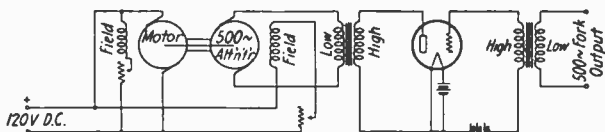

FIG. 16.—A-c thermionic brake on motor-generator drive.

39. Use of Thyatron Tubes. The advent of the Thyatron tube has made it possible to obtain alternating current of considerable size controlled by a small tuning fork in very compact form, sufficient to operate small synchronous motors. This reduces materially the special cost of equipment.

40. Accuracy of Synchronism. For permanent installations, the better practice seems to be to set up tuning forks of accuracies better than 1 part in 100,000 and adjust them with respect to each other from time to time. (The actual results on the pictures themselves furnish an excellent check.) It is then unnecessary to send special signals for synchronizing during the picture operation. It saves ether space and renders the entire operation much simpler.

For temporary installations or for mobile installations such as on airplanes, it is not generally possible to have the same care in set-up which would make such high accuracies possible. Under these conditions, it is generally wiser to lock the receiver to the transmitter by synchronizing signals. For example, there may be a characteristic tone of modulation set up by a small tone generator on the shaft of the motor driving the transmitter. This tone may be used for the picture carrier too, and when received it may be separated out and used to control the speed of the receiving motor. For this latter purpose it is usually better (unless practically perfect signals are available) to interpose some form of inertia between the speed signals and the motor. A tuning fork driven by the signals forms an excellent flywheel for this purpose, and then the driven fork is used to control the speed of the receiving motor. By this means the signals may cease for several seconds without the receiving motor losing control.

If synchronous dots are used for the transmission, they may be used for a step-by-step speed control, but, generally speaking, such methods have not continued in practice, first, owing to the fact that there is such a wide divergence in the size of the dots making it difficult for any relay system to hold to them and, second, owing to the fact that these dots are by no means always perfect.

41. Historical. The first reference to electrical picture transmission is but a short time after the original telegraphic developments. Alexander Bain in Scotland was working previous to 1841, as his first English patent was taken out in that year. He laid down the basic principle of start-stop synchronizing, scanning, and electrochemical recording.

Pendulums were his scanning arms, and a platen dropped at each terminus to present the next line for scanning at the end of each sweep of the arms. Shellac ink on tin foil constituted the original variable resistance. He also suggested raised-type letters for the transmission. Bakewell, in 1846, proposed now usual cylinders running under scanning points. The names of the workers since are legion. Outstanding has been the work of Amstutz, in the United States, who specialized in the use of the engraved line plate; Korn, in Germany, with the selenium cell; Belin, in France, with his high development of the relief method in the "telestereograph." T. Thorne Baker, in England, has been a leading exponent of developing the art for the amateur, using generally the Bakewell form of machine, with the line plate for photographs, and the development of especially light parts to simplify the general operation. Captain O. Fulton has added to this same type of equipment the use of a very neat start-stop release magnet equipment. C. Francis Jenkins applied his motion-picture development of the lens disk to picture transmission as a novel means of making the light spot traverse a flat surface, at both the transmitter and receiver.

42. Bell System. Outstanding perfection has been realized by H. E. Ives and his assistants in the Bell telephone system with the perfection of the transmission of pictures over telephone channels. Transparent film is used wrapped into a cylinder of itself, the photocell picks up the light transmitted from the outside of the cylinder to the center as the photocell moves slowly down the axis. The reception is in the form of an Einthoven galvanometer in which the moving element is a very thin, flat strip of silver. The sideways motion of this strip uncovers the light which passes through to a fine spot on the surface of the recording-film cylinder. First this strip was moved at right angles to the scanning motion, which made a variable-width picture in much the form of a single-line engraving. But this method gave pictures which, when supplied to the newspaper engravers for the production of an engraved plate, gave rise to an objectionable "Moret" between the line structure of the telephoto and the engraving screen. By timing the galvanometer so that the motion of the ribbon is in the same direction as the scanning, and by purposely fusing the edges of the recorded lines by the use of Iceland spar to blend the edges of the lines, a much smoother picture of excellent quality is obtained.

43. Bart-Lane System. Code methods of transmission have been developed by many in which an artist lays out the picture by squares according to a given plan, but it requires an artist and imagination at the receiving end to put life into these blocks. A far better code method is automatic, in which the picture elements set up their own code values. Outstanding in this development have been H. G. Bartholomew and M. L. D. MacFarlane, in England, with the "Bart-Lane" system. Their punched tapes have sent many pictures over the cables between London and New York.

44. Radio Systems. In radio transmission of pictures, the Telefunken Company has been leading in Germany, with Dr. Fritz Schröter and Professor A. Karolus giving emphasis to the Kerr-cell development. In England G. W. Wright has led the activities of the Marconi Company. With the R. C. A., in the United States, the author has been aided in the chemical developments by F. G. Morehouse, in the gas-tube field by

R. M. Williams, and had the advantage of radio-transmission and reception developments led by H. H. Beverage.

45. Picture-transmission Networks. There is a wide network of picture-transmission systems throughout Europe, England, the United States and Japan as well, all over wire lines. Photo-radio circuits have been operated from London to New York, commercially, since May 1, 1926, also between San Francisco and Honolulu; and by the Telefunken Company between Buenos Aires and Berlin.

46. Recent Progress. In 1934 and 1935 considerable progress was made toward simple and portable picture receivers for use in the home by broadcast listeners. In 1935 a large installation of high-quality photograph transmitters and receivers was made by the American Telegraph and Telephone Company for the Associated Press using the wire network of the Bell System.

Apparatus developed by C. J. Young, RCA Victor, for commercial communication, and possibly for home reception, operate on the carbon-paper principle. A bar presses against the carbon paper and makes an impression on white paper beneath when actuated by the incoming signals. This apparatus has been called the "lawn-mower" system (not by its inventor), because in construction and appearance it resembles this familiar grass-mowing instrument.

J. V. L. Hogan has developed several systems of receivers which are exceedingly simple and easily adaptable to the reproduction of cartoons, advertisements, and other pictures of not too great detail. Broadcast station WTMJ in Milwaukee began experiments with the Hogan equipment in 1934 to determine its commercial practicability.

Austin Cooley (see Art. 32, this section) continued his facsimile work and developed a system which used the ordinary telephone wires as the carrier of the facsimile or photograph signals. In this method the audible signals are put into the telephone system by induction, or directly into the microphone, and after transmission, like any telephone conversation, they are taken off, to operate the receiving equipment, either by induction or directly as sounds from the receiver.

Captain O. Fulton, working in the United States, added considerably to existing knowledge of chemical processes used in picture transmission. Starting with the idea of making halftone engravings by a scanning process, Walter Howey developed methods, not only of cutting pictures in metallic plates, but succeeded in making color plates which had a good fineness of detail and excellent color value. Pictures were sent over telephone circuits by this method.

All of these systems, except the Associated Press, are in process of further experiment and are not yet on a commercial basis.

SECTION 21

AIRCRAFT RADIO

BY HARRY DIAMOND B. S., M. S.¹

1. Importance of Radio Communication to Aircraft. The success of any transportation system depends in a large measure upon the rigorous maintenance of safe, scheduled operation. Probably nothing has contributed more to the safety and reliability of transportation systems than the associated communication systems. Radiotelegraph, radiotelephone, the radio beacon, and the radio direction finder have been important elements to such safety in both sea and air transportation.

Radio serves as a communication means between airplanes and between airplane and ground. It furnishes the pilot with weather information, it tells him when he is on or off his course, helps him to land under conditions of poor visibility, and is beginning to be of value in preventing collision with other planes or with fixed objects. It provides the operations office continuous contact with each aircraft in flight and thereby affords full control of all flight operations to conform with existing meteorological conditions and traffic requirements. For the airport traffic manager it furnishes a rapid and certain means for communicating with arriving or departing airplanes and directing their landings or take-offs in a safe and orderly sequence.

Either telegraphy or telephony may be used to communicate from the ground to the airplane or *vice versa*. One-way communication, such as transmission of weather conditions from the ground to the airplane, requires the simplest type of equipment, two-way communication between airplanes or between airplane and ground requires heavier and more expensive equipment. The choice of apparatus is a compromise involving weight, expense, convenience of operation, and safety.

Channels available in the United States are 200 to 410 kc for the government weather-broadcast and radio range-beacon stations and certain frequencies in the 2,700- to 6,500-kc region for two-way communication.

2. Government Radio Facilities along the United States Civil Airways. In the United States, the Department of Commerce is charged with providing aids to the safety of air navigation. An elaborate system of radio aids has been set up to complement the other aids available along the extensive network of civil airways. There are some 75 radio broadcast stations for broadcasting frequent and up-to-date weather information to aircraft in flight and to airports along the route, 95 radio range-beacons for furnishing directional guidance to aircraft under conditions of poor visibility, and 85 marker beacon stations which supplement the

¹ Senior Radio Engineer, U.S. Bureau of Standards.

network of radio broadcast and range-beacon stations. A teletype system providing almost instantaneous typewritten communication connects the radio stations with weather-observation and collecting stations and with air-transport operation's offices. A secondary network of 70 point-to-point radio stations supplements the teletype-writer system.

3. The Radiotelephone Weather-broadcast Station Equipment. These stations employ a crystal-controlled transmitter of the master-oscillator, intermediate-amplifier, power-amplifier type supplying 2 kw of r-f power to the antenna on frequencies of from 200 to 410 kc. The transmitting antenna is either of the T type 125 ft. high and 375 ft. long or, in some special installations, consists of the four insulated vertical steel towers of a radio range-beacon station radiating in parallel.

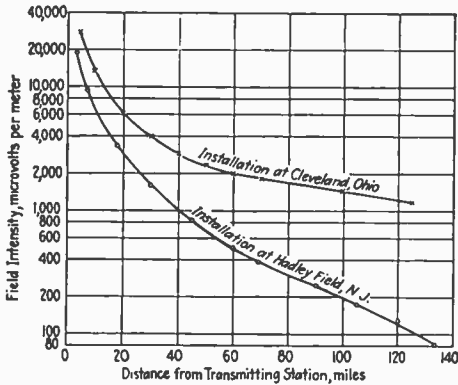

FIG. 1.—Useful service area of weather-broadcast stations.

Either continuous wave (cw), interrupted continuous wave (icw), or telephone operation is provided. While radiotelephony only is employed for broadcasting to the pilot, radiotelegraphy may be used in emergencies, in case of failure of the teletype system and other means of communication, and for interchanging weather information with similar radio stations.

The transmitting circuit for the 2-kw weather-broadcast transmitter is conventional. Harmonic radiation is reduced so that the field intensity on any harmonic is not greater than 0.1 per cent of the fundamental field intensity.

An idea of the useful service area of the weather-broadcast stations may be had from a study of the graphs shown in Fig. 1. The graph of the station formerly at Hadley Field is more typical of average conditions in the United States, the values given in the other graph being unusually high. The measurements were taken on two installations employing identical transmitting sets and not greatly different transmitting antennas; the great difference in field intensities produced is, in all probability, due to the difference in the nature of the terrain along the transmission paths. Experience has shown that a field intensity of about 100 μ v per meter is required to override the static level under the worst

conditions occurring in winter, while a field intensity of about $500 \mu\text{v}$ per meter is necessary in the summer. This indicates a useful distance range of about 130 miles in the winter and 60 to 75 miles in the summer.

The effect of the nature of the terrain upon the field intensity is shown in Fig. 2. The presence of a mountain range considerably increases the attenuation.

4. The Radio Range-beacon Station Equipment. Here is used a 2-kw crystal-controlled transmitter of the master-oscillator, intermediate-amplifier, power-amplifier type. The carrier is modulated in the power amplifier with an audio note of from 500 to 1,000 cps, voltages of that frequency being usually supplied by a modulation alternator. The modulated output of the transmitter is fed into a link circuit which connects to a goniometer and directional antenna system, forming the equivalent of two loop antennas crossed at right angles. A cam-operated relay system in the link circuit automatically keys the radio power to one

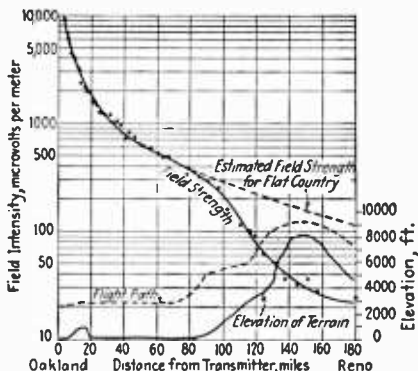

FIG. 2.—Effect of nature of terrain on field strength.

of the directional antennas in accordance with the Morse characteristic *N* (---) and to the second antenna in accordance with the Morse characteristic *A* (—). The coded signals are sent out in groups of four each and are interlocked so that along the four radio beacon courses formed by the intersection of the directional patterns of the two antennas they form a long dash, or continuous monotone signal, interrupted every 12 sec. by the station identification signals. These beacon courses are some 4 to 6 deg. in width. Off the course the monotone signals break up into the component *N* and *A* signals, one or the other being of greater intensity depending upon the side "off course." Details of the goniometer and the directional antenna system will be given in a later article.

Because of the lower radiating efficiency of the directional antenna system, the field intensities set up at varying distances from the transmitting station are roughly one-fifth of the corresponding values for the radiotelephone weather-broadcast stations.

5. Radio Marker Beacons. These stations are located at intervals along the airways to serve two different purposes. The first is to mark

the meeting points of adjacent radio range-beacon courses or to denote a particular locality along the airway, such as an intermediate landing field or an abrupt change in the elevation of the topography. For the former, transmitters capable of transmitting alternately on the two frequencies of the adjacent radio range beacons are employed, while for the latter only single-frequency transmitters are used. Each marker beacon station has a characteristic identifying signal. Its range is limited to 5 to 10 miles so that it may effectively localize the point desired.

The second purpose filled by marker beacons is one of directional guidance as well as marking a locality. Radio marker beacons of this type are miniature radio range beacons. These are located either at points along the airways so as to fill in gaps between the more powerful radio range beacons or at intermediate landing fields to enable pilots to locate the landing areas during adverse weather conditions.

All marker beacon stations are provided with low-power (15-watt) radiotelephone transmitters for communicating with passing aircraft during emergencies. These operate all on the same national frequency, 278 kc.

6. Medium-frequency Service. The services afforded by the government radio aids to aviation to an aircraft equipped with a simple medium-frequency receiving set are as follows:

1. Radiotelephone broadcasts of weather information, landing conditions, and emergency messages from the weather-broadcast and marker beacon stations along the route.
2. Directional guidance between the principal airports along the route.
3. Position-reporting service, if requested, wherein stations along the route report by teletype to the points of departure and arrival when the airplane passes over.

In addition to these services, the same receiver permits receiving traffic instructions from the airport manager. Airport transmitters for this purpose are of 15 watts rating and operate on a national frequency of 224 kc.

TWO-WAY COMMUNICATION BETWEEN AIRCRAFT AND GROUND

7. The Government Radio Aids. Limited facilities for two-way communication between aircraft and ground are afforded. The private flyer may install an airplane transmitter of about $7\frac{1}{2}$ watts power rating operating on 3,105 kc, the national calling and distress frequency for airplanes. The medium-frequency receiving set on the airplane is then sufficient for reception. The pilot can then carry on short-range two-way communication with airport transmitters, radiotelephone transmitters at the marker beacon stations, and in case of emergencies with the radiotelephone weather-broadcast stations. Since a watch is maintained on 3,105 kc at all government airway stations, the private flyer is insured that distress or emergency messages will be heard practically at all times along his route.

8. Two-way High-frequency Communication. To provide for the greater need for constant two-way communication in scheduled operation, the air-transport operators have installed high-frequency ground transmitting stations at the principal airports and have equipped their

airplanes with high-frequency transmitting and receiving sets in addition to the medium-frequency set required for utilizing the government radio aids. The provision of such facilities by all air-transport operators by Jan. 1, 1936, is required by law. The ground stations along a given route operate on the same radio frequency assigned to that route, a separate day and night frequency being required. Communication is generally by radiotelephone because of the greater speed of contact possible. For this service the ground transmitter is of 400 watts and the airplane transmitter of 50 watts.

The pilot of an airplane equipped with a medium-frequency receiving set, a high-frequency receiving set, and a high-frequency 50-watt radiotelephone transmitter capable of operation on the national calling wave and the day or night working wave can

1. Receive the weather-broadcast service and the radio range-beacon service.

2. Communicate on the assigned day or night frequency with aeronautical chain stations.

3. In the event of failure of 2, the pilot may transmit on 3,105 kc, being received by either government or aeronautical ground station. The message may then be relayed over the teletype system and a reply sent on the weather-broadcast transmitter.

4. Communicate at short range with airport and airway keepers on 3,105 kc, requesting position-reporting service, or transmitting emergency messages, and receive acknowledgment on 278 kc.

9. Radio Wave Phenomena in the High-frequency Band. Radio wave propagation in this frequency band depends chiefly on sky-wave

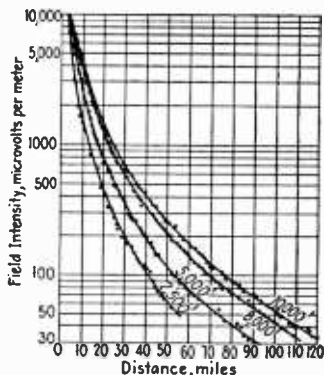

FIG. 3.—Average strength of daytime signals received in an airplane from 500-watt station on 1,510 kc. (Airplane at altitudes designated on graphs.)

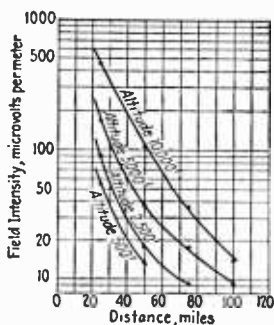

FIG. 4.—Reception from airplane using 50-watt transmitter on 1,625 kc. (Airplane at altitudes designated on graphs.)

radiation returned to earth from the ionized layers. The ground wave is generally of negligible importance beyond distances of the order of 30 miles. The transmission phenomena cannot, therefore, be specified

definitely as in the case of the frequency range used in the government airways radio services. An approximate idea of the transmission characteristics may be had from the following data.

Figure 3 shows the average strength of daytime signals received in an airplane as a function of the distance from a 500-watt radiotelephone ground station on 1,510 kc. Figure 4 shows average reception from an airplane using a 50-watt radiotelephone transmitter of 1,625 kc. Figure 5 shows the effect of frequency upon the attenuation characteristic for a 500-watt ground station.

From these graphs it is seen that the higher frequency appears to be best suited to daytime operation. This has been borne out in practical operation during the past few years, so that the daytime working frequencies throughout the country are of this order.

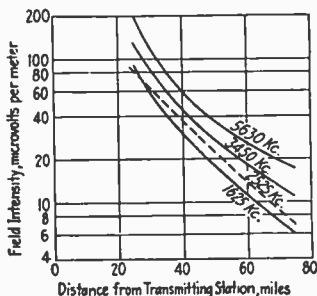

FIG. 5.—Effect of frequency on attenuation of 500-watt ground station.

Similar graphs for transmission during night, showing field strength as a function of distance, are given in Fig. 6. It is even more difficult to generalize from these graphs than for the case of daytime transmission, the movement of the ionized layer involved being more erratic. The graphs do show, however, that the lower frequencies are more reliable for night-time transmission, the transmission on 5,690 kc being unsatisfactory due to excessive fading. Based largely on these data, taken by the Bell Telephone Laboratories for the purpose of laying a groundwork for high-frequency two-way communication between aircraft and ground, frequencies

ranging from 2,900 to 3,500 kc have been assigned for night-working waves. Experience has shown these frequencies to be fairly satisfactory, although frequencies below 2,500 kc would undoubtedly give more reliable night service.

The choice of 3,105 kc for the national day and night calling and distress frequency appears to be a reasonable one on the basis of the foregoing analysis. In this connection it is worth noting that from an electrical viewpoint the higher frequencies offer the advantage of more efficient use on the airplane of fixed antennas of relatively small dimensions.

10. Ground Equipment for Two-way High-frequency Communication. The radio equipment used at the fixed terminal of a typical two-way radiotelephone system has reached a remarkable degree of refinement to meet the particularly exacting requirements encountered in this service.

The transmitter must be capable of operation on any one of a group of frequencies, with facilities for rapid changeover to any other frequency in the group. This is necessary since each transport route has a day and night frequency for communication with aircraft and also a separate day and night frequency for point-to-point communication. Moreover, when the ground station is located at the junction of several routes operated by the same company, provision must be made for communication on either the day or the night frequency corresponding to

each route. Each frequency channel is crystal controlled, the frequency being held constant to within 0.025 per cent. Approximately 400 watts of r-f power on each frequency is required in the antenna to effect reliable communication over the desired distance range.

The receiving equipment must be highly selective because of the many channels that must now be accommodated within the comparatively narrow band of frequencies allocated to this service, stations at the same airport operated by different transport lines being frequently less than 1 per cent apart. Extremely high sensitivity coupled with excellent automatic volume control is required to provide substantially constant output under the varying transmission characteristic which usually obtains in this frequency range and because of the varying distance between the aircraft and ground. Provisions for remote operation must

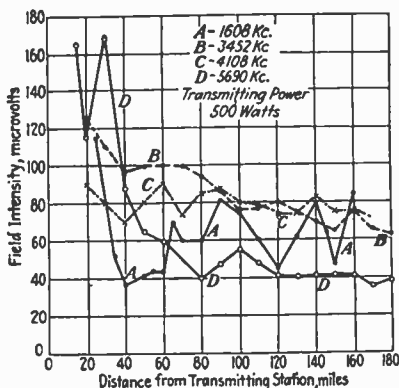

FIG. 6.—Night transmission phenomena.

be provided since, in order to secure freedom from "man-made" interference, the receiving equipment is frequently located as much as 30 miles distant from the operating staff.

11. Ground-station Equipment. Typical of the advanced type of transmitting equipment required for this service is the Western Electric Type 14 transmitter. This transmitter provides crystal-controlled telephone, CW, or tone telegraph transmission on any one of ten frequency channels within the range of 2 to 18.1 megacycles per second. It employs a crystal oscillator, two intermediate buffer-amplifier stages which function either as amplifiers or doublers depending upon the frequency used, a modulating amplifier preceded by two audio stages, and a power amplifier. Each frequency has its own quartz plate and a set of interstage and output coils. The quartz plates are of the new zero-temperature-coefficient type, obviating the need for temperature control and its attendant difficulties. The set is so arranged that any one of the frequencies desired may be selected, by single-digit operation of a telephone dial, within about 1 sec. The dial controls a standard telephone selector switch which picks out a special vertical rod on the back of the transmitter. The rod is raised by a solenoid relay and operates switches

which connect the proper coil and condenser combination in each amplifier stage to the transmitting tubes. The transmitter can be operated with push button, telegraph key, or voice-operated carrier control. The carrier is suppressed automatically during unwanted periods. Provision is made for remote frequency selection and starting and stopping of the carrier. A set of three simple vertical antennas approximately 15, 30, and 60 ft. high may be used to cover the entire range, or any combination of directional and non-directional antennas. The transmitter is a-c operated, requiring approximately a 4-kva, 220-volt, three-phase supply. In a recent set-up of this type of equipment by the Eastern Air Lines, Inc., on the New York to Atlanta route, these transmitters provide telephone ground-to-airplane communication, telephone point-to-point, CW telegraph point-to-point, and RCA facsimile point-to-point for the transmission of long weather sequences and long routine company business. On the telephone point-to-point, provisions are made for the use of Western Electric speech inverters so that the conversations may be of a private nature.

12. Ground-station Receiver. A typical ground-station receiving set is the Western Electric Type 11. The set is a-c operated and consists

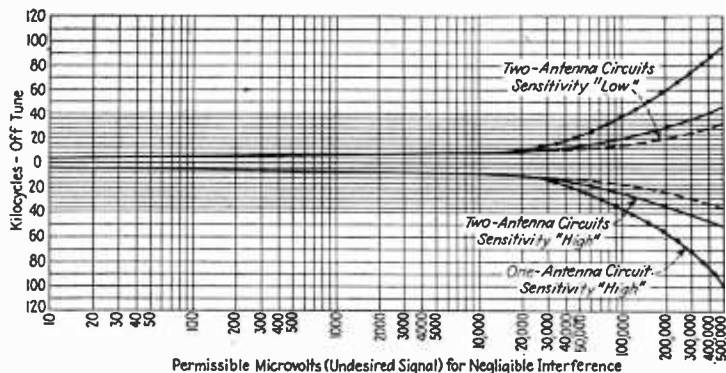

FIG. 7.—Two-carrier selectivity of 2,700- to 6,500-kc. receiver.

of one stage of tuned r-f amplification, a first detector or modulator, an oscillator, three stages of 385-kc amplification, a rectifier used as a detector and automatic volume control, and two stages of a-f amplification. The frequency range is 2,700 to 6,500 kc. The tuning is accomplished by means of a four-gang condenser. The set will deliver 50 mw of audio power for an input r-f voltage of 2 μ v. Maximum audio power output is approximately 1.6 watts. The automatic volume control will hold the output level constant within 6 db for a variation in input voltage of some 80 db. A manual volume control is provided for limiting the background noise when receiving strong signals. Cut-off of audio frequencies either above 3,500 or above 2,000 cps is provided. The selectivity in the intermediate amplifier insures the rejection of signals from stations operating very near to the carrier frequency of the

wanted station, while the selectivity in the r-f circuits prevents adjacent carriers, differing from the desired frequency by more than 30 kc, from entering the modulator in sufficient amount to produce objectionable cross-modulation. The over-all selectivity at 4,500 kc is shown in Fig. 7.

In the case where remote control of the receiver is required, a special type employing two quartz plates, corresponding to the day and night frequency, is available. All the circuits are pretuned so that the frequency is readily changed from one to the other. The receiver frequency and gain may be varied remotely by means of a dial. The receiver output is fed back to the airport station over a standard line and then amplified up to the desired level.

AIRPLANE EQUIPMENT

13. Aircraft Radio Equipment Requirements. Reliability and simplicity of operation are essential. The equipment must be constructed to withstand continued vibration and landing shocks without breakage or change in performance, and must operate under all conditions of weather encountered in flight. Space and weight must be kept down to a minimum. However, reductions in space and weight must not be obtained at the expense of reliability or accessibility for inspection and maintenance.

14. Medium-frequency Aircraft Receiving Set. Particularly high sensitivity and selectivity are required of this type of receiver. Recep-

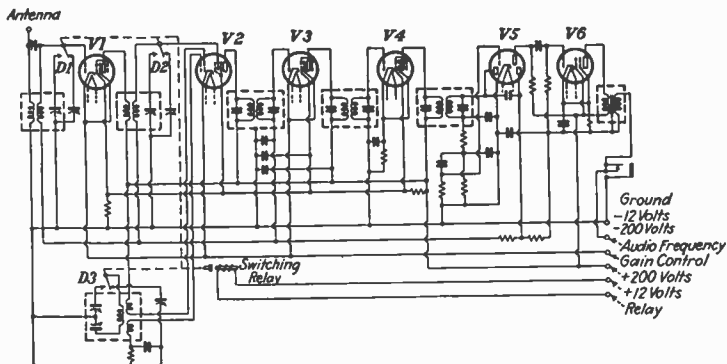

FIG. 8.—Simplified schematic diagram of medium-frequency aircraft receiving set.

tion is invariably from low-power stations with relatively poor antenna systems. It is often necessary to receive a very weak signal (from either airport phone transmitters or airport localizing radio range beacons), with a 2-kw weather-broadcast station operating on an adjacent frequency channel and nearer to the mobile receiver than the station being received.

The schematic circuit diagram of the Western Electric receiver designed for this service is shown in Fig. 8. The superheterodyne circuit affords a

high degree of sensitivity and interstation selectivity. A high signal-to-noise ratio for weak signals is provided through the use of high-voltage step-up in the antenna-coupling circuit. Wide variations may occur in the antenna capacity without affecting this voltage step-up, a feature necessary in preventing loss of sensitivity during the formation of ice on the antenna. The receiver sensitivity is of the order of $1 \mu\text{v}$ input for normal audio output. The selectivity is shown in Fig. 9. Note the wide transmission band and extremely sharp attenuation outside of this band. Maximum audio power output is 600 milliwatts.

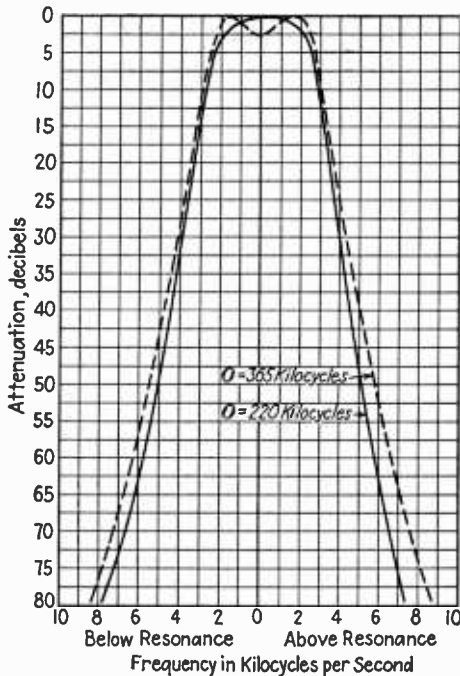

FIG. 9.—Over-all selectivity curves of set of Fig. 8.

A special feature of this unit is the provision of a set of fixed condensers shunted by trimmer condensers which may be connected in place of the variable tuning condensers by means of a switch operated by a solenoid. This provides a convenient method of quickly tuning the receiver to the national airport frequency of 224 kc without disturbing the setting of the variable, ganged condenser, tuned, say, to a radio range-beacon frequency.

The receiver is mounted on a shock-proof mounting, a plug on the receiver engaging a jack on the mounting and making all necessary electrical connections as soon as the receiver is fastened in place. The

set requires for its operation 1.9 amp. d.c. at approximately 12 and 40 ma d.c. at 200 volts. In airplanes equipped with a 12-volt storage battery and charging generator, the low-voltage filament supply is obtained directly from the battery and a small dynamotor operating from the battery furnishes the required plate supply. A ballast lamp is employed in series with the filaments to insure constant filament current under a wide range of battery conditions. A remote-control unit is provided for installation within reach of the pilot for turning the set off and on, controlling its volume, and adjusting the tuning. The tuning control may be a flexible shaft turning in a casing and connecting the tuning crank with the condenser shaft in the receiver through a high reduction-gear system. This high ratio reduces the effect of lost motion

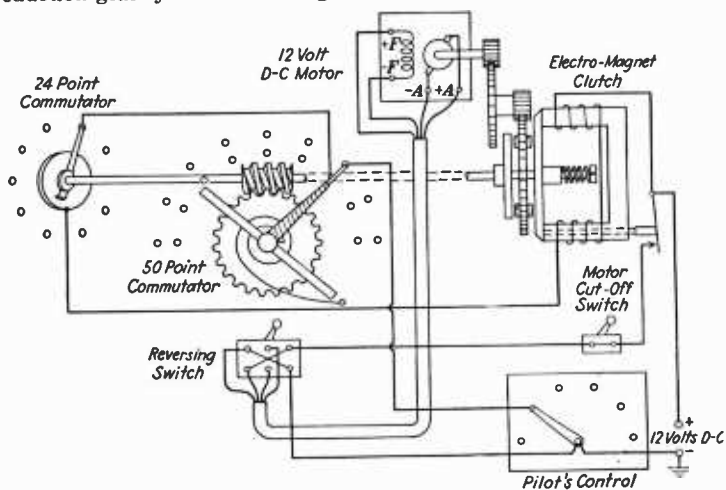

FIG. 10.—Preselected remote tuning arrangement for medium-frequency receiver.

in the flexible shaft to a negligible amount and permits placing the receiver as much as 40 ft. from the tuning control.

An alternative form of remote tuning enables the pilot to choose any one of 12 preselected frequencies, merely by pushing a button or turning a pointer to a definite position. The device consists of a worm wheel coupled to the shaft of the tuning condensers and rotated through a worm driven by a small motor operated from the 12-volt battery. The position at which the tuning condensers stop is controlled by two commutators at the selector unit and a control switch at the pilot's position. Two brushes moving with the worm wheel slide over the segments of one commutator while a brush moving with the worm shaft slides over the segments of the second commutator. The segments of the two commutators and of the pilot's control switch are so interconnected electrically that the position of the switch determines the exact stopping point of the tuning condenser. A simplified schematic of the arrange-

ment is shown in Fig. 10. When the proper position is reached, the drive is stopped by the release of a magnetic clutch. As the latter releases, it applies a brake to the drive shaft and at the same time opens the motor circuit.

15. High-frequency Aircraft Receiving Set. The circuit of the Western Electric high-frequency aircraft receiving set is given in Fig. 11. The set is of the superheterodyne type with crystal-controlled oscillator and obtains power from the 12-volt airplane battery and plate-supply dynamotor. Two quartz plates are used, one for the day and one for the night frequency. The day frequency may be any frequency in the band 2,700 to 4,300 kc, while the night frequency lies in the band 4,300 to 6,500 kc. The set requires 3.2 amp. d.c. at 12 volts for the filaments, 1.2 amp. d.c. at 12 volts for each crystal heater,¹ and 40 ma d.c. at 200 volts for the plate supply. Except for the type of power supply, the receiver is similar to the one described for remote-controlled ground-station operation and has identical characteristics.

The pilot is afforded remote control of the output level and of the sensitivity of the receiver corresponding to which a.v.c. obtains. The latter is required to take care of the large input r-f voltages when the aircraft is close to the transmitting station. No control of frequency is required, except when changing from the day to night frequency or *vice versa*. For this purpose a flexible shaft connects from the pilot's control to the receiver mounting, and, through a worm and gear, operates the switch which connects the r-f circuits of the receiver and the desired quartz crystal in proper combination. The receiver circuits are pre-adjusted to give proper operation at the desired frequencies and the switch has two positions for selecting the two crystals and their corresponding circuits. If desired, the receiver may be operated without quartz crystals by using an oscillator of the self-excited type. An added fine-tuning control is then furnished the pilot to permit compensating for small variations in the oscillator frequency.

16. High-frequency 50-watt Aircraft Radiotelephone Transmitter. The aircraft transmitter shown in Fig. 12 is designed for operation in combination with the medium-frequency and high-frequency receivers just described, and delivers 50 watts of carrier power to the airplane transmitting antenna on any one of three frequencies in the 2,700- to 6,500-kc band. These are usually: the day frequency, the night frequency, and 3,105 kc. To permit ready selection of these frequencies by remote control, the transmitter contains three separate sets of quartz plates, interstage transformers, antenna-tuning coils, and condensers. These are set up for the desired three frequencies, each of which may be selected by a single mechanical control operating a ganged switch. The control works from the same flexible shaft as the h-f receiver control. The transmitter and h-f receiver are thus both shifted from day frequency to night frequency or *vice versa* with one operation by the pilot. The pilot's control has an intermediate position for 3,105-kc operation of the transmitter, the receiver remaining at its operating frequency. As indicated in Art. 8, replies to transmissions on 3,105 kc are received on the beacon receiver.

The transmitting-circuit arrangement comprises a 5-watt crystal oscillator, a first amplifier, a power amplifier using two tubes in parallel,

¹ Recently these have been eliminated through the use of zero-temperature-coefficient crystals, variously known as the A cut or Z cut.

and a 5-watt audio amplifier for amplifying the speech input and modulating on the screen voltage of both amplifiers. The coupling transformers used between the oscillator and first amplifier, and between the

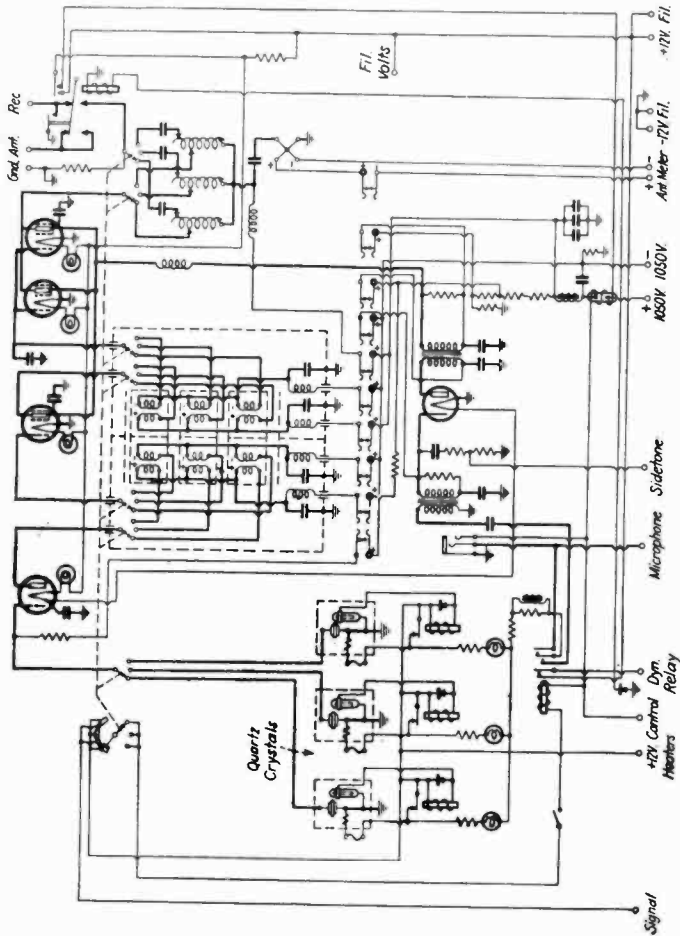

Fig. 12.—Schematic diagram of 50-watt high-frequency transmitter.

two amplifiers, are of special interest in that no tuning condensers are required, the transformers being designed to form band-pass filters in combination with the tube and wiring capacities. The oscillator operates at half the fundamental frequency, doubling being effected in the first

coupling transformer. Coupling between the power amplifier and the antenna is secured by a simple tuned circuit which allows for adjustment in the field to tune to widely different antennas. For convenience, the three coupling transformers are grouped to form a single plug-in unit, as are also the three antenna-tuning circuits. The three-point switches employed to select the desired crystal, pair of interstage transformers, and antenna-coupling units are ganged together and operated by the pilot's control as indicated in the foregoing. An interlocking switch is also connected to the same control, to prevent application of high voltage except when a channel is completed. This switch also lights a lamp in the pilot's control unit when the switches are off position. A thermoelement is connected in the r-f ground circuit to operate an antenna ammeter near the pilot, thereby giving him the opportunity to check output, modulation, etc. The transmitter requires 15 amp. d.c. at 12 volts and 350 ma d.c. at 1,050 volts. The former is usually obtained from the airplane storage battery and the latter from a dynamotor operating from the battery.

17. Typical Arrangement of Airplane Radio Equipment. The arrangement of equipment required on the airplane for fully utilizing the government-operated radio aids and in addition maintaining two-way radiotelephone communication with the aeronautical ground stations is of some interest. The approximate weights and dimensions of the component parts of the installation are given in Table I. Note that these figures do not include the primary source of power on the airplane; usually comprising a 65-amp.-hr., 12-volt storage battery and a d-c generator driven from one of the airplane engines for charging the battery.

TABLE I.—WEIGHTS FOR COMPLETE RADIOTELEPHONE INSTALLATION ON AIRCRAFT

Equipment	Over-all approximate dimensions, inches	Approximate weight, pounds
Medium-frequency receiving set.....	16 × 10 × 9	18
High-frequency receiving set.....	16 × 10 × 9	18
High-frequency 50-watt transmitting set.....	20 × 14 × 10	48
Transmitting and receiving dynamotors, starting relay, etc.....	10 × 10 × 8	33
Control units, switches, jacks, control cables, micro-phones, headsets, etc.....	32
Wiring cables, antenna wire, terminal blocks, etc.....	21
Total.....	170

The complete controls which must be operated by the pilot are as follows: One unit is provided for controlling power to the receivers and the transmitter. Sensitivity and level controls for the two receivers are included in this unit (see Fig. 13). A switch is provided so that the heater circuits of the crystal oscillator in the high-frequency transmitter and receiver may be energized separately from the rest of the equipment. This unit also contains the signal lamp, connected to terminal 12 on the transmitter, which lights when the frequency shift has not been carried out properly. In addition to this unit there is a tuning control for the medium-frequency receiver and a tuning

shift control for the two-way high-frequency receiver and transmitter. The pilot controls the complete system by means of the "talk-listen" button on his microphone.

With the button open (in the "listen" position), both receivers are functioning normally, the high-frequency receiver being connected to the transmitting antenna and the medium-frequency receiver to a separate antenna.

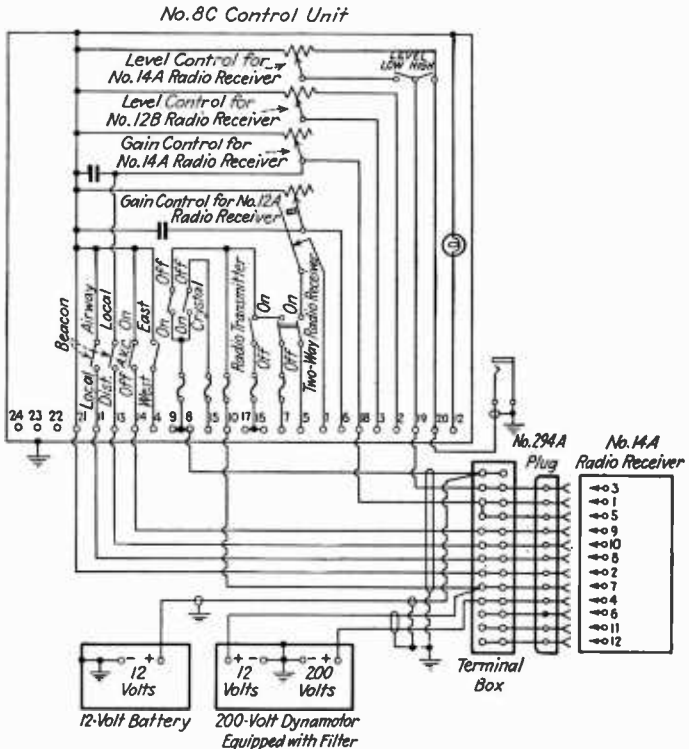

FIG. 13.—Control arrangement for airplane use.

If the external transmitter-filament switch is closed, the transmitter tubes are heating on reduced current. The crystal-heater circuits are in operation. Upon depressing the button to the "talk" position, the following sequence occurs. Relay S_1 in the high-frequency receiver (see Fig. 11) operates to connect the audio amplifier of the receiver as a side-tone amplifier for the transmitter and removes the plate supply from the remainder of the receiver (also from the medium-frequency receiver, if desired). A relay in the transmitter (see Fig. 12) closes two sets of contacts. One of these closes the microphone circuit and connects the speech input to the audio amplifier. The other operates the antenna relay and also places +12 volts on the terminal to start the transmitting dynamotor. The antenna relay removes the

transmitting antenna from the high-frequency receiver and connects it to the transmitter. It also short-circuits a resistor thereby placing full voltage on the filaments of the transmitting tube. The vacuum relay is operated by a contact on the antenna relay, thereby placing plate voltage on the transmitter. In this way, full power is radiated from the transmitter with side tone in the headphones, and without any noise produced in the receiver outputs. Also arcing of the antenna relay, when the button is released, is avoided.

18. High-frequency 20-watt Radiotelegraph and Radiotelephone Transmitting Set. The useful distance range of communication when a 20-watt airplane radiotelegraph set is employed is equivalent to that

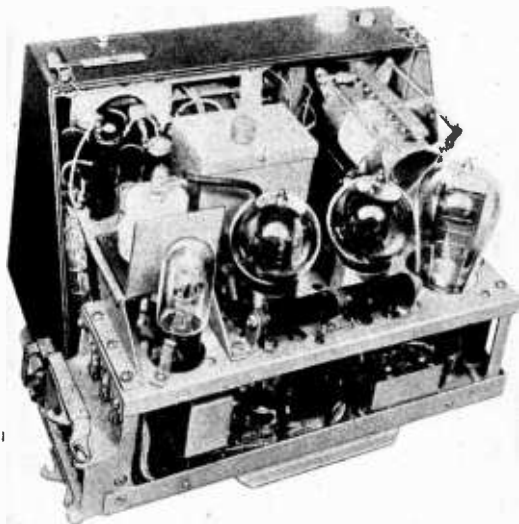

FIG. 14.—A 7½-watt high-frequency airplane transmitter.

obtained with a 50-watt radiotelephone set. The reduction in weight is marked, due partly to the lower weight of the set itself and partly to the lower power-supply requirements. This reduction in weight is retained even though full power-output, 100 per cent modulated, radiotelephone transmission is also provided. The distance range of transmission for the latter is approximately two-thirds that for a 50-watt transmitter.

A 20-watt transmitter designed for cw or mcw radiotelegraph and 100 per cent modulated radiotelephone transmission is manufactured by the RCA Manufacturing Co. The transmitter employs a type 10 tube as the master oscillator, two type 10 tubes as the power amplifier, a type 10 tube as the speech amplifier, and two type 841 tubes as Class B amplifiers. Frequency stability of the master oscillator relies upon careful design of the oscillatory circuit. A frequency range of 2,000 to

6,500 kc is covered, and a switching arrangement which is operated by a single mechanical control permits rapid selection of any one of three predetermined frequencies within this range. The transmitter together with built-in dynamotor weighs 36 lb. and requires a total current of 25 amp. d.c. at 12 volts. Provision is made for supplying 35 to 70 ma d.c. at 200 volts from the dynamotor for operating receiving sets on the airplane. The total weight is to be compared with the value of 81 lb. for the 50-watt radiotelephone transmitter together with transmitting and receiving dynamotors. Moreover, the load on the airplane storage battery and charging generator system while the transmitter and receivers are in operation, namely, 25 amp., is to be compared with approximately 90 amp. for the higher power equipment.

19. High-frequency $7\frac{1}{2}$ -watt Radiotelephone Transmitting Set for Itinerant Pilot. A photograph showing a $7\frac{1}{2}$ -watt crystal-controlled radiotelephone transmitter suitable for use by private flyers on 3,105 kc is shown in Fig. 14. The transmitter uses but three low-power tubes, an oscillator, a modulating amplifier, and a speech amplifier. The oscillator operates at half the fundamental frequency, the operating frequency being selected by the tuned circuit in the oscillator output and passed on to the grid of the modulating amplifier. Modulation is effected in the plate circuit of the modulating amplifier. If the proper quartz plate is provided, operation may be had on any frequency in the band 3,000 to 6,500 kc. The tuned-output circuit may be made to function as a tuned input for a high-frequency receiver for two-way high-frequency communication, if desired. The transmitter requires 4 amp. d.c. at 12 volts and 100 ma d.c. at 520 volts.

AIRCRAFT POWER EQUIPMENT

20. Power-supply Choice. Five determining factors enter into the choice of the power system to be adopted: (1) reliability, (2) weight, (3) availability when main power plant of airplane is crippled, (4) electrical performance, and (5) maintenance required during service. Several distinct types of power-supply systems are available. The receiving-set power requirements are satisfactorily provided by the combination of the 12-volt battery and dynamotor plate supply. The transmitting-set plate-supply requirements, being considerably larger, have led to the development of a number of different arrangements. These include dynamotors driven from the aircraft storage battery, airplane-engine-driven generators, wind-driven generators (now practically obsolete) and auxiliary gasoline-engine-driven generators. In comparing these systems, consideration must be given to the ever-increasing electrical load requirements on a modern transport airport other than radio power supply. These include lighting, motor starters, motors for operating adjustable pitch propellers, retractable landing gear, flaps, fuel and oil pumps, remote-controlled switches and solenoids, etc.

21. Generating Systems. These may be of either the a-c or the d-c type. A-c generators may be designed for either single phase, 500 to 800 cycles, or for three phase, 60 cycles. The higher frequencies provide the advantages of much lighter transformers for stepping the generated voltage up or down to the desired values; and of simple, light-weight filter systems for use in rectifying these voltages when a d-c supply is required. The lower frequency affords the advantage of utilizing standard commercial transformers, rectifiers, and auxiliary electrical

devices (such as motors) on the airplane, thereby reducing cost. Moreover, much better voltage regulation is obtained with the lower frequency. The efficiency and low weight of the higher-frequency system may be retained with 60-cycle operation through the use of three-phase supply. The d-c arrangements have the advantage of directly generating the voltages required by the radio equipment. The units required are, however, much heavier than the a-c generating units. Moreover, since the 12-volt storage battery serves as the central source of power in the d-c systems, very heavy conductors are required in distributing the power.

As the electrical load requirements continue to increase, the eventual power-supply system on large aircraft will probably be an auxiliary gasoline engine driving a three-phase 60-cycle alternator and d-c exciter. For the present, the airplane engine itself continues to act as the primary mover. The most-accepted system appears to be that of a 12-volt d-c charging generator driven from an airplane engine through a centrifugally controlled friction mechanism so as to maintain substantially constant generator speed (and voltage) for all possible airplane-engine speeds. This does away with the hitherto troublesome voltage regulator for maintaining constant generator output voltage. The generator charges the airplane storage battery which in turn drives the necessary dynamotors for obtaining receiver and transmitter plate supply. The chief disadvantage of this system is that emergency operation of the radio equipment in the event of failure of the airplane engine is limited to about 30 min. This is more or less true of all other systems except the separate gasoline-engine-driven generator.

An idea of the weight of the power-supply equipment required for operating the aircraft radio installation described in Art. 17 above may

TABLE II.—WEIGHTS OF POWER-SUPPLY EQUIPMENT

	Dyna- motor system, pounds	Wind- driven double- voltage generator	Combination wind-driven generator and dynamotor	Main engine- driven double-voltage generator	Auxiliary engine-driven double-voltage generator
65 amp.-hr. battery...	70	70		
33 amp.-hr. battery...	36	36	
Cables.....	10	6	15	6	5
50-amp. charging gen- erator and control box.....	47				
Dynamotor.....	26.5				
Double-voltage gen- erator.....		28		50	
Generator dynamotor			36		
Gasoline engine, double-voltage gen- erator unit.....					100
Relay or control box..	2	2	6	3	
Propeller.....		5.5	6.25		
Average fuel.....					7.5
Actual weight.....	155.5	77.5	133.25	95	148.5
Equivalent weight....	44.0	58.0	70.25	33.5	0.0
Effective weight....	199.5	135.5	203.5	128.5	148.5

be had from Table II. The table treats the dynamotor system, the auxiliary-engine-driven system, and several of the older arrangements, corresponding to an electrical output of 700 watts.

AIRPLANE RECEIVING AND TRANSMITTING ANTENNAS

22. Antenna Requirements An aircraft antenna must have a good effective height, must be of sound aerodynamic design, and must be convenient to use under varying air-transport operation conditions. The trailing wire fulfills the first requirement, but fails to meet the second and third requirements. It is still used in modified form in some modern installations for transmission, because of its efficiency and comparatively greater freedom from ice formation. A typical fixed transmitting antenna consists of a mast approximately 6 ft. high mounted above the fuselage and with flat-top wires extending toward the wing tips and the vertical rudder post. An older arrangement consists of two single-wire T units suspended between the two wing tips and the rudder post. If the lead-in wire is taken from the junction of the two flat-top wires at the rudder post, a V antenna results.

A pole extending 4 to 6 ft. vertically above the fuselage has an effective height of about 1 meter, sufficient for use with sensitive receivers. Errors in course indication on the radio range beacon are introduced unless the receiving antenna on the airplane is entirely non-directional. This restriction limits the antenna configuration to either the vertical-pole antennas or to a vertical antenna with flat-top loading, the flat-top elements of which are so arranged that their horizontal effects neutralize each other. The symmetrical, longitudinal, or transverse T antennas with vertical lead-in are examples of the latter type. Considerable use is made in practice of a single wire inclined backward and upward toward the vertical rudder post. With this arrangement, the directional errors are utilized to compensate for the tendency of a pilot to weave about the beacon course.

The discharge of electrically charged rain or snow particles on the receiving antenna leads to what is known as *rain or snow static*, often of sufficient intensity to mar reception even at short distances. The use of a shielded loop antenna (familiar in marine-radio direction finding) for receiving overcomes this type of static and may prove beneficial against the reduction of range of reception during ice formation.

RADIO SHIELDING AND BONDING IN AIRCRAFT

23. Airplane-engine Ignition Shielding. Intense electrical disturbances are set up in the radio receiving circuits by the electrical ignition system of the airplane engine or engines unless ignition shielding is provided. To obtain effective shielding it becomes necessary to enclose the entire electrical system of the engine ignition in a high-conductivity metallic shield. This requires the provision of suitable metallic covers for the magneto distributing heads, for the booster magneto, for the ignition distributing wires running from the magnetos to the spark plugs, for the spark plugs themselves, for the ignition switch, and for the switch and booster magneto leads.

With the low-power ground stations in present use, it is necessary to utilize field intensities not appreciably greater than the prevailing static level. Hence, very careful ignition shielding is essential.

Since the location of the antenna with respect to the interfering source obviously affects the signal to interference ratio, cases are often encountered where partial shielding of the ignition system proves sufficient. In the usual case, exposing even a few inches of high-tension lead or failing to ground the shield at frequent intervals is enough to introduce interference.

COURSE NAVIGATION AND POSITION DETERMINATION

24. Radio systems for guiding aircraft divide into two parts: (1) aids for aircraft flying the established airways, and (2) aids for aircraft flying over independent routes. The first is the more important in the United States. All commercial transport airplanes use fixed airways. The government's aids to air navigation are being provided with the primary view of serving aircraft flying these airways.

An ideal system suitable for use by aircraft flying either fixed airways or independent routes, on land or on sea, is such that:

1. The system shall give the pilot information to enable him to continue along a given route between any two points in a given service area when no landmarks or sky are visible. If he leaves the course, it should tell him how far off he is and to which side, should show him the way back to the course, and should inform him when he arrives at his destination.

2. The necessary directional service shall be available at all times and under all conditions, to all airplanes equipped to receive the service and flying within the area served.

3. The service shall be easily, positively, and quickly available to the pilot, with a minimum of effort on his part.

4. The radio equipment required on the airplane shall be simple, rugged, of light weight, and relatively inexpensive.

5. The ground equipment shall be as simple as possible. The radio frequencies, power, type of emission and location of ground transmitting stations shall be such as to serve the needs with maximum efficiency and conservation of the limited radio channels available.

25. **Direction Finder on Airplane.** One system employs a fixed-coil antenna the plane of which is perpendicular to the longitudinal axis of the airplane. Zero signal is obtained in the receiving-set output as long as the airplane is pointing to the ground transmitting station. This is essentially a "homing" system and is subject to the limitation that a circuitous path is followed if heavy cross winds prevail. This is illustrated in Fig. 15. Course corrections may be made periodically by observation of the compass indications; the course followed is still, however, not the most direct possible. The system also lacks means for giving the pilot the sense of deviation from the course, the signal increasing from zero whether the airplane deviates to the left or to the right. Moreover, the use of a zero-signal indication is difficult under conditions of severe atmospheric disturbances or interference from other services.

To obviate these difficulties, the *Robinson* direction-finding system was developed. In this system, two crossed-coil antennas are used, one coil having its plane along the longitudinal axis of the airplane and the second having the plane perpendicular to this axis. The signal due to the second or auxiliary loop antenna is alternately added to and subtracted from the signal due to the first- or main-loop antenna. When on the course, since no voltage is then induced in the auxiliary coil, the two signals are of equal intensities. This may be readily understood by reference to Fig. 16, where *A* and *B* correspond to the reception characteristics of the main and auxiliary coils,

respectively. When off course to the left, assuming the phase relations indicated in Fig. 16, the sum of the two signals is greater than their difference, while when off course to the right their sum is less than their difference. By providing suitable switching so that the "additive" position precedes the

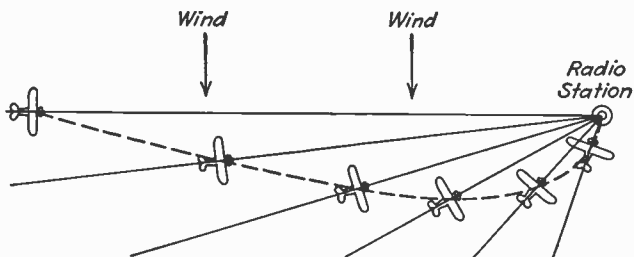

FIG. 15.—Effect of cross winds on path followed with direction finder.

"subtractive" position, the pilot knows that he is off course to the left when the first signal is louder than the second, while he is off course to the right when the reverse holds true. When on the course, the two signals are of equal intensity. To secure sharp off-course indications it is usual to make the auxiliary coil of about six times the effective height of the main coil.

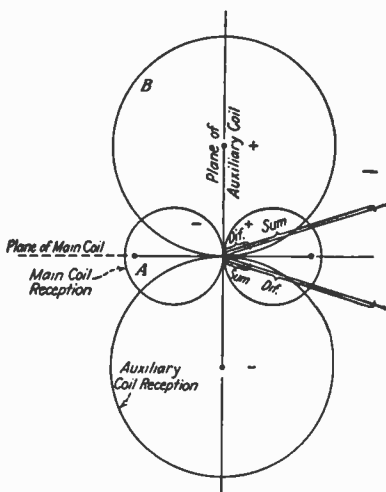

FIG. 16.—Crossed-coil direction-finding system.

In modern aircraft radio practice, the Robinson direction finder has been replaced by equipment giving visual indication of the airplane heading relative to the course directed on the ground transmitting station. A number of commercial units have been introduced and are

successfully employed for flying along independent routes and as adjuncts to the radio range-beacon system. These are generally modifications of the Robinson direction finder in which the main coil is replaced by a vertical antenna, since no directivity is required of this element. The switching to the additive and subtractive positions is accomplished electrically and is performed at a rapid rate. The output signal of the receiving set is switched synchronously with the antenna system, so that it passes alternately in opposite directions through an indicating instrument of the zero-center type, thereby giving right and left indication of the heading of the airplane with respect to the desired course.

A circuit diagram of the earliest published arrangement¹ of this type and one which is similar in most of the essential details to many of the

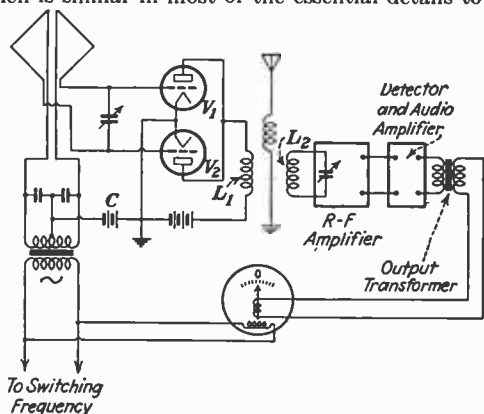

FIG. 17.—Schematic circuit diagram for visual-type airplane radio direction finder.

current commercial units is shown in Fig. 17. In this arrangement the tubes V_1 and V_2 are biased to cut-off by the bias battery C , passing current only when successive half-cycles of the switching frequency alternately make the grids less negative. The r-f voltage passed on from the coil L_1 (in the common plate circuit of V_1 and V_2) to the coil L_2 (connected to the input of a conventional receiving set) is thus alternately reversed. Voltage from a vertical antenna is also fed into L_2 in proper phase relation so that the loop-antenna voltage alternately adds to and subtracts from it. The amplified sum and difference voltage is detected and amplified and then passed through the current coil of an a-c electro-dynamometer-type instrument. The field coil is excited by the switching frequency so that the zero-center pointer is deflected to the right, say, corresponding to the additive condition of the loop and vertical antenna voltages and to the left corresponding to the subtractive condition. The polar diagram indicating the response of the antenna system for the two conditions corresponding to varying directions of the airplane with respect to the transmitting station is shown in Fig. 18. The inter-

¹ See reference to Dieckman at end of section. For a description of commercial equipment, see *Electronics*, October, 1935.

section of the two cardioid patterns corresponds to the zero-center or "course" position of the indicator. Whether the airplane is flying toward or away from the ground station is readily determined by noting whether the pointer deflects to the right or left or *vice versa* as the heading of the airplane is altered to the right or left of the course.

This type of direction finder is quite simple and may be used on any type of ground station, such as in the broadcast band. The same set may be used for the reception of weather-broadcast and range-beacon signals. One important desirable improvement now receiving attention is the elimination of serious and erratic errors in the bearing obtained at night (also in the daytime on the higher broadcast frequencies). A second project on which experimental work is in progress is the connection of the course indicator to control the steering of the airplane, through use of the automatic pilot.

To make full use of the possibilities of a direction finder aboard aircraft, automatic indication of the direction of the station tuned in is required.

26. Direction Finder on the Ground. One system of navigational aids to aircraft is a direction-finding system, but with the direction finder located on the ground. Every airplane utilizing this system carries a radiotelephone (or radiotelegraph) transmitter and receiver. Permanent direction-finding stations are located at ground stations at strategic points. When an airplane desires to learn its position, it transmits a request on the airplane transmitting set, whereupon two or more of the ground direction-finding stations each determines the direction by observations upon the radio waves transmitted from the airplane. Triangulation then gives the airplane's position, which information is transmitted to the airplane.

Five minutes is normally required between the time the request for a bearing is transmitted from an airplane and the time the bearing, as computed by two ground stations, is furnished the airplane. Obviously, the system is best suited to long-distance operation over routes not too heavily congested, such as the recently inaugurated trans-Pacific service.

A simple loop antenna may be used in conjunction with the receiving set required with this system, thereby giving the pilot additional directional or "homing" service to supplement the bearings furnished by the ground station network.

Even with this additional service, however, the airplane is not kept strictly on a given course at all times and is therefore not practicable where airplanes must fly over rigid airway routes.

27. Rotating Radio-beacon System. A method of furnishing navigational aid to a flyer is the rotating radio beacon developed in England. This method employs a transmitter located at an airport, which has a loop antenna rotating at a constant speed of one revolution per minute. A figure-of-eight pattern is thus rotated in space at a constant rate. A special signal indicates when the figure-of-eight minimum passes through north, and also when it passes through east. A pilot listening to the beacon signal in the output of his receiving set can start a stop watch when the north signal is received and stop it when the figure-of-eight

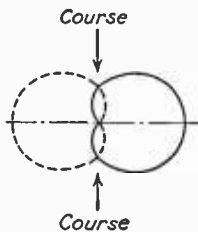

FIG. 18.—Crossed cardioid patterns for visual-type finder.

minimum reaches him. The number of seconds multiplied by six gives him his true direction in degrees from north. The stop watch may be calibrated directly in degrees, so that the position of the second hand, when the minimum signal is received, gives the bearing directly. The east signal is provided to overcome the difficulty in receiving the north signal when the airplane is north or south of the beacon, as on that bearing the signal strength is a minimum.

The transmitter circuit is shown in Fig. 19. The keying of the circuit is automatically carried out by the rotation of the loop antenna. Since the rotation of the loop antenna is used as a basis of computation of bearings, close control of the speed of the driving motor is maintained. To secure as great a useful transmitting range as possible, the loop-antenna current is of

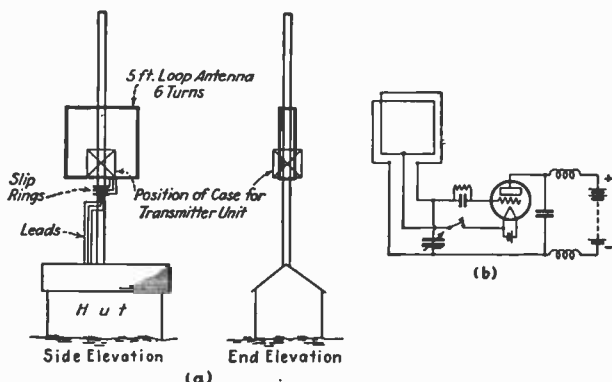

FIG. 19.—Transmitter for rotating beacon.

the order of 70 amp. To reduce the losses in the transmitting circuit to a minimum an air-dielectric transmitting condenser is employed. The power input to the transmitting tube is approximately 2,000 watts.

The receiving antenna is of a non-directional type. The receiving set may be used in the reception of weather-broadcast messages and other communications when not employed in direction determination. The system is capable of giving simultaneous service to any number of airplanes in any direction. Drift may be checked by determining positions periodically, and correction may be employed. A number of disadvantages are, however, inherent in this system. The service is intermittent and somewhat slow, requiring at least 30 sec. for each bearing. The system is not suitable for guiding an airplane along a given fixed route. Since the determination of a minimum signal must be made, this system is particularly subject to interference and atmospheric disturbances.

28. Radio Range-beacon System. The radio range-beacon transmitting station employs two directional antennas placed at right angles to each other. The older stations in the United States employ loop antennas, triangular or hexagonal in shape, from 200 to 300 ft. in length and from 50 to 70 ft. high. The newer stations, more than 50 per cent,

use TL antennas. These comprise four insulated 125-ft. steel towers placed on the corners of a square and fed from the transmitter by buried parallel-wire transmission lines. Each directional antenna consists of two opposite towers on diagonal corners of the square 300 to 500 ft. apart. These are fed in opposite phase so that they correspond to the vertical conductors of the older loop antennas and give the same radiation characteristics in the horizontal plane (see Fig. 20). In this way radiation is confined to the vertical antennas, and the transmission of horizontally polarized electric field components in the sky wave, such as from the horizontal wires of the loop antennas, are avoided. With the loop antennas, these horizontal components upon reflection from the ionized layers produce serious and erratic errors in the indicated beacon courses, often called "night errors," because they occur only at night in the frequency range used. To insure maintenance of the space pattern of the TL antennas, special stabilization features are incorporated in the trans-

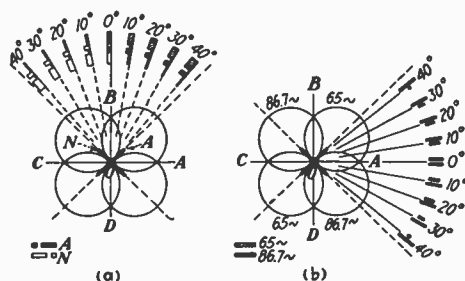

FIG. 20.—Transmitting characteristics of radio range-beacon antenna system.

mission-line circuits which serve to interlock the currents in the two towers of each directional antenna so that a change in phase or magnitude of the current in one tower (due to accidental detuning by weather, etc.) is accompanied by an equivalent change in the other.

The principles of operation of the radio range beacon are evident from Fig. 20. The intensities of the radio waves from the two antennas are equal along the lines OA , OB , OC , and OD which bisect the angles between the two antennas. Elsewhere, one of the two waves is stronger than the other. An airplane may therefore follow a course along the bisectors referred to if means are provided for distinguishing the two sets of radio waves from one another. A different signal is impressed on each set of waves for this purpose. The two types of radio range beacons developed differ mainly in the means employed for distinguishing the two sets of signals.

In the *aural-type* beacon two coded letters are used: generally an N (---) and an A (—). The r-f power fed to one antenna is supplied at time intervals corresponding to the characteristic N while that to the second antenna is furnished in accordance with the characteristic A . The two characteristics are interlocked, so that when received in equal intensities (*i.e.*, along the lines bisecting the two antennas) they merge into a long dash. Off course to one side of these lines the N predominates, while off course to the other side the A predominates. The interlocked signals are now sent in groups of four with a

short coded signal provided between successive groups for identifying the different beacon stations of the airways network. To facilitate use by the pilot, the beacon space pattern is oriented, whenever possible, so that the *A* signal lies in the northeast and southwest quadrants while the *N* signal lies in the southeast and northwest quadrants.

In the *visual-type* beacon, two low-frequency notes, usually 65 and 86.7 cycles, are employed. The r-f power in one antenna is modulated to 65 cycles, while that in the other antenna is modulated to 86.7 cycles. The modulated r-f is on the antennas continuously, instead of throwing from one to the other antenna as in the aural system. This permits the use of a continuously indicating instrument on the airplane. This instrument is connected in the output circuit of the receiving set employed and consists of two vibrating reeds mechanically tuned to the two modulation frequencies used at the beacon station. When the beacon signals are received the two reeds vibrate and, thus, may serve as a device for indicating relative intensities of the signals received from the two loop antennas. In one form of indicator, the vibrating reeds induce voltages in two pick-up coils. These voltages, proportional to the amplitudes of vibration of the two reeds, are rectified by cuprous oxide rectifiers and the rectified voltages applied differentially to the terminals of a zero-center pointer-type instrument. The instrument remains at zero center when the airplane is "on course," *i.e.*, when the two reeds vibrate equally. Off course, the pointer deflects to the right or left depending on which reed has the greater amplitude.

The radio range beacon of either aural or visual type requires only a simple radio receiver aboard the airplane for its reception. Since directional transmission is used at the ground station, a non-directional antenna is employed on the airplane. The same receiving equipment is therefore suitable for receiving the government weather broadcasts. With the visual-beacon system, automatic volume control reception is feasible. The range-beacon system is simple to use by the pilot and permits him to fly along the established airways where all the other aids to aviation are provided.

29. Goniometer. A goniometer is normally used between the radio range-beacon transmitter and the directional antenna system. In the aural-type beacon, the tuned plate circuit of the transmitter is coupled by an untuned link circuit to the primaries of a goniometer, the goniometer secondary windings being connected each in series with one of the crossed-loop antennas or with one of the output circuits feeding the TL antennas. Keying is accomplished in the link circuit by means of the keying cams and consists of connecting the link circuit to one or the other primary. The goniometer is used for convenience in orienting the beacon space pattern and consists of two primary and two secondary windings. The primary windings are crossed at 90 deg., as are also the secondary windings, the two sets of windings being made concentric. One set of windings is fixed and the other set rotatable about the common axis. The angle between the primary and secondary windings may therefore be varied at will. Each primary winding, acting in conjunction with the two crossed secondary windings and the two crossed directional antennas, sets up a system which is electrically equivalent to a single directional antenna. The plane of this phantom antenna is dependent upon the relative coupling of the secondary coils to the primary coil under consideration. Since there are two primary windings, two such phantom antennas exist, the angle between their planes being equal to the angle between the primary windings. The two phantom antennas may therefore be rotated in space (thus changing the position of the equisignal

zones or courses formed by their space patterns) by changing the relative position between the primary and secondary windings. Without the use of the goniometer it would be necessary mechanically to rotate the directional antenna system to secure the same result. In practice, the rotation of the beacon space pattern is convenient in the first adjustment of the beacon, the goniometer being locked in position after this adjustment.

30. Course Orientation to Coincide with Airways at Arbitrary Angles. Several methods have been developed for shifting the range-beacon courses from their 90-deg. relationship in order that they may be aligned with the airways. These are applicable to both the aural-type and the visual-type beacons. While the underlying principles are the same, the

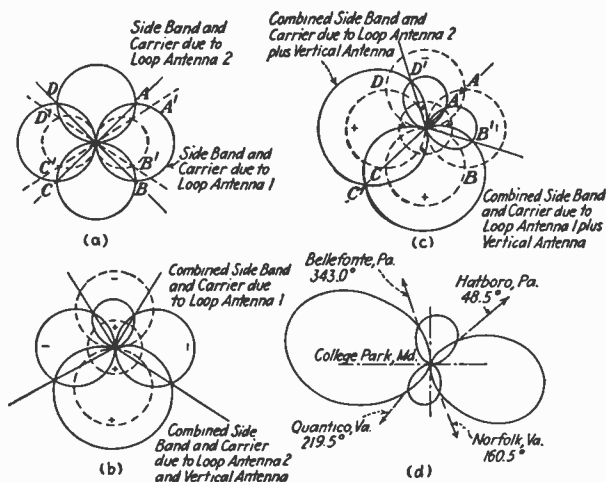

FIG. 21.—Methods of aligning beacon courses with airways.

method of applying them differs for the loop- and TL-antenna systems. Methods applicable to the loop-antenna system are illustrated in Fig. 21. One consists of reducing the current in one of the two loop antennas. The effect secured is shown in Fig. 21a. A second method utilizes the circular radiation from a vertical antenna extending along the beacon tower, in addition to the normal figure-of-eight radiation due to each loop antenna. The vertical antenna may be excited to radiate one or both characteristic waves of the station. The corresponding effects secured are shown in Fig. 21b and c. Combinations of the two methods described are particularly useful. Figure 21d shows the results of one such combination in which the currents in the two loop antennas are reduced while, at the same time, circular radiation is added to the normal figure-of-eight radiations of both antennas. In the case of the TL-antenna system, reduction of the figure-of-eight pattern corresponding to a given directional antenna is obtained by reducing the current in the

output circuit feeding that antenna. Modification of the radiated space pattern of either directional antenna to a pattern intermediate between a figure-of-eight and a cardioid is accomplished by controlling the phase of the currents in the two towers of the antenna. As the time-phase difference departs from 180 deg., the pattern departs from a figure-of-eight and approaches a cardioid, reaching that shape when the time-phase difference is equal to 180 deg. minus the space phase between the two towers in degrees.

31. Visual Course Indications from the Aural Beacon. A method of obtaining both aural- and visual-type beacon signals simultaneously utilizes an aural-beacon transmitter on the ground, the required modifications to the standard transmitter in use being quite minor. Some addition is required to the airplane receiving equipment which, on the whole, is not complex. The visual indicator is not so free from external inter-

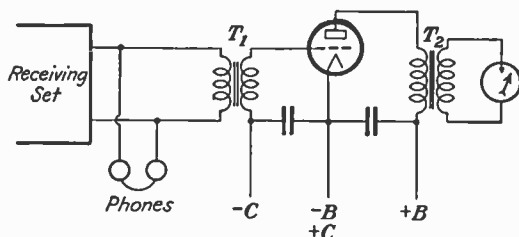

FIG. 22.—Arrangement for converting aural-beacon signals to give visual indication.

ference, particularly atmospherics, as with the visual-type beacon described in Art. 28 and automatic volume control reception is not feasible. However, because of the relatively inexpensive transmitter, the system is quite attractive and is being service tested both in Germany, where it was developed, and in the United States.

This method requires that the coded characteristics be changed from the conventional *N* (—) to a series of dashes (— — —) on one directional antenna and from the conventional *A* (· —) to a series of dots (· · ·) on the second directional antenna. The dashes and dots are interlocked so that on the beacon courses a long monotone is heard. This is broken up every 2 or 3 min. for the station identification signals. Off course to one side, the series of dashes are heard; off course to the other side, the series of dots are heard. The dashes are about five times or more as long as the dots.

The output of the receiving circuit used on the airplane is shown in simplified form in Fig. 22. The signals received in the output of the receiving set are rectified and then applied through a transformer to a special zero-center pointer-type instrument. This instrument is highly damped (slow acting) and in addition is sensitive at zero center but becomes less and less sensitive with increasing deflection to the left or right. The operation of the receiving arrangement will be understood from reference to Fig. 23. *A* represents the currents in various portions of the receiving circuit when dots are being received, while *B* represents the corresponding currents for the dashes. The low-frequency currents in the receiver output are shown at *a*. These may be used for ordinary aural reception. The currents in the output of the

rectifier are shown at *b*. These currents set up voltages in the secondary of transformer T_2 as shown by *c*. Note that the induced voltage is zero during the constant portions of the rectified current, being built up due to the change of flux occurring whenever the rectified current is changing. Note also that the induced voltage is in opposite directions depending on whether the rectified current is increasing or decreasing.

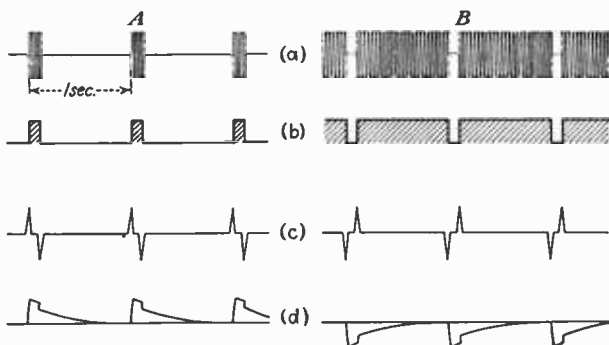

FIG. 23.—Method of visual indication.

Consider the case for the quadrant having dot signals. At the beginning of the dot, the induced voltage deflects the instrument pointer, say, to the left. At the end of the dot, the induced voltage tends to deflect the pointer to the right. However, the time between the beginning and end is so short

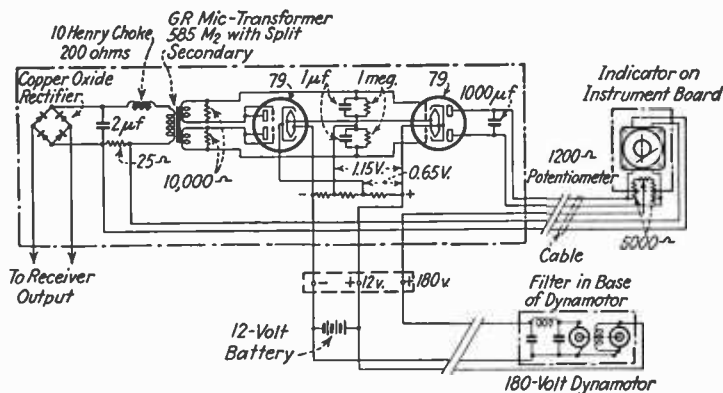

FIG. 24.—Circuit arrangement of aural-visual converter used in U. S.

that the pointer is still in the insensitive position due to time lag of the instrument and therefore remains deflected to the left. During the long space for the dash the needle tends to return to zero, the process being repeated for successive dots. The deflection of the instrument is indicated by *d*, where upward readings indicate deflections to the left.

Next consider the conditions for the quadrants having dash signals. The beginning of the first dash tends to deflect the pointer also to the left. However, during the long period of the dash, the pointer returns to zero. The voltage induced at the end of the dash then deflects the pointer to the right, where it is in the insensitive position so that the voltage induced at the beginning of the next dash (occurring at such a brief time interval after) has relatively small effect. The pointer returns to zero during the long interval of the next dash, being again deflected to the right at the end of the dash. The cycle is thus repeated, the end of each successive dash deflecting the pointer to the right, as shown in *d* where downward readings indicate deflections to the right.

In the United States, a circuit arrangement differing from that of Fig. 22 has been developed which obviates the need for a special instrument and at the same time prevents the return of the pointer to zero after each deflection. The pointer therefore remains steadily deflected to the left or right depending upon whether the dots or the dashes are of greater intensity, the amount of deflection indicating the degree of deviation from the course. The circuit arrangement is shown in Fig. 24.

32. Simultaneous Radiotelephone and Visual-type Radio Range Beacon. When the course indications of the radio range beacon are given on a visual indicator, it becomes possible to provide simultaneous transmission of telephone-broadcast and beacon signals on the same carrier frequency and to receive them simultaneously on the medium-frequency receiving set. This requires that the beacon signals are of audio frequencies less than the lowest frequency required for intelligible speech transmission. Modulation frequencies employed in the reed-type visual beacon are below 100 cps, while for the type sending out aural signals, which may be converted to give visual indication on the airplane, they are 400 cps or less. Intelligible voice transmission may be had when frequencies below 500 cps (certainly when below 200 cps) are omitted. On the airplane an electric filter circuit is necessary in the output circuit of the medium-frequency receiving set so that the beacon signals are directed to the visual-indicator circuit while the speech signals are passed on to the head telephones.

The transmitting circuit design must be so arranged that the normal beacon space pattern, consisting of two crossed figures-of-eight, is in no way affected by the transmission of the speech signals. The latter must be radiated in all directions. Several different arrangements are feasible. One combination which has been the subject of experimental work employs the TL-antenna system plus a fifth tower located at the center of this system. The central tower transmits the carrier and the speech side bands, while the directional antennas of the TL system transmit the upper beacon side band (400 cycles higher than the carrier). Hence the space pattern for the carrier and speech side bands is circular, while the space pattern for the beacon side band consists of a figure-of-eight having its axis first along the plane of one directional antenna and then along the plane of the second directional antenna at right angles to the first, depending on the keying at the transmitter. At the receiving end, the carrier beats with the speech side bands to give speech signals of equal intensity in all directions, while it beats with the beacon side band to give 400-cycle voltages whose intensities vary with direction in proper relation to give interlocked aural beacon signals. These are converted to give visual course indications as outlined in Art. 30.

To secure maximum operating efficiency it is necessary to provide a 90-deg. time-phase displacement between the carrier current in the central tower and that which would be present in the directional antennas if no carrier suppression were effected. This displacement serves to compensate for the 90-deg. time-phase displacement in the radiation fields from the two-tower directional antenna and the single tower located midway between them and thus insures that the carrier and beacon side band arrive in proper phase at the receiving end.

RADIO AIDS TO BLIND LANDING OF AIRCRAFT

33. A radio system of blind landing aids developed at the National Bureau of Standards includes three elements to indicate the position of the landing airplane in three dimensions as it approaches and reaches the point of landing. Lateral position, given for the purpose of keeping the airplane directed to and over the desired landing-field runway, is secured by a small directive beacon of the reed visual type. Approximate distance from this transmitter is given by a distance indicator operating from the automatic volume control in the medium-frequency set used for receiving the runway-beacon signals. Exact longitudinal position, to inform the pilot that he has arrived within the boundaries of the landing field, is given by a boundary-marker beacon. Vertical guidance is given by an inclined ultra-high-frequency radio beam. This landing beam operates on a frequency of about 100 megacycles and is directed at a small angle above the horizontal. It provides a gliding path for the landing airplane.

34. Method of Field Localization. Figure 25 is a three-dimensional view showing the location of the ground transmitting equipment for

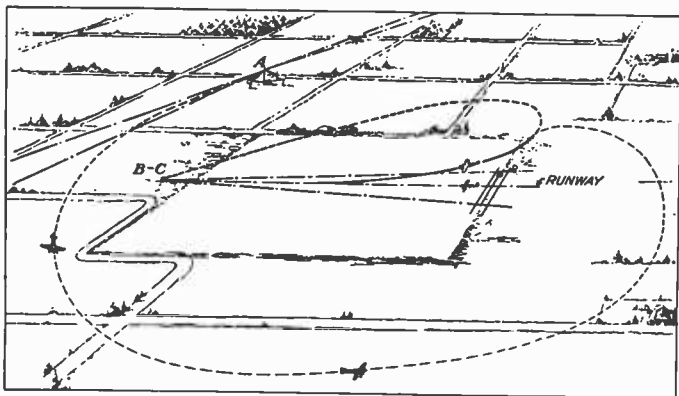

Fig. 25.—Model of leading runway and down-leading radio signal.

orienting a pilot along the desired landing runway, and illustrates the function of the landing beam when used in conjunction with the other elements of the system. *A* is the 2-kw directive radio beacon with large directional antennas, provided at terminal airports for point-to-point flying on the fixed airways. Utilizing the zero-signal zone directly

over the beacon tower, it is possible to locate this beacon to within 100 to 1,000 ft. depending upon the altitude of the airplane. Before reaching the beacon tower the pilot has learned the wind direction at the landing field either through the government weather broadcast or by two-way communication with the ground. Upon receiving the zero-signal indication over the tower of the main beacon, the pilot retunes his medium-frequency receiving set to the frequency of the low-power (200-watt) runway localizing beacon, located at *B*. This beacon, using small loop antennas located at one edge of the field without constituting an obstruction, directs a course along the runway most suitable for landing (under the particular wind conditions then existing). When crossing the boundary of the landing field a signal from the boundary-marker beacon *D*, operating on a radio frequency of about 10,000 kc, is obtained. The marker-beacon transmitting antenna consists of a long horizontal wire 3 to 8 ft. above the ground and extending along the edge of the field at right angles to the runway. The signal is received about 100 ft. before the airplane reaches this antenna and is heard for about 100 ft. after the airplane has passed over the antenna. Since a vertical receiving antenna is employed on the airplane, zero signal is obtained when the airplane is directly over the antenna. This zero-signal zone, therefore, coincides with the landing-field boundary line. If desired, a second similar marker beacon may be used about 2,000 ft. before reaching the landing field to give a warning of its proximity.

The medium-frequency set on the airplane together with a 2-tube marker-beacon set of fixed tuning is sufficient for receiving all these indications. If accurate indications of the absolute height of the airplane above ground are now secured, the complete information necessary for the blind landing of aircraft (in addition to that obtained from the flight instruments) becomes available.

35. Landing Beam. Figure 25 will show how the suitable indication of absolute height above ground is secured. The vertical space pattern of the inclined ultra-high-frequency landing beam located at *C* is clearly indicated. The polar pattern in the horizontal plane is of somewhat lower directivity. The airplane is therefore readily directed approximately along the horizontal axis of the beam by means of the course indications from the runway localizing beacon. It does not, however, fly along the inclined axis of the beam, but on a curved path whose curvature diminishes as the ground is approached. This path is the line of equal intensity of received signal below the inclined axis of the beam. The diminution of intensity as the airplane drops below the inclined axis is compensated by the increase of intensity due to approaching the beam transmitter. Thus, by flying the airplane along such a path as to keep constant the received signal intensity, as observed on a microammeter on the instrument board, the pilot comes down to ground on a curved line suitable for landing. If the airplane rises above this line of equal intensity of received signal, the microammeter deflection increases, while if it drops below this line the microammeter deflection decreases.

36. Equipment Required on the Airplane. With the addition of a visual indicator, the same equipment carried for weather-broadcast and radio-beacon services is used for receiving the signals from the runway localizing beacon. The localizing beacon is of the reed visual type permitting the use of automatic volume control in its reception. This is

quite essential, since the pilot, in making a landing, is concerned with so many things that the burden of close manual adjustment of receiving-set sensitivity must be eliminated.

The instrument for securing runway-course indications may be combined with the landing-beam indicator into a single instrument, which is much simpler to use than two separate instruments. Two perpendicular reference lines are provided on the face of the combined instrument, the vertical reference line corresponding to the position of the runway, and the horizontal reference line to the proper landing path. The pointers of the runway-course indicator and the landing-path indicator are arranged so that they cross each other, the former moving to the right or left of the vertical reference line and the latter above or below the horizontal reference line. The position of the point of intersection of the two pointers thus gives, through a single reading, the position of the airplane with respect to the runway and proper landing path. The instrument indications for several arbitrary positions of the airplane are given in Fig. 26. At *b* the airplane is to the left of the runway

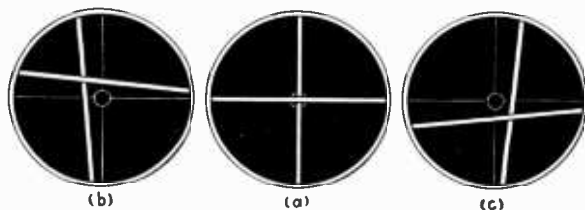

FIG. 26.—Course indicator showing: (a) Airplane on proper course; (b) Airplane too high and to the left of runway; (c) Airplane too low and to the right of runway.

course and too high. At *a* the airplane is on the runway course and on the proper landing path. At *c*, the airplane is to the right of the runway course and too low.

37. Theory of Operation of the Landing Beam. The landing-beam antenna system consists of a conventional directive antenna array. The vertical directive characteristic produced by the array operating in free space would be symmetrical about the horizontal plane, maximum radiation occurring in this plane. However, the presence of the ground, which acts as a perfect dielectric at these frequencies (100 Mc), modifies the vertical characteristic. At grazing incidence, *i.e.*, along the ground surface, the wave reflected from the ground cancels the direct wave to the receiving point, resulting in zero radiation. As the angle of elevation of the receiving point increases, there is an increasing difference in the distance traveled by the direct and reflected waves to reach the receiving point. The resultant phase difference produces increasing field intensity with increasing angle of elevation. When the phase difference is equal to half a period, the angle of maximum radiation is reached. It thus becomes evident how the landing beam shown in Fig. 25 is obtained.

Actually, there are a large number of lines of constant field intensity in the beam. It can be shown that the equation for these lines for the very low angles of elevation involved during a landing (less than 3 deg.) is a parabola. The particular parabola chosen to fit a given airport is a function of the

transmitter power and the receiver sensitivity. Once chosen, it is essential that the position of this path in space does not vary. Horizontally polarized waves are used for the landing beam for this reason, since it has been determined that changes in the ground constants due to different weather conditions will have least effect on the landing path for this type of polarization. Also both the transmitter and receiver are designed to be of extreme simplicity to preclude the possibility of variation in the power output of the transmitter or in the receiver sensitivity. The transmitter may consist simply of a balanced oscillator employing two 852 type tubes and operating from the a-c power supply. The receiver employs three tubes, an r-f amplifier, detector, and audio amplifier. A horizontal half-wave receiving antenna is used on the airplane, located in a wing just ahead of its leading edge. The receiver is fed from this antenna by means of a shielded twisted pair transmission line. The audio output of the set is filtered, rectified, and applied to the horizontal movement of the combined instrument.

Two experimental installations of this system of landing aids, at Newark, N. J., and at Oakland, Calif., have been thoroughly tested by air-transport pilots. These tests have demonstrated the practicability of this system and have also led to improvements directed to greater flexibility and economy in its use.

38. German Landing Beam. A modification of this system, as developed in Germany, has been installed at a number of major airports in Germany and Switzerland. This modification consists of using one ultra-high-frequency transmitting-set and antenna system for producing both the runway-beacon space pattern and the landing path. The antenna system comprises a vertical dipole radiator and two vertical reflector dipoles. The reflector dipoles are keyed, one to dashes and the second to dots, thereby producing two corresponding space patterns which intersect in the horizontal plane and produce two beacon courses. The dashes and dots are interlocked producing the type of signal which may be converted for visual indication as described in Art. 30 above.

Since ultra-high frequencies are employed, the effect of the ground is to produce a vertical radiation pattern in which, for low angles of elevation, the field intensity is directly proportional to the angle of elevation starting from zero at the ground surface. A series of lines of constant field intensity having the shape of parabolas thus exists, as in the case of the regular landing beam, and may be used as landing paths.

Summarizing, the pilot follows a line of constant field intensity in the plane of intersection of the two beacon space patterns. On the airplane, a single ultra-high-frequency receiving set is sufficient for reception of both the runway-course and landing-path indications.

39. Army Landing Aids. A second system of radio landing aids, developed by the U. S. Army Air Corps, utilizes a visual-type radio direction finder for lateral guidance of the landing airplane along the airport runway, two ultra-high-frequency marker beacons for longitudinal guidance, and a sensitive-type barometric altimeter in combination with these other elements for vertical guidance.

The operation of this system is best understood by reference to Fig. 27. *A* and *B* are ground transmitting stations located along the projection of the center line of the airport runway. They send out tone-modulated transmissions suitable for use of the radio compass on the airplane. The power rating of these transmitters is approximately 50 watts, and the antennas used are vertical masts approximately 30 ft. high. Station *A* is placed approximately 1,500 ft. from the approach end of the landing field and

station *B* about 2 miles from it. At each of the stations there is also located a low-power marker beacon operating on a frequency of about 60 Mc and using a half-wave transmitting antenna oriented perpendicularly to the direction of approach of the landing airplane.

Upon reaching the general vicinity of the airport through the use of the main radio range beacon, the pilot tunes his radio direction-finder receiver to station *A* and, upon reaching it, tunes to station *B*. He flies back and forth

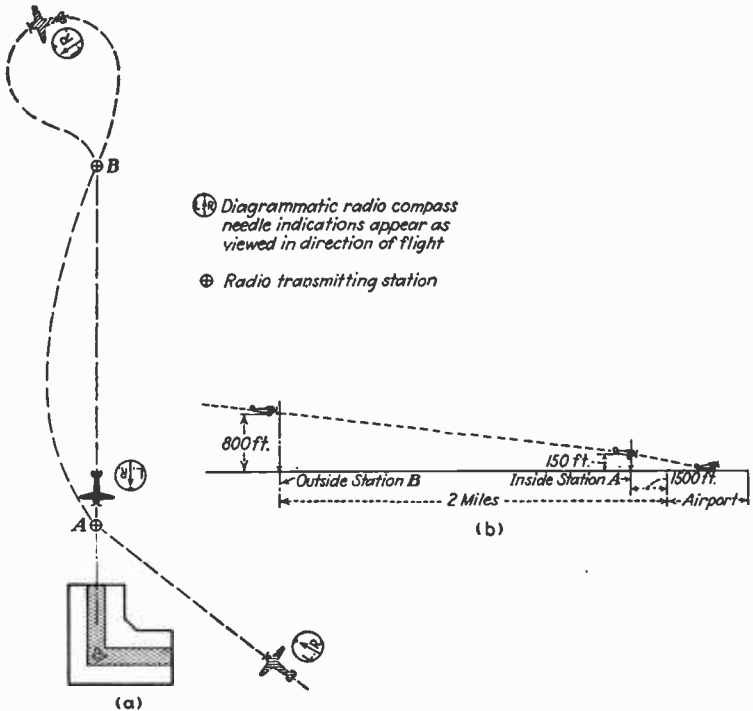

between these two stations as many times as is necessary to establish his course along the projection of the airport runway, setting his directional gyroscopic compass to the value found for that course. The necessity for this maneuver is apparent from a study of Fig. 15 in Art. 25 above. To compensate for possible departure from the true course due to crosswinds, it is essential that the pilot determine exactly the required angle of crabbing of the airplane into the wind. This is particularly important in the case of narrow approaches to the airport with hazards located alongside of the approaches.

Upon establishing the proper course, the pilot makes a final approach to the landing field. The sensitive barometric altimeter is corrected to the barometric pressure obtaining on the ground, as determined by radio information,

and is then relied upon in combination with the other flight instruments to maintain the airplane in a glide such that the altitude is approximately 800 ft. over station *B* and 150 ft. over station *A*. Continuation of this glide results in contacting the airport surface.

The exact point of contact is not so definite as with the first system described depending upon the usual errors in the barometric altimeter, errors in determining the angle of glide of the airplane under varying load and air conditions, and errors in estimating the magnitude of the component of the existing wind along the runway. For this reason the system is safely applicable only to the larger airports and may be used only as an approach system at smaller airports. Assuming the availability of a suitable radio direction finder on the airplane, the system requires somewhat simpler equipment than for the first system described.

ABSOLUTE ALTIMETERS

Absolute altimeters may be used to furnish vertical guidance in either of the two systems of radio landing aids just described and would prove of inestimable value during point-to-point flight. Such altimeters fall into three classifications; the sonic altimeter, the capacity altimeter, and the reflection altimeter.

40. Sonic Altimeter. In this method the time taken by sound to reach the ground and return to the airplane is measured. Knowing the velocity of sound, the height of the airplane above ground may be determined. In a model developed by the General Electric Company two horns are employed: one, driven by an electric trip relay and plunger, sends down the sound wave, and the other receives it back again after reflection from the ground. An instrument which is started by the emitted wave and stopped by the reflected wave records all heights above 50 ft., while below 50 ft. the pilot uses his headphones. At 50 ft., the echo comes back $\frac{1}{10}$ sec. after the emitted sound is sent out, at 5 ft. it comes back $\frac{1}{100}$ sec. later. A sound-delay filter is used in the output of the receiving horn so that the whistle and the echo do not blend into one sound until the airplane is at some point below 5 ft. This indication may be used effectively by the pilot during a landing.

An experimental unit based on this principle and developed by the Bell Telephone Laboratories, Inc., provides visual indication of the height above ground down to a few inches. In this system, the received signal automatically starts the transmitted signal, so that the frequency of occurrence of the emitted sound increases with decreasing altitude. An arrangement of neon lights is used for obtaining the visual indication.

41. In the capacity altimeter, the distance from the ground is measured by detecting the change in the electrical capacity between two plates on the airplane as the airplane approaches the ground. In one arrangement, this capacity is made a part of a resonant circuit, coupled to an extremely stable radio-frequency oscillator. A vacuum-tube voltmeter records the voltage developed across a portion of the resonant circuit. The circuit is adjusted so that the voltmeter-indicating instrument reads zero when the airplane is at any height above 100 ft. The gradual increase in capacity as the airplane approaches the ground serves to bring the resonant circuit into closer tune with the oscillator frequency, the voltmeter indication increasing accordingly. The indicating instrument, once calibrated, serves to indicate true height above ground. Since the capacity between the two plates is practically unchanged at

altitudes greater than of the order of 100 ft., the field of usefulness of the capacity altimeter is limited to landing operations only.

42. The reflection altimeter utilizes the direct reflection of radio waves. Frequencies of the order of 10 to 30 megacycles have been found most useful for securing true reflection from the ground. The phase difference between the transmitted and reflected wave varies cyclically as a function of height above ground. Alexanderson has shown that this cyclic change of phase difference manifests itself in a corresponding change in frequency of the transmitting oscillator. He therefore employs two oscillators on the airplane, one tuned to, say, 30 megacycles, and the other to, say, 27 megacycles, which detect the beat frequency, 3 megacycles. This beat frequency changes cyclically as the altitude of the airplane is varied, passing through a maximum when the reflected wave tends to increase the frequency of the 30-megacycle oscillator at the same time as it decreases the frequency of the 27-megacycle oscillator. A little consideration will show that the maxima occur at 25 m (80 ft.), 75 m (240 ft.), 125 m (400 ft.), etc. Definite indications of true height above ground may therefore be secured at these points. By changing the difference frequency, different points may be obtained.

References

- BARFIELD, R. H.: Recent Developments in Radio Direction Finding, *Jour. I.E.E.*, **68**, 1052-1069, 1930.
- BROMBACHER, W. G.: Measurement of Altitude in Blind Flying, *Tech. Note 503*, August, 1934, National Advisory Committee for Aeronautics, Washington, D. C.
- DAVIS, N. E.: Marconi-Adcock Direction Finder, *Marconi Review*, No. 37, pp. 17-23, July-August, 1932.
- DELLINGER, J. H., and H. DIAMOND: Radio Developments Applied to Aircraft, *Mech. Eng.*, **51**, 509, July, 1929.
- , —, and F. W. DUNMORE: Development of the Visual Type Airway Radio-beacon System, *Bur. Stand. Jour. Res., Res. Paper 159*, March, 1930. *Proc. I.R.E.*, **18**, 796, May, 1930.
- and H. PRATT: Development of Radio Aids to Air Navigation, *Proc. I.R.E.*, **16**, 890, July, 1928.
- DIAMOND, H.: The Cause and Elimination of Night Effects in Radio Range-beacon Reception, *Bur. Stand. Jour. Res., Res. Paper 513*, **10**, 7-34, 1933; *Proc. I.R.E.*, **21**, 808-832, 1933.
- : Performance Tests of Radio System of Landing Aids, *Bur. Stand. Jour. Res., Res. Paper 602*, **11**, 463-490, October, 1933.
- and G. L. DAVIES: Characteristics of Airplane Antennas for Radio Range Beacon Reception, *Bur. Stand. Jour. Res.*, May, 1931; *Proc. I.R.E.*, **20**, February, 1932.
- and F. G. GARDNER: Engine Ignition Shielding for Radio Reception on Aircraft, *Bur. Stand. Jour. Res., Res. Paper 158*, **4**, 415-424, March, 1930; *Proc. I.R.E.*, **18**, 840-861, May, 1930.
- DIECKMAN, M.: Report on the Status of a Direct-indicating Airplane Radio Direction Finder, July, 1927, *Deutsche Versuchsanstalt für Luftfahrt*, Berlin.
- DUNMORE, F. W.: A Course Indicator of Pointer Type for the Visual Radio Range-beacon System, *Bur. Stand. Jour. Res., Res. Paper 336*, **7**, 147-170, 1931; *Proc. I.R.E.*, **19**, 1579-1605, 1931; A Method of Providing Course and Quadrant Identification with the Radio Range-beacon System, *Bur. Stand. Jour. Res., Res. Paper 593*, **11**, 309-325, 1933.
- ENGEL, F. H., and F. W. DUNMORE: A Directive Type of Radiobeacon and Its Application to Navigation, *Bur. Stand. Sci. Res. Paper 840*, 1923.
- FASSBENDER, H.: "High-frequency Technique in Aircraft." Julius Springer, Berlin, 1932.
- GILL, T. H., and N. F. S. HECHT: Rotating-loop Radio Transmitters and Their Application to Direction Finding and Navigation, *Jour. I.E.E.*, **66**, March, 1928.
- HINMAN, W. S., JR.: A Radio Direction Finder for Use on Aircraft, *Bur. Stand. Jour. Res., Res. Paper 621*, **11**, 733-741, 1933.
- KEAR, F. G.: Phase Synchronization in Directive Antenna Arrays with Particular Application to the Radio Range Beacon, *Bur. Stand. Jour. Res., Res. Paper 581*, **11**, 123-139, 1933.

- KEAR, F. G., and G. H. WINTERMUTE: A Simultaneous Radiotelephone and Visual Range-Beacon for the Airways, *Bur. Stand. Jour. Res., Res. Paper* 341, 7, 261-287, 1931; *Proc. I.R.E.*, 20, 478-515, 1932.
- KRAMAR, E.: A New Field of Application for Ultra-short Waves, *Proc. I.R.E.*, 21, 1519-1531, 1933.
- MURPHY, W. H.: Space Characteristics of Antennae, *Jour. Franklin Inst.*, 201, 411, 1926; 203, 289, 1927.
- and L. M. WOLFE: Stationary and Rotating Equi-signal Beacons, *Jour. S.A.E.*, 19, 209, September, 1926.
- NANCE, H. H.: Wire Communication Aids to Air Transportation, *Bell System Tech. Jour.*, 11, 462-476, July, 1932; *Elec. Eng.*, 51, 492-496, July, 1932.
- NELSON, E. L., and F. M. RYAN: Provision of Radio Facilities for Aircraft Communications, *S.A.E.* preprint (St. Louis meeting), February, 1930. See also numerous papers in *Bell Telephone Record* and *Bell System Tech. Jour.* by these and other authors.
- PRATT, H.: Apparent Night Variations with Crossed-coil Radio Beacons, *Proc. I.R.E.*, 16, 625, May, 1928.
- SMITH-ROSE, R. L.: Radio Direction Finding by Transmission and Reception, *Proc. I.R.E.*, 17, 425-478, March, 1929.

SECTION 22

ANTENNAS

BY EDMUND A. LAPORT¹

INTRODUCTION

Antennas, in one form or another, are applied in so many diversified forms in all branches of the radio engineering art that it is doubtful if any radio device, save the vacuum tube, is more widely employed. In spite of its fundamental importance, the most significant advances in antenna technique, including the development of antenna theory, have come at a comparatively late date. From the beginning of radio communication until approximately 1925, the theoretical aspects of the subject were confined more or less to the realms of pure science, while engineering practices remained, to a large degree, where they were in 1900. Since 1925, antenna engineering has become fairly well documented, and its practice has been developed to a very high degree. The antenna engineer, however, must always be more or less of a mathematical physicist.

The transmission and reception of electromagnetic waves used for radio communication are accomplished by radiators and collectors exposed in space and known as antennas. An antenna is a device composed of a system of one or more linear conductors, usually of large electrical dimensions, from a fraction to several wave lengths, which is used to couple a high-frequency a-c generator or receiver to space. Between the transmitting and the receiving antenna there is a combination of earth, water, air, and ionospheres which constitute the mediums in which electromagnetic waves are propagated. The action of the waves in traversing these mediums is very complex at best, being dependent upon many known and other unknown factors. Prominent among the known factors are the transmitting frequency, the radiation characteristics of the transmitting antenna, the orientation of the path of transmission in the earth's magnetic field, the time of day and the conditions of daylight and darkness along the path, the season of the year, solar activity, the electrical characteristics of soil or water in the immediate vicinity of the antenna as well as along the path of the surface waves, the immediate conditions of ionization of the atmosphere at various levels, the distance between transmitter and receiver, and the characteristics of the receiving antenna.

1. Antenna Terminology. There is no standardized "language" as yet in the antenna art. Each writer must, therefore, clearly define the terms he uses. The following terms are used in this work.

1. Meter-amperes. In general, this means $\int i dl$, where i is the r-m-s current in an elementary length of the antenna, dl . The integration is performed

¹ Transmission engineer, Wired Radio, Inc.

over the entire length of the exposed (radiating) parts of the radiator. Viewed geometrically, this is the area of a plot of $r\text{-m-s}$ antenna current in amperes against distance along the antenna measured in meters. The directions of the currents must be considered.

2. *Doublet*. A differential of antenna length, short enough to be considered to have uniform current throughout its length.

3. *Dipole*. A linear conductor with a full half-wave of in-phase currents distributed throughout its length. A half-wave oscillating element.

4. *Self-impedance*. The impedance of a single radiating element in the absence of any influences from other radiators, as measured at a current antinode. The ratio of the impressed voltage and the antinode current.

5. *Mutual Impedance*. The negative ratio of the induced voltage at the current antinode of a second radiator to the antinode current of the first radiator.

6. *Harmonic*. Any natural frequency of oscillation of a system expressed as a number which is the multiple of the fundamental frequency. Not to be confused with overtones.

7. *Antenna Tuning*. The act of resonating an antenna system to some frequency other than a natural frequency by means of reactive devices.

8. *Antenna Loading*. Lumped reactances connected in the antenna system for the purpose of antenna tuning.

9. *Distributed Loading*. Units of reactance added at small electrical intervals along a conductor for the purpose of smoothly modifying the natural distributed constants of the system. Pupinization.

10. *Node, or Nodal Point*. In a standing wave system, the points of either zero or minimum potential or current.

11. *Antinode*. In a standing wave system, the points of maximum potential or current.

12. *Vertical Polarization*. A wave orientation such that all the lines of electric force lie in planes perpendicular to the ground plane.

13. *Horizontal Polarization*. A wave orientation such that the lines of electric force are parallel to the ground plane.

14. *Reflector*. Conductor or conductors so disposed with respect to a radiator as to react upon the latter in a manner which transforms the radiation pattern by suppressing radiation in its direction while reinforcing it in the opposite direction.

15. *Antenna Array*. A multiplicity of radiating elements disposed in any manner whatsoever for the purpose of molding the space characteristic in some desired fashion.

16. *Space Characteristic*. A means for describing the over-all radiation characteristics of an antenna system. Usually refers to a geometrical solid in spherical coordinates with distance from the origin proportional to the radiation intensity in any direction. Radius vectors may be proportional to field intensity or to power. Power flow by radiation in any direction is proportional to the square of field intensity.

17. *Fundamental Frequency*. The frequency at which the impedance of an antenna at a current antinode is minimum. The lowest frequency of oscillation of an antenna.

18. *Fundamental Wave Length*. The length of the space wave emitted by an antenna oscillating at its fundamental frequency.

19. *Mode of Operation*. The ratio of the operating wave length to the fundamental wave length; also, the ratio of the fundamental frequency to the operating frequency.

20. *Electrical Length*. The length of a standing wave in any linear system expressed in degrees or radians. The electrical length of a wire is its actual length in terms of wave lengths and fractions thereof multiplied by 360° . Valid only in systems with sinusoidal current distribution.

21. *Effective Height*. The height h obtained from the following equation:

$$h = \frac{\epsilon d}{1.25fI}$$

where h = effective height in meters
 ϵ = measured field intensity in microvolts per meter
 d = distance in kilometers from the antenna to the point where ϵ is measured
 f = frequency in kilocycles
 I = antenna current at the point where the antenna is energized.

NOTE. d must be small enough so that the effect of attenuation is absent, and great enough to be beyond the limits of the induction field.

22. *Antenna Resistance.* The total dissipative component of the antenna impedance measured at the point where power is introduced.

23. *Radiation Resistance.* The ratio of the total power radiated by an antenna and the square of the current at some reference point in the system, usually the point where power is introduced, or a current antinode.

24. *Oscillating Wire.* A linear conductor containing a standing wave of oscillatory energy.

2. Radiation from Linear Conductors. The existence of a field of force in either electromagnetic or electrostatic form represents a storage of energy in space. Faraday originated the descriptive method of picturing a field in terms of lines of force and lines of equal intensity which formed the basis for subsequent curvilinear geometry which is now more or less familiar to electrical engineers. In ordinary electrical engineering it is customary to concentrate a field as much as possible and to prevent stray lines of force, known as leakage flux, from reaching any considerable distance from an electrical device. In antenna design, however, the opposite case is desired. Here as much as possible of the energy of the field is made to be stored in space which is far removed from the conductor. The linear straight conductor is the most satisfactory practical device for producing distant fields.

In ordinary electrical devices the energy of the electric or magnetic field is returned to the parent circuit when the charge or current that produced it is removed. The field collapses. It takes time for a field to be propagated from one point to another in space, so that its formation or disappearance at any point is not coincident with the events in the conductor which produce it. The finite rate of propagation of electric and magnetic fields, 3×10^8 meters per second, causes events in the field of force to lag behind the events in the parent circuit by a time dependent upon the distance from the circuit. This fact is of no great interest ordinarily, but in connection with antennas it is of primary importance and forms the basis of all radiation phenomena. Assume for simplicity a straight wire which is charged. The electric field has been established out to a very great distance. If the charge be removed suddenly, the collapse of the field will return the stored energy to the circuit after a suitable time interval. If, on the other hand, the charge on the wire be instantly reversed, a field of the opposite polarity forms near the wire before the energy stored in space for the previous charge can return to give up its energy to the wire. The original field becomes detached and manifests itself as a free wave of electric energy traveling in space. When, instead of an instantaneous reversal of the charge on the wire there is a gradual reversal at a rapid rate under the stimulus of a high-frequency generator, some of the energy of the field very near to the wire returns to the circuit before the charge reverses, but a large amount of energy in the more distant fields is unable to return before reversal occurs and becomes a detached field of force, an electromagnetic wave. That por-

tion of the field which returns its energy to the circuit is known as the *induction field* and the detached portion as the *radiation field*. The energy lost by radiation is represented in the impedance of the circuit by the radiation resistance.

Radiation of energy takes place from linear conductors which are electrically unbalanced. When it is desired to prevent radiation, two parallel conductors are placed very close together electrically and equal and opposite charges are distributed identically along the conductors. To produce radiation, the spacing between conductors is increased and the balance of charges upset more and more. The ultimate in this direction is that of the familiar simple antenna, a single straight wire which is completely unbalanced.

3. Fundamental Radiation Formula.¹ Dellinger's derivation of the fundamental radiation formula for an antenna is of the following form:

$$H_t = -\frac{\omega \int_0^l idl}{10cd} \cos \omega \left(t - \frac{d}{c} \right) - \frac{\int_0^l idl}{10d^2} \sin \omega \left(t - \frac{d}{c} \right)$$

where H_t = instantaneous magnetic field intensity in gilberts per centimeter
 $\omega = 2\pi$ times frequency of oscillating current in the wire
 i = instantaneous current at any point in the wire
 l = length of the wire in centimeters
 t = time in seconds
 c = velocity of propagation of light (3×10^{10} cm/sec.)
 d = distance from the wire in centimeters perpendicular to the wire.

The first term is known as the *radiation-field term*, and the second as the *induction-field term*. These two terms are of equal magnitude where $d = \lambda/2\pi$.

After converting the radiation term into the most practical units for engineering usage, we have

$$E_d = 188.4 \frac{\int_0^l I dl}{\lambda d} \quad (\text{for free space transmission})$$

where E_d = millivolts per meter (field intensity)
 I = r-m-s current in amperes in each elementary length dl
 λ = wave length in meters
 d = distance from antenna (in normal direction) in kilometers

$\int_0^l I dl$ = total meter-amperes of system.

For a half-wave dipole in free space, with sinusoidal current distribution,

$$E_d = \frac{60I}{d} \quad (\text{for free space transmission})$$

where E_d = volts per centimeter (field intensity)
 I = r-m-s current at the antinode
 d = distance in centimeters.

The field intensities in directions other than normal to the wire depend upon the length of the wire and the distribution of currents in it.

4. Current and Potential Distribution in Straight Wires. The action of an oscillating wire as an antenna depends upon the current and potential distribution in the wire. These distributions in turn are dependent upon the manner in which charges are propagated in the wire under various conditions of excitation by a high-frequency generator.

¹ DELLINGER, J. H., Principles of Transmission and Reception with Antenna and Coil Aerials, *Bur. Standards Sci. Paper* 354, 1919.

If an uncharged wire be connected to a source of high-frequency energy, charges move from the generator into the wire, travel along the wire, and, after an interval of time depending upon the length of the wire and the velocity of propagation of the charges, arrive at the distant end. If the end of the wire is an open circuit, as most antennas are, there will be a transformation of energy at the end which causes the potential there to double and the current to become zero. The high potential at the end, due to the accumulation of charges which continue to be supplied by the generator, causes another wave of energy to be propagated from the open end back to the generator.

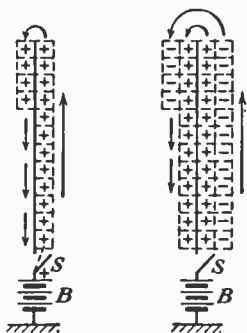

FIG. 1.—Charged wire.

The mechanism of the production of standing waves of current and potential on a linear conductor may be studied analytically by referring to any good text on reflections in transmission lines. A very elementary introduction is given here, however, to establish a physical picture of this important phenomenon. Consider Fig. 1, which is a wire which may be connected to ground through a battery *B* by closing the switch *S*. At first the switch is open, and the wire is at zero potential. Upon closing the switch, a current flows from the battery into the wire, and the wire becomes charged. The charging process is not instantaneous, because time is required for charges to travel the full length of the wire. The current flow from the battery into the wire persists not only for the

duration of the movement of charges to the end of the wire, but until the wave of charges is reflected from the open end back to the battery. During this interval the battery supplies charges as it would to a line of infinite length. It is only when the reflected wave of charges arrives at the battery that the very finite length of the wire is manifest, at which time the excess charge on the entire length of the wire gives it a potential higher than that of the battery. When the wire is finally charged to battery potential, the total energy of the additional charges which compose the reflected wave must be eliminated from the system. After reflection, the wire is positive with respect to the battery so that it may be said the battery is negative with respect to the wire and that it now starts to charge the wire with negative charges. The same process repeats itself until the original positive charges are neutralized and the wire is charged negatively. This continues cyclically. Owing to circuit losses, radiation, etc., there is a gradual consumption of the excess energy of the system, and each reflection is weaker than the one preceding. When the excess energy is consumed completely, the wire reaches steady state with a uniform potential throughout its length equal to that of the battery.

When an a-c generator is used to energize the wire, the same process takes place, but, when the wire is "tuned" to the generator frequency, the reflected energy arrives at the generator when it is reversing its polarity, in which case the energy of the reflected wave is absorbed by the generator and is not re-reflected. Thus, in the typical antenna problem, the characteristic current and potential distribution is the result of a simple reflection—a wave of charges moving from the generator

toward the end of the wire, and the reflection from the end back to the generator.

In the steady state both potential and current vary harmonically in time, but their maximum values vary with their position in the wire. In the simple straight-wire antenna, the variation of potential and of

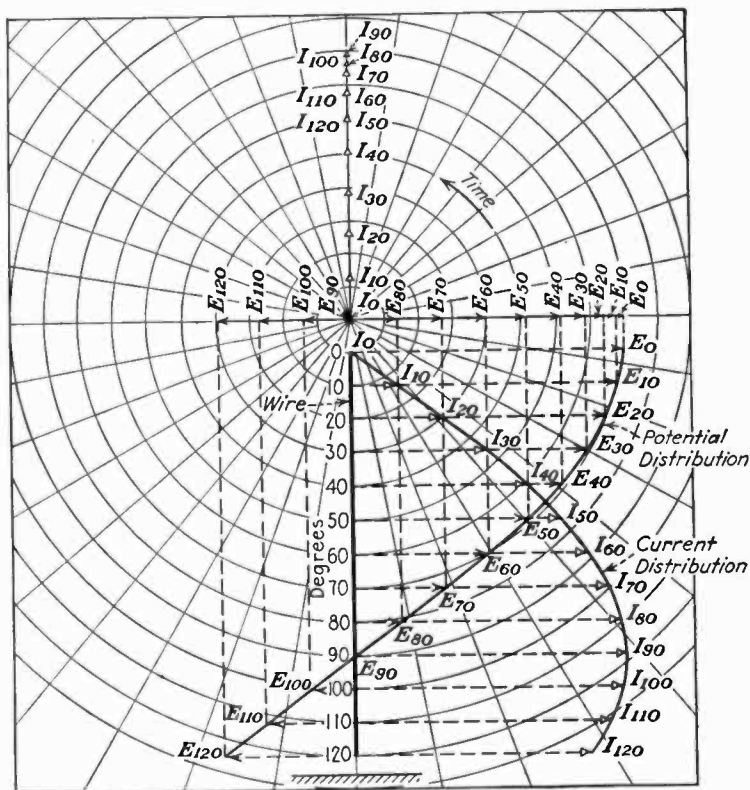

FIG. 2.—Vector relations between current and voltage in a wire 120 deg. long.

current along the wire is very nearly cosinusoidal and sinusoidal, respectively, when measured from the open end of the wire.

There are important relationships between the potential and current distribution, on which the impedance of the antenna depends. By solving the case of a simple reflection in a wire, for example, a wire one-third wave length (or 120 deg.) long, on the assumption that there is no energy dissipated in the system during the propagation of the initial wave of

energy imparted to the wire from the generator and during its reflection from the open end, we obtain the vector relationships between current

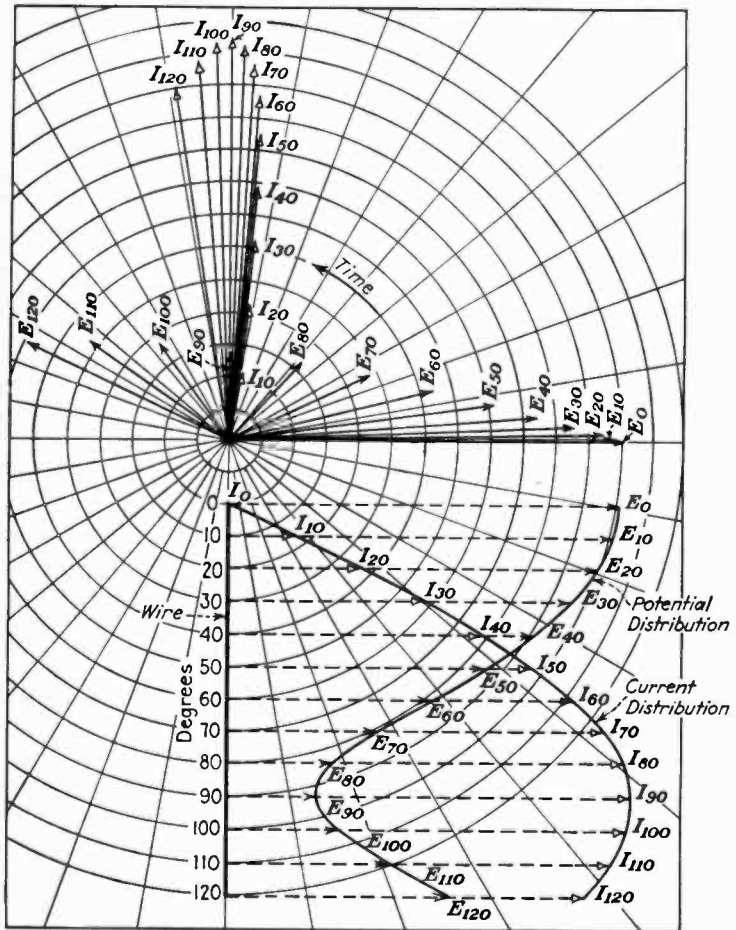

FIG. 3.—Currents and voltages in a wire of 120 deg. when appreciable power loss occurs.

and voltage for several equidistant points along the wire as shown in Fig. 2. Measuring electrical degrees from the open end, it is seen

that, up to a distance of 90 deg., the current vectors are in advance of the voltage vectors and the impedance of the antenna for lengths less than one-quarter wave length is a pure capacitive reactance. When the wire is longer than one-quarter wave length, as in the example, the wire impedance becomes a pure inductive reactance. If this were continued for several quarter-wave lengths, it would be seen that for odd quarter-wave lengths, the impedance of the antenna would be capacitive reactance, and, for even quarter-wave lengths, it would be inductive reactance. At exactly 90 deg. and odd multiples of 90 deg. (potential nodes) the impedance would be zero, while for even multiples of 90 deg. (current nodes) the impedance would be infinite. By plotting out the current and potential vectors against their position along the wire, in two-dimensional rectangular coordinates, it is found that the potential varies cosinusoidally and the current sinusoidally.

Now there cannot exist in nature a dissipationless system. Waves of charges propagated in a wire suffer some attenuation. We know there are Joulian losses in the wire as well as loss of energy through radiation, especially in an antenna wire which is an efficient radiator. Working out the case of a simple reflection in a 120-deg. antenna wire on the basis of a considerable power loss in the wire, we get the vector diagram of currents and voltages shown in Fig. 3. Between 0 and 90 deg. of length the current vectors lead those of potential, but there is now a component of potential in phase with the current, so that the impedance in this range is resistance and capacitive reactance. At 90 deg. the potential vector is in phase with the current vector, at which point the antenna impedance is pure resistance. Beyond the 90-deg. (quarter-wave) point, the voltage vectors swing into a leading position, and the antenna impedance becomes resistance and inductive reactance. This continues up to the half-wave point (not shown in our example), at which place the current vectors come into phase with the voltage. Here again the antenna impedance becomes a finite pure resistance, but of a very high value. In Fig. 3, the several vectors are plotted in rectangular coordinates against their position along the wire. It can be seen plainly that the potential distribution is not cosinusoidal, especially in the vicinity of the node. Voltage passes through a minimum, accompanied by a rapid change of phase, but does not become zero as in Fig. 2. If the wire were made a half wave length long, so that the current would pass through its node, it would be seen that the current also passes through a minimum value, but not zero. The example of Fig. 3 is greatly exaggerated so as to clearly show the problem. In antenna systems, the energy lost is so small with respect to the energy stored in them (very low attenuation of the traveling waves in the wire) that the current distribution is very nearly sinusoidal.

The radiating characteristics of an antenna depend upon the current distribution. When calculating radiation patterns for simple wire antennas, the assumption of sinusoidal current distribution is fully justified. The complex circuital impedance of an antenna, however, is the result of the true current and potential distributions which are not simple harmonic functions of distance along the wire.

5. Current and Potential Distributions in Linear Conductors with Attenuation.¹

¹ EVERITT, W. L., "Communication Engineering," Chap. VI, McGraw-Hill Book Company, Inc., 1932.

$$E_l = E_r \sqrt{\sinh^2 \alpha l + \cos^2 \beta l} / \tan^{-1} (\tan \beta l \tanh \alpha l)$$

$$I_l = \frac{E_r}{Z_0} \sqrt{\sinh^2 \alpha l + \sin^2 \beta l} / \tan^{-1} \left(\frac{\tan \beta l}{\tanh \alpha l} \right)$$

E_l and I_l are the voltage and current, respectively, at any point in the antenna wire which has the distance l from the open end. E_r is the voltage at the open end. αl is the attenuation constant in nepers (hyperbolic radians) per unit length, and βl is the wave-length constant in circular radians per unit length of the wire. Z_0 is the characteristic impedance of the wire. In an antenna this factor has no true scientific significance, but for many practical purposes a value can be placed upon it which has engineering significance.

6. Current Distribution in Antennas of Various Practical Forms.

Radiation phenomena are usually studied in terms of the electromagnetic field, which is associated with the antenna currents.

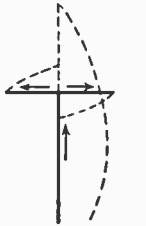

FIG. 4.—Current in simple T antenna.

In matters involving space characteristics, field intensities, etc., the basis of reference is usually the current distribution. In many forms of antennas to be found in practice, there are numerous departures from the simple conditions which produce sinusoidal current distribution. In a single-wire T, current along the vertical portion is distributed as a partial sinusoid and can be calculated as a real part of the equivalent vertical wire. The current in the flat-top sections is linear, very nearly, if each branch is less than 30 deg. long. The current at the top of the vertical is divided equally between the two branches and tapers to zero, or nearly zero, at the ends of the T branches (see Fig. 4).

The current distribution in a single-wire inverted L has also been shown to be nearly sinusoidal, as was assumed from theory.¹

Non-sinusoidal distributions occur in systems that have non-uniform constants per unit length, such as fan, umbrella, and many other forms of multiwire antennas. Irregularities in the distributed L and C of the antenna are sources of reflections and lead to very complicated distributions. With the gradual disappearance of such systems, however, no particular attention need be directed to the matter here.

The uniform section cage antenna is frequently used instead of a single wire though its utility is questionable. When used it is equivalent to a single wire situated along its axis, except in the matter of potential gradients near the conductors.¹

Large capacities at the end of a wire, such as insulator caps, rain shields, corona shields, outriggers, are equivalent, in their effect upon the current distribution, to an elongation of the wire.

7. Antenna Potential and Potential Distribution. In the design of antenna insulation, potential magnitude and distribution must be calculated. Potential distribution can be calculated under the same conditions that current distribution can be, which is principally those cases where the distribution is very nearly cosinusoidal. The actual voltage

¹ WILMOTTE, R. M., Distribution of Current in Transmitting Antennas, *Jour. I.E.E.* (London), June 1928; PIERCE, G. W., "Electric Oscillations and Electric Waves," McGraw-Hill Book Company, Inc., 1920.

can be accurately calculated, once its distribution is known, by measuring the voltage at the point where power is introduced. At this point, the voltage is the antenna current multiplied by the antenna impedance. The essential relations are given in Fig. 5.

Antennas operated at modes greater than approximately 3.0 have very nearly uniform voltage distribution, and all parts of the antenna may be considered to be at the same potential.

8. Impedances of Linear Conductors. Inspection of Fig. 2, shows that the impedance of an antenna, or any linear conductor, depends upon the point at which it is observed. The impedance is of particular interest at the point where the antenna is energized.

The reactance of a linear conductor is given by the following formula:¹

$$X = -\sqrt{\frac{L}{C}} \cot \omega l \sqrt{LC}$$

where X = reactance in ohms, either positive or negative, depending upon angle $\omega \sqrt{LC}$

L and C = microhenries and microfarads per unit length of wire. (For calculating, refer to footnotes ¹ and ².)

$\omega = 2\pi \times$ frequency.

Another formula³ is

$$Z_s = \frac{E_m \cos \frac{2\pi X}{\lambda}}{I_m \sin \frac{2\pi X}{\lambda}} = Z \cot \frac{2\pi X}{\lambda}$$

where Z_s = reactance in ohms for a wire of X meters length
 E_m and I_m = maximum values of voltage and current at their respective antinodes

λ = wave length in meters.

Reactance is negative when $2\pi X/\lambda$ lies in odd quadrants, and positive for even quadrants.

9. Radiation Resistance of Fundamental Forms of Antennas. Radiation resistance for an idealized vertical wire antenna over perfectly conducting ground, at its fundamental frequency f_0 , is

$$R_0 = 36.57 \text{ ohms}$$

The radiation resistance, and the impedance, of a half-wave dipole in free space are

$$R_0 = 73.2 \text{ ohms}$$

$$Z = 73.2 + j42.5 \text{ ohms}$$

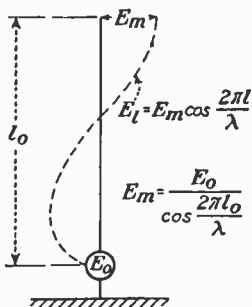

FIG. 5.—Potential distribution.

¹ Radio Instruments and Measurements, Bur. Standards Circ. 74.

² GROVER, F. W., Methods, Formulas and Tables for the Calculation of Antenna Capacity, Bur. Standards Paper 568.

³ EVERITT, W. L., loc. cit.

Radiation resistances for uniform wires in free space, oscillating freely in several successive natural modes (harmonics), as seen at any current antinode, are given in Fig. 6.¹

The radiation resistances for straight vertical grounded antennas over perfectly conducting ground for several successive harmonic modes, as seen from any current antinode in the system, are plotted in a succession

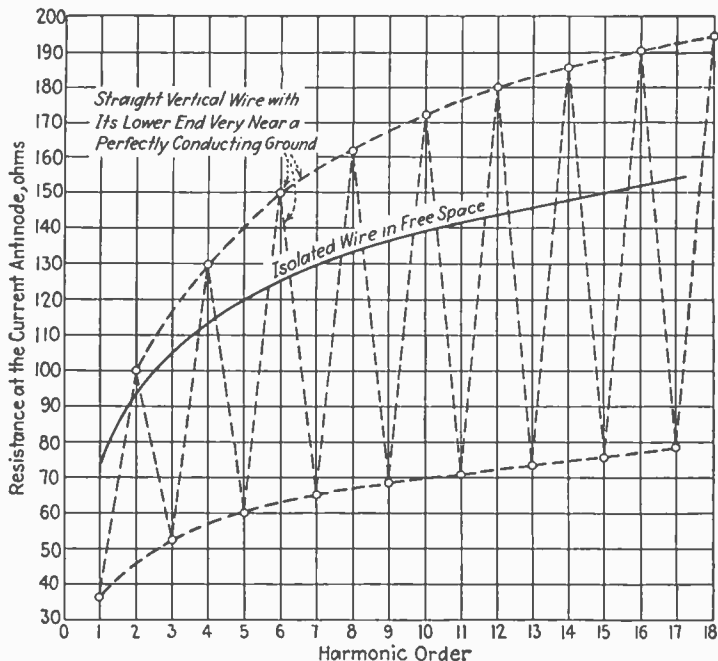

FIG. 6.—Radiation resistances of uniform wires in free space.

of points in Fig. 6.² (The dotted lines connecting these points have no significance as data but merely identify the relationships.)

The radiation resistances for straight wires in free space in which all successive dipole sections have *cophased* currents, as seen from any current antinode, are plotted in ohms against the number of half-wave sections in Fig. 7.¹

The radiation resistances for straight vertical grounded antennas over perfectly conducting ground for modes of operation greater than 1.00 are given in the following table:³

¹ SIEGEL, E., and J. LABUS, *Feldverteilung und Energieemission von Richtantennen, Hochfrequenz Technik und Elektroakustik*, Band 38, Heft 6, 1932.

² LEVIN, S. A. and C. J. YOUNG, *Field Distribution and Radiation Resistance of a Straight Vertical Unloaded Antenna Radiating at One of Its Harmonics*, *Proc. I.R.E.*, May, 1926.

³ PIERCE, G. W., *loc. cit.*

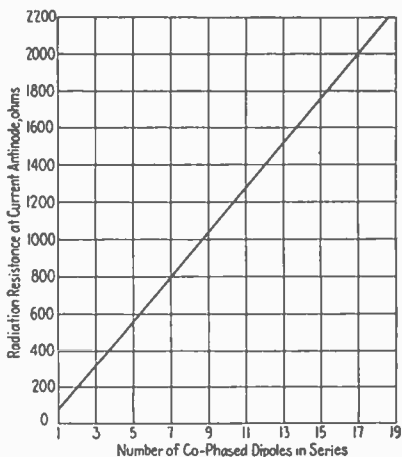

FIG. 7.—Radiation resistance in cophased dipole elements.

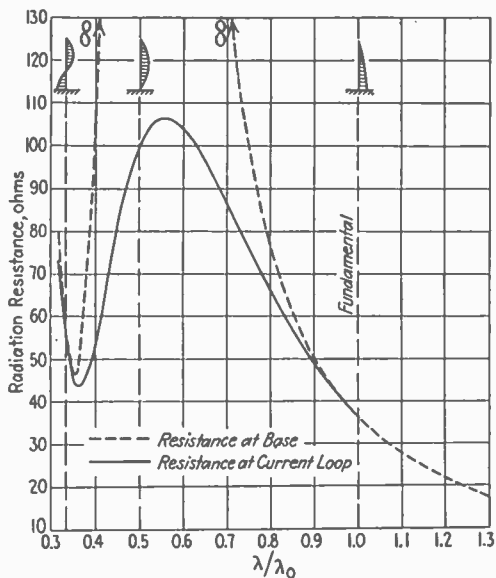

FIG. 8.—Radiation resistance of vertical grounded conductor.

RESISTANCE OF STRAIGHT VERTICAL ANTENNA FOR DIFFERENT VALUES OF WAVE LENGTH OBTAINED BY INDUCTANCE AT THE BASE

λ/λ_0 Ratio of Wave Length to Natural Wave Length	R, Radiation Resistance, Ohms
1.00	36.57
1.12	26.40
1.21	21.70
1.31	17.65
1.43	14.28
1.57	11.62
1.74	9.10
1.97	6.92
2.24	5.19
2.62	3.78
3.14	2.58
3.93	1.65
5.26	0.90
7.85	0.30
15.70	0.082
31.42	0.01

The radiation resistances for straight vertical grounded antennas over perfectly conducting ground, for operating modes between 1.00 and 0.32,

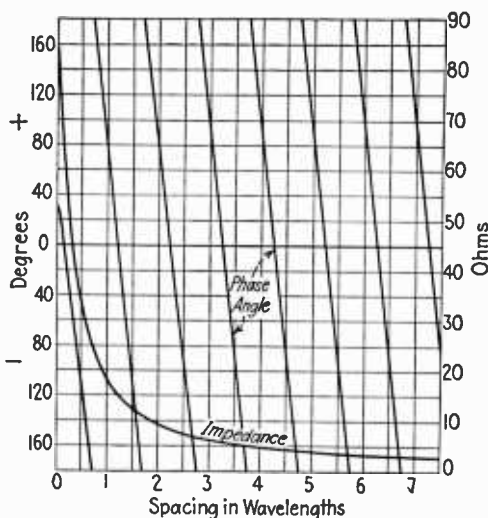

FIG. 9.—Mutual impedance for parallel dipoles.

as seen both from the base and from the current antinode (loop), are given in Fig. 8.¹

The resistance of a vertical half-wave wire with its lower end near ground, as seen from the base (current node), is of the order of 3,600 ohms.

¹ BALLANTINE, S., On the Radiation Resistance of a Simple Vertical Antenna at Wave Lengths below the Fundamental, *Proc. I.R.E.*, December, 1924.

10. Mutual Impedance of Two Parallel Half-wave Dipoles.¹ By definition 5 (Art. 1, Antenna Terminology), we have

$$\text{Mutual impedance } Z_{12} = Z_{21} = -\frac{V_{21}}{I_1}$$

Values of mutual impedances for two parallel dipoles whose current antinodes fall on the same perpendicular bisecting plane are given in Figs. 9 and 10, for various separations.

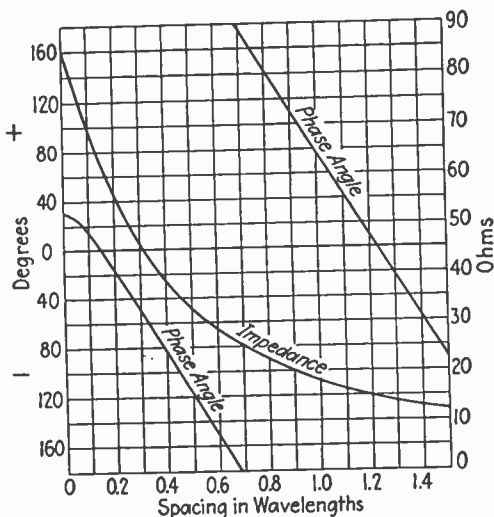

FIG. 10.—Effect of spacing on mutual impedance of dipoles.

11. Mutual Impedance of Colinear Half-wave Dipoles. The mutual impedances between half-wave dipoles which are colinear, in terms of the distances between their adjacent ends, are given in Fig. 11.¹

12. Conditions for an Array of Parallel Dipoles, One Freely Reflecting.¹ The fundamental conditions for an array of two parallel dipoles (radiation resistance, amplitude of current in reflector, and phase of reflector current) are shown in Fig. 12.

13. Radiation of Electromagnetic Waves from a Linear Oscillator. Maxwell's classic wave equations enable one to calculate precisely the field conditions in space around a conductor carrying alternating currents. The difficulties of representing field conditions about an antenna in pictorial form by two-dimensional delineation are almost insurmountable. Nevertheless, this has been attempted at the expense of great labor by Hack, and by Pearson and Lee, which may be seen in Fleming's book.²

¹ CARTER, P. S., Circuit Relations in Radiating Systems and Applications to Antenna Problems, *Proc. I.R.E.*, June, 1932.

² FLEMING, J. A., "Principles of Electric Wave Telegraphy and Telegraphy," Longmans, Green & Company, 1910. (Part II.)

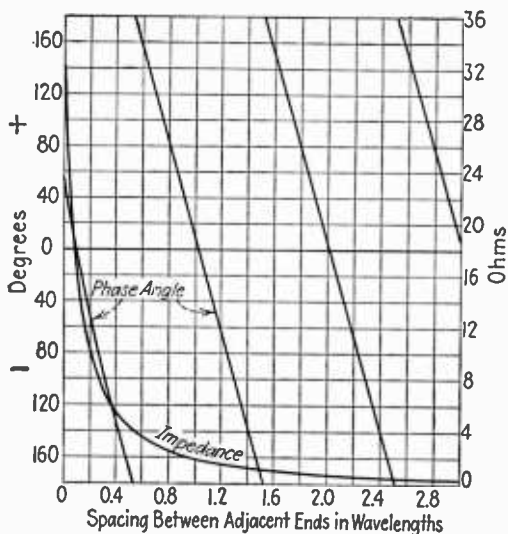

FIG. 11.—Mutual impedance of colinear half-wave dipoles.

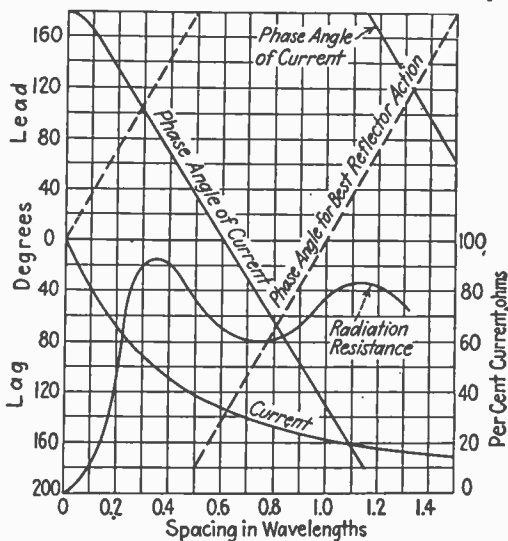

FIG. 12.—Conditions for array of parallel dipoles.

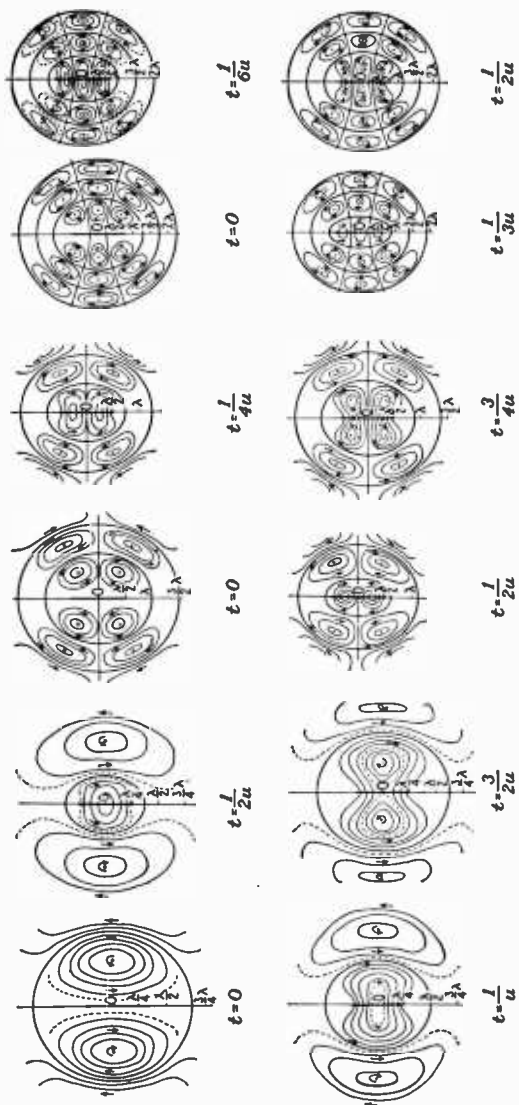
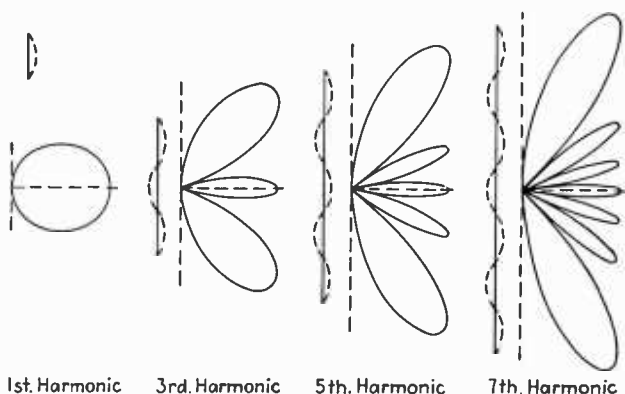

FIG. 13.—Electric field in space around a wire freely oscillating at first, second, and third harmonics. (After Hack.)

For the light it throws on the physical formation of space characteristics there is reproduced in Fig. 13 a diagram by Hack showing the electric field in space around a wire freely oscillating at its first, second, and third harmonics. This affords an accurate view of the manner in which lines



NOTE: All Lobes have a common vertical tangent

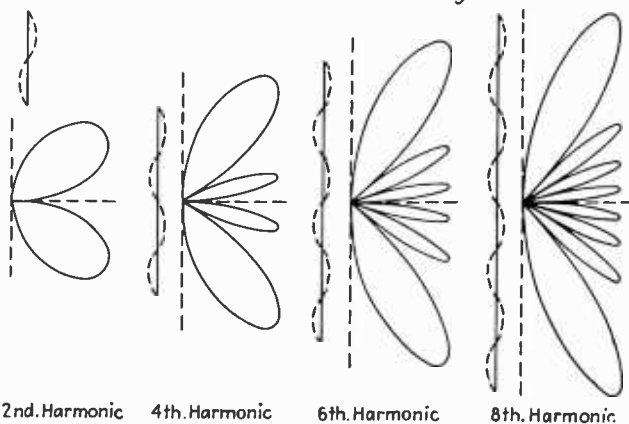

FIG. 14.—Polar diagrams showing radiation from conductor oscillating at several harmonics.

of electric force form about an antenna and become detached from the system.

14. Distribution of Field Intensities in Space about an Oscillating Wire in Free Space. The distribution of radiation in space about a wire with standing waves of a.c. depends upon the length of the wire and the

distribution of currents in it.¹ Characteristic radiation patterns are due to the cumulative effects of wave interference between the radiations from each elemental section of the antenna. For straight wires in free space, with sinusoidal current distributions, oscillating at several successive harmonics, the relative field intensities in any plane through the wire are shown in polar form in Fig. 14. Each pattern is shown associated with the current distribution which produces it.

The angles at which the various maxima and minima occur in patterns of this type may be found from Fig. 15.² (Angles are measured from the wire.)

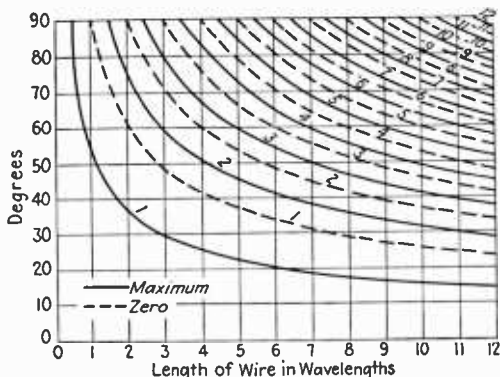

FIG. 15.—Angles at which maxima and minima in wave pattern occur.

15. Distribution of Field Intensities from Vertical Grounded Antennas Oscillating at Several Successive Harmonics. For straight vertical antennas over perfectly conducting ground oscillating in harmonic modes, some characteristic vertical-plane distributions are shown in Fig. 16. These patterns are greatly modified when the lower end of the antenna is not exactly at ground, and change rapidly as the distance between the lower end of the antenna and ground is increased. For data in cases of this sort consult Levin and Young.¹ These patterns are due to wave interferences between radiations from each elemental section of the antenna and with radiations which are reflected back into space from the surface of the ground. The reflected radiations from the ground are also called *image radiations*, since they can be demonstrated to be the equivalent of direct radiations from a subterranean image of the antenna with the same geometrical disposition and the same current distribution.

16. Electrical Images of Antennas. In Fig. 17 are represented the images of several types of vertical, horizontal, and sloping antennas above

¹ BALLANTINE, S., *loc. cit.*; LEVIN, S. A., and C. J. YOUNG, Field Distribution and Radiation Resistance of a Straight Vertical Unloaded Antenna Radiating at One of Its Harmonics, *Proc. I.R.E.*, May, 1926; LAPORT, E. A., Calculation of Vertical Antenna Radiation Patterns, *Electronics*, February, 1935 (Elementary); TERMAN, F. E., "Radio Engineering," Chap. XIV, McGraw-Hill Book Company, Inc., 1932. See also E. SIEGEL and J. LABUS, *loc. cit.*

² CARTER, P. S., C. W. HANSELL, and N. E. LINDENBLAD, Development of Directive Transmitting Antennas for RCA Communications, Inc., *Proc. I.R.E.*, October, 1931.

a perfectly conducting ground. In this figure the current distributions are shown, together with the relative directions of currents in both the antenna and the image.¹

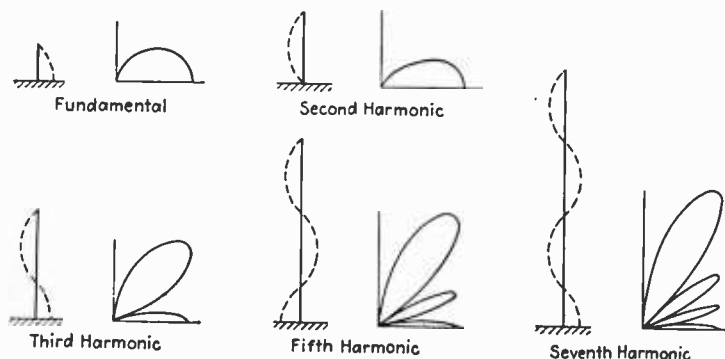

FIG. 16.—Vertical radiator over perfectly conducting ground.

The surface of the earth, which includes rock, soil, and water, is not a perfect conductor. For this reason, the theory of images is compromised somewhat in practice. For precise calculation of antenna performance

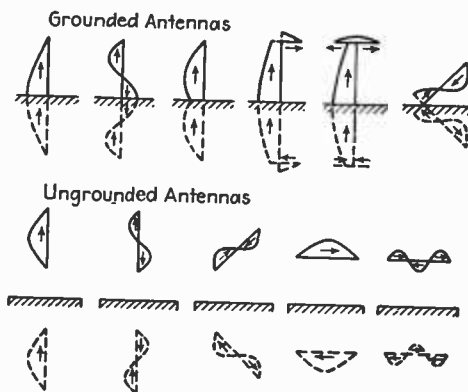

FIG. 17.—Electrical images of antennas.

it is necessary to take into account the effects of finite conductivity and also the inductivity of the ground upon the image radiations. The effect of imperfect ground increases with the frequency of transmission. Under some conditions the ground may act as a perfect insulator.

¹ TERMAN, F. E., *loc. cit.*

An incident wave impinging upon the surface of the earth is broken into two components, one which is refracted into the ground and is dissipated therein, and another which is reflected back into the atmospheric space above ground. This latter has an amplitude less than the incident wave, and its phase may be turned through a considerable angle, sometimes completely reversed. The amplitude and phase of the reflected wave change with the angle of incidence of the waves, and with the frequency of transmission, as well as with the polarization of the incident wave.

The following vector equations for the amplitude and phase of the reflected wave from soil of known electrical constants probably are as convenient as any:¹

The coefficient of reflection \bar{K} for a vertically polarized wave is

$$K_v = \frac{\left[\epsilon - j\frac{2\sigma}{f} \right] \sin \theta - \sqrt{\epsilon - j\frac{2\sigma}{f} - 1 + \sin^2 \theta}}{\left[\epsilon - j\frac{2\sigma}{f} \right] \sin \theta + \sqrt{\epsilon - j\frac{2\sigma}{f} - 1 + \sin^2 \theta}}$$

and for a horizontally polarized wave is

$$K_h = \frac{\sin \theta - \sqrt{\epsilon - j\frac{2\sigma}{f} - 1 + \sin^2 \theta}}{\sin \theta + \sqrt{\epsilon - j\frac{2\sigma}{f} - 1 + \sin^2 \theta}}$$

where \bar{K} = a vector quantity whose amplitude and direction represent, respectively, the magnitude and phase of the reflected wave

ϵ = the dielectric constant, or inductivity, of the soil (average)

σ = the conductivity in e.s.u.

θ = the angle to the horizon

f = the frequency.

17. Directivity Diagrams for an Array of Two Parallel Straight Antennas. Two or more separate sources of radiant energy of the same frequency and polarization set up wave-interference patterns in space which have useful directivity characteristics. In directional radio transmission and reception, advantage is taken of this phenomenon to obtain an unlimited variety of degrees of control for the multitudinous special requirements of radio communication. The directivity diagrams for two identical parallel radiators with equal currents and current distributions, in a plane normal to both radiators, are of fundamental importance in the study of antennas. Directivity diagrams for radiator separations between 0 and 4.0 wave lengths, and for phase differences from zero to 180 deg. ($\frac{1}{2}T$) are displayed in Fig. 18.² The dynamic picture of growth which these patterns demonstrate enables one to estimate the intermediate patterns. In these patterns, the two radiators are along the horizontal (X) axis of the diagram. The reversal of the

¹ TREVOR, B., and P. S. CARTER, Notes on the Propagation of Waves below Ten Meters in Length, *Proc. I.R.E.*, March, 1933.

² FOSTER, R. M., Directive Diagrams for Antenna Arrays, *Bell System Tech. Jour.*, April, 1926.

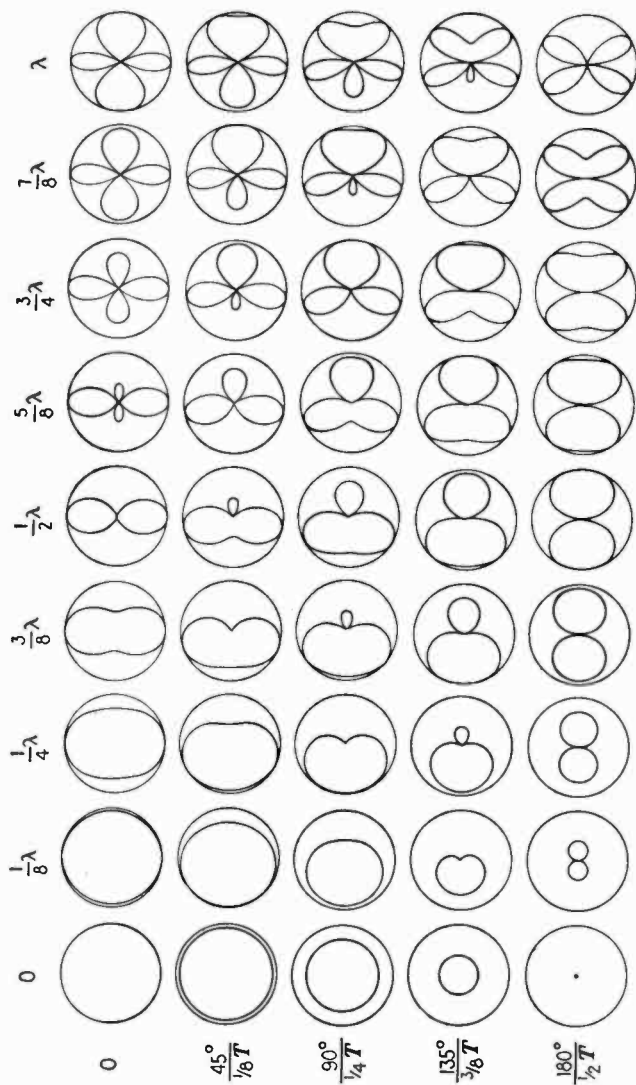

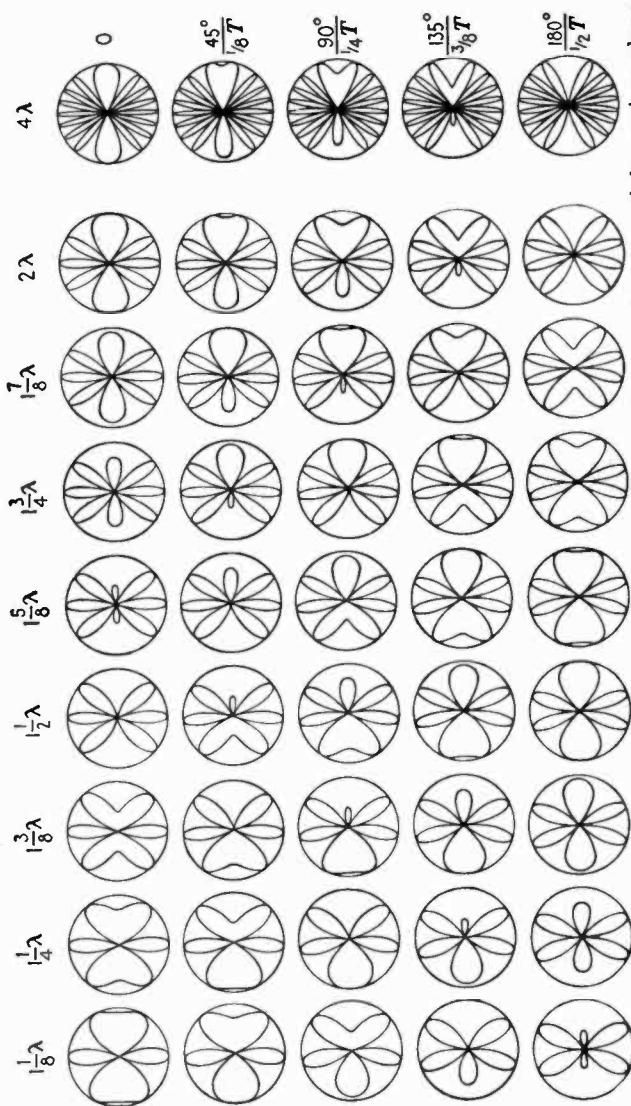

Fig. 18.—Directivity diagrams for radiator separations between 0 and 4 wave lengths and for various phase differences up to $\frac{1}{2} T$.

current in one of the radiators rotates the pattern about its vertical (Y) axis. It will also be noticed that all patterns are symmetrical with respect to the X -axis.

18. Calculation of Directivity Diagrams. For the calculation of any of the directivity patterns for two radiators as specified in the preceding section, two methods are cited here:

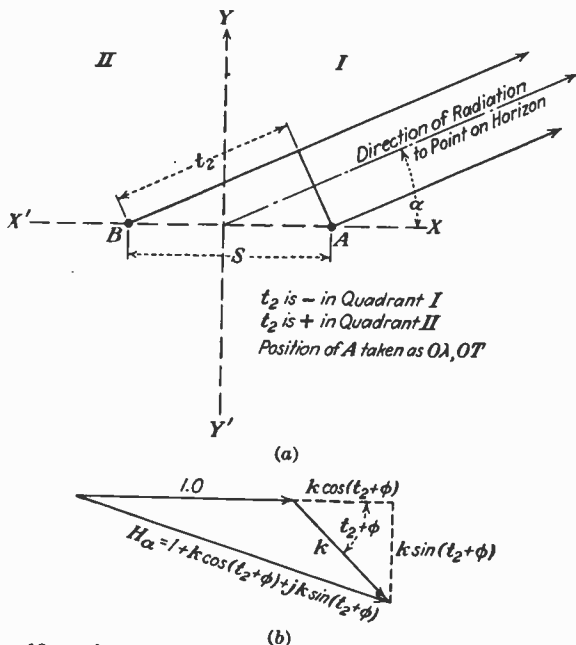

FIG. 19a and b.—Data used in calculating directivity diagrams.

For a linear array of N identical antennas, with the parameters $a\lambda$, bT , the directivity equation in polar coordinates is as follows:¹

$$r_{\theta} = \left| \frac{\sin N(\pi a \cos \theta + \pi b)}{N \sin (\pi a \cos \theta + \pi b)} \right|$$

and when $N = 2$, this reduces to

$$r_{\theta} = |\cos (\pi a \cos \theta + \pi b)|$$

θ is measured from the axis of the array. (It is understood in this equation that all antennas have the same current amplitude.) For diagrams of Fig. 18, $N = 2$.

For an array of two antennas with any current ratio, the following method may be used:

$$\vec{H}_{\alpha} = 1 + k \cos (t_2 + \phi) + jk \sin (t_2 + \phi)$$

¹ FOSTER, R. M., *loc. cit.*

The geometry and symbolism of this equation are given in Fig. 19, and in the following:

- α = angle from axis of the array $x-x'$
 s = spacing between radiators in wave lengths
 $s' = 360s$ = spacing between radiators in electrical degrees
 ϕ = instantaneous phase difference between currents in the two radiators I_A and I_B
 $k = I_B/I_A$ (invert if necessary so that $k < 1.0$)
 $t_z = -s' \cos \alpha =$ phase difference between radiations from A and B , in electrical degrees due to difference in length of path.

This equation is in the form of the addition of two rectangular vectors, as diagrammed in Fig. 19b.

19. Short-cut Determination of the Major Three-dimensional Characteristics for a Two-element Antenna Array. Frequently two-element arrays are employed for directional transmission, in which case it becomes necessary to know the space characteristics. A rough preliminary investigation of the three-dimensional distribution of field intensities in the horizontal plane, the vertical plane through the radiators, and the vertical plane broadside to the radiators may be quickly made in the following manner: From the patterns of Fig. 18, select the horizontal pattern corresponding to the separation and phase difference to be used. From this pattern the *vertical-plane distribution through the radiators* may be found by multiplying the upper half of the pattern (which lies above the X -axis) by the polar characteristic in the vertical plane for one of the antennas. When the radiators are grounded quarter-wave elements, it is merely necessary to multiply the radius vector at any angle by the cosine of the angle. (Perform this for the entire 180 deg.) Familiarity with this method enables one to estimate the vertical-plane distribution immediately by inspection of the horizontal pattern. For the vertical plane broadside to the array, the distribution is the same as for a single antenna. Thus we have

1. The distribution in the plane through the radiators is the same as for the upper half of the horizontal pattern multiplied by the characteristic for one radiator.

2. The broadside plane distribution is the same as the vertical pattern for one radiator.

3. Where there is suppression of radiation in line with the radiators in the horizontal pattern, there will be one or more lobes of high-angle radiation in that direction in the vertical pattern. The shape of the high-angle lobes will depend upon the vertical-plane pattern for one antenna.

4. Where suppression of radiation occurs broadside to the array in the horizontal pattern, there will be proportionate suppression at all vertical angles.

5. Where there is a maximum of radiation in line with the radiators in the horizontal plane, there will be a flattening of the pattern over that of a single radiator, in the vertical plane.

6. When the ratio of currents in the two radiators is other than unity, the angles of maxima and minima occur at the same place, but the nulls and peaks are less pronounced. As the current ratio approaches zero, the pattern approaches that of a single antenna, *viz.*, a circle with 0.707 the diameter of the unit circle in the patterns of Fig. 18.

20. Precise Calculation of Three-dimensional Space Characteristics for an Array of Two Identical Elements. The following method enables one quickly to calculate the relative field intensity at any angle in space with respect to the virtual center of the array. For calculating the

entire space characteristic it is best first to calculate the horizontal pattern as described above, and then to calculate a series of vertical-plane patterns at various angles to the array axis. As the horizontal pattern is symmetrical with respect to the axis $x-x'$, so the space characteristic is symmetrical with respect to the $X-Z$ plane through the radiators. Furthermore, the space characteristic in the half space above the $X-Y$ plane is symmetrical with that in the half space below the $X-Y$ plane. The geometry for use with the following formula for the space char-

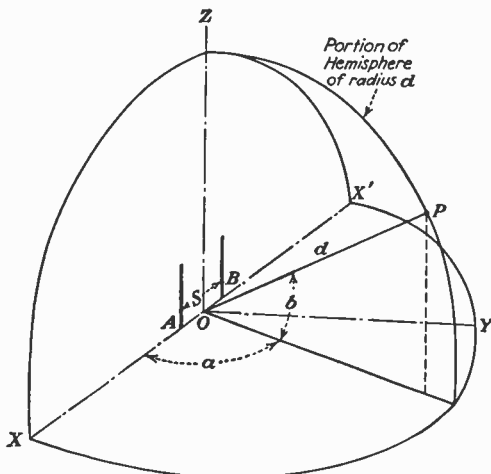

FIG. 20.—Geometry for calculating space characteristic of two-element array. The space characteristic in the upper half-space, for grounded antennas and perfectly conducting ground, is given in Fig. 20.

$$H_{\alpha b} = [1 + k \cos(t_1 + \phi) + jk \sin(t_1 + \phi)] \cdot [1 + \cos t_1 + j \sin t_1] \cdot \left[\frac{\cos(90^\circ \sin b)}{\cos b} \right]$$

(Multiply only the scalar values of each factor.)

In this equation H = field intensity in arbitrary units at an angle (α) measured horizontally with respect to the line through the radiators, and the angle (b) above the horizon

k = current ratio (equal to or less than unity)

t_1 = total phase difference, in degrees, between radiations from A and B in the direction (α) (b)

$$t_1 = [(s' \cos \alpha \cos b) + \phi]$$

and (s') is the spacing between radiators in electrical degrees)

$t_1 = -2h \sin b$, where h is the height of the current anti-node above ground, in electrical degrees

ϕ = initial phase difference between the currents in the two radiators.

NOTE. When the radiators are exact quarter-wave elements, the second factor becomes constant and can be ignored. When the radiators are considerably less than one-quarter wave length in height, the second factor can be ignored and the third factor simplified to $\cos b$.

The above equation is restricted to those cases where the physical length of the radiators does not exceed one-half wave length, though the height of radiators above ground is not restricted.

To obtain the vertical distribution pattern for one radiator, ignore the first factor and use only the second and third.

21. General Solution for the Space Characteristics for Any Array of Antennas Disposed in Any Manner in Three Dimensions. In view of the special nature of the general solution for extended antenna arrays, we shall not attempt to condense this important subject in this work but shall merely refer the interested reader to the references below.¹ Extended antenna arrays are extensively applied in high-frequency directive transmission and are of great engineering importance at the present day.

BROADCAST ANTENNAS, 550 TO 2,000 KC

22. Prevailing Types of Broadcast Antennas. The old-fashioned forms of antenna construction, familiar for many years, are still largely used but deserve no particular attention from present-day engineers because they are rapidly being replaced by more efficient radiators.

Broadcast antennas may be classified as follows:

A. The high vertical single-wire antenna, suspended from a triatic between self-supporting steel towers (widely spaced), and having a fundamental frequency lower than the operating frequency.

B. The high single-wire T-antenna, being similar to A, but with a relatively short T flat top, and operating above its fundamental frequency.

C. The guyed cantilever steel tower, having a height somewhat greater than one-half wave length, the tower itself forming the antenna conductor.

D. The self-supporting (slender) steel tower, having a height from one-quarter to more than one-half wave length, the tower itself being the antenna conductor.

E. The single-wire vertical antenna suspended along the axis of a self-supporting treated-wood tower, and operating, in general, at a frequency much higher than its fundamental.²

F. Directive antenna arrays of two or more vertical elements, designed either to get more advantageous coverage where population distribution is irregular, or to reduce interference in the directions of other stations that may be on the same channel.

23. Progress in Antenna Improvements. The low multiwire with a large L or T flat top was the ordinary form of radio antenna for many years and was used until recently for broadcasting. Since 1927 there has been a rapid development in broadcast antennas, and their form has been greatly modified.³ The trend in 1935 is toward straight vertical

¹ FOSTER, R. M., *loc. cit.*; SIEGEL and LABUS, *loc. cit.*; SOUTHWORTH, G. E., Certain Factors Affecting the Gain of Directive Antennas, *Proc. I.R.E.*, September, 1930; BAÜMLER, M., K. KRÜGER, H. PENDL, and W. PFITZER, Radiation Measurements of a Short-wave Directive Antenna at the Nauen High-power Radio Station, *Proc. I.R.E.*, May, 1931.

² EPPEN, F., and A. GOTHE, Über die Schwundvermindernde Antenne des Rundfunksenders Breslau, *E.N.T.*, Band 10, Heft 4, 1933.

³ BROWN, G. H., and H. E. GIHRING, General Considerations of Tower Antennas for Broadcast Use, *I.R.E. Proc.*, April, 1935; CHAMBERLAIN, A. B., and W. B. LODGE, The Broadcast Antenna, *Proc. Radio Club Amer.*, November, 1934; LAPORT, E. A., Improved Efficiency with Tower Antennas, *Electronics*, August, 1934.

radiators with a height of the order of one-half wave length. The results sought are reduction of high-angle radiation for the reduction of fading, and greater efficiency giving larger service areas for a given power input. The present commercial importance of broadcasting justifies a considerable investment in an improved radiator.

24. Problems in Broadcast-antenna Applications. From a purely theoretical standpoint, it is possible to specify a "best type" of broadcast antenna. From the practical standpoint, it is necessary to consider every application as a special case. The operating frequency, the cost, station power, soil quality, topography and geology, and population distribution in the desired service area, and many other factors bear prominently upon the final choice. In some cases an "ideal" antenna might be only slightly superior in actual service to one that is a considerable departure from the ideal and which might also be much lower in cost. For the engineer no fast rules can be set forth to cover all cases. The choice must take into account the specific characteristics of the available sites, and the propagation conditions must be thoroughly studied by transmitting a test signal from the proposed site which can be measured throughout the expected service area. Conditions in the immediate vicinity of the antenna must also be determined by field measurements. The characteristics of the test antenna must then be fully investigated from measurements of its performance. The test antenna should be of the same general type of construction as the ultimate antenna, though its relative size is unimportant. With experimental data of this nature, a reasonable antenna design can be projected and its performance fairly well predicted.

25. Electrical Performance of Broadcast-type Antennas. In terms of their characteristic current distributions, and relative linear dimen-

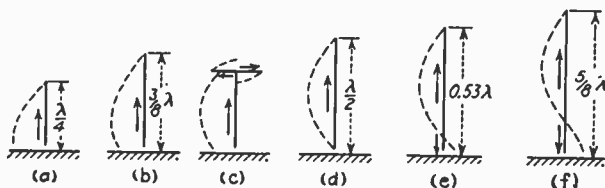

FIG. 21.—Types of broadcast antennas.

sions, several types of broadcast antennas are represented in Fig. 21. As the height of the antenna increases, the position of the current antinode is raised above ground, which causes the high-angle radiation to decrease and the low-angle radiation to increase. The effect of antenna height (in terms of electrical degrees) on the relative distribution of field intensity for five different antenna lengths is demonstrated in Fig. 22, where these data are plotted in rectangular instead of the more usual polar coordinates. The portions of the curves shown as negative field intensities indicate radiations in a secondary (high-angle) lobe in which the direction of the electric field is reversed. For a straight vertical antenna, it is seen that when the height of the current antinode exceeds one-quarter wave length above ground, the high-angle lobe forms rapidly and soon assumes a value unsatisfactory for broadcasting use because of fading. For this type of antenna the 190-deg. length is about the maximum permissible.

This does not imply that there is an electrical limit to the extent to which antennas for broadcasting can be improved. If means are

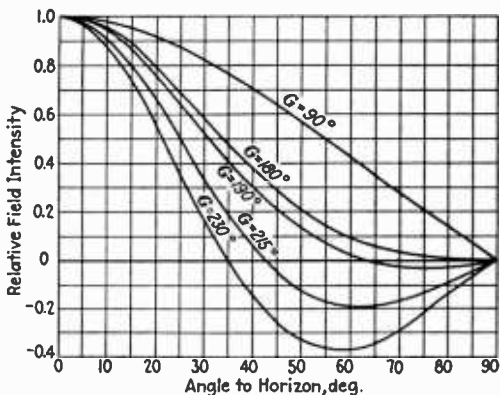

FIG. 22.—Effect of height on field intensity.

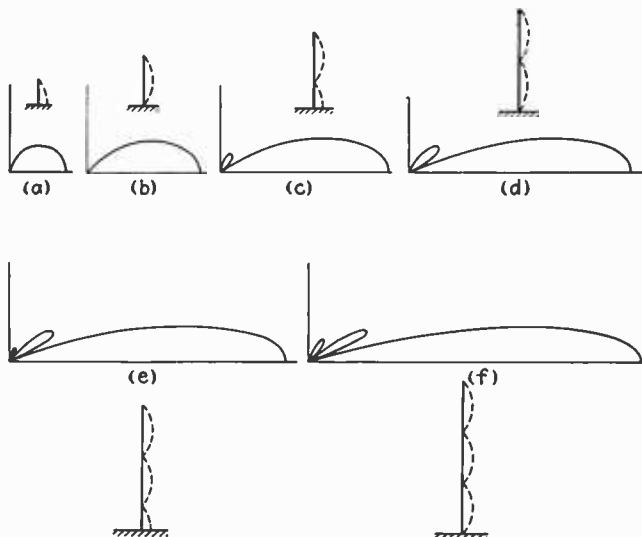

FIG. 23.—Radiation characteristic as antennas increase in height.

employed to prevent the reversal of the current in the lower sections as the height is increased, the improvement increases indefinitely with

height, as shown in Fig. 23.¹ This principle is well known in high-frequency antenna practice and may be practicable, to a certain degree, on the higher broadcasting frequencies.

Another system which has possibilities in allowing beneficial increases in height beyond one-half wave length is the method of Chireix, whereby the self-inductance of the wire is neutralized by the addition of distributed series capacitance along the wire. This, in effect, increases the phase velocity of propagation in the wire, so that a height greatly in excess of a physical half wave is required to produce an electrical half-wave system.

In the electrical design of broadcast antennas, one of the problems is to obtain the maximum meter-amperes for a given power input. To a certain extent, this object is achieved by the same methods which bring about a low-angle concentration of the vertical polar diagram of field distribution.

26. Ground Systems for Broadcast Radiating Systems. The importance of the ground terminal for a radiating system cannot be over-emphasized. If there existed such a thing as a perfectly conducting earth, any sort of a firm connection to the earth would suffice for a terminal. Soils, and even salt-water marsh, at best are poor conductors at radio frequencies. The ground system used with an antenna must make the best possible contact with existing ground substances as found at a station site. A few years ago it was thought that a ground system had only to extend outward as far as the limits of the induction field of the antenna. The major function of the ground system as a reflecting surface for the down-coming waves from the antenna is now generally recognized, and for this purpose a ground system must extend outward for a considerable distance. There have been many temporary theories and practices regarding the configuration of the conductors in the ground system, but there is now, broadly speaking, a convergence of preference for the radial system with an effective earth termination for each wire. Recent studies have further proved the need for a large number of very long radials. The more nearly a system of wires approaches a continuous metallic sheet of great extent, the better it is as a ground system.

The length of radials for a ground system with a modern vertical radiator, or high T antenna, depends upon the height of the center of radiation in the radiator. A radiator with the center of radiation at or near ground permits much shorter radials for a practical optimum performance than one with a current antinode three-eighth wave length above ground.² It has been shown by measurements on a number of radiating systems that the longer the radials the stronger the ground signal for a given power input.³ Available data do not show that an optimum length has been reached in any existing systems.

The extent of a ground system for given performance depends upon the character of the soil at the antenna site. The higher the soil conductivity the sooner will the ground currents become diffused into the soil and consequently the more rapidly will the current in the wire decrease with distance. However, the designer may advantageously assume that he always has poor ground to contend with, and that ground-system design compromises should be as few as possible.

¹ SIEGEL and LABUS, *loc. cit.*

² BROWN, G. H., and H. E. GIHRING, *loc. cit.*

³ CHAMBERLAIN, A. B., and W. B. LODGE, *loc. cit.*

Figure 24¹ will be useful to designers of ground systems, for it is compiled from measurements on many recent installations. See also Brown,² and Brown and Gihring.³

27. Counterpoises. The peculiar value of an elevated counterpoise in place of a direct ground connection in places where ground conditions are poor has been known for many years, and the counterpoise has its merits. In many cases where poor ground conditions make a buried system subject to high losses, an elevated system may be advantageous.

The design for a counterpoise is similar to that for a buried system in that the length required for reasonable effectiveness is determined by the height of the center of radiation in the antenna. It should be well insulated at the ends, and frequently supported, and should be a few feet

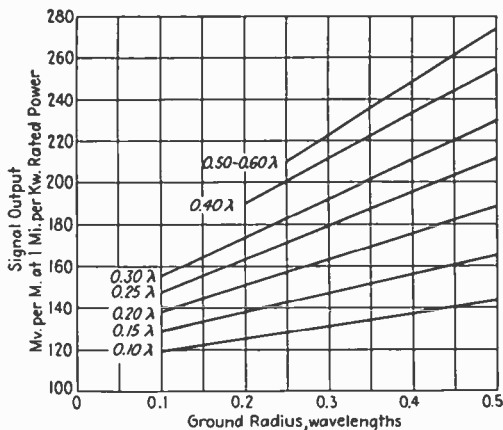

FIG. 24.—Importance of ground system on field strength.

above the ground. There are no data available to justify the use of anything more than a simple system of several radials (the more the better) when used with a vertical antenna. When used with other forms, the counterpoise should extend under all parts of the antenna and preferably project well outside the limits of the antenna proper.

28. Ground Screens.—This name has lately been given to a metallic surface placed under a tower or antenna down-lead where the normal potential gradient in the soil is very high. The screen redistributes the field in such a manner as to effectively decrease the field concentration at such points and therefore decreases the losses in the ground. Where the base of an antenna is at very high potential (such as the base of a half-wave system), a metallic plate several feet in diameter is usually employed as a ground screen, in addition to the regular ground system.

29. Ground Systems for Directive Broadcast Antennas. Where two or more grounded radiating elements are employed in a directive array the considerations for the ground system for each radiator must be

¹ CHAMBERLAIN, A. B., and W. B. LODGE, *loc. cit.*

² BROWN, G. H., The Phase and Magnitude of Earth Currents Near Radio Transmitting Antennas, *Proc. I.R.E.*, February, 1935.

³ BROWN, G. H., and H. E. GIRRING, *loc. cit.*

essentially the same as that for a single radiator. Some economy may be effected when the radiators are electrically close together, when one set of long radials may suffice for the array. In general, typical broadcast arrays require a separate ground system for each radiator except where the radials definitely overlap.

30. Measurement of Antenna Resistance. Both the resistance-variation and the substitution methods are widely used for this purpose and, with proper precautions, have equal merit. Proper instruments of suitable accuracy are essential, as well as considerable skill in making such measurements. The measurement of low-impedance antennas is much simpler than the measurement of those of high impedance in that stray capacitance becomes a major consideration with the latter.¹

The measurement of antenna resistances above 200 or 300 ohms requires especial care and occasionally special methods. A simple method for measuring antenna resistance and reactance of a very high

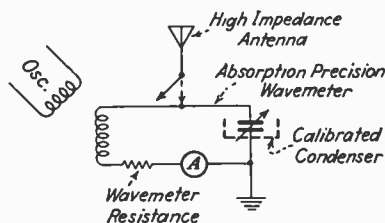

FIG. 25.—Antenna measuring circuit.

impedance antenna is the following: Using an ordinary wave meter of the precision-absorption type equipped with a thermoammeter and a calibrated condenser, adjust the wave meter to the desired frequency and bring the oscillator into tune at this same frequency. Couple the wave meter to the oscillator until full scale deflection of the ammeter results. One side of the wave meter (the shield side) should be grounded to the regular antenna ground system. Note the setting of the variable condenser and the exact meter reading at resonance. Then connect the antenna down-lead to the ungrounded side of the wave meter as shown in Fig. 25, and retune the wave meter for maximum current. Note the condenser setting and the new meter reading for this condition. The lower the antenna resistance, the lower will be the ammeter reading with the antenna attached. Also, if the antenna has an inductive reactance at the particular frequency, the capacitance of the wave meter will have to be increased to restore resonance, and *vice versa*.

By a substitution process, known standard values of resistance and reactance in series are connected in parallel with the wave meter to reproduce the same series of adjustments and readings as observed, first with the wave meter alone, and then with antenna attached to it. The resistance and reactance values which reproduce the antenna values precisely are equal to those of the antenna.

The precautions to be observed in using this method are: The oscillator must be of sufficient power output and regulation as to be unaffected

¹ LAPORT, E. A., Some Notes on the Influence of Stray Capacitance upon the Accuracy of Antenna Resistance Measurements, *Proc. I.R.E.*, May, 1934.

by the presence of the wave meter; the standards of impedance used for substitution must be essentially free from stray capacitance when arranged for use, for small values of stray capacitance can seriously disturb the accuracy of the results; the readings and adjustments before and after adding the shunt impedance must exactly duplicate those observed in the process of measuring the antenna.

If the wave-meter resistance is accurately known, the unknown antenna impedance, in terms of resistance and reactance, can be calculated.

It is customary, in view of certain difficulties in making antenna measurements, to insure greater accuracy by making a series of such measurements over a considerable range of frequencies. Individual errors are averaged out by drawing a smooth curve through the values as plotted out in graphical form. Antenna resistance and reactance measurements over a wide band of frequencies are often invaluable in analyzing the action of an antenna, as well as for predetermining the proper circuit constants to be used for tuning it or matching its impedance to a given transmission line.

31. Measurement of Power Input to a Broadcast Antenna. Under existing regulations, and the premium on power input to the antenna, highly accurate measurements of antenna input are frequently desired. The direct measurement of antenna-input power is made by first measuring the resistance of the antenna and by reading the current entering the antenna with an ammeter of high accuracy. At the present time, however, the prevailing practice is to determine antenna input indirectly by considering power-amplifier input and efficiency. This method is accurate, when the efficiency of the output amplifier is known.

32. Actual Measurements of a Number of Broadcast Antennas. There are tabulated herewith the measurements made on a number of well-constructed antennas used for broadcasting, together with informa-

BROADCAST-ANTENNA CHARACTERISTICS

Designation	Tower height, feet	Tower separation, feet	Type	Length, vertical, feet	Length, horizontal, feet	λ_0 , meters	λ/λ_0	R_0
A	330	750	T	254	200	575	0.76	40.5
B	300	750	T	265	115	530	.70	65
C	200	600	T	160	370	505	.72	84
D	300	750	Vertical	261	0	364	.75	90
E	300	600	T	260	20	392	.82	69
F	T	135	60	264	.89	52
G	165	(?)	T	135	104	316	.74	76
H	350	750	T	310	150	582	.70	110
I	200	500	T	185	20	283	.95	32
J	T	220	220	534	.72	61
K	300	750	T	275	272	650	.70	80
L	300	750	T	280	120	500	.79	46
M	400	750	T	351	150	665	.70	56
N	103	100	T	93	90	258	.97	23
O	250	400	Vertical	228	0	317	.76	72
P	250	400	T	235	380	538	.98	22
Q	300	600	Vertical	273	0	394	.77	64
R	300	750	T	251	100	490	.67	136
S	224	None	Vertical	224	0	304	.76	100
T	60	125	L	60	110	470	.98	12.6
U	None	None	Vertical	206	0	280	.50	3,600

TOWER-RADIATOR DATA

Station	Operating wave length	Tower height ² at operating mode	Base resistance at operating mode	Fundamental wave length	Operating power, watts	Field intensity, 1 mile	Fading observations	Increase in signal intensity over previous antenna	Mode of operation, λ/λ_1	Field intensity per 1,000 watts at 1 mile ⁷	Ground system	
											Number of radials	Length of radials
A.....	348.6	620	200	N.I.	50,000	1,600	See 8, 9	N.I.	N.I.	226	326	1½
Budapest.....	549.6	1,045	269	1,286	120,000	2,800	See 14	See 15	0.435	254	586	1¾
Bi.....	243.8	420	220	584	1,000	225	N.R.	N.R.	0.418	220
Ca.....	212.6	420	185	584	500	175	N.R.	N.R.	0.364	247	N.R.
WFEA.....	209.7	400	185	N.I.	500	100 ¹	N.I.	See 8	N.I.	141	360	1½
WSM.....	461.3	878	212	1,220	50,000	1,380 ¹⁰	See 10	0.378	212	60	450
WCAU.....	256.3	505	97	690	50,000	1,300	See 8	See 8	0.372	184	36	250
WLW.....	428.3	831	185	1,090	50,000	1,900	See 12	0.393	269*	72	450
WIBC.....	232.4	355 ¹¹	1,160	568	1,000	N.I.	N.I.	N.I.	0.41	N.I.	12	150
KDFN.....	211.1	200 ³	N.I.	N.I.	500	N.I.	N.I.	N.I.	N.I.	N.I.	32	169
KMBC.....	315.6	274 ⁴	46.5	375	1,000	200	See 5, 8	See 13	0.84	200	N.I.	N.I.
Breslau.....	325	455	0.4

N.I. means no information available.

N.R. means no report received.

Wave lengths are in meters.

¹ Field intensities are in millivolts per meter.

² Data made public in a paper delivered before Boston Section, I.R.E., in March, 1932. An improvement in over-all performance was shown. No data received in response to questionnaire.

³ Height given in feet above grade level.

⁴ Lower 20 ft. of tower built of wood, the steel resting upon this wood.

⁵ Antenna built upon roof of building.

⁶ Reduced fading reported by listeners, but no engineering data available.

⁷ This is apparently the highest signal intensity at 1 mile ever measured.

⁸ Seasonal variations of several per cent are often noted in such measurements, according to reports.

⁹ New antenna in new location, therefore no comparative data between old and new antennas from same site.

¹⁰ 30 per cent increase in non-fading area.

¹¹ With low inverted L antenna and 50 kw. approximately 700 at 1 mile. With tower, approximately 1,500 at 1 mile. These values were not specifically reported; data obtained from field intensity curves submitted.

¹² Lower 120 ft. of tower built of wood, supporting steel work. ¹³ 32 to 40 per cent increase in signal throughout primary and secondary service areas.

¹⁴ Reports 4 db at 5 miles.

¹⁵ Listeners reports indicate fading audible at 180 to 200 km. Fading-free area doubled.

¹⁶ 25 per cent increase at 1 km over previous antenna operating at mode 0.63. For description of original antenna see Proc. I.R.E., July, 1929, p. 1178.

¹⁷ Depth in feet.

tion on dimensions, form, and type of supporting structure. The measured base resistances are plotted in Fig. 26.

The tabulation¹ as shown on page 756 pertains to vertical radiators of the oscillating-tower type.

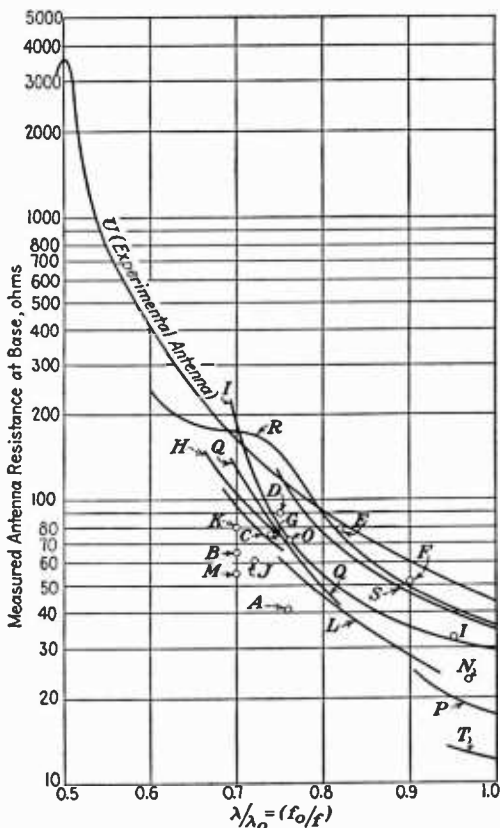

FIG. 26.—Base resistance of typical antennas.

Impedance measurements on several tower radiators of guyed and self-supporting types are shown in Fig. 27.²

33. Tuning and Coupling Systems for Broadcast Antennas. An antenna system practically always appears as a complex impedance at the point where power is introduced. The tuning and coupling apparatus

¹ LAPORT, E. A. *Electronics*, August, 1934, p. 240.

² CHAMBERLAIN AND LODGE, *loc. cit.*

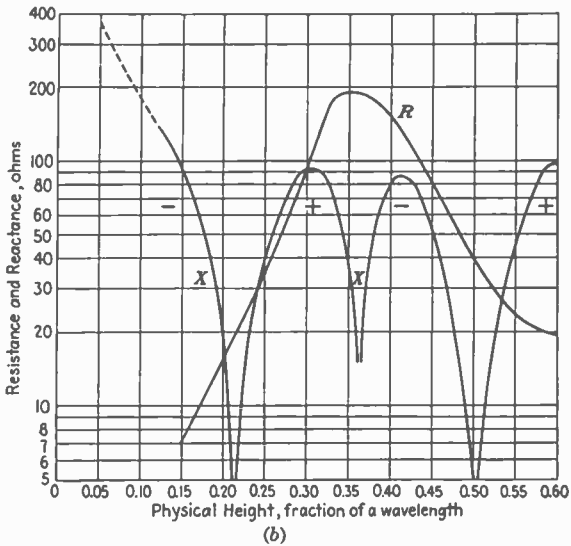
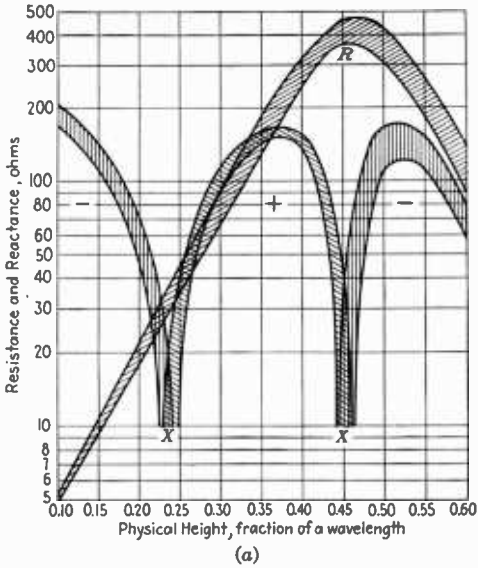

FIG. 27a and b.—Impedance of tower radiators.

design depends upon the impedance of the circuit which includes the antenna. To a very large extent, present practice is to locate the transmitting antenna at a considerable distance from the transmitter and to transfer the energy to the antenna with a transmission line. In such cases, the antenna-tuning apparatus includes transmission-line terminating apparatus. The actual arrangement of apparatus for this purpose depends upon whether a balanced or an unbalanced line is employed. The most frequently used antenna-tuning and transmission-line terminating systems are shown in Fig. 28.

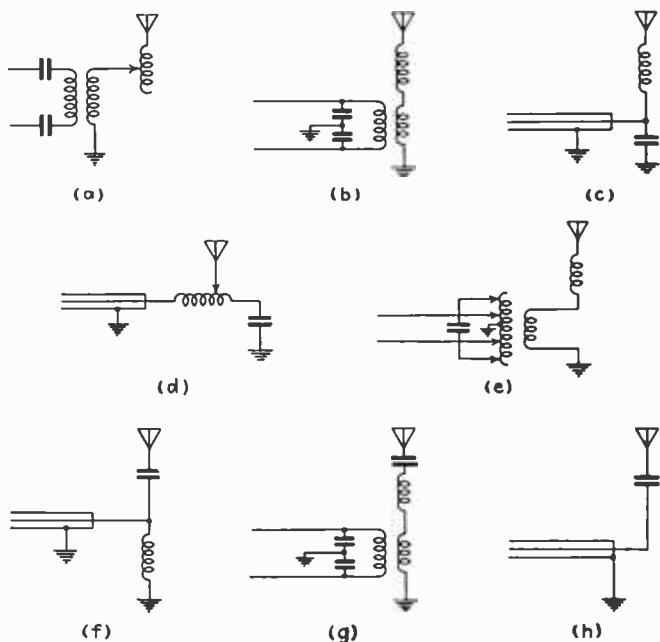

FIG. 28.—Antenna-tuning and transmission-line terminating systems.

34. Antenna-tuning and Transmission-line Termination Adjustments.

When an antenna is fed directly from a transmitter without a transmission line, it is a common practice to tune the antenna to resonance and then adjust the coupling to the transmitter by some form of continuously variable coupling. However, tuning the antenna to resonance is not an essential condition. The antenna tuning and coupling apparatus acts as a transforming circuit which matches the impedance of the antenna to the transmitter or transmission line, and in doing this the voltages are transformed so that the correct value is impressed between antenna and ground to give the desired current for rated antenna input power.

To terminate a transmission line in its characteristic impedance for most efficient power transfer over a line, the following methods are briefly outlined.

35. Balanced Two-wire Line. To prevent excessive radiation from the line itself due to unbalanced currents, mechanical and electrical symmetry must be maintained in the terminating equipment. When a grounded mid-point is introduced, especial care is required to assure that the impedances from both sides of the line or the equipment to ground are identical. To prevent energy losses in the line due to reflections of energy, the terminal impedance must be identical with the surge impedance of the line, which, at radio frequencies, is a pure resistance of the order of 400 to 700 ohms, depending upon its geometrical cross section. This characteristic impedance should be known, and may be measured, or satisfactorily calculated from theoretical formulas (see Sec. 6). Knowing the characteristic impedance of the line (Z_0), the simplest procedure for effecting a termination is as follows:

Calculate or measure Z_0 . Calculate the line current for any given power from $I_0 = \sqrt{W/Z_0}$, and the voltage across the termination under this same condition from $E_0 = \sqrt{WZ_0}$. If a tank-circuit termination is used, with inductive coupling to the antenna circuit, choose a value of capacitance across the line which has a reactance of the order of half that of the value of Z_0 (arbitrary) at the operating frequency. This capacitance must be accurately known so that its reactance can be determined and used to find the proper current through this condenser at resonance when the termination is correct. $I_c = E_0/X_c$.

Knowing now the values of I_0 and I_c , we can take their ratio, I_c/I_0 . Now, by inserting matched ammeters in series with the line at the entrance to the termination, and in series with the capacitance leg of the tank circuit, we know that, when the proper termination has been reached, the ratio I_c/I_0 , previously calculated, must prevail. To obtain a termination that has unity power factor, the tank circuit

FIG. 29.—Antenna adjustment.

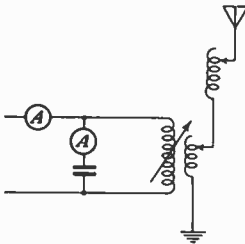

must be close to an antiresonant adjustment. After inserting the ammeters in circuit as shown in Fig. 29, apply power (the amount is unimportant at this stage, because the ratio I_c/I_0 is independent of power), and adjust the primary inductance until the line current I_0 is minimum, at which time the values I_0 and I_c are observed and the ratio calculated. If the ratio is too high, the coupling is too loose, or the impedance of the antenna circuit is too high. If the former, add more coupling turns or otherwise tighten coupling between tank and antenna circuits; if the latter, decrease the reactance of the antenna circuit by increasing inductance for a capacitive antenna or decreasing capacitance for an inductive antenna (both assuming that the antenna is not resonant). Retune the tank circuit and again measure the ratio of currents. If the ratio of currents is too low, the opposite procedure is followed, *i.e.*, the coupling is reduced or the antenna impedance increased, or both. By discrete steps and by careful adjustments, the exact ratio I_c/I_0 is quickly attained. The final test of correctness is to measure simultaneously the current in both

sides of the line at both input end and terminal end. For a short line, all readings will be essentially equal in a properly balanced line. In general, such adjustments are very critical. Voltage induced into the line by radiation from the antenna will disturb the balance of line current, even when the termination is correct.

By this method, a correct adjustment can be made by knowing only Z_0 and X_c .

This method, with slight modifications, can be adapted to the adjustment of all types of radio transmission lines used in broadcasting. It

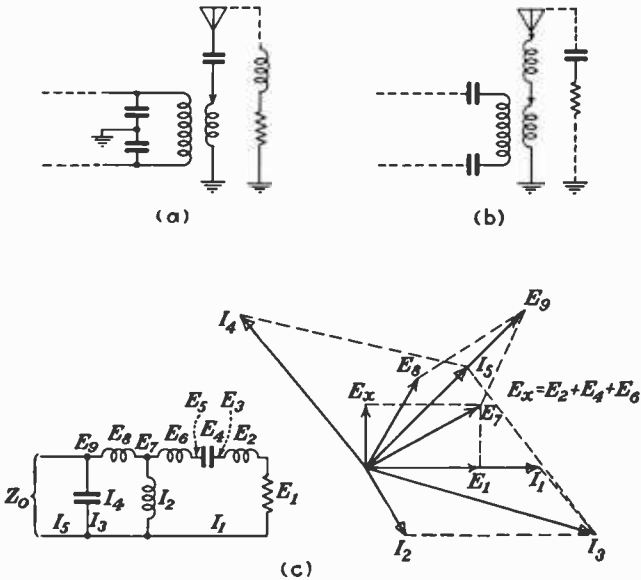

FIG. 30.—Balanced transmission-line terminations. Vector diagram of type (a).

requires less equipment and less information than any other system known to the author. When impedance-measuring apparatus is available, a termination adjustment can be made by adjusting the equipment until the measured impedance is equal to that of the line (assumed to have been previously measured), after which the terminal equipment is connected to the line.

The usual test of a correct line current is a uniform distribution of current along the line, and the absence of standing waves. With a concentric (tubular line), it is convenient to measure currents at the terminal and input ends only. With an open line, tests for absence of standing waves can be made with an incandescent lamp, a neon tube, or a running ammeter. With proper methods of terminating a line, measurements of

currents entering and leaving the line are sufficient to determine a correct adjustment. Broadcast lines are usually short, so that attenuation is hardly observable.

Some typical balanced line terminations and the conditions of final adjustment are shown in Fig. 30.

36. Concentric Transmission Lines. This type of line is the best form of unbalanced line. The outer tube (sheath) is at zero potential. The characteristic impedance of a concentric line is lower than that of the open-wire type, running from 50 to perhaps 150 ohms in common practice. The terminating network must also be unbalanced, as shown in Fig. 31. For the calculation of the characteristic impedance of concentric lines, see Sec. 6.

37. Mechanical Designs for Broadcast Antennas. With the advent of tower radiators, the radio engineer has very little association with the mechanical design of the antenna. The exodus of multiwire aerials in favor of single-wire systems, and the replacement of guyed masts with self-supporting towers, have greatly simplified the mechanical design problems.

Where supported wire antennas are used, the supporting towers should be spaced as far as practical, so as to be well removed from the field of the antenna. The natural frequency of the towers, if steel, should be as distant as possible from the operating frequency to prevent induced oscillating currents of high amplitude in them, which not only increase the losses of radiation power, but deform the radiation pattern in undesirable ways. To remove suitably the natural frequency of a tower from the vicinity of the operating frequency, it is often necessary to sectionalize the tower by breaking up the length of continuous metallic circuit with insulators. Insulators are placed under each leg of the tower at ground, and, on occasion, the tower is broken into two or three electrical sections by insulators disposed throughout the length of the tower. One method is to omit the insulators under the legs at ground and to place them about 100 ft. above ground. The insulators have maximum effectiveness when they have lowest capacitance. The tower itself, when sectionalized, must be designed for minimum capacitance between insulated sections.

The tower loadings are usually based upon the actual horizontal pull from the antenna with a liberal safety factor, together with the maximum reasonable conditions of ice and wind loading. The usual form of antenna-supporting tower used for broadcast antennas is designed for a horizontal pull at the top of 5,000 lb., together with the equivalent of a 100 m.p.h. wind against 1.5 times the projected area of the tower, taken in the same direction as the load pull. Towers built to such specifications have an impressive record for reliability.

The triatic, which holds an antenna between the supporting towers, must be carefully assembled in order to have the strength for which it is designed. The dead parts of the triatic should be broken into short electrical sections by strain insulators of low capacity, or by series of ordinary compression insulators. The sag in the triatic is made such that the normal down-pull of the antenna and the weight of the triatic do not transfer an unsafe pull on the towers. The horizontal pull is reduced by allowing greater sag in the triatic, and, in order to maintain a constant maximum strain on the towers, the triatic is passed over a pulley at the top of the tower and counterbalanced at ground with a weight.

Any abnormal weighting of the antenna, such as sleet formation, pulls the cable away from the counterweight to increase the triatic sag.

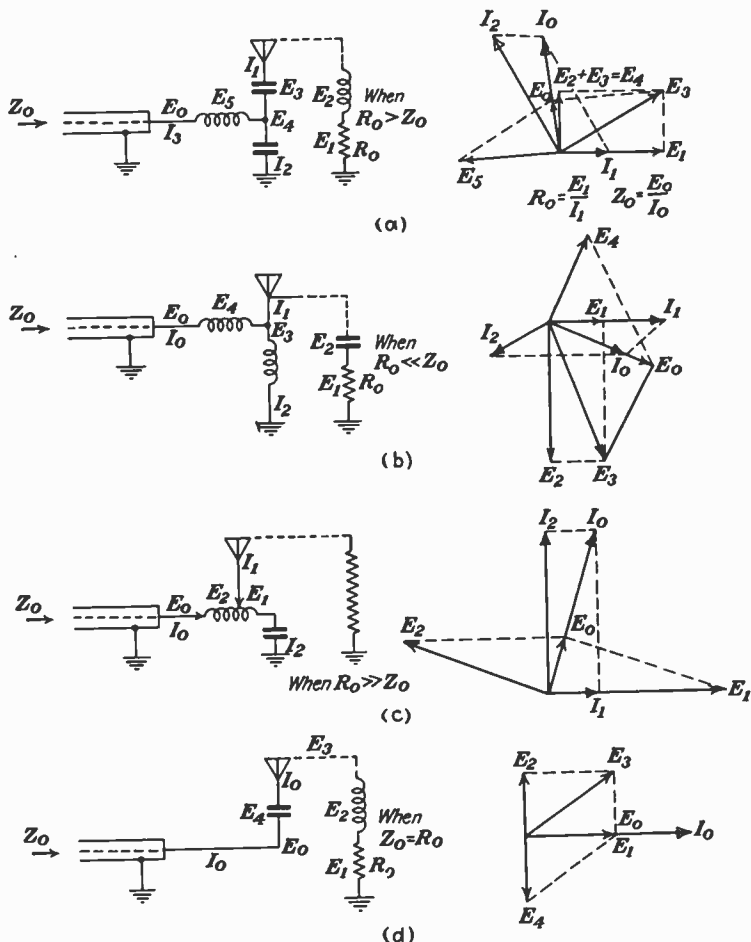

FIG. 31.—Concentric transmission-line terminations.

The antenna down-lead is usually anchored to a heavy block buried directly beneath it. The down-lead is separated from the building housing the transmitter or the antenna-tuning equipment, and the antenna connection taken off at the top of the down-lead insulator. The

upper end of the antenna must in all cases be insulated for high voltage, the actual voltage depending upon the power transmitted. With high antennas, the same provisions must be made for insulating the lower end also. For this purpose, special cylindrical low-capacity insulators are available, equipped with rain shields and corona shields. The antenna conductor should be stranded cable of adequate tensile strength for the application. If the antenna includes a flat top, the extra strength required for duty in the triatic is obtained by employing either phosphor-bronze cable or copper-clad steel cables rather than going to oversized cables of copper. Steel cable is used for the triatic.

To permit lowering and raising the antenna when required, the triatic cable continues down from each tower to a winch suitably located. When the towers are insulated, the antenna cables must also be insulated.

38. Tower Lighting. High antennas in general are a hazard to aviation, and some means for marking the towers at night is now employed widely. Recommendations have not yet been standardized, and it is frequently difficult to obtain comprehensive detailed specifications on what to use in a particular case.

Forms in current use include:

1. Floodlighting the towers from the ground, or from a point some distance from the ground, together with suitable painting.
2. Distributing a number of red lamps along opposite corners of the tower so as to essentially outline it in the darkness.
3. An elaboration of the preceding method whereby the top lights are especially prominent and blink periodically (near airports).
4. Using a strong red rotating beacon light from near the ground as a warning of a dangerous area, but without other lights on the antennas. The lighting of insulated towers requires that the electrical equivalent of insulated sections be maintained in the lighting wiring, and isolation filters have been used opposite each sectionalizing insulator in the towers.

In lighting the high tower antennas, a motor in the ground side of the circuit has been coupled to a self-excited generator mounted above the base insulator in the tower by a coupling shaft of insulating material. The tower lights are connected to the generator in the tower.

Electrical lighting is widely used in the United States. Gas lighting is extensively used in Europe. One great advantage of gas is the ease with which the gas-circuit sections can be insulated.

Recommendations for tower lighting may be obtained from the aviation operating companies or from the U. S. Department of Commerce.

39. Lightning Protection for Antenna Systems. A large antenna system will have very high voltages induced into it by distant lightning so that adequate lightning protection is one of the main design considerations. During snow and dust storms, also, high static potentials are collected by the antenna.

An antenna having a metallic connection to ground will offer no problems in the collection of static potentials. The charges will leak off to ground as rapidly as they accumulate. An antenna with a series condenser, however, requires special attention to draining the antenna without interfering with the tuning equipment and its adjustment. A drain coil of several thousand ohms reactance at the operating frequency is connected between the antenna and any tuning equipment, directly to ground. With a properly designed drain coil, there will be

practically no power loss. Similar drain coils are frequently bridged across insulated sections of the supporting towers.

With lightning, the voltage in the system builds up so rapidly that the drain circuits are ineffective for the first few microseconds, and spark gaps are the usual form of protection in such conditions. High-speed gaps (spherical or hemispherical) of large current capacity are connected between antenna (also insulated tower) and ground, adjusted to break down and discharge the antenna before the spark can seek its way to ground through more vulnerable paths. Frequently a power arc follows and is sustained until other protective devices can operate to interrupt the transmitter momentarily. Open-wire transmission lines require similar protection for safety to equipment when there is no direct metallic connection to ground in the system (see Fig. 32).

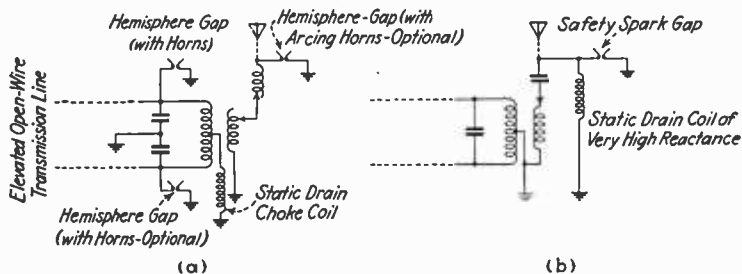

FIG. 32.—Lightning and static draining protective circuits. (a) For elevated transmission line and an antenna with continuous circuit to ground through inductance; (b) for line with direct ground and antenna with series condenser.

40. Directive Broadcast Antennas. Broadcast directive antennas use two vertical radiators in most cases. When very particular problems present themselves, it may be necessary to employ three, and occasionally four, radiators in the array. In general, however, two radiators will provide a wide variety of directional characteristics depending upon the spacing between them and the relative amplitudes and phase relations of their currents. Changes in the impedance of the separate radiators due to changes in ground conditions affect the current amplitudes and phase relations to some extent, which in turn modify the directional pattern of the system. When this occurs to any considerable extent, some special means is necessary to stabilize the radiation pattern, especially when complete suppression of radiation in any particular direction is important. There are methods used to stabilize the array so that the ordinary variations are neutralized.¹

There are two main types of directive antennas: (1) those designed to give the maximum signal in a certain direction; (2) those designed to suppress radiation in a given direction. Directional antennas for broadcasting employ vertical radiators for elements of the array. It is important that the individual radiating elements be very similar or identical,

¹ KEAR, F. G., Maintaining the Directivity of Antenna Arrays, *Proc. I.R.E.*, July, 1934; RODER, H., Elimination of Phase Shifts between the Currents in Two Antennas, *Proc. I.R.E.*, March, 1934.

and that they transmit no horizontally polarized energy (in cases where strict suppression of radiation is essential). It is also important to employ transmission lines for feeding the system which do not radiate, and to shield the transmitter house so that there is no appreciable radiation directly from the transmitter. In type 2 antennas, it is essential that all radiation take place from the antenna. Leakage radiation from coupling lines and the transmitter, while ordinarily of negligible magnitude, might be many times that desired in a null direction.

41. Measurement of Antenna Input Power for a Directive Array. If the directive array is energized from one point, such as when the second radiator is excited by the field of the first, the resistance of the system, as seen from the point where power is introduced, can be directly measured by any of the familiar methods and the input power measured at the same point by the I^2R method. When the radiators are separately energized, the direct measurement of input power may be difficult and impractical. When exactly the same voltage is required at the input to the transmission lines so that they can be connected in parallel at the coupling point to the transmitter, the resistance at the input to the transmission lines can be measured and the power determined from the current entering. In most cases, power input to the antenna is determined by the indirect method, taking into account the power input to the final amplifier and the known efficiency of it.

MARINE TRANSMITTING ANTENNAS

42. Limitations to Shipboard Antennas. There has been little change in the design and construction of shipboard antennas for the reason that there is little choice available. The limited space and the presence of stacks, derricks, etc., place severe limitations on the mechanical arrangement of the antenna. For that reason, shipboard antennas have been but slightly modified in many years. The outstanding change is the gradual abandonment of multiwire forms for the single wire.

43. Modes of Operation. Large vessels in the passenger business now have several transmitters in their radio rooms. For long-wave ship traffic at moderately high powers the ship's antenna has a very short electrical length, which gives a nearly uniform distribution of voltage throughout its length. Such antennas must be insulated equally at all points.

For intermediate-wave operation, ship antennas have fairly good characteristics and efficiency. The antennas on the larger ships have fundamental wave lengths somewhere near the intermediate marine band, so that they operate essentially as quarter-wave systems. For high-frequency telegraph operation, it is now quite the usual practice to use the main ship antenna, operating it at or near one of its harmonics.

A system used on some of the best known American ships is that shown in Fig. 33. This not only permits utilizing the main antenna for all the marine frequencies but provides a convenient means for simultaneously operating the short-wave and intermediate-wave transmitters. For long-wave operation both halves of the antenna are connected in parallel.

Ships having commercial telephone services usually employ separate half-wave dipole antennas fed by terminated transmission lines. These are mounted anywhere on the ship where there is space, frequently using the stacks for support, and often suspended by means of insulator strings from the triatic of the main antenna. Where a half-wave dipole antenna

is used, it is necessary to have a different antenna for each operating frequency.

44. Antenna Characteristics. Shipboard-antenna characteristics vary over extremely wide ranges because of differences in mechanical forms and dimensions, the effects of other conductors in the field on the antenna, the nearness of stacks, etc. For example, antenna resistances in the intermediate- and long-wave bands range from 3 to 10 ohms. Static capacitances range from 400 to 1,200 $\mu\mu\text{f}$. Fundamental wave lengths range from 200 to 500 meters. It is difficult to specify typical antenna characteristics beyond these figures.

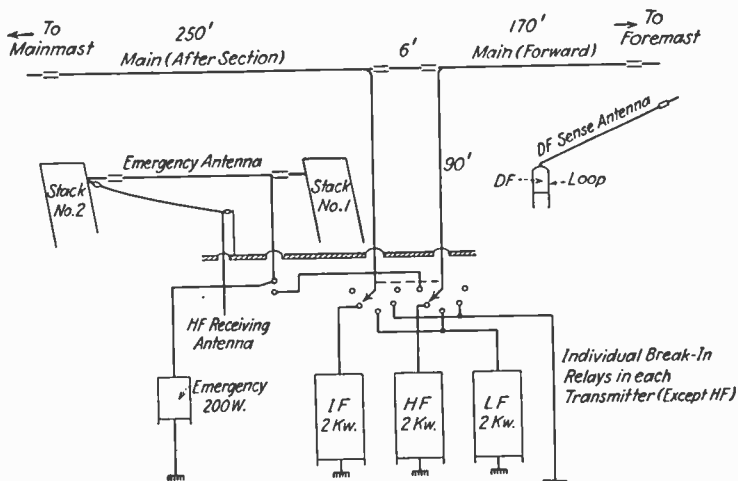

FIG. 33.—Modern marine antenna (SS. Washington and SS. Manhattan).

45. Construction of Ship Antennas. The essential mechanical requirements for an antenna design are extreme ruggedness and reliability under all the severe weather conditions met at sea. Heavy phosphor-bronze stranded cable is employed for the triatic, preferably for the entire antenna. The use of an inverted L or a T is principally determined by the layout of the ship, and the location of the radio room with respect to the antenna. Regular ship-rigging construction is employed. The antenna must be easily lowered and raised. On some ships the antenna must be lowered to permit operating the derricks.

The essential electrical requirements are:

- A maximum of antenna size for a given available space.
- Maximum possible clearance of ship's rigging, bridge, stacks, etc., to reduce losses by induction.
- Liberal high-voltage insulation throughout the length of the antenna, including the deck insulator.
- Avoidance of sharp points, broken strands, or V-bends which would become corona discharge points.

e. Positive firm electrical connections between different sections of the antenna and at the entrance bushings.

f. The use of a single-wire system.

g. The avoidance of the use of hemp guys and stays at points of high-potential gradients near the antenna wire and insulators where rapid deterioration due to burning would result.

46. Shipboard Receiving Antennas. A separate wire receiving antenna is now common practice on shipboard for short-wave reception. For intermediate- and long-wave reception, the main transmitting antenna is quite generally used, connection of the receiver to the antenna being made through a break-in keying relay when the transmitter is not actually transmitting, and to ground when the transmitter is exciting the antenna.

The sense antenna used in conjunction with the direction finder is a separate wire and used only for that purpose.

Broadcast receiving antennas may occupy any remaining space available on the ship.

NON-DIRECTIVE ANTENNAS FOR HIGH-FREQUENCY TRANSMISSION

47. Types of Antennas in Current Use. Antennas for the circular diffusion of energy at high frequencies approach very nearly the fundamental ideal forms. For a given form of antenna for a given performance, the mechanical size is proportional to the transmitting wave length; and when this becomes comparatively short, the mechanical aspects of the problem become very simple.

1. A fundamental and widely applied form of high-frequency transmitting antenna is the half-wave dipole. It can be employed in a variety of ways by changing its orientation in space and its position with respect to ground. When located in hypothetical free space, its electrical values are constant; but, when located within a few wave lengths of real earth, as in practice, they are influenced by orientation and position.

When placed vertically with respect to the surface of the earth, a half-wave dipole transmits vertically polarized fields in every direction. When mounted horizontally, the radiated field is horizontally polarized in any direction perpendicular to the antenna wire, while it is vertically polarized in the directions of the wire. In intermediate directions, the fields will have both vertically and horizontally polarized components, a state called *elliptical polarization*. These conditions have a bearing upon the propagation characteristics of radiation in different directions.

2. A second fundamental type of high-frequency transmitting antenna is a straight wire operated at one of its harmonics. Where one antenna is used for both low- and high-frequency transmission, as on shipboard, we have a case where, at high frequencies, the antenna may be several times the length of a half wave. If such an antenna is vertical, the radiation is uniform in all horizontal directions but of rapidly varying intensity in the vertical plane. The general characteristics were discussed and described in a preceding section.

3. A third important type of non-directional antenna for high-frequency transmission is the vertical wire with the current in adjacent dipole sections cophased. Instead of the current-distribution characteristic of the antenna operating at a natural harmonic, where the current in each successive half-wave section is reversed in direction, this antenna

has currents all flowing in the same direction. This is achieved by using antiresonant coils or networks at each current node in the system except the extreme ends. A vertical antenna of this type produces a high degree of radiation concentration at angles close to the horizontal, a characteristic of great value in efficient long-distance transmission.

48. Feed Methods for High-frequency Antennas. 1. Pure Current Feed. A balanced current-feed system for energizing a divided half-wave

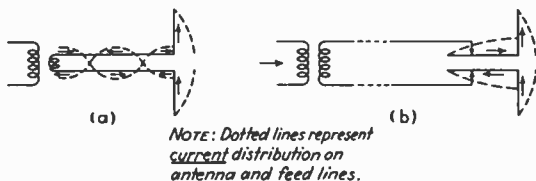

FIG. 34.—Current feed for half-wave dipole. (a) For balanced line; (b) for balanced terminated line.

dipole is shown in Fig. 34 in two forms, where (a) is for the use of a balanced oscillating transmission line throughout, and (b) is for a balanced terminated transmission-line system, the termination being made by means of connections to proper points on a balanced quarter-wave transformation section.

2. Pure Voltage-feed System. Three forms of the pure voltage-feed system are shown in Fig. 35, where (a) is the balanced system using

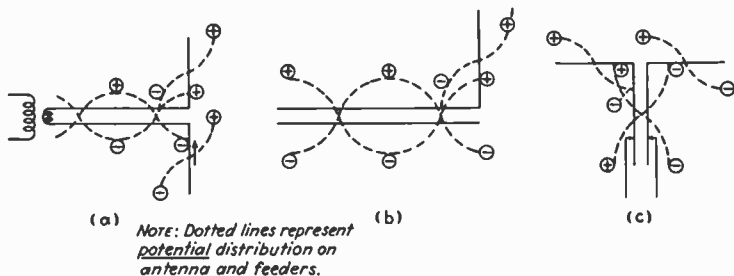

FIG. 35.—Voltage-feed systems (see text).

resonant line feeder, (b) the unbalanced system using resonant line feeder, and (c) a balanced system with balanced terminated transmission line, the antenna impedance being matched to that of the line by means of a resonant line transformer. In the case of (b), the feed line can be a concentric tubular system, the antenna being connected to the inner conductor.

3. Voltage Feed from Terminated Concentric Transmission Line. A recent method of voltage feeding a half-wave dipole from a terminated concentric transmission line is represented schematically in Fig. 36. Here, the concentric line is made to have a characteristic impedance equal to the radiation resistance of the antenna at the current antinode

(73.2 ohms, if the antenna is several wave lengths above ground). A wire, one-quarter wave length long, projects beyond the end of the outer conductor parallel and close to the extension of the inner conductor which continues on to become the antenna. If there is essentially zero radiation resistance due to the opposed quarter-wave sections, these act as a transformer to transfer the radiation resistance at the current antinode of the antenna to across the end of the concentric line, thus effectively terminating the latter.

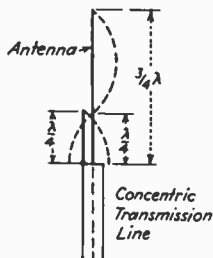

FIG. 36.—Use of quarter-wave wire as matching transformer.

the wires of the feed line to bridge the proper impedance in the antenna, there results a change in the characteristic impedance of the line in that portion which makes a perfect termination theoretically impossible, though satisfactory practical adjustments are obtained. For optimum line balance, exact symmetry of connection is required. The location of the connection points is critical. The adjustment is dependent upon the location of the antenna with respect to ground and other conductors, the effects of insulator caps, etc.

5. *Other Methods of Terminating Open-wire Transmission Lines in Antennas by Means of Networks.* There remain several methods for terminating a balanced transmission line in an antenna by means of networks of inductance and capacitance. The antenna has a certain complex impedance when viewed from any given feed point. To match this impedance to the line impedance, a suitable transforming network is designed.

DIRECTIVE HIGH-FREQUENCY TRANSMITTING ANTENNAS

In this branch of engineering we find the antenna art at its best. Unhampered by serious mechanical obstacles, full advantage may be taken of electrically long radiators, and extended arrays of many such radiators, for obtaining a very high degree of radiation concentration in a desired direction. Present-day high-frequency directive antennas project a beam of electromagnetic energy which is analogous in fact to the beam of a searchlight.

Out of the unlimited variety of possible forms of antenna arrays which are suitable for use in directive radio transmission, experience has brought about a selection of a few types which have exceptional electrical performance and which at the same time have other advantages such as low initial and maintenance costs, ease and stability of adjustment, and physical ruggedness. It seems that each of the major commercial radio

4. *Terminated Transmission Feed.* At high frequencies it is possible to obtain a satisfactory termination of an open balanced transmission line by connecting the extremities of the line directly to the antenna wire as shown in Fig. 37. The connections are made symmetrically to those points on the antenna which show an impedance as nearly as possible like that of the characteristic impedance of the transmission line. In spreading

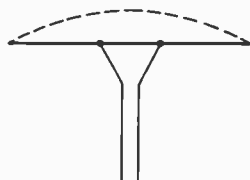

FIG. 37.—Method of connecting line to radiator.

engineering organizations of the world has evolved a system of its own. We find such distinctive systems as the Marconi-Franklin beam, the Telefunken "pine-tree" antenna, the SFR-Chireix-Mesny diamond-grid radiator, the A. T. & T. Co.-Sterba antenna curtain and the RCA broadside, and harmonic-wire end-fire projectors.

The principles of modern directive antenna arrays are easily grasped, once the mechanics of wave interference are understood. However, the detailed design of any one of these systems is an engineering task of formidable proportions. Final adjustments and corrections after erection must be kept to a minimum, because of the great difficulties of making even minor changes once the rigging is complete. In design work of this sort experience plays a prominent part. The theoretical aspects of design have been discussed in a number of papers, of which some are listed in the bibliography.

49. Gain of Directive Antennas. When the radiant energy (which, with a simple antenna, would be widely diffused in space in every direction) is collected and focused into a narrow unidirectional beam by a directive array, there is a gain in effective power of transmission in the favored direction. Gain is usually reckoned in comparison with the field intensity from a single half-wave dipole located at the mean height of the array. On this basis, some present-day directive arrays have gains as high as 22 db or a power gain of 158. Increases in gain result from increases in the radiation area of a broadside array, and with the length of a harmonic wire array.

50. Typical High-frequency Directive Antennas. The following description of typical directional antennas does not exhaust the various types but is representative.

a. The RCA Model A Broadside Antenna.¹ The schematic electrical circuits are shown in Fig. 38. The system consists of a large number of

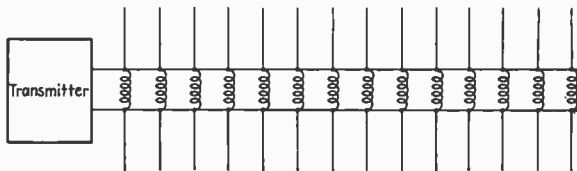

FIG. 38.—RCA model A broadside antenna.

vertical pairs of colinear wires arranged in a plane and energized from a feed bus (transmission line) running through the middle. The feed bus has the series inductance and the parallel capacitance neutralized so as to have the characteristics of infinite phase velocity. All the radiators are thus energized in the same phase, and the direction of maximum transmission is normal to the plane of the radiators. In this system, the over-all length of the radiators is 0.225 wave length, the spacing between radiators is 0.125 wave length, the maximum length of bus on each side of a feed point is 1.5 wave length, and the volt-ampere ratio between bus and radiators is 5. Such a system can have any desired length with progressive improvements in gain and directivity. Another identical array in a second plane can be used as the reflector for unidirectional

¹ CARTER, HANSELL, and LINDENBLAD, *loc. cit.*

transmission. Gain with one bay with directly energized reflector is approximately 10 db.

b. **RCA Models B and C Harmonic Wire Antennas.** The geometry of these antennas is shown in Fig. 39. It was seen in Fig. 14 how the amplitude and direction of the major radiation lobe changed as the length of the wire was increased. In this system, where each radiating wire is 8 wave lengths long, the major lobe has an angle of 17.5 deg. to the wire and all secondary lobes are of relatively low amplitude. By using another radiator parallel to it and spaced 0.872 wave length and energized in opposite phase, one side of the forward and one side of the backward

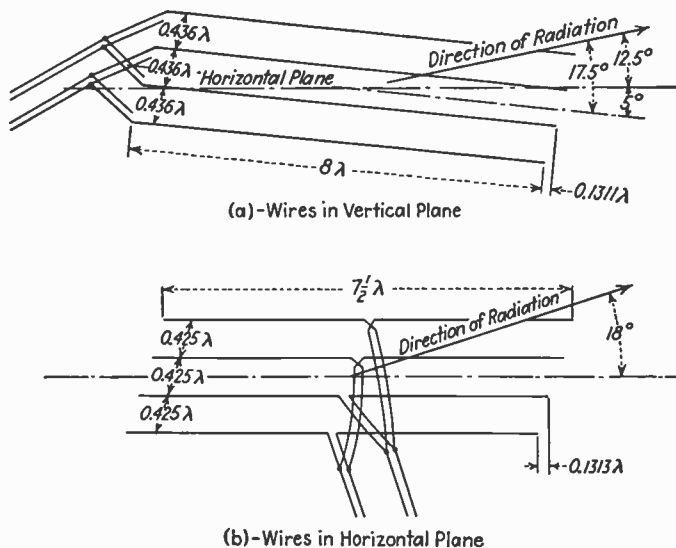

FIG. 39.—RCA model B & C harmonic wire antennas.

radiation lobe are eliminated. By adding two more such wires as reflectors (making now four parallel radiators spaced 0.436 wave length, and staggered 0.131 wave length), the backward lobe is eliminated and the radiation concentrated in one very sharp forward lobe. In the model B, the wires lie in a plane vertical with respect to the ground and transmit vertically polarized waves. In the model C, the wires lie in a horizontal plane and radiate horizontally polarized waves. With these antennas, the gains over a single half-wave dipole are approximately 12 and 12.4 db, respectively.

c. **RCA Model D Antenna.**¹ The layout of the model D projector (one bay) is shown in Fig. 40. In this system, two major radiation lobes (one from each side of the V) have a common direction and reinforce each other while the other two lobes are canceled, as in Fig. 41. By adding another V to the rear as a reflector, the backward lobe of Fig. 41 is

¹ *Ibid.*

removed, giving a very sharp unidirectional beam of radiation. It has a gain of 16 db for one bay. With two sections, the gain increases to approximately 19, with three to nearly 21, and with four, to approxi-

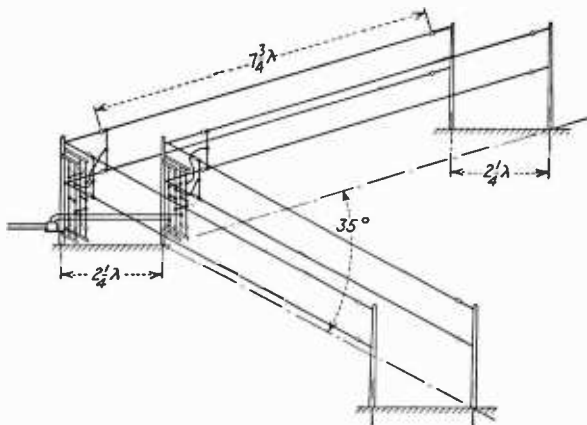

FIG. 40.—RCA model D antenna.

mately 22 db. The last figure is a power ratio of 156 over that for a single half-wave dipole. In practice, the point of the beam is focused at approximately 14 deg. above the horizon.

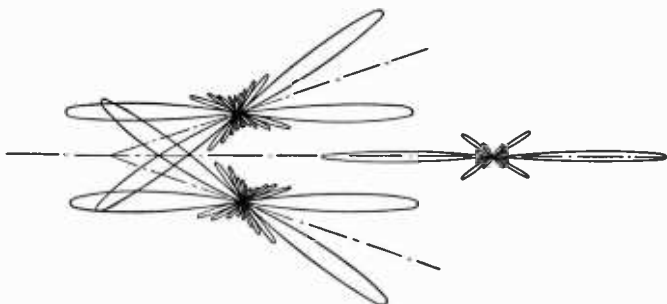

FIG. 41.—Pattern of Fig. 40.

The reference¹ contains a complete engineering and theoretical treatment of the development of these antennas.

d. **The Telefunken Directional Antenna.** The arrangement of this antenna is shown in Fig. 42.² It consists of 64 horizontal dipoles in two vertical planes of 32 each. In each of the two planes there are four lines

¹ *Ibid.*

² BAUMLER, KRUGER, PENDL, and PFITZER, *loc. cit.*

of eight dipoles end to end. The two planes are separated one-quarter wave length, and the second (reflector) is energized by radiation from the first. The dipoles are voltage fed from the potential antinodes of balanced resonant transmission lines, unphasing being obtained by attaching each successive pair of dipoles to alternate wires of the trans-

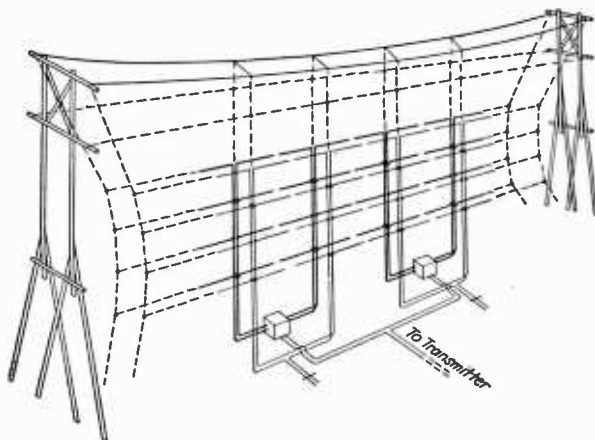

FIG. 42.—Telefunken directional antenna.

mission line. As with all horizontally polarized wave systems, there is zero electric intensity along the ground, but the beam peaks in the vicinity of 10 deg. above the horizontal, with a secondary lobe of 25 per cent peak intensity maximum at 45 deg. The horizontal pattern as measured is shown in Fig. 43.

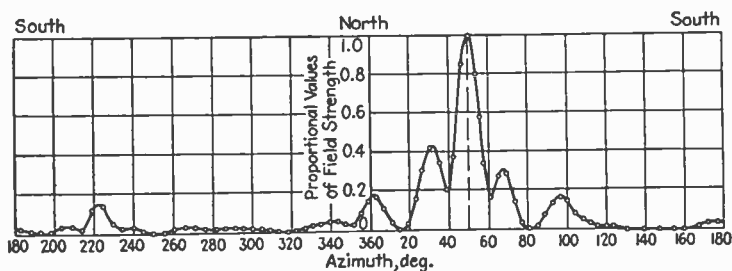

FIG. 43.—Horizontal pattern of Fig. 22.

e. T. Walmsley Antenna of the British Post Office. In Fig. 44 are shown the elements of the Walmsley beam antenna. The radiators arranged as shown produce a bidirectional beam broadside to the array, which usually consists of 48 energized vertical pairs. As a reflector, a curtain of insulated half-wave dipoles is placed one-quarter wave length

behind the array, excited by the backward radiation. A unidirectional beam is obtained in this manner. Due to the lower current amplitudes in the reflectors as compared with those in the directly energized radiators, there is not a complete suppression of backward radiation, and there is a backward lobe with an intensity 22 per cent of that of the forward beam.

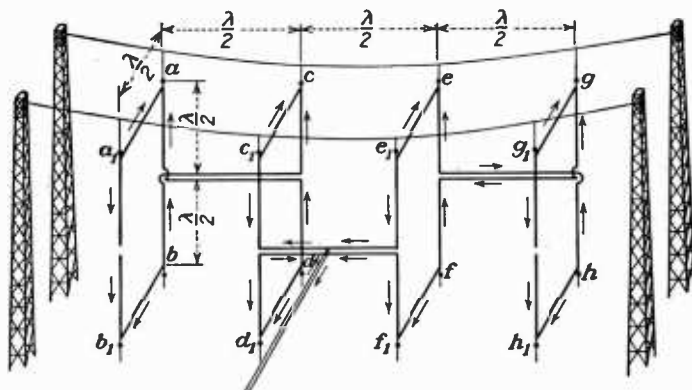
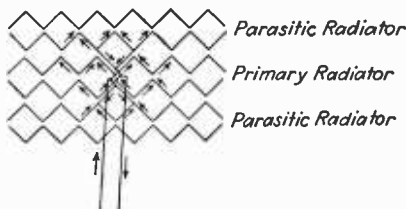

FIG. 44.—Walmsley beam antenna of British Post Office.

f. Marconi-Franklin Beam Antenna. This antenna system, one of the first employed for high-speed short-wave point-to-point communication, consists of a front curtain of vertical radiators, each consisting of several cophased dipoles in series, and another curtain of reflecting wires of the same construction situated one-quarter wave length to the rear. There are twice as many reflectors as radiators. The reflectors are radiation



To Transmitter

FIG. 45.—Chircix-Mesny beam.

excited. In plan view, two reflectors and one radiator form the points of an equilateral triangle. Cophasing of successive radiating dipoles is obtained by winding the intermediate half-wave sections (wherein the currents are reversed) into a small non-radiating coil or web. Reflectors are energized by radiation from the front radiator curtain. A two-bay array has a gain of approximately 18 db.

g. Chireix-Mesny (French) Beam. Another early type of directive antenna for short waves is that used in France, shown schematically in Fig. 45. Each dipole section forms one side of a square. The currents in all the diagonals have cophased vertical and horizontal components. A similar reflecting sheet is placed one-quarter wave length behind the radiator sheet and is energized by radiation to give an essentially unidirectional pattern broadside to the plane of the radiators.

h. Bell System-Sterba Directive Antenna Array. This system, used for some time in the transatlantic telephone service on short waves, is a

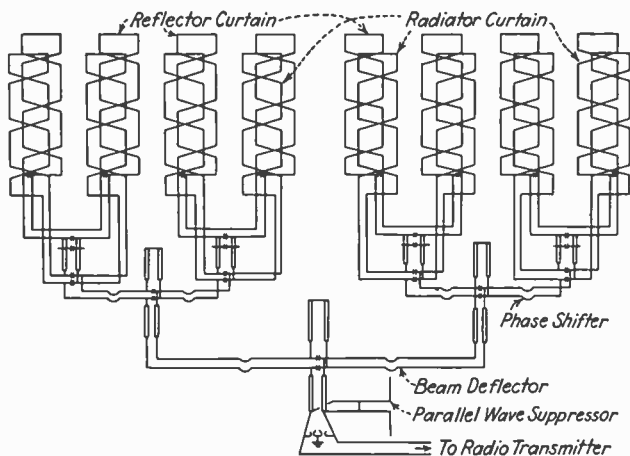

FIG. 46.—Barrage antenna of vertical radiators.

barrage antenna employing a front curtain of several vertical radiators spaced one-half wave length, with unphased currents, and a similar reflector curtain, directly excited by transmission lines. One arrangement of an antenna of this type is shown in Fig. 46, together with transmission lines, phasing devices, protective items, and sleet-melting circuits. The unit element in this array, as shown, is a *panel* 1.5 wave length high and 0.5 wave length wide. The current distribution for one type of panel is shown in Fig. 47. The crossovers constitute balanced non-radiating lines, while currents in all the verticals are unphased. Radiation from the unbalanced horizontal wires at top and bottom is reduced to negligible proportions by having equal and reversed current areas, the current nodes occurring in the middle of these horizontals. In the typical design (two bays supported by three steel towers), gains of approximately 20 to 23 db are achieved.

51. Loop-type Directive Transmitting Antennas. The principal use of loop transmitting antennas has been in connection with radio beacons for guiding ships and aircraft. Some applications are described in the Aircraft Radio section of this Handbook.¹

¹ DIAMOND, H., and F. G. KEAR, A Twelve-course Radio Range for Guiding Aircraft with Tuned-reed Visual Indication, *Proc. I.R.E.*, June, 1930; PRATT, H., Field-intensity

52. Mechanical Design of Directive Antenna Arrays. The mechanical design of a directive array for high gains is as remarkable as the electrical design. Dimensions of electrical portions must be rigorously correct and must remain so, even under conditions of severe wind and ice loading. High-gain broadside projectors are complicated webs of conductors and supporting wires, and rigging them is a specialty cultivated only by experience. The long-wire projectors are simpler, mechanically, and therefore cost less for a given gain.

Self-supporting steel towers and also guyed wood masts are used for support. General practice is to locate the active portions of the antenna at a mean height of the order of 1 wave length or more. Antennas employing vertical radiators composed of several colinear half-wave sections require towers sometimes approaching in height those used for broadcasting applications. Tower designs often include a cross arm of sufficient length to permit hanging the radiator curtain from one end and the reflector curtain from the other.

The rigging is always made up of wires, the supporting wires being broken into very short electrical lengths by insulators so that they have negligible electrical influence. Main supporting wires, usually in the form of catenaries, are under great tension and are so maintained by counterweights and anchors. Means for equalizing tensions in all parts of the rigging are important.

Insulation of the radiators with tension-type low-capacity insulators without metallic caps is practical with modern ceramic materials. Compression-type insulators assembled in strings have been used widely for this purpose also. Break-up insulators in the rigging are usually of the compression type. The voltage at the potential antinodes of the radiators depends upon the power transmitted and the number of radiators depends upon the power transmitted and the number of radiators in the array. Liberal insulation tolerances are necessary.

Ice accumulation on the array is minimized by sleet-melting provisions, whereby large currents at commercial frequency are circulated

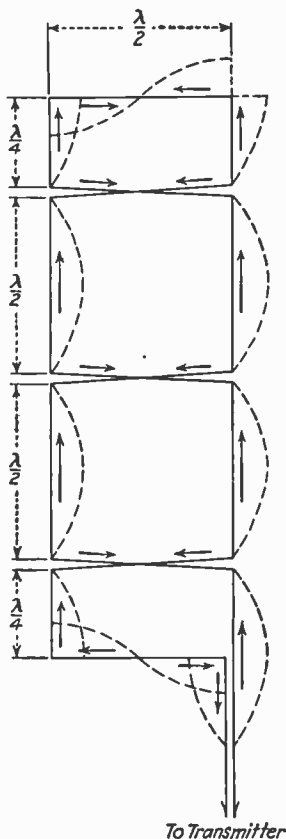

FIG. 47.—Current distribution in barrage antenna panel.

through the conductors whenever there are ice-forming conditions. To pass heating currents through the wires when the antenna is in service requires by-pass circuits of very high impedance to the high frequencies and very low impedance to 60 cycles. Antiresonant networks or the equivalent transmission-line loop circuit fulfill this requirement.

The orientation of an antenna of high directivity is a matter of precise surveying. The peak of the beam is pointed along a great circle to the reception point. By adjusting the relative phases of various bays of an array, the direction of the beam can be controlled within a few degrees.

Transmission lines for transferring power to the antennas are of both concentric and open-wire types. The latter are cheaper and are extensively used. Transmission-line sections are also employed as trans-

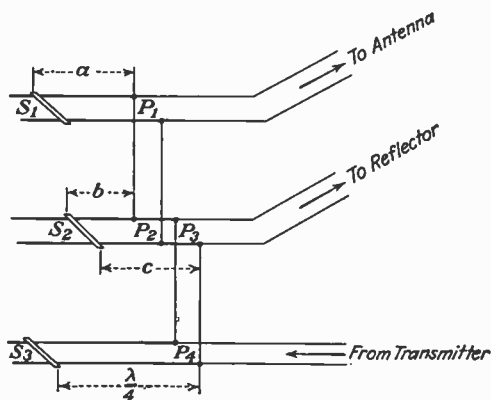

FIG. 48.—Transformer made up of transmission-line section.

formers for obtaining proper relative phases and amplitudes of currents in the various conductors. An example of such a transformer circuit is shown in Fig. 48.¹ With the several types of antennas, switching means are often provided whereby the reflector and radiator screens may be interchanged electrically, thus reversing the beam 180 deg.

ANTENNAS FOR RECEPTION OF ELECTRIC WAVES

53. Non-directional General-purpose Receiving Antennas. The ordinary receiving antenna for general purposes is a single wire, of length more or less proportional to the wave lengths to be received, but usually only a small fraction of these wave lengths in physical length. It takes all the conventional forms, inverted L, T, or vertical. In some cases the antenna is resonated for reception of a particular wave length, but more commonly it is aperiodic by being terminated at the point where receiving apparatus is located in a resistance. One or more receivers of high-input impedance are bridged across the terminating resistance, and selectivity is obtained in the receiving apparatus.

¹ CARTER, HANSELL, and LINDENBLAD, *loc. cit.*

For optimum reception for waves arriving from some preferred direction, account must be taken of the wave tilt and the wire so oriented as to bridge the greatest potential difference in space, which gives a maximum voltage across the terminating resistance. It is well known that any antenna that is not a simple vertical has some inherent directivity, though it may be very small. Where absolute non-directivity is not essential, advantage should be taken of the various simple means for obtaining optimum response to waves coming from preferred directions. Of these, one is to incline the wire at an angle normal to the wave tilt in the vicinity of the receiving site, and another is to locate the wire above any other wires or metallic structures in the vicinity. Field-intensity measurements have shown that the field intensity under or near overhead wires and metallic structures falls to a small fraction of its free-space value when these conductors form *apertures* which are smaller than a wave length in dimensions. However, local electrical noise is not similarly influenced. To obtain a favorable signal-to-noise ratio, it becomes important to have the antenna high above any other parasitic conductors in the vicinity.

54. Directive Receiving Antennas.—Except for mobile stations and home-broadcast reception, there are few cases where some degree of directive discrimination at the receiver is not desirable or even necessary. In the fixed point-to-point services, highly directive receiving antennas are used for both long- and short-wave reception.

There are four main types of relatively high directivity receiving antennas, as follows:

- a. The loop (frame) antenna which can be rotated, or the fixed crossed-loop system with rotating radio goniometer. With these, the directivity is adjustable by the operator. They are usually employed as direction finders.¹
- b. The directive antenna array which is the same as that used for directive transmission. Used for the fixed services, on high frequencies.
- c. The long folded-wire types of which the Bell System-Bruce rhombic antenna is an example. Used for high frequencies in the fixed services.
- d. The long-wire transmission-line type of antenna known as the Beverage, or wave, antenna. Used for low-frequency and high-frequency reception in the fixed services.

55. Loop Antennas.—This form of antenna is well known to the art and is described and explained in almost every publication on elementary radio. Its response is of a very low order, requiring a very high gain receiver. Its small mechanical dimensions make it a useful device for some portable applications, such as military field sets, and field-intensity meters. Its constant electrical characteristics and its independence of ground have special value in the latter application. However, its principal application is in direction-finding apparatus, which is discussed elsewhere in this Handbook.

The response in the maximum directions is very broad, but the minima are very sharp. When used in direction finders, the signal is adjusted for a minimum which can be determined with great accuracy, especially when the loop is balanced to ground. A loop, in conjunction with a vertical wire antenna, produces a unidirectional response which enables one to determine the exact direction of the arriving waves. Without this

¹ SMITH-ROSE, R. L., Radio Direction Finding by Transmission and Reception (with extensive bibliography), *Proc. I.R.E.*, March, 1929; PALMER, L. S., and L. I. K. HONEYBALL, The Action of Short-wave Frame Aerials, *Proc. I.R.E.*, August, 1932.

auxiliary vertical "sense" antenna, the loop has two responsive directions 180 deg. apart and can therefore give errors of this order in cases where there might be some doubt concerning the relative geographical positions of transmitter and receiver, as with ships at sea.

56. Directive Transmitting Antennas Used for Reception. In certain communication systems, such as the Telefunken, Marconi, and Société Radio Française, the receiving antenna is a duplicate of that used for transmission. With extended arrays, there results a directional discrimination comparable with that at the transmitter. Thus static, and interfering signals or disturbances originating in unfavored directions, are essentially eliminated from the receiver. Extended arrays also give a limited measure of diversity effect (discussed more fully under its proper title) which tends to level out fading variations. Any of the directive arrays already described could be used for reception, provided they are properly oriented and polarized.

Some of the special problems in connection with reception may be briefly outlined as follows:

1. The arrival of a multiplicity of waves from the same transmitter, which have definite time differences as well as different angles of arrival.
2. All the components of a wave group have individual variations in intensity and relative phase, so that their group influence is highly variable. The result is familiarly known as *fading*, which may be uniform for a small band of frequencies (such as those composing a modulated signal), or non-uniform. The latter, called *selective fading*, produces serious distortion of telephonic signals.
3. It has been discovered that signals which fade do not fade in exactly the same manner or at exactly the same time at different geographical positions. This latter, now known as the *diversity effect*, has been utilized in the RCA system of diversity reception, to be described.
4. Atmospheric disturbances, as well as interfering signals, are reduced in the same degree as the directivity is increased in a favored direction, thus providing improved signal-to-noise ratios. This advantage falls down, however, when the disturbances originate in the direction of the desired signals.
5. High gain is often required to override receiver noise.

It is plain that these problems are peculiar to the reception end of a communication circuit. Adapting a transmitting array to reception may partially satisfy 1 if its horizontal and vertical directivity is high enough to give a sensible reduction of those minor components of the wave group which are more harmful than useful. A transmitting array seldom is of sufficient geographical extent to give much space equalization of signal by diversity. Furthermore, phase differences continue to exist between the currents in the system due to the various wave components, so that comparatively little improvement in fading is obtained in this manner. From the standpoint of gain, the transmitting type of antenna is perhaps equal to the special types developed for reception purposes. Transmitting antennas, being generally of the resonant conductor type, suffer rather high reradiation losses when used for reception.

57. Folded-wire Receiving Antennas.¹ A very simple and effective type of receiving antenna has been developed by Bruce and his coworkers

¹ BRUCE, E., Developments in Short-wave Directive Antennas, *Proc. I.R.E.*, August, 1931; BRUCE, E., A. C. BECK, and L. R. LOWRY, Horizontal Rhombic Antennas, *Proc. I.R.E.*, January, 1935.

of the Bell System, known as the *rhombic antenna*. This antenna has several useful intermediate forms between an electrically long vertical wire and the horizontal rhomboid, or diamond. Among these are the tilted wire, the vertical inverted V, and the vertical diamond. The application of any one of these forms must take into account the polarization of the incoming waves, the direction and the wave tilt, the frequency range to be covered with one antenna, and the available space.

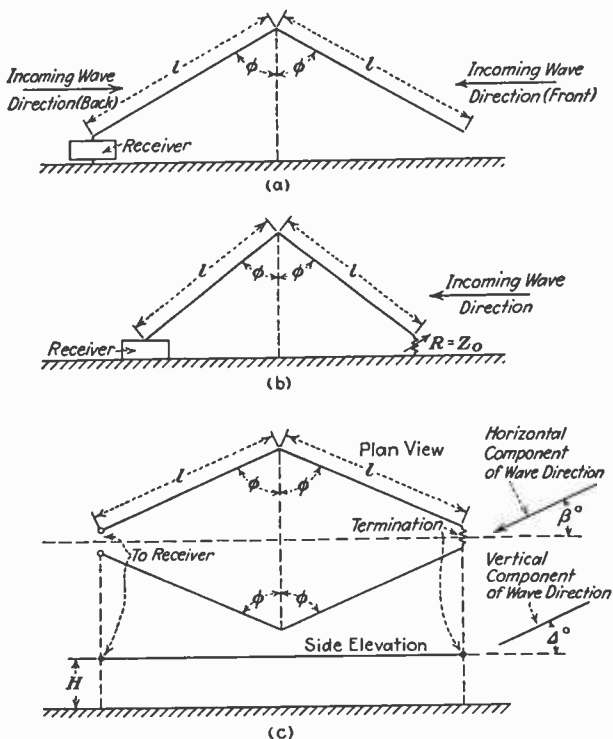

FIG. 49.—Rhombic antennas of Bruce.

Three forms of this antenna are shown in Fig. 49. In (a) is a vertical inverted V which has bidirectional response. In (b) is the same antenna equipped to absorb completely in a terminating resistance all energy received from a backward direction, giving unidirectional response at the receiver. Both *a* and *b* are vertically polarized. In (c), for horizontally polarized waves, terminated to give unidirectional response, there are in effect two opposed V-sections of the type of *a* and *b*. For any wave direction, there exists a wire length l which will give maximum

response. This occurs when the wire length is one-half wave length greater than its projection upon the line representing the wave direction in the plane of the antenna. The horizontal rhombic antenna (*C*) has zero response along the ground, and the peak of the directive pattern can be focused at the vertical angle which corresponds to the incoming wave direction by suitably proportioning the antenna dimensions.

In the design of a horizontal rhombic antenna there are three variables, the length of a side (*l*), the angle ϕ , and the height above ground *H*. The lowest practical height is when

$$H = \frac{\lambda}{4 \sin \Delta}$$

The value of the angle ϕ is obtained when

$$\sin \phi = \cos \Delta$$

For maximum gain the value of *l* is found from the equation

$$l = \frac{\lambda}{2 \sin^2 \Delta}$$

With this value of *l*, the peak of the major directivity lobe may not fall at the desired angle corresponding to the wave direction. Where the received wave direction is unstable, or where maximum signal to noise discrimination is sought, the length is adjusted to focus the point of the beam in the wave direction. This occurs when the length is shortened to

$$l = \frac{0.371}{\sin^2 \Delta}$$

The greater the length, the greater the range of frequencies which can be efficiently received on one antenna.

The main axis of this antenna is oriented in the great-circle direction of the associated transmitting station.

The proper value of the terminating resistance for back-wave suppression is determined experimentally. Impedance measurements of the antenna are made at the receiver end with trial values of resistance at the termination. The proper termination is that which gives the flattest impedance-frequency characteristic. One might make a preliminary determination of the order of the terminal resistance by making a rough calculation of the characteristic impedance of the antenna as a transmission line of parallel wires.

Finally the output terminals of the antenna are connected through a termination network to a transmission line running to the receivers. The terminal impedance is matched to that of the transmission line. Accurate balance to ground must be maintained in the antenna system, as well as in the transmission line, if it be of the open-wire type.

An antenna without termination may be used for transmission, unidirectivity being obtained by using another antenna as a reflector.

58. The Beverage (Wave) Antenna.¹ This type of antenna, one of the earliest effective directive receiving systems to be used commercially, is a long transmission line. It is named after its inventor, H. H. Beverage, but is also called the *wave antenna*. A long open-wire transmission line pointed in the direction of a down-coming wave, has a high degree of exposure to the horizontal component of the wave front, which induces in the line a continuous series of e.m.fs. that are propagated along the wires in the form of a traveling wave. A wave front sets up a wave in the wire which starts at the distant extremity (in the direction of the arrival of the space wave) which is propagated toward the home end where a receiver is situated. In addition, the entire wire receives energy from the down-coming wave, so that the effects are cumulative at the receiver and a relatively large amount of energy is extracted from the space wave for energizing the receiver. The antenna functions only where there is an angular difference between the direction of the wire and the incidental direction of the space wave. This condition is suitably met in practice due to natural conditions, since finite earth conductivity causes a wave traveling in space near the surface to be tilted forward at a considerable angle. Thus a long transmission line parallel to the surface of the ground has a workable inclination with respect to the wave front. This applies to vertical polarization.

The Beverage antenna has many useful forms which are specially adapted to long-wave reception, short-wave reception, bidirectional and unidirectional selectivity, for vertical and horizontal polarization, etc. A thorough treatment of these is impossible here, and detailed data must be obtained from the original and subsequent papers on the subject.

For long waves, the antenna construction is very similar to ordinary open-wire telephone lines. The antennas may be located at a considerable distance from the station and coupled to the receivers by transmission lines. The Beverage antenna is directive in the line of its orientation and is made unidirectional by terminating the distant end in a resistance equal to the characteristic impedance of the line. Thus energy collected from a wave in the backward direction is completely dissipated without producing any influence in the receiver. Directivity may be sharpened by using two or more antennas in an array. This has been done in the system shown in Fig. 50 which is used for transatlantic telephone reception on long waves. One of the several forms of the antenna which is used in this application is that which couples the receiver to the end of the antenna that is nearest the transmitting station. A two-wire line is used to achieve this in the following manner: Waves arriving from the preferred direction act upon the two wires in parallel to ground, and the induced wave of energy in the wire travels to the distant end where it encounters a reactive network called a *reflection transformer*. This device reverses the phase of the wave in one of the wires and reflects the energy from the end back to the receiver, the reflected wave of energy now traveling in the two wires balanced to ground. The receiver coupling network terminates the line and absorbs all the wave energy in actuating the receiver. A wave entering the system from the reverse direction travels along the two wires in parallel against ground, producing

¹ BEVERAGE, H. H., C. W. RICE and E. W. KELLOGG, *The Wave Antenna*, *Trans. A.I.E.E.*, February, 1923; BEVERAGE, H. H., and H. O. PETERSON, Diversity Receiving System of RCA Communications, Inc., for Radio Telegraphy, *Proc. I.R.E.*, April, 1931; AUSTIN BAILEY, S. W. DEAN, and W. T. WINTRINGHAM, Receiving System for Long-wave Transatlantic Radio Telephony, *Proc. I.R.E.*, December, 1928.

no potential difference across the balanced termination and therefore has no influence on the receiver. Instead, the circuit to ground is terminated in the characteristic impedance of the parallel-grounded system, and the unwanted wave is completely dissipated in a resistor.

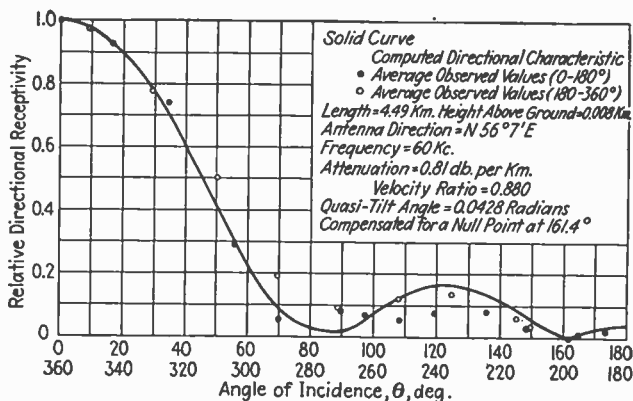

FIG. 50.—Directivity of Beverage antenna.

In its very simplest form, the Beverage antenna is a single straight horizontal wire a few feet above grade level, the length being anywhere from one to several wave lengths. The characteristic impedance of this wire unbalanced to ground is roughly calculable by using the image as

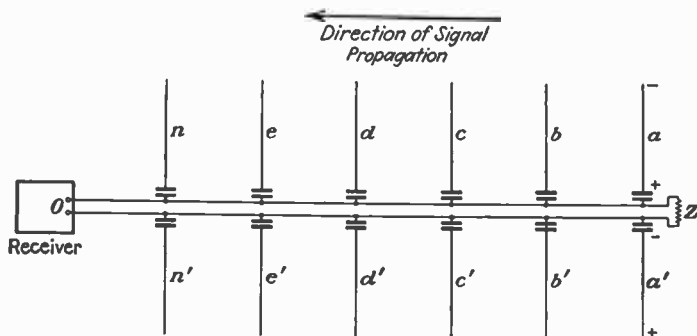

FIG. 51.—High-frequency Beverage antenna.

the second conductor in a parallel wire system. The receiver is coupled in at one end of the line, and the other end is terminated in a resistance equal to the characteristic impedance. Stable ground systems are necessary at both ends.

A form of the Beverage antenna used at high frequencies (horizontally polarized exposure) is shown in Fig. 51. This is a plan view of the conductors. The side wires extract from the traveling waves energy which is coupled into the central transmission line which is balanced to ground. The side wires act as distributed loading of the transmission line, modifying (reducing) its phase velocity of propagation and its characteristic impedance. The branches with their coupling condensers have a capacitive effect on the line within the desired frequency range, and they must be close enough together to produce the effect of continuous loadings (maximum separation three-eighths wave length at the shortest wave length to be received).

A practical form of the antenna, where two are used in broadside for higher directivity, is shown in Fig. 52. This also indicates the method

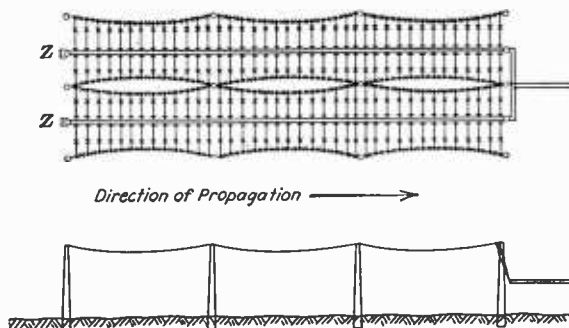

FIG. 52.—Double broadside Beverage antenna.

of rigging it, the location of insulators, etc. With antennas of this type, the signal-to-noise ratio is reduced from 24 to 39 db over that obtained with a single dipole, when the static directions are not in the line of maximum response.

59. Diversity Reception. The fading of high-frequency radio signals has always been a major problem. Antenna design, in the phases treated in this work, is at best only moderately effective in reducing it. Diversity reception has proved a long step forward in combating signal fading. In this system, three separate receiving equipments are employed, the antennas for them being located at different geographical points. The distance between antennas is arbitrary, being in practice sometimes a mile or more. For obvious reasons, the three antennas are not in any straight line but disposed somewhat as shown in Fig. 53. Diversity of fading with geographical separations of this sort produces an average cumulative effect which is quite constant. To eliminate the effect of phase relations when the outputs from the three systems are mixed, this function is achieved after detection.

Any type of receiving antenna may be employed, but in the RCA Diversity Receiving System, the Beverage-Peterson antenna shown in Fig. 52 is used as the unit.

60. Fading Reduction by Directivity Steering. Another effective method of reducing fading of high-frequency signals has been developed

around the characteristics of the horizontal rhombic antenna, and called *directivity steering*. By making the rhombus of large electrical dimensions so as to achieve a high directivity, and then by making the antenna mechanically adjustable so as to control the vertical directivity angle, the more stable wave components of a wave group can be selected to the exclusion of others of different angular direction. Data seem to confirm the theory that fading is largely interference between several distinct wave fronts arriving simultaneously with different amplitude and phase relations (both changing constantly), after having traveled different

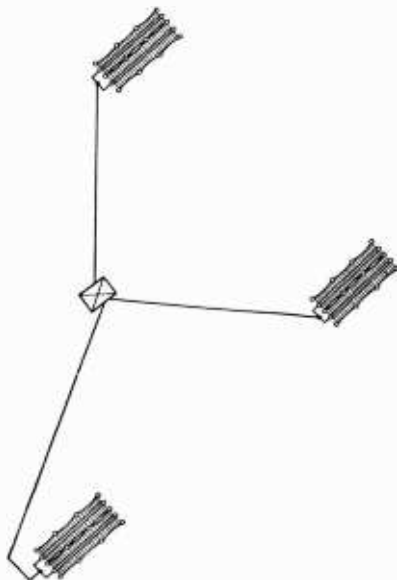

FIG. 53.—Antennas arranged for diversity reception.

paths from transmitter to receiver. By reducing the amplitude of several of the wave components, with respect to one preferred wave by angular discrimination, fading is reduced.

The antenna is made adjustable by anchoring one extremity, say the receiver end, and making the other three flexible by attaching them to their poles with long cables, running over pulleys to counterweights. By drawing up or releasing the far end of the antenna, the entire rigging is lengthened and narrowed, or shortened and broadened. The vertical directivity changes with this adjustment, called *steering*. This adjustment, remotely controlled, can be made while observing the receiving instruments and permits corrective adjustments to be made whenever conditions demand.

BROADCAST RECEIVING ANTENNAS¹

61. All-wave Receiving Antennas. Introduction of all-wave receivers brought with it considerable engineering advance in antennas for home and automobile receivers. Purchasers of broadcast receivers had been educated to believe that practically any length of wire strung practically anywhere so long as one end terminated at the receiver was as good as could be expected in the way of a structure to absorb from space the radiations existing there.

It was found, however, that certain short-wave programs were well received while others came in poorly: Thus a 24- to 29-ft. wire operates fairly well in the principal short-wave bands devoted to broadcasting but is a poor collector of signals on the 550- to 1500-ke band; a wire 100 to 105 ft. long operates very well on the 49- and the 19-m band but poorly on the 31- and the 25-m bands.

Furthermore it was found that while natural static is less on the shorter waves, man-made static is greater. Therefore there is a factor, other than length, which must be considered in erecting an antenna to be used over a wide band of wave lengths, especially since the field strengths on the shorter waves are much less than are normally considered as good signals on the broadcast band. This is the noise problem.

For these reasons engineers designed antennas that not only had the proper length to tune well over various bands, but which could be erected in the open where high signal-to-noise ratios occurred and which could be connected to the receiver through shielded lead-ins or impedance-matched transmission lines.

62. Double-doublet. Various forms of complicated antennas have been designed to operate over a wide frequency band. One such antenna system which has given good results is the double-doublet, a combination of two 29-ft. quarter-wave doublets and two 16½-ft. quarter-wave doublets. The short wires resonate to about 14 Mc while the longer wires resonate to 8 and 24 Mc. When cross connected these doublets give fairly uniform response over the band from 8 to 24 Mc. In practice these wires are actually two lengths of $29 + 16\frac{1}{2}$ or $45\frac{1}{2}$ ft. erected at an angle to each other in the vertical plane. At 29 ft. from one end of each wire a tap is made and the down-leads start from these points. Thus the 29-ft. doublet is series connected to the 16½-ft. doublet with a down-lead taken from the point of connection. When tuning to the region in which either section is most responsive, the other end of portion of the wire merely acts as a high impedance shunt and has little effect upon the pick-up.

There are other antennas, some of them unbalanced single doublets, some unbalanced double-doublets, etc. When erected in clear space, and properly terminated in a transmission line of the proper impedance, such antennas, especially the balanced doublets, will provide a maximum response to signals and a minimum response to noise. It is worth noting, however, that as late as middle 1935 some engineers expressed open scepticism of the merit of erecting such complicated structures, some going so far as to state that a 75-ft. piece of wire in the open and with conventional down-lead would provide as good reception on the average as a complicated doublet system.

¹ By the editor.

63. Shielded Down-leads. A doublet will pick up a maximum of voltage from any passing wave of the proper frequency. It is now necessary to get this voltage into the receiver with as little contamination from unwanted noise voltages as possible. Furthermore a doublet will suffer in pick-up if not properly terminated.

The earliest work¹ on down-leads of scientific design for general broadcast reception was done to relieve the difficulties of apartment dwellers. A multiplicity of antennas on the roof with long down-leads produced

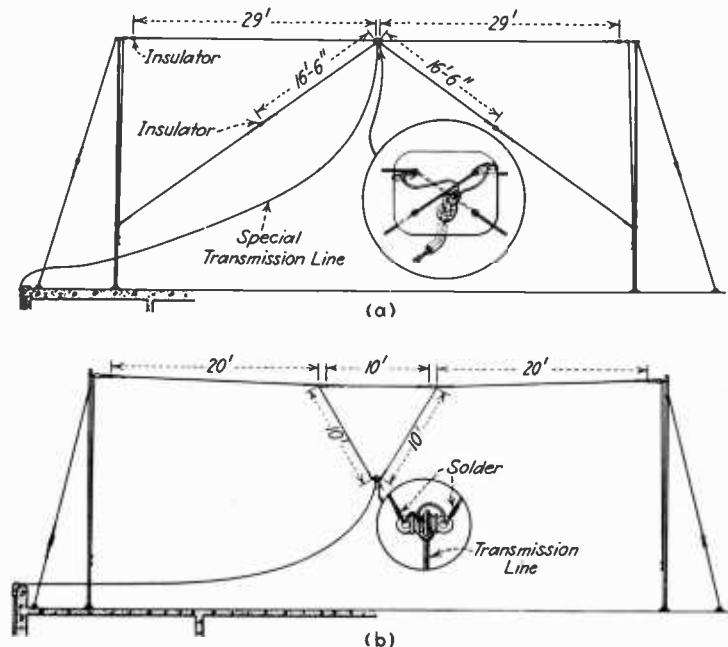

FIG. 54.—Types of all-wave receiving antennas.

mutual interference between the various receivers, did not secure the listener his share of signal free from noise, and had poor pick-up. A high antenna coupled to a shielded down-lead through a transformer which would make the down-lead look like a low impedance could be attached to individual receivers through step-up transformers with considerable benefit. Such antenna systems, with and without amplifiers acting as signal boosters, were designed and erected. A number of receivers could be operated simultaneously without mutual interaction and interference.

The transmission line down-lead was applied to individual broadcast receivers by Kolster Radio where the application was also made to automobile receivers. The full tide of popularity of the idea of having a

¹ ACEVES, J. G., *Proceedings, Radio Club of America*, April, 1931.

good antenna connected to the receiver located some distance away by means of a transmission line did not arrive until 1934. The all-wave receiver interest fostered the general movement to employ better pick-up systems.

The shielded transmission line is expensive and for ordinary installations not so successful as a simpler down-lead made up of a twisted pair of conductors or of two wires transposed at regular intervals along its length. In either case unwanted voltages tend to cancel each other at the receiving end since they travel up (or down) the two wires in the same direction while desired voltages cause currents to flow through the system like a series system and thus produce a voltage across the open, or receiver end.

In such transmission line down-leads it is important that low loss insulation be used. Furthermore it must be of a material that will not absorb moisture with consequent increased losses during wet weather.

Since it is not possible to terminate these lines in their exact and proper impedance, standing waves will appear along them. In an RCA Victor system, for example, an impedance of 180 ohms was selected since most short-wave receivers have input impedances of this order. Since the antenna does not exactly match this figure uniform transmission over the frequency band does not occur. Therefore a certain length of down-lead cable (80 ft.) was fixed upon as having one peak of response at each of the principal short-wave bands.

64. Automobile Radio Antennas. During the first rush of sales of automobile radio sets, in 1933-1934 it was possible to get sufficient pick-up by placing chicken wire networks in the roof of the car. These antennas had an effective height of approximately 0.5 m, a capacity of 160 μmf and a resistance of 20 ohms at 1000 kc.

Steel-top automobiles, however, present a problem which requires for its solution an under-car antenna. Various forms of aerial of this type have been used, varying from a wire strung on the chassis frame, to a window-shade effect in which wires on a frame work are rolled up and placed in a tube to be fastened under the running boards. Any such structures must, with the car and the ground, represent a capacity potentiometer. The antenna is designed to tap off a portion of the capacity voltage between ground and the car. Since the receiver is connected to the automobile the antenna should be as far as possible from the car so that the portion of voltage it receives will be as great as possible. The antenna, naturally, cannot be so far from the car that it approaches too closely the ground or it gets into mechanical troubles.

In an automobile the antenna is surrounded by a field of disturbance set up by the ignition system of the car. This is a steep wave front of electrical radiation with most of its energy in the region above 30 Mc but nevertheless radiating energy all through the radio, and some portion of the audio, spectrum. The farther toward the rear of the car the antenna is placed, the less is the noise voltage because the source is relatively farther removed from the antenna. Shielding the lead-in or using a shielded transmission line with proper impedance terminations aids in reducing noise voltages. With modern automobiles, the hood acts as a shield and automobile engineers are now (1935) realizing the necessity of proper orientation of the various ignition components, the high- and low-tension wiring, etc. All of these efforts to reduce the noise-to-signal ratio have been efficacious.

Still other means have been produced for securing better pick-up of the desired broadcast-band signals and attenuating ignition voltages. It has been useful to make the input to the receiver have a band-pass characteristic so that voltages within the broadcast band are admitted to the receiver but voltages of other frequencies are attenuated as much as possible. Double shielding of the receiver chassis, filtering all leads, etc. are matters of radio set design and not of antenna design.

65. Doublet Auto-radio Antenna. An ingenious method of raising the signal-to-noise ratio has been devised by RCA Victor engineers. Under the running board is placed a metal rod of the proper diameter and material for its pick-up to be a maximum. This rod is 8 ft. long with a tap at the exact center. Then the two ends are bent back on themselves so that the antenna presents the appearance of an elongated

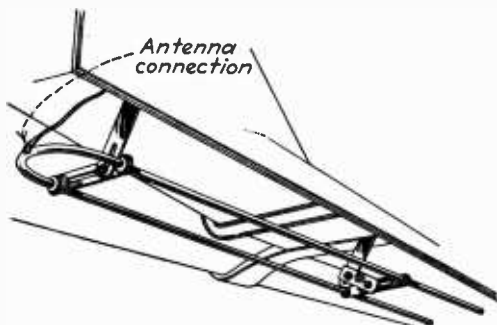

FIG. 55.—Under-car antenna for automobile radio.

U. Each half represents a quarter-wave section of a half-wave doublet resonant to about 7 m where the maximum noise energy has been determined to exist. Noise voltages of this frequency proceed along the wire and at the center, to which the radio receiver antenna post is connected, produce equal and opposite voltages between the tap and the chassis of the car. Broadcast signals, however, look at the antenna as two wires in parallel and their voltages are taken into the receiver.

When used with proper filter-type lead-in and with a receiver designed for it this antenna produces good discrimination against noise voltages in favor of broadcast-band signals.

Bibliography

General Properties of Radiating Systems:

BARROW, W. L.: On the Impedance of a Vertical Half-wave Antenna above an Earth of Finite Conductivity, *Proc. I.R.E.*, February, 1935.

BASHENOFF, V. I., and N. A. MJA80EDOFF: Effective Height of Closed Aerials, *Proc. I.R.E.*, June, 1931.

BECHMANN, R.: Calculation of Electric and Magnetic Field Strengths of any Oscillating Straight Conductors, *Proc. I.R.E.*, March, 1931.

BECHMANN, R.: On the Calculation of Radiation Resistance of Antennas and Antenna Combinations, *Proc. I.R.E.*, August, 1931.

DELLINGER, J. H.: Principles of Transmission and Reception with Antenna and Coil Aerials, *Bur. Standards Sci. Paper 354*, 1919.

MURRAY, F. H.: The Mutual Impedance of Two Skew Antennas, *Proc. I.R.E.*, January, 1933.

PISTOLKORS, A. A.: The Radiation Resistance of Beam Antennas, *Proc. I.R.E.*, March, 1929.

RAMSEY, R. R., and DREISBACK: Radiation and Induction, *Proc. I.R.E.*, August, 1928.

STRATTON, J. A., and H. A. CHINN: The Radiation Characteristics of a Vertical Half-wave Antenna, *Proc. I.R.E.*, December, 1932.

UDA, S.: High-angle Radiation of Short Electric Waves, *Proc. I.R.E.*, May, 1927.

WELLS, N.: Aerial Resistance and Aerial Termination, *Marconi Review*, April, 1934.

Antenna Measurements:

BROWN, G. H., and R. KING: High-frequency Models in Antenna Investigations, *Proc. I.R.E.*, April, 1934.

The Problem of Auto-Radio Antennas, *Electronics* February, 1935.

CLAPP, J. K.: Antenna Measuring Equipment, *Proc. I.R.E.*, April, 1930.

TAYLOR, A. H., and H. F. HASTINGS: Determination of Power in the Antenna at High Frequencies, *Proc. I.R.E.*, August, 1931.

Radio Instruments and Measurements, *Bur. Standards Circ. 74.*

Directive Antennas for High-frequency Transmission and Reception:

MEISSNER, A.: Directional Radiation with Horizontal Antennas, *Proc. I.R.E.*, November, 1927.

STERBA, E. J.: Theoretical and Practical Aspects of Directional Transmitting Systems, *Proc. I.R.E.*, July, 1931.

STERBA, E. J., and C. B. FELDMAN: Transmission Lines for Short-wave Radio Systems, *Proc. I.R.E.*, July, 1932.

STONE, J. S.: Directive Antenna Array, U.S. Patent 1,643,323, September 27, 1927.

YAGI, H.: Beam Transmission of Ultra-short Waves, *Proc. I.R.E.*, June, 1928.

Broadcast Antennas:

BALLANTINE, S.: High-quality Broadcast Transmission and Reception, *Proc. I.R.E.*, May, 1934.

HARBICH, H., and W. HAHNEMANN: Wirksame Bekämpfung des Nahschwundes im Rundfunksendeantennengebilde bestimmter Form, *E.N.T.*, October, 1932.

RICKARD: Graphical Method for Determining the Fundamental Wave Length of a Broadcast Antenna, *Marconi Review*, November, 1933.

RODER, H.: Broadcast Antennas, *Broadcast News (RCA)*, July, 1932.

Ground and Ground Systems:

FELDMAN, C. B.: The Optical Behavior of the Ground for Short Radio Waves, *Proc. I.R.E.*, June, 1935.

Aircraft Antennas:

DIAMOND, H., and G. L. DAVIES: Characteristics of Airplane Antennas for Radio Range Beacon Reception, *Proc. I.R.E.*, February, 1932.

HYLAND, L. A.: Constants of Trailing Wire Antennas, *Proc. I.R.E.*, December, 1929.

Textbooks:

McILWAIN, KNOX, and J. G. BRAINERD: "High-frequency Alternating Currents," John Wiley & Sons, Inc.

MORECROFT, J. H.: "Principles of Radio Communication," John Wiley & Sons, Inc.

PIERCE, G. W.: "Electric Oscillations and Electric Waves," McGraw-Hill Book Company, Inc., 1920.

STEINMETZ, C. P.: "Transient Electric Phenomena and Oscillations," McGraw-Hill Book Company, Inc.

ZENNECK, J. (Seeley): "Wireless Telegraphy," McGraw-Hill Book Company, Inc.

SECTION 23

PHOTOCELLS

BY H. C. RENTSCHLER, PH.D.¹

1. Photoelectricity. Photoelectricity includes all such phenomena where a change in electrical behavior is produced by the action of light. These phenomena may be divided into three classes:

1. Photoelectric Emission.
2. Photoconductivity.
3. Photovoltaic Effect.

2. Photoelectric Emission. In 1888 Hallwachs² showed that a negatively charged zinc sphere, which had been freshly polished, was rapidly discharged when light from an arc was allowed to shine upon it; but that a positively charged sphere did not lose its charge unless a negatively charged body near by was irradiated at the same time. It has since been proved that this effect is due to the emission of electrons from the metal surface due to the light (especially light of short wave length), just as the filament of a thermionic device emits electrons when heated to the proper temperature. This emission of electrons from an illuminated metal is known as *photoelectric emission*. This photoelectric emission makes possible the current in an electrical circuit between the illuminated metal as cathode and a nearby anode.

3. Photoelectric Cell or Phototube. The photoelectric emission from a metal depends upon the condition of the metal surface (whether clean or covered by an oxide film, etc.). To obtain reproducible emission, the cathode and anode are now always mounted in a glass or quartz container which is either highly evacuated or contains an inert gas at a low pressure. Such devices are commonly known as photoelectric cells or phototubes.

4. Phototube Circuit Insulation. The current that can be passed through even the most sensitive phototubes is many times smaller than the current through a small thermionic-valve tube. Thus with the best commercial type of vacuum phototube with the cathode exposed to a 60-watt tungsten lamp at a distance of about 10 in., the maximum current is of the order of 10 to 20 μ a.

Special care is necessary to insulate properly the parts of photoelectric tube circuits so as to avoid electrical leakage. Insulators generally used in electrical circuits even with thermionic devices are often useless for these circuits. For the more sensitive applications it is often necessary to use such insulators as amber, sulphur, or red sealing wax. Where

¹ Member, American Physical Society, American Association for the Advancement of Science, American Optical Society; director of research, Westinghouse Lamp Company.

² HALLWACHS, *Ann. Physik*, **33**, 301, 1888.

phototubes are used for precision measurements or for the detection of very weak light intensities it is desirable to use tubes where the anode and cathode leads are not brought out through the same press.

5. Properties of Photoelectric Emission. The photoelectric emission from a given cathode is practically instantaneous. Lawrence and Beams¹ have shown that the interval between the incidence of the light and the full emission of electrons is less than 10^{-8} sec.

The photoelectric emission from a given cathode is independent of the temperature as long as there is no actual change in the cathode surface and as long as its thermionic emission is negligible.

The photoelectric emission from a given cathode is strictly proportional to the light intensity, provided the quality (color or wave length) of the light is not changed.

For such applications as strictly require one or all of these properties, the phototube is superior to light-sensitive devices using either the principles of Photo-conductivity or the Photovoltaic effect, and it is inferior only in the magnitude of the response for a given intensity.

6. Color Sensitivity. All metals with clean surfaces are photoelectrically active when exposed to light of proper color or wave length. There

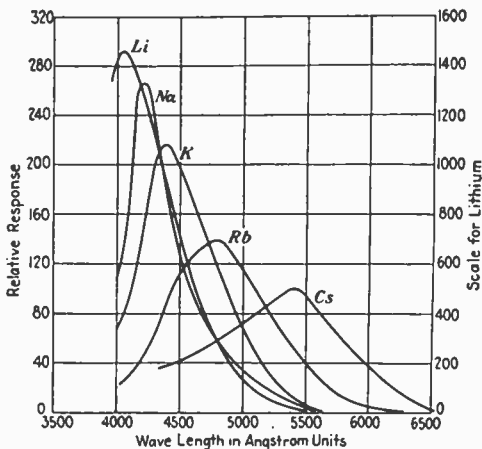

FIG. 1.—Color sensitivity for alkali metals.

is for each metal a longest wave length (called the *threshold wave length*) to which the metal responds. Thus the common metals such as iron, nickel, copper, etc., require very short ultra-violet radiation, while the alkali metals sodium, potassium, etc., are sensitive to visible light. The curves giving the emission or response of a cathode for equal energy of different wave lengths of radiation is called its *color-sensitivity curve*. Thus in Fig. 1 are shown the relative color sensitivities of different tubes containing the different alkali metals as measured by Miss Seiler.² Each

¹ LAWRENCE, E. O., and J. W. BEAMS, *Phys. Rev.*, **29**, 903, 1927.

² SEILER, *Astrophys. Jour.*, **52**, 129, 1920.

of the alkali metals has a definite wave length for which the response is a maximum.

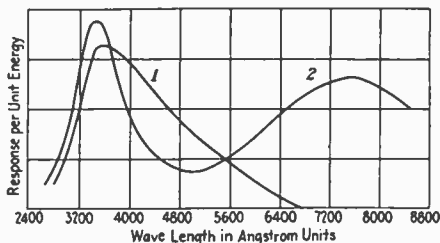

FIG. 2.—Color sensitivity for caesium on magnesium, curve 1. Color sensitivity for caesium on silver oxide specially processed, curve 2.

The color sensitivity of a metal is often dependent upon the thickness of the coating of the active metal deposited upon a second metal as a conducting backing and the treatment given to this coating. Thus in Fig. 2 is shown the relative color-sensitivity curve for a thin layer of caesium on magnesium (curve 1) and the similar response (curve 2) for a thin layer of caesium on silver oxide with a copper backing and processed so that it shows sensitivity for infra-red radiation.¹

When photoelectric tubes are to be used for measuring or detecting

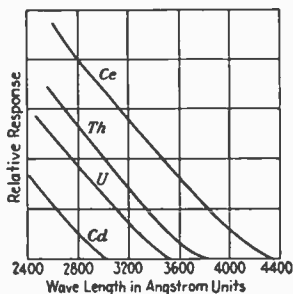

FIG. 3.

FIG. 3.—Sensitivity for vacuum phototubes in quartz bulbs with cathodes of cerium, thorium, uranium, and cadmium.

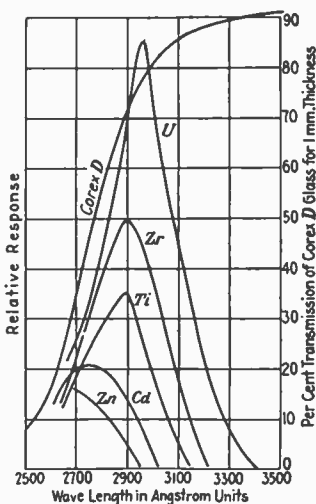

FIG. 4.

FIG. 4.—Sensitivity for phototubes in Corex D glass with uranium, zirconium, titanium, cadmium, and zinc cathodes.

ultra-violet radiation only, the elements cerium, thorium, uranium, and cadmium serve well for tubes having different threshold wave lengths.

¹ Details of the method used in the processing of cathodes to change the relative sensitivity are described by A. R. Olpin, *Phys. Rev.*, **36**, 251, 1930.

In Fig. 3 are shown the relative response curves for these metals as cathodes in quartz bulbs as vacuum-phototubes. The relative response curves for several metals as cathodes in bulbs of ultra-violet transmitting glass known as Corex D (wall thickness about 1 mm) are shown in Fig. 4. The peaks of maximum response for these tubes are not, as was the case with the alkali metals of Fig. 1, an inherent property of the cathode material. The short wave-length response is cut off by the absorption of the radiation by the glass container. These peaks may be shifted by varying the thickness and quality of glass used.

VACUUM AND GAS PHOTOTUBES.

7. Vacuum Tubes. The electrons liberated from the cathode under the influence of light come off with different velocities and in different directions. As the difference of potential between anode and cathode is raised, more of the electrons liberated from the cathode reach the anode, and saturation current is reached when all that leave the cathode are drawn directly to the anode as fast as they are produced. Because of the small emission from the cathode, the effect of space charge is negligible. Curve *a* (Fig. 5) shows the current-voltage relation for a vacuum tube with the specially processed caesium on silver oxide cathode. The slope of the curve and the potential necessary for saturation depend chiefly upon the spacing and shape of the electrodes.

8. Gas Tubes. Since the current obtainable by photoelectric action is very small, attention has always been given to ways for amplifying these currents. This may be accomplished by the use of devices such as three-electrode thermionic amplifier tubes. Another means often resorted to is the so-called "gas photoelectric tube." Here a small amount of an inert gas, such as argon, is introduced into the tube. The photoelectrons as they pass from the cathode to the anode, ionize the gas, and the ions so produced take part in carrying the current. Curve *b* of Fig. 5 is typical showing the current-voltage relation for a gas photoelectric tube which gives curve *a* when evacuated.

Commercial gas tubes usually have a pressure of about 100 μ or less and an amplification due to the gas of about 10. Higher amplifications are possible but result in greater instability of operation.¹

The gas tube is not so linear in its response to light of varying intensity as is the vacuum tube. For most practical purposes, except for precision

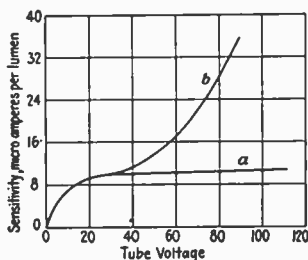

FIG. 5.—Characteristic for vacuum (*a*) and gas-filled (*b*) tubes.

¹ For more detailed discussion of the mechanism of amplification by gas ionization, the reader is referred to the excellent discussion by Campbell and Ritchie in their book on "Photoelectric Cells" (Sir Isaac Pitman & Sons, Ltd., third edition, 1934). Also to J. S. Townsend's book on "Electricity in Gases" (Clarendon Press, Oxford, 1915) for the general theory of ionization by collision. Curves showing the effect of gas pressure on the maximum sensitivity of a photocell are given by Koller (*Jour. Optical Soc. America and Rev. Scientific Instruments*, 19, 135, 1929). See also Hughes and DuBridg, "Photoelectric Phenomena," McGraw-Hill Book Company, Inc. 1932.

measurements requiring high degree of accuracy and wide variations of intensity, its linearity is, however, quite good enough. But gas tubes require greater precautions in their use than do vacuum tubes.

For the protection of the tube and the rest of the apparatus in the circuit it is always well to insert a resistance of from 1,000 to 5,000 ohms in series with the tube. Such a resistance will prevent any damage which might result in the use of gas tubes if a glow developed due to too high an impressed voltage, and the danger of the glow breaking over into an arc. A glow in a phototube must never be permitted for any length of time. In some cases such a glow may result in increased sensitivity of the tube while in other cases it may result in permanent injury to the tube.

9. Choice of Phototube. It is always well to use vacuum tubes in preference to gas tubes whenever it is possible to do so. Vacuum tubes are simpler to handle and capable of giving more accurate and reliable results.

For most general applications, phototubes are operated from artificial-light sources. The most convenient source is the ordinary incandescent lamp. The maximum intensity of radiation from such a source is in the infra-red and falls off rapidly for the visible and ultra-violet. For such applications therefore the best tube to use is one that has as great a sensitivity in the visible and infra red as is obtainable. The phototube almost universally used at present for such applications is the one having the color sensitivity shown in curve 2 (Fig. 2).

Phototubes are now quite extensively used for the photometry of incandescent lamps. For such applications the tube must be very constant, and above all the cathode surface should be uniformly sensitive over the entire surface. The color-sensitivity curve should preferably be similar to that of the average human eye. In practical photometry of incandescent lamps, the general practice is to compare the radiation from the unknown lamp with that from a standard lamp having the same general radiation characteristic and which is operated at approximately the same temperature as the unknown lamp. For such applications the caesium-on-magnesium tube with a special green filter is quite satisfactory.

A similar problem is that of measuring ultra-violet radiation within a definite wave band. There is an ever increasing interest in the use of ultra-violet radiation for health, for medical treatment of certain ailments, and for photo-chemical reactions. Thus it has been fairly well established by the medical profession that radiations effective in the prevention of rickets extends from wave length of about 2,800 to about 3,200 Å. units.

The radiation of about 2,950 Å. units is the most powerful, and the beneficial effect falls off to a low value as the wave length of the radiation approaches either the longer limit of about 3,200 Å. units or the shorter limit of about 2,800 Å. units. Referring to Fig. 4 it is evident that cells covering this range fairly well are now available. It is evident that the definite problem under investigation determines the cell best suited for the test.

10. Phototube Circuits. The practical use of phototubes for the various applications call for circuits to fit the particular use. Generally speaking, the amount of current obtainable in the particular case largely

controls the choice of circuit. The simplest phototube circuit is that shown in Fig. 6.

Here the battery B sends a current through the phototube P when light falls on the cathode. This current is detected or measured by the galvanometer shown as G . If the phototube is relatively sensitive or the intensity of light is sufficiently great, the galvanometer G may be replaced by a microammeter. It is at once evident how variations in light intensity may be followed by changes in reading of the detecting instrument G .

In cases where the light intensity is low so that measurements require extreme sensitivity, an electrometer E and a high resistance R as shown in Fig. 7 are substituted for the galvanometer. In principle the electrometer has two highly insulated conductors A and C , and a movable element N which is maintained at a constant potential. As the potential

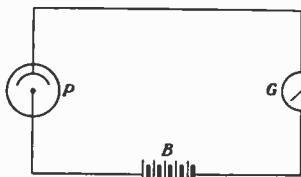

FIG. 6.—Simple circuit for measuring photoelectric current.

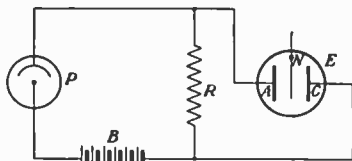

FIG. 7.—Circuit using a high resistance and an electrometer for measuring small photoelectric currents.

between A and C changes, the element N moves with reference to A and C . Thus the electrometer E of Fig. 7 is used to measure the potential drop across the resistance R .¹

The resistance R is of the order of 10 to 1,000 megohms depending upon the sensitivity required.

Campbell and Ritchie² describe commonly known methods of making these high resistances. The writer³ prefers to use the resistance of a special carbon deposit on a glass spiral sealed in an evacuated bulb. Such resistances having any value from a megohm or less to several hundred thousand megohms are easily made. In the use of this circuit it is essential that the lead connecting the phototube to the resistance R and the element A of the electrometer is very carefully insulated.

A simple circuit for measuring very small photoelectric currents is shown in Fig. 8.

Here the battery B sends a current i through the phototube P to charge a condenser K of capacity C to a potential V measured by the electrometer E , in the time t . The average current is given by the equation

$$i = \frac{CV}{t}$$

¹ Detailed instructions describing the uses of electrometers are found in Rutherford's "Radioactive Substances" (Cambridge University Press, 1912) or in any standard treatise on electricity and magnetism.

² CAMPBELL and RITCHIE, "Photoelectric Cells," pp. 126-129.

³ RENTSCHLER and HENRY, *Rev. Scientific Instruments*, 3, 91, 1932.

The phototube used in this method should be of the vacuum type, and the battery voltage should be sufficiently high, and the potential to which the condenser is charged in the observed time should be such that the tube operates with saturation current over the entire time. If these conditions do not hold, corrections must be made in the calculations of the photoelectric current.

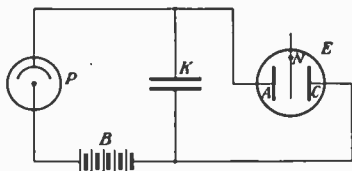

FIG. 8.—Measuring the photoelectric current by noting the rate at which it charges a known condenser.

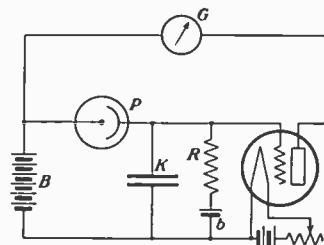

FIG. 9.—Amplifying the photoelectric current by the use of a thermionic tube.

Instead of using extra-sensitive instruments for measuring or detecting the small photoelectric currents, these currents may be amplified by the use of the three-electrode thermionic tubes. Thus the potential drop across the resistance R of Fig. 7 may serve as the control of the potential of the grid with reference to the cathode of a thermionic amplifier tube. In Fig. 9 is shown such a circuit using the same B battery in the plate-to-filament circuit and at the same time supplying the voltage to send the current through the phototube. The battery b is used to supply the proper grid bias. A condenser K represents the capacity of the phototube and its connections. This capacity need be considered only for such circuits where rapidly fluctuating light effects are to be recorded in the plate circuit.

It is at once evident how a relay may be used in place of the meter G , when it is desired to use this circuit for control purposes.

For such applications where a phototube is used for turning on or off a device, a simple gas-discharge tube known as the Grid-Glow tube¹ may replace the amplifier tube as is shown in Fig. 10. This tube is so designed that when voltage is impressed between the cathode and anode, the grid takes on a negative charge thus preventing a breakdown. If the grid is permitted to discharge as through a phototube, when light

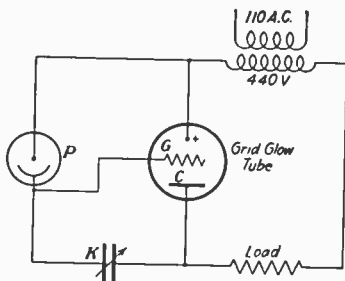

FIG. 10.—Circuit using photoelectric tube with Grid-Glow tube.

¹ KNOWLES, *Elec. Jour.*, 26, 176, 1928. This is the Westinghouse trade name for a grid-controlled rectifier. Thyatron is the corresponding General Electric trade name—THE EDITOR.

falls on the tube, a discharge is started in the anode-to-cathode circuit which is limited only by the impressed voltage and the load resistance. A condenser *K* is generally inserted as shown in Fig. 10 to control the sensitivity of the device.

11. Uses of Photoelectric Tubes.¹ The practical uses of phototubes may be classified under three distinct groups.

1. For measurement of light intensities as:

Photometry of lamps.

Measurements of ultra-violet radiation.

Measurements of light transmission through and reflection from different materials, etc.

For such application, circuits of Fig. 7 to Fig. 10 are suitable.

When a large number of similar measurements or tests are to be made as in photometry, the circuit used is preferably modified to supply the definite need for speed and simplicity of operation. An article by Dr. C. H. Sharp on Use of Photoelectric Cell in Photometry (*Electronics*, August, 1930, pp. 243-245) is an excellent illustration describing the modification of circuit of Fig. 9 for use in practical photometry.

2. For detection and control as:

For counting objects by interrupting a light beam.

For stopping of machinery when an object intercepts the light falling on a phototube.

For turning on of lights when daylight falls below a certain level.

For operating slave clocks from a master clock by having the pendulum interrupt the light falling on a phototube, etc.

For this class of applications, circuits of Figs. 9 and 10 are best modified to meet the definite requirements. Here a suitable relay replaces the meter of circuit Fig. 9 or the load of circuit Fig. 10.

3. Modulation of current by fluctuations of light intensities. This class includes such applications as:

Facsimile transmission.

Transmission of pictures by wire.

Television.

Conversion of sound films into speech, as talking movies, etc.

For these applications the circuit of Fig. 9 is adapted.

12. Photo-conductivity. This is a change in the electrical resistance of a material due to the action of light. This effect is particularly noticeable with the element selenium, which becomes a better electrical conductor in sunlight or under artificial illumination than in the dark.²

13. Selenium Cell. In the construction of selenium cells (frequently called "*selenium bridges*"), the resistance of the selenium is so high that it is necessary to arrange the selenium so that the current passes a short distance through the selenium, and a large area is provided so that as much current as possible will pass through it for a given impressed voltage. Since only the exposed portion is affected by the light it is necessary to use a thin layer.

In one form of bridge these requirements are met by painting and heat treating two closely interpenetrating grids of gold or other metal on glass. These serve as the two leads between which the current flows through the selenium bridging between them. The selenium is spread

¹ Non-communication uses of all types of vacuum tubes will be found described in Henney, "Electron Tubes in Industry," McGraw-Hill Book Company, Inc., 1934.

² NIX, FOSTER C., Photoconductivity, *Rev. Mod. Phys.* 4, 723-766, October, 1932.

over the surface in a thin layer and converted to the proper crystalline light-sensitive variety. To protect the active surface, this structure is generally sealed into a bulb which is exhausted or filled with an inert gas, thereby increasing the stability of the cell.

14. Properties of Selenium Cells. When the intensity of the light falling on a selenium cell is suddenly changed, there is an appreciable time lag before the current assumes a steady value. This time lag may be of the order of several minutes.

The conductivity depends upon the temperature of the cell.

For a fixed applied voltage the current is not strictly proportional to the intensity of the light.

The sensitivity to light of different wave lengths depends upon the crystalline form of the selenium, on the intensity of the light, on the duration of exposure, on the previous illumination, and upon the temperature.

The sensitivity extends well into the infra-red, through the visible into the ultra-violet, with a maximum sensitivity for yellow or red light depending upon the crystalline form of the selenium.

The dark current, that is the current when no light shines on the selenium, for commercial cells varies from a few to several hundred microamperes depending upon the design of the cell. The ratio of light current (that is the current for cell fully illuminated) to dark current is usually about 10 to 1, but cells may be made with a ratio as high as 1,000 to 1 or greater. These higher-ratio cells are usually far less reliable, and commercial cells usually use the smaller ratio. In the use of photo-conductive cells it is always desirable that the light be as uniformly spread over the active surface as is possible. For a detail discussion of the photo-conductive properties of selenium the reader is referred to Mellor's¹ "Inorganic Chemistry."

15. Thalofide Cell. This is a photo-conductive cell prepared by T. W. Case,² which uses the compound thallium oxysulphide in place of selenium. This cell has a maximum sensitivity at a wave length of about 10,000 Ångström units.

16. Photovoltaic Effect. The photovoltaic or Becquerel effect consists in creating an e.m.f. in a voltaic cell by illuminating either an electrode or the electrolyte. One commercial type has a cathode of a semi-cylindrical plate of copper coated with cuprous oxide. A heavy strip of lead serves as the anode, and a dilute solution of lead nitrate is used as the electrolyte. The circuit recommended is that shown in Fig. 11. These cells are often sensitive enough to operate small relays directly without the use of amplifiers or glow-discharge tubes. Like photoconductive devices these are not so well adapted where accuracy and reliability are essential, as are the less sensitive photoelectric emission tubes.

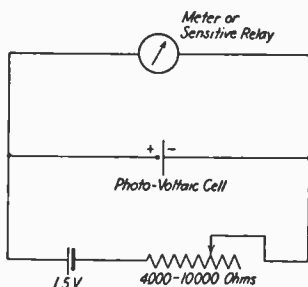

FIG. 11.—Circuit for use with a photovoltaic cell.

¹ MELLOR, "A Comprehensive Treatise on Inorganic and Theoretical Chemistry," vol. X, pp. 693-741.

² CASE, *Phys. Rev.*, 15, 289, 1920; also *Jour. Optical Soc. America* and *Rev. Scientific Instruments*, 6, 398, 1922.

17. Calculation of Voltage across Phototube Load. Characteristic curves similar to those used with vacuum tubes can be utilized to determine the voltage output of phototube circuits. For example, in Fig. 12 with a cell operated at 80 volts with a 5-megohm resistance, 60 volts appears across the cell (20 across the load) at a light flux of 0.3 lumen. In motion picture work, with the film out, the flux is about 0.2 lumen,

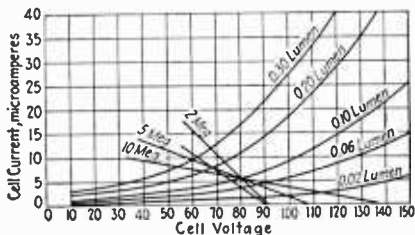

FIG. 12.—Method of calculating voltage across phototube load.

with the film running past the phototube the light coming through the film varies from 0.01 to 0.04 lumen (H. A. DeVry).

18. Commercial Light-sensitive Cells. A commercial selenium cell (FJ-31, General Electric Co.) has the following characteristics:

Average resistance at 100 foot candles.....	0.75 megohm
Average resistance in dark.....	6.0 megohms
Maximum voltage a.c. or d.c.....	125 volts
Maximum current.....	0.5 ma

Its maximum sensitivity is around 7,000 Å., the response falling to 10 per cent at 6,000 and to 40 per cent at 8,000 Å. Measurements show that 90 per cent of the total change of resistance to light changes takes place in one-hundredth of a second. At 0.05 lumen per square inch the

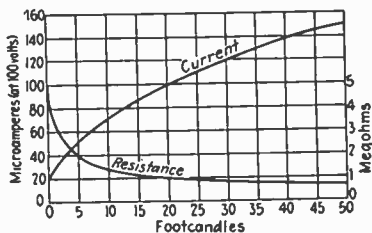

FIG. 13.—Characteristics of FJ-31 selenium tube.

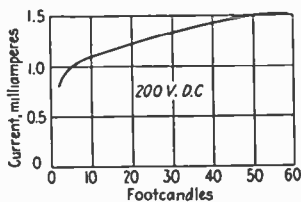

FIG. 14.—Burgess selenium cell characteristic.

relative response of the cell to light interrupted at 7 kc per second is less than one-fifth that at 500 cycles (see Fig. 13).

The Burgess selenium bridge consists of a layer of selenium about 2.5×10^{-3} cm thick on a thin glass base, on the face of which is a gold grid in the form of two interlocking combs. The surface exposed to light is approximately 25 by 50 mm. The selenium is placed in a glass envelope

which is exhausted and then filled with an inert gas. The standard bridge has a dark resistance of about 4 megohms and will deliver about 100 to 150 μ a output current. At 10 foot candles the ratio of dark to light resistance is at least 4 to 1 (see Fig. 14).

In 1931 the Weston Photronic cell was put on the market. It is generally considered as a dry type of voltaic cell, although its action is undoubtedly electronic. It has a linear output when worked into a low-resistance meter and is widely used in illumination and photographic

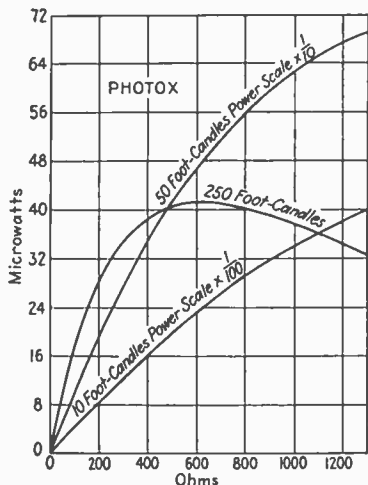

FIG. 15.—Characteristics of Westinghouse photox copper oxide light-sensitive cell.

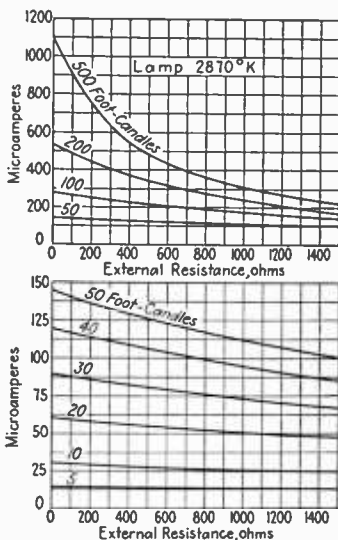

FIG. 16.—Photox characteristics.

exposure meters. A copper oxide type of light-sensitive cell is the Photox of Westinghouse, also used as an illumination meter. There are several other cells of this general type. They are high-current-, low-voltage-producing cells of low terminal resistance.

Characteristics of typical emissive types of phototube are given in the figures. These gaseous or vacuum tubes have high resistance and are capable of producing considerable voltage changes when operated into suitable high resistances. Although most communication applications, such as television, facsimile, and sound pictures, use vacuum or gaseous emissive tubes, a few applications have been made of selenium and other low-voltage output tubes.

GRID-CONTROLLED RECTIFIERS¹

19. Gaseous Triodes. If mercury vapor, or neon, or argon of the proper pressure is admitted to a triode of the proper structure, the

¹ By the Editor.

characteristics of the tube become vastly different from those of high-vacuum triodes. In these gas tubes the plate current is not under complete control of the grid, but on the contrary, the plate current when flowing is independent of variations in grid voltage. If the grid voltage

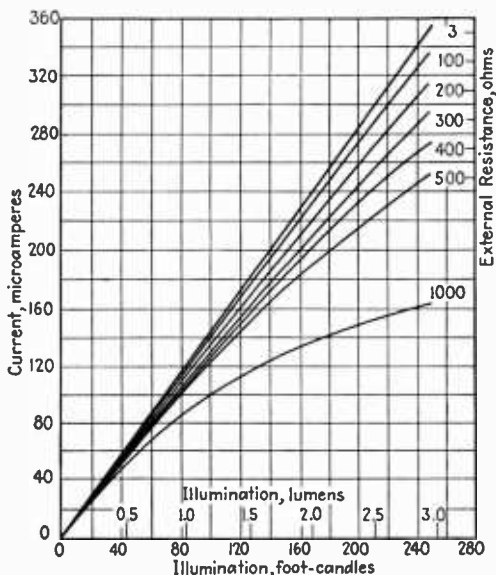

FIG. 17.—Weston Photronic cell characteristics.

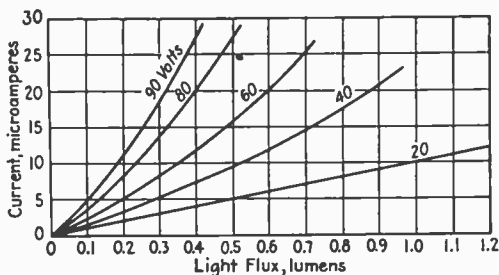

FIG. 18.—Typical emissive phototube characteristics.

has the correct value, depending upon the plate voltage, it can prevent the flow of current by preventing the production of ions in the gas or vapor. If, however, the grid voltage is slightly reduced, *i.e.*, made slightly less negative, so that a few electrons move toward the plate,

they ionize the gas or vapor, producing other electrons and ions and surrounding the grid with the positive remnants of the gaseous molecule. These positive ions form an insulating shield around the grid and prevent its negative voltage from having any appreciable effect upon the flow of electrons to the plate.

These gaseous tubes may be considered as mercury-vapor, or gaseous, rectifiers of the conventional type into which a grid has been placed. A rectifier conducts current during the complete portion of the cycle in which the anode is positive with respect to the cathode. On the other hand, if a grid-controlled rectifier is placed in a circuit operating from a.c. in such a manner that, during only a portion of the cycle,

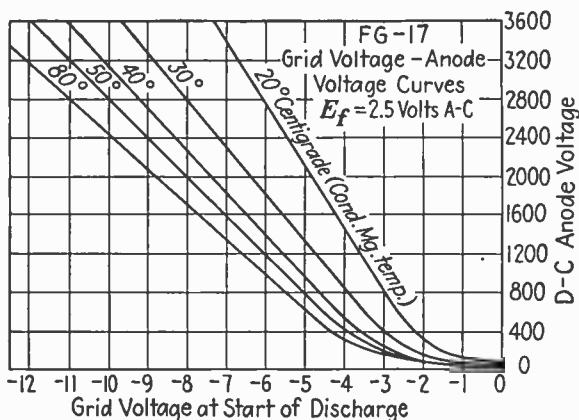

Fig. 19.—Typical mercury-vapor grid-controlled rectifier characteristics.

the grid has the proper voltage to permit the flow of current, then the plate current will flow during that portion of the cycle only. If both grid and plate are operated from a.c., the phase between their voltages may be adjusted so that the grid permits conduction during the entire half cycle (grid and plate voltage in phase) or during some smaller portion of the cycle. Thus the amount of current passed by the rectifier may be under control.

In another type of controlled rectifier (the Ignitron of Westinghouse), a starting electrode is introduced into a mercury pool which acts as the source of electrons. As in the grid-controlled rectifier, once the flow of current has started, no control is exercised over it, and, contrary to the grid-controlled tubes (Grid-glow and Thyatron), there are no intermediate current values; the current flows, or it does not.

In the communication art, gaseous triodes are used as relay tubes. A small voltage applied to the grid of the tube permits a large flow of current. To stop this current flow, when operated from d.c., the plate voltage must be removed. Such tubes have been used as keying relays to control the flow of heating current in a crystal oven, where the grid voltage change is secured from the contacts of a thermostat, etc.

20. Temperature and Other Effects. Mercury-vapor tubes have characteristics which are not independent of temperature. Argon, neon, or other gaseous tubes are independent of temperature but have higher internal voltage drops than mercury-vapor tubes. The characteristics of a typical mercury-vapor tube are shown in Fig. 19. If any one of the curves in this figure is considered, it represents for each value of plate voltage the grid voltage which will prevent the flow of current. At any less negative grid voltage, current will flow.

Finite time is required for the ionization process to build up. Similarly the de-ionization time is finite. These periods are of the order of microseconds, however, and in relay work are generally neglected.

Cathodes for gaseous tubes may be of the filament or the heater type. They may be shielded so far as heat is concerned, so that a small amount of heating power keeps them at the proper temperature for emission. Those with the most efficient cathodes, however, require the longest time to heat up and begin emission.

21. Metal-clad Grid-controlled Mercury-vapor Rectifiers. In supplying plate power for large transmitting stations, it has been the custom in this country to use motor generators, batteries, or mercury-vapor rectifier tubes. In Europe, however, and to some extent in this country, the use of mercury-arc rectifiers of the pool type has been prevalent. Grid-controlled tubes of this general type have come into use for this purpose.

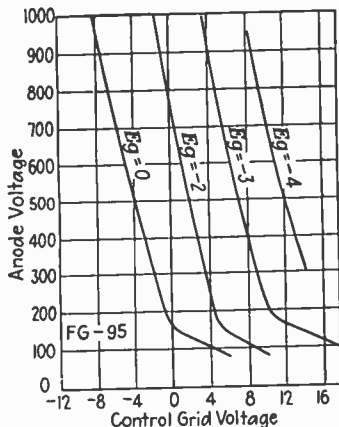

FIG. 20.—Characteristics of shield-grid Thyratron.

References

- ALLEN, H. STANLEY: "Photoelectricity," Longmans, Green & Company, 1925.
 CAMPBELL and RITCHIE: "Photoelectric Cells," 3rd ed., Sir Isaac Pitman & Sons, Ltd., 1934.
 GUDDEN: "Lichtelektrische Erscheinungen," Julius Springer, Berlin, 1928.
 HENNEY: "Electron Tubes in Industry," McGraw-Hill Book Company, Inc., 1934.
 HUGHES: "Photoelectricity," Cambridge University Press, 1914.
 ———: Report on Photoelectricity, *Bull. Nat. Res. Council*, 1921.
 ——— and DuBRIDGE: Photoelectric Phenomena, McGraw-Hill Book Company, Inc., 1932.
 KOLLER, L.R.: "Physics of Electron Tubes," McGraw-Hill Book Company, Inc., 1934.
 Report of the Committee on Standardization, *I.R.E.*, p. 57. 1928.
 ZWORYKIN and WILSON: "Photoelectric Cells and Their Applications," 2d ed., John Wiley & Sons, Inc., 1932.

SECTION 24

SOUND MOTION PICTURES

BY FRANKLIN S. IRBY, M.Sc., Ph.D.¹ AND AARON NADELL²

1. Introduction. The data given on the following pages are intended to cover a brief descriptor of the principal apparatus and methods used in recording and reproducing sound motion pictures. The main amplifier equipment used in sound motion-picture work is similar to that used for public-address systems, electrical transcriptions, broadcasting, etc., with modifications to meet special requirements.

The equipment necessary for recording sound for motion pictures is often greater than that for reproducing and compares with the amount of equipment required for a broadcasting station, as contrasted with a single receiver. Some of the portable sound-recording equipments have, however, been greatly simplified, and require no more units than a small theater reproducing system.

While the various systems of recording differ in details, the principal parts of the apparatus are similar in purpose and design up to the recorder proper. Here, depending upon the method of recording (as described later) the recorders are different in construction and operation.

2. Methods of Recording. The principal methods of recording *sound on film* include: (1) variable-density method (which may be accomplished by using either a light-valve or glowlamp), (2) variable-area method (accomplished by using a galvanometer "vibrator"), (3) recording with a Kerr cell, (4) a film-engraving method, and, (5) a vibrating ribbon (used abroad).

The principal method of recording *sound on disk* involves using an electrical recorder similar to those used in making standard phonograph records.

1. Variable-density Recording. The *light-valve* method uses a light of constant intensity; the ribbons of the valve move in response to a voice current and cause a sound track of variable density to be recorded on the film. When using a *glowlamp* to produce a sound track, a light source, whose intensity is varied, is focused on a film through a slit of fixed dimensions. Sound tracks produced by these two methods are similar. Variable-density sound tracks are shown in Fig. 1a and 1c. The average density of the sound track in this case acts as a "carrier" on which the modulations of the sound waves are recorded in less or greater density variations than the "mean."

2. Variable-area Recording. In general, this is accomplished by using a light of fixed intensity, which is modulated through the operation

¹ Member, American Physical Society; Society of Motion Picture Engineers, U. S. Naval Institute; lieutenant commander, U. S. Naval Reserve; Fox Film Corporation, New York.

² Author of "Projecting Sound Pictures," McGraw-Hill Book Company, Inc.

of a galvanometer, or vibrator, as this unit is called. This produces serrations on the sound-track area of the film, as shown in Fig. 1b.

3. *Recording with Kerr Cell.* In recording sound on film by this method, the light-valve unit or oscillograph unit is replaced by a Kerr cell. The appearance of the sound track using the Kerr cell is similar to the variable-density sound track.

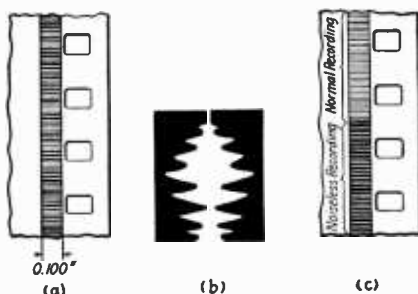

FIG. 1.—(a) Variable-density sound track produced by light-valve ribbons or glow lamp; (b) variable-area noiseless track produced by vibrating mirror; (c) noiseless recording showing greater density during periods of low modulation.

4. *Film-engraving System.* In this method of recording sound on film, an electric-cutting stylus actuated by a power amplifier is used to engrave the sound record directly on the face of the film. The position of the sound track may be inside or outside the sprocket holes. The depth and shape of the groove as cut by this method are similar to those used for cutting disk records (*i.e.*, from 2 to 2.5 mils in depth, and 4 to 6 mils in width).

5. *Vibrating-ribbon Recording.* Several methods developed abroad make use of a vibrating ribbon to cast a fluctuating shadow upon the sound track. One such ribbon valve, developed in Soviet Russia, can be rotated 90 deg., so as to yield at will either variable-area or variable-density recording.¹

6. *Disk Recording.* In recording sound on disk in synchronism with the film record, it is the usual procedure to use soft wax records approximately 17 in. in diameter and from 1 to 2 in. thick. These records are later processed to produce a hard record approximately 16 in. in diameter and $\frac{1}{4}$ in. thick.

The sound record is cut in the highly polished surface of the wax disk by means of an electromechanical recorder. The technique of cutting the wax records is similar to making standard electric phonograph records, except that for sound pictures, the procedure is to record from the center of the disk toward the outer edge, while for common phonograph records, it is the reverse. The standard speed for common phonograph records is 78 r.p.m., while for sound-picture records it is $33\frac{1}{3}$ r.p.m. This speed, with a 16-in. disk, gives a playing time from 10 to 12 min.

a. *Shape of Groove.* The shape of the groove varies somewhat in commercial practice, but it is approximately 0.006 in. wide, and 0.0025

¹ *Jour. Soc. Mot. Pict. Engra.*, March, 1934, p. 158.

in. deep. The pitch of the groove is generally 0.010 to 0.011 in., leaving a space between grooves of about 0.004 in. With only this space available, the maximum safe amplitude is something less than 0.002 in., if the walls of the groove are not to be cut too thin.

b. Cutting Stylus. Aside from the recorder itself, the stylus must be of the correct shape and smoothness to perform properly. Synthetic ruby and similar materials having good wearing qualities are used for the cutting edge.

c. Playback Record. After the wax record has been cut, the sound may be reproduced directly without any further processing, by using a suitable pick-up. Such reproducers have to be carefully counterbalanced and worm-driven to prevent damage to the soft wax records, which then may be played several times without injury. Under actual recording conditions, however, where two records are used for recording, only one is used as a "playback," the other is used for processing.

3. Recording Apparatus. For recording sound pictures, the amount of apparatus required varies somewhat with the different systems and also whether it is designed for studio recording or portable news-reel work. Equipment for the larger studios is rather elaborate and furnishes the necessary facilities for multiple-microphone recording when necessary, also for monitoring, for playback purposes, re-recording, etc. Portable equipment is reduced to the barest essentials, to eliminate weight and space required to make a sound film record with one or more cameras. Monitoring the result in this case is generally accomplished by using a headphone only during recording operations. No playback facilities, as a rule, are provided for portable use.

4. Microphones. The microphones used in sound-picture studios are similar to those used for broadcast studios, public address and similar uses. Generally more careful selection of units and adjustments is required, than for other than sound-picture work. Standard types of inductive microphones with suitable preamplifiers are now generally used. The microphone, and sometimes its associated amplifier, is furnished with a bail, in order to facilitate suspension in desired locations on the stage. Microphone booms, designed especially for this work, are in general use, allowing flexibility of the microphone during recording. One form of dynamic microphone has been introduced for sound-picture recording. The principle of operation is somewhat similar to the Western Electric 555 receiver. An extremely light coil is attached to a thin diaphragm which actuates it in a magnetic field. (See also the data on microphones in the section on Broadcasting.)

5. Velocity Microphone. This is one of the special types of microphones developed by RCA Photophone for sound-picture work. The microphone consists of an extremely thin aluminum ribbon suspended between magnetic poles. The sound waves cause sufficiently strong movement to actuate the electrical circuit. Sound pick-up with such a microphone in the plane of the ribbon results in maximum volume output, while sounds from a position at right angles to the microphone face are not picked up. This gives the microphone desirable directional characteristics.

6. Beam Microphones. These consist of various kinds of parabolic and other forms of reflectors designed for sound concentration. The microphone is placed at the focus of such reflectors, with the face of the microphone facing away from the source of sound. These reflectors

have been used successfully in directional pick-up, especially in certain kinds of outdoor recording.

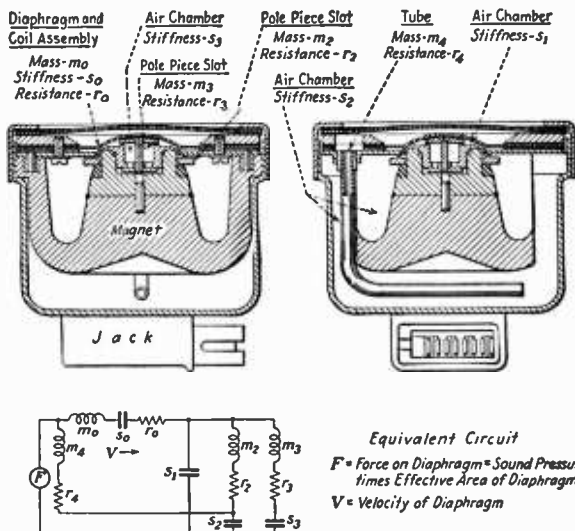

FIG. 2.—Cross-sectional view of dynamic microphone of Bell Telephone Laboratories.

7. Sound-recording Channel. A schematic of a typical recording channel is shown in Fig. 4a. Reference to this diagram will assist in following the description of the principal amplifiers and recorder units given below. A typical transmission-level diagram is shown in Fig. 4b, which indicates the various energy levels of the circuit in decibels from the point of pick-up to the recorder.

8. Preliminary or Booster Amplifier.

This amplifier is mounted between the mixer panel and the volume-control panel. It is used to amplify the output of the mixer before passing through the volume-control panel. Amplification is desired at this point to raise the recording level sufficiently high to prevent undesirable pick-up from stray electric currents or other sources entering the voice-transmission circuit. It also eliminates possible noise when operating the volume-control potentiometer. This amplifier differs in detail for various systems. In the Western Electric system, it is a three-stage resistance-coupled amplifier using three 264-A tubes.

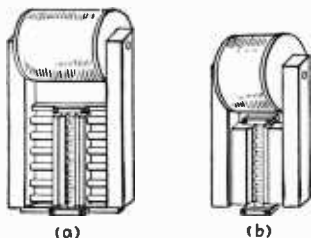

FIG. 3.—(a) Ribbon microphone in which the structure surrounding the ribbon is small; (b) microphone with baffle surrounding the ribbon.

9. Volume-control Panel. The outputs from the individual mixer panels are connected in parallel, and leads from them connected to the input of the preliminary or "booster" amplifier. The output from the preliminary amplifier is fed into a control potentiometer, which permits

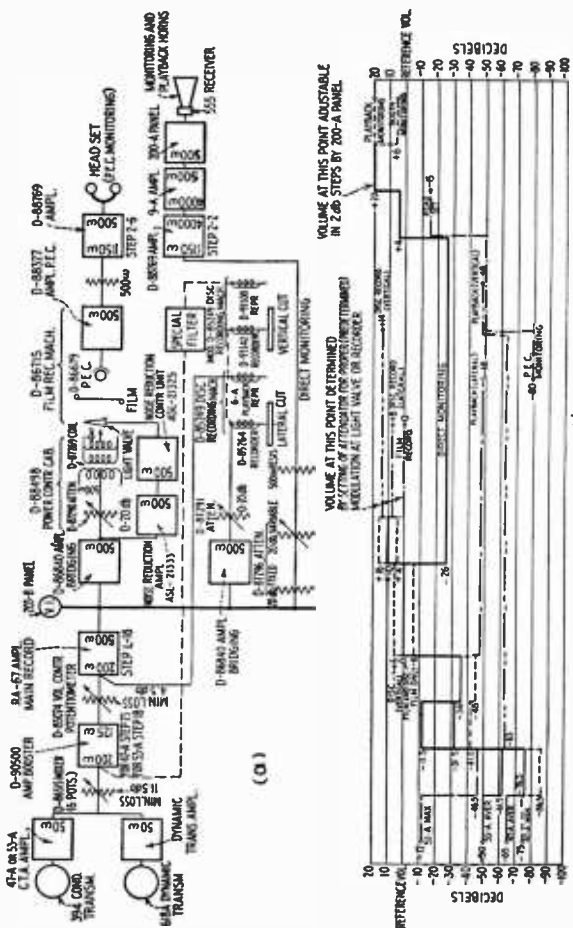

Fig. 4.—(a) Schematic of Western Electric recording system; (b) transmission-level diagram of system.

simultaneous adjustment of the total volume without changing the relative adjustments of individual mixer values. This panel also mounts an extension volume indicator to give a visible indication of the volume level maintained at the bridging bus.

10. Main Amplifier. This amplifier is so designated that it amplifies the output from the volume-control potentiometer, and delivers the amplified current to the bridging bus circuit (or in simpler installations, directly to the power-control panel and recording machine). It is the amplifier furnishing the largest gain in the recording channel. The main amplifier differs in details for the several recording systems. In the Western Electric system it may be an impedance-coupled amplifier with input and output transformers, *i.e.*, the first stage using a Western Electric 102-type tube and the second and third stages, 205-type tubes. The total gain of this amplifier is approximately 70 db. The gain control of the amplifier is provided by a potentiometer in the input circuit.

The PA-47 main amplifier in RCA Photophone system consists of four voltage-amplification resistance-coupled stages, and two push-pull power-output stages in parallel. Non-microphonic tubes are used in the sensitive voltage-amplification stages. The output stages employ 71-A tubes. Each of the push-pull output stages is independent of the other, and two recorders may therefore be fed by the amplifier. The plate circuit in each stage has a resistance-capacity filter and the filament supply is filtered by a reactor. The input has been designed to operate from a 500-ohm line. The output may easily be altered to supply loads of 500, 250, or 167 ohms. The frequency characteristic is flat, to within plus or minus 1 db between 100 and 10,000 cycles and is unaffected by the volume-control setting. The over-all amplification, with average tubes, is approximately 85 db, and each of the two output stages delivers 800 mw of undistorted power. The frequency characteristic of the two output stages shows a maximum deviation of 0.1 db from each other.

11. Bridging Amplifier. One of these amplifiers is required for each recording machine, its principal function being to prevent variation in individual recording circuits from introducing any loss or distortion to other circuits. It divides the electrical circuit output from the main amplifier, depending upon the number of amplifiers connected to the bridging bus. It is essentially a power amplifier, with the input transformer arranged for a high input impedance, making the bridging of several of the amplifiers across the main bus practical.

The bridging-amplifier outputs are connected to the film and wax recording machines in the recording room. The wax recorder requires approximately +8-db volume level, and the film recorder around 0 db.

12. Film Recorders. Up to the point of the recording machine, all methods of sound-picture recording are essentially the same. The types of recorders differ in detail for different systems, depending upon whether they are designed for variable-area or variable-density recording. Where recording units are separate from the cameras, they are mounted on machines usually located in other parts of the studio, but connected to the same electrical motor system for maintaining synchronism with the cameras. In the case of sound-film cameras used in news-reel and similar work, recorders are mounted directly on the cameras.

13. The RCA Photophone recorder¹ used for variable-area recording is shown in Fig. 5. Two coils actuate the galvanometer. One carries the voice current to be amplified; the other, a portion of that current which has been rectified and is used as bias. In the absence of speech modula-

¹ *Jour. Soc. Mot. Pict. Engrs.*, November, 1932, p. 403.

tion a very narrow transparent line is produced down the center of the sound track. A speech signal causes the mirror to vibrate about a central position determined by the bias current and hence to reflect to the film a varying width of the triangular aperture. The type of track produced by this recorder is shown in Fig. 1b.

The recording galvanometer is diagrammed in Fig. 6.

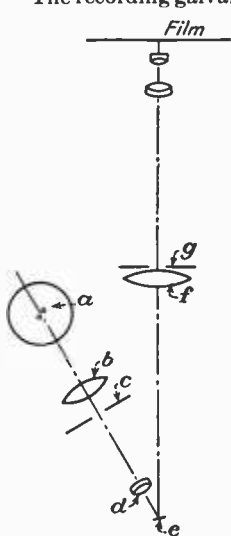

FIG. 5.—Schematic diagram of RCA Photophone recorder. *a*, recording lamp; *b*, condensing lens; *c*, triangular aperture; *d*, lens; *e*, galvanometer mirror; *f*, condenser lens; *g*, mechanical slit.

The increase in sound-print density reduces the ground noise (and consequently increases the volume range of the record) to the extent of about 12 db. A *dialogue equalizer*² is sometimes used with wide-range recording to reduce the low-frequency response during dialogue, and especially for intimate close-ups.

15. Glowlamp Recorder. This consists of a two-element gaseous-discharge tube which varies its illumination in accordance with the voice currents impressed on its circuit. This produces a variable-density sound track similar to the light-valve track. The Acolight, used by Fox Film Corporation, is one of the recorders in this class. The lamp

A proposed variation of this method is *push-ball recording*, in which the sound track carries two images side by side but 180 deg. out of phase. The optical system of the reproducer focuses each recording separately on one cathode of a double-cathode, "full-wave" photocell.¹

14. The Western Electric light-valve recorder consists essentially of a duralumin ribbon "hair-pin" in a plane at right angles to a strong magnetic field. The ribbon is approximately 6 mils wide and $\frac{1}{2}$ mil thick. This ribbon is stretched by means of an adjustable spring over a bridge having a narrow slit for passage of the light from the recording lamp through the optical system to the film.

Set screws are provided to center the ribbon accurately over the slot, which is approximately 8 mils wide and 250 mils long.

The ribbon is tuned after proper spacing on the valve to 9,500 cycles or higher, so that its natural period will be outside the range of the frequencies being recorded. A diagram of the optical system using a light valve for recording is shown in Fig. 7. The light source is provided by a special lamp having a horizontal filament. The lamp socket mounting is so adjustable that the filament can be focused properly on the light-valve slit. The sound track produced is shown in Fig. 1a.

A portion of the speech input is detoured through the *noise-reduction amplifier* of Fig. 4a and used to control a bias current which flows through the hairpin ribbon and in turn controls the ribbon spacing. The result is a *noiseless recording* as shown in the lower half of Fig. 1c.

¹ *Jour. Soc. Mot. Pict. Engrs.*, July, 1932, p. 51.

² *Jour. Soc. Mot. Pict. Engrs.*, April, 1934, p. 254.

is not focused upon the film but a portion of its illumination is allowed to pass through a quartz slit which is in contact with the film.

The recording level for the Aeolight is approximately +12 db. All lamps have a steady d-c component impressed, which causes them to burn at a predetermined exposure. This exposure is modulated by an

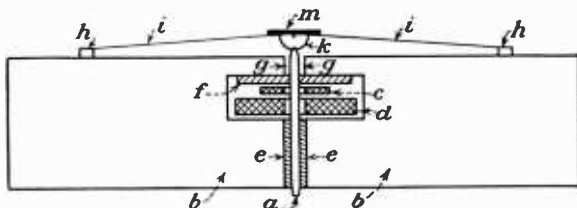

FIG. 6.—Schematic diagram of the galvanometer used to actuate the mirror of Fig. 5. *a*, silicon-steel armature; *b, b*, silicon-steel pole pieces; *c*, voice coil; *d*, bias coil; *e, e*, non-magnetic spacers; *f*, rubber pad for damping at resonance frequency (9,000 cycles); *g, g*, air gaps; *h, h*, prongs providing tension for galvanometer ribbon; *i, i*, galvanometer ribbon; *k*, mirror plate; *m*, mirror. The mirror vibrates rotationally about a center through the ribbon.

a-c component due to the introduction of voice currents from the recording amplifier. The resulting output is a variable-density sound track similar to that shown in Fig. 1a. The illumination from a glowlamp is approximately proportional to the amount of current flowing through it, within the normal recording range.

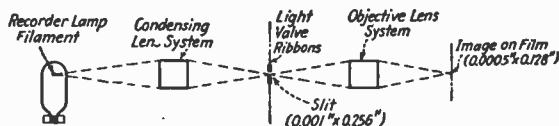

FIG. 7.—Optical system used in light-valve recording.

16. Portable Sound Cameras. All of the above given recorders are adaptable for mounting directly on the camera itself. Studio recording, however, is done on a separate negative. Picture and sound negatives are subsequently united in a master print from which positives are made.¹

MOTOR SYSTEMS

17. Synchronous Motor System. When recording sound for motion pictures, it is essential that the cameras and recording machines (if separate, as in studio installations) are run in exact synchronism and at the desired speed. The systems in general use to accomplish this differ considerably in details, but are standard as regards speed of film, which is 90 ft. per minute.

18. Interlocking Motor System. The Western Electric system consists essentially of a system of interlocking synchronous motors. Each piece of apparatus of the recording system, camera, film recorder, disk recorder, etc., is provided with a separate motor. These are controlled

¹ "Recording Sound for Motion Pictures," McGraw-Hill Book Company, Inc.

by a distributor which is in turn driven by a constant-speed motor using a vacuum-tube control circuit for maintaining accurate speed. Each motor of the synchronous system has a phase-wound rotor and a phase-wound stator. The three terminals of the stator windings of all motors, and also similar terminals of the distributor stator, are connected to a source of 220-volt, 50- or 60-cycle, three-phase power supply. The three terminals of the distributor rotor windings, which are brought out through slip rings, are similarly connected to the rotor windings of all motors in the system. The distributor is direct-coupled to a d-c motor, whose speed is regulated by a special control circuit. A simplified schematic of the interlocking motor system is shown in Fig. 8. Prior to starting the system, a definite synchronizing mark is made on the film by a punch mark in the cameras and recorders.

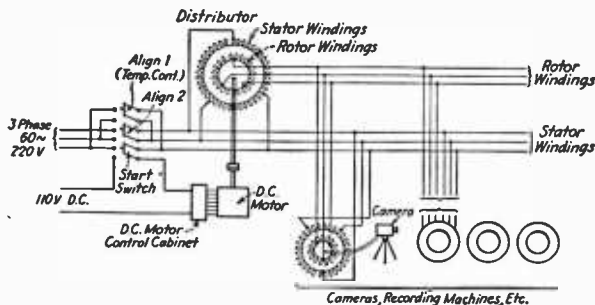

FIG. 8.—Interlocking motor system for driving camera and recorders in synchronism.

Alignment of the motors prior to starting is accomplished by closing align switch 1 and 2 in order, which places single-phase excitation on the system prior to actual starting. This will usually bring all motors in alignment prior to actual starting. Closing of the start switch will apply the other two phases of the stator winding, and also add d-c power to the distributor motor, simultaneously. All motors of the system thereafter run interlocked.

19. Non-interlocking System. This system involves the use of synchronous motors connected directly to a source of 110-volt a-c 50- or 60-cycle power supply. Each piece of the apparatus of the recording system is driven by a separate motor, as in the interlock system. No preliminary alignment, however, is made prior to starting. When ready to record, the main power-supply switch for the particular recording channel is closed, starting all motors together. When up to speed (a few seconds later), a fogging system is operated, to mark a definite synchronizing point upon the film in the cameras and the recording machine. This mark provides a means of matching the sound record with the picture at the proper point when they are combined later for printing.

20. Motor System for News-reel Outfits. Motors for this purpose consist of a small d-c motor of conventional design, connected directly to the camera in some cases, or through a flexible shaft. A source of direct current, usually supplied by storage batteries, furnishes the neces-

sary motive power. A rheostat is provided in the motor circuit for speed adjustment, which is usually required due to temperature changes. A tachometer is connected to the motor shaft, to check the speed.

21. Motor System for Location Trucks. Motors for this purpose are usually of the interlocking type similar to those used in studio installations, though the system is greatly simplified by elimination of motor switching panels and other auxiliary apparatus.

DISK RECORDS

22. Necessary Equipment. Equipment necessary for disk recording consists essentially of a machine lathe especially designed to turn the wax record at a uniform speed, which is $33\frac{1}{3}$ r.p.m. for motion-picture work. The carriage of the lathe is driven with a lead screw carefully machined to move the recorder holder at a predetermined rate while cutting the wax record. The lead screw is driven through a gear train which regulates the number of grooves cut per inch, usually 86, 92, or 98. A recorder holder provides the necessary support for the electrical recorder. The process of recording programs on wax disks for later modulating a radio transmitter, known as *electrical transcription*, is essentially the same as the process described here.

A horizontal turntable, driven through a vertical shaft, is provided for supporting the wax record. The vibration of the driving motor is eliminated on different lathes by various methods. The Western Electric lathe uses an oil dashpot placed below the lathe bench, and through which the vertical shaft of the turntable is driven. This dashpot provides the necessary damping to insure smooth recording on the record. The motor driving the turntable is run in synchronism with the camera motors.

The details given below refer to lateral-cut records, this being the only type of record that has been used, to date, for reproduction of talking pictures in the theater. Vertical-cut records are made by some studios for playback purposes.

In current theater practice sound records synchronized with a moving picture are of the film-track type exclusively. The use of disks for this purpose was attended by several disadvantages: the necessity of selecting the correct disk for every reel, with the inevitable percentage of mistakes; the possibility of loss of synchronization; and the fact that a set of disks as well as a set of films had to be provided.

Disk records are, however, used for incidental music, for exit marches, to avoid hiatus in the sound during the showing of silent trailers, and to accompany an orchestra or a singer. Synchronized disk records are also used with 16-mm film for home entertainment, in schools, and in other non-theatrical fields.

23. Disk Records. The grooves of a disk record are ordinarily spaced about 92 per inch. This allows about 0.011 in. from center to center of the groove, of which 0.006 in. is the width of the groove itself. The maximum lateral motion of the stylus is thus limited to about 0.0025 in. on either side. Generally, 0.002 in. should not be exceeded. Cutters generally used are designed as constant-velocity devices. In practice such cutters have this characteristic only above 200 cycles. Below this point, the amplitude is independent of frequency. If the maximum amplitude for a 200-cycle wave is equal to 0.002 in. on either side of the

center, then a 1,000-cycle amplitude for the same electrical input level would be 0.0004 in.

24. Recorder Attenuator. This unit is usually provided for controlling the relative volume level of the voice currents actuating the electrical recorder. It is connected in the circuit between the output of the final amplifier and the terminals of the recorder or recorder-control box, thence to these terminals.

The recording machines on the market differ in details but consist essentially of the above units.

25. Determining the Starting Point. Disk records for sound pictures are cut from the inside out—just the reverse of regular phonograph records. To obtain a definite starting point for the records when in use, the first groove is spaced an appreciable distance from the rest of the cut. This is obtained by a coarse speed cam actuating the lead screw at the start of recording. As the lead screw makes its first complete revolution, it moves the recorder under the influence of the cam until the recorder is in its normal cutting position.

26. Electrical recorders provided for disk recording are generally designed so that the average linear velocity of the stylus (which may be expressed as the frequency times amplitude) is proportional, over a wide range of frequencies, to the impressed voltage. The method of damping the moving system varies with different records. The Western Electric recorder uses a rubber tube about $\frac{1}{2}$ in. in diameter and 8 in. long, one end of which is fitted to the armature assembly and the other end free. Oil is sometimes used to damp the armature movement in other types of recorders.

27. Cutting stylus consists of a sapphire or other hard point fastened to the lower end of the stylus arm. One end of the sapphire has a rounded point about 0.002-in. radius, and a cutting angle between 86 and 88 deg. for the sides.

The advance ball is a small cylindrical sapphire, ground spherically at one end and held in an adjustable mounting attachment to the recorder. This ball supports the weight of the recorder and the arm, being adjustable, permits regulation of the depth of the groove on the wax.

28. Playback reproducer is provided to permit playing back the wax record immediately after it is cut for rehearsal work and test. This usually renders the wax unsuitable for processing, and for this reason, two wax records are usually provided for each recording channel, one of which can thus be used for playback and the other for processing. The pressure of the needle on the wax is generally adjusted to between 15 and 20 grams.

A needle provided for playback from the soft wax is designed differently from the ordinary needle used for the finished hard record. The Western Electric type has a point 0.003-in. radius. The needle is constructed on a mandrel, ground to a smooth finish, and the point given a chromium plate to improve wearing quality.

29. Checking Speed. The periphery of the turntable is usually divided with vertical lines, so that a neon lamp, operating from a 60-cycle source, may be used as a stroboscope to observe the turntable motion. The lines on a standard turntable are usually arranged so that with 60 cycles on the lamp, as the turntable rotates at exactly $33\frac{1}{3}$ r.p.m., the lines will appear to be stationary. If faster than $33\frac{1}{3}$ r.p.m., the lines will advance slowly, and, if slower than $33\frac{1}{3}$ r.p.m., the reverse will be

the case. This check of the speed is usually made with the wax record on the turntable.

30. Checking the Damping Action. A method of checking the instantaneous constant speed may also be used to check correct damping of the turntable. With the turntable rotating at normal speed, the oscillator for supplying 60-cycle source to the neon lamp may be adjusted until the vertical lines appear stationary. If the disk is now touched lightly by hand, the line or spot observed will appear to shift its position owing to momentary load. As soon as the hand is removed, the line or spot observed should come back to its original position. Observing the movement will determine whether the turntable has insufficient damping or too much damping.

31. Wax-suction Equipment. This equipment is provided to furnish a means of removing the shavings from the wax record during recording. The suction tube is so placed that the shavings thrown off by the stylus are carried away from the face of the wax. A central suction system is usually provided in studios having several recording channels. This usually consists of a turbine suction pump with pipe lines leading from a central suction point to a separator tank placed in each recording room. In some smaller installations, an individual bell jar, with a small suction motor, is used for each turntable.

32. Wax Preparation. Two types of waxes are generally used in sound recording, those having a working temperature of 75°F., and those with a working temperature about 90°F. Matthews type M, 75°F. working temperature, is perhaps most commonly used. It is considered good practice to maintain the room temperature for the type M wax around 75°F. when recording.

The procedure for preparing the wax consists briefly of the following steps:

1. At the center of the wax, which is usually indicated by a cross mark, a $\frac{9}{32}$ -in. hole is drilled to a depth of $\frac{1}{2}$ in.

2. A course cut is made for a depth of about $\frac{1}{8}$ in. on one face of the wax and repeated as necessary to obtain a perfectly flat surface. The wax is later reversed, the first cut surface becoming the base for the finished wax.

3. On reversing the wax, a hole is cut from the other side to meet the hole drilled on the bottom.

4. A course cut is now made on the top surface and repeated where necessary to produce a smooth and flat surface. The wax is now ready for the final shaving or polishing cut, which is done with a sapphire or ruby cutting tool.

5. The face of the shaving knife is usually set at an angle of between 40 and 50 deg. to its line of travel, depending upon the particular design of the knife. Its rounded end is toward the center of the wax. The cutting face of the knife is set at an angle of 90 deg. to the surface of the wax. The turntable revolves in a counterclockwise direction.

6. The suction nozzle is placed close to the cutting knife, about $\frac{1}{8}$ in. from the front face and $\frac{1}{32}$ in. above the cutting edge.

7. The best finishing speed is usually determined by experience, but generally ranges from 150 to 160 r.p.m. The finished cut on the wax should give a perfectly polished surface free from ripples or blemishes of any kind.

33. Record Processing. Briefly, this consists of the various steps after obtaining the soft wax record, to produce the final hard record for commercial use. A complete description of each step would go

beyond the limits of this section. The following are the essential steps in this process:

1. The surface of the soft wax is rendered conductive by spreading a very thin, extremely fine conducting powder, such as graphite, over its surface.

2. Electroplating of this record. The negative electroplate obtained is used to hot-press a molding compound, such as shellac, mixed with a finely ground filler. The first electroplate obtained is called a *master*.

3. Two test pressings are made from the first master, after which it is electroplated with a positive.

4. This *positive* is referred to sometimes as an *original*. From this positive a metal mold or *stamper* record is made.

5. From this record, duplicate originals may be made, and from them duplicate molds or stampers. By thus making a number of duplicates, it is possible to protect the original master from injury, or danger of destroying a valuable record.

6. From each stamper it is possible to obtain as many as 1,000 finished pressings.

34. Playback Recording. In some studios either lateral-cut or vertical-cut records are made in disks composed of cellulose compounds, or of paper or aluminum coated with such compounds. Such records are intended primarily for playback, to determine if a scene needs retaking.

35. Re-recording. It is common practice to select desired portions of a sound record by a process of re-recording. This is done with both disk and film records. Either can be played on standard reproducing equipment, which then serves as the input to the recording system, in place of the microphones. Special re-recording equipment is also used; one type consisting of a film reproducer and a film recorder combined in a single instrument and actuated by a single motor.¹ The output of the reproducer photocell is, of course, returned to the recorder light valve in the same casing only after it has passed through an external amplifier. This instrument is used to copy on 16-mm film a sound track that was originally recorded on 35-mm stock; optical reduction, however, is also used for that purpose.

Re-recording is used to superimpose special sound "effects" upon a record. For this purpose two or more reproducing systems are connected as a parallel input to the recorder amplifier. The method offers superior control over the relative volume of such sounds as gunshots, background music, storms, etc., and, moreover, tends to reduce the cost of production. A library of "effect" records is maintained at many studios.

Originals intended for re-recording are sometimes made abroad by cutting a lateral track in discarded film, which is reported to be entirely serviceable for this purpose and to withstand many playbacks without damage.

SOUND-FILM STANDARDS

36. Society of Motion Picture Engineers' Standards. The dimensional standards for film adopted by the Society of Motion Picture Engineers are given complete in the Transactions.² The dimensions given below are those affecting sound film.

1. *Taking speed* for standard 35- and 16-mm sound pictures is 24 pictures per second.

2. *Projection speed* for standard 35- and 16-mm sound pictures is 24 pictures per second.

¹ *Jour. Soc. Mot. Pict. Engrs.*, March, 1933, p. 219.

² See *Jour. Soc. Mot. Pict. Engrs.*, November, 1934.

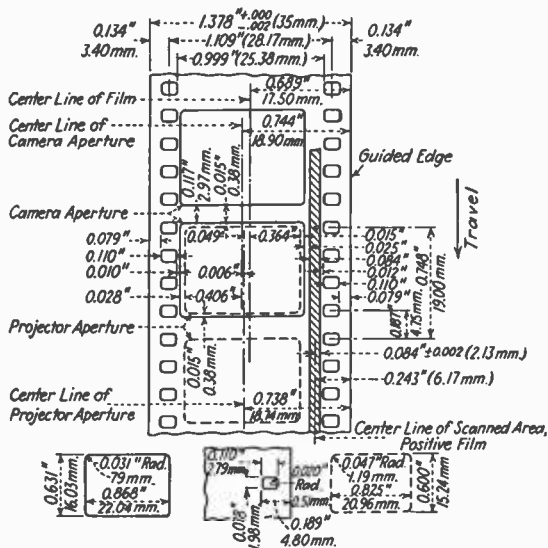

Camera Aperture Perforation Projector Aperture

FIG. 9.—Dimensions of 35-mm film.

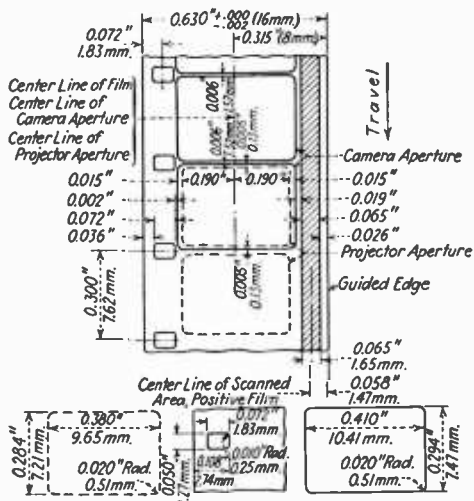

Projector Aperture Perforation Camera Aperture

FIG. 10.—Dimensions of 16-mm film.

THEATER REPRODUCING EQUIPMENT

37. Classification of Theater Apparatus. The equipment used for the reproduction of sound in theaters can be described here most conveniently by classifying it under eight headings: Power Sources, Motor-speed Controls, Drive Systems, Reproducers, Amplifier Systems, Sound Transmission Lines, Loud-speaker Systems, Acoustic Systems.

38. Power Sources. Theater sound equipment commonly requires the following power supplies. (1) A.c. 110 volts, for drive motors and a-c-powered amplifiers; (2) a.c. up to 12 volts for amplifier filaments; (3) filtered d.c. up to 12 volts, at current values up to 4 amp., for d-c filaments, exciter lamp filaments, and speaker fields; (4) filtered d.c. from 12 to 1,000 volts for amplifier tube plates and photocell plates, speaker fields, and grid bias.

1. *A-C 110-volt Supply.* Good regulation is required of this supply, partly because wide fluctuation in voltage will complicate the problem of maintaining steady motor speed, and partly because of the danger of damage to amplifiers in the late evening when peak loads decline abruptly and the line voltage remains high. The methods used to secure constant motor speed under those conditions are described in Art. 39. Protection for amplifiers is commonly secured by use of line-control panels, which may operate by means of multiple-winding transformers, or of rheostats. The transformer type is favored when the theater suffers from deficient as well as excessive line voltage.

Sound equipment is commonly designed for 50- or 60-cycle operation. Rotary converters are used when the only line supply available is of lower frequency, or d.c.

2. *Low-voltage A-C Filaments.* Tube filaments of this description are invariably powered by step-down transformers built into the amplifier or rectifier panels. In apparatus not equipped with such transformers d.c. is used for filament heating.

3. *Filtered D.C. up to 12 Volts.* Methods used for meeting this requirement include (a) storage batteries, (b) single rectifier units, (c) multiple-output rectifier units, (d) common-duct rectifier units, (e) motor generators, (f) voltage-reduction cabinets.

a. *Storage-battery installations* for theater sound sometimes consist of four 12-volt banks. Two banks, called "F batteries," supply tube and exciter filaments, one bank charging while the other is in use. Two banks, called "H batteries," are used similarly to provide speaker field excitation. In a "common-battery" installation only two banks of cells are used for all low-voltage d-c purposes, one charging while the other operates.

Charging from an a-c line is accomplished by means of 5-amp. rectifier tubes; from a d-c line by means of rheostats.

b. *Single rectifier units* may use either 5-amp. rectifier tubes or copper oxide or copper sulfide disks. One rectifier will provide exciting-lamp and amplifier-filament current for each projector and may be located on the front wall of the projection room near its associated projector. One rectifier will provide filament current for main or rack amplifier, while others, which may or may not be placed back stage, will excite the speaker fields. Brute-force filters are included in these rectifier units to smooth the output. The projector rectifiers require the greatest filtering, since perceptible irregularity in their output will be amplified. Speaker supply rectifiers need the least filtering.

c. *Multiple-output rectifiers* use either two or four 5-amp. rectifier tubes and provide as many as seven parallel d-c outputs, each individually filtered.

A single unit of this kind may offer two output circuits supplying the two exciter lamps, two circuits to heat the filaments of the projector-head amplifiers, two circuits to heat the filaments of the rack amplifier, and one circuit to excite the speaker fields. An additional, unfiltered, output may be provided for use through an external filter, in powering the announcing microphone.

d. Common-output rectifier units offer only a single d-c output, which is so heavily filtered that all the above services can be drawn from it in parallel.

e. Motor generators used for low-voltage d-c supply offer a common output and a common filter, which includes capacitors and resistors but (usually) no inductors.

f. Voltage-reduction cabinets are used for services where heavy filtering is not needed, specifically, for the speaker field supply. These cabinets contain either one or two rheostats, and provide up to 50 volts d.c. for speaker fields wired in series or in series multiple. They derive their power from whatever source is used to light the d-c projection arcs. This may be a d-c line or a motor generator, or may be a tube or copper oxide disk rectifier capable of supplying the relatively heavy current (up to 100 amp.) which those arcs require. Rectifiers used for that purpose are often of the three-phase type, with full-wave disk or tube rectification in each phase, the outputs being paralleled. Motor generators used for that purpose are heavily compounded to maintain stability under variations in the arc drain.

Direct current for grid bias is sometimes obtained by means of small dry batteries (No. 703 Eveready) installed in a convenient container on the front of the amplifier panel. Self-biasing circuits are more common.

4. *Filtered D. C. from 12 to 1000 Volts.* As high as 350 volts d.c. has been provided by storage cells of 2 amp.-hr. capacity. As high as 1,000 volts is provided by an external rectifier and filter using Western Electric 219-D tubes, for which mercury-vapor rectifiers have in some cases been substituted with the addition of a suitable resistance. Standard rectifier and filter circuits for amplifier-tube plate supply are built into all recent sound amplifiers. In some instances a voltage amplifier receives its plate supply from the power amplifier following.

High-voltage speaker field windings may be included in the filter circuit of an amplifier, an additional high-voltage line being run back stage for that purpose. In some systems three wires are carried back stage, one being common to both field and voice circuits.

Photocell bias (usually 90 volts) may be obtained by means of standard B batteries or (through an additional filter) from the filtered plate supply of a power amplifier.

39. Motor-speed Controls. Sound-on-film reproduction requires that the projector motor drive the film at 90 ft. per minute and without irregularity. Rapid fluctuation in motor speed results in a tremolo-like sound called "flutter." Slower changes in motor speed create a sighing effect as the pitch of the sound alters, called "wows." Steady operation at incorrect speed means that voices and music will be off pitch. Automatic speed regulators are designed to limit variations in motor speeds to one-third or one-fourth of 1 per cent.

Disk records synchronized with film are driven by the projector motor through a flexible connection shaft.

Disk records not synchronized are played on the synchronous disk turntable if they were recorded at $33\frac{1}{3}$ r.p.m. Disk records made for 78 r.p.m. are rotated by means of a separate synchronous motor. Many theaters are equipped with a double turntable to permit fading over between two such non-synchronous records.

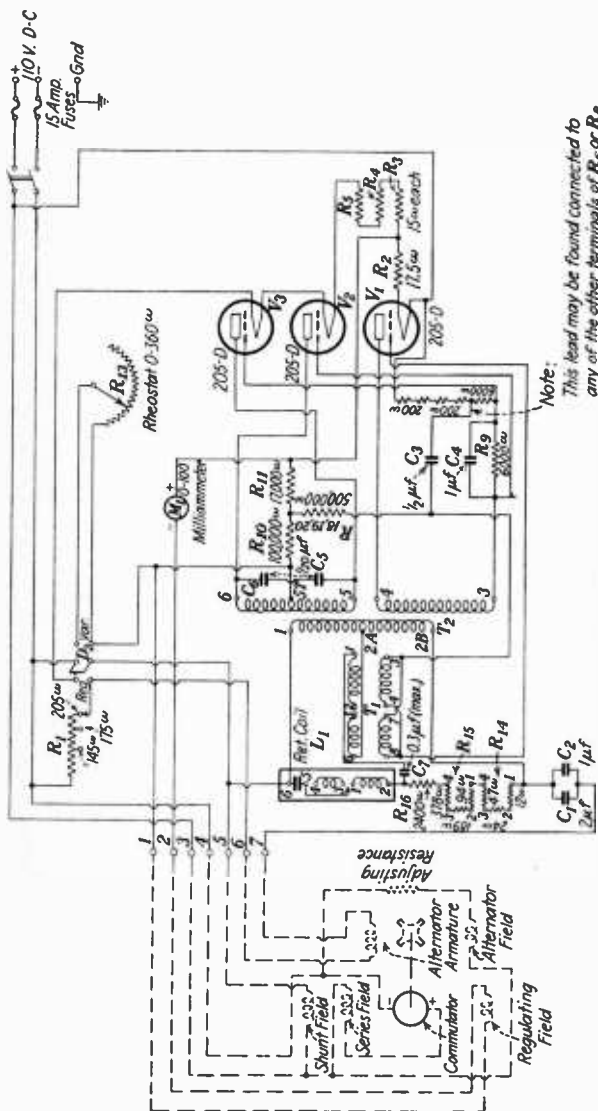

FIG. 11.—Vacuum-tube speed-control circuit.

The commonest method of securing steady and correct speed in the projector drive is to use induction motors wound to operate in synchronism with the power-line frequency.

Where only d-c lines are available, two types of d-c drive are used. RCA employs a centrifugal operated make-and-break contact in the circuit of a field winding. The chattering action of this contact keeps the motor speed constant.

Figure 11 is a circuit drawing of a vacuum-tube speed-control cabinet. The compound-wound motor is shown on the left. Shafted to it, under the same housing, is an inductor alternator, the output of which enters the control cabinet through terminals 6 and 7. At the correct motor speed (1,200 r.p.m.), the output of this inductor is 720 cycles.

The output of the inductor is applied to a Wheatstone-bridge circuit. The arms of that bridge are as follows: Upper left, the retard coil L_1 , with its built-in condenser; lower left, resistors R_{13} , R_{15} , and R_{14} ; the two right-hand arms are the two halves of the primary of transformer T_2 . The bridge circuit is the primary (the upper coils) of T_1 , in series with condenser C_7 . When the output of the inductor generator is precisely 720 cycles (motor speed 1,200 r.p.m.), this bridge is balanced and no current flows in the primary of T_1 . At other speeds the bridge is unbalanced, and current flows in T_1 primary. Retard coil L_1 and its associated condenser is a series-resonant circuit which acts like a resistance in series with capacity at generator frequencies below 720, and like a resistance in series with inductance at generator frequencies above 720. Condenser C_7 serves to rotate the voltage across T_1 primary 90 deg. with respect to the voltage across T_2 primary. Hence, at motor speeds above 1,200 r.p.m., T_1 primary is 180 deg. out of phase with T_2 primary; at speeds below 1,200 r.p.m., the two primaries are in phase; at precisely 1,200 cycles, T_1 , as said, carries no current.

The speed of the motor is controlled by the *regulating field*, which is powered by the rectifier tubes V_2 and V_3 . The grid bias of those tubes is derived from voltage drop in the plate circuit of V_1 . The grid bias of V_1 is obtained partly from the voltage drop across R_2 but modified by the a.c. from the secondary of T_1 .

Hence at normal speed, when there is no voltage across T_1 primary, there is no a.c. on V_1 grid, and the following conditions obtain. During the generator's positive half-cycle: V_1 plate current normal; V_2 and V_3 grid bias normal; normal plate current across V_3 ; no space current in V_2 (plate negative); normal exciting current in the regulating field.

During the generator's negative half-cycle, normal grid bias for V_2 is provided by the charge of condenser C_4 . V_3 then has a negative plate and no space current; space current across V_2 and in regulating field, normal.

At speeds below 1,200 r.p.m. the conditions are as follows: During the positive half-cycle: V_1 grid and plate positive simultaneously; V_1 plate current high, V_2 and V_3 negative grid bias high; V_2 plate current none (plate negative) and V_3 plate current low; regulating field current low; motor speeds up.

During the generator's negative half-cycle, at speeds below 1,200 r.p.m., V_1 and V_3 plates are negative; V_2 grid bias is high by virtue of the charge in condenser C_4 ; V_2 plate current is low; regulating field current is low.

At speeds above 1,200 r.p.m. the conditions are: During the positive half-cycle: V_1 grid and plate 180 deg. out of phase; V_1 grid potential negative, while plate is positive; V_1 space current low; V_2 and V_3 negative grid bias low; V_2 space current (plate negative) none; V_3 space current high; regulating field current high; motor slows down.

During the generator's negative half-cycle V_1 plate is negative; V_3 plate is negative; V_2 grid bias (from C_4) is low; V_2 space current is high; regulating field current is high.

A third source of grid bias for V_1 is provided by the drop across R_{11} . The use of R_{11} for that purpose constitutes a feed-back which sharpens the regu-

lating action, since either increase or decrease in the regulating field current, caused by the action of the regulating circuits already described, further influences the grid bias of V_1 in the same direction. However, the feed-back operates through condenser C_3 , which must alter its charge through the half-million ohms of R_{12} , R_{17} , R_{18} , R_{19} , and R_{20} before a change in the drop across R_{11} can act upon the grid of V_1 . This delay prevents "hunting" (oscillation of the motor speed about an average value), which might otherwise result from the action of R_{11} .

Rheostat R_{13} is used to control the regulating field current when switch D_2 is thrown to the right or "variable" position. The tubes are then unlit and the automatic control ineffective, and the speed of the projector can be varied at will over a wide range. This feature of Fig. 10 is now used only in emergency.

The Wheatstone-bridge circuit of Fig. 11, together with a slightly different vacuum-tube circuit, is used to regulate the speed of a-c projector motors.¹

In Western Electric recording installations the speed of the distributor of the interlocking motor system (Fig. 8) is controlled by circuits of the type of Fig. 11.

Figure 12 is the circuit drawing of another type of a-c projector-drive motor, with its associated control cabinet. F_2 is the field winding; F_1 , dis-

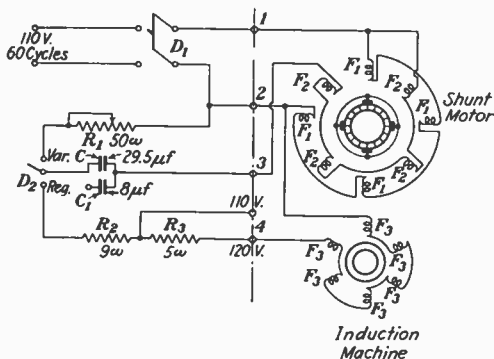

FIG. 12.—A-c projector-drive motor.

placed 90 deg. with respect to F_2 , is used as the equivalent of the armature winding in a d-c shunt motor. The armature brushes are short-circuited. With switch D_2 thrown to variable position, the speed of the motor may be regulated by rheostat R_1 .

F_3 is the stator of an induction machine built into this motor the synchronous speed of which is 1,200 r.p.m. If D_2 is thrown to regulate, F_3 will generate a counter e.m.f. 180 deg. out of phase with the line voltage whenever the motor speed declines, thereby reducing the motor field current. The opposite action takes place at motor speeds above 1,200 r.p.m.

40. Drive Systems. The projector-drive motor actuates the synchronous-disk turntable, the picture projector, and the sound attachment.

¹ *Internat. Projectionist*, February, 1935, p. 10.

The disk turntable is on a pedestal placed to the rear of the motor. The connecting shaft commonly contains rubber couplings, to minimize the transfer of motor vibration. Mechanical filters are used to secure steady motion of the disk. The pedestal may carry a flywheel. The Western Electric pedestal is equipped with a system of spiral springs, and with vanes that rotate in a dashpot of oil.

The film is moved through the picture projector by three sprockets, two of which operate steadily while the third has an intermittent motion. The portion of the film that is directly in line with the projection lens must remain motionless while the shutter opens and light is projected through the film to the screen. The shutter then closes, and the intermittent sprocket moves the film through a distance of one frame (0.748 in.) after which it is again held motionless while the shutter reopens. Loops (slack) are left in the film between the intermittent sprocket and the steadily moving sprockets above and below it.

Below the picture projector the film passes through the *sound head*, after which it is wound up in the lower magazine. Figure 13 shows a

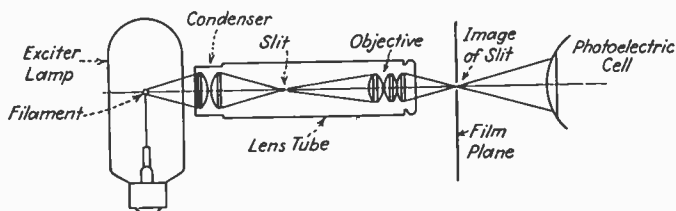

FIG. 13.—Optical system of theater projector.

portion of the projector head, the sound head below it, and a fraction of the lower magazine. The sound unit may contain either one or two sprockets.

All sprockets are driven by the same motor. The methods of transmitting power to them vary. The three sprockets of the projector head are operated by a single-drive gear. Power may be transmitted to this gear through a universal shaft, through gears or through pulleys, or through any combination of these means. The larger manufacturers use several different methods, which vary with the price and quality of the equipment.

The sound sprockets may be driven through a gear connection with the projector drive, or by pulleys or gears independently coupled to the motor.

Mechanical filters are used in all systems to secure smooth motion of the film through the sound unit. The intermittent motion of the film, while in the projector, and the vibration created by the action of the intermittent drive, make this problem difficult. One Western Electric drive uses a flywheel that contains within itself a filter system composed of spiral springs. In one type of RCA sound head the film presses against a revolving drum driven by a ball race that acts as a clutch. This arrangement, called a *rotary stabilizer*, frees the drum from rigid connection with the driving system and protects it, and the film that moves with it, against small irregularities of motion. Another of the

many mechanical filter systems now in use consists of a flywheel driven at three points through flexible rubber studs.

41. Reproducers. Disk reproducers used in sound work are of the conventional magnetic type, commonly oil-damped.

One type of film reproducer is diagrammed in Fig. 14. It consists of an exciting lamp, a lamp with a horizontal filament consuming about 20 watts; an optical system, also called *lens tube* and *slit assembly*, a *sound gate*, through which the film passes, and a photoelectric cell.

The optical system of Fig. 14 is diagrammed in Fig. 13. It focuses an image of the slit upon the film. Since the film moves at a speed of 18 in.

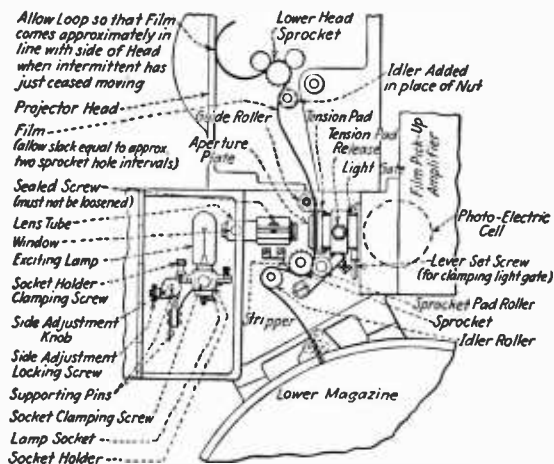

FIG. 14.—Schematic diagram of sound head (Western Electric), showing principal units required for reproducing sound from film.

per second, the reproduction of 9,000-cycle sound requires a light beam no wider than 1 mil at the place where it passes through the sound track.

Focus is corrected in practice primarily by adjusting the position of the exciting lamp, the socket of which is equipped with set screws that permit the lamp to be rotated and moved in three planes, and to be locked in position when the correct adjustment has been found. The favored method for checking exciting-lamp focus is to play a short loop of test film carrying a high frequency, such as 9,000 cycles, the lamp being adjusted for maximum volume. Volume may be judged by ear, but better results are obtained by the use of a volume indicator—a copper oxide rectifier voltmeter calibrated in decibels. In the absence of such test equipment, the sound gate of Fig. 14 is removed and a white card held in front of the photocell. The lamp is then adjusted to throw a clear, white oval upon the card.

The exciter lamp of Fig. 14 can be changed in case of burn-out simply by pulling the socket out through the door of the exciter-lamp compartment and plugging another socket, carrying another lamp previously

focused and ready, into its place. Some manufacturers prefer a sliding or turret arrangement for instantaneous substitution of exciting lamps.

The optical assembly of Fig. 14 is sealed and cannot be opened in the projection room. Some optical systems can be opened for cleaning. Some contain focusing arrangements that can be used in cooperation with the focusing arrangements of the exciter-lamp socket.

The right-hand portion of the gate of Fig. 14, the *tension pad*, can be telescoped toward the right against spring tension and locked in open position, to permit "threading up" or removing film. When the tension-pad release is operated, the gate is driven by a powerful spring into the closed position shown in the illustration. The outside edges of the film are then pressed upon by highly burnished surfaces under spring tension; the film slides between these surfaces and is held by them in the focal point of the exciting light beam.

In other sound heads the film may be drawn tightly against a curved surface over which it slides and which serves the same purpose as the gate, namely, to keep the sound track at the point where the light beam possesses minimum height. Neither method is wholly successful with film that has become warped.

The guide roller seen just above the gate in Fig. 14 is for lateral adjustment of the film. If the film should become laterally displaced, and either sprocket holes or portions of the picture pass through the exciting light beam, a loud, low-frequency sound commonly called "motor boating" will be heard from the speakers. Lateral adjustment of the guide roller is often checked by threading a short length of "blank leader"—raw photographic stock—into the sound unit and photographing the exciting light. Several half-minute exposures are taken, along perhaps six inches or a foot of the leader length. The guides are adjusted until the hair-thin black lines thus made (which are as long as a sound track is wide and can be seen easily without developing) fall definitely into the area between sprocket holes and framing lines and impinge upon neither. From two to a dozen sets of exposures may prove necessary before correct adjustment is found.

The exciting light, modulated by the moving sound track, passes through the gate to the photocell directly behind it, except that in one system the cell is not directly in line with the light but mounted somewhat higher in the sound unit and a prism is used to deflect the light beam upward.

In some equipments the photocell is coupled to the primary of an audio transformer mounted in the sound unit. The secondary of this transformer is of low impedance, and a low-impedance line is then run to the amplifier. In others (those in which the amplifier is of small dimensions and mounted on the front wall of the projection room between the two projectors), high-impedance lines not more than 2 or 3 ft. long connect the photocells directly to the resistance-coupling input of the amplifier. In Western Electric systems a one- or two-tube preamplifier with low-impedance output is mounted on each projector below the photocell and in front of the lower magazine.

Volume output from the two (or three) projectors is usually equalized by modifying the photocell voltage. In Western Electric systems an adjustable resistance pad, called an *attenuator*, is placed in the output circuit of each preamplifier, and the photocell bias is kept constant.

Microphones are sometimes used as sources of theater sound, chiefly to add volume to stage performances, but sometimes also by a singing organist or for manager's announcements. Announcing microphones are usually of the carbon double-button type. Stage microphones may be either carbon, condenser, dynamic or piezo-crystal.

The sound-system amplifier is commonly used with these microphones, but the sound-system speakers, which normally are behind the perforated screen and must be removed for vaudeville, cannot be used efficiently to add volume to stage performance. Instead radio-type cone speakers are employed, mounted either under the proscenium arch or at either side of the stage, or perhaps placed behind the organ grilles.

42. Amplifiers. Theater amplifiers use conventional audio circuits, class A in most instances, although A Prime and class B amplifiers are

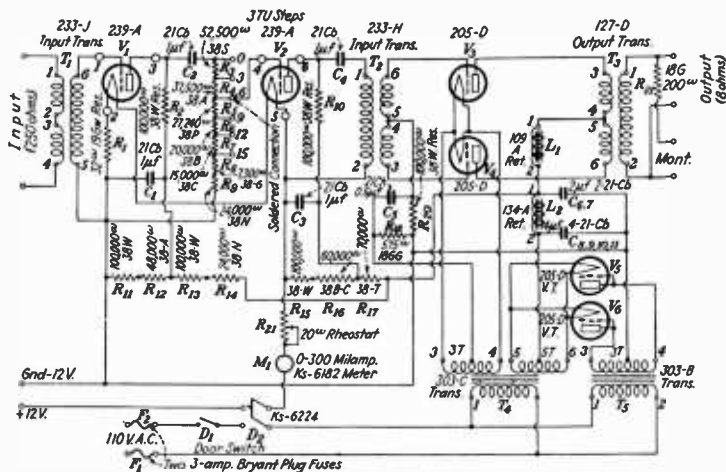

FIG. 15.—Western Electric theater amplifier.

also used. Undistorted output rating runs from 2 to 50 watts, depending on the size of the auditorium and the extent of frequency response desired. For the same auditorium, amplifier output power is commonly increased from two to five times when the range of response is extended below 60 cycles and above 6,000.

Larger theaters use two or more amplifiers in cascade. A total of six stages of audio amplification is not uncommon. Amplifiers are usually mounted on a relay rack placed near a side or rear wall of the projection room, but small amplifiers may be placed on the front wall between two projectors.

Figure 15 is the circuit drawing of a widely used theater amplifier. Western Electric 264-A tubes are now used in place of the 239-A tubes.

43. Sound Transmission Lines. The transmission line between the reproducer and the amplifier is complicated by switches. There are either two or three film reproducers, possibly the same number of

synchronous-disk turntables, two non-synchronous-disk turntables, and a mixer which in turn may be wired to a number of stage microphones. Not all theaters, however, have this much equipment. In some systems the principal volume control is placed in the transmission line between the reproducers and the rack amplifier, although in most equipments the volume control is in a grid circuit of the amplifier.

Impedance match is maintained in these lines, which are commonly of 200 or 500 ohms. Impedance match is also maintained in the speech lines between rack amplifiers connected in cascade.

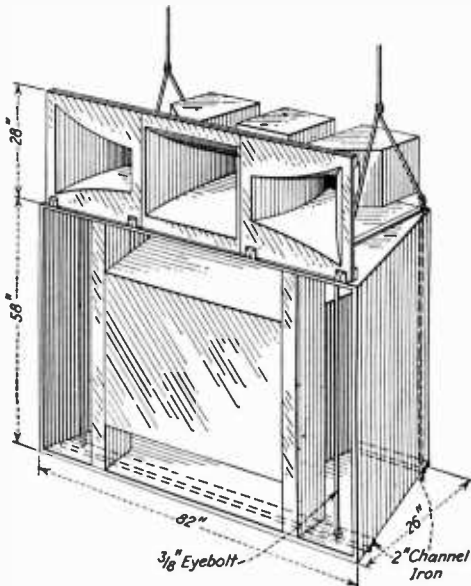

FIG. 16.—RCA speaker system. The "triplet" directional baffles above reproduce sound frequencies down to approximately 100 cycles. The large lower baffle, using the identical unit, reproduces frequencies from 100 cycles down.

Impedance match between the amplifier output and whatever number of loud-speakers may be required by the theater's size and shape is often secured by means of a tapped output transformer, but in some systems a tapped autotransformer is introduced into this circuit. The Western Electric 200-A autotransformer panel has 77 output taps, eleven for each of seven speakers.¹

The speaker voice line may also contain frequency filters to direct correct voice supply to low-, medium- and high-frequency reproducers.

44. Loud-speaker Systems. The simplest theater installations use only two or more radio-type dynamic speakers on flat baffles, but horns

¹ "Projecting Sound Pictures," pp. 179-180, McGraw-Hill Book Company, Inc.

or directional baffles are required to secure satisfactory distribution of sound in the larger auditoriums. Magnetic reproducers are sometimes used as monitors in the projection room, but stage speakers are almost always of the dynamic type, requiring approximately 10 watts of field power.

Wide range of frequency response is sometimes secured by using as many as three groups of speakers: low ("woofers"), medium, and high ("tweeters"). Piezo-crystals as well as dynamic units are currently employed as tweeters.

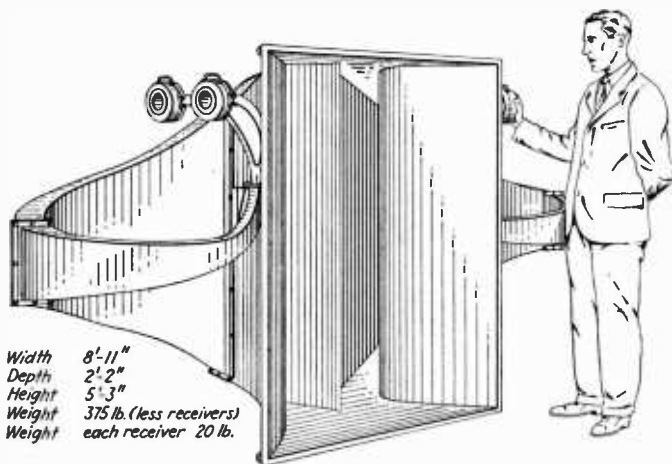

FIG. 17.—Theater horn mounting four W.E. 555-W reproducers. Frequency range about 60–6,000 cps.

Frequently-discriminating baffles are also used. The same unit may be differently baffled to produce an entirely different range of frequency response. In RCA systems such discriminatory baffles are used in connection with frequency filters built into the amplifiers to secure over-all results that will agree with the acoustic qualities of the auditorium. Low-, medium-, and high-frequency units, and filter networks in the speaker transmission lines, are used in the same way in Western Electric installations.

45. Acoustic Systems. A radio receiver is usually considered to have completed its work when sound leaves its baffle, but the same is not true of a theater installation.

The problems presented by auditorium acoustics are very serious and are difficult to control because of the high cost of remodeling or replastering. Elementary acoustic corrections are applied by redirecting the speaker horns or baffles, by using frequency-discriminating baffles, or by modifying the volume applied to speakers reproducing different frequency bands. Drapes are often installed behind the speakers to minimize reverberation from the back-stage walls.

More elaborate corrections may involve refinishing half or more than half of the interior surfaces of an auditorium and fall within the province of an acoustic engineer.

46. Troubles in Reproducing Equipment. Space does not permit detailed treatment of the problems of theater servicing. The primary problem in case of trouble is usually to find which of the many pieces of apparatus is at fault. Thus, a low-frequency hum in the sound may be due to "motor boating" of an amplifier or to a lateral displacement of the sound track which permits sprocket holes to modulate the exciting light, or to an accidental exposure of the photocell to incandescent light from an a-c source; or the same trouble may be caused by defective or improper grounding of some piece of equipment. Again, failure of an amplifier may arise from no fault in the amplifier itself but from outage of a fuse in its battery or rectifier supply line.

Trouble is usually traced by investigating the speech and power transmission lines, the former with headphones and the latter with a voltmeter. The amplifier or other apparatus found faulty by this means is then investigated with either of the above instruments, or with an ohmmeter or an analyzer.

The fact that much theater apparatus exists in duplicate is of great help in finding trouble quickly. Since there are never less than two reproducers, changing over from one projector to another will reveal at once whether a fault lies in the reproducer or elsewhere. Many theaters have duplicate amplifier channels, and all have at least two speakers, including the monitor. Intelligent use of the switching arrangements between these duplicate parts will often eliminate the necessity for detailed investigation of transmission lines.

Sound quality is checked by playing a test reel that carries recordings of different frequencies at uniform volume, and reading the response at each frequency with a volume indicator. Not more than 5-db variation over the range the equipment is intended to reproduce is considered a satisfactory result for apparatus of high quality.

Test reels of exceptionally excellent recordings, especially piano recordings, are used to test the equipment for flutter and wows.

The economic factor is of great importance in theater servicing. Any prolonged dissatisfaction with sound induces the audience to demand refund of its admission and in the space of half an hour may cost the theater its profits for a week. Consequently the most important requirement of theater servicing is to eliminate troubles quickly, even if "haywire" methods must be used temporarily and proper repairs deferred until the day's performance is over.

The same economic pressure is responsible for the frequent use of multiple amplifying channels, liberal margins of safety and overload, and general ruggedness and high quality of construction.

INDEX

A

- A.c. (*see* Current)
A-c ammeters table, 191
A-c generator for auto radio, 487
A-c instruments, moving coil, 189-190
A-c permeability formula, 46
Absorption, coefficient for common materials, 501-504
 modulation, 341-342
Aceves, J. G., 379, 788
Acorn tubes, 272, 308
Acoustic measurements, 523-524
Acoustic systems, 830-831
Acoustics of rooms, 500, 506
Aeolight, 812
Affel, H. A., 357
Aigner, 525
Aiken, C. B., 357
Air, compressed, as dielectric, 103
Air-core coils, calculation of inductance, 92
Air gap, 85
Aircraft radio, 685-723
 Army landing aids, 719-721
 aural beacon, 710
 blind-landing aids, 716-721
 course orientation, 712-713
 direction finders, 705-708
 field localization, 716
 goniometer, 711
 government facilities, 685-686
 "homings" systems, 705
 landing-beam equipment, 717-718
 marker beacons, 687
 medium-frequency service, 688
 power equipment, 702-704
 range-beacon equipment, 687
 Robinson direction-finding system, 705-706
 rotating radio beacon, 708-709
 shielding and bonding, 704-705
 visual beacon, 711, 715-716
 weather-broadcast stations, 686
Airplane equipment, 693-696
Alexanderson alternator, 347, 564-565
Allen, H. S., 805
Alternator, Alexanderson, 347, 564-565
 Goldschmidt, 347, 565-566
Altimeters, absolute, 721
 capacity, 721
 radio, 556
 reflection, 722
 sonic, 721
Amber, 104
Ammeter table, a-c, 191
Ampere, 31, 34
Ampere turns, 72
Amplification, d-c, 669-670
 factor, calculation, 248-249
 measurement, 247-248
 mechanism, 253-254
 voltage per stage, 360-361
Amplifier tubes, class B, 259-260
 detector-amplifier triodes, 254-255
 dual-grid, 258-259
 power pentode, 256-258, 379
 power tetrodes, 256-258
 power triodes, 255-256
 screen-grid supercontrol, 265-267
 triple-grid, 259, 262-265
Amplifier voltmeter, 209
Amplifiers, audio-frequency, 359-392
 class A, 360-385, 393
 push-pull, 378-379
 class AB, 388-390
 class B, 386-388, 393, 417-418
 direct-coupled, 384-385
 frequency equalization, 379-383
 general requirements, 359-360
 high-gain, 385
 impedance-coupled, 366-370, 394
 increasing gain at high frequencies, 381-382
 parallel-feed series-resonance, 380
 power, 362-363
 power supply for, 383-384
 resistance-coupled, 364-366, 393-394
 speech, 630, 637-638
 testing and measurements, 390-392
 transformer-coupled, 370-375, 397-403
 balanced push-pull photocell, 671
 booster, 809
 bridging, 811
 broadcast station, 630
 cascade, 394, 405-406
 intermediate-frequency, 429-431
 main, 811
 modulated, 347, 350-351, 418-420, 638
 noise-reduction, 812
 null detector, 220
 photocell, 669, 671
 preliminary, 809
 radio-frequency, 393-421, 426-427
 biasing, 438
 class B linear, 641-642
 class C, 393
 effect of mutual inductance, 401-403
 fixed-tuned, 427
 neutralized, 409, 411-412
 pentode, 412
 power, 412-417
 regeneration, 407-408
 television, 590-592
 theater, 828

- Amplifiers, tuned, 399-407
 untuned r-f, 429
 Anderson, C. N., 580
 Anderson bridge, 228
 Andrew, Victor J., 582
 Antennas, 724-791
 aircraft, 704
 all-wave, 787
 array, 725, 746-747, 776
 automobile, 789-790
 Beverage, 783-785
 broadcast, 749-766, 787-790
 measurement of, 755
 Chireix, 752
 Chireix-Mesney beam, 776
 circuit terminations, 654-660
 coil, 48
 counterpoise, 753
 current distribution, 727-731
 diamond-shaped, 781-782
 directional, 572-573, 743-747, 765-766
 directivity diagrams, 743-747
 double-doublet, 787
 effective height, 725-726
 folded-wire, 780
 frequency, 725
 ground systems, 752-754
 harmonic-wire, 772
 high-frequency, 768-778
 feed methods for, 769-770
 high-frequency reactance, 49
 ice removal, 668
 input system, 426
 lightning protection, 764-765
 loading, 725
 long-wave, 567-568
 loop, 48, 574, 776, 779
 low-frequency reactance, 48
 Marconi-Franklin beam, 775
 marine, 766-767
 mechanical design, 777-778
 multiple-tuned, 568
 polarization, 725
 power-output measurement, 755
 radiation, 47, 50
 radiation resistance, 733-736
 RCA broadside, 771
 RCA model D, 772-773
 receiving, 778
 resistance, 49
 measurement of, 754-755
 rhombic, 781-782
 sleet melting, 777-778
 standard, 425-426
 Telefunken directional, 773-774
 tower-radiator, 756, 762
 tuning, 725
 tuning and coupling systems, 757-759
 vertical cophased, 768
 voltage distribution, 727-731
 Walmesley beam, 774-775
 wave, 783-785
 wave length, 725
 Antinode, 725
 Arc transmitters, 566-567
 Arguimbau, L. B., 318
 Armco iron, 478
 Arnold, H. D., 357
 Aspect ratio, 595, 597
 Atom, structure of, 31
 Attenuation constant, 162, 169
 Attenuator, single-ladder, 627-628
 Audibility, threshold of, 507
 Audio fidelity, high, design for, 639-641
 Audio-frequency amplifiers, 359-392
 Audio-frequency range in broadcasting, 601-605
 Audio transformer-core material, 45
 Aural beacon, 710
 Austin, L. W., 580
 Austin-Cohen transmission formula, 562
 Automobile radio, converters, 489
 motor generator, 486
 receivers, 454-457
 Average value, 35
 Aviation radio aids, 555-556
 Ayrton-Mather electrostatic voltmeter, 201
 Ayrton-Mather universal shunt, 187
- B
- B-supply systems, vibrator, 455
 Bailey, Austin, 357, 580, 783
 Bain, Alexander, 666, 682
 Bainbridge-Bell, L. H., 599
 Baird cine-television, 582
 Baird, G. E., 105
 Bakelite, 104, 119
 Baker, T. T., 683
 Baldwin telephone, 206
 Ballantine, Stuart, 357, 412, 526, 607, 620, 631, 736, 741, 791
 Balsbaugh and Hersenberg, 226
 Band-elimination filters, 171
 Band-pass filters, 171, 406-407
 Band width, broadcast, 21
 facsimile, 561
 modulation, 355-356
 short-wave, 538-539
 telegraphy, 356, 559-560
 television, 356
 Barber, A. W., 358
 Barber, I. G., 397
 Barclay, W. A., 357
 Barden, W. S., 90
 Barfield, R. H., 722
 Barkhausen-Kurz oscillator, 282, 544-545
 Barnes, E. J., 526
 Barrow, W. L., 790
 Bart-Lane facsimile system, 683
 Bartholomew, H. G., 683
 Bartlett, B. W., 228
 Barton, E. H., 211
 Bashenoff, V. I., 790
 Battery chargers, 483-484
 Bäumler, M., 749, 773
 Beacon, marker, 687
 range, 709-716
 aural type, 710
 use for determining visual course, 713-715
 visual type, 711
 use with radiotelephone, 715-716
 Beam, landing, 717-721
 Beam antenna, 775
 Beams, J. W., 793
 Beat-frequency measurements, 215
 Beat-frequency oscillator, 300-301
 Bechmann, R., 790
 Beck, A. C., 780
 Becquerel effect, 800

- Bedford, A. V., 583
 Bedford, L. L., 585
 Beers, G. L., 422, 599
 Bell facsimile system, 683
 Bell system, Sterba directive array, 776
 Benioff, H., 318
 Beverage, H. H., 580, 684, 783
 Beverage antenna, 783-785
 Binders, resinous, 57
 Blessing, G. W., 486
 Blind landing of aircraft, 716-721
 Boella, M., 319
 Bolton, E. P., 230
 Bostwick, L. G., 525
 Bown, Ralph, 357
 Brainerd, J. G., 791
 Breit, G., 101
 Bridge, a-c, 219-230
 errors, 221-223
 null detector, 219-220
 power supply, 219-220
 transformers, 220-221
 Anderson's six-impedance network, 228
 Burgess selenium, 801-802
 Campbell's, 229
 Carey Foster, 218, 229-230
 Christie, 216
 Grover's, 224
 Hay, 227
 Heaviside equal-arm, 229
 Kelvin, 218-219
 Maxwell's, 226
 measurements, 216-230
 mutual inductance, 229
 Owen's, 226-227
 resonance, 227
 Schering's, 224
 selenium, 799
 slide-wire, 217-218
 Thomas's, 224
 Wheatstone, 216, 219
 Wien, 227-228
 Bridge-type couples, 193
 Broadcasting, 600-662
 antennas, 749-766
 audio-frequency equipment, 633
 audio-frequency range, 601-605
 dynamic range, 632
 international, 554-555
 modulation equipment, 637
 power supply, 644-646
 receiving, 787-791
 service area, 662
 station coverage, 660-662
 station frequency separation, 23-24
 system, elements of, 600-602
 transmitter, parasitic oscillations, 646-649
 r-f harmonics, 649-654
 transmitting equipment, 633-637
 volume range, 632
 Brombacher, W. G., 722
 Brooks, Morgan, 92
 Brown, G. H., 749, 752, 753, 791
 Brown, H. A., 230, 357
 Brown, W. W., 105, 110, 567
 Browning, G. H., 357
 Bruce, E., 780
 Brush Development Company, 612
 Bryant, J. M., 180
 "Buffer" stage, 571
 Burgess selenium bridge, 801-802
 Butterworth, S., 101, 357
 Byrne, J. F., 662
 Byrnes, I. F., 358, 580
- C
- C bias for detectors, 338
 Cadmium cell, 183
 Cadmium tungstate, 588
 Cady, W. G., 292, 319
 Caldwell, F. R., 105, 110
 Cambridge Instrument Company, electrostatic voltmeter, 201
 galvanometer, 189
 Camera, sound, 813
 Campbell, G. A., 181
 Campbell, N. R., 795, 797, 805
 Campbell bridge, 229
 Campbell galvanometer, 189
 Candlepower, 597
 Capacitance (*see* Capacity)
 Capacitive circuit current flow, 41
 Capacitive coupling, 403-405
 Capacity, calculation, 112
 compared with inductance, 226-227
 definition, 33
 effect of frequency on, 113
 interelectrode, 273-276
 effects of, 279-280, 361
 measurement, 99-101, 203-204, 224-225, 274-275
 measuring electrolytic condenser, 118
 phase difference, 106
 power factor, 106
 power loss, 106
 units, 34, 102
 Capacity altimeter, 721
 Capacity requirements of condensers, 125
 Carbon microphones, 617-620
 Carborundum detector, 321
 Carey Foster bridge, 218, 229-230
 Carlson, W. L., 583
 Carrier, controlled, 552
 and side band, physical picture, 345-346
 suppression, 551
 Carrier-suppression modulation, 350-351
 Carson, J. R., 181, 276, 358, 580
 Carter, P. S., 737, 741, 771, 778
 Cascade amplifiers, 405-406
 Case, T. W., 800
 Cathode-ray oscilloscope, 353-354
 Cathode-ray tube, 209-212
 study of transient phenomena, 212
 transducers, 587
 Centimeter of capacity, 102
 Chaffee, E. L., 357
 Chaffee, J. G., 105, 110
 Chain broadcasting, television, 596-597
 Chamberlain, A. B., 749, 752, 753, 757
 Charge, unit of, 34
 Chargers, battery, 483-484
 Chinn, H. A., 777, 791
 Chireix antenna, 752
 Chireix-Mesny beam antenna, 776
 Chireix-Mesny diamond-grid radiator, 771
 Choke, to carry d-c, 476
 vs. condenser-input filter, 480-481
 effect of r-f on oscillator, 313-314

- Choke, filter circuit, tapped, 475
 modulation, 638
- Chopper, 570, 669
- Chrisler, V. L., 301
- Christie bridge, 216
- Cine-televisor, Baird, 582
- Circuits, constants table, 5
 coupled, 42, 153-161
 detection, 322
 equations, 39-41
 inductive, phase relations in, 75
 power in, 78
 inductive and capacitive, current flow
 in, 41
 parameters, 39
 time constant, 74
- Clapp, J. K., 791
- Clark, A. B., 358, 631
- Clayton, J. M., 319
- Clifton, Ireland, 530
- Clokey, A. A., 358
- Clough, Kendall, 475
- Coastal-station transmitters, 570-571
- Cobalt steel, magnetic properties, 44
- Cocking, W. T., 471
- Code, business, 557
 character formation, 559
 continental, 558
 Morse, 557-558
 services, transoceanic, 561-562
 standard, 557
- Code transmission and reception, 557-
 581
 field strength required, 562
 frequency range, 559-560
 short vs. long waves, 563
 speeds attainable, 560-561
- Coercivity, 44
- Coil antenna, 48
 wave lengths, 13
- Coils, apparent inductance, 86
 apparent resistance, 86
 calculation of inductance, 92, 94
 design of inductance, 88
 honeycomb, 89
 iron-core, 90, 430
 Q tables, 135
 reactance, 131
 receiver, 90-91, 427
 types of, 87
 "universal wound," 427
- Cold-cathode oscillator, 585
- Colebrook, F. M., 180, 357
- Coleman, J. B., 580
- Color code of resistors, 63-64
- Color sensitivity, 793-795
- Colpitts oscillator, 280-281, 306
 design, 309-310
 stabilized, 294
- Colwell, R. C., 319
- Commutator, revolving, 673
- Companor, 550, 554
- Compton, K. T., 276
- Condenser, capacity requirements, 125
 compressed air, 120
 effect of frequency on capacity, 113
 effect on oscillators, 313-314
 electrolytic, 115-119
 energy of, 102
 equivalent resistance, 107
 filter, 469
- Condenser, fixed, 114
 gang, 120
 grid-bias, 316
 life tests, 128-129
 loud-speaker, 515, 518
 measurement, 126-128
 mica, 114
 microphones, 615-617
 mounting, 442
 padding, 147-150
 paper, 114
 power required to charge, 103
 Q tables, 135
 rating, 125
 reactance, 131
 series and parallel, 113, 123-124
 tuning, 441
 variable, 119
 design of, 120-125
- Condenser-start motors, 117-119
- Conductance, grid, 252
 mutual, measurement of, 251
 plate, 249
- Conductors, coaxial, 169
- Conklin, Hansell and Finch, 300
- Constants, dielectric, 104
 mathematical and physical, 5
 table, 5
- Continental code, 558
- Control room, 633
- Converters, automobile radio, 489
 frequency, 270-271, 341, 431-432
- Cooley, Austin, 684
- Copper oxide rectifiers, 322
- Copper-wire tables, 10-14
- Core loss, 490, 493
- Core material, audio transformer, 45
 silicon, 477
 specific gravity, 46
- Cores, stacking factor, 46, 81
- Correll, J. A., 180
- Coulomb, 33, 34
- Coulomb's law, 30
- Counterpoises, 753
- Coupled circuits, 42, 153-161
- Couples, bridge-type, 193
- Coupling, coefficient, 153
 direct, 153-154
 indirect, 154-155
 inductive, 155-156
 and capacitive, 158-159
 stray, 159
- Coursey, P. R., 101
- Crandall, I. B., 525
- Crossley, Alfred, 91
- "Cross-talk," 604
- Crystal control (*see* Quartz crystal
 control)
- Crystal detectors, 321
- Crystal microphone, 611-613
- Crystals, Rochelle-salt, 612
- Culver, C. A., 358
- Current, a-c, impedance, 37-39
 average value, 35
 in capacitative circuit, 41
 in coupled circuits, 42
 definition, 34
 effective value, 35
 in inductive circuit, 41
 measuring instruments, 183-201
 meters, high-frequency, 192-194

- Current, nature of, 31
 steady state, 39
 transient, 39, 78
 unit of, 31, 34
- Curtis, A. M., 358
- D
- Damping, critical, 185
 Damping action in recording, 817
- Davidson, W. F., 358
- Davies, Gomer L., 72, 722, 791
- Davis, A. H., 506
- Davis, N. E., 722
- Davis, and Kaye, 525
- Davison, C. J., 246
- Db (*see* Decibel)
- Dean, S. W., 783
- Decibel, 607
 chart, 15
 table, 200
- Decimal equivalents of parts of one inch, 1
- Decker, W. C., 105, 110
- Decrement, logarithmic, 41
 of meters, 185
- Decremeter, 119
- Deeley, P. MacKnight, 116
- De Groot, H. B., 89
- Dellenbaugh, F. S., 181
- Dellinger, J. H., 722, 727, 790
- Demarest, C. S., 357
- Demodulation, 320-341
 of one signal by another, 332
- Detection, 320-341
 characteristic, 320-322
 fidelity in, 327
 of two modulated signals, 331-332
- Detector, crystal, 321
 diode, 334, 339
 distortion, 324
 equations, 322
 fidelity of grid-leak, 335
 grid-current, 327-328
 grid-leak and condenser, 335
 heterodyne, 330-331
 high-amplitude, 328-329
 linear, 329-330
 modern practice, 338-340
 null, 217, 219-220
 percentage distortion, 324
 plate circuit, 326
 screen-grid, 334-338
 superheterodyne, 431
 triode, 324-329
 use in measuring modulation, 353
 values of C bias for, 338
- Detector amplifier triodes, 254-255
- Detector amplifiers, null, 220
- Detector circuit, 322
- Detector oscillator, 340-341
- DeVry, H. A., 801
- Diamagnetic materials, 43
- Diamond, H., 399, 685, 722, 776, 777
- Dieckman, M., 722
- Dielectric, 102
 breakdown voltage, 111
 compressed air, 103
 paper, 114
- Dielectric absorption, 49, 112
- Dielectric constant, 50, 104
 values for insulating materials, 104,
 105, 108-111
- Dielectric film, 116
- Dielectric losses in insulators, 51
- Dielectric materials, 103
- Dielectric properties of materials, 104
- Dielectric strength, 111
- Dietsch, Carl G., 600
- Diode detector, 334, 339
- Dipole, 725
- Dipole impedance, 737
- Direction finders, 705-708, 461
- Directive antennas (*see* Antennas)
- Directivity steering, 785-786
- Disk recording (*see* Sound, on disk
 recording)
- Disk records, 815-818
- Distortion, detection, 324
 in high-fidelity receivers, 458
 measurements, 391-392
 output calculation, 260
- Diversity effect, 780
- Diversity reception, 677
- Dixon, W. R., 291
- Donle, H. P., 357
- Doublet, 725, 787, 790
- Dow, J. B., 318
- Dreisback, R., 791
- Drysdale, C. V., 185, 212
- DuBridge, L. A., 805
- Duddell oscillograph, 189
- Dunmore, F. W., 722
- Duplex-diode pentode, 269
- Duplex-diode triode, 268-269
- Dushman, Saul, 239, 240, 276
- Dye, D. W., 319
- Dynamic modulating characteristics, 639
- Dynamic range in broadcasting, 632
- Dynamic telephone, 206
- Dynatron, 281-282
- Dyne, 30
- Dysart, Birney, 357
- Dysart, L. F., 319
- E
- E.m.f. (*see* Electromotive force)
- Ear, characteristics of, 507
- Eckersley, P. P., 604, 662
- Eckersley, T. L., 662
- Eddy current, 51, 85
- Edelman, P. E., 525
- Effective value, 35
- Einthoven galvanometer, 189
- Elder, F. R., 276
- Electric charge, nature of, 30
- Electrical measurements, 182-230
- Electrical units, systems of, 21
- Electrodynamometer, 190-191
 meters, 181
- Electrolytic condensers, 115-119
- Electromagnetic structures, 44-45
- Electrometer, Kelvin, 201
- Electromotive force, definition of, 32
- Electron, 5, 30, 231-234
 charge, 5
 current, 233
 concentric cylinders, 241
 parallel plates, 240-241
 emission, 233-234

- Electron, free, 31
 multiplier, 585, 597
 properties, 30
 space charge, 233
 stream meters, 209-212
 tube meters, 206-212
 velocity, 31, 232
 Electron-coupled oscillator, 270-271
 Electrostatic voltmeters, 201
 Eller, K. B., 318
 Emission, 234-236
 characteristic, 246
 Emission current, normal, 245
 Emission table, 243
 Enamel coatings for resistors, 57
 Energy, absorption, 51
 of charged condenser, 102
 density, sound, 498
 of electromagnetic field, 50, 331
 flux, 50
 radiation, 51
 Engel, F. H., 722
 Englund, C. R., 305
 Engstrom, E. W., 583, 594, 599
 Eppen, F., 749
 Eppley cell, 183
 Equaliser, dialogue, 812
 series resonant circuit as, 142
 Equations, circuit, 39-41
 Espenschied, Lloyd, 537, 580, 596
 Evans, H. P., 276, 358
 Everitt, W. L., 148, 180, 731, 733
 Evershed, and Vignole, 202
 Ewald, J., 276
 Exposure meters, photographic, 802
 Eyring, Carl F., 525
- F**
- Facsimile transmission, 663-684
 accuracy, 670
 balanced circuits, 670-671
 band-width requirements, 561
 Bart-Lane system, 683
 Bell system, 683
 carbon recording, 666
 carrier systems, 676
 chemical, 666
 chopper-wheel, 669
 corona-discharge exposure, 679
 cross-screen analysis, 666-667
 d-c amplification, 669
 definition, 597
 diversity reception, 677
 dot-dash modulation, 674
 double-modulation method, 674-675
 electric retouching, 672
 general requirements, 663-665
 glow lamps, 678-679
 heat methods, 679-680
 induction motor tuning fork system, 681
 lens disk, 666
 light valves, 678
 modulated d-c amplification, 669-670
 modulation circuit, 676-677
 neon tubes, 676
 pencil-of-light method, 668-669
 photo-analyzers, 667
 photocell amplifiers, 669
 photo-engraving method, 667-668
 Facsimile transmission, picture density, 673-674
 potassium bichromate method, 668
 radio systems, 683
 radio-transmitter keying, 675-676
 recording methods, 678
 scanning methods, 665-666
 spiral and bar recording equipment, 666
 starch-iodine paper, 679
 synchronizing, 665, 680-682
 thyatron tubes, 682
 triggered oscillators, 672
 wave lengths, 677
 Faders, 627-630
 Fading, 532
 areas, 662
 reduction, 785-786
 selective, 780
 Fair, I. E., 286
 Farad, 102
 definition of, 33
 unit of capacity, 34
 Farnham, P. O., 358
 Farnsworth, P. T., 583, 587, 589, 594, 597, 599
 electron multiplier, 585
 Fassbender, H., 722
 Fay, C. E., 307
 Feed-back, acoustic, 442
 negative, 405
 Feedback oscillator, stabilized, 295
 Feed methods for high-frequency antennas (see Antennas)
 Feeling, threshold of, 507
 Feldman, C. B., 181, 596, 791
 Felici mutual-inductance balances, 228-229
 Ferguson, J. G., 228, 358
 Ferrocarril, 91
 Ferromagnetic materials, 43
 Fidelity of receivers, 424
 Field, R. F., 182
 Field, distribution about antenna, 740-741
 electromagnetic, energy of, 50
 intensity survey, 650
 strength, magnetic, 43
 required for code, 562
 Filament calculations, 237-238
 Filament-coated resistors, 60
 Fill, J. V., 91
 Film-engraving method of recording sound, 806
 Filter, 171-180, 442
 band-elimination, 171
 band-pass, 171, 406-407
 chokes, 475
 vs. condenser input, 480-481
 design, 476-478
 condensers, 469
 effect on voltage, 472
 ratings, 479
 constant-K, 173
 decoupling, 159-161
 design chart, low-pass, 471
 design formulas, 176-179
 examples of design, 179-180
 graded, 467-468
 high-pass, 171
 low-pass, 171, 474

- Filter, *m*-derived, 173
 multi-section, 174-175
 resistance-capacity, 442, 472
 scratch, 135, 142, 383
 series-derived, 174
 shunt-derived, 174
 terminations, 175-176
- Fink, Donald G., 24
- Fleming, J. A., 737
- Fletcher, H., 525
- Fluorescent screen, 588
- "Flutter," 821
- Flux, magnetic, 72
- Flux density, 72
 in meters, 184
 in transformers, 490
- "Flying spot," scanning, 583
- Footcandle, 597
- Force, line of, 72
 magnetomotive, 43
- Fortescue, C. L., 488
- Foster, R. M., 743, 749
- Fourier analysis, 24
- Frame, 597
- Franklin, C. S., 527
- Franklin, W. S., 181
- Franks, C. J., 135
- Freeman, H. M., 357
- Frequency, allocation, 539-540
 antenna, 725
 comparison, 215-216
 control, 283-300
 converters, 341, 431-432
 difference, maintaining, 432
 effect on condenser capacity, 113
 equalization in amplifiers, 379-383
 frame, 594
 fundamental, 48
 harmonic, 48
 high, resistance table for, 56
 intermediate, 448-449
 inversion, 351-352, 550-551
 line, 597
 measurement, 204-205
 meter, 204-205
 modulation, 356
 multipliers, 354, 420, 421, 566
 range for code, 559-560
 separation between broadcast stations,
 22
 stability, 539
 tolerance table, 22
 ultra-high, 535-538
 variation, irregular, 551
 video, 598
- Frequency-band suppression, 382-383
- Frequency-response measurements, 390-391
- Frequency-stabilizing circuits, 291-300
- Friis, H. T., 395
- Fry, T. C., 276
- Fuller, L. F., 581
- Fulton, O., 683, 684
- G
- Galena detector, 321
- Galvanometer, astatic, 190
 Cambridge Instrument Company, 189
 Campbell, 189
 characteristics, 186, 189
- Galvanometer, current sensitivity, 186
 Einthoven, 189
 mounting, 186
 vibration, 188
 vibrator, 806
- Gang condensers, 120
- Gardner, F. G., 722
- Gauss, definition, 43
- Geiger, H., 575
- General Electric Company, frequency
 meter, 204-205
- General Radio Company, oecillograph,
 189
- Generator, a-c, for automobile radio, 486
 saw-toothed-wave, 592-594
- Gerlach, E., 525
- Ghosts in television, 595-
- Gihring, H., 749, 752, 753
- Gill, T. H., 722
- Gill-Morell oscillator, 282
- Glace Bay, Nova Scotia, 530
- Glasgow, R. S., 393, 401
- Glass, 104
- Glow rectifiers, 484
- Glowlamp recorder, 806, 812-813
- Glowlamps, 678-679
- Goldschmidt alternator, 347, 565-566
- Goniometer, 711
- Goodwin, W. N., Jr., 192
- Googin, Thomas M., 357
- Gothe, A., 749
- Gray, F. G., 358, 582, 583
- Greaves, V. F., 525
- Greek alphabet, 1
- Green, C. W., 357
- Grid, 243
- Grid-bias condenser, 316
- Grid conductance, 252
- Grid-controlled rectifiers, 802-805
- Grid-current coefficients, 251-252
- Grid-current detection, 327-328
- Grid-glow tube, 798, 804
 in code, 579
- Grid modulation, 420
- Griffiths, W. H. F., 101, 123
- Grimes, David, 90
- Groszkowski, J., 276, 318
- Ground screens, 753
- Ground-station equipment for aircraft,
 690-693
- Ground-station receiver for aircraft, 692
- Ground systems for directive broadcast
 antennas, 753-754
- Grover, F. W., 92, 101, 733
- Grover's bridge, 224
- Gunn, R., 283, 297
- Gunn stabilized oscillator, 297
- H
- H-pad, 628
- Hack, F., 737, 739, 740
- Hague, B., 230
- Hahnemann, W., 791
- Hall, E. L., 102-129
- Hallwachs, W., 792
- Hamburger, F., 318
- Handreck, H., 110
- Hanna, C. R., 476, 525
- Hansell, C. W., 300, 741, 771, 778

- Hanson, O. B., 607, 622, 625
 Harbich, H., 791
 Harder, E. L., 488
 Harmonic content, computing, 24-28
 Harmonic distortion, calculation, 363
 Harmonic-end wire projectors, 771
 Harmonic frequencies, 48
 Harmonic measuring circuit, 425
 Harmonic radiator, 768
 Harmonics, antiresonant circuits to suppress, 654
 broadcasting transmitter r-f, 649-654
 definition, 35, 725
 frequency measurements, 216
 Harris, Sylvan, 357, 358
 Harrison, J. R., 292, 319
 Hartley, R. V. L., 358
 Hartley oscillator, 280-281, 349
 design, 309
 stabilized, 294
 Hastings, H. F., 791
 Hayasi, Tatuo, 282
 Hazeltine, L. A., 277, 410
 Heaton, V. E., 319
 Heaviside equal-arm bridge, 229
 Hecht, N. F. S., 722
 Heising, R. A., 358, 638
 Heising modulation, 348
 Henney, Keith, 358, 799, 804, 805
 Henry, 33, 34, 73
 Henry, D. E., 797
 Herd, J. F., 599
 Hertz, Heinrich, 527
 Herzenberg and Balsbaugh, 226
 Heterodyne detector, 330-331
 High-amplitude detectors, 328-329
 High-frequency aircraft radio, 701-702
 High-frequency antennas (*see* Antennas)
 High frequency, circuit precautions, 540-542
 High-frequency communication, two-way, 690
 High-frequency directive antennas (*see* Antennas)
 inductance measuring, 82
 peculiarities, 528-529
 problems, 556
 High-frequency oscillators, ultra-, 544-545
 High-frequency radiotelephone, 696
 High-frequency receivers, 546-549
 High-frequency superheterodynes, 547
 High-frequency telephone transmitters, 543
 transmission and reception, 527-556
 High-frequency transmitters, 542-546
 High-frequency tubes, 307-308
 ultra-, use of, 535-538
 wave propagation, 532-535
 Hinman, W. S., 722
 Hipernik, 477
 Hitchcock, R. C., 462
 Hoag, J. B., 319
 Hoare, J., 208
 Hobbs, Marvin, 320
 Hoch, E. T., 105, 110
 Hogan, J. V. L., 684
 Hollmann, H. E., 319
 Holmes, R. S., 583
 Hombald, N. E., 358
 Honeyball, L. L. K., 779
 Honeycomb-coil data, 89
 Horns, loud-speaker, 520-521
 Horton, J. W., 300, 358, 583
 Howe, G. W. O., 86
 Howey, W., 684
 Hughes, A. L., 805
 Hulburt, E. O., 529
 Hull, A. W., 281, 283, 292
 Hull, L. M., 277
 Hum, percentage, 474
 test, 425
 Hum compensator, 635
 Humidity characteristics of composition-type resistors, 62
 Humidity tests for resistors, 65
 Hummers, 299
 Hund, August, 89, 230, 302
 Hutcheson, J. A., 641
 Hyland, L. A., 791
 Hysteresis, 51

I

- Iams, H., 599
 Ice, removal from antennas, 568
 Iceland spar, 683
 Iconoscope, 583, 597
 Ignition shielding, 704-705
 Ignitron, 804
 Image, antenna, 741
 Image dissector, 584, 597
 Image-frequency interference, 447
 Image-frequency ratio, 450
 synchronizing, 598
 Impedance, 76
 absolute values, 134
 acoustical, 500
 Impedance-capacitance amplifier, 363, 366-370
 Impedance characteristic, comparison, 213-216
 coupled, 42
 transmission lines, 656
 Impedance-coupled amplifier, 394-396
 definition, 37-38
 dipole, 737
 dissipation factor, 135
 equivalent, 132
 in a-c circuits, 130
 in parallel, 132
 input, 361-362
 in series, 132-134
 linear conductors, 733
 loud-speaker elements, 518-519
 Impedance-matching transformers, 375-378
 measurement, 202-203
 measuring parallel resonance, 152-153
 mechanical, 500
 mutual, 42
 r-f line, 168-169
 series circuit, 138
 Impedance transformer, measuring, 392
 tapered lines as, 171
 values for coils and condensers, 135
 Inductance, 72
 air-core coils, calculation, 92
 apparent, 86
 Inductance bridge, mutual, 410
 calculation, 92-98

Inductance coils, compared with capacitance, 226-227

- definition and units, 33, 73
- design, 88
- design chart, 94
- iron-core, 80, 83, 90-91
- measuring, at high frequencies, 82
 - at low frequencies, 79
 - measuring, 82
- mutual, 99-101, 229
 - filter chokes, 475
 - tuned amplifier, 401-403
- standards, 98
 - unit, 34
- windings chart, 20
- Induction, definition, 43
 - field, 47, 727
 - lines, 43
 - motor-tuning fork recording system, 681
 - regulator, two-phase, 212
- Inductive and capacitive coupling, 403-405
- Inductive-capacitive circuit, current flow, 41
- Inductive circuit, current flow, 41
 - phase relations, 75
 - power in, 78
 - time constant, 41, 74
- Inductive paper condensers, 114
- Inductive reactance, 75
- Inductor microphone, 613-615
- Inductors at radio frequency, 85
- Inductor, types, 86-88
 - variable, 87
- Ink recorder, 580
- Insulation, phototube circuit, 792
 - materials, 104
 - dielectric constant, 104, 105, 108-111
 - power factor, 108-111
- Interference, "monkey chatter," 457
 - problems, superheterodyne, 446-448
- Interrupter, vibrator, 486
- Inversion, frequency, 351-352, 550-551
- Ionization, 31, 234
- Irby, Franklin S., 806
- Iron and steel, magnetic properties, 44
 - saturation, modulation due to, 346-347
- Iron-core coils, 80, 83, 90-91
- Iron-core inductance, measuring, 82
- Iron-core transformers, 397
- Isolantite, 104, 119, 546
- Ives, H. E., 358, 683

J

- Jansky, C. M., 230
- Jarvis, K. W., 320, 358
- Jeans, J. H., 31
- Jen, C. K., 318
- Jenkins, C. F., 588, 683
- Jensen, A. G., 395
- Jimbo, S., 318
- Johnson, K. S., 148, 172, 180, 630
- Jolley, A. C., 185
- Jolliffe, C. B., 358
- Jones, W. C., 358
- Joule heat, 49
- Joule's law, 51
- Julius suspension, 186

K

- Karolus, A., 683
- Karplus, E., 319
- Kaye and Davis, 525
- Kear, F. G., 722, 723, 765, 776
- Keith, Clyde R., 358
- Kell, R. D., 583, 599
- Kellogg, E. W., 525, 526, 580, 783
- Kelly, M. J., 283, 306
- Kelvin bridge, 218-219
- Kelvin electrometer, 201
- Kennelly, A. E., 71, 180, 230, 526
- Kennelly-Heaviside layer, 529-535
- Kerr cell, 587, 678, 683
 - light valve system, 597
- Kidner, C. A., 276
- Kilgore, G. R., 319
- Kinescope, 587, 597
- King, R. W., 276, 318, 358
- King, Ronald, 791
- Kingsbury, B. A., 525
- Kirby, S. S., 662
- Kirchoff's laws, 40
- Knipp, C. T., 357
- Knowles, D. D., 798
- Knudsen, V. O., 504, 506, 525
- Kock, W. E., 304
- Koehler, Glenn, 359
- Koller, L. R., 795, 805
- Kozanowski, H. N., 319
- Kramer, E., 723
- Kranz, L. W., 525
- Krozier, W. D., 525
- Krüger, K., 749, 773
- Kruse, R. S., 319, 527
- Kusunose, Y., 276

L

- LC table, 5-9
- LC λ chart, 9
- LT structure, 627
- Labus, J., 734, 741, 749, 752
- Lack, F. R., 286
- Lamb, H., 525
- Lamson, H., 299
- Landing aids for aircraft, Army, 719-721
- Landing beam, 717-721
- Langley, Ralph H., 91
- Langmuir, I., 239, 241, 276
- Lanterman, W. F., 130, 630
- Lapham, E. G., 319
- Laplace's equation, 240
- Laport, Edmund A., 724, 741, 749, 754, 757
- LaPrade, Ernest, 626
- Lauer, H., 358
- Lawrence, E. O., 793
- Laws, F. A., 71, 230
- Lead-in, shielded, 788-789
- Lecher-stabilized transmitters, 543-544
- Lecher wire system, 305-306
- Lee, Alice, 737
- Leeds and Northrup standards, 182
- Lens disk, 588, 666
- Levin, S. A., 734, 741
- Lewis, A. B., 105, 110
- Light, photo recording by polarized, 678
- Light-sensitive cells, 801-802

- Light valve, 678
 recording, 806, 812
 Lightning protection for antenna systems, 764-765
 Limiting-frequency effect, 529
 Lindenblad, N., 567, 741, 771, 778
 Lindsay, and Stewart, 525
 Line of force, 72
 Line amplifiers, 630
 Linear detector, 329-330
 Lipka, Joseph, 24
 Lissajous figures, 211
 Litz wire, 56, 89, 98, 190, 546
 Llewellyn, F. B., 276, 283, 293, 358
 Load characteristics of resistors, 65
 Lodge, Sir Oliver, 527
 Lodge, W. B., 749, 752, 753, 757
 Loeber, C. W., 319
 Logarithmic decrement, 41
 Logarithms, 16-17
 Long-wave antennas, 567-568
 Loop antenna, 48, 776, 779
 Loud-speakers, calculation of efficiency, 510-515
 condenser, 515, 518
 desirable characteristics, 509
 directional characteristics, 522-523
 high-fidelity, 458
 horns, 520-521
 magnetic armature, 515-517
 measurements, 523
 mechanical impedance, 518-519
 motor, 515-519
 moving conductor, 515, 517-518
 piezo-electric, 515
 polarising field, 516
 radiator, 519-523
 systems for theaters, 829-830
 Lowry, L. R., 780
 Lumen, 597
- M
- McArthur, E. D., 307
 McCana, T. A., 357
 MacDonald, W. A., 357, 403
 MacDonald, W. W., 486
 MacFarlane, M. L. D., 683
 McIlwain, K., 791
 MacKinnon, K. A., 319
 McLachlan, N. W., 525
 MacLeod, H. J., 110
 McNabb, V. C., 486
 McNamara, F. T., 208, 319
 Magnesium tungstate, 588
 Magnetic field, energy in, 33
 Magnetic flux, 72
 Magnetic moment, 43
 Magnetic pole, 72
 Magnetomotive force, 43
 Magnetostriction oscillators, 298
 Magnetron oscillator, 282
 Marconi, G., 527, 528, 530
 Marconi-Franklin beam, 771, 775
 Marine antennas, 766-767
 Marine transmitters, 568-571
 Mark-to-space ratio, 561
 Marrison, W. A., 286, 289, 291
 Marsten, Jesse, 51
 Martin, DeLoss K., 357
 Martin, W. H., 358
 Maser and Steiner, 581
 Massa, Frank, 525
 Mathe, R. C., 358, 583
 Maxwell, Clerk, 101
 Maxwell, definition of, 43
 Maxwell's equations, 47
 Meahl, H. R., 319
 Measurements, a-c bridge, 219-230
 acoustic, 523-524
 amplification factor, 247-248
 antenna resistance, 754-755
 beat frequency, 215
 capacitance, 203-204
 comparison, 212-216
 current, permanent-magnet and moving-coil instruments, 183
 d-c bridge, 216-219
 direct capacitance, 224-225
 electrical, 182-230
 emission characteristic, 246
 four-impedance network, 219
 frequency, 204-205
 impedance, 202-203
 modulation, 352-354
 mutual conductance, 251
 plate resistance, 249-250
 power factor, 204
 resistance, 201-202
 ultra-violet radiation, 799
 Measuring instruments, current, 183-201
 Megaw, E. C., 319
 Megger, 202
 Megohm, 52
 Meissner, A., 791
 Mellor, J. W., 800
 Mercury-vapor rectifiers, 805
 Mertz, Pierre, 582
 Metal tubes (*see* Vacuum tubes)
 Meter-amperes, 724
 Meters, critical damping of, 185
 electrodynamometer, 181
 electron-tube, 206-212
 flux density, 184
 frequency, 204-205
 high-frequency current, 192-194
 hot-wire, 192
 microfarad, 204
 moving-diaphragm, 205-206
 moving-iron, 191-192
 photographic-exposure, 802
 rectifier, 194-199
 shunt and multiplier data, 29
 suspended-vane, 201
 thermocouple, 192
 tuning, 457
 vibrating-reed, 205
 Weston power-factor, 204
 Meyer, E., 526
 Mica, 104
 Mica condensers, 114
 Mica-diaphragm telephone, 206
 Microfarad meter, 204
 Microphone, beam, 808-809
 carbon, 617-620
 cavity-resonance, 614
 condenser, 615-617
 crystal, 611-613
 diaphragm-resonance, 614, 617
 dynamic, or moving-coil, 609-611
 inductor, 613-615
 parabolic reflector, 620-622

- Microphone, placement, 623-626
 requirements, 607
 selection, 622-623
 velocity, 607-609, 808
 Microphone amplifiers, 630
 "Microphone hiss," 619
 Miller, John H., 182
 Millikan, R. A., 30
 Milnor, J. W., 358
 Mines, R., 488
 Mirror, rotating, 588
 vibrating, 588
 Mjasoedoff, N. A., 790
 Model, S. J., 319
 Modulated balanced amplifier, 350-351
 Modulated signals, detection of, 331-332
 Modulation, absorption, 341-342
 amplitude, high-level system, 638
 low-level system, 638
 analysis of, 343-345
 band width necessary for, 355-356
 carrier-suppression, 350-351
 change in percentage, 355
 characteristics, dynamic, 639
 choke, 638
 circuit for facsimile, 676-677
 cross, 355
 dot-dash system, 674
 double, 674-675
 due to iron saturation, 346-347
 effect of resonance, 354
 equipment, 637-641
 fidelity in, 349
 frequency, 356
 grid, 420
 Heising, 348
 measurements, 352-354
 negative, 597
 plate-circuit, 347, 419
 positive, 598
 quantities, 347-348
 secondary, 551
 suppressor, 420
 Modulators, and modulated amplifiers, 638
 power tubes as (table), 350-351
 Moment, magnetic, 43
 Monch, W., 525
 Monitoring, high-fidelity, 627
 "Monkey chatter," 457, 604
 Moonlight, illumination from, 587
 Moore, John B., 557
 Moore, W. H., 319
 Morecroft, J. H., 48, 71, 78, 85, 180, 358, 791
 Morehouse, F. G., 683
 Morris, R. M., 622
 Motion pictures (*see* Sound motion pictures)
 "Motor boating," 467, 827
 Motor generator, automobile radio, 486
 control, 681-682
 Motor-speed controls, 821-824
 Moullin, E. B., 86, 99, 230, 358
 Mourontseff, I. E., 319
 Moving-coil and permanent-magnet instruments, 183
 Moving-iron meters, 191-192
 Mu factor, 252
 Mueller, E. L., 319
 Multiplier data for meters, 29
 Multivibrators, 302-303
 Murphy, W. H., 723
 Murray, F. H., 790
 Mutual inductance (*see* Inductance)
 Mycalex, 546
- N
- Nadell, Aaron, 806
 Nance, H. H., 723
 Navigation in aircraft, (*see* Aircraft radio)
 Nelson, E. L., 358, 723
 Nelson, J. R., 357
 Neon tubes for facsimile, 676
 Networks, recurrent, 161-171
 terminating conditions for, 161
 Neutrodyne, 410-411
 Nipkow disk, 583, 587, 588, 592, 597
 Nix, F. C., 799
 Noble, H. V., 319
 Node, 725
 Noise, in composition-type resistors, 62
 in receiving systems, 440-441
 Noise-reduction amplifier, 812
 Noise suppressor, 439-440
 Noise test for resistors, 66-67
 Non-inductive paper condensers, 114
 Norton, K. A., 662
- O
- Oersted, definition, 43
 Ohm, 34, 52
 Ohmmeter, direct-reading, 202
 Ohm's law, 32, 51
 "Oil-can" effect, 524
 Okabe, K., 319
 Oliver, D. A., 526
 Olney, B., 526
 Olpin, A. R., 794
 Olson, H. F., 525, 607-608
 Oscillation, 277-319
 adjustment, 318
 conditions for, 277-280
 control, 349
 effect of interelectrode capacities, 279-280
 fundamental circuits, 280-283
 methods of avoiding, 408-412
 parasitic, 646-654
 Oscillator, audio-frequency, 300
 Barkhausen-Kurz, 282, 544-545
 beat-frequency, 300-301
 carrier, 300
 cold-cathode, 585
 Colpitts, 280-281, 294, 306
 control, 318
 design, 308-318
 detector, 340-341
 effect of imperfect chokes and condensers, 313-314
 effect of load resistance, 311
 efficiency, 317-318
 electron-coupled, 270-271
 feed-back stabilized, 295
 Gill-Morell, 282
 glow-discharge-tube, 304
 Gunn stabilized, 297
 Hartley, 280-281, 294, 349

- Oscillator, high-frequency, 304-308
 load, 311
 long-line, 543-544
 magnetostriction, 298
 magnetron, 282
- Oscillator-modulator system, 348-349
 output, 317-318
 phase relations, 315
 linear, radiation from, 737-741
 relaxation, 304, 593
 reversed feed-back, 281
 tracking circuit design, 147
 triggered, 672
 tuned-grid tuned-plate, 281
 tuning-fork, 299
 ultrahigh-frequency, 544-545
- Oscilllight, 587, 597
- Oscillograph, Duddell, 189
 General Radio Company, 189
 mirror for, 212
- Oscilloscope, cathode-ray, 353-354
 Output control, manual, 439
- Overload level, 424-425
- Overload tests for resistors, 65-66
- Owens, R. B., 319
- P
- Palmer, L. S., 779
 Palmer, W., 486
- Paper condensers, 114
 life tests on, 128-129
- Paper dielectric, 114
- Parabolic reflector microphone, 620-622
- Paramagnetic materials, 43
- Parameters, circuit, 39
- Parker, R. D., 358
- Pearson, K., 737
- Peltier effect, 236
- "Pencil-of-light" facsimile method, 668-669
- Pender, H., 71
- Pendl, H., 749, 773
- Pentagrid converters, 270-271, 341, 432
- Pentode, duplex-diode, 269
 power amplifiers, 256-258, 379
 r-f amplifiers, 412
 triode, 269
- Percentage hum, 474
- Perikon detector, 321
- Permanent-magnet and moving-coil instruments, 183
- Permeability, 43, 50
 curves, choke iron, 478
 formula, a-c, 46
 incremental, 84
- Pernot, F. E., 101
- Peterson, E., 276, 358
- Peterson, H. O., 783
- Pfitzer, W., 749, 773
- Phase, leading and lagging, 35
- Phase angle, 36, 106
- Phase-changing circuit, 141
- Phase difference of capacity, 106
- Phase relations in oscillators, 315
- Phase resonance, 137
- Photo analyzers, 667
- Photocell, 792-805
 amplifiers, 669, 671
- Photoconductivity, 792, 799
- Photoelectric current, measuring, 797
- Photoelectric emission, 234, 792
- Photoelectric tube, uses, 799
 (See also Phototube)
- Photoelectricity, 792
- Photo-engraving, facsimile, 667-668
- Photograph transmission, American Telephone and Telegraph Company, 684
 Associated Press, 684
- Photographic-exposure meters, 802
- Photometry of lamps, 799
- Photophone recorder, RCA, 811-812
 system, 811
- Phototube, 597, 795-802
 choice of, 796
 circuit, 796-799
 insulation, 792
 load, voltage calculation, 801
- Photovoltaic effect, 792, 800
- Photronic cell, Weston, 802
- Photox, 802
- Picture element, 598
- Picture transmission, 598
- Pierce, G. W., 42, 71, 181, 292, 298, 319, 732, 734, 791
- Piezo-crystal "tweeters," 830
- Piezo-electric effect, 612
- Pistolkors, A. A., 791
- Planck's constant, 5
- Plate detection, 326-327
- Plate modulation, 419
- Plate-circuit modulation, 347
- Playback recording, 818
- Playback reproducer, 808, 816
- Pointer-type meters, 187
- Polarization of antenna, 725
- Polarizing field in loud speaker, 516
- Pole strength, 43
- Police patrol, 553-554
- Polydoroff, W. J., 91, 397
- Polyiron, 91-92
- Porcelain, 104, 119
- Potassium bichromate facsimile method, 668
- Potential contact, 236
 nature, 32
 unit, 34
- Potter, R. K., 357
- Power, output calculation, 260
 required to charge condenser, 103
 sources for reproducing sound in theaters, 820-821
- Power amplifier, calculation of distortion, 363
 dual-grid, 258-259
 neutralizing, 411-412
 output, 363
 pentode, 379
 radio-frequency, 412-417
 sensitivity, 362
 tetrodes and pentodes, 256-258
 triodes, 255-256
 triple-grid, 259
- Power equipment for aircraft, 702-704
- Power factor, 36, 79
 of capacity, 106
 of impedances, measuring, 215
 for insulating materials, 108-111
 measurement, 204
 meter, 204
- Power, formula, 35-36
 in inductive circuit, 78

- Power, input to broadcast antenna, measuring, 755
- Power-level indicators, 198
- Power, loss of capacity, 106
- Power supply, for a-c bridge, 219-220
for amplifiers, 383-384
for broadcasting, 644-646
circuits, design, 462
systems, 462-495
- Power transformer, 488
- Power tubes as modulators (table), 350-351
- Pratt, H., 722, 776
- Preamplifiers, 630
- Preselector circuits, 158-159
- Preston, J. L., 105, 110
- Priess, W. E., 588
- Prince, D. C., 277, 308, 484, 646
- Projector-drive motor, 821
- Propagation, velocity of, 162, 169
- Propagation constant, 162, 169
- Propagation factor, 163
- Proton, definition of, 30
- Puckle, O. S., 585
- Push-pull amplifier, class A, 378-379
- Pyrex, 119, 546
- Q
- Q table for coils and condensers, 135
- Quartz, 104
fused, in variable condensers, 119
- Quartz crystal, circuits, 291-292
in code transmitters, 571
cuts, X-cut characteristics, 285
Y-cut characteristics, 286
frequency control, 284-291
mountings, 290-291
plates, doughnut, 286
temperature control, 289-290
- R
- Radiation, of electromagnetic energy, 51
field, 727
formula for vertical antenna, 47
nature of, 47
resistance of antennas, 733-736
- Radiator, harmonic, 768
loud-speaker, 519-523
- Radio, aids to aviation, 555-556
aircraft (see Aircraft radio)
altimeters, 556
broadcasting (see Broadcasting)
facsimile systems, 683
police-patrol, 553-554
- Radio-frequency amplifiers, 393-421, 426-427
- Radio-frequency inductors, 85
- Radiotelegraph, h-f 20-watt, 701-702
- Radiotelegraphic services, 561-564
- Radiotelephone, aircraft, 696-699
h-f 20-watt, 701-702
used with visual-type radio range beacon, 715-716
- Ramsay, R. R., 791
- Range-beacon equipment, 687
- Ranger, R. H., 663
- Raven-Hart, R., 358
- Rayleigh, Lord, 519, 525
- Raytheon tubes, 484-485
- RCA photophone recorder, 811-812
- Reactance, acoustic, 500
of coils and condensers, 131
effective in coupled circuits, 42
high frequency, of antenna, 49
inductive, 75
iron-core, 392
low frequency, of antenna, 48
mechanical, 500
resonance method of comparing, 215
- Receivers, 422-461
all-wave, 451-454, 548
automobile, 454-457
broadcast, 787-791
cabinet, 442-443
characteristics, 424
coils, 427
for short-wave, 90-91
construction, core materials for, 45
dual-band, 549
ground station for aircraft, 692
high-fidelity, 457-458
high-frequency, 546-549
long-wave, 572
methods of testing, 424-425
multirange, 548
quartz-crystal, 461
regenerative, 423, 450
ship-to-shore, 573
single-signal, 461
skip-band, 549
special, 459-461
superheterodyne, 422-423
superregenerative, 423-424, 451, 547
tuned-radio-frequency, 422, 444
universal, 458-459
"universal-wound" coil used in, 427
- Reception, diversity, 549-550, 785
high-speed, 579-580
- Record processing, 817-818
- Recorder, electrical, 816
film, glowlamp, 812-813
light-valve, 812
photophone, 811-812
ink, 580
- Recorder attenuator, 816
- Recording, checking speed in, 816-817
noiseless, 812
playback, 818
re-, 818
(see also Sound recording)
- Records, disk, 815-818
- Rectification diagrams, 332-333
- Rectifier, 462-495
comparison of high-vacuum and mercury-vapor, 644
copper oxide, 322
dry-coated, 485
glow, 484
grid-controlled, 802-805
mercury-vapor, 482-483
meters, 194-199
Rectox, 485
vacuum-type, 482
volume indicator, 631
- Rectigon tubes, 483-484
- Rectox rectifier, 485
- Reed meter, vibrating, 205
- Reflection altimeter, 722
- Reflections, multiple, 532
- Reflector, antenna, 725

- Regeneration, in amplifiers, 407-408
 tuned-grid tuned-plate, 648
 Regenerative receivers, 423, 450
 Reinartz, J. M., 528
 Relays, voice, 552-553
 Reluctance, definition of, 42
 Re-recording, 818
 Resistance, antenna, 49, 726
 measuring, 754-755
 radiation, 733-736
 of coil, apparent, 86
 of condenser, equivalent, 107
 constant positive, 36-37
 critical damping, 185
 definition, 52
 effective, 35, 52
 as function of frequency, 54
 h-f, 54-56
 infinite, 36-37
 measurement, 201-202
 mechanical, 500
 negative, 36-37
 and Ohm's law, 32
 plate, 249-250
 radiation, 726
 table, 56
 temperature coefficient, 52-53
 unit, 34, 52
 volume-control curve, 69-71
 wire table for high frequency, 56
 Resistance balance, 223-224
 Resistance-capacitance amplifier, 363-366
 Resistance-capacity filters, 442, 472
 Resistance-coupled amplifier, 393-394
 Resistance pads, 165-168
 Resistivity, volume, 52
 Resistors, acceptable performance, 67
 aging tests, 66
 composition-type, 59-63
 filament-coated, 60
 flat iron-clad, 58
 tests, 64-67
 variable, carbon-type, 67-68
 specifications for, 71
 tapers for, 68
 temperature rise of, 58
 wire-wound, 58-59
 voltage characteristics, 59
 voltage coefficient of carbon, 60
 wear characteristics, 71
 wire-wound, protective coatings for, 57
 rating, 57, 58
 Resonance, cavity, 614
 circuit, design, 139-140, 145
 for frequency regulation, 141
 design of parallel resonant circuits, 145
 diaphragm, 614, 617
 effect on modulation, 354
 impedance, measuring parallel, 152-153
 method of comparing reactances, 215
 parallel, 137, 144
 phase, 137
 relations in coupled circuits, 42
 relations in parallel circuits, 143
 series, 137, 141
 Resonance bridge, 227
 Resonant line stabilizers, 299-300
 Rentschler, H. C., 792, 797
 Retardation, 162, 169
 Retentivity, magnetic, 44
 Reverberation, 500
 in studio, 627
 time, 505
 Rice, C. W., 409, 525, 580, 783
 Rice neutralized amplifier, 409
 Richardson, E. G., 525
 Richardson, O. W., 239, 240, 276
 Richardson's temperature equation, 246
 Ringel, A., 526
 Ripple, effect of first condenser on, 473-474
 Ritchie, D., 795, 797, 805
 Roberts, W. Van B., 357, 486
 Robinson, G. D., 357
 Robinson, T. D., 591
 Robinson direction-finding system, 705-706
 Rochelle-salt crystals, 612
 Roder, Hans, 149, 357, 637, 765, 791
 Rolf, B., 662
 Roosenstein, H. O., 319
 Rosa, E. B., 92, 101
 Rowe, H. N., 276
 Rubber, hard, 104, 119
 Rust, C. W., 476
 Ryan, F. M., 723

S

 Sabine, P. E., 504
 Sabine, W. C., 504, 505
 Salsberg, B., 308, 599
 Samuel, A. L., 283, 306, 307
 Saturation, magnetic, 44
 Scanning, methods, facsimile, 665-666
 in television, 583
 progressive, 598
 rectilinear, 598
 staggered, 598
 variable-velocity, 585-586
 Scanning aperture, 585
 Scanning line, 598
 Scheel, Karl, 525
 Schmitt, O. H. A., 385
 Schott, Erich, 110
 Schottky, W., 525
 Schottky effect, 240
 Schröter, F., 683
 Schuster, K., 525
 Scrambling, 351-352, 550-551
 Scratch filter, 383
 Screen-grid amplifiers, 261-262
 Screen-grid detector, 334-338
 Screen-grid tubes, 427-428
 Screen materials, television, 588
 Scroggie, M. G., 488
 Secondary emission, 234
 Seeley, W. J., 29
 Seiler, E. F., 793
 Selectivity, ahead of a.v.c. system, 438
 adjacent-channel, 406
 distant-channel, 406
 of receivers, 424
 of t-r-f receivers, 444-445
 variable, 457
 Selenium bridge, Burgess, 801-802
 Selenium cell, 799-800
 Sensitivity of receivers, 424
 Shackleton, W. J., 358, 397
 Sharp, C. H., 799
 Shea, T. E., 172, 180, 470, 581

- Shielding, 442
 in aircraft, 704-705
 of transmitter, 652
- Ship-to-shore communication, 563-564
- Short-wave automatic volume control, 549-550
- Short-wave technique, 571-572
- Short-wave television, 555
- Shot effect, 441
- Shunt, Ayrton-Mather universal, 187
 and multiplier data for meters, 29
- Side-band transmission, single, 351
- Siegel, E., 734, 741, 749, 752
- Silencer, tuning, 439-440
- Silent, H. C., 358
- Silicon, core material, 477
 detector, 321
- Silmanite, 546
- Sivian, L. J., 525, 622
- Skin effect, 51, 54, 56, 190
- Skip-distance and range table, 536-537
- Skip-distance effect, 529
- Skip-distance region, secondary, 531
- Slawson, Roy, 486
- Sleat, melting on antennas, 777-778
- Slepian, J., 525
- Smith, L. P., 357
- Smith-Rose, R. L., 723, 779
- Snow, H. A., 357, 412
- Snyder, W. F., 301
- Solenoid, 87, 94
- Sound, on disk recording, 806
 reproduction equipment in theaters, 820-831
 transmission, 506-526
 velocity, in common materials, 498-499
- Sound cameras, portable, 813
- Sound effects, special, 818
- Sound film standards, 818
- Sound gate, 826
- Sound motion pictures, 806-831
 acoustic systems, 830
 amplifiers, 828
 drive systems, 824
 loud-speakers, 829-830
 motor speed control, 821-824
 reproducers, 826-828
- Sound recording, methods, 806-808
 motor systems, 813-815
 wax preparation, 817
 Western Electric system, 809
- Sound-recording channel, 809
- Sound waves in air, 497-498
- Southworth, G. E., 749
- Space charge, 233, 239
- Space current calculation in triode, 246-247
- Specific gravity of core materials, 46
- Speech, amplifier, 637-638
 scrambling, 550-551
- Speech-input amplifiers, 630, 637-638
- Speech-input equipment, 633
- Spitzer, E. E., 307
- Square root, of sum of squares, 29
- Square-top waves, 356-357
- Stabilizers, resonant-line, 299-300
 rotary, 825
- Stacking factor in cores, 46
- Standard cell, Eppley, 183
 Weston, 183
- Standards, of electrical current, 182
 Leeds and Northrup, 182
- Starling, S. G., 73, 230
- Static, rain or snow, 704
- Static frequency multipliers, 566
- Steady state, 39, 78
- Steiner and Maser, 581
- Steinmetz, C. P., 791
- Stenzel, H., 526
- Sterba, E. J., 181, 596, 791
- Stewart and Lindsay, 525
- Stickney, F. S., 196
- Stinchfield, J. M., 231
- Stone, J. S., 791
- Stowell, E. Z., 399
- Stratton, J. A., 791
- Strieby, M. E., 596
- Strutt, M. J. O., 512
- Studio, reverberation, 627
- Stylus, cutting, 808, 816
- Sunlight, illumination from, 587
- Superheterodyne, first detector, 431
 high-frequency, 547
 interference problems, 446-448
 oscillator-tracking, 147-150
 receivers, 423-424, 445-449
 translation ratio, 340
- Superregenerative receivers, 423-424
- Suppressor modulation, 420
- Susceptibility, 43
- Symbols, loud-speaker and acoustic, 496
 radio-communication, 18-19
- Synchronism, accuracy of, 682
 facsimile, 665
 in scanning, 592

T

- "Talkies" (*see* Sound motion pictures)
- Tank circuit, 137, 150-152
- Tapers of variable resistors, 68
- Taylor, Albert Hoyt, 527, 529, 791
- Telefunken Company, 683, 684
 directional antenna, 773-774
 "pine-tree" antenna, 771
- Telegraph equipment, printing, 557-559
- Telegraphic method of changing facsimile picture density, 673
- Telephone, 205-206
 transmitters, high-frequency, 543
- Telephony, international, 554-555
- Television, 582-599
 amplifiers, 590-592
 aspect ratio, 595
 concentric line, 596
 chain broadcasting, 596-597
 pictures, lines necessary, 594
 program sources, 582
 receivers, 588-594, 598
 scanning, methods, 583
 theory, 582
 short-wave, 555
 stations, 598
- Temperature chamber, constant, 289
- Temperature coefficient of resistance, 52-53
- Temperature control, crystal, 289-290
- Temperature equation, Richardson's, 246
- Tension pad, 827
- Terebesi, 24

- Terman, F. E., 297-300, 318, 357, 358, 741
 Terman frequency-stabilizing oscillator, 297-298
 Terry, E. M., 319
 Tetrodes, power amplifier, 256-258
 Thalofide cell, 800
 Theater reproducing sound equipment, 820-831
 Thermal agitation, 441
 Thermionic emission, 234-236
 Thermocouple, constantan and platinum, 193
 meter, 192
 Thermophone, 206
 Thomas's bridge, 224
 Thompson, B. J., 308, 319
 Thomson, J. J., 276
 Threshold of audibility, 507
 Threshold of feeling, 507
 Threshold wave length, 793
 Thuras, A. L., 515, 525, 609, 610
 Thyatron, 804
 tubes in facsimile, 682
 Time constant of inductive circuit, 41, 74
 Timing axis, 211
 Tolson, W. A., 583
 Tone control, 135, 142, 433-435, 577-578
 Tourmaline, 543
 Townsend, J. S., 795
 Trainer, M. A., 583
 Transceivers, 545
 Transconductance, 251
 Transcription, electrical, 815
 Transducer, 598
 cathode-ray-tube, 587
 Transformer-coupled amplifier, 363, 370-381, 397-403
 Transformers, bridge, 220-221
 class B amplifier, 388
 constants, calculation, 370-373
 design, 490-495
 flux density, 490
 iron-core, 397
 power, 488
 t-r-f interstage, 428-429
 tapered lines as, 171
 typical i-f, 430
 Transient currents, 78
 Translation ratio, superheterodyne, 340
 Transmission, by balanced two-wire line, 760
 carrier suppression, 551
 facsimile, 663-684, 692
 formula, Austin-Cohen, 562
 loss characteristic, 164
 photograph, 684
 picture, 598
 quasi-optical, 551
 short-wave, 562-563
 single-side-band, 351, 551
 speeds obtainable in code, 560-561
 Transmission-line adjustments, 759-762
 Transmission lines, artificial, 164-165
 attenuation constant, 162, 169
 audio-frequency, 163
 calculations, 656-660
 characteristic impedance, 168-169, 656
 concentric, 762
 equalizer, 633
 general properties, 161-163
 Transmission lines, half-wave, 170
 parallel-wire, 169
 propagation constant, 162
 propagation factor, 163
 quarter-wave, 170
 retardation time, 162, 169
 terminations, 654-660
 in theaters, 828-829
 velocity of propagation, 162
 wave-length constant, 162, 169
 Transmitters, arc, 566-567
 automatic, 577
 broadcasting, 636
 coastal-station, 570-571
 high-frequency, 542-546
 h-f 50-watt aircraft radiotelephone, 696
 keying, 675-676
 Lecher-stabilized, 543-544
 marine, 568-571
 parasitic oscillations, 646-649
 r-f harmonics, 649-654
 shielding, 652
 shipboard, 570-571
 tube, 567
 tube keyer, 570
 Transrectification, 333
 Transoceanic code services, 561-562
 Trevor, B., 743
 Trigonometric functions, 2-4
 Triode, 243-256
 detector, 324-329
 amplifier, 254-255
 duplex-diode, 268-269
 gaseous, 802-804
 pentode, 269
 power amplifier, 255-256
 space-current calculation, 246-247
 static characteristics, 244
 Tube, keyer for transmitter, 570
 mercury-vapor, 805
 (See also Vacuum tube)
 Tube transmitters, 567
 Tungar tubes, 483-484
 Tuning, adjustments, 418
 single-dial, 443
 Tuning-fork oscillators, 299
 Tuning meter, 457
 Turner, H. M., 82, 85, 92
 Turner constant-impedance method of measuring iron-core inductance, 82
 Turner and McNamara, 208
 "Tweeters," 830

U

- Uda, S., 791
 Uehling, E. A., 30
 Ultraaudion, 544
 Ultrahigh-frequency oscillators, 544-545
 Ultra-violet radiation, measuring, 799
 Unit magnetic pole, 72

V

- Vacuum phototube (see Phototube)
 Vacuum tube, acorn, 272, 308
 amplifier tubes, 231-276
 amplifiers, audio-frequency, 359-392
 biasing for amplifier, 438
 cathode-ray, 209-212
 exponential type, 436