

*H A S S E L B L A D*



# User Manual

503CW/503CWD/CFV/CFVII/CFV-39/CFV-50

Version 9

Welcome to Hasselblad

503CW

503CWD

CFV



# C O N T E N T S

<b>Introduction</b>	<b>3</b>	Image storage modes /shooting	31	White balance	49
<b>1 General information</b>	<b>6</b>	Selecting the current medium	31	Media	49
Computer system requirements	7	Using compact flash memory cards	32	Browse	50
Warnings and restrictions	7	Tethered to a computer	33	<b>10 CFV - MENU-Storage</b>	<b>51</b>
Before you start	8	<b>7 CFV - Storage overview / media and batches</b>	<b>34</b>	Delete	52
Working digitally	9	Batches	34	Format	56
Parts & components	10	Navigating media and batches	34	Copy	56
<b>2 Camera body</b>	<b>12</b>	Creating new batches	36	Batch	57
Front protective cover	13	Using Instant Approval Architecture	37	Default Approval Level	58
Rear cover Multicontrol	13	Reading and changing approval status	38	<b>11 CFV - MENU-Settings</b>	<b>59</b>
Opening the focusing hood	13	Browsing by approval status	39	User Interface	57
Built-in magnifier	13	Deleting by approval status	39	Camera	58
Focusing screen and viewfinder image	13	Setting the default status	39	Connectivity diagram	62
Closing the focusing hood	13	<b>8 CFV - Overview of viewing, deleting and copying</b>	<b>40</b>	About	65
Winding crank	14	Basic image browsing	40	Default	65
Accessory rail	14	Choosing the current batch	40	Custom Options	69
Strap attachment and removal	14	Browsing by approval status	40	<b>12 Film magazines</b>	<b>71</b>
<b>3 Lenses</b>	<b>15</b>	Zooming in and out	40	<b>13 Flash / strobe</b>	<b>75</b>
Shutter speed and aperture	16	Zooming in for more detail	41	<b>14 Accessories</b>	<b>78</b>
Attaching the lens	16	Thumbnail views	41	<b>15 Cleaning</b>	<b>80</b>
Removing the lens	17	Preview modes	42	<b>Technical specifications</b>	<b>82</b>
Exposure	17	Using the histogram	43	<b>Troubleshooting</b>	<b>83</b>
Warning mark	17	Underexposure	43	<b>Equipment care and service</b>	<b>84</b>
Exposure values	17	Even exposure	43	<b>Further reading</b>	<b>84</b>
Interlocked shutter speed /aperture	17	Overexposure	43		
Focusing and depth of field	18	Full-details mode	43		
Depth of field preview	18	Battery-saver mode	44		
Pre-release and cable release	18	Full-screen mode	44		
Flash /strobe synchronization	18	Overexposure indicator	44		
<b>4 The Viewfinder System</b>	<b>19</b>	Deleting images - general	45		
Changing the focusing hood or viewfinder	20	Transferring images - general	45		
Changing the magnifier	20	Shortcuts	45		
Changing the focusing screen	20	<b>9 CFV - MENU-ISO, White balance, Media, Browse</b>	<b>46</b>		
<b>5 CFV digital back</b>	<b>21</b>	Menu system overview	46		
General overview	22	Settings check	48		
Parts, components & control panel buttons	23	ISO	48		
Overview of menu structure	27				
<b>6 CFV - Initial general settings</b>	<b>29</b>				
Setting the menu language	30				

## PLEASE NOTE!

The menu on the digital back can be set to seven different languages:



Look at the section **INITIAL GENERAL SETTINGS AND PREPARATION > SETTING THE MENU LANGUAGE** if you want to make a language choice before reading further.



*The Hasselblad 503CW is an extremely popular model from the 500 series. Soon after it was launched it became the workhorse for so many photographers, professional and amateur alike. It is an all-rounder, being as easy to use on location as in the studio.*

*There are many who prefer a more traditional design of camera while wishing to exploit the latest in technology and that is where the Hasselblad 503 CWD comes in. It offers the best from both worlds, mechanical and electronic. And for those who already own V-System cameras and don't want to change, the CFV offers the chance to go digital in the most convenient and economical manner.*

*Hasselblad is the choice of the world's leading photographers, and the name is synonymous with compatibility, reliability and image quality, reaching beyond the ends of the earth and into space. Congratulations, therefore, on a wise choice.*

### **The System**

*The Hasselblad V-System is the most comprehensive medium-format photographic system in the world. It offers magazines for different image formats and films, viewfinders with or without exposure metering capabilities, a number of focusing screens plus a range of lenses..*

### **The Camera**

*The completely mechanical camera body boasts a one-piece aluminium alloy construction to meet professional demands. The Winder CW, specifically designed for the 503CW models, provides fast sequential photography and various choices of remote control, including IR. Altogether, a winning combination for professional or dedicated amateur use.*

### **The Lenses**

*You have access to the whole range of Hasselblad 'C' series lenses both old and new. Lenses are specially manufactured for Hasselblad by Carl Zeiss of Germany – the indisputable leader in camera optics. The Hasselblad specifications of these lenses exceed the demands made by digital capture to ensure the optimum in performance whatever the chosen medium. The integral shutter feature combines with the TTL/OTF facility to provide tremendous flash freedom.*

### **The CFV digital backs**

*The digital backs are custom built to fit the design and functionality of Hasselblad V-System cameras. However, they can also fit onto view cameras using the V-System interface plate for mechanical attachment and flash sync connection to trigger the digital capture for optimum compatibility and economy. They provide both cable free and computer tethered options to suit all types of work. The units offer an ultra high level of integration, two capture formats, image quality and flexibility to the specialist professional photographer or high-end amateur user.*

### **"Instant" user interface**

*The 503CWD and CFV are operated with a straightforward user interface with a series of "instant" one-button-click operations including: instant capture, instant browse, instant approval, instant zoom, and instant image info.*

### **Three modes of operation and storage**

*Optimum portability and image storage are critical for the professional photographer. The 503CWD and CFV offer a choice of portable CF card storage or tethered operation with extended, special capture controls. With these three operating and storage options, the photographer is able to select a mode to suit the nature of the work at hand, whether in the studio or on location.*



### **Phocus**

*Phocus offers an image processing workflow with the highest degree of control. In tethered operation, tools like overlay masking help bring productivity to advanced set composition. Phocus processes the raw 3FR files generated by the Hasselblad 503CWD and CFV. It runs natively on both Macintosh and Windows platforms and is licensed to allow you to provide free copies for all your co-workers and production partners.*

### **3FR format**

*In order to incorporate the unique HNCS feature we have developed a custom Hasselblad raw file format called 3F RAW (3FR). The new 3FR file format is designed to ensure that images captured on Hasselblad digital products are quickly, effectively and safely stored on the available media. This file format includes lossless image compression, which reduces the required storage space by 33%. The 3FR file defines the colors in the Hasselblad RGB color space with its out-of-the-box quality, and used in conjunction with Phocus it removes both the need for experimenting with different color profiles to obtain optimal colors and the need for selective color corrections.*

### **Unique Hasselblad Natural Color Solution**

*In the past, color management solutions have imposed limitations on professional digital photographers, because of the need to choose a specific color profile to suit a specific job in order to capture various skin tones, metals, fabrics, flowers, etc. Hasselblad has helped solve this dilemma, with the development of a single powerful color profile to be used with its Phocus imaging software. Working with the new Hasselblad Natural Color Solution (HNCS) enables you to produce outstanding and reliable out-of-the-box colors, with skin tones, specific product colors and other difficult tones reproduced easily and effectively.*



### **DAC**

*Images captured with a CFV and selected Carl Zeiss C series lenses can claim the tremendous benefits of DAC. This feature, incorporated in Phocus, makes lens model-specific corrections to ensure the ultimate image quality.*

### **Instant Approval Architecture**

*Limitless digital image capture loses some of its potential if the photographer cannot quickly review and select the best images to present to the client. Building on the success of its Audio Exposure Feedback technology, Hasselblad has created Instant Approval Architecture (IAA), an enhanced set of feedback tools, designed to liberate the photographer to focus on the shoot rather than the selection process. IAA triggers audible and visual signals for each image captured, notifying the photographer immediately of its classification status. The information is recorded both in the file and in the file name, providing a quick and easy way to classify and select images, in the field or in the lab. The Hasselblad Instant Approval Architecture brings automated image classification into your digital workflow from the split-second of capture. IAA is a Hasselblad trademark and Hasselblad has a patent pending on the invention. Large enhanced display screens on the new Hasselblad products provide a realistic, high quality and perfect contrast image view, even in bright sunlight, to allow instant on-site image approval.*



*Your new Hasselblad camera provides access to the Hasselblad potential. The realization of this potential is only dependant upon your skill, care and judgement as a photographer. We wish you great success and welcome you to Hasselblad, the most comprehensive medium-format system in the world.*

***The supreme Hasselblad potential is there, it's up to you to exploit it!***

# 1

## General Information

## About this manual

This manual describes how to work with the Hasselblad 503CW/503CWD model cameras and all CFV digital backs.

The manual explains specific practical aspects of camera operation and control, the menu system and suchlike details regarding these products. It is assumed that reasonable levels of general analogue and digital photographic knowledge as well as computer skills are already acquired, so these are not dealt with here.

Please refer to the separate specific user manuals for related Hasselblad products: Phocus, I-adapters, film magazines and accessories.

## Computer system requirements

Whichever shooting mode you choose, final image-storage and correction requires a certain minimum standard regarding computer capabilities. Large images will require a high-performance computer with plenty of memory, advanced graphics capabilities and a recent operating system. In most cases, you will want your computer to include a FireWire 800/400 connector, which will enable you to load images directly from the camera. To load images stored on the removable compact-flash card, you could instead use a compact-flash card reader, but we still recommend FireWire for maximum flexibility.

If you want to power the 503CWD / CFV from a PC laptop (as opposed to a Macintosh laptop), you must ensure that the FireWire port on the computer is capable of supplying power.

The 503CWD and CFV save images as 3FR files which are Hasselblad raw digital-camera capture standards. From Phocus, you can optimize and then export the files to 3F, DNG, TIFF or JPEG formats instead if you wish. The 503CWD and CFV include the Hasselblad Phocus image-capture and editing application. Native versions of Phocus are provided for both Macintosh and Windows platforms. Please see the Phocus Read Me files for complete system requirements.



## Warnings and restrictions

- *Keep the 503CWD or CFV (and all computer equipment) away from moisture wherever possible. If your camera becomes wet, disconnect from power and allow it to dry before attempting to operate again.*
- *Always take great care when you remove the digital back for cleaning—the exposed glass filter that covers the CCD sensor is vulnerable to damage.*
- *Keep all cables connected to or from your camera and computer out of the way where they will not be tripped over.*
- *Never cover the ventilation openings on the 503CWD or CFV when they are running.*

### Note

*Regarding the FireWire connection:*

- *All recent Macintosh computers are compatible, both desktops and laptops.*
- *Most recent desktop PC computers are compatible.*
- *Most laptop PC computers are NOT compatible (but can be modified in many cases).*











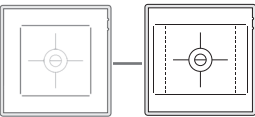




## Before you start

Leave protective covers on as much as possible and avoid touching glass surfaces and inserting fingers into the camera body etc. The 503CW and CFV have a robust construction and are capable of withstanding fairly rough treatment but nevertheless are precision instruments and will serve you longer if treated with respect from the beginning.

Please see below for all accessory items included with delivery. The 503CWD and CFV also include a Phocus CD.

If anything is missing or seems faulty in any way then you should contact your Hasselblad dealer immediately.

Please keep purchase details and the warranty in a safe place.

Accessory items included with delivery	503CW	503CWD	CFV
Front protective cover 	●	●	
Rear cover Multicontrol 	●	●	
Camera strap 	●	●	
Protection cover CFV 		●	●
FireWire cable 		●	●
Flash input sync cable 		●	●
Flash output sync cable 		●	●
CF-Flash card 		●	●
Grey card 		●	●
E-wipes 		●	●
Focusing screen 36 x 36 or 36x48 			● CFV/CFVII 36x36 / ● CFV-39/CFV-50 36x48
Exposure Cable EL 			●
Exposure Cable 503 			●
Adapter EL 			●
Protective Case 			●



## Working digitally

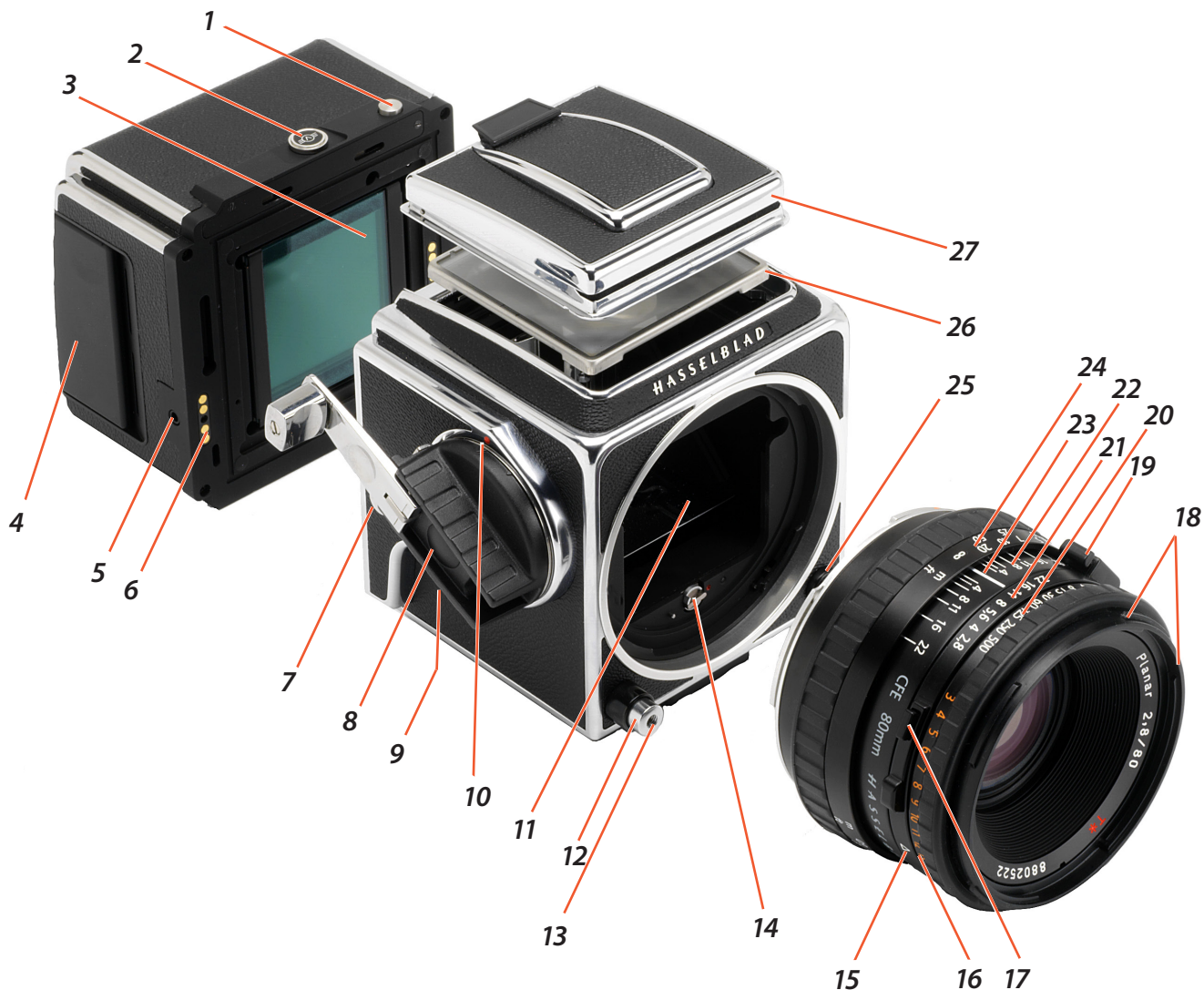
If you have only worked with film before, you will find that working with a digital back is not so very different in many ways. Several changes in routine are needed and a certain amount of experience with digital products and computers is advantageous to lower the learning curve at the beginning. However, practically all of your analogue photographic knowledge is still relevant to achieve optimum results.

The following is in no way intended to be a digital primer but simply aims to highlight some main differentiating points to get started. There are many excellent books on the market that explain in great detail the various aspects of digital photography and post-capture processing.

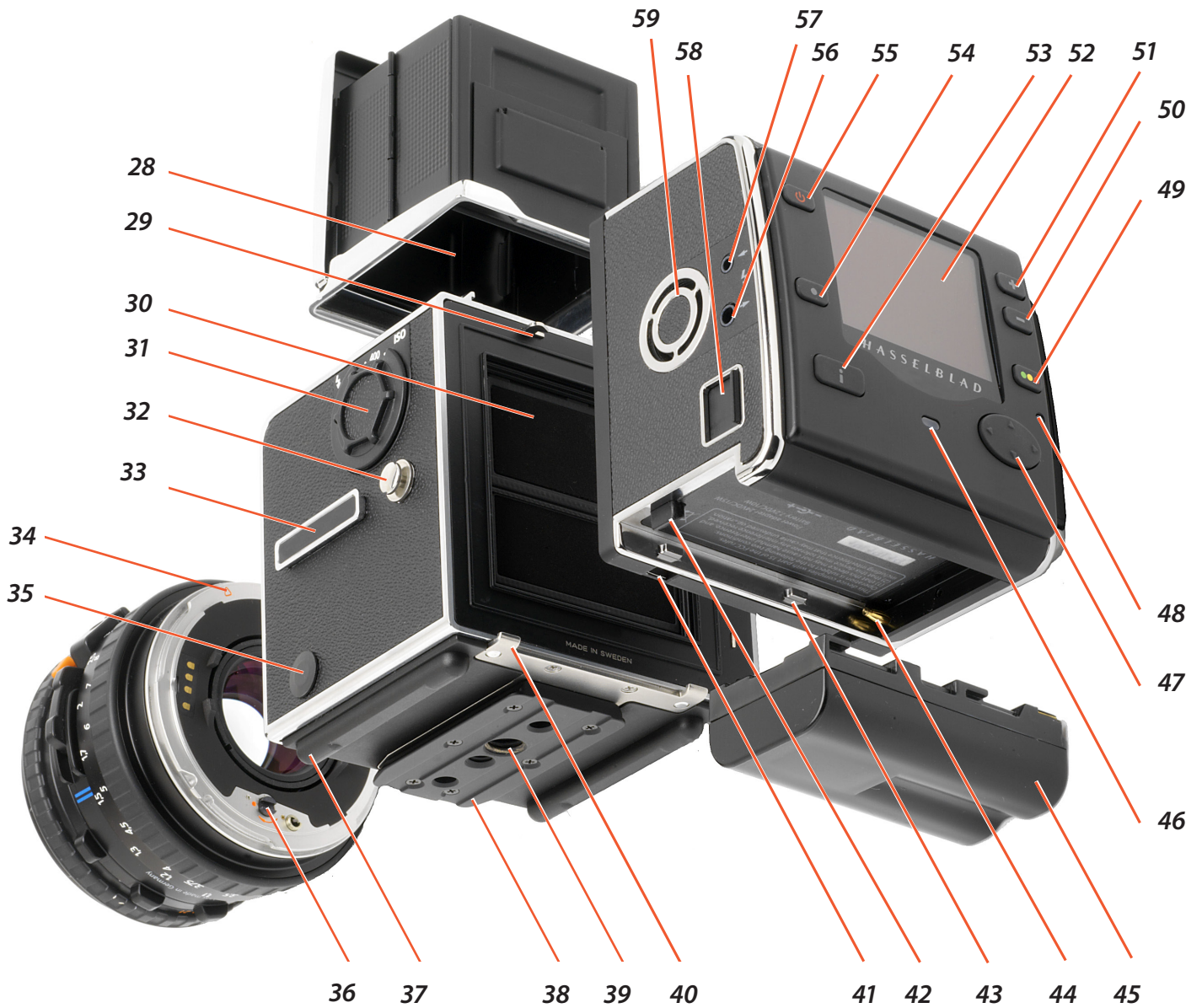
1. **It is essential to ensure you have a fully-charged battery, a spare fully-charged battery, access to battery recharging or access to a computer, depending on how you work. Remember too that a film magazine can act as a reserve for emergencies.**
2. **If you intend to work with a CF card, you must ensure you either have enough capacity on the card for the job in hand or have access to a card reader/separate hard disk/computer to off-load the images.**
3. **The sensitivity ("ISO /film speed") of the sensor can be altered according to circumstances just as you would choose a fast or slow film, thereby providing a range of "speeds". Just as with film, the lower "speed" settings produce finer quality.**
4. **Always check the three basic settings before starting:**
  - ISO ("film speed")
  - White balance (color temperature)
  - Media (where the captured images will be stored).
5. **Remember the size of the sensor causes an 'increase' in the focal length of lenses in practical terms. Compose within the masking on the focusing screen.**
6. **Remember there can be specific restrictions regarding longer exposure times and working with flash/strobe.**
7. **The display screen produces an image as a visual guide only. A histogram display will provide you with the technical information about the optimum exposure.**
8. **Minor color casts on the preview screen can be ignored as there are opportunities to adjust the files later in processing.**
9. **Be extra aware when photographing surfaces with a small regular pattern in the coloring or structure (for example, fine-weave fabrics) as a moiré effect can be produced in certain circumstances. However, some of this can be removed in Phocus in many cases.**
10. **Most other usual photographic practices apply such as using a lens shade, using a tripod when you can, checking for depth of field etc. However good your post-capture skills are on the computer, for optimum results you should still aim for optimum image capture!**



## Parts & Components



- |   |   |
|---|---|
| 1. Magazine catch lock                                      | 14. Drive shaft                                 |
| 2. Magazine catch   | 15. Exposure value index                        |
| 3. Sensor (covered by glass IR filter)                      | 16. Exposure value scale                        |
| 4. CF card cover  | 17. Shutter speed and aperture interlock button |
| 5. Sync socket (for use with Winder CW and EL-type cameras) | 18. External and internal lens accessory mount  |
| 6. Databus contacts   | 19. PC flash/strobe terminal                    |
| 7. Strap lug  | 20. Shutter speed ring                          |
| 8. Winding crank  | 21. Aperture ring and scale                     |
| 9. Pre-release button                                       | 22. Depth-of-field scale                        |
| 10. Winding crank index                                     | 23. Central lens index                          |
| 11. Viewfinder mirror                                       | 24. Focusing ring and scale                     |
| 12. Shutter release button                                  | 25. Lens release button                         |
| 13. Threaded cable release socket                           | 26. Focusing screen: Acute-Matte D screen       |
|   | 27. Focusing hood                               |



28. Focusing hood magnifier

29. Magazine hook

30. Auxiliary shutter

31. Film speed selector

32. Strap lug

33. Accessory rail

34. Lens locating index

35. Dedicated flash/strobe connector

36. Lens drive shaft

37. Camera support

38. Quick-coupling plate

39. Tripod threads, 1/4" & 3/8"

40. Digital back / magazine supports

41. Digital back support slots

42. Battery release catch

43. Battery support lugs

44. Battery contacts

45. Battery (not supplied)

46. Ready light indicator

47. Navigation button

48. Busy light indicator

49. Instant Approval button

50. Zoom out / Value change button

51. Zoom in / Value change button

52. Display

53. Display button

54. Menu button

55. ON / OFF button

56. Flash sync OUT terminal

57. Flash sync IN terminal

58. Firewire 800 socket

59. Ventilator

# 2

## Camera Body

This section describes the basic operations. Follow the instructions step-by-step to avoid damaging the equipment. Check that the winding crank on the right hand side of the camera is locked thus ensuring that the camera is fully wound. If the crank is not locked, rotate it clockwise until it does lock, thereby winding the camera.



### **Front protective cover**

1

Always fit the front protective cover when no lens is attached to protect the mirror and interior.

Attach the cover as you would a lens, see below. To remove, turn the cover (bayonet fitting) in the direction of the arrow and lift it out.



### **Rear cover Multicontrol**

2

Always fit the rear cover Multicontrol when no back is attached to protect the auxiliary shutter. Attach the cover as you would a back, see below.

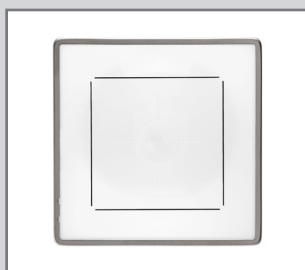
To remove, depress the top part, tilt the cover backwards, and lift it off. See later sections on the other uses of the Rear cover MultiControl.



### **Opening the focusing hood**

3

Lift the lid by firmly gripping the tab on its rear edge, and swinging it up to a vertical position. The hood unfolds automatically and locks in the open position.



### **Built-in magnifier**

4

The magnifier flips up into the viewing position when the oval button inside the lid is moved to the right, as in the illustration. To fold the magnifier down simply press it back down towards the lid until it locks into place. It can easily be exchanged to suit individual eyesight (see "Changing the magnifier").

### **Focusing screen and viewfinder image**

The 503CW is fitted with an Acute-Matte D focusing screen for unrivalled brightness and sharpness. The markings on the screen indicate the format of the sensor in the case of the 503CWD and CFV for correct composition with digital capture. The screen can easily be exchanged for others specially designed for various applications (see "Changing the focusing screen").



### **Closing the focusing hood**

5

Fold away the magnifier by pressing it back down towards the lid until it locks into place. 'Pinch' in the side plates at the hinge points and then push the lid lightly backwards. The hood then automatically folds back down.



### **Note**

*The front protective cover can only be removed when the camera is fully wound.*



## ***Winding crank***

**6, 7**

The winding crank can be removed. Push the catch lever downwards while rotating the crank counter-clockwise and pull the crank straight out from the shaft. To attach it, align the small triangular index mark against the red dot on the camera body. Keep the crank pushed against the camera while turning it clockwise until the larger triangular mark is aligned with the red dot where it will click into position.

## ***Accessory rail***

**8**

The camera has an accessory rail on the left hand side for the spirit level and the adjustable flash shoe (for small flash units).

## ***Strap attachment and removal***

**9, 10, 11**

Place the main body of the strap clip over one of the camera's strap lugs. Press the tip of the clip towards the camera while pulling back on the strap so that the clip slides over the lug and locks into position. To remove the strap, lift the clip locking plate high enough to be able pass over the camera lug. Slide the clip in the direction away from the strap until it is free.

# 3

## Lenses

The 503CW/503CWD is compatible with lenses that have an integral leaf shutter, namely, all C series lenses. CFi/CFE lenses are the latest developments and are mentioned and illustrated here as the conventional choice. C, CF and CB lenses, although differing in specification and appearance to CFi/CFE lenses, are operated in a very similar manner but please see the relevant instruction manuals for complete details.

1. Shutter speed ring
2. F-setting button
3. Warning mark
4. Depth-of-field preview knob
5. PC-socket with positive lock
6. Central lens index
7. Focusing distance scale
8. Lens bayonet plate with red index
9. External and internal front bayonets
10. EV index
11. Exposure value (EV) scale
12. Shutter speed/aperture interlock button
13. Shutter speed scale
14. Aperture ring and scale
15. Depth-of-field scale
16. Infrared focusing index
17. Focusing ring



The illustrations show the CFE version of the 2.8/80 mm lens but the layout of the parts is identical on all CFi/CFE lenses.



## Shutter speed and aperture

1

The shutter speed selector ring is the ring located closest to the front of the lens. To set the speed, turn the ring until the desired marked shutter speed position aligns with the central lens index. The white scale shows the shutter speeds, and the orange scale the exposure values (EV). The aperture setting ring is the second closest ring to the front of the lens. The aperture value is also set against the central lens index. The diaphragm is automatic and stops down to the preset working aperture at the start of the exposure sequence. Therefore in the illustration, the exposure setting is 1/60 second at f/11.

The orange 'F' setting is used only when the lens is attached to a Hasselblad camera in the 200 or 2000 series with a focal plane shutter. The operation of the diaphragm is not affected. The 'F' setting can only be engaged/disengaged when the orange lever is pressed.

### Note

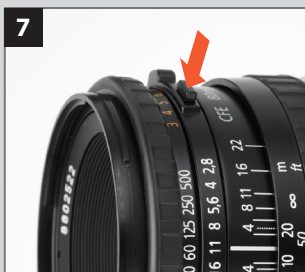
If the F setting is used, exposure errors will occur because the shutter remains open.

## Attaching the lens

2, 3

Make sure that both camera and lens are fully wound. Illustration 2 shows the correct relationship between the drive shaft, the lens drive coupling and their indexes. If the lens is not wound, you can insert a small coin or similar in the coupling slot and rotate it clockwise until it locks (about 4/5 of a turn) When you have aligned the red index on the lens with the one on the camera (illus 3), the lens will drop easily into the bayonet fitting. You can then rotate it clockwise until it stops with a faint click as the lens catch locks it in place.





## Removing the lens

4

Depress the lens release button and rotate the lens counter-clockwise until it stops and lift it out of the mount.

## Exposure

As a general rule for all shutter speed settings except B, you should keep the release button depressed until the lens shutter has opened and closed fully. This is especially important at shutter speeds from 1s to 1/4s, as the auxiliary shutter remains open only when the button is kept depressed (see also 'Warning Mark' below). If you remove the magazine, you can see the auxiliary shutter, consisting of two blinds, covering the rear opening of the camera body. It protects the film from unwanted exposure as the lens' shutter normally is open for focusing.

## Warning mark

5

You will find an orangeline on the shutter speed scale above the 1, 1/2, and 1/4s settings. This is to warn you of possible exposure errors as detailed above. The auxiliary shutter will terminate the exposure prematurely if you relax the pressure on the button too soon. Listen to the buzzing sound of the delay escapement in the lens' shutter and maintain the pressure on the release button until the sound stops.

## Exposure values

6

The aperture and shutter speed combination set opposite the central lens index determines the exposure. Every combination of shutter speed / aperture has an equivalent exposure value (EV) which you can read and set against the red EV index on the right hand side of the lens.

## Interlocked shutter speed /aperture

7

If you want to change the shutter speed or aperture while still keeping the same shutter speed/aperture combination (EV), you can interlock the speed and aperture setting rings by holding down the interlock button which is on the right of the aperture scale. When interlocked, the rings move together, increasing or decreasing the aperture to compensate for a decrease or increase of speed respectively.

## Focusing and depth of field

8

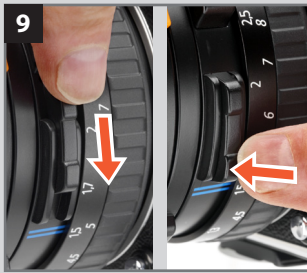
The focusing ring is closest to the camera body. It has a knurled rubber grip and engraved distance scales in feet and metres. Focus the lens by rotating the focusing ring until you obtain a sharp image of the subject in the viewfinder. The distance between the subject and the film plane is read off the focusing ring's distance scale opposite the central lens index. Objects closer or further away than the selected distance will be sharp, within certain limits. The limits of this field of sharp focus-depth of field-vary with the aperture. The depth of field available at any given aperture can be read off the depth of field scale on both sides of the central index. As an example, the illustration indicates how to read the depth of field scale at an aperture of f/11. The depth of field will in this case range from ca 6 metres to infinity.

### Note

You can only remove a lens when the camera is fully wound and not in the pre-released mode (see "Pre-release and cable release).

### Note

For exposure times longer than 1/8 sec when shooting digitally, connect the **Flash sync input cable** (supplied) between the **PC-socket** (flash/strobe sync contact) on the lens and the **Flash sync IN terminal** on the digital back. This eliminates any conflict between the shutter setting and the digital back 'time-out' setting.



## **Depth of field preview**

9

Depth-of-field can be visually checked on the focusing screen. The diaphragm can be stopped down to the preset aperture from its normally wide open position simply by pushing the depth-of-field preview lever downwards until it locks. To reopen the diaphragm, depress the lower part of the lever.

## **Pre-release and cable release**

10

Considerable efforts have been made to reduce camera vibrations caused by moving parts in the exposure sequence. However, if you wish to avoid these vibrations completely, you can pre-release the mechanism by pushing the pre-release button upwards. This causes the following sequence:

1. *The mirror folds up*
2. *The shutter closes and remains closed*
3. *The diaphragm closes to its preset aperture*
4. *The auxiliary shutter opens*

When you subsequently press the release button, only the shutter then operates at the preset speed. As shown in the illustration, you can also attach a cable release to further reduce vibrations.

## **Flash/strobe synchronization**

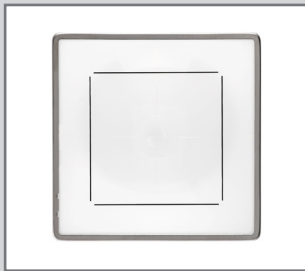
11

The C series lenses have built-in leaf shutters with speeds from 1s to 1/500s and B. Flash synchronization occurs at full shutter opening via the PC flash/strobe terminal. Suitable electronic flash/strobe units can be used at all shutter speeds from 1s to 1/500s as well as B. Please see under 'Flash' the sections on the use of a Hasselblad Flash adapter SCA 390.

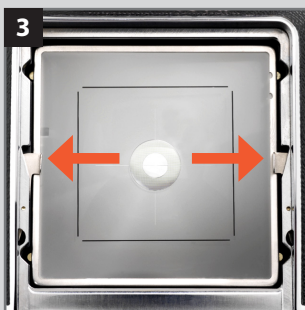
# 4

## Viewfinder System

The 503CW/503CWD is supplied with a light, compact and foldable viewfinder, providing a through-the-lens laterally reversed image. It is easily interchangeable with alternative viewfinders including the prism finders, which produce a laterally corrected image. Please see 'Accessories' for further details about prism finders.



Sensor format markings on the "36x36" screen.



The focusing hood on the standard viewfinder has a built-in 4.5x magnifier for accurate focusing and this can easily be changed to suit individual eyesight. The 503CW is equipped with an Acute-Matte D focusing screen which produces an exceptionally bright and sharp image. The markings indicate the format of the sensor for correct composition with digital capture. The Hasselblad system offers a range of alternative screens for various specific applications, each item easily and quickly interchangeable without the need for special tools or facilities.

### Changing the focusing hood or viewfinder

1

To remove the focusing hood so as to attach any other viewfinder in the present Hasselblad system (please note the PM90 is compatible with film magazines only due to its shape), proceed as follows:

1. Detach the digital back.
2. Fold down the focusing hood to protect it from damage and remove it by sliding it to the rear in its guide slots.
3. Slide the replacement viewfinder into the slots and push it forward until it stops.

When fully inserted the viewfinder is retained in position by a spring-loaded catch until you have reattached the magazine.

### Changing the magnifier

2

Mounted lenses with dioptré correction from +3 to -4 are available, and are easily interchanged as follows:

1. Remove the focusing hood from the camera and open it by lifting the lid.
2. Release the magnifier by pushing the catch to the right.
3. Push the magnifier halfway back down to its folded position.
4. Grip the lower edge of the magnifier plate (through the underside of the hood), and pull firmly.
5. Keep the plate holder halfway down and insert the replacement lens plate with the printed side up. Fold the hood down and replace on the camera.

### Changing the focusing screen

3, 4

1. Detach the magazine and viewfinder.
2. Push the two screen clips to the side into their recesses (fig 3).
3. Place your hand over the screen, and invert the camera. The screen will now drop into your hand (fig 4).
4. Insert the replacement screen, ensuring that the smooth flat side is uppermost and the sharp-edged corners down. Ensure that all four corners of the screen are positively seated on their supports.

You need not return the screen latches. This is done automatically when the viewfinder is replaced.

Should the screen refuse to drop out by itself, ensure that the camera is fully wound, remove the lens and check that the mirror is in the down position. Put a finger through the lens mount and push gently on the screen from underneath, preferably with a soft cloth between the screen and the finger.

#### Note

Do not immerse the screen in water, or use any kind of cleaning fluid.

#### Note

Do not use hot air to dry the screen if it becomes damp.

# 5

## CFV digital back

- Overview

## General overview

In very simple terms, the digital back holds a light sensitive sensor in place at the film plane. The electronic signals from the sensor are then processed and stored as a digital file.

As an electronic color image is made up of three components – red, green and blue which combine to form a so-called RGB image – the sensor's task is to convert a multi spectrum light image into three digital files (red, green and blue) for combination later on.

The digital back uses a CCD (Charged Couple Device) type sensor that has either 16, 39 or 50 million light sensitive areas on its surface each of which creates a pixel.

Each pixel in the sensor is filtered to create the three separate red, green and blue files. Software then processes these electronic files as a package to produce the various formats – TIFF, JPEG etc.

The three components of the image file are later recombined on the computer screen to produce the familiar full color image.

The image file can be temporarily stored either in the digital back with a CF card, or the hard disk on a computer. Processing of these images is carried out in conjunction with the included Phocus software. See the separate Phocus manual for further details.

The digital back is also designed to also fit most Hasselblad V model cameras. Please check the connectivity diagram in this manual for further details, including the possibility of connectivity to large format cameras.

Bear in mind, when working with V series cameras, that the sensor size is important regarding 'lens length'. For example the 16 Mpix sensor is 36.7 x 36.7 mm in size which results in a smaller image (compared to the approx. 60mm x 60mm format produced with a film magazine) therefore the markings on the focusing screen should be used as the guide for composition. This smaller format also in effect 'lengthens' the focal length of the lens in use with a lens factor of x1.5. So, for example, a 50mm lens together with the 16 Mpix digital back will produce a similar apparent perspective that a 75 mm lens would produce if the full 60mm x 60mm format was used. The CFV-39 and CFV-50, however have larger sensors and therefore exploit the focal length of lenses more. The lens factor in both these cases is x1.1.

The 503CWD and CFV are electronic devices and consequently attention to power access is vital. When working untethered it is therefore important to plan either battery charging or battery replacement to ensure continued workflow.

Likewise, image storage is limited, particularly when using flash cards and appropriate steps should also be taken when planning a shoot. External storage is accomplished by FireWire connection to a computer.

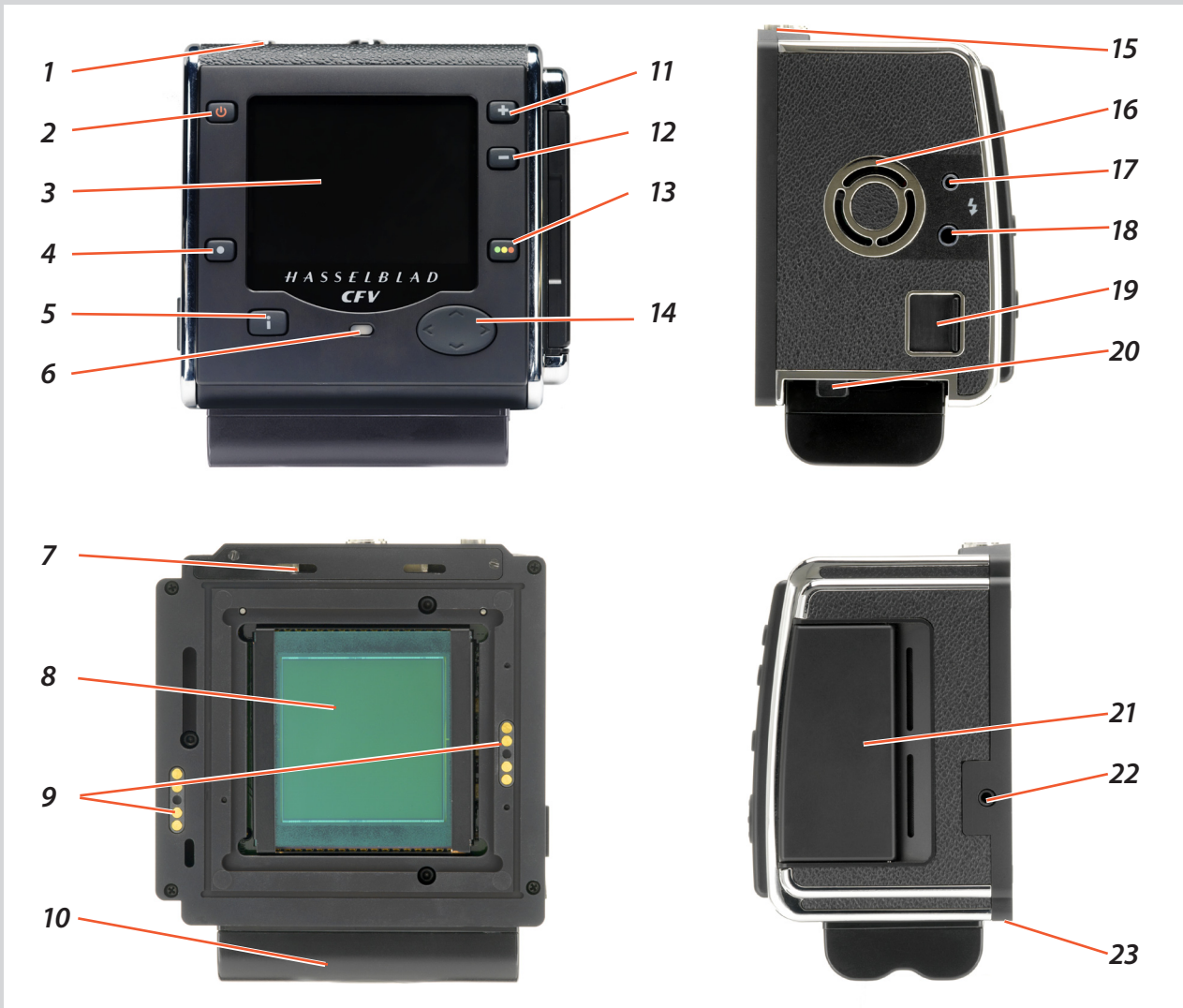
When attaching and removing the digital back, pay particular attention to the image sensor area. The sensor itself is covered and therefore protected by the glass IR filter but take great care when handling. If you need to clean the filter, see later section for specific details. When storing separated from the camera, always ensure you have replaced the protective cover.

If you scratch or mark the filter in any way, it will show up on every shot. Replacements are expensive so treat the glass surface with at least as much care as you would a lens.

The sensor itself is not accessible for any kind of cleaning or maintenance by a user. Do not attempt any such action as you will almost certainly damage it irreparably.

As is the case with all electronic devices pay extra care when working in damp environments and avoid damp conditions for storage.





## Parts, components & control panel buttons


The control panel has a display screen that provides a bright, high-contrast view even in bright surroundings and at fairly acute angles. The panel is the main graphical interface for image checking and settings changes when not connected to a computer.

The buttons are used for browsing images and navigating the menu system. Two of the buttons, located at the bottom-right and -left of the screen, are given an on-screen label that changes according to the current context (e.g. the bottom-right button sets the approval rating when browsing images, but confirms settings when using the menus).

### Digital back retaining catch lock

Ensures that the digital back is not unintentionally removed.


### ON /OFF button

 Powers the digital back.


### Preview screen





Displays preview images and the menu system even in bright light and from acute angles.

### 1 Menu / (Menu Exit) button

 Opens and closes the menu system. Also used for various other tasks (Exit button, for example) as you issue commands within the menu system indicated by a description beside the button on the preview screen.

### Display mode button

 Steps through the various view modes for the preview image: standard, histogram overlay, image details, screen off and full-screen.

<b>Power indicator</b>	<b>6</b>	<b>Digital back retaining catch</b>	<b>15</b>
Glows orange to indicate that the digital back is warming up. Glows green when the digital back is ready.		Locks the mounted digital back onto the camera body.	
<b>Digital back retaining hook slots</b>	<b>7</b>	<b>Ventilator</b>	<b>16</b>
Accepts digital back/magazine retaining hooks on camera body.		Ensures the processor is kept cool.	
<b>CCD and IR filter</b>	<b>8</b>	<b>Flash sync IN terminal</b>	<b>17</b>
This is the light-sensitive element, which is positioned behind a permanently mounted IR filter. Usually, this assembly will either be inside the camera or protected by the cover. Always be very careful not to touch or scratch the surface of the filter when it is exposed and to replace the plastic cover whenever the digital back is not mounted on a camera.		Used when working with studio / strobe flash units. Allows connection to the unit via the flash sync protector cable to ensure correct synchronisation as well as providing protection for the digital back.	
<b>Databus connectors</b>	<b>9</b>	<b>Flash sync OUT terminal</b>	<b>18</b>
For communicating with a Hasselblad ELD model camera body or with a modified Hasselblad 202/203/205 model camera body.		Used when working with studio / strobe flash units. Allows connection to the lens sync contact via the flash sync cable to ensure correct synchronisation.	
<b>Battery (not supplied)</b>	<b>10</b>	<b>FireWire connector</b>	<b>19</b>
7.2V InfoLithium L type (Sony NP-F550 or similar)		Allows the connection to a computer. The digital back requires an 800 connector whereas the computer can be either an 800 or 400.	
<b>Zoom-in button / SELECTION (+ button)</b>	<b>11</b>	<b>Battery retaining catch</b>	<b>20</b>
 Zoom-in button (to make the view larger) for the preview image. Also acts as a selection button when viewing available image batches, media and value setting on the menu.		Ensures secure mounting of battery.	
<b>Zoom-out button / SELECTION (- button)</b>	<b>12</b>	<b>CF card slot cover</b>	<b>21</b>
 Zoom-out button (to make the view smaller) for the preview image. You can continue to zoom out to view several small images at once and finally to view and select batches and media. Also acts as a selection button for value setting on the menu.		Protects card slot.	
<b>Instant Approval / (OK) button</b>	<b>13</b>	<b>Winder / EL terminal</b>	<b>22</b>
 This button steps through the three approval levels, thereby assigning an approval status to the image currently displayed (or selected) in the preview screen (part of the Instant Approval Architecture system). The color coding is based on the traffic signal convention of green, amber (yellow) and red. Also acts as a confirmation button (OK button) for some types of menu operations, such as deleting images; indicated by a label beside the button on the preview screen.		Terminal for connection to a Hasselblad CW winder or Hasselblad EL model camera body. Requires the camera sync cable (supplied).	
<b>Navigation button</b>	<b>14</b>	<b>Digital back support slots</b>	<b>23</b>
 A four-way rocker button enabling you to step through preview images and navigate the menu system. To use it, press the side of the button that corresponds to what you wish to do (e.g., move up, left, right or down).		Accepts digital back/magazine support hooks on camera body.	

**Note**

**IMPORTANT**

*Never attempt to remove the glass IR filter – you will probably ruin the sensor if you do so.*

*See the 'Cleaning' section for details.*



As with all digital products, it is essential that you maintain a constant check on battery condition and preferably have a fully-charged reserve battery with you at all times when not tethered to a computer.



### Tip

Change the **Time Out and Power Down** settings to reduce battery consumption.

### Note

If you remove the digital back, be very careful not to touch or scratch the CCD/filter surface while it is exposed.

Always attach the protective cover for transportation or storage.

## Attaching and removing the digital back

When both attaching and removing the protective cover as well as attaching and removing the digital back to the camera, hold down the magazine catch lock button while sliding the magazine catch. Avoid trying to just 'snap' the digital back or protective cover into place without using the buttons.

## Powering the digital back

The digital back requires power either from the battery (7.2V Sony InfoLithium L type – NP-F550 for example) or from a computer via a FireWire cable.

### To attach a battery:

1. Firstly, ensure the battery is fully charged (see user appropriate manual for battery and charger).
2. Position the battery as in the illustration.
3. Press the battery towards the camera. This automatically depresses the battery retaining catch.
4. Slide the battery into the final position ensuring the contact prongs on the camera are inserted into the battery. The battery retaining catch will now return to the safety position.

### To remove a battery:

1. Depress the battery retaining catch and slide the battery over it. It will then be freely removed.

### FireWire connection:

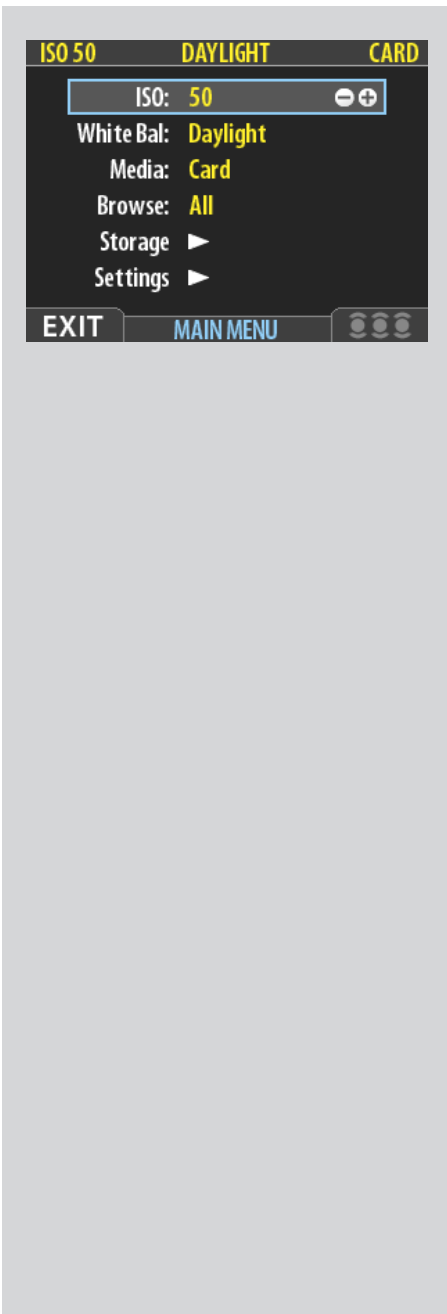
1. Simply connect the FireWire cable between the FireWire port on the digital back and the FireWire port on the computer. You will not need to attach a battery with a FireWire connection.

## ON / OFF button


With a fully charged battery fitted, keep the **ON/OFF** button depressed for at least two seconds. (This time delay helps prevent unintentionally turning the digital back on.) A Hasselblad logo splash screen will appear on the display followed by an audible signal. This signifies that the digital back has been activated.

The digital back will enter standby mode after the preset time to save the battery. Keep the **ON/OFF** button depressed again to turn the digital back off. An audible signal will be heard again to confirm this. (If it appears that you have to press the button twice to turn it off it is because the digital back has already entered standby mode.)

However, you will not need to use this button with a FireWire connection as the active mode is instigated automatically. The splash screen appears but no audible signal is heard from the digital back. There may be an audible signal generated by the computer, however. Removing the FireWire connection turns the digital back off immediately, also without an audible signal from the digital back.





## General

Using the menu is very similar to using a menu on a cell phone or similar. When you enter the menu (by pressing the MENU /  button) you will see an initial list:

- ISO
- White Bal.
- Media
- Browse
- .....
- Storage
- Settings

The first four items are immediately accessible for changes, indicated by the appearance of a plus and minus sign in the highlight frame meaning the settings can be altered by the Zoom in / Zoom out buttons. Storage and Settings are more detailed and therefore require further navigation.

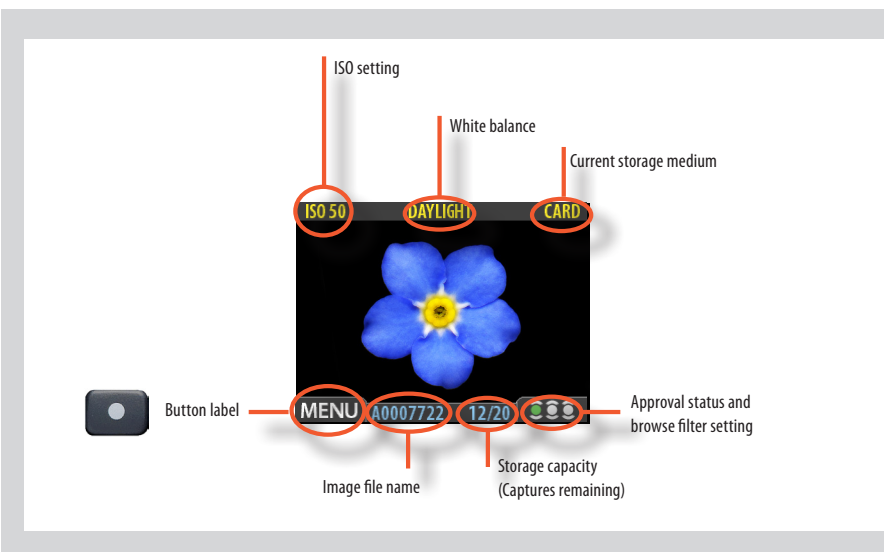
It is advisable to initially quickly skim through this section of the manual to build up a picture of the menu structure and its various sections.

Note that some of the buttons have a double function while others remain single function. For example, the navigation button always leads you through the menu in the direction that the arrowhead illustrates. The Zoom in/out buttons ( and ) though, for example, act as image enlargers and reducers as well as confirmation buttons, according to where you are on the menu.

## Note

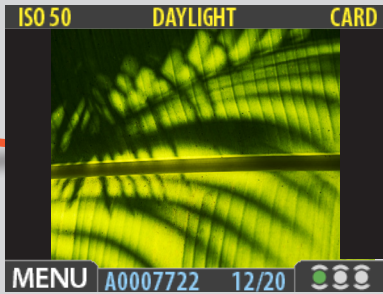
*Time & Date settings on the digital back (which are included with your capture files and batch labels) are updated automatically through a FireWire/Phocus connection. These settings are retained for about two consecutive weeks by a small rechargeable cell that is automatically recharged by the main battery or FireWire with regular use.*

*If problems occur, charge the cell by leaving the digital back ON for approximately 12 hours.*



*The standard preview display is the one shown when you first turn on the camera and is probably the view you will use most often. It features a preview of your most recent shot and basic information about the settings and the image itself. Several other display modes are also available, including histogram, capture details, full-screen and battery saver. Please see **Preview Modes** for details.*

*Furthermore, the display enables you to navigate the menu system and make camera settings; see **Working with the Menus** for details.*



By using the buttons on the control panel you can navigate down through the various levels in the menu. It provides the source of information about image files and also provides a way of making custom settings so the digital back suits your way of working.

Below is a simple overview of what is available and where it is situated on the menu.

# Overview of menu structure

## MENU



- ISO**  
Sets the light sensitivity of the sensor. Equivalent to 'film speed'.
- WHITE BALANCE**  
Set to match the color temperature of light used.
- MEDIA**  
Determines where files will be stored (flash card, ImageBank-II).
- BROWSE**  
Sets the approval status (classification) filter for easier and quicker image browsing.

## STORAGE



- DELETE**  
For single or multiple deletion of images.
- FORMAT**  
Used to format CF cards..
- COPY**  
Copies files from a CF card to an ImageBank-II (CFV-16 only).
- BATCH**  
Used to create new storage folders (batches) and name them.
- DEFAULT APP LEVEL**  
Assigns a default approval status (classification) to all new images.

## SETTINGS



- USER INTERFACE**  
Sets menu language, power down, sound, date & time and several other custom settings.
- CAMERA**  
Sets which type of camera body to be used with the digital back.
- CUSTOM OPTIONS**  
Sets options regarding image format and tilt sensor (CFV-39 and CFV-50 only).
- ABOUT**  
Displays serial number and firmware version.
- DEFAULT**  
Resets all custom settings back to the original factory settings.

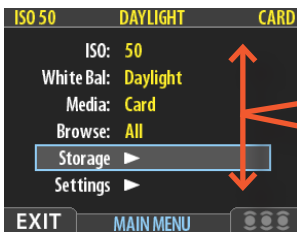
## Simple introductory overview of menu access, navigation and settings choice.



The menu is structured in a manner similar to cell phones and similar electronic devices.

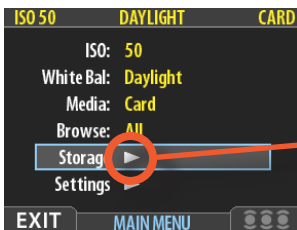
Various branches within the tree system are accessed by pressing the navigation button until you reach the point where a choice has to be made.

The OK (Approve) button or SELECTION (Zoom-in/Zoom-out) buttons are then used to confirm choice.



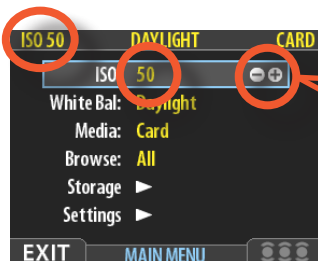
After pressing the MENU button, the main menu list appears. The blue frame highlights where you are on the menu. Press on the 'up' and 'down' symbols on the navigation button to move up and down the list.

You can return to the standard image view by pressing either on the 'left' symbol on the navigation button or on the EXIT/MENU button again.



The need to continue further into the menu is indicated by the arrow symbol beside the menu item.

Press the 'right' arrow symbol on the navigation button to access the next part of the menu.

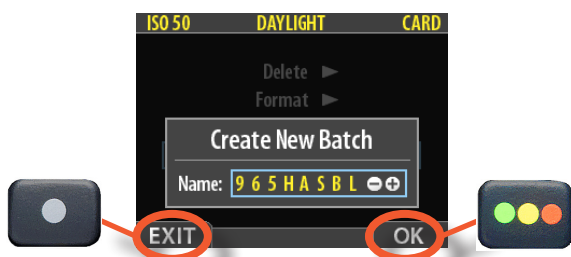


When you reach the final destination of your choice (this might take several moves), PLUS and MINUS symbols appear to the right in the frame round the item.

You then press the Zoom-in /Zoom-out /SELECTION buttons to access a loop list of choices.

In the example on the left, 50 is the ISO value shown. By pressing either button the alternatives appear – 100, 200, 400 and then back to 50 again – both on the list as well as on the upper low to the left (in the case of ISO value).

Pressing the EXIT/MENU button will then confirm the new setting.



In the next example on the left, the name of a new batch is changed by pressing a combination of the Zoom-in /Zoom-out/ SELECTION buttons as well as the navigation button. You can then confirm your choice with the OK (Approve) button or revert to the previous status by pressing the EXIT/MENU button. Note that how for this screen the MENU button is now described as EXIT on the screen, and the Instant Approval button is described as the OK button.

See later sections for more comprehensive information.

# 6

## CFV digital back

- Initial General Settings and Preparation



The initial general setting is language choice which will be retained. You can choose between:

- ENGLISH
- GERMAN
- FRENCH
- ITALIAN
- SPANISH
- JAPANESE
- CHINESE

Before each photographic session, just as in analogue photography, an ISO setting should be made, though in the digital world it matches the job in hand and circumstances as opposed to the sensitivity of the film chosen. A white balance setting should also be made. This is for your convenience regarding the appearance of the image on the camera display and computer monitor though; it will not affect the raw file.

ISO and White Balance are available at the top level of the menu system so you can get to them quickly and easily. They are also shown on-screen in most preview modes, so you can easily keep an eye on them as you work.

The description below is a general illustration of how settings are changed. See later section in this manual for details regarding ISO and White Balance.

### Setting the menu language

Proceed as follows:

1. Press the MENU/EXIT ( ) button to open the menu.
2. Press the NAVIGATOR button ( and ) to select the SETTINGS sub-menu.
3. Press the NAVIGATOR button ( ) to open the SETTINGS menu.
4. Press the NAVIGATOR button ( ) to select the USER INTERFACE sub-menu.
5. Press either ZOOM button ( or ) to choose a new language (in this case, Spanish).
6. Press the MENU/EXIT ( ) button again to close the menu.

### Tip

If you find the digital back has been set to a language you don't understand (a rented camera, for example), you can use the procedure above to get back to your preferred language just by following the actions and appearance in the illustrations here.

## Image storage modes / shooting

*The digital back can store captured images in two ways:*



### Untethered / Compact flash card mode

In this mode the 503CW/503CWD and CFV act independently of other connections. Images are stored on the internal, removable compact-flash card.

- *The main advantage with this mode is the freedom of cables and extra equipment.*
- *The main disadvantages with this mode in the field are the battery power capacity and the size of the card's holding capacity.*

*Please note that the recommended types of CF cards are Sandisk Extreme-III or Lexar Professional 133x. Other cards will work but offer a reduced capture rate.*

### Tethered / Studio mode

This mode enables you to connect the 503CWD and CFV directly to a computer and to operate the system using Hasselblad Phocus software and store images on a computer hard-disk.

- *The main advantages with this mode are the almost limitless storage capacity and being able to work on the images (with Hasselblad Phocus) on a large screen.*
- *The main disadvantage with this mode is the lack of mobility to any great extent.*

## Capture destination

The capture destination is the location to which new captures are saved and from which you can browse using the camera controls. The capture destination is selected automatically:

- *When tethered, captures are always saved directly to the computer hard disk.*
- *When untethered, a compact-flash card is automatically selected.*

## Using compact flash memory cards

When shooting to a compact-flash card, the CFV is completely self-contained. No additional wires or connectors need to be attached.

The 503CWD and CFV are shipped with compact-flash cards. Lossless compression is applied to the images, so the actual size of each capture can vary, thereby affecting the total number of shots you can fit on a card. You can purchase additional cards and change them as each card becomes full.

### Inserting a card

1. Open the CF card cover to reveal the CF slot.
2. Hold the CF card so that the connector holes face into the slot, with the brand label facing in the same direction as the preview screen. Gently press the card into the slot.

*If you encounter resistance, it might be because you are holding the card backwards or upside down.*

*When the card is completely inserted, swing the cover shut again.*

### Removing a card

1. With the CF card cover open, press gently on the card removal button (1a) and then release it. It will now extend out from its original position, as in the illustration (1b).
2. Press firmly on the card removal button (2a) to eject the card for removal (2b).







## ***Tethered to a computer***

Even if you never shoot while connected, you will probably connect the camera to your computer each time you want to download your images, though you might instead use a compact-flash card reader.

### ***Connecting to a computer***

To connect to a computer, simply attach a FireWire cable from the FireWire port on your computer to the port on the side of the digital back. The port is protected behind a sliding cover.

### ***Removing from a computer***

To remove the camera from a computer, simply disconnect the FireWire cable when all image loading activity has finished.

### ***Shooting with Phocus running***

When you are connected to a computer and you want to control the camera from Phocus, the following rules apply:

- ***A Winder CW and the Exposure Cable 503 (supplied) must be attached.***
- ***The destination medium and location are controlled from Phocus.***
- ***The screen and menu system on the digital back are disabled.***
- ***The digital back will take power from the FireWire cable if it is available (not all computers supply power, notably PC laptops. See under 'General Information').***

When initiating a shot from Phocus, the computer sends a signal to the digital back, which triggers the Winder CW which in turn triggers the shutter and flash/strobe lights (if any). The digital back then sends the image back over the FireWire connection to the computer, where it is displayed on the computer screen and saved as a 16-bit-per-color 3FR file in the currently selected folder of the computer hard disk.

*3FR is a proprietary Hasselblad format for storing raw captures. It contains the complete raw image exactly as it was captured by the camera, plus technical details that enable Phocus to process and display the image correctly, amongst other things. This 3FR file is converted into a 3F file (denoted by each file now bearing the suffix ".fff") that furthermore stores a complete history of the Phocus settings that you have applied to each image and stores meta-data such as camera settings, image name, photographer, copyright, etc.*

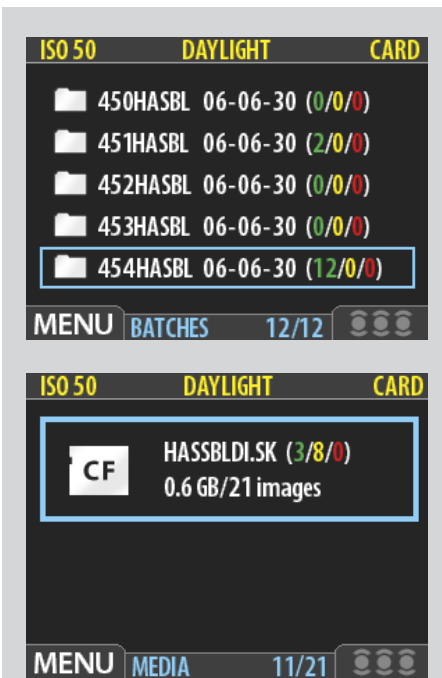
*If you prefer not to correct and adjust your captures in Phocus, then you can export converted 3F files directly to DNG, TIFF or PSD and use Adobe Photoshop, for example.*

*Please refer to the relevant user manuals for further instructions about using Phocus.*

# 7

## CFV digital back

### ■ Storage overview— working with media and batches



#### Note

Each new image will be saved in the latest created batch only. You cannot select any other batch to save a new image in.

#### General

Whichever way you choose to store your images, they should be filed in batches for efficient workflow.

#### Organizing your work with batches

Batches help you to organize your shots as you work. They function just like folders on a computer. Batches have the following properties:

- When you create a new batch, you assign a name to it and it is created as a new folder.
- When you copy images from a compact-flash card, each batch is saved as a sub-folder on the destination disk.
- When deleting multiple images, you are able to restrict your delete command so that it affects just a single batch.
- When browsing images, you will only see images from the current batch.
- You can change between batches by using the navigation controls on the digital back panel.
- The batch name also shows the date on which it was created (using the Year/Month/Day convention).

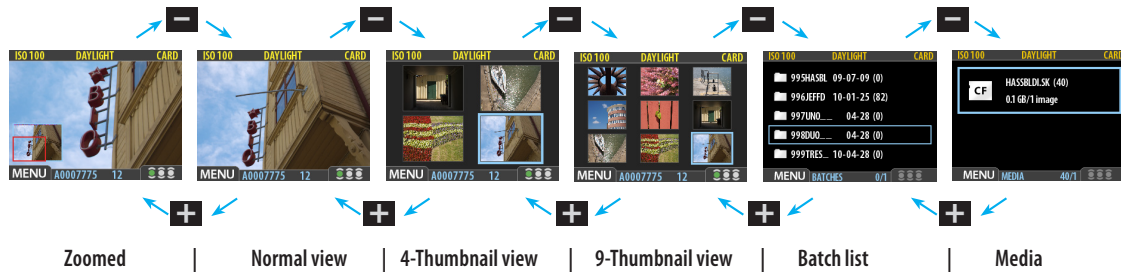
#### Navigating media and batches

The camera always works with a **current medium** and a **current batch**. This is the location at which the camera will save all new shots and the location in which you can browse using the navigator button. There are two ways of selecting the current medium and/or batch:

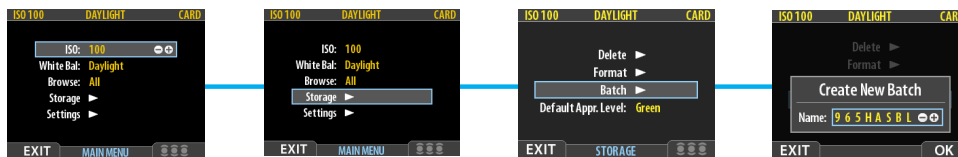
- Using the zoom and navigator buttons. This method enables you to select any existing batch and is therefore useful even when only one type of medium is attached. This method is explained in the procedure below.
- Using the MENU > Storage item on the menu system to choose a medium. This is only relevant when more than one medium is attached (e.g., both a CF card and an ImageBank-II with 16 Mpix model only). When you use this function, you will always go to the most recently created batch from the medium you select. Please see *Selecting the Current Storage Medium* for a complete description of this method.

## Introductory overview

Navigating to batches and media.

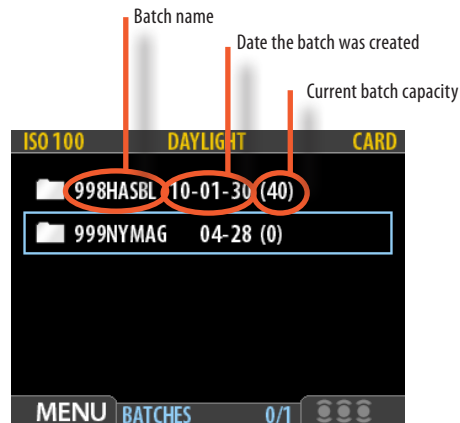


Creating new batches



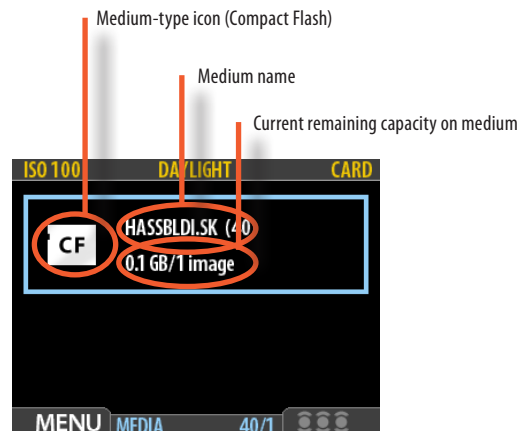
The **BATCH** screen.

The blue frame around a folder tells you that it is the **Current Batch**.






The **MEDIA** screen.

Displays information about the **Current Medium**



**To select the current medium and view batches using the browse controls:**

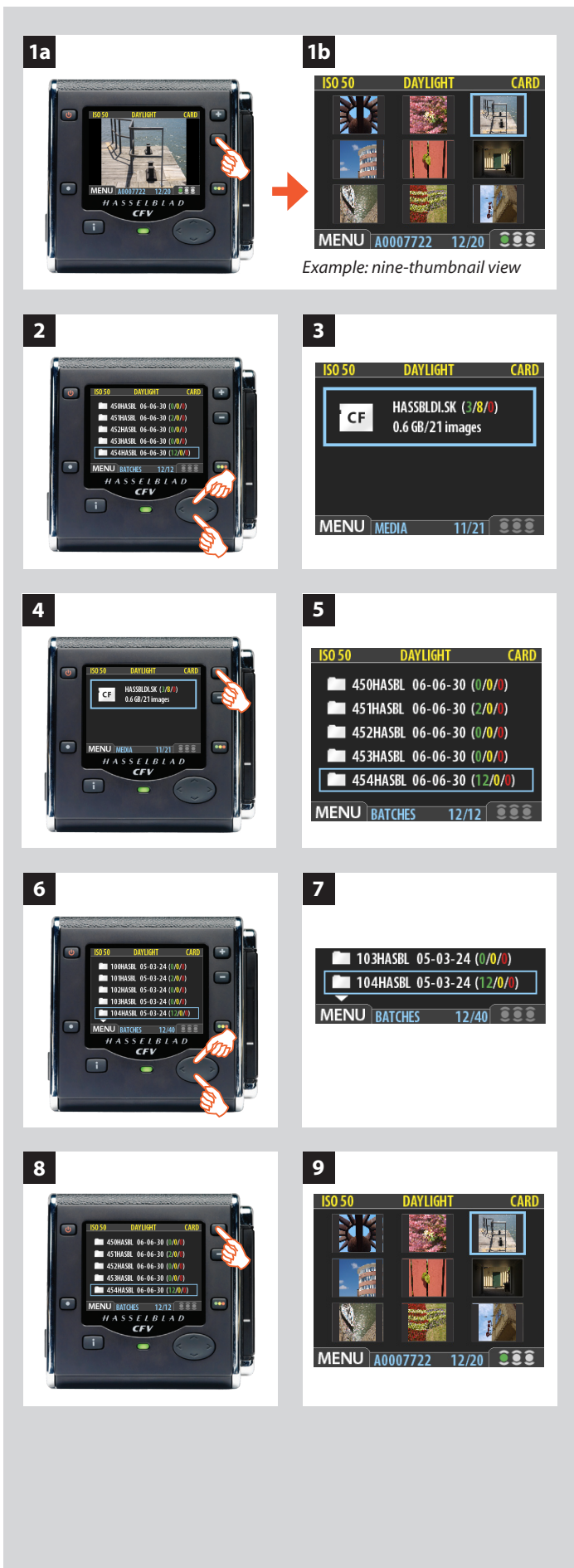
1. Press the zoom-out (  ) button repeatedly until you are all the way at the top zoom level. If you start with the single-image preview view, then you pass through the following views to get there:
  - Single-image preview (as in fig 1a)
  - Four-thumbnail view
  - Nine-thumbnail view (as in fig 1b)
  - Batch list (as in fig 3)
  - Media list (as in fig 4)
2. Each medium shows a name, total size and an estimate for how many images will fit on it. To the right of the medium name is a set of three colored numbers in parentheses. These indicate the total number of images of each approval status (green, yellow and red) that currently exist on that medium. For example, if you see a card that shows (18/5/3), then that card contains a total of 26 images: 18 green (**approved**), 5 yellow (**unclassified**) and 3 red (**delete**).  
If more than one medium is listed, then use ▲ and ▼ to highlight the medium you wish to use.
3. The currently selected medium shows a blue border.
4. Press the zoom-in (  ) button to zoom-in on the currently highlighted medium.
5. A list of batches on this medium now appears. Each batch appears as a folder icon with a name and the date on which it was created. As with the media list, you can read the number of shots of each approval status that are stored in each batch.
6. As with media, use ▲ and ▼ to highlight the batch you wish to view.
7. The currently selected batch shows a blue border.
8. Press the zoom-in (  ) button to zoom in on the currently highlighted batch.
9. The nine-thumbnail view of your selected batch now appears.

**Creating new batches**

You can create any number of batches on each medium. To create a new batch, first make sure you have selected the correct current medium (see **Navigating Media and Batches**) and then use the **MENU > STORAGE > BATCH** item of the menu system to create the new batch. See **Creating Batches** for a detailed procedure.

**Note**

Please note the difference between 'selecting' a medium and 'browsing' a batch. Each new image will automatically be saved in the latest created batch only on the selected medium. You cannot 'select' a batch for storage.



## Using Instant Approval Architecture

The Instant Approval Architecture system helps you to classify your images as quickly as you take them. It works by supplying immediate audio feedback, which tells you instantly whether each new picture is exposed correctly or likely to be over- or underexposed. Thereafter, the system enables you to assign each image one of three status levels. Though you can use the system any way you like, the intention (based on the 'traffic light' principle) is that you should assign the levels as follows:

- **GREEN** for your best shots.
- **YELLOW (AMBER)** for images that need closer inspection.
- **RED** for images that you are unlikely to use.

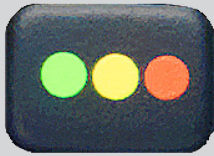






Image File Name  
Green images start with "A"  
Yellow images start with "B"  
Red images start with "C"


 Press the approve button to change the status of the currently selected image


 Press *and hold* the approve button to change the status of the currently selected image


Current approval status (green) and browse-filter setting (show all)

 Show all

 Show green and yellow only

 Show green only

 Show yellow only

 Show red only

One of the greatest advantages of digital photography compared to film is that it costs no more to shoot hundreds of images than it does to shoot one. Photographers therefore tend to take many more pictures when shooting digitally. By assigning approval levels as you work, it can be much easier to sort through and select images when you get back to your computer.

### Note

When the current storage medium is full, red-status images will be deleted (one at a time) to make room for new shots. You can continue shooting until no red-status images remain; if you then try to take additional new shots you will get a medium-full message.

### Note

There are two different actions concerning the approval button. Quickly clicking will change the status whereas pressing and holding will change the browse filter.



### Note

Note that some shots may trigger a warning even though they are exposed according to your intentions. You should consider these warnings only as a guideline. This feature can be turned off.

### Note

If you set Approval to 'Auto', all images will be stored as Green if judged as correct and Yellow if judged as technically doubtful.

No images are ever stored as Red automatically!

### Note

You can set the digital back to filter by approval status as you browse, which means that some images may be hidden (though they are still there). See "Browsing by Approval Status", for details about how to work with the filter.

### Note

Be careful when assigning red status because red images may be deleted if the current storage medium becomes full.

## Standard Instant Approval workflow

The standard method of working with the Instant Approval Architecture is as follows:

1. Take a shot.
2. The camera analyzes the shot to find out if it seems to be over- or underexposed. If it suspects a problem, it does the following:
  - Provides audio feedback (if this option has been chosen) by making a warning sound, which immediately alerts you to a possible problem even if you are not looking at the screen. The warning sound is a rapid string of notes going up the musical scale if the image is judged as overexposed or conversely a rapid string of notes going down the musical scale if the image is judged as underexposed
  - Downgrades the approval status to yellow (if Approval is set to 'Auto').
3. If no problem is detected, then the image is saved with green status.
4. When you are browsing through your shots, keep an eye on the approval status of each and consider whether you should promote or demote each shot based on its appearance on the preview screen. You can also apply a browse filter to, for example, browse only red shots when looking for images to delete or to browse only green shots to make sure you have a good version of each shot that you need.
5. When you begin working with the images on your computer, use the approval status as a guide for organizing your work. For example, you might begin by opening and optimizing the green shots and then go to the yellow shots only if you still need more images and then, finally, check the red shots as a last resort.

Note that the system is very flexible so you can use it in any way that you like. For example, you can set the camera to assign all new images a yellow or green status regardless of the exposure warning. Be careful when assigning red status because red images may be deleted if the current storage medium becomes full.

## Reading and changing the approval status

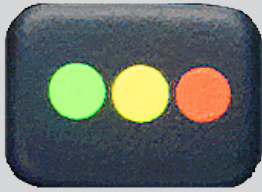
The current approval status of each shot is indicated in two ways:

- In most preview modes, the current status is indicated by a colored dot in the bottom-right corner of the screen.
- Each image is given a name that indicates its approval status. Approved (green) image names start with "A" (e.g., "A000043"); warning (yellow) images start with "B" (e.g., "B000043"); and images marked for delete (red) start with "C". Because of this naming convention, you will also be able to sort your image files by status after you have copied them to your computer (e.g., by listing the folder by file name).

See also the diagram showing where you can read the image name and approval status on the screen.

By keeping an eye on the file name and/or colored dot as you browse your images at the single-image, four-thumbnailed or nine-thumbnailed level, you can easily see the current approval status of each of them.

To change the approval status of the currently displayed/selected image, simply press the approval button until the desired approval status is shown.



## Browsing by approval status


---

You can set the camera to browse by approval status, which means, for example, that you will see only green-status images as you browse a batch (or both green and yellow, or only red, etc.). The current filter setting is indicated on-screen, as illustrated. Filtered images are still there, but they will not be shown until you change the filter setting. Also, if you change the status of an image, the image may 'disappear' if it no longer passes the filter. For example, if you have set the camera to browse only green-status images and then change an image to yellow status, that image will not be shown again until you change the browse filter.

There are many ways to make use of this feature. For example:

- *Set the filter to show only yellow images. Then step through each image and decide whether any of them should be promoted to green or demoted red.*
- *If you are running out of space, set the filter to show only red images and then step through to find shots you can delete.*
- *Set the filter to show only green images. Then step through to make sure you have at least one 'good' example of each shot that you need.*

There are two ways to set the browse filter:

- *Press and hold  until the filter you want to use is shown by the indicator.*
- *Use the MENU > Browse item of the menu system. See **Setting the Browse Filter** for a detailed procedure.*

## Deleting by approval status

---

There are many ways to delete images, including one-at-a-time and multiple delete by batch, media and/or approval status. When deleting several images, you first pick the medium or batch from which you want to delete and then use the **MENU > STORAGE > Delete** item to specify the status of the images to delete. You can choose to delete:

- *All red-status images from the selected batch or medium*
- *All red- and yellow-status images from the selected batch or medium*
- *All images from the selected batch or medium*

See **MENU > Delete** for detailed procedures describing each of the delete options.

## Setting the default status

---

As outlined in "Standard Instant Approval Workflow", the camera normally works by assigning a green status to all images that pass a basic exposure test and a yellow status to all images that fail the test. However, you can change this behaviour if you prefer an alternative workflow. You have the following options:

- **Auto:** *works as described in Standard Instant Approval Workflow .*
- **Green:** *gives all new images a green status, regardless of the exposure warning.*
- **Yellow:** *gives all new images a yellow status, regardless of the exposure warning.*

Regardless of this setting, audio feedback will still be provided if an image is judged to be badly exposed.

Use the **MENU > BROWSE** item to make this setting. See also **Setting the Default Approval Status** for a detailed procedure.

# 8

## CFV digital back

### ■ Viewing, deleting and transferring images



#### **Basic image browsing**

The large, full-color display enables you to inspect your shots while you are still on-location. The display offers full-screen previews, high-magnification zoom, two levels of thumbnails and analysis tools including a full histogram and camera settings.

When you first turn on the camera, the display opens in standard browse mode, showing the last image taken (if any) for the current medium and batch. Likewise, after each new shot, the display shows a preview of the shot.

To browse the images of the current batch, simply press the left ◀ and right ▶ arrows of the navigator button.

#### **Choosing the current batch**

When you browse using the navigator button, you will only see images from the current batch on the current medium. To view another batch, you must navigate to it by zooming out to the batch or media level and then zooming in on the appropriate folder. See **Navigating Media and Batches** for complete details about how to select the current medium and/or batch.

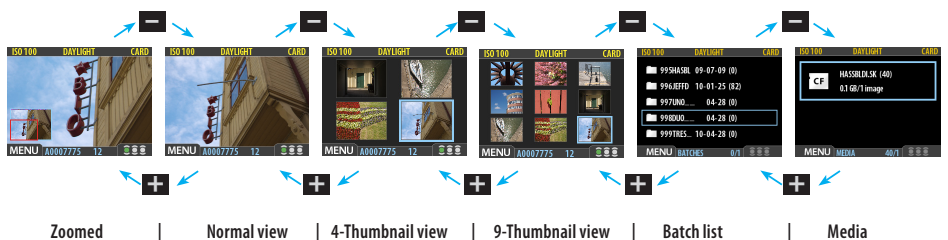
#### **Browsing by approval status**

It is possible to set the camera to browse only images of one or more specific approval levels from the current batch. You can use this, for example, to review all of your red-status shots to make sure you don't need them or to review all of your yellow-status shots to decide whether they should be moved to green or red status. When you use the browse filter, you will not see images excluded by the filter, but they are still there.

See **Using Instant Approval Architecture** for complete details about how to check and set the browse filter.

#### **Zooming in and out**

As illustrated below, you can use the + or - button to see various levels of detail in your images. You can furthermore zoom all the way out to view and select batches and media.

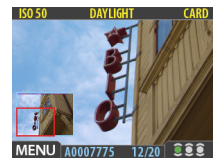




1



2



3



4



## Note

If you continue to zoom out beyond the nine-thumb view, you will come to the batch list and then to the media list. You can use this to select the current batch for browsing and for storing new images.

See **Working with Media and Batches** for details.

## Zooming in for more detail

The preview display has a much lower resolution than your images. You can therefore zoom very far into the images to inspect small details. To do this:

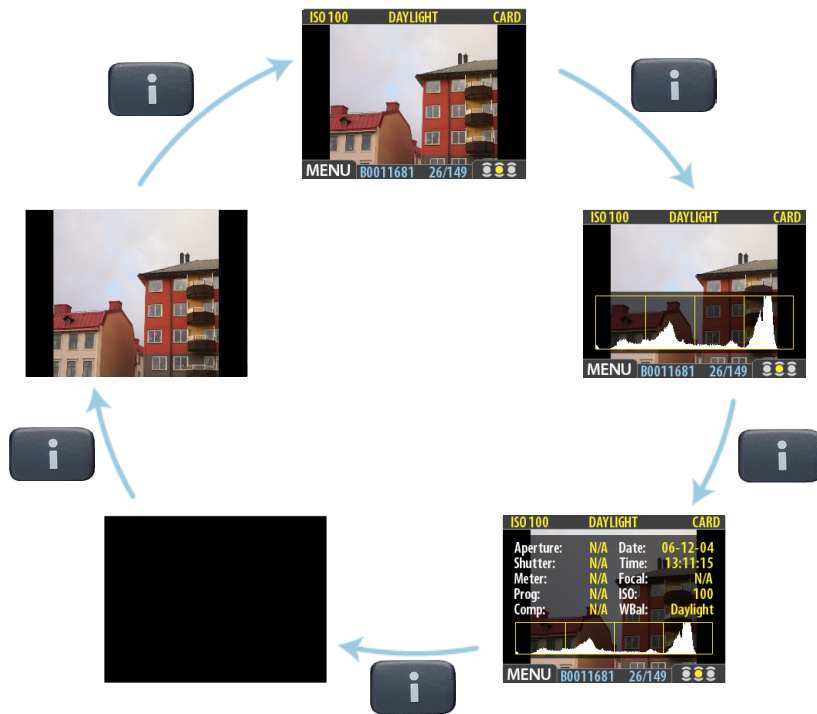
1. Browse to the image you wish to zoom into with the navigation button.
2. Press the zoom-in (+) button to zoom in one step. The screen updates to show both a zoomed image and a thumbnail image that includes a red box outlining the portion of the images currently shown.
3. You can now do the following as needed:
  - Use the navigator button to move the zoom area if you wish to inspect a different part of the image.
  - Zoom further by pressing the zoom-in (+) button more times.
  - Zoom back out one step by pressing the zoom-out (-) button.
4. When you are finished, press and hold the zoom-out (-) button to return to browsing at the standard zoom level.

## Thumbnail views

Preview thumbnails are small versions of each preview, sized to fit either four or nine images on the screen at once. Use them to get an overview of your work so far and to help find specific shots.

To see the thumbnails, start with the standard preview display and press the zoom-out button once to see four thumbnails or twice to see nine.

When viewing thumbnails, the selected image shows a blue border. When an image is selected, you can zoom in on it using the zoom-in button or delete it using **MENU > STORAGE > Delete** (see also **MENU > STORAGE > Delete** for a detailed procedure). Use ▲ and ▼ to scroll the thumbnails when you have more shots than can be shown.



You can cycle through all the available preview modes by pressing the **View-Mode** button.

## Preview Modes

### Choosing the Preview mode

You can use the view-mode button to cycle through the available preview modes.

The preview screen works in several different modes:

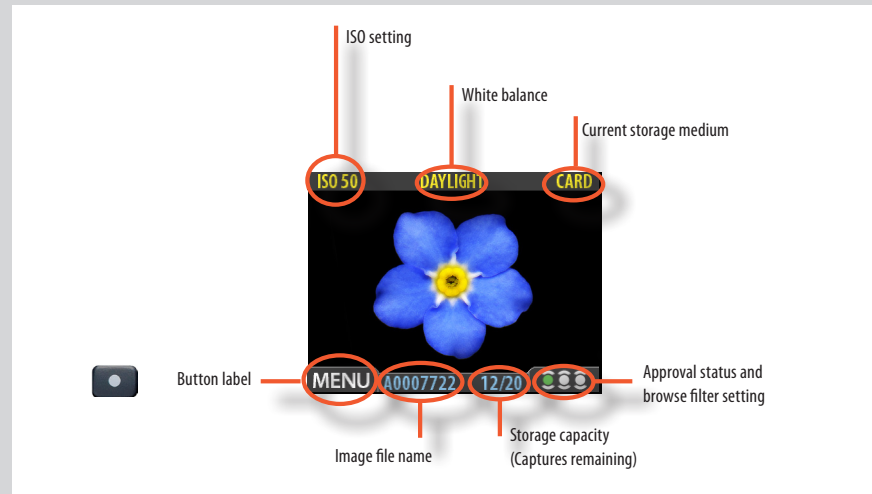
- **Standard preview:**  
shows a preview image surrounded by a display of few important settings.
- **Histogram:**  
shows a preview image overlaid with a histogram.
- **Histogram and full details:**  
shows a preview image overlaid with both a histogram and camera-setting details.
- **Battery saver:**  
turns off the screen, but you can still use the menus and take pictures.
- **Full-screen preview:**  
shows the preview only, with no frame or settings information.

To cycle through the various modes, press the view-mode button on the front panel. The order is circular, as listed above. Each mode is described in detail in the sub-sections below.

Regardless of the current mode, if you zoom in on the image or zoom out to the thumbnails, the display reverts to showing the “standard” preview frame, which shows information about the current image and camera settings around the edges. When you return to the standard zoom level, however, you will then also return to your last-selected preview mode.

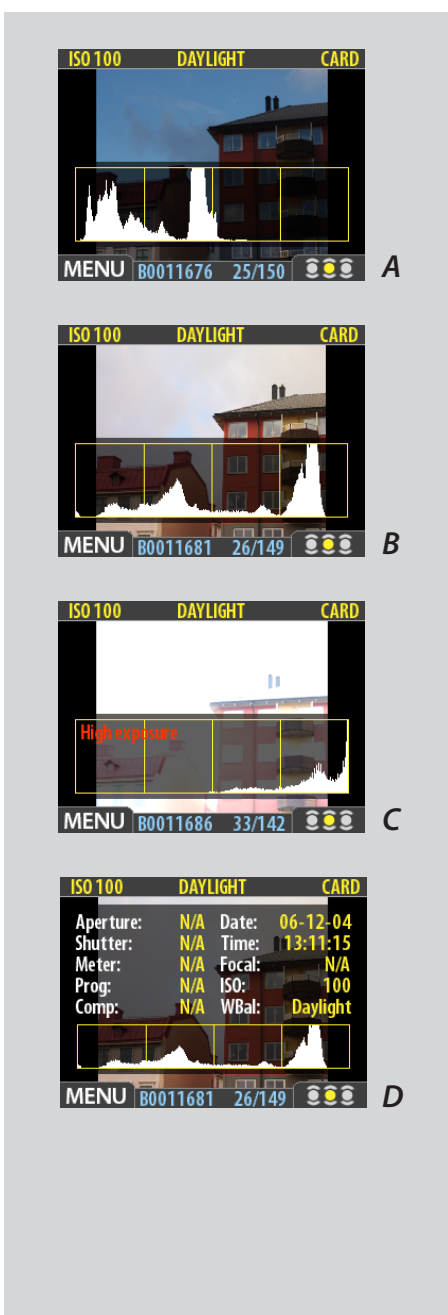
Note that the screen can also operate in menu mode, which does not show a preview, but enables you to make digital back settings. To enter menu mode, press the menu button. See **Working with the Menus** for details.





The standard preview display is the one shown when you first turn on the camera and is probably the view you will use most often. It features a preview of your most recent shot and basic information about the settings and the image itself. Several other display modes are also available, including histogram, capture details, full-screen and battery saver. Please see **Preview Modes** for details.

Furthermore, the display enables you to navigate the menu system and make camera settings; see **Working with the Menus** for details.



## Using the histogram

The histogram provides a graph that indicates the total number of pixels at each brightness level, with brightnesses going from black on the left to white on the right. It is a valuable tool for evaluating your exposure. A well-exposed shot usually has a full range of levels, while under- and overexposed shots tend to show levels concentrated at the left or right part of the scale, respectively.

For example:

### Underexposure A

A histogram that is concentrated on the left with few pixels elsewhere indicates a likely underexposure. Many details will be lost in the shadows.

### Even exposure B

A histogram display that is spread across the full range indicates a likely good exposure. There may still be a few pixels at the extremes, indicating a few spectral highlights and saturated shadows, but this is often normal in a good exposure.

### Overexposure C

A histogram that is concentrated on the right with few pixels elsewhere indicates a likely overexposure. Many details will be lost in the highlights.

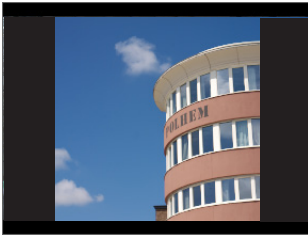
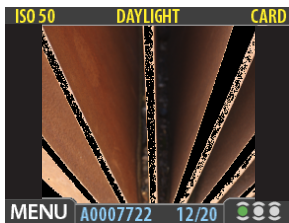
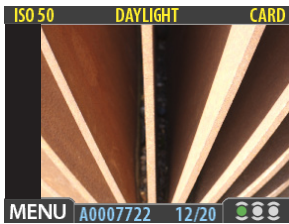
### Full-details mode D

In full-details mode, you can read a complete list of camera settings, plus see the histogram and, in the background, a darkened preview of the image.

The camera-setting details are stored with the image, so you can refer to them using Phocus even after you have loaded the image to your computer and stored it in your archive.

### Note

The histogram is only an indicator that should be interpreted—there are situations in which a doubtful histogram will match an exposure that is very good for the intended effect (and vice-versa).

**1****2**

## Battery-saver mode

In this mode, the digital back is fully responsive, so you can take pictures but the screen is not lit up, thereby saving battery power.

You can enter the menu system while shooting in this mode (which activates the screen until you exit the menu system again) but the approval, zoom and navigator buttons have no effect.

## Full-screen mode

**1**

In full-screen mode, you can browse your images at standard preview resolution without any distracting data surrounding them.

Because the current approval setting is not shown in full-screen mode, the approval button has no effect. This will prevent you from accidentally assigning the wrong status without knowing it.

## Overexposure indicator

**2**

Though the histogram shows you when some of your pixels are overexposed, it does not tell you which ones. In a shot with many bright areas, it can be hard to know whether the key parts of your image are just bright or completely overexposed. To help you find them, the digital back can provide an overexposure indicator, which shows precisely which areas of your shot are overexposed (i.e., pixels that are at maximum brightness, thereby eliminating details).

When enabled, the overexposure indicator flashes the overexposed pixels from black to white.

To enable or disable the overexposure indicator, use the **MENU > SETTINGS > USER INTERFACE > Mark Overexp.** item.

Please see **Items on the USER INTERFACE Menu** for a detailed procedure.

### Tip

You can save battery power by turning down the brightness and/or contrast of the display using the **Items on the MENU > SETTINGS > USER INTERFACE > DISPLAY** menu. See **Making Display Settings** for details.

### Tip

Ways to save battery power include setting a display time-out and/or a power-down time-out (each of these is disabled by default).

Use **MENU > SETTINGS > USER INTERFACE > Power Down** to set a power-down time out.

Use **MENU > SETTINGS > USER INTERFACE > DISPLAY > Time-out** to set a display time-out.

See also **Items on the USER INTERFACE Menu** and **Making Display Settings** for details about these settings.

### Tip

Overexposure indicator shortcut



There is a one-button shortcut for toggling the overexposure marker on and off.

To use it, press and hold **▲** until the indicator is working as you would like (enabled or disabled)

## Tip

### Delete shortcut



There is a one-button shortcut for deleting single images. To use it, select a target image and then press and hold ▼ until the confirm-delete dialog opens.

## Tip

One way of working is to simply assign unwanted images as red. In this way, you retain the option (for a while) of changing your mind later while allowing the system to automatically delete the unwanted images as the storage medium fills up.

## Deleting images – general

The CFV enables you to delete images using any of the following techniques:

- Delete the currently selected image only.
- Delete all images from the current batch
- Delete all images from the current medium
- Delete all red-status images from the current batch
- Delete all red-status images from the current medium
- Delete all red- or yellow-status images from the current batch
- Delete all red- or yellow-status images from the current medium

For complete details about how to use the menu system to delete single or multiple images, please see MENU > STORAGE > Delete.

## Note

You will always be asked to confirm each delete operation.

## Transferring images - general

### Transferring to a computer

To transfer images stored on the compact-flash card to your computer, simply connect the digital back to a computer using a FireWire cable and then run Phocus, which will automate the process. See the Phocus manual for details.

See also **Connecting to the Computer** for details about how to connect to a computer.

## Don't forget the menu shortcuts!

To help you work faster, the digital back provides shortcuts to some of the most commonly used menu commands that do not otherwise have a dedicated button on the front panel. Try to memorize these quick actions to save time and effort later!



### To set the browse filter



Press and hold until your preferred filter is indicated.

See Using Instant Approval Architecture for full details.

### To toggle the over-exposure indicator



Press and hold ▲ until the display begins to flash (or stops flashing) its overexposed areas.

See Overexposure Indicator for full details.

### To delete images



Select the target image and then press and hold ▼ until the delete dialog opens.

See MENU > Delete for full details.

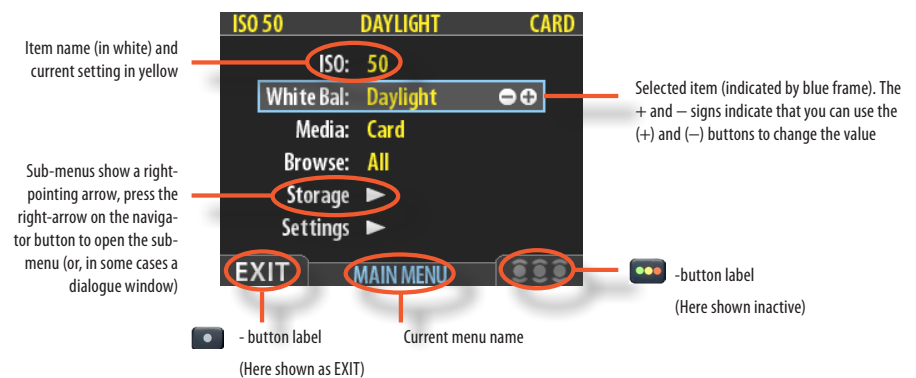
# 9

## CFV digital back

### ■ Menu: ISO, White Balance, Media, Browse

#### Menu system overview

The main menu contains those settings that you will need to access most often as you work on an assignment. It also provides sub-menus that give you access to all other settings, most of which you will need less often.

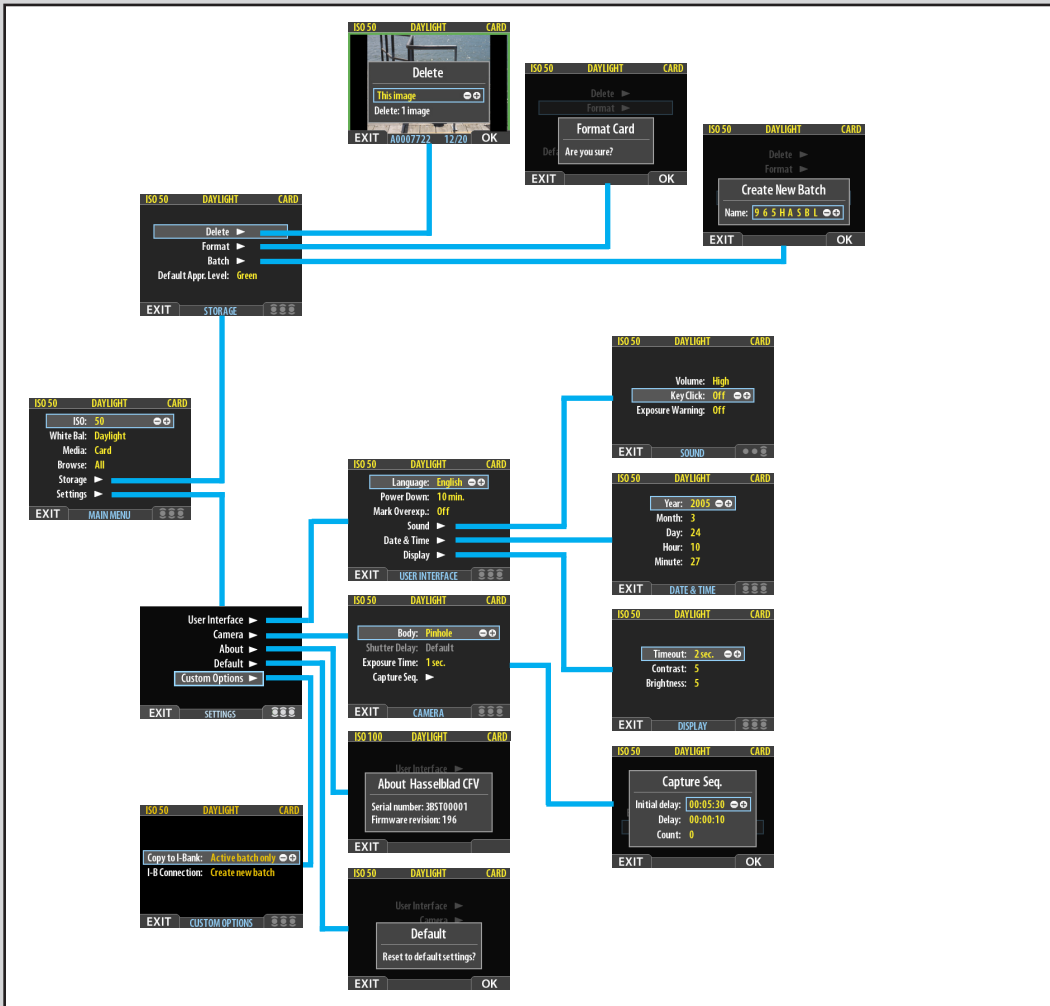


#### Navigating the menu system

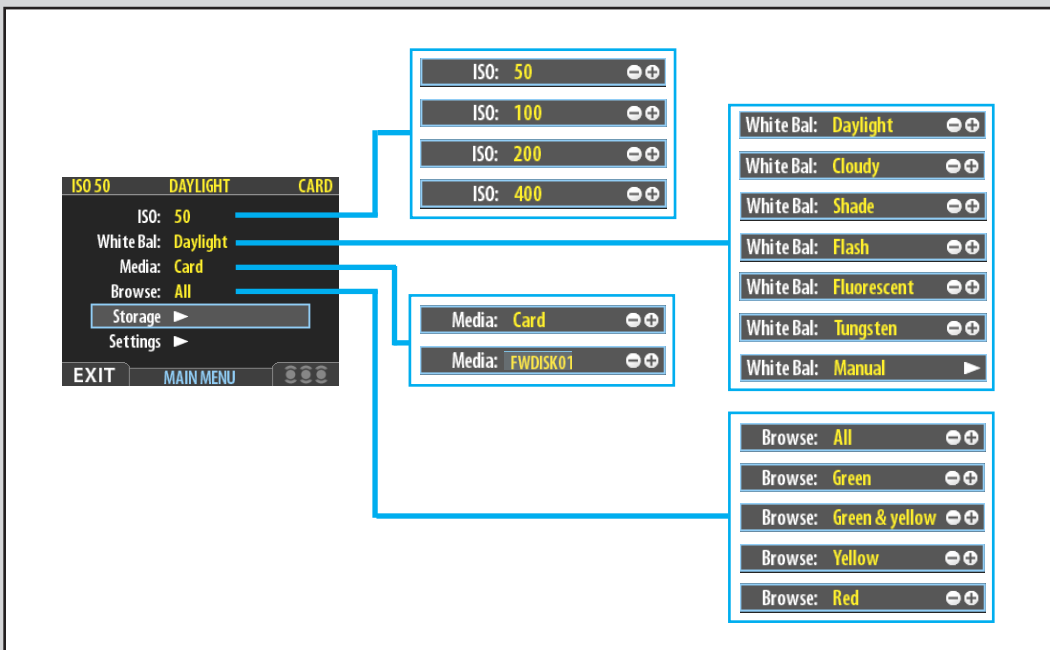
To enter to the menu system, press the **MENU** button on the panel. Any image visible is then replaced by the first level of the menu. Use the navigator button to scroll through the menu items and use the **+** and **-** buttons to change the selected setting. See also **The Control Panel** for button diagrams and descriptions.

Any given menu may include both items and/or sub-menus.

- *Items are settings that are available at the current menu level; they show their current settings next to the item name. To make an item setting, use the navigator ( ) button to select the item and then use the zoom ( + and - ) buttons to select the desired option for that item*
- *Sub-menus do not have settings at the current level; they lead to another menu or dialog. Sub-menus show a right-pointing arrowhead (▶) instead of a value. To open a sub-menu, use the up/down arrowheads (▲ and ▼) of the navigator button to select the sub-menu and then press the right side of the button to open it. There can be several levels of sub-menus.*
- *When you are in a sub-menu, you can go back to the parent menu by pressing the left arrowhead (◀) of the navigator button.*
- *Some sub-menus open a dialog. Dialogs require that you either make a setting or exit the dialog (e.g., to confirm or cancel a delete command). The left arrowhead will have no effect.*



Menu structure



Items on the main menu

As a practical example, a **MENU > SETTINGS > USER INTERFACE > Language** choice item would involve the following procedure:

1. Press the menu (**MENU**) button to open the menu.
2. Use **▲** and **▼** to select the **SETTINGS** sub-menu.
3. Press **▶** to open the **SETTINGS** menu.
4. Press **▶** to select the **USER INTERFACE** sub-menu.
5. Press either the **+** or **-** button to choose a new language (in this case Spanish).
6. Press the **MENU/EXIT** button again to close the menu.

Note also that the menu and approval buttons are situated just outside the bottom-left and bottom-right corners of the screen. As you work through the various menu items, the screen shows a label for each of these buttons. In the text, we therefore give the generic name for the button and the screen name. For example we will refer to: the menu (**MENU**) button, the menu (**EXIT**) button, or the approval (**OK**) button.

## Settings check

**ISO**, **White Balance**, **Media** and **Browse** settings should be checked before each session. They are therefore placed at the top level of the menu for quick and easy access. They are also shown on-screen in most preview modes, so you can easily keep an eye on them as your work.

## ISO

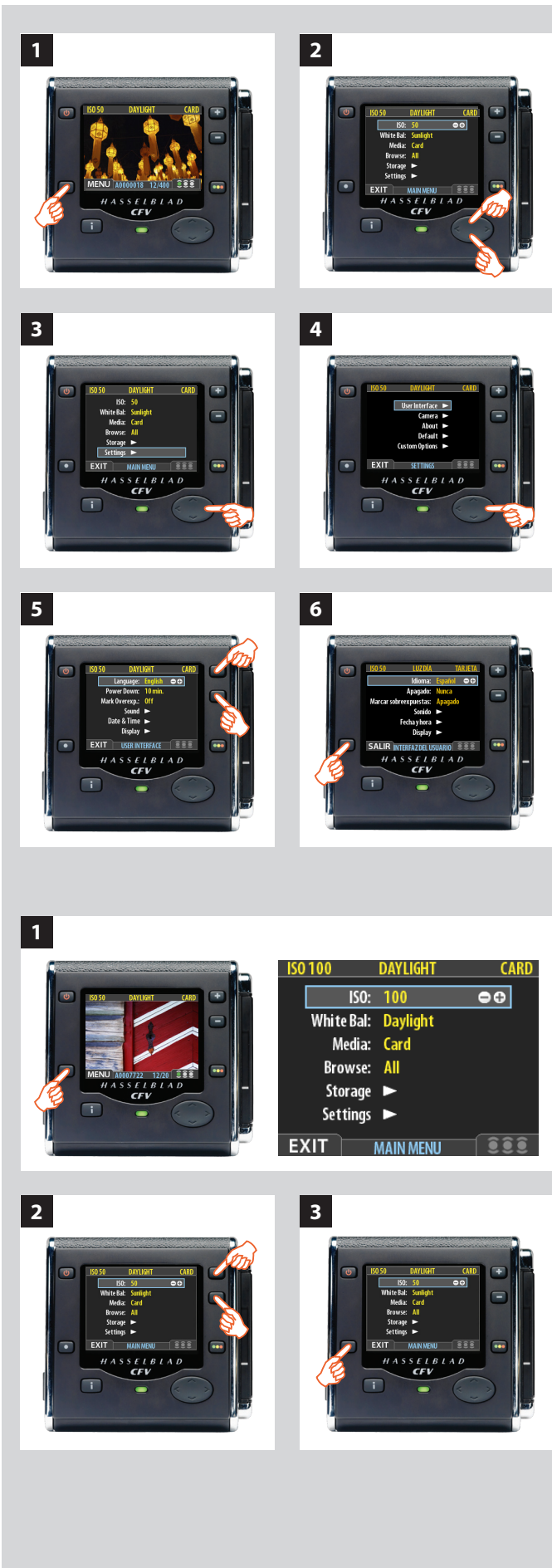
The digital back can be set to the desired rating according to requirements. Note, however, that the “natural” sensitivity of the CCD is ISO 50, so you will get best results with this setting if the light conditions allow.

### To set the ISO:

1. Select the **MENU > ISO** item. This is the top item of the top menu, so it will be selected by default when you enter the menu system. (See also **Navigating the Menu System** for details about how to find this setting.)
2. Use the **+** or **-** button to step through the available ISO settings until the setting you want is shown.
3. Either move on to another setting by using the navigator button or press the menu button to exit the menu system and keep your setting.

## Tip

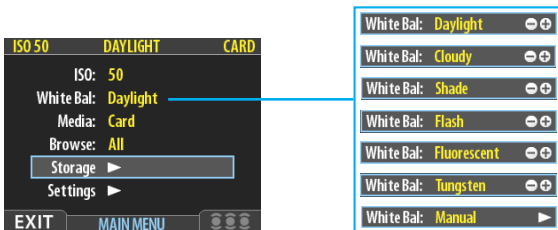
The default sensitivity of the CCD sensor is ISO 50. Higher ISO settings result in progressively noisier images (just as higher ISO film becomes grainier). It is recommended that you use the lowest ISO setting the lighting situation allows.



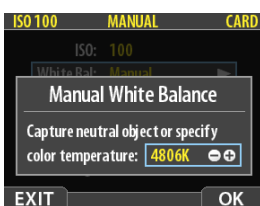




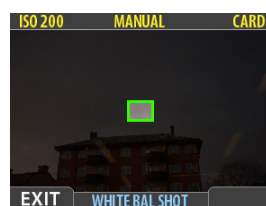
There are seven 'White Balance' settings to choose from.



White Bal. Setting	Setting description
Daylight	For general outdoor use in direct sunlight.
Cloudy	For general outdoor use in cloudy weather.
Shade	For general outdoor use in shady locations out of direct sunlight.
Flash	For general indoor use when using a normal flash/strobe system.
Fluorescent	For use when using fluorescent lighting (strip lights).
Tungsten	For use when shooting indoors under standard tungsten/B lamps.
Manual	For a manual setting



Color temperature can be set manually or read off after a test exposure.



White Balance Shot screen appears after test exposure to illustrate the area chosen for white balance calculation.

## White balance / Grey Balance

There are several ways to make a white/grey balance adjustment. When untethered on location you might prefer to make a quick preset adjustment setting at the same time that you check the ISO and Media settings. Tethered in the studio you might prefer to take the first shot of a grey scale and make the adjustment in Phocus for that session.

### Note

White balance settings are for your viewing convenience only. They in no way affect the raw file which remains 'neutral' awaiting further processing.

#### To select a preset white balance:

- 1a. Press the **MENU** button on the digital back.
- 2a. Use **▲** and **▼** to select the **White Bal:** sub-menu.
- 3a. Use the **+** or **-** button to step through the available choices until the one you want is shown.
- 4a. Either move on to another setting by using the navigator button or press the **MENU** button to exit the menu system and keep your setting.

#### To make a manual white balance setting:

1. Select the **MENU > White Bal > Manual** item.
2. Use the **▶** button to call up the 'Manual White Balance' screen.
3. Here, you can adjust the color temperature to a specific numeral setting in degrees K with the **+** or **-** buttons. Alternatively, you can position the central spot in the viewfinder over an area that you consider should be rendered as neutral in color in the image (a 'grey card' or even a sheet of white paper is ideal) and make a test exposure (ensure the exposure is approximately correct otherwise you will get a warning message). A small rectangle appears on the display marking that particular area. Calculations then take place automatically so that the following shots use the area chosen as the new 'white balance' standard. Using this method you can also read off the screen what the color temperature of the light source has been judged to be in degrees Kelvin.
4. Press the **MENU** button to exit the menu system and keep your setting.

### Note

New settings are retained even when the unit has been turned off and reactivated, so don't forget to make new settings when required.

## Media

The media setting controls where the digital back will store new images and which stored images will be visible in the browse window. Normally though, you have just one type of storage media available. If your selected storage medium has more than one batch (folder) on it, then the batch selected when you use the storage menu item will be the one you most recently created.



**To select the medium to which to save new shots and from which to browse previous shots:**

1. Press the **MENU** button.
2. Use **▲** and **▼** to select the **MEDIA** sub-menu.
3. Use the **+** or **-** button to step through the available media until the name for destination/source you wish to use is shown.
4. Press the **MENU** button to exit the menu system and keep your setting.

### Tip

You can select media using just the **+** and **-** buttons while browsing images. This method also enables you to select a batch as you zoom in from media to batch to thumbnails to preview. See *Navigating Media and Batches* for complete details about this method.



### Browse

The browse filter complements the instant-approval system by enabling you to browse through images according to their approval status. You have the following choices:

- **All:** browses all of the images in the current batch, regardless of their approval status. This is the default.
- **Red:** browses only red-status images from the current batch. These are images that you have marked for likely deletion. You might browse these images to make sure you have not eliminated any usable images and/or to find images that you can delete to make room for new shots.
- **Green:** browses only green-status images from the current batch. These are either new shots that did not trigger an exposure warning or shots that you manually assigned to green after overriding an exposure warning.
- **Green & Yellow:** browses green and yellow-status images, but does not show red-status images. These are probably images that you have either decided to keep or not yet checked for approval status.

**Tip**

**Browse shortcut**

There is a one-button shortcut for changing the browse filter. To use it, press and hold (do not click!) the Instant Approval button until the approval status color appears. Browsing will then only display the images with that classification.

For more information about using the instant-approval system, please see **Using Instant Approval Architecture**.

To set the browse filter using the menus:

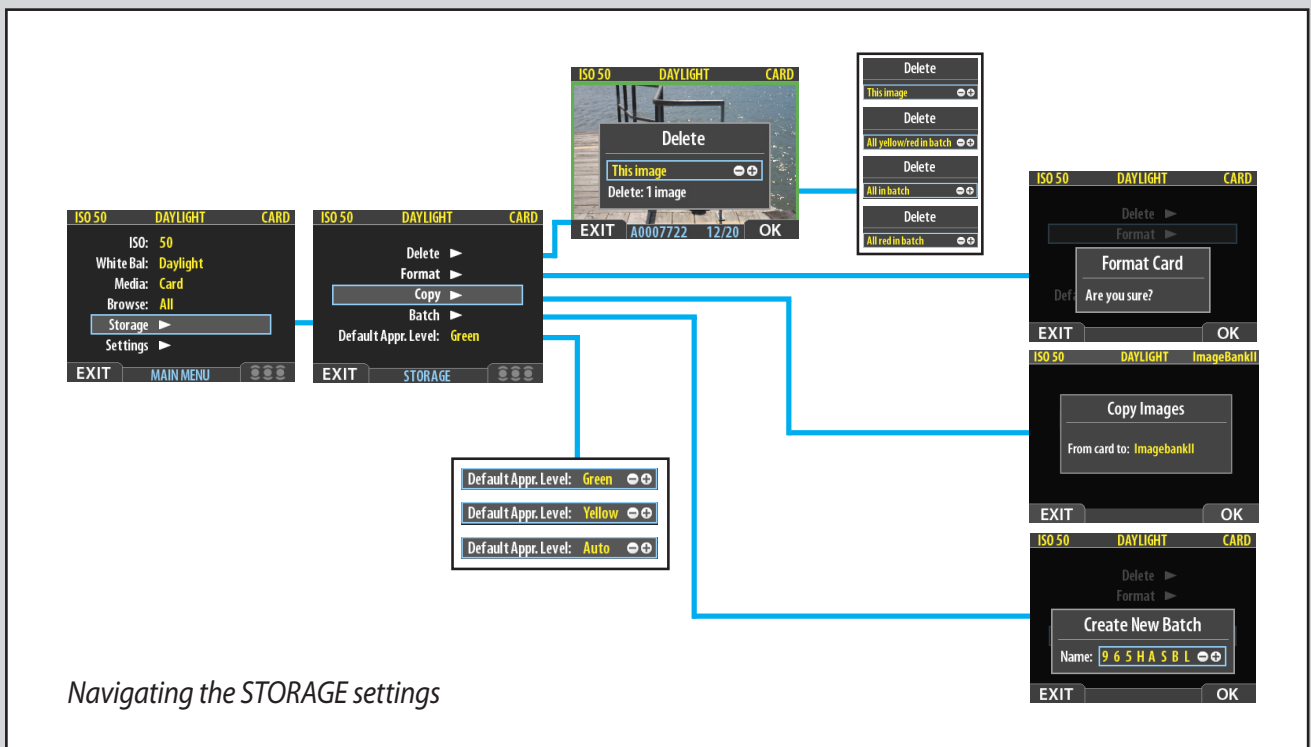
1. Select the **MENU > Browse** item. The current setting is displayed here.
2. Use the **+** or **-** button to step through the filter options (described above) until you have selected the filter you wish to use.
3. Either move on to another setting by using the navigator button or press the menu button to exit the menu system and keep your setting.

The appearance of the 'Empty Browse Filter' message signifies that there are no images with that particular approval status.

# 10

## CFV digital back

### ■ Menu: Storage



*Navigating the STORAGE settings*

## MENU > STORAGE

The **Storage** menu provides items for working with storage media. Here, you can format media, copy images from the camera to a hard disk or computer and create new batches on available media. You can also set the initial approval status (green or yellow) assigned to new pictures.

The first item on the storage list is file deletion. The great advantage of digital capture is of course the ability to judge images on the spot, delete them immediately if necessary and thereby make room for more valuable captures. There are several ways to delete images:

- *Delete a single image*
- *Delete all images from a batch*
- *Delete all images from a medium*
- *Delete all images of a specified approval status (e.g., red) from a batch or medium*

## DELETE

In this example, one image is to be deleted from a batch containing nine images.

### To delete a single image:

1. From a preview image (which is being kept), use the **☰** button to go to the nine-thumbnail (in this case) view.
2. Use the navigator button to select the image you wish to delete. When you are viewing thumbnails, the selected image has a colored border around it. When you are viewing single images, the selected image is the one currently shown. (You can delete an image either from single image view or from thumbnail view).
3. Select **MENU > STORAGE**.
4. Press **▶** to open the **Delete** dialog.
5. You are now shown a full-size preview of the selected image and asked to confirm the delete. Press **OK**.
6. You now return to the main menu. Notice that the unwanted image has now been deleted and the batch only contains the three remaining images. Either move on to another image by using the navigator button or press the menu button to exit the menu system.

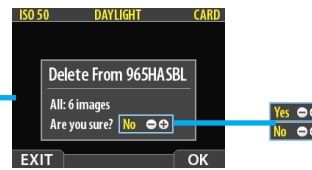
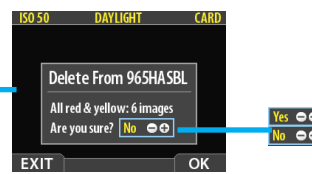
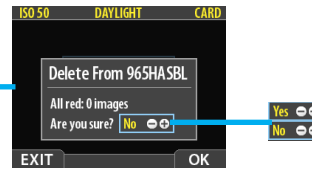
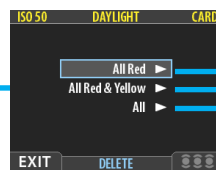
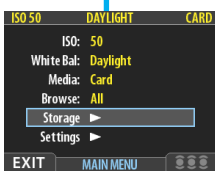
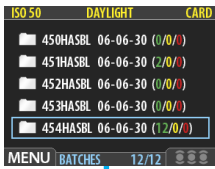
### Tip

#### Delete shortcut



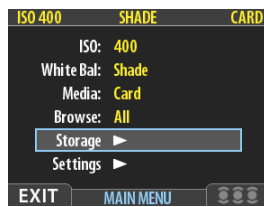
There is also a one-button shortcut for deleting single images. To use it, select a target image and then press and hold the **▼** until the confirm-delete dialog opens.



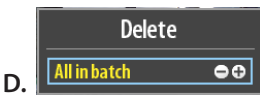
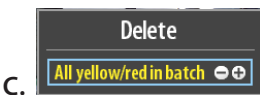
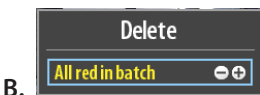
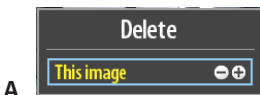


Menus for deleting several images from a batch.

1



2



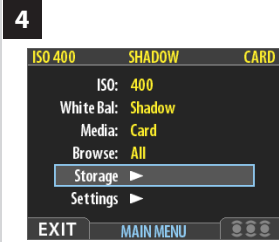
3



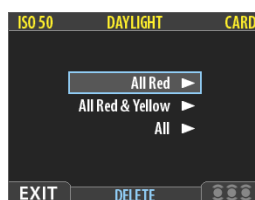
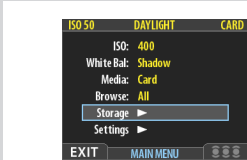
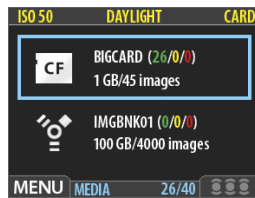
## Deleting several images from a batch

### To delete several images from a selected batch:

- Starting at the single-image preview display, Select **MENU** > **STORAGE** > **Delete**. (See also **Navigating the Menu System** for details about how to find this setting.) Use **▶** to enter the **Delete** submenu.
- Use the **+** or **-** button to select:
  - This image** - deletes the current image only
  - All red in batch** - deletes all red images in the current batch
  - All yellow/red in batch** - deletes all yellow and red images in the current batch
  - All in batch** - deletes all images in the current batch
- Press **OK** to confirm the delete (to exit without delete, press **EXIT**).



4. You now return to the main menu. Either move on to another setting by using the navigator button or
5. Press the menu (EXIT) button to exit the menu system.



### Deleting several images from a selected medium

#### To delete several images at once:

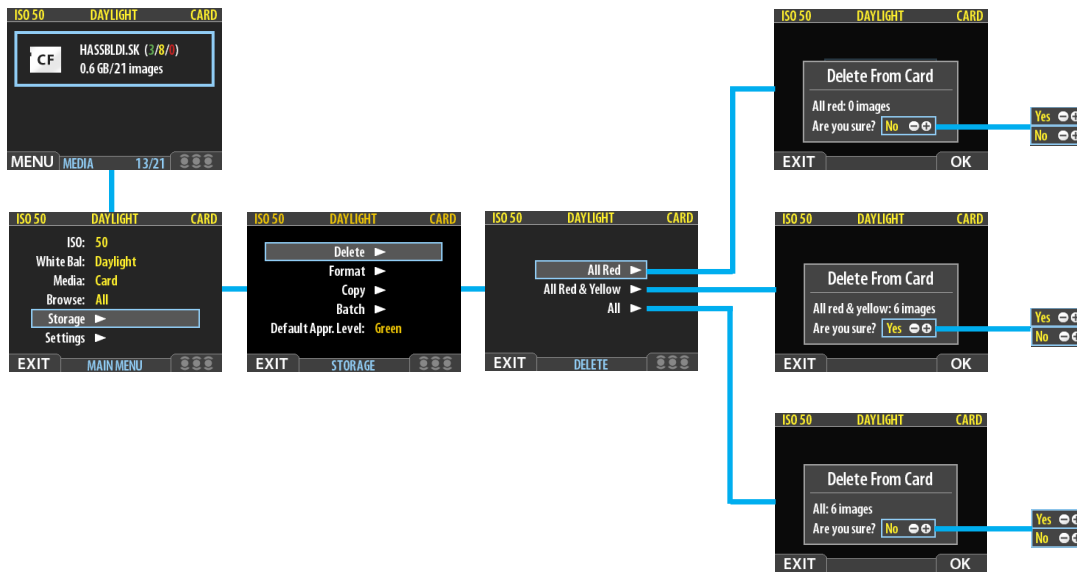
1. Starting at the single-image preview display, press the button three times to go to the list of media.
2. Use and to select the medium from which you wish to delete. You will be deleting from all batches stored on that item.

### Note

Both each listed medium shows a set of three colored numbers in parentheses to the right of the medium name. These indicate the total number of images of each approval status (green, yellow and red) that exist on the medium. For example, if you see a medium that shows (18/5/3), then the medium contains a total of 26 images: 18 green (approved), 5 yellow (unclassified) and 3 red (marked for probable delete).

3. Select MENU > STORAGE > Delete. (See also **Navigating the Menu System** for details about how to find this setting.)
4. Press to open the Delete Image dialog.

Menus for deleting several images from all batches from a selected storage medium.



5



6



7



8



5. You must now select the approval status that you wish to delete. All images from the selected medium that are also of the status that you select here will be deleted by the operation.

Use ▲ and ▼ to select All Red, All Red & Yellow or All.

6. Then press ► to open the delete dialog for your selected status.

You are now asked to confirm the delete.

7. • To confirm, press the + button to change the status to Yes and then press the approve button to execute the delete.

• To cancel, press the menu button to exit; or press the - button to set the status to No and then press the approval button to cancel.

You now return to the main menu. Either move on to another setting by using the navigator button or

8. Press the menu (EXIT) button to exit the menu system.



## FORMAT

The digital back is only able to read and write to media that have been formatted.

However, new cards or disks sometimes arrive without any formatting, or you might want to convert media that are currently using a format that the camera cannot read.

### To format media:

1. If you have more than one type of medium connected (e.g., a compact-flash card and ImageBank-II – 16 Mpix only), then start by selecting the medium you wish to format using the **Storage** item of the main menu (see also **Selecting the Current Storage Medium**).
2. Select **MENU > STORAGE > Format**. (See also **Navigating the Menu System** for details about how to find this setting.)
3. Press the **▶** to open the **Format Card** dialog.
4. You are now asked to confirm the operation.
  - To confirm, press the **OK** button. This will carry out the format and delete all data on the current medium.
  - To cancel, press the **EXIT**.
5. You now return to the **STORAGE** menu. Either move on to another setting by using the navigator button or press the menu (**EXIT**) button to exit the menu system.

## COPY (16 Mpix only)

Files can be copied to an ImageBank-II to free up space on a CF card. All batches and files remain on the card until deleted.

### To copy files:

With an ImageBank-II attached to the camera by a FireWire cable and turned on:

1. Press **MENU** and navigate down to select **STORAGE**.
2. Press the **▶** button and navigate down to **COPY**.

### Note

Each time you get a new compact-flash card, it is recommended that you format it using the digital back as described below, even if the digital back is already able to read it. This will enable the digital back to use the card more efficiently.

### Note

The digital back is capable of formatting any type of medium connected to it, including compact flash cards. When you do this, you will erase all data contained on the target medium.

### Tip

You can also use the format command for the purpose of deleting all images on a disk. This is sometimes faster than using the delete function, but it is not as flexible because all data from all batches will always be erased.



3



4



1



2



3



4



5



- Press the ► button to reach the confirmation dialogue. To confirm, press the **OK** button. (To cancel, press the **EXIT** button.)  
Confirmation will make a copy of all batches and files and store them on the ImageBank-II in a newly created folder called 'CARD0001' (for example). If you connect the camera to the ImageBank-II again, a new folder is automatically created with the name 'CARD0002' (for example) and so on.
- The copying dialogue now appears to inform you of progress. Press **STOP** if you want to cancel the procedure.

## BATCH

Batches help you to organize your work. They are very similar to folders on a computer hard disk. Use the **Batch** command of the **STORAGE** menu each time you want to create a new batch.

For more information about batches, please see **Working with Media and Batches**.

### To create a new batch:

- Press the **MENU** button.
- Press ▼ to navigate down and select the **Storage** dialog. Press ► and then ▼ to navigate down and select **Batch**.
- Press ► to open the **Batch** dialog. The new batch name will always begin with a three-digit number, which automatically increments by one with each new batch. Following this is five letters, which you can assign yourself to help make the batch easier to identify. To set the letters:
  - Use ◀ and ▶ to select one of the five letters.
  - Use the + or - button to step the currently selected letter up or down the alphabet until you have found the letter you want.
  - Continue working until you have set the name you want.
- Press the approve (**OK**) button to save the new batch with the name you selected.
- You now return to the **BATCH** menu. Either move on to another setting by using the navigator button or press the menu (**EXIT**) button to exit the menu system.

## Note

Remember that all new images are stored automatically in the latest batch. It is not possible to store new images in older batches.

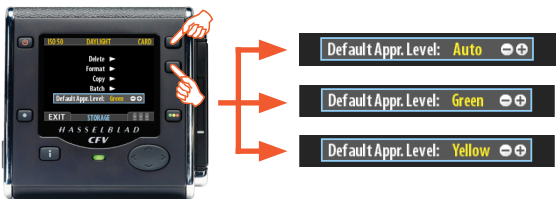
1



2



3



4



## DEFAULT APPR. LEVEL

The Instant Approval Architecture system helps you to evaluate and mark each image based on how well it has come out. By default, the system assigns an initial approval status for each new shot based on an analysis of the distribution of exposure levels. In the factory configuration, the status of each new shot is assigned as follows:

- **Green (approved):**  
*The new shot seems to have been exposed correctly.*
- **Yellow / Amber (unclassified):**  
*The new shot seems to have been over- or under-exposed.*

However, you might choose instead to override this system and have all new shots assigned either as green or yellow, regardless of the exposure analysis results. A typical strategy could be to assign all shots to yellow and then review all of the shots later and promote only the best ones to green status. At the same time you might demote the most doubtful shots to red status.

See also [Using Instant Approval Architecture](#) for complete details about working with the approval system.

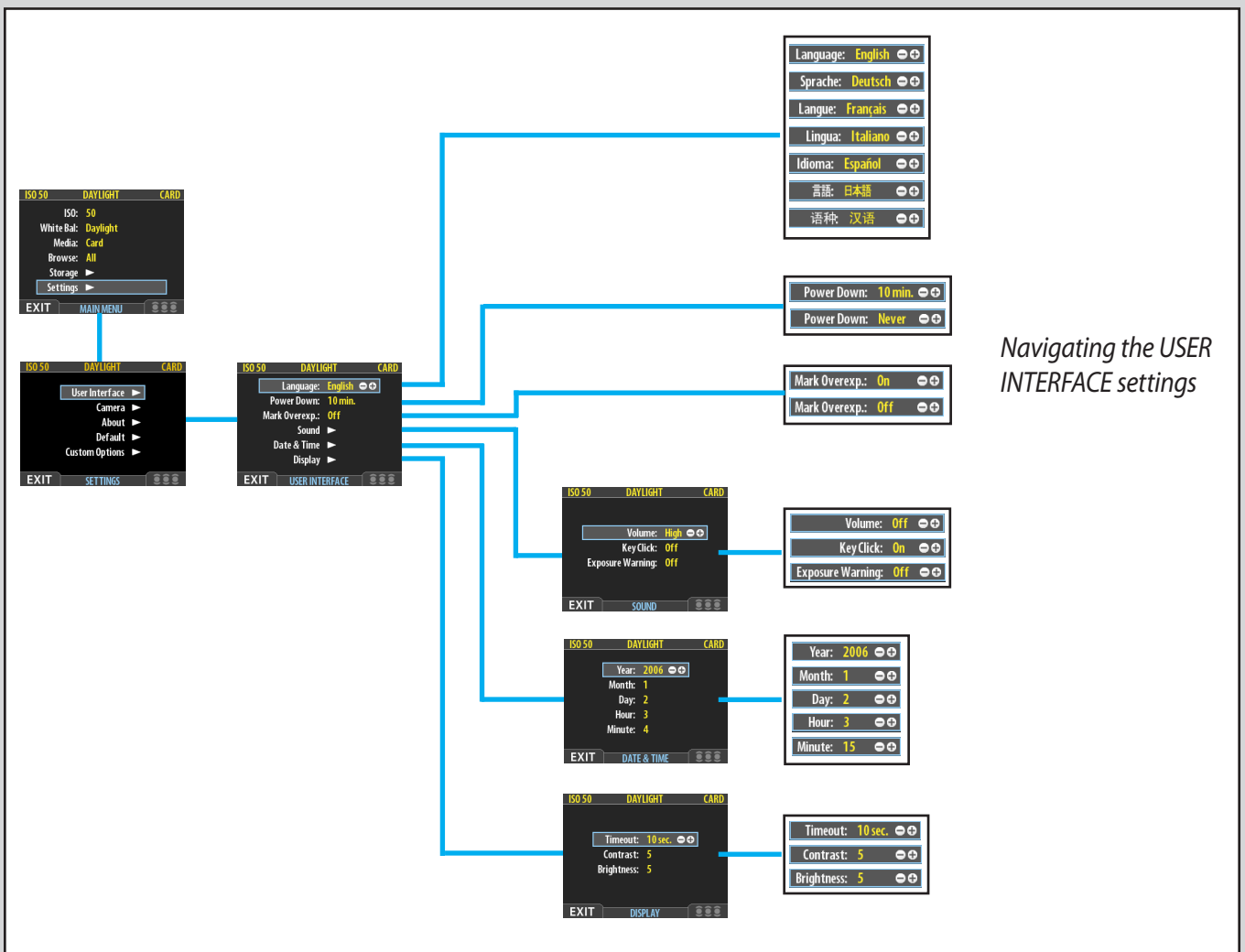
### To change the default status assigned to each new image:

1. Press the **MENU** button.
2. Press **▼** to navigate down and select the **Storage** level.  
Press **▶** and then **▼** to navigate down and select **Default Appr. level**. Press **▶** to open the **Default Appr. level** dialog.
3. Use the **+** or **-** button to step through the available settings until the default status you wish to use (auto, green or yellow) is shown.
4. Either move on to another setting by using the navigator button or press the menu (**EXIT**) button to exit the menu system and keep your setting.

# 11

## CFV digital back

### ■ Menu: Settings



*Navigating the USER INTERFACE settings*

## MENU > SETTINGS > User Interface

By altering the **User Interface** settings, you can control the way the digital back interacts to suit you and your preferred way of working. It also includes date and time settings.

### USER INTERFACE menu items

The user interface menu includes both items and sub-menus. The following items are available here:

- **Language:**

The menu system can be displayed in any of seven languages. This menu item enables you to select your preferred language for the menus.

- **Power Down:**

To help preserve the charge of the battery, you can set the digital back to power down after a specified period of inactivity. The effect is exactly the same as though you had pressed the off button on the camera. Once it has powered down, you must turn the digital back on again before you can continue working. Set this to **Never** to disable this feature (this is the default setting). Set to a value between 3 and 99 minutes to establish a time-out. *(Note the difference between Display 'timeout' and Power Down.)*

- **Mark Overexp.:**

This feature helps draw your attention to areas of your images that are overexposed. When this feature is enabled, the single-image preview display will highlight each overexposed pixel by flashing it white and black.

Set this item to **On** to enable the feature; set to **Off** to disable it.

- **Sound:**

Audio feedback helps let you know if each new image is exposed correctly. This is described in **Standard Instant Approval Workflow**.

This menu item has **Volume** (choose between **High**, **Low** and **Off**), **Key Click** (choose between **On** and **Off**) and **Exposure Warning** (choose between **On** and **Off**).

- **Date & Time:**

An internal clock keeps track of the date and time. This information is used to mark each shot with the date and time at which it was taken. It is also used to label batches with the date on which each batch was created. *(See note under 'General overview of digital back' about keeping the internal battery charged to maintain Date & Time settings.)*

- **Display:**

This feature sets the Timeout (2-30 seconds) on the display, which behaves very much like a screen saver on a computer. When the timeout is reached, the display will be turned off, but the digital back will still be running, so it will immediately respond to a press of the buttons. *(Note the difference between Display 'timeout' and Power Down.)*

This feature also sets the level of **Contrast** (on a scale of 1-10) on the display. Usually, you should leave this set to the default level of 5, however in some viewing environments and/or with some types of images you may wish to increase or decrease this value. A value of 10 provides maximum contrast; a value of 0 provides no contrast (a black screen). You can also help save battery power by using a low value here.

This feature also sets the **Brightness** (on a scale of 1-10) on the display. This sets the brightness shown on the screen. Usually, you should leave this set to the default level of 5, however in some viewing environments and/or with some types of images you may wish to increase or decrease this value. A value of 10 provides maximum brightness; a value of 0 provides minimal brightness. You can also help save battery power by using a low value here.



### Tip

To conserve battery power, change the **Time Out** and **Power Down** settings.

## Setting the options under the User Interface menu

Each of the above items can be set by similar menu navigation. Language, Power Down and Mark Overex can be set immediately by the **+** or **-** buttons while Sound, Date & Time and Display require another move to sub menu for final choice.

### Proceed as follows:

1. Press the menu (**MENU**) button to open the menu.
2. Use **▲** and **▼** to select the **SETTINGS** sub-menu.
3. Press **▶** to open the **SETTINGS** menu.
4. Press **▶** to select the **USER INTERFACE** sub-menu.
5. Use **▲** and **▼** to select the required item.  
Press either the **+** or **-** button to make the new settings in the case of **Language**, **Power Down** and **Mark Overex** or press **▶** again to access **Sound**, **Date & Time** and **Display**.
6. Press the **EXIT** button again to save the new settings and close the menu.

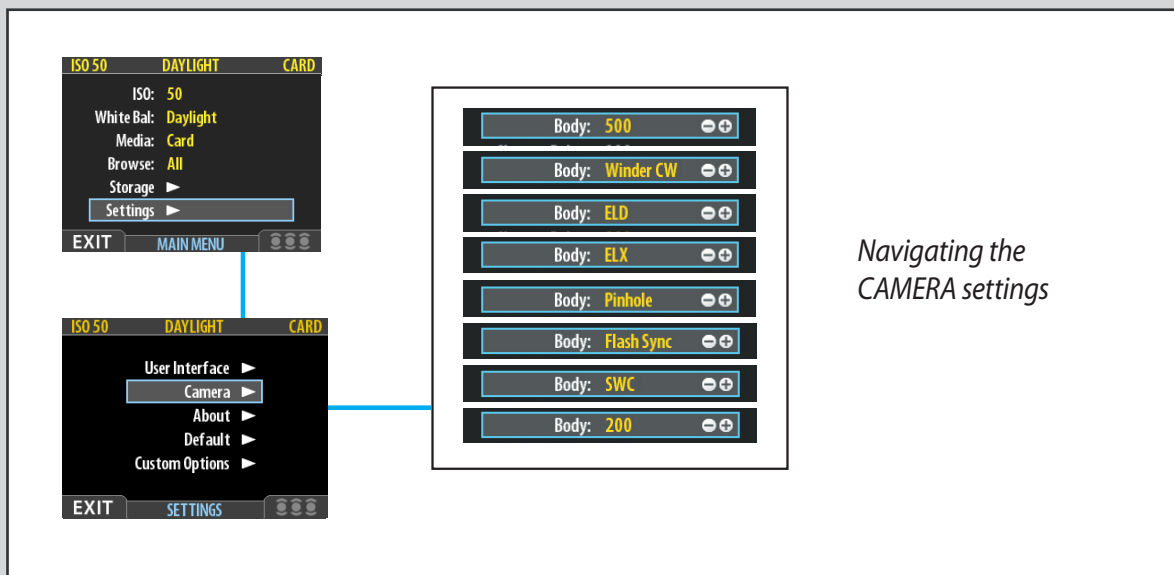
## MENU > SETTINGS > Camera

All Hasselblad V-system cameras can communicate with the digital back without the need for extra cable connections except:

- Unmodified 200 series models using CF lenses in C-mode and the FlexBody accessory.

View cameras (with the appropriate adapter and cables) can also be used.

### Navigating the CAMERA settings



### Exposure Cable 503



*Hasselblad 503CW plus winder CW*

### Adapter EL



*All Hasselblad EL models*

### Exposure Cable EL



*All Hasselblad EL models except ELD*

The exposure time set on the digital back sets the maximum length of exposure. The default setting is 1/8 sec and this is the setting that can be kept for all exposures from 1/8 sec through 1/2000sec. However, this setting should be changed in accordance with the time required if it exceeds 1/8 sec. Times of up to 32 seconds can be set.

If you prefer, you can connect the 'Flash sync input cable' between the lens PC socket and the digital back which allows you to retain the default setting of 1/8 second while still being able to use exposure times longer than 1/8 second. This method also allows the use of the B setting.

## Model setting variations

Look in the list below for the camera model you are using and make the appropriate settings change. Don't forget to change the setting if you change camera model!

### Winder CW

#### For use with 503 CW models:

- *Make a Winder CW setting.*
- *If you want to control the camera from Phocus, connect the 'Exposure cable 503' between the digital back and the Winder CW as in the illustration.*
- *Do not use the winder at rapid sequence setting.*

### ELD

#### For use with ELD models:

- *Make an ELD setting.*
- *A B setting exposure can be made by choosing the 'Bulb' in the 'Exposure Time' setting. The maximum exposure time remains at 32 seconds however.*
- *Only the single shot function (A or AS mode camera settings) should be set on the camera. Rapid sequence shots are not possible.*
- *Use the Adapter EL (supplied) to provide the necessary extension beyond the motor housing of the EL models for battery attachment. It is attached to the digital back in the same manner as a battery, and the battery itself is then attached to the adapter as in the illustration.*

### ELX

#### For use with 500EL/ELM and 500/553ELX models:

- *Make an ELX setting.*
- *The Exposure Cable EL (supplied) should be connected.*
- *All exposures times, including the B setting, function correctly without having to alter the "Exposure Time" setting.*
- *Rapid sequence shots are not possible.*
- *Use the Adapter EL (supplied) to provide the necessary extension beyond the motor housing of the EL models for battery attachment. It is attached to the digital back in the same manner as a battery, and the battery itself is then attached to the adapter as in the illustration.*

### Pinhole

For use with lenses/cameras with no shutter. Intended primarily for use in a studio environment where complete darkness can be achieved and exposures made accordingly (also useful for 'light painting'). In this mode the digital back uses the exposure time (as well as other required stages in a capture sequence) set in the Capture Sequence dialog. The digital back can be triggered either via the **START** (MENU/EXIT) button or from Phocus (see later section for full description of Capture Sequence settings procedure).

## Note

Although the 903SWC and 905SWC models work in conjunction with CFV digital backs, the combination is not recommended for critical work.

The Biogon 38 lens was designed for film use where the unusually close proximity of the lens to the film plane was of no consequence. However, digital sensors and their protective filters make very different demands on the angle and travelling distances of the peripheral rays exiting the rear lens element. Gradual unsharpness consequently occurs towards the edges of the frame, particularly noticeable with flat subjects (typically copying situations, 90° shots against building façades, etc) though these effects will be naturally less obvious with more three-dimensional subjects. Slight green and magenta casts are also caused, though these can be removed digitally in Phocus.

## Flash sync

**For use with un-modified 200 series models (together with C-lenses in C-mode), a FlexBody or view cameras fitted with a Hasselblad adapter.**

- Make a Flash sync setting.
- A Flash sync input cable should be used.
- All exposures times, including the B setting, function correctly without having to alter the "Exposure Time" setting.
- Do not use a winder at rapid sequence setting.

## SWC

**For use with the 903 SWC and 905 SWC models (not recommended for critical use).**

- Make an SWC setting.

PLEASE NOTE: Due to the mechanical design of the SWC, pressing the exposure release button too slowly may cause a faulty capture with a magenta cast. Either press the button much more distinctly or alternatively change the setting from SWC to Flash sync and use the Flash input sync cable to connect the lens to the digital back.

## 200

**For use with modified 202, 203 and 205 models together with F-lenses / CF-lenses in F-mode. (Only these three models can be modified for cable-free compatibility with the CFV/503CWD digital back. Please contact your Hasselblad dealer for further information)**

- Make a 200 setting.
- A Flash sync input cable should not be used.
- All exposures times, including the B setting, function correctly without having to alter the "Exposure Time" setting.
- Do not use a winder at rapid sequence setting.

## 500

**For use with 500C/CM, 501C/CM and 503 CX/CXi/CW models.**

- Make a 500 setting.

## Shutter Delay

There can be differences in the amount of time required in preparation (raising the mirror, opening/closing the shutter etc) for digital capture between various camera models. This corrective feature adjusts the time a little to ensure the image is read out from the sensor. The normal setting is Default and should only be changed if problems are encountered.

## Exposure Time

This setting should be changed for cable-free exposure times longer than 1/8 second, ensuring that it matches the set shutter speed/exposure time on the camera/lens. The settings range from 1/8 second to 32 seconds (1/8 second is the default setting). "< 1/8" as seen on the menu list means 'exposures no longer than 1/8 second'. The ELD also has a "Bulb" setting.

## Capture Sequence

This feature functions in the same manner as an interval timer and only works in conjunction with a motor or winder driven camera model except in the case of the Pinhole setting where it is the only way of controlling such exposures (see later section for full details).

**Initial delay:** Controls the amount of time required to elapse before the first exposure.

**Delay:** Controls the amount of time required between each exposure.

**Count:** Controls the total number of exposures required.

## Setting CAMERA model and options

Proceed as follows:

1. Press the menu (MENU) button to open the menu.
2. Use ▲ and ▼ to select the SETTINGS sub-menu.
3. Press ► to open the SETTINGS menu.
4. Use ▲ and ▼ to select CAMERA.
5. Press ► to open the CAMERA menu.
6. Press either the + or - button to select camera model.
7. Use ▲ and ▼ to select SHUTTER DELAY or EXPOSURE TIME if required.
8. Press either the + or - button to make new settings if required.
9. Press the menu (EXIT) button to exit the menu system and keep your settings.





# Connectivity diagram



CFV digital back

## No 'Exposure' cable required

(except for long exposures)



500 C/CM  
501 C/CM  
503 CX/CXi/CW



SWC / SWC/M  
903 SWC  
905 SWC

*Not recommended for critical use. Please see special note beside the SWC section in this manual.*



Modified 202FA/203 FE / 205 TCC / 205 FCC  
With F type lenses and CF type lenses at F-mode setting



555 ELD  
500 EL/ELM  
500/553 ELX



Battery adapter required for portable use.

## 'Exposure' cable required for control from Phocus

(NOTE: only these cameras/combinations can be controlled from Phocus)



503 CW +  
Winder CW



Exposure cable 503 CW required for Phocus control of 503CW + Winder CW.



500 EL/ELM  
500/553 ELX



Exposure Cable EL required for Phocus control of EL/ELM and ELX use.



Battery adapter required for portable use.

## 'Exposure' cable always required



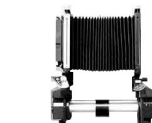
Flash input sync cable



2000 FC / FCM  
2003 FCW  
201 F / 203 FE  
205 TCC / FCC  
With C type lenses  
(C-mode setting)



FlexBody,  
ArcBody (Not recommended for critical use).



Any view camera with Hasselblad V system adapter

**Note:**  
For exposures longer than 1/8 second, use the supplied Flash input sync cable. This applies to all models and combinations.

## Setting EXPOSURE TIME and CAPTURE SEQUENCE

Proceed as follows:

1. Press the menu (MENU) button to open the menu.

2. Use ▲ and ▼ to select the SETTINGS sub-menu.

3. Press ► to open the SETTINGS menu.

4. Use ▲ and ▼ to select CAMERA.

5. Press ► to open the CAMERA menu.

6. Press either the + or - button to select PINHOLE.

7. Press ▲ or ▼ to select EXPOSURE TIME.

8. Press either the + or - button to make an exposure time setting.

9. Press ▼ to select CAPTURE SEQUENCE.

10. Press ► to open the CAPTURE SEQUENCE menu.





11. Press either the **+** or **-** button to make an INITIAL DELAY setting.

**This setting controls the amount of time that elapses before the first exposure in the sequence.**

12. Press **▼** to select DELAY.

13. Press either **+** or **-** to make a DELAY setting.

**This setting controls the amount of time between each exposure in the sequence.**

14. Press **▼** to select COUNT.

15. Press either **+** or **-** to make a COUNT setting.

**This setting controls the number of exposures in the sequence.**

16. Press OK to confirm all the settings.

17. The unit is now ready for sequence start. Note that the MENU/EXIT button now displays START instead:

18. Press START to set the sequence running.

19. Note that the MENU/EXIT button now displays STOP. The sequence can be stopped at any time by pressing this button and the standard menu display returns.

## MENU > SETTINGS > About

Occasionally, Hasselblad releases updates to the internal software (“firmware”) of the digital back. These updates may fix small errors and/or add new features. If you need assistance from Hasselblad technical support it facilitates the situation to know the serial number and current firmware version of the unit. To find this out:

1. Select **MENU > SETTINGS > ABOUT**. (See also *Navigating the Menu System* or details about how to find this setting.)
2. Press **▶** to open the **About** dialog, which shows the serial number and firmware version. When you are done reading the information, press the menu (**EXIT**) button to return to the **SETTINGS** menu. Either move on to another setting by using the navigator button or press the menu (**EXIT**) button again to exit the menu system.

## MENU > SETTINGS > Default

The **DEFAULT** setting will reset all custom settings you have made back to the original default / factory settings.

**To reset all settings:**

1. Select **MENU > SETTINGS > DEFAULT**.
2. Press the **OK** button and then the **EXIT** to return.



## MENU > SETTINGS > Custom Options

Custom Options allows you to make individual settings for the different models:

**Image Format (39/50 Mpix only)**

**Tilt sensor (39/50 Mpix only)**

**Copy to I-Bank (16 Mpix only)**

**I-B connection (16 Mpix only)**

### Image Format (39/50 Mpix only)

This function allows you to choose the capture format, namely, 'Full' or 'Square Crop'. Full produces a rectangular format of 36.7 x 49.1 and Square Crop, a square format of 36.7 x 36.7.

Captures made at the Full setting will, in normal orientation, appear on the display and in Phocus as 'Landscape' oriented rectangular images. Captures made at the Square Crop setting will appear on the display and Phocus as cropped images, marked with an icon. These captures are also full but are tagged to produce a cropped square format. Naturally, you can retain this cropping in Phocus but if you wish, you can move it or even remove it to reveal the full image again. This facility might be advantageous for those who prefer the square format but who would like the option to adjust the exact placing at the editing stage.

In normal orientation, the cropped areas are to the left and right but if the camera is tilted 90° for capture, you will then have the opportunity to edit at the top and bottom instead, as captures will now be saved and appear in 'Portrait' mode.

#### To choose between Full and Square Crop:

1. Select MENU > SETTINGS > CUSTOM OPTIONS.
2. Press the ▼ button to reach: **Image format:**
3. Press either + or - to choose between:  
**Full** or  
**Square Crop**
4. Press EXIT to save.

### Tilt sensor (39/50 Mpix only)

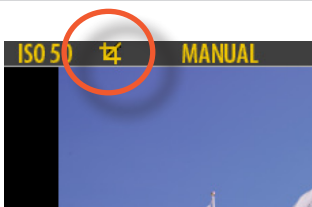
The tilt sensor tags image files according to the orientation of the camera at the time of capture to ensure correct orientation on the display and in Phocus. There may be occasions when this is not required – when the camera is pointing straight up or down, for example – and so the tilt lock can be set at various degree settings.

1. Select MENU > SETTINGS > CUSTOM OPTIONS.
2. Press the ▼ button to reach: **Tilt sensor:**
3. Press either + or - to choose between:  
**Auto** or  
**Lock at 0 degrees, Lock at 90 degrees, Lock at 180 degrees and Lock at 270 degrees.**
4. Press EXIT to save.

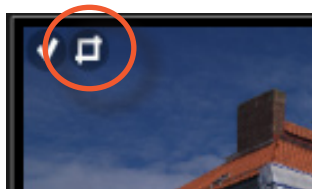


Image format: **Full** + -

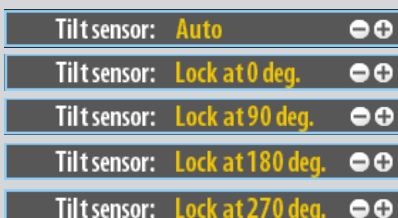
Image format: **Square Crop** + -



Square Crop icon as it appears on the display.



Square Crop icon as it appears in Phocus



Copy to I-Bank: **Active batch only** ◀ ▶

Copy to I-Bank: **Entire card** ◀ ▶

I-B Connection: **Create new batch** ◀ ▶

I-B Connection: **Add to last batch** ◀ ▶

### Copy to I-Bank (16 Mpix only)

---

Files can be copied to an ImageBank-II to free up space on a CF card. All batches and files remain on the card until deleted. See **Copy** in the 'Menu: Storage' chapter for details.

#### To make a selection:

1. Select **MENU > SETTINGS > CUSTOM OPTIONS**.
2. Press the ▼ button to reach: **Copy to I-Bank:**
3. Press either **+** or **-** to choose between:  
**Entire Card** or  
**Active batch only**
4. Press **EXIT** to save.

### I-B Connection (16 Mpix only)

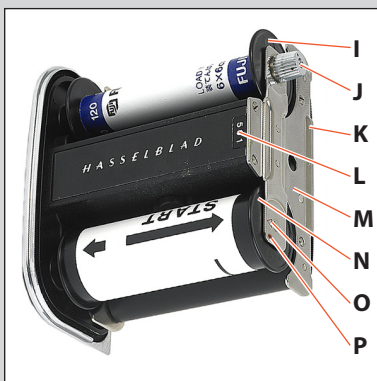
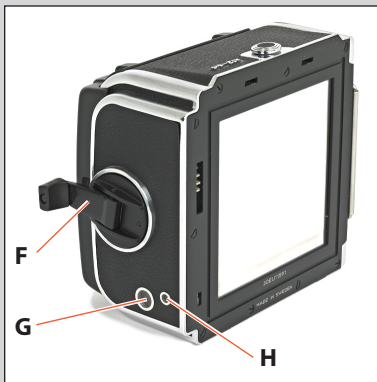
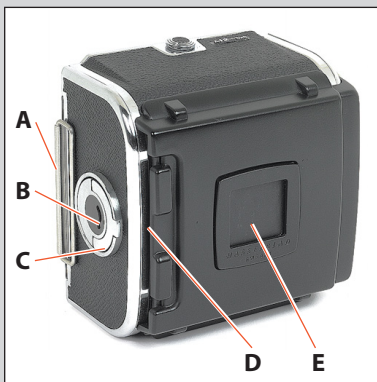
---

Allows you to create new batches or add files to the last batch (on an ImageBank-II).

1. Select **MENU > SETTINGS > CUSTOM OPTIONS**.
2. Press the ▼ button to reach: **I-B Connection:**
3. Press either **+** or **-** to choose between:  
**Create new batch** or  
**Add to last batch**
4. Press **EXIT** to save.

# 12

## Film Magazines



'A12' film magazines accept all 120 size films and produce a 6 x 6cm image. They are easy to use and can be pre-loaded for rapid workflow. They provide the opportunity to vary the type of film used and can be quickly and easily switched mid-film without losing any frames.

There are a number of reasons why using film might either be preferable or even necessary for digital photographers too. For example you might want the specific results you know that a certain film emulsion can produce or you might want to use very long exposure times, etc.

A magazine also functions as an emergency battery-free back up to a digital back. Also, remember that a 6 x 6 cm film magazine use will also allow you to exploit the full focal length of your lenses.

Operation of the magazines is not difficult but pay particular attention to the section on loading. Go through the procedure one step at a time and practice a little until you feel confident. Note especially which way round the spool of film is placed and the positioning of the backing paper under the clamp bar.

The film is automatically advanced frame-by-frame in the magazine by the camera winding mechanism and consequently only when attached to the camera body. Therefore when separated, the magazine and camera body could become unmatched. This can be determined by checking the magazine status indicator or by the winding crank status.

### Parts & components

- |                           |   |
|---------------------------|---|
| A. Magazine slide         | I. Film take-up spool                                 |
| B. Film load indicator    | J. Grooved take-up knob                               |
| C. Film holder key        | K. Film clamp   |
| D. Magazine slide holder  | L. Film holder number                                 |
| E. Film tab holder        | M. Spool clamp bar                                    |
| F. Film winder crank      | N. Film supply spool                                  |
| G. Frame counter          | O. Film load index                                    |
| H. Film advance indicator | P. Film load index for Ilford black & white film only |

### Loading the magazine

The magazine can be loaded on, or off the camera. If it is to be loaded off the camera, then the magazine slide must be inserted first.

In either case, when inserting the slide ensure that its flat side is towards the rear (see detail in illustration 4) as this facilitates the removal of the film holder.

## Step-by-step film loading

1-8

Follow the procedure below in the correct order.

1. Fold out the film holder key.
2. Turn the key counter-clockwise and withdraw the film holder (magazine insert).
3. Place an empty take-up spool under the grooved knob of the spool clamp bar. Insert a roll of film under the other end of the bar, turned the same way as in the illustration. Be sure to remove all of the paper band surrounding a new roll of film.
4. Turn the film holder key clockwise to open the film clamp. Pull 8-10 cm (3-4 in.) of paper backing off the film roll and slide the edge under the clamp.
5. Insert the tongue of the backing paper into the slot in the take-up spool.
6. Turn the grooved knob clockwise until the arrow on the paper backing is aligned opposite the triangular index (or oblong index with Ilford black & white film, see 'Magazine tips') on the spool clamp bar, but no further.
7. Turn the film holder key counter-clockwise and insert the film holder into the magazine. Ensure that it is correctly positioned. Turn the film holder key clockwise to lock the film holder in the magazine and then fold the key back into place.
8. Fold out the film crank and rotate it clockwise about ten turns until it stops. Then turn it counter-clockwise and fold it in. The figure (1) will now be displayed in the automatic frame-counter window indicating that the magazine is loaded and ready for use.

## Magazine load status

9

In the centre of the film holder key there is a crescent-shaped indicator window that shows white when the magazine is freshly loaded. It gradually changes to red as the film is wound through. An all red indicator shows that either the film is used up or that the magazine is empty.

## Removing film from the magazine

10

When the last frame has been exposed and wound on, the magazine blocks the camera for further release.

Wind off the film by folding out the film winding crank, and rotate it clockwise until you can feel the film leaving the supply spool.

You can now withdraw the film holder from the magazine and remove the exposed film.

The frame counter is automatically reset when the film holder is withdrawn from the magazine.

## Film tab holder

11

The end tab of the film pack can be inserted in the holder on the back of the magazine as a reminder of the kind of film that has been loaded into the magazine.







In close-up photography the film-to-subject distance can be an important factor when determining an accurate focus setting. The red line in the illustration marks the location on the film magazines that coincides with the film plane position.

**General points and tips**

- Before you can make an exposure, you must remove the magazine slide. The magazine will then be locked on the camera body, and the camera release button will be unblocked.
- Film is automatically advanced in the magazine after a full turn of the crank.
- You cannot remove a film magazine without re-inserting the magazine slide first.
- Do not attach a magazine showing red to a fully wound camera! This could result in a double exposure.
- The magazine's film winding crank is only blocked at frame 1. A partially exposed film may be wound off at any frame afterwards.
- On the rear of the magazine is a slide pocket where the magazine dark slide can be kept when not in use. Turn the slide with the hinge towards the rear to fold the bow fully into the slide pocket recesses.
- Do not put the film holder down on an unclean surface or where it can attract dust.
- Clean out the magazine housing regularly removing not only dust and particles but also any scraps of paper from previous rolls that may have remained inside.
- Each magazine housing and film holder form a carefully matched pair. Be careful, therefore, when loading more than one magazine at a time not to switch housings and holders. The last three figures of the housing serial number should correspond with the serial number on the film holder.
- Load and unload the magazine away from direct light sources.
- If you keep the slide inserted in an attached magazine, it will act as an exposure lock to prevent inadvertent exposures when the camera and shutter have been wound on.
- Align the arrow on the paper backing of all Ilford black & white films against the oblong index (and no further) on the spool clamp bar and not the triangular index as normal.



**Using infrared film**

Infrared (IR) rays (wavelengths longer than 800 nm) form an image on a plane further away from the lens than the image plane for visible light. To compensate for this difference you have to align the chosen distance against the red IR index and not the normal central index. Proceed as follows:

1. Focus as usual on the focusing screen.
2. Note the distance on the focusing scale that is opposite the central index line.
3. Now rotate the focusing ring to set this distance opposite the dashed IR index line instead of the central index line.

**Note**

Please observe the special information that came with your IR film about restrictions concerning magazine loading, film development, etc.



### ***Double exposure with film***

---

Double (or multiple) exposure is possible with a film magazine. However, as the camera has been designed to prevent accidental double exposure you will have to carry out the following procedure in order to make multiple exposures on the same frame:

1. *Make the initial exposure.*
2. *Insert the magazine slide and remove the magazine.*
3. *Wind the camera with one full revolution of the winding crank.*
4. *Replace the magazine and remove the slide.*
5. *Make the next exposure .*
6. *Repeat the procedure for further exposures on the same frame.*

### ***Flash/strobe with film***

---

Any flash/strobe unit can be connected to the 503 CW / 503 CWD via the PC flash/strobe terminal on the lens for manually controlled flash exposure with flash sync speeds are up to 1/500s.

Automatic flash control, or dedicated flash, is provided by the camera's built-in flash sensor and electronics (TTL/OTF) that measure the light reflected from the central portion of the film; a circle with a diameter of 40 mm.

The metering system is connected to a selector for setting film speed. When an SCA 300 compatible flash/strobe unit is connected through an SCA390 flash/strobe adaptor, the system controls the flash/strobe unit and cuts off the flash when the exposure is correct. Under the left hand edge of the focusing screen an indicator light shows when the flash is ready to be operated and also confirms if the flash output was sufficient to give a correct exposure. The flash/strobe unit powers the camera's electronics and also the flash/strobe adaptor, when that is used.

### ***Setting the film speed for TTL/OTF flash***

The film speed is set via the ISO selector. This is marked in ISO/ASA settings from 64 – 4000. Note that certain films require compensation due to differences in reflective properties of various emulsions. In these instances, the compensation can be made by changing the film speed selector setting. The amount of compensation has to be determined by experiment. Alternatively you can replace the magazine with the Rear cover MultiControl for a few test exposures. The grey surface acts as an 18% grey card to provide a well-balanced starting point for exposures.

Please refer to your flash/strobe unit's operating instructions for more information about other functions when using an automatic flash light-metering that conforms to System SCA flash/strobe photography with flash sensors, or with non-automatic flash/strobe units.

# 13

## Flash / Strobe

Most flash/strobe units are suitable for use with the 503CW/503CWD/CFV, with some combinations offering TTL. Check the chart further on in this chapter to find the specific combination you intend to use.

Pay particular attention when using studio flash/strobe units and tethered to a stationary computer as this cable configuration guards against both personal injury and damage to equipment.

### Portable units

All 500 series and SWC series cameras use the regular PC contact on the lens for flash sync. 200 series models, FlexBody and view cameras require other configurations (see chart).

### Studio flash/strobe units when tethered to a desktop computer

If the 503CWD/CFV is tethered to a computer that is connected to a regular electricity supply system as well as a studio flash/strobe unit that is also connected to a regular electricity supply system/generator system, then make the following connections instead. For your own safety and to protect the electronics in the digital back, please ensure you do this correctly.

- a) Connect the **flash input sync cable** from the sync contact (PC connector) on the lens to the **flash sync IN terminal** on the digital back.
- b) Connect the **flash output sync cable** from the **flash sync OUT terminal** on the digital back to a regular flash/strobe sync cable that is connected to the unit.

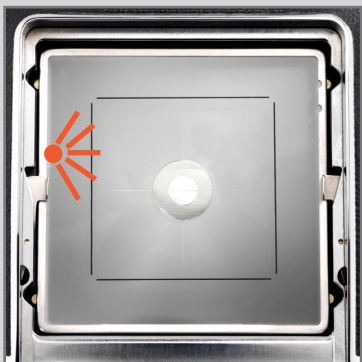
### TTL function

The reflective characteristics of the digital sensor are different to film surface characteristics for which the TTL function was originally designed. However, by changing (in effect, 'tricking') the setting, TTL exposures can be made. Proceed as follows:

Move the ISO selector on the camera so that it becomes approximately  $1\frac{2}{3}$  f/stop higher than the ISO setting on the digital back. Therefore, for example, when the digital back is set at 50 ISO, the 'film speed setting' on the camera should read 160 ISO, and so on. Testing for the most suitable compensation that suits you is recommended.

### Viewfinder indicator

Flash/strobe operation and flash battery-check are indicated by a red light, located under the left edge of the focusing screen. It is operative only when a dedicated flash/strobe is connected to the TTL socket. It indicates three separate states as described below.



### **Ready signal**

A steady red light indicates that the flash/strobe unit is charged and ready to be fired. Absence of any signal indicates the need for fresh batteries.

### **Confirmation signal**

A flashing red light occurring for just over a second immediately after exposure confirms that the light output was sufficient for a proper exposure. It then remains dark until the flash/strobe unit has recharged. The steady red light will then reappear indicating operative status again. The time of reappearance however may vary according to the condition of the batteries.

### **No result signal**

Absence of the flashing confirmation signal after exposure indicates that the flash emitted was not sufficient for correct exposure. The aperture must then be opened more or the flash distance to the subject reduced. Changing to a faster ISO setting on the digital back is also a possibility.

See appropriate manuals for connection details regarding the various units and adapters.

## **CFV and Hasselblad 200 series cameras**

Connection to 200 series cameras depends on whether they are modified or not (contact your local Hasselblad Service Center about modification). TTL is also possible if the flash/strobe unit allows. See the appropriate camera manual for further details.

Please note the difference below – unmodified cameras can only use C lenses (C/ CF /CFi etc) at the C-mode setting whereas modified cameras can use C and F-type lenses.

### **Unmodified cameras (with portable flash/strobe units) with C type lenses:**

- a) Connect the **flash input sync cable** from the sync contact (PC connector) on the lens to the **flash sync IN terminal** on the digital back.
- b) Connect the **flash output sync cable** from the **flash sync OUT terminal** on the digital back to a regular flash sync cable that is connected to the unit.
- c) Use the C-mode setting.
- d) Shutter speeds faster than 1/90 sec allowed.

### **Modified cameras (with portable flash/strobe units) with C type lenses:**

- a) Connect the **flash input sync cable** from the sync contact (PC connector) on the lens to the **flash sync IN terminal** on the digital back.
- b) Connect the **flash output sync cable** from the **flash sync OUT terminal** on the digital back to a regular flash sync cable that is connected to the unit.
- c) Use the C-mode setting.
- d) Shutter speeds faster than 1/90 sec allowed.

### **Modified cameras (with portable flash/strobe units) with F and CF type lenses:**

- a) Connect the **standard PC /flash / strobe sync cable** from the sync contact (PC connector) on the camera body to the unit.
- b) Use F type or CF type lenses at the F-mode setting.
- c) Use a shutter speed no faster than 1/90 sec.

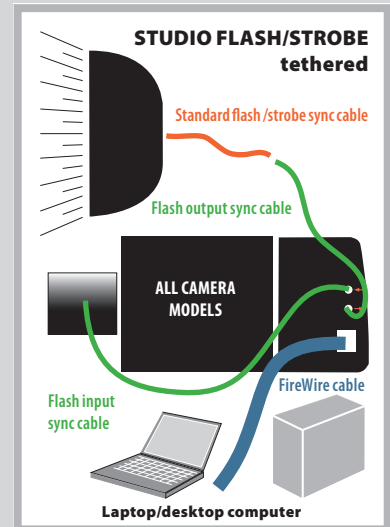
## Flash / strobe connection for CFV digital backs.

Please note the different ways of connecting the various camera body / digital back / flash / computer combinations.

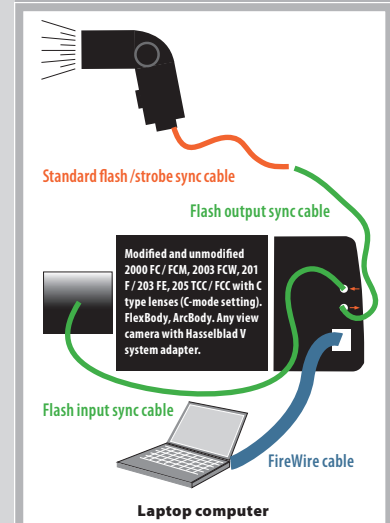
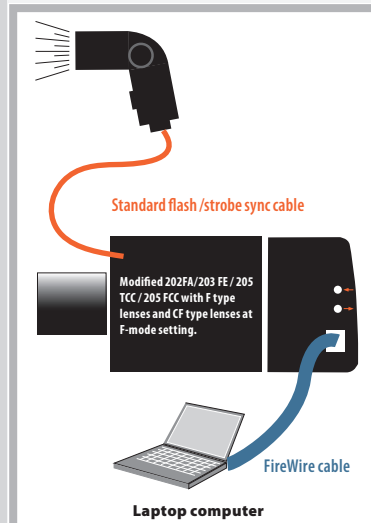
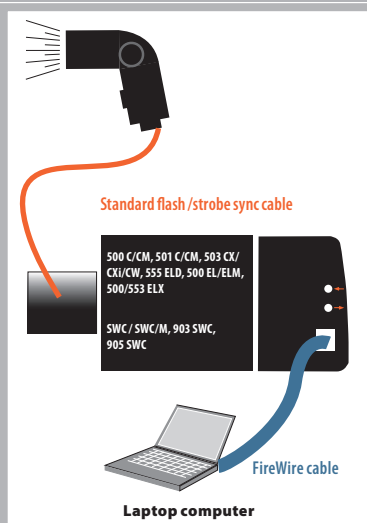
In particular, notice the importance of the correct connections when using a FireWire link directly to a desktop computer in combination with studio flash/strobe.

The Flash input sync cable, Flash output sync cable and FireWire cable are supplied.

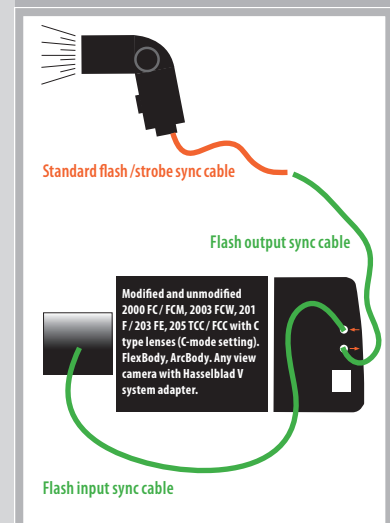
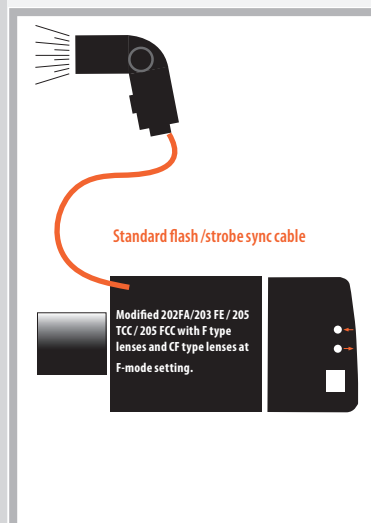
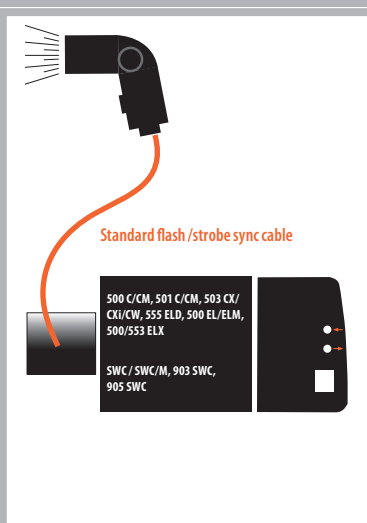
TETHERED / studio / computer



TETHERED / portable / laptop



UNTETHERED / portable / CF card



# 14

## Accessories



In the diagrams, all exit pupils are viewed from the image corners.

*Diagram A*

Exit pupil for a wide-open lens



**A**

*Diagram B*

Exit pupil for a vignette-free stopped down lens



**B**

*Diagram C*

Exit pupil for a slightly vignettted lens (no visible effect on the image)



**C**

*Diagram D*

Exit pupil for a vignettted lens (clearly visible effect on the image)



**D**

Most of the accessories supplied are either self-explanatory or covered in other sections of this manual. The Rear cover MultiControl requires a more in-depth explanation.

### **Rear cover MultiControl (supplied)**

The Rear Cover MultiControl (3051070) not only provides protection for the camera body when a digital back or film magazine is not attached but also provides flash check facility for cameras featuring TTL/OTF (described separately) as well as a vignetting check facility. Checking for possible vignetting is useful when filter combinations, attachments or lens shades are used, to ensure the optimum from the accessories without the risk of inadvertent vignetting.

With the cover in position you can see the so-called 'exit pupil' of the lens through the small holes in the cover. A vignetting free lens has an exit pupil the exact shape of the lens aperture. At maximum aperture there is slight vignetting with all lenses but at f/11 to f/16 the majority of lenses are free of vignetting.

Corner illumination is dependent on the size of the exit pupil. If the filter or lens shade extends too far, the area of the exit pupil diminishes. The shading effect of a professional lens shade, for example, is optimal when it has been extended as far as possible without causing any visible corner vignetting. The amount of this extension is dependent on both the working aperture and the focusing distance for the lens used.

Use the following method when any kind of lens accessory is in place and you want to ensure a result free from vignetting:

1. Fit the accessory. Remove the film magazine but do not attach a Rear Cover MultiControl just yet.
2. Set the shutter on a CF/CFi/CFE lens at the 'F' position and pre-release the camera to open both the lens shutter and the auxiliary shutter. C/CB lens shutters should be set at 'B' and a B exposure made. Use a cable release to lock the released position.
3. Look at the lens exit pupil. Use the stop-down button and change the aperture noticing as you do so the changes in the size of the exit pupil.
4. Look now at an angle roughly in a line from the exit pupil to one corner of the camera back opening. This helps in finding the exit pupil again when the RCMC is attached, which can be troublesome with wide-angle lenses in particular.
5. Attach the RCMC and observe the exit pupil again.
6. Select the working aperture and stop down manually.
7. Set the approximate focusing distance.
8. See the diagrams for a fuller explanation of what you can now see through one of the holes, and act accordingly.



## Optional accessories

As the 503CW / 503CWD models are further developments of previous models, they feature improvements and some differences in design. This means that certain older and now discontinued accessories cannot be used and any forced attempt at mounting them may damage your equipment, so please check carefully before trying. For example, the PM/PME 90 viewfinders and the ArcBody are not compatible with the CFV-39 or CFV-50 for different reasons but are both compatible with film magazine use. For complete and up to date information please visit our website - [www.hasselblad.com](http://www.hasselblad.com). The following list is just a selection (some are discontinued but may be still available).

### Viewfinders

A prism viewfinder with a 45° viewing angle that provides an un-reversed 2.5X magnified focusing screen image. The large eyepiece, especially suitable for users with eyeglasses, has a diopter adjustment range of - 2 to + 1 diopters.

### Winder CW

The Winder CW is a compact, economically designed unit providing not only a motor drive facility but also a comfortable and robust grip.

It features single exposure, continuous exposure as well as multi-exposure modes. Remote control is achieved by a simple release cord or by the unique infrared transmitter – the Hasselblad IR Remote control. Both provide considerable freedom, with the IR Remote control offering an extra remote mode choice facility. Each winder is governed by a unique code from the IR Remote control so there is no risk of controlling other cameras unintentionally. However, one IR Remote control can control several cameras at the same time if desired. As the winder is set close to the camera body, it produces stability and balance for optimum hand held efficiency.

Requires an 'Exposure Cable 503' when used with a digital back. See **MENU > SETTINGS > Camera** for use.

### Tripod quick-coupling

The coupling plate on the bottom of the camera body has both a 1/4 in. and a 3/8 in. tripod thread. It also fits the useful and reliable Hasselblad Tripod Quick-Coupling (3043326). This facilitates rapid and repeatedly accurate attachment and removal of the camera from a tripod or support.

### Professional lens shade

The Proshade 6093T (3040739) provides the ultimate in flare and stray light reduction. It is particularly useful if you have a number of lenses as it fits virtually all lenses in the range. It is supplied with a Proshade mask 6093/250 (3040312) which provides further control for longer lenses when the Proshade is fully extended. The Proshade also functions as a gelatine filter holder.

### Close-up accessories

Four fully automatic extension tubes are available for close-up work. With the exception of Extension tube 8, which cannot be connected directly to the 200-series cameras, they also feature a data bus coupling to transfer data from the lens to the exposure metering system of the camera.

### Film magazine

The Magazine A12 produces 12 frames with 120 film (6x6 cm) and is available in chrome.

*Please visit the Hasselblad website – [www.hasselblad.com](http://www.hasselblad.com) – for details of the complete range of accessories and lenses.*

*There are a number of discontinued accessories for the V-system on the used market but please check for compatibility.*

# 15

## Cleaning



### Note

#### WARNING!

Never attempt to remove the glass filter from the front of the CCD—you will probably ruin the CCD if you do so. If dust manages to get between the IR filter and CCD, please contact your Hasselblad dealer for assistance.

### Removing and attaching the digital back

1, 2

When removing the the digital back from the camera (or protective cover from the digital back), hold down the magazine catch lock button while sliding the magazine catch as in illustration 1.

When attaching the digital back to the camera (or the protective cove to the digital back), repeat the procedure as in illustration 2. Avoid trying to just 'snap' the digital back or protective cover into place without using the buttons.

### Cleaning the CCD Infrared Filter

If you see dark or colored spots or lines in your images, then you may need to clean the outer surface of digital back's infrared (IR) filter. In most cases, the careful use of compressed air will be adequate, but sometimes small particles will get stuck to the surface of the IR filter, requiring for a more thorough cleaning, involving either fluid or wipes. For a good safe cleaning, follow descriptions below.

### Basic cleaning procedure

1. Discharge any static electricity that may have built up on your body by touching the digital back housing.
2. While keeping the magazine catch lock depressed, slide the magazine catch to the right.
3. The top of the digital back will be released (while it rests on the magazine retaining hooks) and it can be swung away from the camera body.
4. Clean the outside surface of IR Filter by spraying it with clean compressed air. If this is not enough, then use one of the procedures outlined below.
5. If you still see spots on your shot after you have cleaned the outside of the infrared filter, then you may have dust on either on the inside of the IR filter or on the CCD itself. This can only be removed at the Hasselblad factory. Contact your Hasselblad dealer for assistance.
6. When reattaching the digital back to the camera, keep the magazine catch lock depressed and the magazine catch to the right. Check that the digital back is firmly in place.





### **Note**

Do not use same side of the e-wipe twice as you will be likely to reapply any particles removed in the first pass.

## **Cleaning using the HAMA Cleaning Fluid and tissues**

---

Note! Hasselblad recommends HAMA Optic Cleaning Fluid 5902.

1. Carefully spray the fluid onto the IR filter at a distance of 10-15 cm (4-5 inches), so that the fluid is applied onto the filter as a thin, even haze. 1-2 sprays are enough. If you apply too little, the fluid will start to dry up before you start wiping the filter. As an alternative you can spray the fluid onto the tissue first, and then apply it to the filter as you wipe it.
2. Fold the tissue several times to match the width of the IR filter—you might use two or three tissues at a time if necessary (to give you a better grip). Be sure to fold the paper so that the coated glossy side faces outwards—do not use the other side, as it can do more harm than good!
3. Gently place the folded tissue onto the edge of the filter using two or three fingers. Be sure to wipe the entire surface evenly. Sweep the filter only once. Do not wipe the same area twice with the same tissue as you might reapply dirt removed in the first sweep.
4. Finally check if the IR filter has been properly cleaned either by visual inspection or by mounting the digital back to the camera and making a shot. If further cleaning is needed, repeat cleaning procedure.

## **Cleaning with an E-Wipe**

---

E-wipes are individually packed wet tissues.

1. Tear at the notch to break seal.
2. Remove e-wipe from its packaging and continue without delay.
3. Fold the tissue to match the width of the IR filter.
4. Apply firm pressure using two or three fingers at the edge of the wipe to ensure an even, firm contact with filter surface. Wipe the surface in one unbroken motion.

## **Cleaning the housings**

---

If the camera becomes dirty, clean it with a soft, clean cloth lightly moistened with water only. Do not use any other solvents and do not allow water to seep in the openings.

## Technical specifications — 503CW camera body

<b>Camera type:</b>	Single lens reflex camera with 6 x 6 cm (2 ¼ x 2 ¼ in) max. film size. Interchangeable lenses, film magazines, viewfinders, and focusing screens.
<b>Design:</b>	Mechanical, with an aluminum alloy camera body shell cast in one piece.
<b>Viewfinder:</b>	Folding focusing hood interchangeable with reflex viewfinder, prism viewfinders with or without built-in light meter, or magnifying hood.
<b>Film advance:</b>	Manual advance or motor driven with Winder CW. Simultaneous shutter winding. Winder CW winding time: 1.05 s, approx. 0.8 frames/sec in continuous mode.
<b>Flash control:</b>	TTL/OTF-metering. ISO 64–4000 with flash/strobe adaptors SCA390 for connection with flash/strobe units from the SCA 300 systems. Metering area within 40 mm diameter in the centre of the image area.
<b>Tripod coupling:</b>	¼ in. and ⅜ in. socket threads and base plate for quick coupling attachment.
<b>External dimensions:</b>	Complete camera with Planar CFE 2.8/80 mm lens: 193mm L x113mm W x110mm H
<b>Weight:</b>	1620 g (Excluding battery and CF card).
<b>Focusing screen</b>	Hasselblad Acute-Matte D focusing screen with sensor format markings.

## Technical specifications — CFV digital back

	16 Mpixels	39 Mpixels	50 Mpixels
<b>Sensor size</b>	16 million pixels	39 Mpixels (5412 x 7212) 29 Mpixels (5412 x 5412)	50 Mpixels (6132 x 8176) 38 Mpixels (6132 x 6132)
<b>Sensor dimensions</b>	36.7 x 36.7 mm	36.7 x 49.1 / 36.7 x 36.7 mm	36.7 x 49.1 / 36.7 x 36.7 mm
<b>Lens factor with V camera</b>	x1.5	x1.1	x1.1
<b>4 GB CF card holds</b>	720 images on average	80 images on average	60 images on average
<b>Capture rate</b>	35 captures per minute	39 captures per minute 1.4 sec./capture.	33 captures per minute 1.1 sec./capture.
<b>ISO speed range</b>	50, 100, 200, 400	50, 100, 200, 400, 800	50, 100, 200, 400, 800
<b>Longest shutter speed</b>	32 seconds	64 seconds	64 seconds
<b>Shooting mode</b>	Single shot		
<b>Multi shot upgrade</b>	Not available		
<b>File format</b>	Lossless compressed Hasselblad 3F RAW		
<b>Image storage</b>	. CF card type II . computer disk when tethered		
<b>Software</b>	Phocus (included)		

## Technical specifications continued — CFV digital back

<b>Color definition</b>	16 bit
<b>Dynamic range</b>	12 f-stops
<b>Color management</b>	Hasselblad Natural Color Solution
<b>DAC digital lens correction</b>	Support for DAC for Carl Zeiss lenses included in Phocus
<b>Color display</b>	TFT type, 2.5 inch
<b>IR filter</b>	Mounted on CCD sensor
<b>Battery power</b>	SONY InfoLithium L, up to 8 hours of shooting capacity
<b>IAA - Instant Approval Architecture</b>	Included, with:
. Histogram analysis	yes
. Acoustic feedback	yes
<b>Computer support</b>	Macintosh: OSX 10.6. PC: Windows XP / Vista / 7 (32 and 64 bit)
<b>Host connection</b>	FireWire 800 (IEEE1394b)
<b>Operating temperature</b>	0 – 45 deg. C / 32 – 113 deg F
<b>Weight / Dimensions</b>	530 g (excluding battery and CF card) / 91 x 90 x 61 mm (W x H x D)
<b>Camera support</b>	All Hasselblad V System cameras manufactured since 1957. 2000 cameras and 201F with C lenses only. 202FA / 203FE and 205FCC camera types need a minor camera modification to use F/FE lenses. The ArcBody is not compatible. SWC/M and newer can be used but has limitations on image quality due to lens design not being suitable for digital capture. All other cameras with Hasselblad V interface.

## Troubleshooting — 503CW

*Hasselblad equipment is built to give long and trouble-free service, especially when you follow the maintenance and care advice at the end of this manual. If however you encounter any operating difficulties because you are not familiar with the camera system, the following table may help to resolve them. If the problem persists and the camera is still under guarantee, you should contact your Hasselblad dealer. If the guarantee has expired, you should contact a Hasselblad Authorised Service Center for advice.*

Problem	Possible cause	Remedy
<b>There is no image on the focusing screen</b>	<ul style="list-style-type: none"> <li>• The camera is in the pre-released or released position</li> <li>• The lens cap is still in place</li> </ul>	<ul style="list-style-type: none"> <li>• Complete the camera release and rewind the camera</li> <li>• Remove the lens cap</li> </ul>
<b>You cannot remove the front protective cover</b>	<ul style="list-style-type: none"> <li>• The camera is in the pre-released or released position</li> </ul>	<ul style="list-style-type: none"> <li>• Complete the camera release and rewind the camera</li> </ul>
<b>You cannot attach the lens</b>	<ul style="list-style-type: none"> <li>• The lens is in the released position</li> <li>• The camera body is in the pre-released or released position</li> </ul>	<ul style="list-style-type: none"> <li>• Wind the lens</li> <li>• Complete the camera release and rewind the camera</li> </ul>
<b>You cannot remove the lens</b>	<ul style="list-style-type: none"> <li>• The camera body is in the pre-released or released position</li> </ul>	<ul style="list-style-type: none"> <li>• Complete the camera release and rewind the camera</li> </ul>

## Equipment care & Service

### EQUIPMENT CARE

- Keep all equipment and accessories out of the reach of small children.
- Do not place heavy objects on the equipment.
- Do not use the batteries except as specified.
- Use only the batteries specified for use with the 503CWD and CFV.
- Remove the batteries when cleaning the camera or if you intend to leave it unused for a long period.
- If you use spare (standard or rechargeable) battery packs be particularly careful to use the supplied protective cap when storing. There is a potential fire risk if the contacts are short circuited across a conductive object (such as keys in a pocket, for example).
- Take particular care when working with strobe / studio flash units to prevent damage to equipment and personal injury.
- Do not attempt to open the digital back.
- Always replace the protective cover when the digital back is not mounted on the camera.
- Do not touch the exposed sensor filter with your fingers.
- Ensure that the databus connections are not damaged or soiled in any way.
- Keep all foreign objects out of the 503CW and CFV openings.
- Keep the original shipping boxes for storage.
- Keep your 503CWD or CFV and all other computer equipment away from moisture. If your 503CWD or CFV becomes wet, disconnect from power and allow it to dry before attempting to operate again.
- Never cover the ventilation openings on the 503CWD or CFV when in use.
- Never try to remove the glass IR filter from the front of the sensor; this will probably ruin the sensor. If dust manages to get between the sensor and IR filter, please contact your Hasselblad dealer for assistance.
- Avoid frequent and severe temperature changes and be particularly careful in humid environments. Allow the equipment to acclimatize whenever possible before use. Try to ensure the storage conditions in such environments are as dry as possible.
- Prevent dust and grit from getting into your equipment. In coastal areas take measures to protect your equipment from sand and salt water spray.

- Avoid physical shocks to the 503CW and CFV. Some form of protective case or camera bag is advised for transportation.
- Hasselblad equipment is much sought after and you should take obvious steps to prevent theft. Never leave it visible in an unattended car, for example. Separate and specific camera insurance cover should be considered by professional users.

### SERVICE

Return your equipment to a service centre for occasional checking and preventive maintenance to ensure optimal reliability.

### DISPOSAL

If you need to dispose of a 503CW, CFV or batteries, please do so in an environmentally friendly manner at the local waste plant/ recycling centre or similar.

#### Disposal of Waste Equipment by Users in Private Households in the European Union



This symbol on the product or on its packaging indicates that this product must not be disposed of with your other household waste. Instead, it is your responsibility to dispose of your waste equipment by handing it over to a designated collection point for the recycling of waste electrical and electronic equipment. The separate collection and recycling of your waste equipment at the time of disposal will help to conserve natural resources and ensure that it is recycled in a manner that protects human health and the environment. For more information about where you can dispose of your waste equipment for recycling, please contact your local city office, your household waste disposal service or the retailer where you purchased the product.

## Further reading

World class results are possible with Hasselblad equipment, witnessed by so many front covers, international advertising campaigns, famous portraits, historical events, etc. But it is the combination of this fine equipment and the abilities of the photographer that produce memorable images. Some of this skill is just sound photographic practice and sometimes it is product specific. The following books are recommended for those that wish to immerse themselves in the world of Hasselblad. The information in them varies from general interest to completely invaluable.

**“The Hasselblad Manual” (Seventh edition) by Ernst Wildi. Published by Focal Press - ISBN-10: 0240810260 / ISBN-13: 978-0240810263.**

Contains all the information you need to know about the operation of the analogue Hasselblad camera systems, including both recent and earlier equipment.

Also contains excellent general practical photographic advice. Written by a world-renowned lecturer on the Hasselblad system and its practical application. A book for the practising Hasselblad photographer.

**“Hasselblad System Compendium” by Richard Nordin. Published by Hove Books - ISBN-10: 1897802102 / ISBN-13: 978-1897802106.**

A complete round up of the history of Hasselblad products until 1998. Contains photos and descriptions of rare items long since out of production. A mine of information for those interested in a chronicle of the company and the development of its products. It contains a unique collection of dates, lists and almost anything you would want to know about the history and background of Hasselblad equipment. A book more for the Hasselblad collector or as an informational source for used equipment.

*The information in this manual is furnished for informational use only, is subject to change without notice, and should not be construed as a commitment by Victor Hasselblad AB & Hasselblad A/S.*

*Not all the images in this manual were taken with a Hasselblad 503CW or CFV. They are used for illustrative purposes only and are not intended to represent the image quality produced by a Hasselblad 503CW or CFV.*

*The text in this manual cannot be reprinted or reused without the express permission of Victor Hasselblad AB & Hasselblad A/S.*

*The images in this manual cannot be reprinted or reused without the express permission of the photographers who took them.*

*All text in this manual:*

*© Victor Hasselblad AB & Hasselblad A/S.*

*Unless otherwise stated, all images in this manual:*

*© Jens Karlsson, David Jeffery and Ove Bengtson.*

*Victor Hasselblad AB & Hasselblad A/S assumes no responsibility or liability for any errors or inaccuracies that may appear in this manual.*

*Victor Hasselblad AB & Hasselblad A/S assumes no responsibility or liability for loss or damage incurred during or as a result of using Hasselblad software or products.*

*Hasselblad, Imacon, Ixpress, FlexColor and Phocus are trademarks of Victor Hasselblad AB & Hasselblad A/S. Adobe and Adobe Photoshop are trademarks of Adobe Systems, Inc. Macintosh, Mac OS and FireWire are registered trademarks of Apple Computer, Inc. InfoLithium is a registered trademark of Sony Corporation.*

*Copyright © 2010*

*Victor Hasselblad AB & Hasselblad A/S*

*All rights reserved.*

Hasselblad A/S  
Hejrevej 30, DK - 2400 Copenhagen,  
Denmark

Victor Hasselblad AB  
Box 220, SE - 401 23 Göteborg,  
Sweden