



Technical Manual

STEREO POWER AMPLIFIER RB-1090-3

Table of Contents

- Specification.....1
- Parts List.....2 ~ 6
- Adjustment.....7 ~ 8
- PCB Assembly.....9
- Schematic Diagram.....10

Specification

Continuous Power Output (20-20kHz, < 0.03%)	380 wats/ch into 8 ohms 700 wats/ch into 4 ohms
Total Harmonic Distortion(20-20kHz, 8 ohms)	< 0.03 %
Intermodulation Distortion(60Hz : 7kHz, 4:1)	< 0.03 %
Frequency Responce (1dB)	10 Hz - 100 KHz
Dampning Factor(20-20,000kHz, 8 ohms)	1000
Speaker Impedance(combined load)	4 ohms minimum
Signal to Noise Ratio(IHF A network)	125 dB
Input Impedance / Sensitivity	33 k ohms / 1.8 volt
Power Requirement	115 volts 60 Hz or 230 volts 50 Hz
Power Consumption	800 watts
Dimensions(W x H x D)	432 x 237 x 406 mm 17 1/8 x 9 3/9 x 15 inches
Panel Height	221 mm
Weight (net)	38 kg, 83.6 Lb.

THE ROTEL CO., LTD

BUNZAN-SHINSEN-BLD. 4F 10-10 SHINSEN-CHO, SHIBUYA-KU,
TOKYO 150-0045, JAPAN

Serial. NO.
Begining 2311001

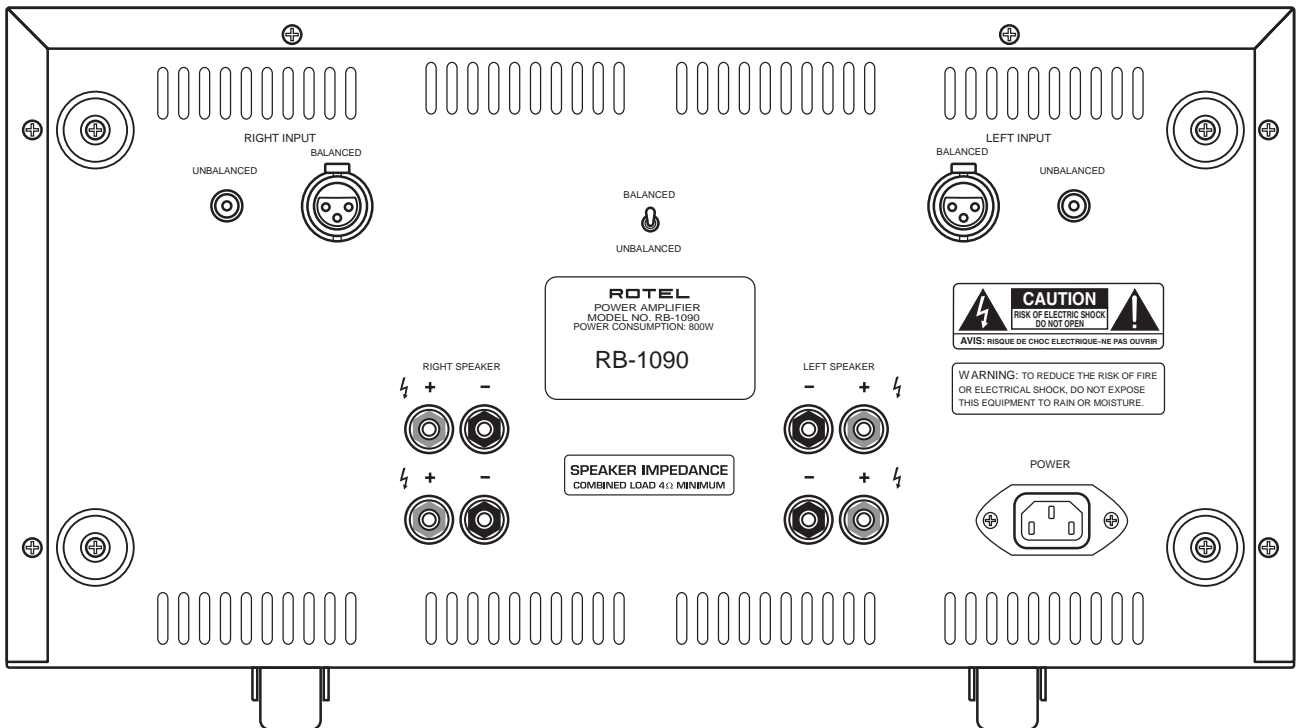
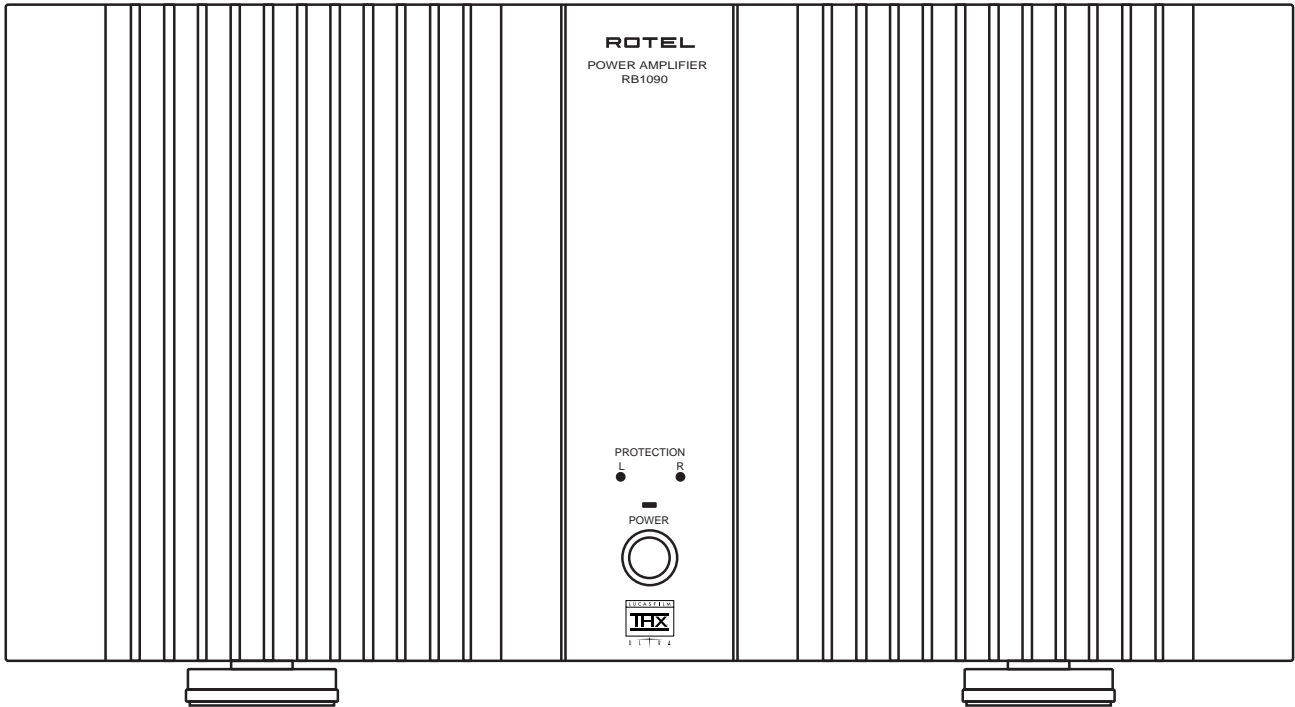

SYMBOL	PARTS NO.	DESCRIPTION
016 X-1271D01-08 PCB ASSY		
	501 X-1271D	PCB ASSY
L601-602	021 TRL-380	SPEAKER COIL 1.6F 9T
IC701,702	031 MPC1237HA	IC (PROTECTION)
IC501,502	031 OPA134PA	IC (OPEAMP)
Q621,622	032 A1932	TRANSISTOR 2SA1932
Q619,620	032 C5174	TRANSISTOR 2SC5174
Q613,614,667,668	033 A1209-ST	TRANSISTOR 2SA1209-ST
Q902	033 B631-EF	TRANSISTOR 2SB631K-EF
Q615,616,669,670	033 C2911-ST	TRANSISTOR 2SC2911-ST
Q901	033 D600-EF	TRANSISTOR 2SD600K-EF
Q607-612,657-662,747-750	033 TA1016-FG	TRANSISTOR 2SA1016KAA-FG
Q751-754	033 TA1376A-LKU	TRANSISTOR 2SA1376AT-LKU
Q601-606,651-656,745,746	033 TC2362-FG	TRANSISTOR 2SC2362KAA-FG
Q755-758	033 TC3478A-LKU	TRANSISTOR 2SC3478AT-LKU
D609-612,903,904	034 T1N4003-TB	DIODE 1N4003-E
D601-608,615,616	034 T1N4148-86	DIODE 1N4148TAP-50
D701,702,713,714	034 T1N4148-86	DIODE 1N4148TAP-50
D751-754	034 T1N4148-86	DIODE 1N4148TAP-50
D905,906	034 TRD16JST1	ZENER DIODE 16V (AB2)
D902	034 W02M	POWER DIODE 1.5A200V
C910,911	041 25BGF470M	ELECTROLYTIC CAPACITOR 25V470uF
C611,612	041 35ZA10MTZ	ELECTROLYTIC CAPACITOR 35V10uF
C601,602	041 35ZA4R7MTZ	ELECTROLYTIC CAPACITOR 35V4.7uF
C607,608,505-508	041 TEEUFC1E101SB	ELECTROLYTIC CAPACITOR 25V100uF
C703,704	041 TUTES1E221-TF	ELECTROLYTIC CAPACITOR 25V220uF
C707,708	041 TUTES1E470-TF	ELECTROLYTIC CAPACITOR 25V47uF
C717,718	041 TUTES1H100-TF	ELECTROLYTIC CAPACITOR 50V10uF
C701,702	041 TUTES1H220-TF	ELECTROLYTIC CAPACITOR 50V22uF
C705,706	041 TUTES1H4R7-TF	ELECTROLYTIC CAPACITOR 50V4.7uF
C903,904	041 TUTES1J221-TS	ELECTROLYTIC CAPACITOR 63V220uF
C623-626	041 VX2A102S	ELECTROLYTIC CAPACITOR 100V1000uF
C709,710	042 TP50V223J	MYLAR CAPACITOR 0.022uF
C613-616	044 FSC160V221H	STYROL CAPACITOR 160V220pF
C627,628	044 FSC160V471H	STYROL CAPACITOR 160V470pF
C691,692	044 KT18-2E104J	MP CAPACITOR MKT1818-410/254
C501,502	044 S50V100PJ	STYROL CAPACITOR 50V100pF
C603,604	044 TFKP2-2A681H	P.P CAPACITOR FKP2-100V681H
VR601-604	051 SFR001-222	SEMI-FIXED RESISTOR VM6CKPH1S-2.2K
R1	054 ERQ2ABJP220S	FUSE RESISTOR 2W 22
R777,778	054 TMFR401K2	METAL FILM RESISTOR 1/4W 1.2K
R607-610,615-618,908,909	054 TMFR401K5	METAL FILM RESISTOR 1/4W 1.5K
R785,786	054 TMFR401K8	METAL FILM RESISTOR 1/4W 1.8K
R715-730	054 TMFR4010R	METAL FILM RESISTOR 1/4W 10
R623,624,629,630	054 TMFR4100R	METAL FILM RESISTOR 1/4W 100
R687-690,697,698	054 TMFR4100K	METAL FILM RESISTOR 1/4W 100K
R701,702,705,706	054 TMFR4100K	METAL FILM RESISTOR 1/4W 100K
R505-508,711,712,(R905)	054 TMFR4010K	METAL FILM RESISTOR 1/4W 10K
R703,704	054 TMFR4120K	METAL FILM RESISTOR 1/4W 120K
R621,622,643,644,733,734	054 TMFR4150K	METAL FILM RESISTOR 1/4W 150K
R775,776	054 TMFR4015K	METAL FILM RESISTOR 1/4W 15K
R509,510,631,632,731,732,R766	054 TMFR4001K	METAL FILM RESISTOR 1/4W 1K
R691,692	054 TMFR4001M	METAL FILM RESISTOR 1/4W 1M
R611,612,619,620,667-670	054 TMFR4220R	METAL FILM RESISTOR 1/4W 220
R501-504,699,700,707,708	054 TMFR4022K	METAL FILM RESISTOR 1/4W 22K
R627,628	054 TMFR403K9	METAL FILM RESISTOR 1/4W 3.9K
R773,774	054 TMFR4033K	METAL FILM RESISTOR 1/4W 33K
R787,788	054 TMFR404K7	METAL FILM RESISTOR 1/4W 4.7K
R633,634	054 TMFR4047R	METAL FILM RESISTOR 1/4W 47
R671-686,693-696,781-784	054 TMFR4047K	METAL FILM RESISTOR 1/4W 47K

Parts List 2/3

SYMBOL	PARTS NO.	DESCRIPTION
R771,772,779,780,613,614	054 TMFR4560R	METAL FILM RESISTOR 1/4W 560
R657,658	054 TMFR4056K	METAL FILM RESISTOR 1/4W 56K
R713,714,625,626	054 TMFR406K8	METAL FILM RESISTOR 1/4W 6.8K
(R905)	054 TMFR406K8	METAL FILM RESISTOR 1/4W 6.8K
R709,710	054 TMFR4068K	METAL FILM RESISTOR 1/4W 68K
R663,664	054 1WS10JF	METAL OXIDE FILM RESISTOR 1W 10
R789,790	054 1WS330JF	METAL OXIDE FILM RESISTOR 1W 330
R655,656	054 3WS10JF	METAL OXIDE FILM RESISTOR 3W 10
R659-662	054 3WS6.8KJF	METAL OXIDE FILM RESISTOR 3W 6.8K
R763-765,767-770	054 MF16-1001-A	MOF RESISTOR 1/6W 1K
R751-758	054 MF16-22R0-A	MOF RESISTOR 1/6W 22
R759-762	054 MF16-6801-A	MOF RESISTOR 1/6W 6.8K
R665,666	054 TMF3300	MOF RESISTOR 330
R635-642,645-652	054 MPC74-0.22F	RESISTOR PLATE 5W 0.22
R653,654	054 MPC71-1F	RESISTOR PLATE 5W 1
R601,602	054 TRC55Z1501F	RESISTOR RC55Z 1.5K
R603,604	054 TRC55Z3302F	RESISTOR RC55Z 33K
R613,R614	054 TRC55Z5600F	RESISTOR RC55Z 560
S901	061 C-4176A07	POWER SWITCH PS3-22-L3AV TV-8 (4P PCB)
RY601,602	063 DE2TU-24	RELAY DE24D2-OT(M)
S401	064 C-4613A01	TOGGLE SWITCH 200DP1T2B2M7RE
DJ1,DJ2	066 C-4575A01	3P CANON JACK (FEMALE) YKF52-5006
CON1,CON2	068 C-3683#2	PCB TERMINAL 3P P7.5 TP WE-12 I-753NA
N1,N2,P1,P2,OUT1,OUT2	069 C-4446A00	PCB TERMINAL Y-105
016 X-1291_01-02 PCB ASSY		
	501 X-1291E	PCB ASSY
T101	022 T-1075N02	SUB TRANSFORMER (with 016 X1291E)
D101	034 W02M	POWER DIODE 1.5A 200V
F101	036 5ST500	FUSE 250VT500MA
F903	036 R251-250	FUSE F250MA
C101	041 TUTES1E471-TS	ELECTROLYTIC CAPACITOR 25V470uF
R106	054 1WS120JF	MOF RESISTOR 1W 120
K104	068 C-3681#1	WRAPPING TERMINAL 2P
AC1.AC5	068 C-4422A01	WRAPPING TERMINAL 2P
016 E-1328A00 PCB ASSY (Surge Absorber)		
	501 E-1328A	PCB ASSY
TH902	034 SCK2R512	SURGE CURRENT THERMISTOR 5Ω
D910	034 TIN4148-86	DIODE 1N4148TAP-50
C920	044 DE1307E472M	SPARK KILLER 4700pF
R901	054 RWH20G10RJ	RESISTOR 20W 10 (for 230V VERSION)
R901	054 RWH20G5RJ	RESISTOR 20W 5 (for 115V VERSION)
RY901	063 OZT-SS-112LM1	RELAY DC 12V TV8 OZT-SS-112LM1
TH901	063 UI300B	THERMOSTAT UI-2
TM1,TM4,TM5,TM6	068 C-3683#1	PCB TERMINAL 2P P7.5 TP WE-11 I-752NA
TM2,TM3	068 C-3683#3	WRAPPING PIN TERMINAL 4P
ACN,ACL	069 C-4370A00	PCB TERMINAL Y-102
016 X-1348A00 PCB ASSY (Delay)		
	501 X-1348-A	PCB ASSY
T11	032 TA608-FG	TRANSISTOR 2SA608KAA-FG
T12	032 TC536-FG	TRANSISTOR 2SC536KAA-F
D11	034 TRD4.7JST1	ZENER DIODE 4.7V (AB2)
C11	041 TUTES1H100-TF	ELECTROLYTIC CAPACITOR 50V10uF
R11,12,14	053 CR14-103J-A	CARBON RESISTOR 1/4W 10K
R13	053 CR14-334J-A	CARBON RESISTOR 1/4W 330K
K13	068 C-3681#3	WRAPPING TERMINAL 4P
HEAT SINKER ASSEMBLY		
Q617,618	032 D1953	TRANSISTOR 2SD1953
Q633,634	033 A1294-OY	TRANSISTOR 2SA1294-OY
Q623-630	033 A1295-OY	TRANSISTOR 2SA1295-OY

Parts List 3/3

SYMBOL	PARTS NO.	DESCRIPTION
Q635,636	033 C3263-OY	TRANSISTOR 2SC3263-OY
Q637-644	033 C3264-OY	TRANSISTOR 2SC3264-OY
	019 TO-3P	INSULATION SHEET(S)
	019 TO-3P2	INSULATION SHEET(L)
	OTHERS	
	011 FP-499A-B	BLACK PANEL ASSY
	011 FP-499A-S	SILVER PANEL ASSY
	011 SG4-02C00	H/S PANEL
	012 RV4-09A00	PUSH BUTTON 14F (BLACK)
	012 RV4-09A01	PUSH BUTTON 14F (SILVER)
	013 SG4-05A00	SUB PANEL SUPPORT(BLACK) .
	013 SG4-05A01	SUB PANEL SUPPORT(SILVER) .
	014 SG3-18A00	UPPER COVER
	015 RP-354C	REAR CHASSIS
	019 C-4638A00	CASTER 32Φ
	019 C-670#18	FELT 56Φ (for FOOT)
	019 C-4418A00	PLASTIC FOOT 26Φ
	019 PK4-07A00T	METAL FOOT 60Φ
T001	022 T-1061U01	POWER TRANSFORMER
T002	022 T-1064U01	POWER TRANSFORMER
D004,D005	034 BR254	POWER SIODE 25A 400V
	034 LTL1214A	LED (RED) 2Φ
	034 SEL1124R	LED (RED) 1X5
	034 SEL1E24W	LED (BLU) 1X5
	036 5ST10	FUSE 250V10A
C001-C008	041 ALS30S1072MF	ELECTROLYTIC CAPACITOR 100V22000uF
SP2A,SP2B	067 C-4717A02	SPEAKER TERMINAL (BLACK)
SP2A,SP2B	067 C-4717A01	SPEAKER TERMINAL (RED))
	069 C-4637A00	AC INLET(3P) 0707-1-CW
	072 C-4392A04	AC CORD SET (SJT AWG14) for USA
	072 C-4393A03	AC CORD SET for EUROPE
	072 C-4423A03	AC CORD SET for AUSTRALIA
	072 C-4639A01	AC CORD SET for U.K.
	081 SG3-22B01	INSIDE CARTON -V01
	081 SG3-23B01	SHIPPING CARTON -V01
	081 SG4-24A00	PACKING (for INSIDE CARTON)
	081 Z-200	STYROL MOULDING
	082 OMRB-1090-1	OWNER'S MANUAL(EFGISD)

Addendum List for Black and Silver

RB1090

SYMBOL	PARTS	DESCRIPTION
①	011 FP-499A-B	BLACK PANEL ASSY
②	011 FP-499A-S	SILVER PANEL ASSY
③	011 SG4-02C00	H/S PANEL H221
	012 RV4-09A00	PUSH BUTTON 14F (BLK)
	012 RV4-09A01	PUSH BUTTON 14F (SLV)
④	013 SG4-05A00	SUB PANEL CHASSIS (BLK)
⑤	013 SG4-05A01	SUB PANEL CHASSIS (SLV)
	034 SEL1124R	LED (RED) 1X5
	034 SEL1E24W	LED (BLU) 1X5

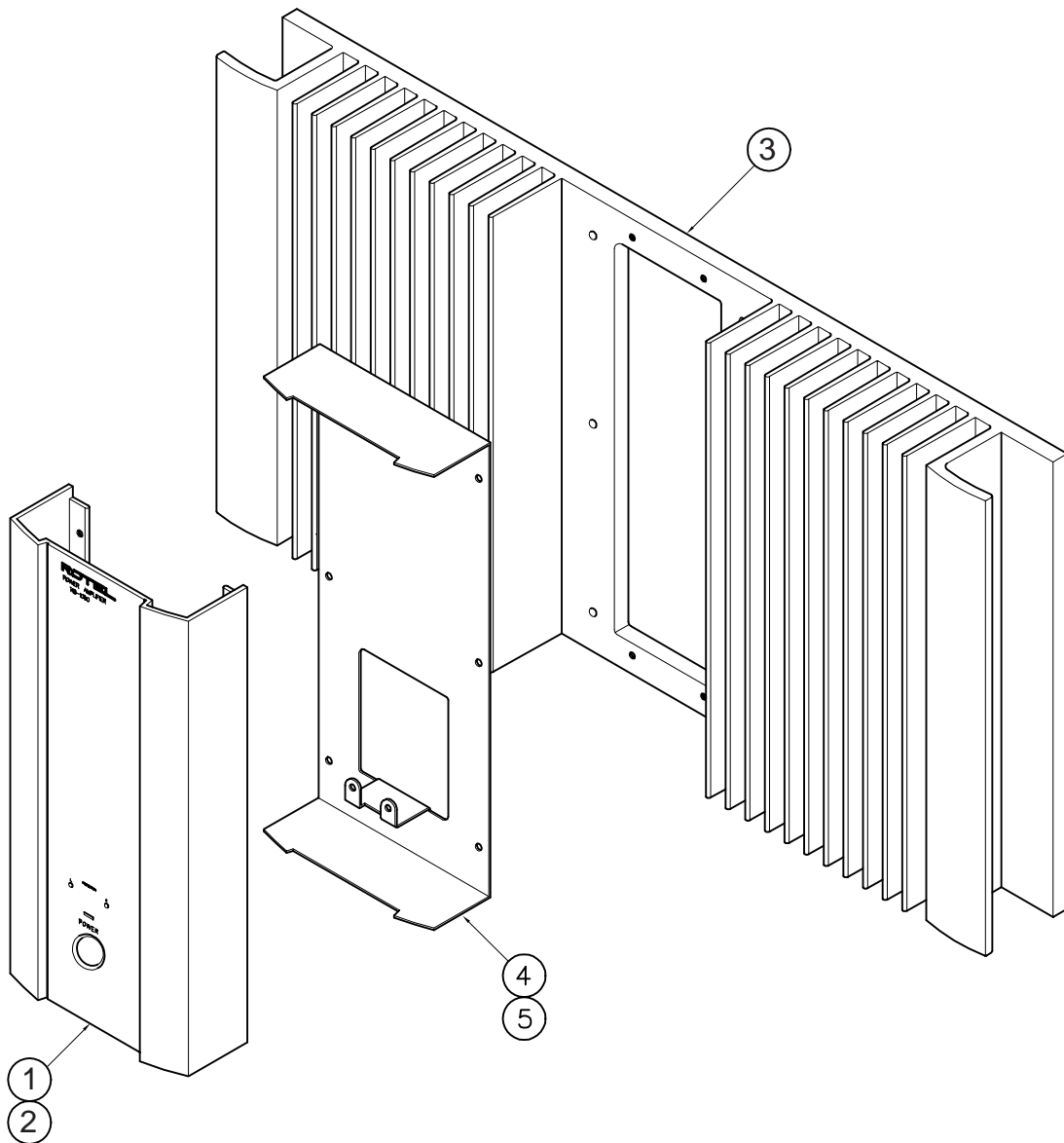

Adjustment

RB-1090

Instruments : DC milli-voltmeter

Notes : Prior to Bias Adjustment, run about 5minutes with rated output(8ohms) and warm up Power Transistor and Heat Sink. Set input off.

Step	Coupling	Location	Adjust	Adjust for
1	L CH OUT	X-1271-01 PCB	VR603	DC milli-voltmeter reads 0mV
2	R CH OUT	X-1271-02 PCB	VR604	
3	TP1	X-1271-01 PCB	VR601	DC milli-voltmeter reads 5mV
4	TP2	X-1271-02 PCB	VR602	

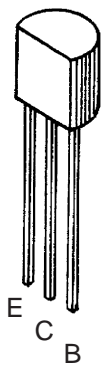

2SA1016K
2SC2362K

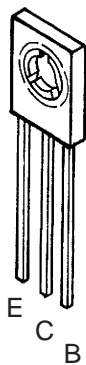

2SB631K
2SD600K
2SA1209
2SC2911
2SD1953

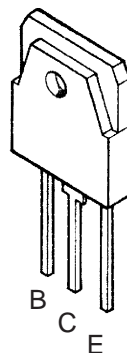

2SA1294
2SC3263

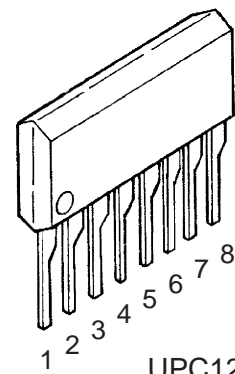

UPC1237HA

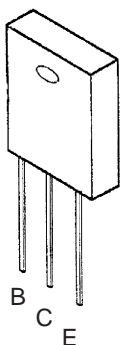

2SC5174
2SA1932

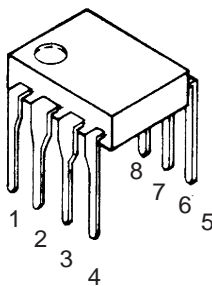

AD711JN
OPA134PA

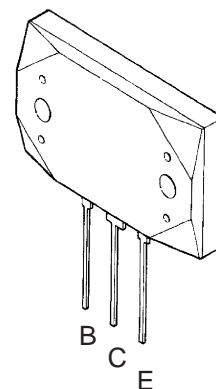

2SA1295
2SC3264

Memo

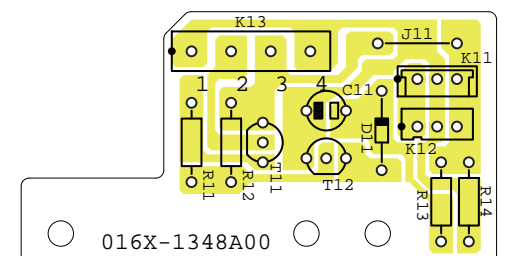
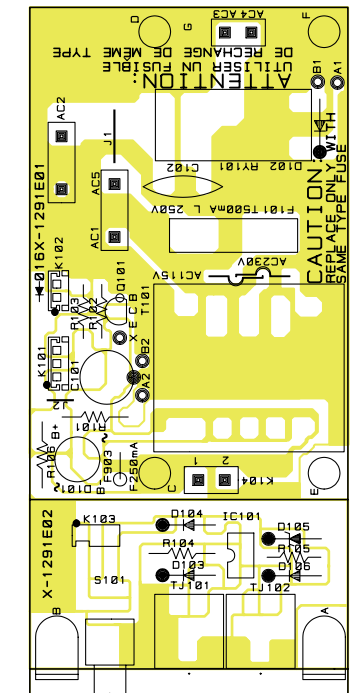
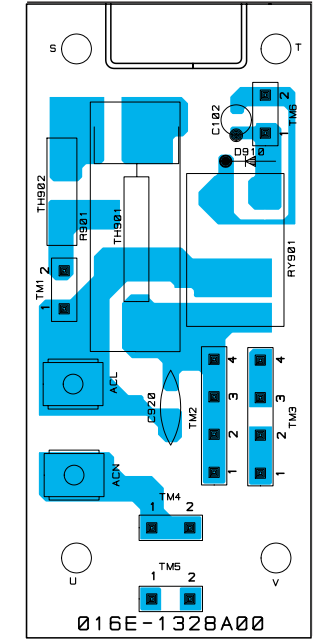
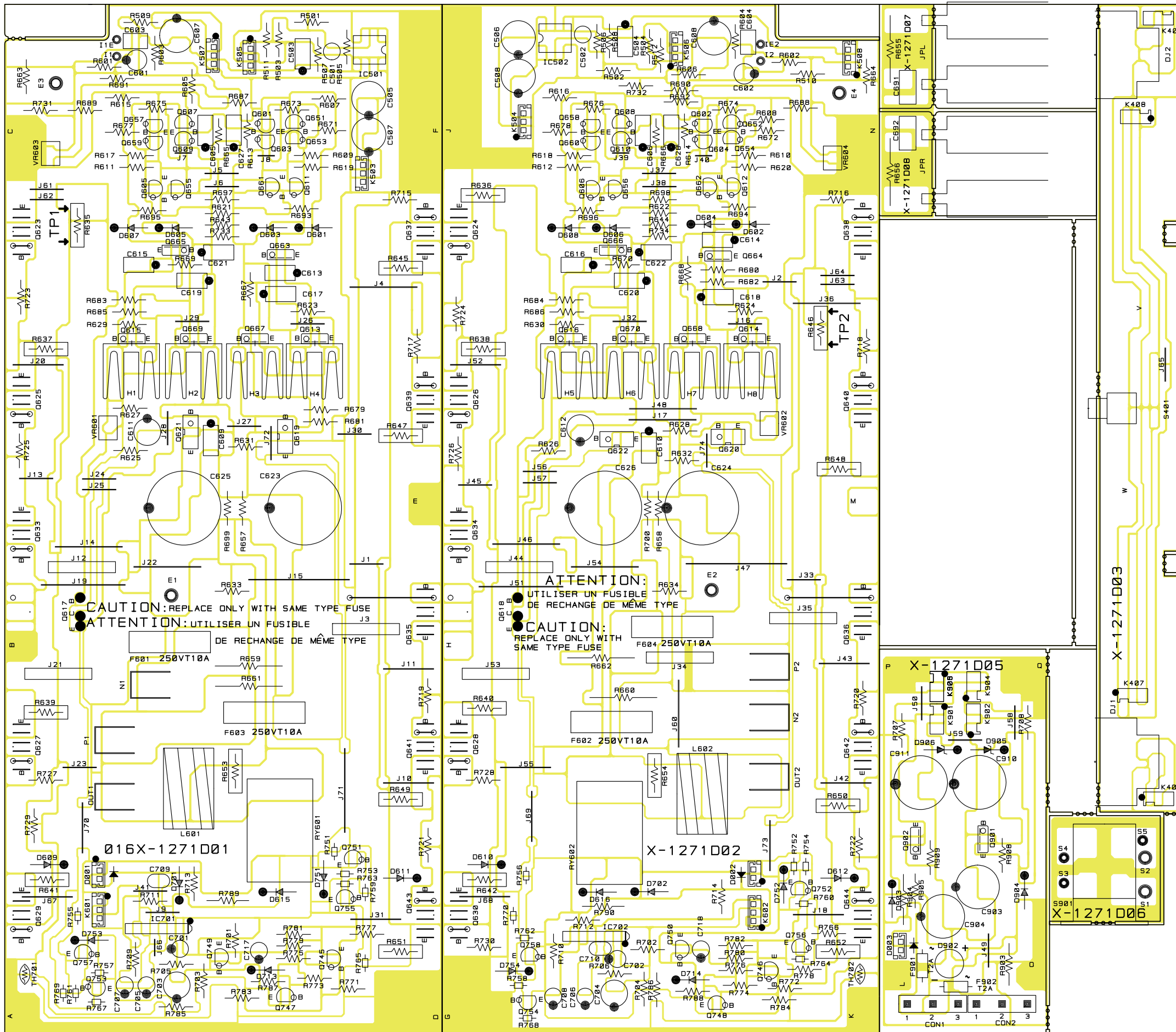

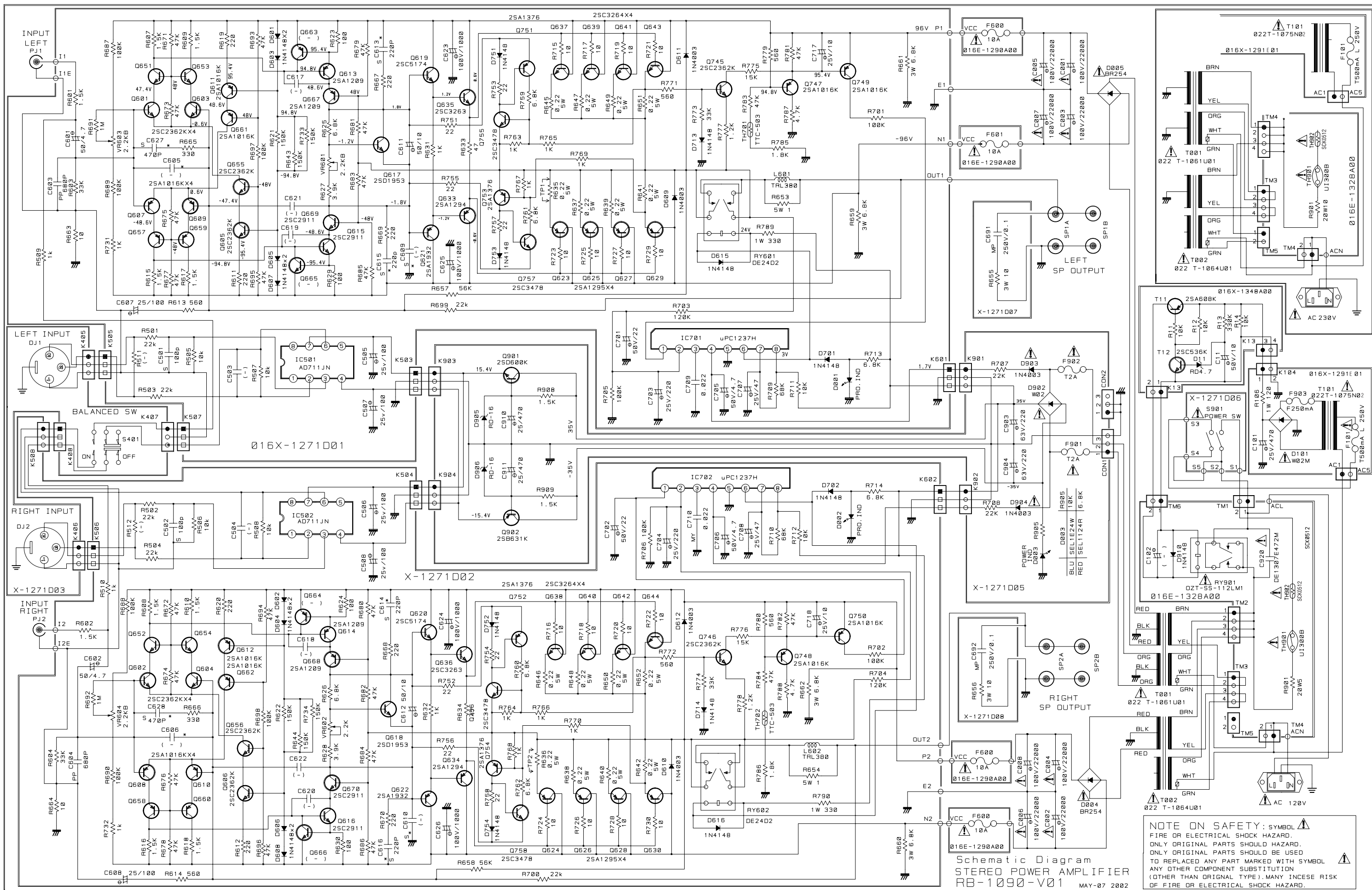

Schematic Diagram
STEREO POWER AMPLIFIER
RB-1090-V01 MAY-07 2002

NOTE ON SAFETY: SYMBOL ⚡
FIRE OR ELECTRICAL SHOCK HAZARD.
ONLY ORIGINAL PARTS SHOULD BE USED.
ONLY ORIGINAL PARTS SHOULD BE USED
TO REPLACE ANY PART MARKED WITH SYMBOL ⚡
ANY OTHER COMPONENT SUBSTITUTION
(OTHER THAN ORIGINAL TYPE), MANY INCREASE RISK
OF FIRE OR ELECTRICAL SHOCK HAZARD.