

STEREO INTEGRATED AMPLIFIER

A-7600II

SERVICE MANUAL

FRONT PANEL

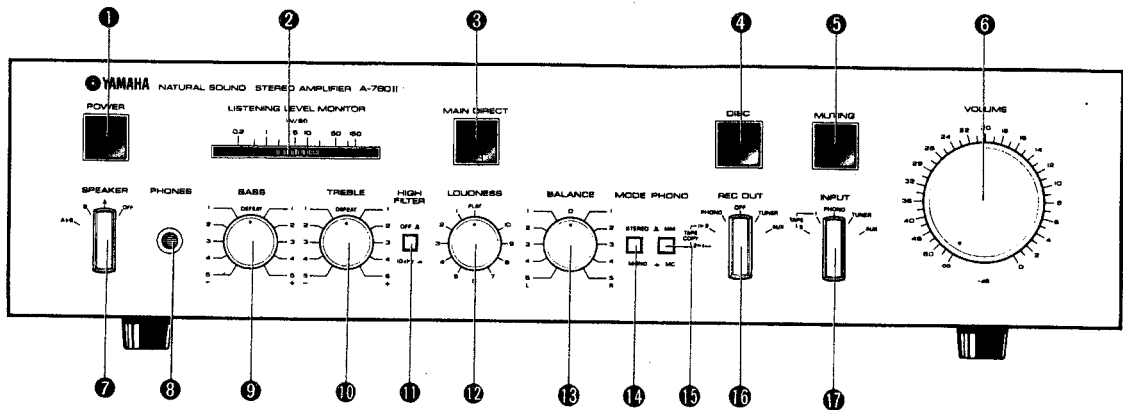

- | | |
|---------------------------|--------------------|
| ① Power Switch | ⑩ Treble Control |
| ② Listening Level Monitor | ⑪ High Filter |
| ③ Main Direct Switch | ⑫ Loudness Control |
| ④ Disc Switch | ⑬ Balance Control |
| ⑤ Muting Switch | ⑭ Mode Control |
| ⑥ Volume Control | ⑮ Phono Selector |
| ⑦ Speaker Switch | ⑯ Rec Out Selector |
| ⑧ Phones Jack | ⑰ Input Selector |
| ⑨ Bass Control | |

CONTENTS

Rear panel	1
Names of the Parts	2
Disassembly Instructions	3
Specifications	5
Adjustments	6
Block Diagram	7
Printed Circuit Layout	7
Printed Circuit Board/Wiring	9
Complete Circuit Diagram	10

004458

SINCE 1887



YAMAHA

NIPPON GAKKI CO., LTD. HAMAMATSU, JAPAN

'82.3.2.65K



Printed in Japan.

REAR PANEL

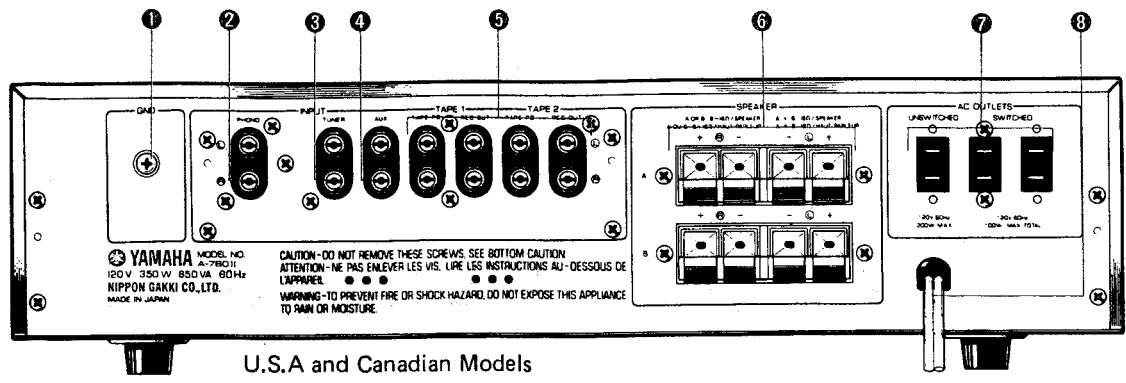

U.S.A and Canadian Models

- ① Gnd terminal
- ② Phono input jacks
- ③ Tuner input jacks
- ④ Aux input jacks
- ⑤ Tape 1, 2 record/playback jacks
- ⑥ Speaker A, B terminals
- ⑦ AC outlets
- ⑧ Power cord

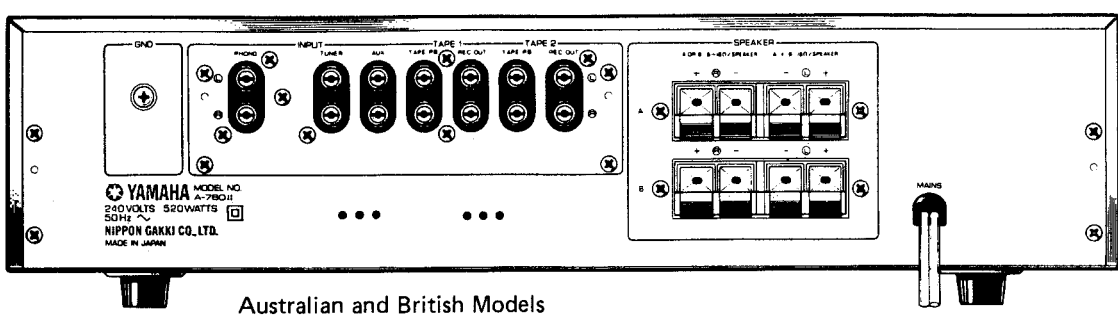

Australian and British Models

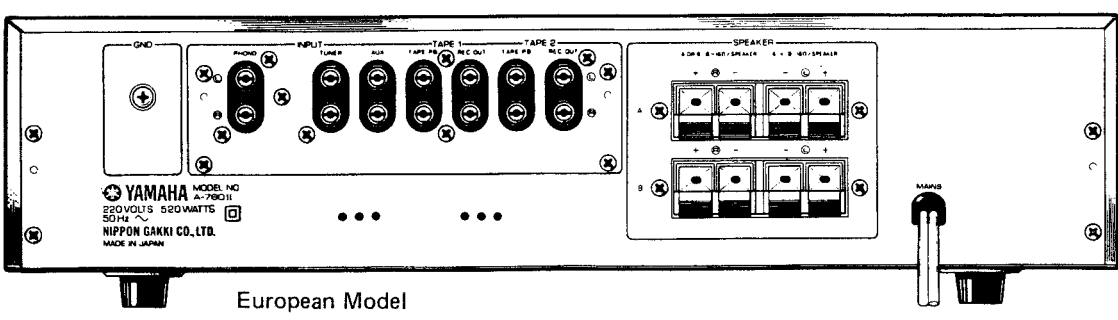

European Model

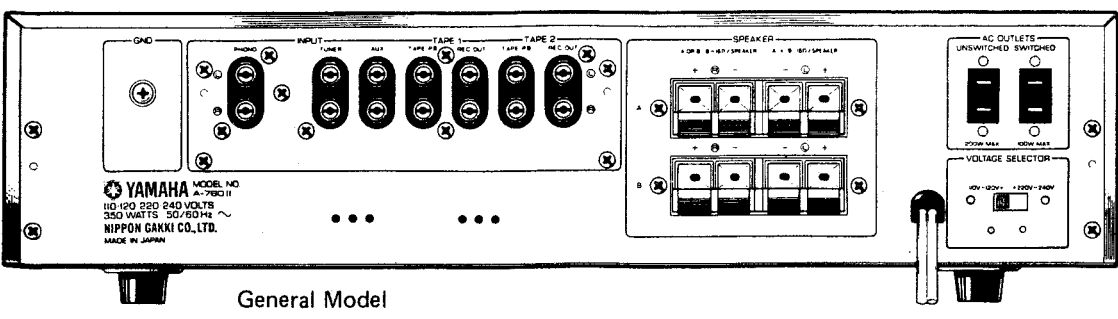

General Model

NAME OF THE PARTS

Internal Top View

U.S.A and Canadian Model

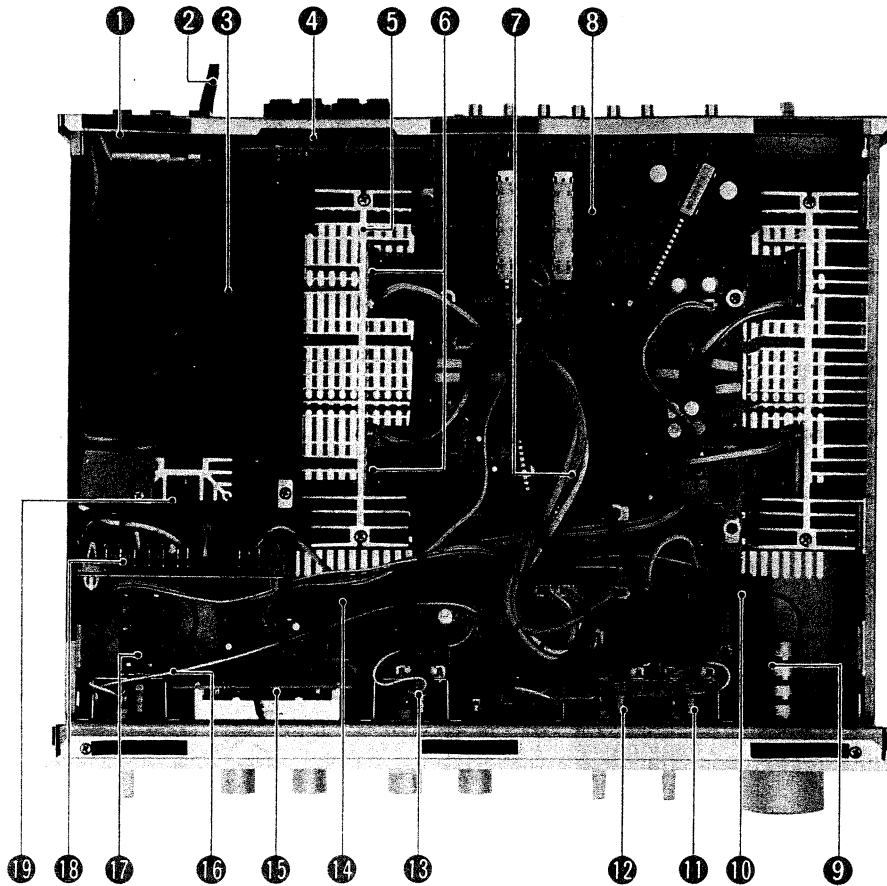

- | | | | |
|---|----------------------------------|---|----------------------------------|
| ① | AC outlet | ⑪ | Muting switch |
| ② | Power cord | ⑫ | Disk switch |
| ③ | Power transformer | ⑬ | Main Direct switch |
| ④ | Main board 2 (NA07861-2) | ⑭ | Tone control board 1 (NA07859-1) |
| ⑤ | Heat sink | ⑮ | Main board 4 (NA07861-4) |
| ⑥ | Power transistor | ⑯ | Main board 5 (NA07861-5) |
| ⑦ | Main board 1 (NA07861-1) | ⑰ | Power switch |
| ⑧ | Function board (NA07857) | ⑱ | Primary board 1 |
| ⑨ | Tone control board 3 (NA07859-3) | | |
| ⑩ | Tone control board 2 (NA07859-2) | | |

DISASSEMBLY INSTRUCTIONS

1. Removing the top cover

Remove screws ① and ② on each side, per photo 1 and remove the top cover by pulling back and lifting up.

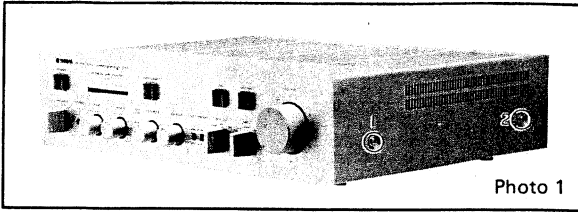

Photo 1

2. Removing the bottom cover

Flip the A-760 II over and remove screws ① ~ ⑨ in photo 2; then remove the bottom cover.

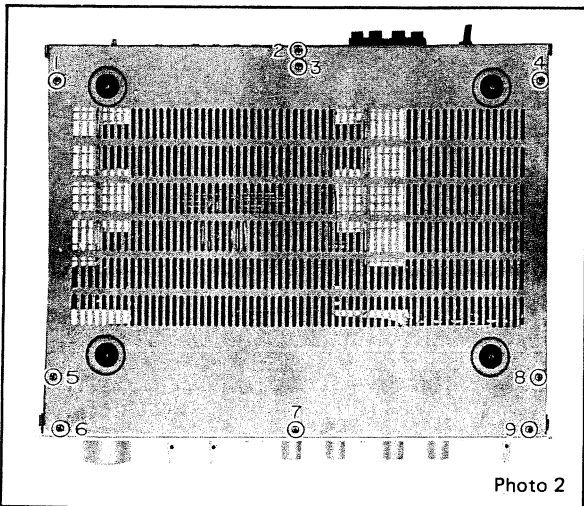

Photo 2

3. Removing the front panel

- Remove the top cover (step 1).
- Remove the bottom cover (step 2).
- Loosen the Speaker, Rec Out and Input knobs with a 1.5 mm allen wrench. Pull each knob off its shaft.
- Disconnect the wires from the Power, Main Direct, Disc and Muting switches being careful not to break them.
- Remove screws ① and ② in photo 3 and remove the front panel by pulling forward.

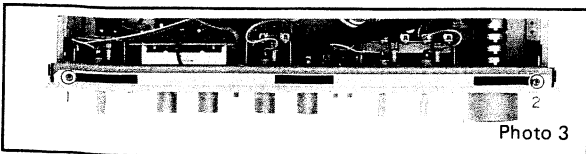

Photo 3

4. Removing the rear panel

- Remove the top cover (step 1).
- Remove the bottom cover (step 2).
- Remove screws ① ~ ②①. The cover can then be taken off.

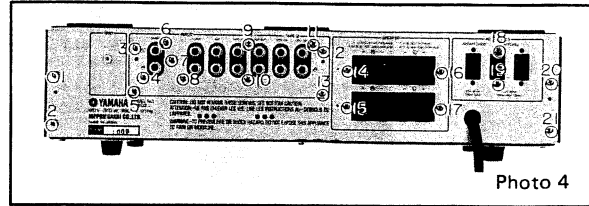

Photo 4

5. Removing the function board

- Remove the top cover (step 1).
- Detach the various cords and connectors; then detach the flexible wire from each switch with a screwdriver. (Fig. 1)
- Take out screws ③ ~ ⑬ photo 4 to remove the function board.

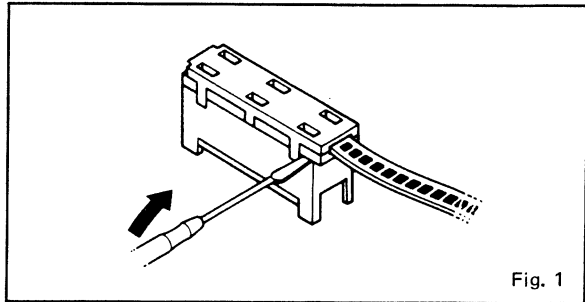
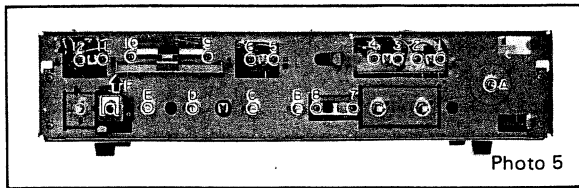

Fig. 1

6. Removing tone control boards 1, 2, and 3, main boards 4 and 5 and the power switch

- Remove the top cover, bottom cover, and front panel (steps 1, 2, 3).
- Pull off the Bass, Treble, Loudness, Balance and Volume controls.
- Tone control boards 2 and 3 can be removed by taking out nut (A) and screws ① ~ ⑥ in photo 5.
- Tone control board 1 can be removed by taking out screws ⑦ and ⑧ and nuts (B) ~ (E) in photo 5.
- Main board 4 is removed by taking out screws ⑨ and ⑩ and pulling off the Listening Level Monitor knob in photo 5.
- The power switch can be removed by removing screws ⑪ and ⑫ in photo 5.
- Main board 5 can be removed by pulling out the phone jack fastener (F) in photo 5 in the direction of the arrow.



7. Removing main board 1 and the heat sink

- a) Remove the top and bottom covers.
- b) Remove the function board (step 5).
- c) Desolder power transistors TR335 ~ TR338.
- d) Take out main board 1 by removing screws ① ~ ⑤ in photo 6.
- e) Detach connectors (A) ~ (D) in photo 6.
- f) Remove the heat sink by taking out screws ⑥ ~ ⑨ in photo 6.

*Make sure that transistors TR321 and TR322 are correctly connected to the heat sink for proper heat dissipation.

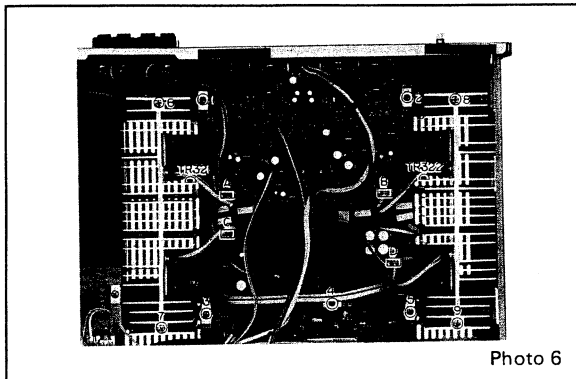

8. Removing the power transformer and primary boards 1 and 2

- a) Remove the top cover (step 1).
- b) Remove the primary board wiring.
- c) Take out screw ① in photo 7 and release primary boards 1 and 2 from board fasteners (A) and (B).
- d) Remove the power transformer cover by taking out screws ② ~ ⑤ in photo 7.
- e) Take out screws ① ~ ④ in photo 8 to remove the power transformer.

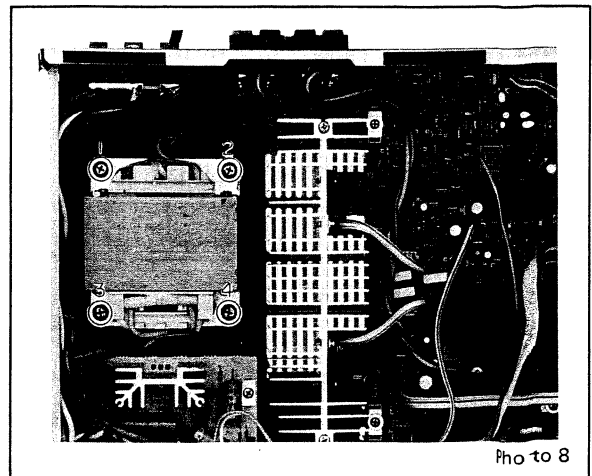
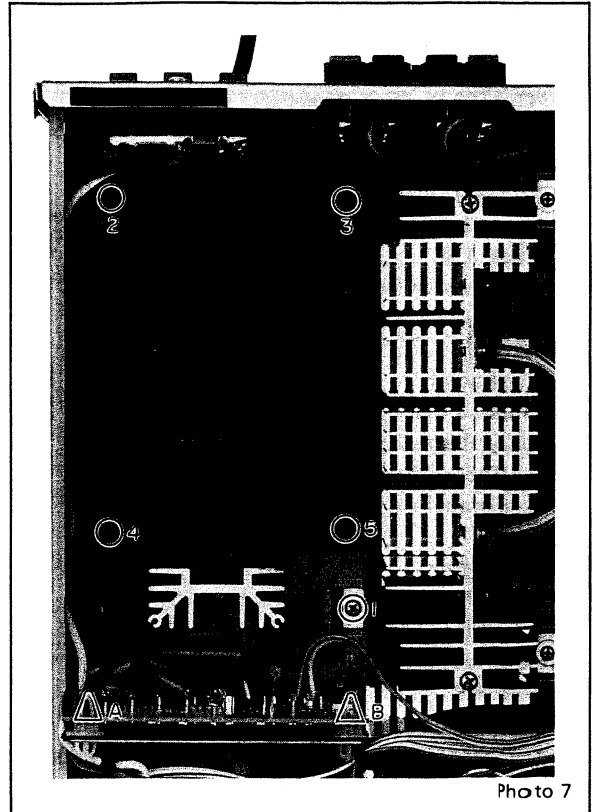

SPECIFICATIONS

Minimum RMS Output Power	
8 ohms, 20 to 20,000Hz (Main Direct ON)	
0.005% THD	80 W + 80 W
8 ohms, 1 kHz 0.002%	
THD	80 W + 80 W
4 ohms clipping power	
1 kHz 0.5% THD	150 W + 150 W
Total Harmonic Distortion	
(20 Hz to 20 kHz)	
Phono MM to Rec Out	
(5 V output)	0.003%
Phono MC to Rec Out	
(5 V output)	0.006%
Aux/Tape/Tuner to Sp	
Out (40 W, Main Direct	
ON)	0.005%
IM Distortion Ratio (60 Hz : 7 kHz = 4 : 1)	
Aux/Tape/Tuner to Sp Out	
8 ohms, 80W	0.002%
8 ohms, 1 W	0.01%
Power Bandwidth (Main Direct ON)	
(8 ohms, 40 W, 0.02%	
THD)	10 Hz to 100 kHz
Damping Factor	
(8 ohms, 1 kHz)	Better than 65
Frequency Response	
(Aux/Tape/Tuner to Sp	
Out, 8 ohms)	1 Hz to 100 kHz
	(+0, -2 dB)
RIAA Deviation	
Phono MM	± 0.2 dB
Phono MC	± 0.3 dB
Input Sensitivity/Impedance	
Phono MM	2.5 mV/47 k ohms
Phono MC	160 μV/100 ohms
Aux/Tape/Tuner	150 mV/47 kohms
Maximum Input Level (1 kHz)	
Phono MM	180 mV RMS
Phono MC	10 mV RMS
Tone Control Characteristics	
Bass	± 10 dB at 20 Hz
Treble	± 10 dB at 20 kHz
Turnover Frequencies	
Bass	500 Hz
Treble	3.5 kHz
Output Level/Impedance	
Rec Out	150 mV/270 ohms
Signal-to-Noise Ratio	
(IHF A Network, Input	
Shorted)	
Phono MM (5 mV)	92 dB
Phono MC (500 μV)	76 dB
Aux/Tape/Tuner	106 dB (Main Direct
	ON)
Signal-to-Noise Ratio (NEW IHF)	
Phono MM	74.5 dB
Phono MC	78 dB
Aux/Tape/Tuner	85 dB (Main Direct
	ON)
Residual Noise	
(IHF A Network)	65 μV
Input Equivalent Noise	
Phono MM	-138 dBV
Phono MC	-142 dBV
Filter Characteristics	
High	10 kHz, 12 dB/oct.
Channel Separation	
(1 kHz, vol. -30 dB, Shorted)	
Aux, Tuner to Sp Out	70 dB
Phono MM to Sp Out	70 dB
Phono MC to Sp Out	70 dB
Continuous Loudness Control	
(Level-Related Equalization)	
Max. Attenuation	20 dB at 1 kHz
Audio Muting	-20 dB
Gain Tracking Error	
(0 to -60 dB)	2 dB
Headphone Output/Impedance	
(0.01% THD)	
	0.72 V/8 ohms
	6.8 V/100 ohms
Power Supplies	120 V, 60 Hz (U,C)
	220 V, 50 Hz (G,W)
	240 V, 50 Hz (A, B)
	110/120/220/240 V,
	50/60 Hz (R)
Power Consumption	350 W/850 VA (C)
	350 W (U, R)
	520 W (A, G, B, W)
AC Outlets	
Switched x 2	100 W max total
Unswitched x 1	200 W max
Dimensions (W x H x D)	435 x 112 x 365 mm
	(17-1/8" x 4-7/16" x
	14-3/8")
Weight	9.1 kg (20 lbs., 7 oz.)
Specifications subject to change without notice.	
U : U.S.A. Model	
C : Canadian Model	
R : General Model	
A : Australian Model	
B : British Model	
G : European Model	
W : West Germany Model	

GENERAL ADJUSTMENTS

Before adjustment

- Make sure that the AC line is $\pm 10\%$
- Wait 5 minutes after power-on to stabilize amplifier operation

Step	Adjustment	Conditions	Location	Test Point	Value	Test Equipment
1	Main B+, B- voltage adjustment	No load	Main board 1 VR303	Between chassis ground and P1 terminal of primary board	$47.5 \pm 0.3V$	Digital voltmeter (tester)
2	Photo coupler current check*	Minimum volume, no load	Between P1 and TP3 of the primary board (if out of range, turn to VR501 and VR303 and adjust B+, B- and P1 - TP3 for rated voltages)		$1.2V \pm 0.1V$ ($2.0V \pm 0.1V$ = FEMKO, DEMKO)	same as above
3	Idling adjustment	Minimum volume	Main board 1, VR301 (L ch), VR302 (R ch)	TP3 - TP4 (L), TP1 - TP2 (R)	6.6 ± 0.5 mV	same as above
4	Output off-set check	Minimum volume		Speaker terminals	L, R within 0 ± 30 mV	same as above

* It is not necessary to check the photo-coupler current of step 2 except when replacing the photo-coupler. Also, perform steps 1 and 2 simultaneously (with two digital voltmeters).

ADJUSTMENT LOCATION DIAGRAM

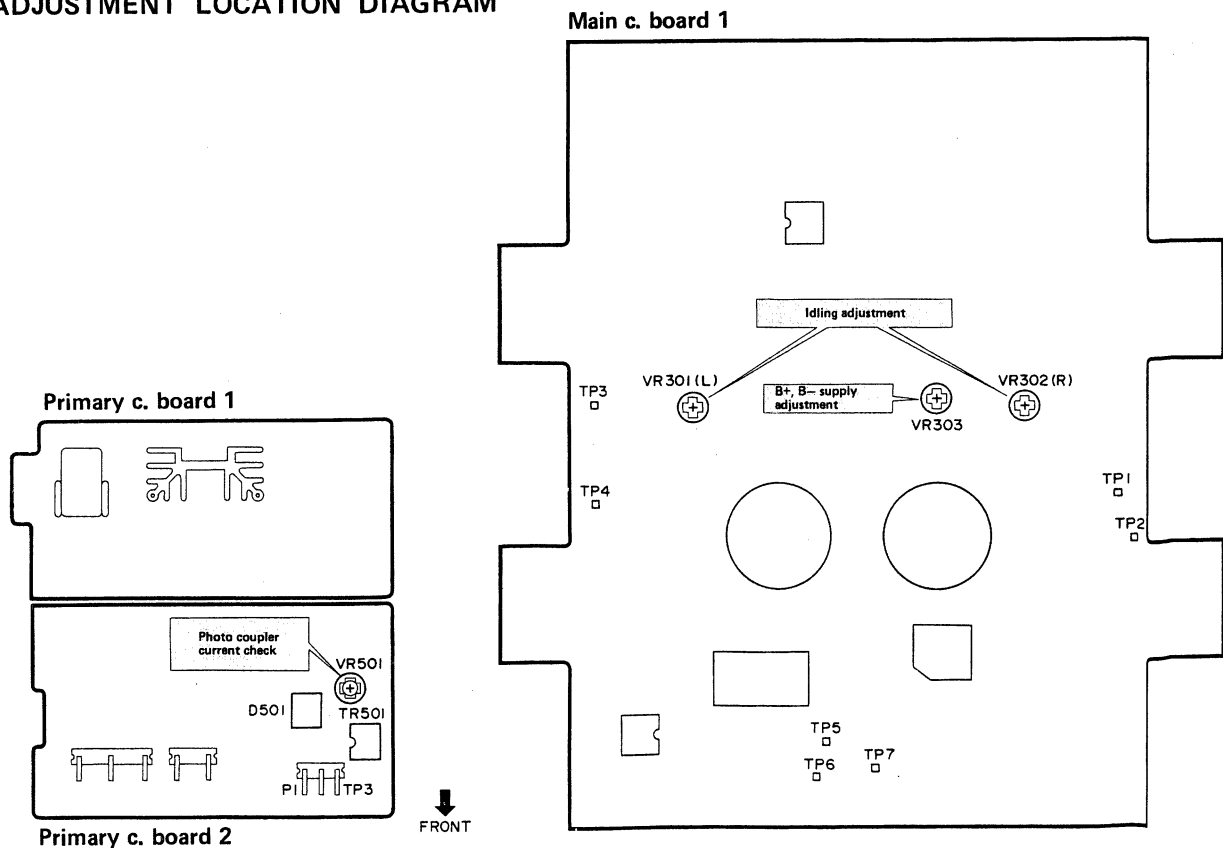

BLOCK DIAGRAM

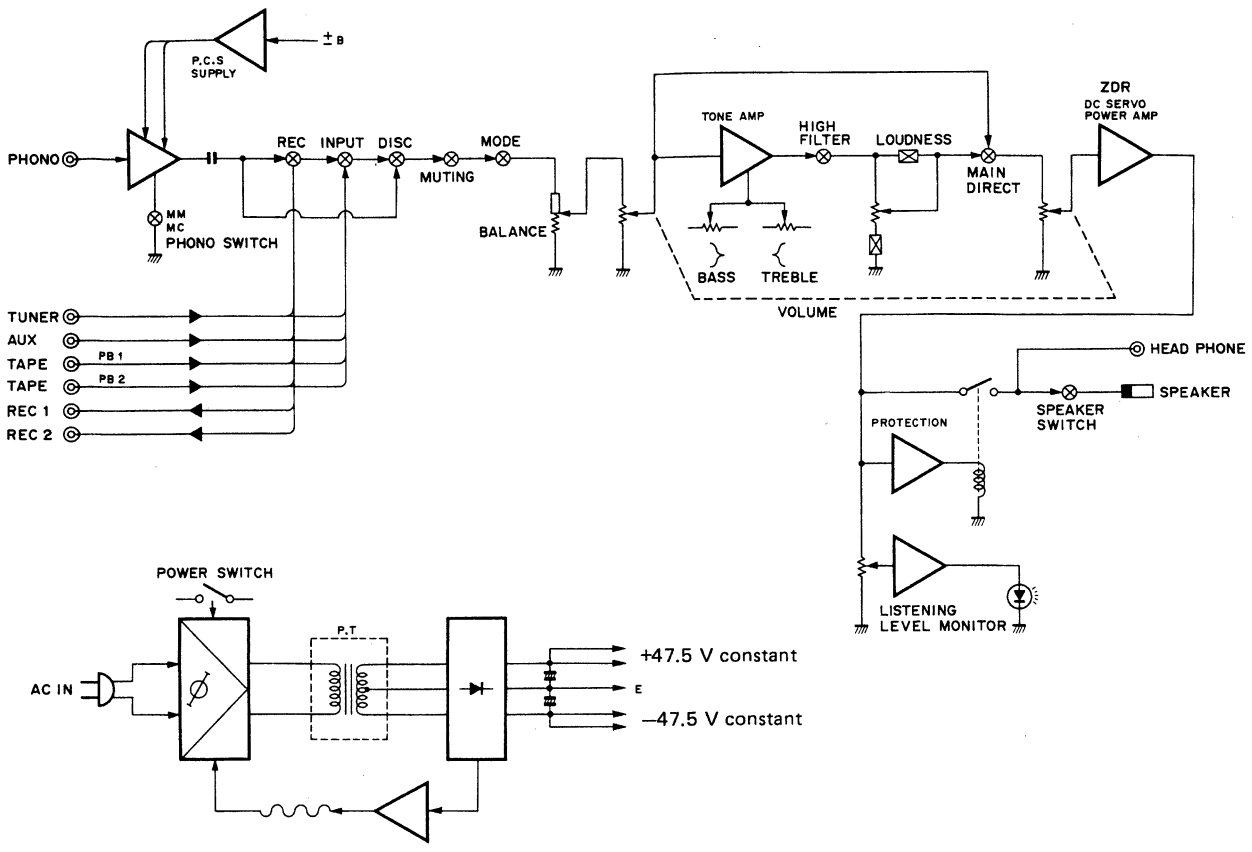

PRINTED CIRCUIT BOARD PATTERN-SIDE COMPONENTS LAYOUT

Primary c. board (Australian, British and European Models)

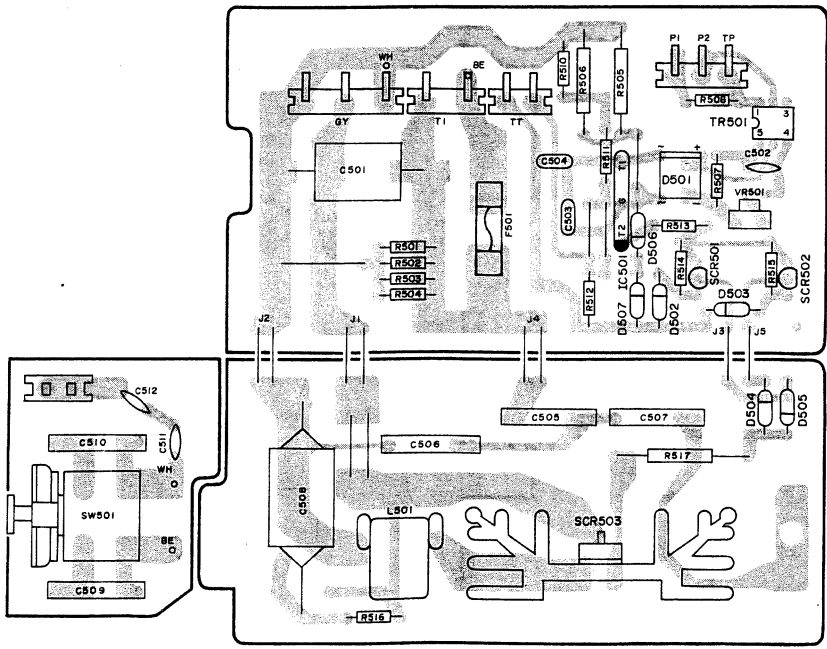

PARTS LIST

A-760 II

STEREO AMPLIFIER

■ CONTENTS	Page
■ EXPLODED VIEW(Allover)	1
■ PARTS LIST(Allover)	2
■ PARTS LIST(Circuit Board)	
Tone Control Circuit Board	4
Function Circuit Board	5
Main Circuit Board	6
Control Circuit Board	
U,C models	11
R model	12
A,G,B,W models	13

Notes

DESTINATION ABBREVIATIONS

U	U.S.A
C	CANADIAN
G	NORTH EUROPEAN
B	BRITISH
R	GENERAL
A	AUSTRALIAN
W	WEST GERMANY

004458

SINCE 1887



YAMAHA

NIPPON GAKKI CO., LTD. HAMAMATSU, JAPAN

EXPLODED VIEW(All over)

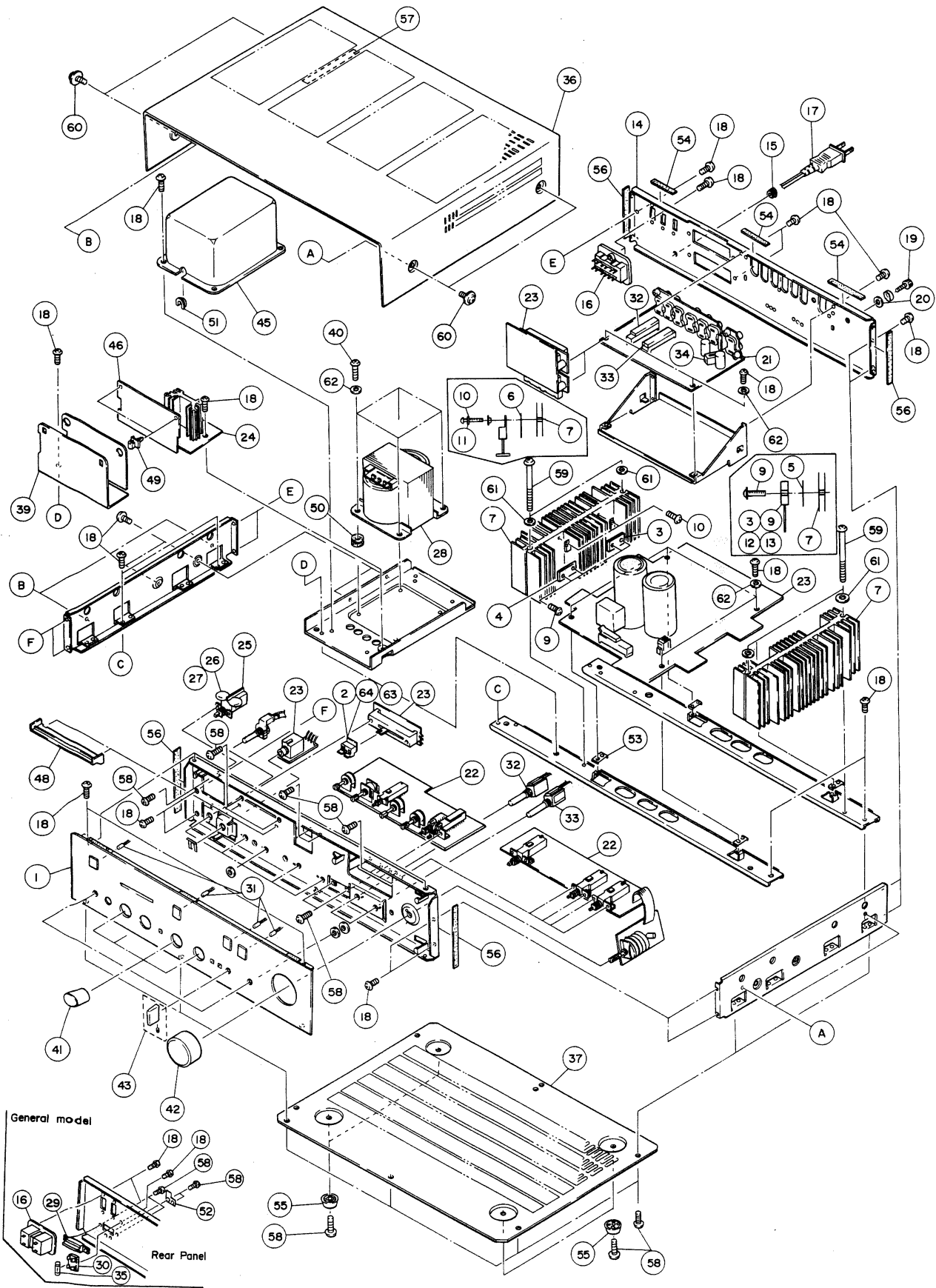

PRINTED CIRCUIT BOARD PATTERN-SIDE COMPONENTS LAYOUT

Primary c. board (U. S. A and Canadian Models)

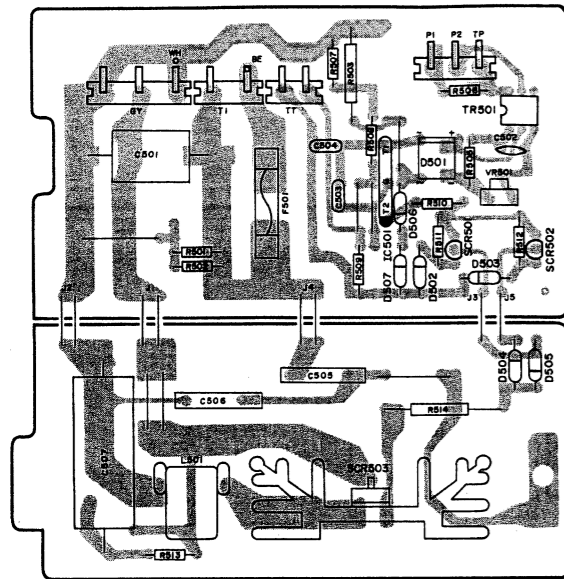

Primary c. board (General Model)

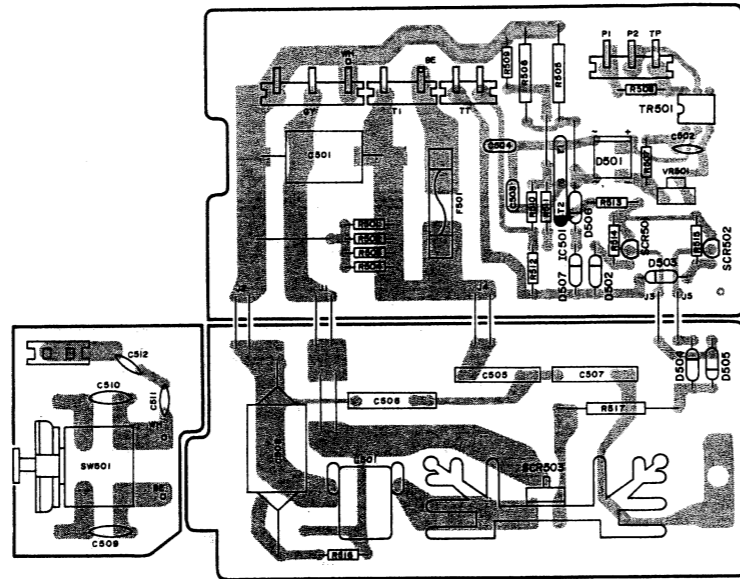

Main c. board 1

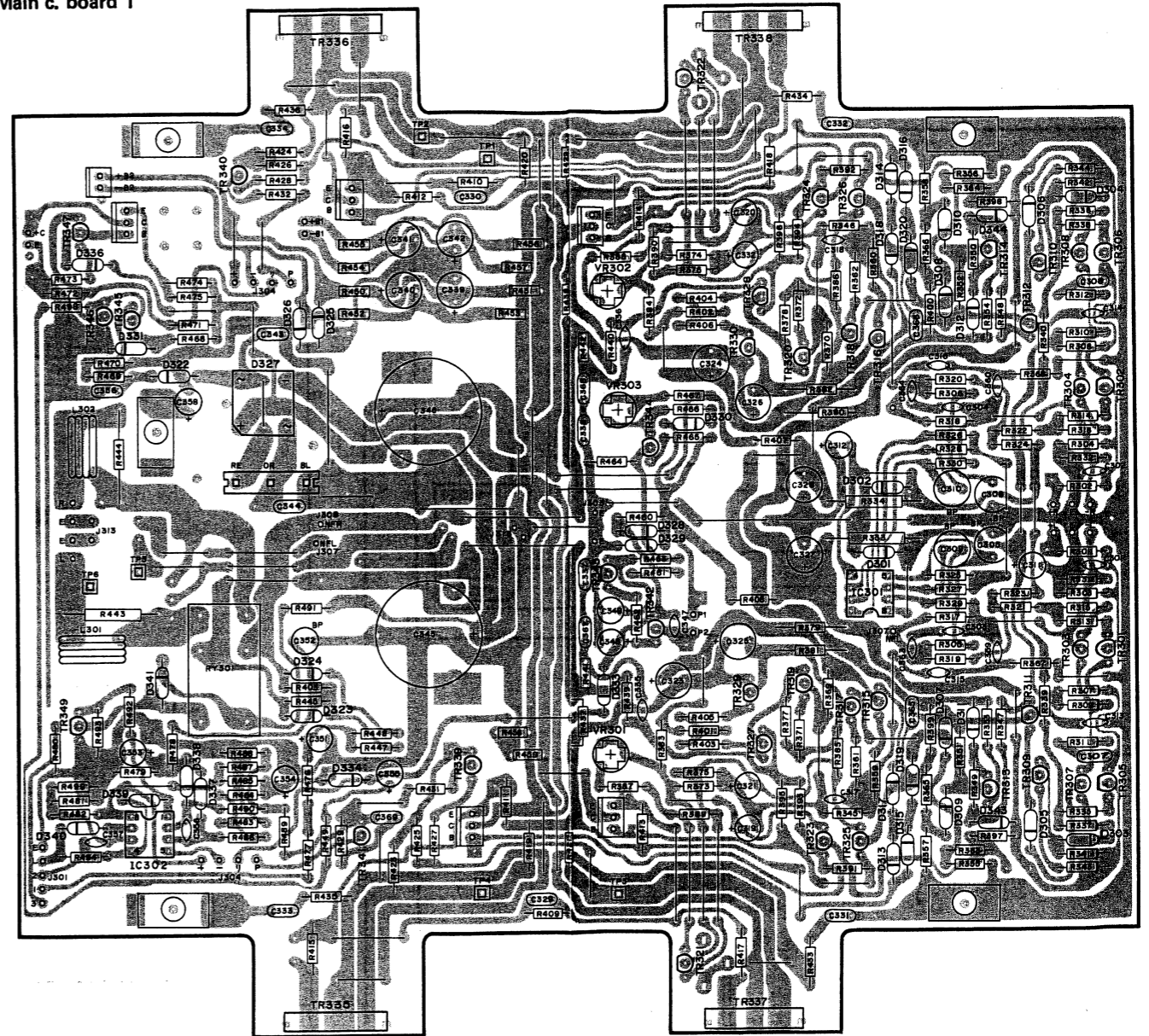

Function circuit board

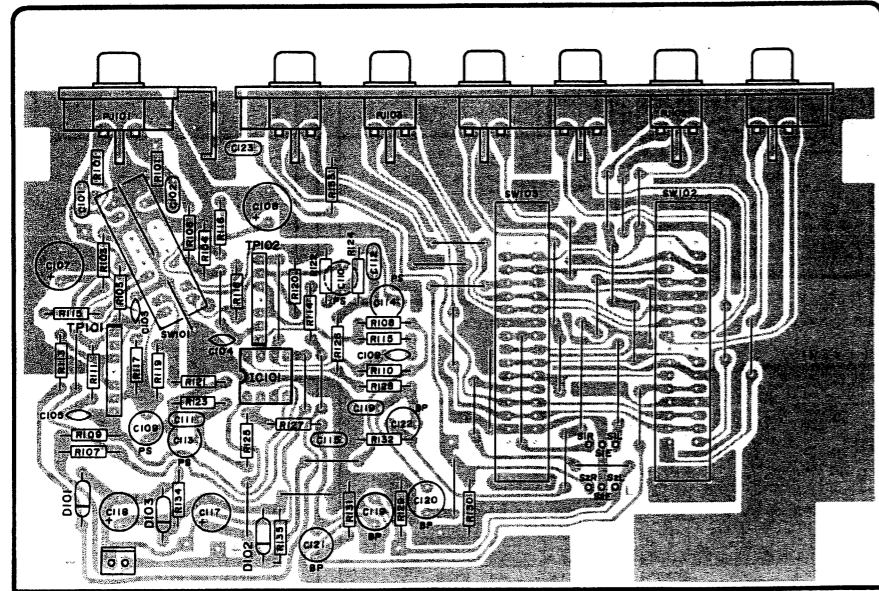

Main c. board 5

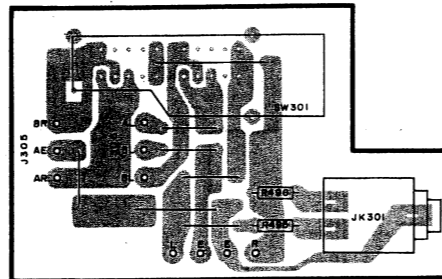

Tone control c. board 3 Tone control c. board 2

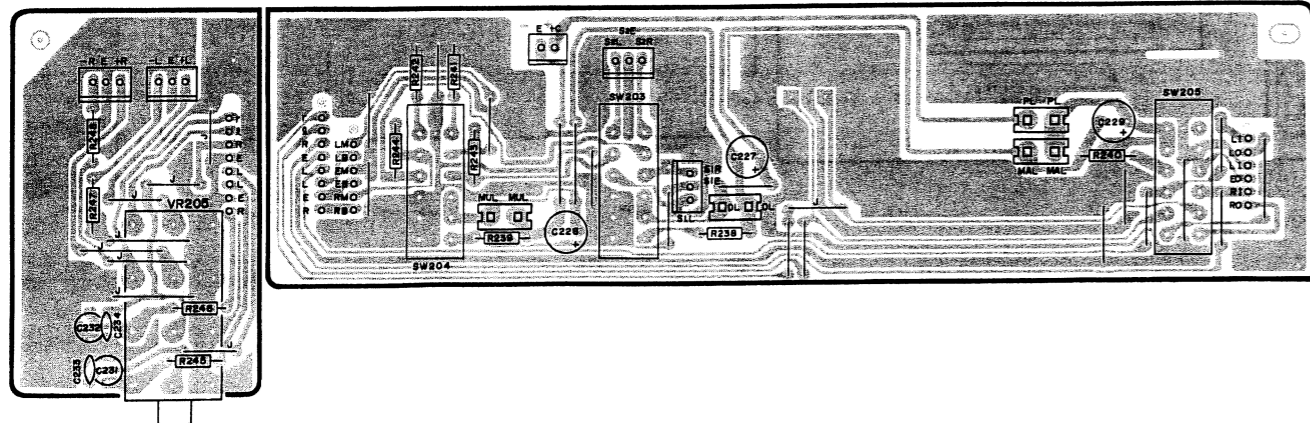

Tone control c. board 1

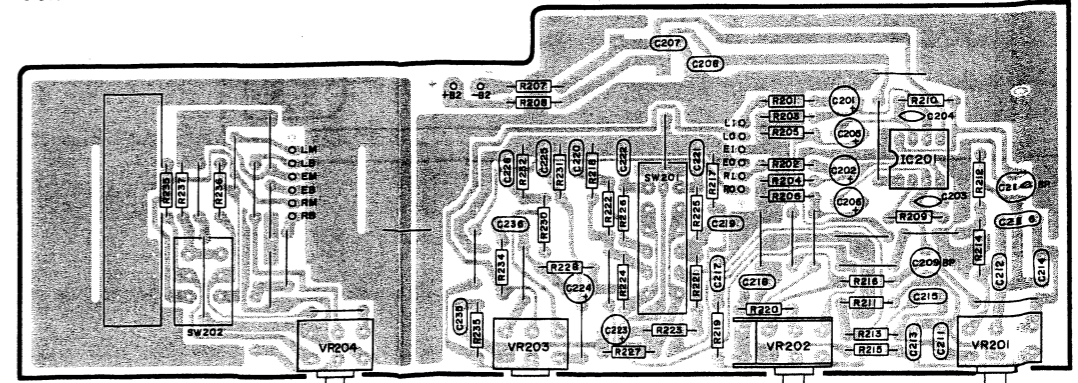

PRINTED CIRCUIT LAYOUT/WIRING

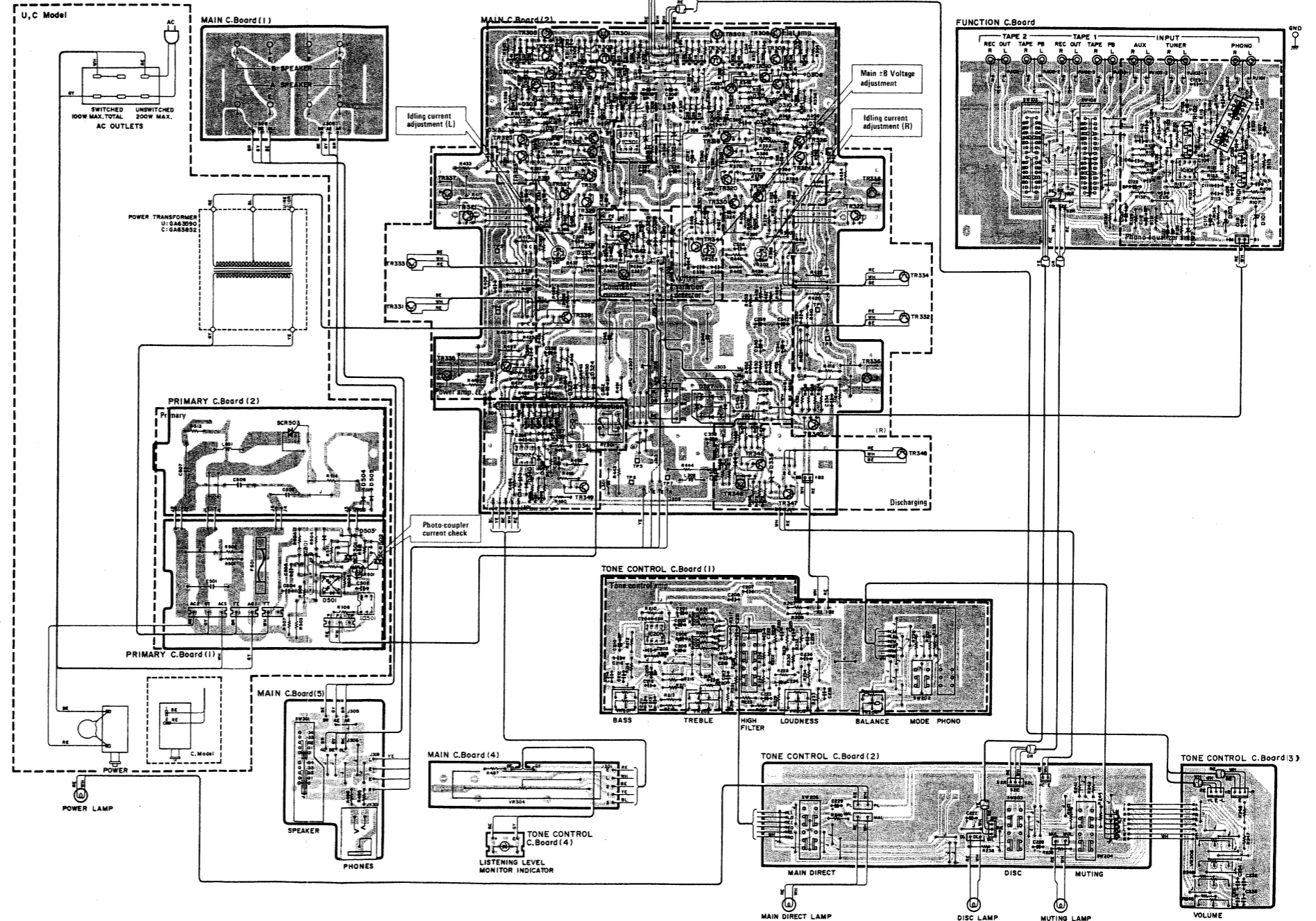
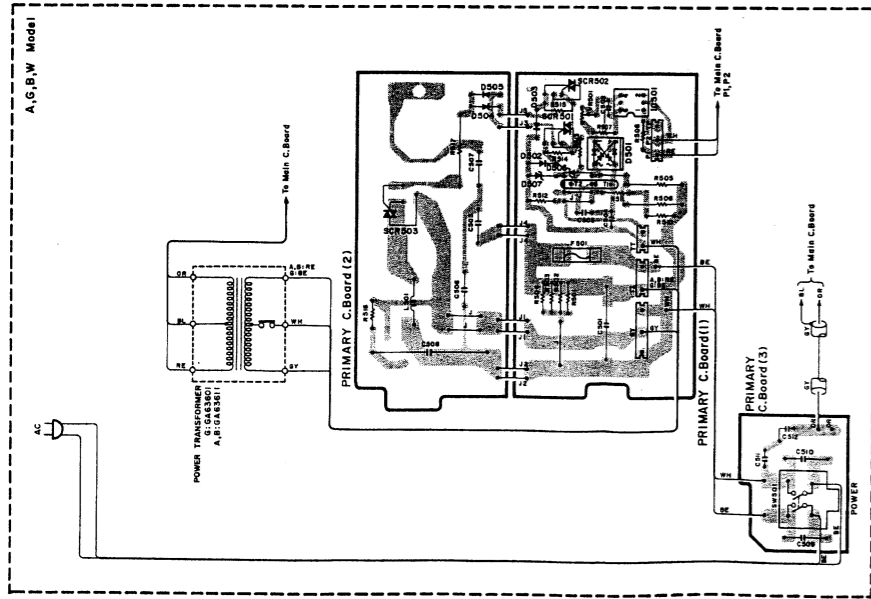
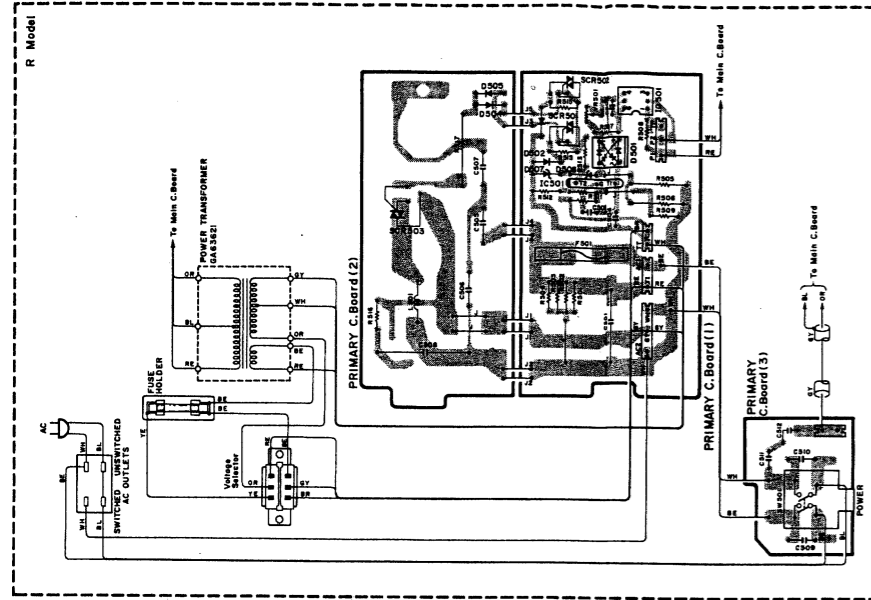

COMPLETE CIRCUIT DIAGRAM

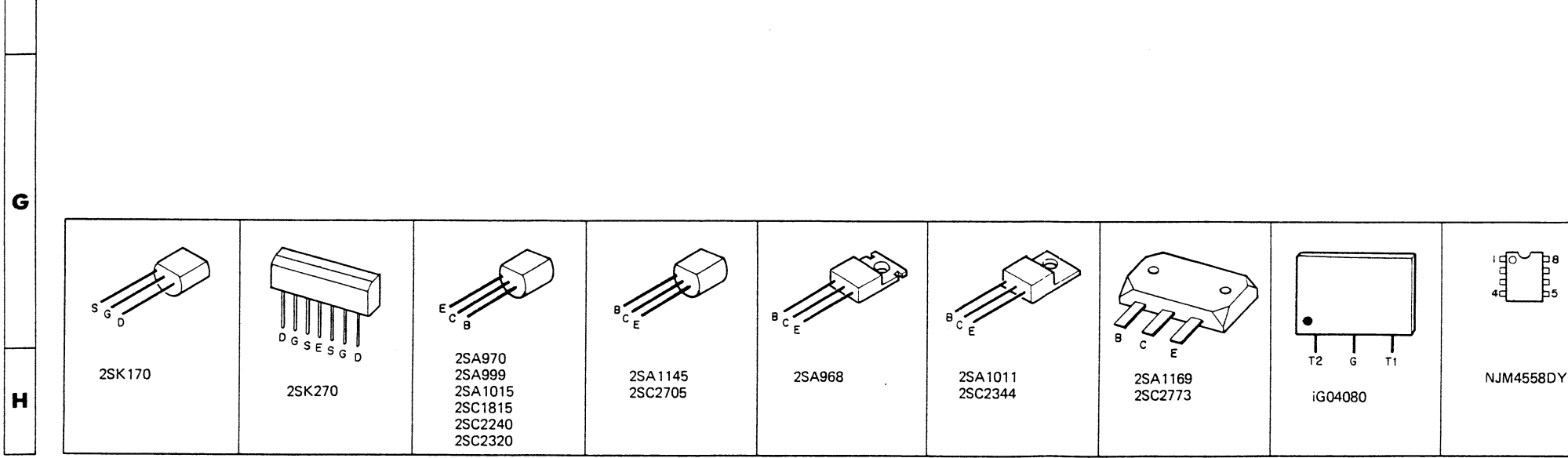
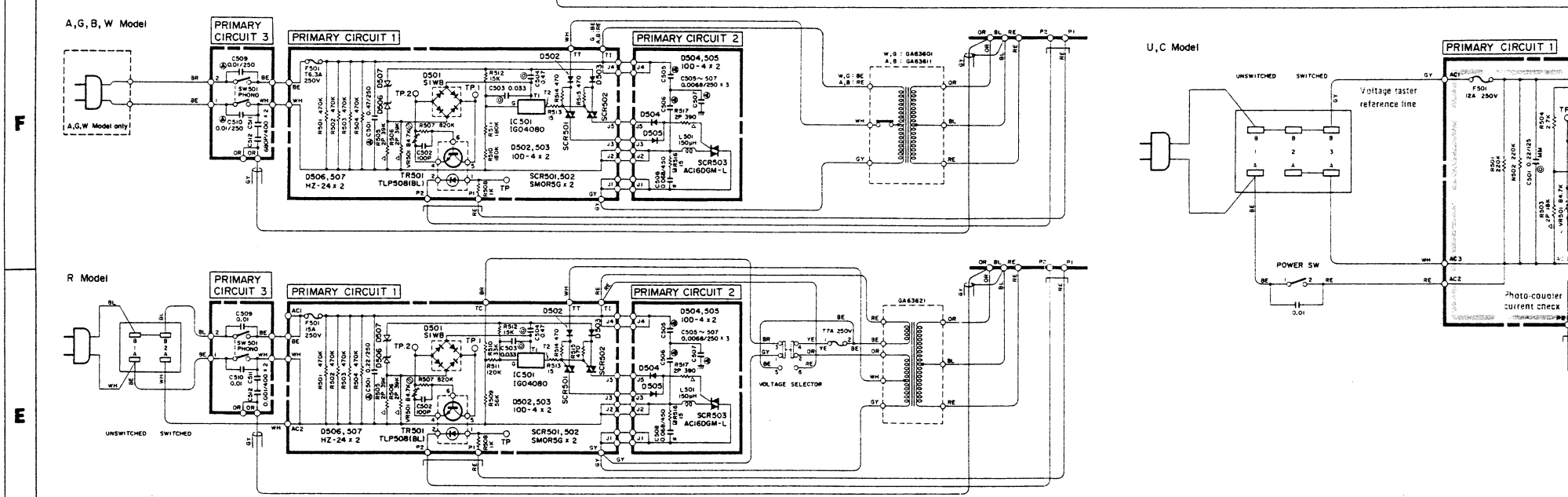
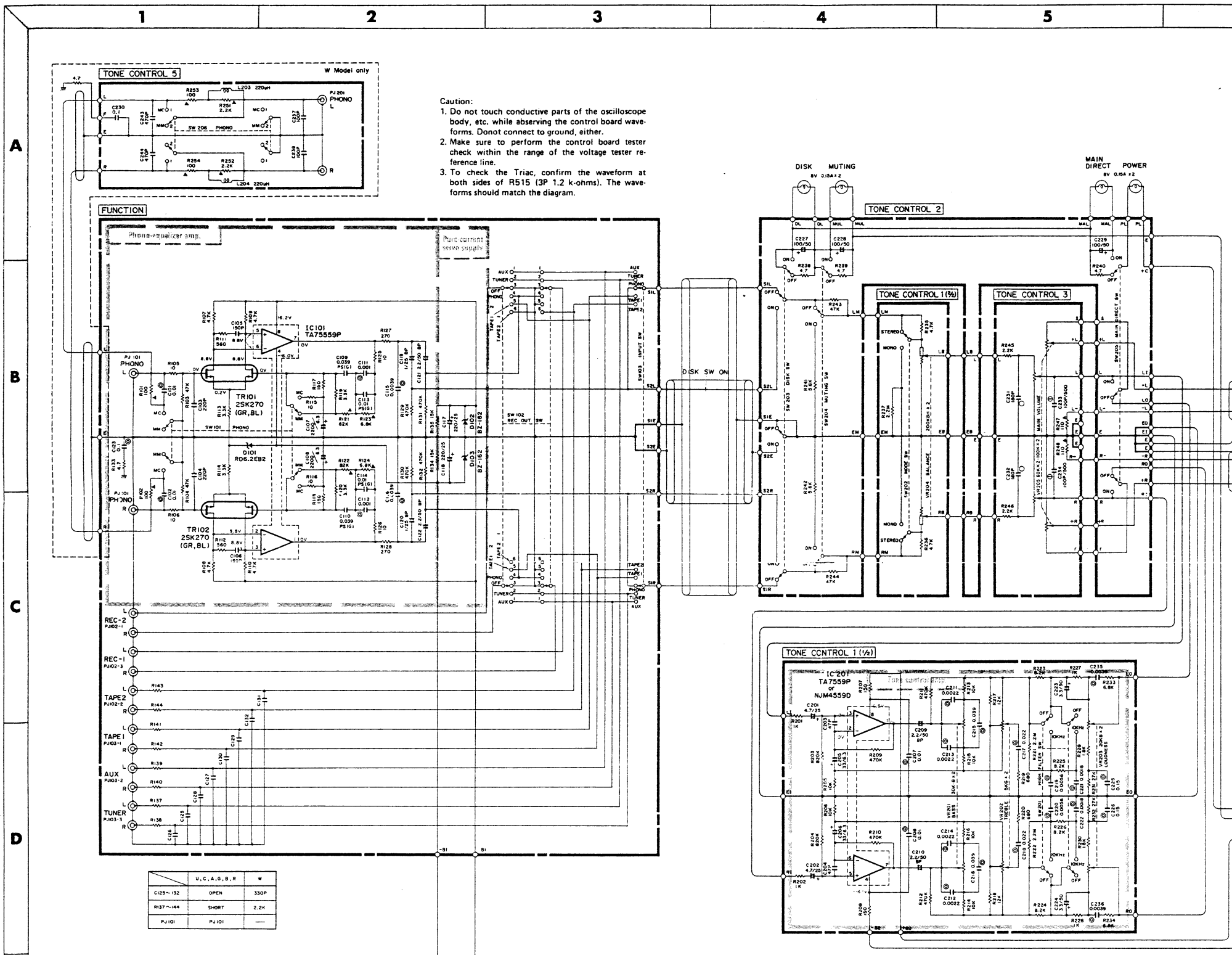

... parts of the oscilloscope
... ing the control board wave-
... ground, either.
... the control board tester
... o of the voltage tester re-
... confirm the waveform at
... P 1.2 k-ohms). The wave-
... diagram.

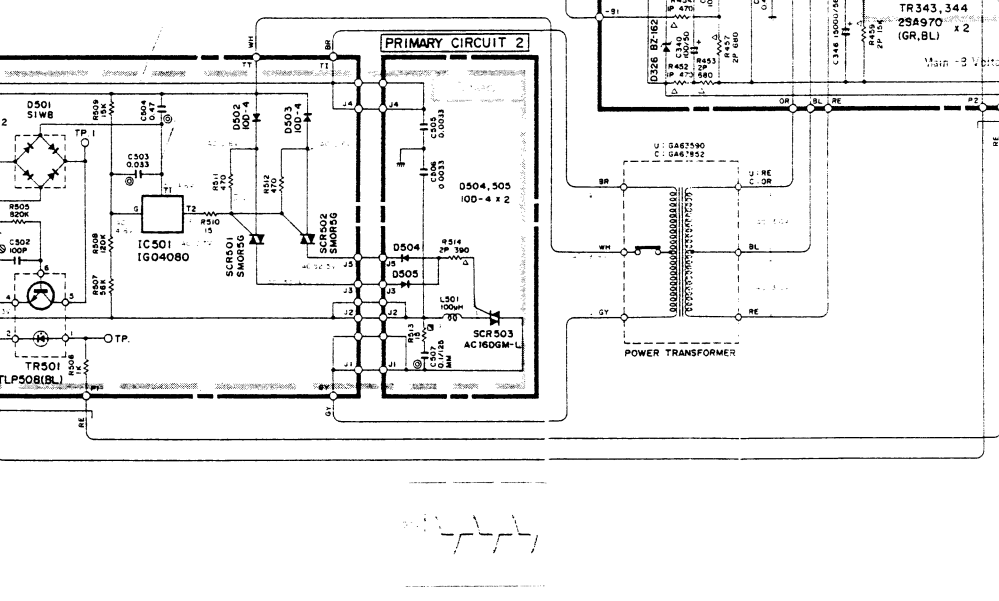
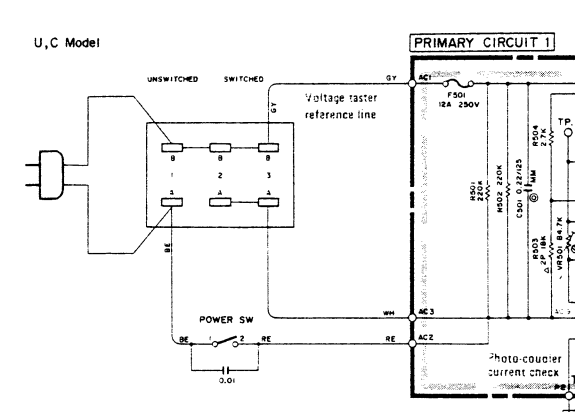
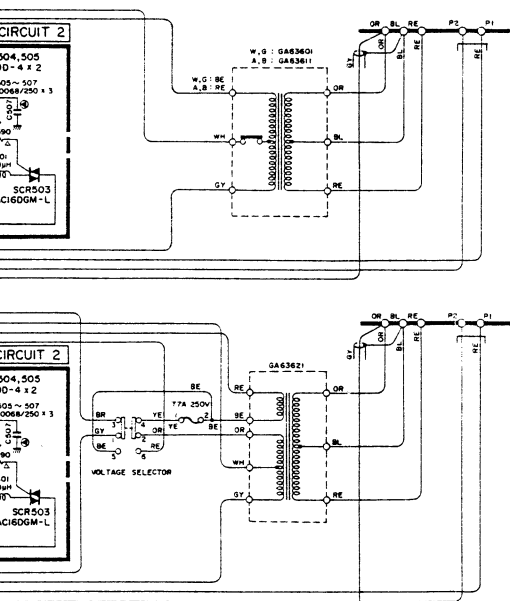
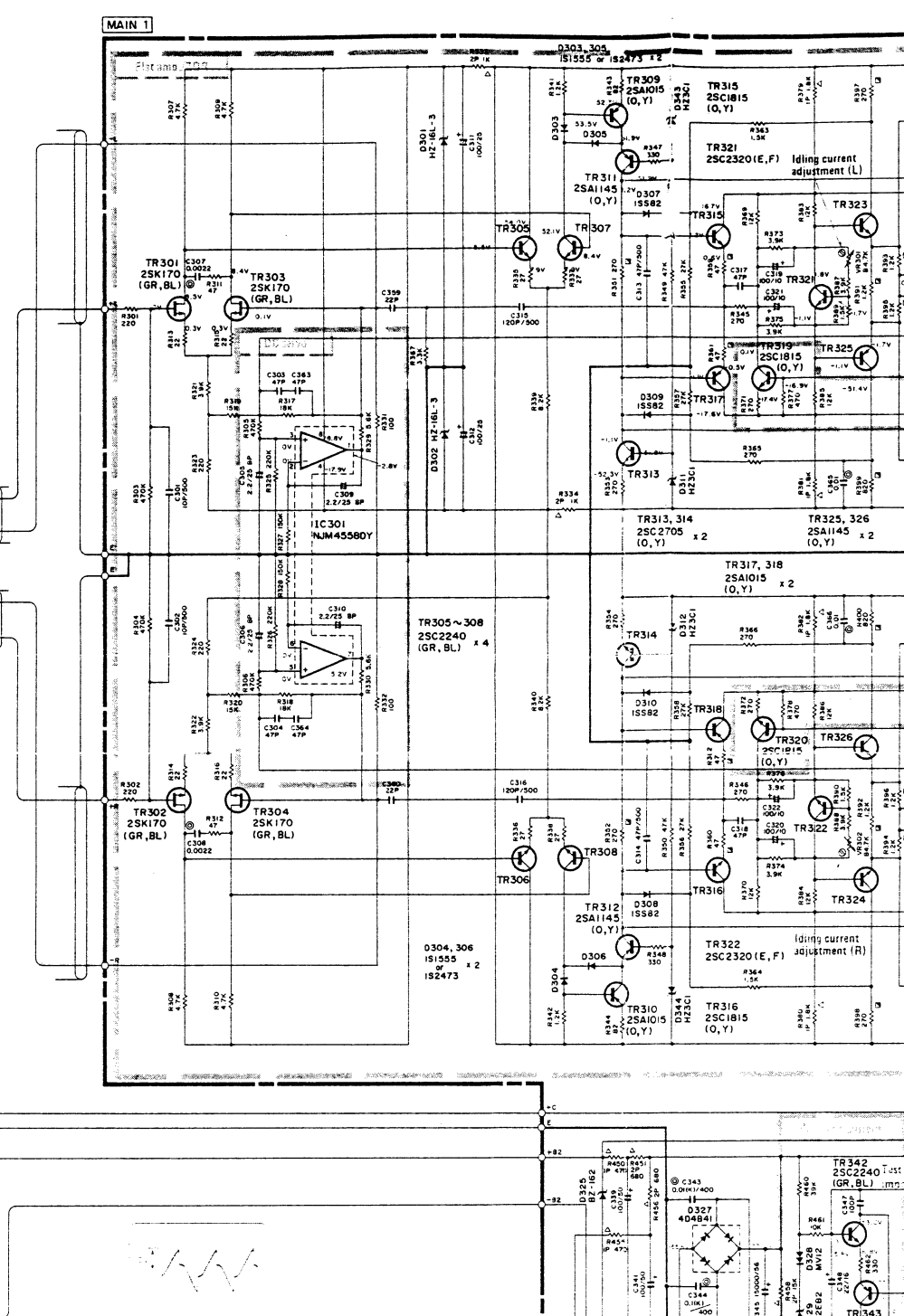
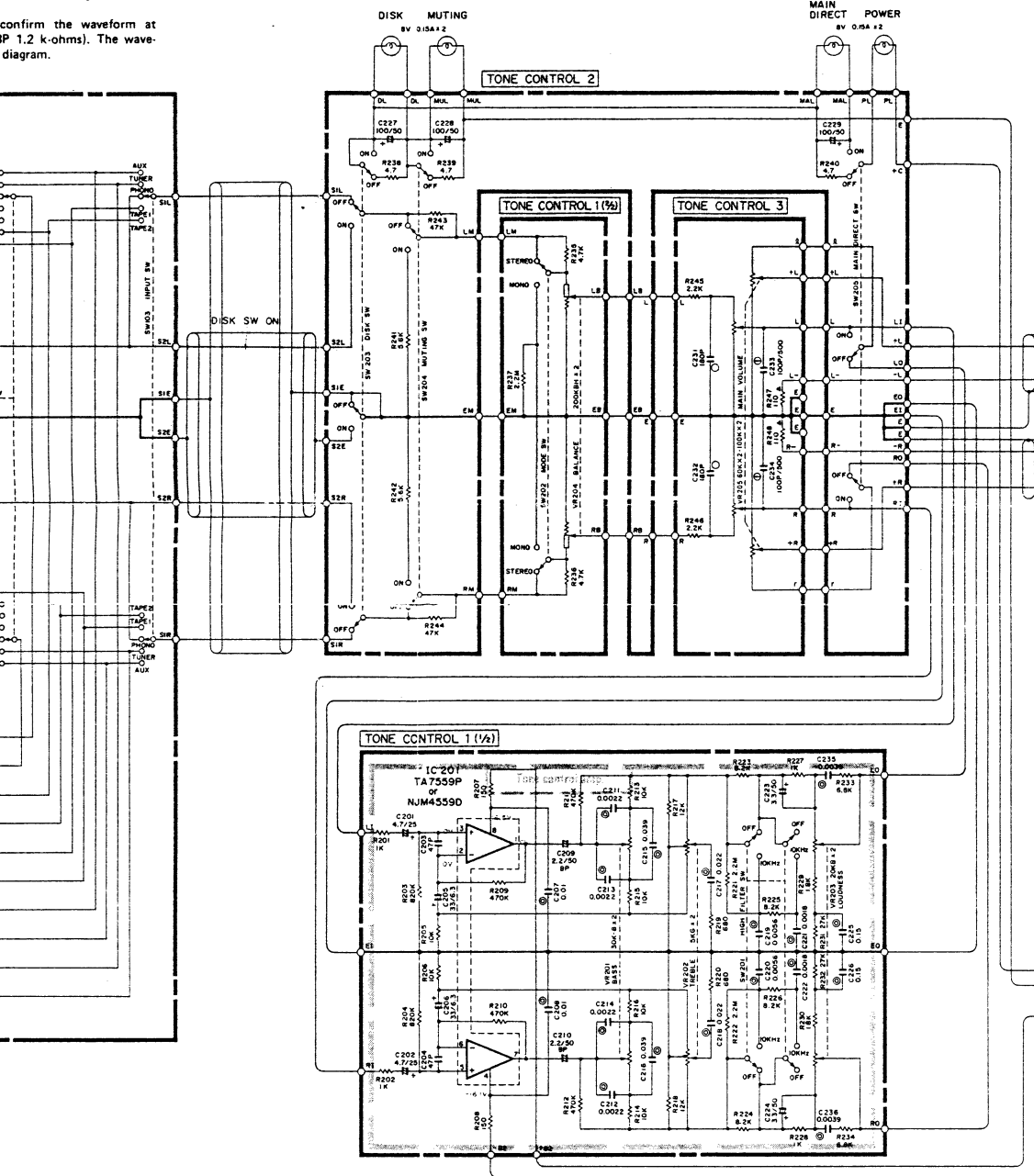

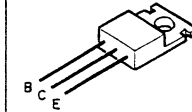
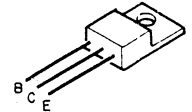
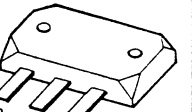
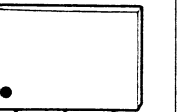
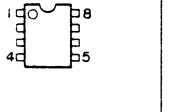
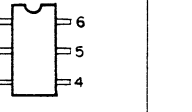
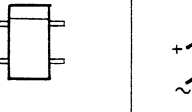
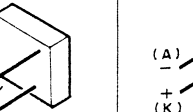
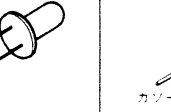
- 
2SA968
- 
2SA1011
2SC2344
- 
2SA1169
2SC2773
- 
T2 G T1
iG04080
- 
NJM4558DY
- 
TLP508
- 
S1WB
- 
4D4B41
- 
(A)
(K)
SLR-34UR

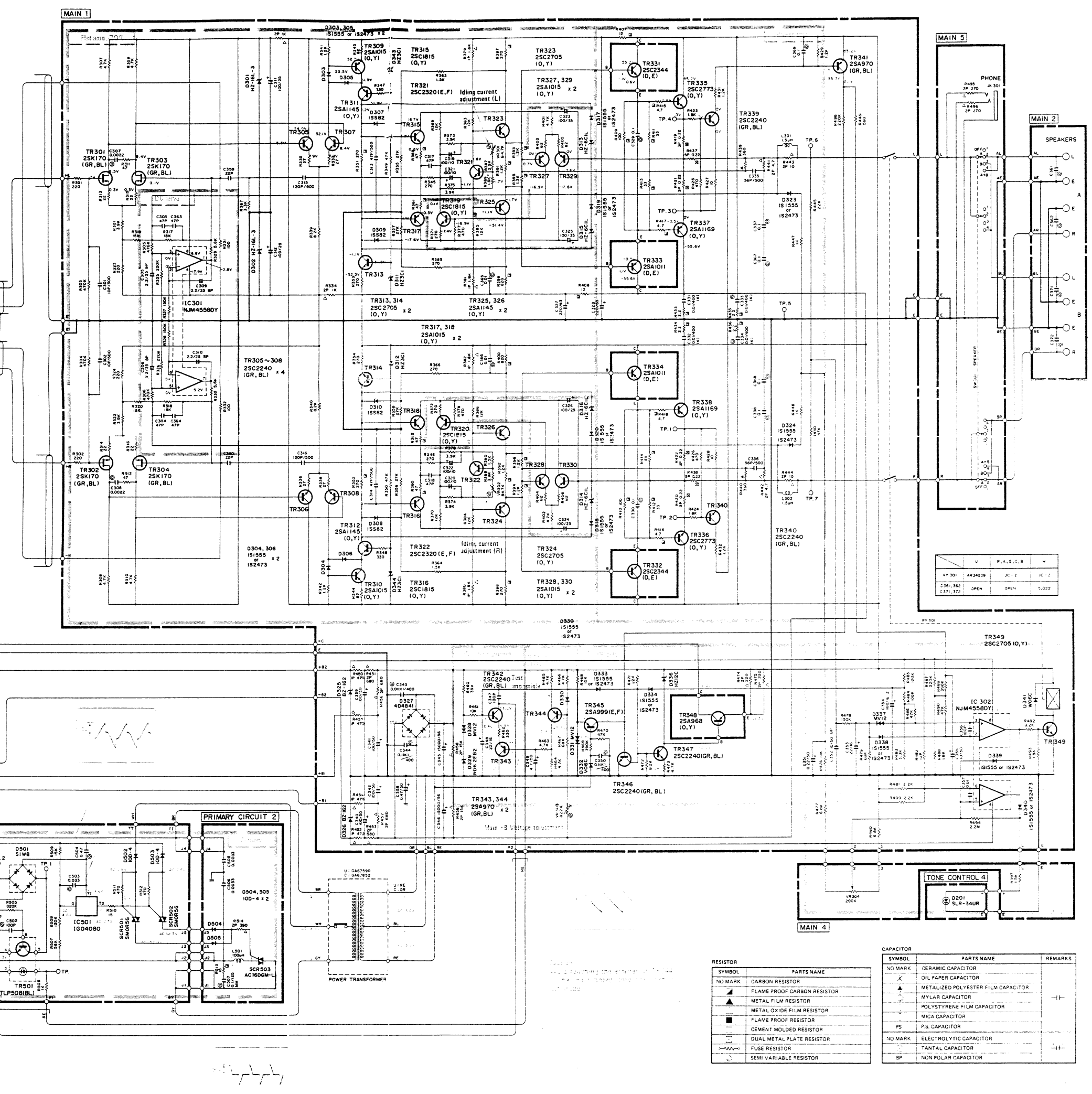

U	R, A, C, B	
RY 501	AK4229	IC-2
C361, 362	OPEN	OPEN
C371, 372	OPEN	OPEN

SYMBOL	PARTS NAME
NO MARK	CARBON RESISTOR
	FLAME PROOF CARBON RESISTOR
	METAL FILM RESISTOR
	METAL OXIDE FILM RESISTOR
	FLAME PROOF RESISTOR
	CEMENT MOLDED RESISTOR
	DUAL METAL PLATE RESISTOR
	FUSE RESISTOR
	SEMI VARIABLE RESISTOR

SYMBOL	PARTS NAME	REMARKS
NO MARK	CERAMIC CAPACITOR	
	OIL PAPER CAPACITOR	
	METALIZED POLYESTER FILM CAPACITOR	
	MYLAR CAPACITOR	
	POLYSTYRENE FILM CAPACITOR	
	MICA CAPACITOR	
PS	P.S. CAPACITOR	
NO MARK	ELECTROLYTIC CAPACITOR	
	TANTAL CAPACITOR	
BP	NON POLAR CAPACITOR	

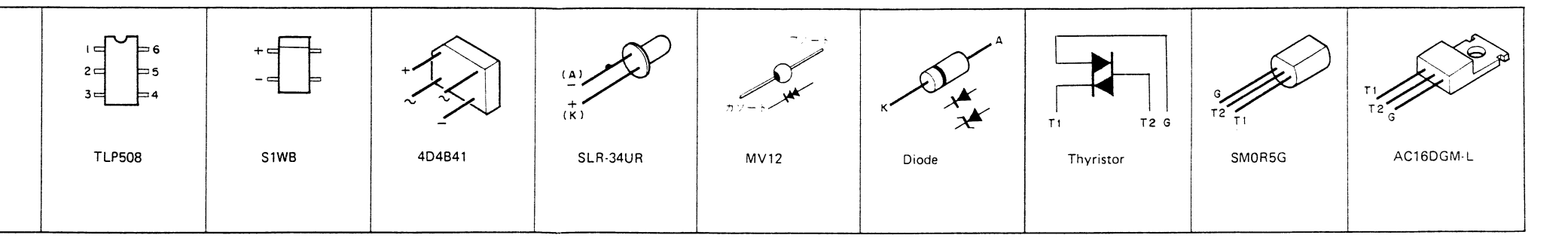

■PARTS LIST(All over)

Ref. No.	Part No.	Description	(部 品 名)	Remarks	Common model	Markets
* 1	NB:60:43:70	Front Panel Unit	フロントパネルユニット			J
* "	NB:60:43:80	"	"			W,R,U,A,G,C,B
* 2	NB:60:42:90	Knob Ass'y	ツマミ Ass'y			
3	iA:11:69:00	Transistor	2SA1169(O,Y)	トランジスタ		
4	iC:27:73:00	"	2SC2773(O,Y)	"		
5	iL:00:02:70	Mica Base	AC-229	マイカベース		
6	iL:00:06:00	"	MT-200	"		
* 7	BA:08:25:30	Heat Sink		放熱板		
8	CB:07:28:80	Bush		絶縁ブッシュ		
9	Ei:33:01:20	Bind Head Tapping Screw	3×12(FCM3-B ϕ)	鉄バインドタッピングネジ		
* 10	ED:82:61:00	Bind Head Screw	M2.6×10	鋼バインド小ネジ		
* 11	EV:20:32:60	Spring Washer	M2.6(FCM3-B ϕ)	スプリングワッシャー		
12	iA:11:69:00	Transistor	2SA1169(O,Y)	トランジスタ		
13	iC:27:73:00	"	2SC2773(O,Y)	"		
* 14	AA:61:05:10	Rear Panel (J)		リヤパネル		J
* "	AA:61:05:30	" (R)		"		R
* "	AA:61:05:20	" (U,C)		"		U,C
* "	AA:61:05:50	" (A,B)		"		A,B
* "	AA:61:05:40	" (G) (W)		"		G,W
15	CB:07:27:50	Cord Stopper	SR-4N-4	コードストッパー		
16	LB:40:10:00	AC Soket	M7025-A(2連)	ACアウトレット		R
"	LB:60:48:10	"	M7026-B(3連)	"		J,U
"	LB:60:43:10	"	M7017-A	"		C
17	MG:00:07:80	AC Cord	Black 2m 6A 250V	電源コード		R
"	MG:00:13:60	"	" 2m 13A 125V	"		U,C
"	MG:00:09:10	"	" 2m 6A 250V	"		W,G
"	MG:00:09:20	"	Gray 2.5m 7.5A 250V	"		A
"	MG:00:10:00	"	Black 2m 6A $\frac{300V}{500}$	"		B
18	EN:33:00:10	Bind Head Tapping Screw	3×8(FCM3-B ϕ)	鉄バインドタッピングネジ		
19	EZ:00:14:00	Screw, for Ground Terminal	$\phi 3.8 \times \phi 10 \times 0.8$ (FNMS-3g)	アース端子ネジ		
20	EV:90:13:60	Sems Plain Washer		鉄セムス平座金		
* 21	NA:07:85:70	Function Circuit Board		ファンクションシート		J,R,A,G,C,B
* "	NA:07:85:80	"		"		U
* "	NA:07:96:30	"		"		W
* 22	NA:07:96:20	Tone Control Circuit Board		トーンコントロールシート		W
* "	NA:07:86:00	"		"		U
* "	NA:07:95:10	"		"		R,A,G,C,B
* 23	NA:07:96:40	Main Circuit Board		メインシート		W
* "	NA:07:86:20	"		"		R,A,G,B
* "	NA:07:86:30	"		"		U
* "	NA:07:86:40	"		"		C
* 24	NA:07:86:60	Control Circuit Board		制御シート		R
* "	NA:07:86:70	"		"		U,C
* "	NA:07:86:80	"		"		W,A,G,B
25	KA:80:23:10	Push Switch	SDV3P E5A 125V	ブッシュSW		J
"	KA:80:23:20	"	SDV3P TV-5	"		U
"	KA:80:24:30	"	Z-33-6 TV-8	"		C
26	Fi:16:41:00	Ceramic Capacitor	0.01 150VACE(P)	セラコン		J
"	Fi:34:41:00	"	0.01 MY(DE)	"		U,C
27	CB:09:52:60	Cover for Capacitor	SB-0833	コンデンサーカバー丸型		U
"	CB:60:08:10	Cover for Capacitor	HY-0102	コンデンサーカバー半丸型		J

* : New Parts (新部品)

Ref. No.	Part No.	Description	(部 品 名)	Remarks	Common model	Markets
28	GA:63:59:00	Power Transformer	電源トランス		A-760	U
"	GA:63:60:10	"	"		"	W,G
"	GA:63:61:10	"	"		"	A,B
"	GA:63:85:20	"	"		"	C
"	GA:64:43:20	"	"		"	J
"	GA:63:62:10	"	"		"	R
29	KA:40:07:40	Slide Switch	ESD-3992	スライドSW		R
30	LB:20:13:00	Fuse Holder		ヒューズホルダー		R
* 31	JB:00:11:00	Pilot Lamp Lead Type	8V 0.15A	パイロットランプリード式		
* 32	KA:90:30:30	Remote Rotary Switch	CONTROL+wire	リモートロータリーSW		
33	KA:90:16:50	"	"	"		
34	KA:90:16:70	Remote Push Switch	Wire Section	リモートブッシュSW		R,U,A,G,C,B
"	KA:90:31:80	"	"	"		W
35	KB:00:13:00	Fuse	T7A 250V	ヒューズタイラッシュ		R
36	AA:60:35:50	Top Cover		トップカバー	A-760	
37	AA:60:36:20	Bottom Cover		ボトムカバー	"	
39	AA:60:41:90	Holder,C+S		C+Sホルダー		
40	AA:60:38:50	Tight Screw with Steps		段付ネジ		
41	BA:07:72:80	Knob, (TONE CONTROL)		T-Cツマミ	CR-240	
* 42	BA:08:25:40	" (VOLUME)		VOL "		
43	BA:07:94:60	" (Switch)		SW "	A-760	
45	BA:07:95:70	Cover, Power Transformer		トランスカバー		J,R,A,G,B
"	BA:07:99:10	"		"		U,C
46	CB:60:24:30	Isolation Plate		絶縁板		J
"	CB:60:46:10	"		"		R,U,A,G,C,B
47	CB:60:29:20	Speacer, Switch		SWスペーサー		C
48	CB:09:97:40	Slit Cover		スリットカバー		
49	CB:09:98:30	Support,P.C		P-Cサポート		
50	CB:09:99:10	Rubber,Anti Vibration		防振ゴム		
51	CB:60:05:70	Bush		リードブッシュ		
52	CB:60:14:40	Stopper,Voltage Selector		VSストッパー		R
* 53	BB:06:97:90	Speacer		スペーサー		J
54	CB:09:98:10	Rubber,Anti Vibration		防振ゴム		
55	CB:09:86:00	Leg		脚		
* 56	CB:60:43:80	Damper		ダンパー		
57	CB:60:05:80	Tape,Anti Vibration		防振テープ		
58	ED:33:00:60	Bind Head Screw	3×6(FCM3-B ϕ)	鉄バインド小ネジ		
* 59	EA:34:07:50	Pan Head Screw	4×75(")	鉄ナベ小ネジ		
60	EZ:00:08:10	B.W Head Screw	4×8 ϕ 10(FNM3-3g)	鉄ブレーワッシャーヘッド小ネジ		
* 61	EV:21:84:00	Flat Washer	$\phi 4$	鋼平座金(小形丸)		
62	EV:42:90:30	Toothed Lock Washer	M3(FCM3-B ϕ)	外歯付歯付座金		
63	Mi:06:99:50	Wire Cord	L=80 2P	リボンワイヤー		
64	iF:00:18:90	LED	SLR-34UR(Red)	LED (赤)		
		Accessories Assembly		付属品 Ass'y		
	TX:90:09:30	Hexagonal Wrench	1.5 ϕ	六角レンチ		

* : New Parts (新部品)

■ PARTS LIST(Circuit Board)

Ref. No.	Part No.	Description	(部 品 名)	Remarks	Common model	Markets
*	NA:07:85:70	Tone Control Circuit Board	トーンコントロールシート			R,A,G,C,B
*	NA:07:86:00					U
C201	UW:84:64:70	Electrolytic Capacitor	4.7μF 25V	ケミコン		
C202	FG:41:14:70	Ceramic Capacitor	47PF 50V(K)	セラコン		
C203	UW:81:73:30	Electrolytic Capacitor	33μF 6.3V	ケミコン		
C206	UA:25:41:00	Mylar Capacitor	0.01μF 50V(J)	マイラーコン		
C207	FM:11:62:20	Electrolytic Capacitor	2.2μF 50V	B・Pコン		
C208	UA:25:32:20	Mylar Capacitor	0.0022μF 50V(J)	マイラーコン		
C209	UA:25:43:90	"	0.039μF "	"		
C210	FA:15:42:20	"	0.022μF "	"		
C211	UA:25:35:60	"	0.0056μF "	"		
C215	UA:25:31:80	"	0.0018μF "	"		
C216	UW:86:63:30	Electrolytic Capacitor	3.3μF 50V	ケミコン		
C217	FA:15:51:50	Mylar Capacitor	0.15μF 50V(J)	マイラーコン		
C218	UW:86:81:00	Electrolytic Capacitor	100μF 50V	ケミコン		
C219	FD:61:21:80	Polystyrene Film Capacitor	180PF 50V(K)	スチコン		
C220	FU:35:21:00	Mica Capacitor	100PF FE500V	マイカコン		
C221	FA:15:33:90	Mylar Capacitor	0.0039μF 50V(J)	マイラーコン		
C222	HJ:35:61:00	Carbon Resistor	1KΩ RD25	カーボン抵抗		
C223	HJ:35:88:20	"	820KΩ "	"		
C224	HJ:35:71:00	"	10KΩ "	"		
C225	HJ:35:51:50	"	150Ω "	"		
C226	HJ:35:84:70	"	470KΩ "	"		
C227	HJ:35:71:00	"	10KΩ "	"		
C228	HJ:35:71:20	"	12KΩ "	"		
C229	HJ:35:56:80	"	680Ω "	"		
C230	HJ:35:92:20	"	2.2MΩ "	"		
C231	HJ:35:68:20	"	8.2KΩ "	"		
C232	HJ:35:61:00	"	1KΩ "	"		
C233	HJ:35:61:80	"	1.8KΩ "	"		
C234	HJ:35:72:70	"	27KΩ "	"		
C235	HJ:35:66:80	"	6.8KΩ "	"		
C236	HJ:35:64:70	"	4.7KΩ "	"		
C237	HJ:35:92:20	"	2.2MΩ "	"		
C238	HJ:35:34:70	"	4.7Ω "	"		
C239	HJ:35:65:60	"	5.6KΩ "	"		
C240	HJ:35:74:70	"	47KΩ "	"		
C241	HJ:35:62:20	"	2.2KΩ "	"		
C242	HU:57:51:10	Metal Film Resistor	110Ω	金属皮膜抵抗		
C243	HS:31:16:00	Vriable Resistor	30KB×2(¹¹ click t=30)	VR16形 1軸 2連		
C244	HS:31:16:10	"	5KG×2 (with CT) t=30	"		
C245	HS:31:15:90	"	20KB×2 (¹¹ click t=30)	"		
C246	HS:31:15:80	"	200KBH×2 (")	"		
C247	HS:32:06:70	"	60K×2/100K×2	VR24形		
C248	iG:03:96:00	IC	NJM4559D	IC	Inter-changeable	
C249	iG:05:44:00	"	TA75559P	"		
C250	KA:80:16:80	Push Switch	4 Unit S	プッシュSW単連S		
C251	KA:90:15:90	Push Switch with Remote	2-2	リモート付プッシュSW 2連		
C252	KA:80:16:90	Push Switch	4 Unit NS	プッシュSW単連NS		
C253	LB:30:07:30	2.5 Pitch Base Pin	3P	2.5ピッチベースピン		
C254	LA:00:21:10	Wrapping Terminal	Type-i	ラッピング端子板		

* : New Parts (新部品)

Ref. No.	Part No.	Description	(部 品 名)	Remarks	Common model	Markets
*	NA:07:85:70	Function Circuit Board	ファンクションシート			J,R,A,G,C,B
*	NA:07:85:80					U
*	NA:07:96:30					W
C101	UA:25:41:00	Mylar Capacitor	0.01μF 50V(J)	マイラーコン		
C102	FG:41:22:20	Ceramic Capacitor	220PF 50V(K)	セラコン		
C103	FG:41:21:50	"	150PF "	"		
C104	FV:81:92:20	Electrolytic Capacitor	2200μF 6.3V	プラスチックケミコン		
C105	FT:76:43:90	Polypropylene Film Capacitor	0.039μF 50V(G)	PSコン		
C106	UA:25:31:00	Mylar Capacitor	0.001μF 50V(J)	マイラーコン		
C107	FT:76:41:00	Polypropylene Film Capacitor	0.01μF 50V(G)	PSコン		
C108	FA:15:33:90	Mylar Capacitor	0.0039μF 50V(J)	マイラーコン		
C109	FV:84:82:20	Electrolytic Capacitor	220μF 25V	プラスチックケミコン		
C110	FZ:00:30:80	"	1μF 25V	B・Pプラスチックケミコン		
C111	FM:11:62:20	"	2.2μF 50V	BPコン		
C112	UA:25:51:00	Mylar Capacitor	0.1μF 50V(J)	マイラーコン		
C113	FG:41:23:30	Ceramic Capacitor	330PF 50V(K)	セラコン		W
C114	HU:07:51:00	Metal Film Resistor	100Ω RE35(F)	金属皮膜抵抗		
C115	HJ:35:74:70	Carbon Resistor	47KΩ RD25	カーボン抵抗		
C116	HJ:35:41:00	"	10Ω "	"		
C117	HJ:35:64:70	"	4.7KΩ "	"		
C118	HJ:35:55:60	"	560Ω "	"		
C119	HJ:35:63:30	"	3.3KΩ "	"		
C120	HJ:35:41:00	"	10Ω "	"		
C121	HJ:35:51:50	"	150Ω "	"		
C122	HJ:35:63:30	"	3.3KΩ "	"		
C123	HU:57:78:20	Metal Film Resistor	82KΩ SN14K2E(F)	金属皮膜抵抗		
C124	HU:57:66:80	"	6.8KΩ "	"		
C125	HJ:35:41:00	Carbon Resistor	10Ω RD25	カーボン抵抗		
C126	HJ:35:52:70	"	270Ω "	"		
C127	HJ:35:84:70	"	470KΩ "	"		
C128	HJ:35:34:70	"	4.7Ω "	"		
C129	HJ:35:71:50	"	15 KΩ "	"		
C130	HJ:35:62:20	"	2.2KΩ "	"		W
C131	IE:10:27:00	Dual FET	2SK270(GR,BL)	デュアルFET		
C132	iF:00:14:70	Zener Diode	RD6.2EB2	ツェナーダイオード		
C133	iF:00:21:20	"	BZ-162	"		
C134	iG:05:44:00	IC	TA75559P	IC		
C135	KA:90:16:80	Remote Push Switch	4 Circuit 2point	リモートプッシュSW		
C136	KA:90:12:30	Remote Rotary Switch	4 Circuit 6Point	リモートロータリーSW		
C137	LB:20:17:30	Pin Jack	2P	2Pピンジャック		
C138	LB:60:19:30	"	6P	6Pピンジャック		
C139	BB:00:44:30	Contact Pin	2.5Pitch SHF-001T-08CS	2.5ピッチコンタクトピン		
C140	LB:30:07:20	Huseing	2.5Pitch H3P-SHF	2.5ピッチハウジング		
C141	CB:60:63:80	Shielded Cap	HY-0202	シールドキャップ		
C142	Mi:07:44:30	Shielded Wire Flat type	L=100	平型PVCシールド線		W
C143	LB:20:13:90	Base Pin	2.5Pitch TEB2P-SHF	2.5ピッチベースピン		
C144	LB:20:13:80	Housing	2.5Pitch H2P-SHF	2.5ピッチハウジング		
C145	LB:30:07:30	Base Pin	2.5Pitch 3P TEB3P-SHF	2.5ピッチベースピン		
C146	LA:00:21:10	Wrapping Terminal	2P P=5 i-type	i型ラッピング端子板		

* : New Parts (新部品)

Ref. No.	Part No.	Description	(部 品 名)	Remarks	Common model	Markets
※	NA 07 96 40	Main Circuit Board				W
※	NA 07 86 20					R/A/G/B
※	NA 07 86 30					U
※	NA 07 86 40					C
	C301 C302	FH 61 11 00 Ceramic Capacitor	10PF 500V CH-type	セラコン		
	C303 C304	FG 41 14 70 "	47PF 50V(K)	"		
※	C305 C306	FZ 00 30 10 Electrolytic Capacitor	2.2 μ F 25V	B・Pプラスチックケミコン		
	C307 C308	UA 25 32 20 Mylar Capacitor	0.0022 μ F 50V(J)	マイラーコン		
	C309 C310	FZ 00 30 10 Electrolytic Capacitor	2.2 μ F 25V	B・Pプラスチックケミコン		
	C311 C312	UW 84 81 00 "	100 μ F 25V	ケミコン		
	C313 C314	FH 61 14 70 Ceramic Capacitor	47PF 500V CH-type	セラコン		
※	C315 C316	FH 61 21 20 "	120PF "	"		
	C317 C318	FG 41 14 70 "	47PF 50V(K)	"		
	C319 -322	UW 82 81 00 Electrolytic Capacitor	100 μ F 10V	ケミコン		
	C323 -326	UW 85 81 00 "	100 μ F 35V	"		
※	C327 C328	UJ 47 82 20 "	220 μ F 63V	"		
	C329 C330	UA 25 51 00 Mylar Capacitor	0.1 μ F 50V(J)	マイラーコン		
	C331 -334	FC 04 41 00 "	0.01 μ F 400V(K)	"		
	C335 C336	FH 61 15 60 Ceramic Capacitor	56PF 500V CH-type	セラコン		
	C337 C338	UA 25 51 00 Mylar Capacitor	0.1 μ F 50V(J)	マイラーコン		
	C339 -342	UW 86 81 00 Electrolytic Capacitor	100 μ F 50V	ケミコン		
	C343 C344	FC 04 41 00 Mylar Capacitor	0.01 μ F 400V(K)	マイラーコン		
※	C345 C346	FZ 00 32 70 Electrolytic Capacitor	15000 μ F 56V	ブロックケミコン		
	C347	FG 41 21 00 Ceramic Capacitor	100PF 50V(K)	セラコン		
	C348	UW 83 72 20 Electrolytic Capacitor	22 μ F 16V	ケミコン		
	C349	UW 86 64 70 "	4.7 μ F 50V	"		
※	C350	FC 04 51 00 Mylar Capacitor	0.1 μ F 400V(K)	マイラーコン		
	C351	UW 56 52 20 Electrolytic Capacitor	0.22 μ F 50V	ケミコン		
	C352	FM 11 71 00 "	10 μ F 50V	B・Pコン		
	C353	UW 83 72 20 "	22 μ F 16V	ケミコン		
	C354	FM 39 81 00 "	100 μ F 16V	Zコン		
	C355	UW 86 71 00 "	10 μ F 50V	ケミコン		
	C356	FG 41 21 00 Ceramic Capacitor	100PF 50V(K)	セラコン		
	C357	FG 44 41 00 "	0.01 μ F 50V(Z)	"		
	C358	UW 96 54 70 Electrolytic Capacitor	0.47 μ F 50V	ケミコン		
	C359 C360	FG 41 12 20 Ceramic Capacitor	22PF 50V(K)	セラコン		
	C361 C362	UA 25 42 20 Mylar Capacitor	0.022 μ F 50V(J)	マイラーコン		W
	C363 C364	FG 41 14 70 Ceramic Capacitor	47PF 50V(K)	セラコン		
	C365 C366	UA 25 41 00 Mylar Capacitor	0.01 μ F 50V(J)	マイラーコン		
	C367 -369	UA 25 51 00 "	0.1 μ F "	"		
	C371 C372	UA 25 42 20 "	0.022 μ F 50V(J)	"		W
	C373 C374	UA 25 41 00 "	0.01 μ F 50V(J)	"		
	L301 L302	GD 90 03 40 Coil, out put	1.5 μ H	アウトプットコイル		
	R301 R302	HJ 35 52 20 Carbon Resistor	220 Ω RD25	カーボン抵抗		
	R303 -306	HJ 35 84 70 "	470K Ω "	"		
	R307 -310	HJ 35 64 70 "	4.7K Ω "	"		
	R311 R312	HJ 35 44 70 "	47 Ω "	"		
	R313 -316	HJ 35 42 20 "	22 Ω "	"		
	R317 R318	HJ 35 71 80 "	18K Ω "	"		
	R319 R320	HJ 35 71 50 "	15K Ω "	"		
	R321 R322	HJ 35 63 90 "	3.9K Ω "	"		
	R323 R324	HJ 35 52 20 "	220 Ω "	"		

※ : New Parts (新部品)

Ref. No.	Part No.	Description	(部 品 名)	Remarks	Common model	Markets
R325 R326	HJ 35 82 20	Carbon Resistor	220KΩ RD25	カーボン抵抗		
R327 R328	HJ 35 81 50	"	150KΩ "	"		
R329 R330	HJ 35 65 60	"	5.6KΩ "	"		
R331 R332	HJ 35 51 00	"	100Ω "	"		
R333 R334	HJ 72 61 00	Metal Oxide Film Resistor	1KΩ 2P	酸金抵抗		
R335 ~336	HJ 35 42 70	Carbon Resistor	27Ω RD25	カーボン抵抗		
R339 R340	HJ 35 68 20	"	8.2KΩ "	"		
R341 R342	HJ 35 61 20	"	1.2KΩ "	"		
R343 R344	HJ 35 48 20	"	82Ω "	"		
R345 R346	HJ 35 52 70	"	270Ω "	"		
R347 R348	HJ 35 53 30	"	330Ω "	"		
R349 R350	HJ 35 74 70	"	47KΩ "	"		
R351 R352	HV 35 52 70	Flame Proof Carbon Resistor	270Ω RDF25SF	不燃化カーボン抵抗		
R353 R354	HJ 35 52 70	Carbon Resistor	270Ω RD25	カーボン抵抗		
R355 ~358	HJ 35 72 70	"	27KΩ "	"		
R359 ~362	HV 35 44 70	Flame Proof Carbon Resistor	47Ω RDF25SF	不燃化カーボン抵抗		
R363 R364	HJ 35 61 50	Carbon Resistor	1.5KΩ RD25	カーボン抵抗		
R365 R366	HJ 35 52 70	"	270Ω "	"		
R367 R368	HJ 35 63 30	"	3.3KΩ "	"		
R369 R370	HJ 35 71 20	"	12KΩ "	"		
R371 R372	HJ 35 52 20	"	220Ω "	"		
R373 ~376	HJ 35 63 90	"	3.9KΩ "	"		
R377 R378	HJ 35 54 70	"	470Ω "	"		
R379 ~382	HL 71 61 80	Metal Oxide Film Resistor	1.8KΩ 1P	酸金抵抗		
R383 ~386	HJ 35 71 20	Carbon Resistor	12KΩ RD25	カーボン抵抗		
R387 R388	HJ 35 63 90	"	3.9KΩ "	"		
R389 R390	HJ 35 61 50	"	1.5KΩ "	"		
R391 ~396	HV 35 61 20	Flame Proof Carbon Resistor	1.2KΩ RDF25SF	不燃化カーボン抵抗		
R397 R398	HV 35 52 70	"	270Ω "	"		
R399 R400	HV 35 58 20	"	820Ω "	"		
R401 R402	HJ 35 64 70	Carbon Resistor	4.7KΩ RD25	カーボン抵抗		
R403 ~406	HJ 35 48 20	"	82Ω "	"		
R407 R408	HV 35 41 20	Flame Proof Carbon Resistor	12Ω RDF25SF	不燃化カーボン抵抗		
R409 R410	HV 35 51 00	"	100Ω "	"		
R411 ~414	HV 35 43 30	"	33Ω "	"		
R415 ~418	HV 35 34 70	"	4.7Ω "	"		
R419 ~422	HZ 00 23 90	Metal Plate Resistor	0.22Ω 3P RGC3	金属板抵抗		
R423 R424	HJ 35 61 80	Carbon Resistor	1.8KΩ RD25	カーボン抵抗		
R425 R426	HJ 35 54 70	"	470Ω "	"		
R427 R428	HJ 35 41 00	"	10Ω "	"		
R429	HJ 35 61 20	"	1.2KΩ "	"		
R430	HJ 35 74 70	"	47KΩ "	"		
R431 R432	HJ 35 61 20	"	1.2KΩ "	"		
R433 ~436	HV 35 32 20	Flame Proof Carbon Resistor	2.2Ω RDF25SF	不燃化カーボン抵抗		
R437 R438	HZ 00 24 00	Metal Plate Resistor	0.22Ω 5P RGC5	金属板抵抗		
R439 R440	HU 57 53 60	Metal Film Resistor	360Ω SN14K2E(F)	金属被膜抵抗		
R441 R442	HL 33 34 70	Metal Oxide Film Resistor	4.7Ω 2P	酸金抵抗		

* : New Parts (新部品)

Ref. No.	Part No.	Description	(部 品 名)	Remarks	Common model	Markets
R443	HL 72 41 00	Metal Oxide Film Resistor	10Ω 2P	酸金抵抗		
R444	HL 72 41 00	"	10Ω 2P	"		
R445	HJ 35 72 20	Carbon Resistor	22KΩ RD25	カーボン抵抗		
R447 R448	HJ 35 61 00	Carbon Resistor	1KΩ RD25	カーボン抵抗		
R449	HJ 35 55 60	"	560Ω "	"		
R450	HL 81 54 70	Metal Oxide Film Resistor	470Ω 1P	酸金抵抗		
R451	HL 82 56 80	"	680Ω 2P	"		
R452	HL 81 54 70	"	470Ω 1P	"		
R453	HL 82 56 80	"	680Ω 2P	"		
R454 R455	HL 81 54 70	"	470Ω 1P	"		
R456 R457	HL 82 56 80	"	680Ω 2P	"		
R458 R459	HL 82 71 50	"	15KΩ 2P	"		
R460	HJ 35 73 90	Carbon Resistor	39KΩ RD25	カーボン抵抗		
R461	HJ 35 71 00	"	10KΩ "	"		
R462	HJ 35 53 30	"	330Ω "	"		
R463 -466	HJ 35 64 70	"	4.7KΩ "	"		
R467	HJ 35 76 80	"	68KΩ "	"		
R468	HJ 35 71 50	"	15KΩ "	"		
R469	HJ 35 83 90	"	390KΩ "	"		
R470	HJ 35 74 70	"	47KΩ "	"		
R471	HJ 35 72 20	"	22KΩ "	"		
R472	HJ 35 68 20	"	8.2KΩ "	"		
R473	HJ 35 64 70	"	4.7KΩ "	"		
R474 R475	HL 82 52 20	Metal Oxide Film Resistor	220Ω 2P	酸金抵抗		
R476	HJ 35 71 00	Carbon Resistor	10KΩ RD25	カーボン抵抗		
R477	HJ 35 66 80	"	6.8KΩ "	"		
R478	HJ 35 81 00	"	100KΩ "	"		
R479	HJ 35 76 80	"	68KΩ "	"		
R480	HJ 35 66 80	"	6.8KΩ "	"		
R481	HJ 35 62 20	Carbon Resistor	2.2KΩ RD25	カーボン抵抗		
R482	HJ 35 71 20	"	12KΩ "	"		
R483	HJ 35 63 30	"	3.3KΩ "	"		
R484	HJ 35 81 00	"	100KΩ "	"		
R485	HJ 35 81 20	Carbon Resistor	120KΩ RD25	カーボン抵抗		
R486	HJ 35 74 70	"	47KΩ "	"		
R487	HJ 35 82 20	"	220KΩ "	"		
R488	HJ 35 61 80	"	1.8KΩ "	"		
R489	HJ 35 83 90	"	390KΩ "	"		
R490	HJ 35 74 70	"	47KΩ "	"		
R491	HV 35 53 90	Flame Proof Carbon Resistor	390Ω RDF25SF	不燃化カーボン抵抗		
R492	HJ 35 68 20	Carbon Resistor	8.2KΩ RD25	カーボン抵抗		
R493	HJ 35 61 80	"	1.8KΩ "	"		
R494	HJ 35 92 20	"	2.2MΩ "	"		
R495 R496	HL 82 52 70	Metal Oxide Film Resistor	270Ω 2P	酸金抵抗		

* : New Parts (新部品)

Ref. No.	Part No.	Description	(部 品 名)	Remarks	Common model	Markets
R497	HJ 35 61 50	Carbon Resistor	1.5KΩ RD25	カーボン抵抗		
R498	HJ 35 82 20	"	220KΩ "	"		
R499	HJ 35 62 20	"	2.2KΩ "	"		
VR301 VR302	HT 41 00 40	Semi Variable Resistor	B4.7KΩ	ソリッドVVR		
VR303	HT 41 00 80	"	B22KΩ	"		
VR304	HQ 10 00 50	Slid Variable Resistor	200KΩ	スライドVVR		
* TR301 ~ 304	iE 10 24 20	FET	2SK170(GR,BL)	FET		
TR305 ~ 308	iC 22 40 00	Transistor	2SC2240(GR,BL)	トランジスタ		
TR309 TR310	iA 10 15 70	"	2SA1015(O,Y)	"		
TR311 TR312	iA 11 45 00	"	2SA1145(O,Y)	"		
TR313 TR314	iC 27 05 00	"	2SC2705(O,Y)	"		
TR315 TR316	iC 18 15 70	"	2SC1815(O,Y)	"		
TR317 TR318	iA 10 15 70	"	2SA1015(O,Y)	"		
TR319 TR320	iC 18 15 70	"	2SC1815(O,Y)	"		
TR321 TR322	iC 23 20 10	"	2SC2320(E,F)	"		
TR323 TR324	iC 27 05 00	"	2SC2705(O,Y)	"		
TR325 TR326	iA 11 45 00	"	2SA1145(O,Y)	"		
TR327 ~ 330	iA 10 15 70	"	2SA1015(O,Y)	"		
TR339 TR340	iC 22 40 00	Transistor	2SC2240(GR,BL)	トランジスタ		
TR341	iA 09 70 00	"	2SA970(GR,BL)	"		
TR342	iC 22 40 00	"	2SC2240(GR,BL)	"		
TR343 TR344	iA 09 70 00	"	2SA970(GR,BL)	"		
TR345	iA 09 99 10	"	2SA999(E,F)	"		
TR346 TR347	iC 22 40 00	"	2SC2240(GR,BL)	"		
TR349	iC 27 05 00	"	2SC2705(O,Y)	"		
D301 D302	iF 00 20 80	Zener Diode	HZ16L-3	ツェナーダイオード		
D303 ~ 306	iF 00 00 40	Diode	IS1555	ダイオード	} Inter-changeable	
"	iF 00 06 70	"	IS2473	"		
D307 ~ 310	iF 00 14 00	"	ISS82	"		
* D311 D312	iF 00 34 80	Zener Diode	HZ3C1	ツェナーダイオード		
D313 ~ 316	iF 00 15 10	"	HZ-6C1L	"		
D317 ~ 320	iF 00 06 70	Diode	IS2473	ダイオード	} Inter-changeable	
"	iF 00 00 40	"	IS1555	"		
D323 D324	iF 00 00 40	Diode	IS1555	ダイオード	} Inter-changeable	
"	iF 00 06 70	"	IS2473	"		
D325 D326	iF 00 21 20	Zener Diode	BZ-162	ツェナーダイオード		
D327	iH 00 08 70	Bridge Diode	4D4B41	ダイオードブリッジ		
D328	iF 00 07 90	Diode	MV12	バリスタ		
D329	iF 00 14 70	Zener Diode	RD6,2EB2	ツェナーダイオード		
D330	iF 00 06 70	"	IS2473	ダイオード	} Inter-changeable	
"	iF 00 00 40	"	IS1555	"		
D331	iF 00 07 90	Diode	MV12	バリスタ		
D332	iH 00 07 10	Diode	W06C	ダイオード		
D333 D334	iF 00 06 70	"	IS2473	"	} Inter-changeable	
"	iF 00 00 40	"	IS1555	"		
D336	iF 00 05 50	Zener Diode	HZ12C	ツェナーダイオード		
D337	iF 00 07 90	Diode	MV12	バリスタ		
D338 ~ 340	iF 00 06 70	Diode	IS2473	ダイオード		

* : New Parts (新部品)

Ref. No.	Part No.	Description	(部 品 名)	Remarks	Common model	Markets
D341	iH 00:07:10	Diode	W06C	ダイオード		
D343 D344	iF 00:34:80	Zener Diode	HZ3C1	ツェナーダイオード		
IC301 IC302	iG 02:84:00	IC	NJM4558DY	IC		
SW301	KA 50:15:60	Selector Switch		SP切換スイッチ	Speaker	
RY301	KC 00:09:20	Relay	JC-2 DC480	リレー		J.R.W.A.G.C.B
"	KC 00:10:60	"	AR34239 "	"		U
JK301	LB 30:13:50	Phones Jack	(White)	ホーンジャック		
*	MZ 08:22:30	Main Connector Ass'y		メインコネクターAss'y		
	LA 00:25:70	Wrapping Terminal type-i	3P P=7.5	i型ラッピング端子板		
	LA 00:29:60	Push Terminal	4P	4Pプッシュターミナル		
	LB 20:13:90	Base Pin	2.5Pitch TEB2P-SHF	2.5ピッチベースピン		
	CB 06:92:50	Binding Tie	BK-1	インシュロックタイ		
	LA 00:41:20	Test Point	Pin, 1P	テストポイントピン		
	BB 06:52:50	Pusher, Transistor		TRプッシャー		
*	BB 06:98:00	Metal Fitting, Earth		アース金具		
West Germany Model						
	NA 07:96:20	Tone Control Circuit Board		トーンコントロールシート		W
C230	FG 45:51:00	Ceramic Capacitor	0.1 μ F 50V(Z)	セラコン		W
C237 C238	FG 41:21:00	"	100PF 50V(K)	"		W
C239 C240	UA 25:41:00	Mylar Capacitor	0.01 μ F 50V(J)	マイラーコン		W
C241 C242	UA 25:43:30	"	0.033 μ F 50V(J)	"		W
C243 C244	FG 41:24:70	"	470PF "	"		W
L201 L202	GE 90:08:40	Coil	15 μ H	フェライドシールドタイプ チョークコイル		W
L203 L204	GB 90:03:30	"	220 μ H	"		W
R249 R250	HJ 35:53:30	Carbon Resistor	330 Ω RD25	カーボン抵抗		W
R251 R252	HU 07:62:20	Metal Film Resistor	2.2K Ω RE35	金属皮膜抵抗		W
R253 R254	HU 07:51:00	"	100 Ω "	"		W
SW206	KA 90:16:80	Push Switch with Remote	4 Unit 2point	リモート付プッシュSW		W
PJ201	LB 20:17:30	Pin Jack	2P	2P ピンジャック		W

* : New Parts (新部品)

Control Circuit Board (U,C models)

Ref. No.	Part No.	Description	(部 品 名)	Remarks	Common model	Markets
	NA 07 86 70	Control Circuit Board				U,C
C501	FC 24 52 20	MM Capacitor	0.22 μ F 125V ECQ-UC(M)	MMコン		
C502	FG 41 21 00	Ceramic Capacitor	100pF 50V(K)	セラコン		
C503	UA 25 43 30	Mylar Capacitor	0.033 μ F 50V(J)	マイラーコン		
C504	UA 55 54 70	"	0.47 μ F "	"		
C505 C506	Fi 34 33 30	Ceramic Capacitor	0.0033 μ F MY(DE)	セラコン		
C507	FC 24 51 00	MM Capacitor	0.1 μ F 125V	MMコン		
L501	GD 90 03 60	Coil	100 μ H	雑防コイル		
R501 R502	HJ 35 82 20	Carbon Resistor	220K Ω R28FSL	カーボン抵抗		
R503	HL 82 71 80	Metal Oxide Film Resistor	18K Ω 2P	酸化膜抵抗		
R504	HJ 35 62 70	Carbon Resistor	2.7K Ω RD25	カーボン抵抗		
R505	HJ 35 88 20	"	820K Ω "	"		
R506	HJ 35 61 00	"	1K Ω "	"		
R507	HJ 35 75 60	"	56K Ω "	"		
R508	HJ 35 81 20	"	120K Ω "	"		
R509	HJ 35 71 50	"	15K Ω "	"		
R510	HJ 35 41 50	"	15 Ω "	"		
R511 R512	HJ 35 54 70	"	470 Ω "	"		
R513	HV 35 41 50	Flame Proof Carbon Resistor	15 Ω RDF25SF	不燃化カーボン抵抗		
R514	HL 82 53 90	Metal Oxide Film Resistor	390 Ω 2P	酸化膜抵抗		
VR501	HT 41 01 50	Solid Variable Resistor	B4.7K Ω SR29R	ソリッドVR		
IC501	iG 04 08 00	Triger IC		トリガーIC		
D501	iH 00 08 80	Bridge Diode	SIWB	ダイオードブリッジ		
D502 D505	iH 00 00 60	Diode	10D-4	ダイオード		
SCR 501,502	iH 00 09 00	Triac	SMOR5G0.5A	トライアック		
SCR 503	iH 00 11 10	"	AC16DGM-L 16A	"		
TR501	iK 00 03 30	Photo Coupler	TLP508(BL)	フォトカブラ		
F501	KB 00 15 40	Fuse	12A 250VUL	ヒューズ		
LB 20 19 70	Fuse Holder Pin	23165081	ヒューズホルダーピン			
LA 00 23 50	Wrapping Terminal type-L	2P P=5	L型ラッピング端子板			
LA 00 23 60	"	3P P=5	"			
LA 00 23 90	"	2P P=7.5	"			
LA 00 24 00	"	3P P=7.5	"			
BA 08 24 20	Heat Sink		放熱板			
BB 06 83 70	Metal Fitting		アース金具			
CB 07 28 80	Insulating Bush		絶縁ブッシュ			
CA 07 18 10	Insulating Plate		絶縁板			
CB 60 14 80	Damper		ダンパー			
iL 00 02 70	Mica Base	AC-229	マイカベース			
EN 33 00 90	Bind Head Tapping Screw	3 \times 10(FCM3-B)	鉄バインドタッピングネジ	Type II		
EN 33 00 70	"	3 \times 8(")	"	"		
EA 02 60 80	Pan Head Screw	2.6 \times 8(")	ナベ小ネジ			

* : New Parts (新部品)

Control Circuit Board (R model)

Ref. No.	Part No.	Description	(部 品 名)	Remarks	Common model	Markets
*	NA 07 86 60	Control Circuit Board	制御シート			R
C501	FR 15 52 20	MP Capacitor	0.22 μ F 250V PME 271	MPコン		
C502	FG 41 21 00	Ceramic Capacitor	100pF 50V(K)	セラコン		
C503	UA 25 43 30	Mylar Capacitor	0.033 μ F 50V(J)	マイラーコン		
C504	UA 55 54 70	"	0.47 μ F "	"		
C505 -507	FR 16 36 80	MP Capacitor	0.0068 μ F 250V PME265	MPコン		
C508	FQ 09 46 80	Oil Capacitor	0.068 μ F 450V ECN-C4A	オイルコン		
C509 C510	Fi 34 41 00	Ceramic Capacitor	0.01 μ F MY(DE)	セラコン		
C511 C512	Fi 33 31 00	"	0.001 μ F AC400V KC(DE)	"		
L501	GD 90 03 90	Coil	150 μ H SF-HP-6A	雑防コイル		
R501 -504	HJ 35 84 70	Carbon Resistor	470K Ω RD25	カーボン抵抗		
R505 R508	HL 82 73 90	Metal Oxide Film Resistor	39K Ω 2P	酸化金抵抗		
R507	HJ 35 88 20	Carbon Resistor	820K Ω RD25	カーボン抵抗		
R508	HJ 35 61 00	"	1K Ω "	"		
R509	HJ 35 75 60	"	56K Ω "	"		
R510	HJ 35 73 30	"	33K Ω "	"		
R511	HJ 35 81 20	"	120K Ω "	"		
R512	HJ 35 71 50	"	15K Ω "	"		
R513	HJ 35 41 50	"	15 Ω "	"		
R514 R515	HJ 35 54 70	"	470 Ω "	"		
R516	HV 35 41 50	Flame proof Carbon Resistor	15 Ω RDF25SF	不燃化カーボン抵抗		
R517	HL 82 53 90	Metal Oxide Resistor	390 Ω 2P	酸化金抵抗		
VR501	HT 41 01 50	Solid Variable Resistor	B4.7K Ω SR29R	ソリッドVR		
IC501	iG 04 08 00	Triger IC		トリガーIC		
D501	iH 00 08 80	Bridge Diode	SIWB	ダイオードブリッジ		
D502 -505	iH 00 00 60	Diode	10D-4	ダイオード		
D506 D507	iF 00 19 40	Zener Diode		ツェナーダイオード		
SCR 501,502	iH 00 09 00	Triac	SMOR5G 0.5A	トライアック		
SCR 503	iH 00 11 10	"	16A AC16DGM-L	"		
TR501	iK 00 03 30	Photo Coupler	TLP508(BL)	フォトカプラー		
SW501	KA 80 21 70	Push Switch	SDS3P 5/80A	プッシュSW		
F501	KB 00 13 80	Fush	15A250V UL	ヒューズ		
*	LB 20 19 70	Fush Holder Pin	23165081	ヒューズホルダーピン		
	LA 00 21 10	Wrapping Terminal type-i	2P P=5	i型ラッピング端子板		
	LA 00 23 50	" type-L	2P P=5	L型ラッピング端子板		
	LA 00 23 60	" "	3P P=5	"		
	LA 00 23 90	" "	2P P=7.5	"		
	LA 00 24 00	" "	3P P=3	"		
	BA 08 24 20	Heat Sink		放熱板		
	BB 06 83 70	Metal Fitting		アース金具		
*	CB 07 28 80	Insulating Bush		絶縁ブッシュ		
	CA 07 18 10	Insulating Plate		絶縁板		
	CB 60 14 80	Damper		ダンパー		
	iL 00 02 70	Mica Base	AC-229	マイカベース		
	EN 33 00 90	Bind Head Tapping Screw	3 \times 10(FCM3-B ϕ)	鉄バインドタッピンネジ	Type II	
	EN 33 00 70	"	3 \times 8(")	"	"	
	EA 02 60 80	Pan Head Screw	2.6 \times 8(")	ナベ小ネジ		

* : New Parts (新部品)

■ Control Circuit Board (W,A,G,B models)

Ref. No.	Part No.	Description	(部 品 名)	Remarks	Common model	Markets
	W 07 55 80	Control Circuit Board	制御回路板			A,G,B,W
C501	FR 15 54 70	MP Capacitor	0.47 μ F 250V PME271	MPコン		
C502	FG 41 21 00	Cermic Capacitor	100pF 50V(K)	セラコン		
C503	UA 25 43 30	Mylar Capacitor	0.033 μ F 50V(J)	マイラーコン		
C504	UA 55 54 70	"	0.47 μ F "	"		
C505 ~507	FR 16 36 80	MP Capacitor	0.0068 μ F 250V PME265	MPコン		
C508	FQ 09 46 80	Oil Capacitor	0.068 μ F 450V ECN-C4A	オイルコン		
C509 C510	FR 16 41 00	MP Capacitor	0.01 μ F 250V	MPコン		
C511 C512	Fi 35 26 80	Ceramic Capacitor	680pF AC400V	セラコン		
L501	GD 90 03 90	Coil	150 μ H SF-HP-6A	雑防コイル		
R501 ~504	HJ 35 84 70	Carbon Resistor	470K Ω RD25	カーボン抵抗		
R505 R506	HL 82 73 90	Metal Oxide Film Resistor	39K Ω 2P	酸化金抵抗		
R507	HJ 35 88 20	Carbon Resistor	820K Ω RD25	カーボン抵抗		
R508	HJ 35 61 00	"	1K Ω "	"		
R510 R511	HJ 35 81 80	"	180K Ω "	"		
R512	HJ 35 71 50	"	15K Ω "	"		
R513	HJ 35 41 50	"	15 Ω "	"		
R514 R515	HJ 35 54 70	"	470 Ω "	"		
R516	HV 35 41 50	Flame Proof Carbon Resistor	15 Ω RDF25SF	不燃化カーボン抵抗		
R517	HL 82 53 90	Metal Oxide Film Resistor	390 Ω 2P	酸化金抵抗		
VR501	HT 41 01 50	Solid Variable Resistor	B4.7K Ω SR29R	ソリッドVVR		
IC501	i G 04 08 00	Triger IC		トリガーIC		
D501	i H 00 08 80	Bridge Diode	SIWB	ダイオードブリッジ		
D502 ~505	i H 00 00 60	Diode	10D-4	ダイオード		
D506 D507	i F 00 19 40	Zener Diode	HZ-24	ツェナーダイオード		
SCR 501,502	i H 00 09 00	Triac	SMOR5G0.5A	トライアック		
SCR 503	i H 00 11 10	"	AC16DGM-L 16A	"		
TR501	i K 00 03 30	Photo Coupler	TLP508(BL)	フォトカプラ		
"	i K 00 03 50	"	4N35	"		Ⓔ Models
SW501	KA 80 21 70	Push Switch	CDS3P 5/8A	プッシュSW		
F501	KB 00 17 60	Fuse	T6.3A 250V \oplus	ヒューズ		
*	LB 20 10 60	Fuse Holder Pin	YSH403T	ヒューズホルダーピン		
	LA 00 21 10	Wrapping Terminal type-i	2P P=5	i型ラッピング端子板		
	LA 00 23 50	" type-L	2P P=5	L型ラッピング端子板		
	LA 00 23 50	"	3P P=5	"		
	LA 00 23 90	"	2P P=7.5	"		
	LA 00 24 00	"	3P P=7.5	"		
	BA 08 24 20	Heat Sink		放熱板		
	BB 06 83 70	Metal Fitting		アース金具		
	CB 07 28 80	Insulating Bush		絶縁ブッシュ		
*	CA 07 18 10	Insulatingh Plate		絶縁板		
	CB 60 14 80	Damper		ダンパー		
	i L 00 02 70	Mica Base	AC-229	マイカベース		
	EN 33 00 90	Bind Head Tapping Screw	3 \times 10(FCM3-B ℓ)	鉄バインドタッピングネジ	type-II	
	EN 33 00 70	"	3 \times 8(")	"	"	
	EA 02 60 80	Pan Head Screw	2.6 \times 8(")	ナベ小ネジ		

* : New Parts (新部品)