

ALINCO

VHF FM TRANSCEIVER

DJ-V17T/E/R/TFH

Instruction Manual

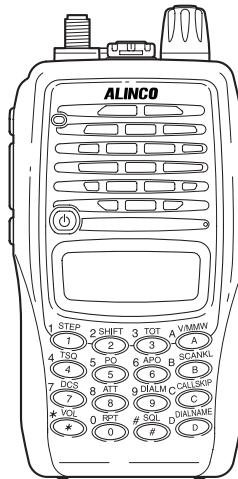

Thank you for purchasing your new Alinco transceiver. This instruction manual contains important safety and operating instructions. Please read this manual carefully before using the product and keep it for future reference.

ALINCO, INC.

NOTICE / Compliance Information Statement

This equipment has been tested and found to comply with the limits for a Class B digital device, pursuant to part 15 of the FCC Rules.

These limits are designed to provide reasonable protection against harmful interference in a residential installation.

This equipment generates, uses, and can radiate radio frequency energy and, if not installed and used in accordance with the instruction manual, may cause harmful interference to radio communications. However, there is no guarantee that interference will not occur in a particular installation. If this equipment does cause harmful interference to radio or television reception, which can be determined by turning the equipment off and on, the user is encouraged to try to correct the interference by one or more of the following measures:

- Reorient or relocate the receiving antenna.
- Increase the separation between the equipment and receiver.
- Connect the equipment into an outlet on a circuit different from that to which the receiver is connected.
- Consult the dealer or an experienced radio/TV technician for help.



**Tested to Comply
With FCC Standards
FOR HOME OR OFFICE USE**

Information in this document is subject to change without notice or obligation. All brand names and trademarks are the property of their respective owners. Alinco cannot be liable for pictorial or typographical inaccuracies. Some parts, options and/or accessories are unavailable in certain areas. Changes or modifications not expressly approved by the party responsible for compliance could void the user's authority to operate the equipment.

VHF FM Transceiver DJ-V17T

This device complies with Part 15 of the FCC Rules. Operation is subject to the following two conditions: (1) This device may not cause harmful interference, and (2) this device must accept any interference received, including interference that may cause undesired operation.

Manufacturer:

ALINCO, INC.
Shin-Dai building 9th Floor 2-6, 1-Chome
Dojimahama, Kita-ku, Osaka 530-0004 JAPAN



Conformity Information

In case the unit you have purchased is marked with a CE symbol, a copy of relative conformity certificate or document can be reviewed at <http://www.alinco.com/usa.html>.

DJ-V17E: VHF FM Transceiver 144.000~145.995MHz



CE 0336 Ⓢ



This device is authorized for use in all EU and EFTA member states. An operator's license is required for this device.

Copyright © All rights reserved. No part of this document may be reproduced, copied, translated or transcribed in any form or by any means without the prior written permission of Alinco. Inc., Osaka, Japan, English Edition Printed in Japan.

Warning







To prevent any hazard during operation of Alinco's radio product, in this manual and on the product you may find symbols shown below. Please read and understand the meanings of these symbols before starting to use the product.





 Danger	This symbol is intended to alert the user to an immediate danger that may cause loss of life and property if the user disregards the warning.
 Alert	This symbol is intended to alert the user to a possible hazard that may cause loss of life and property if the user disregards the warning.
 Caution	This symbol is intended to alert the user to a possible hazard that may cause loss of property or injure the user if the warning is disregarded.

	Alert symbol. An explanation is given.
	Warning symbol. An explanation is given.
	Instruction symbol. An explanation is given.





Alert

■ Environment and condition of use





-  Do not drive while handling the radio for your safety. It is recommended that you check local traffic regulations regarding the use of radio equipment while driving. Some countries prohibit the operation of transceiver while driving.
-  Do not use this product in close proximity to other electronic devices, especially medical ones. It may cause interference to those devices.
-  Keep the radio out of the reach of children.
-  In case a liquid leaks from the product, do not touch it. It may damage your skin. Rinse with plenty of cold water if the liquid contacted your skin.
-  Never operate this product in facilities where radio products are prohibited for use such as aboard aircraft, in airports, in ports, within or near the operating area of business wireless stations or their relay stations.
-  Use of this product may be prohibited or illegal outside of your country. Be informed in advance when you travel.
-  The manufacturer declines any responsibilities against loss of life and/or property due to a failure of this product when used to perform important tasks like life-guarding, surveillance, and rescue.

-  Do not use multiple radios in very close proximity. It may cause interference and/or damage to the product(s).
-  Risk of explosion if battery is replaced with an incorrect type.
-  Dispose of, or recycle used batteries according to your local regulations.
-  The manufacturer declines any responsibilities against loss of life and property due to a failure of this product when used with or as a part of a device made by third parties.
-  Use of third party accessory may result in damage to this product. It will void our warranty for repair.



■ Handling this product





-  Be sure to reduce the audio output level to minimum before using an earphone or a headset. Excessive audio may damage hearing.
-  Do not open the unit without permission or instruction from the manufacturer. Unauthorized modification or repair may result in electric shock, fire and/or malfunction.
-  Do not operate this product in a wet place such as shower room. It may result in electric shock, fire and/or malfunction.
-  Do not place the product in a container carrying conductive materials, such as water or metal in close proximity to the product. A short-circuit to the product may result in electric shock, fire and/or malfunction.

■ About chargers



-  Do not use adapters other than the specified voltage. It may result in electric shock, fire and/or malfunction.
-  Do not plug multiple devices using an adapter into a single wall outlet. It may result in overheating and/or fire.
-  Do not handle adapter with a wet hand. It may result in electric shock.
-  Securely plug the adapter into the wall outlet. Insecure installation may result in short-circuit, electronic shock and/or fire.
-  Do not use the adapter if the plug or socket contacts are dirty. Overheating and/or short-circuiting may result in fire, electric shock and/or damage to the product.

■ About power supply

-  Use only appropriate, reliable power supply of correct voltage and capacity.
-  Do not connect cables in reverse polarity. It may result in electric shock, fire and/or malfunction.
-  Do not plug multiple devices including the power supply into a single wall outlet. It may result in overheating and/or fire.

-  Do not handle a power supply with a wet hand. It may result in electric shock.
-  Securely plug the power supply to the wall outlet. Insecure installation may result in short-circuiting, electronic shock and/or fire.
-  Do not plug the power supply into the wall socket if the contacts are dirty. Short-circuit and/or overheating may result in fire, electric shock and/or damage to the product.
-  Do not modify or remove fuse-assembly from the DC cable. It may result in fire, electric shock and/or damage to the product.

■ Cigar-lighter cable

-  Do not use the cable at any other than the specified voltage. It may result in electric shock, fire and/or malfunction.
-  Do not handle cigar cable with a wet hand. It may result in electric shock.

■ In case of emergency

In case of the following situation(s), please turn off the product, switch off the source of power, then remove or unplug the power-cord. Please contact your local dealer of this product for service and assistance. Do not use the product until the trouble is resolved. Do not try to troubleshoot the problem by yourself.

- When a strange sound, smoke and/or strange odor comes out of the product.
- When the product is dropped or the case is broken or cracked.
- When a liquid penetrated inside.
- When a power cord (including DC cables, AC cables and adapters) is damaged.

-  For your safety, turn off then remove all related AC lines to the product and its accessories from the wall outlet if a thunderstorm is likely.





■ Maintenance

-  Do not open the unit and its accessories. Please consult with your local dealer of this product for service and assistance.







Caution





■ Environment and condition of use

-  Do not use the product in proximity to a TV or a radio. It may cause interference or receive interference.
-  Do not install in a humid, dusty or insufficiently ventilated place. It may result in electric shock, fire and/or malfunction.
-  Do not install in an unstable or vibrating position. It may result in electric shock, fire and/or malfunction when/if the product falls to the ground.
-  Do not install the product in proximity to a source of heat and humidity such as a heater or a stove. Avoid placing the unit in direct sunlight.
-  Be cautious of a dew formation. Please completely dry the product before use when it happens.

■ About transceiver

-  Be cautious of the whip antenna when carried in your shirt-pocket etc. It may make contact with your eye and cause injury.
-  Do not connect devices other than specified ones to the jacks and ports on the product. It may result in damage to the devices.
-  Turn off and remove the power source (AC cable, DC cable, battery, cigar cable, charger adapter etc.) from the product when the product is not in use for extended period of time or in case of maintenance.
-  Never pull the cord alone when you unplug AC cable from the wall outlet.
-  Use a clean, dry cloth to wipe off dirt and condensation from the surface of the product. Never use thinner or benzene for cleaning.

■ About power supply

-  Use only reliable power supply of specific DC output range and be mindful of the polarity of the cable and DC-jack.
-  Always turn off the power supply when connecting or disconnecting the cables.
-  When using an external antenna, make sure that the antenna ground is not common with the ground of the power supply.
-  European users: When a unit is powered from an external DC power source (adapter, power supply, cigar-plug etc.), make sure that this power supply has approval to the level of IEC/EN 60950.

■ **Lightning**

Any person is not safe outdoor during thunderstorm and lightning. This condition is getting worse if somebody keeps a hand-held radio; chances of being hit by lightning are doubled since lightning may hit a radio antenna as well. At this time, there is no hand-held radio having any kind of protection against lightning current (which is higher than 10 kA.). Note also that no car provides adequate protection of its passengers or drivers against lightning as well. Therefore, Alinco will not take responsibility for any danger associated with using its hand-held radios outdoor or inside the car during lightning.

■ **Notice to California resident users**

The Safe Drinking Water and Toxic Enforcement Act of 1986 of the State of California determines that lead and cadmium are considered carcinogens and reproductive toxicants. DJ-V17 that comes with this manual is free from dangerous materials such as lead and cadmium as per RoHS order of EU.

■ **Limited Power Source: For European users**

Adhering to the requirement of the following warning ensures compliance of the transceiver with the safety standard for information technology equipment, EN 60950. Please note that the transceiver enclosure only provides mechanical protection of its internal parts; it will not contain a fire within the device if the fire starts under certain fault conditions. Alinco will not take responsibility for any fire hazard associated with powering the transceiver or charging its batteries using a power source which does not belong to the limited power sources in the meaning of EN 60950. Excluded from possible use with the transceiver are most car cigarette lighters and some DC (AC/DC) power supplies. Make sure that the power supply used with the transceiver is a limited power source.

Introduction

Thank you very much for purchasing this excellent Alinco transceiver. Our products are ranked among the finest in the world. This radio has been manufactured with state of the art technology and it has been tested carefully at our factory. It is designed to operate to your satisfaction for many years under normal use.

PLEASE READ THIS MANUAL COMPLETELY TO LEARN ALL THE FUNCTIONS THE PRODUCT OFFERS. WE MADE EVERY ATTEMPT TO WRITE THIS MANUAL TO BE AS COMPREHENSIVE AND EASY TO UNDERSTAND AS POSSIBLE. IT IS IMPORTANT TO NOTE THAT SOME OF THE OPERATIONS MAY BE EXPLAINED IN RELATION TO INFORMATION IN PREVIOUS CHAPTERS. BY READING JUST ONE PART OF THE MANUAL, YOU RISK NOT UNDERSTANDING THE COMPLETE EXPLANATION OF THE FUNCTION.

Contents

NOTICE / Compliance Information Statement	3
Warning	5
Introduction	9
Contents	10
1.Features	13
1.1 Accessories.....	13
2.Accessories	14
2.1 Installations.....	14
2.1.1 Antenna.....	14
2.1.2 Hand Strap.....	14
2.1.3 Belt Clip.....	14
2.1.4 Battery Pack.....	15
2.1.5 Prevent Short Circuiting the Battery Pack.....	17
2.1.6 Dry Cell Case (optional).....	18
2.1.7 Battery-Level Icon.....	18
3.Names and Operations of Parts	19
3.1 Names and Operations of Keys and Ports.....	19
3.2 Keypad.....	21
3.3 Display (LCD).....	22
4.Basic Operation	23
4.1 Turning On the Power.....	23
4.2 Adjusting the Audio Output (Volume).....	23
4.3 Adjusting the Squelch.....	23
4.4 Setting the Frequency in the VFO Mode.....	24
4.4.1 Setting the Frequency.....	24
4.4.2 Setting the Tuning Step.....	25
4.4.3 Shift Direction and Offset Frequency Settings.....	25
4.5 Memory Mode.....	26
4.5.1 How to Program Memory Channel(s).....	26
4.5.2 Recalling a Memory Channel.....	27
4.5.3 Deleting a Memory Channel.....	27
4.5.4 Programming a Repeater-Access Function Setting.....	27
4.5.5 Programmable Parameters in Memory Channels.....	28
4.6 Call-Channel Mode.....	28

4.7	Receiving	29
4.7.1	Monitor Function.....	29
4.8	Transmitting	30
4.8.1	Selecting the Output Level	30
5.	Useful Functions	31
5.1	Scan Modes.....	31
5.1.1	VFO-Scan.....	31
5.1.2	Memory-Scan	31
5.1.3	Setting Skip Channels	32
5.2	Keylock.....	32
5.3	Tone-Burst	32
5.4	Naming Memory Channels.....	33
5.4.1	Setting Name-Tag.....	33
5.4.2	Using the Channel Name Function	33
5.5	Auto-Power-Off (APO).....	34
5.5.1	Setting APO.....	34
5.5.2	APO Operation	34
5.6	Time-Out-Timer (TOT).....	35
5.6.1	Setting TOT.....	35
5.6.2	TOT Operation	35
5.7	Lamp	35
6.	Selective Calling.....	36
■	Selective Calling Operations	36
6.1	Tone Squelch (TSQ)	36
6.1.1	Setting the Tone Squelch.....	36
6.1.2	Switching Off the Tone Squelch	37
6.1.3	To Differentiate the ENC/DEC Tones	37
6.1.4	Tone Squelch Operation.....	37
6.2	DCS	37
6.2.1	Setting the DCS	37
6.2.2	Changing the DCS Code	38
6.2.3	Switching Off DCS	38
6.2.4	DCS Operation	38
6.2.5	DET Mode in DCS Operation	38
6.3	DTMF Tone Encoding.....	39
6.4	Auto Dialer	40
6.4.1	Setting the Auto Dialer.....	40
6.4.2	Generating the Auto Dialer Codes	40
6.4.3	Redial.....	41

7.Special Functions.....	42
7.1 ATT (Attenuator).....	42
7.2 Battery Refresh.....	42
7.3 Repeater-Access.....	43
8.Set Mode.....	44
8.1 Set Mode Operation.....	44
8.2 Entering the Set Mode.....	44
8.3 Available Parameters.....	45
8.3.1 Menu 1 Battery Save (BS) Function.....	45
8.3.2 Menu 2 Timer/Busy Scan Setting.....	45
8.3.3 Menu 3 Beep Function.....	45
8.3.4 Menu 4 Tone-Burst Frequency Setting.....	45
8.3.5 Menu 5 Clock Shift Setting.....	46
8.3.6 Menu 6 Busy Channel Lockout Setting.....	46
8.3.7 Menu 7 TOT Penalty Time.....	47
8.3.8 Menu 8 DTMF WAIT Time.....	47
8.3.9 Menu 9 DTMF Burst/Pause Time.....	47
8.3.10 Menu 10 DTMF First Digit Burst Time.....	48
8.3.11 Menu 11 Battery Charge Function.....	48
8.3.12 Menu 12 Battery Type Setting.....	49
9.Cloning and Packet Operation.....	50
9.1 Cloning.....	50
9.1.1 Cable Connection.....	50
9.1.2 Master/Slave Units.....	50
9.1.3 Master Unit Operation.....	51
9.1.4 Slave Unit Operation.....	51
9.2 Packet Operation.....	52
9.2.1 Packet Operation Connections.....	52
10.Maintenance and Reference.....	53
10.1 Troubleshooting.....	53
10.2 Resetting.....	54
10.3 Options.....	55
10.3.1 Microphone/Speaker Cable (EDS-10).....	56
10.3.2 Battery Packs.....	56
10.3.3 Using the Chargers.....	57
11.Specifications.....	63

1. Features

This transceiver has the following main features.

- High-grade waterproof compatible to IPX7 * (submersible 1m/3feet for 30min.) and rugged body
- 39 CTCSS tone squelch
- 104 DCS digital code squelch
- Time-Out-Timer
- Alphanumeric display
- 4 tone-burst tones (1750, 2100, 1000, 1450Hz)
- 9 auto dial memories easily accessed from the DTMF keypad with redial function
- Direct frequency entry from the DTMF keypad
- A quick "Repeater-Access" function
- Refresh function for rechargeable battery reconditioning
- Cable Cloning

* The factory guarantees this grade for 1 year when all the jack-covers are properly and securely closed.

1.1 Accessories

- Ni-MH battery pack EBP-65 (7.2V 700mAh)
- EDC-146 (AC 120V) wall charger (T version)
- EDC-147 (AC 230V) wall charger (E/TFH/R version)
- Flexible whip antenna EA0141 (T/E version)
- Flexible whip antenna EA0142 (TFH/R version)
- Belt clip
- Hand strap
- Instruction manual

* Accessories may differ depending on the version you have purchased.

Please contact your local dealer for details of standard accessories and the warranty-policy.

2. Accessories

2.1 Installations

2.1.1 Antenna

■ Attaching the Antenna

1. Hold the antenna by its base.
2. Align the grooves at the base of the antenna with the protrusions on the antenna connector.
3. Slide the antenna down and turn it clockwise until it stops.
4. Confirm that the antenna is securely connected.

NOTE:

This antenna has been designed very flexible. It is softer than conventional ones but not a defect.

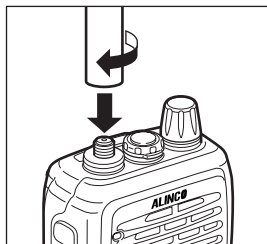

■ Removing the Antenna

Turn the antenna counter-clockwise to disconnect the antenna.

2.1.2 Hand Strap

Attach the hand strap as shown. There are two ways to attach it.

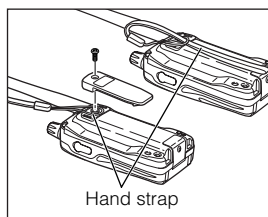

2.1.3 Belt Clip

■ Attaching the Belt Clip

1. Put the belt clip on the back of the unit, and turn the screw clockwise until it stops.
2. Confirm that the belt clip is securely attached.

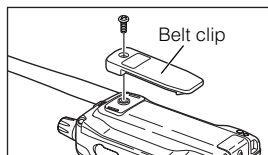

■ Removing the Belt Clip

Turn the screw counter-clockwise to remove the belt clip.

2.1.4 Battery Pack

For the specifications and the charging procedures, please refer to "Battery Packs"(page 56) and "Using the Chargers"(page 57).

■ Attaching the Battery Pack

Align the catches on the battery pack with the grooves on the unit, and close the latch until it clicks.

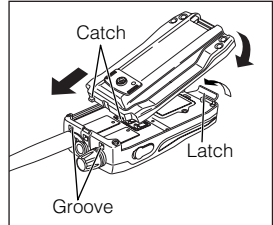

■ Removing the Battery Pack

Push the latch in the direction of the arrow, and pull out the battery pack.

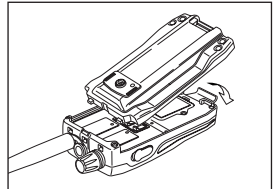

Caution

- The battery pack isn't fully charged when shipped. It must be charged before use.
- Charging should be conducted in a temperature range of 0°C to +40°C (+32°F to +104°F).
- Don't modify, dismantle, incinerate or immerse the battery pack in the water as this can be dangerous.
- Never short-circuit the battery pack terminals, as this can cause damage to the equipment or lead to heating of the battery which may cause burns.
- Unnecessary prolonged charging (overcharging) can deteriorate battery performance.
- The battery pack should be stored in a dry place where temperature is in -10°C to +45°C (-14°F to +113°F) range. Temperatures outside this range can cause the battery liquid to leak. Exposure to prolonged high humidity can cause corrosion of metal components.
- Battery-packs are a consuming part. When its operating time becomes considerably short after a normal charge, please consider that the pack is exhausted and replace it with a new one.
- The battery pack is recyclable. Check with your local waste officials for details on recycling options or proper disposal in your area.



Caution

- Li-ion battery packs can't be charged using DC-jack on the unit (Only Ni-MH battery packs can be charged).
- Risk of explosion, generation of heat or leak of chemicals inside if the battery is replaced by an incorrect type. Use always the recommended types of batteries in this manual only.

■ Charging the Battery Pack Using DC-Jack on the Unit

The unit can charge the EBP-65 and EBP-66 optional Ni-MH battery packs by supplying DC power through the DC-jack on the unit using EDC-146/147/148 wall chargers or an optional DC power supply (DC 12V~DC 16V, 1A or more: IEC/EN 60950 compliant).

1. Attach the battery pack by referring to "Battery Pack" (page 15).

2. Connect the AC adapter plug to the DC-jack on the unit then connect the charger's adapter to the wall outlet.

* AC adapter may look different.

3. Turn on the unit and set the battery charge parameters. Please refer to "Set Mode" (page 44) then:

* "Battery Charge Function" (page 48)

Select CHG-ON.

* "Battery Type Setting" (page 49)

Select BATT-NI.

4. After completing the settings, a flashing  appears on the display. Make sure the icon is flashing then turn off the unit. It takes about 10 hours/30hours for EBP-65/66 respectively to complete the charge.

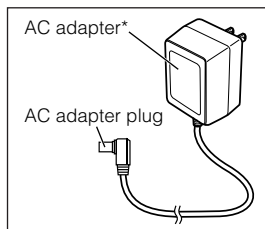

IMPORTANT NOTE:

While this function is activated, without attaching a battery pack or the remaining battery level is below the usable range, the unit turns on by just connecting the DC source such as an adapter or a DC cable (without operating the power key).

NOTE:

- Please read the general safety instructions included in the optional accessories to correctly and safely use them.
- EDC-146/147/148 can't be used as the adapter for operation. These adapters are for charging purposes only.
- Chargers can't perform the correct charge when the AC voltage is unstable.
-  flashes even EBP-65/66 aren't attached. To avoid short-circuit, never activate this function when the pack isn't attached to the unit.
- Li-ion battery packs can't be charged in this way.

2.1.5 Prevent Short Circuiting the Battery Pack

Be extra cautious when carrying the rechargeable battery pack; short circuiting will produce surge current possibly resulting in fire.

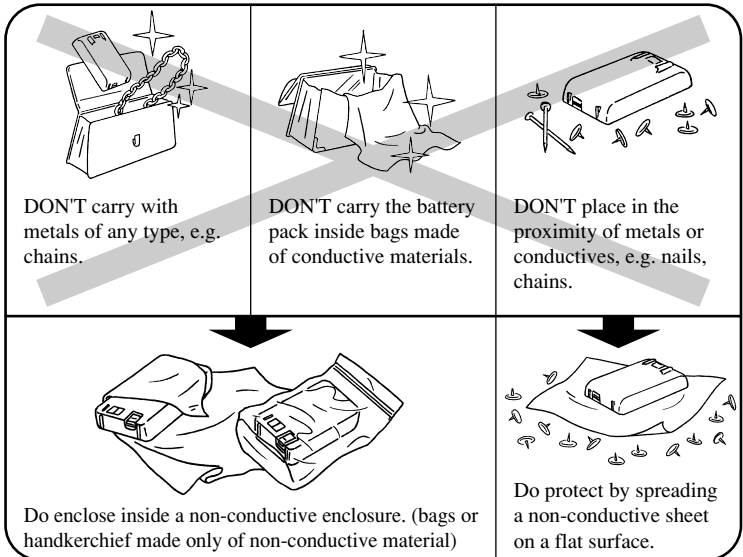

2.1.6 Dry Cell Case (optional)

An EDH-34 is available for operation with using AA cells.

Lift up the catches ① on the top of the case to remove the cover.

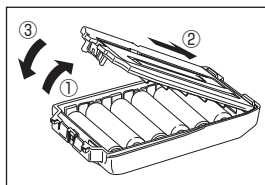

Place 6 AA cells, then close the cover in order of ② then ③. Be sure that the cover is securely closed.

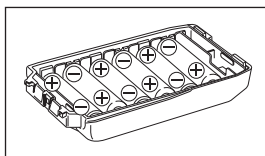

Caution



- This dry cell case isn't water-proof.
- Be extra-cautious to the polarity of the cells (+)/(-). Misplacing cells may result in leak, fire or explosion.
- Use new batteries of the same type and brand when placing them.
- Use of rechargeable cells is prohibited and the manufacturer declines any responsibilities for damages/injuries that may cause to the users and their properties.
- It is recommended to clean the battery contacting terminals with a clean dry cloth from time to time.
- Risk of explosion if batteries are replaced by an incorrect type.
- Batteries are recyclable. Please check the local rules for proper recycle/disposal in your area.

2.1.7 Battery-Level Icon

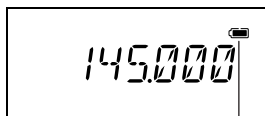
During the operation, a black battery icon indicates that the battery-level is in usable range. When it turns to empty, please charge the pack or replace the cells with new ones.



Battery-level icon

-  The battery is in usable condition.
-  Battery-level is low. Replace or charge the pack.

3. Names and Operations of Parts

3.1 Names and Operations of Keys and Ports

■ Top and Front

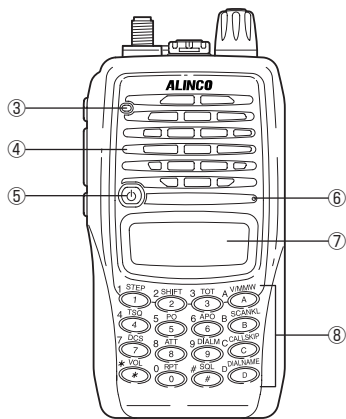
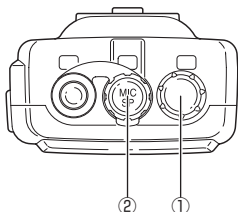

①	Dial	Rotate the dial to select the frequency of operation, memory channel, offset frequency, tone frequency, DCS code, Set mode settings, and the characters for name-tags. Rotating the dial while pressing the FUNC key increases or decreases the frequency in 1MHz order.
②	Microphone/Speaker jack	For an optional speaker/Mic connection. Securely close the cover for water-proof while the accessory isn't in use.
③	TX/RX lamp	Lights green when the squelch is unmuted. Lights red during transmission.
④	Speaker	A speaker is built in.
⑤	Power key	Press the power key down for approximately one second to turn on/off the unit.
⑥	Microphone	Speak into the microphone from a distance of about 5cm (2").
⑦	Display (LCD)	Refer to "Display" (page 22).
⑧	Keypad	Refer to "Keypad" (page 21).

Side

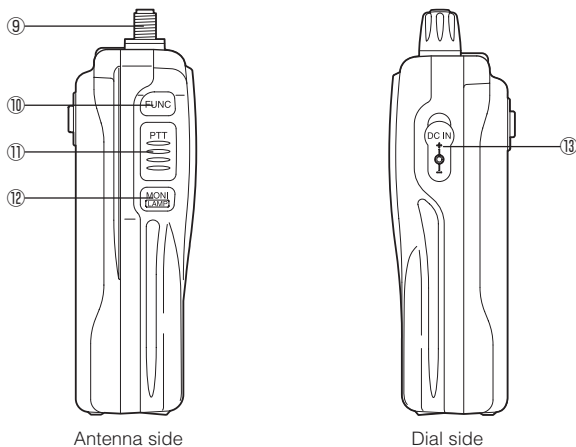

⑨	SMA Antenna Connector	Attach the whip antenna. If you plan to use an optional antenna, select one that is tuned to the operating frequency.
⑩	FUNC key	The FUNC key is used in combination with the other keys to access the various functions of the unit. To enter the Set mode to set operating parameters, press the FUNC key continuously for about 2 seconds.
⑪	PTT key	Press the PTT key to transmit, release to receive.
⑫	MONI key	When the MONI key is pressed, the squelch unmutes regardless of the TSQ/DCS setting. Pressing the MONI key after pressing the FUNC key illuminates display for about 5 seconds. Pressing the MONI key while pressing the PTT key transmits a tone-burst signal.
⑬	DC-IN jack	Connect an external power source of DC 7.0V~DC 16.0V at 2A or more. An optional EDC-36 cigar-cable is available for mobile operation. EBP-65/66 packs can be charged using this jack (page 16).

3.2 Keypad



key	Without pressing the FUNC key.	While F appears after the FUNC key is pressed.
1 STEP ①	Inputs* 1.	Channel step setting (page 25).
2 SHIFT ②	Inputs 2.	Offset frequency setting (page 26).
3 TOT ③	Inputs 3.	Time-Out-Timer setting (page 35).
4 TSO ④	Inputs 4.	Tone Encode / Tone Squelch setting (page 36).
5 PO ⑤	Inputs 5.	Hi / Low power setting (page 30).
6 APO ⑥	Inputs 6.	Auto-Power-Off setting (page 34).
7 DCS ⑦	Inputs 7.	DCS (digital code squelch) setting (page 38).
8 ATT ⑧	Inputs 8.	ATT (Attenuator) setting (page 42).
9 DIALM ⑨	Inputs 9.	Auto dialer memory setting (page 40).
0 RPT ⑩	Inputs 0.	Repeater-Access function setting (page 43).
A VMMW A	Switches between the VFO and Memory mode (page 24).	Memory programming (page 26).
B SCANKL B	Start/Stop scanning (page 31).	Key / Frequency lock setting (page 32).
C CALLSKIP C	Access the Call channel (page 28).	Memory channel skip setting (page 32).
D DIALNAME D	Auto dialer operation (page 40).	Naming memory channels setting (page 33).
# SQL #	SQL adjustment (page 23).	N/A
* VOL *	Audio level adjustment (page 23).	N/A

* The numeric keys can be used for direct VFO frequency input within the DJ-V17's operating range. DTMF tones are generated by pressing the keys during transmissions.

3.3 Display (LCD)

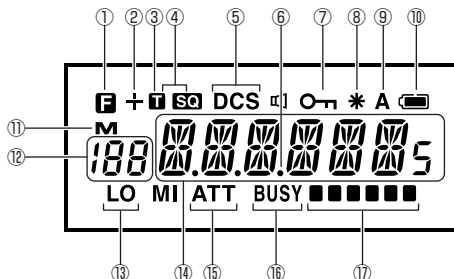

①	F	Appears when the FUNC key is pressed.
②	+	Indicates the shift (+/-) direction.
③	T	Appears when setting the CTCSS tone encoder.
④	T SQ	Appears when setting the tone squelch.
⑤	DCS	Appears when setting the DCS.
⑥	•	Displays the frequency and scan operation.
⑦	LOCK	Displayed when the frequency or the keypad is locked.
⑧	*	Appears when the Repeater-Access function is activated.
⑨	A	Appears when Auto-Power-Off function is activated.
⑩		Indicates battery-level. The black icon flashes when the battery charge function is on.
⑪	M	Displayed when in the Memory mode.
⑫	188	Displays the memory channel No.
⑬	LO	Displayed when the transmission output is in LOW setting.
⑭		Displays the operating frequencies, name-tags and parameters in the setting mode.
⑮	ATT	Appears when the attenuator is activated.
⑯	BUSY	Appears when the squelch is unmuted.
⑰		Indicates the receiving signal (S-meter) and transmission output levels (Power-meter).

4. Basic Operation

4.1 Turning On the Power

Hold the  key down for a second.

To turn off the power, hold the  key down until the display turns off.



4.2 Adjusting the Audio Output (Volume)

- There are 21 audio output levels (00~20).
- The default setting is level 00. There is no audio output at this status.

1. Press the  key. The level is displayed on the LCD.

2. Rotate the dial to increase or decrease the level. As the setting value increases, the audio becomes louder.

3. Press any key except for the MONI key or just leave it for 5 seconds to automatically complete the setting.



4.3 Adjusting the Squelch

Squelch is a function that eliminates the noise when no signals are being received.

- There are 10 squelch levels (00~10).
- The default setting is Level 00.

1. Press the  key. The squelch level is displayed on the LCD.

2. Rotate the dial to increase or decrease the squelch level. Set to the lowest level that the noise is cut.

3. Press any key except for the MONI key or just leave it for 5 seconds to automatically complete the setting.

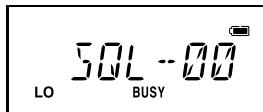

4.4 Setting the Frequency in the VFO Mode

The factory default of this unit is the VFO mode. The VFO mode allows you to change the frequency and operating parameters by using the dial and key operations.

4.4.1 Setting the Frequency

■ To Select the VFO Mode

The ^AVMMW key switches between the VFO and Memory mode each time the key is pressed.

"**M**" is displayed on the LCD when the unit is in the Memory mode.

■ Selecting the Operating Frequency

Rotate the dial clockwise to increase the frequency by one tuning step.

Rotate the dial counter-clockwise to decrease it by one tuning step.

■ To Quickly Change the Frequency

Press the FUNC key, and while **F** is displayed on the screen, rotate the dial to increase or decrease (depending on the direction of rotation) the frequency by 1MHz order.

■ Entry from the Keypad

Use the numeric keys to set the frequency. It accepts valid numbers only.

ie: 145.210 MHz

1. Input the 100MHz digit by pressing ^{1 STEP}1
2. Input the 10MHz digit by pressing ^{4 TSQ}4
3. Input the 1MHz digit by pressing ^{5 PO}5
4. Input the 100kHz digit by pressing ^{2 SHIFT}2
5. Input the 10kHz digit by pressing ^{1 STEP}1

Depending on the tuning step, entry may be required to the 1kHz digit.

The relationship between the tuning step and entry-completion digit is shown in the following chart. The setting will be completed automatically when the last digit is correctly entered and a high-tone beep sounds.

Tuning step	Entry completion digit	Final digit selection
5.0kHz	1kHz	Accept 0 or 5 as valid number.
10.0kHz	10kHz	Accept any of 0 to 9 keys.
12.5kHz	10kHz	When you input the 10kHz digit, the 1kHz digit is set automatically as follows. 0---00.0, 1---12.5, 2---25.0, 3---37.5, 4---invalid, 5---50.0, 6---62.5, 7---75.0, 8---87.5, 9---invalid
15.0kHz	10kHz	Auto-complete after the 10kHz digit entry.
20kHz	10kHz	Auto-complete after the 10kHz digit entry.
25kHz	10kHz	When you input the 10kHz digit, the 1kHz digit is set automatically as follows. 0---00.0, 2---25.0, 5---50.0, 7---75.0 Other entries are invalid.
30kHz	10kHz	Auto-complete after the 10kHz digit entry.

4.4.2 Setting the Tuning Step

1. Press the FUNC key in the VFO mode, and while **F** is displayed, press the **1 STEP** key to display the current tuning step.
2. Rotate the dial to select the desired tuning step.

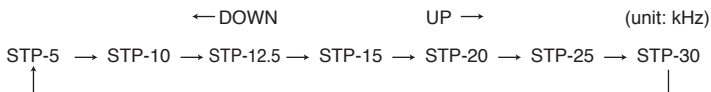

3. Press any key except for the MONI key to complete setting.

NOTE:

- Tuning step can't be changed in the Memory mode.
- When the tuning step is changed from 5kHz, 10kHz, 15kHz, 20kHz or 30kHz to 12.5kHz and 25kHz or vice versa, the operating frequency and the shift width automatically suite to the new setting.

4.4.3 Shift Direction and Offset Frequency Settings

In conventional repeater systems, a signal received on one frequency is retransmitted on another frequency. The difference between these two frequencies is called the offset frequency. The selectable offset frequency of this unit is from 0 to 99.995MHz.

1. Press the FUNC key, and while **F** is displayed, press the $\textcircled{2}^{\text{SHIFT}}$ key to display the current offset frequency and shift direction settings.
2. Each time the $\textcircled{2}^{\text{SHIFT}}$ key is pressed the shift direction changes as indicated below.
A (-) means that the TX frequency is lower than the RX frequency.
A (+) means vice versa.

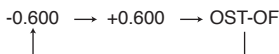

3. Rotate the dial while the shift frequency is being displayed.
Clockwise: each click increases the frequency by one tuning step.
Counter-clockwise: each click decreases the frequency by one tuning step.
Press the FUNC key and rotate the dial to increase or decrease the frequency in 1MHz steps.
4. Press any key except for the MONI or FUNC key to complete setting.

NOTE:

Please refer to "Selective Calling" (page 36) to set the CTCSS/DCS tones usually required for conventional Repeater-Accesses.

4.5 Memory Mode

This mode allows recalling and operating the preprogrammed frequency or setting in the memory channels. This unit provides up to 200 memory channels, 1 CALL channel and 1 Repeater-Access function memory.

4.5.1 How to Program Memory Channel(s)

1. Select a frequency and operating parameters to be programmed in the VFO mode. Programmable parameters are explained later. Press the $\textcircled{A}^{\text{VMMW}}$ key. "**M**" appears on the display.
2. Press the FUNC key to display **F**.
3. Rotate the main dial to select the desired memory channel number while **F** is displayed. An empty channel is shown with a flashing "**M**". Select C for CALL channel programming. "rP ALLFREQ" is explained later.
4. By pressing the $\textcircled{A}^{\text{VMMW}}$ key again while **F** is on the display, a beep sounds and programming is completed.

- Pressing the FUNC then $\text{A}^{\text{VMMW}} \text{A}$ key while **F** is displayed on the programmed channel will delete the memory data and it becomes available for reprogramming.

4.5.2 Recalling a Memory Channel

- Select the Memory mode by pressing the $\text{A}^{\text{VMMW}} \text{A}$ key. "**M**" and channel number appear on the display to indicate that the unit is in the Memory mode.
Repeat to switch between the Memory and VFO modes.
- Select a memory channel.
Rotating the main dial will increase or decrease a memory channel number.

4.5.3 Deleting a Memory Channel

- Select the Memory mode by pressing the $\text{A}^{\text{VMMW}} \text{A}$ key.
- Rotate the dial to select the memory channel No. that you wish to delete.
- Press the FUNC key, and while **F** is displayed on the LCD, press the $\text{A}^{\text{VMMW}} \text{A}$ key. A beep sounds, then "**M**" flashes on the display.

NOTE:

When "**M**" is flashing in step 3 (when the memory contents are displayed as is on the display), it is still possible to cancel the operation by pressing the FUNC key, and while **F** is displayed on the LCD, press the $\text{A}^{\text{VMMW}} \text{A}$ key. After changing channels or modes, this is no longer possible.

4.5.4 Programming a Repeater-Access Function Setting

The "Repeater-Access" function is to set the desired shift and tone parameters to the current operating frequency by just 2 key-touches.

Please set the parameters to be applied to the Repeater-Access function here.

- Enter the Memory mode (by pressing the $\text{A}^{\text{VMMW}} \text{A}$ key if necessary).
- Rotate the dial to select MrpALLFRQ.
- Set the most commonly used Repeater-Access parameters by referring to "Repeater-Access" (page 43). The parameters can be programmed in this memory are marked * in the chart on the next page. By activating the Repeater-Access function these settings are applied to the operating frequency regardless of the VFO/Memory/CALL modes, by temporary replacing the current parameters.
- After programming is completed, press the FUNC key then press the $\text{A}^{\text{VMMW}} \text{A}$ key while MrpALL is displayed to store the edited parameters.
- Rotate the dial to operate in the Memory mode by selecting channels or press the $\text{A}^{\text{VMMW}} \text{A}$ key for VFO mode operation.

4.5.5 Programmable Parameters in Memory Channels

The following parameters can be stored in each of the memory channels.

- Frequency
- Offset frequency *
- Shift direction (+/-) *
- Tone encoder frequency *
- Tone decoder frequency *
- Tone encoder/decoder setting (TSQ) *
- DCS code *
- DCS setting *
- Skip channel setting
- Busy channel lockout (BCLO)
- Transmission power (H/L)
- Battery save setting
- Clock Shift setting
- Alphanumeric channel tag
- Attenata Level

NOTE:

Only parameters marked "*" are programmable in Repeater-Access function memory.

4.6 Call-Channel Mode

This mode is used to recall a most frequently used memory channel (stored in MC channel) with a single key-touch.

1. Press the $\overset{\text{C CALLSKP}}{\text{C}}$ key.

" C " is displayed on the LCD, and the channel programmed in MC is recalled.

2. Press the $\overset{\text{C CALLSKP}}{\text{C}}$ key again or the $\overset{\text{A VMMW}}{\text{A}}$ key in the Call mode to return to original operating mode (VFO/memory).

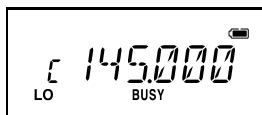



IMPORTANT NOTE:

- The dial and direct key-entry of frequency/memory channel are blocked in the Call mode.
- It is possible to temporary change the offset and CTCSS/DCS related parameters in the Call mode.
- The Scan function is deactivated in the Call mode.
- The CALL channel reprogramming is possible but it can't be deleted from the memory channel mode.

4.7 Receiving

4

1. Turn on the unit.
2. Press the  key and rotate the dial to adjust the audio level as necessary.
3. Press the  key and rotate the dial to adjust the squelch level.
4. Select the frequency that you wish to operate by using the dial or the keypad.
When a signal is received on the frequency that you selected, **BUSY** and S-meter are displayed on the LCD, then the received signal can be heard. The green RX indicator also lights at this time.

4.7.1 Monitor Function

In case the receiving signal is weak and the audio is intermittently cut off by the squelch, press the MONI key. As long as this key is pressed, the squelch including TSQ/DCS unmutes making the audio easier to hear.

- The squelch is unmuted while the MONI key is pressed, regardless of the squelch level setting.
- This function unmutes the squelch even if the DCS and Tone Squelch functions are set.

4.8 Transmitting

1. Select the frequency that you wish by using the dial or keypad.
2. Press the PTT key.
The red TX indicator turns on while transmitting.
3. While holding down the PTT key, speak into the unit at normal voice from the distance of 5cm (2").
4. Release the PTT key to receive.

IMPORTANT NOTE:



- To transmit a tone-burst signal, press the MONI key while holding down the PTT key.
- Speaking too loud, too close or too far from the unit may distort the audio.
- "OFF" appears on the display when the TX frequency is out of the TX range. This may easily happen when the offset is activated.

4.8.1 Selecting the Output Level

Press the FUNC key, and while **F** is displayed on the LCD, press the  key to switch between high and low transmission power output.

When the low power output is selected, "**LO**" is displayed on the LCD (nothing is displayed when the high power is selected).

The initial setting is low power.

The Power-meter display is  when transmitting at the low power, and  when transmitting at the high power.

IMPORTANT NOTE:

The output level can't be altered while transmitting.

5. Useful Functions

5.1 Scan Modes

The scan function automatically searches the receiving signals. There are 2 modes for scan-resume condition.

- Busy Scan: The scan stops when a signal is detected, stays until the signal is gone then resumes scanning.
- Timer Scan: The scan stops when a signal is detected, and resumes scanning after 5 seconds regardless of receiving status.

During scanning, the 1MHz decimal point (•) on the frequency display flashes.

Press any key other than the MONI key to stop scanning.

Scanning starts in the direction of the last dial operation (up or down).

NOTE:

Please refer to the Set mode to switch the setting between Timer and Busy scan modes (page 45).

5

5.1.1 VFO-Scan

1. Use the $\overset{A}{VMMW}$
 $\underset{A}{\text{A}}$ key to select the VFO mode.
2. Press the $\overset{B}{SCANKL}$
 $\underset{B}{\text{B}}$ key to start scanning. The unit scans in accordance with the order of one step.
3. Rotate the dial clockwise/counter-clockwise to change the scan direction.
VFO-scan scans the entire frequency range.
4. Press any key other than the MONI key to stop scanning.

5.1.2 Memory-Scan

1. Use the $\overset{A}{VMMW}$
 $\underset{A}{\text{A}}$ key to select the Memory mode.
2. Press the $\overset{B}{SCANKL}$
 $\underset{B}{\text{B}}$ key to start memory scanning.
3. Rotate the dial clockwise/counter-clockwise to change the scan direction.
Memory-scan scans all programmed memory channels.
4. Press any key other than the MONI key to stop scanning.

NOTE:

Please set the squelch level correctly before scanning, even in the TSQ scanning the normal squelch level adjustment is required to activate this function.

5.1.3 Setting Skip Channels

You can select the memory channels that you wish to skip during the memory-scan.

- Press the FUNC key in the Memory mode, and while **F** is displayed, press the  key to set the currently selected memory channel as a skip channel.
Use the same procedure to clear the skip channel setting.
- The 10MHz decimal point appears for memory channels that are set as skip channels.

5.2 Keylock

Press the FUNC key, and while **F** is displayed, press the  key to set the Keylock function on, and repeat the same to quit.

When the Keylock is on, the  is displayed on the LCD.

When the Keylock is on, other than the following, all operations are blocked.

- * PTT * LAMP * MONI * VOL * SQL * Tone-burst
- * POWER ON/OFF * DTMF tone

NOTE:

Keylock function can't be activated on the Repeater-Access function memory channel.

5.3 Tone-Burst

This function is to generate an audible tone to access European repeaters.

- To output the tone-burst tone, press the MONI key while holding down the PTT key.
The tone is transmitted as long as the MONI key is pressed.
The initial setting for the tone-burst tone is 1750Hz, but this can be changed in the Set mode (page 45).
- While transmitting the tone-burst tone, the CTCSS/DCS tone is temporary suspended.

5.4 Naming Memory Channels

In the Memory mode, it is possible to display up to 7 alphanumeric characters (Name-tag) instead of conventional frequency display.

5.4.1 Setting Name-Tag

1. Select the memory channel.
2. Press the FUNC key, and while **F** is displayed press the $\overset{\text{DIALNAME}}{\text{D}}$ key.
3. [A] flashes on the display.
4. Rotate the dial to select a character to be the first digit.
5. Press the $\overset{\text{DIALNAME}}{\text{D}}$ key to input the next character. The previous character will stop flashing.
6. Repeat the same sequence as necessary.
Press the $\overset{\text{CALLSKIP}}{\text{C}}$ key during setting to delete all characters.
7. Press any key (except MONI, $\overset{\text{CALLSKIP}}{\text{C}}$, $\overset{\text{DIALNAME}}{\text{D}}$) to complete the setting.

5.4.2 Using the Channel Name Function

- Programmed memory channels are displayed with alphanumeric characters. The channel number is displayed as it normally is.
- Press the FUNC key to display the frequency display for 5 seconds. Pressing certain keys during this 5 sec period may immediately recall the alphanumeric display, while other keys access their allocated functions.

5.5 Auto-Power-Off (APO)

This function prevents an useless battery consumption.

5.5.1 Setting APO

Press the FUNC key, and while **F** is displayed on the LCD, press the  key. **A** is displayed on the LCD, and the Auto-Power-Off function is set. Repeat the same to turn it off.

- The initial setting for the APO function is off.

5.5.2 APO Operation

- After having activated the APO and about 30 minutes elapse without any key-operation, the unit turns off automatically alerting with beep sounds. The time to Auto-Power-Off is determined by the last key operation only, not the last signal received.

5.6 Time-Out-Timer (TOT)

This function automatically stops transmission when a preset time is elapsed.

5.6.1 Setting TOT

1. Press the FUNC key, and while **F** is displayed on the LCD, press the $\textcircled{3}^{\text{TOT}}\textcircled{3}$ key. T-OFF is displayed on the LCD.
2. Rotate the dial to change the TOT setting time.
The maximum setting for the TOT time is 450 seconds.

OFF → 30 → 60 → 90 → ----- → 450 (unit: seconds)

3. Press any key other than the MONI key to complete the setting.

5.6.2 TOT Operation

When the preset time is about to be elapsed, a beep sounds to alert that the unit is forced to quit transmitting. Release PTT key to quit transmitting otherwise the TOT penalty may be activated. Refer to page 47 for TOT penalty time setting.

5.7 Lamp

Press the FUNC key, and while **F** is displayed on the LCD, press the MONI key to illuminate the display and DTMF keypad.

- The backlight automatically switches off if there is no key operation for 5 seconds.
- Pressing any key other than the LAMP key extends the LAMP function for another 5 seconds.
- Turning on the power while pressing the MONI key illuminates the backlight permanently. Repeat the same to turn it off.
- When the lamp is set for the "permanent-on" position, pressing the FUNC key then the MONI key to turn on/off the backlight.

NOTE:

The LAMP function consumes battery. The "permanent-on" position is recommended only for the operation using an external power source.

6. Selective Calling

■ Selective Calling Operations

- To communicate only with selected stations, use either the Tone Squelch or the DCS function.
- The Tone Squelch function unmutes the squelch only when a signal added with one of the matching 39 CTCSS tone frequencies is received.
- The DCS function unmutes the squelch only when a signal added with one of matching 104 digital codes is received.
- It isn't possible to use the Tone Squelch and DCS functions at the same time.

6.1 Tone Squelch (TSQ)

6.1.1 Setting the Tone Squelch

1. Press the FUNC key, and while **F** is displayed on the LCD, press the **4^{TSQ}** key to display the current TSQ settings. Each time the **4^{TSQ}** key is pressed, the display shows:

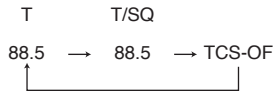

- When only **T** is displayed, the unit encodes the CTCSS tone.
 - When **T SQ** is displayed, the unit encodes and decodes the CTCSS tone.
2. Rotate the dial while the tone frequency is displayed to select one of the 39 CTCSS tones shown below. The tone can be set for encode/decode separately (refer to page 37 for details).

(unit: Hz)									
67.0	69.3	71.9	74.4	77.0	79.7	82.5	85.4	88.5	91.5
94.8	97.4	100.0	103.5	107.2	110.9	114.8	118.8	123.0	127.3
131.8	136.5	141.3	146.2	151.4	156.7	162.2	167.9	173.8	179.9
186.2	192.8	203.5	210.7	218.1	225.7	233.6	241.8	250.3	

3. Press any key other than the MONI key to complete the setting. Observe that both **T** and **SQ** are displayed.

6.1.2 Switching Off the Tone Squelch

Press the ^{4 TSO}4 key in Tone Squelch Setting mode to select TCS-OFF, then press any key other than the MONI key to complete the setting.

6.1.3 To Differentiate the ENC/EDC Tones

It is possible to set the encode and decode tones independently in the Tone Squelch Setting mode.

- To set the encode tone, when **T** is displayed, select a desired tone. The decode tone is set automatically to the same tone.
- To differentiate the decode tone, select another tone in **T SQ** status.

6.1.4 Tone Squelch Operation

The squelch unmutes only when the signal with the same decoding-setting tone is received.

6.2 DCS

6.2.1 Setting the DCS

1. Press the FUNC key, and while **F** is displayed on the LCD, press the ^{7 DCS}7 key. "DCS" is displayed on the LCD, and the DCS code is displayed. The initial setting is 023.

Each time you press the ^{7 DCS}7 key, the display switches between:

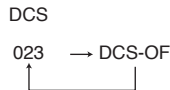

2. Press any key other than the MONI key to complete the setting. Observe that "DCS" is displayed.

6.2.2 Changing the DCS Code

1. Rotate the dial in DCS Code Setting mode (while "DCS" is displayed).
2. Press any key other than the MONI key to complete the setting.
 - The same DCS code is set for ENC/DEC, differential setting isn't available.

One of the following 104 DCS codes can be selected.

023	025	026	031	032	036	043	047	051	053
054	065	071	072	073	074	114	115	116	122
125	131	132	134	143	145	152	155	156	162
165	172	174	205	212	223	225	226	243	244
245	246	251	252	255	261	263	265	266	271
274	306	311	315	325	331	332	343	346	351
356	364	365	371	411	412	413	423	431	432
445	446	452	454	455	462	464	465	466	503
506	516	523	526	532	546	565	606	612	624
627	631	632	654	662	664	703	712	723	731
732	734	743	754						

6.2.3 Switching Off DCS

Select DCS-OFF in the DCS Code Setting mode to turn it off.

6.2.4 DCS Operation

The squelch unmutes only when the unit receives the matching code.

6.2.5 DET Mode in DCS Operation

■ DET Setting

If the DET mode in DCS operation is preferred, while in the DCS Code Setting mode and DCS-OFF is displayed, rotate the dial to eliminate the hyphen (DCS OF) then proceed with the rest of setting sequence.

DET on DCS function stands for Detect-Only mode. In DCS operation, the TX signal carries a digital code. The RX side, just like TSQ, detects this tone stream and determines the squelch operation. This DCS code stream is transmitted all the way through the communication like a CTCSS tone and it is necessary for receiver to correctly and CONTINUOUSLY receive this DCS stream to hold the squelch open, otherwise the CPU thinks that the signal is unwanted and it closes the squelch. But due to noise or weak signal strength etc, sometimes it is difficult to continuously receive a DCS stream. By activating DET, the receiver opens the squelch when the first corresponding DCS stream is received, then thereafter, regardless of the status of the DCS codes, the DCS squelch remains opened.

■ Advantage of DET

It enables DCS squelch operation even in poorer signal conditions.

■ Disadvantage of DET

When it is activated, suppose 2 stations are sharing the same channel and using the DCS selective-calling technique and transmitting at the same time. After station A with its corresponding DCS is gone, you may still hear station B even his DCS code is different from A, although he can't open your DCS squelch by his signal alone.

6.3 DTMF Tone Encoding**■ To Manually Transmit DTMF Tones**

1. Press the numeric, alphabetic or symbol keys while holding down the PTT key. The tones sound as long as the key is pressed.
2. Up to 16 characters of manually transmitted DTMF tones are automatically stored for redialing. Refer to "Redial" (page 41) for operation.

6.4 Auto Dialer

The DTMF tones can be stored in the memory to automatically transmit.

6.4.1 Setting the Auto Dialer

- All 16 DTMF tones up to 16 characters are available for each of 9 memories called an Auto Dialer memory.

■ Programming the Auto Dialer Memories

- Press the FUNC key, and while **F** is displayed on the LCD, press the $\overset{9 \text{ DIALM}}{\text{9}}$ key to enter the Dialer Setting mode. The "M1" appears.
There are six space available for characters on the display, and nothing is displayed initially.
- Select a desired Auto Dialer memory channel from M1 to M9 by rotating the dial.
- Use the DTMF key to input the DTMF tones.

For example: when programming 123456789, the display changes as follows:

[1] → [12] → [123] → [1234] → [12345] → [123456] → [234567] → [345678] → [456789]

- To set a pause instead of a tone, press the FUNC key, and while **F** is displayed, press the $\overset{0 \text{ REPT}}{\text{0}}$ key. "-" is displayed for a pause.
The pausing time is approx. 1 second.
 - Press the FUNC key, and while **F** is displayed, rotate the dial to scroll the display to see the hidden characters.
 - To clear the programming, press the FUNC key, and while **F** is displayed, press the $\overset{C \text{ CALLKP}}{\text{C}}$ key.
- Press the PTT key to complete the programming.

6.4.2 Generating the Auto Dialer Codes

Please program the Auto Dialer memory channel(s) in advance.

- Press the $\overset{\text{DIALNAME}}{\text{D}}$ key. "DIAL" is displayed on the LCD.
- Press one of the $\overset{1 \text{ STEP}}{\text{1}}$ to $\overset{9 \text{ DIALM}}{\text{9}}$ key (corresponding to memory #1~#9) to automatically generate the DTMF tones.

■ Auto Dialer Operation While Transmitting

- While pressing the PTT key, press the FUNC key. "DIAL" is displayed on the LCD. Don't release the PTT to proceed.
- Press one of the $\overset{1 \text{ STEP}}{\text{1}}$ to $\overset{9 \text{ DIALM}}{\text{9}}$ key to automatically transmit the DTMF tones.

6.4.3 Redial

This function generates the last DTMF tones used by the unit.

1. Press the $\overset{\text{DIALNAME}}{\text{D}}$ key while the unit is receiving.
2. Press the $\overset{0}{\text{RPT}}$ key. The last DTMF tones (either the auto dialer code or a manually input DTMF code) is automatically generated from the speaker. The unit doesn't transmit the tones in this operation.
3. To transmit, press the FUNC key while pressing the PTT key, then the $\overset{0}{\text{RPT}}$ key.

Please note that you must operate the DTMF tones at least once to proceed above.

7. Special Functions

7.1 ATT (Attenuator)

Use this function when the receiving signal is interfered by strong signals of nearby channels. When you activate this function, the transceiver attenuates the receiving sensitivity.

1. Press the FUNC key, and while **F** is displayed on the LCD, press the $\text{8} \begin{matrix} \text{ATT} \\ \text{8} \end{matrix}$ key.
2. Rotate the dial to change the ATT level. There are 2 levels; ATT-1 attenuates the received signal by 10dB and ATT-2 does 20dB. Press any key other than the $\text{8} \begin{matrix} \text{ATT} \\ \text{8} \end{matrix}$ or MONI key to complete setting. Observe that "**ATT**" appears on the display.



Press the $\text{8} \begin{matrix} \text{ATT} \\ \text{8} \end{matrix}$ key in the setting sequence to display "ATT-OFF" then press any key other than the $\text{8} \begin{matrix} \text{ATT} \\ \text{8} \end{matrix}$ or MONI key to turn off this function. Observe that "**ATT**" disappears from the display.

7.2 Battery Refresh

Repeating improper recharge of the Ni-MH battery pack may cause so-called the "memory effect" that the battery holds less charge. To avoid this, it is recommended to fully discharge the battery pack then full charge. This function helps discharging the battery pack. Please remove the unit from a charger or a DC cable before this operation.

1. Activate the Keylock (page 32).
2. Press the $\text{A} \begin{matrix} \text{VIMMW} \\ \text{A} \end{matrix}$ key twice, the $\text{B} \begin{matrix} \text{SCANKL} \\ \text{B} \end{matrix}$ key twice, the $\text{C} \begin{matrix} \text{CALLSRP} \\ \text{C} \end{matrix}$ key twice and then the $\text{D} \begin{matrix} \text{DIALNAME} \\ \text{D} \end{matrix}$ key twice. "DISCHG" will be displayed on the LCD, and the battery-refresh starts.

3. To cancel this operation, just turn off the unit, turn it on again, then unlock the Keylock function.
4. The unit will turn off automatically when finished the refresh.

**Caution**

- The time to refresh totally depends on the remaining charge of the battery pack. To discharge the fully-charged EBP-65 may take up to approx. 7 hours.
- When this function is on, the backlight and the keys are illuminated, and noise from the speaker can be heard.
- Before storing the rechargeable battery pack for an extended period of time, please full-charge it after this operation.

7.3 Repeater-Access

1. Press the FUNC key, and while **F** is displayed on the LCD, press the $\overset{0}{\text{RPT}}$ key.
2. Preset parameters on the Repeater-Access function memory will be effective at any frequency. Repeater-Access parameters have priorities over the parameters programmed in the VFO/memory/CALL modes.

8. Set Mode

The Set mode is used to customize the various operational parameters of your DJ-V17.

8.1 Set Mode Operation

This chart shows the available parameters in the Set mode.

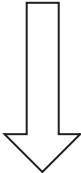
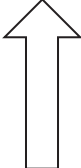
Menu	Default setting	Function	
01	BS-ON	Battery Save ON/OFF	 MONI key
02	TIMER	Timer/Busy scan setting	
03	BEP-ON	Beep sound ON/OFF	
04	1750	Tone-Burst Frequency setting	
05	SFT-OF	CPU Clock Frequency shift ON/OFF	
06	BCL-OF	Busy Channel Lock Out ON/OFF	
07	TP-OFF	TOT Penalty setting	 FUNC key
08	DWT-01	DTMF Wait time setting	
09	DP-60	DTMF Pause/Burst time setting	
10	DB-60	DTMF First Digit Burst time setting	
11	CHG-OF	Battery Charge ON/OFF	
12	BATT-NI	Battery type setting	

8.2 Entering the Set Mode

1. Press the FUNC key for at least 2 seconds.
The unit enters the Set mode.
"BS-ON" is displayed as a factory-default.
2. Press the MONI key or FUNC key to select a menu.
The Monitor function can't be used in this status.
3. Rotate the dial to change the parameter.
4. Press any key other than the MONI key and FUNC key to complete the settings.

The last operated menu will be selected the next time you enter the Set mode.

8.3 Available Parameters

8.3.1 Menu 1 Battery Save (BS) Function

This function prevents useless battery consumption by switching the power ON/OFF at a fixed ratio if there is no key operation or receiving signal for a continuous period of 5 seconds or more.

1. BS-ON is displayed on the LCD.
2. Rotate the dial to select the battery save setting (on or off).

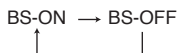

- The factory setting is BS-ON
- The Battery Save function is temporarily suspended when a key is operated or a signal is received.
- Set this parameter OFF for packet operation.
- The display remain unchanged even the BS function is in the OFF cycle.

8.3.2 Menu 2 Timer/Busy Scan Setting

Select the scan-resume condition in this menu (page 31).

1. TIMER is displayed on the LCD.
2. Rotate the dial to select the scan-resume condition between TIMER and BUSY.

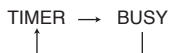

8.3.3 Menu 3 Beep Function

Select OFF to turn off all the beep sounds inclusive of alerting beeps.

1. BEP-ON is displayed on the LCD.
2. Rotate the dial to select the beep setting on and off.

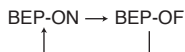

8.3.4 Menu 4 Tone-Burst Frequency Setting

1. 1750 is displayed on the LCD.
2. Rotate the dial to select the tone-burst frequency.

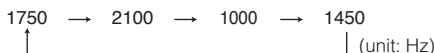

8.3.5 Menu 5 Clock Shift Setting

In the unlikely event that you may hear a weak noise always on the same frequency, it may be so-called a CPU-clock noise. Unfortunately this is due to the circuit-design of this product and can't be eliminated, but can be moved away to another frequency.

1. SFT-OF is displayed on the LCD.
2. Rotate the dial to select the clock shift setting on and off.

SFT-OF → SFT-ON



NOTE:

This function isn't a noise-blanker.

8.3.6 Menu 6 Busy Channel Lockout Setting

This function restricts the PTT (transmit) operation.

1. BCL-OF is displayed on the LCD.
2. Rotate the dial to select the Busy Channel Lockout setting on and off.

BCL-OF → BCL-ON

When Busy Channel Lockout is set to on, transmission is possible only in the following conditions (and isn't possible otherwise).

The alarm sounds if the PTT key is pressed when transmission is prohibited.

- 1) When no signal is being received (BUSY isn't displayed).
- 2) When the tone matches and the squelch is unmuted based on the Tone Squelch setting conditions.
- 3) When the codes match and the squelch is unmuted based on the DCS setting conditions.

8.3.7 Menu 7 TOT Penalty Time

This parameter determines the time to resume the transmission after the unit is forced to quit transmitting by TOT.

1. TP-OFF is displayed on the LCD.
2. Rotate the dial to change the TOT Penalty Time setting.

TP-OFF → TP-1 → ----- → TP-4 → ----- → TP-15
 ↑ _____ (unit: seconds)

Transmission is prohibited until the penalty time elapses.

- An alert beep sounds when the PTT key is pressed during the penalty time.

NOTE:

The following 3 menus explain the Auto Dialer DTMF tone parameters. Please refer to the chart at the end for details.

8.3.8 Menu 8 DTMF WAIT Time

Use this parameter to delay the time to start transmitting the DTMF tones in Auto Dialer operation. The initial setting is 100ms.

1. DWT-01 is displayed on the LCD.
2. Rotate the dial to change the DTMF wait time setting.

DWT-01 → DWT-04 → DWT-07 → DWT-10
 ↑ _____ (unit: 100ms)

8.3.9 Menu 9 DTMF Burst/Pause Time

This parameter determines the length of DTMF tones and pause time between the tones.

1. DP-60 is displayed on the LCD.
2. Rotate the dial to change the DTMF burst/pause time setting.

DP-60 → DP-80 → DP-160 → DP-200
 ↑ _____ (unit: ms)

8.3.10 Menu 10 DTMF First Digit Burst Time

It often happens that the radios fail to receive the very beginning instant of each communication due to squelch/TSQ/DCS etc. By setting the burst time of the first digit longer, the risk to miss the first DTMF tone will decrease.

1. DB-60 is displayed on the LCD.
2. Rotate the dial to select the initial-character burst time.

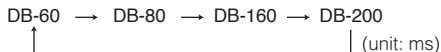

The DTMF Timing Chart

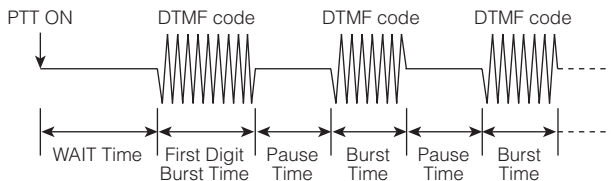

8.3.11 Menu 11 Battery Charge Function

The Ni-MH battery pack can be charged with an external power supply or an optional AC adapter using the DC-jack on the unit. Please select ON to activate this function. The factory setting is OFF.

1. CHG-OFF is displayed on the LCD.
2. Rotate the dial to select the battery charge setting on and off.
3. Please be sure to read "Battery Type Setting" (page 49) to correctly use this function.

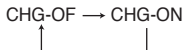

NOTE:

- Please be sure to select OFF when using a dry cell case otherwise it may risk a leak of battery liquid, heat or explosion of the battery cells and the battery case.
- While this function is activated, without attaching a battery pack or the remaining battery level is below the usable range, the unit turns on by just connecting the DC source such as an adapter or a DC cable (without operating the power key).

8.3.12 Menu 12 Battery Type Setting

Select the correct battery type from Ni-MH battery pack, Li-ion battery pack and Alkaline dry cells in order to display the battery-level icon correctly and to perform the battery-charge using the DC-jack.

1. BATT-NI is displayed on the LCD.
2. Rotate the dial to select battery type from Ni-MH battery pack (BATT-NI), Li-ion battery pack (BATT-LI) and Alkaline dry cells (BATT-AL).



NOTE:

Please set this parameter correctly. When the BATT-LI or BATT-AL is selected, previously explained battery charge function can't be performed.

- Cut out the Set Mode Function List below for use as a quick reference.

Reference (Set mode)	BS-ON	TIMER	BEP-ON	1750	SFT-OF	BCL-OF	TP-OFF	DWT-01	DP-60	DB-60	CHG-OF	BATT-NI
	Battery Save	Timer/Busy scan	Beep sound	Tone-Burst Frequency	CPU Clock Frequency shift	Busy Channel Lock Out	TOT Penalty	DTMF Wait time	DTMF Pause/Burst time	DTMF First Digit Burst time	Battery Charge	Battery type

9. Cloning and Packet Operation

9.1 Cloning

The memory data and customized operational parameters can be transferred from a Master unit to other DJ-V17 (Slave units).

9.1.1 Cable Connection

- Make sure that both units are turned off before connecting the cable.
- Connect the Microphone/Speaker jack on the Master unit with the Slave unit using an optional clone cable (EDS-11) as shown below, then turn on both units.

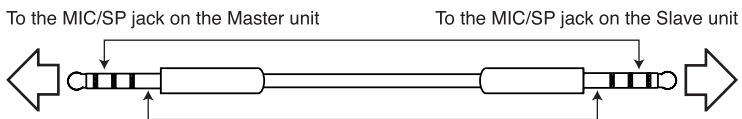

9.1.2 Master/Slave Units

Press the PTT key three times while holding down the MONI key.

"CLONE" is displayed on the LCD, and both units enter the Clone mode.



9.1.3 Master Unit Operation

1. In the Clone mode, press the PTT key of the master unit. "SD***" is displayed on the LCD, and starts the data-transfer.

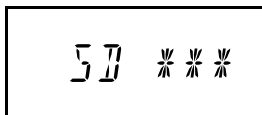

2. After the transfer is completed successfully, "PASS" is displayed.
3. Turn off the unit. Repeat the same sequence to clone more units.

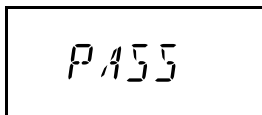

Stop moving the SD***, COMERR etc. on the display means that the cloning is failed. Please read below and repeat the procedure.

9.1.4 Slave Unit Operation

1. When the data is sent from the master unit, "LD***" is displayed on the receiving unit, and the data-transfer starts.

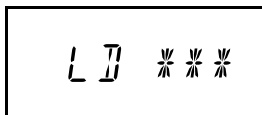

2. After the transfer is completed, "PASS" is displayed.
3. After the cloning is done, turn off the unit by pressing the  key and remove the cable. Repeat the same sequence to clone more units.

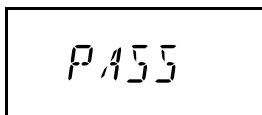

In case the transfer fails, please turn off the slave unit and perform the reset sequence (page 54) to turn on again before retry. If you quit cloning of this slave unit, please reset it anyway otherwise it may not work properly.



Caution

- Don't disconnect the cable during data transmission. If you disconnect the cable at this time, "COMERR" is displayed on the LCD of the master unit, and transmission is aborted.
- When data transfer is performed using the Clone function, all settings in the slave unit are overwritten by the master unit settings.

9.2 Packet Operation

Packet operation is one of the data communication methods, which enables data transmission and reception with a personal computer through an optional TNC unit.

9.2.1 Packet Operation Connections

Connect an optional EDS-10 Microphone/Speaker cable plug to the MIC/SP jack on the top of the unit, and connect the TNC (Terminal Node Controller) to the SP jack with 3.5Ø plug, and to MIC jack with 2.5Ø plug on the EDS-10 as shown below.

- Input level adjustment: The unit doesn't have microphone and speaker level adjustment circuit. Adjust their level on the TNC side.
- Output level adjustment: Use the audio output (*VOL*) key of the unit to adjust the output level from MIC/SP terminal.

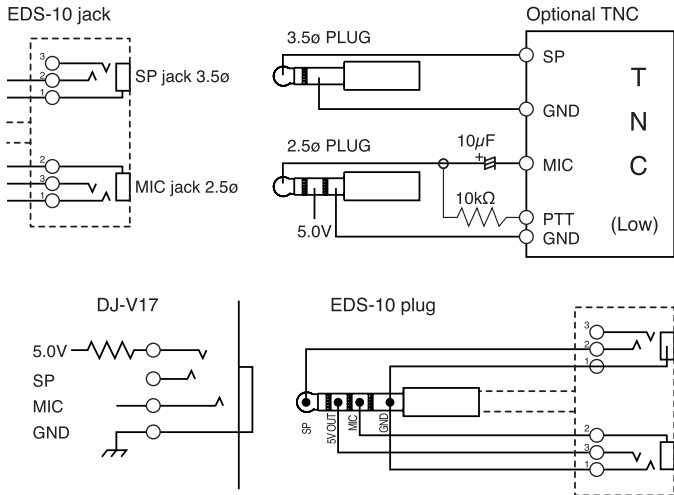

*Power is supplied from internal 5V line through 100Ω resistor.



Caution

- Refer to the TNC's instruction manual when connecting the TNC unit to other devices (personal computer etc.). If the unit, TNC unit and connected personal computer are set too close, noise between them may cause interference.
- Turn the battery save function off during packet operations.
- DJ-V17 operates up to 1200bps only.

10. Maintenance and Reference

10.1 Troubleshooting

Please check the list below before concluding that the unit needs to be serviced. If a problem persists, please reset the unit. The setting/CPU program-related troubles are often resolved by the reset.

Symptom	Possible Cause	Action
Nothing appears on the display when turning on the power.	Poor battery pack connection.	Check that the battery pack terminals are clean, and pack is correctly attached.
	Battery is exhausted.	Recharge or replace the battery.
No Speaker audio. No reception.	You are releasing the key too quickly.	Hold the power key down until the display shows figures.
	Volume too low.	Adjust the audio level.
	Squelch level too high.	Adjust the squelch.
	Tone squelch is on.	Turn off tone squelch.
	DCS is on.	Turn off DCS.
Frequency display is incorrect.	You are pressing the PTT key and transmitting.	Release PTT key.
	CPU error.	Reset the unit.
	A channel name is set.	See Naming Memory Channels function (page 33).
	Squelch is unmuted.	Set squelch so that noise mutes.
Frequency and memory number don't change.	Keylock is on.	Turn off Keylock.
	Transceiver is in the Call mode.	Select the VFO or Memory mode.
Key entry not possible.	Keylock is on.	Turn off Keylock.
Repeater-Access can't be used.	Incorrect setting of parameters.	Set the correct parameters to suit your local repeaters.
Can't transmit. Display flashes or goes out when you transmit.	Battery is exhausted.	Recharge or replace the battery.
Can't transmit. Can't talk to other stations.	Not pressing the PTT key firmly enough.	Press the PTT key and confirm that TX/RX lamp lights red.
	Off-frequency.	Be sure that you are in the TX range and/or check shift status.
	Incorrect frequency.	Check the shift status/repeater settings.
The display flashes or disappears during reception.	Battery is exhausted.	Recharge battery or replace the battery.

* Please be advised that the water-proof shields including jack caps are subject to consume. The factory warranty for IPX7-grade water-proof is 1 year. Please consult with your local dealer when further service-assistance may be necessary. Please visit alinco.com's "DISTRIBUTION" menu to locate the nearest dealer.

10.2 Resetting

When you reset the unit, all settings are returned to the initial factory settings. The reset deletes the programmed memory channels also.

1. Turn on the unit with the FUNC and  keys pressed together.
2. All the icons appear on the display.

Release the keys. All display will disappear for 2 seconds, and then reappear. The initial mode is the VFO.

Factory default settings

	DJ-V17T	DJ-V17E	DJ-V17TFH/R
VFO Frequency	145.000MHz	145.000MHz	155.000MHz
CALL Frequency	145.000MHz	145.000MHz	155.000MHz
Memory Channel	0~199ch Blank	0~199ch Blank	0~199ch Blank
Channel Step	5kHz	12.5kHz	5kHz
Shift	None	None	None
Offset Frequency	0.6kHz	0.6kHz	0.6kHz
Tone Setting	None	None	None
Tone Frequency	88.5Hz	88.5Hz	88.5Hz
DCS Setting	None	None	None
DCS Code	023	023	023
Transmitter Output	Low	Low	Low
Auto Dialer Code	None	None	None
Keylock	off	off	off
Time-Out-Timer	off	off	off
Auto-Power-Off	off	off	off
Volume Level	0	0	0
Squelch Level	0	0	0
Repeater Shift	-	-	-
Repeater Offset Frequency	0.6kHz	0.6kHz	0.6kHz
Repeater Tone Setting	88.5Hz	88.5Hz	88.5Hz

NOTE:

THE RESET DELETES ALL THE MEMORIES.

Please take notes of the important data and keep it for future reference.

10.3 Options

EBP-63	Li-ion Battery Pack (DC 7.4V 1100mAh)
EBP-64	Li-ion Battery Pack (DC 7.4V 1600mAh)
EBP-65	Ni-MH Battery Pack (DC 7.2V 700mAh)
EBP-66	Ni-MH Battery Pack (DC 7.2V 2000mAh)
EDC-36	Mobile Cigarette Lighter Adapter with Active Noise Filter
EDC-37	External DC Power Supply Cable
EDC-43	Mobile Cigarette Lighter Cable for Charging Ni-MH Packs
EDC-143T/E/UK	Trickle Battery Charger (T: 120V E: 240V UK: 240V UK plug)
EDC-143R	Multiple-Charger Basket (An external DC power supply required)
EDC-144A/E/UK	Rapid Battery Charger (A: 120V E/UK: same as above)
EDC-144R	Multiple-Charger Basket (An external DC power supply required)
EDC-146	Wall Charger (120V)
EDC-147	Wall Charger (230V)
EDC-148	Wall Charger (230V) U.K. Socket
EDH-34	Dry Cell Case
EDS-10	Microphone/Speaker Cable
EDS-11	Clone Cable
EME-6	Earphone
EME-12	Headset with VOX *
EME-13	Earphone and MIC with VOX *
EME-15	Tie-pin MIC with VOX *
EME-20	Earphone Microphone *
EMS-47	Speaker Microphone with Audio Control *
EMS-59	Speaker Microphone *
ESC-41	Soft Case

NOTE:

FOR EUROPEAN USERS

Please be advised that some of the accessories listed above aren't RoHS compliant at the moment this manual has been edited. Please refer to an updated brochure or ask your dealer for eventual replacements at the moment of the purchase after July 2006. Use of cigar-plug and DC cables are at your own risk per IEC/EN60950. Refer to page 8 for details.

IMPORTANT NOTE:

All accessories except EBP-63/64/65/66 and soft cases above listed are NOT water-proof. Never use these accessories in wet conditions.

- Please purchase an optional EDS-10 cable to operate optional accessories marked *.
- When using EDC-36, EDC-37, EDC-43, EDC-146, EDC-147, EDC-148, connect them to the unit first before turning on the unit.
- EBP-63, 64, 65 and 66 are IPX7-grade water-proof only when correctly attached and used with DJ-V17.

10.3.1 Microphone/Speaker Cable (EDS-10)

1. Turn off the unit.
2. Turn the plug clockwise until it stops. Check to be sure it is securely connected.
3. Connect the Microphone/Speaker plugs to the each jack.

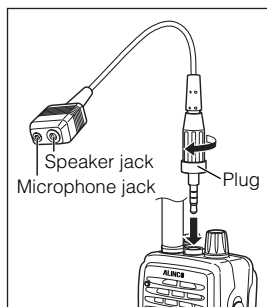

10.3.2 Battery Packs

The battery packs aren't fully charged when shipped. Please charge the pack completely before use.

■ Available Battery Packs for DJ-V17:

EBP-63	Li-ion Battery Pack (DC 7.4V 1100mAh)
EBP-64	Li-ion Battery Pack (DC 7.4V 1600mAh)
EBP-65	Ni-MH Battery Pack (DC 7.2V 700mAh)
EBP-66	Ni-MH Battery Pack (DC 7.2V 2000mAh)

■ Charging Battery Packs

Refer to the chart below for the combination of the proper battery pack and charger. The ○ indicates the usable combination, (* hrs) means the approximate time necessary to full charge the empty pack.

Chargers	Battery Packs		Ni-MH Battery Pack	
	EBP-63	EBP-64	EBP-65	EBP-66
Trickle Charger EDC-143			○(10hrs)	○(14hrs)
Rapid Charger EDC-144	○(2hrs)	○(3hrs)	○(1.5hrs)	○(3.5hrs)
Wall Charger EDC-146/147/148			○(10hrs)	○(30hrs)

10.3.3 Using the Chargers



Caution

Please also read the "Warning" (page 5 of this manual) and the safety instruction that is included in the accessories' package before operating with them for your safety.

■ Charging with the EDC-143 (Trickle Charger)

Please make sure that following items are included in the package.

- EDC-143T: EDC-143 basket, EDC-146 adapter (AC 120V), insulation sheet
- EDC-143E: EDC-143 basket, EDC-147 adapter (AC 240V), insulation sheet
- EDC-143UK: EDC-143 basket, EDC-148 adapter (AC 240V), insulation sheet
- EDC-143R: EDC-143 basket, connection cable, insulation sheet, 2 screws, connective stay



Caution

Before using them for the first time, attach the insulation sheet to cover the screw-terminals to avoid short-circuiting. Please refer to page 61 for instruction.

1. Connect the AC adapter plug to the DC-IN jack on the back of the basket.

*The design of the AC adapter may vary depending on the models.

2. Connect the adapter to an outlet.

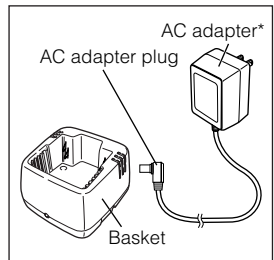

3. Press the sides of the adjustment plate, and attach it to the proper grooves of the basket according to the size of the battery pack. Please be sure to place the plate all the way down to the bottom.

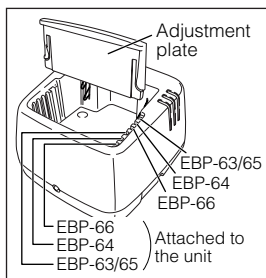
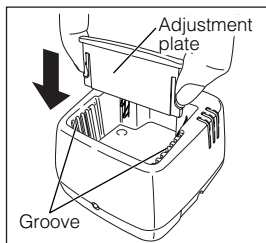

4. Mount the battery (with or without being attached to the unit) in the basket as shown. Turn off the unit while charging.

The red indicator on the basket turns on and charging starts.

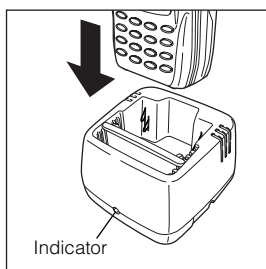

5. After charging time is elapsed (page 56), remove the battery pack from the basket. The red indicator stays turned on as long as the pack is mounted on the basket regardless of the charging status.

Specifications

	EBP-65	EBP-66
Input Voltage	DC 12.0V 150mA	DC 12.0V 150mA
Operating Temperature Range	0°C~+40°C (+32°F~+104°F)	0°C~+40°C (+32°F~+104°F)
Charging Current	70mA	140mA
Battery Capacity	DC 7.2V 700mA	DC 7.2V 2000mA
Charging Time	Approx. 10 hours	Approx. 14 hours

*The charging time may vary depending on the condition of the battery pack and the temperature of the environment.

■ Charging with the EDC-144 (Quick Charger)

Please make sure that following items are included in the package

- EDC-144A: EDC-144 basket, EDC-150 adapter (AC 120V), insulation sheet
- EDC-144E: EDC-144 basket, EDC-151 adapter (AC 240V), insulation sheet
- EDC-144UK: EDC-144 basket, EDC-152 adapter (AC 240V), insulation sheet
- EDC-144R: EDC-144 basket, connection cable, insulation sheet, 2 screws, connective stay



Caution

Before using them for the first time, attach the insulation sheet to cover the screw-terminals to avoid short-circuiting. Please refer to page 61 for instruction.

1. Connect the AC adapter plug to the DC-IN jack on the back of the basket.
*The design of the AC adapter may vary depending on the models.
2. Connect the adapter to an outlet.

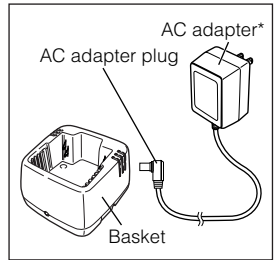

3. Press the sides of the adjustment plate, and attach it to the proper grooves of the basket according to the size of the battery pack. Please be sure to place the plate all the way down to the bottom.

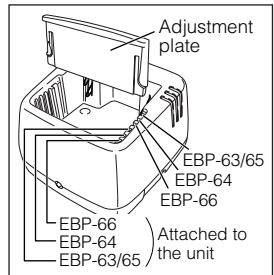
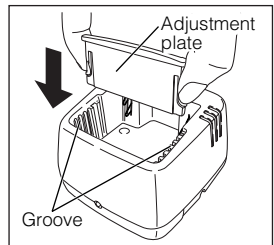

4. Mount the battery (with or without being attached to the unit) in the basket as shown. Turn off the unit while charging.

The red indicator on the basket turns on and charging starts.

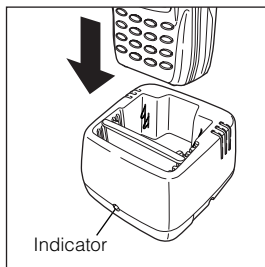

5. The red indicator turns off when the charge is completed. Remove the battery pack from the basket.

NOTE:

The flashing red indicator means that the charger isn't working properly. Stop using it immediately, remove the cord from the outlet and consult with your local Alinco dealer.

Specifications

	EBP-63	EBP-64	EBP-65	EBP-66
Input Voltage	DC 12.0V 700mA			
Operating Temperature Range	0°C~+40°C (+32°F~+104°F)			
Charging Current	600mA			
Battery Capacity	DC 7.4V 1100mA	DC 7.4V 1600mA	DC 7.2V 700mA	DC 7.2V 2000mA
Charging Time	Approx. 2 hours	Approx. 3 hours	Approx. 1.5 hours	Approx. 3.5 hours

*The charging time may vary depending on the condition of the battery pack and the temperature of the environment.

■ Connecting Additional Baskets (EDC-143R/144R)

In order to use EDC-143R and EDC-144R, an optional power supply (IEC/EN 60950 compliant) of 1A/5A minimum respectively is required.

A DC cable isn't included in the package; the suggested DC cable is 20 AWG wire, shorter than 1m (3feet) in length.

1. Make sure that the output voltage of the power supply is DC 12.0V.

2. Connect the terminals with the provided connection cable, the red cable to the positive and the black cable to the negative terminals.

The additional basket can be connected up to 5 in the same way.

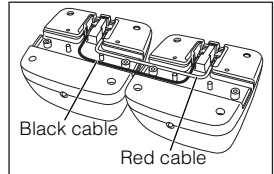

3. Connect the ends of the DC cable to the terminals of the basket.

* This DC cable isn't provided in the products.

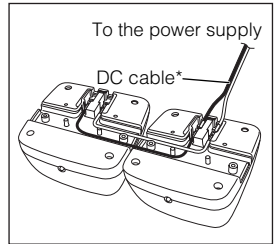

4. Attach the connective stay and the insulation sheets to cover the terminals to avoid short-circuiting.

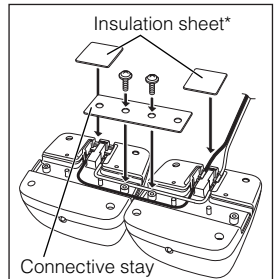

Caution

This insulation sheet marked * is provided to all EDC-143/144 series chargers. Please be sure to cover the bottom of the charger with this sheet as shown above to prevent short-circuiting.

5. Connect the other ends of the DC cable to the output terminals of the power supply.
Be mindful to the polarities of the terminals.

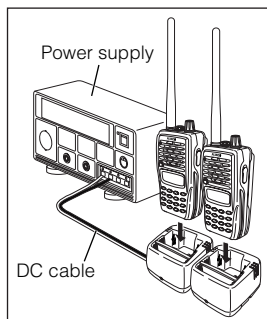

11. Specifications

■ General

Frequency range	T:	TX144~147.995MHz	* 144~147.995MHz
		RX130~173.995MHz	* 144~147.995MHz
	E:	TX144~145.995MHz	* 144~145.995MHz
		RX144~145.995MHz	* 144~145.995MHz
TFH/R:		TX130~173.995MHz	* 150~173.995MHz
		RX130~173.995MHz	* 150~173.995MHz
	* Guaranteed range		
Modulation:	F3E (FM)		
Frequency step:	5, 10, 12.5, 15, 20, 25, 30kHz step		
Memory channel:	200 channels + 1 call channel + 1 Repeater-Access function memory		
Ant. impedance:	50 Ω unbalanced		
Frequency stability:	± 5 ppm		
Mic. impedance:	2k Ω		
Supply voltage:	DC 7.0~16.0V (EXT DC-IN)		
Current consumption:	1.4A (typical) Transmit high at 5W		
	250mA (typical) Receive at 500mW		
	70mA (typical) Standby		
	25mA (typical) Battery save on		
Temperature range:	External DC: -10°C~+60°C (+14°F~+140°F)		
	Battery packs: -10°C~+45°C (+14°F~+113°F)		
Ground:	Negative ground		
Dimension:	58(W)x110(H)x36.4(D)mm		
	(2.28"(W)x4.33"(H)x1.43"(D)) (with EBP-65N)		
Weight:	Approx. 280g (9.9oz) (with EBP-65N)		
DTMF:	16 Buttons Keypad		
Sub audible Tone (CTCSS):	encoder/decoder installed (39 tones)		
Sub audible Tone (DCS):	encoder/decoder installed (104 codes)		

■ Transmitter

Power output:	Approx. 5W (with EBP-65N) Approx. 5W (with DC 13.8V) Approx. 0.8W (LOW output)
Modulation:	Variable reactance
Spurious emission:	-60dB or less
Max. deviation:	±5kHz
Mic. impedance:	2k Ω

■ Receiver

System:	Double-conversion super heterodyne
Sensitivity:	-14.0dB μ (0.2 μ V) or less
Intermediate frequency:	1st IF 21.7MHz 2nd IF 450kHz
Sensitivity:	-6dB: 12kHz or more -60dB: 26kHz or less
AF output:	500mW (MAX) 400mW (8 Ω , 10% distortion)

ALINCO, INC.

Head Office:Shin-Dai building 9th Floor

2-6, 1-Chome, Dojimahama, Kita-ku, Osaka 530-0004, JAPAN

Phone:+81-6-4797-2136 Fax: +81-6-4797-2157

E-mail:export@alinco.co.jp