

ALINCO

VHF FM Mobile Transceiver

DR-B185HT

DR-B185HE

Instruction Manual

Thank you for purchasing your new Alinco transceiver. Please read this manual carefully before using the product to ensure full performance, and keep this manual for future reference as it contains information on after-sales services. In case addendum or errata sheets are included with this product, please read those materials and keep them together with this instruction manual for future reference.

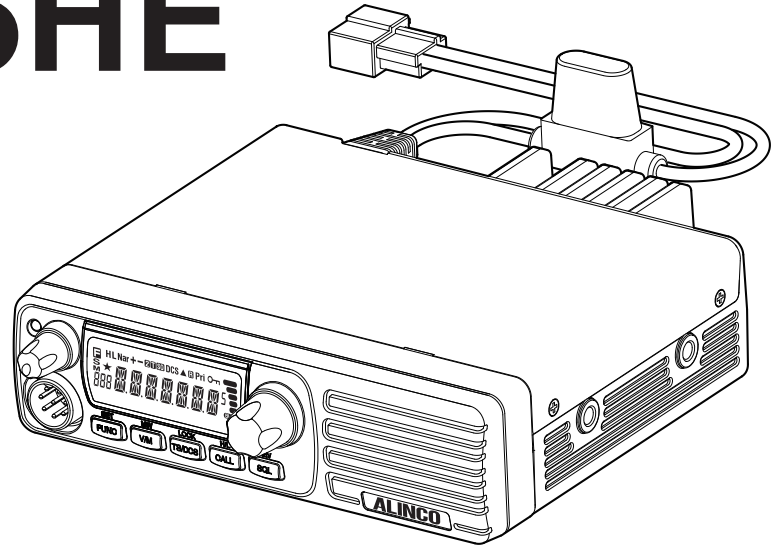



Introduction

Thank you very much for purchasing this excellent Alinco transceiver. Our products are ranked among the finest in the world. This radio has been manufactured with state of the art technology and it has been tested carefully at our factory. It is designed to operate to your satisfaction for many years under normal use.

Please read this manual completely from the first page to the last, to learn all the functions the product offers. It is important to note that some of the operations may be explained in relation to information in previous chapters. By reading just one part of the manual, you may risk not understanding the complete explanation of the function.

Before transmitting

There are many radio stations operating in proximity to the frequency ranges this product covers. Be careful not to cause interference when transmitting around such radio stations.

■ Lightning

Please note that no car provides adequate protection of its passengers or drivers against lightning. Therefore, Alinco will not take responsibility for any danger associated with using its products outdoor or inside the car during lightning.

Features

- **Output power selectable (Hi/Lo)**
- **PC-programmable**
- **Alphanumeric name tags**
- **Sub-tone (CTCSS/DCS) Encode/Decode, DTMF/ANI**
- **Various scan modes, Key lock, Wide/Narrow operations and more at NO extra costs.**

Copyright 2014 All rights reserved. NO part of this document may be reproduced, copied, translated or transcribed in any form or by any means without the prior written permission of Alinco.Inc, Osaka, Japan, English Edition Printed in China.

NOTICE / Compliance Information Statement

This equipment has been tested and found to comply with the limits for a Class B digital device, pursuant to part 15 of the FCC Rules. These limits are designed to provide reasonable protection against harmful interference in a residential installation.

This equipment generates, uses, and can radiate radio frequency energy and, if not installed and used in accordance with the instruction manual, may cause harmful interference to radio communications. However, there is no guarantee that interference will not occur in a particular installation. If this equipment does cause harmful interference to radio or television reception, which can be determined by turning the equipment off and on, the user is encouraged to try to correct the interference by one or more of the following measures:

- Reorient or relocate the receiving antenna.
- Increase the separation between the equipment and receiver.
- Connect the equipment into an outlet on a circuit different from that to which the transceiver is connected.
- Consult the dealer or an experienced radio/TV technician for help.

 **Tested to Comply
With FCC Standards
FOR HOME OR OFFICE USE**

Information in this document is subject to change without notice or obligation. All brand names and trademarks are the property of their respective owners. Alinco cannot be liable for pictorial or typographical inaccuracies. Some parts, options and/or accessories are unavailable in certain areas. Changes or modifications not expressly approved by the party responsible for compliance could void the user's authority to operate the equipment.

VHF FM mobile transceiver DR-B185HT

This device complies with Part 15 of the FCC Rules. Operation is subject

to the following two conditions: (1) This device may not cause harmful interference, and (2) this device must accept any interference received, including interference that may cause undesired operation.



Conformity Information

Alinco, Inc. Electronics Division hereby declare on our sole responsibility that the product(s) listed below comply the essential requirements of the Directive 1999/5/EC, The council of 3/99/99 on Radio Equipment and Telecommunication Terminal Equipment and the mutual recognition of their conformity and with the provisions of Annex, after having performed the required measurements at Notified Bodies per Standards, and relative certificate(s) or document(s) can be reviewed at <http://www.alinco.com/Ce/>

VHF FM mobile transceiver DR-B185HE
144.000~145.995 MHz



This device is authorized for use in all EU and EFTA member states. An operator's license is required for this device.



Check with your local waste officials for details on recycling or proper disposal in your area.





Manufacturer:



ALINCO, Inc. Electronics Division
Yodoyabashi Dai Bldg 13F, 4-4-9, Koraihashi, Chuo-ku, Osaka
541-0043 JAPAN



WARNING







To prevent any hazard during operation of Alinco's radio product, in this manual and on the product you may find symbols shown below. Please read and understand the meanings of these symbols before starting to use the product.

| | |
|--|---|
|  Danger | This symbol is intended to alert the user to an immediate danger that may cause loss of life and property if the user disregards the warning. |
|  Alert | This symbol is intended to alert the user to a possible hazard that may cause loss of life and property if the user disregards the warning. |
|  Caution | This symbol is intended to alert the user a possible hazard that may cause loss of property or injure the user if the warning is disregarded. |

| | |
|---|--|
|  | Alert symbol. An explanation is given. |
|  | Warning symbol. An explanation is given. |
|  | Instruction symbol. An explanation is given. |

ALERT

■ Environment and condition of use:

-  Do not drive while handling the radio for your safety. It is recommended that you check local traffic regulations regarding the use of radio equipment while driving. Some countries prohibit the operation of transceiver while driving.
-  Do not use this product in close proximity to other electronics devices, especially medical ones. It may cause interference to those devices.
-  Keep the radio out of the reach of children.
-  In case a liquid leaks from the product, do not touch it. It may damage your skin. Rinse with plenty of cold water if the liquid contacted your skin.
-  Never operate this product in facilities where radio products are prohibited for use such as aboard aircraft, in airports, in ports, within or near the operating area of business wireless stations or their relay stations.
-  Use of this product may be prohibited or illegal outside of your country. Be informed in advance when you travel.
-  The manufacturer declines any responsibilities against loss of life and/or property due to a failure of this product when used to perform important tasks like life-guarding, surveillance, and rescue.

 Do not use multiple radios in very close proximity. It may cause interference and/or damage to the product(s).

 The manufacturer declines any responsibilities against loss of life and property due to a failure of this product when used with or as a part of a device made by third parties.

 Use of third party accessory may result in damage to this product. It will void our warranty for repair.

■ Handling this product:

 Be sure to reduce the audio output level to minimum before using an earphone or a headset. Excessive audio may damage hearing.

 Do not open the unit without permission or instruction from the manufacturer. Unauthorized modification or repair may result in electric shock, fire and/or malfunction.

 Do not operate this product in a wet place such as shower room. It may result in electric shock, fire and/or malfunction.

 Do not place conductive materials, such as water or metal in close proximity to the product. A short-circuit to the product may result in electric shock, fire and/or malfunction.

 Do not touch the heatsink (on/around the unit mostly found on mobile-base units) as it may become very hot during/after the operation that may risk burn your skin.

■ About power-supply:

 Use only appropriate, reliable and certified power supply of correct voltage and capacity.

 Do not connect cables in reverse polarity. It may result in electric shock, fire and/or malfunction.

 Do not plug multiple devices including the power-supply into a single wall outlet. It may result in overheating and/or fire.

 Do not handle a power-supply with a wet hand. It may result in electric shock.

 Securely plug the power-supply to the wall outlet. Insecure installation may result in short-circuit, electronic shock and/or fire.

 Do not plug the power-supply into the wall outlet if the contacts are dirty and/or dusty. Shortcircuiting and/or overheating may result in fire, electric shock and/or damage to the product.

 Do not modify or remove fuse-assembly from the DC-cable. It may result in fire, electric shock and/or damage to the product.





WARNING

■ In case of emergency:

In case of the following situation(s), please turn off the product, switch off the source of power, then remove or unplug the power-cord. Please contact your local dealer of this product for service and assistance. Do not use the product until the trouble is resolved. Do not try to troubleshoot the problem by yourself.

- When a strange sound, smoke and or strange odor comes out of the product.
- When the product is dropped or the case is broken or cracked.
- When a liquid penetrated inside.
- When a power-cord (including DC-cables, AC-cables and adapters) is damaged.

 For your safety, turn off then remove all related AC-lines to the product and its accessories including the antenna if a thunderstorm is likely.

 Turn off the unit, remove the mobile antenna from its base and keep it in the vehicle if a thunderstorm is likely.
Please read cautions regarding the lightning-protection on page 9 also.

■ Maintenance

 Do not open the unit and its accessories. Please consult with your local dealer of this product for service and assistance.

CAUTION

■ Environment and condition of use:

 Do not use the product in proximity to a TV or a radio. It may cause interference or receive interference.



 Do not install in a humid, dusty or insufficiently ventilated place. It may result in electric shock, fire and/or malfunction.

 Do not install in an unstable or vibrating position. It may result in electric shock, fire and/or malfunction when/if the product falls to the ground.





 Do not install the product in proximity to a source of heat and humidity such as a heater or a stove. Avoid placing the unit in direct sunlight.

 Do not modify, dismantle, incinerate, or immerse the batteries that may be used in accessories you use with this product.
Please check your local regulations for details on recycling option or disposal of the batteries in your area.



■ About transceiver

-  Do not connect devices other than specified ones to the jacks and ports on the product.
It may result in damage to the devices.
-  Turn off and remove the power-source (AC cable, DC cable, battery, cigar-cable, charger adapter etc) from the product when the product is not in use for extended period of time or in case of maintenance.
-  Use a clean, dry cloth to wipe off dirt and condensation from the surface of the product.
Never use thinner or benzene for cleaning.

■ About power-supply

-  Use only reliable power supply of specific DC output range and be mindful of the polarity of the cables and DC jack.
-  Always turn off the power supply when connecting or disconnecting the cables.
-  When using an external antenna, make sure that the antenna ground is not common with the ground of the power supply.
-  European users: When a transceiver is powered from an external DC power source (adapter, power supply, cigar-plug etc), make sure that this power supply has approval to the level of IEC/EN 60950-1.

CONTENTS

| | | | |
|---|-----------|---|-----------|
| Supplied Accessories | 1 | Basic Operations | 15 |
| SUPPLIED ACCESSORIES | 1 | SWITCHING THE POWER ON/OFF | 15 |
| MOBILE INSTALLATION | 2 | ADJUSTING THE VOLUME | 15 |
| Initial Installation | 2 | ADJUSTING FREQUENCY/CHANNEL THROUGH THE DIAL..... | 15 |
| DC POWER CABLE CONNECTION | 3 | SQUELCH LEVEL SETTING | 15 |
| POWER SUPPLY VOLTAGE DISPLAY | 5 | TO RECEIVE SIGNALS..... | 16 |
| ANTENNA CONNECTION..... | 5 | MONITORING FUNCTION | 16 |
| ACCESSORIES CONNECTIONS | 5 | TO TRANSMIT SIGNALS | 16 |
| FRONT PANEL | 7 | CALL MODE | 16 |
| BASIC FUNCTIONS | 7 | KEY OPERATIONS | 17 |
| OPERATIONS BY PRESSING AND HOLDING THE | | SCANNING FUNCTION | 17 |
| FOLLOWING RESPECTIVE KEYS | 7 | DCS SCAN | 19 |
| Getting Acquainted | 7 | CTCSS/DCS ENCODE AND DECODE SETUP | 20 |
| PRESS  KEY UNTIL  ICON APPEARS THEN PRESS | | HIGH/LOW POWER SWITCH | 20 |
| THE FOLLOWING KEY. | 8 | OFFSET DIRECTION SETUP | 21 |
| PRESS  KEY AND FOLLOWING KEY TOGETHER TO | | KEYPAD LOCKOUT | 21 |
| ACTIVATE FOLLOWING FUNCTION:..... | 8 | REVERSE FUNCTION | 21 |
| OPERATIONS WHEN TURNING ON THE POWER WHILE | | PARAMETER SETTING MODE | 22 |
| PRESSING THE FOLLOWING RESPECTIVE KEYS | 9 | CHANNEL STEP SETTING | 22 |
| REAR PANEL..... | 9 | MEMORY NAME (ALPHANUMERIC TAG) | 23 |
| DISPLAY | 10 | MEMORY DISPLAY INDICATOR..... | 23 |
| MICROPHONE | 11 | BEEP | 23 |
| Operating Modes (VFO Mode, Memory Mode, Channel | | DIMMER SETTING..... | 24 |
| Display Mode) | 12 | AUTOMATIC BACK LIGHT | 24 |
| VFO MODE..... | 12 | TIME-OUT-TIMER | 25 |
| MEMORY MODE | 12 | TOT PENALTY | 25 |
| CHANNEL DISPLAY MODE | 14 | AUTO POWER OFF | 25 |
| | | MESSAGE DISPLAYED WHEN TURNING ON THE POWER..... | 26 |

CONTENTS

| | |
|---|----|
| SETTING THE MESSAGE DISPLAYED WHEN TRUNING ON THE POWER | 26 |
| BCLO SETTING..... | 26 |
| OFFSET FREQUENCY | 27 |
| VFO UPPER LIMIT | 27 |
| VFO LOWER LIMIT | 27 |
| TONE-BURST FREQUENCY | 28 |
| DEFAULT TONE VALUE..... | 28 |
| DEFAULT SQ VALUE | 28 |
| DEFAULT DCS VALUE | 29 |
| AUTO-DIALER..... | 29 |
| DTMF TX SPEED | 30 |
| DTMF PAUSE TIME..... | 30 |
| DTMF MONITOR..... | 31 |
| SCAN TYPE..... | 31 |
| SCANNING STOP TIME -TMR..... | 31 |
| SCANNING STOP TIME -BSY | 31 |
| TONE SEARCH SCANNING SPEED | 32 |
| DCS SCANNING SPEED | 32 |
| PRIORITY SCAN SETTING | 32 |
| MEMORY CHANNEL SCANNING SETTING | 33 |
| GROUP SCANNING STEP..... | 33 |
| NARROW MODE..... | 33 |
| BEAT SHIFT..... | 34 |
| TUNING CONTROL..... | 34 |
| S-METER SQUELCH | 34 |
| SQUELCH HANG TIME..... | 35 |
| 2TONE | 35 |
| 2TONE RECEIVING SYSTEM | 36 |
| 2TONE TRANSMISSION TYPE | 36 |

| | |
|--|-----------|
| Cable Clone..... | 37 |
| Maintenance..... | 38 |
| DEFAULT SETTING AFTER RESETTING DR-B185..... | 38 |
| TO RESET | 38 |
| TROUBLE SHOOTING..... | 38 |
| Specifications DR-B185 | 39 |

1

Supplied Accessories

■ SUPPLIED ACCESSORIES

Carefully unpack to make sure the following items are found in the package in addition to this manual:

- Transceiver DR-B185

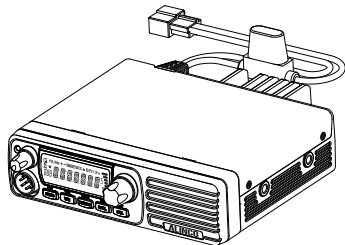

- Microphone EMS-53 or EMS-57 (with DTMF keyboard)

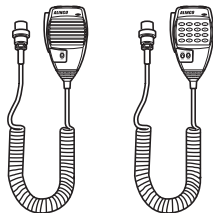

EMS-53

EMS-57

- Mobile Mounting Bracket

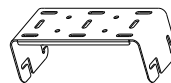

ZFM1004

- Hardware Kit for Bracket

Black Bracket Knob
(4PCS)



ZAE1002

Tapping screws
(M5X20mm)
(4PCS)



S-Washer
(4PCS)



- DC Power Cable with Fuse Holder

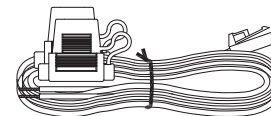

ZUA1007

1 ABOUT STANDARD MICROPHONE

Either EMS-53 or 57 comes with this product.

The instructions in this manual are based on EMS-57, therefore some key operations may not be available to EMS-53 users.

Factory default microphones:

- DR-B185HT : EMS-57 DTMF Remote
- DR-B185HE : EMS-53 Plain

- Spare Fuses
(2PCS)



ZEF1001

The standard accessories may vary slightly depending on the version you have purchased. Please contact your local authorized Alinco dealer should you have any questions. Alinco and authorized dealers are not responsible for any typographical errors there may be in this manual. Standard accessories may change without notice.

Warranty Policy: Please refer to any enclosed warranty information or contact your authorized Alinco dealer / distributor for the warranty policy.

- In order to operate this product, a properly tuned antenna, its feedline with connectors and fixing hardware are necessary. Please consult with your dealer for details.

MOBILE INSTALLATION

The transceiver may be installed in any position in your car, where the controls and microphone are easily accessible and it does not interfere with the safe operation of the vehicle. If your vehicle is equipped with air bags, be certain your radio will not interfere with their deployment. If you are uncertain about where to mount the unit, contact your vehicle's dealer.

1. Install the mounting bracket in the vehicle using the supplied self-tapping screws (4pcs) and flat washers (4pcs).

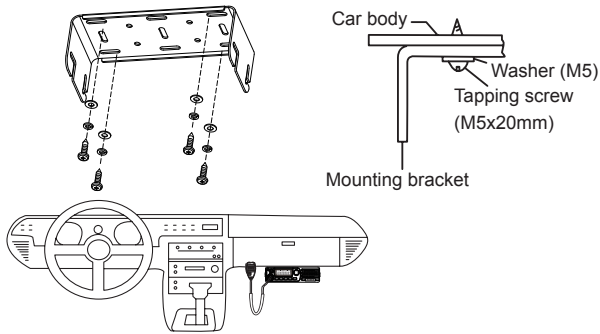

2. Position the transceiver, then insert and tighten the supplied hexagon SEMS screws.

- ▼ Double check that all screws are tightened to prevent vehicle vibration from loosening the bracket or transceiver.



Caution:

Use only the provided screws to fix the bracket, otherwise it voids warranty and you risk damaging the circuit board, components or fall-off of the unit.

- ▼ Determine the appropriate angle of the transceiver, using the 3 screw hole positions on the side of the mounting bracket.

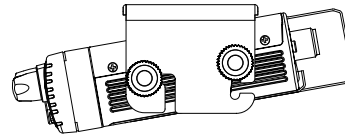
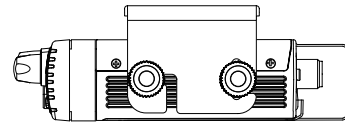
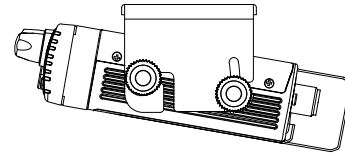

DC POWER CABLE CONNECTION

MOBILE OPERATION

The vehicle battery must have a nominal rating of 12V. Never connect the transceiver to a 24V battery. Be sure to use a 12V vehicle battery that has sufficient current capacity. If the current to the transceiver is insufficient, the display may darken during transmission, or transmitting output power may drop excessively.

1. Route the DC power cable supplied with the transceiver directly to the vehicle's battery terminals using the shortest path from the transceiver.
 - ▼ Never use the cigarette lighter socket as a DC source.
 - ▼ The entire length of the cable must be dressed so it is isolated from heat, moisture, and the engine secondary (high voltage) ignition system/cables.
2. After installing cable, in order to avoid the risk of damp, please use heat-resistant tap to tie together with fuse box. Don't forget to reinforce whole cable.
3. In order to avoid the risk of short circuit, please cut down connection with negative (-) of battery, then connect with radio.
4. Confirm the correct polarity of the connections, then attach the power cable to the battery terminals; red connects to the positive (+) terminal and black connects to the negative (-) terminal.
 - ▼ Never remove the fuse holders from the cable.

5. Reconnect any wiring removed from the negative terminal.

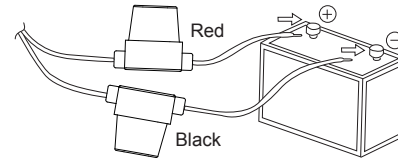

6. Connect the DC power cable to the transceiver's power supply connector.
 - ▼ Press the connectors firmly together until the locking tab clicks.

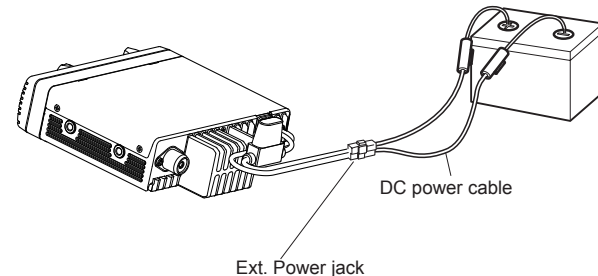

FIXED STATION OPERATION

In order to use this transceiver for fixed station operation, you will need a separate 13.8V DC power supply (not included) , Please contact local dealer to require.

The current capacity of your power supply must be 20A or more.

- ① Connect the DC power cable to the regulated DC power supply and ensure that the polarities are correct. (Red: positive, Black: negative).
- ▼ Never directly connect the transceiver to an AC outlet.
- ▼ Use the supplied DC power cable to connect the transceiver to a regulated power supply.
- ▼ Do not substitute a cable with smaller gauge wires.

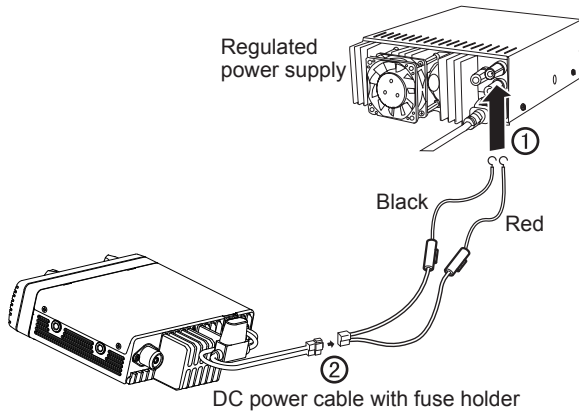

- ② Connect the transceiver's DC power connector to the connector on the DC power cable.
- ▼ Press the connectors firmly together until the locking tab clicks.



NOTE

- ▼ Before connecting the DC power to the transceiver, be sure to switch the transceiver and the DC power supply OFF.
- ▼ Do not plug the DC power supply into an AC outlet until you make all connections.

REPLACING FUSES

If the fuse blows, determine the cause, then correct the problem. After the problem is resolved, replace the fuse. If newly installed fuses continue to blow, disconnect the power cable and contact your dealer for assistance.

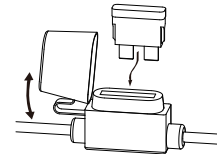

| Fuse Location | Fuse Current Rating |
|-----------------------------------|---------------------|
| Transceiver | 20A |
| Supplied Accessory DC power cable | 20A |



Only use fuses of the specified type and rating, otherwise the transceiver could be damaged.



NOTE

If you use the transceiver for a long period when the vehicle battery is not fully charged, or when the engine is OFF, the battery may become discharged, and will not have sufficient reserves to start the vehicle. Avoid using the transceiver in these conditions.

■ POWER SUPPLY VOLTAGE DISPLAY

After connecting the transceiver to the power supply, the supply voltage can be displayed on LCD by pressing the  key together with the  key.

The display immediately changes as the voltage supply changes, It also displays voltage during transmission.

The transceiver will return to its normal operation when the power is turned ON/OFF or repeat above operation.



The range of displayed voltage is from 7V to 16V DC. Because the displayed value is estimated, please use a voltmeter when a more precise reading is desired.

5

■ ANTENNA CONNECTION

Before operating, install an efficient, well-tuned antenna. The success of your installation will depend on the type of antenna and its correct installation.

Use a 50Ω impedance antenna and low-loss coaxial feed-line that has a characteristic impedance of 50Ω, to match the transceiver input impedance. Coupling the antenna to the transceiver via feed-lines having an impedance other than 50Ω reduces the efficiency of the antenna system and can cause interference to nearby televisions, radio receivers and other electronic equipment.



Transmitting without first connecting an antenna or other matched load may damage the transceiver. Always connect the antenna to the transceiver before transmitting.

All fixed stations should be equipped with a lightning arrester to reduce the risk of fire, electric shock, and transceiver damage.

■ ACCESSORIES CONNECTIONS

✕ EXTERNAL SPEAKER

If you plan to use an external speaker, choose a speaker with an impedance of 8Ω. The external speaker jack accepts a 3.5mm (1/8") mono (2-conductor) plug.

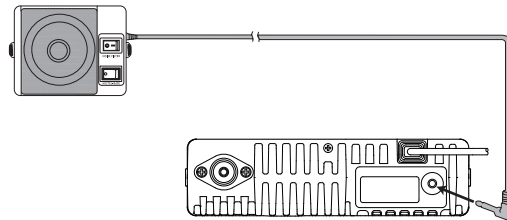

External speaker adopt double port BTL, please care about the connection.
NOTE Do not use the speaker that requires grounding.

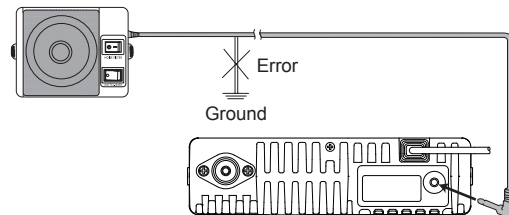

✦ MICROPHONE

For voice communications, connect a provided microphone into the socket on the front of the main unit. Turn the ring firmly on the plug until it locks. Attach the supplied microphone hanger in an appropriate location using the screws included in the screw set.

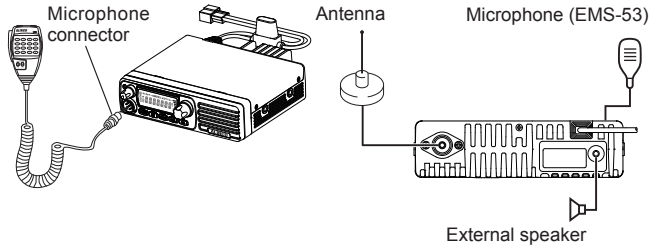

3

Getting Acquainted

FRONT PANEL

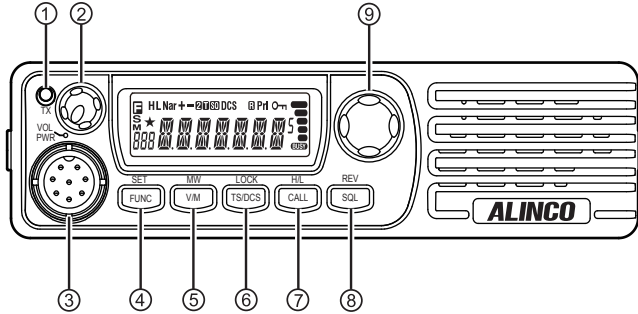



Basic Functions

| NO. | KEY | FUNCTION |
|-----|---------------|---|
| 1 | TX/Busy | Lights green when channel is busy and red when radio is transmitting |
| 2 | VOL knob | Rotate to adjust the audio level. Press to switch the power on/off. (Press and hold to turn off the power.) |
| 3 | Mic.connector | Microphone connection port |
| 4 | | Switches to function mode. |
| 5 | | Switches between VFO mode and Channel mode |
| 6 | | Sets the tone squelch and DCS value |





| NO. | KEY | FUNCTION |
|-----|------|---|
| 7 | | <ul style="list-style-type: none"> In VFO mode Switches the CALL channel/VFO mode (for the frequency being edited). In memory mode Switches the CALL channel/memory mode. In channel display mode Switches the CALL channel/currently displayed channel. |
| 8 | | Adjust Squelch level |
| 9 | Dial | <ul style="list-style-type: none"> In VFO mode Rotate to switch frequencies and various settings. Press to enter the settings. In memory mode/channel display mode Rotate to change memory channels and various settings. Press to enter the settings. |

OPERATIONS BY PRESSING AND HOLDING THE FOLLOWING RESPECTIVE KEYS

| NO. | KEY | FUNCTION |
|-----|----------|---|
| 2 | VOL knob | Press to switch the power on/off. (Press and hold to turn off the power.) |





| NO. | KEY | FUNCTION |
|-----|---|--|
| 4 |  | <ul style="list-style-type: none"> In VFO mode/memory mode Press and hold for 2 seconds to enter parameter setting mode. In channel display mode Operation is invalid. |
| 8 |  | Press and hold for 1 second to activate the monitoring function. Press again to stop. |
| 9 | Dial | <ul style="list-style-type: none"> In VFO mode Starts MHz scan. In memory mode/channel display mode Starts group scan. |

■ **PRESS  KEY UNTIL  ICON APPEARS THEN PRESS THE FOLLOWING KEY.**



| NO. | KEY | FUNCTION |
|-----|---|---|
| 4 |  | Exits from the function mode. |
| 5 |  | <ul style="list-style-type: none"> In VFO mode Stores a frequency on a memory channel. In memory mode/channel display mode Set a skip channel stored on a memory channel. |
| 6 |  | <ul style="list-style-type: none"> In VFO mode/memory mode Sets the operation lock function. In channel display mode Exits from function mode. |
| 7 |  | Sets transmission output. |

| NO. | KEY | FUNCTION |
|-----|---|---|
| 8 |  | Sets the reverse function. |
| 9 | Dial | <ul style="list-style-type: none"> In VFO mode/memory mode Rotate to select a channel. Press to set the shift function. In channel display mode Rotate to exit from function mode. Press to set the shift function. |

■ **PRESS  KEY AND FOLLOWING KEY TOGETHER TO ACTIVATE FOLLOWING FUNCTION:**



| NO. | KEY | FUNCTION |
|-----|---|---|
| 5 |  | <ul style="list-style-type: none"> In VFO mode/channel display mode Operation is invalid. In memory mode Deletes a memory channel. |
| 6 |  | <ul style="list-style-type: none"> In VFO mode/memory mode Sets the automatic dialer. In channel display mode Operation is invalid. |
| 7 |  | Enters clone function mode. (Turn off to exit.) |
| 8 |  | Switches to power supply voltage display mode. |
| 9 | Dial | Pressing switches to the 2Tone setting. (Pre-setting required) |

■ OPERATIONS WHEN TURNING ON THE POWER WHILE PRESSING THE FOLLOWING RESPECTIVE KEYS

| NO. | KEY | FUNCTION |
|-----|---|---|
| 4 |  | Resets the system. Performs a System reset. |
| 5 |  | Switches to Channel display mode from VFO/memory modes. Repeat to resume the previous mode. |



NOTE

Turn on the power while pressing  and  simultaneously to perform a full-reset. It resumes the default system settings and erases all memory data. The deleted memory data can't be recalled.

■ REAR PANEL

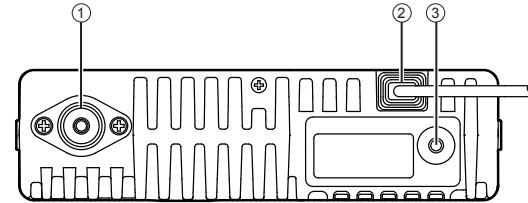

| NO. | KEY | FUNCTION |
|-----|---|---|
| 1 | Antenna Connector | Connect an antenna. |
| 2 | DC power cable | Connect 13.8 V DC power. 20A or more current capacity is required. |
| 3 | DATA terminal/ Ext. Speaker Terminal | Use for the clone function and to connect an optional external speaker. |

About PC programming



NOTE

PC programming utility software is downloadable from www.alinco.com site. An optional ERW-7 PC cable is required. ③ DATA terminal is the port for PC cable connection also.

■ DISPLAY

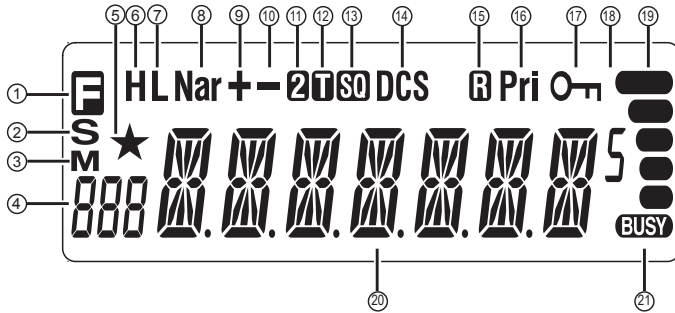

| NO. | KEY | FUNCTION |
|-----|------------|--|
| 1 | F | Lights up when function mode is ON. |
| 2 | S | Lights up when the squelch is set. Flashes while scanning. |
| 3 | M | Lights up when in memory mode. Flashes when the selected memory channel is empty. |
| 4 | 888 | Displays the memory number or menu number. |
| 5 | ★ | Lights up when a skip channel is stored on a memory channel. |
| 6 | H | Lights up when HI Power is set for transmission power. |
| 7 | L | Lights up when LO Power is set for transmission power. |

| NO. | KEY | FUNCTION |
|-----|-----------------|---|
| 8 | Nar | Lights up when Narrow Band is set. Turns off when Wide Band is set. |
| 9 | + | Lights up when the shift direction is positive. |
| 10 | - | Lights up when the shift direction is negative. |
| 11 | 2 | Lights up when the 2-tone is set. |
| 12 | T | Lights up when the CTCSS tone encoding is set. |
| 13 | SQ | Lights up when the CTCSS tone squelch is set. |
| 14 | DCS | Lights up when DCS (Digital Coded Squelch) is set. |
| 15 | R | Lights up when the reverse function is set. |
| 16 | Pri | Lights up while performing priority scan. |
| 17 | Key icon | Lights up when the operation lock function is set. |
| 18 | 5 | Lights up to indicate 0.05 KHz. |
| 19 | 5 bars | Signal strength of receiving and transmitting. |
| 20 | 88888888 | Displays a frequency, channel name or menu item. |
| 21 | BUSY | Lights up when the squelch opens. |

MICROPHONE

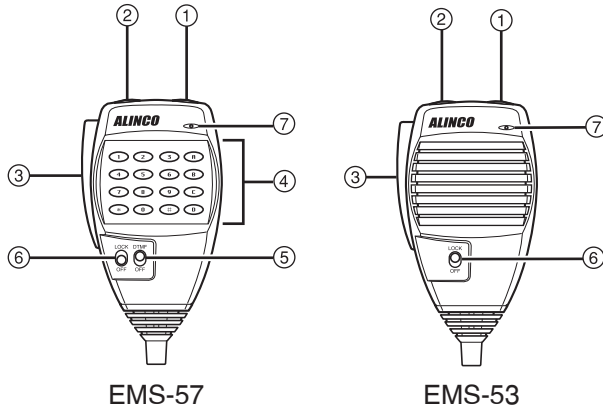

EMS-57

EMS-53

MIC Connector Diagram(in the front view of connector)

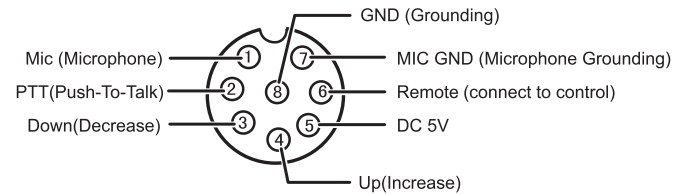

| NO. | KEY | FUNCTION |
|-----|----------------|--|
| 1 | UP | Increase frequency, channel number or setting value. |
| 2 | DOWN | Decrease frequency, channel number or setting value. |
| 3 | PTT | Push-To-Talk key to transmit. |
| 4 | Numerical Keys | Input VFO frequencies and other various oprations |
| 5 | DTMF ON/OFF | Switches between DTMF and function operations. |
| 6 | LOCK Switch | Locks all keys excep PTT. |
| 7 | MIC | Microphone element is located inside. |



Press and hold [UP]/[DOWN] keys until 2nd beep is heard then release it immediately to start scanning.

Press another key to change scanning direction. Press [PTT] to stop. Holding the key will change the frequency continuously until the key is released.

Operating Modes (VFO Mode, Memory Mode, Channel Display Mode)

4

■ VFO MODE



VFO tuning is set as a default mode at the factory. VFO (variable frequency oscillator) allows you to change the frequency in accordance with the selected channel step as you rotate the main dial or by using the [UP]/[DOWN] keys on the microphone.

VFO mode is also used to program the data to be stored in the memory channels or to change the parameter settings of the transceiver.

1. Identify the current mode by checking the display.

If **M** or  icon is NOT displayed on it, the unit is already in the VFO mode.



2. Otherwise press  keys or the  key on the microphone until those icons are gone.

[CHANGE FREQUENCY BY THE CHANNEL STEP]

Rotate the dial clockwise to increase the frequency, counterclockwise to decrease. The [UP]/[DOWN] keys on the microphone act in the same way.

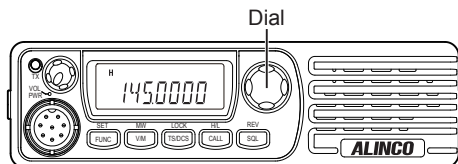

[CHANGE FREQUENCY BY 1 MHZ STEP]

This will enable a quick change of frequency in 1 MHz steps:

1. Press dial. The digits after 100 KHz will disappear from the display.
2. Follow the same sequence as above to change the value.
3. Press [PTT] or the key on the unit.

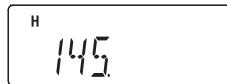

The screen will go back to the normal display.





NOTE

If the unit is not operated for 5 seconds or more, the setting procedure is canceled and the screen will go back to the normal display.

■ MEMORY MODE

The memory mode on this transceiver provides up to 500 channels (0-499), 1 call (quick recall ch) and a pair of program-scan "edge memory" channels for quick, easy access to the preprogrammed frequencies with different parameter settings.

Please note that you must program at least 1 memory channel to enter to the memory mode. See the next page for programming procedure.

1. Press  key or the  key on the microphone.

M icon appears on the display to indicate that the unit is in the memory mode.



Repeat to switch the mode between VFO and memory.

2. In memory mode, rotate the main dial or press [UP]/[DOWN] keys to change the memory channel number.

12

[MEMORY PROGRAMMING]

1. Return to VFO mode by pressing  or A key.

Referring to the list below for the programmable parameters, program in the VFO mode to the desired frequency and settings to be stored later in the memory.



2. When all the settings are complete, press  key.

The  and **M** icons appear and a memory channel character will be indicated on the display.



3. Rotate the dial or press the [UP]/[DOWN] keys to select the desired memory channel into which the current VFO settings will be copied.

An empty channel is shown with a flashing **M** icon. It may be a good practice to "allocate" memory channels in order, such as 0-9 for local repeaters, 10-19 local simplex, 20-49 repeaters within the area, etc. It makes references easier for the group scan feature explained in the scanning function.



4. While  icon is still on the display, press  key.

The VFO settings are copied to the memory channel and a beep will sound twice. The memory channel can be over-written if a previously programmed channel is selected (the memory channels shown with a stable **M** icon).



NOTE



Memory channel characters include C, P1, P2, PR and channel numbers (0-499). Meanings of alphabetical characters will follow.

SPECIAL MEMORY CHANNELS

To program the CALL channel (quick recall) select the channel shown with C on the display.

P1 and P2 for Program scan, and PR for Priority operation settings which instructions will follow.

DELETING A MEMORY CHANNEL

1. To delete a programmed channel, select it in memory mode, press  and  keys together while  icon is on.



The memory is deleted and a beep sounds. The **M** icon starts flashing showing that this channel is now empty.

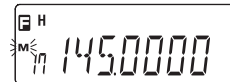

2. To undo delete, press  key only at this state.

However, the Undo function becomes impossible once the channel or the mode is changed.

PROGRAMMABLE DATA IN THE MEMORY CHANNEL

Some features will be explained later, so please read this instruction manual thoroughly prior to programming memories.

Memory channels including 0 - 499, P1, P2, PR and CALL can store following:

- Frequency
- Name
- Shift frequency
- Shift direction

- CTCSS tone both encode and decode
- DCS code both encode and decode
- Scan skip
- Busy Channel Lock Out setting
- Normal/Narrow FM width



This mode is like a landmobile radio, allowing users for communications only prohibiting accesses to parameter setting modes. The reset is also prohibited in this mode, therefore, you should resume VFO/memory mode before resetting.



P1 and P2 can be used as memory channels, but only frequency will apply during the programmed scanning, disregarding settings like tone and shift.

■ CHANNEL DISPLAY MODE

Call up and operate frequencies or settings registered in advance. Channels set in memory mode or with a PC application will appear.

If you enter to the Channel display mode without programming any memory channel, it will display CALL channel only.

1. To switch to channel display mode from VFO mode or memory mode, turn off the power, then turn on the power again while pressing the  key until a beep sounds.

The unit enters the channel display mode.

2. Rotate the dial or press the [UP]/[DOWN] key on the microphone to select a memory channel.



3. To switch to VFO mode or memory mode from channel display mode, turn off the power, then turn on the power again while pressing the  key until a beep sounds.

The unit enters the VFO mode or memory mode.

SWITCHING THE POWER ON/OFF

Press the VOL knob to power on. Press the VOL knob until it turns off.

ADJUSTING THE VOLUME

Turn the VOL knob clockwise to increase the audio level, counterclockwise to decrease.

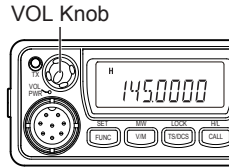

NOTE

Press and hold the  key for 2 seconds to hear a white-noise to set the proper audio level. Press the same key to close squelch.

ADJUSTING FREQUENCY/CHANNEL THROUGH THE DIAL

- Under VFO mode, you can change the current frequency to the desired one through dial; Turn clockwise to increase frequency; turn counterclockwise to decrease. Every click will increase or decrease one step. Press dial, the KHz order digits will be masked. In this status, turn dial or Microphone [UP]/[DOWN] key will increase or decrease frequency quickly by 1MHz step.
- In memory and channel display modes, you can change the current channel to the desired one through dial, clockwise turn to the forward channel, anticlockwise turn to the backward channel. In relative Operating mode, Microphone's [UP]/[DOWN] key has the same function for adjusting frequency and channel.

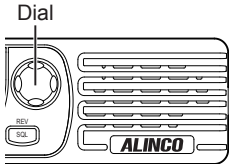

SQUELCH LEVEL SETTING

A squelch eliminates white-noise during the stand-by state (the background noise when a signal is not received).

Higher level settings will keep the squelch “closed” more tightly for quieter monitoring, but weak signals will not be heard. Lower settings allow weaker signals to “open” the squelch but noise may also cause it to open.

- Press  key. **S** icon appears on the display and the squelch level will be shown at the position where the memory number is displayed.

16 levels, between 0 - 15, are available. “0” is the lowest setting.

- By rotating the dial or by using the [UP]/[DOWN] keys on the microphone, adjust the squelch to the desired level. To return to normal use, press [PTT] or any key on the front panel; or if there are no operations within 5 seconds, the unit will store the setting and will return to its original status.

Proper squelch level:



NOTE

In the adjusting procedure, set it to level zero to hear the noise first, then turn the dial to increase the level. When a noise disappears at level 03 for example, select level 04~05 to set as the squelch level.



NOTE

Available steps are 5K, 6.25k, 10K, 12.5K, 15K, 20K, 30K and 50K. See P.22 for selecting desired step.

TO RECEIVE SIGNALS

1. Turn on and adjust audio/squelch levels.
2. Select your desired frequency.

When a signal is received at your desired frequency, **BUSY** will light up and receiving sound will be heard. The S-meter will swing according to the receiving signal strength.



MONITORING FUNCTION

This function allows you to cancel the squelch operation so that weak signals that are below the squelch level can be heard.

1. Press and hold the **[SQU]** key for 1 second or press MIC's **[*]** key.
BUSY will appear and the squelch opens.



2. To cancel the monitoring function, press **[PTT]** key or any key on the unit except for the knob.

TO TRANSMIT SIGNALS

1. Select your desired frequency.
2. Press the **[PTT]** key on the microphone.

The TX indicator lights red and starts transmitting.

3. While pressing the **[PTT]** key, speak into MIC in a normal voice.

Place the microphone about 5 cm away from your mouth when you speak.

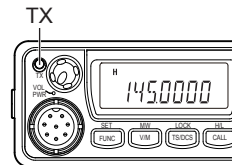

Release the **[PTT]** key to return to receiving mode.

Pressing the **[PTT]** and **[DOWN]** keys simultaneously will transmit a tone call signal.

When the auto-dialer is set, pressing the **[PTT]** and **[UP]** keys simultaneously will transmit the auto-dialer signal set in advance.

When the 2Tone is set, select a mode other than menu mode, then while pressing the **[FUNC]** key, press Dial. The **[2]** icon will light up and the transceiver will enter 2Tone mode. Press **[PTT]** to transmit 2Tone which is set in advance.

If the **[PTT]** key is pressed outside of the transmission frequency range, **[OFF]** will appear on the display and warning beep sounds until the **[PTT]** is released. Enter within the transmitting frequency range to resume transmitting.

CALL MODE

This is a memory mode that allows the transceiver to quickly recall the assigned memory channel by simply pressing the **[CALL]** key, regardless of the current status of the unit.

1. Press **[CALL]** key. The **[C]** icon appears on the display and the transceiver enters the CALL mode. In this mode, the main dial or the **[UP]/[DOWN]** keys cannot change the frequency or memory channels.
2. Press **[CALL]** key again or press **[VM]** key to exit CALL mode.
3. No scan functions are available in CALL mode.

To store a desired setting in the CALL channel, follow the memory mode programming instructions and assign your selected settings to memory channel C. The call channel can be modified but cannot be eliminated or hidden.



SCANNING FUNCTION

Use this function to automatically search for signals. 6 different scan types are available.

In parameter setting mode, choose Timer mode or Busy mode to determine the desired resuming condition. If the CTCSS (TSQ) squelch or DCS squelch is set, the audio can be heard only when the tone/code matches the incoming signal. Otherwise, scanning stops but no audio will be heard. The direction of scan, upward or downward, can be changed during the scan by rotating the dial or pressing UP or DOWN keys in the desired direction.

VFO SCAN

Scans all VFO channels in regard to the preset tuning step.

1. Enter VFO mode.
2. Press and hold [UP]/[DOWN] keys for a second until the 2nd beep is heard then release it immediately to start scanning. **S** icon flashes while scanning. It stops at the frequency where the incoming signal is detected, and resumes the scan according to the selected resume condition.
3. Use dial or [UP]/[DOWN] keys to change the direction. Press any key (other than the [UP]/[DOWN] keys) to exit.

PROGRAM SCAN

This is a type of VFO scan, but by setting the frequency range of the VFO into P1 and P2 channels, it only scans between those frequencies. With setting the P1 and P2 properly, up to 3 Program scan ranges will be available.

When P1, P2 is registered

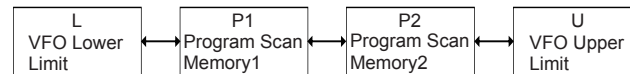

When only P1 is registered

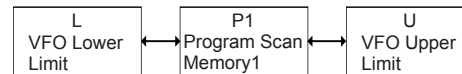

When only P2 is registered

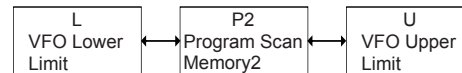

1. Program the P1 and P2 memory channels as you desire in advance.
2. Select a frequency range that you wish to scan. Suppose you wish to monitor a range between lowest VFO frequency and P1, select any frequency between these 2 frequencies.
3. Press [UP]/[DOWN] key for more than 1 second to start scanning. During this scan mode, the "P" icon appears and **S** icon flashes.



NOTE

The scanning step depends on the channel step setting value. If you wish to scan all VFO range, don't program P1/P2 channels.

4. Use dial or [UP]/[DOWN] keys to change the direction. Press any key (other than the [UP]/[DOWN] keys) to exit.

MHZ SCAN

Scan frequencies that are below 1 MHz.

For example, for scanning 144 MHz, frequencies will be scanned repeatedly from 144.000 MHz to 144.995 MHz in accordance with the channel step.

1. Press the  key to enter VFO mode.
2. Press and hold the dial.

When scanning starts, the **S** icon and 1 MHz decimal point of the frequency display will flash.



3. Use dial or [UP]/[DOWN] keys to change the direction. Press any key (other than the [UP]/[DOWN] keys) to exit.

GROUP SCAN

Scan groups in memory mode or channel display mode.

Enough numbers of memory channel must be programmed in advance to use this feature.

Only channels stored on memory channels will be scanned. Channels 0 to 499 will be scanned.



However, C, P1, P2, PR are exceptions.

Scanning starts from the selected memory channel number, and channels will be divided into groups according to the group scan step settings explained later in the set mode (menu 31).

- When the group scanning step is set to 10
50 groups (GROUP1: Channel 0 to 9, GROUP2: Channel 10 to 19, ...)
- When the group scanning step is set to 20

25 groups (GROUP1: Channel 0 to 19, GROUP2: Channel 20 to 39, ...)

- When the group scanning step is set to 30
17 groups (GROUP1: Channel 0 to 29, GROUP2: Channel 30 to 59, ..., GROUP17: Channel 480 to 499)
- When the group scanning step is set to 40
13 groups (GROUP1: Channel 0 to 39, GROUP2: Channel 40 to 79, ..., GROUP13: Channel 480 to 499)
- When the group scanning step is set to 50
50 groups (GROUP1: Channel 0 to 49, GROUP2: Channel 50 to 99, ...)

1. Press the  key to enter memory mode. Or, turn off the power, then turn on the power again while pressing the  key to enter channel display mode.

2. Select a channel from groups within scanning range.

3. Press and hold the dial to start scanning.

When scanning starts, the **S** icon will flash.

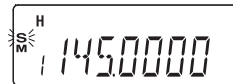

Suppose you programmed 20 memories, set group step as 10, select ch. 5 and start scanning, it scans between ch. 0 and ch. 9.

4. Use dial or [UP]/[DOWN] keys to change the direction. Press any key (other than the [UP]/ [DOWN] keys) to exit.



C,P1,P2 and PR are exceptions and can't perform the group scanning. A beep sounds to alert.

PRIORITY SCAN

Scan priority channels every 5 seconds in VFO mode or on the normal display of memory mode.

Priority scan is always executed in the background when the priority scan setting is set to ON at the Menu 29 in the Set mode setting. **Pri** icon appears while Pri function is activated.

When a priority channel receives a signal, the currently selected frequency or channel will be switched to the priority channel and the **S** icon will flash.



Even if the frequency or channel selected before being switched has a reception channel, the signal received by the priority channel will be prioritized.

19 TONE SCAN

This function automatically searches for the CTCSS tone an incoming signal might carry. This feature is useful to search the encoding tone of a repeater, or to communicate with a station operating in TSQ (CTCSS squelch) mode.

1. Press the **[TSQSS]** key until entering to the CTCSS decode setting mode.
The **T** and **SQ** icons will light up.



2. Press and hold [UP]/[DOWN] keys for a second until the 2nd beep is heard then release it immediately to start scanning. It scans 39 tones in order. Use [UP]/[DOWN] key to change the scanning direction.

The **S** icon will flash, and it stops when the matching tone is detected.



3. The scan won't resume until the operation is repeated.
4. Press any key (other than [UP]/[DOWN] keys) to exit.

MEMORY SCAN(CHANNEL SCAN)

Scans all memory channels unless Memory skip feature is selected for a given memory.

1. Press the **[VM]** key to select memory mode.

M will light up and the transceiver will enter memory mode.

2. Press and hold [UP]/[DOWN] keys for a second until the 2nd beep is heard then release it immediately to start scanning.



3. Use dial or [UP]/[DOWN] keys to change the direction. Press any key (other than the [UP]/[DOWN] keys) to exit.



Memory channels should be programmed in advance to operate memory scanning.

DCS SCAN

This function automatically searches for the DCS tone an incoming signal might carry. This feature is useful to search the encoding tone of a repeater, or to communicate with a station operating in DCS mode.

1. Press the **[TSQSS]** key until entering DCS decode setting mode.
The **DCS** icon will light up.
2. Press and hold [UP]/[DOWN] keys for a second until the 2nd beep is heard then release it immediately to start scanning. It scans 104 tones in order. Use [UP]/[DOWN] key to change the scanning direction.

The **S** icon will flash, and it stops when the matching tone is detected.

- Press any key (other than [UP]/[DOWN] keys) to exit.



■ CTCSS/DCS ENCODE AND DECODE SETUP

In this mode, regardless of the main squelch status, the audio can be heard ONLY when the matching tone/code signal is received. The combination of CTCSS squelch and DCS function is not available; only one or the other may be used for a given channel. In the memory mode, the setting is temporary; changing the channel or turning off the radio will resume the original conditions.

- Press **[TSQ]** key. The current setting will be displayed with **T**, **SQ**, **DCS** icons and relative frequency/code. Press the same key to select T/SQ/DCS setting.

The numbers (such as 88.5) represent the CTCSS frequency in Hz. Use dial or [UP]/[DOWN] keys to select desired parameter.

When it is displayed with the **T** icon only, the unit transmits the sub-audible tone while the PTT is pressed (encode) and the repeater access is enabled



- Press the same key again so that the **T** and **SQ** icons show up on the display. This is the CTCSS decode frequency. This enables CTCSS squelch (or Tone Squelch, TSQ).



- Press it again so that the 3-digit number and **DCS** icon is displayed. This is the DCS code, and it enables DCS encoding and decoding.



Press any key (Except **[FUNC]**, **PWR**, **[TSQ]**, **[UP]/[DOWN]** keys) to enter the setting and return to original status. The **T**, **SQ**, **DCS** icon will remain on the display to show the current selective-calling status. To exit, simply use the **[TSQ]** key and press it until the relative status icon T/TQ/DCS disappears.

The CTCSS encoding and decoding frequencies may be set differently. The standard set of 39 different CTCSS tones are available. DCS encode/decode cannot be separated. The list of selectable tones and codes is shown on Appendix at the end of this booklet.

■ HIGH/LOW POWER SWITCH

Press **[FUNC]** key to display **[P]** icon, then press **[CALL]** key to switch between high/low power. You may use zero (H/L) key on EMS-57 microphone also.

H : Transmits in high power

L : Transmits in low power

■ OFFSET DIRECTION SETUP

Repeater receives a signal(UP-LINK) on one frequency and re-transmits on another frequency(DOWN-LINK). The difference between these two frequencies is called the offset frequency. If the UP-LINK frequency higher than DOWN-LINK frequency, the direction is positive, If it is lower, the shift direction is negative.

1. Press **[FUNC]** key until the **[]** icon appears on the LCD, then press dial, LCD displays offset direction.

2. Repeatedly press the **[FUNC]** key and dial to select offset direction.

3. When LCD displays **+** icon, it indicates positive offset, which means transmitting frequency higher than receiving frequency.



4. When LCD displays **-** icon, it indicates negative offset, which means transmitting frequency lower than receiving frequency.



[] NOTE Shift width(frequency) can be set in the parameter setting mode at menu 13 (p.27).

■ KEYPAD LOCKOUT

Avoiding unintentional operation, this function will lock all keys except [PTT], **[FUNC]**, **[SQL]**, and VOL knob.

1. Press **[FUNC]** key until LCD displays **[]** icon, then press **[TSBSS]** key until LCD displays **[]** icon. Now keypad lockout function is valid.

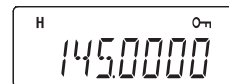

2. Repeat above operation, **[]** icon disappears, indicating keypad lockout function is invalid.

■ REVERSE FUNCTION

This function allows you to reverse the transmission frequency and reception frequency while operating with offset.



The shift offset must be set in advance on the operating channel.

1. Press the **[FUNC]** key, confirm **[]** lights up, then press **[SQL]**.

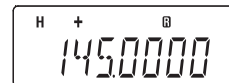

[] icon appears and the receiving frequency is replaced to the transmitting frequency.

2. To cancel the reverse function, repeat the same operation described above.



CTCSS and DCS tones won't be reversed even if encoding and decoding tones are set differently.

The following is the Selectable Parameters' Menu.

IMPORTANT

Please read the following pages thoroughly prior to the change of any parameters.

THE PARAMETERS CANNOT BE SET WITHOUT ENTERING THE SET MODE.

By entering the Parameter Setting mode, some of the radio's operating parameters can be changed to suit your application.

TO USE THE PARAMETER SETTING MODE

1. Press **[FUNC]** key for more than 2 seconds to enter the Parameter Setting mode.
Rotate the dial or **[UP]/[DOWN]** keys to select menu.
2. Press the dial to display "set" on the left corner of LCD. Turn the dial to select the desired value, then press it again to select another menu.
3. Press any key OTHER than **[FUNC]** key, dial to exit the Parameter mode. The only exception is the Channel Tag setting which accepts only **[PTT]**, **[FUNC]**, and **[TS/DS]** keys to exit.



Some menus appear only in certain modes or preprogramming may be required.

■ CHANNEL STEP SETTING

* This menu appears only in VFO mode.

This is to select the channel step to be used in the VFO mode.

Refer to the chart below for the relation of the actual step frequency and how it is displayed.

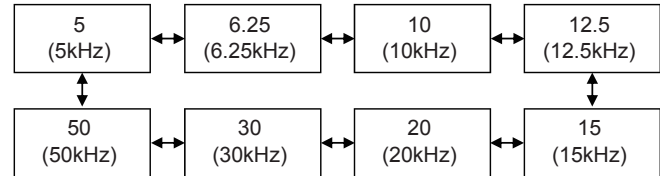

Press **[FUNC]** key until entering the Parameter setting mode.

1. Rotate the dial or press the **[UP]/[DOWN]** keys on the microphone to display the menu number "01".

The current setting will appear on the display.



The default setting is "5 KHz" for DR-B185HT, "12.5 KHz" for HE models.

2. Press dial to display SET, then rotate dial or press the **[UP]/[DOWN]** keys on the microphone to change the setting.
3. Press the dial to set the new value and continue, or press **[PTT]** to set the new value and exit from the parameter setting mode.



Be sure to set the KHz order of the frequency at even-number such as .000, prior to change this parameter in VFO mode.

MEMORY NAME (ALPHANUMERIC TAG)

The memory channels stored in the memory-mode can be displayed with an alphanumeric tag instead of the default frequency display. Program the memory channel first.

There are 48 characters available including A-Z, 0-9.

* This menu appears only in memory mode.

1. Program at least 1 memory channel in advance. Select the memory channel to be Memory-named and enter to the set mode by pressing **[FUNC]** key.
2. Rotate the dial or press the **[UP]/[DOWN]** keys on the microphone to display the menu number "02".
3. Press the dial so that A appears on the display.
4. Rotate the dial to select a character to be programmed.
5. Press the dial again to edit next.
6. Press **[SEL]** key to correct, or **[CALL]** key to erase all characters. Up to 7 characters can be entered.
7. Press **[PTT]**, **[FUNC]** or **[TSIGS]** key to cancel operation and exit.
8. Press **[VM]** key to set and return to the menu mode.



After programming, the alphanumeric tag will be displayed on the designated channels, instead of the frequency, when in memory mode. The memory channel number and other status icons will also be displayed. If you wish to see the programmed frequency, press **[FUNC]** and it will be displayed. To return to the alphanumeric display, press any key.



If the display remains unchanged, follow the instruction of menu 3 and select NM.

MEMORY DISPLAY INDICATOR

Switch the frequency display and memory name display when a memory name is registered using the memory name function.

1. Rotate the dial or press the **[UP]/[DOWN]** keys on the microphone to display the menu number "03".

The current setting will appear on the display.

The default setting is "FRQ" (frequency display).

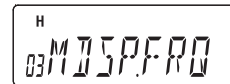

2. Press dial to display SET, then rotate dial or press the **[UP]/[DOWN]** keys on the microphone to change the setting.

The options are as follows.

- ▼ NM: Displays the memory name (Default).
- ▼ FRQ: Displays the frequency.



Regardless of the NM setting, frequency is always displayed on channels that name tags are not programmed.

3. Press the dial.

The unit will go back to menu mode.

BEEP

Set whether or not to sound the operation beep.

1. Rotate the dial or press the **[UP]/[DOWN]** keys on the microphone to display the menu number "04".

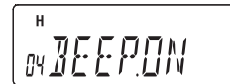

The current setting will appear on the display.

The default setting is "BEEPON".

- Press dial to display SET, then rotate dial or press the [UP]/[DOWN] keys on the microphone to change the setting.

The options are as follows.

- ▼ ON: Beep tones sound.
- ▼ OFF: Beep tones don't sound.



The Time-Out Timer and transmission-related warning beep remain always sound regardless of the beep setting.

- Press the dial.
The unit will go back to menu mode.

■ DIMMER SETTING

The backlight brightness is selectable from 16 levels.

- Rotate the dial or press the [UP]/[DOWN] keys on the microphone to display the menu number "05".

The current setting will appear on the display.

The default setting is "7".



- Press dial to display SET, then rotate dial or press the [UP]/[DOWN] keys on the microphone to change the setting.

The options are as follows.

- ▼ LAMP.MIN: Darkest
- ▼ LAMP.1 to LAMP.14: Bigger numbers for brighter backlight.
- ▼ LAMP.MAX: Brightest

- Press the dial.
The unit will go back to menu mode.

■ AUTOMATIC BACK LIGHT

When pressing any key on the unit, the backlight brightness becomes brightest for a few seconds. Set how many seconds you want to make the backlight brightest.

- Rotate the dial or press the [UP]/[DOWN] keys on the microphone to display the menu number "06".

The current setting will appear on the display.

The default setting is "3" (seconds).

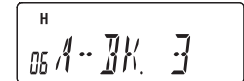

- Press dial to display SET, then rotate dial or press the [UP]/[DOWN] keys on the microphone to change the setting.

The options are as follows.

- ▼ OFF:

Pressing any key on the unit does not make the backlight brightness brightest. 24

- ▼ 3:

Pressing any key on the unit makes the backlight brightness brightest for 3 seconds.

- ▼ 5:

Pressing any key on the unit makes the backlight brightness brightest for 5 seconds.

- ▼ 7:

Pressing any key on the unit makes the backlight brightness brightest for 7 seconds.

- Press the dial.
The unit will go back to menu mode.

■ TIME-OUT-TIMER

The TOT feature is popular in repeater systems. It prohibits the users from transmitting after a certain period of time has elapsed. By setting this function and activating it the radio alerts the user by a beep 5 seconds prior to time-out.

When the time is expired, transmitting stops and the transceiver automatically returns to receiving mode. Until the [PTT] is released once and pressed again, the transceiver will not transmit.

1. Rotate the dial or press the [UP]/[DOWN] keys on the microphone to display the menu number "07".

The current setting will appear on the display.



The default setting is "OFF".

2. Press dial to display SET, then rotate dial or press the [UP]/[DOWN] keys on the microphone to change the setting.

The options are as follows.

- ▼ OFF: Does not set the time out timer.
- ▼ 30 (sec) to 450 (sec) in 15 steps / 30 second increments:
Automatically switches to receiving mode after the set time has elapsed.

3. Press the dial.

The unit will go back to menu mode.

■ TOT PENALTY

When the transmission is shut down in the TOT mode, this function prohibits another transmission for a selected time period.

1. Rotate the dial or press the [UP]/[DOWN] keys on the microphone to display the menu number "08".

The current setting will appear on the display.



The default setting is "OFF".

2. Press dial to display SET, then rotate dial or press the [UP]/[DOWN] keys on the microphone to change the setting.

The options are as follows.

- ▼ OFF: Does not set the TOT penalty time.
- ▼ 1 (sec) to 15 (sec) /15 steps in 1 second increments:
Sets the transmission delay time when transmission is finished by the time out timer.

3. Press the dial.

The unit will go back to menu mode.

■ AUTO POWER OFF

This feature will automatically shut off the transceiver. It is useful for mobile operation to avoid draining the car battery. If there is no activity or use of the radio, it will turn off automatically after 30 minutes followed by a beep sound.

1. Rotate the dial or press the [UP]/[DOWN] keys on the microphone to display the menu number "09".

The current setting will appear on the display.

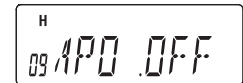

The default setting is "OFF".

2. Press dial to display SET, then rotate dial or press the [UP]/[DOWN] keys on the microphone to change the setting.

The options are as follows.

- ▼ OFF: Does not set the auto power off function.
- ▼ 10 (min) to 60 (min) /6 steps in 10 minute increments:
Automatically turns off the power after the set time has elapsed.

3. Press the dial.

The unit will go back to menu mode.

■ MESSAGE DISPLAYED WHEN TURNING ON THE POWER

Set whether or not to display the message when turning on the power.

1. Rotate the dial or press the [UP]/[DOWN] keys on the microphone to display the menu number "10".

The current setting will appear on the display.

The default setting is "MDL".

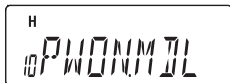

2. Press dial to display SET, then rotate dial or press the [UP]/[DOWN] keys on the microphone to change the setting.

The options are as follows.

- ▼ OFF: Switches to receiving mode immediately.
- ▼ MDL: Displays the "DR-B185" for 2 seconds, then switches to receiving mode.
- ▼ MSG: Displays the message set in the next chapter, then switches to receiving mode.

3. Press the dial.

The unit will go back to menu mode.

■ SETTING THE MESSAGE DISPLAYED WHEN TRUNING ON THE POWER

Set the message displayed when turning on the power.

1. Rotate the dial or press the [UP]/[DOWN] keys on the microphone to display the menu number "11".
2. By refering to the Menu 2 on P.23, edit the message to display.
3. Press the dial.



The unit will go back to menu mode.

■ BCLO SETTING

BCLO stands for Busy Channel Lock Out, and prohibits transmission that may cause interferences to ongoing communications. Transmission is possible only in the conditions:

- When the channel is free and clear (BUSY icon is not displayed).
- The CTCSS/DCS setting of receiving signal is different from the current tone setting.

1. Rotate the dial or press the [UP]/[DOWN] keys on the microphone to display the menu number "12".

The current setting will appear on the display.

The default setting is "OFF".



2. Press dial to display SET, then rotate dial or press the [UP]/[DOWN] keys on the microphone to change the setting.

The options are as follows.

- ▼ ON: Sets the BCLO setting to ON.
- ▼ OFF: Sets the BCLO setting to OFF.



3. Press the dial.

The unit will go back to menu mode.

■ OFFSET FREQUENCY

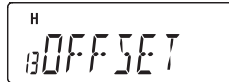
Using this function, the transmission frequency can be shifted by the offset frequency range set for the reception frequency.



 NOTE Please refer P.20 for the shift direction (Press  key then the dial will switch the direction).

1. Rotate the dial or press the [UP]/[DOWN] keys on the microphone to display the menu number "13".

The default setting is "0.6000" (0.6MHz).

2. The options are 0 to 99.9950MHz in accordance with preset channel step.

 NOTE The adjustment step depends on the step setting value.

3. Press the dial.

The unit will go back to menu mode.

■ VFO UPPER LIMIT

* This menu appears only in VFO mode.

* Not available in HE version.

This is to set the upper limit of the VFO. By setting this, dial and [UP]/[DOWN] operation will be limited up to the programmed frequency.

 NOTE Setting changes will not affect memory channels and programmed scanning range.

1. Rotate the dial or press the [UP]/[DOWN] keys on the microphone to display the menu number "14".

The current setting will appear on the display.



The default setting is "174" (174MHz).

2. Press dial to display SET, then rotate dial or press the [UP]/[DOWN] keys on the microphone to change the setting.

The options are between 174 and 137MHz in 1MHz step.

This value should be higher than the frequency set in the next chapter.

3. Press the dial.

The unit will go back to menu mode.

■ VFO LOWER LIMIT

* This menu appears only in VFO mode.

* Not available in HE version.

Set the lower limit frequency used in VFO mode.

 NOTE Setting changes will not affect memory channels and programmed scanning range.

1. Rotate the dial or press the [UP]/[DOWN] keys on the microphone to display the menu number "15".

The current setting will appear on the display.



The default setting is "136" (136MHz).

2. Press dial to display SET, then rotate dial or press the [UP]/[DOWN] keys on the microphone to change the setting.

The options are between 173 and 136MHz in 1MHz step.

This value should be lower than the frequency set in the previous chapter.

3. Press the dial.

The unit will go back to menu mode.

■ TONE-BURST FREQUENCY

This is to access Tone-Burst repeaters which require a certain pitch of audible tone to activate "sleeping" repeaters. Usually, a repeater system does not require the tone once the repeater is activated.

1. Rotate the dial or press the [UP]/[DOWN] keys on the microphone to display the menu number "16".

The current setting will appear on the display.

The default setting is "1750" (1750Hz).

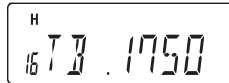

2. Press dial to display SET, then rotate dial or press the [UP]/[DOWN] keys on the microphone to change the setting.

The options are as follows.

▼ 1750 (1750Hz), 2100 (2100Hz), 1000 (1000Hz), 1450 (1450Hz)

3. Press the dial.

The unit will go back to menu mode.

■ DEFAULT TONE VALUE

Set the CTCSS tone encoding value displayed by operating the  key after turning on the power.

1. Rotate the dial or press the [UP]/[DOWN] keys on the microphone to display the menu number "17".

The current setting will appear on the display.

The default setting is "OFF".



2. Press dial to display SET, then rotate dial or press the [UP]/[DOWN] keys on the microphone to change the setting.

Available parameters are OFF and 67.0Hz to 250.3Hz (See the table in the next page). When a tone frequency is selected, it resumes as a default parameter every time the unit is turned on, regardless of previous setting. By setting OFF, the tone selected by

 key remains unchanged.

3. Press the dial.

The unit will go back to menu mode.

■ DEFAULT SQ VALUE

Set the CTCSS tone decoding value which is displayed by operating the  key after turning on the power.

1. Rotate the dial or press the [UP]/[DOWN] keys on the microphone to display the menu number "18".

The current setting will appear on the display.

The default setting is "OFF".



2. Press dial to display SET, then rotate dial or press the [UP]/[DOWN] keys on the microphone to change the setting.

Available parameters are OFF and 67.0Hz to 250.3Hz (See the table below). When a tone frequency is selected, it resumes as a default parameter every time the unit is turned on, regardless of previous setting. By setting OFF, the tone selected by  key remains unchanged.

CTCSS tone chart

| | | | | | | | | | |
|-------|-------|-------|-------|-------|-------|-------|-------|-------|-------|
| 67.0 | 69.3 | 71.9 | 74.4 | 77.0 | 79.7 | 82.5 | 85.4 | 88.5 | 91.5 |
| 94.8 | 97.4 | 100.0 | 103.5 | 107.2 | 110.9 | 114.8 | 118.8 | 123.0 | 127.3 |
| 131.8 | 136.5 | 141.3 | 146.2 | 151.4 | 156.7 | 162.2 | 167.9 | 173.8 | 179.9 |
| 186.2 | 192.8 | 203.5 | 210.7 | 218.1 | 225.7 | 233.6 | 241.8 | 250.3 | |

3. Press the dial.

The unit will go back to menu mode.

■ DEFAULT DCS VALUE

Set the DCS value which is displayed by operating the  key after turning on the power.

1. Rotate the dial or press the [UP]/[DOWN] keys on the microphone to display the menu number "19".

The current setting will appear on the display.

The default setting is "OFF".

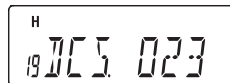

2. Press dial to display SET, then rotate dial or press the [UP]/[DOWN] keys on the microphone to change the setting.

Available parameters are OFF and 023 to 754 (See the table below). When a DCS tone is selected, it resumes as a default

parameter every time the unit is turned on, regardless of previous setting. By setting OFF, the DCS selected by  key remains unchanged.

| | | | | | | | | | |
|-----|-----|-----|-----|-----|-----|-----|-----|-----|-----|
| 023 | 025 | 026 | 031 | 032 | 036 | 043 | 047 | 051 | 053 |
| 054 | 065 | 071 | 072 | 073 | 074 | 114 | 115 | 116 | 122 |
| 125 | 131 | 132 | 134 | 143 | 145 | 152 | 155 | 156 | 162 |
| 165 | 172 | 174 | 205 | 212 | 223 | 225 | 226 | 243 | 244 |
| 245 | 246 | 251 | 252 | 255 | 261 | 263 | 265 | 266 | 271 |
| 274 | 306 | 311 | 315 | 325 | 331 | 332 | 343 | 346 | 351 |
| 356 | 364 | 365 | 371 | 411 | 412 | 413 | 423 | 431 | 432 |
| 445 | 446 | 452 | 454 | 455 | 462 | 464 | 465 | 466 | 503 |
| 506 | 516 | 523 | 526 | 532 | 546 | 565 | 606 | 612 | 624 |
| 627 | 631 | 632 | 654 | 662 | 664 | 703 | 712 | 723 | 731 |
| 732 | 734 | 743 | 754 | | | | | | |

3. Press the dial.

The unit will go back to menu mode.

■ AUTO-DIALER



This will automatically transmit pre-programmed DTMF tones.

TO PROGRAM TONES IN THE AUTO-DIALER MEMORY:

1. Rotate the dial or press the [UP]/[DOWN] keys on the microphone to display the menu number "20".









Pressing the  and  keys simultaneously also displays the menu.

Default display is 0 on the right end of the display. Memory channel icon displays which of the ten autodial memories (0~9) is in use. Last selected memory channel is transmitted.

- Use [UP]/[DOWN] keys to select the desired autodial memory channel from 0 to 9.



- Rotate the dial to select the first digit, then press dial to enter. The Cursor moves toward right. Repeat sequence to complete.
- Use [-] for pause. The display scrolls when the 7th digit is entered. The numbers 0 to 9, A to D, pause, * and # can be stored up to a total of 17 digits. Also the numerical keys on the microphone is usable to set characters.
- To check the entered digits, press  then rotate the dial while  icon is on. Use  key to correct previous,  to delete all characters.
- Press  key to set and return to the menu mode.

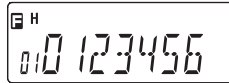

DTMF TX SPEED

Set the tone output speed when outputting DTMF using the automatic dialer.

- Rotate the dial or press the [UP]/[DOWN] keys on the microphone to display the menu number "21".

The current setting will appear on the display.

The default setting is "50" (50ms).

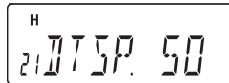

- Press dial to display SET, then rotate dial or press the [UP]/[DOWN] keys on the microphone to change the setting.

The options are as follows.

▼ 50 (50ms), 100 (100ms), 200 (200ms)

- Press the dial.

The unit will go back to menu mode.

DTMF PAUSE TIME

Set the pause time when outputting DTMF using the automatic dialer.

- Rotate the dial or press the [UP]/[DOWN] keys on the microphone to display the menu number "22".

The current setting will appear on the display.

The default setting is "500" (500ms).

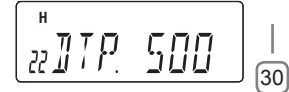

- Press dial to display SET, then rotate dial or press the [UP]/[DOWN] keys on the microphone to change the setting.

The options are as follows.

▼ 100 (100ms) to 2000 (2000ms) (20 steps in 100ms increments)

- Press the dial.

The unit will go back to menu mode.

■ DTMF MONITOR

Set whether or not to output tones and tone calls output using the automatic dialer from the speaker of the unit.

1. Rotate the dial or press the [UP]/[DOWN] keys on the microphone to display the menu number "23".

The current setting will appear on the display.

The default setting is "ON".



2. Press dial to display SET, then rotate dial or press the [UP]/[DOWN] keys on the microphone to change the setting.

The options are as follows.

- ▼ ON: DTMF Tones and Call tones can be heard from the speaker.
- ▼ OFF: Mutes tone sounds.

This feature is applicable for autodialer only. The manual DTMF tone encoding using EMS-57 keypad can't be monitored.

3. Press the dial.

The unit will go back to menu mode.

■ SCAN TYPE

This is to select the scan resume condition. TIMER setting allows the radio to resume scanning after 5 seconds, regardless of the signal receiving status. BUSY setting resumes scanning when the received signal is gone. The scan mode is explained later.

1. Rotate the dial or press the [UP]/[DOWN] keys on the microphone to display the menu number "24".

The current setting will appear on the display.

The default setting is "TMR".



2. Press dial to display SET, then rotate dial or press the [UP]/[DOWN] keys on the microphone to change the setting.

The options are as follows.

- ▼ TMR: Activates the timer scan.
- ▼ BSY: Activates the busy scan.

3. Press the dial.

The unit will go back to menu mode.

■ SCANNING STOP TIME -TMR

From "Switching the Scanning Type", select "Timer scan" to set the duration of time before switching to the next channel when receiving a signal.

1. Rotate the dial or press the [UP]/[DOWN] keys on the microphone to display the menu number "25".

The current setting will appear on the display.

The default setting is "5" (5sec).



2. Press dial to display SET, then rotate dial or press the [UP]/[DOWN] keys on the microphone to change the setting.

The options are as follows.

- ▼ 3 (sec) to 10 (sec)/ 8 steps in 1 second increments

3. Press the dial.

The unit will go back to menu mode.

■ SCANNING STOP TIME -BSY

From "Switching the Scanning Type", select "Busy scan" to set the duration time before resuming the scan after stop receiving a signal.

1. Rotate the dial or press the [UP]/[DOWN] keys on the microphone to display the menu number "26".

The current setting will appear on the display.



The default setting is "5" (5sec).

2. Press dial to display SET, then rotate dial or press the [UP]/[DOWN] keys on the microphone to change the setting.

The options are as follows.

- ▼ OFF (0sec) to 10 (10sec) /11 steps in 1 second increments

3. Press the dial.

The unit will go back to menu mode.

■ TONE SEARCH SCANNING SPEED

Set the scanning speed to search a tone frequency from the incoming tone signal.

1. Rotate the dial or press the [UP]/[DOWN] keys on the microphone to display the menu number "27".

The current setting will appear on the display.

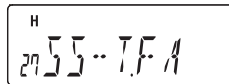

The default setting is "FA".

2. Press dial to display SET, then rotate dial or press the [UP]/[DOWN] keys on the microphone to change the setting.

The options are as follows.

- ▼ FA: Searches fast but less accurate.
- ▼ SLW: Searches slowly but more accurate.

3. Press the dial.

The unit will go back to menu mode.

■ DCS SCANNING SPEED

Set the scanning speed to search a DCS code from the incoming DCS signal.

1. Rotate the dial or press the [UP]/[DOWN] keys on the microphone to display the menu number "28".

The current setting will appear on the display.



The default setting is "FA".

2. Press dial to display SET, then rotate dial or press the [UP]/[DOWN] keys on the microphone to change the setting.

The options are as follows.

- ▼ FA: Searches fast but less accurate.
- ▼ SLW: Searches slowly but more accurate.

3. Press the dial.

The unit will go back to menu mode.

■ PRIORITY SCAN SETTING

Set whether or not to check every 5 seconds whether the priority channel receives a signal or not.

1. Rotate the dial or press the [UP]/[DOWN] keys on the microphone to display the menu number "29".

The current setting will appear on the display.

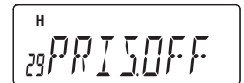

The default setting is "OFF".

2. Press dial to display SET, then rotate dial or press the [UP]/[DOWN] keys on the microphone to change the setting.

The options are as follows.

▼ ON:

Checks every 5 seconds whether the priority channel receives a signal or not.

▼ OFF:

Does not check whether the priority channel receives a signal or not.



If there is no priority channel, ON cannot be selected.

3. Press the dial.

The unit will go back to menu mode.

■ MEMORY CHANNEL SCANNING SETTING

Set whether to exclude skip channels or not when scanning memory channels.

1. Rotate the dial or press the [UP]/[DOWN] keys on the microphone to display the menu number "30".

The current setting will appear on the display.



The default setting is "SKIP".

2. Press dial to display SET, then rotate dial or press the [UP]/[DOWN] keys on the microphone to change the setting.

The options are as follows.

▼ SKIP: Scans excluding skip channel.

▼ ALL: Scans all memory channels regardless of skip setting.

3. Press the dial.

The unit will go back to menu mode.

■ GROUP SCANNING STEP

Set the channel step for group scanning.

1. Rotate the dial or press the [UP]/[DOWN] keys on the microphone to display the menu number "31".

The current setting will appear on the display.

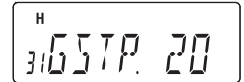

The default setting is "20".

2. Press dial to display SET, then rotate dial or press the [UP]/[DOWN] keys on the microphone to change the setting.

The options are as follows.

▼ 10, 20, 30, 40, 50

3. Press the dial.

The unit will go back to menu mode.

■ NARROW MODE

Select the filter width according to the applied local regulations.

1. Rotate the dial or press the [UP]/[DOWN] keys on the microphone to display the menu number "32".

The current setting will appear on the display.



The default setting is "OFF".

2. Press dial to display SET, then rotate dial or press the [UP]/[DOWN] keys on the microphone to change the setting.

The options are as follows.

▼ ON: Uses narrow mode.

▼ OFF: Conventional FM mode.

3. Press the dial.

The unit will go back to menu mode.

■ BEAT SHIFT

Set whether or not to shift the frequency when the multiple of clock frequency is the receiving frequency. This is not a noise-canceller.

1. Rotate the dial or press the [UP]/[DOWN] keys on the microphone to display the menu number "33".

The current setting will appear on the display.



The default setting is "OFF".

2. Press dial to display SET, then rotate dial or press the [UP]/[DOWN] keys on the microphone to change the setting.

The options are as follows.

▼ ON:

Shifts the frequency when the multiple of clock frequency is the receiving frequency.

▼ OFF:

Does not shift the frequency even when the multiple of clock frequency is the receiving frequency.

3. Press the dial.

The unit will go back to menu mode.

■ TUNING CONTROL

Set whether or not to allow operations for the dial and [UP]/[DOWN] keys on the microphone when the operation lock function is set.

1. Rotate the dial or press the [UP]/[DOWN] keys on the microphone to display the menu number "34".

The current setting will appear on the display.

The default setting is "ON".



2. Press dial to display SET, then rotate dial or press the [UP]/[DOWN] keys on the microphone to change the setting.

The options are as follows.

▼ ON:

Allows to operate the dial and [UP]/[DOWN] keys on the microphone when the operation lock function is set.

▼ OFF:

Does not allow to operate the dial and [UP]/[DOWN] keys on the microphone when the operation lock function is set.

3. Press the dial.

The unit will go back to menu mode.

■ S-METER SQUELCH

S-meter squelch determines the squelch level by the strength of receiving signal. It replaces the conventional noise squelch and the noise squelch level setting is disregarded while S-meter squelch is activated.

1. Rotate the dial or press the [UP]/[DOWN] keys on the microphone to display the menu number "35".

The current setting will appear on the display. The default setting is "OFF".

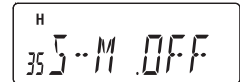

2. Press dial to display SET, then rotate dial or press the [UP]/[DOWN] keys on the microphone to change the setting.

The options are as follows.

▼ ON:

Activates S-meter squelch. Receiving audio is heard only when the signal strength is higher than the determined S-meter level.

▼ OFF:

Deactivates S-meter squelch (Noise squelch activated).

3. Press the dial. The unit will go back to menu mode.

To set the S-meter squelch level, select ON and press dial, then press [PTT] to move to operation mode. Press  key. **S** icon and a segment appear on the display. While **S** is displayed, turn the dial to select the level by moving segments; 5 levels are available. Press the dial or leaving it for 5 seconds sets the level.

■ SQUELCH HANG TIME

35

Set the duration of time before switching to MUTE-CLOSE state after stopping receiving a signal when the S-meter squelch is set to ON.

1. Rotate the dial or press the [UP]/[DOWN] keys on the microphone to display the menu number "36".

The current setting will appear on the display.

The default setting is "OFF".

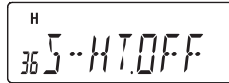

2. Press dial to display SET, then rotate dial or press the [UP]/[DOWN] keys on the microphone to change the setting.

The options are as follows.

▼ OFF (0ms) to 900 (900ms) / 10 steps in 100ms increments.

3. Press the dial.

The unit will go back to menu mode.

■ 2TONE

Set 2Tone system setting tones.

1. Rotate the dial or press the [UP]/[DOWN] keys on the microphone to display the menu number "37". "2Tone" will appear.



2. Press the dial. Use [UP]/[DOWN] keys to select the group from 01 to 16. Rotate the dial to select the system GET99 or MQC2.



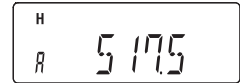

3. By pressing the dial and turning it, select proper value to program tones for the group A,B,C and D(GET99) or A,B and C(MQC2) depending on the system you use.



4. When the parameters are correctly selected, pressing the dial after programming D(GET99) or C(MQC2) will set the values and returns to menu mode.

Exit from the set mode to transmit tones. Select a frequency in VFO mode.

Press  and the dial together. A  icon appears on the display.

Press [PTT] to transmit the tone. The last selected group is used for Tx and Rx. To change the group, repeat above 1 and 2.

■ 2TONE RECEIVING SYSTEM

Select the condition to set 2Tone to Mute-Open.

1. Rotate the dial or press the [UP]/[DOWN] keys on the microphone to display the menu number "38".

The current setting will appear on the display.



The default setting is "OR".

2. Press dial to display SET, then rotate dial or press the [UP]/[DOWN] keys on the microphone to change the setting.

The options are as follows.

▼ OR:

If 2Tone matches Sub-Audio, Mute-Open will be set.

▼ AND:

If 2Tone matches, Mute-Open will be set.

3. Press the dial.

The unit will go back to menu mode.

■ 2TONE TRANSMISSION TYPE

Select the 2Tone transmission type

1. Rotate the dial or press the [UP]/[DOWN] keys on the microphone to display the menu number "39".

The current setting will appear on the display.



The default setting is "IND".

2. Press dial to display SET, then rotate dial or press the [UP]/[DOWN] keys on the microphone to change the setting.

The options are as follows.

▼ IND:

The 2Tone transmission type will be set to "Individual".

▼ GRP:

The 2Tone transmission type will be set to "Group".

▼ SGRP:

The 2Tone transmission type will be set to "Super Group".

3. Press the dial.

The unit will go back to menu mode.

This feature will copy the programmed data and parameters in the master unit to slave units. It copies the parameters and memory program settings.

CONNECTION

Purchase a commonly available 3.5mm ϕ stereo mini-plug audio cable. Make a master unit by setting and programming it as desired. Turn off both units. Connect the cable between the DATA jacks on both master and slave. Turn both radios on after the connection is made.

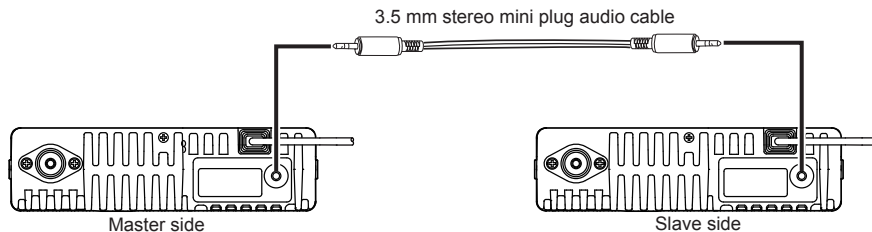

37 [SETTING: MASTER SIDE]

1. Press **[CALL]** key with **[FUNC]** key pressed. CLONE will be displayed and the radio enters the clone mode.
2. Press PTT. SD** will be displayed and it starts sending the data into the slave unit.
3. [PASS] will appear on the display when the data is successfully transmitted.
4. The master radio may stay turned on for the next clone. Turn off the unit to exit from the clone mode.

If the data is not successfully transmitted, turn off both units, make sure the cable connection is correct and repeat the entire operation from the beginning. If you quit the operation in condition that the clone is incompleted please reset the slave unit.

[SETTING: SLAVE SIDE]

1. Go to receive mode (VFO or Memory).
2. When it receives the clone data, LD** shows up on the display.
3. When the transmission is successfully finished, the display will show [PASS].
4. Turn off the power. Disconnect the cable and repeat the sequence to clone the next slave unit.

■ DEFAULT SETTING AFTER RESETTING DR-B185

| | DR-B185 | CTCSS frequency | 88.5Hz |
|-------------------------|-------------------------|-----------------------|--------|
| VFO frequency | 145.000MHz | DCS encode and decode | - |
| Memory channel | C (CALL) | DCS code | 023N |
| Offset direction | - | Output power | HI |
| Offset frequency | 600KHz | Key-lock setting | OFF |
| Channel step | HT: 5KHz HE: 12.5KHz | TOT | OFF |
| CTCSS encode and decode | - | APO | OFF |

Optional functions will be basically deactivated and programmed values are erased.

■ TO RESET

Perform the reset to resume default setting, 2 reset modes are available.

SYSTEM reset

Resumes default setting without erasing memory channel data.

Turn off. Turn on with  key pressed. All LCD segments will be displayed. Release the key and wait until 145.000 is displayed.

ALL reset

Resumes default setting and clears the memory data. The deleted memory data can't be recalled.

Turn off. Turn on with  and  keys pressed together.

All LCD segments will be displayed. Release keys and wait until 145.000 is displayed.

■ TROUBLE SHOOTING

| Problem | Possible Causes and Potential Solutions |
|---|---|
| (a) Power is on, nothing appears on Display. | + and - polarities of power connection are reversed. Connect red lead to plus terminal and black lead to minus terminal of DC power supply. |
| (b) Fuse is blown. | Check and solve problem resulting in blown fuse and replace fuse with a new one. |
| (c) Display is too dim. | Set the LCD backlight parameter properly. |
| (d) No sound comes from speaker. | <ul style="list-style-type: none"> • Squelch level too high. Decrease squelch level. • Selective-calling like TSQ activated. Press [Moni] key to monitor. |
| (e) Key and Dial do not function. | Key-lock function is activated. Cancel Key-lock function. |
| (i) Rotating Dial will not change memory channel. | Transceiver is in CALL mode. Press  . |
| (g) [PTT] key is pressed but doesn't transmit. | <ul style="list-style-type: none"> • Microphone connection is poor. Connect microphone properly. • Antenna connection is poor. Connect antenna properly. |

Please contact your dealer when a technical assistance may be necessary.



NOTE

Reset is not available in Channel display mode, or preprogrammed using PC utility software.

General

| | |
|-----------------------|---|
| Frequency Range | VHF: DR-B185HE 144 - 145.995 MHz DR-B185HT 144 - 147.995 MHz (136-173.995MHz RX only) |
| Number of memory ch | 500 channels |
| Channel step | 5KHz, 6.25KHz, 10KHz, 12.5KHz, 15KHz, 20KHz, 30KHz, 50KHz |
| Operating Voltage | 13.8V DC \pm 15% |
| Squelch | Carrier/CTCSS/DCS/2Tone |
| Frequency Stability | \pm 2.5ppm |
| Operating Temperature | -10°C~+60°C |
| Dimensions(WxHxD) | 164 (W) x 44 (H) x 183.6 (D)mm (6.44" x 1.73" x 7.21") |
| Weight | about 1.5Kg (3.31lbs) |

 Specifications are subject to change without notice due to advancements in NOTE technology.

Receiver

| | Wide band | Narrow band |
|------------------------------|------------------------|------------------------|
| Sensitivity (12dB Sinad) | \leq 0.25 μ V | \leq 0.25 μ V |
| Adjacent Channel Selectivity | \geq 70dB | \geq 60dB |
| Intermodulation | \geq 65dB | \geq 60dB |
| Spurious Rejection | \geq 70dB | \geq 65dB |
| Audio Response | +1~-3dB(0.5 - 2.5 KHz) | +1~-3dB(0.5 - 2.5 KHz) |
| Hum & Noise | \geq 40dB | \geq 35dB |
| Audio distortion | \leq 5% | |
| Audio power output | >2W@10% | |
| Current drain | <1A | |

Transmitter

| | Wide band | Narrow band |
|------------------------|------------------------|------------------------|
| Power Output | 85 W / 5W | |
| Modulation | 16K Φ F3E | 11K Φ F3E |
| Adjacent Channel Power | \geq 70dB | \geq 60dB |
| Hum & Noise | \geq 40dB | \geq 35dB |
| Spurious Emission | \geq 60dB | \geq 60dB |
| Audio Response | +1~-3dB(0.5 - 2.3 KHz) | +1~-3dB(0.5 - 2.3 KHz) |
| Audio Distortion | \leq 5% | |
| Current drain (5W) | <6A | |
| Current drain (85W) | <20A | |

[MEMO]





[MEMO]

[MEMO]



ALINCO, INC.

Yodoyabashi Dai-bldg 13F

4-4-9 Koraibashi, Chuo-ku, Osaka 541-0043 Japan

Phone: +81-6-7636-2362 Fax: +81-6-6208-3802

<http://www.alinco.com>

E-mail: export@alinco.co.jp



CE 0700

DR-B185HE: VHF FM Transceiver 136.000-173.995MHz

All EU and EFTA member states.

Operator license is required.

IC

RoHS



Tested to comply MIL-STD-810G

Shock: Method 514.6/I,IV -Vibration: Method 516.6/I

Copyright Alinco, Inc.

Printed in China

PS0841A

FNEH-EF