

ALINCO

HF + 50MHz ALL MODE TRANSCEIVER

DX-70

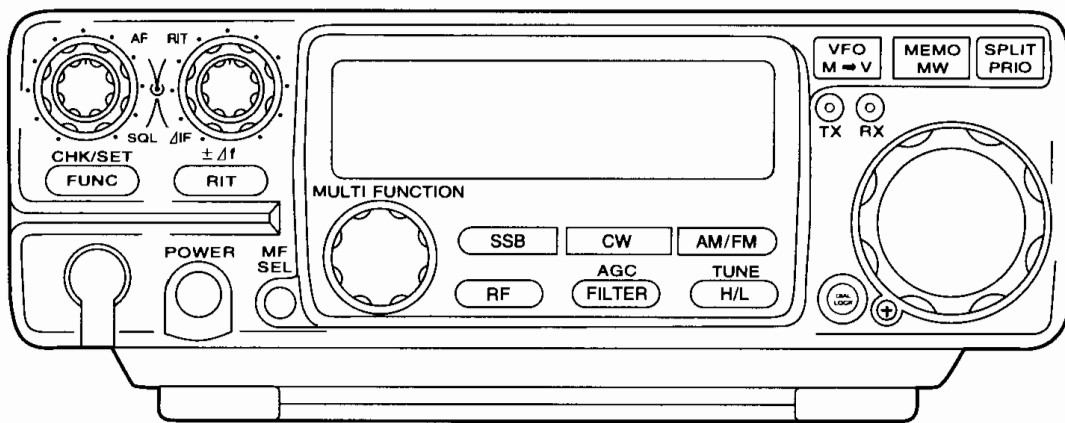

Instruction Manual

Thank you for purchasing this **ALINCO** transceiver. To obtain optimum performance from this transceiver, read this instruction manual thoroughly, and keep it for future reference.

PRECAUTIONS

- Do not open the transceiver case or touch non-user-serviceable components.

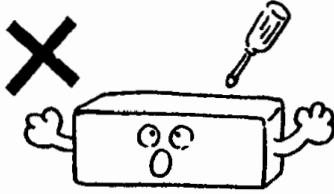

- Do not expose the transceiver to direct sunlight or to source of heat. Also, avoid using the transceiver in a dusty or humid environment.

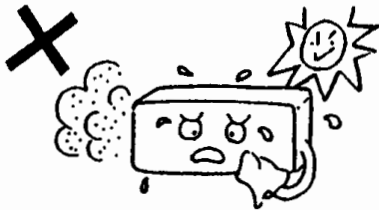

- Do not place anything which might spill over on top of the transceiver.



- For good ventilation, allow about 10 cm (4") between the rear of the transceiver and the wall.

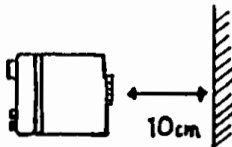

- If the transceiver causes harmful interference to VCR or TV reception, move the transceiver away from the appliance.

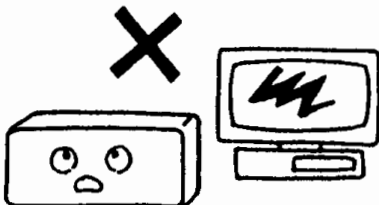

- Do not yank the power cable from its outlets. Also, do not rewire the power cable with other extension cables. Such handling may damage or short-circuit the cable.

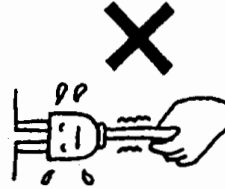

- Use a 13.8 V DC regulated power supply to operate this transceiver. The transceiver must be grounded.

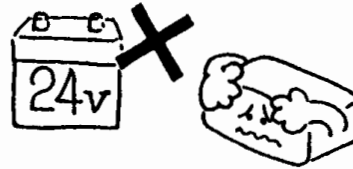

- Beware of moisture condensation. Moisture in the air will condense on the transceiver when you move it from a cold place to a warm place. Condensation will cause the unit to malfunction. If condensation forms on the unit, wipe and let dry.



- If the transceiver ever emits smoke or strange smells, immediately turn it off and unplug it. Then, contact our office or your nearest ALINCO dealer.

CONTENTS

PRECAUTIONS	
HOW TO USE THIS MANUAL.....	iii
Chapter 1 GETTING STARTED	1-1
1.1 FEATURES	1-1
1.2 SUPPLIED ACCESSORIES	1-2
1.3 INSTALLATION AND CONNECTION (FOR BASE STATION).....	1-3
1.4 INSTALLATION AND CONNECTION (FOR MOBILE OPERATION)	1-7
1.5 CONTROLS, CONNECTORS, AND DISPLAY	1-11
Control Panel.....	1-11
Rear Panel Connectors	1-14
Other Components.....	1-15
Microphone.....	1-15
Display.....	1-16
Controls Quick Reference	1-18
Chapter 2 COMMUNICATION	2-1
2.1 RECEPTION BASICS	2-1
2.2 TRANSMISSION BASICS.....	2-8
2.3 SSB OPERATION.....	2-10
2.4 PRACTICAL TECHNIQUES FOR SSB OPERATION.....	2-12
2.5 AM OPERATION	2-14
2.6 GENERAL COVERAGE RECEIVER	2-15
2.7 FM OPERATION.....	2-16
2.8 REPEATER OPERATION.....	2-17
2.9 CW OPERATION	2-18
2.10 PRACTICAL TECHNIQUES FOR CW OPERATION	2-20
2.11 RTTY PACKET OPERATION.....	2-22
2.12 SPLIT-FREQUENCY OPERATION.....	2-23
Chapter 3 MEMORY FEATURES.....	3-1
3.1 BASICS	3-1
3.2 MEMORY MODE OPERATION.....	3-2
3.3 SIMPLEX-VFO-FREQUENCY PROGRAMMING	3-3
3.4 SIMPLEX-MEMORY-FREQUENCY PROGRAMMING	3-4
3.5 SPLIT-FREQUENCY PROGRAMMING (FOR GENERAL USE)	3-5
3.6 SPLIT-FREQUENCY PROGRAMMING (FOR REPEATER OPERATION).....	3-6
3.7 MEMORY CHANNEL DATA ERASING.....	3-8
3.8 MEMORY TO VFO DATA TRANSFER.....	3-9
Chapter 4 SCANNING	4-1
4.1 BASICS	4-1
4.2 BAND SCAN	4-4
4.3 MEMORY SCAN.....	4-5
4.4 PRIORITY SCAN	4-6

Chapter 5 SPECIAL FEATURES	5-1
5.1 INTERFERENCE REDUCERS	5-1
Introduction	5-1
IF SHIFT	5-1
Narrow Filter	5-2
CW BFO REVERSE	5-3
NB (Noise Blanker)	5-3
ATT (Attenuator)	5-3
5.2 OTHER USEFUL FUNCTIONS	5-4
RIT/TXIT Function	5-4
$\pm \Delta f$	5-5
VFO A=B	5-5
DIAL LOCK Function	5-6
Chapter 6 SET-UP	6-1
6.1 BASICS	6-1
6.2 SET-UP ITEMS	6-3
TXIT Function	6-3
Automatic USB/LSB Selection	6-4
Sidetone and CW Offset Setting	6-5
Break-in Delay Time	6-6
LCD Brightness	6-7
Beep	6-8
APO (Automatic Power Off)	6-9
Speech Compressor	6-10
Transmission Inhibit (PTT Key Lock)	6-11
Frequency Step of the MULTI FUNCTION Dial (SSB and CW Modes)	6-12
Frequency Step of the MULTI FUNCTION dial (AM mode)	6-13
Frequency Step of the MULTI FUNCTION dial (FM mode)	6-14
Memory Overwrite Protection	6-15
Memory Frequency Access Protection	6-16
SCAN Mode	6-17
Group Memory Scan	6-18
Chapter 7 MAINTENANCE AND ADJUSTMENT	7-1
7.1 ADJUSTMENT	7-1
Introduction	7-1
Adjustment Item List	7-1
Removing the Covers	7-1
Procedure	7-2
7.2 RESET	7-4
7.3 CLEANING	7-5
7.4 TROUBLESHOOTING	7-6
APPENDIX	
OPTIONS	Appendix-1
EXTERNAL ANTENNA TUNERS AVAILABLE	Appendix-2
SPECIFICATIONS	Appendix-4

HOW TO USE THIS MANUAL

About This Manual

This manual contains the following chapters:

1. GETTING STARTED

Explains how to install and connect the transceiver. This chapter also describes controls, connectors, and display.

2. COMMUNICATION

Gives you the basic procedures for reception and transmission. This chapter also explains how to communicate in the various operating modes, including the **SSB**, **FM**, **AM**, and **CW** modes.

3. MEMORY FEATURES

Explains how to use the memory channels.

4. SCANNING

Describes how each type of scan searches for signals. This chapter also gives you procedures for scanning.

5. SPECIAL FUNCTIONS

Describes the interference eliminators and other useful functions.

6. SET-UP

Explains miscellaneous set-up items and their set-up procedures.

7. MAINTENANCE AND ADJUSTMENT

Explains how to adjust and reset the transceiver. This chapter also shows you procedures for cleaning and troubleshooting.

Document Conventions

Bold typeface

Indicates controls (keys, dials, etc.), connectors, modes, and functions.

Display example

Shows only the related indication.

Icons



Indicates a hazardous situation that, if not avoided, will result in death or serious injury.



Indicates a hazardous situation that, if not avoided, will result in serious damage to the unit.



Indicates an exception or note related to the procedure.



Provides helpful hint.



Indicates a reference page

1.1 FEATURES

DX-70 Advanced Features

HF bands + 50 MHz band operation

Covers HF (1.8 MHz to 28 MHz) and 50 MHz amateur bands in the **SSB**, **AM**, **FM**, and **CW** modes. Separate antenna terminals for HF and 50 MHz bands.

General coverage receiver

Covers 150 kHz to 30 MHz and 50 MHz to 54 MHz in all modes.

Super compact body

178 mm(W) × 58 mm(H) × 228 mm(D); the world's most compact HF + 50 MHz transceiver. (In inches, 7"(W) × 2 1/4"(H) × 9 1/16"(D) approx.)

Detachable control panel

Allows you install the transceiver with greater flexibility whether in your car or in your shack.

Versatile interference eliminators

The **IF SHIFT** function; built-in narrow filter as standard for **SSB**, **CW**, and **AM** modes; and RF attenuator, all effectively help to reject unwanted signals.

Powerful CW operation

Enables you to receive **CW** signals from either the upper or lower side of the carrier frequency. Selectable sidetone. Selectable **FULL BREAK-IN** (QSK), **SEMI BREAK-IN** (7 steps), and **AUTO BREAK-IN** (delay time automatically adjusted with keying speed).

100 memory channels

Each stores mode, filter, split-frequencies, **AGC**, attenuator (or pre-amp), and noise-blanker settings.

1.2 SUPPLIED ACCESSORIES

Checking Accessories

Check if these accessories are included in the shipping carton.

- DC power cable

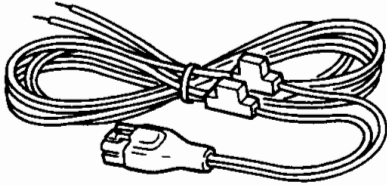

- Microphone

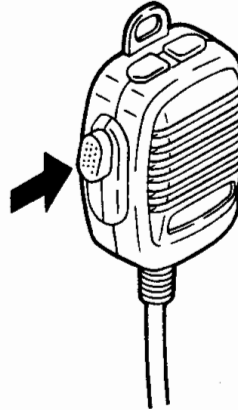

- Fuse

20A

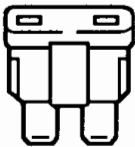

DX-70
DX-70 T

- Instruction manual (this manual)

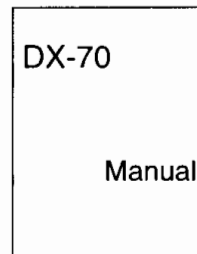

30A

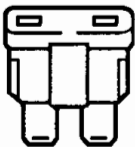

DX-70 EH
DX-70 TH

1.3 INSTALLATION AND CONNECTION (FOR BASE STATION)

Connection Diagram

This diagram shows the connections for a base station.

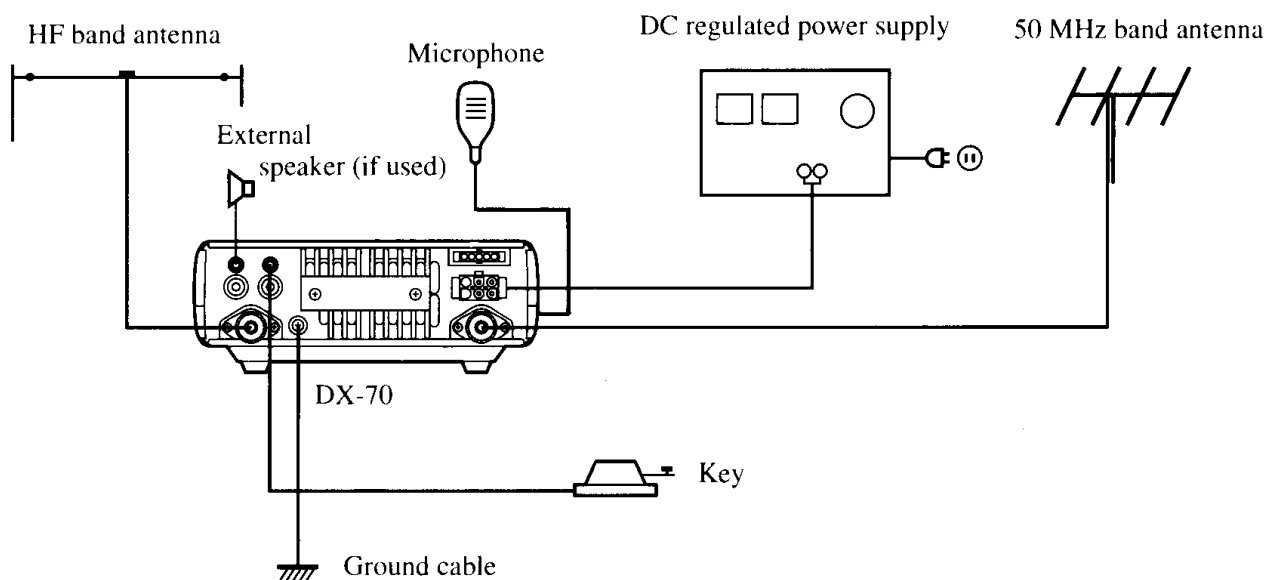

Procedure

1. Connecting an antenna and ground cable

- Antenna connection

Use a properly-adjusted (low SWR) antenna to obtain optimum performance from the transceiver. A 50 ohm impedance coaxial cable with UHF plugs is required for this connection.

 *Tip: It is recommended to use an optional manual antenna tuner (EDX-1) for proper antenna matching.*

- Ground connection

To prevent electric shock hazard and radio interference with other electronic appliances, bury a rod or copper plate under the ground and connect it to the transceiver **GND** terminal. Use a heavy gauge, short cable for this connection.

 **Warning: Do not ground the equipment on gas pipes, electrical conduits, or plastic water pipes.**

Rear Panel Connectors

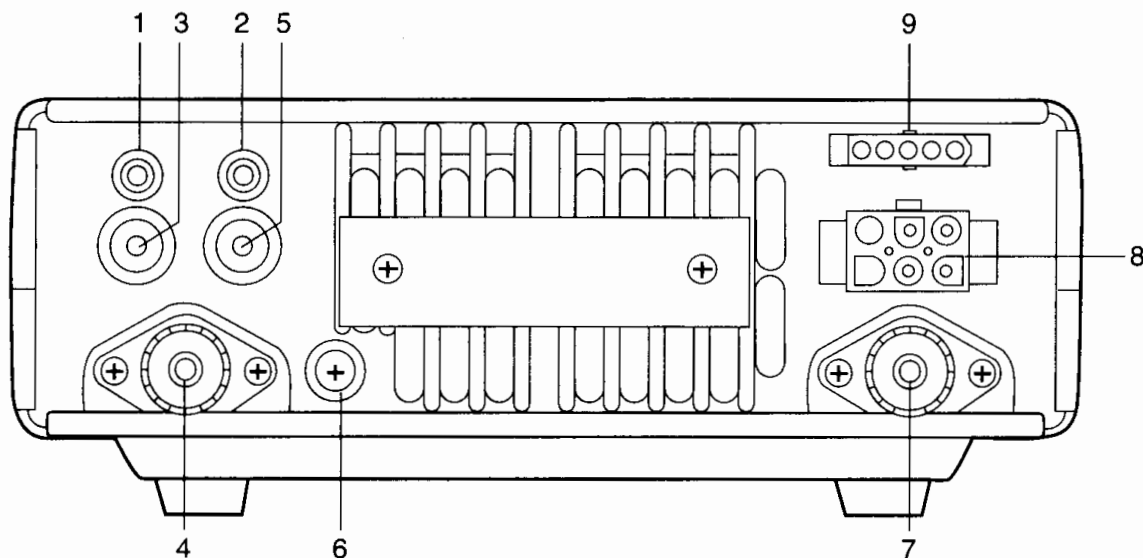

- | | |
|---------------------------------------|--|
| 1. SP jack | For connecting an external speaker or headphones. Takes the 8 to 16 ohm impedance speakers and 8 to 32 ohm headphones. |
| 2. CW-KEY jack | For connecting a telegraph key or electronic-keyer.
⇒ page 1-5 |
| 3. RELAY (external relay) jack | For connecting external equipment such as a linear amplifier for switching between reception and transmission. Takes a phono-plug. A jumper wire must first be cut to activate this jack. ⇒ page 7-2 |
| 4. ANT 1 (antenna 1) connector | For connecting a HF band antenna. Takes a 50 ohm impedance coaxial cable with UHF plugs. |
| 5. External ALC input jack | For connecting the phono-plug from the amplifier ALC circuit when a linear amplifier is used. The ALC input voltage must be from 0 to -3 V DC. |
| 6. GND (ground) terminal | For connecting a grounding cable. |
| 7. ANT 2 (antenna 2) connector | For connecting a 50 MHz band antenna. Takes 50 ohm impedance coaxial cable with a UHF plug. |

 *Tip:*

Connector pin assignment

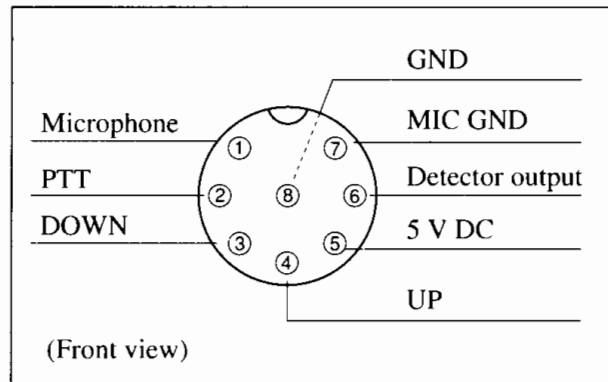

3. Connecting a telegraph key

Connect a 3.5 mm diameter mono plug to the **CW KEY** jack on the rear panel. If using an electronic-keyer, pay attention to the polarity of the plug.

Plug wiring

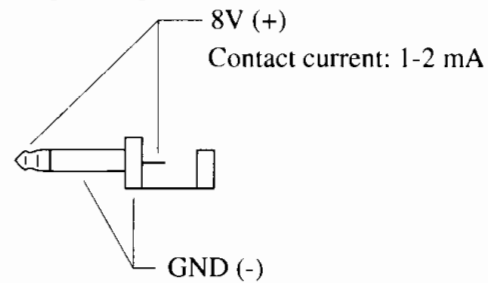

4. Connecting an external speaker (if not using the internal speaker)

Connect a 3.5 mm diameter mono plug to the **EXTERNAL SPEAKER** jack on the rear panel. Use a 3 W or higher external speaker with 8 ohm impedance.

 *Note: When an external speaker is used, no sound is heard from the internal speaker.*

5. Connecting headphones

Connect a 3.5 mm diameter resistor plug to the **EXTERNAL SPEAKER** jack on the rear panel. Use headphones with a 4 to 32 ohm impedance.

Resistor plug

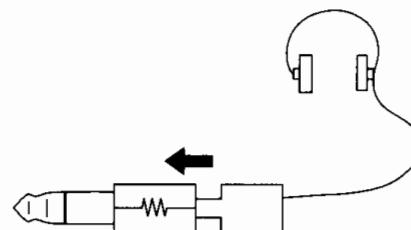

 *Note: For stereo headphones, use a stereo/mono conversion plug to listen to sound from the both channels.*

6. Connecting a DC regulated power supply

This transceiver is designed to operate on a 13.8 V DC regulated power supply. Use the supplied power cable to connect the transceiver and a DC power supply.

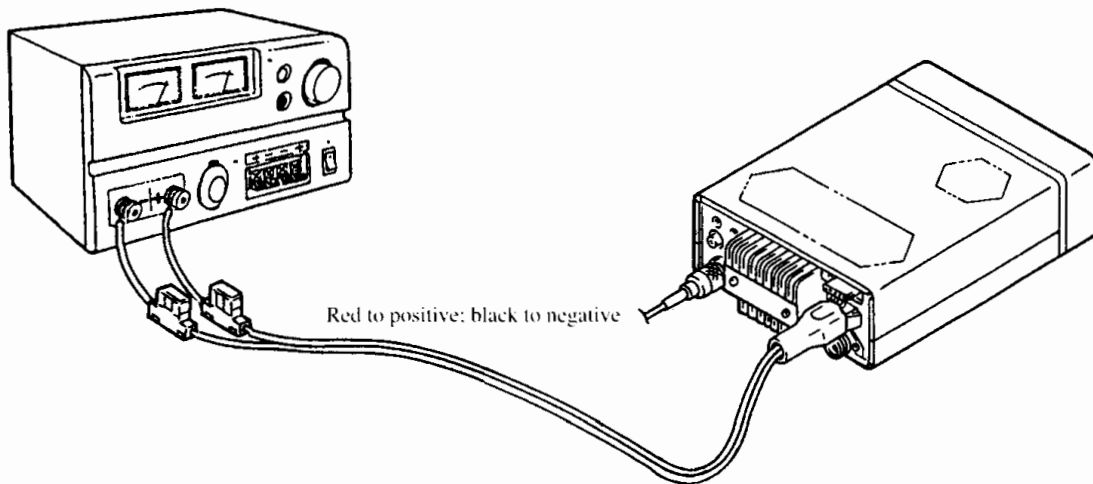

Warning: Before connecting, be sure to turn off the transceiver and DC power supply.

- Recommended DC regulated power supplies (see "OPTIONS")
 - DM-1350Z (Input 220 V AC)
 - DM-1350T (Input 120 V AC)
- Replacing the fuse
 - Use a 20 A blade-type fuse. (DX-70/DX-70T)
 - Use a 30 A blade-type fuse. (DX-70EH/DX-70TH)

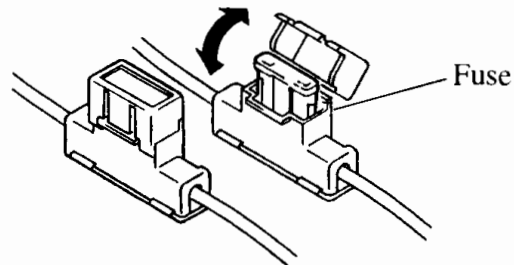

1.4 INSTALLATION AND CONNECTION (FOR MOBILE OPERATION)

Connection Diagram

This diagram shows the connections for mobile operation.

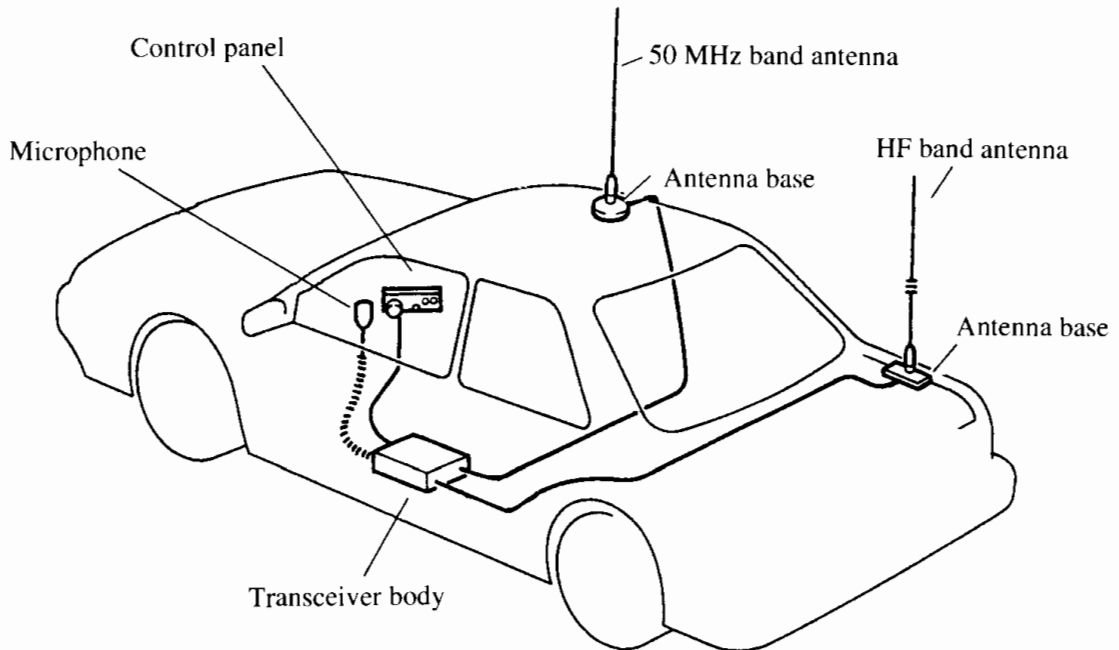

Procedure

1. Installing an antenna

Use a properly-adjusted (low SWR) antenna to obtain optimum performance from this receiver.

1. Secure a commercially-available antenna base in a proper position on your car.
2. Ground the antenna base to the chassis.

⚠ Warning: A ground is indispensable for HF and 50 MHz band antennas.

3. Connect the antenna and transceiver using a 50 ohm impedance coaxial cable with UHF plugs.

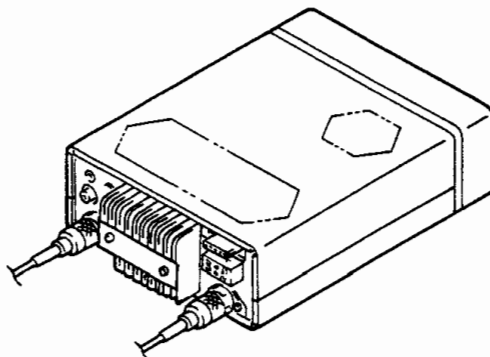

2. Installing the transceiver

■ With Control Panel Attached

- 1.** Attach the optional mobile mount bracket (EBC-9) under the dashboard or in another convenient position.

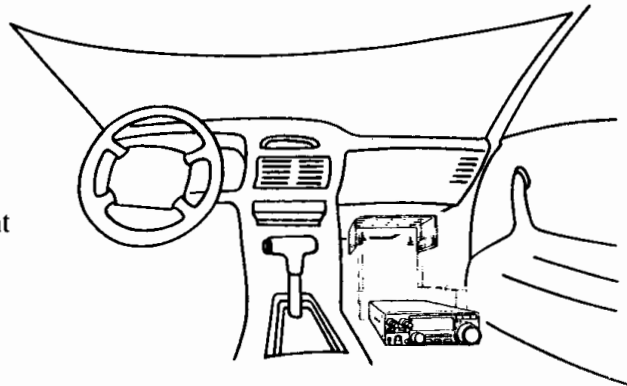

Note: Attach the bracket to a position where the controls and microphone are easily accessible and allow you to safely drive. (Local regulations may apply.)

- 2.** Install the transceiver in the bracket.

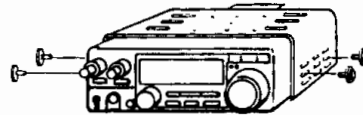

■ With Control Panel Detached

This transceiver can be separated into the control panel and body. Using the optional front control remote kit (EDS-4), front control angle bracket (EBC-8), and microphone extension cable (EDS-5), the panel can be installed in a position convenient for you when driving.

- 1.** Detach the control panel from the body.

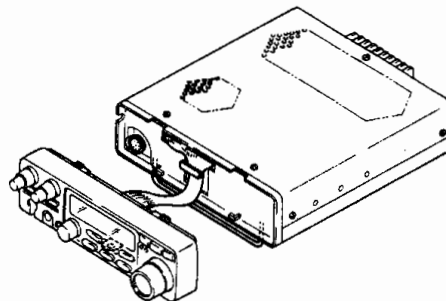

- 2.** If necessary, connect the microphone extension cable to the body.

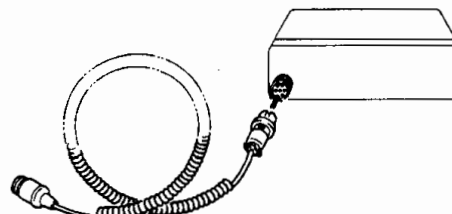

- 3.** Disconnect the two cables from the panel and body, and connect the remote cables of the optional kit instead.

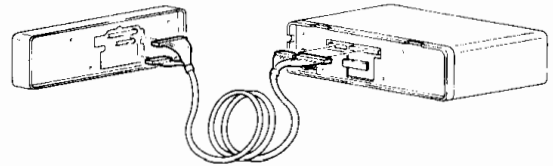

- 4.** Attach the covers of the optional kit to the panel and body.

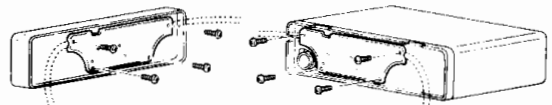

- 5.** Using the front control angle bracket, install the control panel in a position where the controls are easily accessible.

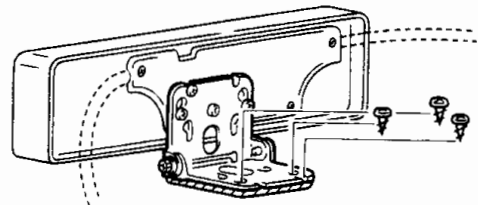

- 6.** Install the body in a proper position such as below a seat.



- 7.** Connect the microphone plug to the extension cable connector.

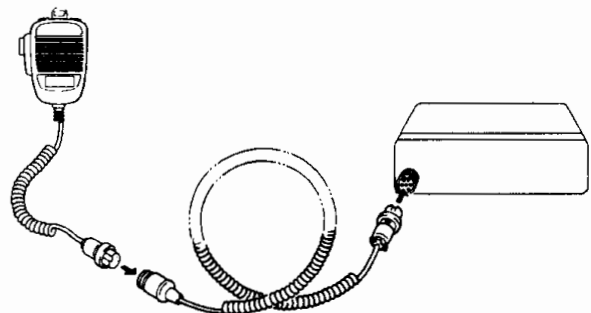

 *Tip: The control panel has screw holes in the bottom side. Using the holes, the panel can also be mounted on a commercially-available angle bracket for in-car TV sets or CD players.*

3. Connecting the power cable

⚠ Caution: Use a 12 V car battery to operate the transceiver.

1. Connect the supplied power cable directly to the car battery.

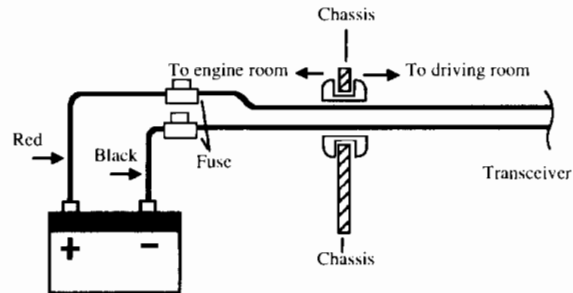

⚠ Note: If threading the cable through wiring holes, use grommets to prevent the cable from coming in contact with the car chassis.

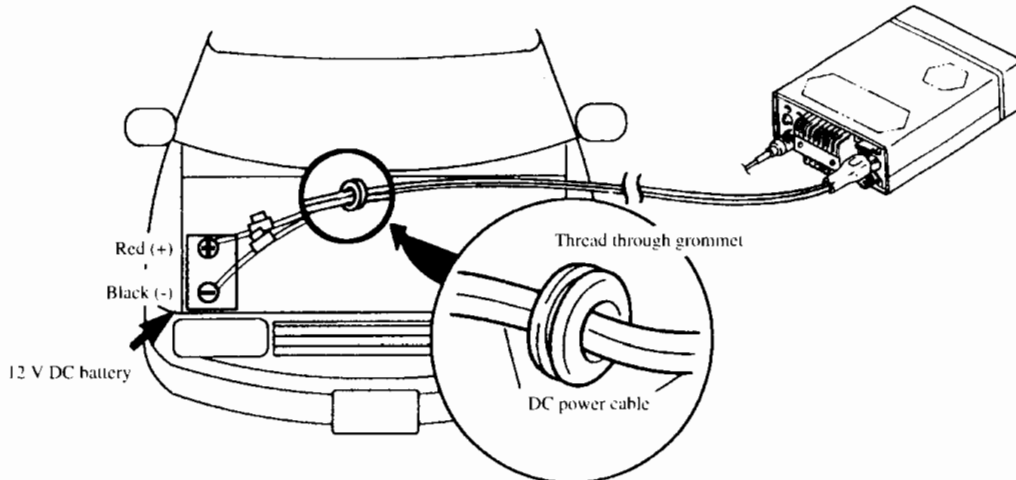

⚠ Caution:

- If using a 24 V car battery, be sure to convert the voltage to 12 V DC with a DC/DC converter.
- Do not connect the power cable to a cigarette lighter connector because the power supply is unstable.

4. Connecting the accessories

- ➡ ● Microphone, page 1-4
- Telegraph key, page 1-5
- External speaker, page 1-5

📌 Tip: The DX-70 is designed to filter ignition noise with the noise blanker (NB). However, if you pick up excessive ignition noise from your car, it is recommended to use a resistor spark plug.

1.5 CONTROLS, CONNECTORS, AND DISPLAY

Control Panel

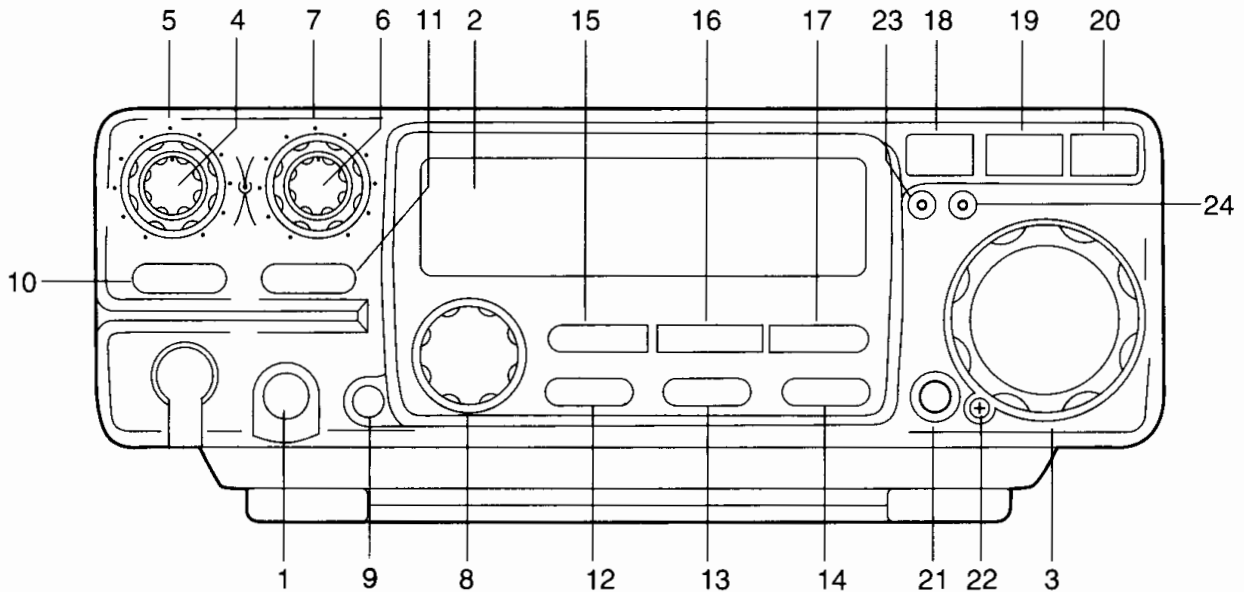

- | | |
|-------------------------------|---|
| 1. POWER switch | Press to turn the power on. |
| 2. LCD display | ➡ <i>page 1-16</i> |
| 3. Main tuning dial | Rotate to select transmit/receive frequencies. |
| 4. AF control knob | Rotate to adjust volume. |
| 5. SQL control knob | Rotate to eliminate noise when no signal is received.
➡ <i>page 2-1</i> |
| 6. RIT control knob | Rotate to fine-tune the receive frequency in the RIT function and the transmit frequency in the TXIT function. |
| 7. ΔIF control knob | Rotate to eliminate the interference by shifting the receive IF pass band.
➡ <i>page 5-1</i> |
| 8. MULTI FUNCTION dial | Rotate to select memory channels and amateur bands, and to change frequency in 1 MHz and 100 kHz increments. Also used to select the transceiver's settings in the SET mode. |

-
- 9. MF SEL key (Multi Function Selector)**
- **VFO** mode
Dial tuning → Memory channel No. → Band → 1 MHz step
→ 100 kHz step
 - **MEMORY** mode
Memory channel No. → Band → 1 MHz step → 100 kHz step
→ Dial tuning
- 10. FUNC key**
- Press to access the blue-marked key functions. Hold down to monitor the transmit frequency during reception. Press and then press and hold this key longer than 2 seconds to access the **SET** mode (see page 6-1).
- 11. RIT key**
- Press to turn the **RIT** or **TXIT** function on/off. After pressing the **FUNC** key, press the **RIT** key to add the **RIT** or **TXIT** shift frequency to the displayed frequency.
- 12. RF key (preamplifier /attenuator)**
- Press to adjust the receiver's front-end gain by switching between the preamplifier and attenuator. Pressing this key will change gain in the following: +10 dB, 0 dB, -10 dB, and -20 dB. After pressing the **FUNC** key, press this **RF** key to turn the **NB** (noise blanker) on/off
⇒ page 2-12, 5-3
- 13. FILTER key**
- Press to select a filter in the **CW**, **SSB**, and **AM** mode. After pressing the **FUNC** key, press the **FILTER** key to select the **AGC** recovery time (see page 2-13)
⇒ page 5-2
- 14. H/L key**
- Press to decrease the output power to about 1/10. After pressing the **FUNC** key, press the **H/L** key to activate an external automatic tuner for proper antenna matching.
⇒ page 2-9
- 15. SSB key**
- Press to select the **USB** or **LSB** mode. In SSB mode, after pressing the **FUNC** key, press the **SSB** key to switch between the **UT** and **LT** modes (see page 2-22). ⇒ page 2-10
- 16. CW switch**
- Press to switch between the **CWU** and **CWL** modes
⇒ page 2-18
- 17. AM/FM key**
- Press to switch between the **AM** and **FM** modes. In the **FM** mode, after pressing the **FUNC** key, press the **AM/FM** key to encode the CTCSS tone to access repeaters. (EJ-26U CTCSS Tone Encoder required ; comes standard for DX-70T.)
⇒ page 2-14, 16

-
- 18. VFO key** Press to switch between the **MEMORY** and **VFO** modes. In the **VFO** mode, press this key to switch between the **VFO A** and **VFO B**. After pressing the **FUNC** key, press the **VFO** key to transfer data from the selected memory channel to one of the **VFO**. Hold down to overwrite the **VFO A** data over the **VFO B** data, and vice versa.
- 19. MEMO key** Press to switch between the **VFO** and **MEMORY** modes. After pressing **FUNC** key, press the **MEMO** key to program a memory channel. Hold down to erase the data in a memory channel.
⇒ page 3-1
- 20. SPLIT key** In the **VFO** mode, press this key to use the **VFO A** for reception and **VFO B** for transmission, and vice versa. In the **MEMORY** mode, press this key to use one memory frequency for reception and another memory frequency for transmission. After pressing the **FUNC** key, press the **SPLIT** key to access the **PRIORITY** mode.
⇒ page 2-23
- 21. DIAL LOCK key** Press to lock the main tuning dial to prevent accidental frequency change.
- 22. Main tuning dial torque screw** Adjusts torque of the main tuning dial.
- 23. TX LED** Brightness indicates the ALC peak level.
- 24. RX LED** Lights when squelch is unmuted.

Rear Panel Connectors

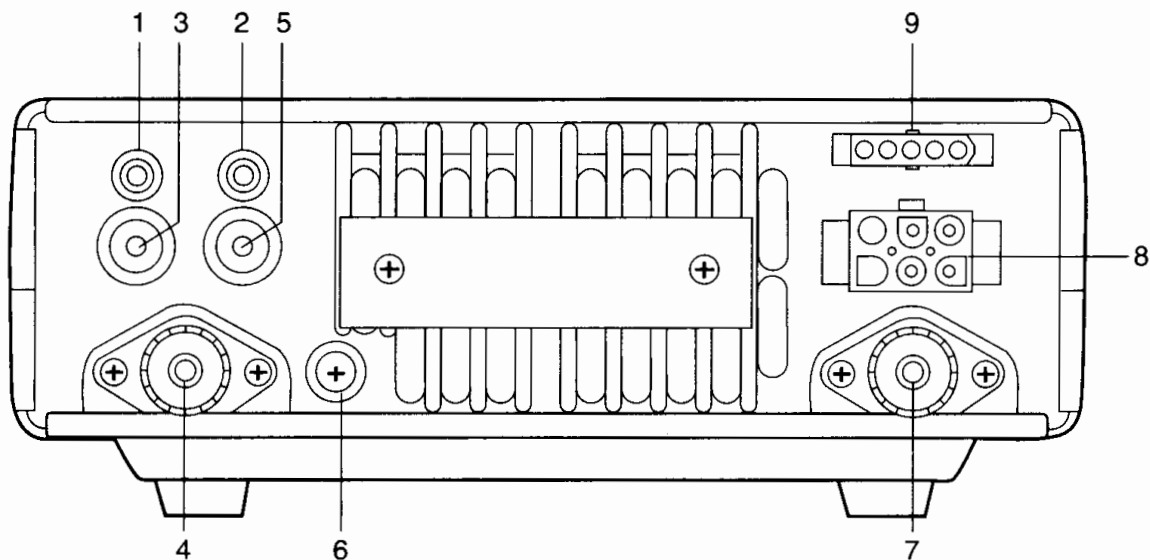

- | | |
|---------------------------------------|--|
| 1. SP jack | For connecting an external speaker or headphones. Takes the 8 to 16 ohm impedance speakers and 8 to 32 ohm headphones. |
| 2. CW-KEY jack | For connecting a telegraph key or electronic-keyer.
⇒ page 1-5 |
| 3. RELAY (external relay) jack | For connecting external equipment such as a linear amplifier for switching between reception and transmission. Takes a phono-plug. A jumper wire must first be cut to activate this jack. ⇒ page 7-2 |
| 4. ANT 1 (antenna 1) connector | For connecting a HF band antenna. Takes a 50 ohm impedance coaxial cable with UHF plugs. |
| 5. External ALC input jack | For connecting the phono-plug from the amplifier ALC circuit when a linear amplifier is used. The ALC input voltage must be from 0 to -3 V DC. |
| 6. GND (ground) terminal | For connecting a grounding cable. |
| 7. ANT 2 (antenna 2) connector | For connecting a 50 MHz band antenna. Takes 50 ohm impedance coaxial cable with a UHF plug. |

8. Power connector

For connecting the supplied DC power cable. Input voltage must be 13.8 V DC \pm 15%.

9. ACC (accessory) connector

For connecting peripherals such as an external automatic antenna tuner.

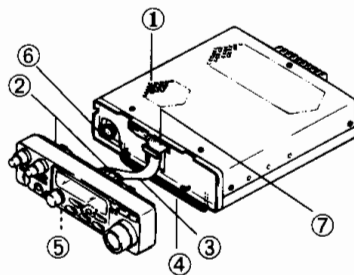
Other Components

1. Internal speaker
2. Control panel latches
3. Control cable
4. Stand
5. Screw holes for bracket
6. Microphone connector
7. Cable holder

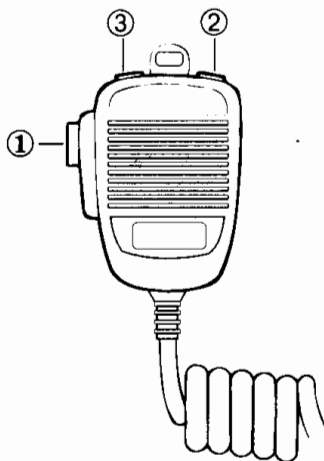
Microphone

1. **PTT key**
Push to transmit, and release to receive. Push to stop scanning.
2. **UP key**
In the **VFO** mode, press this key to change frequency upwards in the selected frequency step. In the **MEMORY** mode, press this key to change memory channel upwards by one channel. Hold down longer than one second to start scanning.
3. **DOWN key**
In the **VFO** mode, press this key to change the frequency downwards in the selected frequency step. In the **MEMORY** mode, press this key to change memory channel downwards by one channel. Hold down longer than one second to start scanning.

Controls Quick Reference

	This key only	FUNC + this key (See notes:)	FUNC + FUNC + this key (See notes:)
FUNC	Accesses FUNC mode	* Monitors transmit frequency.	** Accesses SET mode.
RIT	Switches between RIT and TXIT .	Adds RIT shift frequency to displayed frequency.	TXIT function ON/OFF
RF	Changes RF gain.	NB (noise blanker) ON/OFF	Changes LCD backlight. Beep ON/OFF. AP0 ON/OFF.
FILTER	Switch filter ON/OFF.	Changes AGC mode.	–
H/L	Changes output power.	Activates an external automatic tuner.	–
SSB	Switches between LSB and USB .	Switches to LT and UT . (See page 2-22)	Automatic USB/LSB selection ON/OFF
CW	Switches between CWL and CWU .	–	Changes break-in mode. Selects CW offset and the sidetone.
AM/FM	Switches between AM and FM .	CTCSS tone ON/OFF.	–
VFO	Switches between VFO A and VFO B . Accesses to VFO mode. * Activates VFO A=B function.	Transfers memory to VFO.	Sets frequency steps (MULTI FUNCTION dial tuning step) by mode.
MEMO	Accesses MEMORY mode. * Erase memory channel.	Enters memory channel.	Memory overwrite protection ON/OFF. Memory frequency access protection ON/OFF
SPLIT	SPLIT function ON/OFF * QUICK OFFSET function ON/OFF	PRIORITY function ON/OFF	Selects SCAN mode (condition for stopping and resuming scan). Group memory scan ON/OFF
DIAL LOCK	Locks main tuning dial.	–	Transmission inhibit (PTT key lock) ON/OFF

*: Hold down longer than 1 second.

***: Hold down longer than 2 seconds.



Notes: **FUNC + this key:** Press **FUNC** key, then press this key.

FUNC + FUNC + this key: Press **FUNC** key, then hold **FUNC** key longer than 2 seconds and press this key.



Tip: The items in the forth column are the **SET** mode items. For details, see pages 6-1 to 6-18.

VFO A=B: VFO A frequency is copied to VFO B.

2.1 RECEPTION BASICS

Introduction

Reception is a basic transceiver operation. In this section, you can familiarize yourself with the operation of controls used for reception.

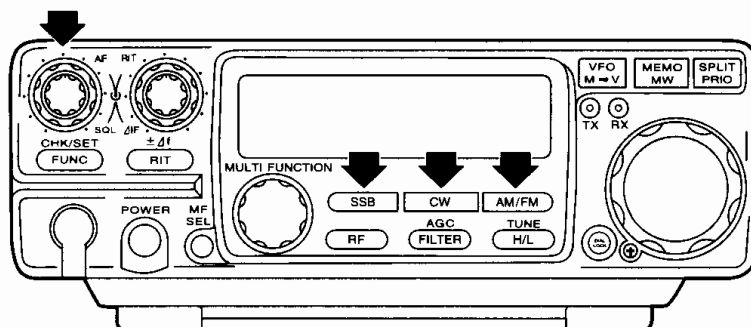

← The arrows indicate the controls used in this procedure.

Procedure

1. Turning power on/off

 **Note:** Make sure that all antenna and power connections are correct before turning the power on.

1. Press the **POWER** switch.
The LCD will come on.
 - To turn the power off, press and hold the **POWER** switch longer than one second and then release it.

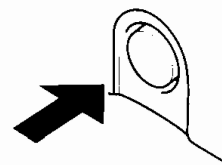

 **Caution:** Be sure to turn off the transceiver before turning off the regulated power supply or turning the ignition key to the off position.

 **Note:** If the power supply drops to below 10 V, the transceiver may turn off automatically. In this case, turn the power on again.

2. Adjusting volume

- Turn the AF control knob clockwise to increase the speaker volume.
- Turn the AF control knob counterclockwise to decrease the speaker volume.

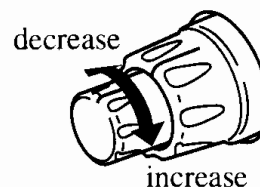

3. Adjusting Squelch

1. Turn the **SQL** knob clockwise until background noise just disappears.
 - The more clockwise the **SQL** control knob is turned, the stronger the received signal is. The **SQL** should be turned fully counterclockwise when receiving weak or unstable signals.

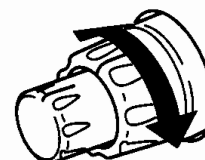

4. Selecting mode (modulation)

- To select **SSB** mode

Pressing the **SSB** key will switch you between the **LSB** and **USB** modes. Select either mode.

SSB

 *Tip: The **SSB** mode is most frequently used in HF bands. Usually, the **LSB** mode is used below 7 MHz amateur band, and the **USB** mode is used above 14 MHz amateur band.*

- To select the **AM** mode

Pressing the **AM/FM** key will switch you between the **AM** and **FM** modes. Select the **AM** mode.

AM/FM

 *Tip: This mode is commonly used to listen to MF and HF broadcasts.*

- To select the **FM** mode

Pressing the **AM/FM** key will switch you between the **AM** and **FM** modes. Select the **FM** mode.

AM/FM

 *Tip: The **FM** mode occupies a wide bandwidth; this will allow reproduction of high quality sound that is less affected by noise. The **FM** mode is often used in 29 MHz and 50 MHz bands.*

- To select **CW** mode

Pressing the **CW** switch will switch you between the **CWU** and **CWL** modes. Select either mode. **CWU** lets you receive **CW** signals on the upper side of the carrier frequency, while **CWL** on the lower side of the carrier frequency.

CW

 *Tip: The **CW** mode is used in Morse communication.*

 *Tip: This transceiver remembers the last used mode.*

5. Selecting amateur bands

Amateur bands are frequency bands that hams are allowed to use. This transceiver covers 10 amateur bands ranging from 1.8 MHz to 50 MHz.

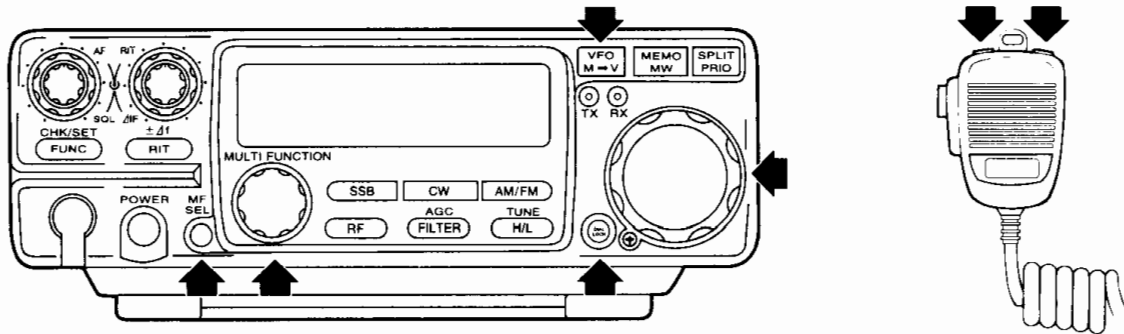

1. Press the **MF SEL** key repeatedly until two cursors ▼ ▼ appear above the MHz frequency indication.

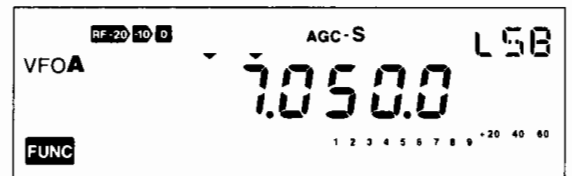

2. Rotate the **MULTI FUNCTION** dial or push the **UP/DOWN** key of the microphone to select the desired band.

Tip: When you select a band, the LCD will display the previously-used frequency in that band.

Note: When a band is changed, you might hear the relay click. This is normal.

3. Press the **MF SEL** key repeatedly until ▼ disappears.
 - Each time the **MF SEL** key is pressed, ▼ shifts in the following manner:

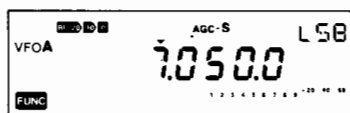

▼ above MHz frequency indication

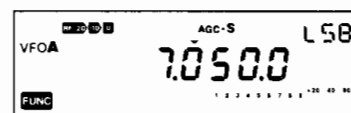

▼ above 100 kHz frequency indication

- Default settings (Default band, frequency and mode for both **VFO A** and **B**)

Band	default (Mode)	10	10.100.0 MHz (USB)	24	24.900.0 MHz (USB)
1.8	1.9000.0 MHz (LSB)	14	14.100.0 MHz (USB)	28	28.100.0 MHz (USB)
3.5	3.6000.0 MHz (LSB)	18	18.100.0 MHz (USB)	29	29.100.0 MHz (USB)
7	7.1000.0 MHz (LSB)	21	21.100.0 MHz (USB)	50	50.100.0 MHz (USB)

Exercise

- Try receiving a 51.000.0 MHz signal in the **FM** mode.

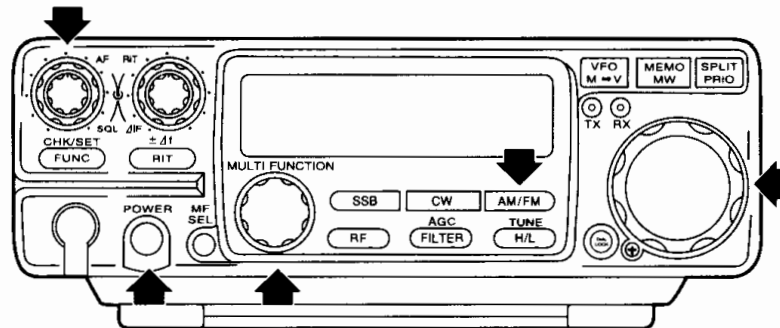

1. Make sure that all antenna connections are correct.

2. Turn the power on.

3. Rotate the **AF** control knob to adjust the volume.



4. Press the **MF SEL** key repeatedly until ▼ ▼ appears above the MHz frequency indication (amateur band selection position).

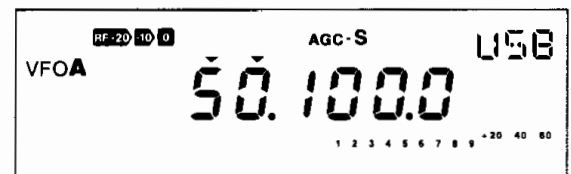

5. Rotate the **MULTI FUNCTION** dial to select the 50 MHz band.

6. Press the **MF SEL** key repeatedly until ▼ appears above the 100 kHz frequency indication.

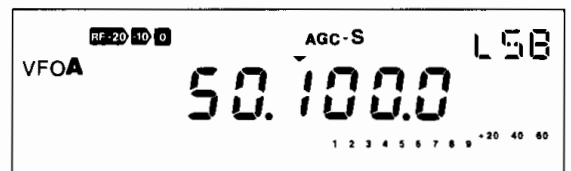

7. Rotate the **MULTI FUNCTION** dial to set the frequency to 51 MHz.

8. Press the **MF SEL** key repeatedly until ▼ disappears.



9. Press the **AM/FM** key to select the **FM** mode.

10. Turn the **SQL** control knob clockwise until the background noise just disappears.

- To receive the neighboring frequencies, use the main tuning dial.

- Likewise, try receiving different frequencies in each band.

 *Tip: This transceiver has a built-in general coverage receiver that covers 150 kHz to 30 MHz. By activating the receiver, you can enjoy MF and HF broadcasts in the **AM** mode.*

Getting Familiar with Useful Functions

In HF and 50 MHz bands, receive conditions vary not only with band and mode but with time and season. To obtain optimum signal reception, get familiar with and take full advantage of these versatile functions.

RF (RF gain)

1. Press the **RF** key to select one of the receiver's front-end gain settings.



- Each time the **RF** key is pressed, the following icon will appear on the LCD:

 A 10 dB preamplifier is activated. This mode will be useful when receiving weak signals.

 This is the factory's default setting. Usually select this setting.

 A 10 dB attenuator is activated. When receiving strong local signals, select this setting.

 A 20 dB attenuator is activated. Select this setting when receiving very strong local signals or when you find such signals near the received signal.

AGC (Automatic Gain Control)

- The **AGC** function automatically adjusts the gain of strong signals and weak signals so that you can hear them at the same volume.



1. Press the **FUNC** key, then press the **FILTER** key to select either the **AGC-S** or **AGC-F** mode.



 **Note:** If there is no key entry within 5 seconds after **FUNC** appears, the function will be canceled.

- **AGC-S** mode: The **AGC** recovery time is long.
- **AGC-F** mode: The **AGC** recovery time is short.

 **Tip:** Usually, the **AGC-S** mode is selected for the **SSB** and **AM** modes. This function will be disabled in the **FM** mode.

RIT (Receive Increment Tuning)

- The **RIT** function allows you to change the receive frequency within a range of ± 1.4 kHz, for example, when the other station shifts the transmit frequency.

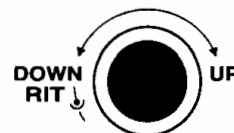

1. Press the **RIT** key.
The “RIT” icon will appear on the LCD.
2. Rotate the **RIT** control knob to adjust the frequency.
 - To exit from the **RIT** function, press the **RIT** key repeatedly until the **TXIT** icon disappears.
 - Press the **FUNC** key, then press the **RIT** key to add the **RIT** shift frequency to the transmit/receive frequency.

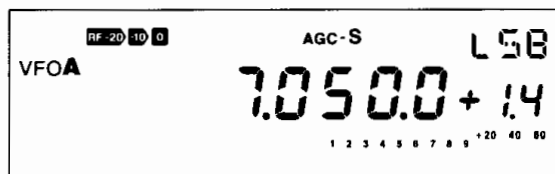
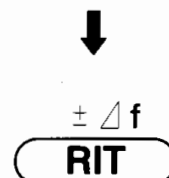

 **Note:** If there is no key entry within 5 seconds after **FUNC** appears, the function will be canceled.

- To activate the **TXIT** function, press the **RIT** key repeatedly until the “TXIT” icon appears (see page 5-4).

 IF shift, filter, and NB, pages 5-1, 2, 3.

2.2 TRANSMISSION BASICS

Introduction

This section explains the preparations and basic procedures for transmission. For details on how to transmit in each mode, see pages 2-10 to 2-24.

Procedure

Transmitting in the voice mode (SSB and AM/FM)

1. Make sure that all antenna, power, and microphone connections are correct.
2. Turn the power on.
3. Using the normal reception procedure, select a clear frequency free of other stations or select the frequency of a station to communicate with.
4. Set the output power level if necessary (see page 2-9).
5. Push and hold the **PTT** key and speak into the microphone. The red **TX** LED will be lit.



Note: Speak 20 to 30 cm away from the microphone. Speaking too close to the microphone may increase distortion.



Using the speech compressor, page 2-9



Adjusting the microphone gain, page 7-2

6. Release the **PTT** key to stop transmitting and return to receive.

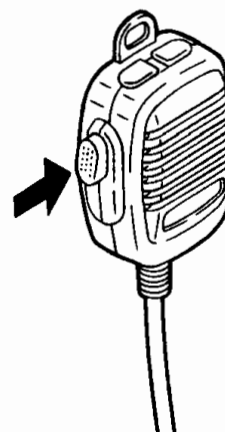

Push to transmit
Release to receive

Transmitting in the CW mode

Keying will automatically start transmit.

1. Make sure that all antenna, power, and microphone connections are correct.
2. Turn the power on and set for reception.
3. Set the output power level if necessary (see page 2-9).
4. Set the desired **BREAK-IN** mode (see page 6-6).



Note: The default setting is the AUTO BREAK-IN mode, meaning the delay time for the SEMI BREAK-IN mode will be set automatically.

5. Begin keying.
The red **TX** LED will light.
6. Stop keying.
Transmission will stop automatically.

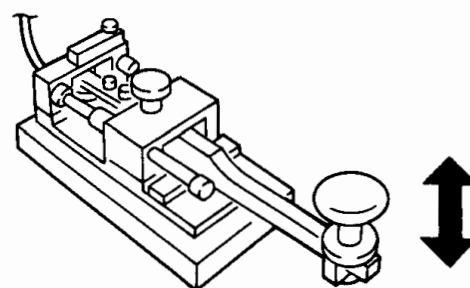

Selecting output power level

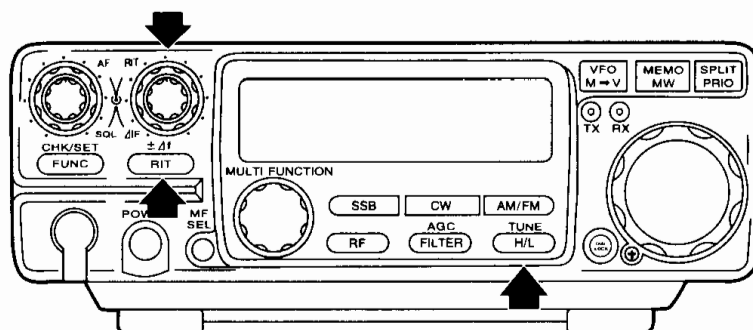

- Pressing the **H/L** key will switch you between the **HIGH** and **LOW** modes. When the “LOW” icon is not displayed, the transceiver is set to the high output power level.

H/L

(W)

		1.9-28MHz (all versions)	50MHz DX-70/DX-70T	50MHz DX-70EH/DX-70TH
SSB,CW,FM	H	100	10	100
	L	10	1	10
AM	H	40	4	40
	L	4	0.4	4



Tips: ■ *Speech compressor:*

Increases talk power to enable clear and powerful transmission. This function is activated only in the SSB or AM mode (see page 6-10 to set the speech compressor).

■ *TXIT function:*

- Press the RIT key repeatedly until the “TXIT” icon appears. Then rotate the RIT control knob to change the transmit frequency within a range of ± 1.4 kHz.
- A TXIT shift frequency is displayed on the middle right of the LCD.
- When the “TXIT RIT” icon appears, it means that you can fine-adjust both transmit and receive frequencies.

RIT

■ *OFF BAND function:*

Stops transmission when you attempt to transmit from outside the amateur band. The LCD will display the following:

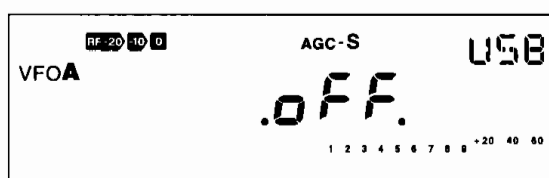

2.3 SSB OPERATION

Introduction

The **SSB** (Single Side Band) mode is most frequently used for voice communication in HF bands. However, when first trying to tune in the **SSB** mode, you may receive noisy and unclear signals. But as you practice receiving in this mode, you will learn the art of tuning, and will be soon able to communicate with even overseas stations.

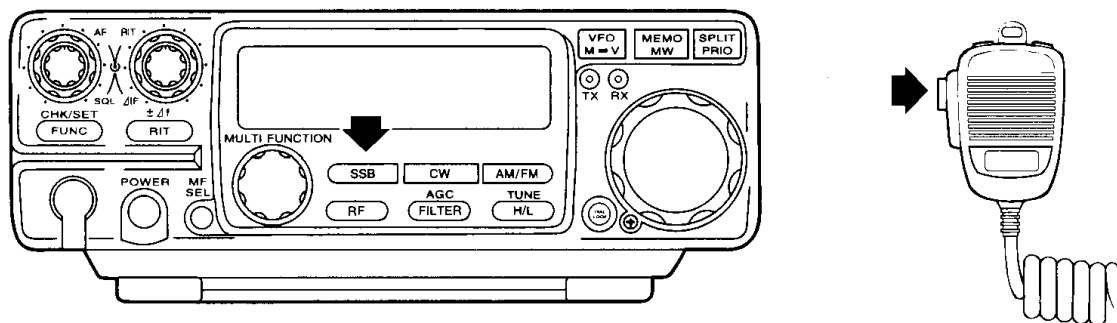



Procedure

 **Note:** Make sure that all antenna, power, and key connections are correct.

1. Turn the power on.
2. Select the desired amateur band (see page 2-3).
3. Press the **SSB** key.

The **LSB** or **USB** mode will be automatically selected according to the selected band.

 **Note:** If the **Automatic USB/LSB Selection function** is set to off, the last-used SSB mode is recalled.

 **Tip:** Usually, the **LSB** mode is used below 7 MHz amateur band, and the **USB** mode is used above 14 MHz amateur band.

 **Note:** The transceiver's squelch circuit interacts with the S meter. Therefore, if the **AGC-F** mode is selected in the SSB mode, squelch may be muted and unmuted according to the signal strength. To prevent this, it is recommended to select the **AGC-S** mode rather than the **AGC-F** mode. In CW mode, we suggest that the squelch knob is set to fully counterclockwise until you get familiar with the operation.

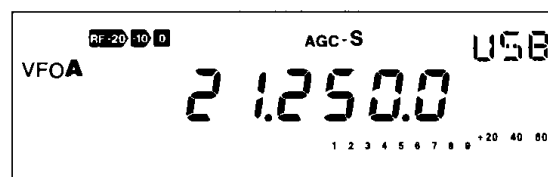
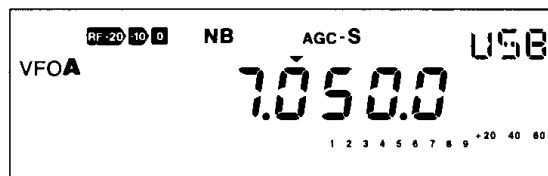

4. Tune in a station to communicate with.

- Select a frequency at which the signal from the station is clearly heard.



Note: ● *Be sure to turn off the RIT or TXIT function after contact is made. Otherwise, your frequency will shift off the other station's frequency on the next contact.*

- *Check to see the frequency is not used by other stations before transmitting.*

5. Push and hold the **PTT** key and speak into the microphone.

The red **TX** LED will be lit. The reading on the **RF** meter and the brightness of the **TX** LED will change according to the intensity of your voice (see "ALC meter," page 1-13).



Note: *Speaking too close to the microphone or too loudly may increase distortion and reduce clarity.*

6. Release the **PTT** key to return to receive.

 *Split-frequency operation, page 2-23*

2.4 PRACTICAL TECHNIQUES FOR SSB OPERATION

Introduction

In **SSB** operation, you may encounter various problems such as bad receive conditions and interference. This section explains how to use the special functions to overcome these problems.

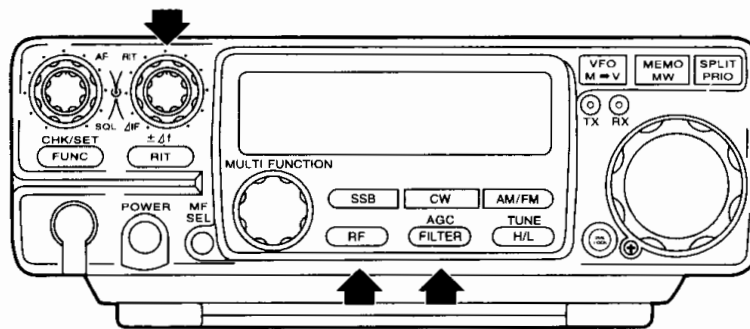

Eliminating Interference (QRM)

Activating the IF SHIFT function

This function eliminates interference by shifting the filter pass band without changing the receive frequency.

1. Turn the Δ IF control knob clockwise or counterclockwise to lessen interference.

Using the filter

Use the 1.0 kHz narrow filter instead of the 2.4 kHz standard filter, which is usually used to filter received signals.

1. Press the **FILTER** key.

The “NAR” icon will appear, indicating that the narrow filter has been selected.

 *Tip: Using the narrow filter in conjunction with the IF SHIFT function will effectively reduce interference.*

Activating the RF attenuator

When the received signal is noisy, it is possible that you are picking up another strong signal from nearby.

1. Press the **RF** key to activate the attenuator.

Communicating in Bad Conditions

In HF and 50 MHz bands, how radio waves travel changes according to time, season, and propagation paths. For example, signals from the other station may fade or alternate between strong and weak. In this case, perform the following.

Using the RF preamplifier

1. Press the **RF** key repeatedly until  appears.

The preamplifier will come on.

Selecting the AGC-F mode

In the **SSB** mode, the **AGC-S** mode is usually selected. However, if there are strong signals or noises near a weakly received signal, the signal is suppressed by the strong signals or noises. In this case, select the **AGC-F** mode to improve receiving conditions.

1. Press the **FUNC** key, then press the **FILTER** key repeatedly until the “AGC-F” icon appears.

 *Note: If there is no key entry within 5 seconds after **FUNC** appears, the function will be canceled.*

Communicating with Off-frequency Stations

When communicating with a group of stations at the same time (round-table QSO), each individual station uses a slightly different frequency. In this case, use the **RIT** function.

Activating the RIT function

1. Press the **RIT** key and rotate the **RIT** control knob to correct your receive frequency.
 - The **RIT** operation does not change your transmit frequency so that the other station does not need to shift the receive/transmit frequency.

Communicating in Pile-ups

Many stations may call one station at the same time. In this case, use the speech compressor so that the station can pick out your call.

Using the speech compressor

1. Set the speech compressor to “ON” in the **SET** mode (see page 6-10).

The compressor will increase the talk power and increase the readability as well.

2.5 AM OPERATION

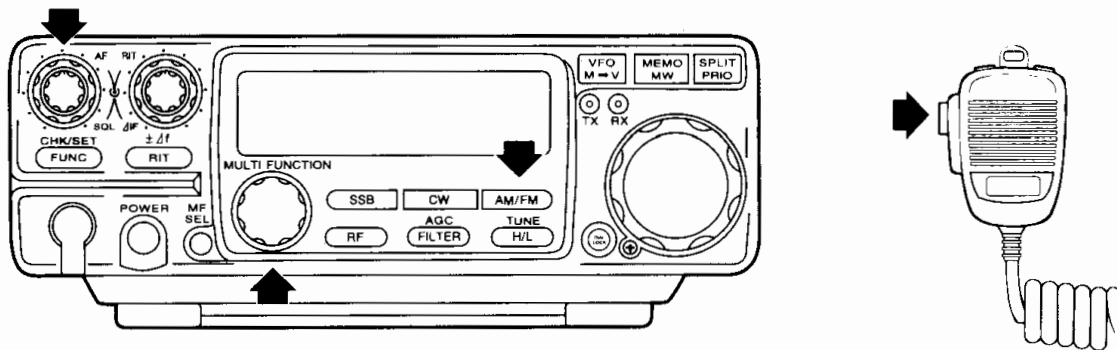

Procedure

! *Note: Make sure that all antenna, power, and microphone connections are correct.*

1. Turn the power on.
2. Select the desired operating band (see page 2-3).
3. Press the **AM/FM** key to select the **AM** mode.

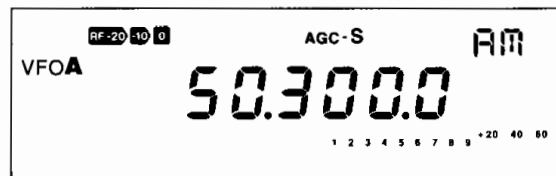

4. Tune in a station to communicate with.

! *Note: Check to see the frequency is not used by other stations before transmitting.*

5. Push and hold the **PTT** key and speak into the microphone.

The red **TX** LED will be lit. The reading of the **RF** meter and the brightness of the **TX** LED will change according to the intensity of your voice.

! *Note: Speaking too close to the microphone or too loudly may increase distortion and reduce clarity. Speak such that the RF meter reading changes by 2 or 3 levels as opposed to not speaking.*

6. Release the **PTT** key to return to receive.

! *Note: The output power level in the AM mode is lower than in the other modes (see page 2-9).*



Tips: ● Using the speech compressor will increase the readability of your transmit signal (see page 2-9).

- Using the narrow filter in conjunction with the **IF SHIFT** function will effectively reduce interference (see page 5-1).

2.6 GENERAL COVERAGE RECEIVER OPERATION

Introduction

This section explains procedures for receiving MF and HF broadcasts using the general coverage receiver.

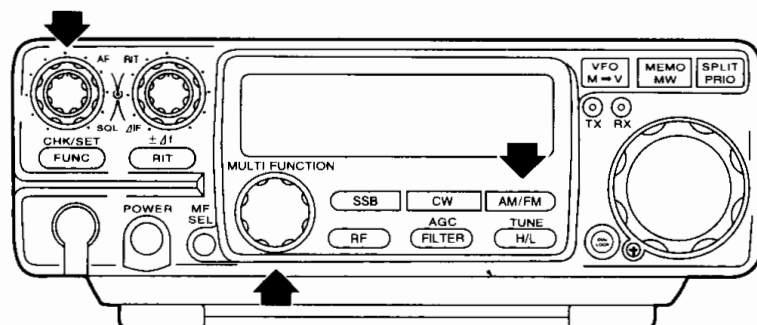

Procedure

Example: Receiving a 670 kHz MF broadcasts

1. Make sure that all antenna and power connections are correct.

2. Turn the power on.

3. Press the **MF SEL** key repeatedly until ▼ appears above the 1 MHz frequency indication.

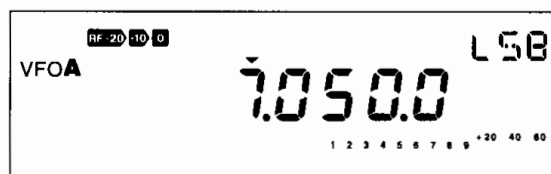

4. Rotate the **MULTI FUNCTION** dial until set as shown on the right.

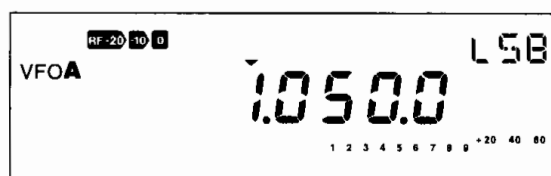

5. Press the **MF SEL** key to display ▼ above the 100 kHz frequency indication.

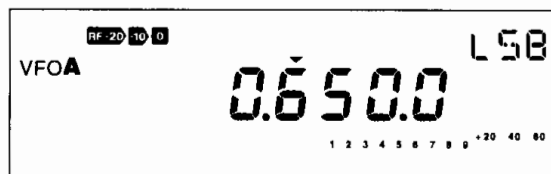

6. Rotate the **MULTI FUNCTION** dial until set as shown on the right.

7. Press the **MF SEL** key repeatedly until ▼ disappears.

8. Press the **AM/FM** key to select the **AM** mode.

9. Rotate the **MULTI FUNCTION** dial or the main tuning dial until set as shown on the right.

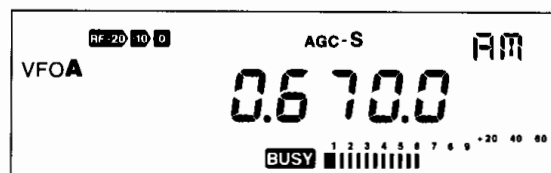

10. Rotate the **AF** control knob to adjust the volume.

2.7 FM OPERATION

Introduction

In the FM (Frequency Modulation) mode, you can enjoy high quality sound that less affected by noise. This mode is frequently used in 29 MHz and 50 MHz bands as well as VHF and UHF bands.

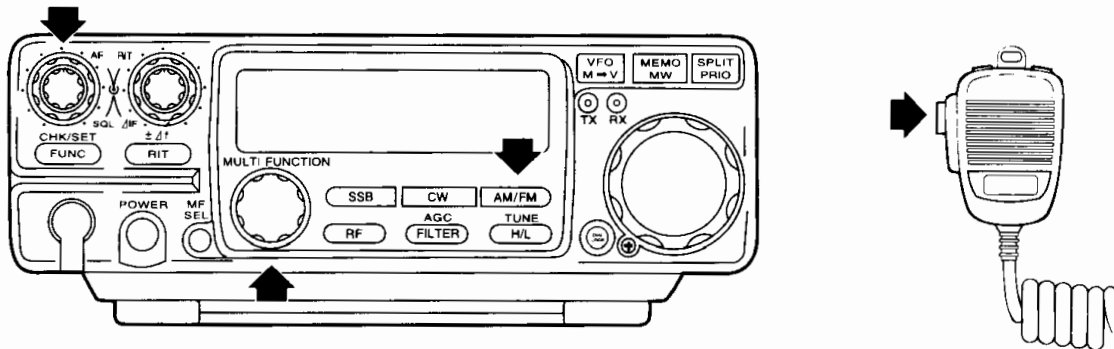

Procedure

! *Note: Make sure that all antenna, power, and microphone connections are correct.*

1. Turn the power on.
2. Adjust squelch level.

! *Note: If squelch level (threshold) is set too high, the transceiver will not be able to pick up weak signals.*

3. Select the desired operating band (see page 2-3).

! *Note: In the FM mode, this transceiver is designed to use the super narrow ($\pm 2.5\text{kHz}$) for 29 MHz band and the narrow ($\pm 5\text{kHz}$) for 50 MHz band.*

4. Press the **AM/FM** key to select the **FM** mode.

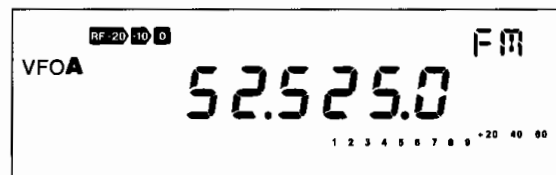

5. Select the desired frequency.

! *Note: Check to see the frequency is not used by other stations before transmitting.*

✎ *Tip: When tuning, the **MULTI FUNCTION** dial is more useful than the main tuning dial. Frequency step for the **MULTI FUNCTION** dial can be selected in the **SET** mode (see page 6-14).*

6. Push and hold the **PTT** key and speak into the microphone.
The red **TX** LED will be lit.
7. Release the **PTT** key to return to receive.

2.8 REPEATER OPERATION

Introduction

This section explains procedures for transmitting through a repeater.

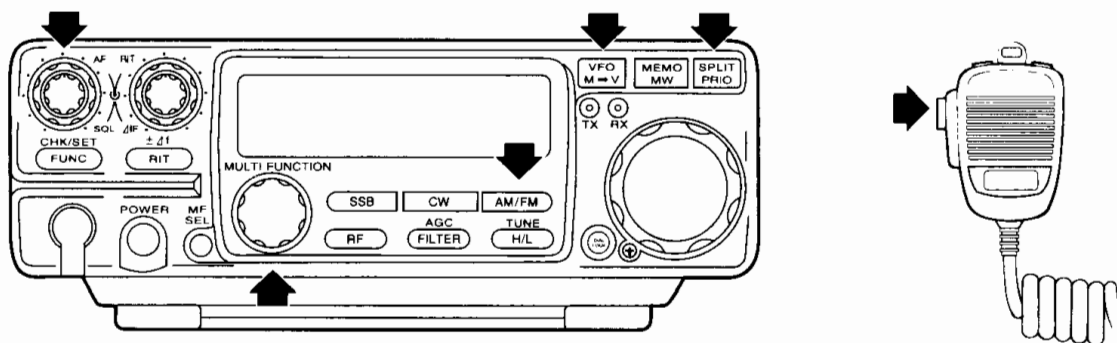

Procedure

Example: Selecting 29.640 MHz for reception and 29.540 MHz for transmission

1. Make sure that all antenna, power, and microphone connections are correct.
2. Turn the power on.
3. Adjust squelch level.
4. Set 29.640 MHz in the **VFO A**.
5. Press the **AM/FM** key to select the **FM** mode.
6. Press the **FUNC** key, then press the **AM/FM** key (if CTCSS tone is required).

FM will appear left of the "FM" icon.

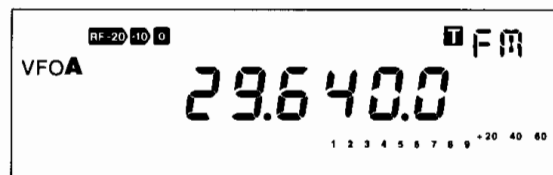

Note: If there is no key entry within 5 seconds after **FUNC** appears, the function will be canceled.

7. Select the proper CTCSS tone frequency with the DIP switch on the bottom side of the transceiver.
 - A CTCSS tone encoder (EJ-26U) comes standard with the DX-70 T / DX-70 TH and optional for the DX-70 / DX-70 EH.
8. While pressing and holding the **SPLIT** key, turn the **MULTI FUNCTION** dial or the main tuning dial to select "-0.100.0."

QUICK OFFSET function, page 2-24

9. Push and hold the **PTT** key and speak into the microphone.
10. Release the **PTT** key to return to receive.

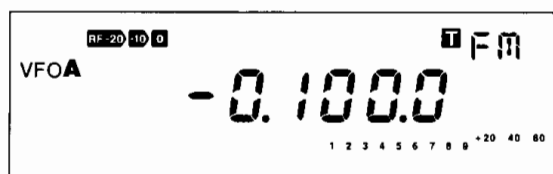

Tip: It is useful to store repeater frequencies in memory channels. Each can also store a split frequency (see page 3-5).

2.9 CW OPERATION

Introduction

In the **CW** (Continuous Wave) mode, you communicate with other stations by transmitting and receiving Morse code. The code is keyed in with the telegraph key. Because of the code, you can more easily communicate with DX stations than in other modes.

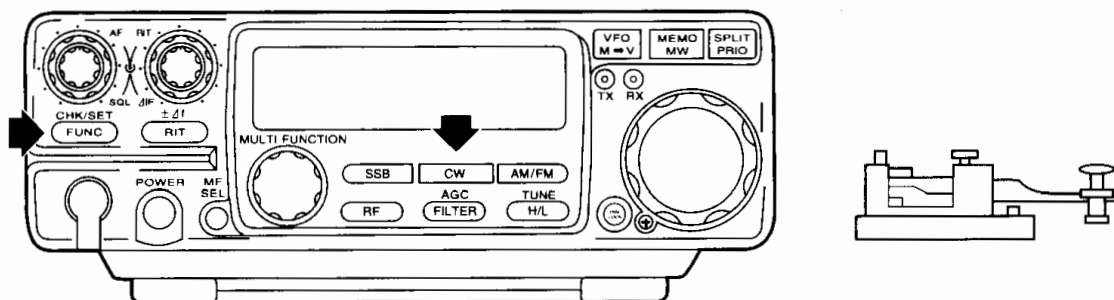

Procedure

 **Note:** Make sure that all antenna, power, and microphone connections are correct.

1. Turn the power on.
2. Select the desired operating band (see page 2-3).
3. Press the **CW** switch to select either the **CWL** or **CWU** mode.

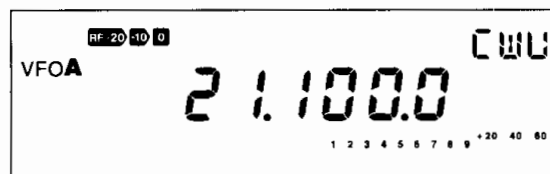

- The **CWL** mode switches reception from the upper sideband to the lower sideband; this is similar to the **LSB** mode, but suited to **CW** reception.
- The **CWU** mode switches reception from the lower sideband to the upper sideband; this is similar to the **USB** mode, but suited to **CW** reception.

 **Note:** In the CW mode, the ex-factory settings are the narrow filter and the AGC-F mode

4. Select a frequency of a station to communicate with.

- Pressing and holding the **FUNC** key allows you to monitor your transmit frequency by sidetone.

While pressing the **FUNC** key, occasionally key down then rotate the main tuning dial until the received signal and the sidetone are heard at the same pitch (zero-in operation).

 *Tip: The sidetone can be selected from 750 Hz, 650 Hz and 850 Hz in the **SET** mode.*

5. Start keying.

 *Tip: This transceiver has the **FULL BREAK-IN** and **SEMI BREAK-IN** modes. For the **SEMI BREAK-IN** mode, you can select one of eight levels including the **AUTO** mode, in which the delay time is set automatically.*

6. Stop keying to receive.

 *Adjusting the sidetone frequency, page 6-5*

2.10 PRACTICAL TECHNIQUES FOR CW OPERATION

Introduction

In **CW** operation, you will encounter various problems such as bad receive conditions and interference. This section explains how to use the special functions to overcome these problems.

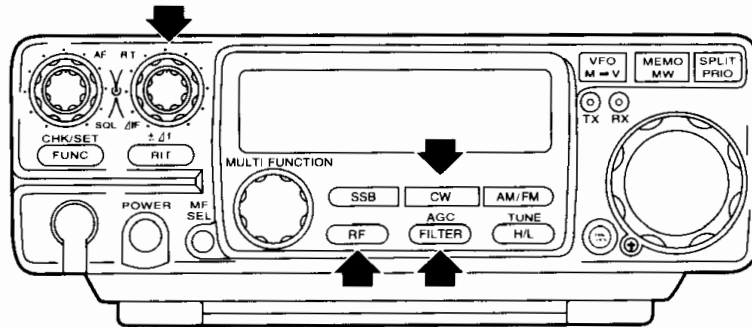

Reducing Interference

Activating IF SHIFT function

- This function eliminates interference by shifting the filter pass band without changing the receive frequency.
1. Turn the Δ IF control knob clockwise or counterclockwise to reduce interference.

Using the filter

- Using the narrow filter in conjunction with the **IF SHIFT** function will effectively eliminate interference.

Activating BFO REVERSE function

1. Select the **CWU** or **CWL** mode.
 - If your station and the other station are zeroed-in, this function will not change the receive tone and transmit frequency.

4. Activating the RF attenuator

- The attenuator can protect the received signal from suppression and cross-modulation caused by neighboring signals.

Communicating in Bad Conditions

Activating the RF preamplifier

- Press the **RF** key repeatedly until  appears.

The preamplifier will come on.

When the received signal is unclear

When the other station calls back to you with a slight offset, you may receive an unclear signal. In this case, perform the following.

Activating the RIT function

- Press the **RIT** key and rotate the **RIT** control knob to adjust your receive frequency.
 - The **RIT** operation does not change your transmit frequency so that the other station does not need to shift the receive/transmit frequency.

Communicating in Pile-ups

Selecting the FULL BREAK-IN mode

- In this mode, keying will transmit and un-keying will receive automatically. This allows you to call with perfect timing.
- Select the **BREAK-IN** mode in the **SET** mode (see page 6-6).

2.11 RTTY PACKET OPERATION (FAX/SSTV)

Introduction

This transceiver has no dedicated mode for RTTY packet, FAX, and SSTV operations. However, these operations can be enabled by using the following procedures.

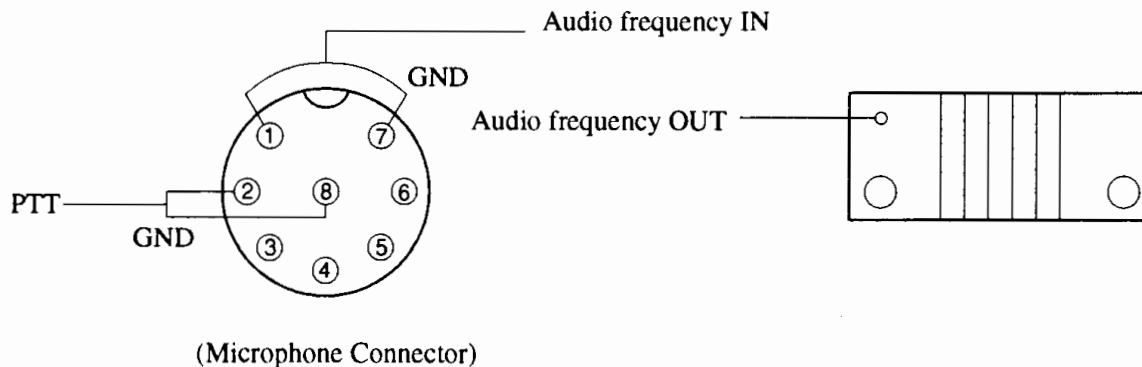

Connecting Additional Equipment

Pin (1) — To audio output of additional equipment.

Pin (7) — To ground of the audio output.

Pin (2) — To PTT output of additional equipment.

Pin (4) — To PTT GND of additional equipment

Pin (6) (unsquelched detector output, 5 K Ω 0.5V P-P) or external speaker jack — To RECEIVE SIGNAL.AF-IN.

Procedure

1. Turn the power on.
2. Select the mode.
 - You may like to choose the mode UT (or LT) which gives a higher pitch passband, suited for data communications such as FAX, SSTV, RITY, etc. To select UT or LT, press the **FUNC** key, then press the **SSB** key.
3. Select the desired operating band.
4. Start receiving.

	Mode commonly used	DX-70
RTTY (AFSK)	LSB	LT
AFSK (300 baud)	SSB	UT/LT
AFSK (1200 baud)	FM	FM
FAX	SSB/FM	UT/LT/FM
SSTV	SSB/FM	UT/LT/FM

2.12 SPLIT-FREQUENCY OPERATION

Introduction

When communicating with a DX (long distance) station that is using a different operating band or is involved in a pile-up, you may use one **VFO** for the receive frequency, and another **VFO** for the transmit frequency. This is called **SPLIT** operation. To facilitate this operation, you can activate the **QUICK OFFSET** function as well as the function that allows you receive and to check the transmit frequency.

 *Tip: Pile-up — the condition where many stations call one station at the same time.*

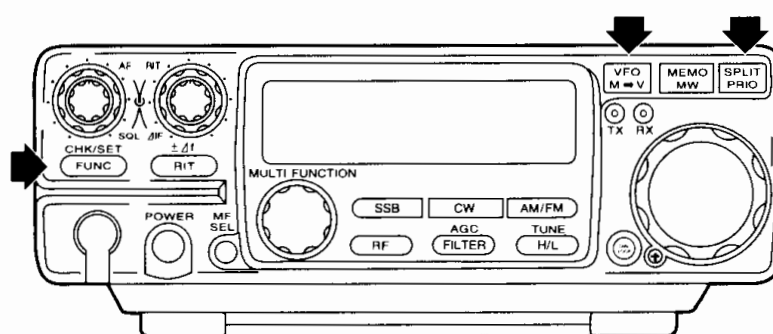

Procedure

Example: Setting the receive frequency to 7.270 MHz and the transmit frequency to 7.070 MHz (This is example only: 7.070 MHz (or 7.270 MHz) may not be allowed for SSB operation in some countries.)

1. Set the desired transmit frequency in the **VFO B**.

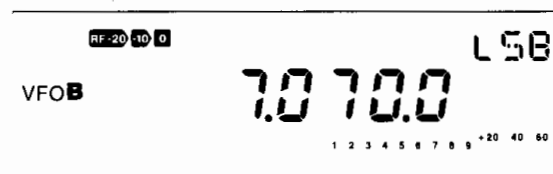

2. Press the **VFO** key to select the **VFO A**. Then set the receive frequency in the **VFO A**.
3. Press the **SPLIT** key.

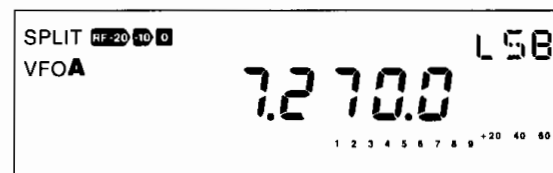

4. Begin communication as usual.

The last displayed VFO (whether **A** or **B**) before pressing the **SPLIT** key becomes the receiving frequency.

- To cancel the split-frequency operation, press the **SPLIT** key again.

**Tips:**

- Pressing and holding the **FUNC** key allows you to monitor the transmit frequency during reception. While monitoring, you can fine-adjust transmit frequency using the main tuning dial or the **TXIT** function.
- Pressing and holding the **VFO** key longer than one second will transfer memory data from the selected **VFO A** or **B** to the other **VFO B** or **A**. This is useful when setting a split frequency.
- Using the **QUICK OFFSET** function will make it easier to set a split frequency. This function is useful, for example, when the other station requires you to shift the current frequency upwards by 20 kHz, or downwards by 30 kHz. This is also useful in repeater operation knowing a predetermined offset frequency.

3.1 BASICS

Introduction

This transceiver can store 100 channels in memory. Each can retain different operating data such as receive and transmit frequencies. It is useful to store regularly used frequencies in the memory.

Features

Storable Data

These items can be stored in any memory channel “00” through “99.”

- Transmit/receive frequency (including split frequency)
- Mode (**SSB**, **CW**, **FM**, **AM**, etc.)
- Filter (standard/narrow, not applicable in the **FM** mode)
- **RF** (preamplifier/attenuator)
- **AGC** (slow/fast, not applicable in the **FM** mode)
- **NB** (ON/OFF, not applicable in the **FM** mode)
- Tone (ON/OFF, for **FM** mode only)

Functions in the MEMORY mode

- Memory frequency access protection (see page 6-16)
- Memory overwrite protection (see page 6-15)
- Memory-VFO transfer (see page 3-9)

Memory backup

This transceiver uses an EEPROM and therefore it can retain data in the memory channels for an extended period without needing a lithium battery to retain the back-up.

3.2 MEMORY MODE OPERATION

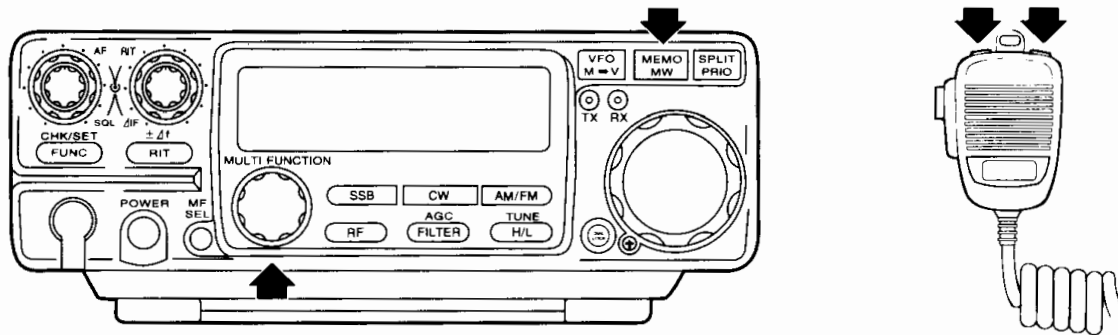

Procedure

Accessing the Memory Mode (For programming the Memories, see following pages.)

1. Press the **MEMO** key.

The last-used memory channel will be recalled.



Selecting a memory channel

2. Rotate the **MULTI FUNCTION** dial or press the **UP/DOWN** key to select the desired memory channel.



- Unprogrammed memory channels will be skipped.
- You can temporarily change the frequency, mode, **RIT** function, etc. in a recalled memory channel. However, next time you select that memory channel, the data originally stored will be recalled.
- In the **SET** mode, you can protect all memory channels from having their frequencies changed.

3.3 SIMPLEX-VFO-FREQUENCY PROGRAMMING

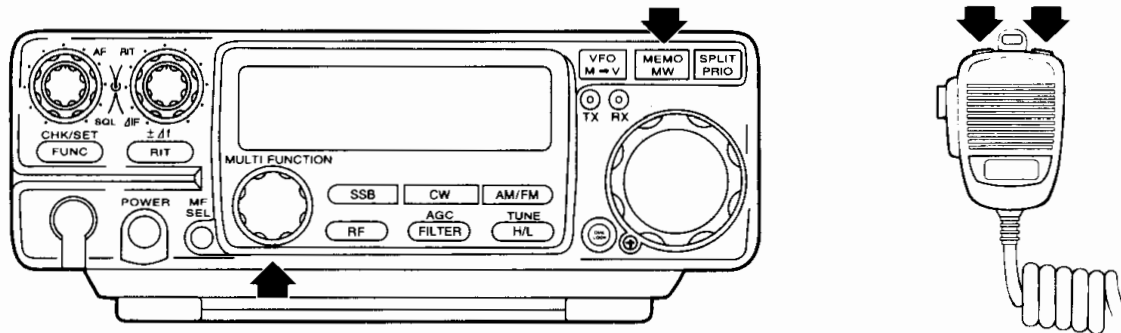

Procedure

Example: Storing 7.050.0 MHz and **LSB** into memory channel “88”

Setting data

1. Set the data to be stored.

Selecting a memory channel

2. Press the **FUNC** key.



3. Rotate the **MULTI FUNCTION** dial or press the **UP/DOWN** key to select memory channel “88.”

Numbers of already programmed channels will be continuously displaying, and those unprogrammed channels will be flashing.

Storing data

4. Press the **MEMO** key.



*Note: If there is no key entry within 5 seconds after **FUNC** appears, the function will be canceled.*

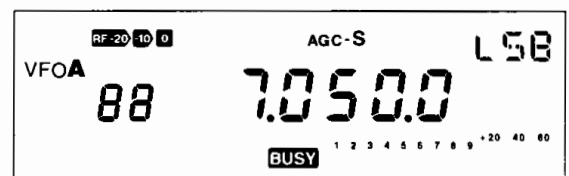

*Note: Pressing the **MEMO** key will overwrite any previous data in that channel with new data.*

3.4 SIMPLEX-MEMORY-FREQUENCY PROGRAMMING

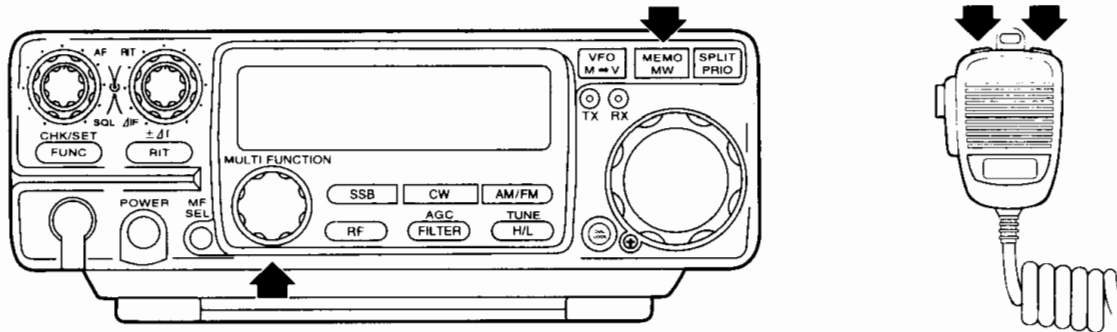

Procedure

Example: Transferring data in memory channel “88” into memory channel “73”

Setting data

1. Select memory channel “88” (programmed).

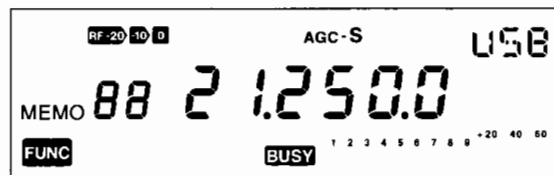

Selecting a memory channel

2. Press the **FUNC** key.
3. Rotate the **MULTI FUNCTION** dial or press the **UP/DOWN** key to select memory channel “73.”

The programmed channel number will be continuously displaying, and the unprogrammed memory channel number will be flashing.

Storing data

4. Press the **MEMO** key.



*Note: If there is no key entry within 5 seconds after **FUNC** appears, the function will be canceled.*



*Note: Pressing the **MEMO** key will overwrite any previous data in that channel with new data.*



- Tips:*
- This function is useful when you want to store the current frequencies and settings into a selected memory channel.
 - In the **SET** mode, you can protect all memory channels from overwrite.

3.5 SPLIT-FREQUENCY PROGRAMMING (FOR GENERAL USE)

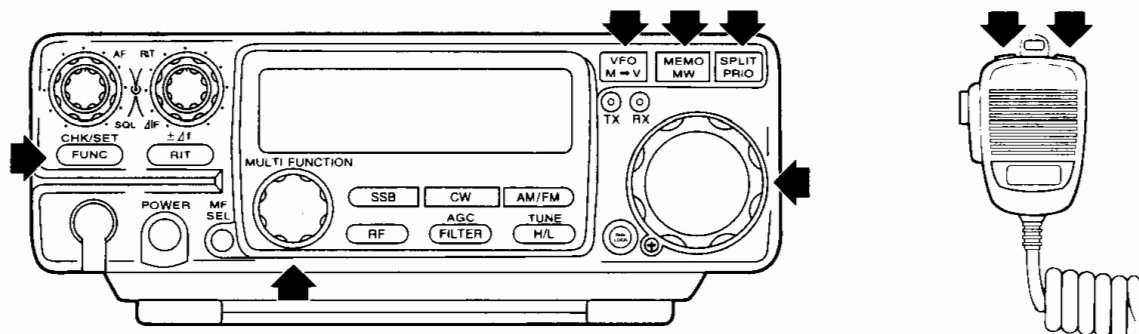



Procedure

Example: Storing 14.275.0 MHz (transmit frequency) and 14.250.0 MHz (receive frequency) into memory channel "59"

Setting data

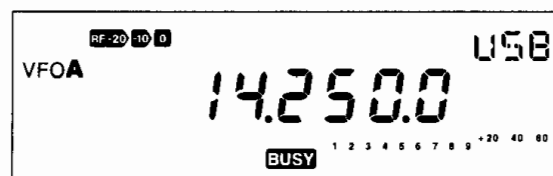
1. Set 14.250 MHz (receive frequency) in the **VFO A**.



 *Note: You can set receive data in the VFO B if preferred. The VFO A does not necessarily have to be selected to store receive frequency.*

2. Press and hold the **SPLIT** key until "0.000.0" is displayed and, with the key down, rotate the main tuning dial to select + 25.0 kHz.

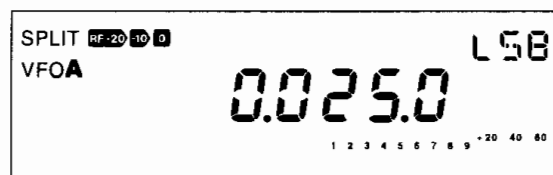

 *QUICK OFFSET function, page 2-24*

Selecting a memory channel

3. Press the **FUNC** key.
4. Rotate the **MULTI FUNCTION** dial or press the **UP/DOWN** key to select memory channel "59."

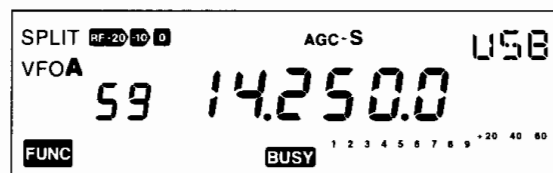

Storing data

5. Press the **MEMO** key.

 *Note: If there is no key entry within 5 seconds after **FUNC** appears, the function will be canceled.*

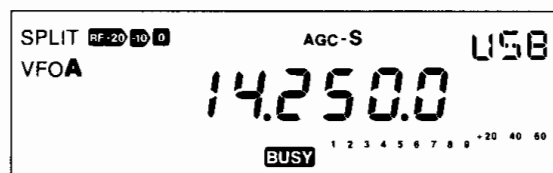

3.6 SPLIT-FREQUENCY PROGRAMMING (FOR REPEATER OPERATION)

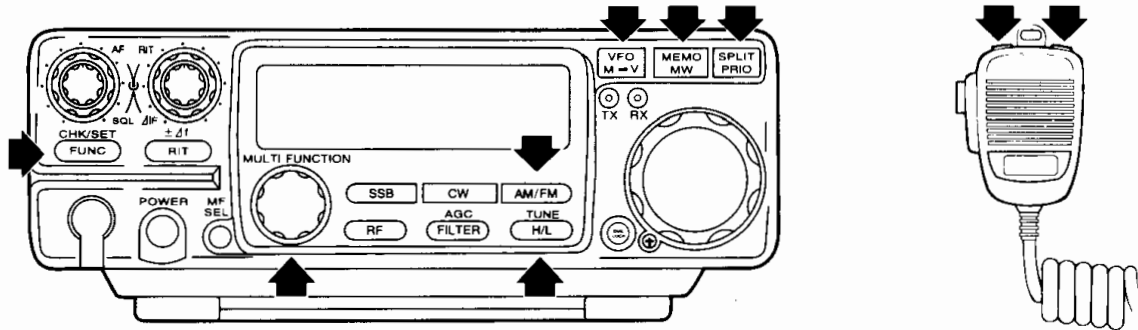



Procedure

Example: Storing 29.540.0 MHz (transmit frequency) and 29.640.0 MHz (receive frequency) into memory channel "03"

Setting data

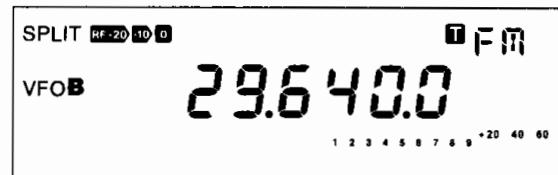
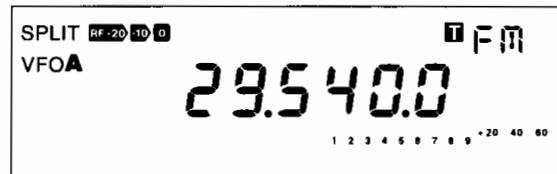
1. Set 29.540.0 MHz (transmit frequency) in the **VFO A**.
 - Also set **FM** and CTCSS tone "ON" in the same channel.
2. Set 29.640.0 MHz (receive frequency) in the **VFO B**.



 *Tip: The **VFO A=B** function is useful to set split frequencies.*

3. Press the **SPLIT** key.

(continued to next page)

Selecting a memory channel

4. Press the **FUNC** key.
 - Press the **FUNC** key while the receive frequency is displayed. The frequency shown in step 2 is the receive frequency.
5. Rotate the **MULTI FUNCTION** dial or press the **UP/DOWN** key to select memory channel "03."

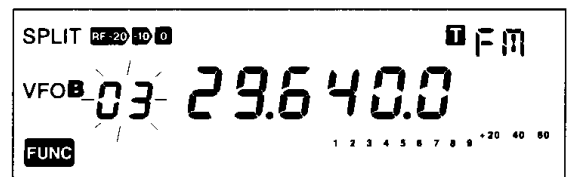

Storing data

6. Press the **MEMO** key.

 *Note: If there is no key entry within 5 seconds after **FUNC** appears, the function will be canceled.*

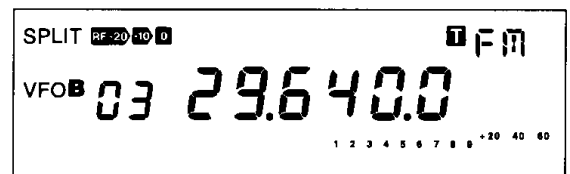

3.7 MEMORY CHANNEL DATA ERASING

Erasing Data in a Selected Memory Channel

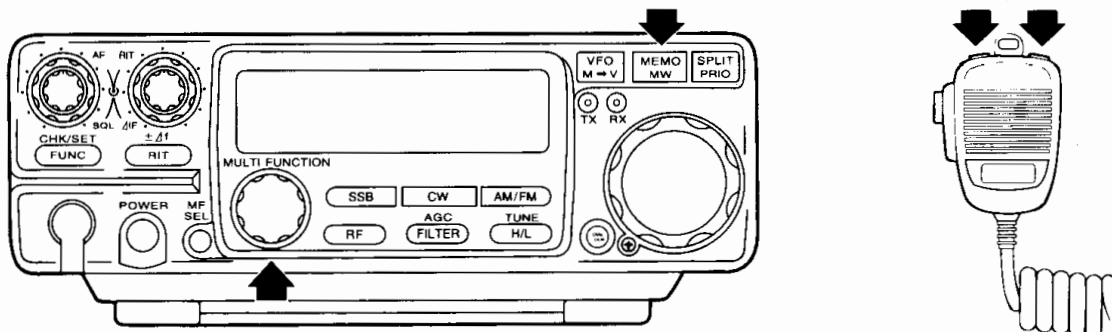

1. Press the **MEMO** key to access the **MEMORY** mode.
2. Rotate the **MULTI FUNCTION** dial or press the **UP/DOWN** key to select a memory channel that contains data you want to erase.



3. Press and hold the **MEMO** key.

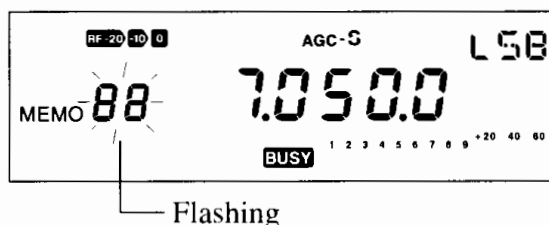

4. Release the key when hearing a beep and the memory channel number starts flashing.



Note: Releasing the key will not affect the current LCD indication, but will erase the data in the selected memory channel.

Erasing All Memory Channels

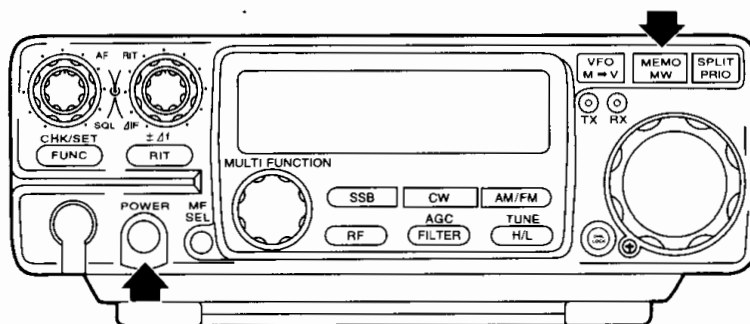

1. While holding down the **MEMO** key, turn the power on.

3.8 MEMORY TO VFO DATA TRANSFER

Introduction

This function can transfer data from any memory channel to the **VFO**. This is useful when you want to tune in a station near the frequency stored in another memory channel.

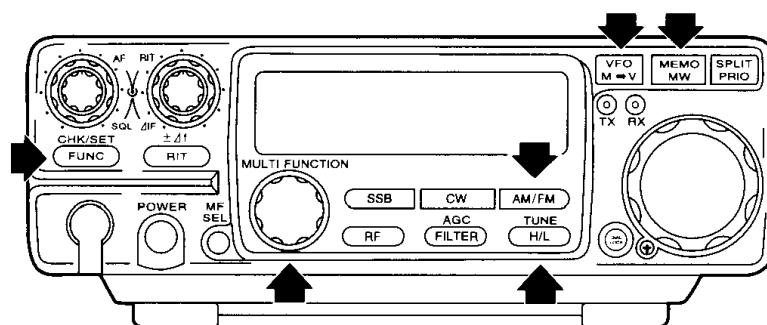

Procedure

Example: Transferring data in memory channel "06" into the **VFO A**

1. Select the **VFO A**.
2. Press the **MEMO** key.
3. Rotate the **MULTI FUNCTION** dial or press the **UP/DOWN** key to select memory channel "06."

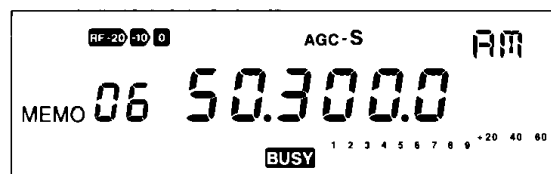



4. Press the **FUNC** key, then press the **VFO(M→V)** key.

 **Note:** If there is no key entry within 5 seconds after **FUNC** appears, the function will be canceled.

5. Press the **VFO(M→V)** key again.

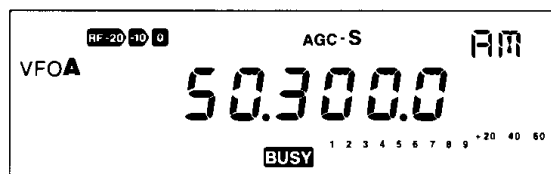
 **Note:** After transfer, the data still remains in the original data.





This page is intentionally left blank.

4.1 BASICS

Introduction

Scanning lets you automatically search for signals across specific a frequency range or among programmed memory channels. There are three types of scans; band, memory, and priority.

Scan Types

Band scan

This scan searches the entire frequency range of the amateur band in user-specified steps.

Band	Range	Step
1.8	1.8000 - 1.9999MHz	Frequency steps are set according to mode. Default settings are as follows: SSB, CW: 1.0 kHz AM: 1.0 kHz FM: 2.5 kHz (See pages 6-12, 13 or 14 to set frequency steps.)
3.5	3.5000 - 3.9999MHz	
7	7.0000 - 7.2999MHz	
10	10.1000 - 10.1499MHz	
14	14.0000 - 14.3499MHz	
18	18.0680 - 18.1679MHz	
21	21.0000 - 21.4499MHz	
24	24.8900 - 24.9899MHz	
28	28.0000 - 29.6999MHz	
50	50.0000 - 53.9999MHz	

- When the general coverage receiver is activated, this scan also searches for signals between adjacent amateur bands. For example, if a 4.500 MHz signal is received, the scan searches for signals from 4.0000 MHz to 6.8999 MHz.

The following diagram shows how signals are scanned, depending on the frequency where the scan is started.

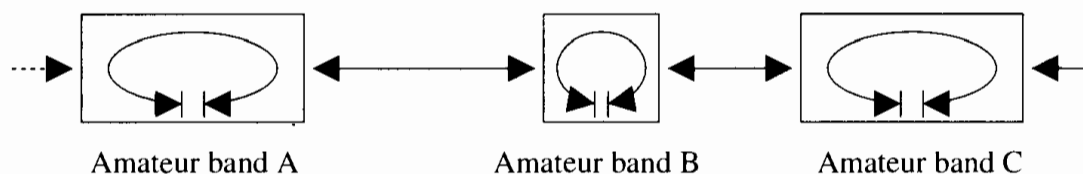

Memory scan

- This scan searches for signals in programmed memory channels in numerical order.
- Unprogrammed memory channels will be skipped.
- The 100 memory channels are grouped into 10 channels (00-09, 10-19, 20-29, . . . , 90-99). The transceiver scans only memory channels belonging to the group you specified. This is called "group memory scan." The group memory scan can be set to on or off in the **SET** mode (see page 6-18).

Memory scan

The transceiver scans only programmed channels. Pressing the microphone's **UP** key will scan upwards and pressing the **DOWN** key will scan downwards through the channels.

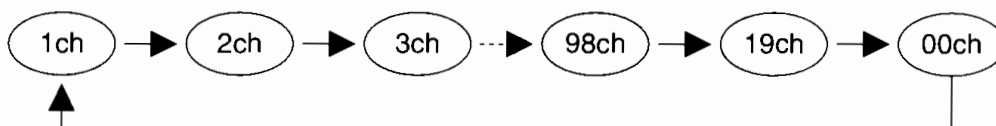

Group memory scan

The transceiver scans only memory channels belonging to the group you specified. [Illust]

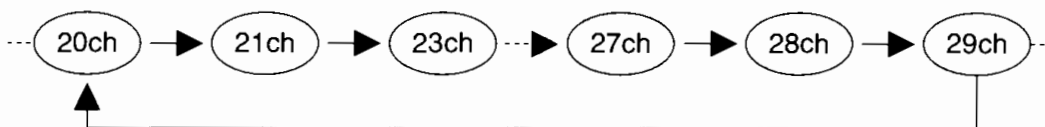

Priority Scan

- The transceiver receives signals on a **VFO** or memory channel for 5 seconds, and then scans a memory or **VFO** you specified for 0.5 seconds (2 seconds if squelch is unmuted).
- This function is usually used in split-frequency operation between the **VFO A/B** and a memory channel.

	Display frequency (5 seconds)	Priority frequency (0.5 seconds)
VFO A priority	VFO A	Memory
VFO B priority	VFO B	Memory
Memory priority A	Memory	VFO A
Memory priority B	Memory	VFO B

Setting SCAN Mode

SCAN modes

Each **SCAN** mode has specific condition for stopping and resuming scanning. You can select one of the **SCAN** modes listed below. (Signal detection is defined by squelch unmuting. Therefore the squelch should be set to threshold.)

LCD	SCAN mode
OF	Stops scanning when a signal is picked up, and quits scanning.
00	Stops scanning when a signal is picked up, and will resume scanning after the signal is dropped.
0	Will not stop scanning even when signals are picked up.
2	Stops scanning when a signal is picked up, and will resume scanning after 2 seconds.
4	Stops scanning when a signal is picked up, and will resume scanning after 4 seconds.
6	Stops scanning when a signal is picked up, and will resume scanning after 4 seconds.

Procedure

1. Press the **FUNC** key, then press and hold the **FUNC** key down longer than 2 seconds.
2. Press the **SPLIT** key repeatedly until "SCAN" appears on the LCD.



*Note: If there is no key entry within 5 seconds after **FUNC** appears, the function will be canceled.*

3. Rotate the **MULTI FUNCTION** dial to select one of the above **SCAN** modes.

4. Press the **FUNC** key.

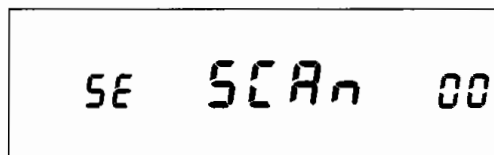
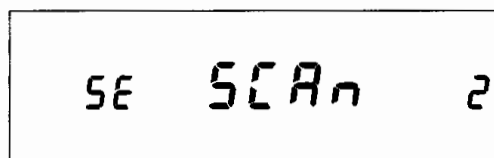

Note: The default is "2," meaning that the scan pauses when a signal is received and will resume after 2 seconds.

4.2 BAND SCAN

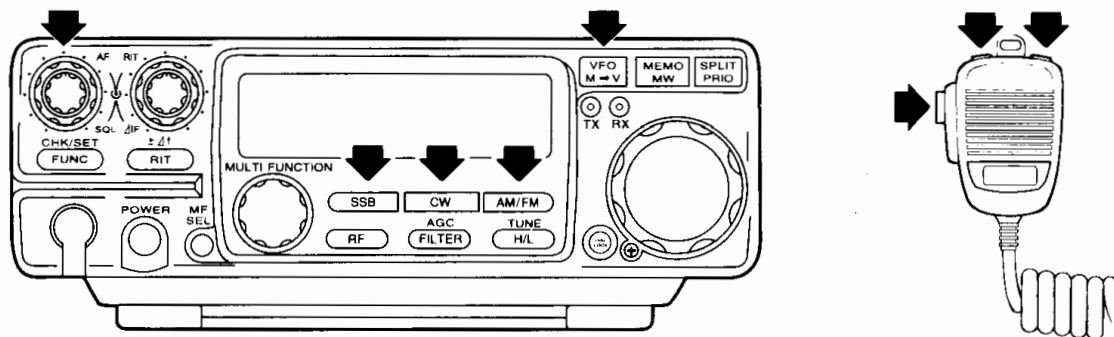

Procedure

1. Press the **VFO** key to access the **VFO** mode.
2. Select the desired band.
3. Select the desired mode.
4. Rotate the **SQL** control knob to adjust squelch level.
5. Hold the **UP/DOWN** key on the microphone down longer than 2 seconds.

The scan will start.

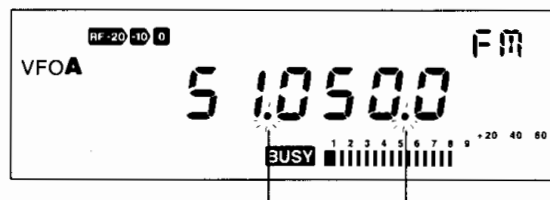

Flash while scanning is in progress.

- Pressing the **UP** key will scan upwards, and pressing the **DOWN** key will scan downwards across the band.



Notes:

- *In the SSB or CW mode, the scan is not likely to pause at a frequency where the received sound is clear. Here, if you have set resumption time long enough, you can fine-tune the frequency using the RIT control knob while the scan pauses.*
- *The scan proceeds to the upper limit of the band and returns to the lower limit of the band, or vice versa.*

6. To cancel the scan, press the **UP/DOWN** or **PTT** key.



Tip: Set frequency steps according to the band used. For example, it is useful to select a 10 kHz step for FM broadcasts in 29 MHz or 50 MHz band.

4.3 MEMORY SCAN

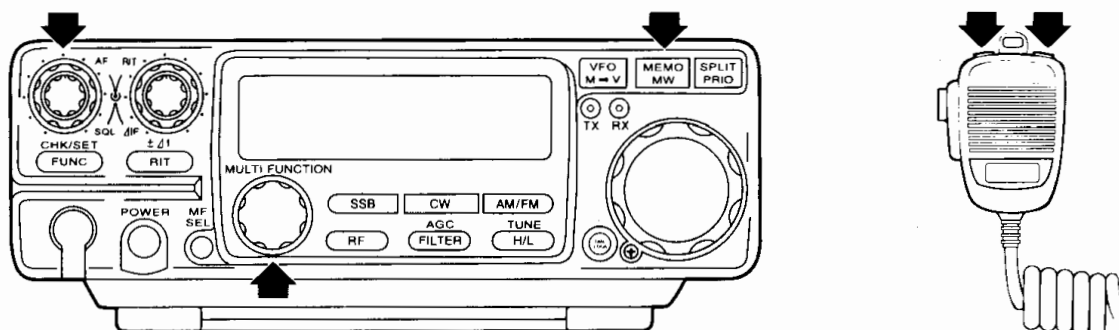

Procedure

1. Press the **MEMO** key to access the **MEMORY** mode.

2. Rotate the **SQL** control knob to adjust squelch level.

 **Note:** If squelch is unmuted, the scan will pause on each programmed memory channel.

3. For group memory scan, rotate the **MULTI FUNCTION** dial to select any memory channel belonging to the group you want to scan.

4. Hold the **UP/DOWN** key on the microphone down longer than 2 seconds.

The scan will start.

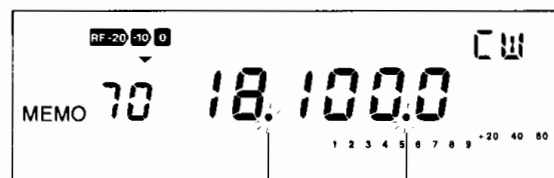

Flash while scanning is in progress.

- Pressing the **UP** key will scan upwards, and pressing the **DOWN** key will scan downwards through memory.

5. To cancel the scan, press the **UP/DOWN** key or **PTT** key.

 **Notes:**

- The scan proceeds to the upper limit and returns to the lower limit of the group (memory channels) or vice versa. Unprogrammed channels will be skipped.
- While scanning is in progress, the main tuning dial, MF SEL key and RIT control knob are still operatable.

4.4 PRIORITY SCAN

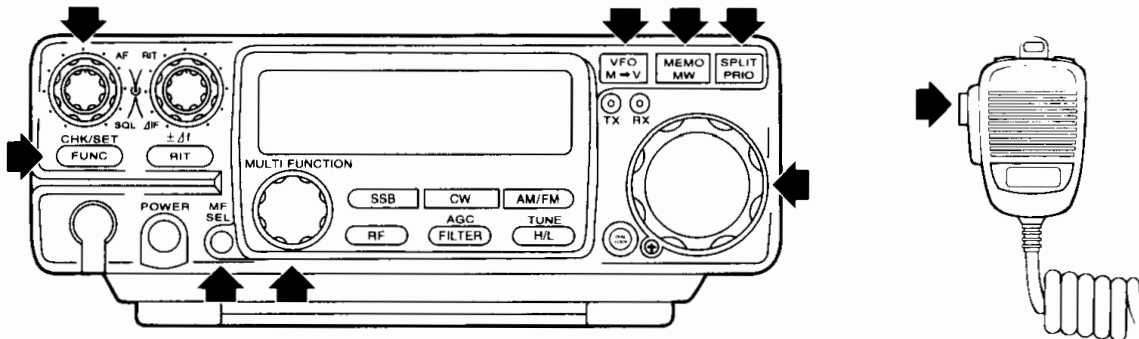

Procedure

Example: Receiving in the **VFO A** mode and momentarily scanning a memory channel (priority channel)

1. Access the **MEMORY** mode and select the memory channel you want to scan momentarily.

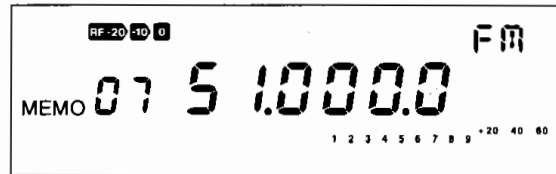

2. Access the **VFO** mode and set the frequency you usually receive.
3. Rotate the **SQL** control knob to adjust squelch level.

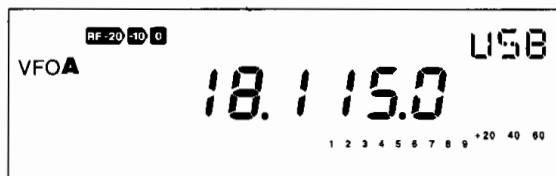

4. Press the **FUNC** key, then press the **SPLIT(PRIO)** key.

 **Note:** If there is no key entry within 5 seconds after **FUNC** appears, the function will be canceled.

The transceiver will receive the **VFO** for 5 seconds and then will scan the memory channel for 0.5 seconds (2 seconds when squelch is unmuted).

- The **SCAN** mode can be selected in the **SET** mode.
5. To exit from this mode, press the **FUNC** key, then press the **SPLIT(PRIO)** or **PTT** key.

 **Note:** If there is no key entry within 5 seconds after **FUNC** appears, the function will be canceled.

5.1 INTERFERENCE REDUCERS

Introduction

This transceiver has built-in functions to reduce interferences. This section explains how to use these functions to reduce interference.

IF SHIFT

The **IF SHIFT** function is used to shift the IF pass band without changing the receive frequency. If there is an interference signal near the received signal, rotate the Δ IF control knob to get the interference signal out of the receive band.

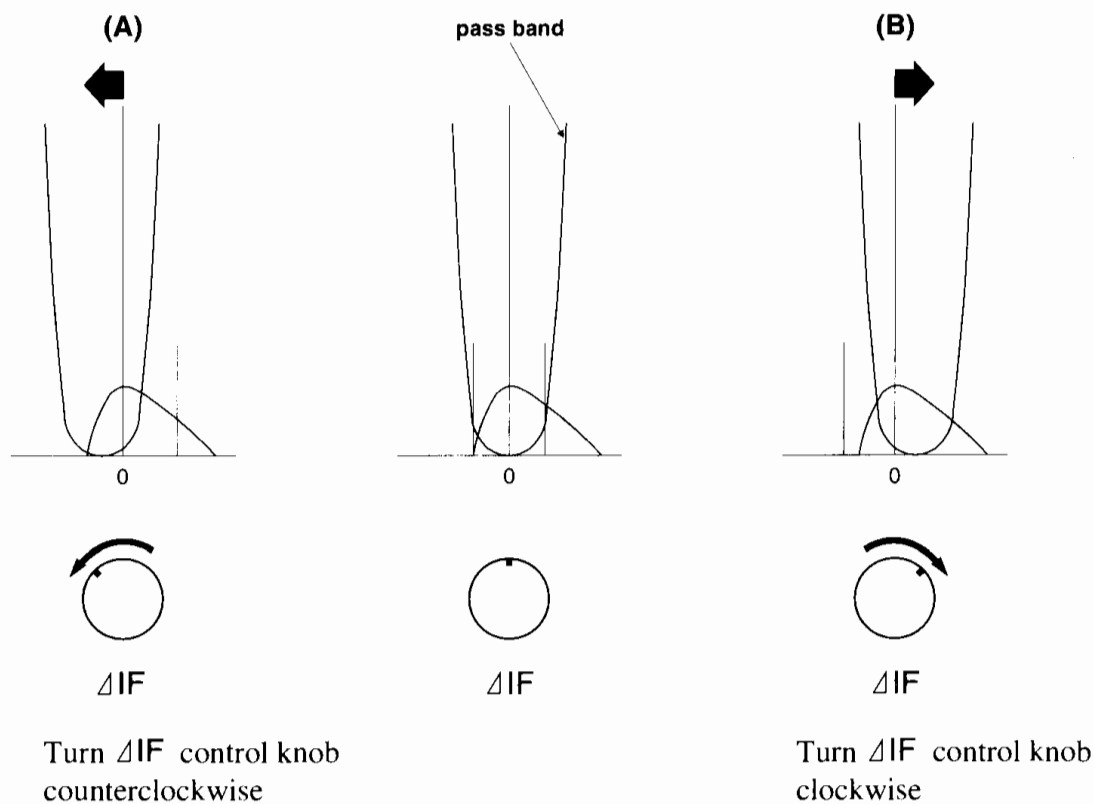

- Notes:**
- This function can shift the IF pass band within a range of only ± 1.5 kHz.
 - This function will be disabled in the **AM** mode when using the standard IF, and in the **FM** mode.

Tip: This function can also be used to adjust the audio quality.

Narrow Filter

The narrow filter can be used in each mode except the **FM** mode. The filter has half the bandwidth the standard filter does. This allows you to effectively reduce interference.

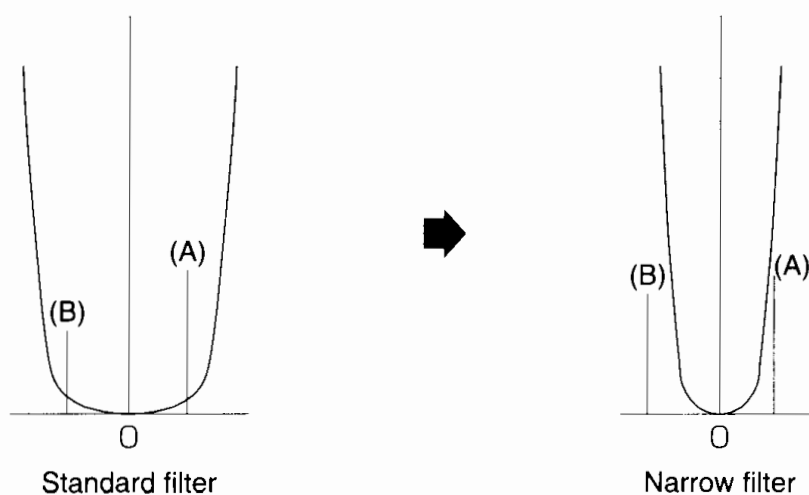

- If there are interference signals (A) and (B) when the standard filter is used, using the narrow filter will reduce the interference.



Notes: Using the narrow filter will change audio quality.

- Filter bandwidth

	Standard	Narrow
CW	1.0	0.5
SSB	2.4	1.0
AM	9.0	2.4
FM	9.0	

1. Press the **FILTER** key to select a filter.

- When the "NAR" icon is displayed on the LCD, the narrow filter is selected.
- To clarify the received signal, use the Δ IF function together.

CW BFO REVERSE

The **CW** mode has **CWU** (upper sideband) and **CWL** (lower sideband) options. Selecting the **CWU** or **CWL** will help reduce interference.

When your receive frequency is zeroed-in with the other station's transmit frequency, this function would not affect the receive tone or transmit frequency.

- (A) Desired signal
- (B) Interference signal
- (C) Reception pitch

1. Press the **CW** switch to select the **CWU** or **CWL** mode.

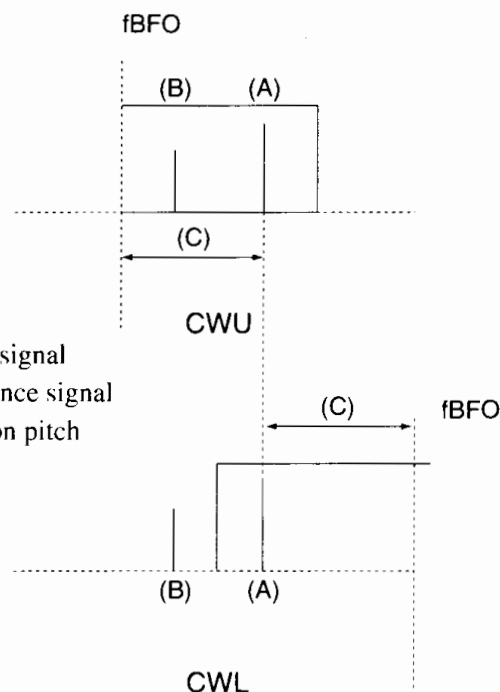

NB (Noise Blanker)

The noise blanker suppresses pulse noise like that from car ignition to clarify the received signal.

1. Press the **FUNC** key, then press the **RF** key.

The "NB" icon will be displayed.



*Note: If there is no key entry within 5 seconds after **FUNC** appears, the function will be canceled.*

ATT (Attenuator)

This function is used to reduce the receiver's front-end gain when you receive very strong signals or interference signals.

- Press the **RF** key to select the receiver's front-end gain setting.

RF-20-10

A -10 dB attenuator is activated.

RF-20

A -20 dB attenuator is activated.

5.2 OTHER USEFUL FUNCTIONS

RIT/TXIT Function

RIT function

The **RIT** function is used to change the receive frequency within a range of ± 1.4 kHz.

 *Tip: This function is useful when the other station has an off frequency.*

TXIT function

The **TXIT** function is used to change the transmit frequency within a range of ± 1.4 kHz.

Procedure

1. Press the **RIT** key.

The displayed icon will change in the following manner:

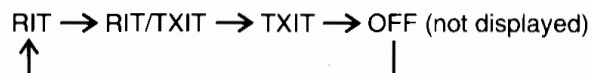

2. Rotate the **RIT** control knob to adjust the receive/transmit frequency.

Displays the mode and **RIT/TXIT** shift frequency.



 *Tip: The **TXIT** function can be disabled in the **SET** mode.*

 **Note:** *If you use the main tuning dial to tune in the frequency while the **RIT** or **TXIT** function is activated, the transmit and receive frequency will be different.*

 $\pm \Delta f$

This function adds the **RIT/TXIT** shift frequency to the displayed frequency.

Procedure

1. Press the **FUNC** key.
2. Press the **RIT** key.

 *Note: If there is no key entry within 5 seconds after **FUNC** appears, the function will be canceled.*

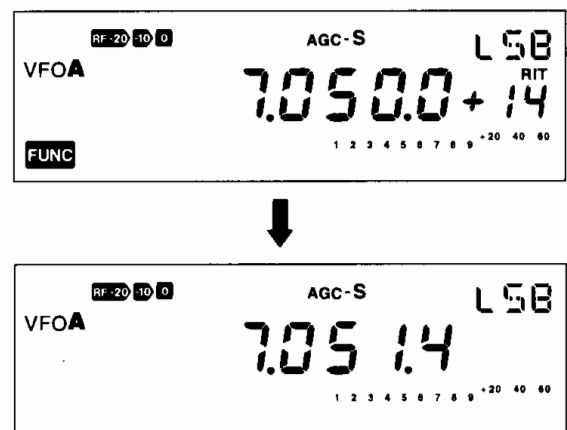

The RIT shift frequency will be added to the displayed frequency, and the RIT function will turn off.

VFO A=B

This function transfers data in the **VFO A** to the **VFO B**, and vice versa.

 *Tip: This function will be useful when you want to keep the current frequency and settings in one VFO, and use or change them in the other VFO. You may also use this function when setting split frequencies.*

Procedure

1. Display the **VFO** where the data you want to transfer is.

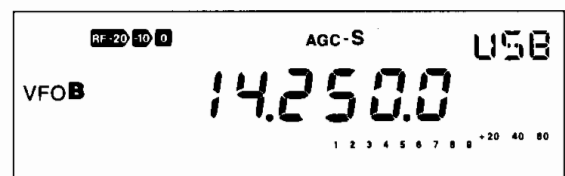

2. Hold the **VFO** key down longer than one second.

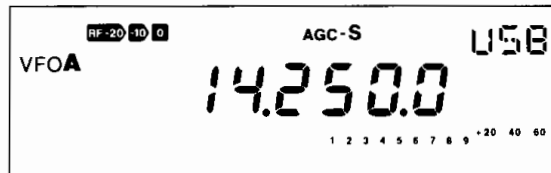

- Now see sure that the **VFO A** and **VFO B** have the same data.

DIAL LOCK Function

This function locks the main tuning dial to prevent accidental frequency changes.

 *Tip: This function is useful in mobile operation where the main tuning dial may be rotated by car vibrations, etc. While this function is activated, tuning is still possible with the **MULTI FUNCTION** dial and **RIT** control knob.*

Procedure

1. Press the **DIAL LOCK** key.

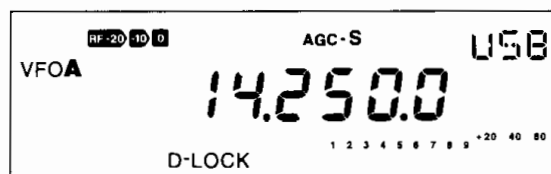
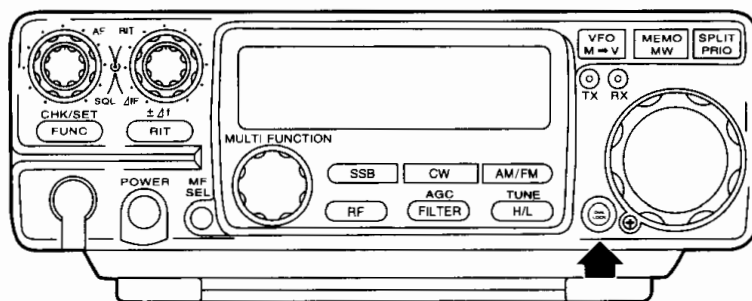

- To cancel this function, press the **DIAL LOCK** key again.

6.1 BASICS

Introduction

The chapter explains the set-up items and procedures in the **SET** mode. This mode is not frequently accessed, but by customizing each function, you can operate this transceiver more effectively and conveniently.

Set-up Item List

- TXIT function
- Sidetone and **CW** offset setting
- LCD brightness
- **APO** (Automatic Power Off)
- Transmission inhibit (**PTT** key lock)
- Memory overwrite protection
- Memory frequency access inhibit
- Group memory scan
- Automatic **USB/LSB** selection
- Break-in delay time
- Beep
- Speech compressor
- Frequency step of the **MULTI FUNCTION** dial
- Scan mode

Basic Procedure

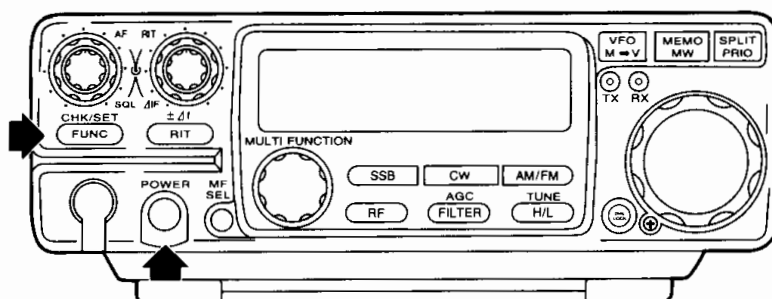

1. Press the **FUNC** key

FUNC will appear.

SE LP OF

2. Press again and hold the **FUNC** key down longer than 2 seconds.

“SE” will appear, indicating the transceiver is in the **SET** mode.

3. Press the key for the function you want to set up.



*Note: If there is no key entry within 5 seconds after **FUNC** appears, the function will be canceled.*

4. Rotate the **MULTI FUNCTION** dial to select the desired option.
5. Press the **FUNC** key to confirm the selection and exit from the **SET** mode.

6.2 SET-UP ITEMS

TXIT Function

Description

The TXIT is a function for fine-tuning only the transmit frequency. If “OF” (OFF) is selected, only the **RIT** function will be activated.

Options

- “On” ■ “OF” (OFF)

(The default is “On”)

Procedure

1. Press the **FUNC** key.
2. Press again and hold the **FUNC** key down longer than 2 seconds to access the **SET** mode.
3. Press the **RIT** key.

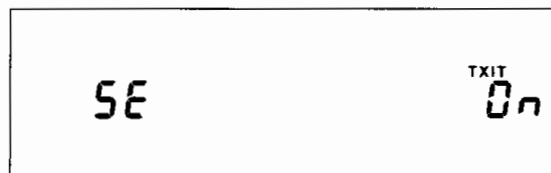

4. Rotate the **MULTI FUNCTION** dial to select “On” or “OF.”



5. Press the **FUNC** key to confirm the selection and exit from the **SET** mode.



*Note: If there is no key entry within 5 seconds after **FUNC** appears, the function will be canceled.*

Automatic USB/LSB Selection

Description

This function automatically selects the **USB** or **LSB** mode depending on which amateur band has been selected in **SSB** mode. If "OF"(OFF) is selected, the last-used **SSB** mode is recalled when you access the **SSB** mode.

Options

- "On" ■ "OF" (OFF)

(The default is "On")

Procedure

1. Press the **FUNC** key.
2. Press again and hold the **FUNC** key down longer than 2 seconds to access the **SET** mode.
3. Press the **SSB** key.

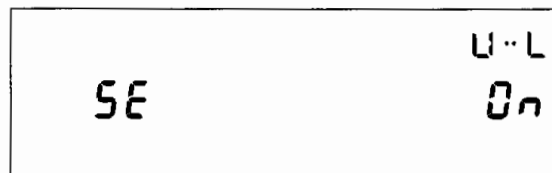

4. Rotate the **MULTI FUNCTION** dial to select "On" or "OF."

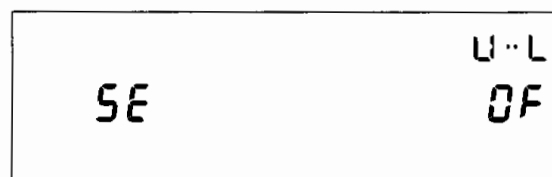

5. Press the **FUNC** key to confirm the selection and exit from the **SET** mode.



*Note: If there is no key entry within 5 seconds after **FUNC** appears, the function will be canceled.*

Sidetone and CW Offset Setting

Description

The sidetone will change according to the **CW** offset you select.

Options

- “650” Hz
- “750” Hz
- “850” Hz

(The default is “750”)

Procedure

1. Press the **FUNC** key.
2. Press again and hold the **FUNC** key down longer than 2 seconds to access the **SET** mode.
3. Press the **CW** switch.
 - If the **BREAK-IN** setting menu is displayed, press this key again.
4. Rotate the **MULTI FUNCTION** dial to select the desired **CW** offset.
5. Press the **FUNC** key to confirm the selection and exit from the **SET** mode.

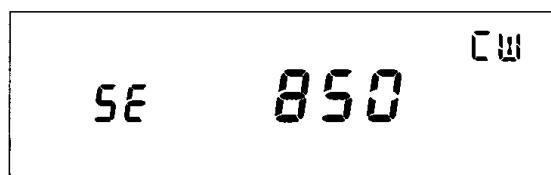
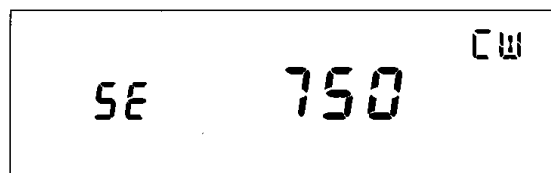

*Note: If there is no key entry within 5 seconds after **FUNC** appears, the function will be canceled.*

Break-in Delay Time

Description

You can select from **AUTO BREAK-IN**, **SEMI BREAK-IN** (selectable 7 steps), and **FULL BREAK-IN**.

Options

- “Auto” The delay time for the **SEMI BREAK-IN** mode will be set automatically according to the code speed being transmitted.
- “dLy 1” to “dLy 7” Select the desired delay time for the **SEMI BREAK-IN** mode (“1” is the shortest, and “7” is the longest).
- “FuLL” The **FULL BREAK-IN** mode

(The default is “Auto”)

Procedure

1. Press the **FUNC** key.
2. Press again and hold the **FUNC** key down longer than 2 seconds to access the **SET** mode.
3. Press the **CW** switch.

 *Note: If the sidetone setting menu is displayed, press this key again.*

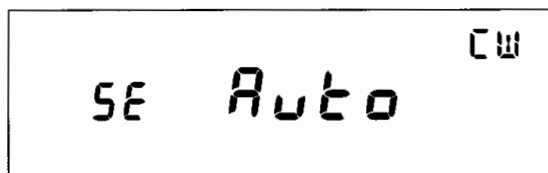

SE Auto CW

4. Rotate the **MULTI FUNCTION** dial to select the desired **BREAK-IN** mode.

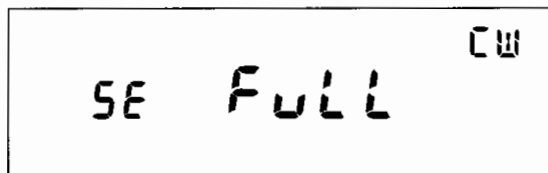

SE FULL CW

5. Press the **FUNC** key to confirm the selection and exit from the **SET** mode.

 *Note: If there is no key entry within 5 seconds after **FUNC** appears, the function will be canceled.*

LCD Brightness

Description

You can change the brightness of the LCD back-light.

Options

- "OF" (OFF)
- "1" to "5"

(The default is "3")

Procedure

1. Press the **FUNC** key.
2. Press again and hold the **FUNC** key down longer than 2 seconds to access the **SET** mode.
3. Press the **RF** key repeatedly until "LP" appears on the LCD.

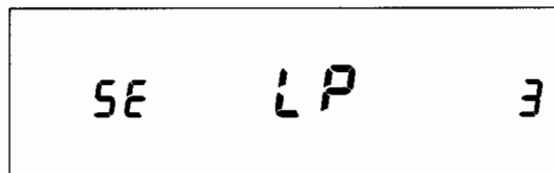

4. Rotate the **MULTI FUNCTION** dial to select the desired brightness.

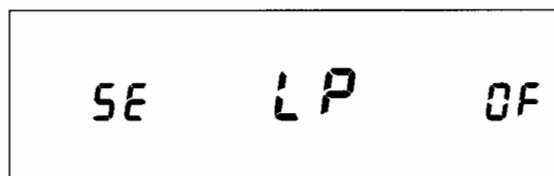

5. Press the **FUNC** key to confirm the selection and exit from the **SET** mode.



*Note: If there is no key entry within 5 seconds after **FUNC** appears, the function will be canceled.*

Beep

Description

If “On” is selected, a high-pitch beep will be heard each time a valid key is pressed, and a low-pitch beep will be heard each time an invalid key is pressed.

Options

- “On” ■ “OF” (OFF)

(The default is “On”)

Procedure

1. Press the **FUNC** key.
2. Press again and hold the **FUNC** key down longer than 2 seconds to access the **SET** mode.
3. Press the **RF** key repeatedly until “bEEP” appears on the LCD.

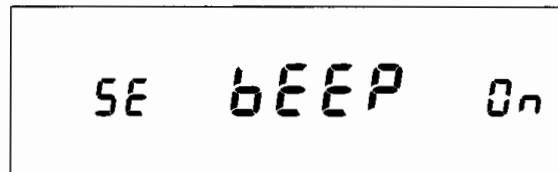

4. Rotate the **MULTI FUNCTION** dial to select “On” or “OF.”

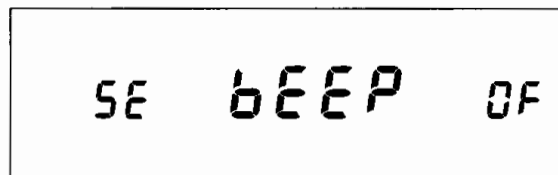

5. Press the **FUNC** key to confirm the selection and exit from the **SET** mode.



*Note: If there is no key entry within 5 seconds after **FUNC** appears, the function will be canceled.*

APO (Automatic Power Off)

Description

If “On” is selected, the transceiver will automatically turn off if there is no key entry for one hour. Before turning off, the transceiver will beep to notify you it is about to shut off.

Options

- “On” ■ “OF” (OFF)

(The default is “OF”)

Procedure

1. Press the **FUNC** key.
2. Press again and hold the **FUNC** key down longer than 2 seconds to access the **SET** mode.
3. Press the **RF** key repeatedly until “APO” appears on the LCD.

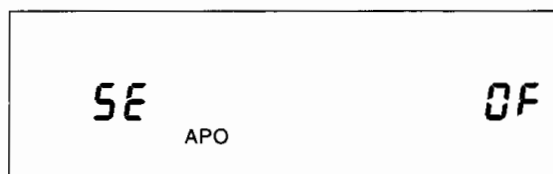

4. Rotate the **MULTI FUNCTION** dial to select “On” or “OF.”

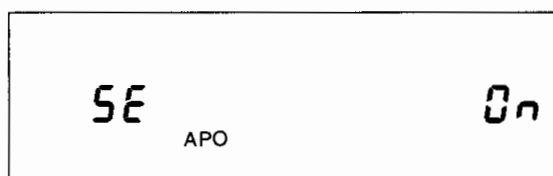

5. Press the **FUNC** key to confirm the selection and exit from the **SET** mode.

 **Note:** If there is no key entry within 5 seconds after **FUNC** appears, the function will be canceled.

Speech Compressor

Description

The speech compressor increases talk power. This is useful for transmission in the **SSB** and **AM** modes.

Options

- "On" ■ "OF" (OFF)

(The default is "OF")

Procedure

1. Press the **FUNC** key.
2. Press again and hold the **FUNC** key down longer than 2 seconds to access the **SET** mode.
3. Press the **H/L** key.



SE SPCH OF

4. Rotate the **MULTI FUNCTION** dial to select "On" or "OF."



SE SPCH On

5. Press the **FUNC** key to confirm the selection and exit from the **SET** mode.



*Note: If there is no key entry within 5 seconds after **FUNC** appears, the function will be canceled.*

Transmission Inhibit (PTT Key Lock)

Description

If “On” is selected, the transceiver can operate only as a receiver.

Options

- “On” ■ “OF” (OFF)

(The default is “OF”)

Procedure

1. Press the **FUNC** key.
2. Press again and hold the **FUNC** key down longer than 2 seconds to access the **SET** mode.
3. Press the **DIAL LOCK** key.

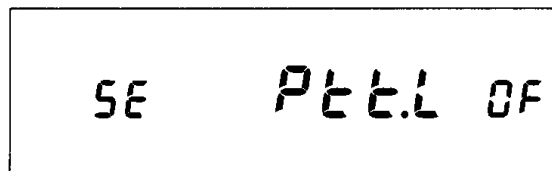

4. Rotate the **MULTI FUNCTION** dial to select “On” or “OF.”

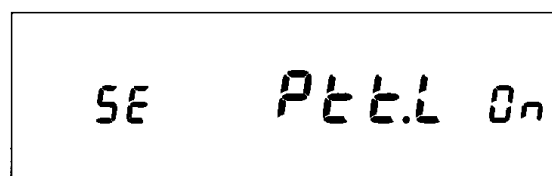

5. Press the **FUNC** key to confirm the selection and exit from the **SET** mode.



*Note: If there is no key entry within 5 seconds after **FUNC** appears, the function will be canceled.*

Frequency Step of the MULTI FUNCTION Dial (SSB and CW Modes) —

Description

You can separate **VFO** frequency steps of the **MULTI FUNCTION** dial for the **SSB** and **CW** modes. When you rotate the **MULTI FUNCTION** dial with no \blacktriangledown displayed, the displayed frequency will change in the step selected here.

Options

- “0.1” (kHz)
 “0.5” (kHz)
 “1.0” (kHz)
 “2.5” (kHz)

(The default is “1.0”)

Procedure

1. Press the **FUNC** key.
2. Press again and hold the **FUNC** key down longer than 2 seconds to access the **SET** mode.
3. Press the **VFO** key repeatedly until “U · L” appears on the LCD.

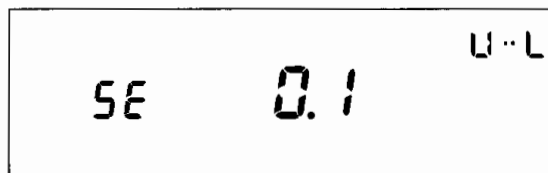

4. Rotate the **MULTI FUNCTION** dial to select the desired frequency step.

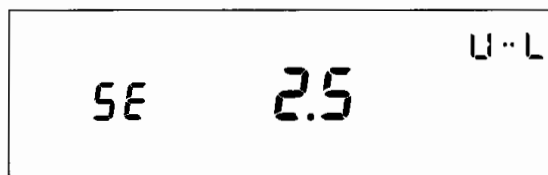

5. Press the **FUNC** key to confirm the selection and exit from the **SET** mode.



*Note: If there is no key entry within 5 seconds after **FUNC** appears, the function will be canceled.*

Frequency Step of the MULTI FUNCTION dial (AM mode)

Description

You can set the specific **VFO** frequency step of the **MULTI FUNCTION** dial for the **AM** mode. When you rotate the **MULTI FUNCTION** dial with no \blacktriangledown displayed, the displayed frequency will change in the step selected here.

Options

- "1.0" (kHz) ■ "2.5" (kHz) ■ "5.0" (kHz)
- "9.0" (kHz) ■ "10.0" (kHz)

(The default is "1.0")

Procedure

- 1.** Press the **FUNC** key.
- 2.** Press again and hold the **FUNC** key down longer than 2 seconds to access the **SET** mode.
- 3.** Press the **VFO** key repeatedly until "AM" appears on the LCD.

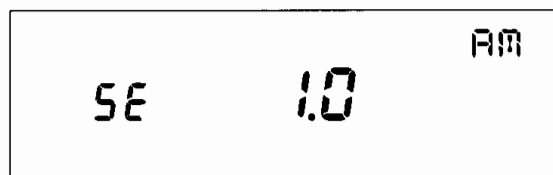

- 4.** Rotate the **MULTI FUNCTION** dial to select the desired frequency step.

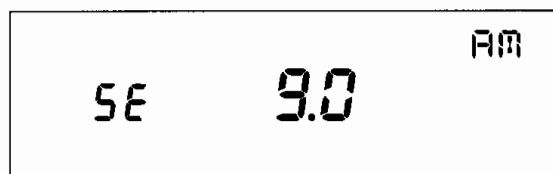

- 5.** Press the **FUNC** key to confirm the selection and exit from the **SET** mode.



*Note: If there is no key entry within 5 seconds after **FUNC** appears, the function will be canceled.*

Frequency Step of the MULTI FUNCTION dial (FM mode)

Description

You can set the specific **VFO** frequency step of the **MULTI FUNCTION** dial for the **FM** mode. When you rotate the **MULTI FUNCTION** dial with no \blacktriangledown displayed, the displayed frequency will change in the step selected here.

Options

- “2.5” (kHz) ■ “5.0” (kHz) ■ “10.0” (kHz) ■ “12.5” (kHz)

(The default is “2.5”)

Procedure

1. Press the **FUNC** key.
2. Press again and hold the **FUNC** key down longer than 2 seconds to access the **SET** mode.
3. Press the **VFO** key repeatedly until “FM” appears on the LCD.

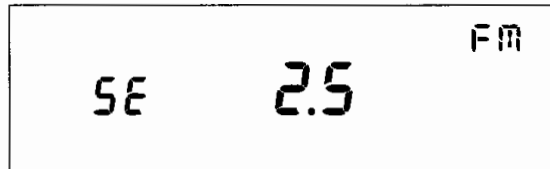

4. Rotate the **MULTI FUNCTION** dial to select the desired frequency step.

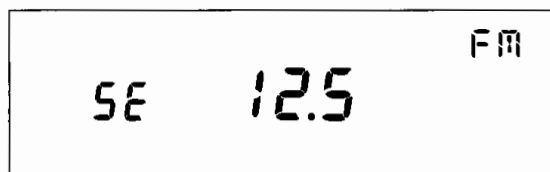

5. Press the **FUNC** key to confirm the selection and exit from the **SET** mode.



*Note: If there is no key entry within 5 seconds after **FUNC** appears, the function will be canceled.*

Memory Overwrite Protection

Description

This function protects all memory channels from overwrite.

Options

- “On”
- “OF” (OFF)

(The default is “OF”)

Procedure

1. Press the **FUNC** key.
2. Press again and hold the **FUNC** key down longer than 2 seconds to access the **SET** mode.
3. Press the **MEMO** key repeatedly until “Prot” appears on the LCD.

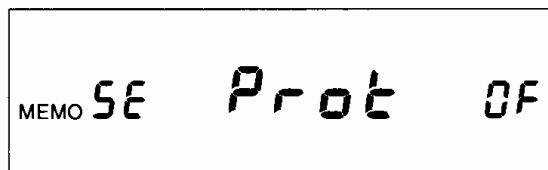

MEMO SE Prot OF

4. Rotate the **MULTI FUNCTION** dial to select “On” or “OF.”

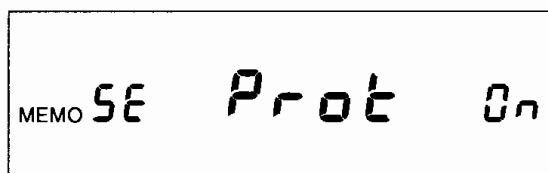

MEMO SE Prot On

5. Press the **FUNC** key to confirm the selection and exit from the **SET** mode.



*Note: If there is no key entry within 5 seconds after **FUNC** appears, the function will be canceled.*

Memory Frequency Access Protection

Description

This function inhibits temporary change of frequencies on all memory channels . While this function is activated, however, you can still temporarily use the **RIT**, mode, **RF** gain or other setting in the selected channel.

Options

- "On" ■ "OF" (OFF)

(The default is "On")

Procedure

1. Press the **FUNC** key.
2. Press again and hold the **FUNC** key down longer than 2 seconds to access the **SET** mode.
3. Press the **MEMO** key repeatedly until "FrEq" appears on the LCD.

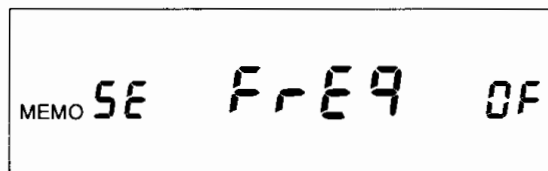

4. Rotate the **MULTI FUNCTION** dial to select "On" or "OF."

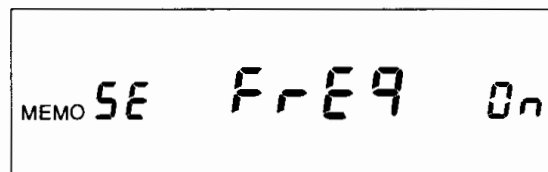

5. Press the **FUNC** key to confirm the selection and exit from the **SET** mode.



*Note: If there is no key entry within 5 seconds after **FUNC** appears, the function will be canceled.*

SCAN Mode

Description

You can select a condition for stopping and resuming scanning.

Options

- "OF" (OFF) Stops scanning when a signal is picked up, and quits scanning.
- "00" Stops scanning when a signal is picked up, and will resume scanning after the signal is dropped.
- "0" Will not stop scanning even when signals are picked up.
- "2" Stops scanning when a signal is picked up, and will resume scanning after 2 seconds.
- "4" Stops scanning when a signal is picked up, and will resume scanning after 4 seconds.
- "6" Stops scanning when a signal is picked up, and will resume scanning after 6 seconds.

(The default is "2")

Procedure

1. Press the **FUNC** key.
2. Press again and hold the **FUNC** key down longer than 2 seconds to access the **SET** mode.
3. Press the **SPLIT** key repeatedly until "SCAN" appears on the LCD.

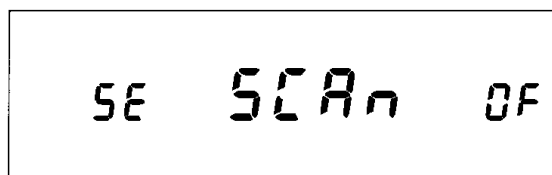

4. Rotate the **MULTI FUNCTION** dial to select the desired **SCAN** mode.

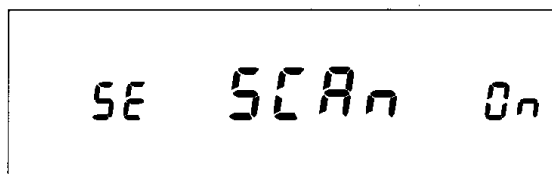

5. Press the **FUNC** key to confirm the selection and exit from the **SET** mode.



*Note: If there is no key entry within 5 seconds after **FUNC** appears, the function will be canceled.*

Group Memory Scan

Description

If “On” is selected, the transceiver scans only memory channels belonging to a group of channels that you specified.

Options

- “On” ■ “OF” (OFF)

(The default is “OF”)

Procedure

1. Press the **FUNC** key.
2. Press again and hold the **FUNC** key down longer than 2 seconds to access the **SET** mode.
3. Press the **SPLIT** key repeatedly until “groP” appears on the LCD.

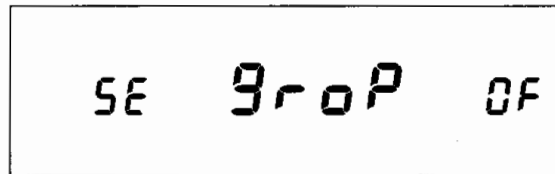

4. Rotate the **MULTI FUNCTION** dial to select “On” or “OF.”

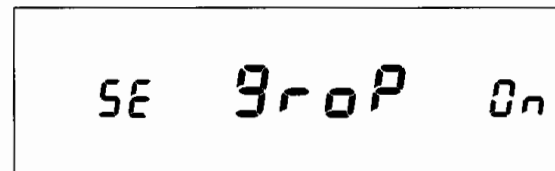

5. Press the **FUNC** key to confirm the selection and exit from the **SET** mode.



*Note: If there is no key entry within 5 seconds after **FUNC** appears, the function will be canceled.*

7.1 ADJUSTMENT

Introduction

This transceiver has been strictly tested and completely adjusted at the factory prior to shipment. When adjusting, therefore, be careful not to touch the non-user-servisable components such as the preset resistors/pots, coils, and trimmers inside.

Adjustment Item List

Remove the covers and perform the following:

- Adjust sidetone volume.
- Adjust microphone gain.
- Select 100 W or 50 W output.
- Cut jumper for the external relay terminal.
- Zero-in on reference frequency

Removing the Covers

Remove the covers as shown below.

- Top cover

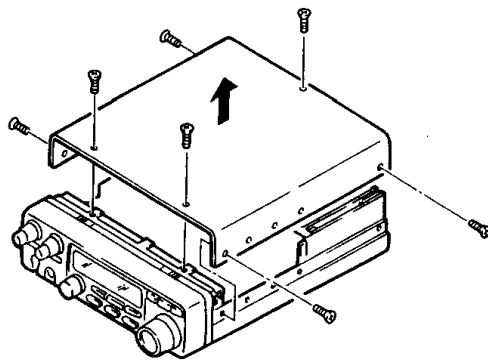

- Bottom cover

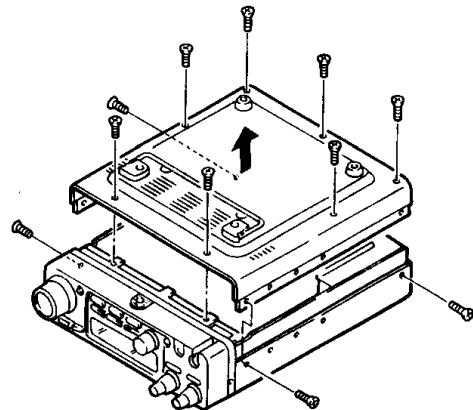

Warning: Be sure to turn the **POWER** switch off and unplug the DC cable before removing the covers.

Procedure

Adjusting sidetone volume

- Turn clockwise to increase, and turn counterclockwise to decrease.

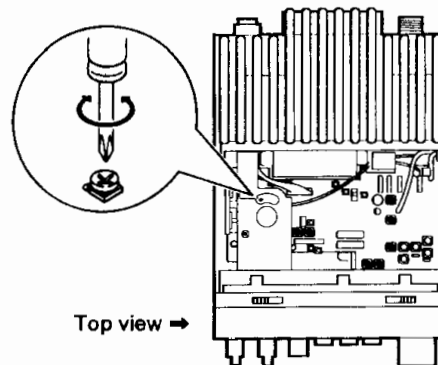

Adjusting microphone gain

- Adjust such that the brightness of the **TX** LED changes according to transmit audio intensity.
- Turn clockwise to increase, and turn counterclockwise to decrease.

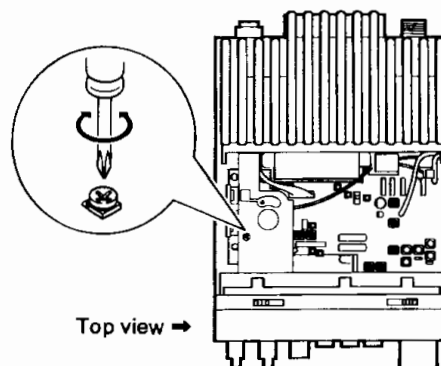

Selecting 100 W or 50 W output (HF only)

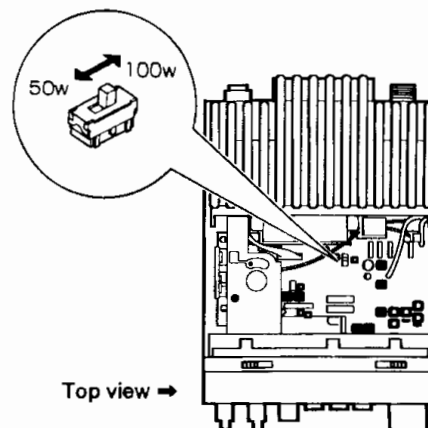

Cutting the resistor jumper for the external relay terminal

- The resistor leg must be cut before connecting an external liner amplifier.

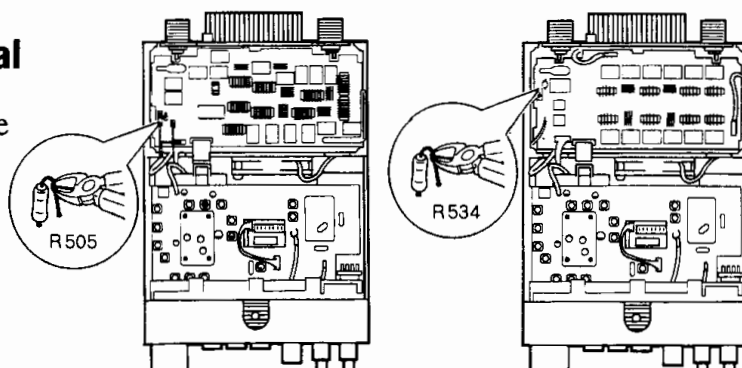

DX-70TH
DX-70EH

Bottom views

DX-70
DX-70T

Zeroing-in on reference frequency

1. Remove the top and bottom covers to access the PLL unit.
2. Access the **SET** mode and set the **CW** offset to 750 Hz (see pages 6-5). Then set transmission to off (see pages 6-11).
3. Select the **CWU** or **CWL** mode. Then let DX-70 display frequency of "5.0000," "10.0000," or "15.0000" to tune in a Standard Time or Frequency station such as WWV and WWVH at 5, 10, or 15 MHz.
4. When the WWV signal is received, you will hear an approximate 750 Hz tone. (If not received, try receiving the WWV or other standard signal at another frequency)
5. Key down in the **CW** mode, and you will hear a 750 Hz sidetone.
6. The WWV tone will mix with the sidetone to produce a beat sound.
7. Adjust the PLL unit (TC701) to achieve a zero-beat sound.

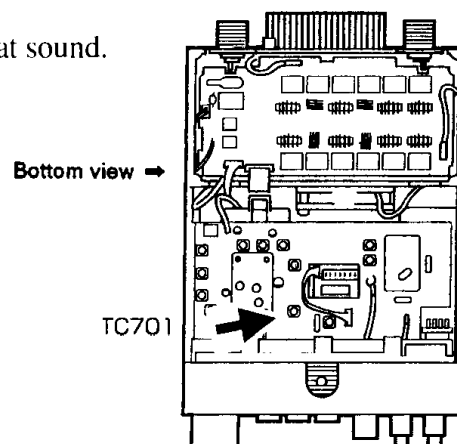

8. Set transmission to on, and restore the **CW** pitch to the original tone.

Adjusting main tuning dial torque

- Tighten the screw at the lower left of the main tuning dial to adjust the dial torque. Turn the screw clockwise to decrease the torque and turn it counterclockwise to increase the torque.

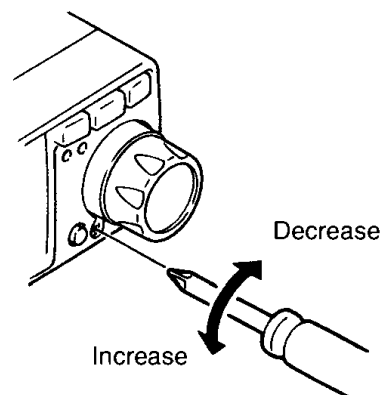

7.2 RESET

Procedure

Resetting all memory channels and SET mode settings

- While pressing the **FUNC** key, turn the power on.

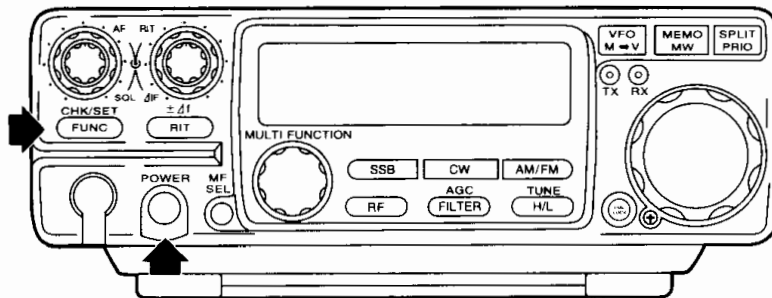

Resetting all memory channels

- While pressing the **MEMO** key, turn the power on.

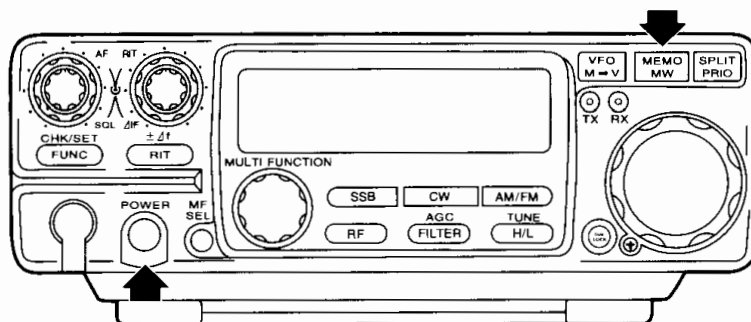

Resetting the VFO's

- While pressing the **VFO** key, turn the power on.

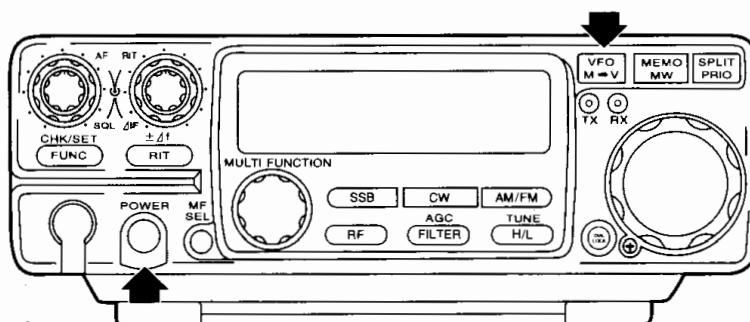

Restoring the SET mode settings to the factory defaults

- While pressing the **SPLIT** key, turn the power on.

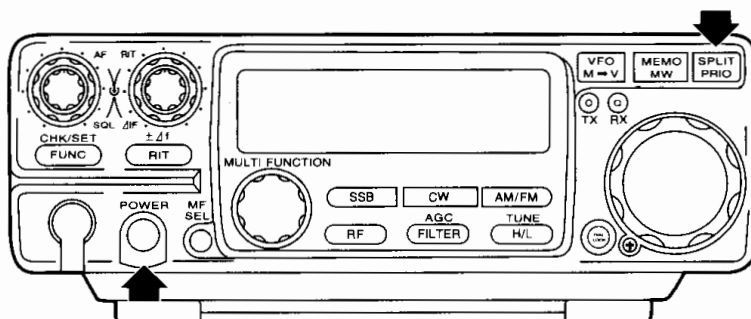

7.3 CLEANING

- Use a dry, silicone or soft cloth to clean the control panel and case.



Notes: ● *When cleaning, do not use thinner, benzine, alcohol, or any solvent that might deform or discolor the transceiver.*

- *If any part of the transceiver is excessively dirty, use a water-diluted neutral detergent to clean.*

7.4 TROUBLESHOOTING

If a problem should occur, first try the troubleshooting procedure given below. If the problem persists, contact your nearest ALINCO dealer.

Symptom	Possible Cause	Remedy
Power does not come on.	<ol style="list-style-type: none"> 1. DC power cable is incorrectly connected. 2. Fuse is blown. 3. Plug polarity is wrong. 4. Power switch of DC regulated power supply is off. 5. Voltage from the power supply is insufficient. 	<ol style="list-style-type: none"> 1. Correctly connect cable. 2. Replace fuse. 3. Correct polarity and replace fuse. 4. Turn power switch on. 5. Supply a regulated 13.8 V DC \pm 15%
Abnormal LCD display.	<ol style="list-style-type: none"> 1. Power supply voltage is low. To transmit at 100W output, the power supply must be capable of supplying 20 Amps continuously at 13.8 V DC 	<ol style="list-style-type: none"> 1. ● Check that DC regulated power supply is used. ● Adjust the operating voltage within a range of 13.8 V DC \pm 15% (11.7 to 15.8 V DC). ● To transmit at 100W output, the power supply must be capable of supplying 20 Amps continuously at 13.8 V DC.
No sound from speaker.	<ol style="list-style-type: none"> 1. AF control knob is turned fully counterclockwise. 2. PTT key of microphone is on. 3. Telegraph key is in transmission. 4. External speaker cable is short-circuited or damaged. 5. Headphones or earphone is plugged into the SP jack. 6. Squelch level is set too high. 	<ol style="list-style-type: none"> 1. Rotate AF control knob to adjust volume. 2. Release PTT key. 3. Stop keying with telegraph key. Also check that cable plug is not short-circuited. 4. Check cable. 5. Unplug headphones or earphone. 6. Turn SQL control knob counterclockwise to unmute squelch.
Only strong signals are received.	<ol style="list-style-type: none"> 1. Squelch is muted. 2. ATT is on. 3. Defective antenna or short-circuited or damaged coaxial cable. 4. Antenna is not suitable for receive band. 	<ol style="list-style-type: none"> 1. Turn SQL control knob counterclockwise. 2. Press RF key to turn ATT off. 3. Check antenna, cable, and especially UHF plugs. 4. Connect correct antenna for receive band.
Received signal is not demodulated.	<ol style="list-style-type: none"> 1. Wrong mode is set. (If SSB, also check LSB and USB) 2. Wrong passband is set. 	<ol style="list-style-type: none"> 1. Press correct mode key. 2. ● Turn ΔIF control knob to a position where proper audio can be heard. ● Select proper filter.

Symptom	Possible Cause	Remedy
No frequency change when rotating the main tuning dial	1. Dial is locked.	1. Press DIAL LOCK key to free dial.
Band scan will not start.	1. ▼ displayed somewhere in the LCD.	1. Press MF SEL repeatedly until ▼ disappears.
Cannot access MEMORY mode.	1. Memory channel is unprogrammed.	1. Program memory channel.
Memory scan will not start.	1. Memory channel is unprogrammed.	1. Program memory channel.
Memory channel cannot be programmed.	1. Memory channel is protected.	1. Turn off memory overwrite protection (<i>see page 6-15</i>).
Memory frequency cannot be changed.	1. Memory frequency overwrite protection is activated.	1. Turn off the protection.
No transmission or low output power	<ol style="list-style-type: none"> 1. Microphone or telegraph key connection is disconnected or poorly connected. 2. Antenna connection is poor or wrong. 3. Antenna matching is improper. 4. Microphone output level is low. 5. Transmission is inhibited (PTT key is locked.) 6. Transmission is made outside the amateur band. 7. Power supply is of insufficient capacity. 	<ol style="list-style-type: none"> 1. Connect microphone or key correctly. 2. Check antenna connection. 3. Correct antenna matching. Connect correct antenna for operating bands. 4. Increase microphone gain. 5. Unlock PTT key in SET mode. 6. Select correct frequency and amateur band. 7. Use a regulated 13.8 V DC power supply with a capacity of 20 Amps continuous duty. The cable for the power supply should be kept as short as possible, and away from co-ax if possible.
Reception and transmission are normal, but communication is impossible.	<ol style="list-style-type: none"> 1. SPLIT function is on. 2. RIT/TXIT function is on. 	<ol style="list-style-type: none"> 1. Turn this function off. 2. Turn this function off.

Symptom	Possible Cause	Remedy
Linear amplifier does not activate.	<ol style="list-style-type: none">1. External relay is not working.2. ALC is set to wrong level.3. Connection between DX-70 and the Linear-amplifier is poor.	<ol style="list-style-type: none">1. Cut internal jumper lead. (See section 7.1 "Cutting the jumper for the external relay terminal.")2. Adjust ALC level on your Linear-amp.3. Check that relay-cable, ALC-cable, co-ax cable are all connected properly between DX-70 and the Linear-amp. Also check that DX-70's HF antenna terminal is connected with the HF Linear-amp, and the 50 MHz antenna terminal for a 50 MHz Linear-amp.

OPTIONS

- EDX-1 antenna tuner for DX-70

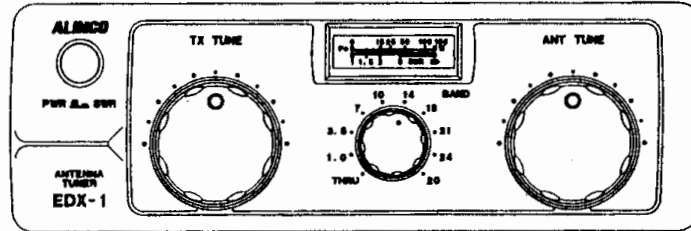

- DC regulated power supply
 - DM-1350T(120VAC)
 - DM-1350Z(220VAC)

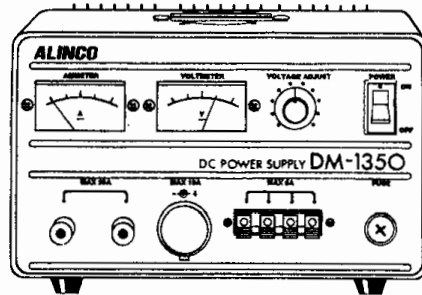

- EJ-26U CTCSS tone encoder
(comes standard with DX-70T/TH)

- EDS-4(1.5m) front control remote kit
EDS-6(4.5m)

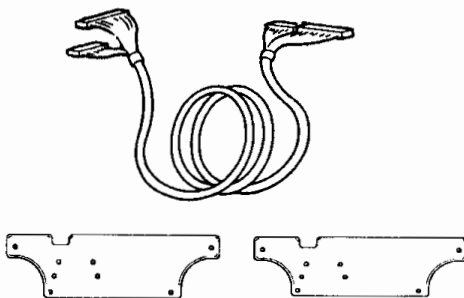

- EDS-5 microphone extension cable
(1.5m extended)

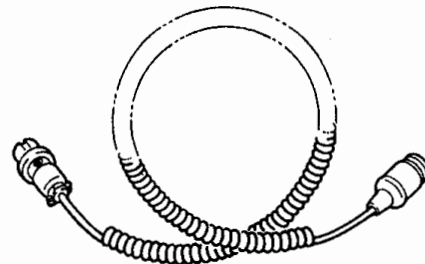

- EBC-8 front control angle bracket

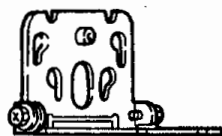

- EBC-9 mobile mount bracket

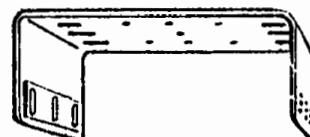

EXTERNAL ANTENNA TUNERS AVAILABLE

ALINCO EDX-1

■ Connection Example

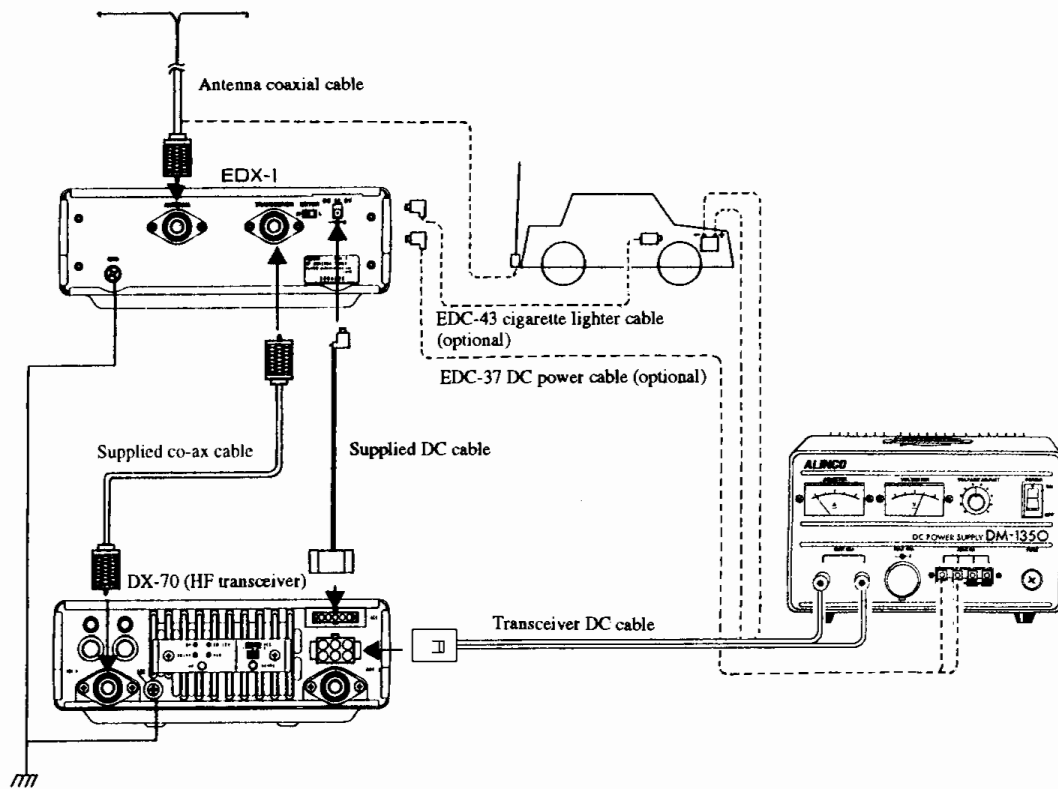

KENWOOD AT-50

■ Connection Example

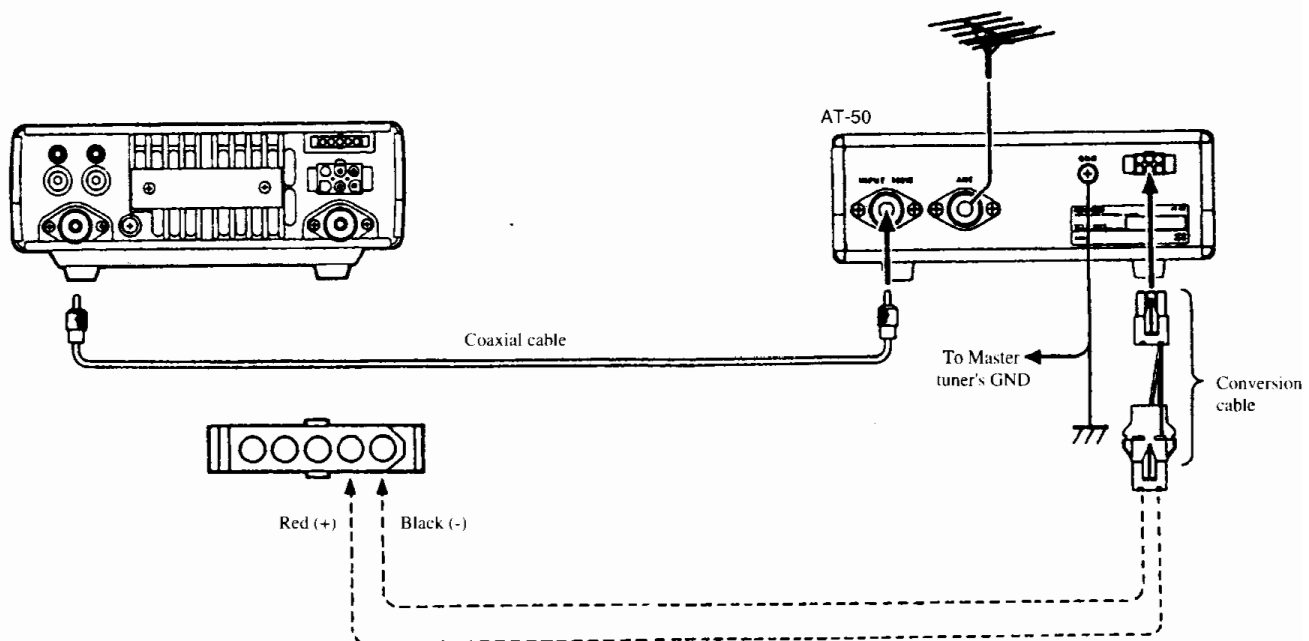

KENWOOD AT-300

■ Connection Example

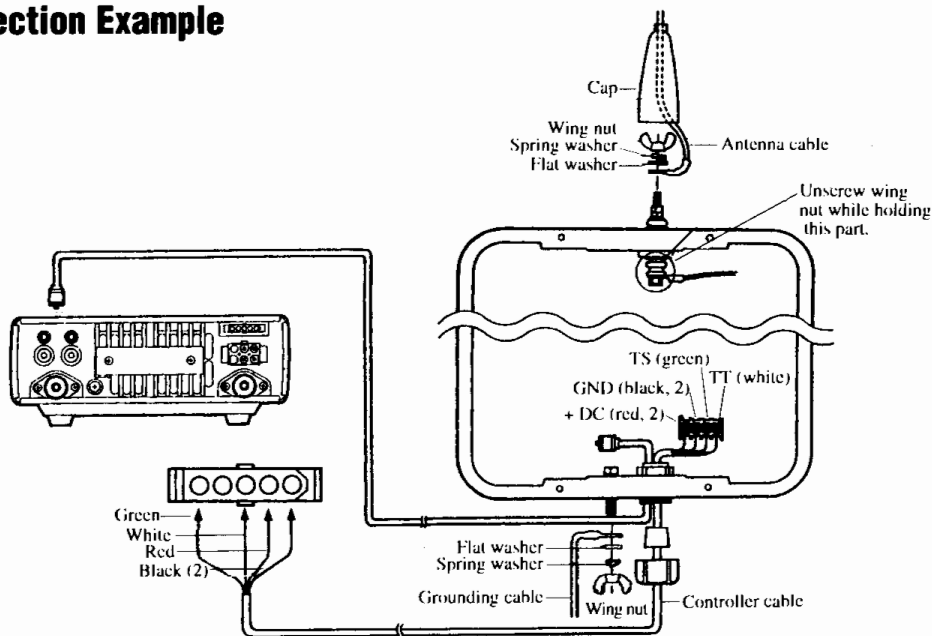

ICOM AH-3

■ Connection Example

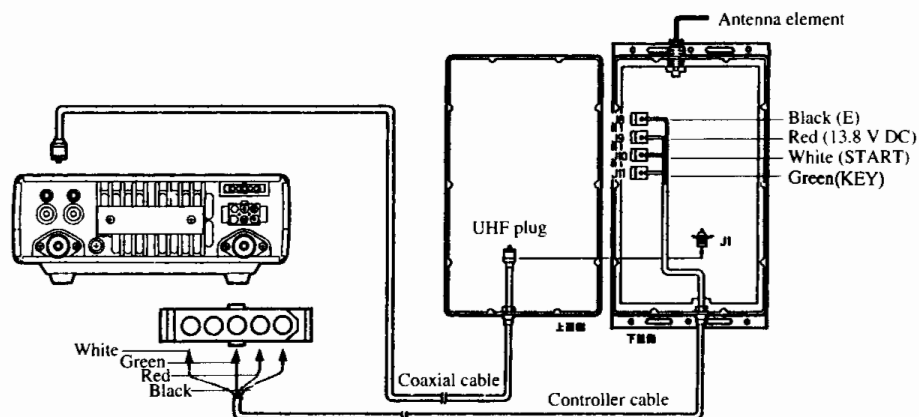

- Notes:**
- For details on how to connect an antenna tuner, see the instruction manual provided with it.
 - Names of products mentioned in this manual are used for identification purposes only and may be trademark and/or registered trademarks of their respective company.

SPECIFICATIONS

■ General

Model		DX-70 / DX-70 T	DX-70 EH / DX-70 TH
Operating mode		J3E(LSB,USB), A1A(CW), F3E(FM)	
Number of memory channels		100	
Antenna impedance		50 Ω unbalanced	
Power requirement		13.8 V DC \pm 15% (11.7 to 15.8 V DC)	
Grounding method		Negative ground	
Current drain	Receive	1.0 A max.	
	Transmit	20 A max.	25 A max.
Operating temperature		-10 °C to +60 °C	
Frequency stability		\pm 10 ppm (-10 °C to +50 °C)	
Dimensions		178(w) \times 58(h) \times 228(d) mm (179 \times 71 \times 268 mm for projections included)	
Weight		Approx. 2.7 kg	

■ Transmitter

Model		DX-70 / DX-70 T	DX-70 EH / DX-70 TH		
Transmit frequency coverage (e.g. U.S. Version)	160 m band	1.8000 to 1.9999MHz			
	80 m band	3.5000 to 3.9999MHz			
	40 m band	7.0000 to 7.2999MHz			
	30 m band	10.1000 to 10.1499MHz			
	20 m band	14.0000 to 14.3499MHz			
	17 m band	18.0680 to 18.1679MHz			
	15 m band	21.0000 to 21.4499MHz			
	12 m band	24.8900 to 24.9899MHz			
	10 m band	28.0000 to 29.6999MHz			
	6 m band	50.0000 to 53.9999MHz			
Power output	HF band	SSB, CW, FM	High	100 W	
			Low	Approx. 10 W	
		AM	High	40 W	
			Low	Approx. 4 W	
	50 MHz band	SSB, CW, FM	High	10 W	100W
			Low	Approx. 1 W	Approx. 10W
		AM	High	4 W	40W
			Low	Approx. 0.4 W	Approx. 4W
Modulation system	SSB		Balanced modulation		
	AM		Low power modulation		
	FM		Reactance modulation		

■ Transmitter (Continued)

Model		DX-70 / DX-70 T / DX-70 EH / DX-70 TH
Spurious emission	HF bands	Less than -50 dB (-45 dB in 10 MHz band)
	50 MHz band	Less than -60 dB
Carrier Suppression		More than 40 dB
Sideband suppression		More than 50 dB (at 1 kHz)
Maximum FM deviation	HF bands	± 2.5 kHz
	50 MHz band	± 5 kHz
Microphone impedance		2 kΩ

■ Receiver

Model		DX-70 / DX-70 T / DX-70 EH / DX-70 TH	
Receiver circuitry		Double conversion superheterodyne	
Receive frequency range		0.1500 MHz to 30.0000 MHz, 50.0000 MHz to 54.0000 MHz	
Intermediate frequency		71.75 MHz (1st) 455 kHz(2nd)	
Sensitivity	SSB, CW (S/N 10 dB)	0.5 to 1.8 MHz	0 dB (1 μV)
		1.8 to 30 MHz	-12 dB (0.25 μV)
		50 to 54 MHz	-16 dB (0.15 μV)
	AM (1 kHz, 30%, Mod, S/N 10 dB)	0.5 to 1.8 MHz	+20 dB (10 μV)
		1.8 to 30 MHz	+6 dB (2 μV)
		50 to 54 MHz	+6 dB (2 μV)
FM (1 kHz, 3.5kHz, DEV, SINAD 12 dB)	28 to 30 MHz	-6 dBμ (0.5 μV)	
	50 to 54 MHz	-10 dBμ (0.3 μV)	
Selectivity	SSB, AM(Narrow)		2.4 kHz/-6 dB, 4.5 kHz/-60 dB
	SSB(Narrow), CW(Standard)		1.0 kHz/-6 dB, 3.0 kHz/-60 dB
	CW(Narrow)		500 Hz/-6 dB, 3.0 kHz/-60 dB
	AM(Standard), FM		9 kHz/-6 dB, 20 kHz/-50 dB
Superiors and image rejection ratio		More than 70 dB	
Audio output power		More than 2.0 W (at 8 Ω, 10% THD)	
RIT/TXIT range		± 1.4 kHz	



Note: Specifications are subject to change without notice.

N O T I C E

This equipment has been tested and found to comply with the limits pursuant to Part 15 of the FCC Rules. These limits are designed to provide reasonable protection against harmful interference in a residential installation. This equipment generates, uses, and can radiate radio frequency energy, and if not installed and used in accordance with the instructions, may cause harmful interference to radio communications. However, there is no guarantee that interference will not occur in a particular installation. If this equipment does cause harmful interference to radio or television reception, which can be determined by turning the equipment off and on, the user is encouraged to try to correct the interference by one or more of the following measures.

- *Reorient or relocate the receiving antenna.*
- *Increase the separation between the equipment and receiver.*
- *Connect the equipment into an outlet on a circuit different from that which the receiver is connected.*
- *Consult the dealer or an experienced radio/TV technician for help.*

ALINCO, INC.

Head office: "TWIN 21" MID Tower Building 23F
1-61, 2-Chome, Shiromi, Chuo-ku, Osaka 540 Japan
Phone: 06-946-8150 Fax: 06-946-8175 Telex: 63086
E-mail: 101243.1446@compuserve.com
U.S.A.: 438 Amapola Ave., Suite 130, Torrance, CA 90501-6201, U.S.A.
Phone: 310-618-8616 Fax: 310-618-8758
<http://www.alinco.com/>
Germany: Eschborner Landstrasse 55, 60489 Frankfurt am Main, Germany
Phone: 069-786018 Fax: 069-789-60766

© Copyright 1996 Alinco, Inc. Osaka Japan
Printed in Japan

PS0221C
