



ELECRRAFT® K3S

HIGH-PERFORMANCE 160 – 6 METER TRANSCEIVER

OWNER'S MANUAL

Revision A1, May 26, 2015

Copyright © 2015, Elecraft, Inc.

All Rights Reserved

Contents

A Note to K3S Owners	3	Receive Antenna In/Out	41
Key to Symbols and Text Styles.....	3	Buffered I.F. Output for Panadapters	41
Quick-Start Guide	4	Using the 100-550 kHz Range.....	41
Introduction.....	7	Using Transverters.....	41
K3S Features.....	7	Scanning	42
Specifications	8	Main and Sub Receiver Antenna Routing	43
Customer Service and Support	10	Preamp 2 Limitations.....	45
Front Panel.....	11	Remote Control of the K3S.....	46
Control Groups	11	Options and Accessories	47
Display (LCD).....	12	Firmware Upgrades.....	47
LEDs.....	13	Configuration	48
Front Panel Connectors	13	Crystal Filter Setup	48
Primary Controls	13	Module Enables	49
Multi-Function Controls.....	14	Miscellaneous Setup	50
VFO Tuning Controls.....	14	VFO A Knob Friction Adjustment	50
Keypad.....	15	VFO B Knob Friction Adjustment	51
Memory Controls.....	16	Real Time Clock Battery Replacement	51
Message Record/Play Controls.....	16	Calibration Procedures.....	52
RIT and XIT Controls	16	Synthesizer.....	52
Rear Panel.....	17	Wattmeter	52
Connector Groups.....	17	Transmitter Gain.....	52
Control and Audio Connections	18	Reference Oscillator	53
Basic Operation	23	Front Panel Temperature Sensor	54
Receiver Setup.....	25	PA Temperature Sensor.....	54
Reducing Interference and Noise	27	S-Meter and RF GAIN Control	54
Transmitter Setup	28	Menu Functions	55
Voice Modes (SSB, AM, FM).....	30	MAIN Menu	55
CW Mode	32	CONFIG Menu.....	57
Data Modes.....	33	Troubleshooting	69
Advanced Operating Features.....	35	Parameter Initialization.....	72
Text Decode And Display	35	Module Troubleshooting	73
CW-to-DATA.....	36	Theory Of Operation.....	77
Tuning Aids: CWT and SPOT	36	RF BOARD	77
Audio Effects (AFX)	37	KAT3A (ATU) and KANT3	79
APF and Dual-Passband CW Filtering.....	37	KIO3B (Audio/Digital I/O)	79
Receive Audio Equalization (EQ).....	37	Front Panel and DSP.....	79
Transmit Audio Equalization (EQ)	37	KREF3 (Ref./2 nd LO).....	81
SPLIT and Cross-Mode Operation.....	38	KSYN3A (Synthesizer)	81
Extended Single Sideband (ESSB).....	38	Firmware.....	81
General-Coverage Receive	38	K3S Block Diagram.....	83
VFO B Alternate Displays.....	38	Appendix A: Crystal Filter Installation.....	84
Alarm and Auto Power-On.....	38	Index	88
Using the Sub Receiver	39		

A Note to K3S Owners

On behalf of our entire design team, we'd like to thank you for choosing the Elecraft K3S transceiver.

The K3S is the same size and weight (~9 lbs.) as its predecessor, the K3. Yet nearly all internal modules have been redesigned, providing enhanced performance and many new features. These include:

- Ultra low-noise synthesizer for exceptional receiver dynamic range and transmit signal purity
- USB port for convenient, single-cable computer control and digital audio interface (an RS232 port is provided, as well, for station compatibility and P3 interfacing); pg. 18
- Built-in second preamp for weak-signal work on 12, 10, and 6 meters; pg. 25
- Three attenuator settings (5/10/15 dB) to optimize performance in strong-signal conditions; pg. 25
- Improved audio circuitry for clean, low-distortion stereo speaker output; pg. 80
- Low-loss ATU option with a true bypass relay, maximizing efficiency with every antenna
- Accurate high-speed CW transmit timing, even when using SPLIT, RIT, and XIT
- 100-550 kHz coverage, including low-level 630-meter (472 kHz) transmit; pg. 41









Exterior changes include all-stainless-steel hardware, new display bezel, and a soft-touch VFO tuning knob.

With its unique combination of compact size and world-class performance, your new K3S can handle the most demanding operating situations, whether you're at home or halfway around the world.

73,

Wayne, N6KR
Eric, WA6HHQ

Key to Symbols and Text Styles

	Important – read carefully
	Operating tip
LSB	LCD icon or characters
	LED
	Enter keypad function
	Tap switch function (labeled <i>on</i> a switch)
	Hold switch function (labeled <i>below</i> a switch; hold for 1/2 sec. to activate)
 SQL	Rotary control without integral switch
 PWR	Tap switch function of rotary control (labeled <i>above</i> a knob)
 MON	Hold switch function of rotary control (labeled <i>below</i> a knob; hold for 1/2 sec.)
MAIN:VOX GN	Typical MAIN menu entry
CONFIG:KAT3	Typical CONFIG menu entry





Quick-Start Guide

To get started using your K3S right away, please read this page and the two that follow, trying each of the controls. The text uses braces to refer to numbered elements in the front- and rear-panel illustrations below. For example, {1} in the text refers to ①. Later sections provide greater detail on all aspects of K3S operation.

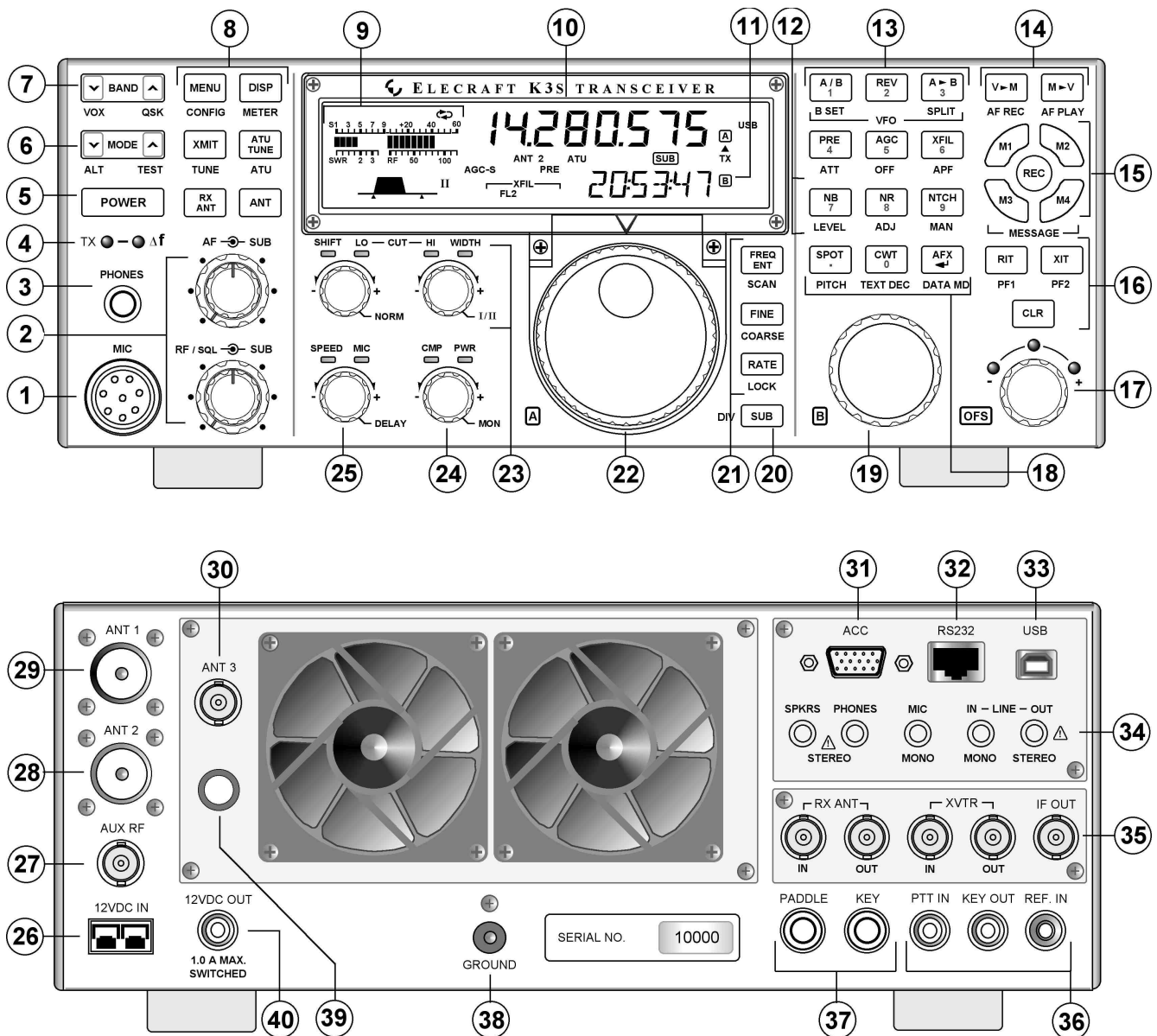
⚠ The first thing you need to know about the K3S is that most switches have two functions. **Tap** (press briefly) to activate the function labeled **on** a switch. **Hold** for about ½ to 1 second to activate the function labeled **below** the switch. In the text, tap functions are shown like this example: **MENU**. An example of a hold function is **CONFIG**. Additional typographical conventions are shown on the previous page.

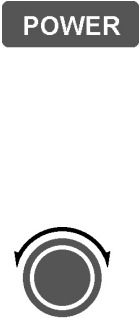
Try tapping **MENU** {8}. This brings up the **MAIN** menu. Rotating VFO B {19} selects menu entries, while rotating VFO A {22} changes their parameters. Tap **MENU** again to exit the menu.

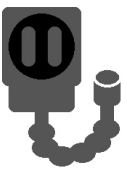

<p>Connections</p> 	<ul style="list-style-type: none"> • Connect a power supply to the DC input jack {26} (see Specifications, pg. 8). • On the K3S /100, a circuit breaker is provided on the fan panel for the 100-W stage {39}. • You can power an accessory device from the switched DC output jack {40} (1.0 A max). • Connect antenna to ANT1 {29} and ground {38}. With an ATU (pg. 24), you can also use ANT2 {28}. AUX RF {27} is for the sub RX; see pg. 17. ANT3 {30} is used with the internal 2-m module (K144XV). Connect an RX-only antenna to RX ANT IN {35}.
<p>The Basics</p> 	<ul style="list-style-type: none"> • Press POWER {5} to turn on the K3S. If there are any error indications, refer to pg. 74. • TAP and HOLD Functions: <i>Tapping</i> briefly activates the function labeled <i>on</i> a switch. <i> Holding</i> for about 1/2 second activates the function labeled <i>below</i> a switch. • Tap either end of BAND {7} to select a band, and MODE {6} for the mode. Set AF gain using \odot AF {2}. Set \odot RF to max. Plug phones in at {3}. For SUB controls, see pg. 39. • The large knob {22} controls VFO A (upper display, {10}). The medium knob {19} controls VFO B (lower display, {11}). VFO A is main RX/TX except in SPLIT (pg. 38). • \odot CMP / PWR is one of four multifunction controls {24}. Each has two primary functions, indicated by green LEDs. The knob has a built-in switch; <i>tap</i> it to select either CMP (compression level) or PWR (power output). <i>Hold</i> the knob in to access its secondary function, MONitor level. Tap again to restore the primary function.
<p>Filter Controls</p> 	<ul style="list-style-type: none"> • Rotate the \odot SHIFT / LO CUT and \odot HI CUT / WIDTH controls {23} to adjust the filter passband. Crystal filters FL1-FL5 are automatically selected as you change the bandwidth. Tap either knob to select shift/width or hi cut/lo cut. (See filter info, pg. 85.) • Hold \odot SHIFT / LO CUT to NORMalize the bandwidth (e.g., 400 Hz CW, 2.8 kHz SSB). • Hold \odot HI CUT / WIDTH to alternate between two filter setups, I and II (per-mode). • Tap XFIL {13} to select crystal filters manually; this also removes any passband shift.
<p>Voice Modes</p>  {1}	<ul style="list-style-type: none"> • Hold METER {8} to see CMP / ALC levels. While talking, set \odot MIC {25} for 4-7 bars of ALC, and \odot CMP for the desired compression. Then return to SWR / PWR (pg. 30). • Optional: Hold TEST {6} for TX TEST mode; allows off-air TX adjustments (pg. 13). • Hold \odot CMP / PWR {24} to set speech MONitor level; tap to return to CMP / PWR. • Hold VOX {7} to select PTT or VOX. Hold \odot SPEED / MIC to set VOX DELAY. • Details: VOX, pg. 31; TX EQ, pg. 37; MIC SEL, pg. 55; SSB/AM/FM, pg. 30.
<p>CW Mode</p>  {37}	<ul style="list-style-type: none"> • \odot SPEED {25} sets the CW keyer speed. Hold this knob to set semi-break-in DELAY. Hold QSK {7} to select full QSK (pg. 32.). Hold VOX {7} to select hit-the-key CW. • Hold PITCH {18} to set sidetone pitch. Hold \odot CMP / PWR to set sidetone MON level. • Tap CWT {18} for tuning aid {9} (pg. 36). With CWT on, SPOT auto-spots (pg. 32). • To select CW text decode/display mode, hold TEXT DEC {18}; rotate VFO B (pg. 32). • CW keying is converted to DATA in FSK D and PSK D modes (below and pg. 36). • Hold APF {13} to turn on audio peaking (APF) or dual-passband filtering (pg. 32).
<p>Data Modes</p>  {33}	<ul style="list-style-type: none"> • Tap MODE {6} until you see the DATA icon turn on (see Data Modes, pg. 33). • Hold DATA MD {18}. Use VFO B to select from: DATA A (PSK31, JT65, and other soundcard-based modes), AFSK A (soundcard-based RTTY), FSK D (RTTY via data input or keyer), or PSK D (PSK via data input or keyer). VFO A selects data baud rate for internal encoder/decoder, if applicable. APF turns on an RTTY filter (DTF, pg. 34). • Hold PITCH {18} to select mark tone and shift (for encoder/decoder and RTTY filter). • Hold TEXT DEC {18} to set up text decode. CWT shows tuning aid (pg. 36).

VFOs and RIT/XIT	<ul style="list-style-type: none"> • RATE {21} selects 10 or 50 Hz VFO/RIT tuning. See VFO menu entries, pg. 57. • FINE {21} selects 1-Hz steps. COARSE selects large steps (MAIN menu, <i>VFO CRS</i>). • Tap FREQ ENT {21} to enter frequency in MHz using numeric keypad & decimal point. Tap return (↵) to complete the entry, or tap FREQ ENT again to cancel (pg. 15). • Hold SCAN to start/stop scanning. SCAN must be preceded by a memory recall (pg. 42). • The RIT and XIT offset knob {17} has LEDs that show -/0/+ offset (pg.16). Tap CLR {16} to zero the offset. <i>Hold CLR</i> for > 2 sec. to add the offset to VFO A, then zero it.
Transmit, ATU, and Antenna Controls	<ul style="list-style-type: none"> • The TX LED {4} indicates that the K3S is in transmit mode. The Δf LED turns on if the RX and TX frequencies are unequal, e.g. SPLIT, RIT/XIT, cross-mode (pg. 13). • XMIT {8} is equivalent to PTT {36}. TUNE puts out full CW power in any mode. • ATU TUNE {8} initiates antenna matching (pg. 24). ATU enables or bypasses the ATU. • ANT selects ANT1 or ANT2. RX ANT selects main or RX antenna (KXV3B module).
Preamp and Attenuator	<ul style="list-style-type: none"> • Tap PRE {13} to turn on the preamp (pg. 25). On 12-6 m, preamp 2 can be used. • Hold ATT {13} to turn on the attenuator (pg. 25). <i>Hold ATT for 2 seconds</i> to go into the <i>MAIN:ATTEN</i> menu entry; per-band attenuation level can be set to 5/10/15 dB.
NB, NR, and Notch	<ul style="list-style-type: none"> • Tap NB {12} to enable DSP and I.F. noise blanking. Hold LEVEL to set DSP NB level (VFO A) and I.F. NB level (VFO B). Fully CCW is OFF in both cases. (Pg. 27.) • Tap NR {12} to turn on noise reduction (saved per-mode). Hold ADJ to tailor noise reduction for the present band conditions (pg. 27). • NTCH {12} turns on auto-notch in SSB mode, manual notch in others. MAN turns on manual notch in any mode, and is also used to adjust manual notch frequency (pg. 27).
SPLIT, BSET, and SUB	<ul style="list-style-type: none"> • Hold SPLIT {13} to enter split mode (RX on VFO A, TX on VFO B). If VFOs A and B are on different frequencies in SPLIT mode, the Delta-F LED (Δf) will turn on (pg. 13). • Hold BSET {13} to adjust VFO B / sub RX settings independently of VFO A (pg. 39). • Tap SUB {20} to turn on the sub receiver (pg. 39). VFO B controls its frequency. • Hold DIV {20} to engage <i>diversity mode</i> (pg. 40), which can reduce signal fading. • VFO B can be linked (slaved) to VFO A using <i>CONFIG:VFO LNK</i> menu entry.
Memories, Messages, and DVR	<ul style="list-style-type: none"> • To store a frequency memory, tap V ► M {14}, then: tap M1-M4 {15} to save a per-band quick memory; or tap 0-9 to save a general-purpose quick memory; or rotate VFO A to select from memories 0-99, then tap V ► M again to save. Tap M ► V to recall. (Pg. 16.) • REC and M1-M4 {15} are also used to record & play voice/CW/DATA messages. The KDVR3 option is required for voice messages and AF REC / AF PLAY (pg. 31).
Menus and Switch Macros	<ul style="list-style-type: none"> • MENU & CONFIG {8} access the MAIN and CONFIG menus. VFO B selects entries; VFO A changes parameters. In general, CONFIG menu entries are used less often. • Tapping DISP {8} within menus shows information about each entry on VFO B (pg. 55). • Menu entries can be assigned to programmable switches PF1, PF2 {16} and M1-M4 {15} (pg. 55). These switches can also be used to create custom SPLITs, etc. (<i>macros</i>, pg. 23).
Other Features	<ul style="list-style-type: none"> • RX and TX EQ (MAIN menu) provide 8 bands of receive/transmit equalization (pg. 37). • Tap AFX {18} to enable the selected audio effect (see <i>CONFIG:AFX MD</i>, pg. 55). • Tap DISP {8} and use VFO B to show time, supply voltage, etc. on VFO B (pg. 38). • The ALARM function (<i>MAIN:ALARM</i> menu entry) can be used to remind you about a contest, net, or QSO schedule, and can even turn the K3S on at alarm time (pg. 38). • The KIO3B module provides a rich set of AF {34} and digital {31-33} I/O (pg. 17).

Introduction

This comprehensive manual covers all the features and capabilities of the Elecraft K3S transceiver. We recommend that you begin with the **Quick-Start Guide** (pg. 4). The **Front Panel** section (pg. 11) and **Rear Panel** section (pg. 17) are for general reference. **Basic Operation** (pg. 23) and **Advanced Operation** (pg. 35) fill in the details.

⚠ Anytime you add new filters or options, refer to **Configuration** (pg. 48) for setup instructions.

K3S Features

The K3S offers a number of advanced features to enhance performance and versatility:

Receiver

- Up to five crystal roofing filters with bandwidths as narrow as 200 Hz (pg. 25)
- Optional high-performance sub receiver, also with up to five crystal filters, allows true diversity receive (pg. 39)
- Second preamp for weak-signal work on 12-6 meters (pg. 25)
- Three attenuation settings (pg. 25)
- Narrow ham-band front-end filters, plus wider band-pass filters for general-coverage receive with KBPF3A option (pg. 47); KPF3A also provides good sensitivity down to 100 kHz, including 2200-m and 630-m bands (pg. 41)

DSP

- 32-bit I.F. DSP for advanced signal processing, including full stereo and other binaural effects (pg. 37)
- Passband tuning and programmable DSP/crystal filter presets (pg. 14)
- 8-band transmit and receive EQ (graphic equalization) (pg. 37)
- Versatile digital voice recorder (DVR) option (pg. 31)

CW and Digital Modes

- Built-in digital-mode demodulation with text displayed on the LCD (CW, RTTY, PSK31/PSK63) (pg. 35)

- APF (audio peaking filter) for digging out weak signals in CW mode (pg. 32)
- Internal CW-to-RTTY or CW-to-PSK31/PSK63 encoding for casual digital-mode QSOs without a computer (pg. 36)
- CW decoded and displayed as you send – great for improving CW skills (pg. 35)
- Automatic CW/data signal spotting and manual fine-tuning display (pg. 32)

User Interface

- Dual VFOs with independent modes, bands, and filter settings (pg. 14)
- 100 memories with alphanumeric labels, plus 4 quick-memories per band (pg. 16)
- Dedicated message play controls for use in CW, data, and voice modes (pg. 32)
- Real-time clock/calendar with alarm and automatic power-on (pg. 38)
- Utility displays show voltage, current drain, RIT/XIT offset, front panel temperature, PA heat sink temperature, etc. (pg. 38)
- Built-in menu help text (pg. 23)
- Programmable switch “macros” to automate often-used operations (pg. 46)
- Custom “power-on banner” can be displayed on power-up (set up using the **K3 Utility** program)

Connectivity

- Remote control via USB or RS232 (pg. 46)
- Line-level analog audio jacks, plus digital audio via the USB port (pg. 17)
- Firmware upgrades via the Internet (pg. 47)
- Front and rear mic and headphone jacks
- Full stereo audio with two speaker outputs

Options and Accessories (pg. 47)

- ATU, sub receiver, digital voice recorder, 100-W PA, 2-meter module, external reference lock, and other internal options
- Fully integrated P3 Panadapter, 500+ W KPA500 amplifier and KAT500 automatic antenna tuner, K3/0-Mini remote control panel, and other accessories

Specifications

A Some specifications apply only if the corresponding option modules are installed (see *Options*, pg. 47).

GENERAL

Frequency Range	Main and Sub Receivers: 100 kHz - 30 MHz and 44-54 MHz (see receiver Sensitivity spec). Transmitter: Amateur bands between 1.8 and 54 MHz (limits vary by country). 144-148 MHz with K144XV option. 630 m (472 kHz) at ~0.5 mW) with KBPF3A. Expanded coverage of MARS allocations on request (U.S.).
Tuning Step Sizes	1, 10, 20, and 50 Hz fine steps; user-configurable coarse tuning steps (per-mode). Direct keypad frequency entry in either MHz or kHz.
Frequency Memories	100 general-purpose memories; 4 scratch-pad memories per band.
Frequency Stability	+/- 5 ppm (0-50 C) TCXO standard; +/- 1 ppm TCXO opt. (+/- 0.5 PPM typ., 0-50 C). K3EXREF option locks TCXO to an external 10-MHz reference (+/- 1 to 2 Hz typ.).
Antenna Jacks	50 ohms nominal. One SO-239 supplied (2nd ant. jack supplied with KAT3A ATU). BNC jacks for RX antenna in/out and transverter in/out (on supplied KXV3B module).
Modes	USB, LSB, AM, FM, CW, DATA (FSK D [direct], AFSK A [Audio], PSK D [Direct] and DATA A [Audio]). Built in PSK, RTTY, and CW text decode/display.
VFOs	Dual VFOs (A and B) with separate weighted tuning knobs
Remote Control Port	USB-B port and RS232 port (RJ45 jack plus supplied RJ45 to DE9 adapter). USB port can also provide line-level audio in/out on the same cable.
Audio I/O	Line-level isolated TX/RX audio interface (mono in, stereo out); front (1/4") and rear (1/8") stereo headphone jacks; stereo speaker jack.
Transverter Interface	Transmit, 0 dBm typ.; XVTR IN/OUT connectors (BNC) on supplied KXV3B module. KXV3B also includes connectors for K144XV internal 2-meter module.
Buffered IF output	BNC connector (KXV3B); see pg. 41 for interface recommendations.
Other I/O	Key/Keyer/Computer, Paddle, PTT In, and KEY Out. Band information output via binary interface and AUXBUS on ACC connector.
Real-Time Clock/Calendar	Accuracy: Approx. +/- 20 ppm (+/- 2 seconds/day). U.S. and E.U. date formats. Battery: 3 V coin cell (see pg. 51 for replacement instructions).
Supply Voltage and Current	13.8 V nominal (11 V min, 15 V max). 17-22 A typical in TX for K3S/100, 3-4 A typical in TX for K3S/10. 1.0 A typical RX (less sub receiver). When using reduced supply voltage (< 12 V), power output should be reduced (e.g. 70 W at 11 V). Recommended supply: 13.8VDC @ 25A, continuous duty for K3S/100; 13.8VDC @ 6A for K3S/10. For best results, use the supplied 5 foot (1.53 m) power cable. When a battery is used, both sides of the battery cable should be protected by fast-blow fuses.
Accessory DC output	Switched, 1.0 A max; 13 V no-load, 12 V max load (@ Vsupply = 13.8 V)
Weight (K3S/100)	Approx. 8.5 lbs. (3.8 kg). With KRX3A sub receiver option, 9.5 lbs. (4.3 kg).
Size	Enclosure only, 4.0 x 10.7 x 10.0 in., HWD (10.2 x 27.2 x 25.4 cm). With projections, 4.4 x 11.1 x 11.8 in. (11.2 x 28.2 x 30.0 cm).

RECEIVER (Main and Sub)*

Sensitivity (MDS)	HF, Preamp off: -133 dBm. Preamp 1: -138 dBm. Preamp 2 (12/10/6 m): -145 dBm.
(Typical values, in 500 Hz bandwidth)	Reduced sensitivity near 8.2 MHz (first I.F.) and from 44-49 MHz. Sensitivity decreases gradually below 1.8 MHz due to intentional high-pass response at the T-R switch. (Use RX ANT input, XVTR IN, or sub receiver's AUX input to avoid the high-pass filter loss.) Note: KBPF3A option required for full general coverage (including 100 to 1700 kHz). Sensitivity falls off below 200 kHz; MDS typically -115 dBm at 137 kHz (2200 m band) using RX ANT IN or XVTR IN.
Dynamic Range	IMD3 at 5 and 20 kHz spacing, 500 Hz BW: ~100 dB. Blocking: ~140 dB.
Image and I.F. Rejection	> 70 dB
Audio Output	2.5 W per channel into 4 ohms; typ. 10% THD @ 1 kHz, 2 W
S-Meter	Nom. S9 = 50 μ V, preamp 1 on; user-adjustable
Preamp	Preamp 1 (all bands): 10 dB; preamp 2 (12/10/6 meters): 20 dB
Attenuator	Main receiver: 5/10/15 dB levels, settable per-band. Sub receiver, 10 dB.
Noise Blanker	Adjustable, multi-threshold/multi-width hardware blanker plus DSP blanker
Receive AF graphic EQ	+/- 16 dB/octave, 8 bands
Filter Controls	IF Shift/Width & Lo/High Cut with automatic crystal filter selection

* Receive specifications are guaranteed only within ham bands. Dynamic range measurements based on 400-Hz, 8-pole filter. See www.elecraft.com for full list of available crystal filters.

TRANSMITTER *

Output Power	K3S/100: 0.1 W –100 W typ. Suggested max from 51-52 MHz, 85 W; 52-54, 70 W. K3S/10 (or K3S/100 with PA bypassed): 0.1 W –12 W, HF-10 m; 8 W max on 6 m. XVTR OUT: HF, -10 to +1.8 dBm; at 472 kHz (630 m), -3 dBm (see pg. 41). K144XV: ~10 W, 144-148 MHz.
	Note: K3S/100 output can be set up to 110 W. However, IMD and spurious products are specified at 100 W, the recommended maximum (lower on 6 m; see above).
Duty Cycle	CW and SSB modes, 100% 10-min. 100W key-down at 25 C ambient
True RF Speech Processor	Adjustable compression
Transmit AF graphic EQ	+/- 16 dB/octave, 8 bands
SSB TX Bandwidth	4 kHz max (> 2.8 kHz requires 6 kHz or 13 kHz crystal filter)
VOX	DSP-controlled, adjustable threshold, delay, and anti-VOX
Full and Semi CW Break-In	Adjustable delay; diode T/R Switching
SSB Carrier Suppression	> 50 dB
Harmonic / Spurious Outputs	> 50 dB below carrier @ 100W (> 60 dB on 6 meters)
CW Offset/Sidetone	300-800 Hz, adjustable (filter center frequency tracks sidetone pitch)
Mic Connector	Front panel, 8 pin; rear panel 3.5 mm; switchable DC bias

* Transmit specifications are guaranteed only within ham bands.

Customer Service and Support

Technical Assistance

You can send e-mail to k3support@elecraft.com and we will respond quickly – typically the same day Monday through Friday. If you need replacement parts, send an e-mail to parts@elecraft.com. Telephone assistance is available from 9 A.M. to 5 P.M. Pacific time (weekdays only) at 831-763-4211. Please use e-mail rather than calling when possible since this gives us a written record of the details of your problem and allows us to handle a larger number of requests each day.

Repair / Alignment Service

If necessary, you may return your Elecraft product to us for repair or alignment. (Note: We offer unlimited email and phone support, so please try that route first as we can usually help you find the problem quickly.)

IMPORTANT: You must contact Elecraft before mailing your product to obtain authorization for the return, what address to ship it to and current information on repair fees and turn around times. (Frequently we can determine the cause of your problem and save you the trouble of shipping it back to us.) Our repair location is different from our factory location in Aptos. We will give you the address to ship your kit to at the time of repair authorization. *Packages shipped to Aptos without authorization will incur an additional shipping charge for reshipment from Aptos to our repair depot.*

Elecraft 1-Year Limited Warranty

This warranty is effective as of the date of first consumer purchase (or if shipped from the factory, the date the product is shipped to the customer). It covers both our kits and fully assembled products. For kits, before requesting warranty service, you should fully complete the assembly, carefully following all instructions in the manual.

Who is covered: This warranty covers the original owner of the Elecraft product as disclosed to Elecraft at the time of order. Elecraft products transferred by the purchaser to a third party, either by sale, gift, or other method, who is not disclosed to Elecraft at the time of original order, are not covered by this warranty. If the Elecraft product is being bought indirectly for a third party, the third party's name and address must be provided at time of order to ensure warranty coverage.

What is covered: During the first year after date of purchase, Elecraft will replace defective or missing parts free of charge (post-paid). We will also correct any malfunction to kits or assembled units caused by defective parts and materials. Purchaser pays inbound shipping to us for warranty repair; we pay shipping to return the repaired equipment to you by UPS ground service or equivalent to the continental USA and Canada. For Alaska, Hawaii, and other destinations outside the U.S. and Canada, actual return shipping cost is paid by the owner.

What is not covered: This warranty does not cover correction of kit assembly errors. It also does not cover misalignment; repair of damage caused by misuse, negligence, or builder modifications; or any performance malfunctions involving non-Elecraft accessory equipment. The use of acid-core solder, water-soluble flux solder, or any corrosive or conductive flux or solvent will void this warranty in its entirety. Also not covered is reimbursement for loss of use, inconvenience, customer assembly or alignment time, or cost of unauthorized service.

Limitation of incidental or consequential damages: This warranty does not extend to non-Elecraft equipment or components used in conjunction with our products. Any such repair or replacement is the responsibility of the customer. Elecraft will not be liable for any special, indirect, incidental or consequential damages, including but not limited to any loss of business or profits.

Front Panel

This reference section describes all front panel controls, the liquid crystal display (LCD), LEDs, and connectors. Operating instructions are covered in later sections.

Control Groups

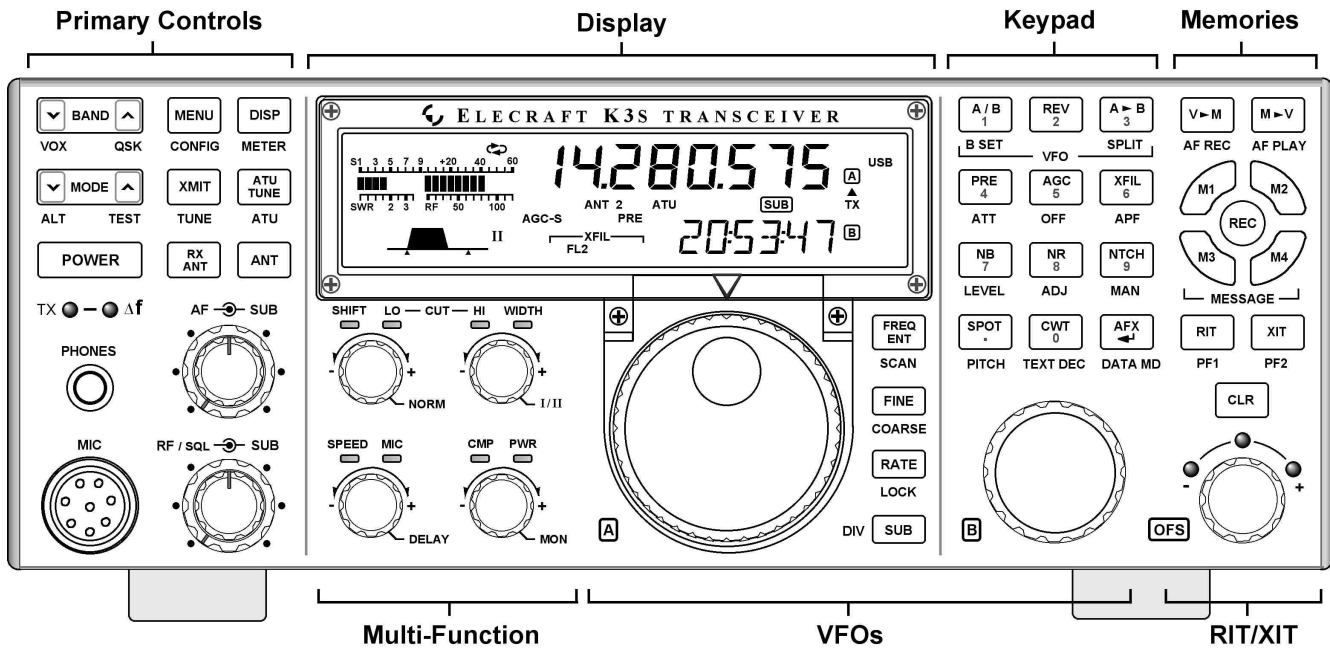

Primary Controls (pg. 13): These controls provide basic transceiver setup, including power on/off, band, operating mode, AF and RF gain and squelch, ATU and transmit controls, display modes, and menus.

Display (pg. 12): The LCD shows signal levels, VFO A and B frequencies, filter bandwidth, operating mode, and the status of many controls. The VFO B display is alphanumeric, so it can show decoded text from digital modes (CW, RTTY, PSK31/PSK63), as well as menus, time and date, help messages, etc.

Multi-Function Controls (pg. 14): The upper two knobs set up receiver DSP filtering. The lower two control transmit parameters, including keyer speed, mic gain, speech compression, and power output level. LEDs above each knob show which function is active; tapping the knob alternates between them. Pressing and holding these knobs (1/2 second or longer) provides access to secondary functions.

Keypad (pg. 15): This group of switches is numbered for use during memory store/recall and direct frequency entry, but each switch also has normal tap and hold functions. The upper row of switches are VFO controls. The remaining rows control receive-mode and miscellaneous functions, such as noise reduction and text decode/display.

Memories (pg. 16): These switches control frequency memory store/recall, message record/play, and audio record/playback (with the DVR). **M1-M4** can also be used as up to eight tap/hold programmable function switches.

VFOs (pg. 14): The large knob controls VFO A; the smaller knob controls VFO B. The four switches between the VFO knobs select tuning rates and control related functions.

RIT/XIT (pg. 16): Three switches control RIT and XIT on/off and clear (offset zero). The OFS knob below the **RIT/XIT** switches selects the offset.

Display (LCD)

Multi-character displays: The 7-segment display (upper) shows the VFO A frequency. The 13-segment display (lower) shows VFO B or text.

Bar graph, receive mode: The bar graph normally acts as an S-meter. If **CWT** is turned on, the right half of the S-meter becomes a tuning aid (pg. 36).

Bar graph, transmit mode: The bar graph normally shows **SWR** and **RF** power output. The **RF** scale will be either **5** and **10** (low power) or **50** and **100** (high power). In voice and data modes, transmit scales can be changed to compression (**CMP**) and **ALC** using **METER**.

VFO Icons: The **TX** icon indicates which VFO is selected for transmit. In TX TEST mode, or when TX is inhibited externally, **TX** flashes (see **TEST**).
LOCK Shows that VFO A or B is locked (see **LOCK**).

A
TX
VFO A is the transmit VFO

TX
B
*VFO B is the transmit VFO; see **SPLIT***

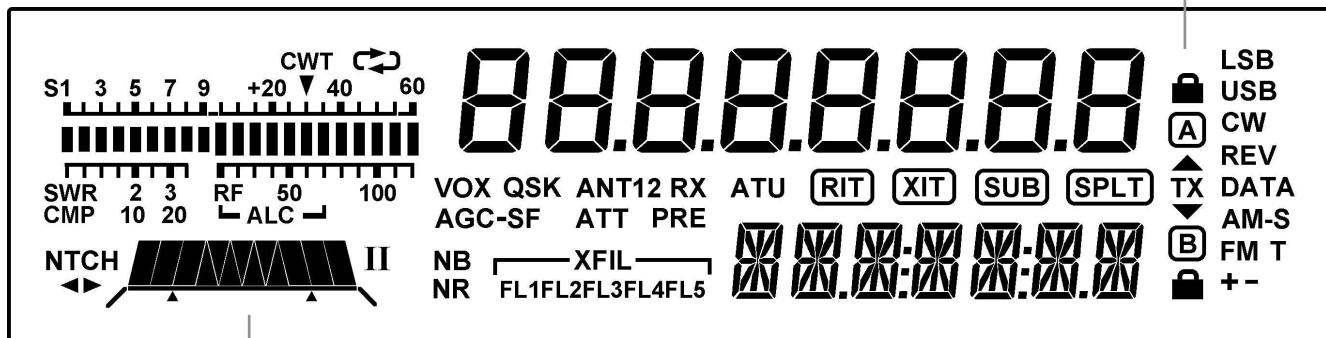

Filter Graphic: This shows the approx. bandwidth and position of the receiver's I.F. passband. See **Filter Passband Controls**, pg. 25.

Filter Icons:

- NTCH** Notch filtering on (**NTCH**, pg. 27)
- ◀▶** Manual notch (**MAN**, pg. 27)
- I / II** Shows selected preset (**I/II**, pg. 14)
- XFIL** Crystal filter selection (**FL1-FL5**)

Mode Icons:

Basic modes (**LSB / USB**, **CW**, **DATA**, **AM**, or **FM**) are selected by tapping either end (Up/Down) of **MODE**. Alternate modes (**CW REV**, **DATA REV**, **AM-S**, **FM +/-**) are selected by holding **ALT**. **LSB** and **USB** are alternates of each other. **+** icon on in SSB modes indicates ESSB (pg. 38). **T** indicates FM/tone, CW/DATA text decode, or AM-Sync auto-tracking.

Other Icons:

- CWT** CW/data tuning aid on (**CWT**, pg. 36)
- ↻** DVR in use (**AF REC / AF PLAY**, pg. 16)
- VOX** VOX enabled (**VOX**, pg. 13)
- QSK** Full break-in CW enabled (**QSK**, pg. 32)
- NB** Noise blanker on (**NB**, pg. 15)
- NR** Noise reduction on (**NR**, pg. 15)
- ANT** Antenna 1 or 2 (**ANT**, pg. 13)
- RX** RX antenna in use (**RX ANT**, pg. 13)
- ATT** Attenuator on (**ATT**, pg. 15)
- PRE** Preamp on (**PRE**, pg. 15); flashes when preamp2 is selected (pg. 25)
- ATU** ATU enabled (**ATU**, pg. 13)
- RIT** RIT on (**RIT**, pg. 16)
- XIT** XIT on (**XIT**, pg. 16)
- SUB** Sub receiver on (**SUB**, pg. 39)
- SPLT** Split mode in effect (**SPLIT**, pg. 38)

LEDs

- **TX [Red]** Turns on in transmit mode.
- **Δ F [Yellow]** The **Delta-F** LED turns on if transmit and receive frequencies or modes are different due to the use of SPLIT, RIT, or XIT.
- ▢ **[Green]** Eight LEDs show which functions are in effect for the **Multifunction Controls** (pg. 14).
- (-) ● ● ● (+) **RIT/XIT OFFSET** If the OFS control is centered, or you tap **[CLR]**, the **green** LED turns on (offset = 0). Otherwise, the **yellow** (-) or (+) LED will be on, indicating the direction of the offset. See **[RIT]**, **[XIT]**, and **[CLR]**.

Front Panel Connectors

PHONES You can use either mono or stereo headphones at either the front- or rear-panel headphone jack. Also see **[AFX]** (pg. 37).

MIC An Elecraft MH2, MD2, Proset-K2, or other compatible mic can be used (see pinout below). To select the front- or rear-panel mic, and to turn bias on/off, use the **MAIN:MIC SEL** menu entry.

Bias must be turned **on** for electret mics (e.g. MH2, MD2, Proset). It must be **off** for dynamic mics (e.g. Heil mics using HC4 or HC5 elements).

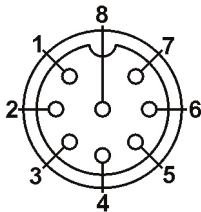

Mic jack, viewed from front of K3

- 1 Mic audio, low-Z (~600 ohms)
- 2 PTT
- 3 DOWN button *
- 4 UP button *
- 5 FUNCTION button *
- 6 8V (10 mA max)
- 7, 8 Ground

* See **CONFIG:MIC BTN** menu entry.

FP ACC This connector (RJ-45, 6 pins) is located on the bottom of the transceiver, near the VFO B knob. At present it is used only for factory test.

Primary Controls

[BAND] Tap left/right end to move among ham bands. **CONFIG:BND MAP** disables bands. For “quick” band switching, see **CONFIG:MEM 0-9**.

[VOX] Selects voice-operated or CW keying-operated transmit (**VOX** icon on), or PTT (**VOX** icon off). Also see **[DELAY]** (pg. 32) and CW VOX auto-off control (**CONFIG:CW WGHT**).

[QSK] Selects either full break-in (**QSK** icon on) or semi break-in keying, if VOX is selected in CW mode. Also see **[DELAY]** (pg.32).

[MODE] Tap the left or right end of this switch to select the operating mode. When **DATA** is selected, the **[DATA MD]** switch is used to specify DATA-A, AFSK A, FSK D, or PSK D (pg. 33).

[ALT] In **LSB** mode, switches to **USB** (and vice-versa). Also selects alternate modes, including: **CW REV**, **DATA REV**, and **AM-S** (pg. 31). In **FM** mode, selects +/- or simplex (pg. 31).

[TEST] Selects TX TEST (**TX** LCD icon flashing); allows key/mic test without actually transmitting.

[POWER] Turns the K3S on or off. **Note: To ensure correct save of operating parameters, turn the K3S off before turning the power supply off.**

[MENU] Displays MAIN menu (pg. 23).

[CONFIG] Displays the CONFIG menu (pg. 23).

[XMIT] Manually-operated transmit. Places the K3S into transmit mode (same as PTT, pg. 28).

[TUNE] Puts out a carrier at the present power level. Also **TUNE Power Level** (pg. 29).

[RX ANT] Enables the receive antenna (pg. 24). If the sub RX is on, **holding [RX ANT]** alternates between the sub’s **MAIN / AUX** antennas (pg. 39).

[DISP] Shows an alternate display on VFO B, such as time, date, voltage, etc. (pg. 38).

[METER] Selects voice transmit bar graph modes: **SWR** and **RF**, or **CMP** and **ALC** (pg. 30).

[ATU TUNE] Matches the antenna (transmitting at up to 10 W) using the KAT3A ATU (pg. 24).

[ATU] Puts the ATU into normal mode (**ATU** icon on) or bypass mode (pg. 24).

[ANT] Selects **ANT 1** or **2**. In BSET mode with the sub receiver on, selects **MAIN** or **AUX** antenna for the sub receiver (pg. 39).

Dual-Concentric Potentiometers

☉ **AF — SUB** AF gain controls for main receiver (inner, or smaller knob) and sub receiver (outer ring, or larger knob).

☉ **RF / sQL — SUB** RF gain (and/or squelch) controls for main and sub receiver.

Two menu entries are provided to control squelch directly: *CONFIG:SQ MAIN*, and *SQ SUB*. They can also be used to reconfigure the RF gain controls as squelch for either receiver, and to select FM-only or all-mode squelch. See **Config Menu** (pg. 57).

Multi-Function Controls

The upper two multi-function controls set up receiver filtering. The lower two controls adjust transmit settings. Each control has two primary functions (white labels) and a secondary function (yellow). **Tap** a control knob to alternate between its primary functions, indicated by two LEDs. **Hold** a knob (~1/2 second or longer) to select its secondary function.

Filter Controls

The primary functions of the filter controls are:

- ☉ **SHIFT** Shift passband either direction
- ☉ **LO CUT** Adjust low-frequency response
- ☉ **HI CUT** Adjust high-frequency response
- ☉ **WIDTH** Adjust width of the passband

As these settings change, so does the filter graphic. Crystal filters are selected automatically (or manually using **XFIL**, pg. 15). Also see **Filter Passband Controls** (pg. 25).

The secondary functions of these controls are:

NORM Normalize passband

Normalizing the passband sets the bandwidth to a fixed, per-mode value (e.g. 400 Hz in CW mode) and centers the passband. (Also see user-defined normal settings, **NORM 1/2**, pg. 26.)

I/II Select preset **I** or **II** (per mode)

Presets **I** and **II** each hold a continuously-updated DSP/crystal filter setup (pg. 26).

Transmit Controls

The primary functions of the transmit controls are:

- ☉ **SPEED** Keyer speed in WPM, 8-50 (8-100 if *CONFIG:CW QRR* is **ON**)
- ☉ **MIC** Mic gain
- ☉ **CMP** Speech compression level
- ☉ **PWR** RF output power in watts (pg. 28)

The present transmit mode determines which primary functions normally apply; for example, in CW mode, the ☉ **SPEED** / **MIC** control defaults to **SPEED**. You can always tap a knob to override the present selection.

The secondary functions of these controls are:

- ☉ **DELAY** VOX delay (voice/data) or CW semi-break-in delay, in seconds
- ☉ **MON** Voice or data monitor level or CW sidetone and alert tone level

i You can optionally **LOCK** the **MIC**, **CMP**, and **PWR** control settings; see *CONFIG:PWR SET*.

VFO Tuning Controls

VFO A controls the upper frequency display. This is normally the RX and TX frequency. In **SPLIT** mode, VFO B controls the transmit frequency (pg. 38). VFO B also controls the sub receiver (pg. 39).

The controls to the right of VFO A include:

FREQ ENT Direct frequency entry (pg. 15)

SCAN Start or stop scanning (pg. 42)

FINE Select 1 Hz tuning for both VFOs and RIT/XIT offset

COARSE Select coarse tuning rate (pg. 24)

RATE Select one of two normal tuning rates (10/50 or 10/20 Hz; pg. 24)

LOCK Lock VFO A (use **BSET** to lock B)

SUB Turn sub receiver on/off (pg. 39)

DIV Turn diversity mode on/off (pg. 40)

i To link VFO B to VFO A, set *CONFIG:VFO LNK* to **ON**. This is not necessary in diversity mode, where VFO A always tunes both receivers.

i VFO A can optionally be coarse-tuned using the RIT/XIT offset control if both **RIT** and **XIT** are off. See *CONFIG:VFO OFS*.

Direct Frequency Entry

To jump to any frequency within the tuning range of the K3, tap **FREQ ENT**, then enter 1 to 3 MHz digits, a decimal point, and 0 to 3 kHz digits. Follow this with **Enter** () to accept or **FREQ ENT** to cancel. The decimal point is optional if no kHz digits are entered, making it very easy to get to the low end of most ham bands.

Examples:

1.825 MHz: **FREQ ENT** **1** **8** **2** **5** 

1.000 MHz: **FREQ ENT** **1** 

50.100 MHz: **FREQ ENT** **5** **0** **.** **1** 

i For frequencies under 1 MHz, start entry with a decimal point. If 4 or more digits are entered without a decimal point, a value in kHz is assumed.

Keypad

Keypad switches have the tap and hold functions listed below. They are also used for selecting quick memories 0-9, and for direct frequency entry.

VFO Controls (Upper row)

The upper row of numeric keypad switches is used to set up VFOs A and B. Their functions are:

A / B	Exchange VFO A and B contents
BSET	Set up VFO B and sub RX (see below)
REV	Exchange VFO A and B temporarily (repeater RX/TX swap in FM-RPT)
A ► B	Copy VFO A frequency to VFO B; tapping twice copies all other settings (also see <i>CONFIG:VFO B->A</i>)
SPLIT	Enable SPLIT receive/transmit

i If **cross-mode** operation is not allowed for the present VFO A and B modes, you'll see **SPL N/A** if you try to enable SPLIT. If cross-mode operation is allowed, the mode icon for VFO B will flash as a warning. Tap any switch to cancel the flash.

Holding **BSET** allows VFO B (and the sub receiver, if on) to be set up directly (pg. 39). As long as **BSET** is displayed, all VFO-related controls and display elements apply to VFO B. An alternative is to exchange VFOs with **A / B**, set up VFO A, then exchange them again.

Receiver Control & Misc. (Lower Rows)

A Receiver control functions normally apply to VFO A/main receiver. If **BSET** is in effect, they apply to VFO B (and the sub receiver if turned on).

PRE	Preamp on/off; also selects preamp 2 if enabled on 12/10/6 meters (pg. 25)
ATT	Attenuator on/off (5/10/15 dB, per-band; hold switch for 2 seconds to go directly to <i>MAIN:ATTEN</i> setting)
AGC	AGC slow/fast (also see <i>CONFIG:AGC DCY</i> , <i>AGC HLD</i> , and other AGC menu entries)
OFF	AGC off/on (when off, an AF limiter is available; see <i>CONFIG:AF LIM</i>)
XFIL	Select next available crystal filter (see <i>CONFIG:FLx ON</i>)
APF	CW: APF or Dual-passband filtering (see <i>CONFIG:DUAL PB</i>); RTTY: dual-tone filtering (pg. 32)
NB	Noise blanker on/off (pg. 27)
LEVEL	Noise blanker levels (pg. 27); use VFO A knob to setup DSP blanker, and VFO B to setup I.F. blanker
NR	Noise reduction on/off (pg. 27)
ADJ	Noise reduction parameter adjust; use VFO B knob (pg. 27)
NTCH	Notch filter auto/manual/off (pg. 27)
MAN	Manual notch frequency (pg. 27); use VFO B knob
SPOT	Spot tone on/off (manual), or auto-spot (if CWT is on; pg. 36)
PITCH	CW sidetone PITCH , PSK pitch, FSK / AFSK MARK tone and shift (pg. 33), or FM tone setup (pg. 31)
CWT	CW/data tuning aid on/off (pg. 36); turn on to use auto-spot
TEXT DEC	Text decode , CW or DATA (pg. 35); use VFO B knob to select mode
AFX	Audio effects on/off (pg. 37); use <i>CONFIG:AFX MD</i> to set mode
DATA MD	DATA mode selection (pg. 33); use VFO B knob

Memory Controls

Frequency Memories

The K3S has 100 general-purpose memories (00-99), plus per-band memories (M1-M4 on each band). Each memory holds VFO A and B frequencies, modes, filter presets, antenna selection, and other settings. Each can have a text label of up to 5 characters (A-Z, 0-9, and various symbols).

i The *Elecraft Frequency Memory Editor* software application can be used to simplify setup and use of memories. Refer to our K3/K3S software web page for details.

To store a general-purpose memory (00-99): First tap **V ► M** (VFO to Memory), then locate the desired memory using the VFO A knob. The VFO A frequencies stored in each memory will be shown as you scroll through them. When you reach the desired memory number, tap **V ► M** again to store, or tap **M ► V** to cancel the operation.

To recall a general-purpose memory: Tap **M ► V**, then select memory **00-99** using VFO A. Tap **M ► V** again to exit.

Memories 00-09 are **quick memories**, accessible with just two switch taps. These could be used to get to a starting point in each of 10 ham bands. Memories **M1** – **M4** are **per-band quick memories**. For example, you might set up **M1** for each band's CW segment, **M2** for the SSB segment, etc.

i **Memories 00-09 can act as if they were band switches; see CONFIG:MEM 0-9.**

To store or recall quick memories: Tap **V ► M** or **M ► V** as before, but instead of rotating VFO A, tap **0** - **9** or **M1** - **M4**.

To erase one or more memories: While scrolling through memories to save or recall, tap **CLR**. Not applicable to per-band quick memories (**M1**-**M4**).

To add or change a memory's text label: First tap **M ► V**, then select a memory (**00-99**) using VFO A. Next, rotate VFO B to select each label position in turn as indicated by the flashing cursor. Use VFO A to change characters. After editing, tap **M ► V** again. (Labels can be edited at any time, including when you initially store a memory using **V ► M**.)

i **Adding an asterisk (*) at the start of a label designates a channel-hopping memory (pg. 42).**

Digital Voice/Audio Recorder (KDVR3)

The DVR can continuously record receive audio (up to 90 seconds). To start/stop audio record, hold **AF REC**. To start/stop playback, hold **AF PLAY**. The  icon flashes during DVR use.

Playback position (0-90 sec.) is shown on the VFO B display; "*" appears if you're within the most recent segment. Use VFO B to change the position.

For DVR voice message record/play, see pg. 31.

Message Record/Play Controls

Five switches provide record and playback of outgoing messages: **M1**, **M2**, **M3**, **M4** and **REC**. These switches provide single-tap play, hold-to-repeat, and other functions that are convenient for contests and for sending often-repeated text or voice messages during QSOs. CW messages can be viewed and edited using *K3 Utility*, if desired.

For details on CW message record/play, see pg. 32. The same messages can be used with CW-to-DATA (pg. 36). For voice message record/play, see **Digital Voice Recorder** (pg. 31).

i **M1** through **M4** can alternatively be used as tap or hold programmable function switches (pg. 23).

RIT and XIT Controls

RIT RIT (receive incremental tuning) on/off.

PF1 Programmable function switch (pg. 23)

XIT XIT (transmit incremental tuning) on/off.

PF2 Programmable function switch (pg. 23)

CLR Sets RIT/XIT offset to 0. Hold for 2 seconds to copy present RIT offset to VFO A before clearing.

The RIT/XIT offset control sets the offset for **RIT** and **XIT**. Three LEDs above the control show at a glance whether an offset is in effect (pg. 11).

i If *CONFIG:RIT CLR* is set to **UNDO ON**, tapping **CLR** will alternate between **0.00** and the last non-zero offset selected, if any.

Rear Panel

Connector Groups

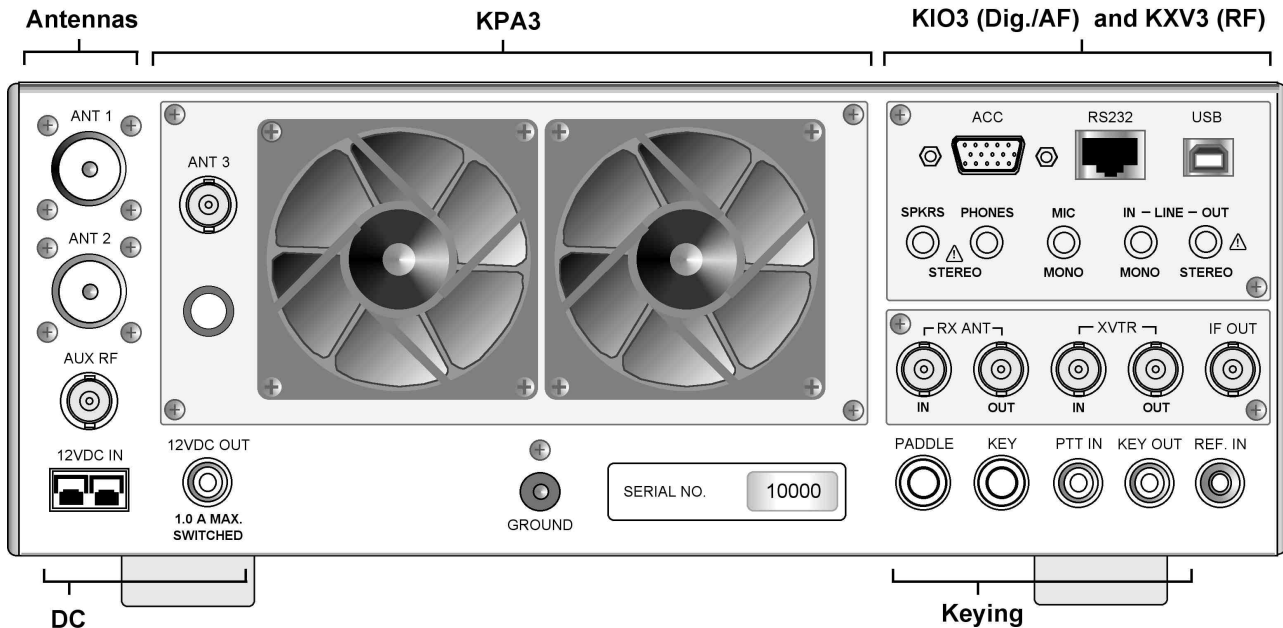

⚠ The appearance of your rear panel may vary depending upon the options installed.

Antennas: **ANT1** (SO-239) is standard. **ANT2** (SO-239) is supplied with the KAT3A ATU option, which includes an antenna switch controlled from the front panel. Both jacks are nominally 50 ohms when the ATU is bypassed. **AUX RF** (BNC) is for use with the KRX3A option; see pg. 39 and pg. 43. **ANT3** (BNC, on the KPA3A option panel) is the antenna jack for the optional K144XV 2-m module.

DC: **12 VDC IN** jack is an Anderson PowerPole connector rated at 30 amps. (See *Specifications*, pg. 8, for detailed power requirements.)

12 VDC OUT (RCA/Phono) provides up to 1.0 A (switched) for use with accessory devices.

Ground Terminal: A good station ground is important for safety and to minimize local RFI.

KPA3A: This option panel is blank in the K3S/10 except for **ANT3** (see above). In the K3S/100, the blank panel is replaced with the fan panel shown, which includes a **circuit breaker**.

KIO3B (pg. 19): Provides computer, auxiliary control, and audio connections. **The USB connector** handles both digitized line-level audio and data (pg. 18). **The RS232/P3 jack** (RJ45) is used with the P3 and/or for RS232 station control; an RJ45-DE9 adapter is included (pg. 19).

KXV3B: Provides a variety of RF I/O signals, including receive antenna in/out (pg. 41), transverter in/out (pg. 41), a buffered I.F. output for use with the Elecraft P3 (pg. 47), and internal I.F. connections for the **K144XV** 2-m module. **Preamp 2**, for weak-signal work on 12/10/6 m, is also included on this module (see pgs. 25 and 45).

⚠ External preamps such as the PR6-10 are not needed with the K3S. See **Preamp 2** (pg. 25).

Keying: **PADDLE** (1/4" jack) is the keyer paddle input (see *CONFIG: CW PDL*). **KEY** (1/4" jack) can be used with a hand key, external keyer, computer, or other device. **PTT IN** (RCA/Phono) is for use with a footswitch, etc. **KEY OUT** (RCA/Phono) is the amplifier T-R relay keying output, capable of keying up to +200VDC @ 5A.

REF IN (SMA): External 10-MHz reference input for use with the K3EXREF option module (see *CONFIG: REF CAL* and *CONFIG: XVn OFS*).

Control and Audio Connections

The K3S provides a full complement of station control and audio interfaces on the KIO3B panel. These interfaces are described in this section.

USB Port (Control and Audio)

The USB port can be used for computer-based remote control. It also acts as the equivalent of a built-in USB sound card, eliminating the need for external converters and additional cables.

A single USB cable can handle all of these interface requirements:

- commands from logging/contesting software
- line-level audio input/output (audio is digitized by the KIO3B's USB interface)
- PTT and CW keying (via "DTR" and "RTS")

Most software applications will work with USB instead of RS232. They will recognize the transceiver's USB port as a "COM" port, and/or as a sound device, selectable from within the application.

An Elecraft P3 Panadapter can be connected directly to the K3S even when the USB port is used with your computer. See details at right.

To connect a computer to the K3S via USB:

- Connect the supplied USB cable from the K3S to any available USB port on your computer. (See illustration below.)
- If you also have a P3, connect it to the RS232/P3 port as shown, using an Elecraft model CBLP3Y cable.
- Set the **CONFIG:RS232** menu parameter to **USB**. Exit the menu.
- With the USB cable plugged in and the K3S turned on, determine which COM or sound device ports have been assigned to the K3S. This can be done from within applications. On Windows PCs, an alternative is to locate the Device Manager (Start > Control Panel > System > Hardware), and view its list of **Ports**. When you plug in the USB cable from the K3S, a new COM port will appear in the list.
- If you plan to do PTT or CW keying from the computer, see **PTT and Keying** (next page).

Optional: Using LINE IN/OUT jacks with USB

We recommend using the digital audio line-in/out capability provided by the USB cable. The analog LINE IN/OUT jacks can then remain unconnected. See pg. 22 for further details on LINE IN/OUT.

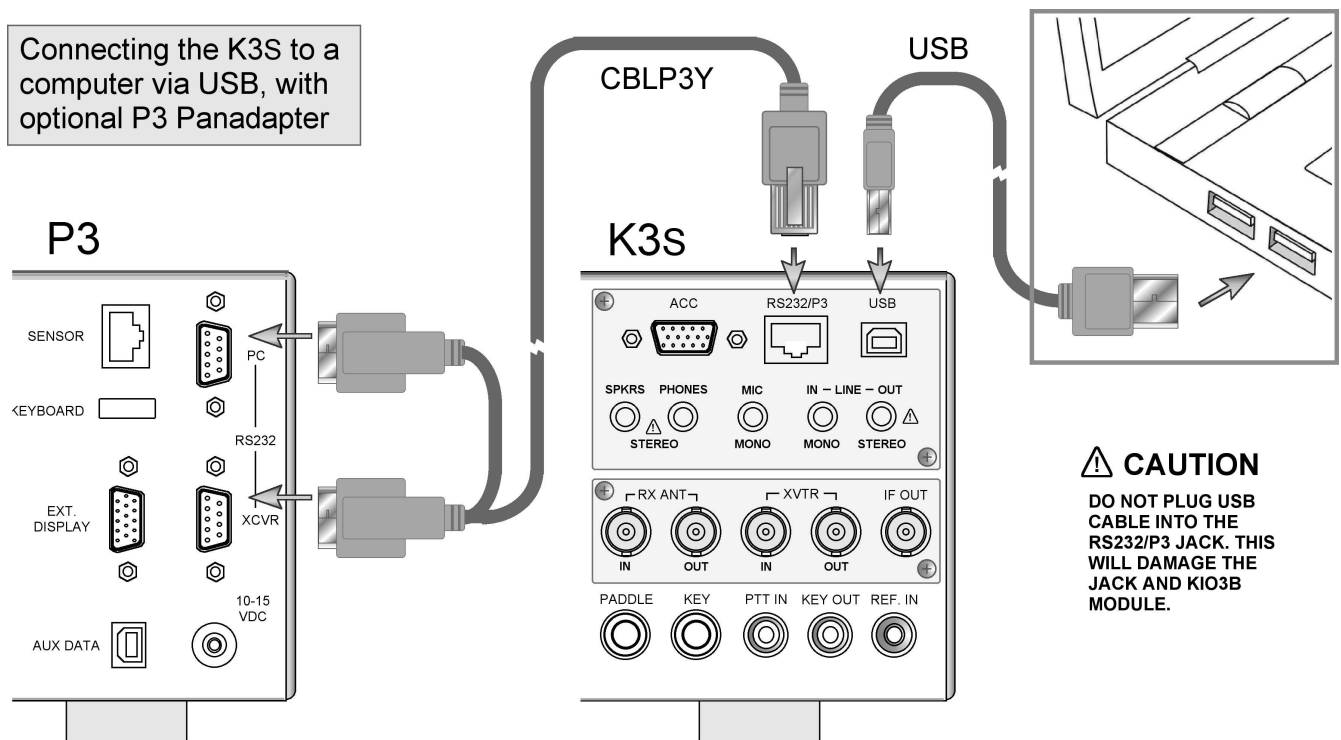

RS232 / P3 Panadapter Port (RJ45)

The RS232/P3 port can be used with an Elecraft P3 Panadapter, or with a computer's RS232 interface.

i In most cases it is preferable to connect the computer to the transceiver's USB port as described on pg. 18. However, RS232-only installations can also be used, as discussed on this page.

An adapter cable to convert RJ45 to DE9 (RS232 standard, female) is supplied with the K3S (Elecraft #E980297). This adapter allows you to connect the K3S to a P3, or to a computer via a user-supplied RS232 cable, as shown below. The adapter cable's DE9 connections are shown on the next page. RJ45 jack connections are shown below.

If you plan to use the RJ45 jack for PTT or keying from the computer, see **PTT and Keying** (pg. 20). Typically such connections would be made at the DE9 end of the supplied adapter, rather than directly at the RJ45 jack.

To connect a P3 Panadapter to the K3S, and optionally connect a computer to the P3 (via RS232):

- Use the supplied Elecraft #E980297 cable to connect the P3 to the K3S as shown (see **illustration below**). At the K3S end, the cable is connected to the RS232/P3 jack. At the P3, the cable connects to the XCVR jack.
- A computer can optionally be connected via RS232 to the P3's PC jack as shown. The cable is user-supplied. (See DE9 signals, next page.)
- Set **CONFIG:RS232** to **38400**.

To connect a computer to the K3S via RS232, without a P3 Panadapter:

- Connect the RJ45 end of cable # E980297 to the K3S as shown below. Connect the DE9 end to a computer, using an additional user-supplied cable if required.
- Set **CONFIG:RS232** to the desired baud rate.

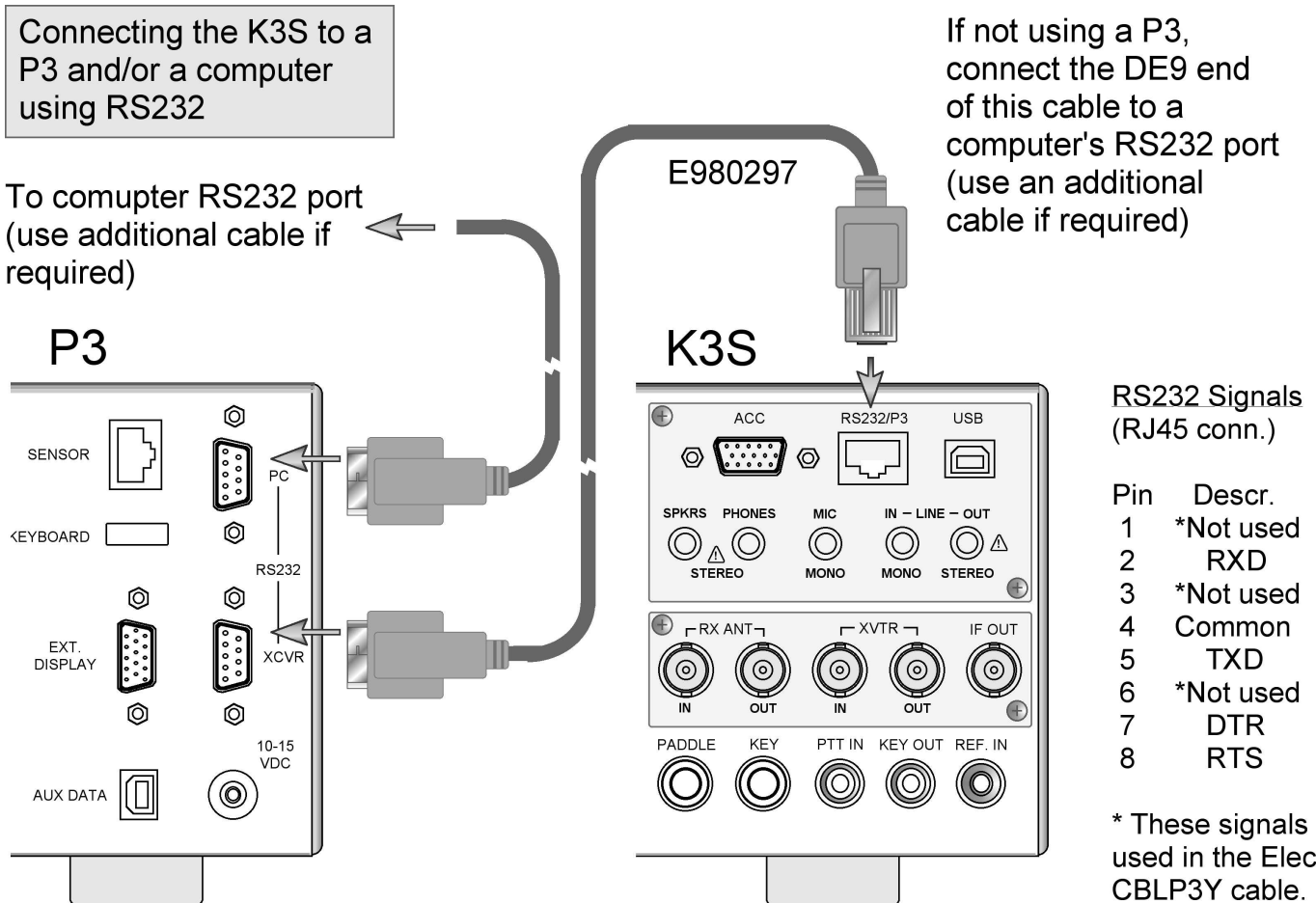

RS232 Adapter Cable

The supplied Elecraft #E970297 cable converts from RJ45 (at the K3S end) to DE9 (RS232 standard). The DE9 end can be connected to a P3's XVTR jack, or to a computer's RS232 port. The pinout for this end of the adapter is shown below.

If an additional RS232 cable is required to reach your computer, it can be wired straight-through, using as few as three wires (RXD, TXD, and ground). DTR and RTS are optional.

⚠ This table uses EIA standard descriptions, which are from the perspective of the PC.

Pin #	Description
1,6,8,9	Not used
2	RXD IN (data to PC from K3S)
3	TXD OUT (data to K3S from PC)
4	DTR (see PTT and Keying , below)
5	Ground (RF isolated)
7	RTS (see PTT and Keying , below)

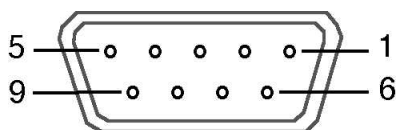

RS232 adapter cable DE9 connections (female)

Serial Port Setup: Set `CONFIG:RS232` for the desired baud rate. Software should be set up at the same rate; 8 data bits, no parity, 1 stop bit.

PTT and Keying (via DTR and RTS)

In the K3S, these are **not** used as serial I/O handshaking lines. Instead, the K3S can use these as PTT IN or KEY IN (see `CONFIG:PTT-KEY`). The default for both signals is *inactive*. Refer to application software documentation to determine if it can use RS232 signal lines for PTT or keying.

⚠ Use these signals with caution. A computer may assert DTR or RTS during power-up, causing the K3S to transmit unexpectedly. If a computer or other device asserts RTS or DTR while you're using the `PTT-KEY` menu entry, the K3S will enter TEST mode as a precaution, allowing you to change the menu setting if required.

ACC (Accessory I/O)

ACC connector pinouts are listed below.

⚠ ACC is not a VGA video connector. The K3S does not provide a video output. (The P3 does have an SVGA video output option; see pg. 47.)

Pin #	Description
1	FSK IN (see FSK Input)
2	AUXBUS IN/OUT (see KRC2 or XV-Series transverter instruction manual)
3	BAND1 OUT (see Band Outputs)
4	PTT IN (in parallel with MIC PTT)
5	Ground (RF isolated)
6	DIGOUT0 (see Transverter Control)
7	K3S ON signal (out) or TX INH (in) (see Transverter Control, TX INH)
8	POWER ON (see pg. 46)
9	BAND2 OUT (see Band Outputs)
10	KEYOUT-LP (10 mA keying output)
11	DIGOUT1 (see DIGOUT1)
12	Ground (RF isolated)
13	BAND0 OUT (see Band Outputs)
14	BAND3 OUT (see Band Outputs)
15	EXT ALC input (see External ALC , pg. 29)

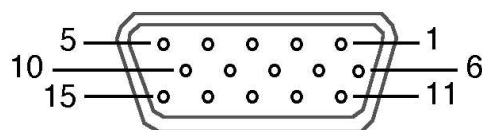

ACC Connector (female, on KIO3B panel)

FSK Input (for FSK D Data Mode)

This is a TTL input pulled up to 5V, compatible with PC outputs. When used with an RS232 signal from the PC, a level translator is required.

DIGOUT 1

DIGOUT1 is a per-band/per-antenna output for controlling external gear. See `CONFIG:DIGOUT1`.

Band Outputs (BAND0-BAND3)

BAND0-BAND3 are open-drain band selection outputs, with internal pull-up resistors to 5 V. Their behavior is controlled by *CONFIG:KIO3B* (see below). Band data is based on VFO A's frequency.

In tables below, **0** = pulled to ground (0 V). **1** = floating to 5 V. External pull-up resistors can be connected a voltage not exceeding 14 V.

With *CONFIG:KIO3B* set to **NOR**, the BAND0-3 outputs are mapped based on the selected HF-6 m band as shown below. On transverter bands, BAND0-3 will all be set to zero.

Band	BAND3	BAND2	BAND1	BAND0
160 m	0	0	0	1
80 m	0	0	1	0
60 m	0	0	0	0
40 m	0	0	1	1
30 m	0	1	0	0
20 m	0	1	0	1
17 m	0	1	1	0
15 m	0	1	1	1
12 m	1	0	0	0
10 m	1	0	0	1
6 m	1	0	1	0

If *CONFIG:KIO3B* is set to **TRN**, BAND0-3 reflect the parameters of the *CONFIG:XVn ADR* menu entry, as shown below. On HF-6 m they're set to 0. Addresses **INT. TRN0-9** are used with the internal 2-m transverter option (K144XV). **INT TRN0** sets all band outputs to 0, while **INT TRN1-9** have the same decodes as **TRN1-9**.

Transverter addresses are also sent to Elecraft XV-series transverters and the KRC2 band decoder accessory via the AUXBUS line. **Note: TRN1-7** are sent as 1-7, but **TRN8-TRN9** are sent as 0.

ADR	BAND3	BAND2	BAND1	BAND0
TRN1	0	0	0	1
TRN2	0	0	1	0
TRN3	0	0	1	1
TRN4	0	1	0	0
TRN5	0	1	0	1
TRN6	0	1	1	0
TRN7	0	1	1	1
TRN8	1	0	0	0
TRN9	1	0	0	1

With *CONFIG:KIO3B* set to **HF-TRN**, the BAND0-3 outputs follow the **NOR** table when HF-6 m bands are selected, and the **TRN** table when a transverter band is selected.

Transverter Control

Normally, when the K3S is turned on, a 5-VDC logic signal appears on ACC pin 7 (**K3S ON**). This could be used with Elecraft XV transverters as an enable signal (pin 8 of J6 on the transverter).

However, pin 7 can alternatively be configured as a transmit inhibit *input* line for use in multi-transmitter stations. (See **TX INH**, below.) In this case it is not available as a power-on signal for Elecraft transverters. Instead, the transceiver's 12-VDC switched output could be used as a transverter ON signal.

For transverter keying, you can use KEYOUT-LP signal (pin 10 of the ACC connector) or the KEY OUT jack (RCA).

With *KIO3B* set to **TRN** or **HF-TRN**, the DIGOUT0 line (ACC, pin 6) will output 0 V when low power mode is selected for the current transverter band (*CONFIG:XVn PWR*). At all other times, DIGOUT0 will be floating (Hi-Z).

TX INH (Transmit Inhibit Signal)

Pin 7 of the ACC connector can be configured as a transmit inhibit input by setting *CONFIG:TX INH* to **LO=Inh** (or **HI=Inh**). Holding pin 7 low (or high) will then prevent transmit. An external 2.2 to 10 K pull-up resistor (to 5 VDC) is required.

⚠ If *TX INH* is set to **OFF**, pin 7 reverts to its default *output* function, K3S ON (see above).

Elecraft KRC2 Universal Band Decoder

An Elecraft KRC2 can be used with the K3 to perform station switching functions; it includes sink and source relay drivers for all bands. The KRC2 obtains band data via the AUXBUS rather BAND0-3. (See *CONFIG:KRC2* for 6-m band mapping). Refer to the KRC2 instruction manual for more information.

SPKRS

STEREO or MONO; 4 to 8 Ω

Plugging in external speaker(s) cuts off the internal speaker. **A stereo plug is recommended**; tip is left speaker, ring is right. If you must use a mono plug, set *CONFIG:SPKRS* to **1** to disable right-channel audio. (This will result in mono headphone output, as well, if you also set *SPKR+PH* to **YES**.)

⚠ If the speaker is not working with headphones unplugged: Locate the *CONFIG:SPKR+PH* menu entry. Tap **1** on the numeric keypad until you see **PH.R SW-** (specifying inverted logic for the rear headphone jack). This is the default setting, required for the K3S.

PHONES

STEREO or MONO; 16 Ω min. recommended

The front and rear-panel headphone jacks are both isolated with series resistors. This allows you to use mono phones on one jack and stereo on the other, if required. You'll need stereo phones for AFX (audio effects) and stereo dual receive (with sub receiver).

i You can plug in headphones and speaker(s) at the same time, and hear audio in both, if you set *CONFIG:SPKR+PH* to **YES**. However, if you set *CONFIG:SPKRS* to **1**, setting *SPKR+PH* to **YES** will result in mono output for both headphones and speakers. You can set *SPKRS* to **2** if you use a stereo plug at the external speaker jack, or if no external speaker is plugged in.

MIC

MONO; hi- or low-Z

This jack accommodates an electret or dynamic mic. Use *MAIN:MIC SEL* to select the rear panel mic (**RP**). Tap **1** to turn on Low or High mic gain range. Tap **2** to turn bias on/off (see pg. 30 for recommendations based on mic type).

For the front-panel mic only, additional microphone gain can be enabled by tapping **7**. **Use this only for very low-output mics. Not required for use with the Elecraft MH2.**

If the rear-panel mic has a PTT line, it can be connected to either the PTT IN jack or the PTT input on the ACC connector (pg. 20).

LINE IN

MONO, transformer-isolated; 600 Ω (nominal)

The LINE IN jack on the K3S can be connected to your computer's soundcard output. (It is preferable in most cases to obtain line-in audio via the USB cable. See pg. 18.)

If a plug is inserted into LINE IN at the K3S, this line input will override the USB port's line-in.

The **MIC** gain control on the K3S sets the line input level when the *MAIN:MIC SEL* menu entry is set to **LINE IN**.

⚠ The LINE IN level should be set carefully to avoid transmit signal distortion due to saturation of the input audio transformer. In addition, computer sound card gain should be set 6 to 10 dB below the level at which the sound card's output stage starts clipping.

LINE OUT

STEREO, transformer-isolated; 600 Ω (nominal)

LINE OUT can be connected to your computer's soundcard inputs. (However, this is not necessary if you're using the USB port for line-level audio.) Normally, the left channel is main receiver audio, and the right channel is sub receiver audio (if applicable). In this case the outputs are post-AGC but pre-AF-gain.

Use *CONFIG:LIN OUT* to set the level, or to switch from a fixed-level setting to **=PHONES**.

⚠ LIN OUT settings above 10 are usually not necessary. This can in some cases cause overloading of either the output transformers in the K3S or the PC soundcard inputs (typically on noise peaks). Either could degrade the performance of demodulation software.

⚠ Some computers have only very high-gain, high-impedance microphone inputs, not line-level inputs. This can make it difficult to adjust the LINE OUT level, and can also worsen noise pickup. If a high-impedance mic input must be used, you can add a resistive attenuator between the K3S and the mic input to improve signal-to-noise level.

Basic Operation

This section covers the fundamentals of K3S receive and transmit operation. It'll also get you started using each of the major operating modes.

Once you're familiar with the K3S, please go on to **Advanced Operating Features** (pg. 35).

Using Tap/Hold Switches

Most K3S switches have two functions. **Tapping** (pressing for less than 1/2 second) activates the function labeled on the switch. **Holding** (pressing for more than 1/2 sec.) activates the function labeled beneath the switch.

Initial Power-Up

- Connect a power supply (pg. 8); antenna or dummy load; key, if used (pg. 16); mic, if used, and station ground (pg. 16).
- Tap **POWER** to turn the K3S on. The LCD should illuminate and show VFO A and B frequencies. (Tapping **POWER** again turns power off.)
- The VFO B display can show a variety of useful parameters in addition to the normal frequency display. To see these, tap **DISP** (left of the display), then rotate the VFO B knob. The VFO B display will cycle through **time**, **date**, **RIT/XIT offset**, **supply voltage**, **current drain**, etc. (pg. 38). You can use these displays to make sure the supply voltage is in range (11-15 V), and that current drain is about 1 amp (higher with sub receiver installed and turned on). Tap **DISP** to return to the normal VFO B frequency display.

Using the Menus

There are two menus: **MAIN** and **CONFIG**. Most entries in the CONFIG menu are used for test, configuration, and alignment, and are used infrequently.

Nearly all menu entries appear in alphanumeric order. In the few exceptions to this, adjacent entries are still closely related.

MAIN Menu

- Tap **MENU** to access the main menu. (Tapping **MENU** again exits the menu.)
- Use VFO B to scroll through the menu entries, referring to the list on pg. 55 for details.
- Change the value (or *parameter*) of any menu entry using VFO A.

CONFIG Menu

- Hold **CONFIG** (*hold* function of the **MENU** switch) to access the CONFIG menu. Holding CONFIG for 3 seconds enters **TERMinal** mode (for use with the K3/0-Mini panel; see pg. 47).
- Use VFO B to scroll through the CONFIG menu entries, referring to the list on pg. 57.

Menu Help

While in the menu, tapping **DISP** shows help information about the present menu entry. For most entries, the default parameter value is shown in parentheses at the start of the help text.

Programmable Functions

Menu entries that you'd like quick access to can be assigned to any of the 10 programmable function switches, **PF1**, **PF2**, and **M1** – **M4** (tap or hold). "**Function**" menu entries can *only* be used via such a switch assignment. (Examples, from the CONFIG menu: *VFO B->A* and *TTY LTR*.)

To set up a programmable function switch, first use **MENU** or **CONFIG** to locate the target menu entry. Next, hold **PF1** or **PF2**; *or*, tap or hold **M1** – **M4**. For example, if you tap **M2**, you'll see **M2T SET** (T for tap), while holding **M2** would show **M2H SET** (H for hold). The assigned switch can then be used as a shortcut to access that entry. **M1** – **M4** can each be assigned a tap and/or hold function.

i Any **M1** – **M4** switch that is used as a programmable function switch will not be available for message play. To cancel a programmable switch assignment and restore a previously-saved message, tap **REC**, then tap the buffer you'd like to restore (**M1** – **M4**), then tap **REC** again.

Macros

Programmable switches can also be used to automate often-used sequences, or *macros*, such as "SPLIT, A>B, move VFO B up 5." Refer to the **CONFIG:MACRO x** menu entry, **K3 Utility** help, or the **K3 Programmer's Reference**.

Band and Mode Selection

Tap either end of **BAND** to select the desired ham band (160 through 6 meters). You can use direct frequency entry (pg. 15), or recall a frequency memory (pg. 16). Individual bands can be mapped out if not needed (see *CONFIG:BND MAP*).

Tap either end of **MODE** to select the operating mode. Hold **ALT** to select an alternate mode, if required. This include **CW REV** (pg. 32), **DATA REV** (pg. 33), **AM-S** (synchronous detection, pg. 31), and **FM +/-** (FM repeater split, pg. 31).

Antenna Selection and Matching

Main Antennas (ANT1 and ANT2)

With a KAT3A ATU installed, you can connect antennas to both **ANT1** and **ANT2**; tap **ANT** to select. Holding **ATU** selects **AUTO** (autotune enabled) or **BYPASS** mode. In **AUTO** mode (**ATU** icon on), the antenna can be matched for best SWR by tapping **ATU TUNE**. Up to 30 ATU settings are saved for both antennas. See *CONFIG:KAT3* for instructions on clearing ATU memories.

The **ATU** icon will flash briefly whenever new settings are automatically loaded.

i Tapping **ATU TUNE** a second time within 5 seconds starts a more extensive match search. The ATU can even be manually tuned if desired. Refer to *CONFIG:KAT3A* for details.

i Holding **ANT** allows names to be assigned to ANT1 and 2 (e.g., 'YAGI'). These will be flashed when you switch antennas. When editing names, VFO B selects the character position to change; VFO A cycles through available characters. Setting the first character to "-" disables name display.

Receive-Only and 2-Meter Module Antennas

Tap **RX** to select the receive-only antenna (**RX ANT IN/OUT** on the KXV3B module, pg. 41). The KRX3A sub receiver either shares the main receiver's selected antenna or uses an auxiliary input (see **AUX RF**, pgs. 39 and 43).

If a K144XV 2-meter module is installed, connect its antenna to **ANT3**. (See K144XV manual.)

Automatic control of a KAT500 ATU

The K3S can automatically recall settings for a connected KAT500 ATU as the VFO is tuned. See *CONFIG:KAT3A* and the KAT500 owner's manual.

Using the VFOs

VFO A is both the main receive and transmit frequency, except during **SPLIT**, in which case VFO B controls the transmit frequency (pg.38). VFO B also controls the sub receiver (pg. 39).

Tap **RATE** to select 10 / 50 Hz per step. The faster rate can be changed using *CONFIG:VFO FST*. The number of counts (or steps) per VFO knob turn can be changed using *CONFIG:VFO CTS*. Tapping **RATE** briefly flashes either the 10-Hz or 100-Hz digit to indicate slow or fast tuning.

For 1-Hz steps, tap **FINE**; for wider steps, use **COARSE** (*CONFIG:VFO CRS* sets coarse steps per-mode). When **FINE** is in effect, a 1-Hz digit will appear in the VFO A display. When **COARSE** is in effect, the 10-Hz digit is not shown.

Tap **A ► B** once to copy VFO A's frequency to VFO B. Tapping **A ► B** a second time within 2 seconds also copies VFO A's filter setup, preamp state, and other settings to VFO B.

A / B exchanges VFO A and B and their settings. (Also see *CONFIG:VFO B->A*.) Pressing **REV** only exchanges the VFOs for as long as you hold it in. (Exception: When using an FM repeater offset, **REV** permanently swaps RX/TX.)

VFO B and the sub receiver can be set up directly by holding **BSET**. While **BSET** is in effect, all icons and VFO-related controls apply to VFO B (and to the sub receiver, if turned on; see pg. 39).

Holding **SUB** turns on diversity mode (pg. 39).

RIT and XIT

The RIT/XIT offset control, at the far right, sets the offset for **RIT** and **XIT**. The offset is shown on the VFO B display as you adjust the control. Three LEDs show whether the offset is 0, (-) or (+).

Tap **CLR** to zero the RIT/XIT offset. Tapping it a second time restores the offset.

To copy the present RIT offset to VFO A, hold **CLR** for 2 seconds. VFO A will be moved to the new frequency before the offset is zeroed.

i If RIT/XIT are both off, the offset control can coarse-tune VFO A (*CONFIG: VFO CRS*). Coarse tuning steps are programmable by mode.

Receiver Setup

This section explains how to use basic receiver controls. Setup for specific operating modes is described in later sections; see *Voice Modes* (pg. 30), *CW Mode* (pg. 32), and *Data Modes* (pg. 33).

Also see *Text Decode and Display* (pg. 35) and *Audio Effects* (pg. 37).

Receiver Gain Controls

Use \odot **AF** — **SUB** (pg. 11) to set the desired main and sub receiver volume level. There are two overall audio volume ranges, LO and HI, which can be selected using *CONFIG:AF GAIN*.

Usually, both \odot **RF** — **SUB** controls will be set fully clockwise (main and sub receiver RF gain). You may wish to reduce RF gain to optimize receiver response to high signal levels or noise.

i If sub RF gain has been configured as squelch for both receivers, then main RF gain will control RF gain for both. (See *CONFIG:SQ MAIN*.)

Preamp and Attenuator Controls

Tap **PRE** to turn on preamp 1 (+10 dB). On 12-6 m, a second tap turns on preamp 2, a +20 dB, ultra low-noise preamp for weak-signal work. The **PRE** icon flashes when preamp 2 is selected. Use *CONFIG:PREAMP2* to enable preamp 2.

Hold **ATT** to turn on the attenuator. The main receiver has 5/10/15 dB settings, selectable per-band via the *MAIN:ATTEN* menu entry. (Holding the ATT switch for over 2 seconds also takes you directly to this menu entry.) The sub RX has a 10-dB attenuator, switchable in BSET mode (pg. 39).

Crystal Filter Selection

You can install up to five crystal filters in the main and sub receivers. For diversity receive, matched filters should be used (pg. 40). Bandwidths as narrow as 200 Hz are available. See Appendix A for recommended filter bandwidths for each mode.

To select a crystal filter manually, tap **XFIL**. The **FL1-FL5** icons show the current selection. This sets the DSP passband to match the crystal filter, and removes any passband shift or lo cut/hi cut. The K3S will also select appropriate crystal filters automatically as you adjust the \odot **SHIFT**, \odot **WIDTH**, \odot **LO CUT**, and \odot **HI CUT** controls.

Filter Passband Controls

As you rotate the filter controls (shift, width, lo cut, hi cut), the associated parameter value is shown on VFO B. The *filter graphic* shows the width and location of the passband, as illustrated below. In these specific examples, segments that turned off as a result of control movement are shown in gray.

High Cut



Low Cut



Width



Shift



i Filter passband controls don't apply in FM mode. SHIFT control granularity can be set to either 10 or 50 Hz in CW and DATA modes; see *CONFIG:PB CTRL*. In Sync AM mode (**AM-S**), SHIFT selects the upper or lower sideband.

Each passband control has an integral switch. These switches are used as follows:

Tapping the control alternates between the two primary functions for that control, for example HI CUT and WIDTH. This is indicated by the two LEDs above each control.

Holding a control activates its secondary function, labeled below the control.

i Tapping or rotating a control shows the present setting. To see the settings of both knob functions without changing them, just tap the control twice.

The secondary functions of the controls are **NORM** and **I/II**, described in the following sections.

Filter Presets (I/II)

Each operating mode provides two “floating” filter presets, **I** and **II**, which store filter settings on a per-VFO, per-mode basis (excluding FM). They are updated continuously as you change filter settings. Fixed (non-floating) per-mode filter settings are also available, as explained below.

You can alternate between the **I** and **II** settings by holding the **I/II** switch. This is especially useful when you’re alternating between wide and narrow settings during contest or DX operation.

Filter Normalization (NORM)

Standard Settings

To get quickly to a standard per-mode bandwidth and reset any passband shift or cut, hold **NORM** (normalize). The normalized AF bandwidth is 400 Hz in CW and DATA modes, 2.7 or 2.8 kHz in SSB modes, and 3.0 kHz for AM¹.

i Whenever you normalize the filter passband, two small “wings” appear at the left and right ends of the DSP filter passband graphic as shown below.



Moving any DSP control makes the “wings” disappear, as a reminder that the passband is no longer normalized.

¹ In AM mode, the I.F. bandwidth required for good fidelity is about twice the AF bandwidth. This is why a 6 kHz or wider crystal filter is needed to effectively use the 3 kHz NORM setting. If an FM filter is installed, it can be used in AM mode to provide good fidelity at even higher AF bandwidth settings.

Custom Settings (NORM1 and NORM2)

In addition to the standard “NORM” values, you can save two of your own setups in each mode, then recall them using the **NORM** function. These setups are referred to as NORM1 and NORM2.

To save a custom normalization setting:

- set up the filter passband as desired for the current mode
- hold **NORM** until you see **<- SAV ->** (3 seconds)
- rotate the knob slightly left or right to save it as **NORM1** or **NORM2**.

(The arrows to the left and right of **SAV** are a reminder that you can rotate the knob to get to the two user-defined normalization settings.)

To recall, hold **NORM** until you see **<- NOR ->** (about 1/2 second), then rotate the knob left or right to recall **NORM1** or **NORM2**.

Narrow DSP Filter Selection

For bandwidth settings of 100 Hz or lower, the DSP normally uses a type of filter that minimizes ringing: the **Finite Impulse Response** or **FIR** filter.

If you’d like steeper filter skirts, and don’t mind a small amount of ringing, you can select **Infinite Impulse Response** or **IIR** filters for these bandwidths. Locate **CONFIG:FLx BW** menu entry, then tap **7** until you see **IIR ON**. Both main and sub receivers will use the same setting.

A IIR filters take longer to change from one bandwidth to another, so you may hear audio artifacts when adjusting the DSP controls. If this is objectionable, use the default FIR filters.

i Another narrowband filter alternative in CW mode is **APF** (audio peaking filter). This filter has a very narrow peak (~30 Hz) but very little ringing due to its broader skirts. See **APF**, pg. 32.

Reducing Interference and Noise

The K3S provides several ways to cut interference, including DSP noise reduction, manual and auto notch, and noise blanking. Also see **Audio Effects** (**AFX**, pg. 37).

There are actually two noise blankers: one at the first I.F. (KNB3 module), and the other at the 2nd I.F. (DSP).

A Noise reduction, noise blanking, and notch filtering should only be used when necessary. These *signal processing* techniques are very effective, but can introduce side effects. Sometimes, reducing the filter bandwidth is the most effective interference-reduction strategy.

Noise Blanking

Tap **NB** to enable I.F. and/or DSP noise blanking.

Next, hold **LEVEL** to set the DSP level (VFO A) and I.F. level (VFO B). You'll initially see **DSP OFF** and **IF OFF** on the VFO A and B displays.

Rotating VFO A clockwise will turn on the DSP NB, showing **DSP t1-1** through **DSP t3-7**. The first number shows the relative pulse integration time, and the second shows the blanking level. The higher the numbers, the more aggressive the DSP blanking action.

Rotating VFO B clockwise will turn on the IF NB, showing **IF NARn**, **IF MEDn**, or **IF WIDn**, where **n** is 1-7. **NAR/MED/WID** refers to narrow/medium/wide blanking pulse widths, and **n** is the blanking level. Higher **n** means more aggressive blanking action. Use **NAR** width when possible to minimize strong-signal interaction effects.

i The **NB** icon will flash slowly if the I.F. blanker setting is too high for the present signal conditions. If this happens, use a lower setting.

Both the DSP and IF blanking settings are saved on a per-band basis. If **CONFIG:NB SAVE** is set to **YES**, the on/off status of **NB** will be also be saved for each band.

i The **DSP noise blanker** is in the 2nd I.F., where it can't be activated by signals outside the crystal filter passband. It can be used with high-duty-cycle and complex-waveform noise generated by computers, switching power supplies, light dimmers, etc. The **I.F. noise blanker** is in the 1st I.F., where it can use very narrow blanking widths. It is most effective at blanking AC line noise, lightning, and other very broadband noise. Often, a combination of the two is the most effective.

Noise Reduction

Noise reduction reduces *random* background noise while preserving meaningful signals. It adds a characteristic "hollow" sound to all signals.

NR turns noise reduction on. It doesn't apply to DATA or FM modes, or with AGC turned off.

Hold **ADJ** to display the NR setting, which is saved per-mode. Use the VFO B knob to tailor NR for the present band conditions. In general, the higher the number, the more aggressive the noise reduction. Settings **F1-1** through **F4-4** are recommended. **F5-1** through **F8-4** use a different algorithm, where the **-x** part of the setting indicates the degree of mix between the DSP-processed and unprocessed signals (**-1** is about 50% processed, **-4** is 100%). A small **M** appears to remind you that a **Mixed** setting is in effect, e.g. **NR^M F5-1**.

Notch Filtering

Notch filtering removes interfering carriers while leaving the desired signal relatively unaffected. The K3S provides automatic and manual notch tuning.

Auto notch will find and remove one carrier, and in some cases more than one. (SSB mode only.)

Manual notch removes one carrier at a specified pitch, and can be used in CW and DATA modes as well as voice. Since manual notching sets up a fixed (rather than adaptive) notch, it can even suppress a keyed carrier, i.e. a Morse code signal.

Tap **NTCH** to turn on notch filtering (**NTCH** icon). This turns on **Auto** notch in SSB mode, and **Manual** notch in other modes (adds **◀▶** icon).

Holding **MANUAL** directly selects manual notch in any mode. Adjust the manual notch frequency using VFO B, then tap **NTCH** again to exit.

Transmitter Setup

Transmit Crystal Filter Considerations

For each operating mode, you must specify which I.F. crystal filter to use for transmit using the **CONFIG:FLTX** menu entry. See pg. 49 for recommended per-mode transmit filter bandwidths.

A Transmit signals are generated on the RF board, so the set of filters installed on the RF board must meet the transmit bandwidth requirements of all modes you plan to use. (Filters installed on the sub receiver board are used only in receive mode.)

Transmit Status LEDs and Icons

Before putting the K3S on the air, you should be familiar with the LEDs and LCD icons that pertain to transmit operation (identified on pgs. 11 and 12). The most important of these are reviewed here.

The **TX** LED turns on during transmit. The **ΔF** (Delta-F) LED turns on if the transmit and receive frequencies differ (**SPLIT** / **RIT** / **XIT**).

The **TX** LCD icon and associated arrows show which VFO is being used for transmit. If you plan to use **SPLIT** mode, See pg. 38.

Multifunction Transmit Controls

There are two multifunction transmit controls. Their primary functions (mode-dependent) are:

- ⊖ **SPEED** CW keyer speed in WPM
- ⊖ **MIC** Mic gain
- ⊖ **CMP** Speech compression level in dB
- ⊖ **PWR** RF output power in watts (6 m and transverter power settings are independent of other bands; also see **Per-Band Power Control**, pg. 29)

The secondary (hold) functions of these controls are:

- ⊖ **DELAY** VOX or CW semi-break-in delay
- ⊖ **MON** Voice/Data monitor or CW sidetone and alert tone level.

VOX, PTT, and QSK

In voice and data modes, use **VOX** to select VOX (pg. 13) or PTT (push-to-talk). PTT can still be used even with VOX selected. Set VOX gain and anti-vox level using **MAIN:VOX GN** and **ANTIVOX**.

In CW mode, use **VOX** to select either VOX or PTT transmit. VOX enables “user-activated” (hit-the-key) transmit, while PTT requires the use of PTT IN (pg. 17) or **XMIT** before CW can be sent.

When the **VOX** icon is on in CW mode, you can use **QSK** to select full (**QSK** icon on) or semi break-in. For more on break-in keying, see pg. 32.

Transmit Metering

Normally, the transmit bar graph shows **SWR** and **RF** (power output). The displayed **SWR** range is 1:1 to 3:1. The **RF** control range is 0 to 12 W in 1-W units, or 0 to 110 W in 10-W units. The power scale changes from watts x1 to watts x10 at 13 watts.

In voice modes, you can use **METER** to switch to compression (**CMP**) and automatic level control (**ALC**) metering. See pg. 30 for information on adjusting the ⊖ **MIC** and ⊖ **CMP** controls.

If you have a KXV3B installed, you can use **milliwatt-level** power output. This is intended for use with transverters, but it can also allow the K3 to act as a very stable, very low-noise signal generator. To route RX and TX through the XVTR jacks on all bands, set **CONFIG:KXV3B** to **TEST**.

When milliwatt-level output is in effect, rotating ⊖ **PWR** will show milliwatts on VFO A, and dBm (dB relative to 1 milliwatt) on VFO B. The RF bar graph displays power output in tenths of a mW.

Off-Air Transmit Testing

The K3S allows you to listen to your CW keying, test your mic and compression settings, or monitor DATA tones, *without* transmitting an on-air signal. To do this, hold **TEST** (right end of the **MODE** control). While you're in TEST mode, the **TX** icon will flash slowly as a reminder that you're off air.

Hold **TEST** again to return to normal operation.

External ALC

⚠ External ALC should only be used to protect your amplifier during operation into a failed load, or during a prolonged overdrive condition. ALC should not be used as a way to clip or compress fast voice peaks, or as a primary means of amplifier or K3S power output control.

⚠ DO NOT set the power level to maximum at the K3S and allow the amp's ALC to control power output. This will result in splatter and key clicks. Instead, adjust the drive on each band so it's just below the amp's ALC activation level. (See *Per-Band Power Control* at right.)

External ALC Setup

External ALC is set up using the *CONFIG:EXT ALC* menu entry. *EXT ALC* defaults to **OFF**. To turn it **ON**, tap **1**. 6 meter external ALC can be turned on/off separately from HF.

The *EXT ALC* menu entry provides a default ALC threshold of **-4.0V**, used by many amplifiers.

If you select **CMP/ALC** metering at the K3, external ALC activity is indicated by 8 or more bars. If you select **SWR/RF** metering, the **CMP/ALC** meter icons will flash during external ALC activity to make you aware of the condition.

Some experimentation may be required to determine the proper setting of the amplifier's ALC output control, if one is provided. Start with the control set for minimum ALC output. Then adjust power output at the K3S such that the amplifier is just reaching its maximum level on voice peaks (in SSB mode) or peak CW power in CW mode.

Next, adjust the amplifier's ALC output control upward until ALC action just begins (or adjust the ALC threshold of the K3S with the *EXT ALC* menu entry). Finally, reduce the drive power just slightly to provide some safety margin. The goal is to have **no** amplifier ALC action during normal operation. If you see an ALC indication at the K3S or the amplifier, reduce the drive power.

Per-Band Power Control

If the *CONFIG:PWR SET* menu parameter is set to **NOR**, output on all HF bands follows the present setting of **PWR**. (6 m and transverter bands are always independent of HF.) If you change *PWR SET* to **PER-BAND**, the power level will be saved independently on each HF band. This is especially useful with external amplifiers, or for those who use QRP levels on one band and QRO on another.

When per-band power control is used with an external amplifier, you can adjust the drive ideally on each band to prevent external ALC activation during normal operation.

TUNE Power Level

If *CONFIG:TUN PWR* is set to **NOR**, power output during **TUNE** will follow the present setting of **PWR**. If you change the *TUN PWR* parameter to a fixed power level, that level will be used during **TUNE**, whether or not you've selected per-band power control (see above).

Transmitter RF Delay

Some amplifiers have slow relays whose switching time must be accommodated to prevent key clicks during CW operation. If your amplifier requires more than 8 ms of relay switching time, you can increase the delay from key-down to RF output at the K3S using *CONFIG:TX DLY*.

⚠ Use the smallest value of TX DLY that works with your amplifier. Larger values will affect QSK and keying timing at high code speeds.

Transmitter Inhibit

Some multi-transmitter stations require that transmitters be able to mutually inhibit each other in order to prevent simultaneous use of resources. The transmit inhibit input at the K3S (TX INH) can be set up for low- or high-active control (pg. 21).

Fan Speed

The K3S/100 includes two large, quiet fans. Fan speeds are normally selected automatically, but you can manually select a minimum fan speed if desired. See the *CONFIG:KPA3* menu entry.

Voice Modes (SSB, AM, FM)

Mode Selection

Tap either end of **MODE** to select **LSB/USB**, **AM**, or **FM** mode. Holding the left end of this control, **ALT**, selects an alternate mode. **LSB** and **USB** are alternates of each other. The alternate for **AM** is **AM-S** (synchronous AM, pg. 31). In **FM** mode, **ALT** enables a repeater offset (pg. 31).

Microphone Selection

The K3S provides both front- and rear-panel mic jacks. Some operators use rear-panel jacks to minimize clutter around the front panel. Use **MAIN:MIC SEL** to select the front panel (**FP**) or rear-panel (**RP**) jack, low or high mic gain range, and bias voltage for electret microphones.

The front-panel mic jack is compatible with the Elecraft MH2, MD2, Proset-K2, and some other 8-pin mics (see pg. 13 for pinout and bias settings).

The rear-panel jack is 3.5 mm (1/8"). The rear-panel PTT IN jack can also be used if required.

Voice Monitoring

Voice monitoring allows you to hear the way you'll sound on the air with your selected mic gain, compression, and TX EQ settings. For voice monitoring without any processing or delays, set **CONFIG:TX MON** to **FAST**.

To set up voice monitoring:

- Hold **TEST** to put the K3S in TX TEST mode, so you won't be transmitting (pg. 13).
- Set **MIC** high enough to hear your voice.
- Press your mic's PTT switch or tap **XMIT**.
- While speaking into the mic, adjust **MON** for the desired level. (DVR playback level can be set differently; see **CONFIG:TX DVR**).
- Exit transmit (release PTT, or tap **XMIT** again).
- You can either leave the K3S in TX TEST mode or go back to normal transmit (hold **TEST**) as you follow the instructions in the next section.

Mic Gain and Compression Settings

See pg. 82 for a general discussion about voice-mode ALC. To set up mic gain and compression:

- Set the monitor level as described earlier.
- Optionally select TX TEST mode (pg. 13) or set power to zero. This will not affect your **CMP/ALC** bar graph readings.
- Set **CMP** to 0.
- Hold **METER** to select **CMP/ALC** metering.
- While speaking into the microphone in a normal voice, adjust **MIC** for a peak ALC meter indication of about 5-7 bars (see below).

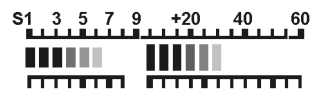

- **CMP** 10 20 **ALC**
- Adjust **CMP** for the desired speech compression level while speaking. The **CMP** scale shows approximate compression level.
- Hold **METER** to select **SWR/PWR** metering.
- If you were in TX TEST mode, return to normal operation by holding **TEST**.
- If you had **PWR** set to 0, set it for the desired level. Key the rig again and verify that you have about the right power output level.

i You can LOCK the MIC, CMP, and PWR settings if required; see **CONFIG:PWR SET**.

Power Level for Voice Modes

Voice power may be slightly different from the CW power you see in when you use **TUNE**. Increasing mic gain cannot correct for this. Instead, use the **CONFIG:TXG VCE** menu entry (voice transmit gain). A value of -1.5 to 1.5 dB should make voice power about the same as when using **TUNE**.

⚠ If you're using an external peak-reading wattmeter, adjust power such that speech peaks remain at or below your desired power level. The RF bar graph may not capture all speech peaks, but your actual output will be close to that set with **PWR**.

Voice Mode VOX Setup

VOX selects push-to-talk (PTT) or voice-operated (VOX) transmit (**VOX** icon on). VOX hold time is set with **DELAY** (pg 14).

MAIN:VOX GN (VOX gain) should be set to trigger at normal speech level, but not in response to incidental noise. Start with low settings (5-10).

MAIN:ANTIVOX sets VOX immunity to RX audio. With the mic closer to the speaker than normal, increase ANTIVOX until the K3S doesn't switch to TX mode when listening to a loud signal.

SSB/CW VFO Offset

The K3S can automatically offset the VFO frequency when you switch from SSB to CW mode, so other stations will hear the correct CW pitch. See **CONFIG:CW WGHT** for details.

Digital Voice Recorder (DVR)

With the KDVR3 installed, you can record and play voice messages as well as capture received audio.

Transmit Message Record and Playback

Tap **REC** to start recording, then tap any of **M1** - **M4**. Remaining buffer time will be displayed as you speak. Tap **REC** again to end, or **CLR** to erase.

Tap **M1** - **M4** to play. To cancel, tap **REC**. If you wish to manually assert PTT when using the DVR, see **CONFIG:KDVR3**. MIC gain has no effect during message play; the gain setting at record time is used. However, DVR monitor level can be set separately (see **CONFIG:TX DVR**).

To auto-repeat, *hold* (rather than *tap*) **M1** - **M4**. **MAIN:MSG RPT** sets the interval (1-255 seconds).

Hold **REC** to select bank 1 or 2 (4 messages each).

Receive Audio Record and Playback

Hold **AF REC** to start/stop record. The  icon will flash slowly while recording. Only the last 90 seconds of audio will be available for playback.

Hold **AF PLAY** to start/stop play. The  icon will flash quickly during play. A seconds counter will be displayed on VFO B, along with an asterisk (*) if you're within the most recent segment. Rotating VFO B adjusts the playback position.

Transmit Noise Gate

The noise gate function mutes mic audio below a selected threshold; this may be useful in noisy environments. See **CONFIG:TX GATE** for details.

AM Operation

A 6 kHz (AM) or 13 kHz (FM) crystal filter is required for AM transmit (pg. 49). Use 2.7 to 13 kHz filters for AM receive (6 kHz recommended).

ALT switches from envelope detection to sync detection (**AM-S**). Sync AM can improve copy during selective fading. When **AM-S** is in effect, rotating **SHIFT** selects the upper or lower sideband; one or the other may improve copy.

VFO A can automatically track AM signals in **AM-S** mode. This can be useful when listening to signals mistuned from a nominal frequency. Tap **SPOT** to zero in on an AM signal one time; tap **CWT** for full-time tracking (**T** icon turns on).

i Use **SPLIT** if you don't want your transmit frequency to change during auto-tracking.

i You can also listen to AM using LSB or USB modes. A 2.7 or 2.8 kHz filter will work well.

FM Operation

An FM crystal filter (at FL1) is required on the RF board and/or sub receiver for FM use; see pg. 48.

i FM mode can be disabled by setting **CONFIG:FM MODE** to **OFF**.

To setup for repeater use:

- Hold **ALT** to select simplex, TX up (+ icon), or TX down (- icon). If an offset is in effect, **REV** swaps RX/TX frequencies and offset direction.
- Set up repeater offsets with **MAIN:RPT OFS**, and VFO step size using **CONFIG:VFO CRS**.
- Hold **PITCH** to set up tone encode. VFO A selects pitch in Hz; VFO B turns tone encode on or off. If **1750** Hz is selected (for European repeaters), an 0.5-s tone burst is sent at the start of each transmission if squelch wasn't already open. Or, you can hold **PITCH** during TX to manually generate a tone burst of any length.
- To see up voice and PL tone deviation, use **CONFIG:FM DEV**.

CW Mode

CW Normal and Reverse

Select CW mode by tapping either end of **MODE**.

Hold **ALT** to alternate between CW **normal** (lower sideband RX) and **reverse** (upper sideband RX).

If you **SPOT** (or auto-spot) a CW signal (pg. 36), then switch between CW normal and reverse, the pitch of the received signal should stay the same.

Basic CW-Mode Controls

In CW mode, **MON** sets the sidetone volume. This is also used as the volume level for alert tones, such as those heard when switches are pressed.

Hold **PITCH** to adjust the sidetone pitch. The peak in response of all filters will track this setting.

Use **AGC** to select slow AGC (**AGC-S**) or fast (**AGC-F**). Slow is fine for casual operating; fast is useful during contests or rapid signal fading.

Hold **QSK** to select **full break-in** (**QSK** icon on) or **semi break-in** operation. **QSK** allows others to “break” your CW transmission by sending one or two characters. With **semi break-in** selected (**QSK** off), the K3S returns to receive mode after a time delay you set using **DELAY**.

VOX must be turned on in CW mode to enable both full and semi break-in operation. If PTT is selected (**VOX** icon off), transmit must be activated using PTT or by tapping **XMIT**. PTT is sometimes activated using a foot switch.

i For **ultra-fast CW full break-in at up to 100 WPM**, set **CONFIG: CW QRQ** to **ON**. If **CW QRQ** is **OFF**, max speed using **VOX** is 60 WPM, and PTT is required for 60 to 100 WPM.

Hold **TEST** to place the K3S into TEST mode. This sets power output to zero, useful for CW practice or for off-the-air checking of recorded CW messages.

Other CW-Mode Configuration Settings

Use the CONFIG menu to set up iambic keying (**CW IAMB**), paddle norm/reverse (**CW PADL**), and keying weight (**CW WGHT**). The **CW WGHT** menu entry can also be used to enable automatic SSB/CW VFO offset (pg. 31).

SPOT and Auto-Spot

When calling another station, you should try to match your frequency to theirs. To facilitate this, the K3S provides both manual and automatic spotting for use with CW and DATA signals. See *Tuning Aids: CWT and SPOT* (pg. 36).

CW Text Decode/Display

The K3S can decode transmitted and received CW signals, displaying the text on VFO B (pg. 35). This is especially useful when you’re learning CW, or if someone who doesn’t know CW is looking over your shoulder while you make CW QSOs. It’s also indispensable for CW-to-DATA operation (pg. 36).

APF and Dual Passband CW (DUAL PB)

In CW mode, **APF** turns on either a narrow audio peaking filter (APF) or dual-passband CW (Dual PB). See pg. 37.

CW Message Record/Play

! Messages can only be recorded using the internal keyer or the **message editor** in **K3 Utility**, not by using a hand key or external keyer.

i If **text decode** is on (pg. 35), CW text sent using the internal keyer is shown on VFO B (pg. 35). Use **TEST** to check messages off-air (pg. 13).

There are 8 message buffers (2 banks of 4). Each holds 250 characters. To switch banks, hold **REC**.

Message Record: To start recording, tap **REC**, then **M1** - **M4**. The remaining buffer space will be displayed as you send. Tap **REC** again to stop.

Message Play: Tap **M1** - **M4** to play. To cancel, tap **REC** or hit the keyer paddle or key.

Message Erase: Tap **REC**, then **M1** - **M4**, then **CLR**.

Auto-Repeat: To auto-repeat a message, *Hold* (rather than *tap*) **M1** - **M4**. **MAIN:MSG RPT** sets the message repeat interval (1 to 255 seconds).

Chaining: *Tapping* **M1** - **M4** during playback chains another message onto the message being played. *Holding* a message switch during playback chains a repeating message.

Data Modes

You don't need a computer to get started with data modes on the K3: it can receive and display RTTY and PSK31 (or PSK63) on its LCD (pg. 35). You can transmit in data modes using your keyer paddle (see **CW-to-DATA**, pg. 36).

Using a computer for data modes is also very convenient on the K3S, as described below. If you're using AMTOR or Pactor, also see pg. 34.

Data Mode Connections

You can transmit and receive data with a computer in three ways:

- Connect your soundcard I/O to the K3S. Use **MAIN:MIC SEL** to use LINE IN/OUT, front-panel mic jack, or rear-panel mic jack. You can use VOX or PTT to control transmit.
- Use the soundcard in receive mode, but use a PC I/O line to do direct FSK (or PSK) modulation. Connect the PC's I/O line to the "FSK IN" line on the ACC connector. (If this signal originates from an RS232 port, it will require RS232-to-TTL level conversion.)
- Send and receive ASCII text via the RS232 interface. To send, insert text into a "KY" command (e.g., "KY CQ DE N6KR;"). To receive, send "TT1;" (text-to-terminal). "TT0;" turns it off. See the K3/KX3 Programmer's Reference, available at www.elecraft.com.

Data Mode Selection

Soundcard-based data communications can be done using LSB or USB mode. However, DATA modes offer several benefits not available in SSB modes.

If you prefer to use LSB or USB, you'll need to manually set **[CMP]** to **0** to prevent data signal distortion. Refer to your data communications software manual to determine how to set up the VFO and computer for accurate frequency display.

To use DATA modes, tap **[MODE]** until the **DATA** icon appears. Next, hold **[DATA MD]**. The present data mode is shown on VFO B, and can be changed by rotating the VFO B knob.

The following data modes are available:

- **DATA A** can be used for all **A**udio-shift transmit modes, including **PSK31/PSK63**, **MFSK**, **AFSK**, etc. The VFO displays the suppressed-carrier frequency, just as when SSB modes are used for data. USB is "normal" for DATA A. Compression is always set to 0.
- **AFSK A** also uses **A**udio-shift transmit, but is optimized for RTTY. The VFO displays the RTTY mark frequency, and LSB is "normal". The built-in text decoder can be used in this mode (pg. 35), as well as the dual-tone RTTY filter (DTF, pg. 34).
- **FSK D** is identical to AFSK A, except that **D**irect modulation is used, via FSK IN, ASCII, or the keyer paddle (pg. 36). The text decoder can be used in this mode (pg. 35), as well as the dual-tone RTTY filter (DTF, pg. 34).
- **PSK D** is a **D**irect-transmit mode for **PSK31** and **PSK63**. It's the only mode that decodes and displays PSK signals with the text decoder (pg. 35). Like FSK D, PSK D lets you transmit via FSK IN, ASCII, or the keyer paddle (pg. 36). You can also use auto-spot with PSK D if the tuning aid is displayed (**[CWT]**, pg. 36).

The **DATA MD** display also shows the data speed in bps on VFO A. This is relevant only if the text decoder is on. In AFSK A, FSK D, and PSK D modes, multiple data speeds are available; select them by rotating VFO A.

Also shown is the current sideband (**LSB** or **USB**). If this sideband is considered "data reverse" for the present mode, then **REV** also appears. You can use **[ALT]** to switch to the other sideband if required. **REV** is not recommended with CW-to-DATA (pg. 36).

Mark/Shift and Pitch Selection (PITCH)

Hold **[PITCH]** to view and change the received mark tone and shift (AFSK/FSK) or center pitch (PSK).

In AFSK/FSK modes, you have a choice of mark tone/shift combinations. Use VFO A to select a tone/shift combination that's compatible with your software. A lower mark pitch makes signal tuning easier when using the text decoder.

RTTY Dual-Tone Filter (DTF)

Hold **APF** to turn on the RTTY dual-tone filter (DTF). This creates two filters, one centered on the mark tone, the other on space, which can often improve RTTY copy. The filter graphic changes to reflect this (see below).



When DTF is on, the range of the **WIDTH** control is adjusted to better match the characteristics of the filter. **SHIFT**, **LO CUT** and **HI CUT** are disabled.

The dual-tone filter can be used with **AFSK A** and **FSK D**. The on/off state of DTF is saved independently for each of these modes.

FSK Transmit Polarity

You can invert the logic level of the FSK IN line in FSK D mode using **CONFIG:FSK POL**. This should be used only with external keying via computer programs such as MMTTY; it is not recommended for use with CW-to-DATA (pg. 36).

Mic Gain, ALC, and Monitor Level

If you're using an audio-shift transmit mode (**LSB**, **USB**, **DATA A**, or **AFSK A**), you'll need to set the **MIC** level while watching the ALC meter. You can use the same procedure outlined for voice modes (pg. 30), except that speech compression should not be used.

In all cases (SSB modes as well as DATA), you can optionally use **MON** to monitor your data signals. The procedure given for voice modes can be used (pg. 30). Voice-mode and DATA-mode monitor levels are independent.

i The **MIC** setting does not apply to direct modulation data modes (**FSK D** and **PSK D**), since no audio is used for transmission. However, you can still use **MON** to monitor the signals.

AMTOR / PacTOR

AMTOR, PacTOR and similar modes can reliably transfer data – including e-mail – via HF radio networks. New modes are under development that may provide even greater reliability. Applications include maritime mobile and emergency communications where the light weight and excellent performance of the K3S are advantageous.

General information regarding K3S set up for these modes appears below.

- Frequency stability is important in these modes. A 1-PPM TCXO is available (KTCXO3-1).
- Connect modem audio I/O to the LINE OUT and LINE IN jacks at the K3S (for LINE OUT, use the TIP contact of a stereo plug). A PTT connection is also usually required. If the modem operates from 12 V (1.0 A or less), it can be powered from the K3S (12 VDC jack).
- Set up the modem (if applicable). Settings may vary depending on the data mode being used.
- Locate **CONFIG:LIN OUT** and set it to 10. A different level may be better for your modem.
- The SYNC DATA feature can be used to minimize T-R delays (it forces the same crystal filter to be used for both receive and transmit). Locate **CONFIG:SYNC DT**. Assign it to a programmable function (e.g., by holding **PF1**), then exit the menu.
- Tap **MODE** to select **DATA**.
- Select an appropriate data sub-mode by holding **DATA MD**, then rotating VFO B. **DATA A** (generic data mode, USB) is used in most cases; see pg. 33 for alternatives, such as **AFSK A**. Tap **AFX** to exit the parameter display.
- Locate **MAIN:MIC SEL** and set the audio source for data to **LINE IN**. Exit the menu.
- If you wish to use SYNC DATA, turn it on by holding **PF1** (or the switch used above). The **-S** icon will appear. A **CONFIG:PTT RLS** value of 10 to 12 may be ideal in this case.
- Some modes may have very high duty cycles; use less than full power output if required.

Refer to your application software for instructions regarding email set up and other operating details.

Advanced Operating Features

Text Decode And Display

The K3S can decode CW, PSK31 or PSK63, and RTTY. Decoded text is displayed on VFO B. In data modes, you can use the internal keyer to transmit PSK and RTTY signals (pg. 36).

Decoded text can also be displayed on an SVGA screen connected to a P3 Panadapter, or using *K3 Utility's Terminal* feature.

i When text decode is enabled, rotating the RIT/XIT offset control doesn't display the offset.

CW Text Decode Setup

To set up CW text decode:

- Set **MODE** to CW.
- If a special VFO B display mode is in effect, cancel it by tapping **DISP**.
- Hold **TEXT DEC**, then select **CW 5-40** (lower WPM range) using VFO B. Below the **CW** icon you'll see a **T** (text decode enabled). The **TX ONLY** setting decodes only CW you send (internal keyer), so the **T** does not appear.
- Adjust the threshold (**THR**) using VFO A. Try **AUTO** or **1 - 6** (also see tips below). Tap **CWT** to exit text-decode setup.
- You'll probably want to turn on **CWT** as a tuning aid (pg. 36). This also enables auto-spot.

CW Text Decode Tips:

- **SPOT** (or **auto-spot**) a signal first, then tune slowly until recognizable words appear.
- Noise or fading may result in invalid character decodes, causing asterisks (*) to appear. In difficult conditions, reduce **WIDTH** to as low as 50 Hz (100-200 Hz for faster CW).
- To optimize text decode, use manual threshold settings. Start with **THR 5**. With **CWT** on, adjust the threshold so that the **CWT** bar flashes in sync with the received CW signal.
- To decode very fast CW, use **CW 30-90**.

Received CW Speed Display:

Received CW speed (from about 10-70 WPM) can be displayed using the **WPM CHK** setting. The left end of the display shows WPM, e.g. **20w CQDX**.

DATA Text Decode Setup

To set up text decode for DATA modes:

- Set **MODE** to DATA. Then hold **DATA MD** and select either **AFSK A**, **FSK D**, or **PSK D** mode using VFO B.
- Use VFO A to choose a data rate for **AFSK A /FSK D** (45/75 bps) or **PSK D** (31/63 bps).
- Tap **AFX** to exit the data-mode display.
- For **AFSK A** or **FSK D**, hold **PITCH** and select the desired mark/shift setting. The lowest mark tone selection (915 Hz) may be more pleasant to listen to than higher tones. (The pitch for **PSK D** mode is fixed at 1010 Hz.) Tap **SPOT** to exit the pitch display.
- Hold **TEXT DEC**, then select **ON** using VFO B. Below the **DATA** icon you should now see a **T**, showing that text decode is enabled.
- Adjust the threshold (**THR**) using VFO A. Start with **THR 0**. Higher settings prevent text decode on weak signals or noise. Tap **CWT** to exit text-decode setup.
- You'll probably want to turn on **CWT** as a tuning aid (pg. 36). This also enables auto-spot (applicable to PSK but not RTTY).

DATA Mode Text Decode Tips:

- Use **FINE** tuning with **PSK D**. **SPOT** (or **auto-spot**) a signal first, then tune slowly in 1-Hz steps until recognizable words appear.
- If you call CQ using PSK31/PSK63 mode, keep RIT on so you can fine-tune responding stations without moving your transmit frequency.
- In difficult conditions, reduce **WIDTH** to the per-mode minimum (typically 50 Hz for PSK, 200 Hz for narrow-shift RTTY).
- In **AFSK A** and **FSK A** modes, the RTTY dual-tone filter may help (DTF, pg. 34).
- RTTY text may shift to *figures* due to noise. If you assign **CONFIG:TTY LTR** to a programmable function switch, you can tap it to quickly shift back to *letters*.

CW-to-DATA

You can use data modes completely stand-alone (i.e., without a computer). Just turn on **text decode** (pg. 35), and send CW using the internal keyer.

CW messages can also be used for CW-to-DATA. This makes it easy to answer a CQ, send a contest exchange, or play a “brag tape” during a QSO.

To set up for CW-to-DATA operation:

- Referring to pg. 35, use **MODE**, **DATA MD**, **TEXT DEC**, and **PITCH** to set up **text decode**. Select either **FSK D** or **PSK D** mode. A small **T** should appear below the **DATA** icon.
- Try tuning in a few stations (turn on **CWT**; pg. 36). Tips for improved copy in tough band conditions are provided on pg. 35.
- Plug a keyer into the PADDLE jack. The first time you try CW-to-DATA, set **PWR** to 0 watts or use TX **TEST** mode (pg. 13).
- All CW you send will be transmitted as data and displayed on VFO B. You’ll hear a CW sidetone, as well as PSK or FSK tones. Adjust the data monitor volume using **MON**. To adjust the CW sidetone monitor level, temporarily switch back to CW mode.
- When calling CQ, use RIT to tune in stations that reply (especially important for **PSK D**).
- Whenever you pause, the K3S will remain in a data *idle* state for about 4 seconds before dropping. To extend the timeout, send BT, which is not transmitted as data.
- To cut the idle transmit period and exit to receive mode, send “.- -” (**IM**mediately exit). This character is not transmitted as data.
- When recording CW messages for use during CW-to-DATA, you can add “.- -” at the end to cut the idle time when they’re played back.

i The CW abbreviation for “and” (ES) is not used in data modes and might lead to confusion. Other prosigns can be used, including KN, SK, and AR.

i If you set VFO B for CW mode rather than DATA mode and use cross-mode **SPLIT** (pg. 38), your CW will not be converted to DATA.

Tuning Aids: CWT and SPOT

Tapping **CWT** turns the upper half of the S-meter into a CW/DATA tuning aid. If no bar appears in the tuning area, the threshold may be set too high; hold **TEXT DEC** and select a lower **THR** value.

When a received CW or PSK31/PSK63 signal is centered in the passband, the CWT display will appear as shown below.

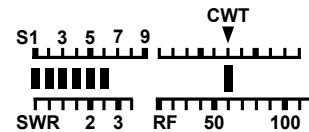

In RTTY modes (**AFSK A** and **FSK D**), mark and space tones are represented by three bars each, with mark to the left of the CWT pointer, and space to the right. When only weak signals are present in the mark/space filters, 1-3 bars will flicker on either side, leading to a “ghosting” effect, as shown here.

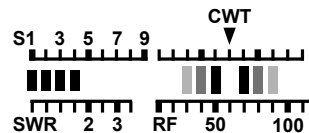

As you tune the VFO close to an RTTY signal, the number of bars will initially increase on one side or the other. Keep tuning until you see a rough balance between left and right bars. (Also see **DTF**, pg. 34, and **CONFIG:TTY LTR**.)

Manual SPOT

If **CWT** is off, you can tap **SPOT**, then manually tune the VFO until the received signal’s pitch matches the sidetone. If you find pitch matching difficult to do, try auto-SPOT (below).

Auto-SPOT

To use auto-spot, first turn on **CWT**. Use a narrow bandwidth (200 to 500 Hz). Tapping **SPOT** will then automatically tune in a received signal that falls within the CWT display range.

Auto-spot may not be usable if more than one signal is in the CWT range, if the signal is extremely weak, or if the code speed is very slow.

Auto-spot coarse-tunes PSK signals, but you’ll need to fine-tune them in 1-Hz steps (**FINE**).

Audio Effects (AFX)

If you have stereo headphones or stereo external speakers, you can take advantage of the DSP's audio effects. These create an illusion of greater acoustic space. For many operators, AFX provides a less-fatiguing receiver sound.

MAIN:AFX MD is used to select the desired AFX setting. Available selections include **DELAY 1-5** (quasi-stereo), and **BIN**, which provides a constant phase shift between the left and right outputs.

Tap **AFX** to turn the selected effect on or off. This can be done even within the **AFX MD** menu entry.

i When the sub receiver is on, turning AFX on may not have any noticeable effect. This is because main/sub dual receive is already in stereo, with different material routed to each audio channel.

APF and Dual-Passband CW Filtering

In CW mode, **APF** is used to turn on either an **Audio Peaking Filter (APF)** or **Dual-Passband Filtering**. Both are described below. **CONFIG: DUAL PB** selects the desired function.

APF can make a dramatic difference in copy of weak signals buried in noise. When APF is turned on, **SHIFT** fine-tunes the center pitch, and **NORM** resets the pitch to that of your sidetone. The filter graphic will be similar to that shown below.



Dual-Passband Filtering (Dual PB) sets up a 150-Hz-wide **focus** filter, set within a wider **context** bandwidth that is attenuated by about 20 dB. This lets you hear off-frequency CW signals, which may be useful if you're calling CQ, running a net, etc. **WIDTH** varies the width of the context filter. The filter graphic appears as above.

Hold **APF** again to exit APF or Dual PB.

i When using either APF or Dual PB, you should reduce the **WIDTH** setting if there are S9+20 or higher signals within the crystal filter passband. This will maintain optimal AGC performance.

Receive Audio Equalization (EQ)

The K3S provides 8 bands of receive audio equalization via the **MAIN:RX EQ** menu entry. RX EQ can compensate for the physical acoustics of your station (room, headphones, speakers, etc.), or just to tailor the audio to your personal preference.

Two receive EQ setups are provided: one for CW mode, and the other for voice modes. RX EQ does not apply to DATA modes.

In the **RX EQ** menu entry, the VFO A display shows 8 individual vertical bar graphs. The example below shows various amounts of EQ for each band.

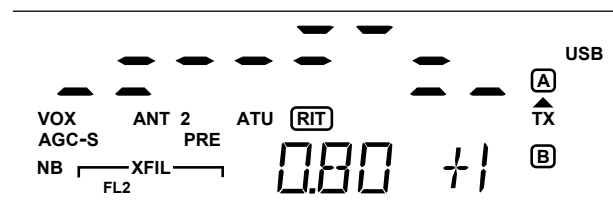

The center frequencies of the 8 audio EQ bands are 50, 100, 200, 400, 800, 1600, 2400, and 3200 Hz. To select a band to change, tap **[1-8]** on the keypad. For example, tapping **[1]** selects the 50-Hz band.

Next, rotate VFO A to specify boost or cut (+/- 16 dB). The illustration above shows the 800 Hz EQ band (**0.80 kHz**) being set to **+1** dB of boost.

You can tap **CLR** to reset all of the **RX EQ** bands to **0** dB (no cut or boost).

Transmit Audio Equalization (EQ)

Transmit audio equalization can compensate for microphones and voice variations. **MAIN:TX EQ** works exactly the same as **RX EQ**, and can be used during transmit.

Two transmit EQ setups are provided: one for SSB, the other for wideband voice modes (ESSB, AM, FM). TX EQ is not applicable to CW or DATA modes.

While adjusting **TX EQ**, you can monitor using headphones (use **MON** to set the level), or listen to your transmitted signal on another receiver.

SPLIT and Cross-Mode Operation

Normally, VFO A is used for both receive and transmit. When **SPLIT** mode is selected, VFO B becomes the transmit VFO. In this case the **SPLT** icon turns on, the **TX** arrow points to **B** (pg. 12) and the yellow delta-F LED (Δf) turns on if receive and transmit frequencies or modes differ.

Cross-mode operation is possible in some cases, such as SSB/CW. You can use **BSET** to directly change the mode of VFO B (pg. 24).

i You can transmit in CW when SSB mode is selected by just hitting the key or paddle; there's no need to use cross-mode split in this case. The SSB station will hear the signal at your sidetone pitch. See *CONFIG: CW WGH*T.

Extended Single Sideband (ESSB)

An increase in SSB voice bandwidth may improve fidelity and reduce listening fatigue.

The normal SSB receive bandwidth is about 2.7-2.8 kHz. If you have a 6 or 13 kHz filter installed, you can use \odot **WIDTH** to select a wider passband.

ESSB transmit is set up as follows:

- **A 6- or 13-kHz filter on the RF board is required.** Specify which of these filters to use for AM transmit by switching to AM mode, then using *FLTX AM*.
- Switch back to SSB mode. Locate *CONFIG: TX ESSB*, tap **1** to turn ESSB on, and use VFO A to select the desired transmit bandwidth. The **+** icon will turn on in the mode area of the LCD. **See cautions below.**
- ESSB, AM and FM have separate TX EQ from regular SSB, allowing you to optimize the transmit passband for these wider-bandwidth modes. See *MAIN: TX EQ*.
- Assign *TX ESSB* to a programmable function switch if you'll be turning it on/off frequently.

⚠ Carrier and spurious signal suppression, passband shape, delay characteristics, fidelity, and other aspects of ESSB performance are not specified. Use ESSB only after carefully monitoring your signal.

General-Coverage Receive

The KBPF3A option includes band-pass filters that cover the areas between ham bands. The K3S will switch between its narrow ham-band filters and the KBPF3A filters as you tune the VFOs.

A KBPF3A module can be installed on the RF board (main receiver) and/or KRX3A (sub).

CONFIG: VFO CRS selects **COARSE** VFO tuning rate in each mode. AM coarse tuning rates include 5, 9, and 10 kHz.

i Sensitivity below 1.8 MHz will be reduced due to the high-pass response of the T-R switch, which protects the PIN diodes. To avoid this loss, you can connect your antenna to RX ANT IN (pg. 41).

VFO B Alternate Displays

The VFO B display can show time, date, RIT/XIT offset, supply voltage, current drain, KPA3A heat sink temperature (PA), and front panel temperature (FP). Tap **DISP** to turn the selected display on or off. Rotate VFO B to select the desired display.

If *CONFIG: TECH MD* is **ON**, additional VFO B displays are available. **SYN1** and **SYN2** show the main and sub synthesizer status, which is normally **OK**. (If you see **PLL1** instead of **SYN1**, see **Troubleshooting**.) **SYN2** status should be **OK** if a 2nd synthesizer (for the sub RX) is installed. **AFV** shows the true RMS value of receiver AF output (mVp-p), unaffected by AF GAIN control. After the AFV reading stabilizes, you can use VFO B to select **dBV**, which is useful for signal strength measurements. Also see *CONFIG: AFV TIM*.

i **AFV** and **dBV** apply to the sub receiver if it is turned on. In this case, you may want to select diversity mode (pg. 40) so you can tune the sub receiver's frequency with VFO A.

Alarm and Auto Power-On

Once you've set the real-time clock (*CONFIG: TIME*), you can use *MAIN: ALARM* to set an alarm. This can be used to remind you of a schedule or net, or to start warming up for a contest.

When an alarm is set, (*) appears in the time display. (Time can be displayed by tapping **DISP**.)

⚠ The K3S will turn **ON** automatically if it was off at alarm time. It will be on the last-used band.

Using the Sub Receiver

The KRX3A option adds an independent, high-performance *sub receiver* to the K3S. It allows you to monitor a second frequency, using different bandwidths or modes. *Diversity receive* is possible if the main and sub receivers use different antennas.

Dedicated Sub Receiver Controls

Tapping **SUB** turns on the sub receiver (and **SUB** icon). VFO B then controls the sub's frequency, and also serves as the TX frequency during SPLIT.

i You should leave the sub off when not in use. This turns off the -3 dB passive splitter used when the sub shares the main receiver's antenna path.

Holding **DIV** turns on diversity receive (pg. 40). The kHz decimal point of VFO A flashes as a reminder. VFO A controls both the main and sub frequencies in diversity receive, but VFO B remains independent so it can be used as the SPLIT transmit frequency.

i VFO B can be linked to VFO A even in non-diversity mode; see *CONFIG:VFO LNK*.

☉ **SUB AF** gain normally sets the sub's volume level. Alternatively, **SUB AF** can be used as a main/sub balance control (see *CONFIG:SUB AF*). With stereo headphones or dual speakers, you'll normally hear main on the left and sub on the right. *CONFIG:L-MIX-R* selects various alternate combinations of main/sub audio mixing.

⚠ *CONFIG:SPKRS* must be set to 2 if you use stereo speakers; otherwise, set it to 1.

☉ **SUB RF** gain normally sets the sub receiver's RF GAIN level. If this knob is assigned to main/sub squelch (*CONFIG:SQ MAIN*), then RF gain for main/sub is controlled by the main RF gain control.

BSET: Additional Sub Receiver Settings

Normally, filter controls, **PRE**, **ATTN**, **MODE**, etc., apply only to the main receiver. To change these settings for the sub receiver, first hold **BSET**. VFO A will show **BSET**, and the S-meter will show the sub receiver's signal level. After you've made the desired sub receiver changes, tap **A/B** or hold **BSET** to exit **BSET**.

Preamp 2 can be used with the sub receiver, though there are some limitations (pg. 45). The sub receiver's switchable attenuation is fixed at 10 dB.

i The sub receiver's band cannot be set independently unless *CONFIG:VFO IND* is set to **YES**. If it's set to **NO**, you'll see **=MAIN** when you tap **BAND** during **BSET**, and the sub receiver band will be the same as main.

Sub Receiver Antenna Selection

The sub receiver gets its RF input either from the main receiver (sharing ANT 1-2 or RX ANT IN), or from its auxiliary antenna input (see pg. 43).

When using **BSET**, you can tap **ANT** to switch the sub between **MAIN** (shared) and **AUX** (the sub's AUX input). When **MAIN** is in effect, the **1-2** and **RX** icons show which antenna the sub is sharing with the main receiver. When **AUX** is in effect, these icons will all be off (if *CONFIG:KRX3* is set for **ANT=BNC**) or will show the non-TX ATU antenna, **1** or **2** (if *KRX3* is set for **ANT=ATU**).

Shortcut: If you're not in **BSET** mode, you can quickly switch the sub between **MAIN** and **AUX** by holding **RX ANT**. (Tapping **RX ANT** turns RX ANT on/off for the main path.)

⚠ The AUX antenna must be well-isolated from the transmit antenna to avoid damage to the sub receiver. If keying activates the sub's carrier-operated relay (heard as a click) keying, try relocating the AUX antenna.

i Using the AUX input for the sub receiver slightly improves sensitivity of both the main and sub receivers because the splitter is not used.

Sub Receiver Band Independence

If *CONFIG:VFO IND* is set to **YES**, you can set the sub receiver to a different band from main. Hold **BSET**, then tap **BAND** up/down to select the sub receiver's band. If you only use band-independence for the sub occasionally, you may want to assign *VFO IND* to a programmable function switch (pg. 23).

⚠ If the two receivers are sharing the main antenna path, putting the sub receiver on a higher-frequency band than main may result in signal loss in the sub. This is due to sharing of the main receiver's low-pass filters. If you select an incompatible band combination, the K3S briefly displays **USE AUX** as a warning. To avoid sub receiver signal loss, use the sub's AUX input.

Diversity Receive

Diversity receive can greatly improve signal copy during fading (QSB). True diversity requires a pair of identical receivers running from a common frequency reference and using two different antennas. The K3S is one of very few transceivers that offer this capability. Most offer only a low-performance sub receiver, or “dual watch” (split-I.F.) circuitry, which doesn’t provide for separate main/sub antennas.

An antenna with different polarization, or at least different orientation, should be used for the sub receiver (via its AUX input). This ensures that the two receivers will not experience the same fading characteristics.

To turn on diversity mode: Hold **DIV**. This sets the sub to the same frequency as main (VFO A), matches the sub’s filter bandwidth to main, and switches the sub receiver to its AUX antenna. The kHz decimal point of the VFO A display flashes as a reminder. VFO A sets the receive frequency for both main and sub in diversity mode. This leaves VFO B free for use as the transmit frequency in SPLIT mode (see details at right).

Mode and filtering changes made to the main receiver will immediately be made at the sub, as well, to preserve diversity characteristics. However, **PRE**, **ATTN** and other receive controls remain independent for the sub. These must be changed using **BSET**. (See pg. 25 for preamp 2 limitations.)

You can change the sub receiver’s antenna selection by holding **BSET**, then tapping **ANT**. When you’re not using BSET, holding **RX ANT** will accomplish the same thing, providing a convenient shortcut.

i The K3S saves the sub receiver’s MAIN/AUX antenna selection independently for diversity and non-diversity modes. The AUX antenna should be used for diversity, as explained above. You might use MAIN with diversity when comparing main/sub receiver gain, such as when adjusting crystal filter gain compensation (**CONFIG:FLx GN**). The built-in true-RMS voltmeter is ideal for this purpose. Entering diversity mode will allow you to tune both receivers with VFO A, while VFO B displays the voltage (see **AFV/dBV**, pg. 38).

Sub Receiver Crystal Filter Considerations

Like the main receiver, the sub has slots for up to five crystal filters. For best dynamic range, we strongly recommend the use of the narrowest filter consistent with each operating mode. CW and DATA operators should have at least one narrow filter, e.g. 400 or 500 Hz, on each receiver.

For diversity receive, we recommend using identical crystal filter configurations for the two receivers. This will ensure that both receivers have the same characteristics when strong QRM is present.

You should also use crystal filters with closely matched offsets (**CONFIG:FLx FRQ**). Otherwise, you may hear a slow phase modulation (similar to a beat note) between the two receivers on some signals. 8-pole filters are already matched (**FLx FRQ** = 0.00). Elecraft can provide pairs of 5-pole crystal filters with offsets within 40 Hz of each other on request. When setting up **FLx FRQ**, use the **average** of the filters’ marked offsets as the value entered for **both** filters (main and sub). If you enter different offsets, you’ll hear phase modulation, even if the offsets are very close.

SPLIT Mode with the Sub Receiver

With the sub receiver installed, in a sense all operation is “split,” since you listen on the sub’s frequency (VFO B) and listen/transmit on the main RX/TX frequency (VFO A). Cross-mode and even cross-band operation is possible in this case. Cross-band operation may require the use of the sub’s AUX antenna source to avoid the low-pass filter problem described on the previous page.

If you do turn on **SPLIT**, the VFO’s roles are reversed, with VFO B controlling the transmit frequency, and VFO A used only for receive. The advantage of this is that the receive controls are always “visible” for VFO A, while receive controls for VFO B must be accessed using **BSET**.

Diversity with SPLIT: In diversity mode you can still use SPLIT, transmitting on the indicated VFO B frequency. But both receivers will be tuned to the frequency of VFO A. Both receivers will always be in the same mode, and will use the same filter settings.

Receive Antenna In/Out

The RX ANT IN/OUT jacks have various uses:

- **Low-noise receiving antenna:** Connect a Beverage or tuned loop to the RX ANT IN jack, then tap **RX ANT** to select it. The **RX** icon will turn on. On 12-6 m, you can optionally turn on preamp 2 for weak-signal work (see pg. 25).
- **Band-pass filters:** You can connect an external filter between RX ANT IN/OUT. Tap **RX ANT** to select it (per-band). RX ANT is active only in receive, so small filter parts can be used.
- **Test signal injection:** The RX ANT IN jack is ideal to inject a test signal, because the generator won't be damaged if you transmit.

Buffered I.F. Output for Panadapters

The K3S provides a buffered receive I.F. signal at the IF OUT jack (~8.215 MHz). This signal is compatible with panadapters such as the Elecraft P3 (pg. 47). Refer to panadapter manual for interfacing and operating instructions.

⚠ Use a short, high-quality coax cable between the K3S and the panadapter.

Using the 100-550 kHz Range

The 100-550 kHz range includes experimental amateur allocations at 137 kHz (2200 meters) and 472 kHz (630 meters). There are also commercial and military test signals, beacons, highway service announcements, etc. A link to an article about this frequency range appears on the Elecraft home page.

To hear signals in this range on the K3S, you'll need the KBPF3A band-pass filter option. To avoid signal attenuation due to the high-pass filter in the T/R switch, you'll need to attach your 100-550 kHz antenna to either RX ANT IN or XVTR IN. You can also transmit on the 472 kHz band at low power (about 0.5 mW) via the XVTR OUT jack. An external amplifier with suitable low-pass filtering will be required.

To enable XVTR IN/OUT for 100-550 kHz use, set *CONFIG:KXV3B* to **TEST**, temporarily.

Using Transverters

Nine user-definable bands are provided for use with transverters. These can be used with the Elecraft K144XV internal 2-m module, Elecraft XV-Series, or other transverters. See pg. 20 for connections.

Transverter Band Setup

Transverter bands are set up using the *XV* menu entries. Tap **1** – **9** within menu entries to select a transverter band to configure.

- Set *XVn ON* to **YES** to enable band *n*.
- *XVn RF* sets the operating frequency (MHz).
- *XVn IF* specifies the I.F. band (7, 14, 21, 28, or 50 MHz). Use 28 MHz for the K144XV option.
- *XVn PWR* sets maximum K3S power output for the current transverter band, in two ranges: **L .01-L1.27** specifies a power level in **milliwatts**; the RF bar graph reads in tenths of a milliwatt in this case (use the XVTR IN/OUT jacks). **H 0.0-H12.0** specifies power in **watts**, via the main ant. jack.
- *XVn OFS* can compensate for frequency offset in the transverter's oscillator. Two offsets are provided for the K144XV (see *XVn OFS*).
- *XVn ADR* specifies a transverter select address. Use **INT. TRN0-9** with the K144XV (see *XVn ADR* description for details).

i For weak-signal transverter work, you may wish to eliminate any possible noise contribution from the HF antennas (ANT1/2 and RX ANT IN). You can improve isolation between the XVTR IN/OUT and RX ANT IN jack by removing any antenna connected to RX ANT IN. Also, if you have a **KAT3**, tap **ANT** to select whichever antenna (1 or 2) contributes less noise on the I.F. band in use. (**Note:** The **ANT 1/2** icons are not displayed if *XVn PWR* is set for **L** power range. You can use the **H** range temporarily to see the icons, if desired.)

⚠ CAUTION: When possible, use mW-level drive and the XVTR IN/OUT jacks with transverters (see *XVn PWR*). If you use high power, via ANT1 or 2, you could accidentally damage a low-level transverter.

Scanning

The scanning features let the K3S tune any band segment continuously, with or without the receiver muted. Scanning can be used to monitor any portion of a band, from a 1-2 kHz range where a station or net is expected to appear, to an entire band. (6-meter scanning range is limited to 50-54 MHz by default; contact Elecraft for details.)

Scanning while muted (normal scanning mode) allows the K3S to ignore stable carriers, unmuting only when "interesting" signals are found. Scanning unmuted ("live" scanning mode) is especially useful when listening for weak signals on very quiet bands. Both are covered below.

Scanning Setup

To use scanning, you first need to store the desired tuning endpoints (VFO A and B) in a memory. After that, you'll be able to simply recall the memory, then start scanning. You can set up scanning ranges for various bands, modes, etc.

To set up a memory for scanning use:

- Set VFO A to the starting frequency, and VFO B to the ending frequency.
- Select the operating mode, preamp/attenuator settings, and filter bandwidth. Also select the tuning rate (using **FINE**, **COARSE** and **RATE**), which affects speed of scanning.
- Store this setting in any memory (pg. 16).

To start scanning:

- Recall a saved scanning memory using **M ▶ V**.
- Hold **SCAN** to start scanning. To scan with the receiver live (unmuted), continue to hold **SCAN** until you see **AF ON** (about 2 seconds).

To stop scanning, rotate VFO A manually, or tap any switch, key, keyer, or mic PTT switch. To restart, hold **SCAN**.

i If the sub receiver is on the same band as the main receiver, and the sub is turned on, you can tune VFO B/sub manually while VFO A/main is scanning.

Channel Hopping

Scanning or manually tuning VFO A over a numbered *memory* range, rather than a *frequency* range, is referred to as **channel hopping**. This is included in the K3S primarily for use on 60 meters, 6 meters, and transverter bands, although it can be used on any band.

i The U.S. 60-meter USB channel assignments correspond to K3S VFO settings of 5330.5, 5346.5, 5357.0, 5371.5, and 5403.5 kHz. The CW channel assignments correspond to VFO settings of 5332.0, 5348.0, 5358.5, 5373.0, and 5405.0 kHz.

A **Memories to be used for channel hopping must be within the same band and have consecutive numbers. They also require a text label that starts with an asterisk (*).**

To set up channel hopping:

- Set VFO A to the first frequency in the intended channel-hopping range. (VFO B does not have to be set higher than VFO A for channel hopping purposes.)
- Tap **V ▶ M**, then select a memory (**00-99**) using VFO A. For 60-meter channels, we suggest using memories 60-up. Start with memory 60 for 5330.5 kHz/USB (US), or your country's first 60-meter allocation. Since each memory saves mode as well as other parameters, you could set up both USB and CW/DATA memories for channel-hop use.
- Rotate VFO B to select each memory label position in turn as indicated by the cursor.
- Use VFO A to change characters. The first character must be an asterisk (*); other label characters are optional.
- After editing, tap **V ▶ M** again.
- In the same manner, set up all other memories to be used for channel hopping.

To enable channel hopping (manually, with VFO A, or via scanning), tap **M ▶ V**, use VFO A to locate one of the memories in the sequential range set up earlier, then tap **M ▶ V** again. VFO A will cycle through this range of memories. To disable channel hopping, tap **RATE** or **FINE** or change bands.

To start channel-hop scanning, hold **SCAN**. You can also use "live" scanning as mentioned at left.

Main and Sub Receiver Antenna Routing

The simplified block diagrams in this section show how antennas are routed to the main and sub receivers. Heavy lines show the default RF path. All antennas are protected from electrostatic discharge by surge arrestors. Receive-only antenna inputs, indicated by asterisks (*), include carrier-operated relay circuitry (C.O.R.).

Basic Antenna Routing

As shown in Figure 1, the basic K3S is supplied with one antenna jack (ANT1, SO-239). The signal from ANT 1 is routed through the **antenna input module** (KANT3) to the main receiver (as well as to the transmitter). The KRX3A sub receiver, if installed, can share the ANT 1 signal via a passive -3 dB splitter and relay K1. When the sub receiver is off or is switched to its AUX RF input (dotted line), K1 bypasses the splitter so it will have no effect on either receiver.

A separate RF I/O connector for the sub receiver antenna is location is provided on the rear panel (AUX RF, BNC). The sub receiver's AUX RF input can be routed to this connector internally. K1 then selects either the main RX path or AUX RF as the sub receiver's RF source. Any receiving antenna connected to AUX RF must be isolated from the transmit antennas so the sub receiver's C.O.R. will not be activated during transmit. **Note:** The sub receiver has its own full set of ham-band and optional general-coverage band-pass filters (KBPF3A), but its image rejection will be best when sharing the main path, which includes receive/transmit low-pass filters.

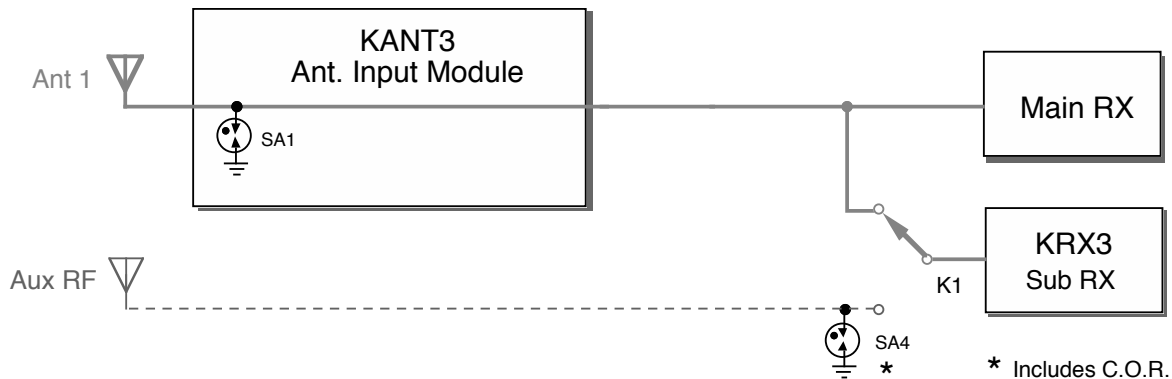

Figure 1. Basic Main/Sub Receiver Routing (no KAT3A)

Receive Antenna (RX ANT IN)

The KXV3B module (Figure 2) adds a separate receiving antenna jack (RX ANT IN). Relay K2 selects either ANT1 or RX ANT for the main receiver. The KXV3B is also the location of preamp 2, provided for weak-signal work on 12, 10, and 6 meters. Some limitations apply to preamp 2 use with the sub receiver (pg. 45).

Note: The transceiver's low-pass filters will not be in the path when RX ANT is selected. This will rarely be an issue, since the main receiver has a full set of ham-band band-pass filters. You can use external filters in conjunction with RX ANT IN if required.

Relay K1 allows the sub receiver to share the main receiver's RF source, or use its AUX RF input. This means that two receiving antennas could be used – one for each receiver.

Not shown is the RX ANT OUT jack. The RX ANT IN/OUT jacks can be used together to “patch in” an external band-pass or low-pass filter.

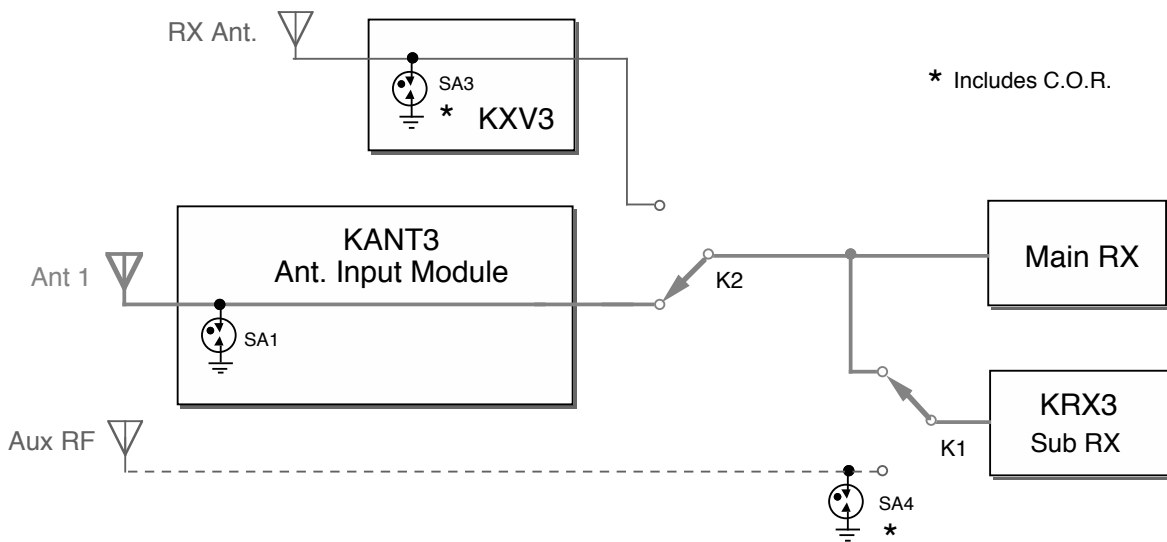

Figure 2. Main/Sub Receiver Routing Including RX ANT IN on KXV3B Module

KAT3A ATU and Antenna 2

The KAT3A internal ATU option, which can be installed in place of the KANT3 antenna input module, provides a second SO-239 antenna jack (ANT 2). As shown in Figure 3, relay K3 routes either ANT 1 or ANT 2 to the main RF path. The antenna *not* routed to the main path (the *non-transmit* antenna) can optionally be used as the sub receiver's AUX RF antenna. This requires that the two antennas connected to the KAT3A be well isolated from each other. If not, the sub receiver's carrier-operated relay may turn on during transmit. If this occurs, you must either move the two antennas farther apart, or not connect the sub receiver to the KAT3A.

It may be preferable to connect the sub receiver's auxiliary RF input to the AUX RF connector on the rear panel. A well-isolated receiving antenna can then be used with the sub receiver when required. (See *CONFIG:KRX3* for sub receiver antenna setup.)

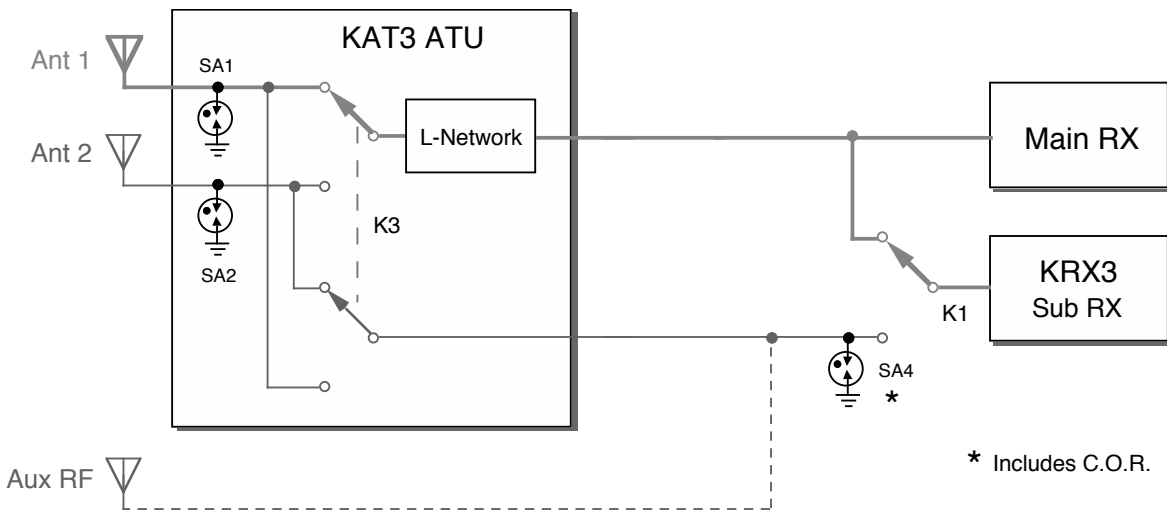

Figure 3. KAT3A ATU Antenna Routing

Figure 4 shows the antenna possibilities when both the KAT3A and KXV3B are taken into consideration. The main receiver can use ANT 1, 2, or RX ANT IN. The sub receiver can either share the main receiver's RF source or use its AUX RF input. The sub's AUX signal can be obtained from either the non-transmit KAT3A antenna or the AUX RF BNC connector, as described earlier. In either case, the sub receiver's antenna must be isolated from the transmitting antenna.

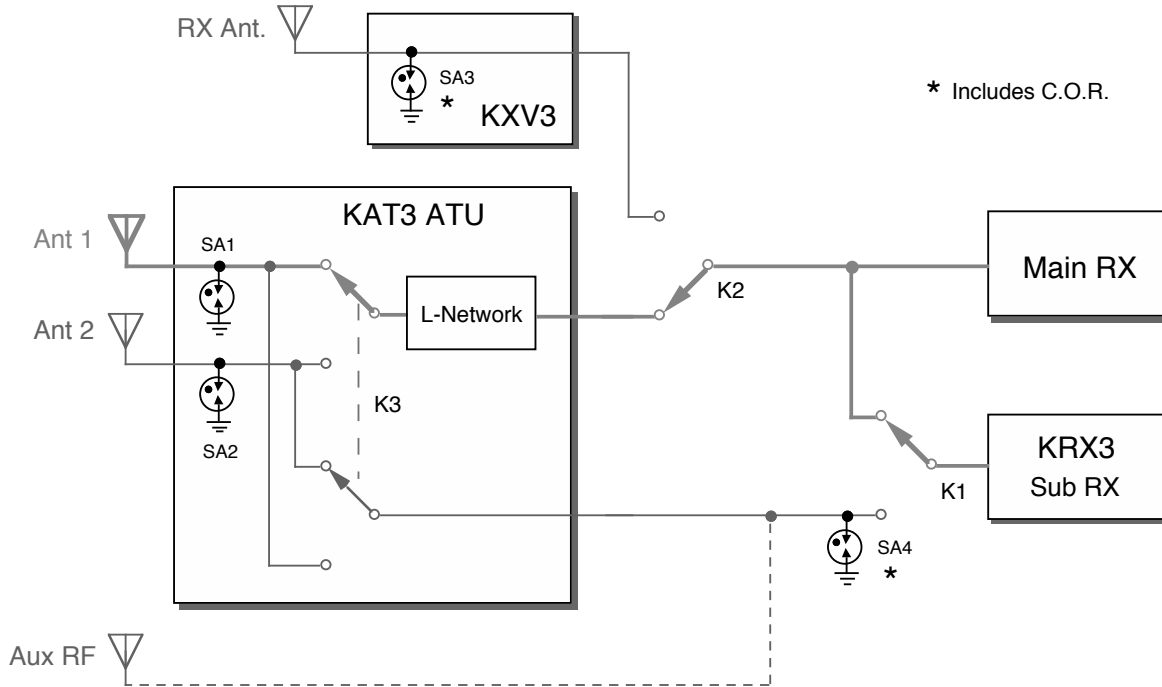

Figure 4. Complete Main/Sub Receiver Antenna Routing

Preamp 2 Limitations

Low-noise amplifier preamp 2 is intended for weak-signal work on the 12, 10, and 6-meter bands. It can be individually enabled on each of these bands using *CONFIG:PREAMP2*.

Since preamp 2 is in the main receive path, it is only available for use with the sub receiver under certain conditions:

- The sub receiver must be sharing the main path, not using its own AUX RF source. This selection is made by tapping **ANT** while in BSET mode (pg. 39). If the sub receiver is using its AUX source, preamp 2 (PRE 2) may still be used by the main receiver, while the sub receiver can have its preamp either on (PRE 1) or off.
- The main and sub receivers must both be on bands between 12 and 6 meters.

⚠ Preamp 2 has high gain (20 dB) in order to provide a very low noise figure. If you hear signal artifacts that suggest receiver overload, such as a rise in the noise floor when a strong nearby station transmits, switch to preamp 1 or turn the preamp off.

Remote Control of the K3S

With appropriate software, any computer with a USB or RS232 port can be used to control the K3S.

A K3S (or K3) can also be controlled remotely from anywhere in the world using a K3/0-Mini panel (pg. 47). The -Mini provides full control, transmit and receive audio, and CW keying, all via a single USB cable to a network-connected local computer. The -Mini duplicates all K3S/K3 front panel functions, as well as the display.

Third-party logging and contesting software is available for various computers and operating systems. Existing applications written for the K2 or K3 should work with the K3S.

For a list of compatible software applications, including configuration requirements, please visit

www.elecraft.com/K3/k3_software.htm

Remote-Control Commands

The K3S has a rich set of remote-control commands. These commands use ordinary ASCII text, so they can be easily tested using a terminal emulator. For example, the command “**FA;**” returns the current VFO A frequency. Using the same command, you can *set* the VFO A frequency, e.g. “**FA0000704000;**” sets the VFO to 7.040 MHz.

Many new commands are provided in addition to the core set of commands supported by the K2. Some existing commands have been updated to directly control the sub receiver (e.g., “**AG\$;**”, which controls sub AF gain). Please refer to the *K3/KX3 Programmer’s Reference* for further details.

Front-Panel Switch Macros

You can set up any programmable front-panel switch (e.g. **PF1**) to execute sequences of remote-control commands directly from the K3S. This is useful for automation of sequences such as: enter split mode, assign VFO A to B, move VFO B up 5, and turn on diversity receive. Refer to *K3 Utility* help or the *Programmer’s Reference* for examples. Also see **CONFIG:MACRO x**.

Remote Power On/Off

A remote-control system can pull the POWER ON line to ground (ACC connector, pg. 20) to turn the K3S **ON**. To turn it **OFF**, the controller must send the K3S a “**PS0;**” remote-control command via the RS232 interface, wait at least 100 ms, then deactivate the POWER ON signal. This sequence ensures that nonvolatile memory is updated correctly before shut-down.

Automatic Antenna Control

Some antenna control units (e.g., those used with SteppIR™ antennas) can track your band and frequency by watching for “**IF;**” (rig information) packets from the K3S. Some computer logging/contesting applications set up the K3S to output these messages periodically, allowing the antenna control unit to “eavesdrop.”

If you’re not using such software, or if you’re not using a computer at all, you can still set up the K3S to output “**IF;**” packets periodically by setting **CONFIG:AUTOINF** to **AUTO 1**. The packets are sent once per second while the VFO frequency is being changed, as well as on any band change.

⚠ If you’re using logging/contesting software, check with the manufacturer before setting AUTOINF to AUTO 1. Some applications may not be tolerant of unsolicited “IF;” packets.

CW/DATA Terminal Applications

The K3S directly supports CW, PSK31 and PSK63, and RTTY ASCII text transmit and receive via its USB or RS232 port. Our *K3 Utility* application includes a simple Terminal function that lets you try out these modes using your computer’s keyboard and monitor.

Elecraft Frequency Memory Editor

Frequency memories can be easily viewed and changed using our *Elecraft Frequency Memory Editor* application. This program shows the contents of all 100 regular memories, and optionally the per-band memories, in a spreadsheet format.

You can also QSY directly to a memory within the editor program using the provided buttons.

Options and Accessories

KPA500: 500 Watt+, 160-6 m amplifier with built-in low-noise power supply and automatic drive-level control (see *CONFIG:PWR SET*). Same size and styling as the K3S.

KAT500: 500 Watt+, wide-range ATU. The K3S can be configured to update the KAT500 as the VFO is turned (see *CONFIG:KAT3*).

P3: The P3 is a fast, very sensitive panadapter with a high-resolution display that shows signals over a 2 to 200 kHz portion of the band. It is styled to match the K3S, and does not require a PC for operation.

K3/0-Mini: The 1.5-inch-thick “Mini” panel duplicates all of the controls of the K3S—but without the radio. With the Mini connected to a computer, you can operate a remotely located K3S (or K3) from anywhere in the world.

K144XV: All-mode, ~10 W output 2-m module. K144RFLK option locks 2 m to main reference.

Crystal Filters: A wide variety of roofing filters can be installed, from 200 Hz to FM bandwidths.

KAT3A: Wide-range, internal 100-W automatic antenna tuner with dual antenna switch and true bypass relay. ANT2 jack supplied with this option.

KPA3A: Internal 100-W upgrade for the K3S/10, with two large fans and separate circuit breaker.

KDVR3: Digital voice recorder, usable both for transmit messages and general audio recording.

KRX3A: High-performance, fully-independent sub receiver with its own set of crystal filters, high-performance KSYN3A synthesizer 32-bit DSP, noise blanker, optional general-coverage filter array (KBPF3, below), and diversity-RX antenna input.

KBPF3A: General-coverage band-pass filter array that allows the K3S main and/or sub receiver to cover the entire LF and HF range of 0.1 to 30 MHz.

KTCXO3-1: High-stability TCXO; 1 PPM nominal, typically better than 0.5 ppm (see calibration instructions, pg. 53).

K3EXREF: Locks the synthesizer in the K3S to an external reference (see *CONFIG:REF CAL*).

PR6 and PR6-10 PREAMPS: These low-noise preamps are not needed with the K3S, since it has a built-in low-noise preamp (on the KXV3B module). See Preamp 2 (pg. 25).

Firmware Upgrades

New features and improvements are available to all K3S owners via firmware upgrades. Upgrades may also be required when you install option modules.

Please visit the Elecraft K3/K3S software page (www.elecraft.com/K3/k3_software.htm) to obtain our free firmware download application, **K3 Utility**. This program runs on PCs, Macs, and Linux platforms. In addition to firmware downloading, **K3 Utility** provides automated RX and TX gain calibration, a custom power-on banner, configuration save/restore, crystal filter setup, CW/DATA message editing, and a terminal function.

⚠ Some applications or peripheral devices may interfere with K3S downloads; check the Help information in K3 Utility if you have difficulty.

Checking your Firmware Revision

Use the CONFIG menu's *FW REVS* menu entry to determine your firmware revision. The serial number of your transceiver, if needed, can be obtained using the *SER NUM* menu entry.

K3s Firmware Self-Test

If the K3S detects an error in its firmware (an incorrect **checksum**), it will flash the **TX** LED and show **MCU LD** on the LCD (with backlight off).

If this occurs, connect the K3S to your computer and reload firmware. While firmware is loading, the Delta-F LED (Δf) will flash. When the download is complete, the K3S should reset and run normally.

Forcing a Firmware Download

If you accidentally load an old or incompatible firmware version and find the K3S unresponsive, do the following: (1) unplug the K3S from the power supply and wait 5 seconds; (2) plug the power supply back in; (3) hold the transceiver's **POWER** switch in; after about 10 seconds, you'll see the **TX** LED flash (you'll also see **MCU LD** on the LCD); (4) load the correct firmware version.

Configuration

Configuring the K3S involves installing modules and filters, then customizing menu settings. Options come with their own installation manuals. Once they're installed, they must be enabled (pg. 57).

⚠ Be sure to save your configuration using *K3 Utility* each time you change menu settings.

Crystal Filter Setup

Crystal filter installation is covered in detail in Appendix A (pg. 84). Once filters have been installed (or moved), follow the steps below.

i The *K3 Utility* software application can also be used to view or change crystal filter settings; click on *Configuration* tab / *Edit Crystal Filters*.

Filter Bandwidth

- Turn the K3S on.
- Hold **CONFIG** to access the CONFIG menu.
- Locate the *FLx BW* menu entry, which will be used in the next step to set up filter bandwidths. “x” will be replaced with 1 through 5, corresponding to crystal filters FL1-FL5.
- Tap **SUB** if you're setting up sub receiver filters. The **SUB** icon will flash.
- Tap **1** or use **XFIL** to select **FL1**.
- Using VFO A, adjust the bandwidth parameter so that it matches the filter installed at the FL1 position. Use the filter information table you filled out in Appendix A.
- Select the remaining filters by tapping **2** through **5** or **XFIL**, adjusting their bandwidth parameters according to the table.
- Stay in the menu for the next filter setup step.

Filter Frequency Offset

- Use VFO B to find the *FLx FRQ* menu entry.
- If you're setting up sub receiver filters, make sure the **SUB** icon is still flashing (tap **SUB** if necessary).
- Tap **1** or use **XFIL** to select **FL1**.

- Adjust VFO A so that the parameter matches FL1's marked frequency offset (as recorded in the filter information table, Appendix A). The default value, **0.00**, corresponds to the nominal filter center frequency of 8215.0 kHz. Most 5-pole filters will have an offset, e.g. “-0.91”. (This has no effect on performance; firmware compensates for the offset.)
- Select the remaining filters and adjust their frequency offsets as required.

Receive Filter Enables (Per-Mode)

You must specify which of the five crystal filters is enabled for receive in each mode.

- Use VFO B to locate the *FLx ON* menu entry.
- Tap **SUB** if you're setting up sub receiver filters.
- Tap **MODE** until the **LSB** icon appears. If you see the **USB** icon instead, hold **ALT** (left end of the **MODE** switch) to select **LSB**.
- Tap **1** or use **XFIL** to select **FL1**.
- Set *FL1 ON* to **YES** or **NO** using VFO A. You should enable both narrow and wide filters for use in SSB modes, since they may be used during copy of data, SSB, or AM signals.
- Use **XFIL** to go to FL2-FL5 in turn, and enable or disable these filters for LSB mode.
- Tap **MODE** to select each of the other modes in turn (USB, CW, DATA, AM, and FM). For each mode, set up the FL1-FL5 enables.

Filter Loss Compensation

You can compensate for the greater loss of narrow crystal filters by specifying added per-filter gain.

- Use VFO B to find the *FLx GN* menu entry.
- Tap **SUB** to set up sub receiver filters. Otherwise, make sure the **SUB** icon is OFF.
- Tap **1** – **5** or **XFIL** to select a filter to modify.
- Use VFO A to set the gain in dB. In general, you'll want to add 1-2 dB for 400-500 Hz filters, and 3-4 dB for 200-250 Hz filters.
- Select any additional filters that require added gain, and adjust their gain amounts.

Transmit Crystal Filter Selection (Per-Mode)

This step applies only to filters on the RF board.

- Select CW mode by tapping **MODE**.
- Use VFO B to find the *FLTX CW* menu entry.
- Rotate VFO A to select a CW transmit filter (2.7 or 2.8 kHz). **Note:** Key clicks may result if a narrower filter is selected for CW transmit.
- Tap **MODE** to select **LSB** or **USB**. The menu entry will become *FLTX SB*.
- Select the filter to be used during SSB and DATA transmit (2.7 or 2.8 kHz).
- If applicable, select a 6- or 13 kHz filter for AM and ESSB (*FLTX AM*), and 13 kHz for FM (*FLTX FM*).

i If you're using a 2.7-kHz 5-pole filter for SSB transmit, you can optionally fine-tune its *FLx FRQ* parameter to equalize LSB and USB transmit characteristics. Monitor with a separate receiver and use headphones, or have another station listen.

Module Enables

This section explains how to set up the various K3S internal modules. Some are supplied with the basic K3S, while others are optional. Module set up can be performed at any time.

⚠ Be sure to save your configuration using *K3 Utility* each time you change menu settings.

Once any option module has been installed, use the associated CONFIG menu entry to enable it (see below). Then turn the K3S off for 5 seconds, and back on so the K3S can find and test the module.

- **KAT3A** ATU module: set *KAT3A* to **BYP**. If you also have a KAT500 ATU (external 500-W antenna tuner) connected to the K3S, refer to the KAT3A menu entry for details on how to enable VFO tracking. This can be used to keep the KAT500 ATU's L-network updated as you tune VFO A on the K3S. (In SPLIT mode, the VFO B frequency is sent to the KAT500 rather than VFO A.)

- **KBPF3A** general-coverage band-pass filter module: set *KBPF3A* to **NOR** (if you're installing a KBPF3A on the sub receiver, first tap **SUB** in the menu entry).
- **KXV3B** RF I/O module: set *KXV3B* to **NOR**. If the menu entry name is shown as **KXV3** (without the **B** suffix), tap **9** to change it. This is required before preamp 2 can be used. (See *CONFIG:PREAMP2* for details on enabling preamp 2.) If you see **ERR XV3**, see **Troubleshooting**.
- **KPA3A** amplifier module: set the *KPA3* menu entry to **PA NOR**. See menu entry description for information on other KPA3 settings.
- **KRX3A** sub receiver: set *KRX3A* to match your selected configuration for the sub receiver's AUX antenna: **ANT=ATU** (KAT3) or **ANT=BNC** (AUX RF jack, rear panel). For details on sub receiver antennas, see pg. 39. You may also need to set up crystal filters for the sub receiver as described on the previous page.
- **K144XV** 2-meter module: Set up all transverter menu entries for this band (starting with *CONFIG XVn ON*, etc.).
- **K3EXREF**: If your K3S is equipped with a K3EXREF module (to lock the synthesizers to an external 10-MHz reference), see *CONFIG:REF CAL* for instructions on enabling it.
- **KDVR3** voice recorder: set *KDVR3* to **NOR**.

Miscellaneous Setup

We suggest setting up at least the items below. You may wish to review the other menu entries as well, starting on pg. 55.

Mic Gain / Bias

MAIN:MIC SEL is used to select either the front- or rear-panel mic, or **LINE IN**. If a mic is selected, you can also tap **1** to select **Lo** or **Hi** mic gain range, and tap **2** to toggle mic bias on/off. See pg. 13 for Elecraft mic bias recommendations. Tap **7** to boost gain for very low-output front panel mics.

AF Gain Range

CONFIG:AF GAIN specifies **LO** or **HI** AF gain range. The default is **HI**.

Time and Date

CONFIG:TIME sets the 24-hour real-time-clock (RTC). Tap **1**/**2**/**3** to adjust HH/MM/SS using VFO A. *K3Utility* can also be used to set the time.

CONFIG:DATE MD selects **US (MM.DD.YY)**, or **EU (DD.MM.YY)** date format using VFO A.

CONFIG:DATE is used to set the date. Tap **1**/**2**/**3** to adjust MM/DD/YY or DD/MM/YY.

Preamp 2

To use preamp 2 for weak-signal work on any of 12, 10, or 6 meters, select each band in turn, then change the **CONFIG:PREAMP2** setting to **ON**.

VFO Setup

Several **CONFIG** menu entries are provided to control VFO behavior:

- **VFO CRS** sets up the **COARSE** tuning increment in kHz (separate for each mode). Tap **1** to turn rounding on/off.
- **VFO CTS** specifies the number of counts per knob turn (VFO A and B): **100**, **200**, or **400**
- **VFO FST** selects the normal VFO fast tuning rate (**20** or **50** Hz)
- **VFO IND**, if set to **YES**, allows VFO B to be set to a different band than VFO A.

Power-On Banner

You can have your call sign or other message shown on power-up. Use **K3 Utility (Configuration tab)** to edit the message.

K3/0-Mini Control

To use a K3/0-Mini panel to control a remotely located K3 or K3S, you must put the –Mini into “Terminal” mode. To do this, hold **MENU** for about 3 seconds. (Hold for 5 seconds to exit.) For further details, refer to the K3/0-Mini manual.

VFO A Knob Friction Adjustment

The VFO A knob’s spin rate can be adjusted by moving the knob in or out slightly. The rubber finger grip on the VFO A knob covers the knob’s set screw, so it must be removed first.

⚠ In the following procedure, use only your fingernails; a tool may scratch the knob.

Using your fingernails at the point identified below, pull the finger grip forward slightly. Rotate the knob and repeat until the grip can be pulled off.

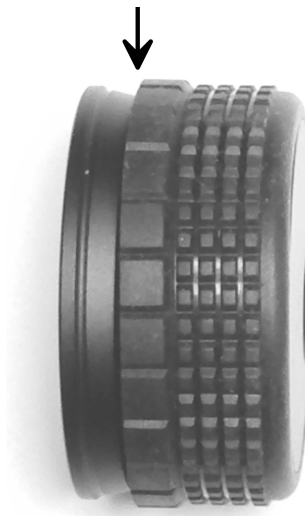

Use the supplied 5/64" (2 mm) Allen wrench to loosen the set screw.

Between the knob and front panel are two felt washers which, when compressed, reduce the spin rate. Move the knob in or out in small increments until the desired rate is obtained. (Re-tighten the set screw each time so you can spin the knob.) Then and replace the finger grip.

VFO B Knob Friction Adjustment

Use the supplied 5/64" (2 mm) Allen wrench to loosen the VFO B knob's set screw.

Between the knob and front panel is a felt washer which, when compressed, reduces the spin rate. Move the knob in or out in small increments until the desired rate is obtained, re-tightening the set screw each time.

Real Time Clock Battery Replacement

⚠ K3S components or modules can be easily be damaged by ESD (electrostatic discharge). To avoid this, put on a grounded wrist strap (with 1 megohm series resistor) or touch a grounded surface before touching anything inside the enclosure. An anti-static work mat is strongly recommended.

The battery for the real time clock/calendar is located on the left side of the RF board. To access it, turn power off, then remove the left side panel. If a sub receiver module is installed (KRX3A), it may be left in place.

Remove the old battery by gently prying it out of its socket using a *non-metallic* tool.

Replace the battery with the same type of 3-V lithium coin cell (CR2032, BR2032, equivalent). The (+) terminal is clearly marked on the battery; it must be oriented as indicated by the (+) symbol on the battery contact. Re-install the KRX3A module (if applicable) and the top cover.

To set the time, date, and date format, refer to the following CONFIG menu entries: *TIME*, *DATE*, and *DATE MD*. (Note: the *CONFIG:BAT MIN* menu entry refers to a battery used as the DC power source for the transceiver, not to the 3-V battery.)

Calibration Procedures

⚠ All calibration procedures are firmware-based. Please do not adjust any of the trimmer capacitors or potentiometers inside the K3S.

⚠ Be sure to save your configuration using *K3 Utility* each time you change menu settings.

Most calibration procedures use **Tech-Mode** menu entries. To enable these, set *CONFIG:TECH MD* to **ON**. Set *TECH MD* to **OFF** afterward.

Synthesizer

The KSYN3A synthesizer used in the K3S does not require calibration.

Wattmeter

⚠ Before doing wattmeter or transmit gain calibration, set both *CONFIG:TUN PWR* and *PWR SET* to **NOR**.

If desired, **TUNE** power readings can be calibrated. This must be done at 5.0 W, 50 W (K3S/100 only), and 1.00 mW.

Low-Power (5 W) Wattmeter Calibration

- Switch to 20 meters. If applicable, put the ATU into bypass mode (hold **ATU**).
- Connect a 50-W capable dummy load (5 W for K3S/10) and an accurate wattmeter to ANT1.
- Switch to ANT1 by tapping **ANT**.
- Set power to exactly 5.0 watts.
- Hold **CONFIG** and locate the *WMTR LP* menu entry. Stay in the menu for the next step.
- Hold **TUNE**; adjust menu parameter for a reading of 5.0 W on the external wattmeter. Then tap **XMIT** to exit TUNE. Exit the menu.

High Power (50 W) Wattmeter Calibration

This applies to the K3S/100 only. Use the same procedure as shown for 5 watts, but set power to 50 W. The wattmeter calibration menu entry name will change to *CONFIG:WMTR HP*.

Milliwatt-meter Calibration (XVTR OUT)

- Set the *CONFIG:KXV3B* menu entry to **TEST**, forcing all bands to temporarily use the KXV3B's transverter output jack. Power will be limited to 1.5 mW. The wattmeter calibration menu entry name will change to *CONFIG:WMTR MW*.
- Connect a dummy load and an accurate RF voltmeter to the XVTR OUT jack.
- Set power to exactly 1.00 milliwatts (0 dBm).
- Hold **TUNE**; adjust the *WMTR MW* menu parameter for 0.224 Vrms on the external voltmeter. Then tap **XMIT** to exit TUNE.
- Set *CONFIG:KXV3B* back to **NOR**.

Transmitter Gain

This procedure is normally done at assembly time or by the factory. It compensates for per-band TX gain variation, and **must be done on every band**.

⚠ If a computer is available, you should use the automated version of the below procedure. Run *K3 Utility* and click on the *Calibration* tab.

Low-Power (5 W) TX Gain Calibration

- Switch to 160 meters.
- Put the ATU into bypass mode (hold **ATU**).
- Connect a dummy load to ANT1.
- Switch to ANT1 by tapping **ANT**.
- Set power to exactly 5.0 watts.
- Hold **TUNE**; VFO B should show about 5 W.
- Tap **XMIT** to exit TUNE.
- **Repeat this procedure on 80-6 meters.**

High Power (50 W) TX Gain Calibration

This applies to the K3S/100 only. Use the same procedure as shown for 5 watts, but set power to 50 W, and use a 50-W dummy load. The **TUNE** power output indication should be about 50 watts. (Use the **K3 Utility** method if a PC is available.)

Milliwatt TX Gain Calibration (XVTR OUT)

Use the **K3 Utility** method if a PC is available.

- Connect a non-inductive 50-ohm resistor or dummy load to the XVTR OUT jack.
- Switch to 160 m.
- Set **CONFIG:KXV3B** to **TEST**. This forces all bands to use the KXV3B's transverter output jack, and output to be limited to 1.5 mW.
- Set power to exactly 1.00 milliwatts (0 dBm).
- Hold **TUNE**; output power should be about 1 mW. Then tap **XMIT** to exit TUNE.
- Repeat the above procedure on 80-6 m.
- Set **CONFIG:KXV3B** back to **NOR**.
- Tap **MENU** to exit the menu.

Reference Oscillator

The reference oscillator is a TCXO, or *temperature-compensated crystal oscillator*. It is normally calibrated at assembly time or by the factory. There are two types: **5 ppm** and **1 ppm**.

Either TCXO can be manually calibrated using an accurate frequency counter (**Method 1**), or by zero-beating the sidetone against a reference signal (**Method 2**). Both are described at right. If a K3EXREF option module is installed, the TCXO will be automatically calibrated to an external 10-MHz reference. Refer to the K3EXREF manual.

If a K144XV module with reference lock (K144RFLK) is installed, it can be set up to track the TCXO (see **CONFIG:XVn OFS**).

If your K3S is equipped with an external reference locking module (K3EXREF), see **CONFIG:REF CAL** for instructions on enabling it.

⚠ Before attempting to calibrate the reference oscillator using Method 1 or 2, allow the transceiver to warm up at room temperature for at least 15 minutes (cover on).

Method 1 (Frequency Counter):

- Locate the **CONFIG:REF CAL** menu entry.
- Connect a frequency counter with **+/-1 Hz or better** accuracy to J1 on the reference oscillator module. Measure the exact frequency in Hz.
- Using VFO A, set the **REF CAL** parameter to match this frequency. Then exit the menu.

Method 2 (Zero-Beating):

- Select CW mode. Set **WIDTH** to about 2.8 kHz. (A wide filter passband is necessary since you may need to move the **REF CAL** parameter a significant amount.)
- Tune the K3S to a strong broadcast station or a known-accurate reference signal. **Use the highest-frequency source you can** (e.g. WWV at 10, 15 or 20 MHz). **Set the VFO to the specified frequency of the signal.**
- Using **MON**, set the sidetone monitor level to roughly match the volume level of the received broadcast or reference signal.
- Locate **CONFIG:REF CAL**.
- Tap **SPOT** to enable the sidetone.
- Adjust the **REF CAL** frequency until the sidetone is zero-beated with the signal. As you approach the correct frequency, you'll hear an undulating "beat note" between the signals. The slower the beat note, the closer they are.
- Cancel **SPOT** and exit the menu.

Front Panel Temperature Sensor

- Turn the K3S OFF. Allow about 15 minutes for the radio to cool to room temperature.
- Turn the K3S ON.
- Locate the *CONFIG:FP TEMP* menu entry. Adjust the parameter to match the reading of a room thermometer. **Note:** Deg. C = (deg. Fahrenheit - 32) * 0.555.

A Front panel compartment temperature can be monitored continuously. Tap **DISP**, then use VFO B to select the **FP xxC** alternate display.

PA Temperature Sensor

- Turn the K3S OFF. Allow about 15 minutes for the PA heat sink to cool to room temperature. **Do not turn the K3S ON during this period.**
- Turn the K3S ON.
- Locate the *CONFIG:PA TEMP* menu entry. Adjust the parameter to match the reading of a room thermometer. **Note:** Deg. C = (deg. Fahrenheit - 32) * 0.555.

A PA heat sink temperature can be monitored continuously. Tap **DISP**, then use VFO B to select the **PA xxC** alternate display.

S-Meter and RF GAIN Control

S-meter and RF GAIN control calibration is normally adequate using the factory settings. The optional S-meter calibration procedure below may provide better results.

i You can optionally linearize main and sub receiver IF gain using the “Calibrate RF GAIN” procedure in *K3 Utility (Calibration tab)*. **This should be done before S-meter calibration.**

Calibrating the S-meter requires a 1-μV/50-μV signal source (an accurate signal generator such as an Elecraft XG2 or XG3 can be used).

- Switch to a band applicable to your signal generator.
- Select CW mode.

- Set transmit power to 0.0 W using **⊖ PWR**.
- The S-meter has both relative and absolute modes. Refer to the *CONFIG:SMTR MD* menu entry description if you wish to switch from relative to absolute. (Relative mode is easier to calibrate and is the factory default.)
- Turn the attenuator off (**ATT**).
- If you have *CONFIG:SMTR MD* set to **NOR**, turn preamp 1 **on (PRE)**. If *SMTR MD* is set to **ABS**, turn the preamp **off**.
- Tap **AGC** to select slow AGC (**AGC-S**).
- Bypass the ATU, if installed, by holding **ATU**.
- Set **⊖ RF GAIN** to maximum (**fully clockwise**). (**Note:** If you’ve assigned the RF gain control for the present receiver to **squelch**, its RF gain will default to maximum unless you’re controlling RF gain from a remote-control computer application.)
- Normalize DSP filtering (hold **NORM**; pg. 14).
- Connect the signal generator to ANT1 and set it for 50 microvolts RF output.
- Tune to the frequency of the signal generator (tune for peak audio response). You can also use **auto-spot** (pg. 32) to accurately match the pitch of the signal, ensuring that it is centered in the passband.
- Locate the *CONFIG:SMTR PK* menu entry; set it to **OFF**.
- Locate the *SMTR SC* menu entry (S-meter scale). Use the VFO A knob to set it to the default value (**14**).
- Locate *SMTR OF* (S-meter offset). Adjust it for an S-9 reading. The default value (**24**) may suffice.
- Switch the signal generator to 1-μV output; the S-meter should now indicate about S-2 to S-3. If not, change *SMTR SC* by 1 unit (try 15 first, then 13, then 16, then 12). After each *SMTR SC* change, re-adjust the *SMTR OF* setting for an S-9 indication.
- When you have completed this procedure, disconnecting the signal generator should now show NO bars on the S-meter.

Menu Functions

⚠ Save your configuration using *K3 Utility* after changing menu settings.

There are two groups of menu functions: **MAIN** and **CONFIG**. Each group is ordered alphanumerically. **MAIN** menu entries are shown below. **CONFIG** entries, which are used for initial configuration and advanced features, start on page 57. Tap **MENU** to access the **MAIN** menu; hold **CONFIG** to access the **CONFIG** menu.

Menu entries you'd like quick access to can be assigned to programmable function switches (pg. 23).

Tapping **DISP** within a menu entry shows usage information in the VFO B display area. For most entries, the default parameter value is shown in parentheses at the start of this help text.

MAIN Menu

Entry	Default	Description
AFX MD	Delay 5	Audio Effects. Selections: DELAY 1-5 (quasi-stereo); BIN (L/R phase shift)
ALARM	OFF	Set alarm/Auto-Power-On time. Tap 1 to turn alarm on/off; tap 2 / 3 to set HH/MM .
ATTEN	10 dB	Main receiver attenuation level (5/10/15 dB, per-band). Holding ATT for 2 seconds brings up this menu entry. (The sub receiver's ATT-on setting is fixed at 10 dB.)
LCD ADJ	8	LCD viewing angle and contrast. Use higher settings if the radio is used at or above eye level. If adjusted incorrectly, bar graphs will be too light or heavy during keying.
LCD BRT	6	LCD backlight brightness. Use DAY in bright sunlight, 2 to 8 for indoor lighting.
LED BRT	4	LED brightness (relative to LCD backlight brightness). Exception: if LCD BRT is set to DAY , LEDs are set to their maximum brightness.
MIC SEL	FP, low range, bias off	Mic/line transmit audio source, mic gain range, and mic bias. Source selections: FP (front panel 8-pin MIC jack), RP (rear panel 3.5 mm MIC jack), and LINE IN (rear-panel LINE IN jack). Note: If a plug is inserted into the LINE IN jack, this audio input will override any digitized audio line-in signal present at the USB port. This is only relevant if the USB port has been selected (see CONFIG:RS232). Tap 1 to toggle between .Low and .High mic gain range for the selected mic. Tap 2 to turn mic BIAS on/off (turn on for electret mics). For the front-panel mic only, tap 7 to turn on an additional gain stage. <i>Use this only with very low-output mics.</i> An apostrophe will appear after the H , e.g. H' .
MIC+LIN	OFF	If set to ON , and MIC SEL is set for FP or RP , the present mic OR line input can be used for transmit audio. Note: Setting MIC SEL to LINE overrides the MIC+LIN menu entry (its parameter becomes "N-A"). When MIC+LIN is in effect, rotating the MIC control shows MIC gain. Set MIC SEL to LINE to adjust LINE IN gain.
MSG RPT	6	Message repeat interval in seconds (0 to 255). To repeat a message, hold M1 – M4 rather than <i>tap</i> . A 6 - 10 sec. interval is about right for casual CQing. Shorter intervals may be needed during contests, and longer for periodic CW beacons.
RPT OFS	600	Sets the transmit offset (in kHz) for repeater operation, from 0 to 5000 kHz. Stored per-band and per-memory. Use ALT to select a +/- offset or simplex operation.

RX EQ	+0 dB, each band	Receiver audio graphic equalizer. VFO A is used as an 8-band bar graph, showing boost or cut (-16 dB to +16 dB in 1 dB increments) for each AF band. The 8 bands are 0.05, 0.1, 0.2, 0.4, 0.8, 1.6, 2.4 and 3.2 kHz. Tap [1-8] to select an AF band. VFO A selects boost/cut. Tap [CLR] to reset all bands to +0 dB. CW RX EQ is separate from RX EQ for voice modes. RX EQ is not applicable to DATA modes.
TX EQ	+0 dB, each band	Transmit audio graphic equalizer (voice modes only). Functions the same as <i>RX EQ</i> , above. TX EQ can be adjusted during transmit. SSB TX EQ is separate from TX EQ for other voice modes. Not applicable to CW or DATA modes.
VOX GN	0	Adjusts the sensitivity of the VOX to match your mic and voice.
ANTIVOX	0	Adjusts immunity of the VOX circuit to false triggering by speaker audio.

CONFIG Menu

 Save your configuration using *K3 Utility* after changing menu settings.

Tech Mode Entries

Menu entries that include [T] are *tech mode* entries. These are only visible if *CONFIG:TECH MD* is set to **ON**. They are normally left at their defaults. Entries described as “**Advanced**” or “**Troubleshooting**” should be changed with caution. Tap **DISP** to see recommended default values (in parentheses at the start of help text).

Sub Receiver Settings

Menu entries marked **SUB** have two settings: one for the main receiver, and one for the sub receiver. If a sub receiver is installed, the menu entries will change to identify which receiver is being set up, with **RF** (main receiver) or **SUB** (sub receiver) at the left end of the parameter. In the **SUB** case, the **SUB** icon will flash.

Prior to adjusting sub receiver menu parameters, you should turn the sub receiver on by tapping **SUB**. This is especially important if you’re adjusting crystal filter settings, because it will allow you to hear the changes as filters are selected and modified. You should also turn SUB AF gain up and MAIN AF gain down.

Even if the sub receiver is turned on, when you first enter the menu, **RF** will be in effect, and the **SUB** icon will be turned off. Tap **SUB** to switch to the sub receiver parameter as required.

Terminal Mode (TERM)

If you hold **CONFIG** for 3 seconds or longer, the K3S will enter “Terminal” mode, which allows the K3S to emulate a K3/0-Mini panel (pg. 47). In this case the K3S will not function as a radio—only as a controller for a remotely located K3 or K3S. To exit Terminal mode, hold **CONFIG** for 5 seconds.

Entry	Default	Description
2 TONE [T]	OFF	(Troubleshooting) Enables built-in 2-tone generator for SSB transmit tests. The internal 2-tone generator only works if LSB or USB mode is selected. After setting 2-tone ON, exit the menu and tap XMIT. You can use  MIC to adjust the amplitude of one of the tones; the other’s amplitude is fixed.
ADC REF [T]	5.00	(Optional) Allows calibration of the voltage reference used by the K3S to measure and display certain values, such as the rig’s supply voltage. First, disconnect anything attached to the ACC jack. Next, locate the <i>ADC REF</i> menu entry. It will initially show 5.00 volts as the reference voltage. Using a DMM set to DC volts, measure the actual voltage at pin 2 of the ACC jack. This must be done while the ADC REF parameter is being viewed in the menu . Note: The (-) probe of the DMM should go to the chassis ground, e.g. at the GROUND lug. Finally, use VFO A to set the <i>ADC REF</i> menu parameter to what you measured at pin 2.
AF GAIN	HI	Sets AF gain range. Available selections are HI or LO .
AF LIM	NOR	(Advanced) Adjustable AF output limiter for use when AGC is turned off. This can protect your ears if a large signal appears. Signals or noise above the threshold will sound highly distorted due to the limiting action, reminding you to back down the AF or RF gain. Typical settings for those who often turn AGC off are 17 to 23; some experimentation will be required.

AFSK TX	FIL OFF	If set to FIL ON , a 400-Hz transmit audio filter is added (via DSP) in order to maximize transmit signal to noise ratio. This may be useful in high-noise computer environments. Applies only to AFSK-A mode (RTTY).
AFV TIM [T]	1000	(Advanced) Integration time for AFV and dBV displays in ms. See VFO B alternate display information (pg. 38).
AGC DCY	NOR	AGC decay characteristic; applies to both fast and slow AGC. NOR selects traditional linear decay. The SOFT setting can reduce IMD caused by traditional AGC, and is especially useful in “pileup” conditions, in some cases making it unnecessary to turn AGC off. Also see <i>AGC HLD</i> , below, which can reduce AGC IMD even further.
AGC HLD	0.00	SLOW AGC “hold” time. Specifies the number of seconds that the SLOW AGC level is held after the signal drops. This can be used to reduce IMD caused by traditional AGC, and is especially useful in “pileup” conditions, in some cases making it unnecessary to turn AGC off. Also see <i>AGC DCY</i> , above.
AGC PLS [T]	NOR	(Advanced) NOR enables AGC noise pulse rejection.
AGC SLP [T]	12	(Advanced) Higher values result in ‘flutter’ AGC (making signals at all amplitudes closer in AF output level).
AGC THR [T]	5	(Advanced) Sets AGC onset point; a higher number moves the onset up.
AGC-F [T]	120	(Advanced) Sets fast AGC decay rate; a higher number means faster decay.
AGC-S [T]	20	(Advanced) Sets slow AGC decay rate; a higher number means faster decay.
AUTOINF [T]	NOR	(Advanced) If set to AUTO 1 , the K3S will send band data on its USB or RS232 port for use with devices such as the SteppIR™ antenna on every band change. (Note: This setting may not be compatible with PC software applications that use the “AI” remote control command.)
BAT MIN	11.0	Low-battery warning threshold; 11.0 recommended. (This refers to a battery used as the DC power supply for the transceiver, not to the 3-V backup battery for the real-time clock.) If the voltage drops below this level, the operator will be alerted with a BAT LOW message. The menu parameter flashes if this occurs within the menu, so the level can be easily tested.
BND MAP	{band} In	Allows you to remove one or more bands from the BAND rotation. Use BAND up/down to select bands, then set them to In or Out using VFO A. (Works with transverter bands, too.) You can still get to mapped-out bands using memory recall, direct frequency entry, or computer-control commands.
CW IAMB	A	Iambic keying mode (A or B). Both modes produce self-completing dots and dashes. Mode B is more efficient for operators who use “squeeze” keying (pressing both paddles at once), because an extra dot or dash is inserted on squeeze release. Mode A lacks this feature, which may be more appropriate for those who only press one paddle at a time (often called “slap” keying).
CW PADL	TIP=DOT	Specifies whether left keyer paddle (“tip” contact on the plug) is DOT or DASH .
CW QRQ	OFF	(Advanced) Set to ON to provide CW keying speeds of up to 100 WPM and faster break-in at all speeds. The internal keyer range becomes 8-100 WPM in this case. Caution: In QRQ mode, the delay from key down to first RF out may be as little as 4 to 5 milliseconds. This may be too fast for some external amplifiers. You can increase the <i>CONFIG:TX DLY</i> setting to compensate, but you should then listen to your signal on another receiver to ensure that your CW keying doesn’t exhibit excessive timing variation. Note: If you use SPLIT, RIT, XIT, or cross-mode, QRQ mode will be temporarily turned off. Filter passband SHIFT/LO CUT/HI CUT cannot be used when CW QRQ is in effect.

CW WGHT	1.15	<p>Adjusts element/space timing ratio (weight) for the internal keyer.</p> <p>Additional functions of this menu entry, via numeric keypad (Advanced):</p> <p>Tap 1 to select SSB -CW (default) or SSB +CW (allows CW in SSB modes).</p> <p>Tap 2 to select @ = STOP ('@' character terminates KY-packet transmission; default) or @ = 'AC' ('@' in a KY packet is sent as .-.-. [@] in CW mode).</p> <p>Tap 3 to select OLD or NEW QSK (default). NEW reduces AF keying artifacts.</p> <p>Tap 4 to select VOX NOR (default) or AUTO OFF. The AUTO OFF setting turns CW VOX <i>off</i> on power-up, avoiding accidental keying by attached PCs, etc.</p> <p>Tap 5 to select automatic VFO offset on SSB/CW mode change (VFO OFS) or no offset (VFO NOR, default). Automatic offset is often used on 6 meters, where mixed-mode QSOs are necessary during fading. Note: Pitch matching will be more accurate if USB is paired with CW REV, and LSB with CW normal.</p>
DATE	N/A	Real-time-clock date, shown as in the format selected by CONFIG:DATE MD (MM.DD.YY or DD.MM.YY). Tap 1 / 2 / 3 to select month / day / year.
DATE MD	US	Select US (MM.DD.YY) or EU (DD.MM.YY) date formats.
DDS FRQ [T]	n/a	Not applicable to the K3S.
DIGOUT1	OFF	<p>DIGOUT1 is a general-purpose open-drain output signal on the ACC connector (pin 11). OFF = floating; ON = pull the line to ground.</p> <p>DIGOUT1 is per-band, and also per-antenna if the KAT3A ATU is installed. It can be used to control remote antenna switches, filters, etc.</p> <p>Max. load current (ON) is 15 mA; max. load voltage (OFF) is 25 VDC.</p>
DUAL PB	APF	Assigns one of two specialized filter functions to the APF switch in CW mode: APF (audio peaking filter) or NOR (Dual-Passband Filtering, or Dual PB). See pg. 37 for details on the two functions.
EXT ALC [T]	OFF t-4.0	(Advanced) Set to ON only if using external ALC with a high-power amplifier (see pg. 29 for details). When set to ON , the external ALC threshold of the K3S (-4.0 V by default) can be varied.
FLx BW SUB	2.70 (FL1)	<p>Crystal filter FL1-5 bandwidth in kHz, where x=1 to 5 (FL1-FL5). Tap 1-5 to select a specific filter, or tap XFIL (6) to select the next filter. Then set the bandwidth to that marked on the crystal filter. (If desired, the value entered can be slightly different from the marked value. For example, you might set the bandwidth of the 8-pole, 400-Hz filter to 0.45 kHz rather than 0.40 kHz. This delays automatic filter switching by the WIDTH control to 0.45, which may be advantageous if you believe the 400-Hz filter still performs well at 450 Hz.)</p> <p>Note: An easier-to-use alternative to the FLx menu entries is the Edit Crystal Filters function of our PC software application, K3 Utility. It shows all filter setups in a single window.</p> <p>Tap 7 to turn IIR DSP filters on (IIR ON) or off (IIR OFF, default) for the 100 and 50 Hz bandwidths. IIR filters have steeper skirts and slightly more ringing than the default FIR filters.</p>
FLx FRQ SUB	0.00 (FL1)	Crystal filter FLx center freq as offset from nominal (8215.0 kHz). Use the offset value specified on the crystal filter's label or PC board, if any. For example, if an Elecraft 5-pole, 200-Hz filter were labeled "-0.91", adjust VFO A for -0.91 .
FLx GN SUB	0 dB (FL1)	Crystal filter FLx loss compensation in dB. 0 dB recommended for wide filters; 2 dB for 400 or 500 Hz filters, and 4 dB for 200 or 250 Hz filters.
FLx ON SUB	ON (FL1), per-mode	Used to specify which filters are available during receive. Each filter must be set to ON or OFF in <i>each</i> mode. You can tap MODE within the menu entry.

FLTX {md}	FL1 (all modes)	Used to specify which crystal filter to use during TX. {md} = CW/SB/AM/FM . Choose filters with bandwidths as follows: SSB, 2.7 or 2.8 kHz (also applies to data); CW, 2.7 or 2.8 kHz; AM, 6 kHz or 13 kHz; FM, 13 kHz or higher. The FM filter, if present, must be installed in FL1. Note: If you're using a 2.7-kHz 5-pole filter for SSB transmit, you can optionally fine-tune its FLx FRQ parameter to equalize LSB / USB transmit characteristics. Monitor your signal on a separate receiver, using headphones.
FM DEV	5.0	(Advanced) FM voice deviation in kHz. Tap [1] to change the function to PL DEV (PL tone deviation). Note: The deviation setting for sub-audible tones (CTCSS) is separate from that for the European standard tone (1750 Hz). Before adjusting PL DEV , select the applicable pitch using the PITCH switch.
FM MODE	ON	If set to OFF , FM will be removed from the mode selections.
FP TEMP	N/A	Used to calibrate the front panel temperature sensor, which reads in degrees C. To convert °F to °C, use Deg. C = (deg. F-32) * 0.555.
FSK POL	1	0 = Inverted FSK transmit data polarity, 1 = Normal data polarity. For use only with external FSK-D keying via programs such as MMTTY. Not recommended for CW-to-DATA use.
FW REVS	N/A	Rotate VFO A to see firmware revisions: MCU (uC), main DSP (d1), aux DSP (d2 , if KRX3A is present), flash parameters (FL), and KDVR3 controller (dr). Tap [1] to see the LCD controller and RF board types. For the K3S, you should see VER B/2 , where B refers to the LCD controller type and 2 refers to the RF board type. Older types apply only to the K3.
KAT3	Not Inst	KAT3A ATU mode; normally set to BYP or AUTO (outside the menu, ATU alternates between the two). Also see test settings below. Tap [1] to enable or disable VFO tracking with a connected KAT500 automatic antenna tuner. KAT500Y (yes) or KAT500N (no) will be flashed on the VFO B display to indicate the current selection. When VFO tracking is enabled, the KAT500's L-network will be continuously updated as the VFO is tuned. Normally the KAT500 tracks VFO A; in SPLIT, it tracks VFO B (the TX VFO). Tap CLR within this menu entry to clear stored L-network data for the present band. This is very useful when matching across the band to a new antenna. Modes L1-L8 , C1-C8 , and Ct are used to test KAT3A relays. Mode LCSET allows manual adjustment of L/C settings (you must exit the menu first). When in LCSET mode, tapping ATU TUNE shows the L and C values; C is changed with VFO A, L is changed with VFO B, and ANT toggles between Ca and Ct .
KBPF3 SUB	Not Inst	If KBPF3A option is installed: set to NOR , exit menu, and turn power off/on. With the KBPF3A installed, the full HF range from 0.1 to 30 MHz can be used. For information on using the 100-550 kHz range, see pg. 41.
KDVR3	Not Inst	If KDVR3 option is installed: set to NOR , exit menu, and turn power off/on. Note: Normally, playing DVR transmit messages automatically asserts PTT. To use manual PTT with DVR transmit (via a footswitch or external sequencing equipment), tap [1] within the KDVR3 menu entry until you see USE PTT .
KIO3B	NOR	Determines function of BAND0-3 outputs on ACC connector. See pg. 21. If the menu entry name is KIO3 (without the B), then the K3S has not correctly detected the KIO3B module, and the USB and RS232 ports will not function. Try turning power off/on. If the problem persists, contact Elecraft.

KPA3	Not Inst	Set to PA NOR if KPA3A 100-W amp installed. Set to PAIO ON if KPA3A is not installed, but the KPAIO3A transition PC board is. Other settings include PA BYP (disables PA if installed), PA fan test settings (PA FN1-FN4 or PAIO FN1-FN4), and PAIO BYP (if transition board is installed, but not the KPA3A module, this setting can be used to test the high power bypass relay).
KRC2	--	Controls the KRC2 band decoder's accessory output settings. Shows ACC OFF or ACC1-3 if a KRC2 is detected; -- if not. To ensure compatibility with both old and new KRC2 firmware, two different 6 meter band decodes are provided. Tap 1 to select BAND6=B6 (addr=10) or BAND6=B10 (addr=9). Refer to the KRC2 manual for further details.
KRX3	Not Inst	If KRX3A option (sub receiver) is installed, set the parameter to match your selected sub receiver AUX RF source: ANT=ATU (the KAT3's non-transmit antenna) or ANT=BNC (the AUX RF BNC jack on the rear panel). Turn power off, then back on.
KXV3B	NOR	The KXV3B module is supplied with the basic K3S. If it is installed: set to NOR , exit menu, and turn power off/on. If not, set to NOT INST . The KXV3B provides RX ANT IN/OUT jacks, transverter I/O jacks (XVTR IN/OUT), preamp 2 (see <i>CONFIG:PREAMP2</i>), a buffered I.F. output for the P3, and internal 2-m module support (K144XV). If the menu entry name is shown as KXV3 (without the B suffix), tap 9 to change it, then exit the menu and turn power off/on. This instructs the K3S to look for the KXV3B module, which includes the preamp 2 circuitry. If you see ERR XV3 , refer to Troubleshooting . If KXV3B is set to TEST , the K3S will transmit at low power (0.10 to 1.50 mW) on all bands, including HF and transverter bands. RF input/output is via the XVTR IN/OUT jacks in this case. Used for troubleshooting or, at present, to transmit at ~0.5 mW on the 630-meter band (472 kHz). Note: The TEST setting is not available until the KXV3B has been configured as described above.
LCD TST	OFF	Rotating VFO A to turn on all LCD segments for test purposes.
LIN OUT	NOR 010	Sets the LINE OUT level. LINE OUT connections go to PC soundcard inputs. Settings above 10 may result in overdrive of the soundcard or saturation of the KIO3's isolation transformers; monitor signals using the PC to avoid this. The LINE OUT jack is active even if <i>CONFIG:RS232</i> is set to USB . The USB port also provides line-out audio via the USB cable. See pgs. 18 and 22. Note: Normally, LIN OUT sets a fixed-level receive-only output for main/sub (Left/Right), compatible with digital modes. Tapping 1 switches LIN OUT to =PHONES , where the line outputs match headphone audio. In this case, line out audio level is controlled by the AF/SUB gain controls.
MACRO x	Function	Used to assign macros (sequences of remote-control commands) to any of the programmable function switches. For example, a single macro can do the equivalent of "SPLIT, up 2 kHz, turn on diversity mode"; setup transmit EQ for a specific operator; configure the K3S for a contest, etc. Macros must first be created using K3 Utility and sent to the K3S. Next, locate the MACRO x menu entry, tap 1-8 to select a macro number (x), then hold the desired programmable switch (e.g. PF1) to assign that macro to it. For details, see K3 Utility help or the <i>Programmer's Reference</i> .

MEM 0-9	NOR	<p>If the parameter is set to BAND SEL, frequency memories 0-9 (“quick memories”) will act like band switches. Once this mode has been selected, exit the menu, then use V ► M to assign individual bands to keypad switches 0-9. For example, use BAND to get to 160 m, tap V ► M, then tap #1. From then on, tapping M ► V, then #1, will take you to your last-used frequency on 160 m, just as if you had used the BAND switch.</p> <p>This menu entry also controls the behavior of memory recall (M ► V) when selecting memories 00-99 using VFO A:</p> <p>Normally, when you tap M ► V, rotating VFO A through memories 00-99 switches the receiver to the indicated frequency as soon as the VFO stops moving. You can change this behavior by tapping 1 in the <i>MEM 0-9</i> menu entry. This alternates between M>V NOR (“live” memory recall) and M>V DLY (“delayed”). In the latter case, the receiver will not switch to new frequencies until you tap M ► V to return to normal operation.</p>
MIC BTN	OFF	<p>Set to ON if your mic has UP/DOWN buttons compatible with the front-panel mic jack. Not applicable to the Elecraft MH2 or MD2 microphones.</p> <p>Tapping UP/DOWN once moves the VFO up/down one step (based on current tuning rate); holding UP/DOWN moves up/down continuously. If frequency moves up/down continuously, your mic is not compatible; set <i>MIC BTN OFF</i>.</p>
L-MIX-R	A B	<p>Sets left/right mix of main (A) and sub (B) audio. Default is main full left, sub full right. A setting of AB B would provide main/sub mixing on the left, etc.</p>
NB SAVE	NO	<p>Set to YES to save noise blanker on/off state per-band. Noise blanker levels, both DSP and I.F., are always saved per-band regardless of this setting.</p>
PA TEMP	N/A	<p>If a KPA3A (100-W PA module) is installed, shows PA heat sink temperature and allows it to be adjusted. See calibration procedure on pg. 54.</p> <p>If you’re operating at high power from a battery, and voltage is dropping enough to cause an erroneous HI TEMP indication, tap 1 in this menu entry to select R ONLY (receive only) temperature sensing, rather than the default (T AND R).</p>
PB CTRL	Shift=.05	<p>(Advanced) Specifies the granularity of the passband SHIFT control on a per-mode basis: .05 (default) or .01 kHz. Select the desired mode first, then select the desired granularity. Limitations: Only applies to CW and DATA modes. Selecting .01 kHz reduces the SHIFT range and disables HI CUT and LO CUT. May interfere with spurious signal removal (<i>CONFIG:SIG RMV</i>), i.e. “removed” signals may not be shifted the right amount, and thus may again be audible.</p>
PREAMP2	OFF	<p>Set to ON to enable preamp 2 on each of 12, 10, or 6 m, as required. If preamp 2 is enabled, then the PRE switch will have three settings: OFF, PRE 1, and PRE 2. Use of preamp 2 with the sub receiver has some limitations (see pg. 45).</p>
PTT-KEY	OFF-OFF	<p>(Advanced) Allows selection of RTS or DTR lines (via the USB or RS232 ports) to activate PTT or key the K3S. (See pg. 19 for connections.) Example: if the parameter is set to RTS-DTR, then the RTS line will activate PTT, and DTR will key the rig. Note: If a computer or other device asserts RTS or DTR <i>while</i> you’re in this menu entry, the K3S will switch to TEST mode (zero output) as a precaution. The TX icon will flash as a reminder. To avoid this, make sure software has flow control and/or keying options turned OFF while you’re changing the <i>PTT-KEY</i> selection.</p>

PTT RLS	20	(Advanced) Provides a delay between release of PTT and dropping of the transmit carrier; intended for use with fast turn-around data protocols such as AMTOR and PacTOR. (No effect in CW, FSK D, or PSK D modes.) A value of 20 or higher may be needed to ensure accurate data transmission with these protocols. If sync data or -S is in effect (see <i>SYNC DT</i>), a lower value, typically 10 to 12, is optimal. Also see AMTOR/PacTOR (pg. 34).
PWR SET	NOR	If set to NOR , the power level on each band follows the present setting of the PWR control. If set to PER-BAND , the power level is saved on each band. This is especially useful with external amplifiers (see ALC discussion on page 82.) If a KPA500 is connected to the K3S via the ACC cable, two sets of per-band power settings are saved: one for “barefoot” operation, one for use with the amp. When the amp is used, an asterisk appears as PWR is rotated (e.g. 30 W*). Tap 1 to LOCK or UNLOCK the MIC, CMP, and PWR controls.
REF CAL [T]	49380000 Hz	Used to calibrate the reference oscillator. VFO A is used to set the reference oscillator frequency in Hz. Typically it will be 49380.000 +/- 1000 Hz. Refer to page 53 for manual reference oscillator calibration details. If a K3EXREF option is installed and connected to an external 10-MHz reference, tap 2 to enable it (XREF IN). With a K3EXREF option installed and an external reference connected, the REF CAL parameter will be calibrated automatically about 10-15 seconds after power-up. An asterisk will appear in the menu entry name (e.g. REF*CAL); the asterisk flashes as long as data is being received from the K3EXREF. Tapping 1 saves the automatically derived value as the default (manual) value. This is not required, but is useful if the external reference is ever disconnected.
RFI DET	NOR	NOR enables detection of high RFI at the antenna in receive mode (see HI RFI warning, Troubleshooting). Set to OFF to disable the warning.
RIT CLR	UNDO OFF	When this parameter is set to “UNDO ON”, tapping RIT/XIT CLR will alternate between 0.00 and the present RIT/XIT offset, if any.
RS232	4800 b	RS232 communications rate in bits per second (bps) <i>or</i> USB port selection. If USB is selected, PC control must be done via the USB port; the USB cable can also handle line-level audio in/out, eliminating the need for a sound card in the PC and associated cables. If USB is not selected, PC control can be done via the RS232/P3 jack (RJ45) as described on pg. 19. Note: During firmware download (via <i>K3 Utility</i>), the baud rate is set automatically to 38400 baud (applies to both RS232 and USB ports). The baud rate is then restored to the value selected in this menu entry.
SER NUM	N/A	Serial number of your K3S, e.g. 10000 . Cannot be changed.

SIG RMV [T]	NOR	<p>(Advanced; Optional) SIG RMV can be used to remove fast-tuning carrier signals (spurs or “birdies”) that are audible even with an antenna connected.</p> <p>Limitations: Applies only to CW/SSB/DATA modes, and only to the main receiver. In CW and DATA modes, <i>SIG RMV</i> should not be used in combination with a <i>CONFIG:PB CTRL</i> setting of Shift=.01. Set this to Shift=.05 first.</p> <p>To undo SIG RMV: Tapping CLR while you’re in the <i>SIG RMV</i> menu entry will delete all spur-removal information for the present band, only.</p> <p>STEPS:</p> <p>(1) Select the desired mode and band (for XVTR bands, use the I.F.).</p> <p>(2) Adjust SHIFT/WIDTH or LO/HI CUT to settings you use most often.</p> <p>(3) Locate a “fast-tuning” spur to be removed. A spur is “fast-tuning” if a 50 Hz change in SHIFT moves the spur 300 Hz or more; such spurs result from high harmonics of the VFO. Ideally, a small shift will move a spur completely out of the audible passband. <i>If you test a spur using SHIFT, be sure to return SHIFT to its original setting before continuing, because SHIFT affects the spur frequency.</i></p> <p>(4) Change the <i>SIG RMV</i> parameter to 0. This saves information about the spur, including its frequency, the current mode, etc.</p> <p>(5) Try different parameter values, starting with -1 or 1, to see if the spur can be shifted out of the audible passband. After changing the parameter <i>each</i> time, exit the menu and see if the spur is gone. (Each saved <i>SIG RMV</i> entry applies to a single 100-Hz VFO segment, e.g. from 28135.30 to 28135.39, so you’ll have to tune slowly through that 100-Hz range using 10-Hz steps.) You may hear a slight tuning artifact as you tune in and out of the affected VFO segment, especially for larger parameter values. This results from a shift in the crystal filter passband.</p> <p>(6) Repeat steps 3 through 5 for adjacent 100-Hz VFO segments if necessary.</p> <p>(7) If applicable, repeat steps 2 through 6 for other SHIFT/WIDTH or LO/HI CUT settings you use in the present mode. Note: If you change your sidetone pitch, you may need to re-do the procedure for spurs removed in CW mode.</p>
SMTR OF	024	S-Meter offset; see calibration procedure and SMTR SC, below (pg. 54).
SMTR SC	014	S-Meter scale. Typically set so that S-9 = 50 µV and S-2 to S-3 = 1 µV with Preamp 1 on, AGC ON, WIDTH of 500 Hz, and <i>SMTR MD</i> set to NOR. See calibration procedure (pg. 54).
SMTR PK	OFF	Set to ON for peak-reading S-meter. (Not applicable in FM mode.)
SMTR MD	NOR	(Advanced) S-meter mode: When set to NOR , preamp/attenuator on/off will affect the S-meter. (The default values of <i>SMTR OF</i> and <i>SMTR SC</i> apply to NOR .) If set to ABS , the S-meter reading will stay fairly constant with different preamp/attenuator settings, but <i>SMTR OF</i> and <i>SMTR SC</i> must be re-aligned.
SPLT SV	YES	If set to YES , SPLIT , RIT , and XIT on/off states are saved per-band.
SPKRS	1	Set to 2 if using two external speakers. This enables binaural effects in conjunction with the AFX switch, as well as stereo dual-receive if the sub receiver is installed. For further details on sub receiver use, see pg. 39.
SPKR+PH	NO	<p>YES = Speaker is always enabled, even when headphones are plugged into PHONES jack. See detailed discussion on pg. 22.</p> <p>A secondary function of this menu entry is to select the speaker-cutout jack logic: Tap 1 until you see PH.R SW-. The minus sign (-) indicates inverted switch logic, required for the jack on the KIO3B audio board. (If this is set incorrectly, you will not be able to hear any speaker output even with headphones unplugged.)</p>

SQ MAIN	0	This menu entry normally sets the main receiver squelch value (0-29). If VFO A is rotated fully clockwise, the parameter changes to =SUB POT . Squelch for both main and sub receivers will then be controlled by the SUB RF/SQL knob, and both main and sub RF gain will be controlled by the MAIN RF/SQL knob. Note: By default, squelch applies only to FM mode. Tapping [1] while in this menu entry alternates between SQL=ALL (all-mode squelch) and SQL=FM .
SQ SUB	0	This menu entry normally sets the sub receiver squelch value (0-29). But if SQ MAIN is set to =SUB POT , then SQ SUB will also change to =SUB POT . Squelch for the sub receiver will then be controlled by the SUB RF/SQL knob, and both main and sub RF gain will be controlled by the MAIN RF/SQL knob.
SUB AF	NOR	If set to BALANCE, then the SUB AF GAIN control becomes main/sub AF balance when the sub is turned on (including diversity mode). In this case MAIN AF GAIN controls the AF gain level for both receivers. When SUB AF is at 12 o'clock, both receivers will be at full volume (main left, sub right). If SUB AF is rotated fully counter-clockwise, you'll hear only the main receiver. If it's rotated fully clockwise, you'll hear only the sub receiver. At intermediate settings you'll hear both. A balance control is very useful for contesting and split operation. But it can also save a lot of AF gain control adjustment (i.e., matching main and sub), since MAIN AF controls both main and sub receiver audio.
SW TEST [T]	OFF	(Troubleshooting) To turn on switch test, rotate VFO A until the parameter becomes SCN ADC . Then hold any switch to see its scan row and column ADC reading. You can also rotate any of the four potentiometers to see their associated ADC readings (main/sub AF gain and main/sub RF gain). If the SUB RF pot is mapped to main/sub squelch, you must switch to FM mode to see its readings.
SW TONE	OFF	If set to ON , enables audible switch feedback tones. Volume level for switch tones is set using the MON control while in CW mode. (Note: For <i>voice</i> feedback on switch press, you may wish to use our K3 Voice program for the PC.) Tones generated: In general, a <i>low-to-high</i> tone pair is generated when a switch function is turned on, and <i>high-to-low</i> when it is turned off. Following ATU TUNE , SWR <= 2:1 results in a normal tone; <= 3:1 a medium-pitch tone; and over 3:1, a high-pitched tone. If CONFIG:RIT CLR is set to UNDO ON , tapping [CLR] a second time (RIT clear "un-do") produces a unique low-to-high tone pair. Some switches do not generate tones because they might interfere with received or transmitted audio (e.g. REV , and M1-M4 message play).
SYNC DT	Function	(Advanced) When SYNC DT (sync data) is activated in either SSB or DATA modes, T/R switching times are reduced to optimize for modes such as AMTOR and PacTOR. The "-S" icon turns on. Do not use SYNC DT for normal SSB/DATA communications. Cannot be changed within the menu; assign to a programmable function. Also see CONFIG:PTT RLS (PTT release delay).
TECH MD	OFF	Set to ON to enable Tech Mode menu entries (those marked with [T] in this list). (Advanced) Tap [1] or [2] to show main or aux DSP internal error information. Tap [CLR] to clear the error information (parameters will then be FFFF).
TIME	N/A	Real-time-clock view/set. Tap [1] / [2] / [3] to set HH / MM / SS. To see the time and other displays during normal operation, tap [DISP] (see pg. 38).
TTY LTR	Function	Performs an RTTY FIGS to LTRS shift when the text decoder is enabled in RTTY modes. Cannot be changed within the menu itself; must be assigned to a programmable function switch.

TUN PWR	NOR	If set to NOR , TUNE power level follows the POWER knob. Otherwise, establishes a fixed power level for TUNE , overriding the present POWER knob setting. Note1: <i>TUN PWR</i> does not pertain to ATU TUNE , which always uses 5 or 10 W and is internally controlled. It also does not apply to transverter bands using the low-power KXV3B output (XVTR OUT). Note2: see <i>CONFIG:PWR SET</i> for per-band power control.
TX ALC [T]	ON	(Troubleshooting) Set to OFF to disable both <i>internal</i> and <i>external</i> transmit ALC (overrides <i>EXT ALC</i> setting). Used when adjusting band-pass filters in TX mode, or for troubleshooting. Set parameter to ON during normal operation.
TX DLY	NOR 008	(Advanced) For use with external amplifiers that have slow relays; sets the time from KEY OUT jack (active low) to first RF in 1-ms steps. To minimize loss of QSK speed, use the shortest delay that works with your amp. Most will work with the default (minimum) setting of 8 ms. CAUTION: If you use any setting above 008, and you're using an external keyer in CW mode, you should listen to your keying on another receiver. At some code speeds and keyer weight settings, your CW keying may exhibit excessive jitter (per-element variation) that can be heard on the air. Note: If <i>CW QRQ</i> is set to ON , the minimum delay from KEY OUT to first RF will be somewhat shorter (approx. 4 to 5 ms rather than 8 ms).
TX DVR	NOR	(Advanced) Set to IND to allow independent control of the DVR transmit playback level, and the monitor normal transmit speech monitor level. In this case, holding the MON knob a second time alternates between DVR level and MON level. Useful for operators who don't normally use the transmit monitor, but would like to hear DVR playback audio during transmit.
TX ESSB	OFF 3.0	(Advanced) Extended SSB transmit bandwidth (3.0 to 4.0 kHz) or OFF . Tap 1 to turn on/off, and rotate VFO A to select the bandwidth. (Also see pg. 38.) If you turn ESSB on/off frequently, you might want to assign this menu entry to a programmable function switch (PF1, PF2, or M1-M4).
TX GATE	OFF 0	(Advanced) The TX noise gate can be used to suppress transmitted audio below a certain level, e.g. that of an amplifier fan. Tap 1 within the <i>TX GATE</i> menu entry to turn the noise gate on/off. Use VFO A to set the desired threshold. Since there's no visual indication that transmit audio is below the threshold, you should adjust it using the transmit voice monitor (MON), ideally while using headphones. Set the threshold high enough to cut off transmit audio due to local noise, but not so high that it causes your voice to drop out too frequently. The <i>TX GATE</i> threshold can be adjusted in TX TEST mode.
TX INH [T]	OFF	(Advanced) If set to LO=INH or HI=INH , an external logic signal can inhibit transmit (see pg. 21). When transmit is inhibited, the TX LCD icon flashes.
TX MON	NOR	(Advanced) When set to NOR , voice monitor audio will be delayed due to DSP signal processing, and will reflect the sound of speech compression, if applicable. FAST may be preferable if you're distracted by these effects. In this case, monitor audio will be "dry" (unprocessed).

TXGN {pwr} [T]	00	<p>(Troubleshooting) Shows transmit gain constant for the present band and power mode, where {pwr} = LP (0-12W), HP (13-120W), or MW (0.1-1.5 mW). The gain constant is updated whenever the TUNE function is activated on a given band <i>at one of three specific power levels</i>: 5.0 W, 50 W, and 1.00 milliwatt. See transmit gain calibration procedure, pg. 52.</p> <p>On 80 m with high power (> 13 W) selected, you should see PR80 as part of the TXGN parameter display. This indicates that the preamp is turned on during QRO transmit on 80 m, and is the default. It should only be turned off for troubleshooting purposes; this is done by tapping PRE.</p> <p>If TX ALC (above) is OFF, the TXGN parameter can be set manually, at very fine resolution. This should only be done for troubleshooting purposes.</p>
TXG VCE [T]	0.0 dB	<p>(Advanced) Balances voice transmit peak power in relation to CW peak power in TUNE mode. Typically set between -1.5 to 1.5 dB.</p>
VCO MD [T]	n/a	<p>The VCO MD setting applies only to the K3, not the K3S.</p> <p>VFO Tuning Noise Reduction (Advanced; applies to K3 or K3S): Tapping 1 in this menu entry alternates between SPI 1 (default) and SPI 2. The SPI 2 setting may eliminate a weak “ticking” noise sometimes heard in the vicinity of 5, 28, or 50 MHz while rotating the VFO.</p>
VFO B->A	Function	Copies VFO B’s frequency to VFO A. Cannot be used within the menu itself; must be assigned to a programmable function switch.
VFO CRS	Per-mode	Per-mode coarse tuning rate (hold COARSE and tune VFO A or B). Tap 1 to turn rounding on/off. Also applies to the RIT/XIT tuning knob if CONFIG:VFO OFS is set to ON , and both RIT and XIT are turned OFF.
VFO CTS	200	VFO counts per turn (100 , 200 , or 400). Smaller values result in easier fine-tuning of VFO; larger values result in faster QSY. Doesn’t apply to the COARSE tuning rate, which always uses 100 counts per turn.
VFO FST	50 Hz	Specifies the faster of the two VFO tuning rates (RATE). The faster rate is 50 Hz per step by default, but can be set to 20 Hz if desired. In this case, VFO CTS = 400 is recommended to ensure adequate fast-QSY speed.
VFO IND	NO	If set to YES , VFO B can be set to a different band than VFO A, which allows listening to two bands at once (main/sub). See pg. 39 for independent main/sub band considerations.
VFO LNK	OFF	Set to YES to link VFO B to VFO A. Rotating VFO A will then move both VFOs. (Note: In diversity mode, VFO B is always controlled by VFO A; it is not necessary to turn VFO LNK on in this case.)
VFO OFS	OFF	If ON , the RIT/XIT offset control can be used to tune VFO A in large steps when both RIT and XIT are turned off. The step sizes vary with mode (see VFO CRS), and are the same as the COARSE VFO tuning rates.
WMTR {pwr} [T]	100	Wattmeter calibration parameter. {pwr} is the power mode: LP (0-12W), HP (13-120W), or MW (0.1-1.5 mW). See calibration procedure (pg. 52).
XVn ON	NO	Tap 1 – 9 to select applicable transverter band (1 - 9). Set parameter to YES to turn the transverter band on.
XVn RF	144	Lower edge for transverter band n (1-9); 0-24999 MHz. (Tap 1 – 9 to select applicable transverter band.) Normally, 144 would be used for the K144XV internal 2-m module. But if the K144XV is being used as an IF for a higher-band transverter, you can set it to the lower edge of the higher band.
XVn IF	28	Specify K3S band to use as the I.F. for transverter band n (1-9). (Tap 1 – 9 to select the transverter band.) I.F. selections include 7 , 14 , 21 , 28 , and 50 MHz. Use 28 MHz for the K144XV internal 2-m module.

XVn PWR	L .01	<p>Sets upper limit on power level for XVTR band n. (Tap 1–9 to select band.) H x.x (High power level) specifies a value in watts, and use of the main antenna jack(s). This should be used with caution, as you could damage a transverter left connected to these antenna jacks accidentally. L x.xx (Low power level) specifies a value in milliwatts. L 1.00 is recommended for the K144XV internal 2-m module. (If <i>CONFIG:PWR SET</i> is set to PER-BAND, the K3S will save the last-used power setting on each band. This is useful for transverter bands.)</p>
XVn OFS	0.00	<p>Offset (-9.99 to +9.99 kHz) for transverter band n (1-9). (Tap 1–9 to select transverter band.) Compensates for oscillator/multiplier chain errors.</p> <p>If the present transverter band is assigned to the K144XV internal 2-m module (by setting <i>XVn ADR</i> to INT. TRN0-9), the <i>XVn OFS</i> parameter will show either 144 or 146 at the left end of the display, depending on whether you have the VFO tuned to 144-145.999999 or 146-148 MHz. You can enter an offset for each of these band segments, which correspond to the 116 and 118 MHz crystals on the K144XV, respectively. (You must have the 2-m band selected before setting these parameters.) These offset values are normally set up at the factory, and are also noted on a label on the K144XV module.</p> <p>If a K144RFLK module is also installed, the K144XV’s 2-m frequency will be locked to the transceiver’s 49.380-MHz reference. The <i>XVn OFS</i> parameters can be automatically calculated in this case. Tap 0 on the keypad in the <i>XVn OFS</i> menu entry until you see REFLOCK displayed. The <i>XVn OFS</i> parameter will then be locked to the <i>REF CAL</i> value, which you’ll need to calibrate. Or, you can use an external reference and the K3EXREF option.</p>
XVn ADR	TRNn or INT. TRNn	<p>This menu entry assigns optional band-decode addresses (TRN1-9, or INT. TRN0-9) to each transverter band. Addresses TRN1-9 are used to automatically select external transverters, while addresses INT. TRN0-9 are used to select the Elecraft K144XV internal 2-meter transverter.</p> <p>Addresses TRN1-TRN9 and INT. TRN0-9 can be sent to the BAND DATA outputs on the KIO3B for use with third-party transverters (BAND0-3; see pg. 21 and <i>CONFIG:KIO3</i>). Addresses TRN1-TRN7 are compatible with Elecraft XV-series transverters and the Elecraft KRC2 band decoder, so they are sent on the “AUXBUS” serial control line (TRN8 and TRN9 are sent as 0 on the auxBus). Tap 1–9 to select the desired transverter band, then rotate VFO A to select the desired decode address.</p> <p>Example 1: To configure an Elecraft K144XV internal 2 m transverter as XVTR band 1, set <i>XV1 RF</i> to 144 MHz, <i>XV1 IF</i> to 28 MHz, and <i>XV1 ADR</i> to INT. TRN0 (or any of INT. TRN 1-9 as needed for external address decode).</p> <p>Example 2: To configure an Elecraft XV432 external transverter as XVTR band 2 , set up <i>XV2 RF</i> as 432 MHz, <i>XV2 IF</i> as 28 MHz, and <i>XV2 ADR</i> as TRN1 (or whatever address matches the DIP switch selection inside the transverter).</p>

Troubleshooting

The most common symptoms and their causes are listed below, in three categories (general, transmit, and receive). Most problems are related to firmware or control settings. Subsequent sections cover **Parameter Initialization** (pg. 72) and **Module Troubleshooting** (pg. 73). If the problem persists, please contact Elecraft support (see pg. 10) or post a question on our email reflector.

General

- **ERR** (error) message appears on the LCD (**ERR FW2**, etc.): Refer to Module Troubleshooting (pg. 73).
- **TERM displayed on VFO B, and controls do not function:** You have entered “Terminal” mode by holding the **CONFIG** switch for 3 or more seconds. Terminal mode allows the K3S to emulate a K3/0-Mini panel for remote-controlling another K3S (or K3). To exit terminal mode, hold **CONFIG** for 5 seconds or turn power off/on. See K3/0-Mini manual for information on remote control of the K3S.
- **Can’t turn power off:** An external device or the KIO3B or KPA3A module may be pulling the POWER ON line low (on the ACC jack). Disconnect external devices one at a time. If that doesn’t reveal the problem, unplug the KIO3’s digital I/O board, then the KIO3B main board, then the KPA3A. Also see **Module Troubleshooting** (pg. 73).
- **General problem with transmit and/or receive:** Many problems can be caused by low power supply voltage or by a noisy or intermittent supply. Check your power supply’s on/off switch, voltage, fuses (if applicable), and DC cabling. The K3S provides both voltage and current monitoring (pg. 38). Also see **Transmit** and **Receive** troubleshooting sections, below.
- **General problem with firmware behavior:** (1) Check all relevant menu settings (see MAIN and CONFIG menu listings in the previous section). In addition to the information in the manual, each menu entry provides help text by tapping **DISP**. (2) Try loading the latest microcontroller and DSP firmware. Review the release notes for changes that may be related to your symptoms. (3) If the above suggestions don’t help, you can try reinitializing the firmware (pg. 69). **Be sure to save important parameter settings first.**
- **Bands missing from **BAND** switch rotation:** See *CONFIG:BND MAP*.
- **NEW K3UTIL SOFTWARE REQUIRED message appears on the LCD:** This indicates that you must install a new version of the firmware upgrade program (*K3 Utility*) in order to load the latest K3S firmware. After installing the new version of *K3 Utility*, reload all new firmware (MCU, DSP, etc.).
- **FPF LOAD PENDING message appears on the VFO A and B displays:** Use our *K3 Utility* software application to load the FPF data file from a PC. Refer to *K3 Utility*’s help information for details.
- **PLL1 appears in place of SYN1 as the synthesizer status (on VFO B):** This indicates that the K3S has not established communication with the KSYN3A module, and has reverted back to the KSYN3 (normally used only with the K3). Turn power off and back on. If the problem persists, turn power off and re-seat the KSYN3A module. If necessary, replace the module.
- **N/A message (Not Applicable):** The function you’re trying to use does not apply in the present context.
- **Mode icon flashes:** This is a reminder that you’re about to set the K3S up for cross-mode SPLIT operation (VFOs in different modes). Tap any key to clear. To view and change VFO B’s mode, use **BSET**.
- **VFO B is blank:** You may have CW or DATA text decode display turned on (**TEXT DEC**, pg. 32) with the **THR** (threshold) control set too high for text decode to proceed.
- **VFO A or B display doesn’t change when the corresponding knob is rotated:** You may have the affected VFO locked (pg. 14).

Transmit

- **BND END:** Attempt to transmit out of the allowed ham band.
- **TX LED on all the time:** This could indicate that PTT is being held on by external equipment. (Verify that *CONFIG:PTT-KEY* is set to **OFF-OFF** if not keying via the USB or RS232 ports. Try disconnecting equipment connected to the ACC, USB, and RS232 jacks.) Also check VOX gain (unplug mic if necessary).
- **HI CUR** or **HI SWR warning (K3S/100):** Check load Z and supply voltage. If voltage is low and/or load Z is under 50 ohms, current can go up for a given requested power level. Reduce power if necessary.
- **HI TEMP warning (K3S/100):** When operating QRO from a battery, low voltage may cause an erroneous temperature reading (see *CONFIG:PA TEMP* for details). Otherwise, PA heat sink temperature has exceeded 84C (PA drops into bypass mode). Check fans, power supply voltage and current, and load impedance. Allow heat sink to cool. Reduce power if necessary. Make sure the *CONFIG:PA TEMP* menu entry is calibrated (allow heat sink to cool to room temperature, then compare menu reading to actual).
- **ALC OFF** is displayed on VFO A during transmit: Set *CONFIG:TX ALC* to **ON**. ALC should only be turned off during band-pass filter alignment (**do not adjust filters without consulting Elecraft support**).
- **Can't transmit in CW mode:** (1) Make sure the key or keyer paddle is plugged into the correct jack. (2) You must have VOX selected (**VOX** icon on) in order to use hit-the-key CW. (3) You may be in **SPLIT** mode, with VFO B set for a voice or data mode. Tap **A/B** or use **BSET** to check VFO B's mode.
- **Can't key external amplifier in CW mode:** Some amplifiers require a longer delay from keyline activation to first RF. See *CONFIG:TX DLY*. (**Caution:** Long *TX DLY* settings may affect keyer timing.)
- **Key clicks in QSK CW mode with an external amplifier:** This may be due to a slow amplifier relay (use *CONFIG:TX DLY*) or incorrect application of external ALC (see *CONFIG:EXT ALC* and pg. 29).
- **Can't use the mic in voice modes:** You may be in **SPLIT** mode, with VFO B set for CW or data mode rather than a voice mode. Tap **A/B** or use **BSET** to check VFO B's mode.
- **No power output:** You may have routed RF through the KXV3's XVTR IN/OUT jacks, either by switching to a transverter band, or by setting *CONFIG:KXV3B* to **TEST**. Also try redoing TX GAIN cal (pg. 52).
- **Relay heard switching during keying:** If this happens only above a certain power level, transmit signal leakage may be activating the carrier-operated-relay circuitry on either the KXV3B module (RF I/O) or the KRX3A (sub receiver). You must improve isolation between transmit and receive antennas or decrease output power. If a relay switches during keying even at very low power levels, it could be due to: (1) SPLIT operation with different bands and/or modes, or the receive VFO tuned outside any ham band; or (2) VFO A is tuned such that a relay switches during T/R due to incorrect VCO calibration (re-run VCO CAL).

Receive

- **HI RFI warning:** A high-power transmitter may be coupling into the antenna in receive mode. The warning occurs when the ANT1 or 2 input signal exceeds about 1 to 2 W. Also see *CONFIG:RFI DET*.
- **HI SIG warning:** An extremely strong, sustained signal (e.g., a broadcast station's carrier) may be causing excessive post-mixer amplifier current when operating on the present band. The K3S will automatically turn the preamp OFF, and in extreme cases will also turn the attenuator ON.
- **HI CUR** or **SPKRS=1 warning:** **HI CUR** may indicate a shorted left speaker channel; the K3S will reduce AF gain. **SPKRS=1** may indicate that *CONFIG:SPKRS* is set to **2**, but a mono external speaker plug is in use, shorting the right speaker channel to ground. The K3S automatically sets *SPKRS* to **1**.
- **No received signal:** Check (1) receiver being squelched (if RF/SQL controls are assigned to squelch via *CONFIG:SQ MAIN* or *SQ SUB*, rotate squelch controls fully counter-clockwise); (2) RF GAIN too low (set RF gain controls fully clockwise); (3) bandwidth too narrow (set \odot WIDTH or tap **XFIL**), and also verify filter configuration settings); (4) switching to an open receive antenna on the KXV3B (RX ANT IN); (5) switching the KAT3A to an open antenna jack; (6) *CONFIG:REF CAL* parameter not adjusted properly; (7) *CONFIG:KXV3B* may be set to **TEST**, which routes all RF through the XVTR IN/OUT jacks.

- **Speaker is not working with headphones unplugged:** Locate the *CONFIG:SPKR+PH* menu entry. Tap ‘1’ on the numeric keypad until you see **PH.R SW-** . The minus sign (-) indicates inverted switch logic, required for the jack on the KIO3B audio board.
- **Received signal level too low:** (1) Try setting *CONFIG:AF GAIN* to **HI**; (2) check headphone and speaker plugs and cables; (3) make sure that *CONFIG:RX EQ* settings are either flat or have not been set for a large amount of cut; (4) recheck filter configuration, including *CONFIG:FLx BW*, *FLx GN*, and *FLx FRQ*; (5) verify that *CONFIG:REF CAL* is properly adjusted; (6) make sure RF GAIN is set to maximum.
- **Spurious signals (“birdies”):** All high-dynamic range receivers exhibit some birdies. Most will be inaudible with an antenna connected. If you find a birdie that’s audible above normal band noise, see the *CONFIG:SIG RMV* menu entry. Autonotch may be useful for removing birdies in voice modes.
- **VFO tuning noise (“ticking”) on some bands, even with antenna connected:** (1) Try **VFO Tuning Noise Reduction** (see *CONFIG:VCO MD*). (2) Try using a very low setting of the DSP noise blanker. (3) If you use the **XREF IN** setting of the *CONFIG:REF CAL* menu entry *without* a K3EXREF reference-locking option installed, you may hear digital switching noise on the 6-m band. Set it to **XREF OUT**.
- **Preamp 2 not available (N/A):** (1) There are limitations on preamp 2 use with the sub receiver (pg. 45). (2) Preamp 2 is only available on the 12/10/6-meter bands, and only when enabled on each of these bands individually using *CONFIG:PREAMP2*. (3) If you see N/A flashed when attempting to use this menu entry, and you are on 12, 10, or 6 meters, then the K3S has not recognized the correct RF board type. Try turning power off/on. If the problem persists, contact Elecraft. (4) Make sure the *CONFIG:KXV3B* menu entry name is **KXV3B**, not **KXV3**. Preamp 2 is only present on the KXV3B module. While in this menu entry, tap **9** to change the menu entry name to **KXV3B**, then exit the menu and turn power off/on. If you have the wrong type of KXV3 module, you will see **ERR XV3** on power-up.

Parameter Initialization

Menu parameters are stored in non-volatile memory (EEPROM and/or FLASH). It is possible, though rare, for parameters to become altered in such a way as to prevent the firmware from running correctly. If you suspect this, you can reinitialize parameters to defaults, then restore a previously-saved configuration (or re-do all configuration steps manually; no test equipment is required).

- If you have a computer available to do configuration save and restore, run the **K3 Utility** program, then use the **Configuration** function to save your present firmware configuration.
- If you don't have access to a computer, you should write down your menu parameter settings. The most important are **CONFIG:FLx BW** and **CONFIG:FLx FRQ** (for each installed filter <x>, also tap **SUB** to obtain sub receiver crystal filter settings, if applicable). You should also note the settings of all module enables (all CONFIG menu entries starting with 'K', e.g. **CONFIG:KAT3**). If you don't record your crystal filter and module settings, you may have to remove the transceiver's top cover (and sub receiver, if installed) to verify which modules as well as crystal filters are installed, as well as the frequency offsets noted on the crystal filters (depends on filter type).
- Turn the K3S OFF (using the POWER switch on the K3S, not the one on your power supply).
- While holding in the SHIFT/LO knob (which is also labeled **NORM** below), turn power ON by tapping the POWER switch on the K3S. Let go of the SHIFT/LO knob after about 2 seconds. You should now see **EE INIT** on the LCD.
- When **EE INIT** completes after a few seconds, you may see **ERR PL1** or other error messages due to initialization. Tap **DISP** to clear each message.
- If you have a computer, restore all parameters using the **Configuration** function of the **K3 Utility** program.
- If you don't have a computer, manually re-enter all menu parameters that you wrote down, above, then re-do firmware configuration and calibration (starting on pg. 48). You can omit any steps pertaining to parameters you've already restored manually.
- See if the original problem has been resolved.

Module Troubleshooting

The K3S is a highly modular transceiver. With the information provided here, you'll be troubleshooting to the module level, not to the component level. In many cases, problems can be resolved by changing a menu setting, loading new firmware (pg. 47) or initializing parameters to factory defaults (see below).

A full set of schematics can be found on our web site. **Due to the use of fine-pitch ICs in the K3, most signal tracing must be done very carefully using fine-tip probes.** Please do not attempt this unless you have experience in troubleshooting surface-mount assemblies; otherwise, you could damage your K3S.

⚠ DO NOT ADJUST ANY TRIMMER CAPACITORS OR POTENTIOMETERS unless you have access to appropriate lab test equipment and have consulted Elecraft support regarding the proper settings. All trimmers have been aligned at the factory, and if misadjusted could degrade performance.

Error Messages (ERR xxx)

An error message may be displayed on VFO B at power-up or during normal operation. In most cases error messages are due to a problem with a single PCB module, and may be due to incorrect firmware configuration.

If you see an error message on VFO B (ERR XXX): Write down the error message, as well as any associated error data shown on the VFO A display (e.g. **E 00005**). Then tap any switch to clear the error code. Multiple errors may occur; in this case, write down each of the messages and VFO A data, if any, before you clear them.

See Error Msg table (next page) for details on specific ERR messages and their associated data values.

Module Removal

⚠ TURN OFF THE POWER SUPPLY OR DISCONNECT THE POWER SUPPLY CABLE before removing or installing modules. If you drop a metal tool inside the K3S with power still applied, you can short a power supply or control line, resulting in damage to the RF board or other modules.

Module de-installation procedure: To see if a given module is the cause of an error message, you must *de-install* it as described below, or you may not be able to tell if removing the module had any effect:

- Turn off power.
- Remove the module.
- Set the associated CONFIG menu entry to **NOT INST.** (See *CONFIG:KAT3*, etc.) **Note:** If the affected module is on the KRX3A (sub receiver), you must tap **SUB** to display its configuration setting. Otherwise the setting shown applies to the main receiver. This applies to the KBPF3A module, as well as crystal filters, which are duplicated on the RF and sub receiver boards.
- Turn power off and wait at least 5 seconds.
- Turn power back on.

Error Message List

* = See module de-installation instructions on previous page.

Error Msg	Problem	Troubleshooting steps
ERR 12V	The circuit breaker on the KPA3A module may be open. PA drops into bypass mode, fans switch to level 2, and PA temp display mode is not available.	Check for short from PA module's 12V line to ground. If there's no short, try resetting the circuit breaker. If there is a short, remove the KPA3A module. Set CONFIG:KPA3 to PAIO ON . While waiting for a replacement, you can use the K3S at reduced power.
ERR AT3	KAT3A not responding	* De-install the KAT3A module (see above). If this eliminates the error message, the KAT3A may be defective. You can substitute a KANT3 antenna input module temporarily, if available.
ERR BP1	No response from RF board BPF shift registers	* De-install option modules one at a time
ERR BP2	No response from KBPF3A option shift registers	* De-install KBPF3A on RF board
ERR BP3	No response from sub RX BPF shift registers	* De-install the KRX3A module, including the SUBIN and SUBOUT boards
ERR BP4	No response from sub RX KBPF3A option	* De-install the KBPF3A module on KRX3A
ERR DS1	No main DSP SPI echo	Reload DSP1 firmware
ERR DS2	Main DSP SPI echo not inverted	Reload DSP1 firmware
ERR DS3	No AUX DSP SPI echo	Reload DSP2 firmware. Note: CONFIG:KRX3 must be set to NOT INST unless the KRX3A option is installed, which includes the aux DSP module (DSP2) and 2 nd synthesizer.
ERR DS4	AUX DSP SPI echo not inverted	Reload DSP2 firmware. Note: CONFIG:KRX3 must be set to NOT INST unless the KRX3A option is installed, which includes the aux DSP module and 2 nd synthesizer.
ERR DSE	Missing echo from a DSP command	Reload DSP1 firmware (and DSP2 firmware, if applicable).
ERR DSG	DSP internal gain error	Turn K3S off and back on to clear the error condition. Please report this to Elecraft, along with DSP internal error information. (In the TECH MD menu entry, tap 1 and 2 to get main/aux DSP info, respectively.)
ERR DSX	Extended DSP command timeout	Reload DSP1 firmware (and DSP2 firmware, if applicable).
ERR DVR	Digital Voice Recorder not found	DVR module may be defective or incorrectly installed, or the MCU or DSP firmware may require updating.
ERR EE1	On-chip EEPROM read/write test failed	MCU may be defective (front panel). Try re-loading MCU firmware first; then try initializing parameters (pg. 72).

ERR EE2	External EEPROM read/write test failed	EEPROM may be defective (front panel). However, this message may also appear if power is turned off/on too rapidly, or if the power supply voltage “bounces” during turn-on due to inadequate regulation. If the power supply is not at fault, try re-loading MCU firmware first; then try initializing parameters (pg. 72).
ERR FP3	Missing display text in flash memory	Try re-loading FPF (flash memory).
ERR FW2	General firmware problem	Try re-loading MCU firmware first; then try initializing parameters (pg. 72).
ERR IF1	RF board IF shift registers not responding	Try turning power off/on. If the problem persists, contact Elecraft.
ERR IF2	Sub RX IF shift registers not responding	Try turning power off/on. If the problem persists, contact Elecraft.
ERR IO1	MISO line stuck low (asserted)	*De-install option modules one at a time. If no failing option module can be found, there may be a problem on the RF board.
ERR IO3	KIO3B not responding	The KIO3B may be defective. Note: The K3S <i>can</i> be operated temporarily without the KIO3B installed. You’ll need to use headphones, and there will be no computer or AF I/O available on the rear panel.
ERR KEY ERR PTT	Attempt to key the transmitter or activate PTT during power-on	Usually caused by an external device shorting KEY or PTT to ground; disconnect such devices until they’re initialized properly. Also see <i>CONFIG:PTT-KEY</i> . If necessary, try removing the KIO3B module or its digital I/O daughter board.
ERR LPF	No response from LPF shift registers	*De-install option modules one at a time. If no failing option module can be found, there may be a problem on the RF board.
ERR PA1	KPAIO3A module not responding	*De-install the KPA3A module and set <i>CONFIG:KPA3</i> to PAIO ON . If this eliminates the error message, the problem is likely to be on the KPA3A module. If not, the problem may be on the KPAIO3A module; remove it as well, and set <i>CONFIG:KPA3</i> to NOT INST .
ERR REF	Missing KREF3 module	Verify that the oscillator can on the KREF3 is fully plugged in. Make sure all internal cables are plugged in between the KREF3 and other modules. If this doesn’t help, the problem may be on the KREF3 module or the RF board. Note: The K3S cannot be used without a KREF3 module.

ERR RXF	Invalid receive crystal filter bandwidth	The crystal filter selected for receive is too wide for the current operating mode. If CONFIG: CW QRQ is ON , the maximum allowed receive crystal filter bandwidth is 2.8 kHz. To turn off filters by mode, use K3S Utility or CONFIG: FLx ON .
ERR TXF	Invalid transmit crystal filter bandwidth	The crystal filter selected for TX (with CONFIG: FLTX) is either too narrow or too wide. You must specify a filter that is 2.7 or 2.8 kHz wide for CW/DATA/SSB, 6 kHz or 13 kHz for AM, and 13 kHz for FM).
ERR TXG	Transmit gain constant out of range	This usually indicates a problem with band-pass filter alignment or one of the low-pass filters. In either case it could affect one or two bands. Consult Elecraft support before attempting to realign band-pass filters; all settings are aligned at the factory.
ERR XV3	KXV3B module not responding, or not selected correctly within menu.	Locate the CONFIG: KXV3B (or KXV3) menu entry. If the menu entry name is KXV3 rather than KXV3B , tap 9 to change it, then exit the menu and turn power off/on. If the error message persists, *de-install KXV3 module and contact Elecraft.

Theory Of Operation

Please refer to the block diagram of the K3S shown at the end of this section. Schematics and additional details can be found on the Elecraft web site. Only basic modules are covered here; for option module circuit details, refer to the individual instruction manuals (KPA3A, KBPF3A, KRX3A, etc.).

RF BOARD

The RF PCB (Printed Circuit Board) is the heart of the K3S transceiver, both physically and electrically. During assembly, it serves as an attachment point for other PCBs as well as chassis panels, acting as the glue that holds things together. During operation, the RF board provides signal routing to and from all modules.

Over two-thirds of the RF board's components are surface mount devices (SMDs), located on the bottom side of the board. These are pre-installed so the complete RF board assembly can be aligned and tested at the factory. The use of SMDs minimizes stray coupling in RF circuits, reduces system cost, and allows the K3S to fit in a modest-size enclosure, compatible with home or field operation.

The RF board is divided into several functional areas, which are described below.

Low-Pass Filters (LPFs)

The relay-switched low-pass filters, used during both transmit and receive, are located in the back-right corner of the RF board. These filters can easily handle 100 watts, and are common to both the K3S/10 and K3S/100. Some LPFs cover one band, while others cover two bands that are close in frequency. The input to the LPF section comes from the KPA3A 100-W amplifier module, if installed; if there's no KPA3A, the input comes from the 10-W amplifier (see below). The output of the low-pass filters is routed through the forward/reflected power bridge, then on to either the antenna input module (KANT3), or the KAT3A automatic antenna tuner, which plugs in at far right.

Low-Power Amplifier (LPA) and T/R Switching

The large hole near the back-middle area of the RF PCB is where the 10-W low-power amplifier module plugs in. The LPA has three connectors that mate with the RF board, and its power transistors attach to the rear bottom cover, which serves as a heat sink. This construction method allows the 10-W module to be tested separately during production. Also in this area is the T/R (transmit/receive) switch, but you'll need to turn the RF board upside down to see most of the components. The T/R switch uses high-power, high-isolation PIN diodes rather than relays, resulting in no switching noise during keying.

Low Power Amplifier (LPA)

The low-power amplifier module is capable of up to 12 W power output, and in the case of the K3S/10, is the final amplifier stage. In the K3S/100, it provides drive to the KPA3A module. The LPA has three gain stages, the last two of which use high-power MOSFET transistors to allow coverage up through 6 meters. At the input to the first gain stage is a 5-dB attenuator, which is switched in under firmware control at certain power levels to optimize transmit gain distribution.

Band-Pass Filters (BPFs)

At back-left is the bank of ham-band BPFs. These filters are just wide enough to cover each ham band, so they provide good rejection of IMD products during both transmit and receive. Hi-Q components, including large toroids, ensure low loss and high signal-handling capability.

General coverage receive capability can be added to the K3S with the KBPF3A option, which includes another 8 band-pass filters that cover all of the areas from 100 kHz to 28 MHz that are not covered by the filters on the RF board. The KBPF3A module mounts directly above the main BPF array, and due to its very short connections, has no effect on the performance of the main BPFs during ham-band operation.

First I.F. Stages

The front-left portion of the RF board is dedicated to the receive/transmit first I.F. (intermediate frequency) circuitry, most of which is on the bottom of the board. The first I.F. is 8.215 MHz, which is low enough to permit the construction of high-quality, narrow-band crystal filters, but high enough to offer good image rejection. The I.F. stages are reversible; i.e., they're used in one direction in receive mode, and the other during transmit. In receive mode, the filtered signal from the BPFs is first routed through a relay-switched attenuator with 5/10/15 dB settings, then to a low-noise diode-switched preamp, high-level switching mixer, and post-mixer amp. The signal next encounters the noise blanker (KNB3), then the crystal filters (see below),

Crystal Filters and 2nd I.F.

In either receive or transmit mode, the I.F. signal is routed to one of up to five plug-in, 8.215-MHz crystal filters (FL1-FL5). Following the crystal filters is the receive I.F. and second mixer, which mixes the 8.215 MHz down to an I.F. of 15 kHz for use by the digital signal processor module (DSP). Excellent 2nd-I.F. image rejection is obtained by cascading an additional crystal filter just ahead of the second mixer. There's also a 15 kHz transmit I.F., which is mixed up to 8.215 MHz on the KREF 3 module, which plugs in near the front-middle of the RF board.

Support Circuitry

Several other modules plug into the RF board. The KPAIO3A, located at the back edge of the RF board, is a vertically mounted board used as an interface between the RF board and the KPA3A 100-W amp module. It provides current sensing, bypass relay, and other functions for the KPA3A, and eliminates the need for any interconnecting cables. The KIO3B and KXV3B, in the back left corner, provide RF, audio, and digital I/O. The main synthesizer, used for the main receiver as well as the transmitter, plugs in at front left and is attached to the front shield. To the right of this is the reference oscillator module (KREF3), as well as the second synthesizer, used for the sub receiver. These also attach to the front shield. The Front Panel/DSP module plugs in at the very front of the RF board. Finally, at the far right you'll find two low-noise linear voltage regulators, one for 5 volts and the other 8 volts. Both are heat-sinked to the right side panel.

Noise Blanker

There are two noise blanker subsystems in the K3: the KNB3 module, and a DSP-based blanker (see *DSP* on pg. 80). The KNB3 is a narrow I.F. pulse blanker that plugs into the RF board. Its broad input bandwidth ensures minimum stretching of fast noise pulses, so it's ideal for suppressing noise from power lines, thunderstorms, and auto ignitions. The DSP blanker can be used on many other types of noise, including radar and other noise with complex waveforms that might cause heavy intermodulation if an I.F. blanker were engaged. Using the two blankers in combination is often extremely effective.

The KNB3 includes a triple-tuned bandpass/time-delay filter, wide-range AGC, and a noise gate. You can think of the noise gate as a switch that is normally closed, allowing received signals to pass unimpeded. When a noise pulse appears, it is amplified to a high level and used to trigger a *one-shot* circuit. This opens the noise gate very briefly (from 5 to about 100 microseconds) to blank the noise pulse. Both the threshold at which blanking action occurs and the length of time the gate is opened are under control of the operator.

1st Mixer

The 1st mixer combines signals from the input band-pass filters with the output of the synthesizer to obtain the 1st I.F., at 8.215 MHz. The mixer is based on a video switching IC with very low ON resistance, resulting in low loss and high signal-handling capability. Since this type of mixer requires low drive, there's very little leak-through of the local oscillator (synthesizer) signal. The mixer also incorporates a balanced VHF low-pass filter to suppress both internally and externally generated VHF/UHF spurs. This keeps the HF spur complement extremely low, despite the use of a down-conversion system architecture.

KAT3A (ATU) and KANT3

The basic K3S/10 includes a KANT3 antenna input module. If you've ordered a KAT3A antenna tuner, the KANT3 is not required and will not be supplied with the kit. In either case, the module plugs into the RF board at the back-right corner. Both the KANT3 and KAT3A provide antenna surge protection, as well as resistors for bleeding off static DC charge. The KAT3A provides a wide-range, switchable C-in/C-out L-network for matching a variety of antennas with SWR as high as 10:1 (100 W) or 20:1 (10 W). There are 8 inductors and 8 capacitors in the L-network, each switched with a DPDT relay for high reliability. The KAT3A also includes a second antenna jack and associated switching relay. There's an additional jack on the board for routing the unused (non-transmit) antenna to the KRX3A sub receiver module.

KIO3B (Audio/Digital I/O)

All audio and digital/computer I/O is routed through the KIO3B. The KIO3B is made up of three PC boards: Main, Audio IO and Digital IO.

The Main KIO3B board plugs directly into the RF board. It includes a relay to disconnect the right speaker channel in case a mono speaker is plugged into the external speaker jack, isolation transformers for Line In and Line Out signals, a connection point for the internal speaker, USB and RS232 serial interfaces, and various control line inputs and outputs for external transverters, band decoders, and the like. This board also contains a differential output microphone amplifier to equalize the gain between the front and rear microphone jacks, as well as to provide noise immunity for the microphone signal from the rear panel area.

The USB port provides a single-cable solution for most PC interface needs, including both control and line-level audio in/out. When the USB port is in use, line-level analog audio is digitized by the KIO3B module and routed to the USB connector itself. This eliminates the need for a computer sound card and associated cables.

Circuitry to allow use of the USB or RS232 port's RTS or DTR signals for PTT and/or KEY inputs is also located on this board. This supports logging and control programs which may use these lines for controlling transmit/receive switching or CW keying.

The Digital IO board plugs into the KIO3B Main board. It includes a USB connector, an RJ45 connector for use with RS232 communications and/or the P3 panadapter, and a DE-15 accessory connector for external band decoders (such as the KRC2), transverters (such as the Elecraft XV series), and similar devices. The DE-15 is also used for direct FSK or PSK signaling.

The Audio IO board includes three stereo outputs: headphone jack, speaker jack, and a transformer-isolated Line Out jack. It also provides two mono inputs: microphone, and an isolated Line In. The Microphone jack can provide bias for an electret microphone when enabled via the *MAIN:MIC SEL* menu entry.

Front Panel and DSP

The Front Panel is a large plug-in module that includes both the Front Panel and DSP boards, as well as the Aux DSP (if a sub receiver is installed) and digital voice recorder module (if the KDVR3 option is installed).

Front Panel Board

This board provides the transceiver's user interface: 35 custom-labeled switches; two dual-concentric potentiometers for gain and squelch control; seven shaft encoders; custom, 240-segment, high-contrast LCD; and 13 discrete LED indicators. Mic and headphones can be plugged into the front panel, or optionally at the rear panel (see KIO3B description, pg. 79).

The Front Panel PCB also includes the microcontroller unit (MCU), which manages the operation of the K3S. All inputs, whether from a switch, knob or external PC, are recognized and acted on by the MCU. All control outputs – such as switching from transmit to receive, sending a CW code element, adjusting the transmitter power, controlling LED brightness, etc. – are produced by the MCU.

The Front Panel also contains a large amount of EEPROM memory for parameter storage, and FLASH memory for program storage. This allows the K3S to be re-programmed with the newest firmware by a simple download from the Internet. It also enables the K3S to remember your favorite settings, particular configuration preferences, and the last setting of controls when power is removed from the radio.

DSP Board

The Digital Signal Processing (DSP) capabilities provide a rich set of features to help combat QRM and QRN while generating some of the cleanest signals to be found in Amateur radio today. A 32-bit floating point DSP is used for highest performance.

In receive, a 15 kHz IF signal from the RF board is buffered and then digitized by a 24-bit Analog to Digital Converter (ADC). This provides over 100 dB of dynamic range within the passband of the selected crystal (roofing) filter. After the ADC, the DSP converts the signal into a floating point value so dynamic range is not compromised during further processing. Noise blanking and limiting, AGC, amplification, IF and AF filtering are all done within the DSP. Several noise blanking algorithms (methods) are available in the DSP, and a sophisticated AGC system is employed. AM, FM, SSB and CW detectors are also implemented by the DSP. Various audio effects, such as Quasi-Stereo and Binaural, are provided here as well as combining the audio signals from the KRX3A (if installed).

After processing, the resulting audio signals are generated in a stereo 24-bit Digital to Analog Converter (DAC) and applied to separate amplifiers for headphones (front and rear) and speaker. The speaker amplifier was redesigned for the K3S to reduce low-level intermodulation products. The power amplifier stage operates at no voltage gain; instead, the required gain is provided by an extremely low-distortion dual audio driver.

A separate 24-bit DAC and amplifier provide Line Out signals that are not affected by the AF Gain control. This output is typically used by sound card digital mode software. When the USB port is used for line-level audio purposes, the analog line in/out signals from the DSP are digitized and added to the USB data stream.

In transmit, Line In, rear or front Microphone signals are sent to a 24-bit ADC and then processed by the DSP. In speech modes (SSB, AM and FM) and soundcard-based data modes, VOX is derived from these signals as well as receive audio. Microphone equalization, bandpass limiting, conversion to 15 kHz IF, envelope clipping and filtering (if applicable) are all done in DSP, then the signal is passed to another 24-bit DAC and presented to the RF board as a 15 kHz IF signal. Direct FSK, direct PSK and CW signals are generated within the DSP for those modes.

Thus, the DSP is responsible for all signal processing between audio and the 15 kHz IF for both receive and transmit. Like all other modules in the K3, the DSP is managed by the MCU.

The DSP board is piggybacked onto the Front Panel board as part of the Front Panel assembly. The Auxiliary DSP (used if the KRX3A Second Receiver Option is installed) and the KDVR3 option plug into the DSP board.

KREF3 (Ref./2nd LO)

The KREF3 module's 49.380-MHz temperature-compensated crystal oscillator (TCXO) is the signal source for the synthesizers. The high-stability TCXO option is typically better than +/- 0.5 PPM over the 0 to 50 C temperature range. This signal is also divided by 6 to provide the 8.230-MHz 2nd-LO signal used by the second receive and transmit mixers. In addition to the TCXO and dividers, the KREF3 provides the 2nd transmit I.F. mixer, which converts the DSP's 15-kHz transmit I.F. output to 8.215 MHz. This signal passes through a wide crystal filter to ensure rejection of mixer products before being routed to the RF board. The KREF3 obtains its DC and low-frequency I/O signals via an 8-pin connector on the RF board, but its RF outputs are fed to the RF board (and sub receiver) via coax cables. The K3EXREF option locks the KREF3 to an external reference.

KSYN3A (Synthesizer)

Low phase noise is key to both receiver and transmitter performance. The KSYN3A uses an extremely clean, integrated oscillator I.C. to generate a wide-range, low-noise local oscillator signal for injection into the first mixer. The local oscillator is locked to the internal 49.380-MHz frequency reference to within a small fraction of 1 Hz on all bands.

The KSYN3A is a significant upgrade to the original KSYN3 synthesizer used in the K3. The earlier design used separate stages for the VCO, PLL (phase-locked loop) and DDS (direct digital synthesizer). In contrast, the KSYN3A's integrated circuitry operates at much higher frequency, and is then divided down to provide the low-jitter signal required to drive the mixer. This results in lower phase-noise at close spacings from the carrier, as well as faster VFO update during T/R switching, enhancing high-speed CW timing. The KSYN3A can also tune to much lower frequencies, allowing operation down to 100 kHz.

Firmware

Overview

The K3S is controlled by a Microchip PIC18F8722 microcontroller (MCU) on the Front Panel PCB module. It uses a highly-optimized, custom operating system to efficiently handle many complex tasks.

At the highest level, the MCU firmware in the K3S runs a continuous *executive loop*. Within this loop, calls are made to handlers for the all user interface elements (switches, potentiometers, encoders, LEDs, LCD, etc.), I/O (USB and RS232 command handling, AUXBUS, SPI peripheral control, T/R switching), and process control (timers, state machines, etc.). In addition, a fast interrupt handler runs every 200 microseconds to service high-speed events such as optical encoder state changes and incoming serial data. This interrupt handler also provides fine-timing services for other functions and state machines, such as RTTY or PSK31/PSK63 text encode/decode.

The main and aux DSPs are peripherals of the MCU. They execute an extensive set of commands, allowing the MCU to specify operating mode, BFO frequencies, keying waveform start/stop, sidetone pitch, AF and IF gain, filter bandwidth and position, and many other parameters. In some cases the MCU polls the DSP for information periodically. For example, if voice VOX is enabled, the MCU polls every few milliseconds to see if the present mic level is above the user's specified VOX threshold, in which case the rig will be switched to TX mode.

Transmit ALC and Per-Band Power Control

To eliminate transmit splatter, all ALC in the K3S is applied *before* the narrow first-I.F. crystal filter. However, with some vocalizations, speech energy may build up within a narrow crystal filter to produce a slight peaking effect. Because of this, the user should set the transceiver's power output level such that it peaks at or below the safe level for any external amplifier under all speech conditions.

To facilitate this, optional per-band power control can be used (see *CONFIG:PWR SET*). This compensates for per-band gain variation in the external amp or the K3S itself, reducing the need for ALC. For example, all crystal filters have a small amount of ripple (typ. +/- 0.5 to 1.0 dB) that can result in a slight difference in average power output between LSB and USB with some voice characteristics. But since you typically use only one of the two sidebands on a given ham band, per-band power control can conveniently compensate for small variations.

K3S Block Diagram

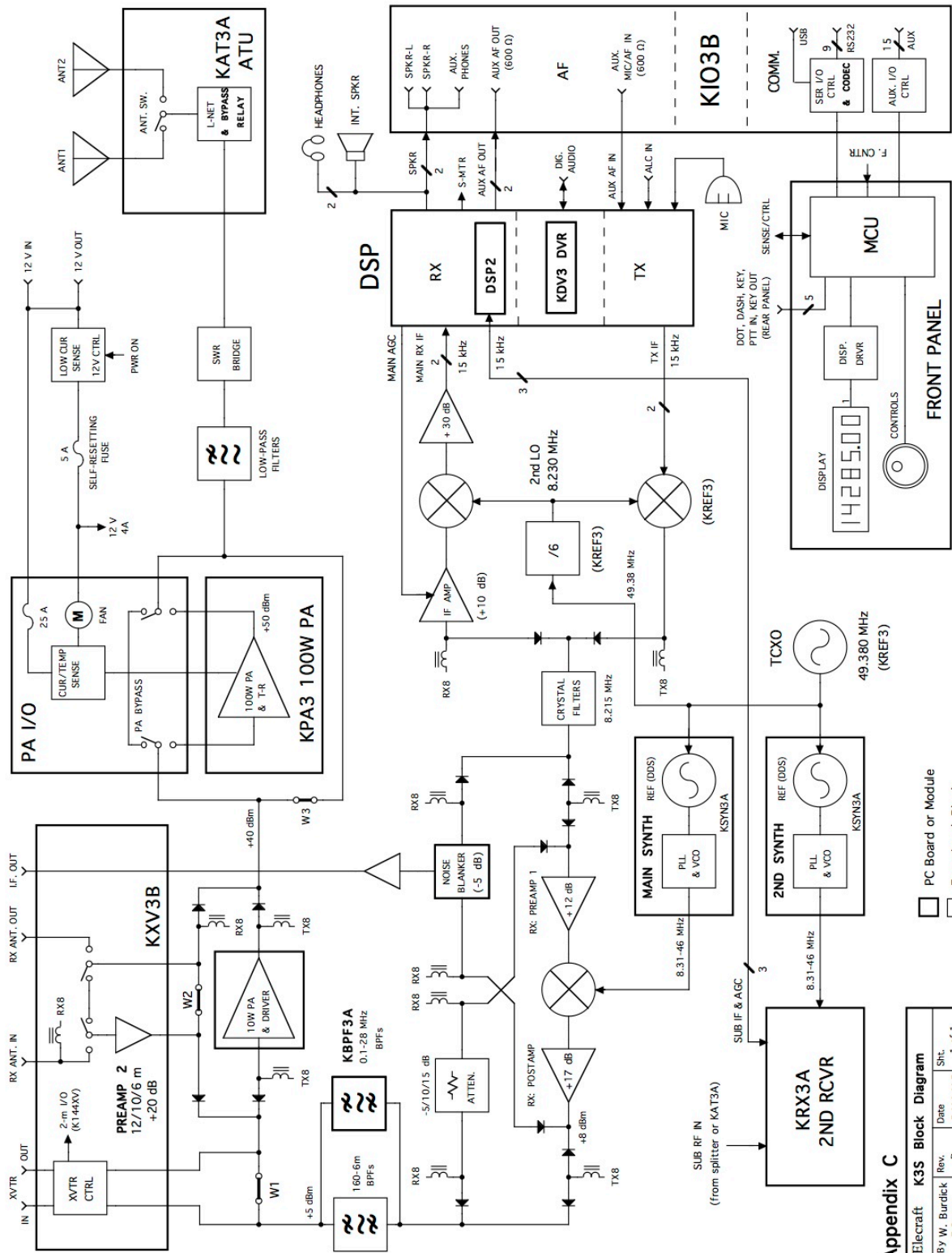

PC Board or Module
 Functional Block

Appendix C

Electcraft K3S Block Diagram			
By	Date	Rev.	Sh.
W. Burdick	5/11/15	B	1 of 1
E. Swartz			

Appendix A: Crystal Filter Installation

⚠ Damage to your K3S due to electrostatic discharge (ESD) can occur if you don't take proper precautions. Such damage is *not* covered by the Elecraft warranty, and could result in costly repairs. We recommend that you use an anti-static mat and wear a conductive wrist strap with a series 1-megohm resistor. An alternative is to touch an unpainted, grounded metal surface frequently while you are working. Do this only when you are not touching any live circuits with your other hand or any part of your body.

⚠ To avoid marring the finish, place a soft cloth under cabinet panels; do not lay them directly on your work surface. Also, do not use a power screwdriver of any kind, as it can slip and gouge the paint.

Installation Procedure

- Disconnect the power cable and all other external cables from the K3S.
- Remove *only* the top-cover screws identified in the drawing below.
- Press gently at the indicated point near the back edge (**X**), then lift off the top cover at the front. Unplug the speaker, then set the top cover aside in a safe place.

⚠ The screws that hold the top cover in place are an important part of the structural design of the K3S. Please be sure to re-install all of them afterward.

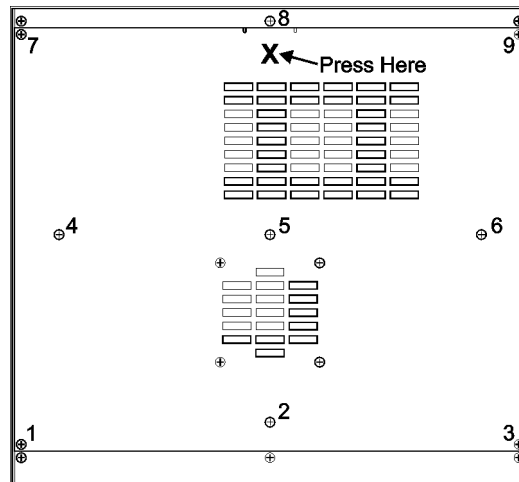

⚠ Put on your wrist strap or touch a grounded surface before touching any K3S components or modules in the following steps.

- If you have the sub receiver installed (KRX3A), refer to its manual for removal instructions.
- If you have the 2-m module installed (K144XV), refer to its manual for removal instructions.

- Locate the crystal filters you presently have installed in slots FL1 - FL5 on the RF board (or sub receiver).

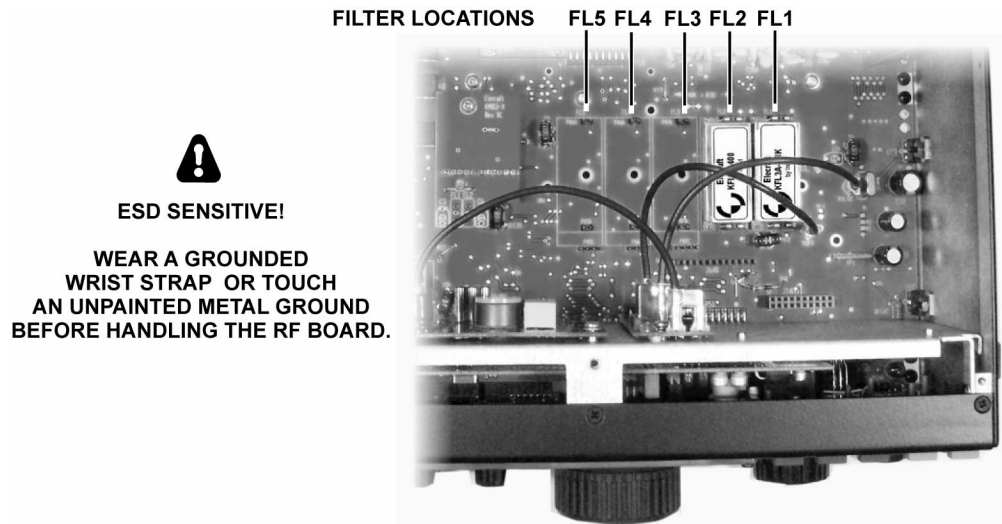

- i** There may be a mix of 5-pole filters (below left) and 8-pole filters (right).

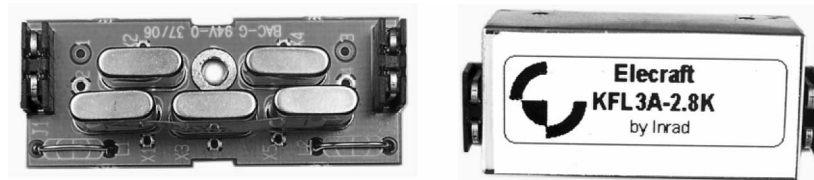

- Review the information below to ensure that your crystal filter setup conforms to K3S requirements.

You can install up to five crystal filters (FL1-FL5) on the RF board, and five on the sub receiver (KRX3A). FM operation requires a 13 kHz wide filter. AM transmit requires a 6 or 13 kHz filter, and SSB/DATA/CW transmit requires a 2.7 or 2.8 kHz filter; other bandwidths can be used for receive in these modes. Filters as narrow as 200 Hz can be used for CW and narrow-band data receive. A mix of 5-pole and 8-pole filters can be used.

There are two rules regarding where these filters can be installed in the K3S and how they're used:

Rule #1: If you plan to use a particular filter for both *transmitting* and *receiving* (main receiver), you'll need to install it on the **RF board**. You can optionally install a filter of the same or similar bandwidth on the sub receiver for receive-only use. (This is recommended since it will keep the receivers identical.)

Rule #2: You can install any filter in any slot, and can leave any slot empty in anticipation of installing a crystal filter there later. However, you should install the **widest** filter closest to **FL1**, the **next widest** to its **left**, etc. Here are two examples that could each apply to either receiver, assuming you follow the rules above:

FL1	6 kHz (AM)	FL1	{saved for FM filter}
FL2	2.7 kHz (SSB/CW/DATA)	FL2	6 kHz (AM)
FL3	1.8 kHz (SSB/CW/DATA)	FL3	2.8 kHz (SSB/CW/DATA)
FL4	500 Hz (CW/DATA)	FL4	{saved for another narrow filter}
FL5	200 Hz (CW/DATA)	FL5	400 Hz (CW/DATA)

Fill in the table below (include sub receiver info, if applicable). Use pencil, since you may change the configuration later. **BANDWIDTH** can be obtained from the model number of each filter. 5-pole filters have a **FREQ OFFSET** marked on the side of one of the crystals, e.g. “-0.85”. The offset for all 8-pole filters is 0.00.

RF BOARD (MAIN RX & TX)			SUB RECEIVER (RX ONLY)		
POSITION	BANDWIDTH	FREQ OFFSET	POSITION	BANDWIDTH	FREQ OFFSET
FL1			FL1		
FL2			FL2		
FL3			FL3		
FL4			FL4		
FL5			FL5		

If you'll be changing RF board filters: Turn the K3S upside down, placing a soft cloth beneath it. Remove the seven black pan head screws retaining the front bottom cover, then lift the cover off.

Remove the screws holding any existing filters that you'll need to move to obtain the order listed above (on both the RF board and sub receiver).



ESD SENSITIVE!

**WEAR A GROUNDED
WRIST STRAP OR TOUCH
AN UNPAINTED METAL GROUND
BEFORE TOUCHING THE RF BOARD.**

**FILTER MOUNTING SCREW LOCATIONS
(TWO FILTERS INSTALLED)**

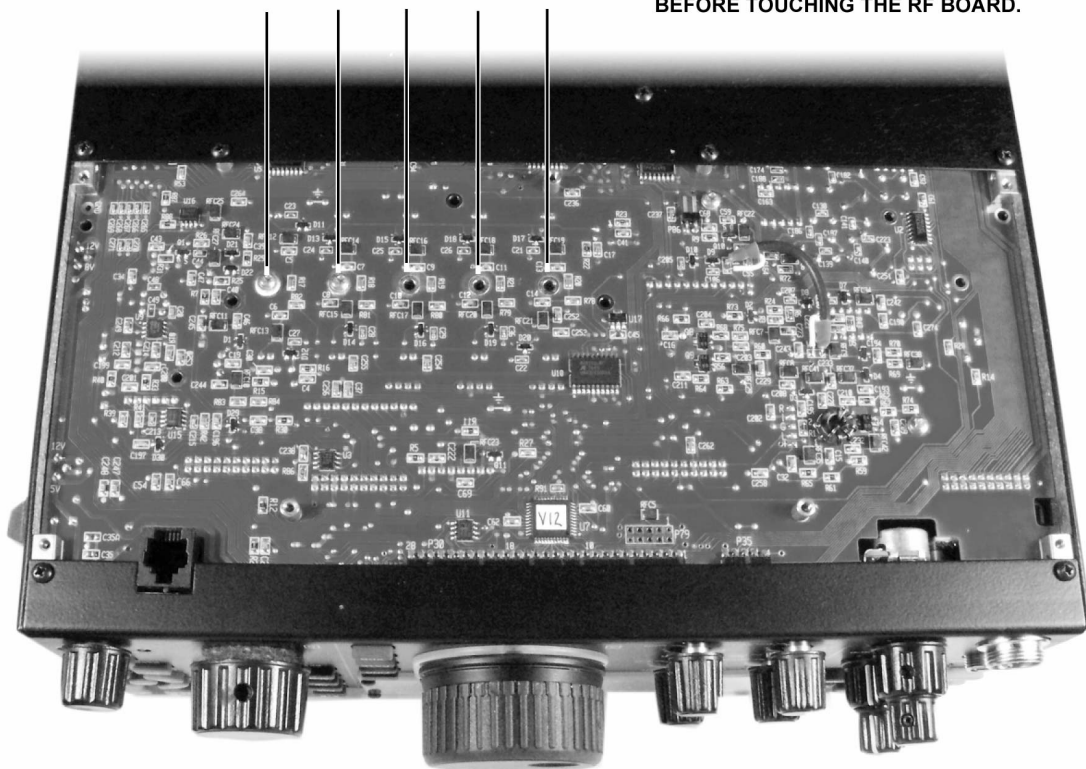

Turn the K3S right side up. Unplug all filters to be repositioned (*those whose mounting screws have been removed*). Lift the filters at each end carefully, first one end then the other, until the connectors separate.

Reposition the filters as required. They will only fit one way. If you put one in backwards, it will not fit within its outline, and the standoff will not line up with the screw hole in the RF board (or sub receiver board).

Turn the K3S (or sub receiver module) upside down again. Install the mounting hardware shown below.

⚠ Filters may be supplied with either a black 3/16" or bright-plated 1/4" pan-head screw. A screw longer than 1/4" may extend into the 8-pole filter unit and damage it.

⚠ Do not over-tighten the screws. Excess torque may pull out the threaded standoff.

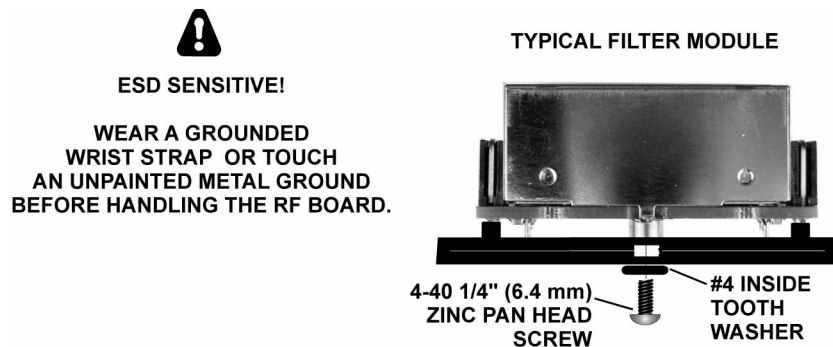

Re-install the bottom cover (if applicable) using seven 4-40 x 3/16" black pan head screws. Replace the screws securely, but do not over tighten them. All screws must be used to maintain shielding performance.

i The top cover and sub receiver (if applicable) will be re-installed in at later step.

Turn to **Crystal Filter Setup** (pg. 48). Follow all instructions for the main receiver and transmitter.

If you have the KRX3A option, re-install the sub receiver module as described in the KRX3A manual. Then turn to **Crystal Filter Setup** and follow all instructions for the sub receiver.

Position the top cover on the K3, with its rear tab inserted *under* the top edge of the rear panel. Then plug the speaker wire into P25 on the KIO3B board at the left rear of the K3S.

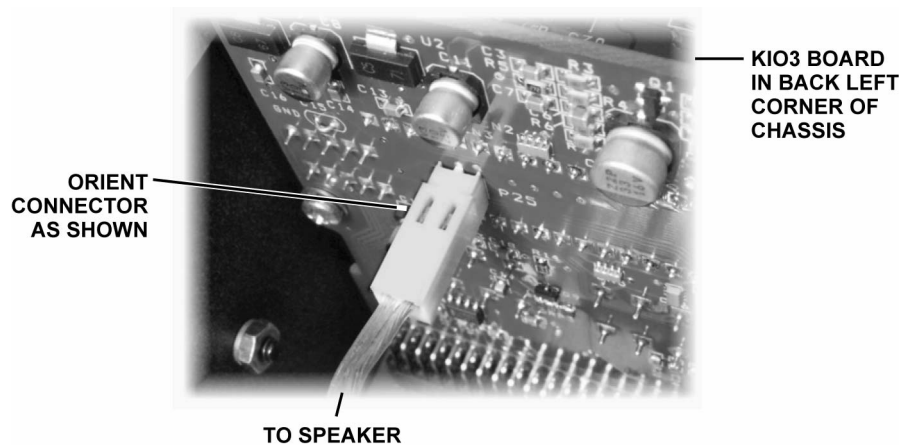

Secure the top cover with 4-40 x 3/16" flat head screws at all locations.

This completes crystal filter installation.

Index

- 12 VDC IN, 17
- 12 VDC OUT, 17
- 1-Hz Tuning, 24
- Accessory 12 VDC Output, 17
- Accessory I/O (ACC), 20
- AF Balance Control, 39, 65
- AF Gain Range, 57
- AF Limiter, 57
- AFSK A Mode, 33
- AFV (Audio Voltmeter), 38, 58
- AFX (Audio Effects), 37
- AGC, 15, 58
- Alarm Function, 6, 38
- ALC, 28, 29, 30, 66, 82
- ALC OFF Warning, 70
- ALC, External, 20, 29, 59, 70
- ALT Switch (Alternate Modes), 24, 32
- Alternate Displays, 38
- AM Mode, 30, 31, 85
- Amplifier Keying Delay, 66
- Amplifier Module, 10 W, 77
- Amplifier Module, 100 W, 49, 61
- ANT3, 17
- Antenna, 5, 6, 17, 41, 43, 47, 52, 54, 70
- Antenna Naming, 24
- APF, 37
- A-to-D Converter Reference, 57
- Attenuator, 15
- Audio Effects (AFX), 22, 37, 80
- Audio Peaking Filter (APF), 37
- Auto Info (AI Mode), 58
- Auto Power-On, 20, 38, 46, 69
- Automatic Antenna Tuner, 24, 60
- Automatic Level Control, 28, 29, 30
- Auto-Spot, 36
- AUX RF, 39, 43
- AUXBUS, 8, 20, 21, 68
- Band Independence (Main/Sub), 67
- Band Mapping, 13, 24, 58
- Band Outputs (BAND0-3), 20, 21, 60
- Band Switching, 13, 62
- Band-Pass Filters, 77
- Bar Graph, 12
- Binaural Audio (AFX), 7, 64, 80
- Block Diagram, 83
- Break-In Delay, 14, 28
- Break-In Keying (QSK), 32
- Buffered I.F. Output, 17, 61
- Calibration Procedures, 52
- Channel Hopping, 42
- Circuit Breaker, 17, 74
- Clock/Calendar, 65
- Compression, 14, 28, 30
- CONFIG Menu, 23, 48, 55, 57, 65
- Configuration, 7, 48, 72
- Connector Groups, 17
- Control Groups, 11
- Cross-Mode Operation, 6, 36, 38
- Crystal Filter Center Frequency, 9, 48
- Crystal Filter Enables, 48
- Crystal Filter Installation, 48, 84, 87
- Crystal Filter Setup, 14, 48, 85, 87
- Crystal Filter, Transmit, 28, 49, 76
- Crystal Filter, Variable Bandwidth, 78
- Current Drain, 7, 23, 38
- Customer Support, 10
- CW Keying Weight, 32, 38, 59
- CW Mode, 32
- CW Normal, 32
- CW Reverse, 12, 13, 24, 32
- CW Speed Display, 35
- CW, Break-In (QSK), 32
- CW, Off-Air Keying, 28, 57
- CW, Sending in SSB mode, 59
- CW, Very High Speed (QRQ), 32, 58
- CWT (CW/DATA Tuning Aid), 36
- CW-to-DATA, 16, 32, 33, 36
- DATA A Mode, 33
- DATA Mode, 33
- DATA Reverse, 12, 13, 24
- Date, 50, 59
- dBV (Audio dB Meter), 38, 58
- Digital Voice Recorder, 7, 16, 31, 60, 79
- DIGOUT0, 20, 21
- DIGOUT1, 20, 59
- Direct Frequency Entry, 15
- Display (LCD), 12, 55
- DSP, 7, 47, 80
- Dual Passband Filtering, 5, 15, 37
- DVR Monitor Level, 31, 66
- Error Messages (ERR xxx), 73
- ESSB, 38, 66
- External ALC, 20, 29, 59, 70
- External Reference, 17
- Fan Panel, 5, 17
- Fan Speed, 29
- Filter Graphic, 12, 14, 25, 34
- FINE Tuning, 24
- Firmware Upgrades, 47
- FM, 60

FM Deviation, 60
FM Mode, 13, 30, 31
FP ACC, 13
Frequency Entry, Direct, 15
Frequency Memories, 16
Frequency Range, 8, 42
Friction Adjustment, VFO Knob, 50, 51
Front Panel, 11
Front Panel Accessory Connector, 13
FSK, 33, 34
FSK D Mode, 33
FSK IN, 20, 33, 34
Full Break-In (QSK), 13, 32
Ground Terminal, 17
Headphones, 13, 22, 61, 64
HI CUR Warning, 70
HI RFI Warning, 70
HI SIG Warning, 70
HI SWR Warning, 70
HI TEMP Warning, 70
HICUT (High Cut), 5, 25, 34
I/II, 12, 14, 25, 26
Iambic Keying, 58
IF OUT, 41
Intermediate Frequency (I.F.), 78
K144XV, 47
K3 Utility PC Application, 46, 47, 48, 69, 72
KANT3, 43, 44, 74, 77, 79
KAT3, 8, 24, 44, 49, 59, 60
KBPF3, 9, 38, 60, 74, 78
KDVR3, 16, 31
KEY OUT, 17, 21, 66
Keyboard, 46
Keyer Paddle, 17, 32, 58
Keyer Speed, 5, 11, 28
Keying Weight, 32
Keypad, 11
KIO3, 6, 18, 69, 75
KNB3, 27, 78
KPA3, 49, 61
KPAIO3, 61, 75, 78
KRC2, 61
KREF3, 81
KRX3, 51, 74, 75, 84
KSYN3, 81, 83
KTCXO3-1, 34, 47
KXV3, 43
LCD Test, 61
LEDs, 13
LINE IN, 22, 33, 34, 50, 55, 79
LINE OUT, 22, 34, 61
LOCUT (Low-Cut), 5, 34
Low-Pass Filter, 39, 43, 76, 77, 79
LPA, 77
M1-M4, 6, 11, 16, 31, 32
Macros, 23, 46
MAIN Menu, 23, 55
Memories, 16, 62
Memory Label, 16, 42
Menu Help, 23
Message Record/Play, 16, 32
Mic Gain, 11, 22, 30, 34, 50, 55
MIC Up/Down Buttons, 62
Microphone, 30, 79, 80
Mode Selection, 15, 24, 30, 60
Noise Blanker (NB), 9, 27, 78
Noise Reduction (NR), 6, 11, 27
NORM1/2 (Filter Normalization), 14, 26
Normalizing Filter Passband, 14, 26
Notch Filtering, 6, 12, 15, 27
Numeric Keypad, 11
Option Module Enables, 49, 72
Options, 8, 47, 48
PA Interface Module, 61, 74, 75, 78
Panadapter, 41
Parameter Save/Restore, 72, 74, 75, 80
Passband Control Granularity, 25, 62
PF1, PF2, 6, 16, 23, 34
PLL voltage, 38
Pot Test (SW TEST), 65
Power Control Locking, 14
POWER ON Signal, 20, 46, 69
Power Supply, 8
Preamp, 12
Presets, 26
Primary Controls, 11, 13
Programmable Function Switch, 6, 11, 16, 23, 31, 32, 34
PSK D Mode, 33
PSK31, 33
PTT (Push To Talk), 20, 28, 31, 62, 70, 75
PTT Release Delay, 63
QSK, 32
Quasi-Stereo (AFX), 37, 55, 80
Quick Memories, 8, 15, 16
Quick-Start Guide, 4, 7
Real Time Clock, 50, 51
Rear Panel, 7, 17
Receive Antenna, 41
Receiver Setup, 25
REF IN, 17
Reference Oscillator, 53, 63, 75, 78, 81
Reference, External, 17
Remote Control, 7, 8, 46, 58
Remote Power-On, 20, 46, 69
Repeater Offset, 31, 55

RF Board, 77
RF GAIN, 54
RFI Detection, 63
RIT, 6, 11, 14, 16, 24, 67
RIT/XIT Offset, 7, 14, 16, 23, 24, 35, 38, 67
Roofing Filter, 7, 80
RS232, 18, 20, 33, 46, 58, 62, 63, 70, 79
RTC, 50
RTTY, 33, 34
RTTY Letters Shift, 65
RX ANT IN/OUT, 41
RX EQ, 37, 56, 71
Scanning, 6, 14, 42
Semi-Break-In, 5, 14, 28
Serial I/O, 20
Serial Number, 63
SHIFT, 12, 14, 25
Sidetone, 32
S-Meter, 12, 54, 64
Speaker, 37, 39, 64
Specifications, 8
Speech Compression, 14, 28, 30
SPKRS=1 Warning, 70
SPLIT and Cross-Mode Operation, 6, 14, 28, 38, 70
SPLIT Save (Per Band), 64
Spot, 15, 32
Spurious Signal Removal (Receive), 64
Squelch, 14, 65
SSB +CW, 59
SSB Mode, 30
SSB, Selecting Alternate Sideband, 12, 30
SSB/CW VFO Offset, 31, 32
Sub Receiver, 5, 17, 39, 43, 44, 45, 49, 57, 61
Supply Voltage, 8
Switch Test, 65
Switch Tones, 65
Sync Data, 34, 63, 65
Synthesizer, 38, 52, 74, 78, 79, 81, 83
Tap/Hold Switch Functions, 11, 23
TCXO, 8, 34, 47, 53, 81
Tech Mode Menu Entries, 65
Temperature Sensor, 54, 60, 62, 70
Terminal Emulator, 46
Text Decode and Display, 25, 32, 35
Theory Of Operation, 77
Time, 50
Transmit Crystal Filter, 28, 49, 76
Transmit Gain Calibration, 52, 67
Transmit Inhibit, 20, 21, 29, 66
Transmit Noise Gate (Voice Modes), 31, 66
Transmitter Setup, 28
Transverter, 8, 9, 20, 21, 41, 52, 61, 70
Transverter Control, 67
Troubleshooting, 69
Tune Power, 66
Tuning Aids, 36
Tuning Rate, VFO, 6, 24, 38, 50, 67
TX EQ, 5, 6, 30, 37, 56
TX LED, 6, 28, 47, 70
TX TEST, 5, 12, 20, 28, 30, 32, 36, 62
TXGN, 67
VFO B Alternate Displays, 38
VFO B to A Copy, 67
VFO Counts per Turn, 67
VFO Knob Friction Adjustment, 50, 51
VFO Tuning Controls, 6, 24, 38, 50, 67
Voice Modes, 5, 25, 30
VOX Delay, 14
VOX, Voice Modes, 13, 31
Wattmeter, 30, 52, 67
WIDTH, 12, 14, 25
XFIL, 15, 48, 59
XIT, 6, 11, 14, 16, 24, 67
XVTR IN/OUT, 9, 41, 52, 61, 70