

-Interconnection Board and Motherboards-

Part of the interconnection between modules and Printed Circuit Boards are the Interconnection Board and the Motherboard.

The Interconnection Board is the interface between receiver control part and receiver HF-Part.

The Interconnection board is connected to the Buffer D/A Converter board via a 60 core ribbon cable, and rearranges these wires to connect to various 10- and 16 wire ribbon cables, which are connected to the various HF-modules.

Various Byte lines from the individual HF- modules are assembled and connected via a 34 wire ribbon cable to the time clock PCB.

The built in AF-transformers can be utilized by the remote control bus via the 26 wire remote control ribbon cable (if fitted), and finally various power supply connections and frontpanel controls are connected to stand alone solder pins.

All printed circuit boards in the control part of the receiver are plugged in the motherboard. Power supply connection and connections from the front panel control to stand alone solder pins are also made. The difference between the Motherboard 155.24 and 155.23 is that the latter is able to handle ISB audio and squelch control in conjunction with the Audio PCB II.

-Interconnection Board and Motherboards-

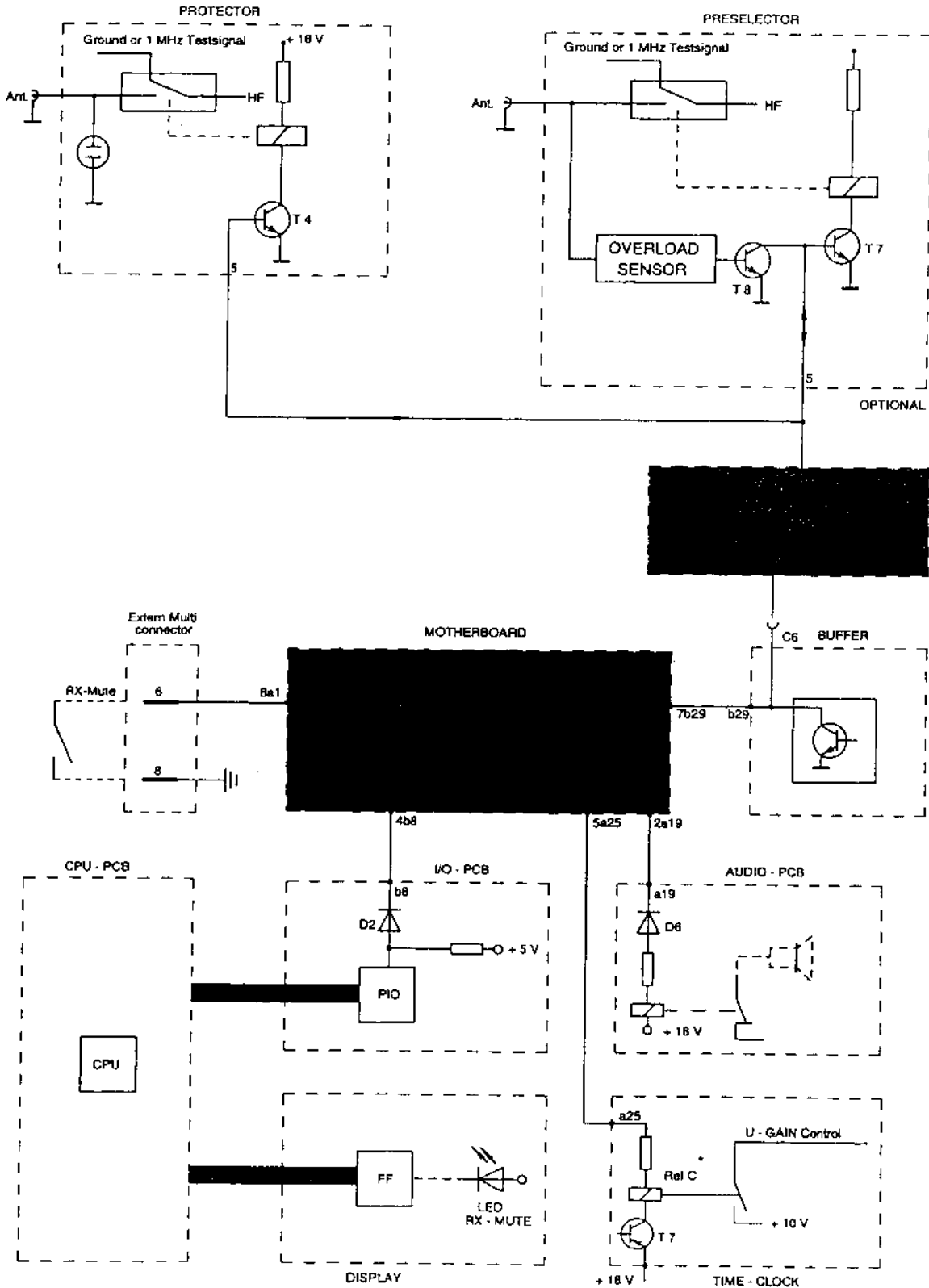

* REL C is disengaged during BITE TEST

Mute Interconnection

RX 1001 M
 or
 RX 5001
 with option
 IF / OUT

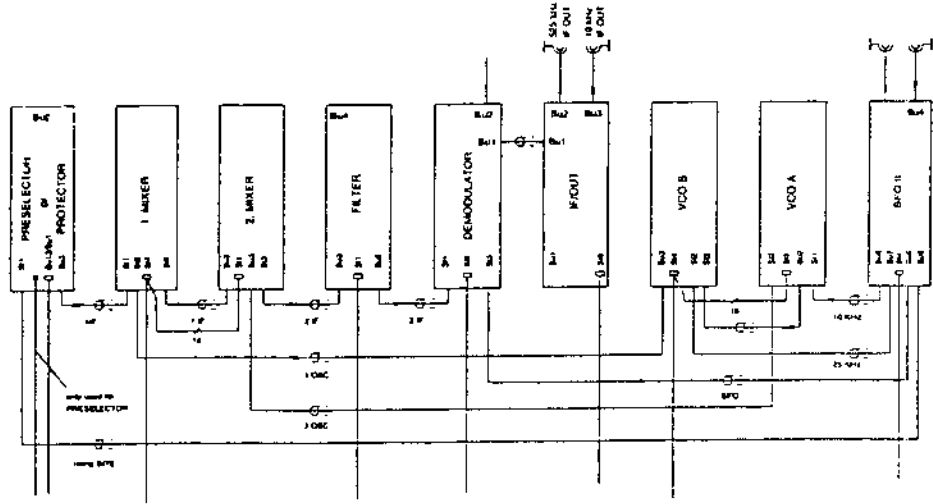

RX PART

RX 5001
 with option
 ISB Demodulator

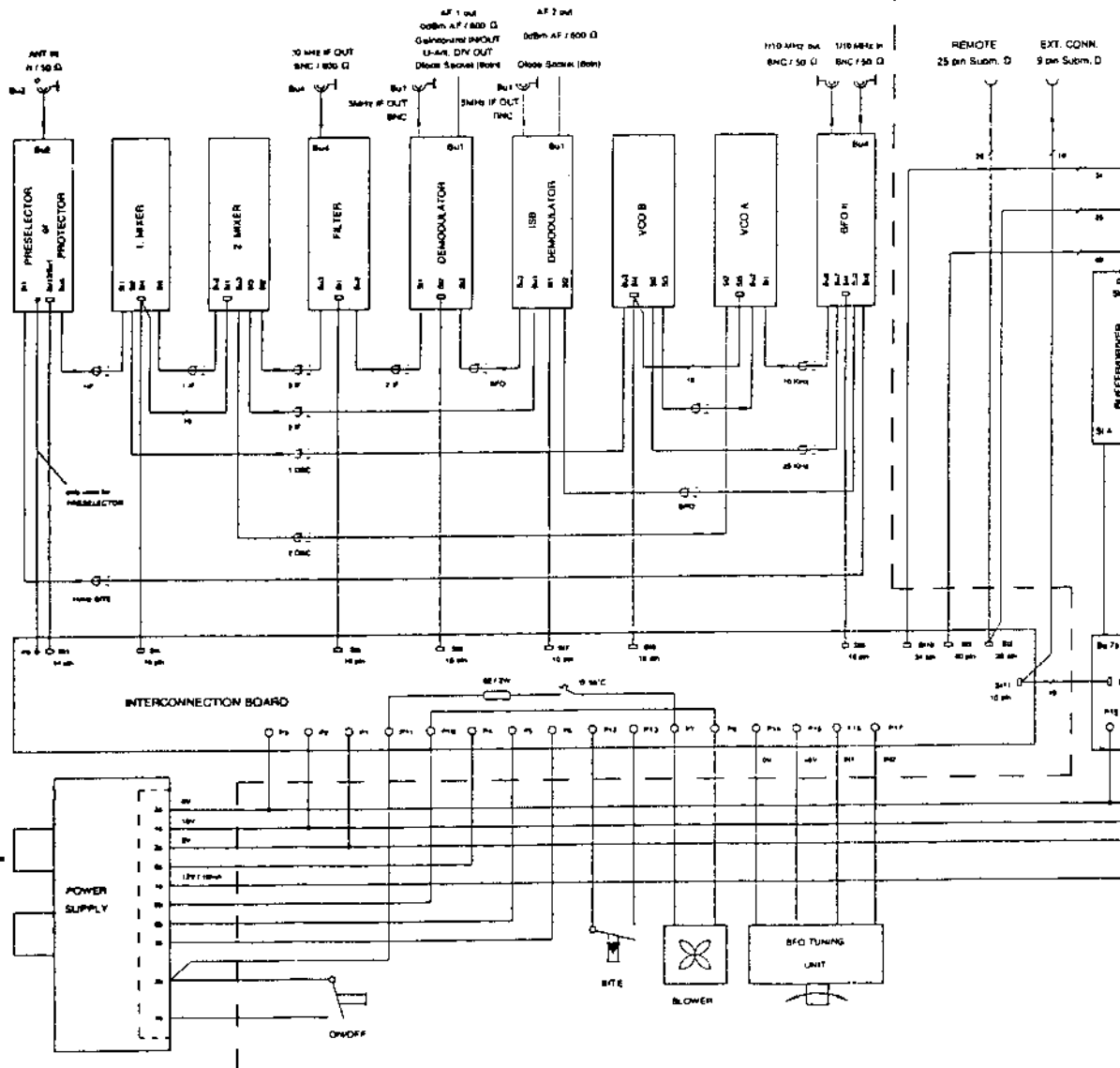

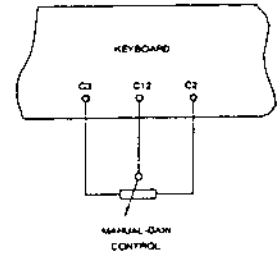
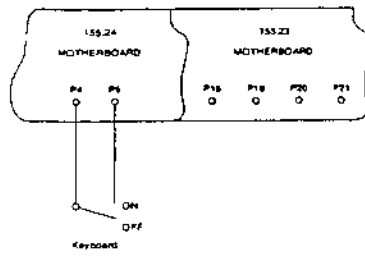

CONTROL PART

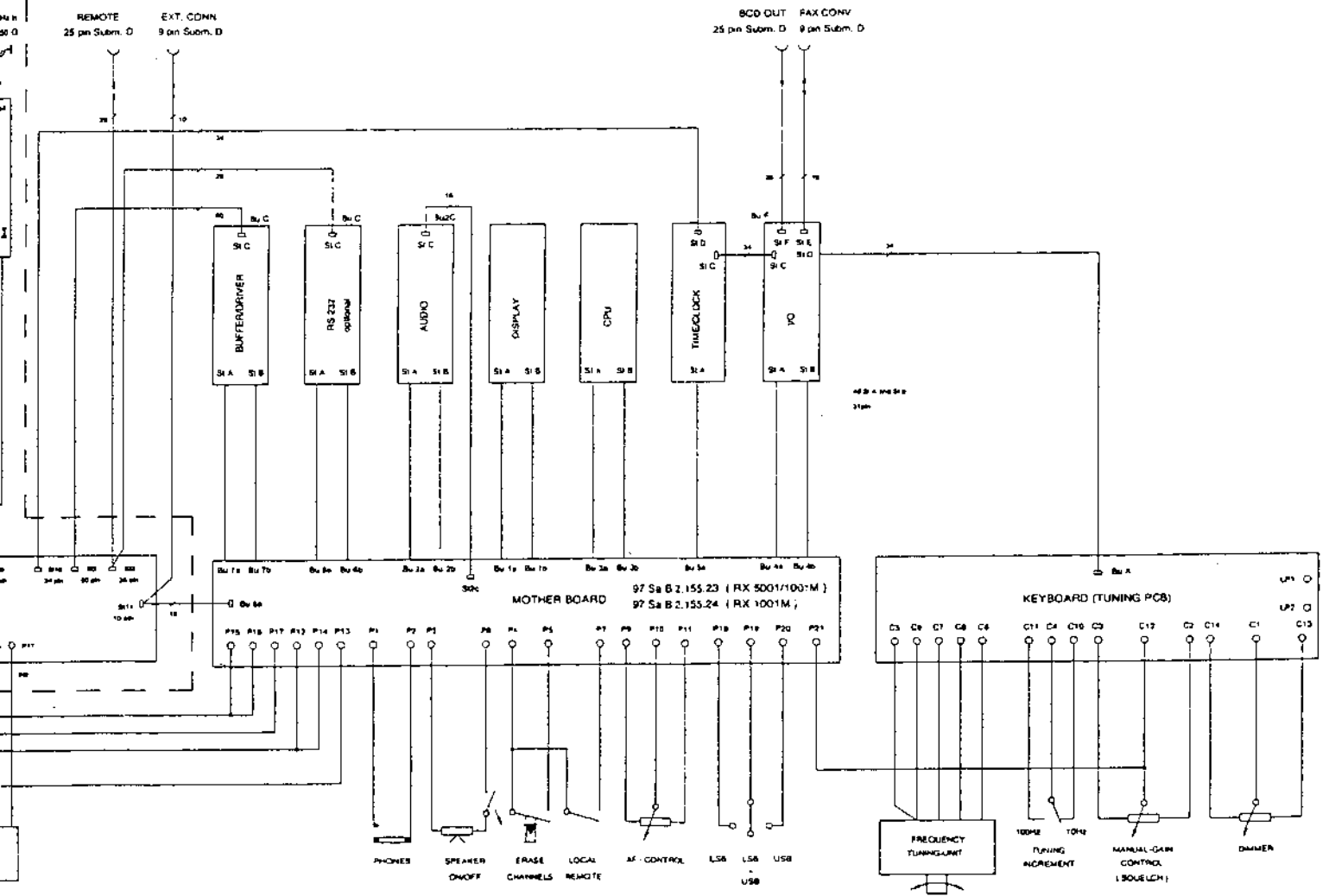

Blockdiagram -Wiring-
RX 1001 M / RX 5001
* RX 1001 M only

-Interconnection Board-

Mechanical layout of HF-Coax interconnections for various options

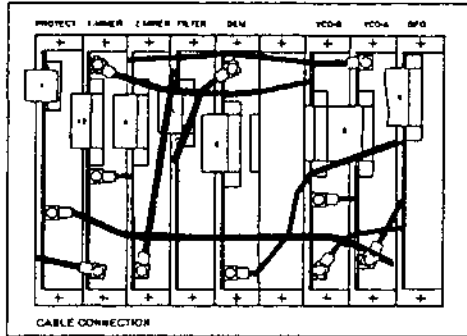

RX 5001 (basic version)

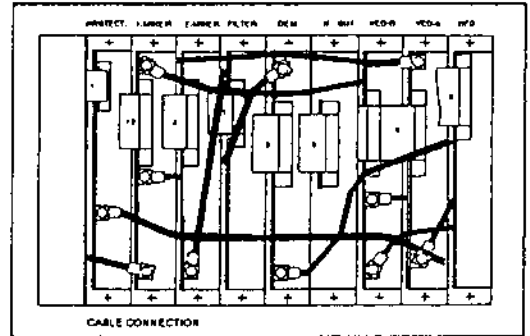

RX 5001 (with option IF-OUT)
RX 1001 MB (basic version)

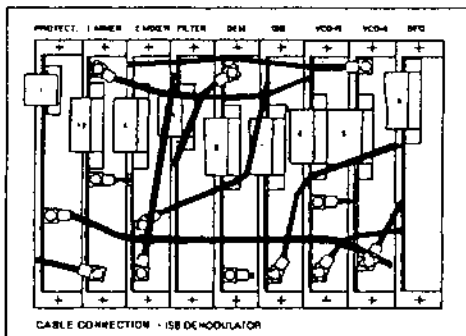

RX 5001 (with option ISB-Demodulator)

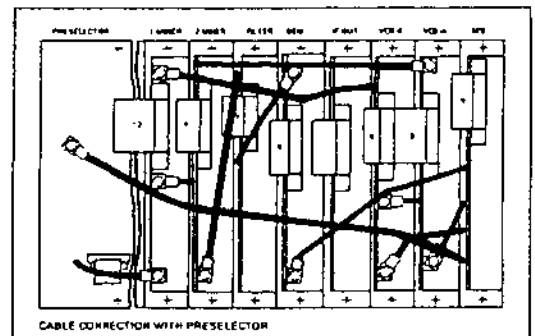

RX 5001 (with option Preselector
and IF-OUT) RX 1001 MVB

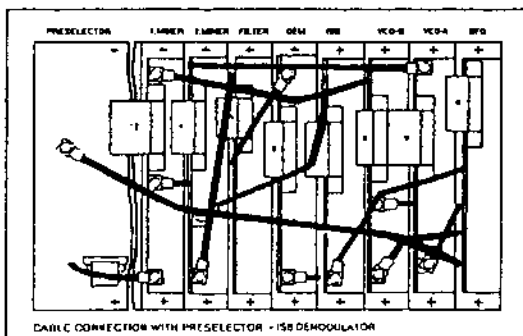

RX 5001 (with option Preselector and
ISB-Demodulator)

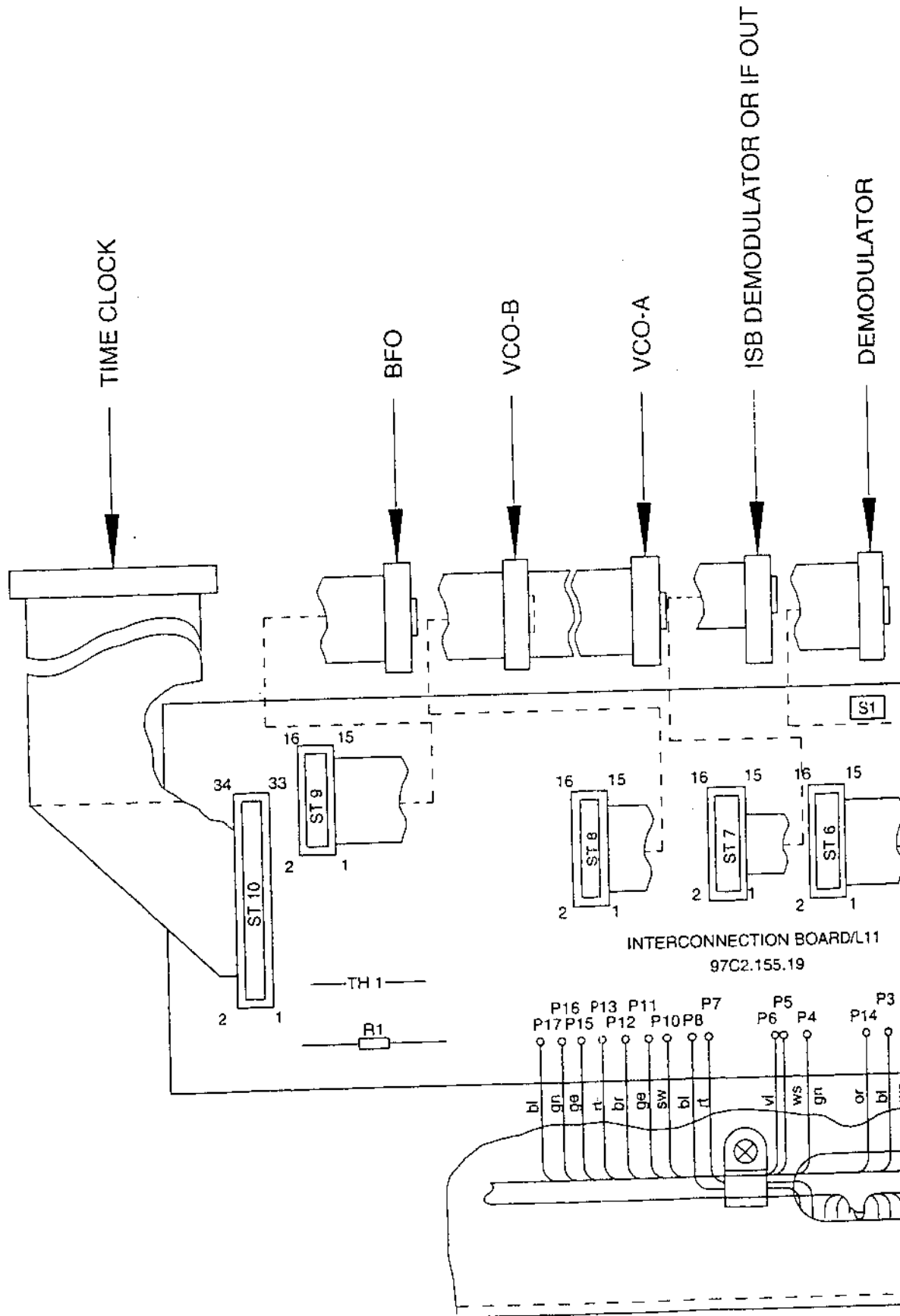

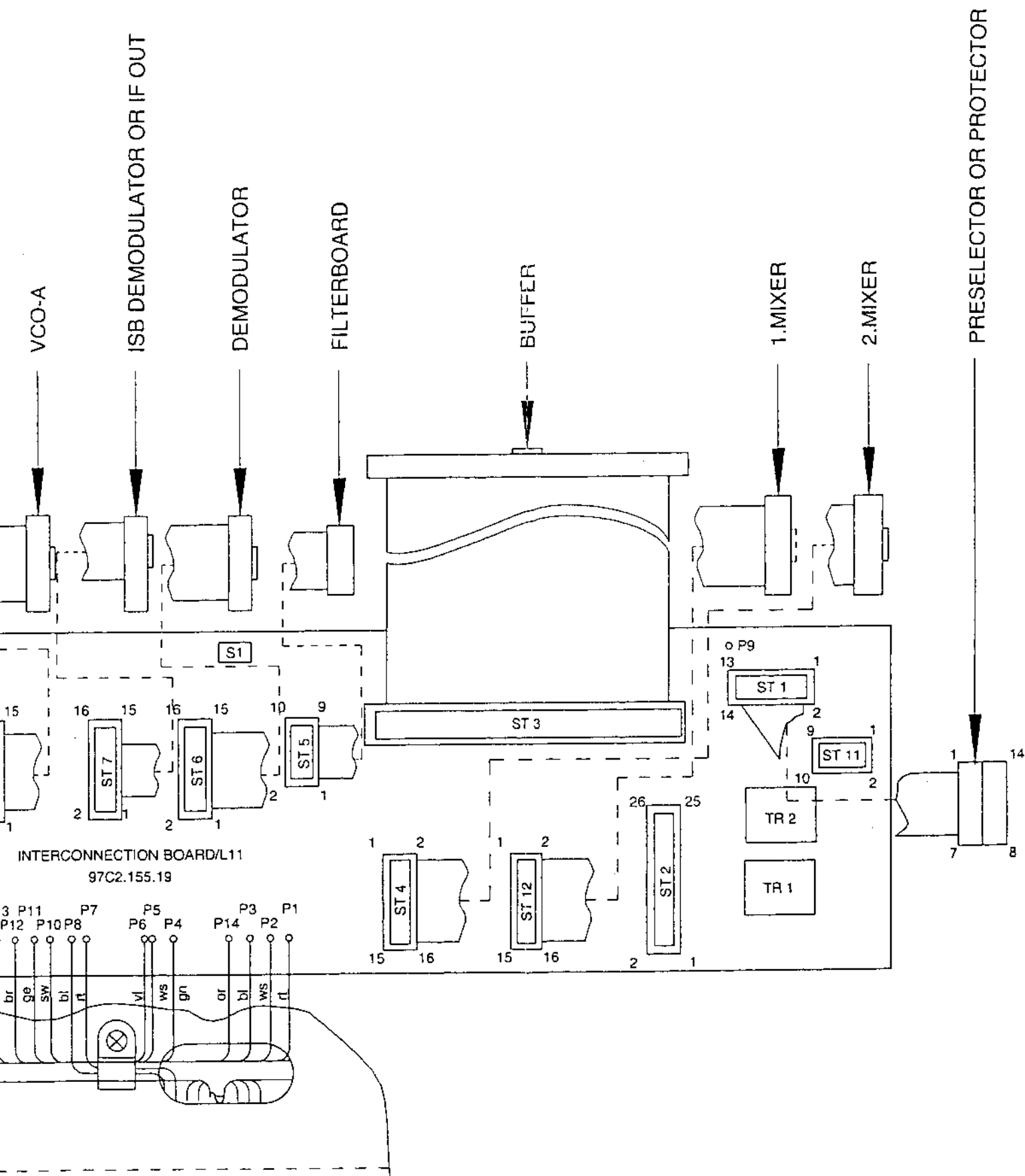

Interconnection Board
Ribbon Cable

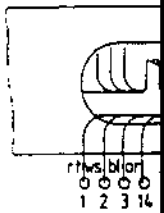
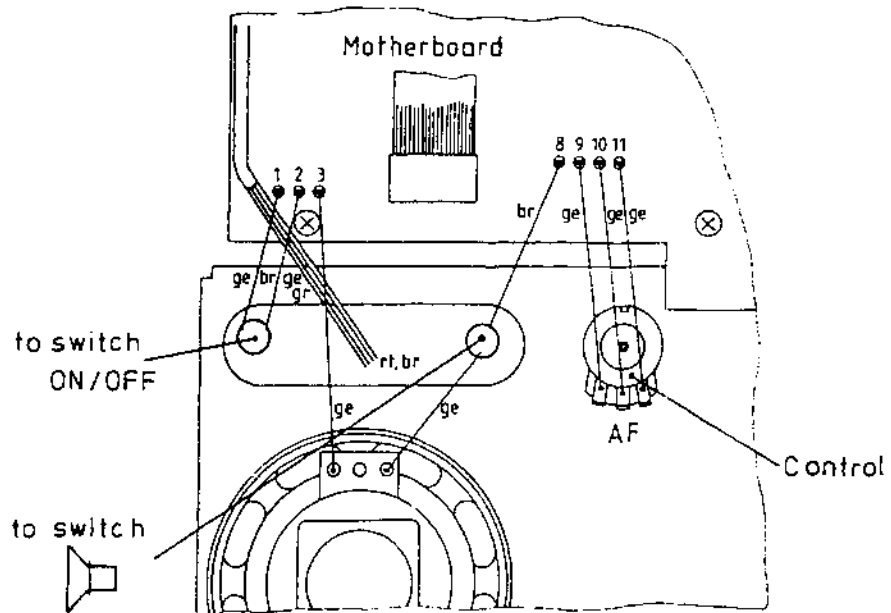
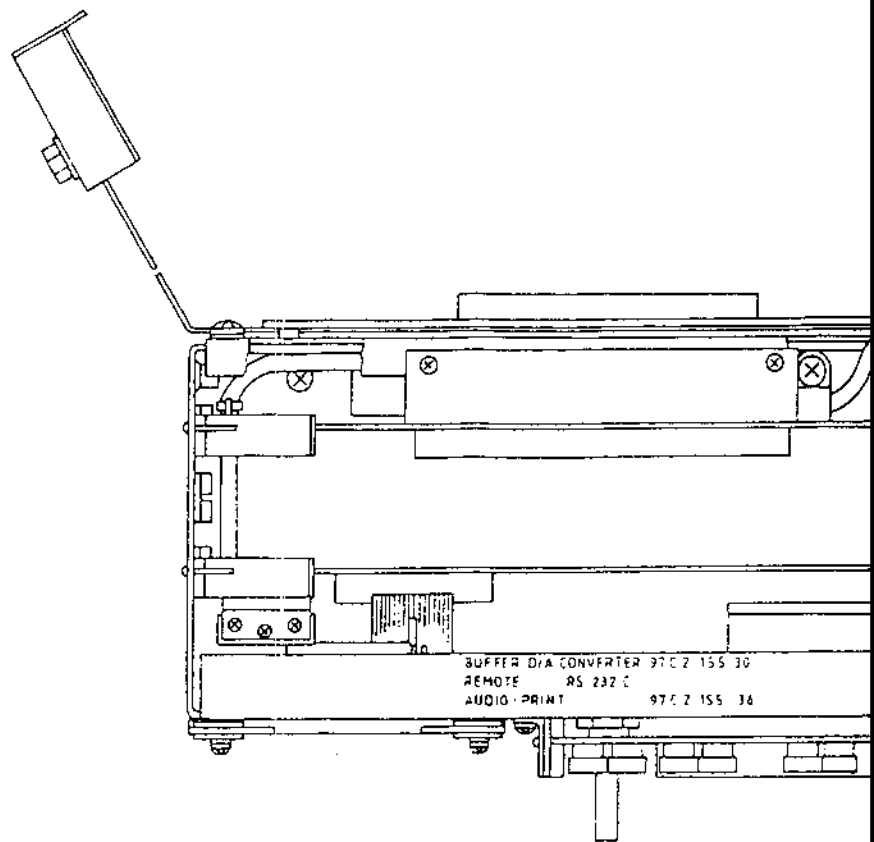

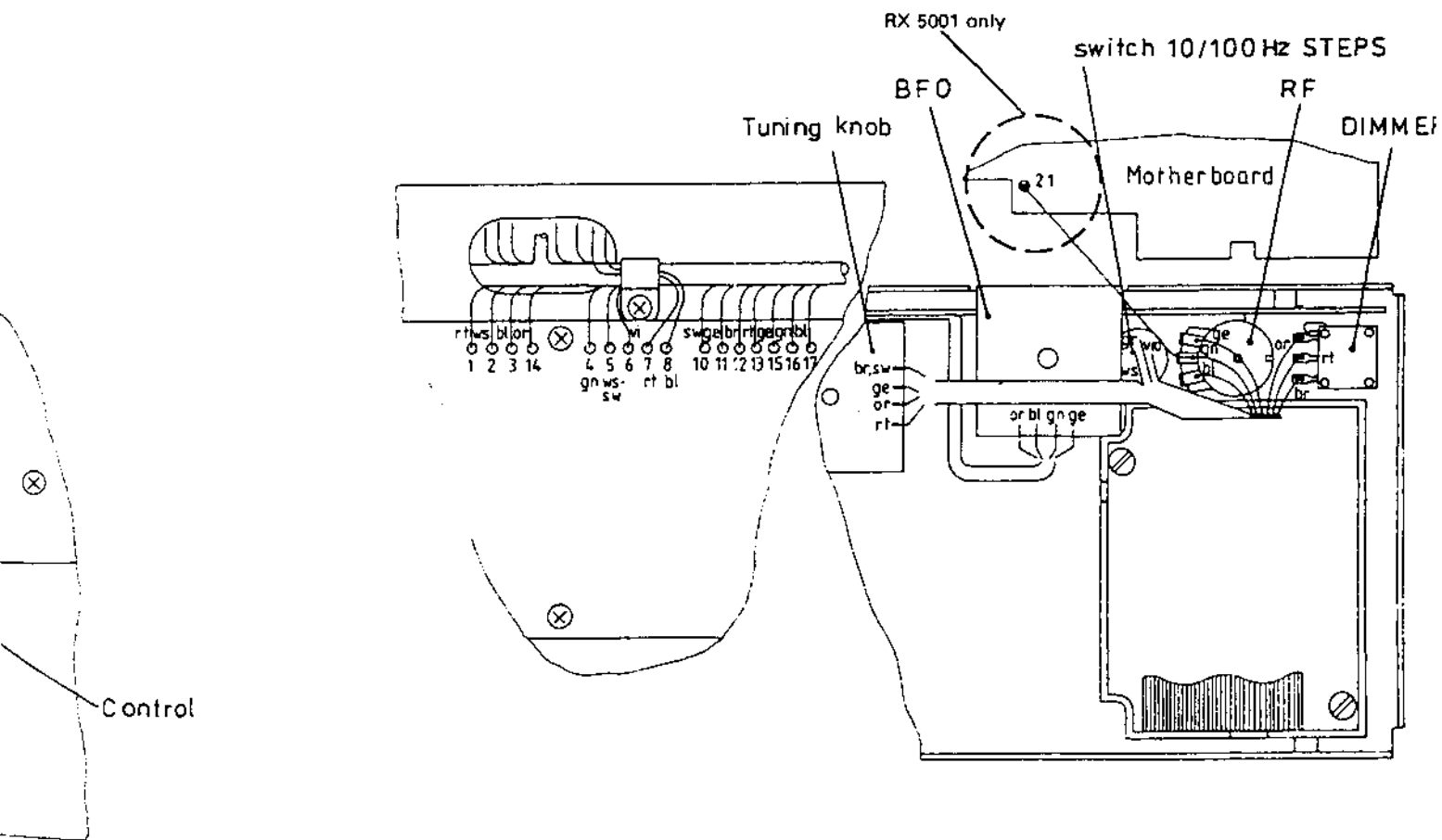
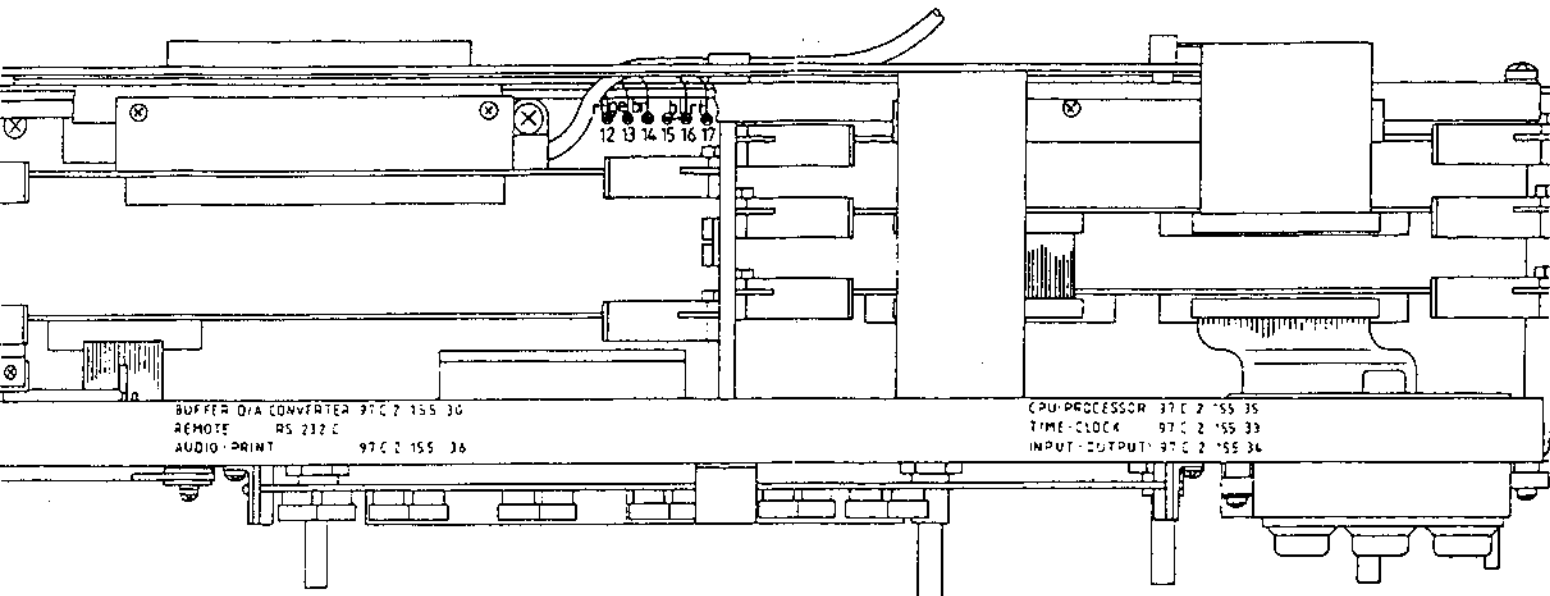

Interconnection Control Part
RX 1001 M / RX 5001

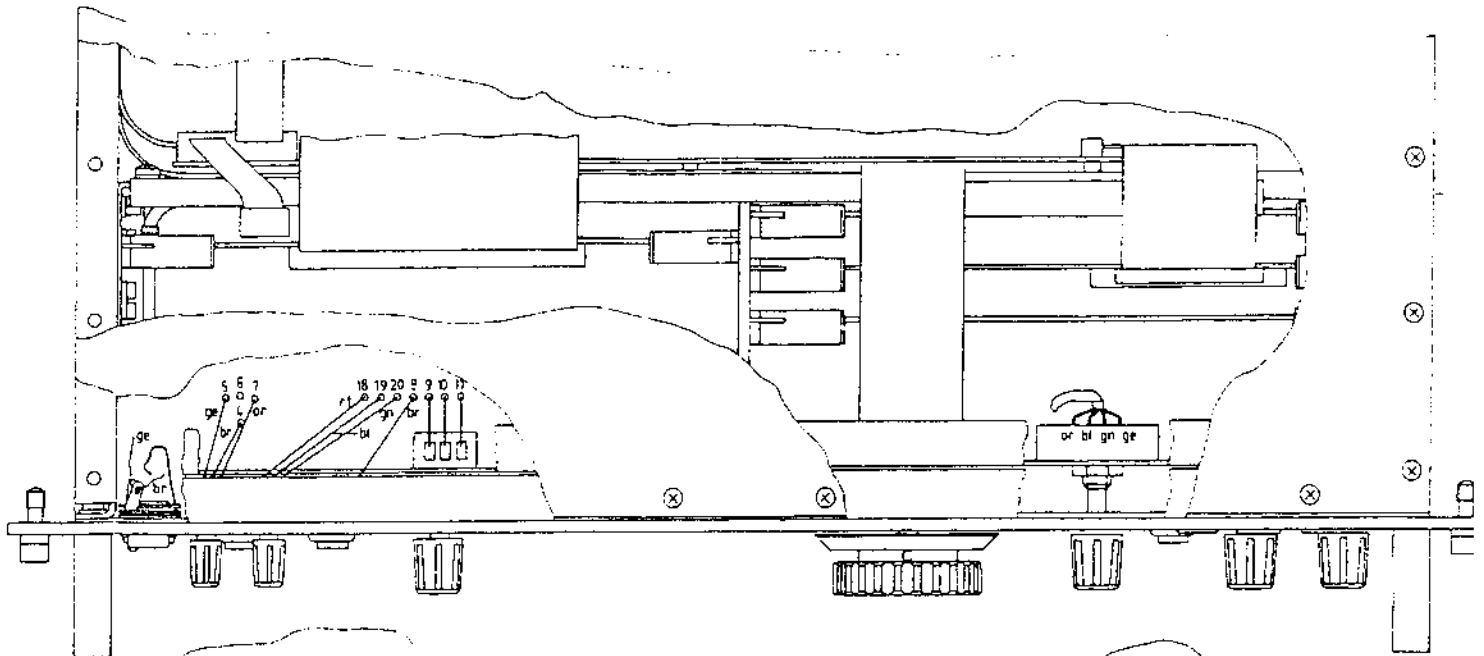

MAINS switch

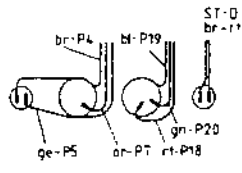
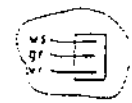
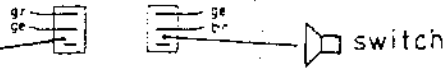

Rear view

RX 5001

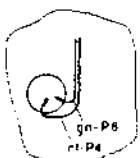

RX 1001 M

Interconnection of the Front Panel - Rear Side

see circuit diagram - INTERCONNECTION BOARD B 97 Sa C 2.155.19

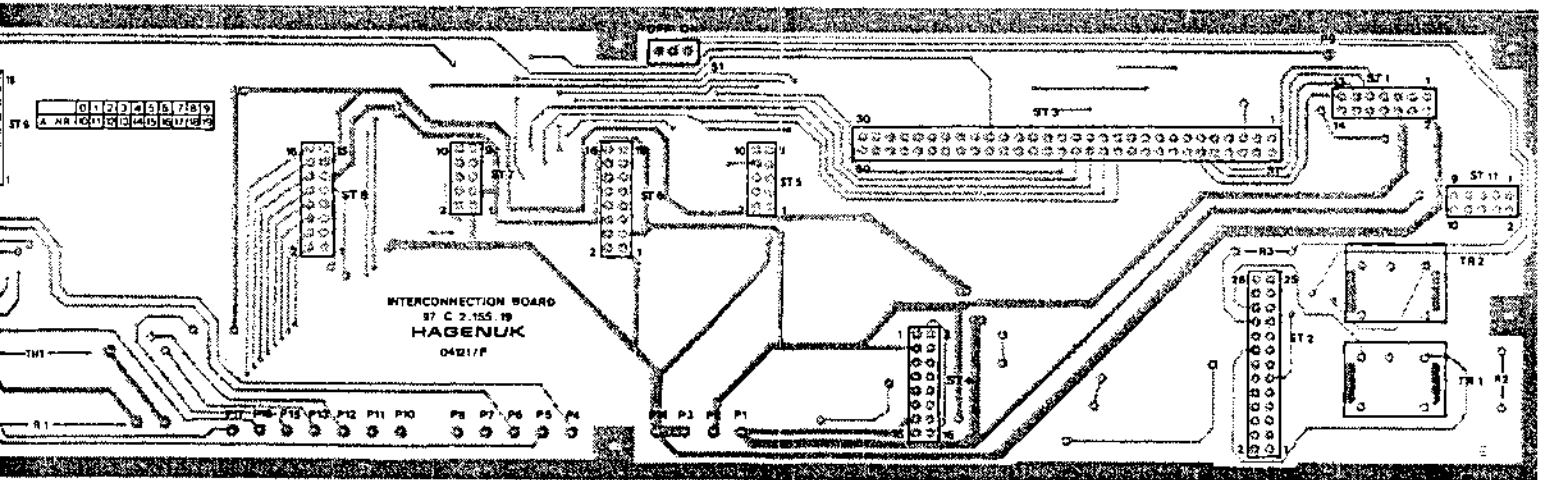
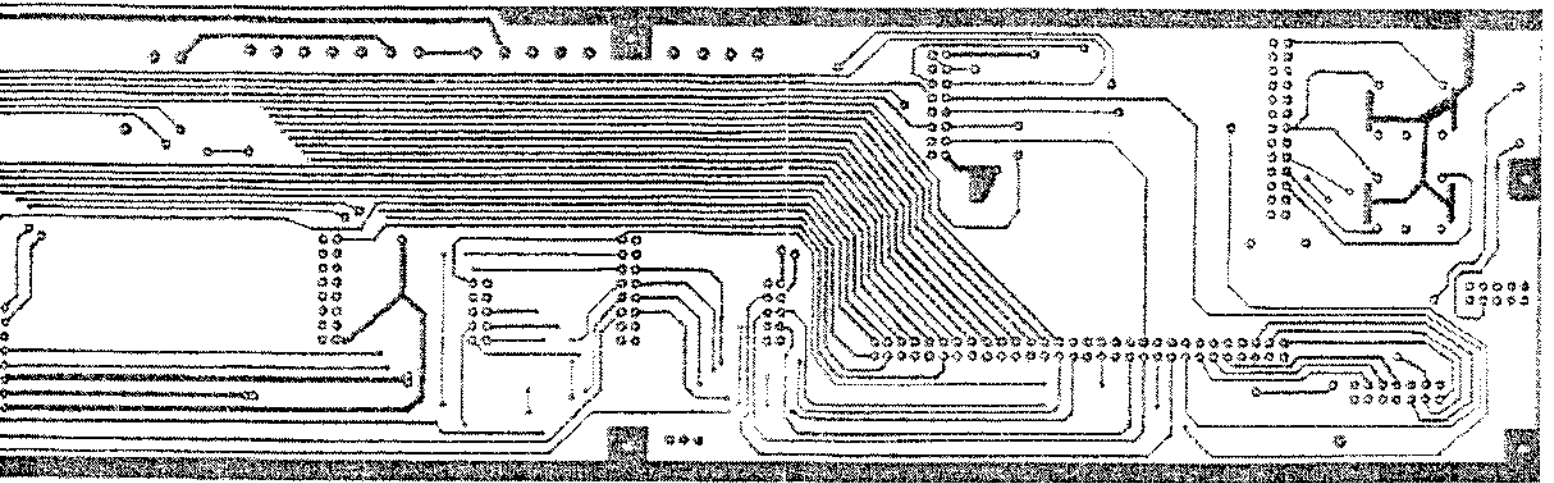

Printed Circuit Board
Interconnection Board
97 C 2.155.19

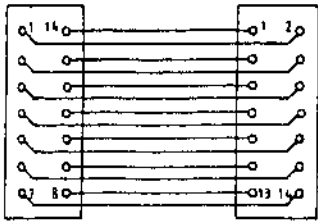

St 1
Preselector or Protector

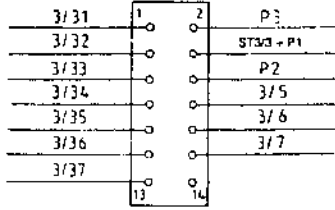

Note: Reference to the Preselector DIL connector Bu13 * are made to the ribbon cable connector St 1. Pin numbers indicated in this drawing referring to the DIL connector Bu13 * of the Preselector do not match with pin numbers on the actual Preselector drawing 97 2.140.150 B
* Protector - Bu 1

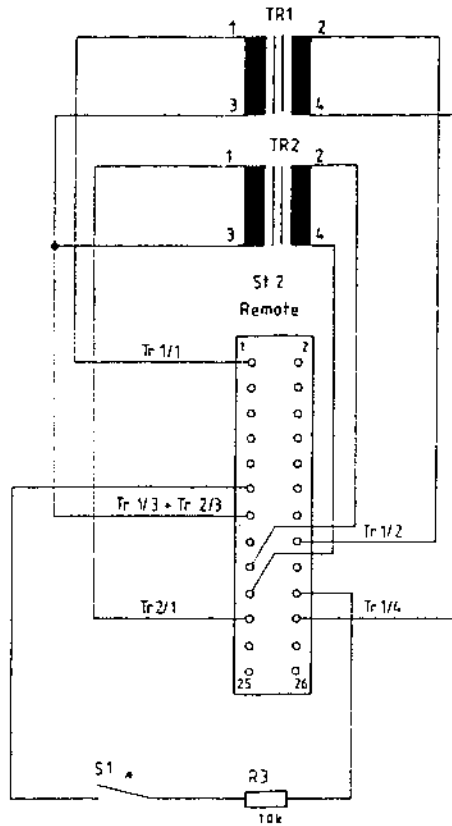

St 4
1. and 2. Mixer

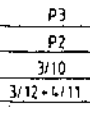
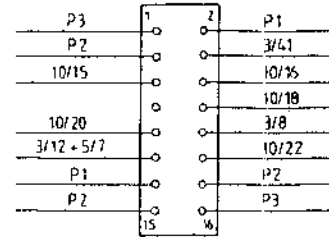

St 7
IF Board or ISB Demodulator

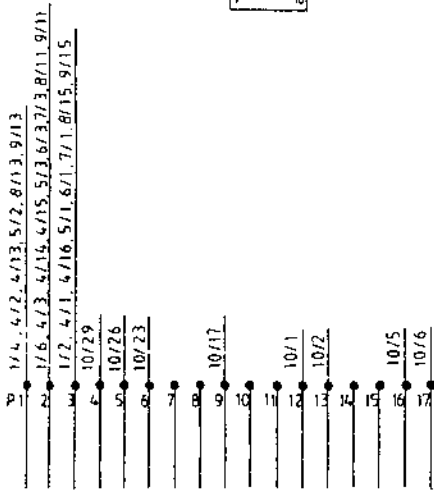
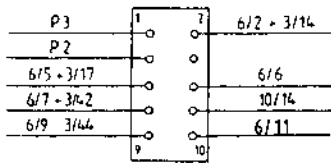

St 8
VCOA - VCOB

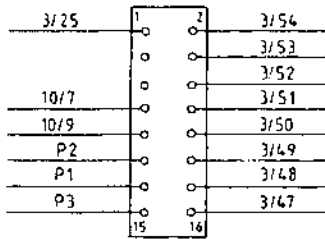

St 9
BFO

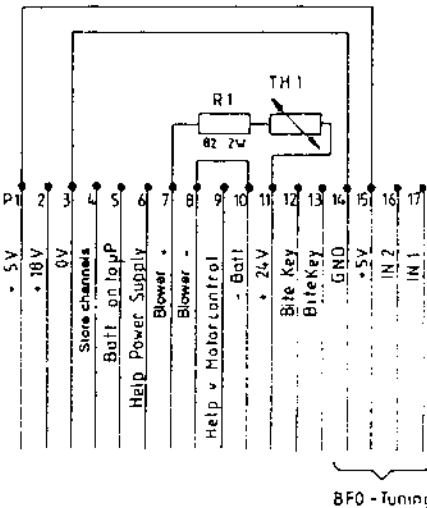
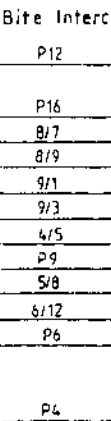
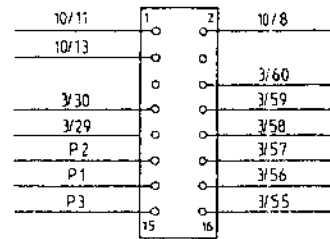

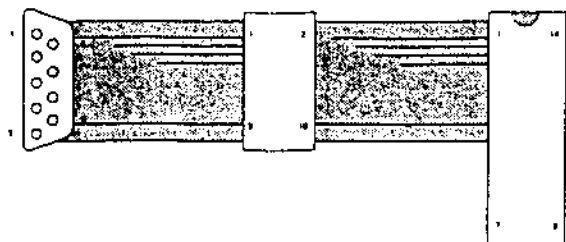
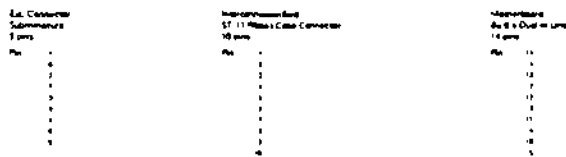
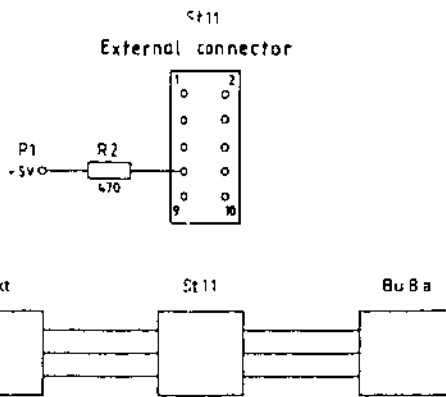
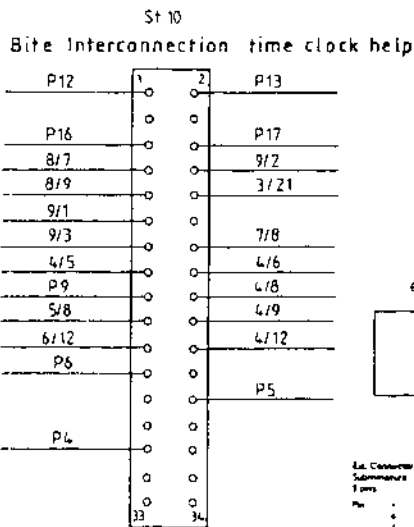
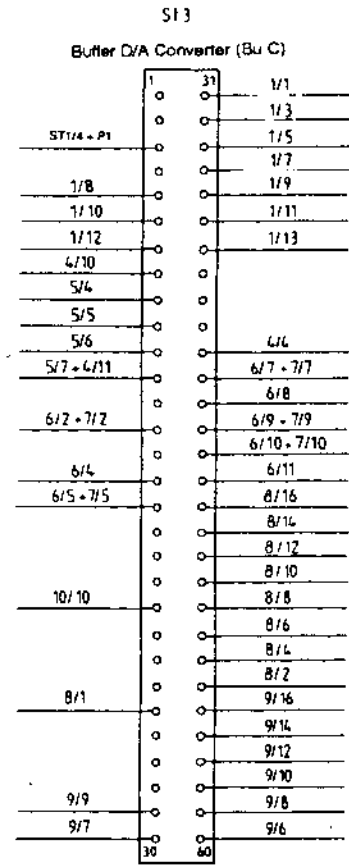
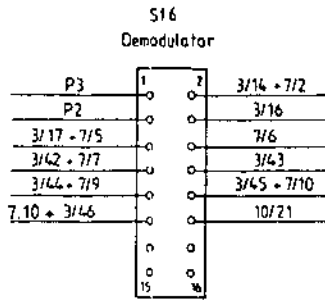
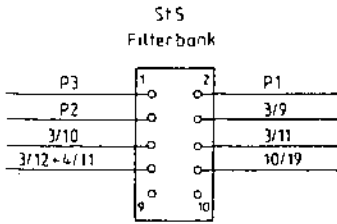

* St has to be switched ON to enable Go/No Go check via V24 interface (DTR/DSR)
In addition S2/2 on I/O p.c.b. has to be On and the switch 600/1200 Baud on the RS 232 Remote p.c.b. has to be set to 600 Baud.
For remote control operation S1 has to be

refer also to chapter 3.1.5

Interconnection Board Circuit Diagram 97 Sa C 2.155.19

Parts lists No.
97 Sa 2.155.19

-Interconnection Board-

Ident No.	Mark	Electr. value	Identity	Manufacturer
-----------	------	---------------	----------	--------------

Supplements:

1810.332		Ribbon Cable	97 E 2.155.110	
1810.340		Ribbon Cable	97 E 2.155.111	
1810.359		Ribbon Cable	97 E 2.155.112	
1810.367		Ribbon Cable	97 E 2.155.113	
1810.375		Ribbon Cable	97 E 2.155.114	
1810.383		Ribbon Cable	97 E 2.155.115	
1905.791		Ribbon Cable	97 E 2.155.118	
1905.805		Ribbon Cable	97 E 2.155.119	
1810.529		Connector Plug 10- pins	609-1027	ANSLEY
1810.537		Connector Plug 26- pins	609-2627	ANSLEY
1841.076		Connector Plug 14- pins	609-1427	ANSLEY
1708.864		Transformer TR1	ST 2524	HAUFE
1708.864		Transformer TR2	ST 2524	HAUFE
1422.944	TS 1	Switch		ITT
1959.492	TS A	Temp. Switch	31.02910	KLUXEN

Resistors:

1810.634	R1	82 5% 2W	DIN 44063-G
0554.898	R2	470 5%	DIN 44052-G
0179.701	R3	10k 5%	DIN 44052-G

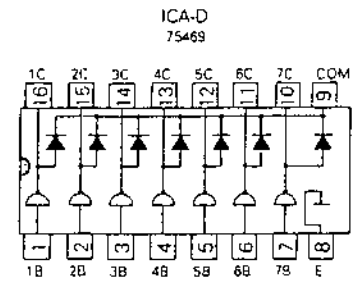
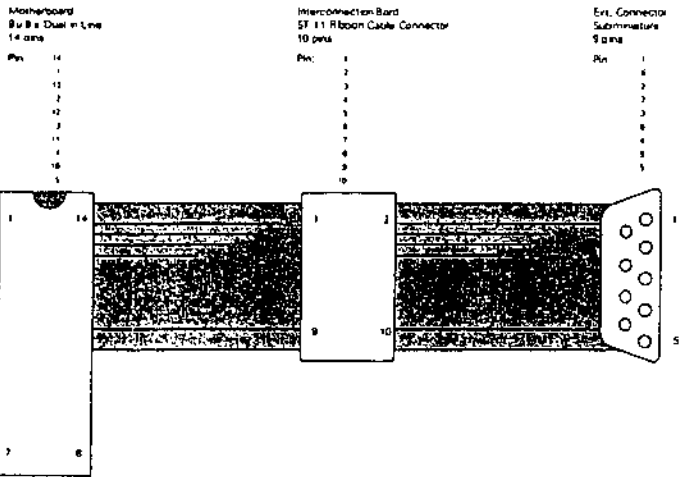

EXTERN CONNECTOR

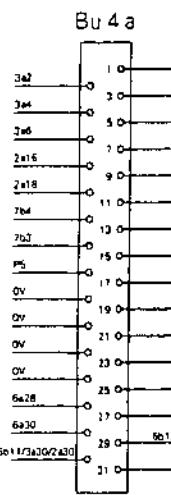
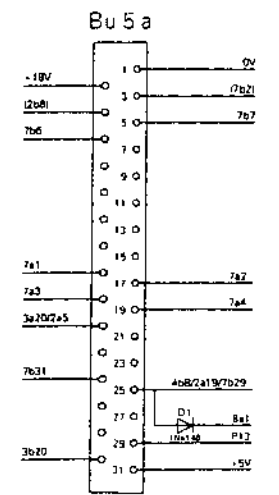
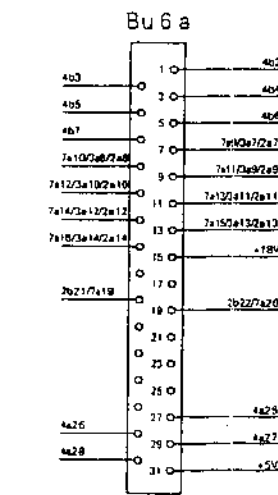
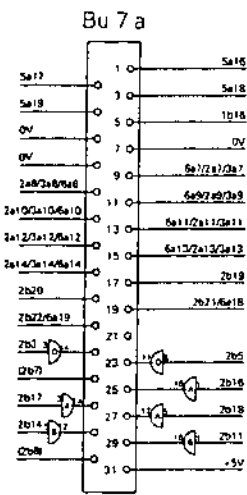
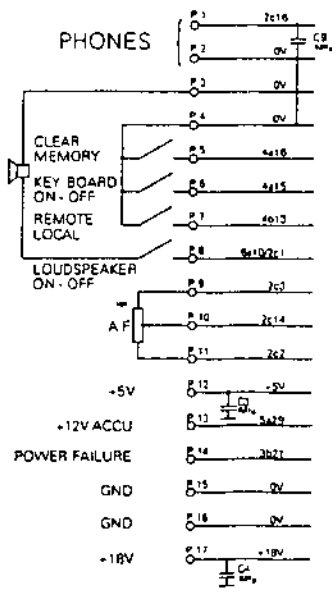
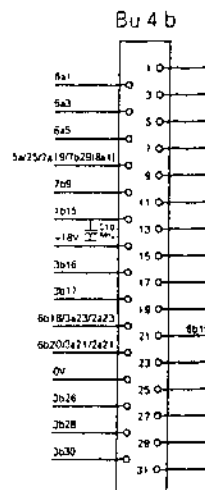
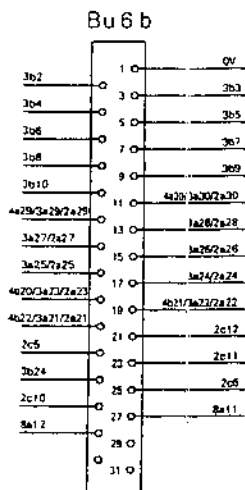
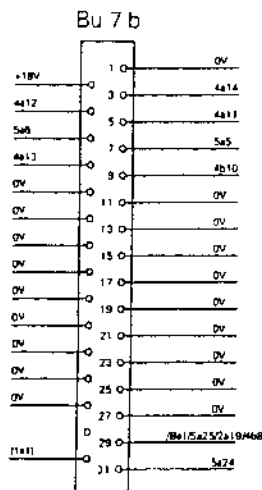
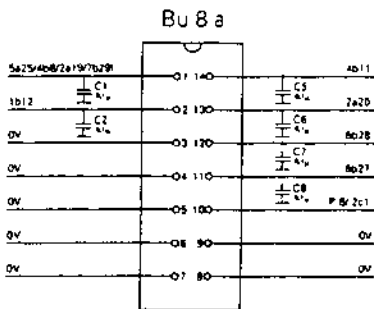

BUFFER
D/A Converter

REMOTE SERIAL INTERFACE

CLOCK

I/O

To be fitted in RX 1001 M only

ICA-D
75469

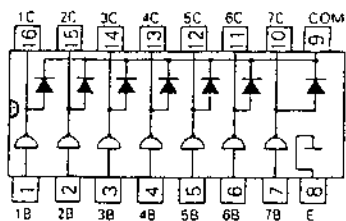

Note:

Reference to the Audio PCB connector C are made to the DIL connector St 2 c. Pin numbers indicated to in this drawing referring to Audio PCB C connector do not match with pin numbers on the actual Audio PCB drawing 97 2.155.37.

Bu 2 c

St 2 c

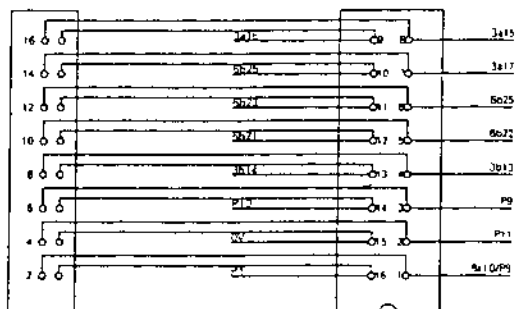

0V
2b1
2b5
2b7
2b9
2b10
2b12
2b14
2b16
2b18
2b20
2b22
2b24
2b26
2b28
2b30

Bu 4 b

Bu 3 b

Bu 2 b

Bu 1 b

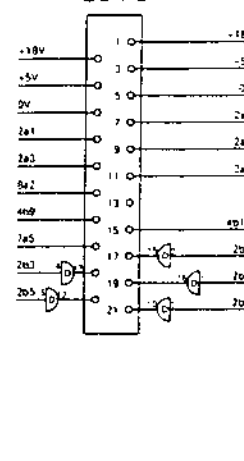
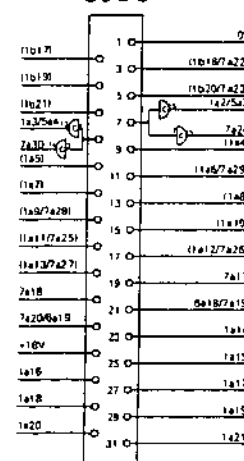
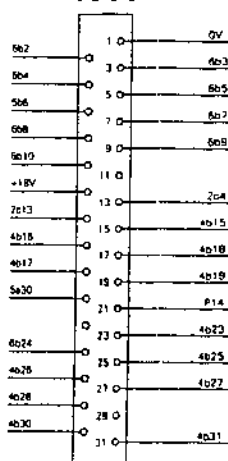
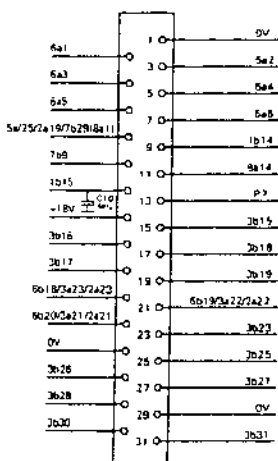

2b1
2b3
2b5
2b7
2b9
2b11
2b13
2b15
2b17
2b19
2b21
2b23
2b25
2b27
2b29
2b31

Bu 5 a

Bu 4 a

Bu 3 a

Bu 2 a

Bu 1 a

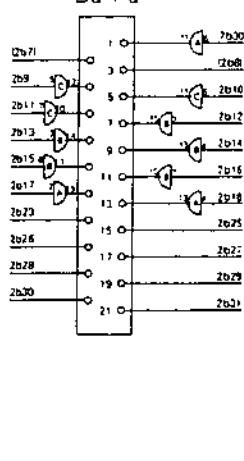
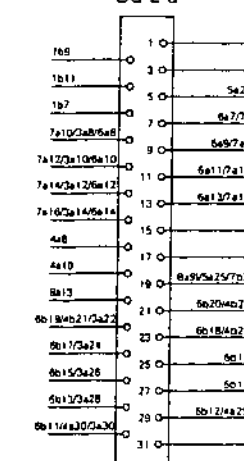
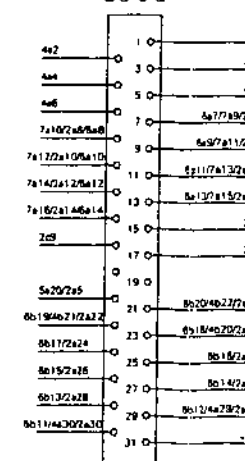
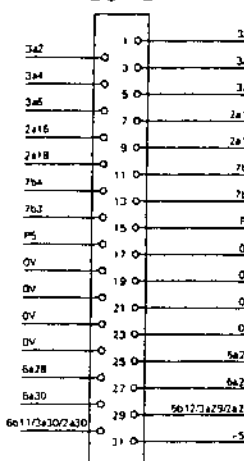
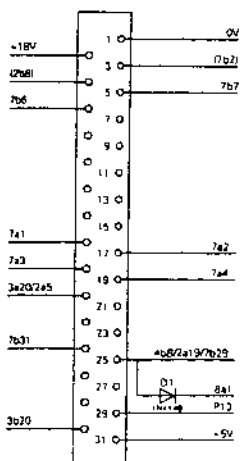

INTERFACE
CLOCK
RX 1001 M only

I/O

CPU

AUDIO

DISPLAY

Motherboard
Circuit Diagram
97 Sa B 2.155.24

see circuit diagram - MOTHERBOARD

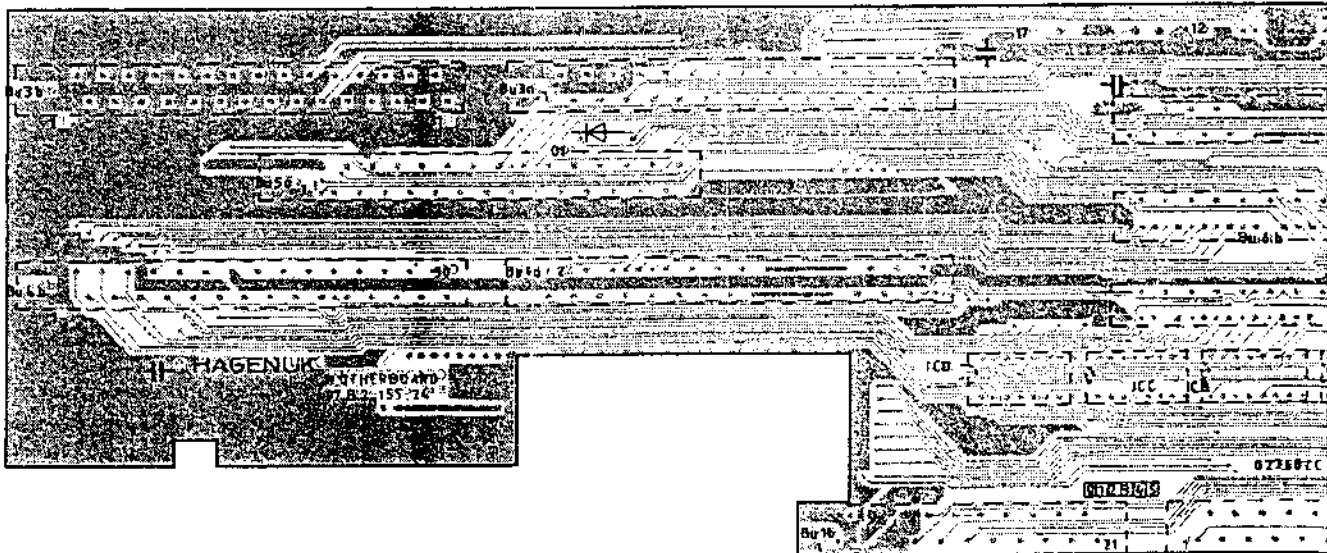
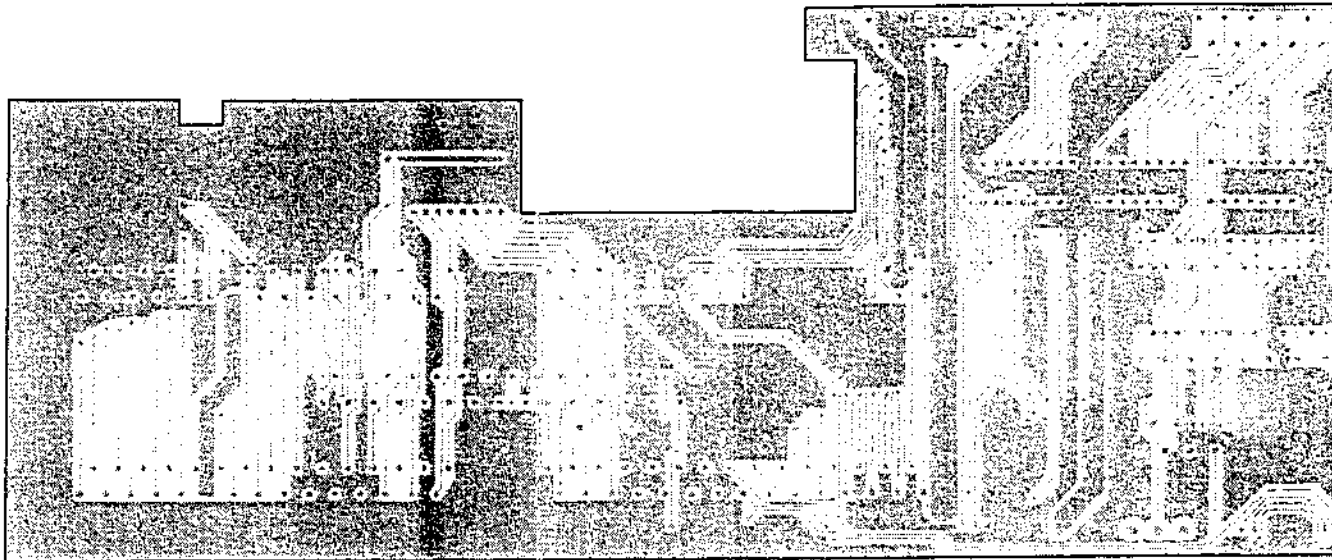

see circuit diagram - MOTHERBOARD B 97 Sa B 2.155.24

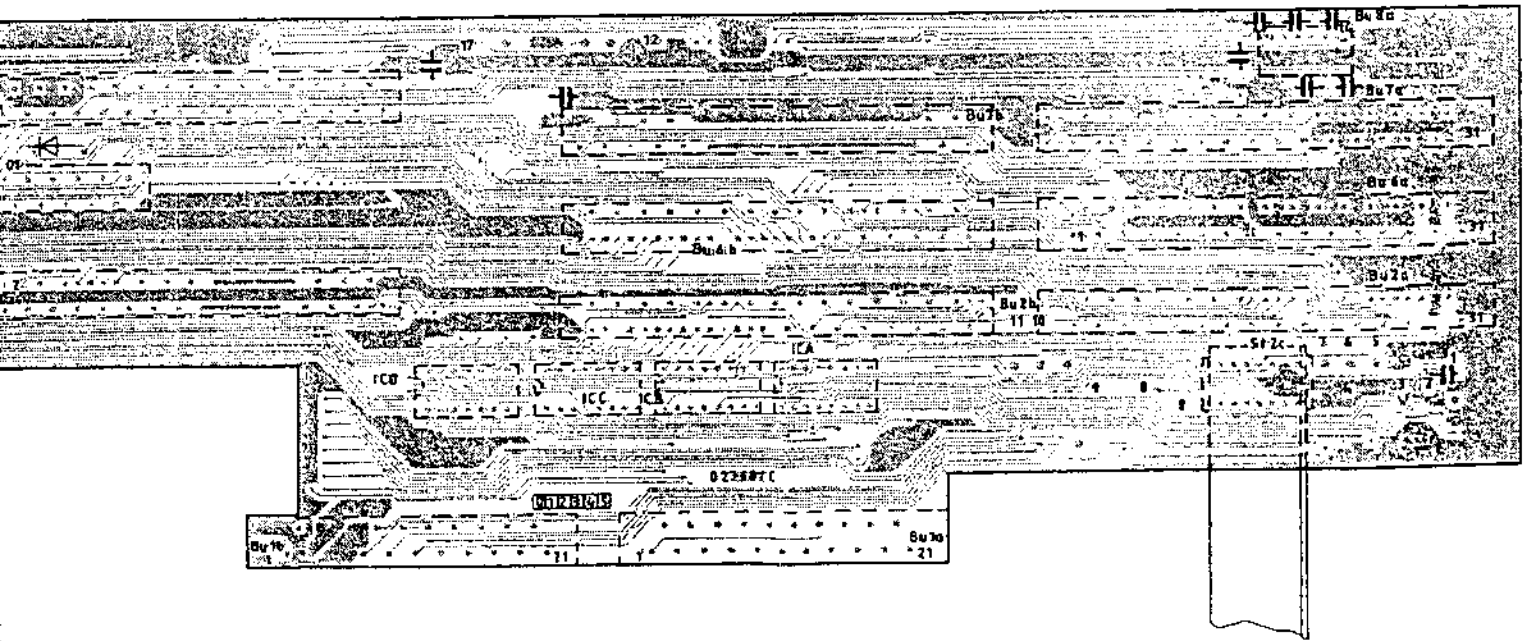
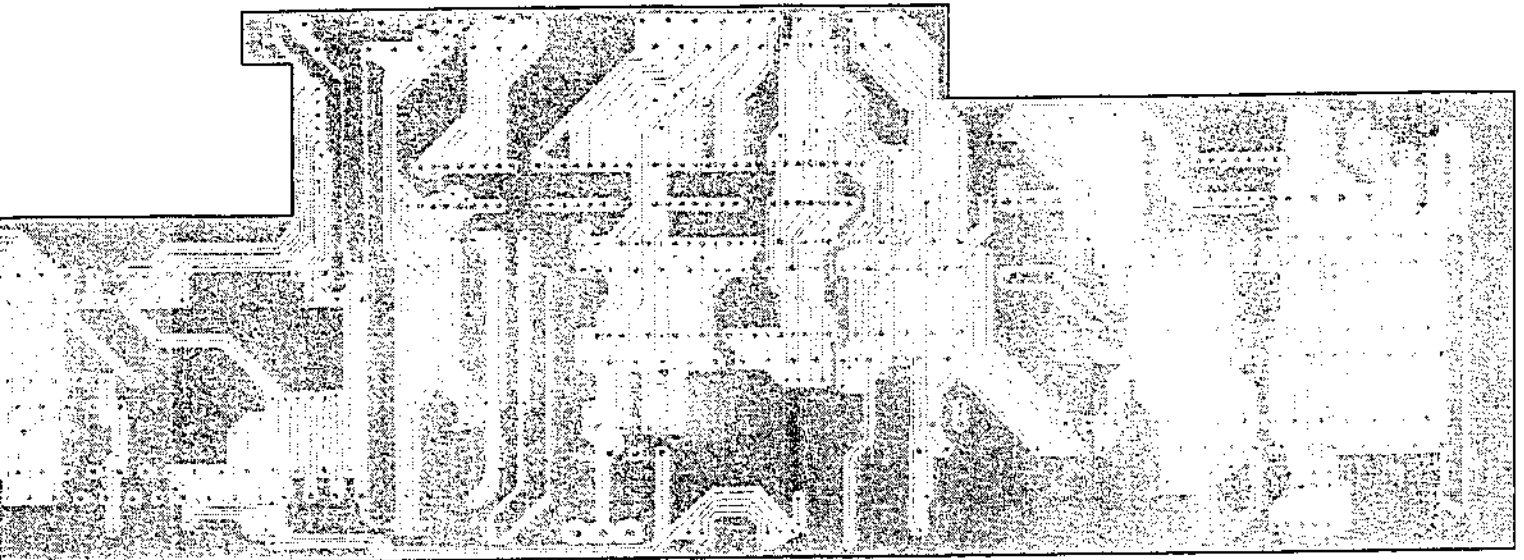

Printed Circuit Board
Motherboard
97 B 2.155.24

-Motherboard RX 1001 M-

Ident-No.	Mark	Electr. value	Identity	Manufacturer
-----------	------	---------------	----------	--------------

Capacitors:

1208.225	C1	0,1 μ F/100 V	CK 06 BX 104 M	SEC
1208.225	C2	0,1 μ F/100 V	CK 06 BX 104 M	SEC
1078.607	C3	0,01 μ F/100 V	CK 05 BX 103 K	SEC
1078.607	C4	0,01 μ F/100 V	CK 05 BX 103 K	SEC
1208.225	C5	0,1 μ F/100 V	CK 06 BX 104 M	SEC
1208.225	C6	0,1 μ F/100 V	CK 06 BX 104 M	SEC
1208.225	C7	0,1 μ F/100 V	CK 06 BX 104 M	SEC
1208.225	C8	0,1 μ F/100 V	CK 06 BX 104 M	SEC
1078.607	C9	0,01 μ F/100 V	CK 05 BX 103 K	SEC
1208.225	C10	0,1 μ F/100 V	CK 06 BX 104 M	SEC

Diodes:

0745.677	D1		1 N 4148	ITT
----------	----	--	----------	-----

Integrated circuits:

1423.711	IC A		75469	
1423.711	IC B		75469	
1423.711	IC C		75469	
1423.711	IC D		75469	

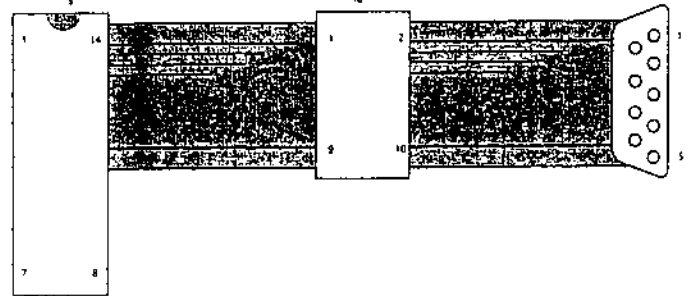
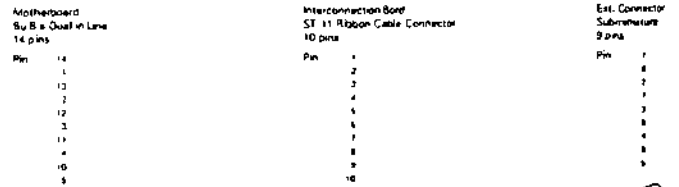

EXTERN CONNECTOR

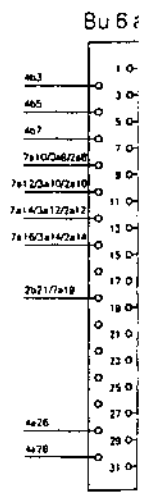
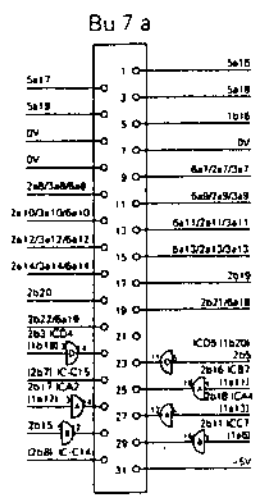
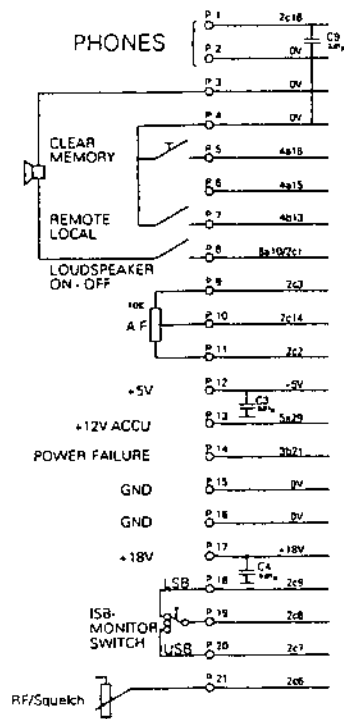
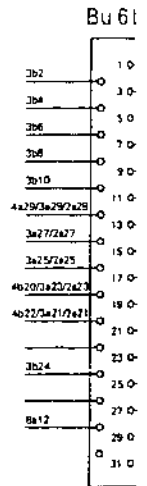
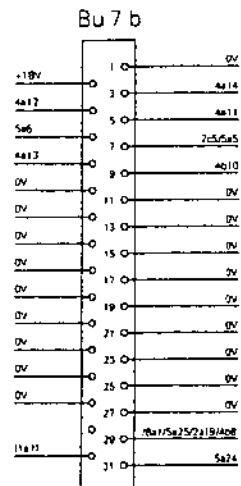
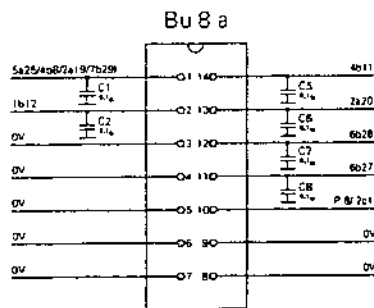

BUFFER D/A Converter

REMOTE SERIAL

To be fitte

see circuit diagram

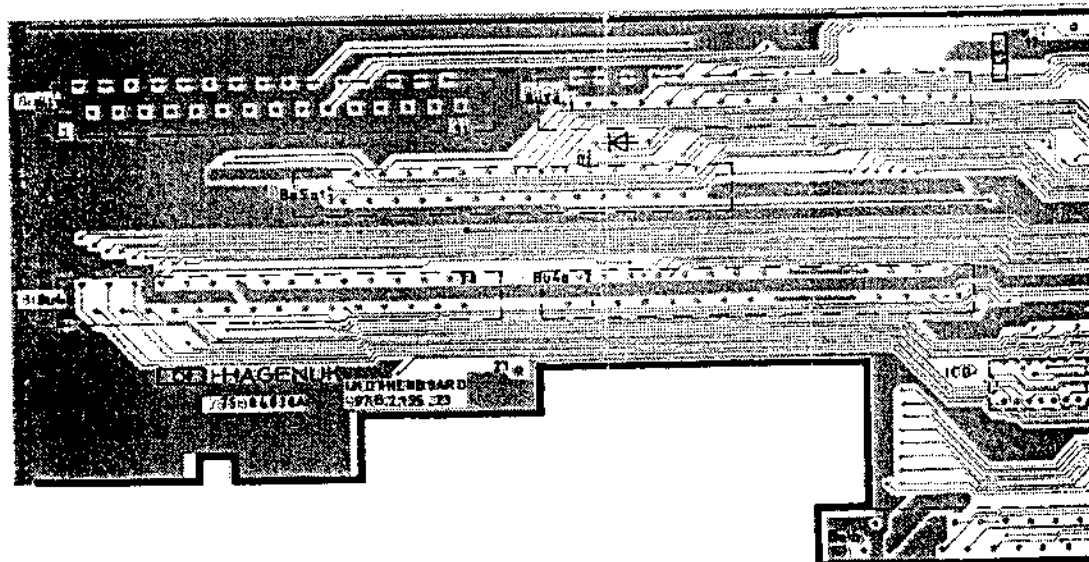
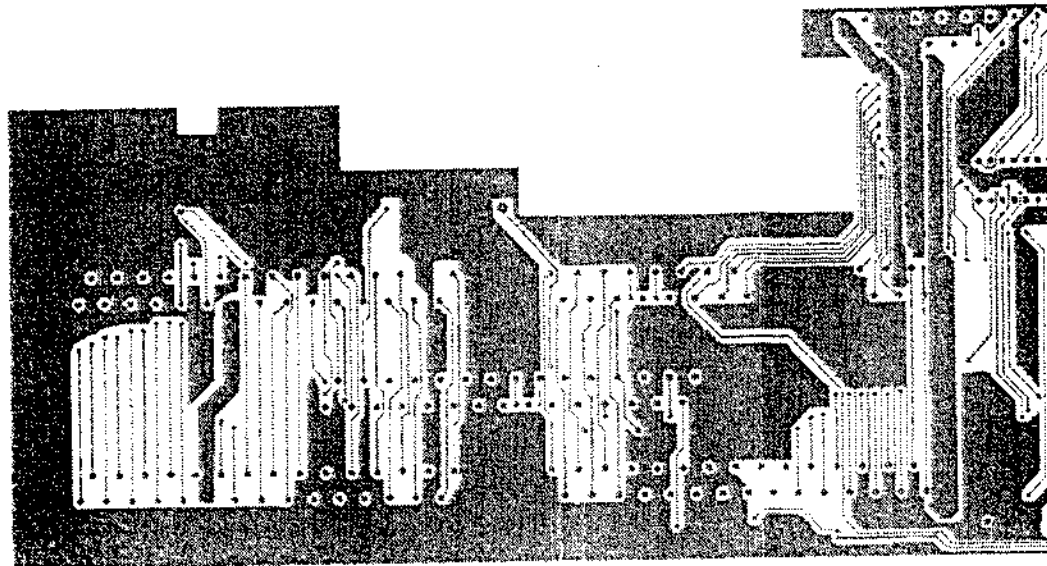

see circuit diagram - MOTHERBOARD 97 Sa B 2.155.23

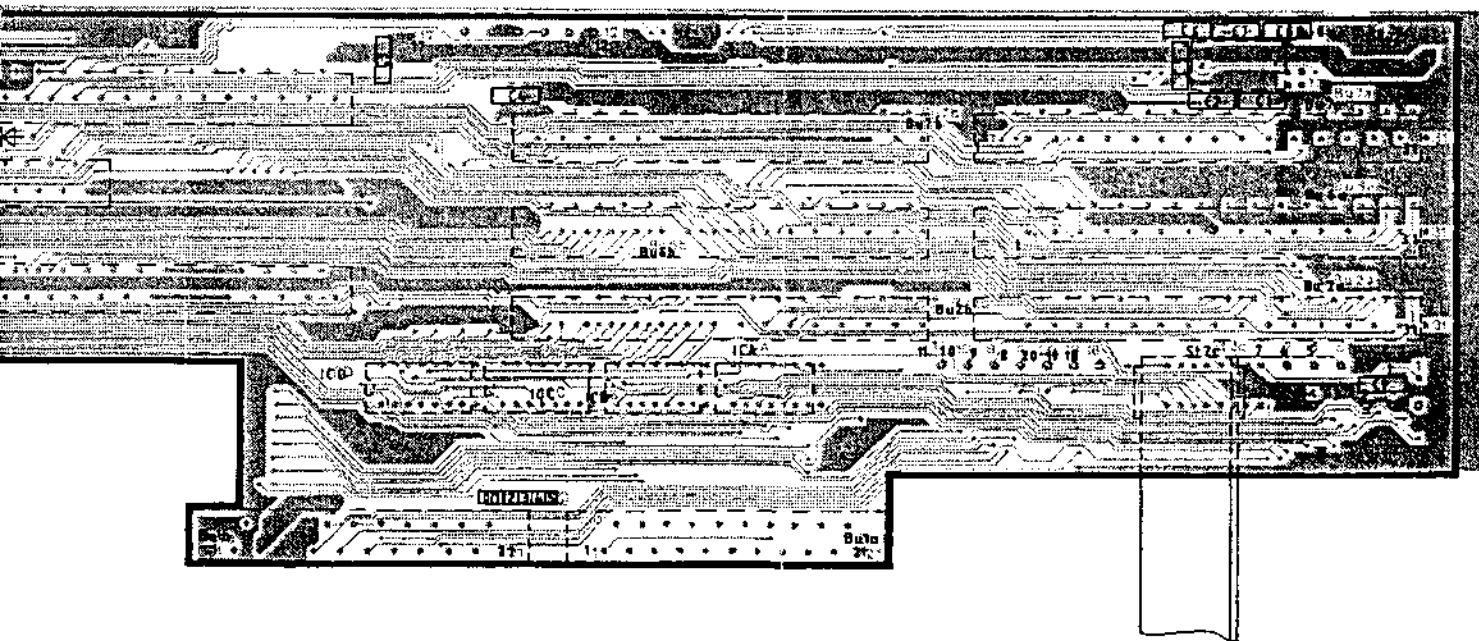
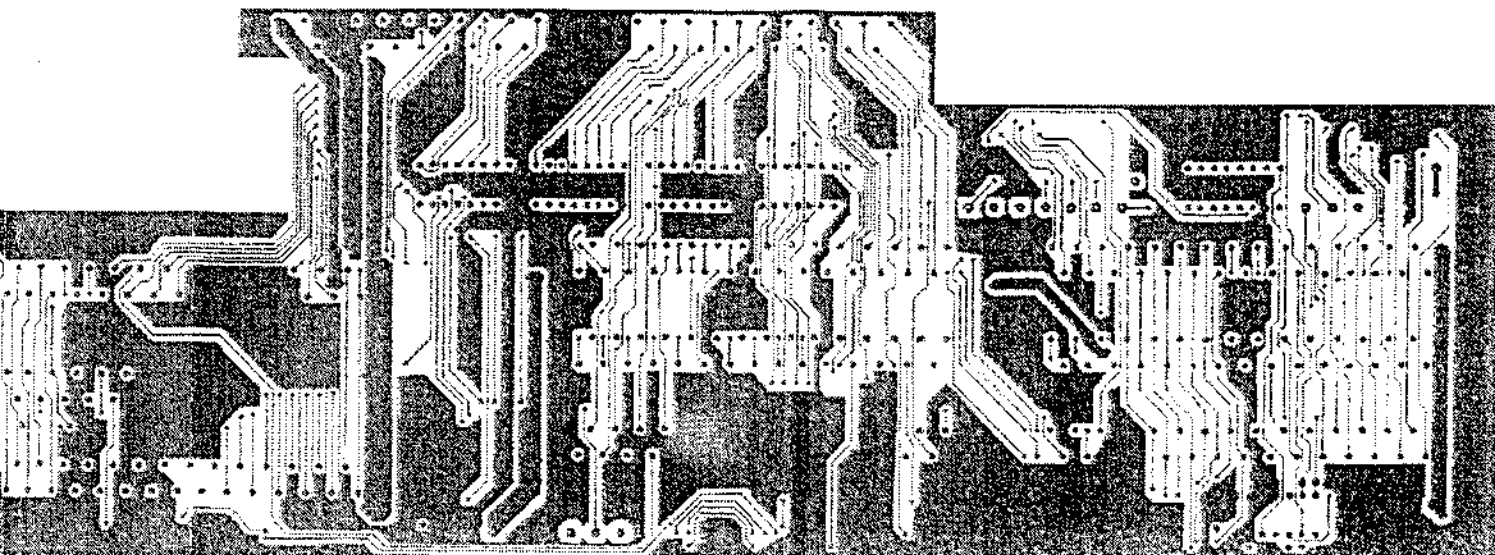

Printed Circuit Board
Motherboard
97 B 2.155.23

-Motherboard RX 5001-

Parts lists No.
97 Sa 2.155.23

Ident-No.	Mark	Electr. value	Identity	Manufacturer
Capacitors:				
1208.225	C1	0,1/20/100 V	CK 06 BX 104 K	SEC
1208.225	C2	0,1/20/100 V	CK 06 BX 104 K	SEC
1078.607	C3	0,01/10/100 V	CK 05 BX 103 K	SEC
1078.607	C4	0,01/10/100 V	CK 05 BX 103 K	SEC
1208.225	C5	0,1/20/100 V	CK 06 BX 104 K	SEC
1208.225	C6	0,1/20/100 V	CK 06 BX 104 K	SEC
1208.225	C7	0,1/20/100 V	CK 06 BX 104 K	SEC
1208.225	C8	0,1/20/100 V	CK 06 BX 104 K	SEC
1078.607	C9	0,01/10/100 V	CK 05 BX 103 K	SEC
1208.225	C10	0,1/20/100 V	CK 06 BX 104 K	SEC

Diodes:

0745.677	D1		1 N 4148	ITT
----------	----	--	----------	-----

Integrated circuits:

1423.711	IC A		IC 75469	
1423.711	IC B		IC 75469	
1423.711	IC C		IC 75469	
1423.711	IC D		IC 75469	

