

ICOM

INSTRUCTION MANUAL

HF TRANSCEIVER
IC-707



Downloaded by
RadioAmateur.EU

Icom Inc.

IMPORTANT

READ THIS INSTRUCTION MANUAL CAREFULLY before attempting to operate the transceiver.

SAVE THIS INSTRUCTION MANUAL. This instruction manual contains important safety and operating instructions for the IC-707.

PRECAUTIONS

⚠ NEVER apply AC power to the [DC 13.8V] socket. This could cause a fire or ruin the transceiver.

⚠ NEVER apply more than 16 V DC to the [DC 13.8V] socket. This could cause a fire or ruin the transceiver.

⚠ NEVER allow children to touch the transceiver.

⚠ NEVER let metal, wire or other objects touch any internal parts or connectors on the rear panel of the transceiver. This will cause an electric shock.

⚠ NEVER expose the transceiver to rain, snow or any liquids.

AVOID using or placing the transceiver in areas with temperatures below -10°C ($+14^{\circ}\text{F}$) or above $+60^{\circ}\text{C}$ ($+140^{\circ}\text{F}$).

AVOID placing the transceiver against walls or putting anything on top of the transceiver. This will obstruct heat dissipation.

AVOID placing the transceiver in excessively dusty environments or in direct sunlight.

AVOID transmitting without an antenna. This will damage the transceiver.

During mobile operation, **DO NOT** operate the transceiver without running the vehicle's engine. The vehicle's battery will quickly run out.

BE CAREFUL! The heatsink becomes hot when operating the transceiver for long periods.

BE CAREFUL! DO NOT apply undue force to the function display. **DO NOT** push the function display.

FOREWORD

Thank you for purchasing the **IC-707 HF TRANSCEIVER**. The **IC-707** is a compact, easy-to-operate transceiver designed with Icom's state-of-the-art technology.

If you have any questions regarding the **IC-707**, feel free to contact your nearest Icom Dealer or Service Center.

EXPLICIT DEFINITIONS

Word	Definition
⚠ WARNING	Personal injury, fire hazard or electric shock may occur.
CAUTION	Equipment damage may occur.
NOTE	If disregarded, inconvenience only. No personal injury, risk of fire or electric shock.

UNPACKING

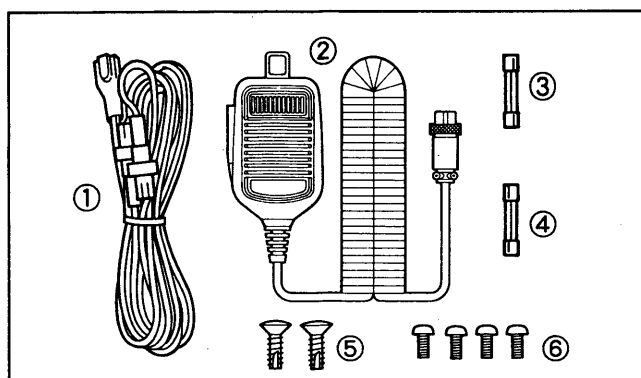

Accessories included with the IC-707:	Qty.
① DC power cable (OPC-025A)	1
② Hand microphone (HM-36)	1
③ Spare fuse (for DC power cable, FGB 20 A)	1
④ Spare fuse (for internal PA unit, FGB 4 A)	1
⑤ 4 X 12 mm self-tapping screws (for optional MB-23)	2
⑥ 3 X 6 mm self-tapping screws (for optional MB-23)	4

TABLE OF CONTENTS

IMPORTANT	i
PRECAUTIONS	i
FOREWORD	i
EXPLICIT DEFINITIONS	i
UNPACKING	i
TABLE OF CONTENTS	ii

1 PANEL DESCRIPTION	1–6
■ Front panel	1
■ Function display	3
■ Microphone (HM-36)	4
■ Rear panel.....	5

2 INSTALLATION AND CONNECTIONS	7–12
■ Mounting the transceiver	7
■ Antenna	7
■ Connections chart	8
■ Power supply connections	9
■ Linear amplifier connections	10
■ Antenna tuner connections	11
■ Antenna selector connections	12
■ AFSK terminal unit connections	12
■ Remote jack (CI-V) information	12

3 OPERATION	13–24
■ Initial settings	13
■ Basic operation	13
■ What are VFO and MEMORY modes?	14
■ Frequency setting	15
■ Voice receiving	17
■ Voice transmitting	19
■ CW mode operation	20
■ RTTY mode operation	21
■ Frequency equalizing operation	22
■ Split frequency operation	22
■ Repeater operation	22
■ AH-3 HF AUTOMATIC ANTENNA TUNER	23
■ AT-160 HF AUTOMATIC ANTENNA TUNER	24
■ IC-AT500, AT-150 HF AUTOMATIC ANTENNA TUNERS	24

4 MEMORY CHANNELS	25–28
■ Channel functions	25
■ VFO and MEMORY mode selection	25
■ Memory channel selection	25
■ Memory channel programming	26
■ Frequency transferring	27
■ Split memory channels	28

5 SCANS	29
■ Scan types	29
■ Pre-operation	29
■ Scan operation	29

6 SET MODE	30–32
■ What is SET mode?	30
■ SET mode construction	30
■ Selectable modes	31
■ Beep tone	31
■ Scan resume	31
■ Tuner type	31
■ CI-V address	32
■ CI-V baud rate	32
■ CI-V transceive	32
■ CI-V data length	32

7 MAINTENANCE AND ADJUSTMENT	33–34
■ Disassembly	33
■ Level presets	34
■ DC power cable fuse replacement	34
■ PA unit fuse replacement	34

8 OPTIONS INSTALLATION	35–36
■ UI-9 FM UNIT	35
■ UT-30 PROGRAMMABLE TONE ENCODER UNIT	35
■ FL-52A or FL-53A CW NARROW FILTER	35
■ CR-338 HIGH-STABILITY CRYSTAL UNIT.....	36
■ PLL reference frequency adjustment	36

9 TROUBLESHOOTING	37–38
■ Troubleshooting chart	37
■ CPU backup battery	38
■ CPU resetting	38

10 INSIDE VIEWS	39–40
■ MAIN unit and VR board	39
■ PA, FILTER and PLL units	40

11 SPECIFICATIONS	41
■ General	41
■ Transmitter	41
■ Receiver	41

12 OPTIONS	42–44
-------------------------	--------------

SCHEMATIC AND BLOCK DIAGRAMS Separate

Technical information

- Microphone connector and the HM-36 schematic diagram
- ACC sockets

1 PANEL DESCRIPTION

Front panel

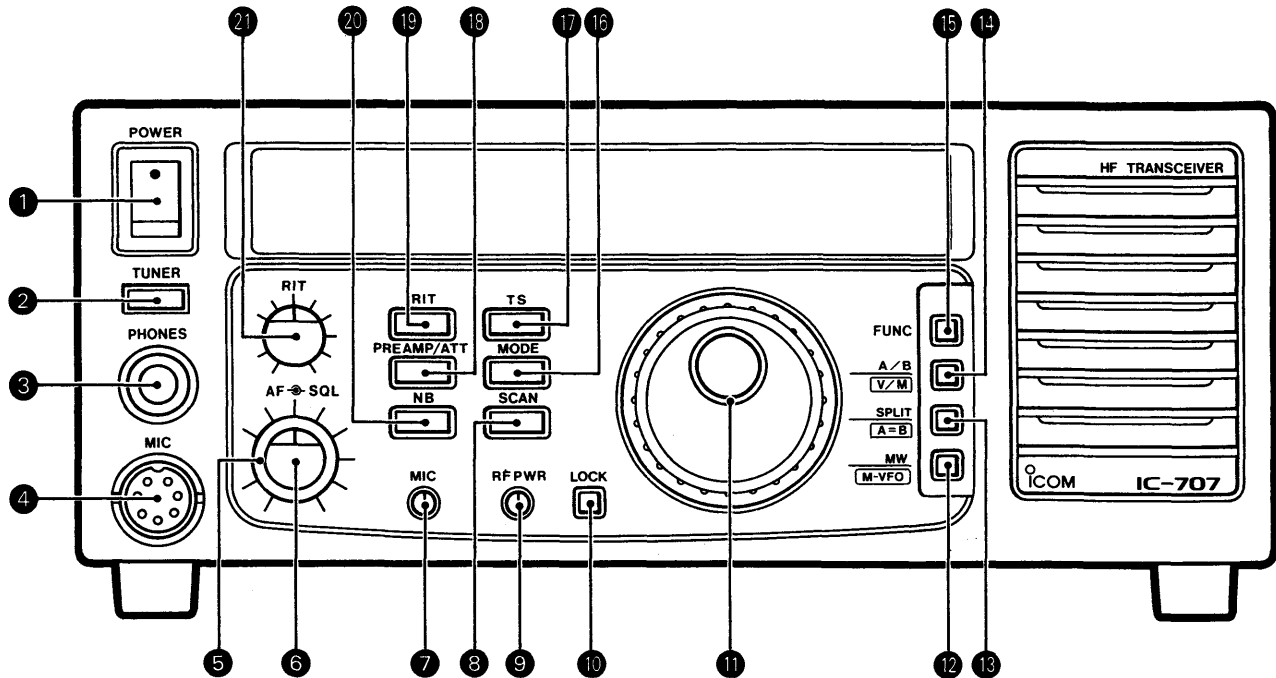

- ① **POWER SWITCH [POWER]** (p. 13)
Turns power ON and OFF.
- ② **ANTENNA TUNER SWITCH [TUNER]** (pgs. 23, 24)
 - For an optional AH-3 HF AUTOMATIC ANTENNA TUNER: When pushed and held, starts tuning.
 - For an optional AT-160 HF AUTOMATIC ANTENNA TUNER: Turns the AT-160 power ON and OFF. When pushed and held, starts re-tuning.

Tuner type selection

Before operation, tuner type selection in SET mode is required. Refer to p. 31.

- ③ **HEADPHONE JACK [PHONES]**
Connects headphones. When headphones are connected, no receive audio comes from the speaker.
- ④ **MICROPHONE CONNECTOR [MIC]** (p. 4)
Connects the supplied hand microphone.

Optional microphones

An optional SM-6, SM-8 or SM-20 DESKTOP MICROPHONE can also be used.

- ⑤ **SQUELCH CONTROL [SQL]** (p. 18)
Adjusts the squelch threshold level.



What is the squelch?

The **squelch** mutes noise when no signal is received.

- ⑥ **AF GAIN CONTROL [AF]** (p. 17)
Adjusts the audio output level from the speaker.

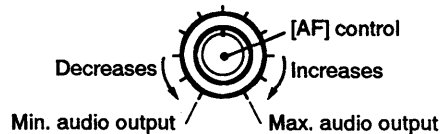

- ⑦ **MICROPHONE GAIN CONTROL [MIC]** (p. 19)
Adjusts microphone input gain.

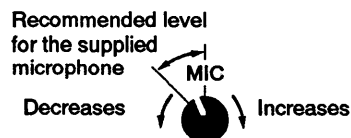

- ⑧ **SCAN SWITCH [SCAN]** (p. 29)
 - While in VFO mode: Starts and stops programmed scan.
 - While in MEMORY mode: Starts and stops memory scan.

What is scan?

- **Programmed scan** repeatedly scans between scan edge frequencies.
- **Memory scan** repeatedly scans memory channels 1 – 30.

- 9 **RF POWER CONTROL [RF PWR]** (p. 19)
Adjusts the RF output power from minimum to maximum.

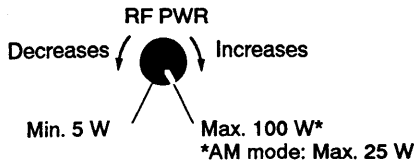

- 10 **DIAL LOCK SWITCH [LOCK]** (p. 15)
Electronically locks the main dial to prevent accidental changing of operating frequency or memory channel.

- 11 **MAIN DIAL** (pgs. 15, 16, 25)
 - Selects displayed frequency.
 - After pushing the [FUNC] switch: Selects a memory channel.

- 12 **MEMORY WRITE SWITCH [MW M▶VFO]** (pgs. 26, 27)
 - When pushed and held, stores the displayed frequency and mode into a memory channel.
 - After pushing the [FUNC] switch: When pushed and held, transfers the memory channel contents into the VFO.

- 13 **SPLIT SWITCH [SPLIT A=B]** (pgs. 22, 28)
 - Activates and cancels split frequency operation.
 - After pushing the [FUNC] switch: Copies displayed VFO contents into undisplayed VFO.

What is split operation?

Split frequency operation allows you to transmit and receive on 2 different frequencies.

- 14 **VFO SWITCH [A/B V/M]** (pgs. 14, 25)
 - Selects VFO A and VFO B alternately.
 - After pushing the [FUNC] switch: Selects VFO mode and MEMORY mode alternately.

What is VFO?

VFO controls required frequencies. VFO stands for Variable Frequency Oscillator.

- 15 **FUNCTION SWITCH [FUNC]**
Provides access to a secondary function. Refer to 11, 12, 13 and 14 above.

- 16 **MODE SWITCH [MODE]** (p. 17)
Selects an operating mode.

Selectable mode restriction

According to your preference, selectable modes can be restricted in SET mode. Refer to p. 31

Required options

- For CW narrow mode: the FL-52A or FL-53A CW NARROW FILTER
 - For FM mode: the UI-9 FM UNIT
 - For accessing a repeater that requires a subaudible tone: the UI-9 and UT-30 PROGRAMMABLE TONE ENCODER UNIT
- Refer to p. 35 for installation.

- 17 **TUNING STEP SWITCH [TS]** (pgs. 15, 16)
Selects 10 Hz, 1 kHz and 1 MHz tuning steps or an amateur band.

Minimum tuning step

Even though 10 Hz digit is not shown on the frequency readout, the minimum tuning step is 10 Hz .

- 18 **PREAMP/ATTENUATOR SWITCH [PREAMP/ATT]** (p. 18)
Activates the preamp or attenuator and cancels them.

What is the preamp?

The **preamp** amplifies a desired weak signal with 10 dB of amplifier gain.

What is the attenuator?

The **attenuator** protects a desired signal from interference with 20 dB of attenuation when:

- very strong signals are near the desired frequency.
- very strong stations are near your location.

- 19 **RIT SWITCH [RIT]** (p. 18)
Activates and cancels the RIT function.

- 20 **NOISE BLANKER SWITCH [NB]** (p. 18)
Activates and cancels the noise blanker.

What is the noise blanker?

The **noise blanker** reduces click noise generated by vehicle ignition systems, etc.

- 21 **RIT CONTROL [RIT]** (p. 18)
Shifts the receive frequency while the RIT function is activated.

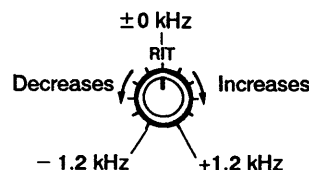

What is the RIT function?

The **RIT control** shifts the receiving frequency to obtain clear audio for an off-frequency signal. RIT stands for Receiver Incremental Tuning.

Function display

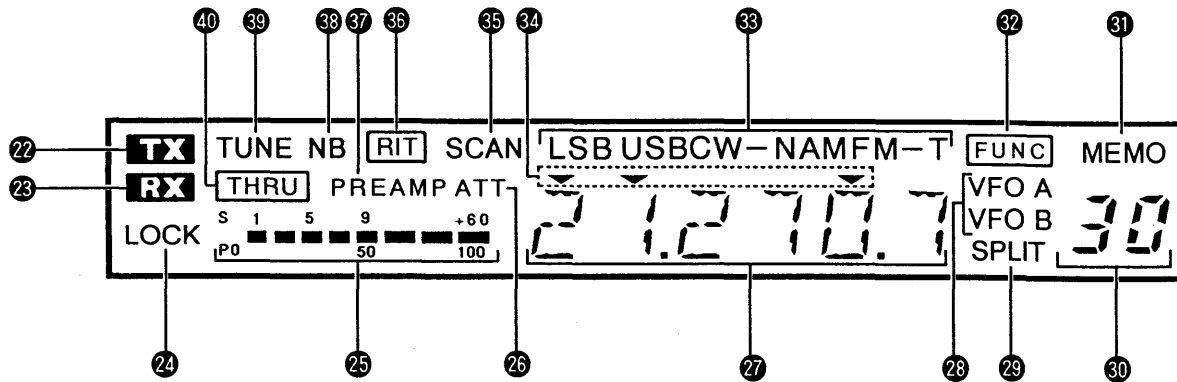

- 22 **TRANSMIT INDICATOR** (p. 19)
Shows that the transceiver is transmitting.
- 23 **RECEIVE INDICATOR** (p. 17)
Shows that the squelch is open while receiving.
- 24 **LOCK INDICATOR** (p. 15)
Shows that the main dial is electronically locked.
- 25 **S/R F INDICATOR** (pgs. 17, 19)
 - Shows the receive signal strength while receiving.
 - Shows the RF output power level while transmitting.
- 26 **ATTENUATOR INDICATOR** (p. 18)
Shows that the RF attenuator is activated.
- 27 **FREQUENCY READOUT**
Shows the operating frequency.
- 28 **VFO INDICATORS** (p. 14)
Shows that VFO mode is selected.
 - Selected VFO is indicated.
- 29 **SPLIT INDICATOR** (pgs. 22, 28)
Shows that the split frequency operation is activated.
 - This indicator blinks for 2 sec. when a split memory channel is selected.
- 30 **MEMORY CHANNEL NUMBER READOUT** (p. 25)
Shows the selected memory channel number.
- 31 **MEMORY INDICATOR** (pgs. 14, 25)
Shows that MEMORY mode is selected.
- 32 **FUNCTION INDICATOR**
Shows that secondary functions can be activated.
- 33 **MODE INDICATORS** (pgs. 17, 20, 21)
Show the operating mode.
- 34 **TUNING STEP INDICATORS** (pgs. 15, 16)
 - When “▼” or “▼▼” disappears: Shows that 10 Hz step is selected.
 - When “▼” appears on the 1 kHz or 1 MHz digit: Shows the selected tuning step.
 - When “▼▼” appears on the 10 MHz and 1 MHz digits: Shows that the band change function is activated.
- 35 **SCAN INDICATOR** (p. 29)
Shows that programmed scan or memory scan is activated.
- 36 **RIT INDICATOR** (p. 18)
Shows that the RIT function is activated.
- 37 **PREAMP INDICATOR** (p. 18)
Shows that the preamp is activated.
- 38 **NOISE BLANKER INDICATOR** (p. 18)
Shows that the noise blanker is activated.
- 39 **TUNE INDICATOR** (pgs. 23, 24)
When an optional AT-160 or AH-3 HF AUTOMATIC ANTENNA TUNER is connected, shows the following conditions:
 - Blinks during tuning operation.
 - Appears continuously when the antenna tuner completes tuning.
- 40 **THROUGH INDICATOR** (pgs. 23, 24)
When an optional AT-160 or AH-3 HF AUTOMATIC ANTENNA TUNER is connected, shows that the [ANT] connector is directly connected to the antenna.

CAUTION: When the AH-3 is connected, **DO NOT** transmit while “THRU” appears, since the transceiver may be damaged.

Microphone (HM-36)

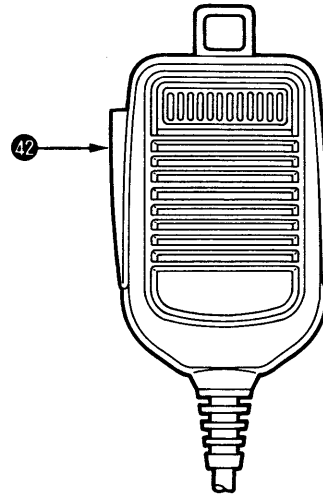
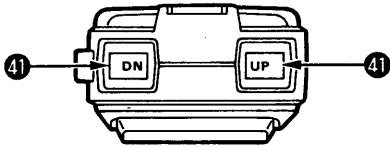

- 41 UP/DOWN SWITCHES [UP]/[DN]** (pgs. 25, 29)
- Select an operating frequency or a memory channel.
 - When pushed and held, change the operating frequency or memory channel continuously.
 - Cancel the programmed scan or memory scan.

- 42 PTT SWITCH [PTT]** (p. 19)
- Push and hold to transmit. Release to receive.

Microphone information

Microphone connector

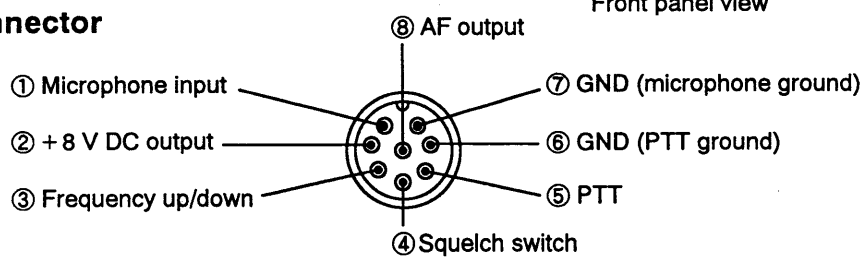

Pin No.	Function	Description
2	+8 V DC output	Max. 10 mA
3	Frequency up	Ground
	Frequency down	Ground through 470 Ω
4	Squelch open	"LOW" level
	Squelch closed	"HIGH" level

CAUTION: DO NOT short pin 2 to ground, since this can damage the internal circuit.

HM-36 schematic diagram

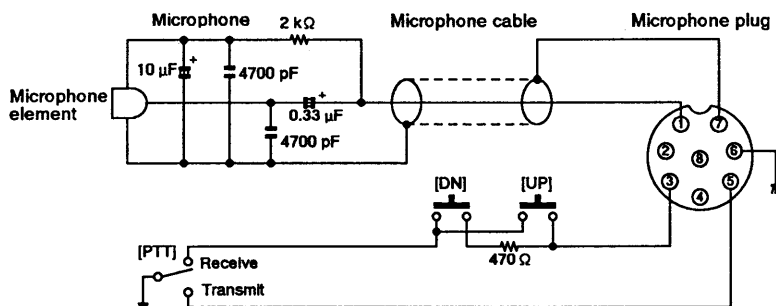

■ Rear panel

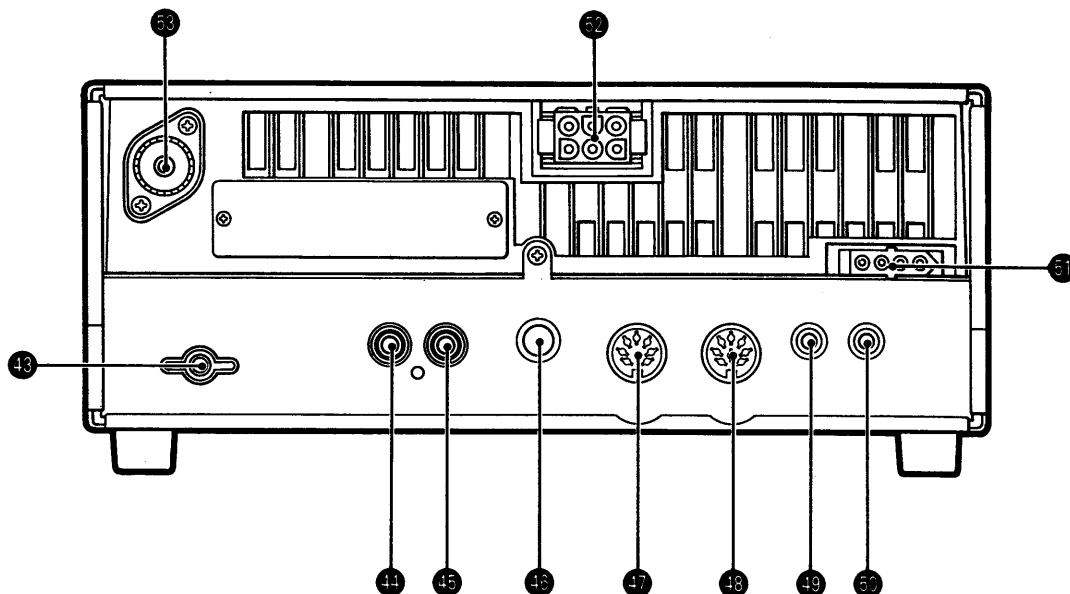

43 GROUND TERMINAL [GND] (p. 7)
Connects to a ground to prevent electrical shocks, TVI (Television Interference), BCI (Broadcasting Interference) and other problems.

44 SEND CONTROL JACK [SEND] (p. 10)
Grounded while transmitting. When grounded transmits. Used to control external equipment such as a non-Icom linear amplifier.

45 ALC INPUT JACK [ALC] (pgs. 6, 10 – 12)
Connects to the ALC output jack of a non-Icom linear amplifier.

Note
For the [SEND] jack and [ALC] jack specifications, refer to p. 6 ACC(1) socket pins 3 and 8, respectively.

46 CW KEY JACK [KEY] (p. 20)
Connects a straight key or electronic keyer with a standard 1/4 inch 3-conductor plug.

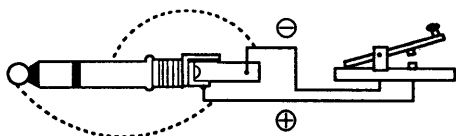

47 ACCESSORY (2) SOCKET [ACC (2)] (p. 6)
7-pin DIN socket. Connects external equipment such as a linear amplifier, an automatic antenna tuner, etc.

48 ACCESSORY (1) SOCKET [ACC (1)] (pgs. 6, 21)
8-pin DIN socket. Connects external equipment such as a linear amplifier, etc.

49 EXTERNAL SPEAKER JACK [EXT SP] (p. 8)
Accepts a 4 – 16 Ω speaker.

Optional speaker
Optional SP-7, SP-20, SP-21 EXTERNAL SPEAKERS are available for base station operation.

50 CI-V REMOTE CONTROL JACK [REMOTE] (pgs. 12, 32)
Designed for remote control using a personal computer and transceive operation with another CI-V transceiver.

Required option
An optional CT-17 CI-V LEVEL CONVERTER is required to connect a personal computer.

51 TUNER CONTROL SOCKET [TUNER] (p. 11)
Accepts the control cable from an optional AT-160 or AH-3 HF AUTOMATIC ANTENNA TUNER.

Downloaded by
RadioAmateur.EU

- 52 **DC POWER SOCKET [DC 13.8V]** (p. 9)
Connects an optional DC power supply or a 12 V vehicle battery through the supplied DC power cable.

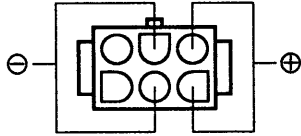

Rear panel view

Optional DC power supply

An optional PS-55 DC POWER SUPPLY is available for AC operation.

- 53 **ANTENNA CONNECTOR [ANT]** (pgs.7, 10 – 12)
Connects to an HF antenna or optional AT-160 or AH-3 HF AUTOMATIC ANTENNA TUNER through a 50 Ω coaxial cable with a PL-259 connector.

ACC socket information

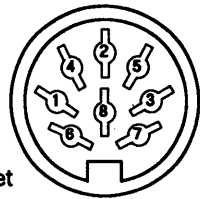

ACC(1) socket

Rear panel view

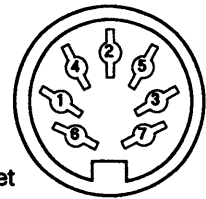

ACC(2) socket

ACC(1) socket

Pin No.	Pin name	Description	Specifications
1	NC	No connection.	—
2	GND	Connects to ground.	Connected in parallel with ACC(2) pin 2.
3	SEND	Input/output pin. Grounded when transmitting. When grounded, transmits.	Ground level : -0.5 to 0.8 V Input current : Less than 20 mA Connected in parallel with ACC(2) pin 3.
4	MOD	Modulator input. Connects to a modulator.	Input impedance : 10 kΩ Input level : Approx. 100 mV rms.
5	AF	AF detector output. Fixed, regardless of the [AF] control position.	Output impedance : 4.7 kΩ Output level : 100 to 350 mV rms
6	SQLS	Squelch output. Grounded when squelch opens.	Squelch open : Less than 0.3 V, 5 mA Squelch closed : More than 6.0 V, 100 μA
7	13.8 V	13.8 V output.	Output current : Max. 1 A Connected in parallel with ACC(2) pin 7.
8	ALC	ALC voltage input.	Control voltage : -4 to 0 V Input impedance : More than 10 kΩ Connected in parallel with ACC(2) pin 5.

ACC(2) socket

Pin No.	Pin name	Description	Specifications
1	8 V	Regulated 8 V output.	Output voltage : 8 V ± 0.3 V Output current : Less than 10 mA
2	GND	Same as ACC(1) pin 2.	
3	SEND	Same as ACC(1) pin 3.	
4	BAND	Band voltage output.	Output voltage : 0 to 8.0 V
5	ALC	Same as ACC(1) pin 8.	
6	NC	No connection.	—
7	13.8 V	Same as ACC(1) pin 7.	

■ Mounting the transceiver

For base operation

Select a location which:

- allows adequate air circulation.
- is free from extreme heat, cold, or vibrations.
- is away from TV sets, radios and other electromagnetic sources.

For mobile operation

Mount the transceiver using an optional IC-MB5 MOBILE MOUNTING BRACKET. Select a location which:

- can support the weight of the transceiver.
- does not interfere with the operation of the vehicle.
- does not interfere with air bags.

Optional MB-23 CARRYING HANDLE

For carrying and transporting, attach the MB-23. Supplied screws with the MB-23 **CANNOT** be used with the IC-707. Use the screws supplied with the IC-707.

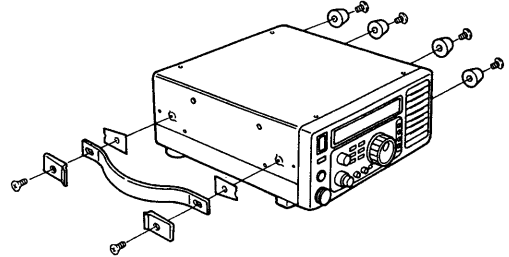

■ Antenna

The antenna is a vital component of your system. Ask your Icom Dealer for suitable antenna and installation information then select an antenna as follows:

If there is enough space:

To expand communication distance, connect a high-gain antenna. An optional AT-160 or AT-150 HF AUTOMATIC ANTENNA TUNER is suitable for HF all band operation.

If there is not enough space:

An optional AH-3 HF AUTOMATIC ANTENNA TUNER is recommended. Required antenna length is as follows:

The lowest frequency	Required antenna length
1.8 MHz	12 m; 40 ft or longer
3.5 MHz	3 m; 10 ft* or longer

*If grounding condition is poor, tuning may not be possible.

CAUTION: Protect your transceiver from lightning by using a lightning arrestor.

For mobile operation:

On 3.5 MHz and above, an optional AH-2b ANTENNA ELEMENT can be connected to the AH-3.

PL-259 connector installation

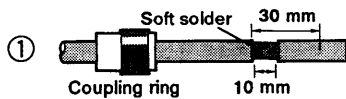

Slide the coupling ring down. Strip the cable jacket and soft solder.



Slide the connector body on and solder it.



Strip the cable as shown at left. Soft solder the center conductor.



Screw the coupling ring onto the connector body.

Grounding

⚠ DANGER! NEVER connect the [GND] terminal to gas or electrical pipe.

To prevent electric shock, TVI (Television Interference), BCI (Broadcasting Interference) and other problems, ground the transceiver through the [GND] terminal on the rear panel.

For best results, connect a heavy gauge wire or strap to a long earth-sunk copper rod. Make the distance between the [GND] terminal and ground as short as possible.

Connections chart

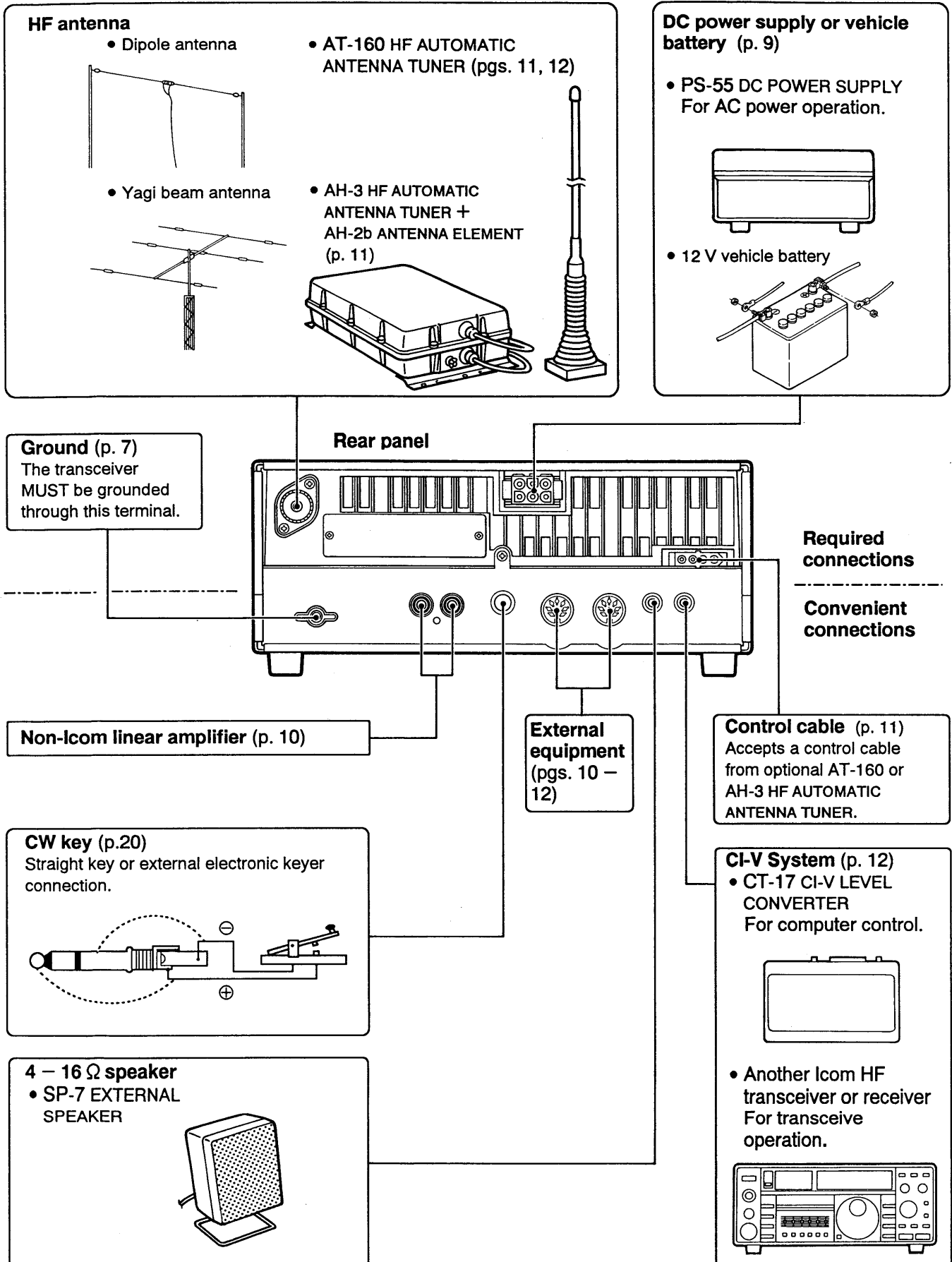

Power supply connections

CAUTION: Before connecting the DC power cable, confirm the following:

- The [POWER] switch is OFF.
- For non-Icom DC power supply or vehicle battery connection, DC power cable polarity is correct.
Red : positive ⊕ terminal
Black: negative ⊖ terminal
- For mobile operation, connect a 12 V battery.

NEVER connect a 24 V battery directly. Connect a suitable DC-DC converter between a 24 V battery and the IC-707. Ask your Icom Dealer for details.

Connecting an Icom DC power supply

An optional PS-55 DC POWER SUPPLY is available for AC power operation.

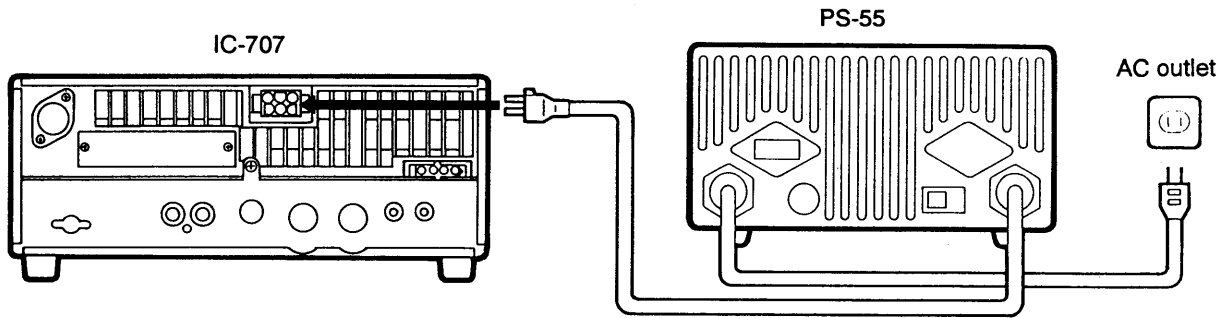

Connecting a non-Icom DC power supply

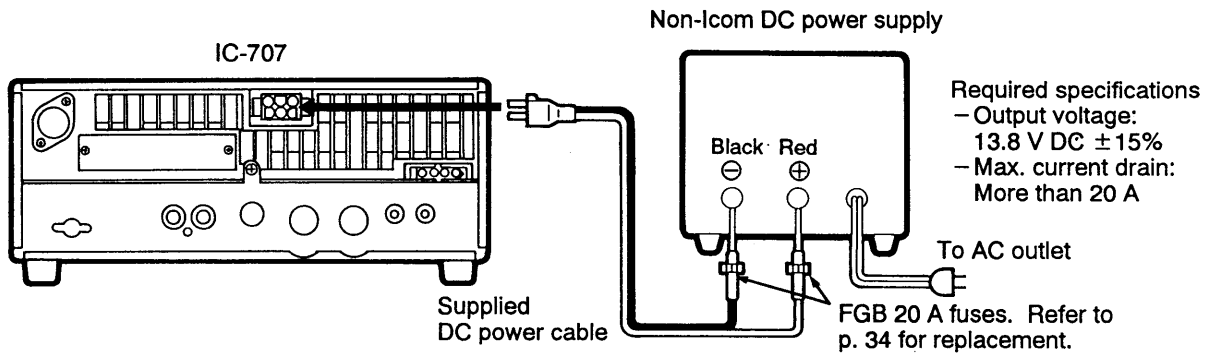

Connecting a vehicle battery

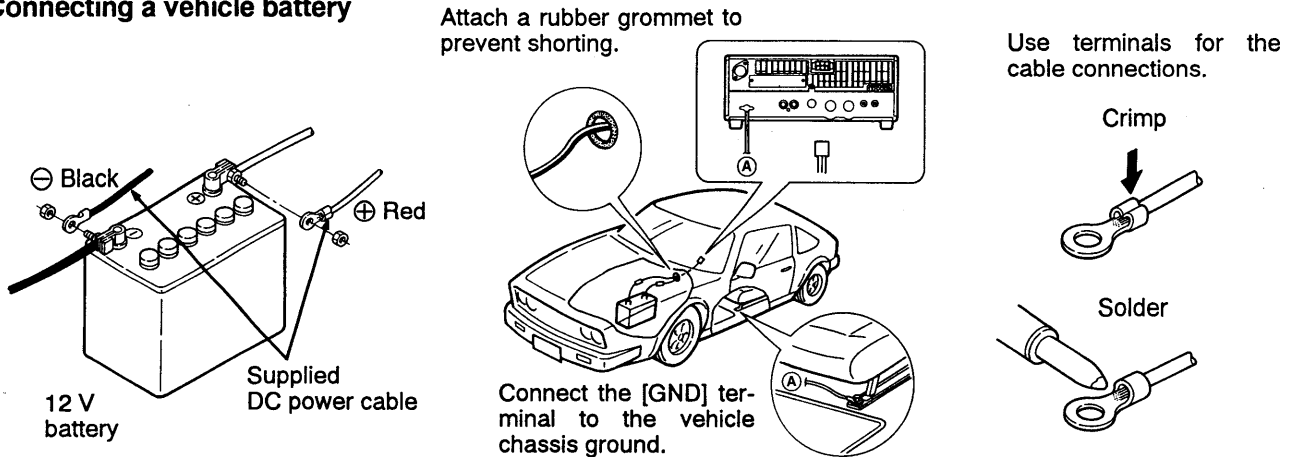

Linear amplifier connections

Connecting the IC-2KL

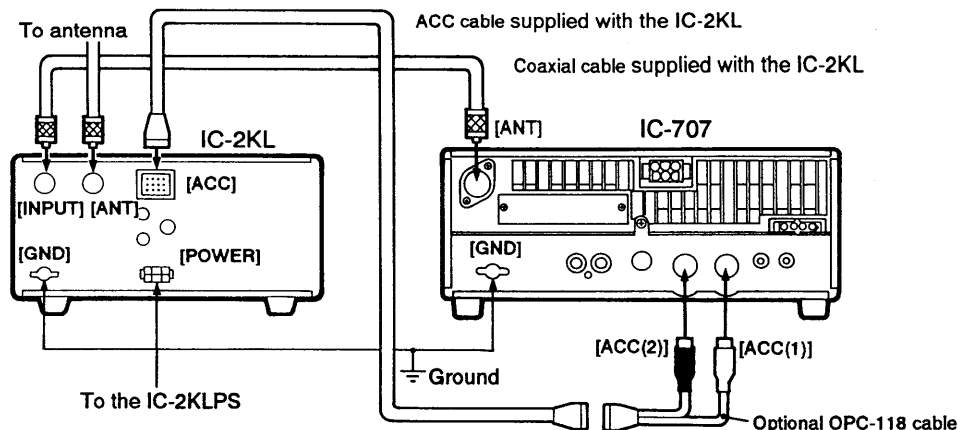

Connecting the IC-4KL

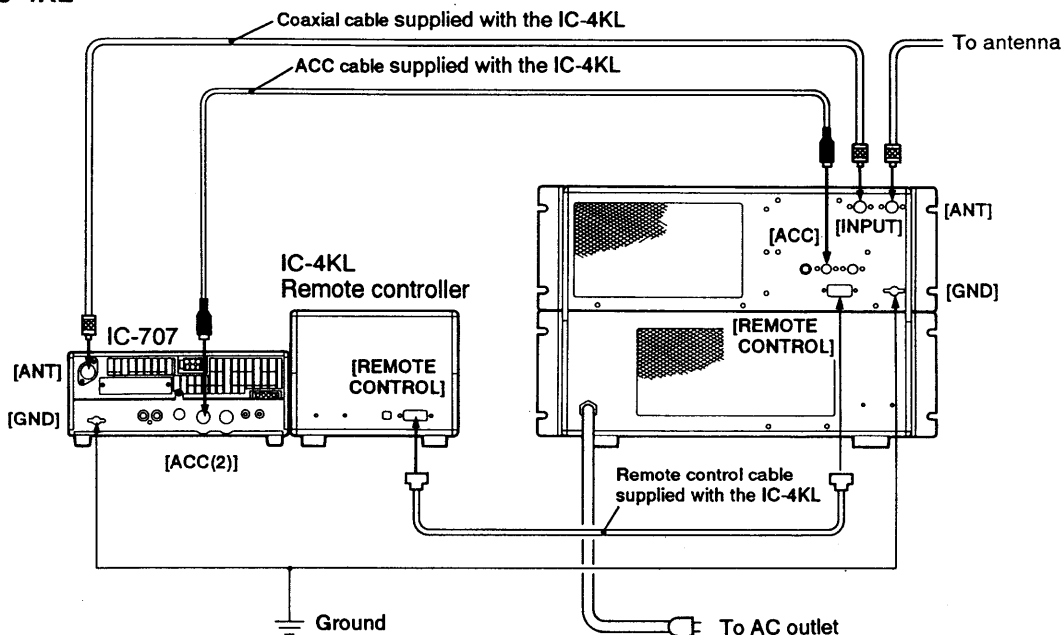

Connecting a non-Icom linear amplifier

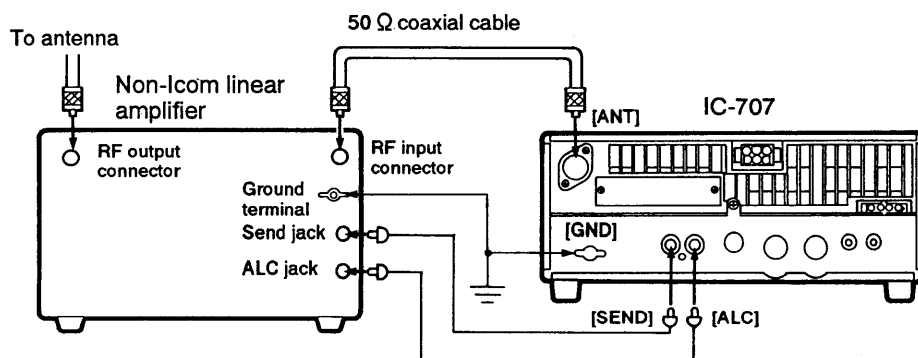

NOTE: The [SEND] jack can control the following specifications of a linear amplifier's relay.
 Max. voltage: 16 V DC Max. current: 20 mA

To control higher voltage or current, connect an external relay. The ALC output voltage of the linear amplifier **MUST** be 0 V to -4 V.

Antenna tuner connections

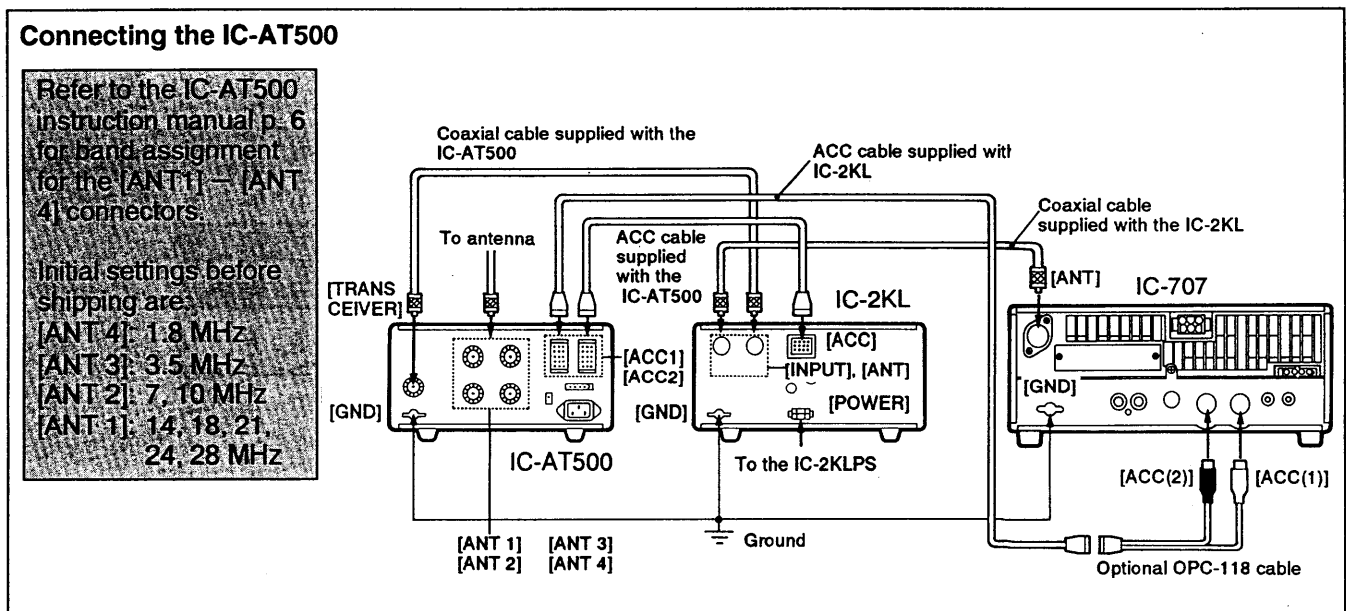
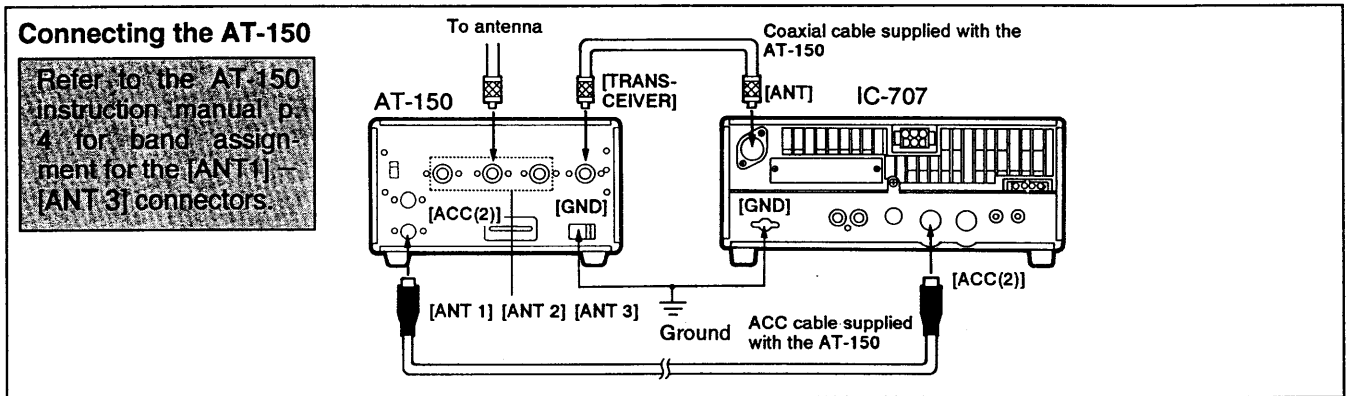
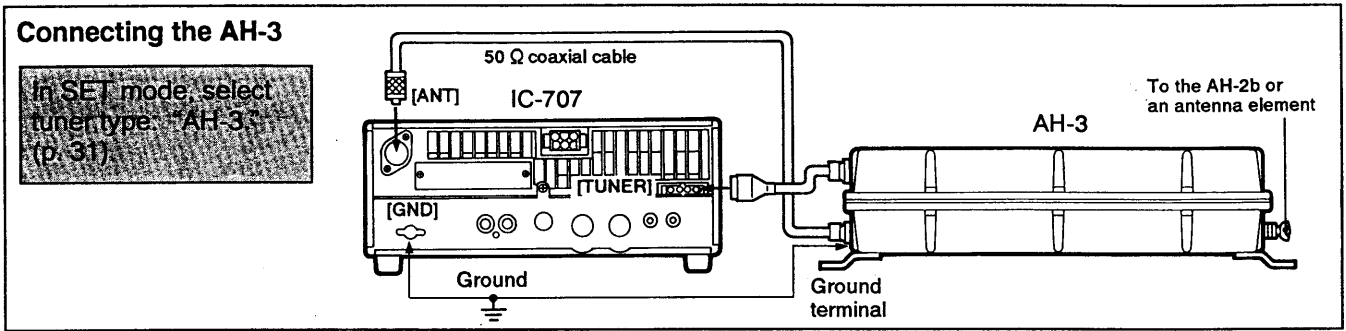
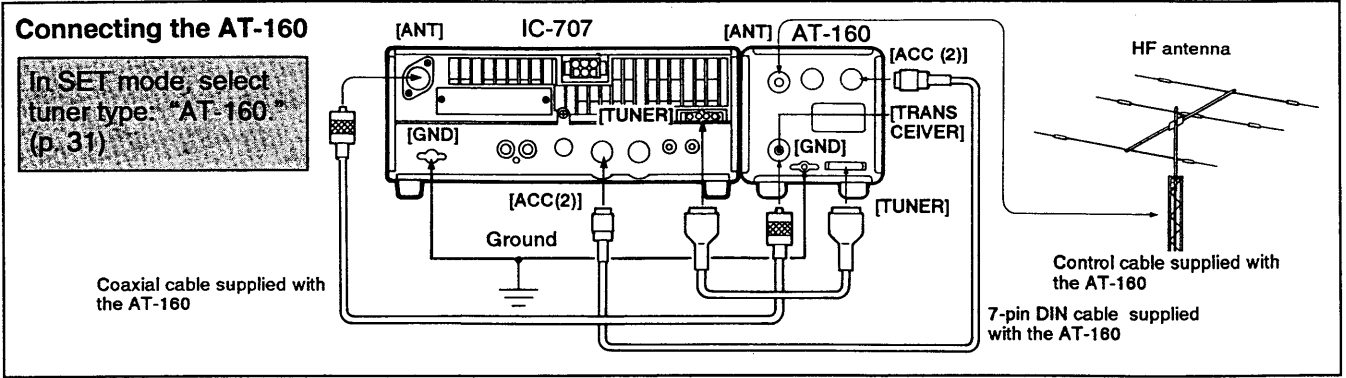

Antenna selector connections

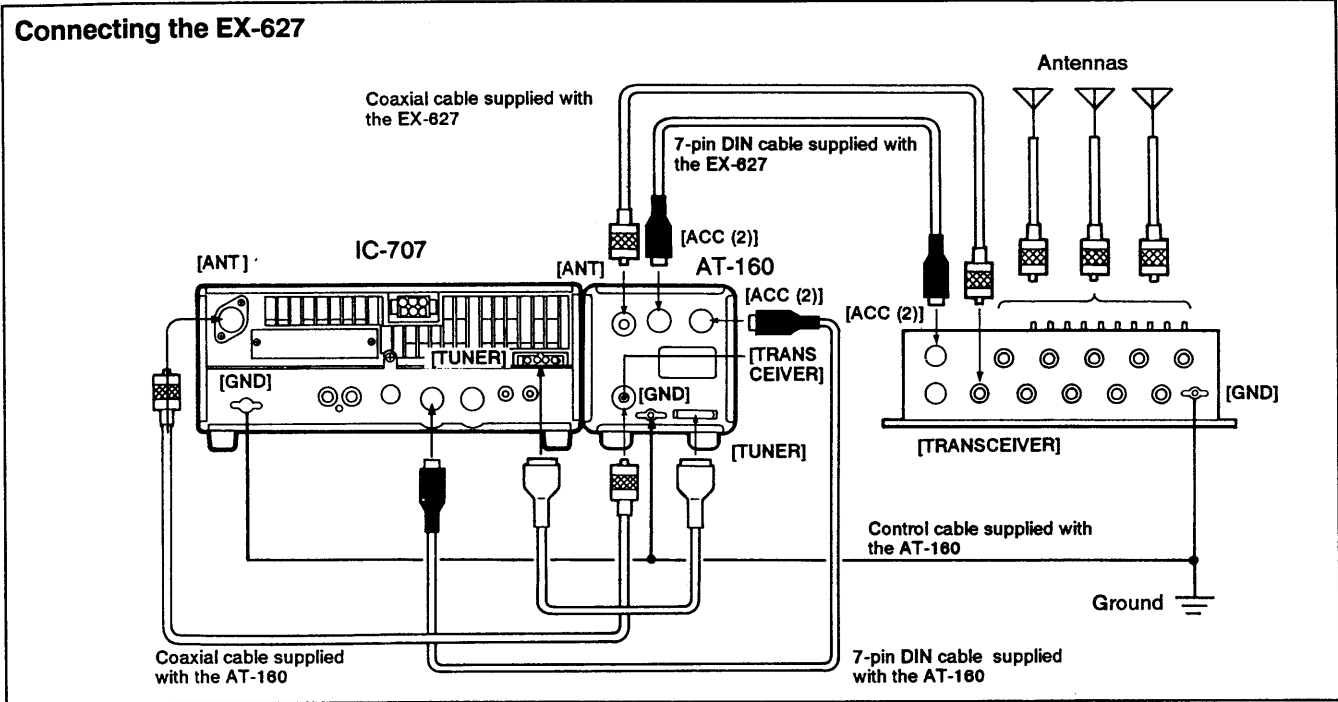

AFSK terminal unit connections

When operating an AFSK mode such as RTTY, AMTOR or packet, connect external equipment to the [ACC(1)] socket.

When connected to the [MIC] connector, the [MIC] control and [AF] control adjustment is required. Refer to p. 21 for RTTY mode operation.

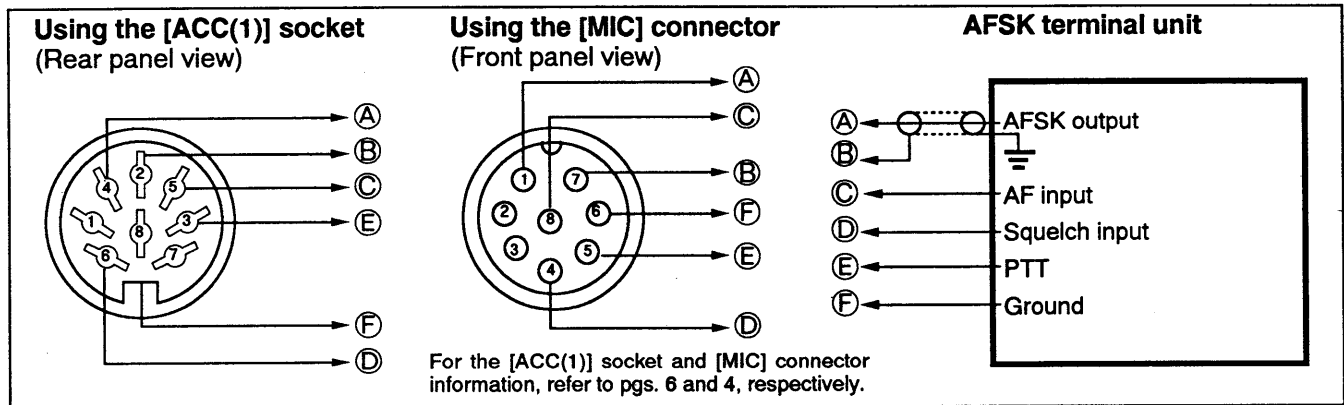

Remote jack (CI-V) information

The [REMOTE] jack can be connected through an optional CT-17 CI-V LEVEL CONVERTER to a personal computer equipped with an RS-232C port. CI-V (Icom Communication Interface-V) controls frequency, operating mode, memory channels, etc. Up to 4 Icom CI-V transceivers or receivers can be connected. Refer to the CT-17 instruction manual and CI-V reference manual for details.

Refer to p. 32 for CI-V condition settings for the IC-707.

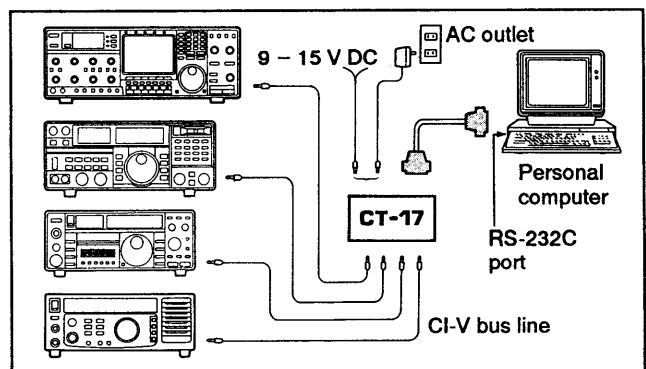

3 OPERATION

Initial settings

Before performing the initial settings, make sure all required connections are complete.

Before power ON, set controls and switches as shown in the figure below.

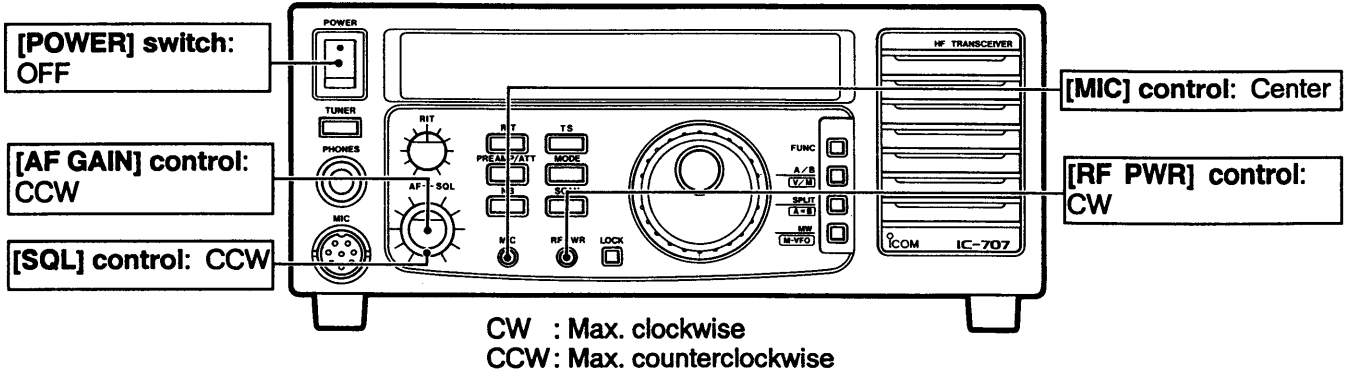

Basic operation

- 1) Turn the [POWER] switch to the ON position.

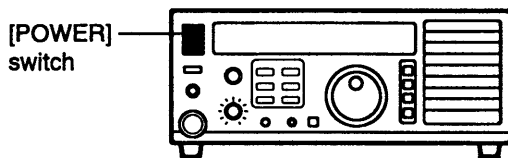

- 2) If "MEMO," "SPLIT," "RIT," "PREAMP," "ATT," "LOCK" or "NB" appears, cancel the function.

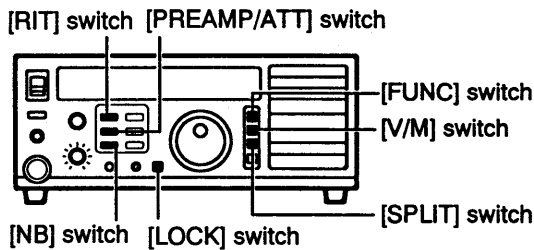
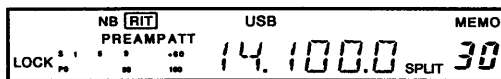

- To cancel "MEMO," push the [FUNC] switch, then push the [V/M] switch.
- To cancel "PREAMP" or "ATT," push the [PREAMP/ATT] switch several times.

- 3) Rotate the [AF] control clockwise to adjust the desired audio output level.

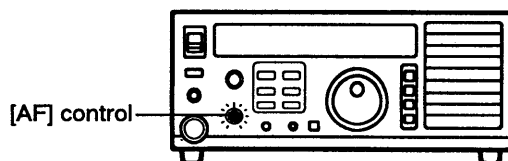

- 4) Push the [MODE] switch several times to select the desired mode.

- For SSB mode operation: Select "LSB" for the 7 MHz band and below. Select "USB" for the 10 MHz band and above.

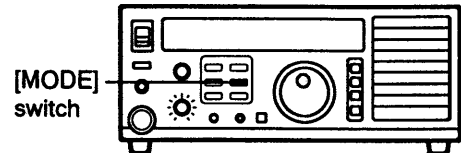

- 5) Rotate the main dial to select a desired frequency.

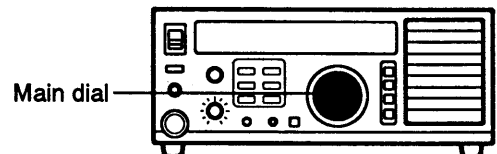

- 6) To compensate for an off frequency or frequency drift, push the [RIT] switch, then rotate the [RIT] control.

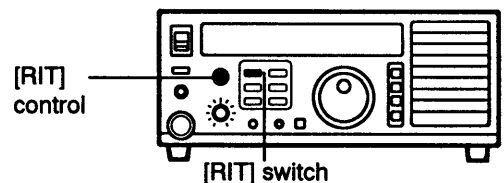

- 7) Push the [PTT] switch on the microphone to transmit. Release the [PTT] switch to receive.

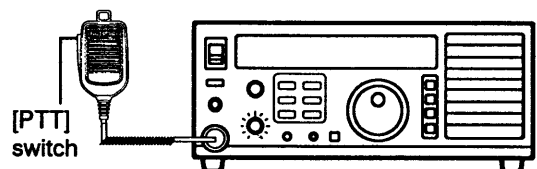

What are VFO and MEMORY modes?

VFO mode

The IC-707 has two VFOs: VFO A and VFO B. Each VFO has a frequency and operating mode.

MEMORY mode

30 memory channels store your often-used frequencies and operating modes.

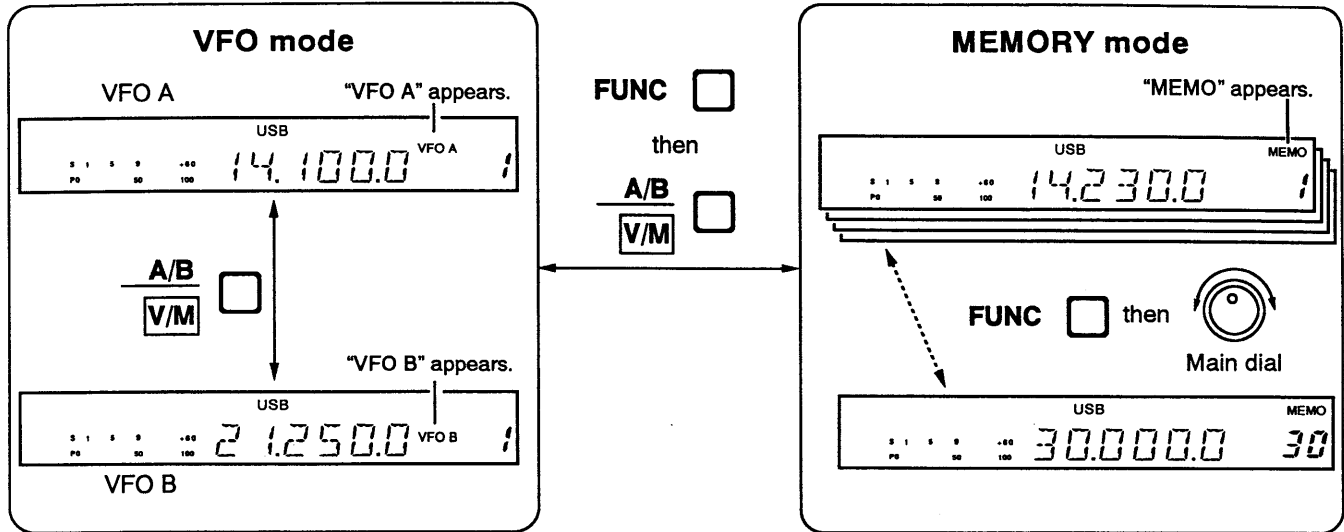

The differences between VFO mode and MEMORY mode

VFO mode

VFO A and VFO B have independent frequencies and operating modes. When the frequency or operating mode is changed, the VFO automatically memorizes the new frequency or operating mode.

When a VFO is selected from another VFO or MEMORY mode, the last-used frequency and operating mode for that VFO appear.

[Example]

VFO A is selected.

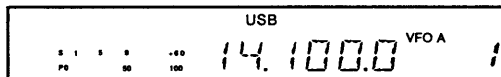

The frequency is changed.

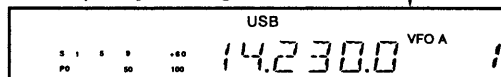

VFO B is selected.

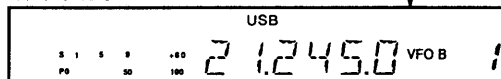

VFO A is selected again.

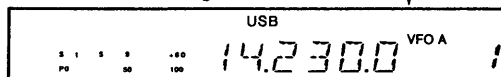

MEMORY mode

Each memory channel has a frequency and operating mode. The frequency and mode can be changed temporarily. Even if the frequency or mode is changed, memory channel contents are not affected.

When the memory channel is selected from another memory channel or VFO mode, the memorized frequency and operating mode appear.

[Example]

Memory channel 1 is selected.

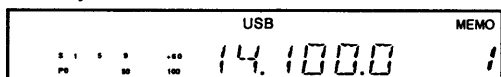

The frequency is changed.

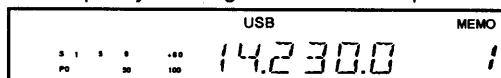

Another memory channel is selected.

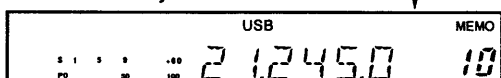

Memory channel 1 is selected again.

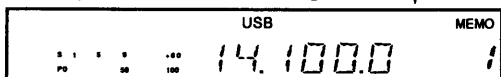

Frequency setting

For ham band use

- 1) Push the [TS] switch several times until the 2 tuning step indicators "▼▼" appear above the 10 MHz and 1 MHz digits.

Select "▼▼" above the 10 MHz and 1 MHz digits.

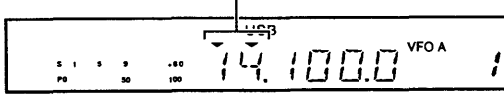

- 2) Rotate the main dial to select the desired band.

Operating mode changes according to the selected band.

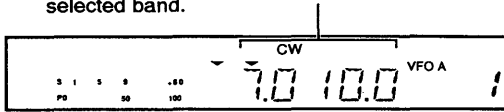

- 3) Push the [TS] switch 1 time.

"▼" disappears.

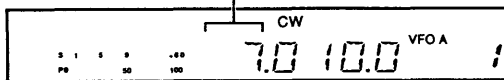

- 4) Rotate the main dial to select the desired frequency.

- Push the [TS] switch 1 time to select the 1 kHz tuning step.

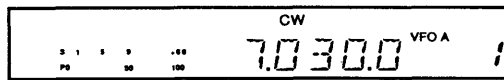

For general coverage receiver use

- 1) Push the [TS] switch several times until 1 tuning indicator "▼" appears above the 1 MHz digit.

Select "▼" above the 1 MHz digit.

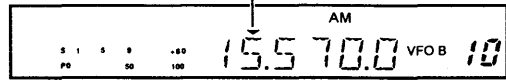

- 2) Rotate the main dial to select the desired band.

Changes in 1 MHz step.

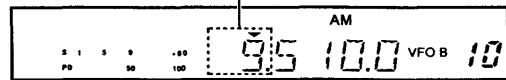

- 3) Push the [TS] switch 3 times.

- 1 indicator "▼" appears above 1 kHz digit.

Select "▼" above the 1 kHz digit.

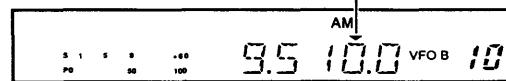

- 4) Rotate the main dial to select the desired frequency.

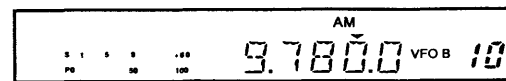

What is band stacking register?

The **band stacking register** stores a frequency and an operating mode on each band. When the ham band is changed, the last-used frequency and operating mode for the newly-selected band appear.

This function is convenient for band switching in contests, and for quick monitoring of propagation conditions on other bands.

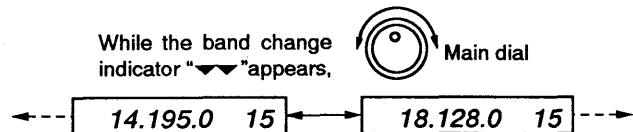

When you do not use the band stacking register, select the MHz tuning indicator instead of band change indicators.

According to frequency during general coverage receiver use, the general coverage receiver band "Gene" moves to a position between the ham bands.

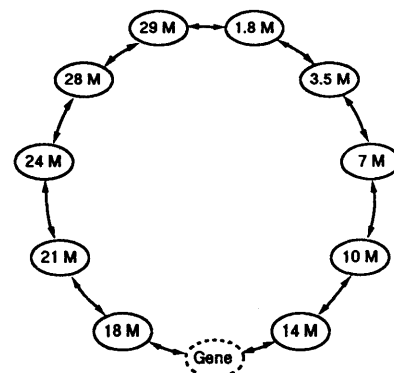

Dial lock function

The dial lock function electronically locks the main dial to prevent accidental frequency changes.

Push the [LOCK] switch to activate and cancel the dial lock function.

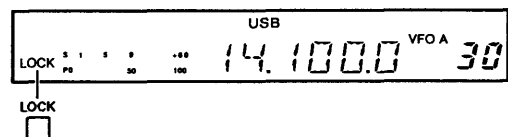

1 kHz tuning step

The operating frequency can be changed in 1 kHz steps for quick tuning.

- 1) Push the [TS] switch several times until "▼" appears on the 1 kHz digit.

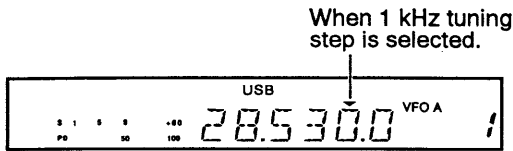

- 2) Rotate the main dial to change the frequency.
- 3) Push the [TS] switch 3 times until "▼" disappears.
- 4) Rotate the main dial for fine tuning if required.

NOTE: When AM or FM mode is selected, the 1 kHz tuning step is automatically selected. When fine tuning is required, push the [TS] switch several times until "▼" disappears.

HF ham bands and propagation characteristics

Allocated frequency ranges vary according to country. Refer to your radio law rule book for details.

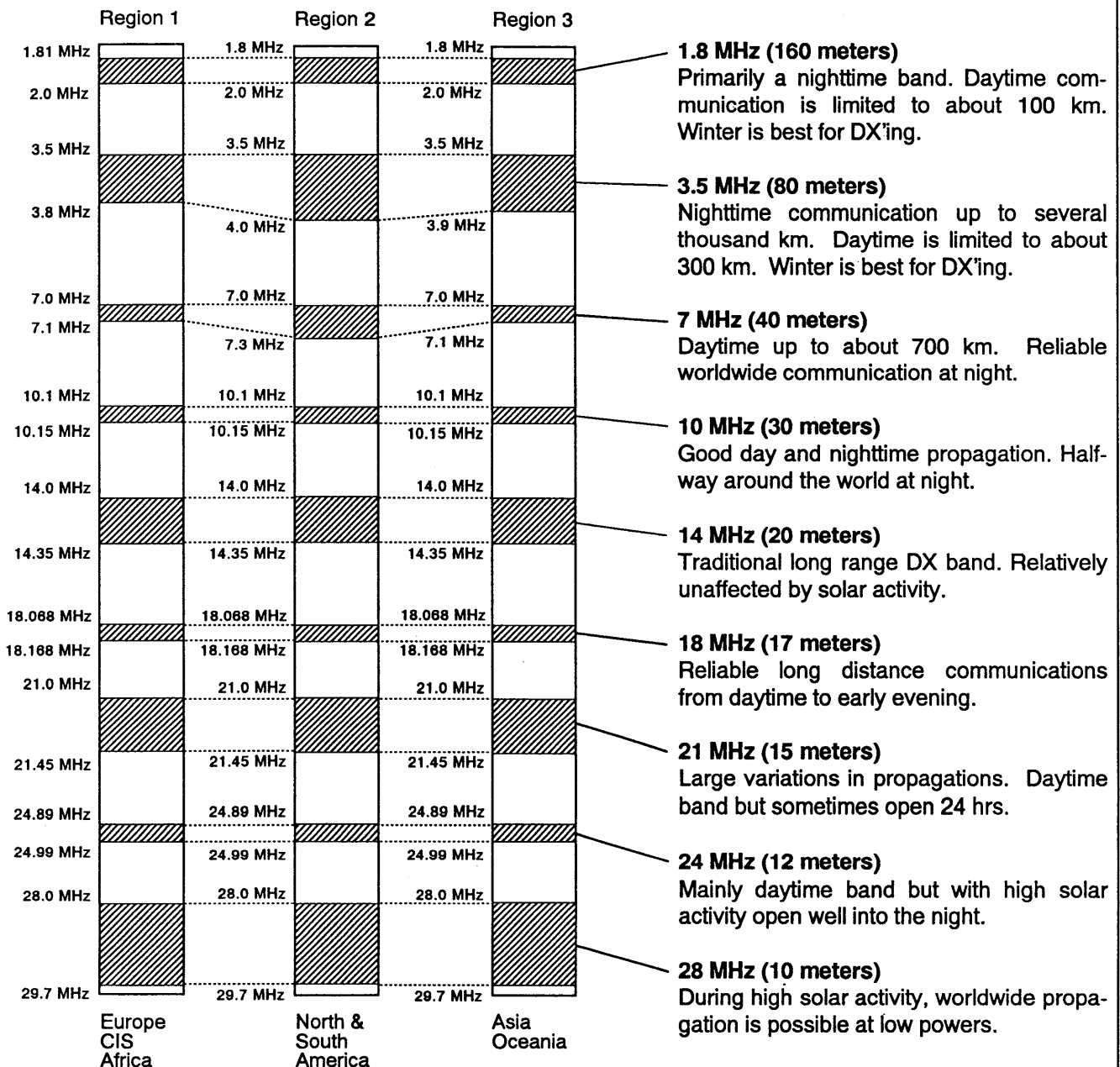

Voice receiving

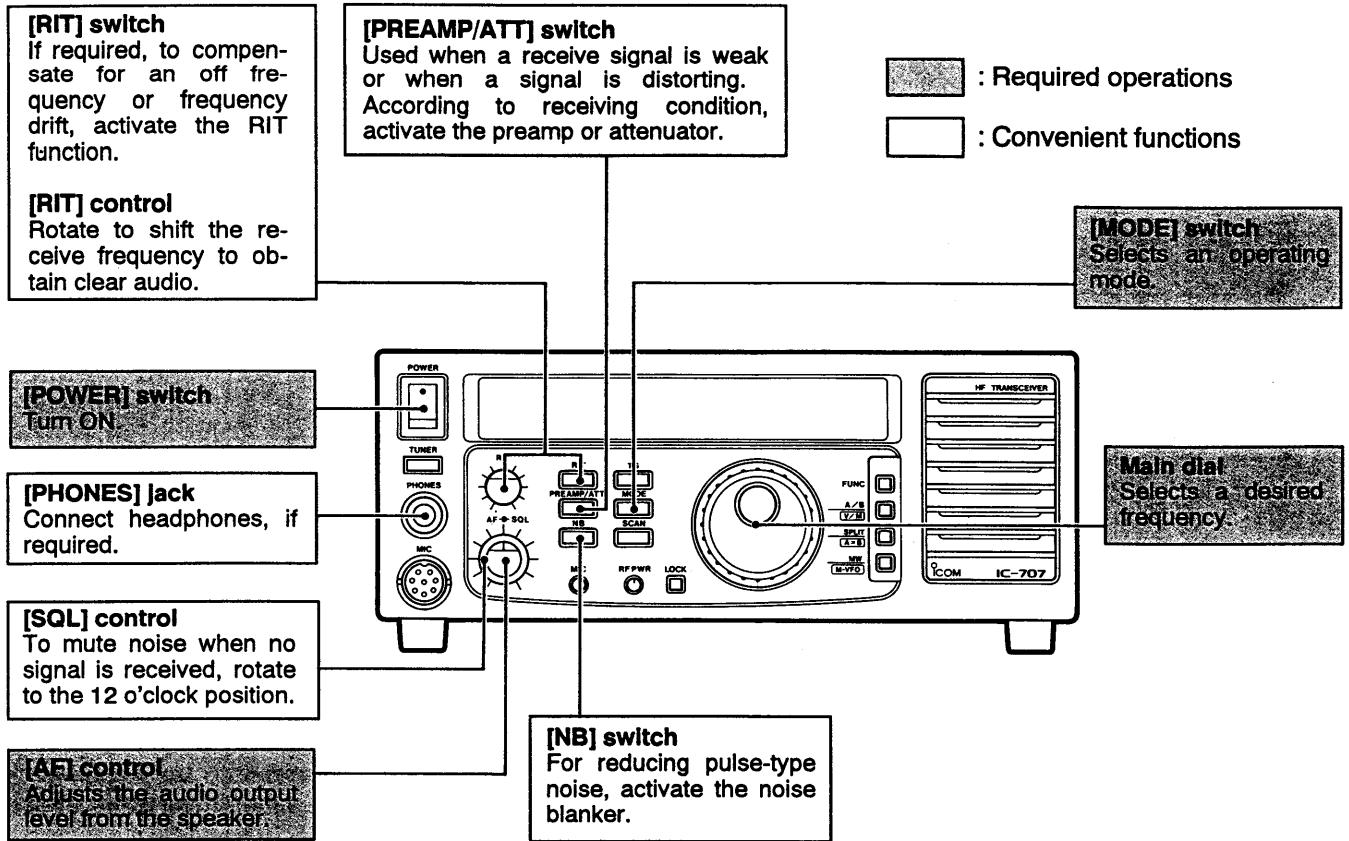

Basic voice receiving

- 1) Turn the [POWER] switch to the ON position.
- 2) Rotate the [AF] control clockwise to adjust the desired audio output level.
- 3) Refer to "Practical modes" at right and select an operating mode.

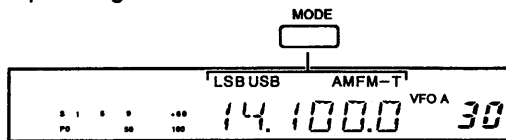

- 4) Rotate the main dial to select an operating frequency in your allowed range for each mode.
- 5) If receive audio is not clear or includes noise, use the functions on page at right.

"RX" appears.

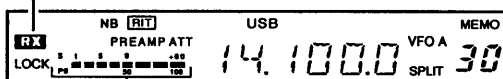

The S/R indicator shows receive signal strength.

Practical modes

- **LSB mode:** For SSB mode operation on the 7 MHz band and below, select "LSB."
- **USB mode:** For SSB mode operation on the 10 MHz band and above, select "USB."
- **AM mode:** For AM mode operation or broadcasting station receiving, select "AM."
- **FM mode:** When an optional UI-9 FM UNIT is installed, "FM" is selectable. Refer to p. 35.
- **FM tone mode:** When an optional UI-9 and UT-30 PROGRAMMABLE TONE ENCODER UNIT is installed, "FM-T" is selectable. Refer to pgs. 22, 35.

Useful functions for each mode

Refer to p. 18 for each function.

- **LSB and USB modes** : RIT function
Preamp
Attenuator
Noise blanker
Squelch
- **AM mode** : Preamp
Attenuator
Squelch
- **FM and FM tone modes:** Squelch
Preamp
Attenuator

RIT function

The RIT function shifts the receive frequency to compensate for an off frequency or frequency drift. The RIT function does not affect the transmit frequency.

Push the [RIT] switch to activate the RIT function.

- "RIT" appears.

Rotate the [RIT] control.

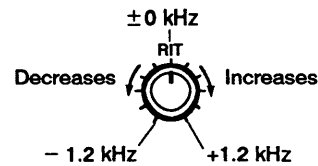

Push the [RIT] switch again to cancel the RIT function.

- "RIT" disappears.

Preamp

The preamp is useful under the following conditions:

- When a receive signal is weak.
- When poor propagation conditions exist.

Push the [PREAMP/ATT] switch 1 time to activate the preamp.

- If "ATT" appears, push 2 times.
- "PREAMP" appears.

Push the [PREAMP/ATT] switch 2 times to cancel the preamp.

- "PREAMP" disappears.

NOTE: When a receive signal is not weak, cancel the preamp. Otherwise, a suddenly appearing strong signal may interfere with the desired signal.

Attenuator

The attenuator is useful to prevent the receive signal from distorting under the following conditions:

- When strong signals are near the desired frequency.
- When strong signal stations are near your location.

Push the [PREAMP/ATT] switch 2 times to activate the attenuator.

- If "PREAMP" appears, push 1 time.
- "ATT" appears.

Push the [PREAMP/ATT] switch 1 time to cancel the attenuator.

- "ATT" disappears.

Noise blanker

The noise blanker reduces click noise generated by vehicle ignition systems, etc.

Push the [NB] switch to cancel the noise blanker.

- "NB" appears.

Push the [NB] switch again to cancel the noise blanker.

- "NB" disappears.

NOTE: To prevent the receive signal from distorting, cancel the noise blanker when click noise is not received.

Squelch function

For quiet standby, the squelch mutes noise when no signal is received. Though squelch operates in all modes, it is particularly useful for FM mode.

Rotate the [SQL] control to the 12 o'clock position to mute noise, if required.

- When the [SQL] control is rotated too far clockwise, weak signals cannot be received.

When the squelch is not required, rotate the [SQL] control to the max. counterclockwise position.

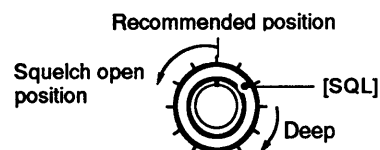

Voice transmitting

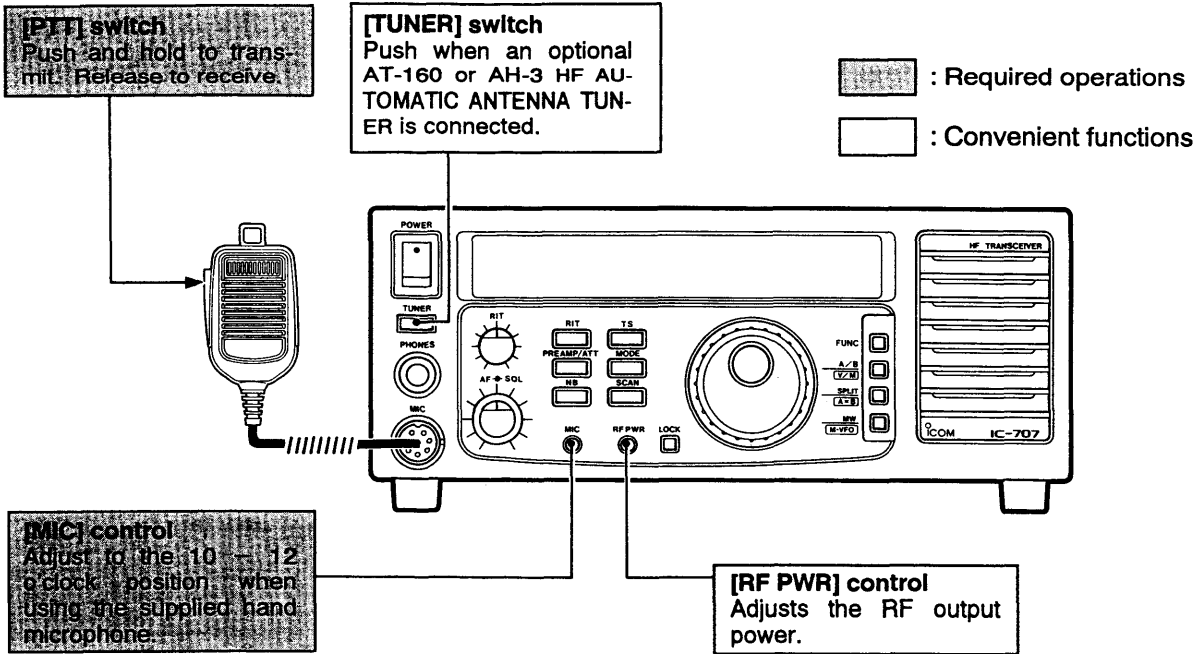

Basic voice transmitting

CAUTION: Transmitting without an antenna may damage the transceiver.

After completing the receiving procedures on pgs. 17 and 18, perform transmitting. To prevent interference, listen on the frequency before transmitting.

- 1) Adjust the [MIC] control to the 10 – 12 o'clock position.
 - Refer to the box below.
- 2) If required, adjust the [RF PWR] control as described in the box below.

- 3) When an optional HF automatic antenna tuner is connected operate as following:
 - AH-3 : Push and hold the [TUNER] switch. (p. 23)
 - AT-160 : If SWR is high, push the [TUNER] switch. (p. 24)

- 4) Push and hold the [PTT] switch and speak into the microphone.
 - **DO NOT** hold the microphone too close to your mouth or speak too loudly.

"TX" appears.

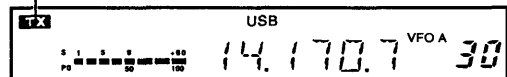

- 4) Release the [PTT] switch to receive.

Microphone gain control

Adjust the [MIC] control to the 10 – 12 o'clock position when using the supplied microphone.

Suitable position differs according to the connected microphone.

When rotated too far counterclockwise, output power becomes too low. When rotated too far clockwise, transmit audio may distort.

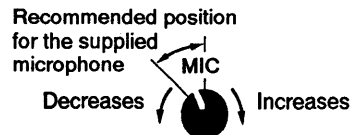

RF power control

If required, adjust RF output power level.

If maximum RF output power is not required, use a lower power to save your vehicle's battery power during mobile operation.

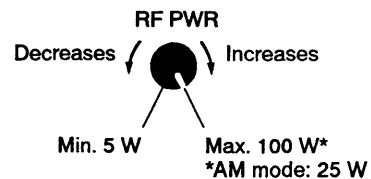

■ CW mode operation

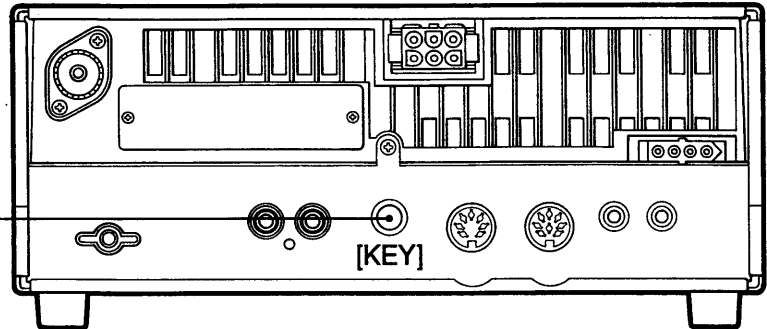
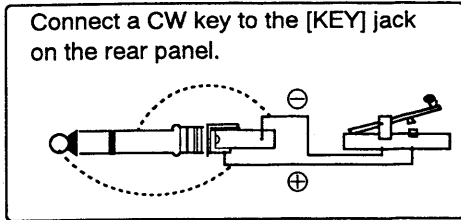

Basic CW operation

NOTE: Only semi break-in operation is possible. Full break-in operation and manual transmit/receive switching are not possible.

- 1) Turn the [POWER] switch to the ON position.
- 2) Push the [MODE] switch several times until "CW" appears.
 - To use "CW-N," an optional FL-52A or FL-53A CW NARROW FILTER is required.

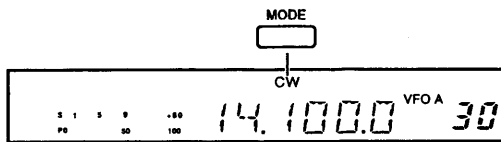

- 3) Rotate the [AF] control clockwise to adjust the desired audio output level.

- 4) Rotate the main dial to select an operating frequency in the allowed range for CW mode.
- 5) When an optional HF automatic antenna tuner is connected operate as following:
 - AH-3 : Push and hold the [TUNER] switch. (p. 23)
 - AT-160 : If SWR is high, push the [TUNER] switch. (p. 24)
- 6) If required, activate the RIT function, preamp, attenuator or noise blanker.
 - Refer to p. 18 for details.
- 7) If required, adjust the [RF PWR] control to adjust the RF output power level as described on page at left.
- 8) Push the key down for transmitting. Release the key for receiving.

Break-in delay time adjustment

The semi break-in function automatically returns to receiving after the break-in delay time elapses from the end of key down.

If required, break-in delay time can be changed by internal adjustment. Refer to p. 34 for adjustment point.

Basic CW side tone level adjustment

The speaker emits CW side tone according to keying. The CW side tone level varies according to the [AF] control.

If required, the receive audio and CW side tone balance can be changed by internal adjustment. Refer to p. 34 for adjustment point.

Optional CW narrow filter

For better CW receiving during crowded band conditions, an optional FL-52A or FL-53A CW NARROW FILTER is useful. Refer to p. 35 for installation.

CW narrow filter specifications

	Center frequency	Passband width
FL-52A	455 kHz	500 Hz/ – 6 dB
FL-53A	455 kHz	250 Hz/ – 6 dB

RTTY mode operation

Connect a TNC with RTTY capability to the [ACC(1)] socket on the rear panel.

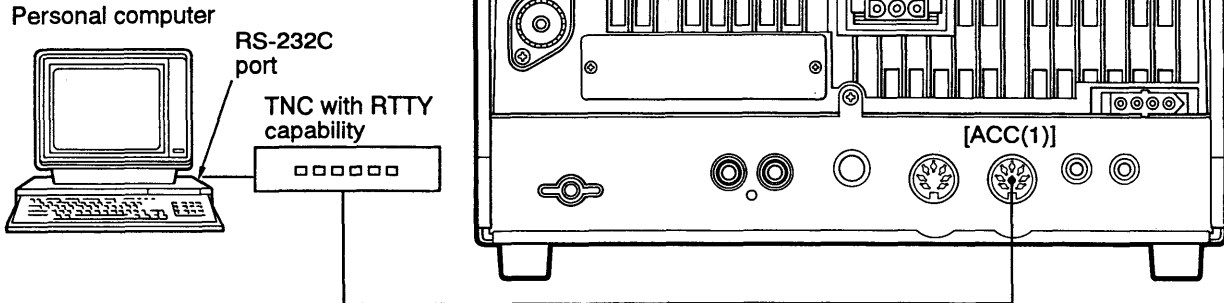

AF input and output levels

Your TNC (Terminal Node Controller) should be connected to the [ACC(1)] socket. Refer to p. 12 and your TNC instruction manual for connection.

When connected to the [MIC] connector, rotate the [AF] control and the [MIC] control to obtain suitable levels. Suitable levels vary according to your TNC.

[ACC (1)] socket

- AF output level from pin 5 is fixed regardless of the [AF] control position.
- AF input level to pin 4 is fixed regardless of the [MIC] control position.

[MIC] connector

- AF output level from pin 8 varies according to the [AF] control position.
- AF input level to pin 1 varies according to the [MIC] control position.

Basic RTTY mode operation

NOTE: Operation varies according to your equipment. Refer to your TNC instruction manual for details.

- 1) Turn the [POWER] switch to the ON position.
- 2) Push the [MODE] switch several times until "LSB" appears.

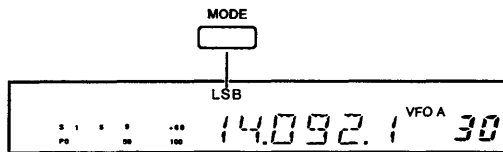

- 3) Rotate the main dial to select an operating frequency in the allowed range for RTTY mode.

- 4) When an optional HF automatic antenna tuner is connected operate as following:
 - AH-3 : Push and hold the [TUNER] switch. (p. 23)
 - AT-160 : If SWR is high, push the [TUNER] switch. (p. 24)
- 5) If your TNC requires, rotate the [SQL] control to the 12 o'clock position to mute noise.
- 6) If required, activate the RIT function, preamp, attenuator or noise blanker.
 - Refer to p. 18 for details.
- 7) If required, rotate the [RF PWR] control to adjust the RF output power level.
- 8) Use the keyboard to transmit.

Operating frequency for RTTY mode

RTTY operating frequency differs from the displayed frequency. When the oscillated frequencies of your TNC are:

Mark = 2125 Hz
Space = 2295 Hz

Refer to the following formula for RTTY operating frequency.

$$\text{Operating freq.} = \text{Displayed freq.} - 2125 \text{ Hz}$$

[Frequency setting example]

When operating at 14.090 MHz, rotate the main dial to select 14.0921 MHz on the function display.

Frequency equalizing operation

Undisplayed VFO frequency and operating mode are equalized to displayed VFO.

1) Select VFO A or VFO B.

2) Push and hold the [FUNC] switch, then push the [A=B] switch until the speaker emits 3 beep tones.

• Undisplayed VFO frequency and operating mode are equalized to displayed VFO.

Split frequency operation

Split frequency operation allows you to transmit and receive on 2 different frequencies using 2 frequencies: one on VFO A and one on VFO B.

Following is an example for setting 21.250 MHz for receiving and 21.360 MHz for transmitting.

1) Select VFO A. Select 21.250 MHz, USB mode.

2) Select VFO B. Select 21.360 MHz, USB mode.

3) Select VFO A. Push the [SPLIT] switch.

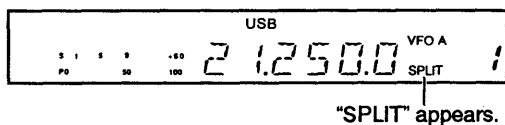

4) Push the [PTT] switch to transmit on 21.360 MHz.

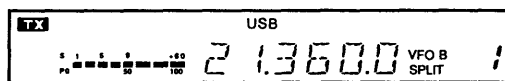

5) Release the [PTT] switch to receive on 21.250 MHz.

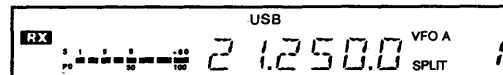

6) To exchange the transmit and receive frequencies, push the [A/B] switch.

Practical example

When you find a DX station on 14.195 MHz and the station says "Up 10 kHz" for your calling frequency:

1) Push the [FUNC] switch, then push the [A=B] switch.

2) Rotate the main dial to select 14.205 MHz.
• 14.195 MHz + 10 kHz = 14.205 MHz.

3) Push the [A/B] switch to change the VFO.

4) Push the [SPLIT] switch.

5) When the DX station is standing by, push and hold the [PTT] switch and call.

Repeater operation

A repeater receives signals and re-transmits them at a different frequency.

NOTE: An optional UI-9 FM UNIT is required for FM mode operation. Refer to p. 35. For accessing a repeater which requires a subaudible tone, an optional UT-30 PROGRAMMABLE TONE ENCODER UNIT is required. Refer to p. 35.

Following is an example to access a repeater that requires a subaudible tone.

- Repeater input frequency : 29.580 MHz
- Repeater output frequency: 29.680 MHz

1) Select VFO A. Select 29.680 MHz, then push the [MODE] switch several times until "FM" appears.

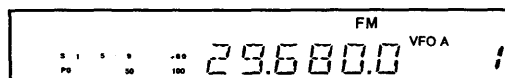

2) Select VFO B. Select 29.580 MHz, then push the [MODE] switch several times until "FM-T" appears.

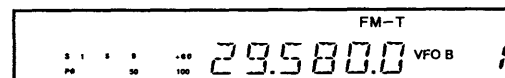

3) Select VFO A. Then, push the [SPLIT] switch.

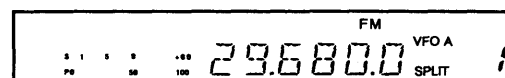

4) Push the [PTT] switch to transmit.

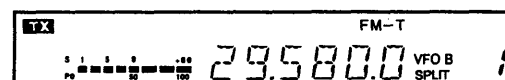

5) Release the [PTT] switch to receive.

AH-3 HF AUTOMATIC ANTENNA TUNER

An optional AH-3 allows you HF operation where antenna element length is restricted due to space.

⚠ WARNING: DANGER HIGH VOLTAGE! NEVER touch the antenna terminal, ground terminal or antenna element while transmitting. Place the AH-3 and antenna in positions where no one touches them.

NEVER operate the AH-3 without an antenna element. The tuner and transceiver may be damaged.

NEVER transmit during internal adjustment to prevent electric shock.

USE the ground terminal for ground connection. The mounting plate is not connected internally.

AVOID using the AH-3 in areas where the temperature is below -10°C ($+14^{\circ}\text{F}$) or above $+60^{\circ}\text{C}$ ($+140^{\circ}\text{F}$).

Installation and connections

Refer to p. 11 for the IC-707 and AH-3 connections. Refer to the AH-3 instruction manual for AH-3 installation and antenna connection details.

AH-3 setting example:

For mobile operation

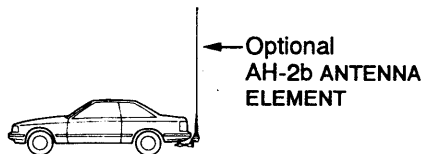

For outdoor operation

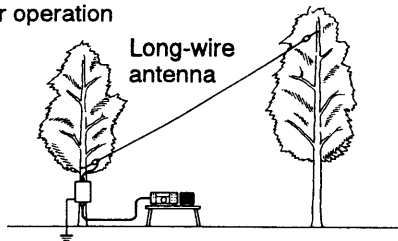

SET mode setting

Refer to pgs. 30, 31, select tuner type "AH-3."

AH-3 operation

The AH-3 requires re-tuning for each frequency. When you change the operating frequency even a little bit, re-tune before transmitting.

Tuning

- 1) Select the desired frequency in a ham band.
- 2) Push and hold the [TUNER] switch until "TUNE" blinks.

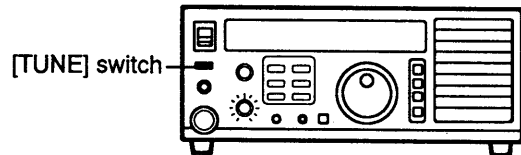

CW mode is automatically selected and "TUNE" blinks.

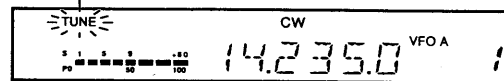

"TUNE" appears constantly when the tuning is complete.

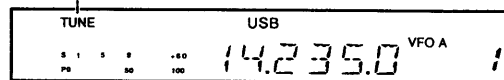

If the AH-3 cannot tune the connected antenna, "THRU" appears. The [ANT] connector is directly connected to the antenna.

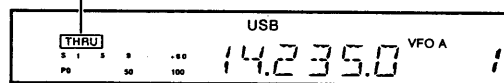

CAUTION: DO NOT transmit if the AH-3 cannot tune the connected antenna, since the IC-707 may be damaged.

Through function

If required, the AH-3 can be bypassed manually.

- 1) While "TUNE" appears, push the [TUNER] switch temporarily.
 - The AH-3 is bypassed and the [ANT] connector is directly connected to the antenna.

"THRU" appears.

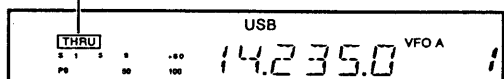

- 2) To activate the AH-3, push and hold the [TUNER] switch.
 - "TUNE" appears.

■ AT-160 HF AUTOMATIC ANTENNA TUNER

The AT-160 matches the IC-707 to the antenna automatically. The AT-160 has memories for auto-preset. No preset operation is required.

Installation and connection

Refer to p. 11 and the AT-160 instruction manual, connect the AT-160 to the IC-707. All required cables are supplied with the AT-160.

SET mode setting

Refer to pgs. 30, 31, select tuner type "AT-160."

AT-160 operation

Only when the antenna is not matched to the operating frequency and SWR is high, activate the AT-160. Otherwise, bypass the AT-160 using the through function.

When you first use the AT-160, manual tuning is required. Once manual tuning is performed, the AT-160 automatically tunes the antenna when you start transmitting.

Manual tuning

Perform manual tuning when:

- you first use the AT-160.
- you want to tune the antenna to a operating frequency before transmitting.

- 1) Select the desired frequency in a ham band.
- 2) Push and hold the [TUNER] switch until "TUNE" blinks.

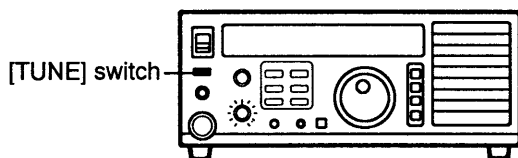

CW mode is automatically selected and "TUNE" blinks.

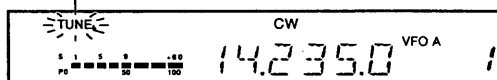

- After tuning, the AT-160 automatically memorizes the matching condition.

If the AT-160 cannot tune the connected antenna, "THRU" appears. The [ANT] connector is directly connected to the antenna.

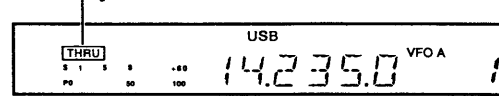

CAUTION: DO NOT transmit if the AT-160 cannot tune the connected antenna, since the IC-707 may be damaged.

Automatic tuning

Once manual tuning is performed, use the automatic tuning function for normal operation.

- 1) Select the desired frequency in a ham band.
- 2) Push the [TUNER] switch to activate the AT-160.

"TUNE" appears.

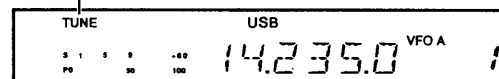

- When you start transmitting, the AT-160 automatically tunes the connected antenna.

NOTE: If the AT-160 cannot tune the connected antenna, "THRU" blinks irregularly during transmission. In this case, to re-tune the antenna, push and hold the [TUNER] switch until "TUNE" blinks.

Through function

When the connected antenna is matched to the operating frequency and SWR is low, bypass the AT-160 manually. This decreases insertion loss.

- 1) While "TUNE" appears, push the [TUNER] switch temporarily.
 - The AT-160 is bypassed and the [ANT] connector is directly connected to the antenna.

"THRU" appears.

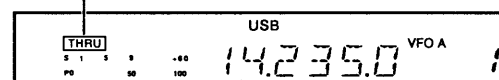

- 2) To activate the AT-160, push the [TUNER] switch temporarily.
 - "TUNE" appears.

■ IC-AT500, AT-150 HF AUTOMATIC ANTENNA TUNERS

Refer to the instruction manual included with each antenna tuner. SET mode selection is not required. The [TUNE] switch is not effective.

4 MEMORY CHANNELS

Channel functions

The IC-707's 32 memory channels are for programmed scan and storing often-used frequencies.

All memory channels are tunable. The frequency and operating mode in each memory channel can be changed temporarily. If required, the changed frequency and mode can be memorized into the memory channel.

Memory channels 26–30, P1 and P2 have the special functions at right.

Memory channel	Capability
1 – 25	Normal memory channels. A frequency and mode in each channel.
26 – 30	Split memory channels for split frequency operation. A pair of transmit and receive frequencies and operating modes in each channel. (p. 28)
P1, P2	Scan edge channels for programmed scan. A frequency and mode in each channel. (p. 29)

VFO and MEMORY mode selection

Push the [FUNC] switch, then push the [V/M] switch to select MEMORY mode or VFO mode.

Refer to p. 14 "Mode types" for VFO mode and MEMORY mode.

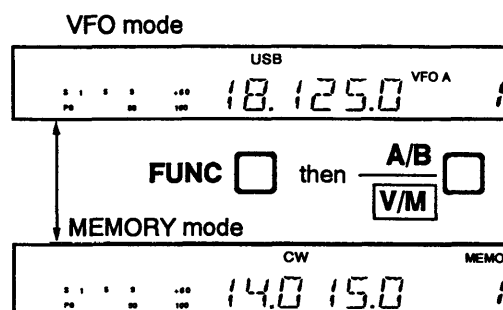

Memory channel selection

While in VFO mode

Only the memory channel readout changes. The function display shows a VFO frequency.

- 1) When "LOCK" appears, push the [LOCK] switch to cancel the dial lock function.

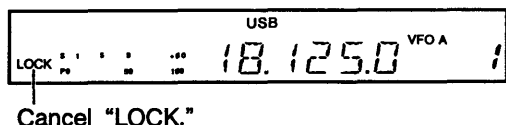

- 2) Push the [FUNC] switch, then rotate the main dial to change the memory channel number readout.

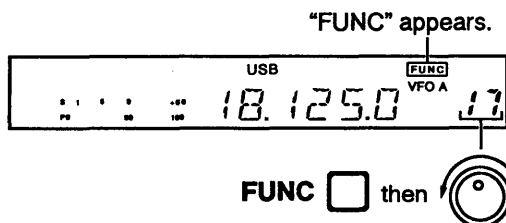

- 3) Push the [V/M] switch to select MEMORY mode.
 - The memory channel contents appear, and "FUNC" disappears.

While in MEMORY mode

The function display shows selected memory channel contents.

- 1) When "LOCK" appears, push the [LOCK] switch to cancel the dial lock function.
 - For channel selection using the [UP]/[DN] switches on the microphone, step 1) is not required.

- 2) Push the [FUNC] switch, then push the [V/M] switch to select MEMORY mode.

- 3) Push the [FUNC] switch, then rotate the main dial.

- Pushing the [UP] or [DN] switch on the microphone also selects a memory channel.

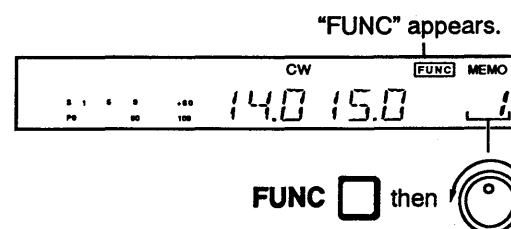

- 4) Push the [FUNC] switch to cancel "FUNC."

Memory channel programming

Memory channel programming can be performed either in VFO mode or MEMORY mode.

While in VFO mode

- 1) In VFO mode, select the desired frequency and operating mode.
- 2) Push the [FUNC] switch, then rotate the main dial to select a memory channel number.
 - To confirm the memory channel contents, refer to page at left.
- 3) Push the [FUNC] switch to cancel "FUNC."
- 4) Push and hold the [MW] switch until the speaker emits 3 beep tones.
 - The displayed frequency and operating mode are programmed into the memory channel.
- 5) To confirm the programmed contents, push the [FUNC] switch, then push the [V/M] switch.

[Example] : Programming 7.088 MHz, LSB mode into memory channel 12.

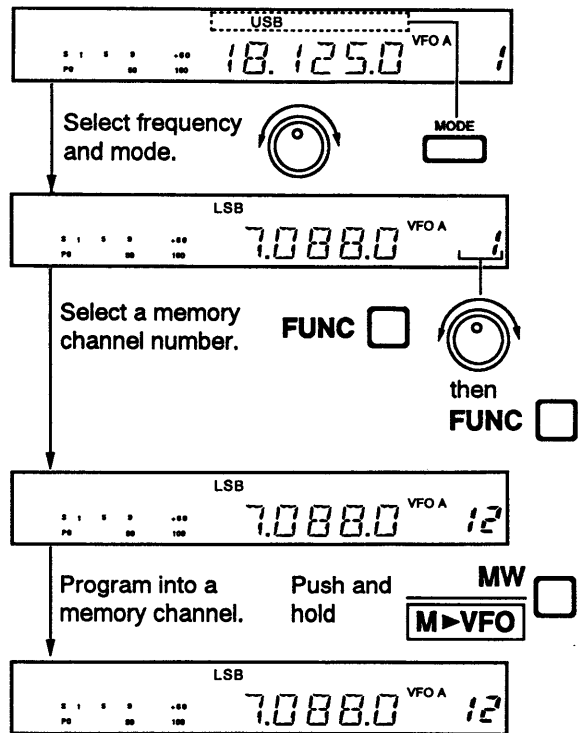

While in MEMORY mode

- 1) In MEMORY mode, push the [FUNC] switch, then rotate the main dial to select a memory channel.
- 2) Push the [FUNC] switch to cancel "FUNC."
- 3) Select the desired frequency and operating mode in MEMORY mode.
- 4) Push and hold the [MW] switch until the speaker emits 3 beep tones.
 - The displayed frequency and operating mode are programmed into the memory channel.

[Example] : Programming 21.280 MHz, USB mode into memory channel 18.

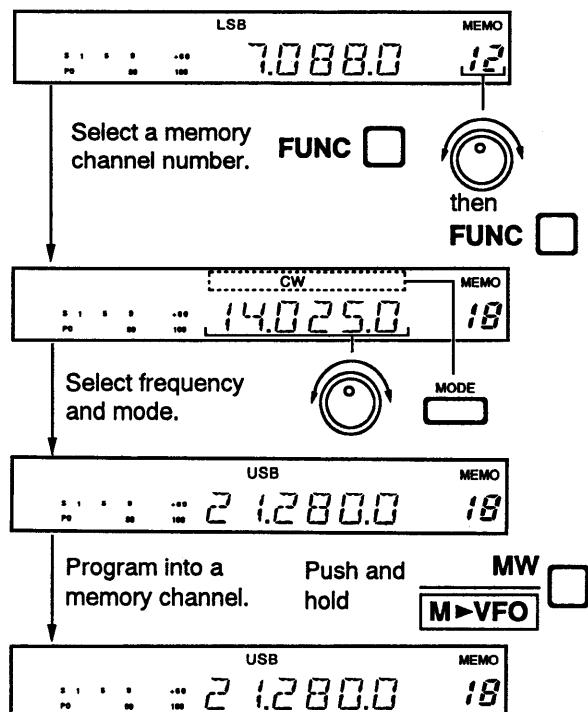

Frequency transferring

The frequency and operating mode in a memory channel can be transferred to VFO mode.

The frequency transferring can be performed in either VFO mode or in MEMORY mode.

While in VFO mode

This method is useful for transferring a memory channel's contents to VFO.

- 1) Select VFO A or VFO B.
 - If required, rotate the main dial to select a memory channel number.
- 2) Push the [FUNC] switch.
 - If required, rotate the main dial to select a memory channel number.
- 3) Push and hold the [M ▶ VFO] switch until the speaker emits 3 beep tones.
 - Transferred frequency and operating mode appear.

Transferring example in VFO mode

VFO A frequency and operating mode : 21.320 MHz, USB mode
 Memory channel 18 contents : 14.020 MHz, CW mode

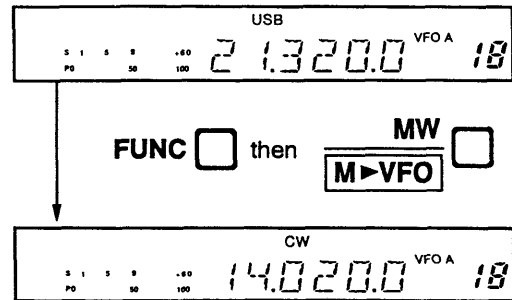

While in MEMORY mode

NOTE: When you change the frequency or operating mode in the selected memory channel:

- **Displayed** frequency and mode are transferred.
- **Programmed** frequency and mode are **NOT** transferred. They remain in the memory channel.

- 1) Push the [FUNC] switch
 - If required, rotate the main dial to select a memory channel number.
- 2) Push and hold the [M ▶ VFO] switch until the speaker emits 3 beep tones.
 - The memory channel contents are transferred to the previously-used VFO.
- 3) To return to VFO mode, push the [FUNC] switch, then push the [V/M] switch.

Transferring example in MEMORY mode

Memory channel 19 contents : 14.028 MHz, CW mode
 Previously used VFO : VFO A

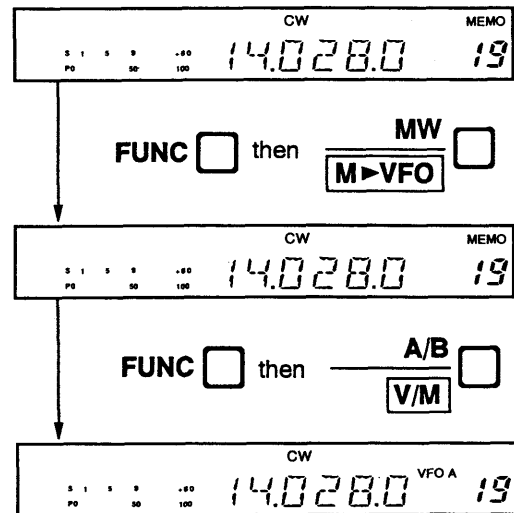

Split memory channels

Memory channels 26 – 30 are split memory channels. Frequencies and operating modes can be programmed for both transmitting and receiving.

These memory channels are especially useful for repeater operation.

Split memory channel selection

Refer to p. 25, select one of memory channels 26 – 30.

While in MEMORY mode:

- “SPLIT” blinks, then disappears if only 1 frequency is programmed in that channel.
- “SPLIT” blinks, then appears continuously if 2 frequencies are programmed in that channel.

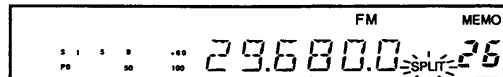

Split memory channel programming

Following is a programming example for memory channel 26.

- Receiving : 29.680 MHz, FM mode
 - Transmitting : 29.580 MHz, FM tone mode*
- *For accessing a repeater which requires a subaudible tone.

- 1) Select 29.680 MHz and FM mode in VFO A.

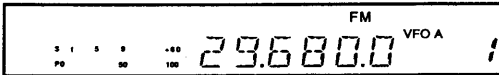

- 2) Select 29.580 MHz and FM tone mode in VFO B.

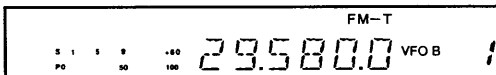

- 3) Push the [FUNC] switch, then rotate the main dial to select memory channel number readout “26.”

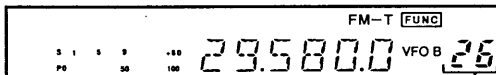

- 4) Push the [FUNC] switch again to cancel “FUNC.”

- 5) Push the [A/B] switch to select VFO A.

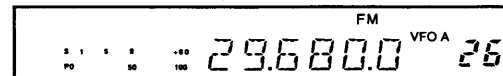

- 6) Push the [SPLIT] switch.

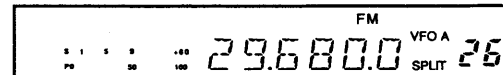

- 7) Push and hold the [MW] switch to program the frequencies into memory channel 26.

- 8) Push the [FUNC] switch, then push the [V/M] switch to select MEMORY mode.

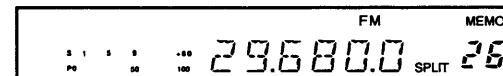

NOTE: An optional UI-9 FM UNIT is required for FM mode operation. Refer to p. 35. For accessing a repeater which requires a subaudible tone, an optional UT-30 PROGRAMMABLE TONE ENCODER UNIT is required. Refer to p. 35.

Split memory channel operation

When one of memory channels 26 – 30 is selected and split frequencies are programmed, split frequency operation is automatically selected.

- 1) Push and hold the [PTT] switch.
 - Transmit frequency appears.

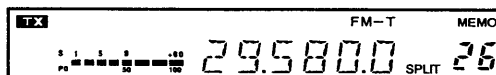

- 2) Release the [PTT] switch to receive.
 - Receive frequency appears.

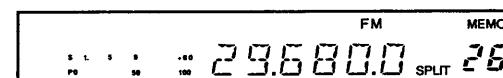

To cancel split frequency operation, push the [SPLIT] switch.

- “SPLIT” disappears.

NOTE: Simplex operation is temporarily selected with the receive frequency in the memory channel. However, split frequencies remain in the memory channel.

5 SCANS

Scan types

2 scan types are available.

Programmed scan

Repeatedly scans all frequencies between 2 specified frequencies in scan edge channels P1 and P2. This is convenient when searching for signals in a specified frequency range.



This scan operates in VFO mode.

Memory scan

Repeatedly scans memory channels 1 – 30 sequentially. This is convenient for searching through often-received frequencies only.

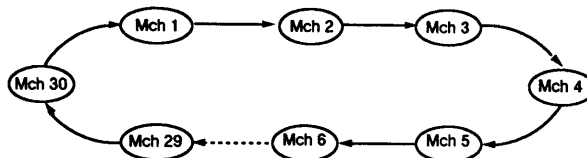

This scan operates in MEMORY mode.

Pre-operation

Memory channel programming

Program memory channels before operating. Refer to pgs. 25, 26 for memory channel programming.

Scan type	Required programming
Programmed scan	Program scan edge frequencies into scan edge channels P1 and P2.
Memory scan	Program desired frequencies into memory channels 1 – 30.

Scan resume setting

When a signal is received and the squelch opens, the scan pauses for 10 sec. According to SET mode setting, the scan is cancelled when a signal is received. Refer to p. 31 "Scan resume."

Squelch condition selection

Scan operation varies according to the [SQL] control setting.

Scan starts	Programmed scan	Memory scan
Squelch open	<ul style="list-style-type: none"> The scan continues until it is cancelled manually. The scan does not pause even when a signal is received. 	<ul style="list-style-type: none"> The scan pauses 10 sec. for each memory channel. If scan resume is OFF in SET mode, the scan does not operate.
Squelch closed	<ul style="list-style-type: none"> When a signal is received and the squelch opens, the scan pauses 10 sec. When a signal disappears while the scan pauses, the scan resumes after 2 sec. 	

Scan operation

- 1) Perform preoperations as described in boxes above.
- 2) Select either VFO mode or MEMORY mode.
 - VFO mode : For programmed scan.
 - MEMORY mode : For memory scan.
- 3) For programmed scan, select 1 kHz tuning step, if required.
 - Refer to p. 16 for details.
- 4) Push [SCAN] to start the scan.

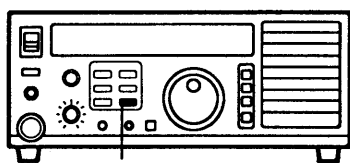

[SCAN] switch

- While in programmed scan

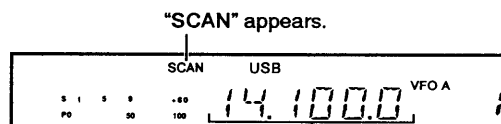

Scans programmed frequency range.

- While in memory scan

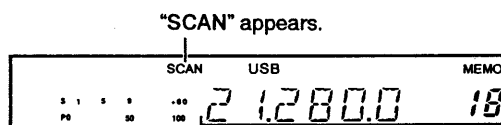

Scans memory channels 1 – 30 sequentially.

- 5) The scan operates as described in the box "Squelch condition selection" above.
- 6) To cancel the scan manually, push the [SCAN] switch or rotate the main dial.

What is SET mode?

SET mode allows you to customize your IC-707. According to your requirements, select the following settings.

NOTE: Each display in the box below shows the initial setting before shipping or after CPU re-setting.

SET mode construction

To select SET mode, while pushing the [LOCK] and [TS] switches, turn the power ON.

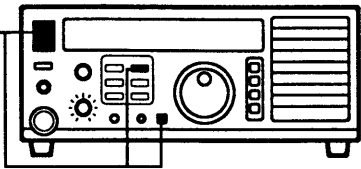

After SET mode settings, to exit SET mode, turn the power OFF.

Selectable operating modes

LSB
ON 1

Beep tone
ON BP 2

Scan resume
ON SR 3

Tuner type
AH-3 4

CI-V address
3EH RD 5

CI-V baud rate
1200/5 6

CI-V transceive
ON TR 7

CI-V data length
OFF 73 8

MODE
Main dial

Main dial

Main dial

AH-3 AT-160
Main dial

Main dial

Main dial

Main dial

Main dial

Select ON or OFF for each mode.
- ON: The mode is selectable.
- OFF: The mode is not selectable.

- ON: The speaker emits beep tones for switch operation.
- OFF: The speaker does not emit beep tones for switch operation.

- ON: The scan pauses for 10 sec. when a signal is received.
- OFF: The scan is cancelled when a signal is received.

- AH-3: For an optional AH-3 HF AUTOMATIC ANTENNA TUNER.
- AT-160: For an optional AT-160 HF AUTOMATIC ANTENNA TUNER.

- 3EH: Icom standard address for the IC-707.
- 01H - 7FH: If required, these addresses are selectable.

- 1200 bps: Icom standard baud rate.
- 300, 4800, 9600 bps: If required, these baud rates are selectable.

- ON: Transceive function is activated.
- OFF: The transceive function is cancelled.

- ON: For transceive operation with the IC-735.
- OFF: For transceive operation with other transceivers.

Selectable modes

If required, selectable mode can be restricted.

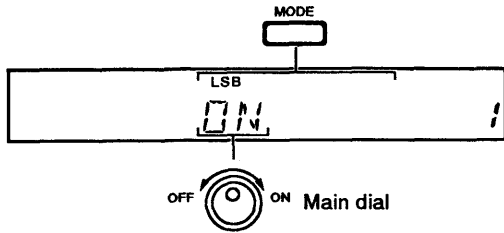

– Initial setting before shipping: all modes ON

Select ON or OFF for each mode:

- ON: The mode is selectable.
- OFF: The mode is not selectable.

You can inhibit not-used modes. This is convenient for example:

- When an optional UI-9 FM UNIT is not installed, turn FM mode and FM tone mode OFF.
- When an optional FL-52A or FL-53A CW NARROW FILTER is not installed, turn CW narrow mode OFF.

This setting does not affect modes for memory channels. A mode in each channel can be used.

Beep tone

For switch operation, the speaker emits beep tones. If required, beep tones can be turned OFF.

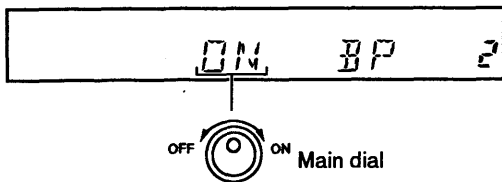

– Initial setting before shipping: ON

Select ON or OFF:

- ON: The speaker emits beep tones for switch operation.
- OFF: The speaker does not emit beep tones for switch operation.

Scan resume

According to requirements, scan resume condition can be selected.

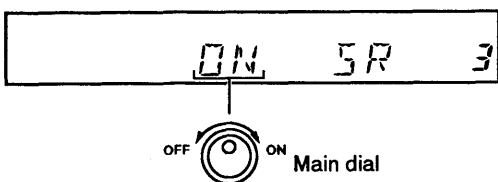

– Initial setting before shipping: ON

Select ON or OFF:

- ON: When a signal is received and the squelch opens, the scan pauses 10 sec. When a signal disappears while the scan pauses, the scan resumes after 2 sec.
- OFF: The scan is cancelled when a signal is received and the squelch opens.

Tuner type

According to an optional HF antenna tuner, select a tuner type.

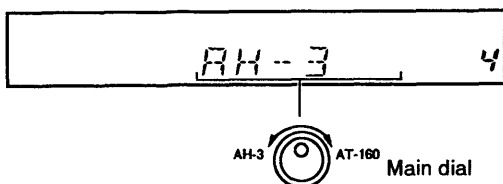

– Initial setting before shipping: AH-3

Select AH-3 or AT-160:

- AH-3: For an optional AH-3 HF AUTOMATIC ANTENNA TUNER.
- AT-160: For an optional AT-160 HF AUTOMATIC ANTENNA TUNER.

■ CI-V address

The IC-707 has Icom standard address 3EH for CI-V System. If required select a different address.

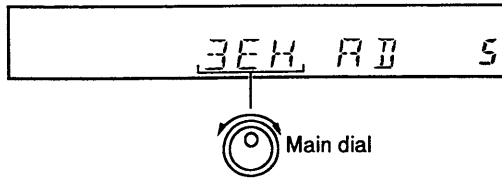

- Initial setting before shipping: 3EH
- Selectable address range: 01H - 7FH

Up to 4 CI-V transceivers can be connected to an optional CT-17 CI-V LEVEL CONVERTER. To distinguish equipment, each CI-V transceiver has its own address in hexadecimal code.

- When a IC-707 is connected, select Icom standard address 3EH.
- When 2 or more IC-707's are connected, select a different address for each IC-707.

■ CI-V baud rate

Icom standard baud rate for CI-V System is 1200 bps. If required, select a different baud rate.

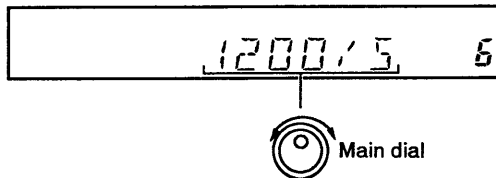

- Initial setting before shipping: 1200 bps
- Selectable baud rate: 300, 1200, 4800 or 9600 bps

Baud rate is the data transfer rate. Each transceiver's and computer's baud rate **MUST** be equal.

■ CI-V transceive

Transceive operation is possible with other CI-V transceivers. If not required, this function can be cancelled.

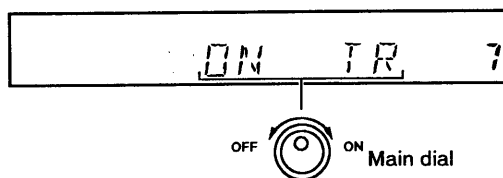

- Initial setting before shipping: ON

When another CI-V transceiver is connected via the [REMOTE] jack, operating frequency and mode are automatically transferred between each other. This is called the transceive function.

Select ON or OFF:

- ON: The transceive function is activated.
- OFF: The transceive function is cancelled.

■ CI-V data length

Only when transceive operation is required with the IC-735, turn this setting ON. For other cases, turn this setting OFF.

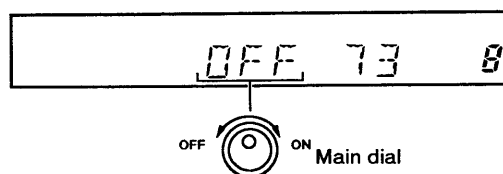

- Initial setting before shipping: OFF

Select ON or OFF:

- ON: For transceive operation with the IC-735.
- OFF: For transceive operation with other transceivers.

Disassembly

For internal maintenance and optional installation, disassemble the transceiver according to the following procedures.

CAUTION: DISCONNECT the DC power cable from the transceiver before performing any internal work.

Removing top and bottom covers

Unscrew 12 screws. (Fig.1)

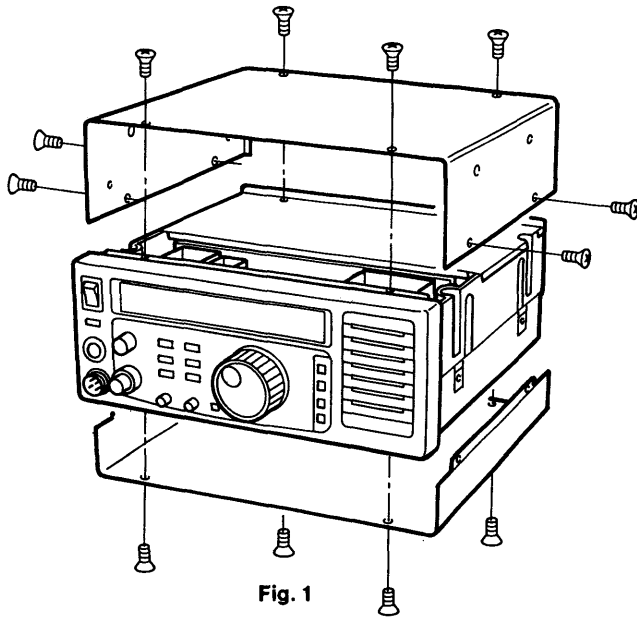

Removing PA unit cover

Unscrew 11 screws. (Fig. 2)

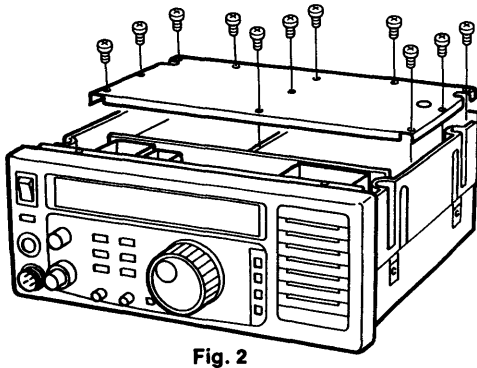

Removing the front panel

Unscrew 4 screws. (Fig. 3)

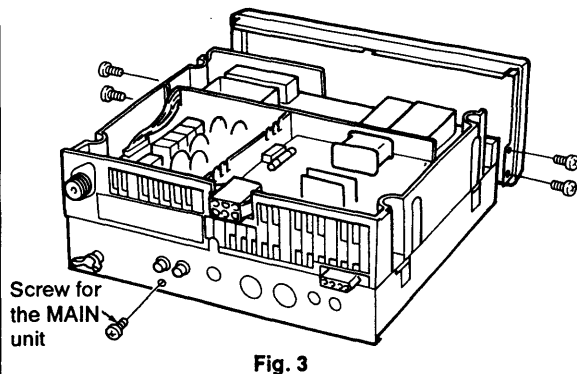

Removing the MAIN unit

Disconnect coaxial cables from J1, J2, J3. Pull out J3 cable from the cooling fan. Disconnect flat cables from J9, J10. Unscrew 8 screws. (Fig. 4) Unscrew 1 screw from the rear panel. (Fig. 3)

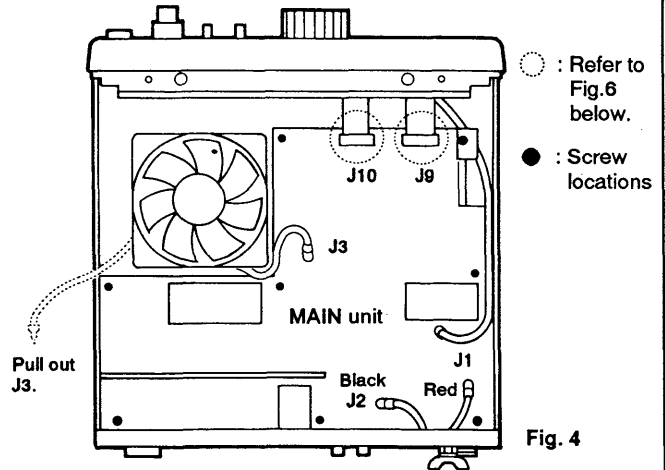

Removing the PLL unit

Disconnect the coaxial cable from J4. Unplug the flat cable from J3. Unscrew 5 screws. (Fig. 5)

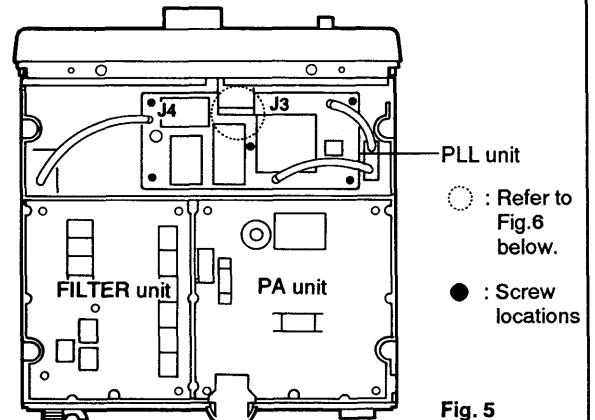

Removing flat cables

Remove flat cables J9, J10 on the MAIN unit and J3 on the PLL unit. (Fig. 6)

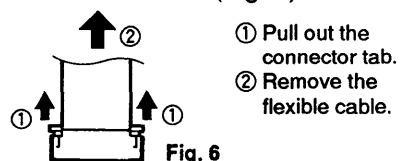

Level presets

Basic beep tone level, basic CW side tone level and CW break-in delay time can be changed.

1) Remove the top and bottom covers.

2) Adjust the following points.

3) Replace the top and bottom covers.

R180: Basic beep tone level adjustment

Beep tone output level for switch operation varies according to the [AF] control. R180 adjusts basic beep tone output level.

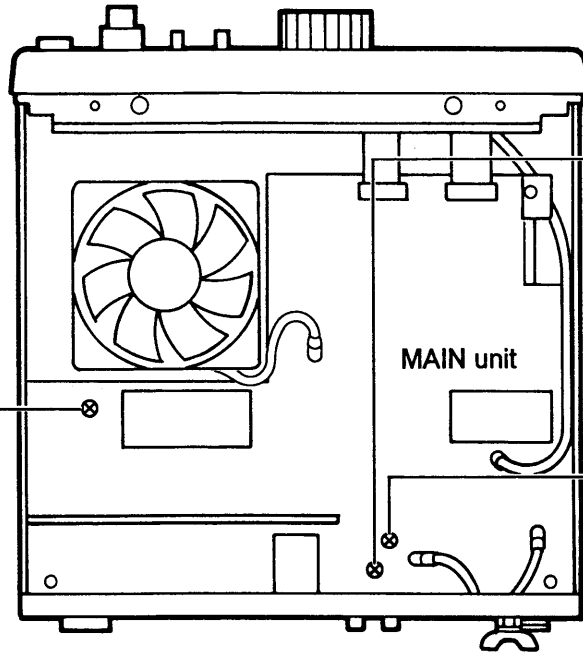

R336: CW break-in delay time adjustment

R336 adjusts delay time according to keying speed or operator's preference.

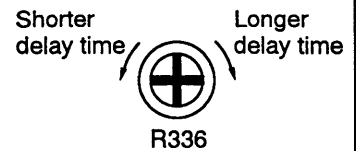

R325: Basic CW side tone level adjustment

CW side tone output level varies according to the [AF] control. R325 adjusts the basic CW side tone output level.



DC power cable fuse replacement

If a fuse in the DC power cable blows, check for the cause, then replace the blown fuse with a new one.

- DC power cable fuses: FGB 20 A

If the power does not come ON even after fuse replacement, the PA unit fuse may have blown. Refer to the box below for details.

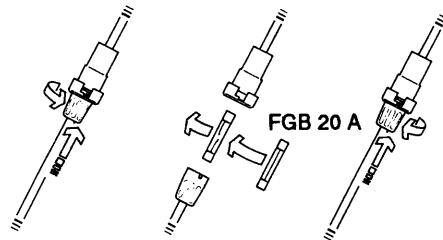

PA unit fuse replacement

The PA unit fuse protects circuits except for the PA unit. If the PA unit fuse blows, check for the cause, remove the top cover and PA unit cover, then replace the blown fuse with a new one.

- PA unit fuse: FGB 4 A

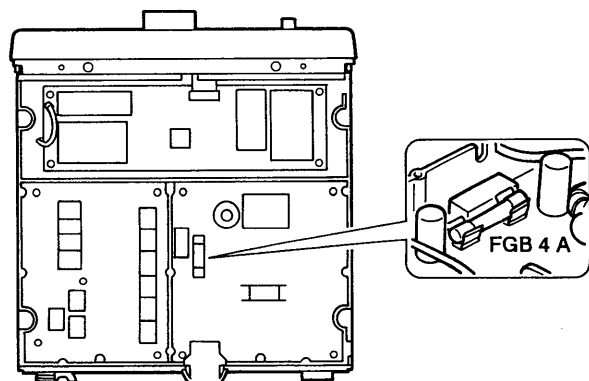

8 OPTIONS INSTALLATION

■ UI-9 FM UNIT

The UI-9 provides FM mode capabilities for the IC-707. The UI-9 also allows you to access a repeater. Refer to p. 22 for repeater operation.

To access a repeater that requires a subaudible tone, refer to the box below.

NOTE: Connectors on the UI-9 must be connected to corresponding pins on the MAIN unit.

1) Refer to p. 33, remove the bottom cover.

2) Attach the UI-9 on the MAIN unit.

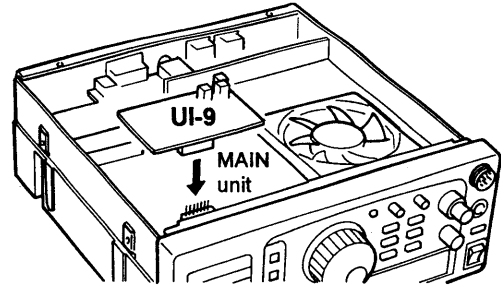

3) Replace the bottom cover.

■ UT-30 PROGRAMMABLE TONE ENCODER UNIT

By connecting the UT-30 to the UI-9, you can access a repeater that requires a subaudible tone. Refer to p. 22 for repeater operation.

1) Refer to the UT-30 instruction sheet to program a subaudible tone frequency.

2) Disconnect the UI-9 from the MAIN unit.

3) Remove the protective paper from the back of the UT-30 to expose the adhesive strip.

4) Attach the UT-30 in the location marked on the UI-9.

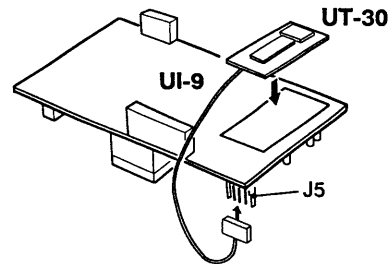

5) Connect a 3-pin plug from the UT-30 to J5 on the UI-9.

6) Re-attach the UI-9 to the MAIN unit, then replace the bottom cover.

■ FL-52A or FL-53A CW NARROW FILTER

The FL-52A and FL-53A CW NARROW FILTERS provide CW narrow mode receiving. Refer to p. 20 for specifications.

1) Refer to p. 33, remove the bottom cover and the MAIN unit.

2) Install either the FL-52A or FL-53A in the MAIN unit.

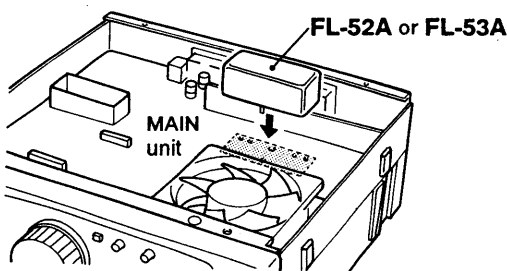

3) Tighten hex nuts and spring washers at the foil side.

4) Solder the leads of the filter at the foil side.

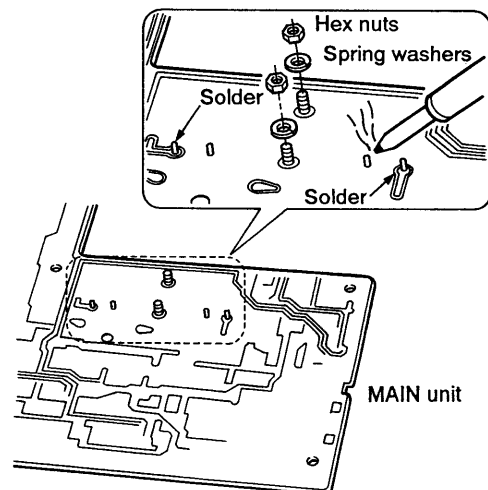

5) Replace the MAIN unit and the bottom cover.

■ CR-338 HIGH-STABILITY CRYSTAL UNIT

The CR-338 improves the total frequency stability.

- Frequency stability : ± 0.5 ppm (−10°C to +60°C;
+14°F to +140°F)

- 1) Refer to p. 33, remove the top cover and the PLL unit.
- 2) Unsolder and remove the original crystal from the PLL unit.
 - Use a de-soldering braid.

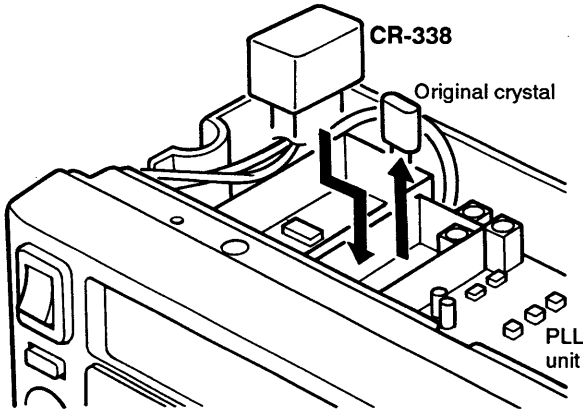

- 3) Unsolder the 4 positions on the PLL unit where the CR-338 is installed.
 - Use a de-soldering braid.
- 4) Install the CR-338 in the PLL unit.
 - Symbols on the bottom of the CR-338 MUST be identically matched with symbols on the PLL unit.
- 5) Bend the leads of the CR-338 at the foil side of the PLL unit and solder them.
- 6) Trim the leads even with the solder points.
- 7) Refer to the box below, adjust the PLL reference frequency.
- 8) Replace the PLL unit and the top cover.

■ PLL reference frequency adjustment

After optional CR-338 installation, PLL reference frequency adjustment is required.

Adjust oscillation frequency 5 min. after power ON.

Connect a frequency counter and adjust oscillation frequency.

- Adjustments points : ① C16 on the PLL unit
② L4 on the PLL unit
Repeat steps ① and ②.
- Measurement point : J3 on the MAIN unit
- Oscillation frequency : 64.000 MHz

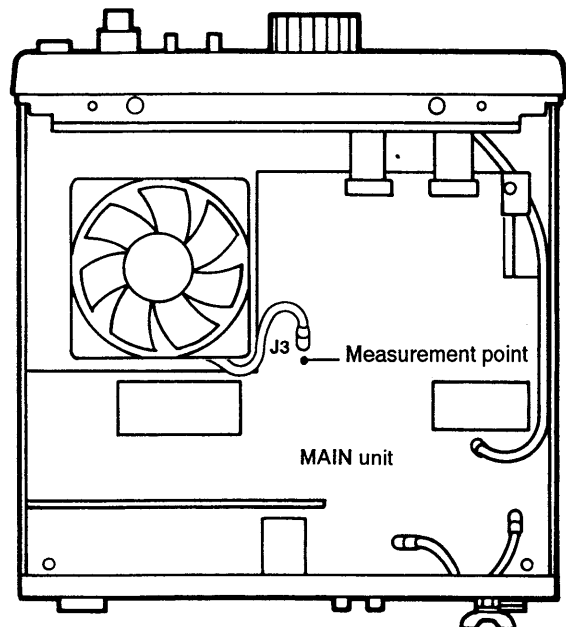
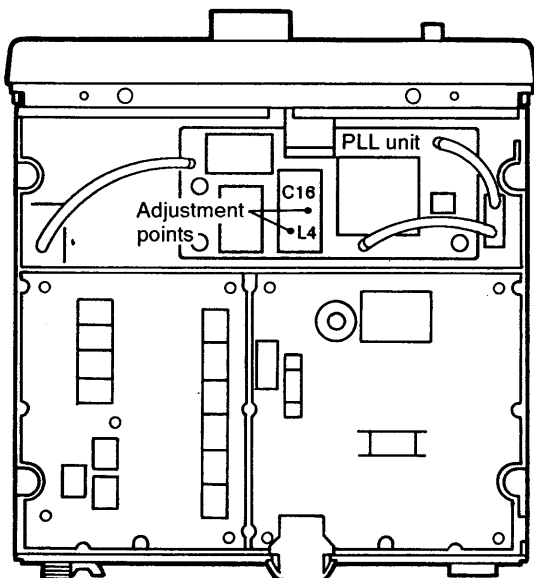

■ Troubleshooting chart

The following chart is designed to help you correct problems which are not equipment malfunctions.

If you cannot solve a problem, contact your nearest Icom Dealer or Service Center.

Problem	Possible cause	Solution	Ref.
Power does not come ON.	• The DC power cable is improperly connected.	• Reconnect the power cable correctly.	p. 9
	• A fuse in the DC power cable or in the PA unit is blown.	• Check for the cause, then replace the blown fuse with a new one.	p. 34
	• For mobile operation, vehicle's battery is exhausted.	• Charge the vehicle's battery.	—
Operating frequency or memory channel cannot be changed.	• The dial lock function is activated.	• Push the [LOCK] switch to cancel the dial lock function.	p. 15
An operating mode cannot be selected.	• The operating mode is set to non-selectable condition in SET mode.	• In SET mode, set the operating mode to the selectable condition.	p. 31
No sound comes from the speaker.	• Volume level is too low.	• Rotate the [AF] control clockwise to obtain a suitable listening level.	p. 17
	• The squelch is closed.	• Rotate the [SQL] control counter-clockwise to open the squelch.	p. 18
	• An external speaker or headphones are connected.	• Disconnect the external speaker or headphone plug.	—
	• CW narrow mode is selected without an optional FL-52A or FL-53A CW NARROW FILTER.	• Install the FL-52A or FL-53A, if required.	p. 35
	• FM mode is selected without an optional UI-9 FM UNIT.	• Install the UI-9, if required.	p. 35
Sensitivity is low.	• The antenna is not connected properly.	• Reconnect the antenna connector.	p. 7
	• The coaxial cable is cut or shorted.	• Check the coaxial cable and correct any improper conditions.	—
	• An antenna not suitable for the operating frequency is connected.	• Connect an antenna suitable for the operating frequency.	—
	• An antenna is not properly tuned when using an optional AH-3 HF AUTOMATIC ANTENNA TUNER.	• Push and hold the [TUNE] switch until "TUNE" blinks to re-tune the antenna.	p. 23
	• The attenuator is activated.	• Push the [PREAMP/ATT] switch 1 time to cancel the attenuator.	p. 18
	• The preamp is cancelled.	• Push the [PREAMP/ATT] switch 1 time to activate the preamplifier, if required.	p. 18
Receive signal is distorted with strong signals.	• The noise blanker is ON.	• Push the [NB] switch to cancel the noise blanker.	p. 18
	• The preamp is ON.	• Push the [PREAMP/ATT] switch 2 times to cancel the preamp.	p. 18
Bass or treble of receive audio is too strong.	• Receive signal is off frequency.	• Push the [RIT] switch and rotate the [RIT] control to obtain clear audio.	p. 18

Transmitting is impossible.	<ul style="list-style-type: none"> • FM mode is selected without an optional UI-9 FM UNIT. • The operating frequency is not selected to a ham band. 	<ul style="list-style-type: none"> • Install the UI-9, if required. • Select the frequency to a ham band. 	<p>p. 35</p> <p>pgs. 15, 16</p>
Output power is too low.	<ul style="list-style-type: none"> • The [RF PWR] control is rotated too far counterclockwise. • The [MIC] control is rotated too far counterclockwise. • The antenna is not connected properly. • The coaxial cable is cut or shorted. • An antenna for another band is connected. • The antenna is not properly tuned when using an optional AH-3 HF AUTOMATIC ANTENNA TUNER. 	<ul style="list-style-type: none"> • Rotate the [RF PWR] control clockwise. • Rotate the [MIC] control to the 10 – 12 o'clock position. • Reconnect the antenna connector. • Check the coaxial cable and correct any improper conditions. • Connect an antenna suitable for the operating frequency. • Push the [TUNER] switch to re-tune the antenna. 	<p>p. 19</p> <p>p. 19</p> <p>p. 7</p> <p>—</p> <p>—</p> <p>p. 23</p>
No contact is possible with another station.	<ul style="list-style-type: none"> • The RIT function is activated. • The split function is activated. 	<ul style="list-style-type: none"> • Push the [RIT] switch to cancel the function. • Push the [SPLIT] switch to cancel the function. 	<p>p. 18</p> <p>p. 22</p>
Repeater cannot be accessed.	<ul style="list-style-type: none"> • The split function is not activated. • Incorrect transmit/receive frequencies are selected. 	<ul style="list-style-type: none"> • Push the [SPLIT] switch to activate the function. • Select the correct frequencies into VFO A and B, or into split memory channels 26 – 30. 	<p>p. 22</p> <p>pgs. 22, 28</p>
Repeater which requires a subaudible tone cannot be accessed.	<ul style="list-style-type: none"> • An optional UT-30 PROGRAMMABLE TONE ENCODER UNIT is not installed. • FM tone mode is not selected. • An incorrect subaudible tone frequency is selected. 	<ul style="list-style-type: none"> • Install an optional UT-30 on to an optional UI-9 FM UNIT. • Select FM tone mode. • Refer to the UT-30 instruction sheet, program a correct subaudible tone frequency. 	<p>p. 35</p> <p>p. 17</p> <p>p. 35</p>
Transmitted signals are distorted.	<ul style="list-style-type: none"> • The [MIC] control is rotated too far clockwise. 	<ul style="list-style-type: none"> • Rotate the [MIC] control to the 10 – 12 o'clock position. 	<p>p. 19</p>

■ CPU backup battery

The IC-707 has a lithium backup battery for retaining memory channel information, etc. When this battery is exhausted, the transceiver transmits and receives normally, but memory channels, etc. are erased. The usual life of the battery is more than 5 years.



■ CPU resetting

CAUTION: Resetting the CPU will clear and initialize VFO A, VFO B, all memory channels and SET mode settings.

If the internal CPU malfunctions, while pushing the [MW] switch and [LOCK] switch, turn the power ON to reset.

MAIN unit and VR board

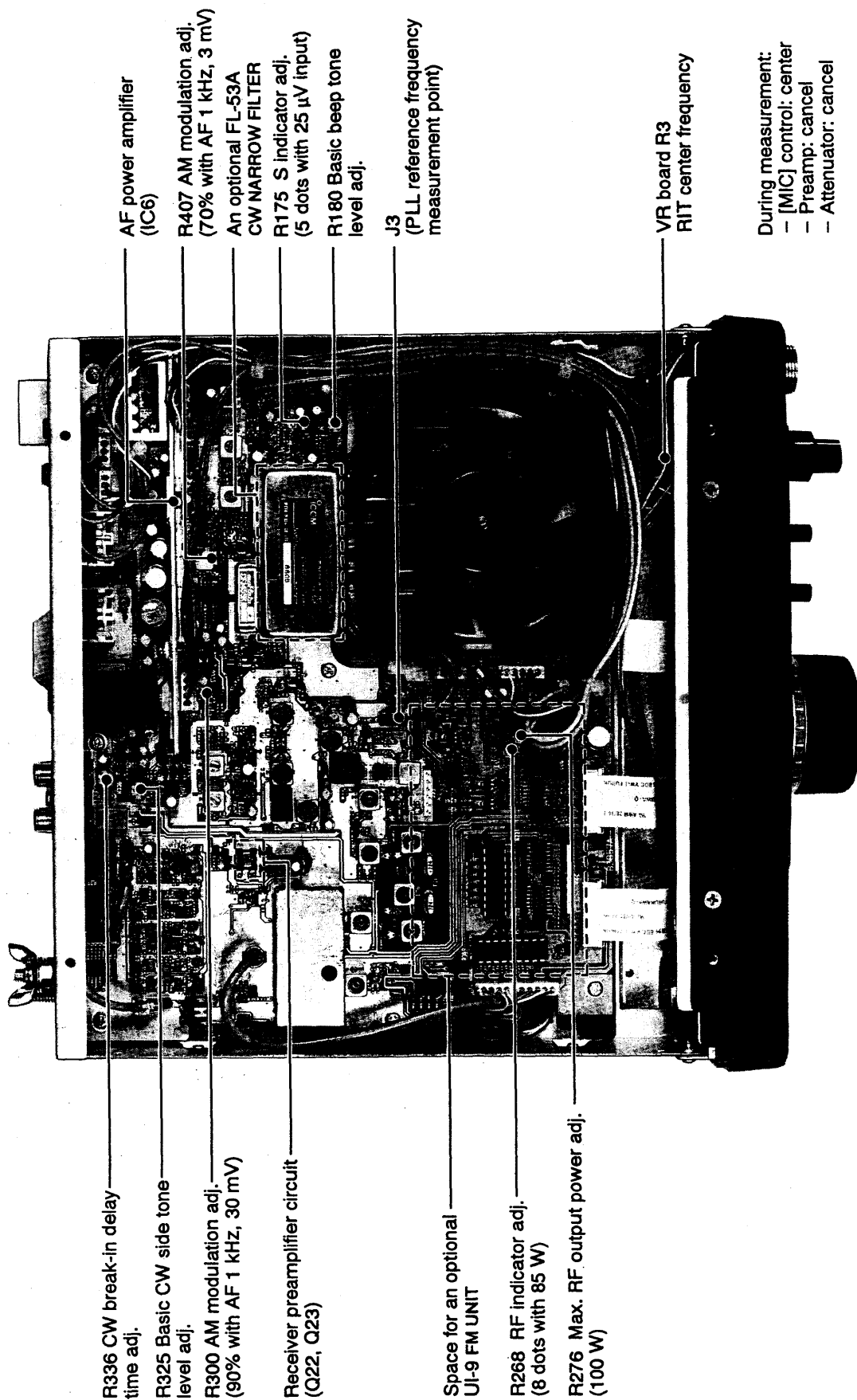

R336 CW break-in delay time adj.

R325 Basic CW side tone level adj.

R300 AM modulation adj. (90% with AF 1 kHz, 30 mV)

Receiver preamplifier circuit (Q22, Q23)

Space for an optional UJ-9 FM UNIT

R268 RF indicator adj. (8 dots with 85 W)

R276 Max. RF output power adj. (100 W)

AF power amplifier (IC6)

R407 AM modulation adj. (70% with AF 1 kHz, 3 mV)

An optional FL-53A CW NARROW FILTER

R175 S indicator adj. (5 dots with 25 μ V input)

R180 Basic beep tone level adj.

J3 (PLL reference frequency measurement point)

VR board R3 RIT center frequency

During measurement:
 - [MIC] control: center
 - Preamp: cancel
 - Attenuator: cancel

■ PA, FILTER and PLL units

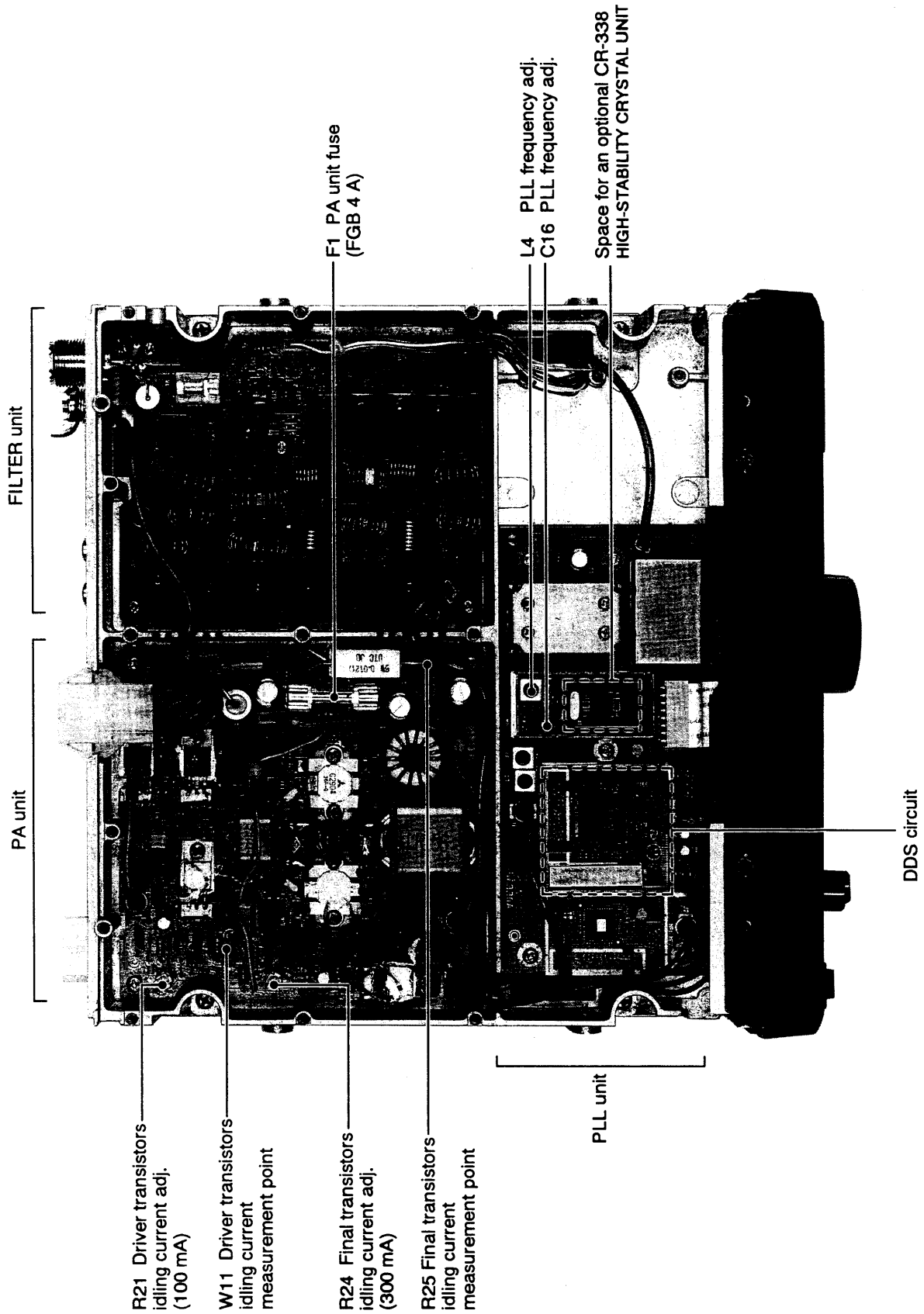

■ General

- Frequency coverage : Transmit*
 - 1.8000 – 1.9999 MHz
 - 3.5000 – 3.9999 MHz
 - 7.0000 – 7.3000 MHz
 - 10.1000 – 10.1500 MHz
 - 14.0000 – 14.3500 MHz
 - 18.0680 – 18.1680 MHz
 - 21.0000 – 21.4500 MHz
 - 24.8900 – 24.9900 MHz
 - 28.0000 – 29.7000 MHz

*Permitted frequency range varies according to country and your class.
- Receive
 - 500 kHz – 30 MHz
- Mode : SSB (USB/LSB), CW, AM, FM*
*An optional UI-9 FM UNIT is required.
- Number of memory channels : Normal channels 25
Split channels 5
Scan edge channels 2
- Antenna impedance : 50 Ω nominal
- Usable temperature : -10°C to +60°C; +14°F to +140°F
- Frequency stability : Less than ±200 Hz
(from 1 min. to 60 min. after power ON, at +25°C; +77°F)
Less than ±30 Hz/hr.
(from 60 min. after power ON, at +25°C; +77°F)
Less than ±350 Hz
(at temperature fluctuations 0°C to +50°C; +32°F to +122°F)
- Power supply requirement : 13.8 V DC ± 15%
- Current drain (at 13.8 V DC) : Transmit 20 A
Receive squelched 1.3 A
max. audio output 2.1 A
- Dimensions : 240(W) × 95(H) × 239(D) mm
9.4(W) × 3.7(H) × 9.4(D) in
(projections not included)
- Weight : 4.1 kg; 9.0 lb

■ Transmitter

- Output power : SSB, CW, FM 5 – 100 W
AM 5 – 25 W
- Modulation system : SSB Balanced modulation
AM Low power modulation
FM Variable reactance frequency modulation
- Spurious emissions : 50 dB below peak output power
- Carrier suppression : More than 40 dB
- Unwanted sideband : More than 50 dB
- Microphone impedance : 600 Ω

■ Receiver

- Sensitivity (preamp ON) : 0.5 – 1.8 MHz AM
Less than 13 μV for 10 dB S/N
1.8 – 30 MHz SSB, CW
Less than 0.16 μV for 10 dB S/N
1.8 – 30 MHz AM
Less than 2.0 μV for 10 dB S/N
28 – 29.7 MHz FM
Less than 0.5 μV for 12 dB SINAD
- Squelch sensitivity (preamp OFF) : SSB, CW Less than 5.6 μV
FM Less than 1.0 μV
- Selectivity : SSB, CW
More than 2.1 kHz/–6 dB
Less than 4.0 kHz/–60 dB
AM
More than 6.0 kHz/–6 dB
Less than 20.0 kHz/–40 dB
FM
More than 12 kHz/–6 dB
Less than 30 kHz/–50 dB
- Spurious and image rejection ratio : More than 70 dB
- Audio output power : More than 2.6 W with an 8 Ω load
- RIT variable range : ±1.2 kHz

IC-4KL 1 kW HF LINEAR AMPLIFIER

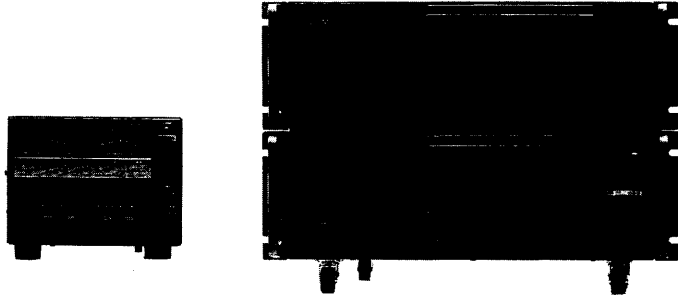

All solid-state full-duty 1 kW linear amplifier. The IC-4KL is fully controlled from the IC-707. No need to tune and no need to switch the operating band. The amplifier/power supply unit and the remote control unit are separated.

IC-2KL 500 W HF LINEAR AMPLIFIER

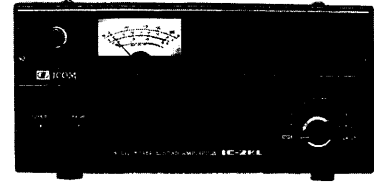

All solid-state 500 W linear amplifier. The power amplifier unit can be separately set-up from the power supply unit.

IC-AT500 HF AUTOMATIC ANTENNA TUNER

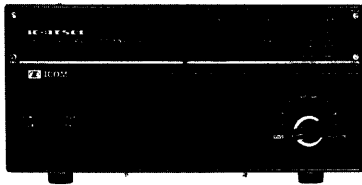

Best match for the IC-707 with the IC-2KL. Includes an automatic antenna selector for 4 separate antennas.

- Input power rating : 500 W

AT-160 HF AUTOMATIC ANTENNA TUNER

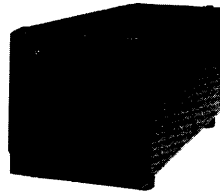

Can be attached to the IC-707 side panel. Power and tuning operation is automatically controlled through the IC-707.

- Input power rating : 150 W

AT-150 HF AUTOMATIC ANTENNA TUNER

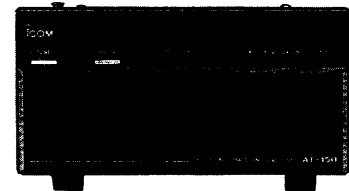

Style and size are matched with the IC-707. Includes an automatic antenna selector for 3 separate antennas, moreover, a long-wire antenna can be tuned.

- Input power rating : 150 W

AH-3 HF AUTOMATIC ANTENNA TUNER

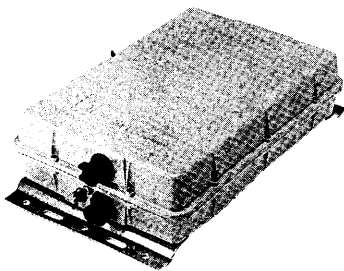

Automatically matches the IC-707 to a long-wire antenna. Convenient for portable or mobile operation.

- Input power rating : 150 W

AH-2b ANTENNA ELEMENT



A 2.5 m long mobile antenna can be used with the AH-3. Includes a sturdy tow hook mount system and all required hardware. For operation above 3.5 MHz.

EX-627 AUTOMATIC ANTENNA SELECTOR

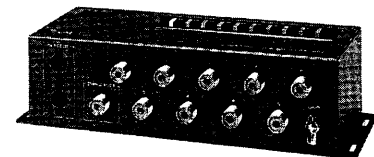

Automatically selects the antenna for the selected ham band. Manual selection is also possible.

- Max. input power : 1000 W PEP

IC-PS15 DC POWER SUPPLY

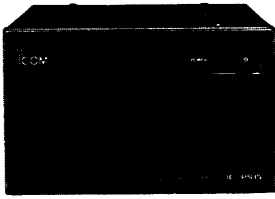

Heavy-duty power supply.

- Output voltage : 13.8 V DC
- Max. current drain: 20 A

IC-PS30 DC POWER SUPPLY

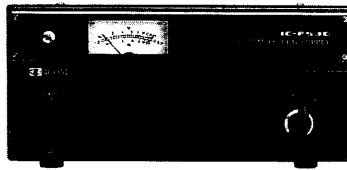

Lightweight power supply. Equipped with a 6-pin DC power cable and 3 extra output connectors.

- Output voltage : 13.8 V DC
- Max. current drain: 25 A

PS-55 DC POWER SUPPLY



Heavy-duty power supply. Built-in cooling fan for full-duty operation. The size is matched with the IC-707.

- Output voltage : 13.8 V DC
- Max. current drain: 20 A

SP-7 EXTERNAL SPEAKER

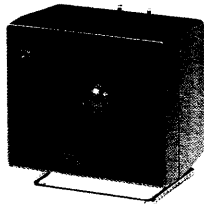

Designed for base station operation. Style and size are matched with the IC-707. Height can be adjusted for your convenience.

- Input impedance : 8 Ω
- Max. input power : 5 W

SP-20 EXTERNAL SPEAKER

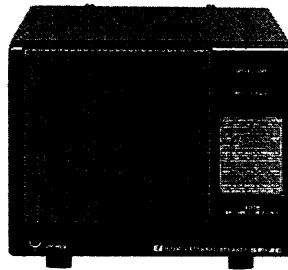

Designed for base station operation. Equipped with 4 types of audio filters, a headphone jack and can be connected to 2 transceivers.

- Input impedance : 8 Ω
- Max. input power : 5 W

SP-21 EXTERNAL SPEAKER

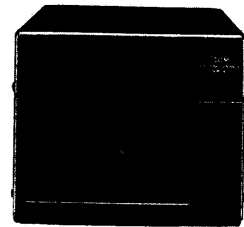

External speaker designed for base station operation.

- Input impedance : 8 Ω
- Max. input power : 5 W

SM-6 DESKTOP MICROPHONE

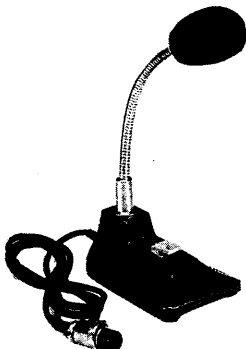

Easy-to-use desktop microphone for base station operation. Electret condenser type.

SM-8 DESKTOP MICROPHONE

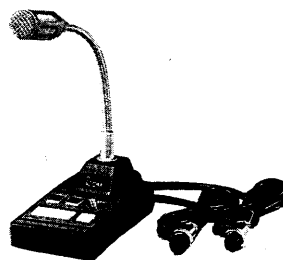

Can be connected to 2 Icom transceivers. Includes [UP]/[DOWN] switches. Electret condenser-type.

SM-20 DESKTOP MICROPHONE



High-quality microphone with a heavy duty base. Includes [UP]/[DOWN] and low frequency cut switches. Electret condenser-type.

CT-16 SATELLITE INTERFACE UNIT

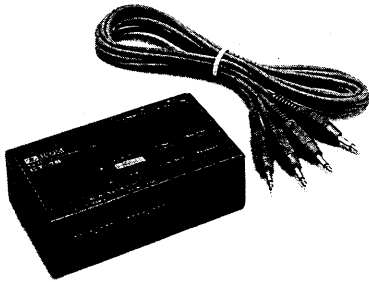

Easy tuning for instant satellite communications.

CT-17 CI-V LEVEL CONVERTER

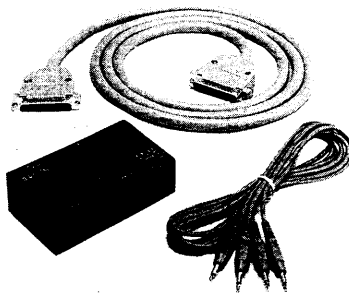

For remote transceiver control using a personal computer equipped with an RS-232C port. You can change frequencies, mode, memory channels, etc. via your computer.

CR-338 HIGH-STABILITY CRYSTAL UNIT

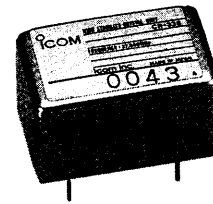

For improved frequency stability. Contains a temperature-compensating oven heater.
 • Frequency stability : ± 0.5 ppm
 (-10°C to $+60^{\circ}\text{C}$; $+14^{\circ}\text{F}$ to $+140^{\circ}\text{F}$)

FL-52A, FL-53A CW NARROW FILTERS

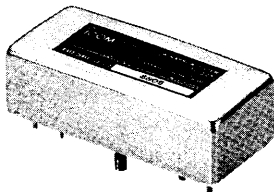

Have good shape factors and provide you with better CW receiving during crowded band conditions.
 Passband width:
 • FL-52A: 500 Hz/ -6 dB
 • FL-53A: 250 Hz/ -6 dB

UI-9 FM UNIT

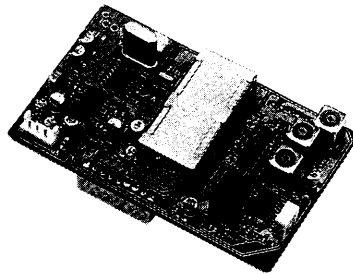

Provides FM mode capability for the IC-707.

UT-30 PROGRAMMABLE TONE ENCODER UNIT

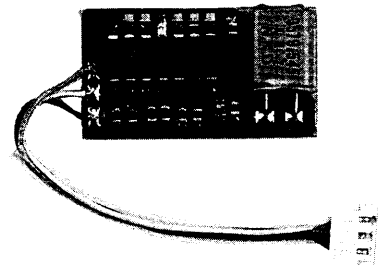

Allows you to access a repeater that require a subaudible tone. Provides 38 programmable subaudible tones.

IC-MB5 MOBILE MOUNTING BRACKET

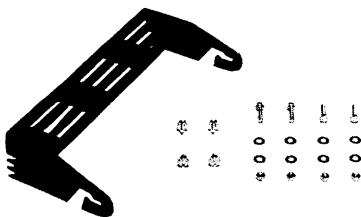

Transceiver bracket for mobile operation.

MB-23 CARRYING HANDLE

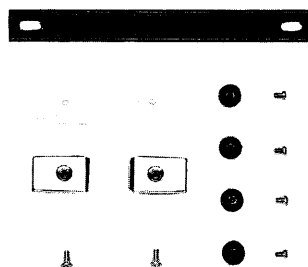

Carrying handle for easy portable operation. For MB-23 use, some screws are supplied with the IC-707.

HM-36 HAND MICROPHONE

Same type as supplied with the IC-707.

OPC-025A DC POWER CABLE

Same type as supplied with the IC-707.

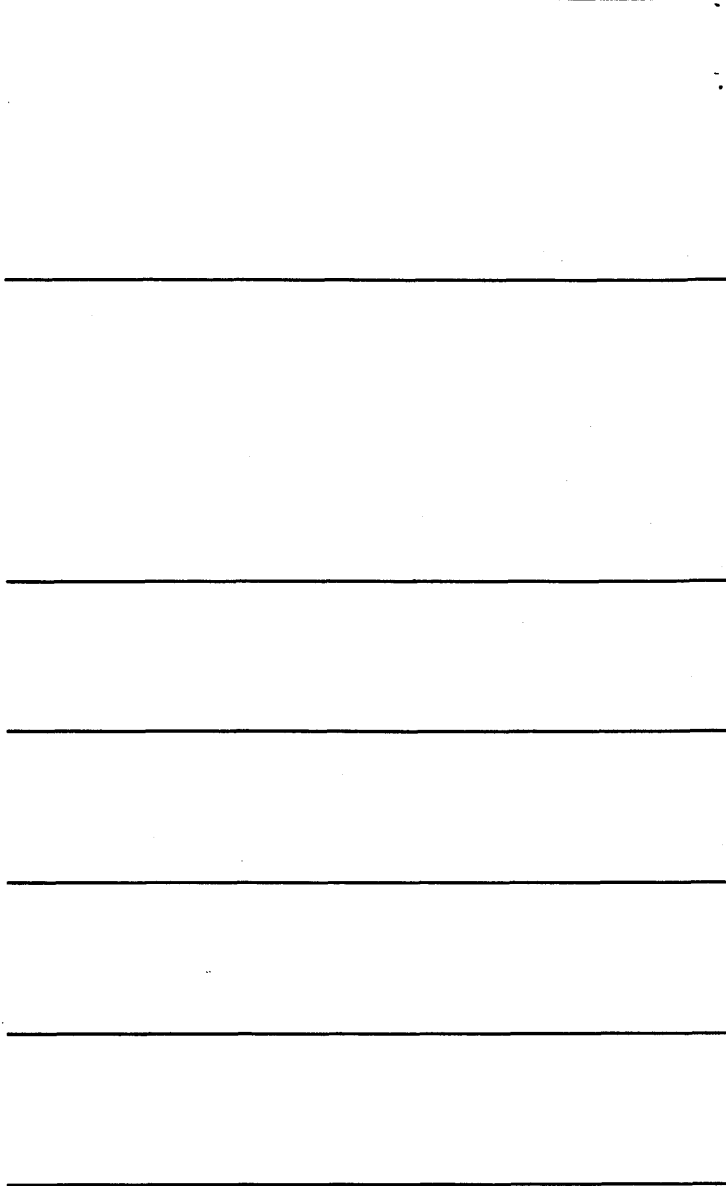

Downloaded by
RadioAmateur.EU