

ICOM

INSTRUCTION MANUAL

HF TRANSCEIVER

**IC-775DSP**  
**IC-775**

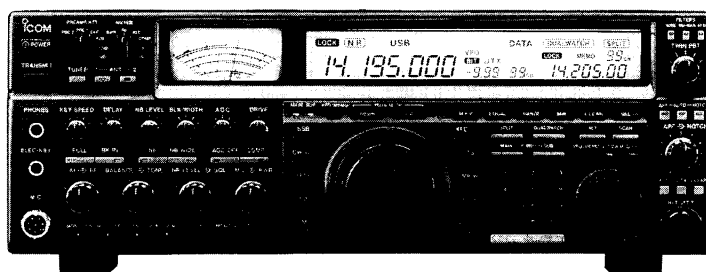

Downloaded by   
Amateur Radio Directory   
  
[www.hamdirectory.info](http://www.hamdirectory.info)

Icom Inc.

## IMPORTANT

**READ THIS INSTRUCTION MANUAL CAREFULLY** before attempting to operate the transceiver.

**SAVE THIS INSTRUCTION MANUAL** — This instruction manual contains important safety and operating instructions for the IC-775DSP and IC-775.

## EXPLICIT DEFINITIONS

WORD	DEFINITION
<b>⚠ WARNING</b>	Personal injury, fire hazard or electric shock may occur.
<b>⚠ CAUTION</b>	Equipment damage may occur.
<b>NOTE</b>	If disregarded, inconvenience only. No risk of personal injury, fire or electric shock.
<b>DSP</b>	The function requires the DSP unit. Utilized with the IC-775DSP and IC-775 with an optional UI-100 DSP UNIT. This manual uses "DSP-equipped type" for these transceivers.

## PRECAUTIONS

**⚠ NEVER** apply AC voltage that exceeds the suggested voltage for each version. This could cause a fire or ruin the transceiver.

**⚠ NEVER** use non-rated fuses. Non-rated fuses could cause a fire or ruin the transceiver.

**⚠ NEVER** let metal, wire or other objects touch any internal components.

**⚠ NEVER** expose the transceiver to rain, snow or any liquids.

**NEVER** allow children to touch the transceiver.

**⚠ CAUTION!** The socket-outlet must be near the transceiver and must be easily accessible.

**⚠ ACHTUNG!** Die Steckdose muß nahe bei diesem Gerät angebracht und zugänglich sein.

**AVOID** using or placing the transceiver in areas with temperatures below  $-10^{\circ}\text{C}$  ( $+14^{\circ}\text{F}$ ) or above  $+60^{\circ}\text{C}$  ( $+140^{\circ}\text{F}$ ).

**AVOID** placing the transceiver in excessively dusty environments or in direct sunlight.

**AVOID** placing the transceiver against walls or putting anything on top of the transceiver. This will obstruct heat dissipation.

In maritime mobile operation, keep the transceiver and microphone as far away as possible from the magnetic navigation compass to prevent erroneous indications.

**BE CAREFUL!** The heatsink will become hot when operating the transceiver continuously for long periods.

## UNPACKING

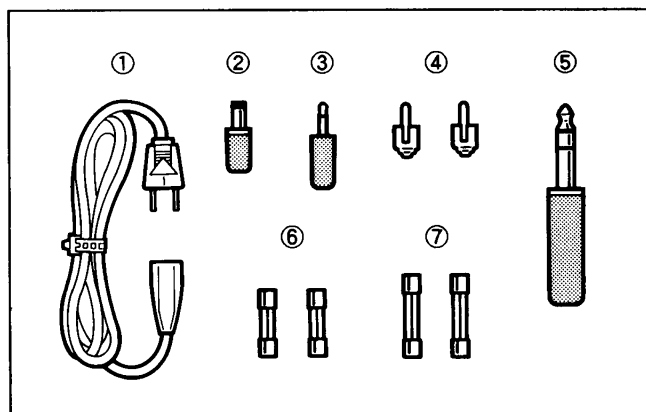

Accessories included with the transceiver:	Qty.
① AC power cable .....	1
② Mini DC power plug (for [DC OUT]) .....	1
③ External speaker plug (for [EXT SP]) .....	1
④ Pin plugs (RCA plugs) .....	2
⑤ CW keyer plug .....	1
⑥ Spare fuses (AC line)* <sup>1</sup> .....	2
⑦ Spare fuses (13.8 V DC line)* <sup>2</sup> .....	2

\*<sup>1</sup> 12 A FGMB fuse for 100 – 120 V versions

5 A high breaking capacity fuse for 220 – 240 V versions

\*<sup>2</sup> 2 A FGB fuse for 100 – 120 V versions

2 A high breaking capacity fuse for 220 – 240 V versions

---

# TABLE OF CONTENTS

---

IMPORTANT .....	i	■ Speech compressor .....	36
EXPLICIT DEFINITIONS .....	i	■ SWR reading .....	36
PRECAUTIONS .....	i	■ Electronic CW keyer .....	37
UNPACKING .....	i	■ Memory keyer .....	37
TABLE OF CONTENTS .....	ii	■ Repeater operation .....	38
<b>1 PANEL DESCRIPTION .....</b>	<b>1 – 13</b>	■ Antenna tuner operation .....	39
■ Front panel .....	1	■ Band memory	
■ Function display .....	10	(for automatic antenna selection) .....	40
■ Rear panel .....	11	■ Dial lock function .....	40
■ Microphone (optional HM-36) .....	13	<b>5 SET MODE .....</b>	<b>41 – 48</b>
<b>2 INSTALLATION AND CONNECTIONS .....</b>	<b>14 – 20</b>	■ Set mode description .....	41
■ Unpacking .....	14	■ P-set mode .....	41
■ Selecting a location .....	14	■ H-set mode .....	44
■ Grounding .....	14	<b>6 MEMORY CHANNELS .....</b>	<b>49 – 52</b>
■ Antenna .....	14	■ Memory channels .....	49
■ Required connections .....	15	■ Memory channel selection .....	49
■ Advanced connections .....	16	■ Memory clearing .....	49
■ Linear amplifier connections .....	17	■ Memory channel programming .....	50
■ External antenna selector or antenna tuner		■ Frequency transferring .....	51
connections .....	18	■ Scan edge memory channels .....	52
■ Transverter jack information .....	18	<b>7 SCANS .....</b>	<b>53 – 54</b>
■ FSK and AFSK (SSTV) connections .....	19	■ Scan types .....	53
■ Remote jack (CI-V) information .....	20	■ Pre-operation .....	53
<b>3 BASIC OPERATION .....</b>	<b>21 – 26</b>	■ Programmed scan operation .....	54
■ When first applying power (CPU resetting) .....	21	■ Memory scan operation .....	54
■ Initial settings .....	21	■ Select memory scan operation .....	54
■ Basic SSB/AM operation .....	22	<b>8 MAINTENANCE AND ADJUSTMENT .....</b>	<b>55 – 56</b>
■ Basic FM operation .....	22	■ Frequency calibration (approximate) .....	55
■ Basic CW operation .....	23	■ Main dial brake adjustment .....	55
■ Basic FSK (RTTY) operation .....	23	■ AC fuse replacement .....	56
■ VFO description .....	24	■ MB-19 installation .....	56
■ Frequency setting with the main dial .....	25	■ Lithium backup battery .....	56
■ Direct frequency entry with the keypad .....	25	■ Cleaning .....	56
■ Advanced tuning functions .....	26	<b>9 TROUBLESHOOTING .....</b>	<b>57 – 58</b>
<b>4 FUNCTION OPERATIONS .....</b>	<b>27 – 40</b>	<b>10 INTERNAL VIEWS .....</b>	<b>59 – 60</b>
■ Memo pad operation .....	27	■ Top view .....	59
■ Twin PBT operation .....	28	■ Left side view .....	59
■ IF notch operation .....	28	■ Bottom view .....	60
■ Auto notch operation (DSP) .....	29	<b>11 OPTIONS .....</b>	<b>61 – 62</b>
■ Noise reduction (DSP) .....	29	<b>12 SPECIFICATIONS .....</b>	<b>63</b>
■ CW pitch control .....	29	SCHEMATIC AND BLOCK DIAGRAMS .....	SEPARATE
■ APF operation .....	30		
■ Noise blanker .....	30		
■ Filter selection .....	31		
■ CW reverse mode .....	31		
■ RIT and ΔTX .....	32		
■ Split frequency operation .....	33		
■ Quick split function .....	33		
■ Channelized split operation .....	34		
■ Dualwatch operation .....	35		
■ Monitor function .....	35		
■ VOX operation .....	36		
■ Meter function .....	36		

### Technical information

• ACC sockets .....	12
• Microphone connector and HM-36 schematic diagram .....	13

# 1 PANEL DESCRIPTION

## Front panel

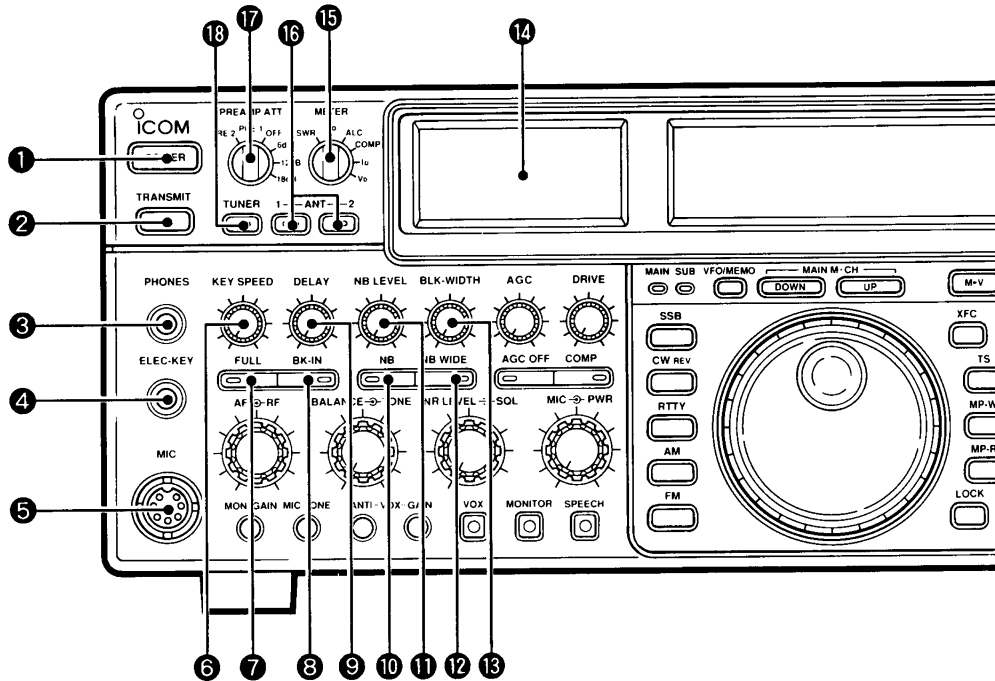

### 1 POWER SWITCH [POWER]

Turns power ON and OFF.

**NOTE:** The function display does not appear immediately when the transceiver is extremely cold. The backlight intensity will take a few minutes to stabilize.

### 2 TRANSMIT SWITCH [TRANSMIT]

Selects transmitting or receiving.

### 3 HEADPHONE JACK [PHONES]

Accepts headphones with 4–16 Ω impedance.

- When headphones are connected, the internal speaker or connected external speaker does not function.

### 4 ELECTRONIC KEYS JACK [ELEC-KEY]

(p. 37)

Accepts a paddle to activate the internal electronic keyer.

- The electronic keyer can be bypassed to connect a straight key or external electronic keyer in P-set mode. (p. 42)

- A straight key jack is separately available on the rear panel. See [KEY] on p. 11.

- Keyer polarity (dot and dash) can be reversed in P-set mode. (p. 42)

- 3-channel memory keyer is available for your convenience. (p. 37)

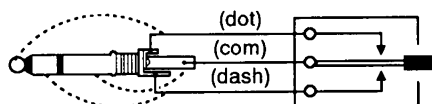

### 5 MICROPHONE CONNECTOR [MIC]

Accepts an optional microphone described on p. 62.

- See p. 13 for microphone connector information.

### 6 ELECTRONIC CW KEYS SPEED CONTROL [KEY SPEED]

Adjusts the internal electronic CW keyer's speed.

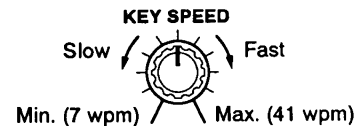

### 7 FULL BREAK-IN SWITCH [FULL]

Selects full break-in or semi break-in operation for CW operation when [BK-IN] is turned ON.



#### FUNCTION

Both **semi** and **full break-in** toggle transmit and receive with CW keying. Full break-in (QSK) can monitor the receive signal during keying.

### 8 BREAK-IN SWITCH [BK-IN] (p. 23)

Turns the break-in operation for CW mode ON and OFF.



**9 VOX/SEMI BREAK-IN DELAY CONTROL [DELAY]** (p. 36)

Adjusts the transmit-to-receive switching delay time for VOX and CW semi break-in operations.

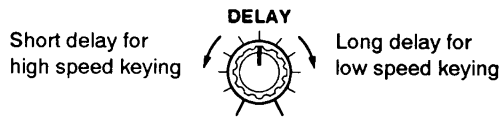

**10 NOISE BLANKER SWITCH [NB]** (p. 30)  
Turns the noise blanker ON and OFF.



**FUNCTION**

The **noise blanker** reduces pulse-type noise such as that generated by automobile ignition systems. This function is not effective for AM and FM, or non-pulse-type noise.

**11 NOISE BLANKER LEVEL CONTROL [NB LEVEL]** (p. 30)

Adjusts the noise blanker threshold level.



**12 NOISE BLANKER WIDE SWITCH [NB WIDE]** (p. 30)

Selects the blanking time of the noise blanker circuit for a normal or wide blank width.

- This switch can be assigned to the noise reduction on/off switch in P-set mode. (p. 43)

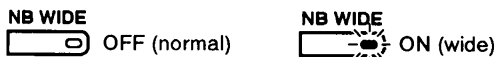

**FUNCTION**

The **wide blank width** effectively reduces wide pulse-type noise known as "woodpecker" noise and key clicks from strong CW signals on nearby frequencies.

**13 BLANK WIDTH CONTROL [BLK-WIDTH]** (p. 30)

Adjusts the blank width of the wide noise blanker circuit. To suppress echo noise from woodpecker signals, etc., rotate [BLK-WIDTH] clockwise. The setting is effective when [NB WIDE] is ON.

**NOTE:** When [BLK-WIDTH] is turned too far clockwise, receive audio is also blanked.

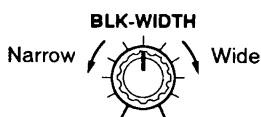

**14 S/RF METER** (p. 36)

Shows the signal strength while receiving. For transmit meter readings, see the following table.

**15 METER SWITCH [METER]** (p. 36)

Selects the S/RF meter functions during transmission as follows:

SWITCH POSITION	MEASUREMENT
[SWR]	Indicates the SWR over the transmission line.
[Po]	Indicates the relative RF output power in watts.
[ALC]	Indicates the ALC level. The ALC circuit begins to activate when the RF output power reaches a preset level.
[COMP]	Indicates the compression level when the speech compressor is in use.
[Id]	Indicates the drain's current of the final FET.
[Vo]	Indicates the drain's terminal voltage of the final FET.

**16 ANTENNA SWITCHES [ANT1]/[ANT2]** (p. 45)

Select antenna 1 or 2.

- Antenna selection can be programmed depending on the band selection such as above the 21 MHz band and below the 18 MHz band, etc.

**17 PREAMP/ATTENUATOR SWITCH [PREAMP/ATT]**

Selects one of 2 receive RF preamps, one of 6 dB, 12 dB or 18 dB attenuators, or bypasses them.

- [PRE1] activates the 10 dB preamp for HF all bands.  
- [PRE2] activates the 16 dB high-gain preamp for 21 MHz band and above.

**FUNCTION**

The **preamp** amplifies received signals in the front end circuit to improve the S/N ratio and sensitivity. Set this switch to [PRE1] or [PRE2] when receiving weak signals. The **attenuator** prevents a desired signal from distorting when very strong signals are near the desired frequency or when very strong electric fields, such as from a broadcasting station, are near your location.

**18 ANTENNA TUNER SWITCH [TUNER]** (p. 39)

- Turns the antenna tuner ON or OFF (bypass) when pushed momentarily.
- Starts to tune the antenna tuner manually when pushed for 2 sec.
  - When the tuner cannot tune the antenna, the tuning circuit is bypassed automatically after 20 sec.

# 1 PANEL DESCRIPTION

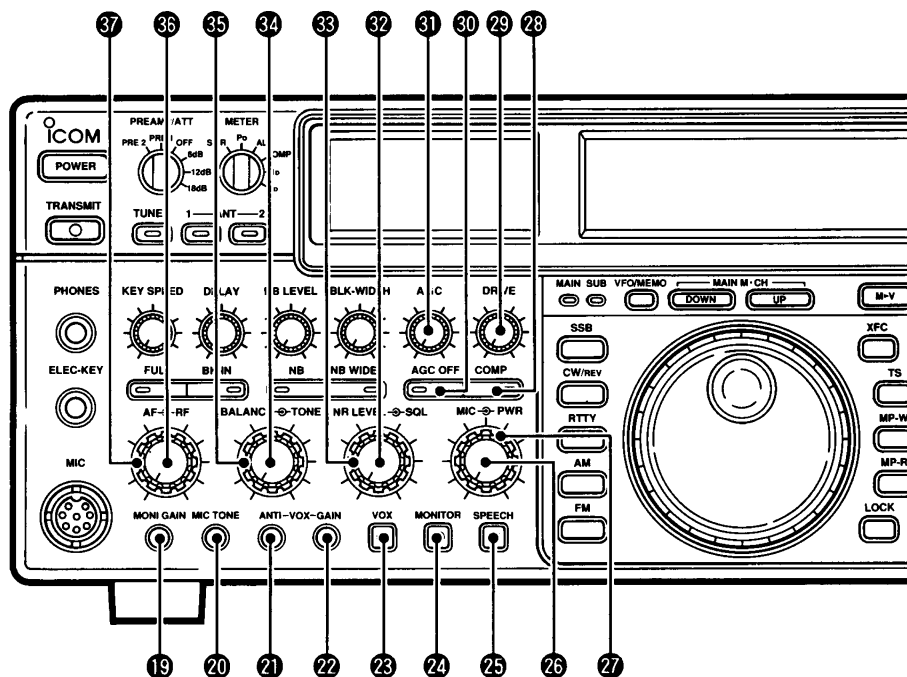

**19 MONITOR GAIN CONTROL [MONI GAIN]** (p. 35)  
Varies the volume of CW sidetone, optional voice synthesizer and monitor output (when [MONITOR] is pushed IN).

**20 MIC TONE CONTROL [MIC TONE]**  
Adjusts the transmit audio response.

**21 ANTI-VOX CONTROL [ANTI-VOX]** (p. 36)  
Adjusts the VOX deactivate level to prevent unwanted VOX control from the speaker audio.

**22 VOX GAIN CONTROL [VOX-GAIN]** (p. 36)  
Adjusts the transmit/receive switching threshold level for VOX operation.

**23 VOX SWITCH [VOX]** (p. 36)  
Turns the VOX function for phone (SSB, AM and FM) operation ON and OFF.

### FUNCTION

The **VOX function** (voice operated transmission) starts transmission without pushing the transmit switch or PTT switch when you speak into the microphone; then, automatically returns to receive when you stop speaking.

**24 MONITOR SWITCH [MONITOR]** (p. 35)  
Monitors your transmitted IF signal.  
- The CW sidetone functions when [MONITOR] is OFF in CW mode.

**25 SPEECH SWITCH [SPEECH]** (p. 44) **UT-66**  
Announces the MAIN readout\* frequency when an optional UT-66 is installed.  
\* SUB readout freq. when pushed together with [XFC].

**26 MIC GAIN CONTROL [MIC]** (inner control) (p. 36)  
Adjusts microphone input gain.

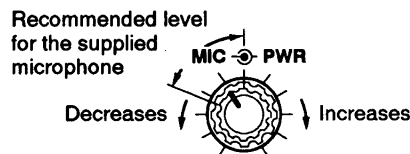

**27 RF POWER CONTROL [PWR]** (outer control)  
Continuously varies the RF output power from minimum (5 W\* for QRP operation) to maximum (200 W\*).

\* AM mode: 5 W to 50 W

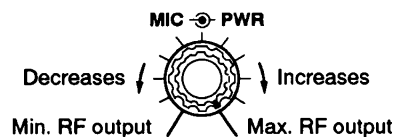

**28 SPEECH COMPRESSOR SWITCH [COMP]** (p. 36)  
Turns the speech compressor ON and OFF.



### FUNCTION

The **speech compressor** compresses the transmitter audio input to increase the average audio output level. Therefore, talk power is increased. This function is effective for long distance communication or when propagation conditions are poor.

- 29 DRIVE CONTROL [DRIVE]** (p. 36)  
 Adjusts the output level of the transmitter's drive stage. Activates in CW, RTTY; and in SSB mode with [COMP] ON.

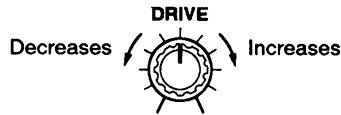

- 30 AGC OFF SWITCH [AGC OFF]**  
 Deactivates the AGC circuit. Use when receiving a very weak signal near a strong signal.

**NOTE:** While [AGC OFF] is ON, the S-meter does not function.



- 31 AGC CONTROL [AGC]**  
 Adjusts the time constant of the AGC circuit when [AGC OFF] is not turned ON.

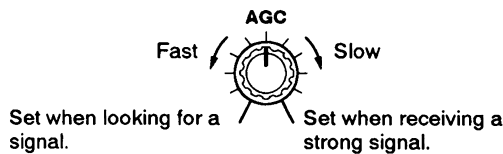

**FUNCTION**

The **AGC** controls receiver gain to produce a constant audio output level even when the received signal strength is varied by fading, etc. Rotate [AGC] max. counterclockwise for tuning and adjust it clockwise depending on the receiving condition. [AGC] control does not function in FM mode.

- 32 NOISE REDUCTION LEVEL CONTROL [NR LEVEL]** (inner control) (p. 29)  
 For [DSP] equipped type  
 Adjusts the noise reduction level or turns the noise reduction OFF. Set for maximum readability.  
 - "[NR]" appears when the noise reduction is in use.  
 - No function for the IC-775 without a DSP unit.

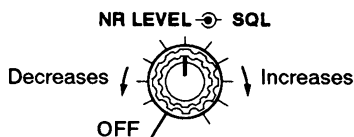

- 33 SQUELCH CONTROL [SQL]** (outer control)
- Adjusts the squelch threshold level. (p. 22)
    - Deep rotation of the control moves the S-meter pointer. The pointer shows the signal strength which can open the squelch.
  - When CW pitch control is assigned to [SQL] in P-set mode, adjusts the received or monitored CW audio tone without changing the displayed frequency. (pgs. 29, 43)
    - The squelch cannot be closed in this case.

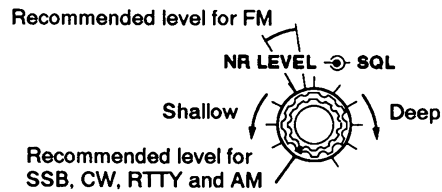

**FUNCTION**

The **squelch** removes noise output from the speaker (closed condition) when no signal is received. The squelch is particularly effective for FM. It is also available for other modes.

**SETTING PROCEDURE**

**Squelch setting:** When operating in FM, first rotate the control fully counterclockwise. Then, rotate the control clockwise to the point where the noise just disappears. This is the best position. The squelch does not open for weak signals when it is set too deep.

- 34 DUALWATCH BALANCE CONTROL [BALANCE]** (inner control) (p. 35)  
 Adjusts the receiver gain balance of MAIN and SUB readout frequencies while in dualwatch.

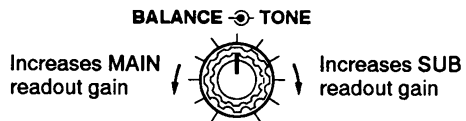

- 35 TONE CONTROL [TONE]** (outer control)  
 Varies the receive audio response.



- 36 AF GAIN CONTROL [AF]** (inner control) (p. 22)  
 Varies the audio output level.

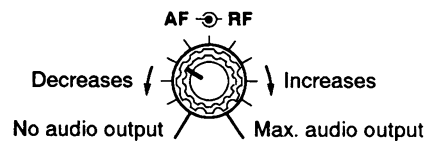

- 37 RF GAIN CONTROL [RF]** (outer control)  
 Adjusts the receiver gain.
- This control should be set to the maximum clockwise position for normal use.
  - Shallow rotation of the control moves the S-meter pointer. The pointer shows the signal strength which can be received.

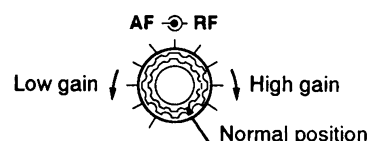

# 1 PANEL DESCRIPTION

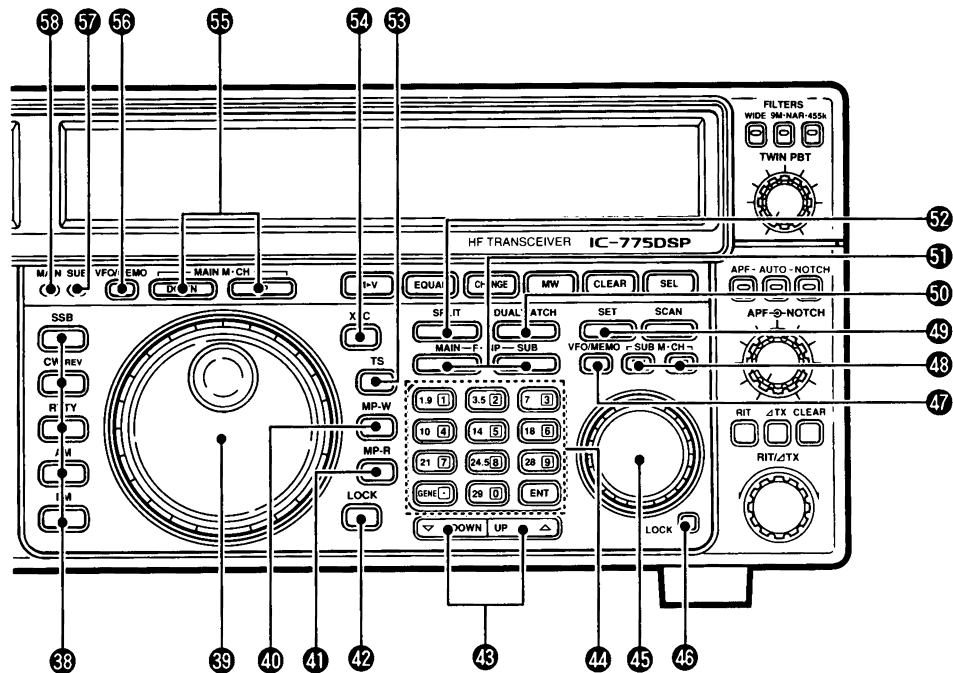

## 38 MODE SWITCHES (pgs. 22, 23)

- Select the desired operating mode.
  - Announces the selected mode when an optional UT-66 is installed. (p. 44)

**SSB** - Selects USB and LSB mode alternately.  
 - Selects USB/LSB DATA mode when pushed for 2 sec. in SSB modes.

**CW/REV** - Selects CW and CW-R (CW reverse) mode alternately. (p. 31)  
 - Activates memory keyer when pushed for 2 sec. in CW modes. (p. 37)

- Select DATA modes when pushed for 2 sec., except in CW modes.
  - Data modes cut the [MIC] input depending on H-set mode condition. (p. 47)

## 39 MAIN DIAL (p. 25)

Changes the MAIN readout frequency, etc.

## 40 MEMO PAD-WRITE SWITCH [MP-W] (p. 27)

Programs the displayed frequency and operating mode into a memo pad.  
 - The 5 most recent entries remain in memo pads.  
 - The memo pad capacity can be expanded from 5 to 10 in H-set mode for your convenience. (p. 45)

## 41 MEMO PAD-READ SWITCH [MP-R] (p. 27)

Each push calls up a frequency and operating mode in a memo pad. The 5 (or 10) most recently programmed frequencies and operating modes can be recalled, starting from the most recent.

## 42 MAIN DIAL LOCK SWITCH [LOCK] (p. 40)

Turns the main dial lock function ON and OFF.  
 - The function electronically locks the main dial.  
 - " **LOCK** " appears above the MAIN readout while the function is ON.

## 43 UP/DOWN TUNING SWITCHES [ΔUP]/[▽DOWN] (p. 26)

Change the displayed frequency up or down in programmed steps (1 kHz to 1 MHz).

## 44 KEYPAD (p. 25)

- Pushing a key selects the operating band.
  - [GENE] selects the general coverage band.
- Pushing the same key 2 or 3 times calls up other stacked frequencies in the band.
  - Icom's TBSR (Triple Band Stacking Register) memorizes 3 frequencies in each band. (p. 25)
- After pushing MAIN or SUB [F-INP], enters your desired frequency. Pushing [ENT] is necessary at the end.
  - (e.g. to enter 14.195 MHz, push [F-INP][1][4][.] [1][9][5][ENT].)

## 45 SUB DIAL (pgs. 33, 35)

Changes the SUB readout frequency during dual-watch or split frequency operation.

## 46 SUB DIAL LOCK SWITCH [LOCK] (p. 40)

Turns the sub dial lock function ON and OFF.  
 - The function electronically locks the sub dial.  
 - " **LOCK** " appears above the SUB readout while the function is ON.



**47 VFO/MEMORY SWITCH for SUB readout [VFO/MEMO]**

Toggles SUB readout operating mode between the VFO mode and memory mode.

**48 MEMORY UP/DOWN SWITCHES for SUB readout [SUB M-CH DN]/[SUB M-CH UP]**

- Select the memory channel number for SUB readout.
  - Memory channels can be selected both in the VFO and memory modes.
- Change the transmit frequency in programmed kHz steps while in channelized split operation. (p. 34)

**49 SET SWITCH [SET] (p. 41)**

- Enters P-set (push-set) mode when pushed.
- Enters H-set (hold-set) mode when pushed and held for 2 sec.
  - The set modes are used to adjust infrequently changed settings.

**50 DUALWATCH SWITCH [DUALWATCH] (p. 35)**

- Turns the dualwatch function ON and OFF when pushed.
- Turns the dualwatch function ON and equalizes the SUB readout frequency to the MAIN readout when pushed for 2 sec. (p. 46)

**51 FREQUENCY-INPUT SWITCHES [MAIN F-INP]/[SUB F-INP] (p. 25)**

Enable the keypad to input a frequency.

- The frequency readout disappears when pushed; and the keypad can be used to enter a frequency directly.
- To cancel the frequency input, push this switch again.

**52 SPLIT SWITCH [SPLIT] (p. 33)**

- Turns the split frequency function ON and OFF when pushed momentarily.
  - Transmit frequency and "[SPLIT]" appear in the SUB readout. The SUB readout blinks 4 times to show the SUB readout is used for transmitting when the function is ON.
- Turns the split frequency function ON and equalizes the SUB readout frequency (transmit frequency) to the receive frequency when pushed for 2 sec.
  - Split shift frequency can be pre-programmed to save time when DX'ing. (p. 33)
  - When pushed together with [XFC] for 2 sec., the MAIN readout frequency (receive frequency) is equalized to the transmit frequency.
- Once the split frequency function is ON, equalizes the transmit frequency to the receive frequency and enters channelized split operation when pushed for 2 sec.
- Activates the subaudible tone encoder and split frequency function when pushed in FM mode.

**53 QUICK TUNING SWITCH [TS] (p. 26)**

- Turns the quick tuning step ON and OFF.
  - While this indicator is displayed, the frequency can be changed in programmed kHz steps.
  - The SUB readout frequency is also changed in the programmed kHz steps.

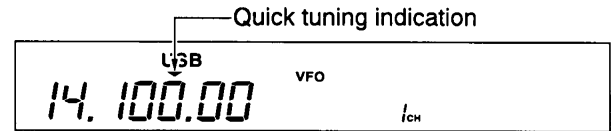

- When pushed for 2 sec., turns the 1 Hz step ON and OFF.
  - 1 Hz indication appears in the MAIN readout and the frequency can be changed in 1 Hz steps.
  - The SUB readout frequency can also be changed in 1 Hz steps.

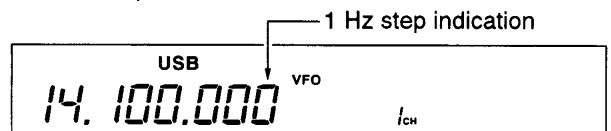

**54 TRANSMIT FREQUENCY CHECK SWITCH [XFC] (pgs. 33, 34, 38)**

Monitors the transmit frequency when pushed and held when the split frequency function is ON.

- While pushing this switch, the transmit frequency can be changed with the main dial, keypad, memo pad, or the [ΔUP]/[▽DOWN] switches.

**55 MEMORY UP/DOWN SWITCHES for MAIN readout [MAIN M-CH DOWN]/[MAIN M-CH UP]**

Select the memory channel number for MAIN readout. (p. 49)

- Memory channels can be selected both in the VFO and memory modes.

**56 VFO/MEMORY SWITCH for MAIN readout [VFO/MEMO] (p. 49)**

Toggles MAIN readout operating mode between the VFO mode and memory mode.

**57 SUB TX/RX INDICATOR [SUB]**

- Lights up in green while receiving a signal on the SUB readout and when the squelch is open.
- Lights up in red while transmitting on the SUB readout frequency during split frequency operation.

**58 MAIN TX/RX INDICATOR [MAIN]**

- Lights up in green while receiving a signal on the MAIN readout and when the squelch is open.
- Lights up in red while transmitting on the MAIN readout frequency.

# 1 PANEL DESCRIPTION

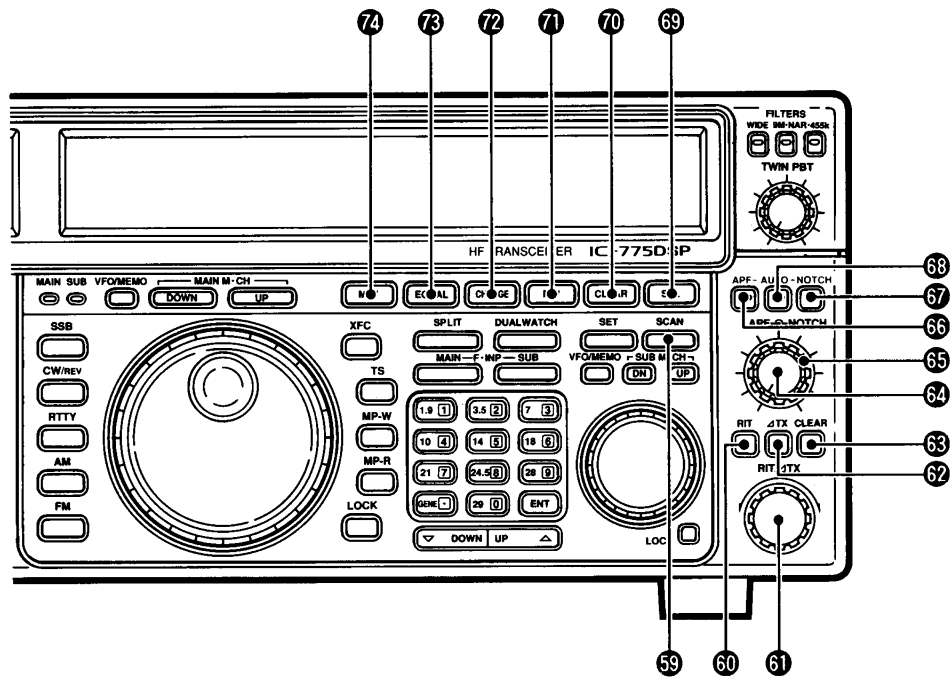

## 69 SCAN SWITCH [SCAN] (p. 53)

Starts and stops a scan.

- In the VFO mode, starts and stops programmed scan.
- In the memory mode, starts and stops memory scan.

## 60 RIT SWITCH [RIT] (p. 32)

Turns the RIT function ON and OFF.

- " **RIT** " is indicated when the function is ON.
- Use the [RIT/ $\Delta$ TX] control to vary the RIT frequency.
- The RIT function can be turned ON even when the  $\Delta$ TX function is ON.
- The RIT range is  $\pm 9.999$  kHz.
- The shift frequency is added to the operating frequency when pushed for 2 sec.

### FUNCTION

**RIT** (Receiver Incremental Tuning) shifts the receive frequency up to  $\pm 9.999$  kHz in 1 Hz steps (or 10 Hz steps) without shifting the transmit frequency.

This is useful for fine tuning stations which call you on an off-frequency or when you prefer to listen to slightly different-sounding voice characteristics, etc.

## 61 RIT/ $\Delta$ TX CONTROL [RIT/ $\Delta$ TX] (p. 32)

Shifts the receive and/or transmit frequency while the RIT and/or  $\Delta$ TX functions are ON.

- Rotate the control clockwise to increase the receive/transmit frequency, or rotate the control counter-clockwise to decrease the receive/transmit frequency.



## 62 $\Delta$ TX SWITCH [ $\Delta$ TX] (p. 32)

Turns the  $\Delta$ TX function ON and OFF.

- " $\Delta$ TX" is indicated when the function is ON.
- Use the [RIT/ $\Delta$ TX] control to vary the  $\Delta$ TX frequency.
- The  $\Delta$ TX function can be turned ON even when the RIT function is ON.
- The  $\Delta$ TX range is  $\pm 9.999$  kHz.
- The shift frequency is added to the operating frequency when pushed for 2 sec.

### FUNCTION

$\Delta$ TX shifts the transmit frequency up to  $\pm 9.999$  kHz in 1 Hz steps (or 10 Hz steps) without shifting the receive frequency. This is useful for simple split frequency operation in CW, etc.

## 63 CLEAR SWITCH [CLEAR] (p. 32)

Clears the RIT/ $\Delta$ TX shift frequency.

## 64 AUDIO PEAK FILTER CONTROL [APF]

(inner control) (p. 30)

Varies the peak frequency of the audio peak filter to pick out a CW signal from interference while the [APF] switch is ON.

- For the DSP-equipped type, turn the auto audio peak filter OFF with [AUTO] or it will be difficult to receive signals. It has an 80 Hz passband width. (p. 30)

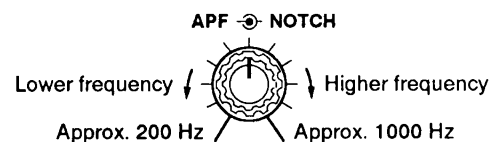

**65 IF NOTCH CONTROL [NOTCH]** (outer control)  
(p. 28)

Adjusts the center frequency of the IF notch filtering frequency while the IF notch function is ON.

- The auto notch function (DSP-equipped type only) can be used together with the IF notch function.

[Simplified example of the notch function]

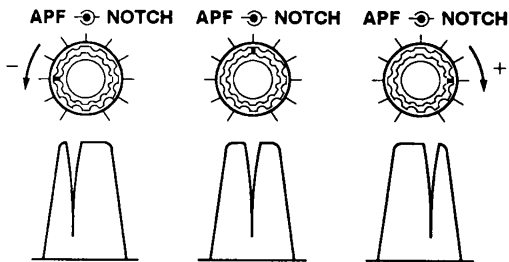

**FUNCTION**

The notch function eliminates unwanted CW or AM carrier tones while preserving the desired signal's audio response. The filtering frequency must be adjusted to effectively eliminate an unwanted tone for the IF notch or turn the auto notch function ON. 2 kinds of notch functions (IF, DSP) are adopted in the DSP-equipped type.

**66 AUDIO PEAK FILTER SWITCH [APF]** (p. 30)

Turns the audio peak filter ON and OFF.

- The red indicator lights when the function is ON.
- Use the [APF] control to vary the peak frequency.

**67 IF NOTCH SWITCH [NOTCH]** (p. 28)

Turns the IF notch function ON and OFF.

- The red indicator lights when the function is ON.
- The auto notch function (DSP-equipped type only) can be used together with the IF notch function.
- Use the [NOTCH] control to vary the filtering frequency.

**68 AF LOW-PASS FILTER SWITCH [AF LPF]**

For Non-DSP type

Turns the 1.5 kHz cut-off audio low-pass filter ON and OFF.

**68 AUTO APF/NOTCH SWITCH [AUTO]** (p. 30)

For [DSP] equipped type

- Turns the auto audio peak filter ON and OFF in CW mode.
  - The peak frequency equals the CW pitch frequency set in P-set mode or by the [SQL] control. (p. 43)
  - Turn the PSN demodulation ON using P-set mode in advance. (p. 42)
  - The red indicator lights when the function is ON.
  - The audio peak filter can be used together with the auto audio peak filter to boost up the attenuation.

- Turns the auto notch function ON and OFF in SSB mode.
  - The red indicator lights when the function is ON.

**69 SELECT SWITCH [SEL]** (p. 54)

- In the memory mode, designates or cancels the MAIN readout memory channel as a select memory channel for select memory scan when pushed momentarily.
  - "SELECT" appears when the MAIN readout channel is a select memory channel.
- Cancels all select memory channels when pushed for 2 sec.
  - "SELECT" disappears from all select memory channels.
- Toggles between memory scan and select memory scan during memory scan.

**70 MEMORY CLEAR SWITCH [CLEAR]** (p. 49)

Clears MAIN readout memory channel contents when pushed for 2 sec. in the memory mode.

- The channel becomes a blank channel and "BLANK" appears.
- This switch does not function in the VFO mode.

**71 MEMORY WRITE SWITCH [MW]** (pgs. 50, 52)

Stores the MAIN readout frequency and operating mode into the MAIN readout memory channel when pushed for 2 sec.

- This switch functions both in the VFO mode and memory mode.
- Memory write and clear can be performed to the MAIN readout only.

**72 MAIN/SUB CHANGE SWITCH [CHANGE]**  
(pgs. 33, 35)

Toggles the frequency and selected memory channel between MAIN and SUB readouts.

- Toggles between transmit frequency and receive frequency when the split frequency function is ON.

**73 VFO EQUALIZATION SWITCH [EQUAL]** (p. 33)

Equalizes the SUB readout frequency to the MAIN readout frequency when pushed for 2 sec.

- Equalizes the receive frequency to the transmit frequency when pushed together with [XFC] for 2 sec. while the split frequency function ON.

**74 MEMORY TRANSFER SWITCH [M ▶ V]** (p. 51)

Transfers the frequency and operating mode in a memory channel to MAIN readout VFO when pushed for 2 sec.

- This switch functions both in the VFO mode and memory mode.

# 1 PANEL DESCRIPTION

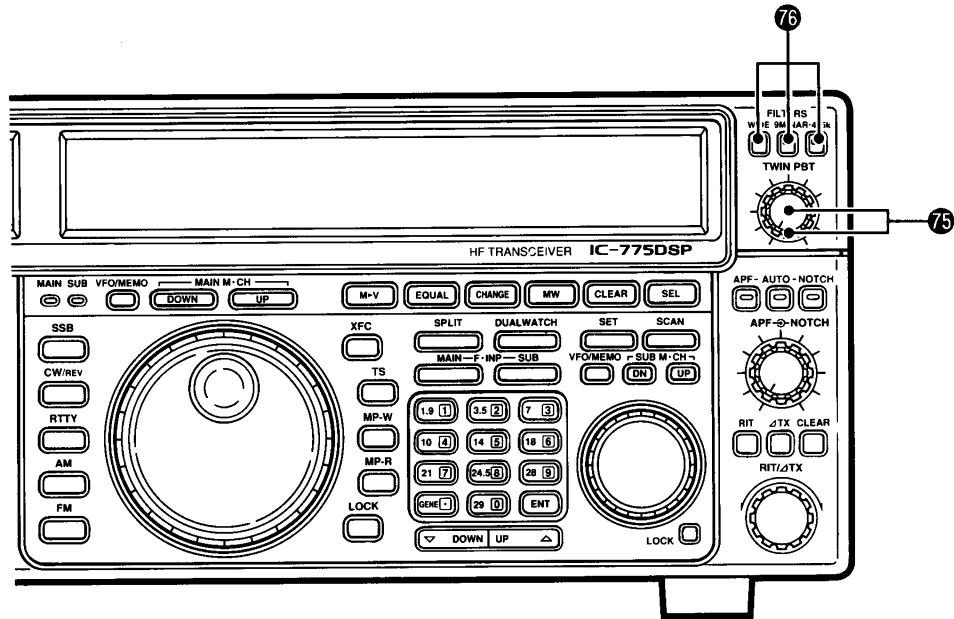

## 75 PASSBAND TUNING CONTROLS [TWIN PBT]

(p. 28)

Adjust the receiver's "passband width" of the 455 kHz and 9 MHz IF filters for the inner and outer controls, respectively.

- Set to the center positions when not in use.
- Variable ranges:  $\pm 1.25$  kHz in 10 Hz steps

### FUNCTION

The **PBT** function electronically narrows the IF passband width to reject interference. The PBT is especially effective in SSB operation and not available in FM operation.

[Simplified example of the PBT function]

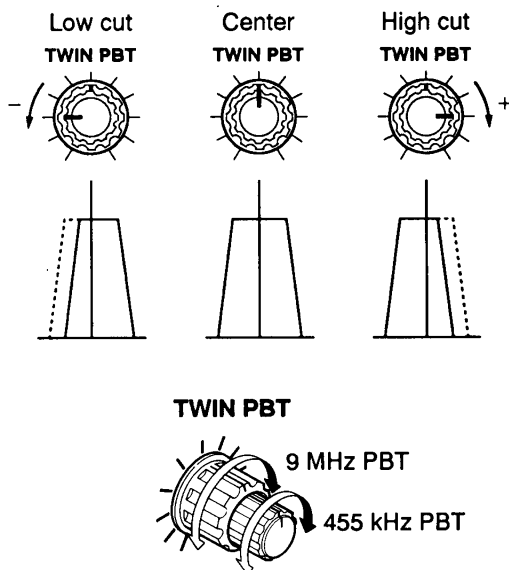

## 76 FILTER SWITCHES [WIDE]/[NAR 455k]/







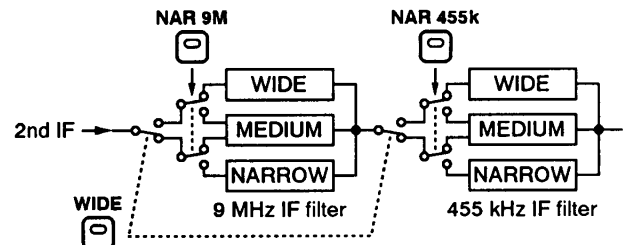













[NAR 9M] (p. 31)

Select the IF filters.

- [WIDE] selects the wider IF filters for the 9 MHz and 455 kHz IF filters.
- [WIDE] does not function in FM mode.
- The switch conditions are memorized in each mode.



[Filter switch condition and selected filters]

Filter switch	9 MHz IF filter	455 kHz IF filter
WIDE 9M-NAR-455k   	WIDE	WIDE
WIDE 9M-NAR-455k   	WIDE	MEDIUM
WIDE 9M-NAR-455k   	MEDIUM	WIDE
WIDE 9M-NAR-455k   	MEDIUM	MEDIUM
WIDE 9M-NAR-455k   	MEDIUM	NARROW
WIDE 9M-NAR-455k   	NARROW	MEDIUM
WIDE 9M-NAR-455k   	NARROW	NARROW

## Function display

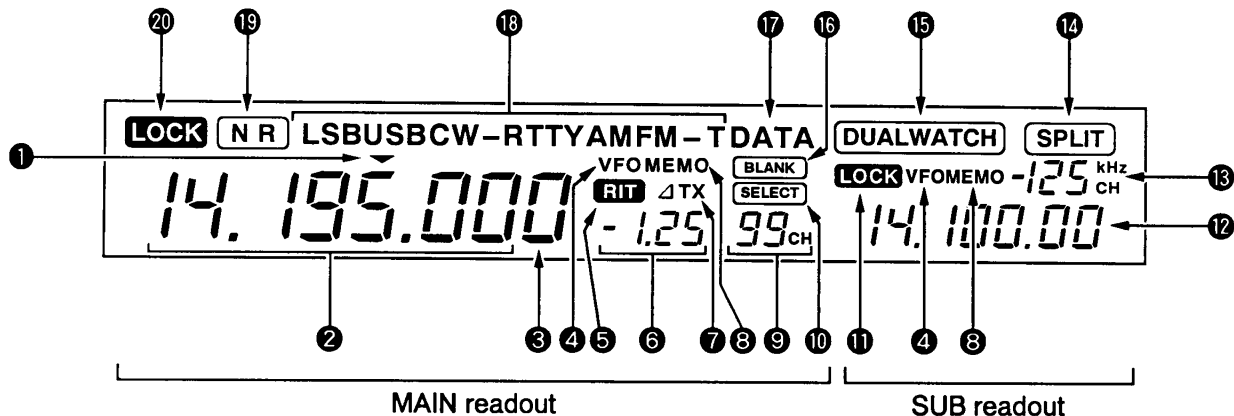

- 1 QUICK TUNING INDICATOR** (p. 26)  
Appears when the quick tuning step is ON.
- 2 MAIN FREQUENCY READOUT**  
• Shows the operating frequency. (p. 25)  
• Shows the receive frequency while the split frequency function is ON. (p. 33)
- 3 1 Hz STEP FREQUENCY READOUT** (p. 26)  
Appears when the 1 Hz step is selected.
- 4 VFO MODE INDICATORS** (p. 24)  
Appears when the VFO mode is selected.
- 5 RIT INDICATOR** (p. 32)  
Appears when the RIT function is ON.
- 6 RIT/Δ TX FREQUENCY READOUT** (p. 32)  
Shows the RIT and/or Δ TX variable frequency.
- 7 Δ TX INDICATOR** (p. 32)  
Appears when the Δ TX function is ON.
- 8 MEMORY MODE INDICATORS** (pgs. 24, 49)  
Appears when the memory mode is selected.
- 9 MAIN MEMORY CHANNEL NUMBER READOUT** (p. 49)  
Shows the selected memory channel number for the MAIN readout.
- 10 SELECT INDICATOR** (p. 54)  
Appears when the displayed MAIN readout memory channel is designated as a select memory channel.
- 11 SUB DIAL LOCK INDICATOR** (p. 40)  
Appears when the sub dial lock function is activated.
- 12 SUB FREQUENCY READOUT**  
Appears when the dualwatch and/or split frequency function is turned ON. (pgs. 33, 35)  
- The readout shows the sub receive frequency or transmit frequency while in dualwatch or split frequency operation, respectively.
- 13 SUB MEMORY CHANNEL NUMBER READOUT**  
• Shows the selected memory channel number while in dualwatch or split frequency operation. (p. 49)  
• Shows the split shift frequency while in channelized split operation. (p. 34)
- 14 SPLIT INDICATOR** (p. 33)  
Appears when the split frequency function is activated and flashes when the channelized split function is activated.
- 15 DUALWATCH INDICATOR** (p. 35)  
Appears when the dualwatch function is activated.
- 16 BLANK INDICATOR** (p. 49)  
Appears when the MAIN readout displayed memory channel is a blank channel (and that it has not been programmed).  
- This indicator appears even in the VFO mode.
- 17 DATA MODE INDICATOR** (p. 23)  
Appears when a data mode is selected.
- 18 MODE INDICATORS** (pgs. 22, 23)  
Show the operating mode.
- 19 NOISE REDUCTION INDICATOR** (p. 29)  
For **[DSP]** equipped type  
Appears when the noise reduction is activated.
- 20 MAIN DIAL LOCK INDICATOR** (pgs. 33, 40)  
Appears when the main dial lock function is activated.

■ Rear panel

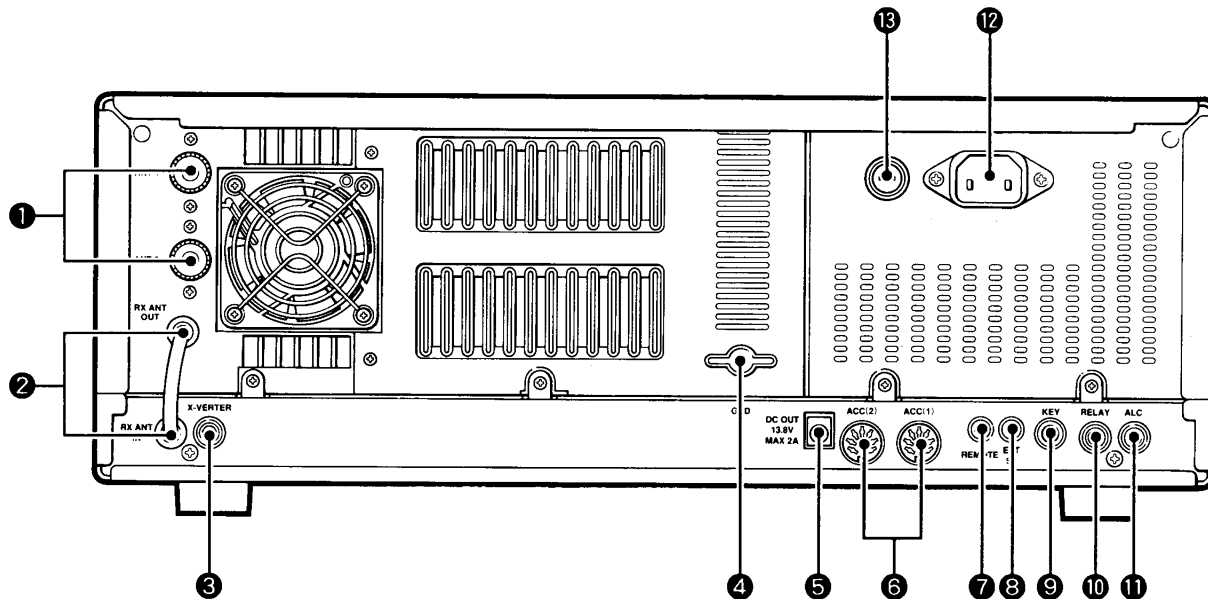

**1 ANTENNA CONNECTORS [ANT1]/[ANT2]**  
 (pgs. 14, 15)  
 Accept a 50 Ω antenna with a PL-259 plug.

**2 RECEIVE ANTENNA JACKS [RX ANT IN]/ [RX ANT OUT]** (p. 15)  
 Located between the transmit/receive switching circuit and receiver's RF stage. Connect an external preamp or RF filter, if desired.

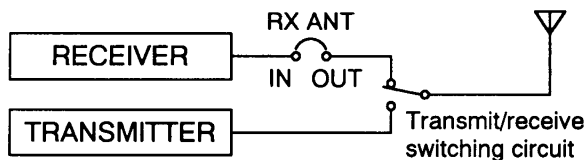

**3 TRANSVERTER JACK [X-VERTER]**  
 (pgs. 12, 18)  
 External transverter input/output jack. Activated by voltage applied to [ACC(2)] pin 6.

**4 GROUND TERMINAL [GND]** (pgs. 14, 15)  
 Connect this terminal to a ground to prevent electric shocks, TVI, BCI and other problems.

**5 13.8 V DC OUTPUT JACK [DC OUT]** (p. 16)  
 Outputs 13.8 V DC for external equipment. Connected in parallel with 13.8 V outputs of [ACC(1) and (2)]. (max. 2 A in total)



**6 ACCESSORY SOCKETS [ACC (1) and (2)]**  
 (p. 12)  
 Enable connection to external equipment such as a linear amplifier, an automatic antenna selector/tuner, TNC for data communications, etc.  
 - See the page at right for socket information

**7 CI-V REMOTE CONTROL JACK [REMOTE]**  
 (p. 20)  
 Designed for use with a personal computer for remote operation of transceiver functions.

**8 EXTERNAL SPEAKER JACK [EXT SP]**  
 (pgs. 16, 61)  
 Accepts a 4 – 16 Ω speaker.

**9 STRAIGHT KEY JACK [KEY]** (p. 15)  
 Accepts a straight key or external electronic keyer with 1/4 inch standard plug.  
 - [ELEC-KEY] on the front panel can be used for a straight key or external electronic keyer. Deactivate the internal electronic keyer in P-set mode. (p. 42)

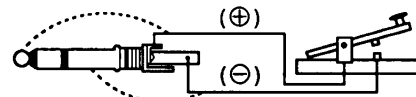

If you use an external electronic keyer, make sure the voltage retained by the keyer is less than 0.4 V when the key is ON.

**10 T/R CONTROL JACK [RELAY]** (p. 17)  
 Goes to ground while transmitting to control external equipment such as a linear amplifier.  
 - Max. control level: 24 V DC/1 A

⑪ **ALC INPUT JACK [ALC]** (p. 17)  
 Connects to the ALC output jack of a non-Icom linear amplifier.

⑫ **AC POWER SOCKET [AC]** (p. 15)  
 Connects the supplied AC power cable to an AC outlet. 2 versions are available.  
 • 100 – 120 V AC (50/60 Hz) version  
 • 220 – 240 V AC (50/60 Hz) version

⑬ **AC FUSE HOLDER [FUSE]** (p. 56)  
 Holds a fuse for the internal AC power supply.  
 • 100 – 120 V versions: 12 A FGMB  
 • 220 – 240 V versions: 5 A (High breaking capability fuse)

**⚠ WARNING: NEVER use a non-rated fuse. This could cause a fire.**

**WARNING: NEVER apply AC voltage exceeds the suggested voltage for each version. This could cause a fire or ruin the transceiver.**

**TECHNICAL INFORMATION**

• **ACC SOCKETS**

ACC(1)	PIN NO.	PIN NAME	DESCRIPTION	SPECIFICATIONS
 Rear panel view	1	RTTY	Controls RTTY keying.	"HIGH" level : More than 2.4 V "LOW" level : Less than 0.6 V Output current : Less than 2 mA
	2	GND	Connects to ground.	Connected in parallel with ACC(2) pin 2.
	3	SEND	Input/output pin. Goes to ground when transmitting. When grounded, transmits.	Ground level : - 0.5 to 0.8 V Input current : Less than 20 mA Connected in parallel with ACC(2) pin 3.
	4	MOD	Modulator input. Connects to a modulator.	Input impedance : 10 kΩ Input level : Approx. 100 mV rms.
	5	AF	AF detector output. Fixed, regardless of [AF] position.	Output impedance : 4.7 kΩ Output level : 100 to 350 mV rms
	6	SQLS	Squelch output. Goes to ground when squelch opens.	SQL open : Less than 0.3 V/5 mA SQL closed : More than 6.0 V/100 μA
	7	13.8 V	13.8 V output when power is ON.	Output current : Max. 1 A Connected in parallel with ACC(2) pin 7.
	8	ALC	ALC voltage input.	Control voltage : - 4 to 0 V Input impedance : More than 10 kΩ Connected in parallel with ACC(2) pin 5.

ACC(2)	PIN NO.	PIN NAME	DESCRIPTION	SPECIFICATIONS
 Rear panel view	1	8 V	Regulated 8 V output.	Output voltage : 8 V ± 0.3 V Output current : Less than 10 mA
	2	GND	Same as ACC(1) pin 2.	
	3	SEND	Same as ACC(1) pin 3.	
	4	BAND	Band voltage output. (Varies with amateur band)	Output voltage : 0 to 8.0 V
	5	ALC	Same as ACC(1) pin 8.	
	6	TRV	Activates [X-VERTER] input/output when "HIGH" voltage is applied.	Input impedance : More than 10 kΩ Input voltage : 2 to 13.8 V
	7	13.8 V	Same as ACC(1) pin 7.	

# 1 PANEL DESCRIPTION

## Microphone (optional HM-36)

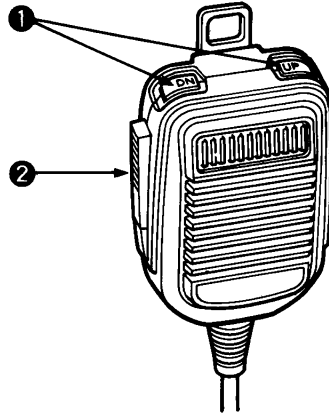

### 1 UP/DOWN SWITCHES [UP]/[DN]

Change the MAIN readout frequency or memory channel.

- Continuous pushing changes the frequency or memory channel number continuously.
- While pushing [XFC], the SUB readout frequency can be controlled while in split frequency operation.
- The [UP]/[DN] switch can simulate a key paddle. Preset in the P-set mode. (p. 42)

### 2 PTT SWITCH (p. 22)

Push and hold to transmit; release to receive.

## TECHNICAL INFORMATION

### • MICROPHONE CONNECTOR

[Front panel view]

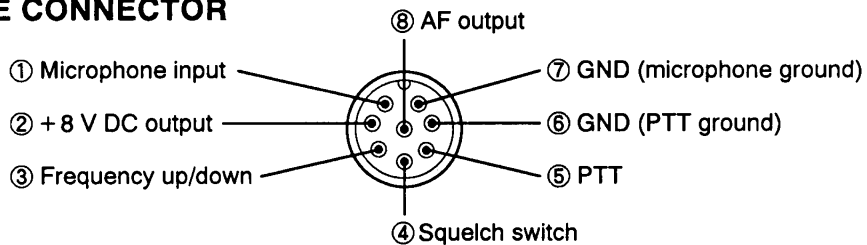

PIN NO.	FUNCTION	DESCRIPTION
②	+ 8 V DC output	Max. 10 mA
③	Frequency up	Ground
	Frequency down	Ground through 470 Ω
④	Squelch open	"LOW" level
	Squelch closed	"HIGH" level

**CAUTION:** DO NOT short pin 2 to ground as this can damage the internal 8 V regulator.

### • HM-36 SCHEMATIC DIAGRAM

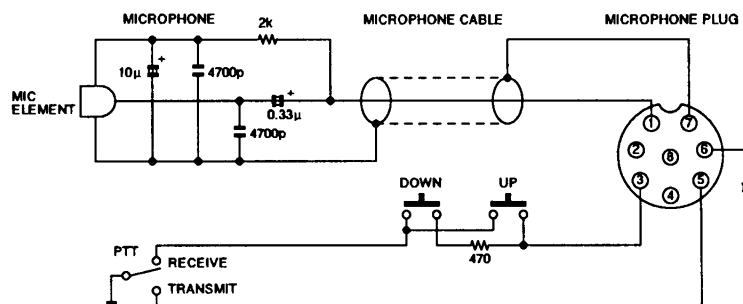



## ■ Unpacking

After unpacking, immediately report any damage or missing items to the delivering carrier or dealer. Keep the shipping cartons.

For a description and a diagram of accessory equipment included with the transceiver, see UNPACKING on the inside front page (p. i) of this manual.

## ■ Selecting a location

Select a location for the transceiver that allows adequate air circulation, free from extreme heat, cold, or vibrations, and away from TV sets, radios and other electro-magnetic sources.

### OPERATING ANGLE ADJUSTMENT

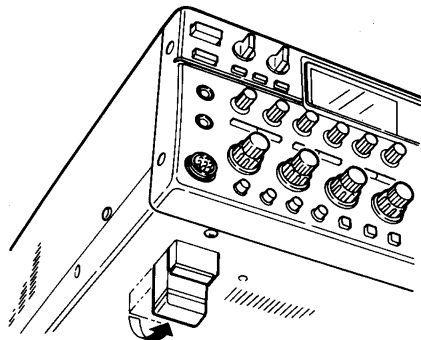

The rubber feet on the bottom of the transceiver provides two operating angles.

## ■ Grounding

To prevent electrical shock, television interference (TVI), broadcast interference (BCI) and other problems, ground the transceiver through the GROUND terminal on the rear panel.

For best results, connect a heavy gauge wire or strap to a long earth-sunk copper rod. Make the distance between the GROUND terminal and ground as short as possible.

**WARNING: NEVER** connect the [GND] terminal to a gas or electric pipe, since the connection could cause an explosion or electric shock.

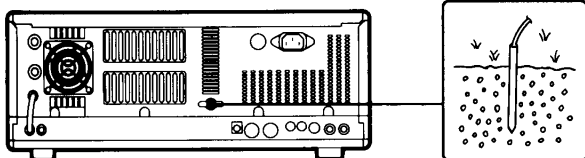

## ■ Antenna

Select antenna(s), such as well-matched 50  $\Omega$  antenna, and feedline. 1.5 : 1 or less of Voltage Standing Wave Ratio (VSWR) is recommended for your required band. Of course, the transmission line should be a coaxial cable.

When using 1 antenna, use the [ANT1] connector.

**CAUTION:** Protect your transceiver from lightning by using a lightning arrestor.

### PL-259 CONNECTOR INSTALLATION

- ① Slide the coupling ring down. Strip the cable jacket and soft solder.
- ② Strip the cable as shown at left. Soft solder the center conductor.
- ③ Slide the connector body on and solder it.
- ④ Screw the coupling ring onto the connector body.

30 mm  $\approx$  9/8 in    10 mm  $\approx$  3/8 in    1-2 mm  $\approx$  1/16 in

### ANTENNA SWR

Each antenna is tuned for a specified frequency range and SWR may be increased out-of-range. When the SWR is higher than approx. 2.0 : 1, the transceiver's power drops to protect the final FET. In this case, an antenna tuner is useful to match the transceiver and antenna. Low SWR allows full power for transmitting even when using the antenna tuner. The IC-775/DSP has an SWR meter to monitor the antenna SWR continuously.

## 2 INSTALLATION AND CONNECTIONS

### Required connections

#### • Front panel

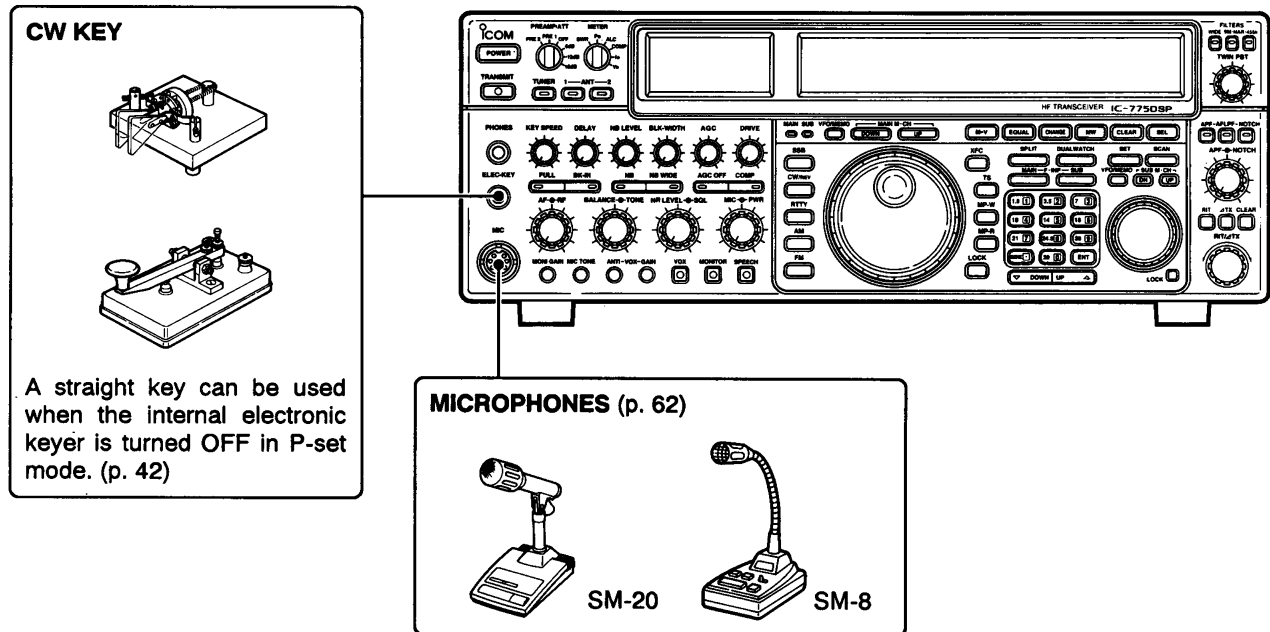

#### • Rear panel

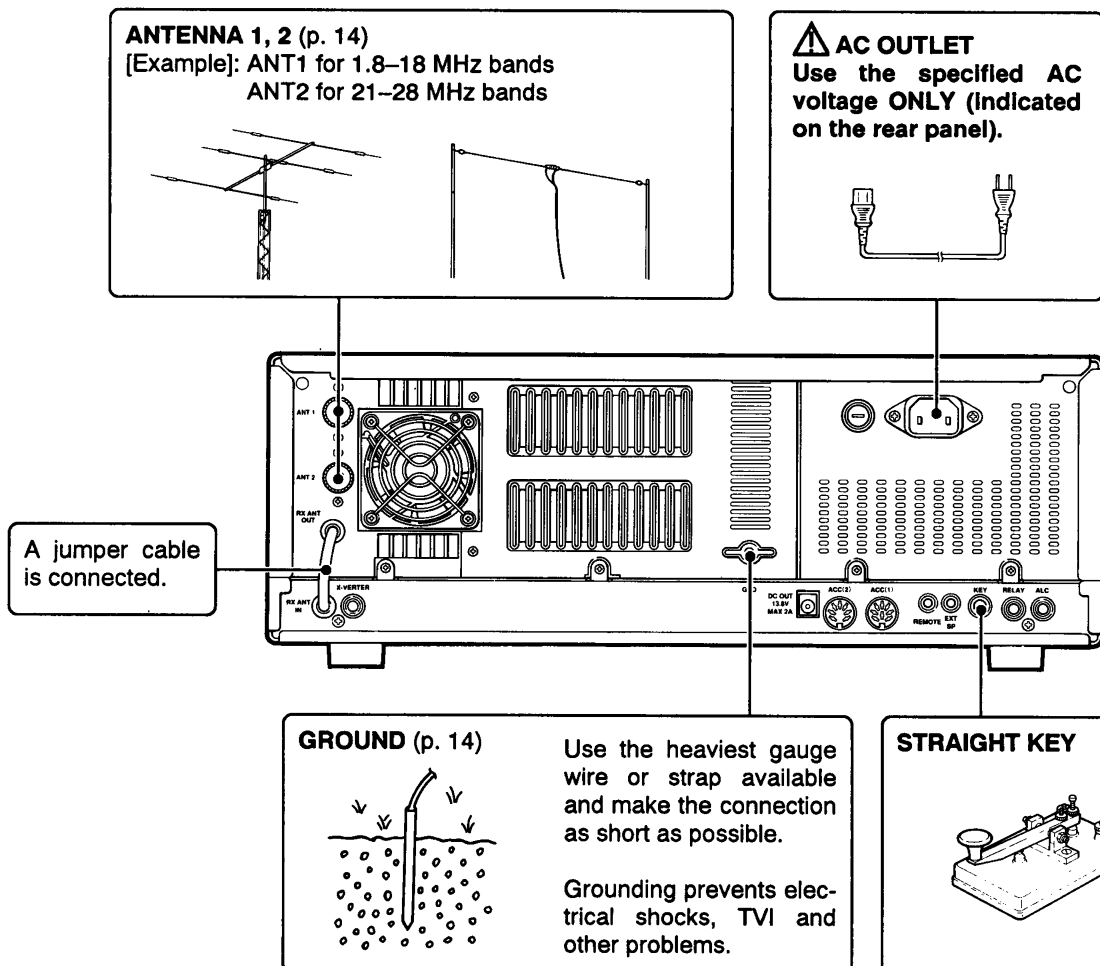

## Advanced connections

### • Front panel

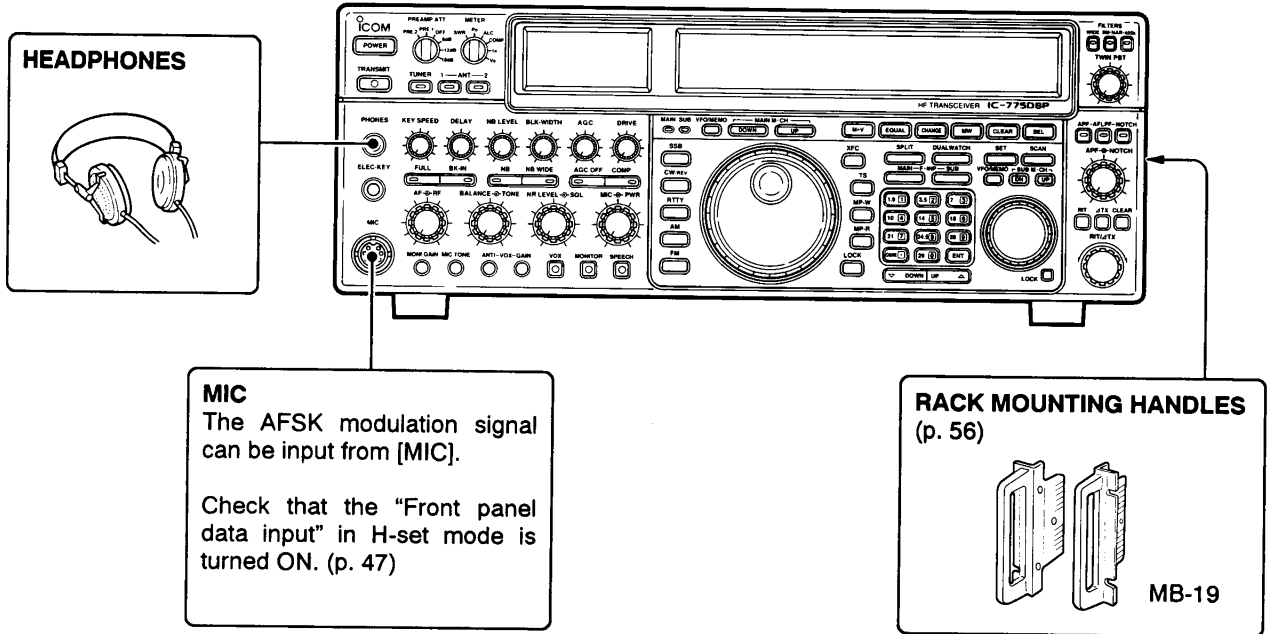

### • Rear panel

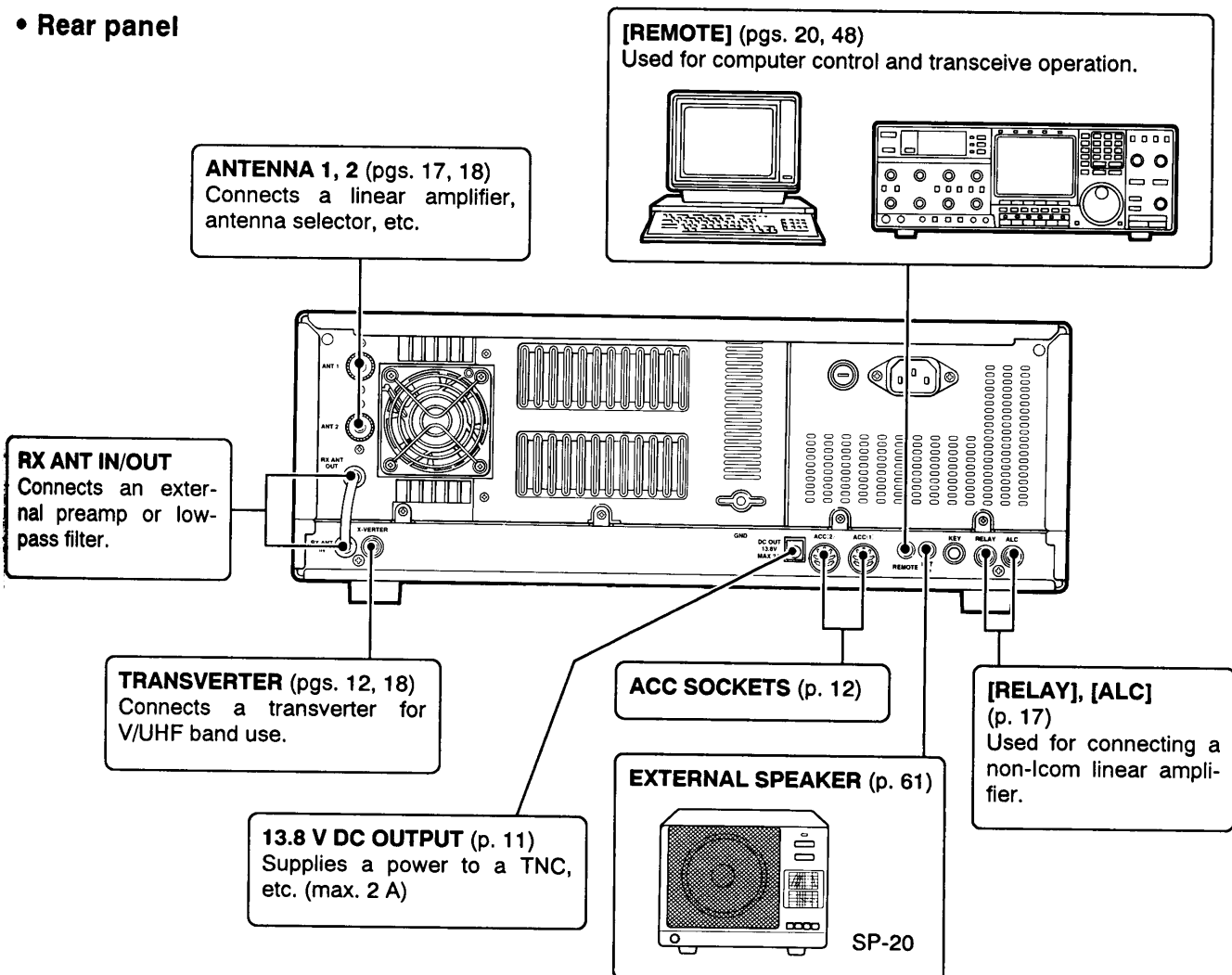

## Linear amplifier connections

Use the [ANT1] connector when connecting a linear amplifier.

### CONNECTING THE IC-4KL

**CAUTION:**  
Set the transceiver output power for 100 W max. with the [PWR] control, otherwise, a protection circuit will activate.

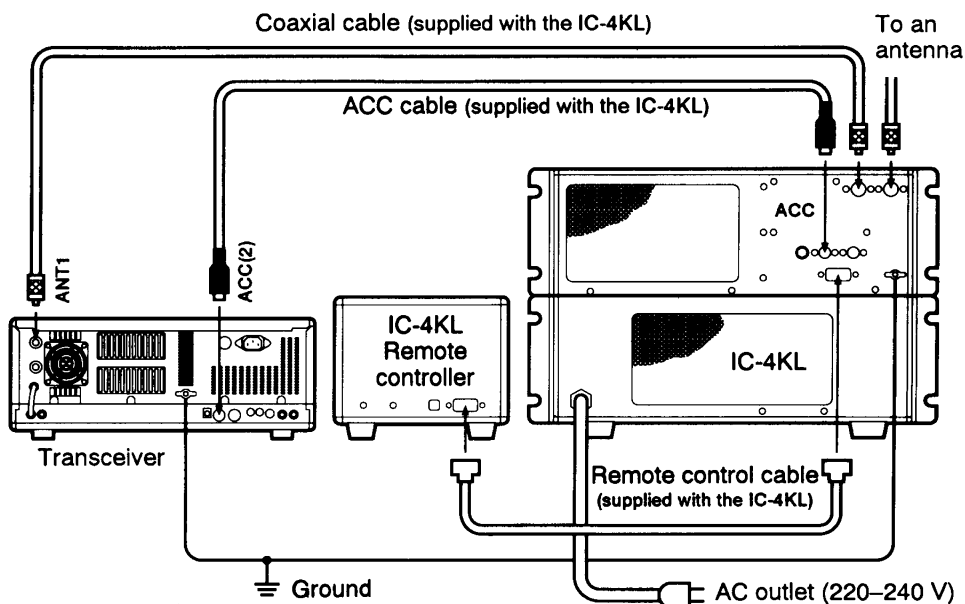

**NOTE:** Turn OFF the transceiver's antenna tuner while tuning the IC-4KL's tuner.

### CONNECTING THE IC-2KL

**CAUTION:**  
Set the transceiver output power for 80 W max. with the [PWR] control, otherwise, a protection circuit will activate.

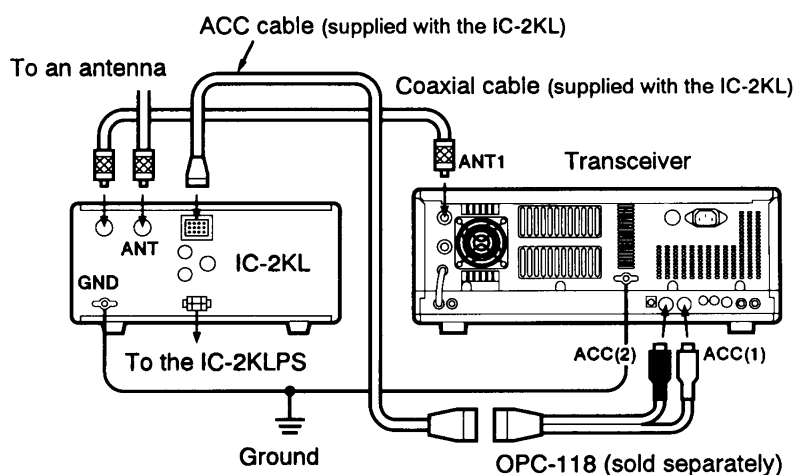

### CONNECTING A NON-ICOM LINEAR AMPLIFIER

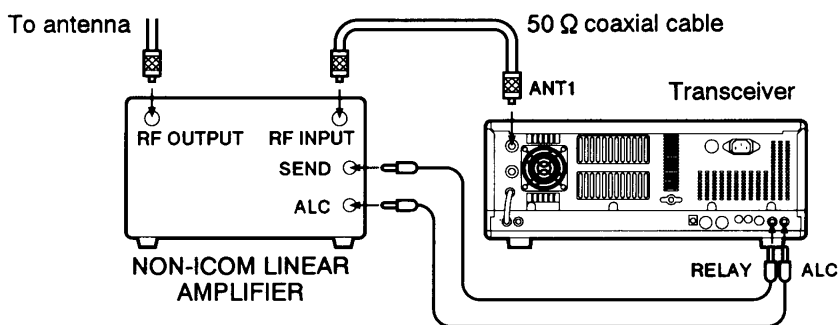

**NOTE 1:** The specifications for the SEND relay are 24 V DC 1 A. If this level is exceeded, a large external relay must be used.

**NOTE 2:** The ALC output level of the linear amplifier must be in the range 0 V to -4 V, and the transceiver does not accept positive voltage.

## External antenna selector or antenna tuner connections

**CAUTION:** The AH-2a HF ALL BAND ANTENNA TUNER cannot be used with the IC-775/DSP. The AH-2a accepts less than 100 W input power.

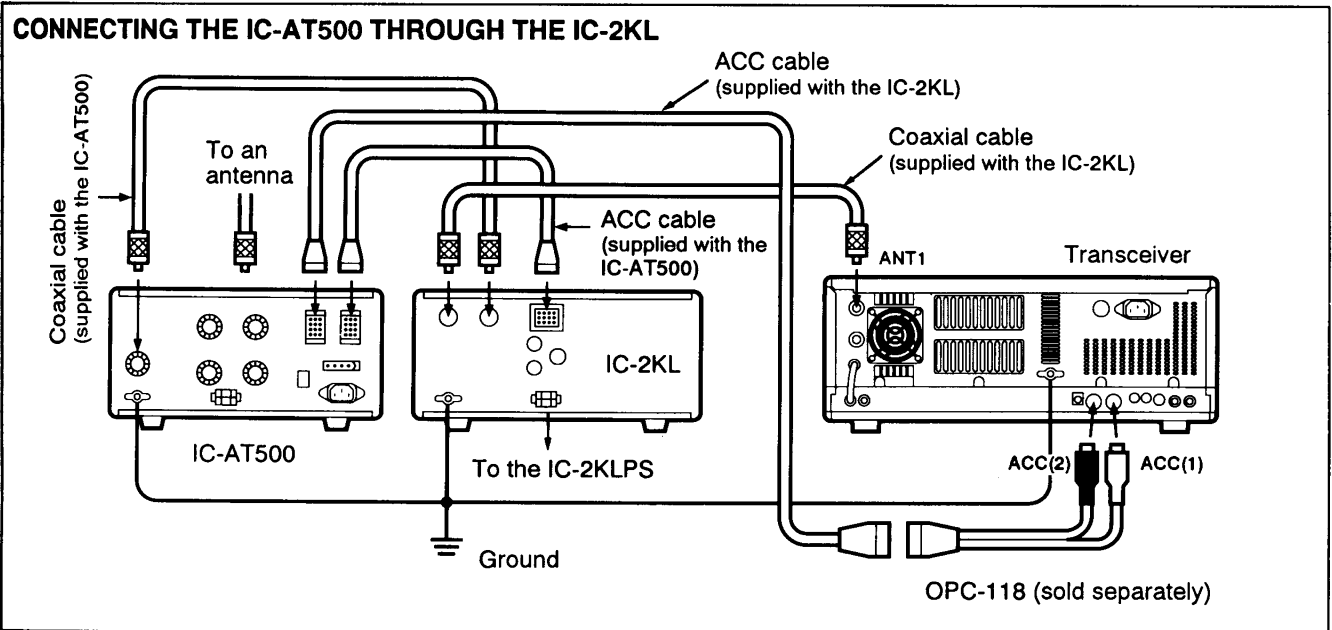
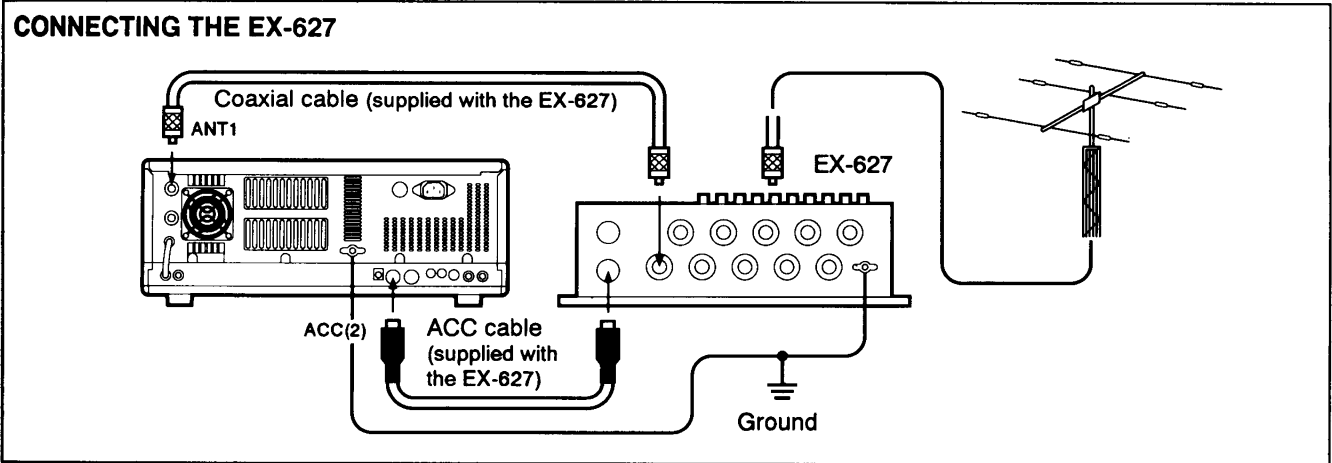

## Transverter jack information

When 2 to 13.8 V is applied to pin 6 of [ACC (2)], this jack is activated for transverter operation and the antenna connectors do not receive or transmit any signals. (p. 12)

While receiving, this jack can be activated as an input terminal from an external transverter.

While transmitting, this jack outputs signals of the displayed frequency at  $-20$  dBm (22 mV) as signals for an external transverter.

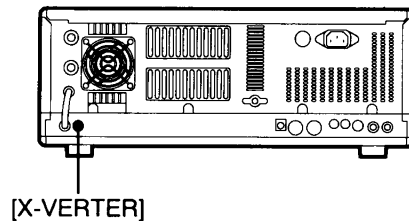

## 2 INSTALLATION AND CONNECTIONS

### ■ FSK and AFSK (SSTV) connections

To connect a terminal unit, TNC or scan converter, refer the diagram below.

For RTTY operation

The optional 250 Hz CW narrow filters may not pass RTTY signals. Be sure to select the appropriate IF filters corresponding to the signal width.

For **[DSP]** equipped type

When operating AFSK or SSTV in SSB mode, the transmit 2.5 kHz low-pass filter is activated at its default setting. (p. 42)

According to the AFSK system, modulation may become shallow or not occur at all. Turn the PSN modulation OFF (p. 41) to cancel the transmit filter in this case.

#### FSK (RTTY) connection

Use RTTY mode for operation

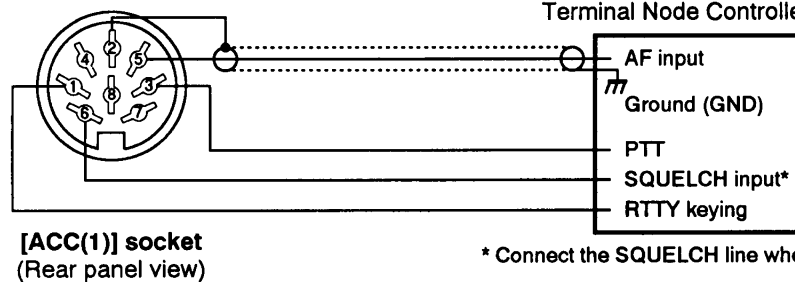

\* Connect the SQUELCH line when required.

#### AFSK and SSTV connections

Use SSB or FM mode for operation

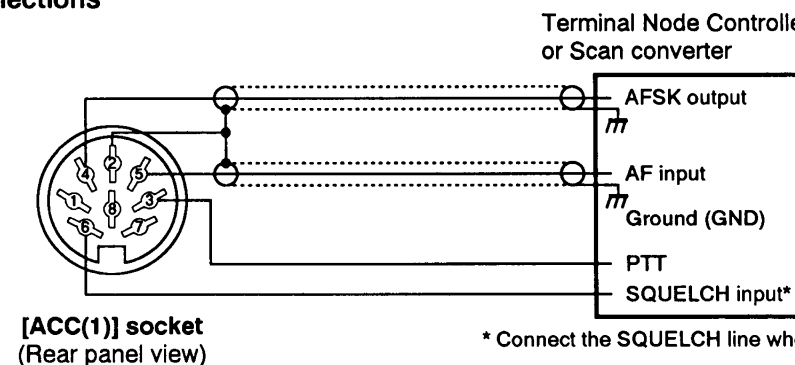

\* Connect the SQUELCH line when required.

#### AFSK and SSTV connections via microphone connector

Use SSB or FM mode for operation

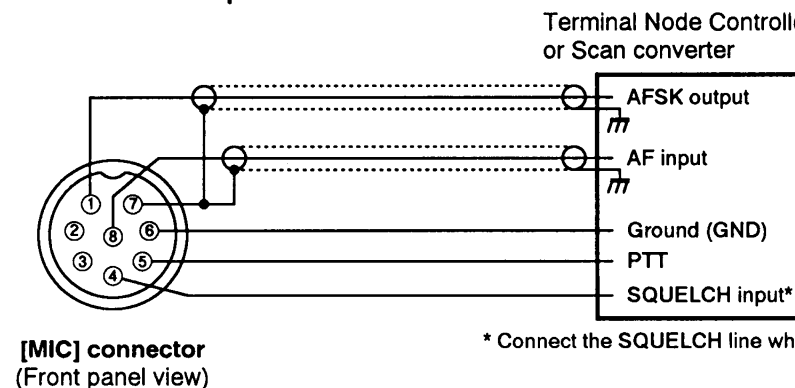

\* Connect the SQUELCH line when required.

When connected to the [MIC] connector, [MIC] and [AF] control adjustment is required. When connected to the [MIC] connector in a DATA mode, turn the front panel data input, in H-set mode, ON. (p. 47)

## Remote jack (CI-V) information

### • CI-V connection example

The transceiver can be connected through an optional CT-17 CI-V LEVEL CONVERTER to a personal computer equipped with an RS-232C port. The Icom Communication Interface-V (CI-V) controls the following functions of the transceiver.

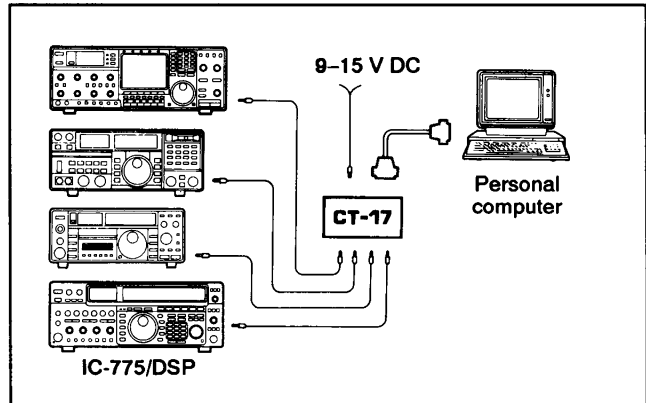

Up to four Icom CI-V transceivers or receivers can be connected to a personal computer equipped with an RS-232C port. See p. 48 for setting the CI-V condition using the H-set mode.

### • Data format

The CI-V system can be operated using the following data formats. Data formats differ according to command numbers. A data area or sub command is added for some commands.

#### CONTROLLER TO IC-775/DSP

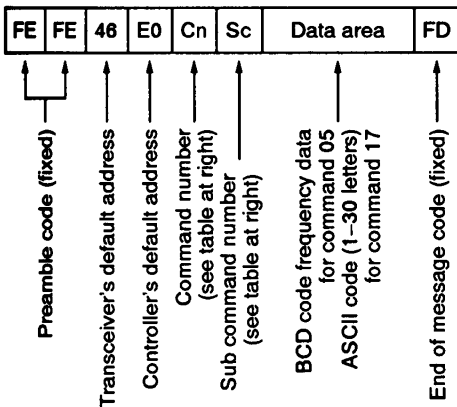

#### OK MESSAGE TO CONTROLLER

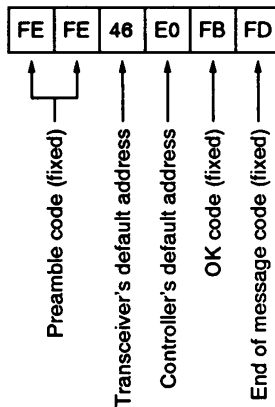

#### IC-775/DSP TO CONTROLLER

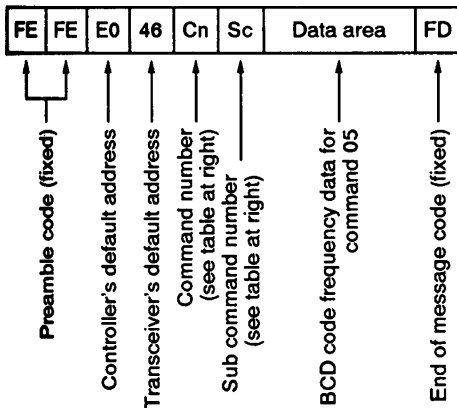

#### NG MESSAGE TO CONTROLLER

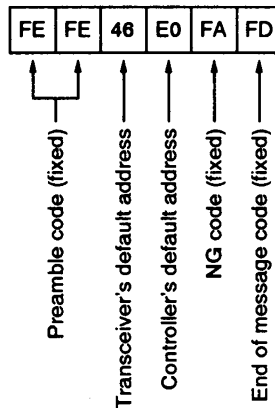

#### COMMAND TABLE

Description	Cn	Sc	
Frequency control	05	Data	
Operating mode and IF filter control	06	LSB	00* <sup>1</sup>
		USB	01* <sup>1</sup>
		AM	02* <sup>1</sup>
		CW	03* <sup>1</sup>
		RTTY	04* <sup>1</sup>
FM	05* <sup>2</sup>		
VFO mode		-	
MAIN ↔ SUB	07	B0	
MAIN=SUB		B1	
Dualwatch OFF		C0	
Dualwatch ON	C1		
Memory mode	08	-	
Memory selection	08	mc* <sup>3</sup>	
Memory write	09	-	
Memory ▶ VFO	0A	-	
Memory clear	0B	-	
Scan stop	0E	00	
Start scan		01	
Split OFF	0F	00	
Split ON		01	
[TS] OFF (10 Hz step)	10	00	
[TS] ON (1-10 kHz steps)		01-10	
[ANT1] selection	12	00	
[ANT2] selection		01	
Electronic keyer input	17	Data	

\*<sup>1</sup> Add "01" to select wide IF filters.  
 Add "02" to select narrow IF filters.  
 \*<sup>2</sup> Add "02" to select narrow IF filters.  
 \*<sup>3</sup> Memory channel number (BCD)  
 P1=0100, P2=0101

#### ASCII code for command 17

- Acceptable characters: A-Z, 0-9, / ? . \_ ( ) and space
- " ^ " continues the next letter without a space; e.g. ^AR = AR,
- ^S^OS = SOS

# 3 BASIC OPERATION

## ■ When first applying power (CPU resetting)

Before first applying power, make sure all connections required for your system are complete by referring to section 2. Then, reset the transceiver using the following procedure.

**NOTE:** Resetting **CLEARs** all programmed contents in memory channels and returns programmed values in the P-set and H-set modes to default values.

- ① Make sure the transceiver power is OFF.
- ② While pushing [CLEAR], push IN [POWER] to turn power ON.
  - The internal CPU is reset.
  - The transceiver displays its initial VFO frequencies when resetting is complete.

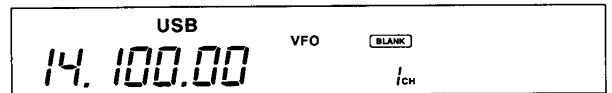
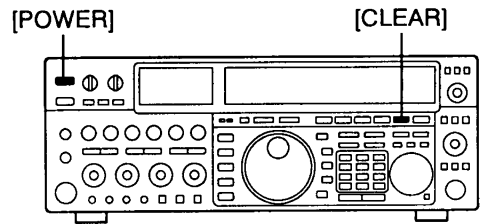

The transceiver displays its initial frequencies. (The initial frequency and mode depend on versions.)

- ▨ Correct the set mode settings after resetting:
  - Optional filter settings in H-set mode (p. 47)

## ■ Initial settings

After resetting the transceiver, set controls and switches as shown in the figure below.

CW : Max. clockwise  
CCW : Max. counterclockwise

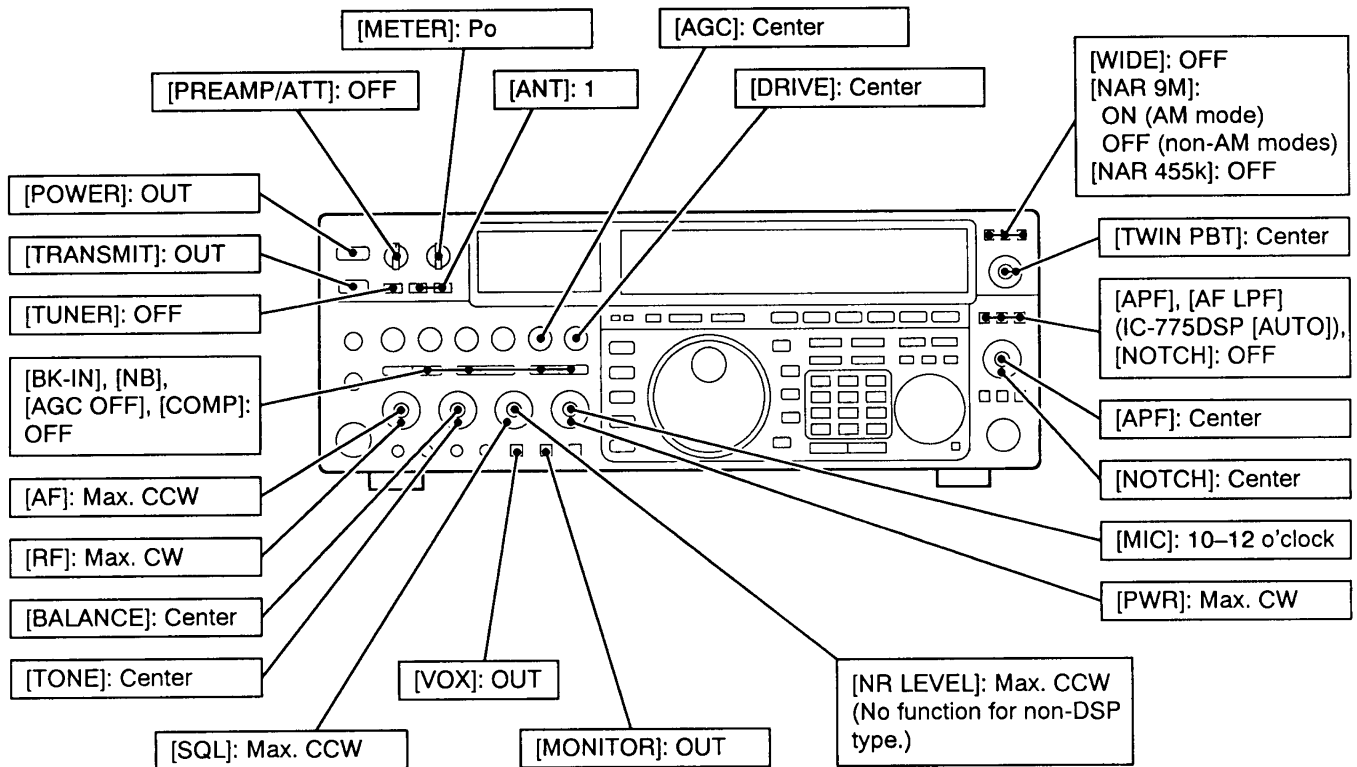

Turn power ON, then check the display. If any of the following indicators appear, turn them OFF as follows:

- Lock indicator " **LOCK** " : Push MAIN or SUB [LOCK].
- Quick tuning step indicator " ▼ " : Push [TS].
- 1 Hz frequency readout : Push [TS].
- Memory mode indicator "MEMO": Push [VFO/MEMO].

- Data mode indicator " **DATA** " : Push the selected mode switch once or twice.
- RIT indicator " **RIT** " : Push [RIT].
- ΔTX indicator " **ΔTX** " : Push [ΔTX].
- Split indicator " **SPLIT** " : Push [SPLIT] once or twice.
- Dualwatch indicator " **DUALWATCH** " : Push [DUALWATCH].



## Basic SSB/AM operation

- ① Make sure the initial settings are complete.
- ② Push the desired band key, [0]–[9], to select the desired band.
- ③ Push [SSB] or [AM] to select the desired mode.
  - Pushing [SSB] selects USB or LSB mode first when operating above or below 10 MHz, respectively.
  - When "DATA" appears, push [SSB] twice or push [AM] again.

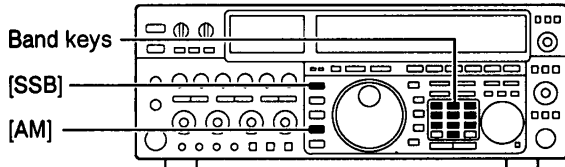

- ④ Rotate the main dial to set the desired frequency.
  - See p. 25 for frequency setting details.
- ⑤ Push [TUNER] for 2 sec. to tune the antenna.
  - [TUNER] lights up when tuning is complete.
  - If it does not light, check your antenna. (p. 39)

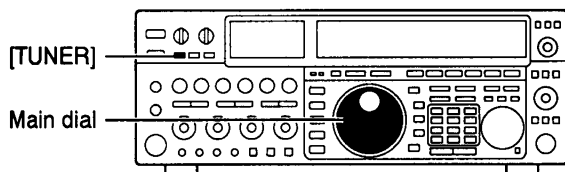

- ⑥ Rotate [AF] clockwise to adjust the desired audio output level.
  - Adjust the [SQL] control when you want to eliminate weaker signals.

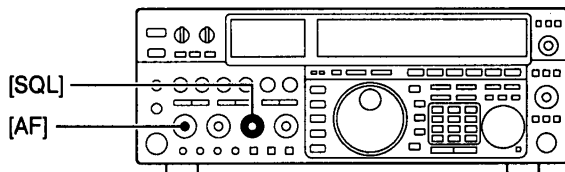

- ⑦ Push the PTT switch on the microphone to transmit. Then, release the PTT switch to return to receive.

### Convenient functions for SSB and AM modes

- Dualwatch function ..... (p. 35)
- Twin passband tuning ..... (p. 28)
- RIT/ $\Delta$ TX function ..... (p. 32)
- Noise reduction\* ..... (p. 29)
- Noise blanker for SSB mode ..... (p. 30)
- IF notch filter ..... (p. 28)
- Auto notch filter\* ..... (p. 29)
- Attenuator/pre-amplifier ..... (p. 2)
- AGC time constant control ..... (p. 4)
- Speech compressor ..... (p. 36)
- Transmit meters ..... (p. 36)
- Split frequency operation ..... (pgs. 33, 34)
- VOX operation ..... (p. 36)
- RF gain control ..... (p. 4)
- Dial lock ..... (p. 40)

\* Available for **[DSP]** equipped type.

## Basic FM operation

- ① Make sure the initial settings are complete.
- ② Push [0] to select the 29 MHz band.
- ③ Push [FM] to select FM mode.
  - When "DATA" appears, push [FM] again.
  - When pushing [SPLIT], duplex (split) and subaudible tone encoder are turned ON simultaneously. See p. 38 for repeater operation details.

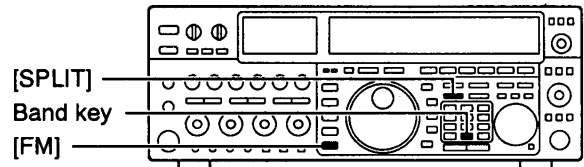

- ④ Rotate the main dial to set the desired frequency.
  - See p. 25 for frequency setting details.
- ⑤ Push [TUNER] for 2 sec. to tune the antenna.
  - [TUNER] lights up when tuning is complete.
  - If it does not light, check your antenna. (p. 39)

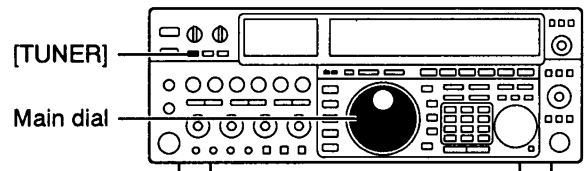

- ⑥ Rotate [AF] clockwise to adjust the desired audio output level.
- ⑦ Rotate [SQL] control clockwise until the audio noise just disappears.

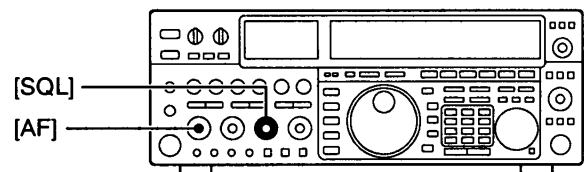

- ⑧ Push the PTT switch on the microphone to transmit. Then, release the PTT switch to return to receive.

### Convenient functions for FM mode

- Dualwatch function ..... (p. 35)
- RIT/ $\Delta$ TX function ..... (p. 32)
- Noise reduction\* ..... (p. 29)
- Auto notch filter\* ..... (p. 29)
- Attenuator/pre-amplifier ..... (p. 2)
- Transmit meters ..... (p. 36)
- Repeater (Split frequency) operation ..... (p. 38)
- Subaudible tone encoder ..... (p. 46)
- VOX operation ..... (p. 36)
- Dial lock ..... (p. 40)

\* Available for **[DSP]** equipped type.

Downloaded by   
 Amateur Radio Directory   
  
[www.hamdirectory.info](http://www.hamdirectory.info)

## Basic CW operation

- ① Connect a paddle to the [ELEC-KEY] jack.  
- A CW keyer or an external electronic keyer can be connected. Deactivate the internal electronic keyer in P-set mode in this case. (p. 42)
- ② Make sure the initial settings are complete. (p. 21)
- ③ Push the desired band key, [0]–[9], to select the desired band.

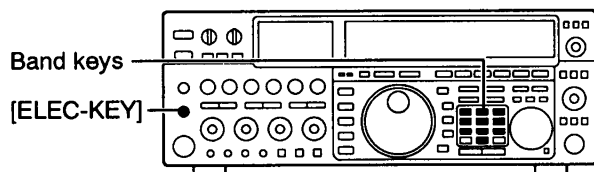

- ④ Push [CW/REV] once or twice to select CW or CW reverse mode. (p. 31)
- ⑤ Rotate the main dial to set the desired frequency.  
- See p. 25 for frequency setting details.

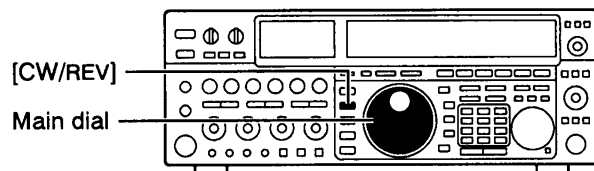

- ⑥ Push [TUNER] for 2 sec. to tune the antenna.  
- [TUNER] lights up when tuning is complete.  
- If it does not light, check your antenna. (p. 39)
- ⑦ Rotate [AF] clockwise to adjust the desired audio output level.  
- Adjust the [SQL] control when you want to eliminate weaker signals.

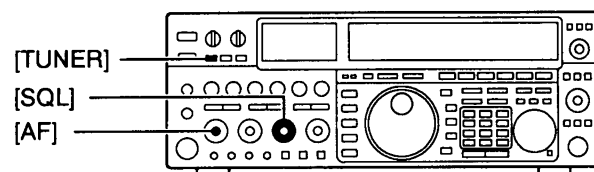

- ⑧ Push [BK-IN] to set the CW semi break-in operation.
- ⑨ Push the connected key down to transmit the CW signal.
- ⑩ Adjust [DELAY] control to your desired switching speed for returning transmit to receive.
- ⑪ Adjust [MONI GAIN] to the desired CW side tone level.  
- The side tone level can be changed relative to both [AF] and [MONI GAIN] controls.

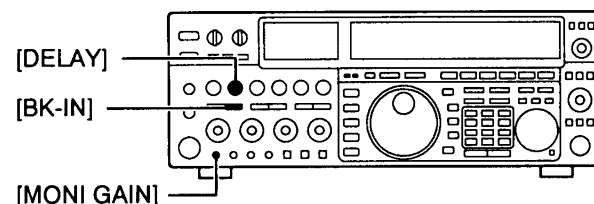

### Convenient functions for CW mode

- Dualwatch function ..... (p. 35)
- Twin passband tuning ..... (p. 28)
- CW narrow filters ..... (p. 31)
- CW pitch control ..... (p. 29)
- Auto audio peak filter\* ..... (p. 30)
- Audio peak filter ..... (p. 30)
- Noise reduction\* ..... (p. 29)
- Noise blanker ..... (p. 30)
- Electronic CW keyer with speed control .. (p. 37)
- CW memory keyer ..... (p. 37)
- RIT/ $\Delta$  TX function ..... (p. 32)
- Attenuator/pre-amplifier ..... (p. 2)
- AGC time constant control ..... (p. 4)
- Transmit meters ..... (p. 36)
- Split frequency operation ..... (pgs. 33, 34)
- Full break-in operation ..... (pgs. 1, 2)
- RF gain control ..... (p. 4)
- Dial lock ..... (p. 40)

\* Available for **[DSP]** equipped type.

## Basic FSK (RTTY) operation

Set the RTTY tone, shift frequency, etc. to appropriate settings in advance. (pgs. 43, 47) Connect external equipment to the ACC(1) socket as described on pgs. 12 and 19.

- ① Make sure the initial settings are complete. (p. 21)
- ② Push the desired band key, [0]–[9], to select the desired band.
- ③ Push [RTTY] or [FM] to select the desired mode.  
- Push [RTTY] or [FM] again for 2 sec. to select a DATA mode.  
- FM is used for PACKET (AFSK operation).
- ④ Rotate the main dial to set the desired frequency.  
- See p. 25 for frequency setting details.
- ⑤ Push [TUNER] for 2 sec. to tune the antenna.  
- [TUNER] lights up when tuning is complete.  
- If it does not light, check your antenna. (p. 39)
- ⑥ Control the transceiver from the external TU or TNC.

### • Default settings for RTTY

- Mark frequency : 2125 Hz
- Space frequency : 2295 Hz
- Shift width : 170 Hz
- Mark polarity : Key open
- Space polarity : Key closed

### • Default settings for RTTY DATA

- Mark frequency : 2025 Hz
- Space frequency : 2195 Hz
- Shift width : 170 Hz
- Mark polarity : Key open
- Space polarity : Key closed

## VFO description

VFO is an abbreviation of Variable Frequency Oscillator, and traditionally refers to an oscillator.

The transceiver's VFO is somewhat different. The VFO of the IC-775 acts like a computer's window and can show one frequency and one operating mode.

You can call up a desired frequency to the VFO with the keypad, memo pad-read switch (see p. 27) or the memory transfer switch (see p. 51). You can also change the frequency with the main dial and select the operating mode with the mode switches.

During dualwatch or split frequency operation, SUB VFO appears. You can change the SUB VFO frequency with the sub dial. While pushing [XFC] during split frequency operation, you can also change the sub readout frequency with the keypad, memo pad-read or the memory transfer switch.

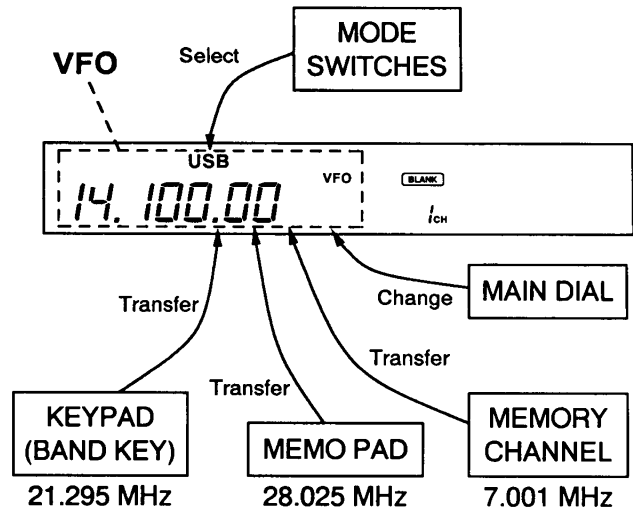

### • The differences between the VFO mode and the memory mode

#### VFO MODE

VFO shows a frequency and operating mode. If the frequency or operating mode is changed, the VFO automatically memorizes the new frequency or new operating mode.

When a VFO is selected from another band or the memory mode, the last used frequency and operating mode for that VFO appear.

#### [EXAMPLE]

VFO is selected.

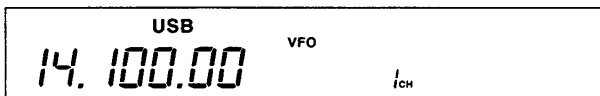

The frequency is changed.

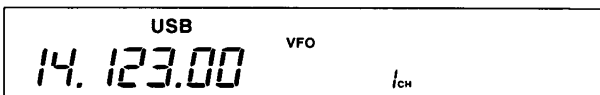

Memory mode is selected.

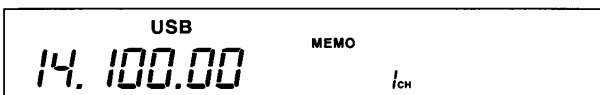

VFO is selected again.

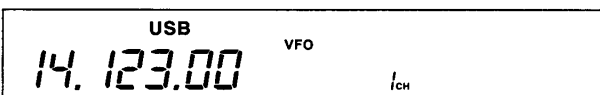

Changed frequency (14.123 MHz) appears.

#### MEMORY MODE (pgs. 49–52)

Each memory channel shows a frequency and operating mode like a VFO. Even if the frequency or mode is changed, the memory channel does not memorize the new frequency or operating mode.

When the memory channel is selected from another memory channel or VFO mode, the memorized frequency and operating mode appear.

#### [EXAMPLE]

Memory channel 1 is selected.

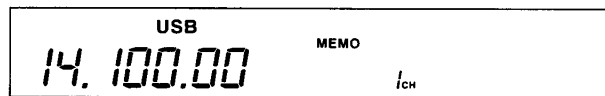

The frequency is changed.

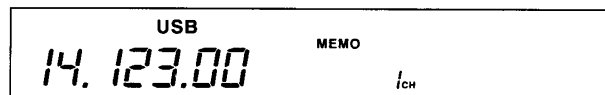

Another memory channel is selected.

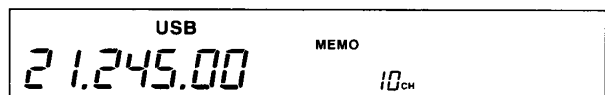

Memory channel 1 is selected again.

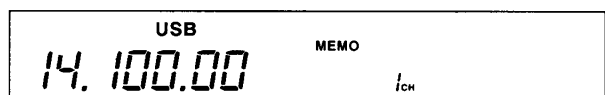

Changed frequency (14.123 MHz) does not appear and memorized frequency (14.000 MHz) appears instead.

## Frequency setting with the main dial

### • For ham band use

- Push the desired band key on the keypad 1–3 times.  
- 3 different frequencies can be selected on each band with the band key. (See TBSR in the box below.)



- Rotate the main dial to set the desired frequency.

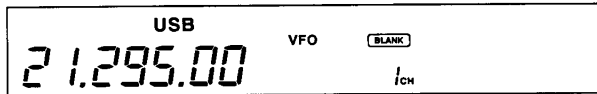

- Select the desired operating mode with the mode switches.

**NOTE:** If the main dial lock function is activated, " **LOCK** " is indicated in the MAIN readout and the main dial does not function. In this case, push MAIN [LOCK] to deactivate the dial lock function.

### • For general coverage receiver use

- Push [GENE] on the keypad 1–3 times.  
- The [GENE] key calls up a frequency for general coverage receiver use.

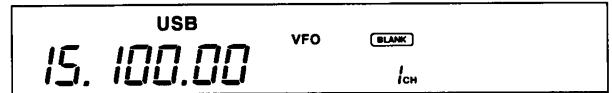

- Rotate the main dial to set the desired frequency.  
- For quick tuning, use [ΔUP]/[▽DOWN] switches or the quick tuning step function (p. 26).

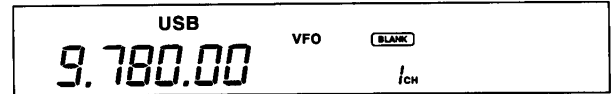

- Select the desired operating mode with the mode switches.

## FUNCTION

The **TBSR (Triple Band Stacking Register)** provides 3 memories in one band. 3 sets of a frequency and mode on each band are automatically stored when used.

If a band key is pushed once, the last used frequency and mode are called up. When the key is pushed again, another stored frequency and mode are called up.

This function is convenient when you operate 3 modes on one band. For example, one register is used for a CW frequency, another for an SSB frequency and the other one for an RTTY frequency.

### [TBSR EXAMPLE]

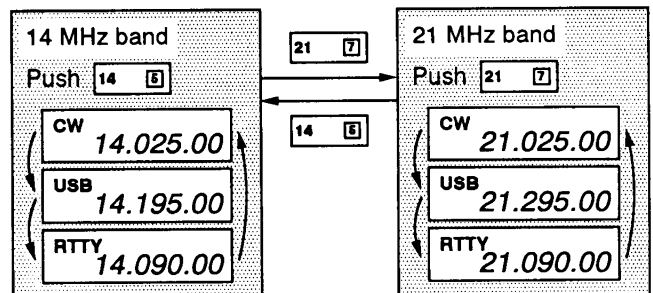

## Direct frequency entry with the keypad

The transceiver has a keypad for direct frequency entry as described below.

- Push MAIN [F-INP].  
- The MAIN readout frequency disappears.
- Input the desired frequency.  
- Input "." (decimal point) between the MHz units and kHz units.
- Push [ENT] to enter the input frequency.  
- To cancel the input, push MAIN [F-INP] instead of [ENT].

### [EXAMPLE]

14.025 MHz  
MAIN F-INP  
[ ] [1] [4] [.] [0] [2] [5] [ENT]

18.0725 MHz  
MAIN F-INP  
[ ] [1] [8] [.] [0] [7] [2] [5] [ENT]

729 kHz  
MAIN F-INP  
[ ] [0] [.] [7] [2] [9] [ENT]

5.100 MHz  
MAIN F-INP  
[ ] [5] [.] [1] [0] [0] [ENT]

7.000 MHz  
MAIN F-INP  
[ ] [7] [0] [0] [0] [ENT]

21.280 → 21.245  
MAIN F-INP  
[ ] [.] [2] [4] [5] [ENT]

## Advanced tuning functions

### QUICK TUNING STEP

The operating frequency can be changed in kHz steps (1–10 kHz programmable) for quick tuning.

- ① Push [TS] to display the quick tuning indicator.

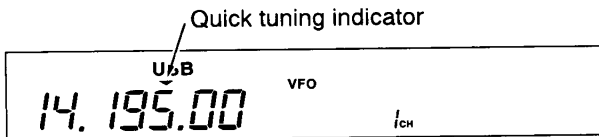

- ② Rotate the main dial to change the frequency in programmed kHz steps.
- ③ Push [TS] again to turn OFF the indicator.
- ④ Rotate the main dial for normal tuning if required.

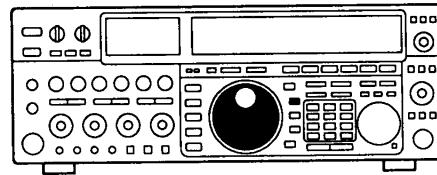

### Programming the kHz step

- ① Push MAIN [F-INP].
- ② Enter the desired kHz step with the digit key(s), [1] – [1][0].
- ③ Push [TS] to set the entered kHz step.

(e.g. For a 9 kHz step, push MAIN [F-INP][9][TS].)

### SELECTING THE 1 Hz STEP

The minimum tuning step of 1 Hz can be used for fine tuning.

Push [TS] for 2 sec. to activate the 1 Hz tuning step; push again to deactivate it.

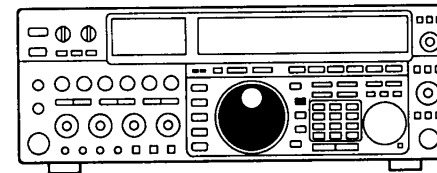
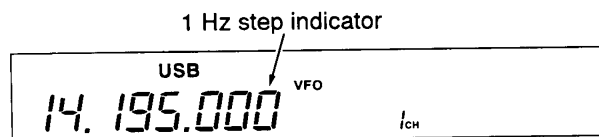

**NOTE:** The 1 Hz readouts for the RIT/ $\Delta$ TX and SUB frequency readout are not available. However, the transceiver functions in 1 Hz resolution for the RIT/ $\Delta$ TX and SUB frequency readout.

### [ $\Delta$ UP]/[ $\nabla$ DOWN] SWITCH TUNING

The [ $\Delta$ UP]/[ $\nabla$ DOWN] switches change the frequency in programmed steps for large frequency changes. You can set this tuning step from 1 kHz – 1 MHz (in 1 kHz intervals).



### Programming the [ $\Delta$ UP]/[ $\nabla$ DOWN] switch tuning steps

- ① Push MAIN [F-INP].
- ② Enter the desired step with the digit key(s), [1] – [1][0][0][0].
- ③ Push [ $\Delta$ UP] or [ $\nabla$ DOWN].

(e.g. For a 5 kHz step, push MAIN [F-INP][5][UP].  
For a 1 MHz step, push MAIN [F-INP][1][0][0][0][UP].)

### CHANGING THE NORMAL TUNING STEP

The transceiver's normal tuning step default setting is 10 Hz. However, this can be changed to 20 Hz or 50 Hz as follows.

- For a 10 Hz step, push MAIN [F-INP][0].[1][TS].
- For a 20 Hz step, push MAIN [F-INP][0].[2][TS].
- For a 50 Hz step, push MAIN [F-INP][0].[5][TS].

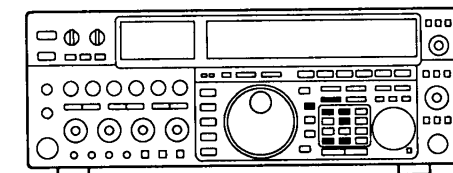

### AUTO TUNING STEP FUNCTION

When selecting AM or FM, the quick tuning step is automatically selected by the auto tuning step function. This function can be turned ON and OFF as desired in the H-set mode. (p. 44)

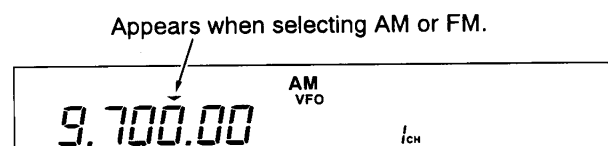

# 4 FUNCTION OPERATIONS

## ■ Memo pad operation

The transceiver has a memo pad function to store frequency and operating mode for easy write and recall. The memo pads are separate from memory channels.

The default number of memo pads is 5, however this can be increased to 10 in the H-set mode if needed. (p. 45).

The memo pad function is convenient when you want to memorize a frequency and operating mode temporarily, such as when you find a DX station in a pile-up or when a desired station is busy for a long time and you want to search for other stations.

Use these memo pads instead of inconvenient paper memo pads for writing frequencies.

### • Writing frequencies and operating modes into memo pads

You can simply write the displayed frequency and operating mode by pushing the [MP-W] switch.

When you write a 6th frequency and operating mode, the oldest written frequency and operating mode are automatically erased to make room for the new settings.

**NOTE:** Each memo pad must have its own unique combination of frequency and operating mode, memo pads containing identical settings cannot be written.

Displayed frequency and mode

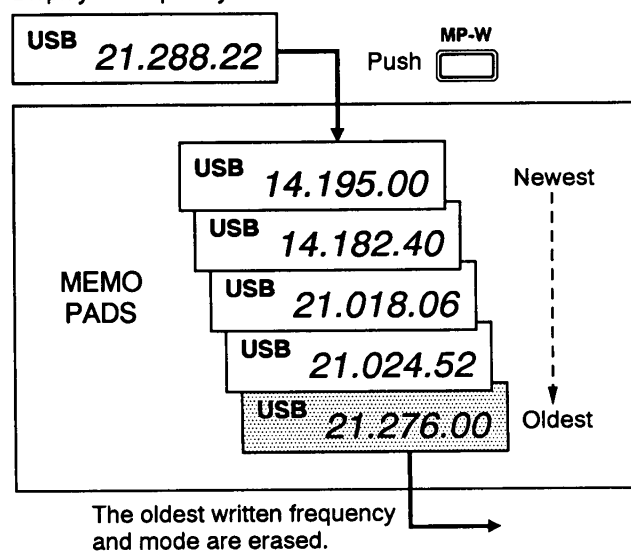

### • Calling up a frequency from a memo pad

You can simply call up the desired frequency and operating mode of a memo pad by pushing the [MP-R] switch one or more times.

- Both VFO and memory modes can be used.
- The frequency and operating mode are called up, starting from the most recently written.

When you call up a frequency and an operating mode from memo pads with [MP-R], the previously displayed frequency and operating mode are automatically stored in a temporary pad. The frequency and operating mode in the temporary pad can be recalled by pushing [MP-R] one or more times.

- You may think there are 6 memo pads because 6 different frequencies (5 are in memo pads and 1 is in the temporary pad) are called up by [MP-R].

**NOTE:** If you change the frequency or operating mode called up from a memo pad with the main dial, etc., the frequency and operating mode in the temporary pad are erased.

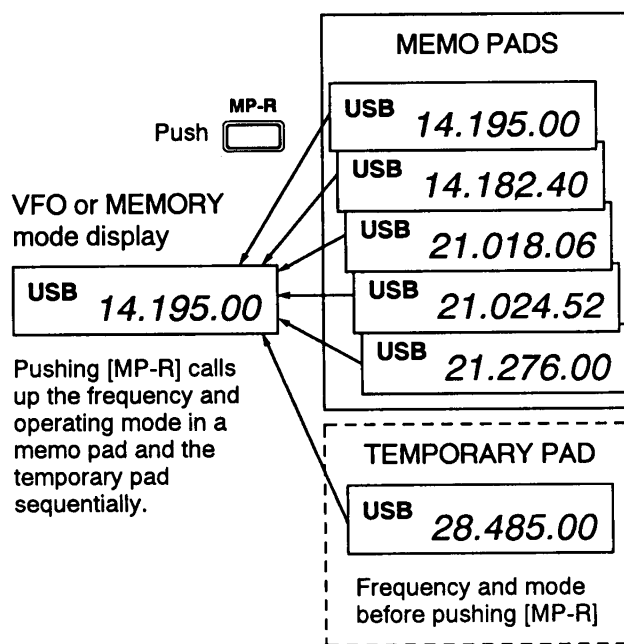

## Twin PBT operation

The twin PBT (Passband Tuning) function electronically narrows the receiver's IF passband widths to reduce interference. Moving both [TWIN PBT] controls to the same position shifts the IF.

PBT variable ranges are  $\pm 1.25$  kHz in 10 Hz steps.

- [TWIN PBT] should normally be set to the center positions when there is no interference.
- When PBT is used, the audio tone may be changed.
- PBT may not function with some IF filter combinations.
- Not available for FM mode.

### PBT OPERATION EXAMPLE

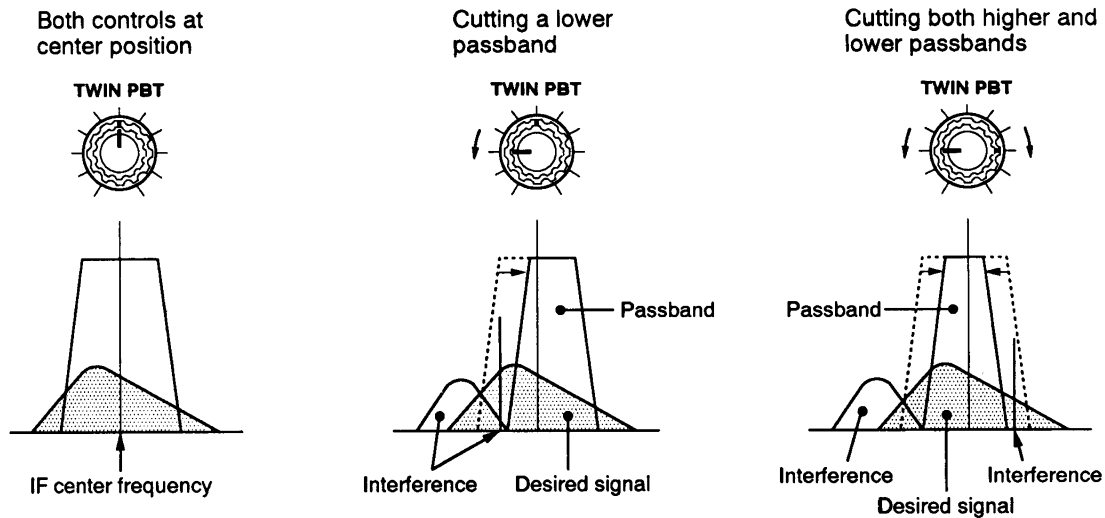

## IF notch operation

The IF notch function attenuates a part of the received signal at the set filtering frequency to eliminate unwanted tones. The IF notch function should be turned OFF when there are no unwanted tones and is not available for FM mode.

This IF notch has a characteristic of max. 45 dB attenuation at the center of your set frequency.

- Auto notch function is separately available (DSP-equipped type only) for a moving noise signal, multiple noise, etc. (p. 29)

### IF NOTCH OPERATION EXAMPLE

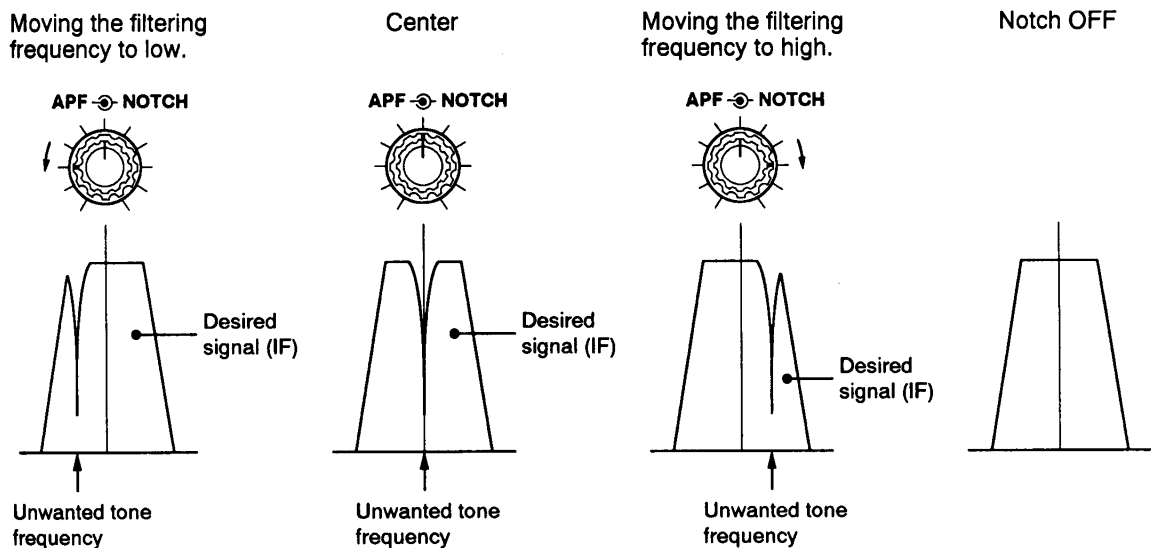

## Auto notch function DSP

The auto notch function automatically attenuates beat tones, tuning signals, etc. more than 3 tones even if they are moving. This function is available for the DSP-equipped type only.

The function can be used together with the manual notch filter (IF-type) and also acts in FM mode.

- ① Select SSB or FM mode.
- ② Push [AUTO] to turn the auto notch function ON.  
- The [AUTO] switch activates the auto APF in CW mode. (p. 30)
- ③ Push [AUTO] again to cancel the function.

Auto notch OFF

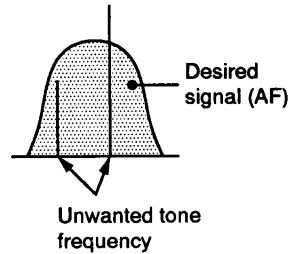

Auto notch ON

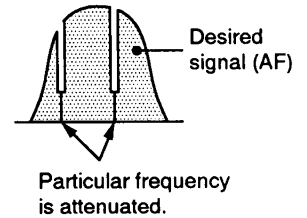

For the IC-775, [AF LPF] functions as the auto notch switch in SSB mode when an optional UI-100 is installed and activated.

## Noise reduction DSP

The noise reduction function reduces noise components and picks up the desired signals which are buried in noise. The received AF signals are converted to digital signals and separated into signals and noise. This function is available for the DSP-equipped type only.

The [NR LEVEL] control adjusts the noise reduction level. Deep rotation results in audio signal masking or distortion. Set [NR LEVEL] for maximum readability. The noise reduction function is not available in AM mode.

"NR" appear when noise reduction is in use.

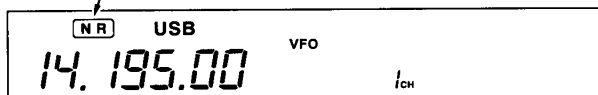

Noise reduction OFF

NR LEVEL SQL

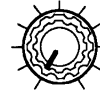

Noise components

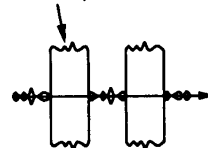

Noise reduction activated

NR LEVEL SQL

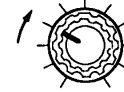

Desired signal (CW)

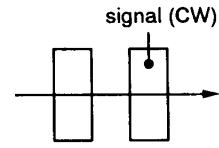

**NOTE:** Rotate [NR LEVEL] max. counter-clockwise to turn the function OFF. The [NB WIDE] switch can be changed to noise reduction on/off switch in P-set mode. (p. 43)

## CW pitch control P-set mode

The received CW audio pitch and monitored CW audio pitch can be adjusted to a comfortable frequency (300 to 900 Hz) without changing the operating frequency.

The [SQL] control functions as a CW pitch control through setting in P-set mode. (p. 43) When selecting the CW pitch control, squelch does not function and stays open.

- ① Push [CW/REV] to select CW mode.
- ② Push [SET] momentarily to enter P-set mode.
- ③ Push [ $\Delta$ UP]/[ $\nabla$ DOWN] several times to select "PitCH" display.  
- When a sub setting display is selected, push [ENT] to exit.

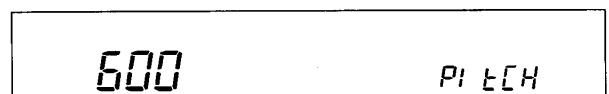

- ④ Connect a key and key down.
- ⑤ Rotate [MONI GAIN] to set the desired side tone level.
- ⑥ Adjust the main dial for the desired frequency.
- ⑦ Push [ENT] to exit P-set mode.



## ■ APF operation

### • Audio peak filter operation

The APF (Audio Peak Filter) changes the receive frequency response by boosting up a particular frequency to pick up a desired CW signal. The peak frequency can be adjusted with [APF] from 200 to 1000 Hz manually.

- ① Push [CW/REV] to select CW mode.
- ② Push [APF] to turn the audio peak filter ON.
  - The red indicator lights when the function is ON.
  - Cancel the auto APF (DSP-equipped type only) when used.
- ③ Rotate [APF] to adjust the peak frequency.
- ④ Push [APF] to cancel the audio peak filter.

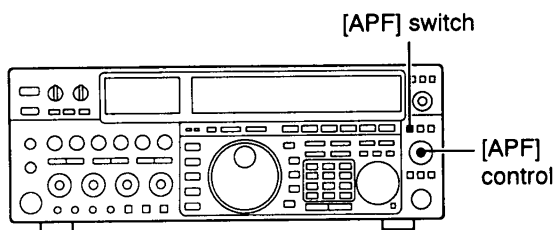

### • Auto audio peak filter operation DSP

An auto APF, which has an 80 Hz ultra narrow passband, is available for the DSP-equipped type. The center frequency of the auto APF is automatically set to the same frequency of the CW pitch setting, thus, you can receive only a zero-in signal.

- ① Push [CW/REV] to select CW mode.
- ② Push [AUTO] to turn the auto APF function ON.
  - The [AUTO] switch activates the auto notch in phone modes (SSB, AM, FM). (p. 29)
- ③ Push [AUTO] again to cancel the function.

▨ For the IC-775, [AF LPF] functions as the auto audio peak filter switch in CW mode when an optional UI-100 is installed and activated.

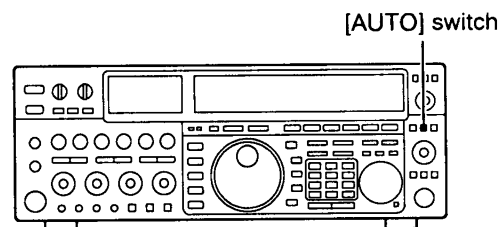

## ■ Noise blanker

The noise blanker eliminates pulse-type noise such as from car ignitions and wide pulse-type noise such as "woodpecker." The noise blanker is not available for FM mode.

- ① Push [NB] to turn the noise blanker ON.
- ② Adjust [NB LEVEL] depending on the noise level if required.
  - If the noise blanker distorts the receive audio, rotate [NB LEVEL] counterclockwise.
- ③ To suppress woodpecker and other wide pulse-type noise, turn [BLK-WIDTH] max. counterclockwise and then push [NB WIDE].
  - The wide noise blanker circuit automatically adjusts the blank width corresponding to the width of the pulse-type noise.
- ④ To suppress echo noise from woodpecker, turn [BLK-WIDTH] clockwise.

▨ **NOTE:** When using the noise blanker, received signals may be distorted if they are excessively strong.

▨ For the DSP equipped type, the [NB WIDE] switch can be assigned to a noise reduction on/off switch. (p. 43) [NB WIDE] can be turned ON and OFF in P-set mode in this case.

### • Woodpecker noise and blank width

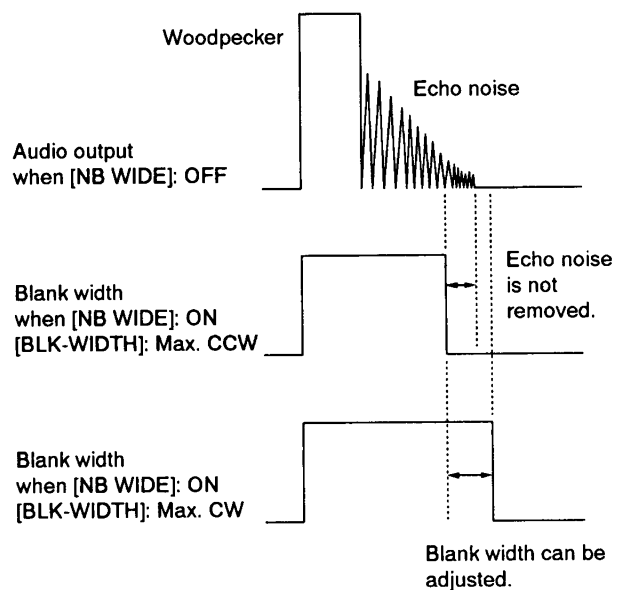

## Filter selection

The filter switches select the IF passband width as shown in the table at right below.

The filter selection is automatically memorized in each mode.

When an optional filter is installed, set the optional filter setting in H-set mode. (p. 47) Optional filters cannot be selected with default setting.

- Push [WIDE] to select the wider IF filters for the 9 MHz and 455 kHz IF filters.
  - [WIDE] does not function in FM mode.
  - The switch conditions are memorized in each mode.
- Push [NAR 9M] or [NAR 455k] to select the narrower IF filter for the 9 MHz or 455 kHz IF filter, respectively.

### FILTER SWITCH CONDITION AND SELECTED FILTERS

Filter switch	9 MHz IF filter	455 kHz IF filter
WIDE 9M-NAR-455k 	WIDE	WIDE
WIDE 9M-NAR-455k 	WIDE	MEDIUM
WIDE 9M-NAR-455k 	MEDIUM	WIDE
WIDE 9M-NAR-455k 	MEDIUM	MEDIUM
WIDE 9M-NAR-455k 	MEDIUM	NARROW
WIDE 9M-NAR-455k 	NARROW	MEDIUM
WIDE 9M-NAR-455k 	NARROW	NARROW

### FILTER SWITCH CONSTRUCTION

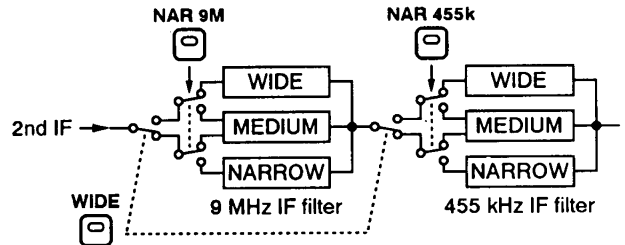

### FILTER SELECTION AND PASSBAND WIDTH

MODE	[WIDE]	9 MHz [NAR]	455 kHz [NAR]
SSB	ON	OFF	6 kHz* (FL-102)
		ON	2.4 kHz
	OFF	OFF	2.4 kHz
		ON	1.9 kHz* (FL-223)
CW, RTTY	ON	OFF	2.4 kHz
		ON	500 Hz
	OFF	OFF	500 Hz
		ON	250 Hz* (FL-101)
AM	ON	OFF	Through
		ON	6 kHz* (FL-102)
	OFF	OFF	6 kHz* (FL-102)
		ON	2.4 kHz
FM	OFF only	OFF	Through
	ON	6 kHz* (FL-102)	ON

\* Optional filters

Passband width are shown at - 6 dB. The optional 250 Hz CW narrow filters may not pass RTTY signals.

## CW reverse mode

The CW-R (CW Reverse) mode receives CW signals with a reverse side CW carrier point like that of LSB and USB modes.

Use when interference signals are near the desired signal and you want to change the interference tone.

- Push [CW/REV] once or twice to select CW or CW-R mode.
  - Check the interference tone.

### Receive audio tone response

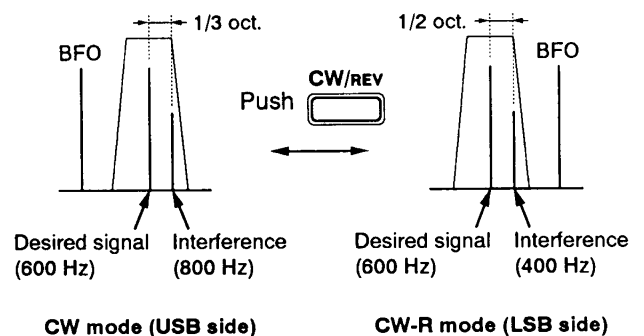

## RIT and ΔTX

### • RIT function

The RIT function shifts the receive frequency up to ±9.999 kHz in 1 Hz steps (10 Hz steps when cancelling the 1 Hz step readout) without moving the transmit frequency.

- See ⑥ on p. 7 for function description.

- 1 Push the [RIT] switch.

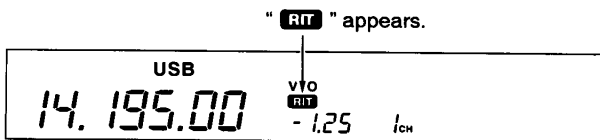

- 2 Rotate the [RIT/ΔTX] control.



- 3 To reset the RIT frequency, push [CLEAR] for 2 sec.

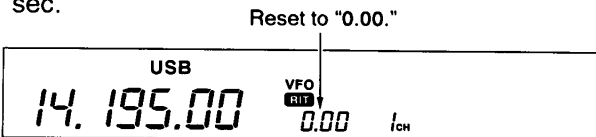

- 4 To cancel the RIT function, push [RIT] again.  
- "RIT" disappears.

**NOTE:** When RIT and ΔTX are ON at the same time, the [RIT/ΔTX] control shifts both the transmit and receive frequencies from the displayed frequency at the same time.

### • ΔTX function

The ΔTX function shifts the transmit frequency up to ±9.999 kHz in 1 Hz steps (10 Hz steps when cancelling the 1 Hz step readout) without moving the receive frequency.

- See ⑥ on p. 7 for function description.

- 1 Push the [ΔTX] switch.

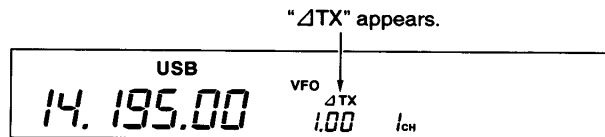

- 2 Rotate the [RIT/ΔTX] control.



- 3 To reset the ΔTX frequency, push [CLEAR] for 2 sec.

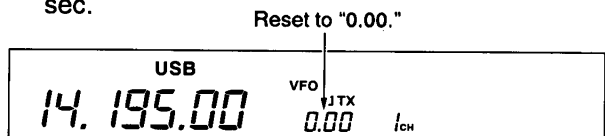

- 4 To cancel the ΔTX function, push [ΔTX] again.  
- "ΔTX" disappears.

### • Calculate function

The shift frequency of the RIT or ΔTX function can be added/subtracted to the displayed frequency.

While displaying the RIT and/or ΔTX shift frequency, push [RIT] or [ΔTX] for 2 sec.

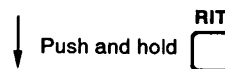
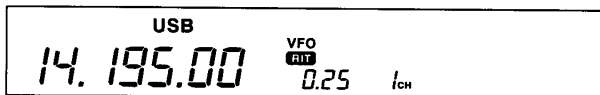

### PRACTICAL EXAMPLE

When you find a DX station on 21.025 MHz/CW and the station is picking up stations transmitting slightly up from 21.025 MHz.

- 1 Push [RIT] and [ΔTX] to turn both the RIT and ΔTX functions ON.
- 2 Rotate [RIT/ΔTX] to find the DX station's receive frequency.
- 3 When you find the DX station's receive frequency, push [RIT] to turn the RIT function OFF.  
- Now you can transmit the DX station's receive frequency and receive the DX station's transmit frequency (21.025 MHz).
- 4 Start transmitting while the station is standing by.

### PRACTICAL EXAMPLE

You find a DX station operating in simplex, however, you have not yet tuned your antenna (or your linear amplifier), and you do not want to transmit your tuning tone on the DX station's frequency.

- 1 Push [ΔTX] to turn the ΔTX function ON.
- 2 Rotate [RIT/ΔTX] to more than ±2 kHz.
- 3 Push [TUNER] for 2 sec. to tune your antenna.  
- Or, tune your linear amplifier with key ON in the CW mode.
- 4 Push [ΔTX] to turn the ΔTX function OFF.
- 5 Start transmitting while the station is standing by.

## Split frequency operation

Split frequency operation allows you to transmit and receive in the same mode on two different frequencies. The split frequency operation is basically performed using 2 frequencies on the MAIN and SUB readouts.

Following is an example of setting 21.290 MHz for receiving and 21.310 MHz for transmitting.

- Set 21.290 MHz (USB) in the VFO mode.

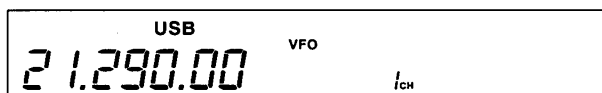

- Push [SPLIT], then push [EQUAL] for 2 sec.
  - The quick split function is much more convenient for selecting the transmit frequency. See the next section for details.
  - Equalized transmit frequency and "SPLIT" appear on the SUB readout.
  - The SUB readout flashes 4 times to show the transmit frequency's readout when the split frequency function is ON.

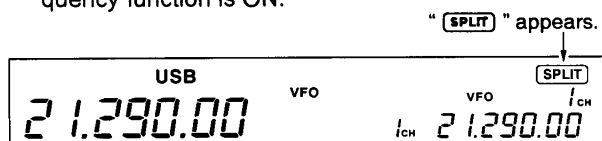

- Rotate the main dial while pushing [XFC] or sub dial to set the transmit frequency to 21.310 MHz.
  - The transmit frequency can be monitored while pushing [XFC] or using dualwatch.

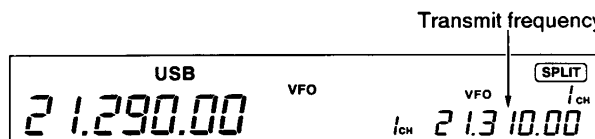

Now you can receive on 21.290 MHz and transmit on 21.310 MHz.

To change the transmit and receive frequencies, push [CHANGE] to exchange the MAIN and SUB readouts.

### CONVENIENT

#### DUALWATCH FUNCTION

The dualwatch function is convenient for tuning the transmit frequency while monitoring both frequencies used for transmitting and receiving.

### CONVENIENT

#### MAIN DIAL LOCK FUNCTION

The main dial lock function and sub dial tuning are convenient for changing only the transmit frequency.

## Quick split function

When you find a DX station, an important consideration is how to set the split frequency. If you can anticipate the necessary shift frequency, it can be pre-programmed into the quick split function.

When you push the [SPLIT] switch for 2 sec., split frequency operation is turned ON and the SUB readout appears with the plus/minus pre-programmed shift frequency from the MAIN readout (or equalized when 0 kHz split shift frequency is programmed).

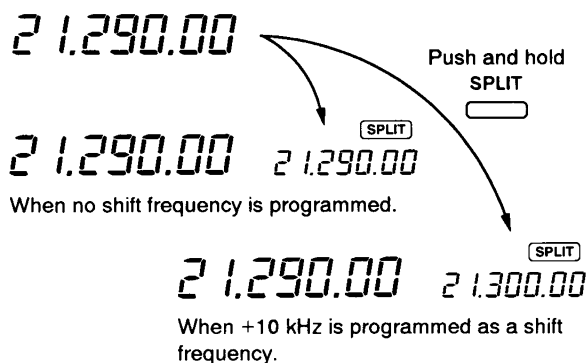

This shortens the time needed to start split frequency operation.

The quick split function is ON by default. For your convenience, it can be turned OFF in H-set mode. (p. 46) In this case, the [SPLIT] switch does not equalize the MAIN and SUB readout frequencies.

#### PROGRAMMING SPLIT SHIFT FREQUENCY

- Push MAIN [F-INP].
- Enter the desired shift frequency with the digit key(s).
  - 1 kHz to 1 MHz can be programmed.
  - When you require a minus shift direction, push [•] in advance.
- Push [SPLIT].

#### [EXAMPLE]

To program 1 kHz shift frequency:

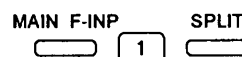

To program -3 kHz shift frequency:



To clear the shift frequency:

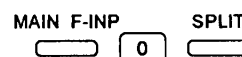

## Channelized split operation

Channelized split operation allows you to set a transmit frequency in the pre-programmed frequency steps (equivalent to the split shift frequency) from the receive frequency during split frequency operation. The channelized split shift frequency can be programmed from 1–99 kHz and can be shifted up to  $\pm 99$  kHz.

- ① Set the receive frequency.
- ② Push [SPLIT] to turn the split frequency operation ON.
- ③ Push [SPLIT] again for 2 sec. to turn the channelized split operation ON.
  - The sub memory channel readout shows the shift frequency.
  - The transmit and receive frequencies are equalized.

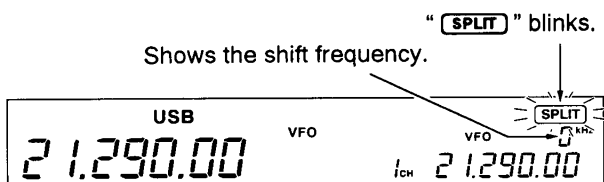

- ④ Push SUB [M-CH UP]/[M-CH DN] one or more times to shift the transmit frequency in the pre-programmed frequency steps.
  - The frequency step is equal to the split shift frequency. See the previous section for programming.
  - Rotate the sub dial to adjust the transmit frequency. This adjustment is cleared when SUB [M-CH UP]/[M-CH DN] is pushed.
  - The transmit frequency can be monitored while pushing [XFC] or using dualwatch.
- ⑤ Push [SPLIT] twice to cancel the function.
  - The SUB readout frequency disappears and the split frequency operation is turned OFF.

### EXAMPLE

Split shift frequency: 5 kHz

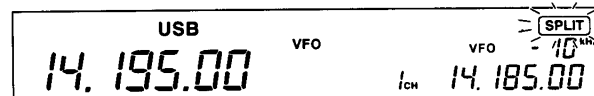
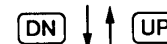
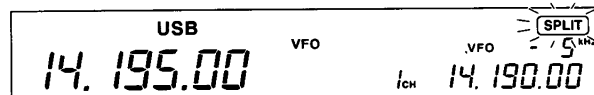
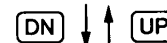
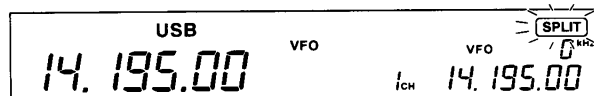
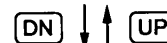
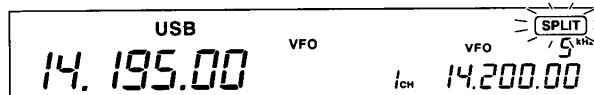
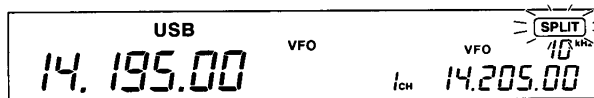

### PRACTICAL EXAMPLE

When you are searching for DX stations and you suspect that a DX station may say "up 'X' kHz" for their receive frequency:

#### PRE-OPERATION

- ① Program 10 kHz for the split shift frequency.
  - Push MAIN [F-INP], [1], [0], [SPLIT].
- ② Program 5 kHz for the [ $\Delta$ UP]/[ $\nabla$ DOWN] switches.
  - Push MAIN [F-INP], [5], [UP].

#### OPERATION

- ① When the DX station says "up 10 kHz":
  - Push [SPLIT] for 2 sec. only.
- ② When the DX station says "up 15 kHz":
  - Push [SPLIT] for 2 sec., then, while pushing [XFC], push [ $\Delta$ UP].

### PRACTICAL EXAMPLE

When you receive a pile-up and you want to start split frequency operation to simplify picking out stations:

#### PRE-OPERATION

- ① Cancel the split shift frequency.
  - Push MAIN [F-INP], [0], [SPLIT].

#### OPERATION

- ① Announce your receive frequency; then, push [SPLIT] for 2 sec.
  - The SUB readout frequency is equalized to the MAIN readout frequency and they appear with "SPLIT."
- ② Rotate the main dial to set your receive frequency in the MAIN readout.
- ③ After you catch one of the calling stations' call signs, push and hold the PTT switch to respond.
  - While pushing [XFC], you can monitor your transmit frequency.

## Dualwatch operation

Dualwatch monitors 2 same mode frequencies simultaneously.

During dualwatch, both frequencies should be on the same band because the bandpass filter in the RF circuit is selected for the MAIN readout frequency.

- 1 Set a desired frequency.

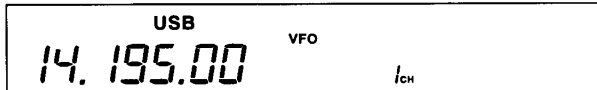

- 2 Push [DUALWATCH] for 2 sec.
  - Equalized receive frequency and "DUALWATCH" appear in the SUB readout. This quick dualwatch function can be turned OFF. (p. 46)
  - Pushing [DUALWATCH] momentarily activates the dualwatch with the previously operated frequency.

"DUALWATCH" appears.

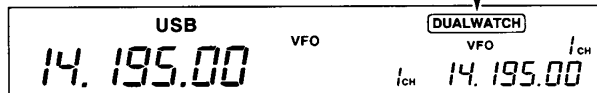

- 3 Set another desired frequency using the sub dial or SUB [F-INP].

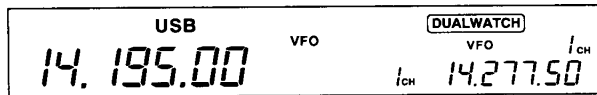

- 4 Adjust [BALANCE] to set a suitable signal strength balance between the MAIN and SUB readout frequencies.
  - S-meter shows the combined signal strength.
- 5 To transmit on the SUB readout frequency, push [CHANGE] or [SPLIT].

/// RIT function can be used for the MAIN readout only. ΔTX function can be used for the transmit readout (MAIN readout when the split function is OFF; SUB readout when the split function is ON).

### Scanning during dualwatch

Scanning operates only for the MAIN readout. To operate the scan during dualwatch, scan on the MAIN readout and use the SUB readout for your QSO using both dualwatch and split frequency operation.

- 1 Program the desired programmed scan edges in the same amateur band. See p. 52 for programming.
- 2 Push [SPLIT] to turn the split frequency function ON.

- The previously operated frequency appears.

"SPLIT" appears.

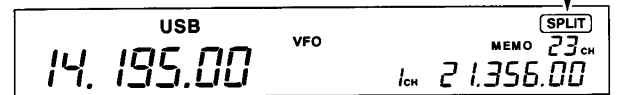

- 3 Select VFO modes for the MAIN and SUB readouts.
- 4 Set the desired operating frequency for the MAIN readout.
- 5 Push [DUALWATCH] for 2 sec.

- The MAIN and SUB readout frequencies are equalized and the dualwatch function is turned ON.

"DUALWATCH" appears.

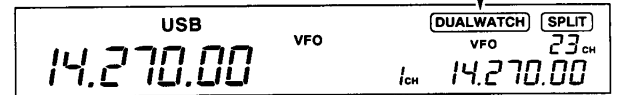

- 6 Push [SCAN] to start the programmed scan.
  - Scan activates on the MAIN readout between the programmed scan edges.
  - Transmitting on the SUB readout stops the scan.

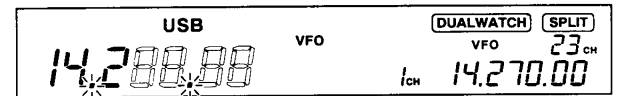

- 7 To cancel the scan, rotate the main dial, or push [SCAN].

## Monitor function

The monitor function allows you to monitor your transmit IF signals in any mode through the speaker. Use for checking the voice characteristics when [MIC TONE] is adjusted or the transmit low-pass/high-pass filters\* are in use. The CW sidetone functions when [MONITOR] is OFF in CW mode.

\* For [DSP] equipped type.

- 1 Push [MONITOR] IN.
- 2 Adjust [MONI GAIN] while transmitting if desired.

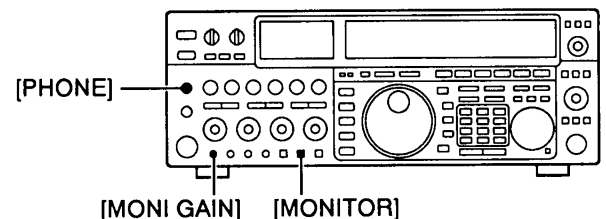

- /// Use headphones to prevent feedback.
- /// For the DSP-equipped type, set the [TONE] control to center position to check the transmit filters' characteristics exactly.

## ■ VOX operation

The VOX (Voice-Operated-Transmission) function toggles between transmit and receive with your voice. This function provides an opportunity to input log entries into your computer, etc., while operating.

- ① Set the [VOX GAIN], [ANTI VOX] and [DELAY] controls maximum counterclockwise.
- ② Select a phone mode. (SSB, AM, FM)  
- VOX function is not available for FM DATA mode.
- ③ Push [VOX] to turn the VOX function ON.
- ④ While speaking into the microphone, rotate [VOX GAIN] clockwise until the transceiver is transmitting.
- ⑤ Adjust [DELAY] for a convenient interval before returning to receive.
- ⑥ If the receive audio from the speaker toggles to transmit, adjust [ANTI VOX] to the point where it has no effect.

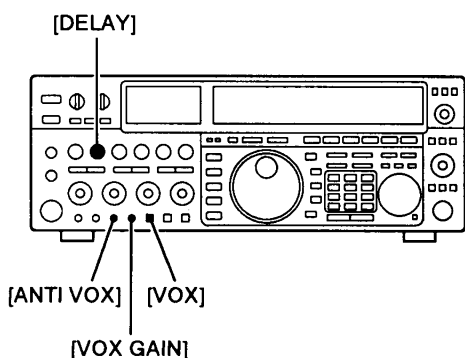

## ■ Speech compressor

The RF speech compressor increases average RF output power, improving signal strength and readability in SSB.

- ① Preset the transceiver as follows:  
[COMP] switch : ON  
[METER] switch : [COMP]  
[MIC] control : Center position  
[DRIVE] control : Center position  
[PWR] control : Max. counterclockwise
- ② Select SSB mode.
- ③ Set the transceiver to transmit. Speak into the microphone at your normal voice level.
- ④ Adjust [MIC] for a peak reading of COMP scale between 10 dB and 20 dB.

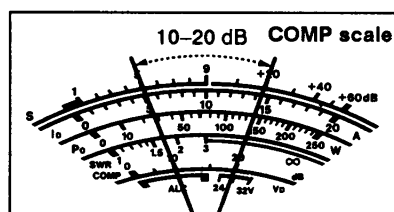

- ⑤ Set [METER] to the ALC position.
- ⑥ Adjust [DRIVE] for an ALC meter reading within ALC zone.

**NOTE:** DO NOT set [MIC] and [DRIVE] too far clockwise. This will distort your signal and cause QRM.

## ■ Meter function

The transceiver has 6 transmit meter functions for your convenience. Select the desired meter with the [METER] switch.

SWITCH POSITION	MEASUREMENT
[SWR]	Indicates the SWR over the transmission line.
[Po]	Indicates the relative RF output power in watts.
[ALC]	Indicates the ALC level. When the meter movement shows the input signal level exceeds the allowable level, the ALC limits the RF power. In such cases, reduce the [MIC] control.
[COMP]	Indicates the compression level when the speech compressor is in use.
[Ia]	Indicates the drain's current of the final FET.
[Vo]	Indicates the drain's terminal voltage of the final FET.

## ■ SWR reading

The SWR meter indicates the SWR over the transmission line in all modes.

- ① Push [TUNER] to turn the antenna tuner OFF.
- ② Set [METER] to the Po position.
- ③ Push [RTTY] to select RTTY mode.
- ④ Push [TRANSMIT].
- ⑤ Rotate [PWR] clockwise past 12 o'clock for more than 30 W output power.
- ⑥ Set [METER] to the SWR position.
- ⑦ Read the SWR on the SWR scale.

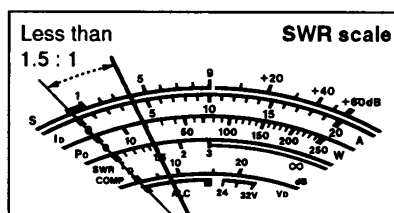

**NOTE:** The built-in antenna tuner matches the transmitter to the antenna when the SWR is lower than 3 : 1.

## Electronic CW keyer

The transceiver has an electronic keyer. Keying speed can be adjusted with [KEY SPEED]. Keying weight, the ratio of dot : space : dash, can be set from 1 : 1 : 2.8 to 1 : 1 : 4.5 in P-set mode.

### • Setting the electronic keyer *P-set mode*

- ① Push [SET] momentarily to enter P-set mode.
- ② Push [ $\Delta$  UP]/[ $\nabla$  DOWN] one or more times to select "ELEC SET" display.  
- When a sub setting display is selected, push [ENT] to exit.

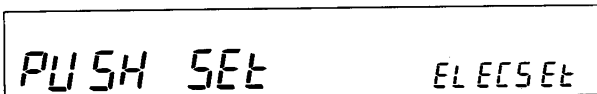

- ③ Push [SET]; then, push [ $\Delta$  UP]/[ $\nabla$  DOWN] one or more times to select "ratio" display.



- ④ Rotate the main dial to select the keying weight.  
- 1 : 1 : 2.8 to 1 : 1 : 4.5 can be set.  
- Check the ratio with side tone in CW mode.
- ⑤ Push [ $\Delta$  UP] to select "PADLE" display.

- ⑥ Rotate the main dial to select the key polarity or to deactivate the internal electronic keyer.  
- "n" (normal polarity)  
- "r" (reverse polarity)  
- "oFF" (for a straight key or external electronic keyer)
- ⑦ Push [ $\Delta$  UP] to select "Ud-PAd" display.
- ⑧ Rotate the main dial to turn the substitute paddle function ON or OFF.  
- When "ON" is selected, the up/down switches of the microphone can be used as a paddle.
- ⑨ Push [ENT] twice to exit P-set mode.

### KEYING WEIGHT EXAMPLE "morse code K"

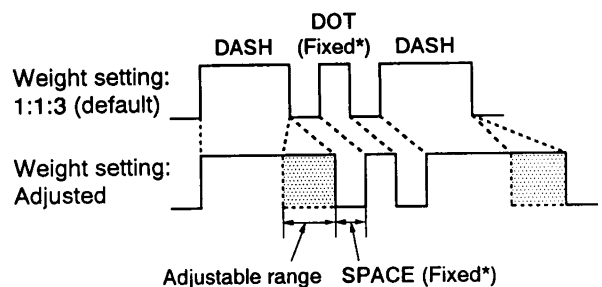

\* SPACE and DOT length can be adjusted with [KEY SPEED] only.

## Memory keyer

The memory keyer memorizes and re-transmits 3 CW keying operations for transmitting an often-used CW sentence, antenna type, etc. Total capacity of the memory keyer is approx. 40 characters in each memory channel.

### • Programming the memory keyer

- ① Be sure the internal electronic keyer is activated in P-set mode. See previous section for details.
- ② Connect a paddle to the [ELEC-KEY] jack.
- ③ Push [CW/REV] to select CW mode. Push [CW] again for 2 sec. to activate the memory keyer.

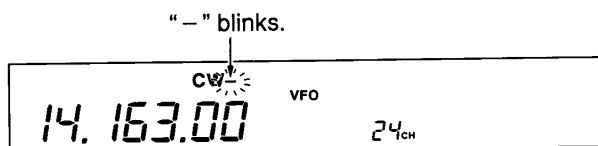

- ④ Push the desired memory channel key, [1], [2] or [3], for 2 sec. to start programming.  
- Remaining step, memory channel number and "CodE in" appear.  
- Push [1], [2] or [3] to clear the previously programmed contents only.

Remaining memory steps      Memory channel number

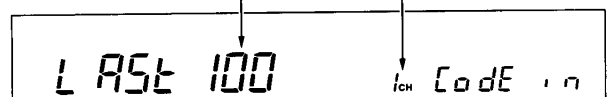

- ⑤ Operate the paddle for programming.
- ⑥ Push [1], [2] or [3] to stop programming.
- ⑦ Repeat steps ④–⑥ to program another memory channel.
- ⑧ Push [CW] to exit memory keyer mode.

### • Transmitting the memory contents

- ① Push [CW/REV] to select CW mode. Push [CW] again for 2 sec. to activate the memory keyer.  
- "—" blinks.
- ② Push [1]–[9] to transmit the memory contents. Transmit speed varies as follows:

KEYS	CHANNELS	SPEED
[1], [2], [3]	1, 2, 3	[KEY SPEED] setting
[4], [5], [6]	1, 2, 3	Programmed speed
[7], [8], [9]	1, 2, 3	[KEY SPEED] setting and repeat interval (4–30 sec.)

- ③ Push [CW] to exit memory keyer mode.  
- Push [1]–[9] to cut the transmission if desired.



■ Memory keyer (continued)

• Programming the keying speed

While the memory keyer is activated, pushing [4], [5] or [6] transmits memory contents 1, 2 or 3 at the programmed speed, respectively. Each key memorizes the [KEY SPEED] setting independently.

- ① Activate the memory keyer.  
- “-” blinks.
- ② Set the desired keying speed with [KEY SPEED].
- ③ Push [4], [5] or [6] for 2 sec. to program the [KEY SPEED] setting into keys 4, 5 or 6, respectively.  
- 3 beeps may sound.
- ④ Push [4], [5] or [6] momentarily to transmit memory contents 1, 2 or 3 at the programmed speed, respectively.

• Programming the repeat interval

While the memory keyer is activated, pushing [7], [8] or [9] repeatedly transmits memory contents 1, 2 or 3, respectively. Each key can independently store a repeat interval (4, 6, 8, 10, 20 or 30 sec.).

- ① Activate the memory keyer.  
- “-” blinks.
- ② Push [7], [8] or [9] for 2 sec. to enter the repeat interval setting display.

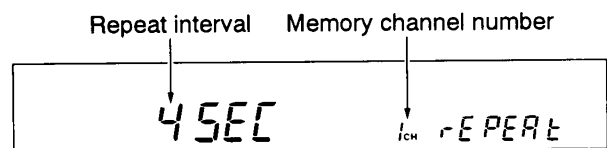

- ③ Rotate the main dial to select the repeat interval.
- ④ Push [7], [8] or [9] to exit the setting display.
- ⑤ Push [7], [8] or [9] momentarily to repeatedly transmit memory contents 1, 2 or 3, respectively.

■ Repeater operation

A repeater amplifies received signals and retransmits them at a different frequency. When using a repeater, the transmit frequency is shifted from the receive frequency by an offset frequency. A repeater can be accessed using split frequency operation with the shift frequency set to the repeater's offset frequency.

NOTE: For accessing a repeater which requires a subaudible tone, set the subaudible tone frequency in H-set mode. Refer to p. 46.

- ① Push [VFO/MEMO] to select VFO mode.

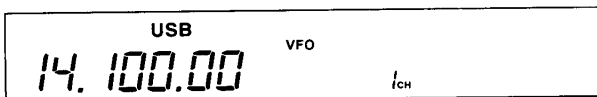

- ② Push the desired band key.
- ③ Push [FM] to select FM mode.  
- When “DATA” appears, push [FM] again.
- ④ Set the receive frequency (repeater output frequency). (p. 25)

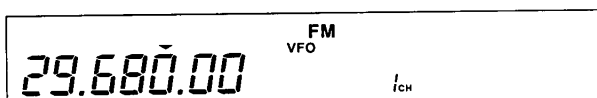

- ⑤ Push [SPLIT] to turn the split frequency function ON, then push [EQUAL] for 2 sec. to equalize the transmit frequency to the receive frequency.  
- Subaudible tone encoder is turned ON automatically when activating the split frequency function in FM mode.  
- The quick split function is much more convenient for selecting the transmit frequency. (p. 33)  
- The SUB readout flashes 4 times to show the transmit frequency's readout when the split frequency function is ON.

“SPLIT” appears.

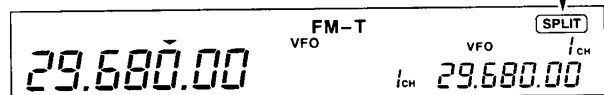

- ⑥ Rotate the main dial while pushing [XFC] or sub dial to set the transmit frequency.  
- The transmit frequency can be monitored while pushing [XFC] or using dualwatch to check whether the other station's transmit signal can be directly received or not.

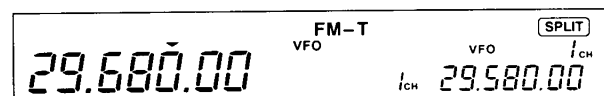

- ⑦ Push and hold [PTT] to transmit.
- ⑧ Release [PTT] to receive.
- ⑨ To return to simplex, push [SPLIT] momentarily to clear the sub display.

## 4 FUNCTION OPERATIONS

### ■ Antenna tuner operation

The internal automatic antenna tuner matches the transceiver to the connected antenna automatically. Once the tuner matches an antenna, the variable capacitor angles are memorized as a preset point for each frequency range (100 kHz steps). Therefore, when you change the frequency range, the variable capacitors are automatically preset to the memorized point.

**CAUTION: NEVER** transmit with the tuner ON when no antenna is connected. This will damage the transceiver. Be careful of the [ANT] switch selection.

#### TUNER OPERATION

Push the [TUNER] switch to turn the internal antenna tuner ON. The antenna is tuned automatically when the antenna SWR is higher than 1.5:1.

- When the tuner is ON, the [TUNER] switch lights.

Push [TUNER].

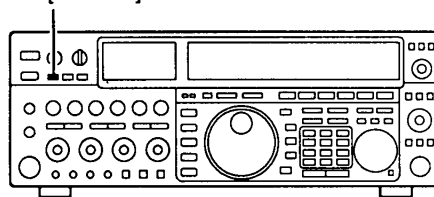

#### MANUAL TUNING

During SSB operation at low voice levels, the internal tuner may not be tuned correctly. In such cases, manual tuning is helpful.

Push the [TUNER] switch for 2 sec., to start manual tuning.

- CW mode is selected, a side tone is emitted, and [TUNER] blinks, then, the previous mode is selected.

If the tuner cannot reduce the SWR to less than 1.5:1 after 20 sec. of tuning, the [TUNER] switch indicator goes out. Check the following in this case:

- the [ANT] switch selection.
- the antenna connection and feedline.
- the antenna SWR (p. 36).

Push [TUNER] for 2 sec.

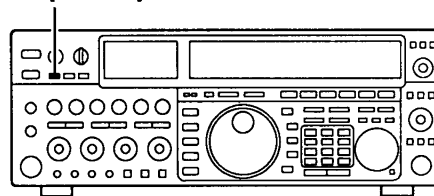

#### AUTOMATIC TUNER START

If you want to turn OFF the tuner under conditions of VSWR 1.5 : 1 or less, use "automatic tune on" and turn the tuner OFF.

See p. 46 item (9) for turning the function ON and OFF.

#### ANTENNA TUNER OF THE IC-4KL or IC-2KL/IC-AT500

When using an external antenna tuner such as the IC-4KL's tuner or IC-AT500 with a linear amplifier, tune with the external antenna tuner, while the internal tuner is turned OFF. After tuning is completed, turn the internal tuner ON. Otherwise, both tuners tune simultaneously and correct tuning may not be obtained.

See the instruction manual included with each antenna tuner for their respective operations.

## ■ Band memory (for automatic antenna selection)

The transceiver covers 0.1 – 30 MHz over 10 bands. Each band has a band memory which can memorize a selected antenna (antenna 1 or antenna 2). When you change the operating frequency beyond a band, the previously used antenna is automatically selected for the new band. This function is convenient when you use 2 antennas.

To use the band memory, enter the H-set mode and confirm that "Aut" is selected as the antenna switch item (p. 45).

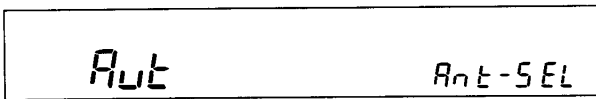

- When "oFF" is selected, the [ANT1]/[ANT2] switches do not function and [ANT1] is always selected.
- When "on" is selected, you can use the [ANT1]/[ANT2] switches, however, band memory does not function. In this case, you must select an antenna manually.

When "Aut" is selected (default setting), the antenna tuner ON/OFF condition is also memorized in the band memory.

When "Aut" or "on" is selected, the antenna tuner ON/OFF condition is consistent with the [ANT1]/[ANT2] switches.

BAND	FREQUENCY RANGE	HAM BAND
1	0.5 – 1.59999 MHz	
2	1.6 – 1.99999 MHz	160 m band
3	2.0 – 5.99999 MHz	80 m band
4	6.0 – 7.99999 MHz	40 m band
5	8.0 – 10.99999 MHz	30 m band
6	11.0 – 14.99999 MHz	20 m band
7	15.0 – 19.99999 MHz	17 m band
8	20.0 – 21.99999 MHz	15 m band
9	22.0 – 25.99999 MHz	12 m band
10	26.0 – 30.00000 MHz	10 m band

As all ham bands are separated as shown above, you can designate antenna 1 or antenna 2 individually for each ham band.

### [ANTENNA SWITCH SELECTION EXAMPLE]

Under the following condition, "Aut" should be selected as the antenna switch set mode item.

- When you use 2 antennas.

Under the following conditions, "oFF" should be selected as the antenna switch set mode item.

- When using 1 antenna.
- When using the EX-627 HF AUTOMATIC ANTENNA SELECTOR for more than 3 antenna connections.
- When using an external antenna tuner.

## ■ Dial lock function

The main dial lock function prevents accidental changes caused by the main dial. The sub dial lock function is also available separately for split or dualwatch operation. (pgs. 33, 35) The lock functions electronically lock the dials.

- ① Push MAIN [LOCK] to activate the main dial lock function.
- ② Push SUB [LOCK] to activate the sub dial lock function during split or dualwatch operation.

Appears when main dial lock is in use.

Appears when sub dial lock is in use.

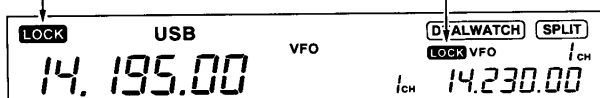

- ③ Push MAIN and/or SUB [LOCK] to cancel the dial lock function.

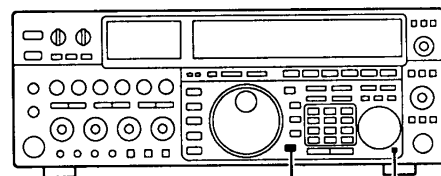

Main dial lock switch      Sub dial lock switch

Even while the dial lock function is activated, memory channel selection can be made with [M-CH UP] or [M-CH DOWN].

## ■ Set mode description

The set mode is used for programming infrequently changed values or conditions of functions. This transceiver has a P-set mode (Push-set mode) and an H-set mode (Hold-set mode) for 26 items in total for the 2 modes:

### • Set mode operation

- ① Push [SET] momentarily to select P-set mode or push and hold [SET] for 2 sec. to select H-set mode.
- ② Push [△UP] or [▽DOWN] several times until the desired item appears.
  - If a sub setting display is previously selected, the desired item may not appear. Push [ENT] to exit the sub setting display.
- ③ Push [SET] to enter sub setting display on some branch items.
  - "PUSH SET" appears for those branch items.
  - Push [△UP] or [▽DOWN] several times until the desired item appears.
- ④ Rotate the main dial to set the values or conditions for the selected item.
  - For the sub setting displays, push [ENT] after setting to exit.
- ⑤ Repeat steps ②-④ to set other items.
- ⑥ After all desired items are set, push [ENT] to exit the set mode.

Push [SET]:

- Momentarily to select P-set mode
- For 2 sec. to select H-set mode

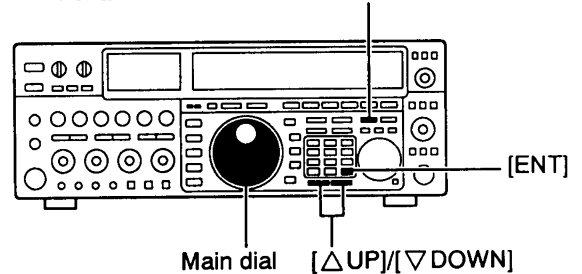

### [DISPLAY EXAMPLE IN A SET MODE]

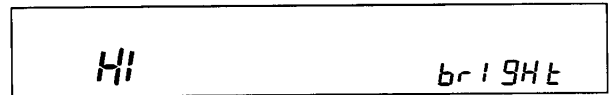

### [DISPLAY EXAMPLE OF A BRANCH ITEM]

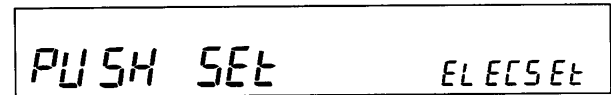

## ■ P-set mode

### (1) Display dimmer "brlGHt"

You can select high or low intensity for the display backlighting to suit lighting conditions and personal preference.

High intensity is fixed but low intensity can be adjusted. (p. 60)



High intensity (default)



Low intensity

### (2) DSP unit activation "dSP unit" DSP

DSP unit can be turned OFF, if desired.

This item does not appear when no DSP unit is installed.

- When DSP unit is OFF in DSP-equipped type:
- The noise reduction, DSP demodulation/modulation, DSP filters, auto notch, auto APF, etc. do not function.
  - [AUTO] ([AF LPF]) activates the audio low-pass filter.



DSP unit ON (default)



DSP unit OFF

**(3) DSP unit settings (branch)** DSP

"dSP-SEt"

The DSP unit not only functions for noise reduction and auto notch but also for PSN modulation/demodulation and audio filtering.

Push [SET] to enter sub setting display. This item does not appear when the DSP unit is not installed or not activated.

PUSH SET dSP-SEt

• **PSN modulation "PSn-t"**

Selects PSN modulation (on) or analog modulation (oFF) in SSB mode.

ON PSn-t

PSN modulator ON (default)

• **PSN demodulation "PSn-r"**

Selects PSN demodulation (on) or analog demodulation (oFF) in SSB/CW mode.

ON PSn-r

PSN demodulator ON (default)

• **Receive AF low-pass filter "r-LPF"**

14 cut-off frequencies within 1.5–3.3 kHz are available.

2.5 r-LPF

2.5 kHz cut-off receive low-pass filter (default)

• **Receive AF high-pass filter "r-HPF"**

18 cut-off frequencies within 80–500 Hz are available.

200 r-HPF

200 Hz cut-off receive high-pass filter (default)

• **Transmit AF low-pass filter "t-LPF"**

7 cut-off frequencies within 2.0–2.9 kHz are available.

2.5 t-LPF

2.5 kHz cut-off transmit low-pass filter (default)

• **Transmit AF high-pass filter "t-HPF"**

18 cut-off frequencies within 80–500 Hz are available.

200 t-HPF

200 Hz cut-off transmit high-pass filter (default)

▨ **NOTE:** Push [ENT] to exit the sub setting display.

**(4) Electronic keyer (branch) "ELEC SEt"**

Push [SET] to enter sub setting display.

PUSH SET ELEcSEt

• **Keying weight "ratio"**

The keying weight, the ratio of dot : space : dash, can be set from 1 : 1 : 2.8 to 1 : 1 : 4.5 for your preference. See p. 37 for a detailed description.

3.0 ratio

1:1:3 keying weight (default)

Downloaded by   
 Amateur Radio Directory   
  
[www.hamdirectory.info](http://www.hamdirectory.info)

• **Electronic keyer on/off and keyer polarity "PA dLE"**

Keying polarity or internal electronic keyer activation can be set to normal or reverse; or turned OFF to use a straight key or external electronic keyer.

n PA dLE

Normal keyer polarity (default)

• **Substitute paddle function "Ud-PA d"**

The up/down keys of the microphone can be substituted for a paddle. When "on" is selected, they do not function as up/down keys in all mode.

oFF Ud-PA d

Substitute paddle OFF (default)

▨ **NOTE:** Push [ENT] to exit the sub setting display.

## 5 SET MODE

### (5) RTTY keying polarity "rty-P"

You can select normal or reverse polarity for RTTY keying.

When the reverse polarity is selected, Mark and Space are reversed.

- Normal : Key open/close = Mark/Space
- Reverse : Key open/close = Space/Mark

n rty-P

Normal RTTY keying polarity (default)

r rty-P

Reverse RTTY keying polarity

### (6) CW pitch setting "PltCH"

The CW pitch can be set within 300–900 Hz in 20 Hz steps in P-set mode.

- Check the pitch with key down in CW mode. (p. 29)

For your convenience, the CW pitch can be adjusted with the [SQL] control after changing the [SQL] control function in P-set mode. In this case, this item does not appear. See item (8) below for details.

600 PltCH

600 Hz CW pitch (default)

460 PltCH

460 Hz CW pitch

### (7) Calibration marker "CAL"

Calibration marker is used for a simple frequency check of the transceiver.

See p. 55 for calibration procedure.

Turn the calibration marker OFF after checking the frequency of the transceiver.

off CAL

Calibration marker OFF (default)

on CAL

Calibration marker ON

### (8) Function arrangement (branch)

"Func SEt"

Push [SET] to enter sub setting display.

PUSH SEt FuncSEt

#### • [SQL] control function "SELECT1"

The [SQL] control can be assigned to CW pitch control ("PltCH"), if desired. In this case, the squelch continuously opens (max. counterclockwise position) and the CW pitch setting of the P-set mode (item 6 above) does not appear.

SQL SELECt1

[SQL] adjusts the squelch threshold level. (default)

#### • [NB WIDE] switch function "SELECT2" DSP

The [NB WIDE] switch can be assigned to noise reduction on/off switch ("nr"), if desired. This item does not appear when the DSP unit is not installed or not activated.

nb-2 SELECt2

[NB WIDE] selects the wide blank width. (default)

#### • Noise blanker wide switch "nb-2" DSP

This item appears only when "nr" is selected in the above item. The [NB WIDE] switch condition can be set.

off nb-2

[NB WIDE] switch is turned OFF. (default)

**NOTE:** Push [ENT] to exit the sub setting display.

## ■ H-set mode

### (1) Confirmation beep "bEEP"

A beep sounds each time a switch is pushed for confirmation. This confirmation beep can be turned OFF for silent operation.

Beep tone volume can be adjusted. (p. 60)

ON bEEP

Confirmation beep ON (default)

OFF bEEP

Confirmation beep OFF

### (2) Voice synthesizer "SPEECH" (UT-66)

The transceiver announces the main readout frequency and mode in English or Japanese when an optional UT-66 VOICE SYNTHESIZER UNIT is installed. Speech can be selected as slow or fast in this item. Announcement volume can be adjusted with [MONI GAIN] and [AF].

After installing an optional UT-66, pushing [SPEECH] announces the operating frequency and pushing a mode switch announces the selected mode.

- "CW-R" mode is announced as CW.
- "DATA" mode is not announced.

ENG - S SPEECH

Slower English (default)

ENG - F SPEECH

Faster English

JPN - S SPEECH

Slower Japanese

JPN - F SPEECH

Faster Japanese

### (3) Auto tuning step function "tS-Aut"

When selecting AM or FM, the quick tuning step is automatically selected by the auto tuning step function. This function can be turned OFF if desired.

ON tS - Aut

Auto tuning step ON (default)

OFF tS - Aut

Auto tuning step OFF

### (4) Scan resume "SC-rES"

You can select scan resume or cancel for when an operating scan detects a signal.

When selecting resume (ON), the scan pauses 10 sec. on the detected signal, then it resumes. If the signal disappears while the scan is paused, the scan resumes 2 sec. later to search for other signals.

When selecting cancel (OFF), the scan stops and turns OFF after detecting a signal.

ON SC - rES

Scan resumes (default)

OFF SC - rES

Scan is canceled

## 5 SET MODE

### (5) Scan speed "SC-SPd"

The transceiver has 2 speeds for scanning, high and low.

HI

SC-SPd

High speed (default)

Lo

SC-SPd

Low speed

### (6) Microphone up/down speed "UP-SPd"

When you push and hold the microphone [UP]/[DOWN] switches, you can change the frequency continuously.

You can select high or low speed tuning for the microphone [UP]/[DOWN] switches.

HI

Ud-SPd

High speed (default, 50 tuning steps/sec.)

Lo

Ud-SPd

Low speed (25 tuning steps/sec.)

### (7) Memo pad capacity "PAd-CH"

You can select the number of memo pads, 5 or 10, for your convenience.

5

PAd-CH

5 memo pad (default)

10

PAd-CH

10 memo pad

### (8) Antenna switches "Ant-SEL"

You can set the antenna connector selection to automatic, manual or non-selection (when using 1 antenna only).

When "Aut" is selected, the [ANT1]/[ANT2] switches are activated and the band memory memorizes the selected antenna. See p. 39 for details.

When "on" is selected, the [ANT1]/[ANT2] switches are activated and select an antenna manually.

When "oFF" is selected, the [ANT1]/[ANT2] switches are not activated and do not function. The [ANT1] connector is always selected in this case.

Aut

Ant-SEL

Antenna switches Auto (default)

on

Ant-SEL

Antenna switches ON

oFF

Ant-SEL

Antenna switches OFF



**(9) Automatic tuner start "Aut-tun"**

You can select the internal tuner operating condition. The tuner has an automatic start capability which starts tuning (the [TUNER] switch is turned ON automatically) when the SWR is within 1.5 – 3.

When "OFF" is selected, the tuner remains OFF even when the SWR is poor. (1.5 – 3)

When "on" is selected, automatic tune starts even when the tuner is turned OFF.

/// The automatic tune does not start when the SWR is higher than 3 because the internal antenna tuner may not be tuned less than SWR 1.5.

on Aut-tun

Automatic tune ON (default)

OFF Aut-tun

Automatic tune OFF

**(10) Quick dualwatch function "q-duAL"**

The [DUALWATCH] switch can be used to set dualwatch operation and SUB readout frequency equalization simultaneously.

When "on" is selected, the [DUALWATCH] switch equalizes MAIN and SUB readout frequencies when pushed for 2 sec.

When "OFF" is selected, the [DUALWATCH] switch does not equalize MAIN and SUB readout frequencies.

on q-duAL

Quick dualwatch function ON (default)

OFF q-duAL

Quick dualwatch function OFF

**(11) Quick split function "q-SPLit"**

The [SPLIT] switch can be used to set split frequency operation and SUB readout frequency equalization (or shifts pre-programmed frequency) simultaneously.

When "on" is selected, the [SPLIT] switch equalizes MAIN and SUB readout frequencies when pushed for 2 sec.

When "OFF" is selected, the [SPLIT] switch does not equalize MAIN and SUB readout frequencies.

on q-SPLit

Quick split function ON (default)

OFF q-SPLit

Quick split function OFF

**(12) Subaudible tone frequency "tonE"**

To access some closed repeaters, your transmit signal needs to include a matching subaudible tone.

The subaudible tone encoder is automatically turned ON when the split frequency function is ON in FM mode.

The transceiver has 50 subaudible tone frequencies.

• Subaudible tone frequency list

(Unit: Hz)

67.0	82.5	100.0	123.0	151.4	171.3	189.9	210.7	250.3
69.3	85.4	103.5	127.3	156.7	173.8	192.8	218.1	254.1
71.9	88.5	107.2	131.8	159.8	177.3	196.6	225.7	
74.4	91.5	110.9	136.5	162.2	179.9	199.5	229.1	
77.0	94.8	114.8	141.3	165.5	183.5	203.5	233.6	
79.7	97.4	118.8	146.2	167.9	186.2	206.5	241.8	

FM-T 88.5 tonE

88.5 Hz subaudible tone (default)

## 5 SET MODE

### (13) RTTY tone settings (branch) "t-PAI"

Push [SET] to enter sub setting display.

PUSH SET t-PAI r

#### • RTTY tone "rtty-t"

The MARK tone of RTTY mode can be selected from high tone (2125 Hz) or low tone (1615 Hz).

2125 rtty-t

2125 Hz mark (default)

#### • RTTY shift width "rtty-s"

The shift width can be selected from 170 Hz, 200 Hz and 425 Hz.

170 rtty-s

170 Hz shift width (default)

#### • RTTY data tone "dAtA-t"

The MARK tone of RTTY DATA mode can be selected from 1070 Hz, 1275 Hz, 1600 Hz, 2025 Hz, 2110 Hz and 2125 Hz.

2025 dAtA-t

2025 Hz data tone (default)

#### • Front panel data input "dAtA-Fr"

The DATA modes inhibit the input from the [MIC] connector. It can be accepted if desired.

no dAtA-Fr

Front panel data input inhibits (default)

NOTE: Push [ENT] to exit the sub setting display.

### (14) Optional filters (branch) "oPt-FIL"

When an optional filter is installed, this selection is necessary, otherwise, the filters cannot be selected.

Push [SET] to enter sub setting display.

PUSH SET oPt-FIL

#### • 9 MHz SSB narrow filter "LSB -9"

When the optional FL-223 is installed, select "yES."

LSB  
no -9-

FL-223 is not installed. (default)

LSB  
yES -9-

FL-223 is installed.

#### • 9 MHz CW narrow filter "CW -9"

When the optional FL-101 is installed, select "yES."

cw  
no -9-

FL-101 is not installed. (default)

#### • 9 MHz AM medium/SSB wide filter "AM -9"

When the optional FL-102 is installed, select "yES."

AM  
no -9-

FL-102 is not installed. (default)

#### • 455 kHz SSB narrow filter "LSB 455"

When the optional FL-222 is installed, select "yES."

LSB  
no 455

FL-222 is not installed. (default)

#### • 455 kHz CW narrow filter "CW 455"

When the optional FL-53A is installed, select "yES."

cw  
no 455

FL-53A is not installed. (default)

NOTE: Push [ENT] to exit the sub setting display.

**(15) CI-V address "CI-Addr"**

The IC-775/DSP has the address of 46H (70) as its default value.

If you want to designate a different address for your IC-775/DSP, rotate the main dial to select the desired address in the range from 1H (1) to 7FH (127).

- Figures marked with an H are hexadecimals and bracketed figures are decimals.

46H [1 -Addr]

Address of 46H (default)

7FH [1 -Addr]

Address of 7FH

**(16) CI-V baud rate "CI-bAud"**

Baud rate is the data transfer rate. The standard baud rate for the Icom CI-V is 1200 bps.

When "Aut" is selected, the baud rate is automatically set with connected controller or remote controller.

If you want to change the baud rate, rotate the main dial to select the desired baud rate from 300 bps, 1200 bps, 4800 bps, 9600 bps or 19200 bps.

Aut [1 -bAud]

Auto baud rate (default)

1200 [1 -bAud]

1200 bps (CI-V standard)

19200 [1 -bAud]

19200 bps

**(17) CI-V transceive "CI-trn"**

Transceive operation is possible with the IC-775/DSP connected to other Icom HF transceivers or receivers.

When "on" is selected, changing the operating frequency, operating mode, etc. on the IC-775/DSP automatically changes those of connected transceivers (or receivers) and vice versa.

on [1 -trn]

Transceive ON (default)

oFF [1 -trn]

Transceive OFF

**(18) CI-V operating frequency data length "CI-731"**

When connecting the IC-775/DSP to the IC-735 for transceive operation, you must change the operating frequency data length to 4 bytes.

When "oFF" is selected, the operating frequency data length is sent in 5 bytes.

When "on" is selected, the operating frequency data length is sent in 4 bytes.

oFF [1 -731]

5 bytes of frequency data (default)

on [1 -731]

4 bytes of frequency data

# 6 MEMORY CHANNELS

## Memory channels

The transceiver has 101 memory channels. The memory mode is very useful for quickly changing to often-used frequencies.

**NOTE:** During dualwatch or split frequency operation, the programmed memory channel contents can be called up for the SUB readout.

All 101 memory channels are tunable which means the programmed frequency can be tuned temporarily with the main dial, etc. in the memory mode.

MEMORY CHANNEL	MEMORY CHANNEL NUMBER	CAPABILITY	TRANSFER TO VFO	OVER-WRITING	CLEAR
Regular memory channels	1 – 99	One frequency and one mode in each memory channel.	Yes	Yes	Yes
Scan edge memory channels	P1, P2	One frequency and one mode in each memory channel as scan edges for programmed scan.	Yes	Yes	No

## Memory channel selection

- Push MAIN [VFO/MEMO] to select the memory mode.  
- "MEMO" appears.
- Push MAIN [M-CH UP]/[M-CH DOWN] several times to select the desired memory channel.  
- [UP] and [DN] on the microphone also select the programmed memory channels in memory mode.
- To return to the VFO mode, push MAIN [VFO/MEMO] again.

**[EXAMPLE]:** Selecting memory channel 17.

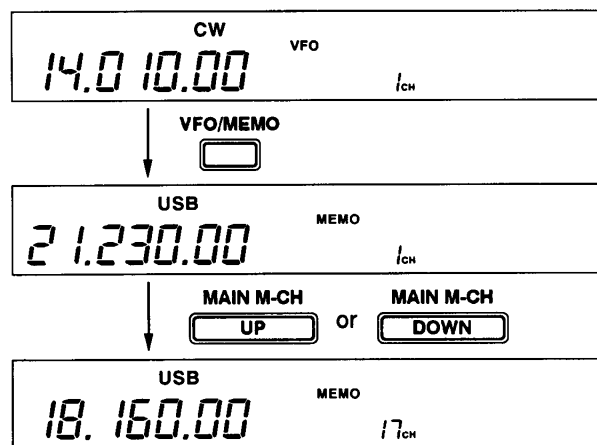

## Memory clearing

Any unnecessary memory channels can be cleared. The cleared memory channels become blank channels.

- Select the memory mode with MAIN [VFO/MEMO].
- Select a memory channel to be cleared with MAIN [M-CH UP]/[M-CH DOWN].
- Push [CLEAR] for 2 sec. to clear the contents.  
- The programmed frequency and operating mode disappear and "BLANK" appears.
- To clear other memory channels, repeat steps ② and ③.

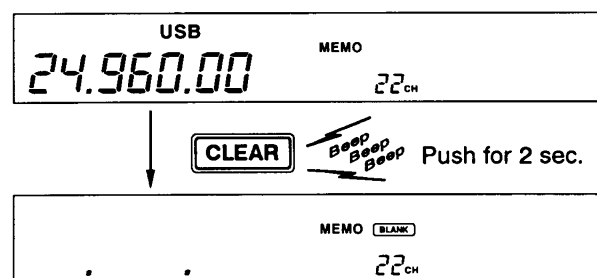

## Memory channel programming

Memory channel programming can be performed either in the VFO mode or in the memory mode.

**NOTE:** Memory channel programming can be performed to the MAIN readout only even when dualwatch is in use.

### • Programming in the VFO mode

- ① Set the desired frequency and operating mode in the VFO mode.
- ② Push MAIN [M-CH UP]/[M-CH DOWN] several times to select the desired memory channel to be programmed.
  - To confirm the memory channel contents, push MAIN [VFO/MEMO]; then push MAIN [VFO/MEMO] again to return to the VFO mode.
  - "BLANK" appears if the selected memory channel is a blank channel (and does not have contents).
- ③ Push [MW] for 2 sec. to program the displayed frequency and operating mode into the memory channel.

To check the programmed contents, push MAIN [VFO/MEMO] to select the memory mode.

During split frequency operation:  
To program the SUB readout contents into the displayed sub memory channel, push [MW] for 2 sec. while pushing [XFC].

**[EXAMPLE]:** Programming 7.088 MHz/LSB into memory channel 12.

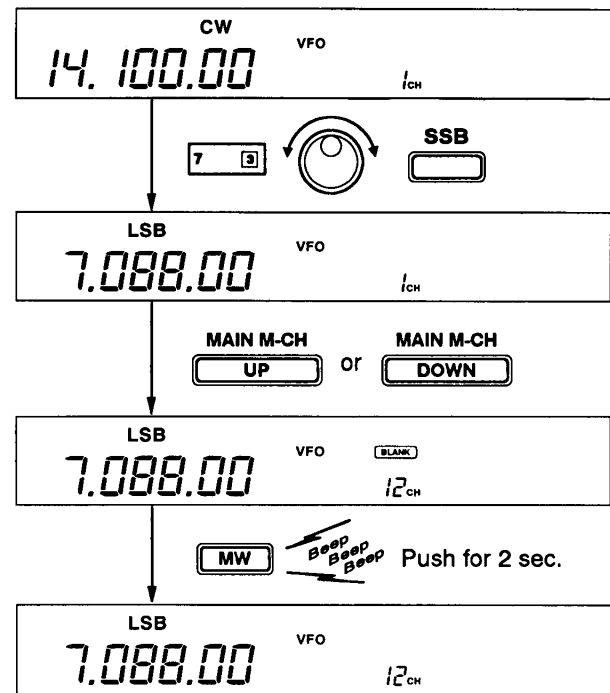

### • Programming in the memory mode

- ① Select the desired memory channel with MAIN [M-CH UP]/[M-CH DOWN] in the memory mode.
- ② Set the desired frequency and operating mode in the memory mode.
  - To program a blank channel, use direct frequency entry with the keypad. (p. 25)
- ③ Push [MW] for 2 sec. to program the displayed frequency and operating mode into the memory channel.

During split frequency operation:  
To program the SUB readout contents into the displayed sub memory channel, push [MW] for 2 sec. while pushing [XFC].

**[EXAMPLE]:** Programming 21.280 MHz/USB into memory channel 18.

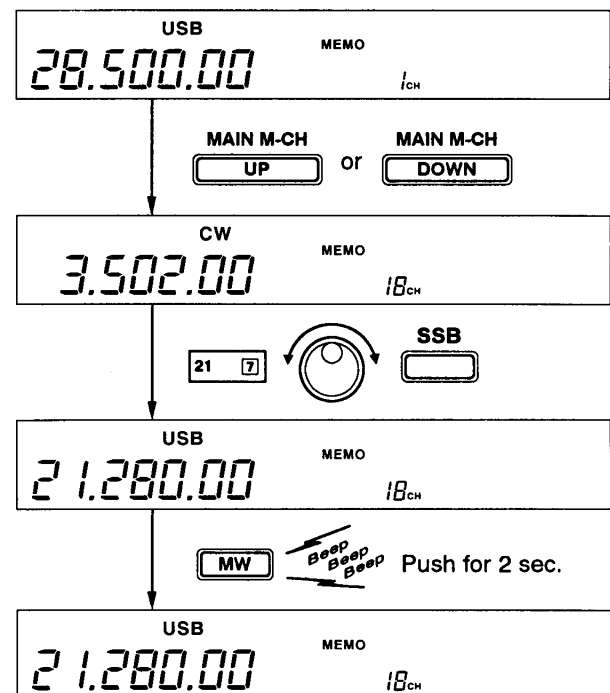

## Frequency transferring

The frequency and operating mode in the memory mode can be transferred to the VFO mode.

The frequency transferring can be performed in either the VFO mode or in the memory mode.

### Transferring in the VFO mode

This is useful for transferring programmed contents to VFO.

- ① Select VFO mode with MAIN [VFO/MEMO].
- ② Select a memory channel with MAIN [M-CH UP]/[M-CH DOWN].
  - To confirm the memory channel contents, push MAIN [VFO/MEMO]; then push MAIN [VFO/MEMO] again to return to the VFO mode.
  - "BLANK" appears if the selected memory channel is a blank channel (and does not have contents). In this case transferring is impossible.
- ③ Push [M▶V] for 2 sec. to transfer the frequency and operating mode.
  - Transferred frequency and operating mode appear on the display.

### TRANSFERRING EXAMPLE IN THE VFO MODE

Operating frequency : 21.320 MHz/USB (VFO)  
 Contents of MEMO 16 : 14.020 MHz/CW

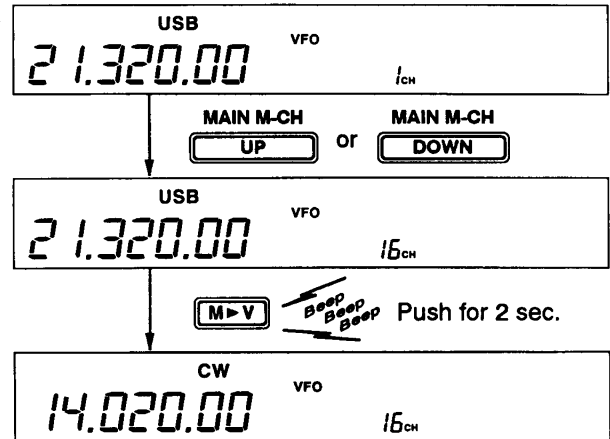

### Transferring in the memory mode

This is useful for transferring frequency and operating mode while operating in the memory mode.

**NOTE:** When you have changed the frequency or operating mode in the selected memory channel:

- **Displayed** frequency and mode are transferred.
- **Programmed** frequency and mode are not transferred, and they remain in the memory channel.

- ① Select a memory channel with MAIN [M-CH UP]/[M-CH DOWN] in the memory mode.
  - And, set the frequency or operating mode if required.
- ② Push [M▶V] for 2 sec. to transfer the frequency and operating mode.
  - Displayed frequency and operating mode are transferred to the VFO.
- ③ To return to the VFO mode, push MAIN [VFO/MEMO].

### TRANSFERRING EXAMPLE IN THE MEMORY MODE

Operating frequency : 14.028 MHz/CW (MEMO 19)

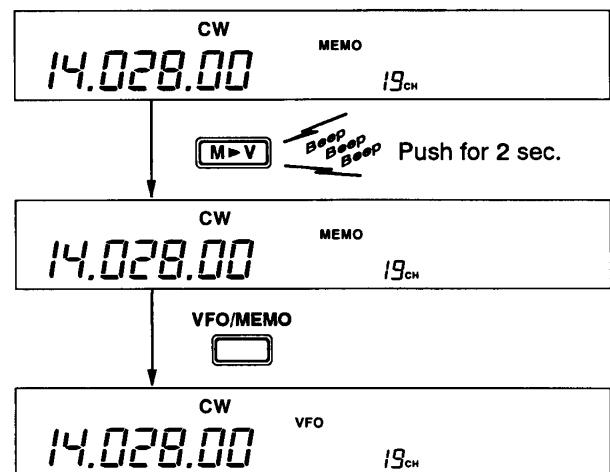

### Transferring in the VFO mode during split frequency operation

- ① Select a memory channel with SUB [M-CH UP]/[M-CH DN] in the VFO mode.
  - To confirm the memory channel contents, push SUB [VFO/MEMO]; then push SUB [VFO/MEMO] again to return to the VFO mode.
  - A blank channel cannot be transferred.
- ② While pushing [XFC], push [M▶V] for 2 sec. to transfer the frequency.
  - Transferred frequency appear in the SUB readout.

### Transferring in the memory mode during split frequency operation

- ① Select a memory channel with SUB [M-CH UP]/[M-CH DN] in the memory mode.
  - And, set the frequency if required.
- ② While pushing [XFC], push [M▶V] for 2 sec. to transfer the frequency.
  - Displayed frequency is transferred to the SUB readout VFO.
- ③ To return to the VFO mode, push SUB [VFO/MEMO].

## Scan edge memory channels

Memory channels P1 and P2 are scan edge memory channels. These memory channels are used to program scan edge frequencies for programmed scan. (p. 54)

Scan edge memory channels can be programmed for 1 frequency and 1 operating mode like regular memory channels. However, memory clearing is impossible. Only overwriting is possible for scan edge memory channels.

### • Scan edge memory channel selection

- ① Push MAIN [VFO/MEMO] to select the memory mode.  
- "MEMO" appears.
- ② Select the desired scan edge memory channel with MAIN [M-CH UP]/[M-CH DOWN].  
- [UP] and [DN] on the microphone also select the programmed memory channels.
- ③ To return to the VFO mode, push MAIN [VFO/MEMO] again.

You can transmit and receive using the programmed frequency and operating mode in the scan edge memory channels.

**[EXAMPLE]:** Selecting scan edge memory channel P1.

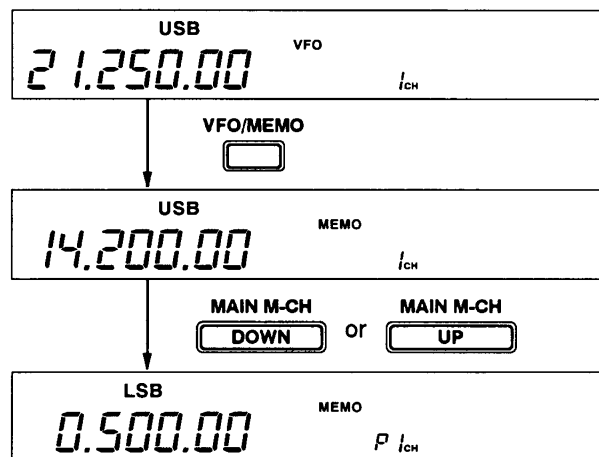

### • Scan edge memory channel programming

A scan edge memory channel can be programmed in either the VFO or memory mode the same way as regular memory channel programming.

Following is an example of programming 28.000/28.050 MHz into scan edge memory channels P1/P2 in the VFO mode.

- ① Set 28.000 MHz in the VFO mode.  
- An operating mode can also be programmed, however, the programmed operating mode does not affect programmed scan.

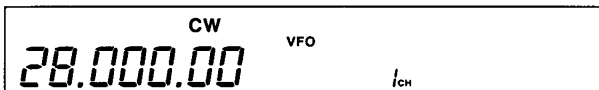

- ② Select the scan edge memory channel P1 with MAIN [M-CH UP]/[M-CH DOWN].

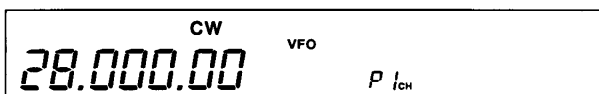

- ③ Push [MW] for 2 sec. to program 28.000 MHz into the scan edge memory channel P1.

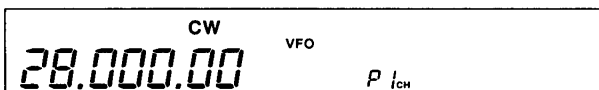

- ④ Change the displayed frequency to 28.050 MHz.

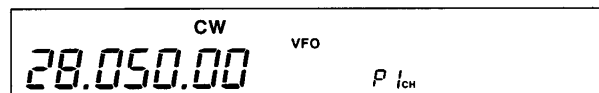

- ⑤ Push MAIN [M-CH UP] to select the other scan edge memory channel, P2.

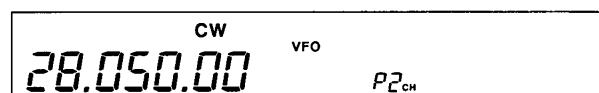

- ⑥ Push [MW] for 2 sec. to program 28.050 MHz into the scan edge memory channel P2.

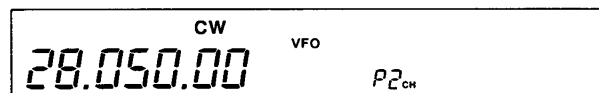

To check the programmed contents, push MAIN [VFO/MEMO] to select the memory mode, then select P1 or P2 with MAIN [M-CH UP]/[M-CH DOWN].

# 7 SCANS

## Scan types

The transceiver has 3 types of scan functions which provide tremendous scanning versatility at the touch of a few switches.

Select the scan which matches your operating needs.

- The scan function can be used on the MAIN readout only.
- You can operate a scan while operating on a frequency using both dualwatch and split function. See p. 35 for details.

### MEMORY SCAN

Repeatedly scans all programmed memory channels.

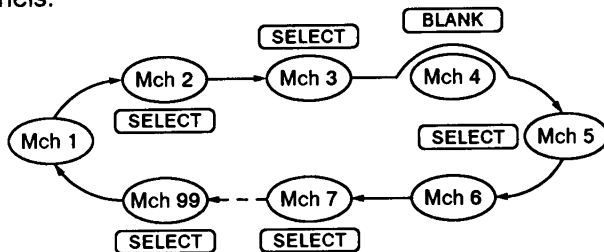

This scan operates in the memory mode.

### PROGRAMMED SCAN

Repeatedly scans between two scan edge frequencies (scan edge memory channels P1 and P2).

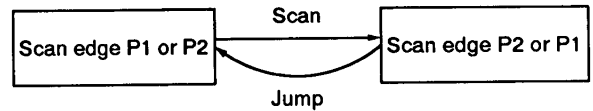

This scan operates in the VFO mode.

### SELECT MEMORY SCAN

Repeatedly scans select memory channels only.

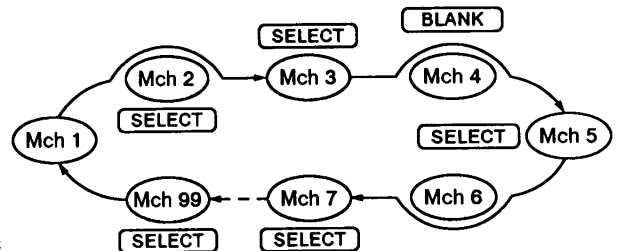

This scan operates in the memory mode.

## Pre-operation

### • Presetting

Program the memory channels before operating a scan as follows:

SCAN TYPE	REQUIRED PRESETTING
<b>PROGRAMMED SCAN</b>	Program scan edge frequencies into scan edge memory channels P1 and P2. (p. 52)
<b>MEMORY SCAN</b>	Program desired scan frequencies into 2 or more memory channels except scan edge memory channels.
<b>SELECT MEMORY SCAN</b>	Designate 2 or more memory channels as select memory channels with the [SEL] switch.

### • Scan resume ON/OFF

You can select the scan to resume or cancel when detecting a signal, in the H-set mode. Scan resume ON/OFF must be set before operating a scan. See p. 44 for ON/OFF setting and scan resume condition details.

### • Squelch condition

Before starting a scan, open or close the squelch for the desired operation as described below:

SCAN STARTS WITH	PROGRAMMED SCAN	MEMORY SCANS
<b>SQUELCH OPEN</b>	The scan continues until it is stopped manually, and does not pause even if it detects signals.	Scan pauses on each channel when the scan resume is ON; not applicable when OFF.
<b>SQUELCH CLOSED</b>	Scan stops when detecting a signal. If you set scan resume to "ON" in the set mode, the scan pauses for 10 sec. when detecting a signal, then resumes. When a signal disappears while scan is paused, scan resumes 2 sec. later.	

### • Scan speed

Scan speed can be selected from 2 levels, high or low, in the H-set mode. See p. 45 for details.



## Programmed scan operation

- ① Select the VFO mode.
- ② Select the desired operating mode.  
- The operating mode can also be changed while scanning.
- ③ Set [SQL] open or closed.  
- See page at left for scan condition.
- ④ Push [SCAN] to start the scan.  
- Decimal points blink while scanning.
- ⑤ When the scan detects a signal, the scan stops, pauses or ignores it depending on the resume setting and the squelch condition.  
- During scan the [TS] switch can be used.
- ⑥ To cancel the scan, push [SCAN].

**NOTE:** If the same frequencies are programmed into the scan edge memory channels P1 and P2, programmed scan does not start.

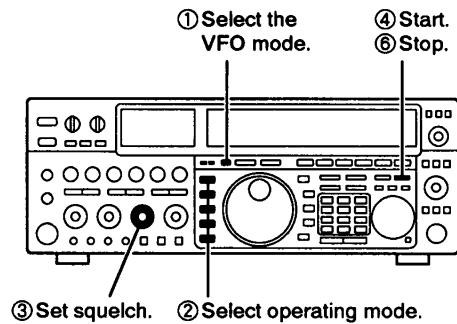

### [DISPLAY EXAMPLE DURING A SCAN]

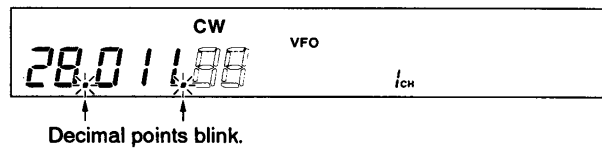

## Memory scan operation

- ① Select the memory mode.
- ② Close the squelch with [SQL].
- ③ Push [SCAN] to start the scan.  
- Decimal points blink while scanning.
- ④ When the scan detects a signal, the scan stops or pauses depending on the scan resume setting.
- ⑤ To cancel the scan, rotate the main dial, or push [SCAN].

**NOTE:** 2 or more memory channels must be programmed for memory scan to start.

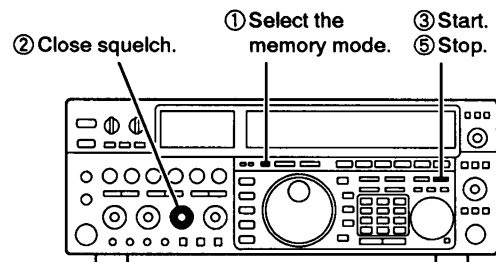

## Select memory scan operation

- ① Select the memory mode.
- ② Close the squelch with [SQL].
- ③ Push [SCAN] to start the memory scan.  
- Decimal points blink while scanning.
- ④ Push [SEL] to activate the select memory scan.  
- "[SELECT]" continuously lights during select memory scan.
- ⑤ When the scan detects a signal, the scan stops or pauses depending on the scan resume setting.
- ⑥ To cancel the scan, rotate the main dial, or push [SCAN].

**NOTE:** 2 or more memory channels must be designated as select memory channels for select memory scan to start.

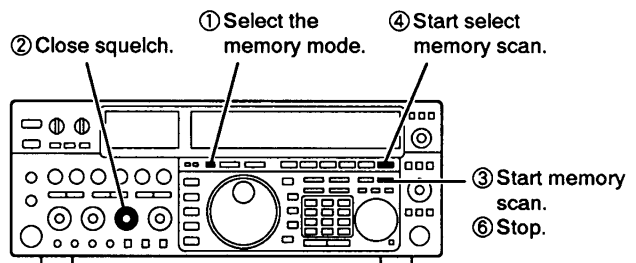

### [DISPLAY EXAMPLE DURING A SCAN]

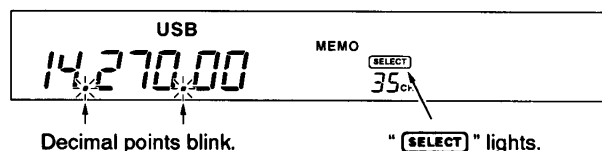

## Frequency calibration (approximate) *P-set mode*

A very accurate frequency counter is required to calibrate the frequency of the transceiver. However, a rough check may be performed by receiving radio station WWV, or other standard frequency signals.

**CAUTION:** Your transceiver has been thoroughly adjusted and checked at the factory before being shipped. You should not calibrate frequencies, except for special reasons.

- ① Push [SSB] to select USB mode. Make sure the [TWIN PBT] controls are set to the center position.
- ② Set the frequency to the standard frequency station minus 1 kHz.
  - When receiving WWV (10.000.00 MHz) as a standard frequency, set the operating frequency for 9.999.00 MHz.
  - Other standard frequencies can also be used.

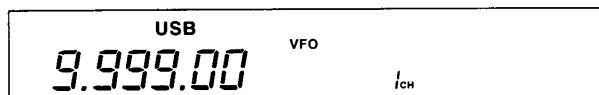

- ③ Push [SET] momentarily to enter P-set mode.
- ④ Push [ΔUP]/[▽DOWN] one or more times to select "CAL" display.
  - When a sub setting display is selected, push [ENT] to exit.

- ⑤ Rotate the main dial clockwise to turn the calibration marker ON.
  - Side tone may be heard.



- ⑥ Adjust the calibration pot on the right side panel of the transceiver for making a zero beat with the received standard signal as shown below.
  - Zero beat means that two signals are exactly the same frequency, resulting in a single tone being emitted.

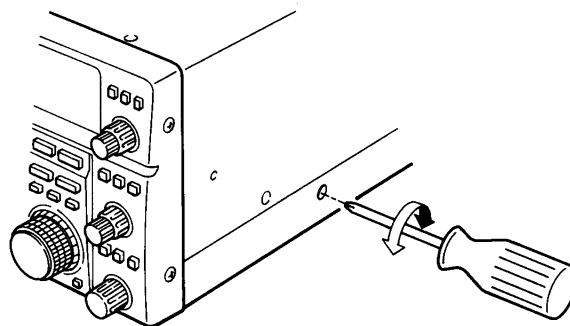

- ⑦ Rotate the main dial counterclockwise to turn the calibration marker OFF in P-set mode.
- ⑧ Push [ENT] to exit P-set mode.

## Main dial brake adjustment

The tension of the main dial may be adjusted to suit your preference.

The brake adjustment screw is located under the rubber grip of the main dial. See the figure at right.

Turn the brake adjustment screw clockwise or counterclockwise to obtain a comfortable tension level while turning the main dial continuously and evenly in one direction.

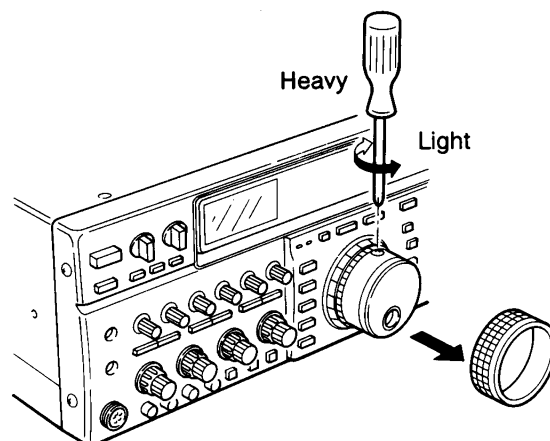

## ■ AC fuse replacement

If a fuse blows or the transceiver stops functioning, try to find the source of the problem, and replace the damaged fuse with a new, rated fuse.

**⚠ WARNING: DISCONNECT** the AC power cable from the transceiver when replacing a fuse.

Use one of the following fuses to match the voltage of the AC outlet:

- 100 – 120 V versions ..... 12 A FGMB
- 220 – 240 V versions ..... 5 A (High breaking capacity fuse)

**⚠ WARNING: NEVER** use non-rated fuses. Non-rated fuses could cause a fire. Use appropriate fuses as described above.

### AC FUSE REPLACEMENT

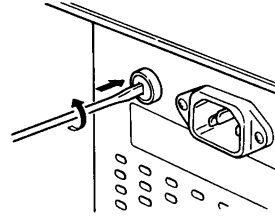

When removing the fuse, push the fuse holder, then set the gutter to the vertical position.

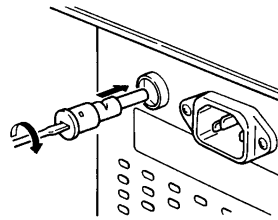

When installing the fuse, set the gutter to the vertical position, then install the fuse. Rotate the fuse holder clockwise to set to the horizontal position.

## ■ MB-19 installation

The optional MB-19 RACK MOUNTING HANDLES allows you to install the transceiver in a 19-in rack.

Remove the 4 screws from both sides of the front panel, then attach the MB-19 to the sides of the transceiver using 6 screws supplied with the MB-19.

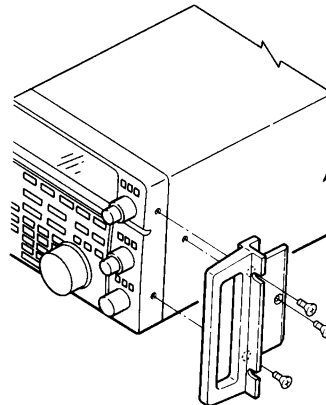

## ■ Lithium backup battery

**CAUTION:** The backup batteries must be replaced by an authorized Icom Dealer or Service Center. If a lithium backup battery is incorrectly replaced, an explosion may occur. Replace with a CR-2032 or equivalent type.

The transceiver has a lithium backup battery on the inside of the front panel (main unit) for retaining operating conditions. The usual life of the backup battery is approximately 5 years.

When the battery is exhausted, the transceiver transmits and receives normally but cannot retain operating conditions except for memory channels.

## ■ Cleaning

If the transceiver becomes dusty or dirty, wipe it clean with a dry, soft cloth.

**AVOID** the use of strong chemical solvents such as thinner, benzene or alcohol to clean the cabinet, as these may damage the transceiver's surfaces.

# 9 TROUBLESHOOTING

The following chart is designed to help you correct problems which are not equipment malfunctions.

If you are not able to locate the cause of a problem or solve it through the use of this chart, contact your nearest Icom Dealer or Service Center.

	PROBLEM	POSSIBLE CAUSE	SOLUTION	REF.
POWER SUPPLY	Power does not come on when the [POWER] switch is pushed.	<ul style="list-style-type: none"> <li>• Fuse is blown.</li> <li>• Internal breaker is thrown.</li> </ul>	<ul style="list-style-type: none"> <li>• Disconnect any connections, then replace the fuse with a spare one.</li> <li>⚠ <b>WARNING:</b> NEVER use a non-rated fuse. This could cause a fire.</li> <li>• Turn power OFF then ON again. The internal breaker should be reset. If the breaker is thrown again, the transceiver may need maintenance.</li> </ul>	<p>p. 56</p> <p>—</p>
	No sound comes from the speaker.	<ul style="list-style-type: none"> <li>• Volume level is too low.</li> <li>• The squelch is closed.</li> <li>• The [RF] control is rotated counterclockwise.</li> <li>• The transceiver is in the transmitting condition.</li> <li>• An external speaker or headphones are connected.</li> <li>• Optional filter setting in H-set mode is wrong.</li> <li>• Auto APF function is activated. (for <b>DSP</b> equipped type)</li> </ul>	<ul style="list-style-type: none"> <li>• Rotate [AF] clockwise to obtain a suitable listening level.</li> <li>• Rotate [SQL] counterclockwise to open the squelch.</li> <li>• Rotate [RF] clockwise. The recommended position is max. clockwise.</li> <li>• Push [TRANSMIT] OUT or check the SEND line of an external unit, if connected.</li> <li>• Check the external speaker or headphone plug connection.</li> <li>• Check the speaker ON/OFF switch or speaker A/B switch, when an optional SP-20 EXTERNAL SPEAKER is in use.</li> <li>• Correct the optional filter setting using H-set mode.</li> <li>• Push [AUTO] ([AF LPF], IC-775 with DSP unit) to cancel the function.</li> </ul>	<p>pgs. 22, 23</p> <p>pgs. 22, 23</p> <p>p. 4</p> <p>p. 1</p> <p>p. 16</p> <p>—</p> <p>p. 47</p> <p>p. 30</p>
RECEIVE	Sensitivity is low.	<ul style="list-style-type: none"> <li>• Incorrect antenna is selected with the [ANT] switches.</li> <li>• The antenna feedline is cut or shorted.</li> <li>• The antenna is not properly tuned.</li> <li>• The preamp 2 is activated on 18 MHz band or below.</li> <li>• The attenuator function is activated.</li> </ul>	<ul style="list-style-type: none"> <li>• Push [ANT1] or [ANT2] to select the matched antenna.</li> <li>• Check the feedline and correct any improper conditions.</li> <li>• Push [TUNER] for 2 sec. to manually tune the antenna.</li> <li>• Set [PREAMP/ATT] to PRE1 or OFF position.</li> <li>• Set [PREAMP/ATT] to OFF position.</li> </ul>	<p>p. 2</p> <p>—</p> <p>p. 39</p> <p>p. 2</p> <p>p. 2</p>
	Receive audio is distorted.	<ul style="list-style-type: none"> <li>• The operating mode is not selected correctly.</li> <li>• PBT function is activated.</li> <li>• Noise blanker function is activated.</li> <li>• Preamp is activated.</li> <li>• [NR LEVEL] is set too far clockwise. (for <b>DSP</b> equipped type)</li> </ul>	<ul style="list-style-type: none"> <li>• Select a suitable operating mode.</li> <li>• Set [TWIN PBT] to the center position.</li> <li>• Push [NB] to turn the function OFF.</li> <li>• Set [PREAMP/ATT] to OFF position.</li> <li>• Set [NR LEVEL] for maximum readability.</li> </ul>	<p>p. 5</p> <p>pgs. 9, 28</p> <p>p. 2</p> <p>p. 2</p> <p>p. 29</p>

	PROBLEM	POSSIBLE CAUSE	SOLUTION	REF.
<b>RX</b>	The [ANT] switches do not function.	<ul style="list-style-type: none"> <li>The antenna switches have not been activated.</li> </ul>	<ul style="list-style-type: none"> <li>Set the antenna switches in the H-set mode to "on" or "Aut."</li> </ul>	p. 45
<b>TRANSMIT</b>	Transmitting is impossible.	<ul style="list-style-type: none"> <li>The operating frequency is not set to a ham band.</li> </ul>	<ul style="list-style-type: none"> <li>Set the frequency to a ham band.</li> </ul>	p. 25
	Output power is too low.	<ul style="list-style-type: none"> <li>[PWR] is set too far counterclockwise.</li> </ul>	<ul style="list-style-type: none"> <li>Rotate [PWR] clockwise.</li> </ul>	p. 3
		<ul style="list-style-type: none"> <li>[DRIVE] is set too far counterclockwise.</li> </ul>	<ul style="list-style-type: none"> <li>Set [DRIVE] to center position.</li> </ul>	p. 36
		<ul style="list-style-type: none"> <li>[MIC] is set too far counterclockwise.</li> </ul>	<ul style="list-style-type: none"> <li>Set [MIC] to a suitable position.</li> </ul>	p. 3
		<ul style="list-style-type: none"> <li>The antenna is not connected properly.</li> </ul>	<ul style="list-style-type: none"> <li>Reconnect the antenna and check the [ANT] switch position.</li> </ul>	p. 15
		<ul style="list-style-type: none"> <li>The antenna feedline is cut or shorted.</li> </ul>	<ul style="list-style-type: none"> <li>Check the feedline and correct any improper conditions.</li> </ul>	—
No contact possible with another station.	<ul style="list-style-type: none"> <li>An antenna for another band is selected.</li> </ul>	<ul style="list-style-type: none"> <li>Select an antenna suitable for the operating frequency.</li> </ul>	p. 2	
	<ul style="list-style-type: none"> <li>The antenna is not properly tuned.</li> </ul>	<ul style="list-style-type: none"> <li>Push [TUNER] for 2 sec. to manually tune the antenna.</li> </ul>	p. 39	
	<ul style="list-style-type: none"> <li>RIT/<math>\Delta</math>TX function is activated.</li> </ul>	<ul style="list-style-type: none"> <li>Push [RIT]/[<math>\Delta</math>TX] to turn the function OFF.</li> </ul>	p. 7	
	<ul style="list-style-type: none"> <li>DATA mode is selected.</li> </ul>	<ul style="list-style-type: none"> <li>Push the desired mode key once or twice.</li> </ul>	p. 5	
Repeater cannot be accessed.	<ul style="list-style-type: none"> <li>Split frequency function and/or dual-watch are activated.</li> </ul>	<ul style="list-style-type: none"> <li>Push [SPLIT] and/or [DUALWATCH] to turn the function OFF.</li> </ul>	pgs. 6, 33, 35	
	<ul style="list-style-type: none"> <li>Split function is not activated.</li> </ul>	<ul style="list-style-type: none"> <li>Push [SPLIT] to turn the function ON.</li> </ul>	pgs. 6, 33	
	<ul style="list-style-type: none"> <li>An incorrect transmit frequency is set.</li> </ul>	<ul style="list-style-type: none"> <li>Set the proper frequencies to the MAIN and SUB readouts.</li> </ul>	p. 38	
Transmitted signals are distorted.	<ul style="list-style-type: none"> <li>Programmed subaudible tone frequency is wrong.</li> </ul>	<ul style="list-style-type: none"> <li>Reset the frequency using H-set mode.</li> </ul>	p. 46	
	<ul style="list-style-type: none"> <li>[MIC] is rotated too far clockwise.</li> </ul>	<ul style="list-style-type: none"> <li>Set [MIC] to a suitable position.</li> </ul>	p. 3	
<b>DISPLAY</b>	The displayed frequency does not change properly.	<ul style="list-style-type: none"> <li>[DRIVE] is rotated too far clockwise with the speech compressor ON.</li> </ul>	<ul style="list-style-type: none"> <li>Set [DRIVE] to a suitable position.</li> </ul>	pgs. 4, 36
		<ul style="list-style-type: none"> <li>The main and/or sub dial lock functions are activated.</li> </ul>	<ul style="list-style-type: none"> <li>Push MAIN and/or SUB [LOCK] to deactivate the functions.</li> </ul>	p. 40
<b>SCAN</b>	Programmed scan does not stop.	<ul style="list-style-type: none"> <li>The internal CPU has malfunctioned.</li> </ul>	<ul style="list-style-type: none"> <li>Perform CPU resetting. (While pushing and holding [CLEAR], turn power ON.)</li> </ul>	p. 21
		<ul style="list-style-type: none"> <li>Squelch is open.</li> </ul>	<ul style="list-style-type: none"> <li>Set [SQL] to the threshold point.</li> </ul>	p. 53
	<ul style="list-style-type: none"> <li>[SQL] is assigned to CW pitch and squelch is open.</li> </ul>	<ul style="list-style-type: none"> <li>Reset [SQL] control arrangement and set it to the threshold point.</li> </ul>	p. 43	
	Programmed scan does not start.	<ul style="list-style-type: none"> <li>The same frequencies have been programmed in scan edge memory channels P1 and P2.</li> </ul>	<ul style="list-style-type: none"> <li>Program different frequencies into scan edge memory channels P1 and P2.</li> </ul>	p. 52
Memory scan does not start.	<ul style="list-style-type: none"> <li>2 or more memory channels have not been programmed.</li> </ul>	<ul style="list-style-type: none"> <li>Program 2 or more memory channels.</li> </ul>	p. 50	
Select memory scan does not start.	<ul style="list-style-type: none"> <li>2 or more memory channels have not been designated as select channels.</li> </ul>	<ul style="list-style-type: none"> <li>Designate 2 or more memory channels as select channels for the scan.</li> </ul>	p. 54	

# 10 INTERNAL VIEWS

Downloaded by  
Amateur Radio Directory  
[www.hamdirectory.info](http://www.hamdirectory.info)

## ■ Top view

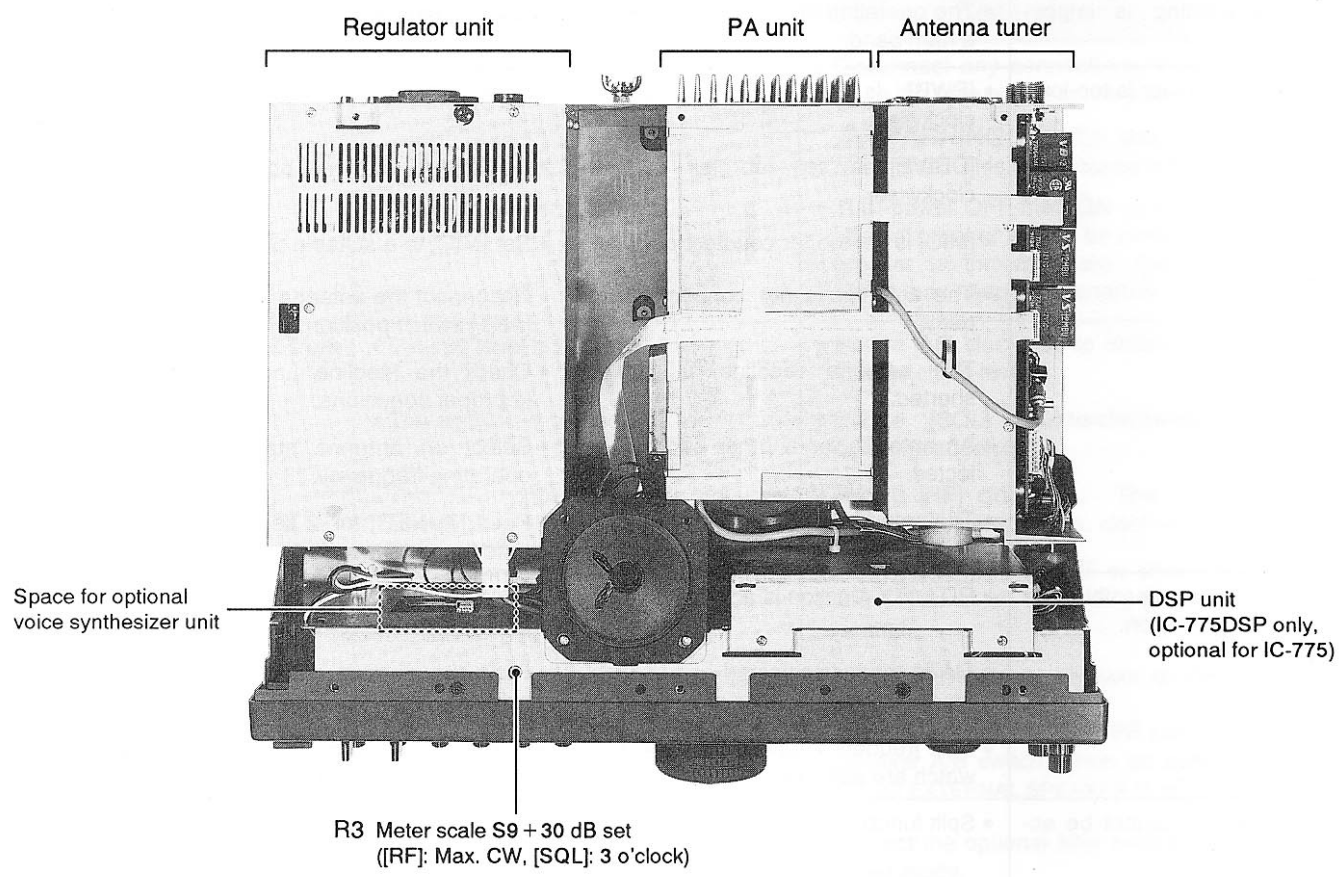

## ■ Left side view

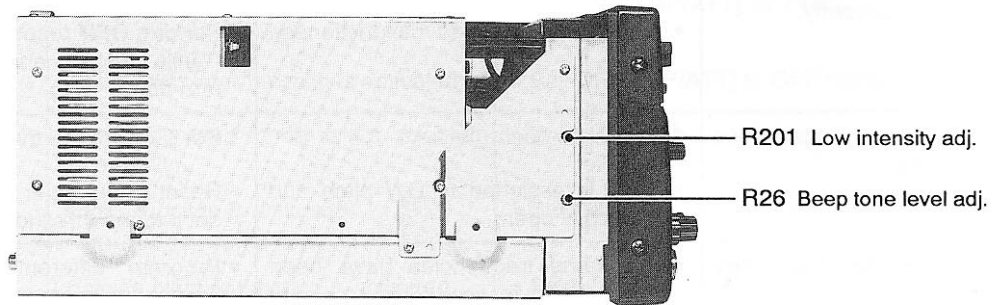

Downloaded by  
Amateur Radio Directory  
www.hamdirectory.info

Bottom view

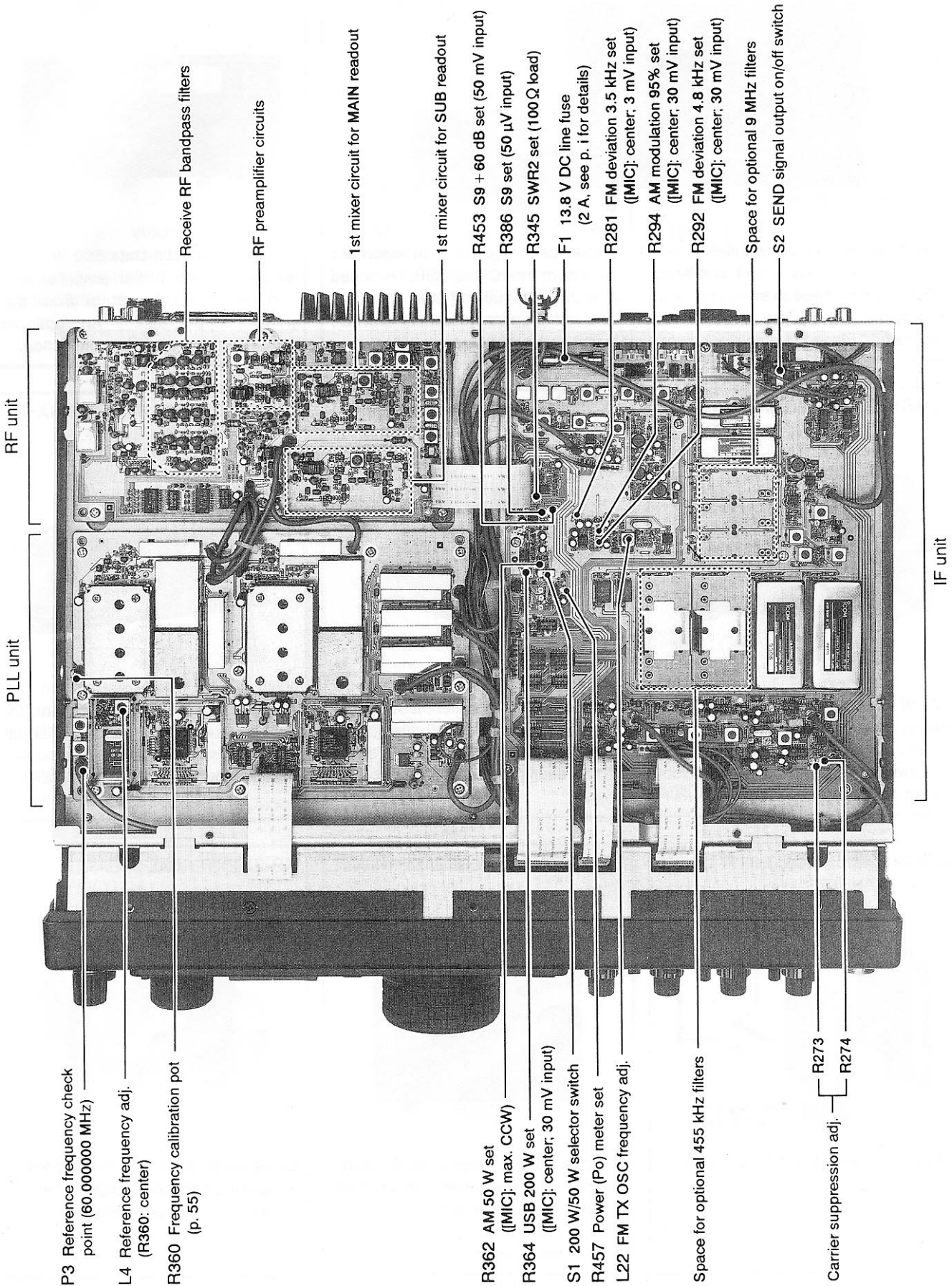

P3 Reference frequency check point (60,000000 MHz)

L4 Reference frequency adj. (R360: center)

R360 Frequency calibration pot (p. 55)

R362 AM 50 W set ([MIC]; max. CCW)

R364 USB 200 W set ([MIC]; center; 30 mV input)

S1 200 W/50 W selector switch

R457 Power (Po) meter set

L22 FM TX OSC frequency adj.

Space for optional 455 kHz filters

Carrier suppression adj. — R273

R274

Receive RF bandpass filters

RF preamplifier circuits

1st mixer circuit for MAIN readout

1st mixer circuit for SUB readout

R453 S9 + 60 dB set (50 mV input)

R386 S9 set (50 μV input)

R345 SWR2 set (100 Ω load)

F1 13.8 V DC line fuse (2 A, see p. 1 for details)

R281 FM deviation 3.5 kHz set ([MIC]; center; 3 mV input)

R294 AM modulation 95% set ([MIC]; center; 30 mV input)

R292 FM deviation 4.8 kHz set ([MIC]; center; 30 mV input)

Space for optional 9 MHz filters

S2 SEND signal output on/off switch

# 11 OPTIONS

## IC-4KL HF 1 kW LINEAR AMPLIFIER

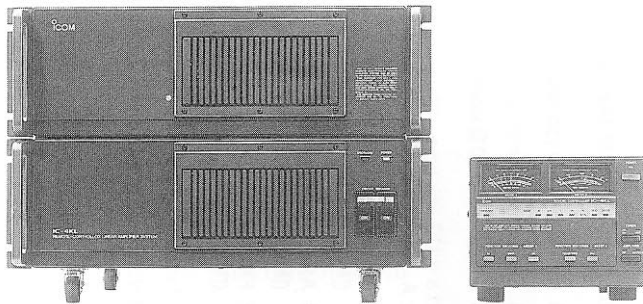

This is an all solid-state full-duty 1 kW linear amplifier including an automatic antenna tuner. The IC-4KL is fully controllable from the IC-775/DSP. No need to tune and no need to switch the operating band. Full-break-in (QSK) operation is possible. The amplifier/power supply unit and the remote control unit are separated. Place the amplifier/power supply unit under your operating desk.

## IC-2KL HF 500 W LINEAR AMPLIFIER



This is an all solid-state 500 W linear amplifier. The power amplifier unit can be separately set-up from the power supply unit. An optional OPC-118 is required for connection.

## IC-AT500 HF AUTOMATIC ANTENNA TUNER

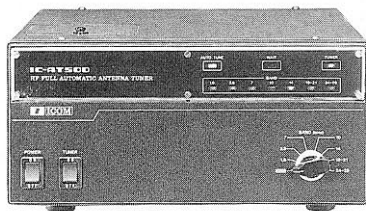

500 W automatic antenna tuner. Best match for the IC-775/DSP with the IC-2KL. Includes an automatic antenna selector for 4 separate antennas.

## UI-100 DSP UNIT (For the IC-775)

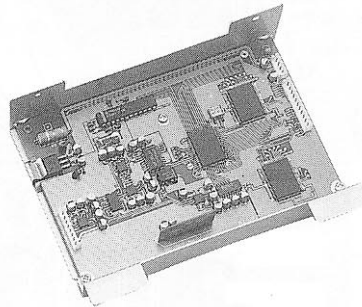

Provides noise reduction, DSP modulation/demodulation, DSP filters, auto notch, auto APF, etc. The IC-775DSP has an equivalent unit.

## EX-627 AUTOMATIC ANTENNA SELECTOR

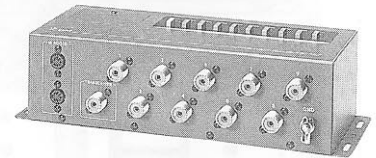

Automatically selects the antenna for the selected ham band. Manual selection is also possible.

- Max. input power : 1000 W PEP

## MB-19 RACK MOUNTING HANDLES

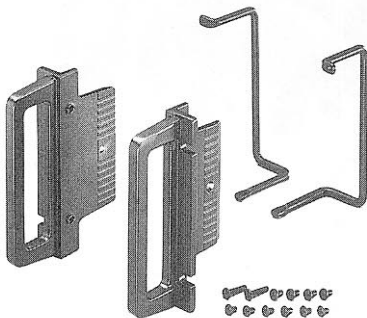

Mounting handles for 19-inch rack.

## SP-20 EXTERNAL SPEAKER



Equipped with 4 types of audio filters, a headphone jack and can be connected to 2 transceivers.

- Input impedance : 8  $\Omega$
- Max. input power : 5 W

## SP-21 EXTERNAL SPEAKER

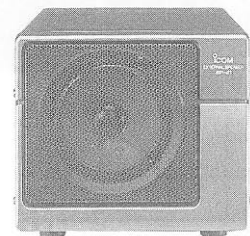

Designed for base station operation.

- Input impedance : 8  $\Omega$
- Max. input power : 5 W



**SM-20 DESKTOP MICROPHONE**



Unidirectional, electret microphone for base station operation. Includes [UP]/[DOWN] switches and a low cut function.

**SM-8 DESKTOP MICROPHONE**

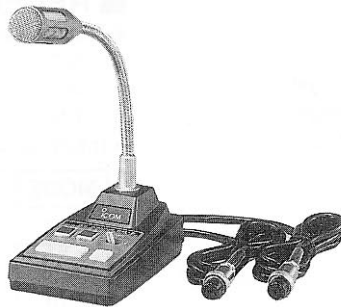

Electret condenser-type desktop microphone including 2 connection cables for simultaneous connection of 2 transceivers. [UP]/[DOWN] switches also come with the microphone.

**CT-16 SATELLITE INTERFACE UNIT**

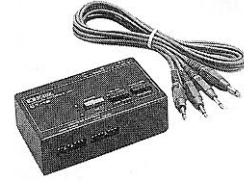

Easy tuning when connecting another Icom VHF transceiver for instant satellite communications.

**CT-17 CI-V LEVEL CONVERTER**

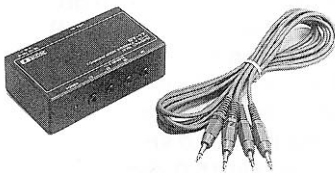

For remote transceiver control using a personal computer equipped with an RS-232C port. You can change frequencies, operating mode, memory channels, etc., via your computer keyboard.

**CR-282 HIGH-STABILITY CRYSTAL UNIT**

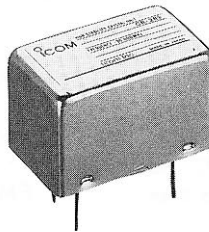

Contains a temperature-compensating oven heater and crystal unit for improved frequency stability.

- Frequency stability:  $\pm 0.5$  ppm ( $-30^{\circ}\text{C}$  to  $+60^{\circ}\text{C}$ ;  $-22^{\circ}\text{F}$  to  $+140^{\circ}\text{F}$ )

**FL-101, FL-102 and FL-223 9 MHz FILTERS**

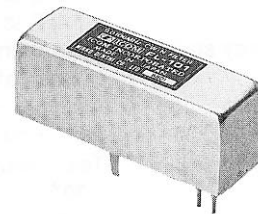

Have good shape factor and provide you with better reception.

- FL-101: 250 Hz/ - 6 dB (CW nar.)
- FL-102: 6.0 kHz/ - 6 dB (SSB wide/AM med./FM nar.)
- FL-223: 1.9 kHz/ - 6 dB (SSB nar.)

**FL-53A and FL-222 455 kHz FILTERS**

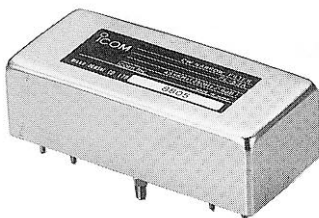

Have good shape factor and provide you with better reception.

- FL-53A : 250 Hz/ - 6 dB (CW nar.)
- FL-222 : 1.9 kHz/ - 6 dB (SSB nar.)

**HM-36 HAND MICROPHONE**



Hand microphone equipped with the [UP]/[DOWN] switches.

**UT-66 VOICE SYNTHESIZER UNIT**

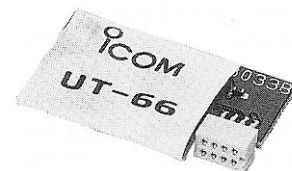

Announces the operating frequency and mode. (p. 3, 44)

# 12 SPECIFICATIONS

## ■ GENERAL

- Frequency coverage:
  - Receive 100 kHz – 29.990 MHz
  - Transmit 1.800 – 1.999999 MHz\*<sup>1</sup>
  - 3.500 – 3.999999 MHz\*<sup>2</sup>
  - 7.000 – 7.300 MHz\*<sup>3</sup>
  - 10.100 – 10.150 MHz
  - 14.000 – 14.350 MHz
  - 18.068 – 18.168 MHz
  - 21.000 – 21.450 MHz
  - 24.890 – 24.990 MHz
  - 28.000 – 29.700 MHz
- \*<sup>1</sup> 1.830–1.850 for Spain version;  
1.810–1.850 for France version;  
1.815–1.835/1.850–1.890 for Germany version
- \*<sup>2</sup> 3.500–3.800 for Spain, France and Germany versions
- \*<sup>3</sup> 7.000–7.100 for Spain, France and Germany versions
- Mode : SSB, CW, RTTY, AM, FM
- Number of memory : 101 (99 regular, 2 scan edges) channels
- Antenna impedance : 50 Ω nominal
- Usable temperature : –10°C to +60°C;  
range +14°F to +140°F
- Frequency stability : Less than ±200 Hz from 1 min. to 60 min. after power ON.  
After that, rate of stability change is less than ±30 Hz/hr. at +25°C; +77°F.  
Temperature fluctuations (0°C to +50°C; +32°F to +122°F) less than ±350 Hz.
- Power supply requirement:
  - 120 V type 100 – 120 V AC
  - 230 V type 220 – 240 V AC
- Power consumption :
  - Transmit max. power 760 VA
  - Receive squelched 140 VA
  - max. audio output 150 VA
- Dimensions : 424(W) × 150(H) × 390(D) mm  
16<sup>11/16</sup>(W) × 5<sup>29/32</sup>(H) × 15<sup>11/32</sup>(D)<sup>\*</sup>  
(projections not included)
- Weight : 16.5 kg; 36.4 lb (without DSP unit)  
16.7 kg; 36.8 lb (with DSP unit)

## ■ TRANSMITTER

- Output power : SSB, CW, RTTY, FM 5 – 200 W  
AM 5 – 50 W  
(continuously adjustable)
- Spurious emissions : Less than –60 dB
- Carrier suppression : More than 40 dB
- Unwanted sideband : More than 55 dB
- Microphone impedance : 600 Ω

## ■ RECEIVER

- Receive system :
  - SSB, CW, RTTY, Quadruple-conversion
  - AM superheterodyne
  - FM Triple-conversion superheterodyne
- Intermediate frequencies: (Unit: MHz)

MODE	SSB	CW, RTTY	AM	FM
1st	69.0115	69.0106	69.0100	69.0100
2nd	9.0115	9.0106	9.0100	9.0100
3rd	0.455	0.455	0.455	0.455
4th	10.6950	10.6950	10.6950	–

- Sensitivity (Preamp 1 ON):
  - SSB, CW, RTTY 100 – 500 kHz Less than 2.0 μV  
(10 dB S/N) 1.8 – 29.99 MHz Less than 0.16 μV
  - AM (10 dB S/N) 0.5 – 1.8 MHz Less than 13.0 μV  
1.8 – 29.99 MHz Less than 2.0 μV
  - FM (12 dB SINAD) 28 – 29.99 MHz Less than 0.5 μV
- Squelch sensitivity (Preamp 1 ON):
  - SSB, CW, RTTY, Less than 3.2 μV at threshold
  - AM
  - FM Less than 0.32 μV at threshold
- Selectivity (Normal filter selection):
  - SSB More than 2.4 kHz/–6 dB  
Less than 4.0 kHz/–60 dB
  - CW, RTTY More than 500 Hz/–6 dB  
Less than 1.0 kHz/–60 dB
  - AM More than 6.0 kHz/–6 dB  
Less than 20.0 kHz/–60 dB
  - FM More than 15.0 kHz/–6 dB  
Less than 30.0 kHz/–60 dB
- Spurious and image : More than 70 dB rejection ratio
- Audio output power : More than 2.6 W at 10% distortion with an 8 Ω load
- RIT/ΔTX : ±9.999 kHz  
variable range

## ■ ANTENNA TUNER

- Matching impedance range:
  - 16.7 – 150 Ω unbalanced  
(Less than VSWR 3:1)
- Minimum operating : 8 W  
input power
- Tuning accuracy : VSWR 1.5:1 or less
- Insertion loss : Less than 1.0 dB  
(after tuning)

Downloaded by   
 Amateur Radio Directory   
  
[www.hamdirectory.info](http://www.hamdirectory.info)

All stated specifications are subject to change without notice or obligation.

**Count on us!**

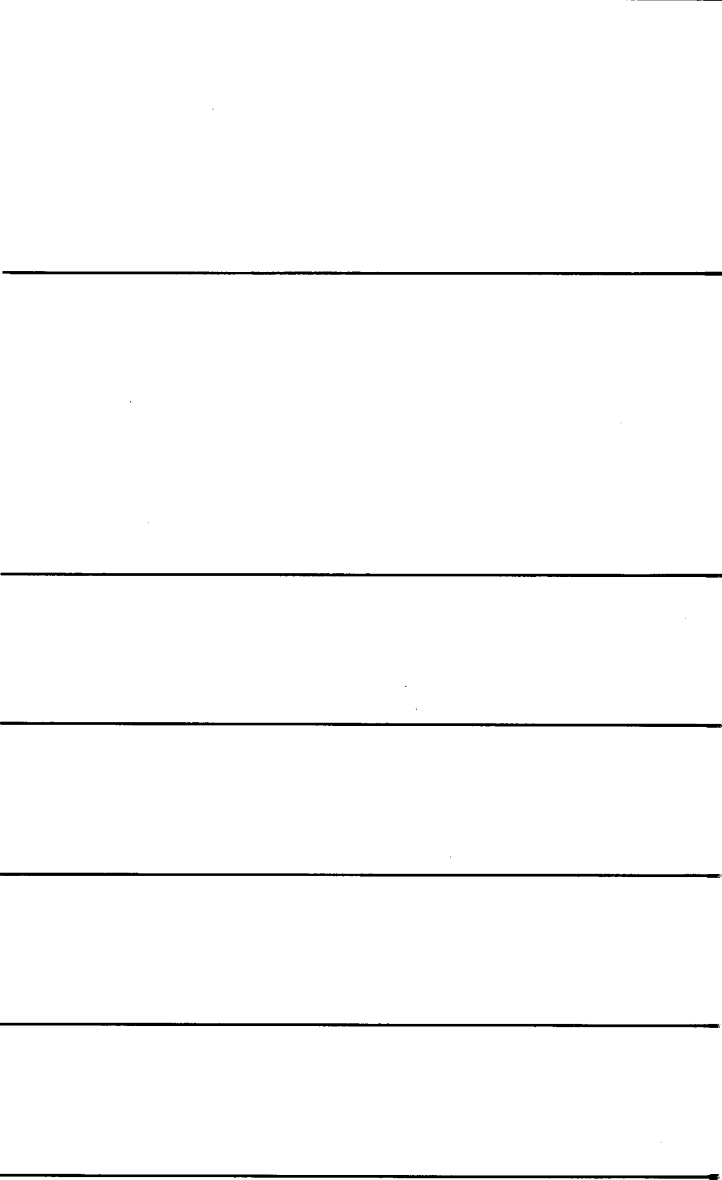
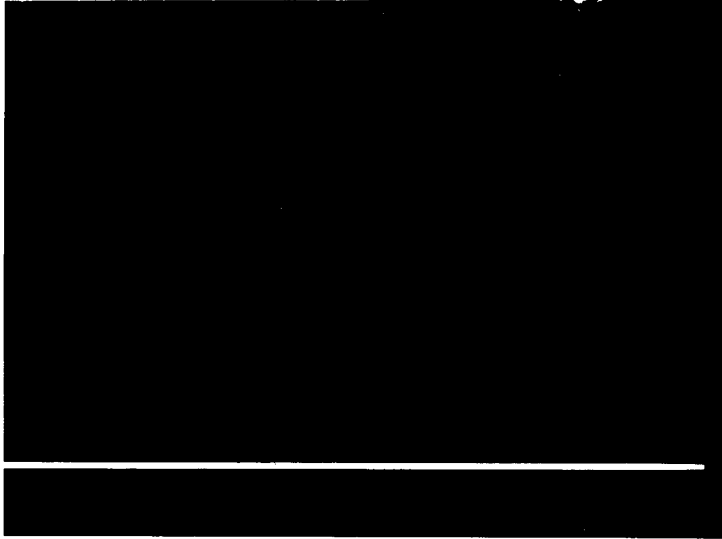

### INTRODUCTION

Thank you for purchasing the IC-775 or IC-775DSP. This guide describes installation of internal units or filters, some adjustment procedures and fuse/battery replacement.

**⚠ WARNING: DISCONNECT** the AC power cable from the transceiver and wait a few minutes before performing any work on the transceiver.

Bracketed page numbers refer to the instruction manual.

### OPENING THE TRANSCEIVER'S CASE

Follow the case and cover opening procedures shown here when you want to install an optional unit or adjust the internal units, etc.

• **To see the RF, IF and PLL units**

- ① Remove 6 screws from the transceiver's top and 4 screws from the sides, then remove the top cover.
- ② Turn the transceiver upside down.
- ③ Remove 8 screws from the bottom cover, then remove the bottom cover.
- ④ Now you can see the RF, IF and PLL units.

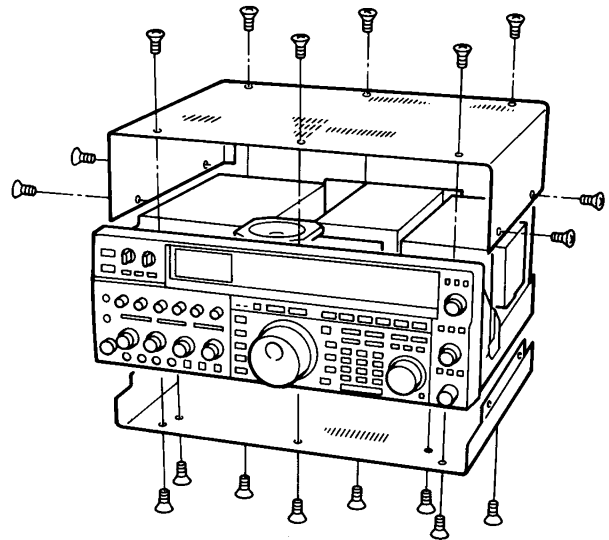

### BEEP TONE VOLUME ADJUSTMENT

Confirmation beeps sound each time a switch is pushed. The beep volume can be adjusted as follows.

- ① Remove the top cover as described above.
- ② Set [AF] to the desired audio output level.
- ③ Turn the confirmation beeps ON in H-set mode. (p. 44)
- ④ Rotate R26 (see right) while pushing [SET] to obtain the desired volume.

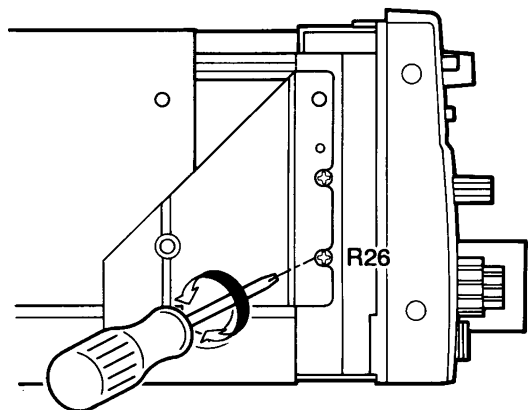

## DISPLAY DIMMER ADJUSTMENT

The low intensity of the display backlighting can be adjusted as follows.

- ① Remove the top cover as described on the first page.
- ② Select low intensity for the display dimmer in P-set mode. (p. 41)
- ③ Rotate R201 (see right) to obtain the desired intensity as shown at right.

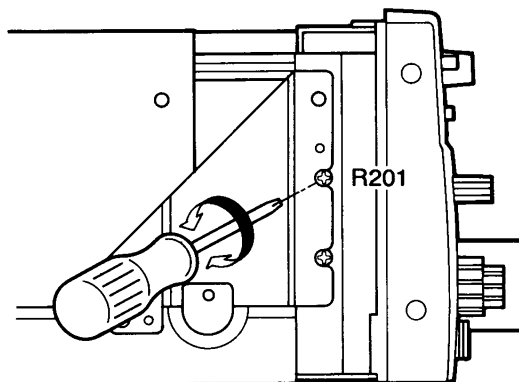

## UI-100 DSP UNIT INSTALLATION

The UI-100 DSP UNIT provides noise reduction, DSP modulation/demodulation, DSP filters, auto notch, auto APF, etc. for the IC-775. The IC-775DSP has a DSP unit as standard.

Install the DSP unit as follows:

- ① Remove the top cover as described on the first page.
- ② Connect the 3 plugs (attached to the backside of the front panel) to the appropriate connectors as shown below.

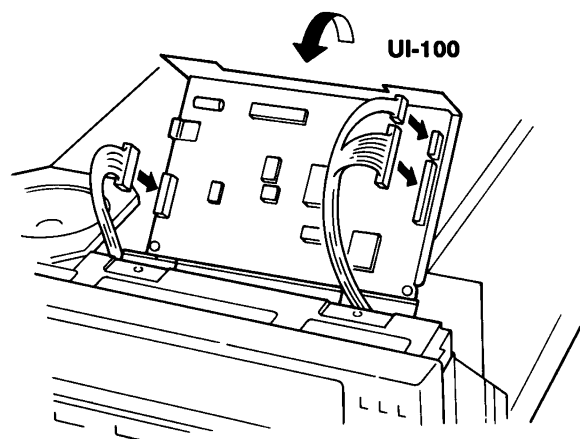

- ③ Insert the DSP unit into the slots at the backside of the main and sub dials.
- ④ Tighten the 2 supplied screws as shown below.
- ⑤ Replace the top cover.

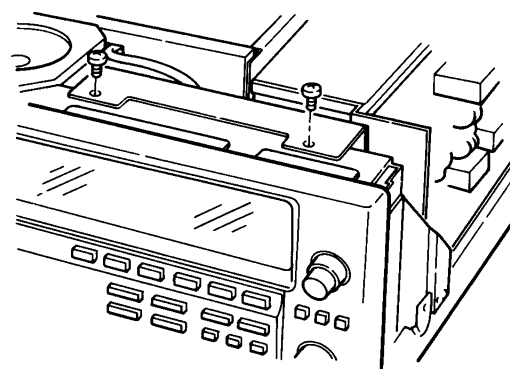

After installation, read the instruction manual as for a "DSP-equipped type" transceiver. The [AF LPF] switch functions as the auto notch switch in SSB mode and the auto APF switch in CW mode.

For DSP function details, refer to the instruction manual.

- Noise reduction (p. 29)
- DSP modulation/demodulation (p. 42)
- DSP filters (p. 42)
- Auto notch (p. 29)
- Auto APF/80 Hz ultra narrow filter (p. 30)

## AC VOLTAGE SELECTION

**⚠ WARNING: DISCONNECT** the AC power cable from the transceiver and wait a few minutes before selecting an AC power voltage.

The regulator unit in the IC-775DSP can be switched to 120 or 230 V AC.

- ① Remove the top and bottom covers as described on the first page.
- ② Remove the 7 screws and the [POWER] switch cover as shown below.

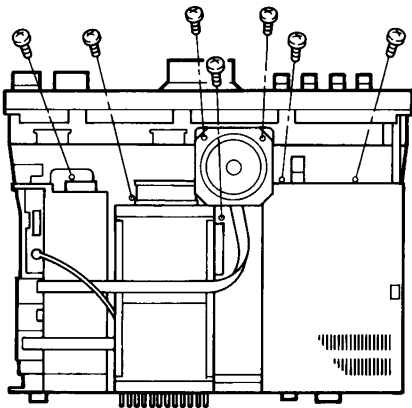

- ③ Remove the 6 screws as shown below.

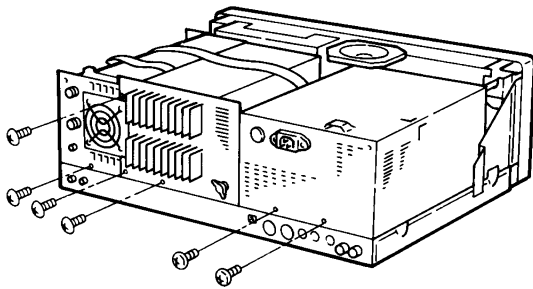

- ④ Remove the speaker, tuner unit, PA unit and regulator unit in sequence. Unplug the 3 power connectors as shown below.

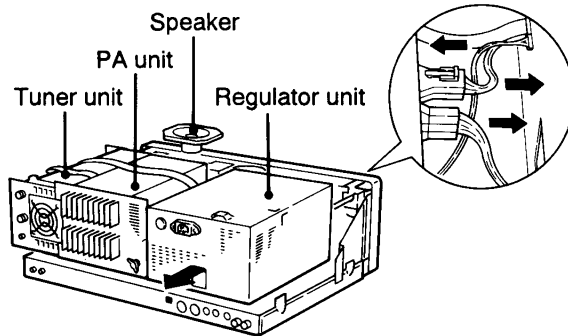

- ⑤ Remove the 16 screws to remove the internal shield cover of the regulator unit.
- ⑥ Unplug the cable as shown in the diagram below, then connect it to the desired voltage position.

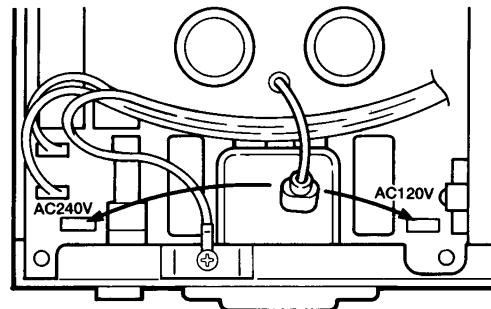

- ⑦ Change the AC fuse to an appropriate one. (p. 56)
- ⑧ Replace the internal shield cover and plug in the 3 power connectors. Replace the regulator unit, then check the movement of the [POWER] switch. Replace the remaining units, covers and screws.

**⚠ WARNING: DO NOT** forget to change the AC fuse when you change the AC input voltage. An incorrect fuse may pose a fire hazard.

- 12 A FGMB fuse for 100–120 V versions
- 5 A high breaking capacity fuse for 220–240 V versions

Downloaded by   
Amateur Radio Directory   
  
[www.hamdirectory.info](http://www.hamdirectory.info)

## OPTIONAL FILTER INSTALLATION

After installing optional filters, the transceiver has 3\* kinds of selectivity for 2nd and 3rd IF filters to provide better S/N (signal-to-noise ratio), or to reject nearby interference.

\* FM mode: 2 kinds of selectivity

Following optional filters are available.

IF	Filter	Passband width	Used selectivity
2nd	FL-101	250 Hz/ - 6 dB	CW nar.
	FL-102	6.0 kHz/ - 6 dB	SSB wide, AM med., FM nar.
	FL-223	1.9 kHz/ - 6 dB	SSB nar.
3rd	FL-53A	250 Hz/ - 6 dB	CW nar.
	FL-222	1.9 kHz/ - 6 dB	SSB nar.

When only 1 filter is installed for selectivity, such as a FL-101 installed but no FL-53A installed, optimum performance cannot be obtained for the selectivity and the twin PBT function does not operate correctly. Both filters, such as FL-101 and FL-53A, should be installed.

### FILTER SELECTION

After the filter(s) are installed, activate the optional filter(s) in H-set mode. (p. 47) If this is not correctly set, the installed filter(s) cannot be selected.

- ① Remove the top and bottom covers as described on the first page.
- ② Insert the filter(s) to the proper position. The locations are shown in the figures below.
  - The FL-53A and FL-222 must be installed in the proper direction.
  - The FL-101, FL-102 or FL-223 work regardless of the direction they are installed in.
- ③ Replace the top and bottom covers.

### FL-102 (or FL-101, FL-223) installation

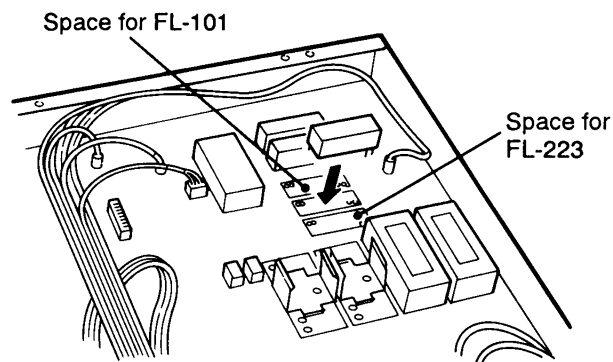

### FL-222 (or FL-53A) installation

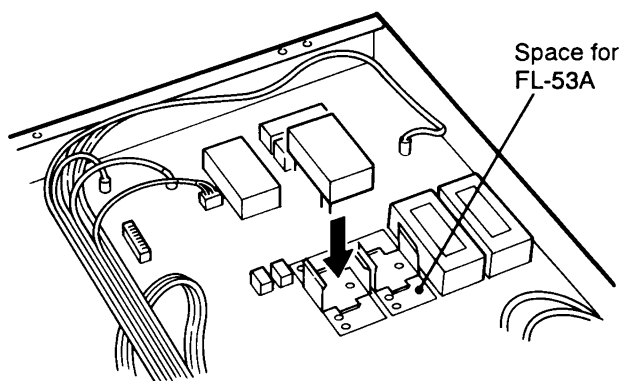

## UT-66 VOICE SYNTHESIZER UNIT INSTALLATION

The UT-66 announces the operating frequency or selected mode in a clear, electronically-generated voice (in English or Japanese).

- ① Remove the top cover as described on the first page.
- ② Plug the UT-66 into J1 on the MAIN unit (back-side of the S/RF meter) as shown in the figure at right.
- ③ Replace the top cover.
- ④ Set the language and speech speed in H-set mode. (p. 44)

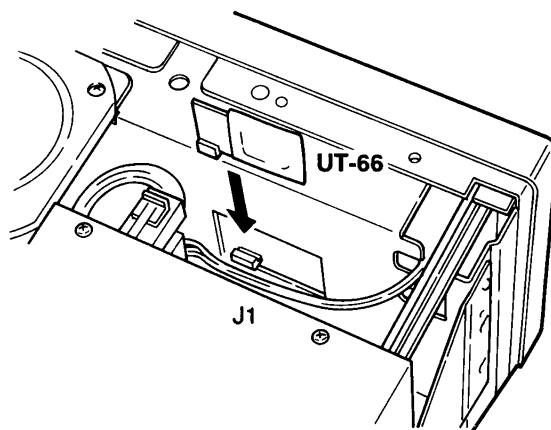

## CR-282 HIGH-STABILITY CRYSTAL UNIT INSTALLATION

By replacing the original crystal unit with this unit, the total frequency stability of the transceiver will be improved.

CR-282 frequency stability:

$\pm 0.5$  ppm

( $-30^{\circ}\text{C}$  to  $+60^{\circ}\text{C}$ ;  $-22^{\circ}\text{F}$  to  $+140^{\circ}\text{F}$ )

- ① Remove the top and bottom covers as described on the first page.
- ② Remove 10 screws from the PLL unit and the ribbon cable from J11; then turn over the PLL unit to see the reverse side. (Fig. 1)
- ③ Unsolder the leads of the installed crystal, then remove the crystal.
  - Use a desoldering braid.
- ④ Unsolder the 4 positions on the PLL unit where the CR-282 will be installed.
- ⑤ Install the CR-282 in the PLL unit, paying attention to orientation.
  - Symbols on the bottom of the CR-282 must be identically matched with symbols on the P.C. board.
- ⑥ Bend the leads of the CR-282 at the foil side of the P.C. board and solder them as shown in figure 2 at right.
- ⑦ Trim the leads even with the solder points.
- ⑧ Replace the PLL unit, ribbon cable and covers.

After changing the crystal unit, frequency adjustment is necessary with L4 on the PLL unit.

- Ask your Icom Dealer or Icom Service Center for details.

**NOTE:** The CR-282 is an oven-heat-type crystal unit, and the specified frequency stability described above is guaranteed 1 min. after power ON.

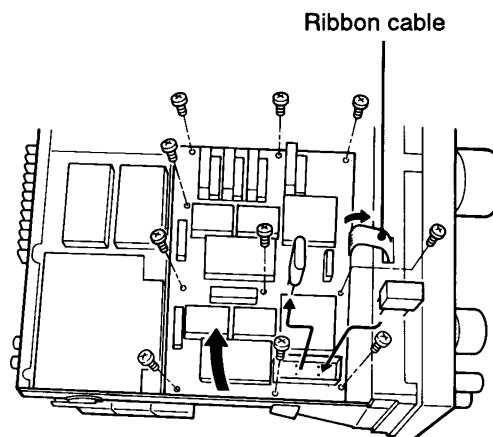

(Fig. 1)

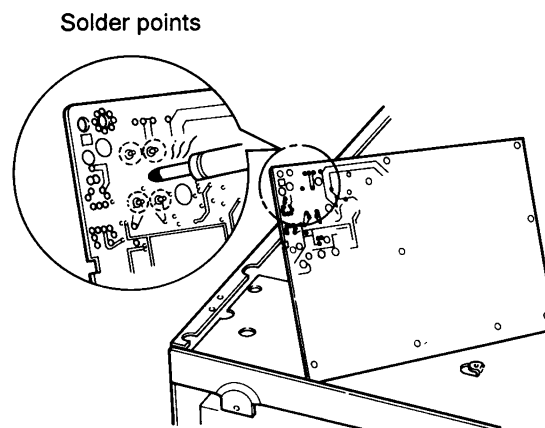

(Fig. 2)



## FUSE REPLACEMENT

**WARNING:** DISCONNECT the AC power cable and wait a few minutes before opening the top and bottom covers.

The transceiver has an external DC line fuse independent of the AC line fuse. This fuse is installed under the bottom cover.

If the fuse blows, try to find the source of the problem, and replace the damaged fuse with a new, rated fuse.

- ① Remove the top and bottom covers as described on the first page.
- ② Replace the damaged fuse with a new, rated fuse as shown at right.
- ③ Replace the top and bottom covers.

2 A FGB fuse for 100 – 120 V versions  
2 A high breaking capacity fuse for 220 – 240 V versions

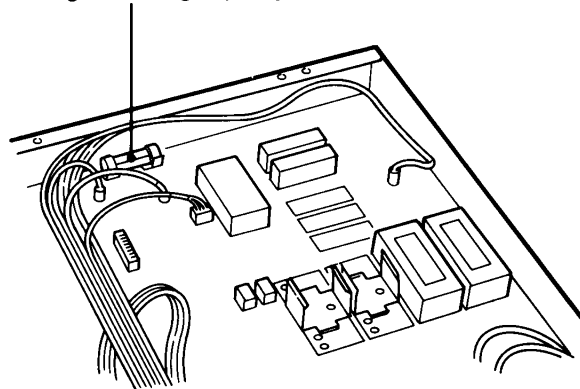

## BACKUP BATTERY REPLACEMENT

The transceiver has a lithium backup battery on the inside of the front panel (MAIN unit) for retaining operating conditions. The usual life of the backup battery is approximately 5 years.

When the backup battery is exhausted, the transceiver transmits and receives normally but cannot retain operating conditions except for memory channels.

**CAUTION:** If the lithium battery is incorrectly replaced, it could explode. Replace with a CR-2032 or equivalent type.

- ① Remove the top and bottom covers as described on the first page.
- ② Remove 8 screws from the front panel as shown in figure 1 at right.
- ③ Remove the front panel.
- ④ Replace the backup battery as shown in figure 2 at right.
- ⑤ Reassemble the front panel.  
- Check that the [POWER] switch works smoothly.
- ⑥ Replace the top and bottom covers.

**CAUTION:** After replacing the lithium battery, turn power ON and OFF, otherwise, the lithium battery will become exhausted rapidly.

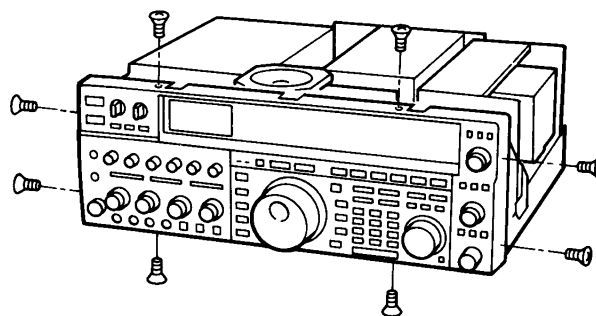

(Fig. 1)

Top side : ⊕  
Bottom side : ⊖  
(⊕ terminal is visible after installation.)

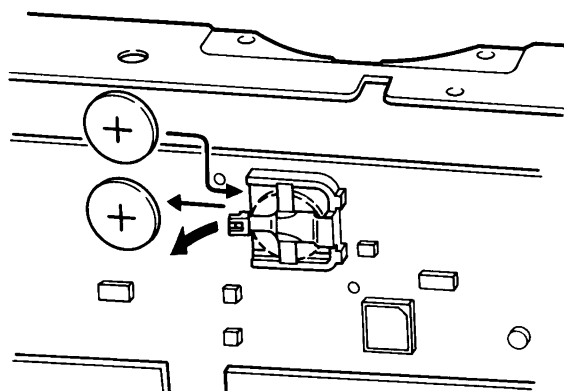

(Fig. 2)