



Downloaded by  
RadioAmateur.EU

# INSTRUCTION MANUAL

## HF/VHF/UHF TRANSCEIVER **IC-9100**



## FOREWORD

Thank you for making the IC-9100 your radio of choice. We hope you agree with Icom's philosophy of "technology first." Many hours of research and development went into the design of your IC-9100.

### FEATURES

- The IC-9100 fully covers HF to 1200 MHz\*<sup>1</sup> multi-band in one transceiver
- Independent dual receivers in one radio; receives two different bands simultaneously
- Optional D-STAR (Digital Smart Technology for Amateur Radio) allows you to operate in the DV mode\*<sup>2</sup> for digital voice and low speed data communication. Linking of D-STAR repeaters over the Internet allows you to communicate virtually anywhere.
- Satellite mode operation

\*<sup>1</sup>The optional UX-9100 is required for 1200 MHz frequency band operation.

\*<sup>2</sup>The optional UT-121 is required for the DV mode operation.

## IMPORTANT

**READ THIS INSTRUCTION MANUAL CAREFULLY** before attempting to operate the transceiver.

**SAVE THIS INSTRUCTION MANUAL.** This manual contains important safety and operating instructions for the IC-9100.

## EXPLICIT DEFINITIONS

WORD	DEFINITION
⚠ <b>DANGER!</b>	Personal death, serious injury or an explosion may occur.
⚠ <b>WARNING!</b>	Personal injury, fire hazard or electric shock may occur.
<b>CAUTION</b>	Equipment damage may occur.
<b>NOTE</b>	If disregarded, inconvenience only. No risk of personal injury, fire or electric shock.

Spurious signals may be received near some frequencies.

These are created in the internal circuit and does not indicate a transceiver malfunction.

## SUPPLIED ACCESSORIES

The transceiver comes with the following accessories.

	Qty.
① Hand microphone .....	1
② DC power cable* <sup>1</sup> .....	1
③ Spare fuse (ATC 5 A) .....	1
④ Spare fuse (ATC 30 A) .....	2
⑤ ACC cable .....	1
⑥ 6.3 (d) mm plug .....	1
⑦ Double-sided tape (see page 176) .....	1
⑧ Ferrite bead* <sup>2</sup> .....	1

\*<sup>1</sup>Differs depending on the version.

\*<sup>2</sup>Not supplied with the non-European versions.

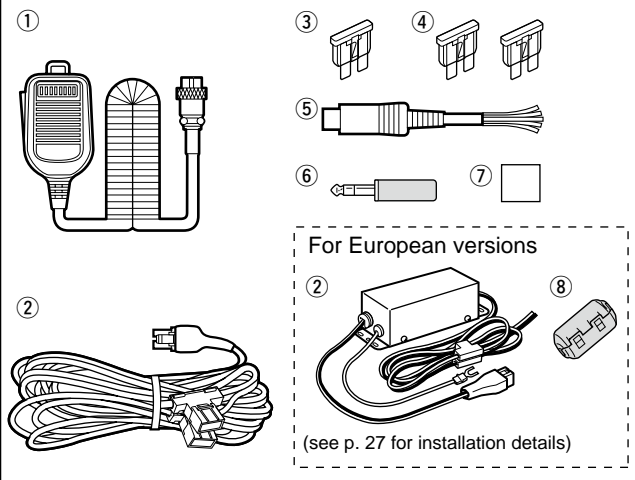

## FCC INFORMATION

### • FOR CLASS B UNINTENTIONAL RADIATORS:

This equipment has been tested and found to comply with the limits for a Class B digital device, pursuant to part 15 of the FCC Rules. These limits are designed to provide reasonable protection against harmful interference in a residential installation. This equipment generates, uses and can radiate radio frequency energy and, if not installed and used in accordance with the instructions, may cause harmful interference to radio communications. However, there is no guarantee that interference will not occur in a particular installation. If this equipment does cause harmful interference to radio or television reception, which can be determined by turning the equipment off and on, the user is encouraged to try to correct the interference by one or more of the following measures:

- Reorient or relocate the receiving antenna.
- Increase the separation between the equipment and receiver.
- Connect the equipment into an outlet on a circuit different from that to which the receiver is connected.
- Consult the dealer or an experienced radio/TV technician for help.

---

## PRECAUTIONS

---

**⚠ DANGER HIGH RF VOLTAGE! NEVER** attach an antenna or internal antenna connector during transmission. This may result in an electrical shock or burn.

**⚠ WARNING! NEVER** operate the transceiver with a headset or other audio accessories at high volume levels. Hearing experts advise against continuous high volume operation. If you experience a ringing in your ears, reduce the volume or discontinue use.

**⚠ WARNING! NEVER** operate or touch the transceiver with wet hands. This may result in an electric shock or damage to the transceiver.

**⚠ WARNING! NEVER** apply AC power to the [DC13.8V] socket on the transceiver rear panel. This could cause a fire or damage the transceiver.

**⚠ WARNING! NEVER** cut the DC power cable between the DC plug and fuse holder. If an incorrect connection is made after cutting, the transceiver may be damaged.

**⚠ WARNING! NEVER** apply more than 16 V DC to the [DC13.8V] socket on the transceiver rear panel, or use reverse polarity. This could cause a fire or damage the transceiver.

**⚠ WARNING! NEVER** let metal, wire or other objects protrude into the transceiver or into connectors on the rear panel. This may result in an electric shock.

**⚠ WARNING!** Immediately turn OFF the transceiver power and remove the power cable if it emits an abnormal odor, sound or smoke. Contact your Icom dealer or distributor for advice.

**⚠ WARNING! NEVER** put the transceiver in any unstable place (such as on a slanted surface or vibrated place). This may cause injury and/or damage to the transceiver.

**CAUTION: NEVER** change the internal settings of the transceiver. This may reduce transceiver performance and/or damage to the transceiver.

In particular, incorrect settings for transmitter circuits, such as output power, idling current, etc., might damage the expensive final devices.

The transceiver warranty does not cover any problems caused by unauthorized internal adjustment.

**CAUTION: NEVER** block any cooling vents on the top, rear, sides or bottom of the transceiver.

**CAUTION: NEVER** expose the transceiver to rain, snow or any liquids.

**CAUTION: NEVER** install the transceiver in a place without adequate ventilation. Heat dissipation may be reduced, and the transceiver may be damaged.

**DO NOT** use harsh solvents such as benzine or alcohol when cleaning, as they will damage the transceiver surfaces.

**DO NOT** push the PTT switch when you don't actually desire to transmit.

**DO NOT** use or place the transceiver in areas with temperatures below  $\pm 0^{\circ}\text{C}$  ( $+32^{\circ}\text{F}$ ) or above  $+50^{\circ}\text{C}$  ( $+122^{\circ}\text{F}$ ).

**DO NOT** place the transceiver in excessively dusty environments or in direct sunlight.

**DO NOT** place the transceiver against walls or putting anything on top of the transceiver. This may overheat the transceiver.

Always place unit in a secure place to avoid inadvertent use by children.

**BE CAREFUL!** If you use a linear amplifier, set the transceiver's RF output power to less than the linear amplifier's maximum input level, otherwise, the linear amplifier will be damaged.

**BE CAREFUL!** The transceiver will become hot when operating the transceiver continuously for long periods of time.

USE only the specified microphone. Other manufacturers' microphones have different pin assignments, and connection to the IC-9100 may damage the transceiver or microphone.

During maritime mobile operation, keep the transceiver and microphone as far away as possible from the magnetic navigation compass to prevent erroneous indications.

Turn OFF the transceiver's power and/or disconnect the DC power cable when you will not use the transceiver for long period of time.

### *For U.S.A. only*

**CAUTION:** Changes or modifications to this device, not expressly approved by Icom Inc., could void your authority to operate this device under FCC regulations.

Icom, Icom Inc. and the Icom logo are registered trademarks of Icom Incorporated (Japan) in Japan, the United States, the United Kingdom, Germany, France, Spain, Russia and/or other countries. Microsoft, Windows and Windows Vista are registered trademarks of Microsoft Corporation in the United States and/or other countries. All other products or brands are registered trademarks or trademarks of their respective holders.

## D-STAR INTRODUCTION

### ◇ About the D-STAR system

In the original D-STAR (Digital Smart Technologies for Amateur Radio) plan, JARL envisioned a system of repeaters grouped together into Zones. A zone would be a group of up to 4 repeaters, linked by 10 GHz "backbone" microwave Link repeaters. Each individual repeater would be called an Area repeater, and would be the Access repeater to begin communications. Calls could be made to other Area repeaters within the Zone, using the backbone Link repeater system. One of the repeaters in the Zone would have an Internet connection, and so in addition to being an Area repeater, it also became the Zone Gateway repeater. The Internet gateway provided a way to communicate to other Zones, giving access to the Area repeaters within them, and eventually to the entire world.

Call signs are the heart of D-STAR operation. Four call signs are used:

- **MY** : This is your own call sign. You enter it once and then basically leave it set, with only a few exceptions.
- **UR** : This is your Destination call sign; that of the actual ham or repeater you wish to contact. CQC-QCQ can also be used to make a general call.
- **R1** : This is the Area/Access repeater call sign; the one you enter to begin your D-STAR repeater communication.
- **R2** : This is the Link/Gateway repeater call sign; the repeater and Internet connection you go through when you want to contact a ham, or another repeater, anywhere else in the world.

Call sign routing, one of the main features of D-STAR, allows hams to contact other hams, or other repeaters using just the ham's or repeater's call sign. The D-STAR system will automatically route your signal to the desired ham or repeater. Call sign capture allows hams using an Icom radio to "capture" a call sign and automatically program their radio for a reply.

Like other communication modes, you can operate simplex D-STAR with other hams, for direct communication.

See pages 85 to 120 for the D-STAR operation details.

/// **NOTE:** The optional UT-121 is required for the D-STAR operation with the IC-9100.

### • D-STAR system outline

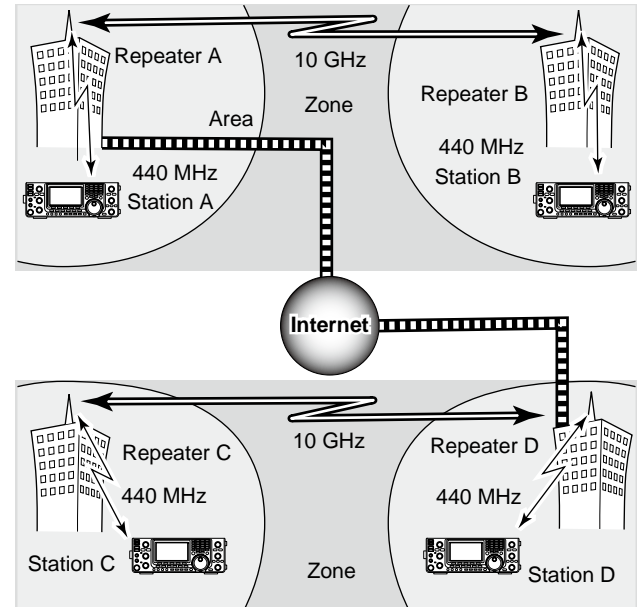

## ◇ D-STAR system description

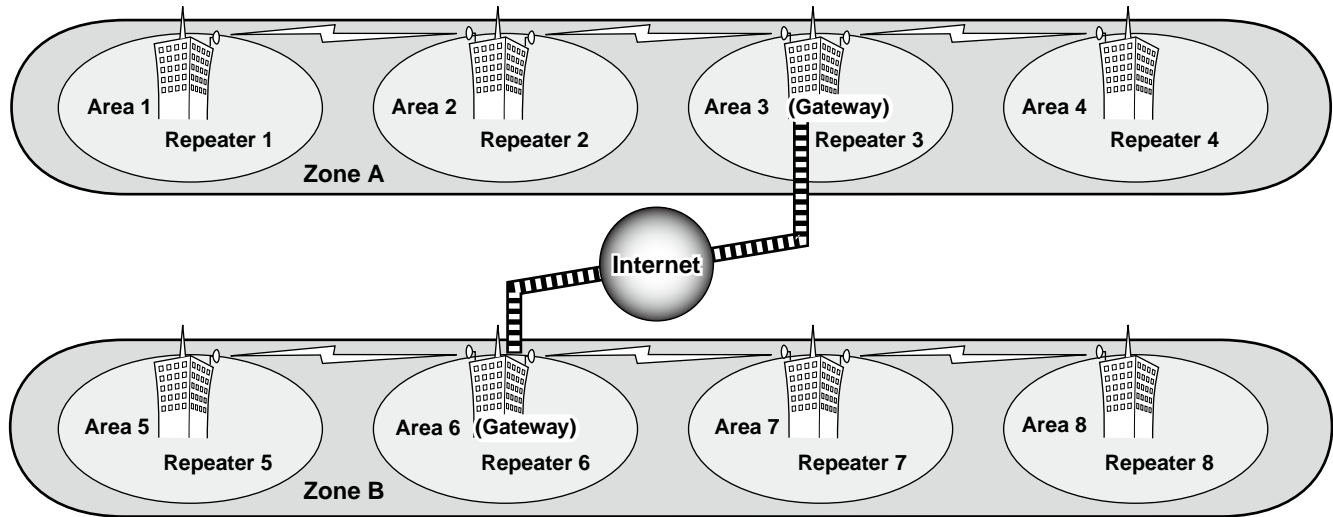

### Area:

The Area is the communication range that is covered by a single repeater. The repeater is called an area, or access repeater in the D-STAR system.



### Zone:

The Zone is composed of several areas, that are linked by a 10 GHz microwave link. Areas 1 to 4 and 5 to 8 make up a zone in the example above.

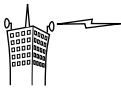

### Link repeater:

The microwave (10 GHz) link repeater provides linking with another repeater site (Area) for zone construction.

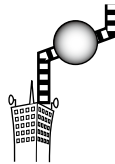

### Gateway repeater:

Gateway repeaters provide communications between different zones via the internet. Repeater 3 and 6 are gateway repeaters at the example above.

# TABLE OF CONTENTS

<b>FOREWORD</b> .....	i	■ Microphone connector information .....	30
<b>IMPORTANT</b> .....	i	■ Microphones.....	30
<b>EXPLICIT DEFINITIONS</b> .....	i	◇ HM-36 .....	30
<b>SUPPLIED ACCESSORIES</b> .....	i	◇ SM-50 (Option) .....	30
<b>FCC INFORMATION</b> .....	i	<b>3 BASIC OPERATION</b> .....	<b>31–46</b>
<b>PRECAUTIONS</b> .....	ii	■ Before first applying power .....	31
<b>D-STAR INTRODUCTION</b> .....	iii	■ Turning ON (Partial resetting).....	31
◇ About the D-STAR system .....	iii	■ MAIN and SUB Bands.....	32
◇ D-STAR system description .....	iv	◇ MAIN/SUB Band selection.....	32
<b>TABLE OF CONTENTS</b> .....	v	◇ SUB Band display .....	32
		◇ SUB Band setting mode operation .....	33
		◇ The SUB Dial function.....	33
<b>1 PANEL DESCRIPTION</b> .....	<b>1–21</b>	■ VFO description.....	34
■ Front panel .....	1	◇ Selecting the VFO A/B .....	34
■ Rear panel.....	10	◇ VFO equalization.....	34
◇ ACC socket information .....	13	■ Selecting VFO/memory mode .....	34
◇ DATA2 socket information .....	14	■ Selecting a frequency band.....	35
■ LCD display .....	15	◇ Using the band stacking registers.....	35
■ Function display .....	19	■ Frequency setting.....	37
◇ M1 (Menu 1) display.....	19	◇ Tuning with [MAIN DIAL] .....	37
◇ M2 (Menu 2) display.....	19	◇ Direct frequency entry with the keypad.....	37
◇ M3 (Menu 3) display.....	19	◇ Quick Tuning function.....	38
◇ D1 display .....	19	◇ Selecting 'kHz' step .....	38
◇ D2 display .....	19	◇ Selecting 1 Hz step .....	39
◇ Function keys on M1 (Menu 1) display .....	20	◇ Auto tuning step function .....	39
◇ Function keys on M2 (Menu 2) display .....	20	◇ ¼ tuning step function .....	39
◇ Function keys on M3 (Menu 3) display .....	21	◇ About the 5 MHz frequency band operation	
◇ Function keys on D1 display .....	21	(only USA version).....	40
◇ Function keys on D2 display .....	21	◇ Band edge warning beep.....	41
		◇ Programming the user band edge .....	42
<b>2 INSTALLATION AND CONNECTIONS</b> .....	<b>22–30</b>	■ Operating mode selection .....	43
■ Selecting a location .....	22	■ Squelch and receive (RF) sensitivity .....	44
■ Grounding .....	22	■ Volume setting.....	45
■ Electronic keyer and microphone connections ..	22	■ Voice synthesizer operation.....	45
■ Antenna connection .....	23	■ Meter Display selection .....	45
■ Required connections .....	24	■ Basic transmit operation.....	46
◇ Rear panel .....	24	◇ Transmitting.....	46
■ Advanced connections .....	25	◇ Microphone gain adjustment.....	46
◇ Front panel.....	25	<b>4 RECEIVE AND TRANSMIT</b> .....	<b>47–68</b>
◇ Rear panel .....	25	■ Operating SSB .....	47
■ External keypad connections .....	26	■ Operating CW .....	48
■ Optional and the external units connections ...	26	◇ About the CW reverse mode.....	49
■ Power supply connections.....	27	◇ About CW pitch control .....	49
■ Connecting a DC power supply.....	27	◇ About keying speed.....	49
◇ Connecting the PS-126		◇ CW sidetone function.....	49
DC POWER SUPPLY .....	27		
◇ Connecting a non-Icom			
DC POWER SUPPLY .....	27		
■ Linear amplifier connections .....	28		
◇ Connecting the IC-PW1/PW1EURO.....	28		
◇ Connecting a non-Icom linear amplifier .....	29		
■ External antenna tuner connection .....	29		
◇ Connecting the AH-4 .....	29		

■ Electronic keyer functions .....	50	<b>6 FUNCTIONS FOR TRANSMIT .....</b>	<b>78–84</b>
◇ Memory keyer menu construction .....	50	■ VOX function.....	78
◇ Memory keyer send menu.....	51	◇ Using the VOX function .....	78
◇ Editing a memory keyer .....	52	◇ Adjusting the VOX function.....	78
◇ Contest number Set mode .....	53	■ Break-in function .....	79
◇ Keyer Set mode .....	54	◇ Semi Break-in operation .....	79
■ Operating RTTY (FSK).....	56	◇ Full Break-in operation.....	79
■ RTTY functions.....	57	■ Speech compressor .....	80
◇ Construction of RTTY menu .....	57	■ Transmit filter width selection .....	80
◇ About RTTY reverse mode .....	58	■ $\Delta$ TX function .....	81
◇ Twin Peak Filter .....	58	◇ $\Delta$ TX Monitor function .....	81
◇ RTTY decoder.....	59	■ Monitor function.....	81
◇ RTTY Set mode .....	60	■ Split frequency operation .....	82
■ Operating AM/FM.....	61	■ Quick Split function .....	83
■ Tone squelch operation .....	62	◇ Split frequency offset setting.....	83
■ DTCS operation .....	63	◇ Split Lock function.....	83
■ Tone scan/DTCS code scan operation.....	64	■ Measuring SWR .....	84
■ Repeater operation .....	65	◇ Spot measurement.....	84
◇ Repeater access tone frequency setting.....	65	◇ Plot measurement.....	84
◇ One-touch repeater function .....	66	<b>7 DV MODE PROGRAMMING .....</b>	<b>85–92</b>
◇ Transmit frequency monitor check.....	66	■ Call sign programming .....	85
◇ 1750 Hz tone burst.....	66	◇ “MY” (Your own call sign) programming .....	85
◇ Setting the Auto Repeater ranges		◇ “UR” (Destination call sign) programming ...	86
(U.S.A. and Korea versions only) .....	67	◇ “R1” (Access/Area repeater call sign) and	
◇ Turning ON the Auto Repeater function		“R2” (Link/Gateway repeater call sign)	
(U.S.A. and Korea versions only) .....	68	programming .....	87
◇ Storing a non standard repeater .....	68	■ Repeater list .....	88
<b>5 FUNCTIONS FOR RECEIVE.....</b>	<b>69–77</b>	◇ Repeater list contents .....	88
■ AFC operation .....	69	■ Repeater list programming.....	89
■ RIT function.....	69	■ Editing a repeater list .....	91
◇ RIT monitor function.....	69	■ Clearing a repeater list.....	92
■ Simple band scope.....	70	<b>8 DV MODE OPERATION .....</b>	<b>93–120</b>
■ Preamplifier .....	71	■ Digital mode operation .....	93
■ Attenuator.....	71	■ Call sign setting .....	93
■ AGC function .....	72	■ Receiving a D-STAR repeater .....	94
◇ AGC speed selection .....	72	■ Received call signs.....	95
◇ Setting the AGC time constant.....	72	◇ Desired call record display .....	95
■ IF filter selection .....	73	◇ One-touch reply using the call record .....	96
◇ IF filter selection.....	73	■ Copying the call sign .....	97
◇ Filter passband width setting .....	73	◇ Copying the call sign memory contents .....	97
◇ 1st IF filter selection .....	74	◇ Copying the call record contents	
◇ IF (DSP) filter shape .....	74	into call sign memory .....	98
■ Twin PBT operation .....	75	■ DR (D-STAR Repeater) mode operation.....	99
■ Noise Blanker .....	76	◇ Communication Form.....	99
◇ NB Set mode.....	76	◇ Access repeater scan .....	100
■ Meter peak hold function.....	76	■ Calling CQ.....	101
■ Noise Reduction.....	77	◇ Storing the set data.....	102
■ Dial Lock function.....	77		
■ Notch function .....	77		

## TABLE OF CONTENTS

■ Calling a specific station.....	103	■ GPS memory operation.....	127
◇ Confirming the setting.....	105	◇ Add a GPS memory.....	127
◇ Settings for “UR” and “R2,” depending on the communication form.....	105	◇ Edit a GPS memory.....	129
■ Simplex operation using the VFO.....	106	◇ GPS alarm setting.....	130
◇ Making a simplex CQ call or a call to an individual station.....	106	◇ GPS memory clearing.....	131
■ Repeater operation using the VFO.....	107	■ GPS Set mode.....	132
◇ Making a CQ call or a call to an individual station through your local area (access) repeater (Local Area call).....	107	■ GPS-A operation.....	137
◇ Making a CQ call or a call to an individual station through a link repeater in the same zone (Zone call).....	108	◇ GPS-A function.....	137
◇ Making a CQ call or a call to an individual station through gateway repeaters (Gateway call).....	109	◇ GPS-A code details.....	137
◇ Settings for “UR” and “R2,” depending on the communication form.....	110	<b>10 MEMORY OPERATION..... 138–144</b>	
■ Message operation.....	111	■ General description.....	138
◇ TX message programming.....	111	◇ Memory channel contents.....	138
◇ Message Transmission.....	112	■ Memory channel selection.....	139
◇ RX message display.....	112	◇ Selection in the VFO mode.....	139
■ DV automatic detection.....	113	◇ Selection in the Memory mode.....	139
■ Automatic Reply function.....	113	■ Call channel selection.....	139
■ Digital squelch functions.....	114	■ Memory channel programming.....	140
■ EMR communication.....	115	◇ Programming in the VFO mode.....	140
◇ Adjusting the EMR AF level.....	115	◇ Programming in the Memory mode.....	140
■ BK mode communication.....	116	■ Call channel programming.....	141
■ Low-speed data communication.....	117	■ Memory clearing.....	141
◇ Connection.....	117	■ Memory contents copying.....	142
◇ Low-speed data communication application setting.....	117	◇ Copying in the VFO mode.....	142
◇ Low-speed data communication operation.....	117	◇ Copying in the Memory mode.....	142
■ Packet loss indication.....	117	■ Memory name programming.....	143
■ DV Set mode description.....	118	■ Memo pad function.....	144
◇ DV Set mode settings.....	118	◇ Writing the displayed data into memo pads.....	144
◇ Calling up the memo pads.....	144	<b>11 SCANS..... 145–152</b>	
<b>9 GPS/GPS-A OPERATION..... 121–137</b>		■ Scan types.....	145
■ GPS operation.....	121	■ Preparation.....	146
◇ GPS screen construction.....	121	■ Voice Squelch Control function.....	146
◇ GPS data communication.....	122	■ Scan set mode.....	147
◇ Sentence formatter setting.....	122	■ Scan edges programming.....	148
◇ Position display.....	123	■ Programmed scan/Fine programmed scan (VFO mode).....	149
◇ Saving your own or received position data.....	124	◇ About the Fine programmed scan.....	149
◇ Display the Grid Locator information.....	124	■ Memory scan (Memory mode).....	150
◇ GPS automatic transmission.....	124	◇ Memory scan.....	150
◇ GPS message programming.....	125	◇ Mode Select scan.....	150
◇ Received GPS message display.....	126	◇ Setting/Cancelling Select Memory channels.....	151
		◇ Select Memory scan.....	151
		■ $\Delta F$ scan and Fine $\Delta F$ scan.....	152
		◇ About the Fine $\Delta F$ scan.....	152



<b>12 SATELLITE OPERATION.....</b>	<b>153–157</b>	<b>17 MAINTENANCE .....</b>	<b>177–182</b>
■ Satellite communications outline.....	153	■ Troubleshooting .....	177
■ Satellite notes.....	153	◇ Transceiver power .....	177
■ Selecting the satellite mode .....	153	◇ Transmit and receive .....	177
◇ Transferring the VFO frequencies to the satellite VFO.....	153	◇ Scanning.....	178
■ Setting the satellite VFO.....	154	◇ Display .....	178
■ Tracking selection .....	154	■ Frequency calibration (approximate) .....	179
◇ Normal tracking.....	154	■ Main dial tuning tension adjustment.....	179
◇ Reverse tracking .....	154	■ Fuse replacement .....	180
■ Satellite memory .....	155	◇ DC power cable fuse replacement.....	180
◇ Satellite memory selection .....	155	◇ Circuitry fuse replacement.....	180
◇ Satellite memory programming.....	155	■ Resetting the CPU .....	181
■ Preparation.....	156	◇ Partial reset.....	181
■ Satellite operation .....	157	◇ All reset.....	181
<b>13 ANTENNA TUNER OPERATION .....</b>	<b>158–160</b>	■ Data cloning .....	182
■ Antenna connection and selection .....	158	◇ Cloning between transceivers .....	182
■ Antenna tuner operation.....	159	◇ Cloning using a personal computer .....	182
◇ Tuner operation .....	159	<b>18 CONTROL COMMAND .....</b>	<b>183–196</b>
◇ Manual tuning .....	159	■ Remote jack (CI-V) information .....	183
■ Optional external tuner operation.....	160	◇ CI-V connection example.....	183
<b>14 SET MODE .....</b>	<b>161–170</b>	◇ Data format .....	183
■ Set mode description .....	161	◇ Command table .....	184
◇ The Set mode settings .....	161	◇ Data content description .....	190
■ Tone control Set mode description .....	169	<b>19 SPECIFICATIONS .....</b>	<b>197–198</b>
◇ The Tone control Set mode settings.....	169	■ General .....	197
<b>15 DATA COMMUNICATION.....</b>	<b>171–173</b>	■ Transmitter.....	197
■ Connections .....	171	■ Receiver .....	198
◇ When connecting to [DATA2].....	171	■ Antenna tuner.....	198
◇ When connecting to [ACC].....	171	<b>20 OPTIONS.....</b>	<b>199–200</b>
◇ When connecting to [MIC].....	171	<b>21 CE.....</b>	<b>201–202</b>
■ Packet (AFSK) operation.....	172		
◇ Frequency display during AFSK operation..	172		
■ Data transmission speed.....	173		
■ Adjusting the TNC output level .....	173		
◇ Using a level meter or synchroscope .....	173		
◇ Not using a measuring device.....	173		
<b>16 OPTION INSTALLATION .....</b>	<b>174–176</b>		
■ Opening the transceiver's case .....	174		
■ UX-9100 1200 MHz BAND UNIT installation .....	175		
■ FL-430/FL-431 1ST IF FILTER installation.....	176		
■ UT-121 DIGITAL UNIT installation .....	176		

<b>1</b>
<b>2</b>
<b>3</b>
<b>4</b>
<b>5</b>
<b>6</b>
<b>7</b>
<b>8</b>
<b>9</b>
<b>10</b>
<b>11</b>
<b>12</b>
<b>13</b>
<b>14</b>
<b>15</b>
<b>16</b>
<b>17</b>
<b>18</b>
<b>19</b>
<b>20</b>
<b>21</b>

## ■ Front panel

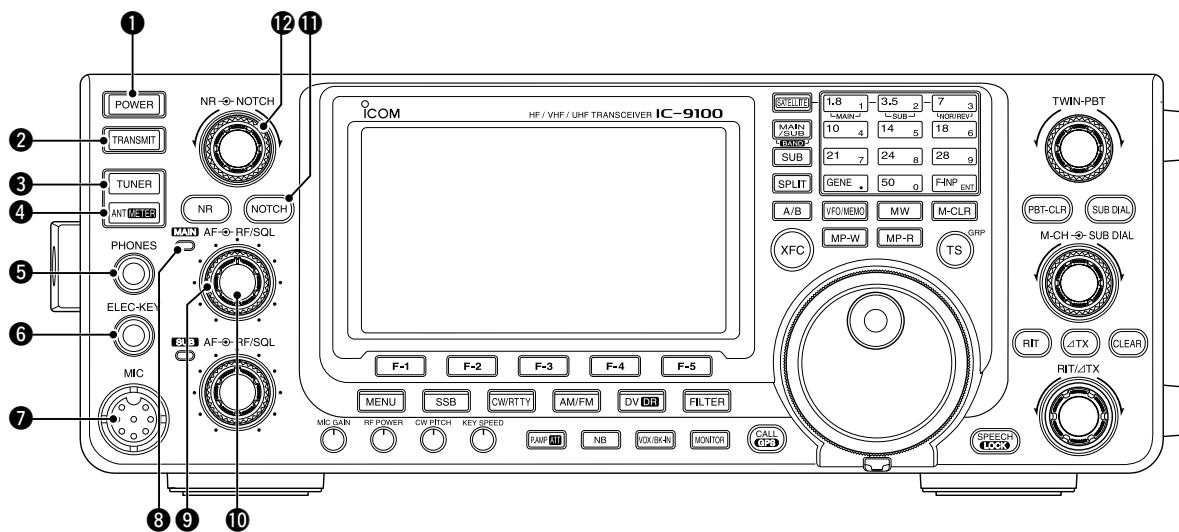

### 1 POWER SWITCH [POWER] (p. 31)

- ➔ Push to turn ON the transceiver power.
  - First, confirm the DC power source is turned ON.
- ➔ Hold down for 1 second to turn OFF the power.

### 2 TRANSMIT SWITCH [TRANSMIT] (p. 46)

- ➔ Push to select transmit or receive.
- While transmitting, the MAIN Band's TX/RX indicator (8) lights red. Only on the satellite mode, the SUB Band's TX/RX indicator (16) lights red.
- While receiving or when the squelch opens, the indicator lights green.

### 3 ANTENNA TUNER SWITCH [TUNER] (p. 159) (Frequency band: HF/50 MHz)

- ➔ Push to turn the internal antenna tuner ON or OFF (bypass).
  - "TUNE" appears when the tuner is turned ON.
  - The internal antenna tuner settings can be memorized in each frequency band.
- ➔ Hold down for 1 second to manually start the antenna tuner.
  - If the tuner cannot tune the antenna within 20 seconds, the tuning circuit is automatically bypassed.

### 4 ANTENNA•METER SWITCH [ANT•METER] ANTENNA SWITCH Operation (p. 158) (Frequency band: HF/50 MHz)

- ➔ Push to select either the ANT1 or ANT2 connector.

### METER SWITCH Operation (p. 45) (Frequency band: ALL)

- ➔ Hold down for 1 second to toggle the transmit meter function between ALC, COMP and SWR.

### 5 HEADPHONE JACK [PHONES]

- ➔ Plug in standard stereo headphones (impedance: 8 to 16  $\Omega$ ).
  - Output power: More than 5 mW with an 8  $\Omega$  load.
  - When headphones are connected, the internal speaker, and any external speaker, are disabled.
  - The MAIN and SUB Band audio can be mixed or separated when using stereo headphones, depending on the "Phone Separate" option in the Set mode. (p. 166)

### 6 ELECTRONIC KEYS JACK [ELEC-KEY]

- ➔ Plug in a bug or paddle type key to use the internal electronic keyer for CW operation. (p. 22)
- Set the keyer type to ELEC-KEY, BUG KEY or Straight key in the "Keyer Type" item of the Keyer Set mode.
- When a straight key is connected, "Straight key" must be selected in the "Keyer Type" item of the Keyer Set mode. (p. 55)
- A straight key jack is located on the rear panel. See [KEY] on pages 11 and 22.
- You can reverse the keyer paddle polarity (dot and dash) in the "Paddle Polarity" item of the Keyer Set mode. (p. 55)
- Four keyer memory channels are available for your convenience. (p. 51)

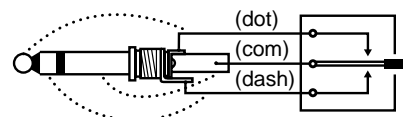

### 7 MICROPHONE CONNECTOR [MIC]

- ➔ Plug in the supplied or an optional microphone.
  - See page 199 for appropriate microphones.
  - See page 30 for microphone connector information.

### 8 MAIN BAND TX/RX INDICATOR

- ➔ Lights green when the squelch opens, or a signal is received on the MAIN Band; lights red during transmit.
- ➔ Blinks green when an off-frequency signal is received, depending on the "FM/DV Center Error" option in the Set mode. (p. 162)

### 9 MAIN BAND RF GAIN CONTROL/ SQUELCH CONTROL [RF/SQL]

(outer control; p. 44)

Rotate to adjust the RF gain and squelch threshold level for the MAIN Band.

The squelch removes noise output to the speaker when no signal is received. (closed condition)

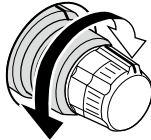

- The squelch is particularly effective for AM and FM, but also works in other modes.
- The 12 to 1 o'clock position is recommended for the most effective use of the [RF/SQL] control.
- [RF/SQL] operates as only an RF gain control in SSB, CW and RTTY (Squelch is fixed open), or a squelch control in AM, FM and DV (RF gain is fixed at maximum sensitivity), when "Auto" is selected as the "RF/SQL Control" item option in the Set mode. (p. 162)

#### • When used as an RF gain/squelch control

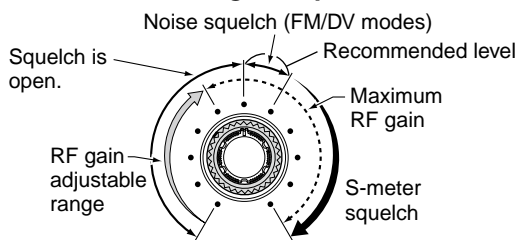

#### • When used as an RF gain control

(Squelch is fixed open; SSB, CW and RTTY only)

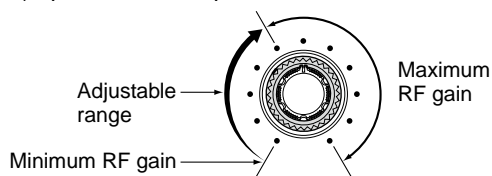

While rotating the RF gain control, a faint noise may be heard. This comes from the DSP unit and does not indicate an equipment malfunction.

#### • When used as a squelch control

(RF gain is fixed at maximum.)

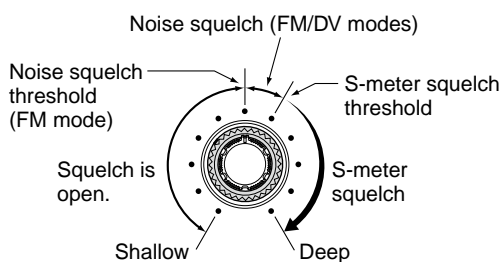

### 10 MAIN BAND AF CONTROL [AF]

(inner control; p. 45)

Rotate to adjust audio output level to the speaker or headphones on the MAIN Band.

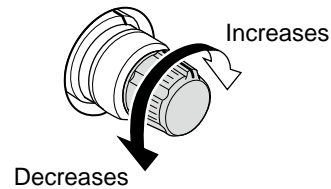

### 11 NOTCH SWITCH [NOTCH] (p. 77)

(Mode = Auto notch : SSB/AM/FM)

Manual notch : SSB/CW/RTTY/AM)

- In the SSB and AM modes, push to toggle the notch function between auto, manual and OFF.
  - Either the Auto or Manual notch function can be turned OFF in the "[NOTCH] SW" item of the Set mode. (p. 36)
- In the FM mode, push to turn the Auto Notch function ON or OFF.
- In the CW or RTTY mode, push to turn the Manual Notch function ON or OFF.
  - "MNF" appears when the Manual Notch function is ON.
  - "ANF" appears when the Auto Notch function is ON.
  - No indicator appears when the notch filter is OFF.
- Hold down for 1 second to switch the manual filter characteristics from wide, mid and narrow, when the Manual Notch function is selected.

#### ✓ What is the notch filter?

The notch filter is a narrow filter that eliminates unwanted CW or AM carrier tones, while preserving the desired voice signal. The DSP circuit automatically adjusts the notch frequency to effectively eliminate unwanted tones.

### 12 MANUAL NOTCH FILTER CONTROL [NOTCH]

(outer control; p. 77)

Rotate to adjust the notch frequency to reject an interfering signal while the manual function is ON.

- Notch filter center frequency:
 

SSB/RTTY	: -1040 Hz to +4040 Hz
CW	: CW pitch freq. -2540 Hz to CW pitch freq. +2540 Hz
AM	: -5060 Hz to +5100 Hz

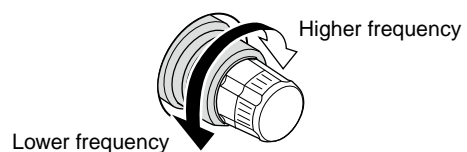

The optional UX-9100 is required for 1200 MHz frequency band operation.  
The optional UT-121 is required for DV mode operation.

■ Front panel (continued)

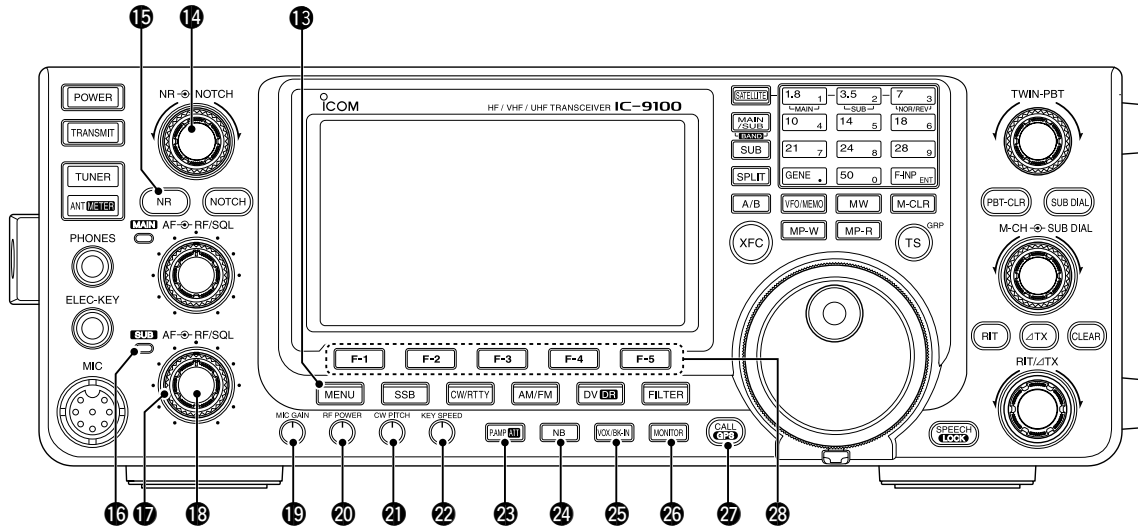

**13 MENU SWITCH [MENU]** (p. 19)  
 ➔ Push to change the set of functions assigned to switches ([F-1] to [F-5]).  
 • Toggles the function display menu between M1 (Menu 1), M2 (Menu 2), M3 (Menu 3), D1 and D2.  
 ➔ Hold down for 1 second to enter the Set mode. Push to return to the previous screen display.

**14 NOISE REDUCTION LEVEL CONTROL [NR]** (inner control; p. 77)  
 Rotate to adjust the DSP noise reduction level when the noise reduction function is in use. Set for maximum readability.  
 • To use this control, first push [NR] (15).

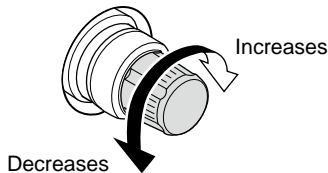

**15 NOISE REDUCTION SWITCH [NR]** (p. 77)  
 Push to turn DSP noise reduction ON or OFF.  
 • "NR" appears when noise reduction is ON.

**16 SUB BAND TX/RX INDICATOR**  
 Lights green when the squelch opens, or a signal is received on the SUB Band; lights red during transmit in the satellite mode.  
 ➔ Blinks green when an off-frequency signal is received, depending on the "FM/DV Center Error" option in the Set mode. (p. 162)

**17 SUB BAND RF GAIN CONTROL/ SQUELCH CONTROL [RF/SQL]** (outer control; p. 44)  
 Rotate to adjust the RF gain and squelch threshold level on the SUB Band. The squelch stops noise output to the speaker when no signal is received. (closed condition)  
 See 9 on page 2 for details.

**18 SUB BAND AF CONTROL [AF]** (inner control; p. 45)  
 Rotate to adjust audio output level to the speaker or headphones on the SUB Band.

**19 MIC GAIN CONTROL [MIC GAIN]** (p. 46)  
 Rotate to adjust the microphone gain.  
 • The transmit audio tone in the SSB, AM and FM modes can be independently adjusted in the tone control Set mode. (p. 169)

✓ **How to set the microphone gain.**

Set the meter function to ALC. (p. 45) While speaking at normal voice level, adjust the [MIC GAIN] control so that in the SSB or AM modes, the ALC meter swings within the ALC range.



**20 RF POWER CONTROL [RF POWER]** (p. 46)  
 Rotate to continuously vary the RF output power.



Frequency band	RF output power range
HF/50 MHz	2 to 100 W (AM: 2 to 30 W)
144 MHz	2 to 100 W
430 MHz	2 to 75 W
1200 MHz	1 to 10 W

**21 CW PITCH CONTROL [CW PITCH]** (outer control; p. 49)  
**(Mode: CW)**  
 Rotate to shift the received CW audio pitch and the CW sidetone pitch without changing the operating frequency.  
 • The pitch can be adjusted from 300 to 900 Hz in approximately 5 Hz steps.



**22 ELECTRONIC CW KEYSER SPEED CONTROL**

**[KEY SPEED]** (p. 49)

**(Mode: CW)**

Rotate to adjust the keying speed of the internal electronic CW keyer to between 6 wpm (minimum) and 48 wpm (maximum).



**23 PREAMP•ATTENUATOR SWITCH [P.AMP•ATT]**

**PREAMP SWITCH Operation** (p. 71)

**(Frequency band: HF/50 MHz)**

➔ Push to select one of two receive RF preamplifiers, or to bypass them.

- “P. AMP<sup>1</sup>” is a wide dynamic range preamplifier. It is most effective for the 1.8 to 21 MHz bands.
- “P. AMP<sup>2</sup>” is a high-gain preamplifier. It is most effective for the 24 to 50 MHz bands.
- No indicator appears when the preamplifiers are not selected.

**(Frequency band: 144/430/1200 MHz)**

➔ Push to turn an optional AG-25, AG-35 or AG-1200\* preamplifier unit ON or OFF, if installed.

- “P.AMP” appears when the preamplifier unit is ON.
- \*AG-1200 has been discontinued, but it can be still be used.

**✓ What is the preamplifier?**

The preamplifier amplifies signals in the front end to improve the S/N ratio and sensitivity. Select “P. AMP<sup>1</sup>” or “P. AMP<sup>2</sup>” when receiving weak signals.

**ATTENUATOR SWITCH Operation** (p. 71)

➔ Hold down for 1 second to turn ON the attenuator.

- “ATT” appears when the attenuator is ON.

➔ Push to turn OFF the attenuator.

- “ATT” disappears.

**✓ What is the attenuator?**

The attenuator prevents a desired signal from being distorted when very strong signals are near it, or when very strong electromagnetic fields, such as from a broadcasting station, are near your location.

**24 NOISE BLANKER SWITCH [NB]** (p. 76)

➔ Push to turn the noise blanker ON or OFF. The noise blanker reduces pulse-type noise such as that generated by vehicle ignition systems. The noise blanker is not effective for non-pulse-type noise.

- “NB” appears when the noise blanker is ON.

➔ Hold down for 1 second to display the “NB” screen. Push to return to the previous screen display.

**25 VOX/BK-IN SWITCH [VOX/BK-IN]**

**VOX SWITCH Operation** (p. 78)

**(Mode: SSB/AM/FM/DV)**

➔ Push to turn the VOX function ON or OFF.

➔ Hold down for 1 second to display the “VOX” screen. Push to return to the previous screen display.

**✓ What is the VOX function?**

The VOX function (voice operated transmission) automatically starts transmission when you speak into the microphone; then automatically returns to receive when you stop speaking.

**BK-IN SWITCH Operation** (p. 79)

**(Mode: CW)**

➔ Push to toggle the break-in operation between semi break-in and full break-in, or to turn OFF the break-in function.

➔ Hold down for 1 second to display the “BKIN” screen (Break-in). Push to return to the previous screen display.

**✓ What is the break-in function?**

The break-in function automatically switches between transmit and receive with your CW keying. Using Full break-in function (QSK), you can hear the receive frequency in-between keying.

**26 MONITOR SWITCH [MONITOR]** (p. 81)

➔ Push to turn the Monitor function ON or OFF to listen to your own transmitted audio.

- “MONI” appears when this function is ON.
- In CW mode, the CW sidetone can be heard, regardless of the [MONITOR] switch setting.

➔ Hold down for 1 second to display the “MONI” screen (Monitor) to set the monitor level. Push to return to the previous screen display.

**27 CALL•GPS SWITCH [CALL•GPS]**

**CALL SWITCH Operation** (p. 139)

Push to select the call channel.

**GPS SWITCH Operation** (p. 121)

Hold down for 1 second to display the “GPS” screen. Push to return to the previous screen display.

**28 FUNCTION SWITCHES [F1]–[F5]**

Push to select the function which is indicated on the LCD display above each switch. (p. 19)

- The functions vary, depending on the selected menu and the operating mode.

The optional UX-9100 is required for 1200 MHz frequency band operation.

## ■ Front panel (continued)

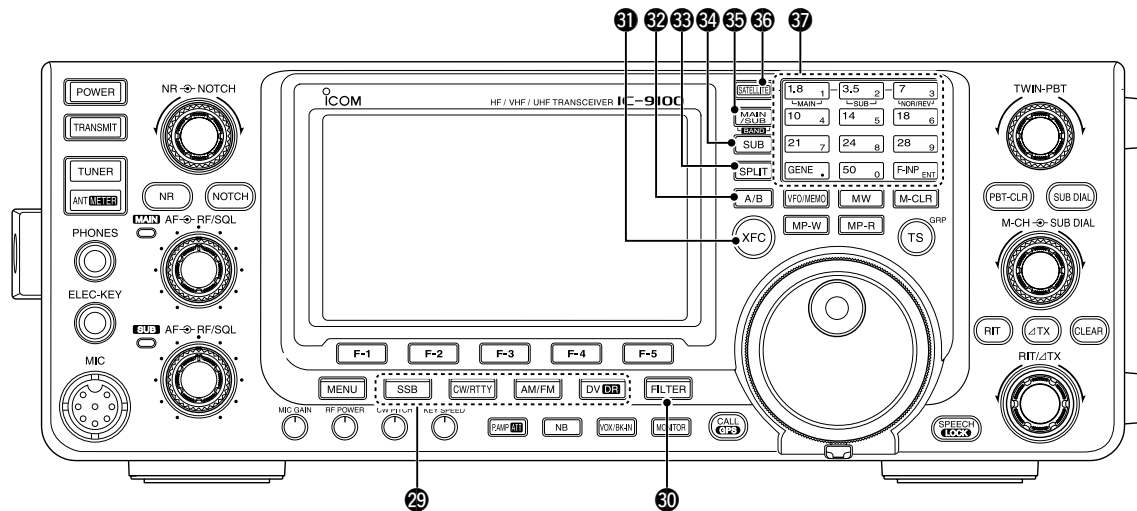
**29 MODE SWITCHES**

Push to select your desired operating mode. (p. 43)

- The built-in speech synthesizer announces the selected mode when the "SPEECH [MODE] SW" item is set to "ON" in the Set mode. (p. 164)

**[SSB]** (p. 47)

- ➔ Push to alternately select the USB or LSB modes.
  - "USB" or "LSB" appears.
- ➔ In the SSB mode, hold down for 1 second to select the SSB data mode (USB-D, LSB-D).
  - "D" appears in addition to "USB" or "LSB."
- ➔ In the SSB data mode, push to return to the normal SSB mode.

**[CW/RTTY]** (pp. 48, 56)

- ➔ Push to alternately select the CW or RTTY modes.
  - "CW" or "RTTY" appears.
- ➔ Hold down for 1 second to switch between the CW and CW-R (CW reverse) modes, in the CW mode.
  - "CW-R" appears when the CW reverse mode is selected.
- ➔ Hold down for 1 second to switch between the RTTY and RTTY-R (RTTY reverse) modes in the RTTY mode.
  - "RTTY-R" appears when the RTTY reverse mode is selected.

**[AM/FM]** (p. 61)

- ➔ Push to alternately select the AM or FM modes.
  - "AM" or "FM" appears.
- ➔ Hold down for 1 second to select the AM or FM data mode (AM-D/FM-D).
  - "D" appears in addition to "AM" or "FM."
- ➔ In the data mode, push to return to the normal AM or FM mode.

**NOTE:**

- In the AM mode, you can transmit on only the HF/50MHz frequency bands.
- The AM mode cannot be selected on the 1200 MHz frequency band.

**[DV•DR]** (p. 85)

- ➔ Push to select the DV mode.
  - "DV" appears.
- ➔ Hold down for 1 second to select the DR mode.
  - "DR" appears.
- ➔ In the DR mode, push to cancel it.
  - "DR" disappears.

**30 FILTER SWITCH [FILTER]** (p. 73)

- ➔ Push to select one of three IF filter settings (1/2/3).
  - The selected filter passband width and shifting value are displayed for 2 seconds on the LCD display.
- ➔ Hold down for 1 second to display the "FIL" screen (Filter) to set the filter passband width.
- ➔ When the "FIL" screen is displayed, hold down for 1 second to return to the previous screen display.

**31 TRANSMIT FREQUENCY CHECK SWITCH [XFC]**

- ➔ During split frequency or repeater operation, hold down to listen to the transmit frequency. (p. 82)
  - While holding down this switch, the transmit frequency can be changed with the main dial, keypad or memo pad.
  - When the split lock function is turned ON, push [XFC] to cancel the dial lock function. (pp. 82, 162)
- ➔ When the RIT function is turned ON, hold down to listen to the receive frequency. (RIT is temporarily cancelled.) (p. 69)
- ➔ When the ΔTX function is turned ON, hold down to listen to the transmit frequency (including ΔTX frequency offset). (p. 81)
- ➔ In the simplex operation, hold down to listen to the receive frequency.
  - The squelch is closed and the interference reject function is temporary OFF while holding down this switch.
- ➔ In the DV mode, the RX monitoring mode is selected by holding down this switch. (p. 118)

**32 VFO SELECT SWITCH [A/B]** (pp. 32, 34)

- ➔ Push to select either VFO A or VFO B.
- ➔ Hold down for 1 second to equalize the undisplayed VFO settings to that of the displayed VFO.

**33 SPLIT SWITCH [SPLIT]** (p. 82)

- ➔ Push to turn the split function ON or OFF.
  - “SPLIT” appears when the split function is ON.
  - The split function is not selectable on the SUB Band.
- ➔ Hold down for 1 second to activate the quick split function.
  - The transmit frequency shifts from the receive frequency according to the “SPLIT Offset” option in the Set mode. (p. 162)
  - The quick split function can be turned OFF in the “Quick SPLIT” item of the Set mode. (p. 162)

**34 SUB SWITCH [SUB]**

- ➔ Push to turn the SUB Band setting mode ON or OFF. (p. 33)
  - “[SUB]” appears when the SUB Band setting mode is ON.
- ➔ Hold down for 1 second to turn the SUB Band display ON or OFF. (p. 32)

**35 MAIN/SUB•BAND SWITCH [MAIN/SUB•BAND]**

- ➔ Push to toggle between the MAIN Band and the SUB Band. (p. 32)
- ➔ Hold down for 1 second one or more times to select HF/50 MHz, 144 MHz, 430 MHz or 1200 MHz frequency band as your operating band. (p. 35)
  - The frequency band, selected in either the MAIN or SUB Band, cannot be selected on the other Band.

**36 SATELLITE SWITCH [SATELLITE]** (p. 153)

- ➔ Push to enter the satellite mode (receive on MAIN Band, transmit on SUB Band).
  - “[SATELLITE]” appears.
  - The last operated frequencies (downlink and uplink) and tracking icon (“[NORMAL]”/“[REVERSE]”) appears.
- ➔ In the satellite mode, push to return to the previous screen display.

**NOTE:** In the DR mode, pushing [SATELLITE] cancels DR, and then switches the transceiver to the satellite mode.

If you want to operate in the DR mode after exiting the satellite mode, you must hold down [DV•DR] for 1 second.

- ➔ Hold down for 1 second to transfer the uplink and downlink frequencies into the satellite VFO.
  - The satellite mode is automatically selected after transferring.
  - “[SATELLITE]” appears.
  - The last operated tracking icon (“[NORMAL]”/“[REVERSE]”) appears.
  - To toggle the tracking operation between normal and reverse, push [NOR/REV] (7 3).
- ➔ In the satellite mode, hold down for 1 second to return to normal operation using the displayed frequencies.

**37 BAND KEYS/KEYPAD**

**BAND KEYS Operation** (pp. 35, 36)

When the HF/50 MHz frequency band is not selected in both the MAIN or SUB Band, you can select the HF/50 MHz frequency band by just holding down the band key for 1 second.

**(Frequency band: HF/50 MHz)**

- ➔ Push to select the operating band.
  - [GENE •] selects the general coverage band.
- ➔ Pushing the same key two or three times calls up other stacked frequencies in the frequency band.
  - Icom’s triple band stacking register memorizes three frequencies in each frequency band.

**(Frequency band: 144/430/1200 MHz)**

- ➔ Pushing [GENE •] two or three times calls up other stacked frequencies in the frequency band, after selecting the 144 MHz, 430 MHz or 1200 MHz frequency band by holding down [BAND](MAIN/SUB) for 1 second.
- ➔ Hold down for 1 second to switch the operating band to the HF/50 MHz frequency band.
  - [GENE •] selects the general coverage band.
  - Pushing the same key two or three times calls up other stacked frequencies in the frequency band.

**KEYPAD Operation** (p. 37)

After pushing [F-INP ENT], push the keys on the keypad to enter a frequency. After entering, push [F-INP ENT] to set the frequency.

- Example: To enter 14.195 MHz;  
Push [F-INP ENT] [1] [4] [•] [1] [9] [5] [F-INP ENT].

**NOTE:** The frequency band, selected in either the MAIN or SUB Band, cannot be selected on the other Band.

While in the satellite mode, the keypad operation is different than described above. See page 154 for details.

The optional UX-9100 is required for 1200 MHz frequency band operation.  
The optional UT-121 is required for DV mode operation.

## ■ Front panel (continued)

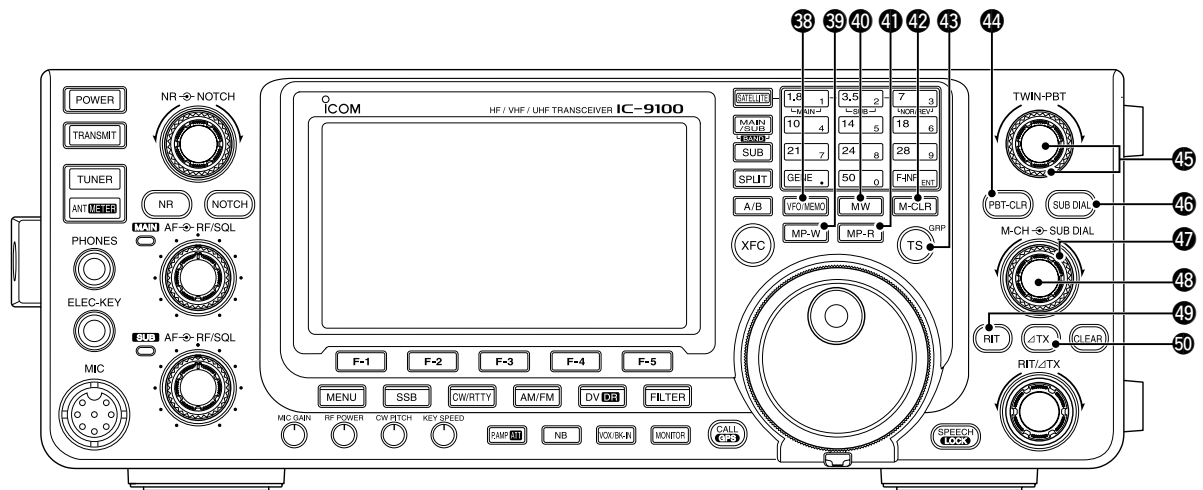
**38 VFO/MEMORY SWITCH [VFO/MEMO]**

- ➔ Push to switch between the VFO and memory modes. (pp. 34, 139)
- ➔ Hold down for 1 second to copy the memory contents to the displayed VFO on the MAIN Band. (p. 142)

**39 MEMO PAD-WRITE SWITCH [MP-W]** (p. 144)

- Push to write the displayed data into a memo pad.
- The 5 most recent entries remain in the memo pads.
  - The memo pad capacity can be extended from 5 to 10 in the "Memopad Numbers" item of the Set mode. (p. 164)

**40 MEMORY WRITE SWITCH [MW]** (p. 140)

- Hold down for 1 second to store VFO data into the selected memory channel.
- This can be done in both the VFO and memory modes.

**41 MEMO PAD-READ SWITCH [MP-R]** (p. 144)

- Push to sequentially call up the contents from the memo pads.
- The 5 (or 10) most recently programmed frequencies and operating modes can be recalled, starting from the most recent.
- The memo pad capacity can be increased from 5 to 10 in the "Memopad Numbers" item of the Set mode. (p. 164)

**42 MEMORY CLEAR SWITCH [M-CLR]** (p. 141)

- In the Memory mode, hold down for 1 second to clear the memory channel.
- The channel becomes a blank channel.
  - This switch is disabled in the VFO mode.

**43 TUNING STEP-REPEATER GROUP SWITCH [TS-GRP]****TUNING STEP SWITCH Operation** (p. 38)

- ➔ Push to toggle between the kHz and MHz\* quick tuning step, or turn OFF the quick tuning.
  - \* When the HF/50 MHz frequency band is selected, MHz step cannot be selected.
- When the "▼" quick tuning icon is displayed above the kHz or MHz digit, the frequency is changed in programmed quick tuning steps or 1 MHz steps.
- When the quick tuning is OFF, the frequency is changed in 10 Hz steps.
- ➔ When the quick tuning is ON, hold down for 1 second to display the "TS" screen (Tuning Step) to select the quick tuning step. (p. 38)
  - 0.1, 1, 5, 6.25, 9, 10, 12.5, 20, 25, 50 and 100 kHz steps are independently selectable for each operating mode.
- ➔ When the quick tuning is OFF, hold down for 1 second to turn the minimum tuning step of 1 Hz ON or OFF. (p. 39)

**CALL SIGN GROUP SWITCH Operation** (p. 93)  
(Mode: DV) (Only when "DR" is displayed.)

- ➔ Push to switch the call sign group.
- ➔ Hold down for 1 second to enter the repeater call sign group selection mode.
  - "►" blinks.
- ➔ When in the repeater group selection mode, push to cancel it.



**44 PBT CLEAR SWITCH [PBT-CLR]** (p. 75)  
(Mode: SSB/CW/RTTY/AM)

- ➔ Push to display the filter passband width and shifting value for 1 second on the function display.
- ➔ Hold down for 1 second to reset the PBT settings.

**45 PASSBAND TUNING CONTROLS [TWIN-PBT]**  
(p. 75)  
(Mode: SSB/CW/RTTY/AM)

Adjusts the receiver's IF filter passband width using the DSP circuit.

- Rotate this control or push [PBT-CLR] to display the PBT settings (passband width and shifting value) for 1 second on the function display.
- Hold down [PBT-CLR] for 1 second to clear the PBT settings.
- The PBT is adjustable in 50 Hz steps in the SSB/CW/RTTY modes, and 200 Hz in the AM mode. In this time, the shift value changes in 25 Hz steps in the SSB/CW/RTTY modes, and 100 Hz in the AM mode.
- These controls function as an IF shift control.

✓ **What is the PBT control?**

The PBT function electronically modifies the IF passband width to reject interference. This transceiver uses the DSP circuit for the PBT function.

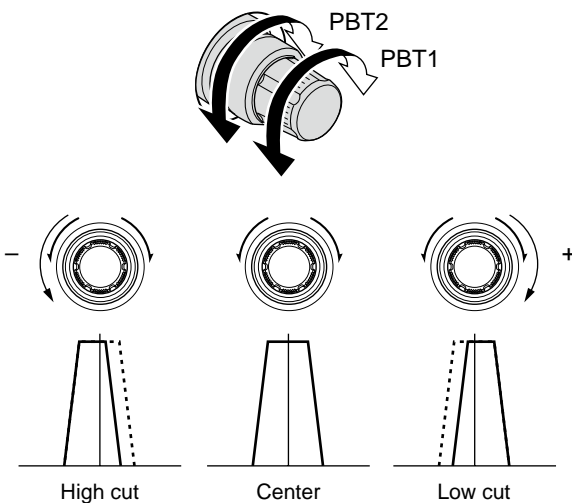

**46 SUB DIAL SWITCH [SUB DIAL]** (p. 33)  
Push to turn the SUB Dial function ON or OFF.

- "SUB DIAL" appears when the SUB Dial function is ON.

**47 SUB DIAL CONTROL**  
(outer control; p. 33)

Rotate to change the SUB Band frequency.

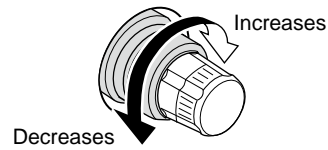

The [SUB DIAL] control's tuning Band (MAIN or SUB) and frequency steps differ, depending on the combination of the SUB Dial function and SUB Band setting mode status, and the status of the quick tuning function. See page 33 for details.

**48 MEMORY CHANNEL CONTROL [M-CH]**  
(inner control; p. 139)

Select a memory channel.

- Rotate clockwise to select a higher memory channel number; rotate counterclockwise to select a lower memory channel number.

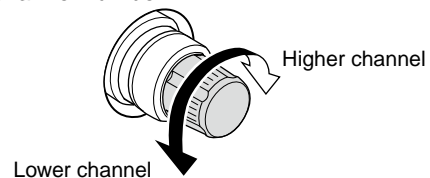

**49 RIT SWITCH [RIT]** (p. 69)

- ➔ Push to turn the RIT function ON or OFF.
  - Use [RIT/ΔTX] control to vary the RIT frequency.
- ➔ Hold down for 1 second to add the shift frequency of the RIT function to or subtract it from the displayed frequency.

✓ **What is the RIT function?**

The RIT (Receiver Incremental Tuning) shifts the receive frequency without shifting the transmit frequency. This is useful for fine tuning stations calling you off-frequency or when you prefer to listen to slightly different-sounding voice characteristics, etc.

**50 ΔTX SWITCH [ΔTX]** (p. 81)

- ➔ Push to turn the ΔTX function ON or OFF.
  - Use [RIT/ΔTX] control to vary the ΔTX frequency.
- ➔ Hold down for 1 second to add the shift frequency of the ΔTX function to or subtract it from the displayed frequency.

✓ **What is the ΔTX function?**

ΔTX shifts the transmit frequency without shifting the receive frequency. This is useful for simple split frequency operation in CW, etc.

The optional UT-121 is required for DV mode operation.

■ Front panel (continued)

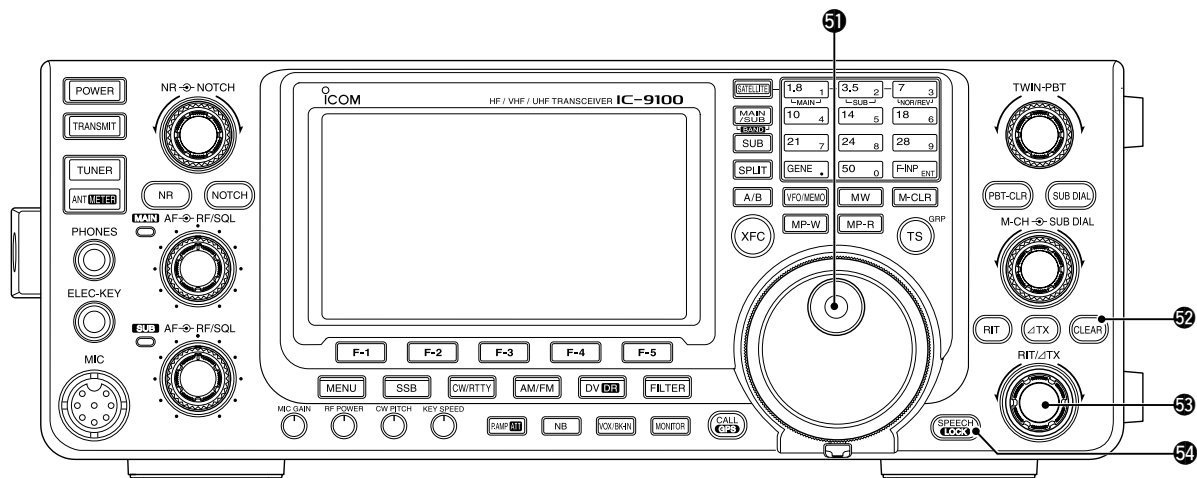

**51 MAIN DIAL** (pp. 37, 161)  
Rotate to change the displayed frequency, select the Set mode settings, etc.

When the SUB Band setting mode is ON, rotating [MAIN DIAL] changes the SUB Band frequency. (p. 33)

**52 CLEAR SWITCH [CLEAR]** (pp. 69, 81)  
Hold down for 1 second\* to clear the RIT/ΔTX shift frequency.  
\* When the “Quick RIT Clear” item in the Set mode is ON, push momentarily to reset the shift frequency. (p. 164)

**53 RIT/ΔTX CONTROL [RIT/ΔTX]** (pp. 69, 81)  
When either or both the RIT/ΔTX functions are ON, rotate to adjust the RIT/ΔTX frequency shift.

- Rotate the control clockwise to increase the frequency, or counterclockwise to decrease the frequency.
- The frequency shift range is ±9.99 kHz in 10 Hz steps. The control tunes in 1 Hz steps when the operating frequency readout is set to the 1 Hz step readout. However, the 1 Hz digit is not displayed on the frequency shift readout.

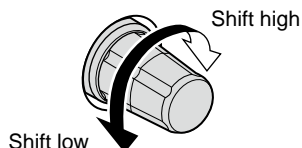

**54 SPEECH/LOCK SWITCH [SPEECH/LOCK]**  
**SPEECH SWITCH Operation** (p. 45)  
➔ Push to audibly announce the S-meter level, the displayed frequency and the operating mode.

- The S-Level announcement can be turned OFF in the “SPEECH S-Level” item of the Set mode. (p. 164)
- When RIT and/or ΔTX are ON, the RIT/ΔTX offset is not included in the frequency announcement.

**LOCK SWITCH Operation** (p. 77)  
➔ Hold down for 1 second to turn the Dial Lock function ON or OFF.

- The function electronically locks the Main dial.
- “” appears when the function is ON.

**NOTE:** The [SPEECH/LOCK] switch operation to activate the voice synthesizer or the dial lock functions can be replaced in the “[SPEECH/LOCK] SW” item of the Set mode. (p. 164)

## ■ Rear panel

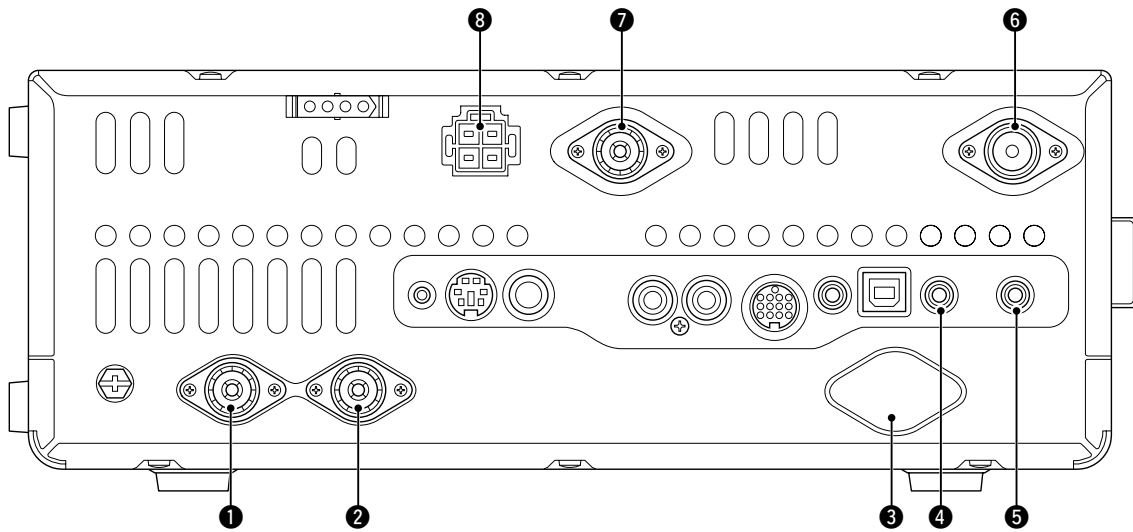

**1 ANTENNA CONNECTOR 1 [ANT1]**

**2 ANTENNA CONNECTOR 2 [ANT2]**

(pp. 24, 25, 158)

Connect a 50 Ω antenna with a PL-259 plug connector for the HF/50 MHz frequency band.

When using an optional AH-4 HF/50 MHz AUTOMATIC ANTENNA TUNER, connect it to the [ANT1] connector. Connecting the AH-4 switches the internal antenna tuner from [ANT1] to [ANT2].

**3 1200 MHz BAND ANTENNA CONNECTOR [1200MHz ANT]** (pp. 24, 158)

Connect a 1200 MHz 50 Ω antenna with a type-N connector, when the optional UX-9100, 1200 MHz band unit, is installed.

**4 MAIN BAND EXTERNAL SPEAKER JACK [EXT-SP (MAIN)]**

**5 SUB BAND EXTERNAL SPEAKER JACK [EXT-SP (SUB)]** (p. 25)

Connect to an external speaker (4 to 8 Ω). By connecting an external speaker to each or both jacks, the audio output for both the MAIN and SUB Bands can be configured as shown below.

External speaker connection	MAIN AF	SUB AF
No connection	Internal speaker	
To the MAIN jack	External speaker	Internal speaker
To the SUB jack	Internal speaker	External speaker
Both	External speakers	

**6 430 MHz ANTENNA CONNECTOR [430MHz ANT]**

(pp. 24, 25, 158)

Connect a 50 Ω antenna with a type-N connector for the 430 MHz frequency band.

**7 144 MHz ANTENNA CONNECTOR [144MHz ANT]**

(pp. 24, 25, 158)

Connect a 50 Ω antenna with a PL-259 connector for the 144 MHz frequency band.

**8 DC POWER SOCKET [DC 13.8V]** (p. 27)

Connect 13.8 V DC through the supplied DC power cable.

Rear panel view

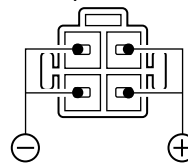

## ■ Rear panel (Continued)

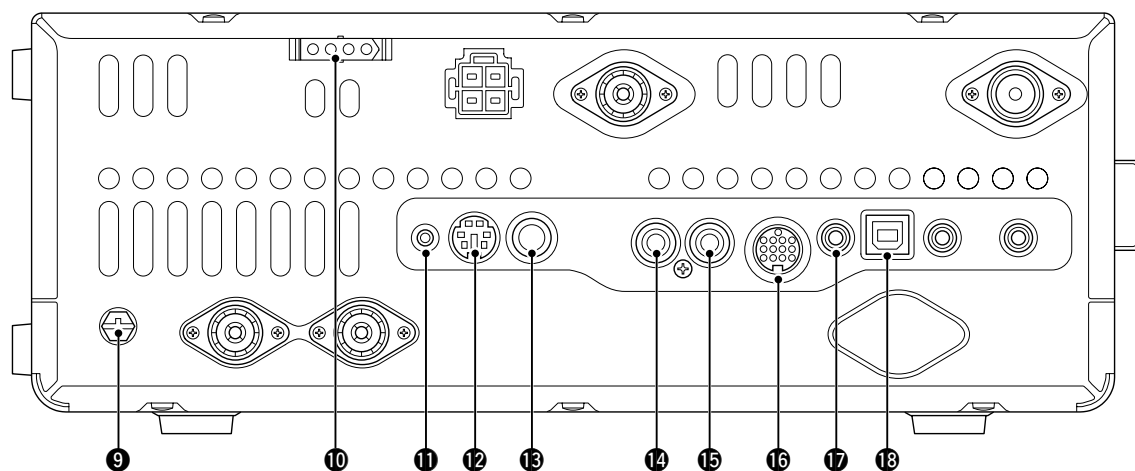
**9 GROUND TERMINAL [GND]** (p. 22)

Connect this terminal to a ground to prevent electrical shocks, TVI, BCI and other problems.

**10 TUNER CONTROL SOCKET [TUNER]** (p. 29)

Connect the control cable from an optional AH-4 HF/50 MHz AUTOMATIC ANTENNA TUNER.

**11 DATA1 JACK [DATA1]** (pp. 26, 168)

➔ Connect a PC through the optional OPC-1529R DATA COMMUNICATION CABLE, for low-speed data communication in the DV mode. (p. 117)

➔ Connect a GPS receiver through the optional OPC-1529R DATA COMMUNICATION CABLE, for GPS operation. (p. 121)

**12 DATA2 SOCKET [DATA2]** (pp. 26, 171)

Connect a TNC (Terminal Node Controller), etc. for high speed data communications.

**13 STRAIGHT KEY JACK [KEY]** (p. 24)

Connect a straight key or external electronic keyer output using a standard 1/4 inch plug.

- To use the internal electronic keyer for CW operation, connect to [ELEC-KEY] on the front panel. (p. 1)

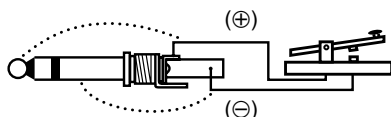
**14 ALC INPUT JACK [ALC]** (p. 25)

Connect to the ALC output jack of a non-Icom linear amplifier.

**15 SEND CONTROL JACK [SEND]** (p. 25)

When transmitting, goes to ground to control an external unit, such as a non-Icom linear amplifier.

**16 ACCESSORY SOCKET [ACC]**

Connect control lines for external equipment such as a linear amplifier, an automatic antenna selector/tuner, a TNC for data communications, etc.

- See page 13 for socket information.

**17 CI-V REMOTE CONTROL JACK [REMOTE]**

(pp. 26, 183)

➔ Connect a PC, using the optional CT-17 CI-V LEVEL CONVERTER, for external control of the transceiver.

➔ Use for transceive function with another Icom CI-V transceiver or receiver.

When the transceive function is set to ON, changing the frequency, operating mode, etc. on the IC-9100 automatically changes those settings on other Icom transceivers or receivers, and vice versa. (p. 167)

➔ Connect another IC-9100, using a mini plug cable\*, for transceiver to transceiver cloning.

\* Purchase separately

## 18 USB (Universal Serial Bus) PORT [USB]

Using a USB cable, connect a PC to do the following:

- Input modulation (p. 167)
- Remotely control the transceiver using CI-V commands (p. 183)
- Send the received audio to the PC
- Send the decoded characters to the PC (pp. 59, 167)
- Low-speed data communication in the DV mode (p. 167)
- Cloning using the optional CS-9100 CLONING SOFTWARE (p. 182)
- Two COM port numbers are assigned to the [USB] connector. One of them is "USB1," used for cloning and CI-V operation. The other one is "USB2," whose function is selected in "USB2/DATA1 Func" (63) item of the Set mode. (p. 167)

### About the USB driver:

The USB driver and the installation guide can be downloaded from our website.

➔ <http://www.icom.co.jp/world/index.html>

The following items are required:

### PC

- Microsoft® Windows® XP, Microsoft® Windows Vista® or Microsoft® Windows® 7 OS
- A USB 1.1 or 2.0 port

### Other items

- USB cable (purchase separately)
- PC software (such as optional RS-BA1 or CS-9100)

/// **NEVER** connect the transceiver to a PC until the USB driver installation has been completed.

### About the modulation input:

Select "USB" in the Set mode item "DATA OFF MOD" or "DATA MOD." The modulation input level from the USB jack can be set in the Set mode item "USB MOD Level." (p. 167)

■ Rear panel (Continued)

◇ ACC socket information

• ACC socket

ACC	PIN No.	NAME	DESCRIPTION	SPECIFICATIONS	
 <p>Rear panel view</p> <p>① brown    ⑧ gray ② red      ⑨ white ③ orange   ⑩ black ④ yellow   ⑪ pink ⑤ green    ⑫ light ⑥ blue     ⑬ light ⑦ purple    green</p> <p>Color refers to the cable strands of the supplied cable.</p>	1	8 V	Regulated 8 V output.	Output voltage : 8 V ± 0.3 V Output current : Less than 10 mA	
	2	GND	Connects to ground.	—	
	3	HSEND *1, 2	Input/output pin.	An external equipment controls the transceiver. When this pin goes low, the transceiver transmits. The transceiver outputs a low signal to control external equipment.	Input voltage (High) : 2.0 V to 20.0 V Input voltage (Low) : -0.5 V to +0.8 V Current flow : Max. 20 mA Output voltage (Low) : Less than 0.1 V Current flow : Max. 200 mA
	4	NC	—	—	
	5	BAND	Band voltage output.	Output voltage : 0 to 8 V	
	6	ALC	ALC voltage input.	Control voltage : -3 V to 0 V Input impedance : More than 3.3 kΩ	
	7	VSEND *1, 2	Input/output pin.	An external equipment controls the transceiver. When this pin goes low, the transceiver transmits. The transceiver outputs a low signal to control external equipment.	Input voltage (High) : 2.0 V to 20.0 V Input voltage (Low) : -0.5 V to +0.8 V Current flow : Max. 20 mA Output voltage (Low) : Less than 0.1 V Current flow : Max. 200 mA
	8	13.8 V	13.8 V output when power is ON.	Output current : Less than 1 A	
	9	NC	—	—	
	10	FSKK	Controls RTTY keying	“High” level : More than 2.4 V “Low” level : Less than 0.6 V Output current : Less than 2 mA	
	11	MOD	Modulator input.	Input impedance : 10 kΩ Input level : Approx. 100 mV rms	
	12	AF*3	AF detector output. Fixed level, regardless of the [AF] control position.	Output impedance : 4.7 kΩ Output level : 100 to 300 mV rms	
	13	SQL S*3	Squelch output. Grounded when squelch opens.	SQL open : Less than 0.3 V/5 mA SQL closed : More than 6.0 V/100 μA	

\*1 When the SEND terminal controls the inductive load (such as a relay), a counter-electromotive force can cause the transceiver’s malfunction or damage. To prevent this, we recommend adding a switching diode, such as an “1SS133,” on the load side of the circuit to the counter-electromotive force absorption. When the diode is added, a switching delay of the relay may occur. Be sure to check its switching action before operation.

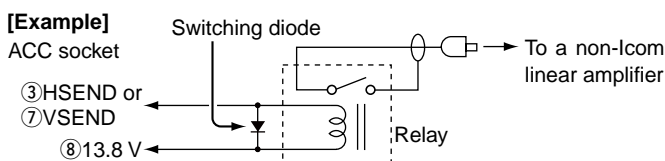

\*2 VSEND is used for the 144 MHz, 430 MHz, and 1200 MHz bands, and HSEND is used for the HF/50 MHz bands by default. You can change this setting in “VSEND Select” of the Set mode. (p. 166)

\*3 The pin 12 (AF) and pin 13 (SQLS) output capabilities are for the MAIN Band’s AF and squelch by default. You can change this setting in “ACC AF/SQL Select” of the Set mode. (p. 166)

• When connecting the ACC conversion cable (OPC-599)

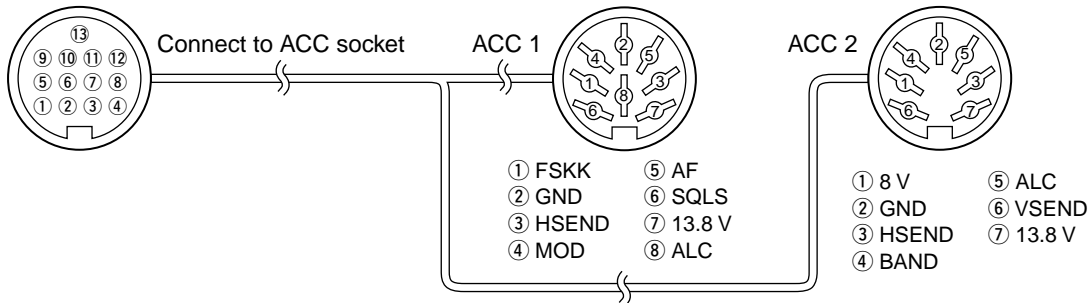

◇ DATA2 socket information

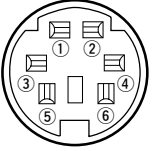
DATA2	PIN No.	NAME	DESCRIPTION	SPECIFICATIONS
 <p>Rear panel view</p>	1	DATA IN	Input terminal for data transmit. (1200 bps: AFSK/ 9600 bps: G3RUH, GMSK)	Input level (1200 bps) : 100 mV Input level (9600 bps) : 0.2 to 0.5 Vp-p
	2	GND	Common ground for DATA IN, DATA OUT and AF OUT.	—
	3	PTTP	PTT terminal for packet operation. Connect to ground to activate the transmitter.	Input voltage (High) : 2.0 V to 20.0 V Input voltage (Low) : -0.5 V to +0.8 V
	4	DATA OUT*	Data out terminal for 9600 bps operation only.	Output impedance : 10 kΩ Output level : 1.0 Vp-p
	5	AF OUT*	Data out terminal for 1200 bps operation only.	Output impedance : 4.7 kΩ Output level : 100–300 mV rms
	6	SQL*	Squelch out terminal. This pin is grounded when the transceiver receives a signal which opens the squelch. <ul style="list-style-type: none"> <li>• To avoid interfering transmissions, connect squelch to the TNC to inhibit transmission when squelch is open.</li> <li>• Keep RF gain at a normal level, otherwise a “SQL” signal will not be output.</li> </ul>	SQL open : Less than 0.3 V/ 5 mA SQL closed : More than 6.0 V/ 100 μA

\* The pin 4 (DATA), pin 5 (AF) and pin 6 (SQL) output capabilities are for the MAIN Band's AF and squelch by default. You can change this setting in “DATA AF/SQL Select” of the Set mode. (p. 166)

## ■ LCD display

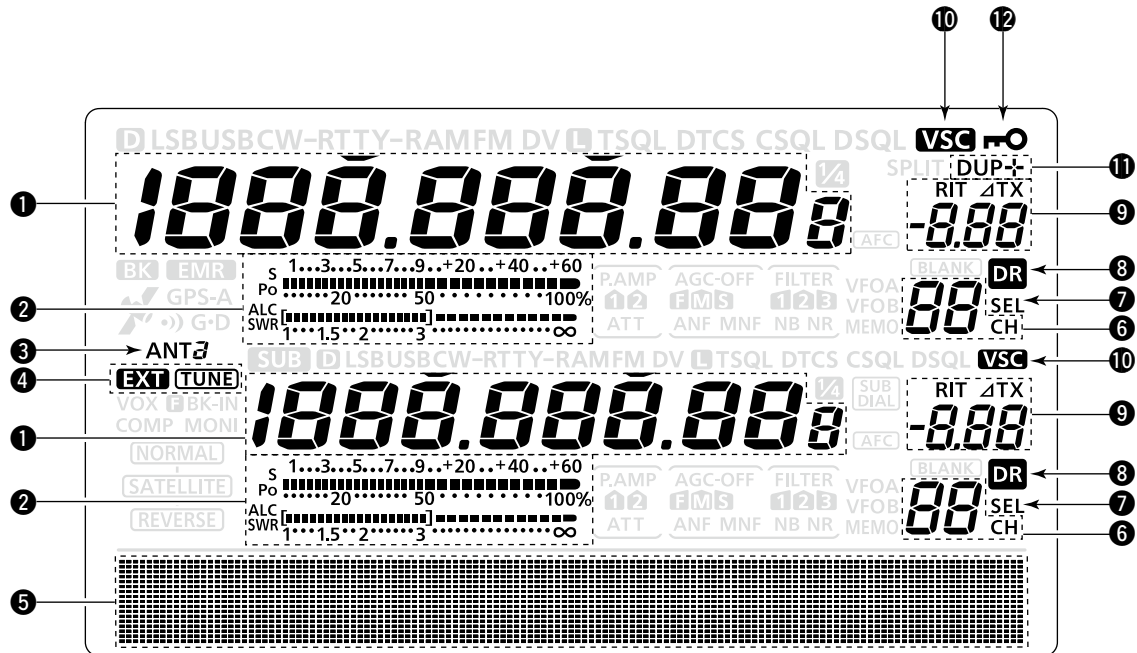

### 1 FREQUENCY READOUTS

Displays the operating frequency.

- When the quick tuning icon “▼” is displayed, the frequency changes in pre-set kHz or 1 MHz quick tuning steps. (p. 38)
- When the quick tuning icon “▼” is not displayed, the frequency changes in 10 Hz or 1 Hz steps. (pp. 37, 39)

### 2 MULTI-FUNCTION METER INDICATION

- ➔ Displays the signal strength while receiving.
- ➔ Displays the relative output power, SWR, ALC or compression levels while transmitting.
- ➔ When the Meter Peak Hold function is ON, the peak level of a received signal strength or the output power is displayed for approximately 0.5 seconds.

### 3 ANTENNA ICON (p. 158)

Displays which antenna connector is selected for HF/50 MHz.

- “ANT1” appears when the [ANT1] connector is selected.
- “ANT2” appears when the [ANT2] connector is selected.

### 4 ANTENNA TUNER ICONS (pp. 159, 160)

- ➔ “TUNE” appears when the antenna tuner is turned ON; “TUNE” blinks during tuning.
- ➔ “EXT” appears when the optional AH-4 external antenna tuner is connected to the [ANT1] connector, and [ANT1] is selected.

### 5 FUNCTION DISPLAY (p. 19)

Shows the function of the function switches ([F1]–[F5]), Set mode items and IF passband width.

### 6 MEMORY CHANNEL READOUTS

Displays the selected memory channel.

### 7 SELECT MEMORY CHANNEL ICON

- ➔ Appears when the selected memory channel is set as a select memory channel. (p. 151)
- ➔ Appears when the repeater can be selected as the access repeater in the DR mode. (p. 100)

### 8 DR MODE ICON (p. 43)

Appears when the DR mode is selected.

### 9 RIT/ΔTX ICONS (pp. 69, 81)

- ➔ “RIT” appears when the RIT function is turned ON.
- ➔ “ΔTX” appears when the ΔTX function is turned ON.
- ➔ Shows the shift frequency of the RIT or ΔTX function.

### 10 VOICE SQUELCH CONTROL ICON (p. 146)

Appears when the VSC (Voice Squelch Control) function is turned ON.

### 11 DUPLEX ICON (p. 65)

“DUP+” appears when plus duplex, “DUP –” appears when minus duplex (repeater) operation is selected.

### 12 DIAL LOCK ICON (p. 77)

Appears when the Dial Lock function is turned ON.



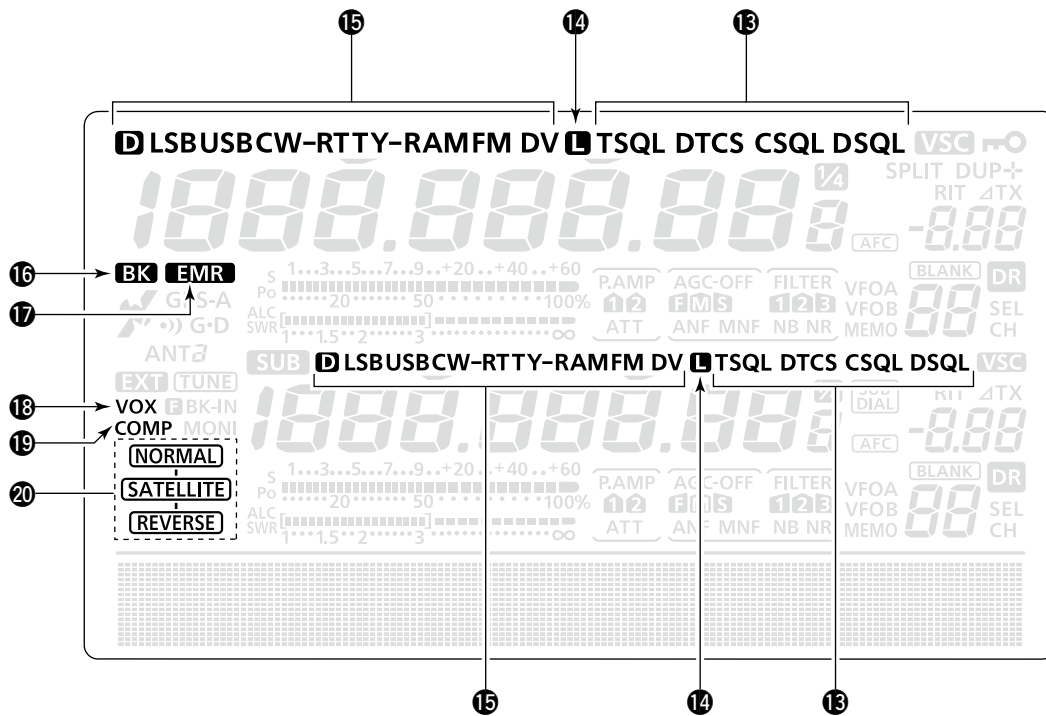

**13 TONE SQUELCH ICONS**

**(Mode: FM)**

- ➔ “T” appears when the repeater tone function is ON. (p. 65)
- ➔ “TSQL” appears when the tone squelch function is ON. (p. 62)
- ➔ “DTCS” appears when the DTCS code squelch function is ON. (p. 63)

**(Mode: DV)**

- ➔ “DSQL” appears when the digital call sign squelch function is ON. (p. 114)
- ➔ “CSQL” appears when digital code squelch function is ON. (p. 114)

**14 PACKET LOSS ICON**

**(Mode: DV)**

Appears when the Packet Loss occurs.

- While operating voice communication or low-speed data communication via the internet network, some packets may be lost due to network error (poor data throughput performance). (p. 117)

**15 MODE ICONS** (p. 43)

Displays the selected operating mode.

- “D” appears when SSB data, AM data or FM data mode is selected.

**16 BK MODE ICON** (p. 116)

**(Mode: DV)**

- ➔ Appears when the BK (Break-in) function is turned ON.
  - The BK function allows you to break into a conversation, where the two original stations are communicating with call sign squelch enabled.
- ➔ Blinks when receiving a break-in call.

**17 EMR MODE ICON** (p. 115)

- ➔ Appears when the EMR (Enhanced Monitor Receive) communication mode is selected.
  - In the EMR communication mode, no call sign setting is necessary when operating in the DV mode.
- ➔ Blinks when receiving an EMR signal.

**18 VOX ICON** (p. 78)

Appears when the VOX function is activated.

**19 SPEECH COMPRESSOR ICON** (p. 80)

Appears when the Speech Compressor function is turned ON.

**20 SATELLITE ICON** (p. 153)

Appears while the satellite mode is selected.

- NORMAL** : Normal satellite mode is selected.
  - When [MAIN DIAL] is rotated, both downlink and uplink frequencies simultaneously increase or decrease in the same step.

- SATELLITE** : Reverse satellite mode is selected.
  - When [MAIN DIAL] is rotated clockwise, downlink frequency increase, and uplink frequency decrease in the same step.
  - When [MAIN DIAL] is rotated counterclockwise, downlink frequency decrease, and uplink frequency increase in the same step.

The optional UT-121 is required for DV mode operation.

## ■ LCD display (Continued)

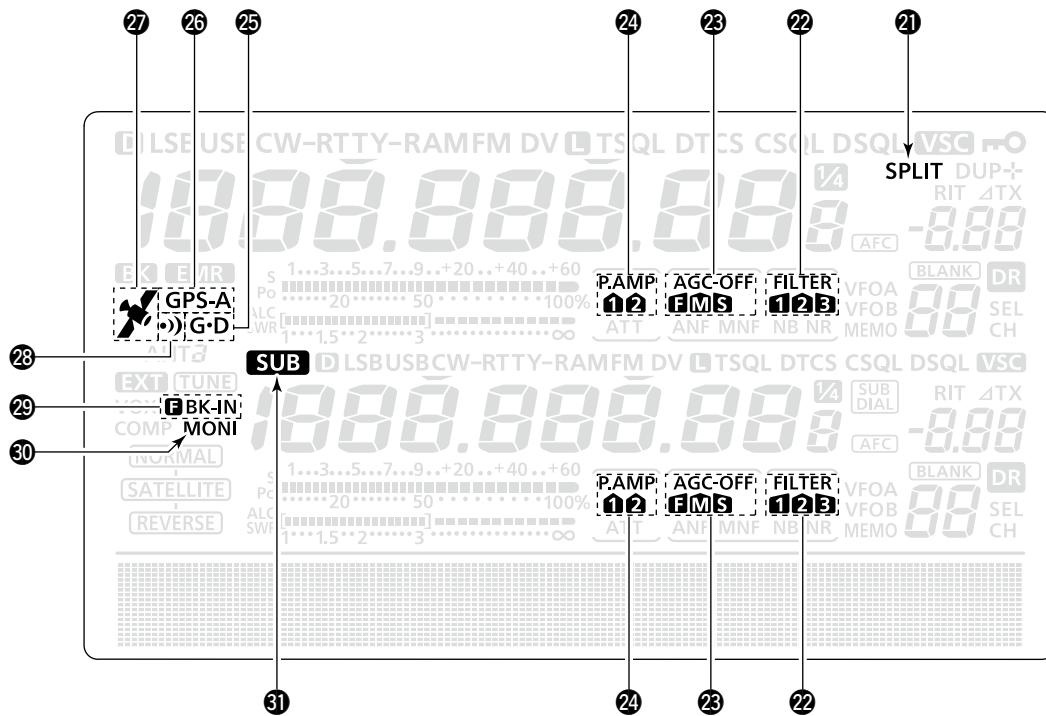
**21 SPLIT ICON** (p. 82)

Appears when the Split function is turned ON.

**22 DSP FILTER ICON** (p. 73)

Displays the selected IF filter.

**23 AGC ICONS** (p. 72)

Displays the selected AGC time constant.

- “**F**” for AGC fast; “**M**” for AGC middle; “**S**” for AGC slow; “-OFF” for AGC OFF.
- In the FM and DV mode, “**F**” for AGC fast is fixed.

**24 PREAMP ICON** (p. 71)

Appears when a preamplifier is turned ON.

- In HF/50 MHz frequency band, either “P. AMP**1**” or “P. AMP**2**” is displayed when the preamp 1 or preamp 2 is ON.

**25 GPS DATA COMMUNICATION ICON**

Appears while the GPS data communication function is selected in the “GPS Out” item of the Set mode. (p. 168).

- A GPS data from the GPS receiver, which is connected to the [DATA1] jack, is output to the [USB] port.

**26 GPS TX ICON** (p. 134)

- ➔ “GPS” appears when the GPS transmission mode is set to GPS.
- ➔ “GPS-A” appears when GPS transmission mode is set to GPS-A.

**27 GPS ICON** (p. 132)

- ➔ Appears when a valid position data is received from a GPS receiver that is connected to the [DATA1] jack.
- ➔ Blinks when an invalid data is received from the GPS receiver.

**28 GPS ALARM ICON** (p. 130)

Appears when the GPS alarm function is turned ON.

**29 BREAK-IN ICON** (p. 79)

- ➔ “**F** BK-IN” appears when the Full Break-in function is turned ON.
- ➔ “BK-IN” appears when the Semi Break-in function is turned ON.

**30 MONITOR ICON** (p. 81)

Appears when the Monitor function is turned ON.

**31 SUB ICON** (p. 33)

Appears when the SUB Band setting mode is ON.

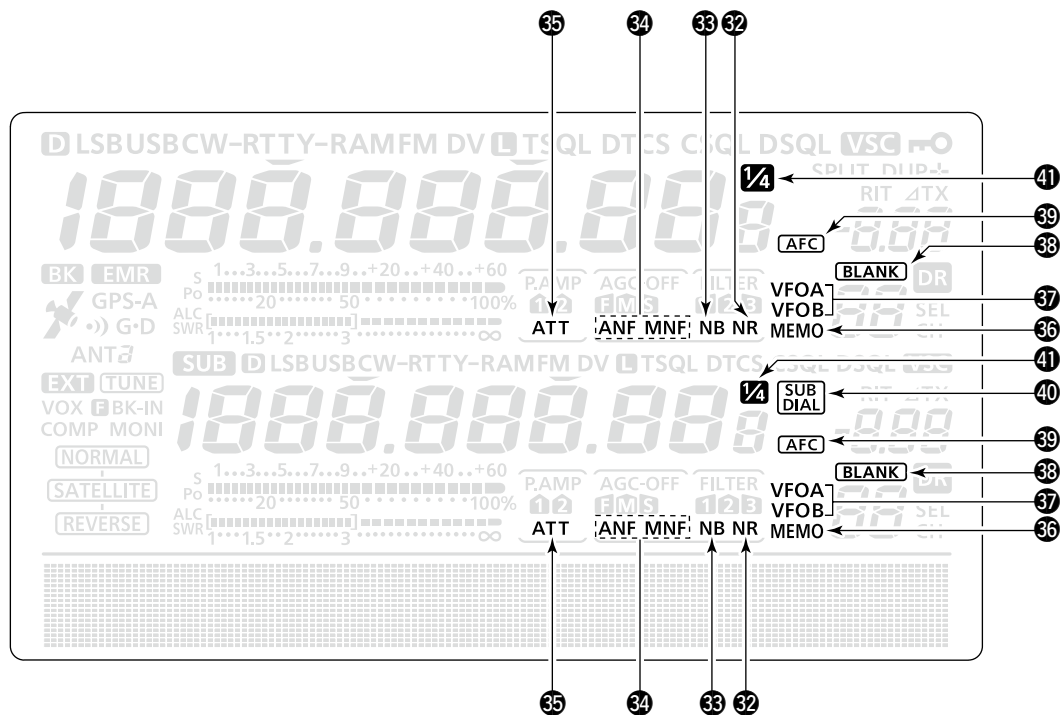

- 32 NOISE REDUCTION ICON** (p. 77)  
Appears when the Noise Reduction function is turned ON.
- 33 NOISE BLANKER ICON** (p. 76)  
Appears when the Noise Blanker function is turned ON.
- 34 NOTCH ICONS** (p. 77)  
**(Mode: SSB/CW/RTTY/AM)**  
➔ “MNF” appears when the Manual Notch function is turned ON.  
**(Mode: SSB/AM/FM)**  
➔ “ANF” appears when the Automatic Notch function is turned ON.
- 35 ATTENUATOR ICON** (p. 71)  
Appears when the Attenuator function is turned ON.
- 36 MEMORY ICON** (pp. 34, 139)  
Appears when the memory mode is selected.
- 37 VFO ICONS** (p. 34)  
Displays whether VFO A or VFO B is selected.
- 38 BLANK MEMORY ICON** (p. 139)  
Appears when the selected memory channel is blank.
- 39 AFC ICON** (p. 69)  
**(Mode: FM/DV)**  
Appears when the AFC (Automatic Frequency Control) function is turned ON.
- 40 SUB DIAL ICON** (p. 33)  
Appears when the SUB Dial function is turned ON.
- 41 1/4 TUNING DIAL SPEED ICON** (p. 39)  
**(Mode: SSB-D/CW/RTTY)**  
Appears when the tuning dial speed is set so that one rotation is equal to 1/4 of the normal rotation.  
• This function is available only when the quick tuning function is turned OFF.

The optional UT-121 is required for DV mode operation.

## Function display

Push [MENU] to toggle the function display menu.

- The set of functions assigned to the function switches change according to the selected menu and operating mode.
- In the DV mode, M3 (menu 3) display can be selected after selecting menu 2.
- In the DR mode, the D1 and D2 displays can be selected.

### ◇ M1 (Menu 1) display

(Mode: SSB)

AGC	DUP	COMP	TBW	SCP
F-1	F-2	F-3	F-4	F-5

(Mode: SSB-D)

AGC	DUP	1/4		SCP
F-1	F-2	F-3	F-4	F-5

(Mode: CW)

AGC	DUP	1/4	KEY	SCP
F-1	F-2	F-3	F-4	F-5

(Mode: RTTY)

AGC	DUP	1/4	RTTY	SCP
F-1	F-2	F-3	F-4	F-5

(Mode: AM)

AGC	DUP			SCP
F-1	F-2	F-3	F-4	F-5

(Mode: FM)

AGC	DUP	AFC	TON	SCP
F-1	F-2	F-3	F-4	F-5

(Mode: DV)

AGC	DUP	AFC	DSQ	SCP
F-1	F-2	F-3	F-4	F-5

Push to select the functions displayed in the display above switches ([F-1] to [F-5])

- Functions vary, depending on the operating mode.

### ◇ M2 (Menu 2) display

SCAN	MEM	SWR	TCON	VSC
F-1	F-2	F-3	F-4	F-5

### ◇ M3 (Menu 3) display

(Mode: DV)

CS	CD	R>CS	UR	DSET
F-1	F-2	F-3	F-4	F-5

### ◇ D1 display

(Mode: DV) (Only when "DR" is displayed.)

CS	CD	R>CS	UR	DSET
F-1	F-2	F-3	F-4	F-5

### ◇ D2 display

(Mode: DV) (Only when "DR" is displayed.)

SCAN	SEL	AFC	DSQ	TCON
F-1	F-2	F-3	F-4	F-5

### ◇ Function keys on M1 (Menu 1) display

#### **AGC KEY [AGC](F-1)** (p. 72)

- ➔ Push to select the time constant of the AGC circuit.
- ➔ Hold down for 1 second to display the “AGC” screen.

#### **DUPLEX KEY [DUP](F-2)** (p. 65)

- ➔ Push to select the duplex direction, or to turn OFF the function.
  - “DUP-” or “DUP+” is displayed during duplex operation.
- ➔ In the FM mode, hold down for 1 second to turn the one-touch repeater function ON or OFF.

#### **SPEECH COMPRESSOR KEY [COMP](F-3)** (p. 80) **(Mode: SSB)**

- ➔ Push to turn the speech compressor function ON or OFF.
  - “COMP” is displayed when the speech compressor is ON.
- ➔ Hold down for 1 second to display the “COMP” screen.

#### **1/4 TUNING FUNCTION KEY [1/4](F-3)** (p. 39) **(Mode: SSB-D/CW/RTTY)**

Push to turn the 1/4 Tuning function ON or OFF.

- “” is displayed when the 1/4 Tuning function is ON.

#### **AFC KEY [AFC](F-3)** (p. 69) **(Mode: FM/DV)**

Push to turn the AFC function ON or OFF.

- “” is displayed when the AFC function is ON.

#### **TRANSMISSION BANDWIDTH KEY [TBW](F-4)** (p. 80)

##### **(Mode: SSB)**

- ➔ Push to display the selected transmission bandwidth.
- ➔ Hold down for 1 second to select the transmission bandwidth.
  - Bandwidth is selectable from wide (WIDE), middle (MID) and narrow (NAR).

#### **MEMORY KEYER MENU KEY [KEY](F-4)** (p. 50) **(Mode: CW)**

Push to display the “KEY” screen (memory keyer) or the “SEND” screen (keyer send), depending on the “KEYER 1st Menu” option in the Set mode (p. 165).

#### **RTTY MENU KEY [RTTY](F-4)** (p. 57)

Push to display the “RTTY” screen.

#### **TONE SQUELCH KEY [TON](F-4)** (pp. 62–64) **(Mode: FM)**

- ➔ Push to select a tone function between subaudible (repeater) tone, tone squelch and DTCS code.
- ➔ Hold down for 1 second to display the “TON” screen of the selected tone function.

#### **DIGITAL SQUELCH KEY [DSQ](F-4)** (p. 114) **(Mode: DV)**

- ➔ Push to select a digital squelch function between digital call sign squelch and digital code squelch.
- ➔ Hold down for 1 second to display the “DSQ” screen (digital squelch).

#### **BAND SCOPE FUNCTION KEY [SCP](F-5)** (p. 70) Push to display the “SCP” screen (band scope).

### ◇ Function keys on M2 (Menu 2) display

#### **SCAN KEY [SCAN](F-1)** (p. 147)

Push to display the “SCAN” screen.

#### **MEMORY NAME KEY [MEM](F-2)** (p. 143)

Push to display the “MEM” screen (memory name edit).

#### **SWR GRAPH FUNCTION KEY [SWR](F-3)** (p. 84)

Push to display the “SWR” screen.

#### **TONE CONTROL SET MODE KEY [TCON](F-4)** (p. 169)

Push to enter the Tone Control Set mode.

#### **VSC FUNCTION KEY [VSC](F-5)** (p. 146)

##### **(Mode: SSB/AM/FM)**

Push to turn the VSC (Voice Squelch Control) function ON or OFF.

- “” appears when the VSC function is ON.

## ■ Function display (Continued)

◇ **Function keys on M3 (Menu 3) display****(Mode: DV)****CALL SIGN KEY [CS](F-1)** (p. 85)

Push to display the "CS" screen.

- The current call sign for DV operation appears.

**CALL RECORD KEY [CD](F-2)** (p. 95)

Push to display the "CD" screen.

- The call record channel appears. (RX01 to RX20)

**R>CS KEY [R>CS](F-3)** (p. 96)

Hold down for 1 second to copy and set the previously received station call sign as the station call sign for making a call.

**UR KEY [UR](F-4)** (p. 101)

Push to display the "UR" screen.

- The desired station or repeater call sign can be selected.

**DSET KEY [DSET](F-5)** (p. 118)

Push to enter the DV Set mode.

◇ **Function keys on D1 display****(Mode: DV)** (Only when "DR" is displayed.)**CALL SIGN KEY [CS](F-1)** (p. 85)

Push to display the "CS" screen.

- The current call sign for DV operation appears.

**CALL RECORD KEY [CD](F-2)** (p. 95)

Push to display the "CD" screen.

- The call record channel appears. (RX01 to RX20)

**R>CS KEY [R>CS](F-3)** (p. 96)

Hold down for 1 second to copy and set the previously received station call sign as the station call sign for making a call.

**UR KEY [UR](F-4)** (p. 101)

Push to toggle the UR and the repeater call sign selection screen.

- The desired station or repeater call sign can be selected.

**DSET KEY [DSET](F-5)** (p. 118)

Push to enter the DV Set mode.

◇ **Function keys on D2 display****(Mode: DV)** (Only when "DR" is displayed.)**SCAN KEY [SCAN](F-1)**

➔ Push to start or cancel the Access repeater scan. (p. 100)

➔ Hold down for 1 second to enter the Scan Set mode. (p. 147)

**SEL KEY [SEL](F-2)** (p. 100)

Hold down for 1 second to display the "SEL" screen. ("R1USE" setting for the selected repeater)

**AFC KEY [AFC](F-3)** (p. 69)

Push to turn the AFC function ON or OFF.

- "AFC" is displayed when the AFC function is ON.

**DSQ KEY [DSQ](F-4)** (p. 114)

➔ Push to select a digital squelch function between digital call sign squelch and digital code squelch.

➔ Hold down for 1 second to display the "DSQ" screen (digital squelch).

**STONE CONTROL SET MODE KEY [TCON](F-5)**

(p. 169)

Push to enter the Tone Control Set mode.

■ **Selecting a location**

Select a location for the transceiver that allows adequate air circulation, free from extreme heat, cold, or vibrations, and away from TV sets, TV antenna elements, radios and other electromagnetic sources.

The base of the transceiver has adjustable feet for desktop use. Set the feet to one of two angles, to meet your operating preference.

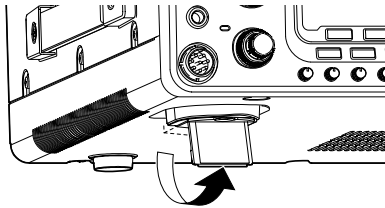

■ **Grounding**

To prevent electrical shock, television interference (TVI), broadcast interference (BCI) and other problems, ground the transceiver using the GROUND terminal on the rear panel.

For best results, connect a heaviest gauge wire or strap to a long ground rod. Make the distance between the [GND] terminal and ground as short as possible.

⚠ **WARNING! NEVER** connect the [GND] terminal to a gas or electric pipe, since the connection could cause an explosion or electric shock.

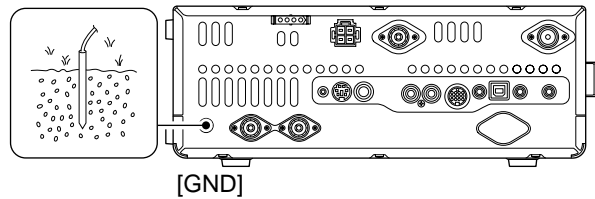

**2**

■ **Electronic keyer and microphone connections**

**ELEC-KEY**

A straight key can also be connected. However, "Straight key" must be selected in the "Keyer Type" item of the Keyer Set mode. (p. 55)

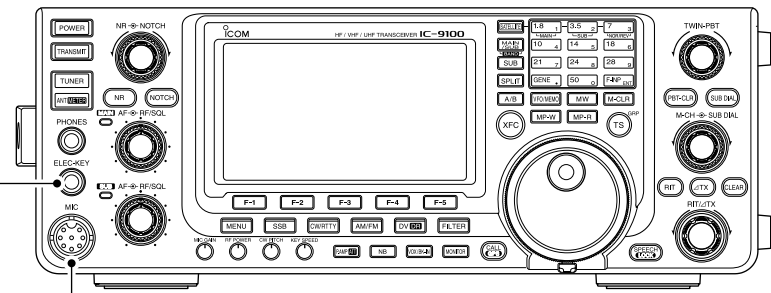

**MICROPHONES (p. 30)**

HM-36      SM-50 (Option)      SM-30 (Option)

## ■ Antenna connection

For radio communications, the antenna is of critical importance, along with output power and receiver sensitivity. Select a well-matched 50  $\Omega$  antenna and coaxial cable feedline. We recommend 1.5:1 or better of Voltage Standing Wave Ratio (VSWR) on your operating bands. The transmission line should be a coaxial cable.

When using a single antenna (for the HF/50 MHz band), use the [ANT1] connector.

**CAUTION:** Protect your transceiver from lightning by using a lightning arrestor.

### Antenna SWR

Each antenna is tuned for a specified frequency range and the SWR usually increases outside the range. When the SWR is higher than approximately 2.0:1, the transceiver automatically reduces the TX power to protect the final transistors. In that case, an antenna tuner is useful to match the transceiver and antenna. Low SWR allows full power for transmitting. The IC-9100 has an SWR meter to continuously monitor the antenna SWR.

#### PL-259 CONNECTOR INSTALLATION EXAMPLE

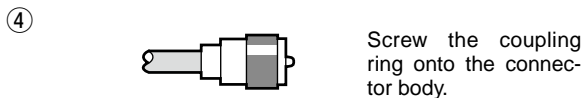
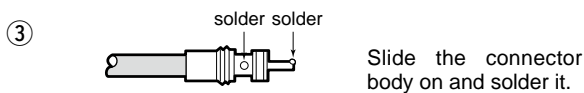
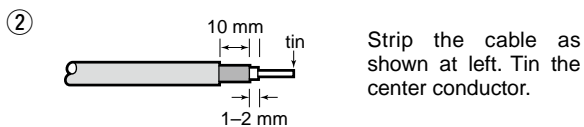
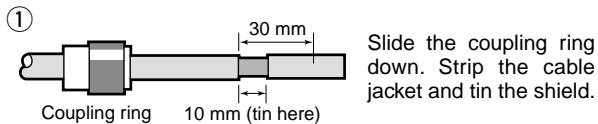

30 mm (1.18 in) 10 mm (0.39 in) 1–2 mm (0.04–0.08 in)

#### TYPE-N CONNECTOR INSTALLATION EXAMPLE

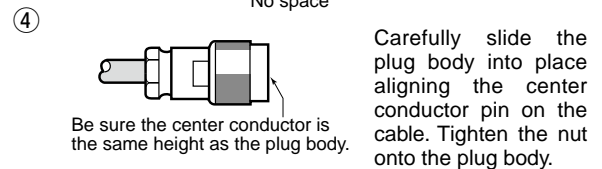
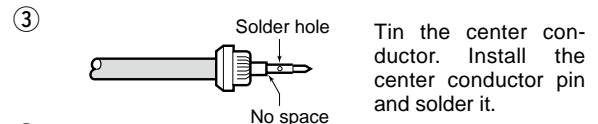
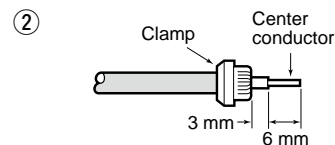
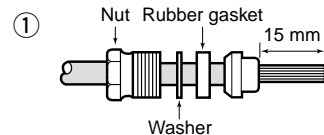

15 mm (0.59 in) 3 mm (0.12 in) 6 mm (0.24 in)



## Required connections

### ◇ Rear panel

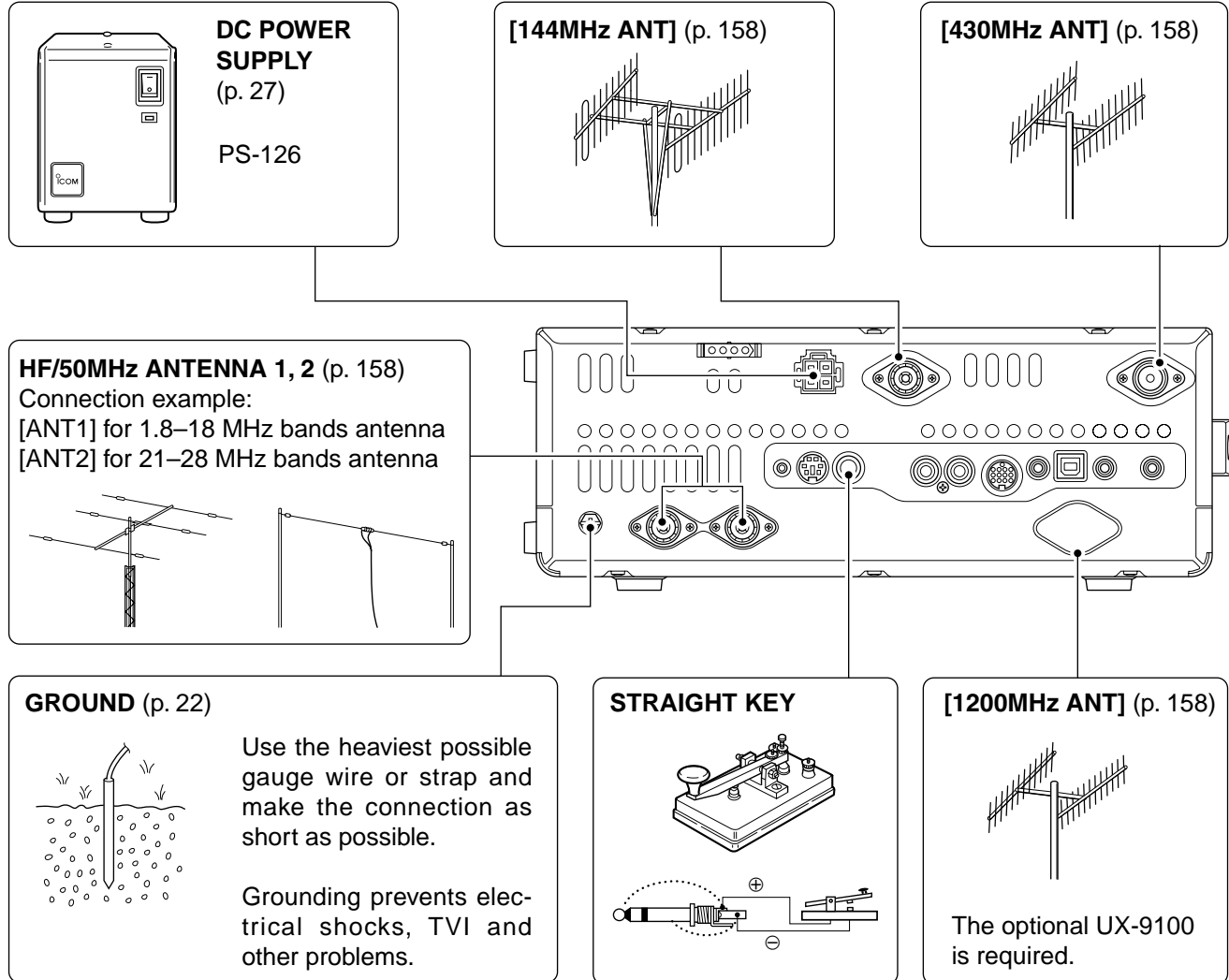

## Advanced connections

### Front panel

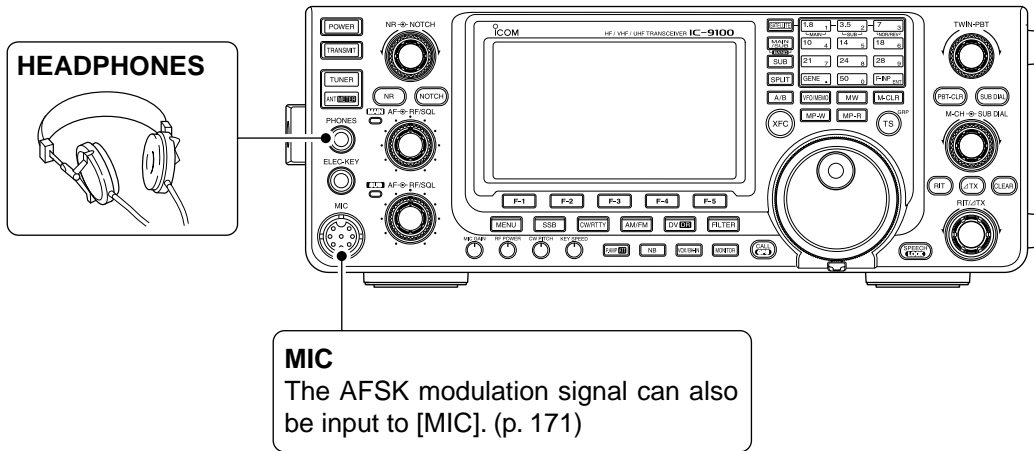

### Rear panel

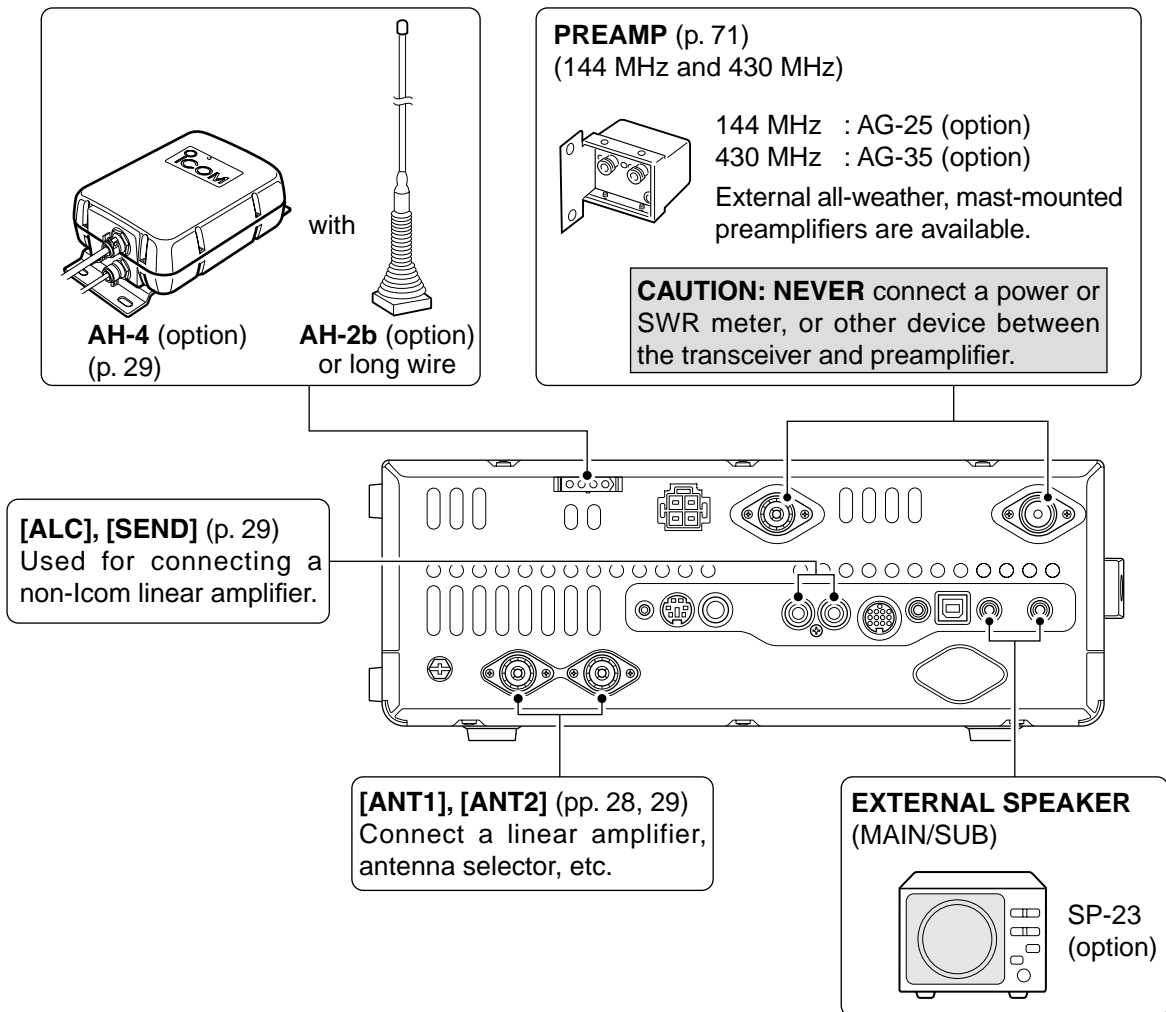

## External keypad connections

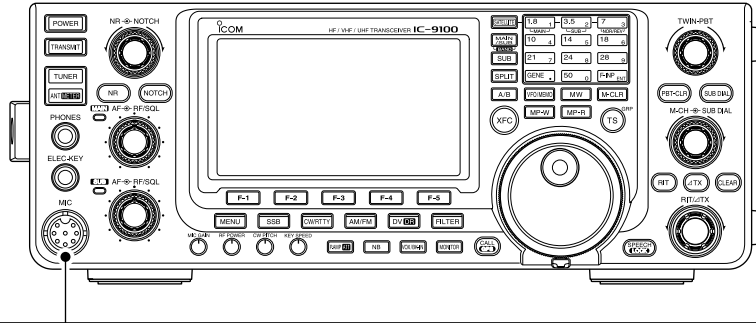

### EXTERNAL KEYPAD

Connect an external keypad for keyer memory control.

When using an external keypad, select "KEYER SEND" in the "External Keypad" item of the Set mode. (p. 167)

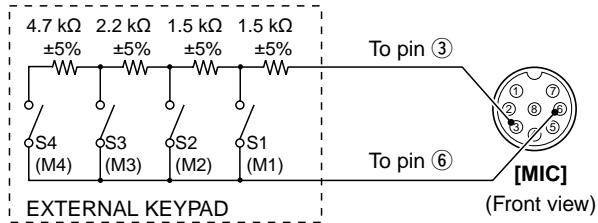

2

## Optional and the external units connections

### REMOTE JACK, USB CONNECTOR (p. 183)

Used for computer control and transceiver operation. The optional CT-17 is required when connecting a PC to [REMOTE].

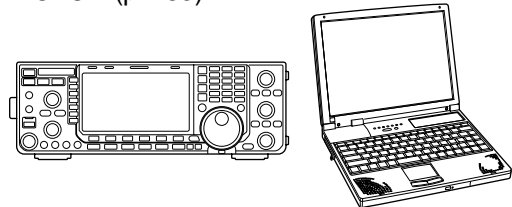

### DATA1 JACK (pp. 117, 121)

Connect the optional OPC-1529R for low speed data communication using a PC and the transceiver, or for the GPS receiver connection. A third-party serial data communication software is required.

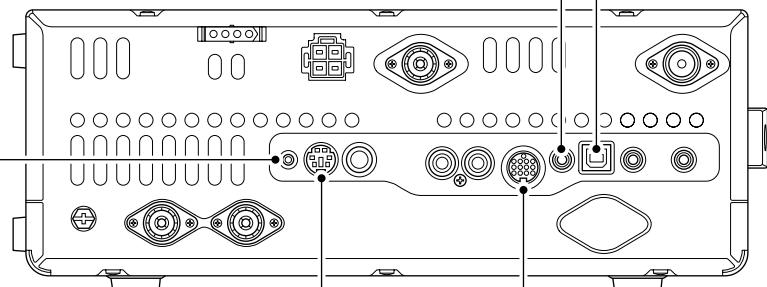

**DATA2 SOCKET**  
(pp. 14, 171)

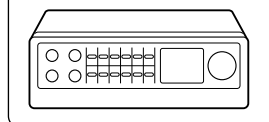

**ACC SOCKET**  
(pp. 13, 171)

## ■ Power supply connections

When operating the transceiver with AC power, use a power supply with 13.8 V DC output and a capacity of at least 24 Amperes.

Refer to the diagrams below.

**CAUTION:** Before connecting the DC power cable, check the following important items.

Make sure:

- The [POWER] switch is OFF.
- Output voltage of the power source is 12 to 15 V when you use a non-Icom power supply.
- DC power cable polarity is correct.  
Red : Positive ⊕ terminal  
Black : Negative ⊖ terminal

## ■ Connecting a DC power supply

### ◇ Connecting the PS-126 DC POWER SUPPLY

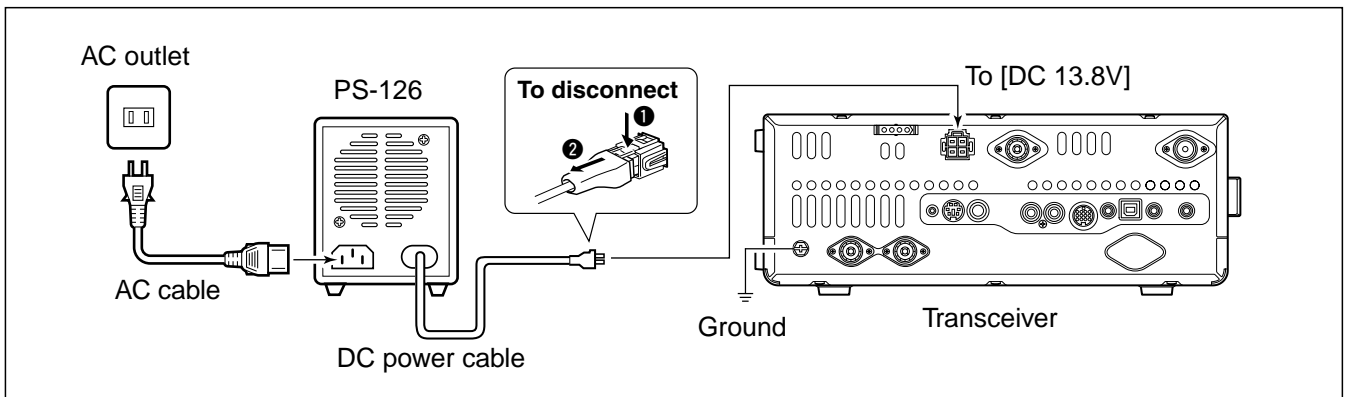

### ◇ Connecting a non-Icom DC POWER SUPPLY

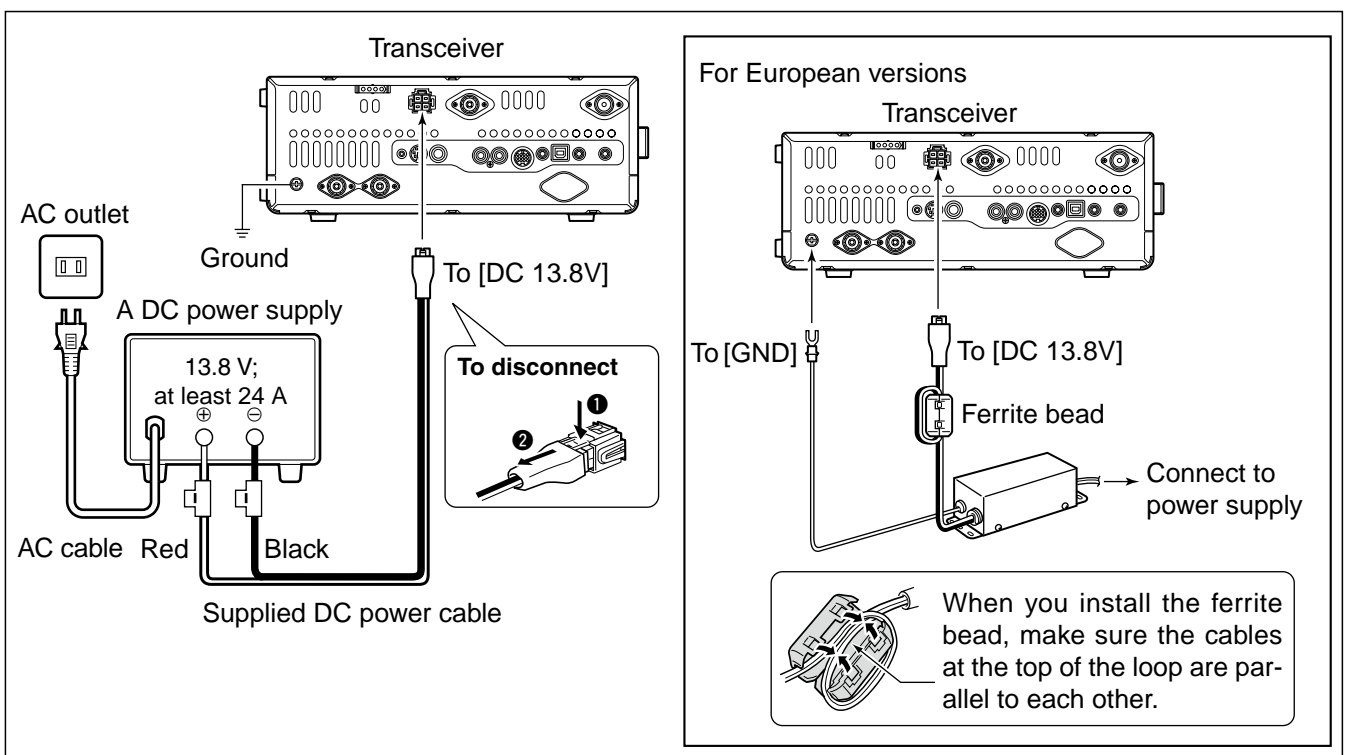

## ■ Linear amplifier connections

### ◇ Connecting the IC-PW1/PW1EURO

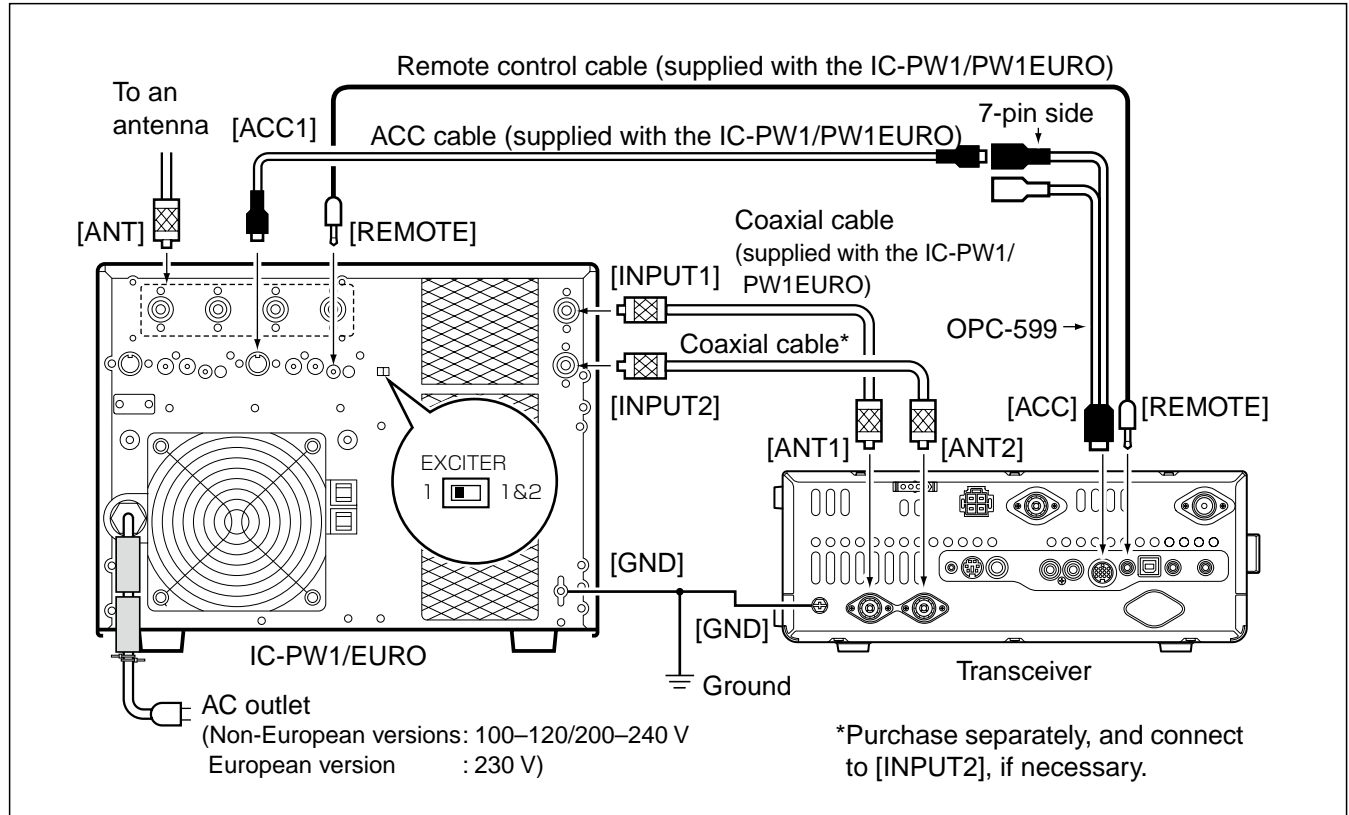

## ■ Linear amplifier connections (Continued)

### ◇ Connecting a non-Icom linear amplifier

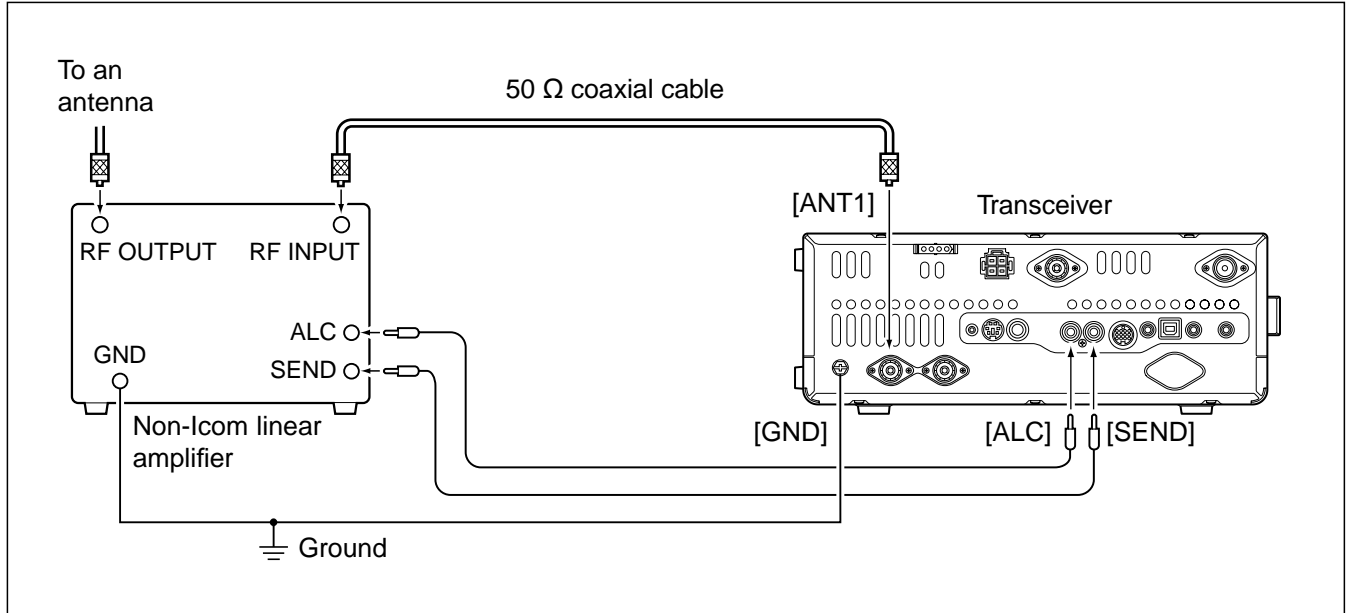

### ⚠ WARNING!

- Set the transceiver output power and linear amplifier ALC output level after referring to the linear amplifier instruction manual.
- The ALC input level must be in the range 0 V to  $-3$  V. The transceiver does not accept a positive voltage. Non-matched ALC and RF power settings could overheat or damage the linear amplifier.
- The IC-9100 SEND terminal (ACC connector pin 3) is rated at 16 V/0.5 A DC. If this value is exceeded, a larger external relay must be used.

## ■ External antenna tuner connection

### ◇ Connecting the AH-4

⚡ The AH-4 must be connected to [ANT1].

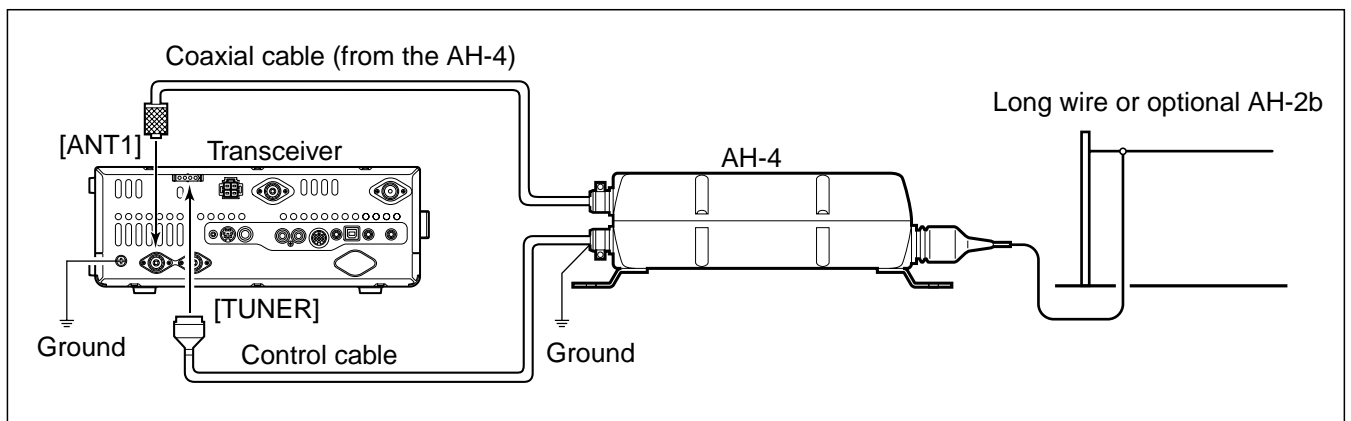

## Microphone connector information

(Front panel view)

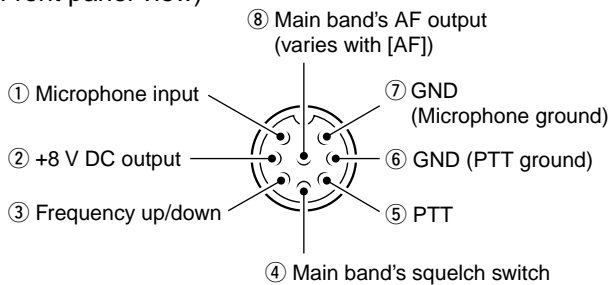

[MIC] Pin No.	FUNCTION	DESCRIPTION
②	+8 V DC output	Max. 10 mA
③	Frequency up	Ground
	Frequency down	Ground through 470 Ω
④	Squelch open	"Low" level
	Squelch closed	"High" level

**CAUTION: DO NOT** short pin 2 to ground as this can damage the internal 8 V regulator. DC voltage is applied to pin 1 for microphone operation. Use caution when using a non-Icom microphone.

2

## Microphones

### ◇ HM-36

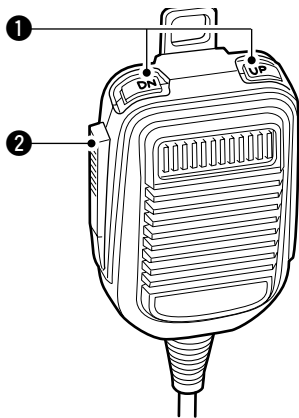

#### ① UP/DOWN SWITCHES [UP]/[DN]

- Push to change the frequency or memory channel.
- While holding down, the frequency or memory channel number continuously increases or decreases.
  - While in the split frequency mode, and holding down [XFC], push to change the transmit frequency.
  - The [UP]/[DN] switch can be used as a key paddle if the "MIC Up/Down Keyer" item setting is "ON" in the Keyer Set mode. In such case, the frequency and memory channel cannot be changed using the [UP]/[DN] switches. (p. 55)
  - You can set the dot-dash polarity of the [UP]/[DN] switch in the "Paddle Polarity" item of the Keyer Set mode. When "Normal" is selected, [UP] sends a dash, and [DN] sends a dot. (p. 55)

### ◇ SM-50 (Option)

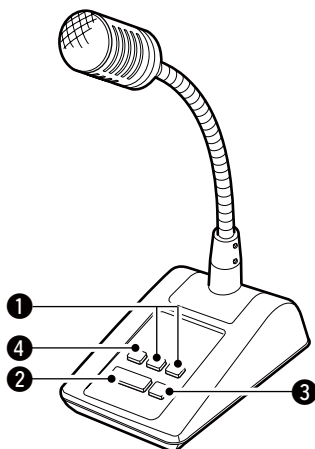

#### ② PTT SWITCH

Hold down to transmit; release to receive.

#### ③ PTT LOCK SWITCH (available on only the SM-50)

Push to toggle between transmit and receive.

#### ④ LOW CUT SWITCH (available on only the SM-50)

Push to cut out the low frequency components of input voice signals.

### ■ Before first applying power

Before turning ON your transceiver for the first time, make sure all connections required for your system are complete by reviewing them in Section 2 of this manual.

After all connections have been made, set controls and switches as shown in the illustration below.

CW : Max. clockwise  
CCW : Max. counterclockwise

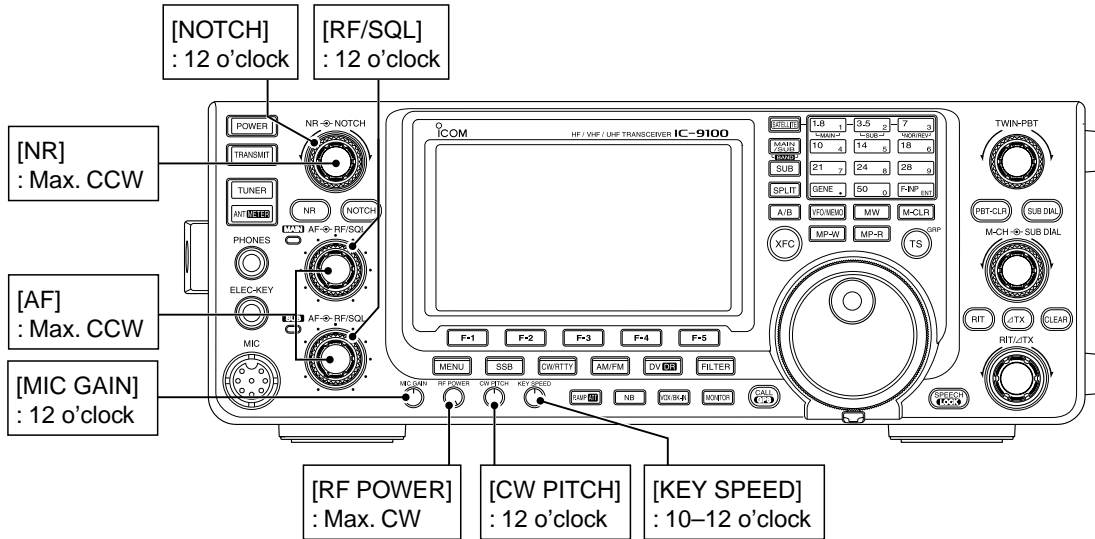

### ■ Turning ON (Partial resetting)

#### First time to Power ON:

Reset the transceiver using the following procedure.

▨ A partial resetting **CLEARs** the operating parameters to their default values (VFO frequency, VFO settings, menu group's contents) without clearing certain data. See page 181 for details.

- ① Make sure the transceiver's power is OFF.
- ② While holding down both [F-INP ENT] and [VFO/MEMO], push [POWER] to turn ON the transceiver.
  - During start-up, the transceiver displays "PARTIAL RESET," then its initial VFO frequencies when resetting is complete.
  - If you operate the transceiver before "PARTIAL RESET" disappears, the resetting will be cancelled.
- ③ Change the Set mode settings to suit your operating needs. (p. 161)

#### Normal Power ON:

Push [POWER] to turn ON the transceiver.

#### Power OFF:

Hold down [POWER] for 1 second to turn OFF the transceiver.

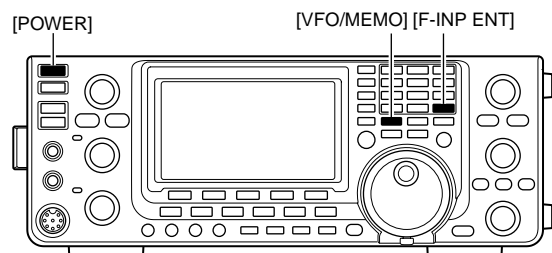

◀ PARTIAL RESET ▶

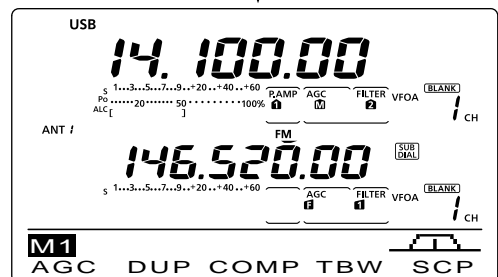

Initial VFO display



## ■ MAIN and SUB Bands

The IC-9100 can operate on the HF/50 MHz, 144 MHz, 430 MHz and 1200 MHz\* frequency bands. These frequency bands can be assigned to the MAIN and SUB Bands for operating convenience.

The frequency band, selected in either the MAIN or SUB Band, cannot be selected on the other Band. For example, if the MAIN Band is set to operate on any frequency within the HF/50MHz band, the SUB Band can simultaneously receive on only the 144 MHz, 430 MHz and 1200 MHz\* frequency bands, or visa versa.

\*The optional UX-9100 is required for the 1200 MHz frequency band operation.

### ◇ MAIN/SUB Band selection

The LCD display shows both the MAIN and SUB Band frequencies. Both Bands can receive signals simultaneously, but not on the same frequency band. Set the frequency band you want to transmit or be called on, as the MAIN Band.

➔ Push [MAIN/SUB] to toggle the MAIN and SUB Bands.

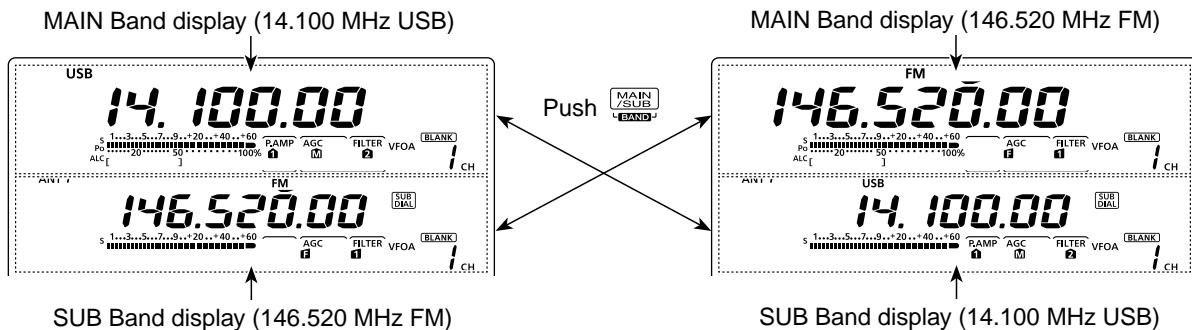

### ◇ SUB Band display

The SUB Band display can be turned OFF to simplify operation.

➔ Hold down [SUB] for 1 second to turn the SUB Band display ON or OFF.

- Nothing is displayed on the SUB Band display when it is turned OFF.

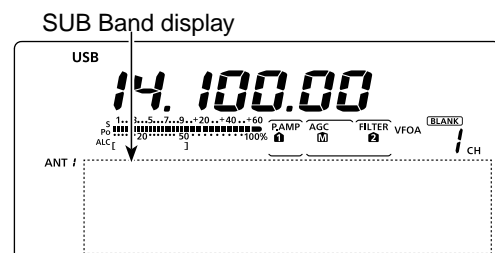
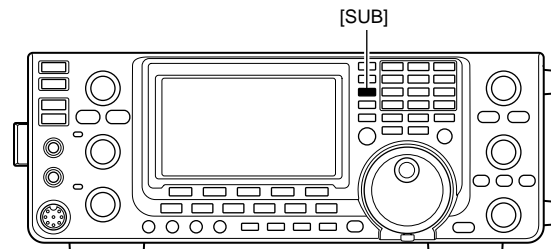

When the SUB Band display is OFF

Both MAIN and SUB Bands have independent features.

**MAIN Band :** Used for both transmitting and receiving. The MAIN Band area is in the upper half of the LCD display.

**SUB Band :** Used for only receiving. The SUB Band area is in the lower half of the LCD display.

### About transmitting

You can transmit on only the MAIN Band— not on the SUB Band. However, while operating in the Satellite mode, you can transmit on the SUB Band.

◇ SUB Band setting mode operation

Normally, tuning, operating mode selection, memory channel selection and programming, are made for the MAIN Band.

When the SUB Band setting mode is ON, the settings and selections are for only the SUB Band.

- You cannot transmit on the SUB Band.
- You cannot make Main Band settings.

- ➔ Push [SUB] to turn the SUB Band setting mode ON or OFF.
  - “[SUB]” appears when the SUB Band setting mode is ON.

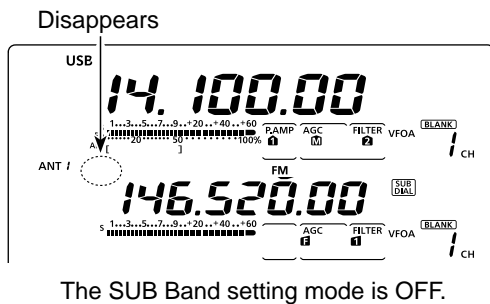
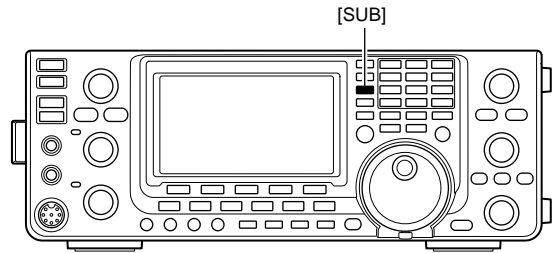

Push [SUB]

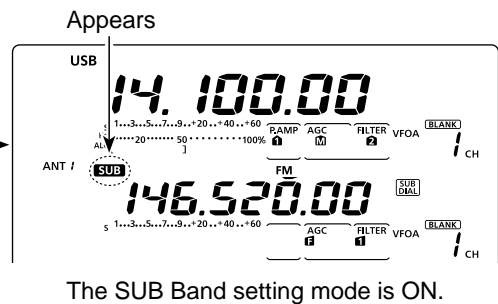

◇ The SUB Dial function

The [SUB DIAL] control's tuning Band and frequency steps differ, depending on the combination of the SUB Dial function and SUB Band setting mode, and the status of the quick tuning function.

- ➔ Push [SUB DIAL] to turn the SUB Dial function ON or OFF.
  - “[SUB DIAL]” appears when the function is ON.

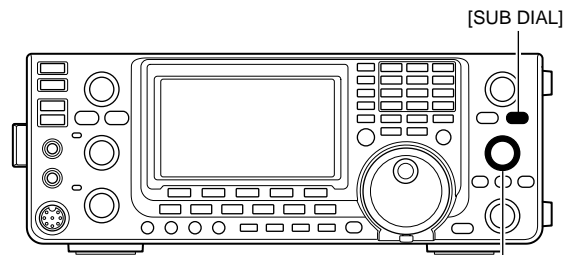

[SUB DIAL] control

About the Tuned Band with the [SUB DIAL] control

SUB Dial function (“[SUB DIAL]” appears when ON is selected.)	SUB Band setting (“[SUB]” appears when ON is selected.)	Tuned Band
ON	ON	SUB Band*
ON	OFF	SUB Band*
OFF	ON	SUB Band†
OFF	OFF	MAIN Band†

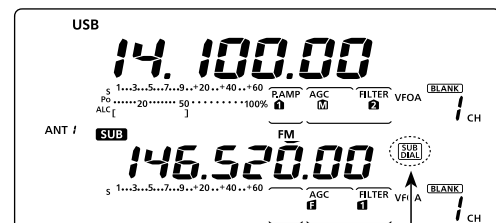

Appears when the SUB Dial function is ON.

\* The frequency changes in 1 Hz, 10 Hz, 1 MHz or pre-set kHz steps, depending on the quick tuning step setting. (p. 38)

† The frequency changes in the programmed kHz steps, even if the quick tuning is OFF.

## ■ VFO description

The IC-9100 has two VFOs; “A” and “B,” for each MAIN and SUB Bands, and are convenient for quickly selecting two frequencies, or split frequency operation. You can use either VFO to call up a frequency and operating mode.

VFO is an abbreviation of Variable Frequency Oscillator.

### ◇ Selecting the VFO A/B

- ➔ Push [A/B] to switch between the VFO A and VFO B.
  - “VFO A” or “VFO B” appears when the VFO is selected.

### ◇ VFO equalization

- ➔ Hold down [A/B] for 1 second to equalize the data in both VFOs.
  - 3 beeps sound when the equalization is complete.

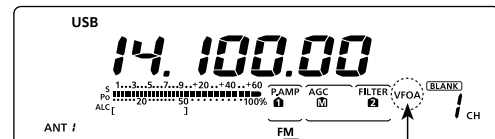
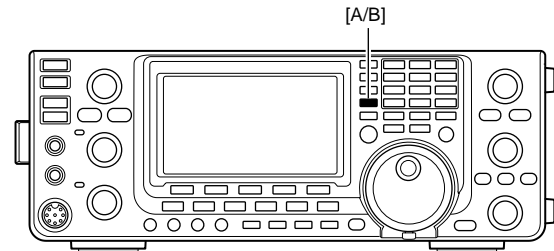

The selected VFO icon

#### Displayed VFO

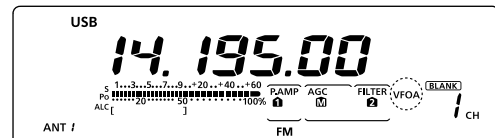

- ① Hold down
- ③ Push

#### Undisplayed VFO

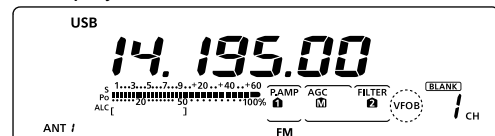

### CONVENIENT!

#### Use two VFOs as quick memories:

When you find a new station, but wish to continue searching, the dual VFO system can be used for quick memory storage.

- ① Hold down [A/B] for 1 second to store the displayed contents into the undisplayed VFO.
- ② Continue searching for stations.
- ③ Push [A/B] to show the stored contents on the undisplayed VFO.
- ④ To continue searching for stations, push [A/B] again to show the displayed VFO.

## ■ Selecting VFO/memory mode

- ➔ Push [VFO/MEMO] to switch between the VFO and memory modes.
  - “VFO A” or “VFO B” appears when in the VFO mode, or “MEMO” appears when in the memory mode.
  - Holding down [VFO/MEMO] for 1 second copies the contents of the selected memory channel into the displayed VFO. (p. 142)

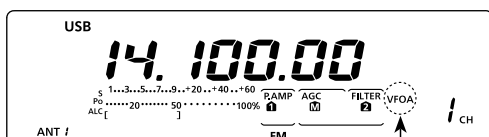
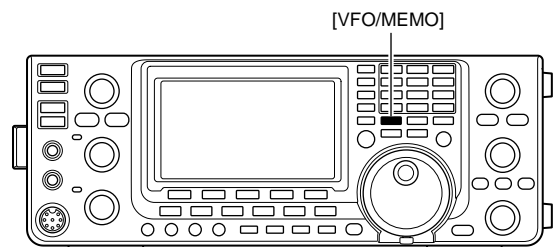

The selected VFO icon

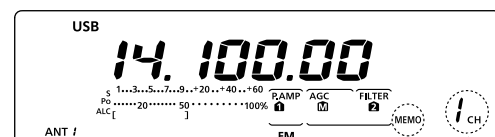

Memory icon

Memory channel number

## ■ Selecting a frequency band

The frequency band you want to use can be selected in the MAIN and SUB Bands.

Before changing the frequency band on the SUB Band, push [SUB] to turn ON the SUB Band setting mode.

In addition to the HF/50 MHz, 144 MHz and 430 MHz frequency bands, the IC-9100 can operate on the 1200 MHz frequency band\*<sup>1</sup>.

- ① Hold down [BAND](MAIN/SUB) for 1 second one or more times until the desired frequency of the bands that are stored in the MAIN or SUB Band, whichever you selected.
- ② To call up the previously selected frequency and operating mode, push a band key or [GENE •] if the HF/50 MHz frequency band was selected in step ①, or push [GENE •] if the 144 MHz, 430 MHz or 1200 MHz frequency band\*<sup>1</sup> was selected.

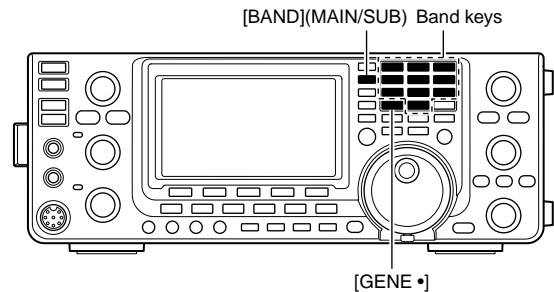

**NOTE:** The same frequency band cannot be simultaneously selected in both MAIN and SUB Bands. The frequency band, selected in either the MAIN or SUB Band, cannot be selected on the other Band.

## ◇ Using the band stacking registers

The triple band stacking register provides 3 memories for each band key to store frequencies and operating modes.

This function is convenient when you operate 3 operating modes on one frequency band.

For example, one register can be used for a CW frequency, another for an SSB frequency and the other one for an RTTY frequency.

If a band key or [GENE •]\* is pushed once, the last used frequency and operating mode are called up. When the key is pushed again, another stored frequency and operating mode are called up.

\* If you are using a frequency band other than HF/50 MHz, you can call up the HF/50 MHz frequency band by pushing the band keys ([1.8 1] to [50 0] or [GENE •]).

See the table below for a list of the available frequency bands and their default frequency and mode settings.

BAND	REGISTER 1	REGISTER 2	REGISTER 3
1.8 MHz* <sup>1</sup>	1.900000 MHz CW	1.910000 MHz CW	1.915000 MHz CW
3.5 MHz* <sup>1</sup>	3.550000 MHz LSB	3.560000 MHz LSB	3.580000 MHz LSB
7 MHz	7.050000 MHz LSB	7.060000 MHz LSB	7.020000 MHz CW
10 MHz* <sup>1</sup>	10.120000 MHz CW	10.130000 MHz CW	10.140000 MHz CW
14 MHz	14.100000 MHz USB	14.200000 MHz USB	14.050000 MHz CW
18 MHz	18.100000 MHz USB	18.130000 MHz USB	18.150000 MHz USB
21 MHz	21.200000 MHz USB	21.300000 MHz USB	21.050000 MHz CW
24 MHz	24.950000 MHz USB	24.980000 MHz USB	24.900000 MHz CW
28 MHz	28.500000 MHz USB	29.500000 MHz USB	28.100000 MHz CW
50 MHz* <sup>1</sup>	50.100000 MHz USB	50.200000 MHz USB	51.000000 MHz FM
144 MHz	145.000000 MHz FM	145.100000 MHz FM	145.200000 MHz FM
430 MHz* <sup>1</sup>	433.000000 MHz FM	433.100000 MHz FM	433.200000 MHz FM
1200 MHz* <sup>1*2</sup>	1295.000000 MHz FM	1295.100000 MHz FM	1295.200000 MHz FM
General* <sup>3</sup>	15.000000 MHz USB	15.100000 MHz USB	15.200000 MHz USB

\*<sup>1</sup> The default frequency and mode settings are differ depending on the version. Above list shows the USA version's.

\*<sup>2</sup> The optional UX-9100 is required for the 1200 MHz frequency band operation.

\*<sup>3</sup> [GENE •] selects the general coverage band.

**(Frequency band: HF/50 MHz)**

- ① Hold down [BAND](MAIN/SUB) for 1 second one or more times until a HF/50 MHz frequency band is displayed.
- ② Push a band key ([1.8 1] to [50 0] or [GENE •]).
  - The previously selected frequency and operating mode are called up as the first band stacking register of that frequency band.
- ③ Select a frequency and an operating mode, and then push the band key.
  - The selected frequency and mode are memorized as that frequency band's first band stacking register.
- ④ Select another frequency and operating mode, and then push the band key.
  - The selected frequency and mode are memorized as that frequency band's second band stacking register.
- ⑤ Select another frequency and operating mode, and then push the band key.
  - The selected frequency and mode are memorized as that frequency band's third band stacking register.
- ⑥ The first band stacking register set in step ③, is called up.
  - When the frequency band key is pushed, the memorized triple band stacking registers are sequentially called up.

**[Example]: 14 MHz frequency band**

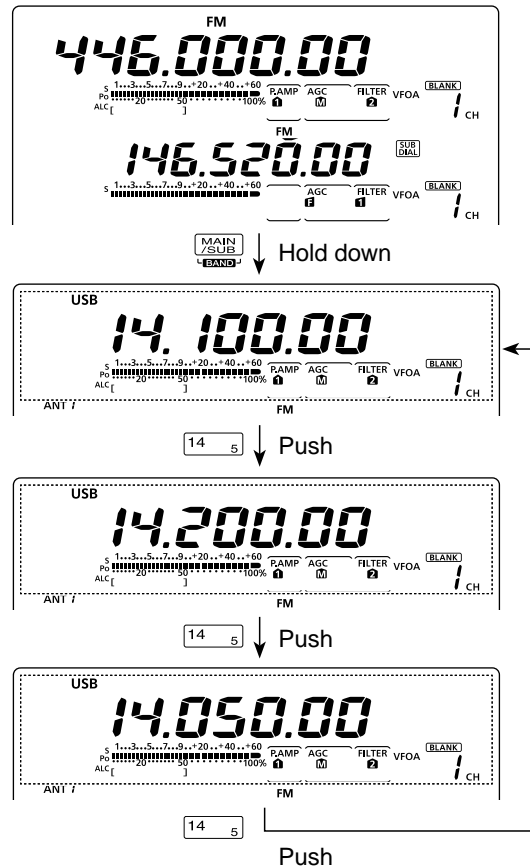

**(Frequency band: 144/430/1200 MHz)**

- ① Hold down [BAND](MAIN/SUB) for 1 second one or more times until a 144 MHz, 430 MHz or 1200 MHz frequency band is displayed.
  - The previously selected frequency and an operating mode are called up as the first band stacking register of that frequency band.
- ② Select a frequency and an operating mode, and then push [GENE •].
  - The selected frequency and mode are memorized as that frequency band's first band stacking register.
- ③ Select another frequency and operating mode, and then push [GENE •].
  - The selected frequency and mode are memorized as that frequency band's second band stacking register.
- ④ Select another frequency and operating mode, and then push [GENE •].
  - The selected frequency and mode are memorized as that frequency band's third band stacking register.
- ⑤ The first band stacking register set in step ②, is called up.
  - When [GENE •] is pushed, the memorised triple band stacking registers are sequentially called up.

**[Example]: 430 MHz frequency band**

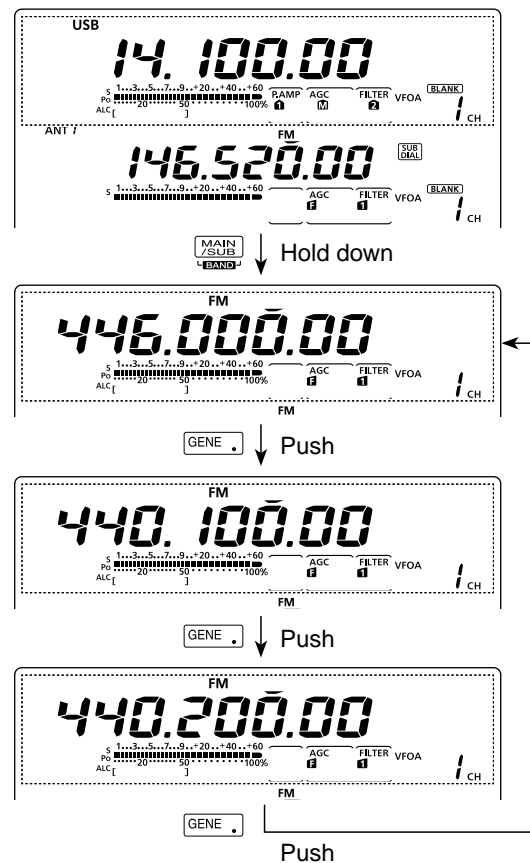

The optional UX-9100 is required for 1200 MHz frequency band operation.

## Frequency setting

You can select the transceiver's frequency by using [MAIN DIAL], or you can enter it using the keypad.

### ◇ Tuning with [MAIN DIAL]

- ① Select the desired frequency band.
  - Hold down [BAND](MAIN/SUB) for 1 second one or more times until the desired frequency band is displayed.
  - Push the desired band key on the keypad or [GENE •] 1–3 times.  
3 different frequencies on each frequency band can be selected with the band key. (See “Using the band stacking registers” on page 35.)
  - The default tuning step differs, depending on the operating mode, frequency band and a version.
- ② Rotate [MAIN DIAL] to set the desired frequency.

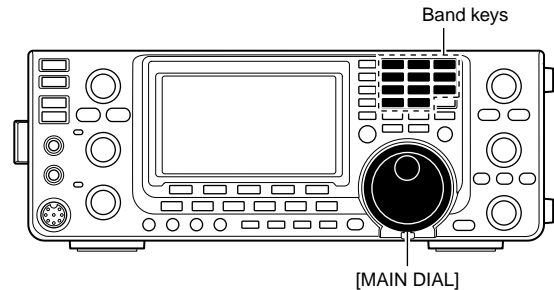

▨ If the Dial Lock function is ON, “**LOCK**” is displayed, and [MAIN DIAL] does not function.  
In this case, hold down [SPEECH/LOCK] for 1 second to turn OFF the lock function. (p. 77)  
▨ When “LOCK/SPEECH” is selected in the “[SPEECH/LOCK] SW” item of the Set mode, pushing [SPEECH/LOCK] turns OFF the lock function. (see p. 164 for details)

### ◇ Direct frequency entry with the keypad

The transceiver has a keypad for direct frequency entry, as described below.

- ① Push [F-INP ENT] to enter frequencies with the keypad.
  - All frequency digits disappear.
- ② Push the numeric keys to input the desired frequency.
  - Push [GENE •] to input a “.” (decimal point) between the 1 MHz digits and 100 kHz digits.
- ③ Push [F-INP ENT] to set the input frequency.
  - To cancel the input, push [EXIT/SET] before pushing [F-INP ENT].

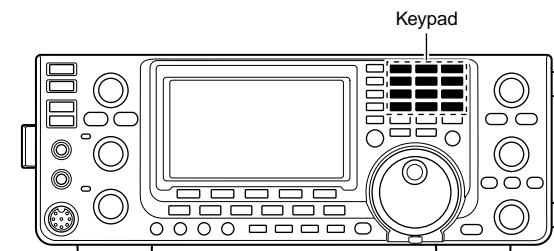

▨ **NOTE:** The frequency band, selected in either the MAIN or SUB Band, cannot be selected on the other Band.

#### [EXAMPLE]

##### 14.025 MHz

[F-INP\_ENT] 1.8 1 10 4 [GENE\_•] 50 0 3.5 2 14 5 [F-INP\_ENT]

##### 18.0725 MHz

[F-INP\_ENT] 1.8 1 24 8 [GENE\_•] 50 0 21 7 3.5 2 14 5 [F-INP\_ENT]

##### 706 kHz

[F-INP\_ENT] 50 0 [GENE\_•] 21 7 50 0 18 6 [F-INP\_ENT]

##### 5.100 MHz

[F-INP\_ENT] 14 5 [GENE\_•] 1.8 1 [F-INP\_ENT]

##### 7.000 MHz

[F-INP\_ENT] 21 7 [F-INP\_ENT]

##### 21.280 MHz ↔ 21.245 MHz

[F-INP\_ENT] [GENE\_•] 3.5 2 10 4 14 5 [F-INP\_ENT]

### ◇ Quick Tuning function

The operating frequency can be changed in 'kHz' or 'MHz' steps for quick tuning.

Select the desired tuning step in each operating frequency band and mode.

- ① Push [TS] to select the 'kHz' or 'MHz' Quick Tuning function step, or turn it OFF.
  - While the quick tuning icon, "▼," is displayed above the 1 kHz or 1 MHz digit, the frequency will be changed in 'kHz' or 'MHz' steps.
  - When the function is OFF, the frequency will be changed in 10 Hz steps.
- ② Rotate [MAIN DIAL] to change the frequency in the selected steps.

#### NOTE:

- To turn OFF the Quick Tuning function, push [TS] again. ("▼" disappears)
- When the Quick Tuning function is OFF, the frequency will be changed in 10 Hz steps.

### ◇ Selecting 'kHz' step

When the 'kHz' quick tuning is selected, the frequency can be changed in the selected 'kHz' steps.

The MAIN and SUB Bands use the common 'kHz' tuning step. You can select it in both Band's.

- ① Push [TS] to turn ON the Quick Tuning function.
  - "▼" appears.
- ② Hold down [TS] for 1 second to display the "TS" screen to select the quick tuning step.
- ③ Select the desired operating mode.
- ④ Rotate [MAIN DIAL] to select the desired 'kHz' step.
  - 0.1, 1, 5, 6.25, 9, 10, 12.5, 20, 25, 50 and 100 kHz are selectable.
  - Hold down [F-3] for 1 second to return to the default setting, if desired.
- ⑤ Repeat steps ③ and ④ to select quick tuning steps for other modes.
- ⑥ Push [TS] to exit the "TS" screen.

NOTE: To display the "TS" screen, the Quick Tuning function must be turned ON first.

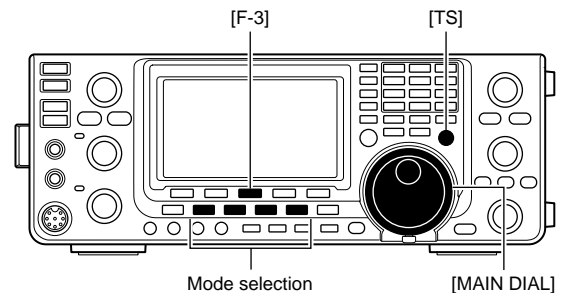
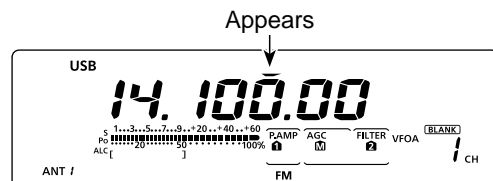
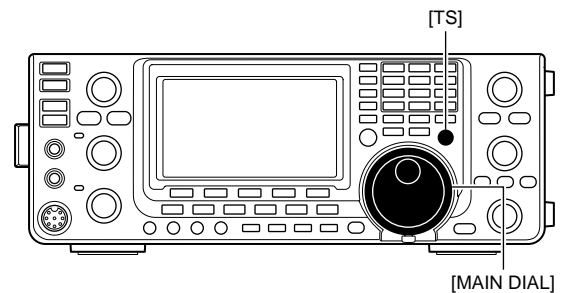

■ Frequency setting (Continued)

◇ **Selecting 1 Hz step**

You can change the frequency in 1 Hz steps for fine tuning.

- ① Push [TS] to turn OFF the Quick Tuning function.
- ② Hold down [TS] for 1 second to turn the 1 Hz tuning step ON or OFF.

**NOTE:**

- When RIT and/or ΔTX are used, they also tune in 1 Hz tuning steps.
- The frequency changes in 50 Hz steps when the [UP]/[DN] switches of the microphone are used for frequency tuning (if the quick tuning function is not selected.)

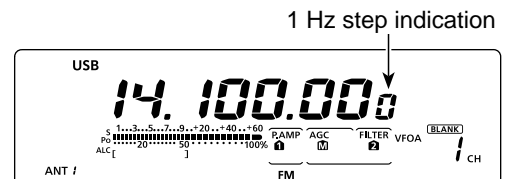
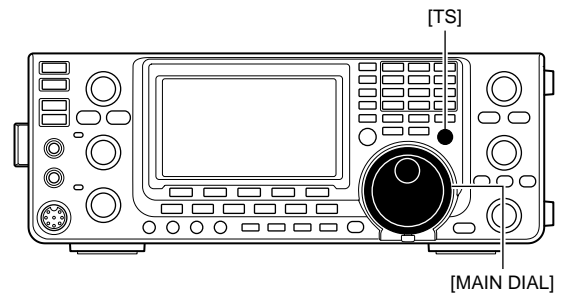

◇ **Auto tuning step function**

When you rotate [MAIN DIAL] rapidly, the tuning speed can automatically accelerate, depending on the "MAIN DIAL Auto TS" option in the Set mode.

- ① Hold down [MENU] for 1 second to enter the Set mode.
- ② Push [▲](F-1) or [▼](F-2) to select "MAIN DIAL Auto TS."
- ③ Rotate [MAIN DIAL] to select the HIGH or LOW tuning speed acceleration, or to turn OFF the function.
  - HIGH: When the tuning step is set to 1 kHz or smaller steps, the tuning speed is approximately five times faster. When the tuning step is set to 5 kHz or larger steps, the tuning speed is approximately two times faster. (default)
  - LOW : Approximately two times faster
  - OFF : Auto tuning step is turned OFF.
- ④ Push [MENU] to save, and exit the Set mode.

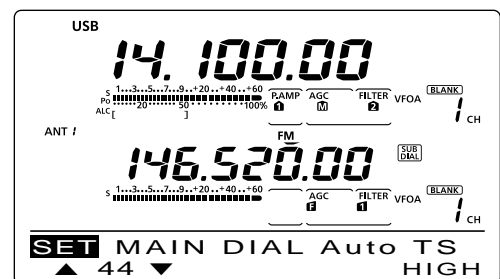
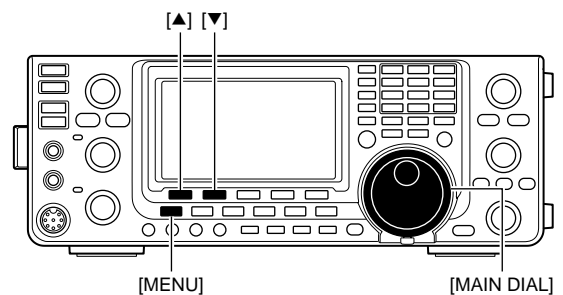

HIGH (default)

◇ **1/4 tuning step function**

**(Mode: SSB-D/CW/RTTY)**

The dial speed is reduced to 1/4 of the normal speed when the 1/4 tuning function is ON, for finer tuning control.

You can set the 1/4 tuning function in each operating frequency band.

This function is selectable only when the quick tuning function is turned OFF.

- ① Push [MENU] to display the "M1" screen (menu 1).
- ② Push [1/4](F-3) to turn the 1/4 tuning function ON or OFF.
  - "1/4" appears when the 1/4 tuning function is ON.

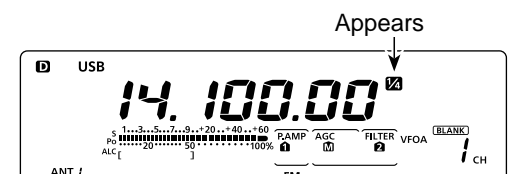
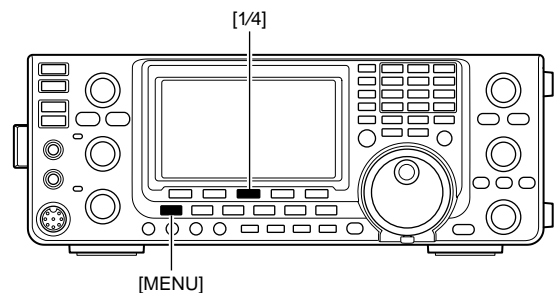

Appears



### ◇ About the 5 MHz frequency band operation (only USA version)

Operation on the 5 MHz band is allowed on 5 discrete frequencies and must adhere to the following:

- The USB mode
- Maximum of 50 watts ERP (Effective Radiated Power)
- 2.8 kHz bandwidth

It's your responsibility to set all controls so that transmission in this band meets the stringent conditions under which amateur operations may use these frequencies.

**NOTE:** We recommend that you store these frequencies, mode and filter settings into memory channels for easy recall.

\*The FCC specifies center frequencies on the 5 MHz band. However, the IC-9100 displays carrier frequency. Therefore, tune the transceiver to 1.5 kHz below the specified FCC channel center frequency.

IC-9100 Displayed Frequency*	FCC Channel Center Frequency*
5.33050 MHz	5.33200 MHz
5.34650 MHz	5.34800 MHz
5.36650 MHz	5.36800 MHz
5.37150 MHz	5.37300 MHz
5.40350 MHz	5.40500 MHz

To assist you in operating the 5 MHz band within the rules specified by the FCC, transmission is illegal on any 5 MHz band frequency other than the five frequencies shown in the table above.

■ Frequency setting (Continued)

◇ **Band edge warning beep**

You can hear a beep tone when you tune into or out of an amateur band's frequency range. A regular beep sounds when you tune into a range, and an lower tone error beep sounds when you tune out of a range.

- ① Hold down [MENU] for 1 second to enter the Set mode.
- ② Push [▲](F-1) or [▼](F-2) to select "Band Edge Beep."
- ③ Rotate [MAIN DIAL] to select the desired band edge warning beep setting.
  - OFF : Band edge beep is OFF.
  - ON (Default) : When you tune into or out of the default amateur band's frequency range, a beep sounds. (default)
  - ON (User) : When you tune into or out of a user programmed amateur band's frequency range, a beep sounds.
  - ON (User) & TX: When you tune into or out of a user programmed amateur band's frequency range, a beep sounds. Also transmission is inhibited outside the programmed range.
- ④ Hold down [F-3] for 1 second to reset to the default value.
- ④ Push [MENU] to save, and exit the Set mode.

/// The beep output level can be set in the "Beep Level" item of the Set mode. (p. 161)

**About the user band edge frequencies**

When "ON (User)" or "ON (User) & TX" is selected in the "Band Edge Beep" item, a total of 30 band edge frequencies can be programmed in the "User Band Edge" item. See the next page for details. If "OFF" or "ON (Default)" is selected, the "User Band Edge" item does not appear in the Set mode.

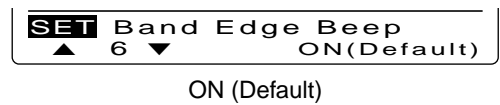
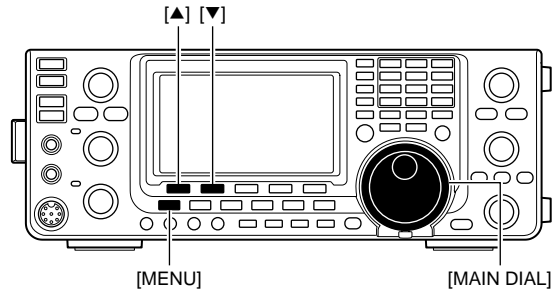

ON (Default)

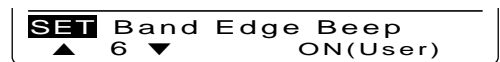

ON (User) selection

F-2

Push



[User Band Edge] item

### ◇ Programming the user band edge

When “ON (User)” or “ON (User) & TX” is selected in the “Band Edge Beep” item, the “User Band Edge” item appears in the Set mode.

A total of 30 band edge frequencies can be programmed in the “User Band Edge” item.

#### NOTE:

- All frequency ranges are set to default, so you should delete or change them to add the desired band edge frequency.
- Program each channel from left to right and each frequency must be higher than the preceding frequency.
- The frequency that is duplicated, or out of an amateur band, cannot be programmed.

- ① Hold down [MENU] for 1 second to enter the Set mode.
- ② Push [▲](F-1) or [▼](F-2) to select “Band Edge Beep.”
- ③ Rotate [MAIN DIAL] to select either “ON (User)” or “ON (User) & TX” option.
- ④ Push [▼](F-2) to select “User Band Edge.”
- ⑤ Push [EDT](F-4) to display the “EDG” screen (band edge program).
- ⑥ Push [▲](F-1) or [▼](F-2) to select the desired band edge.
  - Holding down [▲](F-1) or [▼](F-2) continuously selects the band edges.
  - Push [◀▶](F-3) to select the upper or lower band edge frequency entry status.
  - Hold down [DEL](F-5) for 1 second to delete the selected band edge.
  - Push [INS](F-4) to insert a new blank band edge.
- ⑦ Input the desired frequency with the keypad, then push [F-INP ENT].
  - Push [GENE ◦] to input decimal point (“.”) between the MHz and kHz digits.
- ⑧ Push [MENU] to save.
- ⑨ Push [MENU] again to exit the Set mode.

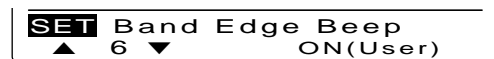
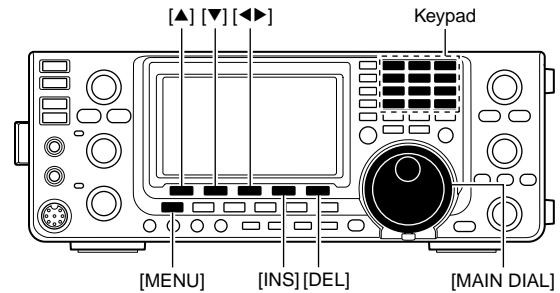

ON (User) setting in the  
“Band Edge Beep” item

F-2  
↓ Push



“User Band Edge” item

F-4  
↓ Push

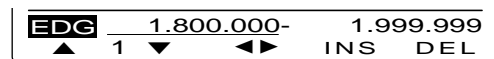

“EDG” screen



“User Band Edge” item

F-3  
↓ Hold down



Band edge initialize screen

F-4  
↓ Hold down



### To reset the band edge frequencies

If you want to reset the band edge frequencies to their default (initial) value, select the “User Band Edge” item, then hold down [DEF](F-3) for 1 second.

The band edge initialize screen appears, then hold down [YES](F-4) for 1 second to reset all band edge frequency settings to their default values.

## ■ Operating mode selection

The usable operating modes in the IC-9100 are listed to the right.

You can select the desired operating mode by pushing the mode switch.

See the diagram to the right for the order of selection.

▨ You can mute the microphone signals when the data mode is selected, depending on the "DATA MOD" option in the Set mode (p. 167).

### • Selecting the SSB mode

➡ Push [SSB] to select the USB or LSB mode.

- "LSB" or "USB" appears.
- When operating above 10 MHz, USB is selected first; when operating below 10 MHz, LSB is selected first.
- Push [SSB] again to toggle between USB and LSB.
- After USB or LSB is selected, hold down [SSB] for 1 second to select the data mode. ("D") appears)
- In the data mode, push [SSB] to return to the normal SSB mode.

### • Selecting the CW/RTTY mode

➡ Push [CW/RTTY] to select the CW or RTTY mode.

- "CW" or "RTTY" appears.
- Push [CW/RTTY] again to toggle between CW and RTTY.
- After CW or RTTY is selected, hold down [CW/RTTY] for 1 second to toggle between normal and reverse modes. ("CW-R" or "RTTY-R" appears.)

### • Selecting the AM/FM mode

➡ Push [AM/FM] to select the AM or FM mode.

- "AM" or "FM" appears.
- Push [AM/FM] again to toggle between AM and FM.
- After AM or FM is selected, hold down [AM/FM] for 1 second to select the data mode. ("D") appears)
- In the data mode, push [AM/FM] to return to the normal AM or FM mode.

#### ▨ NOTE:

- In the AM mode, you can transmit on only the HF/50MHz frequency bands.
- The AM mode cannot be selected on the 1200 MHz frequency band.

### • Selecting the DV mode (including DR mode)\*

➡ Push [DV•DR] to select the DV mode.

- "DV" appears.
- DV mode (digital voice + low-speed data communication) allows you to exchange the text message and call sign, and transmit a position data with a third-party GPS receiver.

➡ Hold down [DV•DR] to turn the DR (D-STAR® Repeater) mode operation ON or OFF.

- "DV" and "DR" appears.
- The DV mode is automatically selected when the DR mode is ON.
- DR (D-STAR Repeater) mode allows you to use a repeater list to operate a D-STAR repeater simply.

### • Usable operating modes

Mode switch	Operating mode	
[SSB]	USB	USB Data
	LSB	LSB Data
[CW/RTTY]	CW	CW Reverse
	RTTY	RTTY Reverse
[AM/FM]	AM	AM Data
	FM	FM Data
[DV•DR]	DV*	

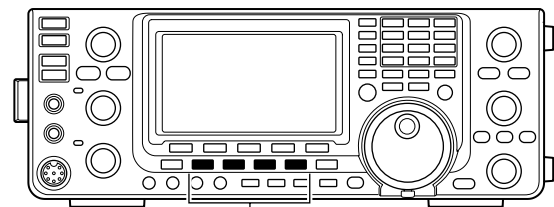

Mode switches

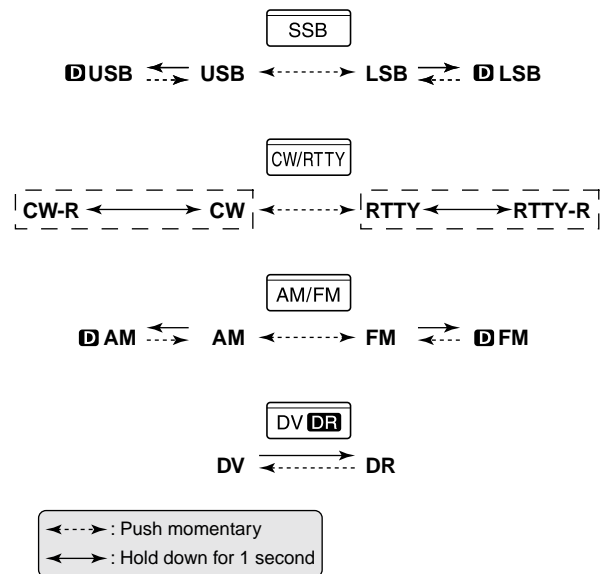

### INFORMATION!

The DV mode can be selected in either MAIN or SUB band. If you select the DV mode in both Bands, the transceiver cannot receive on the SUB Band.

The optional UT-121 is required for DV mode operation.

## ■ Squelch and receive (RF) sensitivity

Adjusts the RF gain and squelch threshold level. The squelch removes noise output to the speaker when no signal is received (closed squelch).

- The squelch is particularly effective for AM and FM, but can also be used in other modes.
- The 12 to 1 o'clock position is recommended for the most effective use of the [RF/SQL] control.
- [RF/SQL] can operate as only an RF gain control (Squelch is fixed open) or only a squelch control (RF gain is fixed at maximum sensitivity) depending on the "RF/SQL Control" option in the Set mode. (p. 162)

SET MODE SETTING	OPERATING MODE	[RF/SQL] OPERATION
RF+SQL (default)	FM/DV	Operates as an RF gain control, and a noise squelch or S-meter squelch.
	SSB/CW/RTTY/AM	Operates as an RF gain control, and an S-meter squelch.
SQL	ALL	Operates as only a squelch control. • RF gain is fixed at maximum sensitivity.
AUTO	SSB/CW/RTTY	Operates as only an RF gain control. • Squelch is fixed open.
	AM/FM/DV	Operates as only a squelch control. • RF gain is fixed at maximum sensitivity.

### ○ Adjusting RF gain (Receive sensitivity)

Normally, [RF/SQL] is set to the 12 o'clock position. Rotate [RF/SQL] to the 11 o'clock position for maximum sensitivity.

- Rotating counterclockwise from the maximum position reduces sensitivity.
- The S-meter indicates receive sensitivity.

While rotating the RF gain control, noise may be heard. This comes from the DSP unit and does not indicate an equipment malfunction.

### ○ Adjusting squelch (Removing non-signal noise)

Rotate [RF/SQL] clockwise when no signal is received, until the noise just disappears.

- The TX/RX indicator light goes out.
- Rotating [RF/SQL] past the threshold point activates the S-meter squelch— this allows you to set a minimum signal level needed to open the squelch.

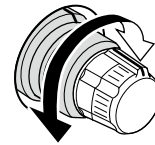
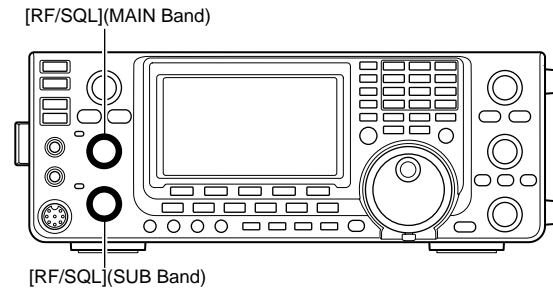

### • When functioning as an RF gain/squelch control

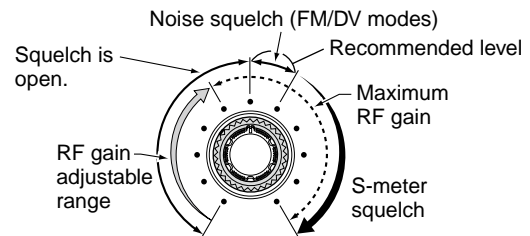

### • When functioning as an RF gain control (Squelch is fixed open; SSB, CW, RTTY only)

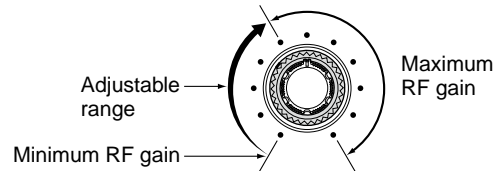

### • When functioning as a squelch control (RF gain is fixed at maximum.)

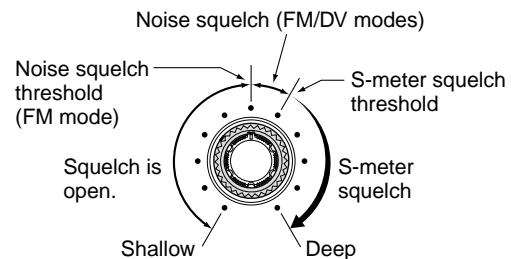

## Volume setting

➔ Rotate the [AF] control clockwise to increase the audio output level, counterclockwise to decrease it.

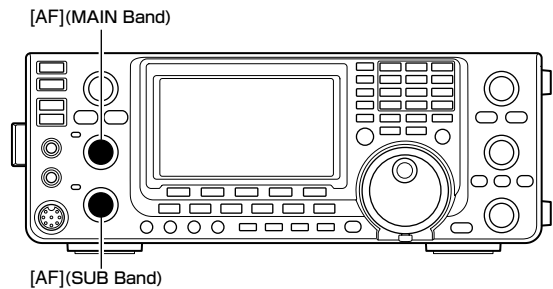
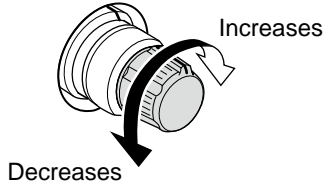

## Voice synthesizer operation

The IC-9100 has a built-in voice synthesizer to announce the operating frequency, mode and S-meter level in clear, electronically-generated voice, in English (or Japanese).

First, select the desired parameters to be announced in the Set mode. (p. 164)

### Initial values for the voice synthesizer parameters

- SPEECH Level : 50%
- SPEECH Language : English
- SPEECH Speed : HIGH
- SPEECH S-Level : ON
- SPEECH [MODE] SW : OFF
- [SPEECH/LOCK] SW : SPEECH/LOCK  
(See **NOTE** as described below.)

➔ Push [SPEECH/LOCK] to announce the currently selected frequency, mode and S-meter level\*.

\* The S-meter level announcement can be turned OFF. (p. 164)

**NOTE:** If “SPEECH/LOCK” is not selected in the “[SPEECH/LOCK] SW” item of the Set mode, you should hold down [SPEECH/LOCK] for 1 second to activate the voice synthesizer. (p. 164)

➔ Push a mode switch to announce the appropriate mode, when the “SPEECH [MODE] SW” item is set to “ON” in the Set mode. (p. 164)

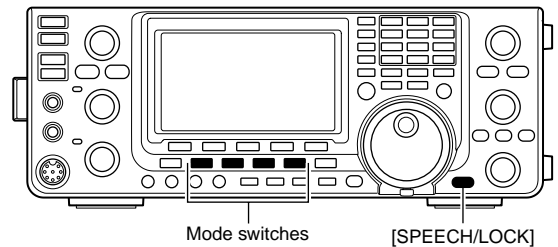

## Meter Display selection

The transmit meter can be toggled between three functions for your convenience.

The RF power meter is always displayed.

➔ Hold down [ANT•METER] for 1 second to toggle the transmit meter function between SWR, ALC and COMP.

- SWR : Displays the SWR of the antenna at the frequency.
- ALC : Displays the ALC level. When the meter movement shows the input signal level exceeds the allowable level, the ALC limits the RF power. In such cases, decrease the microphone gain level.
- COMP : Displays the compression level when the speech compressor is in use.

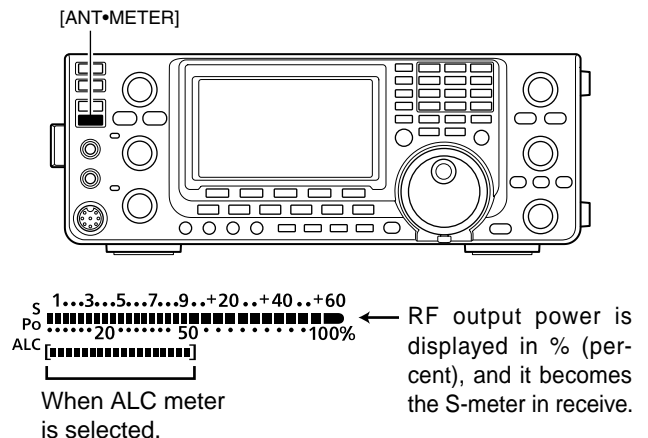

## Basic transmit operation

Before transmitting, monitor the operating frequency to make sure transmitting won't cause interference to other stations on the same frequency. It's good amateur practice to listen first, and then, even if nothing is heard, ask "Is the frequency in use?" once or twice, before you begin operating on that frequency.

### Transmitting

**CAUTION:** Transmitting without an antenna may damage the transceiver.

In the AM mode, you can transmit on only the HF/50MHz frequency bands.

- ① Push [PTT] on the microphone to transmit. (or [TRANSMIT] on the transceiver)
  - The MAIN Band TX/RX indicator lights red.
  - When in the satellite mode, the SUB Band TX/RX indicator lights red. (p. 156)
- ② Release [PTT] again to receive. (or push [TRANSMIT])

### Adjusting the transmit output power

Rotate [RF POWER].

Decreases ↙  ↘ Increases

Frequency band	RF output power range
HF/50 MHz	2 to 100 W (AM: 2 to 30 W)
144 MHz	2 to 100 W
430 MHz	2 to 75 W
1200 MHz	1 to 10 W

### Microphone gain adjustment

(Mode: SSB/AM/FM/DV)

- ① Push [PTT] to transmit.
  - Speak into the microphone at your normal voice level.
- ② In the SSB mode:
 

Hold down [ANT•METER] for 1 second to select the ALC meter. And then, while speaking into the microphone, rotate [MIC GAIN] so that the ALC meter reading stays within the ALC zone.

**In the AM, FM and DV modes:**

While speaking into the microphone, rotate [MIC GAIN] with another station listening to your voice for clarity.

Recommended level for Icom microphones  
Decreases ↙  ↘ Increases

- ③ Release [PTT] to receive.

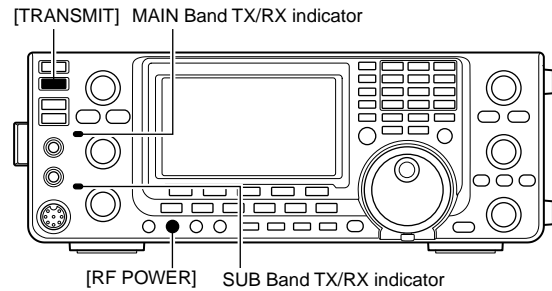

**NOTE:** When you transmit on the HF/50 MHz frequency bands, while monitoring an out of the amateur band frequency on VHF or UHF on the SUB band, the squelch on the SUB Band closes. Therefore, you cannot receive on the VHF or UHF frequency.

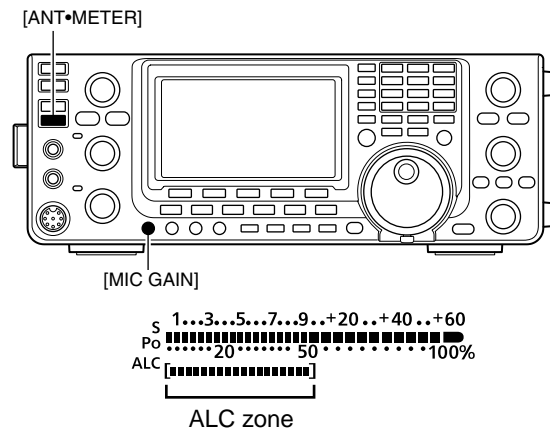

## ■ Operating SSB

- ① Select the desired frequency band. (p. 35)
- ② Push [SSB] to select the LSB or USB mode.
  - When operating above 10 MHz, USB is selected first; when operating below 10 MHz, LSB is selected first.
  - After USB or LSB is selected, hold down [SSB] for 1 second to select the data mode, if needed.
- ③ Rotate [MAIN DIAL] to tune a desired signal.
  - The S-meter indicates the received signal strength.
  - The tuning step can be changed using the tuning step program mode. (p. 38)
- ④ Rotate [AF] (MAIN Band) to adjust the audio to a comfortable listening level.
- ⑤ Push [PTT] on the microphone to transmit. (or [TRANSMIT] on the transceiver)
  - The TX/RX indicator (MAIN Band) lights red.
- ⑥ Speak into the microphone at your normal voice level.
  - Rotate [MIC GAIN] to adjust the microphone gain at this step, if necessary.
- ⑦ Release [PTT] to receive. (or push [TRANSMIT] again)

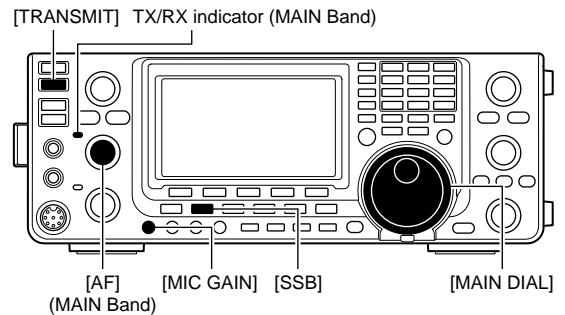

"LSB" or "USB" appears

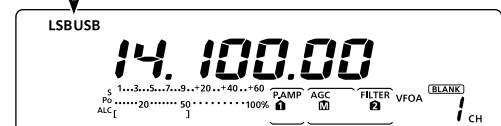

### Convenient Receive functions

- Preamp and attenuator (p. 71)
- Twin PBT (passband tuning) (p. 75)
- AGC (auto gain control) (p. 72)
- Noise blanker (p. 76)
- Noise reduction (p. 77)
- Notch filter (p. 77)
- VSC (voice squelch control) (p. 146)

### Convenient Transmit functions

- Speech compressor (p. 78)
- VOX (voice operated transmit) (p. 80)
- Tone control (p. 169)
- Transmit quality monitor (p. 81)
- Transmit filter width (p. 80)



## ■ Operating CW

- ① Select the desired frequency band. (p. 35)
- ② Push [CW/RTTY] to select CW.
  - After the CW mode is selected, hold down [CW/RTTY] for 1 second to toggle between CW and CW-R modes, if necessary.
- ③ Rotate [MAIN DIAL] to tune a desired signal.
  - The S-meter displays the received signal strength.
  - The tuning step can be changed using the tuning step program mode. (p. 38)
- ④ Rotate [AF] (MAIN Band) to adjust the audio to a comfortable listening level.
- ⑤ Push [TRANSMIT] to transmit.
  - The TX/RX indicator (MAIN Band) lights red.
- ⑥ Use the electric keyer or paddle to key your CW signals.
  - The Po meter indicates transmitted CW output power.
- ⑦ Adjust CW speed with [KEY SPEED].
  - Adjustable between 6 and 48 wpm (words per minute).
- ⑧ Push [TRANSMIT] to receive.

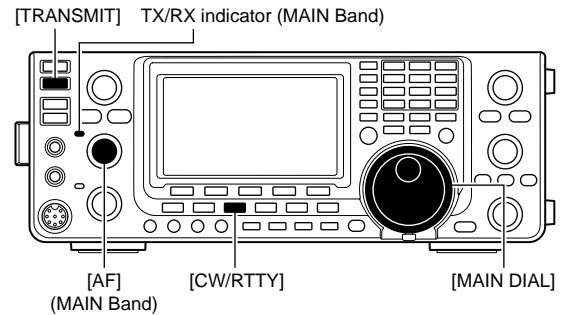

“CW” or “CW-R” appears

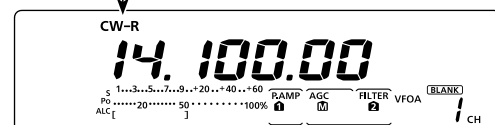

### Convenient Receive functions

- Preamp and attenuator (p. 71)
- Twin PBT (passband tuning) (p. 75)
- AGC (auto gain control) (p. 72)
- Noise blanker (p. 76)
- Noise reduction (p. 77)
- Manual Notch filter (p. 77)
- CW pitch control (p. 49)
- ¼ function (p. 39)

### Convenient Transmit functions

- Break-in function (p. 79)
- Keying speed setting (p. 49)
- Memory keyer (p. 50)

### ■ Operating CW (Continued)

#### ◇ About the CW reverse mode

The CW reverse mode receives signals with a reverse side CW carrier point similar to voice LSB and USB modes.

Use when interfering signals are near a desired signal and you want to reduce the interfering tone.

- ① Push [CW/RTTY] once or twice to select the CW mode.
- ② Hold down [CW/RTTY] for 1 second to toggle between CW and CW-R mode, if necessary.
  - Check that the interfering tone can be reduced.

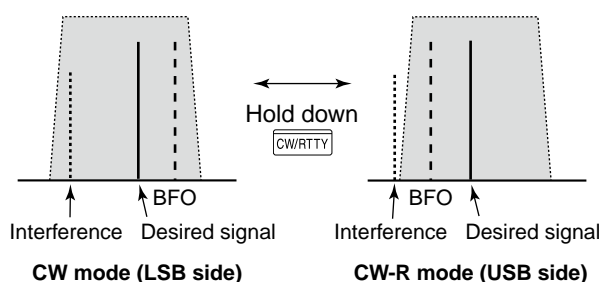

#### ◇ About CW pitch control

The received CW audio pitch and CW sidetone can be adjusted to suit your preference without changing the operating frequency.

- ➔ Rotate [CW PITCH] to suit your preference.
  - Adjustable from 300 to 900 Hz (in 5 Hz steps)

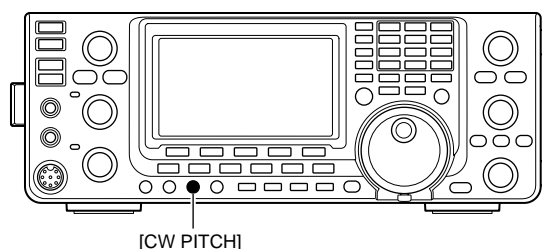

#### ◇ About keying speed

The transceiver's internal electronic keyer speed can be adjusted to between 6 and 48 wpm (words per minute).

- ➔ Rotate [KEY SPEED] clockwise to increase keying speed; counterclockwise to decrease it.

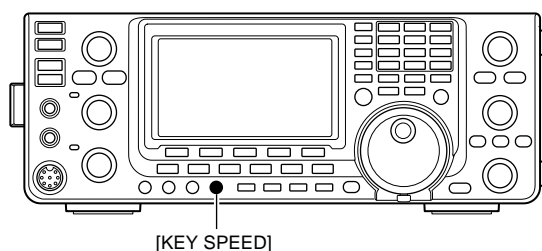

#### ◇ CW sidetone function

When the transceiver is in the receive mode (and the Break-in function is OFF— p. 79), you can listen to the CW sidetone without actually transmitting.

You can also use the CW sidetone to practice CW sending, but be sure to turn OFF the Break-in function.

The CW sidetone level can be adjusted in the “Side Tone Level” item of the Keyer Set mode (p. 54).

## ■ Electronic keyer functions

You can access a number of convenient functions of the built-in electronic keyer in the memory keyer menu.

- ① In the CW mode, push [MENU] to display the "M1" screen (Menu 1).
- ② Push [KEY](F-4) to display the "KEY" screen (Memory Keyer).
- ③ Push [SEND](F-2), [EDT](F-3), [001](F-4) or [SET] (F-5) to select the desired menu.  
See the diagram below.
  - Push [MENU] to return to the previous display.

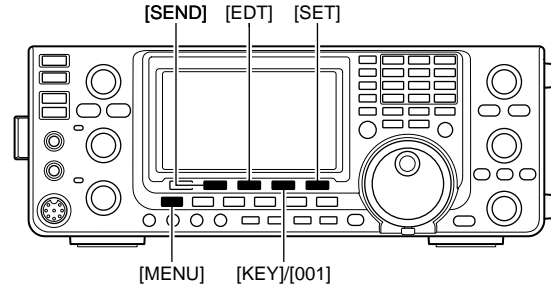

### ◇ Memory keyer menu construction

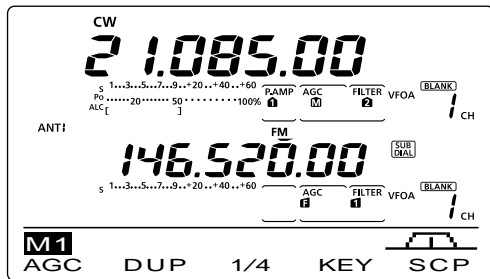

The screen you want to appear first can be selected in the "KEYER 1st Menu" item of the Set mode. (p. 165)

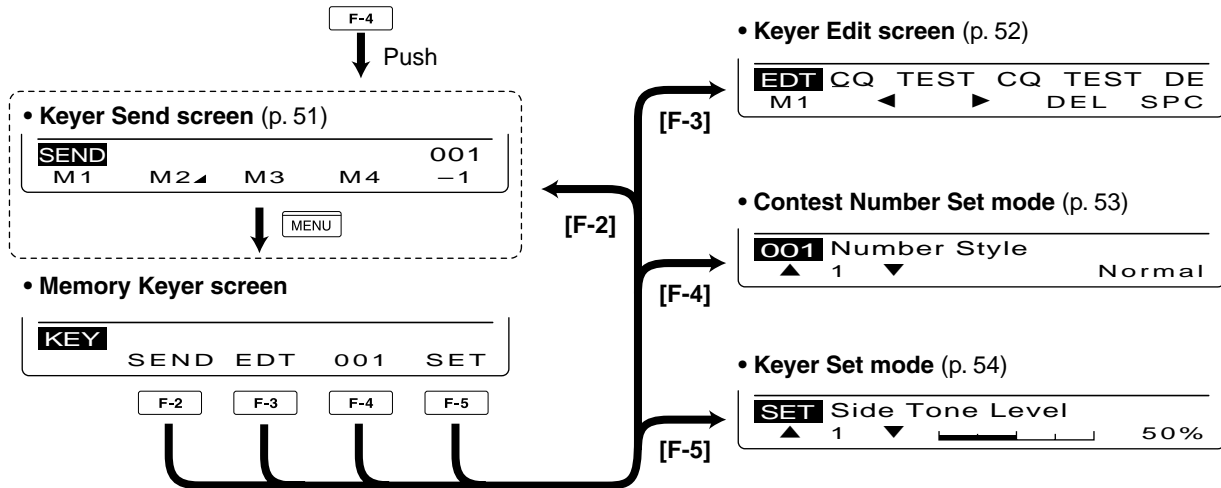

■ Electronic keyer functions (Continued)

◇ Memory keyer send menu

Pre-set characters can be sent using the Keyer Send menu. Contents of the memory keyer are set in the Edit menu.

• Transmitting

- ① In the CW mode, push [MENU] to display the “M1” screen (Menu 1).
- ② Push [KEY](F-4) to display the “KEY” screen (Memory Keyer).
- ③ Push [SEND](F-2) to display the “SEND” screen (Keyer Send).
- ④ Push [TRANSMIT] to switch the transceiver to transmit, or turn ON the Break-in function. (p. 79)
- ⑤ Push one of the function keys, [M1](F-1) to [M4](F-4), to send the memory keyer contents.
  - Holding down a function key for 1 second repeatedly sends the contents; push any function key to cancel the transmission.
  - The contest number counter advances each time the contents are sent.
  - Push [-1](F-5) to reduce the contest number advances by 1 before sending the memory keyer contents to a station a second time.
  - Set the memory keyer repeat interval to between 1 and 60 seconds (1 second steps) in the “Keyer Repeat Time” item of the Keyer Set mode. (p. 54)
- ⑥ Push [MENU] to return to the “KEY” screen (Memory Keyer).
- ⑦ Push [MENU] to return to the “M1” screen (Menu 1).

▨ For your information

When an external keypad is connected to pin 3 and pin 7 of the [MIC] connector, the contents of M1 to M4 can be transmitted without selecting the keyer send menu.  
See page 167 for details.

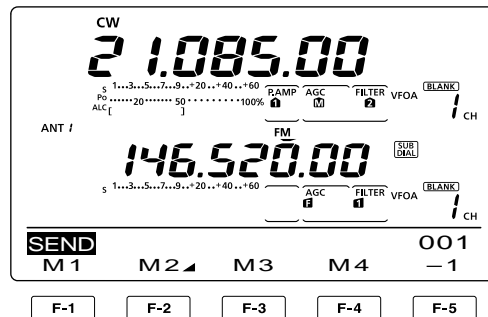

• M1 sending display



• M2 sending display

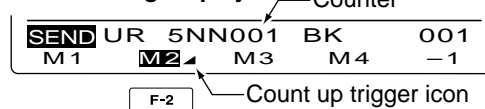

• M3 sending display

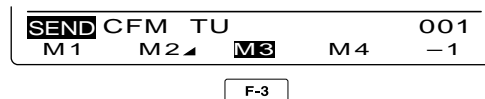

• M4 sending display

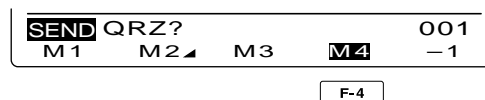

• While transmitting repeatedly

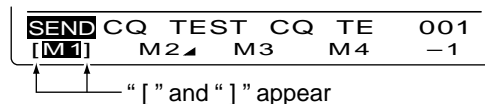

### ◇ Editing a memory keyer

The contents of the memory keyer memories can be set using the memory keyer edit menu. The memory keyer can memorize and re-transmit 4 CW key codes for often-used CW sentences, contest numbers or a count up trigger. The total capacity of the memory keyer is 70 characters per memory channel.

#### • Programming contents

- ① In the CW mode, push [MENU] to display the “M1” screen (Menu 1).
- ② Push [KEY](F-4) to display the “KEY” screen (Memory Keyer).
- ③ Push [EDT](F-3) to display the “EDT” screen (Keyer Edit).
  - The memory keyer content of Channel 1 (M1) is displayed.
- ④ Push [F-1] one or more times to select the memory keyer channel to be edited.
- ⑤ Rotate [MAIN DIAL] to select the desired character or symbol.

When inputting numbers or a decimal point, push the appropriate keypad key.

- Push [DEL](F-4) to delete the selected character, symbol or number.
- Push [SPC](F-5) to input a space.
- When the pre-programmed memory keyer reaches 70 characters, an error beep sounds. In this case, push [◀] (F-2) or [▶] (F-3) to select a character, then push [DEL] (F-4) to delete it.

#### Selectable characters and symbols

A to Z, /? ^ . , @ \*

- ⑥ Push [◀](F-2) to move the cursor backwards, or push [▶](F-3) to move the cursor forwards.
- ⑦ Repeat steps ⑤ and ⑥ to program up to 70 characters memory keyer contents.
- ⑧ Push [MENU] to save, and return to the “KEY” screen (Memory Keyer).
- ⑨ Push [MENU] to return to the “M1” screen (Menu 1).

#### NOTE:

“^” is used to transmit a string of characters with no inter-character space. Put “^” before a text string such as ^AR, and the string “AR” is sent with no space.

“\*” is used to insert the CW contest number. The number automatically advances by 1. This function is available for only one memory keyer channel at a time. “\*” is used in memory keyer channel M2 by default.

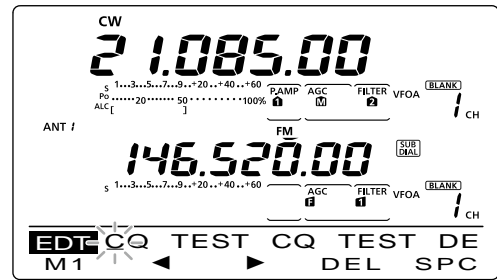

- F-1 Select M1 to M4
- F-2 Move the cursor backwards
- F-3 Move the cursor forwards
- F-4 Delete a character
- F-5 Input a space

#### • M2 default indication

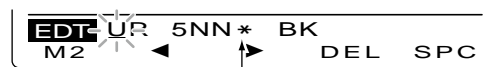

When inputting an asterisk, the counter is incremented by 1.

#### • M3 default indication

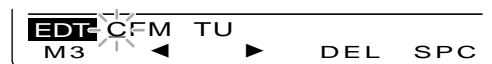

#### • M4 default indication

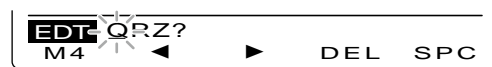

**Example display**— Inputting “QSL TU DE JA3YUA TEST” into the memory keyer channel 3 (M3).



#### Pre-programmed memory keyer contents

Memory keyer channel	Contents
M1	CQ TEST CQ TEST DE JA1 JA1 TEST
M2	UR 5NN* BK
M3	CFM TU
M4	QRZ?

## ■ Electronic keyer functions (Continued)

### ◇ Contest number Set mode

This mode is used to set the contest number, count up trigger and Present number.

#### • Setting contents

- ① In the CW mode, push [MENU] to display the “M1” screen (Menu 1).
- ② Push [KEY](F-4) to display the “KEY” screen (Memory Keyer).
- ③ Push [001](F-4) to enter the Contest Number Set mode.
- ④ Push [▲](F-1) or [▼](F-2) to select the desired item.
- ⑤ Rotate [MAIN DIAL] to select the desired option.
  - Hold down [F-3] for 1 second to reset to the default setting, if desired.
- ⑥ Push [MENU] to save, and return to the “KEY” screen (Memory Keyer).
- ⑦ Push [MENU] to return to the “M1” screen (Menu 1).

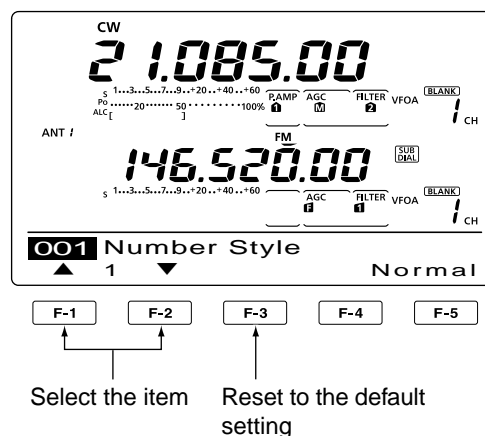

### 1. Number Style (Default: Normal)

This item sets the numbering system used for contest numbers— normal or short morse numbers.

Short morse numbers are also referred to as “cut” numbers.

- Normal : Does not use short morse numbers
- 190→ANO : Sets 1 as A, 9 as N and 0 as O.
- 190→ANT : Sets 1 as A, 9 as N and 0 as T.
- 90→ NO : Sets 9 as N and 0 as O.
- 90→ NT : Sets 9 as N and 0 as T.

### 2. Count Up Trigger (Default: M2)

Set the count-up trigger to one of four memory slots for the contest number exchange. The count-up trigger allows the contest number to automatically advance after each complete number exchange is sent.

- M1, M2, M3 or M4 can be set.

### 3. Present Number (Default: 001)

This item shows the current number for the count-up trigger channel set above.

- Rotate [MAIN DIAL] to change the number, or hold down [CLR](F-3) for 1 second to reset the current number to 001.

## ◇ Keyer Set mode

This Set mode is used to set the CW sidetone, memory keyer repeat time, dash weight, paddle specifications, keyer type, etc.

### • Setting contents

- ① In the CW mode, push [MENU] to display the “M1” screen (Menu 1).
- ② Push [KEY](F-4) to display the “KEY” screen (Memory Keyer).
- ③ Push [SET](F-5) to enter the Keyer Set mode.
- ④ Push [▲](F-1) or [▼](F-2) to select the desired item.
- ⑤ Rotate [MAIN DIAL] to select the desired option.
  - Hold down [F-3] for 1 second to reset to the default setting, if desired.
- ⑥ Push [MENU] to save, and return to the “KEY” screen (Memory Keyer).
- ⑦ Push [MENU] to return to the “M1” screen (Menu 1).

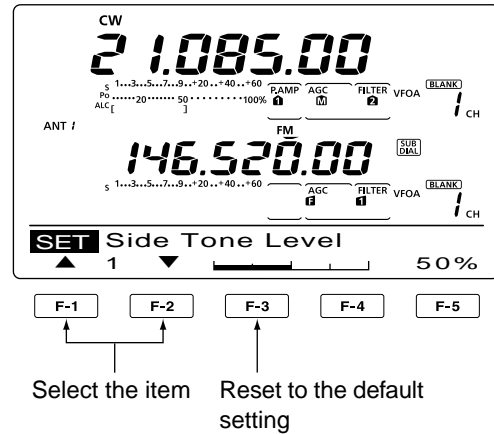

### 1. Side Tone Level (Default: 50%)

Select the CW sidetone output level.

- 0 to 100% in 1% steps can be selected.

### 2. Side Tone L-Limit (Default: ON)

Set the CW sidetone level limit. When the [AF] control is rotated above a specified level, the CW sidetone does not increase.

- ON : CW sidetone level is limited.
- OFF : CW sidetone level is not limited.

### 3. Keyer Repeat Time (Default: 2s)

When sending CW using the repeat timer, set the time between transmission.

- 1 to 60 seconds in 1 second steps can be selected.

### 4. Message Display (Default: Normal)

When you are in the “SEND” screen (Keyer Send), channel numbers are displayed above the function keys. However, you can display the first three characters of the keyer message instead of the channel number.

Select whether to display the channel number or the first three characters of the keyer.

- Normal : Displays the channel number.
- Message : Displays the first three characters of the keyer message.

### 5. Dot/Dash Ratio (Default: 1:1:3.0)

Set the dot/dash ratio.

- 1:1:2.8 to 1:1:4.5 (in 0.1 steps) can be selected.

Keying weight example: Morse code “K”

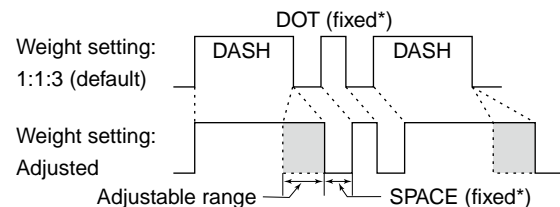

\*SPACE and DOT length can be adjusted with only [KEY SPEED].

### 6. Rise Time (Default: 4ms)

Set the rise time of the transmitted CW envelope.

- 2, 4, 6 or 8 milliseconds can be selected.

About rise time

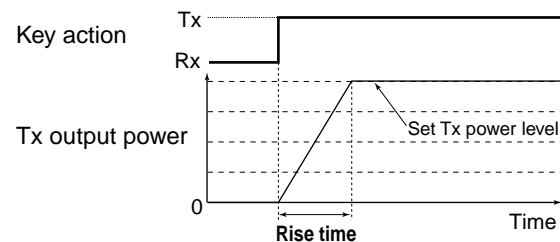

Key clicks on nearby frequencies can be generated if the rise time of a CW waveform is too short.

Continued on the next page.

- Electronic keyer functions
- ◇ Keyer Set mode (continued)

### **7. Paddle Polarity (Default: NORMAL)**

Set the paddle polarity.

- Normal or reverse polarity can be selected.

### **8. Keyer Type (Default: ELEC-KEY)**

Select the keyer type for [ELEC-KEY] connector on the front panel.

- Straight key, BUG-KEY or ELEC-KEY can be selected.

### **9. MIC Up/Down Keyer (Default: OFF)**

Set the microphone [UP]/[DN] switches to be used as a key. (The microphone [UP]/[DN] switches do not work as a “squeeze key.”)

- ON : The [UP]/[DN] switches can be used as a key for CW.
- OFF : The [UP]/[DN] switches cannot be used as a key for CW.

/// **NOTE:** When “ON” is selected, the frequency and memory channels cannot be changed using the [UP]/[DN] switches.



## ■ Operating RTTY (FSK)

When using your RTTY terminal or TNC, consult the manual that comes with the equipment.

- ① Select the desired frequency band. (p. 35)
- ② Push [CW/RTTY] once or twice to select the RTTY mode.
  - After the RTTY mode is selected, hold down [CW/RTTY] for 1 second to toggle between normal and reverse modes, if needed.
- ③ Rotate [MAIN DIAL] to tune a desired signal.
  - The S-meter indicates received signal strength.
  - If the received signal cannot be demodulated, try to select the RTTY reverse mode in step ②.
  - The tuning step can be changed using the tuning step program mode. (p. 38)
- ④ Push [TRANSMIT] to set the transceiver to the transmit mode, or transmit a SEND signal from your TNC.
  - The TX/RX indicator (MAIN Band) lights red.
  - The Po meter displays the transmitted RTTY signal strength.
- ⑤ Use your connected PC or TNC (TU) to transmit RTTY (FSK) signals.
- ⑥ Push [TRANSMIT] to receive.

### Convenient Receive functions

- Preamp and attenuator (p. 71)
- Twin PBT (passband tuning) (p. 75)
- AGC (auto gain control) (p. 72)
- Noise blanker (p. 76)
- Noise reduction (p. 77)
- Notch filter (p. 77)
- ¼ function (p. 39)
- Twin Peak Filter (p. 58)

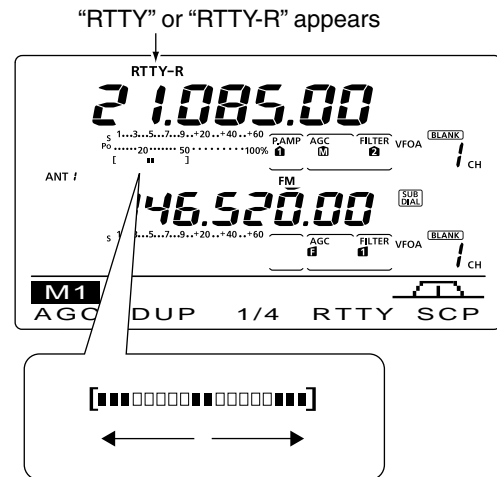
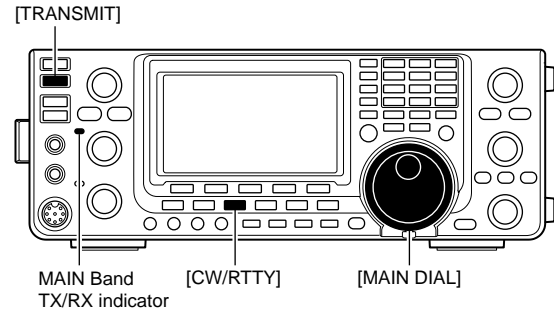

While receiving, the meter functions as the RTTY tuning meter to make correct tuning easier.

Rotate [MAIN DIAL] to the point where both sides of the dots appear equally.

- While transmitting, the meter functions as the transmit meter, SWR, ALC or COMP, selected with [ANT•METER]. (p. 45)

## RTTY functions

The RTTY menu has a number of convenient functions for RTTY operation.

- ① Push [CW/RTTY] once or twice to select the RTTY mode.
  - After the RTTY mode is selected, hold down [CW/RTTY] for 1 second to toggle between normal and reverse modes, if needed.
- ② Push [MENU] to display the "M1" screen (Menu 1).
- ③ Push [RTTY](F-4) to display the "RTTY" screen.
- ④ Push [DEC](F-2), [TPF](F-4) or [SET](F-5) to select the desired menu. See the diagram below.
  - Push [MENU] to return to the previous display.

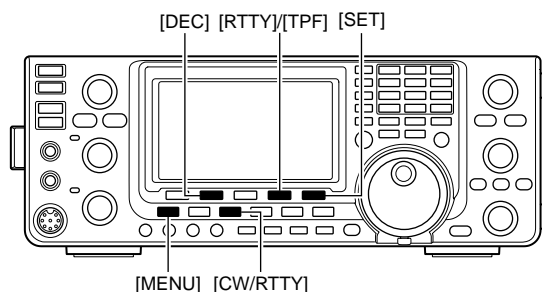

### Construction of RTTY menu

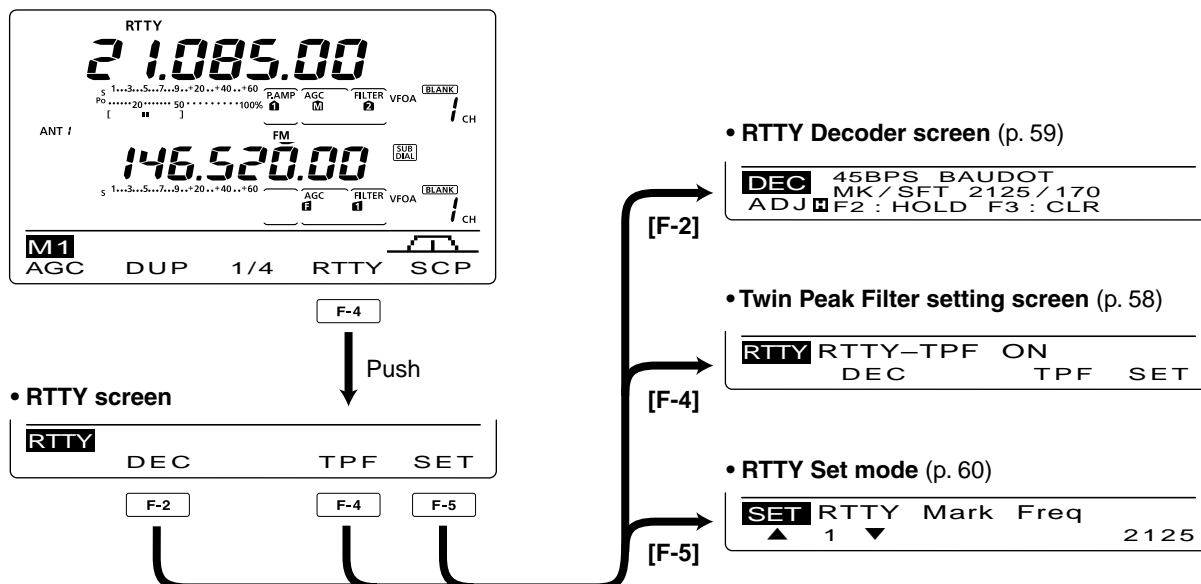

### ◇ About RTTY reverse mode

Received characters are occasionally garbled when the Mark and Space signals are reversed. This reversal can be caused by incorrect TNC connections, setting or commands.

To receive reversed RTTY signals correctly, select the RTTY reverse mode.

- In the RTTY mode, hold down [CW/RTTY] for 1 second to select the RTTY reverse mode.
  - “RTTY-R” appears when the RTTY reverse mode is selected.
  - Hold down [CW/RTTY] for 1 second again to select the normal mode.

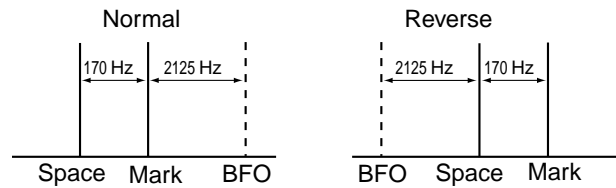

### ◇ Twin Peak Filter

The Twin Peak Filter changes the receive frequency response by boosting 2125 and 2295 Hz for better copying of RTTY signals.

- ① In the RTTY mode, push [MENU] to display the “M1” screen (Menu 1).
- ② Push [RTTY](F-4) to display the “RTTY” screen.
- ③ Push [TPF](F-4) to turn the Twin Peak Filter ON or OFF.
- ④ Push [MENU] to return to the previous display.

**NOTE:** When the Twin Peak Filter is in use, the received audio output may increase. This is normal; not a malfunction.

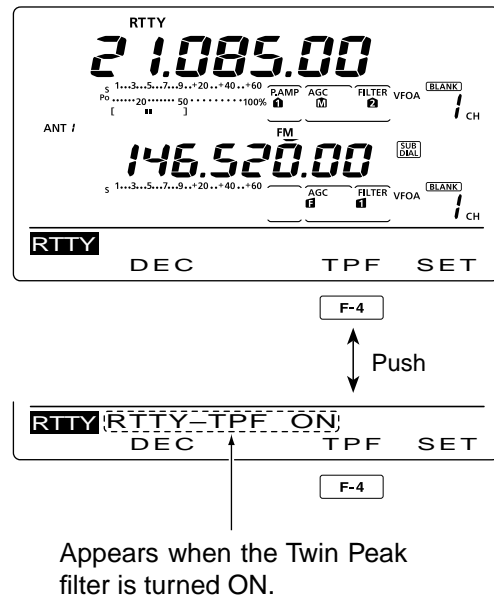

Appears when the Twin Peak filter is turned ON.

■ RTTY functions (Continued)

◇ RTTY decoder

The transceiver has an RTTY decoder for Baudot (mark freq.: 2125 Hz, shift freq.: 170 Hz, 45 bps).

An external terminal unit (TU) or terminal node connector (TNC) is not necessary for receiving a Baudot signal.

- ① In the RTTY mode, push [MENU] to display the “M1” screen (Menu 1).
- ② Push [RTTY](F-4) to display the “RTTY” screen.
- ③ Push [F-2](DEC) to turn ON the RTTY decoder.
  - RTTY decoder screen appears.
- ④ Push [F-2] to turn ON the Hold function to hold the current screen.
  - “H” appears when this function is turned ON.
  - Push [F-2] again to turn OFF the Hold function.
- ⑤ Hold down [F-3] for 1 second to clear the displayed characters.
  - “H” disappears at the same time as the displayed characters are cleared. (The hold function is cancelled.)
- ⑥ Push [MENU] to return to the previous display.

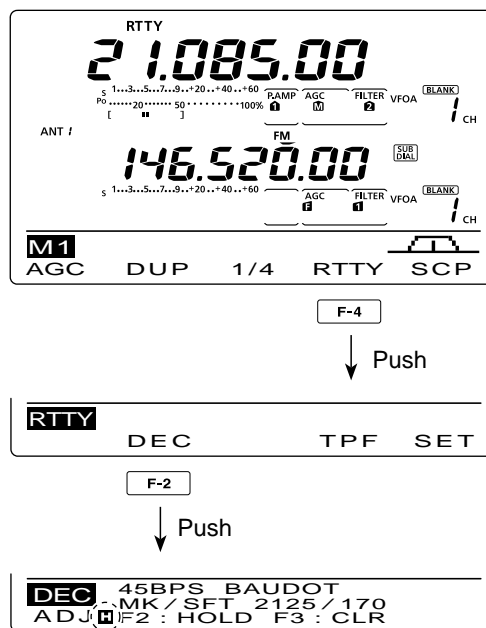

Appears when the Hold function is turned ON.

• Setting the decoder threshold level

If some characters are displayed when no signal is received, adjust the RTTY decoder threshold level.

- ① Select the RTTY decoder screen as described above.
- ② Push [F-1](ADJ) to select the threshold level adjustment mode.
- ③ Rotate [MAIN DIAL] to adjust the RTTY decoder threshold level.
  - Hold down [F-3] for 1 second to reset to the default setting, if desired.
- ④ Push [MENU] to return to the previous display.

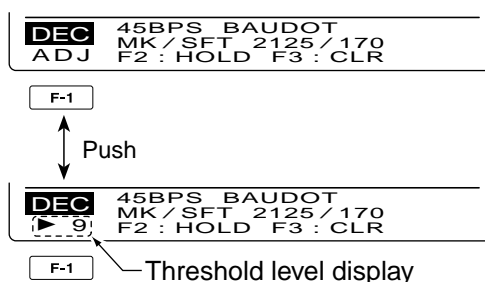

Threshold level display

▨ The number of the decoder display lines, the Un-Shift On Space (USOS) function and new line code can be set in the RTTY Set mode. (p. 60)

## ◇ RTTY Set mode

The RTTY Set mode is used to set the mark and shift frequencies, keying type, decode USOS function, RTTY decoder new line code and the number of decode screen display lines.

### • Setting contents

- ① In the RTTY mode, push [MENU] to display the "M1" screen (Menu 1).
- ② Push [RTTY](F-4) to display the "RTTY" screen.
- ③ Push [SET](F-5) to enter the RTTY Set mode.
- ④ Push [▲](F-1) or [▼](F-2) to select the desired item.
- ⑤ Rotate [MAIN DIAL] to select the desired option.
  - Hold down [F-3] for 1 second to reset to the default setting, if desired.
- ⑥ Push [MENU] to save, and return to the "RTTY" screen.
- ⑦ Push [MENU] to return to the "M1" screen (Menu 1).

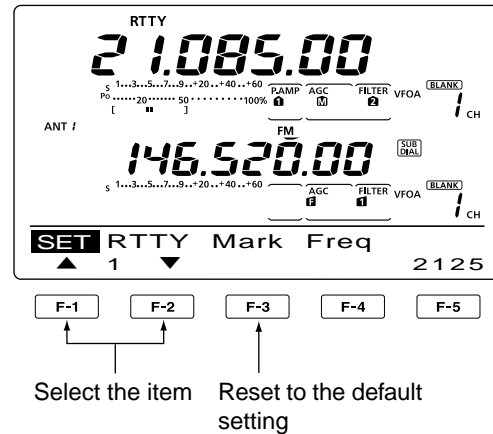

### 1. RTTY Mark Freq (Default: 2125)

Select the RTTY mark frequency.

- 1275, 1615 and 2125 Hz are selectable.

### 2. RTTY Shift Width (Default: 170)

Select the RTTY frequency shift.

- 170, 200 and 425 Hz are selectable.

### 3. RTTY Keying Pol (Default: NORMAL)

Select normal or reverse keying polarity.

- NORMAL : Key open/close = Mark/Space
- REVERSE : Key open/close = Space/Mark

### 4. Decode USOS (Default: ON)

Turn the USOS (UnShift On Space) function ON or OFF. This function decodes a letter code after receiving a "space."

- OFF : Decodes as a character code
- ON : Decodes as a letter code

### 5. Decode New Line (Default: CR,LF,CR+LF)

Select the internal RTTY decoder new line code.  
CR: Carriage Return, LF: Line Feed

- CR,LF,CR+LF : Makes a new line with any code.
- CR+LF : Makes a new line with only the CR+LF code.

### 6. Decode Screen (Default: 3 line)

Set the decoder screen display mode to 2 or 3 lines.

## ■ Operating AM/FM

- ① Select the desired frequency band. (p. 35)
- ② Push [AM/FM] to select the AM or FM mode.
  - After AM or FM is selected, hold down [AM/FM] for 1 second to select the data mode, if needed.
- ③ Rotate [MAIN DIAL] to tune a desired signal.
  - The S-meter displays the received signal strength.
  - The tuning step can be changed in the tuning step program mode. (p. 38)
- ④ Rotate [AF] (MAIN Band) to adjust the audio to a comfortable listening level.
- ⑤ Push [PTT] on the microphone to transmit. (or [TRANSMIT] on the transceiver)
  - The TX/RX indicator (MAIN Band) lights red.
- ⑥ Speak into the microphone at your normal voice level.
  - Rotate [MIC GAIN] to adjust the microphone gain in this step, if necessary.
- ⑦ Release [PTT] to receive. (or push [TRANSMIT] again)

### NOTE:

- In the AM mode, you can transmit on only the HF/50MHz frequency bands.
- The AM mode cannot be selected on the 1200 MHz frequency band.

### Convenient Receive functions

- Preamp and attenuator (p. 71)
- Twin PBT (passband tuning)\* (p. 75)
- AGC (auto gain control) (p. 72)
- Noise blanker (p. 76)
- Noise reduction (p. 77)
- Notch filter (p. 77)
- VSC (voice squelch control) (p. 146)

\*AM only

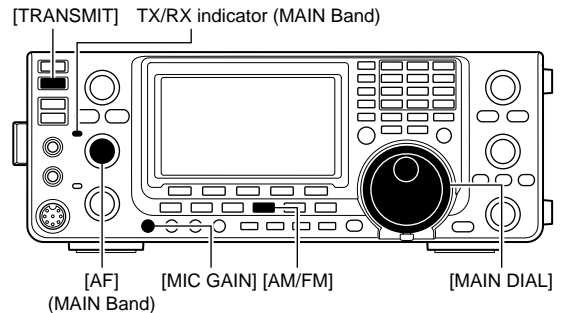

### • AM mode

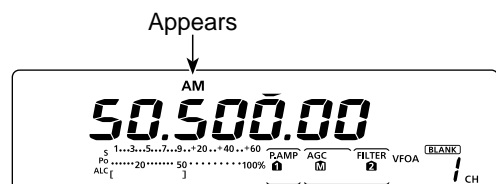

### • FM mode

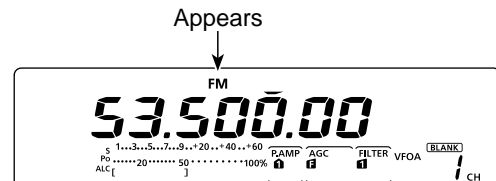

### Convenient functions for transmit

- Speech compressor (p. 78)
- VOX (voice operated transmit) (p. 80)
- Tone control (p. 169)
- Transmit quality monitor (p. 81)

## ■ Tone squelch operation

The tone squelch opens only when you receive a signal containing a matching subaudible tone. You can silently wait for calls from others using the same tone.

- ① Push [AM/FM] once or twice to select the FM mode.
- ② Push [MENU] to display the "M1" screen (Menu 1).
- ③ Push [TON](F-4) one or more times to turn ON the Tone squelch function.
  - "TSQL" appears
- ④ Hold down [TON](F-4) for 1 second to display the "TON" screen.
  - "TSQL Tone" appears on the function display.
- ⑤ Rotate [MAIN DIAL] to select the desired tone squelch frequency. (See the table shown below.)
  - Hold down [F-3] for 1 second to reset to the default setting, if desired.
- ⑥ Push [MENU] to save, and exit the "TON" screen.
- ⑦ Communicate in the usual manner.

### • Available tone squelch frequencies (Unit: Hz)

67.0	85.4	107.2	136.5	165.5	186.2	210.7	254.1
69.3	88.5	110.9	141.3	167.9	189.9	218.1	
71.9	91.5	114.8	146.2	171.3	192.8	225.7	
74.4	94.8	118.8	151.4	173.8	196.6	229.1	
77.0	97.4	123.0	156.7	177.3	199.5	233.6	
79.7	100.0	127.3	159.8	179.9	203.5	241.8	
82.5	103.5	131.8	162.2	183.5	206.5	250.3	

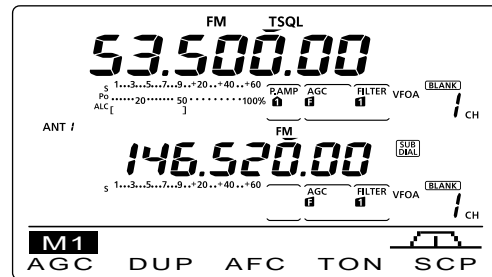
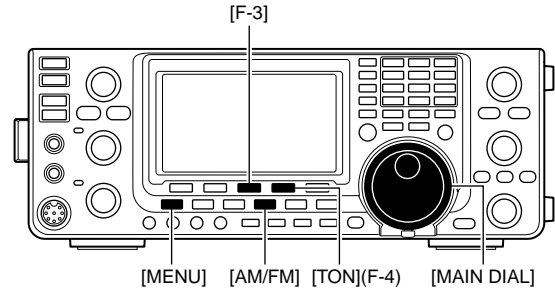

F-4  
↓ Hold down



## ■ DTCS operation

The DTCS function is another method of communications using selective calling. Only received signals having a matching 3-digit code will open the squelch.

- ① Push [AM/FM] once or twice to select the FM mode.
- ② Push [MENU] to display the "M1" screen (Menu 1).
- ③ Push [TON](F-4) one or more times to turn ON the DTCS function.
  - "DTCS" appears
- ④ Hold down [TON](F-4) for 1 second to display the "TON" screen.
  - "DTCS Code" appears on the function display.
- ⑤ Rotate [MAIN DIAL] to select the desired DTCS code number, and push [F-5] to select the desired code polarity.
  - NN : Normal polarity is used for both transmit and receive.
  - NR : Normal polarity is used for transmit, reversed polarity is used for receive.
  - RN : Reversed polarity is used for transmit, normal polarity is used for receive.
  - RR : Reversed polarity is used for both transmit and receive.
  - Hold down [F-3] for 1 second to reset to the default setting, if desired.
- ⑥ Push [MENU] to save, and exit the "TON" screen.
- ⑦ Communicate in the usual manner.

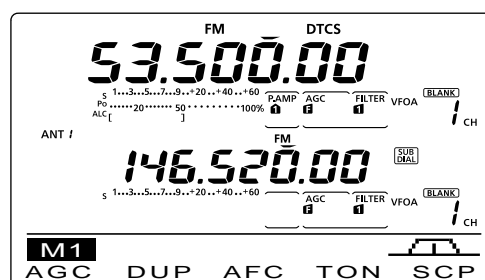
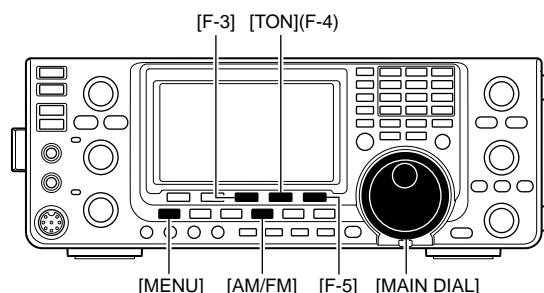

[F-4]  
↓ Hold down



↑ DTCS Code  
↑ DTCS code polarity

### • Available DTCS codes

023	072	152	244	311	412	466	631
025	073	155	245	315	413	503	632
026	074	156	246	325	423	506	654
031	114	162	251	331	431	516	662
032	115	165	252	332	432	523	664
036	116	172	255	343	445	526	703
043	122	174	261	346	446	532	712
047	125	205	263	351	452	546	723
051	131	212	265	356	454	565	731
053	132	223	266	364	455	606	732
054	134	225	271	365	462	612	734
065	143	226	274	371	464	624	743
071	145	243	306	411	465	627	754



## ■ Tone scan/DTCS code scan operation

To search for a repeater's sub-audible tone frequency, a tone scan is available.

By monitoring a repeater signal with a tone squelch or DTCS, you can determine the tone frequency necessary to open the repeater or the squelch.

- ① In the FM mode, push [MENU] to display the "M1" screen (Menu 1).
- ② Hold down [TON](F-4) for 1 second to enter the "TON" screen.
- ③ Push [TON](F-1) one or more times to select the tone type to be scanned.
  - "Rptr Tone" for a repeater tone, "TSQL Tone" for tone squelch or "DTCS Code" for a DTCS code can be selected.
  - When selecting a DTCS code to be scanned, the DTCS code and its polarity is displayed. You can select the desired polarity by pushing [F-5].
  - "NN" : Normal polarity for both transmit and receive.
  - "NR" : Normal polarity for transmit and reverse polarity for receive.
  - "RN" : Reverse polarity for transmit and normal polarity for receive.
  - "RR" : Reverse polarity for both transmit and receive.
- ④ Push [SCAN](F-2) to start the Tone scan.
  - "Rptr Tone SCAN," "TSQL Tone SCAN" or "DTCS Code SCAN" blinks, depending on the type you selected.
  - If "Up/Down" is selected as the "MAIN DIAL (SCAN)" option in the Scan Set mode, rotating [MAIN DIAL] changes the scanning direction. (p. 147)
- ⑤ When a matched tone or code is found, the scan pauses, and the detected sub-audible tone frequency or DTCS code is set.
  - Hold down [F-3] for 1 second to reset to the default setting, if desired.
- ⑥ Push [SCAN](F-2) to cancel the Tone scan.

When the tone scan or DTCS code scan is used in the Memory or Call channel mode, the detected tone frequency or code can be used temporarily.  
To save the detected tone frequency or code setting, you must over-write the Memory or Call channel data. (pp. 140, 141)

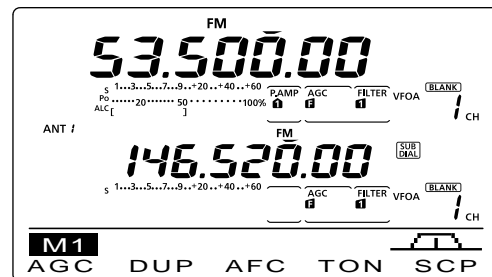
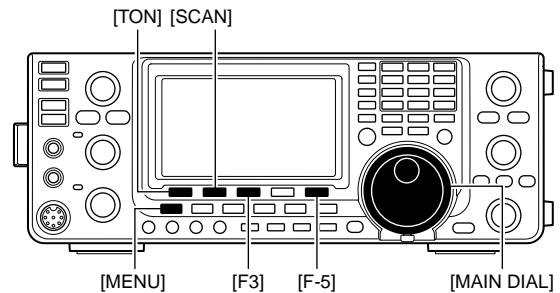

F-4  
↓ Hold down



F-1  
↓ Push to select the tone type.



F-2  
↓ Push to start or cancel the scan.

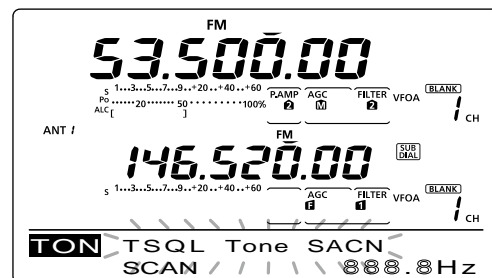

## ■ Repeater operation

A repeater receives transmitted signals and re-transmits them on a different frequency. When using a repeater, the transmit frequency is shifted from the receive frequency by a frequency offset.

A repeater can be accessed using the duplex operation to set the frequency shift to the same value as the repeater's frequency offset.

See page 94 for details on accessing a D-STAR® repeater.

- ① Select the desired frequency band. (p. 35)
- ② Push [VFO/MEMO] to select the VFO mode.
- ③ Push [A/B] to select VFO A.
- ④ Push [AM/FM] to select the FM mode.
- ⑤ Rotate [MAIN DIAL] to set the receive frequency (repeater output frequency).

When the auto repeater function is turned ON (available in only the U.S.A. and Korea versions), steps ⑥ and ⑦ are not necessary. (p. 67)

- ⑥ Push [MENU] to display the "M1" screen (Menu 1), then push [DUP](F-2) one or more times to set the offset direction.
  - "DUP-" or "DUP+" appears.
  - The transmit frequency (repeater input frequency) appears on the function display.
  - The frequency offset (amount of shift) can be set in the "DUP Offset" item of the Set mode. (p. 163)
- ⑦ Push [TON](F-4) to turn ON the repeater tone.
  - "T" appears.
  - The tone frequency can be set in the "TON" screen. 88.5 Hz is set by default. (p. 62)
- ⑧ Communicate in the normal way.

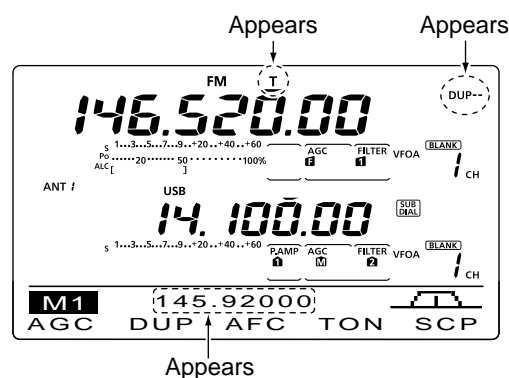
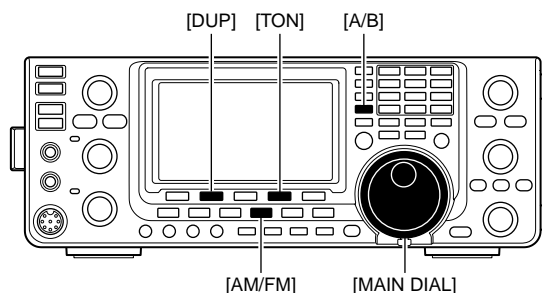

### ◆ Repeater access tone frequency setting

Some repeaters require a subaudible tone to be accessed. Subaudible tones are superimposed on your normal signal and must be set first. You can select 50 tones from 67.0 Hz to 254.1 Hz.

- ① In the FM mode, push [MENU] to display the "M1" screen (Menu 1).
- ② Push [TON](F-4) one or more times to turn ON the tone encoder function.
  - "T" appears.
- ③ Hold down [TON](F-4) for 1 second to display the "TON" screen.
  - "Rptr Tone" appears on the function display.
- ④ Rotate [MAIN DIAL] to select the desired repeater tone frequency. (See the table to the right.)
- ⑤ Push [MENU] to save, and exit the "TON" screen.

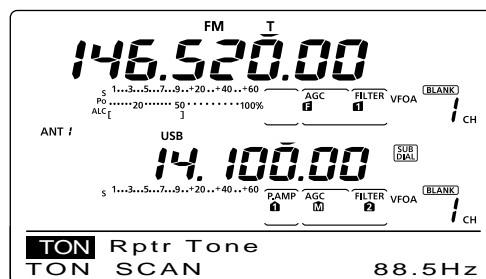

#### • Available tone frequencies (unit: Hz)

67.0	85.4	107.2	136.5	165.5	186.2	210.7	254.1
69.3	88.5	110.9	141.3	167.9	189.9	218.1	
71.9	91.5	114.8	146.2	171.3	192.8	225.7	
74.4	94.8	118.8	151.4	173.8	196.6	229.1	
77.0	97.4	123.0	156.7	177.3	199.5	233.6	
79.7	100.0	127.3	159.8	179.9	203.5	241.8	
82.5	103.5	131.8	162.2	183.5	206.5	250.3	

### ◇ One-touch repeater function

This function allows you to set the repeater operation by holding down one switch.

First, set the frequency offset as well as the repeater access tone frequency (p. 163).

- ① Select the desired frequency band. (p. 35)
- ② In the FM mode, push [A/B] to select VFO A.
- ③ Rotate [MAIN DIAL] to set the desired receive frequency (repeater output frequency).
- ④ Push [MENU] to display the "M1" screen (Menu 1).
- ⑤ Hold down [DUP](F-2) for 1 second to turn ON the One-touch repeater function.
  - "T" and "DUP--" appears.
  - The repeater receive frequency appears on bottom of the function display.
  - The Split frequency operation is automatically turned OFF, if it is ON.
- ⑥ Push [DUP](F-2) once or twice to switch the offset direction.
  - "DUP-" or "DUP+" appears.
- ⑦ Communicate in the normal way.

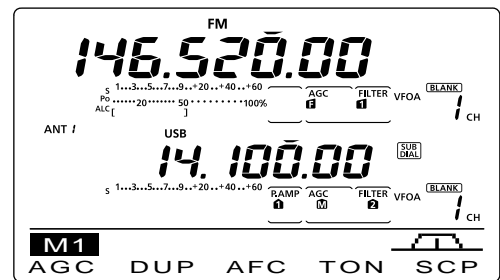

Hold down ↓ Appears ↑ Appears

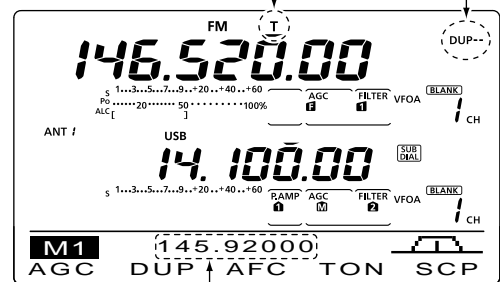

Transmit (repeater receive) frequency appears

### ◇ Transmit frequency monitor check

You may be able to directly receive the other party's transmitted signal without having to go through a repeater. This function helps you to check whether the direct communication can be done, or not.

- ➔ While receiving, hold down [XFC] to see if you can directly receive the other party's transmitted signal.
  - While holding down [XFC], the offset direction and frequency offset are displayed on the function display.

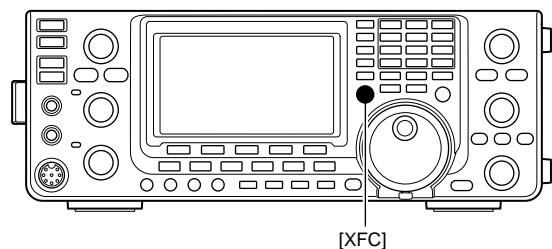

XFC ↓ Hold down



Frequency Offset direction and value.

### ◇ 1750 Hz tone burst

A 1750 Hz tone is required to access most European repeaters.

- ➔ To transmit a 1750 Hz European repeater tone, hold down [TON](F-4) during repeater operation. (p. 65)
  - "T" blinks.

**NOTE:** This function is not available for non-European versions.

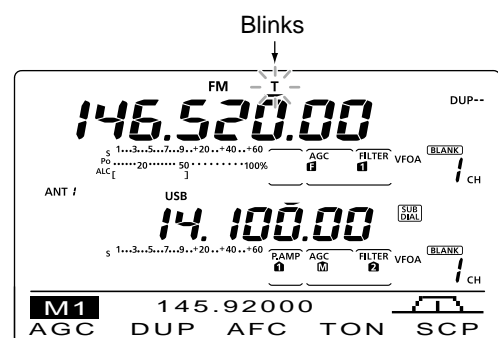



## ■ Repeater operation (Continued)

## ◇ Setting the Auto Repeater ranges

## (U.S.A. and Korea versions only)

The transceiver has three Auto Repeater ranges that can be used for each frequency band. And you can set the desired Auto Repeater ranges by programming the lower and higher edge frequencies into the allowable Memory channel of each band as described below.

- ① Select the desired frequency band. (p. 35)
- ② Push [AM/FM] once or twice to select the FM mode.
- ③ Set the desired lower edge frequency.
- ④ Turn ON the duplex operation, then select the duplex direction. (pp. 65, 163)
  - “DUP-” or “DUP+” is displayed when the duplex is ON.
  - Both one-touch repeater and manual repeater settings are available.
- ⑤ Rotate [M-CH] to select a Memory channel of the selected frequency band.
  - See the Memory channel combination list to the right. If the HF band is selected in step ①, and you want to set Range 1, select Memory channel 1 for the lower edge frequency programming.
- ⑥ Hold down [MW] for 1 second to program the data into the Memory channel.
  - 3 beeps sound when the memory programming is complete.
- ⑦ Set the upper edge frequency.
- ⑧ Rotate [M-CH] to select the opposite Memory channel.
  - Select Memory channel 2 if Memory channel 1 is selected in step ⑤.
- ⑨ Hold down [MW] for 1 second to program the data into the selected Memory channel.
  - 3 beeps sound when the memory programming is complete.
- ⑩ Repeat steps ① to ⑨ to program other ranges.
 

▨ **NOTE:** We recommend that all repeater ranges are programmed into the Memory channel of each band. The previously programmed ranges will be lost.
- ⑪ Hold down [SPEECH/LOCK] for 1 second to turn ON the Dial Lock function.
  - “” appears.
- ⑫ Hold down [POWER] for 1 second to turn OFF the power.
- ⑬ While holding down [AM/FM] and [F-INP ENT], push [POWER] to turn ON the power.
  - “◀ Auto Rptr Set ▶” appears.
  - The programmed auto repeater ranges are set.
  - The memory channels can be used for normal operation after programming.
- ⑭ Hold down [SPEECH/LOCK] for 1 second to turn OFF the Dial Lock function.
  - “” disappears.

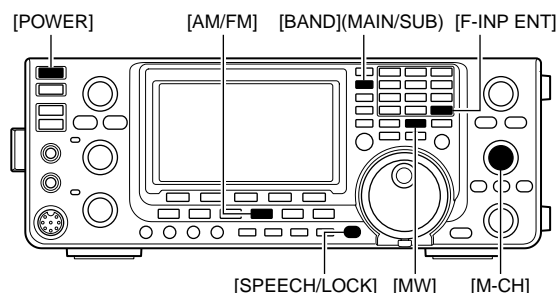

## • Frequency range and shift direction (Default)

## (U.S.A. version)

Band	Frequency range (MHz)	Shift direction
50 MHz	51.620000 – 51.999999	“DUP-”
	52.500000 – 52.999999	
	53.500000 – 53.999999	
144 MHz	145.200000 – 145.999999	“DUP-”
	146.610000 – 146.999999	
	147.000000 – 147.399999	“DUP+”
430 MHz	442.000000 – 444.999999	“DUP+”
	447.000000 – 449.999999	“DUP-”
1200 MHz	1282.000000 – 1295.000000	“DUP-”

## (Korea version)

Band	Frequency range (MHz)	Shift direction
430 MHz	439.000000 – 440.000000	“DUP-”
1200 MHz	1290.000000 – 1293.000000	“DUP-”

## • Memory channel combination of the Auto Repeater ranges

## (Frequency band: HF/144/430/1200 MHz )

	Lower frequency	Higher frequency
Range 1	Memory CH 1	Memory CH 2
Range 2	Memory CH 3	Memory CH 4
Range 3	Memory CH 5	Memory CH 6

## (Frequency band: 50 MHz)

	Lower frequency	Higher frequency
Range 1	Memory CH 7	Memory CH 8
Range 2	Memory CH 9	Memory CH 10
Range 3	Memory CH 11	Memory CH 12

▨ **NOTE:** Auto Repeater ranges must be programmed into the Memory channel of **EACH** band.

The optional UX-9100 is required for 1200 MHz frequency band operation.

### ◇ Turning ON the Auto Repeater function (U.S.A. and Korea versions only)

When the operating frequency falls within the repeater output frequency range, the Auto Repeater function automatically sets the repeater settings (duplex ON/OFF, duplex direction, tone encoder ON/OFF).

- ① Hold down [MENU] for 1 second to enter the Set mode.
- ② Push [▲](F-1) or [▼](F-2) to select "Auto Repeater."
- ③ Rotate [MAIN DIAL] to turn ON the Auto Repeater function.

#### U.S.A. version:

- "ON-1" Activates duplex only.
- "ON-2" Activates duplex and tone.
- "OFF" Auto repeater function is turned OFF.

#### Korea version:

- "ON" Activates duplex and tone.
- "OFF" Auto repeater function is turned OFF.

- ④ Push [MENU] to save, and exit the Set mode.

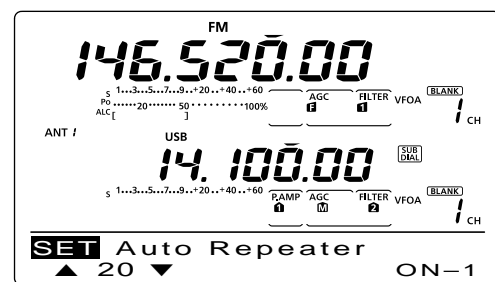
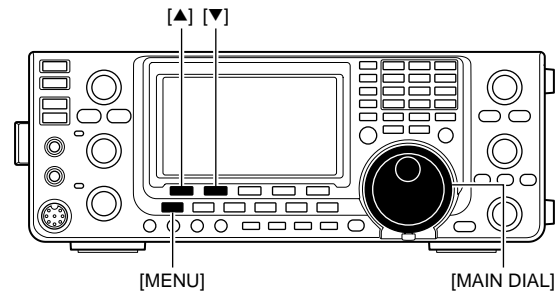

ON-1 (default for the U.S.A. version)

### ◇ Storing a non standard repeater

- ① Turn OFF the Auto Repeater function in the Set mode. (p. 163)
- ② Push [A/B] to select VFO A.
- ③ Rotate [MAIN DIAL] to set the repeater output frequency.
- ④ Push [A/B] to select VFO B.
- ⑤ Rotate [MAIN DIAL] to set the repeater input frequency.
- ⑥ Push [A/B] to select VFO A.
- ⑦ Push [SPLIT] to turn ON the Split function.
- ⑧ Push [TON](F-4) to turn ON the previously set tone encoder.
- ⑨ Rotate [M-CH] to select the desired memory channel.
  - "BLANK" appears when a blank channel is selected.
- ⑩ Hold down [MW] for 1 second to store the set contents into the selected memory channel.

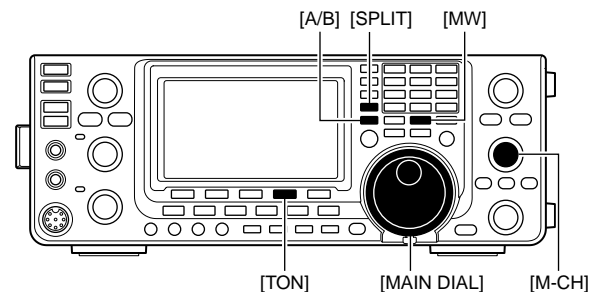

## ■ AFC operation

(Mode: FM/DV)

AFC stands for Automatic Frequency Control. The AFC function tunes the displayed frequency automatically when an off-center frequency is received.

- ① Push [AM/FM] or [DV•DR] once or twice to select the FM or DV mode.
- ② Push [MENU] to display the "M1" screen (Menu 1).
- ③ Push [AFC](F-3) to turn ON the AFC function.
  - "[AFC]" appears when the AFC function is ON.

▨ The AFC limit can be set in the Set mode. (p. 164)  
 ▨ While the AFC limit is ON, AFC stops tuning when the received frequency exits the frequency limit range.

The optional UT-121 is required for DV mode operation.

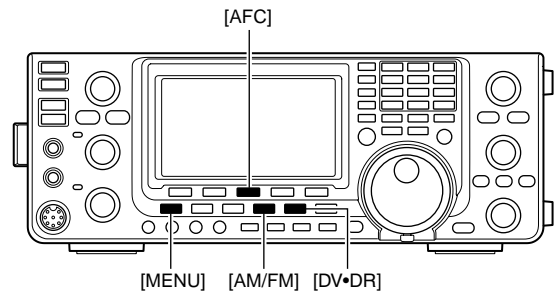

## ■ RIT function

The RIT (Receive Increment Tuning) function compensates for off-frequency operation of the received station.

The function shifts the receive frequency up to  $\pm 9.99$  kHz in 10 Hz steps\*, without changing the transmit frequency.

\*The [RIT/ $\Delta$ TX] control tunes in 1 Hz steps when the operating frequency readout is set to the 1 Hz step readout. However, the 1 Hz digit is not displayed on the frequency shift readout.

- ① Push [RIT] to turn ON the RIT function.
  - "RIT" and the frequency shift appear when this function is ON.
- ② Rotate the [RIT/ $\Delta$ TX] control.
  - Hold down [CLEAR] for 1 second to reset the RIT frequency.
  - Push [CLEAR] momentarily to reset the RIT frequency when the quick RIT clear function is ON. (p. 164)
  - Hold down [RIT] for 1 second to add the frequency shift to the operating frequency.
- ③ To cancel the RIT function, push [RIT] again.
  - "RIT" and the frequency shift disappear.

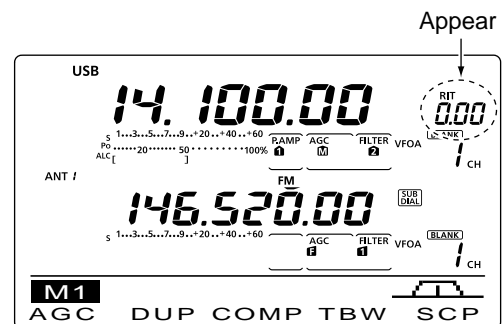
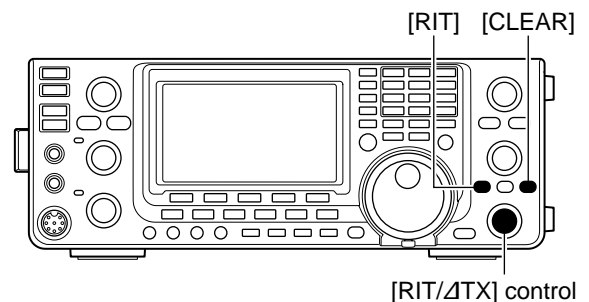

## ◇ RIT monitor function

When the RIT function is ON, holding down [XFC] allows you to listen to the displayed frequency (RIT is temporarily cancelled).

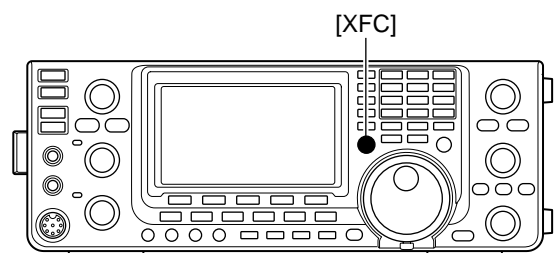

## Simple band scope

The Band Scope function allows you to visually check the location and strength of signals around a specified frequency.

The IC-9100's Band Scope function can be used in any operating mode and any frequency band.

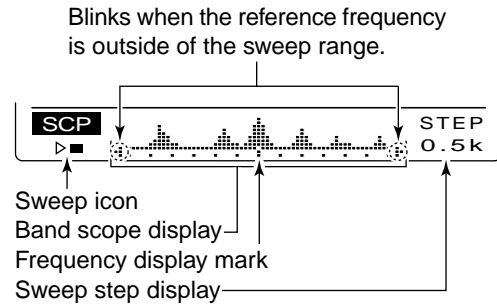

INDICATOR	DESCRIPTION
<b>Sweep icon</b>	While the band scope is sweeping, "▶ □" is displayed; while stopped, "▶ ■" is displayed. <b>Received audio is not heard from the speaker while the band scope is sweeping.</b>
<b>Band scope display</b>	Displays the signal location and strength in relation to the center (displayed) frequency. Signal strength is relative to the S-meter level, S1 to S9, with each vertical dot in the band scope indicator equal to one segment of the S-meter. Signal activity is measured $\pm 30$ steps from the center frequency, with each step equal to the selected sweep step.
<b>Frequency display mark</b>	After a sweep, displays the relative position of the reference frequency. When the reference frequency is outside of the sweep range, "■" or "■" blinks. After changing the frequency, hold down [F-3] for 1 second to automatically return to the center frequency.
<b>Sweep step display</b>	Displays the selected sweep step. 0.5, 1, 2, 5, 10, 20 and 25 kHz are selectable. Each dot of the band scope display is approximately equal to the selected sweep step.

The band scope measures receive signal location and strength over a specified range on either side of a selected frequency, in either the VFO or memory modes.

- ① Rotate [MAIN DIAL] to select a frequency.
- ② Push [MENU] to display the "M1" screen (Menu 1), then push [SCP](F-5) to display the "SCP" screen (Band Scope).
  - Automatically starts sweeping with the previously selected sweeping step.
  - During a sweep, received signals cannot be heard.
- ③ Push [F-5] one or more times to select the desired sweep step.
  - 0.5, 1, 2, 5, 10, 20 and 25 kHz are selectable.
- ④ Push [F-1] to start sweeping, then automatically stop after sweeping.
  - Hold down [F-1] for 1 second to start continuous sweeping. In this case, push [F-1] again to stop the sweeping.
  - During a sweep, "▶ □" is displayed and received signals cannot be heard.
  - If there is a lot of signal noise, turn OFF the Preamplifier to reduce the signal input level, and turn ON the Attenuator to improve the readability of the band scope.
- ⑤ Rotate [MAIN DIAL] to find a signal that you wish to communicate with. If you find the signal, communicate in the normal way.
  - If you want to return to the frequency you were using before rotating [MAIN DIAL], hold down [F-3] for 1 second.
  - If the selected frequency is set outside of the swept range, "■" or "■" blinks.
- ⑥ If you want to update the band conditions while receiving, repeat steps ③ and ④.

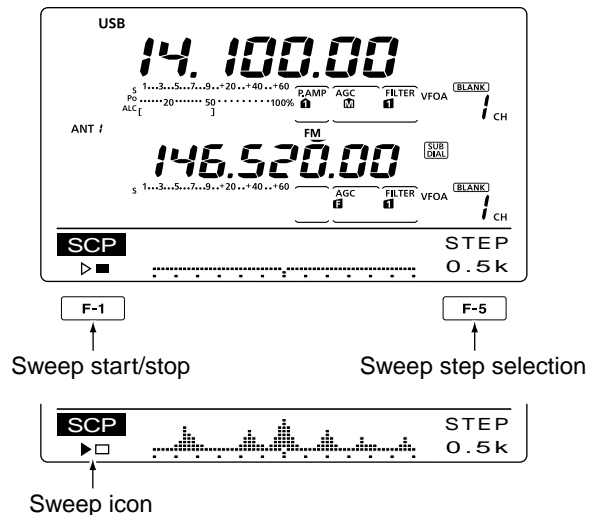

**NOTE:**  
If you select a large sweep step, a wide frequency range can be displayed on the band scope, but some signals may be skipped and not displayed.

## ■ Preamplifier

The preamplifier amplifies weak signals in the receiver front end, to improve the S/N ratio and sensitivity. Turn this function ON when receiving weak signals.

The AG-25, AG-35 or AG-1200\*1 preamplifier unit is required for 144, 430 or 1200 MHz\*2 frequency band.

- Be sure to set the “EXT-P.AMP” item for each frequency band in the Set mode. (pp. 165, 166)

### (Frequency band: HF/50 MHz)

- ➔ Push [P.AMP•ATT] one or more times to set the preamp OFF, preamp 1 ON or preamp 2 ON.
  - Either “P. AMP 1” or “P. AMP 2” is displayed when the preamp 1 or preamp 2 is ON.
  - No indicator is displayed when the preamp is OFF.

<b>P. AMP 1</b>	Wide dynamic range preamplifier. It is most effective for the 1.8 to 21 MHz bands.
<b>P. AMP 2</b>	High-gain preamplifier. It is most effective for the 24 to 50 MHz bands.

### (Frequency band: 144/430/1200 MHz\*2)

- ➔ Push [P.AMP•ATT] once or twice to turn an optional preamplifier unit ON or OFF, if installed.
  - “P.AMP” appears when the preamplifier unit is ON.
  - No indicator is displayed when the preamplifier unit is OFF.

## ■ Attenuator

The attenuator prevents a desired signal from being distorted when very strong signals are near the signal's frequency, or when very strong electromagnetic fields, such as from broadcast stations are near your location. These can both be independently set for each band.

- ➔ Hold down [P.AMP/ATT] for 1 second to turn ON the Attenuator.
  - “ATT” appears on the display when the Attenuator is ON.
- ➔ Push [P.AMP/ATT] momentarily to turn it OFF.

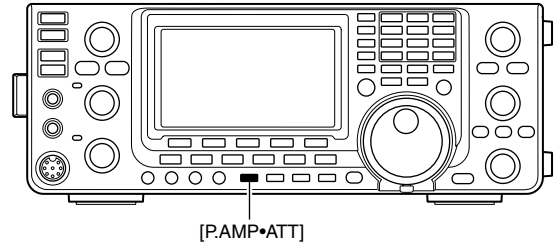

### ✓ About the “P.AMP2” preamplifier

The preamp 2 is a high gain receive amplifier. When it is used in the presence of strong electromagnetic fields, distortion sometimes results. In such cases, use either the “P.AMP 1” or “P.AMP OFF” setting.

Preamp 2 is most effective when:

- Used on bands above 24 MHz and when signals are weak.
- Receive sensitivity is insufficient when using low-gain antennas, or while using a narrow band antenna. (such as small loop, a Beverage antenna or a short Yagi antenna)

\*1 AG-1200 has been discontinued, but it can be still be used.

\*2 The optional UX-9100 is required for 1200 MHz frequency band operation.

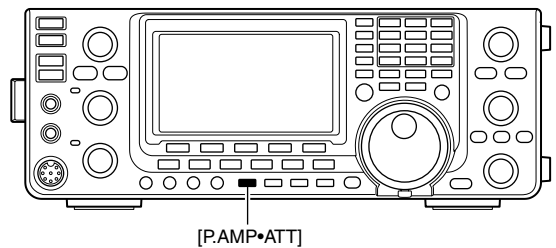

### About the Preamplifier and Attenuator switching procedure

The Preamplifier and Attenuator are switched with [P.AMP/ATT], as shown below.

#### • HF/50 MHz frequency bands

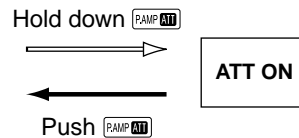
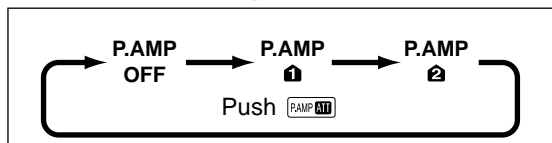

#### • 144/430/1200 MHz frequency bands

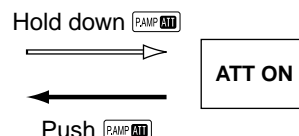
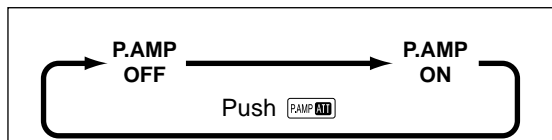



## ■ AGC function

The AGC (Auto Gain Control) controls receiver gain to produce a constant audio output level, even when the received signal strength varies greatly.

The transceiver has 3 pre-set AGC time constants: fast, mid and slow for SSB, CW, RTTY and AM modes.

/// In the FM and DV modes, the AGC time constant is fixed as "FAST" (0.1 second).

### ◇ AGC speed selection

- ① Select either the SSB, CW, RTTY or AM mode.  
(p. 43)
- ② Push [MENU] to display the "M1" screen (Menu 1), then push [AGC](F-1) one or more times to select AGC fast (F), AGC mid (M) or AGC slow (S).

/// "AGC OFF" appears when the selected AGC speed's time constant is set to OFF.

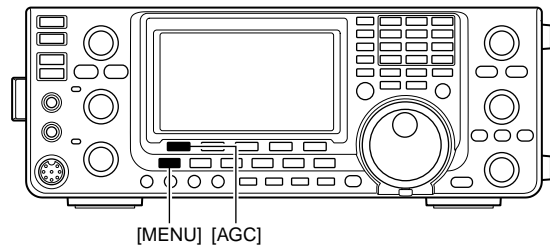

### ◇ Setting the AGC time constant

- ① Select either the SSB, CW, RTTY or AM mode.  
(p. 43)
- ② Push [MENU] to display the "M1" screen (Menu 1), then hold down [AGC](F-1) for 1 second to display the "AGC" screen.
- ③ Push either [FAST](F-2), [MID](F-3) or [SLOW](F-4) to select the desired AGC speed to be set.
  - An underline appears below the time constant display.
- ④ Rotate [MAIN DIAL] to set the desired time constant.
  - AGC time constant can be set to between 0.1 to 8.0 seconds (depending on the mode) or turned OFF.
  - Hold down [FAST](F-2), [MID](F-3) or [SLOW](F-4) for 1 second to reset to the default setting for the selected time constant, if desired.
- ⑤ Select another mode (except for FM and DV), then repeat steps ③ and ④, if desired.
- ⑥ Push [MENU] to save, and exit the "AGC" screen.

#### • Selectable AGC time constant (unit: seconds)

Mode	Default	Selectable AGC time constant
SSB	0.3 (FAST)	OFF, 0.1, 0.2, 0.3, 0.5, 0.8, 1.2, 1.6, 2.0, 2.5, 3.0, 4.0, 5.0, 6.0
	2.0 (MID)	
	6.0 (SLOW)	
CW/RTTY	0.1 (FAST)	OFF, 0.1, 0.2, 0.3, 0.5, 0.8, 1.2, 1.6, 2.0, 2.5, 3.0, 4.0, 5.0, 6.0
	0.5 (MID)	
	1.2 (SLOW)	
AM	3.0 (FAST)	OFF, 0.3, 0.5, 0.8, 1.2, 1.6, 2.0, 2.5, 3.0, 4.0, 5.0, 6.0, 7.0, 8.0
	5.0 (MID)	
	7.0 (SLOW)	
FM/DV	0.1 (FAST)	Fixed

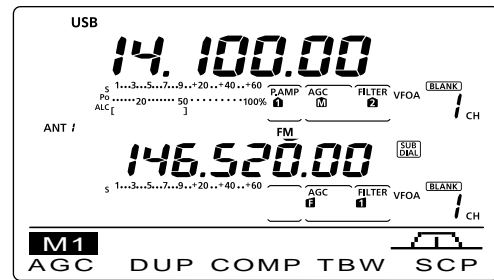

[F-1]

↓ Hold down

#### • When AGC medium is selected

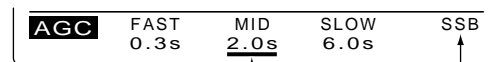

Appears under the selected AGC speed's time constant display. Selected mode

#### • When AGC fast is selected

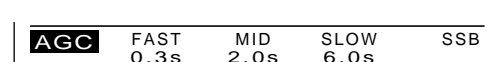

#### • When AGC slow is selected

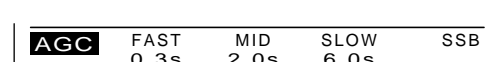

#### /// For your information

When you are receiving a weak signal, and a strong signal is momentarily received, the AGC function quickly reduces the receiver gain. When that signal disappears, the transceiver may not receive the weak signal because of the AGC action. In that case, hold down [AGC](F-1) for 1 second, and rotate [MAIN DIAL] to set the time constant to OFF.

## IF filter selection

The transceiver has 3 passband width IF filters for each mode.

- ▨ The filter selection is automatically memorized in each mode.
- ▨ The PBT shift frequencies are automatically memorized in each filter.

### IF filter selection

- ① Select the desired mode.
- ② Push [FILTER] one or more times to select IF filter 1, 2 or 3.
  - The selected passband width and filter number is displayed on the LCD.

### Filter passband width setting

(Mode: SSB/CW/RTTY/AM)

- ① Hold down [FILTER] for 1 second to display the “FIL” screen (Filter) to set the filter passband width.
- ② Select either the SSB, CW, RTTY or AM mode.
  - Passband widths for FM and DV modes are fixed and cannot be set.
- ③ Push [FILTER] one or more times to select IF filter 1, 2 or 3.
- ④ Push [BW](F-1), then rotate [MAIN DIAL] to adjust the desired passband width. Then push [BW](F-1) to set it.
  - While holding down [BW](F-1), rotating [MAIN DIAL] also adjusts the passband width. After adjustment, release [BW](F-1) to set it.
  - Hold down [F-3] for 1 second to reset to the default setting, if desired.
- ⑤ Repeat steps ② to ④ if desired.
- ⑥ Push [MENU] to save, and exit the “FIL” screen.

Mode	IF filter	Adjustable range (steps)
SSB	FILTER1 (3.0 kHz)	50 to 500 Hz (50 Hz) 600 to 3600 Hz (100 Hz)
	FILTER2 (2.4 kHz)	
	FILTER3 (1.8 kHz)	
SSB-D CW	FILTER1 (1.2 kHz)	50 to 500 Hz (50 Hz) 600 to 3600 Hz (100 Hz)
	FILTER2 (500 Hz)	
	FILTER3 (250 Hz)	
RTTY	FILTER1 (2.4 kHz)	50 to 500 Hz (50 Hz) 600 to 2700 Hz (100 Hz)
	FILTER2 (500 Hz)	
	FILTER3 (250 Hz)	
AM AM-D	FILTER1 (9.0 kHz)	200 Hz to 10 kHz (200 Hz)
	FILTER2 (6.0 kHz)	
	FILTER3 (3.0 kHz)	
FM FM-D DV	FILTER1 (15 kHz)	Fixed
	FILTER2 (10 kHz)*	
	FILTER3 (7.0 kHz)*	

\* When FILTER2 or FILTER3 is selected in the FM mode, the TX modulation changes to the narrow mode (2.5 kHz).

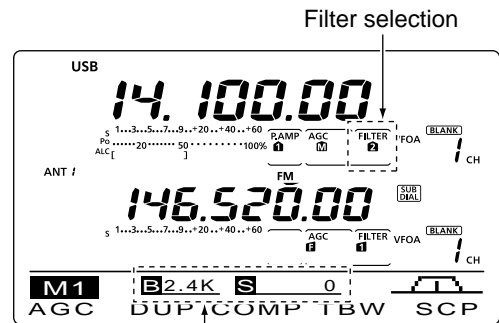
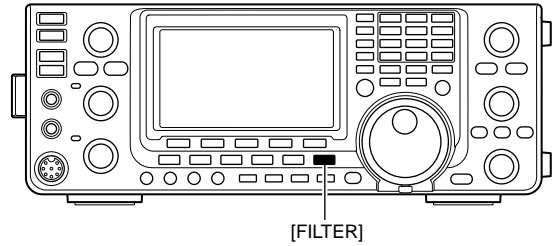

### “FIL” screen display

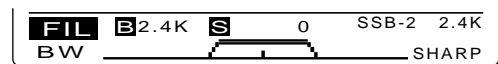

Shows the selected filter and passband width.

### While adjusting the passband width

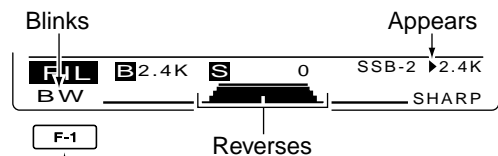

Push [BW](F-1), then rotate [MAIN DIAL] to adjust the passband width. Then push [BW](F-1),

- ▨ The PBT shift frequencies are cleared when the passband width is changed.

- ▨ This “FIL” screen (Filter) graphically displays the PBT shift frequencies and passband width.

### ◇ 1st IF filter selection

(Mode: SSB/CW/RTTY/AM)

The IC-9100 has a 15 kHz filter passband width at the 1st IF frequency. The 1st IF filters reduce interference from strong nearby signals.

If the optional FL-430 1ST IF FILTER (6 kHz) is installed, a 6 kHz filter width can be used. Or, if the FL-431 1ST IF FILTER (3 kHz) is installed, a 3 kHz filter width can be used.

- The filter passband width can be selected on only the HF/50 MHz band frequency.

- ① Hold down [FILTER] for 1 second to display the “FIL” screen (Filter).
- ② Select SSB, CW, RTTY or AM mode.
  - The passband widths for FM and DV modes are fixed, and have no options.
- ③ Hold down [F-5] for 1 second to select the desired filter width from 15 kHz, 6 kHz and 3 kHz.
  - Hold down [F-3] for 1 second to reset to the default filter setting, if desired. (The filter passband width setting is also reset to the default setting.)
- ④ Push [MENU] to save, and exit the “FIL” screen.

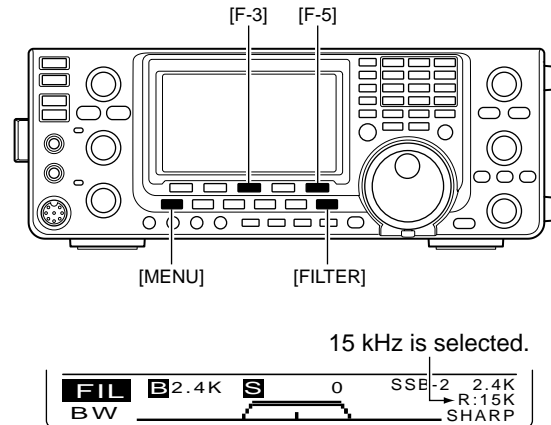

### ◇ IF (DSP) filter shape

(Mode: SSB/CW)

A soft or sharp type of DSP filter shape for both SSB and CW can be independently selected.

- ① Hold down [FILTER] for 1 second to display the “FIL” screen (Filter).
- ② Select the SSB or CW mode.
- ③ Push [F-5] once or twice to select either the soft or sharp filter shape.
- ④ Push [MENU] to save, and exit the “FIL” screen (Filter).

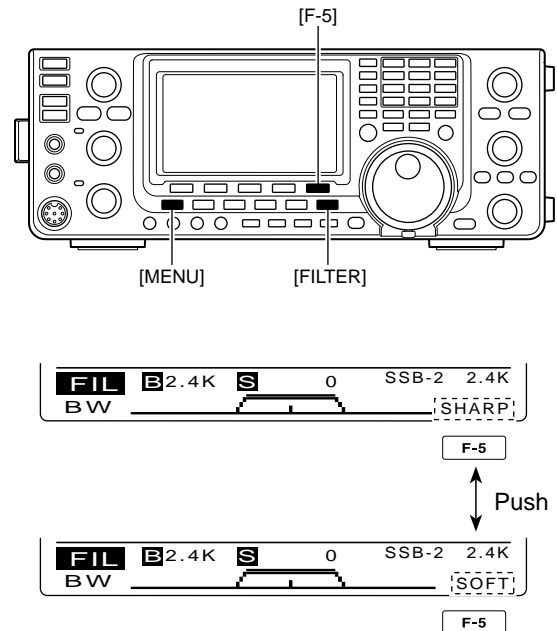

## ■ Twin PBT operation

(Mode: SSB/CW/RTTY/AM)

To reject interference, PBT (Passband Tuning) electronically narrows the IF passband width by shifting the IF frequency slightly outside of the IF filter passband. The IC-9100 uses DSP for the PBT function. Moving both [TWIN-PBT] controls shift the IF passband center frequency both above and below the received frequency.

- The LCD graphically shows the passband width and frequency shift.
- Hold down [FILTER] for 1 second to display the "FIL" screen (Filter). Current passband width and frequency shift are displayed in the "FIL" screen.
- Hold down [PBT-CLR] for 1 second to set the IF frequency to the center position.
  - The "dot" disappears.

The PBT is adjustable in 50 Hz steps in the SSB/CW/RTTY modes, and 200 Hz in the AM mode. In this time, the shift value changes in 25 Hz steps in the SSB/CW/RTTY modes, and 100 Hz in the AM mode.

- The [TWIN-PBT] controls should normally be set to the center positions when there is no interference. The PBT setting should be cleared.
- When the PBT is used, the audio tone may change.
- The controls do not function in the FM and DV modes.
- While rotating the [TWIN-PBT] controls, noise may occur. This comes from the DSP unit and does not indicate an equipment malfunction.
- Pushing [PBT-CLR] displays the filter passband width and shift value for 1 seconds on the function display.

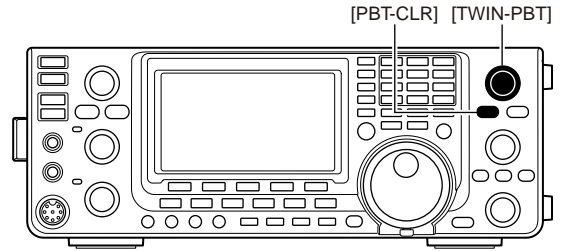

Passband width and shift value are displayed while [TWIN PBT] is used. Appears when passband is shifted.

### • "FIL" screen (Filter) display

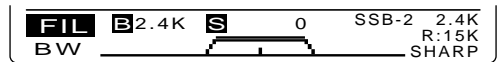

Shows the selected filter and passband width.

### • While adjusting the PBT setting

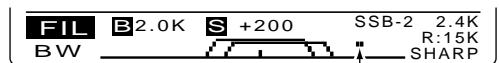

Appears when the passband is shifted.

### PBT OPERATION EXAMPLE

Both controls in the center positions (or hold down [PBT-CLR] for 1 second.)

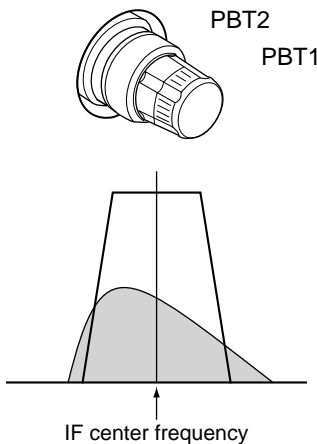

Cutting the lower passband edge

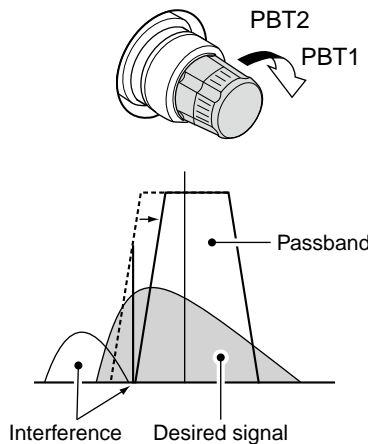

Cutting both lower and higher passband edges

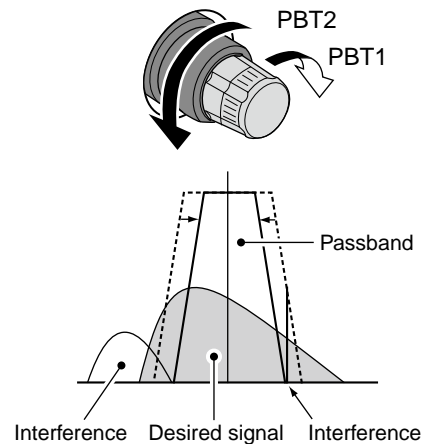

## ■ Noise Blanker

(Mode: SSB/CW/RTTY/AM)

The Noise Blanker eliminates pulse-type noise such as noise from car ignitions.

- ➔ Push [NB] to turn the Noise Blanker function ON or OFF.
  - "NB" is displayed when the Noise Blanker is ON.

When using the Noise Blanker function, received signals may be distorted if they are excessively strong or when used for noise other than pulses. In this case, set the Noise Blanker threshold level to a shallow position, or turn OFF the function. (see below)

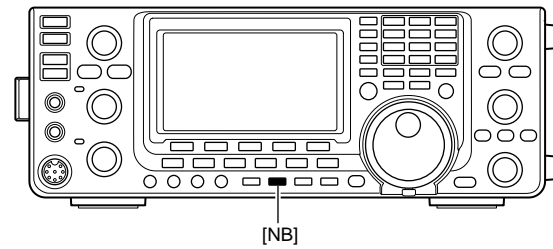

Appears

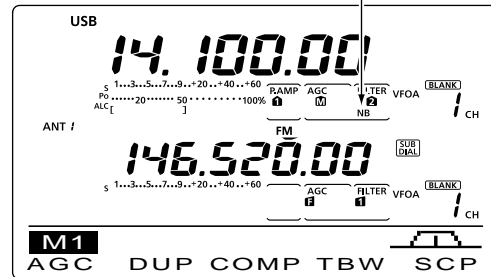

### ◇ NB Set mode

To deal with various types of noise, the attenuation level and noise blanking duration can be set in the NB set mode.

- ① Hold down [NB] for 1 second to display the "NB" screen (Noise blanker).
- ② Push [▲](F-1) or [▼](F-2) to select the desired item.
- ③ Rotate [MAIN DIAL] to select the desired option.
  - Hold down [F-3] for 1 second to reset to the default setting, if desired.
- ④ Push [NB] to save, and return to the previous screen.

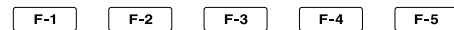
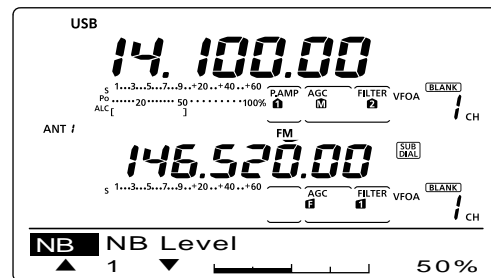

#### 1. NB Level (Default: 50%)

Set the noise blanker threshold level to between 0% and 100%.

#### 2. NB Depth (Default: 8)

Set the noise attenuation level to between 1 and 10.

#### 3. NB Width (Default: 50)

Set the blanking duration to between 1 and 100.

## ■ Meter peak hold function

When the "Meter Peak Hold" item is set to ON in the Set mode, the peak level of a received signal strength or the output power is displayed for approximately 0.5 seconds. (p. 162)

Appears for 0.5 seconds.

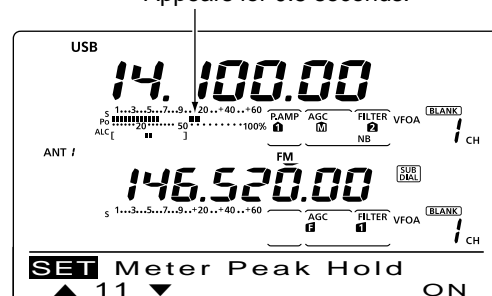

## ■ Noise Reduction

The Noise Reduction function reduces random noise components and enhances audio signals which are buried in noise. The received signals are converted to digital signals and then the audio signals are separated from the noise.

- ① Push [NR] to turn ON the Noise Reduction.
  - “NR” appears.
- ② Rotate the [NR] control to adjust the noise reduction level.
- ③ Push [NR] to turn OFF the Noise Reduction.
  - “NR” disappears.

▨ A large rotation of the [NR] control results in audio signal masking or distortion. Set the [NR] control for maximum readability.

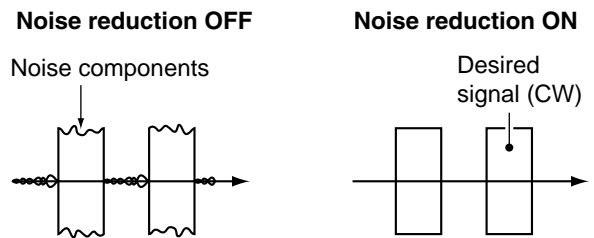
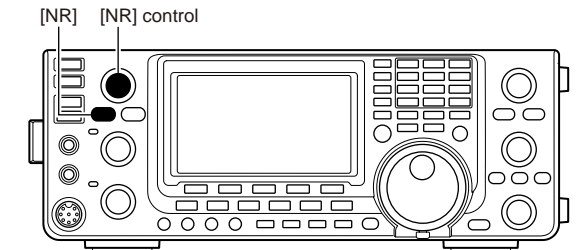

## ■ Dial Lock function

The Dial Lock function prevents frequency changes by accidental movement of [MAIN DIAL] by electronically locking it.

- ➔ Hold down [SPEECH/LOCK] to turn the Dial Lock function ON or OFF.
  - “” appears when the function is ON.

▨ **NOTE:** When the “[SPEECH/LOCK] SW” item is set to “LOCK/SPEECH” in the Set mode, pushing [SPEECH/LOCK] turns ON the Dial Lock function. (p. 164)

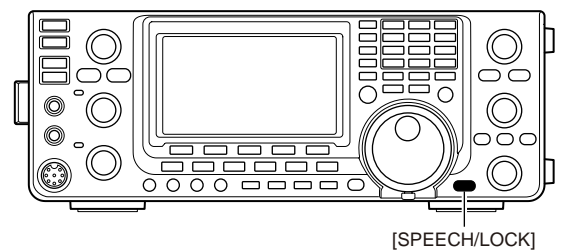

## ■ Notch function

(Mode = Auto notch : SSB/AM/FM  
Manual notch : SSB/CW/RTTY/AM)

This transceiver has Auto and Manual Notch functions. The Auto Notch function uses DSP to automatically attenuate beat tones, tuning signals, etc., even if their frequencies are changing. The Manual Notch function allows you to manually attenuate a frequency via the [NOTCH] control.

- ➔ In the SSB or AM mode, push [NOTCH] to toggle the Notch function between auto, manual and OFF.
  - Either the Auto or Manual notch function can be turned OFF in the Set mode. (p. 165)
- ➔ In the CW or RTTY mode, push [NOTCH] to turn the Manual Notch function ON or OFF.
- ➔ In the FM mode, push [NOTCH] to turn the Auto Notch function ON or OFF.
  - “MNF” appears when the Manual Notch function is ON.
  - “ANF” appears when the Auto Notch function is ON.
  - No indicator appears when the notch filter is OFF.
  - When the Manual Notch function is ON, hold down [NOTCH] for 1 second to select the wide, mid, or narrow manual notch filter width.

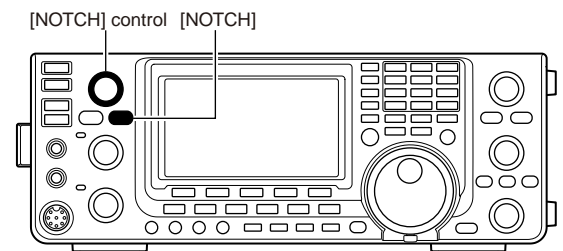

▨ While tuning the manual notch filter, noise may be heard. This comes from the DSP unit and does not indicate an equipment malfunction.

## ■ VOX function

(Mode: SSB/AM/FM/DV)

The VOX (Voice-Operated Transmission) function switches the transceiver between transmit and receive with your voice. This function provides hands-free operation.

### ◇ Using the VOX function

- ① Select a phone mode (SSB, AM, FM, DV). (p. 43)
- ② Push [VOX/BK-IN] to turn ON the VOX function.
  - “VOX” appears.

The optional UT-121 is required for DV mode operation.

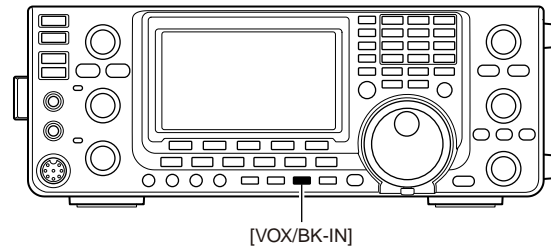

Appears

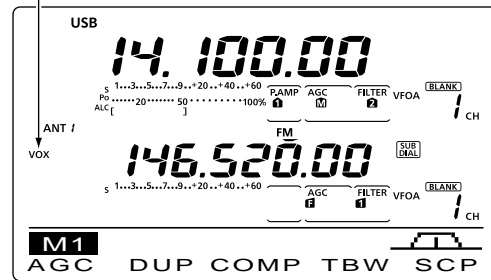

### ◇ Adjusting the VOX function

- ① Select a phone mode (SSB, AM, FM, DV). (p. 43)
- ② Hold down [VOX/BK-IN] for 1 second to display the “VOX” screen.
- ③ Push [▲](F-1) or [▼](F-2) to select the VOX Gain item.
- ④ While speaking into the microphone, rotate [MAIN DIAL] to the point where the transceiver is continuously transmitting.
- ⑤ If the receive audio from the speaker causes the VOX circuit to switch to transmit, push [▲] (F-1) or [▼] (F-2) to select the Anti-VOX item. Then adjust the anti-VOX setting to the point where receive audio does not activate the VOX.
- ⑥ Adjust the VOX delay for a convenient interval before returning to receive after you stop speaking.
- ⑦ Set the VOX voice delay, if desired.
- ⑧ Push [MENU] to return to the previous menu.

#### 1. VOX Gain (Default: 50%)

Adjust the VOX gain to between 0% and 100%, in 1% steps.

Higher values make the VOX function more sensitive to your voice.

#### 2. Anti-VOX (Default: 50%)

Adjust the ANTI-VOX gain to between 0% and 100%, in 1% steps.

Higher values make the VOX function less sensitive to the received audio from a speaker or headphones.

#### 3. VOX Delay (Default: 0.2s)

Set the VOX delay to between 0.0 and 2.0 seconds, for normal pauses in speech before returning to receive.

#### 4. VOX Voice Delay (Default: OFF)

Set the VOX voice delay to prevent clipping of the first few syllables of a transmission when switching to transmit.

OFF, Short, Mid and Long settings can be set.

When using the VOX voice delay, turn OFF the TX monitor function to prevent transmitted audio from being echoed.

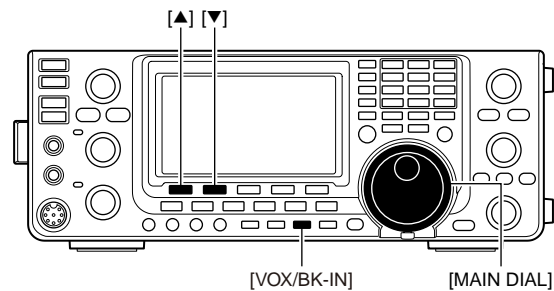

## Break-in function

### (Mode: CW)

The Break-in function is used in the CW mode to automatically toggle the transceiver between transmit and receive when keying. The IC-9100 is capable of Full Break-in or Semi Break-in.

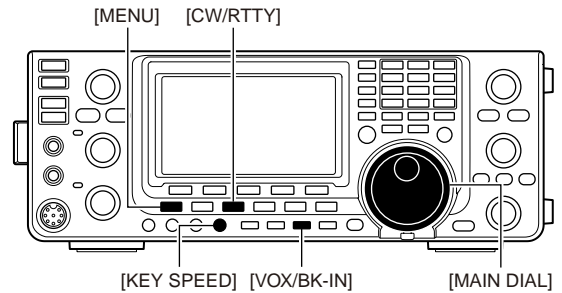

### ◆ Semi Break-in operation

During Semi Break-in operation, the transceiver immediately transmits when you key down, then returns to receive after a pre-set delay time has passed after you stop keying.

- ① Push [CW/RTTY] to select the CW or CW-R mode.
- ② Push [VOX/BK-IN] one or more times to turn ON the Semi Break-in function.
  - “BK-IN” appears.
- ③ Set the break-in delay time (the delay from transmit to receive).
  - Hold down [VOX/BK-IN] for 1 second to display the “BKIN” screen (Break-in).
  - Rotate [MAIN DIAL] to select the desired delay.
    - Hold down [F-3] for 1 second to reset to the default setting, if desired.
- ④ Push [MENU] to return to the previous menu.

When using a paddle, rotate [KEY SPEED] to adjust the keying speed.

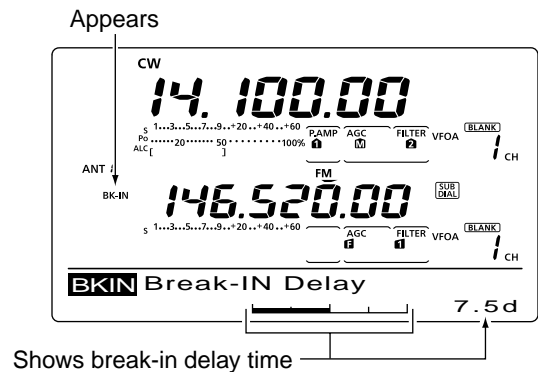

### ◆ Full Break-in operation

During Full Break-in operation, the transceiver transmits when you key down, then immediately returns to receive when you release.

- ① Push [CW/RTTY] to select the CW or CW-R mode.
- ② Push [VOX/BK-IN] one or more times to turn ON the Full Break-in function.
  - “FBK-IN” appears.

When using a paddle, rotate [KEY SPEED] to adjust the keying speed.

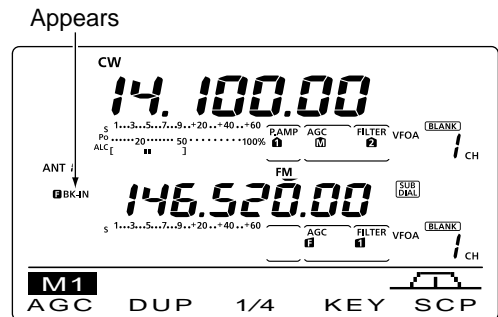



## Speech compressor

(Mode: SSB)

The Speech Compressor function increases average RF output power, improving signal strength and readability.

- ① Push [SSB] to select the USB or LSB mode.
- ② Adjust the [MIC GAIN] control so that the ALC meter reads within the ALC zone, whether or not you speak softly or loudly.
- ③ Push [MENU] to display the "M1" screen (Menu 1), then push [COMP](F-3) to turn ON the Speech Compressor.
- ④ Hold down [COMP](F-3) for 1 second to display the "COMP" screen (Compressor).
- ⑤ While speaking into the microphone at your normal voice level, rotate [MAIN DIAL] so the COMP meter reads within the COMP zone.
  - Hold down [F-3] for 1 second to reset to the default setting, if desired.
- ⑥ Push [MENU] to return to the previous menu.

When the COMP meter peaks above the COMP level zone, your transmitted voice may be distorted.

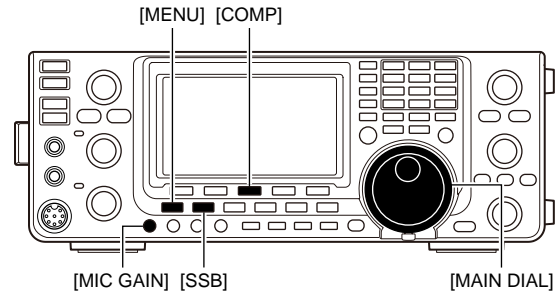

Appears

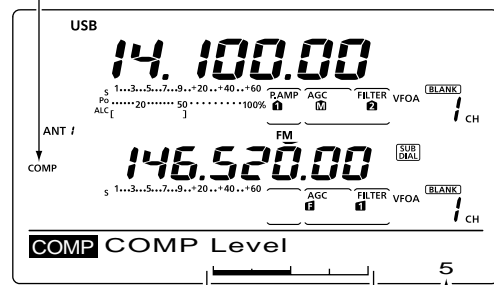

Shows the compression level

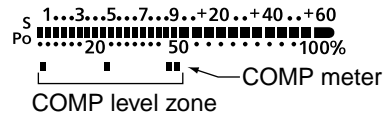

## Transmit filter width selection

(Mode: SSB)

The transmit filter width for the SSB mode can be selected from Wide, Mid or Narrow.

- ① Push [SSB] to select the USB or LSB mode.
- ② Push [MENU] to display the "M1" screen (Menu 1), then hold down [TBW](F-4) for 1 second, one or more times, to select a Wide, Mid or Narrow transmission passband width.
  - Push [TBW](F-4) momentarily to display the selected TX filter width for approximately 1 second.
  - The following filters are specified as the defaults. Each of the filter widths can be set in the Tone control Set mode. (pp. 169, 170)
    - WIDE : 100 Hz to 2900 Hz
    - MID : 300 Hz to 2700 Hz
    - NAR : 500 Hz to 2500 Hz

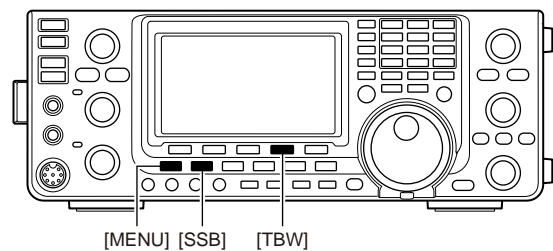

F-4

Hold down



The selected transmit filter width is displayed for approximately 1 second.

## ■ $\Delta$ TX function

The  $\Delta$ TX function shifts the transmit frequency up to  $\pm 9.99$  kHz in 10 Hz steps\* without changing the receive frequency.

\*The [RIT/ $\Delta$ TX] control tunes in 1 Hz steps when the operating frequency readout is set to the 1 Hz step readout. However, the 1 Hz digit is not displayed on the frequency shift readout.

- ① Push [ $\Delta$ TX] to turn ON the  $\Delta$ TX function.
  - “ $\Delta$ TX” and the frequency shift appear when the function is ON.
- ② Rotate [RIT/ $\Delta$ TX].
- ③ To reset the  $\Delta$ TX frequency, hold down [CLEAR] for 1 second.
  - Push [CLEAR] momentarily to reset the  $\Delta$ TX frequency when the Quick RIT Clear function is ON. (p. 164)
- ④ To cancel the  $\Delta$ TX function, push [ $\Delta$ TX] again.
  - “ $\Delta$ TX” and the frequency shift disappear.

When the RIT and  $\Delta$ TX functions are ON at the same time, [RIT/ $\Delta$ TX] shifts both the transmit and receive frequencies from the displayed frequency at the same time.

### ✓ For your convenience— Calculate function

The frequency shift of the  $\Delta$ TX function can be added to or subtracted from the displayed frequency.

While displaying the  $\Delta$ TX frequency shift, hold down [ $\Delta$ TX] for 1 second.

### ◇ $\Delta$ TX Monitor function

When the  $\Delta$ TX function is ON, holding down [XFC] allows you to listen to the transmit frequency (including the  $\Delta$ TX frequency offset).

## ■ Monitor function

The Monitor function allows you to monitor your transmit IF signals in any mode. Use this to check voice characteristics while adjusting transmit parameters. (p. 169)

The CW sidetone functions regardless of the [MONITOR] setting.

- ① Push [MONITOR] to turn ON the Monitor function.
  - “MONI” appears when the Monitor function is ON.
- ② Hold down [MONITOR] for 1 second to display the “MONI” screen (Monitor).
- ③ Rotate [MAIN DIAL] to adjust the monitor level.
  - For the clearest audio output, adjust while holding down [PTT] and speaking into the microphone.
  - Hold down [F-3] for 1 second to reset to the default setting, if desired.
- ④ Push [MENU] to return to the previous menu.

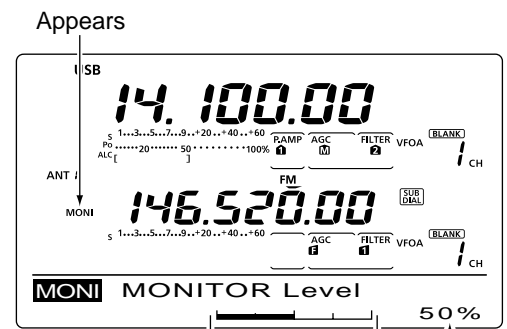
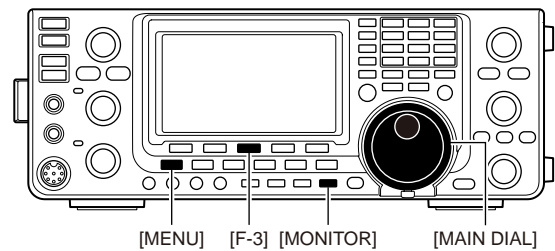
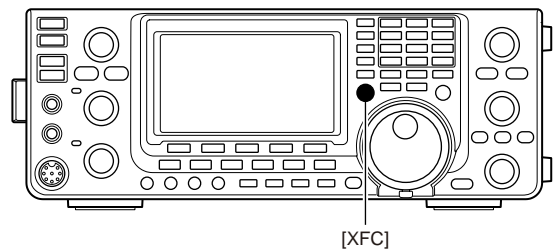
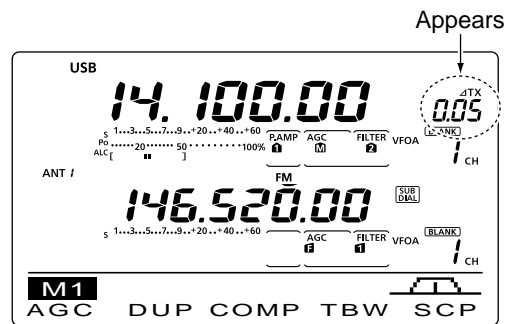
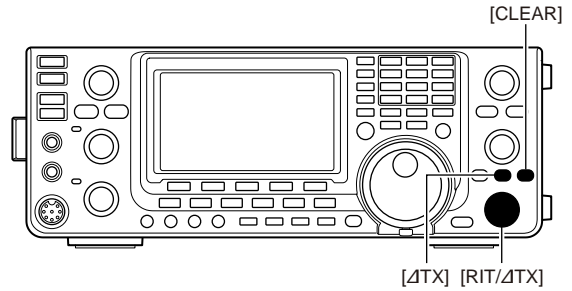

## Split frequency operation

Split frequency operation allows you to transmit and receive on two different frequencies. Split frequency operation is performed using frequencies in VFO A and VFO B.

- The Split frequency operation is automatically turned OFF when turning ON the One-touch repeater function.

The following is an example of setting 21.290 MHz for receiving and 21.310 MHz for transmitting.

- ① Set 21.290 MHz in VFO A.
- ② Push [SPLIT] to turn ON the Split operation.
  - The transmit (VFO B) frequency and "SPLIT" appear.
- ③ Hold down [A/B] for 1 second to equalize the transmit (VFO B) frequency to the receive (VFO A) frequency.
  - The equalized transmit (VFO B) frequency appears.
  - The Quick Split function is much more convenient for selecting the transmit frequency. See the next section for details.
- ④ While holding down [XFC], rotate [MAIN DIAL] to set the transmit frequency to 21.310 MHz.
  - The transmit frequency is displayed while holding down [XFC].
- ⑤ Now you can receive on 21.290 MHz and transmit on 21.310 MHz.

To change the transmit and receive frequencies, push [A/B] to exchange VFO A and VFO B.

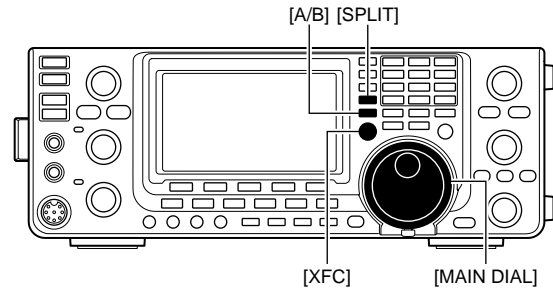

### • After pushing [SPLIT]

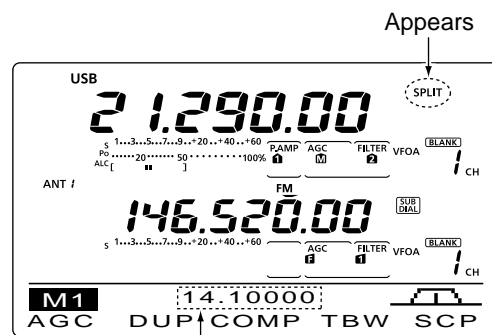

Shows transmit (VFO B) frequency

### • While holding down [XFC]

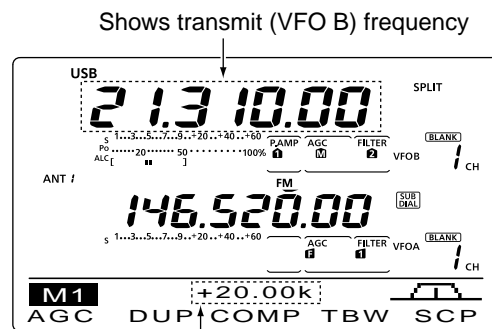

Shows frequency shift and direction

### • After setting up

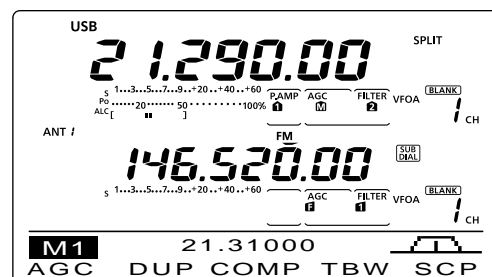

### ✓ CONVENIENT

#### • Direct frequency shift input

The frequency shift can be entered directly.

- ① Push [F-INP ENT].
- ② Enter the desired frequency shift with the digit keys.
  - -9.999 to +9.999 MHz can be set. (in 1 kHz steps)
  - When you require a minus shift direction, first push [GENE •].
- ③ Push [SPLIT] to input the frequency shift to the transmit frequency, and the Split function is turned ON.

[Example]

To transmit on a 1 kHz higher frequency:

- Push [F-INP ENT], [1.8 1] then [SPLIT].

To transmit on 3 kHz lower frequency:

- Push [F-INP ENT], [GENE •], [7 3] then [SPLIT].

#### • Split Lock function

Accidentally releasing [XFC] while rotating [MAIN DIAL] changes the receive frequency. To prevent this, use both the Split Lock and Dial Lock functions to change the transmit frequency only. The Split Lock function cancels the Dial Lock function while holding down [XFC] during split frequency operation.

The Split Lock function is OFF by default, but can be turned ON in the Set mode. (p. 162)

## ■ Quick Split function

When you hold down [SPLIT] for 1 second, the Split frequency operation is turned ON. The undisplayed VFO is automatically changed according to the plus/minus frequency shift programmed in the Set mode. Or the VFOs are equalized when 0 kHz (default setting) is programmed as the split frequency shift. (p. 162)

The Quick Split function is ON by default. For your convenience, it can be turned OFF in the Set mode. (p. 162) In this case, holding down [SPLIT] does not equalize the VFO A and VFO B frequencies.

- ① Suppose you are operating at 21.290 MHz (USB) in VFO A.
- ② Hold down [SPLIT] for 1 second.
  - Split frequency operation is turned ON.
  - The transmit (VFO B) frequency is equalized to the receive (VFO A) frequency.
- ③ While holding down [XFC], rotate [MAIN DIAL] to set the frequency offset between transmit and receive.
  - When [XFC] is released, the receive frequency is displayed.

### ◇ Split frequency offset setting

By setting an often-used split frequency offset in advance, you can use the Quick Split function to select split operation at the push of one switch.

Set the split frequency offset in advance in the “SPLIT Offset” item of the Set mode. (p. 162)

The example at right shows the split offset is set to +0.020 MHz.

- ➔ Hold down [SPLIT] for 1 second. to activate the Quick Split function.
  - The transmit frequency shifts from the receive frequency according to the “SPLIT Offset” option in the Set mode. (p. 162)

### ◇ Split Lock function

The Split Lock function is convenient for changing only the transmit frequency. When the Split Lock function is not used, accidentally releasing [XFC] while rotating [MAIN DIAL], changes the receive frequency.

The Split Lock function is OFF by default, but can be turned ON in the Set mode.

- ① While split frequency operation is ON, hold down [SPEECH/LOCK] for 1 second to activate the split lock function.
  - “” appears.
- ② While holding down [XFC], rotate [MAIN DIAL] to change the transmit frequency.
  - If you accidentally release [XFC] while rotating the [MAIN DIAL], the receive frequency does NOT change.

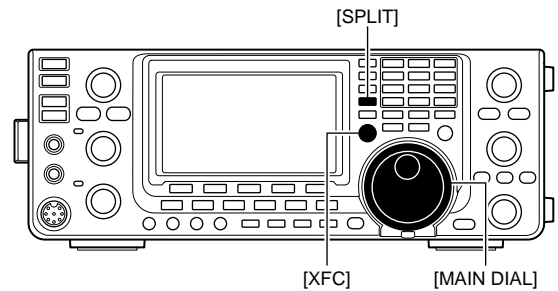

#### • After holding down [SPLIT]

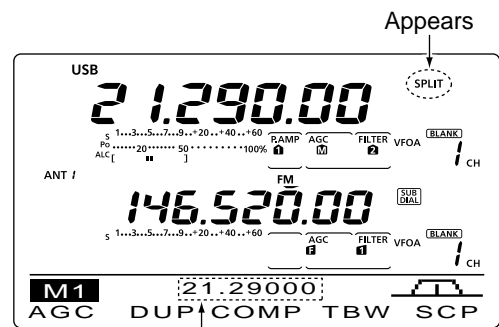

Shows the equalized transmit (VFO B) frequency

#### • After holding down [SPLIT] when the split offset is set to “+0.020” in the Set mode

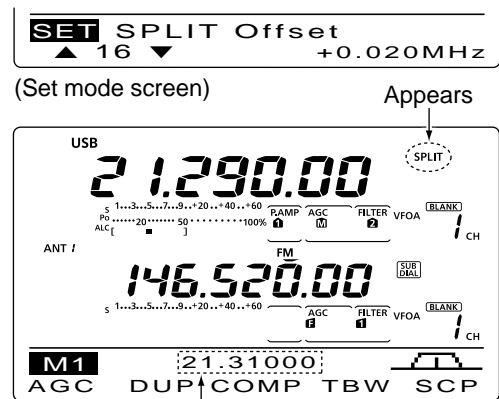

Shows the shifted transmit (VFO B) frequency

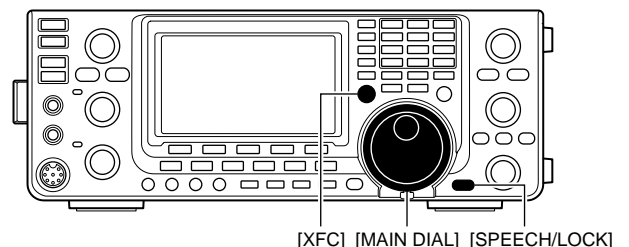

## ■ Measuring SWR

**(Band: HF/50/144/430 MHz)**

The IC-9100 has a built-in circuit for measuring antenna SWR— no external equipment or special adjustments are necessary.

The IC-9100 can measure SWR two ways— spot measurement and plot measurement.

### ◇ Spot measurement

- ① Push [TUNER] once or twice to turn OFF the antenna tuner.
- ② Hold down [ANT•METER] for 1 second, one or more times, to select the SWR meter.
- ③ Push [CW/RTTY] once or twice to select the RTTY mode.
- ④ Push [PTT] on the microphone to transmit. (or [TRANSMIT] on the transceiver).
- ⑤ Rotate [RF POWER] clockwise past the 12 o'clock position for more than 30 W of output power (30%).
- ⑥ Read the SWR on the SWR meter.
- ⑦ Release [PTT] to receive. (or push [TRANSMIT] again)

▨ The built-in antenna tuner matches the transmitter to the antenna when the SWR is less than 3:1\*.  
▨ \* 2.5:1 in the 50 MHz frequency band.

### ◇ Plot measurement

Plot measurement allows you to measure the SWR over an entire band.

- ① Push [MENU] to display the “M2” screen (Menu 2), then push [SWR](F-3).
  - The SWR graph screen appears.
- ② Rotate [RF POWER] clockwise past the 12 o'clock position for more than 30 W of output power (30%).
- ③ Set the center frequency for the SWR to be measured.
- ④ Hold down [F-5] for 1 second one or more times to select 10, 50, 100 or 500 kHz steps as the SWR measuring step.
- ⑤ Push [F-3] one or more times to select 3, 5, 7, 9, 11 or 13 steps as the number of measuring steps.
- ⑥ Push [F-1] to start the measuring.
- ⑦ Push [TRANSMIT] or hold down [PTT] on the microphone to measure the SWR.
  - A frequency marker, “▲,” appears below the SWR graph.
- ⑧ Push [TRANSMIT] again or release [PTT] to move the frequency marker and frequency indication to the next frequency to be measured.
- ⑨ Repeat steps ⑦ and ⑧ to measure SWR over the entire frequency range.
- ⑩ When the measured SWR is more than 1.5:1, adjust the antenna to match with the transceiver.

The antenna SWR cannot be measured on the 1200 MHz frequency band\*.

\* The optional UX-9100 is required.

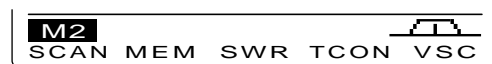
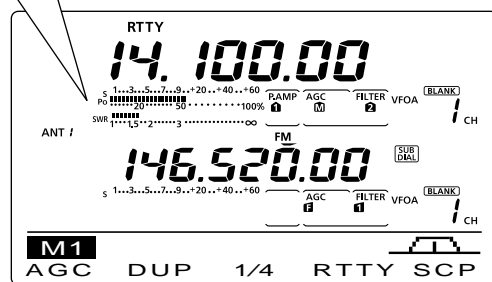
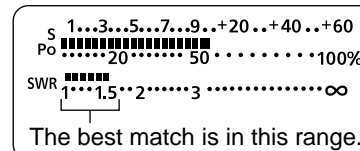

F-3

Push

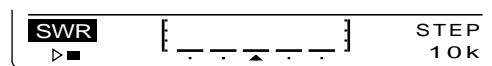

F-1

F-3

F-5

Start measuring  
Select number of SWR measuring steps  
Select SWR measuring step \_\_\_\_\_

#### • Measuring (after pushing [F-1])

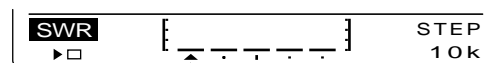

Frequency marker appears and moves after measurement.

When measurement points are set outside of the operable frequency band, the frequency marker blinks.



Typical display SWR varying between 1 and 2, full scale up to SWR 4.0:1.

▨ The optional UT-121 is required for DV mode operation.

## Call sign programming

Four types of call signs are used; “MY” (your own call sign) “UR” (destination call sign, whether it is an individual or a repeater.) “R1” (your access/area repeater call sign) and “R2” (a destination or gateway repeater call sign). Each call sign can be programmed with up to 8 characters.

In addition, you can store up to 6 “MY” call signs, and up to 99 “UR” call signs in the call sign memory. Up to 500 repeater call signs can be stored in the repeater list.

### ◆ “MY” (Your own call sign) programming

Your own call sign must be programmed for both digital voice and low-speed data communications (including GPS transmission).

- ① Push [DV•DR] to select the DV mode.
- ② Push [MENU] one or more times to display the “M3” screen (Menu 3).
  - In the DR mode, push [MENU] once or twice to select the “D1” screen.
- ③ Push [CS](F-1) to display the “CS” screen (Call Sign).
- ④ Push [▼](F-1) one or more times to display the “MY” screen (MY call sign setting).
- ⑤ Rotate [MAIN DIAL] to select MY1, 2, 3, 4, 5, or 6 call sign memory.
- ⑥ Push [EDT](F-3) to enter the call sign programming mode.
  - A cursor appears and blinks.
- ⑦ Rotate [MAIN DIAL] to select the first character to input.
 

When inputting numbers, push the appropriate keypad key.

  - Push [DEL](F-4) to delete the selected character or number.
  - Push [SPC](F-5) to input a space.
- ⑧ Push [◀](F-2) to move the cursor backwards, or push [▶](F-3) to move the cursor forwards.
- ⑨ Repeat steps ⑦ and ⑧ to enter your own call sign.
  - A call sign of up to 8 digits can be set.
  - To program a note (up to 4 characters, for operating radio type, area, etc.), go to step ⑩, otherwise go to step ⑫.
- ⑩ Push [▶](F-3) to move the cursor right side of “/”.
- ⑪ Repeat steps ⑦ and ⑧ to program the desired 4 character note.
- ⑫ Push [MENU] to store the programmed call sign and note.
- ⑬ Push [MENU] again to return to the “CS” screen.

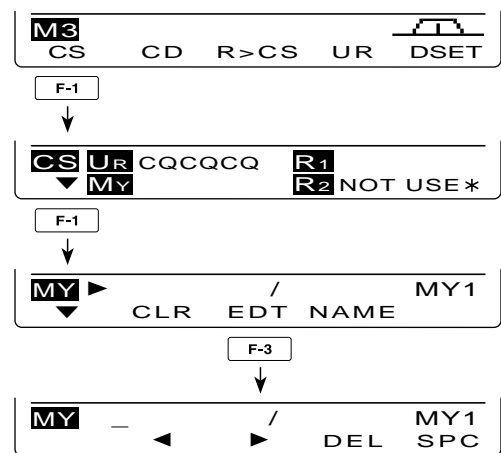
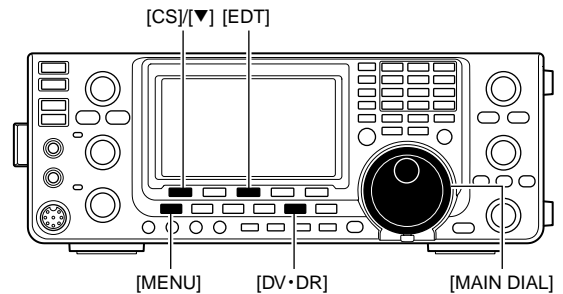

### • Programming a call sign

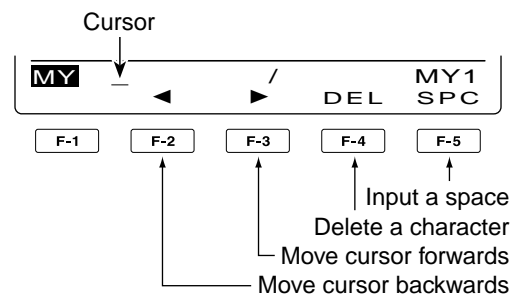
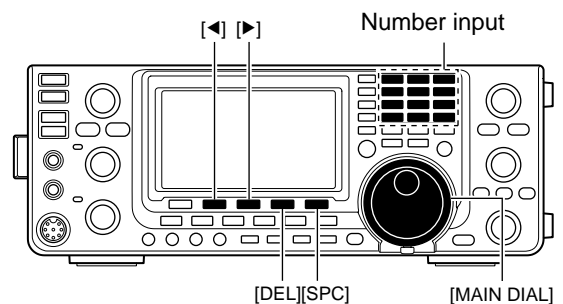

◇ “UR” (Destination call sign) programming

A destination call sign must be programmed to a specific individual station or a repeater, for both digital voice and low-speed data communications.

- ① Push [DV•DR] to select the DV mode.
- ② Push [MENU] one or more times to display the “M3” screen (Menu 3).
  - In the DR mode, push [MENU] once or twice to select the “D1” screen.
- ③ Push [CS](F-1) to display the “CS” screen (Call Sign).
- ④ Push [▼](F-1) one or more times to display the “UR” screen (UR call sign setting).
- ⑤ Rotate [MAIN DIAL] to select the desired call sign memory between “U01” and “U99.”
- ⑥ Push [EDT](F-3) to enter the call sign programming mode.
  - A cursor appears and blinks.
- ⑦ Rotate [MAIN DIAL] to select the first character to input.
  - When inputting numbers, push the appropriate keypad key.
  - Push [DEL](F-4) to delete the selected character or number.
  - Push [SPC](F-5) to input a space.
- ⑧ Push [◀](F-2) to move the cursor backwards, or push [▶](F-3) to move the cursor forwards.
- ⑨ Repeat step ⑦ to enter UR call sign.
  - A call sign of up to 8 digits can be set.
- ⑩ Push [MENU] to store the programmed call sign.
- ⑪ Push [MENU] again to return to the “CS” screen.

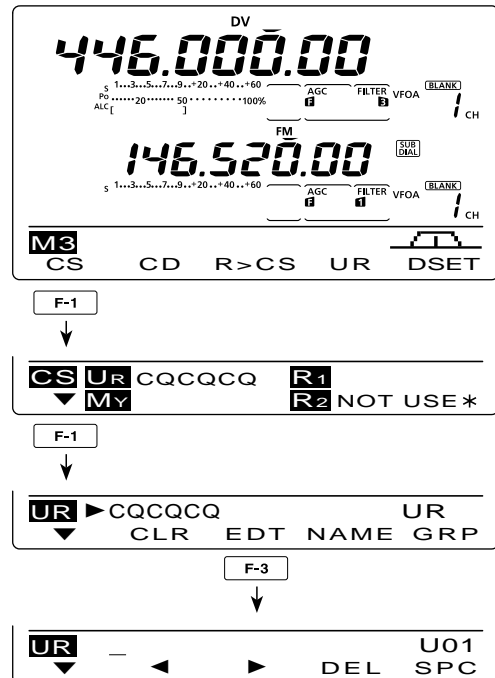
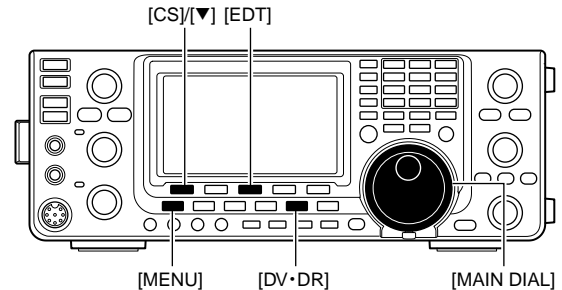

✓ For your information

The IC-9100 has a call sign edit record function. When you edit a call sign that is stored in a call sign memory, the edited call sign is automatically programmed into a blank channel. If all call sign memories are already programmed, the edited call sign will overwrite the selected channel's call sign. The programmed call sign can be over-written anytime, when the “Edit Record” item is set to OFF or Select, in the DV Set mode. (p. 119) However, the call sign that is stored in a regular memory or call channel must be manually overwritten. (Temporary operation is possible).

■ Call sign programming (Continued)

◇ “R1” (Access/Area repeater call sign) and “R2” (Link/Gateway repeater call sign) programming

The access/area and link/gateway repeater call signs must be programmed in “R1” and “R2.”

Other repeater call signs can be stored in the “RP-L” screen (Repeater list) (p. 88).

- ① Push [DV•DR] to select the DV mode.
- ② Push [MENU] one or more times to display the “M3” screen (Menu 3).
  - In the DR mode, push [MENU] once or twice to select the “D1” screen.
- ③ Push [CS](F-1) to display the “CS” screen (Call Sign).
- ④ Push [▼](F-1) one or more times to display the “R1” or “R2” screen (Repeater call sign setting).
- ⑤ Push [EDT](F-3) to enter the call sign programming mode.
  - A cursor appears and blinks.
- ⑥ Rotate [MAIN DIAL] to select the first character to input.
  - When inputting numbers, push the appropriate keypad key.
  - Push [DEL](F-4) to delete the selected character or number.
  - Push [SPC](F-5) to input a space.
- ⑦ Push [◀](F-2) to move the cursor backwards, or push [▶](F-3) to move the cursor forwards.
- ⑧ Repeat steps ⑥ and ⑦ to enter a desired repeater call sign.
  - A call sign of up to 8 digits can be set.
- ⑨ Push [MENU] to store the programmed call sign.
- ⑩ Push [MENU] again to return to the “CS” screen.

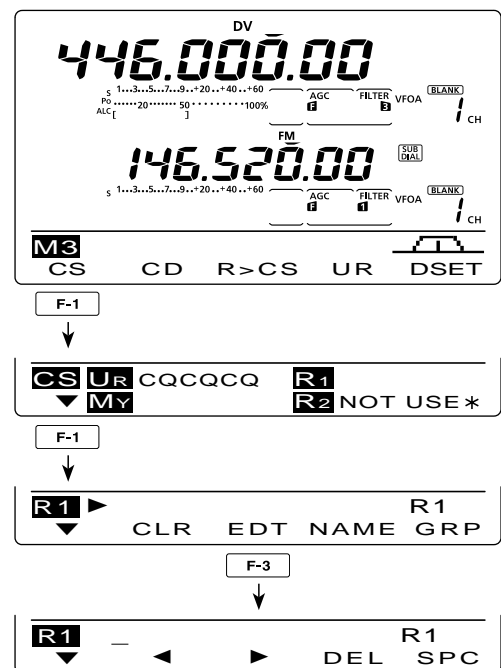
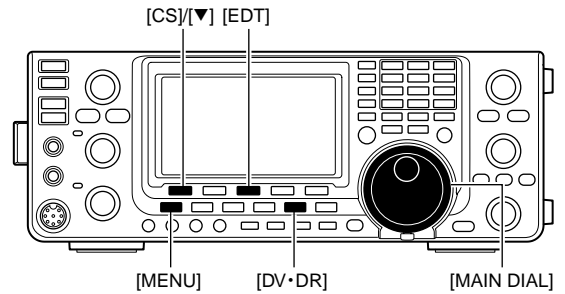



## Repeater list

You can store repeater information for quick and simple communication in up to 500 repeater memory channels (Repeater list) in up to 10 Groups. Programming the repeater list is required for DR mode operation.

The outline of the repeater list is as follows:

- ① Adding new repeaters or editing a list
- ② Selecting a repeater to edit
- ③ Programming repeater data (Repeater name, Call sign, Gateway repeater call sign, Repeater group, etc.)
  - ▨ If a call sign has been programmed, you can skip other data programming, and write only the call sign into the Repeater list.
- ④ Programming access repeater data (Receive frequency, Duplex direction, Frequency offset)

### Repeater list contents

The following contents are included in the repeater list:

- CLR (Repeater list clearing) (p. 92)
- ADD (Repeater list addition) (p. 89)
- EDT (Repeater list editing) (p. 91)
- NAME (Repeater name) (p. 89)
- CS (Repeater call sign) (p. 89)
- GW (Gateway repeater's call sign) (p. 90)
- GROUP (Repeater group) (p. 90)
- R1 USE (Access repeater use) (p. 90)
- FREQ (Repeater input frequency)\* (p. 90)
- DUP (Duplex direction)\* (p. 91)
- OFFSET (Frequency offset)\* (p. 91)
- ADD Write (Save and add to the repeater list) (pp. 91, 92)
- OVER Write (Save and overwrite to the repeater list) (p. 92)

\*Appears when R1 USE is selected as YES.

#### To select the Repeater list entry mode

- ① In the DV mode, push [MENU] one or more times to select the "M3" screen (Menu 3).
  - In the DR mode, push [MENU] once or twice to select the "D1" screen.
- ② Push [DSET](F-5) to display the "DSET" screen.
- ③ Push [RP-L](F-4) to display the "RP-L" screen (Repeater list).

#### In the DV mode

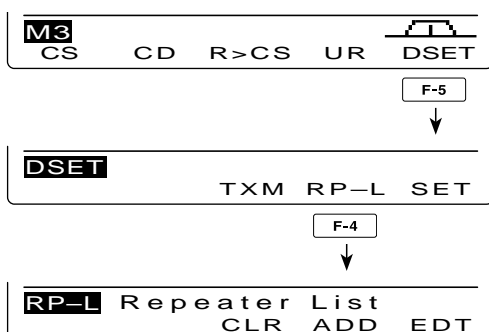

#### In the DR mode

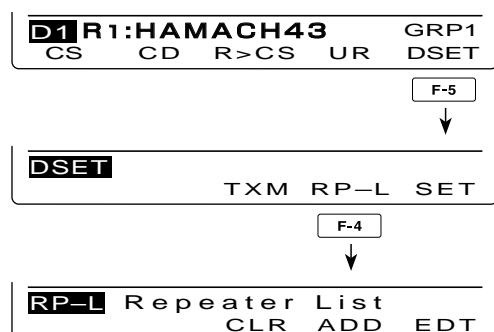

**NOTE:** Repeater lists can be erased by static electricity, electric transients, etc. In addition, they can be erased by an equipment malfunction, and during repairs. Therefore, we recommend that memory data be backed up externally, or be saved to a PC using the optional CS-9100 CLONING SOFTWARE.

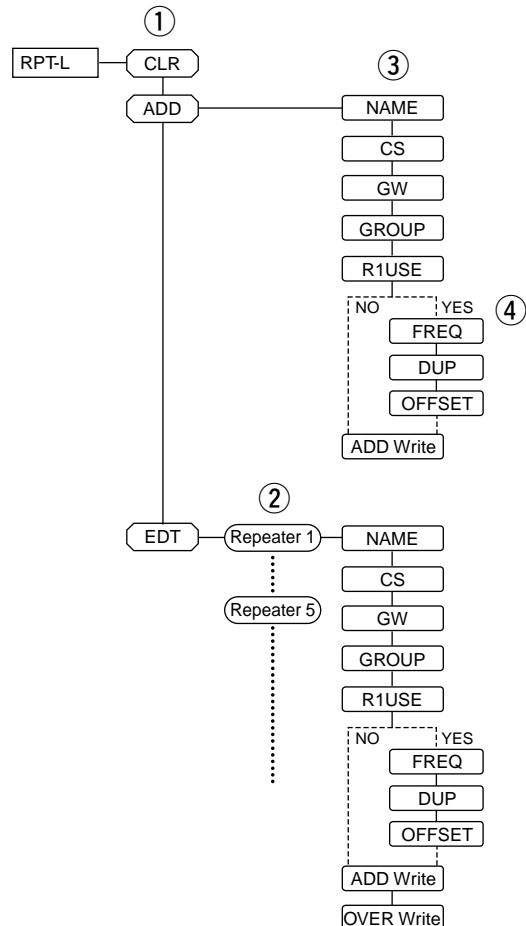

## Repeater list programming

### 1. New repeater list programming

- 1 Push [DV•DR] to select the DV mode.
- 2 Push [MENU] one or more times to display the “M3” screen (Menu 3).
  - In the DR mode, push [MENU] once or twice to select the “D1” screen.



When the “M3” screen is selected.

- 3 Push [DSET](F-5) to display the “DSET” screen.

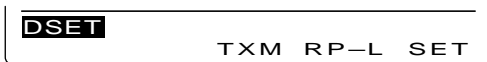

- 4 Push [RP-L](F-4) to display the “RP-L” screen (Repeater list).



- 5 Push [ADD](F-3) to display the “NAME” item (Repeater name).

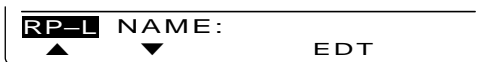

#### To cancel the programmed data:

After programming, push [MENU] to display “Cancel OK?.” Push [YES](F-4) to cancel programming and return to the “RP-L” screen (Repeater list), or push [NO](F-5) to keep programming and return to the previous screen which was selected before pushing [MENU].

### 2. Repeater name programming

- 6 Push [EDT](F-4) to enter the repeater name programming mode.
  - A cursor appears and blinks.

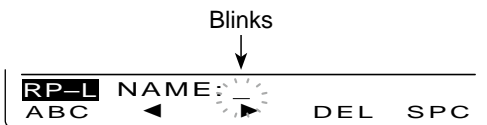

- 7 Push [ABC](F-1) one or more times to select the desired character type.

Character type	Selectable characters
ABC	A to Z
abc	a to z
etc	! # \$ % & \ ? " ' ` ^ + - * / . , ; = < > ( ) [ ] { } ! _ ' @

- 8 Rotate [MAIN DIAL] to select the first character or symbol to input.
  - When inputting numbers or a decimal point, push the appropriate keypad key.
  - Push [DEL](F-4) to delete the selected character, symbol or number.
  - Push [SPC](F-5) to input a space.
  - When all 9 characters have been programmed, an error beep sounds. If you want to reprogram, push [◀](F-2) or [▶](F-3) to select a character, then push [DEL](F-4) to delete it.
- 9 Push [◀](F-2) to move the cursor backward, or push [▶](F-3) to move the cursor forward.
- 10 Repeat steps 7 through 8 to program a name of up to 9 characters.
- 11 Push [MENU] to save the name.

### 3. Repeater call sign programming

- 12 Push [▼](F-2) to display the “CS” item (Repeater Call Sign).
- 13 Push [EDT](F-4) to enter the repeater call sign programming mode.
  - A cursor appears and blinks.

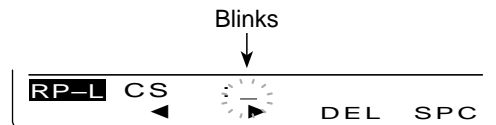

- 14 Rotate [MAIN DIAL] to select the first character or symbol (‘/’ only) to input.
  - When inputting numbers, push the appropriate keypad key.
  - Push [DEL](F-4) to delete the selected character, symbol or number.
  - Push [SPC](F-5) to input a space.
  - When all 8 characters have been programmed, an error beep sounds. If you want to reprogram, push [◀](F-2) or [▶](F-3) to select a character, then push [DEL](F-4) to delete it.
- 15 Push [◀](F-2) to move the cursor backward, or push [▶](F-3) to move the cursor forward.
- 16 Repeat steps 14 through 15 to program a repeater call sign of up to 8 characters.
- 17 Push [MENU] to save the call sign.

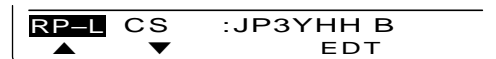

Be sure to add a letter after a repeater call sign, as the repeater node (port), according to the repeater frequency, as shown below. Note that Japanese repeater node letters are different.

- 1200 MHz : A (B in Japan)
- 430 MHz : B (A in Japan)
- 144 MHz : C (no D-STAR repeaters in Japan)

Cross band operation between different nodes in the same repeater area can be made.

#### 4. Gateway repeater call sign programming

When the repeater that was programmed in the previous item has its own gateway capability, skip this setting and go to the next item. If the programmed repeater uses a different gateway repeater, program gateway repeater's call sign as described below.

- 18 Push [▼](F-2) to display the "GW" item (Gateway Repeater Call Sign).
- The programmed repeater's call sign is displayed, and "G" is automatically added as, or overwrites, the 8th digit.

RP-L GW :JP3YHH G  
▲ ▼ EDT

- 19 Push [EDT](F-4) to enter the repeater call sign programming mode.
- A cursor appears and blinks.
- 20 Push [◀](F-2) or [▶](F-3) to select the character to program.
- 21 Rotate [MAIN DIAL] to select the first character or symbol ('/' only) to input.  
When inputting numbers, push the appropriate keypad key.
- Push [DEL](F-4) to delete the selected character, symbol or number.
  - Push [SPC](F-5) to input a space.
  - When all 8 characters have been programmed, an error beep sounds. If you want to reprogram, push [◀](F-2) or [▶](F-3) to select a character, then push [DEL](F-4) to delete it.
- 22 Repeat steps 20 through 21 to program a repeater call sign of up to 8 characters.
- The 8th digit must be "G."
  - For repeaters in a zone with no gateway, enter a common name or call sign, up to 7 digits, in all their gateway repeater cells. The 8th digit must be blank.
- 23 Push [MENU] to save the programmed call sign.

#### 5. Repeater group programming

The IC-9100 has a total of 10 groups (0–9). You can assign and organize up to 500 repeaters in the 10 groups. Group selection is helpful for quick recall of a desired repeater.

- 24 Push [▼](F-2) to display the "GROUP" item (Repeater group).
- Selected group number appears.

RP-L GROUP: ▶GRP1  
▲ ▼

- 25 Rotate [MAIN DIAL] to select the desired repeater group.

#### 6. Access repeater setting (R1 USE)

The programmed repeaters can be set as an access repeater (R1) in the DR mode. To use as R1, the repeater frequency, duplex direction and frequency offset must be programmed.

- 26 Push [▼](F-2) to display the "R1USE" item (Access Repeater Programming).
- The access repeater programming screen appears.

RP-L R1USE: ▶YES  
▲ ▼

- 27 Rotate [MAIN DIAL] to select "YES" or "NO."
- When "NO" is selected, the repeater cannot be selected as an access repeater (R1) in the DR mode.
  - When "YES" is selected, the repeater can be selected as an access repeater (R1) in the DR mode.
- ➔ When "NO" is selected in step 27, skip 'Frequency programming (FREQ)' and go to 'Duplex direction setting (DUP).'
- ➔ When "YES" is selected in step 27, push [▼](F-2) to go to step 28 for the access repeater (R1) programming.

#### 7. Frequency programming (FREQ)

This content appears when "YES" is selected in "R1 USE," as described in 'Access repeater setting (R1 USE)' above.

- 28 Push [▼](F-2) to display the "FREQ" item (Frequency Programming).
- The frequency programming screen is displayed.

RP-L FREQ: . .  
▲ ▼ CLR EDT

- 29 Push [EDT](F-4) to enter the frequency programming mode.
- A cursor appears and blinks.

RP-L F-INP : . .  
▲ ▼

- 30 Push the keypad key to input the frequency, then push [F-INP ENT].
- Hold down [CLR](F-3) for 1 second to clear the displayed frequency.

## ■ Repeater list programming (Continued)

### 8. Duplex direction setting (DUP)

This content appears when “YES” is selected in “R1 USE” as described in ‘Access repeater setting (R1 USE)’ on page 90.

- 31 Push [▼](F-2) to display the “DUP” item (Duplex direction setting).
- The duplex direction setting screen is displayed.

```
RP-L  DUP : ▶OFF
▲      ▼
```

- 32 Rotate [MAIN DIAL] to select the duplex direction.
- OFF : The duplex function is OFF.
  - DUP- : The transmit frequency shifts down from the receive frequency by the offset amount.
  - DUP+ : The transmit frequency shifts up from the receive frequency by the offset amount.

### 9. Frequency offset programming (OFFSET)

This content appears when “YES” is selected in “R1 USE” as described in ‘Access repeater setting (R1 USE)’ on page 90.

- 33 Push [▼](F-2) to display the “OFFSET” item (Frequency offset Programming).
- Frequency offset programming screen is displayed.

```
RP-L  OFFSET: ▶ 0.000.0
▲      ▼      CLR
```

- 34 Rotate [MAIN DIAL] to select the frequency offset.
- Hold down [CLR](F-3) for 1 second to clear the displayed frequency offset.

### 10. Storing the repeater list (ADD Write)

- 35 Push [▼](F-2) to display the “ADD Write” item (Repeater list Storing).

```
RP-L  ADD Write
▲      ▼      WR
```

- 36 Hold down [WR](F-5) to store the entry.
- “ADD Write OK?” appears.

```
RP-L  ADD Write OK?
▲      ▼      YES NO
```

- 37 Hold down [YES](F-4) to store the entry, and return to the RP-L screen.

## ■ Editing a repeater list

This function re-programs a repeater’s data. This is useful when already-programmed data is incorrect or some data should be added to the list.

### 1. Repeater list selection

- Push [DV•DR] to select the DV mode.
- Push [MENU] one or more times to display the “M3” screen (Menu 3).

```
M3
CS  CD  R>CS  UR  DSET
```

- Push [DSET](F-5) to display the “DSET” screen.

```
DSET
TXM RP-L SET
```

- Push [RP-L](F-4) to display the “RP-L” screen (Repeater list).

```
RP-L Repeater List
CLR ADD EDT
```

- Push [EDT](F-5) to display the repeater list.

```
RP-L ▶HAMACH43 SEL GRP1
EDT          SEL GRP
```

- Rotate [MAIN DIAL] to select the desired repeater to be changed.

```
RP-L ▶KOUTOU43 SEL GRP1
EDT          SEL GRP
```

- Hold down [GRP](F-5) for 1 second to enter the repeater group selection mode. (“▶” moves next to the repeater group name, and then blinks.) Rotate [MAIN DIAL] to select the desired group (0 to 9), then push [GRP](F-5). Or, you can select the repeater group using the keypad key.
- “SEL” appears when “R1 USE” setting is set to “YES.” The selected repeaters can be used as an access repeater (R1) in the DR mode, and are scanned during an access repeater scan. You can set the “SEL” setting by pushing [SEL](F-4).

### 2. Repeater data programming

- Push [EDT](F-1) to enter the repeater data programming mode.
- Push [▲](F-1) or [▼](F-2) to select the item to be changed.
- Program the selected item data. See pages 89–91 for new repeater list programming details.

```
RP-L  NAME:KOUTOU43
▲      ▼      EDT
```

**NOTE:** If you are reprogramming a repeater with its own gateway, you must also edit the gateway repeater call sign.

### 3. After programming

#### To add the programmed data as a new list:

- Push [▼](F-2) to select the "ADD Write" item, then hold down [WR](F-5) for 1 second.
  - "ADD Write OK?" appears.

```

RP-L  ADD Write      WR
  ▲      ▼
    
```

- Hold down [YES](F-4) for 1 second to add a new list, and return to the "RP-L" screen.

```

RP-L  ADD Write OK?
  ▲      ▼      YES  NO
    
```

#### To overwrite the programmed data to the selected list:

- Push [▼](F-2) to select "OVER Write" item, then hold down [WR](F-5) for 1 second.
  - "OVER Write OK?" appears.

```

RP-L  OVER Write    WR
  ▲      ▼
    
```

- Hold down [YES](F-4) for 1 second to overwrite to the selected list, and return to the "RP-L" screen.

```

RP-L  OVER Write OK?
  ▲      ▼      YES  NO
    
```

## ■ Clearing a repeater list

Contents of programmed list can be cleared (erased).

- Push [DV•DR] to select the DV mode.
- Push [MENU] one or more times to display the "M3" screen (Menu 3).

```

M3
CS  CD  R>CS  UR  DSET
    
```

- Push [DSET](F-5) to display the "DSET" screen.

```

DSET
TXM  RP-L  SET
    
```

- Push [RP-L](F-4) to display the "RP-L" screen (Repeater list).

```

RP-L  Repeater List
      CLR  ADD  EDT
    
```

- Push [CLR](F-3) to display the repeater list.
- Rotate [MAIN DIAL] to select the desired repeater list to be erased.
  - Hold down [GRP](F-5) for 1 second to enter the repeater group selection mode. ("▶" moves next to the repeater group name, and then blinks.) Rotate [MAIN DIAL] to select the desired group (0 to 9), then push [GRP](F-5). Or, you can select the repeater group using the keypad key.
- Hold down [CLR](F-1) for 1 second.
  - "Clear OK?" appears.
- Hold down [YES](F-4) to clear the selected list, and return to the "RP-L" screen.

## Digital mode operation

The IC-9100 can be operated in the digital voice mode, including low-speed data operation, for both transmit and receive. It can also be connected to a GPS receiver\* to transmit/receive position data.

\*Compatible with an RS-232 output/NMEA format/4800bps/9600 bps

## Call sign setting

Set the desired "UR," "R1," "R2" and "MY" call signs to be used for DV operation, as described below.

**NOTE:** In the DR mode, you can set only "MY" call sign in the "CS" screen (Call Sign).

- ① Push [DV•DR] to select the DV mode.
- ② Push [MENU] one or more times to display the "M3" screen (Menu 3).
  - In the DR mode, push [MENU] once or twice to select the "D1" screen.
- ③ Push [CS](F-1) to display the "CS" screen (Call Sign).
  - You can push [F-4] to toggle between the call sign and the name.
- ④ Push [▼](F-1) one or more times to display the "UR," "R1," "R2" or "MY" screen.
- ⑤ Rotate [MAIN DIAL] to select the desired call sign.
  - UR : "CQCQCQ," individual station call signs (U01–U99) or destination repeater call signs\*<sup>1</sup> is selected.
  - R1 : Your access/area repeater's call sign is selected.
  - R2 : "NOT USE\*" \*<sup>2</sup> or a link/gateway repeater call sign is selected.
  - MY : Your own call signs is selected (MY1–MY6).
  - First selecting the call sign group by pushing [TS•GRP] or [GRP](F-5)\*<sup>3</sup> makes it more convenient when "UR," "R1" or "R2" is displayed. See the right column for details of the repeater call sign group selection.
- ⑥ Push [SET](F-4) to set the selected call sign to be used for DV operation.
- ⑦ Repeat steps ④ to ⑥ to set the other call signs.
- ⑧ Push [▼](F-1) one or more times to return to the "CS" screen.

**NOTE:** You can toggle between displaying the repeater name or the repeater call sign by pushing [NAME](F-4) in the R1 and R2 screens.

\*<sup>1</sup> 'I' is displayed in front of the repeater call sign. The repeater call sign with 'I' is used for the gateway CQ calling.

\*<sup>2</sup> For an area (local) repeater communication only (Link repeater is not used.)

\*<sup>3</sup> [GRP](F-5) is not used in the DR mode.

### About the Time-Out Timer function

The IC-9100 has a Time-Out Timer function for digital repeater operation. The timer limits a continuous transmission to approximately 10 minutes. Warning beeps will sound approximately 30 seconds before time-out and then again immediately before time-out. Be sure to turn ON the function before operating in the digital mode. (p. 162)

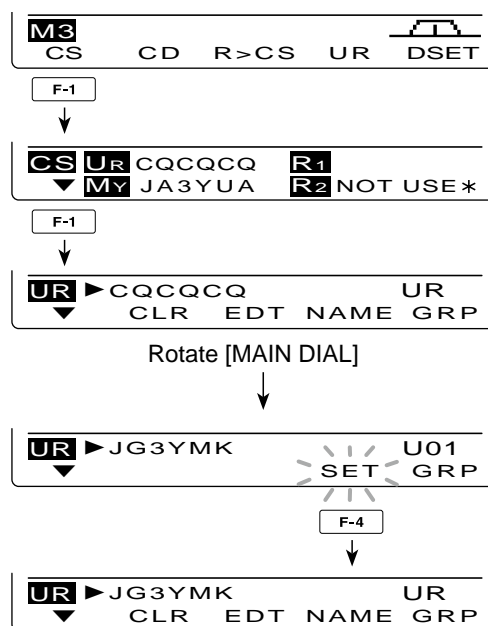
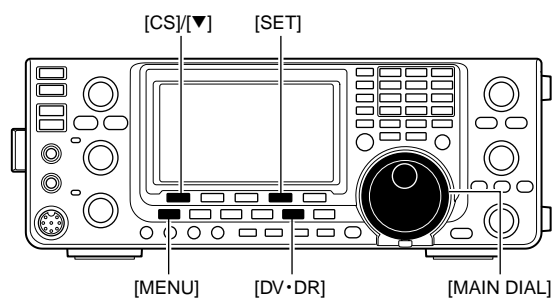

### How to select the repeater call sign group:

Hold down [TS•GRP] or [GRP](F-5)\*<sup>3</sup> for 1 second to enter the group selection mode. Then rotate [MAIN DIAL] to select the desired group. After selecting, push [TS•GRP] or [GRP](F-5)\*<sup>3</sup> to display the repeater call signs in the group.

Or, you can select the repeater group using the keypad key.

- Only repeaters assigned to groups are selectable.

## Receiving a D-STAR repeater

When the IC-9100 receives a signal from a D-STAR repeater, it receives four call signs: the calling station's call sign, the called station's call sign, the R1 repeater call sign (the repeater that receives a signal from the calling station on the uplink frequency), and the R2 repeater call sign (the repeater that transmits a signal on the downlink frequency). You can copy the received call signs into your radio, and reply to the call.

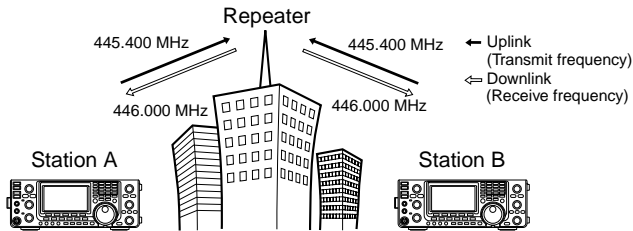

### • Presetting

- ① Select the desired frequency band. (p. 35)
- ② Push [VFO/MEMO] to select the VFO mode.
- ③ Push [A/B] once or twice to select VFO A.
- ④ Set the desired repeater transmit (downlink) frequency. (p. 37)
  - Adjust the output power, if desired. (p. 46)
- ⑤ Push [MENU] to display the "M1" screen (Menu 1).
- ⑥ Hold down [DUP](F-2) for 1 second to turn ON the One-touch repeater function.
  - "T" and "DUP-" appear.
  - The repeater receive (uplink) frequency appears at the bottom of the function display.
- ⑦ Push [DUP](F-2) once or twice to switch the offset to the desired direction.
  - "DUP-" or "DUP+" appears.
  - When the Auto Repeater function is in use, this selection is not necessary (Only U.S.A. and Korean versions). (p. 67)
- ⑧ Push [DV•DR] to select the DV mode. (p. 43)
  - "DV" appears.
  - "T" disappears.
- ⑨ When a signal is received, the calling station's call sign is displayed on the LCD.
  - If the calling station has programmed a note or message, it is displayed after the call sign.

See the next page to view the received call sign.  
To reply to the calling station, see page 96.

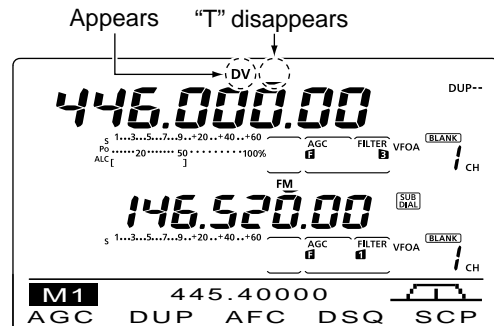
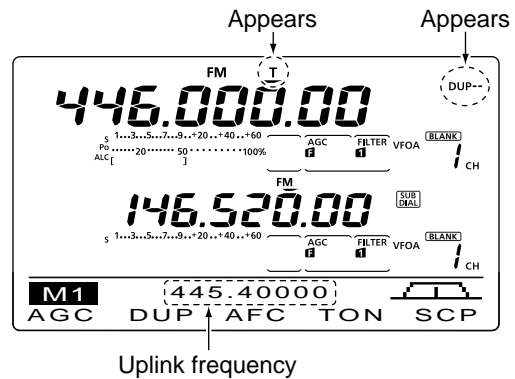
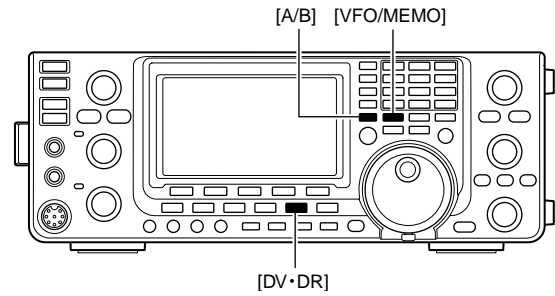

## Received call signs

When a call is received in the DV mode, the calling station and repeater call signs being used can be stored in the received call record. The stored call signs can be displayed in the following manner. Up to 20 calls can be stored.

### Desired call record display

- ① Push [DV•DR] to select the DV mode.
- ② Push [MENU] one or more times to display the "M3" screen (Menu 3).
  - In the DR mode, push [MENU] once or twice to select the "D1" screen.
- ③ Push [CD](F-2) to display the "CD" screen (Call Record).
- ④ Rotate [MAIN DIAL] to select the desired record channel (RX01 to RX20).
  - Hold down [CLR](F-4) for 1 second to clear the selected record channel.
- ⑤ Push [▼](F-1) one or more times to display the call record.
  - CALLER : The calling station's call sign.
  - / : A four character note from the station that made the call.
  - CALLED : The call sign of the station that was called, or "CQCQCQ."
  - RXRPT1 : The call sign of the repeater the calling station accessed, or the call sign of the gateway repeater the calling station used.
  - RXRPT2 : The call sign of the repeater you heard the call on.
  - MSG : Any received message is displayed.

After the MSG screen, the date and time information are displayed. If the received date and time are unknown, the elapsed time after the call was received is displayed (e.g. "(-12:34)"). If the power is turned OFF, then ON, or 48 hours have passed, "---- /-- /----:-" is displayed.

- ⑥ Push [▼](F-1) one or more times to return to the "CD" screen.

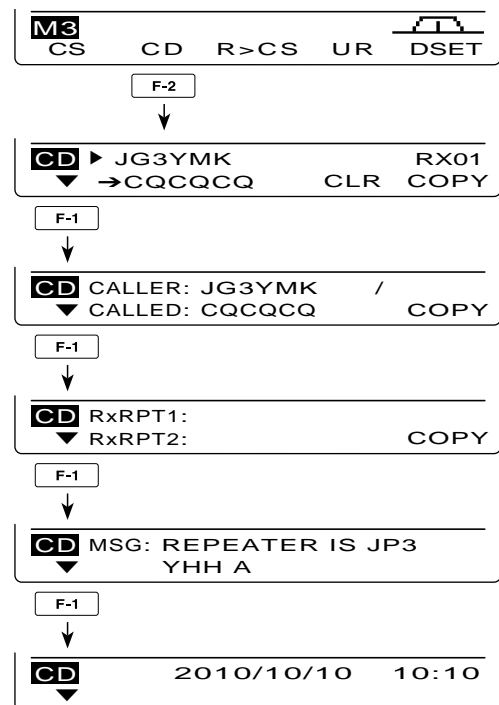
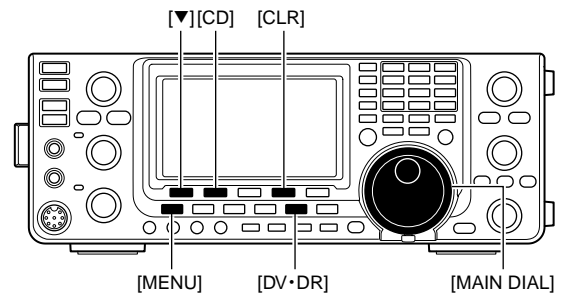



### ◆ One-touch reply using the call record

The calling station's call sign, which is stored in the call record, can be used to quickly and easily reply.

- First, set your own call sign (MY). (p. 85)

#### • After receiving a call

- ① Push [MENU] one or more times to display the "M3" screen (Menu 3).
  - In the DR mode, push [MENU] once or twice to select the "D1" screen.
- ② Hold down [R>CS](F-3) for 1 second to set the other station's call sign.
  - The received call sign is displayed while holding down [R>CS](F-3), and after releasing, two beeps sound.
  - When a call sign has not been received correctly, error beeps sound, and no call sign is set.
- ③ Push [PTT] on the microphone to reply the call. (or push [TRANSMIT] on the transceiver)
- ④ Release [PTT] to receive. (or push [TRANSMIT] again)

#### • Selecting a call record

- ① Push [MENU] one or more times to display the "M3" screen (Menu 3).
  - In the DR mode, push [MENU] once or twice to select the "D1" screen.
- ② While holding down [R>CS](F-3), rotate [MAIN DIAL] to select the desired record channel, then release [R>CS](F-3) to set it.
- ③ Push [PTT] on the microphone to reply the call. (or push [TRANSMIT] on the transceiver)
- ④ Release [PTT] to receive. (or push [TRANSMIT] again)

#### ✓ For your information

When you receive a call addressed to your own call sign, the call signs of the calling station and the repeaters they used can be automatically set for a quick reply. The set call signs are overwritten if another call is received.

The following items must be set to "Auto" in the DV Set mode.

These functions are not available in the DR mode.

- "RX Call Sign Write" item (p. 118):  
The calling station's call sign is automatically set to "UR."
- "RX RPT Write" item (p. 119):  
The repeater call signs are automatically set to "R1" and "R2," if necessary.

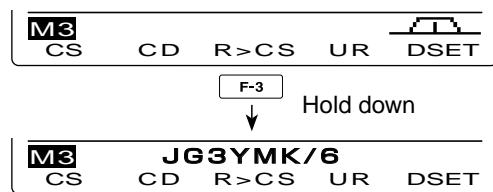
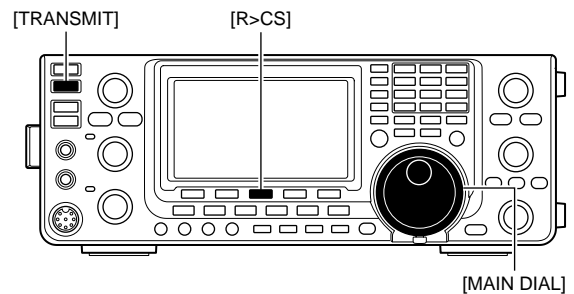

The received call sign is displayed while holding down [R>CS](F-3).

#### **Important!**

One-touch call signs are for only temporary use. They are not saved in a call sign memory. Therefore, when another call sign is set, the previous call sign will be over-written.

If you want to save the set call sign, see 'Copying the call record contents into call sign memory' for details. (p. 98)

## ■ Copying the call sign

### ◇ Copying the call sign memory contents

The memorized UR call sign can be copied into another call sign memory.

**NOTE:**

First, make sure that the “Edit Record” item is set to “Auto” or “Select” in the DV Set mode. (p. 119)

- ① Push [DV•DR] to select the DV mode.
- ② Push [MENU] one or more times to display the “M3” screen (Menu 3).
  - In the DR mode, push [MENU] once or twice to select the “D1” screen.
- ③ Push [CS](F-1) to display the “CS” screen (Call Sign).
- ④ Push [▼](F-1) to display the “UR” screen.
- ⑤ Rotate [MAIN DIAL] to select the desired UR call sign channel to be copied.
  - U01 to U99 can be selected.
- ⑥ Push [EDT](F-3) to enter the call sign programming mode.
  - The 1st digit of the selected call sign blinks.

The displayed contents from step ⑦ are different, depending on the “Edit Record” item setting. (p. 119)

#### When the “Edit Record” item is set to “Auto”

A blank channel is automatically selected, and the call sign channel’s data, selected in step ⑤ above, is displayed.

- ⑦ Edit the displayed call sign as described in page 86.
- ⑧ Push [MENU] to store the edited call sign into the channel.

**NOTE:** If there are no blank channels in the station call sign memory, “Full” appears instead of the channel number. In this case, follow the steps in ‘When the “Edit record” item is set to “Select”,’ as shown below.

#### When the “Edit Record” item is set to “Select”

The selected call sign channel’s data is displayed.

- ⑦ Edit the displayed call sign as described in page 86.
- ⑧ Push [MENU] to set.
- ⑨ Rotate [MAIN DIAL] to select the desired call sign channel to store the data in.
- ⑩ Hold down [SET](F-5) for 1 second to store or overwrite the edited call sign into the selected channel.

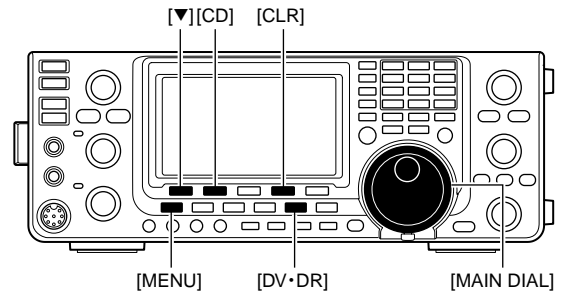

[F-1]



[F-1]



Rotate [MAIN DIAL]



[F-3]



When the “Edit Record” item is set to “Auto.”



[MENU]



When the “Edit Record” item is set to “Select.”

## ◇ Copying the call record contents into call sign memory

This is a way to copy the call record data (“CALLER,” “RXRPT1” and “RXRPT2”) into call sign memory “UR” and a repeater all at the same time, or individually.

- ① Push [DV•DR] to select the DV mode.
- ② Push [MENU] one or more times to display the “M3” screen (Menu 3).
  - In the DR mode, push [MENU] once or twice to select the “D1” screen.
- ③ Push [CD](F-2) to display the “CD” screen (Call Record).
- ④ Rotate [MAIN DIAL] to select the desired record channel (RX01 to RX20).
- ⑤ Push [COPY](F-5) to enter the copy item selection mode.

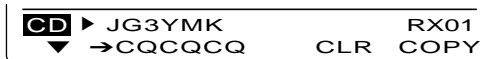

- ⑥ Push [▲](F-1) or [▼](F-2) to select the item to be copied.
  - ALL : The CALLER, RXRPT1 and RXRPT2 call signs.
  - CALLER : The calling station’s call sign
  - RXRPT1 : The call sign of the repeater the calling station accessed, or the call sign of the gateway repeater the calling station used.
  - RXRPT2 : The call sign of the repeater your heard the call on.

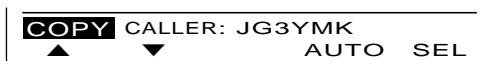

/// The options in step ⑦ are different, depending on your selection in step ⑥.

### When “ALL” is selected in step ⑥:

- ⑦ Select the desired copy destination.
  - LIST : Hold down [LIST](F-4) for 1 second to automatically search a blank call sign memory channel, then copy the call signs of CALLER, RXRPT1 and RXRPT2 into the channel.
  - CURR : Hold down [CURR](F-5) for 1 second to copy the call signs of CALLER, RXRPT1 and RXRPT2 into the current “UR,” “R1” and “R2” memory.



### When “CALLER” is selected in step ⑥:

- ⑦ Select the desired copy destination
  - AUTO : Hold down [AUTO](F-4) for 1 second to automatically search for a blank call sign memory channel, and copy the selected call sign into the detected one.
  - SEL : Push [SEL](F-5) to enter the call sign memory channel selection mode. Rotate [MAIN DIAL] to select the desired channel to be pasted.
    - The contents of the selected channel is displayed in parentheses.
 Hold down [SET](F-5) for 1 second to paste the calling station’s call sign into the selected channel. If a call sign has already been programmed, the selected channel will be overwritten.

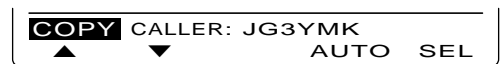

F-5

Push

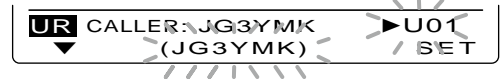

When “SEL” is selected, memory channel number and call sign blink.

### When “RXRPT1” or “RXRPT2” is selected in step ⑥:

- ⑦ Hold down [RP-L](F-5) to copy the repeater call sign into the repeater list “R1” or “R2.”

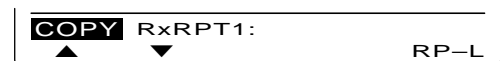

- ⑧ After copying has been completed, transceiver automatically returns to the “CD” screen.

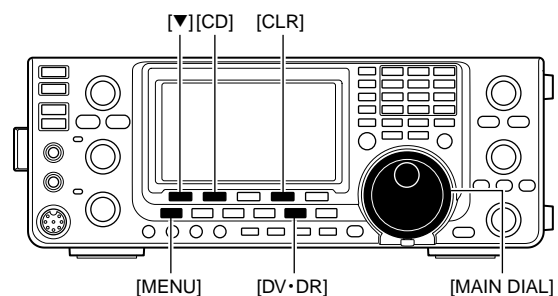

## ■ DR (D-STAR Repeater) mode operation

DR (D-STAR Repeater) mode is used for D-STAR repeater operation. In this mode, you can select the pre-programmed repeaters and UR call sign by using [MAIN DIAL].

### • DR mode operation flow chart

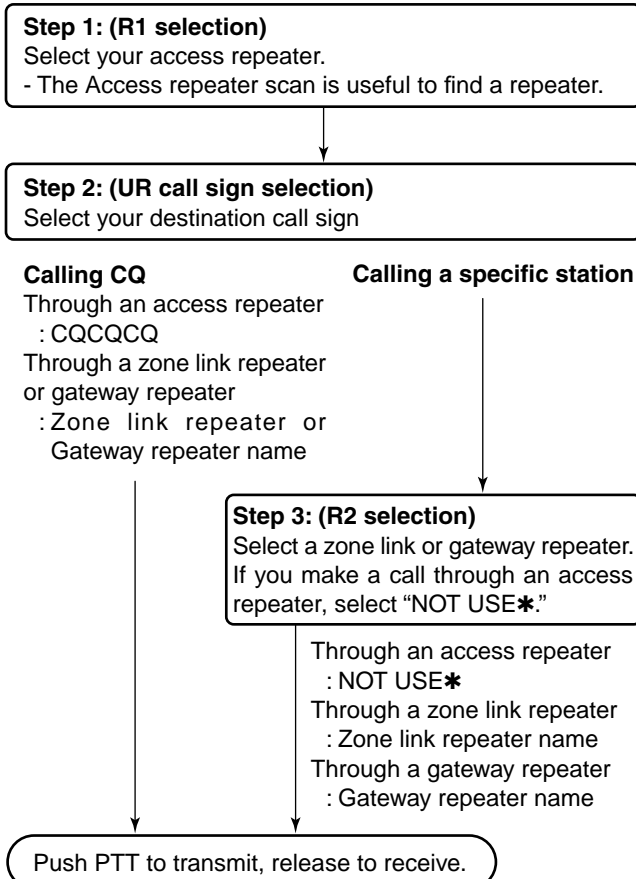

• Repeater settings can be stored into a repeater memory channel (Repeater list).

### ◇ Communication Form

- **Local area call** (pp. 101, 103)  
To call a station through your local area (access) repeater.
- **Zone call** (pp. 102, 104)  
To call a station through your local area (access) repeater and a link repeater in the same zone.
- **Gateway call** (pp. 102, 104)  
To call a station through your local area (access) repeater, gateway repeater and your destination repeater by accessing the internet.

```

D1 R1:HIRANO43 GRP3
CS CD R>CS UR DSET
    
```

Access/Area repeater (R1) selection

```

D1 UR:CQCQCQ CQ
CS CD R>CS UR DSET
    
```

UR call sign (CQ) selection

```

D1 UR:JG3YMK UR
CS CD R>CS UR DSET
    
```

UR call sign (specific station) selection

```

D1 R2:NARA43
CS CD R>CS UR DSET
    
```

R2 (destination repeater) selection

- NOTE:**
- Programming the repeater list is required for DR mode operation. (pp. 89 to 92)
  - You cannot make an Internet call if the selected repeater (R2) has no gateway call sign.
  - While operating voice communication or low-speed data communication via the internet network, some packets may be lost due to network error (poor data throughput performance). In such a case, the transceiver displays "L" on the display to indicate Packet Loss has occurred.

### ◇ Access repeater scan

The Access repeater scan is useful to find a repeater. For rapidly find, the Access repeater scan skips the repeaters which are not specified as a scan target. You can select the desired repeaters as a scan target. See page 90 or 'Access repeater scan's target setting' as described below.

- ① Hold down [DV•DR] for 1 second to select the DR mode.
  - The DV mode is automatically selected.
  - The access repeater selection screen is displayed.
    - Only the repeaters, specified as a scan target are displayed.
- ② Push [MENU] one or more time to display the "D2" screen.
- ③ Push [SCAN](F-1) to start the Access repeater scan.
  - The MHz and kHz decimal points, and "DR" blink while scanning.
  - Hold down [SCAN](F-1) for 1 second to enter the Scan set mode. Push [MENU] to exit the Scan set mode.
    - If "Up/Down" is selected as the "MAIN DIAL (SCAN)" option in the Scan Set mode, rotating [MAIN DIAL] changes the scanning direction. (p. 147)
  - The scan pauses when a signal is received.
- ④ Push [SCAN](F-1) to cancel the scan.

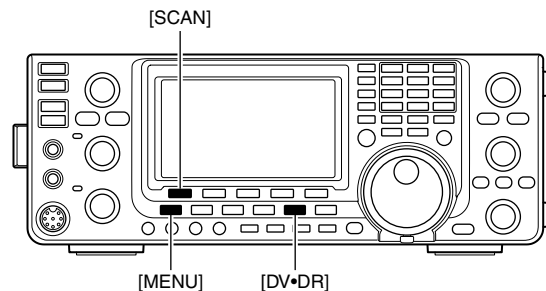

D2 R1:HIRANO43 GRP3  
SCAN SEL AFC DSQ TCON

F-1

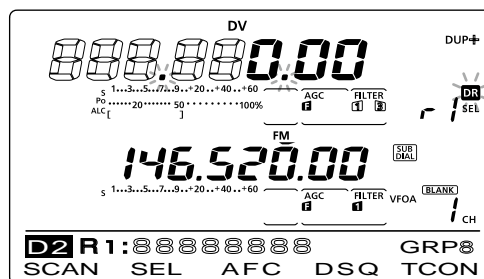

While Access repeater scanning

### • Access repeater scan's target setting

You can select the desired repeaters as a scan target, for faster selection and scanning.

- Non-selected repeaters are skipped during scanning.
- When a repeater is specified as a non-scan target, its "R1USE" setting is automatically set to NO. In this case, the repeater cannot be selected as the access repeater. (p. 90)

- ① In the DR mode, push [MENU] one or more times to display the "D2" screen.
- ② Rotate [MAIN DIAL] to select the desired access repeater.
  - First selecting the repeater call sign group makes it more convenient, if you have programmed repeaters into Groups. See the description in page 93 for details of the repeater call sign group selection.
- ③ Hold down [SEL](F-2) for 1 second to set the select setting to ON.
  - "SEL" appears.
- ④ Push [SEL](F-2) to set the select setting to OFF.
  - "SEL" disappears.
- ⑤ Push [MENU] to return to the "D2" screen.

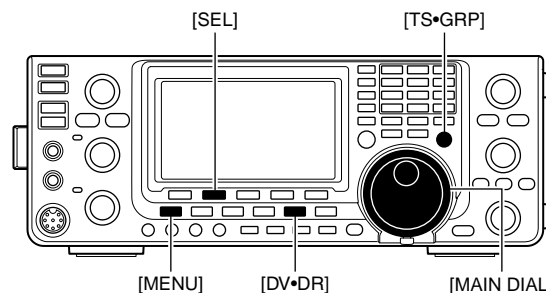

D2 R1:HAMACH43 GRP1  
SCAN SEL AFC DSQ TCON

Rotate [MAIN DIAL]

D2 R1:FUJISW43 GRP1  
SCAN SEL AFC DSQ TCON

F-2 Hold down

D2 SEL FUJISW43 GRP1  
SEL

F-2 Push

D2 FUJISW43 GRP1  
SEL

When the select setting is OFF.

## ■ Calling CQ

First, program a MY call sign in step ①.  
Next program the repeater list (p. 89). After that, follow this guide to access a D-STAR repeater.  
The optional CS-9100\* cloning software is helpful for programming call signs and programming the repeater list.  
\*Cloning cable is required.

- ① Set your own call sign (MY). (p. 85)
- ② Hold down [DV•DR] for 1 second to select the DR mode.
  - The last used access repeater is displayed.
    - If the displayed frequency band on the SUB Band is the same as that of the last used access repeater, selecting the DR mode on the MAIN Band will automatically move the frequency band on the SUB Band to the Main Band display, and turn OFF the SUB Band display.
- ③ Rotate [MAIN DIAL] to select the desired access repeater.
  - Only the repeaters, whose "R1USE" setting is set to YES, or Access repeater scan targets are displayed. (pp. 90, 100)
  - First selecting the repeater call sign group makes it more convenient, if you have programmed repeaters into Groups. (p. 93)
  - Access repeater scan can be used for the selection. (p. 100)
- ④ Push [UR](F-4) to enter the UR call sign selection mode.

Steps ⑤ through ⑦ differ, depending on the communication form.

### Making a CQ call through your local area (access) repeater (Local Area CQ)

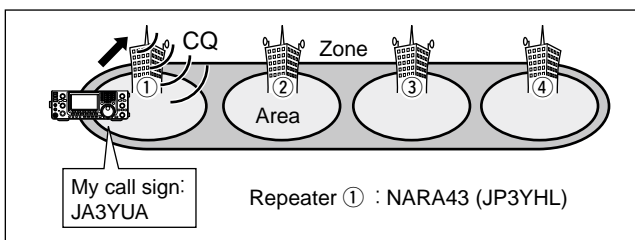

- ⑤ Rotate [MAIN DIAL] to select "CQCQCQ."
  - First selecting a call sign group as "CQCQCQ" by pushing [TS•GRP] makes it more convenient.
- ⑥ Push [PTT] on the microphone to transmit. (or [TRANSMIT] on the transceiver)
  - The MAIN Band TX/RX indicator lights red.
- ⑦ Release [PTT] to receive. (or push [TRANSMIT] again)

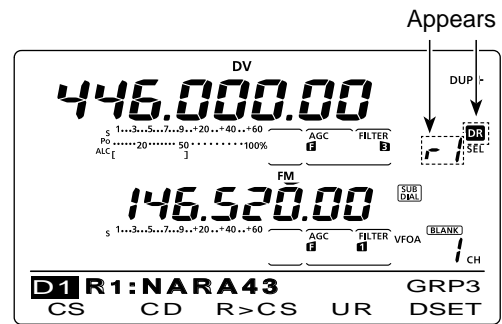
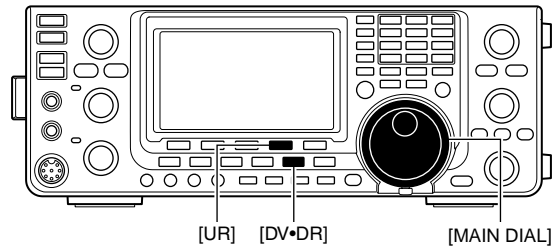

Access repeater selection screen



Repeater group selection screen

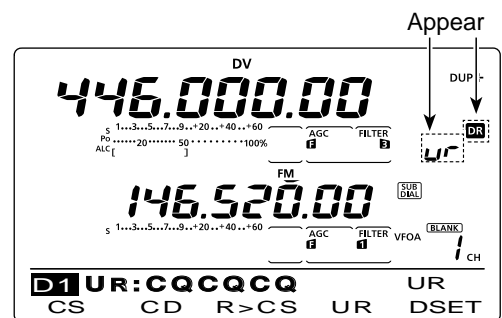
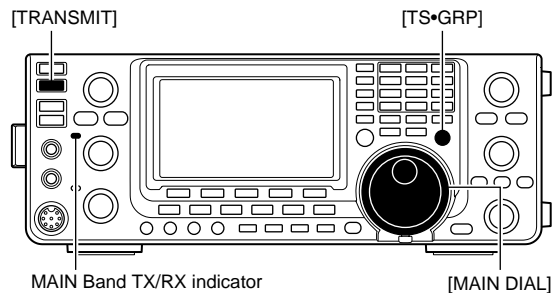

UR call sign selection screen

### Making a Zone CQ/Gateway CQ call

**NOTE:** The settings are the same between Zone CQ and Gateway CQ call.

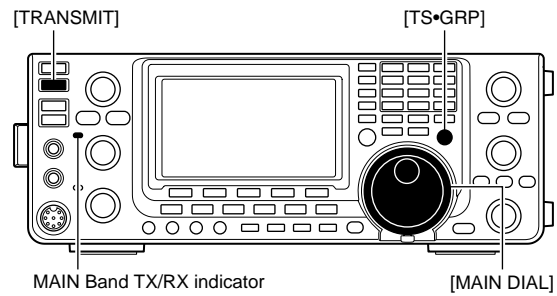
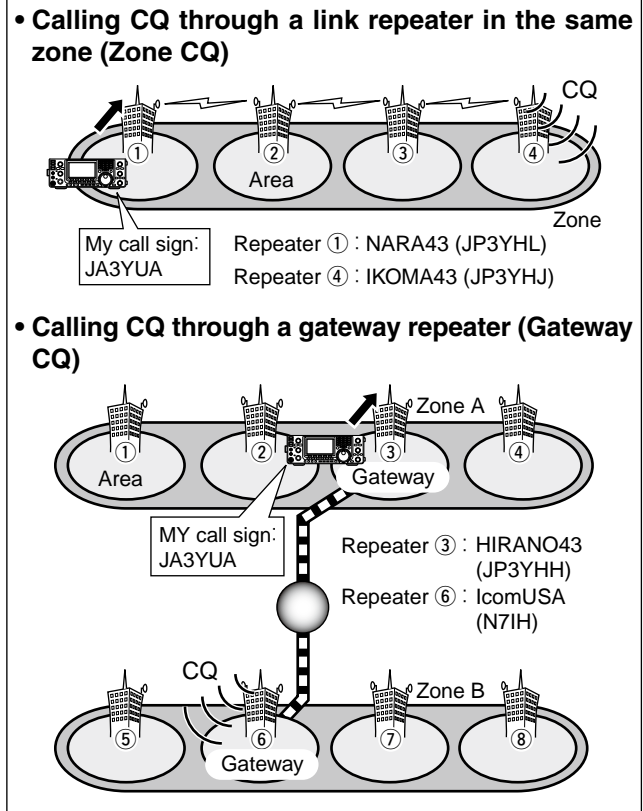

- ⑤ Rotate [MAIN DIAL] to select a desired destination repeater.
  - First selecting the repeater call sign group makes it more convenient, if you have programmed repeaters into Groups. (p. 93)
- ⑥ Push [PTT] on the microphone to transmit. (or [TRANSMIT] on the transceiver)
  - The MAIN Band TX/RX indicator lights red.
- ⑦ Release [PTT] to receive. (or push [TRANSMIT] again)

### ◆ Storing the set data

You can save the temporary setting in the following manner.

- ① After setting, push [MW] to enter the memory select write mode, then rotate [MAIN DIAL] or [M-CH] to select the desired Memory channel, Call channel or Program scan edge channel.
- ② Hold down [MW] for 1 second to store the setting.

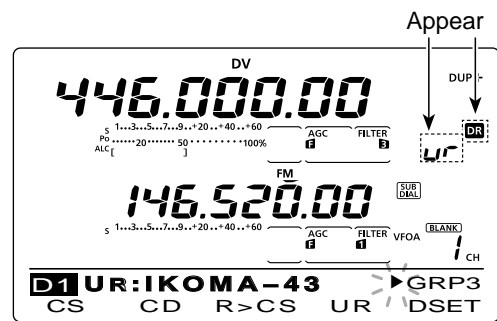

Repeater selection screen

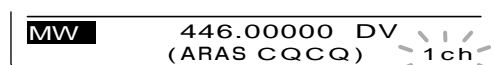

The selected channel number blinks.

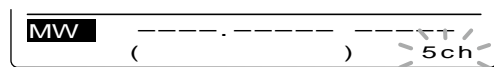

When a blank channel is selected.

## ■ Calling a specific station

This section describes how to call a specific station using the DR mode.

When the Link repeater (R2) is set to “GW,” the designated gateway repeater is automatically set as the Link repeater, and you can make a call to a specific station through the internet.

- ① Set your own call sign.
- ② Hold down [DV•DR] for 1 second to select the DR mode.
  - The last used access repeater is displayed.
    - If the displayed frequency band on the SUB Band is the same as that of the last used access repeater, selecting the DR mode on the MAIN Band will automatically move the frequency band on the SUB Band to the Main Band display, and turn OFF the SUB Band display.
- ③ Rotate [MAIN DIAL] to select the desired access repeater.
  - Only the repeaters, whose “R1USE” setting is set to YES, or Access repeater scan targets are displayed. (pp. 90, 100)
- ④ Push [UR](F-4) to enter the UR call sign selection mode.
- ⑤ Rotate [MAIN DIAL] to select a individual station call sign.
  - First selecting the station call sign memory groups (U01–U99) by pushing [TS•GRP] makes it more convenient.
- ⑥ Hold down [UR](F-4) for 1 second to enter the Link/Gateway repeater (R2) selection mode.

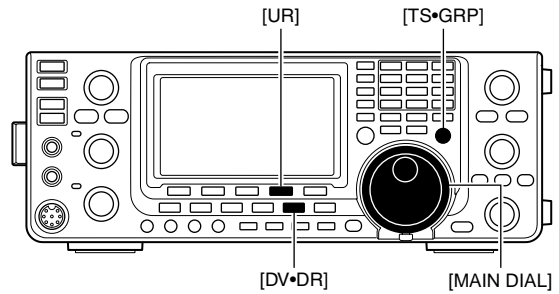

### Making a call to an individual station through your local area (access) repeater (Local Area call)

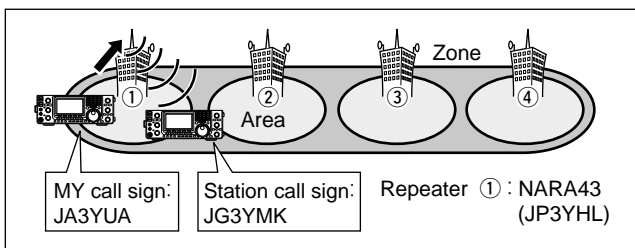

- ⑦ Rotate [MAIN DIAL] to select “NOT USE\*.”
- ⑧ Push [UR](F-4) to exit the Link repeater (R2) selection mode.
- ⑨ Push [PTT] on the microphone to transmit. (or [TRANSMIT] on the transceiver)
  - The MAIN Band TX/RX indicator lights red.
- ⑩ Release [PTT] to receive. (or push [TRANSMIT] again)

▨ If you want to save this temporary setting, push [MW] to enter the memory select write mode. (p. 102)

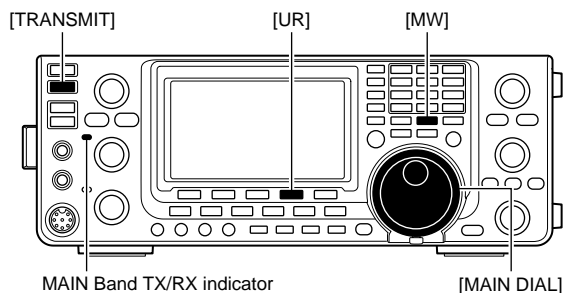



### Making a call to an individual station through a link repeater in the same zone (Zone call)

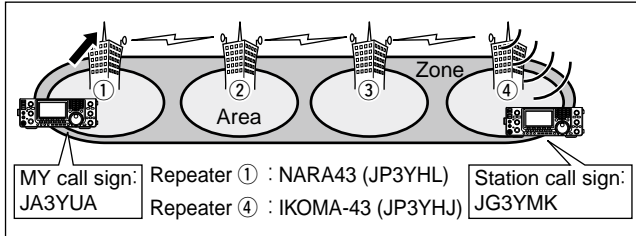

- ⑦ Rotate [MAIN DIAL] to select the link repeater in the same zone.
  - Only repeaters with the same gateway repeater appear.
- ⑧ Push [UR](F-4) to exit the selection mode.
- ⑨ Push [PTT] on the microphone to transmit. (or [TRANSMIT] on the transceiver)
  - The MAIN Band TX/RX indicator lights red.
- ⑩ Release [PTT] to receive. (or push [TRANSMIT] again)

▨ If you want to save this temporary setting, push [MW] to enter the memory select write mode. (p. 102)

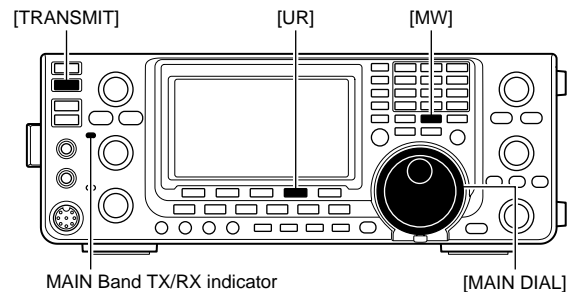

Link repeater in the same zone

### Making a call to an individual station through a gateway repeater (Gateway call)

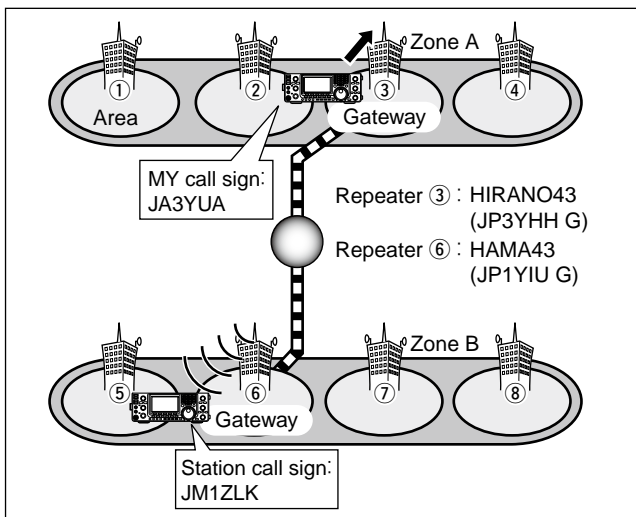

- ⑦ Rotate [MAIN DIAL] to select "GW."
  - The pre-programmed gateway repeater is set as R2.
  - Only repeaters with the same gateway repeater appear.
- ⑧ Push [UR](F-4) to exit the Link repeater (R2) selection mode.
- ⑨ Push [PTT] on the microphone to transmit. (or [TRANSMIT] on the transceiver)
  - The MAIN Band TX/RX indicator lights red.
- ⑩ Release [PTT] to receive. (or push [TRANSMIT] again)

▨ If you want to save this temporary setting, push [MW] to enter the memory select write mode. (p. 102)

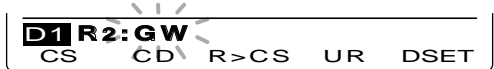
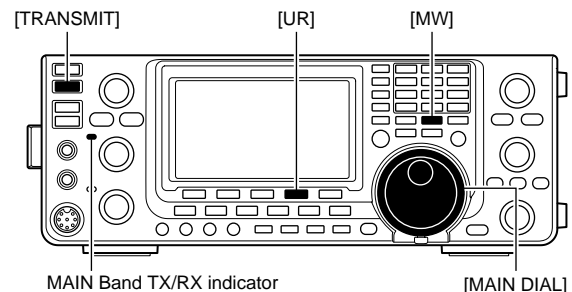

Gateway repeater "GW"

▨ **NOTE:** If other station has accessed a repeater at least once, the D-STAR system will automatically connect to the last repeater the station accessed, even if you don't know where the station is. So it is no need to select the destination repeater.

■ Calling a specific station (Continued)

◇ **Confirming the setting**

- ① In the DR mode, push [MENU] one or more times to display the "D1" screen.
- ② Push [CS](F-1) to display the "CS" screen (Call Sign).
- ③ Push [▼](F-1) one or more times to sequentially display the "UR," "R1," "R2" or "MY" to confirm the current call sign setting.

⚡ **NOTE:** In the DR mode, you can change only the "MY" call sign in the "CS" screen (Call Sign).

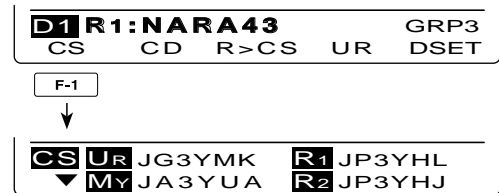
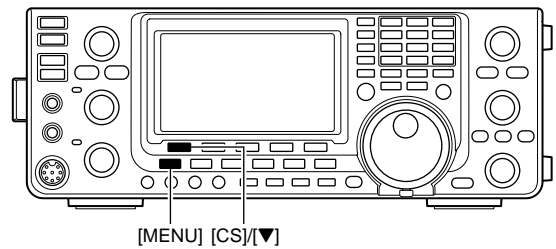

◇ **Settings for "UR" and "R2," depending on the communication form**

Destination: CQ
<p>&lt;Communication form: Local area call&gt;</p> <ul style="list-style-type: none"> <li>• UR setting: CQCQCQ</li> <li>• R2 setting : N/A</li> </ul>
<p>&lt;Communication form: Zone call&gt;</p> <ul style="list-style-type: none"> <li>• UR setting: Destination repeater to send CQ in the same zone</li> <li>• R2 setting : N/A</li> </ul>
<p>&lt;Communication form: Gateway call&gt;</p> <ul style="list-style-type: none"> <li>• UR setting: Destination repeater to send CQ</li> <li>• R2 setting : N/A</li> </ul>

Destination: An individual station
<p>&lt;Communication form: Local area call&gt;</p> <ul style="list-style-type: none"> <li>• UR setting: An individual station</li> <li>• R2 setting : NOT USE*</li> </ul>
<p>&lt;Communication form: Zone call&gt;</p> <ul style="list-style-type: none"> <li>• UR setting: An individual station</li> <li>• R2 setting : Destination repeater in the same zone</li> </ul>
<p>&lt;Communication form: Gateway call&gt;</p> <ul style="list-style-type: none"> <li>• UR setting: An individual station</li> <li>• R2 setting : GW</li> </ul>

⚡ **NOTE:** R1 setting is set to your access repeater's call sign.

## ■ Simplex operation using the VFO

### ◇ Making a simplex CQ call or a call to an individual station

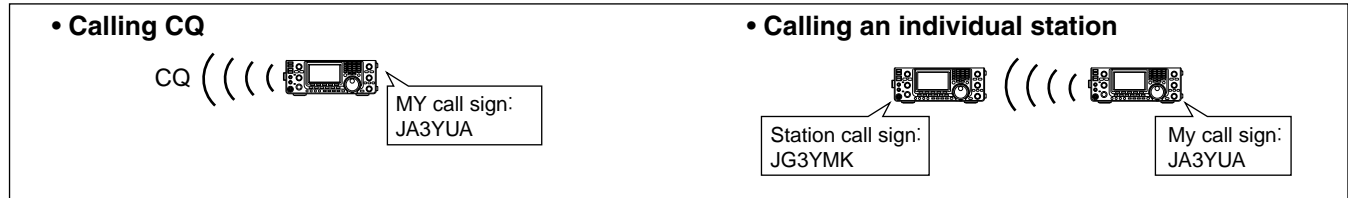

- ① Select the desired frequency band. (p. 35)
- ② Push [VFO/MEMO] to select the VFO mode.
- ③ Push [DV•DR] to select the DV mode.
- ④ Set the desired frequency. (p. 37)
  - Select the output power, if desired. (p. 46)
  - When the duplex operation is selected, push [MENU] one or more times to display the “M1” screen (Menu 1) and push [DUP](F-2) one or more times to turn it OFF.
- ⑤ Push [MENU] twice to display the “M3” screen (Menu 3).
- ⑥ Set your own call sign as the current MY call sign. (p. 85)
- ⑦ Push [UR](F-4) to enter the UR call sign selection mode.
- ⑧ Rotate [MAIN DIAL] to select UR call sign.
  - First selecting the call sign memory groups by pushing [TS•GRP] or [GRP](F-5) makes it more convenient.
  - When calling CQ : Select “CQCQCQ”
  - When calling an individual station : Select the station’s call sign
- ⑨ Push [SET](F-4) to return to the “M3” screen (Menu 3).
- ⑩ Push [PTT] on the microphone to transmit. (or [TRANSMIT] on the transceiver)
  - The MAIN Band TX/RX indicator lights red.
- ⑪ Release [PTT] to receive. (or push [TRANSMIT] again)
  - If another station replies, it’s call sign will be received.
  - Received call signs can be automatically stored into the received call record. See page 95 for details.

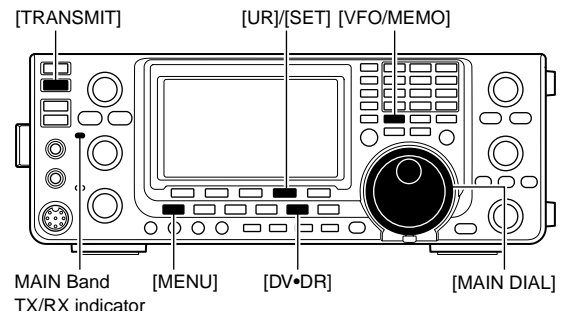

#### • When calling CQ

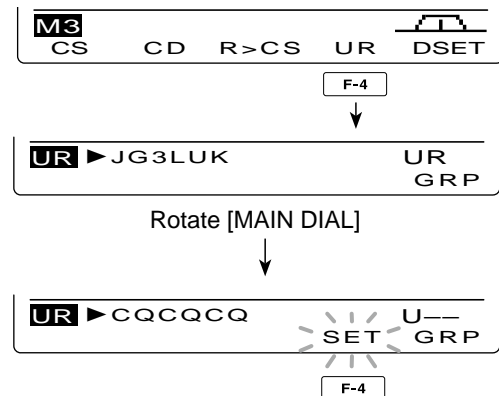

After setting, rotate [M-CH] to select a memory channel, then hold down [MW] for 1 second to save this temporary programmed data into the channel.

**NOTE:** The digital mode is vastly different than the FM mode. One of the differences is that changing the squelch setting in the digital mode will not open it to hear the hiss of “white noise,” like it does in the FM mode. It is only activated for digital squelch functions such as CSQ (Digital code squelch) or DSQ (Digital call sign squelch).

## ■ Repeater operation using the VFO

### ◇ Making a CQ call or a call to an individual station through your local area (access) repeater (Local Area call)

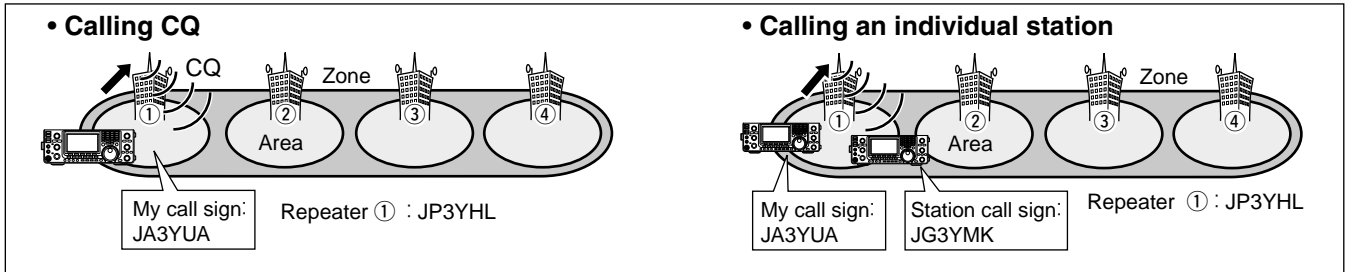

- ① Select the desired frequency band. (p. 35)
- ② Push [VFO/MEMO] to select the VFO mode.
- ③ Push [DV•DR] to select the DV mode.
- ④ Set the repeater's transmit frequency, duplex direction and offset. (pp. 37, 65, 163)
- ⑤ Push [MENU] one or more times to display the "M3" screen (Menu 3).
- ⑥ Push [CS](F-1) to display the "CS" screen (Call Sign).
- ⑦ Push [▼](F-1) to display the "UR" screen, and rotate [MAIN DIAL] to select UR call sign, then push [SET] (F-4).
  - First selecting the call sign memory groups by pushing [TS•GRP] or [GRP](F-5) makes it more convenient.
  - When calling CQ : Select "CQCQCQ"
  - When calling an individual station : Select the station's call sign
- ⑧ Push [▼](F-1) to display the "R1" screen, and rotate [MAIN DIAL] to select the access repeater call sign, then push [SET](F-4).
  - First selecting the repeater call sign group makes it more convenient, if you have programmed repeaters into Groups. (p. 93)
  - Push [NAME](F-4) to toggle the call sign and repeater name display, if the name has been programmed.
- ⑨ Push [▼](F-1) to display the "R2" screen, and rotate [MAIN DIAL] to set R2 to "NOT USE\*," then push [SET](F-4).
- ⑩ Push [▼](F-1) to display "MY," and set your own call sign if necessary, then push [SET](F-4).
- ⑪ Push [PTT] on the microphone to transmit. (or [TRANSMIT] on the transceiver)
  - The MAIN Band TX/RX indicator lights red.
- ⑫ Release [PTT] to receive. (or push [TRANSMIT] again)
  - If another stations replies, it's call sign will be stored in the receive log.
  - Received call signs can be automatically stored into the received call record. See page 95 for details.

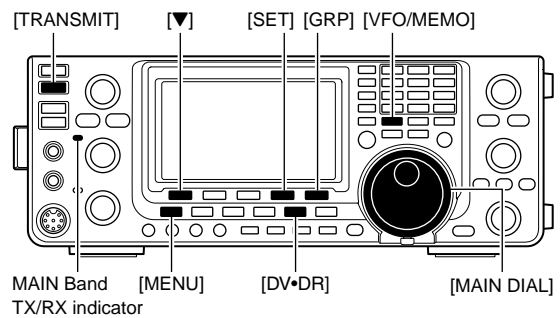

### • When calling CQ through a single repeater

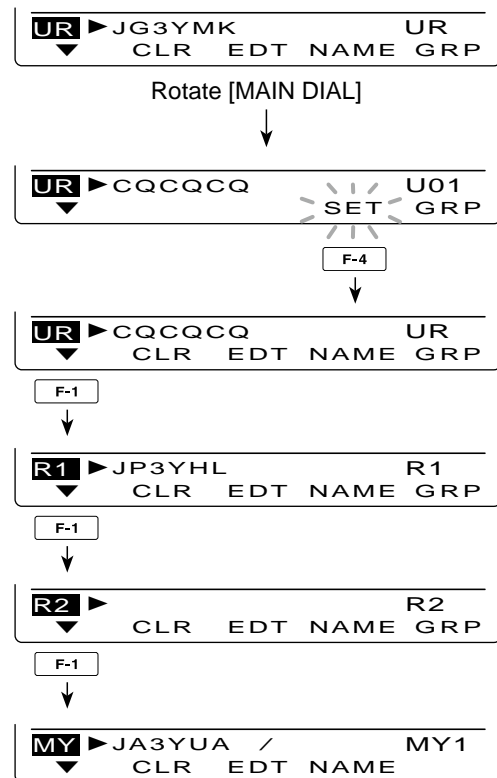

After setting, rotate [M-CH] to select a memory channel, then hold down [MW] for 1 second to save this temporary programmed data into the channel.

◇ Making a CQ call or a call to an individual station through a link repeater in the same zone (Zone call)

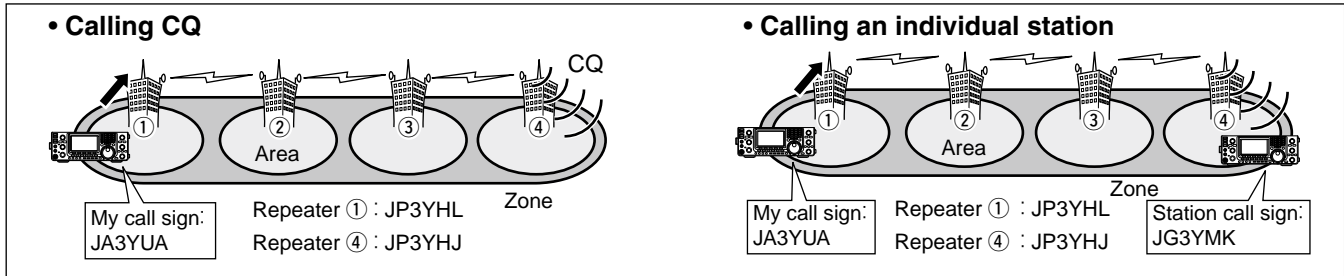

- ① Select the desired frequency band. (p. 35)
- ② Push [VFO/MEMO] to select the VFO mode.
- ③ Push [DV•DR] to select the DV mode.
- ④ Set the repeater's transmit frequency, duplex direction and offset. (pp. 37, 65, 163)
- ⑤ Push [MENU] one or more times to display the "M3" screen (Menu 3).
- ⑥ Push [CS](F-1) to display the "CS" screen (Call Sign).
- ⑦ Push [▼](F-1) to display the "UR" screen, and rotate [MAIN DIAL] to select UR call sign, then push [SET] (F-4).
  - First selecting the call sign memory groups by pushing [TS•GRP] or [GRP](F-5) makes it more convenient.
  - When calling CQ : Select "CQCQCQ"
  - When calling an individual station : Select the station's call sign
- ⑧ Push [▼](F-1) to display the "R1" screen, and rotate [MAIN DIAL] to select the access repeater call sign, then push [SET](F-4).
  - First selecting the repeater call sign group makes it more convenient, if you have programmed repeaters into Groups. (p. 93)
  - Push [NAME](F-4) to toggle the call sign and repeater name display, if the name has been programmed.
- ⑨ Push [▼](F-1) to display the "R2" screen, and rotate [MAIN DIAL] to select the link repeater call sign in the same zone, then push [SET](F-4).
- ⑩ Push [▼](F-1) to display "MY," and set your own call sign if necessary, then push [SET](F-4).
- ⑪ Push [PTT] on the microphone to transmit. (or [TRANSMIT] on the transceiver)
  - The MAIN Band TX/RX indicator lights red.
- ⑫ Release [PTT] to receive. (or push [TRANSMIT] again)
  - If another stations replies, it's call sign will be stored in the receive log.
  - Received call signs can be automatically stored into the received call record. See page 95 for details.

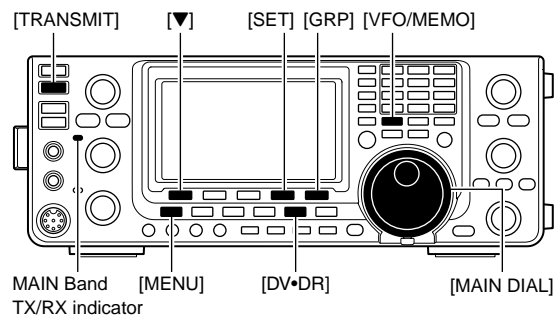

• Calling CQ in the same zone (Zone CQ)

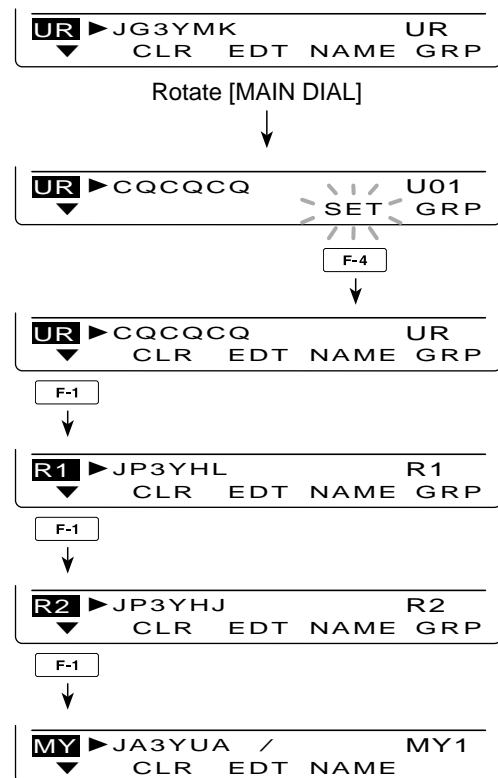

After setting, rotate [M-CH] to select a memory channel, then hold down [MW] for 1 second to save this temporary programmed data into the channel.

■ Repeater operation in the VFO (Continued)

◇ Making a CQ call or a call to an individual station through gateway repeaters (Gateway call)

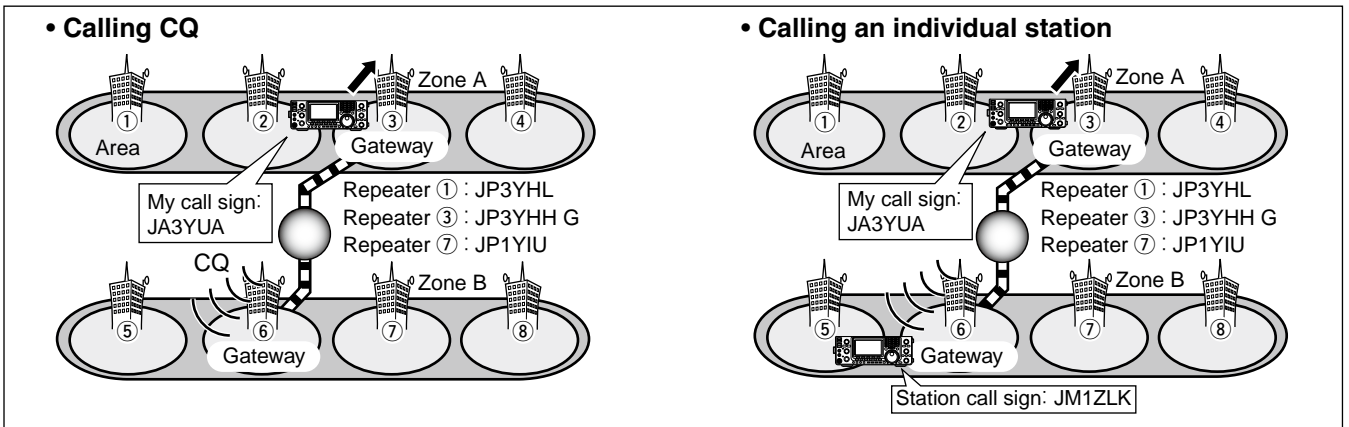

- ① Select the desired frequency band. (p. 35)
- ② Push [VFO/MEMO] to select the VFO mode.
- ③ Push [DV•DR] to select the DV mode.
- ④ Set the repeater's transmit frequency, duplex direction and offset. (pp. 37, 65, 163)
- ⑤ Push [MENU] one or more times to display the "M3" screen (Menu 3).
- ⑥ Push [CS](F-1) to display the "CS" screen (Call Sign).
- ⑦ Push [▼](F-1) to display the "UR" screen, and rotate [MAIN DIAL] to select UR call sign, then push [SET](F-4).
  - First selecting the call sign memory groups by pushing [TS•GRP] or [GRP](F-5) makes it more convenient.
  - When calling CQ : Select a link repeater call sign for sending CQ
  - When calling an individual station : Select the station's call sign
- ⑧ Push [▼](F-1) to display the "R1" screen, and rotate [MAIN DIAL] to select the access repeater call sign, then push [SET](F-4).
  - First selecting the repeater call sign group makes it more convenient, if you have programmed repeaters into Groups. (p. 93)
  - Push [NAME](F-4) to toggle the call sign and repeater name display.
- ⑨ Push [▼](F-1) to display "R2," and rotate [MAIN DIAL] to select your gateway repeater call sign, then push [SET](F-4).
- ⑩ Push [▼](F-1) to display "MY," and set your own call sign if necessary, then push [SET](F-4).
- ⑪ Push [PTT] on the microphone to transmit. (or [TRANSMIT] on the transceiver)
  - The MAIN Band TX/RX indicator lights red.
- ⑫ Release [PTT] to receive. (or push [TRANSMIT] again)
  - If another stations replies, it's call sign will be stored in the receive log.
  - Received call signs can be automatically stored into the received call record. See page 95 for details.

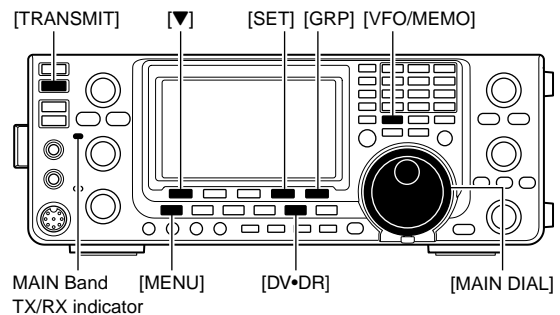

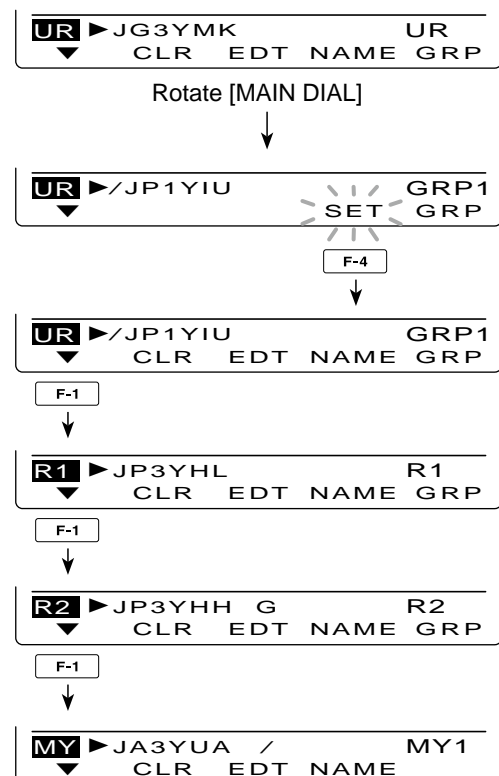

• Calling CQ through the gateway

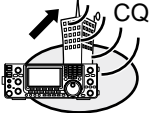
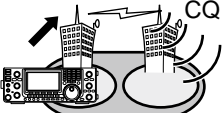
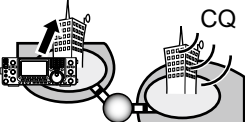

After setting, rotate [M-CH] to select a memory channel, then hold down [MW] for 1 second to save this temporary programmed data into the channel.

◇ Settings for “UR” and “R2,” depending on the communication form

Destination: CQ
<p>&lt;Communication form: Local area call&gt;</p>  <ul style="list-style-type: none"><li>• UR setting: CQCQCQ</li><li>• R2 setting : NOT USE*</li></ul>
<p>&lt;Communication form: Zone call&gt;</p>  <ul style="list-style-type: none"><li>• UR setting: CQCQCQ</li><li>• R2 setting : Destination repeater to send CQ in the same zone</li></ul>
<p>&lt;Communication form: Gateway call&gt;</p>  <ul style="list-style-type: none"><li>• UR setting: Destination repeater to send CQ</li><li>• R2 setting : Your gateway repeater</li></ul>

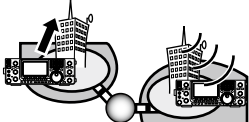
Destination: An individual station
<p>&lt;Communication form: Local area call&gt;</p>  <ul style="list-style-type: none"><li>• UR setting: An individual station</li><li>• R2 setting : NOT USE*</li></ul>
<p>&lt;Communication form: Zone call&gt;</p>  <ul style="list-style-type: none"><li>• UR setting: An individual station</li><li>• R2 setting : Destination repeater in the same zone</li></ul>
<p>&lt;Communication form: Gateway call&gt;</p>  <ul style="list-style-type: none"><li>• UR setting: An individual station</li><li>• R2 setting : Your gateway repeater</li></ul>

/// **NOTE:** R1 setting is set to your access repeater's call sign.

## Message operation

### TX message programming

The transceiver has a total of 5 message memories to store short messages to transmit during DV mode operation. Message of up to 20 characters can be programmed for each memory.

- ① In the DV mode, push [MENU] one or more times to display the "M3" screen (Menu 3).
  - In the DR mode, push [MENU] once or twice to select the "D1" screen.
- ② Push [DSET](F-5) to display the "DSET" screen.
- ③ Push [TXM](F-3) to display the "TXM" screen (Transmit message).
- ④ Rotate [MAIN DIAL] to select the desired transmit message channel.
  - TM1 to TM5 and OFF are selectable.
- ⑤ Push [EDT](F-1) to enter the transmit message programming mode.
  - A cursor appears and blinks.
- ⑥ Push [F-1] one or more times to select the desired character type.

Character type	Selectable characters
ABC	A to Z
abc	a to z
etc	! # \$ % & \ ? " ' ` ^ + - * / . , ; = < > ( ) [ ] { } ! _ - @

- ⑦ Rotate [MAIN DIAL] to select the first character to input.
  - When inputting numbers or a decimal point, push the appropriate keypad key.
  - Push [DEL](F-4) to delete the selected character, symbol or number.
  - Push [SPC](F-5) to input a space.
  - When all 20 characters have been programmed, an error beep sounds. If you want to reprogram, push [◀](F-2) or [▶](F-3) to select a character, then push [DEL](F-4) to delete it.
- ⑧ Push [◀](F-2) to move the cursor backward, or push [▶](F-3) to move the cursor forward.
- ⑨ Repeat steps ⑥ through ⑧ to program a message of up to 20 characters.
- ⑩ Push [MENU] to save the programmed message.

While [SET](F-5) is blinking, push it to set the displayed channel as the first appearance channel when [TXM](F-3) is pushed in step ③.

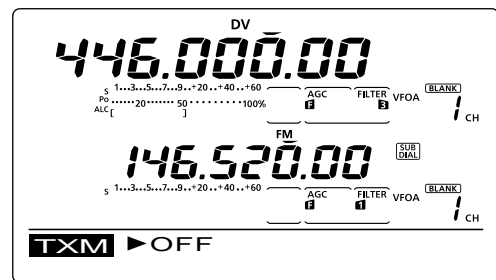
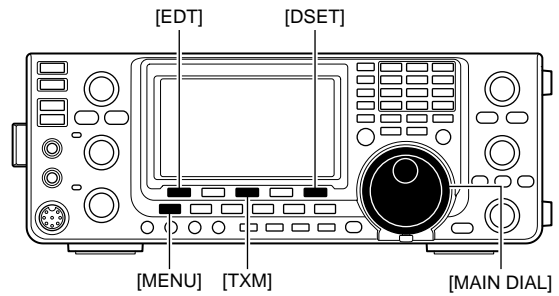

Rotate [MAIN DIAL]

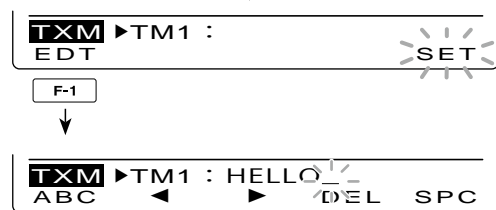

### Programming a transmit message

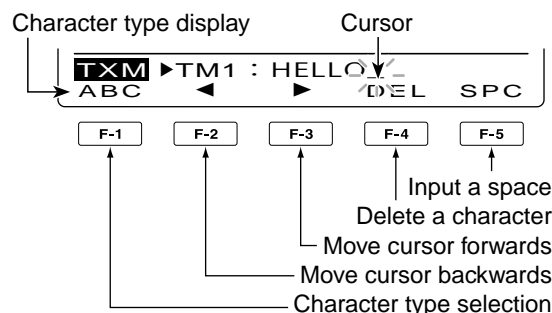
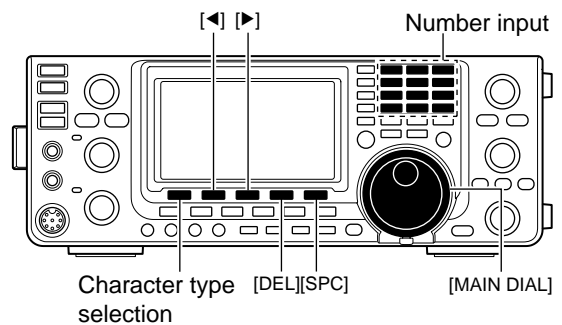



### ◇ Message Transmission

You can select a message channel (TM1–TM5) to turn ON the message transmission function. When a message channel is selected, the transceiver transmits the pre-programmed text message. The default setting is OFF.

- ① Set the operating frequency, call signs and other settings, such as those for repeater operation, as desired.
- ② In the DV mode, push [MENU] one or more times to display the “M3” screen (Menu 3).
  - In the DR mode, push [MENU] once or twice to select the “D1” screen.
- ③ Push [DSET](F-5) to display the “DSET” screen.
- ④ Push [TXM](F-3) to display the “TXM” screen (Transmit message).
- ⑤ Rotate [MAIN DIAL] to select the desired transmit message channel, then push [SET](F-5).
  - TM1 to TM5 are selectable.
  - When OFF is selected, the message is not transmitted.
- ⑥ Push [MENU] to return to the “DSET” screen.
- ⑦ Push [PTT] on the microphone to transmit the message. (or push [TRANSMIT] on the transceiver)
  - The message is transmitted each time you push [PTT] (or [TRANSMIT]).
  - The message is automatically transmitted every 30 seconds during continuous transmission.
  - The MAIN Band TX/RX indicator lights red.

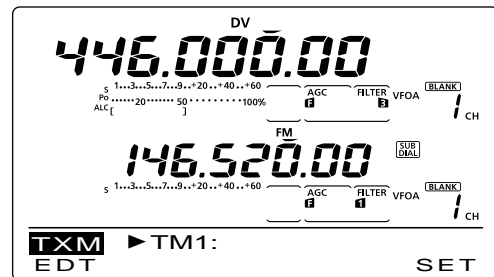
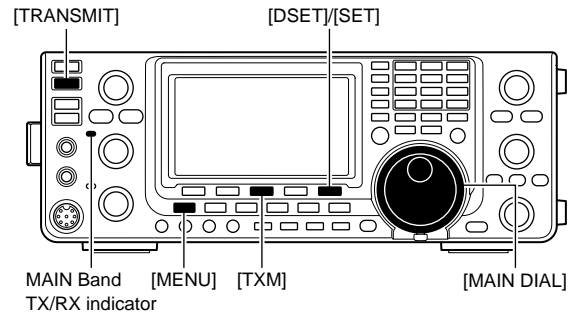

#### ✓ For your information

When a call with a message is received, the call sign and the message scrolls across the function display. The received call sign and/or message display functions can be turned OFF in the DV SET mode, if desired.

- “RX Message Disp” item (p. 119)
- “RX Call Sign Disp” item (p. 119)

### ◇ RX message display

- ① In the DV mode, push [MENU] one or more times to display the “M3” screen (Menu 3).
  - In the DR mode, push [MENU] once or twice to select the “D1” screen.
- ② Push [CD](F-2) to display the “CD” screen (Call Record).
- ③ Rotate [MAIN DIAL] to select the desired record channel (RX01 to RX20).
- ④ Push [▼](F-1) three times to select “MSG” item.
  - The received message is displayed.
- ⑤ Push [▼](F-1) or [MENU] to return to the record channel, selected in step ③.

**NOTE:** Up to 20 messages can be stored, but only one message can be stored for each call sign. The oldest message is cleared when 21st message is received.

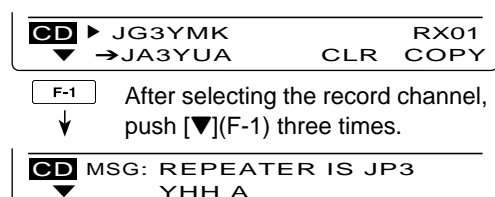
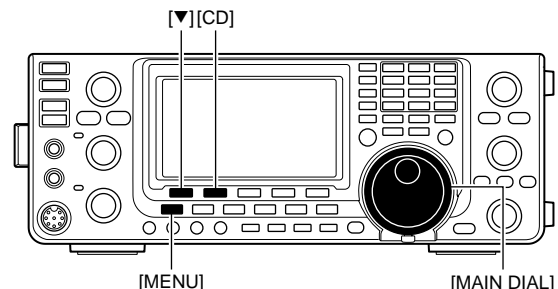

## ■ DV automatic detection

When a non-digital signal is received during DV mode operation, the “DV” and “FM” icons simultaneously blink. The transceiver automatically selects the FM mode to monitor the signal, if the DV Auto Detect function is turned ON.

- ① In the DV mode, push [MENU] one or more times to display the “M3” screen (Menu 3).
  - In the DR mode, push [MENU] once or twice to select the “D1” screen.
- ② Push [DSET](F-5) to display the “DSET” screen.
- ③ Push [SET](F-5) to enter the DV Set mode.
- ④ Push [▲](F-1) or [▼](F-2) to select “DV Auto Detect.”
- ⑤ Rotate [MAIN DIAL] to turn ON the DV automatic detect function.
  - The operating mode is set to DV if this setting is “OFF.”
- ⑥ Push [MENU] to return to the “DSET” screen.

▨ The received FM audio may be distorted when using this function.

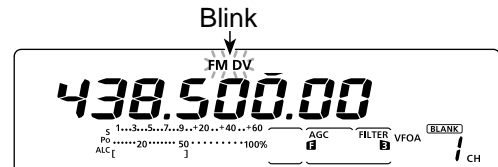
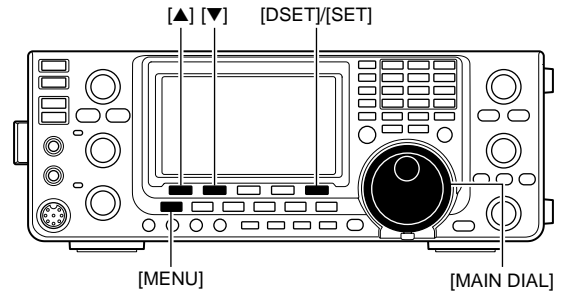

While receiving a non-digital signal while in the DV mode

## ■ Automatic Reply function

When a call addressed to own your call sign is received, the Automatic Reply function automatically replies with your call sign.

- ① In the DV mode, push [MENU] one or more times to display the “M3” screen (Menu 3).
  - In the DR mode, push [MENU] once or twice to select the “D1” screen.
- ② Push [DSET](F-5) to display the “DSET” screen.
- ③ Push [SET](F-5) to enter the DV Set mode.
- ④ Push [▲](F-1) or [▼](F-2) to select “Auto Reply.”
- ⑤ Rotate [MAIN DIAL] to turn ON the Automatic reply function.
- ⑥ Push [MENU] to return to the “DSET” screen.

▨ **NOTE:** The Automatic replay function is automatically turned OFF, when [PTT] (or [TRANSMIT]) is pushed to transmit.

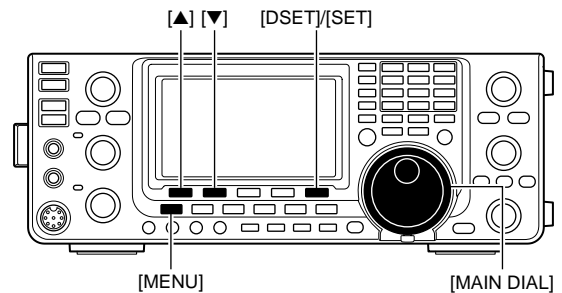

When the Automatic reply function is ON.

## ■ Digital squelch functions

The digital squelch opens only when receiving a signal addressed to your own call sign, or a signal that includes a matching digital code. You can silently wait for calls from others.

**NOTE:** Use digital code squelch function when communicating with two or more stations, because the digital call sign squelch function opens only when receiving a signal addressed to your own call sign. Thus the digital call sign squelch function can be used when communicating with only one station.

- ① Select the desired frequency band. (p. 35)
- ② In the DV mode, push [MENU] one or more times to display the "M1" screen (Menu 1).
  - In the DR mode, push [MENU] once or twice to select the "D2" screen.
  - The setting can be respectively made in the DV mode and the DR mode.
- ③ Push [DSQ](F-4) one or more times to turn ON the digital call sign squelch or digital code squelch.
  - "DSQL" appears when the digital call sign squelch is ON.
  - "CSQL" appears when the digital code squelch is ON.

When digital call sign squelch is turned ON in step ③, skip steps ④ and ⑤, and go to step ⑥.

- ④ When digital code squelch is turned ON in step ③, hold down [DSQ](F-4) for 1 second to display the "DSQ" screen. And rotate [MAIN DIAL] to select the desired code between 00 and 99.
  - Hold down [F-3] for 1 second to reset to the default setting, if desired.
- ⑤ Push [MENU] to return to the "M1" screen (Menu 1).
  - In the DR mode, return to the "D2" screen.
- ⑥ When the received signal includes a matching call sign/code, the squelch opens and the signal can be heard.
  - When the received signal's call sign/code does not match, digital call sign/digital code squelch does not open; however, the S-meter shows signal strength.

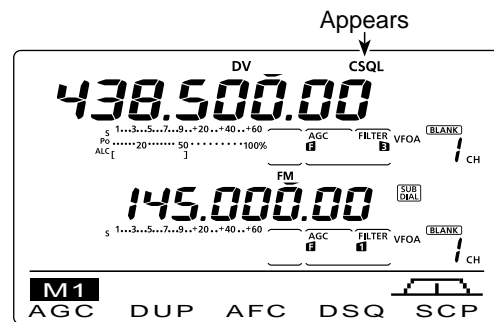
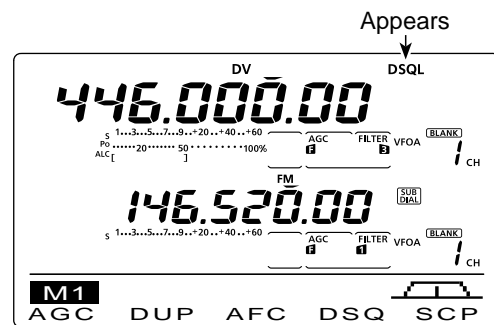
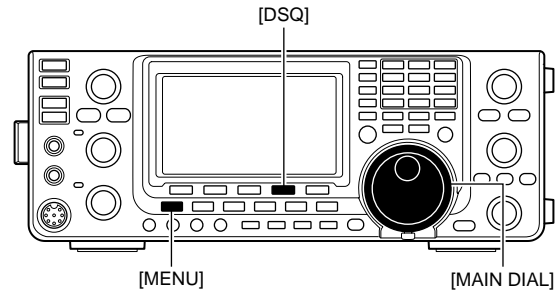

"DSQ" screen (Digital code setting)

## ■ EMR communication

The EMR (Enhanced Monitor Receive) communication mode can be used in only the DV mode. In the EMR mode, no call sign setting is necessary. When an EMR mode signal is received, the audio (voice) will be heard at the specified level, even if the volume setting level is set to the minimum level, or digital call sign/digital code squelch is in use.

- ① Select the desired frequency band. (p. 35)
- ② Set the desired frequency. (p. 37)
- ③ In the DV mode, push [MENU] one or more times to display the "M3" screen (Menu 3).
  - In the DR mode, push [MENU] once or twice to select the "D1" screen.
- ④ Push [DSET](F-5) to display the "DSET" screen.
- ⑤ Push [SET](F-5) to enter the DV Set mode.
- ⑥ Push [▲](F-1) or [▼](F-2) to select "EMR."
- ⑦ Rotate [MAIN DIAL] to turn ON the EMR mode.
  - "EMR" appears.
- ⑧ Push [MENU] to return to the "DSET" screen.
- ⑨ Push [PTT] on the microphone to transmit. (or [TRANSMIT] on the transceiver)
  - The MAIN Band TX/RX indicator lights red.
- ⑩ Release [PTT] to receive. (or push [TRANSMIT] again)
  - "EMR" blinks when receiving an EMR signal.

**NOTE:** The EMR communication function is automatically turned OFF when the transceiver is turned OFF.

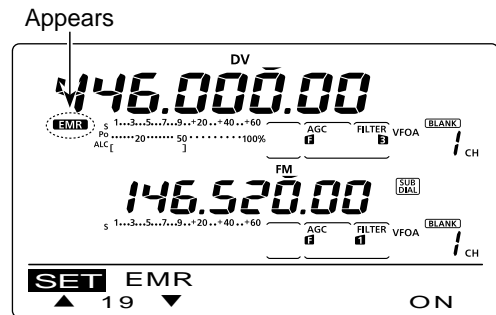
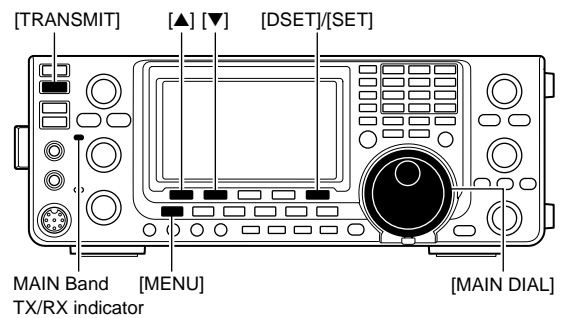

When the EMR communication mode is ON.

### ◇ Adjusting the EMR AF level

The audio output level when an EMR signal is received is adjustable.

When an EMR signal is received, the audio will be heard at the preset level, or the [AF] control level, whichever is higher.

- ① In the DV mode, push [MENU] one or more times to display the "M3" screen (Menu 3).
  - In the DR mode, push [MENU] once or twice to select the "D1" screen.
- ② Push [DSET](F-5) to display the "DSET" screen.
- ③ Push [SET](F-5) to enter the DV Set mode.
- ④ Push [▲](F-1) or [▼](F-2) to select "EMR AF Level."
- ⑤ Rotate [MAIN DIAL] to adjust the EMR audio output level between 0% (minimum) and 100% (maximum).
  - Hold down [F-3] for 1 second to reset to the default setting, if desired.
- ⑥ Push [MENU] to return to the "DSET" screen.



## ■ BK mode communication

The BK (Break-in) function allows you to break into a conversation, where the two other stations are communicating with call sign squelch enabled.

- ① While receiving another station's communication in the DV mode, push [MENU] one or more times to display the "M3" screen (Menu 3).
  - In the DR mode, push [MENU] once or twice to select the "D1" screen.
- ② Hold down [R>CS](F-3) for 1 second to set the other station's call sign.
  - When a call sign has not been received correctly, error beeps sound, and no call sign is set. Try to capture the call sign of the signal again, or enter it manually.
- ③ Push [DSET](F-5) to display the "DSET" screen.
- ④ Push [SET](F-5) to enter the DV Set mode.
- ⑤ Push [▲](F-1) or [▼](F-2) to select "BK."
- ⑥ Rotate [MAIN DIAL] to turn ON the BK function.
  - "BK" appears.
- ⑦ Push [MENU] to return to the "DSET" screen.
- ⑧ When both stations are in standby, push [PTT] on the microphone to transmit. (or push [TRANSMIT] on the transceiver)
  - The programmed call sign station receives the break-in call as well as your call sign.
  - The MAIN Band TX/RX indicator lights red.
- ⑨ Release [PTT] to receive. (or push [TRANSMIT] again)
 

Wait for a reply call from the station who received the break-in call.
- ⑩ After receiving the reply call, communicate normally.
  - "BK" blinks when receiving a break-in call.
- ⑪ To cancel the BK mode communication, turn OFF the BK function in the DV Set mode as shown in steps ④ through ⑥.

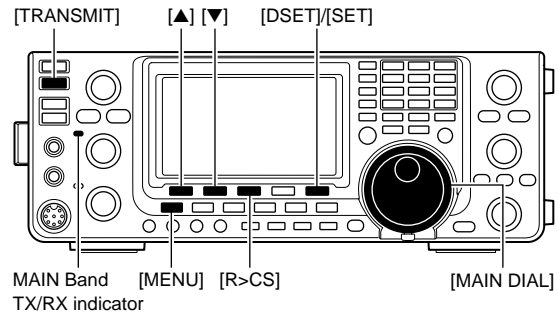

Appears

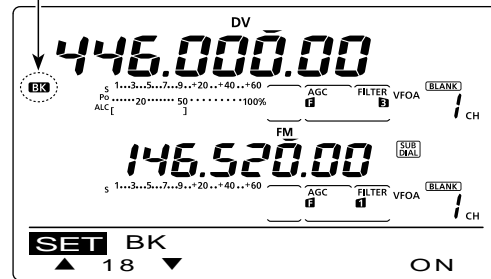

When the BK function is ON.

**NOTE:** The BK function is automatically turned OFF when transceiver is turned OFF.

### How to use Break-in?

While using digital call sign squelch, the squelch never opens (no audio sounds) even if a call is received, unless your own call sign ("MY") is specified. (p. 93)

However, when a call including the "BK ON" signal (break-in call) is received, the squelch will open and audio sounds even if the call is specified for another station.

#### • Station C calling to Station A with "BK OFF"

Station A and B are communicating using the digital call sign squelch.

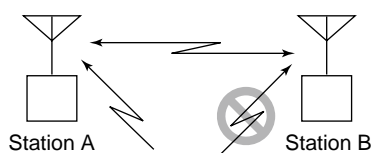

Station B never hears that Station C is calling Station A.

#### • Station C calling to Station A with "BK ON"

Station A and B are communicating using the digital call sign squelch.

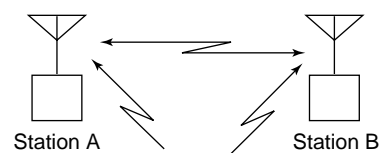

Station B also hears that Station C is calling Station A.

## ■ Low-speed data communication

In addition to digital voice communication, low-speed data communication can be made.

Use the optional OPC-1529R DATA COMMUNICATION CABLE with a third-party serial data communication software.

- A USB port can also be used for the low-speed data communication, depending on the “USB2/DATA1 Func (Ⓢ)” item setting in the Set mode. (p. 164)

**NOTE:** First, turn OFF the “GPS TX Mode” item in the GPS Set mode to send the low-speed data. (p. 134)

### ◇ Connection

Connect the transceiver to your PC using the optional OPC-1529R cable, as illustrated below.

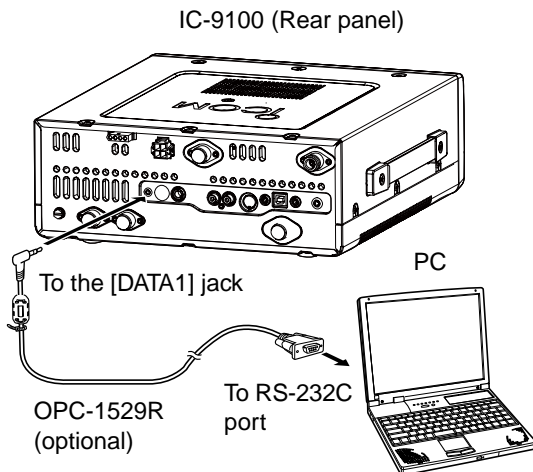

### ◇ Low-speed data communication application setting

Configure the serial data communication software as follows.

- Port : The COM port number which is used by the IC-9100.\*<sup>1</sup>
- Baud rate : 9600/4800 bps\*<sup>2</sup>
- Data : 8 bit
- Parity : None
- Stop : 1 bit
- Flow control : Xon/Xoff

\*<sup>1</sup> Depending on the PC environment, the COM port number used by the IC-9100 may be higher than 5. In such case, use the application which can set to higher than 5.

\*<sup>2</sup> Set the baud rate in the “DVdat/GPS Out Baud” item of the Set mode. (p. 168)

### ◇ Low-speed data communication operation

- ① Set the desired call signs as described in ‘Call sign setting.’ (p. 93)
- ② Follow the instructions of the data communication application software.
- ③ Push [PTT] on the microphone to transmit the data and an audio signal. (or push [TRANSMIT] on the transceiver)
  - The MAIN Band TX/RX indicator lights red.
  - The input data from the [DATA1] jack are automatically transmitted when “AUTO” is selected in the “DV Data TX” item of the DV Set mode. (p. 118)

## ■ Packet loss indication

While operating voice communication or low-speed data communication through the internet, some packets may be lost due to network error (poor data throughput performance). In such a case, the IC-9100 displays “L” on the display to indicate Packet Loss has occurred.

## ■ DV Set mode description

The DV Set mode is used for programming infrequently changed values or functions in the DV mode.

### ◇ DV Set mode settings

- ① In the DV mode, push [MENU] one or more times to display the "M3" screen (Menu 3).
  - In the DR mode, push [MENU] once or twice to select the "D1" screen.
- ② Push [DSET](F-5) to display the "DSET" screen.
- ③ Push [SET](F-5) to enter the DV Set mode.
- ④ Push [▲](F-1) or [▼](F-2) to select the desired item.
- ⑤ Rotate [MAIN DIAL] to select the desired option.
  - Hold down [F-3] for 1 second to reset to the default setting, if desired.
- ⑥ Push [MENU] to save, and return to the "DSET" screen.

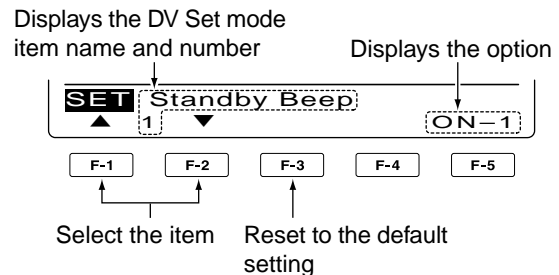
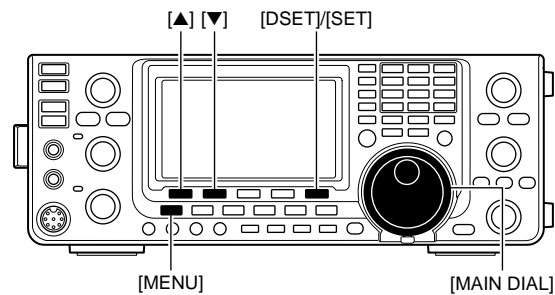

### 1. Standby Beep (Default: ON-1)

Turn the Standby beep function ON or OFF. This function sounds a beep when the other station stops transmitting.

- OFF : Turns OFF the function.
- ON-1 : Turns ON the function to sound a beep.
- ON-2 : Turns ON the function to sound a beep. If the call was sent to your own call sign, the beep has a higher pitch.

### 2. Auto Reply (Default: OFF)

Turn the automatic reply function ON or OFF. This function automatically replies to a call addressed to your own call sign, even if you are away from the transceiver.

This function is automatically turned OFF after you push [PTT] (microphone) or [TRANSMIT].

- OFF : Turns OFF the function.
- ON : The transceiver automatically replies to the call with your own call sign.

### 3. DV Data TX (Default: PTT)

For low-speed data communication, select whether to transmit the input data manually or automatically.

- PTT : Push [PTT] (microphone) or [TRANSMIT] to manually transmit the input data.
- Auto : When data is input from a PC through the [DATA1] jack, the transceiver automatically transmits it.

### 4. Digital Monitor (Default: Auto)

Select the RX monitoring mode by holding down [XFC] while in the DV mode.

- Auto : Monitors in the DV mode or FM mode, depending on the received signal.
- Digital : Monitors in the DV mode.
- Analog : Monitors in the FM mode.

### 5. Digital RPT Set (Default: ON)

Turn the digital repeater setting function ON or OFF. When accessing a repeater that has a call sign different than the transceiver's "R1" setting, this function reads the repeater's downlink signal and automatically sets the correct repeater call sign into "R1."

- OFF : Turns OFF the function.
- ON : Automatically sets the repeater call sign.

### 6. RX Call Sign Write (Default: OFF)

Turn the RX call sign automatic write function ON or OFF.

When receiving a call addressed to your own call sign, this function automatically sets the call sign of the calling station into "UR."

While in the DR mode, this function is disabled.

- OFF : Turns OFF the function.
- Auto : Automatically sets the call sign of the calling station into "UR."

## ■ DV Set mode description (Continued)

**7. RX RPT Write** (Default: OFF)

Turn the repeater call sign automatic write function ON or OFF.

When you receive a call addressed to your own call sign through a repeater, this function automatically sets the repeater call signs included in the signal, into your current "R1" and "R2."

While in the DR mode, this function is disabled.

OFF : Turns OFF the function.

Auto : Automatically sets the call sign of the used repeater into your "R1" and "R2."

**8. DV Auto Detect** (Default: OFF)

Turn the DV mode automatic detect function ON or OFF.

When receiving other than a DV mode signal, during DV mode operation, this function automatically switches to the FM mode.

- OFF : Turns OFF the function. The operating mode is fixed to the DV mode.
- ON : Automatically selects the FM mode for temporary operation.

▨ The received FM audio may be distorted when receiving an FM signal with this function.

**9. Edit Record** (Default: Auto)

Select an option for the call sign edit record function. When a call sign in the memory is edited, this function saves the new call sign in a different memory than the original one.

- OFF : Turns OFF the function. The previously set call sign is overwritten with the edited call sign.
- Select : The edited call sign is programmed into the selected call sign memory.
- Auto : The edited call sign is automatically programmed into a blank memory.

**10. Gateway Auto Set** (Default: Auto)

Turn the gateway automatic set function ON or OFF for calling an individual station in the DR mode.

This function enables the transceiver to automatically set the pre-programmed gateway repeater in "R2."

- OFF : Even selecting an individual station in "UR," the previously used repeater call sign remains in R2.
- Auto : After selecting an individual station in "UR," the pre-programmed gateway repeater is automatically set in R2.

**11. RX Record (RPT)** (Default: ALL)

The transceiver can record data of up to 20 individual calls.

Select whether to record all calls or only the latest call whose called station did not reply, or whose Link repeater was not found.

- ALL : Records all calls.
- Latest Only : Records only the latest call.

**12. RX Call Sign Disp** (Default: Auto)

When a call is received, the call sign of the calling station can be automatically displayed.

- OFF : Turns OFF the function.
- Auto : Automatically displays the call sign of the calling station.

**13. TX Call Sign Disp** (Default: UR)

Select whether or not to display the programmed call sign (MY or UR) at the beginning of your transmission.

- OFF : Turns OFF the function.
- UR : Displays the call sign of the station you called.
- MY : Displays your own call sign.

**14. RX Message Disp** (Default: Auto)

Select whether or not to display and scroll a received message.

- OFF : Does not display the message. To check the message, push [CD] (F-2) in M3, and then select MSG.
- Auto : Automatically displays and scrolls the message.

**15. Scroll** (Default: Fast)

Select the scrolling speed of a message or call sign.

- Slow : Sets the scrolling speed to "Slow."
- Fast : Sets the scrolling speed to "Fast."

**16. DR Call Sign Popup** (Default: ON)

Select whether or not to display a selected station or repeater call sign when the DR mode is selected, or when you switch the "UR," "R1" and "R2" display while in the DR mode.

- OFF : A call sign is not displayed.
- ON : A call sign is displayed.



### **17. Opening Call Sign** (Default: OFF)

Select whether or not to display MY call sign on the LCD when the transceiver is turned ON.

- OFF : Turns OFF the function.
- ON : Displays MY call sign at power ON.

### **18. BK** (Default: OFF)

The break-in function allows you to break into a conversation where two other stations are communicating with call sign squelch enabled.  
See page 116 for details.

- OFF : The break-in function is set to OFF.
- ON : The break-in function is set to ON.
  - “**BK**” appears on the display.

/// **NOTE:** The break-in function is automatically turned OFF when the transceiver is turned OFF.

### **19. EMR** (Default: OFF)

The EMR communication mode can be used for digital mode operation. In the EMR mode, no call sign setting is necessary. When an EMR mode signal is received, the audio (voice) will be heard at the specified level even if the volume setting level is set to minimum level, or digital call sign/digital code squelch is in use.  
See page 115 for details.

- OFF : The EMR function is set to OFF.
- ON : The EMR function is set to ON.
  - “**EMR**” appears on the display.

/// **NOTE:** The EMR communication function is automatically turned OFF when the transceiver is turned OFF.

### **20. EMR AF Level** (Default: 50%)

Enter a number between 0 % (minimum) and 100 % (maximum) to set the audio output level when an EMR signal is received.

When an EMR signal is received, the audio will be heard at the programmed level, or the [AF] control level, whichever is higher.

## ■ GPS operation

You can display your own GPS data in all operating modes. You can also transmit GPS data when in the DV mode. To receive GPS data, connect a third-party GPS receiver that has an RS-232C output and NMEA data format. Third-party GPS receivers connect to the [DATA1] jack of the transceiver.

In addition, GPS messages can also be transmitted in the GPS mode.

### • To connect the GPS receiver

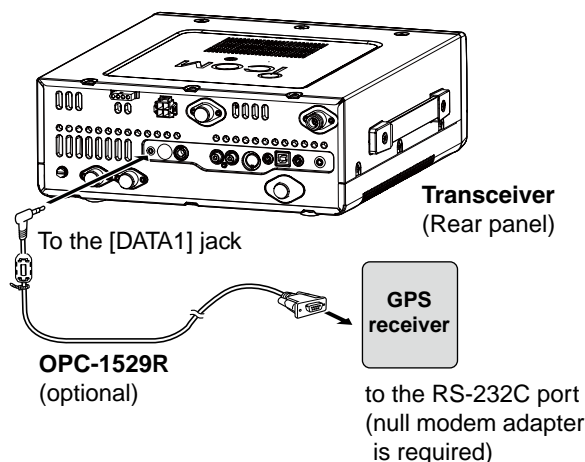

### ◇ GPS screen construction

- ① Hold down [CALL/GPS] for 1 second to display the "GPS" screen.
  - ② Push [POS](F-1), [GPM](F-2), [MSG](F-3) or [SET](F-5) to select the desired menu. See the diagram below.
- Push [MENU] to return to the previous display.

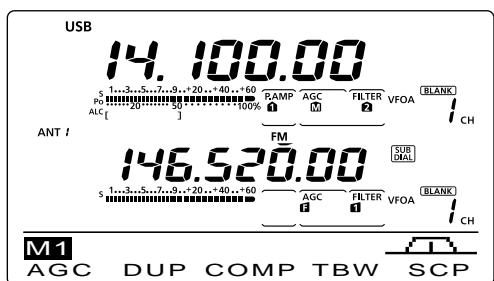
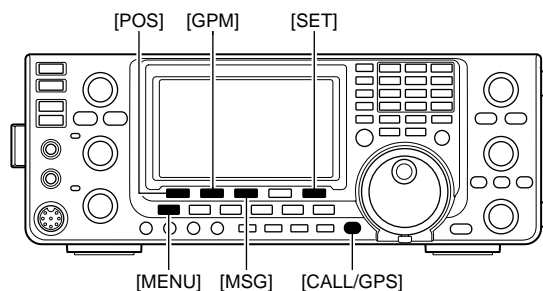

[CALL/GPS] ↓ Hold down

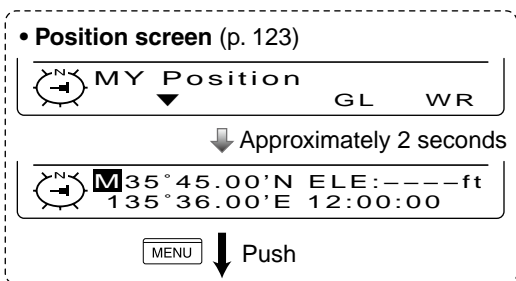

#### • GPS screen

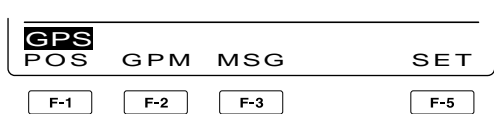

The screen you want to appear first can be selected between GPS and Position in the "GPS 1st Menu" item of the Set mode. (p. 165)

#### • GPS Memory screen (p. 127)

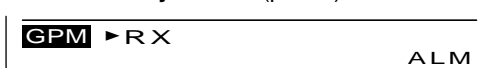

#### • GPS Message screen (p. 125)



#### • GPS Set mode screen (p. 132)



### ◇ GPS data communication

The transceiver transmits GPS data or low-speed data to the PC through the [DATA1] jack, depending on the Set mode setting. (p. 168)

- ① Hold down [MENU] for 1 second to enter the Set mode.
- ② Push [▲](F-1) or [▼](F-2) to select "USB2/DATA1 Func." (64)
- ③ Rotate [MAIN DIAL] to select "GPS" as the function of the [DATA1] jack to be used for position data input.
- ④ Push [MENU] to save, and exit the Set mode.

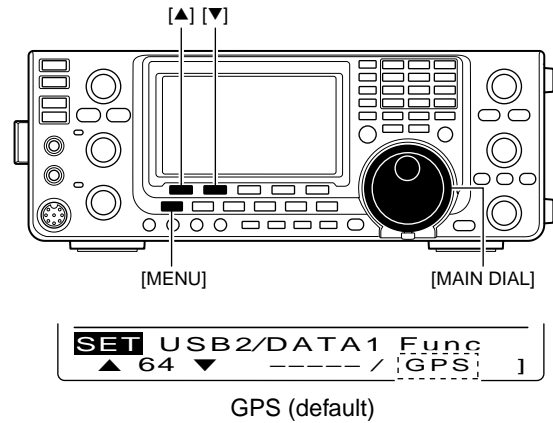

### ◇ Sentence formatter setting

- ① Hold down [CALL/GPS] for 1 second to display the "GPS" screen.
- ② Push [SET](F-5) to enter the GPS Set mode.
- ③ Push [▲](F-1) or [▼](F-2) to select "GPS TX Mode."
- ④ Rotate [MAIN DIAL] to select "GPS."
  - If "Disable" or "GPS-A" is selected, the sentence formatter items as described in step ⑤ will not appear.
- ⑤ Push [▲](F-1) or [▼](F-2) to select the desired GPS sentence.
  - A total of 6 sentences, RMC, GGA, GLL, GSA, VTG and GSV are selectable.
- ⑥ Rotate [MAIN DIAL] to turn the sentence ON or OFF.
  - Hold down [F-3] for 1 second to reset to the default setting, if desired.
- ⑦ Repeat steps ⑤ and ⑥ to select another GPS sentence.
  - Up to four GPS sentences can be selected.
- ⑧ Push [MENU] to save, and return to the "GPS" screen.

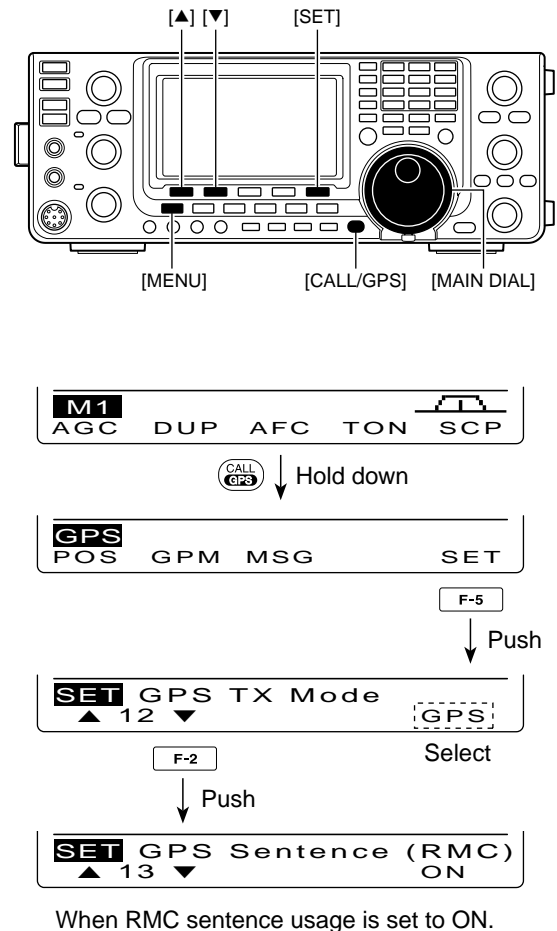

**NOTE:**

Set the GSV sentence to OFF when sending the GPS message to conventional digital transceivers (IC-2820H, IC-E2820, ID-800H, IC-91AD, IC-E91, IC-V82, IC-U82, IC-2200H, ID-1). The GSV sentence is incompatible with them. Those transceivers will not display GPS messages properly if a GSV sentence is sent from the IC-9100.

■ GPS operation (Continued)

◇ Position display

- ① Hold down [CALL/GPS] for 1 second to display the "GPS" screen.
- ② Push [POS](F-1) to display the position data. Then push [F-2] one or more times to display your current position, received position or GPS memory alarm position information.
  - While the position data is displayed, push [F-1] to select North or South as the top of the compass.
  - MY Position : Displays your own latitude, longitude, direction\*, elevation\* and the time\*.
    - \* These items do not appear when "Manual" is selected as the "MY Position" item option in the GPS Set mode. (p. 132)
  - RX Position : Displays the caller's (other station) latitude, longitude, call sign, direction and distance from your position.
  - GPM Position: Displays the GPS Memory channel's latitude, longitude, direction and distance from your position, if the GPS Alarm function is set to the channel.
    - If the GPS Alarm function is set to all channels or a bank, "-" is displayed instead of the position information.
- ③ Push [MENU] to return to the "GPS" screen.

/// **NOTE:** Depending on the GPS signals, your position/elevation may change even though you are stationary.

These sample indications assume that "Position Format" is selected as "ddd°mm.mm," and "Units" is selected as "feet/mile." (p. 132)

"TIME" data may not be displayed, depending on the connected GPS receiver.

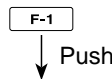
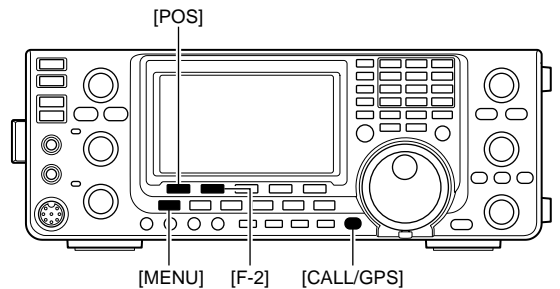

↓ Approximately 2 seconds

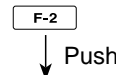

↓ Approximately 2 seconds

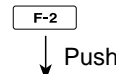

↓ Approximately 2 seconds



### ◇ Saving your own or received position data

- ① Hold down [CALL/GPS] for 1 second to display the “GPS” screen.
- ② Push [POS](F-1), then push [F-2] once or twice to display your own or the caller’s (other station) position information.
  - You cannot save the data on the “GPM Position” screen.
- ③ Hold down [F-5] for 1 second to save the position data to GPS memory (G00).
  - The Memory channel number advances automatically if the next Memory channel already contains information.
  - 50 GPS Memory channel are available.

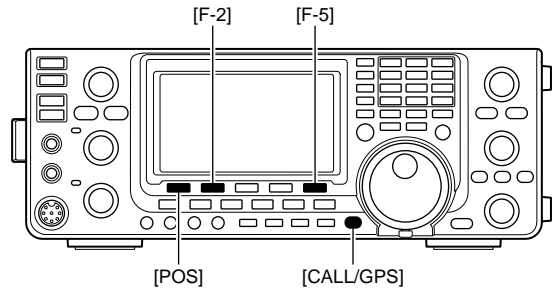

### ◇ Display the Grid Locator information

The Grid Locator expresses the latitude and longitude position data in a short string of characters. The IC-9100 can display it on the LCD.

- ① Hold down [CALL/GPS] for 1 second to display the “GPS” screen.
- ② Push [POS](F-1), then push [F-2] one or more times to display the position information.
- ③ While holding down [F-4], the grid locator information is displayed.

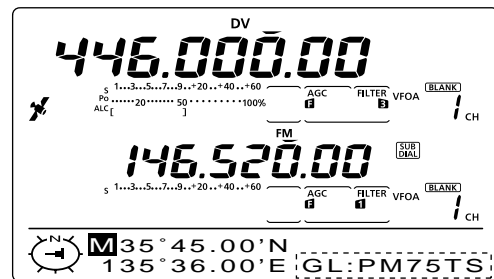

F-4  
Hold down

### ◇ GPS automatic transmission

In the DV mode, this function automatically transmits the GPS receiver’s current position data, at a selected interval.

When a GPS message is programmed, the transceiver transmits it along with the position data. See page 125 for the GPS message programming.

- ① Hold down [CALL/GPS] for 1 second to display the “GPS” screen.
- ② Push [SET](F-5) to enter the GPS Set mode.
- ③ Push [▲](F-1) or [▼](F-2) to select “GPS Auto TX.”
- ④ Rotate [MAIN DIAL] to select the desired position data transmitting interval to 5\*, 10 or 30 seconds; 1, 3, 5, 10 or 30 minutes, or OFF.
  - \*If four GPS sentences are selected in GPS Set mode on page 122, “5 sec.” cannot be selected.
  - The GPS message is also transmitted, if programmed.
- ⑤ Push [MENU] to save, and return to the “GPS” screen.

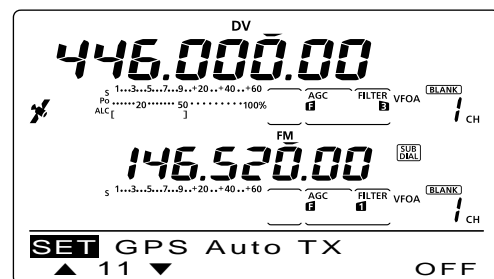
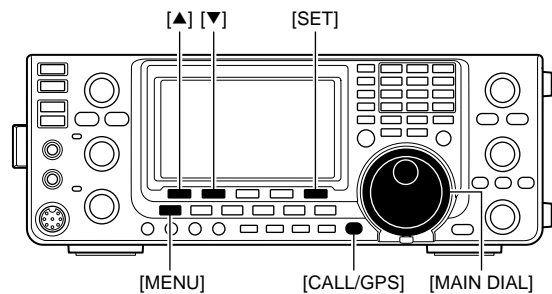

OFF (default)

#### NOTE:

- Your own call sign must be entered to activate the GPS automatic transmission. (p. 93)
- Use GPS automatic transmission in only the simplex mode.
- GPS automatic transmission through a repeater may interfere with other communications.

■ GPS operation (Continued)

◇ GPS message programming

Enter a GPS message of up to 20 characters to be transmitted with the position data.

- ① Hold down [CALL/GPS] for 1 second to display the "GPS" screen.
- ② Push [MSG](F-3) to display the "MSG" screen (GPS Message).
- ③ Push [TXM](F-1) to display the "TXM" screen (TX Message Edit).
  - A cursor appears and blinks.
- ④ Push [F-1] one or more times to select the desired character type.

Character type	Selectable characters
ABC	A to Z
abc	a to z
etc	! # \$ % & \ ? " ' ` ^ + - * / . , ; = < > ( ) [ ] { } ! _ - @

- ⑤ Rotate [MAIN DIAL] to select the first character or symbol to input.
  - When inputting numbers or a decimal point, push the appropriate keypad key.
  - Push [DEL](F-4) to delete the selected character, symbol or number.
  - Push [SPC](F-5) to input a space.
  - When all 20 characters have been programmed, an error beep sounds. If you want to reprogram, push [◀](F-2) or [▶](F-3) to select a character, then push [DEL](F-4) to delete it.
- ⑥ Push [◀](F-2) to move the cursor backward, or push [▶](F-3) to move the cursor forward.
- ⑦ Repeat steps ④ to ⑥ to program a message of up to 20 characters.
- ⑧ Push [MENU] to save the message, and return to the "MSG" screen (GPS Message).
- ⑨ Push [MENU] again to return to the "GPS" screen.

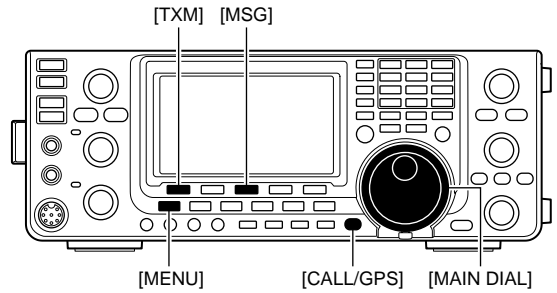

CALL GPS ↓ Hold down



F-3 ↓ Push



F-1 ↓ Push



• To program a message

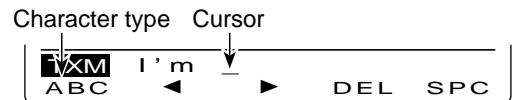
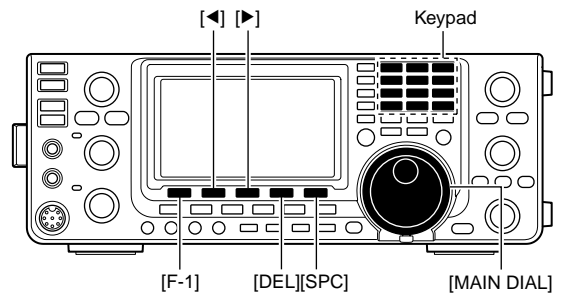

- F-1 Select the character type
- F-2 Move cursor backward
- F-3 Move cursor forward
- F-4 Delete a character
- F-5 Input a space

### ◇ Received GPS message display

- ① Hold down [CALL/GPS] for 1 second to display the “GPS” screen.
- ② Push [MSG](F-3) to display the “MSG” screen (GPS Message).
- ③ Push [RXM](F-2) to display the “RXM” screen (RX message).
  - Messages of up to 36 characters can be displayed. When the received GPS message includes more than 36 characters, push [F-1] to display the rest of the message.
- ④ Push [MENU] to return to the “MSG” screen (GPS Message).
- ⑤ Push [MENU] to return to the “GPS” screen.

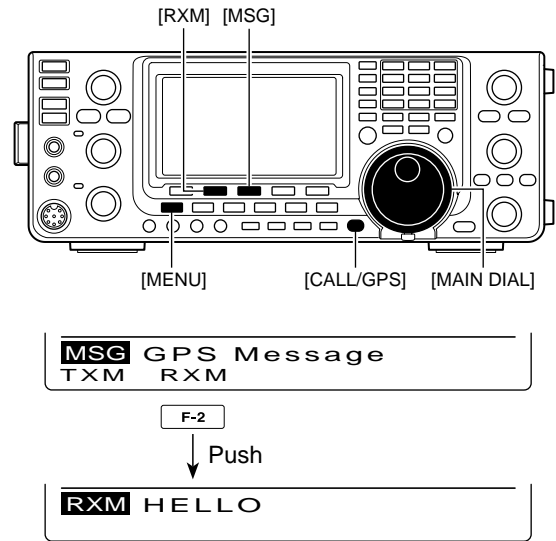

## ■ GPS memory operation

The transceiver has 50 GPS memory channels to store the received position data, or other-used position data, along with an alphanumeric channel name.

### ◇ Add a GPS memory

- ① Hold down [CALL/GPS] for 1 second to display the "GPS" screen.
- ② Push [GPM](F-2) to display the "GPM" screen (GPS Memory).
- ③ Rotate [MAIN DIAL] to select "ALL" or a desired memory bank.
  - The bank can be selected in 'Memory bank setting,' as described on page 128.
- ④ Push [LIST](F-1), then push [ADD](F-1) to enter the "ADD" screen (GPS Memory Add) to manually add new data.

#### ▨ To cancel the programmed data:

When the "ADD" screen is selected, push [MENU] to display "Cancel OK?." Push [YES] (F-4) to cancel programming and return to the "GPM" screen, or push [NO](F-5) to keep programming and return to the "ADD" screen.

- ⑤ Push [▲](F-1) or [▼](F-2) to select the item.

### Memory Name programming

- ① When "NAME" is selected, push [EDT](F-4) to enter the memory name programming mode.
  - A cursor appears and blinks.
- ② Push [F-1] one or more times to select the desired character type.

Character type	Selectable characters
ABC	A to Z
abc	a to z
etc	! # \$ % & \ ? " ' ` ^ + - * / . , ; = < > ( ) [ ] { }   _ ` @

- ③ Rotate [MAIN DIAL] to select the first character or symbol to input.
 

When inputting numbers or a decimal point, push the appropriate keypad key.

  - Push [DEL](F-4) to delete the selected character, symbol or number.
  - Push [SPC](F-5) to input a space.
  - When all 9 characters have been programmed, an error beep sounds. If you want to reprogram, push [◀](F-2) or [▶](F-3) to select a character, then push [DEL](F-4) to delete it.
- ④ Push [◀](F-2) to move the cursor backward, or push [▶](F-3) to move the cursor forward.
- ⑤ Repeat steps ② through ④ to program a name of up to 9 characters.
- ⑥ Push [MENU] to save the programmed name, and return to the "ADD" screen.

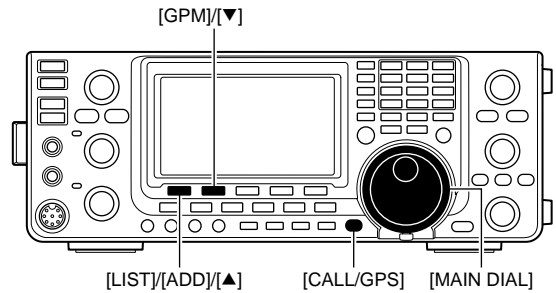

[CALL/GPS] ↓ Hold down



[F-2] ↓ Push



↓ Rotate [MAIN DIAL]



[F-1] ↓ Push



[F-1] ↓ Push

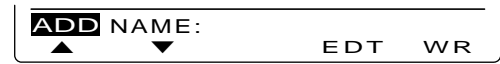

[F-1] [F-2] ↑ Select the item

### • To program a GPS memory name

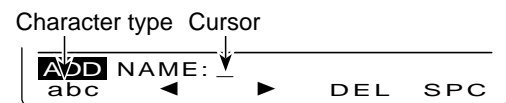
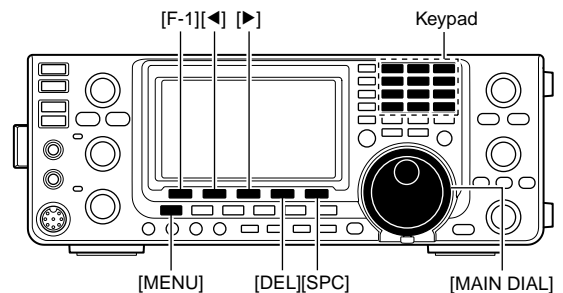

[F-1] [F-2] [F-3] [F-4] [F-5]

Input a space  
Delete a character  
Move cursor forward  
Move cursor backward  
Select the character type



### Latitude data programming

- 7 When "LAT" is selected, rotate [MAIN DIAL] to enter the desired latitude data.
  - A cursor blinks on the programmable digit.
  - Push [◀▶](F-3) to select the digit.
  - Select "N" to input N; North latitude.
  - Select "S" to input S; South latitude.
  - You cannot use the keypad keys.
- 8 Push [▲](F-1) or [▼](F-2) to save the programmed latitude data, and select other item.

### Longitude data programming

- 9 When "LON" is selected, rotate [MAIN DIAL] to enter the desired longitude data.
  - A cursor blinks on the programmable digit.
  - Push [◀▶](F-3) to select the digit.
  - Select "W" to input W; West longitude.
  - Select "E" to input E; East longitude.
  - You cannot use the keypad keys.
- 10 Push [▲](F-1) or [▼](F-2) to save the programmed longitude data, and select other items.

### Time data programming

- 11 When "TIME" is selected, rotate [MAIN DIAL] to enter the desired time data.
  - A cursor blinks on the programmable digit.
  - Push [◀▶] to move the cursor forward and backward.
  - You cannot use the keypad keys.
- 12 Push [▲](F-1) or [▼](F-2) to save the programmed time data, and select other item.

### Memory bank setting

- 13 When "BANK" is selected, rotate [MAIN DIAL] to select the desired bank letter.
  - 14 Push [EDT](F-4) to enter the bank name programming mode.
    - A cursor appears and blinks.
  - 15 Repeat steps 2 through 4 of 'Name programming' on the previous page to program a bank name of up to 9 characters.
  - 16 Push [MENU] to save the programmed bank name, and return to the "ADD" screen.
- 6 After programming, hold down [WR](F-5) for 1 second to write the data into the GPS memory, and return to the "GPM" screen (GPS Memory).
  - 7 Push [MENU] two times to return to the "GPS" screen.

#### • To program a latitude or longitude

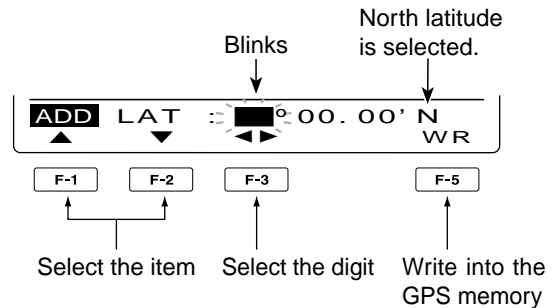

(This illustration is based on entering a latitude.)

#### • To program a time data

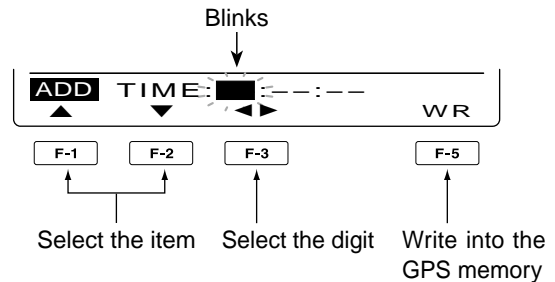

#### • To program a bank name

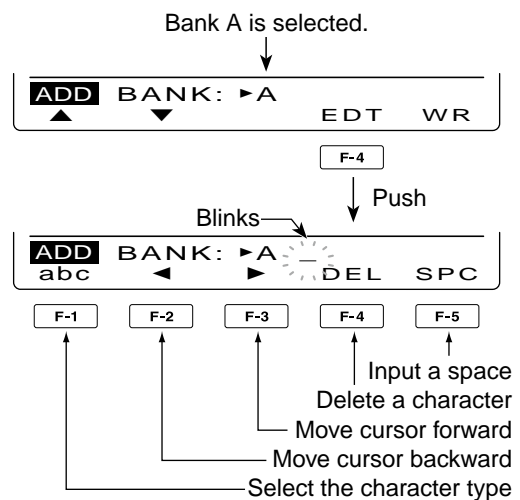

■ GPS memory operation (Continued)

◇ Edit a GPS memory

The GPS memory name, latitude and longitude data, time data and a memory bank name can be edited.

- ① Hold down [CALL/GPS] for 1 second to display the “GPS” screen.
- ② Push [GPM](F-2) to display the “GPM” screen (GPS Memory).
- ③ Rotate [MAIN DIAL] to select “ALL” or desired memory bank.
  - The bank can be selected in ‘Memory bank setting,’ as described on page 128.
- ④ Push [LIST](F-1), then push [EDT](F-2) to enter the “EDT” screen (GPS Memory Edit) to edit the programmed data.
  - “Blank” appears when no memory is programmed.

▨ To cancel the programmed data:

When the “EDT” screen is selected, push [MENU] to display “Cancel OK?.” Push [YES](F-4) to cancel programming and return to the “GPM” screen, or push [NO](F-5) to keep programming and return to the “ADD” screen.

- ⑤ Push [▲](F-1) or [▼](F-2) to select the item.
- ⑥ Enter a memory name, latitude data, longitude data, time and memory bank name, as described in steps ① to ④ of ‘Add a GPS memory’ on pages 127 and 128.
- ⑦ After programming, hold down [WR](F-5) for 1 second to write the data into the GPS memory, and return to the “GPM” screen (GPS Memory).
- ⑧ Push [MENU] two times to return to the “GPS” screen.

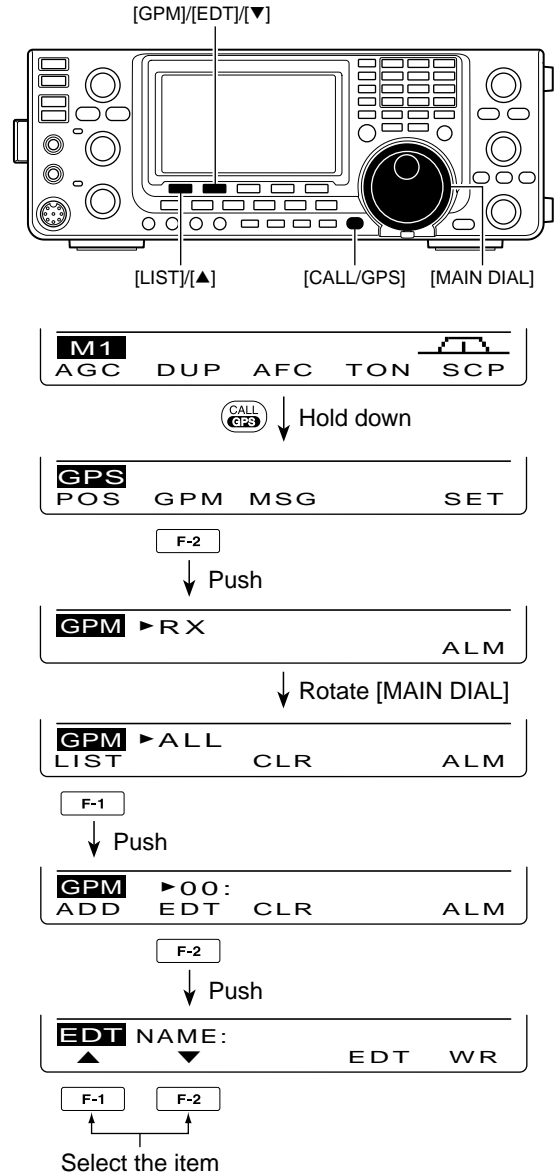

### ◇ GPS alarm setting

A GPS alarm can sound when a target position comes into the alarm area. This function can be set to the caller station, all GPS Memory channels, a specified Memory bank or a specified Memory channel.

- ① Hold down [CALL/GPS] for 1 second to display the "GPS" screen.
- ② Push [GPM](F-2) to display the "GPM" screen (GPS Memory).
- ③ Rotate [MAIN DIAL] to select the desired memory group, or memory channel.
  - "RX," "ALL," a memory bank or memory channel can be selected.
  - You can select a memory channel after pushing [LIST] (F-1) when "ALL" or a memory bank is selected.
- ④ Push [ALM](F-5) to turn ON the Alarm function.
  - Push [ALM](F-5) again to turn OFF the Alarm function.
- ⑤ Push [MENU] to return to the "GPS" screen.

#### ✓ For your information!

- When "RX" or memory channel is selected in step ③, the alarm functions depend on "Alarm Area2" setting in the GPS Set mode. (p. 133)
- When "ALL" or a memory bank is selected in step ③, the alarm functions depend on "Alarm Area1" setting in the GPS Set mode. (p. 133)

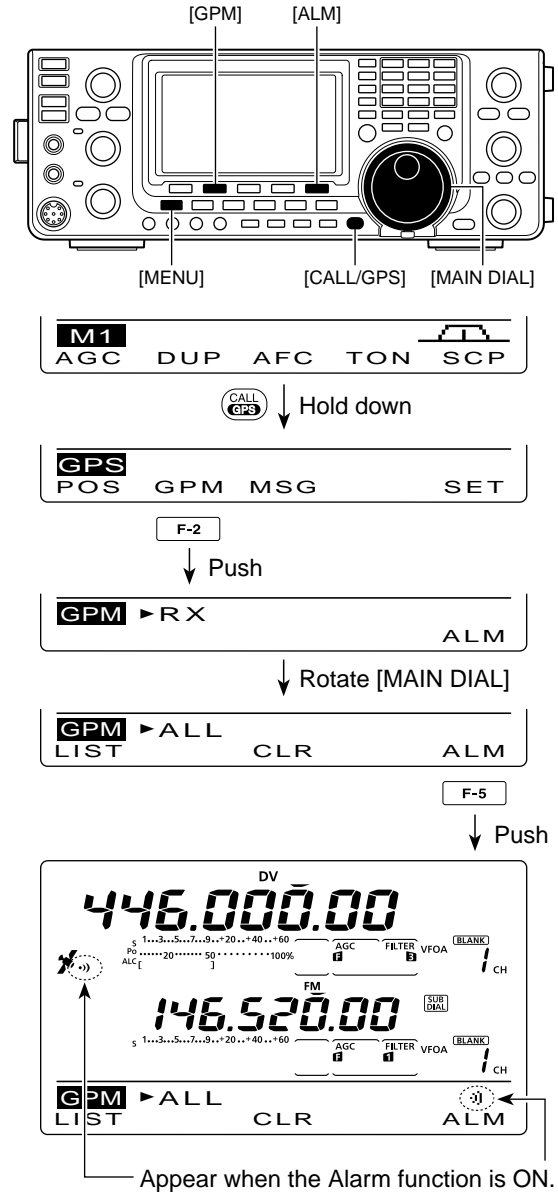

■ GPS memory operation (Continued)

◇ GPS memory clearing

• Clear all memory channels

- ① Hold down [CALL/GPS] for 1 second to display the “GPS” screen.
- ② Push [GPM](F-2) to display the “GPM” screen (GPS Memory).
- ③ Rotate [MAIN DIAL] to select “ALL.”
- ④ Hold down [CLR](F-3) for 1 second to clear all Memory channels.
  - “ALL Clear OK?” appears.
- ⑤ Push [YES](F-4) for 1 second to clear.
  - To cancel clearing, push [NO](F-5).
- ⑥ Push [MENU] two times to return to the “GPS” screen.

• Clear a desired bank

- ① Hold down [CALL/GPS] for 1 second to display the “GPS” screen.
- ② Push [GPM](F-2) to display the “GPM” screen (GPS Memory).
- ③ Rotate [MAIN DIAL] to select the desired Memory bank.
- ④ Hold down [CLR](F-3) for 1 second to clear the selected Memory bank.
  - “BANK Clear OK?” appears.
- ⑤ Push [YES](F-4) for 1 second to clear.
  - To cancel clearing, push [NO](F-5).
- ⑥ Push [MENU] two times to return to the “GPS” screen.

• Clear a desired memory channel

- ① Hold down [CALL/GPS] for 1 second to display the “GPS” screen.
- ② Push [GPM](F-2) to display the “GPM” screen (GPS Memory).
- ③ Rotate [MAIN DIAL] to select “ALL” or a Memory bank, then push [LIST](F-1).
- ④ Rotate [MAIN DIAL] to select the desired GPS Memory channel to be cleared.
- ⑤ Hold down [CLR](F-3) for 1 second to clear the selected Memory channel.
  - “Clear OK?” appears.
- ⑥ Push [YES](F-4) for 1 second to clear.
  - To cancel clearing, push [NO](F-5).
- ⑦ Push [MENU] two times to return to the “GPS” screen.

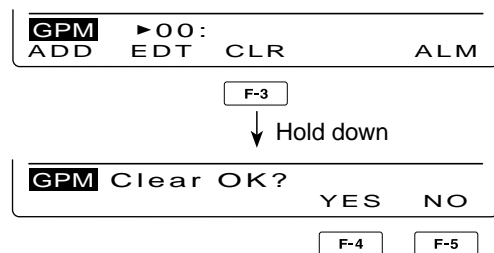
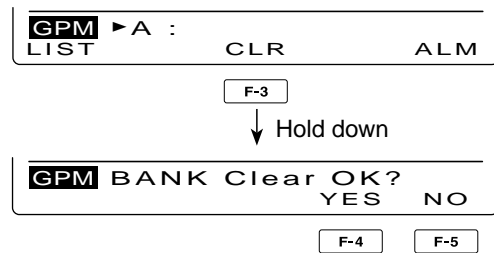
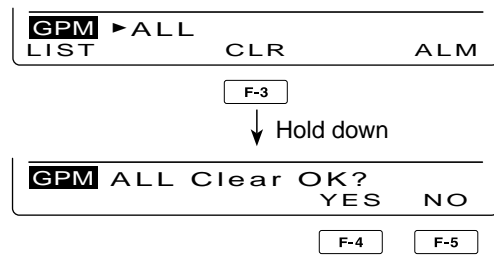
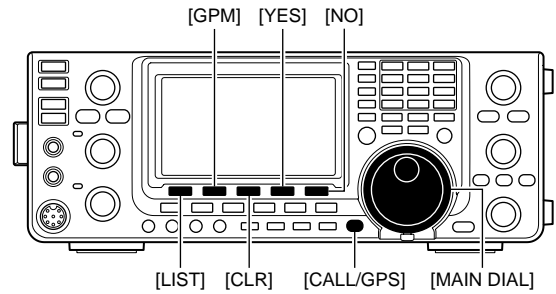

## ■ GPS Set mode

The following individual settings are selectable in the GPS Set mode. Set them to suit your GPS operating needs.

- ① Hold down [CALL/GPS] for 1 second to display the "GPS" screen.
- ② Push [SET](F-5) to enter the GPS Set mode.
- ③ Push [▲](F-1) or [▼](F-2) to select the desired item.
- ④ Rotate [MAIN DIAL] to select the desired option.
  - Hold down [F-3] for 1 second to reset to the default setting, if desired.
- ⑤ Push [MENU] to save, and return to the "GPS" screen.

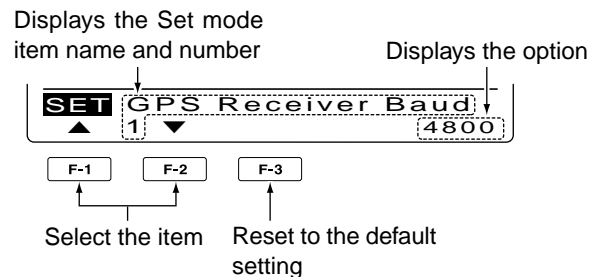
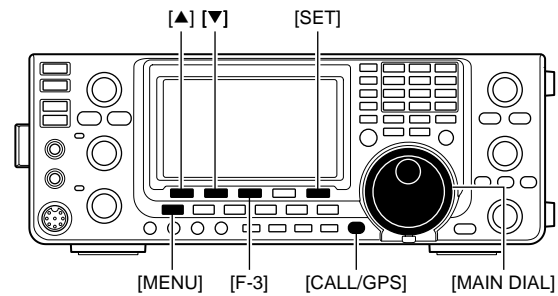

### 1. GPS Receiver Baud (Default: 4800)

Set the baud rate of the GPS receiver to 4800 bps or 9600 bps.

### 2. Position Format (Default: ddd°mm.mm')

Select either the ddd°mm.mm' or ddd°mm:ss" format to display position information.

### 3. Units (Default: feet/mile)

Select either meter or feet/mile format to display the distance and elevation information.

### 4. COMPASS Direction (Default: North REF)

Select the compass display type. When the position data is displayed, push [F-1] to select the compass type.

- North REF : The top of the compass represents north.
- South REF : The top of the compass represents south.

### 5. UTC Offset (Default: ±0:00)

Set the time difference between UTC (Universal Time Coordinated) and the local time to between -14:00 and +14:00 in 00:05 steps.

### 6. GPS Indicator (Default: ON)

Turn the GPS icon ("📶") display function ON or OFF.

- OFF : "📶" does not appear.
- ON : "📶" appears on the display when a valid position data is received; blinks when an invalid data is received.

### 7. MY Position (Default: GPS)

Select either GPS or Manual to enter your current position.

- GPS : The GPS receiver's position data is used.
- Manual : Manually entered position data is used. However, when the GPS receiver is connected to the transceiver, this setting will automatically switch to "GPS."

### 8. Manual Position (Default: LAT : 0°00.00'N LON : 0°00.00'E)

Manually enter your latitude and longitude data. The manually programmed data can be memorised. This item does not appear when "GPS" is selected in "My Position."

- ① Push [EDT](F-4) to enter the position data edit mode.
- ② Push [▲](F-1) or [▼](F-2) to select "LAT" or "LON," and rotate [MAIN DIAL] to enter the desired position data.
  - When "LAT" is selected, enter the latitude data.
  - When "LON" is selected, enter the longitude data.
  - See page 128 for details.
- ③ Hold down [WR](F-5) to write the data.

■ GPS Set mode (Continued)

**9. Alarm Area1 (Default: 0.25')**

When the GPS Alarm function is set to "ALL" or one of the memory banks, set the GPS alarm active range. When ddd°mm.mm' is selected in "Position Format," the active range can be set to between 0'08" and 59'99" in 0'01" steps.

When ddd°mm'ss" is selected in "Position Format," the active range can be set to between 0'05" and 59'59" in 0'01" steps.

See page 132 for details.

- **Example:** Your position : 35°N/135°E  
Alarm Area1 setting : 0.25'

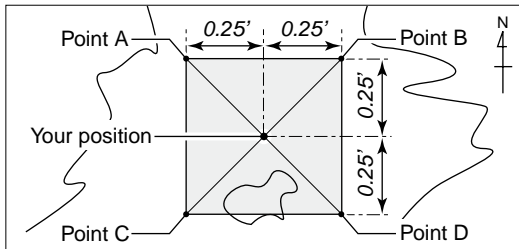

- Position of point A : 35°00.25'N/134°59.75'E
- Position of point B : 35°00.25'N/135°00.25'E
- Position of point C : 34°59.75'N/134°59.75'E
- Position of point D : 34°59.75'N/135°00.25'E

(This description is based on the ddd°mm.mm' position format; p. 132)

When a target position enters the alarm area, the GPS alarm sounds.

**10. Alarm Area2 (Default: Both)**

When the GPS Alarm function is set to the memory channel or "RX," set the GPS alarm active range to "Both," "Extended" or "Limited."

- **Limited** : When the target position is in the approximate 500 meter range, the GPS alarm sounds three times.
- **Extended** : When the target position is in the approximate 1 kilometer range, the GPS alarm sounds three times.
- **Both** : When the target position is in the approximate 1 kilometer range, the GPS alarm sounds one beep, and when it is in the approximate 500 meter range, the alarm sounds three beeps.

500 meter (547 yard)  
1 kilometer (1094 yard)

- **Example:**

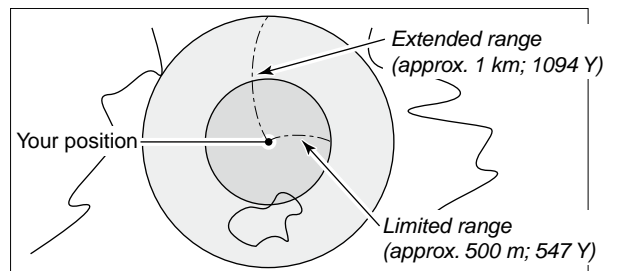

The target position definitions for Alarm Area 2.

**Alarm indication**  
When a target position comes into the alarm area, the icon below appears.

Blinks

### 11. GPS Auto TX (Default: OFF)

Select the desired interval from OFF, 5, 10, 30 seconds, 1, 3, 5, 10 or 30 minutes for automatic position data transmission.

The current position data, received from a GPS receiver, is transmitted at the selected interval when "GPS" or "GPS-A" is selected as the "GPS TX Mode" option as described below.

The GPS message is transmitted as well as the position data, if it is programmed.

Even if this setting is set to OFF, you can manually transmit the position data by pushing [TRANSMIT] or [PTT] (microphone).

#### NOTE:

- When four GPS sentences are selected at the same time, "5sec" cannot be selected.
- When "Manual" is selected in "My Position," the current position data will not be automatically transmitted.

### 12. GPS TX Mode (Default: Disable)

Select the GPS or GPS-A operating mode to transmit the position data from a GPS receiver, or turn OFF the function.

NOTE: When "GPS" or "GPS-A" is selected, low-speed data communication cannot be used.

### 13. GPS Sentence (RMC)\*1 (Default: OFF)

Turn the GPS sentence formatter "RMC" ON or OFF.

### 14. GPS Sentence (GGA)\*1 (Default: ON)

Turn the GPS sentence formatter "GGA" ON or OFF.

### 15. GPS Sentence (GLL)\*1 (Default: OFF)

Turn the GPS sentence formatter "GLL" ON or OFF.

### 16. GPS Sentence (GSA)\*1 (Default: OFF)

Turn the GPS sentence formatter "GSA" ON or OFF.

### 17. GPS Sentence (VTG)\*1 (Default: OFF)

Turn the GPS sentence formatter "VTG" ON or OFF.

### 18. GPS Sentence (GSV)\*1 (Default: OFF)

Turn the GPS sentence formatter "GSV" ON or OFF.

#### NOTE for GPS sentences:

- Up to four GPS sentences are usable at the same time.
- See page 122 for GPS sentence setting details.

### 19. Unproto Address\*2

(Default: API910,DSTAR\*)

Enter an unproto address of up to 56 characters. The manually programmed data can be memorized.

#### Unproto address programming

- 1 Push [EDT](F-4) to enter the unproto address edit mode.
- 2 Push [F-1] one or more times to select the desired character type.

Character type	Selectable characters
ABC	A to Z
abc	a to z
etc	! # \$ % & \ ? " ' ` ^ + - * / . , ; = < > ( ) [ ] { }   _ ' @

- 3 Rotate [MAIN DIAL] to select the first character or symbol to input.
  - When entering number or a decimal point, push the appropriate keypad key.
  - Push [DEL](F-4) to delete the selected character, symbol or number.
  - Push [SPC](F-5) to input a space.
  - When all 56 characters have been programmed, an error beep sounds. If you want to reprogram, push [◀](F-2) or [▶](F-3) to select a character, then push [DEL](F-4) to delete it.
- 4 Push [◀](F-2) to move the cursor backward, or push [▶](F-3) to move the cursor forward.
- 5 Repeat steps 2 through 4 to program an unproto address of up to 56 characters.
- 6 Push [MENU] to save the unproto address, and return to the "SET" screen.

\*1 Appears when "GPS" is selected in "GPS TX Mode."

\*2 Appears when "GPS-A" is selected in "GPS TX Mode."

## ■ GPS Set mode (Continued)

**20. Data Extension\*** (Default: OFF)

Set the data extension capability to "Course/Speed" or OFF.

When you select "Course/Speed," the transceiver's course and speed information is transmitted along with the position data.

**NOTE:** When "Course/Speed" is selected, "Comment (Extension)" appears instead of "Comment," and number of characters is limited to 36.

**21. Time Stamp\*** (Default: OFF)

Select either the DHM or HMS format to transmit the current UTC (Universal Time Coordinated) time as a time stamp, or turn OFF the function.

- OFF : Does not transmit the time information.
- DHM : Transmits the time stamp in the Day, Hour, and Minute format.
- HMS : Transmits the time stamp in the Hour, Minute, and Second format.

**22. GPS-A Symbol\***

(Default: House QTH (VHF))

Select the desired GPS-A symbol which represents your means of transportation.

Selectable symbols:

Ambulance, Bus, Fire Truck, Bicycle, Yacht, Helicopter, Small Aircraft, Ship, Car, Motorcycle, Balloon, Jeep, RV, Truck, Van, House QTH (VHF) and Other

If there is no symbol you want to use, you can make a desired symbol code, as described below.

• **Symbol programming**

- ① Rotate [MAIN DIAL] to select "Other."
  - [EDT](F-4) and the current symbol code appear.
- ② Push [EDT](F-4) to enter the programming mode.
  - A cursor blinks on the first digit.
- ③ Rotate [MAIN DIAL] to select the first digit character to input.
 

**Usable characters:** /, \, 0 to 9, A to Z
- ④ Push [▶](F-3) to select the second digit.
  - A cursor blinks on the second digit.

- ⑤ Push [F-1] one or more times to select the desired character type.

Character type	Selectable characters
ABC	A to Z
abc	a to z
etc	! # \$ % & \ ? " ' ` ^ + - * / . , ; = < > ( ) [ ] { } ! _ ' @ (space)

- ⑥ Rotate [MAIN DIAL] to select the second digit character to input.
 

When inputting numbers or a decimal point, push the appropriate keypad key.
- ⑦ Push [MENU] to save the symbol code, and return to the "SET" screen.

When "Other" is selected, check the symbol codes of APRS®, and set them correctly.

**23. SSID\*** (Default: ---)

To assist in identifying a station's type, the displayed APRS® based SSID is added after the GPS-A data call sign.

- --- : Does not use any SSID. However, if you use a capital letter, it will be used as an SSID.
 

**(Example)**  
JA3YUA → JA3YUA  
JA3YUA A → JA3YUA-A
- (-0) : No SSID. If you use a capital letter, it will be deleted.
 

**(Example)**  
JA3YUA → JA3YUA  
JA3YUA A → JA3YUA
- -1 to -15 : Adds an SSID of -1 to -15 to your call sign. If you use a capital letter, it will be replaced with the SSID.
 

**(Example; "-9" is entered)**  
JA3YUA → JA3YUA-9  
JA3YUA A → JA3YUA-9

**NOTE:** If you have multiple transceivers, your call signs are distinguished by a single capital letter in the D-STAR\* system. When you use an SSID, the capital letter will be replaced by the SSID, depending on the setting.

\* Appears when "GPS-A" is selected in "GPS TX Mode."



## 24. Comment\*

Program a comment of up to 43 characters.  
The programmed comment is transmitted with the GPS position data.  
See 'Comment programming,' as described below.  
This item appears when "Data Extension" is set to OFF, as described on page 135.

## 25. Comment (Extension)\*

Program a comment of up to 36 characters.  
The programmed comment is transmitted with the GPS position data.  
See 'Comment programming,' as described below.  
This item appears when "Course/Speed" is selected in "Data Extension," as described on page 135.

### • Comment programming

- ❶ Push [EDT](F-4) to enter the programming mode.
  - A cursor appears and blinks.
- ❷ Push [F-1] one or more times to select the desired character type.

Character type	Selectable characters
ABC	A to Z
abc	a to z
etc	! # \$ % & \ ? " ' ` ^ + - * / . , ; = < > ( ) [ ] { } ! _ ' @

- ❸ Rotate [MAIN DIAL] to select the first character or symbol to enter.  
When inputting numbers or a decimal point, push the appropriate keypad key.
  - Push [DEL](F-4) to delete the selected character, symbol or number.
  - Push [SPC](F-5) to input a space.
  - When all 43 or 36 characters have been programmed, an error beep sounds. If you want to reprogram, push [◀](F-2) or [▶](F-3) to select a character, then push [DEL](F-4) to delete it.
- ❹ Push [◀](F-2) to move the cursor backward, or push [▶](F-3) to move the cursor forward.
- ❺ Repeat steps ❷ through ❹ to program a comment of up to 43 characters\*.
  - \* 36 characters can only be programmed when "Course/Speed" is selected in "Data Extension."
- ❻ Push [MENU] to save the comment, and return to the "SET" screen.

## ■ GPS-A operation

### ◇ GPS-A function

Set the following to activate the GPS-A function.

- ① Push [DV•DR] to select the DV mode.
- ② Enter the GPS Set mode.
- ③ Set the desired position data transmitting interval in "GPS Auto TX." (p. 134)
- ④ Select "GPS-A" in "GPS TX Mode." (p. 134)
- ⑤ Set the GPS-A mode operation's items. (pp. 134–136)

### ◇ GPS-A code details

In GPS-A operation, the following codes are transmitted to the PC connected to the IC-9100.

GPS-A code is based on APRS® code.  
(APRS® : Automatic Position Reporting System)

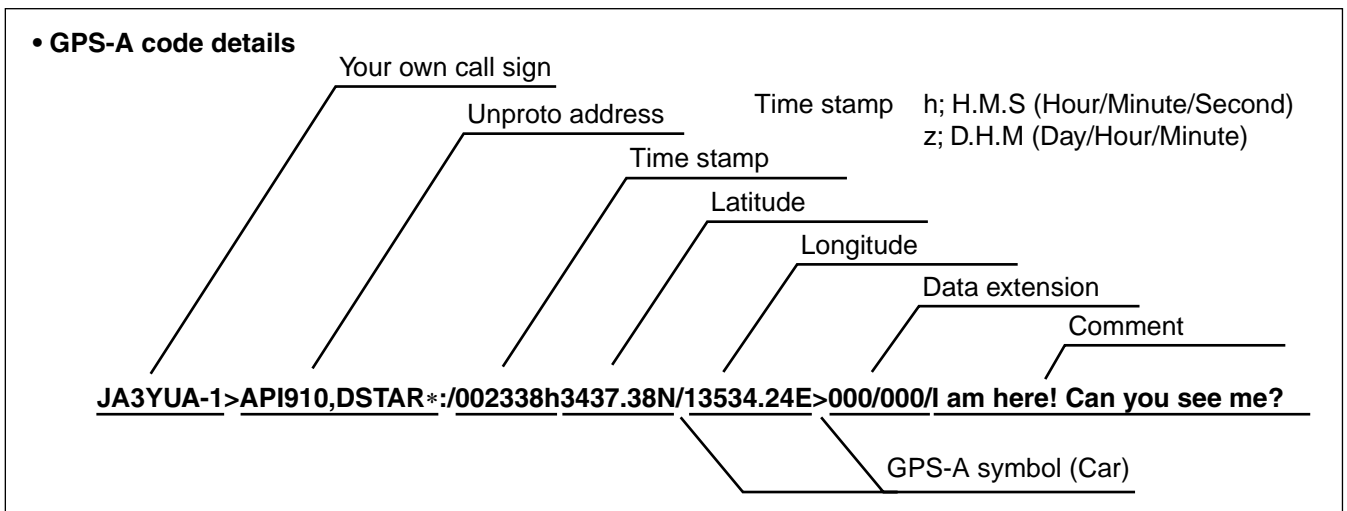

### When connecting the PC with the USB port

Connect a USB cable\* between the transceiver's USB port on the rear panel and the PC. (p. 26)

When "DV dat" is selected as the "USB2/DATA1 Func" (63) item option, the GPS-A data can be send from the USB port. (p. 167)

\* Purchase separately

### When connecting the PC with the [DATA1] jack

Connect the optional OPC-1529R between the transceiver's [DATA1] jack on the rear panel and the PC. (p. 26)

When "DV dat" is selected as the "USB2/DATA1 Func" (64) item option, the GPS-A data can be send from the [DATA1] port. (p. 168)

## ■ General description

The transceiver has 106 Memory channels in each frequency band. (99 regular, 6 scan edges and 1 call)  
The Memory mode is very useful to quickly change to often-used frequencies.

While in the memory mode, all 106 Memory channels are tunable, which means the programmed frequency can be tuned temporarily with [MAIN DIAL].

**NOTE:**

Memory data can be erased by static electricity, electric transients, etc. In addition, they can be erased by malfunction and during repairs. Therefore, we recommend that memory data be backed up or be saved to a PC using the optional CS-9100 CLONING SOFTWARE.

Memory Channels	Descriptions
1–99	Regular Memory channels with Split frequency capability.*
1A/1b–3A/3b	Program Scan Edge Memory channels with only Simplex capability. Stores the scan edge frequencies for programmed scans.
C	Call channel with Split frequency capability*. Instantly recalls a specified frequency.

\*Usable only on HF/50 MHz frequency bands.

## ◇ Memory channel contents

The following information can be programmed into Memory channels:

- Operating frequency (p. 37)
- Operating mode (p. 43)
- IF filter number (p. 73)
- Split data (p. 82)  
(Usable only on the regular Memory channels and Call channel on HF/50 MHz frequency bands.)
- Memory name (p. 143)
- Duplex direction (DUP+ or DUP–) and frequency offset (pp. 65, 163)
- Subaudible tone encoder (p. 65), tone squelch or DTCS squelch ON/OFF (pp. 62, 63)
- Subaudible tone frequency (p. 65), tone squelch frequency or DTCS code with polarity (pp. 62, 63)
- UR Station call sign (p. 86)
- R1/R2 call sign (p. 87)
- Call sign squelch or Digital code squelch ON/OFF (p. 114)
- Digital code (p. 114)

The optional UT-121 is required for DV mode operation.

## Memory channel selection

When the SUB Band setting is turned ON, you can select a Memory channel in the SUB Band as well as in the MAIN Band. (p. 33)

- “**SUB**” appears when the SUB Band setting is ON.

### Selection in the VFO mode

- ① Push [VFO/MEMO] to select the VFO mode.
- ② Rotate [M-CH] to select a Memory channel number.
  - Rotate clockwise to select a higher Memory channel number; rotate counterclockwise to select a lower Memory channel number.
  - All Memory channels, including blank channels, can be selected.
  - “**BLANK**” appears when no information has been programmed into the Memory channel. (Blank channel)
- ③ Push [VFO/MEMO] to select the Memory mode.
  - “MEMO” and contents of the Memory channel appear.

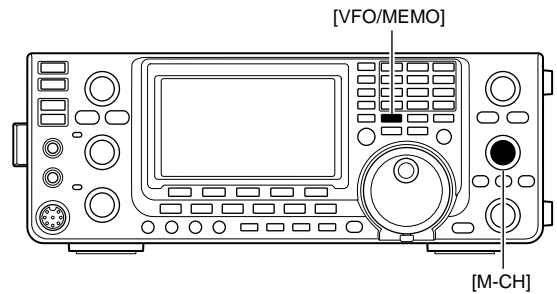

Appears if the selected Memory channel has no information.

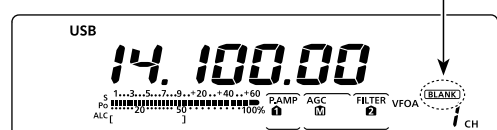

While in the VFO mode

### Selection in the Memory mode

- ① Push [VFO/MEMO] to select the Memory mode.
- ② Rotate [M-CH] to select a Memory channel.
  - Rotate clockwise to select a higher Memory channel number; rotate counterclockwise to select a lower Memory channel number.
  - All Memory channels, including blank channels, can be selected.
  - “**BLANK**” appears when no information has been programmed into the Memory channel. (Blank channel)
  - Memory channels can also be selected using the microphone [UP]/[DN] keys. In such case, the blank channels are skipped.

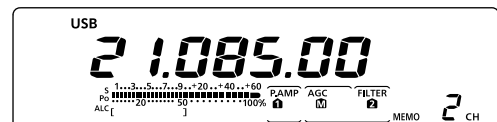

While in the Memory mode

## Call channel selection

Each frequency band has its own Call channel. Factory default frequency and operating modes are programmed into the Call channel. Change these to suit your operating needs. (see page 141)

- ① Push [CALL•GPS] to select the Call channel.
  - A capital “C” appears.
- ② Push [CALL•GPS] again to return to the previous screen display.

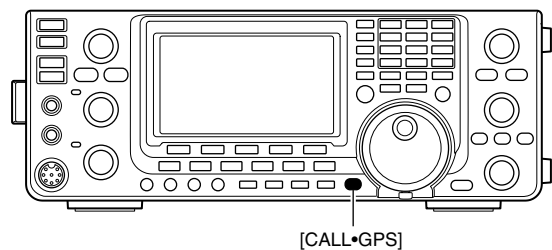

Appears

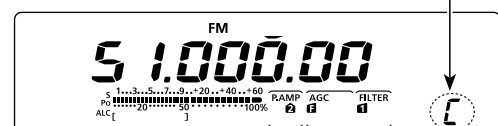

## Memory channel programming

Memory channels can be programmed in either the VFO mode or the Memory mode.

### ◇ Programming in the VFO mode

- ① Push [VFO/MEMO] to select the VFO mode.
- ② Set the desired settings into both VFO A and VFO B.
  - Select the band using [BAND](MAIN/SUB).
  - Set the frequency with [MAIN DIAL] or the keypad. (p. 37)
  - Set the operating mode with the mode switch. (p. 43)
  - Set other data (e.g. frequency offset, duplex direction, tone squelch, split frequency operation, etc.), if desired. (p. 138)
- ③ Rotate [M-CH] to select the Memory channel number to be programmed.
  - “BLANK” appears if the selected Memory channel is a blank channel.
- ④ Hold down [MW] for 1 second to program the contents into the Memory channel.
  - Three beeps sound when the memory programming is complete.

### ◇ Programming in the Memory mode

- ① Push [VFO/MEMO] to select the Memory mode.
- ② Rotate [M-CH] to select the Memory channel to be programmed.
  - The contents of the Memory channel appear in the display.
  - “BLANK” appears if the selected Memory channel is a blank channel.
- ③ Set the desired settings into the Memory channel.
  - Set the frequency with [MAIN DIAL] or the keypad. (p. 37)
    - When a blank channel is selected, you must set the desired frequency using the keypad.
  - Set the operating mode with the mode switch.
  - Set other data (e.g. frequency offset, duplex direction, tone squelch, etc.), if desired.
- ④ Hold down [MW] for 1 second to program the contents into the Memory channel.
  - Three beeps sound when the memory programming is complete.

**NOTE:** If you perform the above operations in a pre-programmed channel, the previous channel data will be overwritten.

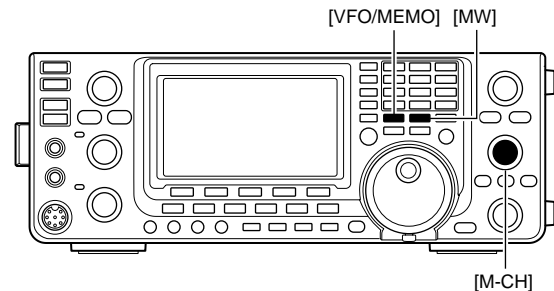

### • During setting the contents

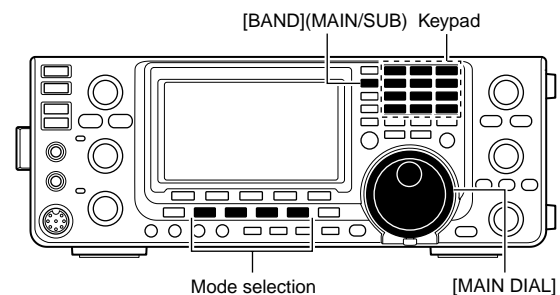

#### [EXAMPLE]:

Programming 7.088 MHz/LSB into the Memory channel 12 while in the VFO mode.

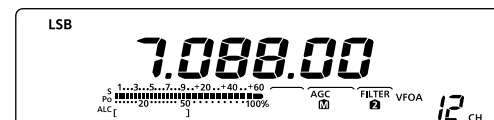

#### [EXAMPLE]:

Programming 21.280 MHz/USB into Memory channel 18 while in the Memory mode.

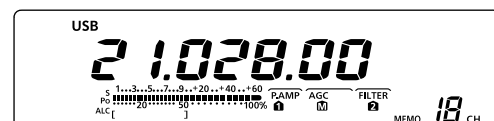

## Call channel programming

The Call channel is programmed in the same way as the regular Memory channels are. It is convenient to program a most-often-used frequency into the Call channel for quick recall. As with Memory channels, the Call channel can also hold split frequencies, and other parameters. See page 138 for details.

- ① Rotate [M-CH] to select the Call channel.
  - A capital “C” appears.
- ② Select the desired frequency and operating mode to program into the Call channel.
- ③ Hold down [MW] for 1 second to program the displayed frequency and operating mode into the Call channel.
  - Three beeps sound when memory programming is complete.

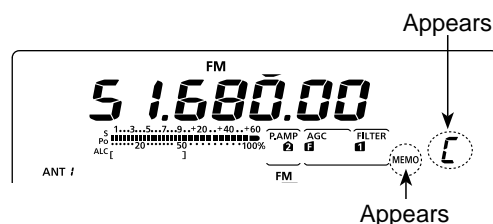
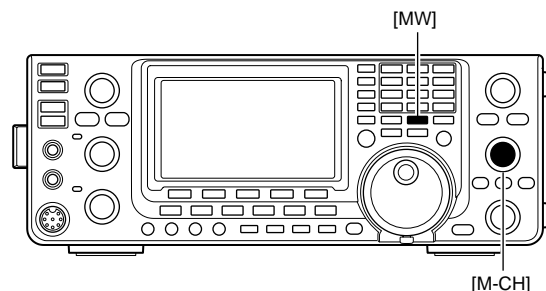

### IMPORTANT!

When the Call channel is selected with [CALL•GPS], you cannot change the memory contents. However, when the Call channel is selected using [M-CH] in the VFO or Memory mode, the memory contents can be changed.

## Memory clearing

Any no-longer-used regular Memory channels can be cleared, and then become blank channels.

- ① Push [VFO/MEMO] to select the Memory mode.
- ② Rotate [M-CH] to select the regular Memory channel to be cleared.
- ③ Hold down [M-CLR] for 1 second to clear the contents.
  - The programmed contents disappear.
  - “BLANK” appears.
  - Three beeps sound when the memory clearing is complete.
- ④ To clear other Memory channels, repeat steps ② and ③.

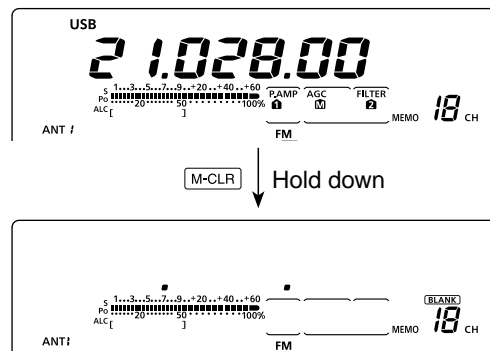
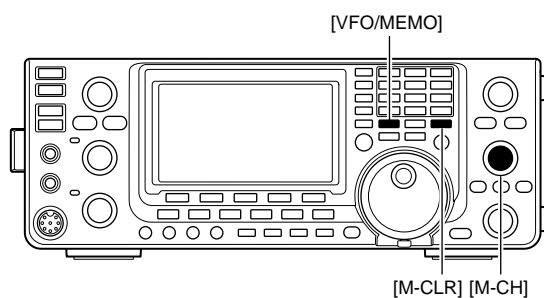

### About the blank channel display

When a blank channel is selected, or after clearing the Memory channel contents, the “BLANK” icon appears, and then after 2 seconds, the operating band appears.

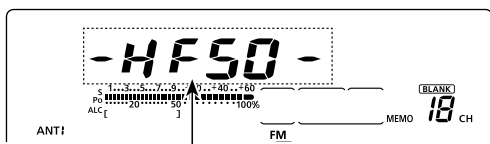

The operating band appears.

## Memory contents copying

The Memory channel contents (frequency, operating mode, etc.) can be copied to the VFO.

The copy can be performed in either the VFO mode or the Memory mode.

### ◇ Copying in the VFO mode

This is useful for copying programmed contents to a displayed VFO.

- ① Push [VFO/MEMO] to select the VFO mode.
- ② Rotate [M-CH] to select the Memory channel number to be copied.
  - “BLANK” appears if the selected Memory channel is a blank channel. In this case nothing can be copied.
- ③ Hold down [VFO/MEMO] for 1 second to copy the Memory channel contents into the VFO.
  - Three beeps sound when the copy is complete.

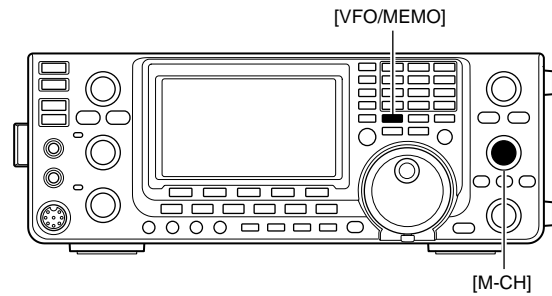

While in the VFO mode

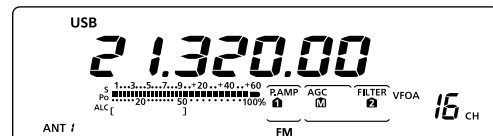

Hold down

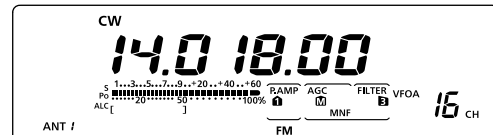

The Memory channel contents are transferred

### ◇ Copying in the Memory mode

This is useful for copying the Memory channel contents while operating in the Memory mode.

When you have changed the displayed frequency, operating mode, etc. in the selected Memory channel:

- **Displayed** data is copied.
- **Programmed** contents in the Memory channel are not copied, but remain only in the Memory channel.

- ① Push [VFO/MEMO] to select the Memory mode.
- ② Rotate [M-CH] to select the Memory channel to be copied.
  - “BLANK” appears if the selected Memory channel is a blank channel. In this case nothing can be copied.
  - Set the frequency or operating mode if required.
- ③ Hold down [VFO/MEMO] for 1 second to copy the Memory channel contents into the VFO.
  - Three beeps sound when the transfer is complete.
- ④ Push [VFO/MEMO] to select the VFO mode.

While in the Memory mode

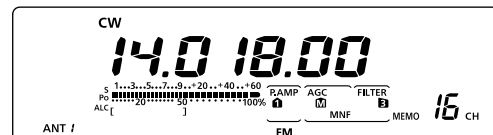

Hold down

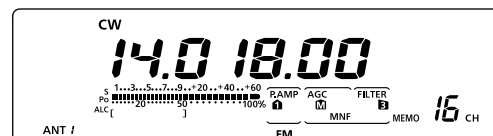

Push

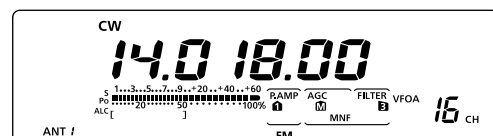

The Memory channel contents are transferred

## Memory name programming

All Memory channels, including scan edges and Call channel, can be tagged with alphanumeric names of up to 9 characters each.

**[EXAMPLE]:** Programming a memory name into Memory channel 99.

- ① Push [VFO/MEMO] to select the Memory mode.
- ② Rotate [M-CH] to select Memory channel 99.
- ③ Push [MENU] one or more times to display the "M2" screen (Menu 2).
- ④ Push [MEM](F-2) to display the "MEM" screen (Memory Menu).
- ⑤ Push [EDT](F-1) to display the "EDT" screen (Memory name Edit).
  - A cursor appears and blinks.
  - If the channel you select is a blank channel, an error beep sounds after pushing [EDT](F1).
- ⑥ Push [F-1] one or more times to select the desired character type.
  - See "Character table list," as shown below.
- ⑦ Rotate [MAIN DIAL] to select the first character or symbol to input.
  - When inputting numbers and a decimal point, push the appropriate keypad key.
  - Push [DEL](F-4) to delete the selected character, symbol or number.
  - Push [SPC](F-5) to input a space.
  - When all 9 characters have been programmed, an error beep sounds. If you want to reprogram, push [◀](F-2) or [▶](F-3) to select a character, then push [DEL](F-4) to delete it.
- ⑧ Push [◀](F-2) to move the cursor backwards, or push [▶](F-3) to move the cursor forwards.
- ⑨ Repeat steps ⑥ to ⑧ to program a memory name of up to 9 characters.
- ⑩ Push [MENU] to save the name, and return to the "MEM" screen (Memory Menu).
- ⑪ Push [MENU] to return to the "M2" screen (Menu 2).

### Character table list

Character type	Selectable characters
ABC	A to Z
abc	a to z
etc	! # \$ % & \ ? " ' ` ^ + - * / . , ; = < > ( ) [ ] { } ! _ - @

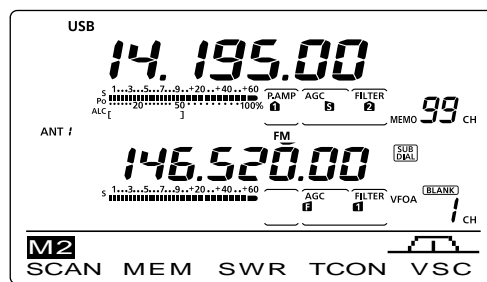
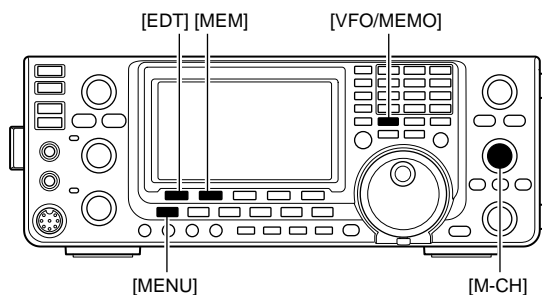

F-2

↓ Push

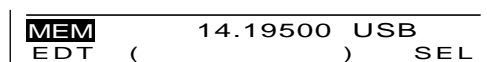

F-1

↓ Push

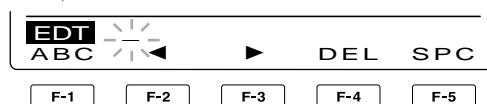

### • When programming a memory name

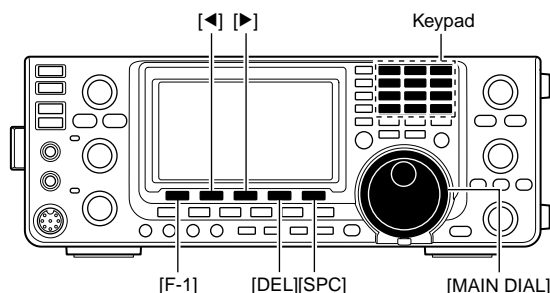

**[EXAMPLE]:** Programming "DX spot" into Memory channel 99.

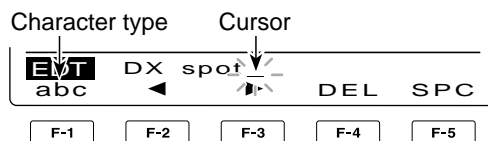

- Input a space
- Delete a character
- Move cursor forwards
- Move cursor backwards
- Select character type



## ■ Memo pad function

The transceiver has a Memo pad function to store the displayed data for easy writing and recalling. The memo pads are separate from the Memory channels. The default number of memo pads is 5. However, you can increase the number to 10 in the “Memopad Numbers” item of the Set mode, if desired. (p. 164)

Memo pads are convenient when you want to memorize the displayed data temporarily, such as when you find a DX station in a pile-up, or when a desired station is busy for a long time and you want to temporarily search for other stations.

Use the transceiver's memo pads instead of relying on hastily scribbled notes that are easily misplaced.

### ◇ Writing the displayed data into memo pads

You can store the displayed data by pushing [MP-W]. When you store the 6th data into memo pads, the oldest stored entry is automatically erased, to make room for the new data.

**NOTE:** Each memo pad must have its own unique set of data; memo pads having identical data cannot be written.

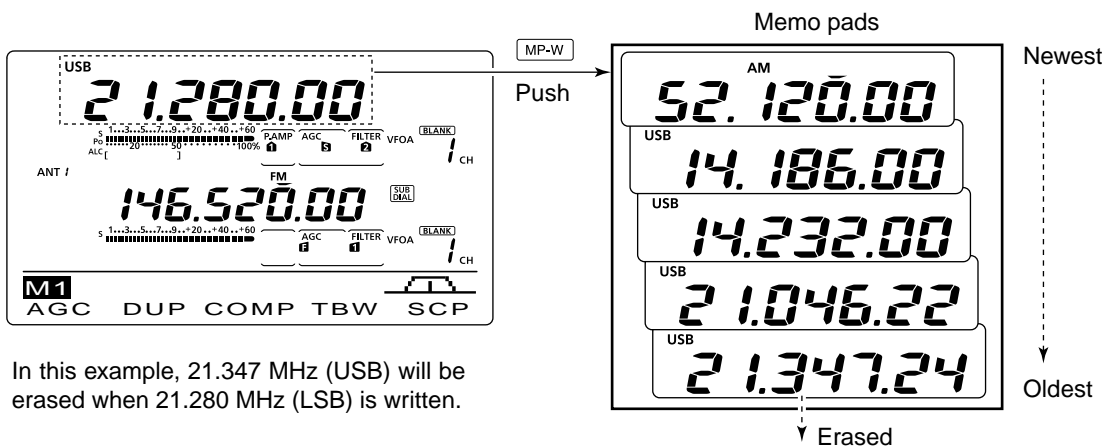

### ◇ Calling up the memo pads

You can call up a memo pad by pushing [MP-R] one or more times while in either the VFO or Memory mode.

- The memo pad data is called up, starting from the most recently written.

When you call up a memo pad, the previously displayed data is automatically stored in a temporary pad. The temporary pad can be recalled by pushing [MP-R] one or more times.

- You may think there are 6 memo pads because 6 different frequencies (5 are in memo pads and 1 is in the temporary pad) are called up by [MP-R].

If you change the data called up from a memo pad, the stored temporary pad data is replaced with the changed data.

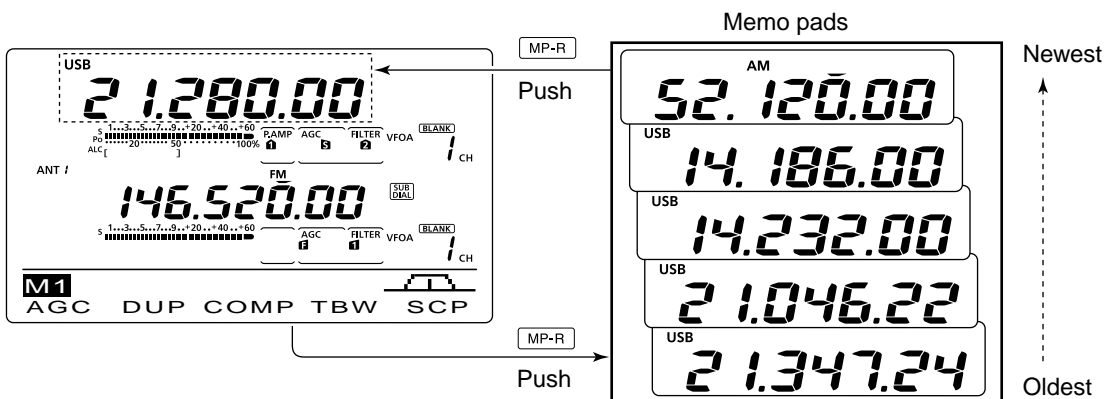

## Scan types

Scanning automatically searches for signals and makes it easier to locate new stations for contact or listening purposes. The IC-9100 has several scan types; Programmed scan, Memory scan, Select Memory scan, Mode Select scan and  $\Delta F$  (Delta Frequency) scan.

The MAIN and SUB Bands can be independently scanned. When the SUB Band setting mode is turned ON ("**SUB**" appears), the SUB Band is scanned.

### PROGRAMMED SCAN (p. 149)

Repeatedly scans between scan edges. P1 scans between 1A and 1b, P2 scans between 2A and 2b, and P3 scans between 3A and 3b frequencies. This scan operates in the VFO mode.

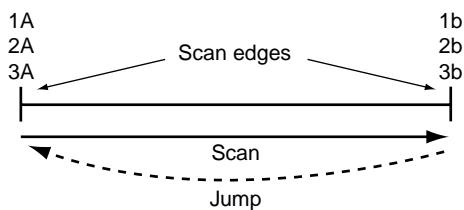

### MEMORY SCAN (p. 150)

Repeatedly scans all programmed Memory channels. This scan operates in the memory mode.

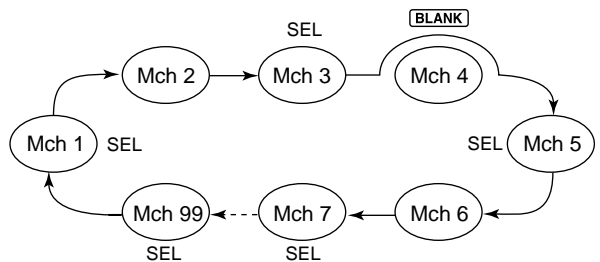

### MODE SELECT SCAN (p. 150)

Repeatedly scans all selected mode Memory channels. This scan operates in the memory mode.

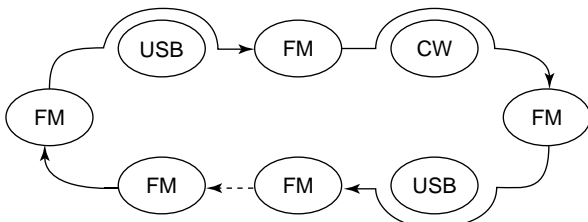

### SELECT MEMORY SCAN (p. 151)

Repeatedly scans all Select Memory channels. This scan operates in the memory mode.

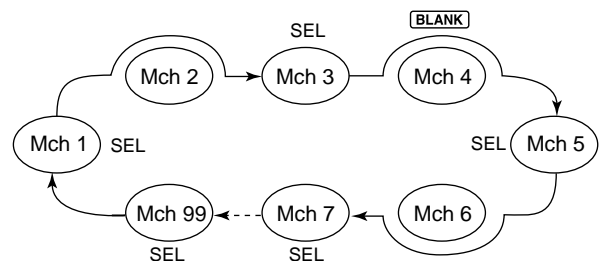

### $\Delta F$ SCAN (p. 152)

Repeatedly scans within the  $\Delta F$  span area. This scan operates in both VFO and memory modes.

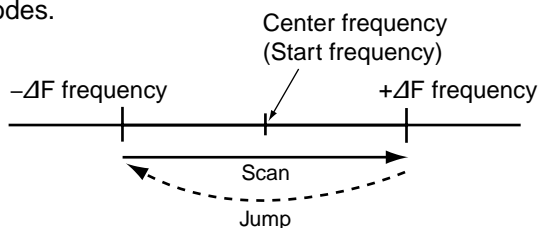

## ■ Preparation

### For a Programmed scan:

Program scan edge frequencies into Program Scan Edge channels “1A–3A” and “1b–3b.” (p. 148)

### For a Memory scan:

Program two or more Memory channels. (Program Scan Edge channels will not be scanned.) (p. 140)

### For a Mode Select scan:

Program two or more Memory channels, all with the same operating mode. (p. 43)

### For a Select Memory scan:

Program two or more Memory channels as Select Memory channels. (p. 151)

### For a $\Delta F$ scan:

Set the  $\Delta F$  span ( $\Delta F$  scan range) in the “SCAN” screen. (p. 152)

### • Scan Resume function

You can select the scan to resume or cancel when detecting a signal in the Scan Set mode. The Scan Resume function must be set before operating a scan. (p. 147)

### • Scan speed

The scan speed can be set to high or low in the Scan Set mode. (p. 147)

## ■ Voice Squelch Control function

### (Mode: SSB/AM/FM)

This function is useful when you do not want unmodulated signals pausing or cancelling a scan. When the Voice Squelch Control (VSC) function is ON, the receiver checks received signals for voice components. The scan pauses, or is cancelled, if a received signal includes voice components, and the tone of the voice components changes within 1 second. See “Squelch status” as described above.

The scan resumes if the received signal includes no voice components, or the tone of the voice components does not change within 1 second.

- ① Push [SSB] or [AM/FM] once or twice to select the operating mode.
- ② Push [MENU] to display the “M2” screen (Menu 2).
- ③ Push [VSC](F-5) to turn the VSC function ON or OFF.
  - “VSC” appears when the VSC function is ON.
  - Push [MENU] to return to the previous display.

- The VSC function is available for phone modes (SSB, AM and FM).
- The VSC function resumes the scan on unmodulated signals, regardless of whether the Scan Resume function is set to ON or OFF.

### • [MAIN DIAL] function

How the [MAIN DIAL] functions during a scan, can be set in the Scan Set mode. (p. 147)

### • Squelch status

#### ○ The scan starts with the squelch open

##### For a programmed scan:

When the tuning step is 1 kHz or less:

The scan continues until it is stopped manually— it does not pause\*, even if signals are detected.

\* The scan is paused when the squelch is closed and then opened. The scan resumes, or is cancelled, depending on the Scan Resume setting.

When the tuning step is 5 kHz or more:

If Scan Resume is ON, the scan pauses on each step when a signal is detected, then resumes.

If the Scan Resume is OFF, the scan does not start.

##### For memory scan:

If Scan Resume is ON, the scan pauses on each channel when a signal is detected, then resumes.

If Scan Resume is OFF, the scan does not start.

#### ○ The scan starts with squelch closed

The scan pauses when signals are detected. The scan resumes, or is cancelled, depending on the Scan Resume setting.

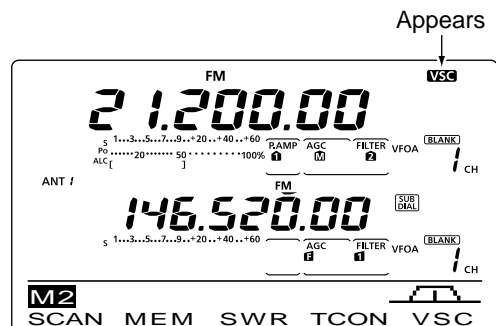

## ■ Scan set mode

The scan speed, Scan Resume function and [MAIN DIAL] scan function can be set in the Scan Set mode.

- ① Push [MENU] one or more times to display the "M2" screen (Menu 2).
- ② Push [SCAN](F-1) to display the "SCAN" screen.
- ③ Push [SET](F-5) to enter the Scan Set mode.
- ④ Push [▲](F-1) or [▼](F-2) to select the desired item.
- ⑤ Rotate [MAIN DIAL] to select the desired option.
  - Hold down [F-3] for 1 second to reset to the default value.
- ⑥ Push [MENU] to save, and return to the "SCAN" screen.
- ⑦ Push [MENU] again to return to the "M2" screen (Menu 2).

### 1. SCAN Speed (Default: HIGH)

Select the desired scan speed between high and low.

- HIGH : The scan is faster.
- LOW : The scan is slower.

### 2. SCAN Resume (Default: ON)

Set the Scan Resume function ON or OFF.

- ON : When a signal is detected, the scan pauses for 10 seconds, then resumes. When a signal disappears, the scan resumes 2 seconds later.
- OFF : When a signal is detected, the scan is cancelled.

### 3. MAIN DIAL (SCAN) (Default: Up/Down)

Select how the [MAIN DIAL] functions, during a scan.

- OFF : Rotating [MAIN DIAL] cancels the scan.
- Up/Down : Rotating [MAIN DIAL] changes the scanning direction.

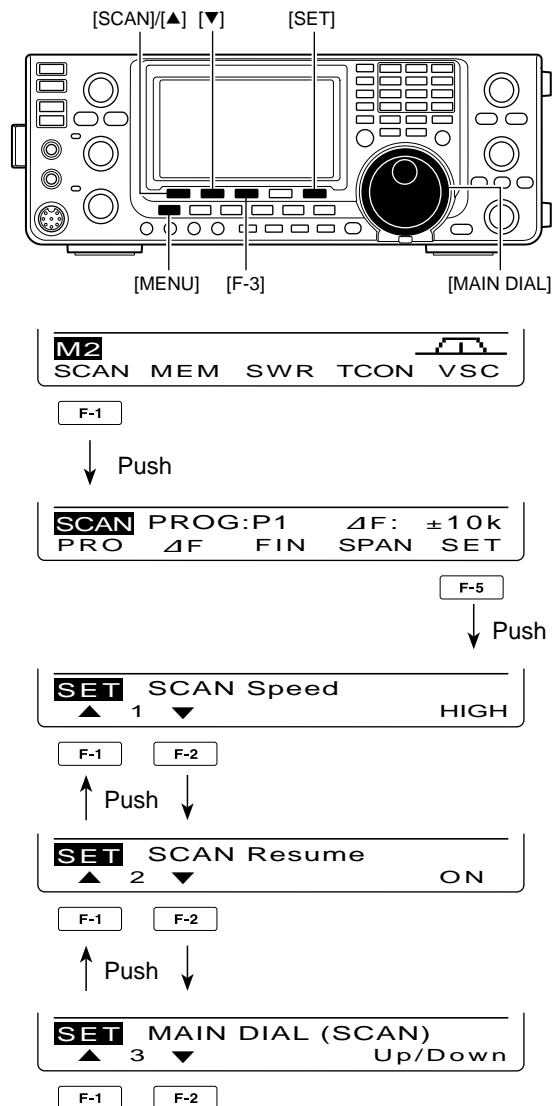

## ■ Scan edges programming

Memory channels 1A–3A and 1b–3b are the Program Scan Edge channels. They are used to program the upper and lower frequency edges for programmed scans. (p. 149)

Each frequency band has its own Scan Edge channels. Factory default frequency and operating modes are programmed into the Scan Edge channels.

▨ If both upper and lower band edges are programmed with the same frequency, a programmed scan cannot start.

**EXAMPLE:** Programming 14.00000 MHz into 1A and 14.35000 MHz into 1b.

- ① Push [VFO/MEMO] to select the VFO mode.
- ② Rotate [M-CH] to select scan edge 1A.
- ③ Set 14.00000 MHz as the lower frequency.
- ④ Hold down [MW] for 1 second to program 14.00000 MHz into scan edge 1A.
  - Three beeps sound when the programming is complete.
- ⑤ Rotate [M-CH] to select scan edge 1b.
- ⑥ Set 14.35000 MHz as the upper frequency.
- ⑦ Hold down [MW] for 1 second to program 14.35000 MHz into scan edge 1b.
  - Three beeps sound when the programming is complete.
- ⑧ If 1A/1b is selected as the scanning range when a programmed scan is started, it will search for signals between 14.00000 MHz and 14.35000 MHz. (p. 149)

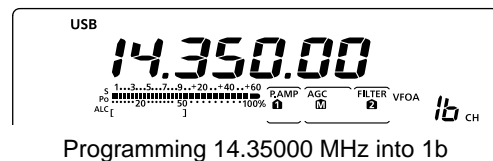
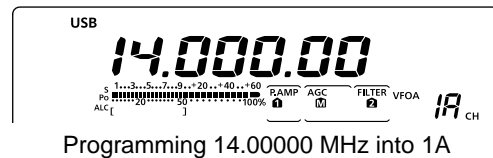
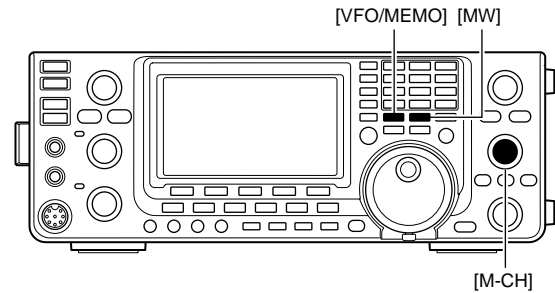

## ■ Programmed scan/Fine programmed scan (VFO mode)

A programmed scan searches for signals between Program Scan Edge channels “1A–3A” and “1b–3b.” Before starting the programmed scan, scan edges must be programmed into these channels. See the previous page for scan edge programming.

▨ If the same frequencies are programmed into the Program Scan Edge channels, the programmed scan will not start.

- ① Push [VFO/MEMO] to select the VFO mode.
- ② Push the mode switch to select the desired operating mode.
  - The operating mode can also be changed while scanning.
- ③ Push [TS] one or more times to select a tuning step. (p. 38)
  - The tuning step can also be changed while scanning.
- ④ Push [MENU] one or more times to display the “M2” screen (Menu 2).
- ⑤ Push [SCAN](F-1) to display the “SCAN” screen.
- ⑥ Set [RF/SQL] open or closed.
  - The scan performance differs, depending on the squelch setting when the scan was started. See page 146 for details.
  - If the [RF/SQL] control function is set to “AUTO,” the squelch is always open in the SSB, CW and RTTY modes. (pp. 44, 162)
- ⑦ Hold down [PRO](F-1) for 1 second to select the desired scan range between “P1,” “P2” and “P3.”
  - The scan searches between programmed scan channels 1A–1b (P1), 2A–2b (P2) or 3A–3b (P3).
- ⑧ Push [PRO](F-1) to start the programmed scan.
  - The MHz and kHz decimal points, and the selected scan range display blink while scanning.
  - If “Up/Down” is selected as the “MAIN DIAL (SCAN)” option in the Scan Set mode, rotating [MAIN DIAL] changes the scanning direction. (p. 147)
- ⑨ When the scan detects a signal, the scan stops, pauses or ignores it, depending on the Scan Resume function, the VSC function or the squelch status.
- ⑩ Push [PRO](F-1) to cancel the scan.

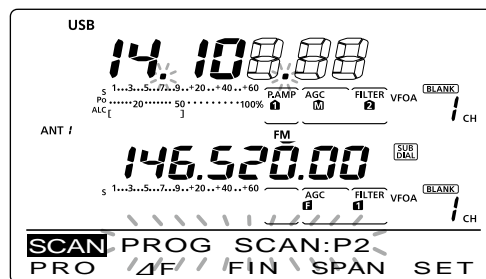
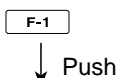
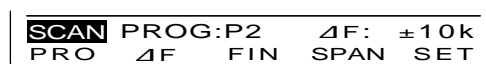
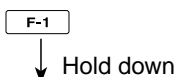
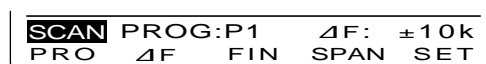
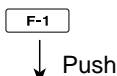
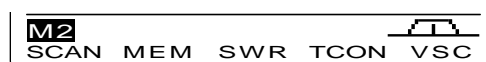
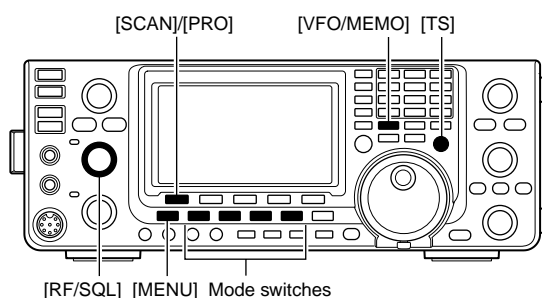

While Programmed scanning

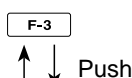
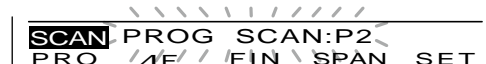

While Fine programmed scanning

### ◇ About the Fine programmed scan

When a signal is received during Fine programmed scan, the scanning tuning step is temporarily set to 10 Hz and the scan speed decreases.

- ① Start the programmed scan.
  - Follow steps ① through ⑧ as described above.
- ② While scanning, push [FIN](F-3) to switch the scan function between a programmed scan and a Fine programmed scan.
- ③ Push [PRO](F-1) to cancel the scan.

## ■ Memory scan (Memory mode)

### ◇ Memory scan

A Memory scan searches for signals through Memory channels 1 to 99.

Blank (unprogrammed) Memory channels are skipped.

**NOTE:** For a Memory scan to start, two or more Memory channels must be programmed. (p. 140)

- ① Push [VFO/MEMO] to select the memory mode.
- ② Push [MENU] to display the "M2" screen (Menu 2).
- ③ Push [SCAN](F-1) to display the "SCAN" screen.
- ④ Set [RF/SQL] open or closed.
  - The scan performance differs, depending on the squelch setting when the scan was started. See page 146 for details.
  - If the [RF/SQL] control function is set to "AUTO," the squelch is always open in the SSB, CW and RTTY modes. (pp. 44, 162)
- ⑤ Push [MEM](F-1) to start the Memory scan.
  - The MHz and kHz decimal points, and "MEMO SCAN" blink while scanning.
  - If "Up/Down" is selected as the "MAIN DIAL (SCAN)" option in the Scan Set mode, rotating [MAIN DIAL] changes the scanning direction. (p. 147)
- ⑥ Push [MEM](F-1) to cancel the scan.

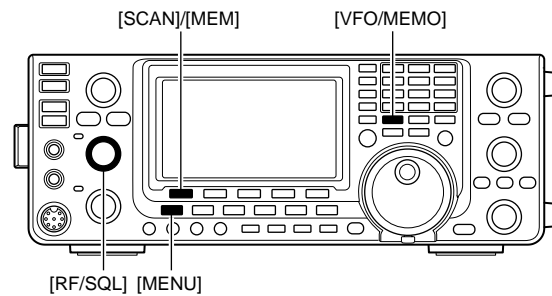

[F-1]

↓ Push



[F-1]

↓ Push



While Memory scanning

### ◇ Mode Select scan

Repeatedly scans all Memory channels with the same operating mode as the displayed mode.

**NOTE:** For a Mode Select scan to start, two or more Memory channels must be programmed, and their operating mode must be the same as the displayed mode.

- ① Follow steps ① through ④ as described above.
- ② Hold down [MEM](F-1) for 1 second to turn ON the Mode Select scan.
  - "MODE-S" appears.
- ③ Push the mode switch to select the desired operating mode to be scanned.
- ④ Push [MEM](F-1) to start the Mode Select scan.
  - The MHz and kHz decimal points, and "MODE-SEL SCAN" blink while scanning.
  - If "Up/Down" is selected as the "MAIN DIAL (SCAN)" option in the Scan Set mode, rotating [MAIN DIAL] changes the scanning direction. (p. 147)
  - Memory scan and Mode Select scan can be switched by holding down [MEM](F-1) for 1 second.
- ⑤ Push [MEM](F-1) to cancel the scan.

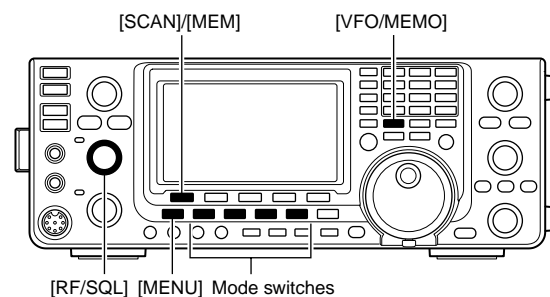

While Mode Select scanning

■ Memory scan (Memory mode) (Continued)

◇ Setting/Cancelling Select Memory channels

All Memory channels can be set as Select Memory channels, except for the Scan Edge and Call channels.

➔ When the “SCAN” screen is displayed, push [SEL] (F-3), or when the “MEM” screen (Memory Menu) is displayed, push [SEL](F-5) to set or cancel the displayed Memory channel as a Select Memory channel.

- “SEL” appears when the channel is set as a Select Memory channel.
- An error beep sounds when the displayed Memory channel is a blank channel.
- Holding down [SEL](F-3) or [SEL](F-5) for 1 second displays “SEL ALL Clear?.” Hold down [YES](F-4) to clear all Select Memory channel settings.

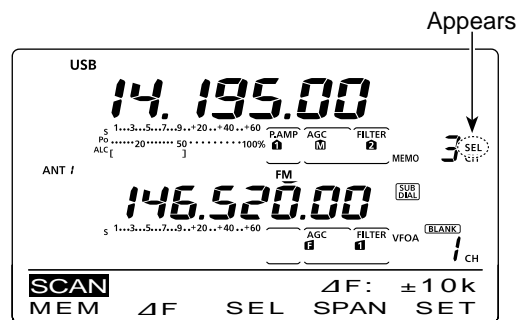

“SCAN” screen

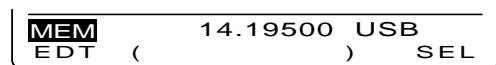

“MEM” screen (Memory Menu)

◇ Select Memory scan

Select Memory scan searches for signals through Memory channels specified as “Sel” (Select).

/// **NOTE:** For a Select Memory scan to start, two or more Memory channels must be designated as Select Memory channels. (See above)

- Follow steps ① through ⑤ as described in ‘◇ Memory scan’ on the previous page, to start Memory scan.
  - While scanning, holding down [MEM](F-1) for 1 second turns ON the Mode Select scan.
- Push [SEL](F-3) to turn ON the Select Memory scan.
  - The scan changes to a Select Memory scan.
  - “SEL-MEMO SCAN” blinks while scanning.
  - Pushing [SEL](F-3) toggles between Memory scan (or Mode Select scan)\* and Select Memory scan.
  - \*Only when the Mode Select scan is turned ON.
  - If “Up/Down” is selected as the “MAIN DIAL (SCAN)” option in the Scan Set mode, rotating [MAIN DIAL] changes the scanning direction. (p. 147)
- Push [MEM](F-1) to cancel the scan.

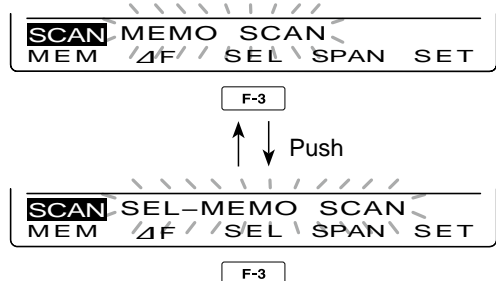

While Select Memory scanning

**About the scan type switching procedure**

You can switch the scan type between various scans while scanning, as shown below.

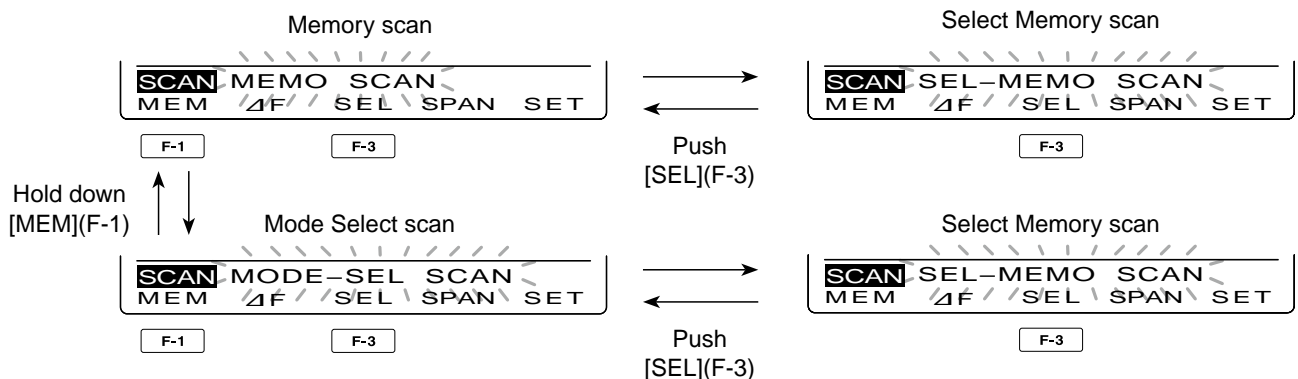



## ■ $\Delta F$ scan and Fine $\Delta F$ scan

$\Delta F$  (Delta Frequency) scan searches for signals within the specified range with the displayed VFO frequency or Memory channel frequency as the center frequency. The frequency range is specified by the width of the selected span.

- ① Push [VFO/MEMO] once or twice to select the VFO mode or memory mode.
- ② Push [MENU] one or more times to display the "M2" screen (Menu 2).
- ③ Push [SCAN](F-1) to display the "SCAN" screen.
- ④ Set [RF/SQL] open or closed.
  - The scan performance differs, depending on the squelch setting when the scan was started. See page 146 for details.
  - If the [RF/SQL] control function is set to "AUTO," the squelch is always open in the SSB, CW and RTTY modes. (pp. 44, 162)
- ⑤ Push [SPAN](F-4) one or more times to select the desired  $\Delta F$  span width.
  - $\pm 5$  kHz,  $\pm 10$  kHz,  $\pm 20$  kHz,  $\pm 50$  kHz,  $\pm 100$  kHz,  $\pm 500$  kHz and  $\pm 1$  MHz are selectable.
- ⑥ Set the center frequency of the  $\Delta F$  scan.
  - In the VFO mode, push the keypad or rotate [MAIN DIAL] to set the center frequency.
  - In the memory mode, rotate [M-CH] to select the desired Memory channel whose frequency will be the center frequency.
- ⑦ Push [ $\Delta F$ ](F-2) to start the  $\Delta F$  scan.
  - " $\Delta F$  SCAN," the MHz and kHz decimal points blink while scanning.
  - If "Up/Down" is selected as the "MAIN DIAL (SCAN)" option in the Scan Set mode, rotating [MAIN DIAL] changes the scanning direction. (p. 147)
- ⑧ When the scan detects a signal, the scan stops, pauses or ignores it, depending on the Scan Resume function, VSC function or the squelch status.
- ⑨ Push [ $\Delta F$ ](F-2) again to cancel the  $\Delta F$  scan.

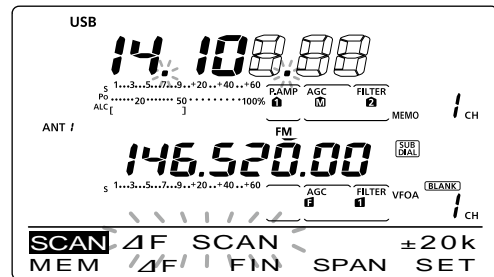
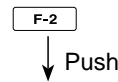
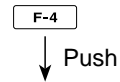
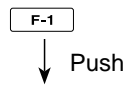
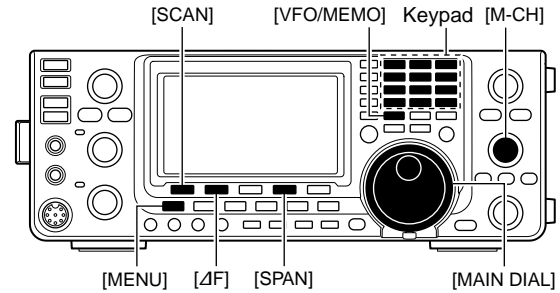

While  $\Delta F$  scanning

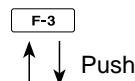

While Fine  $\Delta F$  scanning

### ◇ About the Fine $\Delta F$ scan

When a signal is received during Fine  $\Delta F$  scan, the scanning tuning step is temporarily set to 10 Hz and the scan speed decreases.

- ① Start  $\Delta F$  scan.
  - Follow steps ① through ⑦ as described above.
- ② While scanning, push [FIN](F-3) to switch the scan function between  $\Delta F$  scan and Fine  $\Delta F$  scan.
- ③ Push [ $\Delta F$ ](F-2) to cancel the scan.

## ■ Satellite communications outline

Both Satellite Mode B (435 MHz uplink, 145 MHz downlink) and Mode J (145 MHz uplink, 435 MHz downlink) can be operated with the IC-9100, and Mode L can be operated when the optional UX-9100 1200 MHz BAND UNIT is installed.

Satellite communications is possible only when a satellite is in view and its transponder is operating.

### Orbit information

Orbit information describes satellite location, reaching angles, etc. This information may be available in ham magazines or organization publications, such as those from ARRL, RSGB handbook, etc.

Satellite tracking software is also convenient.

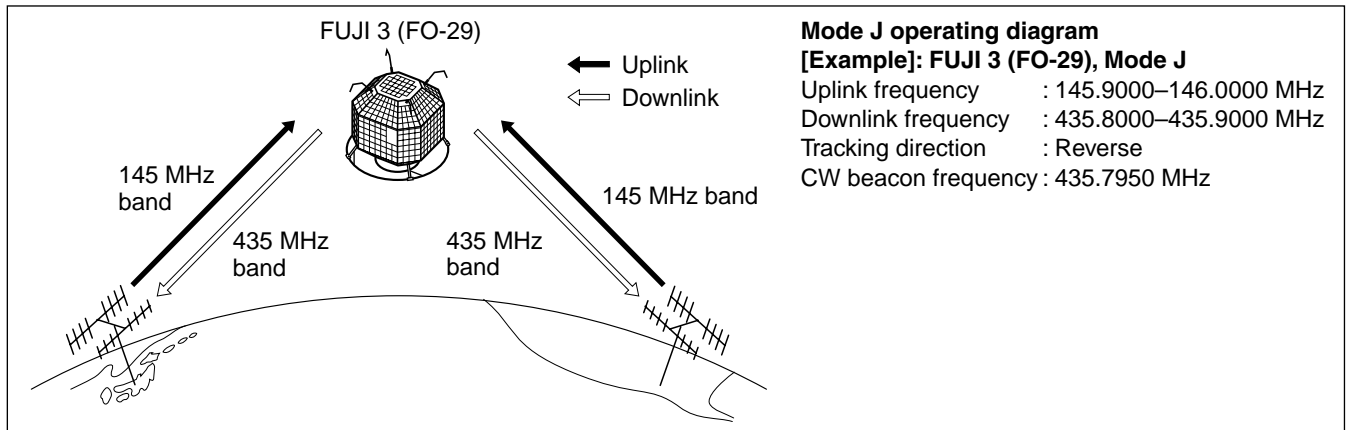

## ■ Satellite notes

- NEVER** set the output power too high. Too much power will shorten the satellite's life.  
Set your transmit power so that your downlink signal level is lower than the beacon's signal level.
- Confirm a satellite's operating mode in advance through documentation (magazines, etc.) or via appropriate satellite tracking software. In the wrong mode, you cannot use the satellite, even if you receive its beacon signal.
- Preamplifiers may be necessary to receive satellite signals. Optional amplifiers, AG-25, AG-35 and AG-1200\* (for the UX-9100), can be used with the IC-9100. (p. 71)  
\*AG-1200 has been discontinued, but it can be still be used.
- When you use a reverse tracking satellite in the SSB mode, use LSB for the uplink frequency and USB for the downlink frequency.
  - When using a normal tracking satellite in SSB mode, use USB for both the uplink and downlink frequencies.

## ■ Selecting the satellite mode

Operating frequencies in the satellite mode can be selected either before or after selecting the mode. Normal and reverse tracking are selectable.

### ◇ Transferring the VFO frequencies to the satellite VFO

- Select the downlink frequency (receive) in the MAIN band, and the uplink frequency (transmit) in the SUB band.
- Hold down [SATELLITE] for 1 second to transfer the frequencies, selected in step ①, to the satellite VFO.
  - The satellite mode is automatically selected after transferring.
  - "[SATELLITE]" and the last operated tracking icon ("[NORMAL]" or "[REVERSE]") appear.
  - VFO or Memory mode data is displayed on the SUB band during satellite mode.

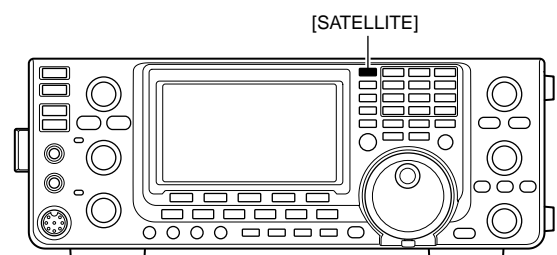

## ■ Setting the satellite VFO

- ① Push [SATELLITE] to enter the satellite mode.
  - “[SATELLITE]” and either “[NORMAL]” or “[REVERSE]” appear.
- ② Push [VFO/MEMO] to toggle between the satellite VFO and Memory mode.
  - VFO or Memory mode data is displayed on the SUB band while in the satellite mode.
- ③ Push [MAIN](1.8 1) to enable downlink frequency tuning.
  - The uplink frequency disappears.
- ④ Select the downlink frequency and the operating mode.
  - Push [MAIN](1.8 1) again after tuning.
- ⑤ Push [SUB](3.5 2) to enable uplink frequency tuning.
  - The downlink frequency disappears.
  - Push [SUB](3.5 2) again after tuning.

**NOTE:** To select the operating mode for uplink, push [SUB] to enable the SUB band setting mode.

In the DR mode, pushing [SATELLITE] cancels it, and then switches the transceiver to the satellite mode. If you want to operate in the DR mode after exiting the satellite mode, you must hold down [DV•DR] for 1 second.

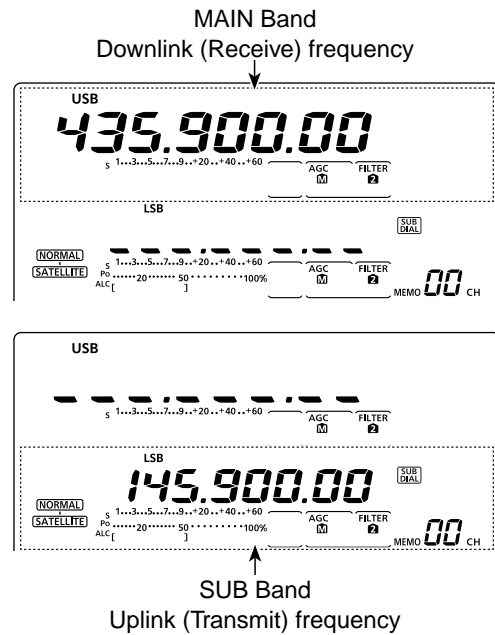
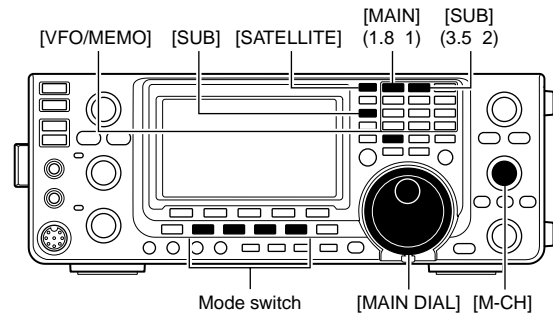

## ■ Tracking selection

- ① Push [SATELLITE] to enter the satellite mode.
  - “[SATELLITE]” and either “[NORMAL]” or “[REVERSE]” appears.
- ② Push [NOR/REV](7 3) to toggle between normal and reverse tracking.

### ◇ Normal tracking

Both downlink and uplink frequencies simultaneously increase or decrease in the same steps when you rotate the [MAIN DIAL].

### ◇ Reverse tracking

The downlink frequency follows the tuning dial rotation, however, the uplink frequency changes in the reverse direction to the [MAIN DIAL] rotation, in the same steps.

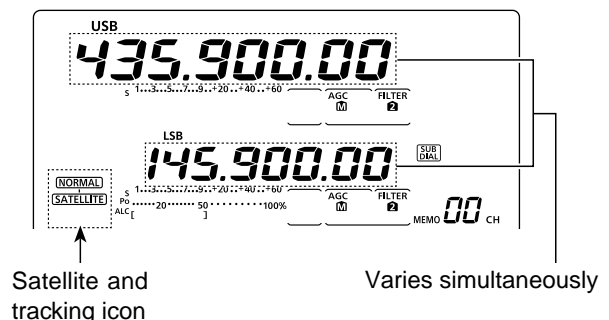
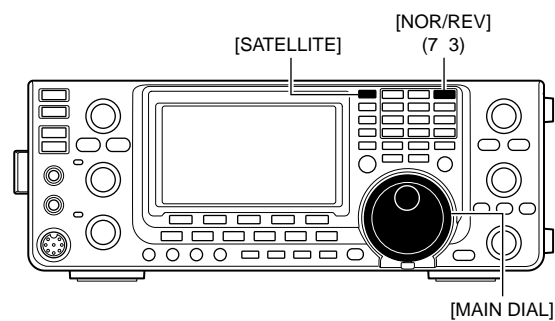

## ■ Satellite memory

The IC-9100 has 20 satellite memory channels (CH 00 to 19) to memorize both uplink and downlink frequencies, operating modes and other data.

### ◇ Satellite memory selection

- ① Push [SATELLITE] to enter the satellite mode.
- ② Push [VFO/MEMO] to select the satellite memory mode.
  - “MEMO” and the memory channel number are displayed beside the uplink frequency (SUB band) display.
- ③ Rotate [M-CH] to select a satellite mode Memory channel.

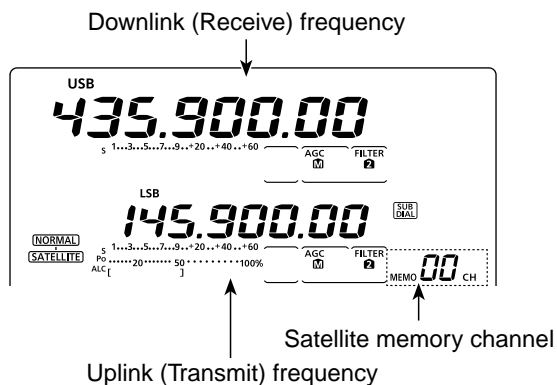

### ◇ Satellite memory programming

- ① Push [SATELLITE] to enter the satellite mode.
- ② Push [VFO/MEMO] to select the satellite memory mode.
- ③ Rotate [M-CH] to select the desired Memory channel.
- ④ Select the desired downlink frequency in the MAIN band, and uplink frequency in the SUB band, as well as the operating mode.
- ⑤ Hold down [MW] for 1 second to program the contents into the Memory channel.
  - Three beeps sound when the memory programming has completed.

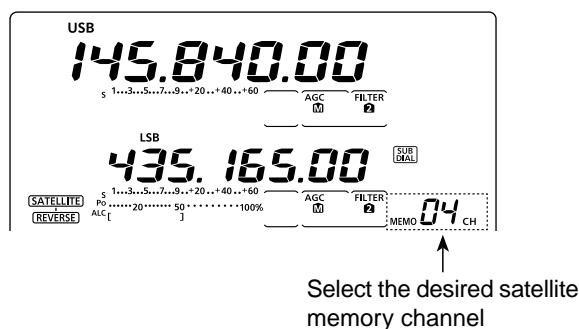

/// **NOTE:** Tracking selection, normal or reverse, is not programmed in the satellite memory channels.

## ■ Preparation

- ① Decide on a usable satellite, and point your antenna direction towards it.
- ② Confirm the approximate location of the satellite and operating mode (e.g. "B," "J," etc.) through a publication (magazine, etc.) or an appropriate satellite tracking software.
- ③ Push [SATELLITE] to enter the satellite mode.
- ④ Push [NOR/REV](7 3) to toggle between normal and reverse tracking.
- ⑤ Select the operating mode as listed below.
  - To select the operating mode for the uplink, push [SUB] before selecting the operating mode.

Satellite	Downlink (MAIN band)	Uplink (SUB band)
Reverse tracking type	USB (or CW)	LSB (or CW)
Normal tracking type	USB (or CW)	LSB (or CW)

- ⑥ Select the desired downlink frequency in the MAIN band to match the beacon frequency.
  - Refer to a ham magazine or book for detailed information.
  - Adjust the antenna direction so that the S-meter shows its strongest level.
  - The S-meter level should be noted to adjust transmit power during a loop test.
- ⑦ Perform a loop test.

### Loop test procedures

- ① Rotate [MAIN DIAL] to select a vacant frequency, within the satellite's coverage, as the downlink frequency on the MAIN band.
- ② Push [PTT] on the microphone to transmit. (or [TRANSMIT] on the transceiver)
- ③ Push [SUB](3.5 2), then select the uplink frequency on the SUB band while transmitting a single tone such as a whistle to find your downlink signal and monitor your own signal correctly.
- ④ Push [SUB](3.5 2) again after setting.

/// **NOTE:** To avoid excessive power, set the output power so that the downlink signal strength is lower than the beacon's strength.

- ⑧ Select the desired frequency to begin your satellite communications.
  - Both the downlink and uplink frequencies change simultaneously.
- ⑨ When your downlink audio drifts (Doppler effect), push [SUB](3.5 2) then rotate [MAIN DIAL] to adjust the uplink frequency (SUB band).  
After adjusting, push [SUB](3.5 2) again.
  - When a particular station's audio is off frequency, use the RIT function (push [RIT]).
- ⑩ To exit the satellite operation, push [SATELLITE].

### ✓ For your convenience

As the transceiver has 20 satellite memory channels, once entered, desired satellite frequencies can be recalled instantly.

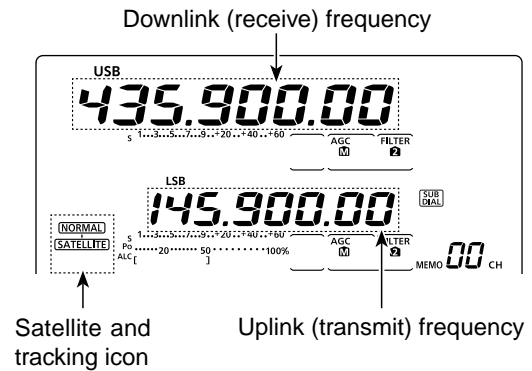

Select the downlink frequency to match with the beacon frequency.

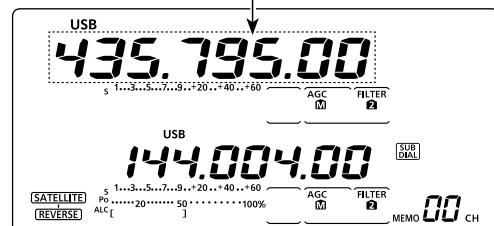

Select a vacant frequency as the downlink frequency, within the satellite's coverage.

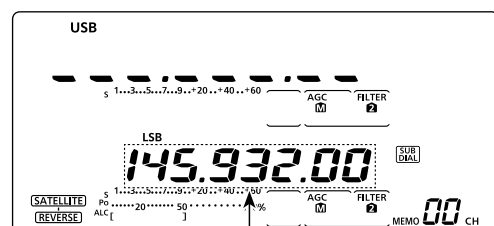
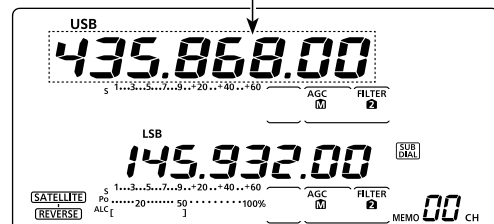

Adjust the uplink frequency

## ■ Satellite operation

When your own signal can be received with a loop test, satellite communication can be performed.

- ① When a frequency is shifted by the Doppler effect, push [SUB](3.5 2), then rotate [MAIN DIAL] to re-tune the uplink frequency.
  - The downlink frequency display disappears.
- ② When the other station's signal frequency is shifted, push [MAIN](1.8 1), then rotate [MAIN DIAL] to re-tune the downlink frequency.
  - The uplink frequency display disappears.
  - You can tune the downlink frequency  $\pm 9.99$  kHz with the RIT. (p. 69)

## ■ Antenna connection and selection

The IC-9100 has 2 antenna connectors for the HF/50 MHz bands, [ANT1] and [ANT2], and a dedicated antenna connector for each of the 144 MHz, 430 MHz and 1200 MHz\* bands; a total of 5 antenna connectors.

You can memorize the antenna for each operating band the IC-9100 covers.

When you change the operating band to one outside of the current memorized antenna band, the antenna is automatically selected for the new band. (See below) This function is especially convenient when you use 2 antennas for HF and 50 MHz band operation.

To use the band memory, select “Auto” as the “[ANT] Switch” option in the Set mode. (p. 163)

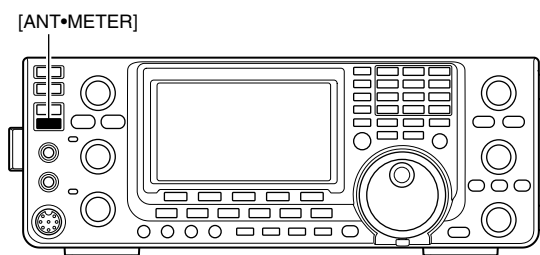

• **Antenna selection mode: “Auto”** (default)

Once an antenna has been selected for use with a band by pushing [ANT•METER], the antenna is automatically selected whenever that band is accessed.

**[EXAMPLE]:** a 3.5/7 MHz antenna is connected to [ANT1], a 21/28/50 MHz antenna is connected to [ANT2]. When the antenna selector function is set to “Auto,” the correct antenna is automatically selected when you changes bands.

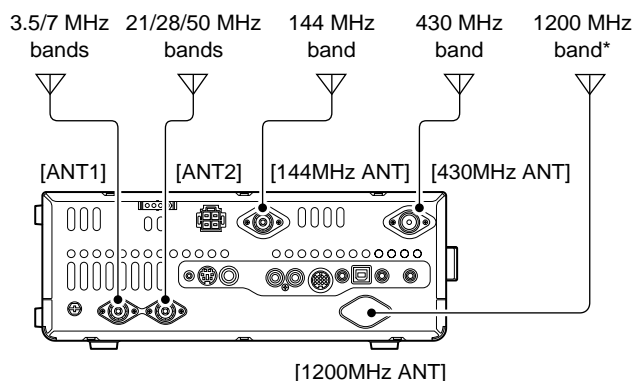

• **Antenna selection mode: “Manual”**

[ANT•METER] functions, however, the band memory function is disabled. In this case, you must select an antenna manually.

• The antenna connectors for the 144 MHz, 430 MHz and 1200 MHz\* bands are automatically selected.

**[EXAMPLE]:** an optional antenna tuner and HF antenna are connected to [ANT1] and a 50 MHz antenna is connected to [ANT2].

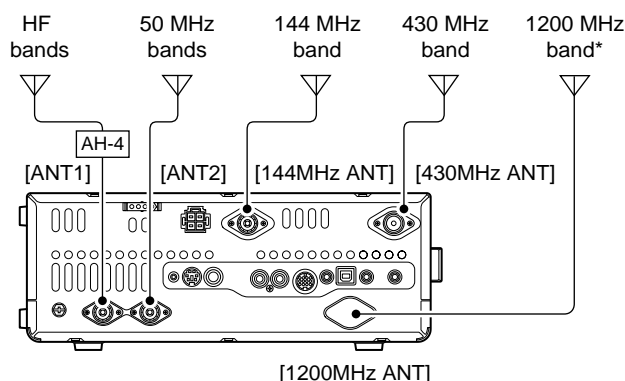

• **Antenna selection mode: “OFF”**

[ANT•METER] does not function. The [ANT1] connector is always selected during HF and 50 MHz bands operation.

\* The optional UX-9100 is required for 1200 MHz frequency band operation.

## ■ Antenna tuner operation

The internal automatic antenna tuner automatically matches the transceiver to the selected antenna. After the tuner matches an antenna, the variable capacitor settings are memorized as a preset point for each frequency range (100 kHz steps). Therefore, when you change the frequency range, the variable capacitors are automatically preset to the memorized setting.

**CAUTION: NEVER** transmit with the tuner ON when no antenna is connected. This will damage the transceiver. Be careful of the antenna selection.

### ✓ For your convenience

When you purchase a brand-new antenna, or you want to change the antenna settings, you can erase all of the internal antenna tuner preset points with "Tuner Preset Clear" in the Set mode. (p. 163)

### ◇ Tuner operation

- ➔ Push [TUNER] to turn ON the internal antenna tuner. The antenna is automatically tuned when the antenna SWR is higher than 1.5:1.
  - When the tuner is ON, "**TUNE**" appears.

### ◇ Manual tuning

Transmitting in SSB with a soft voice, the internal tuner may not automatically tune correctly. In such cases, manual tuning is helpful.

- ➔ Hold down [TUNER] for 1 second to start manual tuning.
  - A sidetone sounds, "**TUNE**" blinks and the TX/RX indicator (MAIN Band) lights red while tuning.
  - If the tuner cannot reduce the SWR to less than 1.5:1 after 20 sec. of tuning, "**TUNE**" disappears and the TX/RX indicator (MAIN Band) goes out.

### NOTES:

- The internal antenna tuner can only tune the HF and 50 MHz bands— the 144 MHz, 430 MHz and 1200 MHz\* bands cannot be tuned.
- **NEVER** transmit without an antenna properly connected to each antenna port in use.
- When 2 antennas are connected, select the antenna to be used with [ANT•METER].
- If the SWR is higher than about 1.5:1 when tuning farther than 100 kHz from an antenna's programmed preset point, hold down [TUNER] for 1 second to start manual tuning.
- The internal tuner may not be able to tune in the AM mode. In such cases, hold down [TUNER] for 1 second to manually tune.

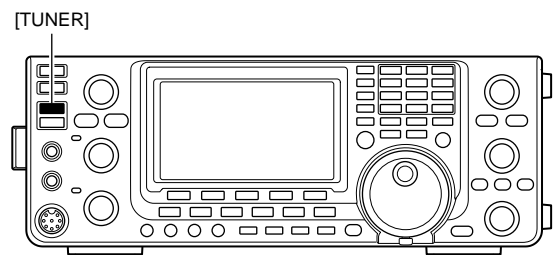

### ○ If the tuner cannot tune the antenna, check the following and try again:

- the correct antenna connector selection.
- the antenna connection and feedline.
- the untuned antenna SWR. (Less than 3:1 for the HF bands; Less than 2.5:1 for the 50 MHz band)
- the transmit power. (8 W for the HF bands; 15 W for the 50 MHz band)
- the power source voltage/current capacity.

If the tuner still cannot reduce the SWR to less than 1.5:1 after checking the above, perform the following:

- try manual tuning one or more times.
- adjust the antenna feedline length. (This is effective for higher frequencies in some cases.)

Even if manual tuning does not match the antenna and the tuner turns OFF the first time, it may match the antenna the second time.

### ○ Tuning a narrow bandwidth antenna

Some antennas, especially for the low bands, have a narrow bandwidth. These antennas may not be tuned beyond the edge of their operating bandwidth, therefore, manually tune such an antenna as follows:

**[Example]:** Suppose you have an antenna which has an SWR of 1.5:1 at 3.55 MHz and an SWR of 3:1 at 3.8 MHz.

- ① Select 3.55 MHz and hold down [TUNER] for 1 second. to start manual tuning.
- ② Select 3.80 MHz and hold down [TUNER] for 1 second to start manual tuning.



• **Automatic tuner start** (HF bands only)

If you want to deactivate the tuner when the VSWR is 1.5:1 or less, use the auto tuner start function and turn OFF the tuner. This function activates the tuner automatically when the SWR is high, and is controlled in the Set mode. (p. 163).

- The tuner may not start if the TX power output is not stable longer than the specified time period in the SSB or CW mode operation.

• **PTT tuner start**

Tuning of the internal\*/external antenna tuner starts when [PTT] is pushed on a new frequency that is more than 1% away from the last-tuned frequency. This function removes the “holding down [TUNER]” operation, and starts tuning on the first transmission on a new frequency.

- \*Tuning starts if the internal antenna tuner is ON. This function is turned ON in the Set mode. (p. 163).

## ■ Optional external tuner operation

• **AH-4 HF/50 MHz AUTOMATIC ANTENNA TUNER**

The optional AH-4 matches the IC-9100 to a long wire antenna more than 7 m/23 ft long (3.5 MHz and above).

- See page 29 for the transceiver and AH-4 connection.
- See the AH-4 instruction manual installation and antenna connection details.

**AH-4 setting example:**

For mobile operation

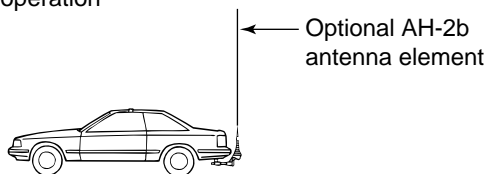

For outdoor operation

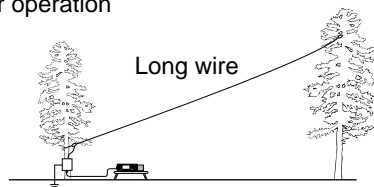

**⚠ DANGER HIGH VOLTAGE!**  
**NEVER** touch the antenna element while tuning or transmitting.

**CAUTION:** operate the AH-4 without an antenna wire or element. The tuner and transceiver will be damaged.

**NEVER** operate the AH-4 when it is not grounded.

Transmitting before tuning may damage the transceiver. Note that the AH-4 cannot tune when using a  $\frac{1}{2} \lambda$  long wire or multiple of the operating frequency.

When connecting the AH-4, the antenna connector assignments are [ANT2] for the internal tuner and [ANT1] for the AH-4. The antenna icon in the LCD displays “ANT” when the AH-4 is connected and selected.

• **AH-4 operation**

Tuning is required for each frequency. Be sure to re-tune the antenna before transmitting when you change the frequency— even slightly.

- ① Select the desired frequency in an HF or 50 MHz band for use with the AH-4.
  - The AH-4 will not operate on frequencies outside the ham bands.
- ② Hold down [TUNER] for 1 second.
  - “TUNE” blinks while tuning.
- ③ “TUNE” appears constantly when tuning is complete.
  - When the connected wire cannot be tuned, “TUNE” disappears and the AH-4 is bypassed. At that point the antenna wire connection route is to the transceiver directly, and not via the AH-4 antenna tuner.
- ④ To bypass the AH-4 manually, push [TUNER].

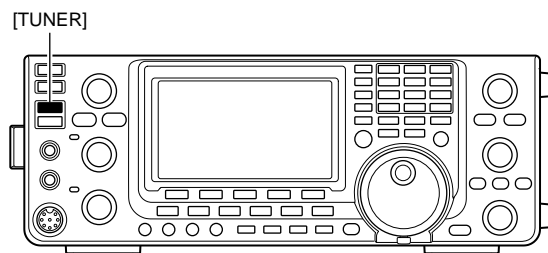

• **Antenna tuner of the IC-PW1/EURO**

When using an external antenna tuner such as the IC-PW1/EURO’s tuner, tune when the internal tuner is turned OFF. After tuning has completed, turn ON the internal tuner.

Otherwise, both tuners simultaneously tune, and proper tuning may fail.

See the instruction manual included with each antenna tuner for their respective operations.

## ■ Set mode description

The Set mode is used for programming infrequently changed values or functions.

### ◆ The Set mode settings

- ① Hold down [MENU] for 1 second to enter the Set mode.
- ② Push [▲](F-1) or [▼](F-2) to select the desired item.
- ③ Rotate [MAIN DIAL] to select the desired option.
  - Hold down [F-3] for 1 second to reset to the default setting, if desired.
- ④ Push [MENU] to save, and exit the Set mode.

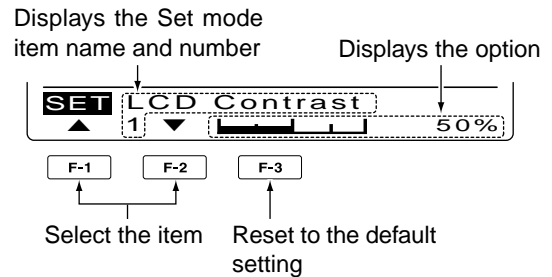
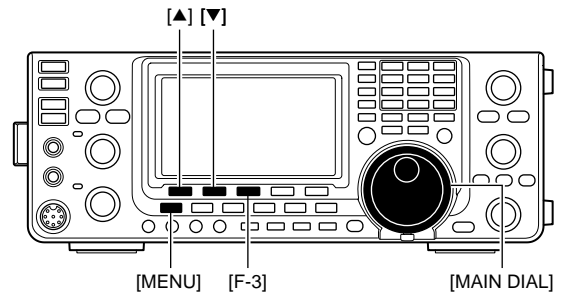

### 1. LCD Contrast (Default: 50%)

Adjust the LCD contrast to between 0% and 100% in 1% steps.

### 2. LCD Backlight (Default: 50%)

Adjust the LCD backlight brightness to between 0% and 100% in 1% steps.

**NOTE:** Regardless of this setting, the LCD backlight brightness is maximum (100%) at power ON by design. (It is not an equipment malfunction.) Then, the brightness level automatically returns to the adjusted value.

### 3. Beep Level (Default: 50%)

Adjust the confirmation and band edge beep tones output level to between 0% and 100% in 1% steps.

### 4. Beep Level Limit (Default: ON)

Turn the confirmation and band edge beep tones output level limiting ON or OFF.

When you set this item to ON, the beep tones are adjusted by the [AF] control until rotating the [AF] control reaches to the specified level. Further rotation will not increase the volume of the beep tones.

- OFF : Beep level adjustment is not limited.
- ON : Beep level adjustment is limited with the [AF] control.

### 5. Beep (Default: ON)

Turn the confirmation beep ON or OFF. Set the beep output level in the "Beep Level" item as described to the left.

- OFF : The confirmation beep is OFF. (Silent operation)
- ON : The confirmation beep sounds each time a switch is pushed.

### 6. Band Edge Beep (Default: ON(Default))

When you tune into or out of an amateur band's frequency range, you can hear a beep tone. If you select "ON (User)" or "ON (User) & TX," you can program a total of 30 band edge frequencies in the "User band Edge" item.

You can set the beep output level in the "Beep Level" item as described to the left.

- OFF : Band edge beep is OFF
- ON (Default) : When you tune into or out of the default amateur band's frequency range, a beep sounds.
- ON (User) : When you tune into or out of a user programmed amateur band's frequency range, a beep sounds.
- ON (User) & TX : When you tune into or out of a user programmed amateur band's frequency range, a beep sounds. In addition, transmission is inhibited outside the programmed range.

## **7. User Band Edge**

This "User Band Edge" item appears only when "ON (User)" or "User (ON) & TX" is selected in the "Band Edge Beep" item. (p. 161)

When you select "ON (User)" or "ON (User) & TX" in the "Band Edge Beep" item, you can program a total of 30 band edge frequencies in this item. See page 42 for programming details.

## **8. Beep Sound (MAIN) (Default: 1000Hz)**

Set a desired beep frequency for the MAIN Band to between 500 Hz and 2000 Hz in 10 Hz steps.

You can set the beep output level in the "Beep Level" item. (p. 161)

## **9. Beep Sound (SUB) (Default: 1000Hz)**

Set a desired beep frequency for the SUB Band to between 500 Hz and 2000 Hz in 10 Hz steps.

You can set the beep output level in the "Beep Level" item. (p. 161)

## **10. RF/SQL Control (Default: RF+SQL)**

Set the [RF/SQL] control operation.

- AUTO : [RF/SQL] functions as only an RF gain control in SSB, CW and RTTY; a squelch control in AM, FM and DV.
- SQL : [RF/SQL] functions as a squelch control.
- RF+SQL : [RF/SQL] functions as a noise squelch or an S-meter squelch in FM; only as an S-meter squelch in SSB, CW, RTTY, AM and DV.

## **11. Meter Peak Hold (Default: ON)**

Turn the Meter Peak Hold function ON or OFF.

When this function is set to ON, the peak level of a received signal strength or the output power is displayed for approximately 0.5 seconds.

## **12. FM/DV Center Error (Default: ON)**

Turn the FM and DV center error detection ON or OFF.

When an off-frequency signal is received, the MAIN and SUB Band's TX/RX indicators blink.

## **13. Time Out Timer (Default: OFF)**

To prevent a prolonged transmission, the transceiver has a Time-Out Timer function.

If a continuous transmission exceeds the set period, the transmission will be cut off.

Set the time period to 3, 5, 10, 20 or 30 minutes, or turn OFF the Time-Out Timer function.

## **14. PTT Lock (Default: OFF)**

Turn the PTT Lock function ON or OFF.

To prevent accidental transmissions, this function inhibits transmitting, when turned ON.

## **15. Quick SPLIT (Default: ON)**

Turn the Quick Split function ON or OFF.

When this item is set to ON, hold down [SPLIT] for 1 second to shift the transmit frequency from the receive frequency, according to the "SPLIT Offset" option as described below. See page 83 for details.

## **16. SPLIT Offset (Default: 0.000MHz)**

Set the offset\* for the quick split function.

\*The difference between transmit and receive frequencies.

The frequency offset can be set to between -9.999 MHz and +9.999 MHz in 1 kHz steps.

## **17. SPLIT LOCK (Default: OFF)**

Turn the Split Lock function ON or OFF.

When this item is set to ON, you can use [MAIN DIAL] to adjust the transmit frequency while holding down [XFC], even while the Dial Lock function is enabled.

See pages 82, 83 for split frequency operation details.

## ■ Set mode description (Continued)

### 18. DUP Offset

Set the offset\* for duplex operation. You can set the repeater offset for each band.

\*The difference between transmit and receive frequencies.

➔ When you select this item, hold down [BAND](MAIN/SUB) for 1 second to select the desired frequency band. Then, rotate [MAIN DIAL] to set the offset.

- The frequency offset can be set to between 0.0000 MHz and 9.9999 MHz\*.

\*99.9999 MHz for the 1200 MHz frequency band.

▨ The default value may differ, depending on the selected frequency band and transceiver version.

#### NOTE:

- You can use this setting only when the Split function is OFF for the HF/50 MHz frequency band.
- “-.---.” is displayed when a blank memory channel is selected, or the satellite mode is ON.

The optional UX-9100 is required for 1200 MHz frequency band operation.

### 19. One Touch Repeater (Default: DUP-)

Set the one touch repeater shift direction.

- DUP- : The transmit frequency shifts down from the receive frequency by the offset amount.
- DUP+ : The transmit frequency shifts up from the receive frequency by the offset amount.

### 20. Auto Repeater

(Default: ON-1 ; for U.S.A. version  
ON ; for Korea version)

(Only U.S.A. and Korea versions)

Set the Auto Repeater function ON or OFF.

To activate the Auto Repeater function, first program the auto repeater frequency range, then select ON. (p. 67)

U.S.A. version:

- ON-1 : Activates duplex only.
- ON-2 : Activates duplex and tone.
- OFF : Auto repeater function is turned OFF.

Korea version:

- ON : Activates duplex and tone.
- OFF : Auto repeater function is turned OFF.

### 21. Tuner (Auto Start) (Default: OFF)

Turn the Automatic Antenna Tuner function ON or OFF. This function is for only the HF bands.

- OFF : The internal antenna tuner remains OFF even when the SWR is high.
- ON : The internal antenna tuner automatically starts tuning when the SWR is high, even if the tuner is turned OFF.

### 22. Tuner (PTT Start) (Default: OFF)

Whenever you push [PTT], the internal or external antenna tuner automatically starts tuning if the operating frequency has changed by more than 1% from the last-tuned frequency.

- OFF : Tuning starts only when [TUNER] is pushed.
- ON : (Internal antenna tuner) Tuning starts when you push [PTT] on a new frequency, if the internal antenna tuner is ON.  
(External antenna tuner) Tuning always starts when you push [PTT] on a new frequency, regardless of whether the external antenna tuner is ON or OFF.

### 23. Tuner Preset Clear

Select the desired antenna.

The selected antenna's preset memory\* is cleared by holding down [CLR](F-4) for 1 second.

\*The variable capacitor settings are memorized as a preset point for each frequency range (100 kHz steps) after the tuner matches an antenna.

- CLR ANT1 : The preset memory of [ANT1]'s antenna is cleared.
- CLR ANT2 : The preset memory of [ANT2]'s antenna is cleared.

### 24. [ANT] Switch (Default: Auto)

Set the antenna switch function to Auto, Manual or OFF. When you change the operating frequency on the HF/50 MHz frequency band, this function will automatically select the correct antenna, or you must do it manually.

- OFF : [ANT•METER] does not function. The [ANT1] connector is always selected.
- Manual : You must manually change the antenna by pushing [ANT•METER].
- Auto : The antenna memorized by the band memory is automatically selected. You can also manually change the antenna by pushing [ANT•METER].

### **25. SPEECH Level** (Default: 50%)

Adjust the speech audio output level to between 0% (no output) and 100% (maximum output).

### **26. SPEECH Language** (Default: English)

Select English or Japanese as the speech language.

### **27. SPEECH Speed** (Default: HIGH)

Select HIGH (faster) or LOW (slower) speech speed.

### **28. SPEECH S-Level** (Default: ON)

The signal level announcement with the voice synthesizer can be turned ON or OFF.

- OFF : Signal level is not announced. Operating frequency and mode are announced.
- ON : Signal level, operating frequency and mode are announced.

### **29. SPEECH [MODE] SW** (Default: OFF)

Turn the Operating Mode Speech function ON or OFF. When this function is ON, the selected operating mode is verbally announced when a mode switch is pushed.

- OFF : The operating mode Speech function is OFF.
- ON : The operating mode Speech function is ON.

### **30. [SPEECH/LOCK] SW** (Default: SPEECH/LOCK)

Select the [SPEECH/LOCK] switch action.

- SPEECH/LOCK: Pushing the [SPEECH/LOCK] switch turns ON the voice synthesizer function. Holding down the [SPEECH/LOCK] switch turns the dial lock function ON or OFF.
- LOCK/SPEECH: Pushing the [SPEECH/LOCK] switch turns the dial lock function ON or OFF. Holding down the [SPEECH/LOCK] switch turns ON the voice synthesizer function.

### **31. Memopad Numbers** (Default: 5)

Set the number of available memo pads to 5 or 10. See page 144 for details.

### **32. MAIN DIAL Auto TS** (Default: HIGH)

Set the Auto Tuning Step function for [MAIN DIAL]. When rapidly rotating [MAIN DIAL], the tuning step automatically changes as selected.

There are two types of auto tuning steps: LOW (Faster) and HIGH (Fastest).

- OFF : Auto tuning step is turned OFF.
- LOW : Approximately 2 times faster.
- HIGH : Approximately 5 times faster when the tuning step is set to 1 kHz or smaller steps; approximately 2 times faster when the tuning step is set to 5 kHz or larger steps.

### **33. MIC Up/Down Speed** (Default: HIGH)

Set the rate at which frequencies are scanned while holding down the microphone [UP]/[DN] switches.

- LOW : Low speed (25 tuning steps/second)
- HIGH : High speed (50 tuning steps/second)

### **34. Quick RIT Clear** (Default: OFF)

Select the RIT/ $\Delta$ TX frequency offset clearing operation with [CLEAR].

- OFF : Holding down [CLEAR] for 1 second clears the RIT and  $\Delta$ TX frequency offset.
- ON : Pushing [CLEAR] instantly clears the RIT and  $\Delta$ TX frequency offset.

### **35. AFC Limit** (Default: ON)

Turn the AFC (Automatic Frequency Control) limit function ON or OFF.

The AFC function automatically compensates the tuning when a received frequency drifts or goes off frequency.

- OFF : The AFC function continues to tune until the displayed frequency changes to reflect the center of the signal.
- ON : The AFC function stops tuning when the frequency goes off the limited frequency range, even if received frequency is off frequency.

AFC limit value:

IF Filter width	AFC limit value
15 kHz	$\pm 10$ kHz
10 kHz	$\pm 7$ kHz
7 kHz	$\pm 5$ kHz

■ Set mode description (Continued)

### 36. [NOTCH] SW (SSB) (Default: Auto/Manual)

Select the Auto, Manual or Auto/Manual notch filter to be used for SSB mode operation.

- Auto : Only the Auto notch filter can be used.
- Manual : Only the Manual notch filter can be used.
- Auto/Manual: Both the Auto and Manual notch filters can be used.

### 37. [NOTCH] SW (AM) (Default: Auto/Manual)

Select the Auto, Manual or Auto/Manual notch filter used for AM mode operation.

- Auto : Only the Auto notch filter can be used.
- Manual : Only the Manual notch filter can be used.
- Auto/Manual: Both the Auto and Manual notch filters can be used.

### 38. MN-Q Popup (MN ON) (Default: ON)

Turn the manual notch filter width display ON or OFF. When this item set to ON, and the manual notch filter is selected with [NOTCH], and the manual notch filter width appears on the function display.

### 39. BW Popup (PBT) (Default: ON)

Turn the IF filter passband width and shift value display ON or OFF.

When this item set to ON, and the [TWIN PBT] control is rotated, the passband width and shifting value appear on the function display.

### 40. BW Popup (FIL) (Default: ON)

Turn the IF filter passband width and shift value display ON or OFF.

When this item set to ON, and [FILTER] is pushed, the passband width and shifting value appear on the function display.

### 41. SSB/CW Sync Tuning (Default: OFF)

Turn the displayed frequency shift function ON or OFF.

When this function is turned ON, the audio pitch or tones of the received signal will remain the same, even when the operating mode is changed between SSB and CW.

The amount of frequency shift may differ, depending on the CW pitch setting.

- OFF : The displayed frequency does not shift.
- ON : The displayed frequency shifts when the operating mode is changed between SSB and CW.

### 42. CW Normal Side (Default: LSB)

Select the sideband used to receive CW in the CW normal mode between LSB and USB.

### 43. KEYER 1st Menu (Default: KEYER-Root)

Select KEYER-Root or KEYER-SEND as the menu that appears first after pushing [KEY](F-4) in the "M1" screen (Menu 1), when the CW mode is selected.

- KEYER-Root : Memory keyer menu appears first.
- KEYER-SEND: Keyer SEND menu appears first.

### 44. GPS 1st Menu (Default: GPS-Root)

Select GPS-Root or GPS-POS as the menu that appears first after holding down [CALL/GPS].

- GPS-Root : GPS menu appears first.
- GPS-POS : Position menu appears first.

### 45. EXT-P.AMP (144) (Default: OFF)

Switch the preamplifier control ON or OFF. When using the optional AG-25, ON must be selected. Otherwise, the preamplifier is never enabled.

### 46. EXT-P.AMP (430) (Default: OFF)

Switch the preamplifier control ON or OFF. When using the optional AG-35, ON must be selected. Otherwise, the preamplifier is never enabled.

**CAUTION: NEVER** connect any equipment, such as an SWR or power meter, between the transceiver and preamplifier due to the transceiver supplies the DC voltage to the preamplifier unit when the unit is ON. Otherwise, the preamplifier may not function correctly, or the transceiver or external equipment may be damaged.

#### **47. EXT-P.AMP (1200) (Default: OFF)**

Switch the preamplifier control ON or OFF. When using the optional AG-1200\*, ON must be selected. Otherwise, the preamplifier will not function.

\*AG-1200 has been discontinued, but it can be still be used.

**CAUTION: NEVER** connect any equipment, such as an SWR or power meter, between the transceiver and preamplifier due to the transceiver supplies the DC voltage to the preamplifier unit when the unit is ON. Otherwise, the preamplifier may not function correctly, or the transceiver or external equipment may be damaged.

This item appears only when the optional UX-9100 is installed.

#### **48. EXT-SP Separate (Default: Separate)**

Select the audio output method when the optional external speakers are connected to both [EXT-SP (MAIN)] and [EXT-SP (SUB)] jacks.

- Separate : The MAIN and SUB Band audio are separately sent to the [EXT-SP (MAIN)] and [EXT-SP (SUB)] jacks.
- Mix : The MAIN and SUB Band audio are combined and sent to both the [EXT-SP (MAIN)] and [EXT-SP (SUB)] jacks.

#### **49. Phone Separate (Default: Auto)**

Select the audio output method when headphones are connected to the transceiver.

- Separate : The MAIN and SUB Band audio are separately sent to the right speaker (MAIN Band) and left speaker (SUB Band).
- Mix : The MAIN and SUB Band audio are combined, and sent to both the right and left speakers.
- Auto : When the SUB Band is displayed, the MAIN and SUB Band audio are separately sent to the right speaker (MAIN Band) and left speaker (SUB Band). When the SUB Band is not displayed, the MAIN Band audio is sent to both the left and right speakers.

#### **50. Sub Band Mute (TX) (Default: OFF)**

Turn the SUB Band Audio Mute function ON or OFF. While transmitting, the SUB band audio is muted when this function is turned ON.

- OFF : The SUB Band audio is not muted while transmitting.
- ON(SP Only) : The SUB Band audio, sent to the speaker, is muted while transmitting.
- ON(SP & USB) : The SUB Band audio, sent to the speaker and USB port, is muted while transmitting.

#### **51. ACC AF/SQL Select (Default: MAIN)**

Set the [ACC] socket's pin 12 (AF) and pin 13 (SQLS) output usage.

- MAIN : Sends the MAIN Band's receive audio and squelch.
- SUB : Sends the SUB Band's receive audio and squelch.

#### **52. DATA AF/SQL Select (Default: MAIN)**

Set the [DATA2] socket's pin 4 (DATA), pin 5 (AF) and pin 6 (SQL) output usage.

- MAIN : Sends the MAIN Band's receive audio and squelch.
- SUB : Sends the SUB Band's receive audio and squelch.

#### **53. VSEND Select (Default: ON)**

Set the [ACC] socket's pin 7 (VSEND) and pin 3 (HSEND) output usage.

- OFF : VSEND is not used. HSEND is used for all bands.
- UHF Only : VSEND is used for the 430 MHz and 1200 MHz bands. HSEND is used for the HF/50 MHz and 144 MHz bands.
- ON : VSEND is used for the 144 MHz, 430 MHz, and 1200 MHz bands. HSEND is used for the HF/50 MHz bands.

■ Set mode description (Continued)

### **54. External Keypad (Default: OFF)**

Turn the external keypad ON or OFF for keyer memory transmission.

See page 26 for the equivalent circuit of an external keypad and connection.

- OFF : The external keypad does not function.
- KEYER SEND: In the CW mode, pushing one of external keypad switches transmits the desired keyer memory contents.

### **55. USB Audio SQL (Default: OFF(OPEN))**

Select whether or not to output the audio from the [USB] connector on the rear panel, according to the squelch state.

The same audio signals are sent from the [USB] connector and the [ACC] sockets.

- The beep tones and the voice synthesizer announcements are not sent.
- The received audio output level cannot be adjusted with the [AF] control.

- OFF (OPEN) : The received audio is always sent, regardless of the squelch state.
- ON : The received audio is sent when the squelch is open.

### **56. USB MOD Level (Default: 50%)**

Set the input modulation level of the [USB] connector to between 0% and 100% in 1% steps.

### **57. 9600bps Mode (Default: OFF)**

Turn the [DATA2] socket's 9600 bps data transmission ON or OFF.

- OFF : For only the regular audio (or slow data) transmission.
- ON : For 9600 bps data transmission.

### **58. DATA OFF MOD (Default: MIC,ACC)**

Select the desired connector(s) for data modulation input in the data OFF mode.

- MIC : Use the signals from [MIC].
- ACC : Use the signals from [ACC] (pin 11).
- MIC, ACC : Use the signals from [MIC] and [ACC] (pin 11).
- USB : Use the signals from [USB].

### **59. DATA MOD (Default: ACC)**

Select the desired connector(s) for data modulation input in the data mode.

- MIC : Use the signals from [MIC].
- ACC : Use the signals from [ACC] (pin 11).
- MIC, ACC : Use the signals from [MIC] and [ACC] (pin 11).
- USB : Use the signals from [USB].

### **60. CI-V Baud Rate (Default: Auto)**

Set the CI-V data transfer rate between 300, 1200, 4800, 9600, 19200 bps and "Auto."

When "Auto" is selected, the baud rate is automatically set according to the data rate of the connected controller.

### **61. CI-V Address (Default: 7Ch)**

To distinguish equipment, each CI-V transceiver has its own Icom standard address in hexadecimal code.

The IC-9100's address is 7Ch.

When 2 or more IC-9100's are connected to an optional CT-17 CI-V level converter, rotate [MAIN DIAL] to select a different address for each IC-9100; the range is 01h to DFh.

### **62. CI-V Transceive (Default: ON)**

Turn the transceive function using the CI-V system ON or OFF.

When this item is set to ON, changing the frequency, operating mode, etc. on the IC-9100 automatically changes those settings on other Icom transceivers or receivers, and vice versa.

- OFF : Transceive function OFF
- ON : Transceive function ON

### **63. USB2/DATA1 Func (Default: [----]/GPS)**

Two COM port numbers are assigned to the [USB] connector. One of them is "USB1," used for cloning and CI-V operation. The other one is "USB2," and the function is selected by this item.

- ---- : "USB2" is not used.
- RTTY : Used to send RTTY decoded signals.
- DVdat : Used for low-speed data input and output.
  - If you set the function of the [DATA1] jack to "GPS," and "DATA1 → USB2" is selected as the "GPS Out" item's option, as described below, "USB2" will be used for the low-speed data input and GPS data output.



#### **64. USB2/DATA1 Func (Default: -----/[GPS ])**

Select the function of the [DATA1] jack.

- ----- : The [DATA1] jack is not used.
- RTTY : Used to send RTTY decoded signals.
- DVdat : Used for low-speed data input and output.
- GPS : Used for the GPS receiver connection for position data input.

#### **65. GPS Out (Default: OFF)**

When a GPS receiver is connected to the [DATA1] jack, the GPS position data is input through the jack. You can select whether or not to send the data from the COM port ("USB2").

/// **NOTE:** You can use this function only when "-----" or "DVdat" is selected as the "USB2/DATA1 Func" (63) option, and "GPS" is selected as the "USB2/DATA1 Func" (64) option.

- OFF : Turns the function OFF.
- DATA1 → USB2 : Sends the GPS position data from the COM port ("USB2").

#### **66. DVdat/GPS Out Baud (Default: 4800)**

Set the DV or GPS data transfer speed to 4800 or 9600 bps.

#### **67. RTTY Decode Baud (Default: 9600)**

Set the RTTY decode monitor speed to 300, 1200, 4800, 9600 or 19200 bps.

#### **68. Calibration Marker (Default: OFF)**

Use as a simple frequency check of the transceiver. See page 179 for calibration procedure.

/// **NOTE:** Turn OFF the calibration marker after checking the frequency of the transceiver.

- OFF : Calibration marker OFF
- ON : Calibration marker ON

#### **69. REF Adjust**

During frequency calibration, set the internal reference frequency to between 0% and 100% range in 1% steps.

/// **NOTE:** The default setting is different for each transceiver.

## ■ Tone control Set mode description

### ◇ The Tone control Set mode settings

- ① Push [MENU] one or more times to display the "M2" screen (Menu 2).
- ② Push [TCON](F-4) to enter the Tone control Set mode.
- ③ Push a mode switch to select the desired operating mode.
- ④ Push [▲](F-1) or [▼](F-2) to select the desired item.
  - Selectable items differ, depending on the selected operating mode.
- ⑤ Rotate [MAIN DIAL] to select the desired option.
  - You can select the option for each operating mode.
  - Hold down [F-3] for 1 second to reset to the default setting, if desired.
- ⑥ Push [MENU] to save, and exit the Set mode.

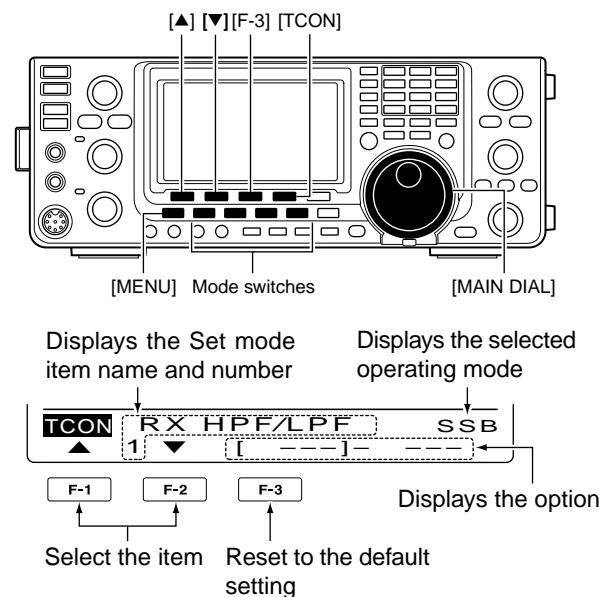

#### 1. RX HPF/LPF (Default: OFF) (Mode: SSB/CW/RTTY/AM/FM/DV)

First select the operating mode, then set the receive audio high-pass filter to between 100 Hz and 2000 Hz in 100 Hz steps.

#### 2. RX HPF/LPF (Default: OFF) (Mode: SSB/CW/RTTY/AM/FM/DV)

First select the operating mode, then set the receive audio low-pass filter to between 500 Hz and 2400 Hz in 100 Hz steps.

#### 3. RX Bass (Default: 0) (Mode: SSB/AM/FM/DV)

First select the operating mode, then set the receive audio bass level to between -5 and +5.

#### 4. RX Treble (Default: 0) (Mode: SSB/AM/FM/DV)

First select the operating mode, then set the receive audio treble level to between -5 and +5.

#### 5. TX Bass (Default: 0) (Mode: SSB/AM/FM/DV)

First select the operating mode, then set the transmit audio bass level to between -5 and +5.

#### 6. TX Treble (Default: 0) (Mode: SSB/AM/FM/DV)

First select the operating mode, then set the transmit audio treble level to between -5 and +5.

#### 7. TBW(WIDE) L (Default: 100) (Mode: SSB)

Set the lower cut-off frequency of the transmission passband width for your wide setting to 100, 200, 300 or 500 Hz.

#### 8. TBW(WIDE) H (Default: 2900) (Mode: SSB)

Set the higher cut-off frequency of the transmission passband width for your wide setting to 2500, 2700, 2800 or 2900 Hz.

#### NOTE:

- When the receive audio high-pass or low-pass filter is active, "RX Bass" and "RX Treble" items will be reset to the default value.
- When the receive audio bass or receive audio treble level is set, "RX HPF/LPF" items (1 and 2) will be turned OFF.

**9. TBW(MID) L** (Default: 300)

(Mode: SSB)

Set the lower cut-off frequency of the transmission passband width for your mid setting to 100, 200, 300 or 500 Hz.

**10. TBW(MID) H** (Default: 2700)

(Mode: SSB)

Set the higher cut-off frequency of the transmission passband width for your mid setting to 2500, 2700, 2800 or 2900 Hz.

**11. TBW(NAR) L** (Default: 500)

(Mode: SSB)

Set the lower cut-off frequency of the transmission passband width for your narrow setting to 100, 200, 300 or 500 Hz.

**12. TBW(NAR) H** (Default: 2500)

(Mode: SSB)

Set the higher cut-off frequency of the transmission passband width for your narrow setting to 2500, 2700, 2800 or 2900 Hz.

## ■ Connections

### ◇ When connecting to [DATA2]

#### • When using a PC application

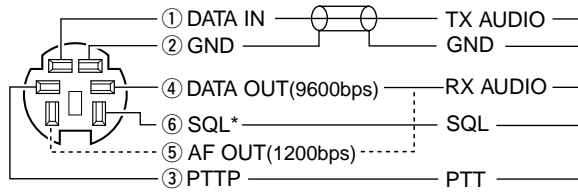

Connect to the serial port, parallel port, speaker jack, microphone jack and line IN/OUT jack, etc. See the instruction manual of the application for details.

\* When connecting the squelch line, consult the necessary manual (TNC, etc.).

#### • When using a TNC

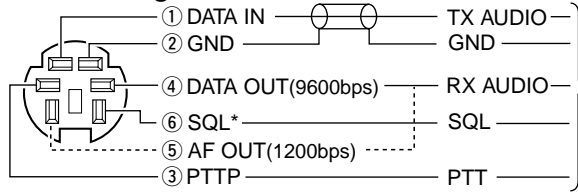

Rear panel view

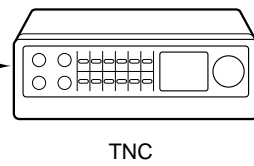

TNC

RS-232C

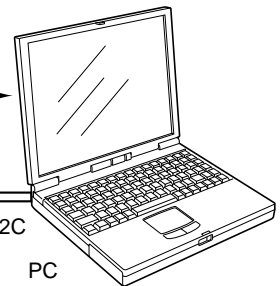

PC

### ◇ When connecting to [ACC]

#### • When using a PC application

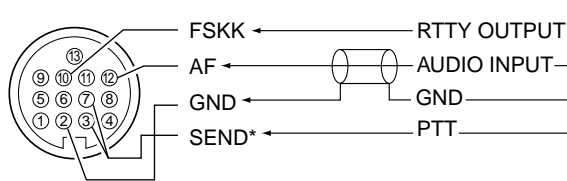

Connect to the serial port, parallel port, speaker jack, microphone jack or line IN/OUT jack, etc. See the instruction manual of the application for details.

\*③ HF/50 MHz : HSEND  
⑦ 144/430/1200 MHz : VSEND

#### • When using a TNC

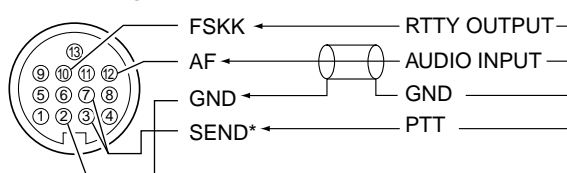

Rear panel view

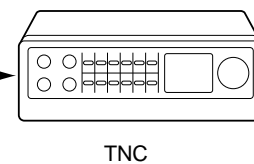

TNC

RS-232C

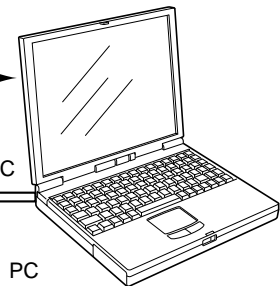

PC

• Select pin 7 (VSEND) and pin 3 (HSEND) output usage in the Set mode. (p. 166)

### ◇ When connecting to [MIC]

#### • When using a PC application

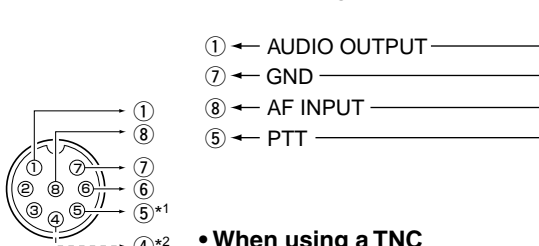

Rear panel view

Connect to the serial port, parallel port, speaker jack, microphone jack and line IN/OUT jack, etc. See the instruction manual of the application for details.

\*1 When using the VOX function, no connection is needed. Refer to the instruction manual of the external equipment.

\*2 When connecting the squelch line, consult the necessary manual.

#### • When using a TNC

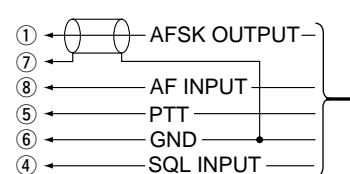

TNC

RS-232C

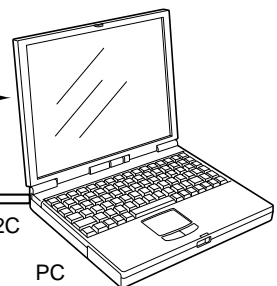

PC

## ■ Packet (AFSK) operation

Before operating packet (AFSK), be sure to consult the operating manual that came with your TNC.

- ① Connect the TNC and PC. (p. 171)
- ② Select the desired band. (p. 35)
- ③ Push [SSB] or [AM/FM] to select the desired operating mode. (p. 43)
- ④ Hold down the same key you pushed in step ③ to select the Data mode.
- ⑤ Rotate [MAIN DIAL] to select the desired frequency.
- ⑥ Transmit your AFSK signals using your PC's keyboard.
  - Rotate [RF POWER] to set the output power.
  - While using a TNC, the relative strength of the transmitted signal is indicated on the Po meter.
  - When operating in the SSB data mode, adjust the output power so that the ALC meter reading stays in the ALC zone.

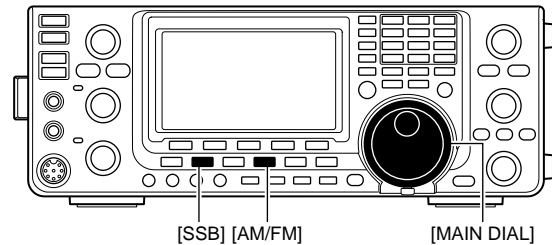

Appears when the FM data mode is selected.

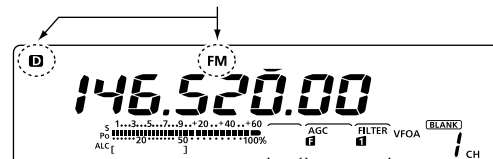

**NOTE:** When connecting the TNC to the ACC socket on the rear panel, select the USB, LSB, AM and FM data mode, or disconnect the microphone and rotate [MIC GAIN] fully counterclockwise.

When the "DATA MOD" item is set to "ACC" (default) in the Set mode, and the data mode is selected, the audio input from the [MIC] connector is automatically cut. In that case, the audio input from the [ACC] socket is used.

Also, when the data mode is selected, the fixed settings listed below are automatically selected;

- Speech compressor: OFF
- Transmit bandwidth : MID (Fixed to the default value; 300 Hz to 2700 Hz.)
- Tx tone (Bass) : 0
- Tx tone (Treble) : 0

## ◇ Frequency display during AFSK operation

When operating AFSK in the SSB mode, the displayed frequency is the signal's carrier point.

- **Example**— LSB/LSB data mode  
Mark freq.: 2125 Hz  
Shift freq.: 200 Hz

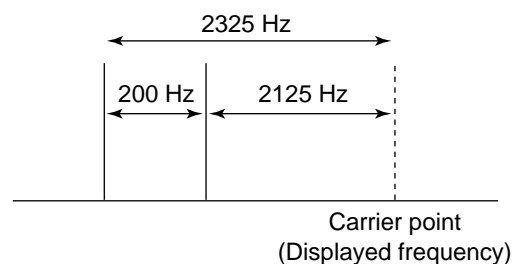

## ■ Data transmission speed

In the FM data mode, the data transmission speed can be set to 9600 bps, only when the data is output from the pin 3 of the [DATA2] socket.

- ① Hold down [MENU] for 1 second to enter the Set mode.
- ② Push [▲](F-1) or [▼](F-2) to select "9600bps Mode."
- ③ Rotate [MAIN DIAL] to turn the 9600 bps mode ON or OFF.
  - ON : 9600 bps data speed
  - OFF : Disables data transmission at 9600 bps.  
This is used for only regular audio or slower data transmission.
- ④ Push [MENU] to save and exit the Set mode.

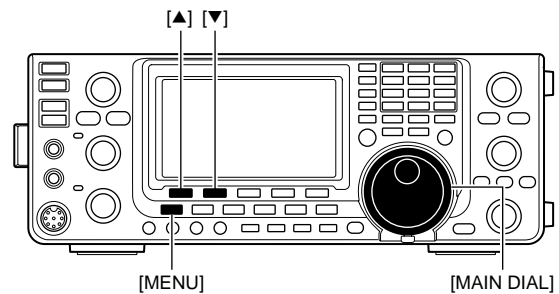

OFF (default)

## ■ Adjusting the TNC output level

When the data transmission speed is set to 9600 bps, the data signal coming from the TNC is applied exclusively to the internal limiter circuitry to automatically maintain band width.

**NEVER** apply data levels from the TNC of over 0.6 Vp-p. Otherwise the transceiver will not be able to maintain the band width, and your transmitted signal may possibly interfere with other stations.

### ◇ Using a level meter or synchroscope

When using a level meter or synchroscope, adjust the TX audio output level (DATA IN level) from the TNC as follows.

- 0.4 Vp-p (0.2 Vrms) : recommended level
- 0.2–0.5Vp-p (0.1–0.25 Vrms) : acceptable level

### ◇ Not using a measuring device

- ① Connect the TNC to the transceiver. (p. 171)
- ② Enter a test mode ("CAL," etc.) on the TNC, then transmit some test data.
- ③ If the transceiver fails to transmit the test data, or transmits sporadically, (TX/RX indicator doesn't light or it flashes):
  - Decrease the TNC output level until the transmit indicator lights continuously.
 If transmission is not successful, even though the TX indicator lights continuously:
  - Increase the TNC output level.

### INFORMATION!

When "RTTY" is selected as the "USB2/DATA1 Func" (63) item option in the Set mode, the USB port sends RTTY decode signal. In this case, you must connect a USB cable\* between the transceiver's USB port on the rear panel and the PC. (p. 167)

\*Purchase separately

- The USB driver and the installation guide can be downloaded from our website.

URL: <http://www.icom.co.jp/world/index.html>

## ■ Opening the transceiver's case

Icom strongly suggests that the customer have their dealer or Icom distributor, for a reasonable fee, install Icom options at the time of the order. Icom understands that even the simplest of installations demands the judgment of a trained Icom technician. Therefore, Icom will not be responsible for damage to the optional unit, or subsequent damage to the transceiver due to user installation problems. The option's or the transceiver's Warranty can be voided in such situations, at the sole judgment of Icom.

The following are instructions for removing the covers of the IC-9100.

**⚠ WARNING!** Turn OFF the power and disconnect the DC power cable from the transceiver before performing any work on the transceiver. Otherwise, there is danger of electric shock and/or equipment damage.

① Remove the two screws from the carrying handle and remove it from the transceiver.

② Remove the six screws from the top of the transceiver and the six screws from the sides, then lift up the top cover.

③ Turn the transceiver upside-down.

**CAUTION: NEVER HOLD THE UNIT BY THE MAIN DIAL OR ANY OTHER KNOBS** when you turn the transceiver upside down. This may damage them, or cause you to drop the transceiver.

④ Remove the six screws from the bottom, and then lift off the bottom cover.

### ✓ About the leg pads

To detach the leg pads from the right side panel of the top/bottom cover, push them out from the inside of each cover, after completing steps ① through ④ above.

**NOTE:** If the thermal sheet on the bottom cover is detached, reattach it in its original position, as illustrated to the right.

The surface of the thermal sheet is sticky, so push it into place, as illustrated to the right.

If the surface of the thermal sheet is dusty, and does not adhere, clean its surface with water, and dry it well before reattaching.

For those customers who still wish to install their own options, knowing the risks and possible consequences, the following information is provided for information purposes only.

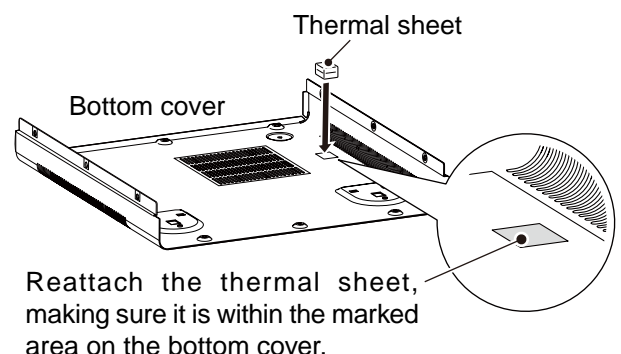
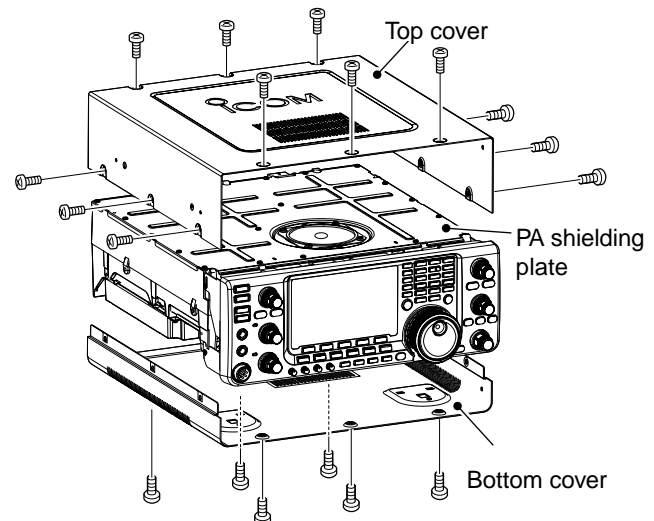
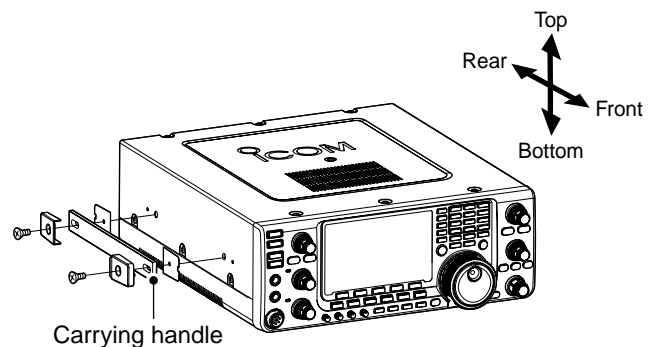

## ■ UX-9100 1200 MHz BAND UNIT installation

The optional UX-9100 is required to operate on the 1200 MHz frequency band.

- ① Remove the top and bottom covers as shown in the diagram on page 174.
- ② Remove the antenna plate from the chassis on the rear panel using a standard flat screwdriver.
  - ⚠ **WARNING!** NEVER push on the antenna plate using your finger to remove it. This may cause an injury.
- ③ Connect the DC power cable, coaxial cables, shield cable and flat cable, as shown to the right.
  - Connect the longer coaxial cable from the transceiver to J12, and the other one, with a white mark near the connector, to J101 on the IF unit.
  - Connect the coaxial cable from the UX-9100's main unit to J11 on the IF unit.
  - Connect the shield cable from the UX-9100's main unit to J602 on the IF unit.
  - Ensure the flat cable is connected to the IF unit correctly, and not upside down. After connecting, fold the cable, but not too tightly, as illustrated to the right.
- ④ Connect the 9-pin connector from the transceiver's front unit to J3 on the IF unit.
- ⑤ Connect the 12-pin connector from the IF unit to J1, and the 11-pin connector to J2 on the transceiver's front unit.

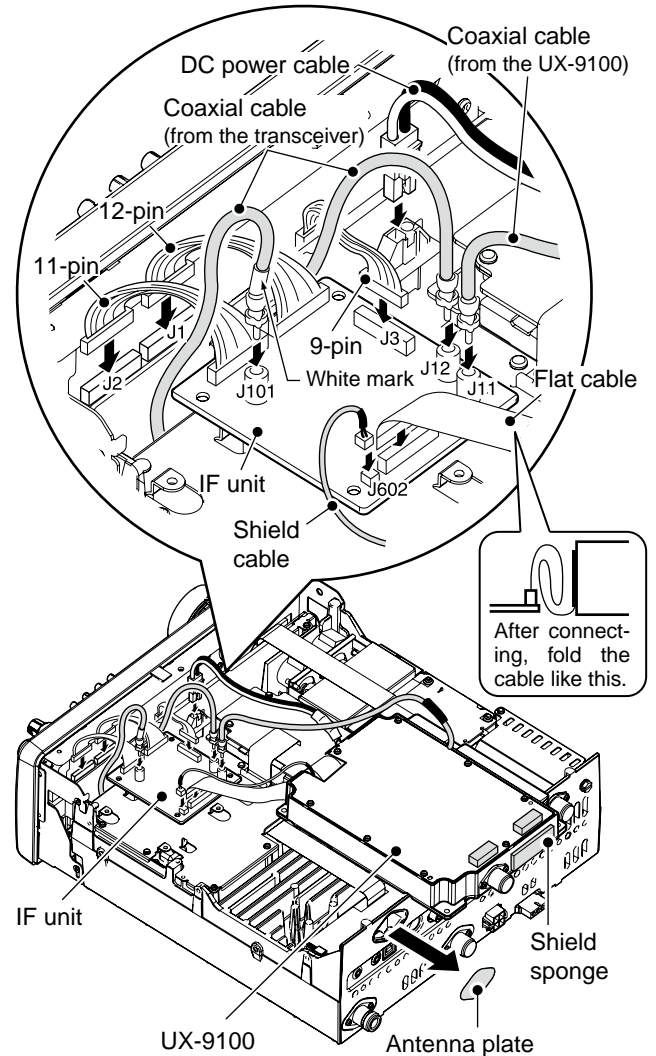

- ⑥ Attach the UX-9100 and IF unit using the eight supplied screws.
  - Make sure the flat cable is not pinched when the UX-9100 is installed.
- ⑦ Return the top and bottom covers to their original positions.

⚠ **WARNING!** When UX-9100 is installed, the unit continues to draw current, even when the transceiver is turned OFF. Therefore, when you don't intend to use the transceiver for a long period of time, disconnect the transceiver's DC power cable.

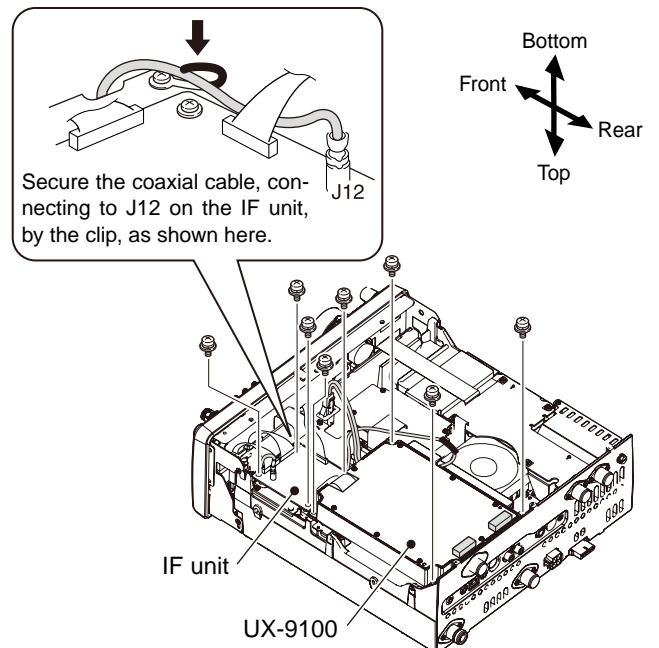



## ■ FL-430/FL-431 1ST IF FILTER installation

The optional filters, FL-430 1ST IF FILTER (6 kHz) or FL-431 1ST IF FILTER (3 kHz) provides 6 or 3 kHz filtering to reduce interference from strong nearby signals.

- ① Remove the top and bottom covers as shown on page 174.
- ② Install the FL-430 or FL-431 as shown to the right.
  - The connectors on the IC-9100 are marked for the appropriate filter.
  - Ensure the FL-430 or FL-431 is installed correctly.
- ③ Return the top and bottom covers to the original positions.

After installation, a 6 kHz or 3 kHz filter width can be used. See page 74 for details.

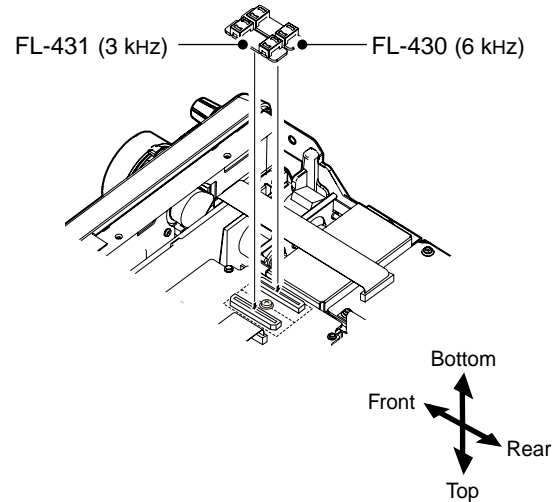

## ■ UT-121 DIGITAL UNIT installation

The optional UT-121 DIGITAL UNIT is required for the DV mode operation.

- ① Remove the top and bottom covers as shown on page 174.
- ② Remove the upper two screws from the front panel (1).
- ③ Loosen the lower two screws on the front panel (2), then slowly fold down the front panel in the direction of the arrow (3).
- ④ Remove the protective paper from one side of the double sided adhesive sheet (4), then place the sheet on the panel, as shown below (5).
- ⑤ Remove the other side of the protective paper, and install the UT-121 as shown below (6).
- ⑥ Return the front panel, top and bottom covers to their original positions.

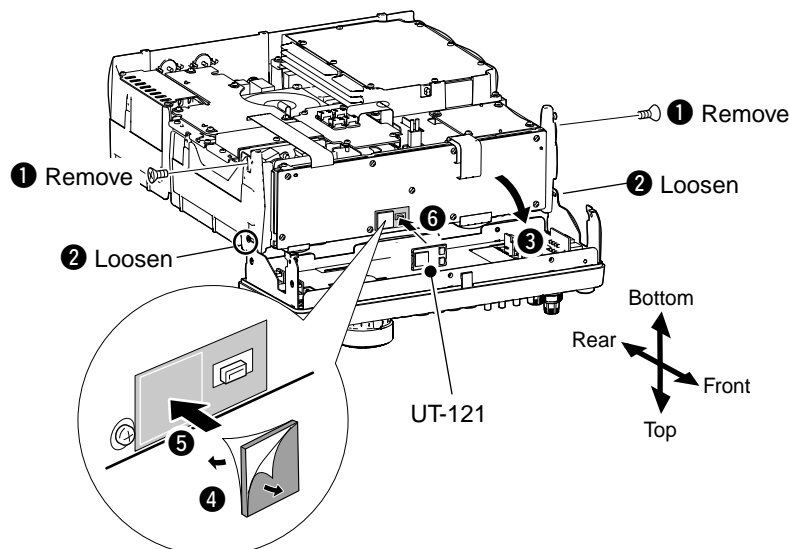

## ■ Troubleshooting

The following chart is designed to help you correct problems which are not equipment malfunctions.

If you are unable to locate the cause of a problem, or solve it through the use of this chart, contact your nearest Icom Dealer or Service Center.

### ◇ Transceiver power

PROBLEM	POSSIBLE CAUSE	SOLUTION	REF.
Power does not turn ON when the [POWER] switch is pushed.	<ul style="list-style-type: none"> <li>The power cable is improperly connected.</li> <li>A fuse is blown.</li> </ul>	<ul style="list-style-type: none"> <li>Re-connect the DC power cable correctly.</li> <li>Correct the cause, then replace the fuse with an equivalent fuse. (Fuses are installed in the DC power cable and in the internal PA unit.)</li> </ul>	p. 27 p. 180

### ◇ Transmit and receive

PROBLEM	POSSIBLE CAUSE	SOLUTION	REF.
No sound from the speaker.	<ul style="list-style-type: none"> <li>The audio volume level is too low.</li> <li>The squelch is closed.</li> <li>The transceiver is in transmit.</li> </ul>	<ul style="list-style-type: none"> <li>Rotate the [AF] control clockwise to obtain a suitable listening level.</li> <li>Rotate the [RF/SQL] control to 11 o'clock position to open the squelch.</li> <li>Push [TRANSMIT] to receive or check the SEND line of an external unit, if connected.</li> </ul>	p. 45 p. 44 p. 46
Sensitivity is too low, and only strong signals are audible.	<ul style="list-style-type: none"> <li>The antenna is not connected properly.</li> <li>The antenna for another band is selected.</li> <li>The antenna is not properly tuned.</li> <li>The attenuator is turned ON.</li> </ul>	<ul style="list-style-type: none"> <li>Re-connect to the antenna connector.</li> <li>Select an antenna suitable for the operating frequency.</li> <li>Hold down [TUNER] for 1 second to manually tune the antenna. (HF/50 MHz frequency band only)</li> <li>Push [P.AMP/ATT] to select "ATT OFF"</li> </ul>	— p. 158 p. 159 p. 71
Received audio is unclear or distorted.	<ul style="list-style-type: none"> <li>The operating mode is not matched.</li> <li>The Passband Tuning function is turned ON.</li> <li>Noise Blanker functions when receiving a strong signal.</li> <li>Preamplifier is turned ON.</li> <li>The Noise Reduction function is turned ON and the [NR] control is too far clockwise.</li> </ul>	<ul style="list-style-type: none"> <li>Select a suitable operating mode.</li> <li>Hold down [PBT-CLR] for 1 second to reset the function.</li> <li>Push [NB] to turn OFF the function.</li> <li>Push [P.AMP/ATT] one or more times to turn OFF the function.</li> <li>Set the [NR] control for maximum readability.</li> </ul>	p. 43 p. 75 p. 76 p. 71 p. 77
[ANT•METER] does not function	<ul style="list-style-type: none"> <li>The Antenna Switch function has not been turned ON.</li> </ul>	<ul style="list-style-type: none"> <li>Set the Antenna Switch function to "Auto" or "Manual" in the Set mode.</li> </ul>	p. 163
Transmitting is impossible.	<ul style="list-style-type: none"> <li>The operating frequency is outside the selected ham band.</li> </ul>	<ul style="list-style-type: none"> <li>Set the frequency to be within the selected ham band.</li> </ul>	p. 37
Output power is too low.	<ul style="list-style-type: none"> <li>The [RF POWER] control is set too far counterclockwise</li> <li>The [MIC GAIN] control is set too far counterclockwise</li> <li>The antenna for another band is selected.</li> <li>The antenna is not properly tuned.</li> </ul>	<ul style="list-style-type: none"> <li>Rotate the [RF POWER] control clockwise.</li> <li>Set the [MIC GAIN] control to a suitable position.</li> <li>Select an antenna suitable for the operating frequency.</li> <li>Hold down [TUNER] for 1 second to manually tune the antenna.</li> </ul>	p. 46 p. 46 p. 158 p. 159
No contact can be made with another station.	<ul style="list-style-type: none"> <li>The RIT or ΔTX function is turned ON.</li> <li>The Split function and/or Duplex function are turned ON.</li> </ul>	<ul style="list-style-type: none"> <li>Push [RIT] or [ΔTX] to turn OFF the function.</li> <li>Push [SPLIT] and/or [DUP](F-2) (in the "M1" screen) to turn OFF the function.</li> </ul>	pp. 69, 81 pp. 65, 82
Transmit signal is unclear or distorted.	<ul style="list-style-type: none"> <li>The [MIC GAIN] control is set too far clockwise.</li> </ul>	<ul style="list-style-type: none"> <li>Set the [MIC GAIN] control to a suitable position.</li> </ul>	p. 46
Repeater cannot be accessed.	<ul style="list-style-type: none"> <li>The split or duplex function is not turned ON.</li> <li>The programmed subaudible tone frequency is wrong.</li> </ul>	<ul style="list-style-type: none"> <li>Push [SPLIT] and/or [DUP](F-2) (in the "M1" screen) to turn ON the function.</li> <li>Reset the frequency.</li> </ul>	pp. 65, 82 p. 65
AM cannot be selected.	<ul style="list-style-type: none"> <li>The 1200 MHz frequency band is selected.</li> </ul>	<ul style="list-style-type: none"> <li>Select the HF/50/144/430 MHz frequency band.</li> </ul>	pp. 43, 61
Transmitting is impossible in AM.	<ul style="list-style-type: none"> <li>The 144/430/1200 MHz frequency band is selected.</li> </ul>	<ul style="list-style-type: none"> <li>Select the HF/50 MHz frequency band.</li> </ul>	pp. 43, 46

### ◇ Scanning

PROBLEM	POSSIBLE CAUSE	SOLUTION	REF.
Programmed scan does not stop.	<ul style="list-style-type: none"> <li>• Squelch is open.</li> </ul>	<ul style="list-style-type: none"> <li>• Set the [RF/SQL] control to the threshold point.</li> </ul>	pp. 44, 146
Programmed scan does not start.	<ul style="list-style-type: none"> <li>• The same frequencies have been programmed into both "1A-3A" and "1b-3b" of the scan edge memory channels.</li> </ul>	<ul style="list-style-type: none"> <li>• Program different frequencies into the "1A-3A" and "1b-3b" scan edge memory channels.</li> </ul>	p. 148
Memory scan does not start.	<ul style="list-style-type: none"> <li>• 2 or more memory channels have not been programmed.</li> </ul>	<ul style="list-style-type: none"> <li>• Program more than 2 memory channels.</li> </ul>	p. 140
Select memory scan does not start.	<ul style="list-style-type: none"> <li>• 2 or more memory channels have not been designated as select channels.</li> </ul>	<ul style="list-style-type: none"> <li>• Designate more than 2 memory channels as select channels for the scan.</li> </ul>	p. 151
Mode select memory scan does not start.	<ul style="list-style-type: none"> <li>• 2 or more memory channels with desired mode have not been programmed.</li> </ul>	<ul style="list-style-type: none"> <li>• Program more than 2 memory channels with the desired operating mode.</li> </ul>	p. 43
ΔF scan does not start.	<ul style="list-style-type: none"> <li>• The center frequency for ΔF scan is not programmed.</li> </ul>	<ul style="list-style-type: none"> <li>• Program the center frequency for a ΔF scan.</li> </ul>	p. 152

### ◇ Display

PROBLEM	POSSIBLE CAUSE	SOLUTION	REF.
The displayed frequency does not change properly.	<ul style="list-style-type: none"> <li>• The dial lock function is turned ON.</li> <li>• The Set mode screen is selected.</li> <li>• The internal CPU has malfunctioned.</li> </ul>	<ul style="list-style-type: none"> <li>• Hold down [SPEECH/LOCK] for 1 second to turn OFF the function.</li> <li>• Push [MENU] to exit the Set Mode.</li> <li>• Reset the CPU.</li> </ul>	<p>p. 77</p> <p>p. 161</p> <p>p. 181</p>

## ■ Frequency calibration (approximate)

A very accurate frequency counter is required to calibrate the frequency of the transceiver. However, a rough check may be performed by receiving radio station WWV, WWVH, or other standard frequency signals.

**CAUTION:** The IC-9100 has been thoroughly adjusted and tested at the factory before being shipped. You should not have to re-calibrate it.

- ① Push [SSB] to select the USB mode.
- ② Push [PBT-CLR] for 1 second to clear the PBT settings and make sure that the RIT/ $\Delta$ TX function is not turned ON.
- ③ Set the frequency to the standard frequency station minus 1 kHz.
  - When receiving WWV or WWVH (at 15.000.00 MHz) as a standard frequency, set the operating frequency for 14.999.00 MHz.
  - Other standard frequencies can also be used.
- ④ Hold down [MENU] for 1 second to enter the Set mode.
- ⑤ Push [ $\blacktriangle$ ](F-1) or [ $\blacktriangledown$ ](F-2) to select "Calibration Marker."
- ⑥ Rotate [MAIN DIAL] to turn ON the calibration marker.
  - A sidetone may be heard.
- ⑦ Push [ $\blacktriangledown$ ](F-2) to select "REF Adjust."
- ⑧ Rotate [MAIN DIAL] to adjust for a zero beat with the received standard signal.
  - Zero beat means that two signals are exactly the same frequency, resulting in a single tone being heard.
- ⑨ Push [ $\blacktriangle$ ](F-1) to select "Calibration Marker."
- ⑩ Rotate [MAIN DIAL] to turn OFF the calibration marker.
- ⑪ Push [MENU] to save, and exit the Set mode.

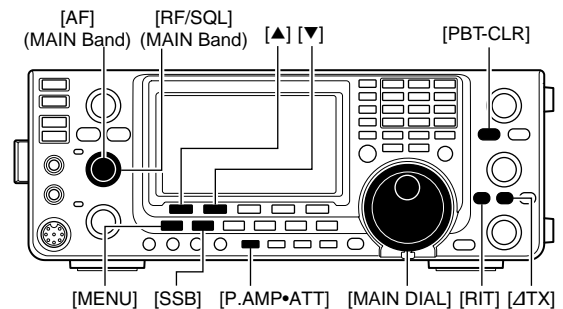

### • Calibration marker item

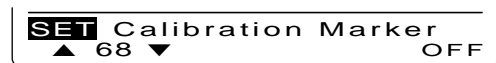

### • REF Adjust item



## ■ Main dial tuning tension adjustment

The tuning tension of [MAIN DIAL] may be adjusted to suit your preference.

The tension adjustment is located on the bottom side of the front panel. See the figure to the right.

Slide the tension adjustment to a comfortable level while turning the dial continuously and evenly in one direction.

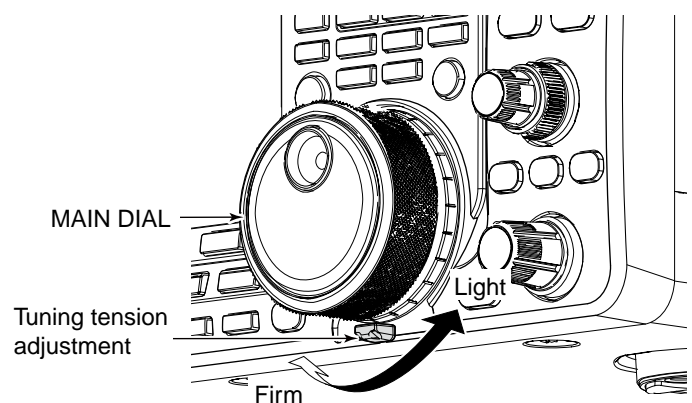

## ■ Fuse replacement

If a fuse blows, or the transceiver stops functioning, find the source of the problem, and repair it. Then replace the damaged fuse with a new, adequately rated fuse.

**⚠ WARNING!** Turn OFF the power and disconnect the DC power cable from the transceiver before performing any work on the transceiver. Otherwise, there is danger of electric shock, equipment damage and/or fire injury.

The IC-9100 has two fuse types installed for transceiver protection.

- DC power cable fuses ..... ATC 30 A
- Circuitry fuse ..... ATC 5 A

### ◇ DC power cable fuse replacement

Refer the figure described to the right for the DC power cable fuse replacement.

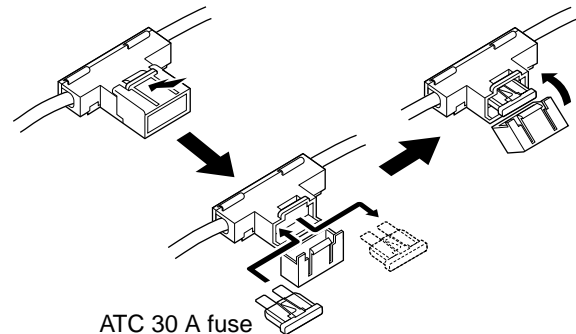

### ◇ Circuitry fuse replacement

Except for the power amplifier, the 13.8 V DC from the DC power cable is applied to all units in the IC-9100, through the circuitry fuse. This fuse is located in the PA unit.

- ① Remove the top cover. (p. 174)
- ② Remove the 22 screws, then remove the PA shielding plate as shown to the right.
- ③ Remove the speaker cable from the connector on the PA unit as shown to the right.
- ④ Replace the circuitry fuse as shown in the diagram to the right.
- ⑤ Replace the speaker cable, PA shielding plate, top cover and screws to their original position.

**⚠ CAUTION: DO NOT** pull the speaker cable when removing the PA shielding plate, or **DO NOT** put the speaker cable under the PA shielding plate when replacing it. This could damage the transceiver.

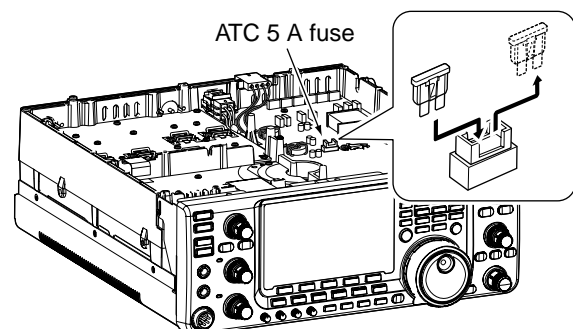
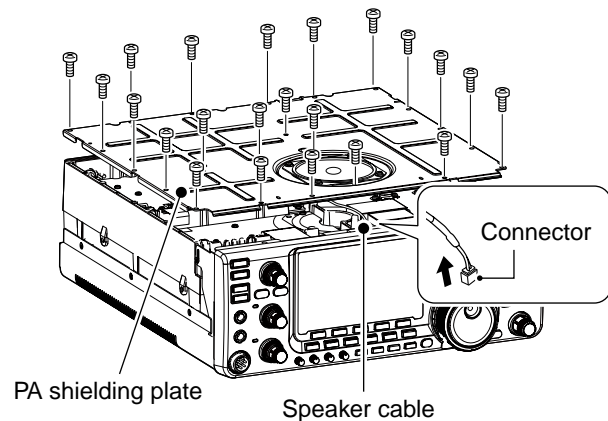

## ■ Resetting the CPU

### ◇ Partial reset

If you want to reset the operating parameters to their default values (VFO frequency, VFO settings, menu group's contents) without clearing certain data as described below, a partial reset can be performed.

The following data will not be cleared when doing a Partial reset:

- Memory contents
- Call sign memories
- Repeater lists
- TX messages
- GPS memories
- GPS messages
- Memory keyer contents
- Programmed user band edge frequencies
- Programmed Auto Repeater frequency ranges
- REF Adj (Reference frequency) setting

- ① First, turn OFF the transceiver power.
- ② While holding down [F-INP ENT] and [VFO/MEMO], push [POWER] to turn ON the power.
  - During start-up, the transceiver displays "PARTIAL RESET," then its initial VFO frequencies when resetting is complete.
  - If you operate the transceiver before "PARTIAL RESET" disappears, the resetting will be cancelled.
- ③ If desired, edit the Set mode settings after resetting.

### ◇ All reset

The display may occasionally display erroneous information (e.g. when first applying power). This may be caused externally by static electricity or by other factors.

If this problem occurs, turn OFF the power. After waiting a few seconds, turn ON the power again. If the problem persists, perform the following procedure.

/// **NOTE:** Resetting the CPU **CLEARs** all programmed contents and returns them to their default settings.

- ① First, turn OFF the transceiver power.
- ② While holding down [F-INP ENT] and [M-CLR], push [POWER] to turn ON the power.
  - During start-up, the transceiver displays "ALL CLEAR," then when resetting is complete, then displays the initial VFO frequencies.
  - If you operate the transceiver before "ALL CLEAR" disappears, the resetting will be cancelled.
- ③ After resetting, edit the Set mode settings, if desired.

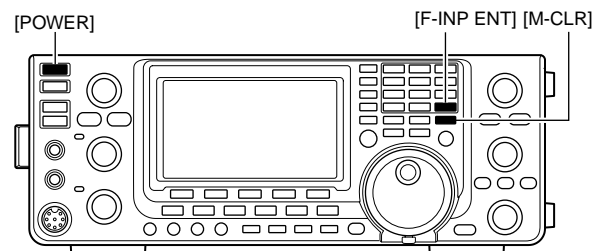
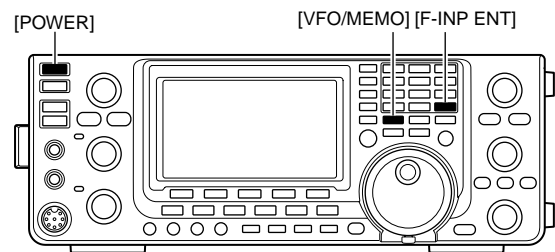

## ■ Data cloning

### ◇ Cloning between transceivers

The IC-9100 has transceiver-to-transceiver data cloning capability.

This function is useful when you want to copy all of the programmed contents from one IC-9100 to another.

- A mini plug cable is required. (Purchase separately)

- ① Connect a mini plug cable to the [REMOTE] jack of the master and sub transceivers.
  - The master transceiver is used to send data to the sub transceiver.
- ② **Sub transceiver's operation:**  
While holding down [F-1] on the sub transceiver, push [POWER] to turn ON the power and enter the cloning mode.

#### Master transceiver's operation:

While holding down [F-2] on the master transceiver, push [POWER] to turn ON the power and enter the cloning mode.

- "CLONE" appears and the transceivers enter the clone standby mode.
  - "M" appears on the master transceiver's display to indicate it as the master transceiver.
- ③ Push [OUT](F-5) on the master transceiver.
    - "CLONE OUT" appears on the master transceiver's display, and the bar meter shows that data is being transferred to the sub-transceiver.
    - "CLONE IN" appears automatically on the sub-transceiver's display, and the bar meter shows that data is being received from the master transceiver.
  - ④ When cloning is finished, turn power OFF, then ON again to exit the cloning mode.
    - "CLONE END" appears automatically on the sub-transceiver's display after the cloning is completed.

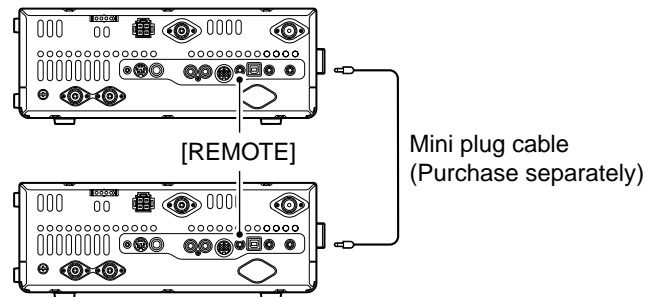

Use as short a mini plug cable as possible.  
Depending on the length of the cable, data cloning cannot be done.

### ◇ Cloning using a personal computer

The optional CS-9100 CLONING SOFTWARE is also available to clone/edit contents with a PC using ICF format files.

Microsoft® Windows® XP (32bit), Windows Vista® (32/64bit) or Windows® 7 (32/64bit) OS is required.

- A USB cable is required to connect the transceiver and a PC. (Purchase separately)

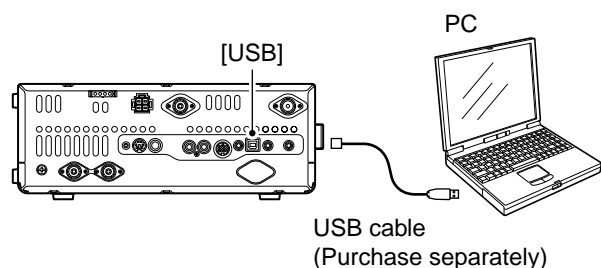

## Remote jack (CI-V) information

### CI-V connection example

The transceiver can be connected through an optional CT-17 CI-V LEVEL CONVERTER to a PC equipped with an RS-232C port. The Icom Communications Interface-V (CI-V) controls the transceiver.

Up to 4 Icom CI-V transceivers or receivers can be connected to the PC. See page 167 for setting the CI-V condition using the set mode.

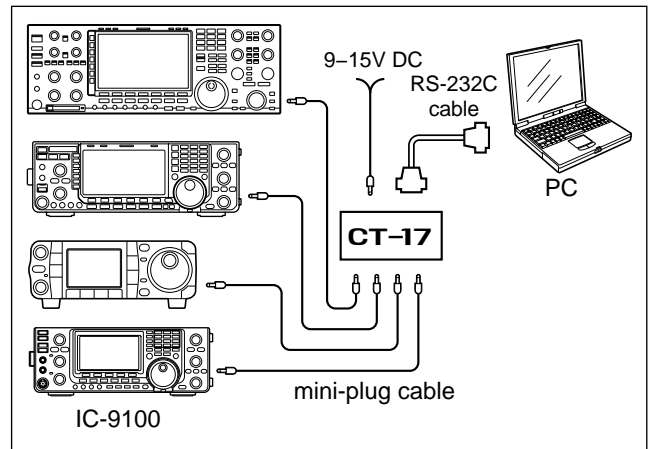

When the transceiver is connected to a PC with the USB cable (purchased separately), the optional CT-17 is not required.

### Data format

The CI-V system can be operated using the following data formats. Data formats differ depending on command numbers. A data area or sub command is added to some commands.

#### Controller to IC-9100

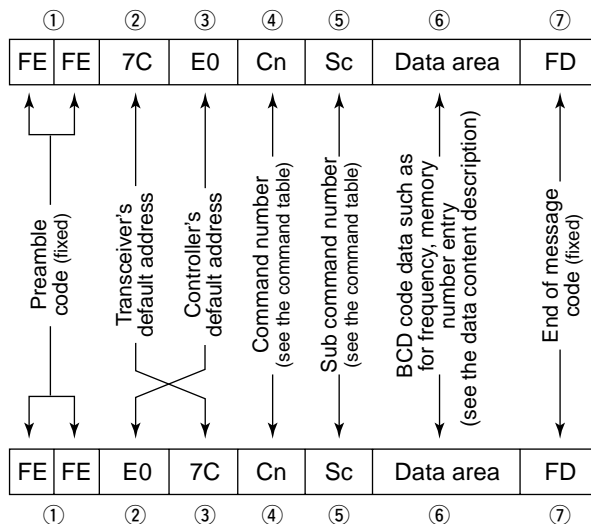

#### IC-9100 to controller

#### OK message to controller

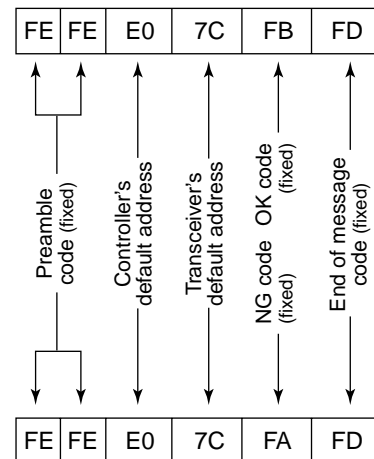

#### NG message to controller



◆ Command table

Cmd.	Sub cmd.	Data	Description
00		see p. 190	Send operating frequency for transceiver
01		see p. 190	Send operating mode for transceiver
02		see p. 191	Read band edge frequencies
03		see p. 190	Read operating frequency
04		see p. 190	Read operating mode
05		see p. 190	Send operating frequency
06		see p. 190	Send operating mode
07			Select VFO mode
	00		Select VFO A
	01		Select VFO B
	A0		Equalize VFO A and VFO B
	B0		Exchange MAIN and SUB Bands
	D0		Select MAIN Band
08			Select SUB Band
			Select Memory mode
		0001 to 0105	Select Memory channel (0001=M-CH01 to 0099=M-CH99, 0100=1A, 0101=1b, 0102=2A, 0103=2b, 0104=3A, 0105=3b)
		0106	Select Call channel
		00 to 19	Select Satellite Memory channel (00=Satellite M-CH00 to 19=Satellite M-CH19)
09			Memory write
0A			Memory copy to VFO
0B			Memory clear
0C			Read offset frequency
0D			Send offset frequency
0E	00		Scan stop
	01		Programmed/memory scan start
	02		Programmed scan start
	03		ΔF scan start
	12		Fine programmed scan start
	13		Fine ΔF scan start
	22		Memory scan start
	23		Select memory scan start
	24		Mode select scan start
	A1		Set ΔF scan span ±5 kHz
	A2		Set ΔF scan span ±10 kHz
	A3		Set ΔF scan span ±20 kHz
	A4		Set ΔF scan span ±50 kHz
	A5		Set ΔF scan span ±100 kHz
	A6		Set ΔF scan span ±500 kHz
	A7		Set ΔF scan span ±1 MHz
	B0		Set as non-select channel
	B1		Set as select channel (The previously set number by CI-V is set after turning power ON, or "1" is selected if no selection is performed.)
	D0		Set scan resume OFF
D3		Set scan resume ON	
0F			Read Split function or duplex setting (00=OFF, 01=ON, 11=DUP-, 12=DUP+)
	00		Set the Split function OFF
	01		Set the Split function ON
	10		Set simplex operation
	11		Set DUP- operation
	12		Set DUP+ operation

Cmd.	Sub cmd.	Data	Description
10		00	Send/read the tuning step 10 Hz (1 Hz)
		01	Send/read the tuning step 100 Hz
		02	Send/read the tuning step 1 kHz
		03	Send/read the tuning step 5 kHz
		04	Send/read the tuning step 6.25 kHz
		05	Send/read the tuning step 9 kHz
		06	Send/read the tuning step 10 kHz
		07	Send/read the tuning step 12.5 kHz
		08	Send/read the tuning step 20 kHz
		09	Send/read the tuning step 25 kHz
		10	Send/read the tuning step 50 kHz
		11	Send/read the tuning step 100 kHz
	12	Send/read the tuning step 1 MHz (except for HF/50 MHz band)	
11		00	Send/read attenuator OFF
		20	Send/read 20 dB attenuator
12	00		Send/read ANT1 selection
	01		Send/read ANT2 selection
13	00		Announce operating frequency, operating mode and S-meter level with voice synthesizer
	01		Announce operating frequency and S-meter level with voice synthesizer
	02		Announce operating mode with voice synthesizer
14	01	0000 to 0255	Send/read [AF] position (0000=max. CCW, 0255=max. CW)
	02	0000 to 0255	Send/read [RF/SQ] position (RF gain level) (0000=max. CCW, 0255=11 o'clock)
	03	0000 to 0255	Send/read [RF/SQ] position (squelch level) (0000=11 o'clock, 0255=max. CW)
	06	0000 to 0255	Send/read [NR] position (0000=max. CCW, 0255=max. CW)
	07	0000 to 0255	Send/read inner [TWIN PBT] position (0000=max. CCW, 0128=center, 0255=max. CW)
	08	0000 to 0255	Send/read outer [TWIN PBT] position (0000=max. CCW, 0128=center, 0255=max. CW)
	09	0000 to 0255	Send/read [CW PITCH] position (0000=max. CCW, 0128=center, 0255=max. CW)
	0A	0000 to 0255	Send/read [RF POWER] position (0000=max. CCW to 0255=max. CW)
	0B	0000 to 0255	Send/read [MIC GAIN] position (0000=max. CCW to 0255=max. CW)
	0C	0000 to 0255	Send/read [KEY SPEED] position (0000=max. CCW to 0255=max. CW)
	0D	0000 to 0255	Send/read [NOTCH] position (0000=max. CCW, 0128=center, 0255=max. CW)
	0E	0000 to 0255	Send/read COMP level (0000=0 to 0255=10)
	0F	0000 to 0255	Send/read Break-IN Delay setting (0000=2.0d to 0255=13.0d)
	12	0000 to 0255	Send/read NB level (0000=0% to 0255=100%)
	15	0000 to 0255	Send/read Monitor gain (0000=0% to 0255=100%)
	16	0000 to 0255	Send/read VOX gain (0000=0% to 0255=100%)
	17	0000 to 0255	Send/read Anti VOX gain (0000=0% to 0255=100%)
	18	0000 to 0255	Send/read CONTRAST level (0000=0% to 0255=100%)
	19	0000 to 0255	Send/read BRIGHT level (0000=0% to 0255=100%)

## ◇ Command table (continued)

Cmd.	Sub cmd.	Data	Description	Cmd.	Sub cmd.	Data	Description
15	01	00	Read squelch status (squelch close)	16	59	00	Send/read Sub band OFF
		01	Read squelch status (squelch open)			01	Send/read Sub band ON
	02	0000 to 0255	Read S-meter level (0000=S0, 0120=S9, 0240=S9+60 dB)	5A	00	Send/read Satellite mode OFF	
	11	0000 to 0255	Read RF power meter (0000=0%, 0141=50%, 0215=100%)		01	Send/read Satellite mode ON	
	12	0000 to 0255	Read SWR meter (0000=SWR1.0, 0041=SWR1.5, 0081=SWR2.0, 0120=SWR3.0)	5B	00	Send/read DSQ/CSQ OFF (DV mode only)	
	13	0000 to 0255	Read ALC meter (0000=Min. to 0120=Max.)		01	Send/read DSQ ON (DV mode only)	
	14	0000 to 0255	Read COMP meter (0000=0 dB, 0120=15 dB, 0240=30 dB)	02	Send/read CSQ ON (DV mode only)		
16	02	00	Send/read Preamp OFF	17		see p. 191	Send CW messages
		01	Send/read Preamp ON (144/430/1200 MHz)	19	00		Read the transceiver ID
		02	Send/read Preamp 2 ON (HF/50 MHz)	1A	00	see p. 195	Send/read memory contents
	12	01	Send/read AGC FAST		01	see p. 191	Send/read band stacking register contents
		02	Send/read AGC MID	02	see p. 191	Send/read memory keyer contents*1	
		03	Send/read AGC SLOW	03	00 to 49		Send/read the selected filter width (AM: 00=200 Hz to 49=10 kHz; other than AM modes: 00=50 Hz to 40/31=3600 Hz/2700 Hz)
	22	00	Send/read Noise Blanker OFF				
		01	Send/read Noise Blanker ON	04	00 to 13		Send/read the selected AGC time constant (00=OFF, AM: 01=0.3 sec. to 13=8.0 sec. SSB/CW/RTTY: 01=0.1 sec. to 13=6.0 sec.)
	40	00	Send/read Noise Reduction OFF				
		01	Send/read Noise Reduction ON	05	0001 to 0255		Send/read LCD contrast level (0000=0% (low) to 0255=100% (high))
	41	00	Send/read Auto Notch function OFF				
		01	Send/read Auto Notch function ON				
	42	00	Send/read Repeater tone OFF				
		01	Send/read Repeater tone ON				
	43	00	Send/read Tone squelch OFF				
		01	Send/read Tone squelch ON				
	44	00	Send/read Speech compressor OFF				
		01	Send/read Speech compressor ON				
	45	00	Send/read Monitor function OFF				
		01	Send/read Monitor function ON				
	46	00	Send/read VOX function OFF				
		01	Send/read VOX function ON				
	47	00	Send/read BK-IN function OFF				
		01	Send/read Semi BK-IN function ON				
		02	Send/read Full BK-IN function ON				
	48	00	Send/read Manual notch function OFF	0002	0000 to 0255	Send/read LCD backlight brightness level (0000=0% (dark) to 0255=100% (bright))	
		01	Send/read Manual notch function ON	0003	0000 to 0255	Send/read beep level (0000=0% to 0255=100%)	
	4A	00	Send/read AFC function OFF	0004	00	Send/read beep level limit OFF	
		01	Send/read AFC function ON		01	Send/read beep level limit ON	
	4B	00	Send/read DTCS OFF	0005	00	Send/read confirmation beep OFF	
		01	Send/read DTCS ON		01	Send/read confirmation beep ON	
	4C	00	Send/read VSC function OFF	0006	00	Send/read band edge beep OFF	
		01	Send/read VSC function ON		01	Send/read band edge beep ON (Beep sounds with a default band)	
	4F	00	Send/read Twin Peak Filter OFF		02	Send/read band edge beep with user setting ON	
		01	Send/read Twin Peak Filter ON		03	Send/read band edge beep with user setting/TX limit ON	
	50	00	Send/read Dial lock function OFF	0007	0050 to 0200	Send/read beep audio frequency for MAIN Band (0050=500 Hz to 0200=2000 Hz)	
		01	Send/read Dial lock function ON	0008	0050 to 0200	Send/read beep audio frequency for SUB Band (0050=500 Hz to 0200=2000 Hz)	
	55	00	Send/read 1st IF filter 3 kHz	0009	00	Send/read Auto selection for [RF/SQL]	
		01	Send/read 1st IF filter 6 kHz		01	Send/read SQL selection for [RF/SQL]	
		02	Send/read 1st IF filter 15 kHz		02	Send/read RF+SQL selection for [RF/SQL]	
	56	00	Send/read DSP filter type SHARP	0010	00	Send/read Meter Peak Hold function OFF	
		01	Send/read DSP filter type SOFT		01	Send/read Meter Peak Hold function ON	
	57	00	Send/read manual notch width WIDE	0011	00	Send/read FM/DV Center Error function OFF	
		01	Send/read manual notch width MID		01	Send/read FM/DV Center Error function ON	
		02	Send/read manual notch width NAR	0012	00	Send/read Time-Out Timer OFF	
	58	00	Send/read SSB transmit bandwidth WIDE		01	Send/read 3 min. Time-Out Timer	
	01	Send/read SSB transmit bandwidth MID		02	Send/read 5 min. Time-Out Timer		
	02	Send/read SSB transmit bandwidth NAR		03	Send/read 10 min. Time-Out Timer		
				04	Send/read 20 min. Time-Out Timer		
				05	Send/read 30 min. Time-Out Timer		
			0013	00	Send/read PTT Lock function OFF		
				01	Send/read PTT Lock function ON		
			0014	00	Send/read Quick Split function OFF		
				01	Send/read Quick Split function ON		
			0015	see p. 192	Send/read Split offset frequency		

Cmd.	Sub cmd.	Data	Description
1A	05	00	Send/read Split Lock function OFF
		01	Send/read Split Lock function ON
	0017	see p. 192	Send/read Duplex offset frequency
	0018	00	Send/read One Touch Repeater DUP-
		01	Send/read One Touch Repeater DUP+
	0019	00	Send/read Auto Repeater OFF
		01	Send/read Auto Repeater ON-1 (for USA version) or ON (for Korea version)
		02	Send/read Auto Repeater ON-2 (for USA version)
	0020	00	Send/read Tuner Auto Start OFF
		01	Send/read Tuner Auto Start ON
	0021	00	Send/read PTT Tune OFF
		01	Send/read PTT Tune ON
	0022	00	Send/read antenna selection OFF
		01	Send/read manual antenna selection
		02	Send/read auto antenna selection
	0023	0000 to 0255	Send/read voice synthesizer level (0000=0% to 0255=100%)
	0024	00	Send/read English selection for voice synthesizer speech language
		01	Send/read Japanese selection for voice synthesizer speech language
	0025	00	Send/read speech speed slow
		01	Send/read speech speed fast
	0026	00	Send/read S-meter level announcement OFF
		01	Send/read S-meter level announcement ON
	0027	00	Send/read operating mode announcement (after pushing mode switch) OFF
		01	Send/read operating mode announcement (after pushing mode switch) ON
	0028	00	Send/read [SPEECH/LOCK] key function setting (Push=SPEECH, Hold down=LOCK)
		01	Send/read [SPEECH/LOCK] key function setting (Push=LOCK, Hold down=SPEECH)
	0029	00	Send/read number of memo pad channels 5
		01	Send/read number of memo pad channels 10
	0030	00	Send/read auto TS for [MAIN DIAL] OFF
		01	Send/read auto TS for [MAIN DIAL] Low
		02	Send/read auto TS for [MAIN DIAL] High
	0031	00	Send/read Low selection for microphone Up/Down speed
		01	Send/read High selection for microphone Up/Down speed
	0032	00	Send/read Quick RIT/ $\Delta$ TX clear OFF
		01	Send/read Quick RIT/ $\Delta$ TX clear ON
	0033	00	Send/read AFC functioning range limit OFF
		01	Send/read AFC functioning range limit ON
	0034	00	Send/read Auto Notch selection for SSB mode
		01	Send/read Manual notch selection for SSB mode
		02	Send/read Auto/Manual Notch selection for SSB mode
	0035	00	Send/read Auto Notch selection for AM mode
		01	Send/read Manual Notch selection for AM mode
02		Send/read Auto/Manual Notch selection for AM mode	

Cmd.	Sub cmd.	Data	Description	
1A	05	0036	00	Send/read Manual Notch filter width pop-up OFF
		01	Send/read Manual Notch filter width pop-up ON	
	0037	00	Send/read BW Popup (PBT) setting OFF	
		01	Send/read BW Popup (PBT) setting ON	
	0038	00	Send/read BW Popup (FIL) setting OFF	
		01	Send/read BW Popup (FIL) setting ON	
	0039	00	Send/read SSB/CW Synchronous Tuning function OFF	
		01	Send/read SSB/CW Synchronous Tuning function ON	
	0040	00	Send/read LSB selection for CW normal side	
		01	Send/read USB selection for CW normal side	
	0041	00	Send/read KEYSER-Root selection for keyer 1st menu	
		01	Send/read KEYSER-SEND selection for keyer 1st menu	
	0042	00	Send/read GPS-Root selection for GPS 1st Menu	
		01	Send/read GPS-POS selection for GPS 1st Menu	
	0043	00	Send/read external preamplifier (AG-25) control for 144 MHz band OFF	
		01	Send/read external preamplifier (AG-25) control for 144 MHz band ON	
	0044	00	Send/read external preamplifier (AG-35) control for 430 MHz band OFF	
		01	Send/read external preamplifier (AG-35) control for 430 MHz band ON	
	0045	00	Send/read external preamplifier (AG-1200) control for 1200 MHz band OFF	
		01	Send/read external preamplifier (AG-1200) control for 1200 MHz band ON	
	0046	00	Send/read Separate selection for the external speaker output method	
		01	Send/read Mix selection for the external speaker output method	
	0047	00	Send/read Separate selection for the headphone audio output method	
		01	Send/read Mix selection for the headphone audio output method	
		02	Send/read Auto selection for the headphone audio output method	
	0048	00	Send/read SUB Band audio mute during transmit on the main band OFF	
		01	Send/read SUB Band audio mute during transmit on the main band ON	
	0049	00	Send/read MAIN selection for the [ACC] AF/SQL line output	
		01	Send/read SUB selection for the [ACC] AF/SQL line output	
	0050	00	Send/read MAIN selection for the [DATA] AF/SQL line output	
		01	Send/read SUB selection for the [DATA] AF/SQL line output	
	0051	00	Send/read VSEND select OFF	
		01	Send/read UHF Only selection for VSEND	
02		Send/read VSEND select ON		
0052	00	Send/read external keypad OFF		
	01	Send/read KEYSER SEND selection for the external keypad		
0053	00	Send/read USB audio squelch OFF (OPEN)		
	01	Send/read USB audio squelch ON		

## ◇ Command table (continued)

Cmd.	Sub cmd.	Data	Description	
1A	05	0054	0000 to 0255 Send/read USB modulation level (0000=0% to 0255=100%)	
		0055	00	Send/read 9600 bps mode OFF
			01	Send/read 9600 bps mode ON
		0056	00	Send/read MIC selection for the modulation input during DATA mode OFF
			01	Send/read ACC selection for the modulation input during DATA mode OFF
			02	Send/read MIC+ACC selection for the modulation input during DATA mode OFF
			03	Send/read USB selection for the modulation input during DATA mode OFF
		0057	00	Send/read MIC selection for the modulation input during DATA mode ON
			01	Send/read ACC selection for the modulation input during DATA mode ON
			02	Send/read MIC+ACC selection for the modulation input during DATA mode ON
			03	Send/read USB selection for the modulation input during DATA mode ON
		0058	00	Send/read CI-V transceive OFF
			01	Send/read CI-V transceive ON
		0059	00	Send/read no function selection for "USB2" (COM port) function
			01	Send/read RTTY selection for "USB2" (COM port) function
			02	Send/read DVdat selection for "USB2" (COM port) function
		0060	00	Send/read no function selection for [DATA1] function
			01	Send/read RTTY selection for [DATA1] function
			02	Send/read DVdat selection for [DATA1] function
		0061	00	Send/read OFF selection for GPS Out
			01	Send/read DATA->USB2 selection for GPS Out
		0062	00	Send/read 4800 bps selection for GPS position data transmission speed of [DATA1]
			01	Send/read 9600 bps selection for GPS position data transmission speed of [DATA1]
		0063	00	Send/read 300 bps selection for RTTY Decode Baud rate
			01	Send/read 1200 bps selection for RTTY Decode Baud rate
			02	Send/read 4800 bps selection for RTTY Decode Baud rate
			03	Send/read 9600 bps selection for RTTY Decode Baud rate
			04	Send/read 19200 bps selection for RTTY Decode Baud rate
		0064	00	Send/read Calibration marker OFF
			01	Send/read Calibration marker ON
		0065	0000 to 0255	Send/read reference frequency (0000=0% to 0255=100%)
		0066	00 to 10	Send/read COMP level (00= Minimum to 10= Maximum)
0067	see p. 192	Send/read SSB RX HPF/LPF setting		
0068	00 to 10	Send/read SSB RX Tone (Bass) level (00=-5 to 10=+5)		
0069	00 to 10	Send/read SSB RX Tone (Treble) level (00=-5 to 10=+5)		
0070	00 to 10	Send/read SSB TX Tone (Bass) level (00=-5 to 10=+5)		
0071	00 to 10	Send/read SSB TX Tone (Treble) level (00=-5 to 10=+5)		
0072	see p. 192	Send/read SSB TX bandwidth for WIDE		

Cmd.	Sub cmd.	Data	Description		
1A	05	0073	see p. 192 Send/read SSB TX bandwidth for MID		
		0074	see p. 192 Send/read SSB TX bandwidth for NARROW		
		0075	see p. 192 Send/read AM RX HPF/LPF setting		
		0076	00 to 10	Send/read AM RX tone (Bass) level (00=-5 to 10=+5)	
		0077	00 to 10	Send/read AM RX Tone (Treble) level (00=-5 to 10=+5)	
		0078	00 to 10	Send/read AM TX tone (Bass) level (00=-5 to 10=+5)	
		0079	00 to 10	Send/read AM TX Tone (Treble) level (00=-5 to 10=+5)	
		0080	see p. 192	Send/read FM RX HPF/LPF setting	
		0081	00 to 10	Send/read FM RX tone (Bass) level (00=-5 to 10=+5)	
		0082	00 to 10	Send/read FM RX Tone (Treble) level (00=-5 to 10=+5)	
		0083	00 to 10	Send/read FM TX tone (Bass) level (00=-5 to 10=+5)	
		0084	00 to 10	Send/read FM TX Tone (Treble) level (00=-5 to 10=+5)	
		0085	see p. 192	Send/read DV RX HPF/LPF setting	
		0086	00 to 10	Send/read DV RX tone (Bass) level (00=-5 to 10=+5)	
		0087	00 to 10	Send/read DV RX Tone (Treble) level (00=-5 to 10=+5)	
		0088	00 to 10	Send/read DV TX tone (Bass) level (00=-5 to 10=+5)	
		0089	00 to 10	Send/read DV TX Tone (Treble) level (00=-5 to 10=+5)	
		0090	see p. 192	Send/read CW RX HPF/LPF setting	
		0091	see p. 192	Send/read RTTY RX HPF/LPF setting	
		0092	00	Send/read Normal selection for contest number style	
			01	Send/read "190 → ANO" selection for contest number style	
			02	Send/read "190 → ANT" selection for contest number style	
			03	Send/read "90 → NO" selection for contest number style	
		0093	04	Send/read "90 → NT" selection for contest number style	
			01	Send/read M1 selection for count up trigger channel	
			02	Send/read M2 selection for count up trigger channel	
			03	Send/read M3 selection for count up trigger channel	
		0094	04	Send/read M4 selection for count up trigger channel	
			0001 to 9999	Send/read present number (0001=1 to 9999=9999)	
			0095	0000 to 0255	Send/read CW sidetone gain (0000=0% to 0255=100%)
			0096	00	Send/read CW sidetone gain limit OFF
		0097	01	Send/read CW sidetone gain limit ON	
01 to 60	Send/read CW keyer repeat time (01=1 sec. to 60=60 sec.)				
0098	00	Send/read Normal selection for message display			
	01	Send/read Message selection for message display			
0099	28 to 45	Send/read CW keyer dot/dash ratio (28=1:1:2.8 to 45=1:1:4.5)			
0100	00	Send/read 2 msec. selection for CW Rise time			
	01	Send/read 4 msec. selection for CW Rise time			
	02	Send/read 6 msec. selection for CW Rise time			
	03	Send/read 8 msec. selection for CW Rise time			

Cmd.	Sub cmd.	Data	Description
1A	05	0101	00 Send/read Normal selection for paddle polarity
			01 Send/read Reverse selection for paddle polarity
		0102	00 Send/read Straight selection for keyer type
			01 Send/read BUG-Key selection for keyer type
			02 Send/read ELEC-Key selection for keyer type
		0103	00 Send/read Mic. up/down keyer OFF
			01 Send/read Mic. up/down keyer ON
		0104	00 Send/read 1275 Hz selection for RTTY mark frequency
			01 Send/read 1615 Hz selection for RTTY mark frequency
			02 Send/read 2125 Hz selection for RTTY mark frequency
		0105	00 Send/read 170 Hz selection for RTTY shift width
			01 Send/read 200 Hz selection for RTTY shift width
			02 Send/read 425 Hz selection for RTTY shift width
		0106	00 Send/read Normal selection for RTTY keying polarity
			01 Send/read Reverse selection for RTTY keying polarity
		0107	00 Send/read RTTY decode USOS OFF
			01 Send/read RTTY decode USOS ON
		0108	00 Send/read "CR,LF,CR+LF" selection for RTTY decode new line code
			01 Send/read "CR+LF" selection for RTTY decode new line code
		0109	00 Send/read 2 lines selection for number of RTTY decoder line
			01 Send/read 3 lines selection for number of RTTY decoder line
		0110	00 Send/read Scan speed Low
			01 Send/read Scan speed High
		0111	00 Send/read Scan resume OFF
			01 Send/read Scan resume ON
		0112	00 Send/read OFF selection for MAIN DIAL function during a scan
			01 Send/read Up/Down selection for MAIN DIAL function during a scan
		0113	0000 to 0255 Send/read NB level (HF/50 MHz) (0000=0% to 0255=100%)
		0114	00 to 09 Send/read NB depth (HF/50 MHz) (00=1 to 09=10)
		0115	0000 to 0255 Send/read NB width (HF/50 MHz) (0000=1 to 0255=100)
		0116	0000 to 0255 Send/read NB level (144 MHz) (0000=0% to 0255=100%)
		0117	00 to 09 Send/read NB depth (144 MHz) (00=1 to 09=10)
0118	0000 to 0255 Send/read NB width (144 MHz) (0000=1 to 0255=100)		
0119	0000 to 0255 Send/read NB level (430 MHz) (0000=0% to 0255=100%)		
0120	00 to 09 Send/read NB depth (430 MHz) (00=1 to 09=10)		
0121	0000 to 0255 Send/read NB width (430 MHz) (0000=1 to 0255=100)		
0122	0000 to 0255 Send/read NB level (1200 MHz) (0000=0% to 0255=100%)		
0123	00 to 09 Send/read NB depth (1200 MHz) (00=1 to 09=10)		
0124	0000 to 0255 Send/read NB width (1200 MHz) (0000=1 to 0255=100)		

Cmd.	Sub cmd.	Data	Description	
1A	05	0125	0000 to 0255 Send/read VOX gain (0000=0% to 0255=100%)	
			0126 0000 to 0255 Send/read ANTI-VOX gain (0000=0% to 0255=100%)	
		0127	00 to 20 Send/read VOX delay time (00=0.0 sec. to 20=2.0 sec.)	
		0128	00 Send/read VOX voice delay OFF	
			01 Send/read Short selection for VOX voice delay	
			02 Send/read Mid selection for VOX voice delay	
		0129	00 Send/read Long selection for VOX voice delay	
			0130 0020 to 0130 Send/read BK-IN delay time (0020=2.0d to 0130=13.0d)	
		0130	0000 to 0255 Send/read MONITOR gain (0000=0% to 0255=100%)	
			0131	00 Send/read Standby Beep OFF
				01 Send/read ON-1 selection for Standby Beep
		0132	02 Send/read ON-2 selection for Standby Beep	
			0132	00 Send/read Auto Reply OFF
		01 Send/read Auto Reply ON		
		0133	00 Send/read PTT selection for DV Data TX	
			01 Send/read Auto selection for DV Data TX	
		0134	00 Send/read Auto selection for Digital Monitor	
			01 Send/read Digital selection for Digital Monitor	
			02 Send/read Analog selection for Digital Monitor	
		0135	00 Send/read Digital RPT Set OFF	
			01 Send/read Digital RPT Set ON	
		0136	00 Send/read RX Call Sign Auto Write OFF	
			01 Send/read Auto selection for RX Call Sign Auto Write	
		0137	00 Send/read RX RPT Call Sign Auto Write OFF	
			01 Send/read Auto selection for RX RPT Call Sign Auto Write	
		0138	00 Send/read DV Auto Detect OFF	
			01 Send/read DV Auto Detect ON	
		0139	00 Send/read Call Sign Edit Record OFF	
			01 Send/read Select selection for Call Sign Edit Record	
			02 Send/read Auto selection for Call Sign Edit Record	
		0140	00 Send/read Gateway Auto Set OFF	
			01 Send/read Auto selection for Gateway Auto Set	
0141	00 Send/read ALL selection for RX Record (RPT)			
	01 Send/read Latest Only selection for RX Record (RPT)			
0142	00 Send/read RX Call Sign Auto Display OFF			
	01 Send/read Auto selection for RX Call Sign Auto Display			
0143	00 Send/read TX Call Sign Display OFF			
	01 Send/read UR selection for TX Call Sign Display			
	02 Send/read MY selection for TX Call Sign Display			
0144	00 Send/read RX Message Display OFF			
	01 Send/read Auto selection for RX Message Display			
0145	00 Send/read Scrolling speed slow			
	01 Send/read Scrolling speed fast			

## ◇ Command table (continued)

Cmd.	Sub cmd.	Data	Description		
1A	05	0146	00	Send/read DR Call Sign Popup OFF	
			01	Send/read DR Call Sign Popup ON	
		0147	00	Send/read Opening Call Sign OFF	
			01	Send/read Opening Call Sign ON	
		0148	00	Send/read BK function OFF	
			01	Send/read BK function ON	
		0149	00	Send/read EMR mode OFF	
			01	Send/read EMR mode ON	
		0150	0000 to 0255	Send/read EMR AF Level (0000=0% to 0255=100%)	
		0151	00	00	Send/read 4800 bps selection for GPS Receiver Baud
				01	Send/read 9600 bps selection for GPS Receiver Baud
		0152	00	00	Send/read ddd'mm.mm' selection for Position Format
				01	Send/read ddd'mm:ss" selection for Position Format
		0153	00	00	Send/read Meter selection for the displaying unit
				01	Send/read Feet/Mile selection for the displaying unit
		0154	00	00	Send/read North REF selection for compass direction
				01	Send/read South REF selection for compass direction
		0155	see p. 192	Send/read UTC Offset	
		0156	00	00	Send/read GPS Indicator OFF
				01	Send/read GPS Indicator ON
		0157	00	00	Send/read GPS selection for MY Position input method
				01	Send/read Manual selection for MY Position input method
		0158	see p. 192	Send/read my position information	
		0159	see p. 193	Send/read Alarm Area1	
		0160	00	00	Send/read Limited selection for Alarm Area2
				01	Send/read Extended selection for Alarm Area2
				02	Send/read Both selection for Alarm Area2
		0161	00	00	Send/read GPS Auto TX OFF
				01	Send/read 5 sec. selection for GPS Auto TX interval
				02	Send/read 10 sec. selection for GPS Auto TX interval
				03	Send/read 30 sec. selection for GPS Auto TX interval
				04	Send/read 1 min. selection for GPS Auto TX interval
				05	Send/read 3 min. selection for GPS Auto TX interval
06	Send/read 5 min. selection for GPS Auto TX interval				
07	Send/read 10 min. selection for GPS Auto TX interval				
0162	00	00	Send/read Disable selection for GPS TX Mode		
		01	Send/read GPS selection for GPS TX Mode		
		02	Send/read GPS-A selection for GPS TX Mode		
0163	00	00	Send/read GPS Sentence (RMC) OFF		
		01	Send/read GPS Sentence (RMC) ON		
0164	00	00	Send/read GPS Sentence (GGA) OFF		
		01	Send/read GPS Sentence (GGA) ON		

Cmd.	Sub cmd.	Data	Description		
1A	05	0165	00	Send/read GPS Sentence (GLL) OFF	
			01	Send/read GPS Sentence (GLL) ON	
		0166	00	Send/read GPS Sentence (GSA) OFF	
			01	Send/read GPS Sentence (GSA) ON	
		0167	00	Send/read GPS Sentence (VTG) OFF	
			01	Send/read GPS Sentence (VTG) ON	
		0168	00	Send/read GPS Sentence (GSV) OFF	
			01	Send/read GPS Sentence (GSV) ON	
		0169	see p. 193	Send/read Unproto Address	
		0170	00	00	Send/read position data extension OFF
				01	Send/read Course/Speed selection for position data extension
		0171	00	00	Send/read Time Stamp OFF
				01	Send/read DHM selection for Time Stamp
		0172	00 to 16	00	Send/read HMS selection for Time Stamp
				01=Bus, 02=Fire Truck, 03=Bicycle, 04=Yacht, 05=Helicopter, 06=Small Aircraft, 07=Ship, 08=Car, 09=Motorcycle, 10=Balloon, 11=Jeep, 12=RV, 13=Truck, 14=Van, 15=House QTH(VHF), 16=Other)	
		0173	see p. 193	Send/read GPS-A Symbol Other	
		0174	00 to 16	Send/read GPS-A SSID (00=-, 01=(-), 02=-1 to 16, -15)	
		0175	see p. 193	Send/read Comment	
		0176	see p. 193	Send/read Comment (Extension)	
		0177	see p. 193	Send/read GPS TX Message	
		1B	06	06	see p. 193 Send/read DATA mode selection
				07	see p. 196 Send/read Satellite memory contents
				00	see p. 193 Send/read Repeater tone frequency
01	see p. 193 Send/read Tone squelch frequency				
02	see p. 193 Send/read DTCS code and polarity				
07	see p. 193 Send/read CSQ code (DV mode)				
1C	00			00	Send/read Transceiver's status (RX)
		01	Send/read Transceiver's status (TX)		
		01	00	Send/read Antenna tuner OFF (through)	
			01	Send/read Antenna tuner ON	
		02	Send/read Manual tuning selection		
02	00	Send/read Transmit frequency monitor check OFF			
	01	Send/read Transmit frequency monitor check ON			
1E	00	00	Read number of available TX frequency band		
		01	see p. 191 Read TX band edge frequencies		
		02	Read number of user-set TX frequency band		
		03	see p. 191 Send/read User-set TX band edge frequencies		
1F	00	00	see p. 193 Send/read DV MY call sign		
		01	see p. 194 Send/read DV TX call signs		
		02	see p. 194 Send/read DV TX message		
20	00	00	00*2	Send/read Auto DV RX Callsigns output OFF	
			01*2	Send/read Auto DV RX Callsigns output ON	
			01	see p. 194 Output DV RX Callsigns	
			02	see p. 194 Read DV RX Callsigns	
		01	00	00*2	Send/read Auto DV RX message output OFF
				01*2	Send/read Auto DV RX message output ON
				01	see p. 194 Output DV RX message
				02	see p. 194 Read DV RX message

Cmd.	Sub cmd.	Data	Description
20	02	00* <sup>2</sup>	Send/read Auto DV RX status output OFF
		01* <sup>2</sup>	Send/read Auto DV RX status output ON
	01	see p. 194	Output DV RX status
	02	see p. 194	Read DV RX status

\*<sup>1</sup> The counter can be inserted into only one channel.

\*<sup>2</sup> Output setting is automatically turned OFF after turning the power OFF, then ON.

## ◆ Data content description

### • Character code setting

Command : 1A 00, 1A 05 0169, 1A 05 0173,  
1A 05 0175, 1A 05 0176, 1A 05 0177,  
1F 02, 20 0001, 20 0002, 20 0101,  
20 0102

Character	ASCII code	Character	ASCII code
A–Z	41–5A	a–z	61–7A
0–9	30–39	Space	20
!	21	#	23
\$	24	%	25
&	26	\	5C
?	3F	"	22
'	27	`	60
^	5E	+	2B
–	2D	*	2A
/	2F	.	2E
,	2C	:	3A
;	3B	=	3D
<	3C	>	3E
(	28	)	29
[	5B	]	5D
{	7B	}	7D
!	7C	_	5F
-	7E	@	40

### • Operating frequency

Command : 00, 03, 05

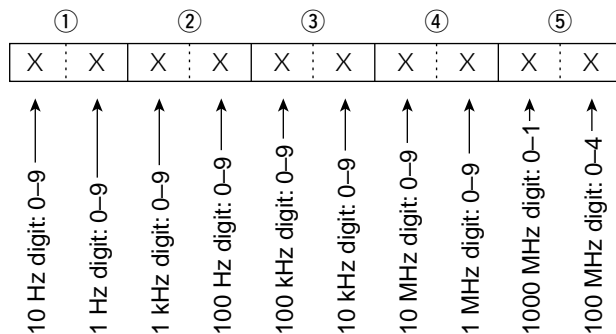

### • Operating mode

Command : 01, 04, 06

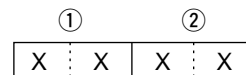

① Operating mode		② Filter setting	
00: LSB	03: CW	07: CW-R	01: FIL1
01: USB	04: RTTY	08: RTTY-R	02: FIL2
02: AM	05: FM	17: DV	03: FIL3

Filter setting (②) can be skipped with command 01 and 06. In that case, "FIL1" is automatically selected with command 01, and the default filter setting of the operating mode is automatically selected with command 06.

◇ Data content description (continued)

• **Band edge frequency setting**

Command 02\*, 1E 01, 1E 03

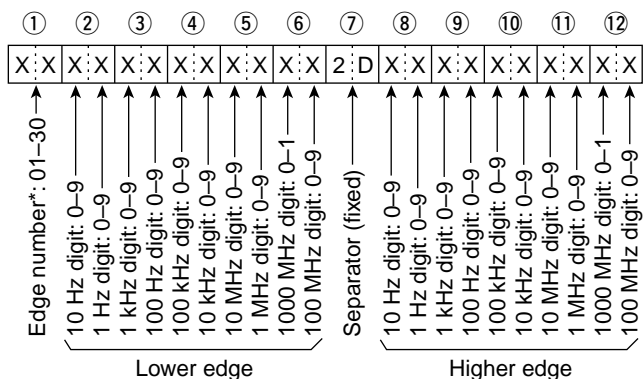

\* Edge number setting is not necessary with command 02.

• **Band stacking register**

Command : 1A 01

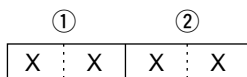

When sending the contents, the codes, such as operating frequency and operating mode\*, should be added after the register code, as shown below.  
\*See ⑤ to ⑮ on 'Memory content setting.' (p. 195)

① Frequency band code

Code	Freq. band	Frequency range (unit: MHz)
01	1.8	1.800000– 1.999999
02	3.5	3.400000– 4.099999
03	7	6.900000– 7.499999
04	10	9.900000–10.499999
05	14	13.900000–14.499999
06	18	17.900000–18.499999
07	21	20.900000–21.499999
08	24	24.400000–25.099999
09	28	28.000000–29.999999
10	50	50.000000–54.000000
11	VHF	108.000000–174.000000
12	UHF	420.000000–480.000000
13	1.2G	1240.000000–1320.000000
14	GENE	Other than above

② Register code

Code	Registered No.
01	1 (latest)
02	2
03	3 (oldest)

For example, when reading the oldest contents in the 21 MHz band, the code "0703" is used.

• **Memory keyer contents**

Command : 1A 02

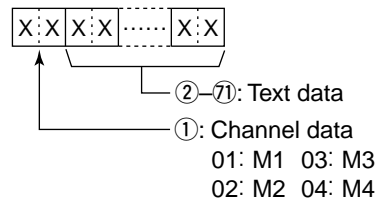

• **Character's code**

Character	ASCII code	Description
0–9	30–39	Number
A–Z	41–5A	Alphabetical characters
a–z	61–7A	Alphabetical characters
space	20	Word space
/	2F	Symbol
?	3F	Symbol
,	2C	Symbol
.	2E	Symbol
@	40	Symbol
^	5E	e.g., to send BT, enter ^BT
*	2A	Inserts contest number (can be used for 1 channel only)

• **CW message contents**

Command : 17

Set a CW message of up to 30 characters.

• **Character's code**

Character	ASCII code	Description
0–9	30–39	Number
A–Z	41–5A	Alphabetical characters
a–z	61–7A	Alphabetical characters
space	20	Word space
/	2F	Symbol
?	3F	Symbol
.	2E	Symbol
–	2D	Symbol
,	2C	Symbol
:	3A	Symbol
'	27	Symbol
(	28	Symbol
)	29	Symbol
=	3D	Symbol
+	2B	Symbol
"	22	Symbol
@	40	Symbol

• "FF" stops sending CW messages.  
• "^" is used to transmit a string of characters with no inter-character space.



• **Split offset frequency setting**

Command : 1A 05 0015

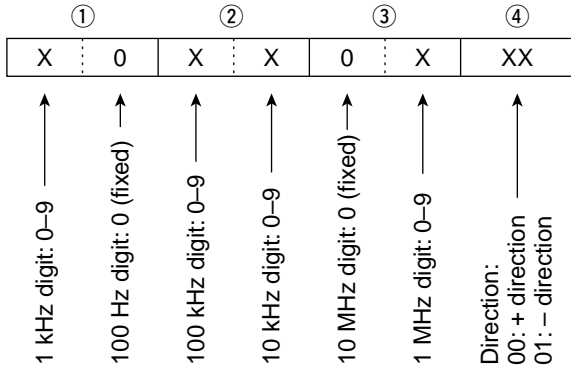

• **RX HPF and LPF settings in each operating mode**

Command : 1A 05 0067, 0075, 0080, 0085, 0090, 0091

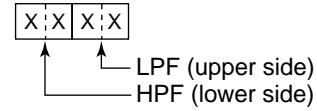

**HPF**  
00: through  
01 to 20: 100 to 2000 Hz

**LPF**  
05 to 24: 500 to 2400 Hz  
25: through

Set the LPF value larger than HPF one.

• **Duplex Offset frequency setting**

Command : 1A 05 0017

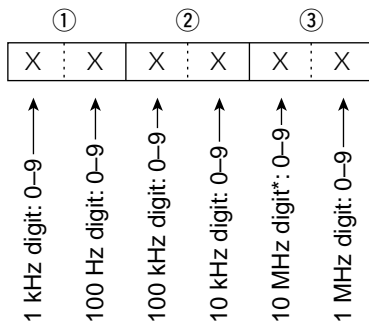

\*10 MHz digit can be entered on only the 1200 MHz frequency band.

• **UTC Offset setting**

Command : 1A 05 0155

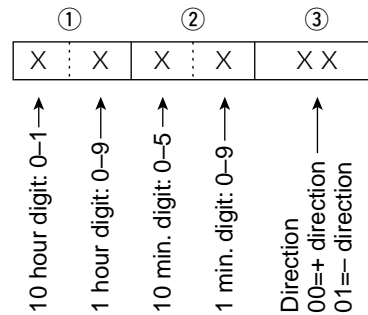

• **SSB transmission bandwidth setting**

Command : 1A 05 0072, 0073, 0074

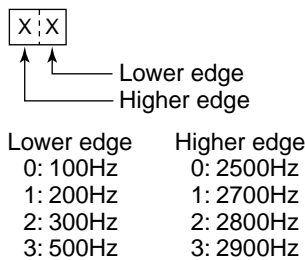

• **My position data setting**

Command : 1A 05 0158

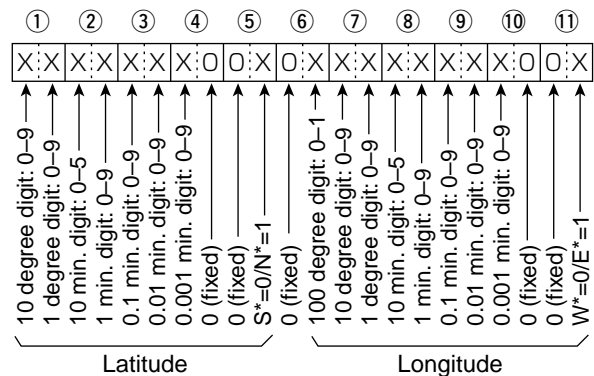

\*S: South latitude N: North latitude  
W: West longitude E: East longitude

◇ Data content description (continued)

• **Alarm area 1 setting**

Command : 1A 05 0159

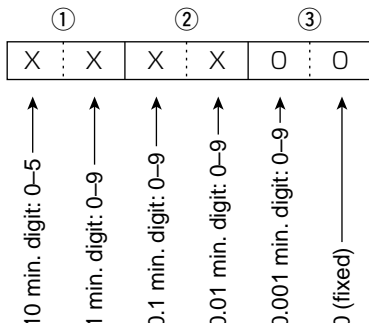

• **Unproto Address setting**

Command : 1A 05 0169

Set an unproto address of up to 56 characters.  
See 'Character code setting.' (p. 190)

• **GPS-A Symbol setting**

Command : 1A 05 0173

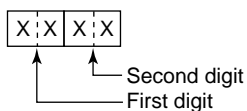

/, \, 0 to 9, A to Z can be used for the first digit character.

See 'Character code setting' for the second digit character. (p. 190)

• **Comment setting**

Command : 1A 05 0175

Set a comment of up to 43 characters.  
See 'Character code setting.' (p. 190)

• **Comment (Extension) setting**

Command : 1A 05 0176

Set a comment of up to 36 characters.  
See 'Character code setting.' (p. 190)

• **GPS message setting**

Command : 1A 05 0177

Set a GPS message of up to 20 characters.  
See 'Character code setting.' (p. 190)

• **Data mode with filter width setting**

Command : 1A 06

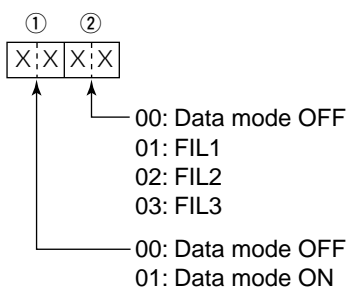

• **Repeater tone/tone squelch frequency setting**

Command : 1B 00, 1B 01

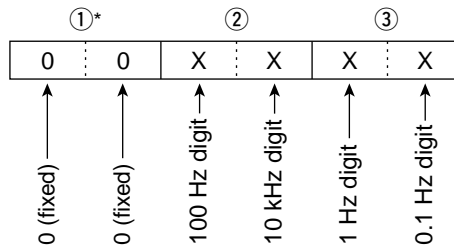

\*Not necessary when setting a frequency.

• **DTCS code and polarity setting**

Command : 1B 02

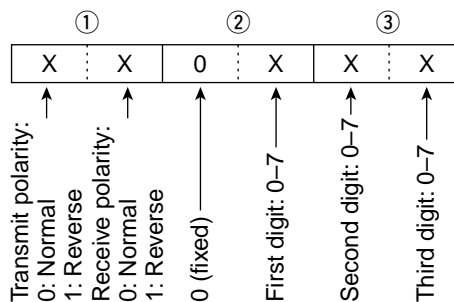

• **Digital code squelch setting**

Command : 1B 07

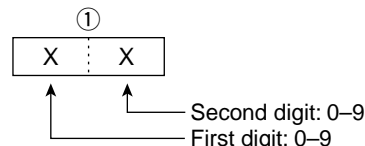

• **DV MY call sign setting**

Command : 1F 00

Set your own call sign and note of up to 12 characters.

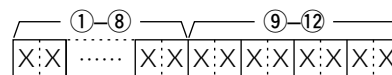

①-⑧ Your own call sign setting

⑨-⑫ Note setting

### • DV TX call signs setting

Command : 1F 01

Set "UR," "R1" and "R2" call signs of 8 characters (fixed).

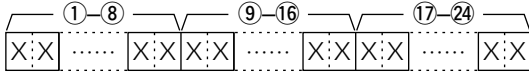

- ①–⑧ UR (Destination) call sign setting
- ⑨–⑯ R1 (Access/Area repeater) call sign setting
- ⑰–⑳ R2 (Link/Gateway repeater) call sign setting

• Character's code of the call sign

Character	ASCII code	Character	ASCII code
0–9	30–39	A–Z	41–5A
Space	20	/	2F

### • DV TX message setting

Command : 1F 02

Set the transmit message of up to 20 characters.  
See 'Character code setting.' (p. 190)

⚡ "FF" stops sending or reading messages.

### • DV RX Status setting

Command : 20 0201, 20 0202

Data	Status	Description
Bit 7	0	—
6	0/1	Receiving a voice call During receiving a digital voice signal, select "1." (Regardless of DSQL and CSQL setting)
5	0/1	Last call finisher When the last call was finished by you, select "1."
4	0/1	Receiving a signal When the audio tone can be heard, select "1."
3	0/1	Receiving a BK call During receiving a BK call, select "1."
2	0/1	Receiving a EMR call During receiving a EMR call, select "1."
1	0/1	Receiving a signal other than DV When "DV" and "FM" are blinking, select "1."
0	0/1	Packet loss status During displaying a packet loss

### • DV RX message setting

Command : 20 0101, 20 0102

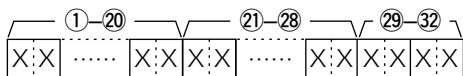

- ①–⑳ RX message (20 characters; fixed)
- ㉑–㉘ Call sign of the calling station (8 characters; fixed)
- ㉙–㉚ Note of the calling station (4 characters; fixed)

See 'Character code setting.' (p. 190)

⚡ "FF" stands for no message receiving after turning ON the transceiver.

### • DV RX call sign setting

Command : 20 0001, 20 0002

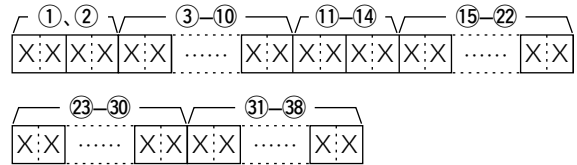

① Header flag data (First byte)

Data		Description
Bit		
7	0 (fixed)	—
6	0 (fixed)	—
5	0 (fixed)	—
4	0/1	0= Voice, 1= Data
3	0/1	0= Direct, 1= Through repeater
2	0/1	0= No Break-in, 1= Break-in
1	0/1	0= Data, 1= Control
0	0/1	0= Normal, 1= Emergency

② Header flag data (Second byte)

Data			Function
Bit 2	Bit 1	Bit 0	
1	1	1	Repeater control
1	1	0	Send auto acknowledge
1	0	1	(Not used)
1	0	0	Request to re-transmit
0	1	1	Send acknowledge
0	1	0	Receive no reply
0	0	1	Repeater disabled
0	0	0	NULL

- ③–⑩ Call sign of the calling station (8 characters; fixed)
- ⑪–⑭ Note of the calling station (4 characters; fixed)
- ⑮–⑳ Call sign of the station that was called (8 characters; fixed)
- ㉑–㉘ Call sign of the access/area repeater (R1) (8 characters; fixed)
- ㉙–㉚ Call sign of the link/gateway repeater (R2) (8 characters; fixed)

See 'Character code setting.' (p. 190)

⚡ "FF" stands for no call sign receiving after turning ON the transceiver.

◇ Data content description (continued)

• **Memory content setting**

Command : 1A 00

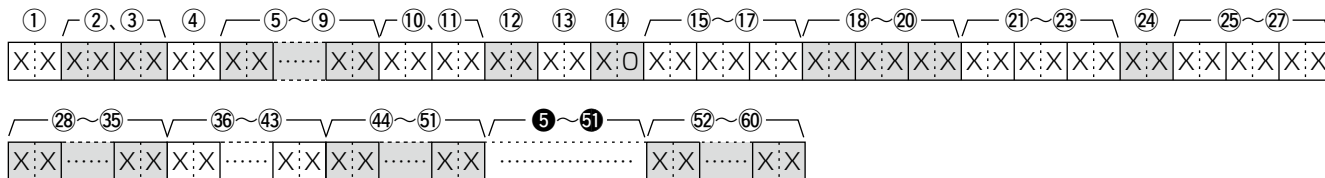

① Frequency band setting

- 00 : HF/50 MHz frequency band
- 01 : 144 MHz frequency band
- 02 : 430 MHz frequency band
- 03 : 1200 MHz frequency band

②, ③ Memory channel number

- 0001–0099 : Memory channel 1 to 99
- 0100 : Programmed scan edge 1A
- 0101 : Programmed scan edge 1b
- 0102 : Programmed scan edge 2A
- 0103 : Programmed scan edge 2b
- 0104 : Programmed scan edge 3A
- 0105 : Programmed scan edge 3b
- 0106 : Call channel

④ Split and Select memory settings

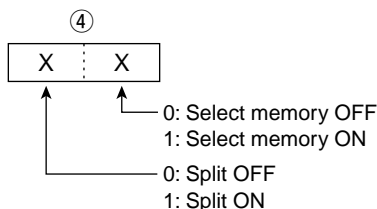

When the program channel is selected, both settings should be “0.”

When the Call channel is selected, the Select memory setting should be “0.”

⑤–⑨ Operating frequency setting

See ‘• Operating frequency.’ (p. 190)

⑩, ⑪ Operating mode setting

See ‘• Operating mode.’ (p. 190)

⑫ **Data mode setting**

- 1 byte data (XX)
- 00: Data mode OFF
- 01: Data mode ON

⑬ Duplex and Tone settings

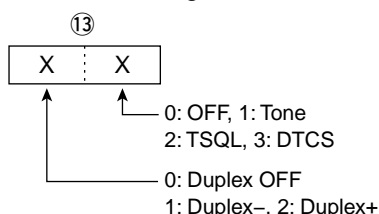

⑭ Digital squelch setting

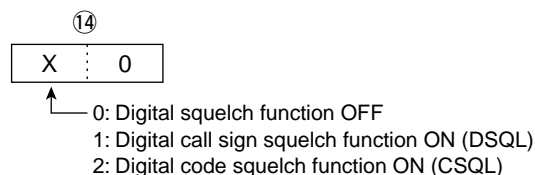

⑮–⑰ Repeater tone frequency setting

⑱–⑳ Tone squelch frequency setting

See ‘• Repeater tone/tone squelch frequency setting.’ (p. 193)

㉑–㉓ DTCS code setting

See ‘• DTCS code and polarity setting.’ (p. 193)

㉔ Digital code squelch setting

See ‘• Digital code squelch setting.’ (p. 193)

㉕–㉗ Duplex offset frequency setting

See ‘• Duplex Offset frequency setting.’ (p. 192)

㉘–㉙ Destination call sign setting (8 characters; fixed)

㉚–㉛ R1 (Access/Area repeater) call sign setting (8 characters; fixed)

㉜–㉝ R2 (Link/Gateway repeater) call sign setting (8 characters; fixed)

See ‘• DV TX call signs setting.’ (p. 194)

㉞–㉟ Memory name setting

9 characters (Fixed)

See ‘• Character code setting.’ (p. 190)

**About clearing operation:**

“1A 00” command with the format as below clears the data of the selected memory channel.

②, ③ : Memory channel 0 to 99

④ : FF

⑤ or later : None

**NOTE:**

- The same data as ⑤–⑤① are stored in ⑤–⑤①.
- When the Split function is ON, the data of ⑤–⑤① is used for transmit.
- Even if the Split function is OFF, enter the data into ⑤–⑤① to match your transceiver. We recommend that you set the same data as ⑤–⑤①.

• **Satellite memory content setting**

Command : 1A 07

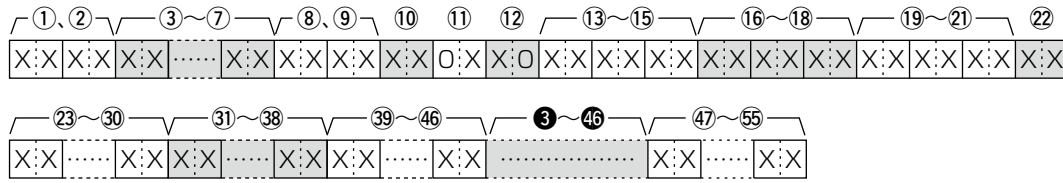

①, ② Satellite memory channel number  
0000–0019 : Satellite memory channel 00 to 19

③–⑦ Operating frequency setting  
See ‘• Operating frequency.’ (p. 190)

⑧, ⑨ Operating mode setting  
See ‘• Operating mode.’ (p. 190)

⑩ Data mode setting  
1 byte data (XX)  
00: Data mode OFF  
01: Data mode ON

⑪ Tone setting

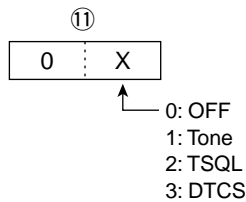

⑫ Digital squelch setting

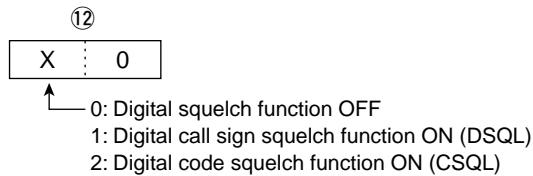

⑬–⑮ Repeater tone frequency setting  
⑯–⑰ Tone squelch frequency setting  
See ‘• Repeater tone/tone squelch frequency setting.’ (p. 193)

⑱–⑲ DTCS code setting  
See ‘• DTCS code and polarity setting.’ (p. 193)

⑳ Digital code squelch setting  
See ‘• Digital code squelch setting.’ (p. 193)

㉓–⑳ Destination call sign setting  
(8 characters; fixed)  
㉕–㉘ R1 (Access/Area repeater) call sign setting  
(8 characters; fixed)  
㉙–㉚ R2 (Link/Gateway repeater) call sign setting  
(8 characters; fixed)  
See ‘• DV TX call signs setting.’ (p. 194)

⑳–㉚ Memory name setting  
9 characters (Fixed)  
See ‘• Character code setting.’ (p. 190)

**NOTE:**  
• The same data as ③–⑳ are stored in ㉓–㉚.  
• ㉓–㉚ is used for the uplink frequency (transmit).  
• ㉓–㉚ is used for the downlink frequency (receive).

## ■ General

- Frequency coverage : (unit: MHz)
  - Receive
    - 0.030–60.000<sup>\*1\*2</sup>
    - 136.000–174.000<sup>\*1\*2</sup>
    - 420.000–480.000<sup>\*1\*2</sup>
    - 1240.000–1320.000<sup>†</sup>
  - Transmit
    - 1.800–1.999<sup>\*2</sup>, 3.500–3.999<sup>\*2</sup>,
    - 5.33050<sup>\*3</sup>, 5.34650<sup>\*3</sup>, 5.36650<sup>\*3</sup>,
    - 5.37150<sup>\*3</sup>, 5.40350<sup>\*3</sup>,
    - 7.000–7.300<sup>\*2</sup>, 10.100–10.150<sup>\*2</sup>,
    - 14.000–14.350<sup>\*2</sup>, 18.068–18.168<sup>\*2</sup>,
    - 21.000–21.450<sup>\*2</sup>, 24.890–24.990<sup>\*2</sup>,
    - 28.000–29.700<sup>\*2</sup>, 50.000–54.000<sup>\*2</sup>,
    - 144.000–148.000<sup>\*2</sup>, 430.000–450.000<sup>\*2</sup>
    - 1240.000–1300.000<sup>†</sup>
- <sup>\*1</sup>Some frequency bands are not guaranteed.
- <sup>\*2</sup>Depending on version. <sup>\*3</sup>USA version only.
- Mode : USB, LSB, CW, RTTY, AM, FM, DV<sup>\*</sup>
  - <sup>\*</sup>The optional UT-121 is required.
- No. of memory channels : 297CH (99CH × 3 band)  
(396CH with UX-9100<sup>†</sup>; 99CH × 4 bands)
- No. of scan edge memory channels : 18CH (6 × 3 band)  
(24CH with UX-9100<sup>†</sup>; 6CH × 4 bands)
- No. of call channels : 3CH (1 × 3 band)  
(4CH with UX-9100<sup>†</sup>; 1CH × 4 bands)
- No. of Satellite memory channels : 20CH
- Antenna connector : SO-239 × 3  
Type-N × 2
- Antenna impedance : 50 Ω (at Antenna Tuner OFF)
- Usable temperature range : 0°C to +50°C (+32°F to +122°F)
- Frequency stability : Less than ±0.5 ppm 5 min. after power ON. (0°C to +50°C; +32°F to +122°F)
- Frequency resolution : 1 Hz
- Power supply : 13.8 V DC ±15% (negative ground)
- Power consumption
  - Transmit
    - Max. power : 24.0 A (HF/50/144/430 MHz band)  
9.0 A (1200 MHz band)<sup>†</sup>
  - Receive
    - Standby : 3.0 A (HF/50/144/430 MHz band)  
4.0 A (1200 MHz band)<sup>†</sup>
    - Max. audio : 4.5 A (HF/50/144/430 MHz band)  
5.5 A (1200 MHz band)<sup>†</sup>
- Dimensions : 315(W) × 116(H) × 343(D) mm  
(projections not included) 12.4(W) × 4.57(H) × 13.5(D) in
- Weight (approximately) : 11.0 kg; 24.2 lb  
11.95 kg; 26.3 lb (with UX-9100)
- ACC connector : 13-pin
- CI-V connector : 2-conductor 3.5 (d) mm (1/8")

## ■ Transmitter

- Output power (continuously adjustable)

Frequency band	Output power
HF/50 MHz	2 to 100 W (AM: 2 to 30 W)*
144 MHz	2 to 100 W
430 MHz	2 to 75 W
1200 MHz <sup>†</sup>	1 to 10 W

(at 13.8 V DC/+25°C)

\* In the AM mode, transmission can be performed only on the HF/50 MHz frequency band.

- Modulation system
  - SSB : Digital PSN modulation
  - AM : Digital Low power modulation
  - FM : Digital Phase modulation
  - DV<sup>\*</sup> : GMSK Digital Phase modulation
- <sup>\*</sup>The optional UT-121 is required.
- Spurious emission (Spurious domain)
  - HF bands : Less than -50 dB
  - 50/144 MHz band : Less than -63 dB
  - 430 MHz band : Less than -61.8 dB
  - 1200 MHz band<sup>†</sup> : Less than -53 dB
- (Out-of-band domain)
  - HF bands : Less than -40 dB
  - 50/144/430 MHz band : Less than -60 dB
  - 1200 MHz band<sup>†</sup> : Less than -50 dB
- Carrier suppression : More than 40 dB
- Unwanted sideband suppression : More than 55 dB  
(1200 MHz: More than 40 dB)<sup>†</sup>
- ΔTX variable range : ±9.999 kHz
- Microphone connector : 8-pin connector
- Microphone impedance : 600 Ω
- ELEC-KEY connector : 3-conductor 6.35(d) mm (1/4")
- KEY connector : 3-conductor 6.35(d) mm (1/4")
- SEND connector : Phono jack (RCA)
- ALC connector : Phono jack (RCA)

<sup>†</sup> The optional UX-9100 is required for 1200 MHz frequency band operation.

<sup>‡</sup> Only when the 1200 MHz frequency band is selected.

## Receiver

- Receive system
  - HF/50/144/430 MHz band: Double superheterodyne system
  - 1200 MHz band<sup>†</sup> : Triple superheterodyne system
- Intermediate frequencies
  - 1st : 64.455 MHz (HF/50 MHz band)  
10.850 MHz (144 MHz band)  
71.250 MHz (430 MHz band)  
243.950 MHz (1200 MHz band)<sup>†</sup>
  - 2nd : 36 kHz (HF/50/144/430 MHz)  
10.950 MHz (1200 MHz)<sup>†</sup>
  - 3rd : 36 kHz (1200 MHz)<sup>†</sup>
- Sensitivity
  - SSB, CW : 0.16  $\mu$ V (1.80–29.99 MHz)<sup>\*1</sup>  
(10 dB S/N) BW=2.4 kHz 0.13  $\mu$ V (50.0–54.0 MHz)<sup>\*2</sup>  
0.11  $\mu$ V (144/430/1200<sup>†</sup> MHz)
  - AM (10 dB S/N) : 12.6  $\mu$ V (0.5–1.799 MHz)<sup>\*1</sup>  
BW=6 kHz 2.0  $\mu$ V (1.80–29.99 MHz)<sup>\*1</sup>  
1.6  $\mu$ V (50.0–54.0 MHz)<sup>\*2</sup>  
1.4  $\mu$ V (144/430 MHz)
  - FM (12 dB SINAD) : 0.5  $\mu$ V (28.0–29.7 MHz)<sup>\*1</sup>  
BW=15 kHz 0.32  $\mu$ V (50.0–54.0 MHz)<sup>\*2</sup>  
0.18  $\mu$ V (144/430/1200<sup>†</sup> MHz)
  - DV (1% BER) : 1.0  $\mu$ V (28.0–29.7 MHz)<sup>\*1</sup>  
CH Space=12.5 kHz 0.63  $\mu$ V (50.0–54.0 MHz)<sup>\*2</sup>  
0.35  $\mu$ V (144/430/1200<sup>†</sup> MHz)
- Squelch sensitivity

Frequency band	Squelch sensitivity
HF	SSB : Less than 5.6 $\mu$ V <sup>*1</sup>
	FM : Less than 0.3 $\mu$ V <sup>*1</sup>
50 MHz	SSB : Less than 5.6 $\mu$ V <sup>*2</sup>
	FM : Less than 0.3 $\mu$ V <sup>*2</sup>
144/430 MHz	SSB : Less than 1.0 $\mu$ V
	FM : Less than 0.18 $\mu$ V
1200 MHz <sup>†</sup>	SSB : Less than 1.0 $\mu$ V
	FM : Less than 0.18 $\mu$ V

\*1 Preamp 1 is ON. \*2 Preamp 2 is ON.

- Selectivity (IF filter shape is set to SHARP)
  - SSB (BW: 2.4 kHz) : More than 2.4 kHz/–6 dB  
Less than 3.4 kHz/–40 dB
  - CW (BW: 500 Hz) : More than 500 Hz/–6 dB  
Less than 700 Hz/–40 dB
  - RTTY (BW: 500 Hz) : More than 500 Hz/–6 dB  
Less than 800 Hz/–40 dB
  - AM (BW: 6 kHz) : More than 6.0 kHz/–6 dB  
Less than 10.0 kHz/–40 dB
  - FM (BW: 15 kHz) : More than 12.0 kHz/–6 dB  
Less than 22.0 kHz/–40 dB
  - DV (CH space: 12.5 kHz): More than –50 dB
- Spurious and image rejection ratio
  - HF/50 MHz band\* : More than 70 dB  
\*except IF through on 50 MHz band
  - 144/430 MHz band : More than 60 dB
  - 1200 MHz band<sup>†</sup> : More than 50 dB
- AF output power : More than 2.0 W at 10%  
(at 13.8 V DC) distortion with an 8  $\Omega$  load
- AF output impedance : 8  $\Omega$
- RIT variable range :  $\pm$ 9.999 kHz

- PHONES connector : 3-conductor 6.35 (d) mm (<sup>1</sup>/<sub>4</sub>"
- External SP connector : 2-conductor 3.5 (d) mm  
(<sup>1</sup>/<sub>8</sub>")/8  $\Omega$
- DSP ANF attenuation : More than 30 dB  
(with 1 kHz single tone)
- DSP MNF attenuation : More than 70 dB
- DSP NR attenuation : More than 6 dB  
(noise rejection in SSB)

## Antenna tuner

- Matching impedance range
  - HF bands : 16.7 to 150  $\Omega$  unbalanced  
(Less than VSWR 1:3)
  - 50 MHz band : 20 to 125  $\Omega$  unbalanced  
(Less than VSWR 1:2.5)
- Minimum operating input power : 8 W (HF bands)  
15 W (50MHz band)
- Tuning accuracy : VSWR 1:1.5 or less
- Insertion loss : Less than 1.0 dB  
(after tuning at RF power 100 W)

All stated specifications are typical and subject to change without notice or obligation.

## IC-PW1/EURO HF/50 MHz ALL BAND 1 kW LINEAR AMPLIFIER



Full-duty 1 kW linear amplifier including an automatic antenna tuner. Has automatic tuning and band selection capability. Full break-in (QSK) operation is possible. The amplifier/power supply unit and the remote control unit can be separated. The optional OPC-599 ADAPTER CABLE is required for connection.

## AH-4 HF AUTOMATIC ANTENNA TUNER



Specially designed to tune a long wire antenna for the HF/50 MHz bands, particularly in portable or mobile operation. The "PTT tune" function provides simple operation.

- Input power rating: 120 W

## PS-126 DC POWER SUPPLY



- Output voltage : 13.8 V DC
- Max. output current : 25 A

## SP-23 EXTERNAL SPEAKER



- 4 audio filters; headphone jack; can connect to 2 transceivers.
- Input impedance: 8  $\Omega$
  - Max. input power: 4 W

## AH-2b ANTENNA ELEMENT



A 2.5 m long antenna element for mobile operation with the AH-4.

- Frequency coverage 7–54 MHz band with the AH-4

## SP-21 EXTERNAL SPEAKER



Designed for base station operation.

- Input impedance: 8  $\Omega$
- Max. input power: 5 W

## SM-30 DESKTOP MICROPHONE



Unidirectional, electret microphone for base station operation. Includes a low cut switch and mic gain control.

## SM-50 DESKTOP MICROPHONE



Unidirectional, dynamic microphone for base station operation. Includes [UP]/[DOWN] switches, a low cut switch and mic gain control.

## HM-36 HAND MICROPHONE



Hand microphone equipped with [UP]/[DOWN] switches. The same as that attached with the transceiver.

## UX-9100 1200 MHz BAND UNIT



Allows you additional all mode operation on the 1200 MHz frequency band.

## FL-430 1ST IF FILTER (6 kHz)

## FL-431 1ST IF FILTER (3 kHz)

(Both filters are for HF/50 MHz Band)



These filters reduce interference from strong nearby signals.



**CT-17** CI-V LEVEL CONVERTER UNIT



For remote transceiver control using a personal computer equipped with an RS-232C port. You can change frequencies, operating mode, memory channels, etc., via your computer.

- **AG-25** WEATHER-PROOF PREAMPLIFIER (for 144 MHz Band)
  - **AG-35** WEATHER-PROOF PREAMPLIFIER (for 430 MHz Band)
- External all-weather, mast mounting preamplifiers for compensating for coaxial cable loss.

- **AG-2400** DOWN CONVERTER UNIT
- All-weather, satellite down converter with superior NF and gain.
- Input frequency : 2400–2402 MHz  
Output frequency : 144–146 MHz  
Conversion gain : More than 25 dB  
Total NF : Less than 1.5 dB

- **OPC-1529R** DATA COMMUNICATION CABLE (RS-232C type)
- Allows low-speed data communication in the DV mode, and receiving a GPS data from a third-party GPS receiver.

- **OPC-599** ADAPTER CABLE
- 13-pin, ACC connector to 7-pin + 8-pin ACC connector.

- **MB-123** CARRYING HANDLE
- Convenient when carrying the transceiver.  
The same as that attached with the transceiver.

- **UT-121** DIGITAL UNIT
- Allows the DV mode operation with the IC-9100.

- **CS-9100** CLONING SOFTWARE
- Use this software to program settings, memory channels and set mode contents quickly and easily via your PC's USB port.  
A USB cable is required. (A-B type, purchase separately)

- **RS-BA1** IP REMOTE CONTROL SOFTWARE
- /// To remotely control radios using the RS-BA1, **BE SURE** that you comply with your local regulations.

Approved Icom optional equipment is designed for optimal performance when used with an Icom transceiver.

Icom is not responsible for the destruction or damage to an Icom transceiver in the event the Icom transceiver is used with equipment that is not manufactured or approved by Icom.

## INSTALLATION NOTES

For amateur base station installations it is recommended that the forward clearance in front of the antenna array is calculated relative to the EIRP (Effective Isotropic Radiated Power). The clearance height below the antenna array can be determined in most cases from the RF power at the antenna input terminals.

As different exposure limits have been recommended for different frequencies, a relative table shows a guideline for installation considerations.

Below 30 MHz, the recommended limits are specified in terms of V/m or A/m fields as they are likely to fall within the near-field region. Similarly, the antennas may be physically short in terms of electrical length and that the installation will require some antenna matching device which can create local, high intensity magnetic fields. Analysis of such MF installations is best considered in association with published guidance notes such as the FCC OET Bulletin 65 Edition 97-01 and its annexes relative to amateur transmitter installations.

The EC recommended limits are almost identical to the FCC specified 'uncontrolled' limits and tables exist that show pre-calculated safe distances for different antenna types for different frequency bands. Further information can be found at <http://www.arrl.org/>.

### • Typical amateur radio installation

Exposure distance assumes that the predominant radiation pattern is forward and that radiation vertically downwards is at unity gain (sidelobe suppression is equal to main lobe gain). This is true of almost every gain antenna today. Exposed persons are assumed to be beneath the antenna array and have a typical height of 1.8 m.

The figures assume the worst case emission of a constant carrier.

For the bands 10 MHz and higher the following power density limits have been recommended:

10–400 MHz    2 W/sq m  
435 MHz    2.2 W/sq m

### EIRP clearance heights by frequency band

Watts	10–2 m	70 cm	23 cm	13 cm and above
1	2.1 m	2 m	2 m	2 m
10	2.8 m	2.7 m	2.5 m	2.3 m
25	3.4 m	3.3 m	2.7 m	2.5 m
100	5 m	4.7 m	3.6 m	3.2 m
1000	12 m	11.5 m	7.3 m	6.3 m

### Forward clearance, EIRP by frequency band

Watts	10–2 m	70 cm	23 cm	13 cm and above
100	2 m	2 m	1.1 m	0.7 m
1,000	6.5 m	6 m	3.5 m	3 m
10,000	20 m	18 m	11 m	7 m
100,000	65 m	60 m	35 m	29 m

In all cases any possible risk depends on the transmitter being activated for long periods. (actual recommendation limits are specified as an average during 6 minutes) Normally the transmitter is not active for long periods of time. Some radio licenses will require that a timer circuit automatically cuts off the transmitter after 1–2 minutes etc.

Similarly some modes of transmission, SSB, CW, AM etc. have a lower 'average' output power and the assessed risk is even lower.

 Versions of the IC-9100 which display the "CE" symbol on the serial number label, comply with the essential requirements of the European Radio and Telecommunication Terminal Directive 1999/5/EC.

 This warning symbol indicates that this equipment operates in non-harmonised frequency bands and/or may be subject to licensing conditions in the country of use. Be sure to check that you have the correct version of this radio or the correct programming of this radio, to comply with national licensing requirement.

### • List of Country codes (ISO 3166-1)

	Country	Codes		Country	Codes
1	Austria	AT	18	Liechtenstein	LI
2	Belgium	BE	19	Lithuania	LT
3	Bulgaria	BG	20	Luxembourg	LU
4	Croatia	HR	21	Malta	MT
5	Czech Republic	CZ	22	Netherlands	NL
6	Cyprus	CY	23	Norway	NO
7	Denmark	DK	24	Poland	PL
8	Estonia	EE	25	Portugal	PT
9	Finland	FI	26	Romania	RO
10	France	FR	27	Slovakia	SK
11	Germany	DE	28	Slovenia	SI
12	Greece	GR	29	Spain	ES
13	Hungary	HU	30	Sweden	SE
14	Iceland	IS	31	Switzerland	CH
15	Ireland	IE	32	Turkey	TR
16	Italy	IT	33	United Kingdom	GB
17	Latvia	LV			



## DECLARATION OF CONFORMITY

We Icom Inc. Japan  
1-1-32, Kamiminami, Hirano-ku  
Osaka 547-0003, Japan



Declare on our sole responsibility that this equipment complies with the essential requirements of the Radio and Telecommunications Terminal Equipment Directive, 1999/5/EC, and that any applicable Essential Test Suite measurements have been performed.

Bad Soden 11th Jan. 2011  
Place and date of issue

**Kind of equipment:** HF/VHF/UHF TRANSCEIVER

Icom (Europe) GmbH  
Communication Equipment  
Auf der Krautweide 24,  
65812 Bad Soden am Taunus,  
Germany

**Type-designation:** IC-9100

Authorized representative name

**Version (where applicable):**

This compliance is based on conformity with the following harmonised standards, specifications or documents:

Y. Furukawa  
General Manager

- i) EN 301 489-1 v1.6.1 (September 2005)
- ii) EN 301 489-15 v1.2.1 (August 2002)
- iii) EN 301 783-2 v1.1.1 (September 2000)
- iv) EN 60950-1 2006 A11: 2009
- v) \_\_\_\_\_
- vi) \_\_\_\_\_

Signature

Icom Inc.

**About AG-25, AG-35 and AG-1200 preamplifiers:**

The use of IC-9100 (#03, #04, #05, #06, #11) in combination with AG-25, AG-35 and/or AG-1200 preamplifiers do not comply with the European Harmonised Standard regulations. Please do not use the IC-9100 with these preamplifiers (AG-25, AG-35 and/or AG-1200) intended for the US, Asian, Oceanian and African markets.

Count on us!

Downloaded by  
RadioAmateur.EU

IC-9100 #03  
(Europe)

**< Intended Country of Use >**  
AT BE CY CZ DK EE  
FI FR DE GR HU IE  
IT LV LT LU MT NL  
PL PT SK SI ES SE  
GB IS LI NO CH BG  
RO TR HR

IC-9100 #04  
(Europe-1)

**< Intended Country of Use >**  
AT BE CY CZ DK EE  
FI FR DE GR HU IE  
IT LV LT LU MT NL  
PL PT SK SI ES SE  
GB IS LI NO CH BG  
RO TR HR

IC-9100 #05  
(Italy)

**< Intended Country of Use >**  
AT BE CY CZ DK EE  
FI FR DE GR HU IE  
IT LV LT LU MT NL  
PL PT SK SI ES SE  
GB IS LI NO CH BG  
RO TR HR

IC-9100 #06  
(Spain)

**< Intended Country of Use >**  
AT BE CY CZ DK EE  
FI FR DE GR HU IE  
IT LV LT LU MT NL  
PL PT SK SI ES SE  
GB IS LI NO CH BG  
RO TR HR

IC-9100 #11  
(France)

**< Intended Country of Use >**  
AT BE CY CZ DK EE  
FI FR DE GR HU IE  
IT LV LT LU MT NL  
PL PT SK SI ES SE  
GB IS LI NO CH BG  
RO TR HR