

ICOM

INSTRUCTION MANUAL

WIDEBAND RECEIVER

IC-R1

Downloaded by
RadioManual.EU

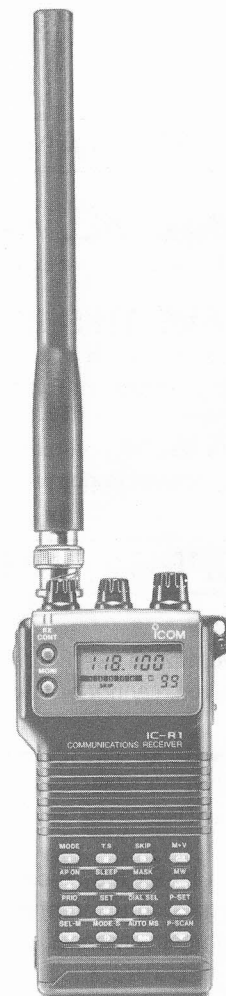

IMPORTANT

READ ALL INSTRUCTIONS carefully and completely before using the **IC-R1**.

SAVE THIS INSTRUCTION MANUAL – This instruction manual contains important safety and operating instructions for the **IC-R1**.

The use of non-Icom battery packs/chargers may impair transceiver performance and invalidate the warranty.

OPERATING NOTES

Information overheard through the IC-R1, but not intended for you, cannot be lawfully used in any way.

The IC-R1 may receive its own oscillated frequency, resulting in no reception or only noise reception, on some frequencies.

The IC-R1 may receive interference from extremely strong signals on different frequencies or when using an external high-gain antenna.

CAUTIONS

NEVER connect a non-recommended charger. This may result in a fire hazard or an electric shock.

NEVER connect more than a 16 V DC power source to the receiver. This will ruin the receiver.

DO NOT use or place the receiver in areas with temperatures below -10°C ($+14^{\circ}\text{F}$) or over $+60^{\circ}\text{C}$ ($+140^{\circ}\text{F}$).

AVOID the use of strong chemical agents such as benzine or alcohol when cleaning, as they may damage the receiver surfaces.

EXPLICIT DEFINITIONS

The following explicit definitions apply to this manual:

WORD	DEFINITION
CAUTION	Equipment damage and/or personal injury could occur.
NOTE	If disregarded, inconvenience only. No risk of personal injury or equipment damage.
Push [x] + [y]	While pushing switch 'x', push switch 'y.'

TABLE OF CONTENTS

IMPORTANT	1	■ Lock function	17	■ Memory scan watch	40
OPERATING NOTES	1	■ Listening example 1	18	9 CLOCK MODE	41~44
CAUTIONS	1	■ Listening example 2	19	■ What is CLOCK mode?	41
EXPLICIT DEFINITIONS	1	6 MEMORY MODE	21~24	■ Setting the time	41
TABLE OF CONTENTS	ii	■ General	21	■ Power-on timer	43
FOREWORD	1	■ Selecting MEMORY mode	21	■ Sleep timer	44
UNPACKING	1	■ Selecting a memory channel	22	10 OTHER FEATURES	45~46
1 PRE-OPERATION	2	■ Programming a memory channel	23	■ Display contrast	45
2 PANEL DESCRIPTION	3~8	■ Transferring a memory to VFO	24	■ Monitor function	45
■ Front and side panels	3	■ Masking a memory channel	24	■ Display lighting	45
■ Top panel	4	7 SCAN OPERATION	25~37	■ Battery indicator	46
■ Keyboard	5	■ What is scanning?	25	■ Beep tones	46
■ Function display	7	■ Scan types	25	■ Power saver	46
3 BATTERY CHARGING	9~10	■ Programmed scan	27	11 SET MODE	47~50
4 ACCESSORY ATTACHMENT ..	11	■ Programming scan edges	29	■ General	47
5 BASIC OPERATION	12~20	■ Programming skip scan	31	■ Entering SET mode	48
■ General	12	■ Setting and cancelling skip information	32	■ Setting displays	48
■ Selecting VFO mode	12	■ Auto-memory write scan	33	12 TROUBLESHOOTING	51~53
■ Selecting a receive mode	13	■ Memory scan	34	■ Troubleshooting	51
■ Selecting a tuning step	14	■ Memory select scan	35	■ Exiting a display	53
■ Tuning a frequency (via the keyboard)	15	■ Mode select scan	36	13 SPECIFICATIONS	54
■ Tuning a frequency (via the tuning control)	16	■ Summary of scan types	37	14 OPTIONS	55
■ Dial select steps	17	8 PRIORITY WATCH	38~40		
		■ What is priority watch?	38		
		■ Types of priority watch	38		
		■ Memory channel watch	39		

FOREWORD

Thank you for purchasing the **IC-R1 WIDEBAND RECEIVER**, a state-of-the-art handheld receiver made with Icom's most advanced technology.

The **IC-R1** has the following features:

- Incredibly compact size and weight including the internal NiCd battery.
- Wideband frequency coverage
0.1~1300 MHz^{1,2} in AM, FM and Wide FM modes.
¹ Guaranteed range: 2~905 MHz. Some versions do not have the full range because of frequency restrictions.
² MHz is an abbreviation of megahertz or 1,000,000 hertz, where hertz is a unit of frequency.

INFO

Electromagnetic radiation which has frequencies of 20,000 Hz (20 kHz) and above is called radio frequency (RF) energy because it is useful in radio transmissions. The IC-R1 receives RF energy and converts it into audio frequency (AF) energy which in turn actuates a loudspeaker to create sound waves. AF energy is in the range of 20~20,000 Hz.

UNPACKING

Accessories included with the IC-R1:

	Qty.
① Handstrap.....	1
② Antenna (FA-4B).....	1
③ Wall charger.....	1
④ Belt clip and screws.....	1 set

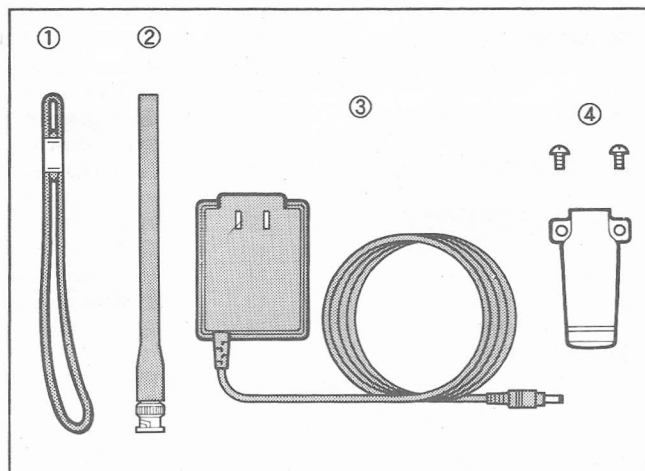

1 Charge the battery.

Connect the supplied wall charger as illustrated in the diagram below.

- The CPU backup battery will also be fully charged.
- See p. 9 for details on safety and use of a desktop charger.

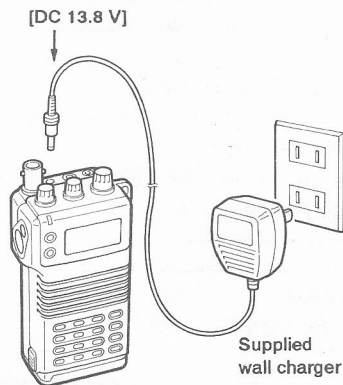

- **NEVER** attempt to charge a battery case containing dry cell (i.e. non-rechargeable) batteries.

2 Reset the receiver.

When first applying power, the internal rechargeable backup battery may be empty. In this case, before you can operate the receiver, the following reset procedure must be performed. While pushing [F] and [CL], rotate [PWR/VOL] to turn power ON.

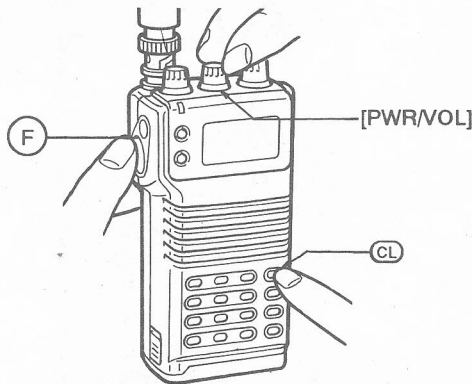

- The display returns to its factory-shipped default settings. (see p. 51)

CAUTION: Resetting the CPU will clear and initialize all memory channel contents, programmed scan edge frequency bands, SET mode settings and clock and timer settings.

3 Connect the antenna.

Insert the supplied antenna into the antenna connector and rotate the antenna as shown in the diagram below. Do not remove the attached rubber cap as it helps prevent dust from entering the receiver.

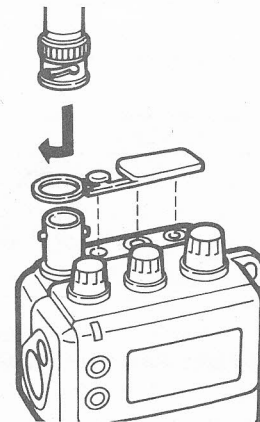

Front and side panels

WATCH SWITCH [W]

Used to activate CLOCK mode. (see p. 41)

FUNCTION SWITCH [F]

While pushing [F], the secondary functions of switches and controls can be accessed. (see pgs. 5, 6)

CONTRAST SWITCH [CONT]

Adjusts the function display contrast. (see p. 45)

MONITOR SWITCH [MONI]

Opens the squelch fully for reception of weak signals under certain conditions. (see pgs. 12, 45)

BATTERY PACK RELEASE BUTTON

Opens the latch for bottom cap or optional battery cap removal. (see p. 11)

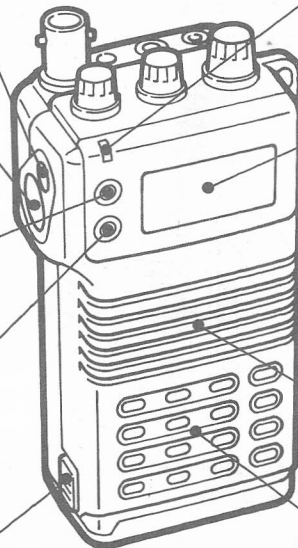

RECEIVE INDICATOR [RX]

Lights up in green while receiving. Indicates that the squelch needs adjustment if it lights while receiving no signal. (see p. 12)

FUNCTION DISPLAY

Indicates the operating condition. (see pgs. 7, 8)

LIGHT SWITCH [LIGHT]

Used to backlight the function display. Lights the display for approximately 5 sec. except when the light function is activated. (see p. 45)

SPEAKER

Emits the receive audio.

KEYBOARD

Numeral and other function keys for tuning and activating functions. (see pgs. 5, 6)

■ Top panel

EXTERNAL DC POWER JACK [DC 13.8 V]

Connects the supplied wall charger for charging the internal batteries or attached battery pack. (see p. 9)

Be careful of overcharging!

Operation with an external DC power source simultaneously charges the battery pack.

ANTENNA CONNECTOR

Connects the supplied flexible antenna. Be careful when connecting an external antenna. (see p. 2 and OPERATING NOTES on p. i)

SQUELCH CONTROL [SQUELCH]

Varies the squelch threshold point for audio mute. (see p. 12)

- Pushing [MONI] opens the squelch fully.

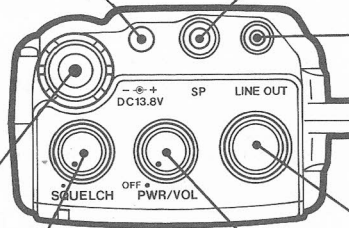

EXTERNAL SPEAKER JACK [SP]

Connects an 8 Ω optional speaker or earphone, if desired.

- The internal speaker will not function when either option is connected.

LINE OUT JACK [LINE OUT]

Use a submini plug to connect to a tape recorder in order to record the signal being received.

- Use the volume control to adjust the recording level.

TUNING CONTROL

Used to set an operating frequency (see p. 16) or a memory channel (see p. 22).





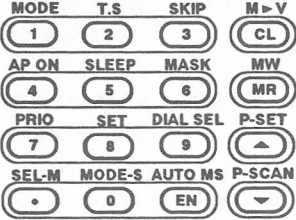

VOLUME CONTROL [PWR/VOL]

Turns power ON and adjusts the audio level. (see p. 12)

1 PANEL DESCRIPTION

Keyboard

KEY	PRIMARY FUNCTION	SECONDARY FUNCTION (while pushing [F])	
MODE 1		In VFO mode: selects a receive mode, FM, AM or W FM. (see p. 13)	
T.S 2		In VFO mode: selects a tuning step. Use together with the tuning control for selection. (see p. 14)	
SKIP 3		In MEMORY mode: designates skip channels for memory scan. (see p. 32)	
AP ON 4		In CLOCK mode: starts the power-on timer. (see p. 43)	
SLEEP 5		Starts the sleep timer. (see p. 44)	
MASK 6		<ul style="list-style-type: none"> When selecting VFO mode: enter a digit for the receive frequency. (see p. 15) 	In MEMORY mode: turns the memory mask function ON and OFF. (see p. 24)
PRIO 7		Starts/stops priority watch. (see pgs. 39, 40)	
SET 8		<ul style="list-style-type: none"> When selecting MEMORY mode: enter a memory channel number. (see p. 22) 	In VFO mode: activates SET mode. (see p. 48)
DIAL-SEL 9		In VFO mode: selects a dial select step. (see p. 17)	
MODE-S 0		In MEMORY mode: starts/stops mode select scan. (see p. 36)	

KEY	PRIMARY FUNCTION	SECONDARY FUNCTION (while pushing [F])
SEL-M 	In VFO mode: clears the digits to the right of the decimal point for frequency input. (see p. 15)	In MEMORY mode: starts/stops memory select scan. (see p. 35)
AUTO MS 	In VFO mode: enters the selected receive frequency. (see p. 15) In MEMORY mode: enters a selected memory channel. (see p. 22)	In VFO mode: starts/stops auto-memory write scan. (see p. 33)
M > V 	Selects VFO mode when pushed in MEMORY mode. (see p. 13) Stops scanning. (see p. 37) Clears numeric key input. (see p. 15)	In MEMORY mode: transfers memory contents to VFO mode. (see p. 24)
MW 	In VFO mode: selects MEMORY mode. (see p. 21) In MEMORY mode: changes the memory channel number in increments of 10. (see p. 22)	In VFO mode: writes to a memory channel. (see p. 23)
P-SET 	In VFO mode: increments or decrements the memory channel number. (see p. 22) In MEMORY mode: increments and decrements memory channels which are NOT masked. (see p. 22)	In VFO mode: activates the condition for setting programmed scan edge frequencies for programmed scan. (see p. 29)
P-SCAN 	In SET or CLOCK modes: changes the display contents. (see pgs. 41, 48)	In VFO mode: starts/stops programmed scan. (see p. 27) In MEMORY mode: starts/stops memory scan. (see p. 34)

1 PANEL DESCRIPTION

■ Function display

FUNCTION INDICATOR

Appears while the function [F] switch is pushed. (see pgs. 5, 6)

FREQUENCY READOUT

Shows the receiving frequency or the SET mode contents. (see pgs. 15 and 47)

DIAL SELECT INDICATORS

One of these indicators appears while pushing [F]. It shows the dial select step. (see p. 17)

S-INDICATOR

Shows the relative signal strength while receiving. (see p. 16)

RECEIVE MODE INDICATOR

Indicates the selected receive mode. (see p. 13)

SET MODE INDICATOR

Appears while SET mode is selected. (see p. 48)

MEMORY CHANNEL INDICATOR

Shows the selected memory channel number. (see p. 22)

PROGRAMMED SCAN INDICATOR

Appears while selecting a programmed scan edge channel. (see p. 29)



LOW BATTERY INDICATOR

Appears when the connected battery requires charging. (see p. 46)

LOCK INDICATOR

Appears while the lock function is activated. (see p. 17)

SCAN INDICATOR

Appears while scanning. (see p. 25)

SKIP INDICATOR

Appears when the selected memory channel is set as a skip channel.

- Blinks while scanning if skip channels have been designated. (see p. 32)

TUNING STEP INDICATORS

Show the selected tuning step. (see p. 14)



AUTO MEMORY WRITE SCAN INDICATOR

Blinks while auto-memory write scan is activated. (see p. 33)

SCAN UP/DOWN INDICATORS

Blink to indicate scan direction while scanning. (see p. 28)

MEMORY INDICATOR

Appears while MEMORY mode is selected. (see p. 21)

PRIORITY WATCH INDICATOR

Appears while operating a priority watch. (see p. 38)

3

BATTERY CHARGING

The IC-R1's internal battery is a rechargeable NiCd and can typically be recharged up to 300 times (approx.) Charge the internal battery when the low battery indicator, 'B' appears.

- When using the receiver without an optional attached battery pack or case the internal battery provides about 2~3 hrs. of operation (with a continuous signal, such as a broadcast, at medium audio output).
- When using the receiver with an optional battery pack or case, the operating times vary with the capacity of the pack or batteries used with the case. When the attached battery pack or case becomes exhausted, remove it and continue operation using the internal battery.

NOTE: When an optional battery pack is attached, the internal battery cannot be charged.

CAUTION: Never attempt to charge a battery case containing non-rechargeable batteries.

Regular charging of the internal battery

Connect the supplied wall charger to the [DC 13.8 V] jack.

[DC 13.8 V]

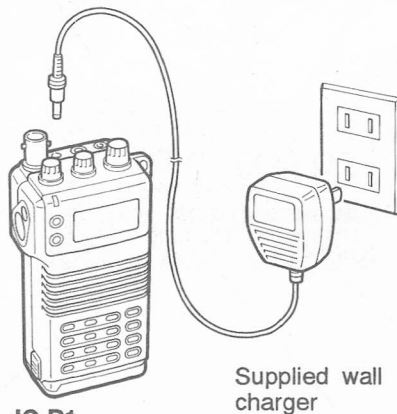

- Charging period: 15 hrs. (approx.)

Rapid charging with the optional BC-72

The BC-72 allows you to rapidly charge the internal battery or an attached optional battery pack.

- To charge the internal battery, the optional BA-12 BATTERY CHARGE ADAPTER must be attached.

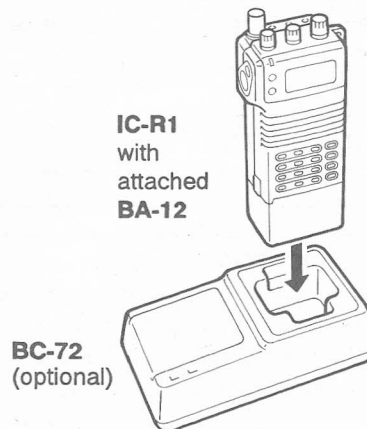

NOTE: NiCd batteries with the BP-90 BATTERY CASE cannot be charged using the BC-72.

- Charging period: 1~2 hrs.(approx.)

Charging with an optional charger or cables

CP-12 (optional)
To cigarette lighter socket

to
[DC 13.8 V]

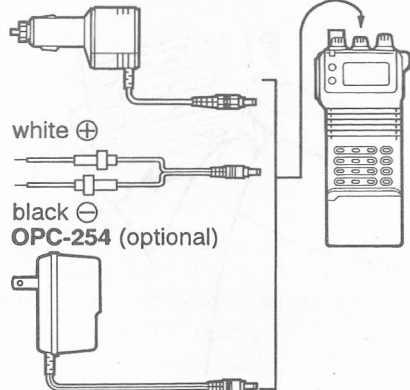

BC-73E/D for BP-81 or 82 only
BC-74A/E/D/V for BP-81~85, 90

- **NEVER** connect the above options when using the BP-90 with dry cell (i.e. non-rechargeable) batteries.
- **Charging period: 15 hrs. (approx.)**

Charging the optional BP-85

To charge the optional **BP-85** by itself, connect the wall charger or optional cable to the charging jack.

BC-74A/E/D/V

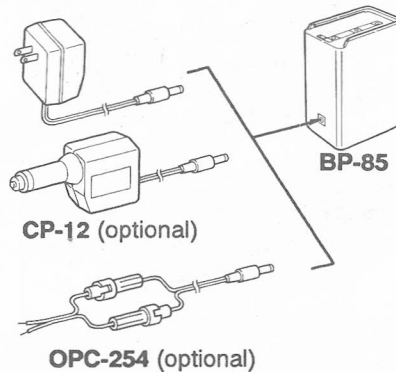

- The **BC-73E/D** cannot be used with the BP-85.
- **Charging period: 15 hrs. (approx.)**

• Using your battery wisely

Overcharging and complete discharging may shorten the life of a battery.

Recharging can usually be performed 300 times, but battery life can be lengthened to about 500 recharges as follows:

1. Avoid overcharging. The charging period should be less than 48 hours.
2. Use the battery until it is almost completely discharged under normal conditions. We recommend battery charging as soon as the low battery indicator appears.

NEVER connect two or more chargers at the same time.

Be sure to turn the receiver power OFF during charging.

Charging may not occur in extreme cold (under 0 °C ; + 32 °F) or extreme heat (over + 40 °C ; + 104 °F).

4

ACCESSORY ATTACHMENT

Handstrap

The handstrap facilitates carrying the receiver.

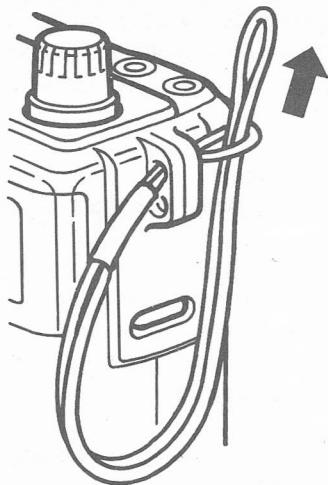

Insert the end of the handstrap through the projecting loop on the receiver using a pointed instrument, such as a mechanical pencil.

Then, put one end of the handstrap through the other end's loop and tighten as shown above.

Belt clip

The belt clip allows you to attach the receiver to your belt.

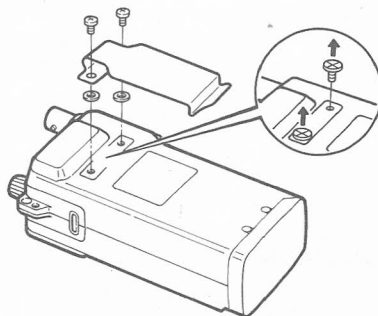

Remove the 2 plastic screws on the rear of the receiver, then attach the belt clip using the supplied metal screws.

Bottom cap removal

Remove the bottom cap when attaching an optional battery pack or when rapid charging the internal battery with the BC-72.

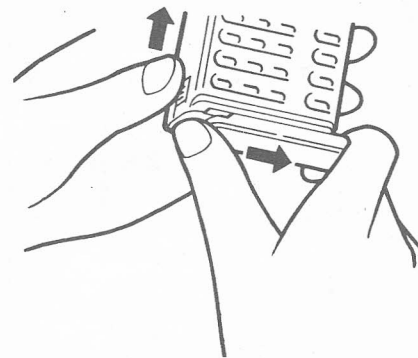

Push the battery pack release button upwards, then slide the bottom cap to the right with the receiver facing you. This enables you to attach an optional battery pack.

■ General

Operating the IC-R1 is easy. However, in order to get the most out of its operating potential, please go through the following procedures, step-by-step. Then, try the examples contained at the end of this chapter.

What is VFO?

The IC-R1 has several modes for operation, each of which has its own distinct functions. VFO (Variable Frequency Operation) is one of these modes.

VFO mode is used to change the operating frequency, receive mode, tuning step, etc. Therefore, for most everyday operations of the receiver, you will be using VFO mode.

■ Selecting VFO mode

1 Turn power ON.

Rotate the [PWR/VOL] control clockwise, until a 'click' is heard.



2 Adjust the volume.

Adjust the audio to a suitable level using the [PWR/VOL] control.



- Check the squelch position when no audio is emitted. (see box at right)

Downloaded by
RadioManual.EU

3 Adjust the squelch.

Rotate the [SQUELCH] control max. counterclockwise, then rotate it clockwise until audio noise is just muted when receiving no signal.

- The [RX] indicator goes out.

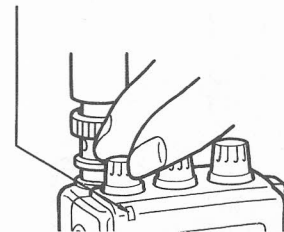

What is squelch?

A squelch circuit allows you to mute undesired noise while receiving no signal and emit audio while receiving signals. This provides quiet standby.

- The [MONI] switch bypasses the mute circuit without changing the squelch setting. This is useful for weak signal reception. (see p. 45)

5 BASIC OPERATION

4 Select VFO mode.

Push [CL] to select VFO mode.

- If the receiver is in CLOCK mode, push [W] to select VFO mode. (see p. 41)
- If the receiver is already in VFO mode, pushing [CL] is not necessary.

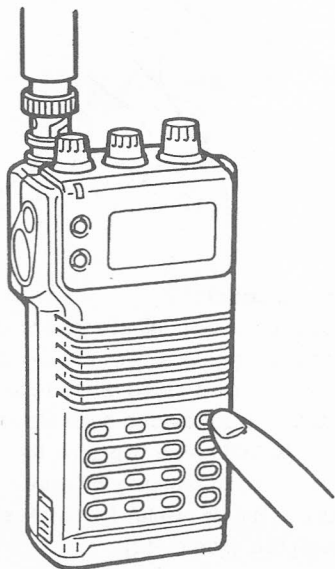

Selecting a receive mode

• What are receive modes?

Radio signals can be propagated in a variety of ways (or modes). Each mode has its own physical properties that determine to some degree its uses.

The IC-R1 receives the 3 most common modes: AM, FM and W FM. When you want to tune to a station, you **MUST** set the receive mode first. The table below shows common uses for each mode.

MODE	COMMON USAGE
AM	commercial, amateur, aviation
FM	amateur, utility
W FM	television, stereo FM

• Major symptoms of incorrect receive mode

- Distorted sound
- Sudden interruption in reception
- Noise only
- Noise with weak reception
- Low or unstable S-indicator value

1 Set the receive mode.

The receive mode can be set in VFO or MEMORY modes.

Push [F] + [1](MODE) to change receive modes.



Indicated



- The current receive mode and 'E' are indicated in the frequency display.
- Push [1](MODE) one or more times to select the desired receive mode.

■ Selecting a tuning step

• What are tuning steps?

Tuning steps are the frequency change increments when you rotate the tuning control or operate a scan. The following steps are available: **0.5, 5, 8, 9*, 10, 12.5, 20, 25, 30 and 50 kHz.**

*For the 108~1630 kHz range only.

It is important to set the proper tuning step for the type of station you want to listen to. Some tuning steps are determined by frequency band or receive mode and others are set by tradition.

Generally speaking, if you set a tuning step smaller than that needed you will still be able to tune the station you want (or scan it), however, tuning (or scanning) will not be as efficient. On the other hand, if you select a tuning step which is too large, you may not be able to find the station you are looking for.

Consult local listings.

1 Call up the tuning step indicator.

Once you have selected VFO mode and the desired receive mode:

Push [F] + [2](T.S).

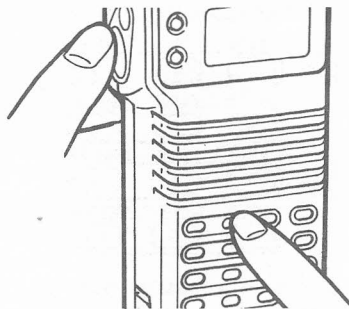

↑
'T.S.' blinks

2 Select the tuning step.

While continuing to push [F], rotate the tuning control to select the desired tuning step.

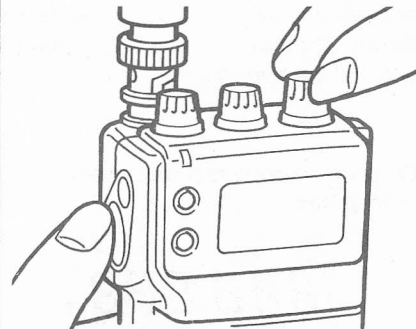

• Release [F] to return to normal operations.



5 BASIC OPERATION

■ Tuning a frequency (via the keyboard)

When you know the exact frequency you want to listen to, the quickest way to tune it in is by direct keyboard entry.

Remember that the frequency must be between 0.1 MHz and 1300 MHz.

The diagram below shows the correlation between the function display frequency digits and the frequency.

• Display readout and frequency correlation

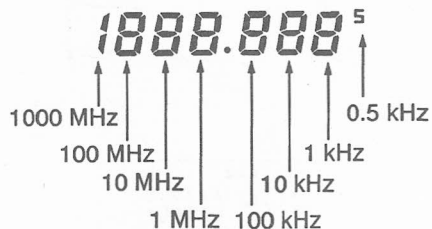

1 Select the frequency.

Select VFO mode and the receive mode in advance, then:

Push the numeral keys in the same order as the frequency you want to tune (including the decimal key).

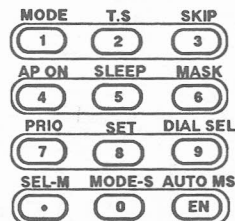

- If you make a mistake, push [CL] and start again.
- To input 0.5 kHz, push [·], then one of [5]~[9].

2 Enter the frequency.

When the frequency you want is displayed:

Push [EN] to enter it.



- If you select a frequency outside of the allowed range, the display will revert back to the previously displayed frequency.

Example:

144.000 MHz → [1] [4] [4] [·] [0]

118.6225 MHz → [1] [1] [8] [·] [6] [2] [2] [·] [5] [EN]

880 kHz (0.88 MHz) → [0] [·] [8] [8] [EN]

■ Tuning a frequency (via the tuning control)

When you want to listen to frequencies near the displayed frequency, the easiest way to tune them is with the tuning control.

All signals have what is called an “occupied bandwidth.” They will be received as long as the receiver is tuned anywhere within this bandwidth, even though the frequency received may not be the central frequency. In order to tune to the central frequency, the tuning step should be made as small as possible (0.5 or 5 kHz) and the receiver tuned to the point of greatest S indicator deflection.

To change frequencies faster than the tuning step, use the dial select function. (see p. 17)

1 Select VFO mode and a receive mode.

Push [CL] to select VFO mode.
Push [F] + [1](MODE) to select a receive mode.

- Set a tuning step if desired.



Receive mode indicator

2 Tune a frequency.

Rotate the tuning control to change the frequency.

- The frequency changes in increments determined by the tuning step.
- To change the frequency faster, use the dial select function. (see p. 17)

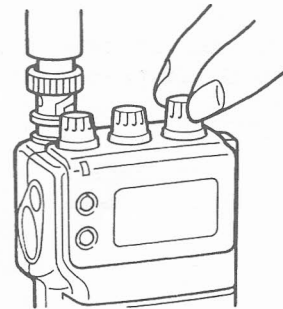

5 BASIC OPERATION

■ Dial select steps

• What are dial select steps?

When tuning with the tuning control and you want to change the frequency faster than the selected tuning step, use the dial select function.

A dial select step is an increment of frequency change much like a tuning step is. Unlike a tuning step however, a dial select step has no relation to the type of station you want to tune or to the scan operations.

Dial select steps are available for **100 MHz, 10 MHz, 1 MHz and 100 kHz.**

Changing the frequency with the dial select step

In VFO mode:

Push and hold [F] to indicate the dial select step, then rotate the tuning control.

To change the dial select step:

Push [F] + [9](DIAL SEL) one or more times until the dial select indicator appears under the frequency digit you want to change.



Dial select indicators

■ Lock function

A lock function is available so that you can listen to one frequency continuously and not worry about accidentally changing it or activating an undesired function.

Activate the function

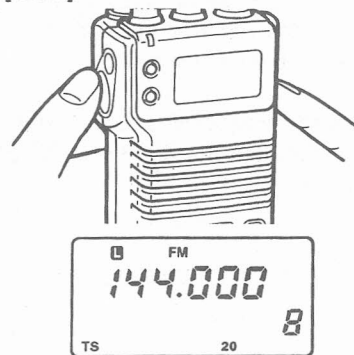

Push [F] + [LIGHT](LOCK).

- "  " appears in the function display.
- All switches and controls are electronically locked except for [PWR/VOL], [SQUELCH], [LIGHT] and [MONI].

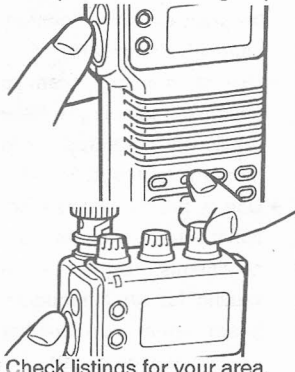

- To turn the function OFF, repeat the above step.

■ Listening example 1 — television broadcast in W FM mode.

<p>1 Turn power ON.</p>	<p>5 Select the receive mode.</p>	<p>6 Select the tuning step.</p>	<p>7 Tune the station.</p>																																
<p>Turn [PWR/VOL] clockwise.</p>	<p>Television sound is broadcast in W FM mode. If the receiver is not already in W FM mode: Push [F] + [1](MODE) one or more times until W FM appears in the function display.</p>	<p>In most countries* television stations are spaced about 50 kHz apart. To select the 50 kHz tuning step: Push [F] + [2](T.S); continue holding [F], then rotate the tuning control until "50" appears in the function display.</p>	<p>Use the keyboard to enter the frequency — (example 59.75 MHz). [Example:]</p>																																
<p>2 Select VFO.</p>			<p>(5) (9) (0) (7) (5) (EN)</p> <table border="1" data-bbox="1166 556 1458 775"> <tr> <td>MODE</td> <td>T.S</td> <td>SKIP</td> <td>M > V</td> </tr> <tr> <td>1</td> <td>2</td> <td>3</td> <td>CL</td> </tr> <tr> <td>AP ON</td> <td>SLEEP</td> <td>MASK</td> <td>MW</td> </tr> <tr> <td>4</td> <td>5</td> <td>6</td> <td>MR</td> </tr> <tr> <td>PRIO</td> <td>SET</td> <td>DIAL SEL</td> <td>P-SET</td> </tr> <tr> <td>7</td> <td>8</td> <td>9</td> <td>▲</td> </tr> <tr> <td>SEL-M</td> <td>MODE-S</td> <td>AUTO MS</td> <td>P-SCAN</td> </tr> <tr> <td>0</td> <td>EN</td> <td></td> <td>▼</td> </tr> </table> 	MODE	T.S	SKIP	M > V	1	2	3	CL	AP ON	SLEEP	MASK	MW	4	5	6	MR	PRIO	SET	DIAL SEL	P-SET	7	8	9	▲	SEL-M	MODE-S	AUTO MS	P-SCAN	0	EN		▼
MODE	T.S	SKIP	M > V																																
1	2	3	CL																																
AP ON	SLEEP	MASK	MW																																
4	5	6	MR																																
PRIO	SET	DIAL SEL	P-SET																																
7	8	9	▲																																
SEL-M	MODE-S	AUTO MS	P-SCAN																																
0	EN		▼																																
<p>Push [CL].</p>	<p>• See p. 14 about tuning steps.</p>	<p>* Check listings for your area.</p>																																	
<p>3 Adjust volume.</p>	<p>Rotate [PWR/VOL] to obtain the desired level of audio output.</p>																																		
<p>4 Adjust squelch.</p>																																			
<p>Rotate [SQUELCH] fully counterclockwise, then clockwise until the audio noise just disappears.</p>																																			

5 BASIC OPERATION

(Example 59.75 MHz)

8 Use the tuning control.

Rotate the tuning control to search for nearby stations above and below the tuned frequency.

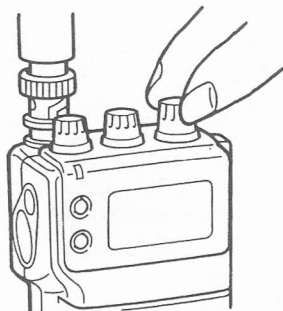

9 Use a scan function.

If desired, use a scan function to automatically search for signals.

- Use programmed scan (p. 27) or programmed skip scan (p. 31) to search through the entire television frequency range.
- Use auto-memory write scan to automatically write frequencies into memory channels. (see p. 33)
- Use a memory scan to search for signals you have previously entered into memory. (see pgs. 34, 35)
- Use a priority watch function if you want to listen to a continuous signal while waiting for an infrequently heard signal on another frequency. (see p. 39)

■ Listening example 2 –

1 Turn power ON.

Turn [PWR/VOL] clockwise.

2 Select VFO.

Push [CL].

3 Adjust volume.

Rotate [PWR/VOL] to obtain the desired level of audio output.

4 Adjust squelch.

Rotate [SQUELCH] fully counterclockwise, then clockwise until the audio noise just disappears.

5 Select the receive mode.

Airband communications are in AM mode. If the receiver is not already in AM mode:

Push [F] + [1](MODE) one or more times until AM appears in the function display.

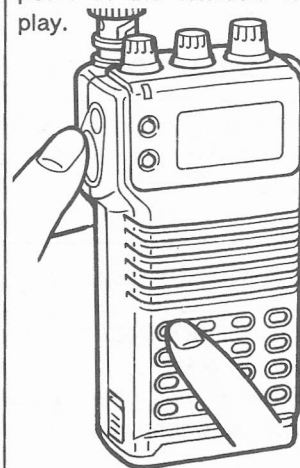

airband broadcast in AM mode. (Example 118.000 MHz)

6 Select the tuning step.

Tuning steps for the airband are usually 25 kHz*. To set the 25 kHz tuning step: Push [F] + [2](T.S); then while continuing to hold [F], rotate the tuning control until "25" appears in the function display.

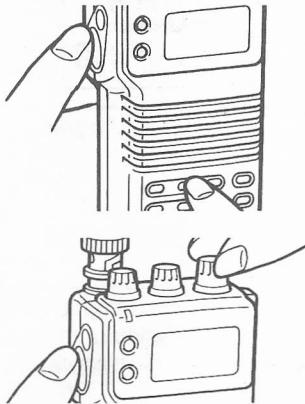

*Check listings for your area.

7 Tune the station.

Enter a frequency of 118.000 MHz* using the keyboard. (see p. 15)

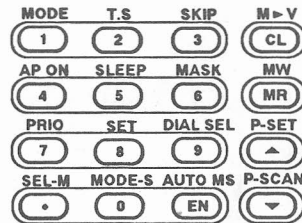

[Enter:]



*Check listings for your area.

8 Use the tuning control.

Rotate the tuning control to search for nearby stations above and below the tuned frequency.

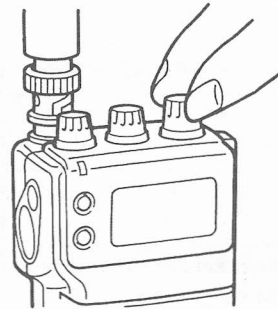

9 Use a scan function.

If desired, use a scan function to automatically search for signals.

- Use programmed scan (p. 27) or programmed skip scan (p. 31) to search through the entire airband frequency range.
- Use auto-memory write scan to automatically write frequencies into memory channels. (see p. 33)
- Use a memory scan to search for signals you have previously entered into memory. (see pgs. 34, 35)
- Use a priority watch function to monitor a particular airband frequency while listening to another frequency in the same or different receive mode. (see p. 39)

6

MEMORY MODE

General

• What is MEMORY mode?

MEMORY mode is the second operating mode – the first being VFO mode. MEMORY mode is used to store often-used frequencies and their receive modes (as well as skip information for scanning). This provides convenient recall and scanning capabilities. Also, frequencies are receivable in MEMORY mode which means you can listen to received signals while you are in MEMORY mode.

The IC-R1 has 100 memory channels for your convenience. The table below lists the memory channels available and their uses.

M-CH	Initial	Main use and characteristics
0	144.000 MHz FM	• This is the only memory channel that cannot be masked.
1~19	144.000 MHz FM	• Used as normal memory channels.
20~79	Masked*	• Skip designation area for programmed scan. (see p. 31)
80~99	Masked*	• Frequency writing area for auto-memory write scan. (see p. 33)

*See p. 24 for an explanation of "masked" memory channels.

Selecting MEMORY mode

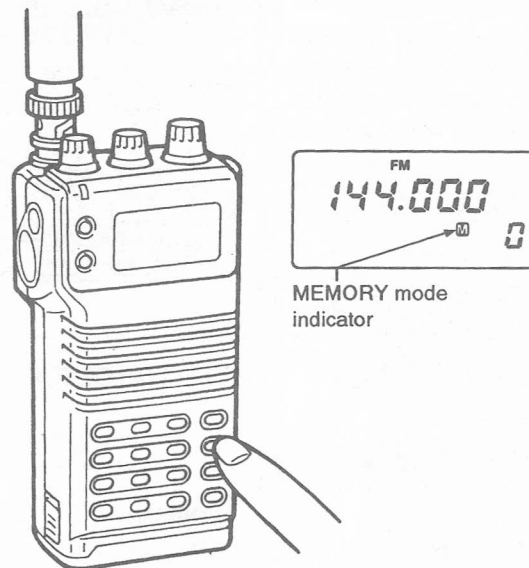

Select MEMORY mode.

- Push [MR] to select MEMORY mode.
- 'M' appears in the function display.
- Push [CL] to return to VFO mode.



■ Selecting a memory channel

NOTE: There are 4 ways to select a memory channel. After selecting MEMORY mode, choose the method most suitable for your purposes.

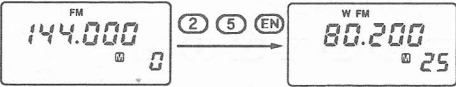
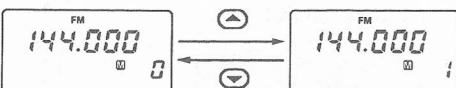
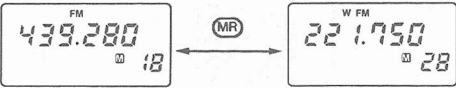
METHOD	FUNCTION DISPLAY/OPERATION	DESCRIPTION
1. Using the tuning control ① – Rotate the tuning control.	Tuning control 	<ul style="list-style-type: none"> • Masked memory channels are not selected. • Channels 20~99 are masked when the IC-R1 is shipped from the factory or after resetting.
2. Using the tuning control ② – While pushing [F], rotate the tuning control.	[F] + Tuning control 	<ul style="list-style-type: none"> • All memory channels can be sequentially selected.
3. Using the numeral keys – Push numeral keys and enter using [EN].		<ul style="list-style-type: none"> • When 3 or more digits are entered with the numeral keys, only the last 2 digits displayed are valid.
4. Using the [▲]/[▼] keys – Push [▲] or [▼].		<ul style="list-style-type: none"> • Masked memory channels are not selected. • When either key is pushed and held the memory channel changes continuously. • You can select a channel in VFO mode. (In this case all memory channel numbers can be selected.)
Changing the memory channel number in units of 10 – Push [MR] one or more times.		<ul style="list-style-type: none"> • Each time you push [MR], the memory channel will change in units of 10. • Convenient before using the [▲]/[▼] keys or tuning control.

6 MEMORY MODE

■ Programming a memory channel — example 145.320 MHz FM into ch 7

1 Select a channel.

- ① Push [MR] to select MEMORY mode.
 - 'M' appears in the function display.
- ② Rotate the tuning control to select memory channel 7.
 - See p. 22 for other methods of selecting a memory channel.

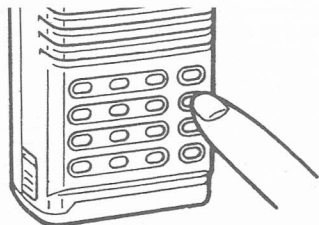

2 Set a frequency and receive mode.

- ① Push [CL] to select VFO mode.

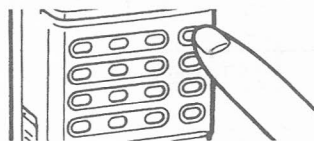

Then set the frequency using the keyboard : [Example:]

① 4 5 • 3 2 EN

- ② Push [F] + [1](MODE) one or more times to select FM mode.



3 Program into the channel.

Push [F] + [MR](MW) for 2 sec.

- The receiver emits 3 beeps.
- To confirm the programming, switch to MEMORY mode.



■ Transferring a memory to VFO

This function is useful when you want to search for signals around the displayed memory channel.

Before transferring the contents, make sure you are in MEMORY mode and the memory channel you want transferred is displayed. (see p. 21)

Transfer the contents.

Push [F] + [CL](M►V) for 2 sec.



■ Masking a memory channel (erasing a memory channel)

Masking a memory channel is like temporarily erasing a memory channel.

This makes it easier to select often-used memory channels. Memory channels which are seldom used or which you want to temporarily hide from view can be masked.

Before masking a memory channel, make sure you are in MEMORY mode and the memory channel you want masked is displayed. (see p. 21)

Mask the channel.

Push [F] + [6](MASK).

- All indications except 'M', 'Mch and '.' disappear.

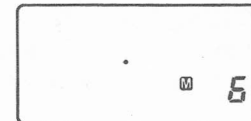

- Memory channel 0 cannot be masked.

What is scanning?

Scanning is an automatic search function that detects signals as it checks through frequencies or memory channels.

Scanning functions are useful for discovering new frequencies to listen to or for searching through previously programmed frequencies for signals.

Scan types

The IC-R1 has 2 major scan types: PROGRAMMED SCAN and MEMORY SCAN. These, in turn, can be subdivided into 3 variations of each, making a total of 6 scan operations.

The following 6 diagrams illustrate the operation of each scan type.

Step-by-step instructions on how and when to use each scan type follow these diagrams.

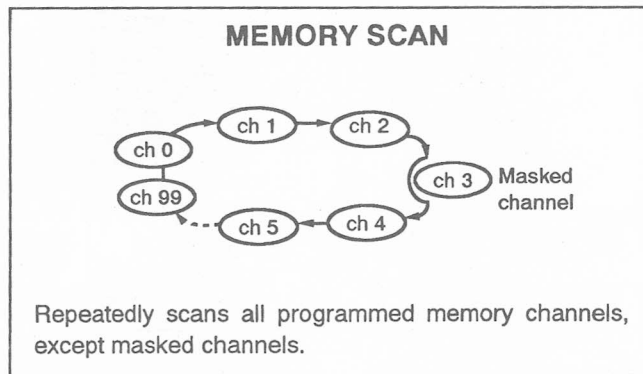
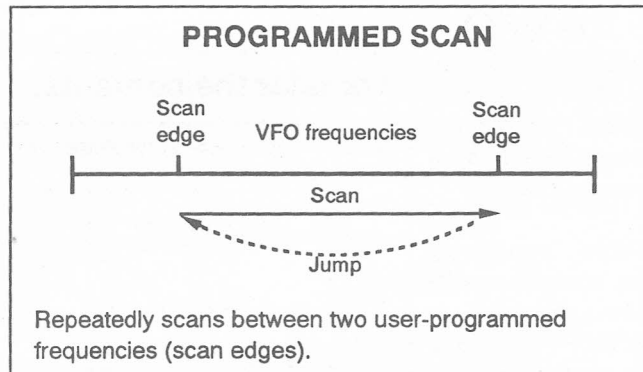

PROGRAMMED SKIP SCAN

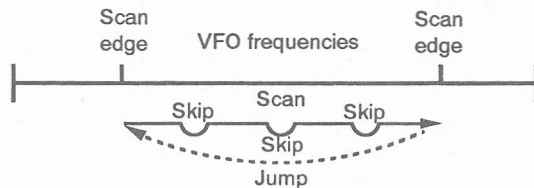

Same as PROGRAMMED SCAN but skips unwanted frequencies that inconveniently pause scanning

AUTO-MEMORY WRITE SCAN

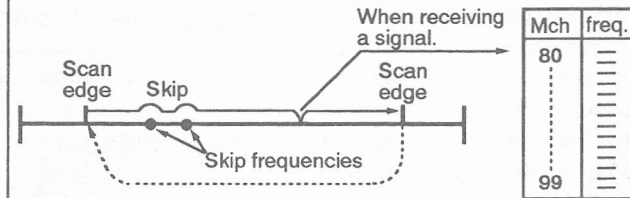

Same as PROGRAMMED SCAN except that paused frequencies are automatically stored in memory channels 80-99.

SELECT MEMORY SCAN

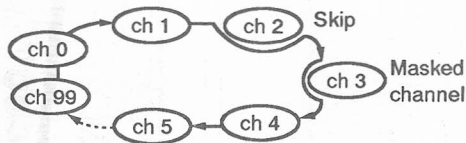

Repeatedly scans all programmed memory channels, except masked channels and those programmed as SKIP frequencies.

MODE SELECT SCAN

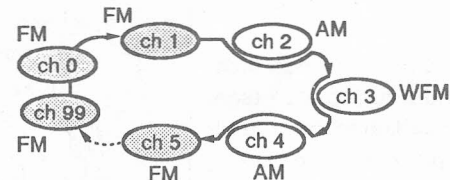

Scans all memory channels programmed for the same receive mode.

7 SCAN OPERATION

■ Programmed scan

Programmed scan searches for signals between two programmed frequencies. This is useful when you want to find signals in one particular frequency range, for example all FM signals between 145.000 MHz and 145.500 MHz.

Before starting programmed scan you must program scan edges (see p. 29). You can program up to 10 separate pairs of scan edges, providing 10 different programmed scans.

Program a receive mode (see p. 13) and a tuning step (see p. 14) according to the type of stations you want to scan.

1 Select VFO mode. Set squelch level.

Push [CL] to select VFO mode.

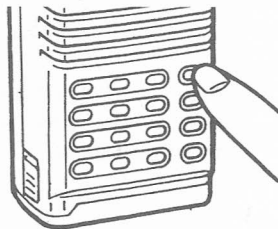

Rotate the [SQUELCH] so that the audio noise is just muted.

- If the squelch level is not set scan will not proceed.



2 Select the group to scan.

Push [F] + [▲] (P-SET) to display one of the scan edge groups.

- If the group you want to scan is not displayed, push [▲]/[▼] one or more times to select the group you want.
- See p. 29 if you want to change the scan edges of a scan edge group.



3 Return to VFO mode.

Push [CL] to return to VFO mode.

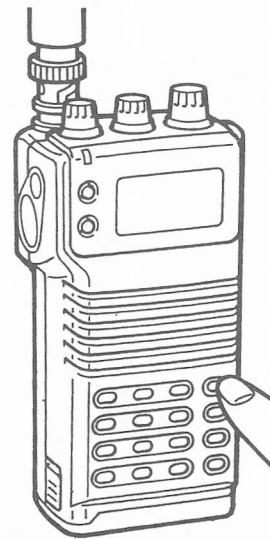

4 Start the scan.

Push [F] + [▼] (P-SCAN) to start programmed scan in the selected group.

- To change the direction of the scan, rotate the tuning control during scanning.

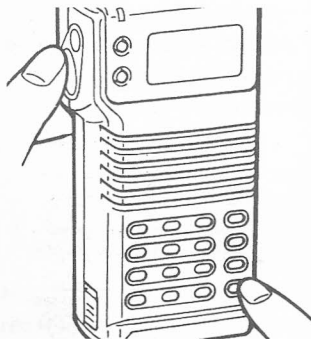

5 Change scan group if desired.

Push one of the digit keys during scanning to select a different scan edge group to be scanned.

- Push [1] for group 1A~1b, [2] for group 2A~2b, etc.

MODE	T.S	SKIP
1	2	3
AP ON	SLEEP	MASK
4	5	6
PRIO	SET	DIAL SEL
7	8	9
SEL-M	MODE-S	AUTO MS
•	0	EN

6 Stop the scan.

Push [CL] to stop the scan.

- Push [MR] to stop the scan and enter MEMORY mode.

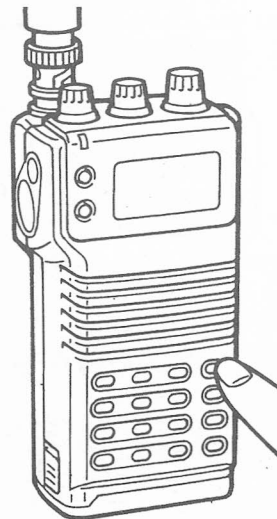

7 SCAN OPERATION

■ Programming scan edges

Scan edge frequencies are stored in 10 pairs of memory channels: 0A/0b ~ 9A/9b. Programmed scan repeatedly searches for signals between the two frequencies in each pair.

The initial settings for the 'A' memory channels are 144.000 MHz, FM with a tuning step of 5 kHz. And those for 'b' memory channels are 146.000 MHz, FM with a 5 kHz tuning step. If these initial settings are not changed, programmed scan will proceed between these 2 frequencies.

1 Select VFO mode.

Push [CL] to select VFO mode.

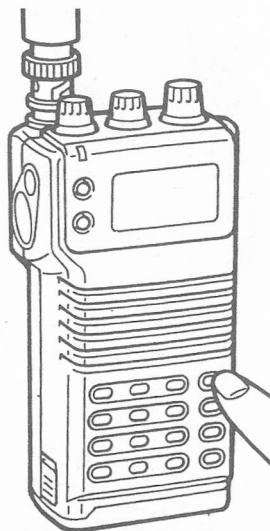

2 Select PROGRAM SET condition.

Push [F] + [▲](P-SET).

- One of the program edge groups will appear.
- Push [▲] or [▼] to increment or decrement the displayed group, respectively.
- Push and hold [▲]/[▼] to step through the groups continuously.



Example: scan edge 2b.



3 Program a scan edge frequency.

Once the desired scan edge is displayed, enter the desired frequency using the keyboard.

- The upper and lower frequency limits can be set in either memory A or b.
- Use the tuning control to set the frequency if the displayed frequency is close to that desired.

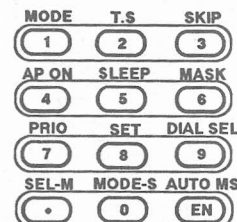

4 Set a receive mode and T. S.

① Push [F] + [1](MODE) one or more times to set the desired receive mode. (see p. 13)

- If the desired receive mode is already displayed, this step is not necessary.

② Push [F] + [2](T.S); then while continuing to hold [F] rotate the tuning control to select the desired tuning step. (see p. 14)

- If the desired tuning step is already displayed, this step is not necessary.

NOTE: Once the desired receive mode and tuning step are set for one scan edge they are automatically set in the other scan edge.

5 Program the other scan edge.

Push [▲] or [▼] to select the other scan edge, then enter the desired frequency using the keyboard.

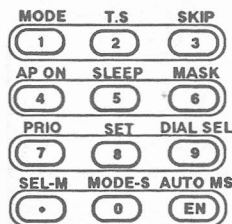

6 Select the group to scan.

When you have programmed as many scan edge groups as desired: Push the [▲]/[▼] keys to select the group to be scanned. (see p.27)

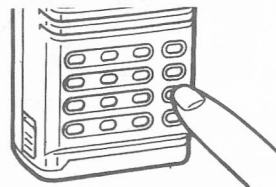

- This step can be skipped if you are not planning to operate PROGRAMMED SCAN immediately. However, keep in mind that PROGRAMMED SCAN always proceeds from the last scan edge selected.

7 Select VFO mode.

Push [CL] to return to VFO mode.

- See p. 27 to start PROGRAMMED SCAN, if desired.

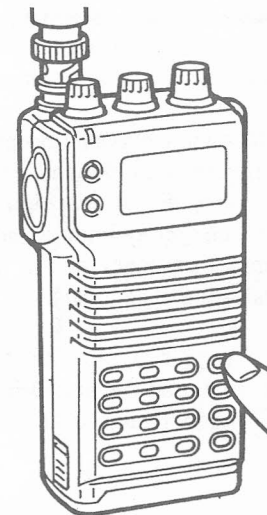

7 SCAN OPERATION

■ Programmed skip scan

This scan allows you to skip unwanted frequencies that inconveniently stop scanning during programmed scan. For example, if you are scanning the airband frequency range, programmed scan may stop on some beacon frequencies (used for navigation purposes). To avoid stopping on these frequencies, programmed skip scan is utilized.

SKIP frequencies can be programmed while paused on a frequency during scanning or can be programmed into memory channels (see p. 32) in advance of scanning.

The frequency skip function can be turned ON and OFF in SET mode. (see p. 49)

1 Select VFO. Adjust squelch.

Push [CL] to select VFO mode.



Rotate [SQUELCH] to mute the audio noise.

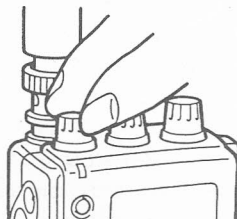

2 Start a scan.

Push [F] + [▼](P-SCAN) to start a scan.

- Select a scan edge channel (see p. 29) in advance, if desired.



3 Program a SKIP frequency.

When the scan stops on an unwanted signal, push [F] + [MR](MW) for 2 sec.



- SKIP frequencies are programmed into memory channels in the order 79-20.
- When all memory channels are programmed, low beep tones are emitted.

■ Setting and cancelling skip information

SKIP frequencies can be programmed into memory channels for more efficient memory scanning (memory select scan – see p. 35).

In addition, skip information can be cancelled when you no longer want a particular frequency programmed as such.

NOTE: SKIP frequencies can be programmed and cancelled regardless of whether or not the frequency skip function has been turned ON in SET mode. (see p. 49) However, in order for programmed skip scan or memory select scan to operate, the frequency skip function must be turned ON.

1 Select a memory channel.

Push [MR] to select MEMORY mode.

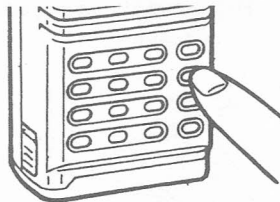

Rotate the tuning control (or use another method) to select a memory channel.

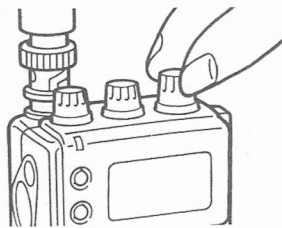

2 Cancel/set skip information.

Push [F] + [3](SKIP).

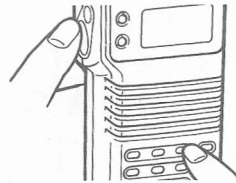

[Example:]
Skip information is set in memory 99:



Skip information is cancelled in memory 99:



Using the mask function to cancel

While in MEMORY mode, push [F] + [6](MASK).

- Displayed memory channel is masked and will be skipped during scanning.
- Repeat this step to unmask the channel.

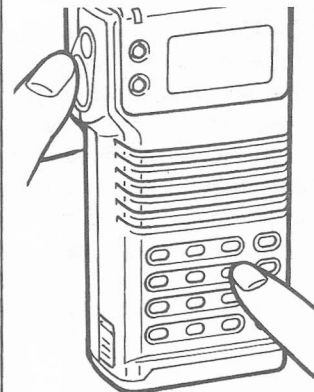

7 SCAN OPERATION

■ Auto-memory write scan

Auto-memory write scan is a convenient function which stores received frequencies in memory channels automatically while scanning. In this way you don't have to remember where you found signals while scanning and you can listen to the signals later using one of the memory scans.

CAUTION: memory channels 80-99 are automatically erased when you start auto-memory write scan. Received frequencies are then stored in these channels in the order in which they are received.

1 Select VFO. Adjust squelch.

Push [CL] to select VFO mode.

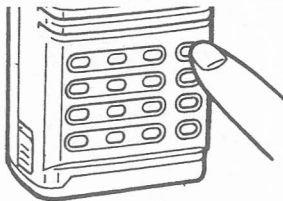

Rotate [SQUELCH] to adjust the audio noise.

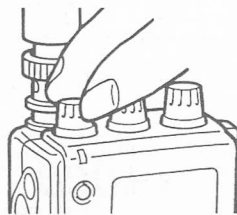

2 Start the scan.

Push [F] + [EN](AUTO MS).

- The scan starts according to the selected scan edge group. (see p. 29)

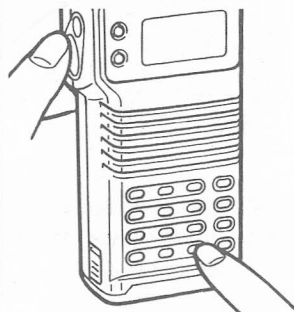

'AUTO' blinks.



3 Stop the scan.

Push [CL] to stop the scan.

- Push [MR] to stop the scan and select MEMORY mode.
- The scan automatically stops when memory channels 80-99 have been programmed.

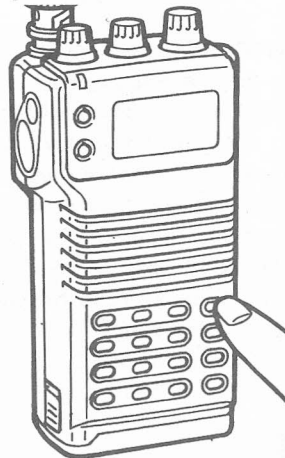

Memory scan

Memory scan scans all memory channels containing programmed frequencies (except masked memory channels).

This scan is useful for searching through your most often listened to frequencies; when you don't remember all of the contents of your memory channels; or when you want to check the signals which have been programmed into memory channels during auto-memory write scan.

NOTE: Scanning in MEMORY mode normally moves from channel 0-99, but the range can be limited in SET mode. (see p. 49)

1 Select MEMORY mode/Set squelch.

Push [MR] to select MEMORY mode.

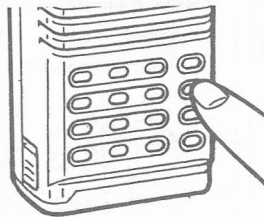

Rotate [SQUELCH] until the noise disappears.

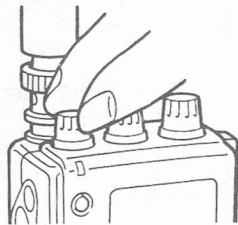

2 Start memory scan.

Push [F] + [▼](P-SCAN) to start the scan.



- While scanning, rotate the tuning control to change the direction of the scan or to resume scanning while paused.
- Scan resume condition can be adjusted in SET mode. (see p. 48)

3 Stop the scan.

Push [MR] to stop the scan.

- Push [CL] to stop the scan and select VFO mode.

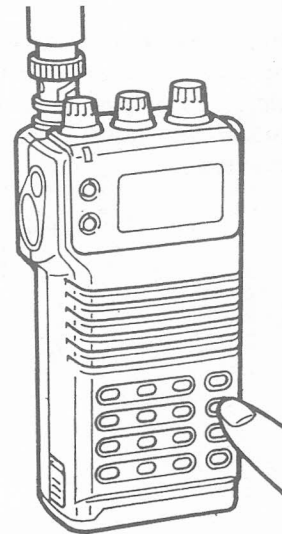

Memory select scan

Memory select scan is the same as memory scan except that memory channels programmed as SKIP frequencies will be skipped during scanning. To program memory channels as SKIP memory channels see p. 32.

This scan is useful for searching through memory channels without pausing on unwanted frequencies (SKIP memory channels).

1 Select MEMORY mode/Set squelch.

Push [MR] to select MEMORY mode.



Rotate [SQUELCH] to mute the audio noise.

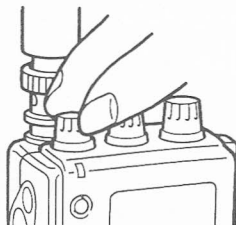

2 Start the scan.

Push [F] + [•](SEL-M) to start the scan.

- SKIP memory channels and masked memory channels will not be scanned.



Blink during scan.

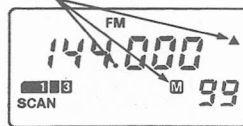

3 Stop the scan.

Push [MR] to stop the scan.

- Push [CL] to stop the scan and select VFO mode.

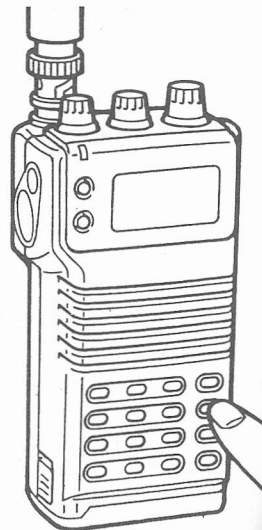

Mode select scan

Mode select scan is a type of memory scan which distinguishes between different receive modes stored in the memory channels. Scanning proceeds through memory channels containing a selected receive mode. For example, only memory channels containing AM programmed frequencies.

This scan is useful when you want to search through memory channels for signals having the same receive mode.

NOTE: Two or more programmed memory channels must be in the same receive mode for mode select scan to operate.

1 Select MEMORY mode/Set squelch.

Push [MR] to select MEMORY mode.

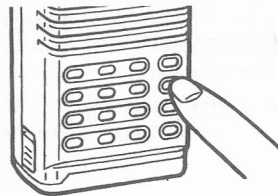

Rotate [SQUELCH] to mute the audio noise.

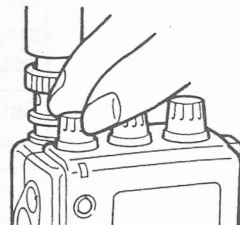

2 Start the scan.

Push [F] + [0](MODE-S) to start the scan.

- Select a memory channel in the receive mode you want to scan.



Blink during scan.



3 Stop the scan.

Push [MR] to stop the scan.



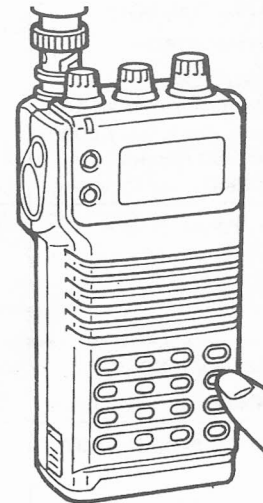



- Push [CL] to stop the scan and select VFO mode.



7 SCAN OPERATION

Summary of scan types

Before operating a scan, make sure that the [SQUELCH] has been properly adjusted (i.e. the audio noise is muted).

SCAN TYPES	START MODE	SCAN START	SCAN STOP	PRE-OPERATION SETTINGS	REF.
Programmed scan	VFO	(F) + 	Push [CL], [MR] or perform the same procedure as for SCAN-START. • If [CL] is used to stop a scan started in MEMORY mode, the IC-R1 enters VFO mode.	Set upper and lower frequency limits (scan edges) for any one of the 10 groups.	p. 27
Programmed skip scan	VFO	(F) + 		Set frequencies to SKIP during programmed skip scanning.	p. 31
Auto-memory write scan CAUTION: The programmed contents in memory channels 80~99 are erased.	VFO	(F) + 		Set upper and lower frequency limits (scan edges) for any one of the 10 groups.	p. 33
Memory scan	MEMORY	(F) + 		Limit the memory channel scan range or all channels that have programmed frequencies will be scanned.	p. 34
Memory select scan	MEMORY	(F) + 		Set memory channels to SKIP during scanning.	p. 35
Mode select scan	MEMORY	(F) + 		Two or more memory channels must be in the same receive mode.	p. 36

■ What is priority watch?

Priority watch checks for signals on one or more memory channels while listening to a VFO frequency.

When receiving a signal, priority watch pauses for 15 sec. or until the signal disappears (whichever comes first).

This function is useful when you want to monitor for a signal that appears infrequently. In this case, you can wait for the signal while listening to another signal on a different frequency.

■ Types of priority watch

There are two types of priority watch: MEMORY CHANNEL WATCH and MEMORY SCAN WATCH. Choose the one which most suits your operating needs.

The two diagrams at the right illustrate the differences between these priority scan types.

MEMORY CHANNEL WATCH

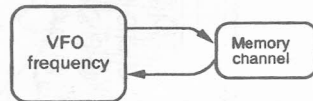

While operating on a VFO frequency, priority watch checks for signals on a selected memory channel every 5 sec.

- When the selected memory channel is masked (hidden), the watch does not start.
- SKIP memory channels can be selected.

MEMORY SCAN WATCH

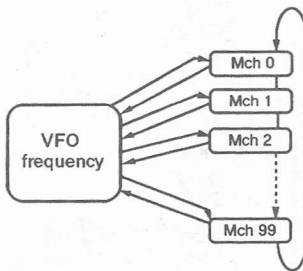

While operating on a VFO frequency, priority watch checks for signals on each memory channel in sequence.

- To monitor a few memory channels only, set the memory scan range. See p. 34 for details.

8 PRIORITY WATCH

Memory channel watch

1 Set VFO frequency.

Push [CL] to select VFO mode.

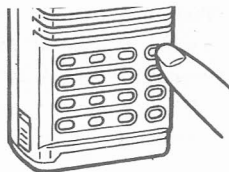

Enter the desired frequency using the keyboard.

- Make sure you are in the correct receive mode.

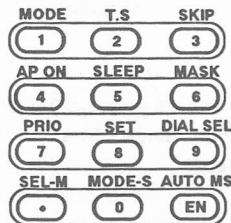

2 Set memory channel/squelch.

Push [MR] to select MEMORY mode.



Rotate the tuning control to select a memory channel.

- See p. 22 for other methods of selecting a memory channel.



Rotate [SQUELCH] to mute the audio noise.



3 Start memory channel watch.

Push [F] + push [7](PRIO).



- Priority watch pauses for 15 sec. when a signal is received on the memory channel, then resumes.



4 Stop the watch.

Push [F] + [7](PRIO) or, push [CL].



- Push [MR] to stop the watch and enter MEMORY mode.
- While receiving a signal on the memory channel, [CL] resumes the priority watch.

Memory scan watch

1 Set VFO frequency/squelch.

- Push [CL] to select VFO mode.
- Enter the desired frequency using the keyboard.
 - Make sure you are in the correct receive mode.

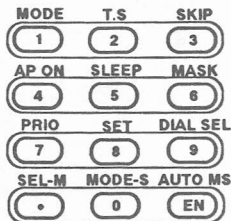

Rotate [SQUELCH] to mute the audio noise.



2 Select MEMORY mode/start scan.

- Push [MR] to select MEMORY mode.
- Push [F] + [▼] (P-SCAN) to start memory channel scan.
 - Memory select scan and mode select scan can also be used. (see pgs. 35, 36)

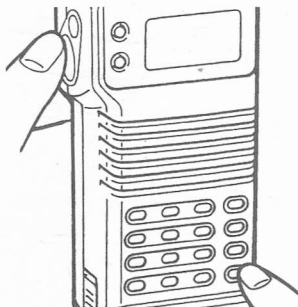

3 Start memory scan watch.

While memory scan is operating, push [F] + [7] (PRIO).



- While on a VFO frequency, memory scan watch briefly checks each memory channel in numerical order.
- When a signal is received on a memory channel, the priority watch pauses for 15 sec.

4 Stop the watch.

Push [F] + [7] (PRIO) or, push [CL].



- Push [MR] to stop the watch and enter MEMORY mode.
- While receiving a signal on a memory channel, [CL] resumes the priority watch.

What is CLOCK mode?

CLOCK mode is used to set the internal clock time, the power-on timer and the sleep timer.

The power-on and sleep timers can be used in conjunction to automatically turn the receiver ON and OFF.

The 24 hour clock system is used with an internal clock error of 1 min/week.

See the flow chart to the right for the relationship between VFO, MEMORY and SET modes and the CLOCK mode operating conditions.

VFO, MEMORY or
SET mode



Time display

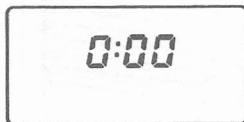

Sleep timer

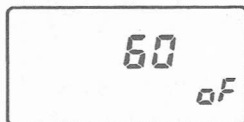

Power-on timer

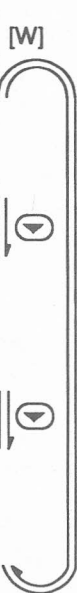

Setting the time — Example:

1 Select the clock display.

Push [W] to select the clock time display.

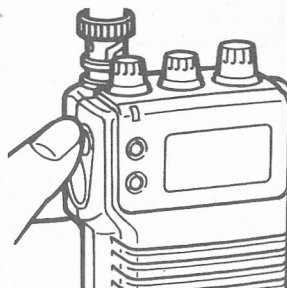

2 Select the hour digit(s).

Push [F] + [8](SET).
• The hour digit(s) blink.

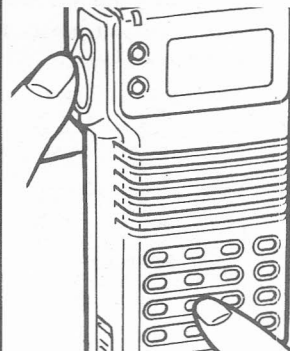

setting the time to 10:30 P.M.

3 Set the hour digit(s).

Rotate the tuning control to set the hour digit(s).

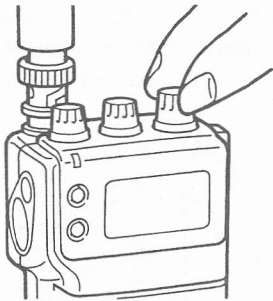

4 Select the minute digits.

Push [▲] to select the minute digits.

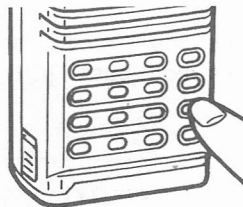

- The minute digits blink.

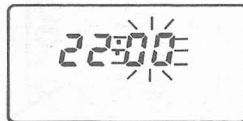

5 Set the minute digits.

Rotate the tuning control to set the minute digits.

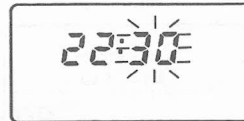
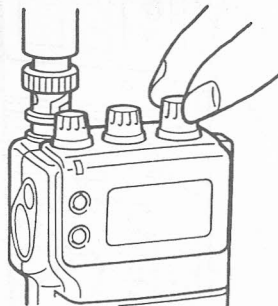

6 Enter the selected time.

Push [EN] to program the selected time.

- The digits stop blinking and the clock starts from 0 sec.
- Push [W] to return to VFO or MEMORY mode.

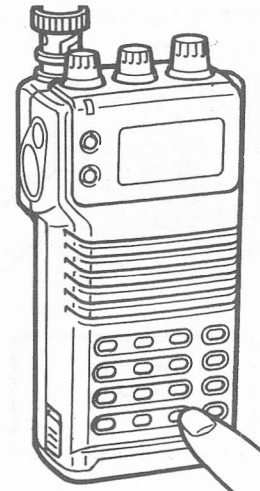

■ Power-on timer — Setting the power-on timer to 7:30.

1 Select power-on condition.

Set desired operating conditions (frequency, receive mode, etc.) in advance, then push [W] to enter the CLOCK mode.

Push [▲] to select the power-on condition.

- 'on' appears.

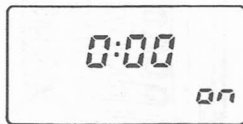
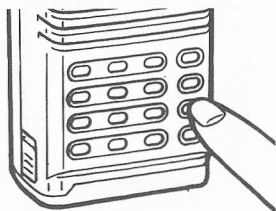

2 Enter the set condition.

Push [F] + [8](SET).

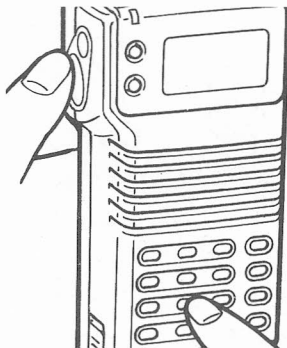

- The hour digit(s) blinks.



3 Set the power-on time.

Rotate the tuning control to set the hour.

Push [▲], then rotate the tuning control to set the minutes.

When the correct time is displayed, push [EN] to enter it.

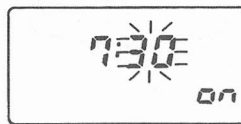

4 Activate the power-on timer.

Push [F] + [4](AP ON).

- The receiver turns OFF and the time is displayed.
- To cancel the power-on timer, turn the power ON and then OFF using [PWR/VOL].



Indicates power-on timer activated.

■ Sleep timer — Setting the sleep timer for 40 min.

1 Select sleep timer condition.

Push [W] to enter CLOCK mode.

Push [▼] to select the sleep timer condition.

- 'oF' appears in the function display.

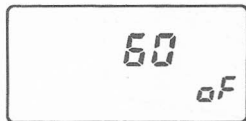
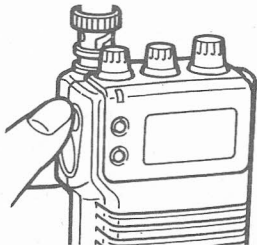

2 Set the sleep timer time.

Rotate the tuning control.

- 60, 40 or 20 min. can be selected.

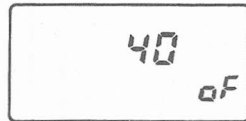
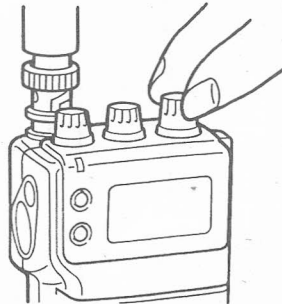

3 Activate the sleep timer.

Push [F] + [5](SLEEP).

- A blinking dot appears.
- Push [F] + [5](SLEEP) again to cancel the function.



Blinking dot indicates the sleep timer is activated.



4 Return to normal operations.

Push [W].

- The receiver will automatically turn OFF after the pre-set time.

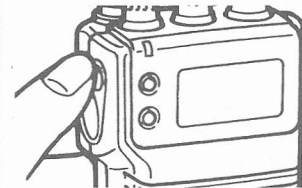

NOTE: Activate the sleep timer in VFO/MEMORY modes by following step 3.

- 'SLEEP' appears for about 2 sec.

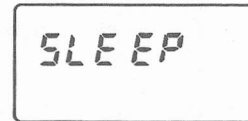

10 OTHER FEATURES

■ Display contrast

While pushing [CONT], rotate the tuning control to change the contrast level of the liquid crystal function display.

- There are 4 levels of contrast.

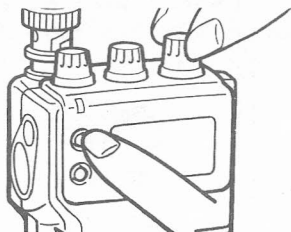

Darker

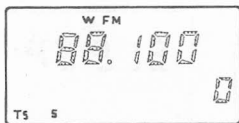

Lighter

■ Monitor function

Push and hold [MONI] to activate the monitor function.

- This allows you to momentarily receive signals that are too weak to open the squelch, without readjusting the [SQUELCH] control.

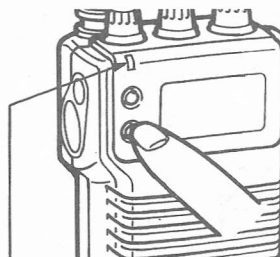

- Receive indicator [RX] lights.

- S-indicator appears or increases.



■ Display lighting

Push [LIGHT] to turn the function display backlight ON.

- The backlighting will automatically turn OFF after 5 sec. (Continuous lighting is also selectable. See p. 49)
- Frequent use of the display lighting will result in decreased operating times because of battery drain.

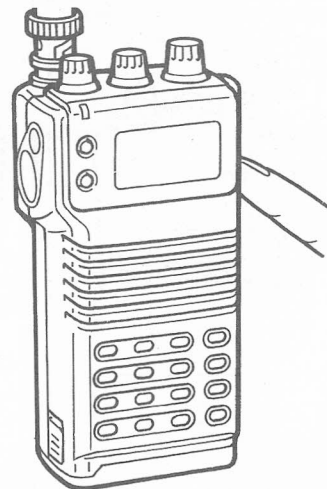

Battery indicator

'' appears in the function display to indicate a low battery condition (either the built-in NiCd batteries or an optional battery pack).

- Charge the batteries as soon as the battery indicator appears.

Battery indicator



- See pgs. 9, 10 for details on battery charging.

Beep tones

Beep tones indicate whether or not an operation has been properly executed. See the table below for the meaning of each beep tone.

BEEP TONE	MEANING
1 short beep	operation executed correctly
1 long beep	[EN] executed correctly
3 short beeps	memory write executed correctly
1 low beep	invalid operation

- The beep tone function can be turned ON and OFF in SET mode. (see p. 50)
- The beep tone volume is directly proportional to the audio output volume.

Power saver

The power saver function conserves battery power by automatically activating after a set period in which no signal is received (standby). See the table below.

DUTY RATE	OPERATING CONDITION
1:1	Receiver standby 125 msec. Receiver circuit OFF 125 msec.
1:2	Receiver standby 125 msec. Receiver circuit OFF 250 msec.
1:4	Receiver standby 125 msec. Receiver circuit OFF 500 msec.
1:8	Receiver standby 125 msec. Receiver circuit OFF 1 sec.
1:16	Receiver standby 125 msec. Receiver circuit OFF 2 sec.

- This function can be adjusted or turned OFF in SET mode. (see p. 50)

11 SET MODE

General

• What is SET mode?

SET mode is accessed from VFO mode and allows you to modify certain receiver conditions to suit your operating requirements.

Adjusting these settings to your own individual preferences allows you to "customize" the receiver's operating parameters to suit your operating style.

If you are not sure what effect changing a particular condition will have on the receiver's performance – experiment with different settings. Don't worry, there is no way you can damage the receiver by altering these settings.

There are 10 conditions which can be modified in SET mode. The displays at right show the initial or reset conditions. See the following pages for an explanation of each condition and how to modify them.

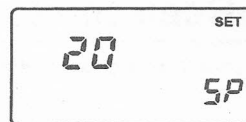

Scan speed (p. 48)

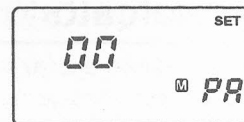

Memory scan range A (p. 49)

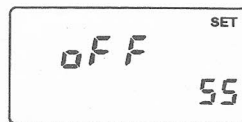

Power saver scan (p. 50)

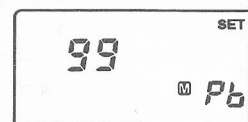

Memory scan range b (p. 49)

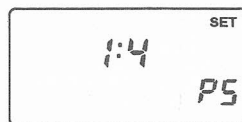

Power saver (p. 50)



Skip function (p. 49)

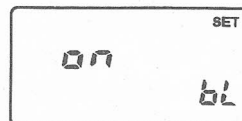

Receive lamp (p. 50)

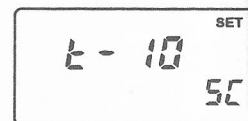

Scan resume (p. 48)

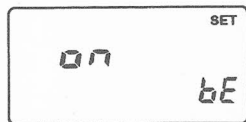

Beep tones (p. 50)

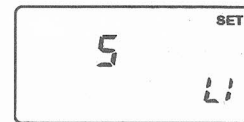

Display lamp (p. 49)

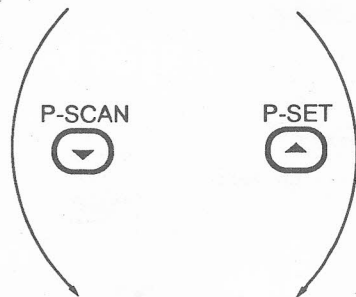

■ Entering set mode

1 Select VFO mode. Enter SET mode.

Push [CL]; then push [F] + [8](SET).

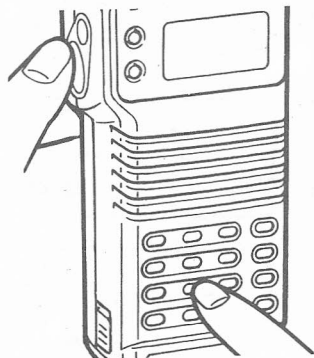
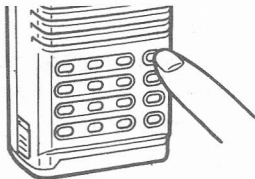

2 Select display and condition.

Push [▲] or [▼] several times to select the desired display, then rotate the tuning control to select the condition.

- Push [CL] to exit SET mode.

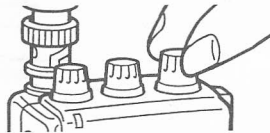
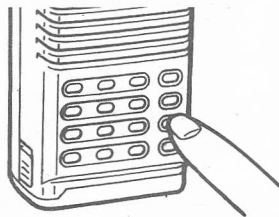

■ Setting displays

Scan speed

Rotate the tuning control.

- '20': scan speed faster.
- '10': scan speed slower.
- Priority watch is not affected.

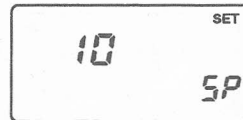
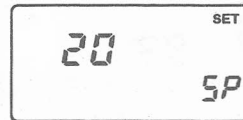

Scan resume condition

Rotate the tuning control.

- 't-10': scan pauses on a signal for about 10 sec.
- 'P-02': scanning resumes about 2 sec. AFTER a received signal disappears.
- This setting has no effect on priority watch resume.

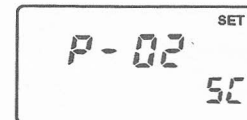
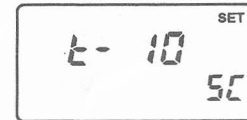
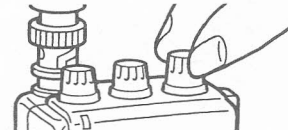

11 SET MODE

Memory scan range A

Rotate the tuning control.

- Limits the range for memory scans.
- Use with memory scan range b to set upper and lower memory channels to be scanned.

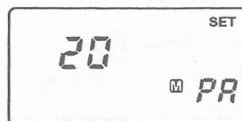
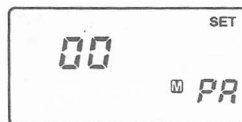

Memory scan range b

Rotate the tuning control.

- Use in conjunction with memory scan range A to set upper and lower memory channels to be scanned.

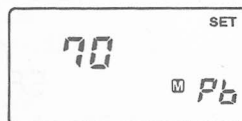
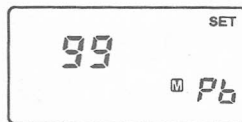

Frequency skip function ON/OFF

Rotate the tuning control.

- Turns the programmed skip scan function ON and OFF.
- 'OFF': your programmed 'SKIP' information is ignored in programmed skip scan and memory scan.

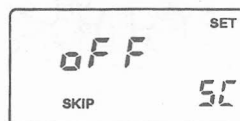

Display lamp control

Rotate the tuning control.

- '5': lamp automatically turns OFF about 5 sec. after pushing [LIGHT].
- 'on': the backlighting can be turned ON/OFF manually with the [LIGHT] switch.

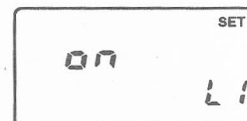
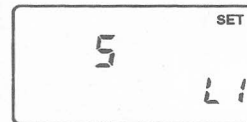

Beep tone ON/OFF

Rotate the tuning control.

- 'ON': beep tone function is ON.
- 'OFF': beep tone function is OFF. (see p. 46 for details)

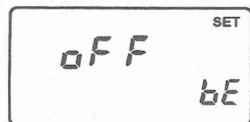
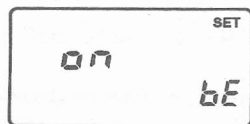

RX (receive) lamp ON/OFF

Rotate the tuning control.

- 'ON': RX lamp lights while receiving a signal.
- 'OFF': RX lamp does not light while receiving a signal.

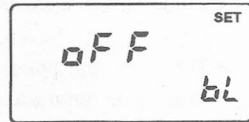
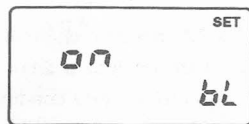

Power saver duty rate

Rotate the tuning control.

- 'OFF': power saver function is deactivated.
- The larger the ratio, the longer the power saver time. (See p. 46 for details)

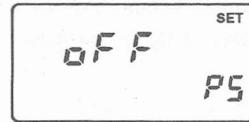
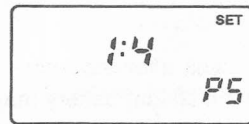

Power saver scan ON/OFF

Rotate the tuning control.

- 'ON': activates the power saver function during scanning if no signal is received.

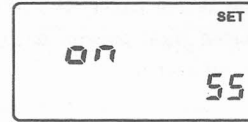
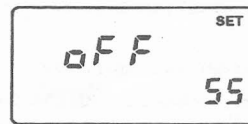
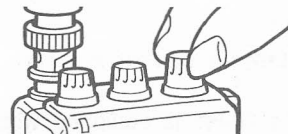

12 TROUBLESHOOTING

■ Troubleshooting

If the IC-R1 does not seem to be functioning as it should be, consult the table on the opposite page. If you cannot resolve the problem in this manner, the receiver may be in need of service. See your local Icom Distributor or Service Center.

An abnormal display during operation is usually caused by a CPU error or external factors such as static electricity. Should this happen, turn power OFF, then ON again. If the display still seems abnormal, reset the receiver's CPU. (see p. 2)

• Lithium backup battery

The IC-R1 is equipped with a lithium backup battery for retaining memory channel contents and SET mode conditions when power is turned OFF.

If the receiver is not used within 1 week after the internal battery is exhausted, the capacity of the lithium battery may become exhausted*, resulting in the loss of this information.

*The lithium battery is normally recharged automatically by the built-in NiCd battery, an optional battery pack or an external power source.

• Recharging the lithium backup battery

If the display remains blank after turning power ON, recharge the lithium backup battery in the following way:

- 1) Recharge the receiver following the normal procedure outlined on pgs. 9, 10. (The lithium battery will be fully operational after about 1 hour of charging.)
- 2) Reset the receiver (see p. 2) and turn the power ON.
 - The receiver's display will show as follows:



- All memory channel contents are returned to their initial settings. (see p. 21)
- All SET mode conditions are returned to their initial settings. (see p. 47)
- Programmed scan frequency bands are returned to their initial settings. (see p. 29)
- The clock and power-on timers both return to 0:00 and the sleep timer returns to 60 min.

PROBLEM	POSSIBLE CAUSE	SOLUTION	REF.
<ul style="list-style-type: none"> No display with power turned ON. The contents of memories are erased. 	<ul style="list-style-type: none"> The lithium backup battery requires recharging. 	<ul style="list-style-type: none"> Charge the internal batteries. 	pgs. 9, 10
<ul style="list-style-type: none"> Weak reception, excessive distortion or too much noise. 	<ul style="list-style-type: none"> Not centered on the frequency. Wrong receive mode. [SQUELCH] is turned too far clockwise. Self-oscillation is being received. Interference. Batteries are exhausted. 	<ul style="list-style-type: none"> Select a small tuning step and set to the central frequency. Push [F] + [1](MODE), one or more times to select the correct receive mode. Rotate [SQUELCH] counter clockwise. Change the frequency. Use the supplied antenna or an antenna tuned to the desired frequency. Charge the internal batteries. 	<p>p. 14</p> <p>p. 13</p> <p>p. 12</p> <p>p. i</p> <p>p. i</p> <p>p. 9</p>
<ul style="list-style-type: none"> Cannot tune with the tuning control. 	<ul style="list-style-type: none"> Frequency lock is ON. 	<ul style="list-style-type: none"> Turn OFF the frequency lock function. 	p. 17
<ul style="list-style-type: none"> Cannot start scanning. 	<ul style="list-style-type: none"> [SQUELCH] is turned too far clockwise. Required settings not preset. 	<ul style="list-style-type: none"> Rotate [SQUELCH] counterclockwise. Review the instructions. 	p. 12
<ul style="list-style-type: none"> Scan does not search some memory channels. 	<ul style="list-style-type: none"> Memory scan range has been limited in SET mode. 	<ul style="list-style-type: none"> Adjust the scan range in SET mode. 	p. 49
<ul style="list-style-type: none"> Scanning is slow. 	<ul style="list-style-type: none"> Improper scan speed. Power saver scan speed is ON. 	<ul style="list-style-type: none"> Select the scan speed in SET mode. Turn OFF the power saver scan. 	<p>p. 48</p> <p>p. 50</p>
<ul style="list-style-type: none"> Cannot enter SET mode. 	<ul style="list-style-type: none"> Not accessed from VFO mode. 	<ul style="list-style-type: none"> Select VFO mode and then try again. 	p. 48
<ul style="list-style-type: none"> Cannot recharge the internal battery. 	<ul style="list-style-type: none"> Internal battery was recharged without turning OFF the power. An external battery pack is exhausted. 	<ul style="list-style-type: none"> Charge the internal battery when power is turned OFF. Disconnect the battery pack and then charge again. 	<p>p. 9</p> <p>p. 11</p>

12 TROUBLESHOOTING

■ Exiting a display

When the receiver shows the following displays, operate as follows to exit the display, if desired.



This display appears when the receiver is in CLOCK mode. To exit the mode, push [W]. (p. 41)



This is one of the SET mode displays (SET appears). To exit the mode, push [CL]. (p. 48)

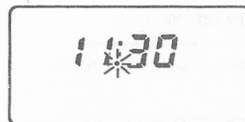

This display appears when the receiver enters the OFF condition using the SLEEP timer. To exit the display, turn [PWR/VOL] OFF, then ON. (p. 44)

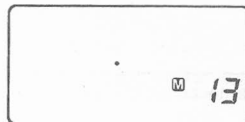

This display appears when a masked memory channel is selected. To exit the display, rotate the tuning control to select an unmasked memory channel. (p. 24)



This display appears when the LOCK function is activated. To exit the display, push [F] + [LIGHT](LOCK). (p. 17)



This display appears when the power-on timer has been activated. To exit the display, turn [PWR/VOL] OFF, then ON again. (p. 43)



If an abnormal display such as this occurs, turn [PWR/VOL] OFF, then ON again. If you cannot exit the display in this manner, reset the receiver. (p. 2)

SPECIFICATIONS 13

• Frequency coverage:

VERSION	FREQUENCY COVERAGE
U.S.A., Australia, Asia	100 kHz~1300 MHz
Germany	13.95~14.5 MHz, 28~29.7 MHz, 144~146 MHz, 430~440 MHz, 1240~1300 MHz
France	100 kHz~87.5 MHz, 108~1300 MHz

Specifications guaranteed 22~905 MHz.

- Selectable tuning steps : 0.5, 5, 8, 9,* 10, 12.5, 15, 20, 25, 30 or 50 kHz
*9 kHz step: 108~1630 kHz only
- Number of memory channels : 100
- Modes : FM, AM, Wide FM (WFM)
- Antenna impedance : 50 Ω (unbalanced)
- Power supply requirement : 7.2 V DC (internal battery)
Optional BP-81~BP-85 or BP-90
External DC power 6~16 V DC
- Current drain : Max. audio output Less than 300mA
Power saved Average 15 mA
(Duty cycle Receive: Standby=1:16)
- Usable temperature range : - 10 °C ~+ 60 °C ; +14 °F ~+ 140 °F
- Dimensions : 49(W) × 102.5 (H) × (D) mm
19 (W) × 4.0 (H) × 1.4 (D) in
- Weight : 280 g; 9.9 oz.

- Receive system : AM, FM Triple-conversion superheterodyne
WFM Double-conversion superheterodyne
- Intermediate frequencies : 1st 266.7000~266.7095 MHz
2nd 10.7000 MHz
3rd 455 kHz (FM/AM only)
- Sensitivity : AM (for 10 dB S/N)
1.6 μV (2~24.9995 MHz)
0.79 μV (25~905 MHz)
FM (for 12 dB SINAD)
0.79 μV (2~24.9995 MHz)
0.4 μV (25~905 MHz)
WFM (for 12 dB SINAD)
6.3 μV (2~24.9995 MHz)
3.16 μV (25~905 MHz)
- Squelch sensitivity : AM 1.26 μV (2~24.9995 MHz)
0.63 μV (25~905 MHz)
FM 0.63 μV (2~24.9995 MHz)
0.32 μV (25~905 MHz)
- Selectivity : AM More than 15 kHz/ - 6 dB
FM More than 15 kHz/ - 6 dB
WFM More than 150 kHz/ - 6 dB
- Audio output power : 150 mW at 10 % distortion with an 8 Ω load
- Audio output impedance : 8 Ω

All stated specifications are subject to change without notice or obligation.

14 OPTIONS

Icom offers a wide variety of options to suit your operating needs.

BATTERY PACKS	OUTPUT VOLTAGE	BATTERY CAPACITY	HEIGHT	CARRYING CASES
Internal batteries	7.2 V	300 mAh	N/A	LC-57
BP-81	7.2 V	110 mAh	30.0 mm; 1.2 in	—
BP-82	7.2 V	300 mAh	40.0 mm; 1.6 in	LC-59
BP-83	7.2 V	600 mAh	59.5 mm; 2.3 in	LC-59
BP-84	7.2 V	1000 mAh	76.0 mm; 3.0 in	LC-61
BP-85	12.0 V	340 mAh	76.0 mm; 3.0 in	LC-61
BP-90*	Battery case for 6 R6(AA) size batteries.		59.5 mm; 2.3 in	LC-59

*Can be charged when NiCd batteries are installed.



BC-72 DESKTOP CHARGER

Rapidly charges the BP-81~BP-85 and IC-R1 internal batteries. Both AC and DC can be used as a power supply.

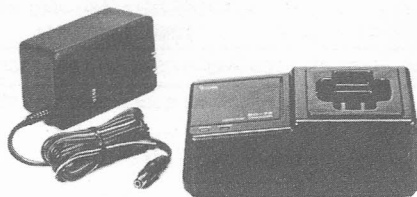

AD-14 BATTERY CHARGE ADAPTER

Allows you to charge the BP-81~BP-84 and BP-90 with NiCd batteries separated from the IC-R1. Use together with the supplied wall charger or an optional CP-12 or OPC-254.

BA-12 BATTERY CHARGE ADAPTER

Allows you to rapidly charge the IC-R1 internal batteries with the BC-72.



CP-12 CIGARETTE LIGHTER CABLE WITH NOISE FILTER

Allows you to use the IC-R1 through a 12 V cigarette lighter socket. Also charges the BP-81~BP-85 and IC-R1 internal batteries.



OPC-254 MINI DC POWER CABLE

For use with a 13.8 V DC power supply. Equipped with fuses. Also charges the BP-81~BP-85 and IC-R1 internal batteries.

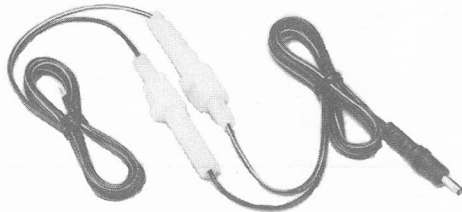

HP-4 COMMUNICATION HEADPHONES

Monaural headphones for clear audio in noisy environments.



MB-30 MOUNTING BRACKET

Conveniently mounts the IC-R1 in a vehicle or on a wall.

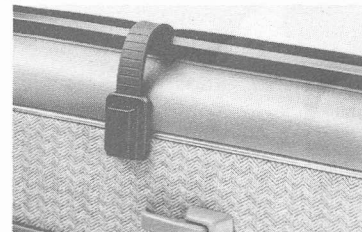

NOTE: Option photo dimensions are not actual sizes and are not in true proportion to each other.

Count on us!

A-5231H-1EX
Printed in Japan
Copyright © 1992 by Icom Inc.

Downloaded by
RadioManual.EU

Icom Inc.
6-9-16, Kamihigashi, Hirano-ku, Osaka 547, Japan