



## INSTRUCTION MANUAL

COMMUNICATION RECEIVER

# IC-R2500



Icom Inc.

---

## FOREWORD

---

Thank you for purchasing this Icom receiver. The IC-R2500 COMMUNICATIONS RECEIVER is designed and built with Icom's state of the art technology and craftsmanship. With proper care, this receiver should provide you with years of trouble-free operation.

We want to take a couple of moments of your time to thank you for making the IC-R2500 your radio of choice, and hope you agree with Icom's philosophy of "technology first." Many hours of research and development went into the design of your IC-R2500.

### ◆ FEATURES

- *Wide frequency coverage with all-mode receive*
- *Both Remote controller operation and PC control application are available*
- *ANF and NR functions are available*  
*(Only when the optional DSP unit is installed.)*
- *IF shift function*
- *Dualwatch operation/Diversity operation*
- *DV and P25 Digital modes are available*  
*(Only when the specific digital unit is installed.)*

---

## IMPORTANT

---

**READ ALL INSTRUCTIONS** carefully and completely before using the receiver.

**SAVE THIS INSTRUCTION MANUAL—** This instruction manual contains important operating instructions for the IC-R2500.

---

## EXPLICIT DEFINITIONS

---

WORD	DEFINITION
⚠ <b>WARNING!</b>	Personal injury, fire hazard or electric shock may occur.
<b>CAUTION</b>	Equipment damage may occur.
<b>NOTE</b>	Recommended for optimum use. No risk of personal injury, fire or electric shock.

Icom, Icom Inc. and the ICOM logo are registered trademarks of Icom Incorporated (Japan) in the United States, the United Kingdom, Germany, France, Spain, Russia and/or other countries.

## SUPPLIED ACCESSORIES

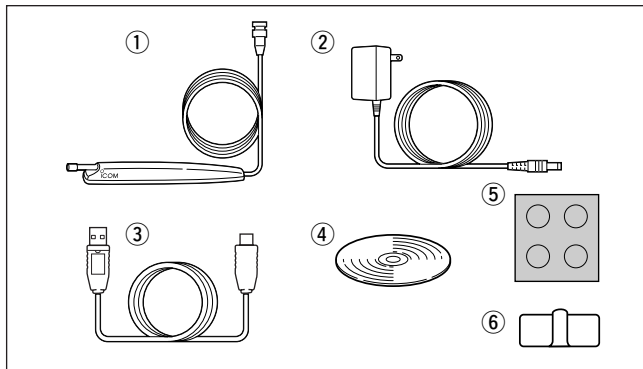

① Antenna .....	1
② AC adapter* .....	1
③ USB cable .....	1
④ CD .....	1
⑤ Foot pad sheet.....	1
⑥ Cable hanger .....	1

\*Not supplied with some versions.

## SPECIFICATIONS

Specifications are provided in the IC-PCR1500/IC-PCR2500's Instruction manual.

## OPTIONS

### UT-106\* DSP UNIT

Provides AF DSP functions such as noise reduction and auto notch.

### UT-108\* DTMF DECODER UNIT

Provides DTMF decode function for sub band.

### UT-118\* DIGITAL UNIT

Provides DV (digital) mode operation.

### UT-122\* DIGITAL UNIT

Provides P25 (digital) mode operation.

### CP-12L CIGARETTE LIGHTER CABLES

For operation and charging via a 12 V cigarette lighter socket.

### OPC-254L DC POWER CABLES

For operation and charging via an external power supply.

### SP-10 EXTERNAL SPEAKER

For all-round mobile operation. Cable length: 1.5 m; 4.9 ft

### OPC-1156 SEPARATION CABLE

For extended separate installation. 3.5 m; 11.5 ft

### MB-84 REMOTE CONTROLLER BRACKET

Mounts the remote controller in a convenient location.

### MB-65 MOUNTING BASE

Mounts the controller with the MB-84. Adjustable angle and direction for optimum positioning.

\*: The optional units UT-106, UT-108, UT-118, UT-122 installations are described in the IC-PCR1500/IC-PCR2500's Instruction manual.

---

## PRECAUTIONS

---

**⚠ WARNING! NEVER** connect the receiver via the OPC-254L to an AC outlet. This may pose a fire hazard or result in an electric shock.

**⚠ WARNING! NEVER** operate the receiver while driving a vehicle. Safe driving requires your full attention— anything less may result in an accident.

**NEVER** connect the receiver to a power source of more than 14 V DC. This will damage the receiver.

**NEVER** connect the receiver to a power source using reverse polarity. This will damage the receiver.

**NEVER** cut the DC power cable between the DC plug and fuse holder. If an incorrect connection is made after cutting, the receiver may be damaged.

**DO NOT** leave the main unit powered ON and connected to a vehicle's electrical system. The main unit draws approx. 550 mA. This will eventually drain the vehicle's battery.

**NEVER** expose the receiver to rain, snow or any liquids. The receiver may be damaged.

**NEVER** operate or touch the receiver with wet hands. This may result in an electric shock or damage the receiver.

**NEVER** place the receiver where normal operation of the vehicle may be hindered or where it could cause bodily injury.

**NEVER** let objects impede the operation of the cooling fan on the rear panel.

**AVOID** using or placing the receiver in direct sunlight or in areas with temperatures below  $-10^{\circ}\text{C}$  ( $+14^{\circ}\text{F}$ ) or above  $+60^{\circ}\text{C}$  ( $+140^{\circ}\text{F}$ ).

**BE CAREFUL!** The receiver will become hot when operating it continuously for long periods.

**AVOID** setting the receiver in a place without adequate ventilation. Heat dissipation may be affected, and the receiver may be damaged.

**AVOID** the use of chemical agents such as benzine or alcohol when cleaning, as they can damage the receiver's surfaces.

*For U.S.A. only*

**CAUTION:** Changes or modifications to this device, not expressly approved by Icom Inc., could void your authority to operate this device under FCC regulations.

---

## ABOUT APCO PROJECT 25

---

This device made under license under one or more of the following US patents: #4,590,473, #4,636,791, #5,148,482, #5,185,796, #5,271,017, #5,377,229.

The IMBE™ voice coding technology embodied in this product is protected by intellectual property rights including patent rights, copyrights and trade secrets of Digital Voice Systems, Inc. This voice coding Technology is licensed solely for use within this communications equipment. The user of this technology is explicitly prohibited from attempting to decompile, reverse engineer, or disassemble the object code, or in any other way convert the object code into a human-readable form. U.S. Pat. nos. #5,870,405, #5,826,222, #5,754,974, #5,701,390, #5,715,365, #5,649,050, #5,630,011, #5,581,656, #5,517,511, #5,491,772, #5,247,579, #5,226,084, #5,195,166.

P25 digital mode is available when the optional UT-122 DIGITAL UNIT is installed.

---

# TABLE OF CONTENTS

---

FOREWORD .....	i	■ Attenuator function .....	15
IMPORTANT .....	i	■ NB function .....	16
EXPLICIT DEFINITIONS .....	i	■ AGC function .....	16
SUPPLIED ACCESSORIES .....	ii	■ AFC function .....	17
SPECIFICATIONS .....	ii	■ VSC function .....	17
OPTIONS .....	ii	■ IF filter selection .....	18
PRECAUTIONS .....	iii	■ IF shift function .....	18
ABOUT APCO PROJECT 25 .....	iv	■ Duplex operation .....	19
TABLE OF CONTENTS .....	v	■ Weather channel operation (USA/CANADA versions only) .....	20
<b>1 CONNECTION .....</b>	<b>1–2</b>	■ Single band operation .....	22
■ Rear panel connection .....	1	<b>5 MEMORY OPERATION .....</b>	<b>23–32</b>
■ Antenna installation .....	2	■ General description .....	23
<b>2 PANEL DESCRIPTION .....</b>	<b>3–10</b>	■ Memory channel selection .....	23
■ Front panel—controller .....	3	■ Programming a memory channel .....	24
■ Function display .....	7	■ Programming channel names .....	25
■ Rear panel—main unit .....	9	■ Copying memory contents .....	27
<b>3 SETTING A FREQUENCY .....</b>	<b>11–13</b>	■ Memory clearing .....	29
■ Preparation .....	11	■ Memory bank setting .....	30
■ Tuning step selection .....	12	■ Memory bank selection .....	31
■ Using the tuning dial .....	13	■ Transferring bank contents .....	31
■ Receive mode selection .....	13	<b>6 SCAN OPERATION .....</b>	<b>33–37</b>
<b>4 BASIC OPERATION .....</b>	<b>14–22</b>	■ Scan types .....	33
■ Receiving .....	14	■ Scan start/stop .....	34
■ Monitor function .....	14	■ Scan edges programming .....	35
■ Lock function .....	15	■ Skip scan .....	36
		■ Scan resume condition .....	37

<b>7</b>	<b>PRIORITY WATCH .....</b>	<b>38</b>
	■ Priority watch types .....	38
	■ Priority watch operation .....	38
<b>8</b>	<b>POCKET BEEP AND TONE SQUELCH .....</b>	<b>39–42</b>
	■ Pocket beep operation .....	39
	■ Tone/DTCS squelch operation .....	41
	■ Tone scan .....	42
<b>9</b>	<b>DIGITAL MODE OPERATION .....</b>	<b>43–48</b>
	■ Digital mode operation .....	43
	■ Pocket beep operation .....	43
	■ Digital squelch operation .....	45
	■ Call sign programming (for DV mode) .....	47
	■ ID code programming (for P25 mode) .....	48
<b>10</b>	<b>SET MODE .....</b>	<b>49–64</b>
	■ General .....	49
	■ Set mode items .....	49
<b>11</b>	<b>OTHER FUNCTIONS .....</b>	<b>65–68</b>
	■ DSP operation (Optional UT-106 is required).....	65
	■ DATA cloning (IC-PCR2500 control software must be installed) ...	66
	■ Partial reset .....	67
	■ All reset.....	67
	■ Internal audio switch.....	68
<b>12</b>	<b>TROUBLESHOOTING .....</b>	<b>69</b>
<b>13</b>	<b>DOC .....</b>	<b>70</b>

## ■ Rear panel connection

The antenna holder is backed with double-sided tape. Remove the protective paper when the antenna is fixed to any place.

The dualwatch operation or diversity operation requires antennas connected to both [ANT1] and [ANT2].

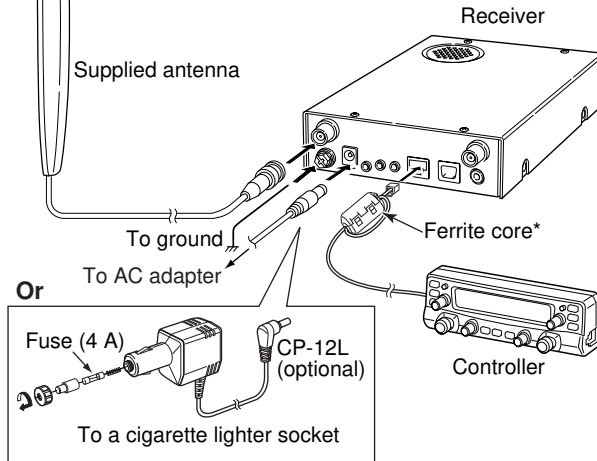

\*: Ferrite core may not be present on all versions.

## ◆ DC power supply connection

Use a 12 V DC power supply with at least 4 A capacity. Make sure the ground terminal of the DC power supply is grounded.

### • CONNECTING TO A DC POWER SUPPLY

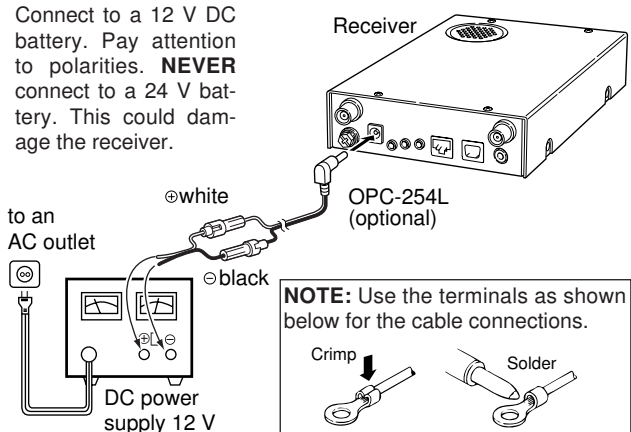

⚠ **CAUTION!** NEVER remove the fuse-holders from the DC power cable.

### ◆ Fuse replacement

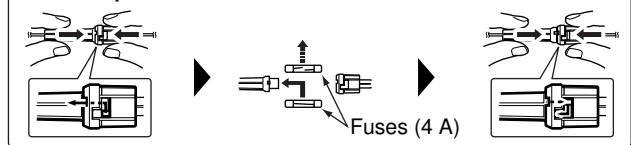



◆ OPC-1156 connection

- ① Connect the controller plug to the OPC-1156 jack.
- ② Detach the ferrite core from the controller cable, then attach it to the OPC-1156 as shown below.
  - Make sure to wind the cable on the ferrite core.
- ③ Connect the OPC-1156 plug to the [CONTROLLER] connector of the receiver.

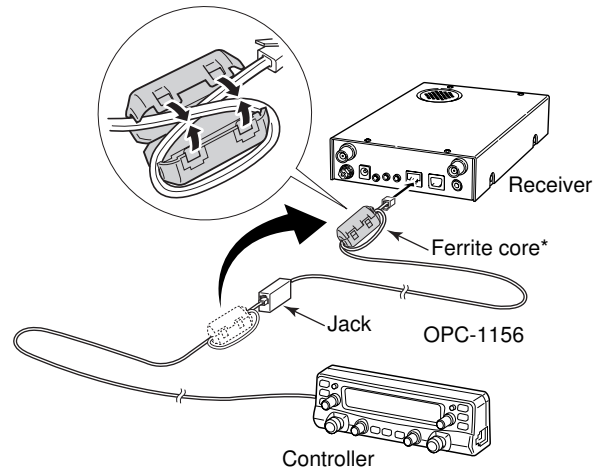

\*: Ferrite core may not be present on all versions.

■ Antenna installation

◆ Antenna location

To obtain maximum performance from the receiver, select a high-quality antenna and mount it in a good location. It is not necessary to use radials on a magnetic mount (“mag mount”) antenna.

## ■ Front panel—controller

The keys ② to ⑤ are for the main band only.

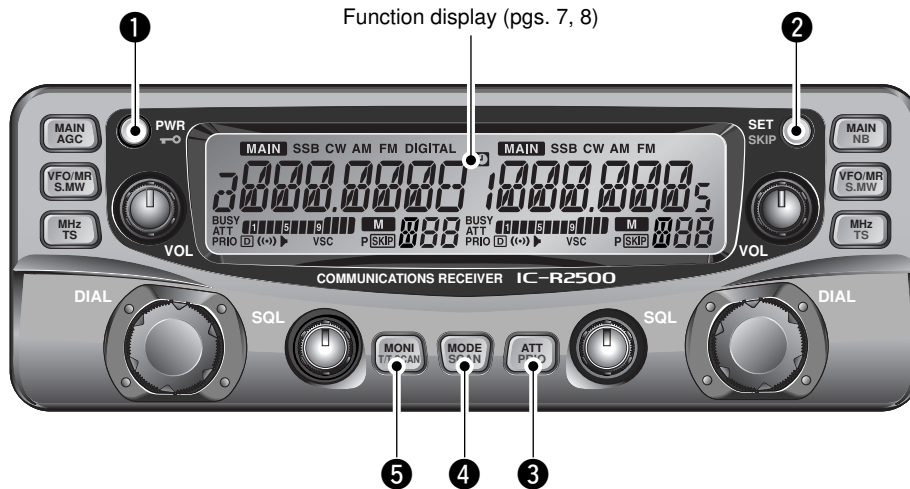

**1 POWER KEY [PWR•↔]**

- ➔ Push and hold for 1 sec. to turn the controller power ON and OFF. (p. 11)
- ➔ Continue to hold this key down for 2 sec. after power ON to turn the lock function ON and OFF. (p. 15)

**2 SET-SKIP KEY [SET-SKIP]**

- ➔ Push to enter *set mode*. (p. 49)
- ➔ Push and hold for 1 sec. to turn the channel skip setting ON and OFF for memory/VFO skip scan operation. (p. 36)

**3 ATTENUATOR/PRIORITY KEY [ATT-PRIO]**

- ➔ Push to turn the ATT (Attenuator) function ON and OFF. (p. 15)
- ➔ Push and hold for 1 sec. to start priority watch. (p. 38)

**4 MODE-SCAN KEY [MODE-SCAN]**

- ➔ Push and hold for 1 sec. to enter *receive mode select mode*. (p. 13)
  - Rotate main band's [DIAL] to select the desired receive mode.
- ➔ Push and hold for 1 sec. to start a scan. (p. 34)
  - Cancels a scan when pushed during scan.

**5 MONITOR-TONE-TONE SCAN KEY****[MONI-T/T-SCAN]**

- ➔ Push to turn the monitor function ON and OFF. (p. 14)
- ➔ Push and hold for 1 sec. to enter the tone function selection mode. (pgs. 34, 41, 44, 46)
  - Pocket beep (CTCSS), tone squelch, pocket beep (DTCS), DTCS squelch or tone function OFF can be selected in FM mode.
  - Pocket beep (DSQL), digital call sign squelch, pocket beep (CSQL), digital code squelch or digital squelch function OFF can be selected in DV\*1 mode.
  - Pocket beep (NAC), digital NAC squelch, pocket beep (Selective), digital selective squelch or digital squelch function OFF can be selected in P25\*2 mode.
- \*1: The optional UT-118 is required.
- \*2: The optional UT-122 is required.

Some versions already come with the UT-122 installed.

- ➔ Push and hold for 1 sec. during tone function selection mode to start the tone scan. (p. 42)

## 2 PANEL DESCRIPTION

The same controls for both the left and right bands are arranged symmetrically.

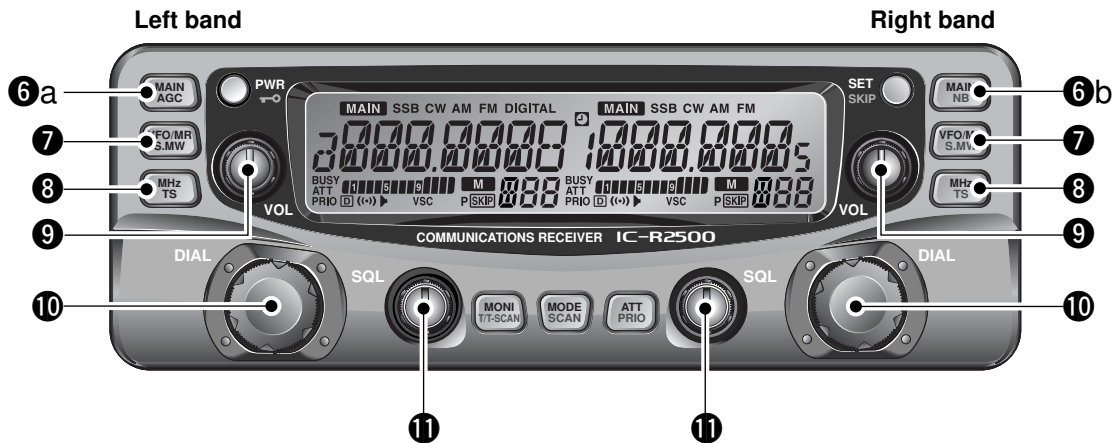

**6a MAIN•AGC KEY [MAIN•AGC]**

- ➔ Push to select the left band as main band. (p. 11)
- ➔ Push and hold for 1 sec. to turn the AGC (Automatic Gain Control) function ON and OFF. (p. 16)

**6b MAIN•NB KEY [MAIN•NB]**

- ➔ Push to select the right band as main band. (p. 11)
- ➔ Push and hold for 1 sec. to turn the NB (Noise Blanker) function ON and OFF. (p. 16)

**7 VFO/MEMORY•MEMORY WRITE KEY [VFO/MR•S.MW]**

- ➔ Push to select from VFO, memory and weather channel\* modes. (pgs. 11, 20, 23)  
\*Weather channels available for USA/CANADA versions only.
- ➔ Push and hold for 1 sec. to enter *select memory write mode* for memory channel programming. (pgs. 24, 25, 35)

**8 MHz TUNING•TUNING STEP [MHz•TS]**

- ➔ Push to select from band selection, 1 MHz or 10 MHz tuning. (p. 13)
- ➔ Push and hold for 1 sec. to enter *tuning step select mode*. (p. 12)
  - Rotate [DIAL] to select the desired tuning step.

**9 VOLUME CONTROL [VOL] (p. 14)**

Adjusts the audio level for left and right band.

**10 TUNING DIAL [DIAL]**

Selects the operating frequency (p. 13), memory channel (p. 23), the setting of the set mode item and the scanning direction (p. 34) for left and right band.

**11 SQUELCH CONTROL [SQL]**

Varies the squelch level for left and right band. (p. 14)

## 2 PANEL DESCRIPTION

### ■ Function display

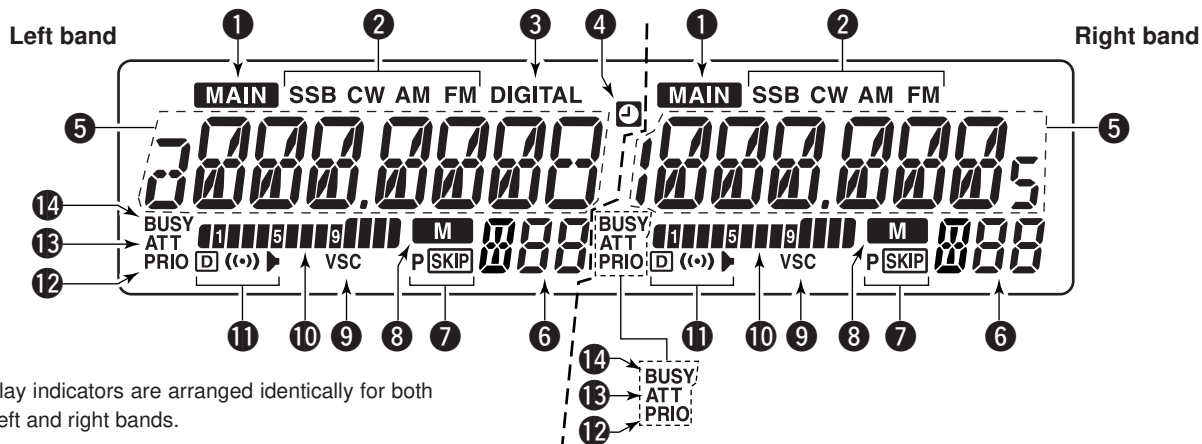

\*Display indicators are arranged identically for both the left and right bands.

#### ❶ MAIN INDICATOR (p. 11)

Indicates the main band for function control.

#### ❷ RECEIVE MODE INDICATORS FOR ANALOG

Shows the selected receive mode.

- SSB (LSB/USB), CW, AM and FM (FM/WFM) are available.

#### ❸ RECEIVE MODE INDICATOR FOR DIGITAL

Appears while the digital mode is selected.

- The optional UT-118 for DV mode or UT-122 for P25 mode is required. Some versions come with the UT-122 installed.

#### ❹ AUTO POWER-OFF INDICATOR (p. 52)

Appears while the auto power OFF function is activated.

#### ❺ FREQUENCY READOUT

Shows the operating frequency, channel names, set mode contents, etc.

- Frequency decimal point blinks while scanning. (p. 34)

#### ❻ MEMORY CHANNEL NUMBER INDICATORS

➔ Shows the selected memory channel number. (p. 11)

➔ Shows the selected bank initial. (p. 31)

➔ “L” appears when the lock function is activated. (p. 15)

**7 SKIP INDICATORS** (p. 36)

- “SKIP” appears when the displayed memory channel is specified as a skip channel.
- “P(SKIP)” appears when the displayed frequency is specified as a program skip frequency.

**8 MEMORY INDICATOR** (pgs. 11, 23)

Appears when *memory mode* is selected.

**9 VSC INDICATOR** (p. 17)

Appears when the VSC function is in use.

**10 S-METER INDICATORS**

Shows the relative signal strength while receiving signals. (p. 14)

**11 TONE INDICATORS**

- During FM mode operation:
  - “▶” appears while the tone squelch function is in use. (p. 41)
  - “☐” appears while the DTCS squelch function is in use. (p. 41)
- During DV\*1 (Digital) mode operation:
  - “▶” appears while the digital call sign squelch function is in use. (p. 45)
  - “☐” appears while the digital code squelch function is in use. (p. 45)

➤ During P25\*2 (Digital) mode operation:

- “▶” appears while the digital NAC squelch function is in use. (p. 45)
- “☐” appears while the digital selective squelch function is in use. (p. 45)

➤ “(••)” appears with the “▶” or “☐” indicator while the pocket beep function is in use. (pgs. 39, 43)

\*1: The optional UT-118 is required.

\*2: The optional UT-122 is required.

Some versions come with the UT-122 installed.

**12 PRIORITY INDICATOR** (p. 38)

Appears while priority watch is activated; blinks while priority watch is paused.

**13 ATT INDICATOR** (p. 15)

Appears when the ATT function is in use.

**14 BUSY INDICATOR**

- Appears when a signal is being received or the squelch is open. (p. 14)
- Blinks while the monitor function is in use. (p. 14)

## 2 PANEL DESCRIPTION

### ■ Rear panel—main unit

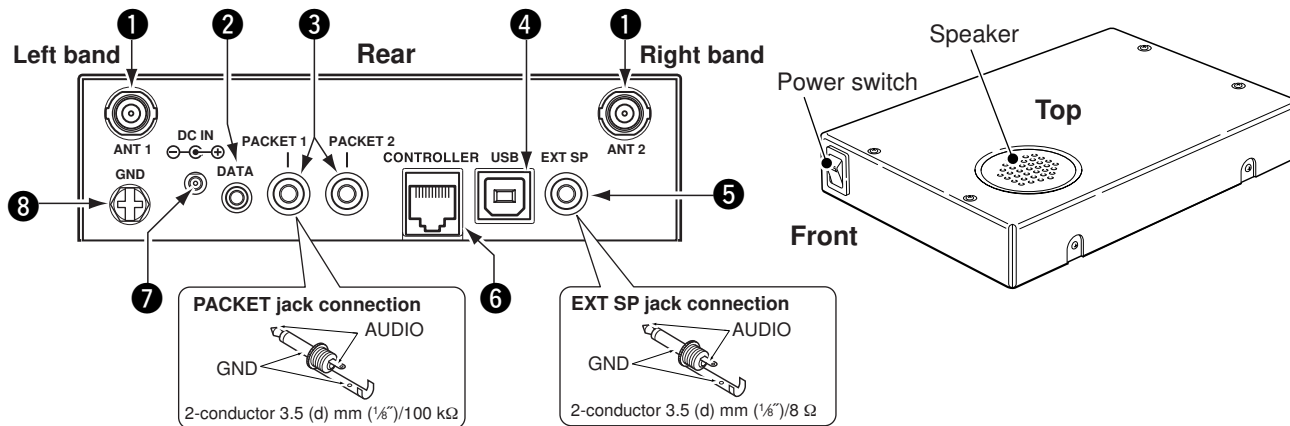



**1 ANTENNA CONNECTORS [ANT]**

Connect a 50 Ω antenna with a BNC connector and a 50 Ω coaxial cable.

[ANT1] for left band, [ANT2] for right band.

Two antennas must be connected to [ANT1] and [ANT2] during dualwatch operation or diversity operation. Diversity operation requires two antennas of the same performance in suitable places. Ask your antenna dealer for installation details.

**2 DATA JACK [DATA]**

Connect to a PC via an RS-232 cable (D-sub 9 pin) for DV\*1 mode data communication in RS-232 format.

\*1 : The optional UT-118 is required.

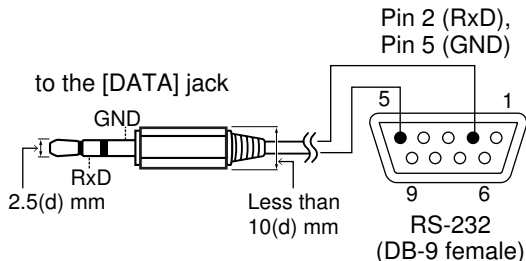

**3 PACKET JACKS [PACKET]**

Connect a TNC (Terminal Node Controller), etc. for data communications. The receiver can support 9600 bps packet communication (AFSK).

**4 USB CONNECTOR [USB]**

Connects to a PC via a supplied USB cable. This connector is only used for control software operation.

- No connection is necessary when the IC-R2500's controller is in use.

**CAUTION: NEVER** insert any other object than a USB cable, such as a metallic object, otherwise the Main unit may be damaged.

**5 EXTERNAL SPEAKER JACK [EXT SP]**

Connect an 8 Ω external speaker.

- Audio output power is more than 0.5 W.

**6 CONTROLLER [CONTROLLER]**

Connects to a controller via an extension cable. This connector is only used for IC-R2500's controller operation.

- No connection is necessary when the control software is in use.

**CAUTION: NEVER** insert any other object than the controller cable, such as a metallic object, otherwise the Main unit may be damaged.

**7 POWER JACK [DC IN]**

Accepts 12 V DC ±15% via the supplied DC power cable.

**8 GROUND TERMINAL [GND]**

Connect this terminal to a ground.

# 3

## SETTING A FREQUENCY

### ■ Preparation

#### ◇ Turning power ON/OFF

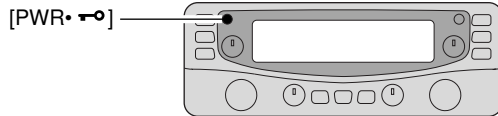

➔ Push [PWR] for 1 sec. to turn power ON and OFF.

#### ◇ MAIN band

The IC-R2500 can receive signals on both the left and right bands simultaneously.

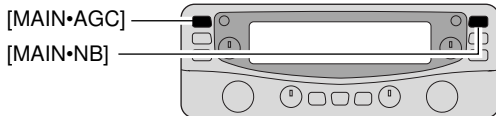

➔ Push the desired band's [MAIN-AGC] or [MAIN-NB] to select the main band.

- "MAIN" indicates the main band.

#### ◇ VFO and memory modes

The receiver has 2 basic operating modes: *VFO mode* and *memory mode*. Select *VFO mode* first to set an operating frequency.

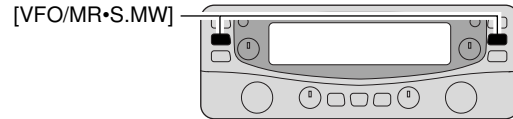

"M" indicator appears when memory mode is selected

➔ Push the desired band's [VFO/MR-S.MW] to select *VFO mode*.

➔ Push [VFO/MR-S.MW] again to select *memory mode*.

- "M" indicator appears when *memory mode* is selected.

## ■ Tuning step selection

When using the tuning dial to change the frequency, or when a scan function is activated, the frequency changes in increments determined by the set tuning step. This can be changed if desired.

The following tuning step are available.

- |                    |                    |                    |
|--------------------|--------------------|--------------------|
| • 0.01 kHz (10 Hz) | • 0.02 kHz (20 Hz) | • 0.05 kHz (50 Hz) |
| • 0.1 kHz (100 Hz) | • 0.5 kHz (500 Hz) | • 1 kHz            |
| • 2.5 kHz          | • 5 kHz            | • 6.25 kHz         |
| • 8.33 kHz         | • 9 kHz            | • 10 kHz           |
| • 12.5 kHz         | • 15 kHz           | • 20 kHz           |
| • 25 kHz           | • 30 kHz           | • 50 kHz           |
| • 100 kHz          | • 125 kHz          | • 150 kHz          |
| • 200 kHz          | • 500 kHz          | • 1000 kHz (1 MHz) |

- ① Push the desired band's **[MAIN]** to select the main band.
  - Push the same band's **[VFO/MR-S.MW]** to select *VFO mode*, if necessary.
- ② Push and hold **[MHz•TS]** for 1 sec. to enter *tuning step select mode*.

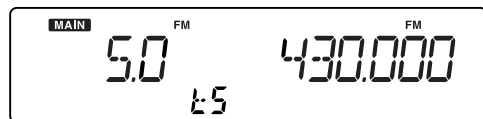
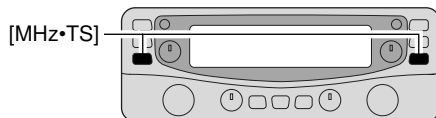

- ③ Rotate the same band's **[DIAL]** to select the desired tuning step.

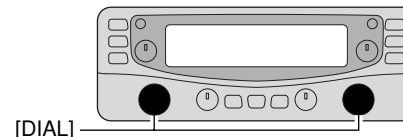

- ④ Push **[MHz•TS]** to exit *tuning step select mode*.
  - Or push any other keys for the same band or any of the shared keys below the display to exit *tuning step select mode*.

### 3 SETTING A FREQUENCY

#### ■ Using the tuning dial

- ① Rotate the desired band's **[DIAL]** to set the frequency.
  - If *VFO mode* is not selected, push the same band's **[VFO/MR•S.MW]** to select *VFO mode*.
  - The frequency changes in the selected tuning steps. (p. 12)

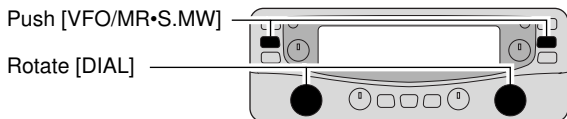

- ② To change the frequency band or tune in 1 MHz (10 MHz) steps, push **[MHz•TS]**, then rotate the band's **[DIAL]**.

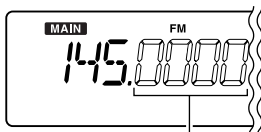

While the band selection mode is selected, the digits below 100 kHz disappear.

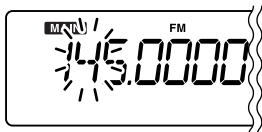

While 10 MHz tuning step is selected, the 10 MHz digit blinks.

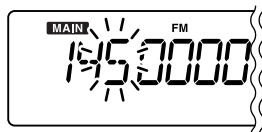

While 1 MHz tuning step is selected, the 1 MHz digit blinks.

- ③ Push **[MHz•TS]** to return to the normal display.

#### ■ Receive mode selection

Receive modes are determined by the physical properties of the radio signals. The receiver has 6 receive modes: USB LSB, CW, AM, WFM and FM modes. The mode selection is stored independently in each memory channel. Additionally, IC-R2500 has a DV or P25 mode when the optional UT-118 or UT-122 units are installed, respectively. In DV or P25 mode, the right band can select AM, FM and WFM mode only.

Typically, AM mode is used for the AM broadcast stations (0.495–1.620 MHz), air band (118–135.995 MHz), and short-wave broadcasts. WFM is used for FM broadcast stations (76–107.9 MHz). WFM mode can be selected on 1300 MHz band or below.

- ① Push **[MODE•SCAN]** to enter *receive mode select mode*.

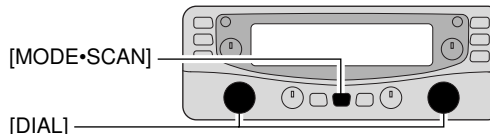

- ② Rotate main band's **[DIAL]** to select the desired mode.

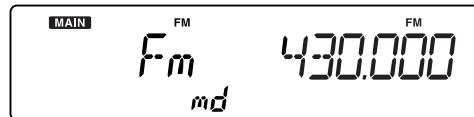

- ③ Push any key for main band to exit *receive mode select mode*.

## ■ Receiving

- ① Set the audio level for the main band.
  - ➔ Push the desired band's **[MAIN]**.
  - ➔ Push **[MONI•T/T-SCAN]** to open the squelch.
  - ➔ Rotate the main band's **[VOL]** to adjust the audio level.
  - ➔ Push **[MONI•T/T-SCAN]** to close the squelch.
- ② Set the squelch level.
  - ➔ Rotate the main band's **[SQL]** fully counterclockwise in advance, then rotate **[SQL]** clockwise until the noise just disappears.
- ③ Set the operating frequency in the main band. (pgs. 11–13)
  - When interference due to strong signals is received, push **[ATT•PRIO]** to turn the attenuator function ON. (p. 15)
- ④ When a signal is received on the set frequency, squelch opens and the receiver emits audio.
  - “BUSY” appears and the S-meter shows the relative signal strength for the received signal.



Appears when receiving a signal.

## ■ Monitor function

This function is used to listen to weak signals without disturbing the squelch setting or to open the squelch manually even when mute functions such as the tone squelch are in use.



- ➔ After pushing **[MAIN]** to select the desired band (left or right) as the main band, push **[MONI•T/T-SCAN]** for 1 sec. to open the squelch.
  - “BUSY” blinks.
  - Push **[MONI•T/T-SCAN]** again to cancel the function.

## 4 BASIC OPERATION

### ■ Lock function

To prevent accidental frequency changes and unintentional function access, use the lock function.

- Continue to hold **[PWR• ]** down for 2 sec. after power ON to turn the lock function ON and OFF.
- **[MONI-T/T-SCAN]** (monitor function only), **[VOL]**, **[SQL]**, **[MAIN-AGC]** (main band selection only) and **[MAIN-NB]** (main band selection only) can be used while the lock function is in use.

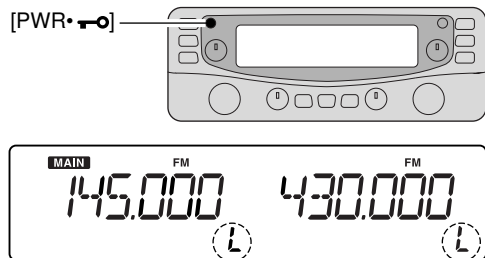

2 "L"s appear while the lock function is activated.

### ■ Attenuator function

The attenuator prevents a desired signal from being distorted when very strong signals are near the desired frequency or when very strong RF fields, such as from a broadcasting station, are near your location. The attenuator reduces signal strength by about 20 dB and this function can be activated on 1300 MHz or below.

- Push **[ATT•PRIO]** momentarily to toggle the attenuator function ON and OFF.
- Push **[MAIN]** to select the desired band (left or right) as the main band in advance.
- "ATT" appears when the attenuator function is in use.

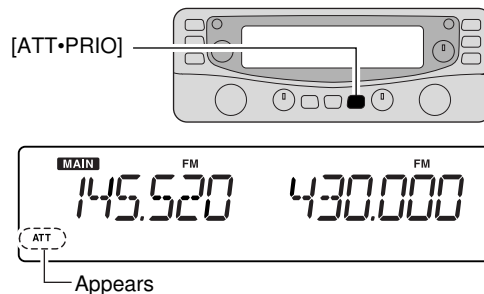

## ■ NB function

The NB (noise blanker) function removes pulse-type noise when SSB, CW or AM mode is selected.

- ➔ After pushing **[MAIN]** to select the desired band (left or right) as the main band, push and hold **[MAIN•NB]** for 1 sec. to toggle the NB function ON and OFF.
- “nb-On” or “nb-OFF” appears for a moment when the NB function is turned ON or OFF, respectively.

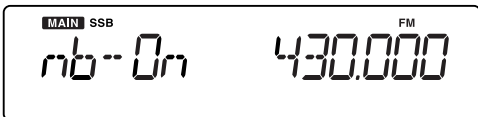
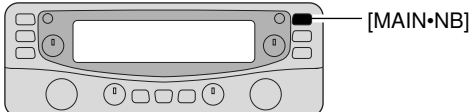

## ■ AGC function

The AGC (Automatic Gain Control) function controls receiver gain to produce a constant audio output level even when the received signal strength varies from fading, etc. A slow-response AGC function is selectable for SSB, CW or AM mode.

- ➔ After pushing **[MAIN]** to select the desired band (left or right) as the main band, push and hold **[MAIN•AGC]** for 1 sec. to toggle the AGC function Slow and Fast.
- “AGC-S” or “AGC-F” appears for a moment when the AGC function is selected Slow or Fast, respectively.

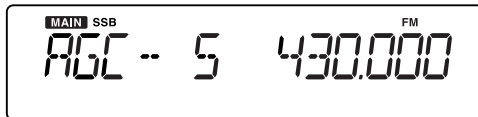
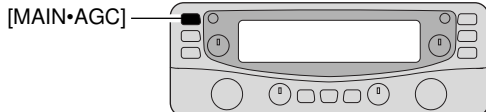

▨ While in FM or WFM mode, the AGC function is fixed as Fast and AGC Slow cannot be selected.

## 4 BASIC OPERATION

### ■ AFC function

USING SET MODE

The AFC (Automatic Frequency Control) function tunes the displayed frequency automatically when an off-center frequency is received. It activates in FM mode and only when the selected IF filter is 6 kHz or 15 kHz.

- ① Push the desired band's **[MAIN]** to select the main band.
- ② Select FM mode.
- ③ Push **[SET•SKIP]** to enter *set mode*.
- ④ Push **[SET•SKIP]** or **[ATT•PRIO]** several times until "AFC" appears.

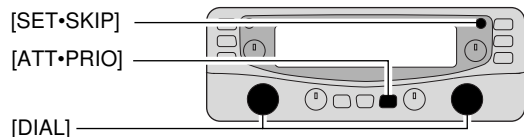

- ⑤ Rotate the main band's **[DIAL]** to toggle the AFC function ON and OFF.

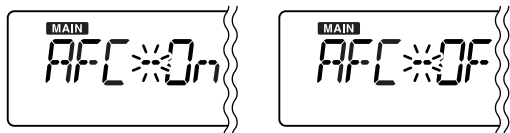

- ⑥ Push any key for the main band to exit *set mode*.

### ■ VSC function

USING SET MODE

The VSC (Voice Squelch Control) function opens the squelch only when receiving a modulated signal. This function is very useful while scanning, the VSC pauses only when modulated signals are received. Scanning continues when unmodulated or beat signals are received.

- ① Push the desired band's **[MAIN]** to select the main band.
- ② Push **[SET•SKIP]** to enter *set mode*.
- ③ Push **[SET•SKIP]** or **[ATT•PRIO]** several times until "VSC" appears.

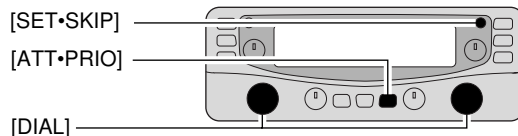

- ④ Rotate the main band's **[DIAL]** to toggle the VSC function ON and OFF.

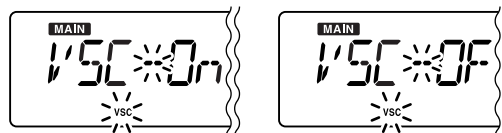

- ⑤ Push any key for the main band to exit *set mode*.



## ■ IF filter selection

USING SET MODE

The receiver has 2 to 4 IF passband filter widths for each mode. Selectable passband widths are 3, 6, 15, 50 and 230 (depending on the selected mode).

### • Selectable passband width for each mode.

SSB mode : 3 (2.8 kHz) or 6 kHz

CW mode : 3 (2.8 kHz) or 6 kHz

AM mode : 3 (2.8 kHz), 6 kHz, 15 kHz or 50 kHz

WFM mode: 50 kHz or 230 kHz

FM mode : 6 kHz, 15 kHz or 50 kHz

- ① Push the desired band's **[MAIN]** to select the main band.
- ② Push **[SET•SKIP]** to enter *set mode*.
- ③ Push **[SET•SKIP]** or **[ATT•PRIO]** several times until "VSC" appears.

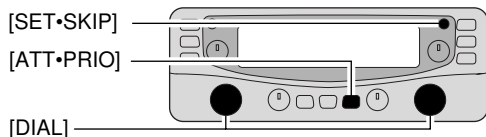

- ④ Rotate the main band's **[DIAL]** to select the desired IF passband width.

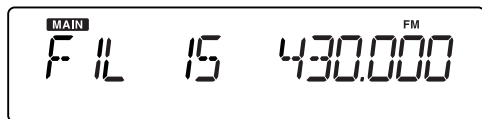

- ⑤ Push any key for the main band to exit *set mode*.

## ■ IF shift function

USING SET MODE

The IF shift function electronically changes the passband frequency of the IF (Intermediate frequency) cutting out higher or lower frequency components of the IF to reject interference. This function is available when the receive mode is SSB or CW mode, and shifts the IF frequency up to  $\pm 25$  steps (in 1 step: 50 Hz).

- ① After pushing **[MAIN]** to select the desired band (left or right) as the main band, push **[SET•SKIP]** to enter *set mode*.
- ② Push **[SET•SKIP]** or **[ATT•PRIO]** several times until "SfT" appears.

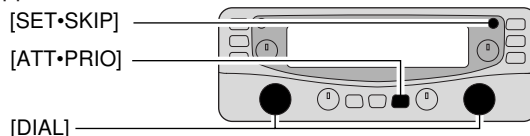

- ③ Rotate the main band's **[DIAL]** to set the shifting direction and frequency range.

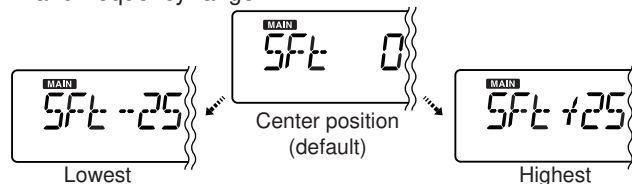

- ④ Push any key for the main band to exit *set mode*.

## 4 BASIC OPERATION

### ■ Duplex operation

Duplex communication uses two different frequencies for transmitting and receiving. Generally, duplex is used in communication through a repeater, some utility communications, etc.

During duplex operation, the transmit station frequency is shifted from the receive station frequency by the offset frequency. Repeater information (offset frequency and shift direction) can be programmed into memory channels. (p. 24)

#### ◆ Setting

USING SET MODE

- ① Push the desired band's **[MAIN]** to select the main band.
- ② Push **[SET•SKIP]** to enter *set mode*.
- ③ Push **[SET•SKIP]** or **[ATT•PRIO]** several times until the duplex direction setting item "OFF dP," "DUP- dP" or "DUP+ dP" appears.

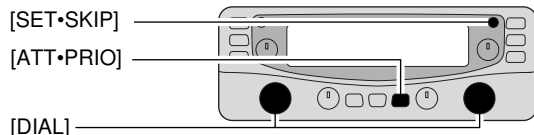

- ④ Rotate the main band's **[DIAL]** to select the duplex direction, "DUP- dP" or "DUP+ dP."

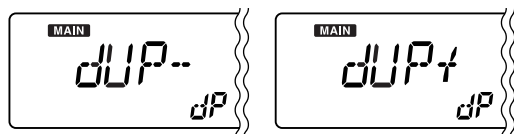

- ⑤ Push **[SET•SKIP]** once to advance to the offset frequency setting item.
- ⑥ Rotate the main band's **[DIAL]** to set the desired offset frequency within 0.000–1000.000 MHz range.
  - The tuning step, selected in *VFO mode*, is used for setting.
  - Push **[MHz•TS]** then rotate the main band's **[DIAL]** to change the frequency in 10 MHz steps, or push again then rotate the main band's **[DIAL]** to change the frequency in 1 MHz steps. (Each push toggles 1 MHz, 10 MHz or selected tuning steps.)

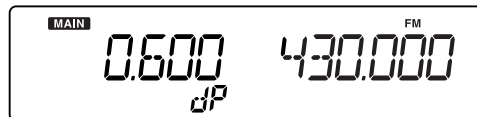

- ⑦ Push any key for main band to exit *set mode*.

◇ Operation

- ① Set the receive station frequency (repeater output frequency).
- ② Push **[MONI•T/T-SCAN]** to monitor the transmit station frequency (repeater input frequency) directly.

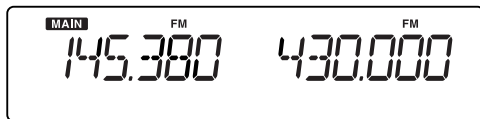
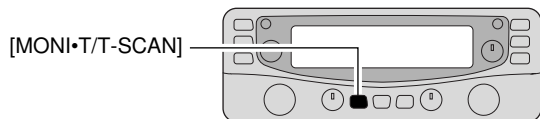

↓ Frequency shifts the offset frequency

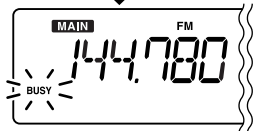

## ■ Weather channel operation (USA/CANADA versions only)

◇ Weather channel selection

- ① Push **[VFO/MR•S.MW]** to select *memory mode* in the desired band (left or right).
- ② Push **[MHz•TS]** to enter *memory type selection mode*.

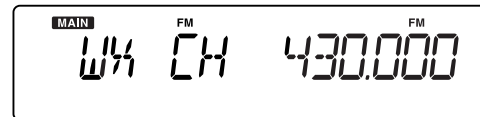
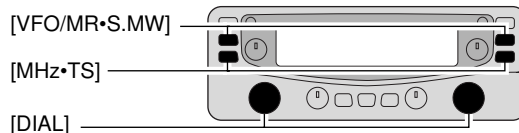

Weather channel group indication

- ③ Rotate **[DIAL]** to select the weather channel group.
- ④ Push any key for main band or any of the shared keys below the display to set the channel indication.
  - Channel number appears.

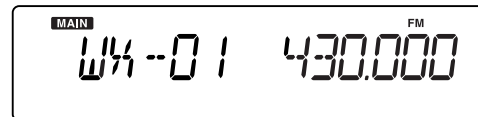

- ⑤ Rotate **[DIAL]** to select the desired weather channel.
- ⑥ To return to regular *memory mode*, repeat steps ② to ④ and select "bAnk --" at step ③.

## 4 BASIC OPERATION

### ◇ Weather alert function

NOAA broadcast stations transmit weather alert tones before important weather announcements. When the weather alert function is turned ON, the selected weather channel is monitored each 5 sec. for the announcement. When the alert signal is detected, the "ALT" and the WX channel are displayed alternately and sounds a beep tone until the receiver controls are manipulated. The previously selected weather channel is checked periodically during standby or while scanning.

- ① Select the desired weather channel.
- ② Turn the weather alert function ON in *set mode*.
  - Push **[MAIN]** to select the desired band (left or right) as the main band in advance.
  - Push **[SET•SKIP]** to enter *set mode*.
  - Push **[SET•SKIP]** or **[ATT•PRIO]** to select the weather alert item, then rotate the main band's **[DIAL]** to set ON.
  - Push any key for main band to exit *set mode*.
- ③ Select the desired stand-by condition.
  - Select VFO or memory channel.
  - Scan or priority watch operation can also be selected.

- ④ When the alert is detected, a beep sounds and the following indication will be displayed.

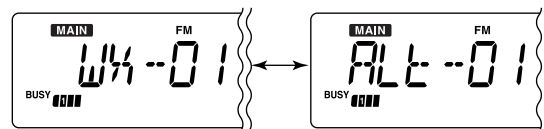

Shows above indications alternately.

- ⑤ Turn the weather alert function OFF in *set mode*.

**NOTE:** While receiving a signal (on a frequency other than the weather alert ON frequency), the receiving signal or audio will be interrupted momentarily every 5 sec. (approx.) in case the alert function is turned ON. This is caused by the WX alert function. To eliminate the interruptions, set the weather alert item OFF in *set mode*.

## ■ Single band operation

### ◇ Single band/Dualwatch operation

Dualwatch operation monitors two frequencies simultaneously. The IC-R2500 has two independent receiver circuits: left band, and right band (available frequencies, operating mode and functions are different depending on bands).

Single band operation is useful when only one frequency is being watched. The right band can be inhibited.

- ① Select the left band as the main band.  
 ➔ Push **[MAIN•AGC]** once to select left band, if necessary.
- ② Push **[SET•SKIP]** to enter *set mode*.
- ③ Push **[SET•SKIP]** or **[ATT•PRIO]** several times to select “SUB” item.
- ④ Rotate the left band’s **[DIAL]** to turn the sub band ON for dualwatch or OFF for single band operation.

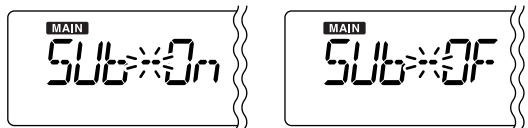
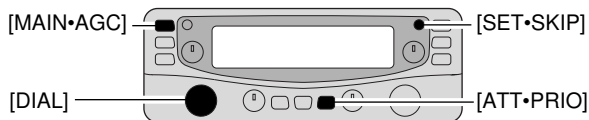

- ⑤ Push any key for main band to exit *set mode*.
- /// When the dualwatch operation is in use, IC-R2500 must be connected to two antennas. ([ANT1] and [ANT2])

### ◇ Diversity operation

The diversity receiving compares the receiving signal strength from two different antennas, ANT1 and ANT2, and automatically selects the strongest signal. This feature is useful when you are listening in a moving vehicle or the transmitting station itself is moving. Diversity receiving is available from 50 MHz to 1300 MHz on FM, P25 and DV modes only.

- ① Turn the sub band OFF to select single band operation as described at left.
- ② Rotate right band’s **[DIAL]** to turn the diversity function ON or OFF.

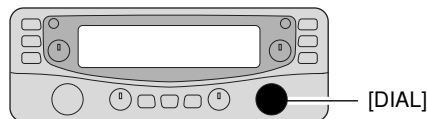

“d-” indicator appears while [ANT1] is selected,  
 “-d” indicator appears while [ANT2] is selected.

- /// With the squelch open in FM mode while receiving a weak signal, diversity receiving does not work properly.
- /// AGC is disabled during diversity receiving.

## ■ General description

The receiver has 1100 memory channels including 100 scan edge memory channels (50 pairs) for storage of often-used frequencies. And a total of 21 memory banks, A to H, J to R, T, U, W and Y are available for storing groups of frequencies, etc. Up to 100 channels can be assigned to a bank.

### ◆ Memory channel contents

The following information can be programmed into memory channels:

- Operating frequency (p. 13)
- Receive mode (p. 13)
- Tuning step (p. 12)
- Attenuator ON/OFF (p. 15)
- IF filter selection (p. 18)
- Duplex direction (DUP+ or DUP-) with an offset frequency (p. 19)
- Squelch control system ON/OFF and its frequency or code (pgs. 39, 41, 43, 45)
- Scan skip information (p. 36), etc.

## ■ Memory channel selection

- ① Push the desired band's **[VFO/MR•S.MW]** once or twice to select *memory mode*.
  - “**M**” indicator appears.

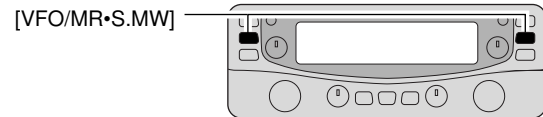

“**M**” indicator appears when memory mode is selected

- ② Rotate the same band's **[DIAL]** to select the desired memory channel.
  - Programmed memory channels only can be selected.

If memory banks or weather channels\* mode appears at step ①, push **[MHz•TS]** and rotate **[DIAL]** to select “bAnk --,” then push any keys for the main band or any of the shared keys below the display to return to channel selection.

\*Available for USA/CANADA versions only.

## ■ Programming a memory channel

VFO settings, including the set mode contents such as sub-audible tone frequency, offset and scan skip information can be programmed into a memory channel.

- ① Set the desired frequency in the desired band (left or right).
  - ➔ Push the desired band's **[VFO/MR•S.MW]** once or twice to select *VFO mode*.
  - ➔ Set the frequency using the same band's **[DIAL]**.
  - ➔ Set other data (e.g. tone frequency, duplex information, etc.) if required.
- ② Push and hold the same band's **[VFO/MR•S.MW]** for 1 sec. to enter *select memory write mode*.
  - "M" indicator and the memory channel number blink.

- ③ Rotate the same band's **[DIAL]** to select the memory channel to be programmed.
  - Memory channels not yet programmed are blank.
- ④ Push and hold **[VFO/MR•S.MW]** for 1 sec. to program.
  - 3 beeps sound
  - Memory channel number automatically increases when continuing to push **[VFO/MR•S.MW]** after programming.

### ✓ CONVENIENT

Memory programming can be made quicker by copying memory information to different memory channels (p. 27).

**[EXAMPLE]:** Programming 145.800 MHz into memory channel 20 (blank channel).

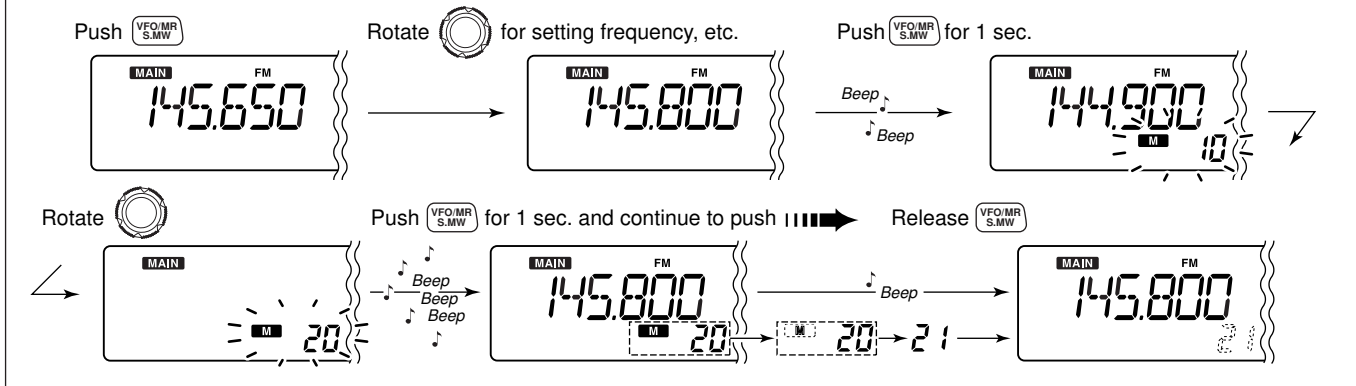

## ■ Programming channel names

Each memory channel can be programmed with an alphanumeric channel name for easy recognition and can be indicated independently by channel. Names can be a maximum of 6 characters— see the table on next page for available characters.

- ① Select the desired memory channel to be programmed.
  - ➔ Push **[VFO/MR-S.MW]** to select *memory mode*, then rotate the same band's **[DIAL]** to select the desired memory channel.
- ② Push and hold **[VFO/MR-S.MW]** for 1 sec. to enter *select memory write mode*.
  - “**M**” indicator and the memory channel number blink.

- ③ Push **[SET-SKIP]** several times to select the memory name programming condition, “m nAmE.”
  - Frequency readouts disappear and a cursor blinks.
- ④ Rotate the same band's **[DIAL]** to select the desired character.
  - The selected character blinks.
- ⑤ Push **[ATT-PRIO]** to move the cursor to the right.
  - Repeat pushing **[ATT-PRIO]** to return to the first digit.
- ⑥ Repeat steps ④ and ⑤ until the desired channel name is displayed.
- ⑦ Push and hold **[VFO/MR-S.MW]** for 1 sec. to program the name and exit *select memory write mode*.

**[EXAMPLE]:** Programming “CLUB” into memory channel 12.

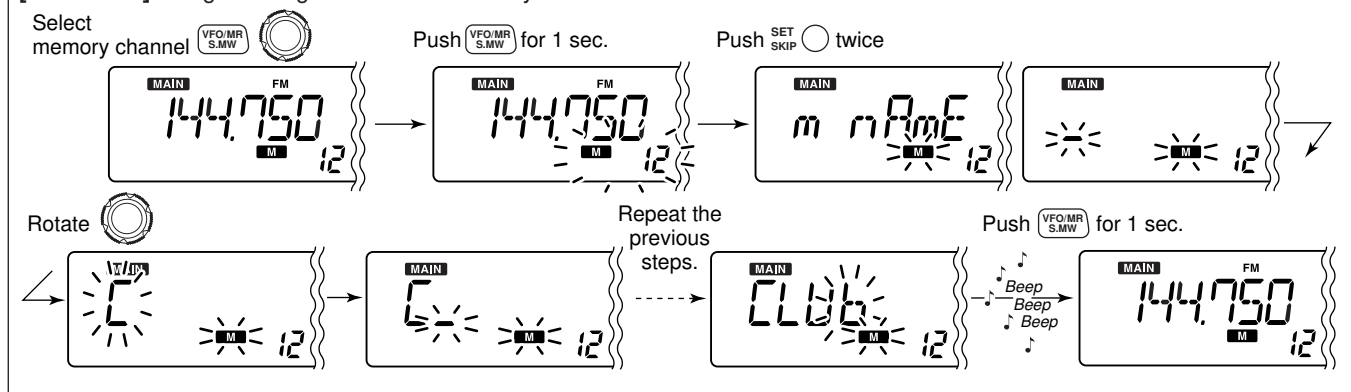



• Available characters

(space)	A(A)	b(B)	C(C)	d(D)	E(E)	F(F)	G(G)	H(H)
l(l)	J(J)	k(K)	L(L)	m(M)	n(N)	O(O)	P(P)	Q(Q)
R(R)	S(S)	t(T)	U(U)	V(V)	W(W)	X(X)	Y(Y)	Z(Z)
0(0)	1(1)	2(2)	3(3)	4(4)	5(5)	6(6)	7(7)	8(8)
9(9)	+(+)	-(-)	'(')	=(=)				

◇ To indicate the channel name

using SET MODE

The channel name indication can be set independently for each memory channel.

- ① Select the desired memory channel in the main band.
  - Push **[VFO/MR-S.MW]** once or twice to select *memory mode*, then rotate the same band's **[DIAL]** to select the desired memory channel.
    - "M" and memory channel number appear.
- ② Push **[SET-SKIP]** to enter *set mode*.
- ③ Push **[SET-SKIP]** or **[ATT-PRIO]** several times to select "Anm" item.
- ④ Rotate same band's **[DIAL]** to turn the memory name indication ON.

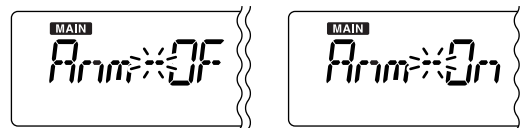

- ⑤ Push any key for main band to exit *set mode*.

/// **NOTE:** When no memory name is programmed, the stored frequency is displayed.

## ■ Copying memory contents

This function transfers a memory channel's contents to VFO (or another memory channel). This is useful when searching for signals near a memory channel frequency and for recalling the subaudible tone frequency, etc.

### ◇ Memory ↔ VFO

- ① Select the desired band's (left or right) memory channel to be transferred.
  - ➔ Push the desired band's **[VFO/MR·S.MW]** several times to select *memory mode*, then rotate the same band's **[DIAL]** to select the desired memory channel.
    - “**M**” and memory channel number appear.
- ② Push and hold **[VFO/MR·S.MW]** for 3 sec. to transfer the selected memory channel contents to *VFO mode*.
  - *VFO mode* is selected automatically.

**[EXAMPLE]:** Transferring the contents of memory channel 30 to VFO.

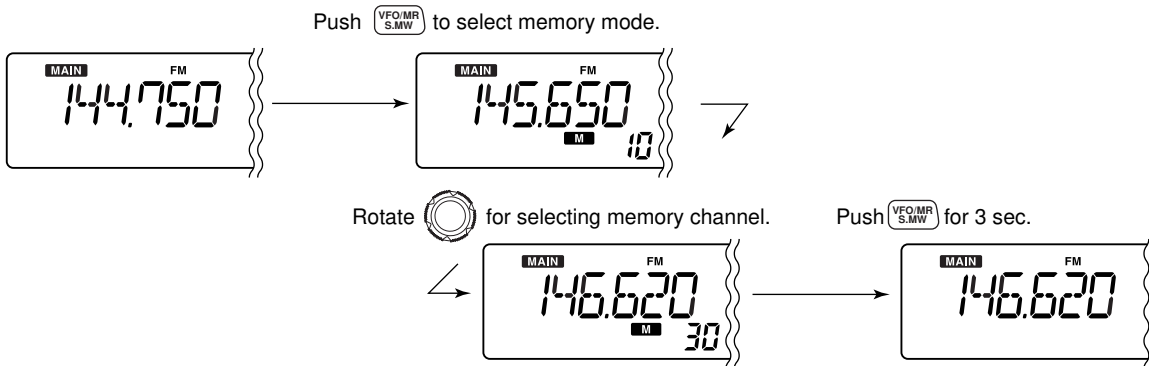

◇ **Memory**↔**memory**

- ① Select the desired band's (left or right) memory channel to be transferred.
  - ➔ Push the desired band's [VFO/MR·S.MW] several times to select *memory mode*, then rotate the same band's [DIAL] to select the desired memory channel.
    - "M" and memory channel number appear.
- ② Push and hold the same band's [VFO/MR·S.MW] for 1 sec. to enter *select memory write mode*.
  - "M" and memory channel number blink.
- ③ Rotate the same band's [DIAL] to select the target memory channel.
  - Scan edge channels, 0A/0B to 49A/49B can also be selected.
- ④ Push and hold [VFO/MR·S.MW] for 1 sec. to transfer the selected memory channel contents to the target memory channel.
  - The targeted memory channel and transferred contents are displayed.

[EXAMPLE]: Transferring the contents of memory channel 22 to channel 23.

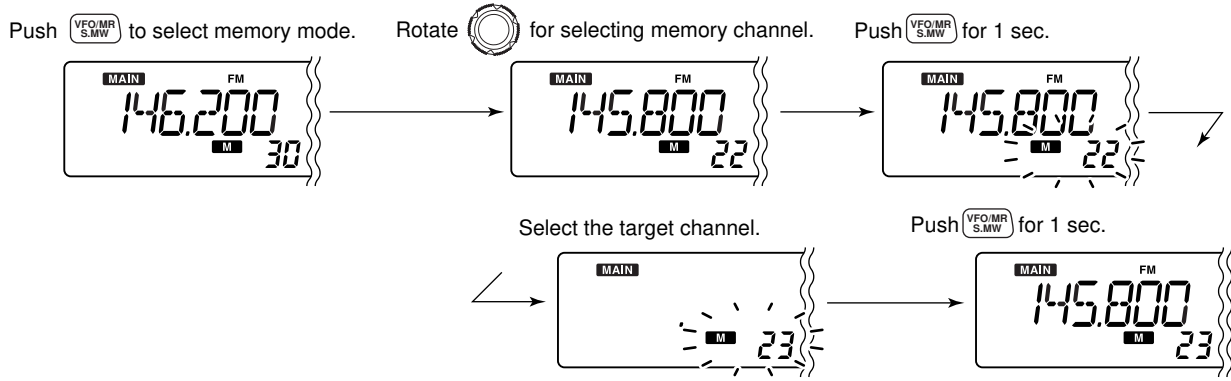

## 5 MEMORY OPERATION

### Memory clearing

Contents of programmed memories can be cleared (erased), if desired.

- 1 Push **[VFO/MR-S.MW]** to select VFO mode in the main band.
- 2 Push the same band's **[VFO/MR-S.MW]** for 1 sec. to enter select memory write mode.
  - “**M**” indicator and the memory channel number blink.
- 3 Rotate the same band's **[DIAL]** to select the memory channel to be cleared.
  - Memory channels not yet programmed are blank.

- 4 Push **[SET-SKIP]** three times to select “CLEAR,” then push and hold **[VFO/MR-S.MW]** for 1 sec.
  - 3 beeps sound.
  - The cleared channel display changes to blank.
  - “**M**” and the memory channel number blink continuously.
- 5 Push the same band's **[MAIN]** or **[MHz-TS]** to exit select memory write mode, or repeat steps 3 and 4 to clear another channel.
- 6 Push the same band's **[VFO/MR-S.MW]** to return to VFO mode.

**NOTE:** Be careful!— the contents of cleared memories CANNOT be recalled.

**[EXAMPLE]:** Clearing memory channel 20.

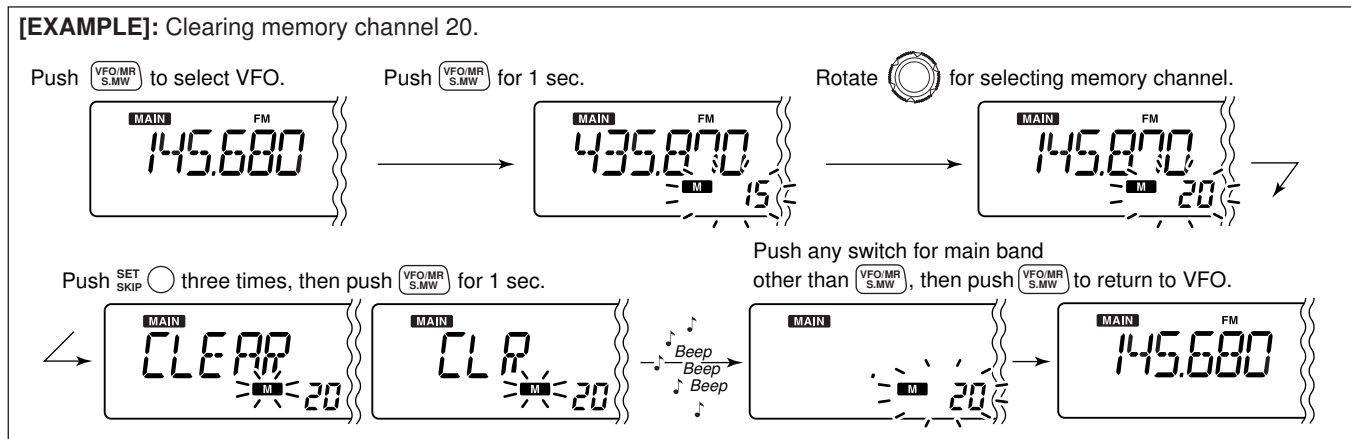

## ■ Memory bank setting

The IC-R2500 has a total of 21 banks (A to H, J to R, T, U, W, Y). Regular memory channels, 0 to 999, may assigned into the desired bank for easy memory management.

- ① Select the desired memory channel.
  - ➔ Push **[VFO/MR•S.MW]** to select *memory mode* in the main band, then rotate the same band's **[DIAL]** to select the desired memory channel.
    - “**M**” and memory channel number appear.
- ② Push and hold the same band's **[VFO/MR•S.MW]** for 1 sec. to enter *select memory write mode*.
  - “**M**” indicator and the memory channel number blink.
- ③ Push **[SET•SKIP]** once to select “bAnk.”

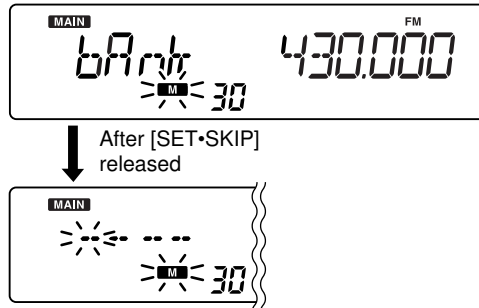

USING *SET MODE*

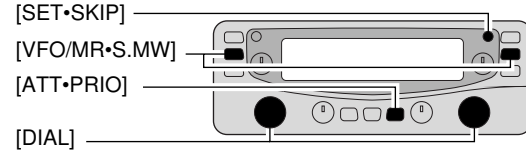

- ④ Rotate the same band's **[DIAL]** to select the desired bank and bank channel.
  - Push **[ATT•PRIO]** to toggle the bank or bank channel selection.
  - Banks A to H, J to R, T, U, W and Y are available.
  - Only vacant bank channel numbers will be displayed.

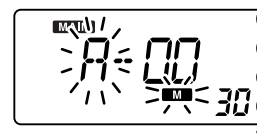

Bank selection

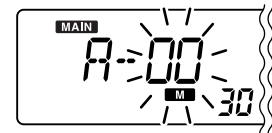

Bank channel selection

- ⑤ Push and hold **[VFO/MR•S.MW]** for 1 sec. to program the bank and exit *select memory write mode*.

## ■ Memory bank selection

- ① Push **[VFO/MR•S.MW]** to select *memory mode* in the desired band (left or right).
- ② Push **[MHz•TS]** to enter *memory type selection mode*.

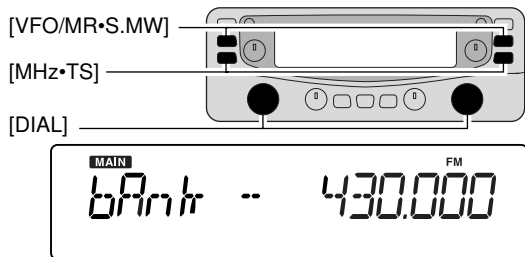

- ③ Rotate the same band's **[DIAL]** to select the desired bank (A to H, J to R, T, U, W or Y).
  - Only programmed banks are displayed.
- ④ Push any key for the main band or any of the shared keys below the display to set the bank indication.
  - Bank's indicator appears at top of the memory channel.
- ⑤ Rotate the same band's **[DIAL]** to select the contents in the bank.
- ⑥ To return to regular *memory mode*, repeat steps ②–④ and select “bAnk --” at step ③.

### • Memory bank indication

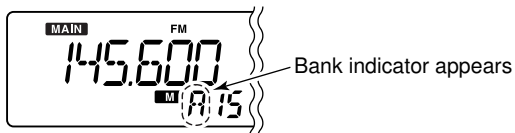

## ■ Transferring bank contents

The bank contents of programmed memory channels can be cleared or transferred to another bank.

**/// INFORMATION:** Even if the bank is cleared of memory channels, the memory channel contents still remain programmed.

- ① Select the desired bank contents to be transferred or erased from the bank in the main band.
  - ➔ Push the main band's **[VFO/MR•S.MW]** several times to select *memory mode*.
  - ➔ Push the same band's **[MHz•TS]** then rotate the same band's **[DIAL]** to select the desired memory bank.
    - Bank's indicator appears at top of the memory channel.
  - ➔ Push any key for the main band or any of the shared keys below the display to select the bank then rotate the same band's **[DIAL]** to select the desired contents.

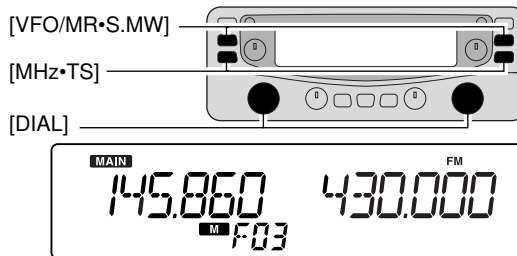

- ② Push **[VFO/MR-S.MW]** for 1 sec. to enter *select memory write mode*.

- “**M**” indicator and the memory channel number blink.

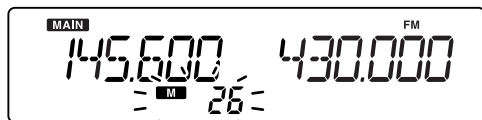

Memory channel blinks

- ③ Push **[SET-SKIP]** once to select “bAnk.”

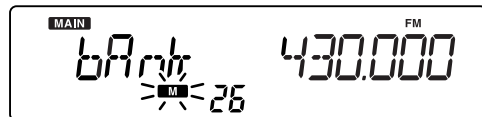

↓ After **[SET-SKIP]**  
released

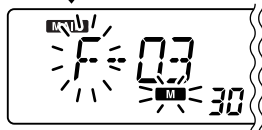

- ④ Rotate the same band’s **[DIAL]** to select the desired bank indicator to transfer or erase.

- Push **[ATT-PRIO]** to toggle the bank or bank channel selection.
- Select “--” indication when erasing the contents from the bank.
- Vacant bank channel numbers are only be displayed.

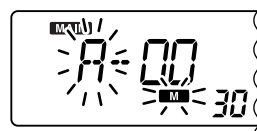

Bank selection

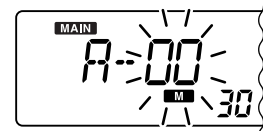

Bank channel selection

- ⑤ Push and hold **[VFO/MR-S.MW]** for 1 sec. to program the bank and return to regular *memory mode*.
- ⑥ Repeat steps ① to ⑤ for transferring or erasing an another bank’s contents.

# 6

## SCAN OPERATION

### Scan types

Scanning searches for signals automatically and makes it easier to locate new stations.

There are 5 scan types and 4 resume conditions to suit your operating needs.

#### FULL SCAN (p. 34)

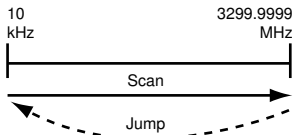

Repeatedly scans all frequencies over the entire band.

Some frequency ranges are not scanned according to the frequency coverage of the receiver's version.

#### PROGRAMMED SCAN (p. 34)

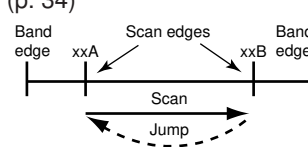

Repeatedly scans between two user-programmed frequencies. Used for checking for frequencies within a specified range such as repeater output frequencies, etc.

#### MEMORY (SKIP) SCAN (p. 34)

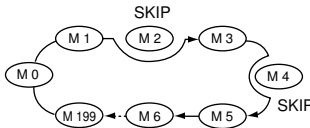

Repeatedly scans memory channels except those set as skip channel. Skip channels can be turned ON and OFF by pushing and holding **[SET•SKIP]** in *memory mode*.

#### ALL/SELECTED BANK SCAN (p. 34)

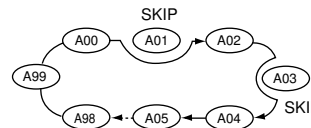

Repeatedly scans all bank channels or selected bank channels. Skip scan is also available.

#### FREQUENCY/MEMORY SKIP FUNCTION (p. 36)

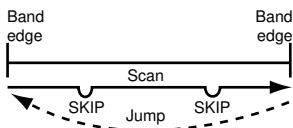

Skips unwanted frequencies or channels that inconveniently stop scanning. This function can be turned ON and OFF by pushing and holding **[SET•SKIP]** in *memory mode*.



## ■ Scan start/stop

### ◇ Preparation

Scan resume condition (p. 37); program scan edges (p. 35); program two or more memory channels (p. 24); set skip settings (p. 36), if desired.

### ◇ Operation

- ① Push [**VFO/MR•S.MW**] once or twice to select *VFO mode* for full/programmed scan; or to select *memory mode* for memory/bank scan.
  - Select the desired bank in *memory type selection mode* for bank scan.
- ② Set the squelch level to the point where noise is just muted.
- ③ Push and hold [**MODE•SCAN**] for 1 sec. to start the scan.
  - To change the scanning direction, rotate the main band's [**DIAL**].
  - The memory channel readout blinks the scan type as below.

**IMPORTANT!:** To perform memory or bank scan, two or more memory/bank channels **MUST** be programmed, otherwise the scan will not start.

- ④ Push [**SET•SKIP**] (or [**ATT•PRIO**]) to select full and programmed scan (P00 to P49), if VFO is selected in step ①.
- ⑤ To stop the scan, push [**MODE•SCAN**].

/// **About the scanning steps:** The selected tuning step in each frequency band (in *VFO mode*) is used during scan.

/// The bank-link setting can be changed in *set mode*. See (p. 56) for details.

#### • During full scan

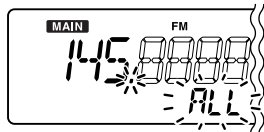

Push [**SET•SKIP**] to select full (ALL) or programmed scan (P00–P49) in sequence.

While pushing and holding [**MODE•SCAN**], rotate [**DIAL**] also to select full (ALL) or programmed scan (P00–P49).

#### • During programmed scan

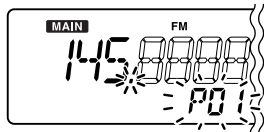

Indicates scan edge channels.  
 • P01 stands for 01A/01B  
 • P00 to P49 are available when they are programmed, and selected with [**SET•SKIP**].

#### • During memory scan

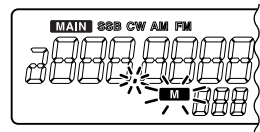

**NOTE:** When SSB, CW, AM, FM, WFM or Digital mode frequencies are programmed into memory channels randomly, memory scan is slow because changing modes takes time. In this case, assign the SSB, CW, AM, FM, WFM or Digital mode frequencies into separate banks where bank scan can be used. And using the bank scan is helpful.

#### • During bank scan

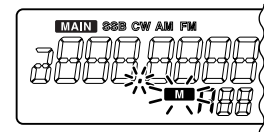

Indicates bank channel.

## 6 SCAN OPERATION

### ■ Scan edges programming

Scan edges can be programmed in the same manner as memory channels. Scan edges are programmed into scan edges, 0A/0B to 49A/49B, in memory channels.

- ① Push the desired band's **[VFO/MR-S.MW]** once or twice to select *VFO mode*.
- ② Set the edge frequency of the desired frequency range:
  - Set the frequency using the same band's **[DIAL]**.
  - Set other data (e.g. tone squelch, etc.), if desired.
- ③ Push and hold the same band's **[VFO/MR-S.MW]** for 1 sec. to enter *select memory write mode*.
  - "M" indicator and the memory channel number blink.
- ④ Rotate the same band's **[DIAL]** to select one of scan edge channel, 0A to 49A.
- ⑤ Push and hold **[VFO/MR-S.MW]** for 1 sec. to program.
  - 3 beeps sound and *VFO mode* is automatically selected.
  - Scan edge 0B to 49B is automatically selected when continuing to hold **[VFO/MR-S.MW]** after programming.
- ⑥ To program a frequency for the other pair of scan edges, 0B to 49B, repeat steps ② to ④.
  - If the same frequency is programmed into a pair of scan edges, programmed scan will not function.

**[EXAMPLE]:** Programming 144.000 MHz into scan edge 1A.

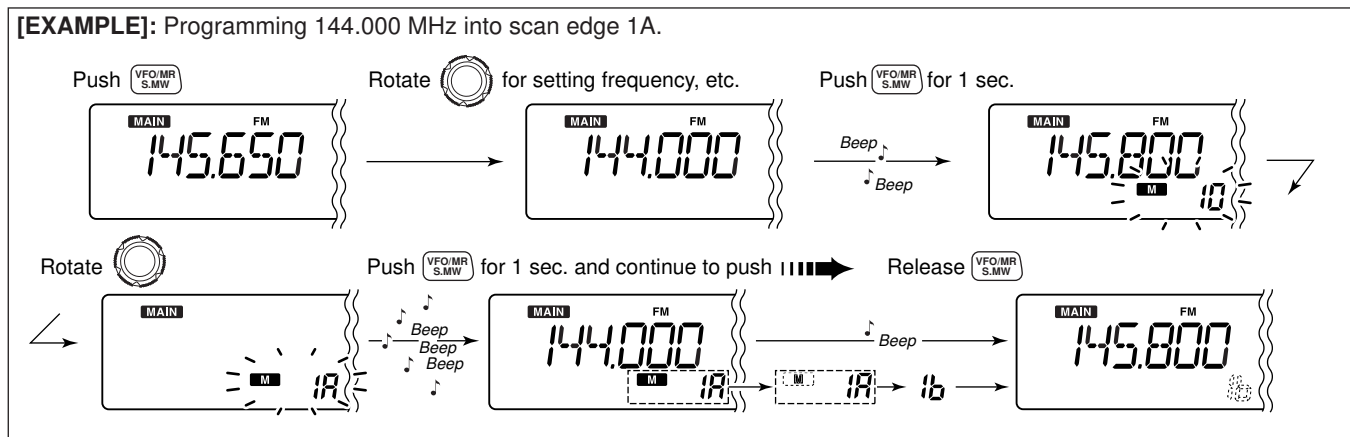

## ■ Skip scan

### ◇ Skip channel/frequency setting

You can set the selected memory channel as a skip channel which is skipped during memory skip scan. In addition, it can be set as a skip channel for both memory skip scan and frequency skip scan. These are useful to speed up the scan interval.

- ① Select a memory channel.
  - ➔ Push the main band's **[VFO/MR•S.MW]** once or twice to select *memory mode*, then rotate the same band's **[DIAL]** to select the desired memory channel to be a skip channel.
    - “**M**” and memory channel number appear.
- ② Push and hold **[SET•SKIP]** for 1 sec. several times to set the skip condition.
  - (no indication): The channel is scanned during scan.
  - **[SKIP]** : The channel is skipped during scan.
  - **P[SKIP]** : The channel is skipped during scan and the programmed frequency is skipped during VFO scan, such as programmed scan.

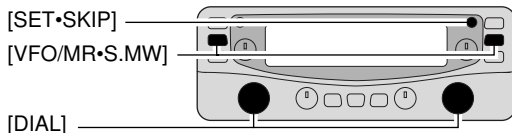

The display shows that memory channel 16 is set as a skip channel.

### ◇ Skip scan setting

USING SET MODE

- ① Push the main band's **[VFO/MR•S.MW]** once or twice to select *VFO mode*.
- ② Push **[SET•SKIP]** to enter *set mode*.
- ③ Push **[SET•LOCK]** or **[ATT•PRIO]** several times until “PSC” appears.

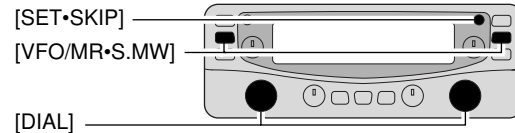

- ④ Rotate the main band's **[DIAL]** to toggle the skip scan function ON and OFF.

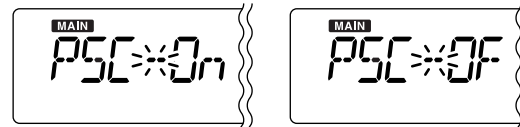

- ⑤ Push any key for the main band to exit *set mode*.
- ⑥ Then start the scan to activate the skip scan (memory skip scan or frequency skip scan).

## 6 SCAN OPERATION

### ■ Scan resume condition

The scan resume condition can be selected a timed timer or pause scan. The selected resume condition is also used for priority watch. (p. 38)

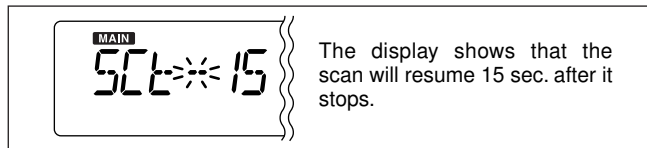

- ① Push **[MAIN•AGC]** (or **[MAIN•NB]**) to select the desired band (left or right) as the main band.
- ② Push **[SET•SKIP]** to enter *set mode*.

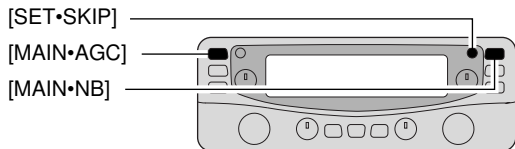

- ③ Push **[SET•SKIP]** or **[ATT•PRIO]** several times until “Sct” or “SCP” appears.

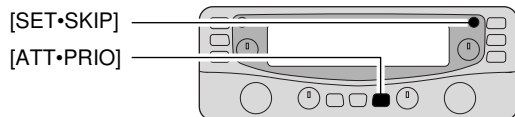

USING SET MODE

- ④ Rotate the main band's **[DIAL]** to set the desired timer:
  - “SCP-2” : Scan pauses until the signal disappears and then resumes 2 sec. later.
  - “Sct-15” : Scan pauses 15 sec. while receiving a signal.
  - “Sct-10” : Scan pauses 10 sec. while receiving a signal.
  - “Sct-5” : Scan pauses 5 sec. while receiving a signal.

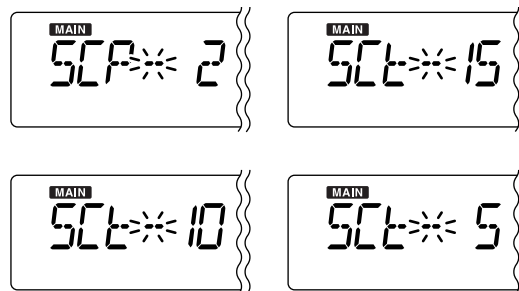
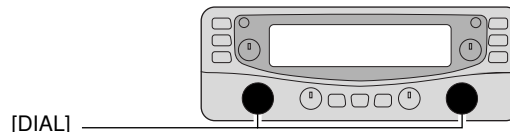

- ⑤ Push any key for the main band to exit *set mode*.

## ■ Priority watch types

Priority watch checks for signals on the frequency every 5 sec. while operating on a VFO frequency or scanning. The receiver has two priority watch types to suit your needs.

The watch resumes according to the selected scan resume condition. See (p. 37) for details.

/// **NOTE:** If the pocket beep function is activated, the receiver automatically selects the tone/DTCS squelch function when priority watch starts.

### MEMORY CHANNEL WATCH

While operating on a VFO frequency, priority watch checks for a signal on the selected memory channel every 5 sec.

- A memory channel with skip information can be watched.

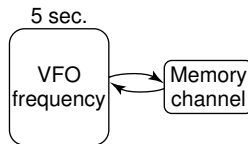

### MEMORY SCAN WATCH

While operating on a VFO frequency, priority watch checks for signals on each memory channel in sequence.

- The memory skip function and/or memory bank scan is useful to speed up the scan.

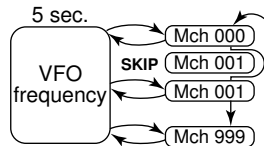

## ■ Priority watch operation

① Push the main band's **[VFO/MR•S.MW]** once or twice to select *VFO mode*; then set an operating frequency.

② Set the watched channel(s).

#### **For memory channel watch:**

Select the desired memory channel.

#### **For memory scan watch:**

Select *memory mode*, or the desired bank group; then, push and hold **[MODE•SCAN]** for 1 sec. to start memory scan or bank scan.

③ Push and hold **[ATT•PRIO]** for 1 sec. to start the watch.

- The receiver checks the memory/bank channel(s) every 5 sec.
- The watch resumes according to the selected scan resume condition. (p. 37)
- While the watch is paused, pushing and holding **[ATT•PRIO]** for 1 sec. resumes the watch manually.

④ Push and hold **[ATT•PRIO]** for 1 sec. to stop the watch.

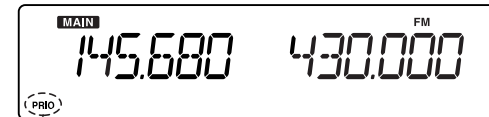
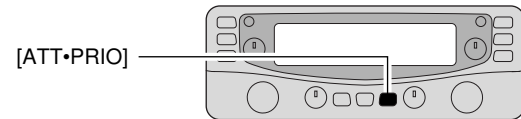

"PRIO" appears

## ■ Pocket beep operation

This function uses subaudible tones for calling and can be used as a “common pager” to inform you that someone has called while you were away from the receiver.

### ◇ Waiting for a call from a specific station

- ① Set the operating frequency in FM mode.
- ② Push **[SET•SKIP]** to enter *set mode* in the main band.

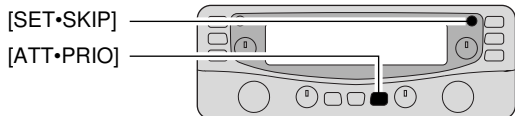

- ③ Push **[SET•SKIP]** or **[ATT•PRIO]** several times until “Ct” (when selecting the tone squelch) or “dt” (when selecting the DTCS squelch) appears.

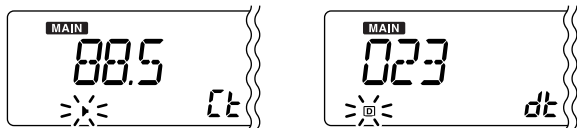

Tone squelch frequency setting      DTCS code setting

- ④ Rotate the main band's **[DIAL]** to select the desired tone frequency or DTCS code.

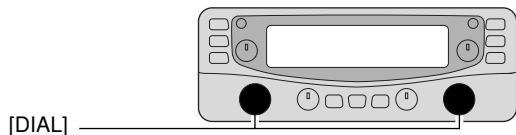

- ⑤ When operating the pocket beep function with DTCS code squelch, push **[SET•SKIP]** once then rotate the main band's **[DIAL]** to select the DTCS polarity.

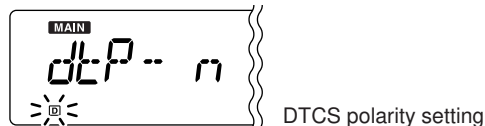

DTCS polarity setting

- ⑥ Push any key for the main band to exit *set mode*.
- ⑦ Push and hold **[MONI•T/T-SCAN]** for 1 sec. to enter *tone squelch selection mode*, then rotate the main band's **[DIAL]** until “((•) ▶)” or “Ⓜ ((•))” appears to turn the pocket beep function ON with tone squelch or DTCS squelch, respectively.

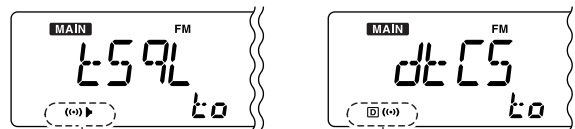
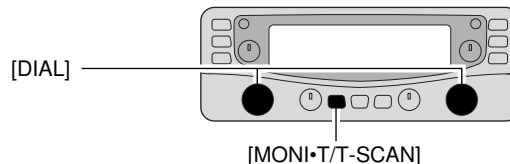

Appears when the pocket beep with tone squelch is turned ON.

Appears when the pocket beep with DTCS squelch is turned ON.

- ⑧ Push any key for the main band or any of the shared keys below the display to exit *tone squelch selection mode*.

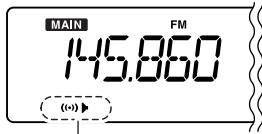

Appears when the pocket beep with tone squelch is activated.



Appears when the pocket beep with DTCS squelch is activated.

- ⑨ When a signal with a matching tone is received, the receiver emits beep tones and blinks “((•)).”
- Beep tones sound for 30 sec. and “((•))” blinks. To stop the beeps and blinking manually, push any key.

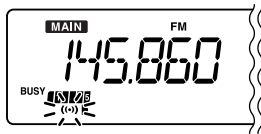

- ⑩ Push and hold **[MONI-T/T-SCAN]** for 1 sec. to enter *tone squelch selection mode*, then rotate the main band’s **[DIAL]** to cancel the tone squelch or DTCS squelch function.
- “oFF” is selected for turning the function OFF.

◇ Available tone frequency list

67.0	79.7	97.4	118.8	146.2	167.9	186.2	206.5	241.8
69.3	82.5	100.0	123.0	151.4	171.3	189.9	210.7	250.3
71.0	85.4	103.5	127.3	156.7	173.8	192.8	218.1	254.1
71.9	88.5	107.2	131.8	159.8	177.3	196.6	225.7	
74.4	91.5	110.9	136.5	162.2	179.9	199.5	229.1	
77.0	94.8	114.8	141.3	165.5	183.5	203.5	233.6	

NOTE: The receiver has 51 tone frequencies and consequently their spacing is narrow compared to units having 38 tones. Therefore, some tone frequencies may receive interference from adjacent tone frequencies.

◇ Available DTCS code list

023	054	125	165	245	274	356	445	506	627	732
025	065	131	172	246	306	364	446	516	631	734
026	071	132	174	251	311	365	452	523	632	743
031	072	134	205	252	315	371	454	526	654	754
032	073	143	212	255	325	411	455	532	662	
036	074	145	223	261	331	412	462	546	664	
043	114	152	225	263	332	413	464	565	703	
047	115	155	226	265	343	423	465	606	712	
051	116	156	243	266	346	431	466	612	723	
053	122	162	244	271	351	432	503	624	731	

◇ Calling a waiting station using pocket beep

A subaudible tone matched with the station’s CTCSS tone frequency or 3-digit DTCS code with the correct polarity is necessary. Use the tone squelch on the next page (p. 41).

## ■ Tone/DTCS squelch operation

The tone or DTCS squelch opens only when receiving a signal with the same pre-programmed subaudible tone or DTCS code. You can silently wait for a signal using the same tone.

- ① Set the operating frequency in FM mode.
  - Push **[MAIN]** to select the desired band (left or right) as the main band in advance.
- ② Program the CTCSS tone frequency or DTCS code in set mode. (p. 39)
- ③ Push and hold **[MONI•T/T-SCAN]** for 1 sec. to enter tone squelch selection mode, then rotate the main band's **[DIAL]** until "►" or "Ⓚ" appears in the function display.

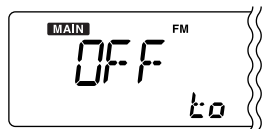

Tone OFF setting



Tone squelch setting



DTCS setting

- ④ When a signal with a matching tone is received, the squelch opens and the receiver emits audio.
  - When the received signal includes an unmatched tone, the squelch does not open. However, the S-meter indicator shows the received signal strength.
  - To open the squelch manually, push **[MONI•T-T-SCAN]**.
- ⑤ To cancel the tone squelch or DTCS squelch function, repeat steps ③ until "OFF" appears, then push any key.

### ◇ Reverse action for tone or DTCS squelch

- Enter tone squelch selection mode as described in steps ① to ③ as shown left, then rotate the main band's **[DIAL]** to select either reverse action for the tone or DTCS squelch as below.



for Tone squelch

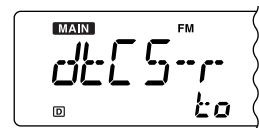

for DTCS

#### How does the Reverse action work?

When the reverse action is selected for either the tone squelch, "t59L-r," or DTCS squelch, "dtCS-r," and a signal with the matched tone (or DTCS) is received, the squelch closes, and the receiver mutes the signal. You can listen to signals with any tone other than the specified tone.



## ■ Tone scan

By monitoring a signal using with pocket beep, tone or DTCS squelch, you can determine the tone frequency or DTCS code necessary to open the squelch.

- ① Set the desired operating frequency or memory channel to be checked for a tone frequency or code.
  - Push **[MAIN]** to select the desired band (left or right) as the main band in advance.
- ② Push and hold **[MONI•T/T-SCAN]** for 1 sec and rotate the main band's **[DIAL]** to select the tone type, tone squelch or DTCS, to be scanned.
  - Either "▶" or "□" appears.
- ③ Push and hold **[MONI•T/T-SCAN]** for 1 sec. to start the tone scan.
  - To change the scanning direction, rotate the main band's **[DIAL]**.

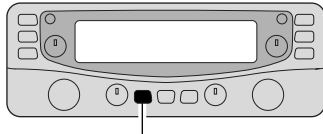

[MONI•T/T-SCAN]

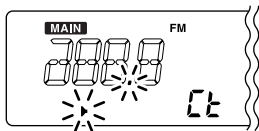

During CTCSS frequency scan

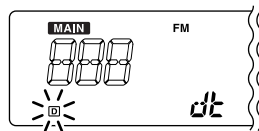

During DTCS code scan

- ④ When the CTCSS tone frequency or 3-digit DTCS code is matched, the squelch opens and the tone frequency is temporarily programmed into the VFO or memory channel.
  - The tone scan pauses when a CTCSS tone frequency or 3-digit DTCS code is detected.
  - The decoded CTCSS tone frequency or 3-digit DTCS code is used for the tone decoder depending on the selected tone condition or type in step ②.
    - "▶" : CTCSS tone decoder
    - "□" : DTCS tone decoder
- ⑤ Or push any key for the main band or any of the shared keys below the display to stop the scan.

**NOTE:** The decoded tone frequency is programmed temporarily when a memory is selected. However, this will be replaced by the programmed information when the memory channel is re-selected.

UT-118 or UT-122's installation is described in the IC-PCR2500's Instruction manual. See the installation details.

## ■ Digital mode operation

The IC-R2500 can operate in DV\*<sup>1</sup> mode or P25\*<sup>2</sup> mode when the optional UT-118 or UT-122 is installed.

\*<sup>1</sup>: The optional UT-118 is required.

\*<sup>2</sup>: The optional UT-122 is required.

Some versions come with the UT-122 installed.

- ① Select the left band as the main band.  
➔ Push **[MAIN•AGC]** once to select left band, if necessary.
- ② Set the operating frequency in digital mode.
- ③ Push **[MODE•SCAN]** to enter *receive mode select mode*.

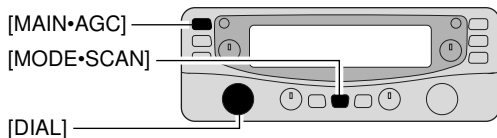

- ④ Rotate left band's **[DIAL]** to select the desired digital mode.

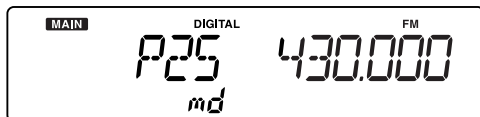

- ⑤ Push any key to exit *receive mode select mode*.

## ■ Pocket beep operation

This function uses digital code/call sign for calling and can be used as a "common pager" to inform you that someone has called while you were away from the receiver. The digital code or digital call sign squelch does not function during low-speed data communication in DV mode.

### ◆ Waiting for a call from a specific station

- ① Select the left band as the main band.  
➔ Push **[MAIN•AGC]** once to select left band, if necessary.
- ② Set the operating frequency in DV (P25) mode.
- ③ Program the digital code or call sign in *set mode*.  
➔ Push **[SET•SKIP]** to enter *set mode*.

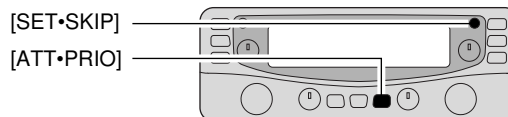

- ➔ Push **[SET•SKIP]** or **[ATT•PRIO]** several times until "OPT" appears, then rotate left band's **[DIAL]** to select "On."
- ➔ Push **[SET•SKIP]** or **[ATT•PRIO]** several times until desired item appears.
  - "CAL" when programming the calls sign for the digital call sign squelch in DV mode.
  - "dCd" when programming the digital code squelch in DV mode.
  - "nA" when programming the NAC code for the digital NAC squelch in P25 mode.
  - "t1" and "U1" when programming the TGID and Unit ID for the digital selective squelch.

- ④ Rotate the left band's **[DIAL]** to select the desired call sign or code.  
 • Push **[MODE•SCAN]** (or **[MONI•T/T-SCAN]**) to move the cursor.

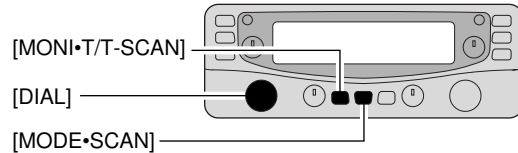

- ⑤ Push any key for the main band to exit *set mode*.  
 ⑥ Push and hold **[MONI•T/T-SCAN]** for 1 sec. to enter *tone squelch selection mode*, then rotate left band's **[DIAL]** until “**[ ] ((•))**” or “**((•)) ▶**” appears to turn the pocket beep function ON with digital call sign squelch or digital code squelch for DV mode (digital NAC squelch or digital selective squelch for P25 mode), respectively.

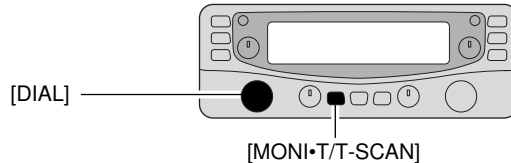

#### • DV mode operation

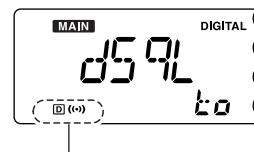

Appears when the pocket beep with digital call sign squelch is turned ON.

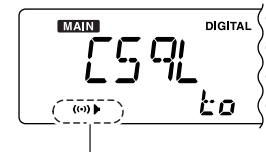

Appears when the pocket beep with digital code squelch is turned ON.

#### • P25 mode operation

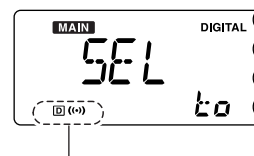

Appears when the pocket beep with digital Selective squelch is turned ON.

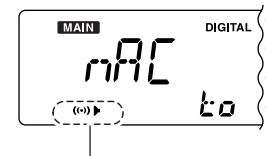

Appears when the pocket beep with digital NAC squelch is turned ON.

## 9 DIGITAL MODE OPERATION

- ⑦ Push any key for the main band or any of the shared keys below the display to exit *tone squelch selection mode*.

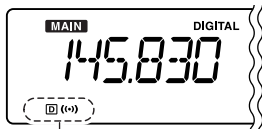

Appears when the pocket beep is activated.

DV: with digital call sign squelch  
P25: with digital selective squelch

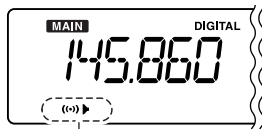

Appears when the pocket beep is activated.

DV: with digital code squelch  
P25: with digital NAC squelch

- ⑧ When a signal with a matching code/call sign is received, the receiver emits beep tones and blinks “((•))”.
- Beep tones sound for 30 sec. and “((•))” blinks. To stop the beeps and blinking manually, push any key.

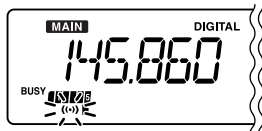
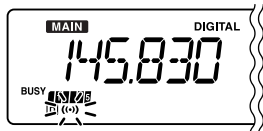

- ⑨ Push and hold **[MONI-T/T-SCAN]** for 1 sec. to enter *tone squelch selection mode*, then rotate left band's **[DIAL]** to cancel the digital squelch function.
- “oFF” is selected for turning the function OFF.

## ■ Digital squelch operation

While in DV mode operation, the digital call sign (DSQL) or digital code squelch opens only when receiving a voice signal with the same pre-programmed digital call sign or code, respectively.

While in P25 mode operation, 2 types of digital squelch, NAC or Selective, are available.

- ① Select the left band as the main band.
  - ➔ Push **[MAIN-AGC]** once to select left band, if necessary.
- ② Set the operating frequency in DV (P25) mode.
- ③ Program the digital code or call sign in *set mode*.
  - ➔ Push **[SET-SKIP]** to enter *set mode*.

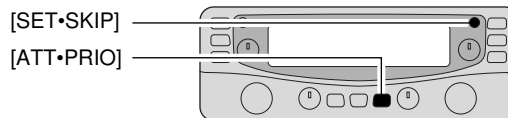

- ➔ Push **[SET-SKIP]** or **[ATT-PRIO]** several times until “OPT” appears, then rotate left band's **[DIAL]** to select “On.”
- ➔ Push **[SET-SKIP]** or **[ATT-PRIO]** several times until desired item appears.
  - “CAL” when programming the calls sign for the digital call sign squelch in DV mode.
  - “dCd” when programming the digital code squelch in DV mode.
  - “nA” when programming the NAC code for the digital NAC squelch in P25 mode.
  - “t1” and “U1” when programming the TGID and Unit ID for the digital selective squelch.

- ④ Rotate the left band's **[DIAL]** to select the desired call sign or code.  
 • Push **[MODE•SCAN]** (or **[MONI•T/T-SCAN]**) to move the cursor.

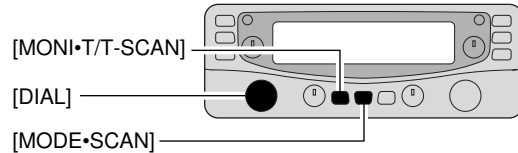

- ⑤ Push any key for the main band to exit *set mode*.  
 ⑥ Push and hold **[MONI•T/T-SCAN]** for 1 sec. to enter *tone squelch selection mode*, then rotate left band's **[DIAL]** until “▶” or “◻” appears in the function display.

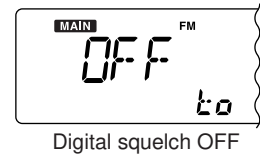
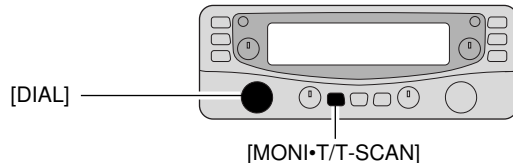

#### • DV mode operation

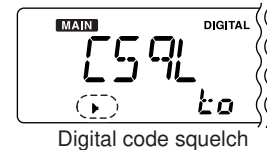
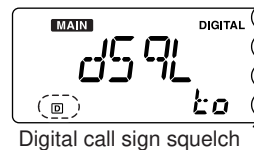

#### • P25 mode operation

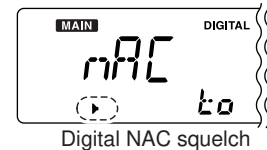
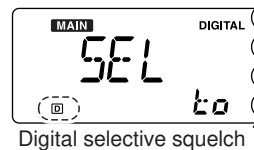

- ⑦ When a signal with the matched code/call sign is received, the squelch opens and the receiver emits audio.  
 • When the received signal includes an unmatched code /call sign, the squelch does not open. However, the S-meter indicator shows the received signal strength.  
 • To open the squelch manually, push **[MONI•T/T-SCAN]**.  
 ⑧ To cancel the digital squelch function, repeat steps ③ until “OFF” appears, then push any key.

## ■ Call sign programming (for DV mode)

USING SET MODE

Sets your own call sign for digital call sign squelch operation. Up to 8 characters are programmable.

- ① Push **[SET•SKIP]** to enter *set mode*.
- ② Push **[SET•SKIP]** or **[ATT•PRIO]** several times until “OPt” appears, then rotate main band’s **[DIAL]** to select “On.”

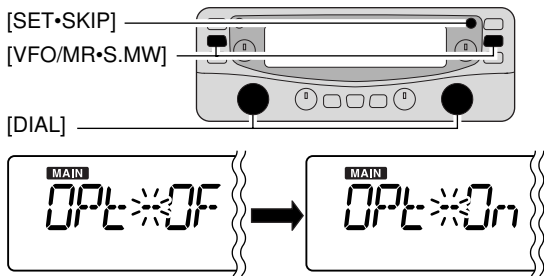

- ③ Push **[SET•SKIP]** or **[ATT•PRIO]** several times until “CAL” appears.
  - The 1st digit blinks.

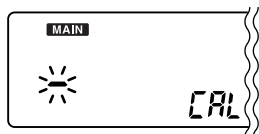

- ④ Rotate main band’s **[DIAL]** to select the desired character or code.
  - Push **[MODE•SCAN]** or **[MONI•T/T•SCAN]** to move the cursor to right or left, respectively.
- ⑤ Push **[MODE•SCAN]** to select 2nd digit, then rotate main band’s **[DIAL]** to select the desired character or code.
  - 2nd digit blinks (1st digit stop blinking).
  - Repeat this step for programming your own call sign.

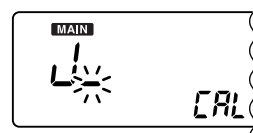

- ⑥ Push any key for the main band to exit *set mode*.

If the wrong call sign or code is programmed, the digital squelch will not open. Please make sure of the correct call sign or code before programming.

## ■ ID code programming (for P25 mode)

Sets the desired NAC code for P25 digital (NAC) squelch or TGID/Unit ID for P25 digital (Selective) squelch operation.

- ① Push **[SET-SKIP]** to enter *set mode*.
- ② Push **[SET-SKIP]** or **[ATT-PRIO]** several times until "Opt" appears, then rotate main band's **[DIAL]** to select "On."

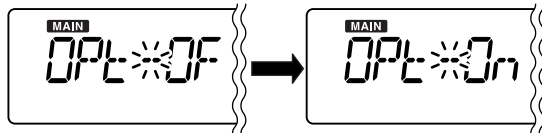
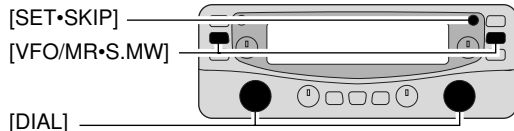

- ③ Push **[SET-SKIP]** or **[ATT-PRIO]** several times until "nA" appears.
  - The 1st digit blinks.
  - NAC code is selectable from 0–FFF.

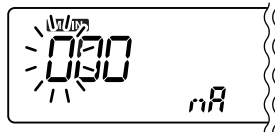

- ④ Rotate main band's **[DIAL]** to select the desired code.
  - Push **[MODE-SCAN]** or **[MONI-T/T-SCAN]** to move the cursor to right or left, respectively.

- ⑤ Push **[MODE-SCAN]** to select 2nd digit, then rotate main band's **[DIAL]** to select the desired code.
  - 2nd digit blinks (1st digit stop blinking).
  - Repeat this step for programming your NAC code.
- ⑥ Push **[SET-SKIP]** or **[ATT-PRIO]** several times until "t1" appears.
  - The 1st digit blinks.
  - TGID code is selectable from 0–65535.

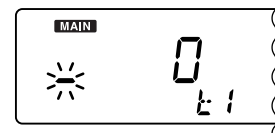

- ⑦ Repeat step ④ and ⑤ to program the TGID code.
- ⑧ Push **[SET-SKIP]** or **[ATT-PRIO]** several times until "U1" appears.
  - The 1st digit blinks.
  - Unit ID code is selectable from 1–9999999.

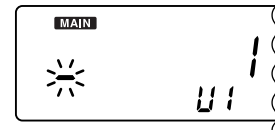

- ⑨ Repeat step ④ and ⑤ to program the Unit ID code.
- ⑩ Push any key for the main band to exit *set mode*.

# 10 SET MODE

## ■ General

### • Set mode operation

- ① Push the desired band's **[MAIN]** to select the main band.
- ② Push **[SET-SKIP]** to enter *set mode*.
- ③ Push **[SET-SKIP]** or **[ATT-PRIO]** to select the desired item.
- ④ Rotate the main band's **[DIAL]** to select the condition or value.
- ⑤ Push any key for main band or or any of the shared keys below the display to exit *set mode*.

## ■ Set mode items

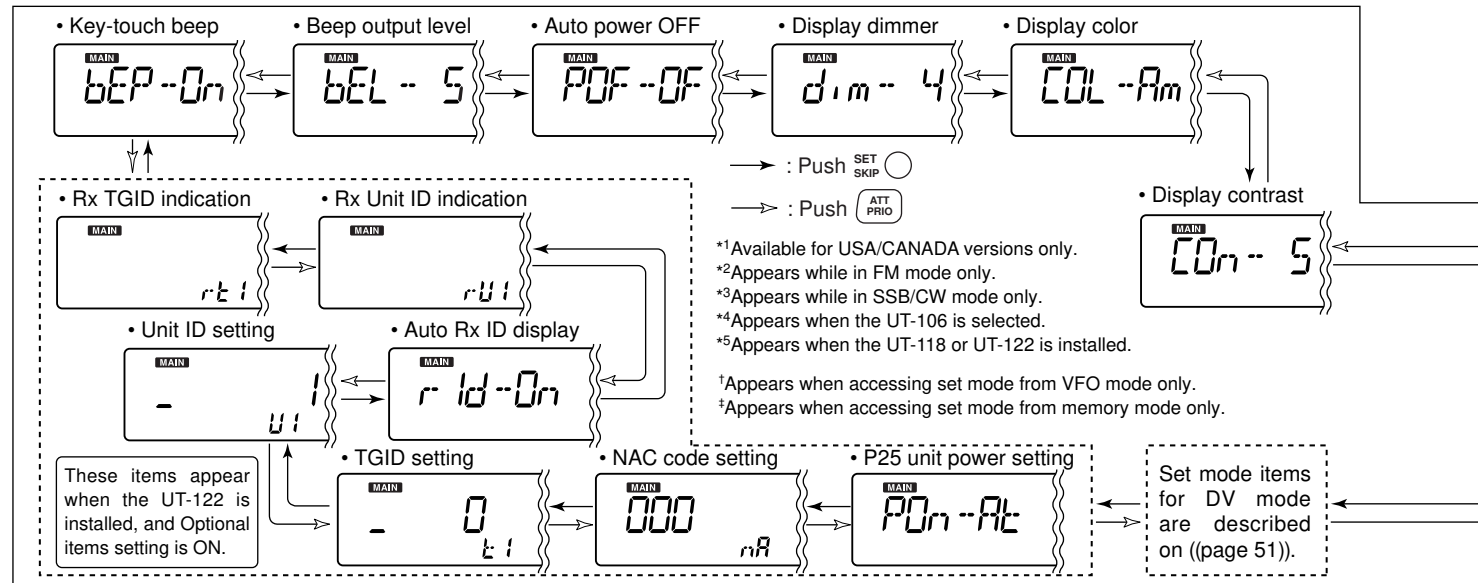



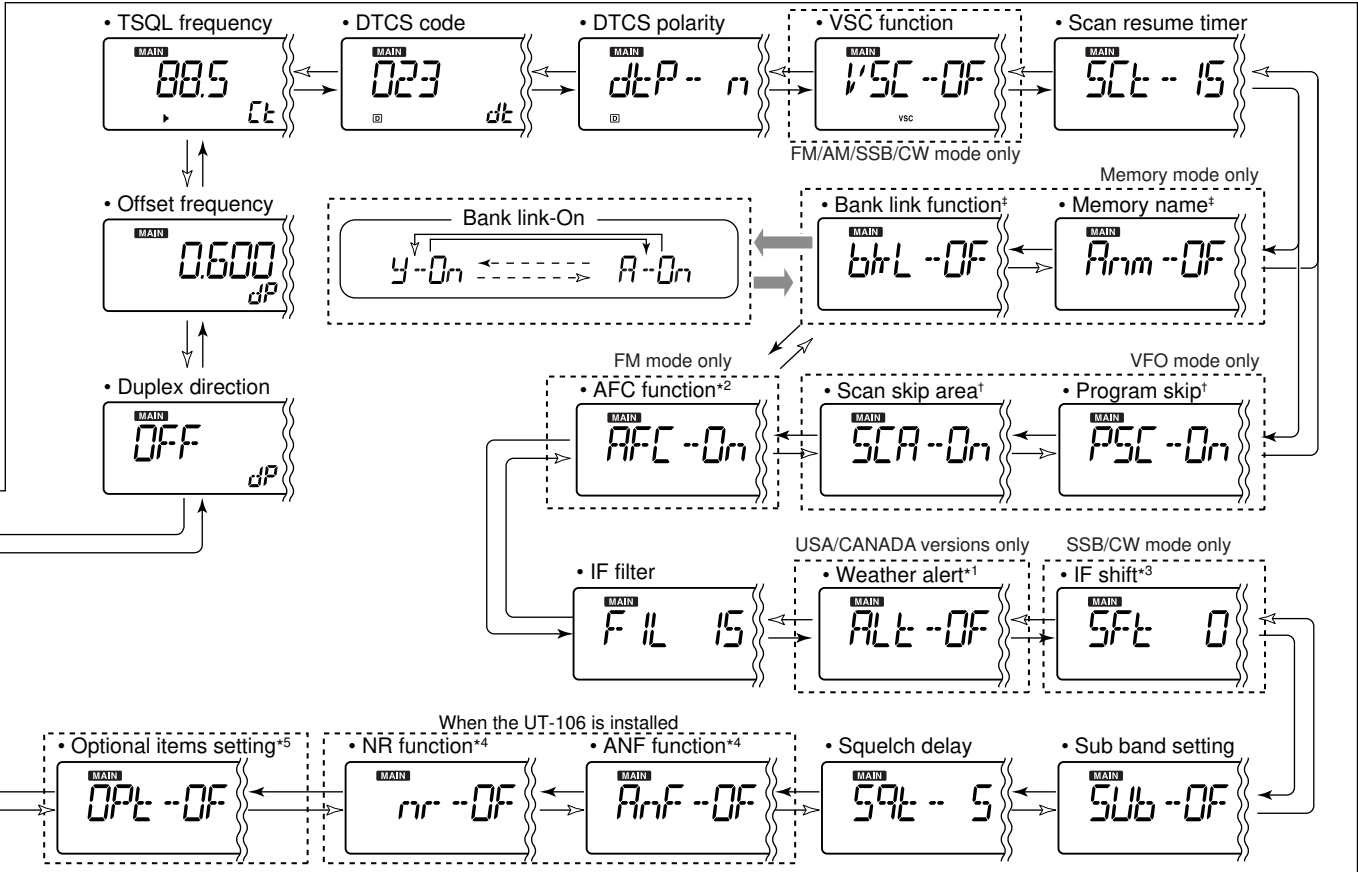

# 10 SET MODE

## ◆ Set mode items for DV mode

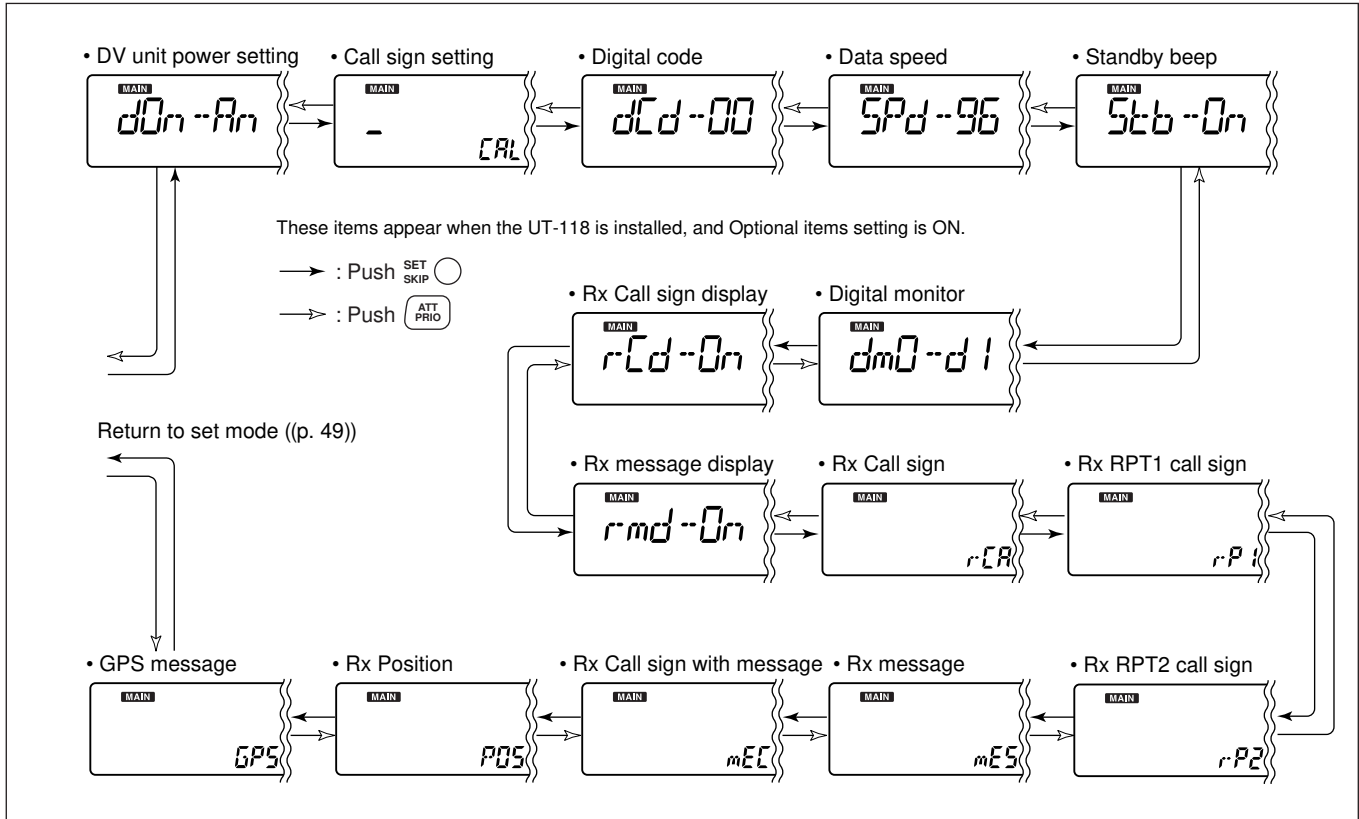

### ◆ Key-touch beep

The key-touch beep can be turned OFF for silent operation.  
(default: ON)

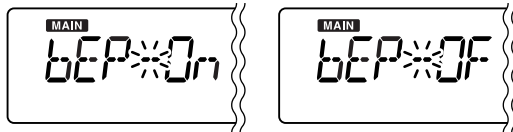

Even when this item is set to OFF, the power-on beep and pocket beep function still sound. The power-on beep can not be set to OFF.

### ◆ Beep output level

Adjust the beep level from 1 to 9 for key-touch beep, power-on beep and pocket beep function.  
(default: 5)  
When the previous set mode item “bEP” is set to OFF, this setting level does not affect key-touch.

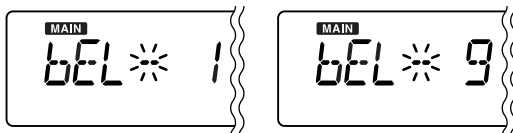

### ◆ Auto power OFF

The receiver can be set to automatically turn OFF with a beep after a specified period during which no key operations are performed.

30 min., 1 hour, 2 hours and OFF can be specified. The specified period is retained even when the receiver is turned OFF by the auto power OFF function. To cancel the function, select “OFF” for this item in *set mode*.  
(default: OFF)

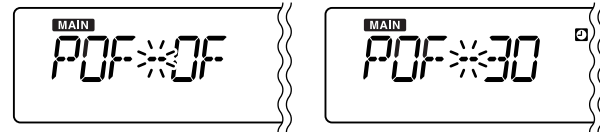

### ◆ Display dimmer

Adjust the display lighting level.  
The levels 1 (dark) to 4 (bright: default) are available.

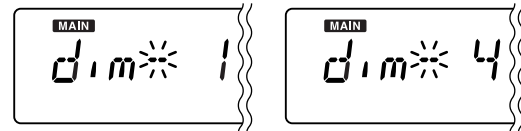

## 10 SET MODE

### ◇ Display color

The display color can be set to amber (default) or green.

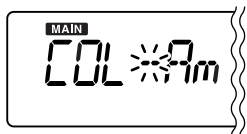

Amber setting

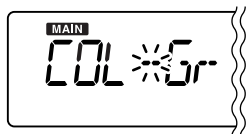

Green setting

### ◇ Display contrast

The LCD contrast can be adjusted through 9 levels.  
(default: 5)

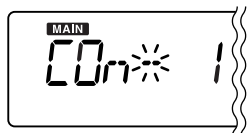

### ◇ Duplex direction

Sets the duplex direction. The displayed frequency shifts by the programmed offset frequency (see next item) when monitor function is in use (pushing [MONI-T/T-SCAN]).

- OFF : Simplex operation. (default)
- DUP- : The displayed frequency shifts down during monitor.
- DUP+ : The displayed frequency shifts up during monitor.

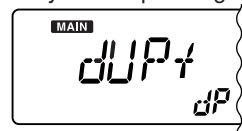
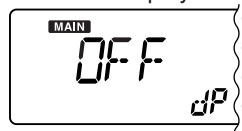

### ◇ Offset frequency

Sets the duplex offset frequency for each frequency band independently within a 0 to 1000 MHz range. During duplex operation (DUP- or DUP+), the monitoring frequency (pushing [MONI-T/T-SCAN]) shifts by the offset frequency.

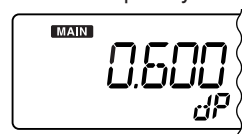

The default value may differ according to the selected frequency band (before accessing *set mode*) and receiver version.

/// The selected tuning step in *VFO mode* is used for setting the offset frequency.

### ◇ Tone frequency

Sets subaudible tone frequency for tone squelch operation. Total of 51 tone frequencies (67.0–254.1 Hz) are available. (default: 88.5 Hz)

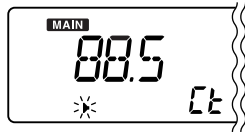

#### • Available tone frequency list

67.0	79.7	97.4	118.8	146.2	167.9	186.2	206.5	241.8
69.3	82.5	100.0	123.0	151.4	171.3	189.9	210.7	250.3
71.0	85.4	103.5	127.3	156.7	173.8	192.8	218.1	254.1
71.9	88.5	107.2	131.8	159.8	177.3	196.6	225.7	
74.4	91.5	110.9	136.5	162.2	179.9	199.5	229.1	
77.0	94.8	114.8	141.3	165.5	183.5	203.5	233.6	

### ◇ DTCS code

Sets DTCS code for DTCS squelch operation. Total of 104 codes (023–754) are available. (default: 023)

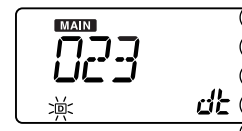

#### • Available DTCS code list

023	054	125	165	245	274	356	445	506	627	732
025	065	131	172	246	306	364	446	516	631	734
026	071	132	174	251	311	365	452	523	632	743
031	072	134	205	252	315	371	454	526	654	754
032	073	143	212	255	325	411	455	532	662	
036	074	145	223	261	331	412	462	546	664	
043	114	152	225	263	332	413	464	565	703	
047	115	155	226	265	343	423	465	606	712	
051	116	156	243	266	346	431	466	612	723	
053	122	162	244	271	351	432	503	624	731	

### ◇ DTCS polarity

Selects DTCS polarities from n (normal) and r (reverse). (default: n)

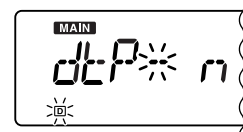

normal (default)

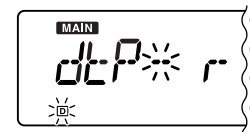

reverse

## 10 SET MODE

### ◇ VSC setting

Turns VSC (Voice Squelch Control) ON and OFF.  
(default: OFF)

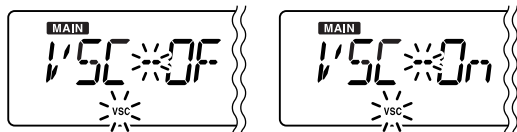

### ◇ Scan resume timer

Selects scan resume timer from SCT-15 (default), SCT-10, SCT-5 and SCP-2. Scan resumes after the specified period when the received signal disappears.

- SCT-15/10/5 : Scan pauses for 15/10/5 sec. when the received signal disappears.
- SCP-2 : Scan pauses on a signal until signal disappears, then resumes 2 sec. after the signal disappears.

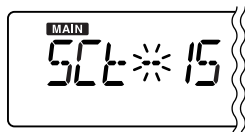

### ◇ Program scan skip setting

Sets the program scan skip setting ON and OFF for VFO scan operation, such as programmed scan. (default: ON)  
This item appears when *set mode* is accessed from *VFO mode* only.

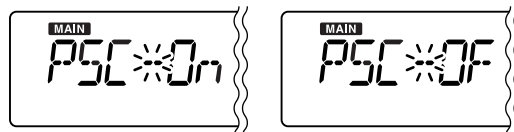

### ◇ Scan skip area setting

Sets the pre-programmed scan skip area setting ON and OFF for VFO scan operation, such as programmed scan.  
This item appears only when the scan skip area setting is programmed by cloning (p. 66) and *set mode* is accessed from *VFO mode*.

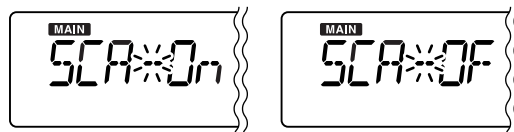

### ◇ Memory name setting

Sets memory name appearance ON (appear) and OFF (does not appear; default).

This item appears when *set mode* is accessed from *memory mode* only.

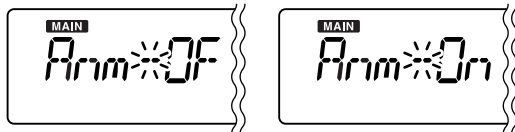

### ◇ Memory bank link function

Sets the memory bank link function ON and OFF (default). The link function provides continuous banks scan, that scans all contents in the selected banks during bank scan.

This item appears when *set mode* is accessed from *memory mode* only.

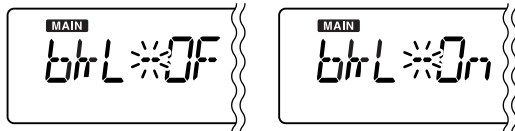

#### • Bank link setting

- ① Rotate main band's [DIAL] to select the memory bank link function ON.
- ② Push and hold [SET-SKIP] or [ATT-PRIO] for 1 sec. to enter *bank link setting mode*.
- ③ Push [SET-SKIP] or [ATT-PRIO] to select the desired bank to be linked.

- A : Bank A      • b : Bank B      • C : Bank C      • d : Bank D
- E : Bank E      • F : Bank F      • G : Bank G      • H : Bank H
- J : Bank J      • k : Bank K      • L : Bank L      • m : Bank M
- n : Bank N      • o : Bank O      • P : Bank P      • q : Bank Q
- R : Bank R      • t : Bank T      • U : Bank U      • W : Bank W
- y : Bank Y

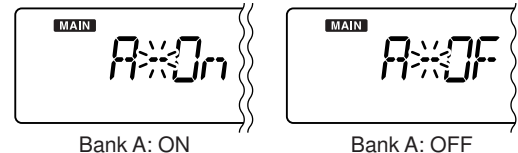

- ④ Rotate the main band's [DIAL] to select "On (default)" to linking the bank.
- ⑤ Repeat steps ③ and ④ to set the link condition.
- ⑥ Push any key for the main band to return to *set mode*.

## 10 SET MODE

### ◇ AFC setting

Turns AFC (Automatic Frequency Control) function ON and OFF.  
(default: OFF)

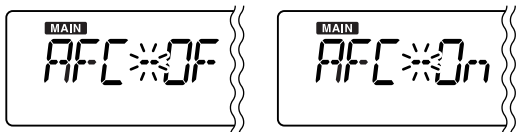

### ◇ Filter setting

Select the IF filter passband width from 3, 6, 15, 50 and 230 kHz (depending on the selected mode.)

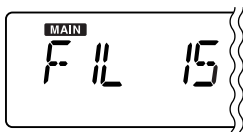

### ◇ Weather alert function

U.S.A./CANADA versions only

Turns weather alert function ON and OFF.

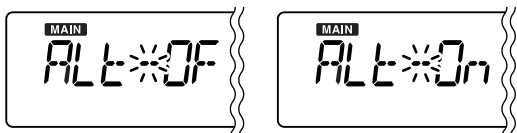

### ◇ IF shift frequency setting

Select the IF shift frequency up to  $\pm 25$  steps (in 1 step: 50 Hz).

This item appears when the receive mode is selected SSB or CW mode only.

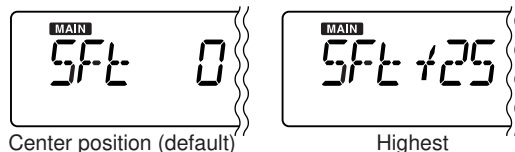

### ◇ Sub band setting

Turns the sub band setting ON and OFF.

- On : Dualwatch operation. (default)
- OF : Single band operation or diversity operation.

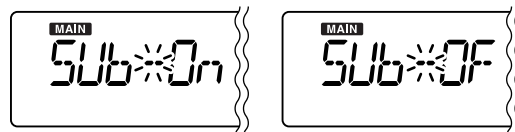



### ◇ Squelch delay

Selects squelch delay to short or long to prevent repeated opening and closing of the squelch during reception of the same signal.

- S : Short squelch delay.
- L : Long squelch delay.

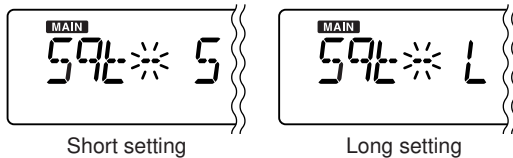

### ◇ ANF setting

Turns ANF (Automatic Notch Filter) function ON and OFF. The ANF function automatically attenuates up to 3 beat tones, tuning signals, etc. even if their frequency varies. The ANF function can be used in SSB, AM, FM and WFM modes.

☞ This item appears when optional UT-106 is installed.

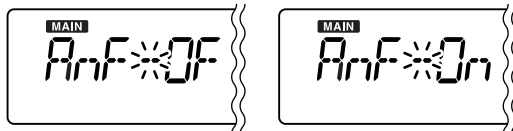

### ◇ NR setting

Selects NR (Noise Reduction) level from 1 to 15 and OFF (default).

The NR function enhances desired signals in the presence of noise by using the DSP circuit. The amount of enhancement is adjustable.

The NR level can result in audio signal masking. Set the noise reduction level for maximum readability.

☞ This item appears when optional UT-106 is installed.

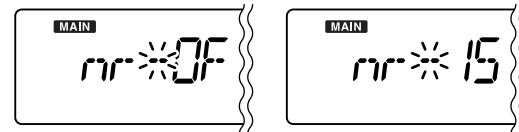

### ◇ Optional (digital) items indication

Turns *expanded set mode* for digital operation ON and OFF.

☞ This item appears when optional UT-118 or UT-122 is installed.

- OF : Digital items are not displayed in *set mode*. (default)
- On : Digital items are displayed in *set mode*.

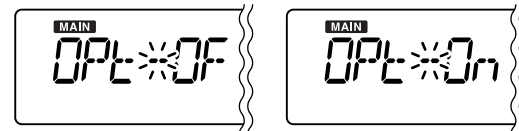

## 10 SET MODE

### ◇ DV unit power setting

Selects the DV unit (UT-118) power setting from Auto and ON.

☞ This item appears when optional UT-118 is installed and Optional items setting (p. 58) is ON.

- At : DV unit is turned ON automatically when digital mode is selected. (default)
- On : DV unit is turned ON when the receiver is powered ON.

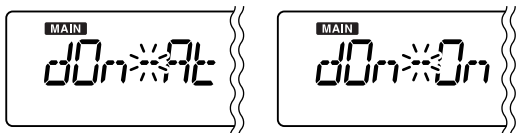

### ◇ Call sign setting

Sets your own call sign for digital call sign squelch operation. Up to 8 characters are programmable.

☞ This item appears when optional UT-118 is installed and Optional items setting (p. 58) is ON.

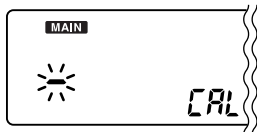

- Push [MODE•SCAN] (or [MONI•T/T•SCAN]) to move the cursor.
- Rotate main band's [DIAL] to select the desired character or code.

### ◇ Digital code setting

Sets the desired digital code for digital code squelch operation. Total of 100 codes (00–99) are available. (default: 00)

☞ This item appears when optional UT-118 is installed and Optional items setting (p. 58) is ON.

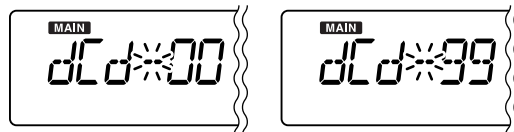

### ◇ Data speed setting

Sets the low-speed data communication speed between the receiver Main unit and PC to 4800 bps or 9600 bps.

(default: 9600 bps)

☞ This item appears when optional UT-118 is installed and Optional items setting (p. 58) is ON.

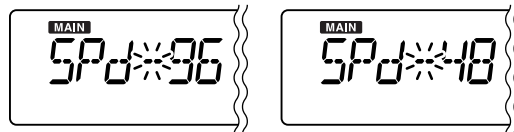

### ◇ Standby beep setting

Sets beep emission to ON or OFF when the receiving station finishes transmission or the receiving signal disappears.

(default: ON)

☞ This item appears when optional UT-118 is installed and Optional items setting (p. 58) is ON.

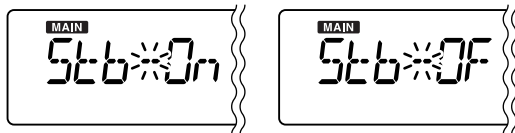

### ◇ Digital monitor

This function is used to listen to an analog signal (FM mode signal) without changing the receiving mode during DV mode operation.

(default: Digital)

☞ This item appears when optional UT-118 is installed and Optional items setting (p. 58) is ON.

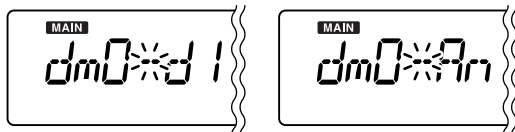

### ◇ Auto RX call sign display

When this setting is ON, transmitter's call sign is displayed automatically.

(default: ON)

☞ This item appears when optional UT-118 is installed and Optional items setting (p. 58) is ON.

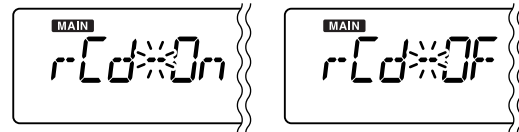

### ◇ Auto RX message display

When this setting is ON and the received signal includes a message, the message is displayed automatically.

(default: ON)

☞ This item appears when optional UT-118 is installed and Optional items setting (p. 58) is ON.

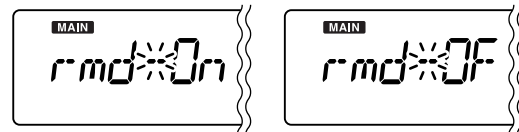

## 10 SET MODE

### ◇ RX call sign indication

This item stores and indicates the newest received call sign. The received call sign is cleared once the receiver is turned OFF.

☞ This item appears when optional UT-118 is installed and Optional items setting (p. 58) is ON.

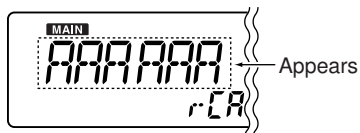

(AAAAAA: Call sign example)

• Push [MODE-SCAN] (or [MONI-T/T-SCAN]) to move the cursor.

### ◇ RX RPT1 call sign indication

This item stores and indicates the newest received RPT1 call sign. The received call sign is cleared once the receiver is turned OFF.

☞ This item appears when optional UT-118 is installed and Optional items setting (p. 58) is ON.

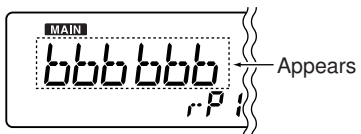

(BBBBBB: Call sign example)

• Push [MODE-SCAN] (or [MONI-T/T-SCAN]) to move the cursor.

### ◇ RX RPT2 call sign indication

This item stores and indicates the newest received RPT2 call sign. The received call sign is cleared once the receiver is turned OFF.

☞ This item appears when optional UT-118 is installed and Optional items setting (p. 58) is ON.



(CCCCC: Call sign example)

• Push [MODE-SCAN] (or [MONI-T/T-SCAN]) to move the cursor.

### ◇ RX message indication

This item stores and indicates the newest received message. The received message is cleared once the receiver is turned OFF.

☞ This item appears when optional UT-118 is installed and Optional items setting (p. 58) is ON.



(HELLO: Message example)

• Push [MODE-SCAN] (or [MONI-T/T-SCAN]) to move the cursor.

### ◇ RX call sign with message indication

This item stores and indicates the newest received call sign with message. The received call sign is cleared once the receiver is turned OFF.

☞ This item appears when optional UT-118 is installed and Optional items setting (p. 58) is ON.

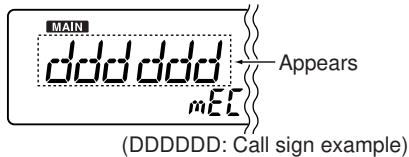

• Push [MODE-SCAN] (or [MONI-T/T-SCAN]) to move the cursor.

### ◇ RX position indication

When the transmitter sends position information, this item stores and indicates the newest received position information. The received position information is cleared once the receiver is turned OFF.

☞ This item appears when optional UT-118 is installed and Optional items setting (p. 58) is ON.



• Push [MODE-SCAN] (or [MONI-T/T-SCAN]) to change the display format.

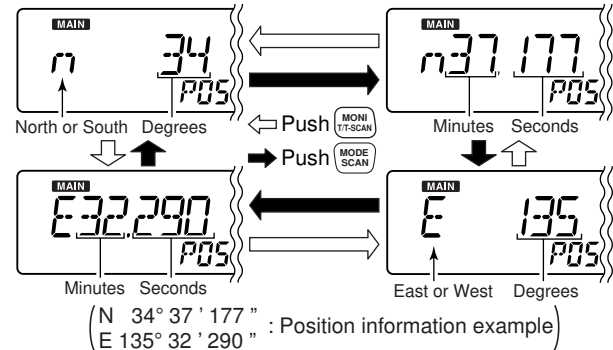

### ◇ RX GPS message indication

When the transmitter sends position information with message, this item stores and indicates the newest received GPS message. The received GPS message is cleared once the receiver is turned OFF.

☞ This item appears when optional UT-118 is installed and Optional items setting (p. 58) is ON.

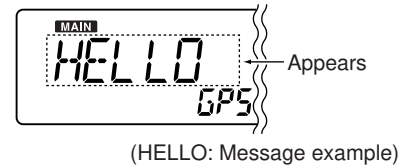

• Push [MODE-SCAN] (or [MONI-T/T-SCAN]) to move the cursor.

## 10 SET MODE

### ◇ P25 unit power setting

Selects the P25 unit (UT-122) power setting from Auto and ON.

☞ This item appears when optional UT-122 is installed and Optional items setting (p. 58) is ON.

- At : P25 unit is turned ON automatically when digital mode is selected. (default)
- On : P25 unit is turned ON when the receiver is powered ON.

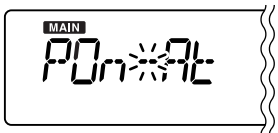

### ◇ NAC code setting

Sets the desired NAC code for P25 digital (NAC) squelch operation. NAC code is selectable from 0–FFF. (default: 000)

☞ This item appears when optional UT-122 is installed and Optional items setting (p. 58) is ON.

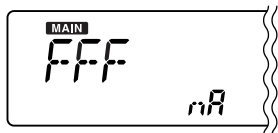
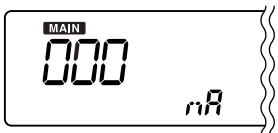

- Push [MODE-SCAN] (or [MONI-T/T-SCAN]) to move the cursor.
- Rotate main band's [DIAL] to select the desired code.

### ◇ TGID code setting

Sets the desired TGID code for P25 digital (Selective) squelch operation. TGID code is selectable from 0–65535.

(default: 0)

☞ This item appears when optional UT-122 is installed and Optional items setting (p. 58) is ON.

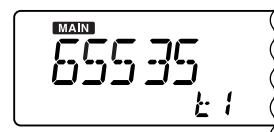
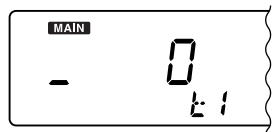

- Push [MODE-SCAN] (or [MONI-T/T-SCAN]) to move the cursor.
- Rotate main band's [DIAL] to select the desired code.

### ◇ Unit ID code setting

Sets the desired Unit ID code for P25 digital (Selective) squelch operation. Unit ID code is selectable from 1–9999999. (default: 1)

☞ This item appears when optional UT-122 is installed and Optional items setting (p. 58) is ON.

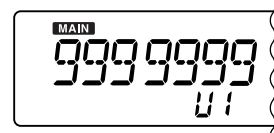

- Push [MODE-SCAN] (or [MONI-T/T-SCAN]) to move the cursor.
- Rotate main band's [DIAL] to select the desired code.

### ◇ Auto RX ID display

When this setting is ON, transmitter's ID is displayed automatically. (default: ON)

☞ This item appears when optional UT-122 is installed and Optional items setting (p. 58) is ON.

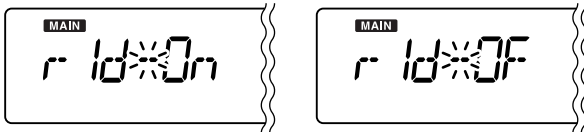

### ◇ RX Unit ID indication

This item stores and indicates the newest received Unit ID. The received ID is cleared once the receiver is turned OFF.

☞ This item appears when optional UT-122 is installed and Optional items setting (p. 58) is ON.



(1000001: Unit ID example)

### ◇ RX TGID indication

This item stores and indicates the newest received TGID. The received ID is cleared once the receiver is turned OFF.

☞ This item appears when optional UT-122 is installed and Optional items setting (p. 58) is ON.

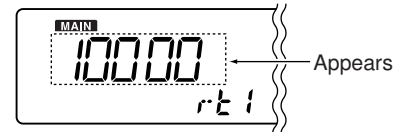

(10000: TGID example)

# 11 OTHER FUNCTIONS

UT-106 installation is described in the IC-PCR2500's Instruction manual. See the installation details.

## ■ DSP operation (Optional UT-106 is required)

### ◆ ANF function

USING SET MODE

The ANF (Automatic Notch Filter) function automatically attenuates beat tones, tuning signals, etc., even if they're frequency changes. This function can be activated in SSB, AM, FM modes.

- ① Select any of SSB, AM or FM mode in the desired band (left or right).
- ② Push **[SET•SKIP]** to enter *set mode*.
- ③ Push **[SET•SKIP]** or **[ATT•PRIO]** several times until "AnF" appears.

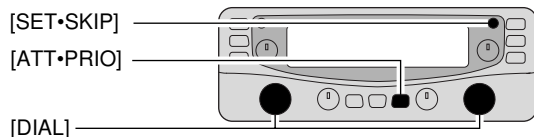

- ④ Rotate same band's **[DIAL]** to toggle the ANF function ON and OFF.

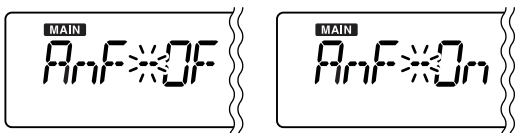

- ⑤ Push any key for main band to exit *set mode*.

### ◆ NR function

USING SET MODE

The NR (Noise Reduction) function reduces noise components and picks out desired signals which are buried in noise. The received AF signals are converted to digital signals and then the desired signals are separated from the noise. This function is available for all operating modes.

- ① Select the desired band (left or right) as main band.
- ② Push **[SET•SKIP]** to enter *set mode*.
- ③ Push **[SET•SKIP]** or **[ATT•PRIO]** several times until "nr" appears.

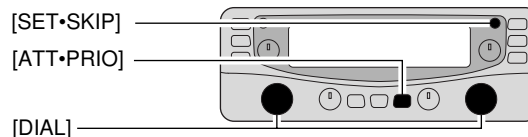

- ④ Rotate same band's **[DIAL]** to select the NR level from 1 to 15 or OFF.

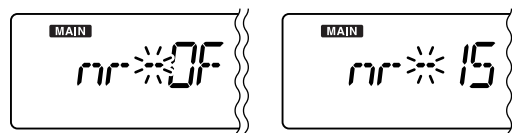

- ⑤ Push any key for main band to exit *set mode*.



## ■ DATA cloning (IC-PCR2500 control software must be installed)

Cloning allows you to quickly and easily transfer the programmed contents from a personal computer to a receiver using the IC-PCR2500 control software.

### ◇ Cloning using a personal computer

Data can be cloned to and from a personal computer (Microsoft® Windows® XP/2000/Me/98SE) and other settings can also be programmed from a PC. Consult the IC-PCR1500/IC-PCR2500's Instruction manual for cloning details.

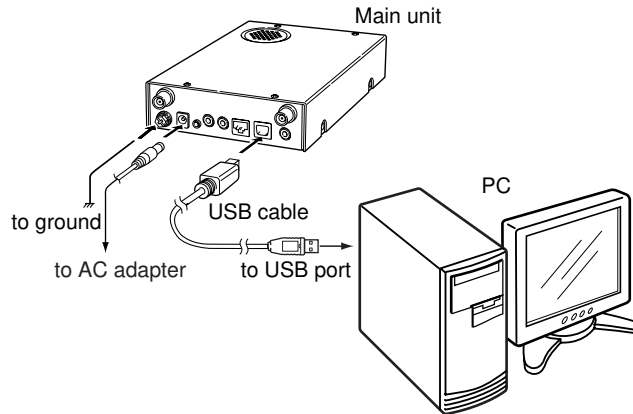

### ◇ Available functions

- Reading or writing Clone data
- Programming memory channels/memory banks/scan edges
- Programming set mode settings
- Transferring the data of PC (PCR2500) to receiver (R2500) or receiver (R2500) to PC (PCR2500)
- Automatic mode settings
  - The automatic mode setting automatically sets the receive mode, IF filter passband width, tuning step, etc. after inputting frequency ranges.
- Skip area settings
  - The skip area setting is available for skipping unwanted frequency ranges that inconveniently stop scanning.

Microsoft and Windows are registered trademarks of Microsoft Corporation in the U.S.A. and other countries.

## 11 OTHER FUNCTIONS

### ■ Partial reset

AT POWER ON

If you want to initialize the operating conditions (VFO frequency, VFO settings, set mode contents) without clearing the memory contents, a partial reset function is available.

- While pushing either band's **[VFO/MR•S.MW]**, turn the power ON to partially reset the both bands at same time.

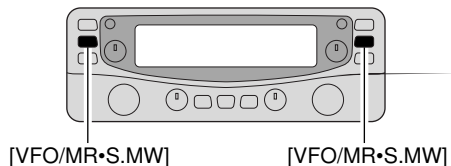

### ■ All reset

AT POWER ON

The function display may occasionally display erroneous information (e.g. when first applying power). This may be caused externally by static electricity or by other factors.

If this problem occurs, turn power OFF. After waiting a few seconds, turn power ON again. If the problem persists, perform the following procedure.

- Partial resetting is also available. See left for details.

#### /// IMPORTANT!:

Resetting the receiver **CLEARs** all memory information and initializes all values in the receiver to their default settings.

- While pushing both band's **[MHz•TS]**, turn the power ON to reset the CPU.

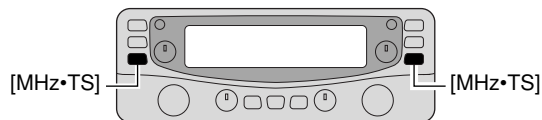

While pushing both [MHz•TS], turn power ON.

## ■ Internal audio switch

The internal switch must be set properly to use an external speaker, headphones or earphone.

**CAUTION:** DISCONNECT the AC adaptor or DC power cable from the receiver Main unit before performing any work on the receiver.

- ① Turn the receiver Main unit power OFF, then disconnect the AC adaptor or DC power cable.
- ② Unscrew the 8 screws and disconnect the connected cables, then remove the top cover.
  - Be careful not to lose the screws.

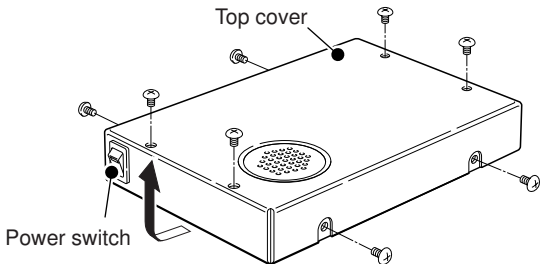

- ③ Set the switch as shown at right.
  - Set the switch to [SPEAKER] when an external speaker is connected to the receiver. (default)
  - Set the switch to [PHONES] when a headphones or earphone are/is connected to the receiver.
- ④ Replace the top cover, cables and screws to the original position.

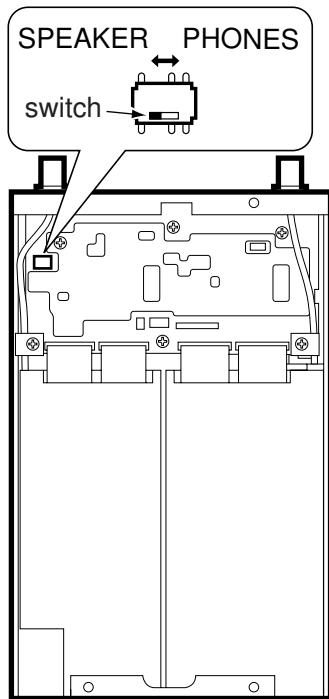

# 12 TROUBLESHOOTING

If your receiver seems to be malfunctioning, please check the following points before sending it to a service center.

PROBLEM	POSSIBLE CAUSE	SOLUTION	REF.
Does not turn on.	<ul style="list-style-type: none"> <li>The AC adapter is not fully seated in the power jack on the rear panel.</li> </ul>	<ul style="list-style-type: none"> <li>Check the connection.</li> </ul>	p. 1
No sound comes from the speaker.	<ul style="list-style-type: none"> <li>Volume level is too low.</li> <li>Squelch level is set too high.</li> <li>Selected tone or DTCS squelch does not match received signal.</li> </ul>	<ul style="list-style-type: none"> <li>Rotate [VOL] to obtain a suitable level.</li> <li>Rotate [SQL] to set the squelch level.</li> <li>Turn the appropriate function OFF.</li> </ul>	p. 14 p. 14 p. 41
Sensitivity is low and only strong signals are audible.	<ul style="list-style-type: none"> <li>Antenna feedline or the antenna connector has a poor contact or is short circuited.</li> <li>Attenuator function is activated.</li> </ul>	<ul style="list-style-type: none"> <li>Check, and if necessary, replace the feedline or reattach the antenna connector..</li> <li>Push [ATT•PRIO] to turn the Attenuator function OFF.</li> </ul>	p. 1 p. 15
Frequency cannot be changed.	<ul style="list-style-type: none"> <li>The lock function is activated.</li> </ul>	<ul style="list-style-type: none"> <li>Push and hold [PWR•] for 2 sec. after power ON to turn the function OFF.</li> </ul>	p. 15
Program scan does not operate.	<ul style="list-style-type: none"> <li>The squelch is open.</li> <li>The start and end frequencies are the same.</li> </ul>	<ul style="list-style-type: none"> <li>Set the squelch to the threshold point.</li> <li>Program different start and end frequencies.</li> </ul>	p. 14 p. 35
Memory scan does not operate.	<ul style="list-style-type: none"> <li>The squelch is open.</li> <li>Only 1 memory channel is programmed or other channels are set as skip channel.</li> </ul>	<ul style="list-style-type: none"> <li>Set the squelch to the threshold point.</li> <li>Program other memory channels or cancel the memory skip function in the desired channels.</li> </ul>	p. 14 pgs. 24, 36
Receive audio is distorted.	<ul style="list-style-type: none"> <li>The operating mode is not selected correctly.</li> </ul>	<ul style="list-style-type: none"> <li>Push and hold [MODE•SCAN] for 1 sec., then rotate [DIAL] to select suitable operating mode.</li> </ul>	p. 13



We Icom Inc. Japan  
 1-1-32, Kamiminami, Hirano-ku  
 Osaka 547-0003, Japan

Declare on our sole responsibility that this equipment complies with the essential requirements of the Radio and Telecommunications Terminal Equipment Directive, 1999/5/EC, and that any applicable Essential Test Suite measurements have been performed.

**Kind of equipment:** COMMUNICATIONS RECEIVER

**Type-designation:** IC-PCR2500/R2500

**Version (where applicable):**

This compliance is based on conformity with the following harmonised standards, specifications or documents:

- i) Article 3.1a EN 60950-1 (2001):A11:2004
- ii) Article 3.1b EN 301489-1 and EN 301489-15
- iii) Article 3.2 EN 301 783-2

**DECLARATION OF CONFORMITY**



Düsseldorf 24th Mar.2006  
 Place and date of issue

Icom (Europe) GmbH  
 Himmelgeister straÙe 100  
 D-40225 Düsseldorf

Authorized representative name  
 H. Ikegami  
 General Manager

Signature

**Icom Inc.**

12  
 13





# Count on us!

#02 Europe

<Intended Country of Use>			
<input checked="" type="checkbox"/> GER	<input type="checkbox"/> FRA	<input checked="" type="checkbox"/> ESP	<input checked="" type="checkbox"/> SWE
<input checked="" type="checkbox"/> AUT	<input checked="" type="checkbox"/> NED	<input checked="" type="checkbox"/> POR	<input checked="" type="checkbox"/> DEN
<input type="checkbox"/> GBR	<input checked="" type="checkbox"/> BEL	<input checked="" type="checkbox"/> ITA	<input checked="" type="checkbox"/> FIN
<input checked="" type="checkbox"/> IRL	<input checked="" type="checkbox"/> LUX	<input checked="" type="checkbox"/> GRE	<input checked="" type="checkbox"/> SUI
<input checked="" type="checkbox"/> NOR			

#03 U.K.

<Intended Country of Use>			
<input type="checkbox"/> GER	<input type="checkbox"/> FRA	<input type="checkbox"/> ESP	<input type="checkbox"/> SWE
<input type="checkbox"/> AUT	<input type="checkbox"/> NED	<input type="checkbox"/> POR	<input type="checkbox"/> DEN
<input checked="" type="checkbox"/> GBR	<input type="checkbox"/> BEL	<input type="checkbox"/> ITA	<input type="checkbox"/> FIN
<input type="checkbox"/> IRL	<input type="checkbox"/> LUX	<input type="checkbox"/> GRE	<input type="checkbox"/> SUI
<input type="checkbox"/> NOR			

#06 France

<Intended Country of Use>			
<input type="checkbox"/> GER	<input checked="" type="checkbox"/> FRA	<input type="checkbox"/> ESP	<input type="checkbox"/> SWE
<input type="checkbox"/> AUT	<input type="checkbox"/> NED	<input type="checkbox"/> POR	<input type="checkbox"/> DEN
<input type="checkbox"/> GBR	<input type="checkbox"/> BEL	<input type="checkbox"/> ITA	<input type="checkbox"/> FIN
<input type="checkbox"/> IRL	<input type="checkbox"/> LUX	<input type="checkbox"/> GRE	<input type="checkbox"/> SUI
<input type="checkbox"/> NOR			