



INSTRUCTION MANUAL

COMMUNICATIONS RECEIVER IC-R5

This device complies with Part 15 of the FCC rules. Operation is subject to the following two conditions: (1) This device may not cause harmful interference, and (2) this device must accept any interference received, including interference that may cause undesired operation.

Icom Inc.



Downloaded by
Amateur Radio Directory
www.hamdirectory.info

FOREWORD

Thank you for purchasing this Icom product. The IC-R5 COMMUNICATIONS RECEIVER is designed and built with Icom's superior technology and craftsmanship. With proper care, this product should provide you with years of trouble-free operation.

We want to take a couple of moments of your time to thank you for making your IC-R5 your radio of choice, and hope you agree with Icom's philosophy of "technology first." Many hours of research and development went into the design of your IC-R5.

◇ FEATURES

- *Covers 0.150–1309.995 MHz* wide frequency range*

*Some frequency bands are inhibited according to version

- *External power supply operation*
- *1250 memory channels* with 18 banks available*

*200 auto write and 50 scan edge channels are included.

- *Built-in bar-antenna*
- *New DMS (Dynamic Memory Scan) System*

IMPORTANT

READ ALL INSTRUCTIONS carefully and completely before using the receiver.

SAVE THIS INSTRUCTION MANUAL— This instruction manual contains important operating instructions for the IC-R5.

EXPLICIT DEFINITIONS

WORD	DEFINITION
⚠ WARNING!	Personal injury, fire hazard or electric shock may occur.
CAUTION	Equipment damage may occur.
NOTE	Recommended for optimum use. No risk of personal injury, fire or electric shock.

Icom, Icom Inc. and the ICOM logo are registered trademarks of Icom Incorporated (Japan) in the United States, the United Kingdom, Germany, France, Spain, Russia and/or other countries.

PRECAUTION

⚠ WARNING! NEVER operate the receiver with a ear-
phone, headphones or other audio accessories at high vol-
ume levels. Hearing experts advise against continuous high
volume operation. If you experience a ringing in your ears, re-
duce the volume level or discontinue use.

⚠ WARNING! NEVER connect the receiver to an AC
outlet. This may pose a fire hazard or result in an electric
shock.

⚠ WARNING! NEVER operate the receiver while dri-
ving a vehicle. Safe driving requires your full attention—any-
thing less may result in an accident.

⚠ WARNING! NEVER throw a battery cell into a fire
since as internal battery gas can cause explosion.

⚠ WARNING! NEVER disassemble the battery cell. If
the battery cell's internal material (electrolyte liquid) gets into
your eyes, wash your eyes with water and obtain treatment
from an eye doctor immediately.

NEVER connect the receiver to a power source of more
than 6 V DC directly. This will damage the receiver.

NEVER connect the receiver to a power source using re-
verse polarity. This will damage the receiver.

NEVER expose the receiver to rain, snow or any liquids.
The receiver may be damaged.

NEVER operate or touch the receiver with wet hands. This
may result in an electric shock or damage the receiver.

NEVER solder the battery cell. This may damage the bat-
tery.

AVOID using or placing the receiver in direct sunlight or in
areas with temperatures below -10°C ($+14^{\circ}\text{F}$) or above
 $+60^{\circ}\text{C}$ ($+140^{\circ}\text{F}$).

AVOID the use of chemical agents such as benzine or al-
cohol when cleaning, as they can damage the receiver's sur-
faces.

Even when the receiver power is OFF, a slight current still
flows in the circuits. Remove batteries from the receiver when
not using it for a long time. Otherwise, the installed batteries
will become exhausted, and will need to be recharged.

For U.S.A. only

CAUTION: Changes or modifications to this device, not ex-
pressly approved by Icom Inc., could void your authority to
operate this device under FCC regulations.

SUPPLIED ACCESSORIES

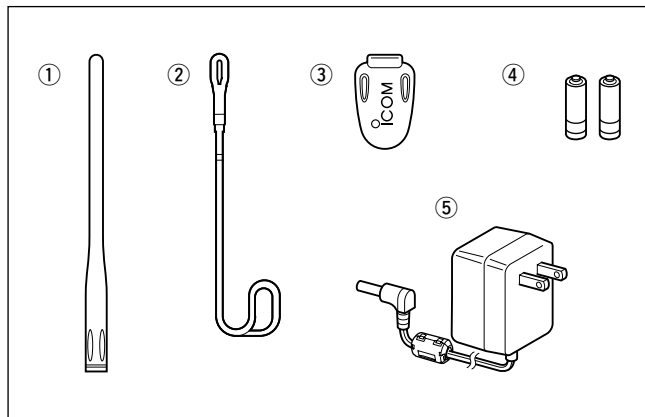

① Antenna	1
② Hand strap	1
③ Belt clip	1
④ Ni-Cd battery cells [†]	2
⑤ AC adapter*	1

*Not supplied with UK and Italy versions.

[†]Not supplied with Italy version.

OPERATING THEORY

Electromagnetic radiation which has frequencies of 20,000 Hz (20 kHz*) and above is called radio frequency (RF) energy because it is useful in radio transmissions. The IC-R5 receives RF energy from 0.150 MHz* to 1309.995 MHz and converts it into audio frequency (AF) energy which in turn actuates a loudspeaker to create sound waves. AF energy is in the range of 20 to 20,000 Hz.

*kHz is an abbreviation of kilohertz or 1000 hertz, MHz is abbreviation of megahertz or 1,000,000 hertz, where hertz is a unit of frequency.

OPERATING NOTES

The IC-R5 may receive its own oscillated frequency, resulting in no reception or only noise reception, on some frequencies.

The IC-R5 may receive interference from extremely strong signals on different frequencies or when using an external high-gain antenna.

TABLE OF CONTENTS

FOREWORD	i	■ Receive mode selection	12	■ DTCS polarity setting.....	37
IMPORTANT	i	■ Monitor function	13	■ Tone scan	38
EXPLICIT DEFINITIONS	i	■ Attenuator function	13	9 SET MODE	39–47
PRECAUTION	ii	■ Duplex operation	14	■ General	39
SUPPLIED ACCESSORIES	iii	■ Dial select step	15	■ Set mode items.....	40
OPERATING THEORY	iii	5 MEMORY CHANNELS	16–24	10 OTHER FUNCTIONS	48–53
OPERATING NOTES	iii	■ General description	16	■ Antenna selection	48
TABLE OF CONTENTS	iv	■ Memory channel programming.....	16	■ [DIAL] function assignment.....	49
QUICK REFERENCE GUIDE	I–VI	■ Memory bank setting	17	■ Weather channel operation	49
■ Preparation	I	■ Memory bank selection.....	18	■ Data cloning	51
■ Receiving a signal	III	■ Programming memory/bank name	19	■ Auto power-off function.....	52
■ Memory programming.....	IV	■ Selecting display type.....	20	■ Partial reset	53
■ Programmed scan operation.....	V	■ Copying memory contents.....	21	■ All reset	53
1 PANEL DESCRIPTION	1–4	■ Memory clearing.....	22	11 FREQUENCY TABLE	54–61
■ Front, top and side panels	1	■ Transferring memory contents.....	23	■ TV channels.....	54
■ Function display	3	■ Erasing/transferring bank contents.....	24	■ VHF marine channels	57
2 BATTERY CHARGING	5–6	6 SCAN OPERATION	25–31	■ Weather channels.....	57
■ Battery installation	5	■ Scan types.....	25	■ Other communications in the USA	58
■ Caution	5	■ Full/band/programmed scan.....	26	■ Other communications— other countries	60
■ Battery charging	6	■ Scan edges programming	27	12 MAINTENANCE	62–63
3 FREQUENCY AND CHANNEL SETTING	7–10	■ Memory/bank/all bank scan.....	28	■ Troubleshooting.....	62
■ VFO and memory channels.....	7	■ Auto memory write scan	29	■ CP-18A/E fuse replacement.....	63
■ Operating band selection.....	7	■ Skip channel/frequency setting.....	30	13 SPECIFICATIONS	64
■ Setting a frequency.....	9	■ Scan resume condition	31	14 OPTIONS	65
■ Setting a tuning step.....	9	7 PRIORITY WATCH	32–34	15 POCKET GUIDE	66–67
■ Selecting a memory channel	10	■ Priority watch types	32	16 CE	68
■ Lock function	10	■ Priority watch operation	33		
4 BASIC OPERATION	11–15	8 TONE SQUELCH AND POCKET BEEP	35–38		
■ Receiving	11	■ Tone/DTCS squelch operation.....	35		
■ Setting audio volume	11	■ Tone squelch frequency/DTCS code setting.....	36		
■ Squelch level setting.....	12				

1

2

3

4

5

6

7

8

9

10

11

12

13

14

15

16

QUICK REFERENCE GUIDE

■ Preparation

◇ Battery installation

- ① Remove the battery cover from the receiver.
- ② Install 2 R6(AA) size Ni-Cd, Ni-MH or alkaline cell batteries.
 - Be sure to observe the correct polarity.
 - Charge Ni-Cd or Ni-MH batteries before use. (See the right page for charging instructions.)

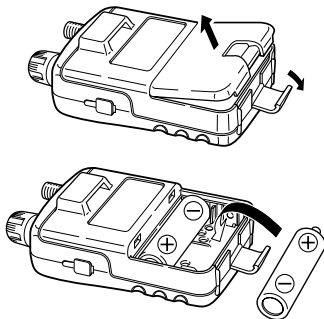

Keep battery the contacts clean. It's a good idea to clean the battery terminals once a week.

◇ Belt clip

Conveniently attaches to your belt.

Slide the belt clip into the plastic loop on the back of the receiver.

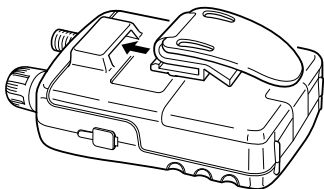

◇ Antenna

Insert the supplied antenna into the antenna connector and screw down the antenna as shown at right.

NEVER hold the antenna when carrying the receiver.

Keep the jack cover attached when jack is not in use to protect the connectors from dust and moisture.

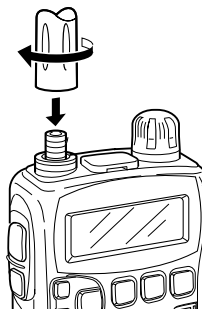

✓ For your information

Third-party antennas may increase receiver performance. An optional AD-92SMA ANTENNA CONNECTOR ADAPTER is available to connect an antenna with a BNC connector.

◇ Handstrap

Slide the handstrap through the loop on the side of the belt clip as illustrated at right. Facilities carrying.

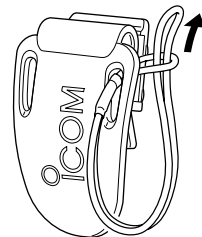

◇ Charging the battery

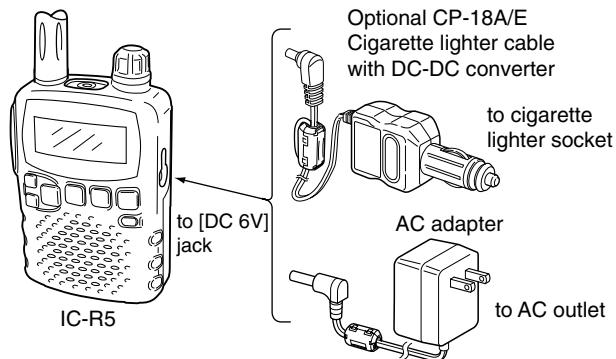

- ① Install the Ni-Cd batteries.
 - Ni-MH batteries can also be charged.
- ② Plug the AC adapter into an AC outlet.
- ③ Insert the adapter plug into the [DC 6V] of the receiver.
- ④ The battery confirmation is displayed as above right.

⚠ WARNING!:
NEVER charge the alkaline batteries.

- ⑤ Rotate [DIAL] to select “Y” then push [BAND•LOCK].

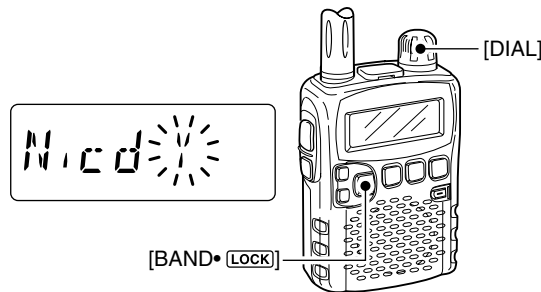

- ⑥ The charging confirmation is displayed as below.
- ⑦ Rotate [DIAL] to select “Y” then push [BAND•LOCK] to start battery charging.

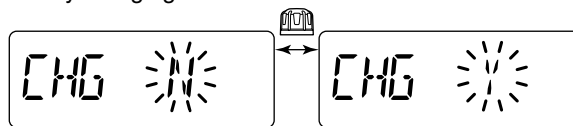

• The battery indicator scrolls during charge as below.



• Both segments blink when completely charged.

QUICK REFERENCE GUIDE

■ Your first scanning experience

Now that you have your IC-R5 ready, you are probably excited to start listening. We would like to take you through a few basic operation steps to make your first “Scanning Experience” enjoyable.

◇ About default setting

The [DIAL] control function can be traded with [▲]/[▼] keys function in set mode. However, in this QUICK REFERENCE GUIDE, the factory default setting ([DIAL] sets operating frequency) is used for simple instruction.

◇ Basic operation

1. Turning ON the receiver

- ➔ Push [PWR] for 1 sec. to turn the power ON.

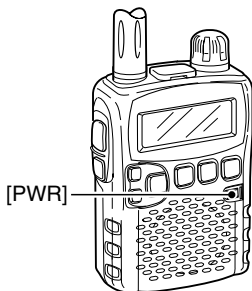

2. Adjusting audio level

- ➔ Push [▲]/[▼] to set the desired audio level.

3. Adjusting squelch level

- ➔ While pushing [SQL], rotate [DIAL] to set the squelch level.

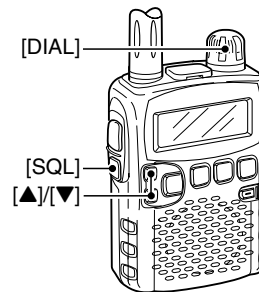

4. Tune the desired frequency

The tuning dial will allow you to dial in the frequency you want to operate. Pages 9 and 15 will instruct you on how to set the tuning speed.

- ① Push [BAND•LOCK] several times to select the desired frequency band.
 - While pushing [BAND•LOCK], rotate [DIAL] also select frequency band.
- ② Rotate [DIAL] to set the desired receive frequency.
 - While pushing [FUNC], rotate [DIAL] to select frequency in 1 MHz step.

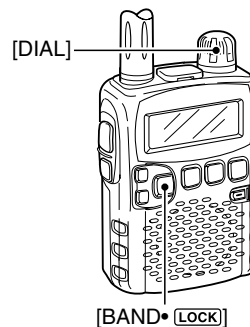

5. Receive mode selection

- ➔ Push [MODE•SCAN] several times to select the desired receive mode.
- FM, WFM and AM are available.



[MODE•SCAN]

■ Memory programming

The IC-R5 has a total of 1250 memory channels (including 200 auto write channels and 50 scan edges) for storing often used receive frequency, mode, etc.

1. Setting frequency

In VFO mode, set the desired receive frequency mode.

- When “**MR**” indicator is displayed, push [V/M•S.MW•**SKIP**] to select the VFO mode.

2. Selecting a memory channel

Push [V/M•S.MW•**SKIP**] for 1 sec., then rotate [DIAL] to select the desired memory channel.

- “**MR**” indicator and memory channel number blink.

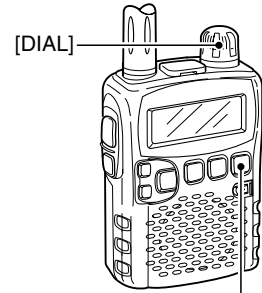
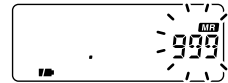

[V/M•S.MW•**SKIP**]

3. Writing a memory channel

Push [V/M•S.MW•**SKIP**] for 1 sec. until 3 beeps sound.

- Memory channel number automatically increases when continuing to push [V/M•S.MW•**SKIP**] after programming.

QUICK REFERENCE GUIDE

■ Programmed scan operation

25 pairs, 50 channels of memories are used for programmed scan operation, that specifying a scanning ranges. The programmed scan scans between “xxA” and “xxB” (xx=00 to 24) frequencies. Therefore, before operating the programmed scan, different frequencies must be programmed into “A” and “B” channels.

◆ Programming scan edges

A start frequency must be programmed into a “xxA,” and end frequency must be programmed into a “xxB” memory channel.

1. Setting frequency

In VFO mode, set the desired receive frequency mode.

- When “**MR**” indicator is displayed, push [V/M•S.MW•**SKIP**] to select the VFO mode.

2. Selecting a scan edge channel “A”

Push [V/M•S.MW•**SKIP**] for 1 sec., then rotate [DIAL] to select one of the desired scan edge channel “A.”

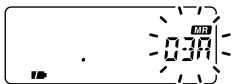

- “**MR**” indicator and scan edge channel number blink.

3. Writing a memory channel

Push [V/M•S.MW•**SKIP**] for 1 sec. until 3 beeps sound.

- Scan edge channel “B” is automatically selected when continuing to push [V/M•S.MW•**SKIP**] after programming.
- After programming is completed, return to VFO indication.

4. Selecting a scan edge channel “B”

Push [V/M•S.MW•**SKIP**] for 1 sec., then rotate [DIAL] to select one of the desired scan edge channel “B.”

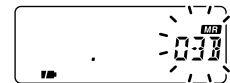

- “**MR**” indicator and scan edge channel number blink.
- When the scan edge channel “B” is already selected at step 3. (continuing to push [V/M•S.MW•**SKIP**] after programming), skip this step.

5. Writing a memory channel

Push [V/M•S.MW•**SKIP**] for 1 sec. until 3 beeps sound.

- The next scan edge channel “A” is automatically selected when continuing to push [V/M•S.MW•**SKIP**] after programming.
- After programming is completed, return to VFO indication.

◆ Starting scan

1. Select VFO mode.

Push [V/M•S.MW•SKIP] to select the VFO mode for full, band and programmed scan operation.

- Select memory mode by pushing [V/M•S.MW•SKIP] again for memory or bank scan.

2. Selecting a scanning type

Push [MODE•SCAN] for 1 sec., then rotate [DIAL] to select one of the desired scanning type.

- Available scan types when VFO mode is selected; “ALL” for full scan; “BAND” for the selected band; one of “PROGxx” (xx=0 to 24) for programmed scan.
- Available scan types when memory bank is selected; “ALL” for all bank scan; “BANK” for the selected bank scan.

• Scan type indication examples

- Full scan

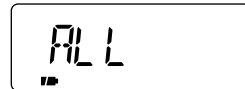

- Program scan

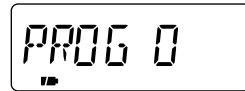

- Bank scan

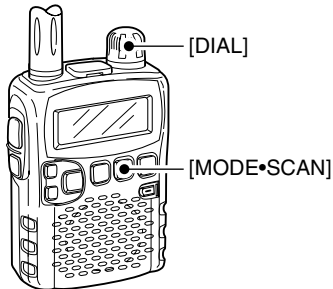
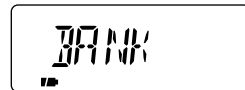

3. Starting scan

Push [MODE•SCAN] to start scan.

- Rotate [DIAL] to change the scanning direction.

- Full/Band scan

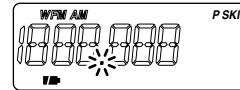

- Programmed scan

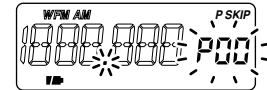

- Memory/All bank scan

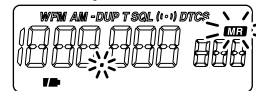

- Bank scan

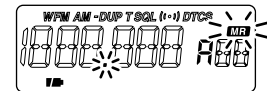

4. Cancelling scan

Push [MODE•SCAN] again to stop scan.

✓ For your information

The memory channel number you program the scan edges into correlate “PROGxx” as follows:

00A/00B: Scans between frequencies programmed in 00A and 00B channels, and select “PROG 00”

01A/01B: Scans between frequencies programmed in 01A and 01B channels, and select “PROG 01”



23A/23B: Scans between frequencies programmed in 23A and 23B channels, and select “PROG 23”

24A/24B: Scans between frequencies programmed in 24A and 24B channels, and select “PROG 24”

■ Front, top and side panels

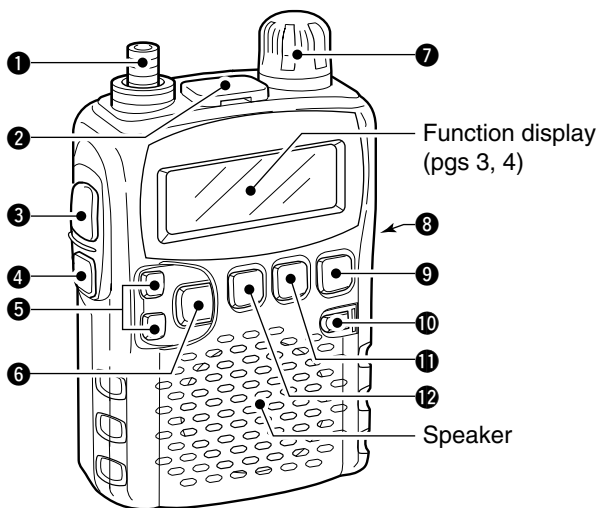

1 ANTENNA CONNECTOR (p. 1)

Connects the supplied antenna.

- An optional AD-92SMA is available for connecting an antenna with a BNC connector.

2 EXTERNAL SPEAKER CONNECTOR [SP]

Connect an optional earphone or headphone.

The internal speaker will not function when any external equipment is connected. (See p. 65 for a list of available options.)

3 FUNCTION SWITCH [FUNC]

While pushing this switch, access to secondary function.

4 SQUELCH SWITCH [SQL]

➔ Push and hold to temporarily open the squelch and monitor the operating frequency. (p. 13)

➔ While pushing this switch, rotate [DIAL]* to adjust the squelch level. (p. 12)

5 UP/DOWN SWITCHES [▲]/[▼]

Adjusts audio volume level.* (p. 11)

6 BAND•LOCK SWITCH [BAND•LOCK]

➔ Push to select the operating frequency band. (p. 7)

➔ After pushing [FUNC], push for 1 sec. to toggle the lock function ON and OFF. (p. 10)

7 CONTROL DIAL [DIAL]

- Rotate to select the operating frequency.* (p. 9)
- While scanning, changes the scanning direction.* (p. 26)
- While pushing [SQL], sets the squelch level.* (p. 12)
- While pushing [FUNC], sets the operating frequency in 100 kHz, 1 MHz or 10 MHz in VFO mode.* (p. 9)
- While pushing [FUNC], selects the memory channel in 10 channels steps in memory mode.* (p. 10)
- While pushing [BAND•LOCK], selects the operating band in VFO mode.* (p. 7)

8 EXTERNAL DC-IN CONNECTOR [DC 6V] (p. 6)

Connects an AC adapter or an optional cigarette lighter cable for both charging the installed re-chargeable battery and operating.

9 VFO/MEMORY•MEMORY WRITE SWITCH

[V/M•S.MW•SKIP]

- Toggles between VFO and memory mode. (p. 7)
- Push for 1 sec. to enter memory edit condition. (p. 16)
- After pushing [FUNC], select scan skip condition. (p. 30)

10 POWER SWITCH [PWR]

Push for 1 sec. to turn the receiver power ON and OFF.

11 MODE•SCAN SWITCH [MODE•SCAN]

- Push to select the receive mode. (p. 12)
- Push for 1 sec. to start a scan. (p. 26)
- While pushing [FUNC], start a tone scan. (p. 38)

12 TUNING STEP•SET SWITCH [TS•SET]

- Push to enter tuning step selecting mode. (p. 9)
- Push for 1 sec. to enter set mode. (p. 39)
- While pushing [FUNC], trade [DIAL] and [▲]/[▼] function. (p. 49)

*The function of [DIAL] and [▲]/[▼] can be traded. See page 49 for details.

1 PANEL DESCRIPTION

■ Function display

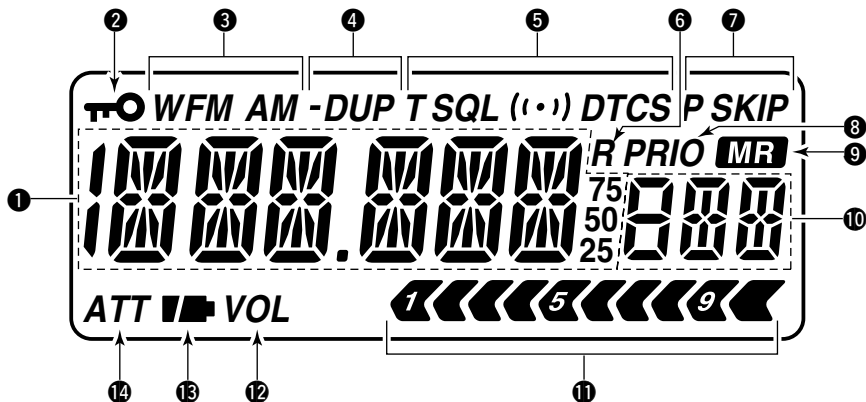

❶ FREQUENCY READOUT

Shows variety of information, such as an operating frequency, set mode contents, memory names.

- The smaller “75,” “50” and “25” to the right of the readout indicate 0.75, 0.5 and 0.25 kHz, respectively.
- The decimal point blinks during scan.

❷ LOCK INDICATOR (p. 10)

Appears when the lock function is activated.

❸ RECEIVE MODE INDICATOR (p. 12)

Shows the selected receive mode.

- FM, WFM and AM are available.

❹ DUPLEX INDICATORS (p. 14)

“DUP” appears when plus duplex, “-DUP” appears when minus semi-duplex (repeater) operation is selected.

❺ TONE INDICATORS

- ➔ “T SQL” appears while the tone squelch function is in use. (p. 35)
- ➔ “DTCS” appears while the DTCS squelch function is in use. (p. 35)
- ➔ “((.))” appears with the “T SQL” or “DTCS” indicator while the pocket beep function (with CTCSS or DTCS) is in use. (p. 35)

6 AUTO WRITE CHANNEL INDICATOR (p. 29)

Appears when auto write channel is selected.

7 SKIP INDICATORS (p. 30)

- “SKIP” appears when the selected memory channel is specified as a skip channel.
- “P SKIP” appears when the displayed frequency is specified as a skip frequency.

8 PRIORITY WATCH INDICATOR (p. 33)

Appears when priority watch is in use.

9 MEMORY INDICATOR (pgs. 7, 10)

Appears when memory mode is selected.

10 MEMORY CHANNEL NUMBER INDICATORS

Shows the selected memory channel number. (pgs. 7, 10)

11 SIGNAL STRENGTH INDICATOR (p. 11)

Shows the relative signal strength while receiving signals.

12 VOLUME EXCHANGE INDICATOR (p. 49)

Appears when the function of [DIAL] and [▲]/[▼] are traded.

13 BATTERY INDICATOR

- Both segments appear when the installed batteries have ample capacity.
 - They do not appear when operating with an external power source.
- Only the right segment “■” appears when the batteries are nearing exhaustion.
- Scrolls while charging the installed rechargeable batteries. (p. 6)



- Both segments blink when completely charged.

14 ATTENUATOR INDICATOR (p. 13)

Appears when the RF attenuator is in use.

■ Battery installation

Before installing, or replacing the batteries, push [PWR] for 1 sec. to turn the power OFF.

- ① Remove the battery cover from the receiver.
- ② Install 2 R6 (AA) size Ni-Cd or Ni-MH batteries.
 - Be sure to observe the correct polarity.

▨ Keep the battery contacts clean to avoid rust or poor contact. It's a good idea to clean the battery terminals once a week.

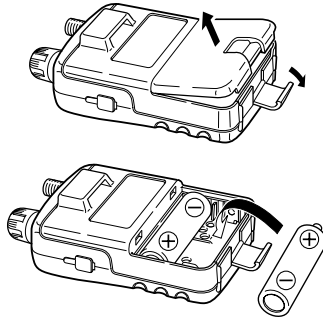

■ Caution

◇ Battery caution

- **CAUTION! NEVER** short the battery terminals. Also, current may flow into nearby metal objects such as a necklace, so be careful when placing battery cells in handbags, etc.
- **NEVER** mix old and new batteries.
- **Make sure** all battery cells are the same brand, type and capacity. Either of the above may cause a fire hazard or damage the receiver if ignored.

- **NEVER** incinerate used battery cells. Internal battery gas may cause explosion.

If your re-chargeable batteries seem to have no capacity even after being charged, completely discharge them by leaving the power ON overnight. Then fully charge the batteries again. If the batteries still does not retain a charge (or very little charge), a new battery cells must be purchased.

◇ Charging caution

⚠ **WARNING! NEVER** charge dry or alkaline batteries.

AVOID over charging— The installed re-chargeable batteries can be charged during operation when the AC adapter or the optional cigarette lighter cable is connected. To prevent over charging, the IC-R5 has charging timer that automatically disconnecting the charging line electronically after 15 hours from charging. However, the charging timer will reset and start charging again when disconnect then re-connecting the AC adapter or CP-18A/E more than 1 min. interval.

- Recommended temperature for charging:
 $\pm 0^{\circ}\text{C}$ to $+40^{\circ}\text{C}$ (; $+32^{\circ}\text{F}$ to $+140^{\circ}\text{F}$)
- Connect the supplied (or optional for UK and Italy versions) AC adapter or optional cigarette lighter cable only when charging the installed Ni-Cd or Ni-MH batteries. **NEVER** use other manufactures' chargers.

▨ **CAUTION: BE SURE** to disconnect the CP-18A/E from the cigarette lighter socket when charging is finished, because, a slight current still follows in the CP-18A/E and the vehicle's battery will become exhausted.

■ Battery charging

◇ Charging connections

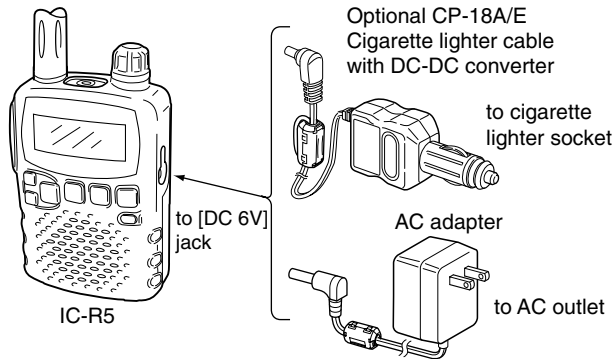

• **Charging periods:** Approx. 10 hours

◇ Charging description

- ① Install the Ni-Cd batteries. (See left page)
 - Ni-MH batteries can also be charged.
- ② Plug the AC adapter into an AC outlet; or the optional CP-18A/E into a cigarette lighter socket.
- ③ Insert the adapter plug into [DC 6V] of the receiver.
- ④ The battery type confirmation is displayed as above right.
 - When no confirmation display is indicated, insert the adapter plug while pushing [FUNC].
 - Once the batteries are removed for more than 2 sec., the following operations are necessary.

- ⑤ Rotate [DIAL] to select “Y” then push [BAND•LOCK].

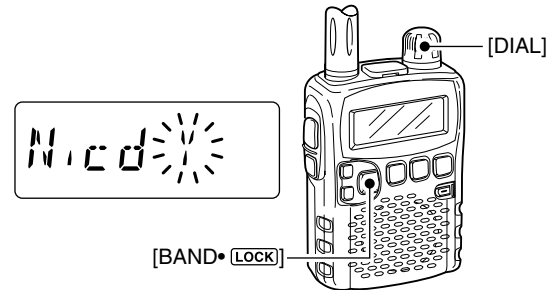

- ⑥ The charging confirmation is displayed.
- ⑦ Rotate [DIAL] to select “Y” then push [BAND•LOCK] to start battery charging.

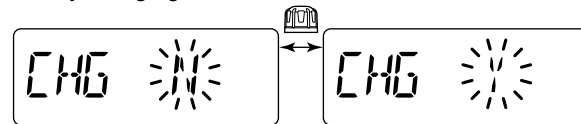

• The battery indicator scrolls during charge as below.



- When the batteries are charged completely, the battery indicator (both segments) blinks.
- Takes approximately 10 hours for fully charge with the supplied Ni-Cd cells.

3

FREQUENCY AND CHANNEL SETTING

■ VFO and memory channels

The IC-R5 has 2 normal operating modes: VFO mode and memory mode.

VFO mode is used for the desired frequency setting within the frequency coverage.

➔ Push [V/M•S.MW•**SKIP**] to select VFO mode.

Memory mode is used for the desired frequency setting within the frequency coverage.

➔ Push [V/M•S.MW•**SKIP**] to select memory mode.

- See p. 16 for memory programming details.

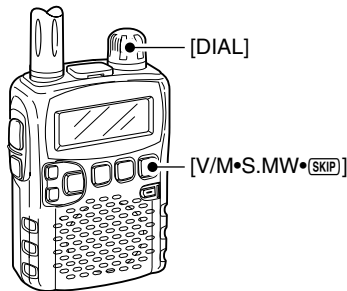

• VFO mode indication

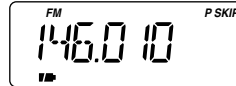

• Memory mode indication

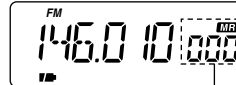

"MR" and memory channel number appear.

What is VFO?

VFO is an abbreviation of Variable Frequency Oscillator. Frequencies for receiving are generated and controlled by the VFO.

■ Operating band selection

The receiver can receive the AM broadcast, HF band, 50 MHz, FM broadcast, VHF air, 144 MHz, 300 MHz, 400 MHz, 800 MHz,* 1200 MHz, television channels or Weather channels†.

➔ Push [BAND•**LOCK**] several times to select the desired frequency band.

- When a memory mode is selected, push [V/M•S.MW•**SKIP**] to select VFO mode first, then push [BAND•**LOCK**] to select the desired band.

➔ While pushing and holding [BAND•**LOCK**], rotating [DIAL] also selects frequency band.

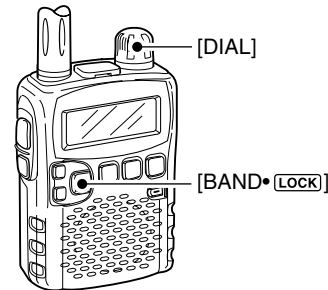

/// Available frequency bands are differ depending on version.
/// See the specification for details.

/// *Some frequency ranges are inhibited for the USA version due to local regulation.

/// †Available for the USA version only.

• Available frequency bands

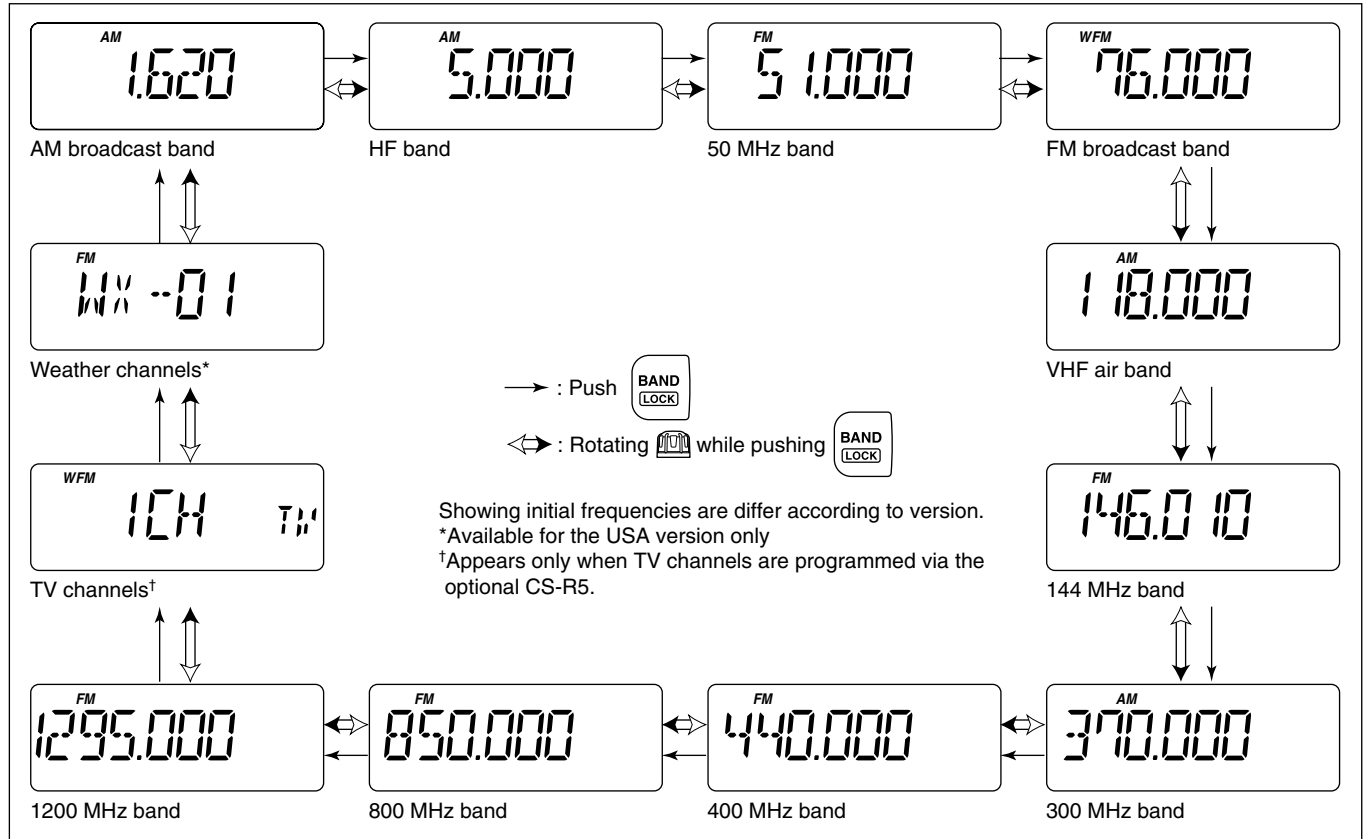

3 FREQUENCY AND CHANNEL SETTING

■ Setting a frequency

- ① Push [V/M•S.MW•SKIP] to select VFO mode, if necessary.
- ② Select the desired frequency band with [BAND•LOCK].
 - Or, while pushing and holding [BAND•LOCK], rotate the [DIAL] to select the desired frequency band.
- ③ Rotate [DIAL] to select the desired frequency band.
 - The frequency changes according to the preset tuning steps.
 - See the right section for setting the tuning step.
 - While pushing and holding [FUNC], rotate [DIAL] to change the frequency in 1 MHz steps (default).

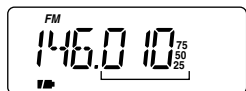
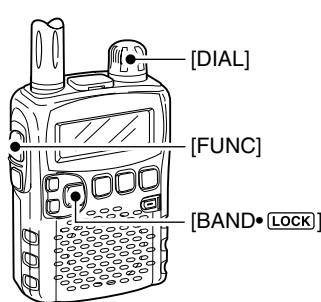

[DIAL] changes the frequency according to the selected tuning step.

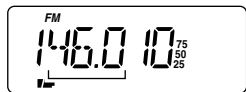

While pushing [FUNC], [DIAL] changes the frequency in 1 MHz steps (default).

▨ The 1 MHz tuning step (dial select step) can be set to 100 kHz, 1 MHz or 10 MHz tuning steps in set mode. See p. 15 for details.

■ Setting a tuning step

The tuning step can be selected for each frequency band, however, the tuning steps, 8.33 kHz and 9 kHz, are appeared when setting the tuning step for the VHF air band and AM broadcast band, respectively. The following tuning steps are available for the IC-R5.

- 5.0 kHz
- 6.25 kHz
- 8.33 kHz
- 9.0 kHz
- 10.0 kHz
- 12.5 kHz
- 15.0 kHz
- 20.0 kHz
- 25.0 kHz
- 30.0 kHz
- 50.0 kHz
- 100.0 kHz

◆ Tuning step selection

- ① Push [V/M•S.MW•SKIP] to select VFO mode, if necessary.
- ② Push [BAND•LOCK] to select the desired frequency band.
 - Or, while pushing and holding [BAND•LOCK], rotate the [DIAL] to select the desired frequency band.
- ③ Push [TS•SET] to enter tuning step selecting condition.
- ④ Rotate [DIAL] to select the desired tuning step.
- ⑤ Push [TS•SET] to return to VFO mode.

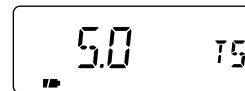
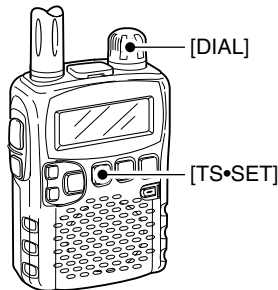

5 kHz tuning step

■ Selecting a memory channel

- ① Push [V/M•S.MW•SKIP] to select the memory mode.
 - “MR” appears when a memory channel is selected.
- ② Rotate [DIAL] to select the desired memory channel.
 - Only programmed memory channels can be selected.
 - While pushing and holding [FUNC], rotate [DIAL] to select a memory channel in 10 channels steps.

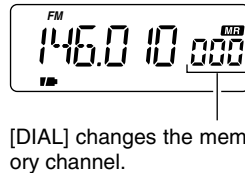
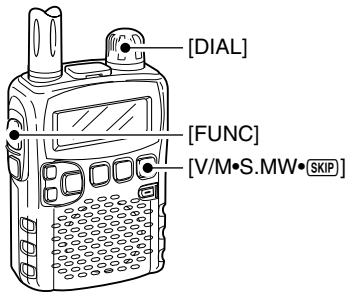



[DIAL] changes the memory channel.

■ Lock function

To prevent accidental frequency changes and unnecessary function access, use the lock function.

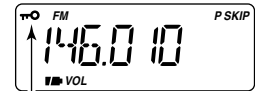
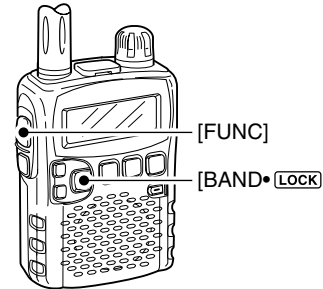
- While pushing [FUNC], push [BAND•LOCK] for 1 sec. to turn the lock function ON and OFF.
 - “” appears while the lock function is activated.
 - [SQL] and [▲]/[▼] can be used while the lock function is in use with default setting. Either or both [SQL] and [▲]/[▼] keys are also locked in set mode. (p. 43)



“” appears while the lock function is in use.

■ Receiving

Make sure charged Ni-Cd or brand new alkaline batteries are installed (p. 5).

- ① Push [PWR] for 1 sec. to turn power ON.
- ② Push [▲] or [▼] to set the desired audio level.
 - The frequency display shows the volume level while setting. See the section at right for details.
- ③ Set the receiving frequency. (p. 9)
- ④ Set the squelch level. (p. 12)
 - While pushing [SQL], rotate [DIAL].
 - The first click of [DIAL] indicates the current squelch level.
 - “LEVEL 1” is loose squelch and “LEVEL 9” is tight squelch.
 - “AUTO” indicates automatic level adjustment with a noise pulse count system.
 - Push and hold [SQL] to open the squelch manually.
- ⑤ When a signal is received:
 - Squelch opens and audio is emitted.
 - The S-meter shows the relative signal strength level.

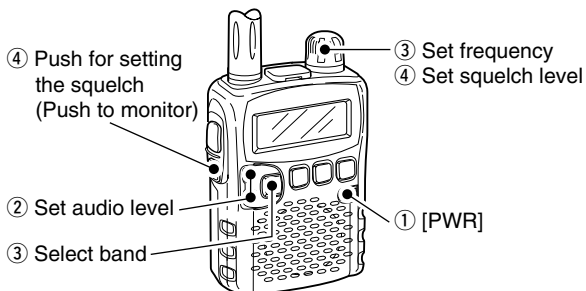

■ Setting audio volume

The audio level can be adjusted through 32 levels.

- ➔ Push [▲] or [▼] to adjust the audio level.
 - Beep tone sounds while setting. The tone sound let you know the approximate sound level.
 - Pushing and holding either key change the audio level continuously.
 - The display shows the volume level while setting.

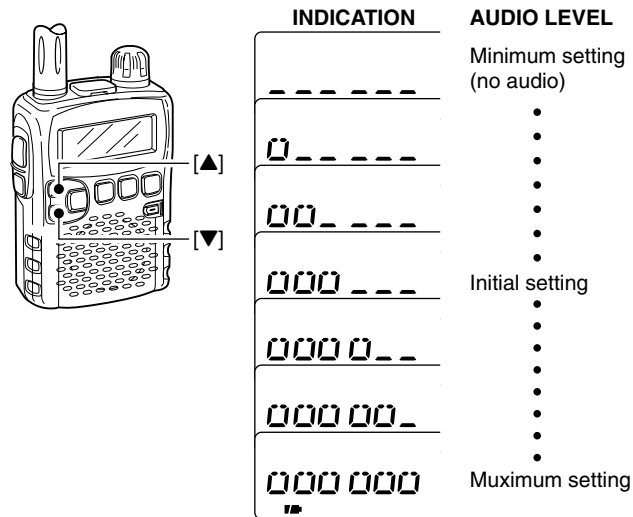

■ Squelch level setting

The squelch circuit mutes the received audio signal depending on the signal strength. The receiver has 9 squelch levels, a continuously open setting and an automatic squelch setting.

- ➔ While pushing and holding [SQL], rotate [DIAL] to select the squelch level.
 - “LEVEL 1” is loose squelch and “LEVEL 9” is tight squelch.
 - “AUTO” indicates automatic level adjustment with a noise pulse count system.
 - “OPEN” indicates continuously open setting.

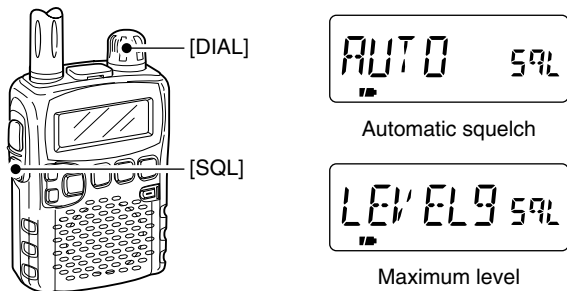

■ Receive mode selection

Receive modes are determined by the physical properties of the radio signals. The receiver has 3 receive modes: FM, AM and WFM modes. The mode selection is stored independently in each band and memory channels.

Typically, AM mode is used for the AM broadcast stations (0.495–1.620 MHz) and air band (118–135.995 MHz), and WFM is used for FM broadcast stations (76–107.9 MHz).

- ➔ Push [MODE•SCAN] several times to select the desired receive mode.

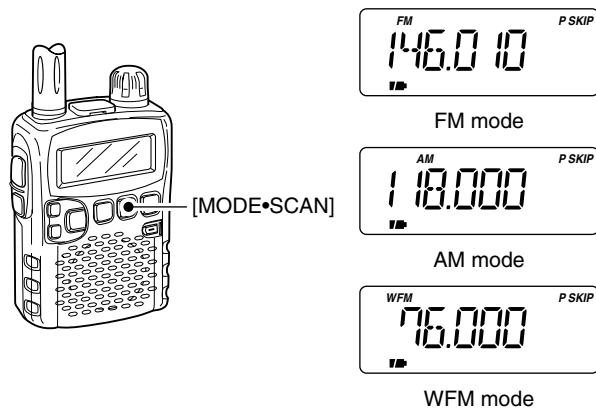

4 BASIC OPERATION

■ Monitor function

This function is used to listen to weak signals without disturbing the squelch setting or to open the squelch manually even when mute functions such as the tone squelch are in use.

- ➔ Push and hold [SQL] to monitor the operating frequency.
 - The 1st segment of the S-meter blinks.

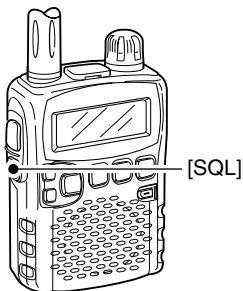

The 1st segment blinks

/// The [SQL] switch can be set to 'sticky' operation in expanded set mode. See page 43 for details.

■ Attenuator function

The attenuator prevents a desired signal from distorting when very strong signals are near the desired frequency or when very strong electric fields, such as from a broadcasting station, are near your location.

- ➔ While pushing [FUNC], push [SQL] to toggle the attenuator function ON and OFF.
 - "ATT" appears when the attenuator functions is in use.

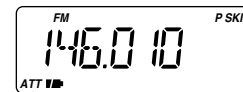
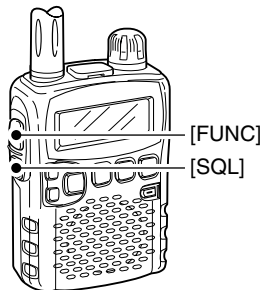

"ATT" appears while the attenuator functions is in use.

■ Duplex operation

USING EXPANDED SET MODE

Duplex communication uses 2 different frequencies for transmitting and receiving. Generally, duplex is used in communication through a repeater, some utility communications, etc.

During duplex operation, the transmit station frequency is shifted from the receive station frequency by the offset frequency. Repeater information (offset frequency and shift direction) can be programmed into memory channels. (p. 16)

◆ Setting

- ① Set the receive station frequency (repeater output frequency).
- ② Push [TS•SET] for 1 sec. to enter set mode.
- ③ Rotate [DIAL] to select “EXPAND.”
 - “EXPAND” disappears after 1 sec. and “OFF” (default) and “EX” appear.

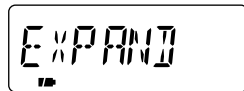
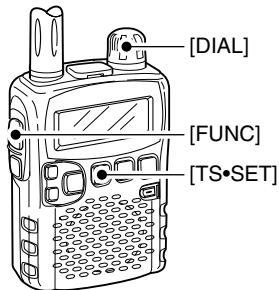

Expanded set mode item

↓ After 1 sec.

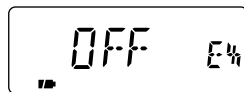

Setting indication

- ④ While pushing [FUNC], rotate [DIAL] to select “ON.”
- ⑤ Rotate [DIAL] to select “OFFSET.”
 - “OFFSET” disappears after 1 sec. and “0.000” (default) and “OW” appear.

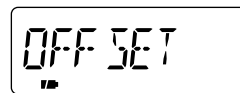

After 1 sec.



Offset frequency item

Setting indication

- ⑥ While pushing [FUNC], rotate [DIAL] to set the desired offset frequency within 0.000–159.995 MHz range.
 - The tuning step, selected in VFO mode, is used for setting.
- ⑦ Rotate [DIAL] to select “DUP.”
 - “DUP” disappears after 1 sec. and “OFF” (default) and “DP” appear.



After 1 sec.

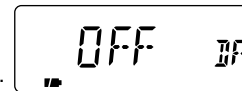

Duplex item

Setting indication

- ⑧ While pushing [FUNC], rotate [DIAL] to select “-DUP” or “+DUP.”
- ⑨ Push [TS•SET] to exit set mode.
- ⑩ Push and hold [SQL] to monitor the transmit station frequency (repeater input frequency) directly.

4 BASIC OPERATION

■ Dial select step

USING SET MODE

This receiver has a 1 MHz tuning step for quick frequency setting. This dial select step can be set to 100 kHz, 1 MHz or 10 MHz steps, as desired.

◆ Setting dial select step

- ① Select VFO mode with [V/M•S.MW•SKIP].
- ② Push [TS•SET] for 1 sec. to enter set mode.
- ③ Rotate [DIAL] to select “D SEL.”
 - “D SEL” disappears after 1 sec. and “1M” (default) and “DS” appear.
- ④ While pushing [FUNC], rotate [DIAL] to select the desired dial select step.
 - 100 kHz, 1 MHz and 10 MHz can be selected.
- ⑤ Push [TS•SET] momentarily to exit set mode.

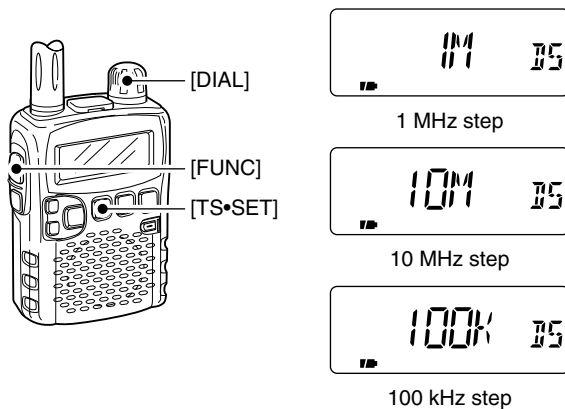

■ General description

The receiver has 1050 memory channels including 50 scan edge memory channels (25 pairs) for storage of often-used frequencies. And a total of 18 memory banks, A to H, J, L, N, O to R, T, U and Y are available for usage by group, etc. Up to 100 channels can be assigned into a bank.

◆ Memory channel contents

The following information can be programmed into memory channels:

- Operating frequency (p. 9)
- Receive mode (p. 12)
- Duplex direction (DUP or –DUP) with an offset frequency (p. 14)
- Tone squelch or DTCS squelch ON/OFF (p. 35)
- Tone squelch frequency or DTCS code with polarity (pgs. 36, 37)
- Scan skip information* (p. 30).

■ Memory channel programming

- ① Push [V/M•S.MW•SKIP] to select VFO mode.
- ② Set the desired frequency:
 - Select the desired band with [BAND•LOCK].
 - Set the desired frequency with [DIAL].
 - Set other data (e.g. offset frequency, duplex direction, tone squelch, etc.), if desired.
- ③ Push [V/M•S.MW•SKIP] for 1 sec. to select select memory write condition.
 - 1 short and 1 long beep sound.
 - “MR” indicator memory channel number blink.
- ④ Rotate [DIAL] to select the desired channel.
 - Scan edge channel, 00A/B to 24A/B can also be selected.
 - While pushing [FUNC], rotate [DIAL] to selects memory channel in 10 channels steps.
- ⑤ Push [V/M•S.MW•SKIP] for 1 sec.
 - 3 beeps sound
 - Memory channel number automatically increases when continuing to push [V/M•S.MW•SKIP] after programming.

[EXAMPLE]: Programming 145.870 MHz into memory channel 20 (blank channel).

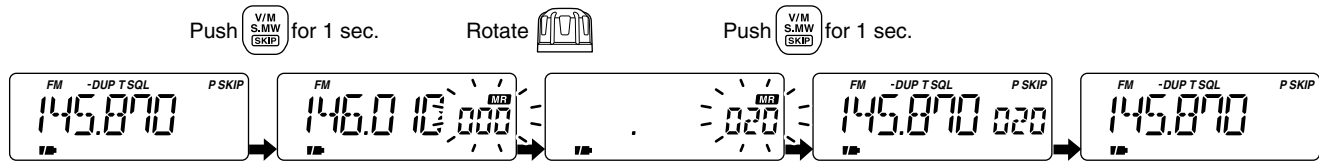

5 MEMORY CHANNELS

Memory bank setting

The IC-R5 has a total of 18 banks (A to H, J, L, N, O to R, T, U and Y). Regular memory channels, 000 to 999, are assigned into the desired bank for easy memory management.

- ① Push [V/M•S.MW•SKIP] for 1 sec. to select select memory write condition.
 - 1 short and 1 long beep sound.
 - “MR” indicator memory channel blink.
- ② Rotate [DIAL] to select the desired memory channel.
- ③ While pushing [MODE•SCAN], rotate [DIAL] to select “BANK.”
 - After releasing [MODE•SCAN], “- - - - -” is displayed instead of the frequency indication, and only “MR” indicator blinks.
 - Bank group and channel number is displayed if the selected memory channel has already been assigned into a bank, the previous .
 - “BANK” item can also be selected by pushing [MODE•SCAN] several times.

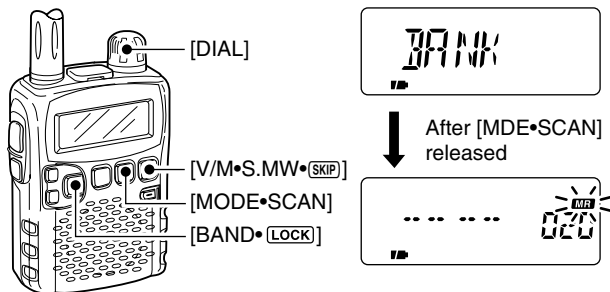

- ④ While pushing [BAND•LOCK], rotate [DIAL] to select the desired bank group.
 - Bank group A to H, J, L, N, O to R, T, U and Y are available.
 - The bank group can also be selected by pushing [BAND•LOCK] several times.

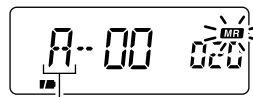

Bank group is selected with [BAND•LOCK]

- ⑤ Rotate [DIAL] to select the desired bank channel number.
 - Vacant bank channel numbers are only be displayed.

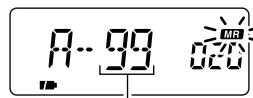

Bank channel is selected with [DIAL]

- ⑥ Push [V/M•S.MW•SKIP] momentarily to set the channel into the bank.
 - Return to the previous indication.

Memory bank selection

- ① Push [V/M•S.MW•SKIP] to select memory mode, if desired.
- ② While pushing [BAND•LOCK], rotate [DIAL] to select the desired bank (A to H, J, L, N, O to R, T, U and Y).
 - The bank can also be selected by pushing [BAND•LOCK] several times.
 - The only programmed banks are displayed.

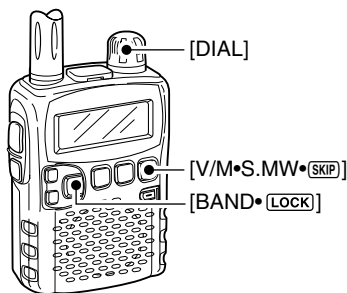

- ③ Rotate [DIAL] to select the bank channel.
 - The only programmed channels are displayed.

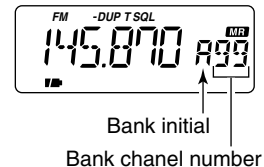

- ④ To return to regular memory condition, rotate [DIAL] while pushing [BAND•LOCK], or push [BAND•LOCK] several times.

5 MEMORY CHANNELS

■ Programming memory/bank name

Each memory channel can be programmed with an alphanumeric channel name for easy recognition and can be indicated independently by channel. Names can be a maximum of 6 characters.

- ① Push [V/M•S.MW•**SKIP**] to select memory mode.
- ② Rotate [DIAL] to select the desired memory channel.
- ③ Push [V/M•S.MW•**SKIP**] for 1 sec. to select select memory write condition.
 - 1 short and 1 long beep sound.
 - “**MR**” indicator and memory channel number blink.

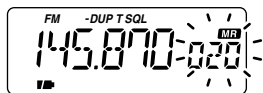

- ④ While pushing [MODE•SCAN], rotate [DIAL] to select “M NAME” or “B NAME” when programming the memory name or the bank name, respectively.
 - The item can also be selected by pushing [MODE•SCAN] several times.
 - After releasing [MODE•SCAN], an under bar blinks for the first digit instead of the frequency indication, and only “**MR**” indicator blinks.

Memory name selection



Bank name selection



- ⑤ While pushing [FUNC], rotate [DIAL] to select the desired character.
 - The selected character blinks.
- ⑥ Rotate [DIAL] to move the cursor to left or right.

Memory name

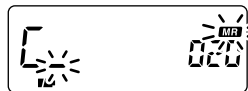

Bank name

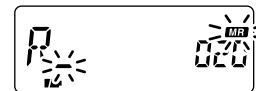

- ⑦ Repeat steps ⑤ and ⑥ until the desired 6-character channel names are displayed.
- ⑧ Push [MODE•SCAN] several times, or rotate [DIAL] while pushing [MODE•SCAN] to select “S.MW” item.

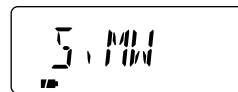

- ⑨ Push [V/M•S.MW•**SKIP**] for 1 sec. to program the name and exit the channel name programming condition.
 - 3 beeps sound.

• Available characters

A to Z, 0 to 9, (,), *, +, -, ,, /, |, = and space.

NOTE: The bank name can only be programmed into each bank. Therefore, previously programmed bank name will be displayed when bank name indication is selected. And also, the programmed bank name is assigned for the other bank channels automatically.

■ Selecting display type

During memory mode operation, one of the programmed memory name, bank name or the channel number can be displayed instead of the frequency for your preference.

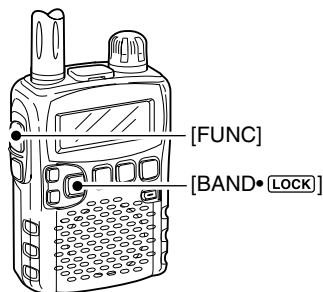

When no memory or bank name is programmed with the selected memory channel, frequency is displayed on the function display.

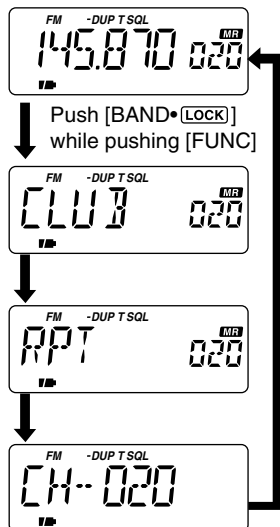

- ① Push [V/M•S.MW•SKIP] to select memory mode.
 - [BAND•LOCK] to select the desired bank group.
- ② While pushing [FUNC], push [BAND•LOCK] to select display type from frequency, bank name, memory name and channel number indications.

◇ Selecting bank channel indication

During bank channel operation, the bank channel number can also be displayed instead of the memory channel number indication.

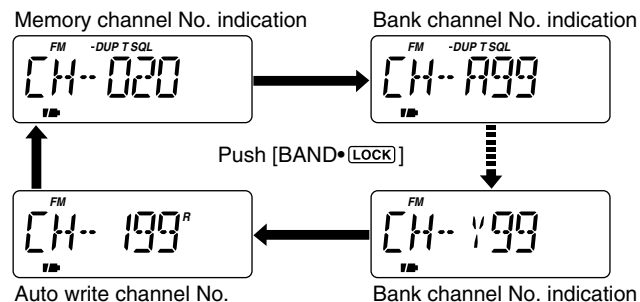

- After selecting channel number indication as described at left, push [BAND•LOCK] to select the desired bank.

5 MEMORY CHANNELS

■ Copying memory contents

This function transfers a memory channel's contents to VFO (or another memory channel). This is useful when searching for signals around a memory channel frequency and for recalling the offset frequency, subaudible tone frequency etc.

◇ Memory ↔ VFO

- ① Select the memory channel to be copied.
 - ➔ Push [V/M•S.MW•**SKIP**] to select memory mode, then rotate [DIAL] to select the desired memory channel.
 - Select the bank channel with [BAND•**LOCK**] and [DIAL], if desired.
- ② Push [V/M•S.MW•**SKIP**] for 1 sec. to select select memory write condition.
 - 1 short and 1 long beep sound.
 - “**MR**” indicator memory channel number blink.
- ③ Rotate [DIAL] to select “VF.”
- ④ Push [V/M•S.MW•**SKIP**] for 1 sec. again.
 - VFO mode is selected automatically.

/// Pushing [V/M•S.MW•**SKIP**] for 2 sec. at the step ②, can also be copied the memory contents to VFO. In this case, the steps ③ and ④ are not necessary.

◇ Memory ↔ memory

- ① Select the memory channel to be transferred.
 - ➔ Push [V/M•S.MW•**SKIP**] to select memory mode, then rotate the tuning dial to select the desired memory channel.
- ② Push [V/M•S.MW•**SKIP**] for 1 sec. to select select memory write condition.
 - 1 short and 1 long beep sound.
 - “**MR**” indicator memory channel number blink.
 - Do not hold [V/M•S.MW•**SKIP**] for more than 1 sec. otherwise the memory contents will be copied to VFO.
- ③ Rotate [DIAL] to select the target memory channel.
- ④ Push [V/M•S.MW•**SKIP**] for 1 sec. again to transfer.

[EXAMPLE]: Copying channel 20 to 51.

Select memory channel

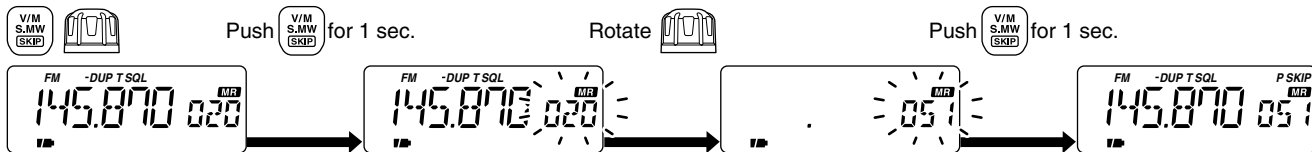

Memory clearing

Contents of programmed memories can be cleared (blanked), if desired.

- ① Push [V/M•S.MW•SKIP] for 1 sec. to select memory write condition.
 - 1 short and 1 long beeps sound.
 - “MR” indicator and memory channel number blink.
 - Do not hold [V/M•S.MW•SKIP] for more than 2 sec. otherwise the memory contents will be copied to VFO.
- ② Rotate [DIAL] to select the desired memory channel to be cleared.
- ③ While pushing [MODE•SCAN], rotate [DIAL] to select “CLEAR.”
 - After releasing [MODE•SCAN], “CLR” is displayed instead of the frequency indication, and only “MR” indicator blinks.
 - “CLEAR” item can also be selected by pushing [MODE•SCAN] several times.

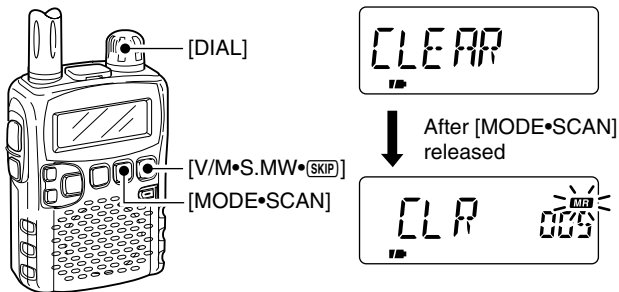

- ④ Push [V/M•S.MW•SKIP] for 1 sec. to clear the contents.
 - 3 beeps sound.
 - Return to VFO or memory mode, if VFO is selected before performing the step ①.
 - Return to select memory write conditions if memory mode is selected before performing the step ①.— “MR” indicator memory and channel number blink. Push [V/M•S.MW•SKIP] momentarily to return to memory mode.

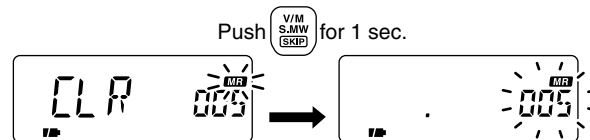

While pushing [FUNC], push [V/M•S.MW•SKIP] for 1 sec. after the step ② is operated can also be cleared the memory contents. In this case, the steps ③ and ④ are not necessary.

NOTE: Be careful!— the contents of cleared memories CANNOT be re-called even in bank channel operation.

5 MEMORY CHANNELS

■ Transferring memory contents

Contents of programmed memory channels can be transferred to another memory.

- ① Push [V/M•S.MW•**SKIP**] for 1 sec. to enter select memory write condition.
 - 1 short and 1 long beeps sound.
 - “**MR**” indicator and memory channel number blink.
 - Do not hold [V/M•S.MW•**SKIP**] for more than 2 sec. otherwise the memory contents will be copied to VFO.
- ② Rotate [DIAL] to select the desired memory channel to be transferred.
- ③ While pushing [MODE•SCAN], rotate [DIAL] to select “CLEAR” item.
 - Pushing [MODE•SCAN] several times also “CLEAR” item is selectable.
- ④ Push [V/M•S.MW•**SKIP**] for 1 sec.
 - The displayed contents are cleared.

/// **CONVENIENT!:**

Instead of the steps ③ and ④ operations, while pushing and holding [FUNC], push [V/M•S.MW•**SKIP**] for 1 sec. also clearing the contents.

- ⑤ Rotate [DIAL] to select the desired target memory channel.
- ⑥ Push [V/M•S.MW•**SKIP**] for 1 sec. to transfer the contents.

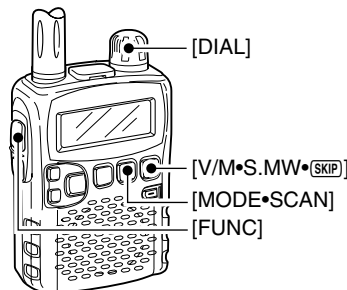

• **Example**— Transferring the contents of memory channel 20 to channel 30.

Steps ① and ②

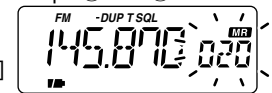

Step ③

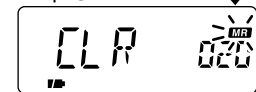

Step ④

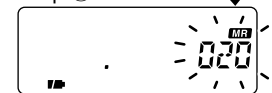

Step ⑤

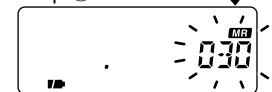

Step ⑥

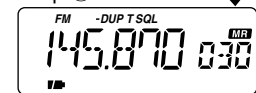

Erasing/transferring bank contents

Contents of programmed memory channels can be or transferred to another memory.

INFORMATION: Even if the memory bank contents are cleared, the memory channel contents still remain programmed.

- ① Select the desired bank contents to be transferred or erased from the bank.
 - ➔ Push [V/M•S.MW•**SKIP**] to select memory mode.
 - ➔ While pushing [BAND•**LOCK**], rotate the [DIAL] to select the desired memory bank group.
 - ➔ Rotate [DIAL] to select the bank channel.
 - Bank initial stops blinking.
 - Select the bank channel with [BAND•**LOCK**] and [DIAL], if desired.
 - Bank initial blinks.
- ② Push [V/M•S.MW•**SKIP**] for 1 sec. to enter select memory write condition.
 - 1 short and 1 long beeps sound.
 - Displays the original memory channel number automatically and “**MR**” indicator and memory channel number blink.
 - Do not hold [V/M•S.MW•**SKIP**] for more than 2 sec. otherwise the bank contents will be copied to VFO.

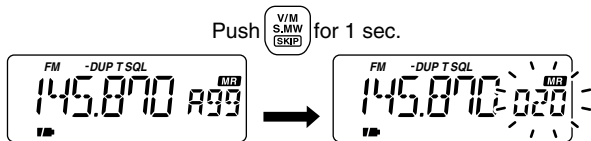

- ③ While pushing [MODE•SCAN], rotate [DIAL] to select “BANK” item.
 - Pushing [MODE•SCAN] several times, “BANK” item is also selectable.
- ④ While pushing [BAND•**LOCK**], rotate [DIAL] to select the desired bank group to be transfer.
 - Select “- - - - -” indication when erasing the contents from the bank.

When transferring

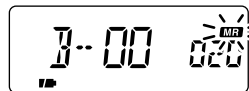

When erasing

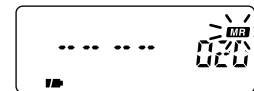

- ⑤ Rotate [DIAL] to select the desired bank channel.
- ⑥ While pushing [MODE•SCAN], rotate [DIAL] to select “S.MW” item.
 - Pushing [MODE•SCAN] several times, “S.MW” item is also selectable.
- ⑦ Push [V/M•S.MW•**SKIP**] for 1 sec.

6

SCAN OPERATION

Scan types

Scanning searches for signals automatically and makes it easier to locate new stations for contact or listening purposes.

There are 7 scan types and 4 resume conditions to suit your operating needs.

FULL SCAN (p. 26)

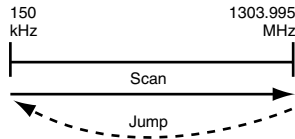

Repeatedly scans all frequencies over the entire band.

Some frequency ranges are not scanned according to the frequency coverage of the receiver's version.

SELECTED BAND SCAN (p. 26)

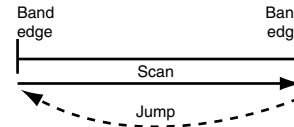

Repeatedly scans all frequencies over the entire selected band.

PROGRAMMED SCAN (p. 26)

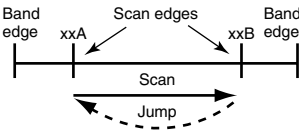

Repeatedly scans between two user-programmed frequencies. Used for checking for frequencies within a specified range such as repeater output frequencies, etc.

MEMORY (SKIP) SCAN (p. 28)

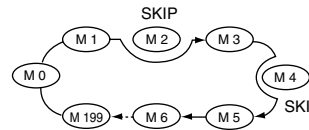

Repeatedly scans memory channels except those set as skip channels. Skip channels can be turned ON and OFF by pushing [FUNC] + [V/M•S.MW•**SKIP**] in memory mode.

ALL/SELECTED BANK SCAN (p. 28)

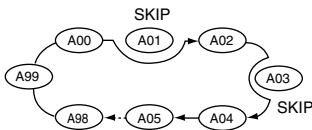

Repeatedly scans all bank channels or selected bank channels. The skip scan is also available.

FREQUENCY/MEMORY SKIP FUNCTION (p. 30)

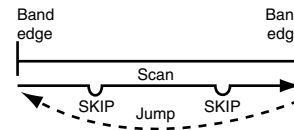

Skips unwanted frequencies or channels that inconveniently stop scanning. This function can be turned ON and OFF by pushing [FUNC] + [V/M•S.MW•**SKIP**] in either VFO or memory mode.

■ Full/band/programmed scan

- ① Select VFO mode with [V/M•S.MW•**SKIP**].
 - Select the desired frequency band with [BAND•**LOCK**], if desired.
- ② Set the squelch to the point where noise is just muted.
- ③ Push [MODE•SCAN] for 1 sec. to enter scanning type selection condition.
- ④ Rotate [DIAL] to select the desired scanning type.
 - “ALL” for full scan; “BAND” for band scan, “PROGxx” for programmed scan (xx= 0 to 24; programmed scan edges numbers only displayed)

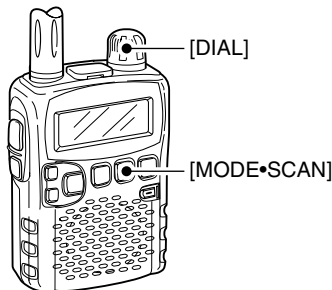

• Full scan selection

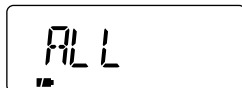

• Band scan selection

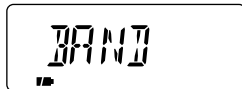

• Programmed scan selection

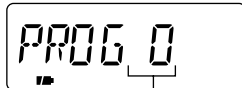

Selectable between “0” to “24” if programmed

- ⑤ To start the scan, push [MODE•SCAN].
 - Scan pauses when a signal is received.
 - Rotate [DIAL] to change the scanning direction, or resumes manually.
 - Push [MODE•SCAN] again to stop the scan.

• During full/band scan

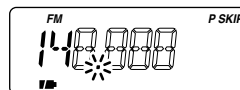

• During programmed scan

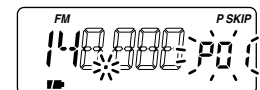

NOTE: Instead of the steps ③ to ⑤ operations, while pushing and holding [MODE•SCAN], rotate [DIAL] to select the desired scan type. In this case, scan starts when releasing [MODE•SCAN].

About the scanning steps: The selected tuning step in each frequency band (in VFO mode) is used during scan.

6 SCAN OPERATION

■ Scan edges programming

Scan edges can be programmed in the same manner as memory channels. Scan edges are programmed into scan edges, 00A/00B to 24A/24B, in memory channels.

- ① Push [V/M•S.MW•SKIP] to select VFO mode.
- ② Set the desired frequency:
 - ➔ Select the desired band with [BAND•LOCK].
 - ➔ Set the desired frequency with [DIAL].
 - ➔ Set other data (e.g. offset frequency, duplex direction, tone squelch, etc.), if desired.
- ③ Push [V/M•S.MW•SKIP] for 1 sec. to select select memory write condition.
 - 1 short and 1 long beeps sound.
 - “MR” indicator and memory channel number blink.
- ④ Rotate [DIAL] to select the desired programmed scan edge channel from 00A to 24A.

- ⑤ Push [V/M•S.MW•SKIP] for 1 sec.
 - 3 beeps sound
 - The other scan edge channel “B,” 00B to 24B, automatically selected when continuing to push [V/M•S.MW•SKIP] after programming.
- ⑥ To program a frequency for the other pair of scan edges, 00B or 24B, repeat steps ② and ④.
 - If the same frequency is programmed into a pair of scan edges, programmed scan will not function.

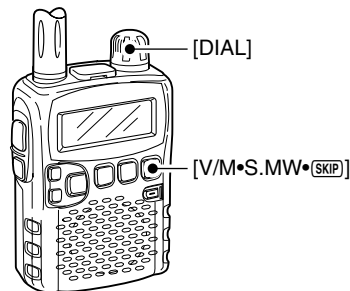

[EXAMPLE]: Programming 145.300 MHz into scan edges 03A.

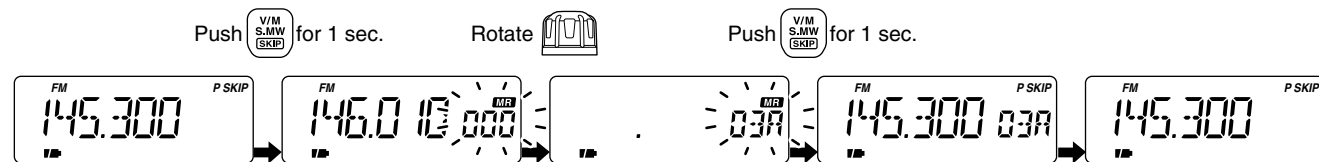

Memory/bank/all bank scan

- ① Select memory mode with [V/M•S.MW•SKIP].
 - Select the desired bank with [BAND•LOCK] for bank scan.
- ② Set the squelch to the point where noise is just muted.
- ③ Push [MODE•SCAN] for 1 sec.;
 - **When memory mode is selected at the step ①:**
- start memory scan.
 - **When a bank channel is selected at the step ①:**
- enter scan type selection mode.
- ④ Rotate [DIAL] to select the desired scanning type.
 - “ALL” for all bank scan; “BANK” for bank scan.

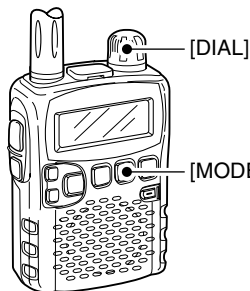

• All bank scan selection

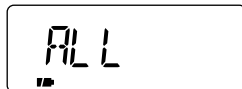

• Bank scan selection

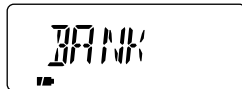

- ⑤ Push [MODE•SCAN] momentarily to start all bank or bank scan.
 - Scan pauses when a signal is received.
 - Rotate [DIAL] to change the scanning direction, or resumes manually.
- ⑥ To stop the scan, push [MODE•SCAN].

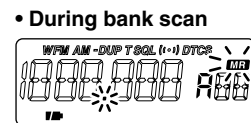
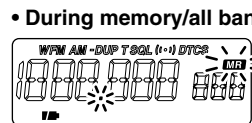

IMPORTANT!: To perform memory or bank scan, 2 or more memory/bank channels **MUST** be programmed, otherwise the scan never starts.

6 SCAN OPERATION

■ Auto memory write scan

This scan is useful for searching a specified frequency range and automatically storing busy frequencies into memory channels. The same frequency ranges used for program scan are used for auto memory write scan.

- ① Select VFO mode with [V/M•S.MW•**SKIP**].
- ② Push [MODE•SCAN] for 1 sec. to enter scanning type selection condition.
- ③ Rotate [DIAL] to select the desired scanning type.
 - “ALL” for full scan; “BAND” for band scan, “PROGxx” for programmed scan (xx= 0 to 24; programmed scan edges numbers only displayed)
- ④ Push [MODE•SCAN] to start the scan.
- ⑤ Push [V/M•S.MW•**SKIP**] to turn the automatic memory write function ON and OFF.
 - “**MR**” indicator blinks.

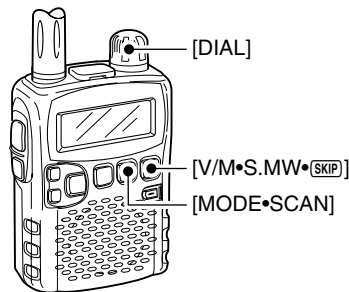

- ⑥ Push [MODE•SCAN] to stop scan.

• During auto memory write scan

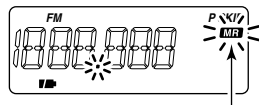

“**MR**” indicator blinks during auto memory write scan.

◇ During auto-memory write scanning:

- When signal is received, scan pauses and the frequency is stored into auto memory write channel group (R000–R199).
 - 2 short beeps sound when stored.
- Scan resumes after frequency storing.
- When all channels are stored, the scan cancels automatically and 1 long beep sounds.

◇ Re-calling the stored frequencies:

- ① Push [V/M•S.MW•**SKIP**] to select memory mode.
- ② Push [BAND•**LOCK**] several times, or while pushing [BAND•**LOCK**], rotate [DIAL] to select the auto memory write channel group.
 - “R” appears.
- ③ Rotate [DIAL] to select the desired channel.

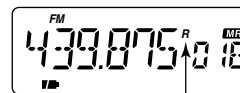

“R” appears when auto memory write channel group is selected.

◇ Clearing the stored frequencies:

- ① Select the auto memory write channel group.
- ② While pushing [FUNC], push [V/M•S.MW•**SKIP**] for 1 sec. to clear the all channels contents.
 - 1 short and 1 long beeps sound.

/// **NOTE:** The auto memory write channel contents CANNOT be cleared by an independent channel. Thus it is good idea to copy the contents into regular memory channel.

■ Skip channel/frequency setting

Memory channels can be set to be skipped for memory skip scan. In addition, memory channels can be set to be skipped for both memory skip scan and frequency skip scan. These are useful to speed up the scan interval.

- ① Select a memory channel:
 - ➔ Push [V/M•S.MW•**SKIP**] to select memory mode.
 - ➔ Rotate [DIAL] to select the desired channel to be a skip channel/frequency.
- ② Push [V/M•S.MW•**SKIP**] for 1 sec. to enter select memory write condition.
- ③ Push [MODE•SCAN] several times to select “SKIP” item.
 - While pushing [MODE•SCAN], rotating [DIAL] can also select “SKIP” item.

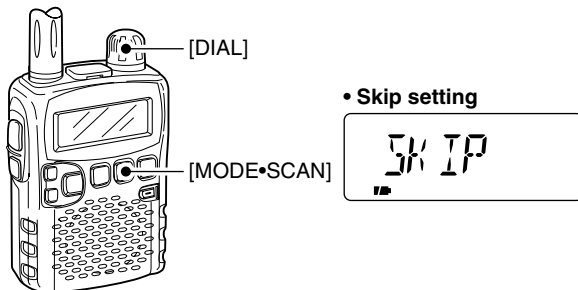

- ④ While pushing [FUNC], rotate [DIAL] to select the skip condition from “SKIP,” “PSKIP” or “OFF” for the selected channel.
 - SKIP : The channel is skipped during memory or bank scan.
 - PSKIP : The channel is skipped during memory/bank scan and the programmed frequency is skipped during VFO scan, such as programmed scan.
 - OFF : The channel or programmed frequency is scanned during any scan.
- ⑤ Push [MODE•SCAN] several times, or while pushing and holding [MODE•SCAN] rotate [DIAL] to select “S.MW” item.
- ⑥ Push [V/M•S.MW•**SKIP**] for 1 sec. to set the skip condition.
 - “SKIP” or “P SKIP” indicator appears, according to the skip selection in the step ④.

• Skip channel setting

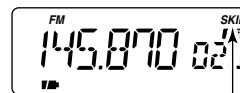

“SKIP” appears

• Program skip setting

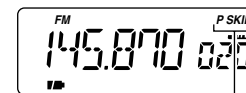

“P SKIP” appears

✓ CONVENIENT!

The skip setting can also be set with the following operation for easy setting.

- ① Select the desired memory channel to be set as a skip channel/frequency.
- ② While pushing [FUNC], push [V/M•S.MW•**SKIP**] to select the skip condition from “SKIP,” “P SKIP” and “OFF (no indication).”

6 SCAN OPERATION

■ Scan resume condition

◇ Scan pause timer

The scan pauses when receiving signals according to the scan pause time. It can be set from 2–20 sec. or unlimited.

- ① Push [TS•SET] for 1 sec. to enter set mode.
- ② Rotate [DIAL] to select “EXPAND” item.
- ③ While pushing [FUNC], rotate [DIAL] to turn the expand set mode selection ON.
- ④ Rotate [DIAL] to select “PAUSE” item.
- ⑤ While pushing [FUNC], rotate [DIAL] to set the desired scan pausing time from 2–20 sec. (2 sec. steps) and “HOLD.”
 - “2SEC”–“20SEC”: Scan pauses 2–20 sec. while receiving a signal.
 - “HOLD” : Scan pauses on a received a signal until it disappears.
- ⑥ Push [TS•SET] to exit set mode.

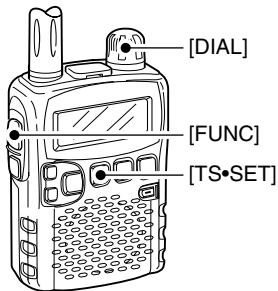

• Pause timer setting

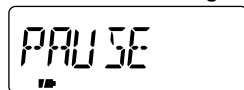

↓ After 1 sec.

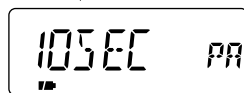

Setting indication

USING EXPANDED SET MODE

◇ Scan resume timer

The scan re-starts after a signal disappears according to the resume time. it can be set from 0–5 sec. or unlimited.

- ① Push [TS•SET] for 1 sec. to enter set mode.
- ② Rotate [DIAL] to select “EXPAND” item.
- ③ While pushing [FUNC], rotate [DIAL] to turn the expand set mode selection ON.
- ④ Rotate [DIAL] to select “RESUME” item.
- ⑤ While pushing [FUNC], rotate [DIAL] to set the desired scan pausing time from 0–5 sec. (1 sec. steps) and “HOLD.”
 - “0SEC” : Scan restarts immediately after the signal disappears.
 - “1SEC”–“5SEC” : Scan restarts 1–5 sec. after the signal disappears.
 - “HOLD” : Scan restarts by rotating [DIAL] only.
- ⑥ Push [TS•SET] to exit set mode.

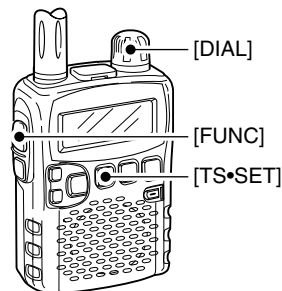

• Resume timer setting

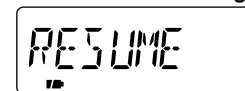

↓ After 1 sec.

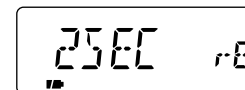

Setting indication

■ Priority watch types

Priority watch checks for signals on a frequency every 5 sec. while operating on a VFO frequency or scanning. The receiver has 3 priority watch types to suit your needs.

The watch resumes according to the selected scan resume condition. See the left page for details.

/// NOTES:

/// If the pocket beep function is activated, the receiver automatically selects the tone squelch function when priority watch starts.

◆ About priority beep function

When receiving a signal on the priority frequency, you can be alerted with beeps and a blinking “(·) .” This function can be activated when setting the priority watch function ON.

MEMORY CHANNEL WATCH

While operating on a VFO frequency, priority watch checks for a signal on the selected memory channel every 5 sec.

- A memory channel with skip information can be watched.

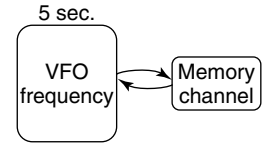

MEMORY SCAN WATCH

While operating on a VFO frequency, priority watch checks for signals on each memory channel in sequence.

- The memory skip function and/or memory bank scan is useful to speed up the scan.

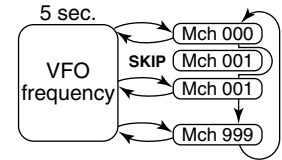

VFO SCAN WATCH

While scanning on VFO mode, priority watch checks for signals on the selected memory channel every 5 sec.

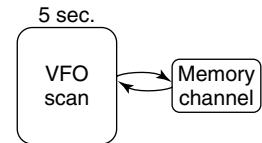

Priority watch operation

Memory channel watch and memory scan watch

① Select VFO mode; then, set an operating frequency.

- TV channel can also be selected.

② Set the watching channel(s).

For memory channel watch:

Select the desired memory channel.

For memory scan watch:

Select memory mode, or the desired bank group; then, push [MODE•SCAN] for 1 sec. to start memory/bank scan.

③ Push [TS•SET] for 1 sec. to enter set mode.

④ Rotate [DIAL] to select "PRIO" item.

⑤ While pushing [FUNC], rotate to turn the priority watch ON.

- Select "BELL" if the priority beep function is necessary.

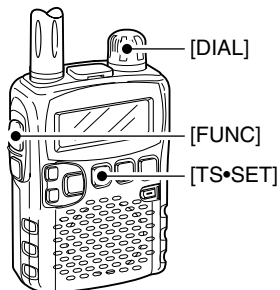

Priority setting item

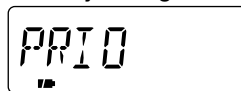

Priority ON

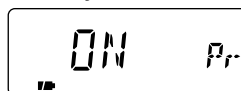

Priority beep ON

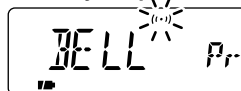

⑥ Push [TS•SET] to exit set mode and start the watch.

- "PRIO" indicator appears.
- The receiver checks the memory/bank channel(s) every 5 sec.
- The watch resumes according to the selected scan resume condition. (p. 31)

During priority watch

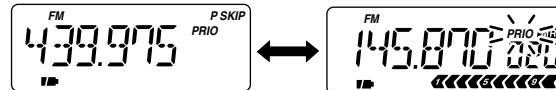

Monitors VFO frequency for 5 sec.

Pauses on a memory (bank) channel when a signal is received.

During priority watch with priority beep

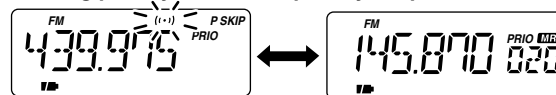

Emits beep and blinks "((•))" indicator when a signal is received on a memory (bank) channel.

⑦ Push [TS•SET] to cancel the watch.

◆ VFO scan watch

- ① Select memory mode.
 - Select a memory bank, if desired.
- ② Push [MODE•SCAN] for 1 sec. to start memory/bank scan, if desired.

▨ When scanning memory/bank channels:

▨ Starts memory/bank scan first. Memory/bank scan cannot be started after VFO scan is started.

- ③ Push [TS•SET] for 1 sec. to enter set mode.
- ④ Rotate [DIAL] to select “PRIO” item.
- ⑤ While pushing [FUNC], rotate to turn the priority watch ON.
 - Select “BELL” if the priority beep function is necessary.
- ⑥ Push [TS•SET] to exit set mode and start the watch.
 - “PRIO” indicator appears.
- ⑦ Push [MODE•SCAN] for 1 sec. to enter scan type selection condition.
- ⑧ Rotate [DIAL] to select the desired scan type from “ALL,” “BAND” and “PROGxx (xx= 0–24).”
- ⑨ Push [MODE•SCAN] to start the VFO scan watch.
 - The receiver checks the memory channel(s) every 5 sec.
 - The watch resumes according to the selected scan resume condition. (p. 31)
- ⑩ Push [TS•SET] to cancel the watch and scan.

• During VFO scan watch

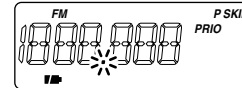

Searches VFO frequencies for 5 sec.



Pauses on a memory (bank) channel when a signal is received.

• During VFO scan watch with priority beep

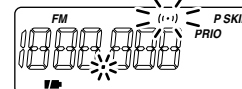

Emits beep and blinks “((•))” indicator when a signal is received on a memory (bank) channel.

■ Tone/DTCS squelch operation

The tone or DTCS squelch opens only when receiving a signal with the same pre-programmed subaudible tone or DTCS code, respectively. You can silently wait for the specified signal using the same tone.

- ① Set the desired frequency in FM mode.
- ② Push [TS•SET] for 1 sec. to enter set mode.
- ③ Rotate [DIAL] to select “EXPAND” item.
- ④ While pushing [FUNC], rotate [DIAL] to turn the expanded set mode ON.
- ⑤ Rotate [DIAL] to select “TSQL” item.
- ⑥ While pushing [FUNC], rotate [DIAL] to select the desired subaudible tone condition from “TSQL,” “P BEEP,” “DTCS,” “P DTCS” and “OFF.”



Tone squelch selection



Tone squelch with pocket beep function selection

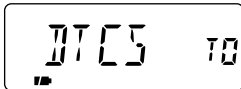

DTCS selection



DTCS with pocket beep function selection

- ⑦ Push [TS•SET] to exit set mode.
 - One of “TSQL,” TSQL ((•)), “DTCS” or “((•)) DTCS” appears according to the tone selection in the step ⑥.

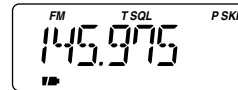

Tone squelch selection

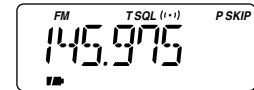

Tone squelch with pocket beep function selection

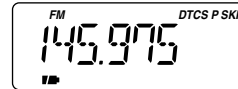

DTCS selection

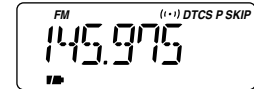

DTCS with pocket beep function selection

- ⑧ When a signal with the matched tone is received, the squelch opens and the receiver emits audio. When pocket beep function is activated, the receiver also emits beep tones and blinks “((•))”.
 - Beep tones sound and “((•))” blinks for 30 sec.
- ⑨ Push [FUNC] to stop the beeps and blinking manually.
 - “((•))” disappears and the pocket beep function is deactivated.
- ⑩ To cancel the tone squelch or DTCS, select “OFF” with the “TSQL” item in the expanded set mode, as described in the step ⑥.

■ Tone squelch frequency/DTCS code setting

88.5 Hz and 023 is set as the default for the tone squelch frequency and the DTCS code, respectively. The frequency and code can be selected as desired.

- ① Push [TS•SET] for 1 sec. to enter set mode.
- ② Rotate [DIAL] to select “EXPAND” item.
- ③ While pushing [FUNC], rotate [DIAL] to turn the expanded set mode ON.
- ④ Rotate [DIAL] to select “TONE” item when selecting the tone squelch frequency; select “CODE” item when selecting the DTCS code.

Tone squelch frequency selection



DTCS code selection

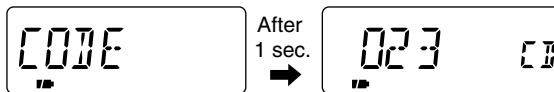

- ⑤ While pushing [FUNC], rotate [DIAL] to select the desired subaudible tone frequency or DTCS code.
 - See the tables at right.
- ⑥ Push [TS•SET] to exit set mode.

• Available tone frequency list

67.0	79.7	94.8	110.9	131.8	156.7	171.3	186.2	203.5	229.1
69.3	82.5	97.4	114.8	136.5	159.8	173.8	189.9	206.5	233.6
71.9	85.4	100.0	118.8	141.3	162.2	177.3	192.8	210.7	241.8
74.4	88.5	103.5	123.0	146.2	165.5	179.9	196.6	218.1	250.3
77.0	91.5	107.2	127.3	151.4	167.9	183.5	199.5	225.7	254.1

NOTE: The receiver has 50 tone frequencies and consequently their spacing is narrow compared to units having 38 tones. Therefore, some tone frequencies may receive interference from adjacent tone frequencies.

• Available DTCS code list

023	054	125	165	245	274	356	445	506	627	732
025	065	131	172	246	306	364	446	516	631	734
026	071	132	174	251	311	365	452	523	632	743
031	072	134	205	252	315	371	454	526	654	754
032	073	143	212	255	325	411	455	532	662	
036	074	145	223	261	331	412	462	546	664	
043	114	152	225	263	332	413	464	565	703	
047	115	155	226	265	343	423	465	606	712	
051	116	156	243	266	346	431	466	612	723	
053	122	162	244	271	351	432	503	624	731	

8 TONE SQUELCH AND POCKET BEEP

■ DTCS polarity setting

As well as the code setting, the polarity setting is also available for the DTCS operation. When a different polarity is set, the DTCS never releases audio mute even a signal with matched code number is received.

- ① Push [TS•SET] for 1 sec. to enter set mode.
- ② Rotate [DIAL] to select “EXPAND” item.
- ③ While pushing [FUNC], rotate [DIAL] to turn the expanded set mode ON.
- ④ Rotate [DIAL] to select “DTCS P” item.

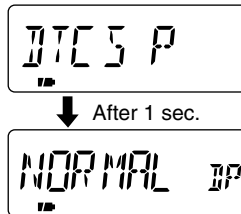
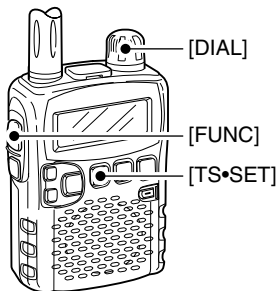

- ⑤ While pushing [FUNC], rotate [DIAL] to select the polarity from normal (NORMAL) and reverse (REV).

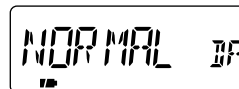

Normal polarity

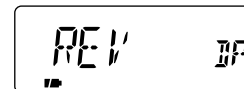

Reverse polarity

- ⑥ Push [TS•SET] to exit set mode.

■ Tone scan

By monitoring a signal that is being operated with pocket beep, tone or DTCS squelch function, you can determine the tone frequency or DTCS code necessary to open a squelch.

- ① Set the frequency to be checked for a tone frequency or code.
- ② Turn the desired tone type, tone squelch or DTCS, ON in expanded set mode.
 - One of “TSQL” or “DTCS” appears.
 - Even the pocket beep function is activated, the function is cancelled when starts the tone scan.
- ③ While pushing [FUNC], push [MODE•SCAN] to start the tone scan.
 - To change the scanning direction, rotate [DIAL].



[FUNC]

[MODE•SCAN]

Tone squelch scan

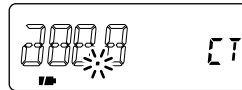

DTCS scan

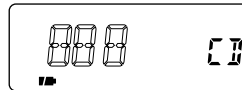

- ④ When the CTCSS tone frequency or 3-digit DTCS code is matched, the squelch opens and the tone frequency or code is temporarily programmed into the selected condition, such as memory channel.
 - The tone scan pauses when a CTCSS tone frequency or 3-digit DTCS code is detected.

NOTE: The decoded tone frequency or code is programmed temporarily when a memory channel is selected. However, this will be cleared when the memory channel is re-selected.

✓ For your convenient!

Even no tone type is selected, either tone squelch or DTCS, pushing [MODE•SCAN] while pushing and holding [FUNC] also start tone scan. In this case, the tone scan searching for tone squelch frequency only.

■ General

Set mode is used for programming infrequently changed values or conditions of functions.

In addition, the IC-R5 has an expanded set mode which is used for programming even more infrequently changed values or conditions of functions. When turning the expanded set mode OFF, only half of the set mode items are displayed for simple operation.

◆ Set mode entering and operation

- ① Push [TS•SET] for 1 sec. to enter set mode.
- ② Rotate [DIAL] to select the desired item.
- ③ While pushing [FUNC], rotate [DIAL] to select the desired value or condition.
- ④ Push [TS•SET] to exit set mode, or rotate [DIAL] to select another set mode item.

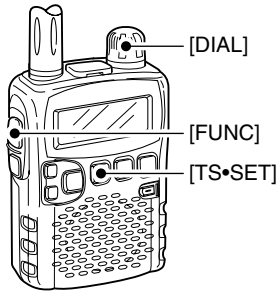

◆ Expanded set mode ON/OFF

- ① Push [TS•SET] for 1 sec. to enter set mode.
- ② Rotate [DIAL] to select "EXPAND" item.



- ③ While pushing [FUNC], rotate [DIAL] to turn the expanded set mode ON and OFF.



Expanded set mode OFF







Expanded set mode ON

- ④ Rotate [DIAL] to select the desired item.
- ⑤ While pushing [FUNC], rotate [DIAL] to select the desired value or condition.
- ⑥ Push [TS•SET] to exit set mode, or rotate [DIAL] to select another item.

■ Set mode items

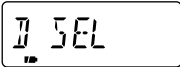
The following items are available in the set mode and expanded set mode.

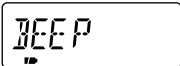
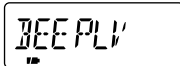
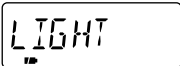
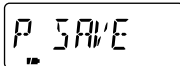

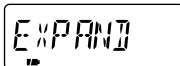



◇ General set mode items

- Dial select step (p. 41) 
- Priority watch (p. 41) 
- Key-touch beep (p. 41) 
- Beep output level (p. 41) 
- Display backlighting (p. 41) 
- Power save (p. 42) 
- Antenna selection* (p. 42) 
- Expanded set mode (p. 39) 

*Appears when accessing set mode from AM broadcast band or FM broadcast band only.

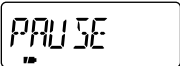
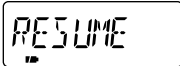
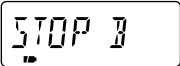
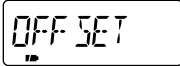
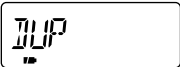
◇ Expanded set mode items

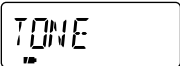
- Key lock effect (p. 43) 
- Dial speed acceleration (p. 43) 

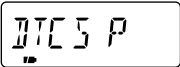
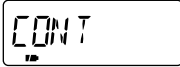
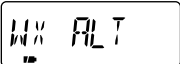
- Monitor switch action (p. 43) 
- Auto power OFF (p. 44) 
- Scan pause timer (p. 44) 
- Scan resume timer (p. 44) 
- Scan stop beep (p. 44) 
- Offset frequency (p. 45) 
- Duplex direction (p. 45) 
- Tone squelch (p. 45) 
- Tone frequency (p. 46) 
- DTCS code (p. 46) 
- DTCS polarity (p. 46) 
- LCD contrast (p. 47) 
- Weather alert† (p. 47) 

†Available for the USA version only.

9 SET MODE

◆ Dial select step

Select the tuning step while pushing [FUNC] from 100 kHz, 1 MHz (default) and 10 MHz.

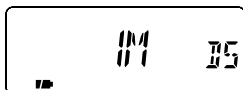

1 MHz step



100 kHz step

◆ Priority watch

Turn the priority watch or priority beep (priority watch with beep emission capability) ON. (default: OFF)

- ON : Start priority watch after exiting set mode.
- BELL : Emits beeps and blinking “((•))” indicator when a signal is received on the priority frequency.

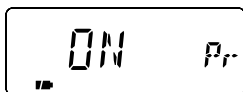

Priority watch ON

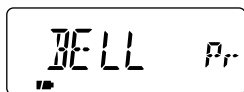

Priority beep ON

◆ Key-touch beep

The key-touch beep can be turned OFF for silent operation. (default: ON)

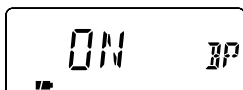

Key-touch beep ON

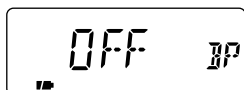

Key-touch beep OFF

◆ Beep output level

Adjust the key-touch beep tone level to the desired level within 32 levels or to the related level with volume control.

- VOLUME : The beep tone level is linked with the volume set level. (default)
- _____ - 000 000 : The beep tone level is fixed in 32 steps.

/// The key-touch beep (previous item) must be set to ON to have a beep tone.

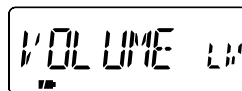

Related to volume level



Fixed output level

◆ Display backlighting

The receiver has display backlighting with a 5 sec. timer for nighttime operation. The backlighting can be turned ON continuously or turned OFF, if desired.

- AUTO : Lights when some operation is performed, goes out after 5 sec. (default)
- ON : Lights continuously during receiver power is ON.
- OFF : Never lights.

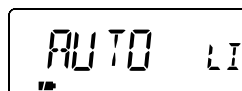

Auto setting

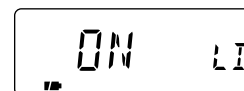

Continuously ON setting

◇ Power save

The power save function reduces the current drain to conserve battery power. This power save function can be turned OFF, if desired.

In the default setting (“ON” selection), the power save function is activated in 1:4 (125 msec.: 500 msec.) ratio when no signal is received for 5 sec. The ratio becomes 1:8 (125 msec.: 1 sec.) when no signal is received for another 60 sec.

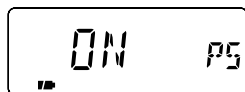

Power save ON

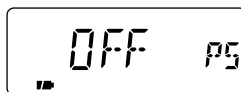

Power save OFF

◇ Antenna selection

This item appears only when accessing set mode from AM or FM broadcast band, 0.495–1.620 MHz or 76.000–107.995 MHz (differ according to version), respectively. And the selectable condition is differ according to the selected band.

Select using antenna for the AM or FM broadcast band reception independently.

- EXT : Use the antenna connected to the antenna connector. (default)
- BAR : Use the internal bar antenna for AM broadcast band reception. (This selection appears only when accessing set mode from AM broadcast band.)
- EAR : Use the connected earphone's cable as the antenna for FM broadcast band reception. (This selection appears only when accessing set mode from FM broadcast band.)

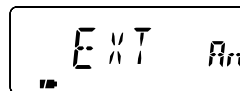

External antenna



Internal bar antenna

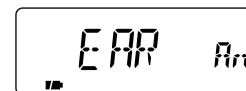

Connected earphone cable

9 SET MODE

◆ Key lock effect

While the key lock function is ON, [▲]/[▼] and [SQL] can still be accessed. Accessible switches can be set to one of 4 groups.

[PWR] and [FUNC]+[BAND•LOCK] are also accessible during the lock, however, these switches are not effected by this setting.

- NORMAL : [▲]/[▼] and [SQL] are accessible. (default)
- NO SQL : [SQL] is accessible.
- NO VOL : [▲]/[▼] are accessible.
- ALL : No accessible switch is available, except [PWR] and [FUNC]+[BAND•LOCK].



Normal lock condition

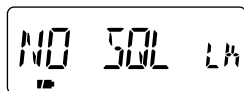

Squelch level can be adjusted

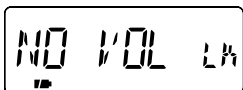

Audio output can be adjusted

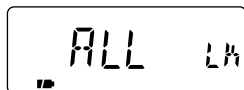

Receiver power and lock function only switchable

◆ Dial speed acceleration

The dial speed acceleration automatically speeds up the tuning dial speed when rotating [DIAL] rapidly.

- ON : The dial speed acceleration is tuned ON. (default)
- OFF : The dial speed acceleration is turned OFF.

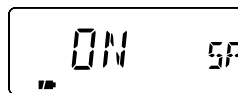

The acceleration ON



The acceleration OFF

◆ Monitor switch action

The monitor switch, [SQL], can be set as a 'sticky' switch. When set to the sticky condition, each push of [SQL] toggles the monitor function ON and OFF.

- PUSH : Pushing and holding [SQL] to monitor the frequency. (default)
- HOLD : Push [SQL] momentarily to monitor the frequency and push momentarily again to cancel it.

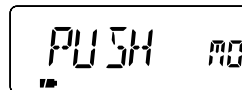

Push to monitor

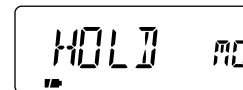

Push and hold [SQL] to monitor

◆ Auto power OFF

The receiver can be set to automatically turn OFF after a specified period with a beep when no key operations are performed.

30 min., 1 hour, 1.5 hours, 2 hours and OFF (default) can be specified. The specified period is retained even when the receiver is turned OFF by the auto power OFF function. To cancel the function, select "OFF" in this set mode.

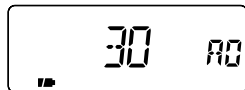

30 min. timer

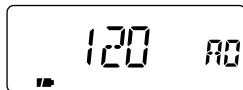

2 hrs. timer

◆ Scan pause timer

Selects the scan pause time. When receiving signals, the scan pauses according to the scan pause time.

- 2–20 : Scan pauses for 2–20 sec. on a received signal, and selected in 2 sec. steps. (default: 10 sec.)
- HOLD : Scan pauses on a received signal until it disappears. Rotate [DIAL] to resume manually.

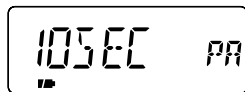

Scan pauses for 10 sec.

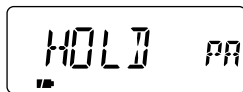

Scan pauses until signal disappears

◆ Scan resume timer

Selects scan resume time. Scan resumes after the specified period when the received signal disappears.

- 0 : Scan resumes immediately when the received signal disappears.
- 1–5 : Scan pause 1–5 sec. after the received signal disappears. (default: 2 sec.)
- HOLD : Scan pauses on the received signal even if it disappears. Rotate [DIAL] to resume manually.



Scan resumes after 2 sec.

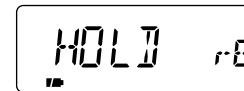

Scan resumes manually

◆ Scan stop beep

Turns the scan stop beep function ON and OFF.

When the function is activated ("ON" is selected), a long beep will sounds each time when signal is received during scan.



No beep is sound when receiving a signal

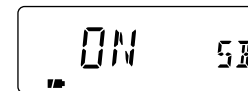

A long beep is sound when receiving a signal

9 SET MODE

◆ Offset frequency

Sets the duplex offset frequency for each frequency band independently within 0 to 159.995 MHz range. During duplex operation (–DUP or +DUP), the monitoring frequency (while [SQL] is pushed) shifts the set frequency.

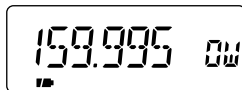

The default value may differ according to the selected frequency band (before accessing set mode) and receiver version.

▨ The selected tuning step in VFO mode is used for the offset frequency setting.

◆ Duplex direction

Sets the duplex direction. The displaying frequency shifts the programmed frequency in offset frequency above when monitor function is in use (while pushing [SQL]).

- OFF : Simplex operation. (default)
- –DUP : The displaying frequency shifts down during monitor.
- +DUP : The displaying frequency shifts up during monitor.

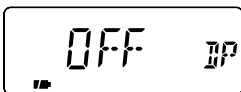

Simplex operation



Positive duplex operation

◆ Tone squelch

Sets tone or DTCS squelch operation and pocket beep capability, when waiting for the desired signal.

- OFF : Regular noise squelch operation. (default)
- TSQL : Using tone squelch. The squelch opens only when a signal with matched subaudible tone is received.
- P BEEP : In addition to the “TSQL” setting, alert beeps will sound when a signal with matched tone is received.
- DTCS : Using DTCS squelch. The squelch opens only when a signal with matched DTCS code is received.
- P DTCS : In addition to the “DTCS” setting, alert beeps will sound when a signal with matched DTCS code is received.

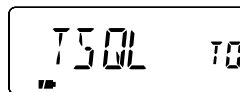

Tone squelch operation

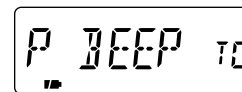

Pocket beep operation

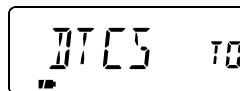

DTCS squelch operation

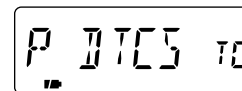

DTCS beep operation

▨ The subaudible tone frequency and DTCS code is programmed in the tone frequency and DTCS code item, respectively.

◇ Tone frequency

Sets subaudible tone frequency for tone squelch operation. Total of 50 tone frequencies (67.0–254.1 Hz) are available. (default: 88.5 Hz)



88.5 Hz setting

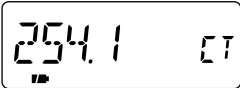

254.1 Hz setting

• Available subaudible tone frequencies

67.0	79.7	94.8	110.9	131.8	156.7	171.3	186.2	203.5	229.1
69.3	82.5	97.4	114.8	136.5	159.8	173.8	189.9	206.5	233.6
71.9	85.4	100.0	118.8	141.3	162.2	177.3	192.8	210.7	241.8
74.4	88.5	103.5	123.0	146.2	165.5	179.9	196.6	218.1	250.3
77.0	91.5	107.2	127.3	151.4	167.9	183.5	199.5	225.7	254.1

◇ DTCS code

Sets DTCS code for DTCS squelch operation. Total of 104 codes (023–754) are available. (default: 023)



Code 023 setting



Code 754 setting

• Available DTCS code

023	054	125	165	245	274	356	445	506	627	732
025	065	131	172	246	306	364	446	516	631	734
026	071	132	174	251	311	365	452	523	632	743
031	072	134	205	252	315	371	454	526	654	754
032	073	143	212	255	325	411	455	532	662	
036	074	145	223	261	331	412	462	546	664	
043	114	152	225	263	332	413	464	565	703	
047	115	155	226	265	343	423	465	606	712	
051	116	156	243	266	346	431	466	612	723	
053	122	162	244	271	351	432	503	624	731	

∕∕ The polarity can also be set in “DTCS polarity” as follow.

◇ DTCS polarity

Sets DTCS polarity from normal and reverse. (default: NORMAL)



Normal setting

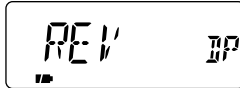

Reverse setting

9 SET MODE

◆ LCD contrast

Sets the LCD contrast within 1 (light) to 4 (dark) levels as desired. (default: 3)

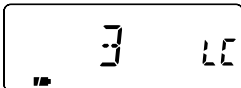

Contraset 3 setting

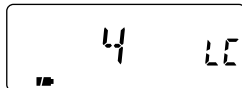

Contraset 4 setting

◆ Weather alert function

U.S.A. version only

Turns weather alert function ON and OFF.

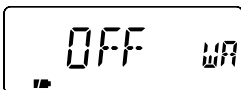

Weather alert OFF



Weather alert ON

■ Antenna selection

USING EXPANDED SET MODE

The IC-R5 has an internal bar antenna for receiving AM broadcast band (0.495–1.620 MHz) signals. In addition, the connected earphone's cable can be used as an antenna for receiving FM broadcast band (76.000–107.995 MHz; differ according to version) signals.

◆ Selecting antenna

- ① Select VFO mode with [V/M•S.MW•**SKIP**].
- ② Push [BAND•**LOCK**] several times, or while pushing [BAND•**LOCK**] rotate [DIAL] to select the AM or FM broadcast band.
- ③ Push [TS•SET] for 1 sec. to enter set mode.
- ④ Rotate [DIAL] to select "ANT" item.
 - "ANT" disappears after 1 sec. and "EXT" (default) and "An" appear.

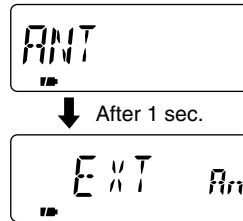
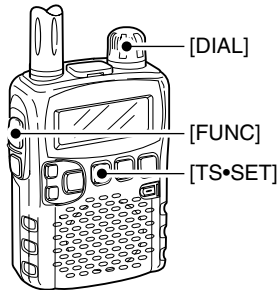

- ⑤ While pushing [FUNC], rotate [DIAL] to select "BAR" when set mode has accessed from the AM broadcast band; select "EAR" when set mode has accessed from the FM broadcast band.

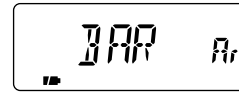

Bar antenna selection
for 0.495–1.620 MHz band

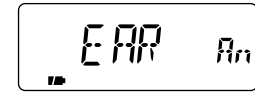

Earphone cable selection
for 76.000–107.995 MHz band

- ⑥ Push [TS•SET] momentarily to exit set mode.

NOTE:

- Some noise or spurious may be received when the internal bar or earphone cable is used for antenna.
- The supplied or third party's antenna **MUST BE** connected to the antenna connector to receive signals other than AM or FM broadcast bands.
- When receiving an AM broadcast signal with internal bar antenna, aim the receiver to better audio direction.
- When the internal bar or earphone cable is used for antenna, the attenuator function cannot be used.

10 OTHER FUNCTIONS

■ [DIAL] function assignment

The [DIAL] control can be used as an audio volume control instead of [▲]/[▼] keys to suit your preference. However, while [DIAL] is functions as an audio volume, [▲]/[▼] keys function as tuning control.

➔ While pushing [FUNC], push [TS•SET] to toggle the [DIAL] function from tuning dial and audio volume.

- “VOL” appears when [DIAL] functions as an audio volume.

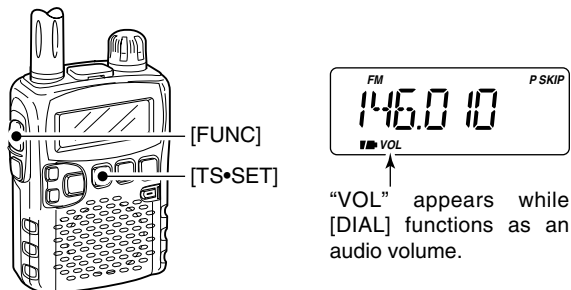

• [DIAL] and [▲]/[▼] functions

	No “VOL” indication	“VOL” appears
[DIAL]	Frequency, Memory channel, Squelch level, Scanning direction, Set mode item and condition set	Audio volume
[▲]/[▼]	Audio volume set	Frequency, Memory channel, Squelch level, Scanning direction, Set mode item and condition set

■ Weather channel operation

U.S.A. version only

◆ Weather channel selection

- ① Select VFO mode with [V/M•S.MW•SKIP].
- ② Push [BAND•LOCK] several times, or while pushing [BAND•LOCK] rotate [DIAL] to select the weather channel group.
- ③ Rotate [DIAL] to select the desired weather channel.

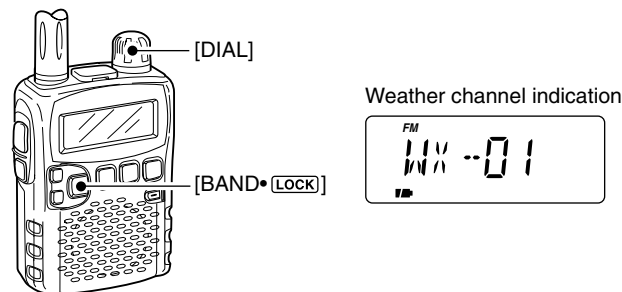

- ④ Push [BAND•LOCK] to change frequency band, or push [V/M•S.MW•SKIP] to select memory mode.

◇ Weather alert function

NOAA broadcast stations transmit weather alert tones before important weather announcements. When the weather alert function is turned ON, the selected weather channel is monitored each 5 sec. for the announcement. When the alert signal is detected, the “AL.T” and the WX channel are displayed alternately and sounds a beep tone until the receiver is operated. The previously selected (used) weather channel is checked periodically during standby or while scanning.

- ① Select the desired weather channel.
- ② Turn the weather alert function ON in set mode.
 - ➔ Push [TS•SET] to enter set mode.
 - ➔ Rotate [DIAL] to select the weather alert item, then rotate [DIAL] while pushing and holding [FUNC] to set ON.
 - ➔ Push [TS•SET] to exit set mode.
- ③ Set the desired stand-by condition.
 - Select VFO or memory channel.
 - Scan or priority watch operation can also be selected.
- ④ When the alert is detected, a beep sounds and the following indication will be displayed.

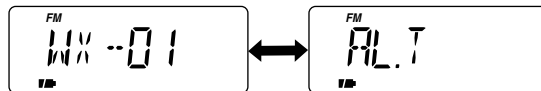

Show above indications alternately.

- ⑤ Turn the weather alert function OFF in set mode.

NOTE: While receiving a signal (on a frequency other than the weather alert ON frequency), the receiving signal or audio will be interrupted momentarily every 5 sec. (approx.) in case the alert function is turned ON. This symptom is caused by the WX alert function. To cancel these symptoms, set the weather alert item OFF in set mode.

10 OTHER FUNCTIONS

■ Data cloning

AT POWER ON

Cloning allows you to quickly and easily transfer the programmed contents from one receiver to another; or data from a personal computer to a receiver using the optional CS-R5 CLONING SOFTWARE.

◇ Cloning between receivers

① Connect the OPC-474 cloning cable to the [SP] jack of the master and sub-receivers.

- The master receiver is used to send data to the sub-receiver.

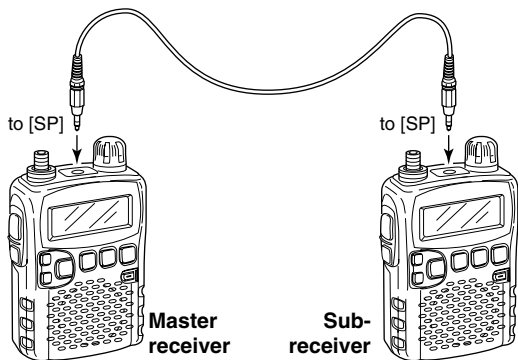

② While pushing [V/M•S.MW•**SKIP**], turn power ON to enter cloning mode (master receiver only— power ON only for sub-receiver).

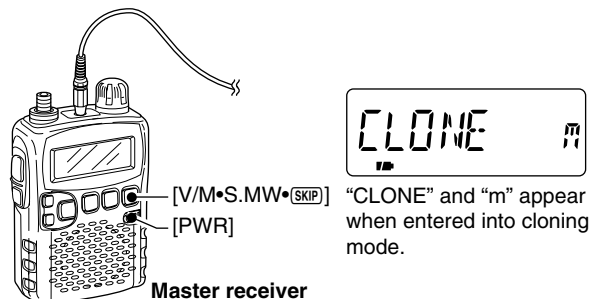

“CLONE” and “m” appear when entered into cloning mode.

③ Push [SQL] on the master receiver.

- The receiver show following indications.

Master receiver indications



Sub-receiver indications



During cloning



After cloning

④ When cloning is finished, turn power OFF, then ON to exit cloning mode.

◇ Cloning using a personal computer

Data can be cloned to and from a personal computer (Microsoft® Windows® 98/Me/2000/XP) using the optional CS-R5 CLONING SOFTWARE and the optional OPC-478U CLONING CABLE. Consult the CS-R5 CLONING SOFTWARE HELP file for details.

◇ Cloning error

NOTE: DO NOT push any key on the sub-receiver during cloning. This will cause a cloning error.

When the display appears as below, a cloning error has occurred.

In such a case, both receivers automatically return to the clone standby condition and cloning must be repeated.

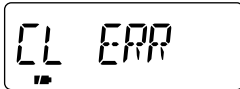

■ Auto power-off function

USING EXPANDED SET MODE

The IC-R5 can be set to automatically turn OFF after a specified period in which no operation is performed.

120 min., 90 min., 60 min., 30 min. and OFF can be specified. The specified period is retained even when the receiver is turned OFF by the auto power-off function. To cancel the function, select "OFF" in step ③ below.

- ① Push [TS•SET] for 1 sec. to enter set mode.
- ② Rotate [DIAL] to select "AP OFF" item.
 - Turn the expanded set mode ON for selection. (p. 39)

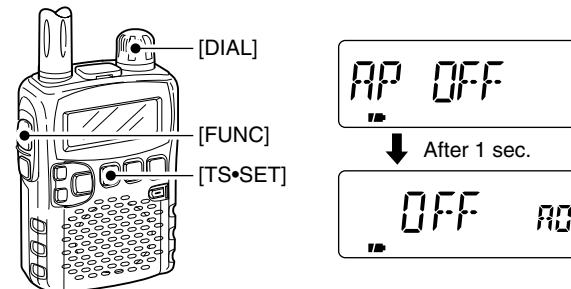

- ③ While pushing [FUNC], rotate [DIAL] to select the desired time or to turn the function OFF.
- ④ Push [TS•SET] to exit set mode.

10 OTHER FUNCTIONS

■ Partial reset

AT POWER ON

If you want to initialize the operating conditions (VFO frequency, VFO settings, set mode contents) without clearing the memory contents, a partial resetting function is available for the receiver.

- ➔ While pushing [FUNC] and [TS•SET], turn the power ON to partially reset the receiver.

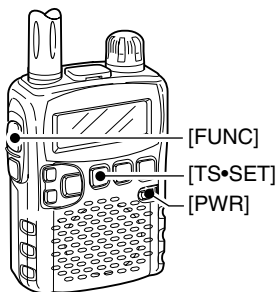

■ All reset

AT POWER ON

The function display may occasionally display erroneous information (e.g. when first applying power). This may be caused externally by static electricity or by other factors.

If this problem occurs, turn power OFF. After waiting a few seconds, turn power ON again. If the problem persists, perform the following procedure.

- Partial resetting is also available. See left for details.

/// IMPORTANT!:

Resetting the receiver **CLEARs** all memory information and initializes all values in the receiver, including TV channel skip setting.

- ➔ While pushing [FUNC] and [V/M•S.MW•SKIP], turn the power ON to reset the CPU.

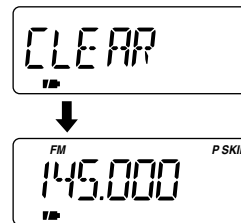
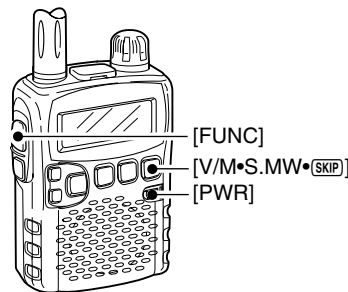

*The appearing frequency is different according to receiver version.

■ TV channels

The following tables show the channels versus video and audio frequencies depending on each version.

◆ U.S.A. channels

(unit: MHz)

CH	Freq.	CH	Freq.	CH	Freq.
2	59.75	27	553.75	52	703.75
3	65.75	28	559.75	53	709.75
4	71.75	29	565.75	54	715.75
5	81.75	30	571.75	55	721.75
6	87.75	31	577.75	56	727.75
7	179.75	32	583.75	57	733.75
8	185.75	33	589.75	58	739.75
9	191.75	34	595.75	59	745.75
10	197.75	35	601.75	60	751.75
11	203.75	36	607.75	61	757.75
12	209.75	37	613.75	62	763.75
13	215.75	38	619.75	63	769.75
14	475.75	39	625.75	64	775.75
15	481.75	40	631.75	65	781.75
16	487.75	41	637.75	66	787.75
17	493.75	42	643.75	67	793.75
18	499.75	43	649.75	68	799.75
19	505.75	44	655.75	69	805.75
20	511.75	45	661.75		
21	517.75	46	667.75		
22	523.75	47	673.75		
23	529.75	48	679.75		
24	535.75	49	685.75		
25	541.75	50	691.75		
26	547.75	51	697.75		

◆ CCIR channels (unit: MHz)

CH	Freq.	CH	Freq.
1	46.75	40	628.75
2	53.75	41	636.75
3	60.75	42	644.75
4	67.75	43	652.75
5	180.75	44	660.75
6	187.75	45	668.75
7	194.75	46	676.75
8	201.75	47	684.75
9	208.75	48	692.75
10	215.75	49	700.75
11	222.75	50	708.75
12	229.75	51	716.75
21	476.75	52	724.75
22	484.75	53	732.75
23	492.75	54	740.75
24	500.75	55	748.75
25	508.75	56	756.75
26	516.75	57	764.75
27	524.75	58	772.75
28	532.75	59	780.75
29	540.75	60	788.75
30	548.75	61	796.75
31	556.75	62	804.75
32	564.75	63	812.75
33	572.75	64	820.75
34	580.75	65	828.75
35	588.75	66	836.75
36	596.75	67	844.75
37	604.75	68	852.75
38	612.75	69	860.75
39	620.75		

◆ Australian channels

(unit: MHz)

CH	Freq.	CH	Freq.
0	51.75	43	637.75
1	62.75	44	644.75
2	69.75	45	651.75
3	91.75	46	658.75
4	100.75	47	665.75
5	107.75	48	672.75
5A	143.75	49	679.75
6	180.75	50	686.75
7	187.75	51	693.75
8	194.75	52	700.75
9	201.75	53	707.75
10	214.75	54	714.75
11	221.75	55	721.75
28	532.75	56	728.75
29	539.75	57	735.75
30	546.75	58	742.75
31	553.75	59	749.75
32	560.75	60	756.75
33	567.75	61	763.75
34	574.75	62	770.75
35	581.75	63	777.75
36	588.75	64	784.75
37	595.75	65	791.75
38	602.75	66	798.75
39	609.75	67	805.75
40	616.75	68	812.75
41	623.75	69	819.75
42	630.75		

11 FREQUENCY TABLE

◆ China channels

CH	Freq.	CH	Freq.
1	56.25	32	669.75
2	64.25	33	677.75
3	72.25	34	685.75
4	83.75	35	693.75
5	91.75	36	701.75
6	174.75	37	709.75
7	182.75	38	717.75
8	190.75	39	725.75
9	198.75	40	733.75
10	206.75	41	741.75
11	214.75	42	749.75
12	222.75	43	757.75
13	477.75	44	765.75
14	485.75	45	773.75
15	493.75	46	781.75
16	501.75	47	789.75
17	509.75	48	797.75
18	517.75	49	805.75
19	525.75	50	813.75
20	533.75	51	821.75
21	541.75	52	829.75
22	549.75	53	837.75
23	557.75	54	845.75
24	565.75	55	853.75
25	613.75	56	861.75
26	621.75	57	869.75
27	629.75	58	877.75
28	637.75	59	885.75
29	645.75	60	893.75
30	653.75	61	901.75
31	661.75	62	909.75

(unit: MHz)

CH	Freq.
63	917.75
64	925.75
65	933.75
66	941.75
67	949.75
68	957.75

◆ New Zealand channels (unit: MHz)

CH	Freq.
1	50.75
2	60.75
3	67.75
4	180.75
5	187.75
6	194.75
7	201.75
8	208.75
9	215.75
10	222.75
11	229.75

◆ UK channels

(unit: MHz)

CH	Freq.
21	477.25
22	485.25
23	493.25
24	501.25
25	509.25
26	517.25
27	525.25
28	533.25
29	541.25
30	549.25
31	557.25
32	565.25
33	573.25
34	581.25
35	589.25
36	597.25
37	605.25
38	613.25
39	621.25
40	629.25
41	637.25
42	645.25
43	653.25
44	661.25
45	669.25
46	677.25
47	685.25
48	693.25
49	701.25
50	709.25
51	717.25

◆ French channels (unit: MHz)

CH	Freq.	CH	Freq.
2	49.25	43	653.75
3	54.00	44	661.75
4	57.25	45	669.75
5	182.50	46	677.75
6	190.50	47	685.75
7	198.50	48	693.75
8	206.50	49	701.75
9	214.50	50	709.75
10	222.50	51	717.75
21	477.75	52	725.75
22	485.75	53	733.75
23	493.75	54	741.75
24	501.75	55	749.75
25	509.75	56	757.75
26	517.75	57	765.75
27	525.75	58	773.75
28	533.75	59	781.75
29	541.75	60	789.75
30	549.75	61	797.75
31	557.75	62	805.75
32	565.75	63	813.75
33	573.75	64	821.75
34	581.75	65	829.75
35	589.75	66	837.75
36	597.75	67	845.75
37	605.75	68	853.75
38	613.75	69	861.75
39	621.75		
40	629.75		
41	637.75		
42	645.75		

◆ Indonesian channels

(unit: MHz)

CH	Freq.	CH	Freq.
2	53.75	40	628.75
3	60.75	41	636.75
4	67.75	42	644.75
5	180.75	43	652.75
6	187.75	44	660.75
7	194.75	45	668.75
8	201.75	46	676.75
9	208.75	47	684.75
10	215.75	48	692.75
11	222.75	49	700.75
12	229.75	50	708.75
21	476.75	51	716.75
22	484.75	52	724.75
23	492.75	53	732.75
24	500.75	54	740.75
25	508.75	55	748.75
26	516.75	56	756.75
27	524.75	57	764.75
28	532.75	58	772.75
29	540.75	59	780.75
30	548.75	60	788.75
31	556.75	61	796.75
32	564.75	62	804.75
33	572.75	63	812.75
34	580.75	64	820.75
35	588.75	65	828.75
36	596.75	66	836.75
37	604.75	67	844.75
38	612.75	68	852.75
39	620.75	69	860.75

◆ Italian channels (unit: MHz)

CH	Freq.	CH	Freq.
A	59.25	42	644.75
B	67.75	43	652.75
C	87.75	44	660.75
D	180.75	45	668.75
E	188.75	46	676.75
F	197.75	47	684.75
G	206.75	48	692.75
H	215.75	49	700.75
H1	222.75	50	708.75
H2	229.75	51	716.75
21	476.75	52	724.75
22	484.75	53	732.75
23	492.75	54	740.75
24	500.75	55	748.75
25	508.75	56	756.75
26	516.75	57	764.75
27	524.75	58	772.75
28	532.75	59	780.75
29	540.75	60	788.75
30	548.75	61	796.75
31	556.75	62	804.75
32	564.75	63	812.75
33	572.75	64	820.75
34	580.75	65	828.75
35	588.75	66	836.75
36	596.75	67	844.75
37	604.75	68	852.75
38	612.75	69	860.75
39	620.75		
40	628.75		
41	636.75		

◆ Taiwan channels

(unit: MHz)

CH	Freq.
7	179.75
8	185.75
9	191.75
10	197.75
11	203.75
12	209.75

◆ FOT channels

(unit: MHz)

CH	Freq.
4	181.75
5	189.75
6	197.75
7	205.75
8	213.75
9	221.75

11 FREQUENCY TABLE

■ VHF marine channels

(unit: MHz)

CH No.	Ship Transmit	Ship Receive	CH No.	Ship Transmit	Ship Receive
01	156.050	160.650	21A	157.050	157.050
01A	156.050	156.050	21b	161.650	161.650
02	156.100	160.700	22	157.100	161.700
03	156.150	160.750	22A	157.100	157.100
03A	156.150	156.150	23	157.150	161.750
04	156.200	160.800	23A	157.150	157.150
04A	156.200	156.200	24	157.200	161.800
05	156.250	160.850	25	157.250	161.850
05A	156.250	156.250	25b	161.850	161.850
06	156.300	156.300	26	157.300	161.900
07	156.350	160.950	27	157.350	161.950
07A	156.350	156.350	28	157.400	162.000
08	156.400	156.400	28b	162.000	162.000
09	156.450	156.450	60	156.025	160.625
10	156.500	156.500	61	156.075	160.675
11	156.550	156.550	61A	156.075	156.075
12	156.600	156.600	62	156.125	160.725
13	156.650	156.650	62A	156.125	156.125
14	156.700	156.700	63	156.175	160.775
15	156.750	156.750	63A	156.175	156.175
16	156.800	156.800	64	156.225	160.825
17	156.850	156.850	64A	156.225	156.225
18	156.900	161.500	65	156.275	160.875
18A	156.900	156.900	65A	156.275	156.275
19	156.950	161.550	66	156.325	160.925
19A	156.950	156.950	66A	156.325	156.325
20	157.000	161.600	67	156.375	156.375
20A	157.000	157.000	68	156.425	156.425
21	157.050	161.650	69	156.475	156.475

■ Weather channels (unit: MHz)

WX CH	Frequency
01	162.550
02	162.400
03	162.475
04	162.425
05	162.450
06	162.500
07	162.525
08	161.650
09	161.775
10	163.275

■ Other communications in the USA

◇ HF CB (Citizens Band) channels

CH	Frequency	CH	Frequency
1	26.965 MHz	21	27.215 MHz
2	26.975 MHz	22	27.225 MHz
3	26.985 MHz	23	27.255 MHz
4	27.005 MHz	24	27.235 MHz
5	27.015 MHz	25	27.245 MHz
6	27.025 MHz	26	27.265 MHz
7	27.035 MHz	27	27.275 MHz
8	27.055 MHz	28	27.285 MHz
9	27.065 MHz	29	27.295 MHz
10	27.075 MHz	30	27.305 MHz
11	27.085 MHz	31	27.315 MHz
12	27.105 MHz	32	27.325 MHz
13	27.115 MHz	33	27.335 MHz
14	27.125 MHz	34	27.345 MHz
15	27.135 MHz	35	27.355 MHz
16	27.155 MHz	36	27.365 MHz
17	27.165 MHz	37	27.375 MHz
18	27.175 MHz	38	27.385 MHz
19	27.185 MHz	39	27.395 MHz
20	27.205 MHz	40	27.405 MHz

◇ MURS channels

CH	Frequency
1	151.820 MHz
2	151.880 MHz
3	151.940 MHz
4	154.570 MHz
5	154.600 MHz

◇ GMRS (General Mobile Radio Service) channels

Transceiver Receive	Transceiver transmit
462.5500 MHz	467.5500 MHz
462.5625 MHz	
462.5750 MHz	467.5750 MHz
462.5875 MHz	
462.6000 MHz	467.6000 MHz
462.6125 MHz	
462.6250 MHz	467.6250 MHz
462.6375 MHz	
462.6500 MHz	467.6500 MHz
462.6625 MHz	
462.6750 MHz	467.6750 MHz
462.6875 MHz	
462.7000 MHz	467.7000 MHz
462.7125 MHz	
462.7250 MHz	467.7250 MHz

◇ BRS (Business Radio Service) channels

Dot color	Frequency
Red	151.625 MHz
Purple	151.955 MHz
Blue	154.570 MHz
Green	154.600 MHz
White	462.575 MHz
Black	462.625 MHz
Orange	462.675 MHz
Brown	464.500 MHz
Yellow	464.550 MHz
"J" Dot	467.763 MHz
"K" Dot	467.813 MHz
Silver Star	467.850 MHz
Gold Star	467.875 MHz
Red Star	467.900 MHz
Blue Star	467.925 MHz

◇ FRS (Family Radio Service) channels

CH	Frequency	CH	Frequency
1	462.5625 MHz	8	467.5625 MHz
2	462.5875 MHz	9	467.5875 MHz
3	462.6125 MHz	10	467.6125 MHz
4	462.6375 MHz	11	467.6375 MHz
5	462.6625 MHz	12	467.6625 MHz
6	462.6875 MHz	13	467.6875 MHz
7	462.7125 MHz	14	467.7125 MHz

11 FREQUENCY TABLE

◆ General aviation frequencies

Frequency	Description
121.500	Emergencies
122.000	Flight Advisory Service
122.200	Flight Service Stations
122.700	Unicom— Uncontrolled airports
122.725	Unicom— Private airports
122.750	Unicom— Air-to-air communications
122.800	Unicom— Uncontrolled airports
122.900	Search & rescue training, & uncontrolled airports
122.950	Unicom— Controlled airports
123.000	Unicom— Uncontrolled airports
123.025	Helicopters— Air-to-air communications
123.050	Unicom— Heliports
123.075	Unicom— Heliports
123.100	Search & Rescue
123.300	Flight Schools
123.450	Air-to-air communications (unofficial)
123.500	Flight Schools
123.600	Flight Service Stations— Uncontrolled airports
148.125	Civil Air Patrol Repeaters— Secondary
148.150	Civil Air Patrol Repeaters— Primary
156.300	Aircraft-to-ship— safety
156.400	Aircraft-to-ship— commercial
156.425	Aircraft-to-ship— non-commercial
156.450	Aircraft-to-ship— commercial
156.625	Aircraft-to-ship— non-commercial
156.900	Aircraft-to-ship— commercial
243.000	Military Emergency “Guard”
255.400	Flight Advisory Service
257.800	Civilian Towers
311.000	SAC Primary
321.000	SAC Secondary
381.800	USCG— Primary

◆ Cable TV (IRC)

(unit: MHz)

CH	Frequency range	Remarks
2– 13	54–216	(same as broadcast VHF)
14– 22	120–174	Mid band Ch. A–I
23– 36	216–300	Super band J–W
37– 53	300–402	Hyper band AA–QQ
54– 64	402–468	
65– 94	468–648	(Ultra band)
95– 99	90–120	Low band A5–A1
100–125	648–804	(Ultra band)

◆ Wireless Microphones

169.445 MHz

169.505 MHz

170.245 MHz

170.305 MHz

171.045 MHz

171.105 MHz

171.845 MHz

171.905 MHz

*Power limited to 1/20 watt. These frequencies are also used at drive-in windows at some fast-food restaurants.

■ Other communications— other countries

◇ LPD (Low Power Device) channels

(unit: MHz)

CH	Frequency	CH	Frequency	CH	Frequency
1	433.075	30	433.800	59	434.525
2	433.100	31	433.825	60	434.550
3	433.125	32	433.850	61	434.575
4	433.150	33	433.875	62	434.600
5	433.175	34	433.900	63	434.625
6	433.200	35	433.925	64	434.650
7	433.225	36	433.950	65	434.675
8	433.250	37	433.975	66	434.700
9	433.275	38	434.000	67	434.725
10	433.300	39	434.025	68	434.750
11	433.325	40	434.050	69	434.775
12	433.350	41	434.075		
13	433.375	42	434.100		
14	433.400	43	434.125		
15	433.425	44	434.150		
16	433.450	45	434.175		
17	433.475	46	434.200		
18	433.500	47	434.225		
19	433.525	48	434.250		
20	433.550	49	434.275		
21	433.575	50	434.300		
22	433.600	51	434.325		
23	433.625	52	434.350		
24	433.650	53	434.375		
25	433.675	54	434.400		
26	433.700	55	434.425		
27	433.725	56	434.450		
28	433.750	57	434.475		
29	433.775	58	434.500		

◇ PMR446 channels (unit: MHz)

CH	Frequency
1	446.00625
2	446.01875
3	446.03125
4	446.04375
5	446.05625
6	446.06875
7	446.08125
8	446.09375

11 FREQUENCY TABLE

◆ UHF C.R.S (Citizen Radio Service) channels

CH	Frequency	CH	Frequency
1	476.425 MHz	21	476.925 MHz
2	476.450 MHz	22	476.950 MHz
3	476.475 MHz	23	476.975 MHz
4	476.500 MHz	24	477.000 MHz
5	476.525 MHz	25	477.025 MHz
6	476.550 MHz	26	477.050 MHz
7	476.575 MHz	27	477.075 MHz
8	476.600 MHz	28	477.100 MHz
9	476.625 MHz	29	477.125 MHz
10	476.650 MHz	30	477.150 MHz
11	476.675 MHz	31	477.175 MHz
12	476.700 MHz	32	477.200 MHz
13	476.725 MHz	33	477.225 MHz
14	476.750 MHz	34	477.250 MHz
15	476.775 MHz	35	477.275 MHz
16	476.800 MHz	36	477.300 MHz
17	476.825 MHz	37	477.325 MHz
18	476.850 MHz	38	477.350 MHz
19	476.875 MHz	39	477.375 MHz
20	476.900 MHz	40	477.400 MHz

■ Troubleshooting

If your receiver seems to be malfunctioning, please check the following points before sending it to a service center.

PROBLEM	POSSIBLE CAUSE	SOLUTION	REF.
No power comes on.	<ul style="list-style-type: none"> • The batteries are exhausted. • The battery polarity is reversed. 	<ul style="list-style-type: none"> • Replace the batteries or charge the batteries. • Check the battery polarity. 	pgs. 5, 6 p. 5
No sound comes from the speaker.	<ul style="list-style-type: none"> • Volume level is too low. • Squelch level is set too tight. • Different tone is selected with tone squelch. 	<ul style="list-style-type: none"> • Push [▲] to obtain a suitable level. • While pushing [SQL], rotate [DIAL] to set the squelch level. • Turn the appropriate function OFF. 	p. 11 p. 12 p. 35
Sensitivity is low and only strong signals are audible.	<ul style="list-style-type: none"> • Attenuator function is activated. 	<ul style="list-style-type: none"> • While pushing [FUNC], push [SQL] to turn the attenuator function OFF. 	p. 13
Frequency cannot be set.	<ul style="list-style-type: none"> • The lock function is activated. 	<ul style="list-style-type: none"> • While pushing [FUNC], push [BAND•LOCK] for 1 sec. to turn the function OFF. 	p. 10
No beep sound.	<ul style="list-style-type: none"> • Beep tones are turned OFF or the beep tone level is too low. 	<ul style="list-style-type: none"> • Turn beep tone ON or set the beep tone level to appropriate level in set mode. 	p. 41
Receive audio is distorted.	<ul style="list-style-type: none"> • The operating mode is not selected correctly. 	<ul style="list-style-type: none"> • Push [MODE•SCAN] several times to select a suitable operating mode. 	p. 12
Desired set mode item cannot be selected.	<ul style="list-style-type: none"> • “EXPAND” item is set to OFF. • Some set mode items can be selected in the AM or FM broadcast band only. 	<ul style="list-style-type: none"> • Turn “EXPAND” item ON. • Choose the AM or FM broadcast band. 	p. 39 p. 7
Programmed scan does not start.	<ul style="list-style-type: none"> • Program scan edges are not programmed. 	<ul style="list-style-type: none"> • Program a pair of scan edge channels. 	p. 27
Memory or bank scan does not start.	<ul style="list-style-type: none"> • No or only one memory or bank channel is programmed. 	<ul style="list-style-type: none"> • Program at least 2 memory or bank channels 	pgs. 16, 17
Installed batteries cannot be charged.	<ul style="list-style-type: none"> • The batteries over discharged. 	<ul style="list-style-type: none"> • Re-install the batteries (wait at least for 1 sec.), then plug the AC adapter while pushing [FUNC]. 	p. 6

12 MAINTENANCE

■ CP-18A/E fuse replacement

If the fuse blows or the receiver stops functioning while operating with the optional CP-18A/E, find the source of the problem if possible, and replace the damaged fuse with a new, rated one (FGB 5 A) as shown below.

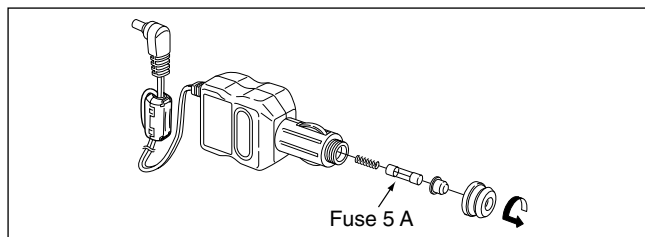

◇ GENERAL

- Frequency coverage : (Unit: MHz)
 - USA 0.150–823.995, 849.000–868.995, 894.000–1309.995
 - France 0.150–29.995, 50.200–51.200, 87.500–108.000, 144.000–146.000, 430.000–440.000, 1240.000–1300.000
 - Other than above 0.150–1309.995 MHz
- Number of memory channels : 1250 (incl. 50 scan edges and 200 auto write channels)
- Frequency resolution : 5, 6.25, 8.33,* 9*, 10, 12.5, 15, 20, 25, 30, 50, 100 kHz
 - *selectable depending on the operating frequency band.
- Operating temperature range : –10°C to +60°C; +14°F to +140°F
- Reference frequency stability : ±6 ppm (–10°C to +60°C)
- Power supply requirement : 2 AA (R6) alkaline calls
2 AA (R6) Ni-Cd or Ni-MH cells
6.0 V DC ±5% (with AC adapter or CP-18A/E)
- Current drain (at 3.0 V DC: approx.):
 - standby (power saved) 41 mA typical
 - max. audio 170 mA typical
 - charging (at 6.0 V DC) 120 mA typical
- Antenna connector : SMA (50 Ω)
- Dimensions (proj. not included) : 58(W) × 86(H) × 27(D) mm
2⁹/₃₂(W)×3³/₁₆(H)×1¹/₁₆(D) in
- Weight (approx.) : 185 g; 6.5 oz

◇ RECEIVER

- Receive system : Triple-conversion superheterodyne
- Intermediate frequencies : 1st: 266.7 MHz, 2nd: 19.65 MHz, 3rd: 450 kHz
- Sensitivity and squelch sensitivity (except spurious points):
 - FM (1 kHz/3.5 kHz Dev.; 12 dB SINAD)
 - 1.625–4.995 MHz 0.32 μV typ.
 - 5.000–179.995 MHz 0.2 μV typ.
 - 118.000–246.995 MHz 0.18 μV typ.
 - 247.000–329.995 MHz 0.2 μV typ.
 - 330.000–469.995 MHz 0.18 μV typ.
 - 470.000–832.995 MHz 0.28 μV typ.
 - 833.000–999.995 MHz 0.28 μV typ.
 - 1000.000–1309.995 MHz 0.35 μV typ.
 - WFM (1 kHz/52.5 kHz Dev.; 12 dB SINAD)
 - 76.000–108.000 MHz 0.89 μV typ.
 - 175.000–221.995 MHz 0.71 μV typ.
 - 470.000–770.000 MHz 1.0 μV typ.
 - AM (1 kHz/30% MOD.; 10 dB S/N)
 - 0.495–4.995 MHz 1.3 μV typ.
 - 5.000–29.995 MHz 0.71 μV typ.
 - 118.000–136.000 MHz 0.56 μV typ.
 - 222.000–246.995 MHz 0.56 μV typ.
 - 247.000–329.995 MHz 0.71 μV typ.
- Selectivity :
 - AM/FM : More than 15 kHz/–9 dB
Less than 30 kHz/–60 dB
 - WFM : More than 150 kHz/–6 dB
- AF output power (at 3.0 V DC) : 100 mW typical at 10% distortion with an 8 Ω load
- Ext. speaker connector : 3-conductor 3.5 (d) mm (1/8")/8 Ω

Downloaded by
Amateur Radio Directory
www.hamdirectory.info

14 OPTIONS

Options

BC-149 A/D AC ADAPTER



Regularly charges the installed batteries.
6 V DC/1 A output.

CP-18A/E CIGARETTE LIGHTER CABLE WITH DC-DC CONVERTER



Allows you to operate the receiver through a 12 V cigarette lighter socket, and also charges the installed rechargeable batteries regularly. A DC-DC converter is built-in.

AD-92SMA ANTENNA CONNECTOR ADAPTER



Allows you to connect an external antenna with a BNC connector.

SP-13 EARPHONE



Provides clear receive audio in noisy environments.

LC-146A CARRYING CASE

Helps protect the receiver from scratches, etc.

OPC-474 CLONING CABLE

For connection between receivers for data cloning.

CS-R5 CLONING SOFTWARE

+ **OPC-478U** CLONING CABLE

(USB type)

Allows you to transfer data, such as memories, and quickly and easily edit and store data via a PC (for Microsoft® Windows® 98/Me/2000/XP). Current RS-232C (DB 9-pin) type cloning cable, OPC-478, is also available.

POCKET GUIDE 15

Important operating instructions are summed up in this and the following page for your simple reference.
By cutting along the line and folding on the dotted line, it will become a card sized operating guide which can easily be carried in a card case or wallet, etc.

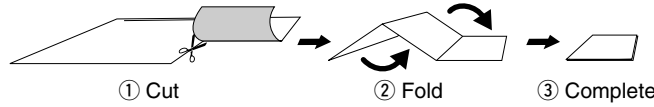

ICOM POCKET GUIDE IC-R5

■ VFO and memory mode selection

- ➔ Push [V/M•S.MW•**SND**] to toggle between VFO and memory mode.

■ Receive mode selection

- ➔ Push [MODE•SCAN] several times to select the desired mode

■ Audio level setting

- ➔ Push [▲] to increase, push [▼] to decrease the audio level.

■ Squelch level setting

- ➔ While pushing [SQL], rotate [DIAL] to set the squelch level.

—SOUTH HERE—

■ Frequency band selection

- ➔ Push [BAND•**LOCK**] several times, or while pushing [BAND•**LOCK**], rotate [DIAL] to select the desired frequency band.

■ Tuning step selection

- ➔ Push [T•SET], then rotate [DIAL] to select the desired tuning step.
 - Push [T•SET] again to return to the previous condition.

■ Key lock function

- ➔ While pushing [FUNC], push [BAND•**LOCK**] for 1 sec. to toggle the key lock function ON and OFF.
 - “**PK**” appears when the lock function is in use.

■ Attenuator function

- ➔ While pushing [FUNC], push [SQL] to toggle the attenuator ON and OFF.
 - “**PK**” appears when the lock function is in use.

■ Frequency setting

- ① Push [V/M•S.MW•**SND**] to select VFO mode.
- ② Rotate [DIAL] to set the desired operating frequency.

■ Memory channel selection

- ① Push [V/M•S.MW•**SND**] to select memory mode.
 - While pushing [FUNC], [DIAL] rotation changes memory channel in 10 channels steps.
- ② Rotate [DIAL] to set the desired memory channel.

■ Memory bank channel selection

- ① Push [V/M•S.MW•**SND**] to select memory mode.
- ② Push [BAND•**LOCK**] several times, or while pushing [BAND•**LOCK**], rotate [DIAL] to select the desired bank.
 - Rotate [DIAL] to select the desired bank channel.

■ Memory channel programming

- 1 Set the desired frequency and other functions in VFO mode.
- 2 Push [V/M•S.MW•**[SKIP]**] for 1 sec. to enter select memory write condition.
 - 1 short and 1 long beeps sound!
- 3 Rotate [DIAL] to select the desired memory channel number.
- 4 Push [V/M•S.MW•**[SKIP]**] for 1 sec. again to program the contents into the selected channel.
 - 3 beeps sound!

■ Scan skip setting

- 1 Push [V/M•S.MW•**[SKIP]**] to select memory mode.
- 2 Rotate [DIAL] to select the desired memory channel.
- 3 While pushing [FUNC], push [V/M•S.MW•**[SKIP]**] to set the skip setting (skip channel or skip frequency) ON and OFF.

■ VFO scans

- 1 Push [V/M•S.MW•**[SKIP]**] to select VFO mode.
- 2 Push [MODE•SCAN] for 1 sec.
 - One of scan type "ALL," "BAND" or "PROG xx" (xx=0-24) appear.

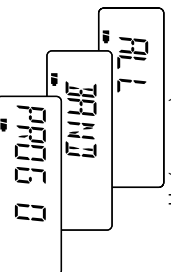

- 3 Rotate [DIAL] to select the desired scan type. Push [MODE•SCAN] momentarily to start scan.
 - Rotate [DIAL] to change the scanning direction.
 - During scan, push [V/M•S.MW•**[SKIP]**] to start auto memory write scan.
- 4 Push [MODE•SCAN] momentarily again to stop scan.

■ Memory scans

- 1 Push [V/M•S.MW•**[SKIP]**] to select memory mode.
 - Push [BAND•**[LOCK]**] to select a bank, if desired.
- 2 Push [MODE•SCAN] for 1 sec.
 - One of scan type "ALL" or "BANK" appear, for bank scan. Rotate [DIAL] to select the desired scan type, in this case.
 - When memory mode is selected at step ①, memory scan starts.

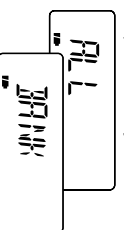

- 3 Push [MODE•SCAN] momentarily to start bank scan.
 - Rotate [DIAL] to change the scanning direction.
- 4 Push [MODE•SCAN] momentarily again to stop scan.



We Icom Inc. Japan
1-1-32, Kamiminami, Hirano-ku
Osaka 547-0003, Japan

Declare on our sole responsibility that this equipment complies with the essential requirements of the Radio and Telecommunications Terminal Equipment Directive, 1999/5/EC, and that any applicable Essential Test Suite measurements have been performed.

Kind of equipment: COMMUNICATIONS RECEIVER

Type-designation: IC-R5

Version (where applicable): _____

This compliance is based on conformity with the following harmonised standards, specifications or documents:

- i) Article 3.1a EN 60950: 1992+A11
- ii) Article 3.1b EN 301489-1 and EN 301489-15
- iii) Article 3.2 EN 301 783-2
- iv) _____
- v) _____

DECLARATION OF CONFORMITY



Düsseldorf 10 Oct. 2002
Place and date of issue

Icom (Europe) GmbH
Himmelgeisterstraße 100
D-40225 Düsseldorf

Authorized representative name
T. Maebayashi
General Manager

Signature

Icom Inc.

Count on us!

Downloaded by
Amateur Radio Directory
 www.hamdirectory.info

A-6198H-1EX-①
Printed in Japan
© 2002 Icom Inc.

Icom Inc.
1-1-32 Kamiminami, Hirano-ku, Osaka 547-0003 Japan