



INSTRUCTION MANUAL

COMMUNICATIONS RECEIVER IC-R6

This device complies with Part 15 of the FCC Rules. Operation is subject to the following two conditions: (1) this device may not cause harmful interference, and (2) this device must accept any interference received, including interference that may cause undesired operation.

WARNING: MODIFICATION OF THIS DEVICE TO RECEIVE CELLULAR RADIOTELEPHONE SERVICE SIGNALS IS PROHIBITED UNDER FCC RULES AND FEDERAL LAW.

Icom Inc.

Downloaded by
RadioAmateur.EU



FOREWORD

Thank you for purchasing this Icom product. The IC-R6 COMMUNICATIONS RECEIVER is designed and built with Icom's superior technology and craftsmanship. With proper care, this product should provide you with years of trouble-free operation.

We want to take a moment of your time to thank you for making your IC-R6 your radio of choice, and hope you agree with Icom's philosophy of "technology first." Many hours of research and development went into the design of your IC-R6.

◇ **FEATURES**

- *Covers 0.100–1309.995 MHz* wide frequency range*

*Some frequency bands are prohibited, depending on the receiver version

- *External power supply operation*
- *1300 memory channels with 22 banks available*
- *150 mW* AF power with BTL (bridge-tied load) amplifier*

*At 10% distortion with a 16 Ω load (internal speaker)

IMPORTANT

READ ALL INSTRUCTIONS carefully and completely before using the receiver.

SAVE THIS INSTRUCTION MANUAL— This instruction manual contains important operating instructions for the IC-R6.

EXPLICIT DEFINITIONS

WORD	DEFINITION
⚠ DANGER!	Personal death, serious injury or an explosion may occur.
⚠ WARNING!	Personal injury, fire hazard or electric shock may occur.
CAUTION	Equipment damage may occur.
NOTE	Recommended for optimum use. No risk of personal injury, fire or electric shock.

Icom, Icom Inc. and the Icom logo are registered trademarks of Icom Incorporated (Japan) in Japan, the United States, the United Kingdom, Germany, France, Spain, Russia and/or other countries.

Microsoft, Windows and Windows Vista are registered trademarks of Microsoft Corporation in the United States and/or other countries.

PRECAUTIONS

⚠ WARNING! NEVER operate the receiver with a earphone, headphones or other audio accessories at high volume levels. Hearing experts advise against continuous high volume operation. If you experience a ringing in your ears, reduce the volume level or discontinue use.

⚠ WARNING! NEVER operate the receiver while driving a vehicle. Safe driving requires your full attention—anything less may result in an accident.

⚠ WARNING! NEVER connect the receiver to an AC outlet. This may pose a fire hazard or result in an electric shock.

⚠ WARNING! NEVER throw a battery cell into a fire since as internal battery gas can cause explosion.

⚠ WARNING! NEVER disassemble the battery cell. If the battery cell's internal material (electrolyte liquid) gets into your eyes, wash your eyes with water and obtain treatment from an eye doctor immediately.

NEVER connect the receiver to a power source of more than 6.3 V DC directly. This will damage the receiver.

NEVER connect the receiver to a power source using reverse polarity. This will damage the receiver.

NEVER expose the receiver to rain, snow or any liquids. The receiver may be damaged.

NEVER operate or touch the receiver with wet hands. This may result in an electric shock or damage the receiver.

NEVER solder the battery cell. This may damage the battery.

DO NOT use or place the receiver in direct sunlight or in areas with temperatures below -10°C ($+14^{\circ}\text{F}$) or above $+60^{\circ}\text{C}$ ($+140^{\circ}\text{F}$).

DO NOT use harsh solvents such as benzine or alcohol to clean the receiver, because they can damage the receiver's surfaces.

Even when the receiver power is OFF, a slight current still flows in the circuits. Remove batteries from the receiver when not using it for a long time. Otherwise, the installed batteries will become exhausted, and will need to be recharged.

FCC INFORMATION

• FOR CLASS B UNINTENTIONAL RADIATORS:

This equipment has been tested and found to comply with the limits for a Class B digital device, pursuant to part 15 of the FCC Rules. These limits are designed to provide reasonable protection against harmful interference in a residential installation. This equipment generates, uses and can radiate radio frequency energy and, if not installed and used in accordance with the instructions, may cause harmful interference to radio communications. However, there is no guarantee that interference will not occur in a particular installation. If this equipment does cause harmful interference to radio or television reception, which can be determined by turning the equipment off and on, the user is encouraged to try to correct the interference by one or more of the following measures:

- Reorient or relocate the receiving antenna.
- Increase the separation between the equipment and receiver.
- Connect the equipment into an outlet on a circuit different from that to which the receiver is connected.
- Consult the dealer or an experienced radio/TV technician for help.

CAUTION: Changes or modifications to this device, not expressly approved by Icom Inc., could void your authority to operate this device under FCC regulations.

OPERATING THEORY

Electromagnetic radiation, which has frequencies of 20,000 Hz (20 kHz*) and above, is called radio frequency (RF) energy because, it is useful in radio transmissions. The IC-R6 receives RF energy from 0.100 MHz* to 1309.995 MHz and converts it into audio frequency (AF) energy which in turn actuates a loudspeaker to create sound waves. AF energy is in the range of 20 to 20,000 Hz.

*kHz is an abbreviation of kilohertz or 1000 hertz, MHz is abbreviation of megahertz or 1,000,000 hertz, where hertz is a unit of frequency.

OPERATING NOTES

The IC-R6 may receive its own oscillated frequency, resulting in no reception or only noise reception, on some frequencies.

The IC-R6 may receive interference from extremely strong signals on different frequencies or when using an external high-gain antenna.

TABLE OF CONTENTS

FOREWORD	i
IMPORTANT	i
EXPLICIT DEFINITIONS	i
PRECAUTIONS	ii
FCC INFORMATION	iii
OPERATING THEORY	iii
OPERATING NOTES	iii
TABLE OF CONTENTS	iv–v
SUPPLIED ACCESSORIES	v
QUICK REFERENCE GUIDE	I–VII
■ Preparation	I
■ Your first scanning experience	III
■ Memory programming	IV
■ Programmed scan operation	V
1 PANEL DESCRIPTION	1–4
■ Front, top and side panels	1
■ Function display	3
2 BATTERY CHARGING	5–8
■ Battery installation	5
■ Caution	5
■ Battery charging	7
3 FREQUENCY AND CHANNEL SETTING	9–12
■ VFO and memory channels	9
■ Frequency band selection	9
■ Setting a frequency	11
■ Setting a tuning step	11
■ Selecting a memory channel	12
■ Lock function	12

4 BASIC OPERATION	13–17
■ Receiving	13
■ Setting audio volume	13
■ Squelch level setting	14
■ Receive mode selection	14
■ Monitor function	15
■ Attenuator function	15
■ Duplex operation	16
■ Dial select step	17
5 MEMORY CHANNELS	18–27
■ General description	18
■ Selecting a memory channel	18
■ Memory channel programming	19
■ Memory bank setting	20
■ Memory bank selection	21
■ Programming memory/bank name	22
■ Selecting display type	23
■ Copying memory contents	24
■ Memory clearing	25
■ Transferring memory contents	26
■ Erasing/transferring bank contents	27
6 SCAN OPERATION	28–37
■ Scan types	28
■ Full/band/programmed link/programmed scan	29
■ Scan edges programming	30
■ Programming scan name	31
■ Programming other contents	32
■ Memory/all bank/bank link/bank scan	33
■ Auto memory write scan	34



TABLE OF CONTENTS

■ Skip channel/frequency setting	35
■ Scan resume setting	37
7 PRIORITY WATCH	38–40
■ Priority watch types	38
■ Priority watch operation	39
8 TONE SQUELCH AND POCKET BEEP	41–44
■ Tone squelch frequency/DTCS code setting	41
■ Tone/DTCS squelch operation	43
■ Tone scan	44
9 Set mode	45–56
■ General	45
■ Set mode items	46
10 OTHER FUNCTIONS	57–63
■ Antenna selection	57
■ [DIAL] function assignment	58
■ Auto power-off function	58
■ Weather channel operation	59
■ Data cloning	61
■ Partial reset	63
■ All reset	63
11 CONTROL COMMAND	64–61
■ General	64
■ Data format	64
■ Command table	65
12 FREQUENCY TABLE	67–74
■ TV channels	67
■ VHF marine channels	70
■ Weather channels	70
■ Other communications in the USA	72

■ Other communications— other countries	73
13 MAINTENANCE	75–76
■ Troubleshooting	75
■ CP-18A/E fuse replacement	76
14 SPECIFICATIONS	77
15 OPTIONS	79
16 POCKET GUIDE	80–81
17 CE	81–82

SUPPLIED ACCESSORIES

① Antenna	1
② Hand strap	1
③ Belt clip	1
④ Ni-MH batteries*	2
⑤ AC adapter*	1

* Not supplied, or the shape is different, depending on the receiver version.

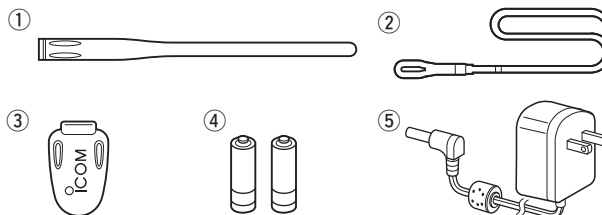

QUICK REFERENCE GUIDE

■ Preparation

◇ Battery installation

- ① Remove the battery cover from the receiver.
- ② Install two AA (LR6) size Ni-MH or alkaline cell batteries.
 - Be sure to observe the correct polarity.
 - Charge the Ni-MH batteries before use. (See page II for charging instructions.)

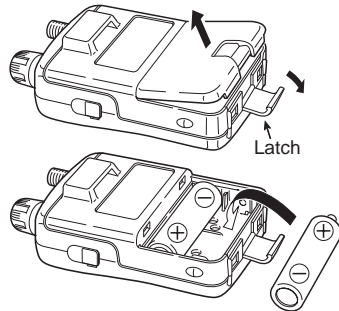

Keep the battery terminals clean. It's a good idea to clean the battery terminals once a week.

◇ Belt clip

Conveniently attaches to your belt.

To attach the belt clip:

Slide the belt clip into the plastic loop on the back of the receiver.

To detach the belt clip:

Hold down the tab (①), and slide the belt clip in the direction of the arrow (②).

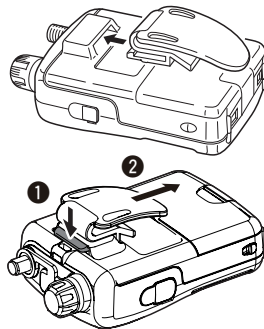

◇ Antenna

Insert the antenna connector into the antenna base and tighten the antenna screw.

- **NEVER** carry the receiver by holding only the antenna.
- When the jack is not in use, **keep** the jack cover attached to protect the connectors from dust and moisture.

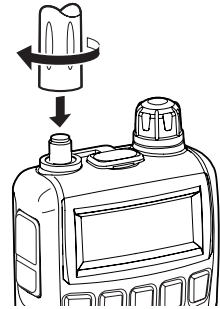

✓ **For your information**

Third-party antennas may increase receiver performance. An optional AD-92SMA ANTENNA CONNECTOR ADAPTER is available to connect an antenna with a BNC connector.

◇ Handstrap

To facilitate carrying the receiver, slide the hand strap through the loop on the top of the belt clip.

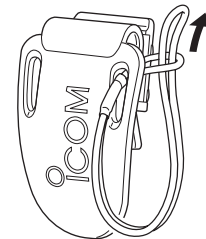

QUICK REFERENCE GUIDE

◇ Charging the battery

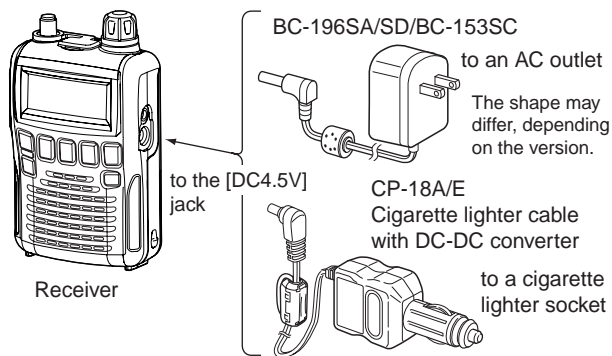

- ① Install the Ni-MH batteries.
- ② Plug the AC adapter into an AC outlet.
- ③ Insert the adapter plug into the [DC4.5V] of the receiver.
 - The battery confirmation is displayed.

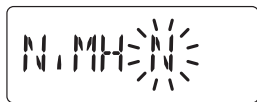

⚠ WARNING!
NEVER attempt to charge the alkaline batteries.

NOTE: When no operation is performed for 10 seconds, the receiver automatically skips these settings, and the receiver cannot charge the batteries. In that case, remove the batteries for more than 2 seconds and retry these setting from step ①.

- ④ Rotate [DIAL] to select "Y," then push [BAND].

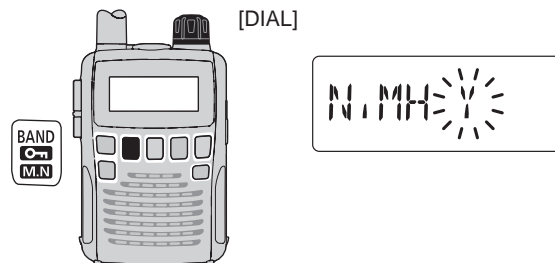

- The charging confirmation is displayed.



- ⑤ Rotate [DIAL] to select "Y," then push [BAND] to start the battery charging.

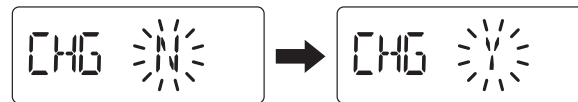

Rotate 

Then, push 

- The battery icon scrolls during charge.



- Both segments blink when completely charged.

■ Your first scanning experience

Now that you have your IC-R6 ready, you are probably excited to start listening. We would like to take you through a few basic operation steps to make your first “Listening Experience” enjoyable.

◇ About the default settings

The **[DIAL]** control function can be traded with the **[▲]/[▼]** keys function. However, in this QUICK REFERENCE GUIDE, the factory default setting (**[DIAL]** selects the operating frequency) is used for simple instruction.

◇ Basic operation

1. Turning ON the receiver

- ➔ Hold down **[PWR]** for 1 second to turn the power ON.



2. Adjusting audio level

- ➔ Push **[▲]/[▼]** to set a desired audio level.

3. Adjusting squelch level

- ➔ While holding down **[SQL]**, rotate **[DIAL]** to set the squelch level.



4. Setting a desired frequency

The tuning dial will allow you to dial in the frequency you want to listen to. Pages 11 and 17 will instruct you on how to set the tuning speed.

- ① Push **[BAND]** repeatedly to select a frequency band.
 - While holding down **[BAND]**, then rotating **[DIAL]** will also select a frequency band.
- ② Rotate **[DIAL]** to set the receive frequency.
 - While holding down **[FUNC]**, rotate **[DIAL]** to select frequencies in MHz steps.



QUICK REFERENCE GUIDE

■ Your first scanning experience (continued)

5. Receive mode selection

- ➔ Push **[MODE]** repeatedly to select a desired receive mode.
 - The FM, WFM or AM is selectable.



■ Memory programming

The IC-R6 has 1300 memory channels for storing often used receive frequency, mode, etc.

1. Setting frequency

In the VFO mode, set a desired receive frequency and receive mode.

- When the "**MR**" icon is displayed, push **[V/M]** to select the VFO mode.

2. Selecting a memory channel

Hold down **[S.MW]**(V/M) for 1 second, then rotate **[DIAL]** to select a desired memory channel.

- The "**MR**" icon and memory channel number blink.

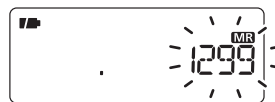

3. Writing a memory channel

Hold down **[S.MW]**(V/M) for 1 second until 3 beeps sound.

- The memory channel number automatically increases if you continue to hold down **[S.MW]**(V/M) after programming.

■ Programmed scan operation

25 pairs (50 channels) of scan edge memories, specify the scanning ranges, are used for programmed scan operation. The programmed scan scans between the frequencies in channels “xxA” and “xxB” (xx=00 to 24). Therefore, before operating the programmed scan, different frequencies must be programmed into “A” and “B” scan edge channels.

◇ Programming scan edges

A start frequency must be programmed into a “xxA,” and an end frequency must be programmed into a “xxB” memory channel.

1. Setting frequency

In the VFO mode, set a desired receive frequency and receive mode.

- When the “**MR**” icon is displayed, push **[V/M]** to select the VFO mode.

2. Selecting a scan edge “A” channel

Hold down **[S.MW]**(V/M) for 1 second, then rotate **[DIAL]** to select one of the 25 scan edge “A” channels.

- The “**MR**” icon and scan edge channel number blink.

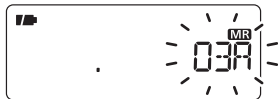

3. Writing a scan edge channel

Hold down **[S.MW]**(V/M) for 1 second until 3 beeps sound.

- The paired scan edge “B” channel is automatically selected if you continue to hold down **[S.MW]**(V/M) after programming.
- When programming is completed, return to the VFO mode.

4. Setting frequency

In the VFO mode, set a desired receive frequency.

5. Selecting a scan edge “B” channel

Hold down **[S.MW]**(V/M) for 1 second, then rotate **[DIAL]** to select one of the 25 scan edge “B” channels.

- The “**MR**” icon and the scan edge channel number blink.
- When the scan edge “B” channel is already selected in step 3, (by holding down **[S.MW]**(V/M) after programming), skip this step.



6. Writing a scan edge channel

Hold down **[S.MW]**(V/M) for 1 second until 3 beeps sound.

- The next scan edge “A” channel is automatically selected if you continue to hold down **[S.MW]**(V/M) after programming.
- When programming is completed, return to the VFO mode.

QUICK REFERENCE GUIDE

◇ Starting scan

1. Select the VFO mode.

Push **[V/M]** to select the VFO mode for a VFO scan operation, such as full scan, band scan and programmed scan.

- Select the memory mode by pushing **[V/M]** again for a memory scan operation, such as all memory scan, bank link scan or bank scan.

2. Selecting a scan type

Hold down **[SCAN](MODE)** for 1 second, and then rotate **[DIAL]** to select one of the desired scanning types.

- Select “ALL” for full scan, “BAND” for band scan, “P-LINK x” for programmed link scan (x= 0 to 9), “PROGxx” for programmed scan (xx= 0 to 24; only programmed scan edge numbers are displayed).
- Select “M-ALL” for all memory scan, “B-ALL” for all bank scan, “B-LINK” for bank link scan or “BANK-x” for bank scan (x= A to R, T, U, W, Y; only programmed bank groups are displayed).

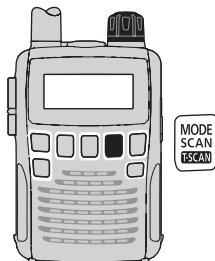

Scan type display examples

In the VFO mode

- Full scan

ALL

- Band scan

BAND

- Program link scan

P-LINK 0

- Program scan

PROG 0

In the memory mode

- All memory scan

M-ALL

- All bank scan

B-ALL

- Bank link scan

B-LINK

- Bank scan

BANK-A

3. Starting scan

Push **[SCAN]**(MODE) to start the scan.

- Rotate **[DIAL]** to change the scanning direction.

In the VFO mode

- Full/Band scan

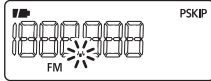

- Program link
Program scan

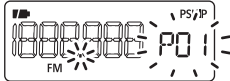

In the memory mode

- All memory/All bank
bank link scan



- Bank scan



4. Cancelling scan

Push **[SCAN]**(MODE) again to stop the scan.

✓ For your information

The memory channel number you program the scan edges into correlates "PROGxx" as follows:

00A/00B: Selects "PROG 00" to scan between frequencies programmed in channels 00A and 00B.

01A/01B: Selects "PROG 01" to scan between frequencies programmed in channels 01A and 01B.

•
•
•
•

23A/23B: Selects "PROG 23" to scan between frequencies programmed in channels 23A and 23B.

24A/24B: Selects "PROG 24" to scan between frequencies programmed in channels 24A and 24B.

■ Front, top and side panels

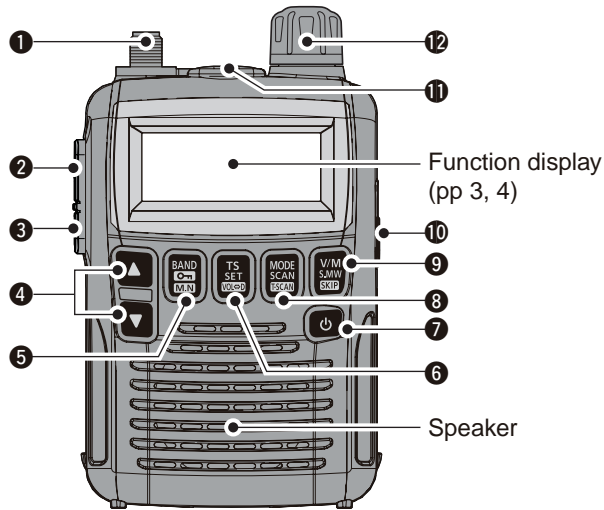

1 ANTENNA CONNECTOR (p. 1)

Connect the supplied antenna.

- An optional AD-92SMA is available for connecting an antenna with a BNC connector.

2 FUNCTION KEY [FUNC]

While holding down this switch, access a key's secondary or third function.

*The functions of [DIAL] and [▲]/[▼] can be exchanged.
See page 58 for details.

3 SQUELCH • ATTENUATOR KEY [SQL] • [ATT](SQL)

- ➔ Hold down to temporarily open the squelch and monitor the operating frequency. (p. 15)
- ➔ While holding down this switch, rotate [DIAL]* to adjust the squelch level. (p. 14)
- ➔ While holding down [FUNC], push to toggle the attenuator function ON or OFF. (p. 15)

4 UP/DOWN KEYS [▲]/[▼]*

Adjusts the audio volume level. (p. 13)

5 BAND • LOCK • MEMORY NAME KEY

[BAND] • [C-] (BAND) • [M.N.] (BAND)

- ➔ Push to select the operating frequency band. (p. 9)
- ➔ While holding down [FUNC], push and hold for 1 second to toggle the lock function ON or OFF. (p. 12)
- ➔ During memory mode operation, hold down [FUNC], then push this key to select the display type.
 - The display shows the memory bank name¹, memory name² and channel number in sequence, and then returns to the frequency display. (*The memory bank name or memory name must have preprogrammed.)

6 TUNING STEP • SET • DIAL EXCHANGE KEY

[TS] • [SET](TS) • [VOL↕D](TS)

- ➔ Push to enter the tuning step selecting mode. (p. 11)
- ➔ Hold down for 1 second to enter the Set mode. (p. 45)
- ➔ While holding down [FUNC], push to exchange the [DIAL] and [▲]/[▼] keys' functions. (p. 58)

7 POWER KEY [⏻]

Hold down for 1 second to turn the receiver power ON or OFF.

8 MODE • SCAN • TONE SCAN KEY

[MODE] • [SCAN](MODE) • [FSCAN](MODE)

- ➔ Push to select the receive mode. (p. 14)
- ➔ Hold down for 1 second to enter the scan type selection mode. (pp. 29, 33)
 - Push again to start the scan.
- ➔ While holding down [FUNC], push to start a tone scan. (p. 44)

9 VFO/MEMORY • MEMORY WRITE • SKIP KEY

[V/M] • [S.MW](V/M) • [SKIP](V/M)

- ➔ Toggles between the VFO and the memory mode. (p. 9)
- ➔ Hold down for 1 second to enter the memory edit mode. (p. 19)
- **While in the VFO mode** (p. 29)
 - Hold down [FUNC], then push this key to set the VFO skip scan setting ON or OFF.
- **While in the memory mode** (p. 35)
 - Hold down [FUNC], then push this key to select the scan skip setting for the selected channel.

10 EXTERNAL DC-IN CONNECTOR [DC4.5V] (p. 7)

Connect an AC adapter or an optional cigarette lighter cable for both charging the installed rechargeable battery and operating. Connectable voltage is from 4.5 V DC to 6.3 V DC.

11 EXTERNAL SPEAKER CONNECTOR [SP]

Connect an optional earphone or headphones. The internal speaker will not function when any external equipment is connected. (See page 79 for a list of available options.)

12 CONTROL DIAL [DIAL]*

- ➔ Rotate to select the operating frequency. (p. 11)
- ➔ While scanning, changes the scanning direction. (pp. 29, 33)
- ➔ While holding down [SQL], sets the squelch level. (p. 14)
- ➔ While holding down [FUNC], sets the operating frequency in 100 kHz, 1 MHz or 10 MHz in the VFO mode. (pp. 11, 17)
- ➔ While holding down [FUNC], selects the memory channel in 10 channels steps in the memory mode. (pp. 12, 18)
- ➔ While holding down [BAND], selects the frequency band in the VFO mode. (p. 9)

*The functions of [DIAL] and [▲]/[▼] can be exchanged. See page 58 for details.

■ Function display

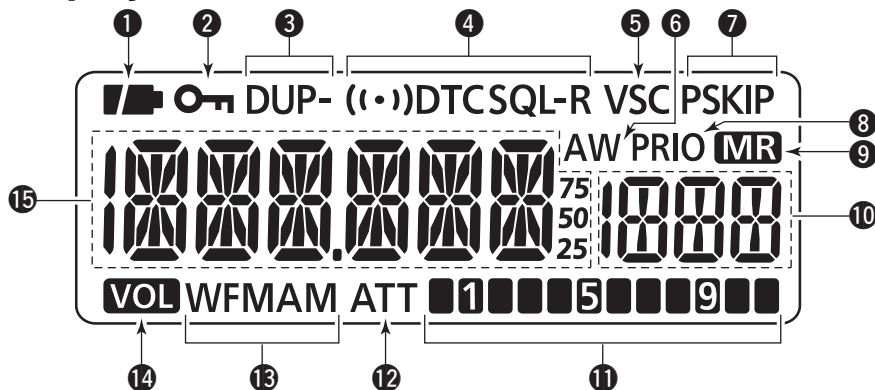

1 BATTERY ICON

- ➔ Both segments appear when the batteries have ample capacity.
 - They do not appear when operating with an external power source.
- ➔ Only the right segment “■” appears when the batteries have less than half capacity.
- ➔ Scrolls while charging the rechargeable batteries. (p. 8)



- ➔ Both segments disappear when completely charged.

2 LOCK ICON (p. 12)

Appears when the lock function is activated.

3 DUPLEX ICONS (p. 16)

“DUP” appears when plus duplex, and “DUP-” appears when minus duplex operation is selected.

4 TONE ICONS (p. 43)

- ➔ “T SQL” appears while the tone squelch function is in use.
- ➔ “T SQL-R” appears while the reverse tone squelch function is in use.
- ➔ “DTCS” appears while the DTCS squelch function is in use.
- ➔ “DTCS” appears while the reverse DTCS squelch function is in use.
- ➔ “((·))” appears with the “T SQL” or “DTCS” icon while the pocket beep function (with Tone squelch or DTCS squelch) is in use.

- 5 VSC ICON** (p. 52)
Appears while the VSC (Voice Squelch Control) function is in use.
- 6 AUTO WRITE CHANNEL ICON** (p. 34)
Appears when an auto write channel is selected.
- 7 SKIP ICONS**
- **While in the VFO mode** (p. 29)
“PSKIP” appears when the VFO skip scan setting is ON.
 - **While in memory mode** (p. 35)
 - “SKIP” appears when the selected memory channel is specified as a skip channel.
 - “PSKIP” appears when the displayed frequency is specified as a skip channel for the memory scan or skip frequency for the VFO scan.
- 8 PRIORITY WATCH ICON** (pp. 39, 40)
Appears while priority watch is in use.
- 9 MEMORY ICON** (pp. 9, 18)
Appears when the memory mode is selected.
- 10 MEMORY CHANNEL NUMBER**
Shows the selected memory channel number. (pp. 9, 18)
- 11 SIGNAL STRENGTH INDICATOR** (p. 13)
Shows the relative signal strength while receiving signals.
- 12 ATTENUATOR ICON** (p. 15)
Appears while the RF attenuator is in use.
- 13 RECEIVE MODE ICONS** (p. 14)
Shows the selected receive mode.
 - FM, WFM and AM modes are selectable.
- 14 VOLUME EXCHANGE ICON** (p. 58)
Appears when the function of [DIAL] and [▲]/[▼] are exchanged.
- 15 FREQUENCY READOUT**
Shows a variety of information, such as the operating frequency, Set mode contents, memory names.
 - The smaller “75,” “50” or “25” to the right of the frequency readout shows the 0.75, 0.5 or 0.25 kHz, respectively.
 - The decimal point blinks during a scan.

■ Battery installation

Before installing, or replacing the batteries, hold down [⏻] for 1 second to turn the power OFF.

- ① Remove the battery cover from the receiver.

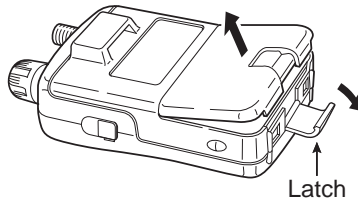

- ② Install two AA (LR6) size Ni-MH batteries.
• Be sure to observe the correct polarity.

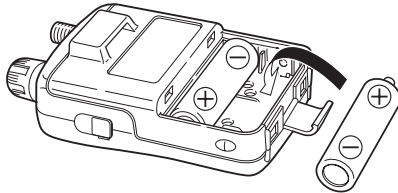

■ Caution

- ⚠ **DANGER! NEVER** short the battery terminals (or charging terminals on the bottom of the receiver). Also, current may flow into nearby metal objects such as a necklace, so be careful when placing batteries (or the receiver) in handbags, etc.
Simply carrying with or placing near metal objects such as a necklace, etc. may cause shorting. This may damage not only the batteries, but also the receiver.
- ⚠ **DANGER! NEVER** incinerate used batteries. Internal battery gas may cause an explosion.
- ⚠ **DANGER! NEVER** immerse the batteries in water. If the batteries become wet, be sure to wipe them dry **BEFORE** installing them to the receiver.
- When installing batteries, make sure they are all the same brand, type and capacity. Also, do not mix new and old batteries together.
- Never use batteries whose insulated covering is damaged.
- **Keep** battery terminals clean to avoid rust or misscontact. It's a good idea to clean battery terminals once a week.

◇ Caution for the Ni-MH batteries

- **CAUTION:** Always use the batteries within the specified temperature range, -5°C to $+60^{\circ}\text{C}$ ($+23^{\circ}\text{F}$ to $+140^{\circ}\text{F}$). Using the batteries out of their specified temperature range will reduce the battery's performance and battery life.

- **CAUTION:** Shorter battery life could occur if the batteries are left completely discharged, or in an excessive temperature environment (above +55°C; +131°F) for an extended period of time. If the batteries must be left unused for a long time, they must be detached from the receiver after charging. Keep them safely in a cool dry place at the following temperature range:

- 20°C to +45°C (-4°F to +113°F) (up to a month)
- 20°C to +35°C (-4°F to +95°F) (up to six months)
- 20°C to +25°C (-4°F to +77°F) (up to a year*)

* We recommend charging the batteries every 6 months.

- If your Ni-MH batteries seem to have no capacity, even after being charged, completely discharge them by leaving the power ON overnight. Then, fully charge the batteries again. If the batteries still do not retain a charge (or only very little charge), a new batteries must be purchased. Prior to using the receiver for the first time, the batteries must be fully charged for optimum life and operation.
- The supplied batteries are rechargeable batteries. Charge the batteries before first operating the receiver, or when the batteries become exhausted. If you want to prolong the battery life, the following points should be observed:
 - Avoid over charging.
 - Use the batteries until it becomes almost completely exhausted, under normal conditions.

◇ Charging caution

- **⚠ WARNING! NEVER** charge alkaline batteries. The receiver can charge only the Ni-MH batteries (1.2 V, 1400 mAh typical). Other types of rechargeable battery, such as Ni-Cd or Li-Ion cannot be charged.
- **AVOID over charging**— The installed rechargeable batteries can be charged during operation when the AC adapter or the cigarette lighter cable is connected. To prevent over charging, the IC-R6 has charging timer that automatically disconnecting* the charging line electronically after 15 hours from charging. However, the charging timer will reset and start charging again when disconnect then reconnecting the AC adapter or CP-18A/E more than 1 minute interval.
 - * When the "CHARGE" setting in the Set mode is set to "CHG2 (default)," the receiver continues to trickle charge after 15 hours have past.
- Recommended temperature range for charging: between 0°C (+32°F) and +40°C (+104°F) by the receiver.
- Use the BC-196SA/SD/BC-153SC AC adapter or CP-18A/E cigarette liter cable only. **NEVER** use other manufacturers' chargers.
- The external DC power supply voltage must be between 12–16 V to charge the batteries and for operation when using an optional CP-18A/E.
- If the battery icons ("▢" and "▣") disappear only 1 minute after connecting to the DC power supply, the batteries may have problem. In this case, contact your Icom dealer/distributor, or purchase new batteries.

2 BATTERY CHARGING

■ Battery charging

◇ Charging connections

⚠ **WARNING!**
NEVER attempt to charge alkaline batteries.

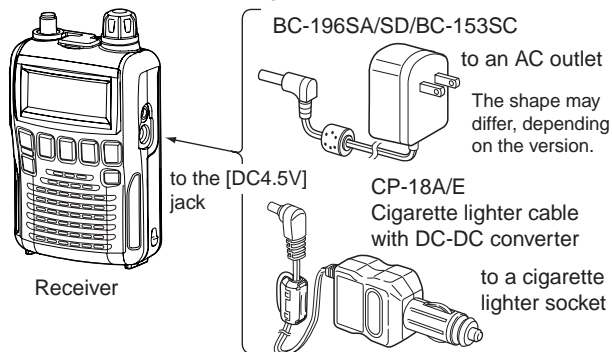

- Charging period: Approx. 15 hours*
* Charging pauses when the receiver's temperature is out of its specified temperature range (at that time both battery icons blink), then resumes when it returns to the specified range. In that case, the charging time will be longer than 15 hours.
- External DC power operation becomes possible when using an AC adapter or cigarette lighter cable. The installed Ni-MH batteries can also be charged simultaneously.
- **CAUTION: BE SURE** to disconnect the CP-18A/E from the cigarette lighter socket when charging is finished, because, a slight current still flows in the CP-18A/E and will drain the vehicle's battery.

◇ Charging description

When charging the installed batteries at the first time, or once the batteries are removed for more than 2 seconds, the following operations are necessary.

- ① Install Ni-MH batteries. (See page 5.)
- ② Plug the AC adapter into an AC outlet; or the CP-18A/E into a cigarette lighter socket.
- ③ Insert the adapter plug into [DC4.5V] of the receiver.
 - The battery confirmation is displayed.

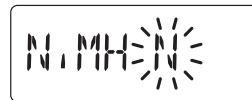

- ⚠ If the confirmation does not appear, following operation is necessary.
- ① Disconnect the adapter plug from [DC4.5V].
 - ② Holding down **[FUNC]**, insert the adapter plug again.
 - ③ Release **[FUNC]**.

NOTE: When no operation is performed for 10 seconds, the receiver automatically skips these settings, and the receiver cannot charge the batteries. In that case, remove the batteries for more than 2 seconds and retry these setting from step ①.

- ④ Rotate [DIAL] to select “Y,” then push [BAND].

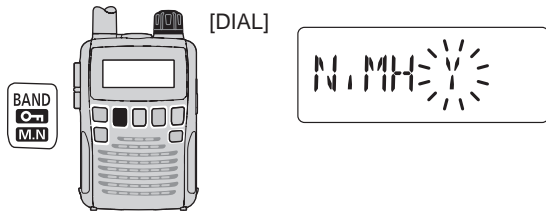

- The charging confirmation is displayed.



- ⑤ Rotate [DIAL] to select “Y,” then push [BAND] to start the battery charging.

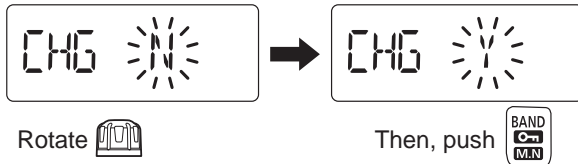

- While charging, the icons show “,” “” and “” (disappears) in sequence, and “CHARGE” appears when the receiver’s power is OFF. The icons and “CHARGE” disappear when the battery pack is completely charged.
- It takes approximately 13 hours to fully charge the Ni-MH batteries.

◇ Charger stand BC-194

The BC-194 can be used as a convenient stand for the receiver, as well as a charger when used the BC-196SA/SD, BC-153SC or CP-18A/E as its power source.

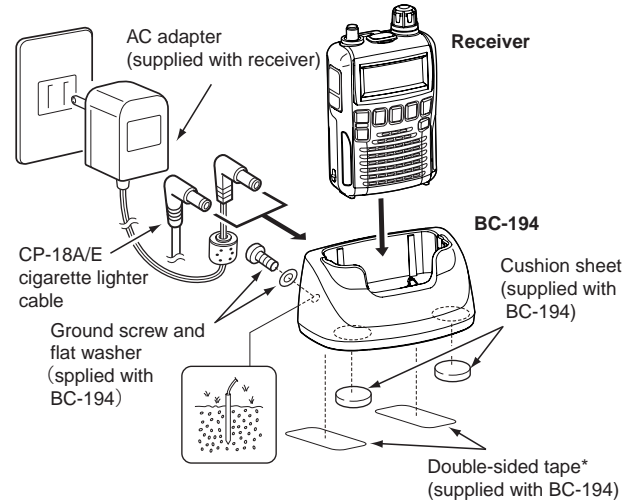

*One sheet supplied. You can cut the desired size.

The BC-194 contains a line filter. If the ground screw is connected to earth ground, the BC-194 will reduce some noises from the power source.

3

FREQUENCY AND CHANNEL SETTING

■ VFO and memory channels

The IC-R6 has two normal operating modes: the VFO mode and the memory mode.

The VFO mode is used for a desired frequency setting within the frequency coverage.

➔ Push **[V/M]** to select the VFO mode.

The memory mode is used for quick recall of the preprogrammed memory channels.

➔ Push **[V/M]** to select the memory mode.

- See page 19 for memory programming details.

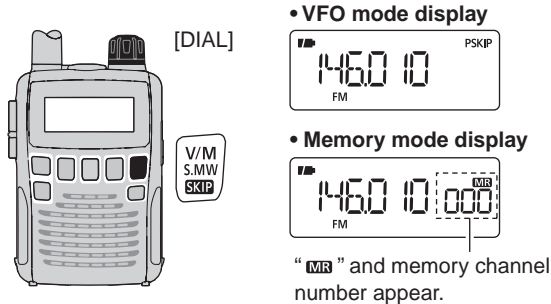

What is VFO?

VFO is an abbreviation of Variable Frequency Oscillator. Operating frequencies are generated and controlled by the VFO.

■ Frequency band selection

The receiver can receive the AM broadcast, HF band, 50 MHz, FM broadcast, VHF air, 144 MHz, 300 MHz, 400 MHz, 800 MHz,* 1200 MHz or Weather channels†.

▨ Available frequency bands differ, depending on the version. See the specifications for details.

▨ *Some frequency ranges are prohibited in the USA version by regulation.

▨ †Available in only the USA version.

➔ Push **[BAND]** repeatedly to select a desired frequency band.

• When the memory mode is selected, push **[V/M]** to select the VFO mode first, then push **[BAND]** to select a desired band.

➔ While holding down **[BAND]**, rotating **[DIAL]** also selects the frequency band.



• Available frequency bands

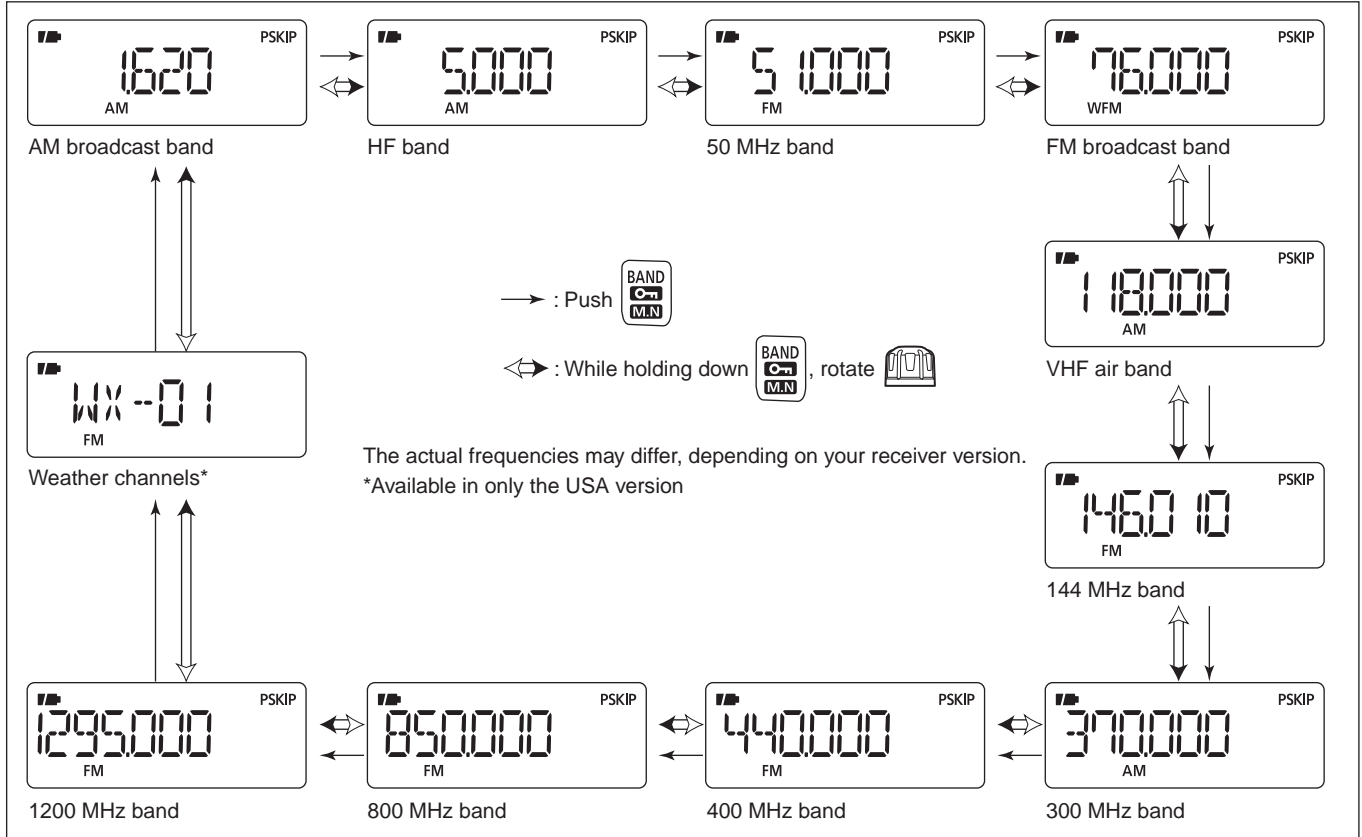

3 FREQUENCY AND CHANNEL SETTING

■ Setting a frequency

- ① Push **[V/M]** to select the VFO mode, if necessary.
- ② Select a desired frequency band with **[BAND]**.
 - Or, while holding down **[BAND]**, rotate **[DIAL]** to select a desired frequency band.
- ③ Rotate **[DIAL]** to select a desired frequency.
 - The frequency changes according to the preset tuning step. See the section to the right for setting the tuning step.
 - While holding down **[FUNC]**, rotate **[DIAL]** to change the frequency in 1 MHz steps (default).

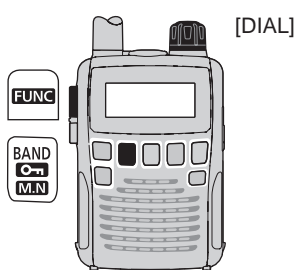

[DIAL] changes the frequency according to the selected tuning step.



While holding down **[FUNC]**, rotating **[DIAL]** changes the frequency in 1 MHz steps (default).

▨ The MHz tuning step (dial select step) can be set to 100 kHz, 1 MHz or 10 MHz tuning steps in the Set mode.
▨ See page 17 for details.

■ Setting a tuning step

The tuning step can be selected for each frequency band. However, additional steps become selectable in only the VHF Air band (8.33 kHz) and in the AM broadcast band (9 kHz). The following tuning steps are available for the IC-R6.

- | | | | |
|-------------|-------------|------------|-------------|
| • 5.0 kHz | • 6.25 kHz | • 8.33 kHz | • 9.0 kHz |
| • 10.0 kHz | • 12.5 kHz | • 15.0 kHz | • 20.0 kHz |
| • 25.0 kHz | • 30.0 kHz | • 50.0 kHz | • 100.0 kHz |
| • 125.0 kHz | • 200.0 kHz | | |

◇ Tuning step selection

- ① Push **[V/M]** to select the VFO mode, if necessary.
- ② Push **[BAND]** to select a desired frequency band.
 - Or, while holding down **[BAND]**, rotate **[DIAL]** to select a desired frequency band.
- ③ Push **[TS]** to enter the tuning step selecting mode.
- ④ Rotate **[DIAL]** to select a desired tuning step.
- ⑤ Push **[TS]** to return to the VFO mode.



5 kHz tuning step

■ Selecting a memory channel

- ① Push **[V/M]** to select the memory mode.
 - “**MR**” appears when the memory mode is selected.
- ② Rotate **[DIAL]** to select a desired memory channel.
 - Only programmed memory channels can be selected.
 - While holding down **[FUNC]**, rotate **[DIAL]** to select a memory channel in 10 channel steps.

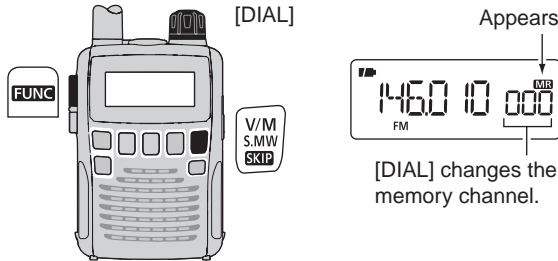

■ Lock function

To prevent accidental frequency changes and unnecessary function access, use the lock function.

- ➔ While holding down **[FUNC]**, push and hold **[LOCK]**(BAND) for 1 second to turn the lock function ON or OFF.
 - “**LOCK**” appears while the lock function is activated.
 - **[SQL]** and **[▲]/[▼]** can be used while the lock function is in use with default setting. Either or both **[SQL]** and **[▲]/[▼]** keys can also be locked in the Set mode. (p. 49)

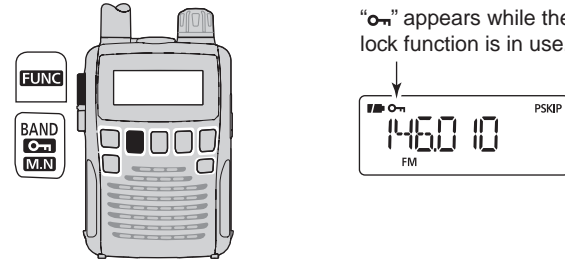

■ Receiving

Make sure charged Ni-MH or brand new alkaline batteries are installed. (p. 7)

- ① Hold down [⏻] for 1 second to turn power ON.
- ② Push [▲] or [▼] to set a desired audio level.
 - The function display shows the volume level while setting. See the section to the right for details.
- ③ Set the receive frequency. (p. 11)
- ④ Set the squelch level. (p. 14)
 - While holding down [SQL], rotate [DIAL].
 - The first click of [DIAL] indicates the current squelch level.
 - "LEVEL 1" is loose squelch and "LEVEL 9" is tight squelch.
 - "AUTO" indicates automatic level adjustment using a noise pulse count system.
 - Hold down [SQL] to open the squelch manually.
- ⑤ When a signal is received:
 - The squelch opens and audio is heard.
 - The S-meter shows the relative signal strength.

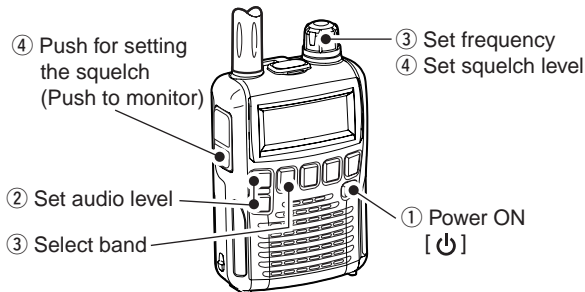

■ Setting audio volume

The audio level can be adjusted through 40 levels.

- ➔ Push [▲] or [▼] to adjust the audio level.
- A beep tone sounds while adjusting. The tone sound lets you know the approximate sound level.
 - Holding down either key will continuously change the audio level.
 - Holding down [▲] or [▼], then rotating [DIAL] will also adjust the audio level.
 - The display shows the volume level while setting.

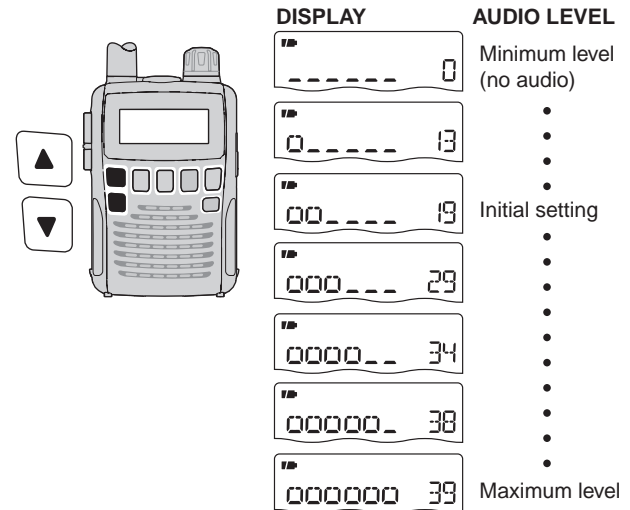

■ Squelch level setting

The squelch circuit mutes the received audio signal, depending on the signal strength. The receiver has 9 squelch levels, a continuously open setting and an automatic setting.

- ➔ While holding down **[SQL]**, rotate **[DIAL]** to select the squelch level.
 - “LEVEL 1” is loose squelch (for weak signals) and “LEVEL 9” is tight squelch (for strong signals).
 - “AUTO” indicates the automatic level adjustment using a noise pulse count system.
 - “OPEN” indicates the continuously open setting.

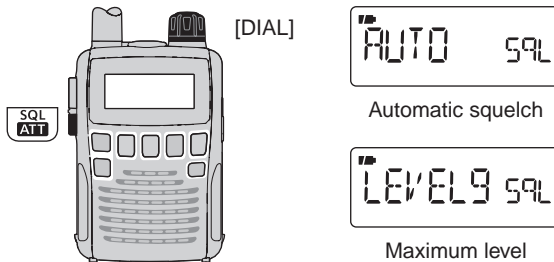

■ Receive mode selection

The receiver has three receive modes, FM, AM and WFM. The mode selection is independently stored in each band and memory channels.

Typically, the AM mode is used for the AM broadcast stations (0.495–1.620 MHz) and air band (118–135.995 MHz), and WFM is used for FM broadcast stations (76–107.9 MHz).

- ➔ Push **[MODE]** repeatedly to select a desired receive mode.

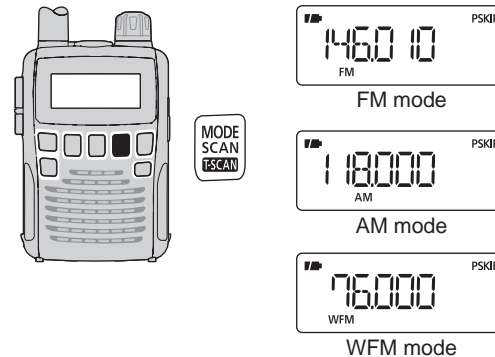

4 BASIC OPERATION

■ Monitor function

This function is used to listen to weak signals, without disturbing the squelch setting. It can also be used to open the squelch manually, even when mute functions such as the tone squelch are in use.

➔ Hold down **[SQL]** to monitor the receive frequency.



The 1st/2nd segments blink

/// The **[SQL]** switch can be set to a 'sticky' operation in the Expand set mode. See page 49 for details.

■ Attenuator function

The attenuator prevents a received signal from distorting when very strong signals are near a desired frequency, or when very strong electric fields, such as from a broadcasting station, are near your location.

➔ While holding down **[FUNC]**, push **[ATT]**(SQL) to turn the attenuator function ON or OFF.



"ATT" appears while the attenuator functions is in use.

/// When the signal is received by the bar antenna, this function is not effective.

■ Duplex operation

Duplex communication uses two different frequencies for transmitting and receiving. Generally, duplex is used in communication through a repeater, some utility communications, etc.

During duplex operation, the transmit station frequency is shifted from the receive frequency by the frequency offset. Repeater information (frequency offset and shift direction) can be programmed into memory channels. (p. 19)

◇ Setting

- ① Set the station's receive frequency (repeater output frequency).
- ② Hold down **[SET]**(TS) for 1 second to enter the Set mode.
- ③ Rotate **[DIAL]** to select the "EXPAND" item.
 - "EXPAND" disappears after 1 second and "OFF" (default) and "EX" appear.

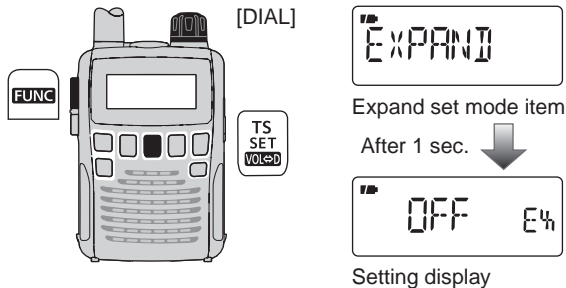

- ④ While holding down **[FUNC]**, rotate **[DIAL]** to select "ON."

USING EXPAND SET MODE

- ⑤ Rotate **[DIAL]** to select the "OFFSET" item.
 - "OFFSET" disappears after 1 second and "0.600" (default) and "OW" appear.
 - (Default offset differs depending on the frequency band or receiver version.)

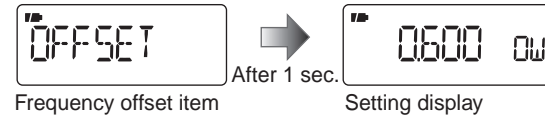

- ⑥ While holding down **[FUNC]**, rotate **[DIAL]** to set a desired frequency offset within 0.000–159.995 MHz range.
 - The tuning step, selected in the VFO mode, is used for setting.
- ⑦ Rotate **[DIAL]** to select the "DUP" item.
 - "DUP" disappears after 1 second and "OFF" (default) and "DP" appear.

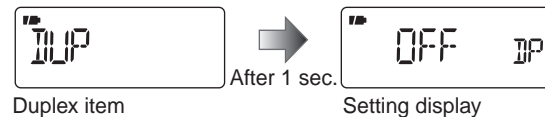

- ⑧ While holding down **[FUNC]**, rotate **[DIAL]** to select "-DUP" or "+DUP."
- ⑨ Push **[SET]**(TS) to exit the Set mode.
- ⑩ Hold down **[SQL]** to directly monitor the station's transmit frequency (repeater input frequency).

4 BASIC OPERATION

■ Dial select step

USING *SET MODE*

This receiver has a MHz tuning step for quick frequency setting. You can select 100 kHz, 1 MHz or 10 MHz steps, as desired.

◇ Setting dial select step

- ① Push **[V/M]** to select the VFO mode.
- ② Hold down **[SET](TS)** for 1 second to enter the Set mode.
- ③ Rotate **[DIAL]** to select the "D SEL" item.
 - "D SEL" disappears after 1 second and "1M" (default) and "DS" appear.
- ④ While holding down **[FUNC]**, rotate **[DIAL]** to select a desired dial select step.
 - 100 kHz, 1 MHz and 10 MHz can be selected.
- ⑤ Push **[SET](TS)** to exit the Set mode.

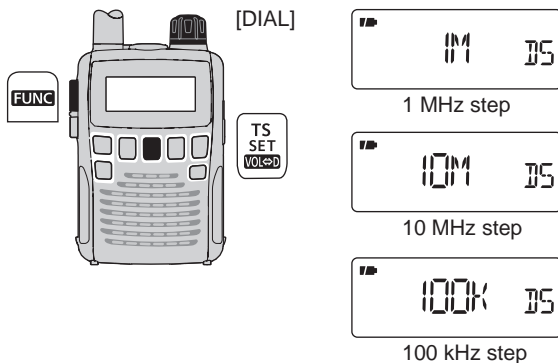

■ General description

The receiver has 1300 memory channels for storage of often-used frequencies. A total of 22 memory banks, A to R, T, U, W and Y can be selected. Up to 100 channels can be assigned to each bank.

◇ Memory channel contents

The following information can be programmed into memory channels:

- Receive frequency (p. 11)
- Receive mode (p. 14)
- Duplex direction (+DUP or -DUP) with a frequency offset (p. 16)
- Tone squelch or DTCS squelch ON/OFF (p. 43)
- Tone squelch frequency or DTCS code with polarity (pp. 41, 42)
- Tuning step (p. 11)
- Attenuator function ON/OFF (p. 15)
- Voice squelch control ON/OFF (p. 52)
- AF filter ON/OFF (p. 55)
- Scan skip setting (p. 35)
- Memory bank (p. 20)
- Memory name (p. 22)

■ Selecting a memory channel

- ① Push **[V/M]** to select the memory mode.
 - Push **[V/M]** to toggle between the VFO mode and the memory channel mode.
- ② Rotate **[DIAL]** to select a desired memory channel.
 - Only programmed channels are displayed.
 - While holding down **[FUNC]**, rotate **[DIAL]** to select the memory channel in 10 channel steps.

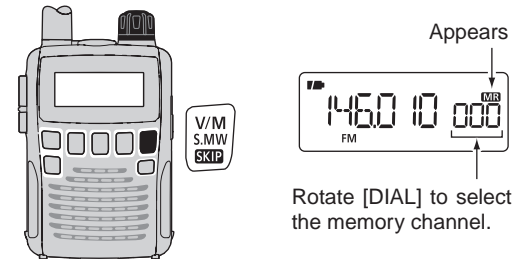

NOTE: Memory data can be erased by static electricity, electric transients, etc. In addition, it can be erased by a malfunction and during repairs. Therefore, we recommend that memory data be written down or saved to a PC using the CS-R6 CLONING SOFTWARE.

5 MEMORY CHANNELS

Memory channel programming

- ① Push **[V/M]** to select the VFO mode.
- ② Set a desired frequency:
 - ➔ Select a desired band with **[BAND]**.
 - ➔ Set a desired frequency with **[DIAL]**.
 - ➔ Set other data (e.g. frequency offset, duplex direction, tone squelch, etc.), if desired.
- ③ Hold down **[S.MW](V/M)** for 1 second to enter the select memory write mode.
 - 1 short and 1 long beep sounds.
 - The **"MR"** icon and memory channel number blink.

- ④ Rotate **[DIAL]** to select a desired channel.
 - Scan edge channels 00A/B to 24A/B can also be selected.
 - While holding down **[FUNC]**, rotate **[DIAL]** to select memory channels in 10 channel steps.
- ⑤ Hold down **[S.MW](V/M)** for 1 second.
 - 3 beeps sound.
 - The memory channel number automatically increases if you continue to hold down **[S.MW](V/M)** after programming.

NOTE: Push **[V/M]** to cancel programming and exit the select memory write mode, before memory programming is finished.

[EXAMPLE]: Programming 145.870 MHz into memory channel 20 (a blank channel).

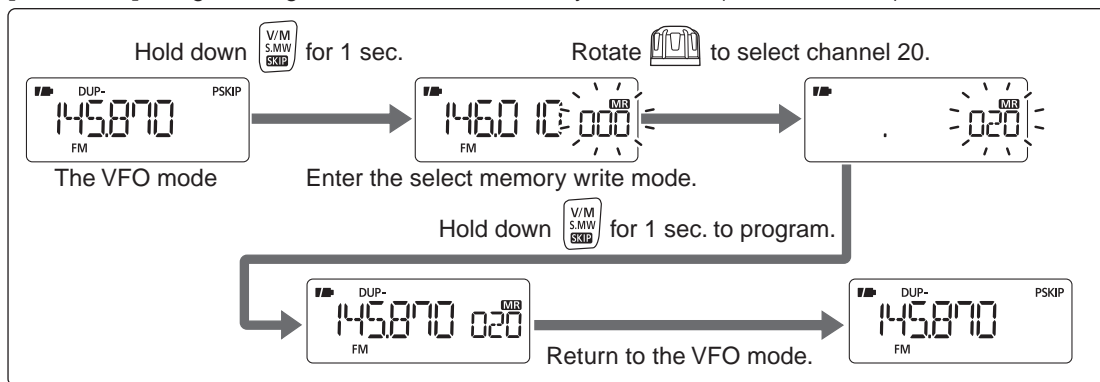

Memory bank setting

The IC-R6 has a total of 22 banks (A to R, T, U, W and Y). Regular memory channels 000 to 1299 can be assigned to any desired bank, for easy memory management.

- ① Hold down **[S.MW]**(V/M) for 1 second to enter the select memory write mode.
 - 1 short and 1 long beep sounds.
 - The “**MR**” icon and memory channel number blink.
- ② Rotate **[DIAL]** to select a desired memory channel.
- ③ While holding down **[MODE]**, rotate **[DIAL]** to select the “**BANK**” item.
 - The bank group and channel number are displayed if the selected memory channel has already been assigned to a bank.
 - The “**BANK**” item can also be selected by pushing **[MODE]** repeatedly.

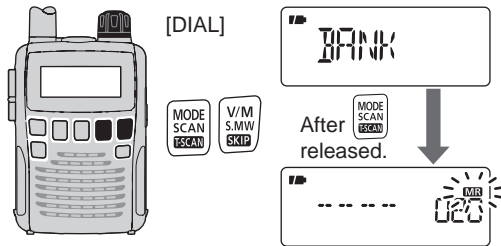

- After releasing **[MODE]**, “-- -- -- --” is displayed instead of the frequency display, and only the “**MR**” icon blinks.

- ④ While holding down **[BAND]**, rotate **[DIAL]** to select a desired bank group.
 - Bank groups A to R, T, U, W and Y are selectable.
 - The bank groups can also be selected by repeatedly pushing **[BAND]**.

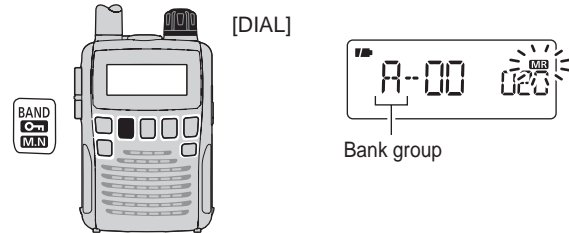

- ⑤ Rotate **[DIAL]** to select a desired bank channel number.
 - Only vacant bank channel numbers are displayed.

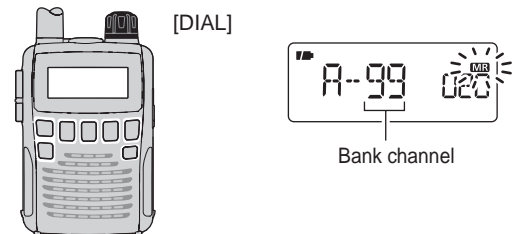

- ⑥ Hold down **[S.MW]**(V/M) for 1 second to assign the channel to the bank.
 - Return to the previous screen before entering the select memory write mode.

5 MEMORY CHANNELS

■ Memory bank selection

- ① Push **[V/M]** to select the memory mode.
- ② While holding down **[BAND]**, rotate **[DIAL]** to select a desired bank.
 - The bank can also be selected by pushing **[BAND]** repeatedly.
 - Only banks with entries are displayed.

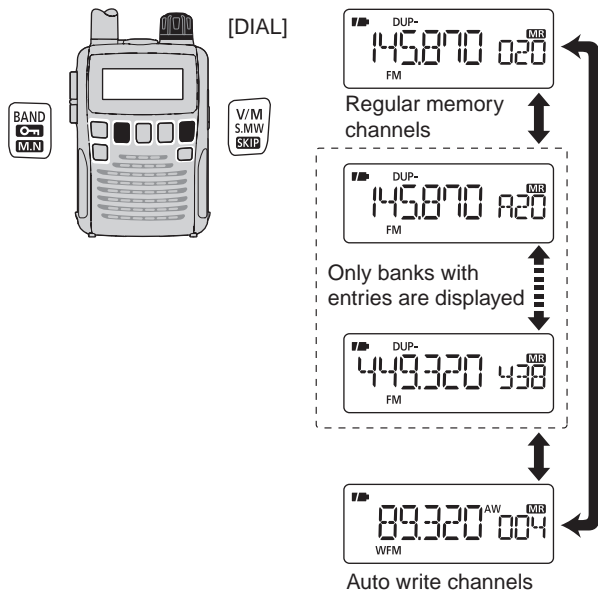

- ③ Rotate **[DIAL]** to select the bank channel.
 - Only programmed channels are displayed.

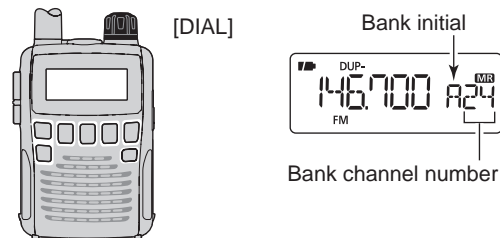

- ④ To return to a regular memory channel, while holding down **[BAND]** then rotate **[DIAL]**, or repeatedly push **[BAND]**.

■ Programming memory/bank name

Each memory channel can be programmed with an alphanumeric channel name for easy recognition, and can be displayed independently by channel. Names can be a maximum of 6 characters.

- ① Push **[V/M]** to select the memory mode.
- ② Rotate **[DIAL]** to select a desired memory channel.
- ③ Hold down **[S.MW]**(V/M) for 1 second to enter the select memory write mode.
 - 1 short and 1 long beep sounds.
 - The “**MR**” icon and memory channel number blink.



- ④ While holding down **[MODE]**, rotate **[DIAL]** to select the “M NAME” or “B NAME” item when programming the memory name or the bank name, respectively.
 - The item can also be selected by pushing **[MODE]** repeatedly.

Memory name selection



Bank name selection



- After releasing **[MODE]**, a line blinks under the first digit, and the “**MR**” icon blinks.

- ⑤ While holding down **[FUNC]**, rotate **[DIAL]** to select a desired character.
 - The selected character blinks.
- ⑥ Rotate **[DIAL]** to move the cursor to the right or to the left.

Memory name

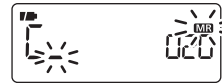

Bank name

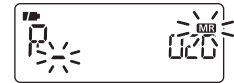

- ⑦ Repeat steps ⑤ and ⑥ until a desired 6-character channel name is displayed.
- ⑧ Hold down **[S.MW]**(V/M) for 1 second to program the name and exit the programming mode.
 - 3 beeps sound.

• Available characters

A to Z, 0 to 9, (,) , * , + , - , , / , = and space.

NOTE: Only one bank name can be programmed into each bank. Therefore, the previously programmed bank name will be displayed when bank name is selected. Also, the programmed bank name is automatically assigned to another bank channel.

5 MEMORY CHANNELS

■ Selecting display type

During memory mode operation, either the programmed bank name, memory name or the channel number can be displayed, instead of the frequency display.

- ① Push **[V/M]** to select the memory mode.
 - If desired, push **[BAND]** repeatedly to select a desired bank group.
- ② While holding down **[FUNC]**, push **[M.N.](BAND)** repeatedly to select the display type from frequency, bank name, memory name or the channel number.

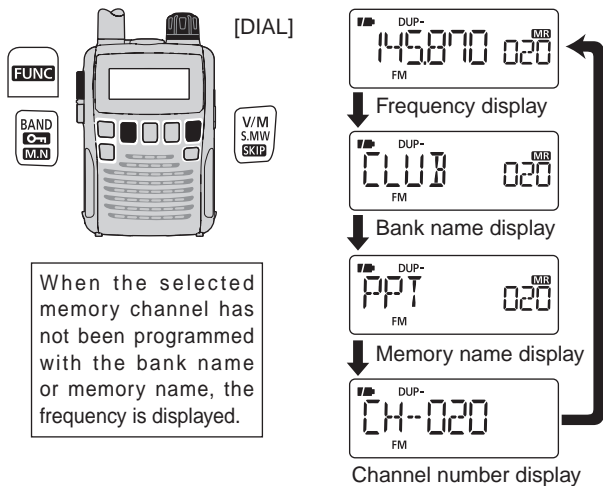

◇ Selecting bank channel display

During bank channel operation, the bank channel number can also be displayed, instead of the memory channel number.

- ① Select the channel number display as described to the left.
- ② While holding down **[BAND]**, rotate **[DIAL]** to select a desired bank.
 - The bank can also be selected by pushing **[BAND]** repeatedly.

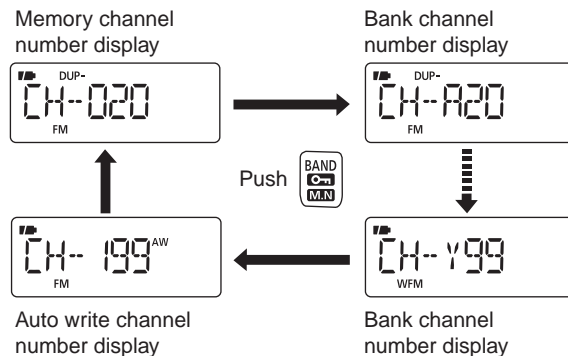

■ Copying memory contents

This function copies a memory channel's contents to the VFO (or another memory channel). This is useful when searching for signals around a memory channel frequency and for recalling the frequency offset, subaudible tone frequency etc.

◇ Memory → VFO

- ① Select the memory channel to be copied.
 - ➔ Push **[V/M]** to select the memory mode, then rotate **[DIAL]** to select a desired channel.
 - If desired, push **[BAND]** repeatedly to select a desired bank group, then rotate **[DIAL]** to select a desired bank channel.
- ② Hold down **[S.MW]**(V/M) for 1 second to enter the select memory write mode.
 - 1 short and 1 long beep sounds.
 - The "**MR**" icon and memory channel number blink.
- ③ Rotate **[DIAL]** to select "VF."
- ④ Hold down **[S.MW]**(V/M) for 1 second to write the selected channel contents into the VFO.
 - The VFO mode is automatically selected.

▨ Holding down **[S.MW]**(V/M) for 2 seconds in step ② will also copy the memory contents to the VFO. In that case, steps ③ and ④ are not necessary.

◇ Memory → memory

- ① Select the memory channel to be copied.
 - ➔ Push **[V/M]** to select the memory mode, then rotate **[DIAL]** to select a desired channel.
- ② Hold down **[S.MW]**(V/M) for 1 second to enter the select memory write mode.
 - 1 short and 1 long beep sounds.
 - The "**MR**" icon and memory channel number blink.
 - Do not hold down **[S.MW]**(V/M) for more than 2 seconds. Otherwise the memory contents will be copied to the VFO.
- ③ Rotate **[DIAL]** to select the target memory channel.
- ④ Hold down **[S.MW]**(V/M) for 1 second again to copy.

[EXAMPLE]: Copying channel 20 to 51.

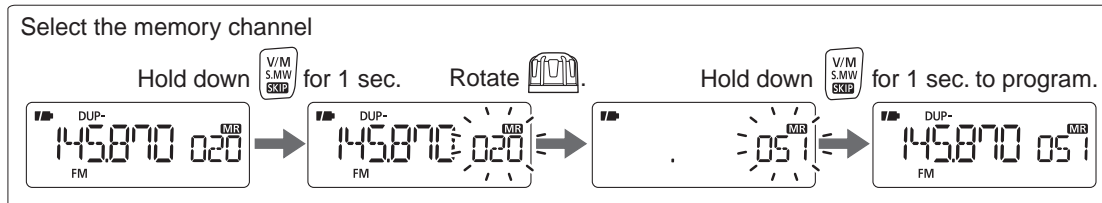

5 MEMORY CHANNELS

■ Memory clearing

Contents of programmed memories can be cleared (erased), if desired.

- ① Hold down **[S.MW]**(V/M) for 1 second to enter the select memory write mode.
 - 1 short and 1 long beep sounds.
 - The “**MR**” icon and memory channel number blink.
 - Do not hold down **[S.MW]**(V/M) for more than 2 seconds. Otherwise the memory contents will be copied to the VFO.
- ② Rotate **[DIAL]** to select a desired memory channel to be cleared.
- ③ While holding down **[MODE]**, rotate **[DIAL]** to select the “CLEAR” item.
 - The “CLEAR” item can also be selected by pushing **[MODE]** repeatedly.

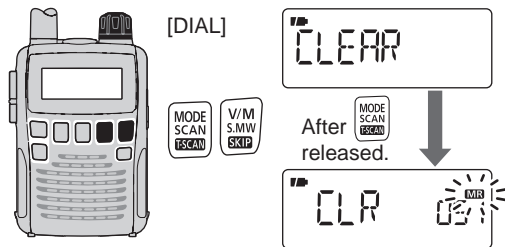

- After releasing **[MODE]**, “CLR” is displayed and the “**MR**” icon blinks.

- ④ Hold down **[S.MW]**(V/M) for 1 second to clear the contents.
 - 3 beeps sound.
 - The cleared channel changes to a blank channel.
 - Return to the select memory write mode. The “**MR**” icon and memory channel number blink.

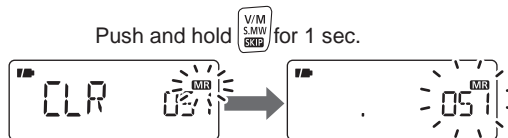

- ⑤ Push **[V/M]** to return to the screen displayed before you entered the select memory write mode in step ①.

/// CONVENIENT!:

Instead of doing steps ③ and ④, while holding down **[FUNC]**, pushing and holding **[S.MW]**(V/M) for 1 second also clears the contents.

/// **BE CAREFUL!** The contents of cleared memories CANNOT be recalled, even in the bank channel mode.

■ Transferring memory contents

The contents of programmed memory channels can be transferred to other memory channels.

- ① Hold down **[S.MW]**(V/M) for 1 second to enter the select memory write mode.
 - 1 short and 1 long beep sounds.
 - The “**MR**” icon and memory channel number blink.
 - Do not hold down **[S.MW]**(V/M) for more than 2 seconds. Otherwise the memory contents will be copied to the VFO.
- ② Rotate **[DIAL]** to select a desired memory channel to be transferred.
- ③ While holding down **[MODE]**, rotate **[DIAL]** to select the “CLEAR” item, then release **[MODE]**.
 - Pushing **[MODE]** repeatedly also selects the “CLEAR” item.
- ④ Hold down **[S.MW]**(V/M) for 1 second.
 - The displayed contents are cleared.

/// CONVENIENT!:

Instead of doing steps ③ and ④, while holding down **[FUNC]**, pushing and holding **[S.MW]**(V/M) for 1 second also clears the contents.

- ⑤ Rotate **[DIAL]** to select a desired target memory channel.
- ⑥ Hold down **[S.MW]**(V/M) for 1 second to transfer the contents.

• **Example**

Transferring the contents of memory channel 51 to channel 33.

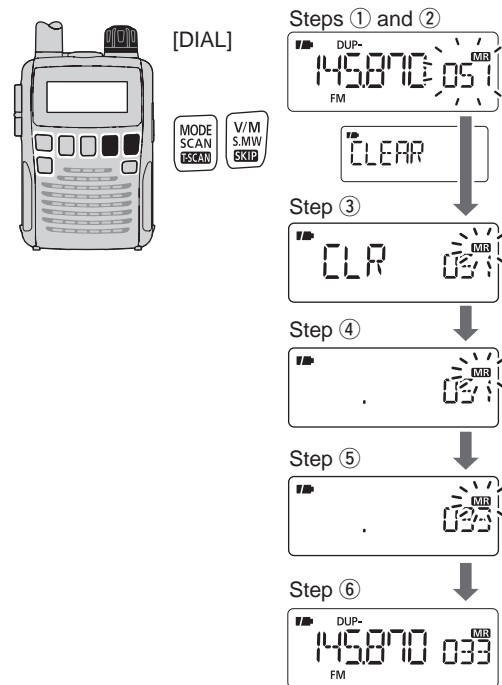

Erasing/transferring bank contents

The contents of programmed memory channels can be erased or transferred to other memory channels.

INFORMATION: Even if the memory bank contents are erased, the memory channel contents still remain programmed.

- ① Select a desired bank contents to be transferred or erased from the bank.
 - ➔ Push **[V/M]** to select the memory mode.
 - ➔ While holding down **[BAND]**, rotate **[DIAL]** to select a desired memory bank group.
 - ➔ Rotate **[DIAL]** to select the bank channel.
- ② Hold down **[S.MW]**(V/M) for 1 second to enter the select memory write mode.
 - 1 short and 1 long beep sounds.
 - Do not hold down **[S.MW]**(V/M) for more than 2 seconds. Otherwise the bank contents will be copied to the VFO.

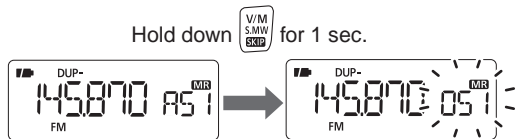

• The original memory channel number is automatically displayed, then the “**MR**” icon and the memory channel number blink.

- ③ While holding down **[MODE]**, rotate **[DIAL]** to select the “**BANK**” item.
 - Pushing **[MODE]** repeatedly also selects the “**BANK**” item.
- ④ While holding down **[BAND]**, rotate **[DIAL]** to select a desired bank group to transfer. Or, select the “**-- -- -- --**” display when erasing the contents from the bank.
 - If “**-- -- -- --**” is selected in this step, skip step ⑤, and go to step ⑥.



[DIAL]

To transfer the bank contents in bank E.



To erase

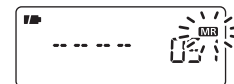

- ⑤ Rotate **[DIAL]** to select a desired bank channel.
- ⑥ Hold down **[S.MW]**(V/M) for 1 second to erase or transfer the bank contents.

■ Scan types

Scanning automatically searches for signals and makes it easier to locate new stations.

FULL SCAN (p. 29)

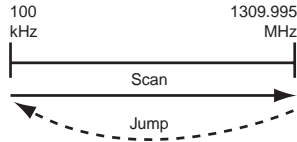

Repeatedly scans all frequencies over the entire band.

Some frequency ranges are not scanned, depending on the frequency coverage of the receiver version.

SELECTED BAND SCAN (p. 29)

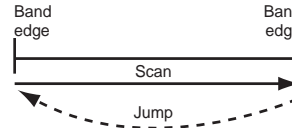

Repeatedly scans all frequencies over the entire selected band.

PROGRAMMED SCAN (p. 29)

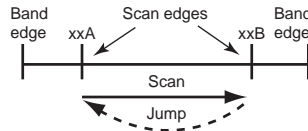

Repeatedly scans between two user-programmed frequencies. Used to check for frequencies within a specified range, such as repeater output frequencies, etc.

MEMORY (SKIP) SCAN (p. 33)

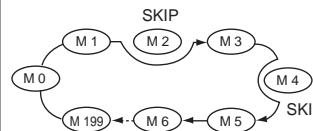

Repeatedly scans memory channels, except those set as skip channels. Skip channels can be turned ON or OFF by pushing **[FUNC] + [SKIP]**(V/M) in the memory mode.

ALL/SELECTED BANK SCAN (p. 33)

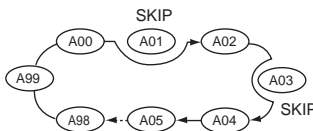

Repeatedly scans all bank channels or selected bank channels. The skip scan is also selectable.

FREQUENCY/MEMORY SKIP FUNCTION (p. 35)

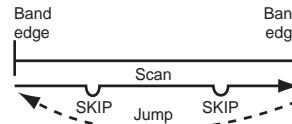



Skips unwanted frequencies or channels that inconveniently stop scanning. This function can be turned ON or OFF by pushing **[FUNC] + [SKIP]**(V/M) in either the VFO or the memory mode.

6 SCAN OPERATION

Full/band/programmed link/programmed scan

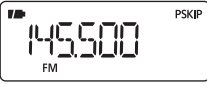

- ① Push **[V/M]** to select the VFO mode.
 - Push **[BAND]** to select a desired frequency band.
- ② Set the squelch level.
- ③ Hold down **[SCAN](MODE)** for 1 second to enter the scan type selection mode.
- ④ Rotate **[DIAL]** to select a desired scanning type.
 - Select "ALL" for full scan, "BAND" for band scan, "P-LINK x" for programmed link scan (x= 0 to 9), "PROGxx" for programmed scan (xx= 0 to 24; only programmed scan edge numbers are displayed).



[DIAL]  Hold down  for 1 sec.

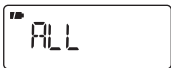

Rotate 

• Full scan • Program link scan

Selectable between "0" to "9" if programmed (p. 53)

• Band scan • Program scan

Selectable between "0" to "24" if programmed (p. 30)

- ⑤ To start the scan, push **[SCAN](MODE)**.
 - The scan pauses when a signal is received.
 - Rotate **[DIAL]** to change the scanning direction. This also resumes scanning.
 - Push **[SCAN](MODE)** again to stop the scan.

During full/band scan

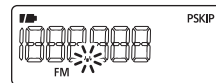

During programmed/ link program scan

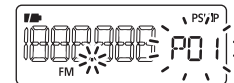

NOTE: Instead of doing steps ③ to ⑤, while holding down **[SCAN](MODE)**, rotate **[DIAL]** to select a desired scan type. In this case, the scan starts after releasing **[SCAN](MODE)**.

✓ CONVENIENT!

The memorised skip frequencies can be skipped or scanned during a VFO scan.

- ➔ In the VFO mode, hold down **[FUNC]**, then push **[SKIP](V/M)** to set the skip scan setting ON or OFF. (default: ON)

The scan link name or scan name can be displayed instead of "P-LINK x" for program link scan (x= 0 to 9), "PROGxx" for programmed scan (xx= 0 to 24) when scan link name or scan name is programmed.

Scan link name or scan name is not displayed during scan.

■ Scan edges programming

Scan edges can be programmed in the same manner as memory channels. Scan edges are programmed into scan edge memory channels, 00A/00B to 24A/24B.

- ① Push **[V/M]** to select the VFO mode.
- ② Set a desired frequency:
 - ➔ Push **[BAND]** to select a desired band.
 - ➔ Rotate **[DIAL]** to set a desired frequency.
 - ➔ Set other data (e.g. frequency offset, duplex direction, tone squelch, etc.), if desired.
- ③ Hold down **[S.MW]**(V/M) for 1 second to enter the select memory write mode.
 - 1 short and 1 long beep sounds.
 - The "**MR**" icon and memory channel number blink.

- ④ Rotate **[DIAL]** to select a desired programmed scan edge channel from 00A to 24A.
- ⑤ Hold down **[S.MW]**(V/M) for 1 second.
 - 3 beeps sound
 - The matched "B" channel is automatically selected if you continue to hold down **[S.MW]**(V/M) after programming.
- ⑥ To program a frequency for the other pair of scan edges, 00B or 24B, repeat steps ② and ⑤.
 - If the same frequency is programmed into a pair of scan edges, the programmed scan will not function.

[EXAMPLE]: Programming 145.370 MHz into scan edge channel 03A (a blank channel).

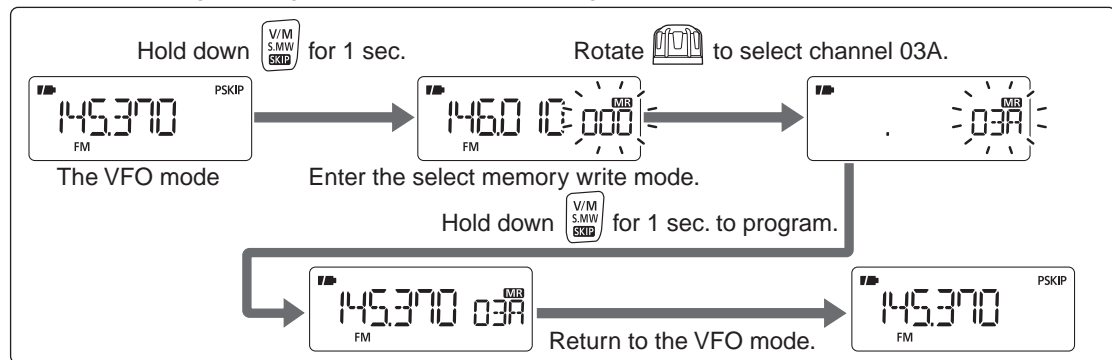

■ Programming scan name

Each pair of scan edge channels can be programmed with an alphanumeric scan name for easy recognition, and can be displayed during scan selection. Names can be a maximum of 6 characters.

- ① Push **[V/M]** to select the memory mode.
- ② Rotate **[DIAL]** to select a desired scan edge channel.
- ③ Hold down **[S.MW](V/M)** for 1 second to enter the select memory write mode.
 - 1 short and 1 long beep sounds.
 - The “**MR**” icon and memory channel number blink.



- ④ While holding down **[MODE]**, rotate **[DIAL]** to select the “S NAME” item.
 - The item can also be selected by repeatedly pushing **[MODE]**.

Scan name selection



- After releasing **[MODE]**, a line blinks under the first digit, and the “**MR**” icon blinks.

- ⑤ While holding down **[FUNC]**, rotate **[DIAL]** to select a desired character.
 - The selected character blinks.
- ⑥ Rotate **[DIAL]** to move the cursor to the left or to the right.



- ⑦ Repeat steps ⑤ and ⑥ until a desired 6-character scan name is displayed.
- ⑧ Hold down **[S.MW](V/M)** for 1 second to program the name and exit the programming mode.
 - 3 beeps sound.

• Available characters

A to Z, 0 to 9, (,) , * , + , - , , , / , | , = and space.

NOTE: Only one scan name can be programmed into each pair. Therefore, the programmed scan name is automatically assigned to another edge channel.

■ Programming other contents

The programmed scan can store the scanning step, receive mode and attenuator settings.

- ① Push **[V/M]** to select the memory mode.
- ② Rotate **[DIAL]** to select a desired scan edge channel.
- ③ Hold down **[S.MW]**(V/M) for 1 second to enter the select memory write mode.
 - 1 short and 1 long beep sounds.
 - The “**MR**” icon and memory channel number blink.



- ④ While holding down **[MODE]**, rotate **[DIAL]** to select the “TS,” “MODE” or “ATT” item when programming the tuning step, the receive mode or the attenuator setting.
 - The item can also be selected by repeatedly pushing **[MODE]**.

Scan step selection



Receive mode selection



Attenuator setting



- ⑤ Rotate **[DIAL]** to select a desired option.
Or, select the “-- -- --” display when erasing the contents from the option.
 - If “-- -- --” is selected in this step, the program scan uses the VFO settings.
- ⑥ Hold down **[S.MW]**(V/M) for 1 second to program the name and exit the programming mode.
 - 3 beeps sound.

During the full/band scan:

The selected tuning step, received mode and attenuator settings in each frequency band are used.

During the programmed/programmed link scan:

The programmed tuning step, received mode and attenuator settings in each programmed scan edge are used.

6 SCAN OPERATION

Memory/all bank/bank link/bank scan

- ① Push **[V/M]** to select the memory mode.
- ② Set the squelch level.
- ③ Hold down **[SCAN](MODE)** for 1 second to enter the scan type selection mode.
- ④ Rotate **[DIAL]** to select a desired scanning type.
 - Select "M-ALL" for all memory scan, "B-ALL" for all bank scan, "B-LINK" for bank link scan or "BANK-x" for bank scan (x= A to R, T, U, W, Y; only programmed bank groups are displayed).

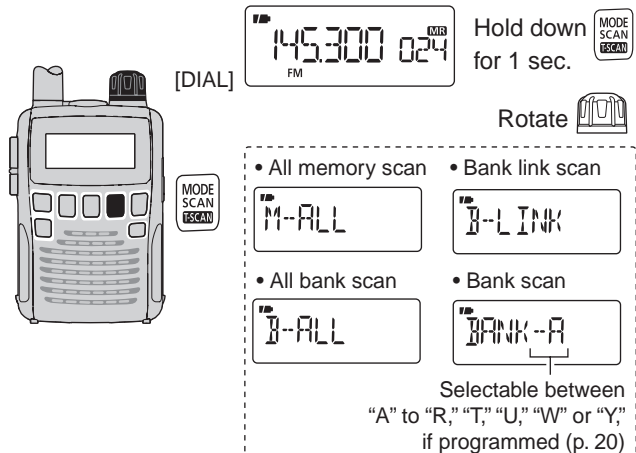

See page 53 for details of the bank link programming.

- ⑤ To start the scan, push **[SCAN](MODE)**.
 - The scan pauses when a signal is received.
 - Rotate **[DIAL]** to change the scanning direction. This also resumes scanning.
 - Push **[SCAN](MODE)** again to stop the scan.

During memory/ all bank/bank link scan

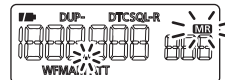

During bank scan

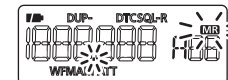

IMPORTANT: To perform a memory or bank scan, two or more memory/bank channels **MUST** be programmed, otherwise the scan will not start.

■ Auto memory write scan

This scan is useful for searching a specified frequency range, and automatically storing busy frequencies into memory channels. The same frequency ranges used for a program scan are also used for an auto memory write scan.

- ① Start a VFO scan.
 - ➔ Push **[V/M]** to select the VFO mode.
 - ➔ Set the squelch level.
 - ➔ Hold down **[SCAN](MODE)** for 1 second to enter the scan type selection mode.
 - ➔ Rotate **[DIAL]** to select a desired scanning type.
 - Select “ALL” for full scan, “BAND” for band scan, “P-LINK x” for programmed link scan (x= 0 to 9), “PROGxx” for programmed scan (xx= 0 to 24; only programmed scan edge numbers are displayed).
 - ➔ Push **[SCAN](MODE)** to start the scan.
- ② Push **[V/M]** to turn the auto memory write function ON or OFF.
 - The “**MR**” icon blinks.
 - Push **[SCAN](MODE)** to stop the scan.

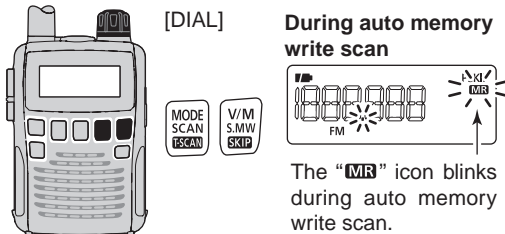

◇ During auto memory write scanning:

- When a signal is received, the scan pauses for approximately 5 seconds and the frequency is stored into an auto memory write channel group (^{AW}000—^{AW}199).
 - 2 short beeps sound when stored.
- The scan resumes after frequency storing.
- When all channels are stored, the scan automatically stops and 1 long beep sounds.

◇ Re-calling the stored frequencies:

- ① Push **[V/M]** to select the memory mode.
- ② Push **[BAND]** repeatedly, or while holding down **[BAND]**, rotate **[DIAL]**, to select the auto memory write channel group.
 - “**AW**” appears.
- ③ Rotate **[DIAL]** to select a desired channel.

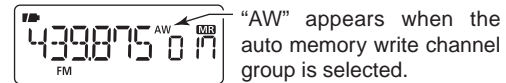

◇ Clearing the stored frequencies:

- ① Select the auto memory write channel group.
- ② While holding down **[FUNC]**, push and hold **[S.MW](V/M)** for 1 second to clear all the channels’ contents.
 - 1 short and 1 long beep sounds.

NOTE: The auto memory write channel contents CANNOT be cleared by an independent channel. Thus it is a good idea to copy the contents into a regular memory channel.

6 SCAN OPERATION

■ Skip channel/frequency setting

Memory channels can be set to be skipped for a memory skip scan. In addition, memory channels can be set to be skipped for both a memory skip scan and a frequency skip scan. These are useful to speed up the scan time.

- ① Select a memory channel:
 - ➔ Push **[V/M]** to select the memory mode.
 - ➔ Rotate **[DIAL]** to select a desired channel to be a skip channel/frequency.
- ② Hold down **[S.MW]**(V/M) for 1 second to enter the select memory write mode.
- ③ Push **[MODE]** repeatedly to select the "SKIP" item.
 - While holding down **[MODE]**, rotating **[DIAL]** can also select the "SKIP" item.

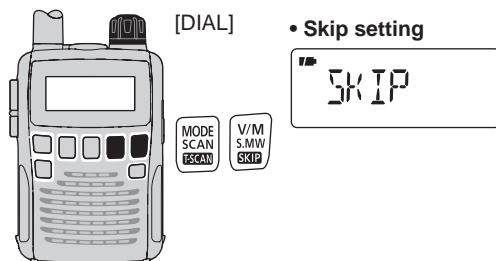

- ④ While holding down **[FUNC]**, rotate **[DIAL]** to select the skip option from "SKIP," "PSKIP" or "OFF," for the selected channel.
 - **SKIP** : The channel is skipped during a memory or bank scan.
 - **PSKIP** : The channel is skipped during a memory/bank scan. The programmed frequency is skipped during a VFO scan, such as a programmed scan.
 - **OFF** : The channel or programmed frequency is scanned during any scan.
- ⑤ Hold down **[S.MW]**(V/M) for 1 second to store the skip status.
 - The "SKIP" or "PSKIP" icon appears, according to the skip selection in step ④.

• Skip channel setting



"SKIP" appears

• Program skip setting

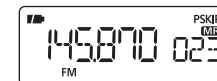

"PSKIP" appears

✓ CONVENIENT!

The skip setting can also be set using the following steps, for easy setting.

- ① Select a desired memory channel to be set as a skip channel/frequency.
- ② While holding down **[FUNC]**, push **[SKIP]**(V/M) to select the skip status from "SKIP," "PSKIP" or "OFF (no indication)."

◇ Storing the skip frequencies during a VFO scan

During a VFO scan, the skip frequencies can be stored into the highest blank memory channel which is automatically selected with the following operation.

- ① Start a VFO scan.
 - Push **[V/M]** to select the VFO mode.
 - Set the squelch level.
 - Hold down **[SCAN](MODE)** for 1 second to enter the scan type selection mode.
 - Rotate **[DIAL]** to select a desired scanning type.
 - Select "ALL" for full scan, "BAND" for band scan, "P-LINK x" for programmed link scan (x= 0 to 9), "PROGxx" for programmed scan (xx= 0 to 24; only programmed scan edge numbers are displayed).
 - Push **[SCAN](MODE)** to start the scan.
- ② When the scan pauses and you want to set the paused frequency as a skip frequency.
 - Hold down **[FUNC]**, then push and hold **[S.MW](V/M)** for 1 second to store the paused frequency into the highest blank memory channel.
 - While holding down **[FUNC]**, the scan pauses; and after writing the frequency, the scan resumes.

6 SCAN OPERATION

■ Scan resume setting

◇ Scan pause timer

The scan pauses when receiving signals, according to the scan pause time. It can be set from 2–20 seconds, or unlimited.

- ① Hold down **[SET]**(TS) for 1 second to enter the Set mode.
- ② Rotate **[DIAL]** to select the “EXPAND” item.
- ③ While holding down **[FUNC]**, rotate **[DIAL]** to turn the Expand set mode selection ON.
- ④ Rotate **[DIAL]** to select the “PAUSE” item.
- ⑤ While holding down **[FUNC]**, rotate **[DIAL]** to set a desired scan pausing time from 2–20 seconds (2 seconds steps) or “HOLD.”
 - “2SEC”–“20SEC”: The scan pauses 2–20 seconds while receiving a signal.
 - “HOLD” : The scan pauses on a received signal until it disappears.
- ⑥ Push **[SET]**(TS) to exit the Set mode.

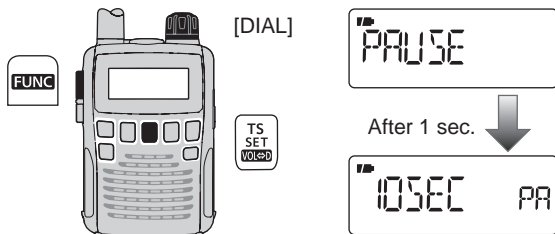

USING EXPAND SET MODE

◇ Scan resume timer

The scan resumes after a signal disappears, according to the resume time. It can be set from 0–5 seconds, or unlimited.

- ① Hold down **[SET]**(TS) for 1 second to enter the Set mode.
- ② Rotate **[DIAL]** to select the “EXPAND” item.
- ③ While holding down **[FUNC]**, rotate **[DIAL]** to turn the Expand set mode selection ON.
- ④ Rotate **[DIAL]** to select the “RESUME” item.
- ⑤ While holding down **[FUNC]**, rotate **[DIAL]** to set a desired scan pausing time from 0–5 seconds (1 second steps) or “HOLD.”
 - “0SEC” : The scan resumes immediately after the signal disappears.
 - “1SEC”–“5SEC” : The scan resumes 1–5 seconds after the signal disappears.
 - “HOLD” : The scan resumes only by rotating **[DIAL]**.
- ⑥ Push **[SET]**(TS) to exit the Set mode.



/// The scan resume timer must be set shorter than the scan pause timer, otherwise this timer will not be activated.

■ Priority watch types

Priority watch checks for signals on a frequency every 5 seconds, while operating on a VFO frequency or scanning. The receiver has four priority watch types to suit your needs.

The watch resumes according to the selected scan resume setting. See page 37 for details.

NOTE:

If the pocket beep function is activated, the receiver automatically selects the tone squelch or DTCS squelch function, when priority watch starts.

◇ About the priority beep function

When receiving a signal on the priority frequency, you can be alerted with beeps and a blinking “(•)”. This function is activated when setting the priority watch function ON.

MEMORY CHANNEL WATCH

While operating on a VFO frequency, priority watch checks for a signal on the selected memory channel every 5 seconds.

- A memory channel with skip information can be watched.

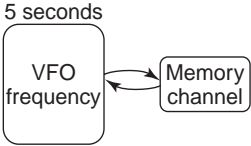

MEMORY SCAN WATCH

While operating on a VFO frequency, priority watch sequentially checks for signals on each memory channel.

- The memory skip function and/or memory bank scan is useful to speed up the scan.

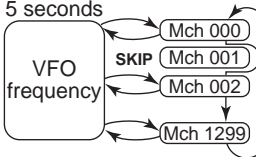

VFO SCAN WATCH

While scanning in the VFO mode, priority watch checks for signals on the selected memory channel every 5 seconds.

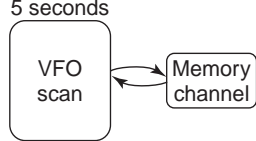

VFO/MEMORY SCAN WATCH

While scanning in the VFO mode, priority watch sequentially checks for signals on each memory channel every 5 seconds.

- The memory skip function and/or memory bank scan is useful to speed up the scan.

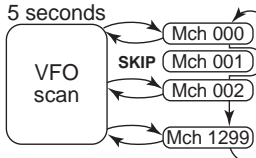

Priority watch operation

Memory channel/memory scan watch

① Select the VFO mode; then, set an operating frequency.

② Select the channel(s) to be watched.

For a memory channel watch:

Select a desired memory channel.

For a memory scan watch:

➔ Push **[V/M]** to select the memory mode.

➔ Hold down **[SCAN](MODE)** for 1 second to enter the scan type selection mode.

➔ Rotate **[DIAL]** to select a desired scan type, then push **[SCAN](MODE)** again to start the memory/bank scan.

③ Hold down **[SET](TS)** for 1 second to enter the Set mode.

④ Rotate **[DIAL]** to select the priority watch set item.

⑤ While holding down **[FUNC]**, rotate **[DIAL]** to select "ON."

• Select "BELL" if the priority beep function is desired.

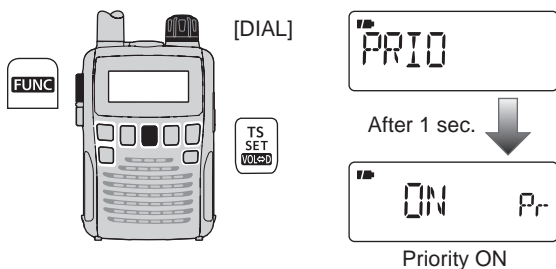

⑥ Push **[SET](TS)** to exit the Set mode and start the watch.

- The "PRIO" icon appears.
- The receiver checks the memory/bank channel(s) every 5 seconds.
- The watch resumes according to the selected scan resume setting. (p. 37)

During priority watch



Monitors the VFO frequency for 5 seconds.



Pauses on a memory channel when a signal is received.

During priority watch with the priority beep



A beep tone sounds and the "((•))" icon blinks when a signal is received on a memory channel.



⑦ Push **[SET](TS)** to cancel the watch.

◇ VFO scan watch

① Select the channel(s) to be watched.

For a memory channel watch:

Select a desired memory channel.

For a memory scan watch:

- ➔ Push [V/M] to select the memory mode.
- ➔ Hold down [SCAN](MODE) for 1 second to enter the scan type selection mode.
- ➔ Rotate [DIAL] to select a desired scan type, then push [SCAN](MODE) again to start the memory/bank scan.

- ② Hold down [SET](TS) for 1 second to enter the Set mode.
- ③ Rotate [DIAL] to select the priority watch set item.
- ④ While holding down [FUNC], rotate [DIAL] to select “ON.”
 - Select “BELL” if the priority beep function is desired.



- ⑤ Push [SET](TS) to exit the Set mode and start the watch.
 - The “PRIO” icon appears.
- ⑥ Hold down [SCAN](MODE) for 1 second to enter the scan type selection mode.
- ⑦ Rotate [DIAL] to select a desired scan type from “ALL,” “BAND,” “P-LINK x (x= 0 to 9)” or “PROGxx (xx= 0–24).”

- ⑧ Push [SCAN](MODE) to start the VFO scan watch.
 - The receiver checks the memory channel(s) every 5 seconds.
 - The watch resumes according to the selected scan resume setting. (p. 37)

During a VFO scan watch

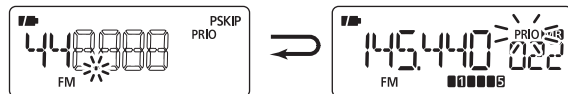

Searches the VFO frequencies for 5 seconds.

Pauses on a memory channel when a signal is received.

During a VFO scan watch with the priority beep

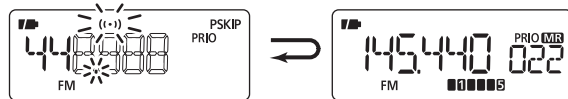

A beep tone sounds and the “(•)” icon blinks when a signal is received on a memory channel.

- ⑨ Push [SET](TS) to cancel the watch and scan.

■ Tone squelch frequency/DTCS code setting

◇ Tone and DTCS squelches

The tone squelch (CTCSS) or DTCS squelch opens only when receiving a signal containing a matching subaudible tone or DTCS code, respectively. You can silently wait for a specified signal using the same tone or code.

◇ Reverse tone/DTCS squelch

The reverse tone/DTCS squelch is convenient if you want to ignore a specific signal. The receiver mutes the squelch when a signal with the matched tone or code is received. "T SQL-R" / "DTCS -R" is displayed when the reverse tone squelch/reverse DTCS squelch is set.

◇ Pocket beep

These functions use subaudible tones or DTCS codes for calling and can be used as a "common pager" to inform you that someone has called while you were away from the receiver.

◇ Setting subaudible tones for tone squelch

88.5 Hz and 023 are set as the defaults for the tone squelch frequency and the DTCS code, respectively. Other frequencies and codes can be selected as desired.

- ① Hold down **[SET]**(TS) for 1 second to enter the Set mode.
- ② Rotate **[DIAL]** to select the "EXPAND" item.
- ③ While holding down **[FUNC]**, rotate **[DIAL]** to turn the Expand set mode ON.
- ④ Rotate **[DIAL]** to select the "TONE" item when selecting the tone squelch frequency; select the "CODE" item when selecting the DTCS code.

Tone squelch frequency selection



DTCS code selection



- ⑤ While holding down **[FUNC]**, rotate **[DIAL]** to select a desired subaudible tone frequency or DTCS code.
 - See the next page for details of available tone frequencies or DTCS codes.
- ⑥ Push **[SET]**(TS) to exit the Set mode.

• Available tone frequencies (unit: Hz)

67.0	79.7	94.8	110.9	131.8	156.7	171.3	186.2	203.5	229.1
69.3	82.5	97.4	114.8	136.5	159.8	173.8	189.9	206.5	233.6
71.9	85.4	100.0	118.8	141.3	162.2	177.3	192.8	210.7	241.8
74.4	88.5	103.5	123.0	146.2	165.5	179.9	196.6	218.1	250.3
77.0	91.5	107.2	127.3	151.4	167.9	183.5	199.5	225.7	254.1

NOTE: The receiver has 50 tone frequencies and consequently their spacing is narrow compared to units having 38 tones. Therefore, some tone frequencies may receive interference from adjacent tone frequencies.

• Available DTCS codes

023	054	125	165	245	274	356	445	506	627	732
025	065	131	172	246	306	364	446	516	631	734
026	071	132	174	251	311	365	452	523	632	743
031	072	134	205	252	315	371	454	526	654	754
032	073	143	212	255	325	411	455	532	662	
036	074	145	223	261	331	412	462	546	664	
043	114	152	225	263	332	413	464	565	703	
047	115	155	226	265	343	423	465	606	712	
051	116	156	243	266	346	431	466	612	723	
053	122	162	244	271	351	432	503	624	731	

◇ DTCS polarity setting

As well as the code setting, the polarity setting is also available for DTCS operation. When a different polarity is set, the DTCS never releases the audio mute, even if a signal with matched code number is received.

- ① Hold down **[SET]**(TS) for 1 second to enter the Set mode.
- ② Rotate **[DIAL]** to select the “EXPAND” item.
- ③ While holding down **[FUNC]**, rotate **[DIAL]** to turn the Expand set mode ON.
- ④ Rotate **[DIAL]** to select the “DTCS P” item.



- ⑤ While holding down **[FUNC]**, rotate **[DIAL]** to select either normal (NORMAL) and reverse (REV) polarity.

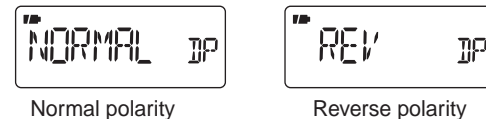

- ⑥ Push **[SET]**(TS) to exit the Set mode.

■ Tone/DTCS squelch operation

- ① Set a desired frequency in the FM mode.
- ② Hold down **[SET]**(TS) for 1 second to enter the Set mode.
- ③ Rotate **[DIAL]** to select the “EXPAND” item.
- ④ While holding down **[FUNC]**, rotate **[DIAL]** to turn the Expand set mode ON.
- ⑤ Rotate **[DIAL]** to select the “TSQL” item.
- ⑥ While holding down **[FUNC]**, rotate **[DIAL]** to select a desired subaudible tone setting from “TSQL ((·)),” “TSQL,” “DTCS ((·)),” “DTCS,” “T SQL-R,” “DTCS-R” or “OFF.”



Tone squelch with pocket beep



DTCS squelch



Tone squelch



Tone squelch (reverse)

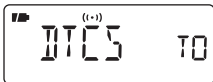

DTCS squelch with pocket beep

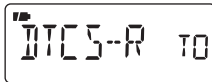

DTCS squelch (reverse)

- ⑦ Push **[SET]**(TS) to exit the Set mode.
 - Either “((·)) T SQL,” “T SQL,” “((·)) DTCS,” “DTCS,” “T SQL-R” or “DTCS -R” appears, according to the tone selection in step ⑥.

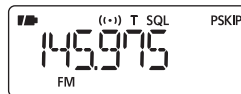

Tone squelch with pocket beep



DTCS squelch

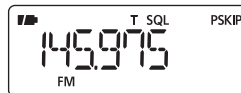

Tone squelch

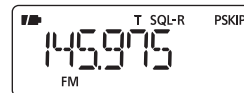

Tone squelch (reverse)

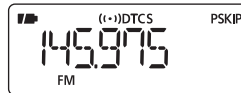

DTCS squelch with pocket beep



DTCS squelch (reverse)

- ⑧ When a signal with the matched tone is received, the squelch opens and audio is heard.
 - When the pocket beep function is activated, the receiver also emits beep tones and blinks “((·)).”
 - Beep tones sound and “((·))” blinks for 30 seconds.
- ⑨ Push **[FUNC]** to manually stop the beeps and blinking.
 - “((·))” disappears and the pocket beep function is deactivated.
- ⑩ To cancel the tone squelch or DTCS, set the “TSQL” item to “OFF” in the Expand set mode, as described in step ⑥.

■ Tone scan

By monitoring a signal that is being operated with pocket beep, tone or DTCS squelch function, you can determine the tone frequency or DTCS code necessary to open a squelch.

- ① Set the frequency to be checked for a tone frequency or code.
- ② Turn a desired tone type, tone squelch or DTCS ON in the Expand set mode.
 - One of "TSQL" or "DTCS" appears.
 - Even the pocket beep function is activated, the function is cancelled when starts the tone scan.
- ③ While holding down **[FUNC]**, push **[TSCAN]**(MODE) to start the tone scan.
 - To change the scanning direction, rotate **[DIAL]**.

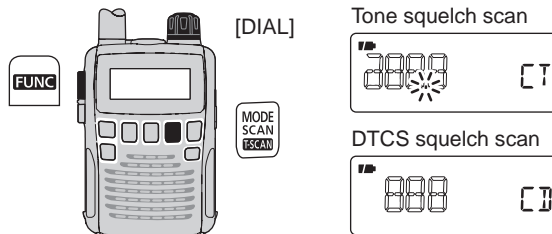

- ④ When the CTCSS tone frequency or 3-digit DTCS code is matched, the squelch opens and the tone frequency or code is temporarily programmed into the selected condition, such as memory channel.
 - The tone scan pauses when a CTCSS tone frequency or 3-digit DTCS code is detected.

NOTE: The decoded tone frequency or code is programmed temporarily when a memory channel is selected. However, this will be cleared when the other memory channel is selected.

✓ For your convenient!

Even no tone type is selected, either tone squelch or DTCS, pushing **[TSCAN]**(MODE) while holding down **[FUNC]** also start tone scan. In this case, the tone scan searching for tone squelch frequency only.

■ General

The Set mode is used for programming infrequently changed values or options of the receiver's functions.

In addition, the IC-R6 has the Expand set mode which is used for programming even more infrequently changed values or options of the functions. When turning the Expand set mode OFF, only half of the Set mode items are displayed, for simple operation.

◇ Set mode entering and operation

- ① Hold down **[SET]**(TS) for 1 second to enter the Set mode.
- ② Rotate **[DIAL]** to select a desired item.
- ③ While holding down **[FUNC]**, rotate **[DIAL]** to select a desired value or option.
- ④ Push **[SET]**(TS) to exit the Set mode, or repeat steps ② and ③ to set other items.

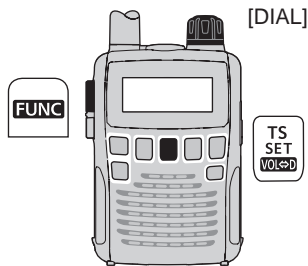

◇ Expand set mode ON/OFF and operation

- ① Hold down **[SET]**(TS) for 1 second to enter the Set mode.
- ② Rotate **[DIAL]** to select the "EXPAND" item.



- ③ While holding down **[FUNC]**, rotate **[DIAL]** to turn the Expand set mode ON or OFF.



Expand set mode OFF



Expand set mode ON

- ④ Rotate **[DIAL]** to select a desired item.
- ⑤ While holding down **[FUNC]**, rotate **[DIAL]** to select a desired value or option.
- ⑥ Push **[SET]**(TS) to exit the Set mode, or repeat steps ④ and ⑤ to set other items.

■ Set mode items

The following items are available in the Set mode and the Expand set mode.

◇ General Set mode items

Guide	Item name	Ref.
D SEL	Dial select step	p. 47
PRIO	Priority watch	p. 47
BEEP	Key-touch beep	p. 47
BEEPLV	Beep output level	p. 47
LIGHT	Display backlighting	p. 48
P SAVE	Power save	p. 48
ANT	Antenna selection	p. 48
EXPAND	Expand set mode	p. 49

◇ Expand set mode items

Guide	Item name	Ref.
LOCK	Key lock effect	p. 49
SPEED	Dial speed acceleration	p. 49
MONI	Monitor switch action	p. 49
AP OFF	Auto power OFF	p. 50
PAUSE	Scan pause timer	p. 50
RESUME	Scan resume timer	p. 50
STOP B	Scan stop beep	p. 50
OFFSET	Frequency offset	p. 51
DUP	Duplex direction	p. 51
TSQL	Tone squelch	p. 51
TONE	Tone frequency	p. 52
CODE	DTCS code	p. 52
DTCS P	DTCS polarity	p. 52
VSC	Voice squelch control	p. 52
B-LINK	Memory bank link function	p. 53
P-LINK	Program scan link function	p. 53
CONT	LCD contrast	p. 55
WX ALT [†]	Weather alert function	p. 55
AF FIL	AF filter	p. 55
CHARGE	Charge	p. 55
CIVADR	CI-V address	p. 56
CIVBAU	CI-V baud rate	p. 56
CIVTRN	CI-V transceive	p. 56

[†]Available in only the USA version.

9 SET MODE

◇ Dial select step (D SEL)

Select the tuning step between 100 kHz, 1 MHz and 10 MHz for a temporary faster frequency setting. To set a frequency with the increased tuning step, hold down [FUNC], and then rotate [DIAL].
(default: 1M)

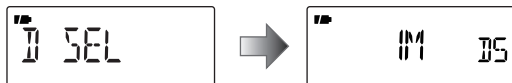

◇ Priority watch (PRIO)

Set the priority watch or priority beep (priority watch with beep sounds) to ON.
(default: OFF)

- OFF : Turns the function OFF.
- ON : Starts priority watch after exiting the Set mode.
- BELL : When a signal is received on the priority frequency, beeps sound and the (••) icon blinks.

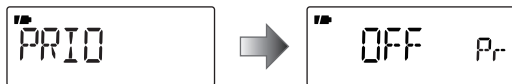

◇ Key-touch beep (BEEP)

The key-touch beep can be turned OFF for silent operation.
(default: ON)

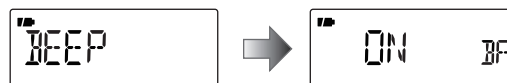

◇ Beep output level (BEEPLV)

Adjust the key-touch beep tone level to one of 40 set levels, or set it to follow the volume control level.

(default: VOLUME)

- VOLUME : The beep tone level is linked to the volume set level.
- _ _ _ _ _ - 0 0 0 0 0 : The beep tone level is independently adjustable to one of 40 levels.

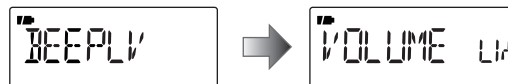

/// The key-touch beep (previous item) must be set to ON in order to have a beep tone.

◇ Display backlighting (LIGHT)

The receiver has a backlit display with a 5 second timer, for dim light operation. The backlighting can be turned ON continuously, or turned OFF, if desired. (default: AUTO1)

- OFF : Never lights.
- ON : Lights continuously while receiver power is ON.
- AUTO1: Lights when an operation is performed, goes out after 5 seconds.
- AUTO2: Lights when an operation is performed, goes out after 5 seconds. However, while operating with an external DC power source, the backlight stays ON.

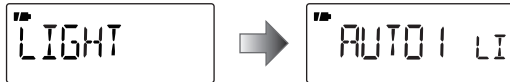

◇ Power save (P SAVE)

The power save function reduces the current drain to conserve battery power. This power save function can be turned OFF, if desired.

In the default setting "AUTO," the power save function is activated in an approximately 50 msec.: 500 msec. ratio when no signal is received for 5 seconds. The ratio becomes 50 msec.: 1 sec. when no signal is received for another 60 seconds.

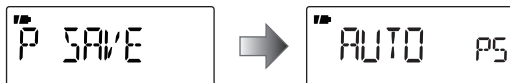

◇ Antenna selection (ANT)

The earphone antenna is active for all band (except for AM broadcast band) and all receive mode, but it is mostly effective only for the strong signal, such as FM broadcast band, 76.000–107.995 MHz (actual frequency range differs according to the receiver version). When using an earphone, the FM antenna setting may cause interference on other bands, and should be turned OFF.

The internal bar antenna is active only for the AM broadcast band reception, 0.495–1.620 MHz (actual frequency range differs according to the receiver version).

- EXT : Uses the antenna connected to the antenna connector. (default)
- BAR : Uses the internal bar antenna for the AM broadcast band reception. (This selection appears only when accessing the Set mode in the AM broadcast band in the AM mode.)
- EAR : Uses the connected earphone cable as the antenna for a strong signal reception. (This selection will not appear when accessing the Set mode in the AM broadcast band.)

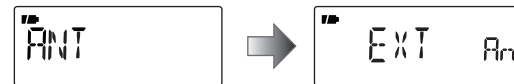

9 SET MODE

◇ Expand set mode (EXPAND)

Turn the Expand set mode ON or OFF. (default: OFF)

- OFF : Displays only the regular Set mode.
- ON : Displays the regular set mode and the Expand set mode.

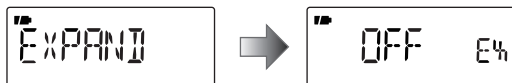

◇ Key lock effect (LOCK)

Even while the key lock function is ON, the volume control, squelch adjustment and monitor key ([SQL]) is still usable. Usable keys can be set to one of four groups.

[P] and [FUNC]+[BAND] are also usable during the locked state. However, these switches are not effected by this setting. (default: NORMAL)

- NORMAL : Volume control, squelch adjustment and monitor key are accessible.
- NO SQL : The squelch adjustment and monitor key are accessible. (The function of [SQL] is not locked.)*
- NO VOL : Volume control is accessible. (The function of volume control is not locked.)*
- ALL : No key function is usable, except [P] and [FUNC]+[BAND].

*"NO" indicates the function is not locked.

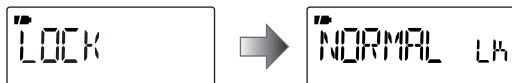

◇ Dial speed acceleration (SPEED)

The dial speed acceleration automatically speeds up the tuning dial speed, when rotating [DIAL] rapidly. (default: ON)

- OFF : The dial speed acceleration is turned OFF.
- ON : The dial speed acceleration is tuned ON.

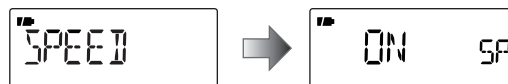

◇ Monitor switch action (MONI)

The monitor switch, [SQL], can be set as a 'sticky' switch. When set to the sticky condition, each push of [SQL] toggles the monitor function ON or OFF. (default: PUSH)

- PUSH : Hold down [SQL] to monitor the frequency.
- HOLD : Push [SQL] momentarily to monitor the frequency and push momentarily again to cancel it.

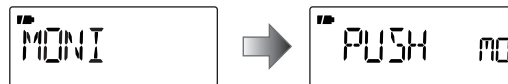

◇ Auto power OFF (AP OFF)

The receiver can be set to automatically turn OFF, and sound a beep, after a specified period when no key operations are performed.

OFF (default), times of 30, 60, 90, 120 minutes and BUSY can be specified. The (repetitive) period is retained even when the receiver is turned OFF, even by the auto power OFF function. To cancel the function, select "OFF".

When "BUSY" is selected, the receiver will automatically turn OFF when no key operations are performed and no signal is received for 3 minutes.

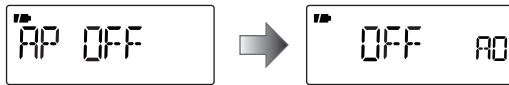

◇ Scan pause timer (PAUSE)

Selects the scan pause time. When receiving signals, the scan pauses according to the scan pause time.

(default: 10SEC)

- 2–20SEC: The scan pauses for 2–20 seconds on a received signal, and is selected in 2 seconds steps.
- HOLD : The scan pauses on a received signal until it disappears. Rotate [DIAL] to resume manually.

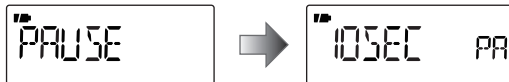

◇ Scan resume timer (RESUME)

Selects the scan resume time. The scan resumes after the specified period after the received signal disappears.

(default: 2SEC)

- 0SEC : The scan resumes immediately after the received signal disappears.
- 1–5SEC : The scan pauses 1–5 seconds after the received signal disappears.
- HOLD : The scan pauses on the received frequency, even if the signal disappears. Rotate [DIAL] to manually resume the scan.

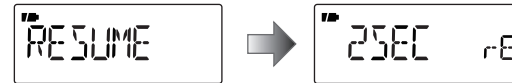

▨ The scan resume timer must be set shorter than the scan pause timer, otherwise this timer will not be activated.

◇ Scan stop beep (STOP B)

Turns the scan stop beep function ON or OFF (default).

When the function is activated ("ON" is selected), a long beep will sound each time a signal is received during a scan.

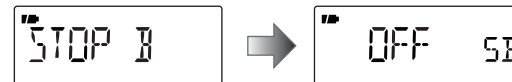

9 SET MODE

◇ Frequency offset (OFFSET)

Sets the frequency offset for each frequency band independently within the range of 0 to 159.995 MHz. While **[SQL]** is held down, the monitoring frequency shifts up or down from the set operating frequency, according to the duplex setting (+DUP or -DUP).

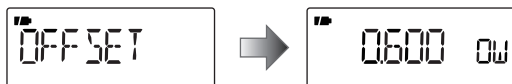

The default value may differ depending on the selected frequency band before accessing the Set mode, and the receiver version.

/// The selected tuning step in the VFO mode is used when setting the frequency offset.

◇ Duplex direction (DUP)

Selects the duplex direction. The displaying frequency shifts the programmed frequency in frequency offset above when monitor function is in use (while holding down **[SQL]**).

- OFF : Simplex operation. (default)
- -DUP : The displayed frequency shifts down during monitor.
- +DUP : The displayed frequency shifts up during monitor.

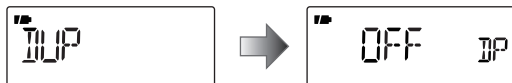

◇ Tone squelch (TSQL)

Selects the tone or DTCS squelch operation and pocket beep, so you can wait for a desired signal. (default: OFF)

- OFF : Regular noise squelch operation.
- TSQL ((•)) : In addition to the “TSQL” setting, alert beeps will sound when a signal with the matched subaudible tone is received.
- TSQL : Selects tone squelch. The squelch opens only when a signal with a matched subaudible tone is received.
- DTCS ((•)) : In addition to the “DTCS” setting, alert beeps will sound when a signal with a matched DTCS code is received.
- DTCS : Selects DTCS squelch. The squelch opens only when a signal with a matched DTCS code is received.
- TSQL-R : Selects reverse tone squelch. The squelch mutes only when a signal with a matched subaudible tone is received.
- DTCS-R : Selects reverse DTCS squelch. The squelch mutes only when a signal with a matched DTCS code is received.

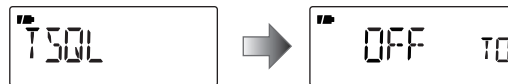

/// The subaudible tone frequency is programmed in the tone frequency option and DTCS code is programmed into the DTCS code option.

◇ Tone frequency (TONE)

Selects a subaudible tone frequency for tone squelch operation. A total of 50 tone frequencies (67.0–254.1 Hz) are selectable. (default: 88.5 Hz)

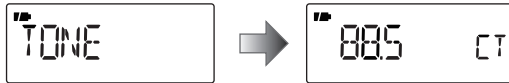

• Available tone frequencies (unit: Hz)

67.0	79.7	94.8	110.9	131.8	156.7	171.3	186.2	203.5	229.1
69.3	82.5	97.4	114.8	136.5	159.8	173.8	189.9	206.5	233.6
71.9	85.4	100.0	118.8	141.3	162.2	177.3	192.8	210.7	241.8
74.4	88.5	103.5	123.0	146.2	165.5	179.9	196.6	218.1	250.3
77.0	91.5	107.2	127.3	151.4	167.9	183.5	199.5	225.7	254.1

◇ DTCS code (CODE)

Selects a DTCS code for DTCS squelch operation. A total of 104 codes (023–754) are selectable. (default: 023)

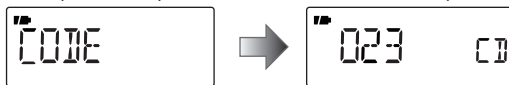

• Available DTCS codes

023	054	125	165	245	274	356	445	506	627	732
025	065	131	172	246	306	364	446	516	631	734
026	071	132	174	251	311	365	452	523	632	743
031	072	134	205	252	315	371	454	526	654	754
032	073	143	212	255	325	411	455	532	662	
036	074	145	223	261	331	412	462	546	664	
043	114	152	225	263	332	413	464	565	703	
047	115	155	226	265	343	423	465	606	712	
051	116	156	243	266	346	431	466	612	723	
053	122	162	244	271	351	432	503	624	731	

◇ DTCS polarity (DTCS P)

Selects the DTCS polarity between normal and reverse. (default: NORMAL)

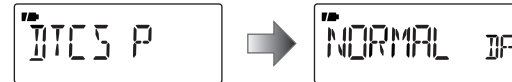

◇ Voice squelch control (VSC)

This function is useful when you don't want unmodulated signals pausing a scan. When the voice squelch control function is activated, the receiver checks received signals for voice components. If a received signal includes voice components, and the tone of the voice components changes within 1 second, the scan pauses (or stops). If the received signal includes no voice components, or the tone of the voice components does not change within 1 second, the scan resumes. (default: OFF)

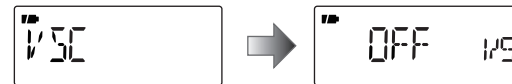

9 SET MODE

◇ Memory bank link function (B-LINK)

Turns the memory bank link function ON (default) or OFF. The link function provides continuous bank scan, scanning all channels in the selected banks during bank scan.



• Bank link setting

- ① Push **[MODE]** to enter the bank link setting mode.
- ② Rotate **[DIAL]** to select a bank that you want to change the link setting.



- ③ While holding down **[FUNC]**, rotate **[DIAL]** to set the link setting ON or OFF.

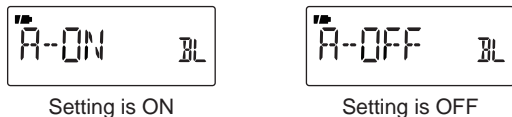

- ④ Repeat steps ② and ③ until the bank link setting is finished.
- ⑤ Push **[TS]** to exit the bank link setting mode.

◇ Program scan link function (P-LINK)

Sets the program scan link function. During a program scan, the link function performs a continuous program scan in the selected program scan number.

Default settings for LINK0 to LINK9; PROG 1 to PROG 24 are linked, but PROG 0 is not linked.



• Confirming a program scan link

- ① Push **[MODE]** to enter the program scan link setting.



- ② Rotate **[DIAL]** to select the program scan link number that you want to confirm, then push **[MODE]**.
 - "LINK" appears.



- ③ Push **[MODE]**, then rotate **[DIAL]** to confirm the linked program scans.



- ④ Push **[TS]** three times to exit the program scan link setting.

• **Changing a program scan link**

- ① Push **[MODE]** to enter the program scan link setting.

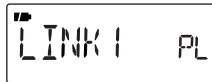

- ② Rotate **[DIAL]** to select the program scan link number that you want to change.
- ③ Push **[MODE]**, then rotate **[DIAL]** to select the option, "ADD" or "CLEAR."



- ④ Rotate **[DIAL]** to select the desired program scan.
 - When "ADD" is selected in step ③, only non-linked program scans are displayed. When "CLEAR" is selected in step ③, only linked program scans are displayed.



- ⑤ Push **[MODE]** to set the program scan link setting.
- ⑥ Repeat steps ④ and ⑤ to add or clear the program scan to or from the link, or push **[TS]** twice to exit the program scan link setting.

• **Changing a program scan link name**

- ① Push **[MODE]** to enter the program scan link setting.



- ② Rotate **[DIAL]** to select the program scan link number that you want to change.
- ③ Push **[MODE]**, then rotate **[DIAL]** to select "NAME."
- ④ Push **[MODE]** to enter the name programming.
- ⑤ While holding down **[FUNC]**, rotate **[DIAL]** to select the desired character, number, symbol or space.
 - Rotate **[DIAL]** right or left to move the cursor right or left, respectively.



- ⑥ When you are finished entering a name, push **[MODE]** to save the name and then exit the name programming.



- ⑦ Push **[TS]** twice to exit the program scan link setting.
- ⑧ Push **[TS]** to exit the Set mode.

9 SET MODE

◇ LCD contrast (CONT)

Selects the LCD contrast level between 1 (light) and 5 (dark), as desired. (default: 2)

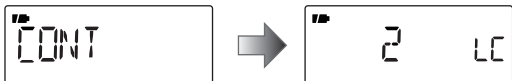

◇ Weather alert function (WX ALT)

U.S.A. versions only

Turns the weather alert function ON or OFF. (default: OFF)

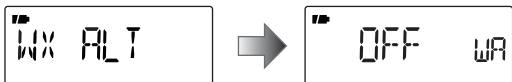

◇ AF filter (AF FIL)

The AF filter suppresses high-pitch tones when this setting is ON. (default: OFF)

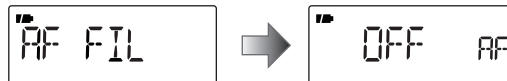

◇ Charge (CHARGE)

Select the CHG1 or CHG2 charge, which will be activated after the charge timer ends. (default: CHG2)

- CHG1 : Stops charging after 15 hours have passed.
- CHG2 : Continues to trickle charge the battery, even after 15 hours have passed.

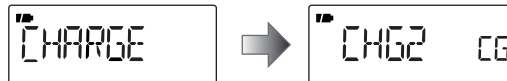

◇ CI-V address (CIVADR)

To distinguish individual equipment, each CI-V transceiver/receiver has its own Icom standard address as a hexadecimal number. The IC-R6's address is "7E."

When 2 or more IC-R6 receivers are connected with an optional CT-17 CI-V LEVEL CONVERTER, set a different address for each of them in the range "01" to "DF." (default: 7E)

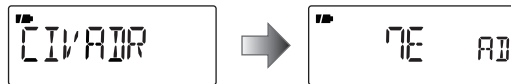

See page 64 for more details.

◇ CI-V baud rate (CIVBAU)

Sets the baud rate from 300, 1200, 4800, 9600, 19200 bps or AUTO. When "AUTO" is selected, the baud rate is automatically set according to the connected controller setting or other Icom CI-V radio setting. (default: AUTO)

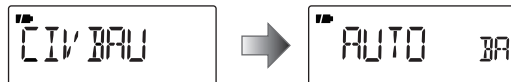

◇ CI-V transceive (CIVTRN)

CI-V transceive operation is possible even if the IC-R6 receiver is connected to an Icom CI-V radio. When set to "ON," the frequency and the operating mode of the IC-R6 automatically change to those of the connected radios, and vice versa. (default: ON)

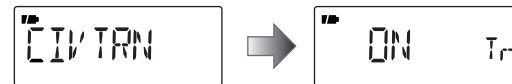

10 OTHER FUNCTIONS

■ Antenna selection

The IC-R6 has an internal bar antenna installed for receiving AM broadcast band (0.495–1.620 MHz; varies depending on version) signals. In addition, the connected earphone cable can be used as an antenna for receiving strong signals.

◇ Selecting antenna

- ① Push **[V/M]** to select the VFO mode.
- ② Push **[BAND]** repeatedly, or while holding down **[BAND]** rotate **[DIAL]** to select a desired band.
- ③ Push **[SET](TS)** for 1 second to enter the Set mode.
- ④ Rotate **[DIAL]** to select the “ANT” item.
 - “ANT” disappears after 1 second and “EXT” (default) and “An” appear.

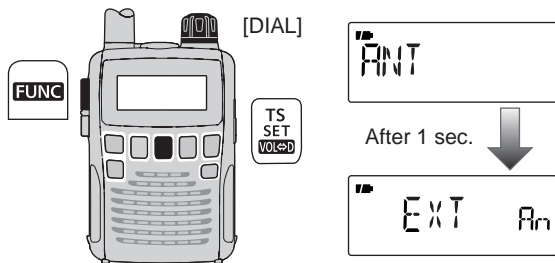

- ⑤ While holding down **[FUNC]**, rotate **[DIAL]** to select “BAR” when the Set mode has accessed from the AM broadcast band in AM mode; select “EAR” when the “ANT” item is selected for the strong signals.



Bar antenna selection
for 0.495–1.620 MHz band



Earphone cable selection
for strong signals

- ⑥ Push **[SET](TS)** to exit the Set mode.

NOTES:

- Some noise or spurious may be received when the internal bar or earphone cable is used as an antenna.
- The supplied or third party's antenna **MUST BE** connected to the antenna connector to receive signals other than strong signals, such as AM broadcast band or near by stations.
- When receiving an AM broadcast signal with internal bar antenna, aim the receiver to better audio direction.
- When the internal bar is used as an antenna, the attenuator function cannot be used.

■ [DIAL] function assignment

The [DIAL] control can be used as an audio volume control, instead of the [▲]/[▼] keys. However, while [DIAL] functions as an audio volume control, the [▲]/[▼] keys function as tuning controls.

- ➔ While holding down [FUNC], push [VOL] (TS) to toggle the [DIAL] function between tuning dial and audio volume.
 - The “VOL” icon appears when [DIAL] functions as the volume control.



“VOL” appears when [DIAL] functions as the audio volume control.

• [DIAL] and [▲]/[▼] functions

	No “VOL” icon	“VOL” appears
[DIAL]	Frequency, Memory channel, Squelch level, Scanning direction, Set mode item and option setting	Audio volume
[▲]/[▼]	Audio volume set	Frequency, Memory channel, Squelch level, Scanning direction, Set mode item and option setting

■ Auto power-off function

USING EXPAND SET MODE

The IC-R6 can be set to automatically turn OFF after a specified period in which no operation is performed.

OFF (default), times of 30, 60, 90, 120 minutes and BUSY* can be specified. The specified period is retained even when the receiver is turned OFF by the auto power-off function. To cancel the function, select “OFF” in step ③ below.

* When “BUSY” is selected, the receiver will automatically turn OFF when no key operations are performed and no signal is received for 3 minutes.

- ① Hold down [SET] (TS) for 1 second to enter the Set mode.
- ② Rotate [DIAL] to select the “AP OFF” item.
 - Turn the Expand set mode ON for selection. (p. 45)

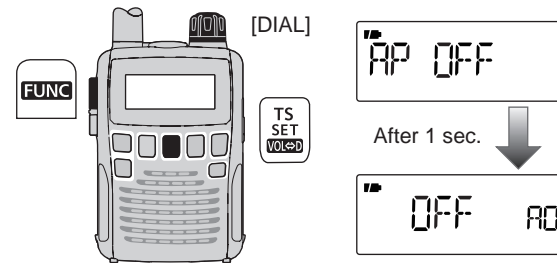

- ③ While holding down [FUNC], rotate [DIAL] to select a desired time or to turn the function OFF.
- ④ Push [SET] (TS) to exit the Set mode.

Weather channel operation

U.S.A. versions only

Weather channel selection

- ① Push **[V/M]** to select the VFO mode, if the receiver is in another mode is selected.
- ② While holding down **[BAND]**, rotate **[DIAL]** to select the weather channel group.
 - The weather channel group can also be selected by pushing **[BAND]** repeatedly.
- ③ Rotate **[DIAL]** to select a desired weather channel.

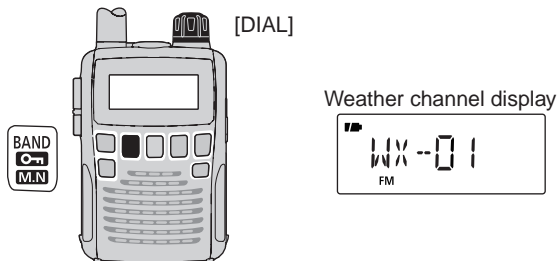

- ④ Push **[BAND]** to change frequency bands, or push **[V/M]** to select the memory mode.

Weather alert function USING EXPAND SET MODE

NOAA broadcast stations transmit weather alert tones before important weather announcements. When the weather alert function is turned ON, the selected weather channel is monitored every 5 seconds for the announcement. When the alert signal is detected, the "ALT" and the WX channel are displayed alternately, and a beep tone sounds until the receiver is operated. The previously selected (used) weather channel is checked periodically during standby, or while scanning.

- ① Select a desired weather channel.
- ② Turn the weather alert function ON in the Set mode.
 - ➔ Hold down **[SET](TS)** for 1 second to enter the Set mode.
 - ➔ Rotate **[DIAL]** to select the weather alert option. Then, while holding down **[FUNC]**, rotate **[DIAL]** to set "ON".
 - ➔ Push **[SET](TS)** to exit the Set mode.
- ③ Set a desired stand-by condition.
 - Select the VFO or a memory channel.
 - Scan or priority watch operation can also be selected.
- ④ When an alert is detected, a beep sounds and the following indicator will be displayed.



The above icons are alternately displayed.

- ⑤ Turn the weather alert function OFF in the Set mode.

NOTE: While receiving a signal (on a frequency other than the weather alert ON frequency), the received signal or audio will be interrupted momentarily approximately every 5 seconds when the alert function is turned ON. This is caused by the WX alert function. To eliminate the interruption, set the weather alert item OFF in the Set mode.

10 OTHER FUNCTIONS

■ Data cloning

Cloning allows you to quickly and easily transfer the programmed contents from one receiver to another; or data from a personal computer to a receiver, using the optional CS-R6 CLONING SOFTWARE and the appropriate cloning cable.

◇ Cloning between receivers

- ① Connect the OPC-474 cloning cable to the [SP] jack of the master and sub-receivers.
 - The master receiver is used to send data to the sub-receiver.

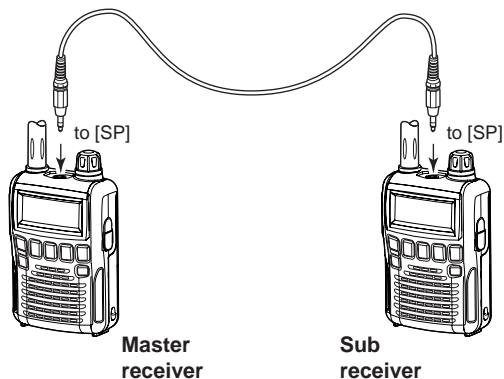

/// **NOTE: DO NOT** push any key on the sub-receiver during cloning. This will cause a cloning error.

- ② Hold down **[V/M]** of only the master receiver, and then turn it ON. For the sub-receiver, simply turn it ON. (See below for more information.)

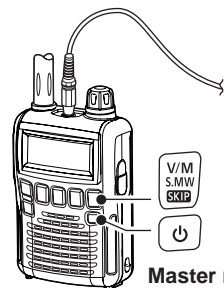

Master receiver



“CLONE” and “m” appear when entered the cloning mode.

✓ **CLONING MODE ENTRY (except Master receiver):**

When the CI-V baud rate (p. 56) is selected any other than “9600” or “AUTO,” the following operations are required.

- ① Turn the receiver's power OFF.
- ② While holding down **[MODE]**, push and hold **[P]** for 1 second to enter the cloning mode.

③ Push [SQL] on the master receiver.

- The receiver displays the following.

Master receiver display**Sub-receiver display**

During cloning



After cloning

④ When cloning is finished, turn power OFF, then ON to exit the cloning mode.

◇ Cloning using a personal computer

Data can be cloned to and from a personal computer (Microsoft® Windows® 2000/XP/Windows Vista® or Windows® 7) using the optional CS-R6 CLONING SOFTWARE and the optional OPC-478/OPC-478UC CLONING CABLE. Consult the CS-R6 CLONING SOFTWARE HELP file for details.

◇ Cloning error

/// **NOTE: DO NOT** push any key on the receiver during cloning. This will cause a cloning error.

When the display appears as shown below, a cloning error has occurred.

In such a case, receiver automatically returns to the clone standby condition and cloning must be repeated.



10 OTHER FUNCTIONS

■ Partial reset

If you want to initialize the operating settings (VFO frequency, VFO settings, Set mode contents) without clearing the memory contents, a partial reset of the receiver can be done.

- ➔ While holding down **[FUNC]** and **[TS]**, turn the power ON to partially reset the receiver.

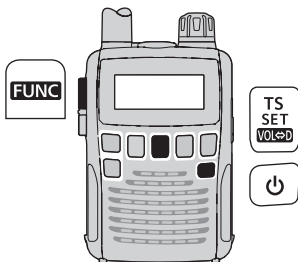

■ All reset

The function display may occasionally display erroneous information (e.g. when first applying power). This may be caused externally by static electricity or by other factors.

If this problem occurs, turn power OFF. After waiting a few seconds, turn power ON again. If the problem persists, perform the following procedure.

- Partial resetting is also available. See the details to the left.

/// IMPORTANT:

Resetting the receiver **CLEARs** all memory information and initializes all values in the receiver. The preprogrammed (depending on the receiver version) memory information is also cleared.

- ➔ While holding down **[FUNC]** and **[V/M]**, turn the power ON to reset the CPU.

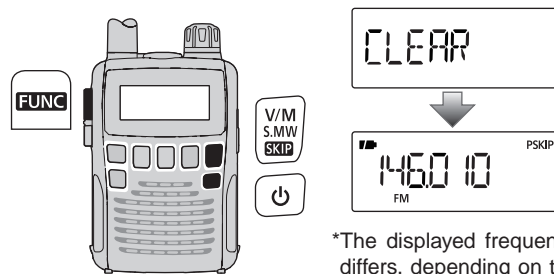

*The displayed frequency differs, depending on the receiver version.

■ General

The IC-R6 can be connected to a PC via the PC's RS-232C port using an optional CT-17 CI-V LEVEL CONVERTER. This allows you to control the receiver from the PC and/or transfer data from the receiver to the PC.

Control is provided via Icom's CI-V Communication Interface.

/// An appropriate application for CI-V command is not supplied from Icom.

CI-V connections example

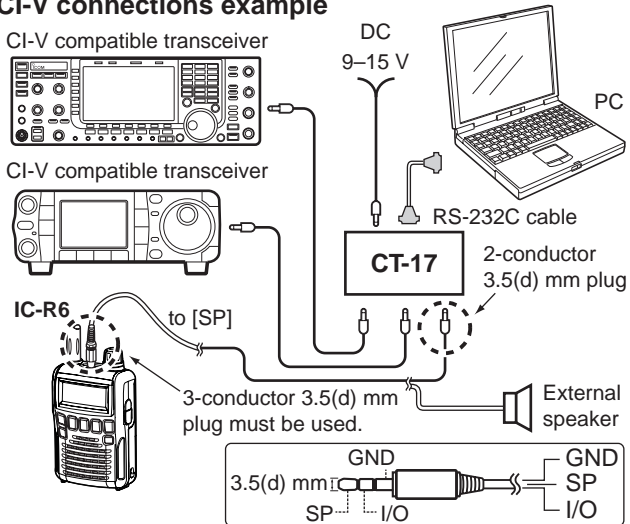

■ Data format

The CI-V system can be operated using the following data formats. Data formats differ according to command numbers. A data area is added for some commands.

Controller → IC-R6

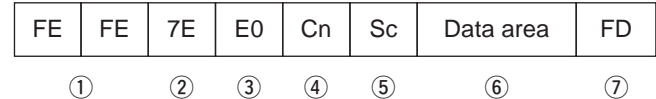

IC-R6 → Controller

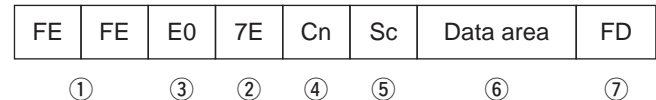

- ① Preamble code (fixed)
- ② Receiver's default address
- ③ Controller's default address
- ④ Command number (see page 65)
- ⑤ Sub command number (see page 65)
- ⑥ BCD code data for frequency/mode/Squelch condition entry
- ⑦ End of message code (fixed)

11 CONTROL COMMAND

■ Command table

Cmd.	Sub Cmd.	Data	Description
00		see the right	Send frequency data for transceive
01		02, 05, 06	Send mode data for transceive 02=AM, 05=FM, 06=WFM
03		see the right	Read operating frequency
04		02, 05, 06	Read operating mode 02=AM, 05=FM, 06=WFM
05		see the right	Set operating frequency
06		02, 05, 06	Operating mode selection 02=AM, 05=FM, 06=WFM
11		00/10	Send/read the attenuator function setting 00=OFF, 10=ON (approx. 10dB)
12		00/01	Send/read ANT selection 0.495 to 1.620 MHz band: 00=EXT, 01=BAR* **"BAR" can only be selected in AM mode. Other frequency band: 00=EXT, 01=EAR
14	01	see p. 66	Send/read the volume level
	03	see p. 66	Send/read the squelch level
15	01	00/01	Read the squelch status 00=Squelch close, 01=Squelch open
	02	see p.66	Read the S-meter level
16	43	00, 01, 02	Send/read the tone squelch setting 00=OFF, 01=TSQL, 02=TSQL-R
	4B	00, 01, 02	Send/read the DTCS squelch setting 00=OFF, 01=DTCS, 02=DTCS-R

Cmd.	Sub Cmd.	Data	Description
16	4C	00/01	Send/read the VSC function setting 00=OFF, 01=ON
19	00		Read the receiver ID
1A	00	00/01	Send/read the AF filter setting 00=Filter OFF, 01=Filter ON
1B	01	see p. 66	Set/read TSQL tone frequency
	02	see p. 66	Set/read DTCS code with polarity

◇ Data content description

• Receive frequency (Command: 00, 03, 05)

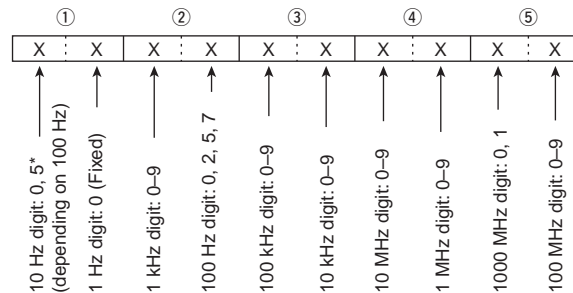

When the tuning step is selected 8.33 kHz (Air band),
100 Hz digit, 10 Hz digit and 1 Hz digit can be set 3 or 6.

* 0: When 100 Hz digit is 0 or 5, 5: When 100 Hz digit is 2 or 7

• Audio volume level (Command: 14 01)

VR level	Data	VR level	Data	VR level	Data
0 (min)	0000-0005	14	0090-0095	28	0179-0185
1	0006-0012	15	0096-0101	29	0186-0191
2	0013-0018	16	0102-0108	30	0192-0197
3	0019-0025	17	0109-0114	31	0198-0204
4	0026-0031	18	0115-0121	32	0205-0210
5	0032-0037	19	0122-0127	33	0211-0217
6	0038-0044	20	0128-0133	34	0218-0223
7	0045-0050	21	0134-0140	35	0224-0229
8	0051-0057	22	0141-0146	36	0230-0236
9	0058-0063	23	0147-0153	37	0237-0242
10	0064-0069	24	0154-0159	38	0243-0249
11	0070-0076	25	0160-0165	39	0250-0255
12	0077-0082	26	0166-0172		
13	0083-0089	27	0173-0178		

• Squelch level (Command: 14 03)

SQL level	Data	SQL level	Data
OPEN	0000-0022	LEVEL5	0140-0162
AUTO	0023-0045	LEVEL6	0163-0185
LEVEL1	0046-0069	LEVEL7	0186-0208
LEVEL2	0070-0092	LEVEL8	0209-0231
LEVEL3	0093-0115	LEVEL9	0232-0255
LEVEL4	0116-0139		

• S-meter level (Command: 15 02)

S-meter	Data	S-meter	Data	S-meter	Data
-	0000	5	0080	Full	0160
1	0016	7	0112		
3	0048	9	0144		

• Tone squelch frequency setting (Command: 1B 01)

See page 52 for available tone frequencies for details.

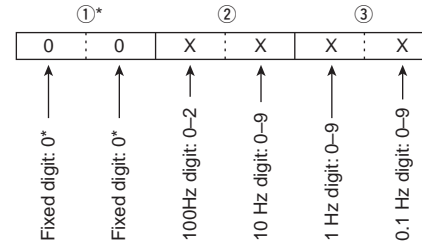

*Not necessary when setting a frequency.

• DTCS code with polarity setting (Command: 1B 02)

See page 52 for available DTCS codes for details.

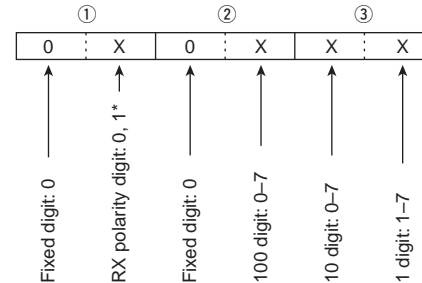

* 0=Normal, 1=Reverse

Not necessary when the normal polarity is set

12 FREQUENCY TABLE

■ TV channels

The following tables show the channels versus video and audio frequencies, depending on each version.

◇ U.S.A. channels

		(unit: MHz)			
CH	Freq.	CH	Freq.	CH	Freq.
2	59.75	27	553.75	52	703.75
3	65.75	28	559.75	53	709.75
4	71.75	29	565.75	54	715.75
5	81.75	30	571.75	55	721.75
6	87.75	31	577.75	56	727.75
7	179.75	32	583.75	57	733.75
8	185.75	33	589.75	58	739.75
9	191.75	34	595.75	59	745.75
10	197.75	35	601.75	60	751.75
11	203.75	36	607.75	61	757.75
12	209.75	37	613.75	62	763.75
13	215.75	38	619.75	63	769.75
14	475.75	39	625.75	64	775.75
15	481.75	40	631.75	65	781.75
16	487.75	41	637.75	66	787.75
17	493.75	42	643.75	67	793.75
18	499.75	43	649.75	68	799.75
19	505.75	44	655.75	69	805.75
20	511.75	45	661.75		
21	517.75	46	667.75		
22	523.75	47	673.75		
23	529.75	48	679.75		
24	535.75	49	685.75		
25	541.75	50	691.75		
26	547.75	51	697.75		

◇ CCIR channels (unit: MHz)

CH	Freq.	CH	Freq.
1	46.75	40	628.75
2	53.75	41	636.75
3	60.75	42	644.75
4	67.75	43	652.75
5	180.75	44	660.75
6	187.75	45	668.75
7	194.75	46	676.75
8	201.75	47	684.75
9	208.75	48	692.75
10	215.75	49	700.75
11	222.75	50	708.75
12	229.75	51	716.75
21	476.75	52	724.75
22	484.75	53	732.75
23	492.75	54	740.75
24	500.75	55	748.75
25	508.75	56	756.75
26	516.75	57	764.75
27	524.75	58	772.75
28	532.75	59	780.75
29	540.75	60	788.75
30	548.75	61	796.75
31	556.75	62	804.75
32	564.75	63	812.75
33	572.75	64	820.75
34	580.75	65	828.75
35	588.75	66	836.75
36	596.75	67	844.75
37	604.75	68	852.75
38	612.75	69	860.75
39	620.75		

◇ Australian channels

		(unit: MHz)	
CH	Freq.	CH	Freq.
0	51.75	43	637.75
1	62.75	44	644.75
2	69.75	45	651.75
3	91.75	46	658.75
4	100.75	47	665.75
5	107.75	48	672.75
5A	143.75	49	679.75
6	180.75	50	686.75
7	187.75	51	693.75
8	194.75	52	700.75
9	201.75	53	707.75
10	214.75	54	714.75
11	221.75	55	721.75
28	532.75	56	728.75
29	539.75	57	735.75
30	546.75	58	742.75
31	553.75	59	749.75
32	560.75	60	756.75
33	567.75	61	763.75
34	574.75	62	770.75
35	581.75	63	777.75
36	588.75	64	784.75
37	595.75	65	791.75
38	602.75	66	798.75
39	609.75	67	805.75
40	616.75	68	812.75
41	623.75	69	819.75
42	630.75		

◇ China channels

CH	Freq.	CH	Freq.
1	56.25	32	669.75
2	64.25	33	677.75
3	72.25	34	685.75
4	83.75	35	693.75
5	91.75	36	701.75
6	174.75	37	709.75
7	182.75	38	717.75
8	190.75	39	725.75
9	198.75	40	733.75
10	206.75	41	741.75
11	214.75	42	749.75
12	222.75	43	757.75
13	477.75	44	765.75
14	485.75	45	773.75
15	493.75	46	781.75
16	501.75	47	789.75
17	509.75	48	797.75
18	517.75	49	805.75
19	525.75	50	813.75
20	533.75	51	821.75
21	541.75	52	829.75
22	549.75	53	837.75
23	557.75	54	845.75
24	565.75	55	853.75
25	613.75	56	861.75
26	621.75	57	869.75
27	629.75	58	877.75
28	637.75	59	885.75
29	645.75	60	893.75
30	653.75	61	901.75
31	661.75	62	909.75

(unit: MHz)

CH	Freq.
63	917.75
64	925.75
65	933.75
66	941.75
67	949.75
68	957.75

◇ New Zealand channels

(unit: MHz)

CH	Freq.
1	50.75
2	60.75
3	67.75
4	180.75
5	187.75
6	194.75
7	201.75
8	208.75
9	215.75
10	222.75
11	229.75

◇ UK channels

(unit: MHz)

CH	Freq.
21	477.25
22	485.25
23	493.25
24	501.25
25	509.25
26	517.25
27	525.25
28	533.25
29	541.25
30	549.25
31	557.25
32	565.25
33	573.25
34	581.25
35	589.25
36	597.25
37	605.25
38	613.25
39	621.25
40	629.25
41	637.25
42	645.25
43	653.25
44	661.25
45	669.25
46	677.25
47	685.25
48	693.25
49	701.25
50	709.25
51	717.25

◇ French channels (unit: MHz)

CH	Freq.	CH	Freq.
2	49.25	43	653.75
3	54.00	44	661.75
4	57.25	45	669.75
5	182.50	46	677.75
6	190.50	47	685.75
7	198.50	48	693.75
8	206.50	49	701.75
9	214.50	50	709.75
10	222.50	51	717.75
21	477.75	52	725.75
22	485.75	53	733.75
23	493.75	54	741.75
24	501.75	55	749.75
25	509.75	56	757.75
26	517.75	57	765.75
27	525.75	58	773.75
28	533.75	59	781.75
29	541.75	60	789.75
30	549.75	61	797.75
31	557.75	62	805.75
32	565.75	63	813.75
33	573.75	64	821.75
34	581.75	65	829.75
35	589.75	66	837.75
36	597.75	67	845.75
37	605.75	68	853.75
38	613.75	69	861.75
39	621.75		
40	629.75		
41	637.75		
42	645.75		

12 FREQUENCY TABLE

◇ Indonesian channels

(unit: MHz)

CH	Freq.	CH	Freq.
1A	53.75	40	628.75
2	60.75	41	636.75
3	67.75	42	644.75
4	180.75	43	652.75
5	187.75	44	660.75
8	194.75	45	668.75
7	201.75	46	676.75
8	208.75	47	684.75
9	215.75	48	692.75
10	222.75	49	700.75
11	229.75	50	708.75
21	476.75	51	716.75
22	484.75	52	724.75
23	492.75	53	732.75
24	500.75	54	740.75
25	508.75	55	748.75
26	516.75	56	756.75
27	524.75	57	764.75
28	532.75	58	772.75
29	540.75	59	780.75
30	548.75	60	788.75
31	556.75	61	796.75
32	564.75	62	804.75
33	572.75	63	812.75
34	580.75	64	820.75
35	588.75	65	828.75
36	596.75	66	836.75
37	604.75	67	844.75
38	612.75	68	852.75
39	620.75	69	860.75

◇ Italian channels (unit: MHz)

CH	Freq.	CH	Freq.
A	59.25	42	644.75
B	67.75	43	652.75
C	87.75	44	660.75
D	180.75	45	668.75
E	188.75	46	676.75
F	197.75	47	684.75
G	206.75	48	692.75
H	215.75	49	700.75
H1	222.75	50	708.75
H2	229.75	51	716.75
21	476.75	52	724.75
22	484.75	53	732.75
23	492.75	54	740.75
24	500.75	55	748.75
25	508.75	56	756.75
26	516.75	57	764.75
27	524.75	58	772.75
28	532.75	59	780.75
29	540.75	60	788.75
30	548.75	61	796.75
31	556.75	62	804.75
32	564.75	63	812.75
33	572.75	64	820.75
34	580.75	65	828.75
35	588.75	66	836.75
36	596.75	67	844.75
37	604.75	68	852.75
38	612.75	69	860.75
39	620.75		
40	628.75		
41	636.75		

◇ Taiwan channels

(unit: MHz)

CH	Freq.
7	179.75
8	185.75
9	191.75
10	197.75
11	203.75
12	209.75

◇ FOT channels

(unit: MHz)

CH	Freq.
4	181.75
5	189.75
6	197.75
7	205.75
8	213.75
9	221.75

NOTE:

TV channel reception is available for only analog TV broadcasting. It is not available for digital TV broadcasting.

■ VHF marine channels

(unit: MHz)

CH No.	Ship Transmit	Ship Receive
01	156.050	160.650
01A	156.050	156.050
02	156.100	160.700
03	156.150	160.750
03A	156.150	156.150
04	156.200	160.800
04A	156.200	156.200
05	156.250	160.850
05A	156.250	156.250
06	156.300	156.300
07	156.350	160.950
07A	156.350	156.350
08	156.400	156.400
09	156.450	156.450
10	156.500	156.500
11	156.550	156.550
12	156.600	156.600
13	156.650	156.650
14	156.700	156.700
15	156.750	156.750
16	156.800	156.800
17	156.850	156.850
18	156.900	161.500
18A	156.900	156.900
19	156.950	161.550
19A	156.950	156.950
20	157.000	161.600
20A	157.000	157.000
21	157.050	161.650

CH No.	Ship Transmit	Ship Receive
21A	157.050	157.050
21b	161.650	161.650
22	157.100	161.700
22A	157.100	157.100
23	157.150	161.750
23A	157.150	157.150
24	157.200	161.800
25	157.250	161.850
25b	161.850	161.850
26	157.300	161.900
27	157.350	161.950
28	157.400	162.000
28b	162.000	162.000
60	156.025	160.625
61	156.075	160.675
61A	156.075	156.075
62	156.125	160.725
62A	156.125	156.125
63	156.175	160.775
63A	156.175	156.175
64	156.225	160.825
64A	156.225	156.225
65	156.275	160.875
65A	156.275	156.275
66	156.325	160.925
66A	156.325	156.325
67	156.375	156.375
68	156.425	156.425
69	156.475	156.475

CH No.	Ship Transmit	Ship Receive
70	156.525	156.525
71	156.575	156.575
72	156.625	156.625
73	156.675	156.675
74	156.725	156.725
77	156.875	156.875
78	156.925	161.525
78A	156.925	156.925
79	156.975	161.575
79A	156.975	156.975
80	157.025	161.625
80A	157.025	157.025
81	157.075	161.675
81A	157.075	157.075
82	157.125	161.725
82A	157.125	157.125
83	157.175	161.775
83A	157.175	157.175
83b	161.775	161.775
84	157.225	161.825
84A	157.225	157.225
85	157.275	161.875
85A	157.275	157.275
86	157.325	161.925
86A	157.325	157.325
87	157.375	161.975
87A	157.375	157.375
88	157.425	162.025
88A	157.425	157.425

■ Weather channels (unit: MHz)

WX CH	Frequency
01	162.550
02	162.400
03	162.475
04	162.425
05	162.450
06	162.500
07	162.525
08	161.650
09	161.775
10	163.275

12 FREQUENCY TABLE

■ Other communications in the USA

◇ HF CB (Citizens Band) channels

CH	Frequency
1	26.965 MHz
2	26.975 MHz
3	26.985 MHz
4	27.005 MHz
5	27.015 MHz
6	27.025 MHz
7	27.035 MHz
8	27.055 MHz
9	27.065 MHz
10	27.075 MHz
11	27.085 MHz
12	27.105 MHz
13	27.115 MHz
14	27.125 MHz
15	27.135 MHz
16	27.155 MHz
17	27.165 MHz
18	27.175 MHz
19	27.185 MHz
20	27.205 MHz

CH	Frequency
21	27.215 MHz
22	27.225 MHz
23	27.255 MHz
24	27.235 MHz
25	27.245 MHz
26	27.265 MHz
27	27.275 MHz
28	27.285 MHz
29	27.295 MHz
30	27.305 MHz
31	27.315 MHz
32	27.325 MHz
33	27.335 MHz
34	27.345 MHz
35	27.355 MHz
36	27.365 MHz
37	27.375 MHz
38	27.385 MHz
39	27.395 MHz
40	27.405 MHz

◇ GMRS (General Mobile Radio Service) channels

Transceiver Receive	Transceiver transmit
462.5500 MHz	467.5500 MHz
462.5625 MHz	
462.5750 MHz	467.5750 MHz
462.5875 MHz	
462.6000 MHz	467.6000 MHz
462.6125 MHz	
462.6250 MHz	467.6250 MHz
462.6375 MHz	
462.6500 MHz	467.6500 MHz
462.6625 MHz	
462.6750 MHz	467.6750 MHz
462.6875 MHz	
462.7000 MHz	467.7000 MHz
462.7125 MHz	
462.7250 MHz	467.7250 MHz

◇ BRS (Business Radio Service) channels

Dot color	Frequency
Red	151.625 MHz
Purple	151.955 MHz
Blue	154.570 MHz
Green	154.600 MHz
White	462.575 MHz
Black	462.625 MHz
Orange	462.675 MHz
Brown	464.500 MHz
Yellow	464.550 MHz
"J" Dot	467.763 MHz
"K" Dot	467.813 MHz
Silver Star	467.850 MHz
Gold Star	467.875 MHz
Red Star	467.900 MHz
Blue Star	467.925 MHz

◇ MURS channels

CH	Frequency
1	151.820 MHz
2	151.880 MHz
3	151.940 MHz
4	154.570 MHz
5	154.600 MHz

◇ FRS (Family Radio Service) channels

CH	Frequency	CH	Frequency
1	462.5625 MHz	8	467.5625 MHz
2	462.5875 MHz	9	467.5875 MHz
3	462.6125 MHz	10	467.6125 MHz
4	462.6375 MHz	11	467.6375 MHz
5	462.6625 MHz	12	467.6625 MHz
6	462.6875 MHz	13	467.6875 MHz
7	462.7125 MHz	14	467.7125 MHz

◇ **General aviation frequencies** (unit: MHz)

Frequency	Description
121.500	Emergencies
122.000	Flight Advisory Service
122.200	Flight Service Stations
122.700	Unicom— Uncontrolled airports
122.725	Unicom— Private airports
122.750	Unicom— Air-to-air communications
122.800	Unicom— Uncontrolled airports
122.900	Search & rescue training, & uncontrolled airports
122.950	Unicom— Controlled airports
123.000	Unicom— Uncontrolled airports
123.025	Helicopters— Air-to-air communications
123.050	Unicom— Heliports
123.075	Unicom— Heliports
123.100	Search & Rescue
123.300	Flight Schools
123.450	Air-to-air communications (unofficial)
123.500	Flight Schools
123.600	Flight Service Stations— Uncontrolled airports
148.125	Civil Air Patrol Repeaters— Secondary
148.150	Civil Air Patrol Repeaters— Primary
156.300	Aircraft-to-ship— safety
156.400	Aircraft-to-ship— commercial
156.425	Aircraft-to-ship— non-commercial
156.450	Aircraft-to-ship— commercial
156.625	Aircraft-to-ship— non-commercial
156.900	Aircraft-to-ship— commercial
243.000	Military Emergency "Guard"
255.400	Flight Advisory Service
257.800	Civilian Towers
311.000	SAC Primary
321.000	SAC Secondary
381.800	USCG— Primary

◇ **Cable TV (IRC)** (unit: MHz)

CH	Frequency range	Remarks
2– 13	54–216	(same as broadcast VHF)
14– 22	120–174	Mid band Ch. A–I
23– 36	216–300	Super band J–W
37– 53	300–402	Hyper band AA–QQ
54– 64	402–468	
65– 94	468–648	(Ultra band)
95– 99	90–120	Low band A5–A1
100–125	648–804	(Ultra band)

◇ **Wireless Microphones**

- 169.445 MHz
 - 169.505 MHz
 - 170.245 MHz
 - 170.305 MHz
 - 171.045 MHz
 - 171.105 MHz
 - 171.845 MHz
 - 171.905 MHz
- *Power limited to 1/20 watt. These frequencies are also used at the drive-in windows at some fast-food restaurants.

12 FREQUENCY TABLE

■ Other communications— other countries

◇ LPD (Low Power Device) channels

CH	Frequency
1	433.075
2	433.100
3	433.125
4	433.150
5	433.175
6	433.200
7	433.225
8	433.250
9	433.275
10	433.300
11	433.325
12	433.350
13	433.375
14	433.400
15	433.425
16	433.450
17	433.475
18	433.500
19	433.525
20	433.550
21	433.575
22	433.600
23	433.625
24	433.650
25	433.675
26	433.700
27	433.725
28	433.750
29	433.775

CH	Frequency
30	433.800
31	433.825
32	433.850
33	433.875
34	433.900
35	433.925
36	433.950
37	433.975
38	434.000
39	434.025
40	434.050
41	434.075
42	434.100
43	434.125
44	434.150
45	434.175
46	434.200
47	434.225
48	434.250
49	434.275
50	434.300
51	434.325
52	434.350
53	434.375
54	434.400
55	434.425
56	434.450
57	434.475
58	434.500

(unit: MHz)

CH	Frequency
59	434.525
60	434.550
61	434.575
62	434.600
63	434.625
64	434.650
65	434.675
66	434.700
67	434.725
68	434.750
69	434.775

◇ PMR446 channels (unit: MHz)

CH	Frequency
1	446.00625
2	446.01875
3	446.03125
4	446.04375
5	446.05625
6	446.06875
7	446.08125
8	446.09375

◇ UHF C.R.S (Citizen Radio Service) channels

CH	Frequency	CH	Frequency
1	476.425 MHz	21	476.925 MHz
2	476.450 MHz	22	476.950 MHz
3	476.475 MHz	23	476.975 MHz
4	476.500 MHz	24	477.000 MHz
5	476.525 MHz	25	477.025 MHz
6	476.550 MHz	26	477.050 MHz
7	476.575 MHz	27	477.075 MHz
8	476.600 MHz	28	477.100 MHz
9	476.625 MHz	29	477.125 MHz
10	476.650 MHz	30	477.150 MHz
11	476.675 MHz	31	477.175 MHz
12	476.700 MHz	32	477.200 MHz
13	476.725 MHz	33	477.225 MHz
14	476.750 MHz	34	477.250 MHz
15	476.775 MHz	35	477.275 MHz
16	476.800 MHz	36	477.300 MHz
17	476.825 MHz	37	477.325 MHz
18	476.850 MHz	38	477.350 MHz
19	476.875 MHz	39	477.375 MHz
20	476.900 MHz	40	477.400 MHz

13 MAINTENANCE

■ Troubleshooting

If your receiver seems to be malfunctioning, please check the following points before sending it to a service center.

PROBLEM	POSSIBLE CAUSE	SOLUTION	REF.
No power comes on.	<ul style="list-style-type: none">• The batteries are exhausted.• The battery polarity is reversed.	<ul style="list-style-type: none">• Replace or charge the batteries.• Check the battery polarity.	pp. 5, 7 p. 5
No sound comes from the speaker.	<ul style="list-style-type: none">• Volume level is too low.• Squelch level is set too tight.• A different tone squelch tone is selected.	<ul style="list-style-type: none">• Push [▲] to obtain a suitable level.• While holding down [SQL], rotate [DIAL] to set the squelch level.• Turn the appropriate function OFF.	p. 13 p. 14 p. 41
Sensitivity is low and only strong signals are audible.	<ul style="list-style-type: none">• The attenuator function is activated.	<ul style="list-style-type: none">• While holding down [FUNC], push [SQL] to turn the attenuator function OFF.	p. 15
Frequency cannot be set.	<ul style="list-style-type: none">• The lock function is activated.	<ul style="list-style-type: none">• While holding down [FUNC], push [LOCK](BAND) for 1 second to turn the function OFF.	p. 12
No beep sounds.	<ul style="list-style-type: none">• The beep tones are turned OFF or the beep tone level is too low.	<ul style="list-style-type: none">• Turn the beep tone ON, or set the beep tone level to appropriate level in the Set mode.	p. 47
Audio is distorted.	<ul style="list-style-type: none">• The operating mode is not selected correctly.	<ul style="list-style-type: none">• Push [MODE] repeatedly to select a suitable operating mode.	p. 14
Desired Set mode item cannot be selected.	<ul style="list-style-type: none">• The "EXPAND" item is set to OFF.	<ul style="list-style-type: none">• Turn the "EXPAND" item ON.	p. 45
Programmed scan does not start.	<ul style="list-style-type: none">• Program scan edges are not programmed.	<ul style="list-style-type: none">• Program a pair of scan edge channels.	p. 30
Memory or bank scan does not start.	<ul style="list-style-type: none">• No or only one memory or bank channel is programmed.	<ul style="list-style-type: none">• Program at least 2 memory or bank channels	pp. 19, 20
Installed batteries cannot be charged.	<ul style="list-style-type: none">• The batteries are over discharged.	<ul style="list-style-type: none">• Re-install the batteries (wait at least for 2 second), then plug the AC adapter or CP-18A/E while holding down [FUNC].	p. 7

■ CP-18A/E fuse replacement

If the fuse blows, or the receiver stops functioning while operating with the optional CP-18A/E, find the source of the problem if possible, solve it and only then replace the damaged fuse with a new rated one (FGB 5 A) as shown.

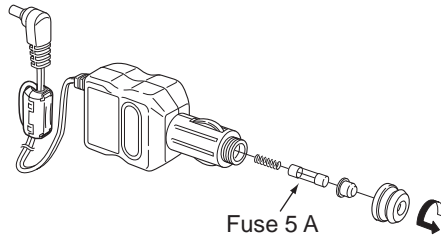

14 SPECIFICATIONS

◇ GENERAL

- Frequency coverage : (Unit: MHz)
 - USA : 0.100–821.995,
851.000–866.995,
896.000–1309.995
 - France : 0.100–29.995,
50.200–51.200,
87.500–107.995,
144.000–146.000,
430.000–440.000,
1240.000–1300.000
 - Other than above : 0.100–1309.995
- Number of memory channels : 1300
- Frequency resolution : 5, 6.25, 8.33*, 9*, 10, 12.5, 15, 20,
25, 30, 50, 100, 125, 200 kHz
 - * Selectable depending on the operating frequency band.
- Receive modes : FM, WFM, AM
- Operating temperature range : –10°C to +60°C; +14°F to +140°F
- Reference frequency stability : ±1.0 ppm (+25°C)
- Power supply requirement : 2 AA (R6) alkaline cells
2 AA (R6) Ni-MH cells
4.5 to 6.3 V DC
(with AC adapter or CP-18A/E)
- Current drain (backlight OFF at 3.0 V DC):
 - rated audio : 130 mA typical
 - receive standby : 65 mA typical
 - power save : 30 mA typical
 - charging : 140 mA typical
- Antenna connector : SMA (50 Ω)
- Dimensions : 58(W) × 86(H) × 29.8(D) mm
(projections not included) 2⁹/₃₂(W)×3³/₁₆(H)×1³/₁₆(D) in
- Weight (approximately) : 200 g; 7.1 oz
(with supplied antenna and batteries)

All stated specifications are subject to change without notice or obligation.

◇ RECEIVER

- Receive system : Triple-conversion superheterodyne
- Intermediate frequencies : 1st 266.7 MHz
2nd 19.65 MHz (FM/AM)
19.95 MHz (WFM)
3rd 450 kHz (FM/AM)
750 kHz (WFM)
- Sensitivity (except spurious points):
 - FM (1 kHz/±3.5 kHz Dev.; 12 dB SINAD)
 - 1.625–4.995 MHz 0.32 μV typical
 - 5.000–29.995 MHz 0.25 μV typical
 - 30.000–469.995 MHz 0.18 μV typical
 - 470.000–832.995 MHz 0.32 μV typical
 - 833.000–1029.995 MHz 0.28 μV typical
 - 1030.000–1309.995 MHz 0.35 μV typical
 - WFM (1 kHz/±52.5 kHz Dev.; 12 dB SINAD)
 - 76.000–108.000 MHz 1.1 μV typical
 - 175.000–221.995 MHz 1.1 μV typical
 - 470.000–770.000 MHz 1.8 μV typical
 - AM (1 kHz/30% MOD.; 10 dB S/N)
 - 0.495–4.995 MHz 1.3 μV typical
 - 5.000–29.995 MHz 0.89 μV typical
 - 118.000–136.000 MHz 0.63 μV typical
 - 222.000–246.995 MHz 0.63 μV typical
 - 247.000–329.995 MHz 0.79 μV typical
- Selectivity :
 - AM/FM : More than 12 kHz/–9 dB
Less than 30 kHz/–60 dB
 - WFM : More than 150 kHz/–6 dB
- Audio output power : (at 10% distortion/3.0 V DC)
 - Internal speaker : More than 150 mW with a 16 Ω load
 - External speaker : 80 mW typical with an 8 Ω load
- Ext. speaker connector : 3-conductor 3.5 (d) mm (1/8")/8 Ω

15 OPTIONS

- **BC-196SA/SD** AC ADAPTER

- **BC-153SC** AC ADAPTER

For regular charging of the installed Ni-MH batteries. Same as supplied one. (Not supplied with some receiver version.)

BC-196SA/SD : 4.5 V DC/400 mA output

BC-153SC : 6.0 V DC/1 A output

- **CP-18A/E** CIGARETTE LIGHTER CABLE WITH DC-DC CONVERTER

Allows you to operate the receiver through a 12 V cigarette lighter socket. You can also charge the installed Ni-MH batteries.

- **BC-194** CHARGER STAND

Allows you to charge the receiver on the desktop. Requires an AC adapter or cigarette lighter cable.

- **AD-92SMA** ANTENNA CONNECTOR ADAPTER

Allows you to connect an external antenna with a BNC connector.

- **SP-13** EARPHONE

Provides clear audio in noisy environments.

- **HP-4** HEADPHONE

Light weight monaural headphone.

- **LC-146A** CARRYING CASE

Helps protect the receiver from scratches, etc.

- **CT-17** CI-V LEVEL CONVERTER

For receiver remote control using a PC.

- **OPC-474** CLONING CABLE

For receiver-to-receiver cloning.

- **OPC-478/OPC-478UC** CLONING CABLE

Used for data cloning between receiver and a PC with CS-R6 (cloning software).

- **CS-R6** CLONING SOFTWARE

Provides quick and easy programming of such settings as memory channels and Set modes contents via your PC's RS-232C terminal (using OPC-478), or USB port (OPC-478UC). Either OPC-478 or OPC-478UC is required.

Approved Icom optional equipment is designed for optimal performance when used with an Icom receiver. Icom is not responsible for the destruction or damage to an Icom receiver in the event the Icom receiver is used with equipment that is not manufactured or approved by Icom.

POCKET GUIDE 16

Important operating instructions are summed up on this and the following page for your simple reference.

By cutting along the line and folding on the dotted line, it will become a card sized operating guide which can easily be carried in a card case or wallet, etc.

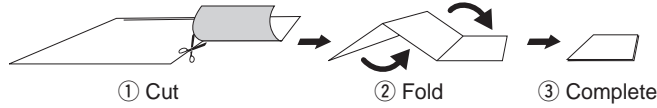

ICOM POCKET GUIDE IC-R6

- **VFO and memory mode selection**
 - ➔ Push [V/M] to toggle between the VFO and the memory mode.
- **Receive mode selection**
 - ➔ Push [MODE] repeatedly to select a desired mode.
- **Audio level setting**
 - ➔ Push [▲] to increase the audio level, push [▼] to decrease it.
- **Squelch level setting**
 - ➔ While holding down [SQL], rotate [DIAL] to set the squelch level.

◀CUT HERE▶

■ Frequency band selection

- ➔ Push [BAND] repeatedly, or hold down [BAND], rotate [DIAL] to select a desired frequency band.

■ Tuning step selection

- ➔ Push [TS], then rotate [DIAL] to select a desired tuning step.
- Push [TS] again to return to the previous screen.

■ Key lock function

- ➔ While holding down [FUNC], push [CA] [BAND] for 1 sec. to toggle the key lock function ON or OFF.
- "rLO" appears when the lock function is in use.

■ Attenuator function

- ➔ While holding down [FUNC], push [ATT] [SQL] to toggle the attenuator ON or OFF.
- "ATT" appears when the attenuator function is in use.

■ Frequency setting

- ① Push [V/M] to select the VFO mode.
- ② Rotate [DIAL] to set a desired receive frequency.

■ Memory channel selection

- ① Push [V/M] to select the memory mode.
- ② Rotate [DIAL] to set a desired memory channel.
 - While holding down [FUNC], rotate [DIAL] changes the memory channel in 10 channel steps.

■ Memory bank channel selection

- ① Push [V/M] to select the memory mode.
- ② Push [BAND] repeatedly, or while holding down [BAND], rotate [DIAL] selects a desired bank.
- ③ Rotate [DIAL] to select a desired bank channel.



CE Versions of the IC-R6 which display the 'CE' symbol on the serial number label, comply with the essential requirements of the European Radio and Telecommunication Terminal Directive 1999/5/EC

■ Memory channel programming

- ① Set a desired frequency and other functions in the VFO mode.
- ② Hold down [S.MW](V/M) for 1 second to enter the select memory write mode.
 - 1 short and 1 long beep sounds.
- ③ Rotate [DIAL] to select a desired memory channel.
- ④ Hold down [S.MW](V/M) for 1 second to program the contents into the selected channel.
 - 3 beeps sound.

■ Scan skip setting

- ① Push [V/M] to select the memory mode.
- ② Rotate [DIAL] to select a desired memory channel.
- ③ While holding down [FUNC], push [SKIP](V/M) to set the skip setting (skip channel or skip frequency) ON or OFF.

• List of Country codes (ISO 3166-1)

	Country	Codes		Country	Codes
1	Austria	AT	18	Liechtenstein	LI
2	Belgium	BE	19	Lithuania	LT
3	Bulgaria	BG	20	Luxembourg	LU
4	Croatia	HR	21	Malta	MT
5	Czech Republic	CZ	22	Netherlands	NL
6	Cyprus	CY	23	Norway	NO
7	Denmark	DK	24	Poland	PL
8	Estonia	EE	25	Portugal	PT
9	Finland	FI	26	Romania	RO
10	France	FR	27	Slovakia	SK
11	Germany	DE	28	Slovenia	SI
12	Greece	GR	29	Spain	ES
13	Hungary	HU	30	Sweden	SE
14	Iceland	IS	31	Switzerland	CH
15	Ireland	IE	32	Turkey	TR
16	Italy	IT	33	United Kingdom	GB
17	Latvia	LV			

■ VFO scans

- ① Push [V/M] to select the VFO mode.
- ② Hold down [SCAN](MODE) for 1 second.
 - A scan type appears.

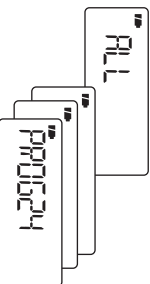

- ③ Rotate [DIAL] to select a desired scan type.
- ④ Push [SCAN](MODE) to start the scan.
 - Rotate [DIAL] to change the scanning direction.
 - During scan, push [V/M] to start the auto memory write scan.
- ⑤ Push [SCAN](MODE) again to stop the scan.

■ Memory scans

- ① Push [V/M] to select the memory mode.
- ② Hold down [SCAN](MODE) for 1 second.
 - A scan type appears.

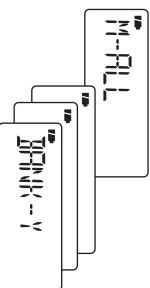

- ③ Rotate [DIAL] to select a desired scan type.
- ④ Push [SCAN](MODE) to start the scan.
 - Rotate [DIAL] to change the scanning direction.
- ⑤ Push [SCAN](MODE) again to stop scan.



DECLARATION OF CONFORMITY

We Icom Inc. Japan
1-1-32, Kamiminami, Hirano-ku
Osaka 547-0003, Japan



Declare on our sole responsibility that this equipment complies with the essential requirements of the Radio and Telecommunications Terminal Equipment Directive, 1999/5/EC, and that any applicable Essential Test Suite measurements have been performed.

Bad Soden 24th Dec. 2009

Place and date of issue

Kind of equipment: COMMUNICATIONS RECEIVER

Icom (Europe) GmbH
Communication Equipment
Auf der Krautweide 24,
65812 Bad Soden am Taunus,
Germany

Type-designation: IC-R6

Authorized representative name

Version (where applicable):

This compliance is based on conformity with the following harmonised standards, specifications or documents:

- i) EN 301 489-1 v1.6.1 (September 2005)
- ii) EN 301 489-15 v1.2.1 (August 2002)
- iii) EN 301 783-2 v1.1.1 (September 2000)
- iv) EN 60950-1 (2001): A11: 2004

Y. Furukawa
General Manager

Signature

Icom Inc.

Count on us!

#02 Europe
#12 Europe-1

<Intended Country of Use>											
<input checked="" type="checkbox"/> AT	<input checked="" type="checkbox"/> BE	<input checked="" type="checkbox"/> CY	<input checked="" type="checkbox"/> CZ	<input checked="" type="checkbox"/> DK	<input checked="" type="checkbox"/> EE						
<input checked="" type="checkbox"/> FI	<input type="checkbox"/> FR	<input checked="" type="checkbox"/> DE	<input checked="" type="checkbox"/> GR	<input checked="" type="checkbox"/> HU	<input checked="" type="checkbox"/> IE						
<input type="checkbox"/> IT	<input checked="" type="checkbox"/> LV	<input checked="" type="checkbox"/> LT	<input checked="" type="checkbox"/> LU	<input checked="" type="checkbox"/> MT	<input checked="" type="checkbox"/> NL						
<input checked="" type="checkbox"/> PL	<input checked="" type="checkbox"/> PT	<input checked="" type="checkbox"/> SK	<input checked="" type="checkbox"/> SI	<input type="checkbox"/> ES	<input checked="" type="checkbox"/> SE						
<input type="checkbox"/> GB	<input checked="" type="checkbox"/> IS	<input checked="" type="checkbox"/> LI	<input checked="" type="checkbox"/> NO	<input checked="" type="checkbox"/> CH	<input checked="" type="checkbox"/> BG						
<input checked="" type="checkbox"/> RO	<input checked="" type="checkbox"/> TR	<input checked="" type="checkbox"/> HR									

#03 U.K.

<Intended Country of Use>											
<input type="checkbox"/> AT	<input type="checkbox"/> BE	<input type="checkbox"/> CY	<input type="checkbox"/> CZ	<input type="checkbox"/> DK	<input type="checkbox"/> EE						
<input type="checkbox"/> FI	<input type="checkbox"/> FR	<input type="checkbox"/> DE	<input type="checkbox"/> GR	<input type="checkbox"/> HU	<input type="checkbox"/> IE						
<input type="checkbox"/> IT	<input type="checkbox"/> LV	<input type="checkbox"/> LT	<input type="checkbox"/> LU	<input type="checkbox"/> MT	<input type="checkbox"/> NL						
<input type="checkbox"/> PL	<input type="checkbox"/> PT	<input type="checkbox"/> SK	<input type="checkbox"/> SI	<input type="checkbox"/> ES	<input type="checkbox"/> SE						
<input checked="" type="checkbox"/> GB	<input type="checkbox"/> IS	<input type="checkbox"/> LI	<input type="checkbox"/> NO	<input type="checkbox"/> CH	<input type="checkbox"/> BG						
<input type="checkbox"/> RO	<input type="checkbox"/> TR	<input type="checkbox"/> HR									

#05 Italy
#15 Italy-1

<Intended Country of Use>											
<input type="checkbox"/> AT	<input type="checkbox"/> BE	<input type="checkbox"/> CY	<input type="checkbox"/> CZ	<input type="checkbox"/> DK	<input type="checkbox"/> EE						
<input type="checkbox"/> FI	<input type="checkbox"/> FR	<input type="checkbox"/> DE	<input type="checkbox"/> GR	<input type="checkbox"/> HU	<input type="checkbox"/> IE						
<input checked="" type="checkbox"/> IT	<input type="checkbox"/> LV	<input type="checkbox"/> LT	<input type="checkbox"/> LU	<input type="checkbox"/> MT	<input type="checkbox"/> NL						
<input type="checkbox"/> PL	<input type="checkbox"/> PT	<input type="checkbox"/> SK	<input type="checkbox"/> SI	<input type="checkbox"/> ES	<input type="checkbox"/> SE						
<input type="checkbox"/> GB	<input type="checkbox"/> IS	<input type="checkbox"/> LI	<input type="checkbox"/> NO	<input type="checkbox"/> CH	<input type="checkbox"/> BG						
<input type="checkbox"/> RO	<input type="checkbox"/> TR	<input type="checkbox"/> HR									

#07 France
#17 France-1

<Intended Country of Use>											
<input type="checkbox"/> AT	<input type="checkbox"/> BE	<input type="checkbox"/> CY	<input type="checkbox"/> CZ	<input type="checkbox"/> DK	<input type="checkbox"/> EE						
<input type="checkbox"/> FI	<input checked="" type="checkbox"/> FR	<input type="checkbox"/> DE	<input type="checkbox"/> GR	<input type="checkbox"/> HU	<input type="checkbox"/> IE						
<input type="checkbox"/> IT	<input type="checkbox"/> LV	<input type="checkbox"/> LT	<input type="checkbox"/> LU	<input type="checkbox"/> MT	<input type="checkbox"/> NL						
<input type="checkbox"/> PL	<input type="checkbox"/> PT	<input type="checkbox"/> SK	<input type="checkbox"/> SI	<input type="checkbox"/> ES	<input type="checkbox"/> SE						
<input type="checkbox"/> GB	<input type="checkbox"/> IS	<input type="checkbox"/> LI	<input type="checkbox"/> NO	<input type="checkbox"/> CH	<input type="checkbox"/> BG						
<input type="checkbox"/> RO	<input type="checkbox"/> TR	<input type="checkbox"/> HR									

#08 Spain
#18 Spain-1

<Intended Country of Use>											
<input type="checkbox"/> AT	<input type="checkbox"/> BE	<input type="checkbox"/> CY	<input type="checkbox"/> CZ	<input type="checkbox"/> DK	<input type="checkbox"/> EE						
<input type="checkbox"/> FI	<input type="checkbox"/> FR	<input type="checkbox"/> DE	<input type="checkbox"/> GR	<input type="checkbox"/> HU	<input type="checkbox"/> IE						
<input type="checkbox"/> IT	<input type="checkbox"/> LV	<input type="checkbox"/> LT	<input type="checkbox"/> LU	<input type="checkbox"/> MT	<input type="checkbox"/> NL						
<input type="checkbox"/> PL	<input type="checkbox"/> PT	<input type="checkbox"/> SK	<input type="checkbox"/> SI	<input checked="" type="checkbox"/> ES	<input type="checkbox"/> SE						
<input type="checkbox"/> GB	<input type="checkbox"/> IS	<input type="checkbox"/> LI	<input type="checkbox"/> NO	<input type="checkbox"/> CH	<input type="checkbox"/> BG						
<input type="checkbox"/> RO	<input type="checkbox"/> TR	<input type="checkbox"/> HR									

A-6810H-1EX-①
Printed in Japan
© 2010 Icom Inc.

Printed on recycled paper with soy ink.

Downloaded by
RadioAmateur.EU

Icom Inc.

1-1-32 Kamiminami, Hirano-ku, Osaka 547-0003, Japan