

IC-R70

COMMUNICATIONS RECEIVER

INSTRUCTION MANUAL



Downloaded by

Amateur Radio Directory



TABLE OF CONTENTS

SECTION	1	SPECIFICATIONS	1
SECTION	2	FEATURES	2
SECTION	3	INSTALLATION	3
SECTION	4	OPERATING CONTROLS.....	5
	4-1	FRONT PANEL.....	5
	4-2	UNDER ACCESS COVER	7
	4-3	REAR PANEL.....	8
SECTION	5	OPERATING INSTRUCTIONS.....	10
	5-1	HOW TO TUNE	10
	5-2	SSB OPERATION	13
	5-3	CW OPERATION.....	14
	5-4	RTTY OPERATION	14
	5-5	AM OPERATION.....	15
	5-6	FM OPERATION (OPTION).....	15
	5-7	OTHER OPERATIONS	15
SECTION	6	CIRCUIT DESCRIPTION	17
SECTION	7	INSIDE VIEWS	18
SECTION	8	OPTION INSTALLATION.....	20
SECTION	9	TROUBLESHOOTING	21
SECTION	10	BLOCK DIAGRAM.....	22
SECTION	11	SCHEMATIC DIAGRAM.....	SEPARATE

SECTION 1 SPECIFICATIONS

GENERAL

Number of Semiconductors:

Transistors	77
FET	14
IC (Includes CPU)	43
Diodes	180

Frequency Coverage:

Ham Band	1.8MHz ~ 2.0MHz
	3.5MHz ~ 4.1MHz
	6.9MHz ~ 7.5MHz
	9.9MHz ~ 10.5MHz
	13.9MHz ~ 14.5MHz
	17.9MHz ~ 18.5MHz
	20.9MHz ~ 21.5MHz
	24.5MHz ~ 25.1MHz
	28.0MHz ~ 30.0MHz

General Coverage

0.1MHz ~ 30.0MHz
(German version: 0.2MHz ~ 26.1MHz)
Thirty 1MHz Segments

Frequency Control:

CPU based 10Hz step Digital PLL synthesizer with dual VFO system

Frequency Readout:

6 digit 100Hz readout.

Frequency Stability:

Less than 250Hz after switch on 1 min to 60 mins, and less than 50Hz after 1 hour. Less than 500Hz in the range of -10°C to $+60^{\circ}\text{C}$.

Power Supply Requirements:

117V or 235V $\pm 10\%$ 50 ~ 60Hz 30VA
(100V/200V/220V use requires internal modification)

Antenna Impedance:

50 ohms Unbalanced
(Single wire can be used on 0.1 ~ 1.6MHz)

Weight:

7.4kg (10.3 lbs)

Dimensions:

111mm(H) x 286mm(W) x 276mm(D)
(4-3/8 inch x 11-1/4 inch x 10-7/8 inch)

RECEIVER

Receiving System:

Quadruple Conversion Superheterodyne with continuous Bandwidth Control
(F_3^* : Triple Conversion Superheterodyne)

Receiving Mode:

A_1 , A_3 J (USB, LSB), F_1 (Output FSK audio signal), A_3 , F_3^*

IF Frequencies:

1st	70.4515MHz
2nd	9.0115MHz
3rd	455KHz
4th	9.0115MHz (except F_3^*) with continuous Bandwidth Control (except F_3^*)

2nd IF Center Frequency:

SSB (A_3 J)	9.0115MHz
CW(A_1) RTTY (F_1)	9.0106MHz
AM (A_3) FM* (F_3)	9.0100MHz

Sensitivity (when preamplifier is ON):

SSB, CW, RTTY	Less than 0.15 microvolts (0.1 ~ 1.6MHz : 1 microvolt) for 10dB S+N/N
AM	Less than 0.5 microvolts (0.1 ~ 1.6MHz : 3 microvolts)
FM*	Less than 0.3 microvolts for 12dB SINAD (1.6 ~ 30MHz)

Selectivity:

SSB, CW, RTTY	2.3KHz at -6dB (Adjustable to 500Hz min) 4.2KHz at -60dB
CW-N, RTTY-N	500Hz at -6dB 1.5KHz at -60dB
AM	6KHz at -6dB (Adjustable to 2.7KHz min) 18KHz at -60dB
FM*	15KHz at -6dB 25KHz at -60dB

Spurious Response Rejection Ratio:

More than 60dB

Audio Output:

More than 2 Watts

Audio Output Impedance:

8 ohms

*When optional FM unit is installed.

Specifications are approximate and are subject to change without notice or obligation.

Downloaded by

Amateur Radio Directory

SECTION 2 FEATURES

GENERAL COVERAGE RECEIVER CAPABILITY

The IC-R70 has capabilities for an all amateur band receiver as well as a general coverage receiver between 100KHz and 30MHz with thirty 1MHz segments. The Up-conversion system using a high side IF and Microcomputer Control System make these capabilities possible.

In addition to these, the low-pass filters and the band-pass filters selected by an electronic signal from the BAND UP/DOWN button, make a no tune-up system.

DUAL 10Hz STEP DIGITAL VFO

The dual digital VFO consists of the PLL unit, which has a triple looped Phase-Locked-Loop, and the LOGIC unit, used to control the PLL, has the Microcomputer Control System.

Three tuning frequency resolutions of 10Hz, 100Hz and 1KHz steps are selectable with the TUNING RATE SELECT switches. Two separate VFO's can be used independently on any desired band.

OUTSTANDING RECEIVER PERFORMANCE

The IC-R70 employs a dual conversion superheterodyne system which has the first IF at 70.4515MHz and the second IF at 9.0115MHz.

The RF amplifier circuit is a wide band push-pull amplifier using low-noise and wide dynamic range junction FET's, and the mixer is a high level Double Balanced Mixer developed by ICOM.

These advanced devices and system give higher spurious response rejection ratio, higher sensitivity and wider dynamic range.

PASS-BAND TUNING

The IC-R70 has a built-in Pass-Band Tuning system developed by ICOM that allows you to continuously adjust the pass band of the IF. By turning the control, you can eliminate interference from a nearby signal, thus providing clear reception.



SECTION 3 INSTALLATION

BE SURE TO READ THE FOLLOWING INSTRUCTIONS BEFORE USE.

3-1 UNPACKING

Carefully remove your receiver from the packing carton and examine it for signs of shipping damage. Should any be apparent, notify the delivering carrier or dealer immediately, stating the full extent of the damage. It is recommended you to keep the shipping cartons. In the event storage, moving, or reshipment becomes necessary they will be handy. Accessory cables, plugs, etc., are packed with the receiver. Make sure you have not overlooked anything.

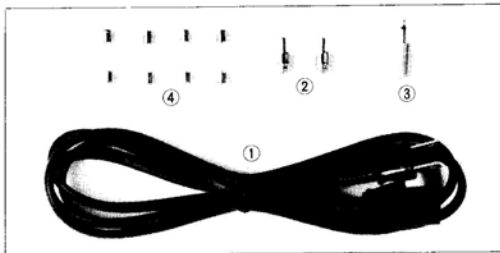

- | | |
|------------------------------------|---|
| 1. AC Power Cord | 1 |
| 2. Pin Plugs | 2 |
| 3. External Speaker Plug | 1 |
| 4. Spare Fuses | 4 |

3-2 RECOMMENDATIONS FOR INSTALLATION

1. Avoid placing the IC-R70 in direct sunlight, high temperature, dusty or humid places.
2. Be sure that nothing is on and just behind the rear panel to ensure good ventilation. Also avoid places near outlets of heaters, air conditioners, etc.
3. Place the unit so that the controls and switches can easily be handled and the frequency indication and meter can easily be read.
4. Use the Ground Lug!

3-3 POWER SUPPLY

The receiver has a built-in AC power supply. Connect the supplied AC power cord to the AC power socket on the rear panel of the unit, and the opposite side plug of the power cord into any convenient AC power outlet.

When you wish to use the receiver with an AC power supply voltage other than the original one, you must make internal wiring modifications as per the following drawings.

If you are not familiar with soldering or do not understand the drawings, don't attempt to make any modifications, but contact the nearest ICOM service center or authorized dealer.

Pov.

For 100V AC

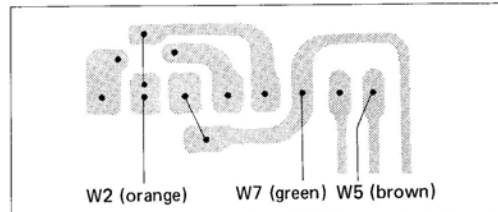

For 117V AC

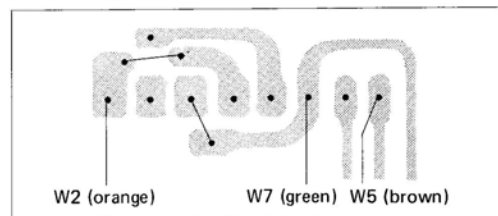

For 200V AC

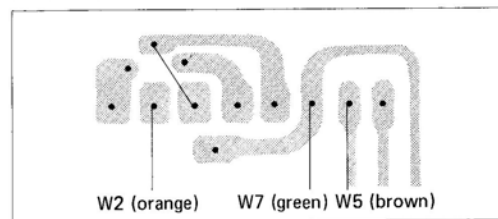

For 220V AC

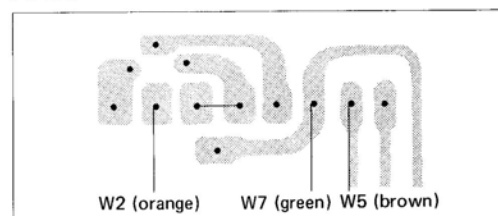

For 235V AC

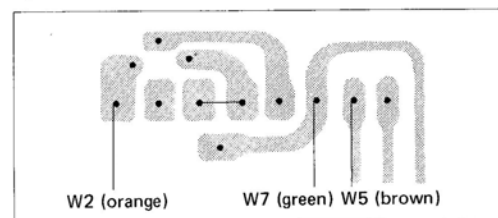

NOTE: For DC operation, contact your nearest ICOM service center or authorized ICOM dealer.

3-4 ANTENNA

Antennas play a very important role in radio communication. If the antenna is inferior, your receiver cannot give you the best performance. With a good antenna and feeder cable having 50 ohms impedance, you should easily get the desired matching and performance. Carefully install a high performance antenna that suits the frequency band(s) you wish to operate on and place it as high as possible. Be especially careful of the condition of the connectors as loose connections will deteriorate the performance.

Since the IC-R70 is a general coverage receiver it is recommended that a long-wire general coverage antenna and an antenna coupler be used. To attempt to use the Ham band antenna for general coverage reception could result in mismatching, and attendant poor reception. However, it is good enough for strong broadcasting stations.

Example of various antennas:

• Long Wire Antenna

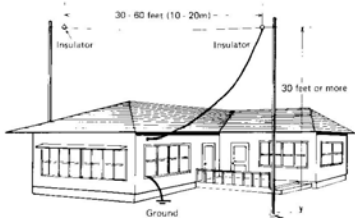

• Dipole Antenna

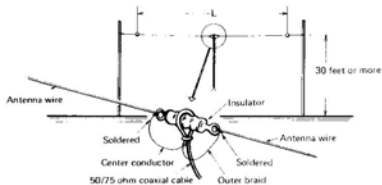

$$L(m) = \frac{143}{\text{Frequency (MHz)}} \quad \text{or} \quad L(\text{feet}) = \frac{468}{\text{Frequency (MHz)}}$$

• Multiband Antenna

L1, L2 and L3 can be calculated by the same formula as for dipole antenna.

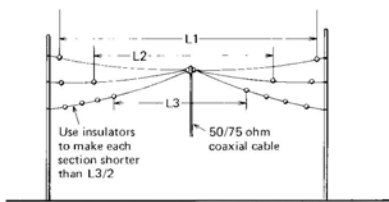

3-5 GROUND

In order to prevent electrical shocks, and other problems, be sure to connect a heavy wire ground, as short as possible, from a good earth point to the ground terminal on the rear panel.

Example of various ground systems:

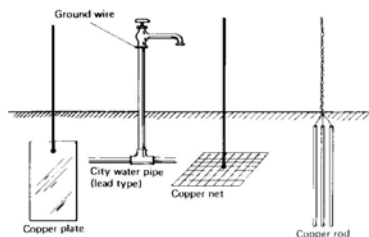

3-6 EXTERNAL SPEAKER

The IC-R70 contains an internal speaker, and is also designed so that it can drive an external speaker from the external (EXT) speaker jack on the rear panel. Be sure the impedance of the external speaker is 8 ohms, and remember that with the external speaker connected, the internal speaker is disabled.

3-7 HEADPHONES

Any good headphone set, including stereo type, that have 4-16 ohms impedance can be used. With the plug inserted halfway into the PHONES jack, both the headphone and speaker will operate. This is convenient when others wish to listen in on the station.

With a stereo headphone set inserted this way, however, the headphone will lose the sound on one side. With the plug inserted completely, only the headphone works.

3-8 CAUTIONS

As the unit has already been closely adjusted with highly sophisticated measuring instruments, never tamper with the turnable resistors, coils, trimmers, etc.

C-MOS is used in the Logic unit as well as the PLL. C-MOS ICs are very susceptible to excessive static charges and over-current and care must be used when handling them. Therefore, avoid touching the Logic unit and the nearby circuitry unless absolutely necessary. When it is necessary to check the circuitry, observe the following points.

Ground all measuring instruments, the soldering iron, and other tools. Do not connect or disconnect the C-MOS IC from its socket, or solder it when the power is on. Do not apply voltage of less than -0.5 or more than +5 Volts to the input terminals of the IC. DO NOT MEASURE WITH AN OHMMETER.

SECTION 4 OPERATING CONTROLS

4-1 FRONT PANEL

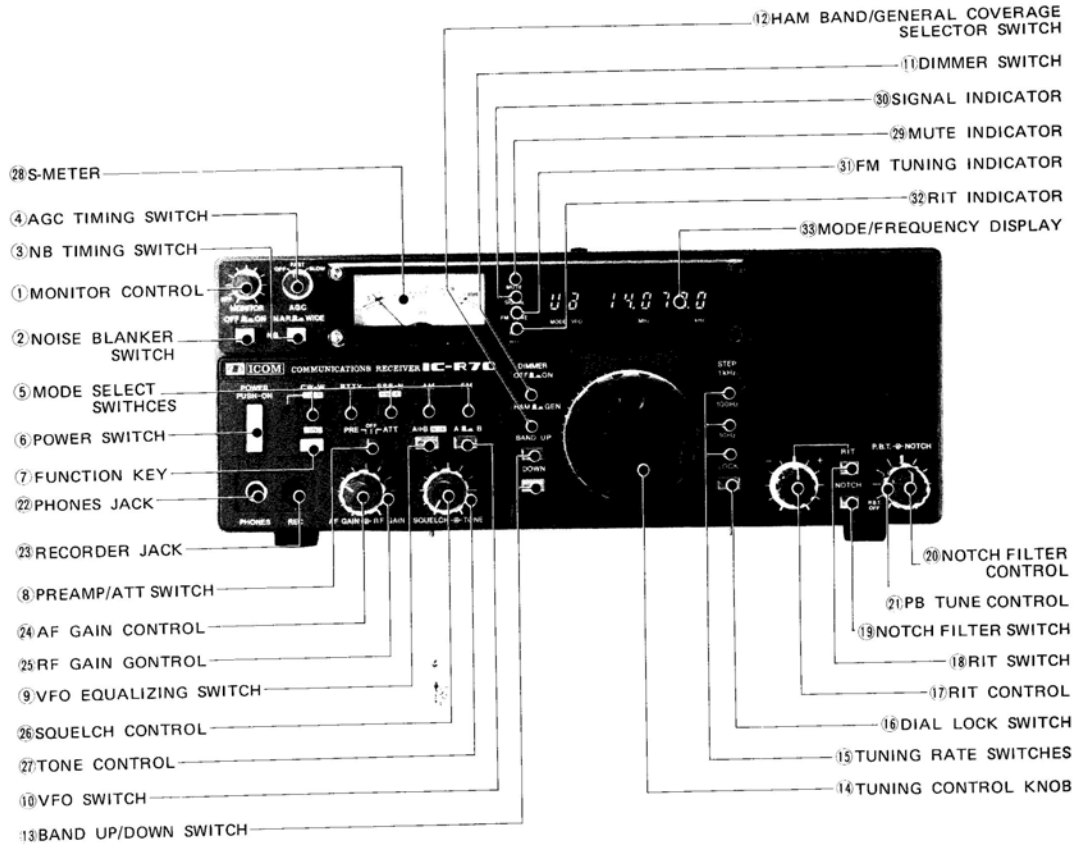

1. MONITOR CONTROL

When using this set together with a transmitter or transceiver, actual transmitted signals can be monitored.

This control switches the monitor circuit ON and OFF, and controls its audio level. Use headphones or reduce monitor audio volume to prevent feedback to the transmitter microphone.

2. NB (NOISE BLANKER) SWITCH

When pulse type noise such as automobile ignition noise is present, push this switch in. The noise will be reduced to provide comfortable reception.

3. NB TIMING SWITCH

The noise blanker blanking time can be selected NORMAL and WIDE by this switch. It will be effective against any types of noises.

4. AGC TIMING SWITCH

For changing the time-constant of the AGC (Automatic Gain Control) circuit. By setting the switch to slow position, the AGC voltage is released more slowly. Set the switch to provide comfortable reception.

When the switch is in the OFF position, the AGC function is turned OFF and the S-meter does not swing even if a signal has being received. (The AGC does not actuate on the FM mode.)

5. MODE SELECT SWITCHES

Selects any one of five operating modes by simply pushing the desired switch. Additionally, the CW and SSB switches have dual functions as follows.

1. CW : For normal CW operation.

CW-N : Pushing the FUNCTION key first, then the CW button, a filter is switched to the Narrow CW filter.

SSB-N : For normal SSB operation, upper sideband (USB) for 10MHz band and above, and lower sideband (LSB) for 9MHz band and below.

SSB-R : For reverse SSB operation, lower sideband (LSB) for 10MHz band and above, and upper sideband (USB) for 9MHz band and below.

6. POWER SWITCH

This switch is a push-lock type switch which controls the input AC power to the set. When the switch is pushed in and locked, power is supplied to the set. The switch is pushed again and released, the power to all circuits is cut. (If the MEMORY switch on the rear panel is turned ON, the power will be continuously supplied to the CPU to memorize the operating frequency, mode, etc.)

7. FUNCTION KEY

Increases the function of the CW and SSB MODE SELECT and the VFO EQUALIZING switch by pushing this key switch first.

8. PREAMP/ATT (Attenuator) SWITCH

Switches RF preamplifier and attenuator in the RF circuit.

When the switch is in the OFF position, both preamplifier and attenuator are removed from the circuit, and incoming signals will be fed to the receiver directly.

When using a small antenna or receiving a weak signal, set the switch in the "PRE" position, and the preamplifier is put in the RF circuit and provides higher sensitivity.

When nearby signals interfere with reception, or receiving a very strong signal, set this switch in the "ATT" position. This removes the preamplifier from the circuit and inserts the attenuator into the circuit. This gives about 20dB attenuation.

For normal operation leave this switch in the "OFF" position.

9. VFO EQUALIZING SWITCH

When "A" VFO and "B" VFO have different frequencies, by pushing this switch, "B" VFO will have the same frequency as "A" VFO. This switch has dual functions, by pushing the FUNCTION key first, then this switch, "A" VFO will have the same frequency as "B" VFO.

10. VFO SWITCH

You can select either of the built-in two VFO's, "A" VFO or "B" VFO with this switch.

In addition, when the VFO is switched from "A" VFO to "B" VFO, the frequency indicated on the frequency display just prior to switching goes into a memory inside the CPU. Thus even if "B" VFO is being used, switching to "A" again will enable you to operate at the initial frequency. Switching from "B" to "A" results in the same operation.

11. DIMMER SWITCH

By pushing this switch in, the intensity of the meter illumination and frequency display is reduced. Use this in the dark to prevent glare.

12. HAM BAND/GENERAL COVERAGE SELECTOR SWITCH

Selects the function of the set. In the HAM (out) position the receiver functions in any of nine HAM bands between 1.8MHz and 28MHz. In the GENERAL COVER position (in) the set functions as a general coverage receiver between 0.1MHz and 30MHz.

13. BAND UP/DOWN SWITCHES

Changes the operating band upward or downward. In the HAM BAND operation, the band skips to the next upper or lower band with each push. (28MHz band is divided into two segments of 28-29MHz and 29-30MHz.)

In the GENERAL COVERAGE operation, the band changes to next upper or lower 1MHz segment. When the band reaches the highest band, the next is the lowest band. Also when the band reaches the lowest band, the next is the highest band.

14. TUNING CONTROL KNOB

Rotating the TUNING CONTROL KNOB clockwise increases the frequency, while rotating it counterclockwise decreases the frequency. The frequency is changed in 10Hz, 100Hz or 1KHz steps which is according to the TUNING RATE switches. One complete rotation of the tuning knob results in a 1KHz frequency increase or decrease in 10Hz steps, 10KHz in 100Hz steps and 100KHz in 1KHz steps.

15. TUNING RATE SWITCHES

The small vernier marks on the tuning knob are changed to correspond to 10Hz, 100Hz or 1KHz steps which is selected by pushing the switch either 10Hz, 100Hz or 1KHz.

16. DIAL LOCK SWITCH

After the IC-R70 is set to a certain frequency by pushing the DIAL LOCK switch, the VFO is electronically locked at the displayed frequency, thus inactivating the operation of the tuning knob. To change frequency, the dial lock must first be disengaged by pushing and releasing the DIAL LOCK switch again.

17. RIT CONTROL

Shifts the receive frequency ± 800 Hz either side of the displayed frequency. When the RIT is ON, the RIT INDICATOR is illuminated. Rotating the control to the (+) side raises the receive frequency, and rotating to the (-) side lowers the receive frequency. With the RIT ON, if the TUNING CONTROL KNOB is moved one increment, the RIT circuit is automatically pulsed OFF. Therefore it is unnecessary to manually turn OFF the RIT when changing operating frequency. The frequency shift by turning the RIT Control is not indicated on the frequency display.

18. RIT SWITCH

Push once for ON; if OFF is desired push the switch again.

When the RIT is ON the RIT INDICATOR will light. (Note: The RIT will also pulse OFF when the TUNING CONTROL knob is turned.)

19. NOTCH FILTER SWITCH

Switches the notch filter function ON and OFF.

20. NOTCH FILTER CONTROL

Shifts the notch filter frequency. Adjust the control so that the interference is reduced.

21. P.B. TUNE (PASS BAND TUNING) CONTROL

Allows continuous tuning of the pass-band selectivity by moving the filter up to 500Hz from the upper or lower side in SSB, CW and RTTY, and 2.7KHz in AM. Not only improves selectivity, but also can improve the audio tone. Normal position is in the center (12 o'clock) or OFF position and is 2.3KHz wide in SSB, and 6KHz wide in AM.

22. PHONES JACK

Accepts a standard 1/4 inch headphone plug for headphones of 4 ~ 16 ohms. Stereo phones can be used without modification.

23. RECORDER JACK

Accepts a 3.5mm mini plug for a tape recorder to record receiving signals. The output is a certain level regardless of the position of the AF GAIN control.

24. AF GAIN CONTROL

Controls the audio output level. Clockwise rotation increases the level.

25. RF GAIN CONTROL

Controls the gain of the RF section. Clockwise rotation gives the maximum gain. As the control is rotated counterclockwise, the needle of the METER rises, and only signals stronger than the level indicated by the needle will be heard.

26. SQUELCH CONTROL

Sets the squelch threshold level. To turn OFF the squelch function, rotate this control completely counterclockwise. To set the threshold level higher, rotate the control clockwise.

27. TONE CONTROL

Controls the receiver audio tone. Adjust the control to provide comfortable reception.

28. S-METER

Signal strength of an incoming signal is indicated on a scale of S1 ~ S9 and S9 to S9+40dB, and a linear scale divided into five.

29. MUTE INDICATOR

Illuminates when the receiver is in the mute mode for an

external transmitter or transceiver.

30. SIGNAL INDICATOR

Illuminates when the squelch is opened.

31. FM TUNING INDICATOR

Illuminates when the set is tuned to an incoming signal frequency within 1KHz. (When optional FM unit is installed.)

32. RIT INDICATOR

Illuminates when RIT is turned ON.

33. MODE/FREQUENCY DISPLAY

The frequency of the IC-R70 is displayed on a luminescent display tube. Since the 1MHz and 1KHz decimal points are displayed, the frequency can easily be read. The frequencies indicated are the carrier frequencies of each mode in AM, USB, LSB and CW. In the RTTY mode, the mark frequency (2125Hz beat tone) is displayed.

4-2 UNDER THE ACCESS COVER

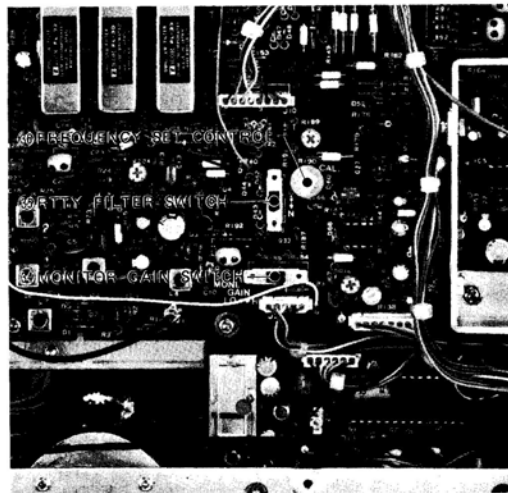

34. MONITOR GAIN SWITCH

Switches the gain of the receiver (monitor) in the mute mode, High and Low. Set the switch for comfortable monitoring.

35. RTTY FILTER SWITCH

Switches the crystal filters, 500Hz/-6dB (for CW) and 2.3KHz/-6dB (for SSB) in the RTTY mode. The selected filter is provided for the RTTY reception when the RTTY mode select switch on the front panel is pushed.

36. FREQUENCY SET CONTROL

This control is for fine adjustment of the reference frequency of the PLL unit, which is local oscillator frequency. Do not turn it unless you want to change the frequency.

4 - 3 REAR PANEL

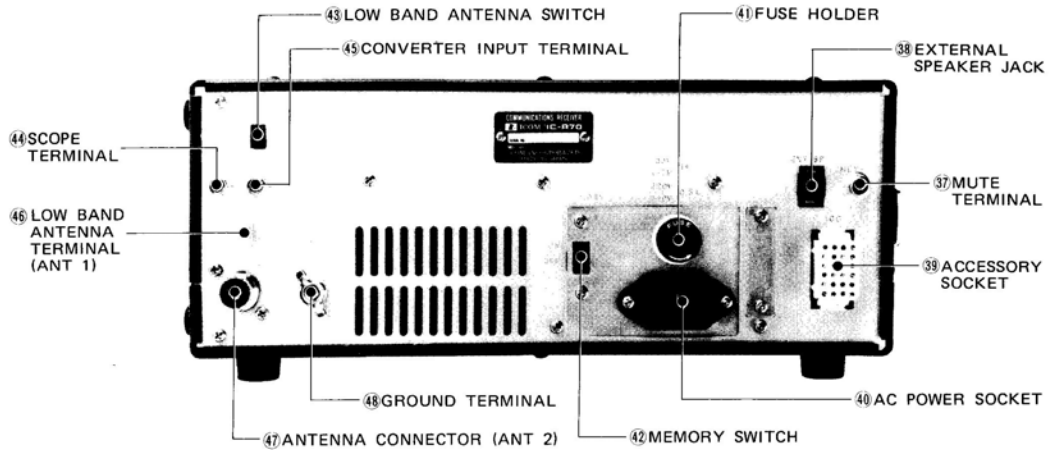

37. MUTE TERMINAL

When you wish to use the set together with a transmitter or transceiver, ground this terminal in the transmit mode, and the set is muted and monitors the transmitted signals.

38. EXTERNAL SPEAKER JACK

When an external speaker is used, connect it to this jack. Use a speaker with an impedance of 8 ohms. When the external speaker is connected, the built-in speaker does not function.

39. ACCESSORY (ACC) SOCKET

Various functions are available through the accessory socket such as frequency control, receiver output, T/R changeover, and so forth. The table below shows those terminals.

PIN No.	FUNCTION
1.	8 Volts DC is available when the squelch is closed.
2.	13.8 Volts DC in conjunction with the power switch operation.
3.	When this terminal is grounded, the set becomes in the mute mode.
4.	Output from the receiver detector stage. Fixed output regardless of AF output or AF gain.
5.	NC (no connection)
6.	8 Volts DC is available when Pin 3 is grounded. (relay can not be directly actuated. Max. 5mA.)
7.	NC
8.	Ground
9.	NC
10.	Input for TRVA converter control signal.
11.	Input for TRVB converter control signal.
12.	Output reference voltage for band switching.
13.	INPUT/OUTPUT for external band switching.
14.	NC
15.	NC

PIN No.	FUNCTION
16.	Input for external control (DBC signal).
17.	NC
18.	Input for external control (RC signal).
19.	Output for external control (DV signal).
20.	Input for external control (RT signal).
21.	Input/Output for external control (DB1).
22.	Input/Output for external control (DB2).
23.	Input/Output for external control (DB4).
24.	Input/Output for external control (DB8).

ACC SOCKET CONNECTIONS



Outside view

40. AC POWER SOCKET

For connection of the supplied AC power cable.

41. FUSE HOLDER

This holds a fuse for the AC power circuit. If the fuse is blown, replace it with a new 1 Amp fuse for 100/117V operation, or 0.5 Amp fuse for 200/220/235V operation after checking the cause. Open the fuse holder with a Phillips head screwdriver.

42. MEMORY SWITCH

When this switch is in the ON (up) position, the power to the CPU of the set is supplied continuously, even when the POWER SWITCH on the front panel is turned OFF, to retain all the operating frequencies of the two VFO's, etc. When this switch is set at the OFF position, all the power, including that to the CPU, is turned OFF by turning OFF the POWER SWITCH, so that all the operating frequencies of the two VFO's, etc., are erased.

**INTERRUPTORE ANTENNA
BANDA BASSA**



43. LOW BAND ANTENNA SWITCH

Switches the low band (1600KHz and below) antenna terminals; ANT 1 (46 LOW BAND ANTENNA TERMINAL) for a high impedance antenna such as a long wire antenna, and ANT 2 (47 50 ohm ANTENNA CONNECTOR) for a 50 ohm coaxial cable.

44. SCOPE TERMINAL

This terminal brings out the 70.4515MHz IF signal from the mixer in the receiver. Not only observes of the received signal, but also these signals of a selected band width are possible by using a panadaptor or panascope.

45. CONVERTER INPUT TERMINAL

VHF and UHF operation using a suitable converter with the IC-R70 is possible. This terminal is for converter connection.

CONNETTORE ANT. BANDA BASSA

46. LOW BAND ANTENNA TERMINAL (ANT 1)

For connection of a low band antenna to receive 1600KHz and below. When operating frequency goes to 1600KHz and below, the antenna terminal will be changed from 47 ANTENNA connector to this terminal automatically. (When the 43 LOW BAND ANTENNA SWITCH is set at the ANT 1 position).

47. ANTENNA CONNECTOR (ANT 2)

This is used to connect the antenna to the set. Its impedance is 50 ohms and connects with a PL-259 connector.

48. GROUND TERMINAL

To prevent electrical shock, and other problems, be sure to ground the equipment through the GROUND TERMINAL. For best results use as heavy a gauge wire or strap as possible and make the connection as short as possible.

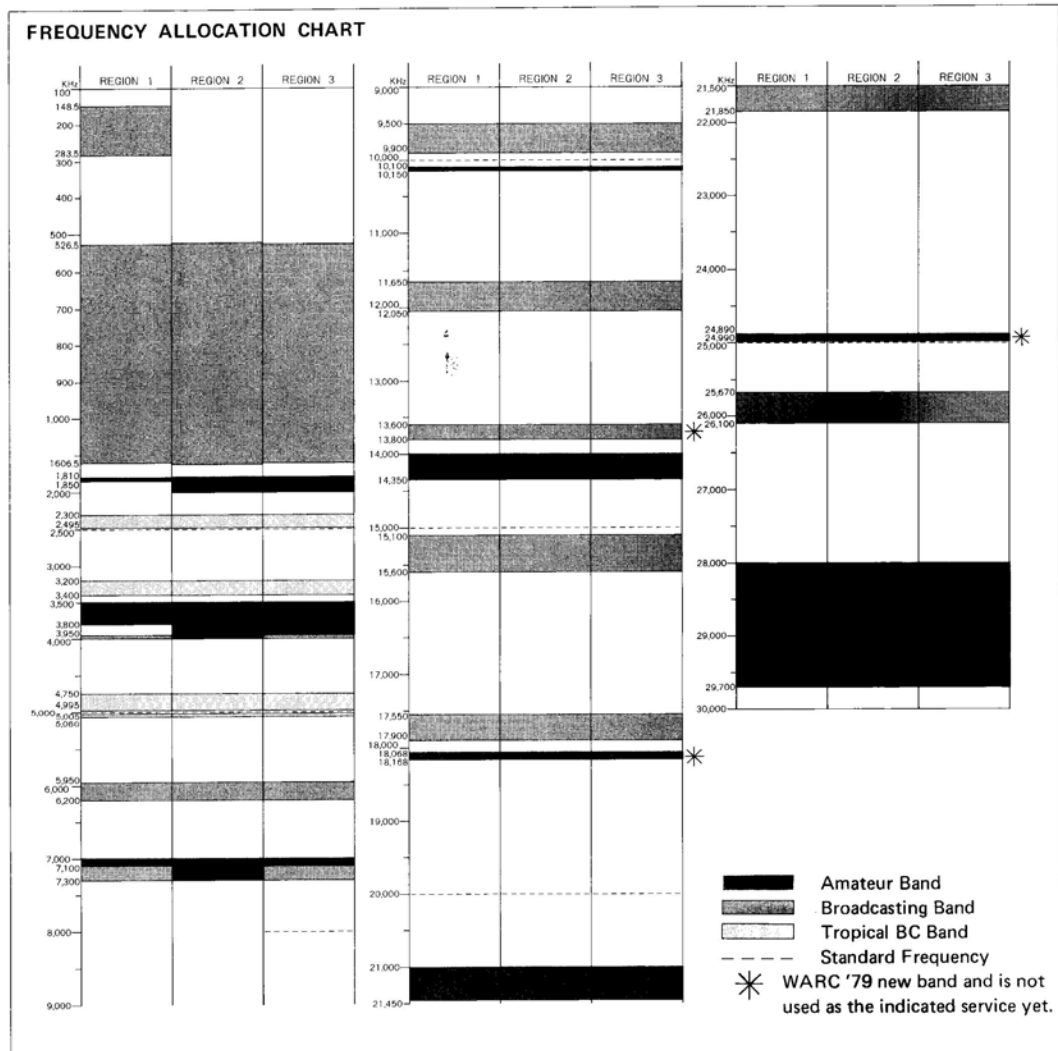

SECTION 5 OPERATING INSTRUCTIONS

5 - 1 HOW TO TUNE

The following instructions are for tuning in any mode. Please read carefully and understand fully before turning ON your unit. Proper tuning is necessary for optimum operation.

5 - 1 - 1 FREQUENCY DISPLAY IN EACH MODE

In the HAM band mode, when the set is first turned ON, the following readouts will appear on the MODE/FREQUENCY DISPLAY (when "A" VFO is selected).

L3 7100.0

If the Function Key is pushed and then the SSB button, USB will be selected. In that case, the display will be:

U3 7097.0

When changing to other modes, the display will be as follows:

CW or CW-N (Narrow): **L3 7099.4**

AM: **R3 7100.0**

RTTY: **r3 7099.4**

FM: **F3 7100.0**

When "B" VFO is selected, the display will be:

U6 7097.0

To avoid the trouble of recalibrating the dial when you change the operating mode, the displayed frequency is set to shift to the carrier frequency of each mode automatically. For the differences of the frequency shifts of the various modes, refer to the following figure.

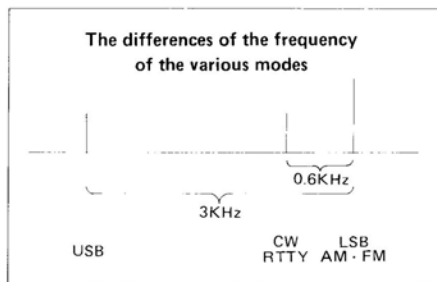

In the GENERAL COVERAGE mode, when the set is first turned ON, the display will be:

U3 15.000.0

The frequency shifts of the various modes are the same as those of the HAM band, refer to the above figure.

In the SSB mode, the sideband will be automatically selected to the one usually used on the band, i.e., upper sideband (USB) for the 10MHz band and above, and lower sideband (LSB) for the 7MHz band (9MHz band in the GENERAL COVERAGE mode) and below. If reverse sideband

is desired, push the FUNCTION key first, then push the SSB switch.

CAUTION: In the GENERAL COVERAGE mode, displayed frequency and actual operating frequency are different at the band edges of each band as per the following figures.

In the LSB, AM or FM mode (at the low edge of 15MHz band).

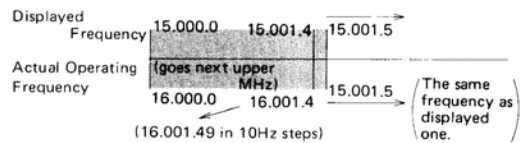

In the CW or RTTY mode (at the low edge of 15MHz band).

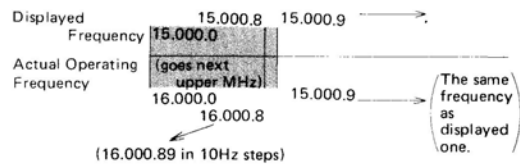

In the USB mode (at the high edge of 15MHz band).

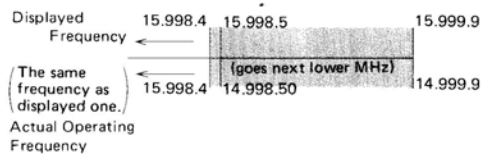

NOTE: This is true for 28 and 29MHz band in the HAM band mode.

5 - 1 - 2 TUNING CONTROL KNOB

The receive frequency is displayed on a 7 segment Electroluminescent display down to 100Hz digits. Rotating the tuning knob clockwise increases the frequency, while turning counterclockwise decreases the frequency in which steps are selected by the TUNING RATE switches, i.e., 10Hz, 100Hz or 1KHz steps.

One complete rotation of the tuning knob results in 1KHz with 10Hz steps, 10KHz with 100Hz steps, or 100KHz with 1KHz steps with a frequency increase or decrease.

Exact calibration is not necessary as the displayed frequency will always be correct but you may calibrate the scale on the tuning knob for use as an analog type frequency display.

If you want to calibrate the scale during operation, set the frequency readout to 0.0KHz, push the dial lock switch, then set the large increment on the tuning scale to line up

with the indicator arrow and then push the dial lock switch again.

The tuning knob scale may require recalibration if you:

1. Turn the knob while the frequency is locked by use of the Dial Lock switch.
2. Turn the knob beyond the band edge.

Brake Adjustment

If the knob is too loose or too stiff for comfortable use, you can adjust the torque by tightening or loosening the brake adjustment screw accessible from underneath the set.

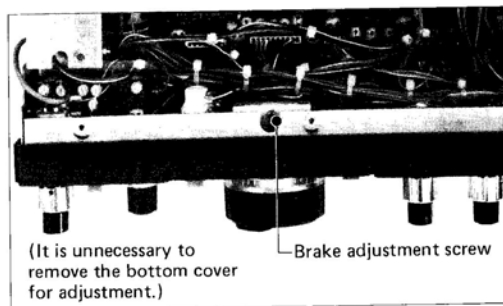

The following instructions should be used to adjust the tension of the Tuning Knob.

1. The Tuning knob tension will become tighter by turning the brake adjustment screw clockwise, and will become looser by turning the screw counterclockwise.
2. While performing this adjustment, the Tuning knob must be turned continuously as the screw is adjusted in order to set the tension for a comfortable touch.

On all HAM bands except the 28MHz band, the displayed frequency will not go beyond the highest band edge even by turning the tuning knob clockwise, or beyond the lowest band edge by turning the knob counterclockwise. On the 28MHz band, since this band width is much wider than the others, the IC-R70 provides "automatic revert" over either MHz for operating convenience. When the frequency display shows 28.999.9MHz and the tuning knob is turned clockwise, the displayed frequency jumps down to 28.000.0 MHz and continues up from there. Likewise, by continuing to turn counterclockwise beyond the bottom edge of the band, the frequency jumps up from 28.000.0MHz to 28.999.9MHz and goes down from that point. The same holds true for the 29MHz segment, and the general coverage mode.

The frequency range of each band in the HAM band mode is shown in the following chart.

In the GENERAL COVERAGE mode, the frequency range is ".000.0" to ".999.9" of each MHz.

The displayed frequency shows the carrier frequency in the USB, LSB, AM, CW and FM modes, and the Mark frequency in the RTTY mode.

Band	Frequency Range
1.8	1.800.0 ~ 1.999.9
3.5	3.500.0 ~ 4.099.9
7.0	6.900.0 ~ 7.499.9
10.0	9.900.0 ~ 10.499.9
14.0	13.900.0 ~ 14.499.9
18.0	17.900.0 ~ 18.499.9
21.0	20.900.0 ~ 21.499.9
24.0	24.500.0 ~ 25.099.9
28.0	28.000.0 ~ 28.999.9
	29.000.0 ~ 29.999.9

5 - 1 - 3 TUNING RATE SWITCHES

Pushing one of the Tuning Rate switches will change the basic tuning rate of the set.

When the 10Hz switch is pushed, the tuning rate becomes 10Hz. The 10Hz may be read from the increments on the tuning knob.

When the 100Hz switch is pushed, the tuning rate becomes 100Hz.

When the 1KHz switch is pushed, the tuning rate is changed to correspond to 1KHz steps. The last significant-digit on the display will remain as the previous one. This position will allow you to quickly change over a great frequency range.

5 - 1 - 4 DIAL LOCK SWITCH

After the IC-R70 is set at a certain frequency, by pushing the Dial Lock switch the VFO is locked at the displayed frequency, thus inactivating the operation of the tuning knob. To change the frequency, the Dial Lock must first be disengaged by pushing and releasing the Dial Lock switch again.

5 - 1 - 5 VFO SWITCH

The CPU in the IC-R70 contains two "VFO's". The VFO's are labeled "A" VFO and "B" VFO and are selectable with the VFO Switch. This dual VFO system gives the IC-R70 many very convenient features. Please read this section very carefully and perform the operation several times until you are comfortable with the system.

1. "A" VFO is selected by placing the VFO switch in the "A" position. The receive frequency will be controlled by "A" VFO, displayed on the frequency readout, and stored in "A" memory.
2. "B" VFO is selected by placing the VFO switch in the "B" position. The receive frequency will be controlled by "B" VFO, displayed on the frequency readout, and stored in "B" memory.

EXAMPLE:

When the set is turned ON, 7.100.0 will be displayed on the readout.

This will occur whether the VFO switch is in either the "A" or "B". Rotating the tuning knob clockwise will increase the frequency in 100Hz (10Hz or 1KHz) steps. Rotating the tuning knob counterclockwise will decrease the frequency in 100Hz (10Hz or 1KHz) steps.

- Switching from one VFO to the other VFO does not clear the first VFO. The frequency is retained in VFO's memory.

EXAMPLE:

If 14.125.0MHz is set with "A" VFO, and the VFO switch is set to "B" VFO, the frequency readout will show "B" VFO's frequency, but 14.125.0MHz is still stored in "A" VFO's memory. Returning the VFO switch to "A" VFO position, and 14.125.0 will be displayed on the readout. Accordingly, if the switch is placed in the "B" VFO position, the frequency that was set with the "B" VFO will appear. This allows you to set a certain frequency with one VFO, work up and down the band with the other VFO, and periodically check the set frequency simply by switching between "A" and "B" VFO.

- The IC-R70 will perform this operation even on two different bands. A frequency is set in either "A" or "B" VFO on one band, the VFO switch is set to the other VFO, and the band set to any other band you wish to receive.

EXAMPLE:

Set "A" VFO to 14.255.0MHz. Set the VFO switch to "B" VFO. Switch to the 21MHz band. The frequency readout will read 21.100.0MHz. Operate anywhere you wish with "B" VFO. When you want to return to 14.255.0MHz, switch back to "A" VFO. The frequency readout will show 14.255.0MHz.

5 - 1 - 6 VFO EQUALIZING SWITCH

This switch allows either VFO's to be brought to the exact frequency of the other VFO without turning the tuning knob.

EXAMPLE:

When "A" VFO is 14.255.5MHz and "B" VFO is 21.355.0 MHz, pushing the VFO Equalizing switch, "B" VFO's frequency becomes the same as "A" VFO's (14.255.5MHz). Now the "A" VFO's frequency is memorized in the "B" VFO, and you can operate anywhere with "A" VFO. When you want to return to the previous frequency (14.255.5 MHz), switch back to "B" VFO. It's very easy.

To reverse this (A the same as B), push the Function Key first.

5 - 1 - 7 HAM/GENERAL COVERAGE SWITCH

This two position switch selects the range of frequencies to be covered by the Band Up/Down switches. In the HAM (out) position the frequencies available are those of the 9 amateur bands, between 1.8MHz and 28MHz. In the general coverage mode (in) the unit covers in the range 0.1 to

30MHz with thirty 1MHz segments.

5 - 1 - 8 BAND UP/DOWN SWITCHES

These switches labeled UP and DOWN increment the radio one band at a time in the desired direction. When in the HAM band mode this switch will move the receiver to the next band with each push. When in the General Coverage mode the band changes up or down in 1MHz segments. When the set reaches the highest band in either mode it will automatically return to the lowest band, or vice versa, as per the following charts.

In the HAM band mode

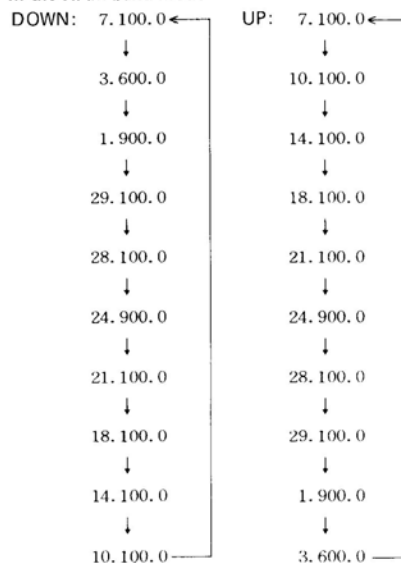

In the GENERAL COVERAGE mode

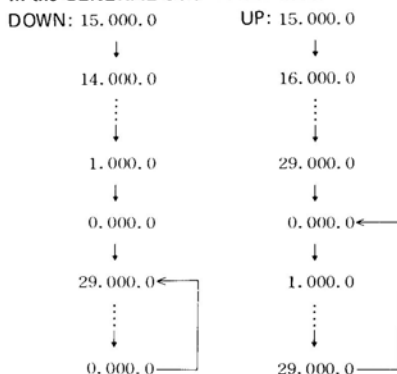

5 - 1 - 9 RIT (RECEIVE INCREMENTAL TUNING)

By using the RIT circuit, you can shift the receiving frequency $\pm 800\text{Hz}$ ($\pm 3\text{KHz}$ in AM and FM modes) either side of the displayed frequency without moving the displayed frequency itself. By pushing the RIT switch once the RIT

circuit is turned ON and the RIT Indicator is lit. The receiving frequency is shifted with the RIT Control knob.

When the RIT Control knob is in the "0" position, the displayed and receiving frequencies are the same.

Rotating the control to the (+) side raises the receiving frequency, and rotating to the (-) side lowers the frequency. To turn OFF the RIT control, again push the RIT switch and the RIT Indicator will go OFF. When the RIT circuit is OFF, the displayed and receiving frequencies are the same regardless of the setting of the RIT control knob.

NOTE: The RIT circuit is operational when the frequency is locked with the dial lock button. The frequency shifted by turning the RIT control is not indicated on the frequency display.

When the RIT circuit is ON, if the tuning knob is moved by one increment, the RIT circuit is automatically pulsed OFF.

If you do not wish the RIT to pulse OFF automatically when the tuning knob is turned, the switch shown below will allow this function. If this is done it is important that the RIT be at the "0" position during tuning performed with the Tuning Knob.

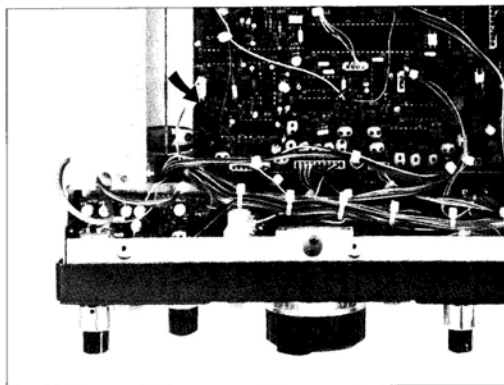

5 - 2 SSB OPERATION

5 - 2 - 1 RECEIVING

After connecting an antenna, AC power cord, etc., set knobs and switches as follows.

POWER SWITCH	OFF (OUT)
HAM BAND/GENERAL COVER SELECT SWITCH	HAM (OUT)
PREAMP/ATT SWITCH	OFF
AGC TIMING SWITCH	SLOW
NOISE BLANKER (NB) SWITCH	OFF (OUT)
VFO SWITCH	A (OUT)
AF GAIN CONTROL	Completely Counterclockwise
RF GAIN CONTROL	Completely Clockwise

P.B. TUNE CONTROL	OFF or Center (12 o'clock) position
RIT CONTROL	Center (12 o'clock) position
NOTCH FILTER SWITCH	OFF (OUT)

The other controls are unrelated to receiving and need not be set at this time.

Now turn ON the power switch. The meter lamp will be illuminated and L B 71000 will be shown on the MODE/FREQUENCY display in the HAM band mode.

In SSB operation there is both a USB (upper side band) and an LSB (lower side band). LSB is usually used on the 1.8, 3.5 and 7MHz bands, while USB is usually used on the 10MHz band and above. The IC-R70 selects the normally used sideband according to the band in which you are operating.

When you wish to operate on a band other than the 7MHz band, push the BAND UP/DOWN switches to select the band you wish to operate.

Slowly turn the AF GAIN control clockwise to a comfortable level. Rotate the tuning knob until a signal is received. The S-meter needle will move according to the signal strength, so tune for the highest possible meter reading and the clearest audio. If you cannot get a clear signal, you may be receiving in the opposite sideband. If so, change the mode to the proper sideband, by pushing the FUNCTION switch, then the SSB switch.

If no signal can be heard but only noise, turn the SQUELCH control clockwise until the noise from the speaker stops and set it just below this threshold. (When adjusting the SQUELCH control setting, if some communication signals can be heard, turn the tuning control in either direction and set it where only noise can be heard.) Your receiver will now remain silent until an incoming signal is received which opens the squelch and lights the SIGNAL indicator. If the squelch is unstable due to the reception of weak signals or fading signals, adjust the SQUELCH control further until the proper threshold is obtained.

5 - 2 - 2 NB (NOISE BLANKER)

Push the noise blanker Switch ON (in) when there is pulse type noise, such as ignition noise from automobile motors. Noise will be suppressed and even weak signals will be received comfortably.

When the NB TIMING switch is set in the WIDE position (in), the noise blanker will effectively work for "woodpecker's noise", however, if the receiving signal is too strong, the noise blanker may work with the receiving signal itself, and some distortion may be caused in the receiving audio or keying form. At this time, set the NB TIMING Switch in the NAR (narrow) position (out), or turn the NB switch OFF.

5 - 2 - 3 AGC (AUTOMATIC GAIN CONTROL)

The IC-R70 has a fast attack/slow release AGC system which holds the peak voltage of rectified IF signals from

the IF amp circuit for a certain period. Therefore, during the pauses in normal speech of the received signal, uncomfortable noise will not be heard. The meter indicates the peak value for a certain period, facilitating reading of the meter "S" function.

For normal SSB reception, turn the AGC TIMING Switch to the SLOW position. Turn the AGC TIMING Switch to the FAST position, when tuning or receiving signals with short interval fading. When in the FAST position, the time constant is shortened.

When this switch is set at the OFF position, the AGC circuit is turned OFF, and the S-meter does not work even if a signal is received. However the RF GAIN control is still active and the needle of the meter moves depending on the control position.

5 - 2 - 4 PREAMP/ATT SWITCH

Slide the PREAMP/ATT Switch to the PRE position when receiving weak signals. In the PRE position, an RF preamplifier is inserted into the receiving antenna circuit, increasing sensitivity and giving easy reception.

Slide the PREAMP/ATT switch to the ATT position when strong nearby signals disturb signal reception or make "S" reading difficult. In the ATT position, the RF amplifier is removed from the circuit and a 20dB attenuator is inserted into the receiving antenna circuit, reducing interfering signals and giving more stable reception. In normal operation the PREAMP/ATT switch is left in the OFF position.

5 - 2 - 5 P.B. (PASS-BAND) TUNING

Pass-Band Tuning is a system to narrow the band width (selectivity) of the frequencies that will pass through the crystal filter electronically from either the upper or lower side continuously by up to 500Hz. This is very effective in reducing interference from nearby signals.

To use the PBT system, rotate the PBT control clockwise until it clicks on and continue rotating it to its mid range position. This is the widest position and is equivalent to the bandwidth in the OFF position.

For example, while receiving in the LSB mode, if you get interference from a lower frequency (interfering signals are high-pitched tones), narrow the band width by turning the P.B. tuning control counterclockwise. When the interfering signals are low-pitched tones, they are from a higher frequency, and you should narrow the band width by turning the P.B. tuning control clockwise.

When receiving in the USB mode, the band width is narrowed in the opposite manner. Interference from a higher frequency will be high-pitched tones, and the P.B. tuning control should be turned clockwise. Interference from a lower frequency will be low-pitched tones and the P.B. tuning control is turned counterclockwise.

This control can also be used for audio tone adjustment, so it may be set for the most comfortable reception.

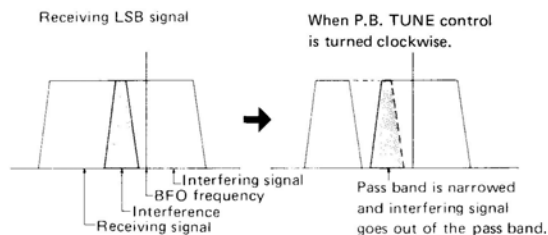
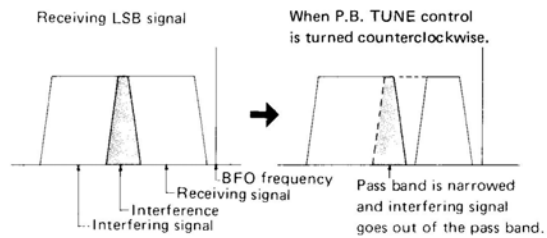

5 - 2 - 6 NOTCH FILTER

This circuit notches a frequency in the IF pass-band, so this is effective to reduce interference such as a beat-tone signal.

To use this function, push the NOTCH FILTER switch ON and turn the NOTCH FILTER control so that the interference is reduced.

5 - 3 CW OPERATION

5 - 3 - 1 RECEIVING

For CW reception, push the MODE SELECT Switch for CW mode, or CW-N mode (first the FUNCTION key, then the CW switch).

Other switches and knobs are set the same as for SSB reception.

When the MODE SELECT Switch is set at the CW-N mode, the narrow crystal filter is activated and the total selectivity of CW reception is improved (500Hz/-6dB). Also, with this filter, internal noise is reduced for comfortable CW reception and an improved signal to noise (S/N) ratio.

In addition, a narrower crystal filter, FL-63, is optional for this set. When you replaced the original narrow filter by this filter, the selectivity is improved to 250Hz/-6dB in the CW-N mode.

The Pass Band Tuning system can be used to narrow the band width up to 500Hz in CW mode the same as in the SSB mode.

Also, use the Noise Blanker, AGC switch and/or PREAMP/ATT switch depending on the receiving conditions, the same as SSB reception.

5-4 RTTY OPERATION

For RTTY operation, a teletypewriter and a demodulator (terminal unit) which is operational with audio input are required. Any demodulator with 2125/2295Hz filters (narrow, 170Hz shift) can be used with the IC-R70.

5-4-1 RECEIVING

Audio signals for the demodulator can be supplied from Pin 4 of the ACC socket on the rear panel, or from the RECORDER jack on the front panel. The level of the audio signals from Pin 4 of the ACC socket does not vary by

turning the AF GAIN Control, and the level is about 300mVp-p maximum.

Set the operating mode for RTTY, by pushing the MODE SELECT switch "RTTY". The other controls are the same as those for SSB reception. When tuning an RTTY signal, set the TUNING RATE SELECT switch in the 10Hz position, and tune to get audio signals of 2125Hz for MARK and 2295Hz for SPACE. (Use the tuning indicator of the terminal unit for easy tuning.) Also turn the P.B. Tune control for clear reception.

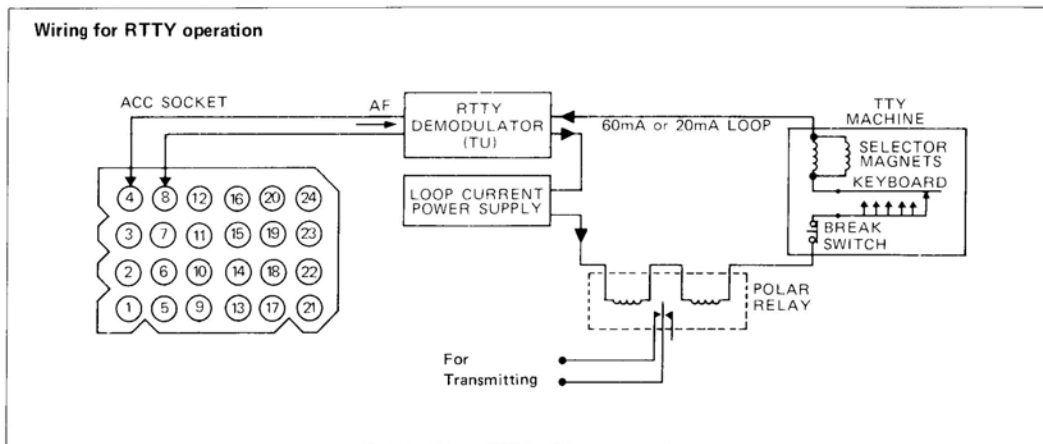

5-5 AM OPERATION

5-5-1 RECEIVING

Set the operating mode for AM, by pushing the MODE SELECT switch "AM". The other controls are the same as those for SSB reception.

When tuning an AM signal, tune for maximum signal strength as indicated on the S-meter and the clearest audio.

The RIT control shifts the receiving frequency $\pm 3\text{KHz}$ in this mode. Also the Pass Band Tuning control narrows the band width up to 2.7KHz.

When you wish to receive on 1.599.9MHz and below, connect a low band antenna to the LOW BAND ANT terminal on the rear panel.

5-6 FM OPERATION (OPTION)

5-6-1 RECEIVING

Set the operating mode for FM, by pushing the MODE SELECT switch "FM". The other controls are the same as those for SSB reception, however, the Pass Band Tuning control, Notch Filter, Noise Blanker and AGC circuits do not work in this mode.

When tuning an FM signal, tune for maximum signal strength as indicated on the meter and to light the FM tuning indicator.

5-7 OTHER OPERATIONS

5-7-1 WWV RECEPTION

To receive WWV (or other standard frequency station), set the operating band to 10MHz in the HAM band mode, and the MODE to any mode. Tune to 10.000.0MHz on the frequency display.

Since the IC-R70 has a General Coverage capability, any of WWV's frequencies can be received. Merely set to the GENERAL COVERAGE mode and USB or CW, and tune to the desired frequency.

The WWV signal can be used for alignment of a frequency counter, marker oscillator, or the frequency display.

5-7-2 SIMPLE FREQUENCY ALIGNMENT

A very accurate frequency counter is necessary to align the frequency of the IC-R70. However, the frequency can be aligned simply by receiving the WWV signal.

1. Set the frequency display to 10.000.0MHz in the HAM band and be sure that you are receiving the WWV signal.

2. Set the operating mode to USB or LSB. Some beat tone can be heard.
3. Rotate the FREQUENCY SET Control, located under the access cover, so that the beat tone becomes zero beat.

5 - 7 - 3 CONVERTER CONNECTION

The CONVERTER terminal can be used for a VHF/UHF converter INPUT terminal.

The converter's input frequency and signal level should be as follows:

Converter INPUT Frequency

Operating Band	Input Frequency
50MHz	20 ~ 24MHz
144MHz	24 ~ 26MHz
430MHz	20 ~ 30MHz

- Input Level : 1 μ V for S/N 10dB

Also, apply converter mode control signals to Pin 10 and 11 of the ACCESSORY socket as shown below.

Converter mode control signals:

TRV A (Pin 10)	TRV B (Pin 11)	BAND
L	H	50MHz
H	L	144MHz
H	H	430MHz
L	L	OFF

H = +5V L = 0V

In the converter mode, the frequency display shows 1MHz digit to 100Hz digit.

5 - 7 - 4 SCOPE TERMINAL

This terminal brings out the 70MHz IF signal from the mixer in the receiver. Observation of not only the received signal, but also of signals of the selected band width are possible by using a panadapter or panascope.

5 - 7 - 4 TRANSMITTER CONNECTION

This receiver can be used with a transmitter or transceiver for amateur radio service or other services.

Cable connections with a transmitter or transceiver are shown below.

Be sure to ground Pin 3 of the accessory socket or the mute terminal in the transmit mode.

5 - 7 - 6 MONITOR OPERATION

When using this set together with a transmitter or transceiver, actual transmitted signals can be monitored.

Tune the receiver to the transmitting frequency, then turn the MONITOR control clockwise (click ON) and further for comfortable audio level. At this time, use headphones or reduce monitor audio volume to prevent howling.

If the transmitting signal is too strong for monitoring, set the MONITOR GAIN switch under access cover to the "LOW" position.

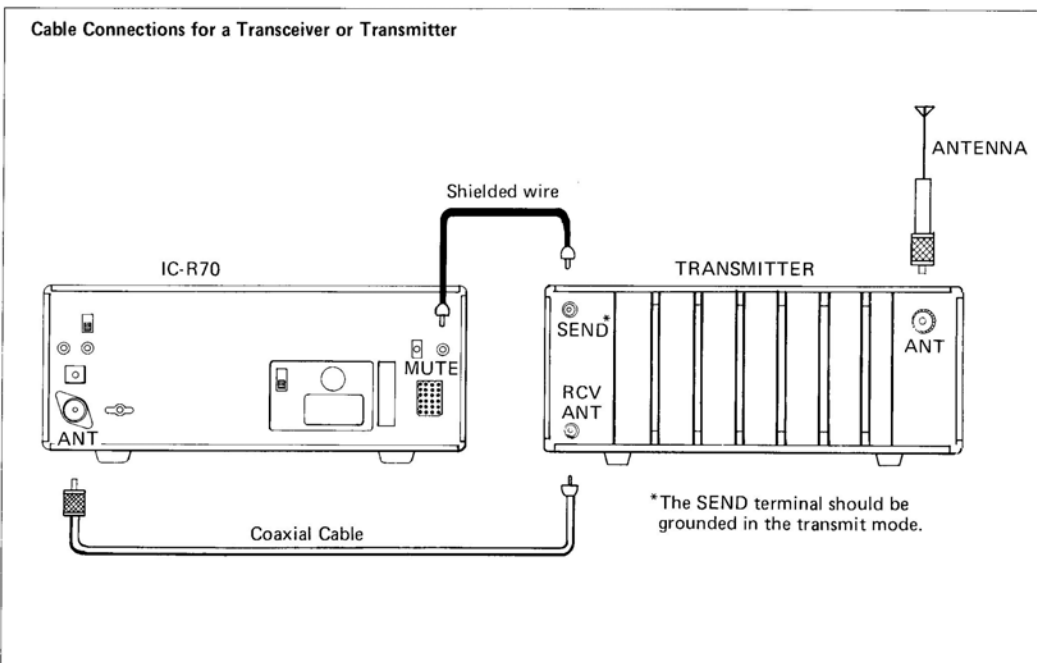

SECTION 6 CIRCUIT DESCRIPTION

The IC-R70 uses a phase-locked-loop (PLL) consisting of three loops for the local oscillator. The PLL is controlled by a Microcomputer system. The basic circuit uses an up-conversion with a First IF of 70.4515MHz and a Second IF of 9.0115MHz. Included within the MAIN Unit is the Pass Band Tuning circuit.

6-1 RF UNIT

Composed of a band-pass filter for each band, preamplifier, attenuator, 1st mixer and a 1st IF amplifier.

When a signal is received by the antenna, it passes through an appropriate band-pass filter which is chosen by a band signal from the LOGIC unit.

When the PRE/ATT switch is set at the PRE position, the signal is amplified by a wide-band amplifier about 10dB. This amplifier uses push-pull of junction FET's, 2SK125's to achieve low noise and wide dynamic range.

When the PRE/ATT switch is set at the ATT position, the signal bypasses the RF amplifier and goes to the attenuator circuit and is attenuated 20dB.

When the PRE/ATT switch is set at the OFF position, the signal bypasses both the RF amplifier and attenuator, and goes directly to the 1st mixer.

The 1st mixer is a double balanced mixer (DBM), where it is mixed with the 1st local oscillator signal from the PLL unit, becoming a 70MHz signal, passes through a pair of monolithic filter and is sent to the 2nd mixer in the MAIN unit through the 1st IF amplifier.

6-2 MAIN UNIT

Composed of the 2nd mixer, a crystal filter for each, SSB, AM and CW, IF amplifiers, Pass Band Tuning circuit, BFO, the SSB, AM detectors and IF amplifiers. In the 2nd mixer, also a DBM, the signal is mixed with the 61.44MHz signal of the 2nd local oscillator signal from the PLL unit, and a 9MHz signal is obtained, and sent to the IF circuitry.

The circuit for the Noise Blanker consists of noise amplifiers, a noise detector, a pulse amplifier and AGC circuit which blocks the noise pulses at the IF when noise is present.

The signal from the 2nd mixer is fed to the crystal filter, through an amplifier, to the IF amplifier, then to the Pass Band Tuning circuit composed of two mixers, 455KHz ceramic filters and the VXO circuit.

When the P.B.T. is turned ON the VXO frequency can be changed $\pm 1.8\text{KHz}$ ($\pm 3.3\text{KHz}$ in AM). The circuit makes a choice of what frequencies will pass electronically through the ceramic filter.

The P.B.T. will operate in all modes except FM.

Then the signal is sent to the second mixer then to the product detector, the squelch control and the AF attenuator. In the case of AM, the signal goes to the AM detector, then to an AF amplifier, the squelch control and the attenuator. The AF signal from the attenuator is applied to a high performance and low distortion AF power amplifier IC, and amplified and fed to the speaker.

The BFO has two crystal units, one is for USB and the other is for LSB, CW and RTTY. The oscillation frequency is shifted appropriate value for each mode.

6-3 LOGIC UNIT

This unit is composed of proprietary CPU for treating data such as up/down signal detection control, the dial lock control circuit, the tuning rate select circuit, the band switching control circuit, code converter circuit, and the I/O control circuit.

The dial clock signals are generated by the rotary encoder directly connected to the tuning knob. The up/down control circuit detects the rotating direction of the tuning knob, and puts out the up/down control signal for the CPU.

The CPU is a 4-bit microcomputer which has a program to control the set. The CPU's function are determined by the input signals, such as the dial clock signal, up/down signal and the signals from the function switches, and the CPU puts out signals to control the operating band, frequency, mode, tuning steps, display, and so on.

6-4 PLL UNIT

This unit is composed of three Phase-Locked Loops for the 1st Local Oscillator, a crystal oscillator and multiplier for the 2nd Local Oscillator, and voltage regulators for this unit.

The first loop puts out 13.15 ~ 23.14MHz with 10KHz steps.

This output signal is divided by 100 (131.5KHz ~ 231.4 KHz) and used for the reference frequency of the second loop.

The local oscillator of this loop oscillates 20.48MHz. This output is multiplied by 3 and puts out 61.44MHz for the 2nd local oscillator of the set.

The second loop puts out 30.8515 ~ 30.9514MHz with 10Hz steps. This output signal is used for the local oscillator of the main loop.

The local oscillator of this loop is a VXO (Variable Xtal Oscillator), and provides 10Hz steps. This output is multiplied by 3 and puts out 30.72MHz. Thus, this loop provides 10Hz steps on the operating frequency.

The third loop, i.e., the main loop, puts out 70.4515MHz ~ 100.4514MHz, as the 1st local oscillator of the set, with 10Hz steps, for entire band. This loop has four VCO's which divide the oscillation frequency range by segments of; 70.4515 ~ 78.4514MHz, 78.4515 ~ 85.4514MHz, 85.4515 ~ 92.4514MHz and 92.4515 ~ 100.4514MHz to improve the C/N (Carrier/Noise) ratio.

SECTION 7 INSIDE VIEWS

7-1 TOP VIEW

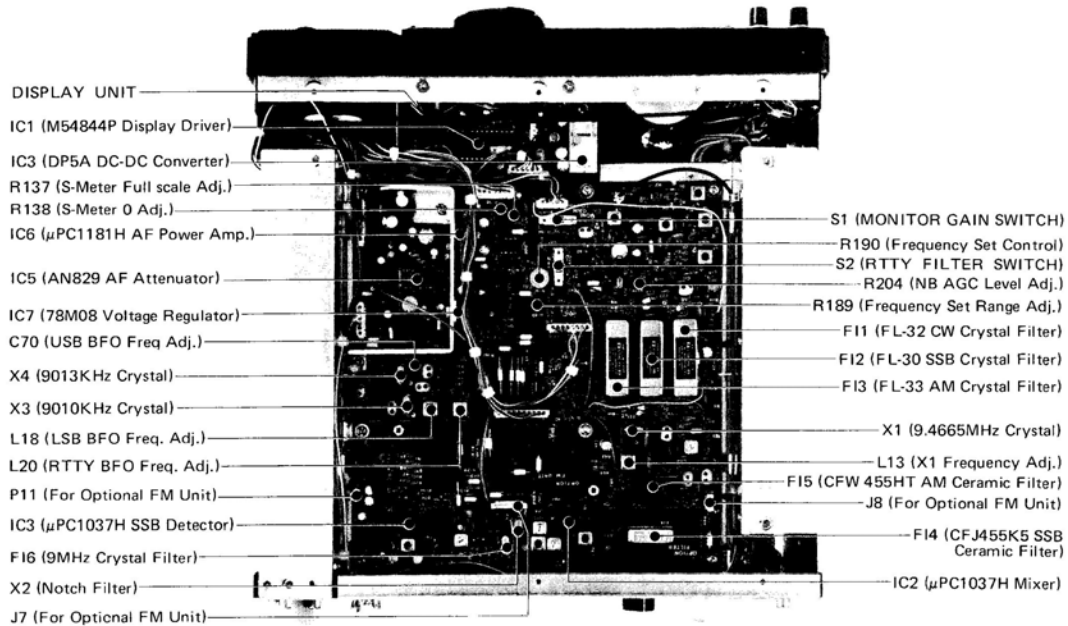

7-2 RF UNIT

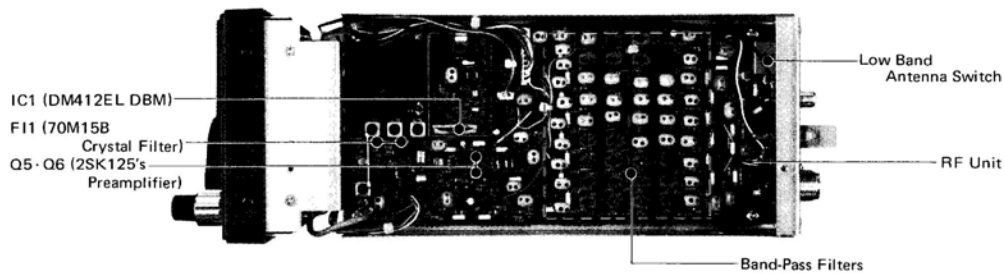

Downloaded by

 Amateur Radio Directory

7-3 BOTTOM VIEW

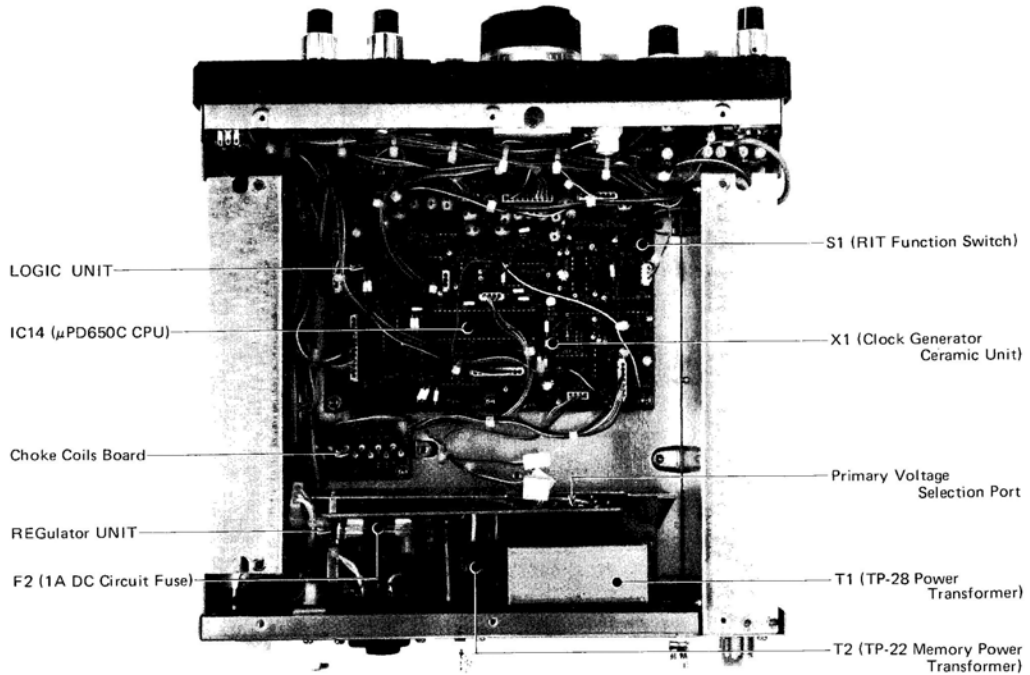

7-4 PLL UNIT

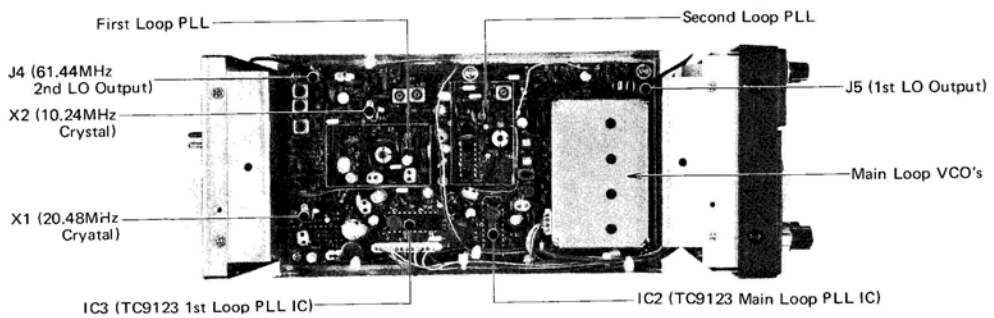

SECTION 8 OPTION INSTALLATION

8 - 1 INSTALLATION OF THE FM UNIT

Before performing any work on the set, make sure that the power cord is detached from the receiver.

1. Remove the top cover.
2. Install the FM unit to the position shown in the photo with two screws supplied.
3. Plug the P11 (2 pins) from the front panel to J1 of this unit, P2 (6 pins) of this unit to J7 on the MAIN unit and P1 (2 pins coaxial cable) of this unit to J8 on the MAIN unit.
4. This completes the installation.
5. Replace the top cover.

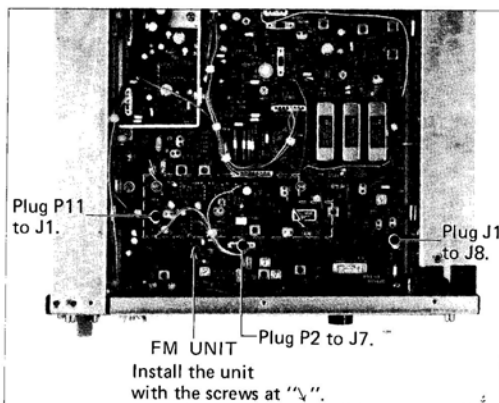

8 - 2 INSTALLATION OF THE FL-63 NARROW CW FILTER

The following tools are needed for the installation of the options:

Phillips Screwdriver	Diagonal cutters
Screwdriver	Soldering Iron (40W)
Solder	Soldering tool
De-soldering braid	

Before performing any work on the set, make sure that the power cord is detached from the receiver.

1. Remove the top cover.
2. Unscrew the seven screws retaining the MAIN unit board shown in the photo. Then turn the board over to front side so that the foil side of the board can be seen.
3. Remove the solder from the original CW filter FL-32's terminal pins and legs on the foil of the board, using a de-soldering braid, then remove the crystal filter.
4. Insert the FL-63 narrow CW filter to the position where the original filter FL-32 was installed. At this time, be sure to orient the filter so that the label of the filter is facing the same direction as the others.

Bend the leads and legs flush with the opposite side of the board and solder them in. Trim the leads even with the solder points. This completes the installation.

5. Replace the MAIN unit board and top cover.
6. No adjustment is required, and the filter provides 250Hz/6dB pass-band.

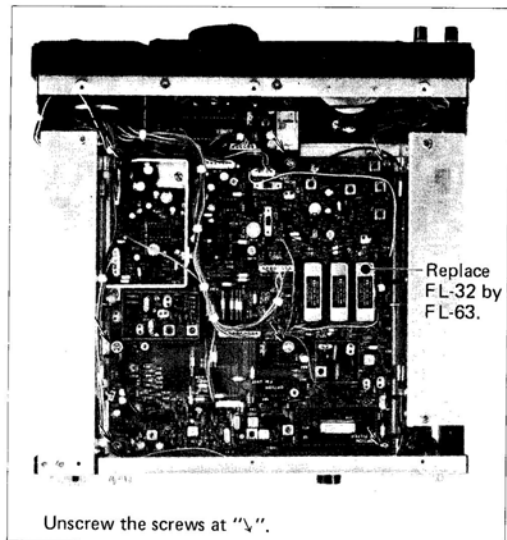

8 - 3 INSTALLATION OF THE FL-44 455KHz SSB FILTER

1. Follow steps 1 and 2 of the FL-63 NARROW CW FILTER instructions.
2. Remove the solder from the F14, ceramic filter and R73, resistor on the MAIN unit board shown in the photo below, using a de-soldering braid, then remove the F14, ceramic filter and R73, resistor.
3. Insert the FL-44 to the position where the ceramic filter was installed (shown in the photo below) and retain it by two supplied nuts then solder its terminal pins.
4. Replace the MAIN unit board and top cover.
5. No adjustment is required for operation.

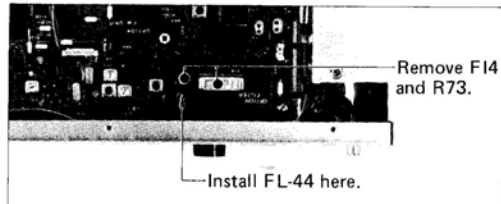

SECTION 9 TROUBLESHOOTING

Your IC-R70 has been carefully adjusted at the factory prior to shipping. The chart below has been provided to help you correct problems which are not equipment malfunctions. If you are unable to locate the trouble, or correct the fault, please contact your dealer or the nearest ICOM Service Center.

Problem	Possible Cause	Solution
1. Power does not come on when the switch is pushed.	Power cable is improperly connected. Blown fuse.	Carefully reconnect power cable. Check for the cause, then replace the fuse with a spare one.
2. No sound comes from the speaker.	AF GAIN control knob is completely counterclockwise. The external speaker cable is connected to the unit but not to the external speaker jack on the external speaker. Headphones are connected to the PHONES jack.	Turn the knob clockwise to a suitable level. Connect the cable to the speaker jack on the external speaker. Unplug the headphones.
3. Sensitivity is low and only strong signals are audible.	RF GAIN control knob is turned fully counterclockwise. The antenna feed line is cut or shorted. The Attenuator is ON.	Turn the RF Gain control knob fully clockwise. Check the feed line and correct any improper condition. Set the PRE/ATT switch to OFF position or PRE position.
4. The "S" meter is higher than the "0" position even when there is no signal.	RF GAIN control knob is turned fully counterclockwise.	Turn the knob fully clockwise.
5. Only incomprehensible voices are heard during SSB reception.	Receiving the wrong sideband.	Set the sideband opposite the one you are receiving, either USB or LSB.
6. The tone of the received signal is very high or low pitched.	Maladjustment of the P.B. Tune control.	Set the P.B. Tune control knob to the clear tone position, or P.B.T. OFF position.
7. The RIT LED goes out even though you did not depress the RIT ON/OFF switch to turn it OFF.	The RIT is automatically turned OFF when the Tuning Knob is rotated unless the interior RIT control switch is in the OFF position. The Power switch has been turned OFF.	You may change the unit so that the automatic RIT OFF function does not operate when you rotate the Tuning knob. (See page 13.) Depress the RIT ON/OFF switch again to turn on the RIT.
8. The frequency does not change by rotating the Tuning knob.	DIAL LOCK is engaged.	Disengage the DIAL LOCK by pressing the DIAL LOCK button.
9. An abnormal figure is displayed on the frequency display or fails to illuminate.	The Power switch was turned OFF and ON too quickly.	Turn the Power switch OFF, wait 30 seconds, and then turn it ON again.

SECTION 10 BLOCK DIAGRAM

RF/MAIN UNITS

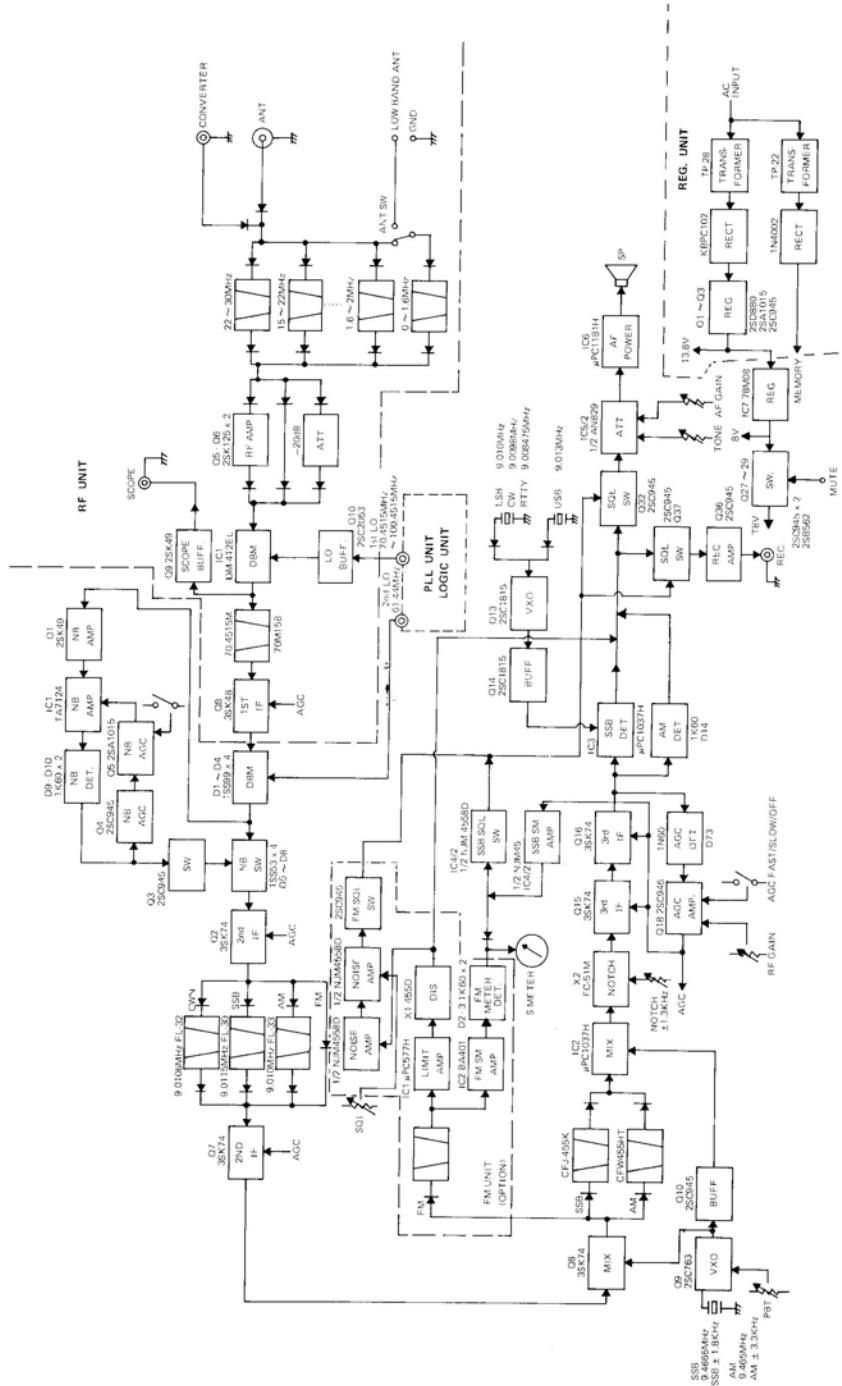

Downloaded by

Amateur Radio Directory