

iCOM

INSTRUCTION MANUAL

COMMUNICATIONS RECEIVER
IC-R9000L



Downloaded by
Amateur Radio Directory

www.hamdirectory.info

Icom Inc.

INTRODUCTION

Thank you for choosing this new Icom product.

The **IC-R9000L** is an advanced communications receiver designed for professional, worldwide communications. Equipped with Icom's state-of-the-art LCD monitor, the **IC-R9000L** includes an advanced multi-functional scanning system, a spectrum scope and an excellent stability oscillator that give you sophisticated measuring capability.

IMPORTANT

- (1) **READ THIS INSTRUCTION MANUAL CAREFULLY** before attempting operation. If you have any questions regarding the operation of the IC-R9000L, feel free to contact your nearest authorized Icom Dealer or Service Center.
- (2) **SAVE THIS INSTRUCTION MANUAL** — This instruction manual contains important safety and operating instructions for the IC-R9000L.

PRECAUTIONS

- (1) **NEVER** let metal, wire or other objects touch any internal part of the receiver. Risk of electrical shock could occur.
- (2) **NEVER** place the receiver within the reach of children or babies at any time.
- (3) **NEVER** expose the receiver to rain, snow or any liquid.
- (4) **DO NOT** operate the receiver when it is covered by objects which impede heat dispersal.
- (5) **AVOID** using the receiver in temperatures below -10°C ($+14^{\circ}\text{F}$) or over $+50^{\circ}\text{C}$ ($+122^{\circ}\text{F}$). The receiver may not function properly in extreme temperatures.
- (6) **AVOID** placing the receiver in excessively dusty environments and in direct sunlight.
- (7) **BE CAREFUL!** The heatsink may become hot when operating the receiver continuously for long periods.
- (8) Unplug the AC power cable from the AC outlet and wait a few minutes when opening the receiver cover.

EXPLICIT DEFINITIONS

The following explicit definitions apply to this instruction manual.

WORD	DEFINITION
WARNING	Personal injury, fire hazard or electric shock may occur.
CAUTION	Equipment damage may occur.
NOTE	If disregarded, inconvenience only. No personal injury, risk of fire or electric shock.

UNPACKING

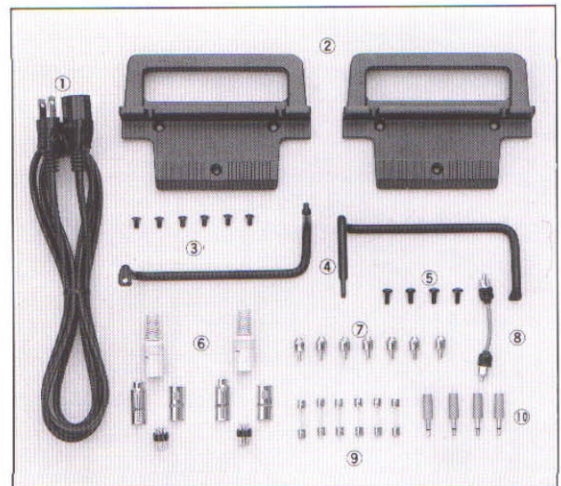

Accessories included with the IC-R9000:	Qty.
① AC power cable	1
② Rack mounting handles	1 set
③ Screws (for rack mounting handles)	6
④ Rear stands	1 set
⑤ Screws (for rear stands)	4
⑥ DIN plugs (8-pin)	2 sets
⑦ Pin plugs (RCA plugs)	7
⑧ Connection cable	1
⑨ Spare fuses (2 A for fuse holder)	2
(4 A for internal regulator)	2
(0.5 A for ACC socket)	2
⑩ Mini plugs	4

TABLE OF CONTENTS

INTRODUCTION	i	6 BASIC OPERATION	32 ~ 36
IMPORTANT	i	6-1 INITIAL SETTINGS	32
PRECAUTIONS	i	6-2 FREQUENCY SETTINGS	33
EXPLICIT DEFINITIONS	i	6-3 RECEIVING	35
UNPACKING	i	7 FUNCTIONS RECEIVING	37 ~ 38
TABLE OF CONTENTS	ii	7-1 IF SHIFT	37
1 FEATURES	1 ~ 2	7-2 NOTCH FILTER	37
2 CONTROL FUNCTIONS	3 ~ 10	7-3 AUTOMATIC GAIN CONTROL (AGC)	38
2-1 FRONT PANEL	3	7-4 NOISE BLANKER	38
2-2 REAR PANEL	7	8 MEMORY CHANNELS	39 ~ 40
2-3 LCD MONITOR	9	8-1 MEMORY CHANNEL SELECTION	39
2-4 HATCH COVER	10	8-2 MEMORY WRITING	41
3 CRT DISPLAY SCREEN MENU ...	11 ~ 23	8-3 SELECTED MEMORY NUMBER	42
3-1 SCREEN MENU CONSTRUCTION	11	8-4 MEMORY NOTE	42
3-2 MENU 1 SCREEN	14	8-5 MEMORY CLEARING	43
3-3 MENU 2 SCREEN	14	8-6 MEMORY EDITOR FUNCTION	44
3-4 SCAN CONDITION SCREENS	15	9 SCANNING	45 ~ 54
3-5 MEMORY LIST SCREEN	16	9-1 PRE-OPERATION	45
3-6 MEMORY EDIT SCREEN	17	9-2 PROGRAMMED SCAN	47
3-7 MEMORY NOTE WRITE SCREEN	17	9-3 PRIORITY SCAN	49
3-8 SPECTRUM SCOPE SCREEN	18	9-4 Δ F SCAN	50
3-9 CLOCK & TIMER SCREEN	18	9-5 MEMORY SCAN	51
3-10 SLEEP TIMER SCREEN	19	9-6 SELECTED MODE MEMORY SCAN	52
3-11 DAILY TIMER SET (1) SCREEN	19	9-7 SELECTED NUMBER MEMORY SCAN	53
3-12 DAILY TIMER SET (2) SCREEN	20	9-8 AUTO MEMORY WRITE SCAN	54
3-13 CLOCK ADJUSTMENT (1) SCREEN	20	10 CLOCK AND TIMER OPERATION	55 ~ 58
3-14 CLOCK ADJUSTMENT (2) SCREEN	21	10-1 CLOCK ADJUSTMENT	55
3-15 TERMINAL MONITOR SCREEN	21	10-2 SLEEP TIMER	56
3-16 DATA FORMAT SCREEN	22	10-3 DAILY TIMER	57
3-17 CI-V CONDITION SCREEN	22	11 MAINTENANCE	59 ~ 63
3-18 FSK MODE SELECT SCREEN	23	11-1 TROUBLESHOOTING	59
3-19 BANK STATUS SCREEN	23	11-2 CLEANING	60
4 INSTALLATIONS	24 ~ 26	11-3 BACKUP BATTERIES	61
4-1 UNPACKING	24	11-4 COVER REMOVAL	61
4-2 SELECTING LOCATION	24	11-5 FUSE REPLACEMENT	62
4-3 ANTENNA	24	11-6 CPU RESETTNG	63
4-4 GROUNDING	24	12 ADJUSTMENT	64 ~ 65
4-5 ANTENNA CONNECTORS	25	12-1 FREQUENCY CALIBRATION	64
4-6 HANDLES AND STANDS	25	12-2 MAIN DIAL BRAKE ADJUSTMENT	64
4-7 CONNECTIONS	26	12-3 OPTIONAL VOICE SYNTHESIZER UNIT	65
5 SYSTEM INTERCONNECTIONS ...	27 ~ 31	13 INSIDE VIEWS	66
5-1 TAPE RECORDER CONNECTIONS	27	14 SPECIFICATIONS	67
5-2 MONITOR DISPLAY CONNECTION	28	15 OPTIONS	68
5-3 FSK TERMINAL UNIT	29		
5-4 ACCESSORY SOCKET INFORMATION	30		
5-5 REMOTE JACK INFORMATION	31		

FULL, CONTINUOUS 100 kHz ~ 1999.8 MHz COVERAGE WITH ALL MODES

The IC-R9000L is an all-mode, super wide-band receiver that continuously covers a frequency range of 100 KHz to 1999.8 MHz. Many parts of the world are now accessible. Tune in world news agencies that use FAX and RTTY, aircraft, marine and business contacts, emergency services, government, satellite, amateur, CB (Citizen's Band) and numerous other stations near your home or on the other side of the world.

Some versions do not cover the entire range.

MULTI-FUNCTIONAL LCD MONITOR

Icom's advanced multi-functional LCD monitor is built into the IC-R9000L. Receive frequencies, modes, and additional *useful data are displayed for your operating convenience.* The LCD monitor has the following outstanding features:

• SPECTRUM SCOPE FOR VISUAL SIGNAL CONFIRMATION

At a glance, you can check relative signal strengths of nearby receive frequencies. The span of the spectrum scope can be selected for ± 25 , ± 50 or ± 100 kHz according to your needs.

• MEMORY LIST

Using the memory list screen, you can see the contents of 10 memory channels at once. Memory channels can be rolled for viewing other memory channels.

• TERMINAL MONITOR

This screen allows you to monitor RTTY or packet radio on the LCD monitor. ASCII (RS-232C level) code data from RTTY terminal unit or TNC (Terminal Node Controller) can be monitored.

1000 MEMORY CHANNELS STORING REQUIRED FREQUENCIES

A total of 1000 memory channels store frequencies, mode, filter width and tuning step increments. 1000 memory channels are grouped in 10 memory banks (each 100-digit channel numbers). You can use different memory banks according to station type, frequency ranges, or whatever your preference.

By using the memory list screen, many more convenient functions are provided: up to 8 character notes for your reference; the advanced, super convenient memory editor function easily moves, copies and deletes the memory contents.

SUPER-HIGH FREQUENCY STABILITY

Another Icom achievement is the IC-R9000L's very high frequency stability in the difficult-to-manage GHz range. Frequency stability is ± 0.25 ppm* in ranges greater than 30 MHz and ± 25 Hz* in ranges less than 30 MHz.

*0°C ~ +50°C; +32°F ~ +122°F

MULTI-SCAN FUNCTIONS

The IC-R9000L has 7 different scan functions. It's the perfect system for searching for desired signals quickly. The scan speed is adjustable to suit your needs, and its speed is unbelievably fast — 13 channels/sec or more.

PROGRAMMED SCAN

Scans between pre-programmed scan edges.

MEMORY SCAN

Scans memory channels.

SELECTED NUMBER MEMORY SCAN

Scans memory channels with the same programmed selected number.

SELECTED MODE MEMORY SCAN

Scans memory channels with the same programmed mode.

PRIORITY SCAN

Monitors specified memory channels.

Δ F SCAN

Scans around the receiving frequency.

AUTO MEMORY WRITE SCAN

Programs receive frequencies into memory channels during programmed scan.

SCANNING PAUSE, TIMER AND VSC (Voice Scan Control)

The IC-R9000L provides versatile scan resume functions when a signal is received: the scan cancels, pauses until a signal disappears, pauses for adjustable time, and pauses for the mixed condition of "signal disappears" and "adjustable time."

Also, a newly developed audio detecting VSC system allows you to skip inconvenient signals such as signals with no modulation, beat signals, and noise component signals.

ADDITIONAL OUTSTANDING FEATURES





- A wide variety of tuning steps. 10 Hz, 100 Hz, 1 kHz, 5 kHz, 9 kHz, 10 kHz, 12.5 kHz, 20 kHz, 25 kHz and 100 kHz available.
- Automatic dial click functions when more than 5 kHz tuning steps are selected.
- Built-in DDS (Direct Digital Synthesizer) for high-speed scanning with a high C/N (Carrier-to-Noise) ratio.
- Excellent sensitivity for all frequency coverages with a high dynamic range of 103.5 dB*.
- * On 14 MHz band, CW mode, filter narrow.
- Dual clock, 2 kinds of sleep timers and 5 independent daily timers.
- An advanced AFC (Auto Frequency Control) for automatic tuning of the center frequency of the receive signal.
- A threshold-adjustable, width-selectable noise blanker.
- Advanced interference rejection circuits, IF shift and notch filter.
- Recording control through a tape recorder with optional frequency recording.
- CI-V control system.
- Rack mounting handles for mounting with a 19-inch rack.

Downloaded by
 Amateur Radio Directory

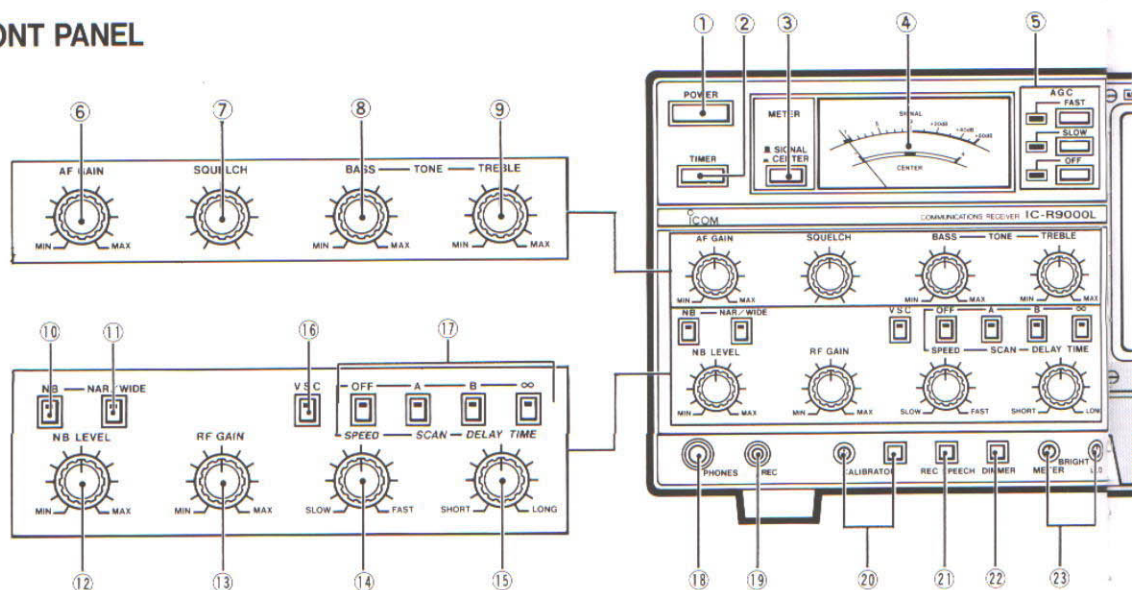
www.hamdirectory.info

2-1 FRONT PANEL

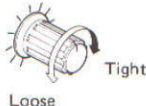

- ① **POWER SWITCH [POWER]**
Turns ON and OFF main power.
- ② **TIMER SWITCH [TIMER] (p. 56)**
Activates a timer function.
-  : Alarm timer or OFF.
 : Sleep timer or daily timer.
- ③ **METER SWITCH (p. 36)**
Selects a meter function.
-  : Signal strength meter.
 : Center meter (activates in FM or WFM).
- ④ **MULTI-FUNCTION METER (p. 36)**
Shows the relative signal strength or signal deviation.
See ③ METER SWITCHES for selection.
- ⑤ **AGC SWITCHES (p. 38)**
Select the AGC time constant, slow, fast and OFF.
- ⑥ **AF GAIN CONTROL [AF GAIN]**
Adjusts audio output level.
- ⑦ **SQUELCH CONTROL [SQUELCH] (p. 35)**
Adjusts squelch threshold level.
• When [RF GAIN] is rotated counterclockwise the squelch may open except in FM or WFM mode.
- SQUELCH
- 
- ⑧ **BASS RESPONSE CONTROL [BASS]**
Adjusts the bass response of the audio output.
- ⑨ **TREBLE RESPONSE CONTROL [TREBLE]**
Adjusts the treble response of the audio output.
- ⑩ **NOISE BLANKER SWITCH [NB] (p. 38)**
Activates the noise blanker circuit. Use together with [NB LEVEL].
• Noise blanker deactivates in FM and WFM modes.
- ⑪ **NOISE BLANKER WIDTH SWITCH [NAR/WIDE] (p. 38)**
Removes wide-type pulse noise known as "woodpecker."
• Turn ON [NB] to use this switch.
• LED goes out : Narrow selected
• LED lights up : Wide selected
- ⑫ **NOISE BLANKER LEVEL CONTROL [NB LEVEL] (p. 38)**
Adjusts the noise blanker threshold level. Suppresses noise without signal distortion.
• Turn ON [NB] to use this control.
- ⑬ **RF GAIN CONTROL [RF GAIN] (p. 35)**
Adjusts gain at the RF stage.
• The S-meter needle rises when the control is rotated counterclockwise.
• Only those signals stronger than the level indicated by the needle will be heard.
- ⑭ **SCAN SPEED CONTROL [SPEED] (pgs. 48 ~ 54)**
Adjusts the scanning speed.
- ⑮ **SCAN DELAY TIME CONTROL [DELAY TIME] (p. 46)**
Adjusts the time delay between "scan stop" and "scan resume."
• Select scan resume switches [A] or [B] to use this control.

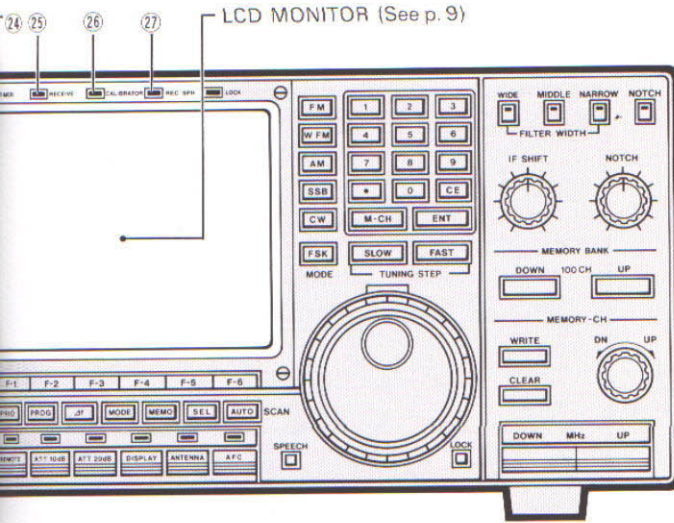

Downloaded by
 Amateur Radio Directory

www.hamdirectory.info

- 16 **VOICE SCAN CONTROL SWITCH [VSC]** (p. 46)
 Restarts a scan after a few seconds when it stops on a signal without voice or audio signals.
- 17 **SCAN RESUME SWITCHES** (p. 46)
 Select the scan resume condition.

[OFF]	Scanning does not resume while a signal is being received. Scanning resumes approx. 3 sec. after a signal disappears.
[A]	Resumes scanning several seconds* after scanning stops. Scanning stops for several seconds* even if the signal disappears.
[B]	Resumes scanning several seconds* after scanning stops. Scanning resumes approx. 3 sec* after the signal disappears.
[∞]	Cancels a scan when a signal is received.

*Time can be adjusted with the [DELAY TIME] control.

- 18 **HEADPHONES JACK [PHONES]**
 Accepts 4 ~ 16 Ω mono or stereo headphones with a standard 1/4 inch plug.
- 19 **RECORDING JACK [REC]** (p. 27)
 Audio output jack for a tape recorder. The fixed audio output level is set for a tape recorder AUX jack.
 • Refer to p. 65 Section 12 - 3 for voice synthesizer information.
- 20 **CALIBRATOR POT AND SWITCH [CALIBRATOR]** (p. 64)
 The calibrator pot adjusts the reference oscillator frequency. Use a screw driver to adjust.

The calibrator switch generates calibration markers every 500 kHz up to 29.500 MHz.

- 21 **RECORDER SPEECH SWITCH [REC SPEECH]** (p. 65)
 Announces the frequency through the [REC], [LINE OUT] and [SPEECH OUT] jacks when scan stops.
 • An optional UT-36 VOICE SYNTHESIZER UNIT is needed for this function.
 • Refer to p. 65 Section 12 - 3 for [REC SPEECH] and [LINE MIX] combination.
- 22 **DIMMER SWITCH [DIMMER]**
 Dims the intensity of the LCD monitor, function meter, and all indicators on the front panel.
- 23 **BRIGHT CONTROLS [METER], [LCD]**
 Adjust the following intensities.
 [METER]: Meter and indicators
 [LCD] : LCD monitor (Set to the 2 o'clock position)

NOTE: Great intensity will shorten the life of the LCD monitor.



- 24 **TIMER INDICATOR [TIMER]** (p. 56)
 Indicates the [TIMER] switch is ON.
- 25 **RECEIVE INDICATOR [RECEIVE]**
 Indicates the squelch is open.
- 26 **CALIBRATOR INDICATOR [CALIBRATOR]** (p. 64)
 Indicates the [CALIBRATOR] switch is ON.
- 27 **RECORDER SPEECH INDICATOR [REC SPH]** (p. 65)
 Indicates the [REC SPEECH] switch is ON.

2 CONTROL FUNCTIONS

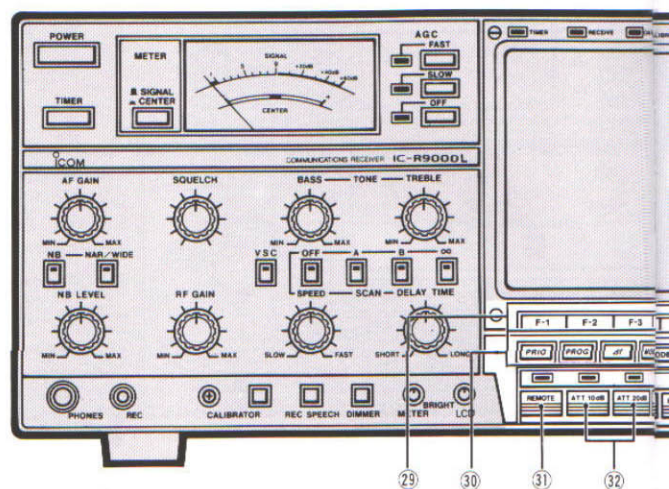

28 LOCK INDICATOR [LOCK] (p. 10)

Indicates the [LOCK] switch is ON.

29 LCD MULTI-FUNCTION SWITCHES [F-1] ~ [F-6] (pgs. 11 ~ 23)

Select LCD monitor menu functions.

30 SCAN SWITCHES

[PRIO]	Starts and stops priority scan.	(p. 49)
[PROG]	Starts and stops programmed scan.	(p. 47)
[Δf]	Starts and stops ΔF scan.	(p. 50)
[MODE]	Starts and stops selected mode memory scan.	(p. 52)
[MEMO]	Starts and stops memory scan.	(p. 51)
[SEL]	Starts and stops selected number memory scan.	(p. 53)
[AUTO]	Starts and stops auto memory write scan.	(p. 54)

31 CI-V REMOTE RESET SWITCH [REMOTE] (p. 31)

The indicator above the switch lights up when one of the following CI-V remote commands is received through the [REMOTE] jack on the rear panel:

- AF gain controlling data
- RF gain controlling data
- Squelch level controlling data

The switch resets the above commands and respects the individual controls.

32 ATTENUATOR SWITCHES (p. 35)

Select 10 dB, 20 dB or 30 dB RF attenuation to prevent front end overload.

- To select 30 dB attenuation, push both [ATT 10dB] and [ATT 20dB].

33 DISPLAY SWITCH [DISPLAY]

Sets the LCD monitor to an external video input.

34 ANTENNA SELECTOR SWITCH [ANTENNA] (p. 26)

Allows output of 13.8 V DC (max. 100 mA) from the rear panel [ANT SEL] jack. Use an external antenna selector, preamplifier, etc., with this voltage.

This switch can be used with the rear panel [HF ANT SW] when operating below 30 MHz. See p. 7 ⑥ [HF ANT SW] for more details.

35 AUTO FREQUENCY CONTROL SWITCH [AFC] (p. 35)

Turns ON and OFF the AFC function.

- Activates in FM or WFM mode.

36 MODE SWITCHES (p. 36)

Select the operating mode.

- WFM mode cannot be selected below 30 MHz.

37 KEYBOARD (p. 33)

Sets the operating frequency or memory channel.

Selects a scan group during programmed scan, auto memory write scan or selected number memory scan.

[1] ~ [0]	Enter the operating frequency or memory channel number.
[.]	Sets a MHz digit.
[CE]	Clears entered digits during frequency input.
[M-CH]	Sets the memory channel using the entered number.
[ENT]	Sets the operating frequency using the entered frequency.

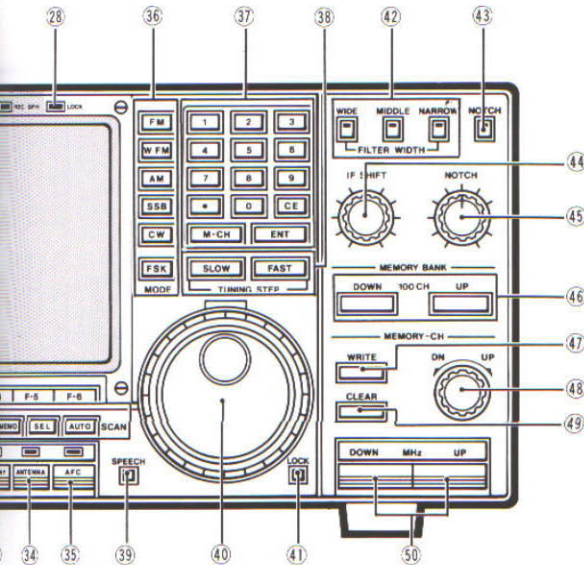

38 TUNING STEP SWITCHES [SLOW]/[FAST] (p. 34)
Select the main dial step increments in 10 Hz, 100 Hz, 1 kHz, 5 kHz, 9 kHz, 10 kHz, 12.5 kHz, 20 kHz, 25 kHz or 100 kHz steps.

39 SPEECH SWITCH [SPEECH] (p. 65)
Announces the operating frequency with a synthesized voice.
• An optional UT-36 VOICE SYNTHESIZER UNIT is needed for operation.

40 MAIN DIAL (p. 34)
Sets the operating frequency; changes programmed contents on the function screen.

41 LOCK SWITCH [LOCK] (p. 10)
Deactivates the main dial and some other switches.

Switch function is selected by internal [LOCK] switch located under the hatch cover.

42 FILTER WIDTH SWITCHES (p. 36)
Set the IF filter to a wide, middle or narrow width.
• In WFM mode, filter width is fixed even if the switches are changed.
• In FM mode, [WIDE] cannot be selected below 30 MHz.



43 NOTCH SWITCH [NOTCH] (p. 37)
Activates the notch filter circuit. Use together with the [NOTCH] control.
• No effect in FM and WFM modes.

44 IF SHIFT CONTROL [IF SHIFT] (p. 37)
Electronically shifts the IF frequency to reduce interference from adjacent frequency signals.

45 NOTCH CONTROL [NOTCH] (p. 37)
Adjusts the notch filter frequency to remove a beat signal.
• Push the [NOTCH] switch to use this control.

46 MEMORY BANK SWITCHES [DOWN]/[UP] (p. 39)
Change memory channels up or down in 100 channel steps.

47 MEMORY WRITE SWITCH [WRITE] (p. 41)
Stores the displayed contents (frequency, mode, filter width and tuning step) into the selected memory channel.
• Push and hold this switch to write a memory.

48 MEMORY CHANNEL SELECTOR [DN UP] (p. 39)
Selects a memory channel.

49 MEMORY CLEAR SWITCH [CLEAR] (p. 43)
Clears the contents from the selected memory channel.
• To clear the memory, push and hold this switch.

50 MHz UP/DOWN SWITCHES [DOWN]/[UP] (p. 34)
Change the operating frequency in 1 MHz steps.

2 CONTROL FUNCTIONS

2-2 REAR PANEL

Downloaded by
Amateur Radio Directory
www.hamdirectory.info

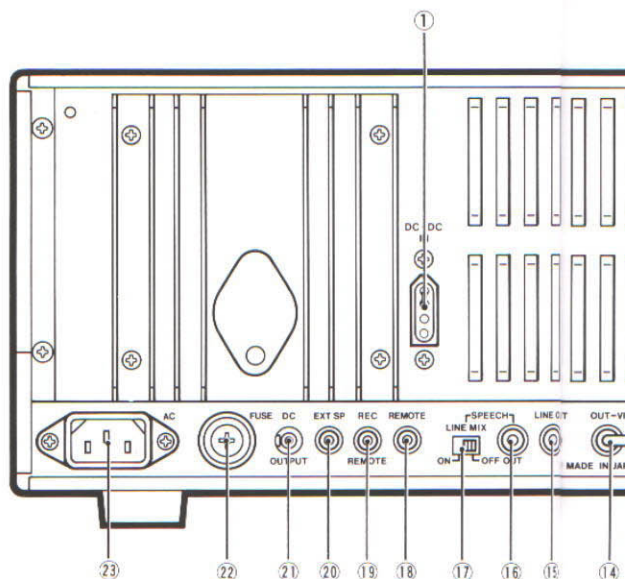

① DC-DC POWER SOCKET

Accepts a regulated 13.5 ~ 15 V DC input. This socket does not accept voltage from a non-regulated power source such as a vehicle's battery.

- Some versions do not have this socket.

② 30 MHz ~ 1000 MHz ANTENNA CONNECTOR (p. 26)

Connects a 50 Ω 30 ~ 1000 MHz antenna with a type-N connector. This connector is automatically selected when operating in 30 ~ 1000 MHz.

③ 1000 MHz ~ 2000 MHz ANTENNA CONNECTOR (p. 26)

Connects a 50 Ω 1 ~ 2 GHz antenna with a type-N connector. This connector is automatically selected when operating in 1000 ~ 1999 MHz.

④ GROUND TERMINAL [GND] (p. 26)

Connect this terminal to ground using the heaviest gauge wire or strap available, and make the connection as short as possible.

⑤ HF ANT 1 CONNECTOR [HF ANT 1] (p. 26)

Connects a 50 Ω HF antenna with a PL-259 connector. This connector is used when operating below 30 MHz. See ⑥ [HF ANT SW].

⑥ HF ANTENNA SWITCH [HF ANT SW]

Selects connections at [HF ANT 1] or [HF ANT 2] when operating below 30 MHz.

SWITCH POSITION		SELECTED CONNECTOR
[HF ANT SW]	[ANTENNA] (Front panel)	
ANT 1	OFF	HF ANT 1
	ON	HF ANT 1
ANT 2	OFF	HF ANT 2
	ON	HF ANT 1

⑦ ANTENNA SELECTOR VOLTAGE OUTPUT JACK [ANT SEL] (p. 26)

Outputs 13.8 V DC (max. 100 mA) when the [ANTENNA] switch on the front panel is ON. Use for an external preamplifier or antenna selector, if desired.

⑧ HF ANTENNA 2 JACK [HF ANT 2] (p. 26)

Connects a high impedance HF antenna such as a long wire antenna with an RCA jack (400 ~ 500 Ω). This connector is used when operating below 30 MHz. See ⑥ [HF ANT SW] above.

⑨ SPARE JACK [SPARE]

No connection.

⑩ IF OUTPUT JACK [IF OUT]

Outputs a 10.7 MHz IF signal.

Output level is the same level as an antenna input signal or below (when the AGC function is activated or the attenuator is ON.)

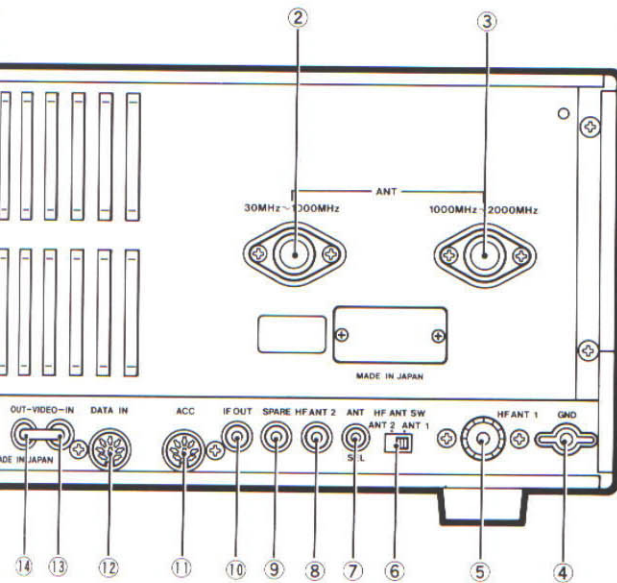

11 ACC SOCKET [ACC] (p. 30)

Input and output connections for an external terminal unit for use with data communications such as RTTY, FAX, etc.

12 DATA INPUT SOCKET [DATA IN] (p. 30)

- Accepts ASCII code input at the RS-232C level for display on the terminal monitor screen.
- Outputs LCD monitor signals.

13 VIDEO INPUT JACK [VIDEO-IN] (p. 29)

Accepts video signals (NTSC system) for display on the LCD monitor when the [DISPLAY] switch is ON.

14 VIDEO OUTPUT JACK [OUT-VIDEO] (p. 28)

Outputs video signals when TV frequencies with WFM mode are received. Either the NTSC or PAL system can be accepted depending on the version.

- The France version does not output video signals.

15 LINE OUT JACK [LINE OUT] (p. 27)

Audio output jack for a tape recorder. The fixed audio output level is set for a tape recorder AUX jack.

- See p. 65 Section 12 - 3 for voice synthesizer information.

16 SPEECH OUTPUT JACK [SPEECH OUT] (p. 28)

Outputs an operating frequency with a synthesized voice when scan stops.

- An optional UT-36 VOICE SYNTHESIZER UNIT is needed for operation.
- Push IN the [REC SPEECH] switch to activate this jack.

17 LINE MIX SWITCH [LINE MIX] (p. 65)

Inputs synthesized voice operating frequency information into the [LINE OUT] and [REC] jacks when scan stops.

- An optional UT-36 VOICE SYNTHESIZER UNIT is needed for this function.
- Push IN the [REC SPEECH] switch to use this switch.

18 CI-V REMOTE CONTROL JACK [REMOTE] (p. 31)

Connects a personal computer via an optional CT-17 CI-V LEVEL CONVERTER for external control of the frequency, audio level, etc.

19 RECORDER REMOTE JACK [REMOTE] (p. 27)

Shorts when the squelch opens. This jack is used for controlling the tape running of a tape recorder when you wish to record the receive audio.

20 EXTERNAL SPEAKER JACK [EXT SP] (p. 26)

Connect a 4 ~ 8 Ω speaker to this jack, if required.

21 13.8 V DC OUTPUT JACK [DC] (p. 26)

Outputs a regulated 13.8 V DC (max. 100 mA).

22 FUSE HOLDER [FUSE] (p. 62)

Holds the specified 2 A fuse for internal AC power supply protection. See p. 62 for details.

23 AC POWER SOCKET [AC]

Connects the supplied AC power cable to a domestic AC outlet.

2-3 LCD MONITOR

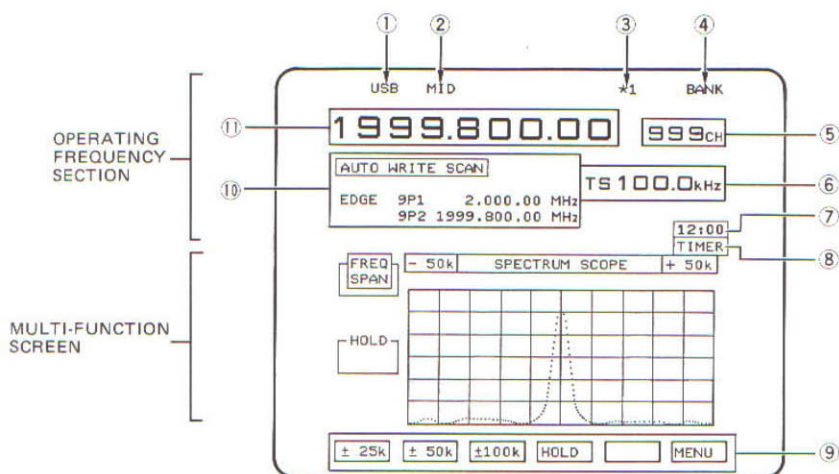
**① MODE INDICATOR**

Indicates operating mode.

- The [MODE] switches located left of the keyboard select an operating mode.
- WFM mode cannot be selected below 30 MHz.

② IF FILTER WIDTH INDICATOR (p. 36)

Indicates the width of the IF filter being used: wide, middle or narrow.

- The [FILTER WIDTH] switches located at the top right of the front panel select the desired filter width.
- In FM mode, "WIDE" cannot be selected below 30 MHz.

③ SELECT NUMBER INDICATOR (p. 53)

Indicates the programmed number for selected number memory scan.

- The select number is programmed in the memory list screen.

④ BANK INDICATOR (p. 40)

Indicates memory bank status "BANK" or "NO-BANK."

- Memory bank status is selected in the memory bank status screen.
- Memory scan bank and the priority scan bank differ from this indicator.

⑤ MEMORY CHANNEL READOUT (p. 39)

Shows the selected memory channel number.

- The memory list screen provides original memory contents checking, even if you have changed the frequency on the selected memory channel.

⑥ TUNING STEP READOUT (p. 34)

Shows the selected tuning step.

- The [SLOW] and [FAST] switches select the desired tuning step.

⑦ CLOCK READOUT (p. 55)

Shows the time of clock 1 when a functional screen is selected.

- When either the menu 1, menu 2, or clock & timer screen is selected, the times of clock 1 and 2 are shown in the original area.

⑧ TIMER INDICATOR (p. 56)

"TIMER" appears when the daily timer is set and the [TIMER] switch is OFF.

"SLEEP" appears when the sleep timer is set and the [TIMER] switch is ON.

"ALARM" appears when the sleep or daily timer is set and the [TIMER] switch is OFF.

No indicator appears when the daily timer is set out of the setting time range and the [TIMER] switch is OFF.

⑨ FUNCTION SWITCHES GUIDE (pgs. 11 ~ 23)

Indicates the function of the LCD MULTI-FUNCTION SWITCHES.

⑩ SCANNING CONDITION READOUT (pgs. 47 ~ 54)

Appears while scanning and displays the operating condition of a scan.

- The readout will disappear approx. 1 second after a [SCAN] switch is pushed, when scanning cannot be activated (e.g., a programmed scan edge is not programmed).

⑪ FREQUENCY READOUT

Shows the operating frequency with 10 Hz step accuracy.

2-4 HATCH COVER

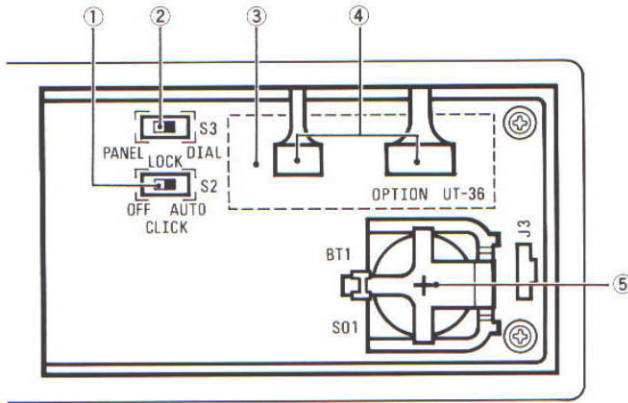

① MAIN DIAL CLICK SWITCH [CLICK]

Turns ON and OFF the main dial click function.

AUTO : Main dial click automatically functions when the tuning step is more than 5 kHz or when the main dial is used with switches [F-1] ~ [F-6].

OFF : Main dial click does not function regardless of tuning step or some switches.

② LOCK SWITCH [LOCK]

Selects the function of the [LOCK] switch on the front panel.

DIAL : Locks only the main dial.

PANEL : Locks the main dial and the following switches:

③ SPACE FOR OPTIONAL UT-36 VOICE SYNTHESIZER UNIT [UT-36] (p. 65)

Install an optional UT-36 VOICE SYNTHESIZER UNIT here, if desired.

④ CONNECTORS FOR UT-36 (p. 65)

Connect these connectors when installing an optional UT-36.

⑤ CLOCK BATTERY (p. 61)

Lithium battery for clock operation. The battery is activated when power is OFF.

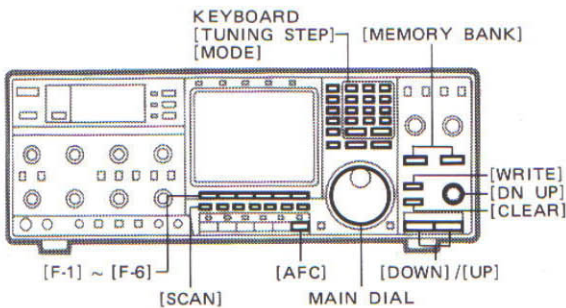

[SCAN CONDITION] with MAIN DIAL 12:00

1) MEMO SCAN

BANK 0 M1 0ch
M2 99ch

SEL-No. *1
SEL-MODE USB

2) PROG SCAN
MODE= USB TS= 10
OP1 2,000.00 MHz
OP2 26,000.00 MHz

3) ΔF SCAN
Center F ± 2.5kHz

3) PRIO SCAN
BANK 0 P= 0ch

MD TS GROUP EDGE SET 3 MENU

PROGRAMMED SCAN CONDITION SCREEN (pgs. 15, 47)

SET 1

SET 3

[SCAN CONDITION] with MAIN DIAL 12:00

1) MEMO SCAN

BANK 0 M1 0ch
M2 99ch

SEL-No. *1
SEL-MODE USB

2) PROG SCAN
MODE= USB TS= 10
OP1 2,000.00 MHz
OP2 26,000.00 MHz

3) ΔF SCAN
Center F ± 2.5kHz

3) PRIO SCAN
BANK 0 P= 0ch

ΔF F ΔF H BANK PR-CH SET 1 MENU

ΔF AND PRIORITY SCAN CONDITION SCREEN (pgs. 16, 49, 50)

MEMORY EDIT 12:00

Mch	FREQUENCY	MODE	TS	SEL	NOTE
96	-----	-----	---	---	---
97	-----	-----	---	---	---
98	-----	-----	---	---	---
99	-----	-----	---	---	---
> 0	2,000.00	USB M	10		
1	5,000.00	AM M	10.0		
2	10,000.00	AM M	10.0		
3	145,000.00	FM M	20.0		
4	430,000.00	USB M	10		
5	-----	-----	---	---	---

ROLL SET CLEAR MOVE COPY END

MEMORY EDIT SCREEN (pgs. 17, 44)

EDIT

END

USB M10

2.000.00

1*09%6'() *+,-./0123
456789:;<=>?@ABCDEF
GHIJKL*NOPQ
RSTUVWXYZ[]
^_`abcde
fghijklmno
pqrstuvwxy
z{|}~

Mch	FREQUENCY	MODE	TS	SEL	NOTE
96	-----	-----	---	---	---
97	-----	-----	---	---	---
98	-----	-----	---	---	---
99	-----	-----	---	---	---
> 0	2,000.00	USB M	10		
1	5,000.00	AM M	10.0		
2	10,000.00	AM M	10.0		
3	145,000.00	FM M	20.0		
4	430,000.00	USB M	10		
5	-----	-----	---	---	---

ENT <-- <--> SPACE CE SET

MEMORY NOTE WRITE SCREEN (pgs. 17, 42)

SET or CE

[SLEEP SET] with MAIN DIAL

SLP 1 90 min SLP 2 OFF TIME

89-03-31 FRI 12:00:00

3:00

- 10 OFF SLP 2 MENU

SLEEP TIMER SCREEN (pgs. 19, 56)

SLEEP

[DAILY TIMER SET] with MAIN DIAL

CH	SEL	DAY	ON	OFF	Mch
A	---	---	0:00	0:00	89-03-31 FRI
B	---	---	0:00	0:00	12:00:00
C	---	---	0:00	0:00	3:00
D	---	---	0:00	0:00	
E	---	---	0:00	0:00	
F	---	---	0:00	0:00	

CH SEL SET MENU

DAILY TIMER SET (1) SCREEN (pgs. 19, 57)

TIMER

SET

SET

[DAILY TIMER SET] with MAIN DIAL

CH	SEL	DAY	ON	OFF	Mch
A	---	---	0:00	0:00	89-03-31 FRI
B	---	---	0:00	0:00	12:00:00
C	---	---	0:00	0:00	3:00
D	---	---	0:00	0:00	
E	---	---	0:00	0:00	
F	---	---	0:00	0:00	

DAY ON OFF Mch BLANK SET

DAILY TIMER SET (2) SCREEN (pgs. 20, 57)

[CLOCK ADJUST] with MAIN DIAL

YEAR => Year
DATE => Month & Date
DAY => Day
CLK1 => Hour & Min & OADJ
CLK2 => Hour & Min
NOTE => Comment Write

89-03-31 FRI 12:00:00

3:00

YEAR DATE DAY CLK1 CLK2 NOTE MENU

CLOCK ADJUSTMENT (1) SCREEN (pgs. 20, 55)

ADJ

NOTE

SET

or CE

USB M10

2.000.00

1*09%6'() *+,-./0123
456789:;<=>?@ABCDEF
GHIJKL*NOPQ
RSTUVWXYZ[]
^_`abcde
fghijklmno
pqrstuvwxy
z{|}~

[CLOCK ADJUST] with MAIN DIAL

YEAR => Year
DATE => Month & Date
DAY => Day
CLK1 => Hour & Min & OADJ
CLK2 => Hour & Min
NOTE => Comment Write

89-03-31 FRI 12:00:00

3:00

ENT <-- <--> SPACE CE SET

CLOCK ADJUSTMENT (2) SCREEN (pgs. 21, 55)

3 LCD MONITOR SCREEN MENU

All screens including "MENU" return to the menu 1 screen by pushing [F-6] "MENU."

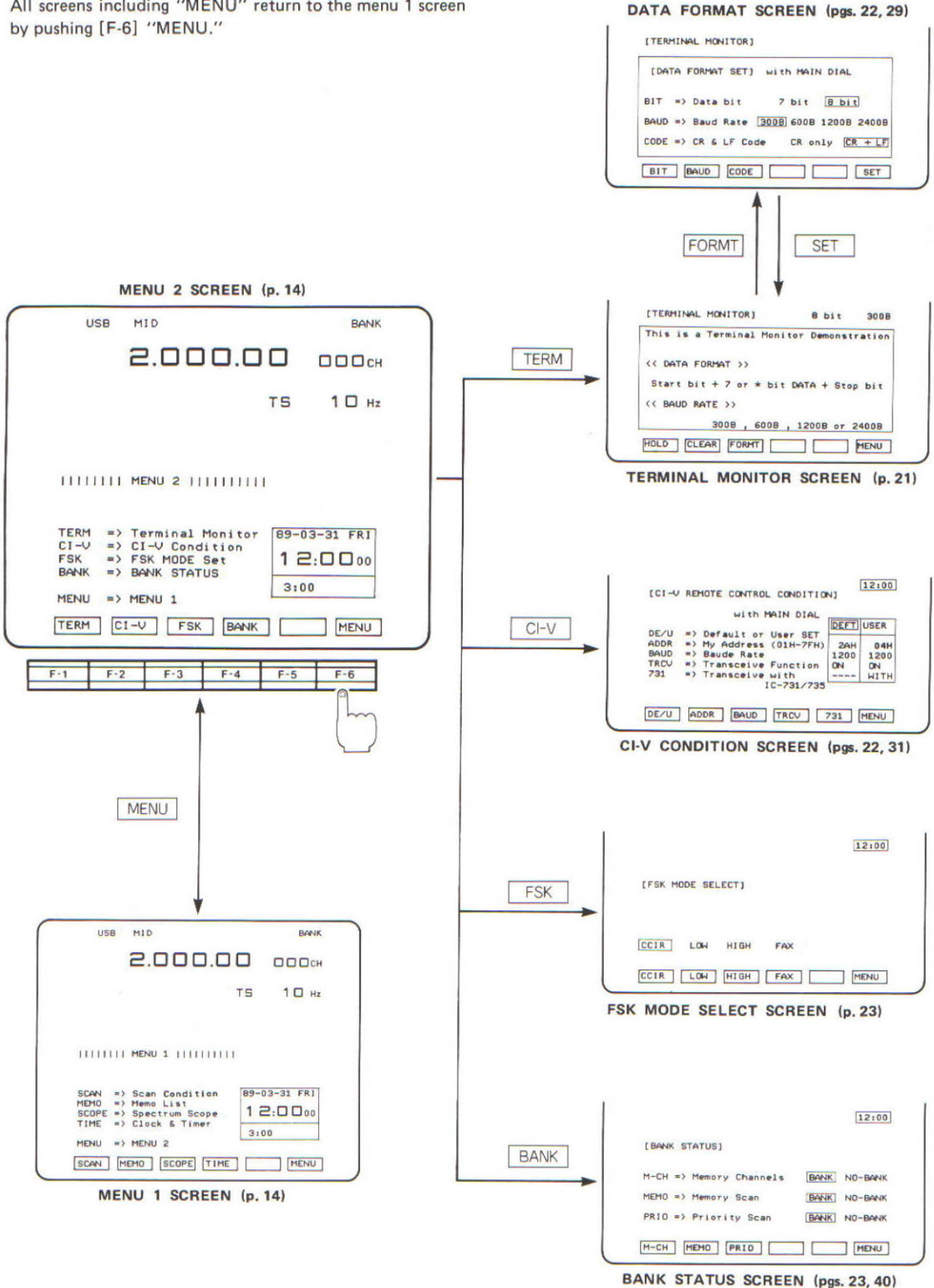

3-2 MENU 1 SCREEN

USB	MID	BANK
2.000.00		000CH
TS		10 Hz
MENU 1		
SCAN => Scan Condition	89-03-31 FRI	
MEMO => Memo List	12:0000	
SCOPE => Spectrum Scope		
TIME => Clock & Timer	3:00	
MENU => MENU 2		
SCAN	MEMO	SCOPE
TIME		MENU

All operational screens below are accessed from the menu 1 screen. Push the switch below to select the desired screen.

SWITCH	ACCESSED SCREEN	REF.
"SCAN" [F-1]	One of scan condition screens.	pgs. 15, 16 pgs. 47 ~ 54
"MEMO" [F-2]	Memory list screen	pgs. 16, 40 ~ 44
"SCOPE" [F-3]	Spectrum scope screen	p. 18
"TIME" [F-4]	Clock & timer screen	pgs. 18, 55~58
"MENU" [F-6]	Menu 2 screen	See below

3-3 MENU 2 SCREEN

USB	MID	BANK
2.000.00		000CH
TS		10 Hz
MENU 2		
TERM => Terminal Monitor	89-03-31 FRI	
CI-V => CI-V Condition	12:0000	
FSK => FSK MODE Set		
BANK => BANK STATUS	3:00	
MENU => MENU 1		
TERM	CI-V	FSK
BANK		MENU

All operational screens below are accessed from the menu 2 screen. Push the switch below to select the desired screen.

SWITCH	ACCESSED SCREEN	REF.
"TERM" [F-1]	Terminal monitor screen	pgs. 21, 29
"CI-V" [F-2]	CI-V condition screen	pgs. 22, 31
"FSK" [F-3]	FSK mode select screen	p. 23
"BANK" [F-4]	Bank status screen	pgs. 23, 40
"MENU" [F-6]	Menu 1 screen	See above

3 LCD MONITOR SCREEN MENU

3-4 SCAN CONDITION SCREENS

(1) MEMORY SCAN CONDITION SCREEN

To access this screen from MENU 1, push [F-1] then push [F-5] until this screen appears. (p. 51)

(2) PROGRAMMED SCAN CONDITION SCREEN

To access this screen from MENU 1, push [F-1] then push [F-5] until this screen appears. (p. 47)

3 scan condition screens are available corresponding to 7 different scans.

Setting conditions for memory scan, selected mode memory scan and selected number memory scan.

SWITCH	FUNCTION
"BANK" [F-1]	Sets the memory bank status of memory scans (includes selected mode and number memory scans) to "BANK" or "NO-BANK."
"M 1" [F-2]	To set a memory scan edge, push and hold the switch then rotate the main dial.
"M 2" [F-3]	To set the other edge of "M1," push and hold the switch and rotate the main dial.
"SEL-N" [F-4]	To program a number in selected number memory scan, push and hold the switch then rotate the main dial.
"SET 2" [F-5]	Accesses the programmed scan condition screen.
"MENU" [F-6]	Returns to the menu 1 screen.

Sets conditions for programmed scan and auto memory write scan.

SWITCH	FUNCTION
"MO TS" [F-1]	To set a mode and tuning step for programmed scan, push the switch then push a [MODE] switch and a [TUNING STEP] switch.
"GROUP" [F-2]	To select a programmed scan group from 0P ~ 9P, push and hold the switch then rotate the main dial.
"EDGE" [F-3]	To set an edge of programmed scan, push the switch then enter the desired edge frequency using the keyboard.
"SET 3" [F-5]	Accesses the ΔF/priority scan condition screen.
"MENU" [F-6]	Returns to the menu 1 screen.

(3) ΔF AND PRIORITY SCAN CONDITION SCREEN

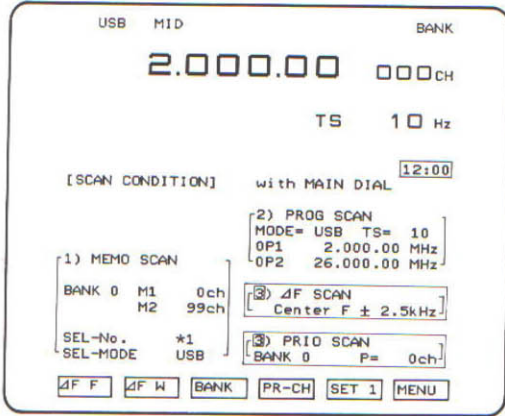

To access this screen from MENU 1, push [F-1] then push [F-5] until this screen appears. (pgs. 49, 50)

Sets conditions for ΔF scan and priority scan.

SWITCH	FUNCTION
"ΔF F" [F-1]	Selects the center frequency of ΔF scan to fixed or variable.
"ΔF W" [F-2]	To select the ΔF scan width, push and hold the switch then rotate the main dial.
"BANK" [F-3]	Set the memory bank status of priority scan to "BANK" or "NO-BANK."
"PR-CH" [F-4]	To select the priority channel, push and hold the switch then rotate the main dial.
"SET 1" [F-5]	Accesses the memory scan condition screen.
"MENU" [F-6]	Returns to the menu 1 screen.

3-5 MEMORY LIST SCREEN

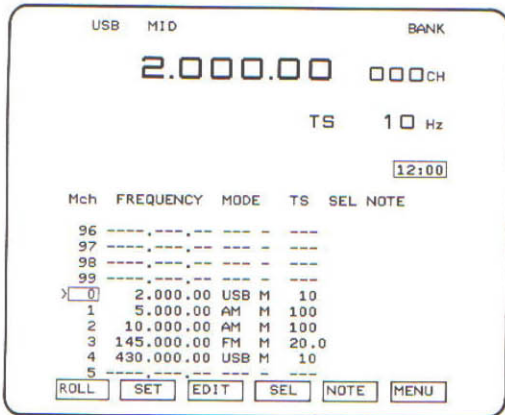

To access this screen from MENU 1, push [F-2] "MEMO." (p. 40)

Lists up to 10 memory channels and programs the selected memory number.

SWITCH	FUNCTION
"ROLL" [F-1]	To scroll the memory channel list, push and hold the switch then rotate the main dial.
"SET" [F-2]	To instantly select the memory channels, push and hold the switch then rotate the main dial.
"EDIT" [F-3]	Accesses the memory edit screen.
"SEL" [F-4]	To program or change the selected memory number, push and hold the switch then rotate the main dial.
"NOTE" [F-5]	Accesses the memory note write screen.
"MENU" [F-6]	Returns to the menu 1 screen.

3 LCD MONITOR SCREEN MENU

3-6 MEMORY EDIT SCREEN

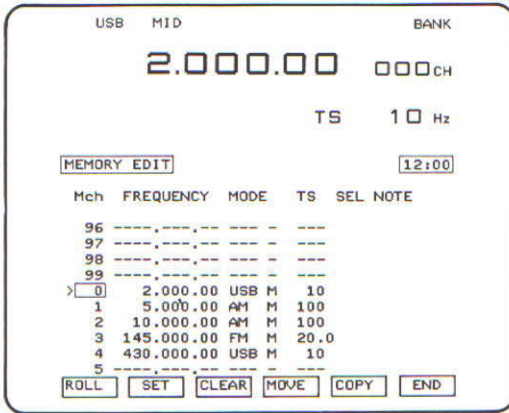

To access this screen from MENU 1, push [F-2] "MEMO" then push [F-3] "EDIT." (p. 44)

An advanced function for editing any of the 1000 memory channels. Can be used to copy, move or clear any memory channel.

SWITCH	FUNCTION
"ROLL" [F-1]	To scroll the memory channel list, push and hold the switch then rotate the main dial.
"SET" [F-2]	To set the edit area, push and hold the switch then rotate the main dial.
"CLEAR" [F-3]	Clears the memories in the edit area.
"MOVE" [F-4]	Moves the memories from the edit area.
"COPY" [F-5]	Copies the memories of the edit area.
"END" [F-6]	Returns to the memory list screen.

3-7 MEMORY NOTE WRITE SCREEN

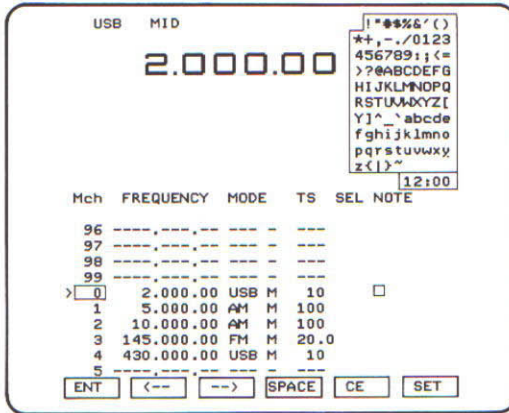

To access this screen from MENU 1, push [F-2] "MEMO" then push [F-5] "NOTE." (p. 42)

Programs a note of up to 8 characters into the memory channel list of your choice. Select characters with the main dial.

SWITCH	FUNCTION
"ENT" [F-1]	Retrieves a character from the character area and enters it in the channel.
"<--" [F-2]	Moves the cursor to the left side.
"-->" [F-3]	Moves the cursor to the right side.
"SPACE" [F-4]	Clears the character on the cursor.
"CE" [F-5]	Cancel the entered note, saves the previous note and then returns to the memory list screen.
"SET" [F-6]	Stores the entered note and then returns to the memory list screen.

3-8 SPECTRUM SCOPE SCREEN

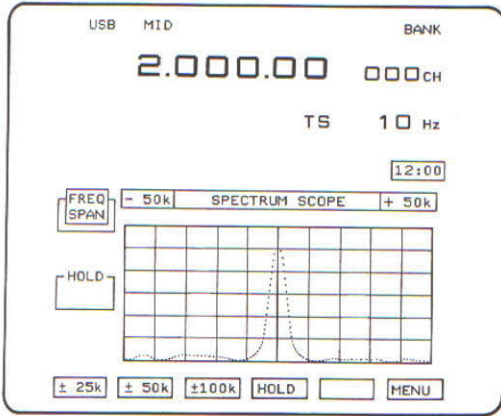

To access this screen from MENU 1, push [F-3] "SCOPE."

Displays the signal spectrum on an 80 x 256 dot spectrum scope.

SWITCH	FUNCTION
"± 25 k" [F-1]	Selects a ±25 kHz spectrum bandwidth.
"± 50 k" [F-2]	Selects a ±50 kHz spectrum bandwidth.
"± 100 k" [F-3]	Selects a ±100 kHz spectrum bandwidth.
"HOLD" [F-4]	Freezes the displayed spectrum waveform.
"MENU" [F-6]	Returns to the menu 1 screen.

3-9 CLOCK & TIMER SCREEN

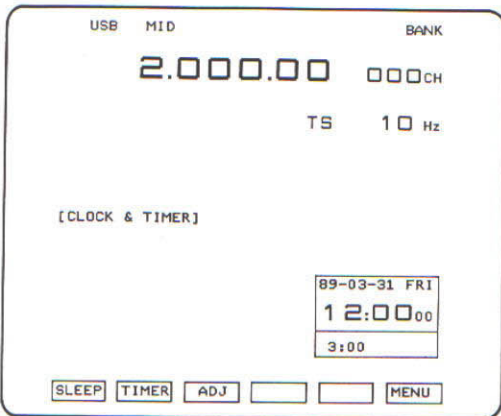

To access this screen from MENU 1, push [F-4] "TIME."

The receiver has 2 clocks, selectable sleep timers and 5 daily timers. Access the screens for the clocks and timers from this screen.

SWITCH	FUNCTION
"SLEEP" [F-1]	Accesses the sleep timer screen.
"TIMER" [F-2]	Accesses the daily timer set (1) screen.
"ADJ" [F-3]	Accesses the clock adjustment (1) screen.
"MENU" [F-6]	Returns to the menu 1 screen.

3 LCD MONITOR SCREEN MENU

3-10 SLEEP TIMER SCREEN

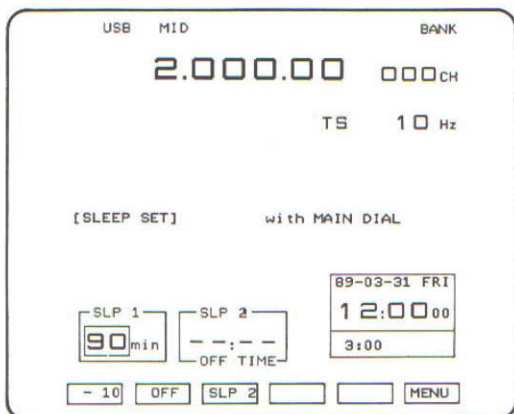

To access this screen from MENU 1, push [F-4] "TIME" then push [F-1] "SLEEP." (p. 56)

Turns ON and OFF the 2 sleep timers and sets the time of the SLP 1 timer (Time-off timer) and SLP 2 timer (Clock timer).

SWITCH	FUNCTION
"SLP 1" "-10" [F-1]	Activates and sets the time of the SLP 1 timer. 10 to 90 minutes in 10-minute steps can be set.
"OFF" [F-2]	Turns OFF the sleep timers (SLP 1 and 2).
"SLP 2" [F-3]	Activates the SLP 2 timer. To set the time, push and hold the switch then rotate the main dial.
"MENU" [F-6]	Returns to the menu 1 screen.

3-11 DAILY TIMER SET (1) SCREEN

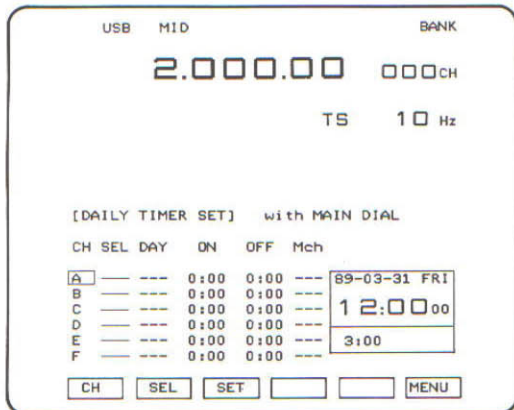

To access this screen from MENU 1, push [F-4] "TIME" then push [F-2] "TIMER." (p. 57)

Selects and activates daily timers.

SWITCH	FUNCTION
"CH" [F-1]	To select one of 6 daily timers, push and hold the switch then rotate the main dial.
"SEL" [F-2]	Activates and deactivates the selected timer. A number appears indicating the order in which a timer will be activated.
"SET" [F-3]	Accesses the daily timer set (2) screen.
"MENU" [F-6]	Returns to the menu 1 screen.

3-12 DAILY TIMER SET (2) SCREEN

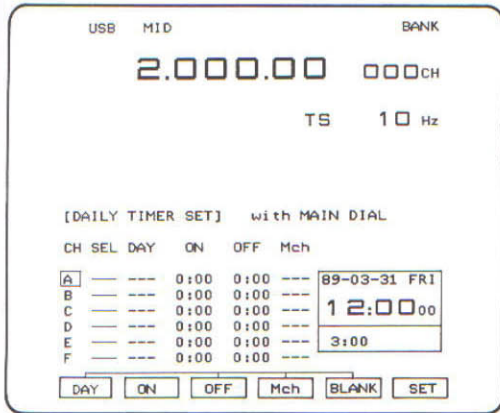

To access this screen from MENU 1, push [F-4] "TIME" then [F-2] "TIMER" then [F-3] "SET." (p. 57)

Sets the ON/OFF time, day and memory channel of the selected daily timer on the daily timer (1) screen.

SWITCH	FUNCTION
"DAY" [F-1]	To set the day for the timer, push and hold the switch then rotate the main dial. To operate the timer every day, push and hold "BLANK" then push this switch.
"ON" [F-2]	To set the power ON time, push and hold the switch then rotate the main dial.
"OFF" [F-3]	To set the power OFF time, push and hold the switch then rotate the main dial. To operate the timer for only power ON, push and hold "BLANK" then push this switch.
"M ch" [F-4]	To set a memory channel on which the timer turns ON, push and hold the switch then rotate the main dial. To use the operating frequency when power is ON, push and hold "BLANK" then push this switch.
"BLANK" [F-5]	To make blank, push and hold the switch then push "DAY," "OFF" or "M ch."
"SET" [F-6]	Returns to the daily timer set (1) screen.

3-13 CLOCK ADJUSTMENT (1) SCREEN

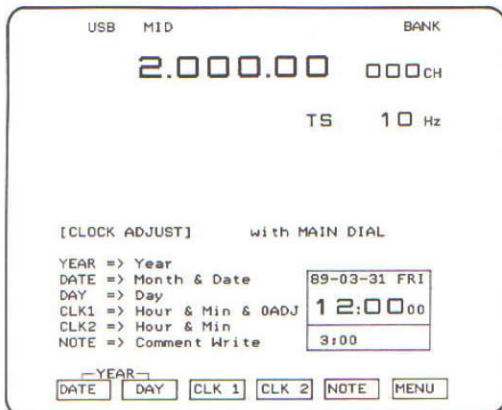

To access this screen from MENU 1, push [F-4] "TIME" then push [F-3] "ADJ." (p. 55)

Sets clock 1 and clock 2.

SWITCH	FUNCTION
"DATE" [F-1]	To set the month and date, push and hold the switch then rotate the main dial. To set the year, push and hold the switch and "DAY" then rotate the main dial.
"DAY" [F-2]	To set the day, push and hold the switch then rotate the main dial.
"CLK 1" [F-3]	Sets the seconds at 0. To set the time of clock 1, push and hold the switch then rotate the main dial.
"CLK 2" [F-4]	To set the time of clock 2, push and hold the switch then rotate the main dial.
"NOTE" [F-5]	Accesses the clock adjustment (2) screen.
"MENU" [F-6]	Returns to the menu 1 screen.

3 LCD MONITOR SCREEN MENU

3-14 CLOCK ADJUSTMENT (2) SCREEN

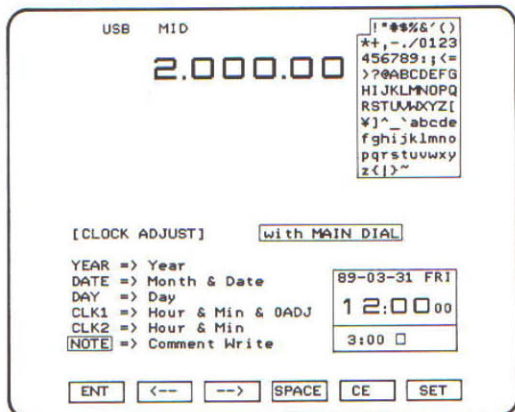

To access this screen from MENU 1, push [F-4] "TIME" then [F-3] "ADJ" then [F-5] "NOTE." (p. 55)

Programs a note of up to 6 characters into the clock 2 of your choice. Select characters with the main dial.

SWITCH	FUNCTION
"ENT" [F-1]	Retrieves a character from the character area and enters it into the clock 2.
"<--" [F-2]	Moves the cursor to the left side.
"-->" [F-3]	Moves the cursor to the right side.
"SPACE" [F-4]	Clears the character on the cursor.
"CE" [F-5]	Cancel entered note and saves the previous note and then returns to the clock adjustment (1) screen.
"SET" [F-6]	Stores the entered note and then returns to the clock adjustment (1) screen.

3-15 TERMINAL MONITOR SCREEN

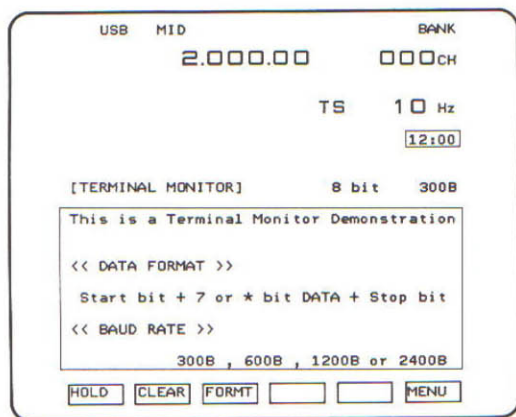

To access this screen from MENU 1, push [F-6] "MENU" then push [F-1] "TERM." (p. 29)

Monitors ASCII input from the [DATA IN] socket on the rear panel. When no data is input, the screen displays a demonstration of its functions.

SWITCH	FUNCTION
"HOLD" [F-1]	Freezes the screen.
"CLEAR" [F-2]	Clears the screen.
"FORMT" [F-3]	Accesses the data format screen.
"MENU" [F-6]	Returns to the menu 1 screen.

3-16 DATA FORMAT SCREEN

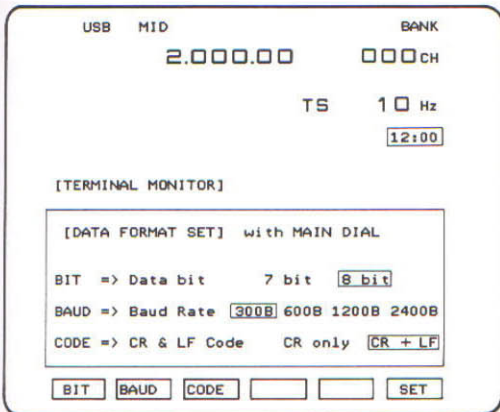

To access this screen from MENU 1, push [F-6] "MENU" then [F-1] "TERM" then [F-3] "FORMT." (p. 29)

Sets the data length, baud rate and line feed command for the terminal monitor screen.

SWITCH	FUNCTION
"BIT" [F-1]	To select a character length of 7 of 8 bits, push and hold the switch then rotate the main dial.
"BAUD" [F-2]	To select the baud rate, push and hold the switch then rotate the main dial.
"CODE" [F-3]	To select the line feed command, CR or CR + LF, push and hold the switch then rotate the main dial. CR: carriage return LF: line feed
"SET" [F-6]	Returns to the terminal monitor screen.

3-17 CI-V CONDITION SCREEN

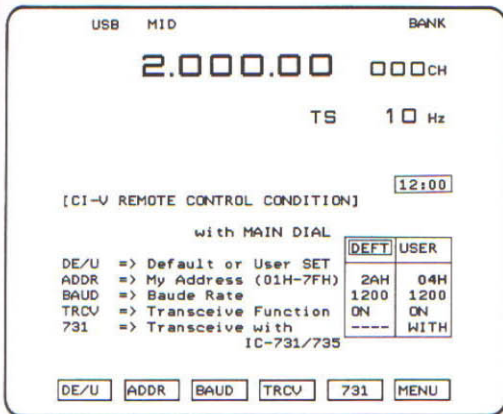

To access this screen from MENU 1, push [F-6] "MENU" then push [F-2] "CI-V." (p. 31)

Sets the CI-V remote control conditions.

SWITCH	FUNCTION
"DE/U" [F-1]	Selects the standard CI-V condition for the IC-R9000 or user programmed condition. To select a default or user programmed condition, push and hold the switch then rotate the main dial.
"ADDR" [F-2]	To select the address number of the "USER" area, push and hold the switch then rotate the main dial. 01H ~ 7FH address numbers can be provided.
"BAUD" [F-3]	Select the baud rate of the "USER" area, push and hold the switch then rotate the main dial.
"TRCV" [F-4]	To turn the transceive function ON and OFF, push and hold the switch then rotate the main dial.
"731" [F-5]	When operating the transceive function with the IC-735, set the "731" parameter to the "WITH" condition. To set the "731" parameter, push and hold the switch then rotate the main dial. Data length: IC-735 4 bytes, another radio 5 bytes
"MENU" [F-6]	Returns to the menu 1 screen.

3 LCD MONITOR SCREEN MENU

3-18 FSK MODE SELECT SCREEN

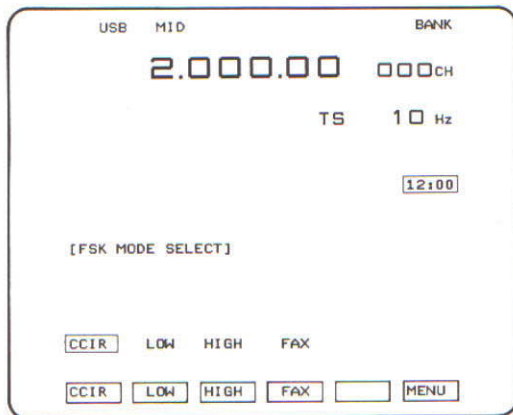

To access this screen from MENU 1, push [F-6] "MENU" then push [F-3] "FSK."

NOTE: The mark and space frequencies are 5 Hz off frequency when operating in "HIGH" and "LOW." This condition does not affect normal operations.

Selects one of 4 different mark and space frequency combinations for FSK corresponding to the frequency of the transmit station. An external demodulator is necessary for FSK operation.

SWITCH	FUNCTION
"CCIR" [F-1]	Use for RTTY reception with the CCIR system. Mark freq. : 1615 Hz Space freq.: 1785 Hz Shift width: 170 Hz
"LOW" [F-2]	Use for RTTY reception with a system known as "LOW TONE" in some European countries. Mark freq. : 1440 Hz Space freq.: 1270 Hz Shift width: 170 Hz
"HIGH" [F-3]	Use for normal RTTY reception. Mark freq. : 2120 Hz Space freq.: 2290 Hz Shift width: 170 Hz
"FAX" [F-4]	Use for FAX reception. Black freq. : 1500 Hz White freq.: 2300 Hz Shift freq. : 800 Hz
"MENU" [F-6]	Returns to the menu 1 screen.

3-19 BANK STATUS SCREEN

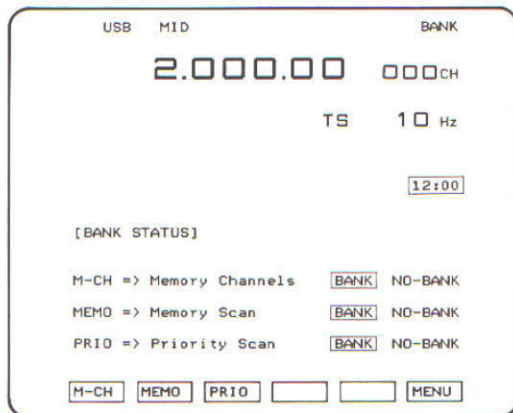

To access this screen from MENU 1, push [F-6] "MENU" then push [F-4] "BANK." (p. 40)

Sets the bank status of the memory channel, memory scan and priority scan to "BANK" (separated by 10 groups) or "NO-BANK" (not separated).

SWITCH	FUNCTION
"M-CH" [F-1]	Sets memory channels to "BANK" or "NO-BANK."
"MEMO" [F-2]	Sets the memory scan range in a bank or over the bank. This can also be set in the memory scan condition screen.
"PRIO" [F-3]	Sets the priority channel in a bank or over the bank. This can be set in the priority/ΔF scan condition screen.
"MENU" [F-6]	Returns to the menu 1 screen.

4-1 UNPACKING

After unpacking, immediately describe any damage to the delivering carrier or dealer. Keep the shipping cartons. For a description and diagram of accessory equipment included with the IC-R9000L, see UNPACKING on the inside front cover.

4-2 SELECTING LOCATION

Select a location for the receiver with space for thorough air circulation and access to the front and rear panels. Keep away from extreme heat, cold, vibrations and electromagnetic sources.

4-3 ANTENNA

Antennas play a very important role in receiver operation. If the antenna is poor, your receiver cannot give you the best performance.

The IC-R9000L requires at least 3 antennas for full coverage 100 kHz ~ 2000 MHz. Select an antenna, such as a well-matched 50 Ω antenna and feedline. When you wish to use a long wire antenna for short wave bands, use one as long as possible (at least 10 m, 32.8 ft).

●HF BAND ANTENNA



●30 ~ 1000 MHz ANTENNA

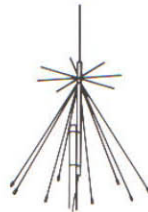

●1000 ~ 2000 MHz ANTENNA

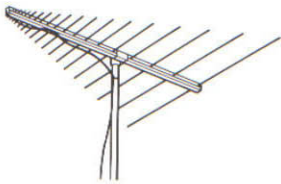

●HF BAND LONG-WIRE ANTENNA

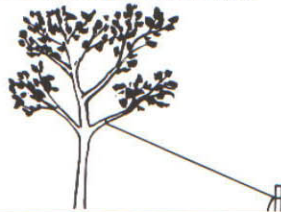

4-4 GROUNDING

To prevent accidents involving electricity and interference from a transceiver, ground the receiver through the [GND] terminal on the rear panel.

For best results, connect a heavy gauge wire or strap to a cold water pipe or long earth-sunk copper rod. Make the distance between the [GND] terminal and ground as short as possible.

WARNING: NEVER use a gas pipe or electrical conduit pipe for grounding.

4 INSTALLATIONS

Downloaded by
Amateur Radio Directory

www.hamdirectory.info

4-5 ANTENNA CONNECTORS

(1) TYPE-N CONNECTOR INSTALLATION

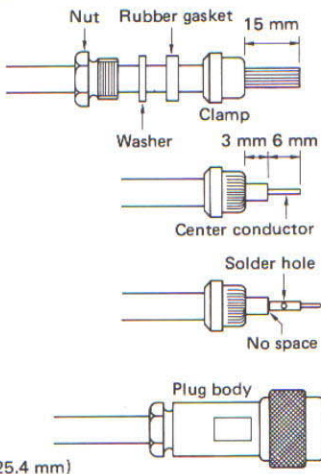

- 1) Slide the nut, washer, rubber gasket and clamp over the coaxial cable. Cut the end of the cable evenly.
- 2) Strip the cables and fold the braid back over the clamp as shown at left.
 - The clamp end should be flush with end of the vinyl jacket.
 - Evenly trim the braid end.
- 3) Soft solder the center conductor. Install the center conductor pin and solder it.
- 4) Carefully slide the plug body into place aligning the center conductor pin on the cable. Tighten the nut onto the plug body.
 - Be sure the center conductor is the same height as the plug body.

(1 inch = 25.4 mm)

(2) PL-259 CONNECTOR INSTALLATION

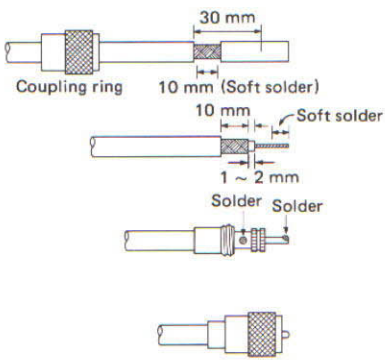

- 1) Slide the coupling ring over the coaxial cable. Strip the cable jacket only and soft solder.
 - Keep the jacket for soft soldering.
- 2) Strip the cable as shown in the diagram at left. Tin the center conductor the entire length of the exposed braid.
- 3) Slide the connector body over the cable and solder as shown at left.
- 4) Screw the coupling ring onto the connector body.

(1 inch = 25.4 mm)

4-6 HANDLES AND STANDS

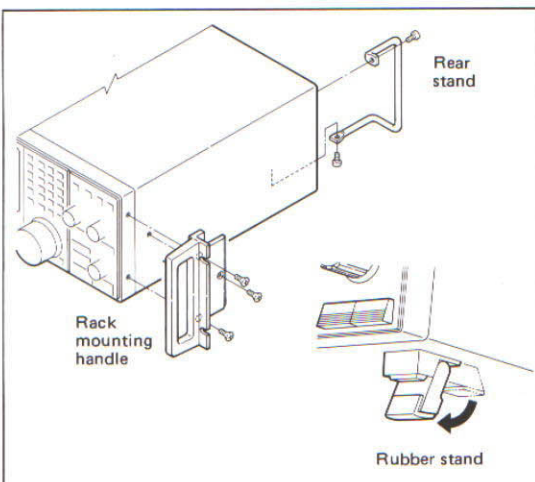

• RACK MOUNTING HANDLES

Remove the 4 screws from both sides of the front panel, then attach the rack mounting handles to the sides of the receiver using the unpacked screws.

• RUBBER STANDS

The rubber stands on the bottom of the IC-R9000L give the receiver 2 selectable angles.

• REAR STANDS

Attach the rear stands using the supplied screws, if desired. The rear stands allow you to set the receiver facing up or to protect the connectors on the rear panel.

4-7 CONNECTIONS

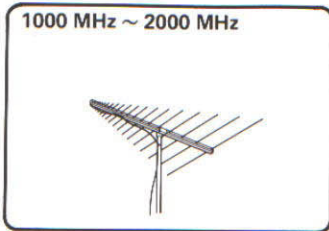
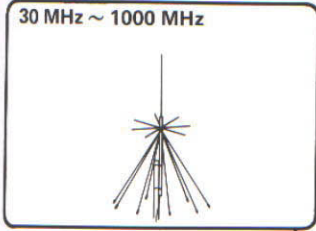

Refer to Section 5-1 for details.

When operating with 13.8 V DC power supply. Accepts only regulated power source. (Some versions do not have.)

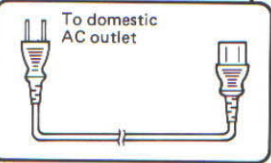
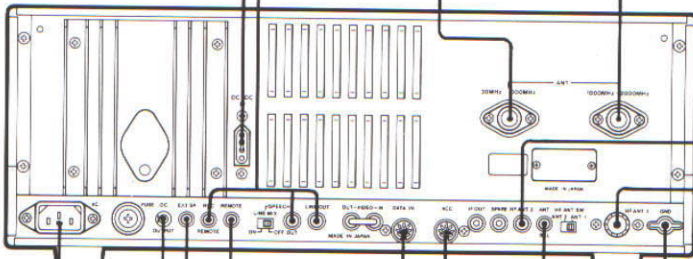
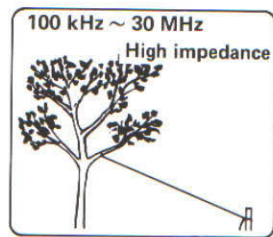

Refer to Section 5-4 (p. 30) for details.

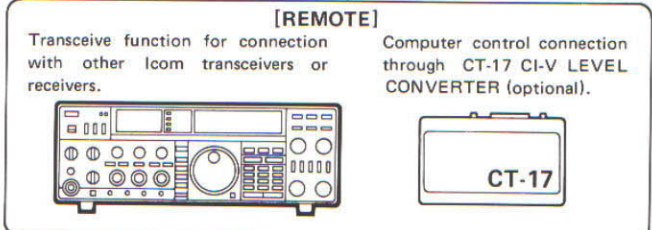
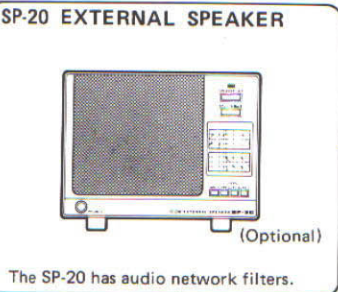
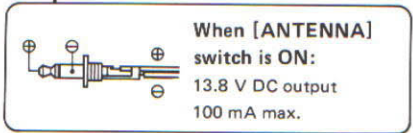
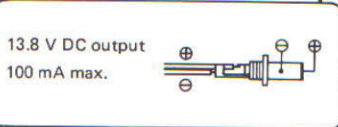
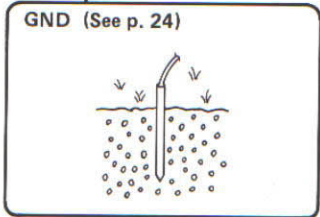

5-1 TAPE RECORDER CONNECTIONS

(1) RECORDING FROM THE FRONT PANEL

You can easily record audio through the [REC] jack on the front panel. Audio output level is fixed for the AUX jack of a tape recorder, regardless of the [AF GAIN] position.

When an optional UT-36 VOICE SYNTHESIZER UNIT is installed, the synthesized voice announces the frequency the scan has stopped on. Refer to p. 65 Section 12 - 3 for details.

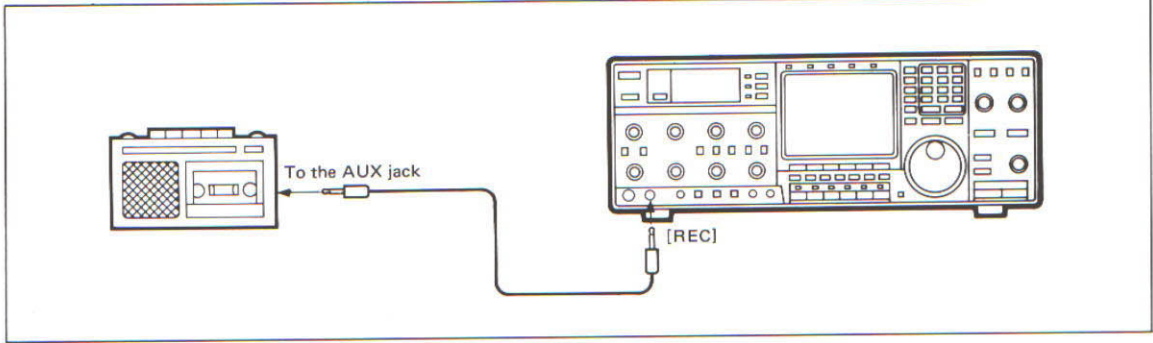

(2) RECORDING WITH THE REMOTE CONTROL

The [REC REMOTE] jack shorts when the receiver is ON and the squelch is open. Activates a tape recorder with the daily timer and allows recording only when a signal opens the squelch.

- The Voice Scan Control (VSC) function (p. 46) and auto memory write scan (p. 54) are helpful for making the desired recording.

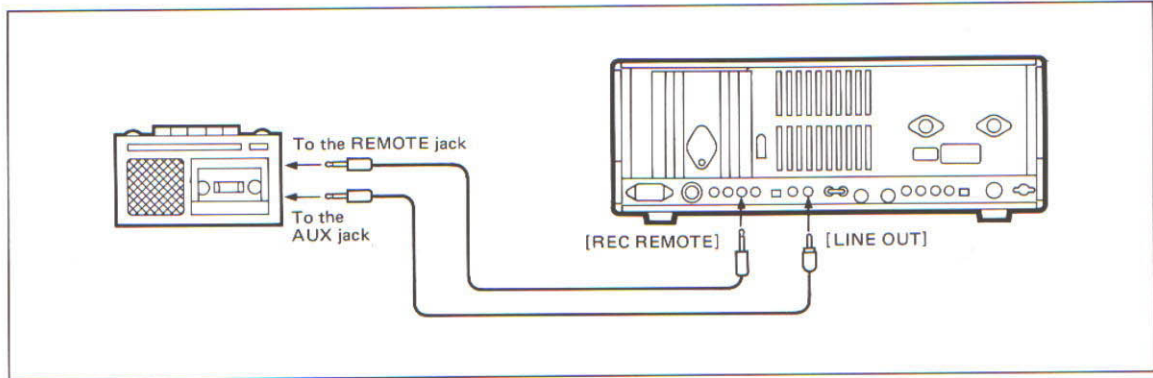

(3) SEPARATELY RECORDING AUDIO AND FREQUENCY

An optional UT-36 VOICE SYNTHESIZER UNIT is needed for this operation.

When using a stereo tape recorder for recording, received audio and a frequency with a synthesized voice can be separately recorded.

When recording this way, you can search ahead of the audio signal recorded in the tape recorder using the frequency recording channel search.

- The Voice Scan Control (VSC) function (p. 46) and auto memory write scan (p. 54) are helpful for making the desired recording.

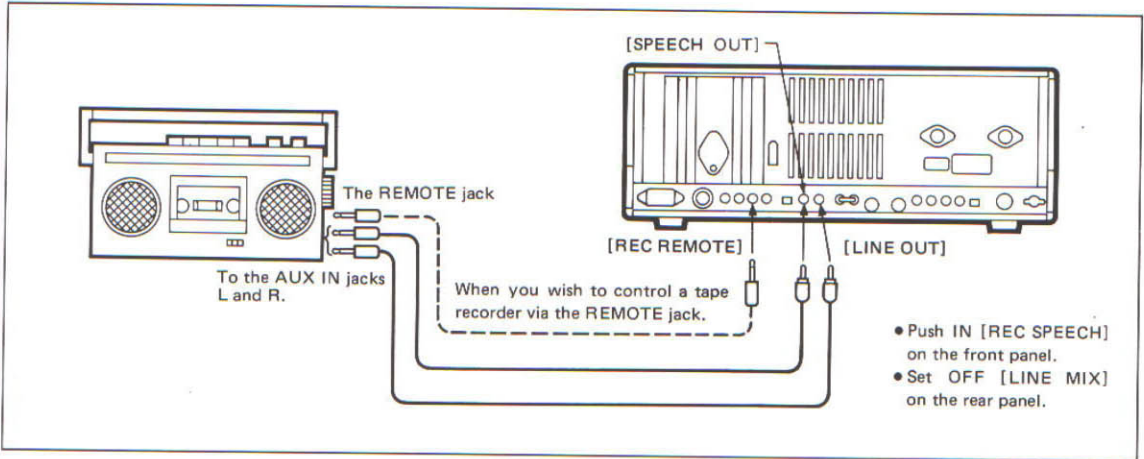

5-2 MONITOR DISPLAY CONNECTION

A monitor display can be connected to the IC-R9000L via the [DATA IN] socket. You can monitor the LCD monitor information on a large size display.

The IC-R9000L includes a picture signal decoder. When connecting a TV set equipped with a VIDEO IN jack, you can monitor TV signals such as amateur TV.

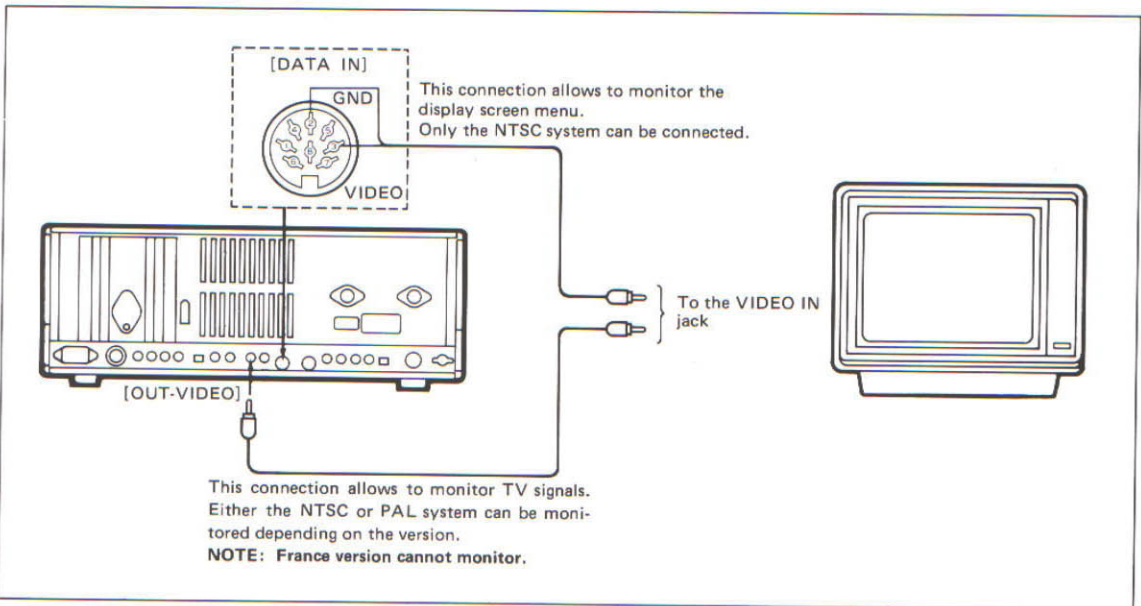

5 SYSTEM INTERCONNECTIONS

5-3 FSK TERMINAL UNIT

If you require FSK reception such as RTTY or FAX, external demodulator is necessary. Connect the AFSK input jack of the demodulator to the [ACC] socket or the [LINE OUT] jack on the rear panel.

If the demodulator has ASCII code (RS-232C level) output or video output, the demodulated signal can be displayed on the CRT monitor

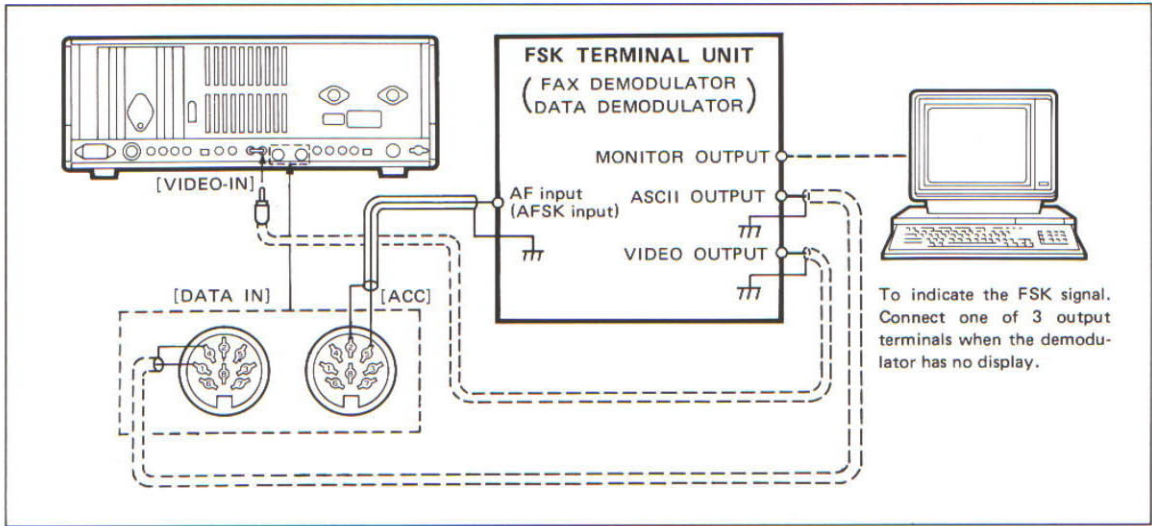

■ DATA FORMAT SCREEN

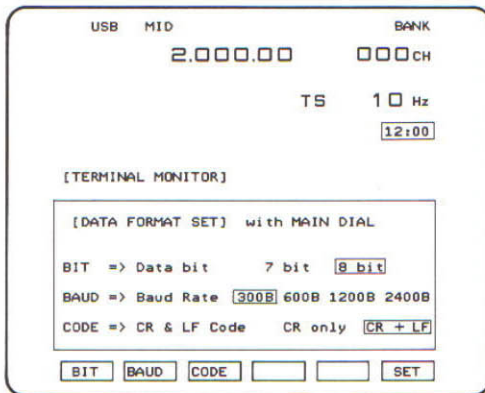

When an external FSK demodulator has ASCII code (RS-232C level) output, the terminal monitor screen can be used for FSK monitoring. Format the monitor system to the external demodulator using the data format screen.

- 1) Selects the data format screen:
 - When the menu 2 screen is displayed, push [F-1] "TERM," and then push [F-3] "FORMT."
- 2) To select 7 or 8 bit data, push and hold [F-1] "BIT" then rotate the main dial.
- 3) To select the baud rate, push and hold [F-2] "BAUD" then rotate the main dial.
- 4) To select the line feed command, push and hold [F-3] "CODE" then rotate the main dial.
 - CR: carriage return LF: line feed
- 5) Push [F-6] "SET" to return to the terminal monitor screen.
- 6) When no ASCII code is received, the demonstration operates on the screen. As soon as the ASCII code is received, the screen clears and displays the incoming data.

5-4 ACCESSORY SOCKET INFORMATION

PIN NUMBERS



(Rear panel view)

CONNECTOR ASSEMBLY

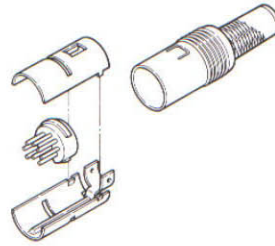

■ ACC SOCKET

PIN NO.	PIN NAME	DESCRIPTION	SPECIFICATIONS
1	ANT SW	Outputs 5 V when the [ANTENNA] switch is ON.	Output current : 100 μ A max. Output impedance : 10 k Ω
2	GND	Connected to ground.	
3	SEND	When grounded, attenuator activates and then audio is muted.	GROUND level : -0.5 ~ +0.8 V Input current : Less than 20 mA
4	NC	No connection	
5	AF	AF detector output. Fixed regardless of [AF GAIN].	Output impedance : 47 k Ω Output level : 100 ~ 300 mV rms
6	SQL S	Squelch output. Goes to ground when squelch opens.	Squelch open : Less than 0.3 V/5 mA Squelch closed : More than 6.0 V/100 μ A
7	13.8 V	13.8 V output when power is ON.	Output current : 100 mA
8	M OUT	Outputs S-meter level.	Output voltage : 0 ~ approx. 4 V Output impedance : 10 k Ω

■ DATA-IN SOCKET

PIN NO.	PIN NAME	DESCRIPTION	SPECIFICATIONS
1	DATA IN	ASCII code input for the terminal monitor screen.	RS-232C level
2	VIDEO GND	Connected to ground.	
3	VIDEO	Video signal output.	Output level : 1 V p-p Output impedance : 75 Ω
4	DATA GND	Connected to ground.	
5 ~ 8	NC	No connection	

5-5 REMOTE JACK INFORMATION

The [REMOTE] jack on the rear panel is an input/output port for control of the IC-R9000L frequency, mode, memory channel, etc. Using the [REMOTE] jack, the IC-R9000L can be controlled by a personal computer* or another Icom CI-V transceiver.

* An optional CT-17 CI-V LEVEL CONVERTER is necessary. Use a personal computer equipped with an RS-232C serial output port. See basic sample software descriptions in the CT-17 instruction manual.

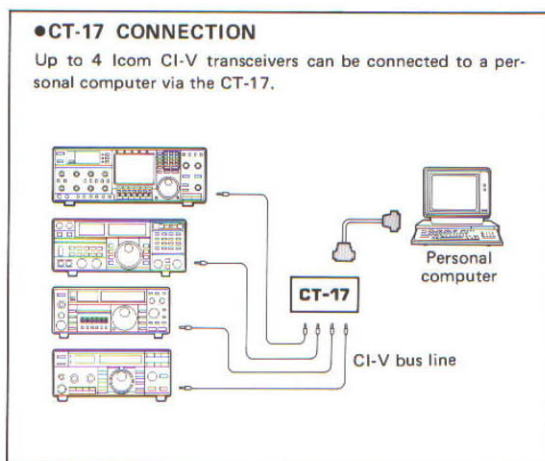
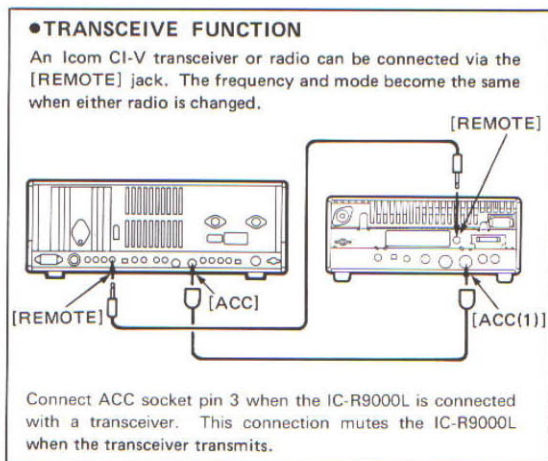

■ CI-V CONDITION SCREEN

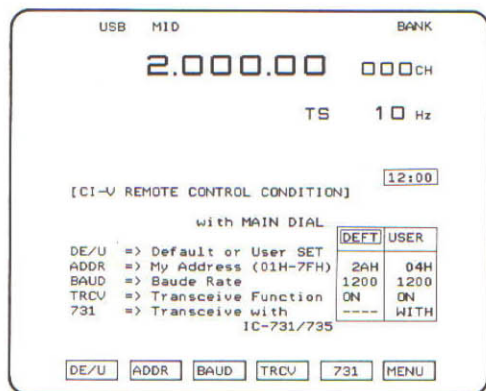

The IC-R9000L has standard default data for CI-V control. However, this data can be changed using the CI-V condition screen if desired.

- 1) Select the CI-V condition screen:
 - Push [F-2] "CI-V" when the menu 2 screen is displayed.
- 2) Push and hold [F-1] "DE/U" then rotate the main dial to select the "USER" condition for changing data.
- 3) To change the address number, push and hold [F-2] "ADDR" then rotate the main dial.
 - Address numbers 01H ~ 7FH can be selected.
- 4) To change baud rates, push and hold [F-3] "BAUD" then rotate the main dial.
 - Baud rates at 300, 1200, 4800 and 9600 bps can be selected.
- 5) To turn OFF the transceive function, push and hold [F-4] "TRCV" then rotate the main dial.
- 6) To change the frequency data length to 4 bytes, push and hold [F-5] "731" then rotate the main dial.
 - "WITH": Transceive with the IC-735.
 - "----": Transceive with another Icom radio.
- 7) Push [F-6] "MENU" to return to the menu 1 screen.

6-1 INITIAL SETTINGS

NOTE: Follow all instructions in Section 4 before operating the receiver.

- 1) Be sure the [POWER] switch is in the out position, then connect the AC cable into a domestic AC power outlet.
- 2) Be sure antennas are securely connected to the proper antenna connectors.
 - 3 antennas are necessary for all band coverage.
- 3) Be sure the receiver is grounded through the [GND] terminal.
- 4) Push the [POWER] switch IN to turn ON power.
- 5) Set switches and controls as shown in the table below.

■ SWITCH AND CONTROL SETTING

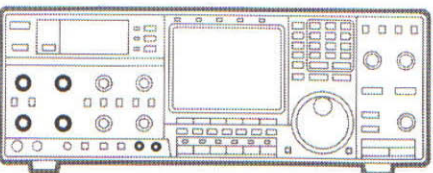
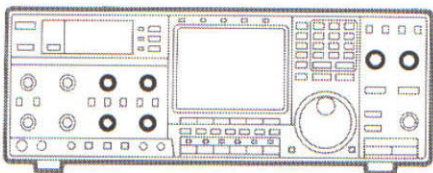
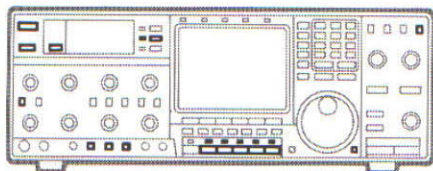

SWITCH	POSITION	SWITCH	POSITION
POWER	IN	ATT 10 dB	OFF
TIMER	OUT	ATT 20 dB	OFF
METER	OUT	DISPLAY	OFF
NB	OFF	ANTENNA	OFF
CALIBRATOR	OUT	AFC	OFF
REC SPEECH	OUT	NOTCH	OFF
DIMMER	OUT	LOCK	OFF
AGC	SLOW		

CONTROL	POSITION	CONTROL	POSITION
BASS	CENTER	DELAY TIME	CENTER
TREBLE	CENTER	IF SHIFT	CENTER
SCAN SPEED	CENTER	NOTCH	CENTER

CONTROL	POSITION	CONTROL	POSITION
AF GAIN	MIN.	RF GAIN	MAX.
SQUELCH	Counter-clockwise	BRIGHT METER	Clockwise
NB LEVEL	MIN.	BRIGHT CRT	2 o'clock

6-2 FREQUENCY SETTINGS

There are 2 ways to set a frequency: with the main dial or keyboard. Use both in combination for quick tuning.

NOTE: DO NOT change the memory channel when setting the frequency with the main dial, otherwise the set frequency will be erased.

If you need to change the memory channel, write the frequency into the memory channel before changing the memory channel. See p. 41 for memory writing information.

(1) USING THE KEYBOARD

Downloaded by
 Amateur Radio Directory

www.hamdirectory.info

- 1) Push IN the [POWER] switch to turn ON power.
- 2) Enter the desired frequency using the digit key.
 - Push the [.] key after entering the 1 MHz digit and before entering the 100 kHz digit.
 - The CRT display shows the entered number.
- 3) When entering a wrong number, push the [CE] key to retrieve the previous frequency.
- 4) Push [ENT] to store the entered frequency.
 - To enter 0 in succession, push [ENT] before entering all digits.

NOTE: When selecting the programmed scan condition screen, the operating frequency may not be entered with the keyboard.

[EXAMPLES]

<p>• Setting frequency at 145.0 MHz.</p> <p>Push keys <input type="text" value="1"/> <input type="text" value="4"/> <input type="text" value="5"/> <input type="text" value="ENT"/></p> <p>Frequency readout . 1.45 145.000.00</p>
<p>• Setting frequency at 145.5 MHz.</p> <p>Push keys <input type="text" value="1"/> <input type="text" value="4"/> <input type="text" value="5"/> <input type="text" value="."/> <input type="text" value="5"/> <input type="text" value="ENT"/></p> <p>Frequency readout . 1.45 145. . 145. . 5 145.500.00</p>
<p>• Setting frequency at 300 kHz (0.3 MHz).</p> <p>Push keys <input type="text" value="0"/> <input type="text" value="."/> <input type="text" value="3"/> <input type="text" value="ENT"/></p> <p>Frequency readout 0. . 0. . 3 0.300.00</p>
<p>• Changing frequency from 1296.550 MHz to 1296.750 MHz.</p> <p>Push keys <input type="text" value="1296.550.00"/> <input type="text" value="."/> <input type="text" value="7"/> <input type="text" value="5"/> <input type="text" value="ENT"/></p> <p>Frequency readout 1296.550.00 1296. . 1296. . 75 1296.750.00</p>

(2) USING THE MAIN DIAL

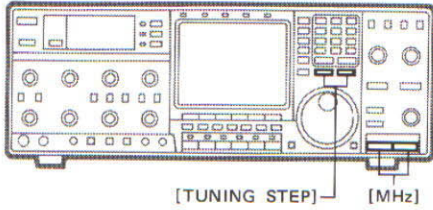

- 1) Push IN the [POWER] switch to turn ON power.
- 2) Set the desired band using the keyboard or the [MHz] switches, [DOWN] or [UP].
- 3) Set the desired tuning step using the [TUNING STEP] switches, [FAST] or [SLOW].
 - 10 Hz, 100 Hz, 1 kHz, 5 kHz, 9 kHz, 10 kHz, 12.5 kHz, 20 kHz, 25 kHz and 100 kHz are available.
- 4) Rotate the main dial to set the desired frequency.

●MAIN DIAL CLICK

The main dial click is automatically turned ON when a tuning step greater than 5.0 kHz is selected.

This dial click function can be turned OFF. See p. 10 Section 2 - 4 for details.

●TUNING STEP NOTE

1. The following procedures clear the frequencies below the tuning step:
 - 1) Set the frequency with the keyboard.
 - 2) Change the tuning step.
 - 3) Rotate the main dial.
2. The following procedures hold the frequencies below the tuning step:
 - 1) Change the tuning step.
 - 2) Set the frequency with the keyboard.
 - 3) Rotate the main dial.
3. When the tuning step is not changed, the frequencies below the tuning step are held.

[EXAMPLES]

●Setting: Frequency → Tuning step → Main dial

Push keys	<input type="text" value="4"/> <input type="text" value="3"/> <input type="text" value="0"/> <input type="text" value="."/> <input type="text" value="0"/> <input type="text" value="0"/> <input type="text" value="2"/> <input type="text" value="4"/> <input type="text" value="ENT"/>	<input type="text" value="FAST"/>	Rotate the main dial.
Frequency readout	430.002.40 TS 20.0 kHz	430.002.40 TS 25.0 kHz	430.025.00 ← Cleared TS 25.0 kHz

●Setting: Tuning step → Frequency → Main dial

Push keys	<input type="text" value="SLOW"/> or <input type="text" value="FAST"/>	<input type="text" value="4"/> <input type="text" value="3"/> <input type="text" value="0"/> <input type="text" value="."/> <input type="text" value="0"/> <input type="text" value="0"/> <input type="text" value="2"/> <input type="text" value="4"/> <input type="text" value="ENT"/>	Rotate the main dial.
Frequency readout	430.250.00 TS 25.0 kHz	430.002.40 TS 25.0 kHz	430.027.40 ← Held TS 25.0 kHz

6 BASIC OPERATION

6-3 RECEIVING

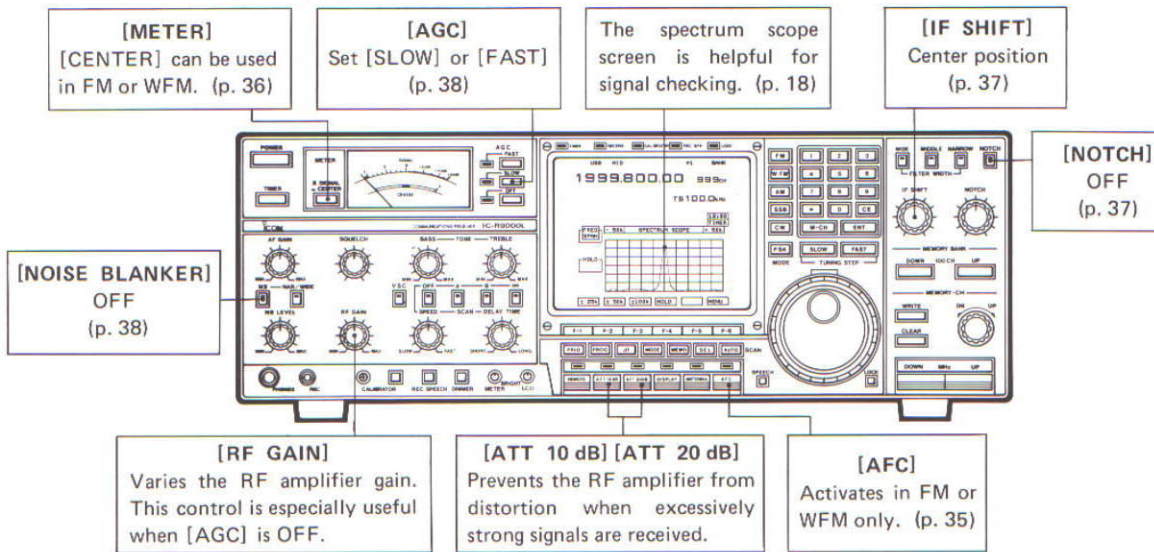

1) Set switches and controls as described in Section 6 - 1.

2) Push a [MODE] switch to set the operating mode.
• See MODE SELECTION at right (on p. 36).

3) Set the [SQUELCH] control to max. counterclockwise.

4) Adjust the [AF GAIN] control to the desired audio level.

5) Set the desired receive frequency using the keyboard and
the main dial. See Section 6 - 2 for details.
• When a signal is received, the meter shows the relative
signal strength.

6) Select a filter width, wide, middle or narrow.
• See FILTER SELECTION at right (on p. 36).

7) Rotate the [SQUELCH] control clockwise if you want
to mute the audio noise.

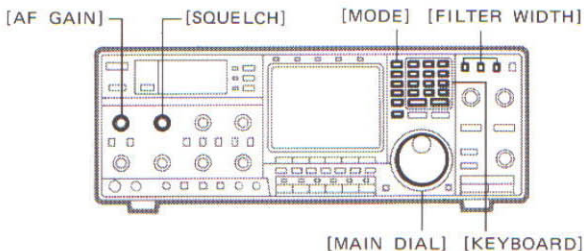

Tech Talk from Icom

Q. What is AFC?

A. AFC means Automatic Frequency Control. The AFC circuit automatically compensates for a frequency when a receive frequency drifts or goes off frequency.

When the receiver receives an off frequency from the center of an FM signal, the received audio signals are distorted. The discriminator circuit outputs voltage which is different when the center frequency is received.

The AFC circuit in the IC-R9000L detects the output voltage from the discriminator circuit and applies the voltage to the CPU to change N-data for the PLL circuit. N-data will be changed until the center frequency is received.

Therefore, the operating frequency of the IC-R9000L is automatically adjusted to the center of a receive frequency by the AFC circuit.

■ MODE SELECTION

MODE	SELECTION	COMMUNICATIONS EXAMPLE	NOTE
FM	Push [FM].	Business band, Marine band, Amateur band, etc.	Used mainly in VHF and UHF bands.
WFM	Push [WFM].	TV band, FM broadcasting, etc.	Above 30 MHz only.
AM	Push [AM].	Broadcasting, Air band, Citizen band, etc.	
SSB	Push [SSB]. once for USB, twice for LSB.	Amateur band, Marine in HF band, etc.	SSB consists of USB and LSB. Amateur bands above 10 MHz use USB and below 10 MHz use LSB.
CW	Push [CW].	Amateur band, Other communications.	Used by Morse code.
FSK	Push [FSK].	Radio press, AMTOR, SITOR, etc.	FSK uses two audio signals, mark and space. An external terminal unit is needed to demodulate them. Use the FSK mode select screen for mark/space frequency selection (p. 23).

■ FILTER SELECTION

MODE	SWITCHES	SELECTED FILTER WIDTH	NOTE
SSB, CW, FSK	WIDE	2.6 kHz	The wide filter increases audio clearly. Use when no interference occurs.
	MIDDLE	2.4 kHz	
	NARROW	500 Hz	
AM	WIDE	15.0 kHz	The narrow filter reduces interference. Use when busy signals are received.
	MIDDLE	6.0 kHz	
	NARROW	2.6 kHz	
FM	WIDE	30.0 kHz	For NOAA satellite receiving. Above 30 MHz only.
	MIDDLE	15.0 kHz	For general FM signal receiving.
	NARROW	6.0 kHz	For business band receiving (12.5 kHz step).
WFM	Any	150 kHz	Filter width is not changed even when switches are selected.

■ METER FUNCTIONS

● CENTER METER (FM and WFM only)

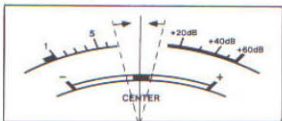

The center meter allows you fine tuning since the meter shows the signal deviation from the center frequency.

● SIGNAL METER WITH [SQUELCH] or [RF GAIN]

The S-meter shows the squelch threshold point when the [SQUELCH] control is rotated clockwise.

The S-meter shows the relative RF attenuation level when the [RF GAIN] control is rotated counterclockwise.

● SIGNAL METER WITH AGC OFF

The S-meter may not operate when the [AGC] switches are set to the "OFF" position.

7-1 IF SHIFT

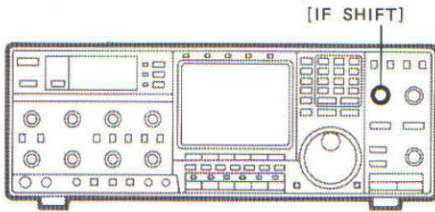

IF shift is a system designed to electronically shift the passband of frequencies that pass through the crystal filter.

IF shift is used to reduce interference from adjacent frequency signals.

- Rotate the [IF SHIFT] control either clockwise or counterclockwise to eliminate interference.

NOTE: IF shift does not function in FM and WFM modes.

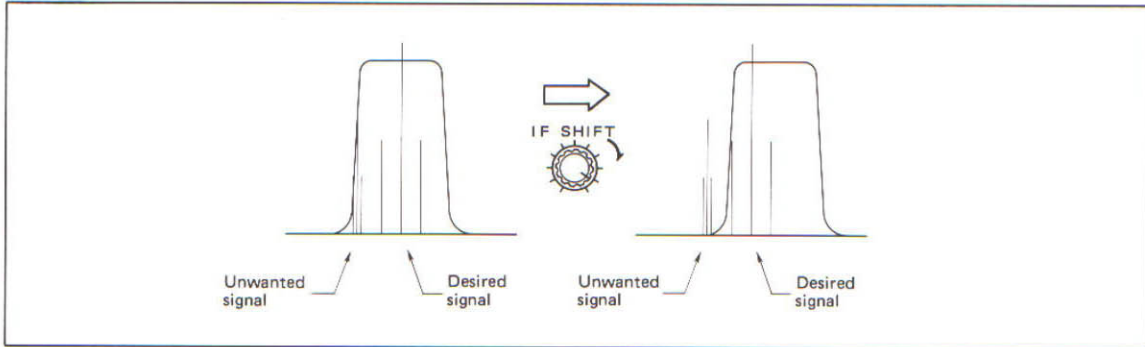

7-2 NOTCH FILTER

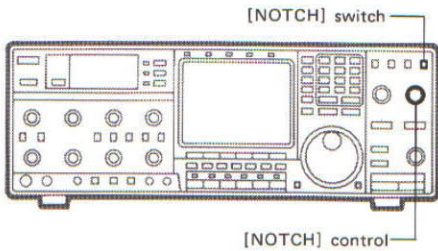

The notch filter attenuates a particular frequency in the IF passband, such as that of an interference beat signal.

- 1) Push the [NOTCH] switch.
- 2) Rotate the [NOTCH] control to minimize interference.

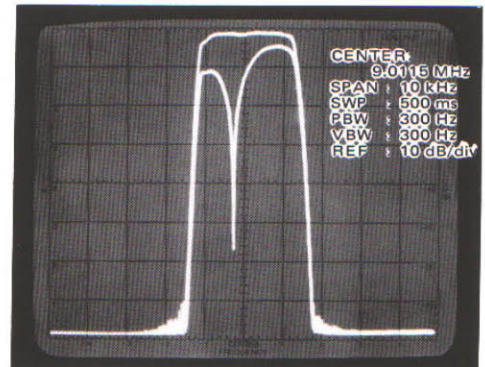

7-3 AUTOMATIC GAIN CONTROL (AGC)

AGC holds audio output constant during fluctuations in signal strength. AGC keeps irritating background noise from being heard during the short pauses in speech.

OFF POSITIONS:

Used when receiving a very weak signal located near stronger signals. In this case, the [RF GAIN] control is useful for reducing receive gain.

- The S-meter does not move when the AGC is set to OFF.
- The received audio may be distorted when a strong signal is received.

FAST POSITION:

Normally used when receiving a signal with short interval fading such as in CW or FSK mode, or when searching for a signal with the main dial.

SLOW POSITION:

Normally used when receiving a signal in SSB mode.

In FM, WFM or AM mode, use the "SLOW" or "FAST" positions.

The noise blanker effectively reduces interference from pulse-type noise such as car ignition systems and wide pulse-type noise known as "woodpecker" noise.

- 1) Push the [NB] switch ON.
- 2) Adjust the [NB LEVEL] control as required depending on the noise level.
- 3) To suppress "woodpecker" noise and other wide pulse-type noise, push the [NAR/WIDE] switch ON ("WIDE" is set).

NOTE: If you turn the [NB LEVEL] control too far clockwise, the audio output from the speaker may be distorted.

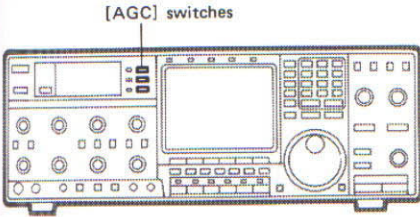

7-4 NOISE BLANKER

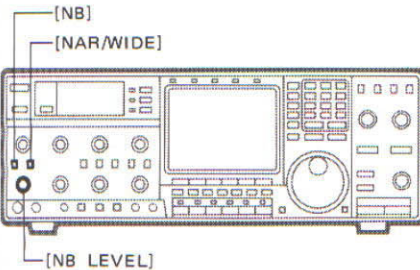

Tech Talk from Icom

Q. Why does the receiver need AGC?

- A. AGC is necessary to output signals constantly from the speaker regardless of the strength of incoming signals.

Signals of varying strengths enter the receiver circuit through the antenna connector. In SSB or CW mode especially, signal strength changes a lot from the wave characteristics.

AGC reduces the receiver gain when a strong signal is received, preventing distortion of speaker output. After strong signals disappear the receiver gain returns to the original gain. AGC automatically controls the receiver gain.

AGC "slow" or "fast" selects the return speed of the receiver gain from the reduced gain to the original gain. By holding the receiver gain for short periods, AGC constantly emits receive signals from the speaker and signals can be comfortably heard.

One aspect of AGC is that very weak signals located near stronger signals may be blocked when the AGC is set in the "slow" or "fast" position. AGC is therefore equipped with an OFF position for times when you wish to receive very weak signals without reducing receiver gain.

8-1 MEMORY CHANNEL SELECTION

Downloaded by
 Amateur Radio Directory

www.hamdirectory.info

(1) USING THE CHANNEL SELECTOR

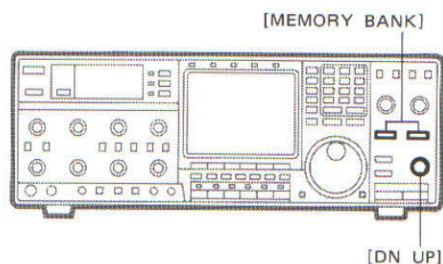

(2) USING THE KEYBOARD

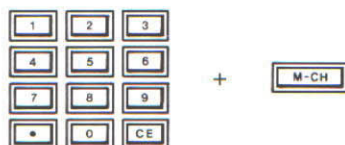

The IC-R9000L has a total of 1000 memory channels (10 groups of 100 memory channels) and 20 programmable scan edge channels separate from the memory channels. Each memory channel stores a frequency, mode, filter width and tuning step.

Memory channels 900 ~ 999 are used for auto write memory scan. See p. 54 for details.

- 1) Push a [MEMORY BANK] switch, [DOWN] or [UP] to select the desired memory bank (100-unit channel number).
- 2) Rotate the [DN UP] selector to select the desired memory channel.
 - When "BANK" is displayed on the right top of the CRT display, the [DN UP] selector cannot select memory channel in another memory bank. See p. 40 (4) MEMORY BANK for details.

- 1) Enter the desired memory channel number using the keyboard.
- 2) Push the [M-CH] key.
 - When entering more than 3 digits, the last 3 digits are entered.

[EXAMPLES]

• Selecting memory channel 123.	
Push keys	<input type="checkbox"/> 1 <input type="checkbox"/> 2 <input type="checkbox"/> 3 <input type="checkbox"/> M-CH
Frequency readout	. 1.23 000ch 10.000.00 123ch
• Selecting memory channel 21.	
Push keys	<input type="checkbox"/> 2 <input type="checkbox"/> 1 <input type="checkbox"/> M-CH
Frequency readout	. .21 123ch 10.000.00 021ch
• When more than 3 digits are entered.	
Push keys	<input type="checkbox"/> 1 <input type="checkbox"/> 2 <input type="checkbox"/> 3 <input type="checkbox"/> 4 <input type="checkbox"/> 5 <input type="checkbox"/> 6 <input type="checkbox"/> M-CH
Frequency readout	1.234.56 021ch 10.000.00 456ch

(3) USING THE MEMORY LIST SCREEN

The memory list screen shows 10 of the 1000 memory channels at one time.

- 1) Access the memory list screen:
 - Push [F-2] "MEMO" when the menu 1 screen is displayed.
- 2) Select the desired memory bank (100-unit channel number) using the [MEMORY BANK] switches, [DOWN] or [UP].
 - See (4) MEMORY BANK below for details.
- 3) Push and hold [F-1] "ROLL" or [F-2] "SET" then rotate the main dial.
 - See the displays below for details.
- 4) To return to the menu 1 screen, push [F-6] "MENU."

•"ROLL" and "SET"

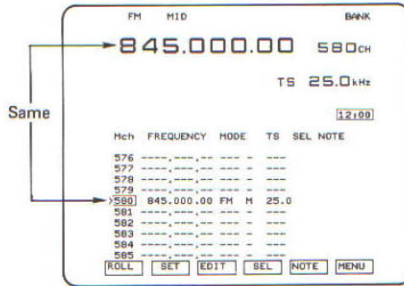
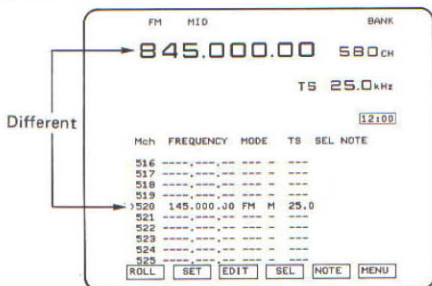

- "ROLL" is helpful when checking the memory channels while keeping the operating frequency.
- Memory writing and clearing can be performed on the memory list screen.

- "SET" is helpful for instant selection of a memory channel.
- The memory channel in the operating frequency section is also changed.

(4) MEMORY BANK

1000 memory channels are separated by 10 groups (banks) for quick searching in a group. The status of "BANK" or "NO-BANK" is displayed on the right top of the CRT display.

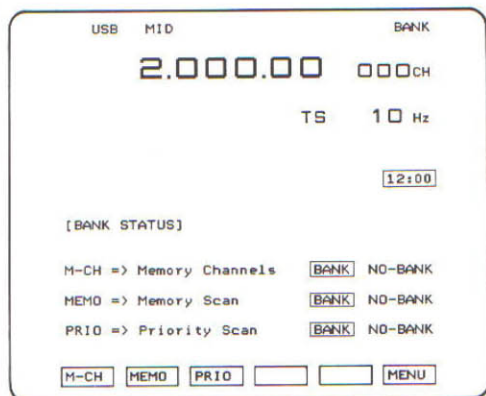

MEMORY BANK STATUS SCREEN

- Select "BANK" when you require memories to be separated.
- Select "NO-BANK" when you do not require memories to be separated (every memory channel can be scrolled without using the [MEMORY BANK] switches).

- 1) Access the memory bank status screen:
 - Push [F-4] "BANK" when the menu 2 screen is displayed.
- 2) Push [F-1] "M-CH" to select "BANK" or "NO-BANK" status.
- 3) Push [F-6] "MENU" to return to the menu 1 screen.

NOTE: The memory scan bank and the priority scan bank can also be set in the scan condition screen. Refer to pgs. 49 and 51.

8 MEMORY CHANNELS

8-2 MEMORY WRITING

There are 2 ways to write a memory channel.

- (1) Writing in the operating frequency section. You can perform memory writing when any screen is selected. However, the original memory contents are erased.
- (2) Writing in the memory list screen. Original memory contents are not erased.

(1) IN THE OPERATING FREQUENCY SECTION

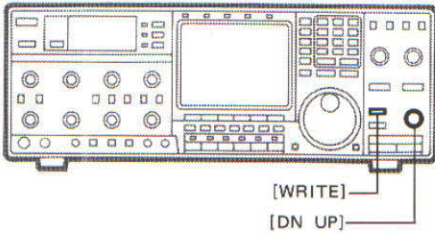

- 1) Select the memory channel:
 - Use the [DN UP] selector or the keyboard. See p. 39 for details.
- 2) Set the frequency, mode, filter width and tuning step.
- 3) Push and hold the [WRITE] switch until the receiver emits 3 beeps.
 - Memory writing is completed.

(2) IN THE MEMORY LIST SCREEN

- 1) Set the frequency, mode, filter width and tuning step.
- 2) Access the memory list screen:
 - Push [F-2] "MEMO" when the menu 1 screen is displayed.
- 3) Push and hold [F-1] "ROLL" then rotate the main dial to select the desired memory channel.
- 4) Push and hold the [WRITE] switch until the receiver emits 3 beeps.
 - Memory writing is completed without erasing original contents.

•MEMORY WRITING IN THE MEMORY LIST SCREEN

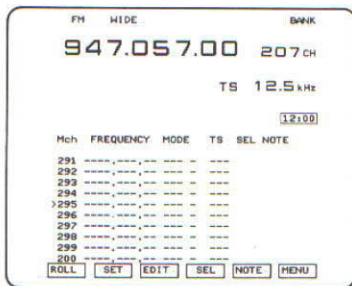

Memory channel selected "ROLL" and the main dial.

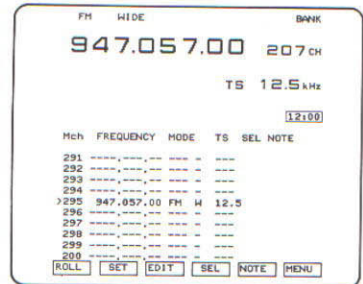

The contents are written into the memory list screen.

8-3 SELECTED MEMORY NUMBER

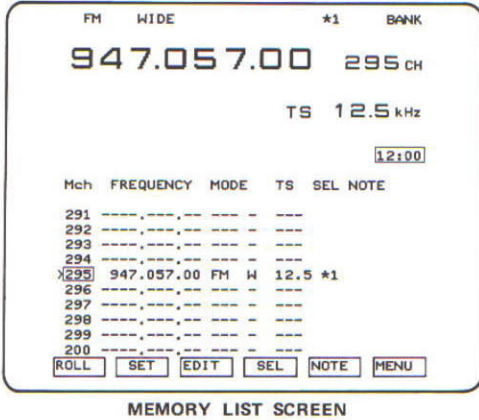

Selected memory numbers are used for the selected number memory scan described on p. 53. Scanning operates only on channels programmed with the same number. 9 selected memory numbers are available for scanning group separation.

- 1) Access the memory list screen.
 - Push [F-2] "MEMO" when the menu 1 screen is displayed.
- 2) Select the memory channel to program the selected memory number:
 - Use [F-1] "ROLL" or [F-2] "SET" with the main dial.
- 3) Push [F-4] "SEL" to program the selected memory number.
 - To change the number, push and hold [F-4] "SEL" then rotate the main dial.
 - The programmed scan edge channels (1P1 ~ 9P2) do not accept writing.
- 4) To erase the number, push [F-4] "SEL" again.

SELECT NUMBER ALL CLEAR

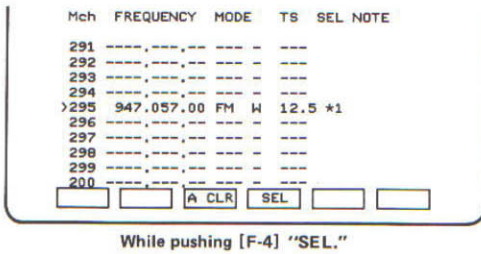

The same selected memory numbers can be erased simultaneously in the memory list screen.

- 1) Set the memory bank: "BANK" or "NO-BANK" (p. 40).
 - "NO-BANK" : Erased in all memory channels.
 - "BANK" : Erased in the selected bank only.
- 2) Push and hold [F-4] "SEL" then rotate the main dial to select the desired number to be erased.
- 3) Push and hold [F-4] "SEL" then [F-3] "A CLR" until the receiver emits 3 beeps.

8-4 MEMORY NOTE

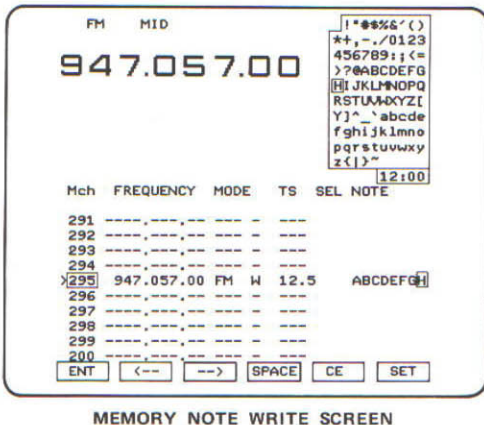

8 characters of the note can be written in each memory channel for your reference.

- 1) Access the memory list screen:
 - Push [F-2] "MEMO" when the menu 1 screen is displayed.
- 2) Select the memory channel to write a memory note:
 - Use [F-1] "ROLL," or [F-2] "SET" with the main dial.
- 3) Push [F-5] "NOTE" to access the memory note write screen.
- 4) Choose a character with the main dial.
- 5) Push [F-1] "ENT" to write the character.
- 6) Repeat steps 4 and 5 to write your desired note.
 - When wrong characters are written, pushing [F-5] "CE" clears all input then returns the screen to the memory list screen.
- 7) Use "-->," "<--" and "SPACE" to move the cursor.
- 8) Push [F-6] "SET" to store the note.
 - The screen returns to the memory list screen.

8 MEMORY CHANNELS

8-5 MEMORY CLEARING

(1) IN THE OPERATING FREQUENCY SECTION

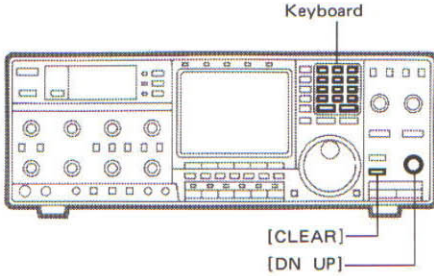

There are 2 ways to clear a memory channel: clearing in the operating frequency section and in the memory list screen.

- 1) Select the memory channel to be cleared.
 - Use the keyboard or the [DN UP] selector.
- 2) Push and hold the [CLEAR] switch until the memory is cleared.

(2) IN THE MEMORY LIST SCREEN

- 1) Access the memory list screen:
 - Push [F-2] "MEMO" when the menu 1 screen is displayed.
- 2) Push and hold [F-1] "ROLL" then rotate the main dial to select the desired memory channel.
- 3) Push and hold the [CLEAR] switch until the memory on the memory list screen is cleared.
 - The memory on the operating frequency section is not erased.

•MEMORY CLEARING IN THE MEMORY LIST SCREEN

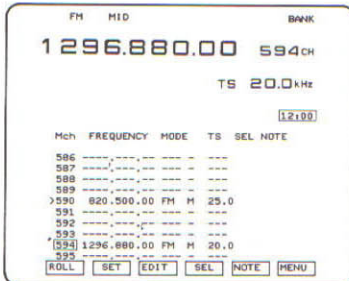

Memory channel selected "ROLL" with the main dial.

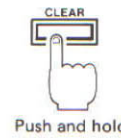

Push and hold

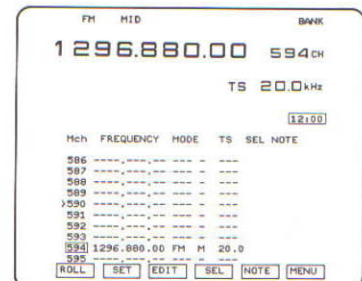

The memory contents in the memory list screen are cleared.

8-6 MEMORY EDITOR FUNCTION

The memory editor function allows you to easily re-program the memory channels using copy, move and clear.

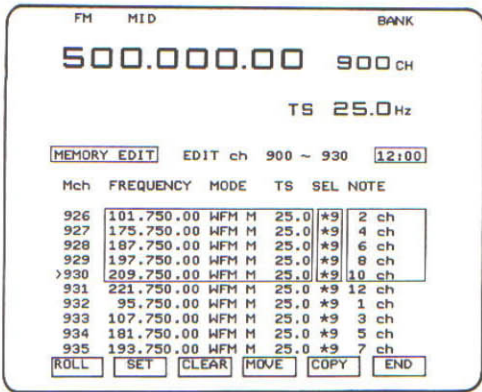

MEMORY EDIT SCREEN

- 1) Access the memory list screen:
 - Push [F-2] "MEMO" when the menu 1 screen is displayed.
- 2) Push [F-3] "EDIT" to access the memory edit screen.
- 3) Select an edge of the memory channel area you wish to edit:
 - Use [F-1] "ROLL" with the main dial or the [MEMORY BANK] switches, [UP] or [DOWN].
- 4) Push and hold [F-2] "SET" then rotate the main dial to surround the memory channels.
 - The desired channel area lights with bright intensity.
- 5) Select the desired memory channel area you wish to move or copy.
 - Use [F-1] "ROLL" with the main dial or the [MEMORY BANK] switches, [UP] or [DOWN].
 - When you wish to clear the surrounded channels, skip to step 6.
- 6) Push and hold the desired key to edit:
 - [F-3] "CLEAR" : Clears the surrounded channels.
 - [F-4] "MOVE" : Moves the surrounded channels.
 - [F-5] "COPY" : Copies the surrounded channels.
 - [F-6] "END" : Cancels the memory editor function.
 - The end of the edited channels comes to the center of the memory list screen.

CAUTION: Other memory channels which you previously programmed here may be erased.

[EXAMPLE]

• Copy from memory channels 900 ~ 930 to 240 ~ 270.

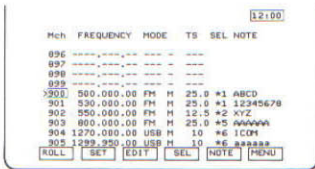

The memory list screen.

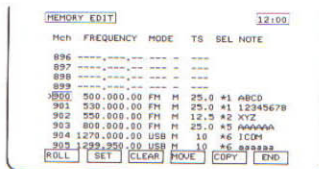

The memory edit screen.

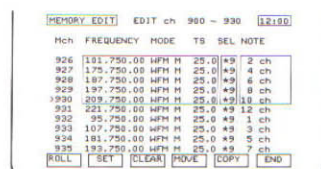

Release [F-2] "SET."

Push [F-3] "EDIT."

Push and hold [F-2] "SET" then rotate the main dial.

Select memory channel 240.

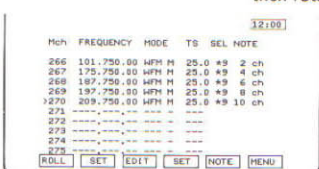
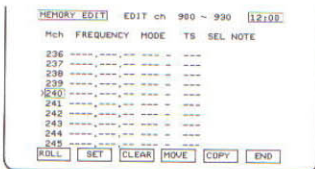

Edited copy is completed.

Push [F-5] "COPY."

(2) VOICE SCAN CONTROL (VSC) FUNCTION



(3) SCAN RESUME CONDITION

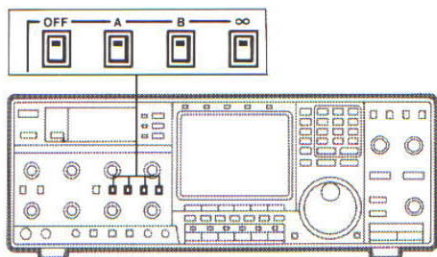

Scanning restarts a few seconds after stopping when a signal not including audio or voice components is received.

- Turn ON the [VSC] switch to activate the VSC function.

SWITCH	OPERATION
[OFF]	Scanning does not resume while a signal is received. Resumes approx. 3 seconds after the signal disappears.
[A]	Resumes scanning several seconds* after scanning stops. Scanning stops for several seconds* even if the signal disappears.
[B]	Resumes scanning several seconds* after scanning stops. Scanning resumes approx. 3 seconds after the signal disappears.
[∞]	Cancels scanning when a signal is received.

* The [DELAY TIME] control adjusts delay time 3 ~ 20 seconds (until 30 sec. when the [REC SPEECH] switch is turned ON).

(4) TAPE RECORDER CONTROL

When a signal is received, the IC-R9000L controls the tape running of a tape recorder through the remote jack on both the IC-R9000L and the tape recorder. You can record the received signal even if you have left the receiver. See p. 27 for connection information.

(5) SCANNING WITH THE SPECTRUM SCOPE SCREEN

Scanning can operate using the spectrum scope screen. However, the scope screen is automatically in the "HOLD" condition while scanning. The "HOLD" condition is canceled when scanning stops.

Tech Talk from Icom

Q: How does the IC-R9000L (Voice Scan Control) differ from former VSCs?

A: The IC-R9000L detects audio components in receive signals differently.

The IC-R9000L VSC detects both audio signal components and a variation of the received audio tone. Former VSCs detected only receive signals whether they included audio signal components or not.

Therefore, older receivers equipped with former VSCs do not resume scanning when they receive a signal modulated with no variation of the audio signal. Carrier waves with no audio signal or no variation of audio signals are always unwanted signals.

The IC-R9000L, however, resumes scanning when it receives unwanted signals such as those mentioned above. The VSC turns ON because the IC-R9000L VSC detects variation of the audio signal.

The VSC starts to sample the received signal for one second when the scan stops. If the received signal includes audio signals and the tone of the audio signals changes, the scan stops on the frequency.

The new VSC system is therefore very useful for auto memory write scan or audio recording with a tape recorder during scanning.

9-2 PROGRAMMED SCAN

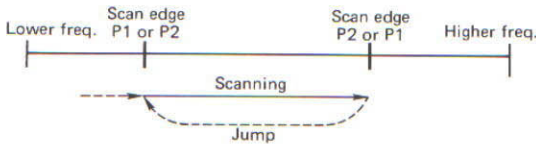

(1) SETTING PROGRAMMED SCAN EDGES

• USING THE [WRITE] SWITCH

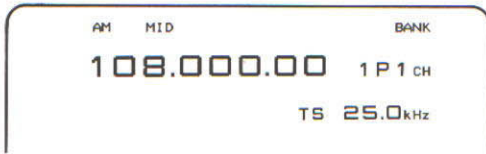

• USING THE SCAN CONDITION SCREEN

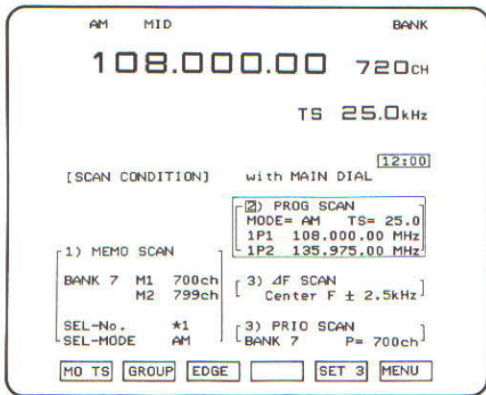

PROGRAMMED SCAN CONDITION SCREEN

Programmed scan repeatedly scans between 2 user-programmed scan edges. The scan edges can be programmed up to 10 groups (20 channels). You can select one of 10 groups to search a signal.

There are 2 ways to program the scan edges: using the [WRITE] switch or using the scan condition screen.

Program a frequency, mode and tuning step on each scan edge channel (1P1 ~ 9P2) as you would write a memory channel. See p. 41 Section 8 - 2 MEMORY WRITING for details.

- 1) Access the scan condition screen:
 - Push [F-1] "SCAN" when the menu 1 screen is displayed.
- 2) Push [F-5] "SET 1" or "SET 2" until it becomes "SET 3."
 - The programmed scan condition screen as shown in the diagram at left is selected.
- 3) Push and hold [F-2] "GROUP" then rotate the main dial to select the desired programmed scan group to be written.
- 4) Push [F-3] "EDGE."
 - A programmed scan edge frequency lights with bright intensity.
- 5) Enter the scan edge frequency using the keyboard.
- 6) Repeat steps 4 and 5 to program the other side of the scan edge frequency.
- 7) Push [F-1] "MO TS" then push a MODE switch ([FM], [AM], etc.).
- 8) Push a [TUNING STEP] switch, [SLOW] or [FAST], to set the desired tuning step.
- 9) Push [F-6] "MENU" to return to the menu 1 screen.

(2) PROGRAMMED SCAN OPERATION

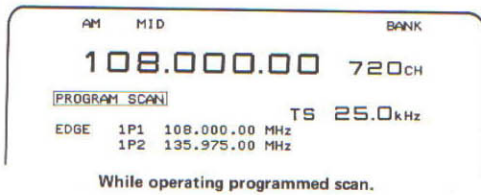
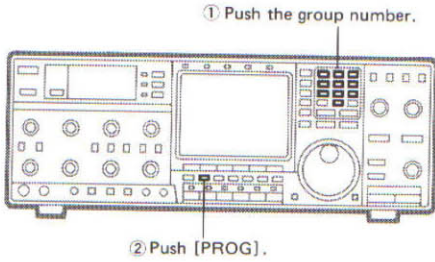

- 1) Select the desired resume condition. See p. 46 Section 9-1 (3) SCAN RESUME CONDITION.
- 2) Adjust the [SQUELCH] control to the threshold point.
- 3) Enter the desired scan group number using the keyboard.
 - If you do not enter the scan group number, the previous scan group is automatically used.
- 4) Push the [PROG] switch to start programmed scan.
 - Programmed scan does not activate when the programmed scan edges are not programmed.
- 5) Adjust the [SPEED] control to the desired scanning speed.
- 6) To stop scanning, push a [SCAN] switch ([PRIO], [PROG], etc.) or a CRT function switch ([F-1] ~ [F-6]).
 - The main dial also stops scanning.

•SCAN GROUP INFORMATION

SCANNING PURPOSE	SCAN NAME	SEPARATE GROUP NUMBER	SEPARATION METHOD
Scanning in the operating frequency	Programmed scan (Auto memory write scan)	10	Using programmed scan edges OP1/OP2 ~ 9P1/9P2
	ΔF scan	1	
Scanning in the memory channels	Memory scan	10 + 1	Using 10 memory banks + "NO-BANK" (Scan range can be programmed.)
	Selected number memory scan	90 + 9	Using 9 selected numbers x (10 memory scan banks + "NO-BANK")
	Selected mode memory scan	70 + 7	Using 7 operating modes x (10 memory scan banks + "NO-BANK")
Watching a memory channel during reception	Priority scan	10 + 1	A priority memory channel x (10 priority scan banks + "NO-BANK")

9-3 PRIORITY SCAN



Priority scan watches a particular memory channel during operation. Priority channels can be set for one channel on each memory bank or for one channel that ignores the memory bank.

NOTE: The priority scan bank is separately set from the memory channel bank. "BANK" or "NO-BANK" indicated on the right top of the LCD monitor has no relation to the priority scan bank.

(1) SETTING A PRIORITY CHANNEL

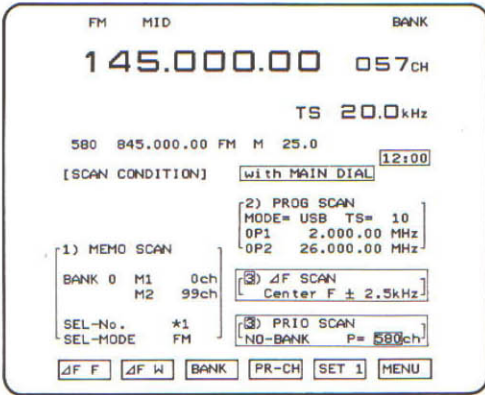

ΔF/PRIORITY SCAN CONDITION SCREEN
(While pushing [F-4] "PR-CH.")

(2) PRIORITY SCAN OPERATION

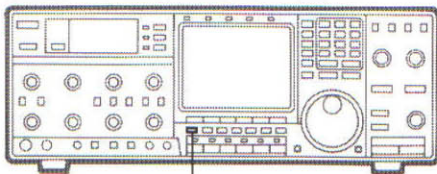

[PRIO]

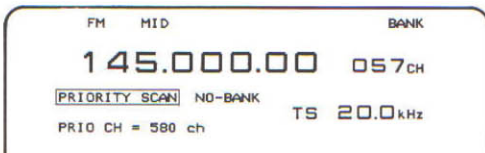

While operating priority scan.

- 1) Access the scan condition screen:
 - Push [F-1] "SCAN" when the menu 1 screen is displayed.
 - 2) Push [F-5] "SET 2" or "SET 3" until it becomes "SET 1."
 - The ΔF/priority scan condition screen as shown in the diagram at left is selected.
 - 3) Push [F-3] "BANK" to select the priority channel in the "BANK" or "NO-BANK" status.
 - The priority bank can also be selected in the bank status screen.
 - 4) Push and hold [F-4] "PR-CH" then rotate the main dial to select the desired memory channel as a priority channel.
 - 5) Push [F-6] "MENU" to return to the menu 1 screen.
- 1) Set the priority channel. See (1) SETTING A PRIORITY CHANNEL above.
 - 2) Select the desired resume condition. See p. 46 Section 9 - 1 (3) SCAN RESUME CONDITION.
 - 3) Adjust the [SQUELCH] control to the threshold point.
 - 4) Push the [PRIO] switch to start priority scan.
 - If the operating channel equals the priority channel, priority scan deactivates.
 - 5) Adjust the [SPEED] control to the desired scanning speed.
 - 6) To stop scanning, push a [SCAN] switch ([PRIO], [PROG], etc.) or a CRT function switch ([F-1]~[F-6]).
 - The main dial also stops scanning.

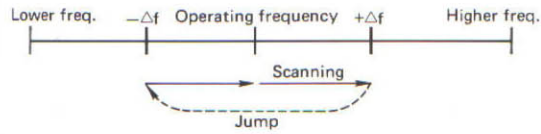
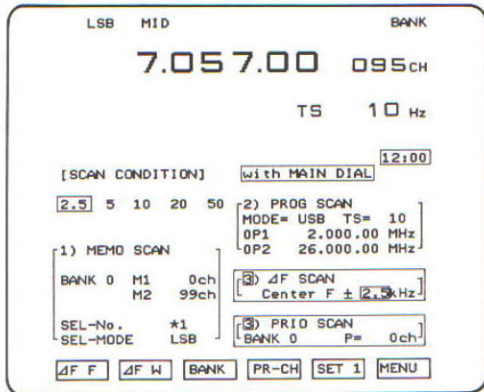
9-4 ΔF SCAN(1) SELECTING THE ΔF SCAN WIDTH

ΔF /PRIORITY SCAN CONDITION SCREEN
(While pushing [F-2] " ΔF W.")

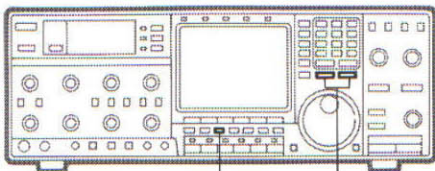
(2) ΔF SCAN OPERATION

② Push [Δf]. ① Set the tuning step.



While operating ΔF scan.

ΔF scan scans a small amount of the frequency width around an operating frequency.

- 1) Access the scan condition screen:
 - Push [F-1] "SCAN" when the menu 1 screen is displayed.
- 2) Push [F-5] "SET 2" or "SET 3" until it becomes "SET 1."
 - The ΔF /priority scan condition screen as shown in the diagram at left is selected.
- 3) Push and hold [F-2] " ΔF W" then rotate the main dial to select the desired ΔF width (scanning range).
 - ΔF width can be selected in $\pm 2.5, 5, 10, 20$ or 50 kHz steps.
- 4) Push [F-1] " ΔF F" to select a fixed or variable ΔF scan center frequency.
 - Variable ("Center F" appears):
 ΔF scan operates around the operating frequency.
 - Fixed (frequency appears):
 ΔF scan operates around a fixed frequency even if the operating frequency is changed.
- 5) Push [F-6] "MENU" to return to the menu 1 screen.

- 1) Select the desired resume condition. See p. 46 Section 9 - 1 (3) SCAN RESUME CONDITION.
- 2) Adjust the [SQUELCH] control to the threshold point.
- 3) Set the tuning step using the [TUNING STEP] switches, [SLOW] or [FAST].
 - Be sure the tuning step does not exceed the scanning range.
- 4) Push the [Δf] switch in the [SCAN] switches to start ΔF scan.
 - When the center frequency is fixed and the operating frequency exceeds the scanning range, ΔF scan does not activate.
- 5) Adjust the [SPEED] control to the desired scanning speed.
- 6) To stop scanning, push a [SCAN] switch ([PRIO], [PROG], etc.) or a CRT function switch ([F-1]~[F-6]).
 - The main dial also stops scanning.

9-5 MEMORY SCAN

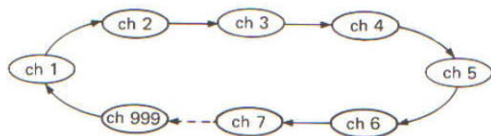

(1) SETTING THE MEMORY SCAN RANGE

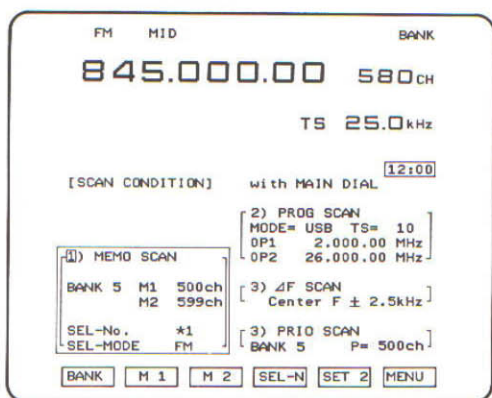

MEMORY SCAN CONDITION SCREEN

Memory scan repeatedly scans memory channels in a user-programmed scanning range. The scanning range can be programmed for each memory bank ("BANK") or for ignoring the memory bank ("NO-BANK").

NOTE: The memory scan bank is set separately from the memory channel bank. "BANK" or "NO-BANK" indicated on the right top of the CRT display has no relation to the memory scan bank.

- 1) Access the scan condition screen:
 - Push [F-1] when the menu 1 screen is selected.
- 2) Push [F-5] "SET 1" or "SET 3" until it becomes "SET 2."
 - The memory scan condition screen as shown in the diagram at left is selected.
- 3) Push [F-1] "BANK" to select the memory scan range in "BANK" or "NO-BANK."
 - The memory scan bank can also be selected in the bank status screen.
- 4) Select the desired memory bank (100-unit channel number) using the [MEMORY BANK] switches, [DOWN] or [UP] when "BANK" is selected in step 3.
 - When "NO-BANK" is selected, skip to step 5.
- 5) Push and hold [F-2] "M 1" then rotate the main dial to set a memory scan edge.
- 6) Push and hold [F-3] "M 2" then rotate the main dial to set the other side memory scan edge.
- 7) Push [F-6] "MENU" to return to the menu 1 screen.

(2) SCAN OPERATION

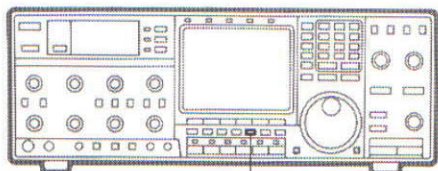

[MEMO]

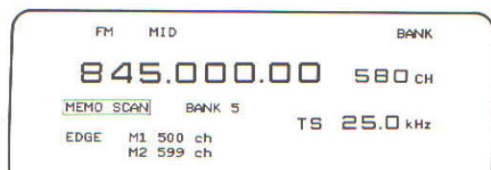

While operating memory scan.

- 1) Set the memory scan range. See (1) SETTING THE MEMORY SCAN RANGE above.
- 2) Select the desired resume condition. See p. 46 Section 9-1 (3) SCAN RESUME CONDITION.
- 3) Adjust the [SQUELCH] control to the threshold point.
- 4) Push [MEMO] in the [SCAN] switches to start memory scan.
 - At least 2 memory channels must be programmed in the selected memory scan range for scanning to operate.
- 5) Adjust the [SPEED] control to the desired scanning speed.
- 6) To stop scanning, push a [SCAN] switch ([PRIO], [PROG], etc.) or a CRT function switch ([F-1]~[F-6]).
 - The main dial also stops scanning.

9-6 SELECTED MODE MEMORY SCAN

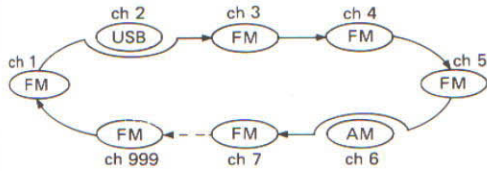

SELECTED MODE MEMORY SCAN OPERATION

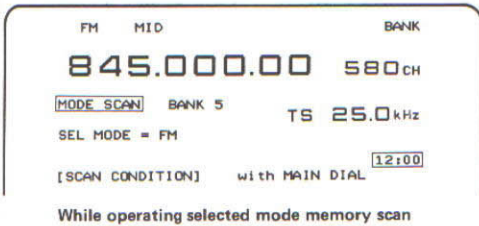
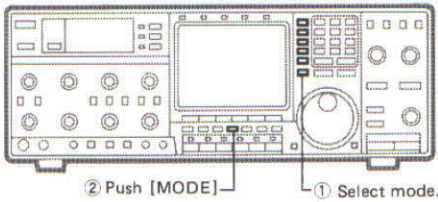

Selected mode memory scan repeatedly scans memory channels with the same selected operating mode. Scanning occurs in a bank or in all memory channels that can be selected by the memory scan bank.

- 1) Set the memory scan bank. See p. 51 Section 9-5 (1) SETTING THE MEMORY SCAN RANGE steps 1~4.
 - Memory scan edges do not function in selected mode memory scan.
- 2) Select the desired resume condition. See p. 46 Section 9-1 (3) SCAN RESUME CONDITION.
- 3) Adjust the [SQUELCH] control to the threshold point.
- 4) Select the desired mode to be scanned, FM, AM, USB, etc.
- 5) Push [MODE] in the [SCAN] switches to start selected mode memory scan.
 - At least 2 memory channels with the same mode must be programmed to operate scanning.
- 6) Adjust the [SPEED] control to the desired scanning speed.
- 7) To stop scanning, push a [SCAN] switch ([PRIO], [PROG], etc.) or a CRT function switch ([F-1]~[F-6]).
 - The main dial also stops scanning.

Tech Talk from Icom

Q: Why is it so difficult to increase scan speed?

A: The most important factor determining scanning speeds is the PLL lockup time. The faster the lockup time the faster the scanning speed.

However, when lockup times increase, the quality of VCO output signals (C/N) decreases. Decreased signal quality means the scan may not stop when a signal is received. Lockup times and VCO signal quality therefore work against each other.

How to solve the problem? Icom found a way. By using the DDS (Direct Digital Synthesizer) in the PLL circuit, the PLL creates a very short lockup time.

Using the DDS, Icom succeeded in providing faster scanning speeds without decreasing the quality of VCO output signals. The scanning speed in the IC-R9000L is 13 channels/second or more – a speed at least twice as fast as former Icom equipment (not equipped with the DDS system). And you can be certain that the IC-R9000L's scan will stop when a signal is received.

9-7 SELECTED NUMBER MEMORY SCAN

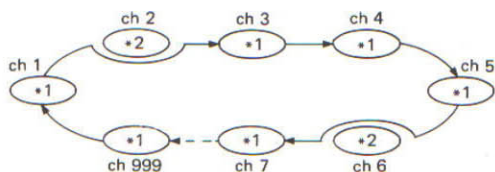

Selected number memory scan repeatedly scans memory channels with the same programmed number. Scanning occurs in a bank or in all memory channels that can be selected by the memory scan bank.

To program a scan number into memory channels, see p. 42 Section 8 - 3 SELECTED MEMORY NUMBER.

(1) SELECTING A MEMORY SCAN NUMBER

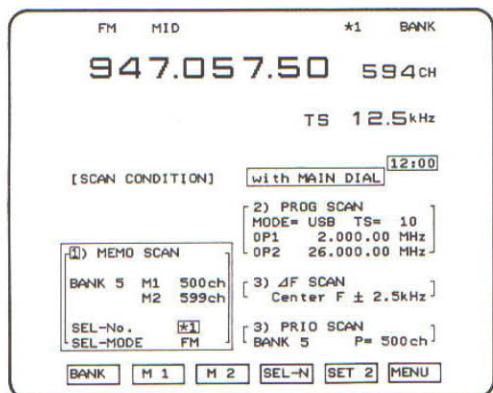

MEMORY SCAN CONDITION SCREEN
(While pushing [F-4] "SEL-N.")

Using the memory scan condition screen, select the number of the group to be scanned in selected number memory scan. The selected number can also be selected by pushing a digit key before starting or during scanning.

- 1) Access a scan condition screen:
 - Push [F-1] "SCAN" when the menu 1 screen is displayed.
- 2) Push [F-5] "SET 1" or "SET 3" until it becomes "SET 2."
 - The memory scan condition screen as shown in the diagram at left is selected.
- 3) Push and hold [F-4] "SEL-N" then rotate the main dial to select the selected number.
- 4) Push [F-6] "MENU" to return to the menu 1 screen.

(2) SCAN OPERATION

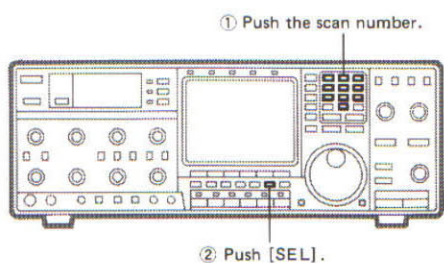

- 1) Set the memory scan bank. See p. 51 Section 9 - 5 (1) SETTING THE MEMORY SCAN RANGE steps 1~4.
 - Memory scan edges do not function in selected mode memory scan.
- 2) Select the desired resume condition. See p. 46 Section 9 - 1 (3) SCAN RESUME CONDITION.
- 3) Adjust the [SQUELCH] control to the threshold point.
- 4) Push a digit key to select the desired scan number to be scanned.
- 5) Push the [SEL] switch to start selected number memory scan.
 - At least 2 memory channels with the same selected number must be programmed to operate scanning.
- 6) Adjust the [SPEED] control to the desired scanning speed.
- 7) To stop scanning, push a [SCAN] switch ([PRIO], [PROG], etc.) or a CRT function switch ([F-1]~[F-6]).
 - The main dial also stops scanning.



While operating selected number memory scan.

10 CLOCK AND TIMER OPERATION

10-1 CLOCK ADJUSTMENT

(1) MAIN CLOCK

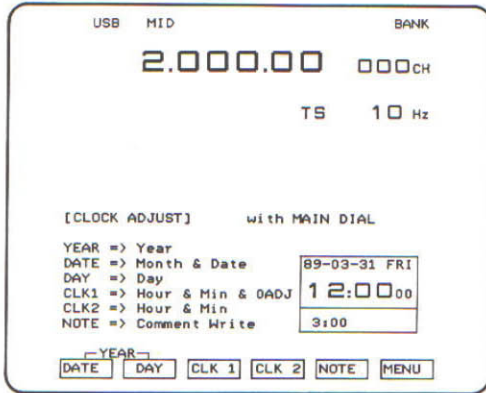

CLOCK ADJUSTMENT (1) SCREEN

(2) SUB CLOCK

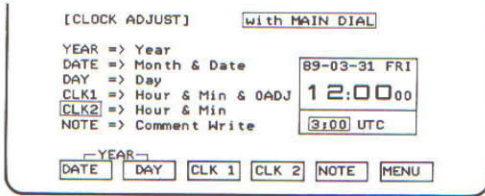

CLOCK ADJUSTMENT (1) SCREEN

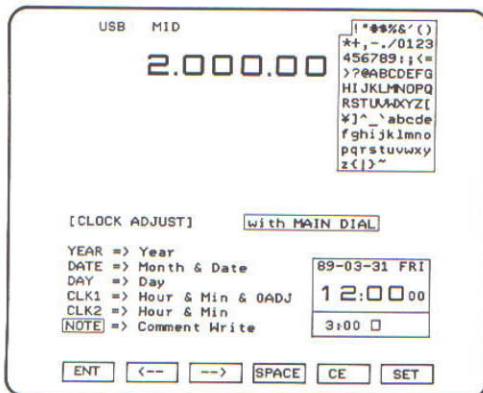

CLOCK ADJUSTMENT (2) SCREEN

The IC-R9000L has 2 clocks: the main and sub clocks. The main clock displays the year, month, day, hour, minute and second. The sub clock displays the hour, minute and a note of up to 6 characters.

- 1) Access the clock & timer screen:
 - Push [F-4] "TIME" when the menu 1 screen is displayed.
- 2) Push [F-3] "ADJ" to access the clock adjustment (1) screen as shown in the diagram at left.
- 3) To set the year, push and hold [F-1] "DATE" and [F-2] "DAY" and then rotate the main dial.
- 4) To set the month and date, push and hold [F-1] "DATE" then rotate the main dial.
- 5) To set the day, push and hold [F-2] "DAY" then rotate the main dial.
- 6) To set the time, push and hold [F-3] "CLK 1" then rotate the main dial.
- 7) To set the second at 0, push [F-3] "CLK 1."

- 1) Access the clock adjustment (1) screen:
 - See (1) MAIN CLOCK steps 1 and 2 above.
- 2) To set the time of the sub clock, push and hold [F-4] "CLK 2" then rotate the main dial.
- 3) To write a note in the clock 2 area, push [F-5] "NOTE."
 - The clock adjustment (2) screen appears.
 - If you do not need to write, skip to step 9.
- 4) Choose a character using the main dial.
- 5) Push [F-1] "ENT" to write the character.
- 6) Repeat steps 4 and 5 to write your desired note.
 - When wrong characters are written, pushing [F-5] "CE" clears all input then returns the screen to the clock adjustment (1) screen.
- 7) Use "→", "←" and "SPACE" to move the cursor.
- 8) To store the note, push [F-6] "SET."
 - The note is written and the screen returns to the clock adjustment (1) screen.
- 9) Push [F-6] "MENU" to return to the menu 1 screen.

10-2 SLEEP TIMER

(1) SLEEP 1 TIMER

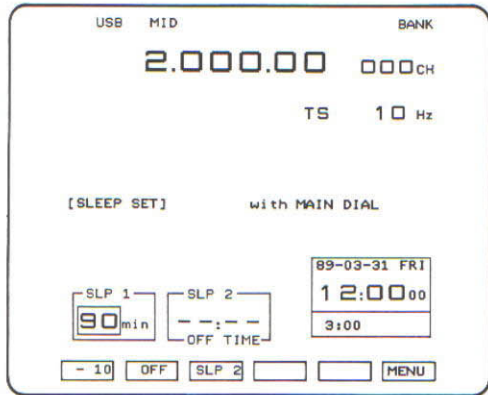

SLEEP TIMER SCREEN (When selecting sleep 1)

(2) SLEEP 2 TIMER

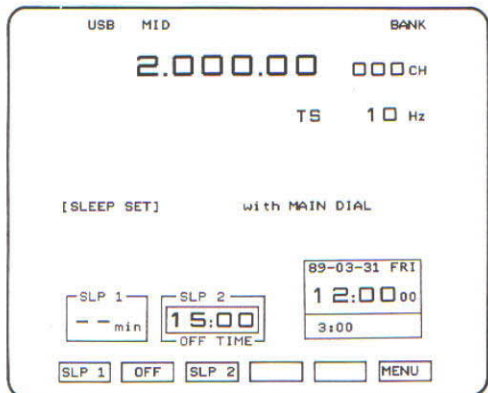

SLEEP TIMER SCREEN (When selecting sleep 2)

The selectable sleep timers, sleep 1 (Time-off Timer) and sleep 2 (Clock Timer), turn OFF the receiver.

When the [TIMER] switch is OFF the sleep timer functions as an alarm timer which emits beeps for 2 sec. as an alarm at the programmed off time.

- 1) Access the clock & timer screen:
 - Push [F-4] "TIME" when the menu 1 screen is displayed.
- 2) Push [F-1] "SLEEP" to access the sleep timer screen.
- 3) To adjust the sleep 1 time from 0 ~ 90 minutes, push [F-1] "-10" (or "SLP 1").
- 4) Set the [TIMER] switch on the front panel.
 - IN : sleep timer activates.
 - OUT : alarm timer activates.
- 5) Push [F-6] "MENU" to return to the menu 1 screen.
- 6) To turn the sleep timer OFF, push [F-2] "OFF" when the CRT shows the sleep timer screen.

- 1) Access the sleep timer screen:
 - See (1) SLEEP 1 TIMER steps 1 and 2 above.
- 2) To adjust the off time, push and hold [F-3] "SLP 2" then rotate the main dial.
- 3) Set the [TIMER] switch on the front panel.
 - IN : sleep timer activates.
 - OUT : alarm timer activates.
- 4) Push [F-6] "MENU" to return to the menu 1 screen.
- 5) To turn the sleep timer OFF, push [F-2] "OFF" when the CRT shows the sleep timer screen.

NOTE: When the daily timer has been turned ON, the SLP 2 area shows the daily timer off time. See Section 10 - 3 for daily timer information.

10 CLOCK AND TIMER OPERATION

10-3 DAILY TIMER

(1) PROGRAMMING A DAILY TIMER

DAILY TIMER (2) SCREEN

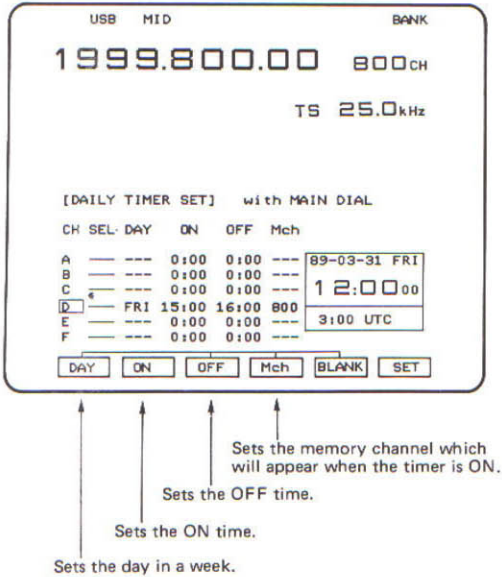

(2) OPERATING THE DAILY TIMERS

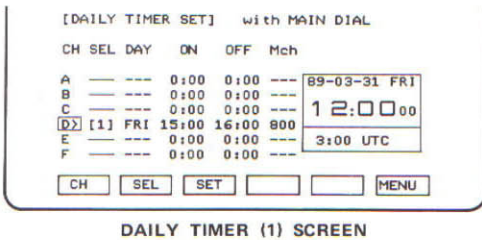

NOTE: To operate the daily timer together with the sleep timer, set the sleep timer before pushing in the [TIMER] switch.

5 programmed daily timers turn the receiver ON and OFF. The programmable contents include the day, ON/OFF time and memory channel you want receive in.

- 1) Access the clock & timer screen:
 - Push [F-4] "TIME" when the menu 1 screen is displayed.
 - 2) Push [F-2] "TIMER" to select the daily timer set (1) screen.
 - 3) Push and hold [F-1] "CH" then rotate the main dial to select one of 5 timers.
 - 4) Push [F-3] "SET" to set the timer contents on the selected timer.
 - The daily timer (2) screen appears.
 - 5) Push and hold one of [F-1]~[F-4] then rotate the main dial to set your desired timer contents as shown in the diagram at left.
 - 6) To program blank status, push and hold [F-5] "BLANK" and push the desired key: "DAY," "OFF" or "Mch."
 - When "DAY" is blank, the timer activates every day.
 - When "OFF" is blank, the timer functions as power ON only.
 - When "Mch" is blank, the displayed frequency appears at the timer ON.
 - 7) Push [F-6] "SET" to return to the daily timer set (1) screen.
 - 8) Program another daily timer (begin again from step 3) or push [F-6] "MENU" to return to the menu 1 screen.
- 1) Access the daily timer set (1) screen:
 - See (1) PROGRAMMING A DAILY TIMER step 1 and 2 above.
 - 2) Push and hold [F-1] "CH" then rotate the main dial to select the desired timer.
 - 3) Push [F-2] "SEL" to activate the timer.
 - The activated timer lights at a bright intensity.
 - Priority number appears in "SEL" area depending on programmed time.
 - 4) Repeat steps 2 and 3 when activating another timer simultaneously.
 - 5) Push IN the [TIMER] switch on the front panel.
 - 6) Push [F-6] "MENU" to start the daily timer function.
 - After several seconds, power automatically turns OFF and will turn ON again at the programmed ON time.
 - When the sleep timer is programmed, power will turn OFF after sleep time finishes.

(3) FUNCTION OPERATION

●CHECKING THE OFF TIME

The OFF time of the daily timer can be checked on the clock & timer screen. Push [F-4] "TIME" when the menu 1 screen is displayed.

●CHANGING THE OFF TIME

The OFF time can be changed when the timer is ON without changing the programming on the daily timer (2) screen, if required.

- Select the sleep timer screen and set the desired OFF time on the SLP 2 (Clock Timer).
- The programmed OFF time remains at the original time.

●DAILY TIMER CANCELING

If you wish to cancel the daily timer which has been turned ON and to operate the next programmed timer, turn the [POWER] switch OFF and then ON.

- The receiver is turned OFF as soon as the power comes ON.

●SLEEP TIMER CANCELING

If you wish to cancel the sleep timer when operating the sleep timer together with the daily timer, turn the [POWER] switch OFF and then ON.

- The receiver is turned OFF as soon as the power comes ON.

(4) PROGRAMMING NOTE

(1) When the ON time is the same for 2 programs.

The later OFF time program is selected.

CH	SEL	DAY	ON	OFF	Mch
A	[2]	FRI	13:00	14:00	001
B	[1]	FRI	13:00	15:00	002

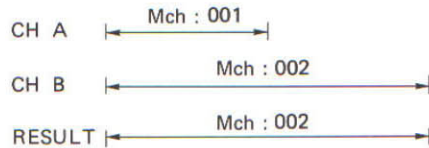

(2) When the OFF time and ON time are the same on 2 programs.

The Mch changes.

CH	SEL	DAY	ON	OFF	Mch
A	[1]	FRI	13:00	14:00	001
B	[2]	FRI	14:00	15:00	002

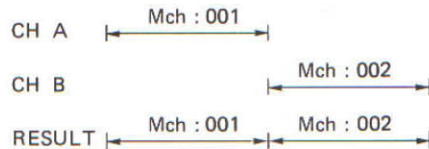

(3) When 2 programs overlap.

Only the first program is selected.

CH	SEL	DAY	ON	OFF	Mch
A	[1]	FRI	13:00	14:00	001
B	[2]	FRI	13:30	14:30	002

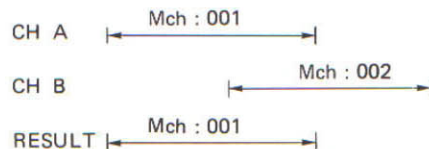

11-1 TROUBLESHOOTING

The following chart is designed to help you correct problems which are not equipment malfunctions. If you are unable to locate the cause of the problem or solve it through the use of this chart, contact your nearest Icom Dealer or Service Center.

■ RECEIVING

PROBLEM	POSSIBLE CAUSE	SOLUTION	REF.
<ul style="list-style-type: none"> Power does not come ON. 	<ul style="list-style-type: none"> [TIMER] is pushed IN. Both [BRIGHT] controls are rotated too far CCW. The fuse is blown. 	<ul style="list-style-type: none"> Turn [TIMER] OFF. Set [METER] max. CW. Set [LCD] to the 2 o'clock position. Check the cause, then replace the fuse. 	<p>p. 57</p> <p>p. 4</p> <p>p. 62</p>
<ul style="list-style-type: none"> No sound comes from the speaker or volume is too low. 	<ul style="list-style-type: none"> [RF GAIN] is rotated too far CCW. [SQUELCH] is rotated too far CW. WFM mode is selected for an FM signal. CI-V volume command is received ([REMOTE] LED lighted). 	<ul style="list-style-type: none"> Rotate [RF GAIN] max. CW. Rotate [SQUELCH] CCW. Push [FM]. Push [REMOTE] to reset the remote command. 	<p>p. 32</p> <p>p. 32</p> <p>p. 36</p> <p>p. 5</p>
<ul style="list-style-type: none"> Sensitivity is too low. 	<ul style="list-style-type: none"> Antennas are not connected. Wrong antenna is connected or wrong antenna connector is used. [ATT 10 dB] or [ATT 20 dB] is ON. [HF ANT SW] is set at "ANT 1" when you use the [ANT 2] jack. 	<ul style="list-style-type: none"> Connect the antenna. The IC-R9000L requires 3 antennas for all band coverage. Check the antenna and connect it to the correct connector. Turn [ATT 10 dB] and [ATT 20 dB] OFF. Set the [HF ANT SW] to "ANT 2." Be sure the [ANTENNA] switch is OFF. 	<p>p. 26</p> <p>p. 26</p> <p>p. 35</p> <p>p. 7</p>
<ul style="list-style-type: none"> S-meter does not move. 	<ul style="list-style-type: none"> [AGC] is set in the "OFF" position. [METER] is set at "CENTER." [SQUELCH] or [RF GAIN] is rotated so the meter does not show "0." 	<ul style="list-style-type: none"> Set [AGC] to "SLOW" or "FAST." Set [METER] to "SIGNAL." Rotate the [SQUELCH] max. CCW and [RF GAIN] max. CW. 	<p>p. 38</p> <p>p. 36</p> <p>p. 36</p>
<ul style="list-style-type: none"> Receive audio is unclear or distorted. 	<ul style="list-style-type: none"> [IF SHIFT] is rotated too far CCW or CW. The wrong [MODE] switch is pushed. [AGC] is set to "OFF" even when the receive signal is strong. [NB LEVEL] is rotated too far CW. 	<ul style="list-style-type: none"> Set [IF SHIFT] to center position. Push correct [MODE] switch. Set [AGC] to "SLOW" or "FAST," or push [ATT 10 dB] or [ATT 20 dB]. Rotate [NB LEVEL] CCW. 	<p>p. 37</p> <p>p. 36</p> <p>p. 38</p> <p>p. 38</p>
<ul style="list-style-type: none"> [AFC] cannot be turned ON. 	<ul style="list-style-type: none"> The operating mode is not set in FM or WFM. 	<ul style="list-style-type: none"> Select FM or WFM mode to activate AFC. 	<p>p. 35</p>
<ul style="list-style-type: none"> WFM mode cannot be set. 	<ul style="list-style-type: none"> The operating frequency is lower than 30 MHz. 	<ul style="list-style-type: none"> WFM mode cannot be selected below 30 MHz. Set the frequency above 30 MHz. 	<p>p. 36</p>
<ul style="list-style-type: none"> [WIDE] in the [FILTER WIDTH] switches cannot be selected. 	<ul style="list-style-type: none"> The operating frequency is lower than 30 MHz in FM mode. 	<ul style="list-style-type: none"> [WIDE] cannot be selected below 30 MHz in FM mode. Set the frequency above 30 MHz. 	<p>p. 36</p>
<ul style="list-style-type: none"> A synthesize voice is not emitted when pushing [SPEECH]. 	<ul style="list-style-type: none"> An optional UT-36 VOICE SYNTHESIZER UNIT is not installed. [REC SPEECH] and [LINE MIX] are set to ON. 	<ul style="list-style-type: none"> Install the UT-36. Push OUT [REC SPEECH]. Or set switches to the proper position. See the table in Section 12 - 3. 	<p>p. 65</p> <p>p. 65</p>

CW: Clockwise CCW: Counterclockwise

■ FREQUENCY AND MEMORY SETTING

PROBLEM	POSSIBLE CAUSE	SOLUTION	REF.
• Main dial does not function.	• [LOCK] is pushed IN.	• Push [LOCK] OUT.	p. 10
• [LOCK] switch does not lock the keyboard, LCD function switches, etc.	• Internal LOCK switch is set at "DIAL."	• Set the internal LOCK switch to "PANEL."	p. 65
• The main dial click does not function.	• Internal CLICK switch is set to "OFF."	• Set the internal CLICK switch to "AUTO."	p. 10
• The selected frequency is erased.	• The memory channel is changed before writing into memory.	• Write into memory when you change the memory channel.	p. 33
• Memory channels in another 100-unit channel cannot be selected.	• The memory bank is set at "BANK."	• Use the [MEMORY BANK] switch or set the memory bank to "NO-BANK."	p. 40

■ SCANNING

PROBLEM	POSSIBLE CAUSE	SOLUTION	REF.
• No scan will function.	• [SQUELCH] is open and [∞] is selected.	• Turn [SQUELCH] CW until noise disappears.	p. 46
• Programmed scan and auto memory write scan do not function.	• The scan edge frequencies of the selected scanning group are not programmed.	• Program the scan edge frequencies or select the programmed scan group.	p. 47
• ΔF scan does not function.	• The tuning step is wider than ΔF width.	• Select the slow tuning step or wider ΔF width.	p. 50
• Selected mode memory scan does not function.	• The same mode channels are not programmed in the operating bank.	• Program the memory with the same mode or select the bank programmed with the same mode.	p. 52
• Memory scan does not function.	• Memory scan bank is set to "BANK" and the operating memory channel is in a programmed scan edge channel.	• Change to another memory channel or set the memory scan bank to "NO-BANK."	p. 51
• Selected number memory scan does not function.	• The same scan numbers are not programmed in the operating bank.	• Program the memory with the same number or select the bank programmed with the same mode.	p. 53
• Auto memory write scan not function.	• All memory channels 900 ~ 999 are programmed.	• Move the contents of memory channels to other memory channels or push and hold the [AUTO] switch.	p. 54

■ CLOCK AND TIMER

PROBLEM	POSSIBLE CAUSE	SOLUTION	REF.
• Timer does not function even when the timer has been set.	• [TIMER] is not pushed IN.	• Push [TIMER] IN.	p. 56
	• "SEL" is not pushed on the daily timer.	• Push [F-2] "SEL" when the daily timer set (1) screen is displayed.	p. 57
	• Programmed contents are cleared by CPU resetting.	• Set the time of the daily timer again.	p. 57
• The daily timer [2] is shown in the "SEL" area does not function.	• The OFF time of [1] timer is set later than the ON time of the [2] timer.	• Set the time of the daily timer again.	p. 58

11-2 CLEANING

If the receiver becomes dusty or dirty, wipe it clean with a dry, soft cloth.

AVOID the use of strong chemical agents such as benzine or alcohol, as they may damage the receiver's surfaces.

11-3 BACKUP BATTERIES

■ CLOCK BATTERY

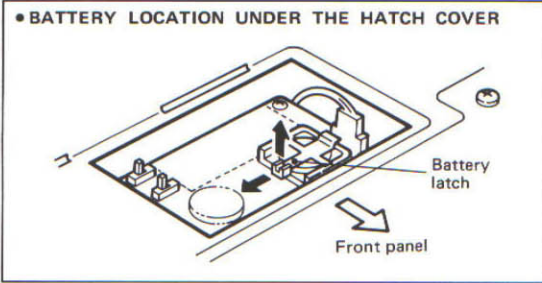

■ MEMORY BACKUP BATTERY

The IC-R9000L has two lithium batteries: one for clock and one of memory backup.

The usual life of the clock battery is approx. 2 years after shipment from the factory. If the clocks are slow or there is a numbering malfunction, replace the battery with a new one.

- 1) Disconnect the AC power cable.
- 2) Open the hatch cover on the top cover.
- 3) Pull up the battery latch, then remove the battery.
- 4) Insert a new battery (CR2032) with the proper polarity.
 - Be sure the ⊕ side of the battery is up.

CAUTION: BE CAREFUL! Battery installation with reverse polarity will damage the internal circuit.

- 5) Close the hatch cover, then adjust the clock time.

The usual life of the memory backup battery is approx. 5 years. When the battery is exhausted, the receiver operates normally but the receiver cannot retain memory information.

CAUTION: Memory backup battery replacement must be done by an authorized Icom Dealer or Service Center.

11-4 COVER REMOVAL

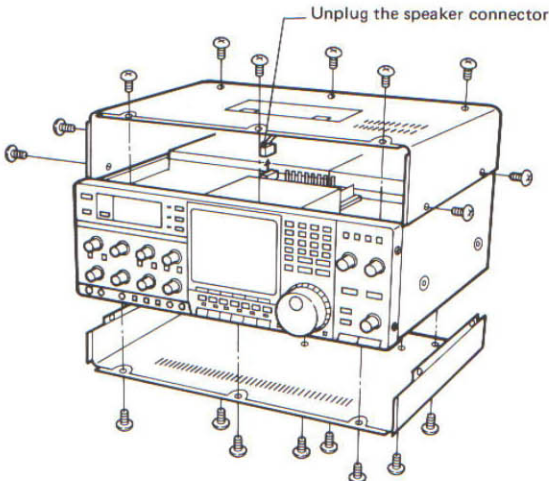

WARNING: DISCONNECT the AC power cable from the receiver before performing any work on the receiver.

- 1) Turn OFF the [POWER] switch.
- 2) Disconnect the AC power cable.
- 3) Remove the mounting handles and rear stands, if they are attached.
- 4) Unscrew the 10 screws from the top cover and 8 screws from the bottom cover as shown in the diagram at left.
- 5) Remove the top cover slowly and unplug the speaker connector.
- 6) Remove the bottom cover.

11-5 FUSE REPLACEMENT

WARNING: DISCONNECT the AC power cable from the receiver before performing any work on the receiver.

The IC-R9000 has 3 fuses for receiver protection:

- AC power input (2 A)
- Regulator circuit (4 A)
- 13.8 V output jack (0.5 A)

If the fuse blows or the receiver stops functioning, find the source of the problem, if possible, and replace the damaged fuse with a new, rated fuse.

The AC power input fuse is held in the [FUSE] holder. Unscrew the [FUSE] holder using a philips head screw driver, then replace the damaged fuse with a new, rated one.

- **REPLACEMENT FUSE :** FGB 2 A
(FGMS 2 A for German version.)

The regulator circuit fuse is located under the RF-A unit.

- 1) Remove the top and bottom covers. See Section 11 - 4 (p. 61) for details.
- 2) Open the shield case from the PA unit and unplug connector J2 as shown in the diagram.
- 3) Unscrew 1 screw holding the RF-A unit on each side (a total of 2 screws). Lift up the RF-A unit from the rear side toward the front side as shown in the diagram at left.
- 4) Replace the damaged regulator circuit fuse with a new, rated one.

- **REPLACEMENT FUSE :** FGB 4 A

When an external connection via the [DC OUTPUT JACK] or the [ACC] socket has a problem, the fuse may blow. If the fuse blows, the receiver operates normally. However, the above jacks do not output 13.8 V DC.

- 1) Remove the top and bottom covers. See Section 11 - 4 (p. 61) for details.
- 2) Set the receiver upside down.
- 3) Replace the damaged fuse with a new, rated one.
 - The 13.8 V DC output fuse is located near the [LINE MIX] switch on the rear panel.
 - Refer to p. 66 for detailed location.

- **REPLACEMENT FUSE :** FGB 0.5 A

(1) AC POWER INPUT FUSE

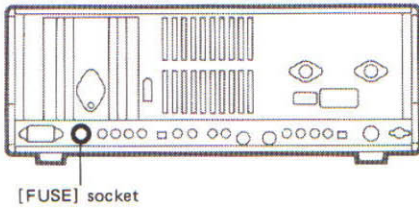

(2) REGULATOR CIRCUIT FUSE

• FUSE LOCATION UNDER THE TOP COVER

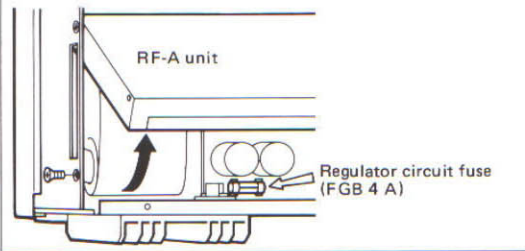
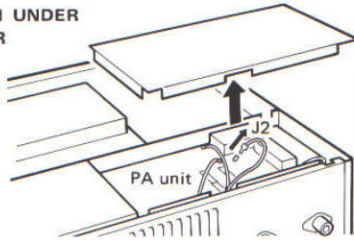

(3) 13.8 V DC OUTPUT JACK

• FUSE LOCATION UNDER THE BOTTOM COVER

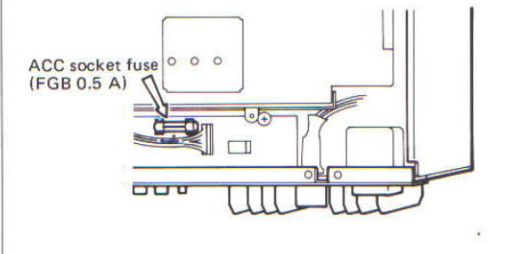

11-6 CPU RESETTING

(1) LOGIC CHECK SCREEN

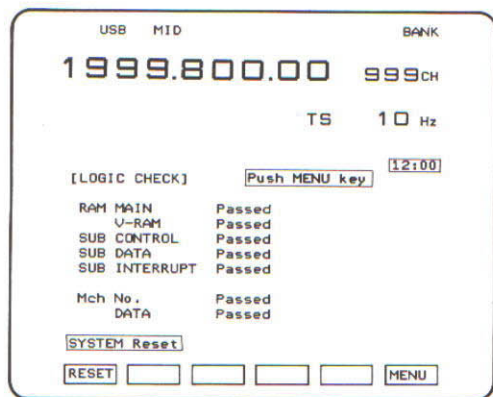
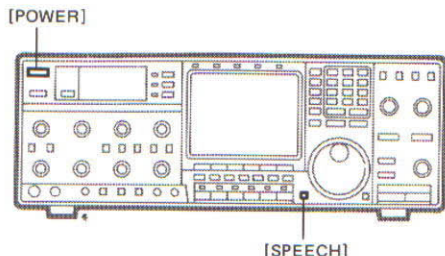

LOGIC CHECK SCREEN

(2) DIRECT CPU RESETTING

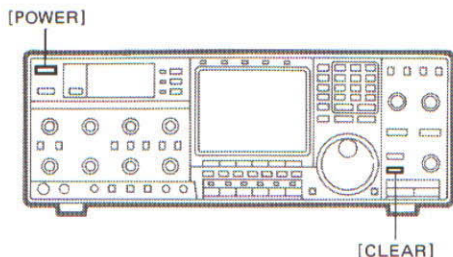

The LCD monitor may occasionally display erroneous information (e.g., when first applying power). This may be caused externally by static electricity or other factors.

If this problem should occur, turn OFF power. Wait a few seconds and turn ON again. If the problem continues, check the internal CPU and RAM IC chips using the logic check screen.

The logic check screen tests a main CPU, sub CPU and RAM IC chips for correct functioning.

- 1) Turn OFF the [POWER] switch.
- 2) Push and hold the [SPEECH] switch then turn the [POWER] switch ON. Then release the [SPEECH] switch.
 - The logic check screen appears approx. 10 sec. after power is ON.
- 3) When the screen shows "Passed" to all check point, push [F-6] "MENU."
 - The menu 1 screen is displayed.
- 4) If another comment is displayed on the screen, push [F-1] "RESET."

CAUTION: When pushing [F-1] "RESET," all memory information is erased.

The receiver checks the following items on the logic check screen:

INDICATOR	DESCRIPTION
RAM MAIN	8 k bytes RAM for MAIN CPU.
V-RAM	128 k bytes V-RAM for LCDC.
SUB CONTROL	Control line between MAIN CPU and SUB CPU.
SUB DATA	Data transferring between MAIN CPU and SUB CPU.
SUB INTERRUPT	Interrupt data line to SUB CPU.
Mch No.	Indicating memory channel number.
DATA	The decimal and width of all memory channels.

The internal CPU can be reset without displaying the logic check screen. Use direct CPU resetting when you wish to erase all memory channels.

- 1) Turn [POWER] OFF.
- 2) Push and hold the [CLEAR] switch then turn [POWER] ON.
- 3) The CPU is now reset and the menu 1 screen is displayed.

12-1 FREQUENCY CALIBRATION

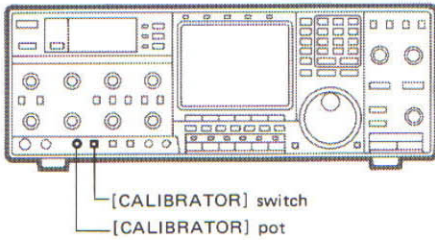

A very accurate frequency counter is necessary to calibrate the frequency of the IC-R9000L. However, a simple calibration may be performed by receiving radio station WWV, or other standard frequency signals.

The calibration adjusts the reference oscillator. Each band calibration is therefore unnecessary.

- 1) Set USB mode.
- 2) Set the operating frequency to the standard frequency station minus 1 kHz.
 - Use a standard frequency below 30 MHz.

EXAMPLE:

When using WWV (10.00000 MHz), adjust the operating frequency to 9.99900 MHz.

$$10.00000 \text{ MHz} - 0.00100 \text{ MHz (1 kHz)} = 9.99900 \text{ MHz}$$

- 3) Turn ON the [CALIBRATOR] switch.
- 4) Adjust the [CALIBRATOR] pot for a zero beat.
 - Zero beat means that two signals are exactly the same frequency, resulting in a single audio tone being emitted.

When you can receive a very accurate station above 1 GHz, calibration can also be performed using the spectrum scope screen. Use FM or AM mode when using the spectrum scope screen.

12-2 MAIN DIAL BRAKE ADJUSTMENT

• ADJUSTMENT HOLE LOCATION

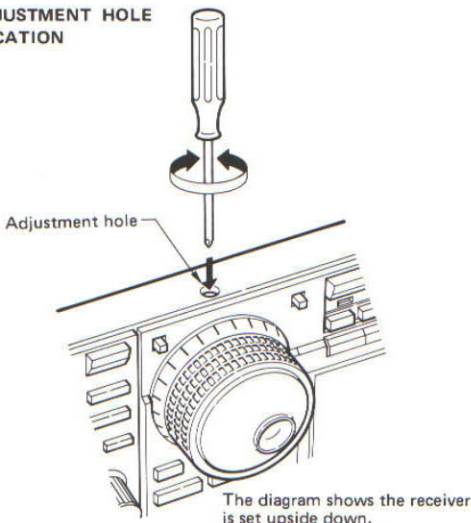

The tension of the main dial may be adjusted to suit your operating needs.

- 1) Use a philips head screw driver.
- 2) The brake adjustment screw is located on the bottom of the receiver cabinet below the main dial.
- 3) Turn the brake adjustment screw to a comfortable tension level while turning the main dial continuously and evenly in one direction.

12-3 OPTIONAL VOICE SYNTHESIZER UNIT

■ UNIT INSTALLATION

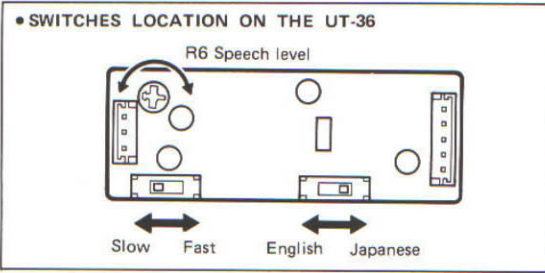
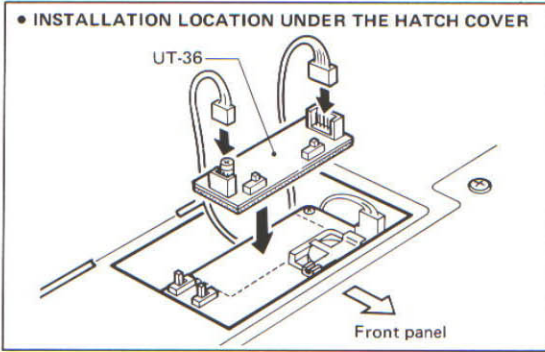

An optional UT-36 VOICE SYNTHESIZER UNIT announces the operating frequency when the [SPEECH] switch is pushed or when scanning stops.

- 1) Disconnect the AC power cable.
- 2) Open the hatch cover on the top cover.
- 3) Connect 2 connectors (3 pins and 5 pins) inside the IC-R9000L to the UT-36.
- 4) Remove the protective paper attached to the bottom of the UT-36 to expose the adhesive strip.
- 5) Attach the UT-36 properly as shown in the diagram at left.
- 6) Set the language, speech speed and speech level as shown in the diagram at left.
- 7) Close the hatch cover.

■ VOICE SYNTHESIZER OPERATION

The UT-36 announces a synthesized voice through the speaker or jacks depending on the switch positions. Set the switches to the desired positions.

SWITCH POSITION		WHEN PUSHING [SPEECH]			WHEN SCANNING STOPS		
[LINE MIX]	[REC SPEECH]	INTERNAL SPEAKER	[REC [LINE OUT]	[SPEECH] OUT]	INTERNAL SPEAKER	[REC [LINE OUT]	[SPEECH OUT]
OFF	OFF	Speech	Speech	Speech	No speech	No speech	No speech
	ON	No speech	No speech	Speech	No speech	No speech	Speech
ON	OFF	Speech	Speech	Speech	No speech	No speech	No speech
	ON	Speech	Speech	Speech	Speech	Speech	Speech

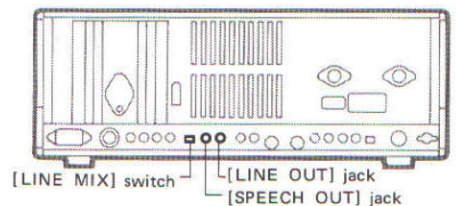
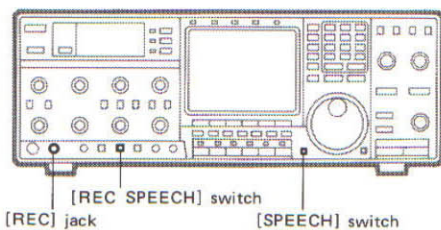

TOP VIEW

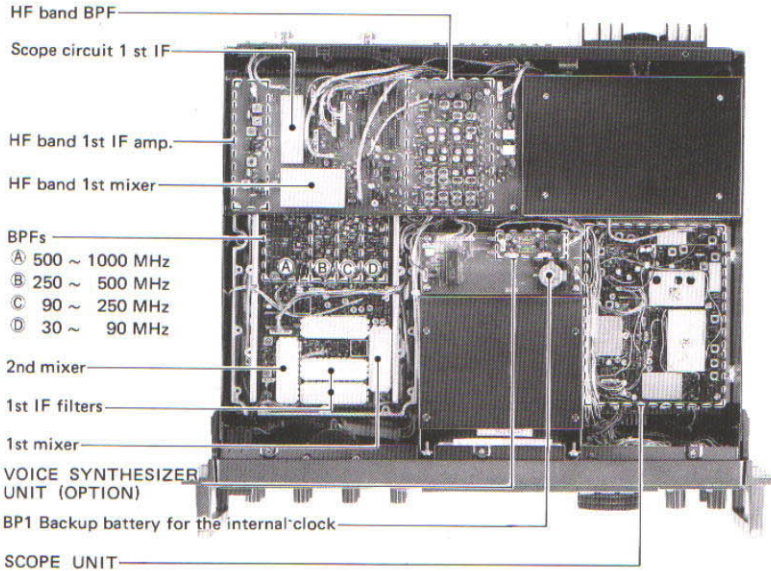

The picture above shows the top cover view without shield covers.

Input AC voltage selector plugs are located underneath the RF-A UNIT as shown at left. See p. 62 for the unit removal.

WARNING:
DISCONNECT the AC power cable and wait several minutes then change the selector plugs.

100 V AC input

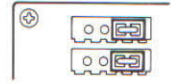

117 V AC input

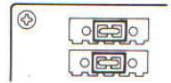

220 ~230 V AC input



The German version cannot be changed.

BOTTOM VIEW

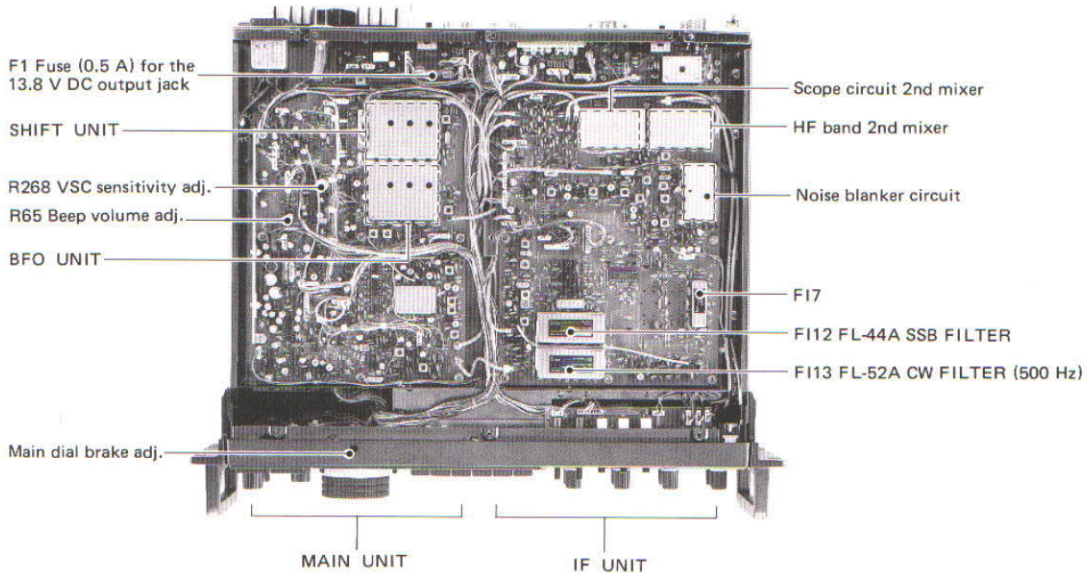

14 SPECIFICATIONS

• Frequency coverage

VERSION	FREQUENCY COVERAGE
U.S.A., Europe, Australia	0.10000 ~ 1999.80000
Germany	13.95000 ~ 14.50000 28.00000 ~ 29.70000 144.00000 ~ 146.00000 430.00000 ~ 440.00000 1240.00000 ~ 1300.00000
France	0.10000 ~ 87.49999 108.00000 ~ 1999.800000

Unit : MHz

- Mode : USB, LSB, CW, FSK, AM, FM, Wide FM
- Receive system : Superheterodyne system
- Intermediate frequencies

FREQUENCY	0.10000 ~ 29.99999	30.00000 ~ 499.99999	500.00000 ~ 999.99999
1st IF	48.79376 ~ 48.80000	778.60001 ~ 778.70000	278.60001 ~ 278.70000
2nd IF	10.70000	10.70000	10.70000
3rd IF	0.45500	0.45500	0.45500
4th IF	10.70000	10.70000	10.70000

Frequencies above 1000 MHz use a crystal conversion system.

Unit : MHz

• Sensitivity

MODE	SSB, CW, FSK	AM	FM	Wide FM
0.10000 ~ 0.49999	0.5 μ V	3.2 μ V	—	—
0.50000 ~ 1.79999	1.0 μ V	6.3 μ V	—	—
1.80000 ~ 29.99999	0.16 μ V _{Typ.}	1.0 μ V _{Typ.}	—	—
30.00000 ~ 999.99999	0.32 μ V	1.4 μ V	0.5 μ V	1.4 μ V
1000.00000 ~ 1239.99999	0.63 μ V	4.0 μ V	1.0 μ V	4.0 μ V
1240.00000 ~ 1299.99999	0.32 μ V	2.0 μ V	0.5 μ V	2.0 μ V
1300.00000 ~ 1599.99999	0.63 μ V	4.0 μ V	1.0 μ V	4.0 μ V
1600.00000 ~ 1999.80000	1.0 μ V _{Typ.}	5.6 μ V _{Typ.}	1.4 μ V _{Typ.}	5.6 μ V _{Typ.}

10 dB S/N for SSB, CW, FSK and AM.

12 dB SINAD for FM and Wide-FM

Maximum sensitivity values are indicated in the chart above.

• Selectivity

- SSB, CW, FSK More than 2.4 kHz/−6 dB
- AM More than 6 kHz/−6 dB
- FM More than 15 kHz/−6 dB
- Wide FM More than 150 kHz/−6 dB

• Audio output power

: More than 2.5 W at 10% distortion with an 8 Ω load

• Audio impedance

: 4 ~ 8 Ω

• Power supply requirement

: 100 ~ 120 V AC (U.S.A. version)
220 ~ 240 V AC (Australia, Europe and France versions)
220 V (German version)

• Antenna impedance

: 50 Ω (unbalanced)

• Power consumption

: Less than 110 VA

• Usable temperature range

: −10°C ~ +50°C (+14°F ~ +122°F)

• Frequency stability

: 0.1 ~ 30 MHz \pm 25 Hz
30 ~ 1999.8 MHz \pm 0.25 ppm
(0°C ~ +50°C; +32°F ~ +122°F)

• Dimensions

: 424(W) x 150(H) x 365(D) mm 16.7(W) x 5.9(H) x 14.4(D) in
(projections not included)

• Weight

: 20.0 kg (44.1 lb)

All stated specifications are subject to change without notice or obligation.

Downloaded by
Amateur Radio Directory

www.hamdirectory.info

SP-20 EXTERNAL SPEAKER WITH AUDIO FILTERS



An external speaker with audio filters. Received audio quality can be changed with the filters. Size and style match the IC-R9000.

AH-7000 SUPER WIDEBAND OMNIDIRECTIONAL ANTENNA



Frequency coverage:
25 ~ 1300 MHz (Receive)
50, 144, 430, 900, 1200 MHz bands (Transmit).

UT-36 VOICE SYNTHESIZER UNIT

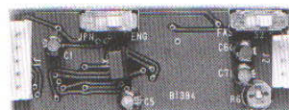

Announces the displayed frequency in English or Japanese. Speech speed can be changed in 2 steps.

CT-16 SATELLITE INTERFACE UNIT

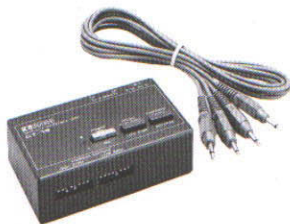

Easy tuning for instant satellite communications.

CT-17 CI-V LEVEL CONVERTER

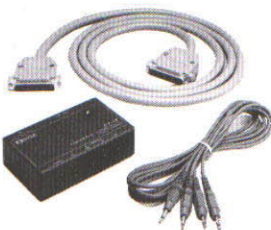

For remote receive control using a personal computer equipped with an RS-232C I/O port. You can change operating frequencies, memory channels, etc., with your computer keyboard.

Count on us!

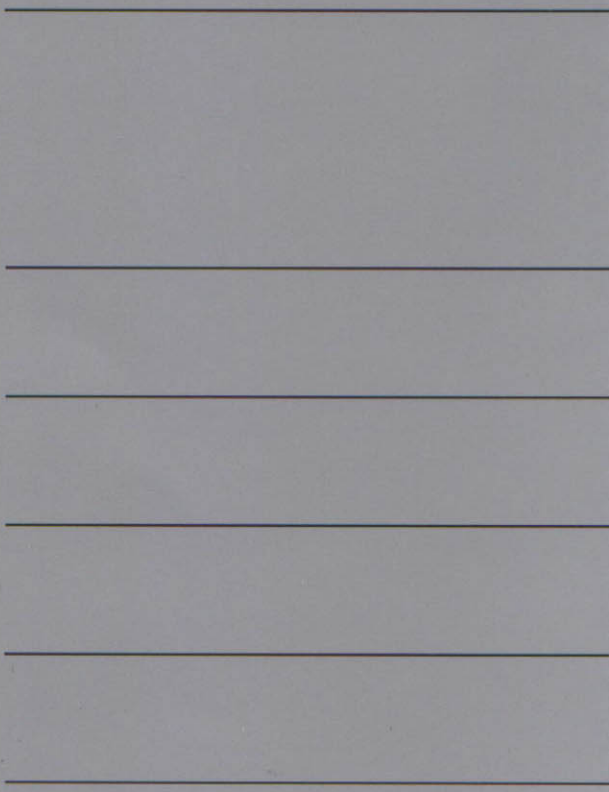
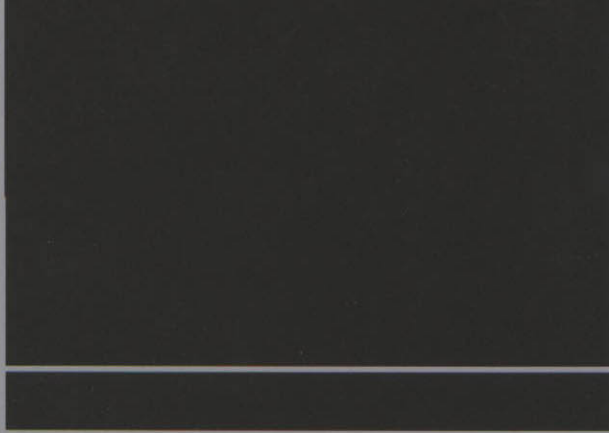

Downloaded by
Amateur Radio Directory

www.hamdirectory.info