

## **TABLE OF CONTENTS**

I	SPECIFICATION .....	1
II	DISCRIPTION .....	2
III	INSTALLATION .....	2
IV	CONTROL FUNCTIONS .....	6
V	OPERATION .....	8
VI	THEORY OF OPERATION .....	10
VII	MAINTENANCE .....	14
VIII	AC POWER SUPPLY WIRING.....	15
IX	ALIGNMENT CHART .....	16

## SECTION I - SPECIFICATIONS

### GENERAL :

Frequency coverage	144.00 to 148.00 MHz
Number of Transistors and Diodes	Transistors ..... 39 FET ..... 7 IC ..... 1 Diodes ..... 28
Modulation Type	F3
Power Voltage	DC 13.5V $\pm$ 20% negative ground or AC 117V (or 234V) $\pm$ 10%
Current Drain (At DC 13.5V)	Transmit: HI (10W) average 2.1 A LOW (1W) average 1.2 A Receive : average 0.2 A
Antenna Input	50 ohms
Size	4-3/8"(111mm)high x 9-1/8"(230mm)wide x 10-1/4"(260mm)depth
Weight	14 lbs. (6 kg)
<b>TRANSMITTER :</b>	
RF Power Output	HI ..... 10 W LOW ..... 1 W
Frequency Control	Crystal (18 MHz) multiplied x 8
Maximum Frequency Deviation	Adjustable between 3 to 16 KHz
Audio Input	10 Kohms
Modulation System	Variable reactance phase modulation
Microphone	10 Kohms - Dynamic microphone with push button switch
<b>RECEIVER :</b>	
Reception Frequencies	24 channels for 144 MHz band. Built-in crystal units for 4 channels.
Reception System	Double Superheterodyne
Intermediate Frequencies	1st intermediate : 10.7 MHz 2nd intermediate : 455 KHz
Sensitivity	a. Better than 0.4 uV 20db quieting b. S + N/N at 1 uV input, 30 db or more
Spurious Response	-60 db, or less
Squelch	Adjustable 5 to -15 db (1uV = 0 db)
Band width	$\pm$ 15 KHz/-6 db point $\pm$ 25 KHz/-50 db point
Audio Output Power	1.5 W
Audio Output Impedance	8 ohms
Frequency Control	Crystal (14 MHz) multiplied x 9

### ACCESSORIES

Make sure the following accessories are included :

- (1) Microphone (dynamic type) ..... 1
- (2) Microphone hook ..... 1
- (3) AC Power cord ..... 1
- (4) DC Power cord ..... 1
- (5) Spare fuses (1A) ..... 2
- (6) Spare fuses (5A) ..... 2
- (7) Plug for speaker ..... 1
- (8) Silicon cloth ..... 1
- (9) Channel table ..... 1
- (10) Instruction manual ..... 1

## SECTION II – DESCRIPTION

This transceiver is an extremely rugged, completely solid state transceiver. State of the art devices such as Integrated Circuits, Field Effect Transistors, varactors, and Zener diodes, are engineered into its tight-knit, straightforward, electronic design throughout both transmitter and receiver.

Designed for base station use in conjunction with the IC-20(IC 20X). Featuring 24 channel capability, crystal controlled, both transmitting and receiving; plug-in for external VFO in the receive mode; built-in center discriminator meter; built-in S and SWR meter; and RIT circuit for 2nd stage tuning to crystal frequencies above or below standard. Reliability, low current demand, compactness, unexcelled performance, and ease of operation are the net result. The dual conversion receiver with its FET front end and high-Q filter network boasts low noise and sensitivity of 0.4  $\mu$ V, or less. Signal gain of 90 db, or more, is accomplished from the second mixer back by virtue of numerous IF amplifier stages. The need for additional front end RF amplification is thus eliminated. Zener-regulated crystal-controlled first and second local oscillators produce unmatched stability. Audio reproduction is of an unusually high order of distortion-free clarity.

The transmitter section will produce a minimum of 10 Watts RF out. Again, a Zener regulated crystal oscillator is employed for initial frequency stability. Twenty-four crystal controlled channels are provided for operating convenience and versatility. High-Q LC coupling and shielded stages provide minimum interstage spurious reaction. An encased low-pass filter is placed at the output to further insure undesirable frequency products not being emitted. An ingenious final PA transistor protection device (APC) is incorporated in the final output circuitry. A tiny VSWR bridge and four DC amplifiers constantly monitor the output for high VSWR, a shorted or absent antenna load, or other difficulty that would cause irreparable final transistor damage. Should these difficulties occur, the APC instantaneously disables the driver and final PA, without damage. A two-way power supply, AC or DC, is built in.

All circuitry is constructed in a series of modules which are easily removable for servicing. The modules are housed in a sturdy, anodized brass frame, which is in turn, housed in a rigid metal chassis, providing for an extremely durable and rugged unit. Premium care has been taken to filter and regulate internal DC voltages. A DC input filter is provided to eliminate alternator or generator "whine" generated in the vehicle. Power line inputs are voltage regulated to smooth out power fluctuations to within  $\pm 10\%$ . Test points are brought up from all major circuits to facilitate maintenance checks and trouble shooting, should the need arise.

Each unit comes with built-in speaker, a high-quality dynamic microphone, microphone clip, AC and DC cables, external speaker plug, and operating manual. An optional mobile mounting bracket is available.

A modern styled face plate, easy-to-read meters, and convenient controls, with design that will compliment your ham shack or auto. A welcome addition to any fixed station or dashboard.

## SECTION III – INSTALLATION

### 1. Unpacking:

Carefully remove your transceiver from the packing carton. It is recommended you keep

the shipping cartons. In the event storage, moving, or re-shipment is necessary, they come in very handy. Accessory hardware, cables, etc., are packed with the transceiver. Make sure you have not overlooked anything.

2. Location:

Where you place the transceiver in your station or automobile is not critical and should be governed by convenience and accessibility entirely. Since the unit is so compact, many mobile possibilities present themselves. If used, the mobile mounting bracket will provide you with some guide as to placement. Anyplace where it can be mounted with metal screws, bolts, or pop-rivets, will work. The IC-21 (IC-21X) is designed for high convenience in fixed-station use; beneath the front of the cabinet is a foldaway stand that can be used to tilt the set up, or folded flat when not in use, or the IC-21 (IC-21X) can be left sitting on its built-on legs. The unit occupies a space of 4 3/8" high x 9 1/16" wide x 10 1/4" deep. Its weight is 14 lbs.

3. Power Requirements:

The IC-21 is supplied ready to operate from any 117 V AC source, or 13.5 VDC, 2.5 ampere negative-ground source. The "IC-21X" transformer can be wired for 100, 117, 200, 220, or 234 Volt. An automobile, 12 volt, negative ground, system is usually more than adequate. Some note must be taken, however, of the condition of the vehicle's electrical system. Items such as a low battery, worn generator-alternator, poor voltage regulator, et cetera, will impair operation of your transceiver, as well as the vehicle. High noise generation, or low voltage delivery can be traced to these deficiencies during DC operation. Receiver gain and transmitter output will be greatly impaired.

**CAUTION:** Excessive voltage (above 15V DC or 15% AC V) will cause damage to your transceiver. Be sure to check the source voltage before plugging in the power cord.

Included with your transceiver is an AC power cable and a DC power cable, with plugs attached, great care should be taken to not interchange them. On the DC cable the Red Wire is positive (+) and the Black Wire is negative (-). If your mobile installation permits, it is best to connect these directly to the battery terminals. This arrangement eliminates random noise and transient spikes sometimes found springing from the automotive accessory wiring. If such an arrangement is not practicable, than any convenient B+ lead in the interior of the vehicle, and the negative frame, can be utilized. Your transceiver provides an internal DC filter that will take out the large amount of transient difficulties, anyway. Remember, the unit operates on a negative ground system, only - it cannot be used in a positive ground automobile. After making your connections, simply insert the plug into your transceiver (see Fig. 2).

4. Antenna:

The most important single item that will influence the performance of any communication system is the antenna. For that reason, a good, high-quality, gain antenna of 50 ohms impedance is recommended, fixed or mobile. In VHF as well as the low bands, every watt of ERP makes some difference. Therefore, 12 watts average output plus 3 db of gain antenna equals 24 watts ERP, presuming low VSWR, of course. The little more invested in a gain type antenna is well worth it.

When adjusting your antenna, whether fixed or mobile, by all means follow the manufacturer's instructions. There are some pitfalls to be aware of. If a SWR meter is used remotely that is a diode-VSWR meter, and not engineered for VHF applications, readings will invariably have errors of 40% or more. Rather than this, use an in-line Watt Meter similar to the Drake WV-4, or Bird Model 23, with VHF cartridge. Further, when adjusting a mobile antenna, do so with the motor running, preferably above normal idling speed. This will insure proper voltage level to the transceiver.

Do not become alarmed if your transceiver fails to transmit at times during the antenna tune-up procedure. Remember, your transceiver has a built-in Automatic Protection Circuit (APC) that will disable the transmitter if VSWR, a shorted coaxial line or connector, or other antenna deficiency is present. A quick check on a good 50 ohm dummy load will show the transceiver to be working. The difficulty will lie with the antenna, or its transmission line. The RF coaxial connector on the rear chassis mates with a standard PL-259 connector. Some models may have metric thread, if this is the case, a matching metric PL-259 is provided. In any event, the RF connector will mate with almost any PL-259 connector, if care is taken to seat them properly.

5. Microphone:

A high-quality dynamic microphone is supplied with your transceiver. Merely plug it into the proper receptacle on the front panel. Should you wish to use a different microphone, make certain it is of the high impedance type; at least 10K, or better. Particular care should be exercised in wiring, also, as the internal electronic switching system is dependent on it. See the schematic for the proper hook-up. Under no circumstances use a "gain pre-amp" type microphone. The audio system in your transceiver is more than adequate and additional pre-amplification is unnecessary. To use this class microphone is to invite distortion and possible damage to the transceiver.

6. Crystals:

Your transceiver has twenty-four channels, both transmit and receive, or a total of forty-eight crystal positions. The channel selector switch selects in each position one transmit and one receive channel of its twenty-four positions. It also has a plug-in, external VFO accessory socket. Merely plug in the remote VFO to the remote VFO accessory plug (see Fig. 3), then plug in the interior plug, located at the top of the crystal board (see Fig. 3). To order additional crystals from a manufacturer, the following correlation data is provided. Remember to specify high activity as a prerequisite to your acceptance:

Crystal Data	
Holder type:	HC-25/u
Calibration Tolerance:	0.0025%
Load Capacitance:	20 pf
Effective Resistance:	15 ohms, or less
Transmit Crystals:	Crystal Frequency
	<u>Desired Operation Frequency</u>
	8
Receive Crystals:	Crystal Frequency
	<u>Desired Operating Frequency - 10.7 MHz</u>
	9

Trimmers have been placed on the crystal board to assist you in "tweaking" new crystals on frequency. Consult the trimmer location chart (see Fig. 1) for their positions.

The amount of frequency spread between any two receiving or any two transmitting frequencies should not exceed 2 MHz. Since the receiver and transmitter are independent of each other, you may have any practical amount of frequency separation you wish here. Only two or more widely spaced frequencies for the receiver alone, or for the transmitter alone, need be considered under the 2 MHz limitation. For accurate crystal alignment it is best to use a frequency counter, however, an easy method of tuning to crystals is as follows:

1. Receiving:
  - a. Use a calibrated IC-20(IC-20X) or IC-21(IC-21X) signal source.
  - b. Set RIT Control (#5) to 0, or off.
  - c. Next adjust trimmer for that particular channel to a '0' reading on the Discriminator Meter (#9).
  
2. Transmitting:
  - a. Turn the Squelch Control (#3) full counter-clockwise, past the "click."
  - b. Adjust trimmer for that particular channel for a '0' reading on the Discriminator Meter (#9).
  - c. By turning the Mic Gain Control (#16) the deviation can be set for the best transmit tone.

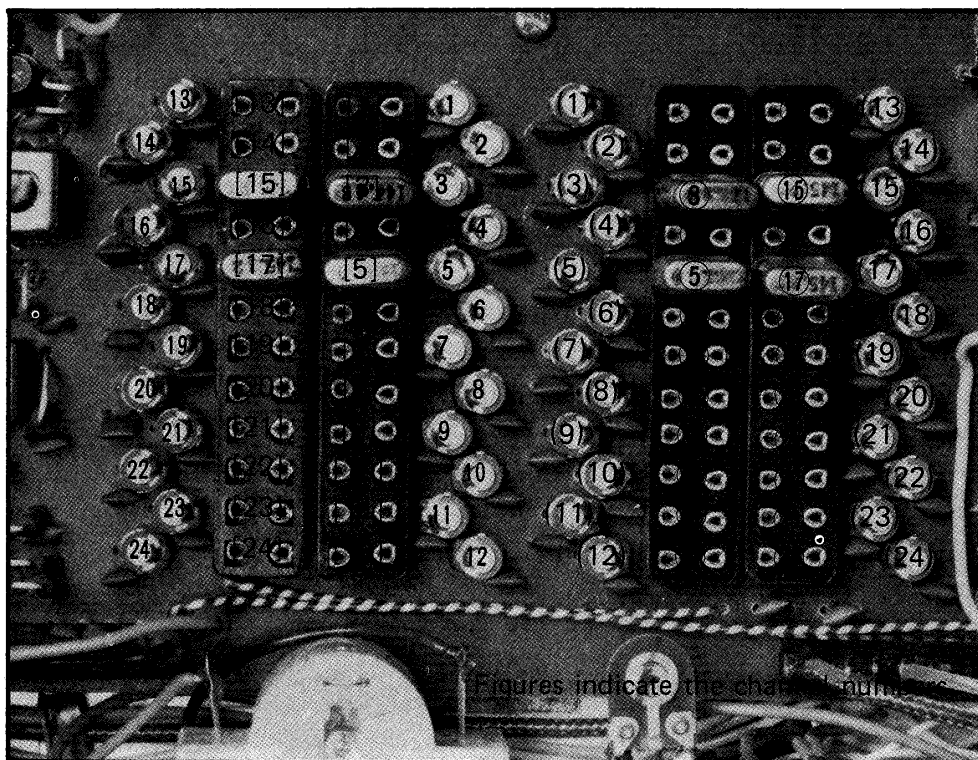

\* Front Panel

- [1] ~ [24] Crystal unit sockets for transmission
- 1 ~ 24 Transmitting frequency adjust trimmers
- ① ~ ②④ Crystal unit sockets for reception
- (1) ~ (24) Receiving frequency adjust trimmers

(Fig. 1)

Fig. 2 B

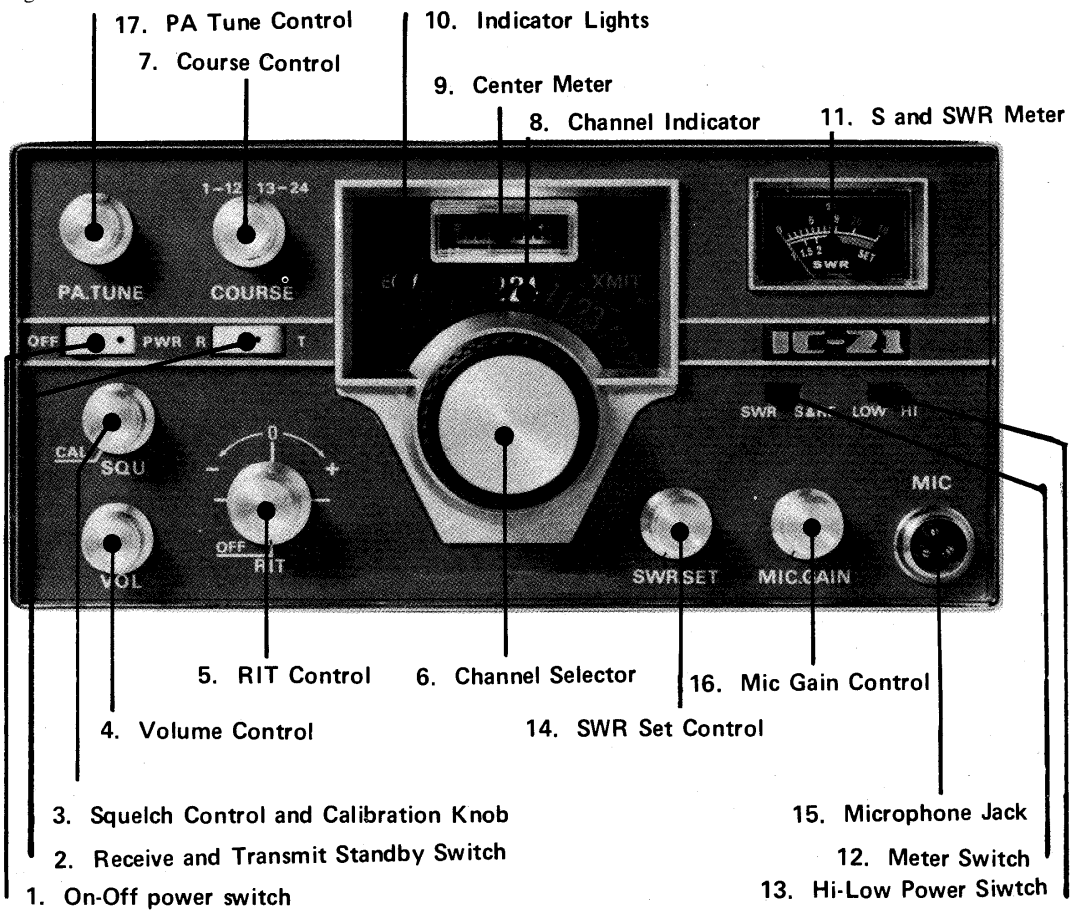

Rear Panel  
 Fig. 2 A

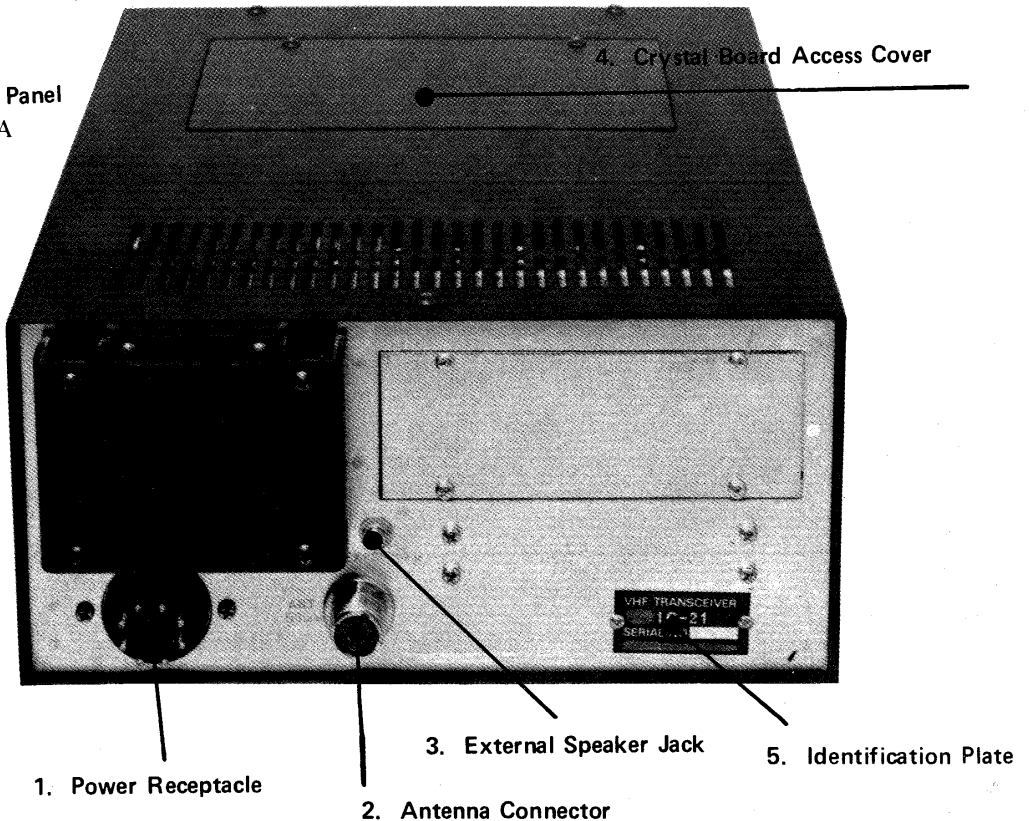

## SECTION IV – CONTROL FUNCTIONS

1. On – Off Power Switch. For AC and DC.
2. Receive and Transmit Standby Switch; The set is internally wired for push-to-talk.
3. Squelch Control and Calibration Knob: Controls threshold point of the receiver; during calibration turn to calibration position (fully counter-clockwise).
4. Volume Control: Controls audio output level of the receiver.
5. RIT Control: For adjusting the receiving frequency about  $\pm 5$  KHz.
6. & 7. Channel Selector & Course Control: The channel selector is coupled with the course selector control; 1 to 12 and 13 to 24, switching of the course control changes the readings on the channel selector accordingly.
8. Channel Indicator: Illuminated 1 through 24 indicator.
9. Center Meter: Monitors discriminator current, if the meter indicates to the right of the 0 the incoming signal is too high, and to the left, too low.
10. Indicator Lights: Indicates when the set is in Receive mode (blue) RECV; Transmit mode (red) XMIT; both are illuminated.
11. & 12. S and SWR Meter and Switch: To read out S or SWR switch accordingly; S meter indicates incoming signal strength, when transmitting indicates the relative RF current of the  $50\Omega$  line. In the SWR position the meter reads the reflected coaxial line current. The meter is illuminated with a pleasing reflective color on the meters themselves.
13. Hi-Low Power Switch: In the high position output power is 10 Watts; in the low position output is 1 Watt.
14. SWR Set Control: For adjusting SWR set the switch in position S & RF readout.
15. Microphone Jack: For connection to the 3 prong plug of the microphone.
16. Mic Gain Control: Controls modulation level of the transmitter.
17. PA Tune Control: Controls tuning of the final amplifier circuit.

### Rear Panel:

1. Power Receptacle: For AC or DC power cable; use caution and don't confuse the AC cable with the DC, or vice versa.
2. Antenna Connector: A SO 239, chassis mounted, for connection to the PL 259 of the antenna line.
3. External Speaker Jack: For an  $8\Omega$ , 1 Watt or more, external speaker, the plug for the speaker is provided.
4. Crystal Board Access Cover: Remove the two screws to gain access to the crystal boards and remote VFO plug-in.
5. Identification Plate: States model, serial number, and date of manufacture. Note: It would be well to make a separate record of the serial number of your set for insurance purposes.



## SECTION V – OPERATION

1. Initial Preparations:
  - a. Connect the microphone to the microphone jack.
  - b. Connect the antenna to the antenna coax connector. Make sure the coax line is of the correct impedance (50 ohms) and is neither shorted nor open circuited.
  - c. Make sure the power switch is in the off position, then connect the power supply cable to the power supply receptacle. For AC operation make sure you use only the AC cable, and connect to an AC source. (see transformer wiring instructions for other voltages). For DC operation the red lead should be connected to the positive side of the power source and the black lead to the negative side. In the event that these leads are improperly connected the IC-21 will not function. No damage will be incurred, since protection is provided in the IC-21 for this purpose.
  - d. Turn the volume control to the maximum counter-clockwise position, and the squelch control to the minimum on position. Set the S and SWR Meter Switch (#12) to S and RF position, and the RIT Control (#5) to Off or the center position.
  
2. Operation:
  - a. Set the power switch (#1) to On and the channel indicator and meters will be illuminated, and the RECV indicator (#10, blue) will light up.
  - b. Switch Channel Selector (#6) and Course (#7) to desired channel.
  
3. Reception:
  - a. Adjust the volume control to a comfortable listening level of noise, if no signal is present.
  - b. Carefully adjust the squelch control clockwise until the noise just disappears. This is the proper squelch threshold setting, and must be done when no signal is present. Your set will now remain silent until an incoming signal is received and opens the squelch. If the squelch is unstable due to the reception of weak or unstable stations, adjust the squelch further until the proper threshold is obtained.
  - c. The S meter indicates the signal strength of the incoming stations and is calibrated in S units, and db over S9.
  - d. If the 0 center meter indicates to the right the incoming signal is too high, left too low; adjust for the center using the RIT Control. This Receiver Incremental Tuning Control varies the 2nd local oscillator for accurate tuning.
  
4. Transmitting:
  - a. First set the PA Tune Control (#17) to center; SWR Set Control (#14) to S & RF readout; Mic Gain (#16) 2/3 open.
  - b. Set the Hi-Low Switch (#13) to Low, turn the power switch on, then set the Receive and Transmit Switch (#2) to the transmit setting, or push the PTT button on the microphone and the set is ready for transmitting. At the same time the indicator light will be illuminated in red (XMIT) and the blue (RECV) light will go out, the meter will be illuminated, and will provide an indication of the relative power output of the transmitter. The pointer will be on or near the red mark on the meter scale when on high power, and just a little over one on low.
  - c. With the PA Tune control (#17) tune the set for the maximum reading on the S meter, move SWR Set Control (#14) to the center position.
  - d. Now switch the Hi-Low Switch (#13) to the high position, push the PTT on the microphone, or set the Standby Switch to T.



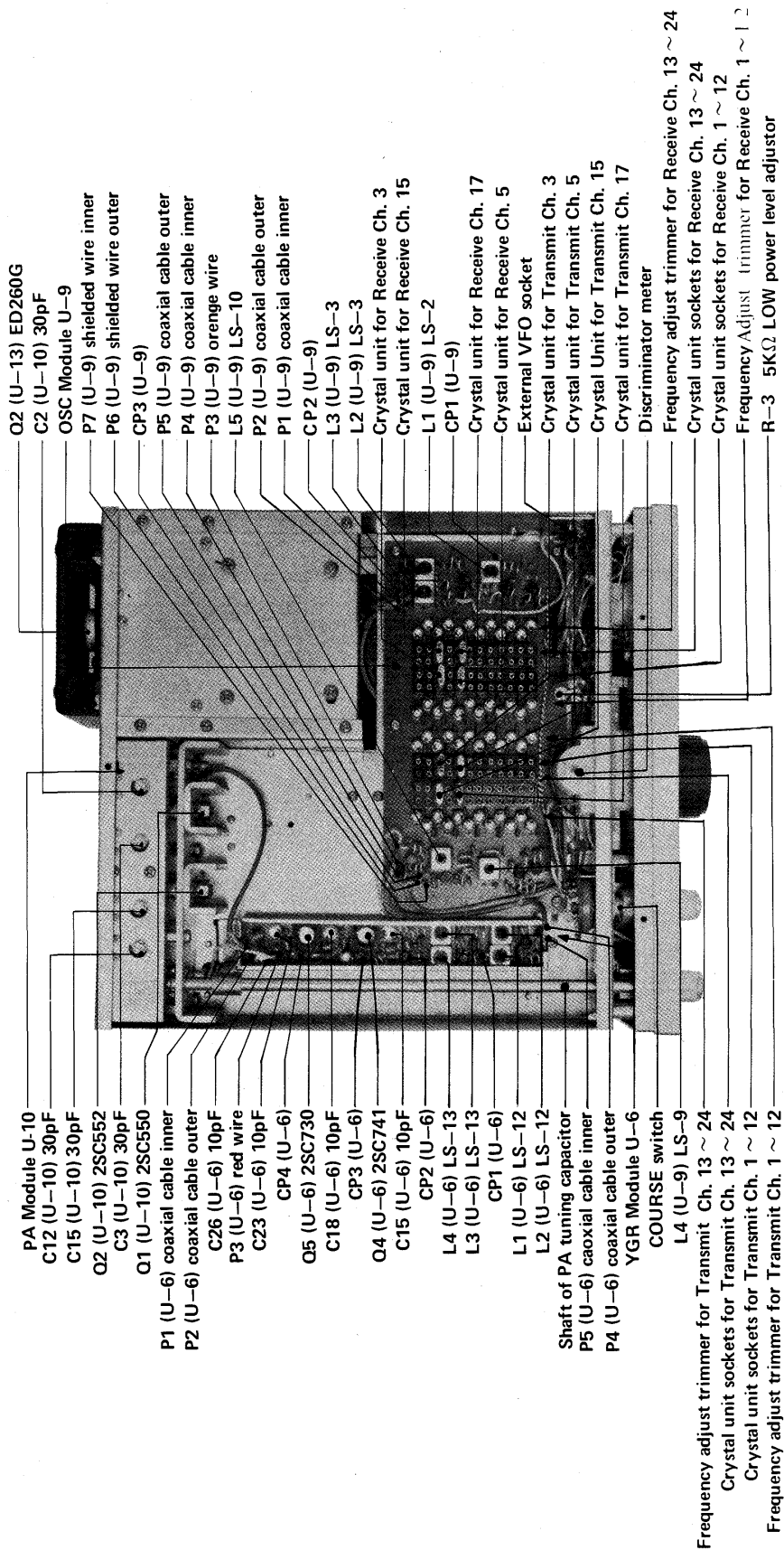

Fig. 3

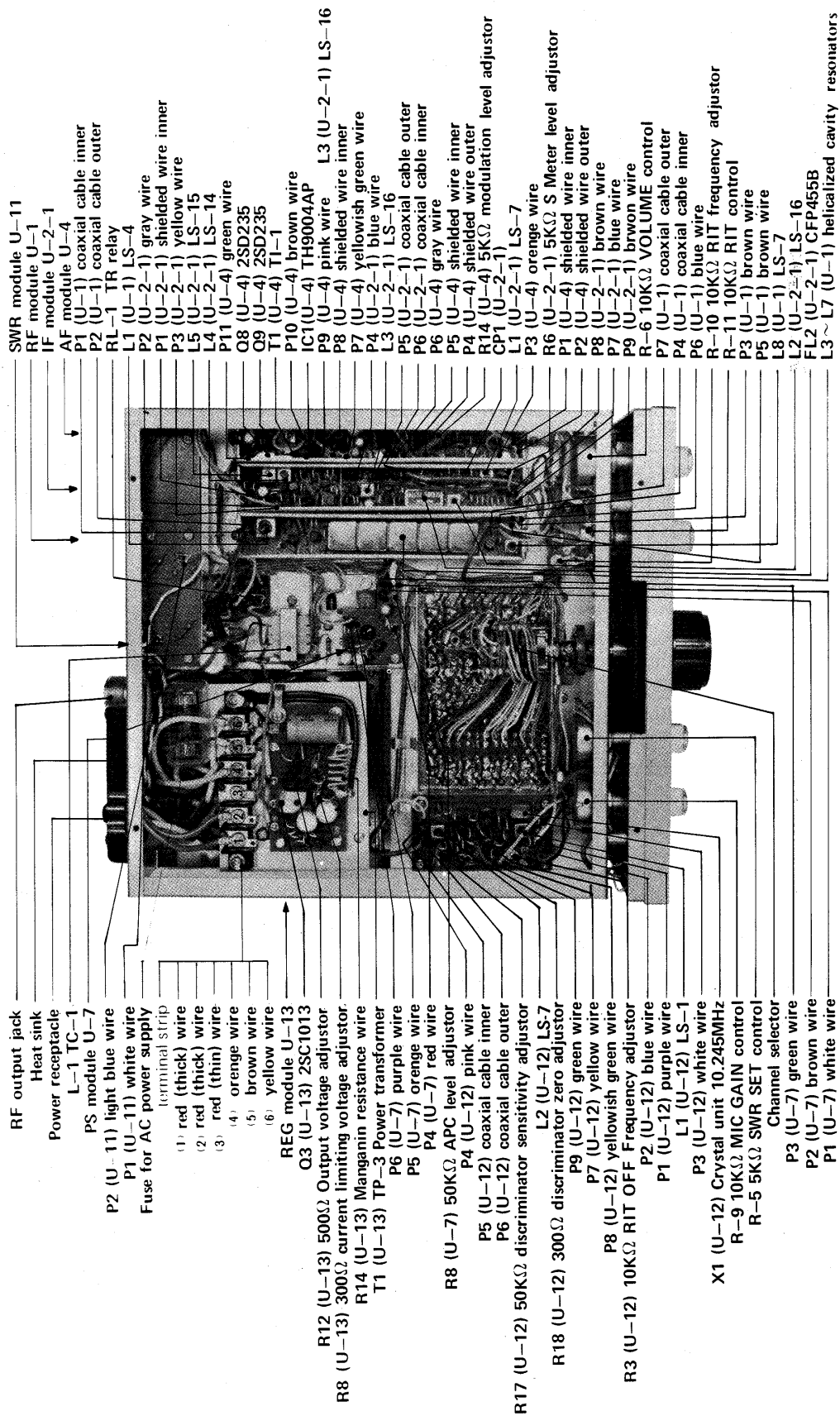

Fig. 4

## SECTION VI – THEORY OF OPERATION

### 1. Receiver RF Amplifier and First Mixer (Module U-1) (B-006A)

The input signal is amplified by the field effect cascade amplifier, Q1 and Q2 (2SK19s), and passed into the RF filter. This filter is a high Q helicalized cavity resonator, with excellent bandpass characteristics and shockproof construction. From the output of the helical resonators the signal is fed to the gate of the first mixer, Q3 (2SK19), where it is mixed with the output from the receiver crystal oscillator unit, which is fed into the source of Q3 to obtain the 10.7 MHz. IF signal. The output of the mixer is fed through the first ceramic filter (FL1 SFC 10.7MA) to the IF amplifier. All transistors in the receiver RF unit are field effect transistors, which have the highest possible sensitivity and signal to noise ratio and the lowest possible cross-modulation.

### 2. Receiver and Transmitter Oscillator and Modulator (Module U-9) (B-012A)

The receiver crystal oscillator is a fundamental oscillator circuit at 14 MHz. using Q1 (2SC372). The trimmers in series with the crystals make it possible to alter the crystal frequency several KHz. The output is taken from the emitter and tripled by Q2 (2SC372), and again tripled by Q3 (2SC784). The output signal is then fed into the First Mixer in the receiver RF unit, Q3 (U-1) (2SK19), giving it the first IF of 10.7 MHz. In the Transmitter Crystal Oscillator transistor Q4 (2SC373) operates as a fundamental oscillator at a frequency of 18 MHz. The output of this oscillator, taken from its emitter, is fed to the base of transistor Q5 (2SC373) which operates as a buffer amplifier between the oscillator and phase modulator circuit. Trimmer capacitors are provided in series with each crystal which allow the frequency of the oscillator to be varied by several KHz. Thus the final output of the transmitter can be set precisely on the desired frequency.

The Phase modulation circuit consists of Varactor diode D2 (MV3047), R24, 26, 27, 28, 29, C26 and C27. Resistors R24 and R29 provide a bias voltage for the reverse biasing of the Varactor diode D2. An audio voltage is coupled into this same bias point through the 1 mh inductor. This audio voltage is derived from the speech amplifier circuit (U-4).

The modulated signal is amplified by Q6 (2SC372), then this signal is fed into the exciter.

### 3. Receiver 1st IF Amplifier, 2nd Mixer, 2nd IF Amplifier, Limiter and Discriminator (Module U-2-1) (B-009)

The 10.7 MHz signal from the first ceramic filter in the RF unit is amplified by Q1 (2SC371) and fed to the gate of the 2nd Mixer Q2 (2SK19) through the 2nd ceramic filter FL1 (SFC 10.7MA). The variable resistor in the emitter circuit of the First IF transistor Q1 adjusts the IF gain and S meter sensitivity. The 2nd Oscillator (U-12) is crystal-controlled and operates on  $10.245 \text{ MHz} \pm 5 \text{ KHz}$ , its signal is fed into the gate of the 2nd Mixer Q2 (2SK19) to obtain the 455 KHz IF signal, which is passed through the 3rd ceramic filter (FL2-CFP 455B) and amplified by Q3, 4, 5, 6, 7, and 8 (2SC371s). The output of Q8 is then demodulated in the discriminator circuit, consisting of L4, L5, and D7 and D8 (1N60s).

#### 2nd Oscillator and Meter DC Amplifier (Module U-12) (B-013)

a. The 2nd Oscillator Q1 (2SC371) is a  $10.245 \text{ MHz} \pm 5 \text{ KHz}$ , the plus or minus 5 KHz is controlled by varactor diode D1 (MV201) coupled from the emitter of Q1 to the buffer amplifier Q2 (2SC371), then the signal is fed to Q9 (U-2-1), the signal from the emitter is then fed into the 2nd Mixer's gate Q2 (U-2-1). (U-2-1).

b. Meter DC Amplifier: The discriminator's DC is amplified by Q3 and Q4 (2SK30s), this acts as a differential amplifier and activates the movement of the 0 center meter; the receiving signal frequency is indicated as high/low, or directly on frequency by the meter. By changing the RIT Control the 2nd local oscillator can be tuned to achieve "on frequency" signals.

4. **Receiver Audio Amplifier, Squelch, and Speech Amplifier (Module U-4) (B-008)**

The output of the discriminator drives two circuits: the audio amplifier, and the squelch. The audio signal, after being adjusted by the volume control R-1, is then fed to IC1 (TH9004AP), followed by the audio power amplifier stage Q8 and Q9 (2SD235s), which gives an audio output of 1.5 Watts. The squelch circuit is driven by the noise present in the output of the discriminator when no carrier exists. The noise is amplified by transistors Q5 and Q6 (2SC371s), and rectified by the diodes D3 and D4 (1N60s). The resulting DC voltage is used to forward bias Q7 (2SC373), which becomes conductive, reducing the voltage on pin 3 of the IC preamplifier, resulting in silencing of the audio amplifier. When a carrier is present in the antenna the noise in the 455 KHz IF decreases due to the quieting action of the limiter, in turn reducing the output from the squelch detector, and causing Q7 (2SC373) to stop conducting, thereby allowing the IC preamplifier and audio power amplifier to perform normally. The squelch is adjusted to choose the amount of DC required to cut off Q7.

The signal from the microphone is amplified by Q1 and Q2 (2SC371s), fed to the deviation limiter, which consists of D1 and D2 (1N60s), and the active audio filter Q3 (2SC371), and further amplified by Q4 (2SK30) before being fed to the modulation circuit in the transmitter oscillator unit.
5. **Power Supply Circuit (Module U-7) (B-007)**

This circuit provides a source of regulated voltage for the receiver circuits and control of output power during antenna mismatch conditions, as described herein.

The receiver voltage is regulated to about 8 volts by the series pass transistor Q5 (2SC620) which has its base set at 9 volts by the zener diode D1 (1N757). Capacitor C5 acts to eliminate voltage transients and noise from the output of the regulator.

The action of transistors Q1, Q2 (2SC371s), Q3 (CDC-9000) and Q4 (2SD235) is described in the APC circuit. Resistor R-3, connected to the resistor network, consisting of resistors R1 and R2 is used to provide an adjustment in output power when the Hi-Low Power switch is set in the low power position. Adjustment of this resistor controls the base drive to the regulator transistors Q2, 3, and 4. This adjustment in effect controls the actual voltage supplied to the driver transistor Q1 (U-10) and the power output transistor Q2 (U-10) when the Hi-Low Power switch is in the low power position. The output power can be set to any value from tenths of a watt to a few watts. This feature is useful when using the transceiver as an exciter driving a linear amplifier.
6. **Exciter (Module U-6) (B-004)**

The modulated signal from Q6 (U-9) is multiplied eight times to a final frequency of 144 MHz by transistors Q1, 2, (2SC373s) and Q3 (2SC773). Each of these transistors act as frequency doublers. Double-tuned circuits are used between stages to minimize spurious radiation and to achieve an even response over the 144 to 148 MHz range. The 144 MHz signal is amplified by Q4 (2SC741) and Q5 (2SC730) to a power level of one watt. This signal is fed into the power amplifier.
8. **Transmitter Power Amplifier (Module U-10) (B-010A)**

The signal from the multiplier and pre-driver unit is amplified to 10 watts by transistor Q1 (2SC550) and Q2 (2SC552). Transistor Q2 is the power output stage and is coupled to the antenna through the spurious filter.
9. **Spurious Filter and SWR Coupler (Module U-11) (B-014A & B-015A)**

The spurious filter consists of L1 (LA-8), L2 (LA-9), and L3 (LA-10). The SWR coupler consists of diodes D1~D4 (1N60s). The SWR Coupler drives the SWR meter. The reflected SWR is fed from the coupler into the APC (U-7).

10. Transmitter Automatic Protection Circuit (APC):

The APC acts to decrease the power output of transistors Q1 and Q2 (U-10) if the antenna is seriously mismatched. A reflected power detector is provided by the SWR Coupler (U-11). When the antenna is mismatched this circuit senses a high reflected power and provides base drive to transistor Q1 (U-7), in the Power Supply unit. This transistor will conduct sufficient base drive to reduce the base drive of transistor Q2 (U-7). When transistor Q2 (U-7) begins to turn off it reduces the drive to the complementary transistor pair, consisting of Q3 and Q4 (U-7). This pair acts as a series regulator for the voltage supplied to the driver transistor Q1 and the power output transistor Q2 (U-10). When they begin to turn off, due to a lack of base drive, then voltage supplied to Q1 and Q2 (U-10) is reduced to about six or eight Volts, which reduces the power output to a safe value. This lower power prevents damage to Q1 and Q2 (U-10) when the antenna is mismatched.

11. AC Power Supply (Module U-13) (B-011)

This power supply unit provides power for the set from an AC or DC source. When the DC plug is attached the voltage is directly supplied to each part of the set. When using an AC source, AC is reduced by the transformer T1 (TP-3), and rectified by D3 (DS10 BN-L), and supplies the voltage regulator. The regulator consists of D2 (1N709), Q2 (ED260G), Q3 (2SC1013), and Q4 (2SC373), the regulated voltage then moves to each part of the set. When an overload or short occurs the circuit is protected by Q1 (2SC373), which will not conduct under these conditions, due to R15 feeding voltage to the emitter. When normal voltage is present Q1's emitter voltage is reduced lower than the base voltage, thus it conducts, and is bypassed, and the base voltage of Q1 and Q2 remains low. When an overload or short occurs the emitter voltage rises, cutting off base voltage and thus it acts as a bypass for Q2 and Q3. This circuit allows only low voltages to be passed to Q2 and Q3. The action of the protection is instantaneous. When this occurs even though the circuit is protected it is wise to turn off the power supply immediately and trace down the trouble. The protection point can be changed by adjusting R8, which is a variable resistor.

## SECTION VII – MAINTENANCE

1. The necessity of completely realigning the unit is infinitely small. Almost without exception it is component failure that causes the breakdown. To further defend this position, it is unlikely the average owner would have the instrumentation and facilities necessary to accomplish a full realignment, if it did become necessary. Having such facilities and instrumentation it is not too presumptive to assume he would know how to use such equipment, and be a fully qualified FM technician. If this were the case, no formal alignment instructions would be necessary, and techniques well known to him can and will suffice to align the unit. All of the foregoing is by way of saying that this transceiver is a complicated and, electronically speaking, delicate machine. Precision instrumentation and test jigs are employed in its manufacture to insure that it meets its specifications. Adjustments other than those outlined herein should not be undertaken unless the owner is highly skilled in such techniques.
2.
  - a. Remove the three retaining screws from the top and from both sides, a total of nine, and remove the chassis cover. Then remove the four retaining screws from the bottom plate; use care when removing the bottom plate as the speaker is mounted to the plate, and soldered leads could be pulled loose.
  - b. Connect a dummy load (50 ohms) or a wattmeter to coax connector (#2 Fig. 2).
  - c. Connect the power supply cord to the power jack (#1 Fig. 2) and the microphone to the microphone jack.

- d. The multipliers, driver and power output stages should be aligned on Low power first, then set the Hi-Low Power switch to High power. Align these stages according to the alignment chart provided. Be careful not to transmit for more than 5 seconds during each alignment step, as damage could be caused to the transistors due to overload during this procedure. Another IC-21 or IC-20, with discriminator meter wired in, can be used during this procedure, as the measuring equipment.
3. Receiver Alignment:
    - a. Remove the microphone from the transceiver to prevent accidental transmission during receiver alignment.
    - b. Allow the test oscillator or generator to stabilize the output frequency drift.
    - c. Connect the test oscillator or generator to the antenna coax connector. Set the test oscillator or generator to the desired frequency, and tune the RIT Control (#5, Fig. 2) for a '0' reading on the Discriminator Meter (#9, Fig. 2). Set the Squelch Control (#3, Fig. 2) to the maximum counter-clockwise position, before the "click".
    - d. Align the receiver according to the chart provided (Chart #1).
    - e. When setting the receiver to a desired frequency the discriminator meter should be monitored and the receiver trimmer capacitors adjusted to cause the S meter to read a maximum and the discriminator meter to read '0'. Refer to Figure 3 for the location of the proper trimmer corresponding to the channel to be used. Adjust these trimmers very slowly while observing the Discriminator Meter. Another IC-21, or a IC-20, with discriminator meter installed, operating on the desired frequency, can be used for this purpose, also.

## SECTION VIII – AC POWER SUPPLY WIRING

The AC-Power supply comes wired for 117/220 Volt AC operation, Figure A, and C, below. For wiring in other voltages see Figures B, and D:

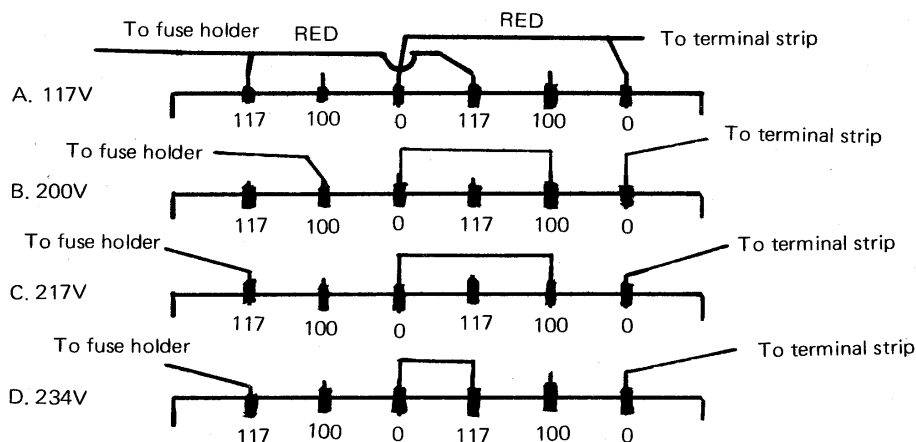

### WARNING:

Voltages of  $\pm 10\%$  of the above indicated levels are acceptable. Use caution and check the source voltage prior to operation, as exceeding the voltages indicated by 15% can damage the transceiver.



# ALIGNMENT CHART (Chart 1)

## IC-21 VOLTAGE CHART

UNIT NO.	NO.	NAME	BASE	EMITTER	COLLECT,	TEST POINT	ANY OTHERS
U-1	Q1	2SK19	0 (G)	0.15 (S)	7.6 (D)		FET
"	Q2	"	0 (G)	1.6 (S)	7.4 (D)		"
"	Q3	"	0 (G)	1.1 (S)	8.1 (D)		"
U-2-1	Q1	2SC371	2.2-3.2	1.5-2.5	4.0-8.0		R36
"	Q2	2SK19	0 (G)	1.3 (S)	8.0 (D)		
"	Q3	2SC371	0.7	0	2.4		
"	Q4	"	5.8	5.2	6.1		
"	Q5	"	0.7	0	1.0		
"	Q6	"	2.8	2.3	3.4		
"	Q7	"	5.2	4.9	6.0		
"	Q8	"	1.0	1.1	7.0		
"	Q9	"	1.8	2.0	7.3		
"	CP1					1.6	
"	CP2					3.4	
"	CP3					0	
U-4	* Q1	2SC371	0.24	0.03	1.4		
"	* Q2	"	1.4	0.8	6.5		
"	* Q3	"	7.0	6.7	8.4		
"	* Q4	2SK30	0 (G)	0.8 (S)	4.0 (D)		FET
"	Q5	2SC371	1.2	0.6	8.0		
"	Q6	"	1.2	0.6	7.0		
"	Q7	2SC373	0.7	0	5.0-0		SQL, OFF-ON
"	Q8	2SD235	7.0	6.5	13.5		
"	Q9	"	0.7	0	6.5		
"	* CP1					8.4	
"	CP2					8.4	

UNIT NO.	NO.	NAME	1	2	3	4	5	6	7	ANY OTHERS
U-4	IC 1	TH9004AP	0.6-0	1.3-0	5.0-0	-	0	13.0	0.6-0	SQL, OFF-ON

U-6	* Q1	2SC373	1.2	0.8	13					
"	* Q2	"	0.8	0.8	13					
"	* Q3	2SC773	0.7	1.3	13.2					
"	* Q4	2SC741	-	1.2	13.0					
"	* Q5	2SC730	-	0	13.5					
"	* CP1							0.8		
"	* CP2							1.3		
"	* CP3							1.2		
"	* CP4							-0.1~-0.3		DRIVE LEVEL
U-7	* Q1	2SC372	0-0.7	0	8.5-1.5					SWR REF,
"	* Q2	2SC372	8.5-1.5	7.8-1.0	12.8					APC ON-OFF
"	* Q3	CDC-9000	13.5	12.8	12.5-6.0					"
"	* Q4	2SD235	12.5-6.0	12.5-6.0	13.5					"
"	* Q5	2SC620	8.9	8.2	12.2					
U-9	Q1	2SC372	1.9	1.6	5.3					
"	Q2	"	0.5	0.5	6.0	2.0				
"	Q3	2SC784	0.7	0.7	5.9	3.4				
"	* Q4	2SC372	1.0	0.5	6.0	0				
"	* Q5	"	0.8	0.4	5.6					
"	* Q6	"	1.0	0.5	4.4					
"	CP1							0.5		
"	CP2							0.02-0.4		OSC LEVEL
"	CP3							0.5-0.7		
U-10	* Q1	2SC550	-	0	13-6					
"	* Q2	2SC552	-	0	13-6					
U-12	Q1	2SC371	1.5	1.2	6.5					
"	Q2	2SC371	0.9	0.4	6.0					
"	Q3	2SK30	-0.3~+0.3(G)	0.2-0.4 (S)	3.0-5.0 (D)					CENTER METER -5 ~ +5
"	Q4	"	0 (G)	0.3(S)	3.4-3.6 (D)					"
U-13	Q1	2SC373	1.5-1.0	1.6-0.4	13.5-0					NORMAL-PROTECTION ACTS
"	Q2	ED260G	13.5-0	13.5-0	18					"
"	Q3	2SC1013	13.5-0	13.5-0	18					"
"	Q4	2SC373	6.0-0	5.7-0	13.5-0					"

\* Reading taken in the TRANSMIT

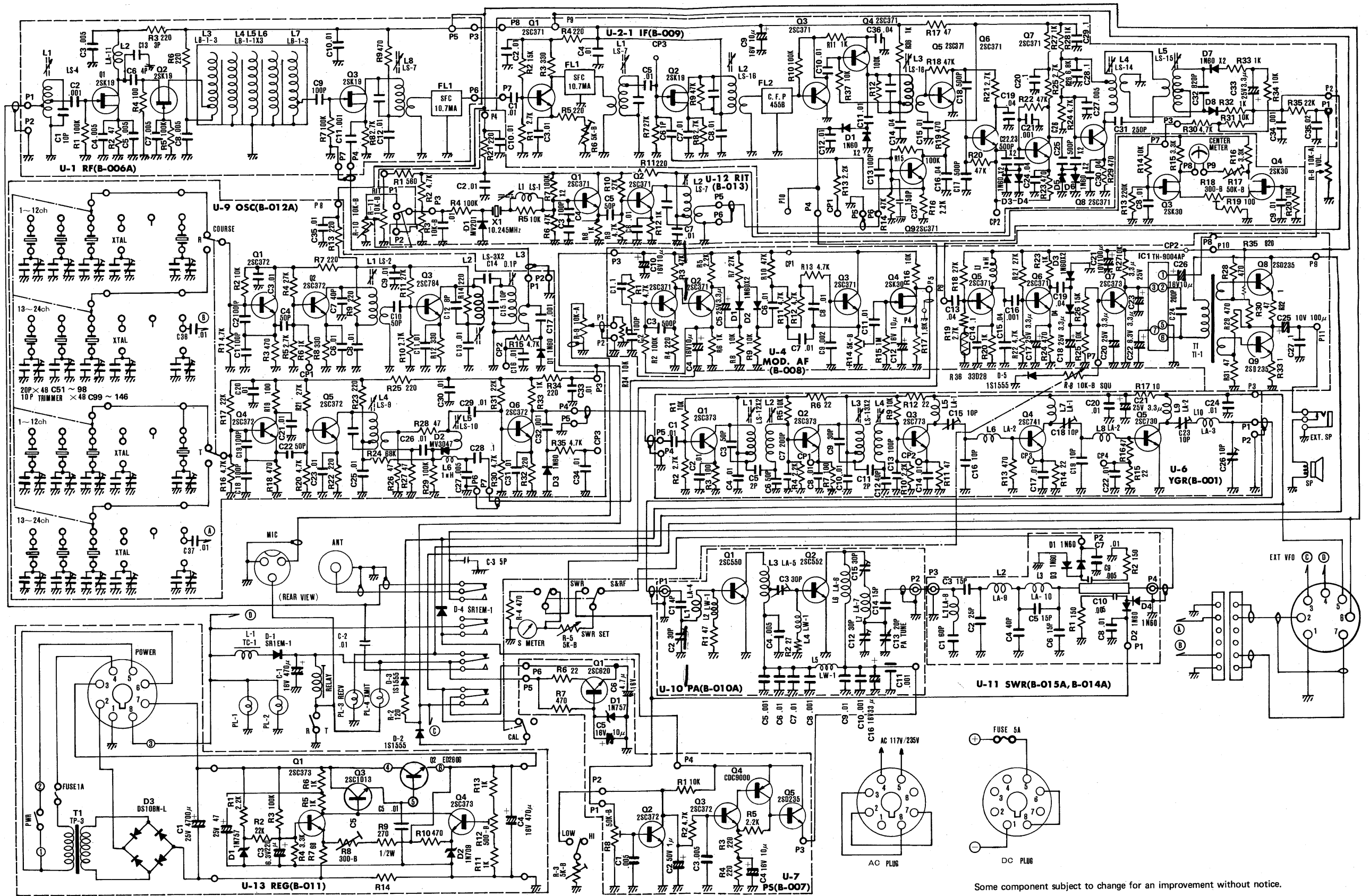

Some component subject to change for an improvement without notice.