

Downloaded by
RadioAmateur.EU

IC-240

PLL SYNTHESIZED
2-METER
TRANSCEIVER

INSTRUCTION
MANUAL

 ICOM

TABLE OF CONTENTS

I. SPECIFICATIONS	1
II. DESCRIPTION	2
III. INSTALLATION	3
IV. OPERATION	8
V. CONTROL FUNCTIONS	9
VI. INSIDE VIEW	11
VII. THEORY OF OPERATION	13
VIII. DIODE MATRIX CHARTS	20
IX. VOLTAGE CHARTS	22
X. BLOCK DIAGRAM	24
XI. PARTS LIST	26
XII. P.C. BOARD LAYOUT	

SECTION I SPECIFICATIONS

Downloaded by
RadioAmateur.EU

General:

Number of semiconductors	Transistors	41
	FET	7
	IC	13
	Diode	33 (Except Matrix Board)
Frequency Coverage		144MHz ~ 146MHz
Antenna Impedance		50 Ohms unbalanced
Power Supply Requirements		DC 13.8V \pm 15% Negative Ground 2.5A Max.
Current Drain		Transmitting: Approx. 2.0A Receiving: At Max. Audio. Approx. 0.7A Squelched Approx. 0.4A
Dimensions		58mm(H) x 156mm(W) x 218mm(D)
Net Weight		1.9 Kg

TRANSMISSION:

Transmitting Frequency	22 Channels in the 144MHz Band Programmable by a diode matrix for any channels on 25KHz spacing
Emission Mode	16F3
Output Power	10W
Max. Frequency Deviation	5KHz
Modulation System	Variable reactance phase modulation
Spurious Emission	More than 60dB below carrier
Microphone	Impedance: 600 Ohms Input level: 10mV typical Dynamic or optional Electret condenser microphone

RECEPTION:

Receiving Frequency	22 Channels in 144MHz Band
Modulation Acceptance	16F3
Receiving System	Double super heterodyne
Intermediate Frequency	First IF 10.7MHz Second IF 455KHz
Sensitivity	Less than 0.5 μ V for 20dB Noise quieting More than 30dB S+N+D/N+D at 1 μ V
Squelch Sensitivity	Less than 0.3 μ V
Spurious Response Rejection Ratio	More than 60dB
Selectivity	\pm 7.5KHz at the -6dB point \pm 15KHz at the -60dB point
Audio Output Power	More than 1 Watt
Audio Output Impedance	8 Ohms

SECTION II DESCRIPTION

This transceiver is extremely rugged and completely solid state. State of the art devices such as Integrated Circuits, Field Effect Transistors, Varactor and Zener diodes are engineered into a tight-knit straightforward electronic design throughout both transmitter and receiver. Reliability, low current demand, unexcelled performance and ease of operation are the net result.

The dual conversion receiver with its FET front end and high-Q helicalized cavity resonators boasts low noise and sensitivity of $0.5\mu\text{V}$ or less. Signal gain of 90dB or more is accomplished from the second mixer back by virtue of a 4-stage IF amplifier. The need for additional front end RF amplification is thus eliminated. PLL controlled first and crystal-controlled second local oscillators produce excellent stability. Audio reproduction is of an unusually high order of distortion free clarity.

The transmitter section will produce a minimum of 10 watts RF output. Again, a phase locked loop is employed for initial frequency stability. Twenty two (22) channels are provided for operating convenience and versatility. High-Q stages provide minimum interstage spurious response. A low pass filter is placed at the output to further insure undesirable frequency products not being emitted. Final PA transistor protection circuit is incorporated in the final circuitry. A new design heat sink is employed to increase final amplifier reliability.

All circuitry is constructed on printed circuit boards which are easily accessible for servicing. The printed circuit boards are housed in a sturdy frame which is, in turn, housed in a rigid metal case providing an extremely durable and rugged unit. Care has been taken to filter and regulate internal DC voltages. A DC input filter is provided to eliminate alternator or generator "whine" generated in the vehicle environment. Test points are brought up from all major circuits to facilitate maintenance checks and trouble shooting should the necessity arise.

Each unit comes complete with built-in speaker, a high quality dynamic microphone, mobile mounting bracket, microphone clip, DC cabling and plug, external speaker plug, and operating manual. A modern styled face plate, large S meter, small size and low profile design complete the unit's styling. A welcome addition to a dashboard or fixed station.

SECTION III INSTALLATION

Unpacking:

Carefully remove your transceiver from the packing carton and examine it for signs of shipping damage. Should any be apparent, notify the delivering carrier or dealer immediately, stating the full extent of the damage. It is recommended you keep the shipping cartons. In the event storage, moving, or reshipment becomes necessary, they come in handy. Accessory hardware, cables, etc., are packed with the transceiver. Make sure you have not overlooked anything.

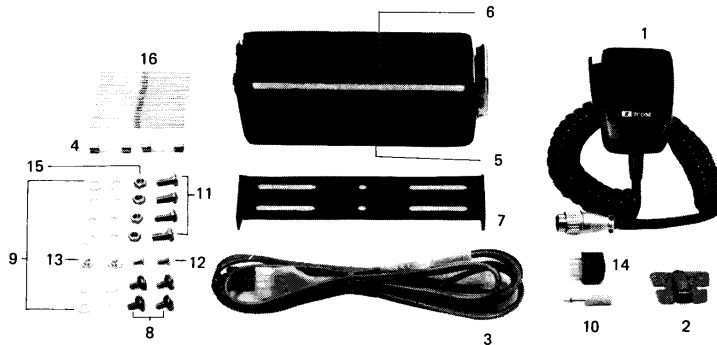

- | | | | |
|------------------------------|---|-----------------------------------|----|
| 1. Microphone (dynamic type) | 1 | 9. Flat washers | 6 |
| 2. Microphone hook | 1 | 10. Plug for speaker | 1 |
| 3. Power cord | 1 | 11. Mounting screws | 4 |
| 4. Spare fuses (5A) | 2 | 12. Screws for additional bracket | 2 |
| 5. Installing holder A | 1 | 13. Flat head screw's nuts | 2 |
| 6. Installing holder B | 1 | 14. Acc. plug | 1 |
| 7. Installing angle joint | 1 | 15. Mounting screw's nut | 4 |
| 8. Gimp screws | 4 | 16. Diodes for Matrix | 20 |

Location:

Where you place the transceiver in your automobile is not critical and should be governed by convenience and accessibility. Since the unit is so compact, many mobile possibilities present themselves. In general, the mobile mounting bracket will provide you with some guide as to placement. Any place where it can be mounted with metal screws, bolts, or pop-rivets will work. For fixed station use, a power supply should be designed to produce 3 amps for the transceiver.

Mounting bracket installation

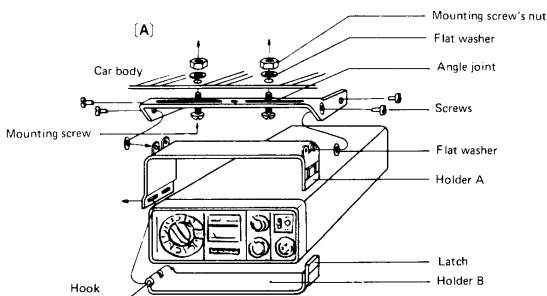

Angle adjustment

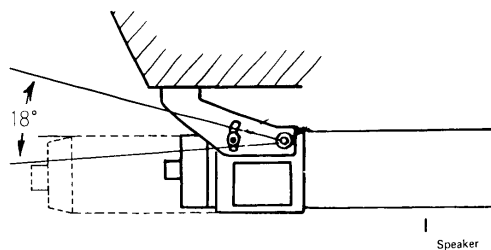

Transceiver installation

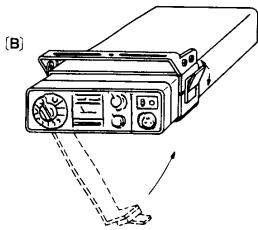

Optional installation

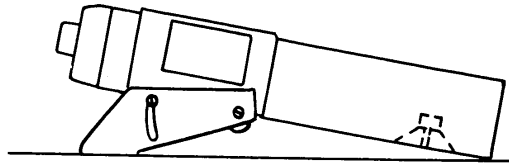

Power Requirements:

The transceiver is supplied ready to operate from any regulated 13.8V DC, 2.5 ampere negative ground source. An automobile 12 volt, negative ground, system is usually more than adequate. Some note must be taken, however, of the condition of the vehicle's electrical system. Items such as low battery, worn generator/alternator, poor voltage regulator, etc., will impair operation of your transceiver as well as the vehicle. High noise generation or low voltage delivery can be traced to these deficiencies. If an AC power supply other than the matching ICOM AC power supply is used with your transceiver, make certain it is adequately regulated for both voltage and current. Low voltage while under load will not produce satisfactory results from your transceiver. Receive gain and transmitter output will be greatly impaired. Caution against catastrophic failure of the power supply should be observed.

CAUTION: Excessive Voltage (above 15VDC) will cause damage to your transceiver. Be sure to check source voltage before plugging in the power cord.

Included with your transceiver is a DC power cable with plug attached. The Red Wire is positive (+), the Black, negative (-). If your mobile installation permits, it is best to connect these directly to the battery terminals. This arrangement eliminates random noise and transient spikes sometimes found springing from automotive accessory wiring. If such an arrangement is not possible, then any convenient B+ lead in the interior of the vehicle and the negative frame can be utilized. Your transceiver provides an internal DC filter that will take out a large amount of transient difficulties anyway. Remember, the unit operates on a negative ground system only—it cannot be used in a positive ground automobile. After making your connections, simply insert the plug into your transceiver. When your transceiver is mated with its matching ICOM AC power supply, the power cable is simply plugged in the same receptacle in the transceiver and the AC line cord into any convenient wall receptacle.

Rear external connections

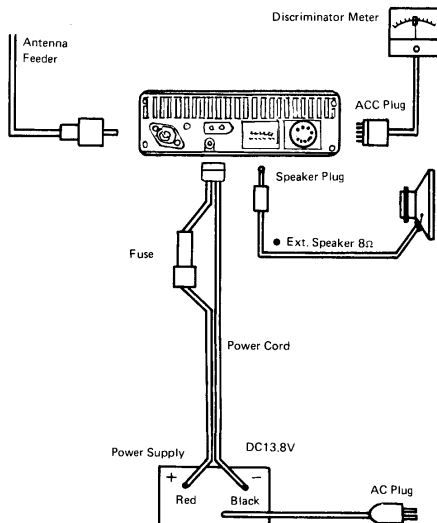

Antenna:

The most important single item that will influence the performance of any communication system is the antenna. For that reason, a good, high-quality, gain antenna of 50 ohms impedance is recommended, fixed or mobile. In VHF as well as the low bands, every watt of ERP makes some difference. Therefore, 10 watts average output plus 3 dB of gain antenna equals 20 watts ERP, presuming low VSWR of course. The few more dollars invested in a gain type antenna is well worth it. When adjusting your antenna, whether mobile or fixed, by all means follow the manufacturer's instructions. There are some pitfalls to be aware of. For example, do not attempt to adjust an antenna for lowest VSWR when using a diode VSWR meter not engineered for VHF applications. Such readings will invariably have an error of 40% or more. Instead, use an in line watt similar to the Drake WV-4, Bird Model 43 or Sierra Model 164B with VHF cartridge. Further, when adjusting a mobile antenna, do so with the motor running preferably above normal idling speed. This will insure proper voltage level to the transceiver.

The RF coaxial connector on the rear chassis mates with a standard PL-259 connector. Some models may have metric thread. In any event, the RF connector will mate with almost any PL-259 connector if care is taken to seat them properly.

Microphone:

A high quality dynamic microphone is supplied with your transceiver. Merely plug it into the proper receptacle on the front panel. Should you wish to use a different microphone, make certain it is approximately 500 ohms. Particular care should be exercised in wiring also, as the internal electronic switching system is dependent upon it. See the schematic for the proper hook up.

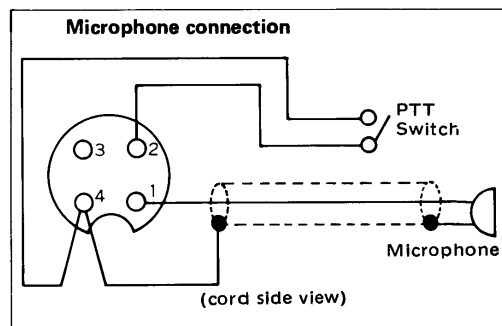
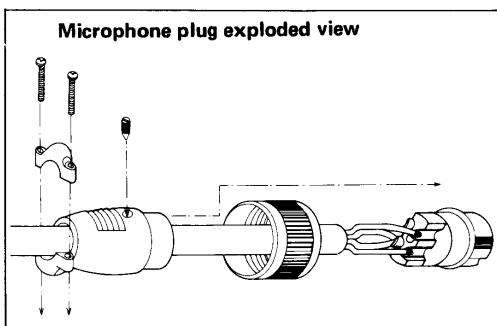

External Speaker:

An external speaker jack and plug is supplied with your unit in the event another speaker is desirable. The external speaker impedance should be 8 ohms, and when used, will disable the internal speaker. An 8 ohm headset can be utilized as well.

Synthesizer Programming:

Your transceiver does not use crystals to set the frequency. It has 22 channels programmable on a diode matrix board and selected by the channel selector switch. In addition, the channel selected has three options of how the offset is handled: receive and transmit on the programmed frequency (SPX), receive 600KHz higher than the programmed frequency (DPX A), and transmit 600KHz above the programmed frequency (DPX B). The programming is done on the diode matrix board by soldering computer grade silicon diodes into the boards in the locations indicated on the diode matrix diagram. Please refer to the chart on pages 20 for the locations.

The frequency programming formula is shown below.

$$N = \frac{\text{Desired Frequency (transmit or receive)} - 142.4}{0.025}$$

For Duplex operation the lower of the two frequencies must be placed in the formula as the desired frequency.

Example 1: Desired Simplex frequency: 144.600MHz

$$N = \frac{144.600 - 142.4}{0.025} = 88$$

$$88 - 64 - 16 - 8 = 0$$

The Matrix position value printed on the diode matrix board is subtracted from “N” until zero is achieved. These numbers represent diode positions. The frequency 144.600MHz would then be programmed by placing diodes in positions 64, 16, and 8 on the matrix vertical line.

Example 2: Desired Simplex frequency: 145.575MHz

$$N = \frac{145.575 - 142.4}{0.025} = 127$$

$$127 - 64 - 32 - 16 - 8 - 4 - 2 - 1 = 0$$

Again the frequency would be programmed by placing diodes in position 64, 32, 16, 8, 4, 2 and 1 on the matrix “N” vertical line.

The diodes can be inexpensive Silicon type available most anywhere. Germanium diodes can not be used.

Matrix board sample diode installation

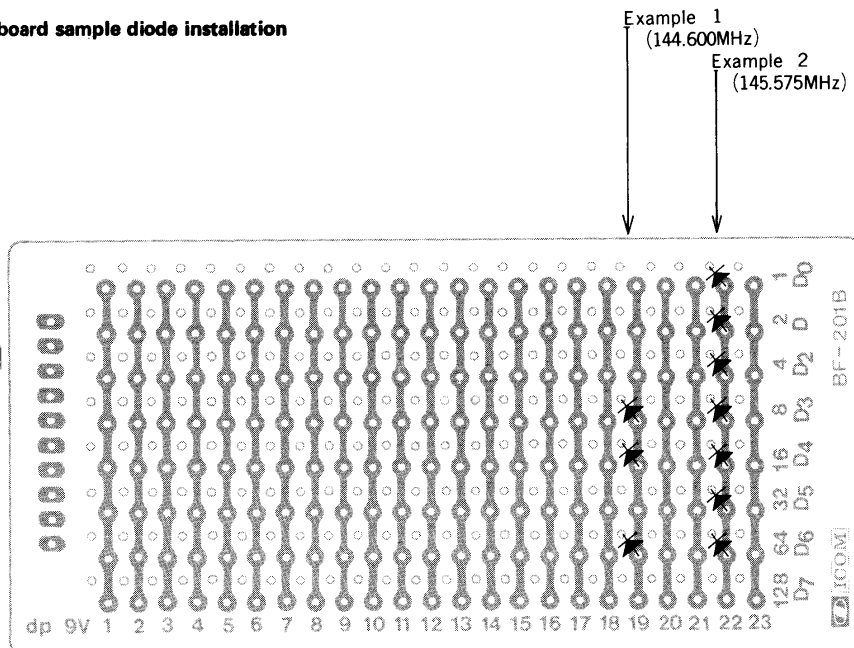

CAUTION:
DO NOT USE A SOLDERING IRON OF MORE THAN 40 WATTS ON THE MATRIX

The matrix board may be removed by taking out the hold-down screw at the end of the board and pulling gently straight up on the other end to disconnect the matrix from the connector. The numbers 1 through 22 indicate the channel number to be programmed and the numbers D-0 through D-7 indicate the position in which the diode is to be placed cor-

responding to the insert positions on the Frequency vs Martix Chart. Insert the diode into the line for the desired channel with the cathode pointing UP. The cathode lead is bent down to go through the board to connect to the other side. After the diodes have been inserted for the channel, turn the board over carefully so as to not have the diodes fall out and solder each of the leads with a small tip, low wattage soldering iron. Clip the diode lead off as close to the board as possible. Replace the board on its connector and replace the screw in the end.

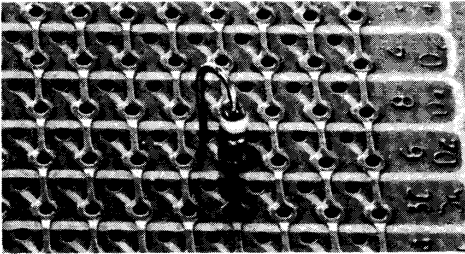

Instal diode as shown

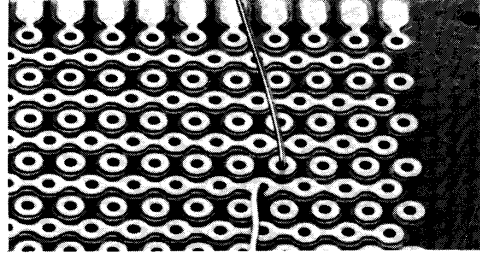

Bend leads on underside

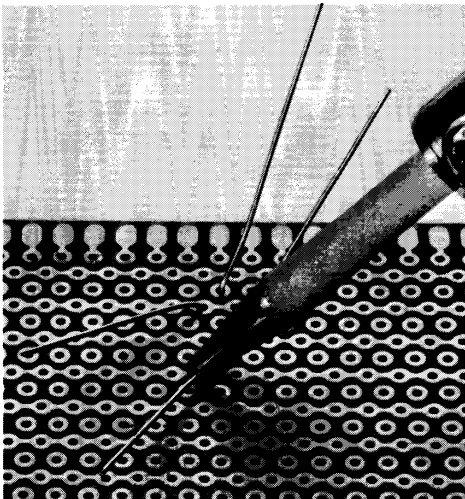

Use low watt iron to heat leads

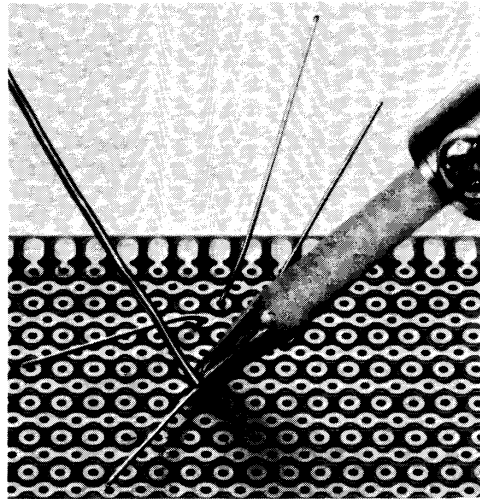

Apply solder sparingly

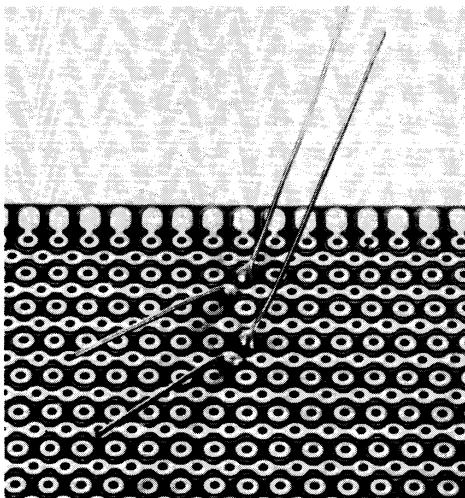

Check for shorted pattern

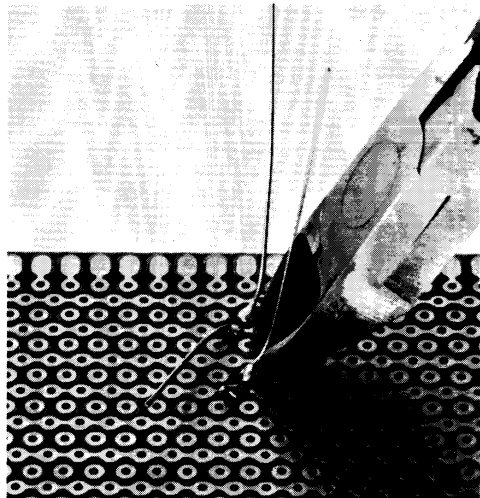

Trim leads cleanly

SECTION IV OPERATION

Initial Preparations:

Make sure the function switch is in the off position, then connect the power supply cord to the power supply jack. The red lead should be connected to the positive side of the power source and the black lead to the negative side. In the event that these leads are improperly connected, the transceiver will not function. Reversing polarity will blow out the fuse in the power supply cord due to actuation of the protective circuit.

Connect the microphone to the microphone jack.

Connect the antenna to the antenna coax connector. Make sure the coax line is of the correct impedance (50 ohms) and is neither shorted nor open.

Turn the volume and squelch controls to the maximum counter-clockwise position.

Operation:

When the function switch is set to either the DUP or SIM position the set is switched on and the channel indicator window. The RX indicator and meter will be illuminated.

Switch the channel selector to the desired channel.

Choose the proper DUP offset setting, or SIM for simplex operation.

If the desired receiving frequency is 600KHz higher than the transmitting frequency (programmed frequency), set to the A position of the internal Duplex Switch. And if the desired transmitting frequency is 600KHz higher than the receiving frequency (programmed frequency), set the switch to the B position.

Reception:

Adjust the volume control to a comfortable listening level of noise, if no signal is present.

Carefully adjust the squelch control clockwise until the noise just disappears, and RX indicator goes out. This is the proper squelch threshold setting and must be done when no signal is present. Your transceiver will now remain silent until an in-coming signal is received which opens the squelch and lights the RX indicator. If the squelch is unstable due to the reception of weak or mobile stations, adjust the squelch control further until the proper threshold is obtained.

The S meter indicates the signal strength of the incoming signals and is calibrated in S units and dB over S9. The light illuminating the meter acts also as lock indicator for the PLL. If the meter lamp goes out, PLL is unlocked or the channel selector is in a nonprogrammed position.

Transmitting:

Push the PTT (push to talk) button on the microphone and the transceiver will transmit. At the same time the TX indicator will be illuminated red and the meter will provide an indication of relative power output of the transmitter. Hold the microphone about three inches from your mouth and speak in a normal voice. The microphone is of the dynamic type and provides good pickup for all levels of voice.

To receive again, just release the PTT button. This will also switch off the transmit light.

SECTION V CONTROL FUNCTIONS

FRONT VIEW

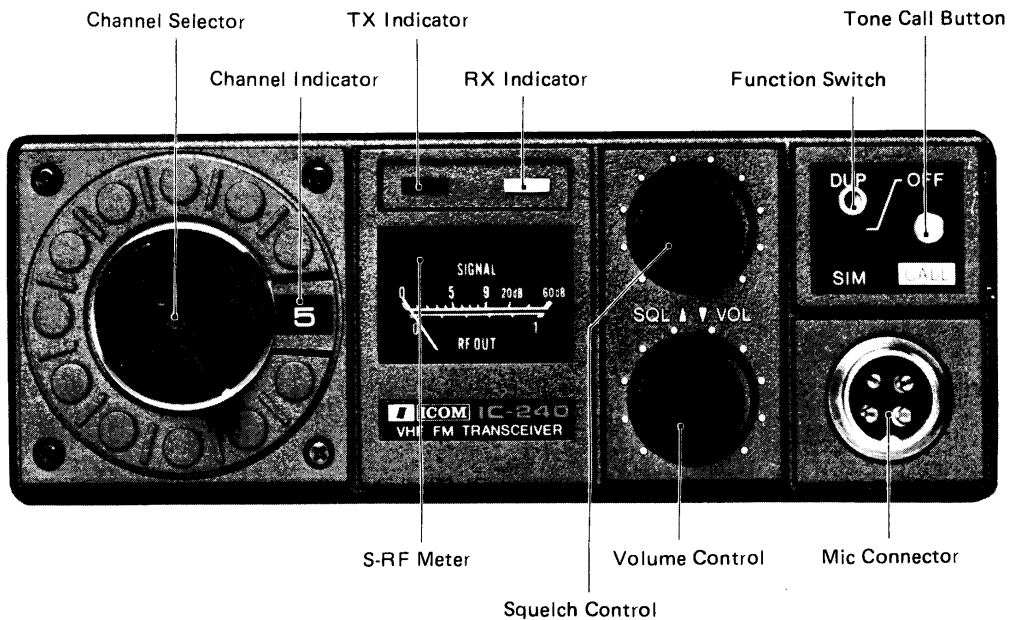

- Channel Selector:** Selects one of 22 channels.
- Channel Indicator:** Shows the operating channel.
- TX Indicator:** Shows RF is being emitted.
- RX Indicator:** Illuminates when a signal is received or squelch is opened.
- S-RF Meter:** Reads signal strength in receive mode and relative RF output in transmit mode.
The meter face is illuminated when the transceiver is switched on. The meter lamp goes out when the PLL is unlocked or the channel selected is unprogrammed.
- Volume Control:** Controls audio output level of the receiver.
- Squelch Control:** Controls squelch threshold point of the receiver.
- Microphone Jack:** Accepts 4 prong mike plug supplied on the microphone.
- Function Switch:** Chooses duplex operation (DUP) or simplex operation (SIM).
Selectable +600KHz transmit or receive duplex modes by internal Duplex Switch (See page 8).
- Tone Call Button:** Actuates the tone circuit for repeater operation.

BACK VIEW

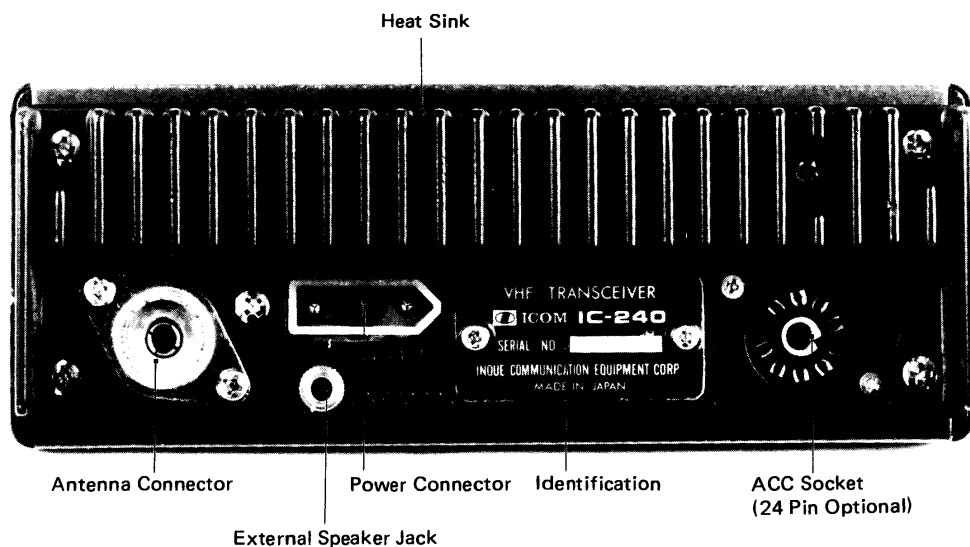

Antenna Connector: Accepts standard PL-259 coaxial connector.

External Speaker Jack: This jack mates with the supplied for external 8 ohm speaker or headset use. The use of this jack mutes the internal speaker.

Power Connector: Mates with DC cord plug or power cord of the IC-3PE AC power supply.

Identification Plate: States model, serial number.

Accessory Socket: Center Meter, etc., can be connected here.

Programmed Frequency Chart

Channel Indicator	Channel No.	Programmed Frequency (Simplex)	* Duplex (A)	
			Transmit	Receive
0	R0	145.000MHz	145.000MHz	145.600MHz
1	R1	145.025	145.025	145.625
2	R2	145.050	145.050	145.650
3	R3	145.075	145.075	145.675
4	R4	145.100	145.100	145.700
5	R5	145.125	145.125	145.725
6	R6	145.150	145.150	145.750
7	R7	145.175	145.175	145.775
8	R8	145.200	145.200	145.800
9	R9	145.225	145.225	145.825
A				
B				
C				
D				
E				
F				
G				
20	S20	145.500	145.500	Out of band
21	S21	145.525	145.525	Out of band
22	S22	145.550	145.550	Out of band
23	S23	145.575	145.575	Out of band
24	S24	145.600	145.600	Out of band

* When Duplex B, Transmit Frequency and Receive Frequency are reversed.

SECTION VI INSIDE VIEW

(TOP)

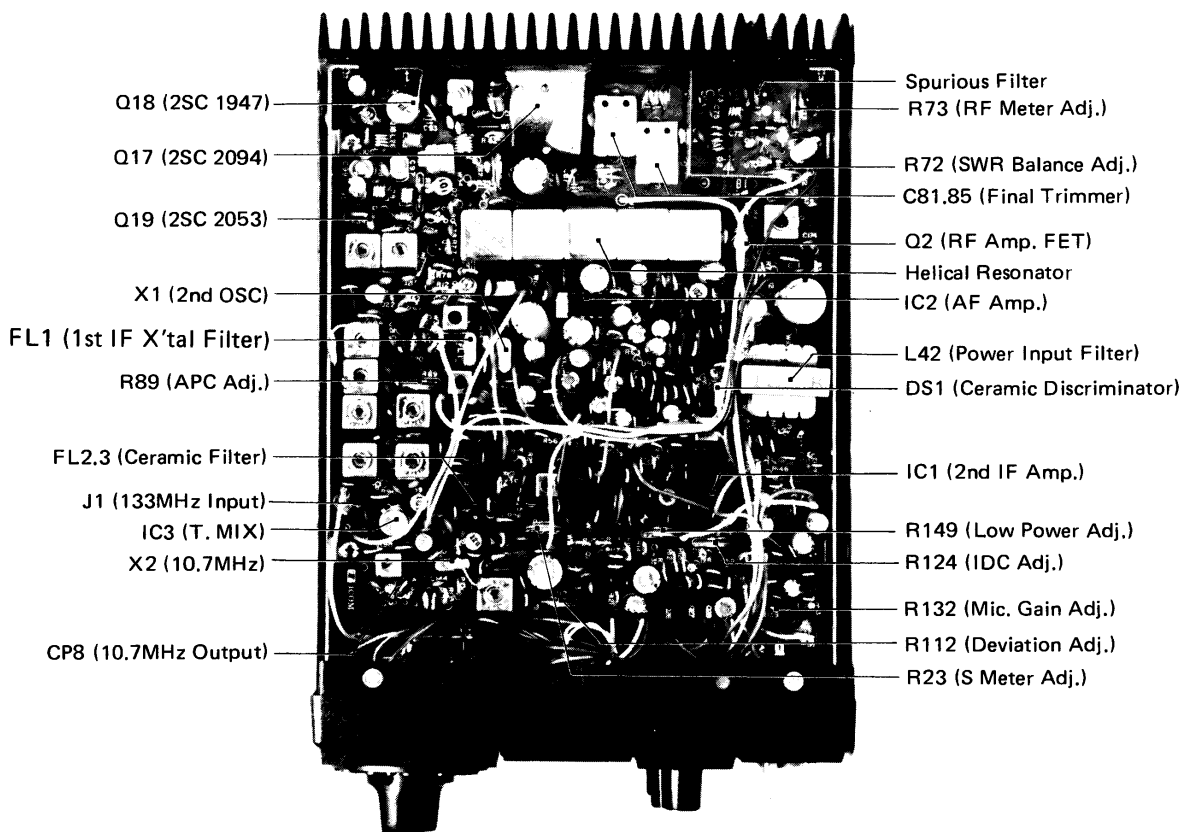

(BOTTOM)

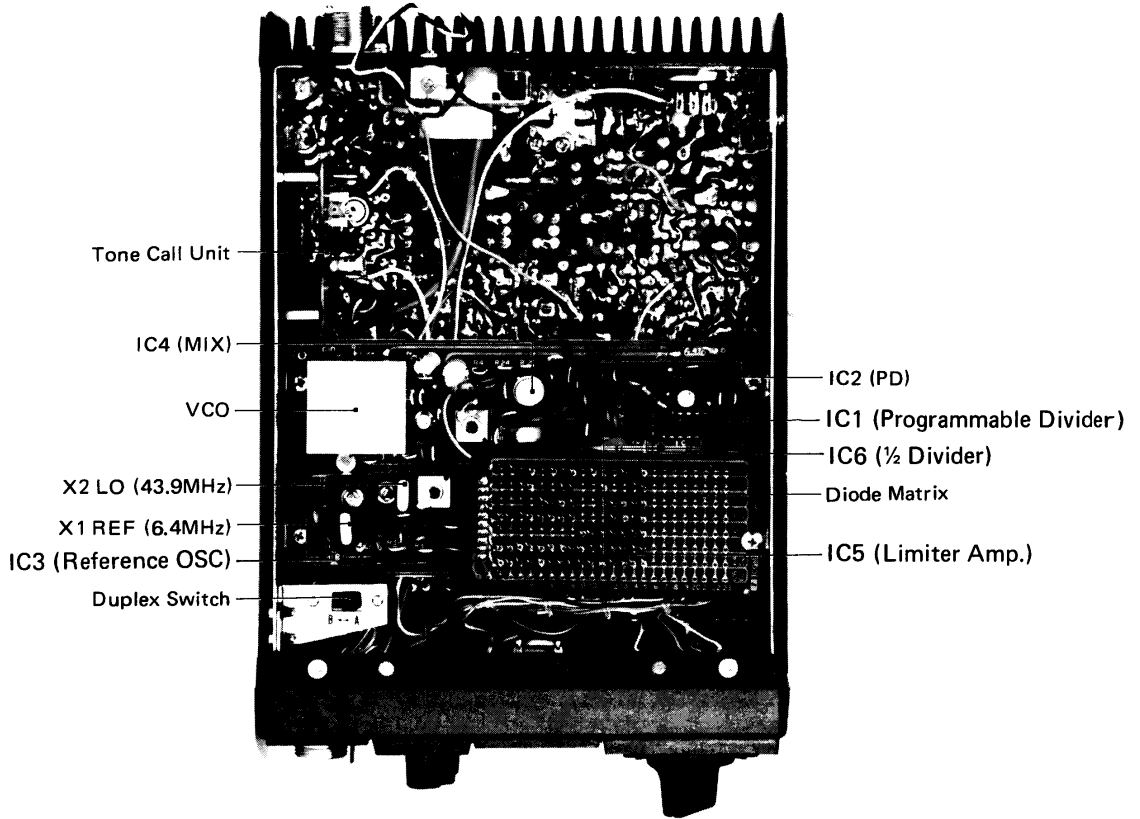

SECTION VII THEORY OF OPERATION

The receiver is a double super heterodyne, with a first intermediate frequency of 10.7MHz and a second intermediate frequency of 455KHz. A digital phase-locked loop (PLL) circuit is used as the first local oscillator, and since the 133MHz signals are oscillated fundamentally, spuriousness is held to a minimum.

Frequency setting is effected simply by a combination of diode programs, and once the VCO is set at the factory, there is no need for further adjustment, even when additional programs are installed.

Outstanding characteristics are ensured by use of MOS FETs for the RF amplifier and first mixer, a 5-stage helical cavity filter in the RF circuit, a monolithic crystal filter in the first IF circuit, and 2 ceramic filters in the second IF circuits.

The transmitter uses a crystal oscillator to produce the 10.7MHz signals which are direct-frequency modulated. These signals are mixed with the 133MHz signals from the PLL circuit which is the same as the first local oscillator of the receiver, and amplified to provide a 144MHz band output.

RECEIVER CIRCUITS

Antenna Switching Circuit

Signals from the antenna pass through transmit-receive switching diodes D1, D2 and D32 (1SS55s) and after amplification by RF amplifier Q2 (3SK40), are applied to the first gate of the first mixer Q3 (3SK40).

When the switching circuit is set at "receive" the switch control transistor Q1 (2SA639) is turned on by R + 9V, and as the forward voltage is now applied to diodes D1, D2 and D32, signals from the antenna pass through the diodes and are fed to Q2.

During transmission, R +9V is turned off, Q1 is turned off, and forward voltage across D1, D2 and D32 is terminated. Reverse voltage due to transmission output, is applied and so D1, D2 and D32 are turned off, preventing the transmitter output from entering the receiver section.

Radio Frequency Circuit

The output of the RF amplifier, Q2, is fed to a band-pass filter, consisting of a 5-stage helical cavity filter, and serves to reduce interference or other problems caused by strong out-of-band signals.

Receive signals are converted to the first intermediate frequency, 10.7MHz, at the second gate of first mixer Q3, to which 133MHz first local oscillator signals from the PLL unit are supplied via the local oscillator transmit-receive switching diode D15 (1SS53).

Intermediate Frequency Circuits

The first IF circuit must have sharp characteristics in order to reduce interference by signals

in the pass-band or secondary image frequency interference. These characteristics are ensured in the IC-240 by use of monolithic crystal filter 10M20A.

Signals that have passed through the crystal filter are supplied together with 10.245MHz signals from the second local oscillator Q9 (2SC945) to the gate of second mixer Q4 (2SK49), for conversion to the 455KHz second IF.

In the second IF amplifier, which has excellent selectivity due to 2 CFU455E ceramic filters, signals are amplified by Q5 – Q7 (2SC945s). After removal of noise and other AM components by IC1 (μ PC577H) functioning as a limiter, the signals are detected in terms of audio frequency signals by a ceramic discriminator.

This ceramic discriminator has outstanding temperature characteristics, linearity and detection sensitivity, which guarantee clear, stable reception.

Audio signals from the discriminator are divided into audio signals and noise component signals to operate the squelch circuit.

Audio Circuit

In the audio amplifier, audio signals are passed through the de-emphasis circuit consisting of R39 and C40, and amplified by Q8 (2SC1571). High frequency components are cut by a low-pass filter (2SC1571), in order to improve the signal-to-noise ratio. Then the audio signals are adjusted to a suitable level by volume control R-2, amplified by AF power amplifier IC2 (μ PC575C2) to 1.5W or more, and fed to the speaker.

During transmission, positive voltage is applied via D13 (1SS53) to pin No.8 of IC2, and so it does not function, and there is no risk of transmission signals being supplied to the receiver circuit.

Squelch Circuit

This is a noise circuit that suppresses noise when signals enter the set. To avoid erroneous operation due to audio signals, noise components of about 25KHz are selectively amplified.

Squelch control R-1 is located immediately after the discriminator, thus increasing the dynamic range of the circuit.

Noise components from squelch control R-1 are amplified by Q13 and Q14 (2SC945s), rectified by D7 and D8 (1N60s), and with C57, R62 and R6 ensure correct timing sequence for smooth squelching supplied to the base of squelch control transistor Q12 (2SC945).

When there are no audio signals, rectified DC voltage from D7 and D8 is applied to the base of Q12, turning it on. Since the collector of Q12 is connected to the base of AF amplifier Q8, base voltage of Q8 falls and Q8 is turned off, thus squelch action is applied, and no audio is amplified by IC2. At this time, signal lamp control transistor Q11 (2SC945) does not conduct, and so the signal lamp goes off.

When incoming signals are received, noise is suppressed, the base voltage of Q12 falls, and Q12 is turned off. Therefore, normal voltage is applied to the base of Q8, the squelch circuit

is opened, and audio signals are heard from the speaker. Q11 also is turned on, and the signal lamp lights up.

The point at which squelch becomes operative (squelch threshold) is adjusted by R-1.

During transmit, positive voltage is supplied through R60 to the base of Q12 and the squelch circuit is operative, so squelch action is started the moment there is switchover from transmit to receive, and no loud crackling or similar noise is heard.

TRANSMITTER CIRCUITS

10.7MHz Oscillator, Modulation Circuits

10.7MHz signals are oscillated by Q24 (2SC945) and amplified audio signals from the microphone are supplied to varicap diode D17 (1S2688) connected in series with the crystal unit. Voltage of these signals causes the capacitance of D17 to vary, and frequency modulation is effected. Since this transceiver is a heterodyne type, any frequency deviation that occurs in this circuit appears unchanged as a frequency deviation in the 144MHz band, and so use is made of a crystal unit with special characteristics to ensure suitable frequency deviation and stability.

Mixer Circuit

These modulated signals are taken out at the emitter of Q24, and after balanced conversion by L39, are applied to transmit mixer IC3 (TA7045M).

133MHz band signals from the PLL unit, which is the same as the first local oscillator of the receiver, are supplied through local oscillator transmit-receive switching diode D16 (1SS53) to IC3 and mixed with the 10.7MHz modulated signals to give signals of $133\text{MHz} \pm 10.7\text{MHz}$. As a balanced mixer is used for this mixing stage, 10.7MHz and 133MHz band signals are canceled and do not appear in the output.

Power Amplifier

The signals are further passed through a concentrated band-pass filter, to produce signals in the 144MHz band only, and then amplified by Q22 (3SK40), Q19 (2SC2053), Q18 (2SC1947), and Q17 (2SC2094), to 10 watts or more.

Since this output includes harmonics, it is passed through 2 Chebyshev sections, and 1 constant-k section low-pass filter, to attenuate harmonics to -60dB or more.

Audio Frequency Circuit

In the AF amplifier, audio signals from the microphone are amplified by Q30 (2SC1571), and Q29 (JA1050) in the AF amplifier, and instantaneous frequency deviation is kept below a set value by an IDC circuit consisting of Q28 (2SC1571), Q27, and Q26 (2SC945s). R24 regulates bias of Q26, and keeps the chopped waveforms symmetrical. D18 and D19 (1N60s) serve as temperature compensators for the IDC circuit.

Q25 (2SC945) is an active low-pass filter which cuts out harmonics produced in the IDC circuit, and prevents spread of the sidebands. Output is taken out at the emitter of Q25.

Maximum frequency deviation is adjusted by R112. R113 is a thermistor which minimizes frequency deviation caused by temperature variations.

Output Power Control

In the output power control circuit, a portion of the 144MHz band signals from the base of power amplifier Q17 is rectified by D12 and D29 (1S473s), and DC-amplified by Q15 (2SK44), and Q16 (JA1050), to control the collector voltage of Q19. Adjustment of the output power is effected by changing the threshold level of D12 and varying DC output voltage from D29.

APC Circuit

In the APC (automatic protection) circuit, reflected waves are rectified by D10 (1N60) of the SWR detector, amplified by Q20 (2SC945), and Q21 (JA1050) to bring them up to the level of Q22's source voltage. This lowers input excitation level to the power amplifier stage and reduces input power to the last stage, thus preventing damage to transistors due to high SWR. The operating point of the APC is adjusted by R89.

Meter Circuit

The meter functions as an S meter which indicates received signal strength during reception, and output power level during transmission.

During reception, the meter indicator needle is caused to move by a portion of the IF signals taken from the collector of the second IF amplifier Q7 and rectified by D4 (1N60). Meter indicator deflection can be adjusted by altering gain of the second IF amplifier Q5 by R23 in series with the by-pass capacitor of the emitter of Q5.

During transmission, the meter indicator is deflected as D11 (1N60) in the SWR detector rectifies forward travelling waves. Meter indication can be adjusted by R73 so that 10W output during transmission gives 4/5 scale deflection.

Power Supply Circuit

Regardless of whether the transceiver is switched to receive mode or not, power is always supplied from a constantly activated source to the receiver AF amplifier (excluding the power amplifier circuit), and PLL circuit. This power source supplies current through R142, D20 (1SS53) and zener diode D21 (XZ096), producing a regulated voltage of about 9.6V. This corresponds to the reference voltage of D1's cathode, and is applied to the base of Q31 (JA1600), resulting in a regulated voltage of about 9.5V which is taken out at the ~~emitter~~ emitter of Q31.

The power source which is operative during reception supplies voltage to the RF amplifier, first and second mixers, second IF amplifier, and second local oscillator. Similar to the constantly activated source in the receive mode power circuit, current flows through R147, D27 (1SS53), and D21.

A reference voltage is supplied to the base of Q34 (JA1600) and regulated voltage is taken from the emitter of Q34. The power source which is in operation during transmit supplies power to the 10.7MHz oscillator, transmit mixer, IF amplifier, driver bias circuit, and APC control circuit. Similar to the receive mode power circuit, in the transmit mode power cir-

circuit current flows through R143, D22 (1SS53), and D21. A reference voltage is supplied to the base of Q32 (JA1600), and regulated voltage is taken out from the emitter of Q32.

The ALC control circuit, exciting amplifier, power amplifier, and AF power amplifier are supplied directly with 13.8V DC.

If the power supply is connected with polarity reversed, the equipment is protected. Since D28 (SR10N2R) becomes forward biased, a large current flows and causes the fuse in the external power supply cord to blow.

Transmit-Receive Switching Circuit

During reception, since the microphone push-to-talk (PTT) switch is off, there is no flow of current through D24, D26 (1SS53s), receive power supply becomes operative, and receive +9V is obtained. Also, since D25 (1SS53) is off, voltage is supplied through R145 to the base of Q33 (2SC945) and turns Q33 on. The base of Q32 is connected to ground through D23 (1SS53), and so the transmit power supply is inoperative, and the transceiver is set in the receive mode.

During transmission, the PTT switch is on, Q34's base is connected to ground through D26, and output voltage of the receive power supply becomes zero. D24 connected to the emitter of Q34 rapidly discharges voltage stored in the receive circuit capacitor to prevent receiver and transmitter from functioning simultaneously during switching. At the same time, Q33 is turned off, as its base is connected to ground through D25, and so the D21 reference voltage is applied to the base of Q32, +9V is obtained from the transmit power supply, and the transceiver will transmit.

PLL Circuit

This transceiver incorporates a phase-locked loop (PLL) circuit for both transmission and reception. A portion of the 133MHz signals produced by the VCO (voltage control oscillator) is converted and divided. Then the phase of these signals is compared with that of a reference frequency of 12.5KHz. The phase difference results in a DC voltage which is used to control oscillation frequency of the VCO. In this manner, although the VCO is a self-oscillator, it has the same outstanding stability as a crystal oscillator.

VCO-Frequency Conversion Circuit

The VCO is a clap oscillator, using Q8 (2SK19), and oscillates in the 133MHz band. The oscillation frequency is locked by DC voltage which is supplied from the comparator to varicap diode D3 (ITT410) inserted in series with the oscillation coil.

The oscillator output is taken at the source of Q8, and passed through buffer Q5 (3SK40) to become local oscillator signals for the receiver and the transmitter. A part of these signals is supplied to PLL mixer IC4 (TA7045M), which mixes the signals with the 131.7MHz signals from the PLL local oscillator. The output of the mixer consists of signals whose frequency is 6MHz, or less. The differential input of IC4 131.7MHz reduces the amount of spurious signals appearing in the PLL output.

The PLL local oscillator produces 43.9MHz signals with Q7 (2SC784), and the signals at 3 times this frequency, i.e., 131.7MHz, are taken from the collector of Q7.

As the converted signals from the PLL mixer IC4 are at a low level, they are amplified by IC5 (μ PC577H). Q6 (2SC945) functions as an interface with divider IC6.

Since maximum operating frequency of programmable divider IC1 is low, Q6 output frequency is halved by IC6 (μ PD4013C), which has a high operating frequency, to produce signals of 3MHz or less, which are supplied to the programmable divider.

Divider Circuit

Programmable divider IC1 (TC5080P) divides IC6 output at a ratio determined by a diode matrix program. A maximum of 255 programs can be specified by insertion of diodes in locations corresponding to binary code values.

Reference Oscillator

IC3 (TC5082P) consists of a crystal oscillator and a 12-stage high-speed divider. The crystal oscillator produces 6.4MHz signals, and signals that have been divided down to 1/256, i.e., 25KHz signals, are obtained at the 8th stage of the high-speed divider. IC6 halves these signals again to give reference signals of 12.5KHz.

Phase Comparator

IC2 (TC5081P) comprises a digital phase comparator and an active low-pass filter amplifier. Divided signals from IC1 and 12.5KHz reference signals from IC3 are fed to the phase comparator, which produces an output proportional to the phase difference of the two inputs. This output is passed through the low pass filter consisting of R9, R10, R8, C10 and the filter amplifier in IC2, and is supplied to D3 of the VCO, to control the VCO frequency.

If the frequency of IC1 output is higher than the reference frequency set by IC3, voltage supplied to D3 falls and the VCO frequency is lowered. If IC1 output frequency is lower than the reference frequency, voltage to D3 becomes higher and the VCO frequency is increased. In this way, the VCO frequency is locked to the reference frequency.

Q3 (2SC945) is a ripple filter which further smoothes out the power supply voltage supplied to the VCO and phase comparator, to give improved stability if voltage variations occur.

Lock Indication Circuit

When the PLL is locked, voltage at pin No.4 of IC2 becomes equal to the power supply voltage. But when the lock is released, pulses with a width proportional to the phase difference appear at this pin.

These pulses are integrated by R7, C8 and supplied to the base of Q4 (JA1050). When Q4 base voltage exceeds the junction voltage, Q4 conducts, and voltage is supplied to the base of Q1 (2SC945), and Q1 also conducts. Voltage at the collector of Q1 becomes zero, D1, D5 (1SS53s) connected to the Q1 collector are turned on, base voltage of Q32 and Q34 in the main unit is lowered, power supply voltage for transmit-receive signals becomes zero, and both transmitting and receiving operations are stopped. Therefore, when the lock is released and the transceiver is switched to reception, the RX indicator lamp lights up, whatever the position of the squelch control, while for transmission the TX indicator lamp and the RX

indicator lamp light up, indicating that the lock has been released. At the same time, Q2 (2SC945) is turned off, since its base is connected to the collector of Q1, and the meter lamp goes out, thus giving a further indication of lock release.

Lock Start Circuit

The upper frequency limit for application of PLL lock is determined mainly by the maximum operating frequency of the halving divider IC6. Oscillator coil L7 of the VCO is adjusted so that the frequency of the input to IC6 does not exceed IC6's maximum operating frequency when the low-pass filter output voltage is at maximum. Because of this, lock is not released, even if the free-running oscillation frequency of the VCO reaches the upper frequency limit.

The lower frequency limit is equal to the local oscillator frequency (131.7MHz) minus the IC6 input frequency determined by the IC1 program. Lock is not applied if the VCO frequency becomes lower than this lower limit. Therefore, to ensure that lock is always applied when the transceiver power supply is switched on, the circuit is arranged so that overvoltage of the differentiating circuit of C24 and R12 is supplied, via D2 (1SS53), to D3 of the VCO, to bring D3 temporarily to a high voltage. While this voltage is falling, the VCO free-running frequency is always brought into a range permitting lock to be applied.

Diode Matrix

This is a matrix circuit network consisting of a binary code converter for obtaining desired frequencies. This is done by setting the divide ratios as required for use in the programmable divider to supply input to the 22 channels of the channel selector.

Adding Circuit

This is a logic circuit for performing duplex operations necessary for use of a repeater. It consists of IC7 (μ PD4049C), IC8 (μ PD4030C) and IC9, IC10 (μ PD4011Cs).

When +9V is applied to the duplex terminal of this circuit, N24 is added to the binary output of the diode matrix, resulting in operation at a frequency which is 600KHz higher than the programmed frequency.

If the internal duplex switch is set to A, voltage is supplied to the duplex terminal during reception, and the receive frequency is 600KHz higher than the transmit frequency (programmed frequency). If the switch is set to B, voltage is supplied to the duplex terminal during transmit and the transmit frequency is 600KHz higher than receive frequency (programmed frequency).

Tone Call Circuit

This circuit produces a tone burst for opening the repeater. If the tone call push-button is pressed during transmission, the circuit is actuated, and a multivibrator, IC1 (TC4011P), produces a tone burst.

Oscillation frequency can be adjusted by R6. Output of the circuit is supplied to the mike amplifier.

SECTION VIII DIODE MATRIX CHARTS

For Duplex operation, the lower of the two frequencies (transmit or receive) must be used as the desired frequency.

Desired Frequency (MHz)	PLL Output Frequency (MHz)	1/M Frequency (MHz)	Total N	DIODE INSERT POSITIONS									
				128 D7	64 D6	32 D4	16 D4	8 D3	4 D2	2 D1	1 D0		
144.000	133.300	1.600	64		*								*
144.025	133.325	1.625	65		*								
144.050	133.350	1.650	66		*						*		
144.075	133.375	1.675	67		*						*	*	
144.100	133.400	1.700	68		*				*				*
144.125	133.425	1.725	69		*				*	*			*
144.150	133.450	1.750	70		*				*	*	*		*
144.175	133.475	1.775	71		*				*	*	*	*	*
144.200	133.500	1.800	72		*			*					*
144.225	133.525	1.825	73		*			*			*		*
144.250	133.550	1.850	74		*			*		*	*		*
144.275	133.575	1.875	75		*			*		*	*	*	*
144.300	133.600	1.900	76		*			*	*	*	*		*
144.325	133.625	1.925	77		*			*	*	*	*	*	*
144.350	133.650	1.950	78		*			*	*	*	*	*	*
144.375	133.675	1.975	79		*			*	*	*	*	*	*
144.400	133.700	2.000	80		*		*						*
144.425	133.725	2.025	81		*		*						*
144.450	133.750	2.050	82		*		*			*	*		*
144.475	133.775	2.075	83		*		*			*	*	*	*
144.500	133.800	2.100	84		*		*		*	*	*	*	*
144.525	133.825	2.125	85		*		*		*	*	*	*	*
144.550	133.850	2.150	86		*		*		*	*	*	*	*
144.575	133.875	2.175	87		*		*		*	*	*	*	*
144.600	133.900	2.200	88		*		*	*					*
144.625	133.925	2.225	89		*		*	*					*
144.650	133.950	2.250	90		*		*	*		*	*		*
144.675	133.975	2.275	91		*		*	*		*	*	*	*
144.700	134.000	2.300	92		*		*	*	*	*	*	*	*
144.725	134.025	2.325	93		*		*	*	*	*	*	*	*
144.750	134.050	2.350	94		*		*	*	*	*	*	*	*
144.775	134.075	2.375	95		*		*	*	*	*	*	*	*
144.800	134.100	2.400	96		*	*							*
144.825	134.125	2.425	97		*	*							*
144.850	134.150	2.450	98		*	*				*	*	*	*
144.875	134.175	2.475	99		*	*				*	*	*	*
144.900	134.200	2.500	100		*	*			*	*	*	*	*
144.925	134.225	2.525	101		*	*			*	*	*	*	*
144.950	134.250	2.550	102		*	*			*	*	*	*	*
144.975	134.275	2.575	103		*	*			*	*	*	*	*
145.000	134.300	2.600	104		*	*		*					*
145.025	134.325	2.625	105		*	*		*					*
145.050	134.350	2.650	106		*	*		*		*	*	*	*

Desired Frequency (MHz)	PLL Output Frequency (MHz)	1/M Frequency (MHz)	Total N	DIODE INSERT POSITIONS							
				128 D7	64 D6	32 D5	16 D4	8 D3	4 D2	2 D1	1 D0
145.075	134.375	2.675	107		*	*		*		*	*
145.100	134.400	2.700	108		*	*		*	*		
145.125	134.425	2.725	109		*	*		*	*		*
145.150	134.450	2.750	110		*	*		*	*	*	
145.175	134.475	2.775	111		*	*		*	*	*	*
145.200	134.500	2.800	112		*	*	*				
145.225	134.525	2.825	113		*	*	*				*
145.250	134.550	2.850	114		*	*	*			*	
145.275	134.575	2.875	115		*	*	*			*	*
145.300	134.600	2.900	116		*	*	*		*		
145.325	134.625	2.925	117		*	*	*		*		*
145.350	134.650	2.950	118		*	*	*		*	*	
145.375	134.675	2.975	119		*	*	*		*	*	*
145.400	134.700	3.000	120		*	*	*	*			
145.425	134.725	3.025	121		*	*	*	*			*
145.450	134.750	3.050	122		*	*	*	*		*	
145.475	134.775	3.075	123		*	*	*	*		*	*
145.500	134.800	3.100	124		*	*	*	*	*		
145.525	134.825	3.125	125		*	*	*	*	*		*
145.550	134.850	3.150	126		*	*	*	*	*	*	
145.575	134.875	3.175	127		*	*	*	*	*	*	*
145.600	134.900	3.200	128	*							
145.625	134.925	3.225	129	*							*
145.650	134.950	3.250	130	*						*	
145.675	134.975	3.275	131	*						*	*
145.700	135.000	3.300	132	*					*		
145.725	135.025	3.325	133	*					*		*
145.750	135.050	3.350	134	*					*	*	
145.775	135.075	3.375	135	*					*	*	*
145.800	135.100	3.400	136	*				*			
145.825	135.125	3.425	137	*				*			*
145.850	135.150	3.450	138	*				*		*	
145.875	135.175	3.475	139	*				*		*	*
145.900	135.200	3.500	140	*				*	*		
145.925	135.225	3.525	141	*				*	*		*
145.950	135.250	3.550	142	*				*	*	*	
145.975	135.275	3.575	143	*				*	*	*	*
146.000	135.300	3.600	144	*			*				

SECTION IX VOLTAGE CHARTS

MAIN UNIT

No.	Transmit				Receive				Notes
	Base or Gate 1	Gate 2	Collector or Drain	Emitter or Source	Base or Gate 1	Gate 2	Collector or Drain	Emitter or Source	
Q1	0.2V		-25V	0.26V	8.2V		6.8V	8.2V	
Q2					0V	4.3V	8.1V	0.24V	
Q3					0V	0V	9.1V	0V	
Q4					0V		8.0V	1.3V	
Q5					1.85V		9.6V	1.7V	
Q6					0.67V		2.45V	0V	
Q7					5.0V		6.6V	4.7V	
Q8	0V		9.6V	0V	1.35V		5.1V	1.0V	Squelch Opened
Q9					2.4V		9.3V	3.2V	
Q10	5.9V		9.6V	5.5V	6.1V		9.7V	5.7V	
Q11	0.05V		13.8V	0V	0.75V		0.35V	0V	Squelch Opened
Q12	0.65V		0.75V	0V	0V		8.0V	0V	
Q13					1.35V		5.8V	0.80V	
Q14					1.35V		9.4V	0.75V	
Q15	0.26V		12.9V	0.9V	0V		13.5V	0.7V	
Q16	12.9V		6.6V	13.7V	13.5V		13.8V	13.8V	
Q17	-0.125V		13.7V	0V	0V		13.8V	0V	
Q18	-0.4V		13.7V	0V	0V		13.8V	0V	
Q19	0.85V		7.2V	0.18V	0.05V		13.8V	0V	
Q20	0.02V		9.5V	0V					
Q21	9.6V		0.26V	9.7V					
Q22	0V	4.6V	8.4V	0.26V					
Q23	—	—	—	—	—	—	—	—	Delated
Q24	4.7V		9.7V	4.2V					
Q25	5.7V		9.6V	5.4V	5.8V		9.6V	5.4V	
Q26	0.70V		1.65V	0V	0.70V		1.65V	0V	
Q27	0.65V		0.70V	0V	0.65V		0.70V	0V	
Q28	0.55V		0.65V	0V	0.55V		0.65V	0V	
Q29	8.3V		7.7V	8.8V	8.3V		7.7V	8.8V	
Q30	8.4V		8.1V	7.9V	8.4V		8.1V	7.9V	
Q31	10.3V		12.6V	9.7V	10.3V		12.7V	9.7V	
Q32	10.3V		12.9V	9.7V	0.9V		13.8V	0.35V	
Q33	0.75V		10.3V	0.26V	1.55V		0.85V	0.85V	
Q34	0.85V		13.7V	0.26V	10.3V		12.9V	9.7V	

Transmit

No.	Pin No.														Notes
	1	2	3	4	5	6	7	8	9	10	11	12	13	14	
IC2	1.6V	13.7V	13.7V	0V	0.55V	13.7V	0V	5.2V							
IC3	6.4V	3.4V	0V	2.8V	6.4V	9.7V	9.7V	9.7V							

Receive

No.	Pin No.														Notes
	1	2	3	4	5	6	7	8	9	10	11	12	13	14	
IC1	5.3V	1.8V	1.8V	0V	8.5V	3.0V	8.6V								
IC2	1.55V	13.8V	13.3V	8.0V	6.8V	13.8V	0V	1.95V							

PLL UNIT

No.	Base or Gate 1	Gate 2	Collector or Drain	Emitter or Source
Q1	0V		9.3V	0V
Q2	0.75V		0.6V	0V
Q3	9.5V		9.7V	8.8V
Q4	8.8V		0V	8.8V
Q5	0V	3.5V	8.3V	1.25V
Q6	0.5V		3.8V	0V
Q7	1.4V		8.5V	0.75V
Q8	0V		8.4V	0V

No.	Pin No.															
	1	2	3	4	5	6	7	8	9	10	11	12	13	14	15	16
IC1	*	*	*	*	*	*	*	*	0V	0.5V	0V	0V	9.0V	-	4.5V	9.0V
IC2	7.5V	○3.7V	○3.7V	○8.8V	8.8V	○3.7V	4.5V	0.5V	0V	0.5V	0V	0V	9.0V	-	4.5V	9.0V
IC3	2.4V	3.3V	3.5V	-	7.6V	-	-	3.8V	0V							
IC4	1.0V	1.1V	0V	0.3V	1.0V	5.6V	5.6V	5.6V								
IC5	5.0V	1.9V	1.9V	0V	8.3V	3.0V	9.0V									
IC6	4.5V	3.2V	4.5V	0V	3.2V	0V	0V	0V	4.5V	0V	3.8V	4.5V	4.5V	9.0V		
IC7	9.0V	*	*	*	*	*	*	0V	*	*	*	*	-	*	*	-
IC8	*	*	*	*	*	*	*	*	*	*	*	*	▲9.0V	9.0V		
IC9	▲9.0V	*	*	*	*	*	*	*	*	*	*	*	*	9.0V		
IC10	9.0V	*	*	*	▲9.0V	*	0V	*	*	*	*	*	▲9.0V	9.0V		

Notes:

- * : 9.0V or 0V according to matrix program and Duplex/Simplex change over.
- : When the lock is released, goes to 0V or near.
- ▲ : When simplex mode, goes to 0V.

TONE CALL UNIT

No.	Pin No.													
	1	2	3	4	5	6	7	8	9	10	11	12	13	14
IC1	4.5V	9.0V	4.5V	4.5V	4.5V	4.5V	0V	9.0V	9.0V	0V	9.0V	0V	0V	9.0V

Note: When the tone call push-button is pressed during transmission.

SECTION X BLOCK DIAGRAM

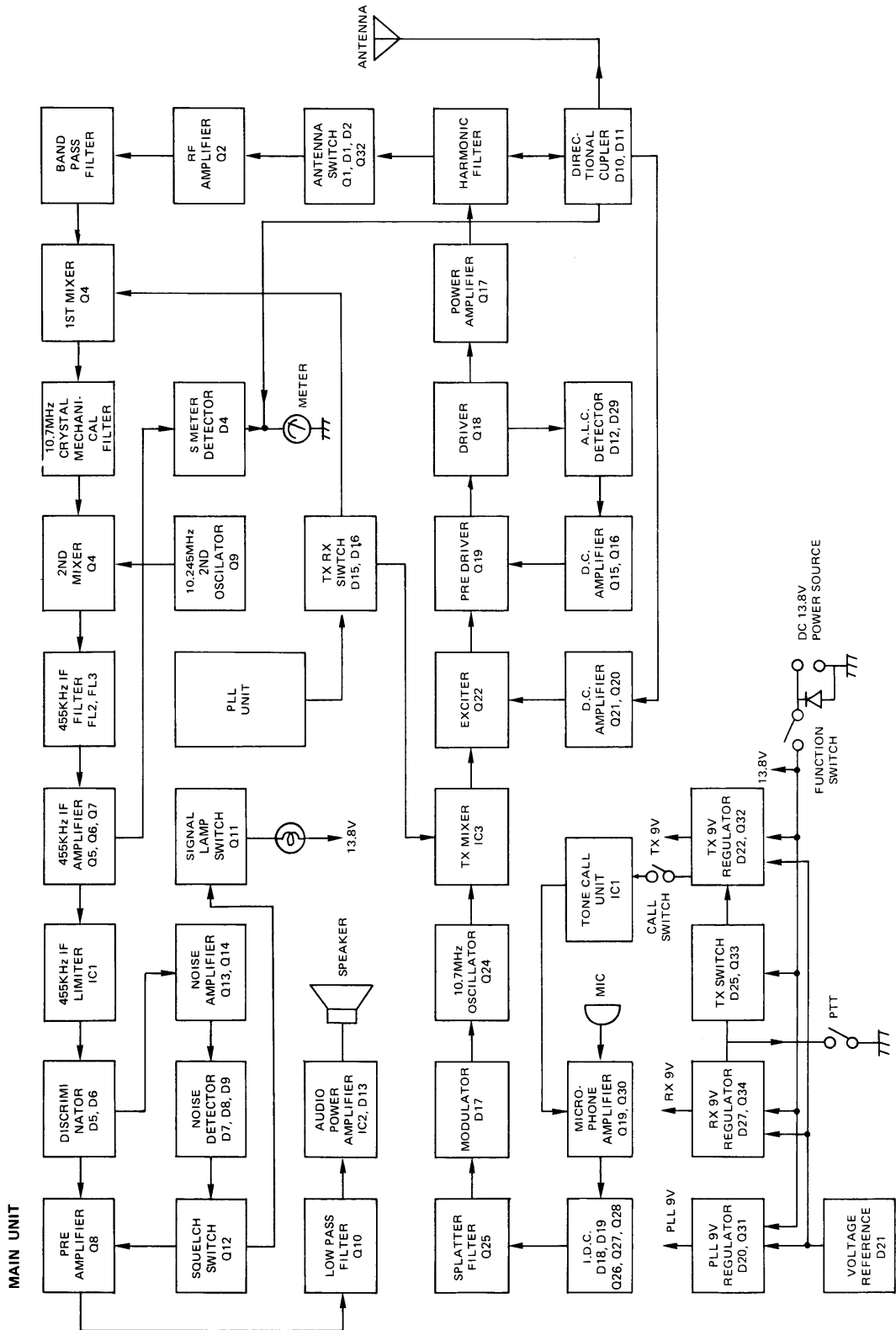

PLL UNIT

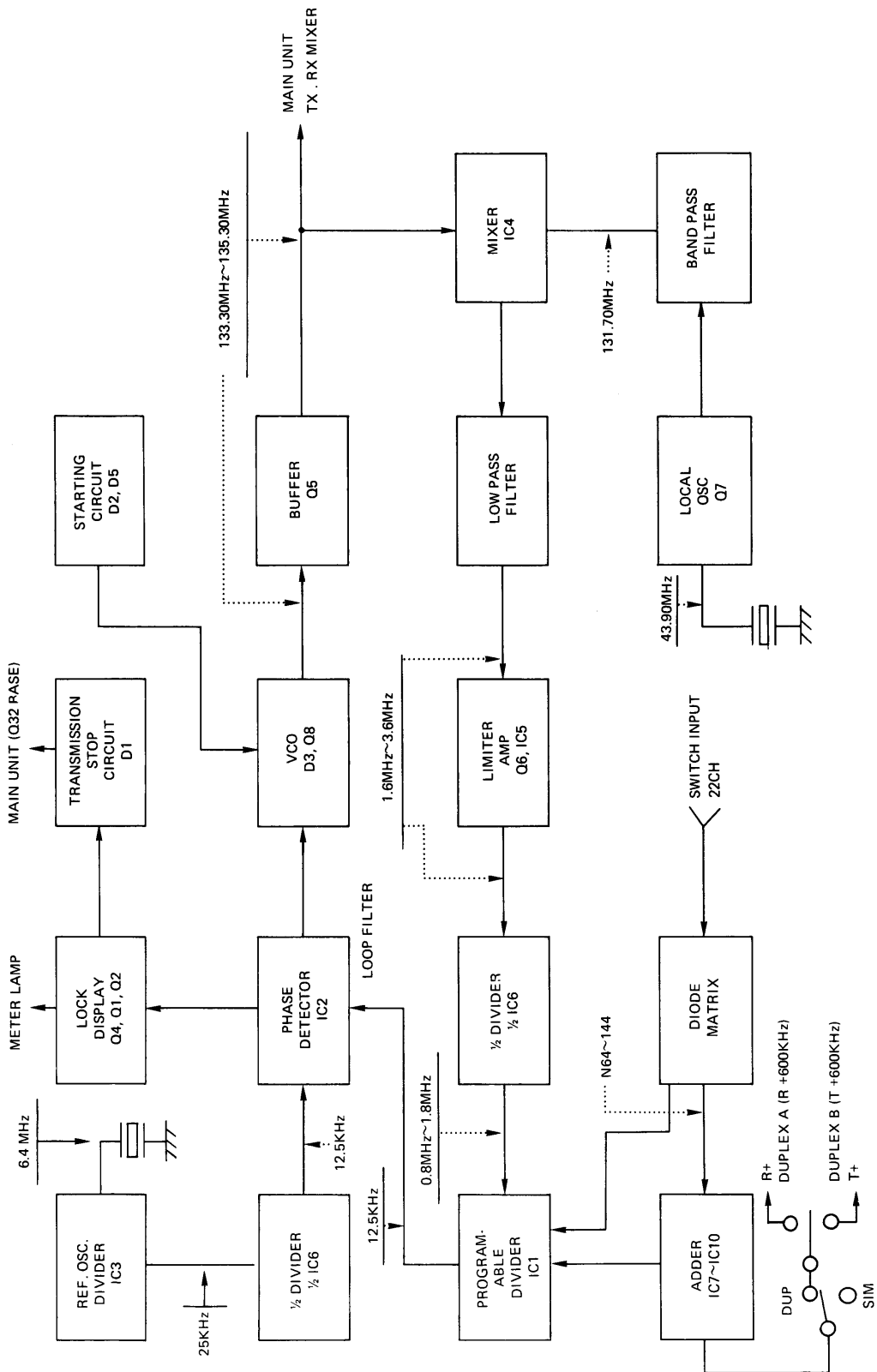

SECTION XI PARTS LIST

MAIN UNIT			
Ref. No.	Description	Part No.	Board Location
IC1	IC	μPC577H	B2
IC2	IC	μPC575C2	D3
IC3	IC	TA7045M	B5
Q1	Transistor	2SA639	E1
Q2	FET	3SK40M	E1
Q3	FET	3SK40M	D4
Q4	FET	2SK49H2	C4
Q5	Transistor	2SC945P	B4
Q6	Transistor	2SC945P	B3
Q7	Transistor	2SC945P	B3
Q8	Transistor	2SC1571G	C3
Q9	Transistor	2SC945P	C4
Q10	Transistor	2SC1571G	C4
Q11	Transistor	2SC945K	C3
Q12	Transistor	2SC945K	C3
Q13	Transistor	2SC945P	D2
Q14	Transistor	2SC945P	D2
Q15	FET	2SK44D	D5
Q16	Transistor	JA1050	E5
Q17	Transistor	2SC2094	F3
Q18	Transistor	2SC1947	F5
Q19	Transistor	2SC2053	E5
Q20	Transistor	2SC945P	C5
Q21	Transistor	JA1050	D5
Q22	FET	3SK40M	D5
Q23	-	-	-
Q24	Transistor	2SC945P	A5
Q25	Transistor	2SC945P	A3
Q26	Transistor	2SC945R	A2
Q27	Transistor	2SC945R	A2
Q28	Transistor	2SC1571G	A2
Q29	Transistor	JA1050	A1
Q30	Transistor	2SC1571G	A1
Q31	Transistor	JA1600G	B1
Q32	Transistor	JA1600G	B1
Q33	Transistor	2SC945P	B1
Q34	Transistor	JA1600G	B1
D1	Diode	1SS55	E1
D2	Diode	1SS55	E2
D3	Diode	1S2473	B4
D4	Diode	1N60	B3
D5	Diode	1N60	C2
D6	Diode	1N60	C2
D7	Diode	1N60	D2
D8	Diode	1N60	D2
D9	Diode	1S1555	C2
D10	Diode	1N60	E1
D11	Diode	1N60	F1
D12	Diode	1S2473	E4
D13	Diode	1SS53	C3
D14	Diode	1S1555	F5
D15	Diode	1SS53	B6
D16	Diode	1SS53	B5
D17	Vari Cap	1S2688C	A4
D18	Diode	1N60	A2
D19	Diode	1N60	A2
D20	Diode	1SS53	B1
D21	Diode	XZ096	B1
D22	Diode	1SS53	B1

MAIN UNIT			
Ref. No.	Description	Part No.	Board Location
D23	Diode	1SS53	B1
D24	Diode	1SS53	B1
D25	Diode	1SS53	B2
D26	Diode	1SS53	B1
D27	Diode	1SS53	B1
D28	Diode	SR10N-2R	D1
D29	Diode	1S2473	E4
D30	Diode	1SS53	C1
D31	Diode	1SS53	A5
D32	Diode	1SS55	E1
R1	Resistor	150 ohm	ELR¼W E1
R2	Resistor	1K ohm	ELR¼W E1
R3	Resistor	4.7K ohm	ELR¼W D1
R44	Resistor	22 ohm	ELR¼W D1
R5	Resistor	100K ohm	ELR¼W D1
R6	Resistor	100K ohm	ELR¼W D1
R7	Resistor	100 ohm	ELR¼W D1
R8	Resistor	220 ohm	ELR¼W E2
R9	Resistor	220 ohm	ELR¼W E1
R10	Resistor	2.2K ohm	ELR¼W D4
R11	Resistor	100 ohm	ELR¼W D4
R12	Resistor	220 ohm	ELR¼W D5
R13	Resistor	220 ohm	ELR¼W D4
R14	Resistor	1K ohm	ELR¼W B4
R15	Resistor	1.5K ohm	ELR¼W C4
R16	Resistor	1K ohm	ELR¼W C5
R17	Resistor	470 ohm	ELR¼W B4
R18	Resistor	470 ohm	ELR¼W B4
R19	Resistor	2.2K ohm	ELR¼W B5
R20	Resistor	3.3K ohm	ELR¼W B4
R21	Resistor	47K ohm	ELR¼W B4
R22	Resistor	330 ohm	ELR¼W B3
R23	Trimmer	3K ohm	FR-10 A4
R24	Resistor	150K ohm	ELR¼W B4
R25	Resistor	220 ohm	ELR¼W B4
R26	Resistor	10K ohm	ELR¼W B4
R27	Resistor	100K ohm	ELR¼W B3
R28	Resistor	220 ohm	ELR¼W B2
R29	Resistor	470 ohm	ELR¼W B2
R30	Resistor	100K ohm	ELR¼W B3
R31	Resistor	470 ohm	ELR¼W B3
R32	Trimmer	5K ohm	FR-10 B3
R33	Resistor	100 ohm	ELR¼W B2
R34	Resistor	100 ohm	ELR¼W B2
R35	Resistor	3.3K ohm	ELR¼W C2
R36	Resistor	10K ohm	ELR¼W C2
R37	Resistor	10K ohm	ELR¼W C2
R38	Resistor	10K ohm	ELR¼W C2
R39	Resistor	22K ohm	ELR¼W C2
R40	Resistor	22K ohm	ELR¼W C2
R41	Resistor	10K ohm	ELR¼W C2
R42	Resistor	150K ohm	ELR¼W C3
R43	Resistor	39K ohm	ELR¼W C2
R44	Resistor	1K ohm	ELR¼W C3
R45	Resistor	4.7K ohm	ELR¼W C3
R46	Resistor	220 ohm	ELR¼W B4
R47	Resistor	100K ohm	ELR¼W C4
R48	Resistor	47K ohm	ELR¼W C4
R49	Resistor	2.2K ohm	ELR¼W C4
R50	Resistor	1K ohm	ELR¼W C4
R51	Resistor	100 ohm	ELR¼W D3

MAIN UNIT			
Ref. No.	Description	Part No.	Board Location
R52	Resistor	22K ohm	ELR¼W C3
R53	Resistor	47K ohm	ELR¼W B3
R54	Resistor	5.6K ohm	ELR¼W C3
R55	Resistor	5.6K ohm	ELR¼W C3
R56	Resistor	5.6K ohm	ELR¼W B4
R57	Resistor	1K ohm	ELR¼W C4
R58	Resistor	56K ohm	ELR¼W C3
R59	Resistor	10K ohm	ELR¼W C3
R60	Resistor	150K ohm	ELR¼W C3
R61	Resistor	27K ohm	ELR¼W C3
R62	Resistor	15K ohm	ELR¼W C3
R63	Resistor	10K ohm	ELR¼W C3
R64	Resistor	4.7K ohm	ELR¼W D2
R65	Resistor	1K ohm	ELR¼W D2
R65	Resistor	27K ohm	ELR¼W D2
R67	Resistor	4.7K ohm	ELR¼W D2
R68	Resistor	1K ohm	ELR¼W D2
R69	Resistor	27K ohm	ELR¼W D2
R70	Resistor	2.7K ohm	ELR¼W D2
R71	Thermistor	33D28	D2
R72	Trimmer	100 ohm	FR-10 E1
R73	Trimmer	30K ohm	FR-10 F1
R74	Trimmer	3K ohm	FR-10 E4
R75	Resistor	220 ohm	ELR¼W E4
R76	—	—	—
R77	Resistor	56K ohm	ELR¼W D5
R78	Resistor	100 ohm	ELR¼W D5
R79	Resistor	2.2K ohm	ELR¼W D5
R80	Resistor	10K ohm	ELR¼W E5
R81	Resistor	4.7 ohm	R25J F4
R82	Resistor	100 ohm	ELR¼W F4
R83	Resistor	15 ohm	ELR¼W F5
R84	Resistor	22 ohm	ELR¼W E6
R85	Resistor	4.7K ohm	ELR¼W E5
R86	Resistor	470 ohm	ELR¼W E6
R87	Resistor	47 ohm	ELR¼W F5
R88	Resistor	470 ohm	R25 E5
R89	Trimmer	100K ohm	FR-10 C5
R90	Resistor	4.7K ohm	ELR¼W C5
R91	Resistor	4.7K ohm	ELR¼W C5
R92	Resistor	220 ohm	ELR¼W D5
R93	Resistor	47 ohm	ELR¼W D5
R94	Resistor	100K ohm	ELR¼W D5
R95	Resistor	100K ohm	ELR¼W D6
R96	Resistor	1K ohm	ELR¼W D5
R97	Resistor	4.7K ohm	ELR¼W A5
R98	Resistor	10K ohm	ELR¼W A5
R99	Resistor	330 ohm	ELR¼W A5
R100	—	—	—
R101	Resistor	1.2K ohm	ELR¼W A5
R102	Resistor	4.7K ohm	ELR¼W A4
R103	Resistor	22K ohm	ELR¼W A5
R104	Resistor	12K ohm	ELR¼W A4
R105	Resistor	3.3K ohm	ELR¼W A4
R106	Thermistor	23D29	A4
R107	Resistor	4.7K ohm	ELR¼W A4
R108	Resistor	22K ohm	ELR¼W A4
R109	Resistor	4.7K ohm	ELR¼W A4
R110	Resistor	220K ohm	ELR¼W A4
R111	Resistor	15K ohm	ELR¼W A4
R112	Trimmer	1K ohm	FR-10 A3
R113	Thermistor	33D28	A3

MAIN UNIT			
Ref. No.	Description	Part No.	Board Location
R114	Resistor	100 ohm	ELR¼W A3
R115	Resistor	10 ohm	ELR¼W A3
R116	Resistor	22K ohm	ELR¼W A3
R117	Resistor	5.6K ohm	ELR¼W A3
R116	Resistor	5.6K ohm	ELR¼W A3
R119	Resistor	5.6K ohm	ELR¼W A3
R120	Resistor	1K ohm	ELR¼W A2
R121	Resistor	47K ohm	ELR¼W A3
R122	Resistor	470 ohm	ELR¼W A2
R123	Resistor	4.7K ohm	ELR¼W A2
R124	Trimmer	3K ohm	FR-10 A2
R125	Resistor	2.2K ohm	ELR¼W A2
R126	Resistor	22K ohm	ELR¼W A2
R127	Resistor	1K ohm	ELR¼W A2
R128	Resistor	22 ohm	ELR¼W A2
R129	—	—	—
R130	Resistor	2.2K ohm	ELR¼W A2
R131	Resistor	100 ohm	ELR¼W B1
R132	Trimmer	10K ohm	FR-10 A1
R133	Resistor	3.3K ohm	ELR¼W A1
R134	Resistor	4.7K ohm	ELR¼W A1
R135	Resistor	2.2K ohm	ELR¼W A1
R136	Resistor	22 ohm	ELR¼W A1
R137	Resistor	4.7K ohm	ELR¼W A1
R138	Resistor	2.2K ohm	ELR¼W A1
R139	Resistor	4.7K ohm	ELR¼W A1
R140	Resistor	2.2K ohm	ELR¼W A1
R141	Resistor	15 ohm	ELR¼W B1
R142	Resistor	560 ohm	ELR¼W B1
R143	Resistor	560 ohm	ELR¼W B1
R144	Resistor	15 ohm	ELR¼W B1
R145	Resistor	4.7K ohm	ELR¼W B1
R146	Resistor	15 ohm	ELR¼W B1
R147	Resistor	560 ohm	ELR¼W B1
R148	Resistor	2.2K ohm	ELR¼W A2
R149	Trimmer	1K ohm	FR-10 A2
R150	Resistor	470 ohm	ELR¼W D3
R151	Resistor	120K ohm	ELR¼W D3
R152	Resistor	150K ohm	ELR¼W D3
R153	Resistor	47K ohm	ELR¼W D3
R154	Resistor	4.7K ohm	ELR¼W C4
R155	Resistor	47 ohm	ELR¼W B6
R156	—	—	—
R157	—	—	—
R158	Resistor	47 ohm	ELR¼W A5
R159	Resistor	2.2K ohm	R25 A5
C1	Ceramic	0.01µF	50V D1
C2	Ceramic	0.001µF	50V E1
C3	Ceramic	0.001µF	50V E1
C4	Dip Mica	10pF	50V E1
C5	Ceramic	0.01µF	50V D2
C6	Ceramic	0.001µF	50V E1
C7	Ceramic	0.01µF	50V D2
C8	Ceramic	0.01µF	50V E1
C9	Ceramic	0.01µF	50V E2
C10	Ceramic	0.01µF	50V D4
C11	Ceramic	0.01µF	50V D4
C12	Ceramic	0.01µF	50V D5
C13	Mylar	0.039µF	50V B4
C14	Ceramic	2pF	50V C4
C15	Mylar	0.039µF	50V B5

MAIN UNIT				
Ref. No.	Description	Part No.	Board Location	
C16	Mylar	0.01 μ F	50V	B4
C17	Mylar	0.039 μ F	50V	B4
C18	Mylar	0.039 μ F	50V	B4
C19	Mylar	0.039 μ F	50V	B3
C20	Mylar	0.01 μ F	50V	B3
C21	Electrolytic	10 μ F	16V	B3
C22	Mylar	0.01 μ F	50V	B3
C23	Mylar	0.01 μ F	50V	B3
C24	Mylar	0.056 μ F	50V	B3
C25	Mylar	0.056 μ F	50V	B2
C26	Mylar	0.01 μ F	50V	B3
C27	Mylar	0.01 μ F	50V	B3
C28	Mylar	0.01 μ F	50V	B3
C29	Mylar	0.001 μ F	50V	B2
C30	Electrolytic	10 μ F	16V	B2
C31	Mylar	0.056 μ F	50V	B2
C32	Mylar	0.056 μ F	50V	B2
C33	Mylar	0.056 μ F	50V	B2
C34	Mylar	0.056 μ F	50V	B2
C35	Mylar	0.002 μ F	50V	C2
C36	Mylar	0.056 μ F	50V	B2
C37	Electrolytic	4.7 μ F	25V	C2
C38	Mylar	0.01 μ F	50V	C2
C39	Mylar	0.001 μ F	50V	C2
C40	Mylar	0.056 μ F	50V	C2
C41	Electrolytic	0.47 μ F	50V	C2
C42	Mylar	0.02 μ F	50V	C2
C43	Electrolytic	10 μ F	16V	C3
C44	Electrolytic	0.47 μ F	50V	C3
C45	Ceramic	0.01 μ F	50V	C4
C46	Ceramic	30pF	50V	C4
C47	Styrene	100pF	50V	C4
C48	Styrene	200pF	50V	C4
C49	Electrolytic	10 μ F	16V	D2
C50	Mylar	0.01 μ F	50V	B3
C51	Ceramic	100pF	50V	C4
C52	Mylar	0.01 μ F	50V	C3
C53	Electrolytic	0.47 μ F	50V	C4
C54	Mylar	0.003 μ F	50V	C3
C55	Electrolytic	3.3 μ F	35V	C3
C56	Electrolytic	3.3 μ F	35V	C3
C57	Electrolytic	3.3 μ F	25V	D3
C58	Electrolytic	10 μ F	16V	C2
C59	Mylar	0.039 μ F	50V	D2
C60	Electrolytic	4.7 μ F	25V	D2
C61	Mylar	0.002 μ F	50V	D2
C62	Mylar	0.039 μ F	50V	C2
C63	Mylar	0.1 μ F	50V	C2
C64	Mylar	0.01 μ F	50V	D2
C65	—	—	—	—
C66	Ceramic	10pF	50V	F1
C67	Electrolytic	0.47 μ F	50V	F1
C68	—	—	—	—
C69	Ceramic	2pF	50V	F1
C70	Ceramic	0.01 μ F	50V	F1
C71	Ceramic	20pF	50V	F1
C72	Ceramic	3pF	50V	F2
C73	Ceramic	40pF	50V	F2
C74	Ceramic	6pF	50V	F2
C75	Ceramic	15pF	50V	F2
C76	Ceramic	0.001 μ F	50V	E4
C77	Ceramic	0.01 μ F	50V	E4

MAIN UNIT				
Ref. No.	Description	Part No.	Board Location	
C78	Ceramic	0.001 μ F	50V	E5
C79	Mylar	0.1 μ F	50V	E4
C80	Ceramic	0.01 μ F	50V	E5
C81	Trimmer	70pF type-C		E2
C82	Ceramic	40pF	50V	F2
C83	Electrolytic	220 μ F	16V	E4
C84	Ceramic	0.01 μ F	50V	E3
C85	Trimmer	70pF type-C		F3
C86	Ceramic	15pF	50V	F3
C87	Ceramic	0.001 μ F	50V	E3
C88	Ceramic	10pF	50V	F5
C89	Ceramic	15pF	50V	E4
C90	Ceramic	68pF	50V	F4
C91	Trimmer	50pF CVE50-11		F4
C92	Trimmer	20pF CVC20-11		E5
C93	Ceramic	0.001 μ F	50V	F5
C94	Ceramic	0.01 μ F	50V	F5
C95	Electrolytic	4.7 μ F	25V	E6
C96	Ceramic	0.01 μ F	50V	E6
C97	Trimmer	10pF CVO5C-12		E5
C98	Ceramic	5pF	50V	E5
C99	Trimmer	10pF CVO5C-12		E5
C100	Ceramic	15pF	50V	F5
C101	Ceramic	0.001 μ F	50V	E5
C102	Ceramic	0.01 μ F	50V	E6
C103	Mylar	0.1 μ F	50V	D4
C104	Electrolytic	220 μ F	10V	D4
C105	Mylar	0.003 μ F	50V	D3
C106	Electrolytic	47 μ F	16V	D3
C107	Electrolytic	4.7 μ F	25V	D3
C108	Electrolytic	4.7 μ F	25V	C3
C109	Electrolytic	47 μ F	16V	D3
C110	Electrolytic	33 μ F	10V	C4
C111	Electrolytic	0.47 μ F	50V	D3
C112	Ceramic	500pF	50V	D3
C113	Ceramic	0.001 μ F	50V	C5
C114	—	—	—	—
C115	Ceramic	0.01 μ F	50V	F5
C116	Electrolytic	10 μ F	16V	F6
C117	Ceramic	7pF	50V	E5
C118	—	—	—	—
C119	Ceramic	0.5pF	50V	D6
C120	Ceramic	6pF	50V	D5
C121	Ceramic	0.01 μ F	50V	D5
C122	Ceramic	0.01 μ F	50V	E5
C123	Ceramic	0.001 μ F	50V	D5
C124	Ceramic	0.01 μ F	50V	D5
C125	Ceramic	0.01 μ F	50V	D5
C126	Ceramic	0.01 μ F	50V	D5
C127	Ceramic	0.01 μ F	50V	D5
C128	Ceramic	4pF	50V	C5
C129	Ceramic	0.35pF	50V	C5
C130	Ceramic	0.35pF	50V	C5
C131	Ceramic	0.35pF	50V	C5
C132	Ceramic	0.35pF	50V	B5
C133	Ceramic	6pF	50V	C5
C134	Ceramic	6pF	50V	C5
C135	Ceramic	6pF	50V	B5
C136	Ceramic	6pF	50V	B5
C137	Ceramic	7pF	50V	B5
C138	Ceramic	0.01 μ F	50V	B5
C139	Ceramic	6pF	50V	B5

MAIN UNIT			
Ref. No.	Description	Part No.	Board Location
C140	Ceramic	0.01 μ F	50V B5
C141	Ceramic	0.01 μ F	50V A5
C142	Ceramic	0.01 μ F	50V A5
C143	Ceramic	0.01 μ F	50V A5
C144	Ceramic	100pF	50V A5
C145	Ceramic	200pF	50V A5
C146	Ceramic	10pF	50V A4
C147	Ceramic	0.01 μ F	50V A4
C148	Mylar	0.0047 μ F	50V A4
C149	Mylar	0.1 μ F	50V A4
C150	Electrolytic	220 μ F	10V A3
C151	Mylar	0.003 μ F	50V A3
C152	Mylar	0.01 μ F	50V A3
C153	Mylar	0.01 μ F	50V A3
C154	Ceramic	100pF	50V A3
C155	Electrolytic	100 μ F	10V A2
C156	Electrolytic	4.7 μ F	25V A3
C157	Mylar	0.0047 μ F	50V A2
C158	Electrolytic	33 μ F	10V A2
C159	Mylar	0.01 μ F	50V A2
C160	Electrolytic	100 μ F	10V A1
C161	Electrolytic	4.7 μ F	25V A1
C162	Electrolytic	47 μ F	10V A1
C163	Mylar	0.001 μ F	50V A1
C164	Electrolytic	4.7 μ F	25V A1
C165	Mylar	0.001 μ F	50V A1
C166	Mylar	0.001 μ F	50V A1
C167	Electrolytic	47 μ F	10V B1
C168	Ceramic	0.01 μ F	50V C2
C169	Ceramic	0.01 μ F	50V B1
C170	Electrolytic	10 μ F	16V B1
C171	Electrolytic	470 μ F	16V D1
C172	Ceramic	0.01 μ F	50V B2
C173	Ceramic	0.04 μ F	50V D1
C174	Ceramic	0.001 μ F	50V E1
C175	Ceramic	0.01 μ F	50V E5
C176	Ceramic	0.001 μ F	50V E1
C177	Ceramic	0.01 μ F	50V B5
C178	Electrolytic	10 μ F	16V B5
L1	Coil	LS-4	E1
L2	Coil	LB-1-3A	E2
L3	Coil	LB-1-1	E3
L4	Coil	LB-1-1	E3
L5	Coil	LB-1-1	E4
L6	Coil	LB-1-3A	E4
L7	Coil	LS-81	D5
L8	Coil	LS-79	C4
L9	Coil	LS-20	B4
L10	Choke Coil	102 1mH	B2
L11	Coil	LS-16	C2
L12	Choke Coil	102 1mH	D2
L13	-	-	-
L14	Coil	LR-13	F1
L15	Coil	LA-71	F2
L16	Coil	LA-71	F2
L17	Coil	LW-5	F2
L18	-	-	-
L19	Coil	LA-74	F2
L20	Coil	LA-73	E3
L21	Coil	LW-1	F4
L22	-	-	-

L23	Coil	LA-31	F4
L24	Coil	LA-96	F5
L25	Coil	LW-1	F5
L26	Coil	LA-71	F5
L27	Coil	LA-96	E5
L28	Coil	LA-71	E5
L29	Coil	LS-73	D6
L30	Coil	LS-73	D5
L31	Coil	LS-73	C6
L32	Coil	LS-73	C6
L33	Coil	LS-73	C6
L34	Coil	LS-73	C5
L35	Coil	LS-73	B6
L36	Coil	LS-73	B5
L37	Choke Coil	101 100 μ H	B5
L38	Choke Coil	101 100 μ H	A5
L39	Coil	LS-66A	A5
L40	Choke Coil	100 10 μ H	A4
L41	Coil	LS-80	A4
L42	Choke Trans	TC-1B	C1
L43	Coil	LA-17	D4
L44	Choke Coil	101 100 μ H	E5
FL1	Xtal Filter	10M20A	C4
FL2	Ceramic Filter	CFU-455E	B4
FL3	Ceramic Filter	CFU-455E	B4
DISC-1	Ceramic Discriminator	455D	C2
X1	X'tal	HC-18/u 10.245MHz	C4
X2	X'tal	HC-18/u 10.700MHz	A4
CP1	Check Point		C2
CP2	Check Point		C4
CP3	Check Point		A5
PLL UNIT			
Ref. No.	Description	Part No.	Board Location
IC1	IC	TC5080P	E2
IC2	IC	TC5081P	E3
IC3	IC	TC5082P	A1
IC4	IC	TA7045M	C3
IC5	IC	μ PC577H	D2
IC6	IC	μ PD4013C	E3
IC7	IC	μ PD4049C	C2
IC8	IC	μ PD4030C	D2
IC9	IC	μ PD4011C	C1
IC10	IC	μ PD4011C	D1
Q1	Transistor	2SC945-Q	E1
Q2	Transistor	2SC945	E1
Q3	Transistor	2SC945	B3
Q4	Transistor	JA1050	E2
Q5	FET	3SK40-K	B3
Q6	Transistor	2SC945-Q	D3
Q7	Transistor	2SC748-BN	B1
Q8	FET	2SK19-GR	A3
D1	Diode	1SS53	E1
D2	Diode	1SS53	B3
D3	Vari cap	ITT410	A2
D4	Diode	1SS53	B3

MAIN UNIT				
Ref. No.	Description	Part No.	Board Location	
D5	Diode	1SS53	E1	
R1	Resistor	680 ohm	R25	A1
R2	Resistor	1K ohm	ELR25	E1
R3	Resistor	22K ohm	ELR25	E1
R4	Resistor	2.2K ohm	ELR25	C3
R5	Resistor	10K ohm	R25	E2
R6	Resistor	10K ohm	ELR25	F2
R7	Resistor	10K ohm	R25	F1
R8	Resistor	470 ohm	ELR25	E3
R9	Resistor	4.7K ohm	ELR25	F3
R10	Resistor	4.7K ohm	ELR25	F3
R11	Resistor	47K ohm	R25	A3
R12	Resistor	22K ohm	ELR25	B3
R13	Resistor	100K ohm	R25	A3
R14	Resistor	100K ohm	R25	A2
R15	Resistor	100K ohm	ELR25	B2
R16	Resistor	100 ohm	ELR25	A2
R17	Resistor	150K ohm	ELR25	B3
R18	Resistor	100K ohm	ELR25	B3
R19	Resistor	47 ohm	ELR25	B3
R20	Resistor	47 ohm	ELR25	B2
R21	Resistor	220 ohm	ELR25	C3
R22	Resistor	22K ohm	ELR25	C2
R23	Resistor	10K ohm	ELR25	C3
R24	Resistor	220 ohm	ELR25	C3
R25	Resistor	15 ohm	ELR25	D3
R26	Resistor	470 ohm	ELR25	C3
R27	Resistor	47 ohm	ELR25	D3
R28	Resistor	470 ohm	ELR25	D3
R29	Resistor	150K ohm	R25	D3
R30	Resistor	330 ohm	ELR25	D3
R31	Resistor	1K ohm	ELR25	B1
R32	Resistor	1K ohm	ELR25	B1
R33	Resistor	22K ohm	ELR25	B1
R34	Resistor	4.7K ohm	ELR25	B1
R35	Resistor	680 ohm	ELR25	B1
R36	Resistor	10K ohm	R25	C2
R37	Resistor Array	10K ohm	X8	C1
R38	Resistor	10K ohm	R25	E3
C1	Dip Mica	39pF	50V	A1
C2	Trimmer	CVO5 18pF		A2
C3	Dip Mica	51pF	50V	A2
C4	Ceramic	0.01 μ F	50V	A1
C5	—	—		
C6	Electrolytic	10 F	50V	E3
C7	Electrolytic	—		
C8	Electrolytic	10 μ F	16V	E2
C9	Electrolytic	100 μ F	10V	B3
C10	Ceramic	0.0047 μ F	50V	A3
C11	Electrolytic	47 μ F	10V	A2
C12	Ceramic	0.01 μ F	50V	B2
C13	Ceramic	8pF	50V	B3
C14	Ceramic	0.001 μ F	50V	B2
C15	Ceramic	0.01 μ F	50V	B2
C16	Ceramic	0.01 μ F	50V	B2
C17	Ceramic	0.01 μ F	50V	C2
C18	Ceramic	0.001 μ F	50V	C3
C19	Ceramic	0.01 μ F	50V	E1
C20	Ceramic	0.01 μ F	50V	E1
C21	Ceramic	0.01 μ F	50V	C3

C22	Ceramic	0.04 μ F	50V	C3
C23	Ceramic	0.01 μ F	50V	D3
C24	Electrolytic	33 μ F	10V	B3
C25	Ceramic	40pF	50V	D3
C26	Ceramic	40pF	50V	D2
C27	Ceramic	0.01 μ F	50V	D3
C28	Mylar	0.056 μ F	50V	D3
C29	Ceramic	0.01 μ F	50V	D3
C30	Ceramic	0.01 μ F	50V	D3
C31	Ceramic	0.001 μ F	50V	D3
C32	Ceramic	0.04 μ F	50V	D3
C33	Ceramic	2pF	50V	B2
C34	Ceramic	8pF	50V	B1
C35	Ceramic	0.01 μ F	50V	B1
C36	Ceramic	25pF	50V	B1
C37	Ceramic	50pF	50V	B1
C38	Trimmer	CVO5 18pF		B2
C39	Ceramic NPO	10pF	50V	B1
C40	Ceramic NPO	10pF	50V	A2
C41	Super Dip Mica	150pF	50V	A2
C42	Ceramic	0.01 μ F	50V	A2
C43	Ceramic NPO	30pF	50V	A3
C44	Ceramic NPO	40pF	50V	B3
C45	Ceramic NPO	40pF	50V	B2
C46	Ceramic NPO	40pF	50V	B2
C47	—	—		—
C48	Ceramic	30pF	50V	D2
C49	Ceramic	15pF	50V	A1
C50	Ceramic	200pF	50V	E3
C51	Ceramic	39pF	50V	C3
C52	Ceramic	39pF	50V	C3
L1	Coil	LS-3A		C2
L2	Choke Coil	100 10 μ H		E1
L3	Coil	LR-11A or B		C2
L4	Choke Coil	100 10 μ H		D3
L5	Coil	LS-3A		B2
L6	Coil	LW-10		B1
L7	Coil	LS-92		A3
L8	Coil	LW-5		A3
L9	Choke Coil	100 10 μ H		C3
X1	X'tal	HC-18/u 6.4MHz		A1
X2	X'tal	HC-18/u 43.9MHz		B2
MAXTRIX UNIT				
Ref. No.	Description	Part No.	Board Location	
J1	Connector	3022-10A	C1	
CP	Check Point		A1	
D	Diodes	1SS53s		
J1	Connector	3022-10A		

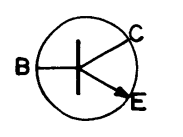
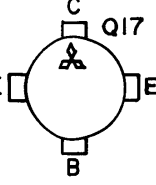
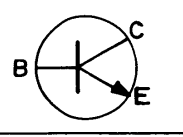
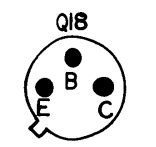
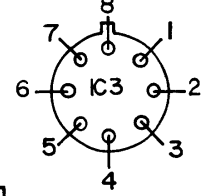
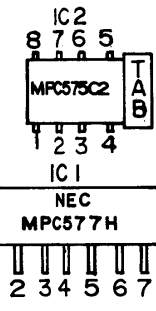
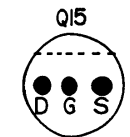
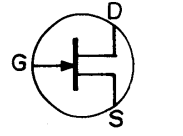
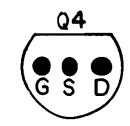
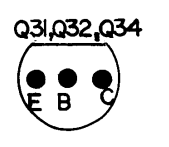
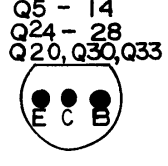
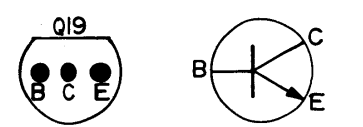
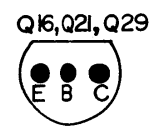
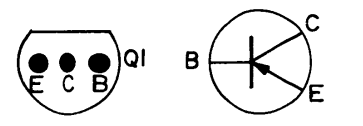
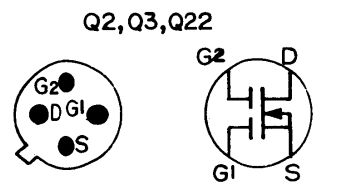
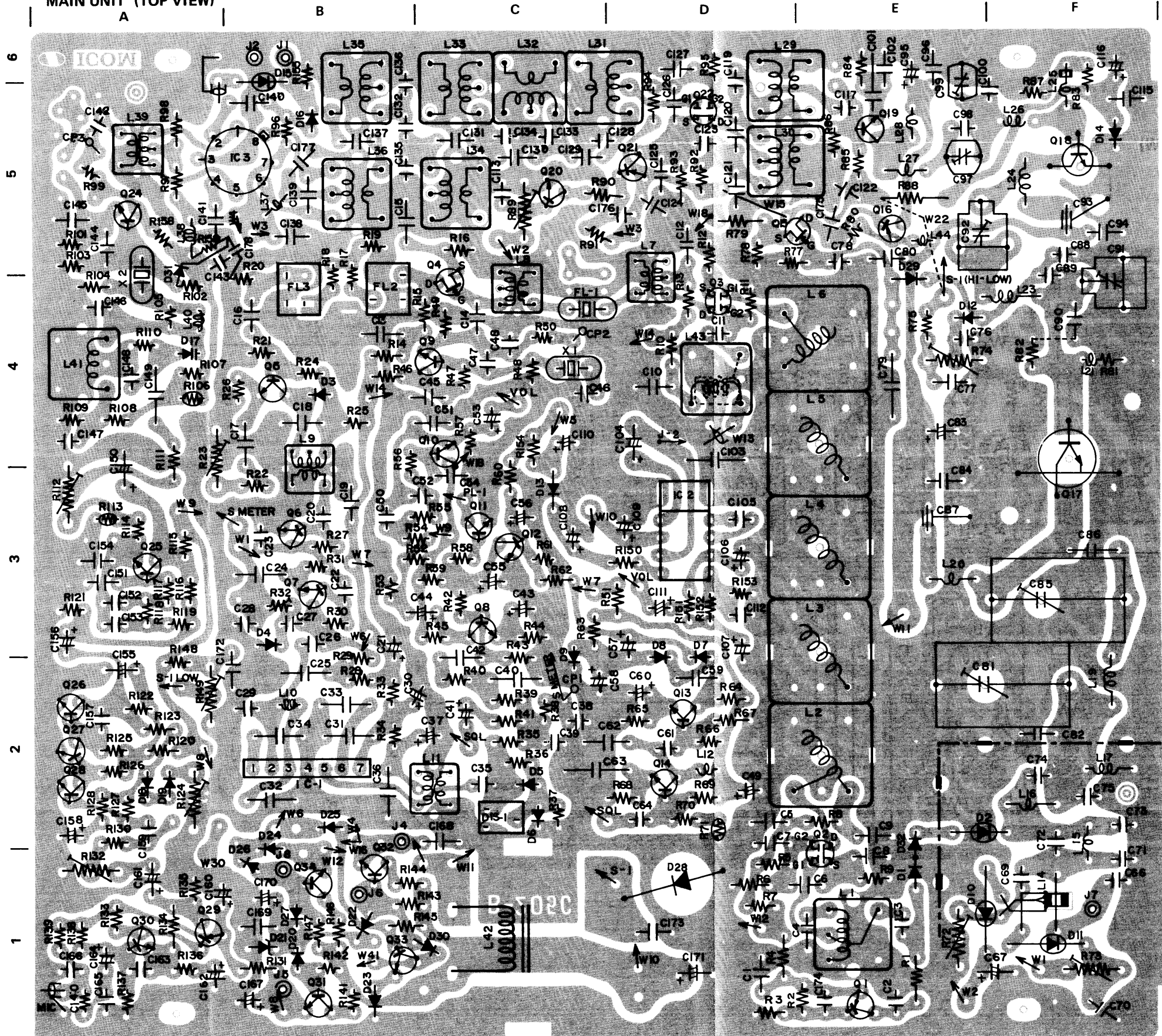

PLL UNIT (TOP VIEW)

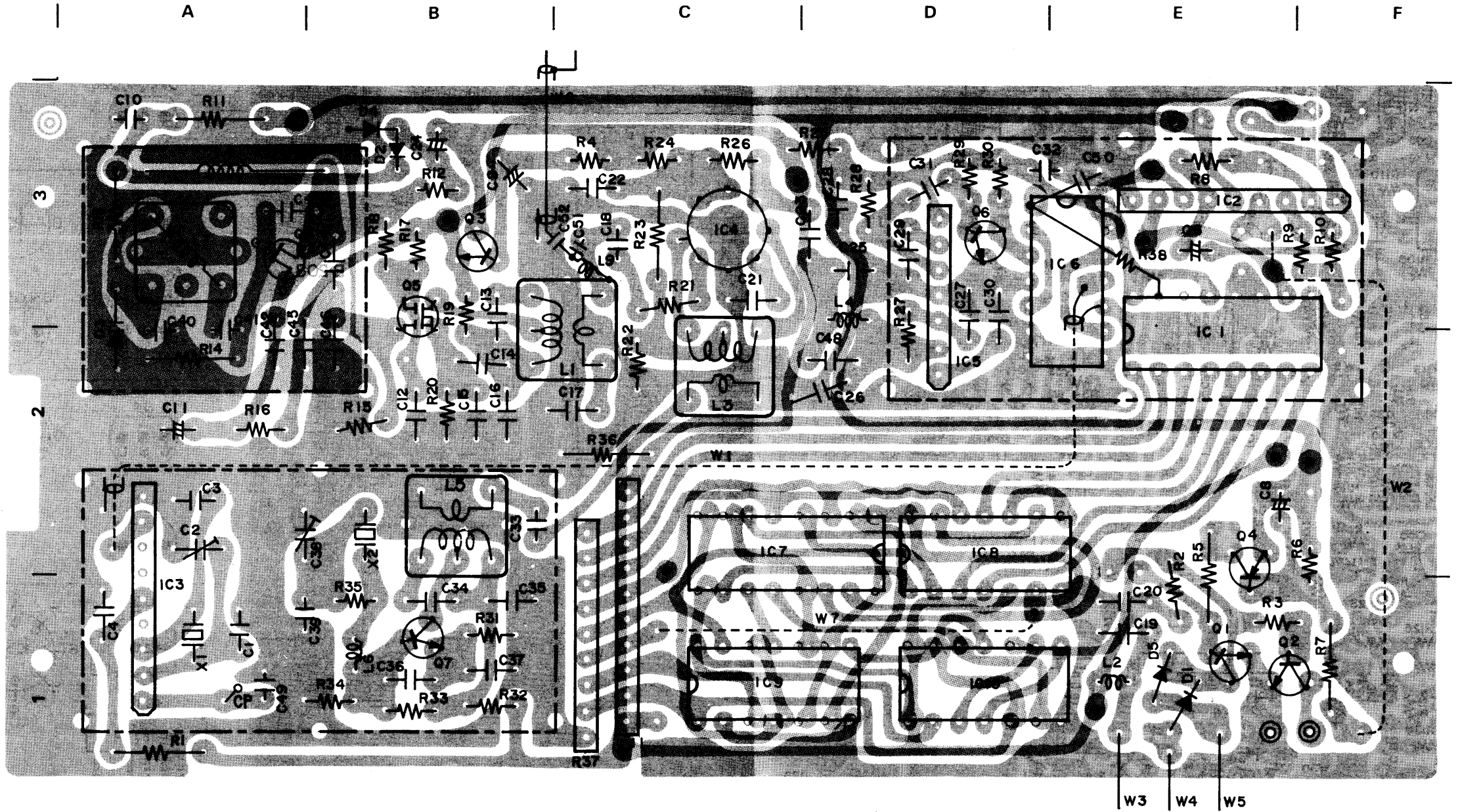

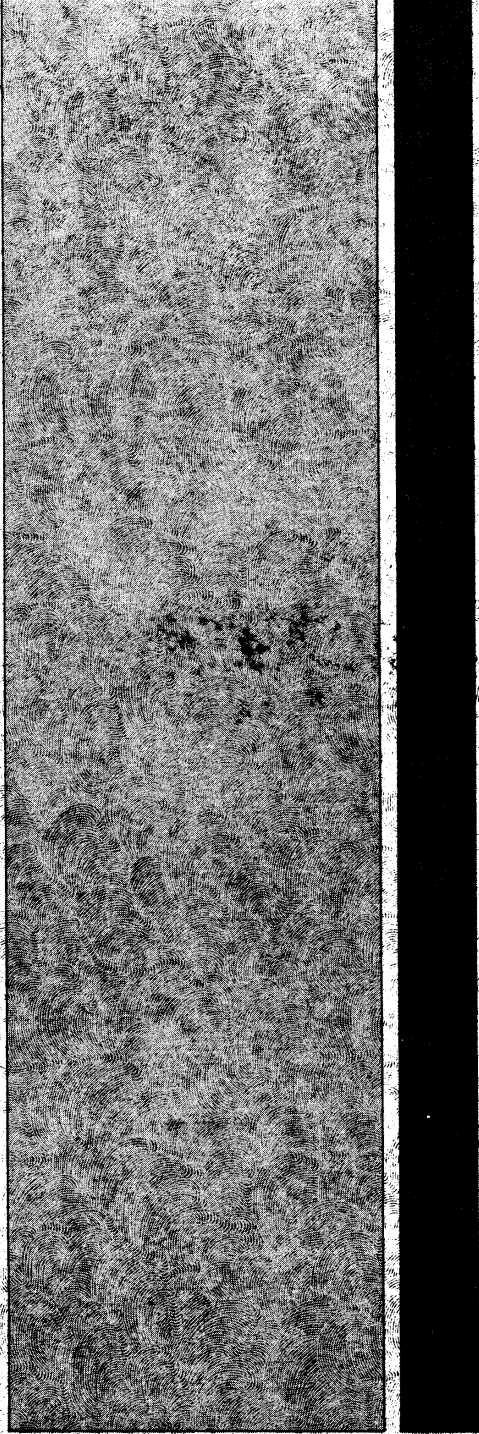

ICOM INCORPORATED

**1-6-19, KAMI KURATSUKURI, HIRANO-KU,
OSAKA, JAPAN**

