

IC-251^{A/E}

144MHz ALL MODE TRANSCEIVER

INSTRUCTION MANUAL

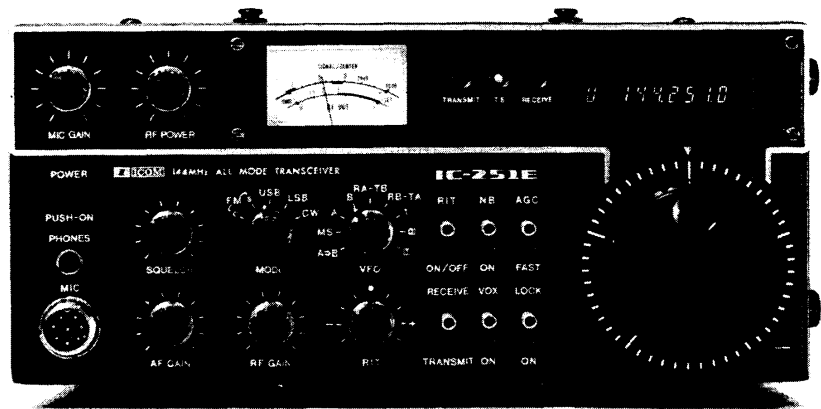

TABLE OF CONTENTS

I. SPECIFICATIONS	1
II. DESCRIPTION	3
III. INSTALLATION	4
IV. CONTROL FUNCTIONS.....	7
V. OPERATION	15
VI. INSIDE VIEW	28
VII. TROUBLE SHOOTING.....	30
VIII. VOLTAGE CHARTS.....	33
IX. BLOCK DIAGRAM	38
X. OPTIONS	39
XII. P.C. BOARD LAYOUT.....	SEPARATE
XIII. SCHEMATIC DIAGRAM.....	SEPARATE

SECTION I SPECIFICATIONS

GENERAL

Numbers of semi-conductors	: Transistor	99
	FET	12
	IC	36 (IC-251A : 35)
	Diode	133 (IC-251A : 132)
Frequency coverage	: 144.0000 ~ 145.9999MHz	
	(IC-251A : 143.8000 ~ 148.1999MHz)	
Frequency resolution	: SSB 100Hz steps FM 5KHz steps	
	1KHz steps with TS button depressed	
Frequency Control	: Microcomputer based 100Hz step Digital PLL synthesizer.	
	Independent Transmit-Receive Frequency Capability.	
Frequency Readout	: 7 digit Luminescent display 100Hz readout.	
Frequency stability	: Within ± 1.5 KHz	
Memory channels	: 3 channels, any inband frequency programmable	
Usable conditions	: Temperature: $-10^{\circ}\text{C} \sim 60^{\circ}\text{C}$ ($14^{\circ}\text{F} \sim 140^{\circ}\text{F}$)	
	Operationable time: Continuous	
Antenna impedance	: 50 ohms unbalanced	
Power supply requirement	: 13.8V DC $\pm 15\%$ (negative ground) 3A Max. or 117V/240V	
	AC $\pm 10\%$	
Current drain (at 13.8V DC)	: Transmitting	
	SSB (PEP 10W)	Approx. 2.3A
	CW, FM (10W)	Approx. 2.3A
	FM (1W)	Approx. 1.0A
	Receiving	
	At max, audio output	Approx. 0.6A
	Squelched	Approx. 0.4A
Dimensions	: 111mm (H) x 241mm (W) x 264mm (D)	
Weight	: Approx. 5.0 Kgs	

TRANSMITTER

Output power	: SSB	10W (PEP)
	CW	10W
	FM	1 ~ 10W (Adjustable)
Emission mode	: SSB (A3J, USB/LSB), CW (A1), FM (F3)	
Modulation system	: SSB	Balanced modulation
	FM	Variable reactance frequency modulation
Max. frequency deviation	: ± 5 KHz	
Spurious emission	: More than 60dB below peak power output	
Carrier Suppression	: More than 40dB below peak power output	
Unwanted Sideband	: More than 40dB down at 1000Hz AF input	
Microphone	: 1.3K ohm dynamic microphone with built-in preamplifier	
	and push-to-talk switch.	
Operating mode	: Simplex, Duplex	
	(Any inband frequency separation programmable)	
Tone Burst	: 1750Hz ± 0.1 Hz (IC-251A : Not installed)	

Downloaded by

Amateur Radio Directory

RECEIVER

Receiving system	: SSB, CW	Single conversion superheterodyne
	FM	Double conversion superheterodyne
Receiving Mode	: SSB (A3J, USB/LSB), CW (A1), FM (F3)	
Intermediate Frequency	: SSB, CW	10.7MHz
	FM	10.7MHz, 455KHz
Sensitivity	: SSB, CW	Less than 0.5 microvolts for 10dB S+N/N
	FM	More than 30dB S+N+D/N+D at 1 microvolt
		Less than 0.6 microvolts for 20dB Noise quieting
Squelch sensitivity	: SSB, CW	Less than 0.6 microvolts
	FM	Less than 0.4 microvolts
Spurious response rejection ratio	: More than	60dB
Selectivity	: SSB, CW	More than ± 1.2 KHz at -6 dB point
		Less than ± 2.4 KHz at -60 dB point
	FM	More than ± 7.5 KHz at -6 dB point
		Less than ± 15 KHz at -60 dB point
Audio output power	: More than	1.5W
Audio output impedance	: 8 ohms	



Downloaded by

 Amateur Radio Directory

SECTION II DESCRIPTION

144MHz ALL-MODE TRANSCEIVER INCORPORATING A MICROCOMPUTER

CPU control with ICOM's original programs provides various operating capabilities. No-backlash dial controlled by ICOM's unique photo-chopper circuit. Band-edge detector and Endless System provides out-of-band protection. No variable capacitors or dial gear, giving problem-free use. The IC-251A/E provides FM, USB, LSB, CW coverage in the 144~146MHz (IC-251A:143.8~148.2MHz) frequency range. Thus the IC-251A/E can be used for mobile, DX, local calls, and satellite work.

MULTI-PURPOSE SCANNING

Memory Scan allows you to monitor three different memory channels. Program Scan provides scanning between two programmed frequencies. Adjustable scanning speed. Auto-stop stops scanning when a signal is received, in all modes.

DUAL VFO'S

Two separate VFO's can be used either independently or together for simplex operation, and any desired frequency split in duplex operation.

CONTINUOUS TUNING SYSTEM

ICOM's new continuous tuning system features a luminescent display that follows the tuning knob movement and provides an extremely accurate readout. Frequencies are displayed in 7 digits representing 100MHz to 100Hz digits.

Automatic recycling restarts tuning at the top of the band, ie., the high edge when the dial goes below the low edge. Recycling changes the high edge to the low edge as well. Quick tuning in 1KHz steps is available, and fine tuning in 100Hz steps in the SSB and CW modes, and 5KHz steps and 1KHz steps in the FM mode, is provided for trouble free QSO.

EASIER OPERATION AND LIGHTER WEIGHT

The most compact, lightest weight all-mode 144MHz transceiver. First to use a pulse power supply in communication equipment, for lighter weight. 50mm-diameter large tuning control knob for smooth and easy tuning. Trouble-free controlling knobs for both receiving and transmitting. LED indicator for transmit and receive modes.

MOST SUITABLE FOR BOTH FIXED AND PORTABLE STATIONS

Built-in 117V/240V AC and DC power supplies. Convenient Dial Lock switch for mobile operation. Easy-carry handle. Effective Noise Blanker to reduce outcoming pulse noise. IC-SM5 high quality stand microphone is suitable for fixed station operation. Powerful audio output, 1.5 watts at 8 ohm, for easy listening even in noisy surroundings.

OUTSTANDING PERFORMANCE

The RF amplifier and first mixer circuits using MOS FET's, and other circuits provide excellent Cross Modulation and Two-Signal Selectivity characteristics. The IC-251A/E has excellent sensitivity demanded especially for mobile operation, high stability, and with Crystal Filters having high shape factors, exceptional selectivity.

The transmitter uses a balanced mixer in a single conversion system, a band-pass filter and a high-performance low-pass filter. This system provides distortion-free signals with a minimum spurious radiation level.

SECTION III INSTALLATION

UNPACKING

Carefully remove your transceiver from the packing carton and examine it for signs of shipping damage. Should any be apparent, notify the delivering carrier or dealer immediately, stating the full extent of the damage. It is recommended you keep the shipping cartons. In the event storage, moving, or reshipment becomes necessary, they come in handy. Accessory hardware, cables, etc., are packed with the transceiver. Make sure you have not overlooked anything.

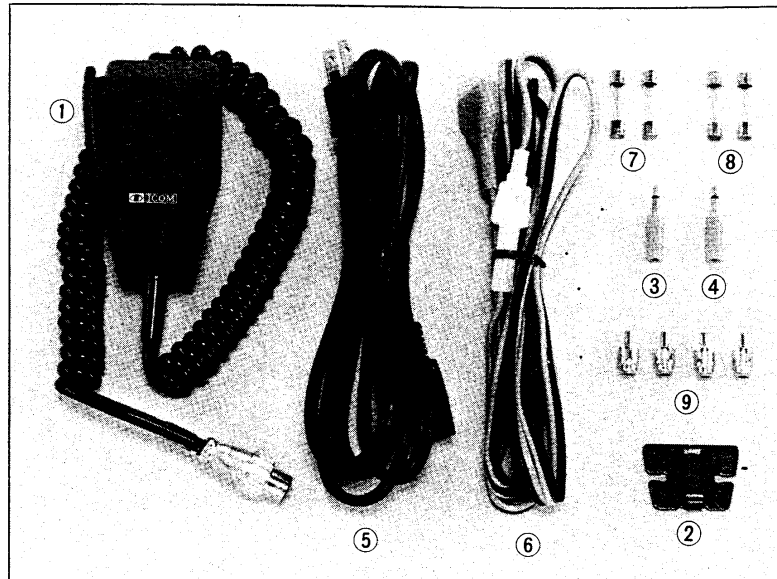

- | | | | |
|--|---|-------------------------------------|-----------------------------------|
| 1. Microphone (dynamic type) | 1 | 7. Spare Fuse (2A) for AC | 2 |
| 2. Microphone hook | 1 | 8. Spare Fuse (5A) for DC | 2 |
| 3. External Speaker Plug | 1 | 9. Pin Plug. | 4 |
| 4. Key Plug | 1 | 10. Jumper Plug. | 1 |
| 5. AC Power Cord. | 1 | | (Inserted in the DC power socket) |
| 6. DC Power Cord. | 1 | | |

RECOMMENDATIONS FOR INSTALLATION

1. Avoid placing the IC-251A/E in direct sunlight, high temperature, dusty or humid places.
2. Left sides of the unit, function as heatsinks. The temperature there will usually become relatively warm. Any equipment should be at least 1 inch (3cm) away from the unit so as to provide good ventilation. Also avoid places near outlets of heaters, air conditioners etc.
3. Place the unit so that the controls and switches can easily be handled and the frequency indication and meter can easily be read.
For mobile installation, an optional mounting bracket is available. Select the best location that can stand the weight of the unit and that does not interfere with your driving in any way.
5. Use the Ground Lug!

POWER SUPPLY

For AC operation:

The IC-251A/E has a built-in AC power supply. Connect the supplied AC power cord to the AC power socket on the rear panel of the IC-251A/E, and the opposite side plug of the power cord into any convenient AC power outlet. Be sure that the jumper plug is inserted to the DC power socket on the rear panel.

For DC operation:

If you would like to use your car battery or any other DC power supply, be sure that its output voltage is 12~15 Volts and the current capacity is at least 3 Amps. The maximum power consumption of the set during transmission runs from 2.5~3 Amps, so keep that in mind if the unit is installed in your automobile. Attention should also be paid to the condition of the battery and electrical system.

The connection of the DC power cord supplied with the IC-251A/E is done in the following way: First make sure that the power switch of the unit is in the OFF position and the T/R switch is in the receive position. Connect the cord to the DC power supply with the RED lead to the positive terminal and the BLACK lead to the negative terminal. (Reverse connection will cause the protection circuit to operate and blow the fuse.) Connect the DC plug to the socket on the rear panel of the IC-251A/E. Refer to the drawing below.

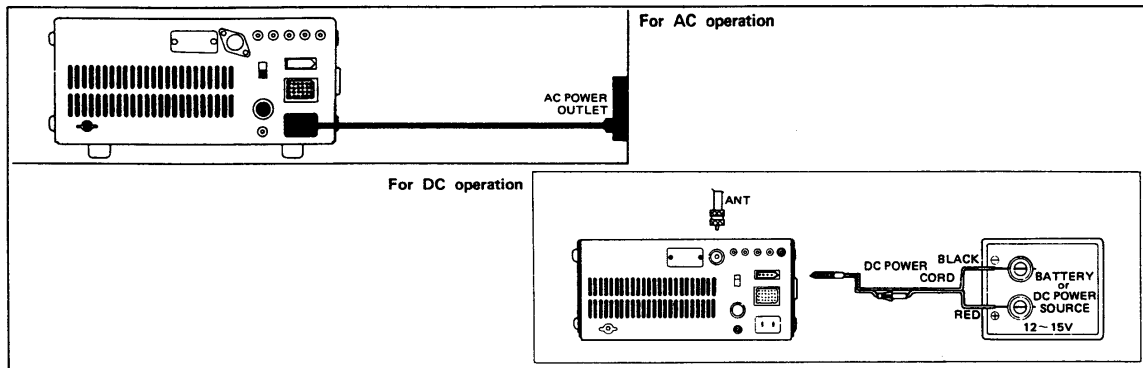

ANTENNA

The most important single item that will influence the performance of any communication system is the antenna. For that reason, a good, high-quality, gain antenna of 50 ohms impedance is recommended, fixed or mobile. In VHF as well as the low bands, every watt of ERP makes some difference. Therefore, 10 watts average output plus 3dB of gain antenna equals 20 watts ERP, presuming low VSWR of course. The few more dollars invested in a gain type antenna is well worth it. When adjusting your antenna, whether mobile or fixed, by all means follow the manufacturer's instructions. There are some pitfalls to be aware of. For example, do not attempt to adjust an antenna for lowest VSWR when using a diode VSWR meter not engineered for VHF applications. Such readings will invariably have an error of 40% or more. Instead, use an in-line watt meter similar to the Drake WV-4, Bird Model 43 or Sierra Model 164B with VHF cartridge. Further, when adjusting a mobile antenna, do so with the motor running preferably above normal idling speed. This will insure proper voltage level to the transceiver.

The RF coaxial connector on the rear chassis mates with a standard PL-259 connector. Some models may have metric threads. In any event, the RF connector will mate with almost any PL-259 connector if care is taken to seat them properly.

EXTERNAL SPEAKER

The IC-251A/E contains an internal speaker, and is also designed so that it can drive an external speaker from the external (EXT) speaker jack on the rear panel. Be sure the impedance of the external speaker is 8 ohms, and remember that with the external speaker connected, the internal speaker is disabled.

HEADPHONES

Any good headphone set, including stereo type, that has 4~16 ohms impedance can be used. With the plug inserted halfway into the PHONES jack, both the headphones and speaker will operate. This is convenient when others wish to listen in on the station, or you wish to record contacts using a tape recorder connected to the headphones jack. With a stereo headphone set inserted this way, however, the headphones will lose the sound on one side. With the plug inserted completely, only the headphones work.

MICROPHONE

A high quality dynamic microphone with built-in preamplifier is supplied with your transceiver. Merely plug it into the proper receptacle on the front panel. Should you wish to use a different microphone, make certain it has a proper preamplifier. Particular care should be exercised in wiring also, as the internal electric switching system is dependent upon it. See the schematic for the proper hook up.

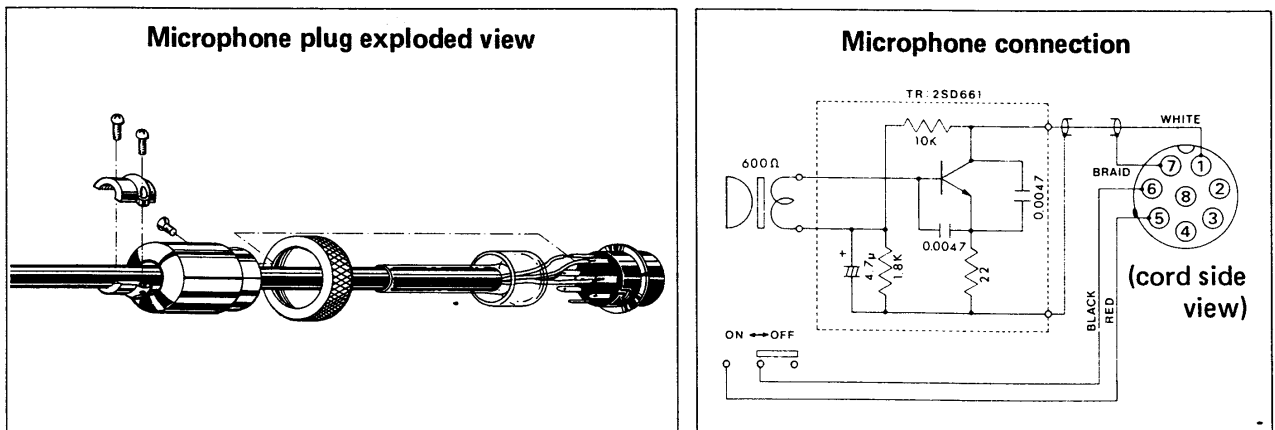

CW KEY

When operating CW, connect the Key to the Key Jack with the plug supplied. The connection of the plug is shown below.

If the terminals have polarity, be sure to make the correct connection. Note that the keyed voltage when switching with semiconductors or relays with resistors in the circuit, should be adjusted to be below 0.4 Volts!

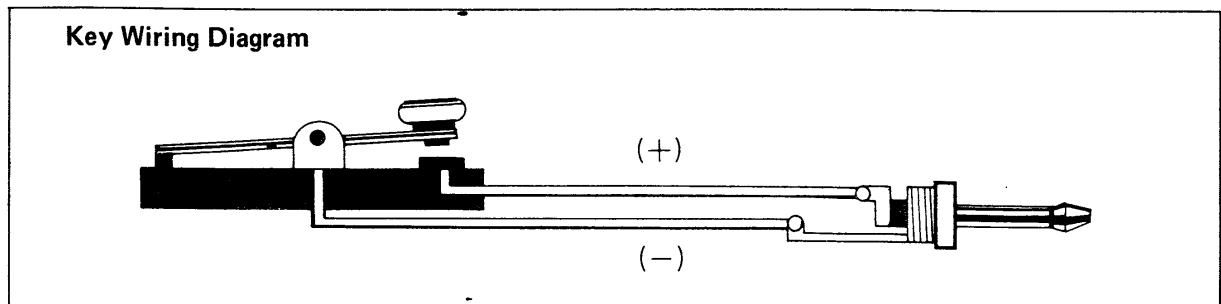

GROUND

In order to prevent electrical shocks, TVI, BCI and other problems, be sure to connect a heavy wire ground, as short as possible, from a good earth point to the ground terminal on the rear panel.

5. MIC CONNECTOR

Connect the supplied microphone or optional microphone to this jack. The IC-SM5 stand-type Electret microphone can also be used. If you wish to use a microphone other than one of these, refer to the drawing on page 6.

6. SQUELCH CONTROL

Sets the squelch threshold level. To turn OFF the squelch function, rotate this control completely counterclockwise. To set the threshold level higher, rotate the control clockwise. The squelch function operates in all modes.

7. AF GAIN CONTROL

Controls the audio output level in the receive mode. Clockwise rotation increases audio output.

8. RF GAIN CONTROL

Controls the gain of the RF and IF section in the receive mode. Clockwise rotation gives maximum gain with no signal present. As the control is rotated counterclockwise, the needle of the Multi-Function meter rises, and only signals stronger than indicated on the meter will be heard. This will eliminate noise during the absence of signals.

9. MODE SELECT SWITCH

This switch selects the mode of operation for both transmit and receive. The initial letter of each mode is displayed on the frequency display unit according to the switch setting.

FM-c	Frequency modulation, and the Multi-function Meter functions as a discriminator meter in the receive mode.
FM-s	Frequency modulation, and the Multi-function Meter functions as a signal strength meter in the receive mode.
USB	Upper Sideband
LSB	Lower Sideband
CW	Continuous Wave, for CW operation

10. VFO/MEMORY SWITCH

Selects an operating VFO from "A" VFO and "B" VFO, and selects the other various operations.

A → B	Instantly sets the frequency of "B" VFO to the same as that of "A" VFO.
MS	Sets the MEMORY SCAN function. Push the MS/MW Button to start scanning the three programmed frequencies in Memory Channels 1, [2] and [3].
A	Selects "A" VFO for both transmit and receive. Programmed Scan "A" is started by pushing the MS/MW Button while at this setting.
B	Selects "B" VFO for both transmit and receive. Programmed Scan "B" is started by pushing the MS/MW Button while at this setting.
RA-TB	Selects "A" VFO for receive and "B" VFO for transmit.
RB-TA	Selects "B" VFO for receive and "A" VFO for transmit.
1, [2], [3]	Selects the three Memory Channels. [2] and [3] are also used for Programmed Scan operation. For details of this operation, refer to MEMORY CHANNEL OPERATION on page 20.

In addition, when the VFO is switched from "A" VFO to "B" VFO, the frequency indicated on the frequency display just prior to switching goes into a memory inside the CPU chip. Thus, even if "B" VFO is being used, switching to "A" again will enable you to operate at the initial frequency. Switching from "A" to "B" results in the same operation.

11. RIT CONTROL

Shifts the receiver frequency $\pm 800\text{Hz}$ either side of the transmit frequency. When the RIT is ON, the RIT LED is illuminated. The LED also represents the "0" position. Rotating the control to the (+) side raises the receiver frequency, and rotating to the (-) side lowers the receiver frequency. With the RIT ON, if the Tuning Control Knob ⑳ is moved one increment, the RIT circuit is automatically pulsed OFF. Therefore it is not necessary to manually turn OFF the RIT when changing operating frequency. The frequency shift by turning the RIT Control is not indicated on the frequency display.

12. RIT SWITCH

This is a spring-loaded switch for the RIT Control. To turn ON the RIT, push down once. If the OFF position is desired, push down again. When the RIT is ON, the LED above the RIT control knob is lit. This LED also indicates the center position of the RIT control. When the RIT circuit is OFF, the LED is also OFF. Also, if the RIT is ON, rotating the Tuning Knob by one increment will pulse the RIT OFF. The RIT remains ON even after the power is turned OFF.

13. NOISE BLANKER SWITCH

When pulse-type noise such as automobile ignition noise is present, set this switch to the ON (down) position. The noise will be reduced to provide comfortable reception.

14. AGC (AUTOMATIC GAIN CONTROL) SWITCH

With this switch you can select the time constant of the AGC circuit. With the switch in the AGC (up) position, the AGC voltage is released slowly, and thus is suitable for SSB reception. With the switch in the FAST (down) position, the AGC voltage is released faster, and the AGC is suitable for stations suffering from fast fading or when operating in the CW mode.

15. TRANSMIT/RECEIVE (T/R) SWITCH

This switch is for manually switching from transmit to receive and vice versa. Set the switch to RECEIVE (up) and the IC-251A/E is in the receive mode. Set the switch to TRANSMIT (down) and it switches to transmit. When switching with the PTT switch on the microphone or with the VOX switch set to ON, the T/R switch must be in the RECEIVE position.

16. VOX SWITCH

This switches the VOX circuit ON and OFF. When the switch is in the ON (down) position in SSB, T/R switching is accomplished by means of a voice signal. In CW operation, semi-break-in switching by means of keying is possible.

17. DIAL LOCK SWITCH

After the IC-251A/E is set to a certain frequency for rag chewing, mobile operation, etc., by switching the DIAL LOCK Switch to the ON position (down), the VFO is electronically locked at the displayed frequency, and this inactivates the operation of the Tuning Knob. To change frequency, the Dial Lock must first be disengaged by setting the DIAL LOCK Switch to OFF (up) position.

18. TUNING SPEED (TS) and TONE CALL BUTTON

Pushing the TUNING SPEED Button will illuminate the TS indicator LED, and the small vernier marks on the Tuning Knob are changed to correspond to 1KHz increments in any mode. At the same time, the 100Hz digits are cleared on the display to show "0" in the last digit. When the Tuning Speed Button is depressed again, the TS indicator LED goes OFF and the small vernier marks will again correspond to 5KHz steps in the FM mode and 100Hz steps in all other modes. This button will allow you to quickly QSY over a great frequency range in SSB and CW, and to tune in FM signals which are off from 5KHz-step frequencies.

When the DIAL LOCK Switch is set in the ON position, this button operates as the TONE CALL Switch. (IC-251E only)

Most repeaters require a 1750Hz Tone-burst for initial access. In the transmitting mode, by depressing the Tone Call Switch for the required period for a repeater, the tone burst generator actuates and you can access the repeater.

19. MEMORY SCAN START/STOP & MEMORY WRITE (MS/MW) BUTTON

The following three functions are provided by pushing the MS/MW Button.

MEMORY WRITE	Writing a frequency into Memory Channel 1, [2], or [3].
SCAN START	Starting the "A" and "B" scans and Memory Scan.
SCAN STOP	Stopping any of the scan functions.

20. TUNING CONTROL KNOB

Rotating the Tuning Control Knob clockwise increases the frequency, while rotating it counterclockwise decreases it. The frequency is changed in 100Hz steps (all modes except FM) and 5KHz steps (FM mode) which correspond to the smaller vernier marks on the knob. When the TUNING SPEED Button is pushed and the TS indicator LED is illuminated, the frequency is changed in 1KHz steps, which correspond to the smaller vernier marks on the knob, in all modes including FM.

By rotating the Tuning Control knob clockwise beyond the highest edge of the band the operating frequency is automatically reverted to the lowest edge of the band, and vice versa. This system prevents you from operating out of the amateur radio band.

When QSYing over a large frequency range is required in the SSB or CW mode, use the TUNING SPEED Button.

When the operating frequency needs to be locked, use the DIAL LOCK Switch.

21. MULTI-FUNCTION METER

This meter functions as a relative RF output meter in transmit mode, and as an S-meter (signal strength meter) in receive mode, unless the MODE Select Switch is set at the FM-c position, in which case the meter functions as a discriminator meter in the receive mode.

22. TRANSMIT INDICATOR LED

When your set is in the transmit mode, this LED is lit.

23. TUNING SPEED (TS) INDICATOR LED

Illuminates when the TUNING SPEED Button is pressed to set the dial to 1KHz-step tuning.

24. RECEIVE INDICATOR LED

Illuminates when the squelch is opened in the receive mode.

25. FREQUENCY DISPLAY

The frequency of the IC-251A/E is displayed on a luminescent display tube. Since the 1MHz and 1KHz decimal points are displayed, the frequency can be easily read. The frequency indicated is the carrier frequency of each mode. The frequency which is changed by use of the RIT is not changed on the frequency display. The letter shown to the left of the frequency indication is the initial letter of the operating mode set by the MODE Select Switch.

REAR PANEL

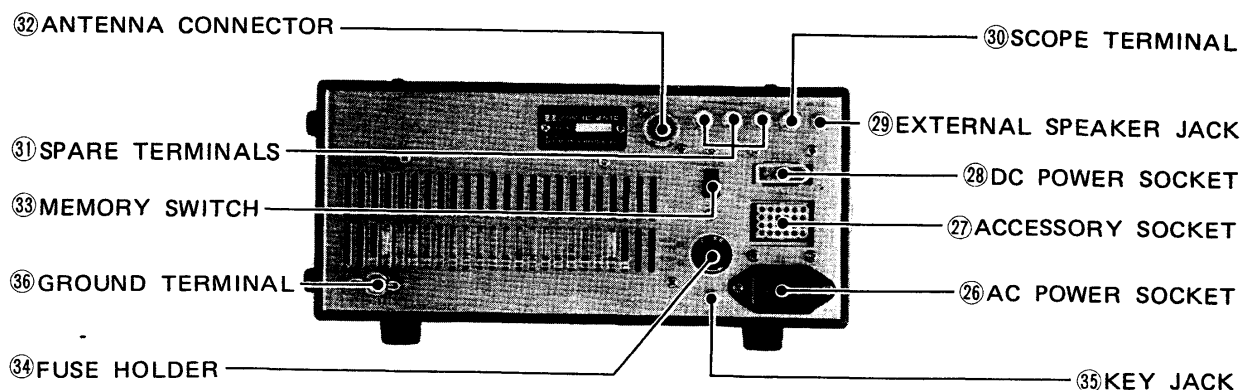

26. AC POWER SOCKET

Connect the included AC power cable to this connector and the included jumper plug to the DC power connector for AC operation.

27. ACCESSORY (ACC) SOCKET

The table below shown terminal connections of this connector.

NOTE: IC-RM2/3 does not function with the IC-251A/E.

ACC SOCKET CONNECTIONS

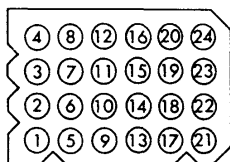

Outside view

PIN No.	FUNCTION
1.	Output from squelch control stage. (+7V when squelch is ON)
2.	13.8 Volts DC in conjunction with the power switch operation. (0.3A Max.)
3.	Connected to Push-to-talk, T/R change-over switch. When grounded, the set operates in the transmit mode.
4.	Output from the receiver detector stage. Fixed output regardless of AF output of AF GAIN Control.
5.	Output from Transmitter MIC amplifier stage.
6.	8 Volts DC available when transmitting. (Relay can not be directly actuated. 5mA Max.)
7.	Input for external ALC voltage.
8.	Ground.
9. ~ 15.	NC (no connection).
16.	Control signal (DBC) input terminal for external control.
17.	NC (no connection).
18.	NC (no connection).
19.	Control signal (DV) output terminal for external control.
20.	Control signal (RT) input terminal for external control.
21.	Data signal (DB1) input/output terminal for external control.
22.	Data signal (DB2) input/output terminal for external control.
23.	Data signal (DB4) input/output terminal for external control.
24.	Data signal (DB8) input/output terminal for external control.

28. DC POWER SOCKET

Connect the included DC power cable when DC operation is required. Connect the included jumper plug to this socket when AC operation is required.

29. EXTERNAL SPEAKER JACK

When an external speaker is used, connect it to this jack. Use a speaker with an impedance of 8 ohms. When the external speaker is connected, the built-in speaker does not function.

30. SCOPE TERMINAL

This terminal brings out the 10.7MHz IF signal from the mixer in the receiver. Observation of not only the received signal, but also of signals of the selected band width are possible by using a panadaptor or panascope.

31. SPARE TERMINAL

This terminal is available for your personal use, such as for adding accessory circuits, etc., if desired.

32. ANT (ANTENNA) CONNECTOR

This is used to connect the antenna to the set. Its impedance is 50 ohms and connects with a PL 259 connector.

33. MEMORY SWITCH

When this switch is in the ON (up) position, the power to the CPU of the IC-251A/E is supplied continuously, even when the POWER Switch on the front panel is turned OFF, to retain all the programmed frequencies in the Memory Channels, the operating frequencies of

the two VFO's, etc. When this switch is set at the OFF (down) position, all the power, including that to the CPU, is turned OFF by turning OFF the POWER Switch, so that all the programmed frequencies in the Memory Channels, the operating frequencies of the two VFO's, etc., are erased.

34. FUSE HOLDER

This holds the fuse for the AC power circuit. If the fuse is blown, replace it with a new fuse (2 Amp for 117V/1 Amp for 240V) after checking the cause. Open the fuse holder with a Phillips head driver.

35. KEY JACK

For CW operation, connect the key here using the included key plug.

36. GROUND TERMINAL

To prevent electrical shock, TVI, BCI and other problems, be sure to ground the equipment through the GROUND TERMINAL. For best results use as heavy a gauge wire or strap as possible and make the connection as short as possible, even in mobile installations.

CONTROLS UNDER ACCESS COVER

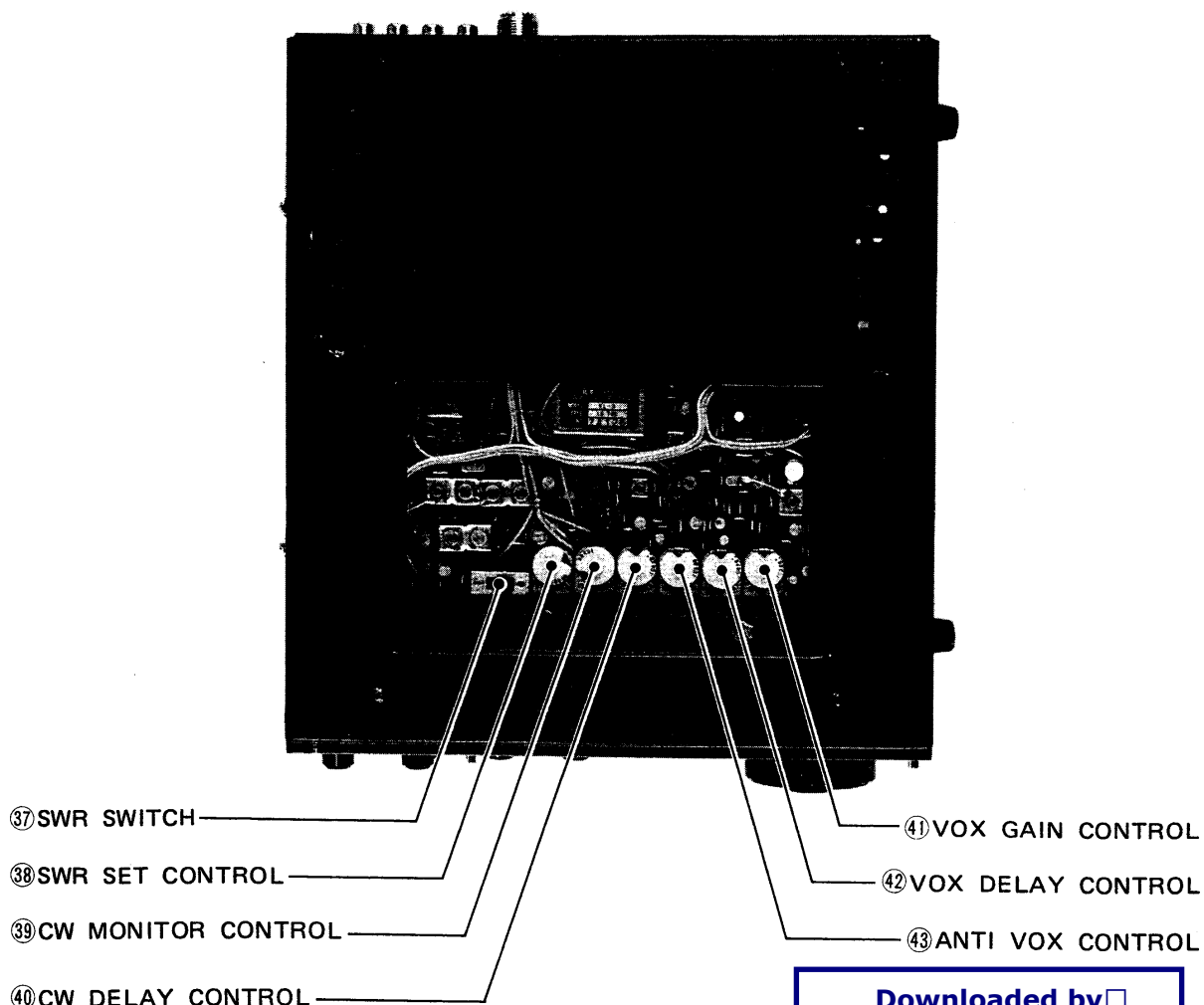

Downloaded by

Amateur Radio Directory

37. SWR SWITCH

When measuring SWR, calibration SET and SWR reading functions are selected with this switch. Remember, at the factory, the switch is in the SET position and fixed in place with a plastic screw to prevent it from switching to SWR. Remove the screw before attempting to read SWR!

38. SWR SET CONTROL

This control calibrates the meter needle to the SET position when you want to determine the value of SWR. The set must be transmitting a carrier, then adjust the control until the meter needle reaches the SET point.

39. CW MONI (MONITOR) CONTROL

This control adjusts the audio volume of the side tone (monitor) audio during CW transmit operation. Adjust it to your desired level for easy listening.

40. CW DELAY (CW time delay constant) CONTROL

In semi-break-in CW operation, this controls the TX/RX switchover time delay. Adjust it to suit your keying speed.

41. VOX GAIN CONTROL

This control adjusts input signal level via the microphone to the VOX circuit. For VOX operation in SSB, adjust the control so that the VOX circuit will operate with normal speech.

42. VOX DELAY (VOX time constant) CONTROL

This controls the TX to RX switching time. Adjust it so TX to RX switching will not occur during short pauses in normal speech.

43. ANTI VOX CONTROL

In VOX (SSB) operation, the VOX circuit may operate by sound from the speaker causing a switch to transmit. This trouble can be prevented by adjusting the input level of the ANTI VOX circuit with this control, along with the VOX gain control so that the VOX circuit only operates from the operator's voice, not by sound from the speaker.

SECTION V OPERATION

HOW TO TUNE

The following instructions are for tuning in any mode. Please read carefully and understand fully before turning ON your unit. Proper tuning is necessary for optimum operation.

PRESET FREQUENCIES

When the POWER switch is turned ON, the frequency display will be 145.000.0 representing 145.000.0MHz, when the VFO/Memory Switch is in the "A", "RA-TB", "MS", "1", "2" and "3" positions, and the display will show 145.600.0 representing 145.600.0MHz, the switch is in the "B" and "RB-TA" positions. The frequencies of the VFOs and the Memory Channels are preset so that they start from the frequencies shown above whenever the IC-251A/E is turned ON with the MEMORY Switch in the OFF position or whenever the power to the CPU is cut for even a short time. Turn the VFO/Memory Switch to the "A" position.

FREQUENCY DISPLAY ON EACH MODE

Turn the MODE Select Switch to "FM", to "USB", to "LSB", and to "CW". The displayed frequency will be changed as follows.

At the "FM" position 

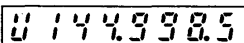
At the "USB" position 

At the "LSB" position 

At the "CW" position 

To avoid the trouble of recalibrating the dial when you change the operating mode, the displayed frequency is set to shift to the carrier frequency of each mode automatically. For the differences of the frequency shifts of the various modes, refer to the following figure.

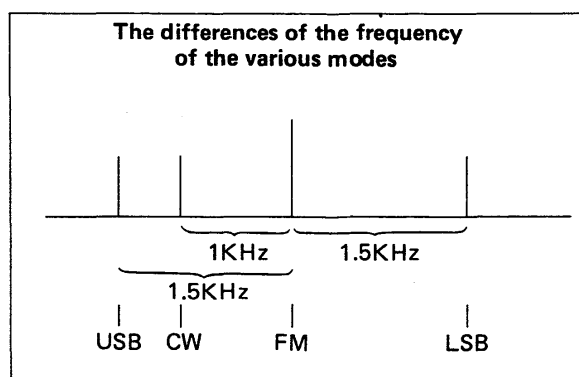

NOTE: At some operating frequencies, when changing the operating mode, the frequency display may indicate a frequency which is out of the operating range of the IC-251A/E. If this happens, rotate the Tuning Control either clockwise or counterclockwise by at least one small vernier mark on the Knob. Do not set the IC-251A/E in the transmit mode, before following this procedure.

TUNING CONTROL

Rotating the Tuning Knob clockwise increases the frequency; turning it counterclockwise decreases the frequency in 100Hz steps in the USB, LSB and CW modes and in 5KHz steps in the FM mode. The smaller vernier marks on the knob represent 100Hz (5KHz in the FM mode).

When you reach 145.999.9 in the SSB or CW modes, or 145.995.0 in the FM mode, turning the Tuning Control Knob clockwise will bring the operating frequency to 144.000.0, the lowest edge, and you can continue increasing the frequency from there by continuing to rotate the Knob clockwise. The VFO endless system functions in the same way when decreasing the frequency from 144.000.0, and will prevent you from inadvertently operating out of the amateur radio band. (IC251A : 145.999.9 and 144.000.0 should be read 148.199.9 and 143.800.0).

When the MODE Select Switch is set to the "FM" position from any other mode, the last two digits of the display frequency are designed to show "0.0", and the frequency is shifted in 5KHz steps by rotating the Tuning Control. If 5KHz-step frequency shift with the last two digits other than "0.0" is desired, set the dial using the following procedure.

The TS Switch must be OFF.

Set the VFO Switch to "A", and the MODE Select Switch to "USB".

By rotating the Tuning-Control, set the last two digits on the display at the frequency you desire.

Set the VFO Switch to "B" and then the MODE Select Switch to "FM".

Set the VFO Switch to "A".

- This completes the setting so that the frequency is shifted in 5KHz steps with the desired figures in the last two digits of the operating frequency. To reset the last two digits to "0.0", push the TS Button twice.

If the knob is too loose or too stiff for comfortable use, you can adjust the torque by tightening or loosening the brake adjustment screw accessible from underneath the set.

Brake Adjustment

The following instructions should be used to adjust the tension of the Tuning Knob.

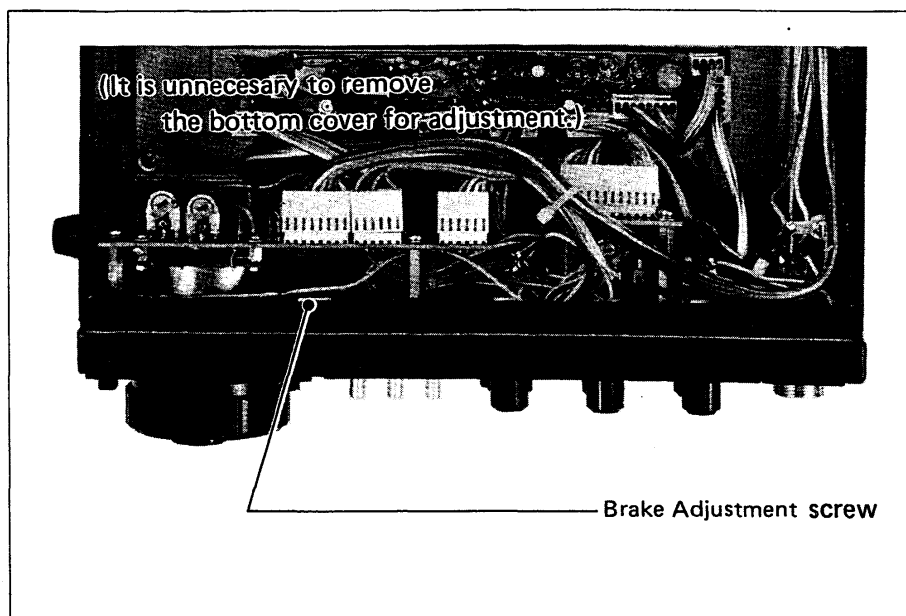

1. The Tuning knob tension will become tighter by turning the brake adjustment screw clockwise, and will become looser by turning the screw counterclockwise.
2. While performing this adjustment, the Tuning knob must be turned continuously as the screw is adjusted in order to set the tension for a comfortable touch.

DIAL LOCK SWITCH

After the IC-251A/E is set at a certain frequency for rag chewing, mobile operation, etc., turning the Dial Lock Switch to the ON (down) position, the VFO is locked at the displayed frequency, thus inactivating the operation of the tuning knob. To change the frequency, the Dial Lock must first be disengaged by turning the dial lock switch again to OFF (up) position, the frequency will change with the direction of the tuning knob rotation.

TS (TUNING SPEED) BUTTON

Pushing the TS Button, the TS indicator LED will be illuminated. While this indicator is ON, the frequency is increased or decreased in 1KHz steps in all modes, and the smaller vernier marks on the Knob correspond to 1KHz steps.

VFO SELECT SWITCH

The CPU in the IC-251A/E contains two "VFO's" for both receiving and transmitting. The VFO's are labeled "A" VFO and "B" VFO and are selectable with the VFO Select Switch. This dual VFO system gives the IC-251A/E many very convenient features. Please read this section very carefully and perform the operation several times until you are comfortable with the system. Try the example!

1. "A" VFO is for both transmitting and receiving and is selected by placing the VFO Select Switch in the "A" position. The transmit and receive frequency will be controlled by "A" VFO, displayed on the frequency display and stored in "A" memory.
2. "B" VFO is for both transmitting and receiving and is selected by placing the VFO Select Switch in the "B" position. The transmit and receive frequency will be controlled by "B" VFO, displayed on the frequency display, and stored in "B" memory.
3. RA-TB: The receive frequency is controlled by "A" VFO and the transmit frequency is controlled by "B" VFO. Both frequencies are stored in their respective memories, and displayed during their respective operation times ("A" frequency during receive, and "B" frequency during transmit). Both frequencies will remain at the same frequency difference they were set at.
4. RB-TA: The receive frequency is controlled by "B" VFO and the transmit frequency is controlled by "A" VFO, the reverse of the above. Again, both frequencies are stored in their respective memories, and displayed during their respective operation times (this time "B" frequency during receive and "A" frequency during transmit). Also both frequencies will remain at the same frequency difference they were set at.
5. A → B: Instantly sets the frequency of "B" VFO to the same as that of "A" VFO. This is very convenient when the RIT control can not cover the transmitting and receiving frequencies differ by more than 800Hz or when you want to QSO with several KHz split transmitting and receiving frequencies.

NOTE: The MS, 1, ②, and ③ positions are described in the "MEMORY CHANNEL OPERATION" on page 20.

- When the IC-251A/E is first turned ON, 145.000.0MHz is preset into the "A" VFO and 145.600.0MHz is preset into "B" VFO.

FOR EXAMPLE:

When the VFO/MEMORY Switch is set in the "A" position and the set is turned ON, 145.000.0 will be displayed on the readout. This will occur whether the VFO/MEMORY Switch is in either the "A" or "RA-TB" or Memory Channels positions.

When the VFO/MEMORY Switch is set in the "B" position or "RB-TA" position, 145.600.0 will be displayed on the readout. Rotating the tuning knob clockwise will increase the frequency, and rotating the tuning knob counterclockwise will decrease the frequency in 100Hz steps. (5KHz steps in the FM mode)

- Switching from one VFO to the other VFO does not clear the first VFO. The frequency is retained in the VFO's memory.

FOR EXAMPLE:

If 145.125.0MHz is set with "A" VFO, and the VFO switch is set to "B" VFO, the frequency readout will show "B" VFO's frequency, but 145.125.0MHz is still stored in "A" VFO's memory. Returning the VFO Switch to "A" VFO position, and 145.125.0 will be displayed on the readout. Accordingly, if the switch is placed in the "B" VFO position, the frequency that was set with the "B" VFO will appear. This allows you to set a certain frequency with one VFO, work up and down the band with the other VFO, and periodically check the set frequency simply by switching between "A" and "B" VFO. It also allows you to search for a clear frequency with one VFO, while keeping your operating frequency on the other VFO. When you have found a clear frequency, switch back to your operating frequency, inform the station you are in contact with of the new frequency, and switch back. It's that simple!

- "RA-TB" or "RB-TA" positions will allow you to operate a repeater or split transmit/receive frequencies.

FOR EXAMPLE:

Set the VFO/MEMORY Switch in the RA-TB or RB-TA position and turn the POWER Switch ON. "B" VFO will be preset 600KHz above "A" VFO.

Set "A" VFO to 145.125.0MHz or "B" VFO to 145.725.0MHz. Then set the VFO/MEMORY Switch to the "RB-TA" position. 145.725.0MHz will be shown on the readout during receive ("B" VFO) and 145.125.0MHz during transmit ("A" VFO). You are now receiving on 145.725.0MHz and transmitting on 145.125.0MHz, so you can access an 145.125/145.725 repeater.

If you change the receiving ("B" VFO) frequency, the transmitting ("A" VFO) frequency will follow the receiving frequency at the same frequency difference. So, first, set "A" VFO or "B" VFO at the frequencies for repeater input/output frequency. This makes repeater operation simple.

FOR EXAMPLE:

If you change the receiving frequency from 145.725MHz to 145.675MHz, the transmitting frequency will change from 145.125MHz to 145.075MHz, so now you can access an 145.075/145.675 repeater.

Setting the VFO/MEMORY Switch to RA-TB reverses the above.

- When you want to change to DUPLEX operation, after using "A" VFO and "B" VFO independently, and "A" VFO and "B" VFO do not have a 600KHz frequency difference.

FOR EXAMPLE:

Set the VFO/MEMORY Switch to "A" position and set "A" VFO to 145.725.0MHz, and the VFO/MEMORY Switch to "B" position and "B" VFO to 145.125.0MHz. Then set and the VFO/MEMORY Switch to RA-TB position. 145.725MHz will be shown on the readout during receive ("A" VFO) and 145.125.0MHz during transmit ("B" VFO). You are now receiving on 145.725.0MHz and transmitting on 145.125.0MHz, so you can access an 145.125/145.725 repeater.

If you change the receiving ("A" VFO) frequency, the transmitting ("B" VFO) frequency will follow the receiving frequency at the same frequency difference. So, first, set "A" VFO and "B" VFO at the frequencies for repeater input/output frequency separation.

FOR EXAMPLE:

If you change the receiving frequency from 145.725MHz to 145.675MHz, the transmitting frequency will change from 145.125MHz to 145.075MHz, so now you can access an 145.075/145.675 repeater.

Setting the VFO/MEMORY Switch to RB-TA reverses the above.

- When you want to operate repeaters or split transmit/receive frequencies that have a frequency difference other than ± 600 KHz.

FOR EXAMPLE:

Set the VFO/MEMORY Switch to "A" position and set "A" VFO to 145.725MHz, and the VFO/MEMORY Switch to "B" position and "B" VFO to 145.025.0MHz. Then set the VFO/MEMORY Switch to the "RA-TB" position. 145.725.0 will be shown on the readout during receive ("A" VFO) and 145.025.0 during transmit ("B" VFO). You are now receiving on 145.725MHz and transmitting on 145.025.0MHz, so you can access a 700KHz separation 145.025/145.725 repeater.

If you change the receiving ("A" VFO) frequency, the transmitting ("B" VFO) frequency will follow the receiving frequency at the same frequency difference. So, first, set "A" VFO and "B" VFO at the frequencies for repeater input/output frequency separation. This makes repeater operation simple.

FOR EXAMPLE:

If you change the receiving frequency from 145.725MHz to 145.875MHz, the transmitting frequency will change from 145.025MHz to 145.175MHz, so now you can access an 145.175/145.875 repeater.

Setting the VFO/MEMORY Switch to "RB-TA" reverses the above.

When you want to change to the SIMPLEX mode from DUPLEX operation, set the VFO/MEMORY Switch to the A or B position. The transmit and receive frequency will now be controlled by "A" VFO or "B" VFO, but the other VFO will not follow the selected VFO.

RIT (RECEIVE INCREMENTAL TUNING)

By using the RIT circuit, you can shift the receive frequency $\pm 800\text{Hz}$ either side of the transmit frequency without moving the transmit frequency itself. Therefore, when you get a call slightly off frequency, or when the other station's frequency has shifted, you can tune in the receiving frequency without disturbing the transmitting frequency. By pushing the RIT switch down once (it's a spring loaded switch) the RIT circuit is turned ON and the RIT LED is lit. The receive frequency is shifted with the RIT knob.

When the RIT knob is in the "0" position, the transmitting and receiving frequencies are the same. Rotating the control to the (+) side raises the receiving frequency, and rotating to the (-) side lowers the frequency. To turn OFF the RIT control, again push the RIT switch once and the RIT LED will go OFF. When the RIT circuit is OFF, the transmit and receive frequencies are the same regardless of the setting of the RIT control knob.

When the RIT circuit is ON, if the tuning knob is moved by one increment, the RIT circuit is automatically pulsed OFF. However, this function can be eliminated by continuously depressing the RIT switch with your finger, while turning the tuning knob, the RIT circuit will remain operational while tuning.

Other things to remember are: The RIT circuit is operational when the frequency is locked with the dial lock switch. The frequency shifted by turning the RIT control is not indicated on the frequency display. When the transmitting and receiving frequencies differ by more than 800Hz use "A" and "B" VFOs as outlined previously.

MEMORY CHANNEL OPERATION

MEMORY-WRITE (PROGRAMMING THE MEMORY CHANNELS)

Only "A" VFO can be used for memory-writing.

1. Set the Tuning Control to the desired frequency, using "A" VFO. For example, set it for 145.700.0 on the display.
2. Set the VFO/MEMORY Switch to the channel to be programmed (1, 2, or 3). For example, set it at Memory Channel 1. If no frequency has been programmed since turning the power of the unit ON, 145.000.0 will be shown on the display and the unit will receive on this frequency.
3. One push of the MS/MW Button erases the previous programmed frequency (145.000.0) and programs the new frequency (145.700.0) into Memory Channel 1.
4. Program any desired frequencies in Memory Channels 2 and 3 in the same manner. Memory Channels 2 and 3 are used also for the Programmed Scan. For Programmed Scan operation, refer to SCANNING OPERATION.

MEMORY READING

Set the VFO/MEMORY Switch to the desired Memory Channel 1, 2, or 3. At whichever frequency the "A" or "B" VFO was set, that previously programmed frequency is recalled. When the VFO/MEMORY Switch is set back to "A" or "B" VFO, the previous operating frequency of that VFO will again be shown on the display.

The programmed frequencies in the three Memory Channels are maintained as long as the power, including MEMORY power, of the IC-251A/E is not turned OFF or new frequencies reprogrammed. When the MEMORY Switch on the rear panel is set to ON (up), all the programmed frequencies on the Memory Channels and the operating frequencies of both "A" and "B" VFO's are retained even when the POWER Switch is turned OFF.

SCANNING OPERATION

The IC-251A/E provides various scanning operations. Read the following instructions carefully to fully enjoy the IC-251A/E's many capabilities.

MEMORY SCAN

This is to scan the three Memory Channels continuously.

1. Program three desired frequencies in Memory Channels 1, 2, and 3.
2. Set the VFO/MEMORY Switch to the "MS" position. At this time, the operating or displayed frequency is not changed.
3. Depress the MS/MW Switch, and the display frequency starts scanning the programmed frequencies in the Memory Channels 1, 2, 3, 1, 2, 3. . .
4. If the SQUELCH is engaged, the scan stops when the squelch is opened and receives a signal. To stop scanning without opening the squelch, depress the MS/MW Button. Depress it again to restart the scanning.

PROGRAMMED SCAN "A"

This is to scan between two desired frequencies, which are programmed in Memory Channels 2 and 3.

1. Program the frequencies of the high and low edge of the desired scanning range in Memory Channels 2 and 3. Regardless of which channel the higher frequency is programmed in, the scan starts from the high edge of the range.
For example, program 145.2MHz in Memory Channel 2 and 145.8MHz in Memory Channel 3.
2. Set the VFO Switch to "A". Depressing the MS/MW Button starts the scan from the high edge (145.8MHz) to the low edge. The scanning frequency increments depend on the MODE Switch setting and the TS Button setting.
3. When the scanning frequency reaches the low edge (145.2MHz), it automatically returns to the high edge (145.8MHz) and continues scanning down to provide endless scanning operation.
4. While the SQUELCH is engaged, the squelch opening when a signal is received will stop the scanning automatically to lock onto the frequency. Depressing the MS/MW Button will restart the scan from the frequency at which it stopped. If the RECEIVE indicator LED is lit because the SQUELCH is not engaged, the scan does not stop at any signals.
5. To stop the scan operation, depress the MS/MW Button. Depressing the MS/MW Button again restarts the scan from the high edge (145.8MHz) of the programmed range.

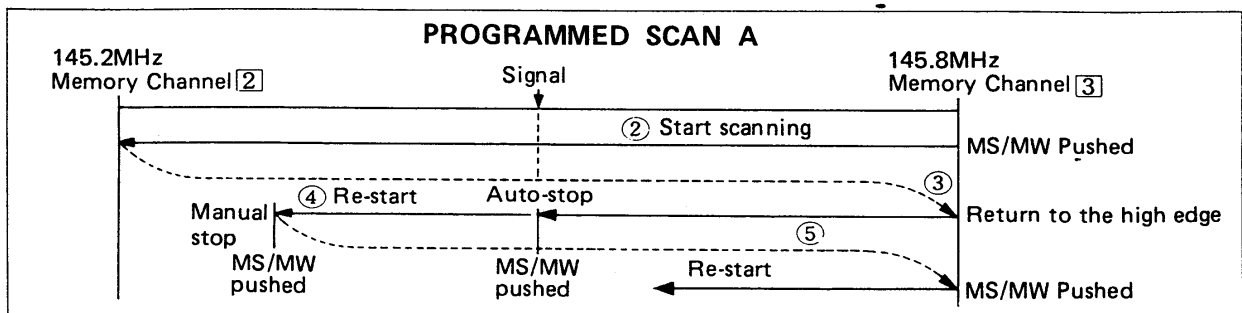

PROGRAMMED SCAN "B"

As with PROGRAMMED Scan "A", this is a scanning operation between two programmed frequencies in Memory Channels ② and ③, the basic difference being shown in 3 below.

1. Program the frequencies of the high and low edge of the desired scanning range in Memory Channels ② and ③. It does not matter in which Memory Channel the higher frequency is programmed. For instance, program 145.2MHz in Memory Channel ② and 145.8MHz in Memory Channel ③.
2. Set the VFO/MEMORY Switch to "B" and the SQUELCH Control above the threshold. By depressing the MS/MW Button, the scan is started from the high edge of the programmed range (145.8MHz) to the lower frequency. Programmed Scan "B" is also an endless scanning operation, and when the scan reaches the low edge of the programmed range (145.2MHz), it reverts to the high edge and again starts down.
3. The scanning operation automatically stops when the SQUELCH is opened by any signals, and the signals can be monitored. After approximately 16 seconds, the scan automatically starts again from the frequency the scan stopped at, continuing to the lower frequencies.
4. Depressing the MS/MW Button while the scan is operating or during the 16 seconds of monitoring, clears the scanning operation and the VFO goes back to normal operation.
5. Depressing the MS/MW Switch again starts the scanning from the high edge of the programmed range.

The scanning speed can be adjusted by the SCAN SPEED Control located in the PLL unit. Rotating the control clockwise makes the scanning speed faster.

The Tuning Control does not function while the scan is operating. In Programmed Scan "B" mode, during the 16-second stop of the scanning when the squelch is opened, the VFO can be used freely, and after the 16 seconds, the scan starts from the frequency set by the VFO as long as the frequency is within the programmed scanning range. (See the INSIDE VIEW on Page 29.)

When faster scanning is required in SSB or CW mode, push the TS Button to set the scanning step at 1KHz. Normally the 1KHz-step scanning is good enough to search SSB and CW signals and provides much faster scanning in the range.

NOTE: The auto-stop circuit functions with SSB or CW signals, but the scan does not always stop at the exact carrier frequencies. When the scan stop operating on one of these signals, tune in to the signals for suitable reception by rotating the Tuning Control and by setting the MODE Select Switch to the proper mode.

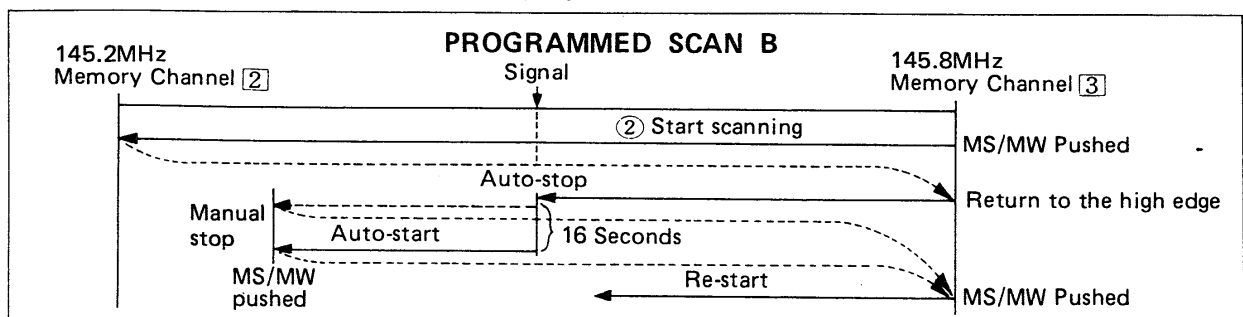

SSB OPERATION

1. RECEIVING

After connecting an antenna, microphone, etc., set knobs and switches as follows.

POWER SWITCH	OFF (button out position)
T/R SWITCH	RECEIVE (UP)
VOX SWITCH	OFF (UP)
AGC SWITCH	SLOW (UP)
NB (NOISE BLANKER) SWITCH	OFF (UP)
MODE SELECT SWITCH	USB or LSB
VFO/MEMORY SWITCH	"A"
AF GAIN CONTROL	Fully Counterclockwise
RF GAIN CONTROL	Fully Clockwise
SQL CONTROL	Fully Counterclockwise
DIAL LOCK SWITCH	OFF (UP)
RIT CONTROL	Center (12 o'clock) position

The other knobs are unrelated to receiving and need not be set at this time.

In SSB operation there is both a USB (upper side band) and an LSB (lower side band). USB is usually used on the band, while LSB is usually used on the downlink of the satellite communications. Select the mode according to your use.

Now turn ON the power switch. The meter lamp will be illuminated and "145.000.0" will be shown on the frequency display. Slowly turn the AF gain control clockwise to a comfortable level. Rotate the Tuning Knob until a signal is received. The multi-function meter needle will move according to the signal strength, so tune for the highest possible meter reading and the clearest audio. If you cannot get a clear signal, you may be receiving in the opposite sideband. If so, change the mode switch to the proper sideband.

The VFO's in the IC-251A/E change in 100Hz steps. Therefore the maximum possible difference in your receiving frequency and the received signal frequency is 50Hz. However, for normal voice signal reception, a difference of 50Hz is negligible and indeed may be hard to distinguish. Since the frequency is changed in 100Hz steps with the IC-251A/E, as opposed to continuous variable frequency systems, tuning is simplified and more accurate.

If squelch operation is required to cut out noise when no signal is received, turn the SQUELCH Control clockwise until the noise from the speaker stops and leave it just below this threshold.

2. NB (NOISE BLANKER)

Turn the NB switch ON (down) when there is pulse type noise, such as ignition noise from automobile motors. Noise will be suppressed and even weak signals will be received comfortably. The noise blanker may not work as effectively when there is a strong signal on a nearby frequency or when there is continuous (not pulse type) noise.

3. AGC (AUTOMATIC GAIN CONTROL)

The IC-251A/E has a fast attack/slow release AGC system which holds the peak voltage of rectified IF signals from the IF amp circuit for a certain period. Therefore, during the pauses in normal speech of the received signal, uncomfortable noise will not be heard. The multi-function meter indicates the peak value for a certain period, facilitating reading of the meter "S" function.

For normal SSB reception, set the AGC switch in the AGC (up) position. Set the AGC switch in the FAST (down) position, when tuning or receiving signals with short interval fading. When in the FAST position, the time constant is shortened.

4. TRANSMITTING

Before transmitting, listen in the receive mode to make sure your transmission will not interfere with other communications. If possible, use a dummy load for adjustment instead of an antenna. Set the MIC GAIN CONTROL to the CENTER (12 o'clock) position.

Other knobs and switches are left in the same positions as for receiving. When the T/R switch is moved to transmit, or when the PTT (push to talk) switch on the microphone is depressed, the transmit LED is illuminated. By speaking into the microphone, the meter needle will move according to the strength of your voice and SSB signals will be transmitted.

Hold the microphone about three inches from your mouth and speak in a normal voice. The microphone is of the dynamic type and provides good pickup for all levels of voice.

To receive again, turn the T/R switch to RECEIVE or release the PTT button. This will also switch OFF the transmit indicator.

5. HOW TO USE THE VOX CIRCUIT

The IC-251A/E has a built-in VOX (voice operated relay) which allows automatic T/R switching by voice signals into the microphone. For VOX use, set the knobs inside the top access cover as follows:

VOX GAIN CONTROL	Fully Counterclockwise
VOX DELAY CONTROL	Fully Clockwise
ANTI VOX CONTROL	Fully Counterclockwise

Turn the VOX switch on the front panel to the ON (down) position. Leaving the T/R switch in the receive position and without pushing the PTT switch, turn the VOX gain control clockwise while speaking into the microphone. At a certain point, the T/R switching circuit will be activated by your voice. This is the proper position for the VOX gain control. See the VOX Gain control at a level which provides for T/R switching at your normal voice level. Transmit-release time (the time delay before the set automatically returns to receive when you stop talking) is controlled by the VOX delay control. Turning the control counterclockwise makes the time shorter. Set it at a position which is comfortable and which allows for short pauses in normal speech.

Adjust the ANTI VOX control so that the VOX circuit is not activated by sounds from the speaker by turning the control clockwise while receiving a signal.

CW OPERATION

1. RECEIVING

For CW reception, set the MODE Select Switch to the CW position. Other switches and knobs are set the same as for SSB reception.

Rotate the tuning knob until an 800Hz (approx.) beat tone is heard from the speaker or headphones. Set the noise blanker switch and/or the AGC switch for clear reception, the same as for SSB reception.

2. TRANSMITTING

Insert the keyer plug into the KEY Jack on the rear panel of the unit, and set knobs and switches the same as for CW reception.

By setting the T/R switch to Transmit, the transmit LED is lit and shows that you are ready for CW transmission. When you key the keyer, the meter needle moves and your CW signal is transmitted.

3. CW MONITOR

When keying, the side tone oscillator circuit is activated and an 800Hz tone is heard from the speaker. The loudness of this tone is adjusted by rotating the CW MONI Control, located under the access cover. Rotating the control clockwise makes the tone louder. (In the receive mode, this side tone is audible and can therefore be used for Morse Code Practice, adjustment of the keyer, etc.) To receive again, place the T/R switch in the receive position.

4. SEMI-BREAK-IN OPERATION

The IC-251A/E has Semi-Break-In CW capability when using the VOX function. When keying, the unit is automatically set in the transmit mode. After keying, it is returned to the receive mode, also automatically, after a given transmit-release delay time constant. Leave the T/R switch in the Receive position, and set the VOX switch in the ON (down) position.

The transmit release delay time constant is set by adjusting the CW DELAY Control located under the access cover. Turning the CW DELAY Control clockwise will make the transmit release time longer. Set for your keying speed.

FM OPERATION

1. RECEIVING

Set knobs and switches as follows.

MODE SELECT SWITCH	FM-s or FM-c
VFO SWITCH	A or B
SQUELCH CONTROL	Completely Counterclockwise

Other knobs and switches are set the same as for SSB reception.

Adjust the AF GAIN control to a comfortable listening level of noise, if no signal is present.

Carefully adjust the squelch control clockwise until the noise just disappears, and the RECEIVE indicator goes out. This is the proper squelch threshold setting and must be done when no signal is present. Your transceiver will now remain silent until an incoming signal is received which opens the squelch and lights the RECEIVE indicator. If the squelch is unstable due to the reception of weak or mobile stations, adjust the squelch control further until the proper threshold is obtained.

When the MODE SELECT Switch is in the "FM-s" position, the multi-function meter indicates the signal strength of the incoming signals and is calibrated in S units and dB over S9. When the MODE SELECT Switch is in the "FM-c" position, the meter indicates the off set of the incoming signals.

The NOISE BLANKER and the AGC circuits do not actuate in this mode.

2. TRANSMITTING

Set knobs and switches as follows.

MIC GAIN CONTROL	Center (12 o'clock) position
RF POWER CONTROL	Completely Counterclockwise

Other knobs and switches are left in the same positions as for receiving.

Turn the T/R switch to TRANSMIT or push the PTT (push to talk) button on the microphone and the transceiver will transmit. At the same time the TRANSMIT indicator will be illuminated red and the multi-function meter will provide an indication of relative power output of the transmitter.

Rotate the RF POWER control while watching the meter needle of the multi-function meter for the desired output power. The output power is adjustable between 1 watt to 10 watts in this mode.

Now, speak into the microphone the same as SSB transmitting. The VOX circuit does not actuate in this mode.

If you need a tone-burst for initial access of the repeater, set the DIAL LOCK Switch in the ON position and depress the Tone Call Switch (same as TS BUTTON) for the required period. (Tone-burst periods vary individually from 100 milliseconds to 2 seconds.) (IC-251E only)

3. REPEATER OPERATION

When the IC-251A/E is first turned ON, "A" VFO will be preset at 145.000MHz and "B" VFO will be preset at 145.600MHz. This frequency difference is normal repeater input/output frequency separation.

If you desire to operate repeaters after you have used "A" VFO and/or "B" VFO independently or transmit/receive frequencies that have a frequency difference other than $\pm 600\text{KHz}$, set the "A" VFO and "B" VFO frequencies to make desired repeater input/output frequency separation.

Then turn the VFO/MEMORY Switch to "RA-TB" or "RB-TA" position. When the VFO/MEMORY Switch is set in the "RA-TB" position, during receive, the set is controlled by "A" VFO and receives on "A" VFO frequency (repeater output frequency).

During transmit, the set is controlled by "B" VFO and transmits on "B" VFO frequency (repeater input frequency). So now you can access the repeater.

If a repeater has reversed input/output frequencies or you desire to listen the repeater input frequency, turn the VFO/MEMORY Switch to RB-TA position. Now you will receive on "B" VFO frequency and transmit on "A" VFO frequency.

OTHER OPERATIONS

VSWR READING

The IC-251A/E has a built-in VSWR meter for checking antenna matching in order to avoid problems caused by VSWR. Set the Mode switch to the FM position, and T/R switch to Transmit.

Adjust the SWR SET control so that the meter needle points to "SET" on the meter scale. Set the SWR switch, located under the access cover, to the SWR position (Before your unit is shipped, the SWR switch is fixed in place in the SET position with a plastic screw. Remove this screw before trying to make VSWR readings). With the switch in the SWR position, SWR reading can be seen on the meter. Although this unit is built to handle VSWR of up to 2 : 1, it is recommended that the antenna(s) be adjusted for the lowest possible VSWR. After taking the reading, return the switch to the SET position. You need not replace the screw.

FOR SATELLITE COMMUNICATION USE

At present there are two active satellites for amateur radio use, AMSAT OSCAR 7 was launched in November, 1974 and AMSAT OSCAR 8 was launched in March, 1978. Satellite communications can be made by using an IC-251A/E for receiving/transmitting and an IC-402 (70 centimeter SSB/CW transceiver) for transmitting/receiving in Mode B and Mode J, and an IC-251A/E for transmitting and an IC-701 (HF SSB/CW/RTTY transceiver) for receiving in Mode A.

NOTE: FM mode is prohibited for these satellite communications.

For frequency information refer to the chart below. Further information on communicating through satellites can be found in various amateur radio books and periodicals.

FREQUENCY CHART

SATELLITE	MODE	UPLINK (Transmitting) FREQUENCY	DOWNLINK (Receiving) FREQUENCY	BEACON
AMSAT OSCAR 7 (AO-7)	A	145.85MHz ~ 145.95MHz (USB/CW)	29.4MHz ~ 29.5MHz (USB/CW)	29.502MHz 435.100MHz
	B	432.125MHz ~ 432.175MHz (USB/CW)	145.975MHz ~ 145.925MHz (LSB/CW)	145.975MHz
AMSAT OSCAR 8 (AO-8)	A	145.85MHz ~ 145.95MHz (USB/CW)	29.4MHz ~ 29.5MHz (USB/CW)	29.402MHz
	J	145.90MHz ~ 146.00MHz (USB/CW)	435.2MHz ~ 435.1MHz (LSB/CW)	435.097MHz

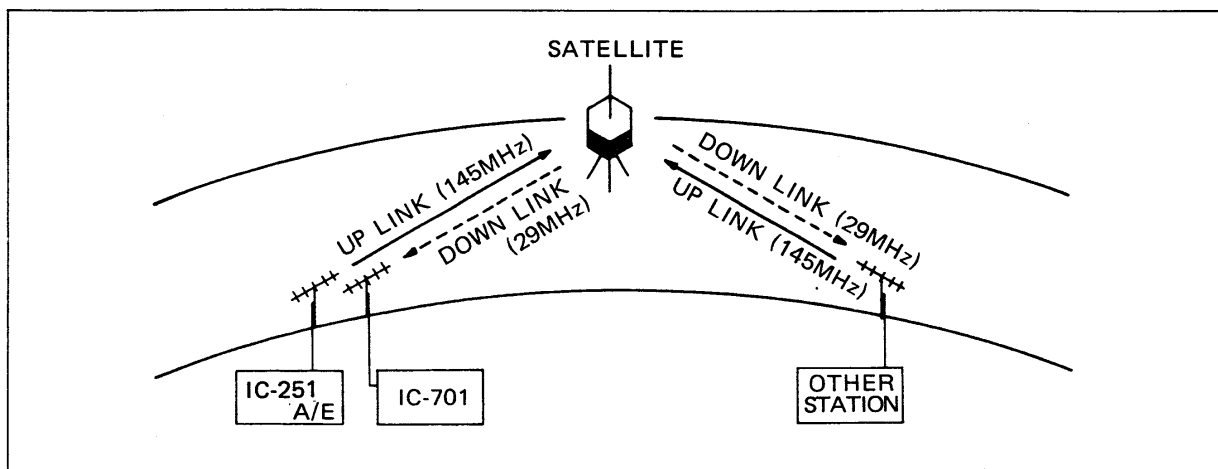

SECTION VI INSIDE VIEW

MAIN PC BOARD SIDE

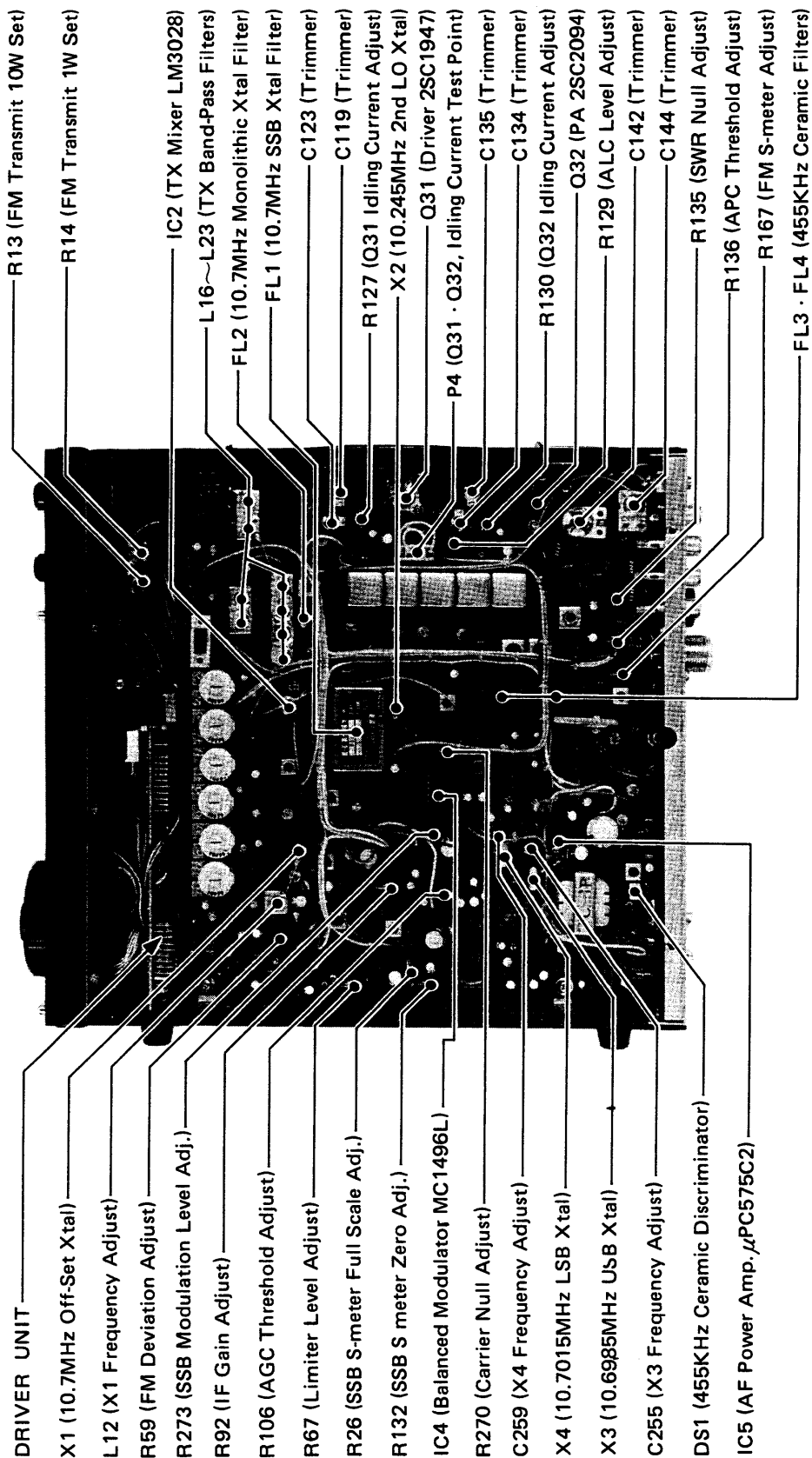

PLL UNIT SIDE

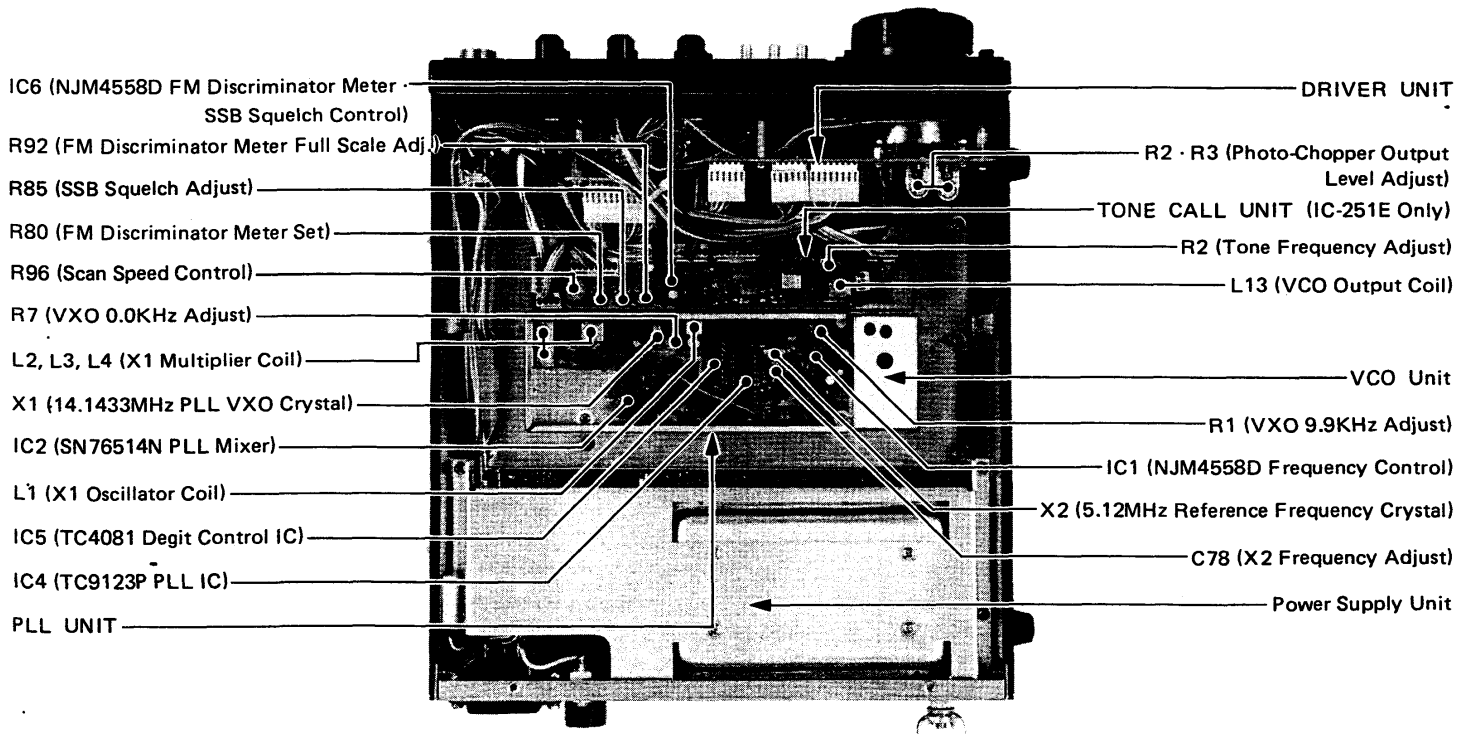
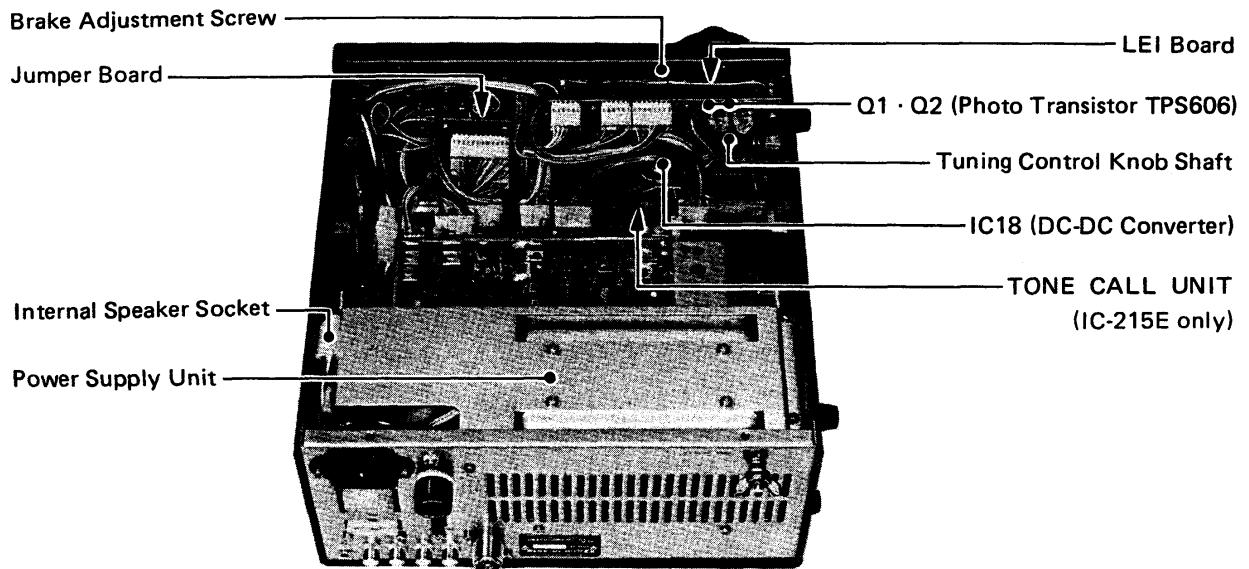

SECTION VII TROUBLE SHOOTING

Your IC-251A/E has been tested very carefully at the factory before shipping. The chart below has been designed to help you correct any problems which are not equipment malfunctions. If you are not able to locate the problem and/or solve it through use of this chart, please contact your dealer or ICOM distributor for assistance.

Problem	Possible Cause	Solution
1. Power does not come ON when the switch is pushed.	<p>Power cable is improperly connected.</p> <p>Power cord is connected with the polarity reversed. (When using DC power source)</p> <p>Blown fuse.</p> <p>Jumper plug is not plugged in. (When using the AC power source)</p>	<p>Carefully reconnect power cable.</p> <p>Disconnect the power cord, replace the blown fuse, then reconnect the power cord observing proper polarity.</p> <p>Check for the cause, then replace the fuse with a new one.</p> <p>Insert the jumper plug into the DC power socket.</p>
2. No sound comes from the speaker.	<p>AF GAIN Control knob is completely counterclockwise.</p> <p>The unit is in the transmit mode, either by the T/R switch or the PTT switch on the microphone.</p> <p>SQUELCH setting is turned too far clockwise.</p> <p>External speaker is in use.</p> <p>The internal speaker cable is not connected.</p> <p>A headphone is connected to the PHONES jack.</p>	<p>Turn the knob clockwise to a suitable level.</p> <p>Put the unit in the receive mode.</p> <p>Turn the SQUELCH control counterclockwise until noise can be heard and reset it just below the threshold.</p> <p>Check if the external speaker plug is inserted properly or if the external speaker cable is cut.</p> <p>Connect the speaker connection.</p> <p>Unplug the headphone.</p>
3. Sensitivity is low and only strong signals are audible.	<p>RF GAIN Control knob is turned fully counterclockwise.</p> <p>The antenna feed line is cut or shorted.</p>	<p>Turn the RF Gain control knob fully clockwise.</p> <p>Check the feed line and correct any improper condition.</p>
4. During receive, the "S" meter is higher than the "0" position even when there is no signal.	<p>RF GAIN Control knob is turned counterclockwise.</p> <p>Mode select switch is in the FM-C position.</p>	<p>Turn the knob fully clockwise.</p> <p>Set the Mode select switch in the FM-S position.</p>
5. Only incomprehensible voices are heard during SSB reception.	<p>Receiving the wrong sideband.</p> <p>Receiving FM signals.</p>	<p>Set the MODE switch to the sideband other than the one you are using, either USB or LSB.</p> <p>Set the MODE switch to the FM position.</p>

Problem	Possible Cause	Solution
<p>6. No output power or low output power.</p>	<p>RF POWER setting is turned too far counterclockwise. (in FM mode)</p> <p>MIC GAIN setting is too low. (in SSB mode)</p> <p>When SSB or FM is desired, but the MODE switch is in the CW position.</p> <p>PTT switch is not functioning due to improper connection of the mic connector.</p> <p>The antenna feed line is cut or shorted.</p>	<p>Turn the RF POWER control clockwise while watching the multi-function meter, to obtain the proper output power.</p> <p>Turn the MIC GAIN Control clockwise to the center (12 o'clock) position.</p> <p>Set the MODE switch to the USB, LSB or FM position.</p> <p>Check the connection of the MIC connector and correct any problems.</p> <p>Check the antenna feed line and correct any improper connection.</p>
<p>7. The RF POWER control does not function.</p>	<p>The MODE Select switch is in the SSB (USB or LSB) or CW position.</p>	<p>As the RF POWER control functions in the FM mode only, set the switch to the FM position.</p>
<p>8. No modulation. (No RF output in SSB mode.)</p>	<p>Bad connection of the MIC connector.</p> <p>The MIC cable is cut.</p> <p>MIC GAIN control is fully counterclockwise.</p>	<p>Check the connection of the MIC connector and correct any problems.</p> <p>Repair the disconnected or cut wire.</p> <p>Turn the MIC Gain control clockwise to obtain the proper modulation.</p>
<p>9. The receive mode functions properly and your signals are transmitted, but you are unable to make contact with another station. (When desiring SIMPLEX mode.) (When desiring DUPLEX mode.)</p>	<p>The VFO Select is in the RA-TB or RB-TA position.</p> <p>The receive frequency is off set from the transmit frequency by the RIT control.</p> <p>The VFO Select switch is in the A, B or Memory position.</p> <p>Improper frequency split or input/output frequency of the repeater.</p>	<p>Set the VFO Select switch to the A, B or Memory position.</p> <p>Turn OFF the RIT, or set the RIT control knob to the center (12 o'clock) position.</p> <p>Set the VFO Select switch to the RA-TB or RB-TA position.</p> <p>Set the proper frequency split and turn the VFO Select switch to the RA-TB or RB-TA position according to repeater input/output frequency.</p>
<p>10. Left side of the unit case become a little hot.</p>	<p>As left side of the case is used as heat sink for the transmitter final transistor even during normal operation, it may get as hot as 35°C (63°F) above room temperature.</p>	<p>Make sure that the area around the unit has as much ventilation as possible.</p>
<p>11. The RIT LED goes out even though you did not depress the RIT ON/OFF switch to turn it OFF.</p>	<p>The RIT is automatically turned OFF when the Tuning knob is rotated.</p>	<p>Depress the RIT ON/OFF switch again to turn ON the RIT.</p>

Problem	Possible Cause	Solution
12. The frequency does not change by rotating the Tuning knob.	DIAL LOCK is engaged.	Disengage the DIAL LOCK by moving the DIAL LOCK switch.
13. The scale on the Tuning knob is not in calibration with the displayed frequency.	The TUNING SPEED button was depressed when the Tuning knob was set with one of the small increments at the center point, the Tuning knob was rotated when the DIAL LOCK was engaged.	Set the Tuning dial so that one of the large increments is at the center point, and push the TUNING SPEED button, and the scale will be calibrated.
14. The last digit of the memorized or displayed frequency has changed to 0.	The TUNING SPEED button was pressed, or the VFO Select switch was turned while pressing the TUNING SPEED button.	Release the TUNING SPEED button, and set the unit to the desired frequency with the Tuning knob.
15. An abnormal figure is displayed on the display, or the display fails to illuminate.	The Power switch was turned OFF and ON too quickly.	Turn the Power switch and the memory switch OFF, wait a few seconds, and then turn them ON again.
16. The memorized frequencies are lost and the display shows 145.000.0 when the power switch is turned ON.	The memory switch was turned OFF. The main switch of the power source was turned OFF or the power plug was unplugged. The power failed (when using the AC power source).	Turn ON the memory switch on the rear panel. Use the continuous operating power source or optional memory power source.
17. Unable to key when using an electronic keyer.	The Switching circuit of the electronic keyer does not close completely. Polarity of the connection wires from the keyer is reversed. The MODE switch is not in the CW position.	Replace the keyer with one having a voltage of less than 0.4V between the two keying lines at the key down position, or modify your keyer so that the voltage is less than 0.4 Volts. Connect the keyer wires observing proper polarity. Place the MODE switch in the CW position.
18. The scan operation does not function when the MS/MW switch is pushed.	No frequency is programmed in the memory channels or the same frequency is programmed in all the memory channels.	Program the required frequencies in the memory channels following the instructions for "MEMORY-WRITE" on page 20.

SECTION VIII VOLTAGE CHARTS

NOTE: Measuring instrument is a 50K Ω /V multimeter.

MAIN UNIT TRANSISTORS

TR No.	TRANSMIT				RECEIVE				REMARKS
	BASE OR GATE1	GATE2	COLLECTOR OR DRAIN	EMITTER OR SOURCE	BASE OR GATE1	GATE2	COLLECTOR OR DRAIN	EMITTER OR SOURCE	
Q 1					0		8.5	0.2	NB ON
Q 2					1.0		8.0	1.0	NB ON
					1.7		8.0	1.0	NB ON
Q 3					1.6		9.2	1.0	NB ON
					1.6		9.2	1.0	NB ON
Q 4					0		1.7	GND	NB ON
Q 5					0		7.4	0	NB ON
Q 6					7.4		0	8.0	NB ON
Q 7					0	4.0	8.6	0.4	
Q 8					0	3.9	8.2	0.8	
Q 9					1.3		0	0.8	
Q10					3.7		9.0	3.0	
					3.5		9.0	3.0	
Q11					1.6		3.6	1.0	
Q12	4.5		9.0	3.8					FM mode
Q13	5.4		9.1	5.0					
Q14	0.6		1.6	GND					
Q15	0.5		0.6	GND					
Q16	0.5		0.5	GND					
Q19					5.8		-8.8	4.0	
Q20					-7.0		3.9	-7.8	
Q21					-7.6		9.2	-7.0	
Q22					-8.6		-7.6	-8.8	
Q23					-8.5		9.1	-7.6	
Q24					-8.2		-8.8	-8.8	
Q25					-8.2		3.4	-8.8	
Q26					-8.4		8.9	-7.8	
Q27					-4.6		1.2	-5.2	
Q28	0	4.2	8.0	0.2					
Q29	9.2		0.2	9.2					
Q30	1.2		13.5	0.5					
Q31	0.4		13.5	GND					
Q32	0.4		13.5	GND					
Q33	0		9.0	GND					
Q34					10.0		13.5	9.2	
Q35	10.0		13.5	9.2					
Q36	10.0		0.7	0.2					
Q37	10.0		13.5	9.2	10.0		13.5	9.2	
Q39					0.6		0.6	GND	
Q40					4.4		6.2	4.0	
Q41					0.5		2.0	GND	

MAIN UNIT TRANSISTORS (Continued)

TR No.	TRANSMIT				RECEIVE				REMARKS
	BASE OR GATE1	GATE2	COLLECTOR OR DRAIN	EMITTER OR SOURCE	BASE OR GATE1	GATE2	COLLECTOR OR DRAIN	EMITTER OR SOURCE	
Q42					2.0		9.0	1.4	
Q43					0		7.0	0.8	
Q44					2.5		7.5	2.3	
Q45					0		9.0	0.3	
Q46					0	0	8.8	GND	
Q47					0	3.8	9.0	0	
Q48					8.4		9.0	9.0	
Q49					1.4		5.0	0.8	
Q50					5.0		9.2	4.6	
Q52					0.2		7.4	GND	
Q53					1.3		4.2	0.9	
Q54					1.3		8.8	0.7	
Q55	0.6		0	GND	0		9.2	GND	VOX ON
Q56	0.1		8.4	0.2	0.1		0	0.1	VOX ON
Q57	0.8		0.2	0.2	0.7		0.1	0.1	VOX ON
Q58	6.4		7.0	6.0	6.4		7.0	6.0	
Q59	0		6.4	GND	0		6.4	GND	
Q60	0.6		0	GND	0.6		0	GND	
Q61	1.2		3.1	0.6	1.2		3.1	0.6	
Q62	0.1		7.4	GND	0.7		0	GND	
Q63	-0.7		7.4	GND	0		0	GND	
Q64	-4.2		8.4	-5.0					
Q65	8.4		9.0	9.1					
Q66	4.3		7.9	3.7					
Q67	2.0		2.8	1.4	2.0		2.8	1.4	
Q68	1.4		2.8	1.2	1.4		2.8	1.2	
Q69	1.9		5.6	1.3					
Q70	0		8.5	0					
Q71	0		8.2	0					
Q72	8.2		0	8.6					
Q73	8.2		0	8.2					
Q74	0		8.2	0					
Q75	1.9		5.6	1.3					

MAIN UNIT IC IN TRANSMIT MODE

IC No.	PIN No.														REMARKS
	1	2	3	4	5	6	7	8	9	10	11	12	13	14	
IC2	5.1	2.6	GND	2.0	5.1	7.6	8.0	7.8							
IC4	2.0	1.4	1.4	2.0	1.4	7.0	0	4.0	0	4.0	0	7.0	0	GND	
IC6	1.3	1.3	GND	4.5	4.5										In FM mode

MAIN UNIT IC IN RECEIVE MODE

IC No.	PIN No.																REMARKS
	1	2	3	4	5	6	7	8	9	10	11	12	13	14	15	16	
IC1	2.6	2.0	GND	1.0	2.6	3.6	3.2	3.6									
IC3	5.0	1.6	1.6	GND	6.9	2.8	6.9										
IC5	1.9	0	13.5	6.6	7.8	13.5	13.5	1.8									
IC7	5.0	GND	9.2														
IC8	4.8	5.0	5.0	6.4	3.8	1.8	1.0	GND	1.8	1.2	1.8	0	0	1.8	1.5	5.0	

PLL UNIT TRANSISTORS

TR No.	TRANSMIT				RECEIVE				REMARKS
	BASE OR GATE1	GATE2	COLLECTOR OR DRAIN	EMITTER OR SOURCE	BASE OR GATE1	GATE2	COLLECTOR OR DRAIN	EMITTER OR SOURCE	
Q 1	*		*	GND	*		*	GND	
Q 2	*		*	GND	*		*	GND	
Q 3	1.7		6.5	1.2	1.7		6.5	1.2	
Q 4	1.2		7.4	0.8	1.2		7.4	0.8	
Q 5	1.2		7.4	0.9	1.2		7.4	0.9	
Q 6	1.1		4.2	0.4	1.1		4.2	0.4	
Q 7	1.2		5.8	0.8	1.2		5.8	0.8	
Q 8	GND		6.5	2.0	GND		6.5	2.0	VCO Unit
Q 9	1.0		5.7	0.2	1.0		5.7	1.0	VCO Unit
Q10	7.2		0	7.8	7.2		0	7.8	
Q11	0		9.8	GND	0		0.8	GND	
Q12	1.1		7.0	0.4	1.1		7.0	0.4	
Q13	GND		0.6	0.6	GND		0.6	0.6	RIT ON
Q14	0.6		0	GND	0.6		0	GND	RIT ON
Q15	-8.5		GND	-9.2	-8.5		GND	-9.2	
Q16	-9.2		-8.5	-9.6	-9.2		-8.5	-9.6	
Q17	1.9		7.2	1.4	1.9		7.2	1.4	
Q18	0		7.6	0	4.0		7.6	3.5	SQL Opened
Q19	13.8		13.8	13.8	13.8		13.8	13.8	Tone ON

* Pulse activated

PLL UNIT IC (When the operating frequency is 145.000MHz)

IC No.	PIN No.																REMARKS
	1	2	3	4	5	6	7	8	9	10	11	12	13	14	15	16	
IC1	0	0	0	-9.0	3.9	3.9	2.7	8.0									
IC2	-	8.2	7.2	4.0	2.5	GND	-	-	2.5	4.0	4.0	4.0	7.2	-			
IC3	1.4	1.4	GND	7.2	8.0												
IC5	*	*	*	*	*	*	GND	*	*	*	*	*	*	7.7			
IC6	8.3	GND	-9.0														
IC4	GND	*	*	*	*	*	*	*	*	*	-	3.0	7.3	3.1	0	3.9	
	PIN No.																
	17	18	19	20	21	22	23										
	0	7.7	3.8	3.0	3.2	7.7											

* Pulse activated

DRIVER UNIT TRANSISTORS

TR No.	TRANSMIT				RECEIVE				REMARKS
	BASE OR GATE1	GATE2	COLLECTOR OR DRAIN	EMITTER OR SOURCE	BASE OR GATE1	GATE2	COLLECTOR OR DRAIN	EMITTER OR SOURCE	
Q 4	9.2		0	8.4	9.2		0	8.4	
Q 5	6.3		0	5.0	6.3		0	5.0	
Q 6	0.65		0.65	0	0.65		0.65	0	
Q 7	13.8		8.6	13.8	13.8		8.6	13.8	
Q 8	0.65		13.8	0	0.65		13.8	0	
Q 9	0		13.8	0	0		13.8	0	
Q10	0		0	0	0		0	0	
Q11	0.75		0	0	0.75		0	0	
Q12	0.7		0	0	0.7		0	0	RIT ON
Q12	0		7.0	0	0		7.0	0	RIT OFF

NOTE:

Other devices work in C-MOS level and with pulse signals, so the voltages can not be measured with a 50K Ω /V multimeter.

The function of the CPU is identified with reading the relationship between the R output and the K input signals.

Refer the timing chart of the R output signals on the next page. The relationship between the R output and the K input signals can be checked with a dual trace oscilloscope, and also the level of these signals can be measured with the scope.

The driver unit consists of several C-MOS IC's and P-MOS IC's. P-MOS IC's are IC9 TMS1115 CPU and IC10 TMS1024 I/O port, and the others are C-MOS IC's.

Refer to the following threshold level chart for measuring these levels.

THRESHOLD LEVEL CHART

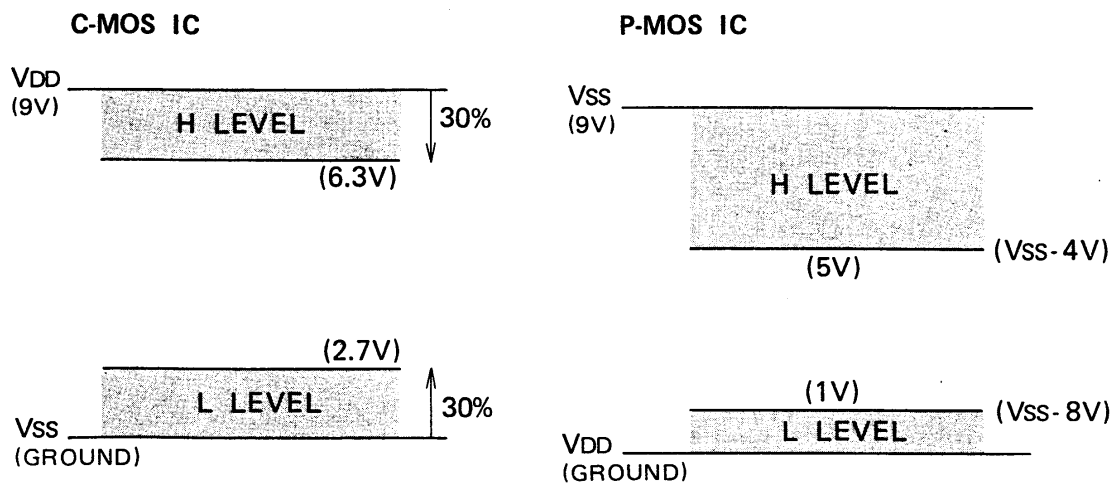

R OUTPUT TIMING CHART

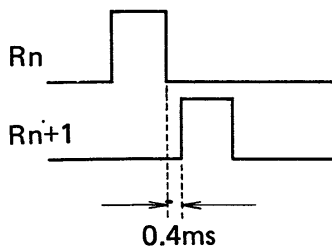
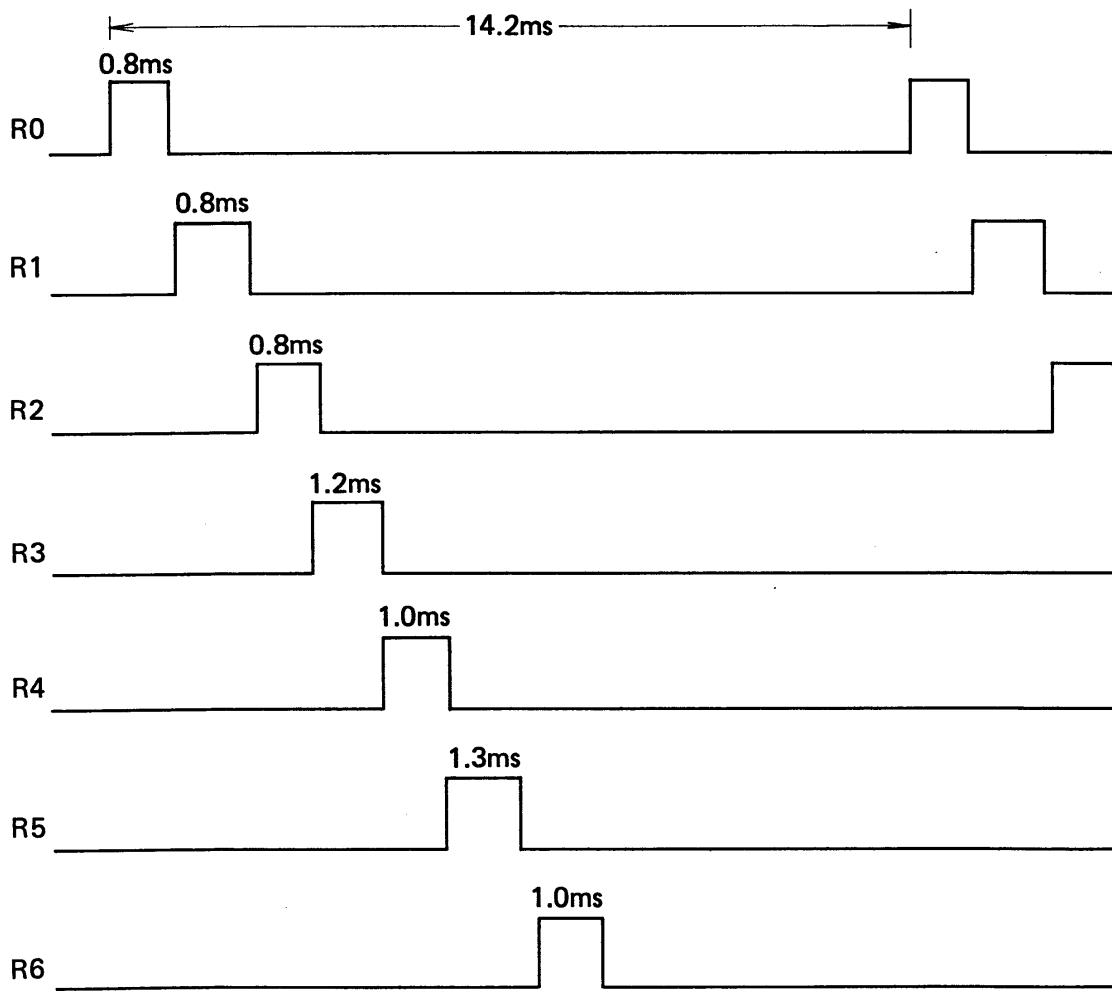

Each R output has a 0.4 milliseconds interval.

SECTION IX BLOCK DIAGRAM

Downloaded by
Amateur Radio Directory

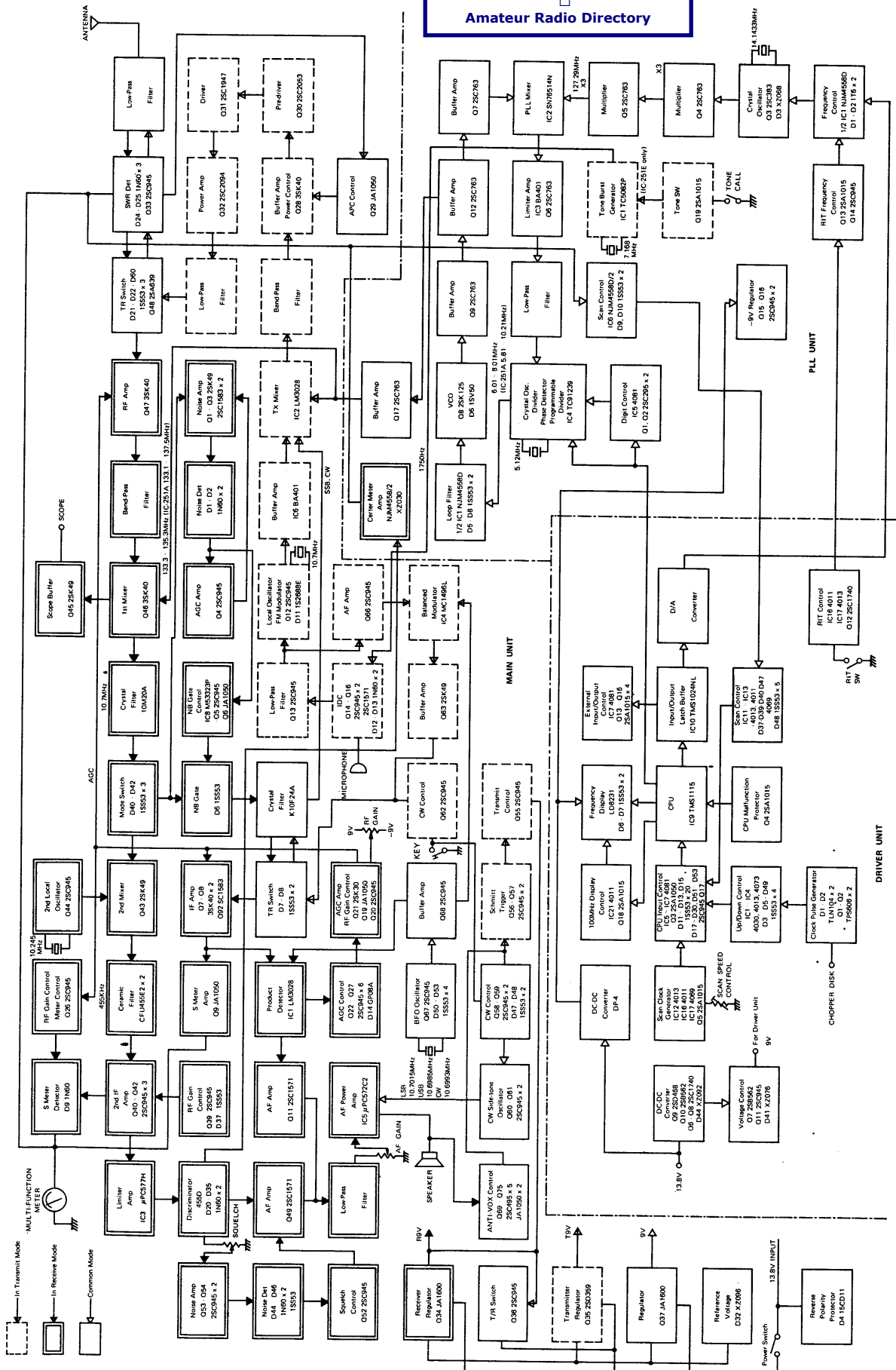

SECTION X OPTIONS

We have prepared a variety of options for the transceiver IC-251A/E in order to enlarge its use.

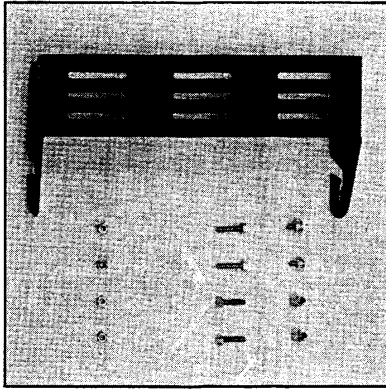

IC-MB5
MOBILE MOUNTING
BRACKET
FOR IC-251A/E

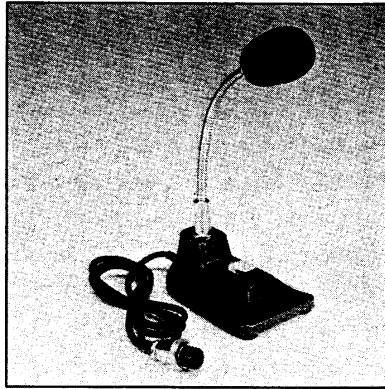

IC-SM5
DESK MICROPHONE
ELECTRET CONDENSER
TYPE

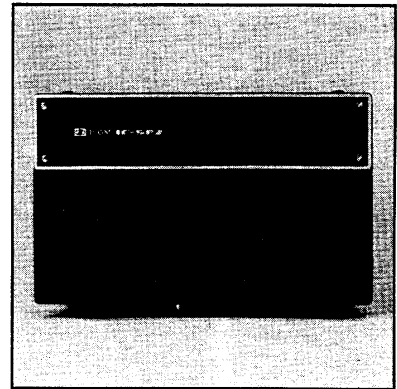

IC-SP2
EXTERNAL
SPEAKER



IC-HP1
HEADPHONES

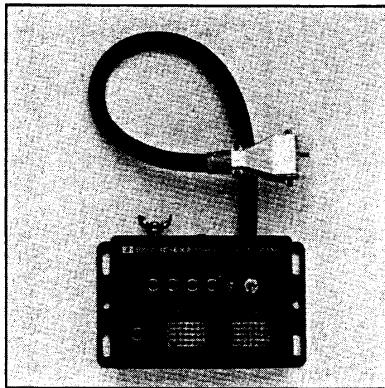

IC-EX1
EXTENSION TERMINAL
IC-EX2
EXTENSION TERMINAL
WITH 25KHz MARKER

AC POWER SUPPLY UNIT

The AC power supply built in the unit is a newly developed switching regulator system, providing light weight and a high level of efficiency.

PI UNIT

The AC power supplied from Pins 2 and 3 of P1 is fed to the memory power transformer L2. The output voltage from the secondary of L2 is rectified and filtered by D2 and C7, and switched by Q1 before being fed to the SW REG Unit. The rectified and filtered power is put out also to the fourth Pin of P1 as the 10 ~ 14V memory power source. D3 is an overvoltage-protection zener diode, and D4 is a reverse-flow-protection diode. The AC power from Pins 1 and 3 of P1 through line filter L1 is rectified by D1 and supplied through filter C5 and C6 to the SW REG. IC1 is operated by the divided voltage with R5 and R6 to turn ON Q1.

SW REG (Switching Regulator) UNIT

+120V from H1 and -120V from H2 are fed through various noise filters to the collector of Q1 and the emitter of Q2. IC1 is a switching regulator IC and contains a 5V reference voltage, oscillator circuit, op-amp, comparator, and current limit circuit. The oscillating frequency is set by the time constant circuit of R3 and C6. The pulse signals from Pins 12 and 13 are fed through the pulse transformer L5 to Q1, to switch Q1 and Q2 alternately so that the $\pm 120V$ is put out at the primary of L6. The output voltage at the secondary is rectified by D1 and filtered by L7, L8, C13, and C14, and then 13.8V DC is put out at Pin 5 of P1.

POWER SUPPLY UNIT BLOCK DIAGRAM

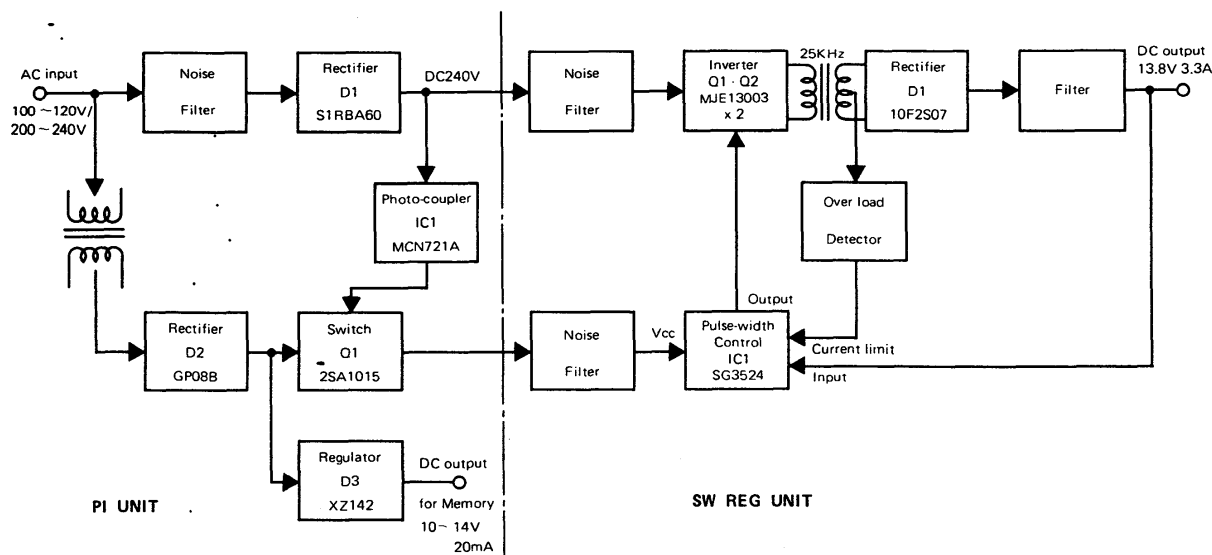



ICOM INCORPORATED

1-6-19, KAMI KURATSUKURI, HIRANO-KU,
OSAKA JAPAN

Printed in Japan