

IC-260^{A/E}

144MHz ALL MODE TRANSCEIVER

INSTRUCTION MANUAL



TABLE OF CONTENTS

I. SPECIFICATIONS	2
II. DESCRIPTION	4
III. INSTALLATION	5
IV. CONTROL FUNCTIONS.....	9
V. OPERATION	13
VI. INSIDE VIEW	24
VII. TROUBLE SHOOTING.....	26
VIII. VOLTAGE CHARTS.....	29
IX. BLOCK DIAGRAM	34
X. P.C. BOARD LAYOUT.....	SEPARATE
XI. SCHEMATIC DIAGRAM.....	SEPARATE

SECTION I SPECIFICATIONS

GENERAL

Numbers of semi-conductors	: Transistor	72
	FET	9
	IC	45 (IC-260A : 44)
	Diode	91 (IC-260A : 90)
Frequency coverage	: 144.0000 ~ 145.9999MHz	
	(IC-260A : 143.8000 ~ 148.1999MHz)	
Frequency resolution	: SSB 100Hz steps FM 5KHz steps	
	1KHz steps with TS button depressed	
Frequency Control	: Microcomputer based 100Hz step Digital PLL synthesizer	
	Independent Transmit-Receive Frequency Capability	
Frequency Readout	: 7 digit LED 100Hz readout	
Frequency stability	: Within ± 1.5 KHz	
Memory channels	: 3 channels, any inband frequency programmable	
Usable conditions	: Temperature: $-10^{\circ}\text{C} \sim 60^{\circ}\text{C}$ ($14^{\circ}\text{F} \sim 140^{\circ}\text{F}$)	
	Operationable time: Continuous	
Antenna impedance	: 50 ohms unbalanced	
Power supply requirement	: 13.8V DC $\pm 15\%$ (negative ground) 3.5A Max.	
Current drain (at 13.8V DC)	: Transmitting	
	SSB (PEP 10W)	Approx. 2.2A
	CW, FM (10W)	Approx. 3.1A
	FM (1W)	Approx. 1.6A
	Receiving	
	At max audio output	Approx. 0.8A
	Squelched	Approx. 0.6A
Dimensions	: 64mm (H) x 185mm (W) x 223mm (D)	
Weight	: Approx. 2.7Kgs	

TRANSMITTER

Output power	: SSB High 10W (PEP) Low 1W (PEP)	
	CW High 10W Low 1W	
	FM High 10W Low 1W	
Emission mode	: SSB (A3J, USB/LSB), CW (A1), FM (F3)	
Modulation system	: SSB Balanced modulation	
	FM Variable reactance frequency modulation	
Max. frequency deviation	: ± 5 KHz	
Spurious emission	: More than 60dB below peak power output	
Carrier Suppression	: More than 40dB below peak power output	
Unwanted Sideband	: More than 40dB down at 1000Hz AF input	
Microphone	: 1.3K ohm dynamic microphone with built-in preamplifier and push-to-talk switch.	
Operating mode	: Simplex, Duplex	
	(Any inband frequency separation programmable)	
Tone Burst	: 1750Hz ± 0.1 Hz (IC-260A : Not installed)	

RECEIVER

Receiving system	: SSB, CW Single conversion superheterodyne FM Double conversion superheterodyne
Receiving Mode	: SSB (A3J, USB/LSB), CW (A1), FM (F3)
Intermediate Frequency	: SSB, CW 10.75MHz FM 10.75MHz, 455KHz
Sensitivity	: SSB, CW Less than 0.5 microvolts for 10dB S+N/N FM More than 30dB S+N+D/N+D at 1 microvolt Less than 0.6 microvolts for 20dB Noise quieting
Squelch sensitivity	: Less than 0.4 microvolts
Spurious response rejection ratio	: More than 60dB
Selectivity	: SSB, CW More than ± 1.2 KHz at -6 dB point Less than ± 2.4 KHz at -60 dB point FM More than ± 7.5 KHz at -6 dB point Less than ± 15 KHz at -60 dB point
Audio output power	: More than 2W
Audio output impedance	: 8 ohms



SECTION II DESCRIPTION

144MHz ALL-MODE TRANSCEIVER INCORPORATING A MICROCOMPUTER

CPU control with ICOM's original programs provides various operating capabilities. No-backlash dial controlled by ICOM's unique photo-chopper circuit. Band-edge detector and Endless System provides out-of-band protection. No variable capacitors or dial gear, giving problem-free use. The IC-260A/E provides FM, USB, LSB, CW coverage in the 144 ~146MHz (IC-260A : 143.8 ~148.2MHz) frequency range. Thus the IC-260A/E can be used for mobile, DX, local calls, and satellite work.

MULTI-PURPOSE SCANNING

Memory Scan allows you to monitor three different memory channels. Program Scan provides scanning between two programmed frequencies. Adjustable scanning speed. Auto-stop stops scanning when a signal is received, in all modes.

DUAL VFO'S

Two separate VFO's can be used either independently or together for simplex operation, and any desired frequency split in duplex operation.

CONTINUOUS TUNING SYSTEM

ICOM's new continuous tuning system features an LED display that follows the tuning knob movement and provides an extremely accurate readout. Frequencies are displayed in 7 LED digits representing 100Hz digits.

Automatic recycling restarts tuning at the top of the band, ie., 145.999.9MHz when the dial goes below 144.000.0MHz. Recycling changes 145.999.9MHz to 144.000.0MHz as well. Quick tuning in 1KHz steps is available, and fine tuning in 100Hz steps in the SSB and CW modes, and 5KHz steps and 1KHz steps in the FM mode, is provided for trouble free QSO.

(IC-260A : 145.999.9MHz and 144.000.0MHz should be read 148.199.9MHz and 143.800.0MHz.)

OUTSTANDING PERFORMANCE

The RF amplifier and first mixer circuits using MOS FETs, and other circuits provide excellent Cross Modulation and Two-Signal Selectivity characteristics. The IC-260A/E has excellent sensitivity demanded especially for mobile operation, high stability, and with Crystal Filters having high shape factors, exceptional selectivity.

The transmitter uses a balanced mixer in a single conversion system, a band-pass filter and a high-performance low-pass filter. This system provides distortion-free signals with a minimum spurious radiation level.

ADDITIONAL CIRCUITS

The IC-260A/E has a built-in Noise Blanker, CW Break-in, CW Monitor, APC, and many other circuits for your convenience.

The IC-260A/E has everything you need to really enjoy VHF operation, in an extremely compact, rugged transceiver.

SECTION III INSTALLATION

UNPACKING

Carefully remove your transceiver from the packing carton and examine it for signs of shipping damage. Should any be apparent, notify the delivering carrier or dealer immediately, stating the full extent of the damage. It is recommended you keep the shipping cartons. In the event storage, moving, or reshipment becomes necessary, they come in handy. Accessory hardware, cables, etc., are packed with the transceiver. Make sure you have not overlooked anything.

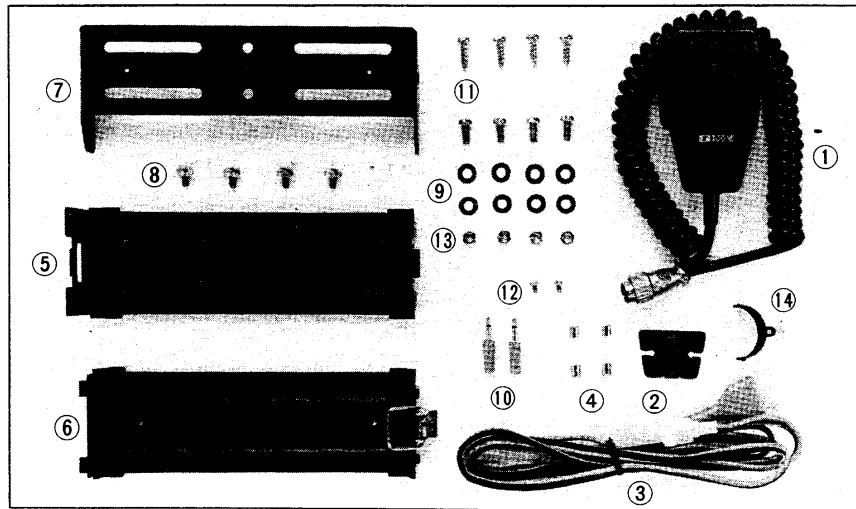

1. Microphone (dynamic type)	1	8. Gimp screws	4
2. Microphone hook	1	9. Flat washers	12
3. Power cord.	1	10. Plugs for speaker and key	2
4. Spare fuses (10A)	2	11. Mounting screws	8
5. Installing holder A.	1	12. Screws for additional bracket.	2
6. Installing holder B.	1	13. Mounting screw's nuts	4
7. Installing angle joint.	1	14. Quick tuning knob adaptor	1

LOCATION

Where you place the transceiver in your automobile is not critical and should be governed by convenience and accessibility. Since the unit is so compact, many mobile possibilities present themselves. In general, the mobile mounting bracket will provide you with some guide as to placement. Any place where it can be mounted with metal screws, bolts, or pop-rivets will work. For fixed station use, a power supply should be designed to produce 3.5 amps for the transceiver.

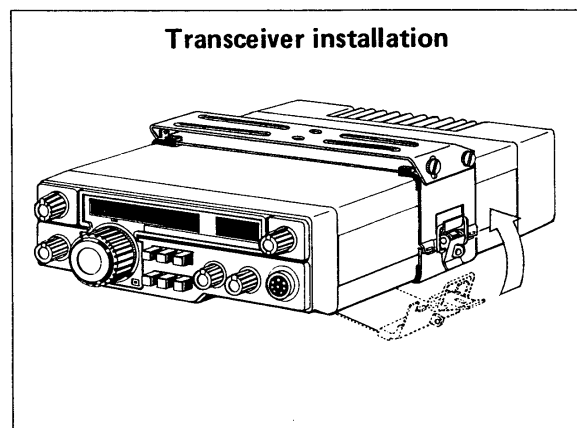
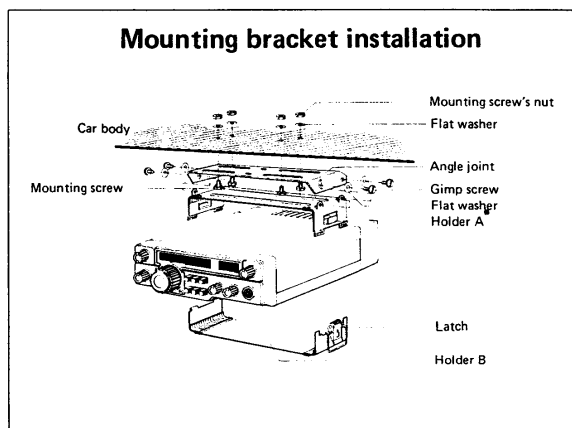

Angle adjustment

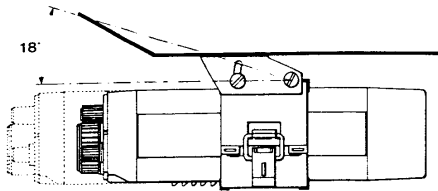

Optional installation

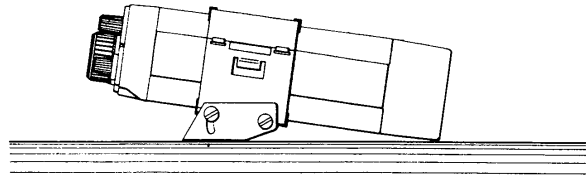

POWER REQUIREMENTS

The transceiver is supplied ready to operate from any regulated 13.8V DC, 3.5 ampere negative ground source. An automobile 12 volt, negative ground, system is usually more than adequate. Some note must be taken, however, of the condition of the vehicle's electrical system. Items such as low battery, worn generator/alternator, poor voltage regulator, etc., will impair operation of your transceiver as well as the vehicle. High noise generation or low voltage delivery can be traced to these deficiencies. If an AC power supply is used with your transceiver, make certain it is adequately regulated for both voltage and current. Low voltage while under load will not produce satisfactory results from your transceiver. Receiver gain and transmitter output will be greatly impaired. Caution against catastrophic failure of the power supply should be observed.

CAUTION: Excessive Voltage (above 15VDC) will cause damage to your transceiver. Be sure to check source voltage before plugging in the power cord.

Included with your transceiver is a DC power cable with plug attached. The Red Wire is positive (+), the Black, negative (-). If your mobile installation permits, it is best to connect these directly to the battery terminals. This arrangement eliminates random noise and transient spikes sometimes found springing from automotive accessory wiring. If such an arrangement is not possible, then any convenient B+ lead in the interior of the vehicle and the negative frame can be utilized. Remember, the unit operates on a negative ground system only; it cannot be used in a positive ground automobile. After making your connections, simply insert the plug into your transceiver.

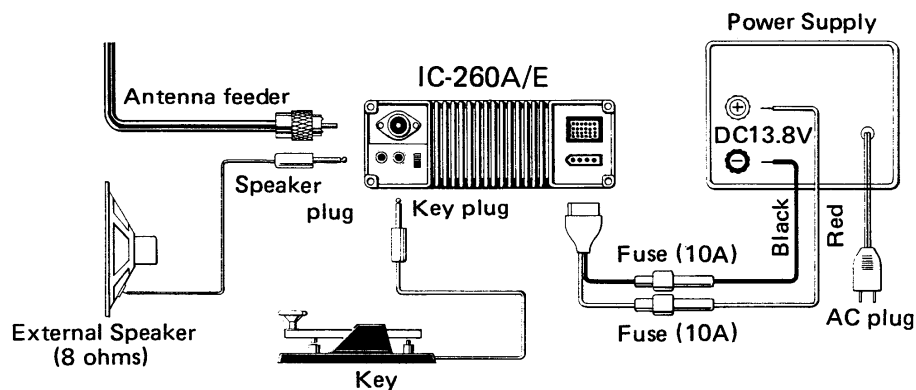

ANTENNA

The most important single item that will influence the performance of any communication system is the antenna. For that reason, a good, high-quality, gain antenna of 50 ohms impedance is recommended, fixed or mobile. In VHF as well as the low bands, every watt of ERP makes some difference. Therefore, 10 watts average output plus 3dB of gain antenna equals 20 watts ERP, presuming low VSWR of course. The few more dollars invested in a gain type antenna is well worth it. When adjusting your antenna, whether mobile or fixed, by all means follow the manufacturer's instructions. There are some pitfalls to be aware of. For example, do not attempt to adjust an antenna for lowest VSWR when using a diode VSWR meter not engineered for VHF applications. Such readings will invariably have an error of 40% or more. Instead, use an in line watt meter similar to the Drake WV-4, Bird Model 43 or Sierra Model 164B with VHF cartridge. Further, when adjusting a mobile antenna, do so with the motor running preferably above normal idling speed. This will insure proper voltage level to the transceiver.

The RF coaxial connector on the rear chassis mates with a standard PL-259 connector. Some models may have metric threads. In any event, the RF connector will mate with almost any PL-259 connector if care is taken to seat them properly.

MICROPHONE

A high quality dynamic microphone with built-in preamplifier is supplied with your transceiver. Merely plug it into the proper receptacle on the front panel. Should you wish to use a different microphone, make certain it has a proper preamplifier. Particular care should be exercised in wiring also, as the internal electricals switching system is dependent upon it. See the schematic for the proper hook up.

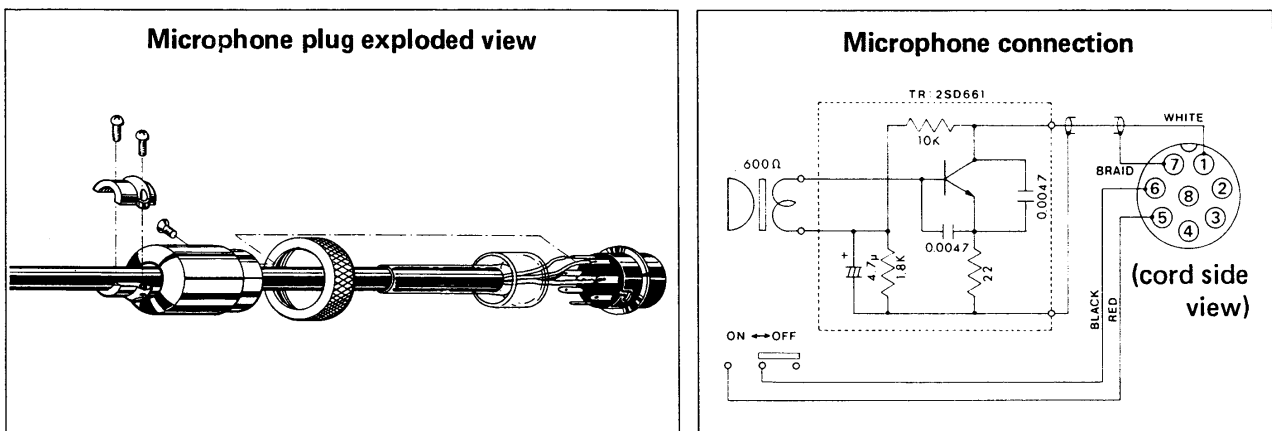

EXTERNAL SPEAKER

An external speaker jack and plug is supplied with your unit in the event another speaker is desirable. The external speaker impedance should be 8 ohms, and when used, will disable the internal speaker. An 8 ohm headset can be utilized as well.

CW KEY

When operating CW, connect the Key to the Key Jack with the plug supplied as shown in the figure. If the terminals have polarity, be sure to make the correct connection. Note that the keyed voltage when switching with semiconductors or relays with resistors in the circuit, should be adjusted to be below 0.4 Volts!

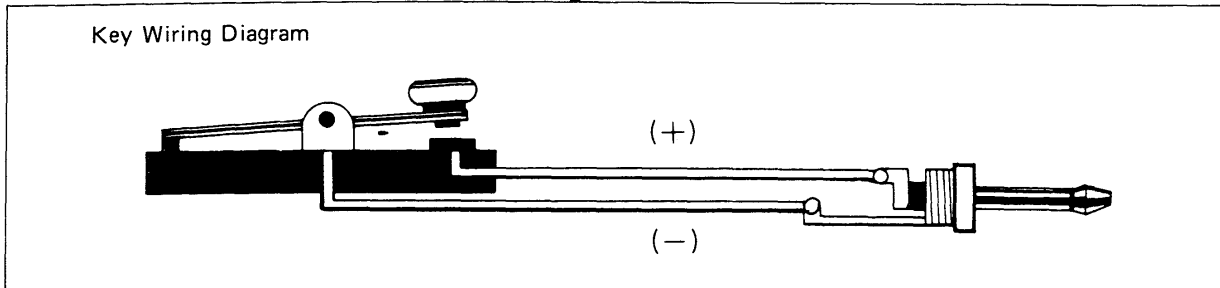

QUICK TUNING KNOB ADAPTOR

The tuning control knob has click-stops. For easy, faster tuning, especially in the SSB mode, put the quick tuning knob adaptor on the tuning control knob.

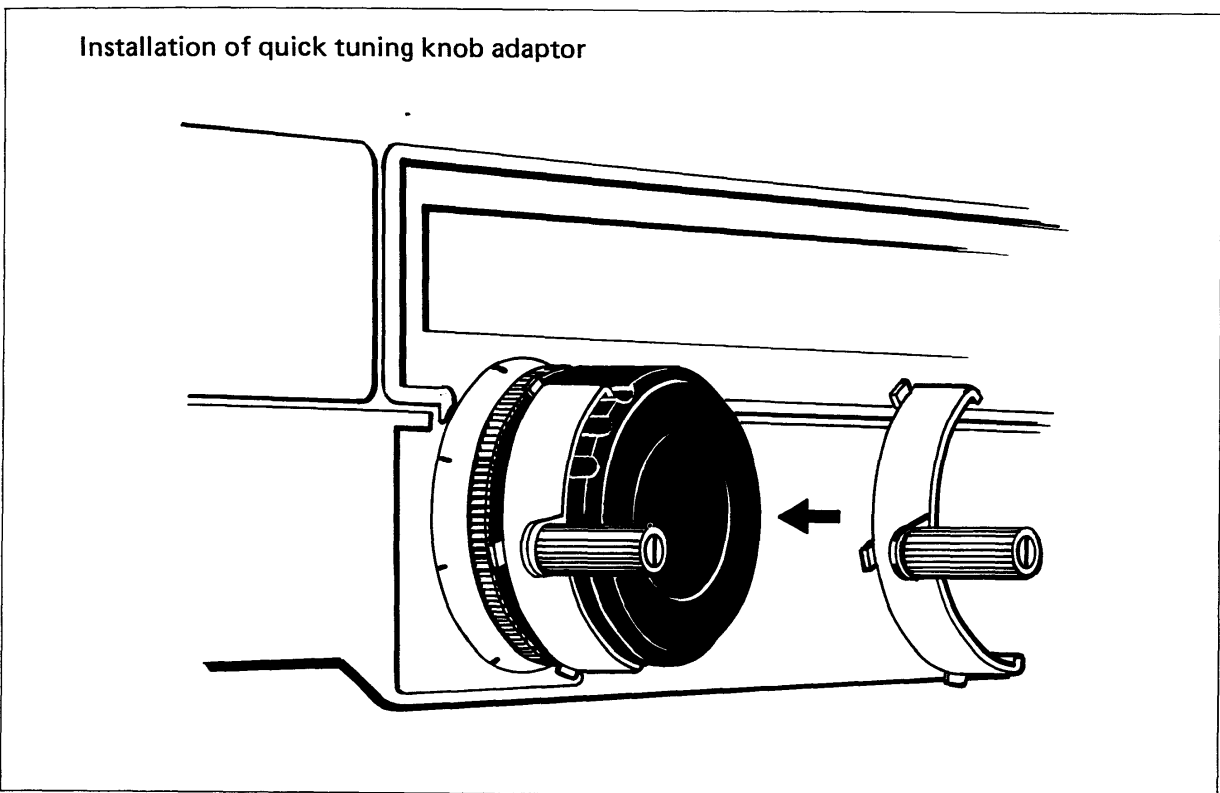

SECTION IV CONTROL FUNCTIONS

FRONT PANEL

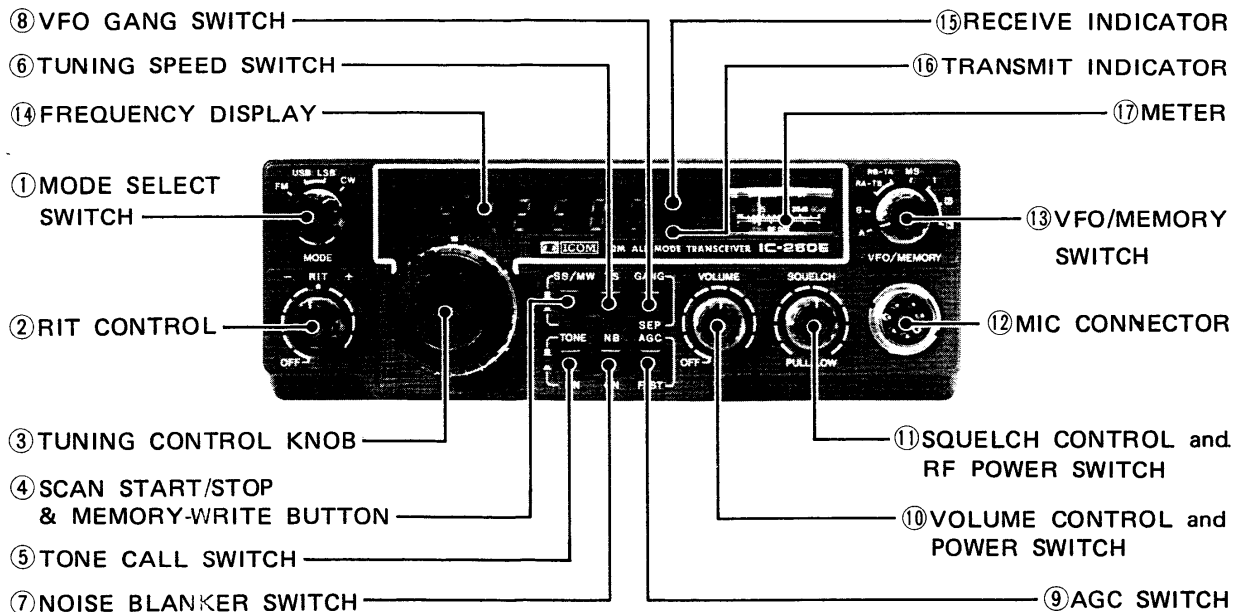

1. MODE SELECT SWITCH

Selects either side band, USB or LSB, for SSB operation. For FM or CW operation, set the switch in the desired mode.

2. RIT CONTROL

Shifts the receive frequency $\pm 800\text{Hz}$ either side of the transmit frequency. Rotating the control to the (+) side raises the receiver frequency, and rotating to the (-) side lowers the receiver frequency. The frequency shift by turning the RIT Control is not indicated on the frequency display.

If the OFF position is desired, turn the RIT Control completely counterclockwise. (It will "click" OFF). Then the transmit and the receive frequencies are the same.

3. TUNING CONTROL KNOB

Rotating the TUNING CONTROL KNOB clockwise increases the frequency, while rotating it counterclockwise decreases the frequency. The frequency is changed in 100Hz steps in the SSB and CW modes and in 5KHz steps in the FM mode which correspond to the click-stops. The smaller vernier marks on the knob each indicate two click-stops and the larger marks represent ten click-stops.

When tuning up past 145.9999MHz, (145.999MHz When TS Switch is pushed.) the frequency will automatically revert to 144.000MHz. Likewise, when tuning down past 144.000MHz, the frequency will automatically revert to 145.9999MHz (145.999MHz).
(IC-260A : 145.9999MHz and 144.000MHz should be read 148.1999MHz and 143.800MHz.)

4. SCAN START/STOP & MEMORY WRITE (SS/MW) BUTTON

The following three functions are provided by pushing the SS/MW Button.

MEMORY WRITE Writing a frequency into Memory Channel 1, ②, or ③.

SCAN START Starting the Programmed Scan and Memory Scan.
SCAN STOP Stopping any of the scan functions.

5. TONE CALL SWITCH

Most repeaters require a 1750Hz Tone-burst for initial access. Depressing the Tone Call Switch for the required period for a repeater, Puts the set in the transmit mode and the tone burst generator actuates and you can access the repeater. (IC-260A : The Tone Call unit is not installed, this switch can be used for a Transmit/Receive switch.)

6. TUNING SPEED SWITCH

Pushing the tuning speed switch IN, and rotating the tuning knob will result in changing the frequency in 1KHz steps in any mode. This button will allow you to quickly QSY over a great frequency range in SSB and CW and to tune in FM signals which are off from 5KHz-step frequencies.

7. NB (NOISE BLANKER) SWITCH

When pulse type noise such as automobile ignition noise is present, set this switch to the ON (locked in) position. The noise will be reduced to provide comfortable reception. (The Noise Blanker does not activate in the FM mode.)

8. VFO GANG SWITCH

Selects the relationship between "A" VFO and "B" VFO. In the GANG (up) position, the second VFO will follow the selected VFO at the same frequency difference they were set at. In the SEP (locked in) position, "A" VFO and "B" VFO do not have a relationship, and both VFO's can be used independently.

9. AGC (AUTOMATIC GAIN CONTROL) SWITCH

With this switch you can select the time constant of the AGC circuit. With the switch in the AGC (up) position, the AGC voltage is released slowly, and thus is suitable for SSB reception. With the switch in the FAST (locked in) position, the AGC voltage is released faster, and the AGC is suitable for stations suffering from fast fading or when operating in the CW mode. (The AGC circuit does not activate in the FM mode.)

10. VOLUME CONTROL and POWER SWITCH

When the control is turned completely counterclockwise, the power is OFF. By turning the control clockwise beyond the "click", the unit is turned ON and the audio level increases by further rotating it clockwise.

11. SQUELCH CONTROL and RF POWER SWITCH

Turning this control clockwise sets the squelch threshold higher. To turn OFF the squelch function, turn this control completely counterclockwise.

By pulling the Squelch control knob, the RF output power is reduced to 1 watt. By depressing the knob to the normal position, the RF output power returns to 10 watts.

12. MIC CONNECTOR

Connect the supplied microphone to this jack. If you wish to use a different microphone, refer to the drawing on page 7.

13. VFO/MEMORY SWITCH

Selects operation with the tuning control ("A" and "B" positions) or operation with the

memory channels (1~③). See "PROGRAMMING THE MEMORY CHANNELS" on page 18 for more details.

In addition, when the VFO is switched from one VFO to the other VFO, the frequency indicated on the frequency display just prior to switching goes into a memory inside the CPU. Thus even if "B" VFO is being used, switching to "A" again will enable you to operate at the initial "A" frequency. Switching back from "A" to "B" results in the same operation.

14. FREQUENCY DISPLAY

The seven large 7 segment LED's represent the digits between 100MHz and 100Hz of the operating frequency. The frequency indicated is the carrier frequency of each mode. If you turn the RIT control ON to change the receive frequency and rotate the RIT control knob, the frequency display will not change.

15. RECEIVE INDICATOR

Illuminates when the squelch is opened in the receive mode.

16. TRANSMIT INDICATOR

Illuminates in the transmit mode.

17. METER

The numbers on the S-meter represent S1 through S9 and 20 and 60dB over S9. The RF output level meter functions only as a relative output meter and does not indicate the wattage. These functions are switched automatically when T/R switching is made.

REAR PANEL

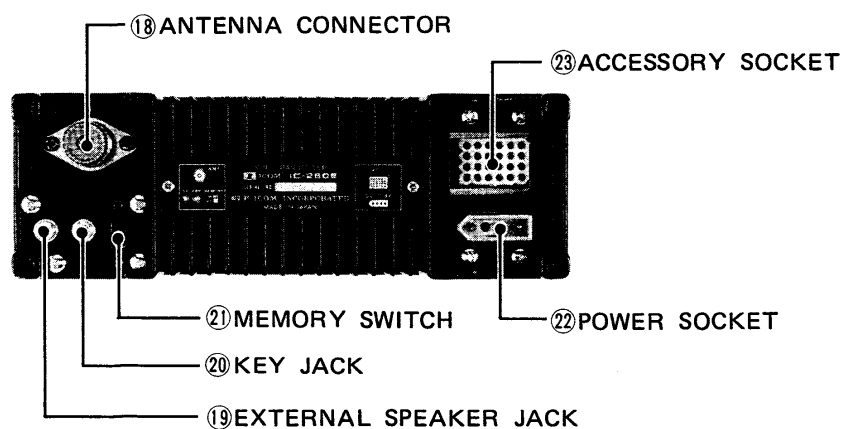

18. ANTENNA CONNECTOR

This is used to connect the antenna to the set. Its impedance is 50 ohms and connects with a PL-259 connector.

19. EXTERNAL SPEAKER JACK

When an external speaker is used, connect it to this jack. Use a speaker with an impedance of 8 ohms. When the external speaker is connected the built-in speaker does not function.

20. KEY JACK

For CW operation, connect the key here using the included key plug.

21. MEMORY SWITCH

When this switch is in the ON (up) position, the power to the CPU of the IC-260A/E is supplied continuously, even when the POWER Switch on the front panel is turned OFF, to retain all the programmed frequencies in the Memory Channels, the operating frequencies of the two VFO's, etc. When this switch is set at the OFF (down) position, all the power, including that to the CPU, is turned OFF by turning OFF the POWER Switch, so that all the programmed frequencies in the Memory Channels, the operating frequencies of the two VFO's etc., are erased.

22. POWER SOCKET

Connect the supplied power cord to this socket.

23. ACCESSORY SOCKET

The table below shows terminal connections of this connector.

NOTE: IC-RM2/3 does not function with the IC-260A/E.

ACC SOCKET CONNECTIONS

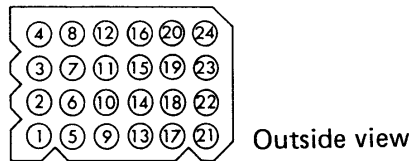

PIN No.	FUNCTION
1.	Output from squelch control stage. (+7V when squelch is ON)
2.	13.8 Volts DC in conjunction with the power switch operation. (0.3A Max.)
3.	Connected to Push-to-talk, T/R change-over switch. When grounded, the set operates in the transmit mode.
4.	Output from the receiver detector stage. Fixed output regardless of AF output of VOLUME Control.
5.	Output from Transmitter MIC amplifier stage.
6.	8 Volts DC available when transmitting. (Relay can not be directly actuated. 5mA Max.)
7.	Input for external ALC voltage.
8.	Ground.
9.	NC (no connection).
10.	Output of the voltage applied to the meter.
11.	NC (no connection).
12.	Input for external Noise Blanker control signals.
13. ~ 15.	NC (no connection).
16.	Control signal (DBC) input terminal for external control.
17.	NC (no connection).
18.	NC (no connection).
19.	Control signal (DV) output terminal for external control.
20.	Control signal (RT) input terminal for external control.
21.	Data signal (DB1) input/output terminal for external control.
22.	Data signal (DB2) input/output terminal for external control.
23.	Data signal (DB4) input/output terminal for external control.
24.	Data signal (DB8) input/output terminal for external control.

SECTION V OPERATION

HOW TO TUNE

The following instructions are for tuning in any mode. Please read carefully and understand fully before turning ON your unit. Proper tuning is necessary for optimum operation.

PRESET FREQUENCIES

When the POWER switch is turned ON, the frequency display will be 145.000.0 representing 145.000.0MHz, when the VFO/Memory Switch is in the "A", "RA-TB", "MS", "1", "2" and "3" positions, and the display will show 145.600.0 representing 145.600.0MHz, the switch is in the "B" and "RB-TA" positions. The frequencies of the VFO's and the Memory Channels are preset so that they start from the frequencies shown above whenever the IC-260A/E is turned ON with the MEMORY Switch in the OFF position or whenever the power to the CPU is cut for even a short time. Turn the VFO/Memory Switch to the "A" position.

FREQUENCY DISPLAY ON EACH MODE

Turn the MODE Select Switch to "FM", to "USB", to "LSB", and to "CW". The displayed frequency will be changed as follows.

At the "FM" position 145.000

At the "USB" position 144.998.5

At the "LSB" position 145.001.5

At the "CW" position 144.999.0

To avoid the trouble of recalibrating the dial when you change the operating mode, the displayed frequency is set to shift to the carrier frequency of each mode automatically. For the differences of the frequency shifts of the various modes, refer to the following figure.

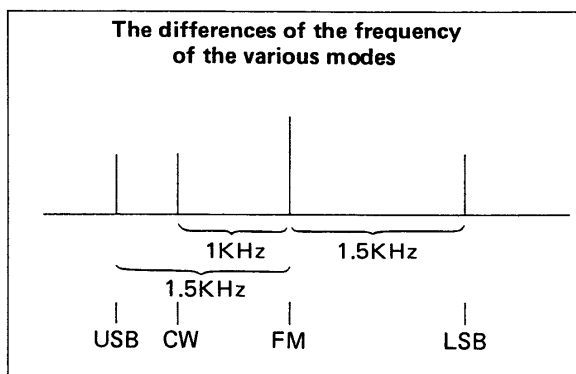

When the MODE Select Switch is set in the "FM" position from any other mode, the last two digits of the operating frequency is cleared to "0.0", and the decimal point of the 1KHz digit, and the 100Hz digit of the frequency display are turned OFF.

NOTE: At some operating frequencies, when changing the operating mode, the frequency display may indicate a frequency which is out of the operating range of the IC-260A/E. If this

happens, rotate the Tuning Control either clockwise or counterclockwise by at least one click-stop of the Knob. Do not set the IC-260A/E in the transmit mode, before following this procedure.

TUNING CONTROL

Rotating the Tuning Knob clockwise increases the frequency; turning it counterclockwise decreases the frequency in 100Hz steps in the SSB or CW modes, or 5KHz steps in the FM mode (1KHz steps when the TS Switch is pushed IN in any mode).

The click stops of the knob change in 100Hz steps in the SSB or CW modes, or 5KHz steps in the FM mode (1KHz when the TS Switch is pushed IN). The smaller vernier marks on the knob represent two click stops and the larger marks represent ten click stops. One complete rotation of the tuning knob results frequency increase or decreases of a 5KHz (250KHz in FM mode and 50KHz when the TS Switch is pushed IN).

When you reach 145.999.9MHz in the SSB or CW modes, or 145.995MHz in FM mode (145.999 MHz when the TS Switch is pushed IN) turning the Tuning Control Knob clockwise will bring the operating frequency to 144.000MHz, the lowest edge, and you can continue increasing the frequency from there by continuing to rotate the Knob clockwise. The VFO endless system functions in the same way when decreasing the frequency from 144.000MHz, and will prevent you from inadvertently operating out of the amateur radio band. (IC-260A : 145.999.9MHz and 144.000MHz should be read 148.199.9MHz and 143.800MHz.)

TUNING SPEED (TS) SWITCH

By pushing the TS Switch IN, the frequency is increased or decreased in 1KHz steps in any mode.

In the SSB or CW modes, when the TS switch is pushed IN, the decimal point of the 1KHz digit, and the 100Hz digit are turned OFF, and the click stops of the tuning knob change in 1KHz steps. If the 100Hz digit of the previous operating frequency is off set from "0", this off set frequency is remained in the memory of the CPU. Thus the actual operating frequency has a difference caused by such off set. (Maximum possible difference is 900Hz.)

In the FM mode, when the TS switch is pushed IN, the decimal point of the 1KHz digit is turned ON and the click stops of the tuning knob change in 1KHz steps.

VFO/MEMORY SWITCH and VFO GANG SWITCH

The CPU in the IC-260A/E contains two "VFO's" for both receiving and transmitting. The VFO's are labeled "A" VFO and "B" VFO and are selectable with the VFO/MEMORY Switch, and can be selected to follow each other or operate independently with the VFO GANG Switch. This dual VFO system gives the IC-260A/E many very convenient features. Please read this section very carefully and perform the operation several times until you are comfortable with the system. Try the example!

1. "A" VFO is for both transmitting and receiving and is selected by placing the VFO/MEMORY Switch in the "A" position. The transmit and receive frequency will be controlled by "A" VFO, displayed on the frequency display and stored in "A" memory.
2. "B" VFO is for both transmitting and receiving and is selected by placing the VFO/MEMORY Switch in the "B" position. The transmit and receive frequency will be controlled by "B"

VFO, displayed on the frequency display, and stored in "B" memory.

3. RA-TB: The receive frequency is controlled by "A" VFO and the transmit frequency is controlled by "B" VFO. Both frequencies are stored in their respective memories, and displayed during their respective operation times ("A" frequency during receive, and "B" frequency during transmit).
4. RB-TA: The receive frequency is controlled by "B" VFO and the transmit frequency is controlled by "A" VFO, the reverse of the above. Again, both frequencies are stored in their respective memories, and displayed during their respective operation times (this time "B" frequency during receive and "A" frequency during transmit).

NOTE: The MS, 1, 2, and 3 positions are described in the "MEMORY CHANNEL OPERATION" on page 18.

- When the IC-260A/E is first turned ON, 145.000.0MHz is preset into the "A" VFO and 145.600.0MHz is preset into "B" VFO.

FOR EXAMPLE:

When the VFO/MEMORY Switch is set in the "A" position and the set is turned ON, 145.000.0 will be displayed on the readout. This will occur whether the VFO/MEMORY Switch is in either the "A" or "RA-TB" or Memory Channels positions.

When the VFO/MEMORY Switch is set in the "B" position or "RB-TA" position, 145.600.0 will be displayed on the readout. Rotating the tuning knob clockwise will increase the frequency, and rotating the tuning knob counterclockwise will decrease the frequency in 100Hz steps. (5KHz steps in the FM mode)

- Switching from one VFO to the other VFO does not clear the first VFO. The frequency is retained in the VFO's memory.

FOR EXAMPLE:

When the VFO GANG Switch is set in the "SEP" (pushed IN) position, if 145.125.0MHz is set with "A" VFO, and the VFO switch is set to "B" VFO, the frequency readout will show "B" VFO's frequency, but 145.125.0MHz is still stored in "A" VFO's memory. Returning the VFO Switch to "A" VFO position, and 145.125.0 will be displayed on the readout. Accordingly, if the switch is placed in the "B" VFO position, the frequency that was set with the "B" VFO will appear. This allows you to set a certain frequency with one VFO, work up and down the band with the other VFO, and periodically check the set frequency simply by switching between "A" and "B" VFO. It also allows you to search for a clear frequency with one VFO, while keeping your operating frequency on the other VFO. When you have found a clear frequency, switch back to your operating frequency, inform the station you are in contact with of the new frequency, and switch back. It's that simple!

NOTE: When the VFO GANG Switch is set in the "GANG" (out) position, one VFO follows the other VFO at the same frequency difference they were set at. (If a frequency is not set in "A" VFO or "B" VFO with the VFO GANG Switch in the "SEP" position "B" VFO is set 600KHz above "A" VFO.)

- "RA-TB" or "RB-TA" positions will allow you to operate a repeater or split transmit/receive frequencies.

FOR EXAMPLE:

Set the VFO GANG Switch in the "GANG" position and turn the POWER Switch ON. "B" VFO will be preset 600KHz above "A" VFO.

Set "A" VFO to 145.125.0MHz or "B" VFO to 145.725.0MHz. Then set the VFO/MEMORY Switch to the "RB-TA" position. 145.725.0MHz will be shown on the readout during receive ("B" VFO) and 145.125.0MHz during transmit ("A" VFO). You are now receiving on 145.725.0MHz and transmitting on 145.125.0MHz, so you can access a 145.125/145.725 repeater.

If you change the receiving ("B" VFO) frequency, the transmitting ("A" VFO) frequency will follow the receiving frequency at the same frequency difference. So, first, set "A" VFO or "B" VFO at the frequencies for repeater input/output frequency. This makes repeater operation simple.

FOR EXAMPLE:

If you change the receiving frequency from 145.725MHz to 145.675MHz, the transmitting frequency will change from 145.125MHz to 145.075MHz, so now you can access a 145.075/145.675 repeater.

Setting the VFO/MEMORY Switch to RA-TB reverses the above.

- When you want to change to the DUPLEX operation, after using "A" VFO and "B" VFO independently, and "A" VFO and "B" VFO do not have a 600KHz frequency difference.

FOR EXAMPLE:

Set the VFO GANG Switch to the "SEP" position, and set "A" VFO to 145.725.0MHz and "B" VFO to 145.125.0MHz. Then set the VFO GANG Switch to the "GANG" position, and the VFO/MEMORY Switch to the RA-TB position. 145.725.0MHz will be shown on the readout during receive ("A" VFO) and 145.125.0MHz during transmit ("B" VFO). You are now receiving on 145.725.0 MHz and transmitting on 145.125.0MHz, so you can access 145.125/145.725 repeater.

If you change the receiving ("A" VFO) frequency, the transmitting ("B" VFO) frequency will follow the receiving frequency at the same frequency difference. So, first, set "A" VFO and "B" VFO at the frequencies for repeater input/output frequency separation.

FOR EXAMPLE:

If you change the receiving frequency from 145.725MHz to 145.675MHz, the transmitting frequency will change from 145.125MHz to 145.075MHz, so now you can access 145.075/145.675 repeater.

Setting the VFO/MEMORY Switch to RB-TA reverses the above.

- When you want to operate repeaters or split transmit/receive frequencies that have a frequency difference other than ± 600 KHz.

FOR EXAMPLE:

Set the VFO GANG Switch to the "SEP" position and set "A" VFO to 145.725.0MHz and "B" VFO to 145.025.0MHz. Then set the VFO GANG Switch to the "GANG" position, and the VFO/MEMORY Switch to the "RA-TB" position. 145.725.0 will be shown on the readout during receive ("A" VFO) and 145.025.0 during transmit ("B" VFO). You are now receiving on 145.725.0MHz and transmitting on 145.025.0MHz, so you can access a 700KHz separation 145.025/145.725 repeater.

If you change the receiving ("A" VFO) frequency, the transmitting ("B" VFO) frequency will follow the receiving frequency at the same frequency difference. So, first, set "A" VFO and "B" VFO at the frequencies for repeater input/output frequency separation. This makes repeater operation simple.

FOR EXAMPLE:

If you change the receiving frequency from 145.725MHz to 145.875MHz, the transmitting frequency will change from 145.025MHz to 145.175MHz, so now you can access an 145.175/145.875 repeater.

Setting the VFO/MEMORY Switch to "RB-TA" reverses the above.

When you want to change to the SIMPLEX mode from DUPLEX operation, set the VFO/MEMORY Switch to the A or B position.

If you set the VFO GANG Switch to "GANG" position, the transmit and receive frequency will now be controlled by "A" VFO or "B" VFO, but the other VFO will follow the selected VFO at the same frequency difference they were set at, so you can return to DUPLEX operation easily.

RIT (RECEIVER INCREMENTAL TUNING)

By using the RIT circuit, you can shift the receive frequency ± 800 Hz either side of the transmit frequency without moving the transmit frequency itself. Therefore, when you get a call slightly off frequency, or when the other station's frequency has shifted, you can tune in the receiving frequency without disturbing the transmitting frequency.

When the RIT knob is in the center (12 o'clock) position, the transmitting and receiving frequencies are the same. Rotating the control to the (+) side raises the receiving frequency, and rotating to the (-) side lowers the frequency. To turn OFF the RIT control, turn the knob completely counterclockwise to the OFF position. (It will "click" OFF.)

When the RIT circuit is OFF, the transmit and receive frequencies are the same.

Other things to remember are: The frequency shifted by turning the RIT control is not indicated on the frequency display. When the transmitting and receiving frequencies differ by more than 800Hz, use "A" and "B" VFO's as outlined previously.

MEMORY CHANNEL OPERATION

MEMORY-WRITE (PROGRAMMING THE MEMORY CHANNELS)

Only "A" VFO can be used for memory-writing.

1. Set the Tuning Control to the desired frequency, using "A" VFO. For example, set it for 145.700.0 on the display.
2. Set the VFO Switch to the channel to be programmed (1, 2, or 3). For example, set it at Memory Channel 1. If no frequency has been programmed since turning the power of the unit ON, 145.000.0 will be shown on the display and the unit will receive on this frequency.
3. One push of the SS/MW Button erases the previous programmed frequency (145.000.0) and programs the new frequency (145.700.0) into Memory Channel 1.
4. Program any desired frequencies in Memory Channels 2 and 3 in the same manner. Memory Channels 2 and 3 are used also for the Programmed Scan. For Programmed Scan operation, refer to SCANNING OPERATION.

MEMORY READING

Set the VFO/MEMORY Switch to the desired Memory Channel 1, 2, or 3. At whichever frequency the "A" or "B" VFO was set, that previously programmed frequency is recalled. When the VFO/MEMORY Switch is set back to "A" or "B" VFO, the previous operating frequency of that VFO will again be shown on the display.

The programmed frequencies in the three Memory Channels are maintained as long as the power, including MEMORY power, of the IC-260A/E is not turned OFF or new frequencies reprogrammed. When the MEMORY Switch on the rear panel is set to ON (up), all the programmed frequencies on the Memory Channels and the operating frequencies of both "A" and "B" VFO's are retained even when the POWER Switch is turned OFF.

SCANNING OPERATION

The IC-260A/E provides various scanning operations. Read the following instructions carefully to fully enjoy the IC-260A/E's many capabilities.

MEMORY SCAN

This is to scan the three Memory Channels continuously.

1. Program three desired frequencies in Memory Channels 1, 2, and 3.
2. Set the VFO/MEMORY Switch to the "MS" position. At this time, the operating or displayed frequency is not changed.
3. Depress the SS/MW Button, and the display frequency starts scanning the programmed frequencies in the Memory Channels 1, 2, 3, 1, 2, 3. . .
4. If the SQUELCH is engaged, the scan stops when the squelch is opened and receives a signal. To stop scanning without opening the squelch, depress the SS/MW Button. Depress it again to restart the scanning.

PROGRAMMED SCAN

This is to scan between two desired frequencies, which are programmed in Memory Channels 2 and 3.

1. Program the frequencies of the high and low edge of the desired scanning range in Memory Channels 2 and 3. Regardless of which channel the higher frequency is programmed in, the scan starts from the high edge of the range.

For example, program 145.200MHz in Memory Channel ② and 145.800MHz in Memory Channel ③.

2. Set the VFO/MEMORY Switch to "A" or "B". Depressing the SS/MW Button starts the scan from the high edge (145.800MHz) to the low edge. The scanning frequency increments depend on the MODE Switch setting and the TS Button setting.
3. When the scanning frequency reaches the lowest edge (145.200MHz), it automatically returns to the high edge (145.800MHz) and continues scanning down to provide endless scanning operation.
4. While the SQUELCH is engaged, the squelch opening when a signal is received will stop the scanning automatically to lock onto the frequency. Depressing the SS/MW Button will restart the scan from the frequency at which it stopped. If the RECEIVE indicator LED is lit because the SQUELCH is not engaged, the scan does not stop at any signals.
5. To stop the scan operation, depress the SS/MW Button. Depressing the SS/MW Button again restarts the scan from the high edge (145.800MHz) of the programmed range.

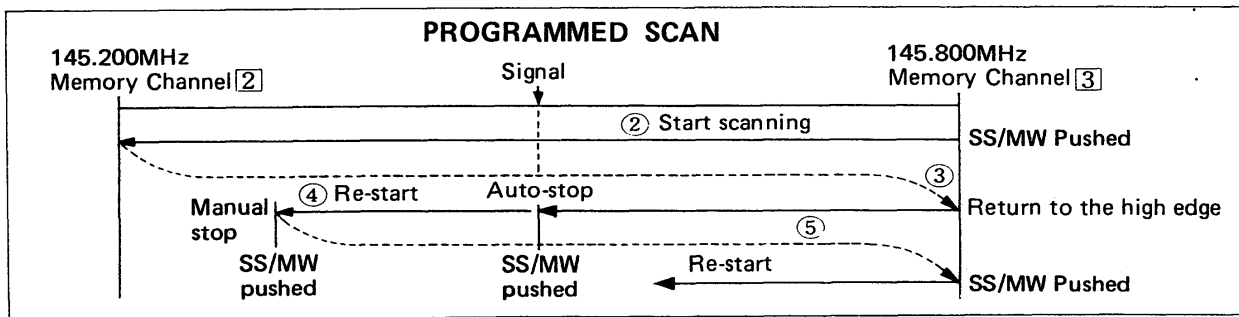

6. If this frequency is changed with turning the Tuning Control knob while the scan is stopped with auto-stop action, the scanning will restart from the VFO frequency.

In this case, if the VFO frequency is below the low edge frequency, the frequency jumps to the high edge frequency (145.800MHz) and restarts from the high edge.

If the changed frequency is higher than the high edge frequency and the SS/MW Button is pushed, scanning will begin at the VFO frequency, scan down to the low edge but will return to the preprogrammed high edge frequency.

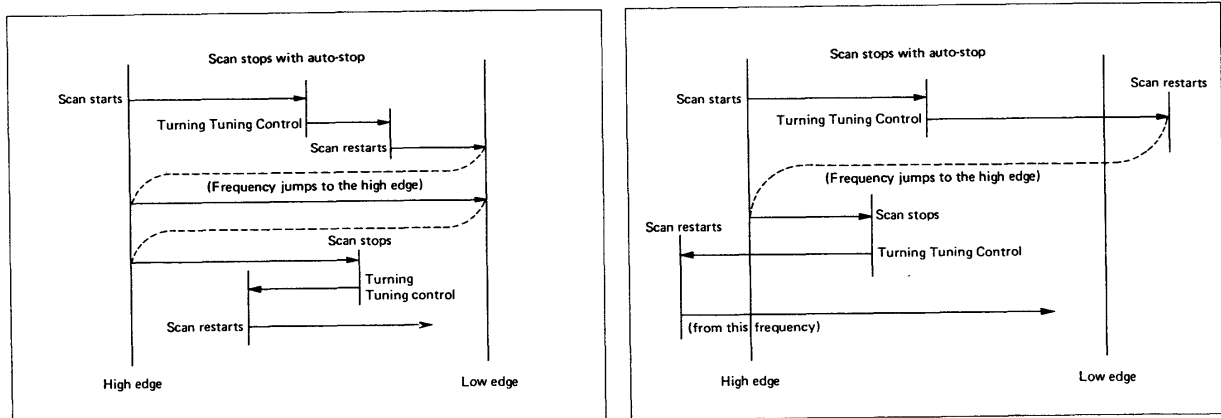

7. The scanning speed can be adjusted by the SCAN SPEED Control located on the driver unit inside cover. Rotating the control clockwise makes the scanning speed faster.

The Tuning Control does not function while the scan is operating.

SSB OPERATION

1. RECEIVING

After connecting an antenna, microphone, etc., set knobs and switches as follows.

MODE SELECT SWITCH	USB or LSB
RIT CONTROL	"OFF" position or center (12 o'clock) position
NOISE BLANKER SWITCH	OFF (OUT)
VFO GANG SWITCH	"SEP" (Pushed IN)
AGC SWITCH	normal (OUT)
VOLUME CONTROL and POWER SWITCH	Completely counterclockwise (OFF position)
SQUELCH CONTROL and RF POWER SWITCH	Completely counterclockwise (Pull switch is normal position.)
VFO/MEMORY SWITCH	"A"

The other knobs are unrelated to receiving and need not be set at this time.

In SSB operation there is both a USB (upper side band) and an LSB (lower side band). USB is usually used on the band, while LSB is usually used on the downlink of the satellite communications. Select the mode according to your use.

Now turn ON the power switch. The meter lamp will be illuminated and "145.000.0" ("145.600.0" when VFO/MEMORY Switch is in "B" position.) will be shown on the LED readout. Slowly turn the VOLUME Control clockwise to a comfortable level. Rotate the tuning knob until a signal is received. The meter needle will move according to the signal strength, so tune for the highest possible meter reading and the clearest audio. If you cannot get a clear signal, you may be receiving in the opposite sideband. If so, change the MODE SELECT Switch to the proper sideband.

The VFO's in the IC-260A/E change in 100Hz steps. Therefore the maximum possible difference in your receiving frequency and the received signal frequency is 50Hz. However, for normal voice signal reception, a difference of 50Hz is negligible and indeed may be hard to distinguish. Since the frequency is changed in 100Hz steps with the IC-260A/E, as opposed to continuous variable frequency systems, tuning is simplified and more accurate.

If squelch operation is required to cut out noise when no signal is received, turn the SQUELCH Control clockwise until the noise from the speaker stops and leave it just below this threshold.

For tuning and Memory Channel operation refer to "HOW TO TUNE" on page 13 and "MEMORY CHANNEL OPERATION" on page 18.

2. NB (NOISE BLANKER)

Set the noise blanker ON (pushed IN) when there is pulse type noise, such as ignition noise from automobile motors. Noise will be suppressed and even weak signals will be received comfortably. The noise blanker may not work as effectively when there is a strong signal on a nearby frequency or when there is continuous (not pulse type) noise.

3. AGC (AUTOMATIC GAIN CONTROL)

The IC-260A/E has a fast attack/slow release AGC system which holds the peak voltage of

rectified IF signals from the IF amp circuit for a certain period. Therefore, during the pauses in normal speech of the received signal, uncomfortable noise will not be heard. The meter indicates the peak value for a certain period, facilitating reading of the meter "S" function.

For normal SSB reception, set the AGC switch in the OUT (slow) position. Set the AGC Switch in the FAST (pushed IN) position, when tuning or receiving signals with short interval fading. When in the FAST position, the time constant is shortened.

4. TRANSMITTING

Before transmitting, listen in the receive mode to make sure your transmission will not interfere with other communications. If possible, use a dummy load for adjustment instead of an antenna.

Knobs and switches are left in the same positions as for receiving. When the PTT (push to talk) switch on the microphone is depressed, the transmit LED is illuminated. By speaking into the microphone, the meter needle will move according to the strength of your voice and SSB signals will be transmitted.

Hold the microphone about three inches from your mouth and speak in a normal voice. The microphone is of the dynamic type with a built-in preamplifier and provides good pickup for all levels of voice. Speaking too loudly into the microphone does not increase the RF output power, but causes some distortion in the SSB signals or spurious radiation. If you wish to decrease the peak power to 1 watt, pull the SQUELCH control and RF POWER Switch to the LOW (out) position.

To receive again, release the PTT button. This will also switch OFF the transmit indicator.

CW OPERATION

1. RECEIVING

For CW reception, set the MODE Select Switch to the CW position. Other switches and knobs are set the same as for SSB reception.

Rotate the tuning knob until an 800Hz (approx.) beat tone is heard from the speaker or headphones. Set the noise blanker switch and/or the AGC switch for clear reception, the same as for SSB reception.

2. TRANSMITTING

Insert the keyer plug into the KEY Jack on the rear panel of the unit, and set knobs and switches the same as for CW reception.

The IC-260A/E has Semi-Break-In CW capability. When keying, the unit is automatically set in the transmit mode. After keying, it is returned to the receive mode, also automatically, after a given transmit-release delay time constant. When you key the keyer, the transmit LED is lit and the meter needle moves and your CW signal is transmitted.

3. CW MONITOR

When keying, the side tone oscillator circuit is activated and an 800Hz tone is heard from the speaker. The loudness of this tone is adjusted by rotating the CW MONI Control, located on the main unit inside cover. Rotating the CW MONI Control clockwise makes the tone louder.

FM OPERATION

1. RECEIVING

Set knobs and switches as follows.

MODE SELECT SWITCH	FM
VFO GANG SWITCH	GANG (out)
VFO/MEMORY SWITCH	A or B
SQUELCH CONTROL	Completely counterclockwise

Other knobs and switches are set the same as for SSB reception.

When the IC-260A/E is first turned ON, "A" VFO will be preset at 145.000MHz and "B" VFO will be preset at 145.600MHz. This frequency difference is normal repeater input/output frequency separation.

If you desire to operate repeaters or split transmit/receive frequencies that have a frequency difference other than $\pm 600\text{KHz}$, set the "A" VFO and "B" VFO frequencies to make desired repeater input/output frequency separation or split transmit/receive frequencies.

Turn the Volume Control clockwise to a comfortable audio level.

If no signal can be heard but only noise, turn the Squelch Control clockwise until the noise from the speaker stops and set it just below this threshold. (When adjusting the Squelch Control setting, if some communication signals can be heard, turn the tuning control either direction and set it where only noise can be heard.) Your transceiver will now remain silent until an in-coming signal is received which opens the squelch and lights the RECEIVE indicator. If the squelch is unstable due to the reception of weak or mobile stations, adjust the squelch control further until the proper threshold is obtained.

The meter indicates the signal strength of the incoming signals and is calibrated in S units and dB over S9.

The NOISE BLANKER and the AGC circuits do not actuate in this mode.

Turn the tuning control to the desired frequency.

For tuning and Memory Channel operation refer to "HOW TO TUNE" on page 13 and "MEMORY CHANNEL OPERATION" on page 18.

2. TRANSMITTING

For simplex operation, set VFO/MEMORY Switch in the "A", "B" or 1~ memory channel position.

The operating frequency is selectable with the VFO/MEMORY Switch and the Tuning Control knob.

For duplex operation, set the VFO/MEMORY Switch in the "RA-TB" or "RB-TA" position.

In the "RA-TB" position, the receiving frequency is controlled by "A" VFO and the transmitting frequency is controlled by "B" VFO.

In the "RB-TA" position, the receiving frequency is controlled by "B" VFO and the transmitting frequency is controlled by "A" VFO.

MEMORY channels can not be used for duplex operation.

For more details refer to "HOW TO TUNE" on page 13 and "MEMORY CHANNEL OPERATION" on page 18.

If the lower output power (1 watt) is sufficient, set the Squelch Control and RF Power Switch to the LOW (out) position.

Depress the PTT (push to talk) Switch on the microphone and the transceiver will transmit. At the same time the TRANSMIT indicator will be illuminated red and the meter will provide and indication of relative power output of the transmitter.

SATELLITE COMMUNICATION

At present there are two active satellites for amateur radio use, AMSAT OSCAR 7 was launched in November, 1974 and AMSAT OSCAR 8 was launched in March, 1978. Satellite communications can be made by using an IC-260A/E for receiving/transmitting and IC-402 (70 centimeter SSB/CW transceiver) for transmitting/receiving in Mode B and Mode J, and an IC-260A/E for transmitting and IC-701 (HF SSB/CW/RTTY transceiver) for receiving in Mode A.

NOTE: FM mode is prohibited for these satellite communications.

For frequency information refer to the chart below. Further information on communicating through satellites can be found in various amateur radio books and periodicals.

FREQUENCY CHART

SATELLITE	MODE	UPLINK (Transmitting) FREQUENCY	DOWNLINK (Receiving) FREQUENCY	BEACON
AMSAT OSCAR 7 (AO-7)	A	145.85MHz ~ 145.95MHz (USB/CW)	29.4MHz ~ 29.5MHz (USB/CW)	29.502MHz 435.100MHz
	B	432.125MHz ~ 432.175MHz (USB/CW)	145.975MHz ~ 145.925MHz (LSB/CW)	145.975MHz
AMSAT OSCAR 8 (AO-8)	A	145.85MHz ~ 145.95MHz (USB/CW)	29.4MHz ~ 29.5MHz (USB/CW)	29.402MHz
	J	145.90MHz ~ 146.00MHz (USB/CW)	435.2MHz ~ 435.1MHz (LSB/CW)	435.097MHz

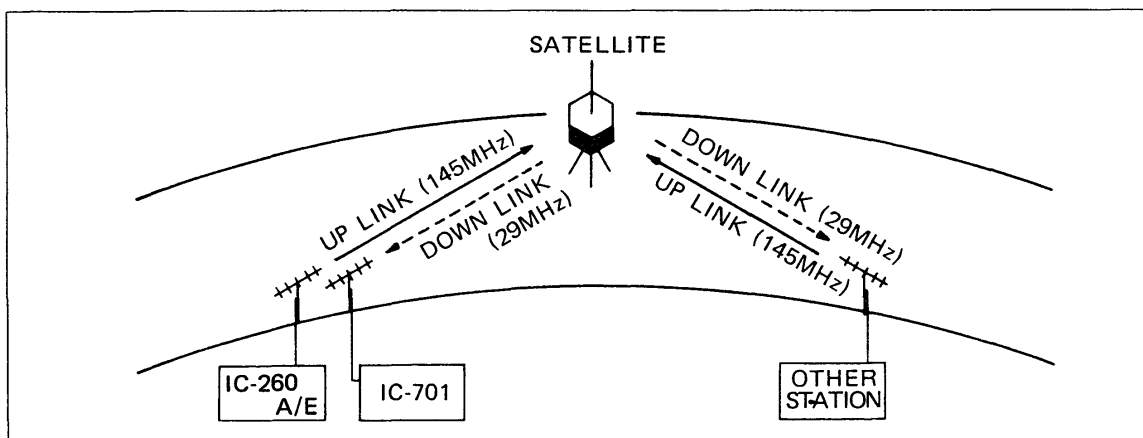

SECTION VI INSIDE VIEW

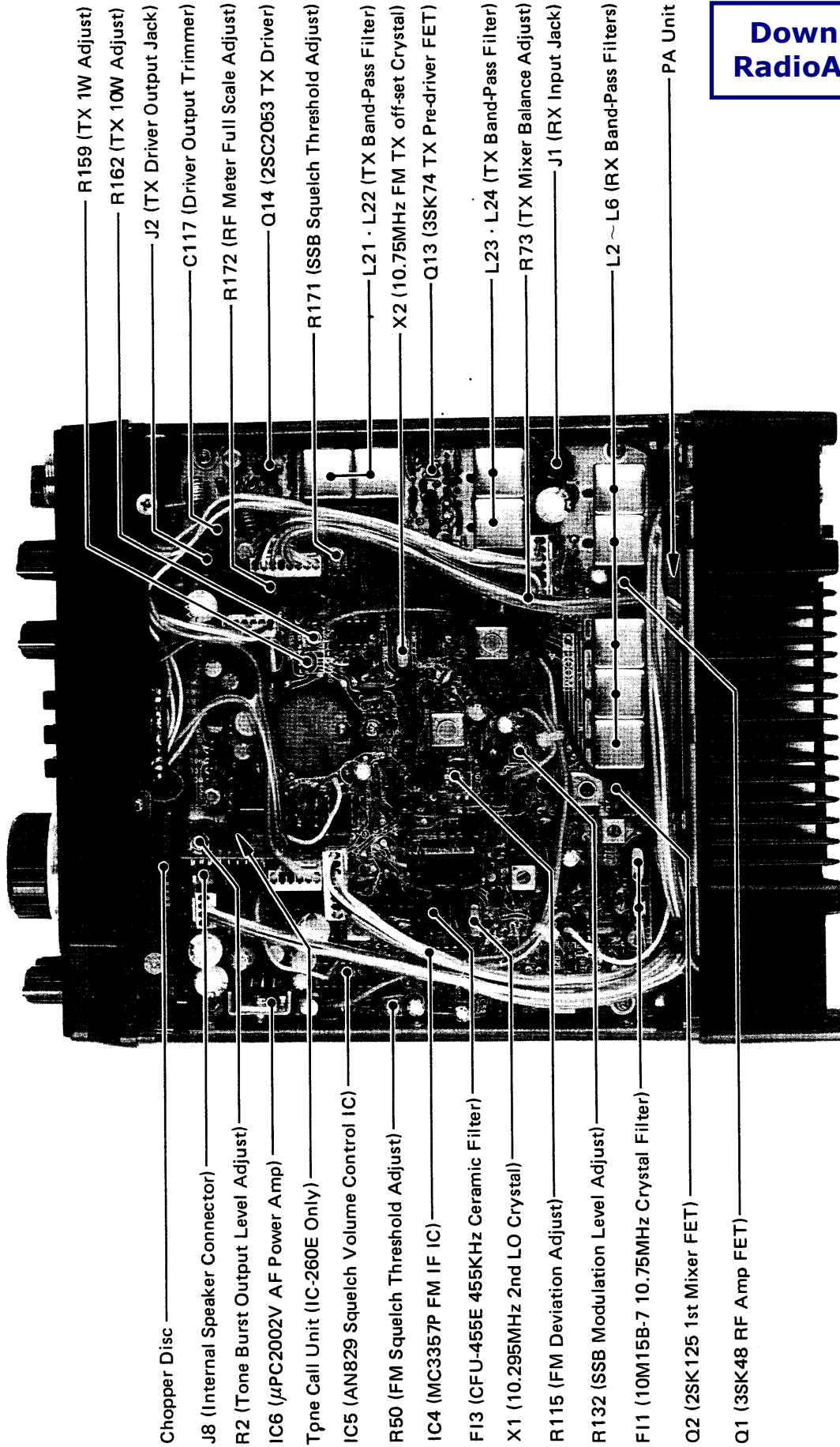

- Chopper Disc
- J8 (Internal Speaker Connector)
- R2 (Tone Burst Output Level Adjust)
- IC6 (μ PC2002V AF Power Amp)
- Tpne Call Unit (IC-260E Only)
- IC5 (AN829 Squelch Volume Control IC)
- R50 (FM Squelch Threshold Adjust)
- IC4 (MC3357P FM IF IC)
- F13 (CFU-455E 455KHz Ceramic Filter)
- X1 (10.295MHz 2nd LO Crystal)
- R115 (FM Deviation Adjust)
- R132 (SSB Modulation Level Adjust)
- F11 (10M15B-7 10.75MHz Crystal Filter)
- Q2 (2SK125 1st Mixer FET)
- Q1 (3SK48 RF Amp FET)
- R159 (TX 1W Adjust)
- R162 (TX 10W Adjust)
- J2 (TX Driver Output Jack)
- C117 (Driver Output Trimmer)
- R172 (RF Meter Full Scale Adjust)
- Q14 (2SC2053 TX Driver)
- R171 (SSB Squelch Threshold Adjust)
- L21 · L22 (TX Band-Pass Filter)
- X2 (10.75MHz FM TX off-set Crystal)
- Q13 (3SK74 TX Pre-driver FET)
- L23 · L24 (TX Band-Pass Filter)
- R73 (TX Mixer Balance Adjust)
- J1 (RX Input Jack)
- L2 ~ L6 (RX Band-Pass Filters)
- PA Unit

Downloaded by
RadioAmateur.EU

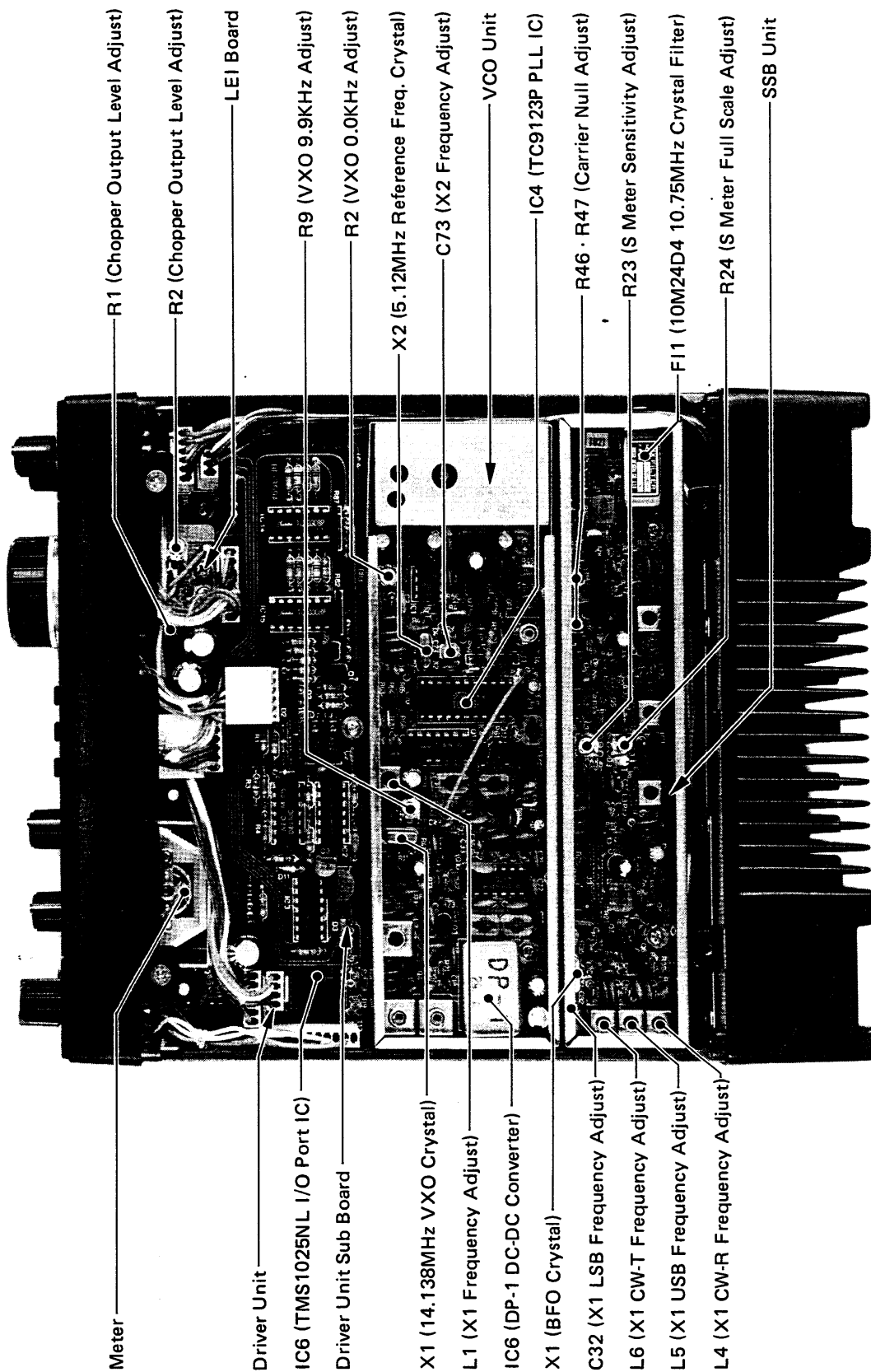

- Meter
- Driver Unit
- IC6 (TMS1025NL I/O Port IC)
- Driver Unit Sub Board
- X1 (14.138MHz VXO Crystal)
- L1 (X1 Frequency Adjust)
- IC6 (DP-1 DC-DC Converter)
- X1 (BFO Crystal)
- C32 (X1 LSB Frequency Adjust)
- L6 (X1 CW-T Frequency Adjust)
- L5 (X1 USB Frequency Adjust)
- L4 (X1 CW-R Frequency Adjust)
- R1 (Chopper Output Level Adjust)
- R2 (Chopper Output Level Adjust)
- LEI Board
- R9 (VXO 9.9KHz Adjust)
- R2 (VXO 0.0KHz Adjust)
- X2 (5.12MHz Reference Freq. Crystal)
- C73 (X2 Frequency Adjust)
- VCO Unit
- IC4 (TC9123P PLL IC)
- R46 · R47 (Carrier Null Adjust)
- R23 (S Meter Sensitivity Adjust)
- F11 (10M24D4 10.75MHz Crystal Filter)
- R24 (S Meter Full Scale Adjust)
- SSB Unit

SECTION VII TROUBLE SHOOTING

Your IC-260A/E has been tested very carefully at the factory before shipping. The chart below has been designed to help you correct any problems which are not equipment malfunctions. If you are not able to locate the problem and/or solve it through use of this chart, please contact your dealer or ICOM distributor for assistance.

Problem	Possible Cause	Solution
1. Power does not come ON when the switch is turned.	Power cord is improperly connected. Power cord is connected with the polarity reversed. Blown fuse.	Carefully reconnect power cord. Disconnect the power cord, replace the blown fuse, then reconnect the power cord observing proper polarity. Check for the cause, then replace the fuse with a new one.
2. No sound comes from the speaker.	VOLUME Control knob is completely counterclockwise, but not "clicked OFF". The unit is in the transmit mode, by the PTT switch on the microphone. SQUELCH setting is turned too far clockwise. External speaker is in use. The internal speaker cable is not connected.	Turn the knob clockwise to a suitable level. Put the unit in the receive mode. Turn the SQUELCH control counterclockwise until noise can be heard and reset it just below the threshold. Check if the external speaker plug is inserted properly or if the external speaker cable is cut. Connect the speaker connection.
3. Sensitivity is low and only strong signals are audible.	The antenna feed line is cut or shorted.	Check the feed line and correct any improper condition.
4. Only incomprehensible voices are heard during SSB reception.	Receiving the wrong sideband. Receiving FM signals.	Set the MODE switch to the sideband other than the one you are using, either USB or LSB. Set the MODE Switch to the FM position.

Problem	Possible Cause	Solution
<p>5. No or low RF output.</p>	<p>RF Power switch is set at the Low position.</p> <p>PTT Switch is not functioning due to bad connection of the MIC connector.</p> <p>The antenna feeder is cut or shorted.</p> <p>When SSB or FM is desired, but the MODE Switch is in the CW position.</p>	<p>Set the RF Power switch to the High (normal) position.</p> <p>Check the connection of the MIC connector and correct any problems.</p> <p>Check the antenna feeder and correct any problems.</p> <p>Set the MODE Switch to the USB, LSB or FM position.</p>
<p>6. No modulation. (No RF output in SSB mode.)</p>	<p>Bad connection of the MIC connector.</p> <p>The MIC cable is cut.</p>	<p>Check the connection of the MIC connector and correct any problems.</p> <p>Repair the disconnected or cut wire.</p>
<p>7. The frequency does not change by rotating the Tuning knob.</p>	<p>VFO/MEMORY Switch is set in one of the memory channels.</p>	<p>Set the VFO/MEMORY Switch to the "A" or "B" position.</p>
<p>8. The receive mode functions properly and your signals are transmitted, but you are unable to make contact with another station. (When desiring SIMPLEX mode.) (When desiring DU-PLEX mode.)</p>	<p>The VFO/MEMORY Switch is in the RA-TB or RB-TA position.</p> <p>The receive frequency is off set from the transmit frequency by the RIT control.</p> <p>The VFO/MEMORY Switch is in the A/B or Memory position.</p> <p>Improper frequency split or input/output frequency of the repeater.</p>	<p>Set the VFO/MEMORY Switch to the A/B or Memory position.</p> <p>Turn OFF the RIT, or set the RIT control knob to the center (12 o'clock) position.</p> <p>Set the VFO/MEMORY Switch to the RA-TB or RB-TA position.</p> <p>Set the proper frequency split and turn the VFO/MEMORY Switch to the RA-TB or RB-TA position according to repeater input/output frequency.</p>
<p>9. The memorized frequencies are lost and the display shows 145.000.0 when the power switch is turned ON.</p>	<p>The memory switch was turned OFF.</p> <p>The main switch of the power source was turned OFF or the power plug was unplugged.</p> <p>The power failed (when using the AC power source).</p>	<p>Turn ON the memory switch on the rear panel.</p> <p>Use the continuous operating power source or optional memory power source.</p>

Problem	Possible Cause	Solution
10. The memory scan operation does not function when the SS/MW Switch is pushed.	No frequency is programmed in the memory channels or the same frequency is programmed in all the memory channels. The VFO/MEMORY Switch is not in the MS position.	Program the required frequencies in the memory channels following the instructions for "MEMORY CHANNEL OPERATION" on page 18. Set the VFO/MEMORY Switch in the MS position.
11. The programmed scan operation does not function when the SS/MW Switch is pushed.	No frequency is programmed or the same frequency is programmed in the memory channels 2 and 3. The VFO/MEMORY Switch is not in the A or B position.	Program the low edge and the high edge frequencies into the memory channels 2 and 3. Set the VFO/MEMORY Switch in the A or B position.
12. The scan does not stop even if a signal is received.	The squelch has opened when the scan started.	Engage the squelch on a no signal frequency, then start the scan by pressing the SS/MW Switch.
13. The scale on the Tuning knob is not in calibration with the displayed frequency.	The TUNING SPEED button was depressed when the Tuning knob was set with one of the small increments at the center point, the Tuning knob was rotated when the DIAL LOCK was engaged.	Set the Tuning dial so that one of the large increments is at the center point, and push the TUNING SPEED button, and the scale will be calibrated.
14. The last digit of the memorized or displayed frequency has changed to 0.	The TUNING SPEED button was pressed, or the VFO Select switch was turned while pressing the TUNING SPEED button.	Release the TUNING SPEED button, and set the unit to the desired frequency with the Tuning knob.
15. An abnormal figure is displayed on the display fails to illuminate.	The Power switch was turned OFF and ON too quickly.	Turn the Power switch and the memory switch OFF, wait a few seconds, and then turn them ON again.
16. Unable to key when using an electronic keyer.	The Switching circuit of the electronic keyer does not close completely. Polarity of the connection wires from the keyer is reversed. The MODE Switch is not in the CW position.	Replace the keyer with one having a voltage of less than 0.4V between the two keying lines at the key down position, or modify your keyer so that the voltage is less than 0.4 Volts. Connect the keyer wires observing proper polarity. Place the MODE Switch in the CW position.

SECTION VIII VOLTAGE CHARTS

NOTE: Measuring instrument is a 50K Ω /V multimeter.

MAIN UNIT TRANSISTORS

TR No.	TRANSMIT				RECEIVE				REMARKS
	BASE OR GATE1	GATE2	COLLECTOR OR DRAIN	EMITTER OR SOURCE	BASE OR GATE1	GATE2	COLLECTOR OR DRAIN	EMITTER OR SOURCE	
Q 1	0	5.1	0	GND	0	5.2	8.4	GND	
Q 2	0		0	0	0		7.6	2.2	
Q 3	0	5.1	0	0	0	5.2	8.6	0.4	
Q 4	0		0	GND	0.7		5.2	GND	
Q 5	0.6		1.7	GND	0		0	GND	
Q 8	0		0	0	0.5		4.7	0	
Q 9	0		8.9	2.4	0		0	0	
Q10	0		8.9	3.1	0		0	0	
Q11	0		7.1	GND	0		5.8	GND	
Q12	0		5.2	GND	0.7		0	GND	
Q13	0	0.3	11.4	5.2	0	0	12.0	0	
Q14	0.7		9.3	GND	0		12.0	GND	
Q15	0.6		0	0	6.8		9.0	6.2	
Q16	0.5		0	GND	0		6.4	GND	
Q18	9.9		11.3	9.2	0		12.0	0	
Q19	0		9.9	GND	0.7		0	GND	
Q20	9.9		11.5	9.3	9.6		10.5	9.0	
Q21	0		11.9	0	9.6		11.0	0	
Q22	0.6		0	GND	0		9.6	GND	
Q23	4.4		7.2	3.8	1.1		0.5	0.5	
Q24	3.6		8.8	3.1	0		0.2	0	
Q25	2.5		9.2	2.1	0		0	0	
Q26	0		0.6	GND	0.7		0	GND	
Q27	0		1.8	GND	0.7		3.5	GND	
Q28	0		0	GND	0.2		0	GND	In CW mode
Q29	1.4		5.6	0.8	0		0	0	In CW mode
Q30	0		0.7	GND	0.2		0.1	GND	In CW mode
Q31	0.7		0	GND	0		11.0	GND	In CW mode
Q33	0		0	GND	6.0		0	GND	

MAIN UNIT IC IN TRANSMIT MODE

IC No.	PIN No.																REMARKS
	1	2	3	4	5	6	7	8	9	10	11	12	13	14	15	16	
IC1	5.1	1.7	1.8	GND	10.3	2.8	10.5										
IC2	0	GND	0														
IC3	0	0	0	0	0	0	0	GND	0	0	0	0	0	0	0	0	
IC4	0	0	0	0	0	0	0	0	0	0	0	0	0	0	GND	0	
IC5	1.1	4.1	3.6	GND	9.0	2.4	0	1.3	5.4	4.5	0	6.7	0.6	0			
IC6	0.4	0.7	GND	5.5	12.5												
IC7	1.4	1.8	0	-9.0	3.8	3.7	-2.2	11.8									
IC8	1.4	1.4	GND	5.8	5.8												
IC9	4.1	4.1	3.9	1.2	0.7	0.7	5.8	6.2									

MAIN UNIT IC IN RECEIVE MODE

IC No.	PIN No.																REMARKS
	1	2	3	4	5	6	7	8	9	10	11	12	13	14	15	16	
IC1	5.3	2.0	2.0	GND	10.5	4.4	11.5										
IC2	5.0	GND	8.2														
IC3	4.8	5.0	5.0	6.4	3.8	1.8	1.0	GND	1.8	1.2	1.8	0	0	1.8	1.5	5.0	
IC4	6.0	5.4	5.8	6.1	1.0	1.0	1.0	6.0	3.0	2.0	2.0	0	5.6	0	GND	2.0	
IC5	1.2	4.6	3.8	GND	9.4	2.0	0	1.5	6.0	5.0	0	7.3	1.4	0			
IC6	0.6	0.8	GND	6.0	12.0												
IC7	1.4	2.0	1.4	-9.0	4.2	11.5	12.0										
IC8	0.4	0.4	GND	0.4	0.4												
IC9	0	0	0	0	0	0	0	0									

SSB UNIT TRANSISTORS

TR No.	TRANSMIT				RECEIVE				REMARKS
	BASE OR GATE1	GATE2	COLLECTOR OR DRAIN	EMITTER OR SOURCE	BASE OR GATE1	GATE2	COLLECTOR OR DRAIN	EMITTER OR SOURCE	
Q 1	0	3.3	0	0	0	3.3	8.8	0.3	
Q 2	0.3	3.4	0	0	0	3.4	9.0	1.1	
Q 3	-8.2		3.4	-8.7	-8.2		3.4	-8.7	
Q 4	3.2		3.4	3.4	3.2		3.4	3.4	
Q 5	0		0	0	1.0		0	1.5	
Q 6	0		6.3	GND	0.6		0	GND	In CW mode
Q 7	3.8		8.0	3.6	3.8		8.0	3.6	
Q 8	3.6		8.0	3.5	3.6		8.0	3.5	
Q 9	0		2.7	GND	0.6		0	GND	In CW mode
Q10	7.1		7.8	1.3	0		0	0	
Q11	3.4		3.2	3.2	3.4		3.2	3.2	

SSB UNIT IC IN TRANSMIT MODE

IC No.	PIN No.																REMARKS
	1	2	3	4	5	6	7	8	9	10	11	12	13	14	15	16	
IC1	0	0	GND	0	0												
IC2	9.2	8.0	7.3	GND	4.0	4.0	4.0										
IC3	9.0	7.8	7.1	GND	3.9	3.9	3.9										

SSB UNIT IC IN RECEIVE MODE

IC No.	PIN No.																REMARKS
	1	2	3	4	5	6	7	8	9	10	11	12	13	14	15	16	
IC1	1.4	1.4	GND	8.6	8.6												
IC2	9.2	8.0	7.3	GND	4.0	4.0	4.0										
IC3	0	0	0	GND	0	0	0										

PLL UNIT TRANSISTORS (When the operating frequency is 145.000MHz.)

TR No.	TRANSMIT				RECEIVE				REMARKS
	BASE OR GATE1	GATE2	COLLECTOR OR DRAIN	EMITTER OR SOURCE	BASE OR GATE1	GATE2	COLLECTOR OR DRAIN	EMITTER OR SOURCE	
Q 1	0.6		0	GND	0		0	GND	
Q 2	1.9		6.6	1.3	1.9		6.6	1.3	
Q 3	1.4		8.2	1.1	1.4		8.2	1.1	
Q 4	1.4		8.1	1.1	1.4		8.1	1.1	
Q 5	1.2		3.8	0.5	1.2		3.8	0.5	
Q 6	7.5		8.4	8.5	7.5		8.4	8.5	
Q 7	8.2		7.5	8.5	8.2		7.5	8.5	
Q 8	GND		6.5	2.0	GND		6.5	2.0	
Q 9	1.0		5.7	0.2	1.0		5.7	0.2	
Q10	1.4		5.7	1.1	1.4		5.7	1.1	
Q11	1.2		7.6	0.5	1.2		7.6	0.5	
Q12	*		*	GND	*		*	GND	
Q13	*		*	GND	*		*	GND	

* Pulse activated

PLL UNIT IC (When the operating frequency is 145.000MHz)

IC No.	PIN No.																REMARKS
	1	2	3	4	5	6	7	8	9	10	11	12	13	14	15	16	
IC1	0	0	0	-9.0	3.9	3.9	2.7	8.0									
IC2	-	8.2	7.2	4.0	2.5	GND	-	-	2.5	4.0	4.0	4.0	7.2	-			
IC3	1.4	1.4	GND	7.2	8.0												
IC5	*	*	*	*	*	*	GND	*	*	*	*	*	*	7.7			
IC6	8.3	GND	-9.0														
IC4	GND	*	*	*	*	*	*	*	*	*	-	3.0	7.3	3.1	0	3.9	
	PIN NO.																
	17	18	19	20	21	22											
0	7.7	3.8	3.0	3.2	7.7												

* Pulse activated

DRIVER UNIT TRANSISTORS (When the operating frequency is 145.000MHz.)

TR No.	TRANSMIT				RECEIVE				REMARKS
	BASE OR GATE1	GATE2	COLLECTOR OR DRAIN	EMITTER OR SOURCE	BASE OR GATE1	GATE2	COLLECTOR OR DRAIN	EMITTER OR SOURCE	
Q 1	0.6		0	GND	0.6		0	GND	
Q 2	8.0 8.0		8.5 0.2	8.6	8.0 8.0		8.5 0.2	8.6	
Q 5	*		11.0	*	*		11.0	*	
Q 6	*		11.0	*	*		11.0	*	
Q 7	*		11.0	*	*		11.0	*	
Q 8	*		11.0	*	*		11.0	*	
Q 9	*		11.0	*	*		11.0	*	
Q10	*		11.0	*	*		11.0	*	
Q11	*		11.0	*	*		11.0	*	
Q12	*		*	0	*		*	0	

* Pulse activated

DRIVER UNIT TRANSISTORS (Continued)

TR No.	TRANSMIT				- RECEIVE				REMARKS
	BASE OR GATE1	GATE2	COLLECTOR OR DRAIN	EMITTER OR SOURCE	BASE OR GATE1	GATE2	COLLECTOR OR DRAIN	EMITTER OR SOURCE	
Q13	*		*	0	*		*	0	
Q14	*		*	0	*		*	0	
Q15	*		*	0	*		*	0	
Q16	*		*	0	*		*	0	
Q17	*		*	0	*		*	0	
Q18	*		*	0	*		*	0	
Q19	4.6		0	GND	4.6		0	GND	
Q20	3.8		13.0	3.2	3.8		13.0	3.2	
Q25	9.0		0	8.6	9.0		0	8.6	
Q26	0		0.3	GND	0.7		0	GND	SQL Opened
Q26	0		0.3	GND	0		6.8	GND	SQL Closed
Q27	8.9		*	9.0	8.9		*	9.0	
Q28	0		8.6	GND	0.6		0	GND	
Q29	0.7		0.1	GND	0.7		0.1	GND	
Q30	0.6		0	GND	0.6		0	GND	

* Pulse activated

DRIVER UNIT IC (When the operating frequency is 145.000MHz.)

IC No.	PIN No.																REMARKS
	1	2	3	4	5	6	7	8	9	10	11	12	13	14	15	16	
IC 1	8.3	8.6	0	0	0	GND	GND	0.2	GND	0	7.6	GND	6.4	8.6			
IC 2	0	8.6	0	0	8.6	0	GND	0	8.4	0	0	8.6	0	8.6			
IC 3	0	8.6	8.6	0	8.6	GND	GND	GND	9.0	0	*	0	8.6	8.6			
IC 4	*	*	*	*	*	*	GND	*	*	*	*	*	*	8.6			
IC 5	*	*	*	*	*	*	GND	*	*	*	*	*	*	8.6			
IC 9	*	*	*	*	*	*	GND	*	*	*	*	*	*	8.6			
IC10	*	*	*	*	*	GND	GND	*	*	*	*	*	8.6	8.6			
IC11	0.5	8.6	0	7.0	*	*	GND	*	*	*	*	*	*	8.6			
IC12	0	8.6	0	0	0	0	GND	0	0	0	*	*	0	8.6			
IC13	8.6	3.2	2.6	13.0	GND	3.2	GND	8.6									
IC14	Δ0	GND	Δ0	Δ0	GND	Δ0	GND	Δ0	GND	Δ0	Δ0	GND	Δ0	9.0			
IC15	Δ0	GND	Δ0	Δ0	GND	Δ0	GND	Δ0	GND	Δ0	Δ0	GND	Δ0	9.0			
IC 6	8.6	*	*	0	GND	GND	0	0	0	0	0	0	0	0	0.5	0.5	
IC 7	*	*	*	GND	*	*	*	*	0	*	*	*	*	*	*	*	
IC 8	8.6	*	*	GND	8.4	*	Δ0	Δ0	Δ0	Δ0	Δ0	Δ0	Δ0	Δ0	0	8.6	
	PIN No.																
	17	18	19	20	21	22	23	24	25	26	27	28	29	30	31	32	
IC 6	0.2	8.4	8.4	0	0	0	0	*	*	0	8.4	0	0	0	0	0	
IC 7	*	5.4	5.4	8.6	*	*	*	*	*	*	*	*					
IC 8	0	0.5	0	0	0	0	*	*	*	GND	*	*					
	PIN No.																
	33	34	35	36	37	38	39	40									
IC 6	GND	0	*	*	*	GND	*	*									

* Pulse activated

Δ 8.6V or 0V according to operating frequency.

NOTE:

Other devices work in C-MOS level and with pulse signals, so the voltages can not be measured with a 50KΩ/V multimeter.

The function of the CPU is identified with reading the relationship between the R output and the K input signals.

Refer to the following timing chart of the R output signals. The relationship between the R output and the K input signals can be checked with a dual trace oscilloscope, and also the level of these signals can be measured with the scope.

The driver unit consists of several C-MOS IC's and P-MOS IC's. P-MOS IC's are IC6 TMS1025NL I/O port, IC7 TMS1115 CPU and IC10 TMS1024NL I/O port, and the others are C-MOS IC's.

- Refer to the following threshold level chart for measuring these levels.

R OUTPUT TIMING CHART

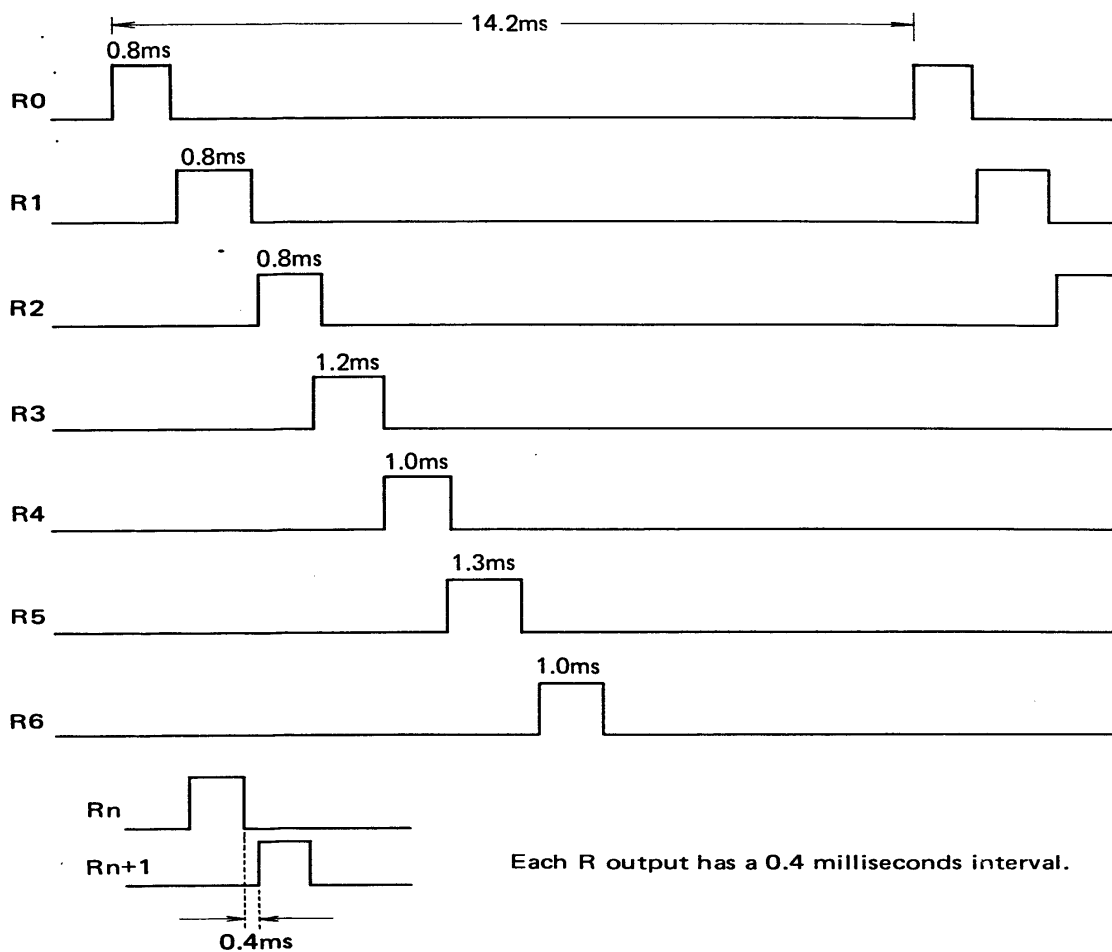

THRESHOLD LEVEL CHART

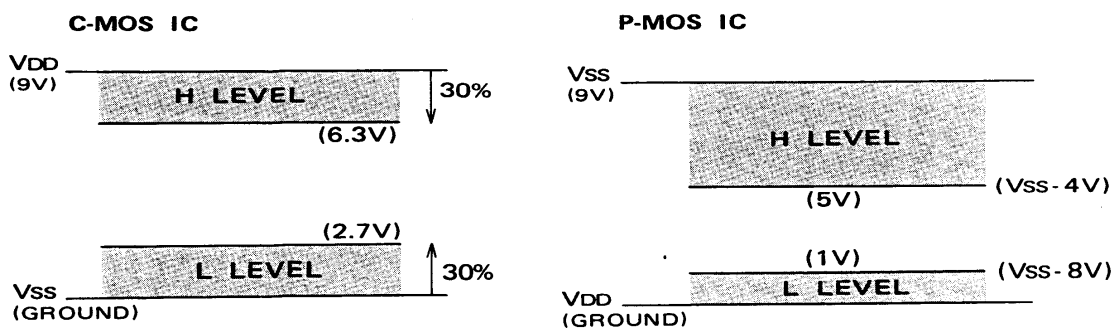

SECTION IX BLOCK DIAGRAM

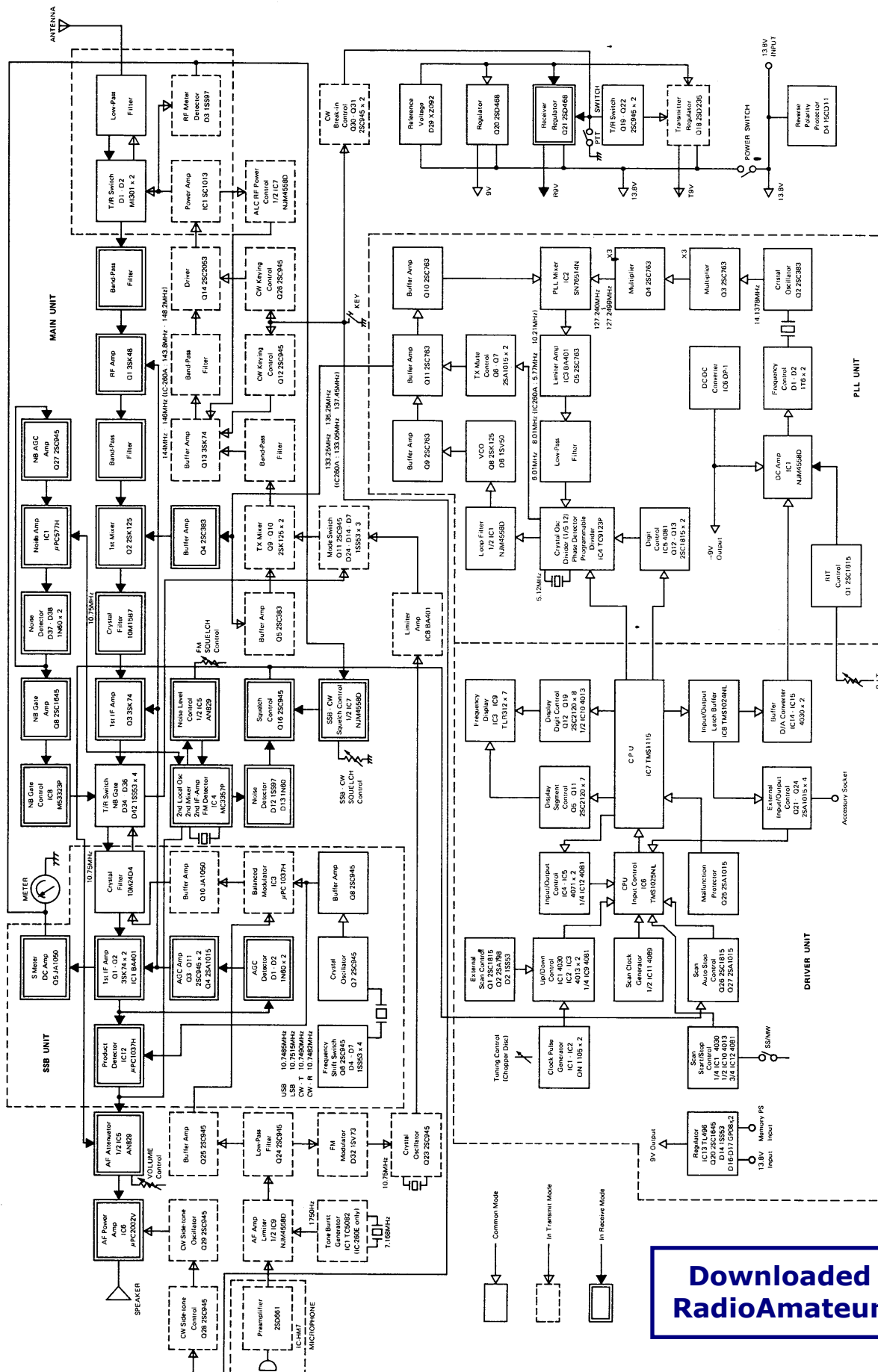

Downloaded by  RadioAmateur.EU



ICOM INCORPORATED

1-6-19, KAMI KURATSUKURI, HIRANO-KU,
OSAKA JAPAN

Downloaded by
RadioAmateur.EU

Printed in Japan