

SECTION IX BLOCK DIAGRAM

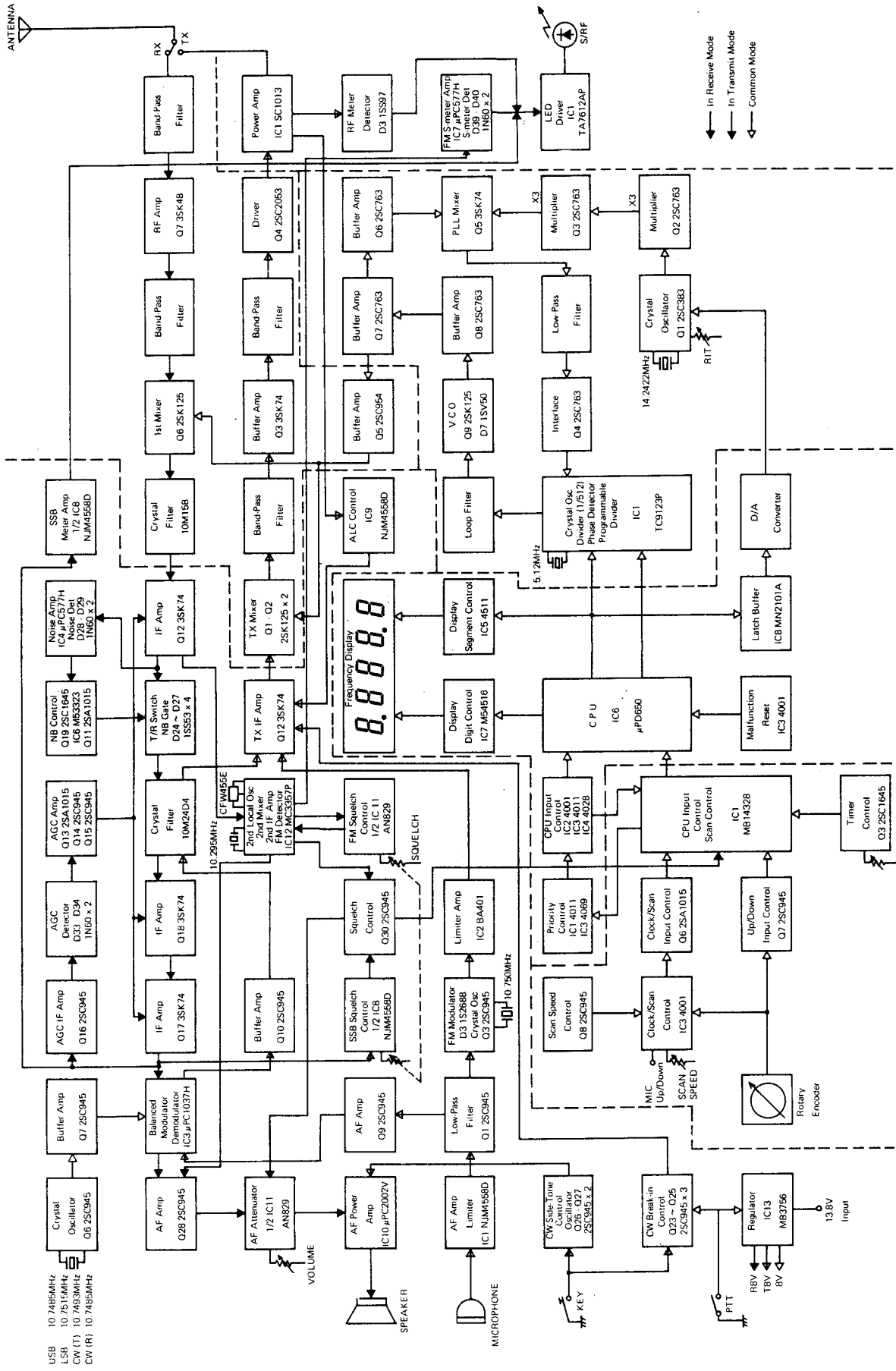

USB 10.7485MHz
 LSB 10.7513MHz
 CW (T) 10.7485MHz
 CW (R) 10.7485MHz

In Receive Mode
 In Transmit Mode
 Common Mode

IC-290A/E SCHEMATIC DIAGRAM

MIC

DIAL

SQ L

LOW POW

POWER

TONE

PRI

S/S

AGC

NB

TS

+ SIMPLEX

-

VFO-A/B

MR

MW

RIT

RIT

VOL

MEMO

CH 1

0

1

2

3

4

5

6

7

8

9

0

1

2

3

4

5

6

7

8

9

0

1

2

3

4

5

6

7

8

9

0

1

2

3

4

5

6

7

8

9

0

1

2

3

4

5

6

7

8

9

0

1

2

3

4

5

6

7

8

9

0

1

2

3

4

5

6

7

8

9

0

1

2

3

4

5

6

7

8

9

0

1

2

3

4

5

6

7

8

9

0

1

2

3

4

5

6

7

8

9

0

1

2

3

4

5

6

7

8

9

0

1

2

3

4

5

6

7

8

9

0

1

2

3

4

5

6

7

8

9

0

1

2

3

4

5

6

7

8

9

0

1

2

3

4

5

6

7

8

9

0

1

2

3

4

5

6

7

8

9

0

1

2

3

4

5

6

7

8

9

0

1

2

3

4

5

6

7

8

9

0

1

2

3

4

5

6

7

8

9

0

1

2

3

4

5

6

7

8

9

0

1

2

3

4

5

6

7

8

9

0

1

2

3

4

5

6

7

8

9

0

1

2

3

4

5

6

7

8

9

0

1

2

3

4

5

6

7

8

9

0

1

2

3

4

5

6

7

8

9

0

1

2

3

4

5

6

7

8

9

0

1

2

3

4

5

6

7

8

9

0

1

2

3

4

5

6

7

8

9

0

1

2

3

4

5

6

7

A/E SCHEMATIC DIAGRAM

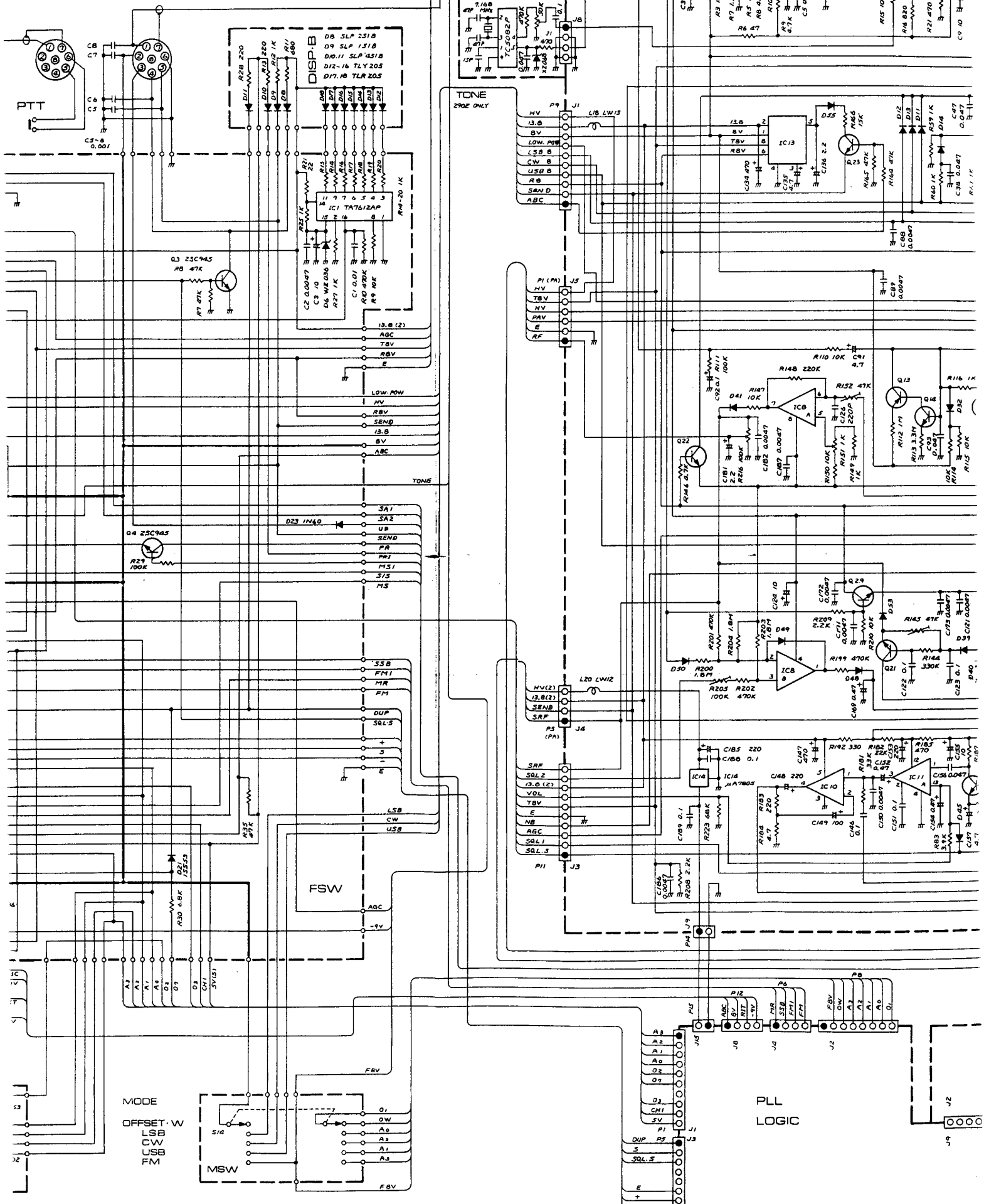

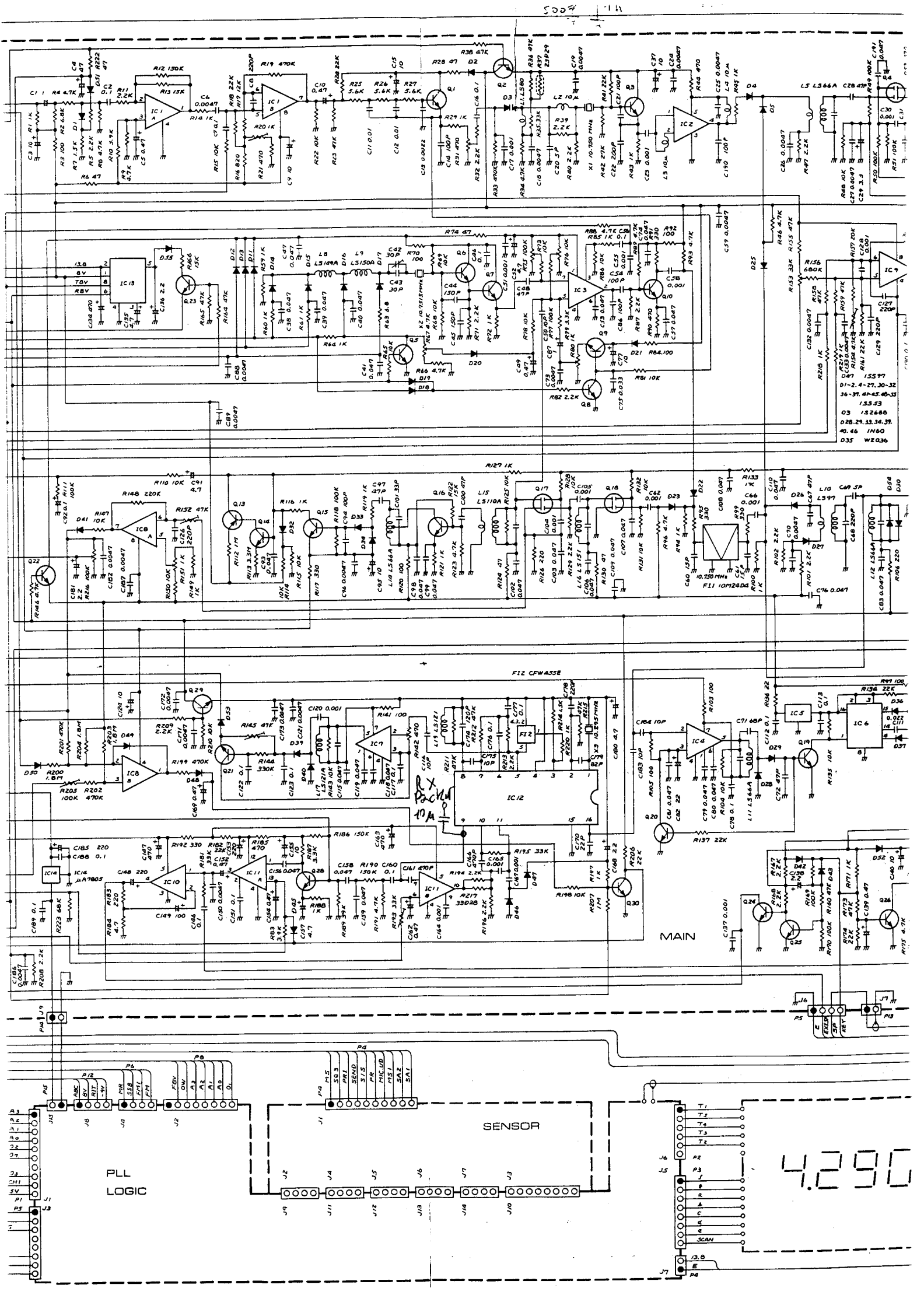

D1	15597
D2	01-2-4-27.30-32
D3	36-37-44-45-46-55
D4	1.5S53
D5	1.52488
D6	028.29.33.34.37
D7	40.46 IN60
D8	D35 WE036

MAIN

SENSOR

PLL LOGIC

4.290

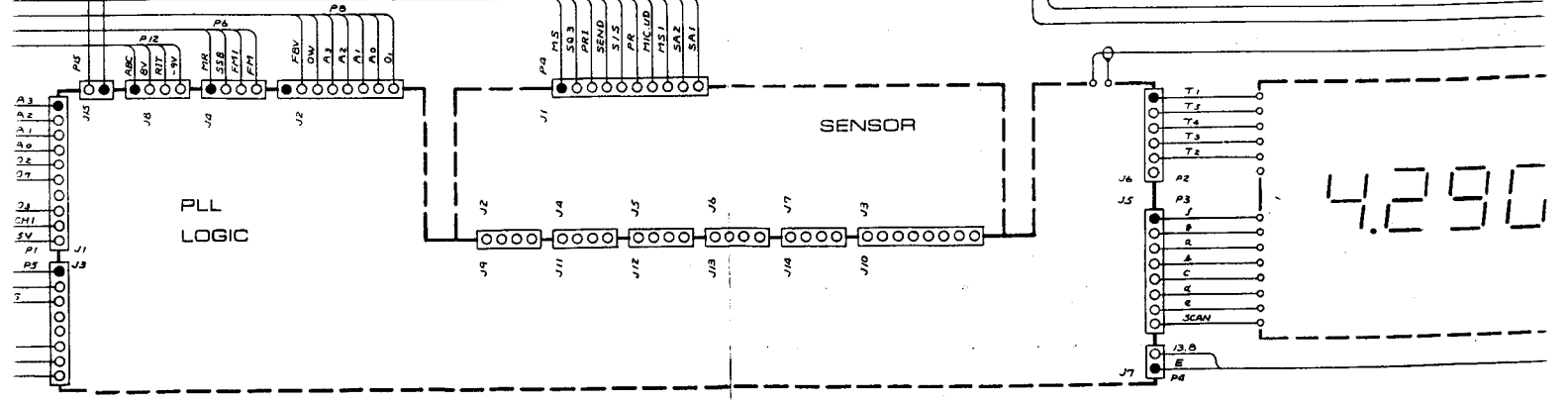

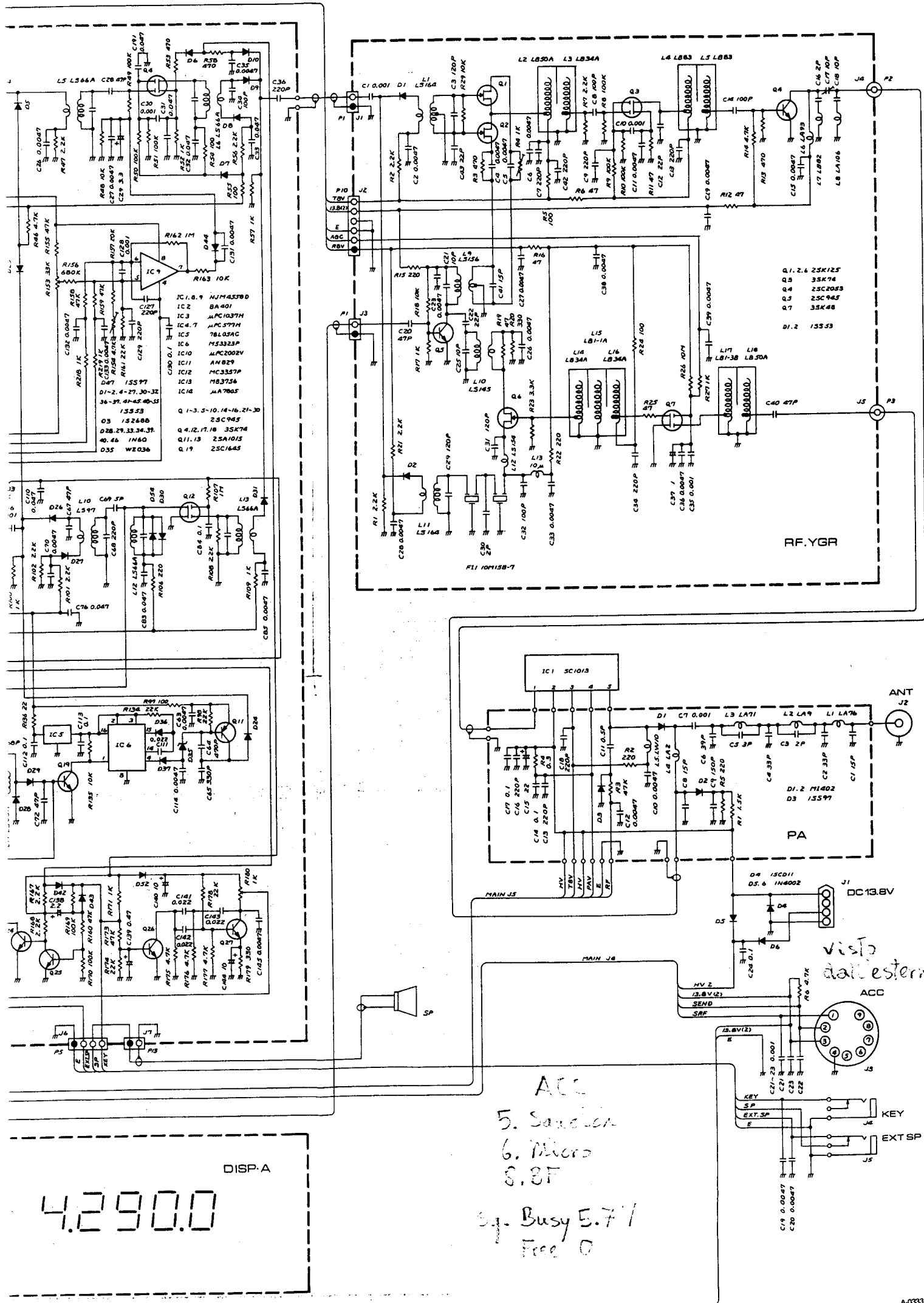

4.290.0

DISP.A

ACC
 5. Sonda
 6. Micro
 8.8F
 Sq. Busy 5.71
 Free 0

visto dall'esterno.

- Q1, 2, 4 2SK125
- Q3 3SK74
- Q4 2SC2053
- Q5 2SC945
- Q7 3SK48
- D1, 2 1SS33

RF.YGR

PA

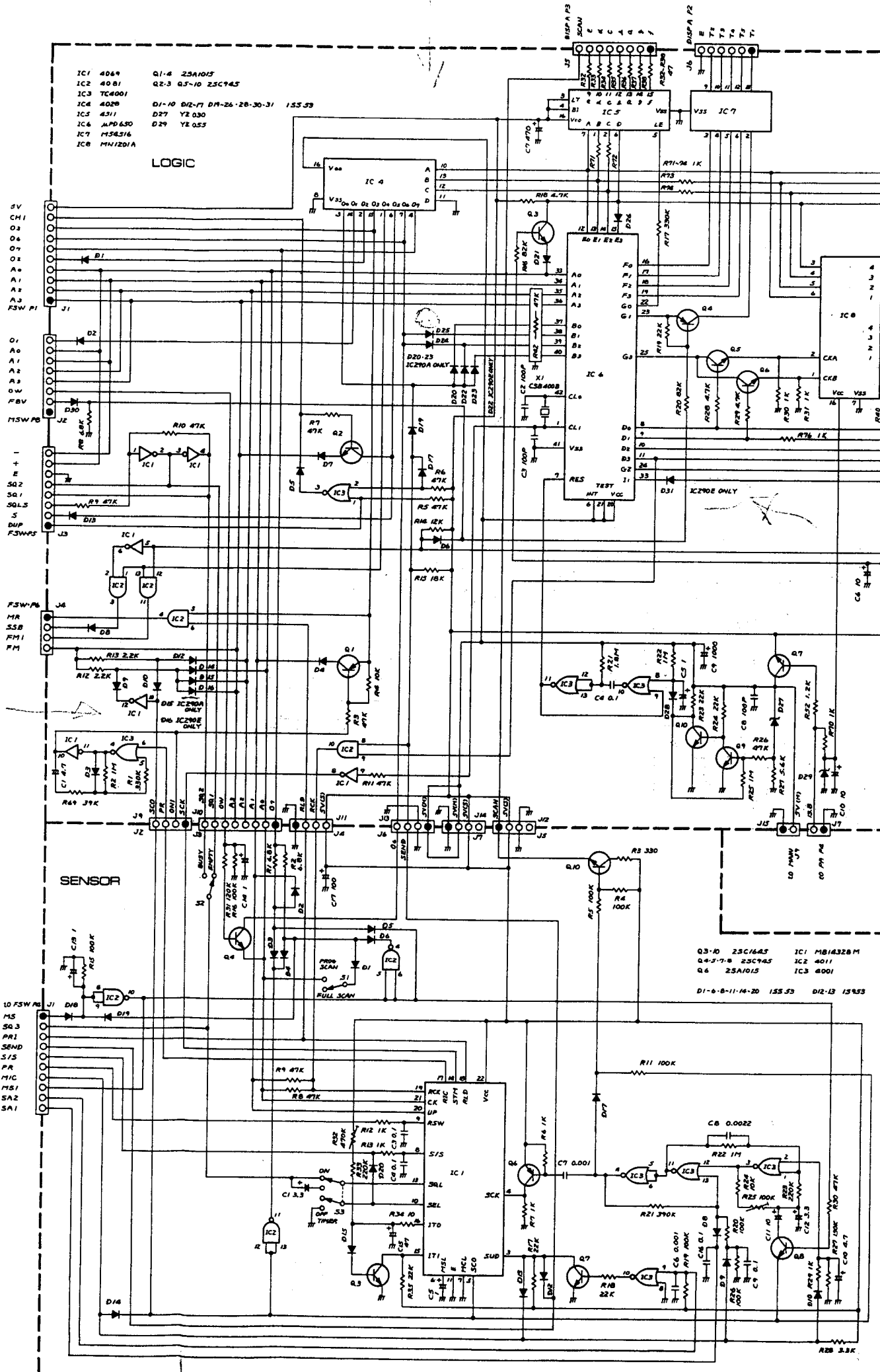

- IC1 4069
- IC2 4081
- IC3 TC4001
- IC4 4020
- IC5 4311
- IC6 ALPD630
- IC7 M58316
- IC8 MN1201A
- Q1-4 2SA1015
- Q2-3 Q3-10 2SC945
- D1-10 D12-17 D19-26-28-30-31 1SS53
- D27 YE 030
- D29 YE 053

LOGIC

SENSOR

- Q3-10 2SC1645
- Q4-5-7-8 2SC945
- Q6 2SA1015
- IC1 MB14328 M
- IC2 4011
- IC3 4001
- D1-6-8-11-14-20 1SS53
- D12-13 1S453

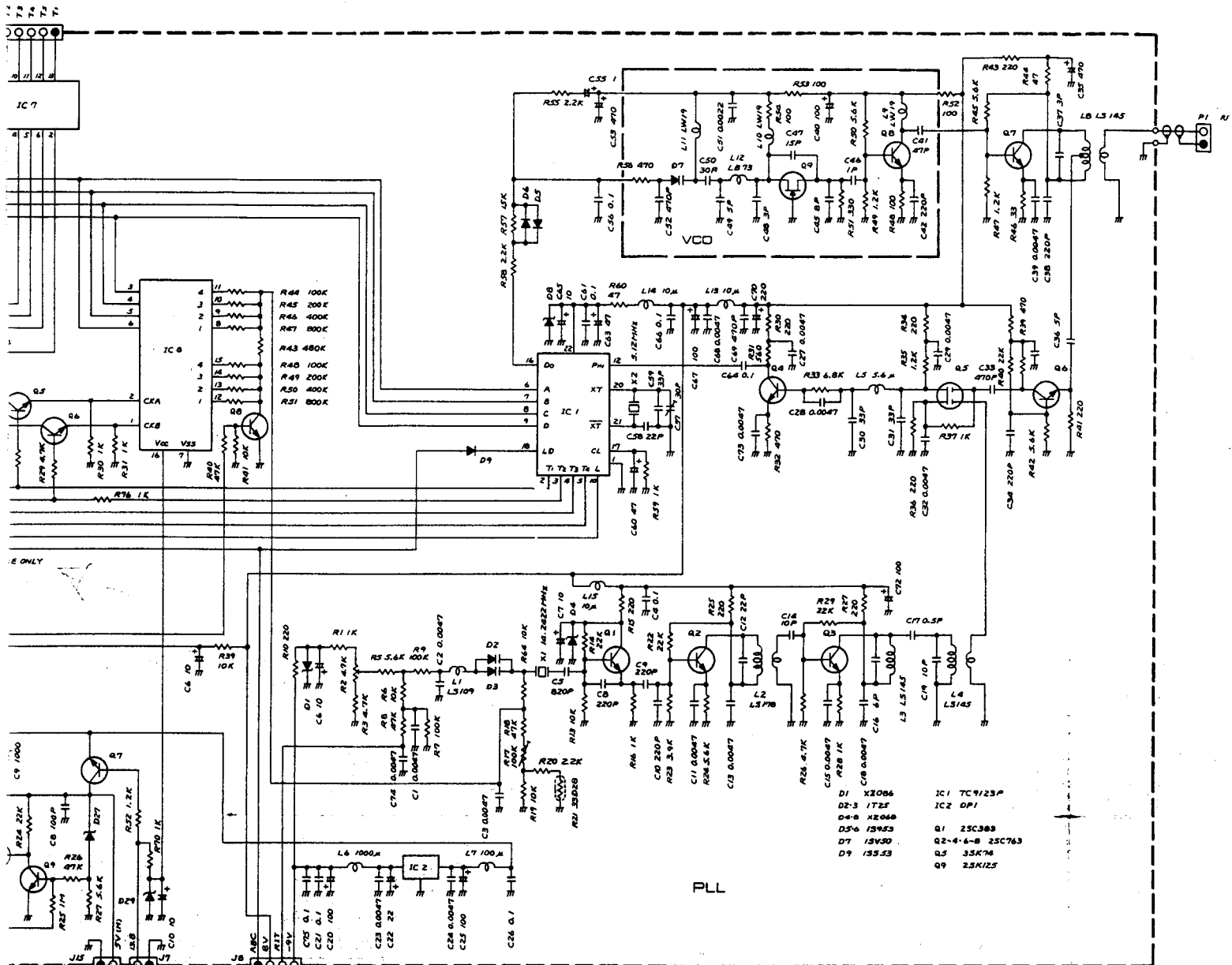

- | | | | |
|------|-------|----------|---------|
| D1 | X1086 | IC1 | 7C9123P |
| D2-3 | 1T25 | IC2 | DP1 |
| D4-8 | X2048 | Q1 | 25C388 |
| D5-6 | 13953 | Q2-4-6-8 | 25C763 |
| D7 | 13950 | Q5 | 35K76 |
| D9 | 15553 | Q9 | 25K125 |

- | | | | |
|--------------|---------|--------|----------|
| 3-10 | 25C1645 | IC1 | M814328M |
| 4-5-7-8 | 25C945 | IC2 | 4011 |
| 5 | 25A1015 | IC3 | 4001 |
| 6-8-11-16-20 | 15553 | D12-13 | 15953 |

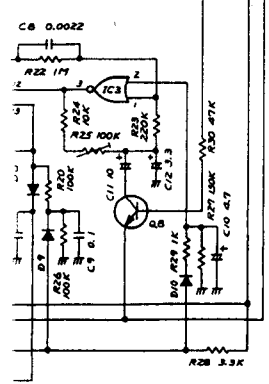



ICOM

tone call unit

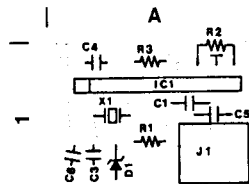

SENSOR BOARD

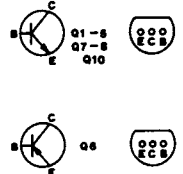
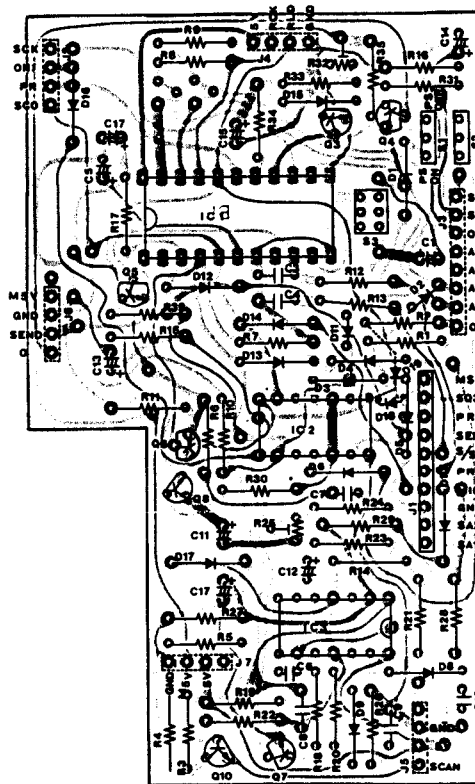

PLL

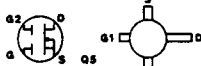
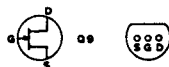
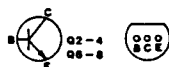
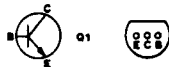

LOGIC

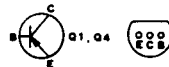
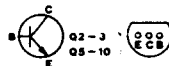

* USA ONLY
* EUR ONLY

UNIT LAYOUT

LED BOARD

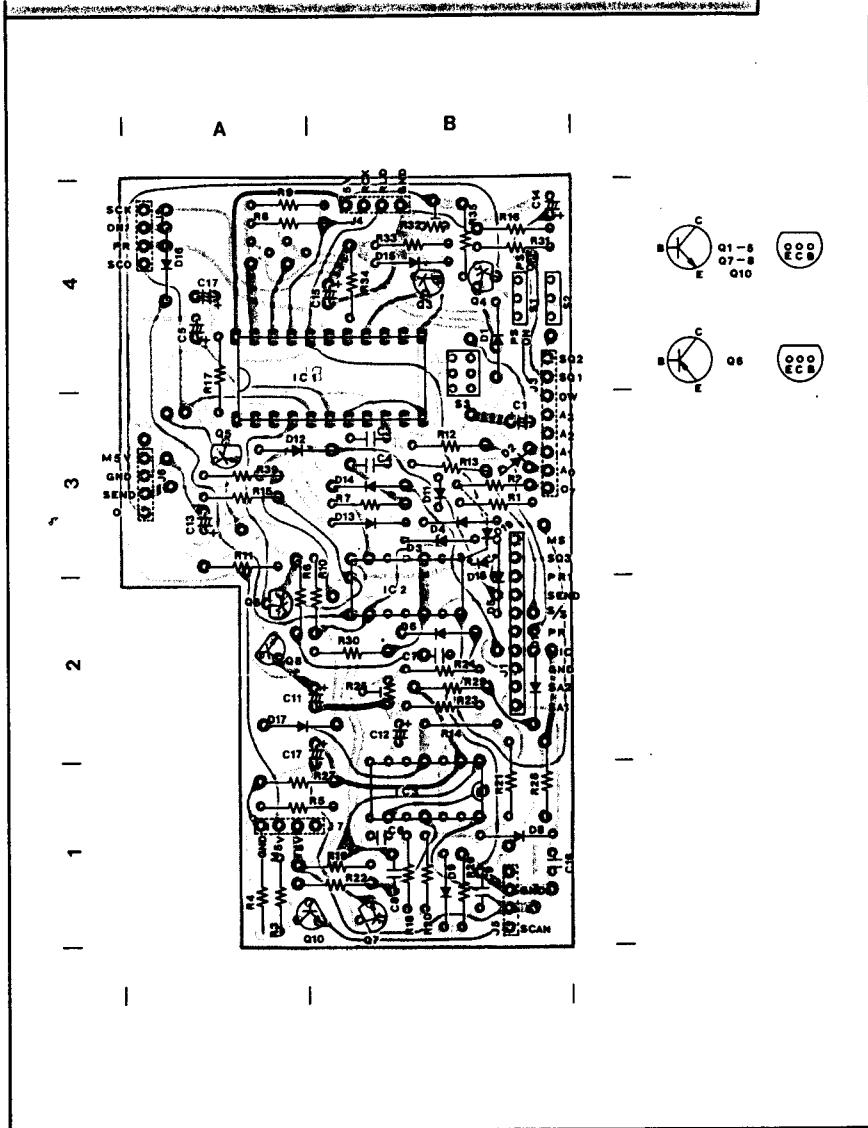
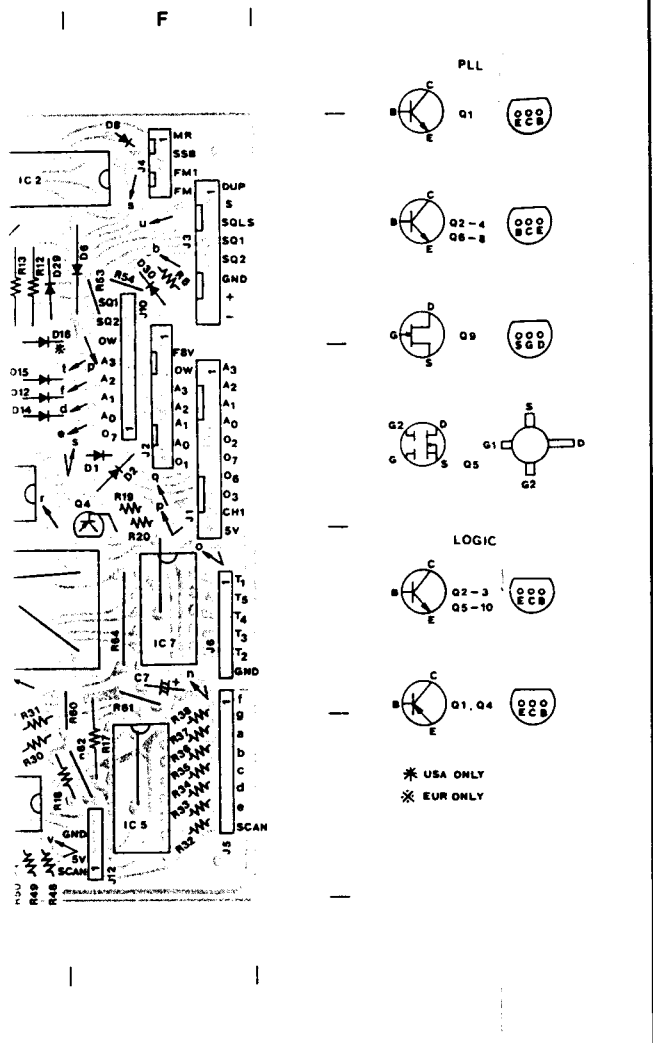

UNIT LAYOUT

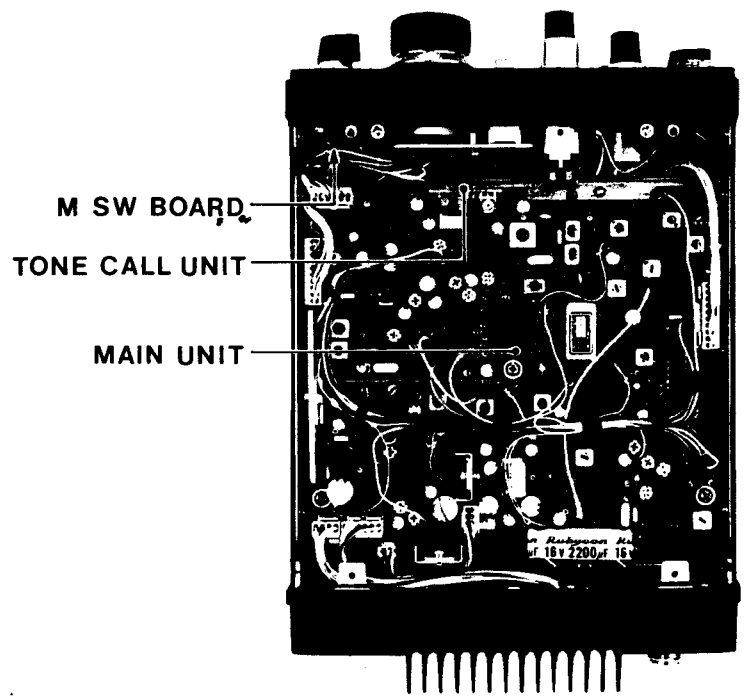
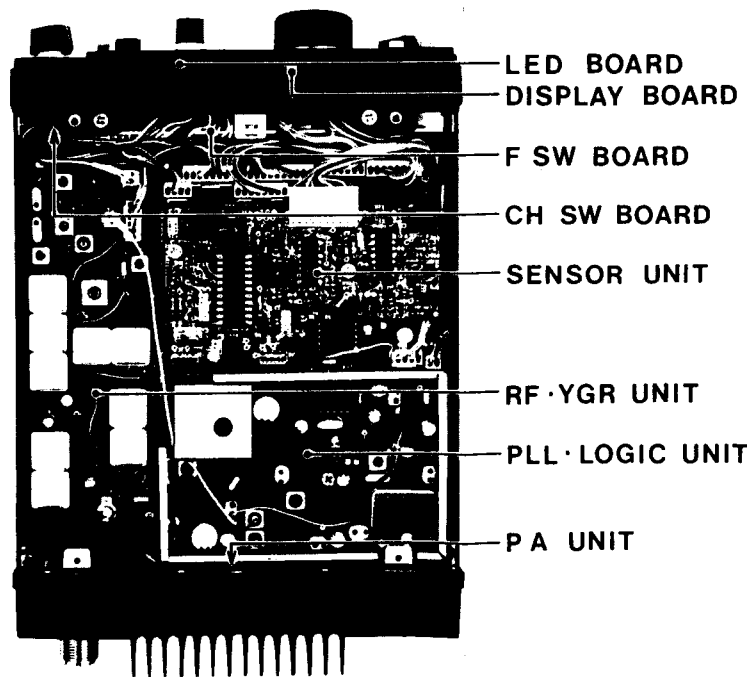

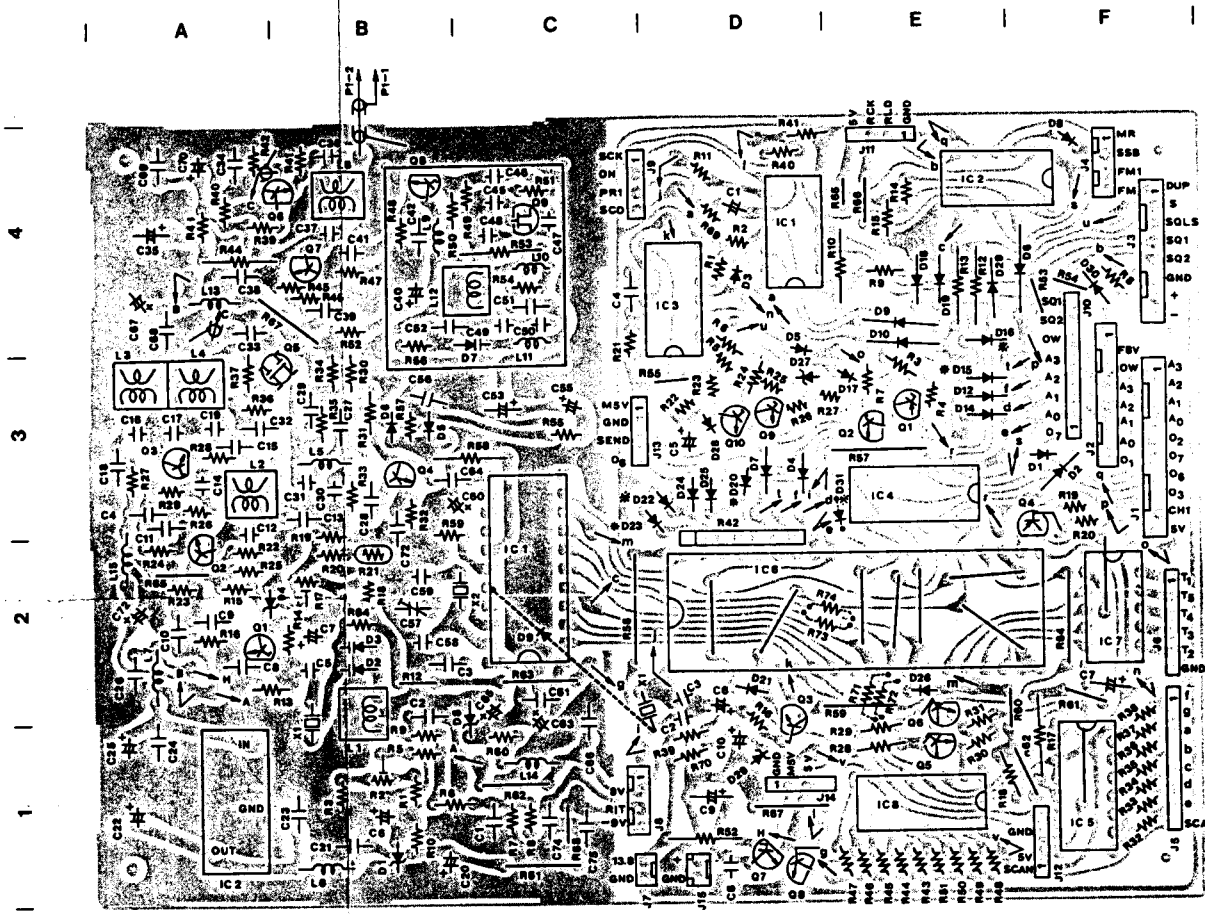

PA UNIT

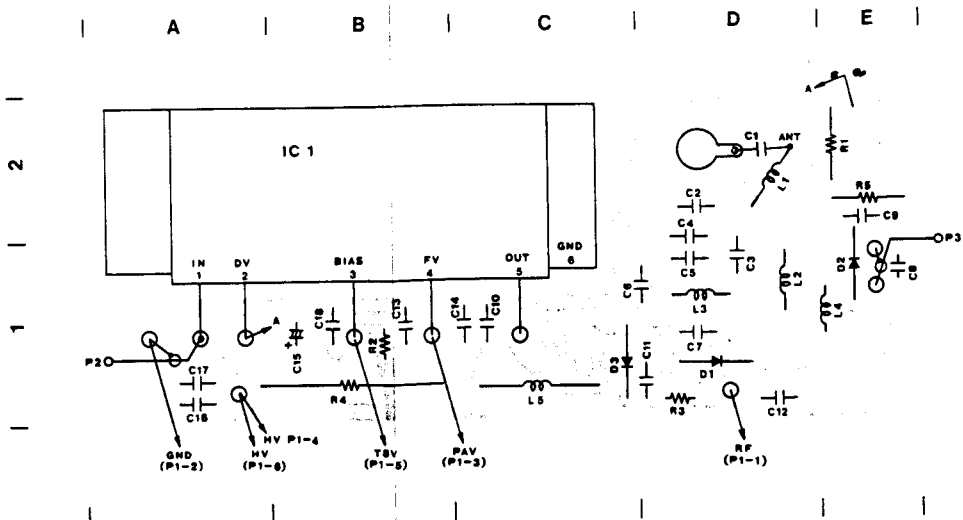

UNIT LAYOUT

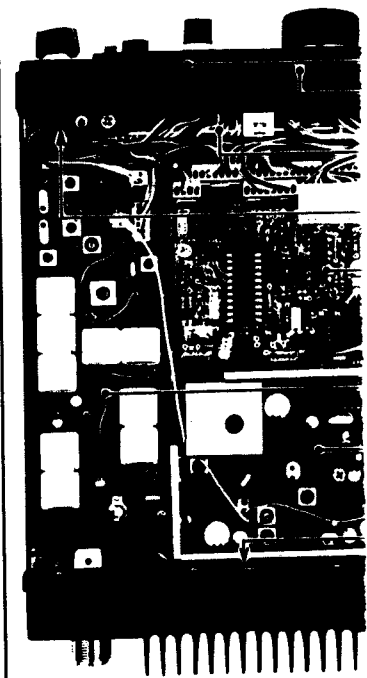

ICOM INCO

A | B | C | D | E | F

5

4

3

2

1

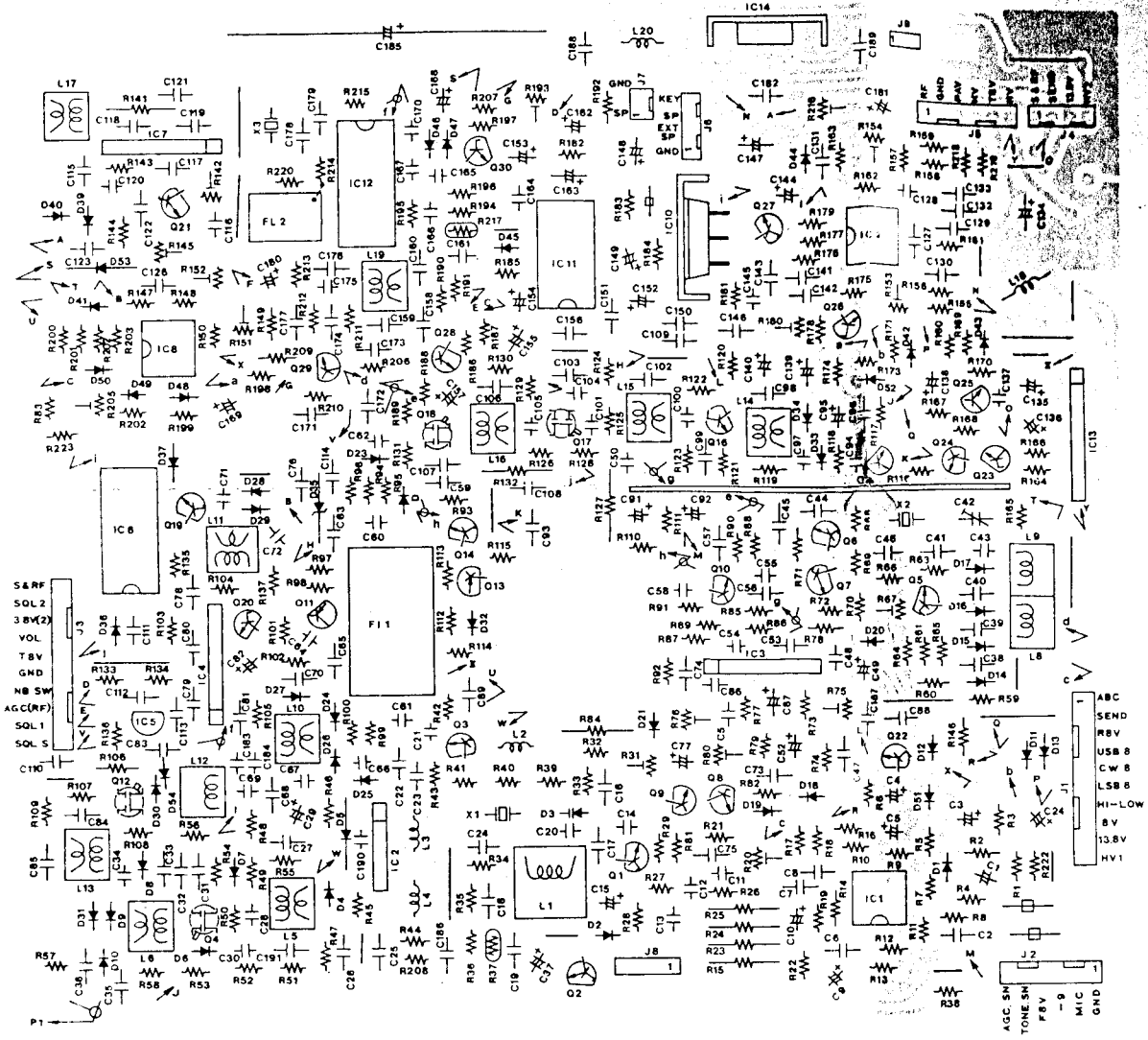

A | B | C | D | E | F

2

1

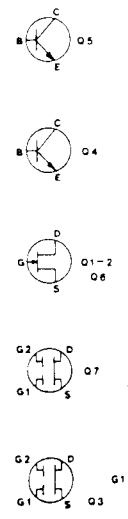
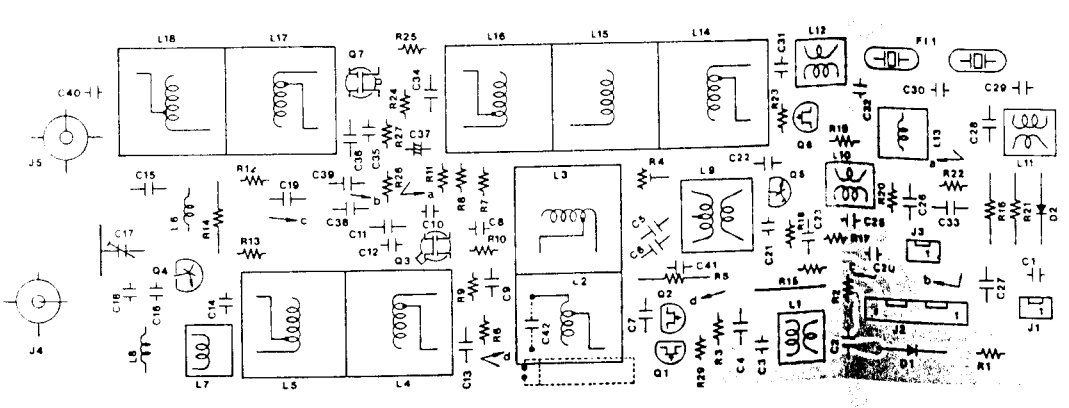

IC-290A/E

BOARD LAY

EF UNIT

■ CH SW BOARD

■ LED BOARD

■ DISPLAY BOARD

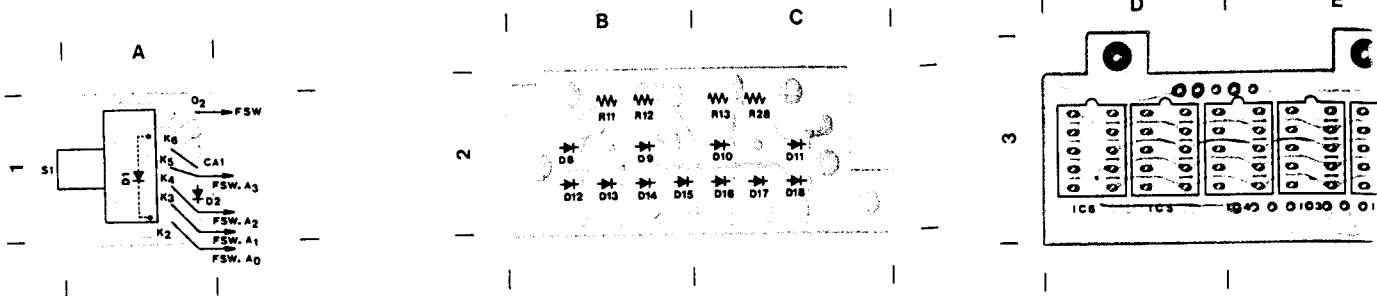

MAIN UNIT

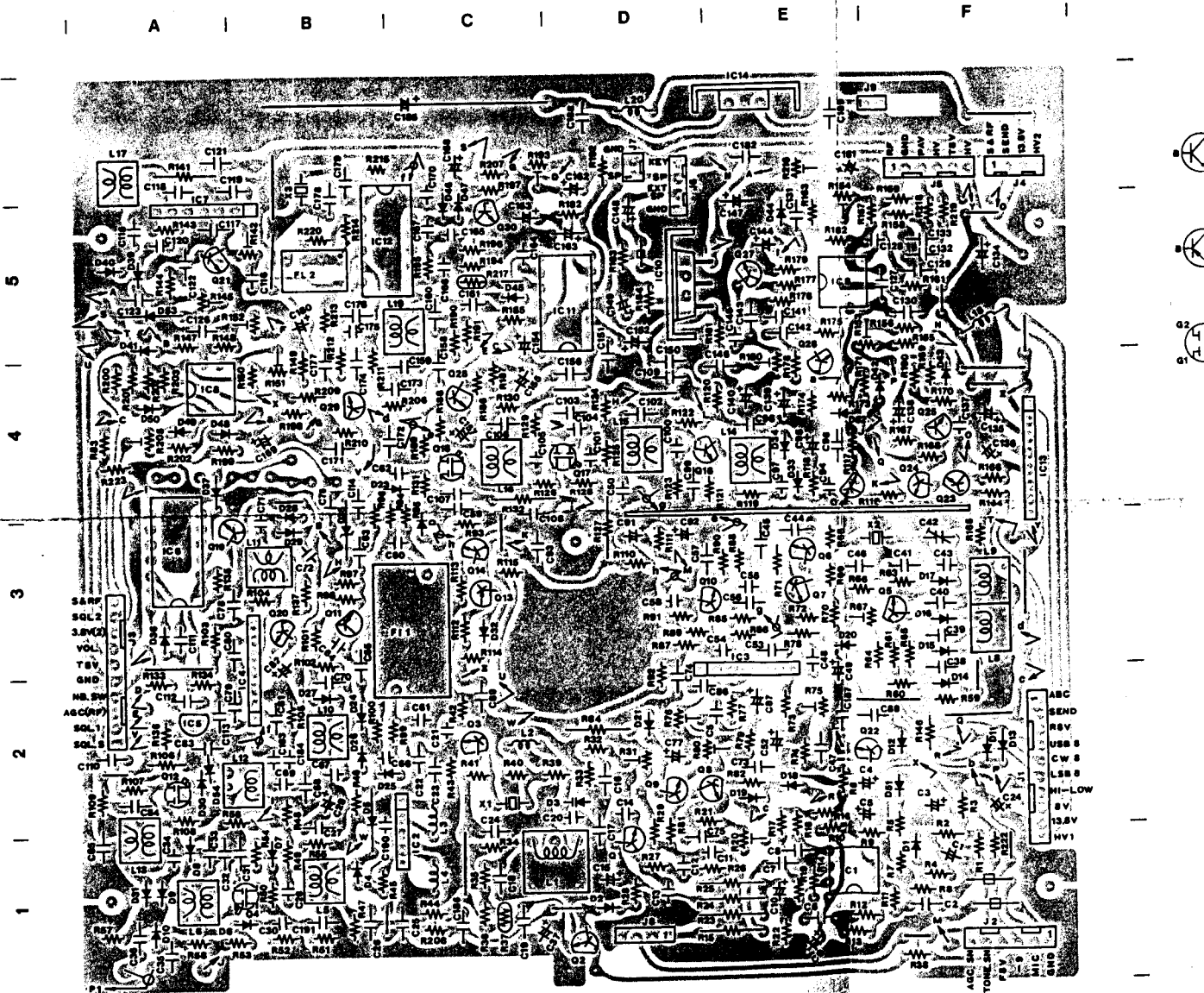

LAYOUT

Y BOARD

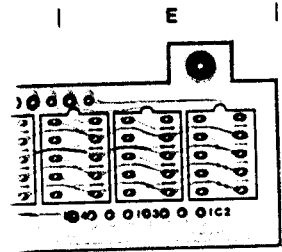

M SW BOARD

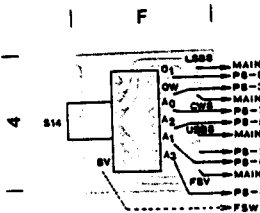

F SW BOARD

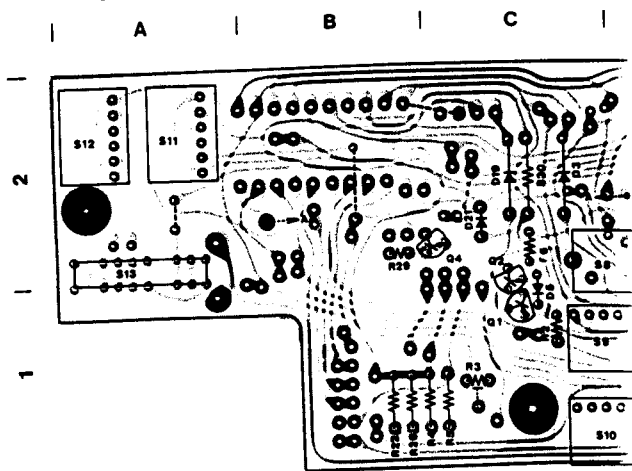

PLL LOGIC UNIT

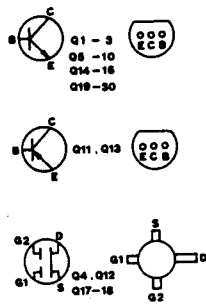
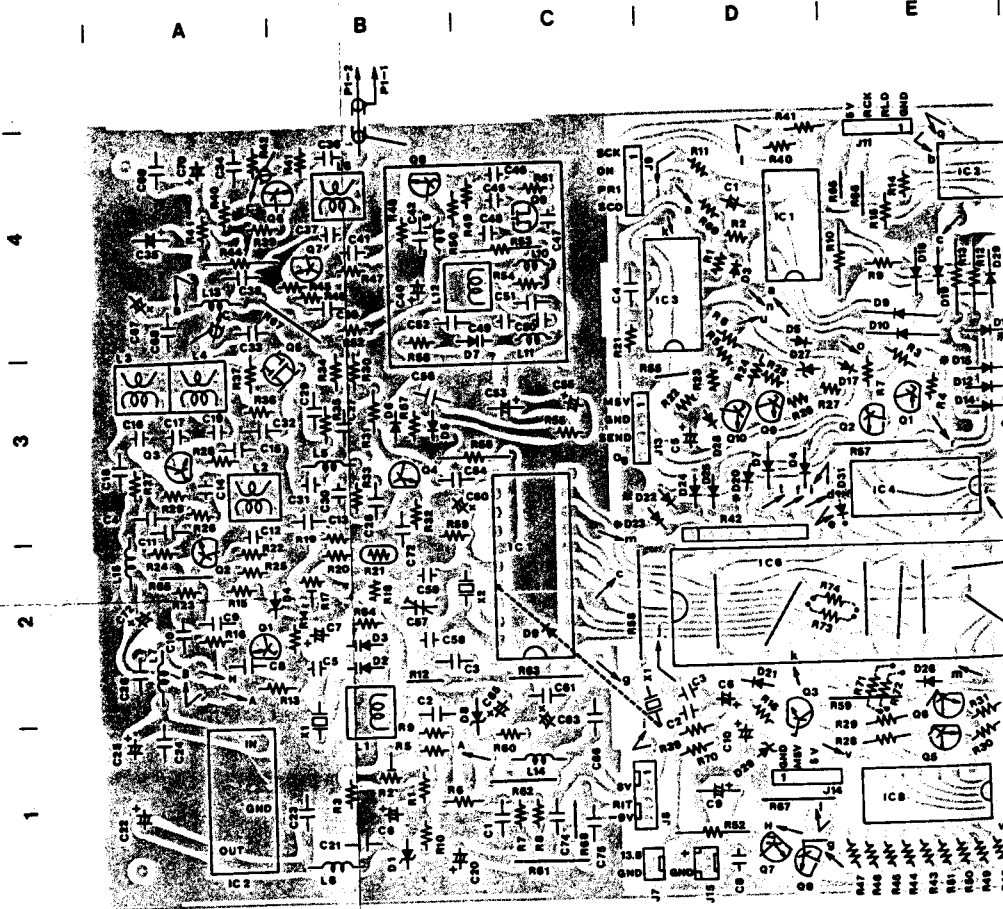

PA UNIT

