

# ICOM

## INSTRUCTION MANUAL

DUAL BAND  
FM TRANSCEIVER

**IC-3230H**

**IC-3230A**

**IC-3230E**

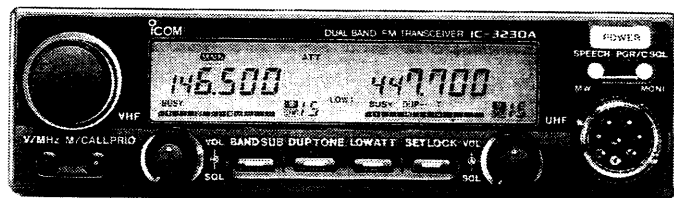

Icom Inc.

---

# IMPORTANT

---

**READ ALL INSTRUCTIONS** carefully and completely before using the transceiver.

**SAVE THIS INSTRUCTION MANUAL** — This instruction manual contains important safety and operating instructions for the **IC-3230A/E/H**.

---

# FOREWORD

---

Thank you for choosing this Icom product.

The **IC-3230A/E/H** is a 144 and 430 (440) MHz dual band mobile transceiver. The **IC-3230A/E/H** is a compact, easy-to-operate, multi-function transceiver designed using Icom's state-of-the-art technology.

---

# TABLE OF CONTENTS

---

IMPORTANT .....	i
FOREWORD .....	i
TABLE OF CONTENTS .....	i
CAUTIONS .....	ii
UNPACKING .....	ii
1 PANEL DESCRIPTION .....	1~6
2 INSTALLATION .....	7~10
3 MODE CONSTRUCTION .....	11~12
4 FREQUENCY SETTING .....	13~16
5 RECEIVING .....	17~22
6 TRANSMITTING .....	23~27
7 MEMORY MODE .....	28~30
8 CALL CHANNEL .....	31~32
9 SCAN OPERATION .....	33~37
10 PRIORITY WATCH .....	38~40
11 UP SWITCH REMOTE .....	41
12 PAGER AND CODE SQUELCH .....	42~47
13 POCKET BEEP AND TONE SQUELCH .....	48~50
14 HM-56/A ADVANCED FUNCTIONS .....	51~55
15 OPTIONAL DTMF REMOTE .....	56~60
16 MAINTENANCE .....	61~62
17 SPECIFICATIONS .....	63
18 OPTIONS .....	64

# CAUTIONS

**NEVER** connect the transceiver to an AC outlet or to a power source of more than 16 V DC. These connections will ruin the transceiver.

**NEVER** connect the transceiver to a power source using reverse polarity. This connection will ruin the transceiver.

**NEVER** place the transceiver where normal operation of the vehicle may be hindered or where it could cause bodily injury.

**NEVER** allow children to touch the transceiver.

**DO NOT** use or place the transceiver in areas with temperatures below  $-10^{\circ}\text{C}$  ( $+14^{\circ}\text{F}$ ) or over  $+60^{\circ}\text{C}$  ( $+140^{\circ}\text{F}$ ).

**AVOID** placing the transceiver in areas of direct sunlight, such as the dashboard.

**BE CAREFUL!** The heatsink may become hot when operating the transceiver continuously for long periods.

# UNPACKING

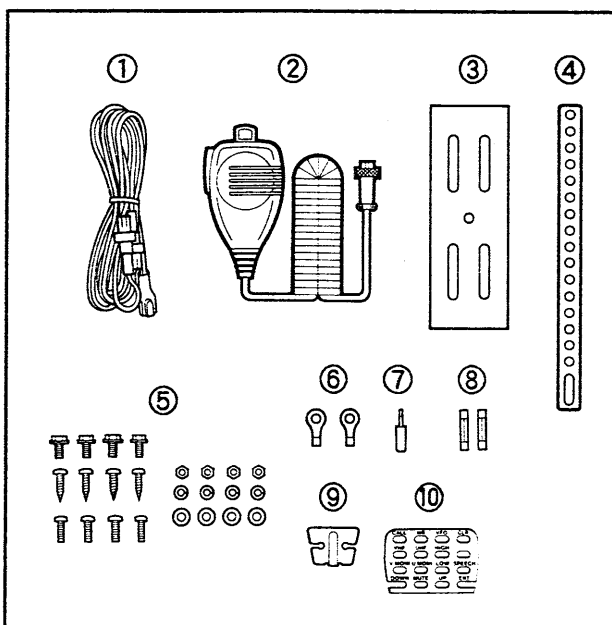

Included accessories:	Qty.
① DC power cable (OPC-044B) .....	1
② Microphone* .....	1
③ Mounting bracket .....	1
④ Mounting support bracket .....	1
⑤ Mounting screws, nuts and washers .....	1 set
⑥ Cable lugs .....	2
⑦ External speaker plug .....	1
⑧ Fuses (15 A) .....	2
⑨ Microphone hanger .....	1
⑩ Microphone sheet for HM-56/A .....	1

* U.S.A. version:	HM-56A
Australia and Asia versions:	HM-58
Europe and Italy versions:	HM-59

## Front panel

### VHF VOLUME CONTROL [VOL] (p. 17)

Adjusts the VHF band audio output level.

### VHF SQUELCH CONTROL [SQL] (p. 17)

Adjusts the VHF band squelch threshold level.

### TUNING CONTROL

Selects the operating frequency (p. 14), the memory channel (p. 28), the contents of the SET mode display (p. 12) and the scanning direction (pgs. 34, 35).

### VFO/MHz SWITCH [V/MHz]

Selects VFO mode. (p. 13)

Selects the 1 MHz tuning step in VFO mode. (p. 15)

Selects the 10 MHz tuning step when pushed and held. Some versions do not have this tuning step. (p. 15)

### MEMORY/CALL CHANNEL SWITCH [M/CALL/PRIO]

Selects MEMORY mode or call channel. (pgs. 28, 31)

Activates the priority watch function when pushed and held. (pgs. 39, 40)

Cancels the priority watch function when the function is activated. (pgs. 39, 40)

### BAND SWITCH [BAND/SUB]

Selects either VHF or UHF for the MAIN band.

Activates the SUB band access function when pushed and held.

### DUPLEX/TONE SWITCH [DUP/TONE]

Selects simplex, - duplex or + duplex. (p. 25)

Activates the subaudible tone encoder\*<sup>1</sup> (p. 26); optional\*<sup>2</sup> pocket beep or tone squelch function (p. 48) when pushed and held.

\*<sup>1</sup> U.S.A. version: Built-in.

Other versions: Optional except for 88.5 Hz.

\*<sup>2</sup> The UT-67 TONE SQUELCH UNIT is necessary.

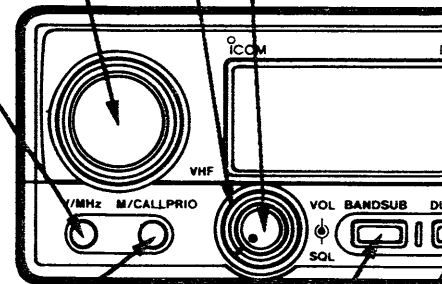

## MEMORY WRITE SWITCH [SPEECH/MW]

Programs a memory channel or a call channel. (pgs. 29, 31)

Transfers the contents of a memory channel or a call channel to the VFO. (pgs. 30, 32)

Announces the operating band frequency in a synthesized voice when an optional UT-66 VOICE SYNTHESIZER UNIT is installed. (p. 22)

## POWER SWITCH [POWER]

Turns the power ON and OFF.

## MONITOR SWITCH [PGR/C SQL/MONI]

Opens the accessing band squelch and monitors the transmit frequency when pushed and held. (pgs. 23, 25)

Activates the pager or code squelch function when an optional UT-55 DTMF ENCODER/DECODER UNIT is installed. (pgs. 42~47)

## MICROPHONE CONNECTOR (p. 4)

Connects the supplied microphone or another suitable microphone.

## UHF SQUELCH CONTROL [SQL] (p. 17)

Adjusts the UHF band squelch threshold level.

## UHF VOLUME CONTROL [VOL] (p. 17)

Adjusts the UHF band audio output level.

## SET MODE SWITCH [SET/LOCK]

Accesses SET mode and advances the SET mode display. (p. 12)

Activates the lock function when pushed and held. (p. 13)

## TRANSMIT POWER SWITCH [LOW/ATT]

Selects 1 of the 3 transmit output power levels. (p. 23)

Activates the RF attenuator function when pushed and held. (p. 18)

Reverses the SET mode display in SET mode. (p. 12)

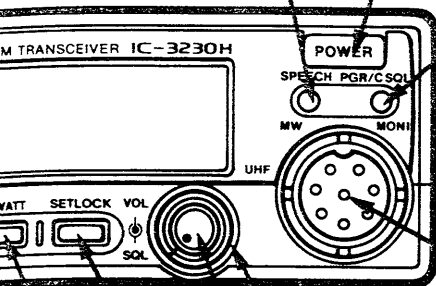

# 1 PANEL DESCRIPTION

## Function display

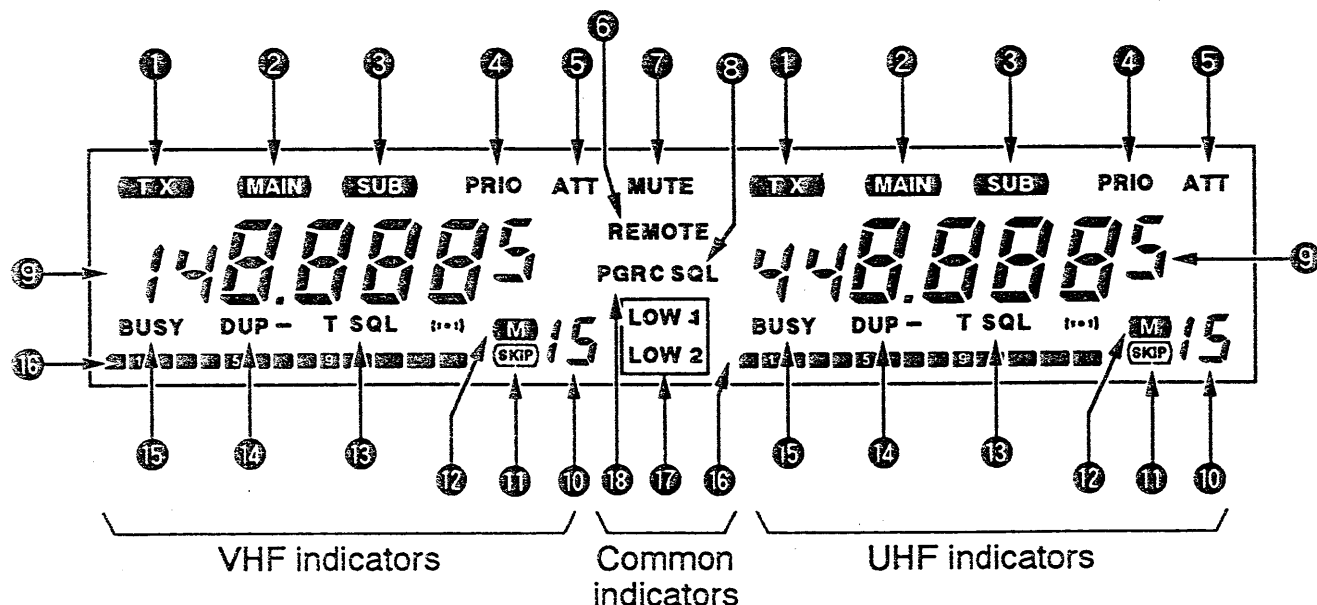

① **TRANSMIT INDICATORS** (p. 24)  
Appear while transmitting.

② **MAIN BAND INDICATORS**  
Appear above the frequency readout of the MAIN band.

③ **SUB BAND ACCESS INDICATORS**  
Appear when the SUB band access function is activated. (p. 19)  
Blink when optional External DTMF Remote is activated. (p. 59)

④ **PRIORITY WATCH INDICATORS** (pgs. 39, 40)  
Appear when priority watch is activated.

⑤ **RF ATTENUATOR INDICATORS** (p. 18)  
Appear when the RF attenuator is in use.

⑥ **REMOTE INDICATOR**  
Appears when optional Mic or External DTMF Remote is on standby. (p. 56)

Blinks when optional Mic or External DTMF Remote is in use. (pgs. 57, 59)

⑦ **MUTE INDICATOR** (p. 58)  
Appears when the optional AF mute function is in use. The HM-56/A and the optional UT-55 are necessary.

⑧ **CODE SQUELCH INDICATOR** (p. 47)  
Appears when the optional code squelch function is in use.

⑨ **FREQUENCY READOUTS**  
Display the operating frequencies (except during SET mode).

## ⑩ MEMORY CHANNEL READOUTS

Display the memory channel numbers. (p. 28)

- A large "L" appears when the lock function is activated. (p. 13)
- A large "C" appears while on the call channel. (p. 31)
- A small "c" appears when VFO mode is selected from the call channel.

## ⑪ SKIP INDICATORS (p. 36)

Appear when the displayed memory channel is programmed as a skip channel.

## ⑫ MEMORY INDICATORS (p. 28)

Appear when MEMORY mode is selected.

## ⑬ TONE INDICATORS

"T" appears when the subaudible tone encoder is turned ON. (p. 26)

"T SQL" appears when the optional tone squelch function is used. (p. 50)

"T SQL (•••)" appears when the optional pocket beep function is in use. (p. 49)

## ⑭ DUPLEX INDICATORS (p. 25)

"DUP-" or "DUP" appear when semi-duplex is selected for repeater operation.

## ⑮ BUSY INDICATORS

Appear when a signal received or when the squelch is open.

## ⑯ S/R F INDICATORS

Display the relative strength of a received signal. (p. 17)

Display the selected output power while transmitting. (p. 23)

## ⑰ LOW POWER INDICATORS (p. 23)

Appear when low power 1 or 2 is selected on the MAIN band.

## ⑱ PAGER INDICATOR (pgs. 45, 46)

Appears when the optional pager function is activated.

### Microphone connector (front panel view)

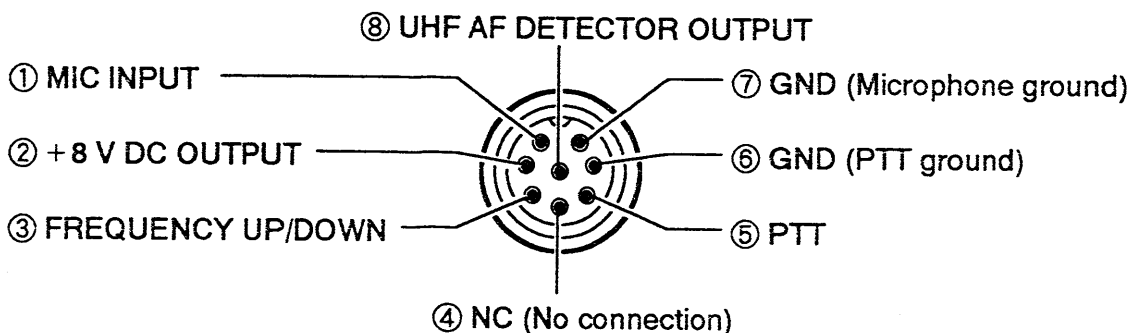

# 1 PANEL DESCRIPTION

## ■ Rear panel

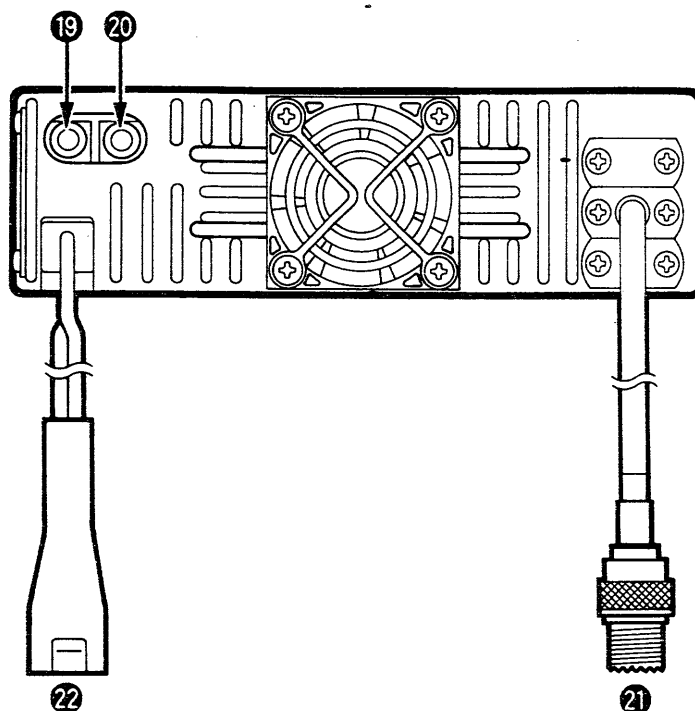

**19 430 (440) MHz SPEAKER JACK**  
[430 (440) MHz SP]

Connects a 4–8 Ω speaker. See the below table for details.

**20 144 MHz SPEAKER JACK**  
[144 MHz SP]

Connects a 4–8 Ω speaker. See the below table for details.

**21 ANTENNA CONNECTOR** (p. 9)

Connects a 50 Ω dual band antenna with a PL-259 connector to the transceiver.

**22 POWER RECEPTACLE [DC13.8V]**  
(p. 8)

Accepts 13.8 V DC with the supplied DC power cable.

### ● Speaker information

CONNECTED SPEAKER	VHF AUDIO	UHF AUDIO
With no external speakers	Internal speaker (mixed audio)	
[144 MHz SP] only	External speaker	Internal speaker
[430 (440) MHz SP] only	External speaker (mixed audio)	
2 external speakers (one connected to each jack)	External speaker via [144 MHz SP]	External speaker via [430 (440) MHz SP]



## Microphone

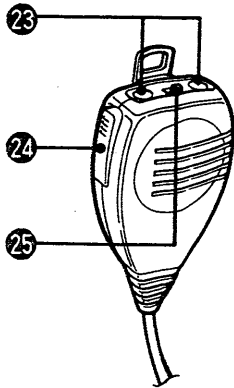

Top and side panel

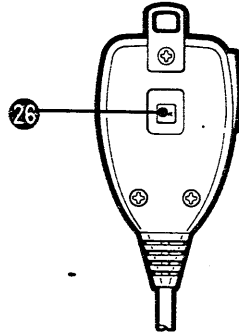

HM-59 rear panel  
(Europe and Italy versions)

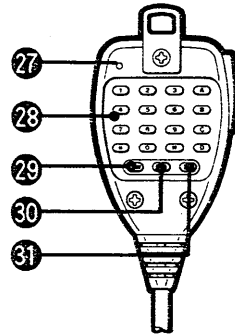

HM-56/A rear panel  
(U.S.A. version)

### 23 FREQUENCY UP/DOWN SWITCHES [UP], [DN]

- Push either switch to change the operating frequency or memory channel.
- Push and hold either switch to start scanning.
- Once a function has been programmed for Up Switch Remote, [UP] activates the function. (p. 41)
- [UP] activates optional Mic DTMF Remote when in standby. (p. 57)

### 24 PTT SWITCH

Push and hold to transmit; release to receive.

### 25 LOCK SWITCH [LOCK]

Prevents accidental input from all keys except the PTT switch and [TONE] of the HM-59 HAND MICROPHONE.

### 26 TONE CALL SWITCH [TONE]

(HM-59 only)

Push and hold to transmit a 1750 Hz tone call signal for repeater access.

### 27 ACTIVE INDICATOR (HM-56/A only)

Lights up or blinks when a key is pushed or a tone is being transmitted.

### 28 DTMF KEYBOARD (HM-56/A only)

Use DTMF codes for auto patching, repeater control, optional Mic DTMF Remote and other functions.

- Attach the supplied microphone sheet to the HM-56/A keyboard.

### 29 MEMORY WRITE KEY [MW] (HM-56/A only)

Used when writing a DTMF code into DTMF memory or re-dial code memory.

### 30 MEMORY READ KEY [MR] (HM-56/A only)

Used when recalling and transmitting a DTMF code from DTMF code memory.

### 31 RE-DIAL KEY [RD] (HM-56/A only)

Used when recalling and transmitting the last-transmitted DTMF code.

## Location

Select a location which can support the weight of the transceiver and does not interfere with driving in any way. We recommend the locations shown in the diagram below.

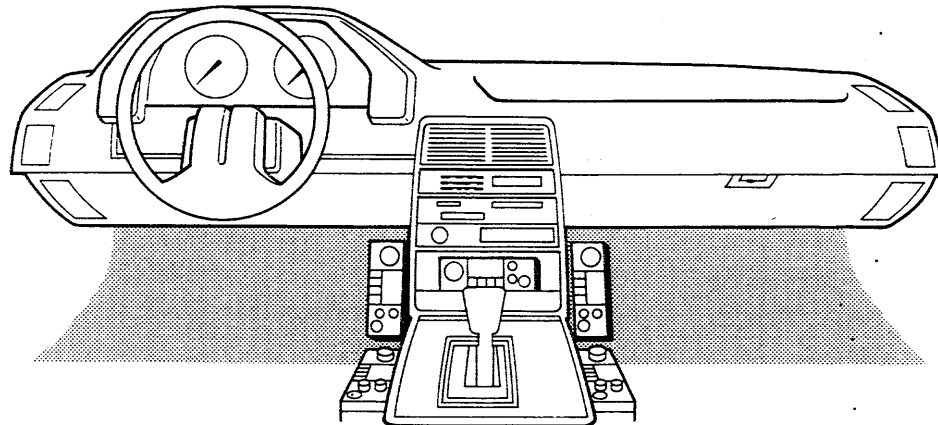

**NEVER** place the transceiver where normal operation of the vehicle may be hindered or where it could cause bodily injury.

**DO NOT** place the transceiver where hot or cold air blows directly onto it.

**AVOID** placing the transceiver in direct sunlight.

## Mounting

1) Drill 4 holes where the mounting bracket is to be installed.

- Approx. 5.5~6 mm when using nuts; Approx. 2~3 mm when using self-tapping screws.  
(1 mm  $\approx$  1/32 in)

2) Insert the supplied screws, nuts and washers through the mounting bracket and tighten.

3) The supplied mounting support bracket may help achieve a secure fit.

4) Adjust the angle for the clearest view of the function display.

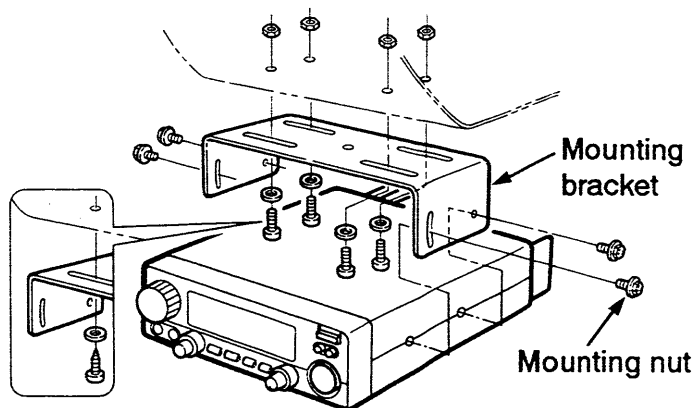

When using self-tapping screws.

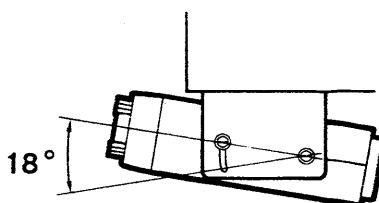

## Battery connection

### CONNECTING TO A DC POWER SOURCE

**NEVER** connect the transceiver directly to a 24 V battery.

**DO NOT** use the cigarette lighter socket for power connections.

To prevent voltage drops, solder or crimp the supplied cable lugs when connecting the power cable to the battery.

**NOTE:** Use cable lugs for the cable connections.

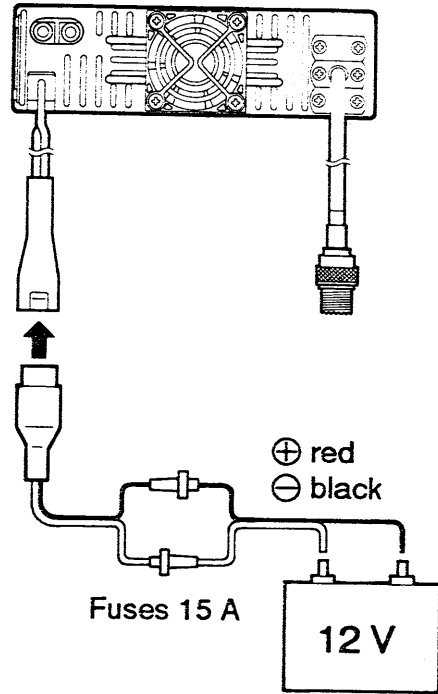
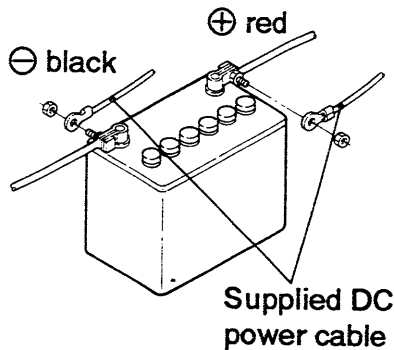
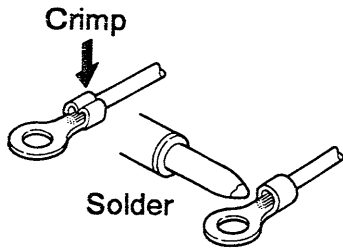

## DC power supply connection

### CONNECTING TO A DC POWER SUPPLY

Use a 13.8 V DC power supply as below:

IC-3230A/E : More than 8 A capability.

IC-3230H : More than 11 A capability.

Make sure the ground terminal of the DC power supply is grounded.

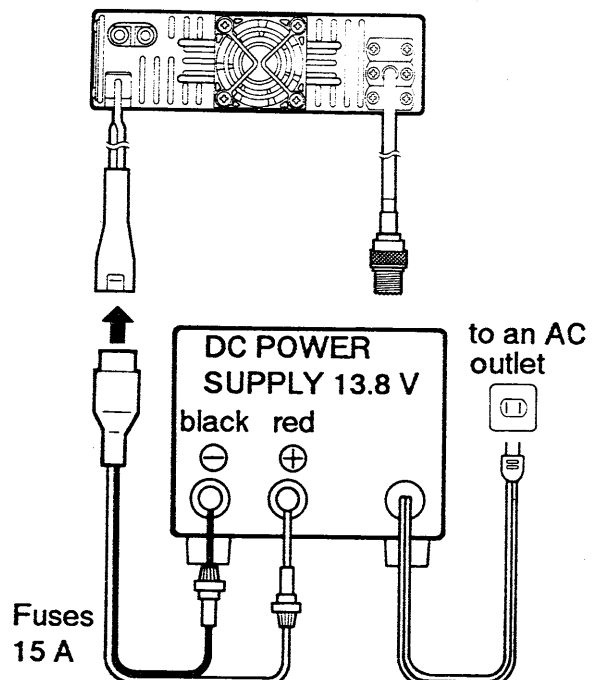

## 2 INSTALLATION

### ■ Antenna connection

#### • ANTENNA LOCATION

You can use a dual band antenna because a duplexer is installed in the IC-3230A/E/H. However, an external duplexer must be connected when using a separate antenna for each band.

To obtain maximum performance from the transceiver, select a high-quality antenna and mount it in a good location.

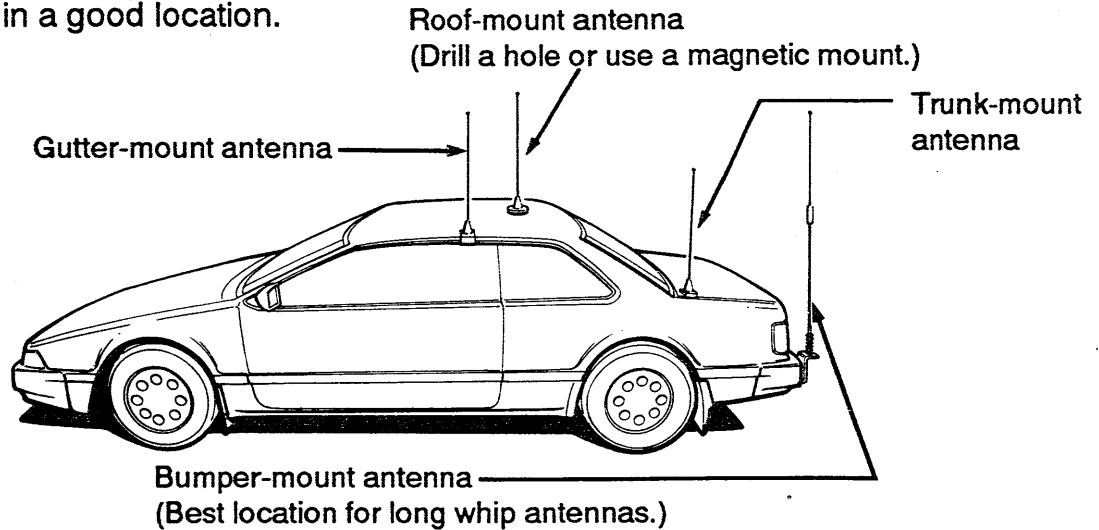

#### • ANTENNA CONNECTOR (PL-259)

- 1) Slide the coupling ring over the coaxial cable.
- 2) Strip the cable as shown in the diagram, and soft solder the center conductor.
- 3) Slide the connector body onto the cable and solder.
- 4) Screw the coupling ring onto the connector body.

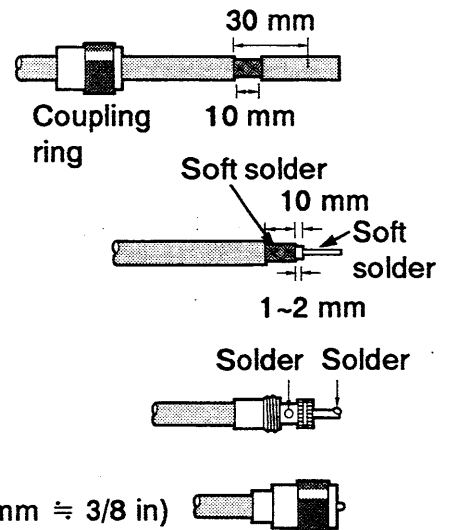

#### • ANTENNA CONNECTION

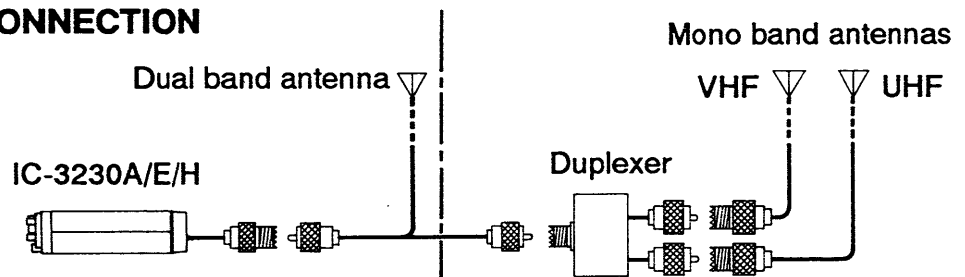

## Optional unit installation

There are 3 types of optional internal units available.

- **UT-55 DTMF ENCODER/DECODER UNIT**

Allows you to operate the pager and code squelch function. Necessary for an optional Mic DTMF Remote and External DTMF Remote.

- **UT-66 VOICE SYNTHESIZER UNIT**

Announces the operating band frequency in English or Japanese.

- **UT-67 TONE SQUELCH UNIT**

Allows you to operate a repeater that requires a subaudible tone for access, the pocket beep function or the tone squelch function.

For installation, proceed as follows:

- 1) Unscrew the 6 screws then remove the top cover as shown in the diagram below. (Fig. 1)
- 2) Install the optional unit as shown in the diagram below. (Fig. 2)
- 3) For the U.S.A. version, replace the UT-67 with the built-in TONE UNIT.
- 4) Replace the top cover and screws.

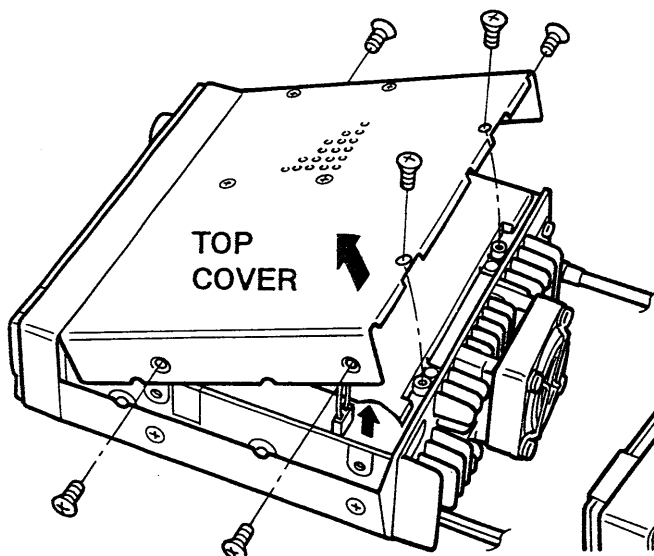

(Fig. 1)

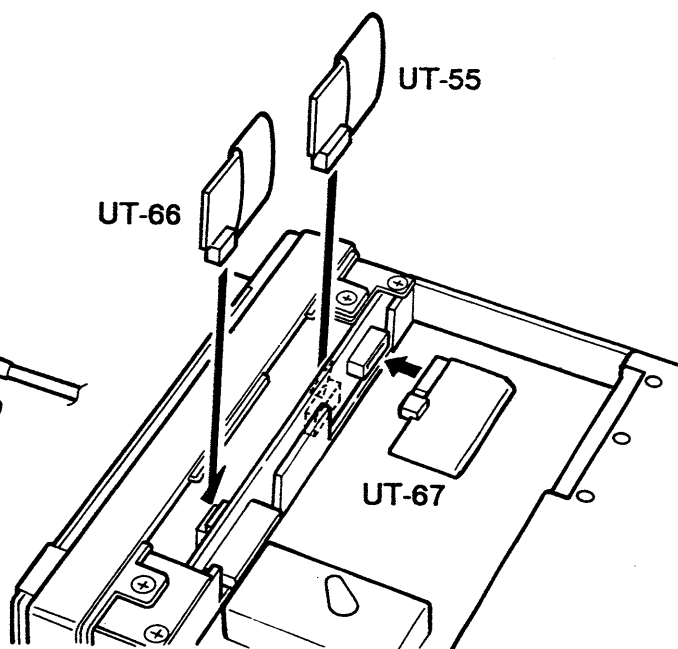

(Fig. 2)

## Mode types

The IC-3230A/E/H has 3 different modes and 1 call channel on each band, VHF and UHF, for multi-function operations.

### VFO MODE (p. 13)

Used for frequency setting and normal operations over the entire band.

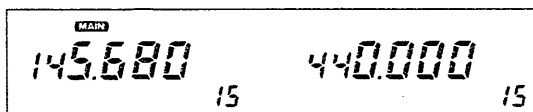

### MEMORY MODE (p. 28)

Used for operating the transceiver using memory channel contents. 15 memory channels are available for programming in each band.

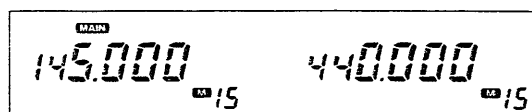

### CALL CHANNEL (p. 31)

Used for operating the transceiver with a most-often-used programmable channel.

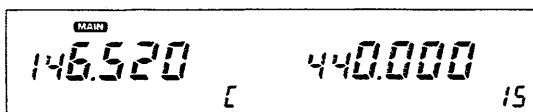

### SET MODE (p. 12)

Used for programming infrequently used settings.

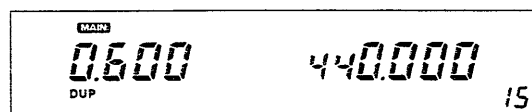

## Mode arrangement chart

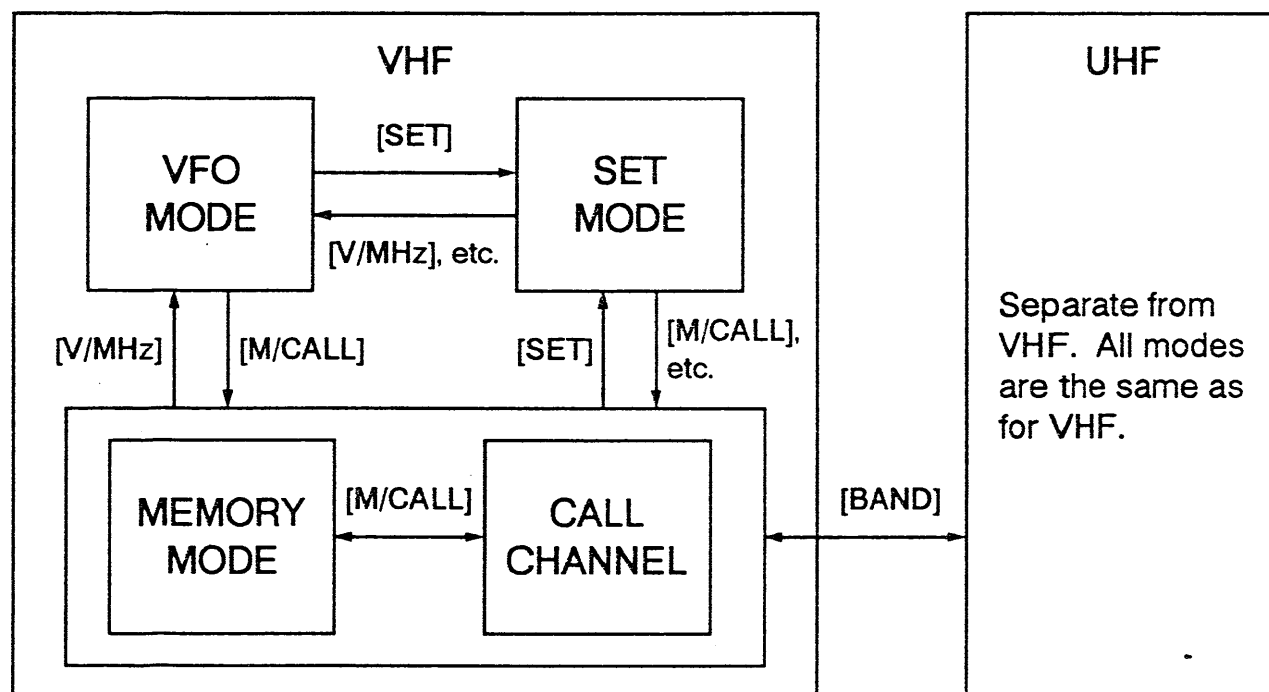

# Set mode construction

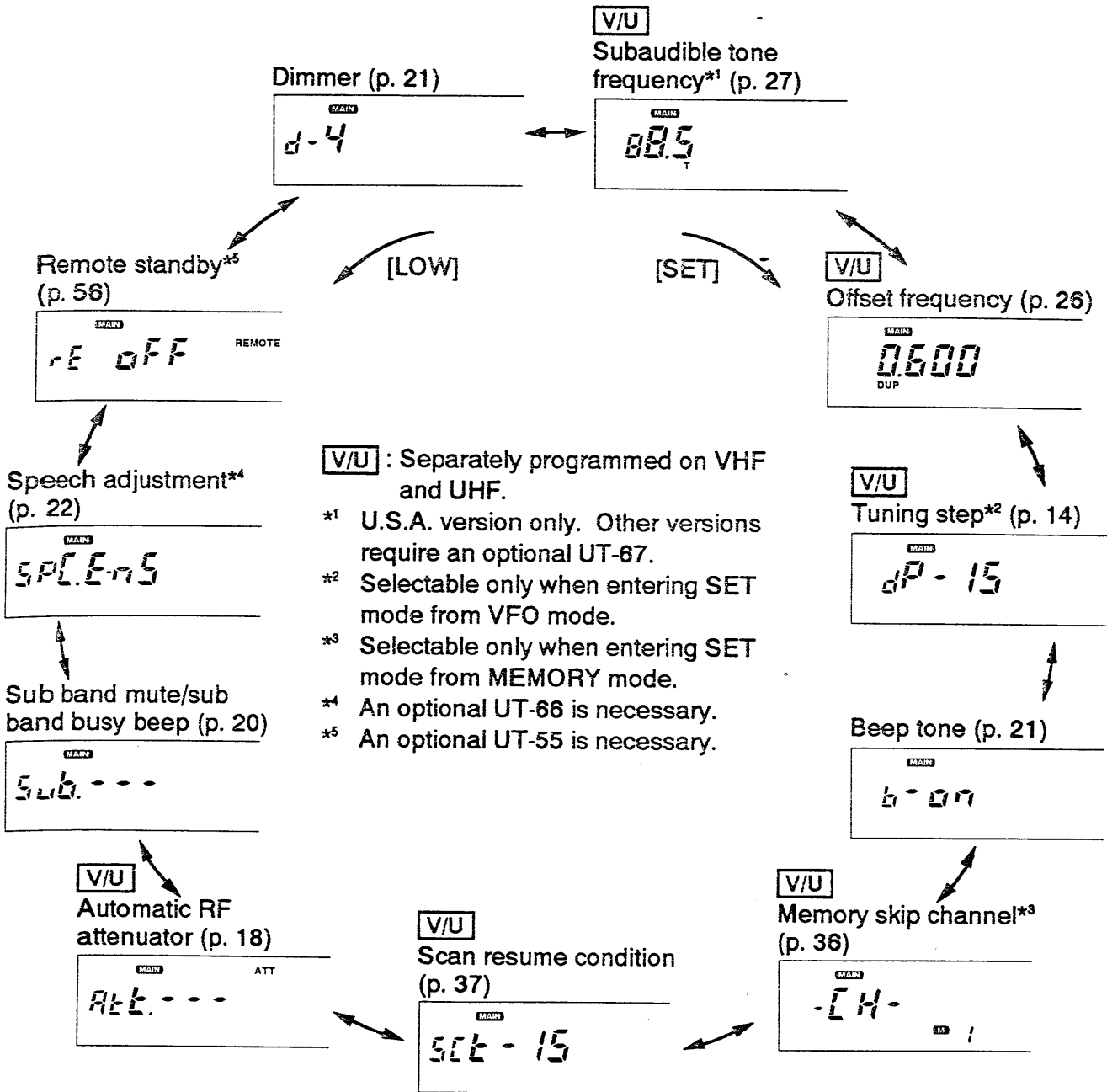

## • SELECTING SET MODE

- 1) Push [BAND] to select the desired band.
- 2) Select either VFO or MEMORY mode.
- 3) Push [SET] to enter SET mode.

## NOTE:

- If no operation is performed for 30 sec. while in SET mode, the transceiver returns to the previous mode automatically.
- When setting the tuning step, enter SET mode from VFO mode.
- When setting the skip channel, enter SET mode from MEMORY mode.

## ■ Selecting VFO mode

### 1. Turn power ON.

Push **IN** the [POWER] switch on the front panel to turn power ON.

- The frequency display shows as follows when first applying power.

U.S.A. version : 146.52 MHz, 440.00 MHz

Asia version : 146.52 MHz, 430.00 MHz

Other versions: 145.00 MHz, 430.00 MHz

Push [POWER].

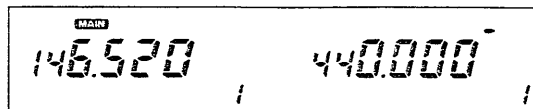

### 2. Select desired band.

Push [BAND] to select either VHF or UHF as the MAIN band.

- “ **MAIN** ” appears above the selected band frequency readout.
- **MAIN** band: Used for transmitting and receiving.
- **SUB** band : Used for receiving only.

Push [BAND].

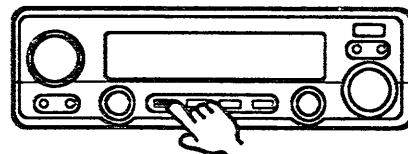

When UHF is selected as the MAIN band.

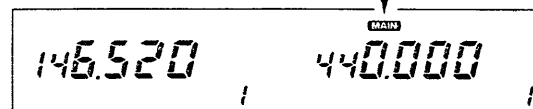

### 3. Select VFO mode.

Push [V/MHz] to select VFO mode when the transceiver is not in VFO mode.

- Be sure “ **M** ” and “ **L** ” are not indicated on the function display.
- If the digits below 100 kHz unit disappear, push [V/MHz] again.

Push [V/MHz].

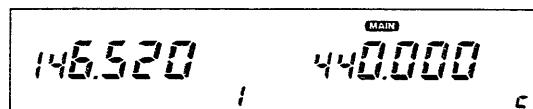
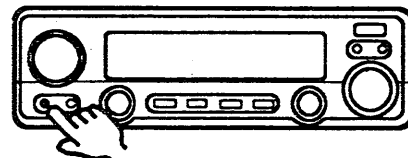

### ● Lock function

To prevent accidental frequency changes and unnecessary function access, use the lock function.

The lock function locks the tuning control and switches electronically.

Push and hold [SET/LOCK] until “L” appears in the memory channel readout to activate the function.

- To cancel the function, push and hold [SET/LOCK] until “L” disappears.
- [PTT], [MONI] and optional [SPEECH] can be used while the lock function is in use.



## ■ Using the tuning control

### 1. Select VFO mode in the desired band. Push [V/MHz].

Push [BAND] to select the desired band, then push [V/MHz] to select VFO mode when the transceiver is not in VFO mode.

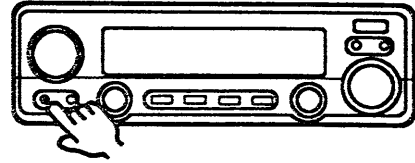

### 2. Set the frequency.

Rotate the tuning control to set the desired frequency.

- Frequency changes the selected tuning steps. See below for details.
- For quick frequency selection, push [V/MHz] in VFO mode; then, rotate the tuning control.

Rotate the tuning control.

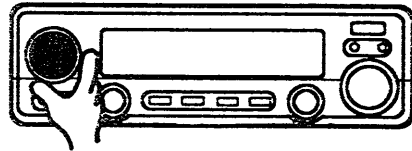

### USING SET MODE

#### • TUNING STEP SELECTION

VFO mode → SET mode  
V/U separate setting

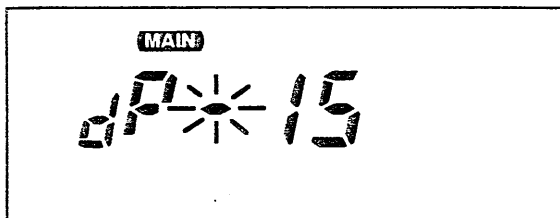

The display shows the 15 kHz tuning step has been selected.

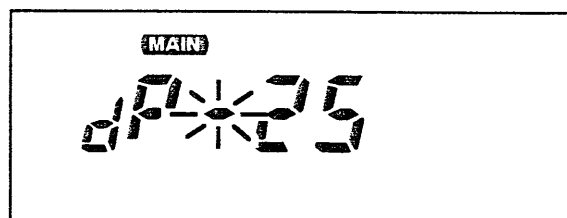

The display shows the 25 kHz tuning step has been selected.

- 1) Push [BAND] to select VHF or UHF.
- 2) Push [V/MHz] to select VFO mode.
- 3) Push [SET] several times until "dP" appears on the function display as shown above.
  - Refer to p. 12 for SET mode details.
- 4) Rotate the tuning control for the desired tuning step.
  - 5, 10, 12.5, 15, 20 and 25 kHz steps are available.
- 5) Push any switch except [SET] and [LOW] to set the value and to exit SET mode.

## 4 FREQUENCY SETTING

### ■ Using the [UP]/[DN] switches

#### 1. Select VFO mode in the desired band.

Push [BAND] to select the desired band, then push [V/MHz] to select VFO mode when the transceiver is not in VFO mode.

Push [V/MHz].

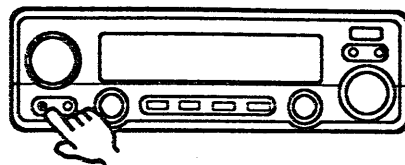

#### 2. Set the frequency.

Push [UP] or [DN] on the microphone to set the desired frequency.

- Check that [LOCK] on the microphone is OFF.
- The frequency changes the selected tuning steps. See p. 14 for details.

Push [UP] or [DN].

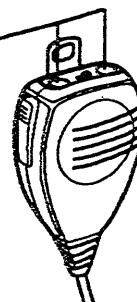

- When Up Switch Remote is in use or optional DTMF Remote is in standby, [UP] or [DN] cannot be used for frequency setting. See pgs. 41 or 56-60 for details.

- When optional DTMF Remote is activated, the frequency can be set using a DTMF code. (pgs. 56 ~ 60)
- If [UP] or [DN] is pushed and held, programmed scan starts. (p. 34)

### ■ MHz tuning step selection

#### Selecting 1 MHz steps

Push [V/MHz] in VFO mode to select 1 MHz tuning steps.

- The 100 kHz digit and below disappear.
- Push [V/MHz] again to cancel.

Push [V/MHz].

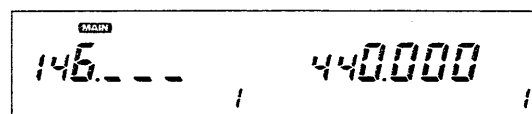

#### Selecting 10 MHz steps\*

Push and hold [V/MHz] to select 10 MHz tuning steps.

- The 1 MHz digit and below disappear.
- Push and hold [V/MHz] again to cancel.

\* Some versions do not have this function.

Push and hold [V/MHz].

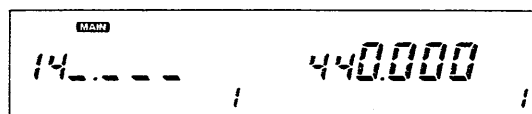

# Setting example

Setting 147.80 MHz.

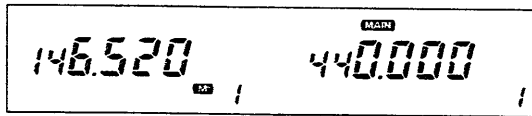

Push [BAND] to select the desired band.

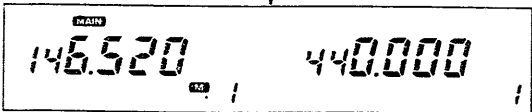

Push [V/MHz] to select VFO mode.

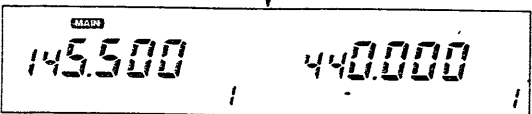

Push [V/MHz] to select the 1 MHz tuning step.

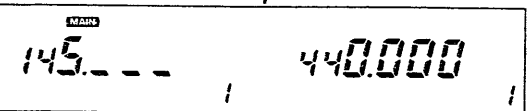

Rotate the tuning control to set the MHz unit.

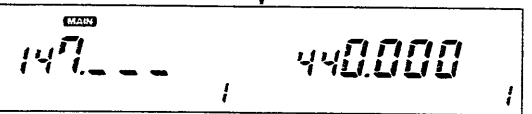

Push [V/MHz] to cancel the MHz tuning step.

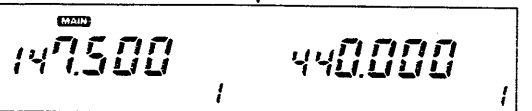

Rotate the tuning control to set the kHz unit.

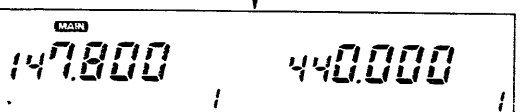

Setting 447.28 MHz.

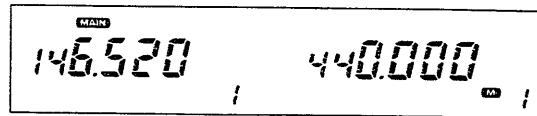

Push [BAND] to select the desired band.

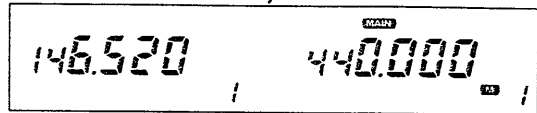

Push [V/MHz] to select VFO mode.

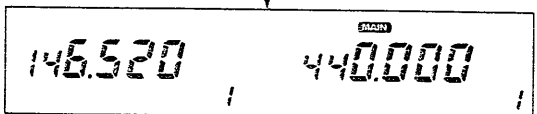

Push [V/MHz] to select the 1 MHz tuning step.

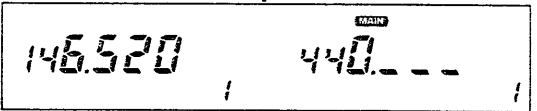

Rotate the tuning control to set the MHz unit.

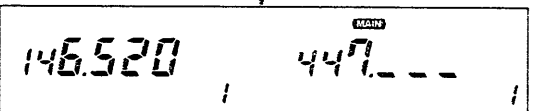

Push [V/MHz] to cancel the MHz tuning step.

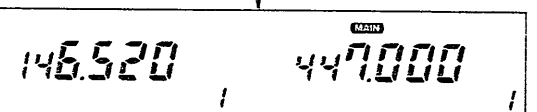

Rotate the tuning control to set the kHz unit.

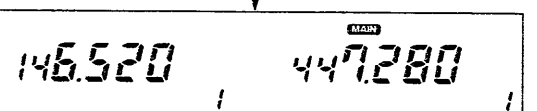

## Receiving

The transceiver allows you to receive both VHF and UHF bands simultaneously.

### 1. Select the desired band.

*Push [BAND] to select either VHF or UHF as the MAIN band.*

*Push [V/MHz] to select VFO mode when the transceiver is not in VFO mode.*

Push [BAND].

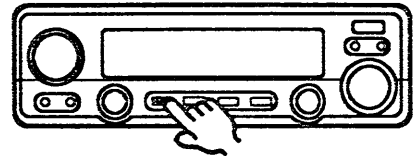

### 2. Adjust the audio level.

*Rotate both [SQL]'s max. counter-clockwise to open the squelches and set both [VOL]'s to the desired audio levels.*

*Rotate both [SQL]'s clockwise until the noise disappears.*

Adjust both [VOL] and [SQL].

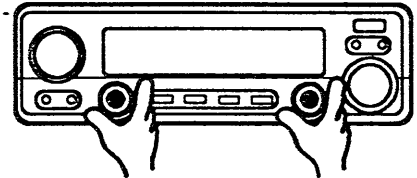

### 3. Set the frequency.

*Set the operating frequency using the tuning control or [UP]/[DN] on the microphone. (See pgs. 13~16 for details.)*

- See p. 19 for SUB band access and setting a frequency for the SUB band.

Rotate the tuning control.

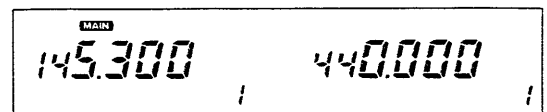
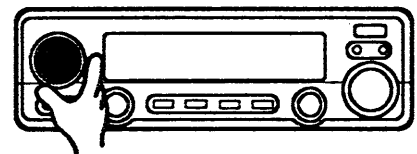

### 4. When receiving a signal:

*When receiving a signal on the set frequency, squelch opens and the transceiver emits audio.*

- SUB band mute or SUB band busy beep is useful for dual band receiving. (p. 20)

"BUSY" appears and the S/Rf indicator shows relative signal strength.

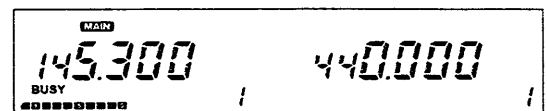

## RF attenuator

The 20 dB RF attenuator does not allow reception of weak signals. This attenuator, therefore, is useful for short-distance contact since undesired long-distance signals will be eliminated.

### Activate the RF attenuator.

Push and hold [LOW/ATT] until "ATT" appears.

- To cancel the function, push and hold [LOW/ATT] until "ATT" disappears.
- The RF attenuator can be separately set in the MAIN band and SUB band.
- An automatic RF attenuator with output power selection is available. See below.

Push and hold [LOW/ATT].

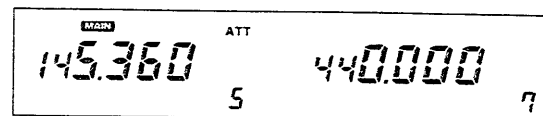
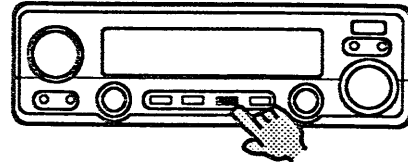

### USING SET MODE

#### • AUTOMATIC RF ATTENUATOR

V/U separate setting

The RF attenuator function can be automatically turned ON when low power 1 is selected.

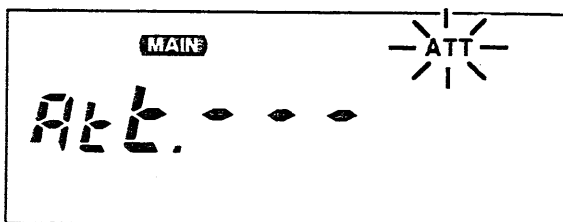

The display shows the Automatic RF attenuator is OFF.

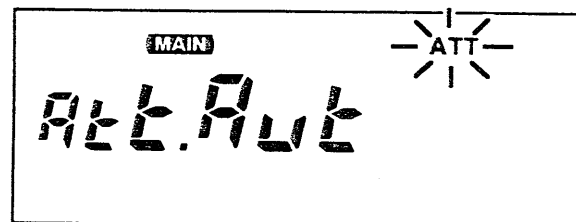

The display shows the Automatic RF attenuator is ON.

- 1) Push [BAND] to select VHF or UHF.
- 2) Push [SET] several times until "Att" appears on the function display and the RF attenuator indicator blinks as shown above.
  - Refer to p. 12 for SET mode details.
- 3) Rotate the tuning control to set the condition.
  - "Att. - - -" : Automatic RF attenuator OFF
  - "Att.Aut" : Automatic RF attenuator ON
- 4) Push any switch except [SET] and [LOW] to set the condition and to exit SET mode.

## 5 RECEIVING

### ■ SUB band access

This function allows you to change SUB band settings such as frequency and memory channel while operating in the MAIN band.

It is easy to access the SUB band and return to the MAIN band with the [BAND] switch.

#### 1. Activate the SUB band access.

*Push and hold [BAND/SUB].*

- The MAIN band still functions for receiving and transmitting.

Push and hold [BAND/SUB].

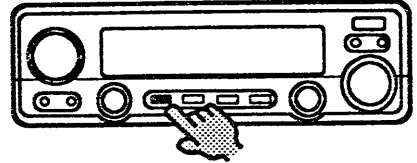

"SUB" appears.

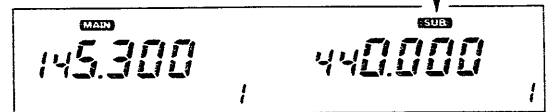

#### 2. Set the SUB band operating frequency.

*Set a SUB band operating frequency or memory channel using the tuning control or [UP]/[DN] on the microphone.*

- Set functions, if desired.
- The MAIN band output power cannot be changed while accessing the SUB band.
- Neither the optional pager nor the code squelch function can be activated during the SUB band access operation. (pgs. 45–47)

Rotate the tuning control.

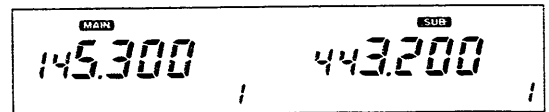
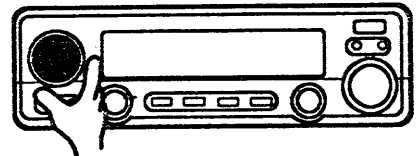

#### 3. Exit the SUB band access.

*To exit the SUB band, push and hold [BAND/SUB] until "SUB" disappears.*

- To switch from the SUB band to the MAIN band, push [BAND].

Push and hold [BAND/SUB].

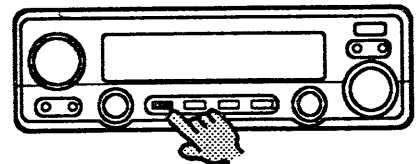

"SUB" disappears.

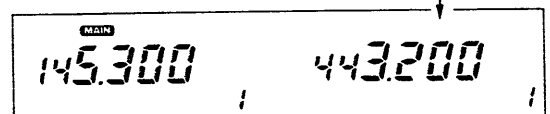

### USING SET MODE

#### • SUB BAND MUTE/SUB BAND BUSY BEEP

V/U same setting

The SUB band mute function automatically cuts out SUB band AF signals when both MAIN and SUB band signals are received.

The SUB band busy beep sounds when the SUB band squelch is closed to inform you that the SUB band squelch has been opened.

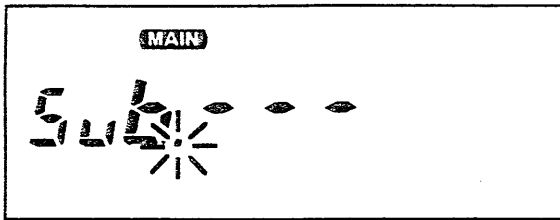

The display shows the SUB band mute function and SUB band busy beep are OFF.

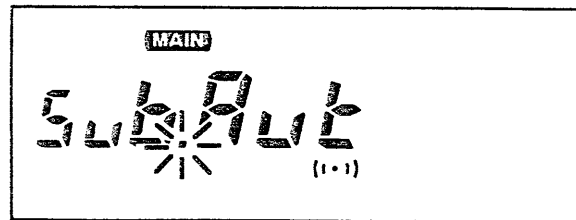

The display shows the SUB band mute function and SUB band busy beep are ON.

1) Push [SET] several times until "Sub" appears on the function display as shown above.

- Refer to p. 12 for SET mode details.

2) Rotate the tuning control to set the condition.

DISPLAY	SUB BAND MUTE	BUSY BEEP
Sub. ---	OFF	OFF
Sub. --- (101)	OFF	ON
Sub.Aut	ON	OFF
Sub.Aut (101)	ON	ON

3) Push any switch except [SET] and [LOW] to set the condition and to exit SET mode.

## ■ Beep tone and dimmer

### USING SET MODE

#### • BEEP TONE ON/OFF

You can select silent operation with beep tone OFF or confirmation operation with beep tone ON.

To inform you which band is operating, a high beep tone or a low beep tone is emitted while operating on the VHF or UHF band, respectively.

- 1) Push [SET] several times until "b-on" or "b-oFF" appears on the function display as shown at right.

- Refer to p. 12 for SET mode details.

- 2) Rotate the tuning control to set the condition.

- 3) Push any switch except [SET] and [LOW] to set the condition and to exit SET mode.

V/U same setting

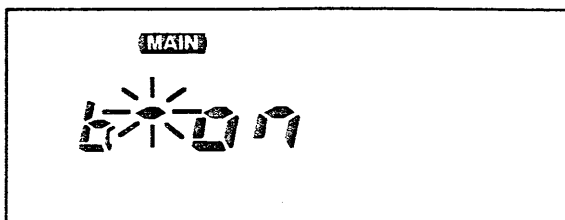

The display shows the beep tone is ON.

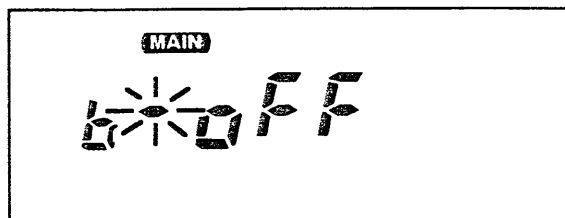

The display shows the beep tone is OFF.

### USING SET MODE

#### • DIMMER ADJUSTMENT

Adjust the intensity to suit lighting conditions and personal preference.

- 1) Push [SET] several times until one of "d-1" ~ "d-4" appears on the function display as shown at right.

- Refer to p. 12 for SET mode details.

- 2) Rotate the tuning control to set the desired intensity.

- The intensity level can be changed in 4 steps from d-1 (Dark) to d-4 (Bright).

- 3) Push any switch except [SET] and [LOW] to set the value and to exit SET mode.

V/U same setting

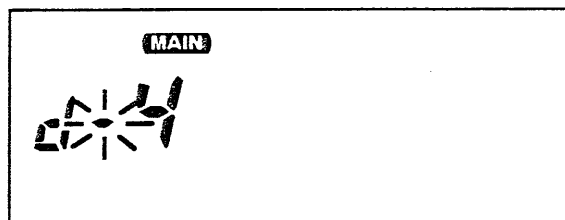



## Optional voice synthesizer

The transceiver announces the operating frequency in English or Japanese when an optional UT-66 VOICE SYNTHESIZER UNIT is installed. This function can be activated even when the lock function is turned ON. See p. 10 for installation.

### Activate the voice synthesizer.

Push [SPEECH] to announce the operating frequency.

Push [SPEECH].

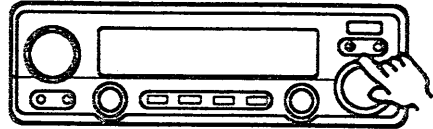

- While accessing the SUB band, the transceiver announces the SUB band frequency.
- 4 types of speech conditions are available. See below.

### USING SET MODE

#### • SPEECH ADJUSTMENT

(An optional UT-66 is necessary.)

V/U same setting

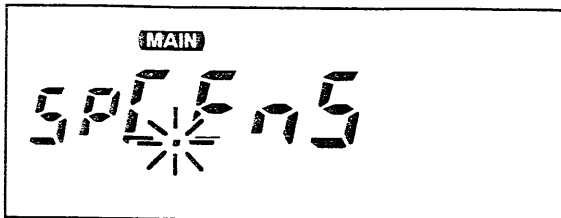

The display shows slower English is selected.

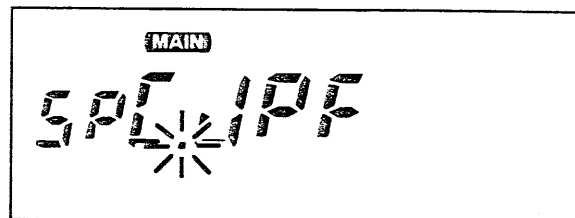

The display shows faster Japanese is selected.

1) Push [SET] several times until "SPC" appears on the function display as shown above.

- Refer to p. 12 for SET mode details.

2) Rotate the tuning control to set the condition.

DISPLAY	SPEECH CONDITION
SPC.EnS	Slower English
SPC.EnF	Faster English
SPC.JPS	Slower Japanese
SPC.JPF	Faster Japanese

3) Push any switch except [SET] and [LOW] to set the condition and to exit SET mode.



#### 4. Transmit a signal.

*Push and hold the PTT switch and speak into the microphone.*

- The S/RF indicator shows the selected output power.
- **DO NOT** hold the microphone too close to your mouth or speak too loudly. This may distort the signal.

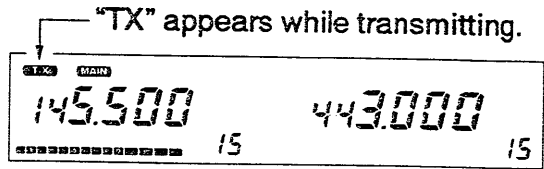

#### 5. Release the PTT switch to receive.

### ■ Crossband full duplex operation

The transceiver can receive a signal on the SUB band while transmitting on the MAIN band. Using this capability, full duplex operation is possible. No special setting is necessary for full duplex operation.

#### 1. Set the operating frequencies.

*Set the desired transmit and receive frequencies on the MAIN and SUB bands respectively for your transceiver. (p. 14)*

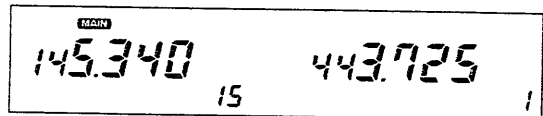
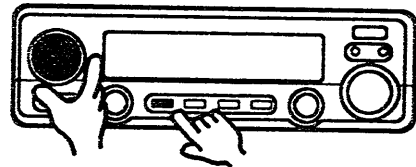

#### 2. Set the operating frequencies for the other transceiver.

*Set the same frequencies, but in reverse order, on the MAIN and SUB bands for the other transceiver.*

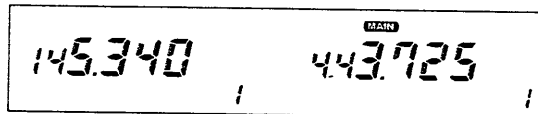

#### 3. Operate with full duplex.

*Push and hold the PTT switch to operate with full duplex.*

- Transmitting and receiving activate simultaneously.

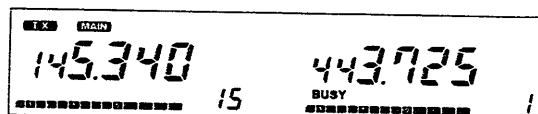

## 6 TRANSMITTING

### ■ Operating through a repeater

When operating through a repeater, set the transceiver to semi-duplex. Some repeaters require a subaudible tone, a 1750 Hz tone or DTMF tones.

#### 1. Set the operating frequency.

Push [BAND] to select the desired band and then push [V/MHz] to select VFO mode.

Rotate the tuning control to set the operating frequency. (p. 14)

Rotate the tuning control.

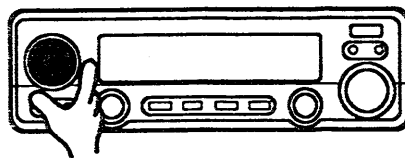

#### 2. Select duplex direction.

Push [DUP] once or twice for – duplex or + duplex respectively.

- “DUP –” or “DUP” appears.  
“DUP –”: TX freq. = RX freq. – Offset freq.  
“DUP” : TX freq. = RX freq. + Offset freq.

Push [DUP].

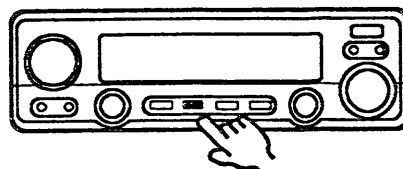

#### 3. Set the offset frequency.

Set the desired offset (shift) frequency.

- See the box at right for details.

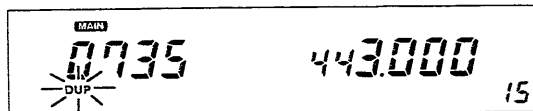

#### 4. Activate a tone if required.

Activate a tone, when the repeater requires a tone. See page at right for details.

#### 5. Access a repeater.

Push and hold the PTT switch to transmit and release it to receive.

- While receiving, push and hold [MONI] to check whether the transmit frequency (repeater input frequency) is busy or not.

#### 6. Return to simplex.

To return to simplex, push [DUP] once or twice to clear the “DUP” indicator.

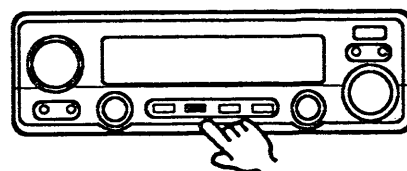

- **CTCSS SUBAUDIBLE TONE**

The U.S.A. version has 38 subaudible tones. Other versions have 88.5 Hz only and other subaudible tones require an optional UT-67 TONE SQUELCH UNIT.

*Push and hold [DUP/TONE] until only "T" appears.*

- To set a subaudible tone frequency, use SET mode. See the next page for details.

- **DTMF TONES (U.S.A. version)**

*Push the desired digit keys on the microphone to transmit DTMF tones.*

See pgs. 51~55 for advanced DTMF operation.

- **1750 Hz TONE CALL (Europe and Italy versions)**

When using the supplied HM-59:

*Push and hold [TONE] on the microphone for about 1~3 sec. to transmit a 1750 Hz tone call signal.*

When using the optional HM-56:

Refer to "HM-56/A ADVANCED FUNCTIONS." (p. 55)

### USING SET MODE

- **OFFSET FREQUENCY SETTING**

V/U separate setting

1) Push [BAND] to select VHF or UHF.

2) Push [SET] several times until "DUP" appears and blinks on the function display as shown at right.

- Refer to p. 12 for SET mode details.

3) Rotate the tuning control to set the desired offset frequency.

- Use [V/MHz] for quick MHz setting.
- The tuning step selection is valid for this setting. (p. 14)

4) Push any switch except [V/MHz], [SET] and [LOW] to set the value and to exit SET mode.

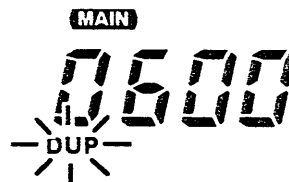

**NOTE:** When the transmit frequency is out of the band, transmission is impossible and "OFF" appears on the function display.

# 6 TRANSMITTING

## USING SET MODE

### • SUBAUDIBLE TONE FREQUENCY SETTING

(An optional UT-67 is necessary, except for the U.S.A. version.)

V/U separate setting

- 1) Push [BAND] to select VHF or UHF.
- 2) Push [SET] several times until "T" appears and blinks on the function display.
  - Refer to p. 12 for SET mode details.

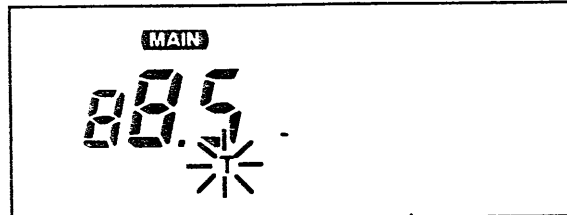

- 3) Rotate the tuning control to set the desired subaudible tone frequency.
- 4) Push any switch except [SET] and [LOW] to set the value and to exit SET mode.

### • SUBAUDIBLE TONE FREQUENCY LIST

67.0	97.4	136.5	192.8
71.9	100.0	141.3	203.5
74.4	103.5	146.2	210.7
77.0	107.2	151.4	218.1
79.7	110.9	156.7	225.7
82.5	114.8	162.2	233.6
85.4	118.8	167.9	241.8
88.5	123.0	173.8	250.3
91.5	127.3	179.9	
94.8	131.8	186.2	(Unit: Hz)

## ■ Selecting a memory channel

15 memory channels are available in each band for storing often-used frequencies such as those used for repeaters, group calls, etc.

### 1. Select the desired band.

*Push [BAND] to select VHF or UHF.*

Push [BAND].

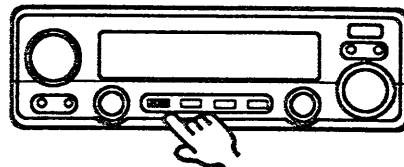

### 2. Select MEMORY mode.

*Push [M/CALL] once or twice to indicate "M" and a memory channel number.*

Push [M/CALL].

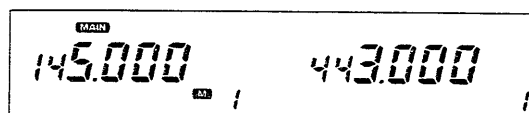
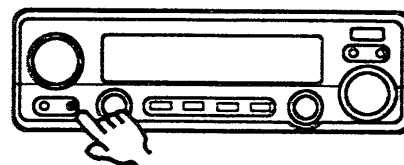

### 3. Select a memory channel.

*Rotate the tuning control to select the desired memory channel.*

- [UP] or [DN] on the microphone can also be used.
- If [UP] or [DN] is pushed and held, memory scan starts. (p. 35)
- Memory channels "A" and "b" are used for the programmable scan edges. (p. 33)
- When optional DTMF Remote is activated, the memory channel can be selected using a DTMF code. (pgs. 56-60)

Rotate the tuning control.

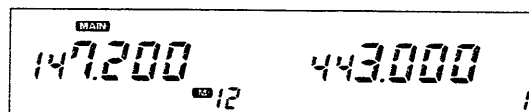
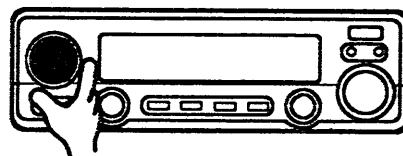

**NOTE:** When Up Switch Remote is activated, [UP] or [DN] cannot be used for frequency setting. See p. 41 for details.

## ■ Programming a memory channel

You can program the following data into a memory channel:

- Operating frequency
- Duplex information (offset direction and offset frequency)
- Tone squelch\*<sup>1</sup> or subaudible tone encoder ON/OFF and its tone frequency\*<sup>2</sup>.

\*<sup>1</sup> An optional UT-67 is necessary for all versions.

\*<sup>2</sup> An optional UT-67 is necessary to change the frequency, except for the U.S.A. version.

### 1. Select a memory channel.

Select the memory channel for programming as described on p. 28.

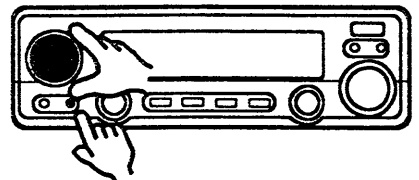

"M" appears.

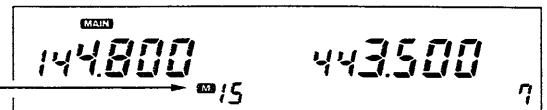

### 2. Select VFO mode.

Push [V/MHz] to select VFO mode.

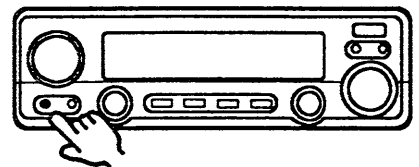

"M" disappears.

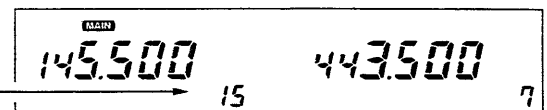

### 3. Set a frequency.

Set the desired data, as described above, into the memory channel.

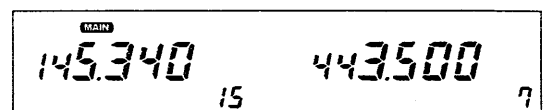
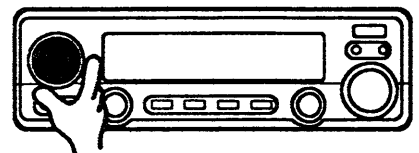

### 4. Program into the channel.

Push and hold [MW] for 2 sec.

- If the beep tone is ON, 3 beeps alert you that the contents are programmed.
- Push [M/CALL] to select the memory channel if you want to confirm the programming.

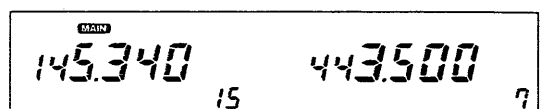
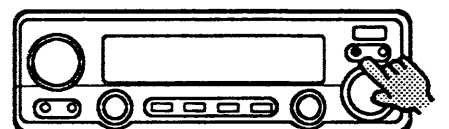



## ■ Transferring memory data

You can copy and transfer the contents of a memory channel into the VFO.

This function is especially useful when searching for signals around the memory or call channel frequencies.

### 1. Select memory channel.

*Select the desired memory channel as described on p. 28.*

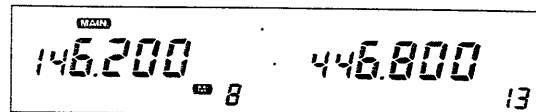
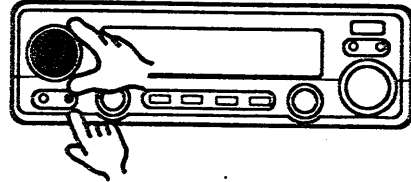

### 2. Transfer the contents.

*Push and hold [MW] for 2 sec.*

- The contents are transferred to the VFO.
- The transceiver goes into VFO mode automatically.

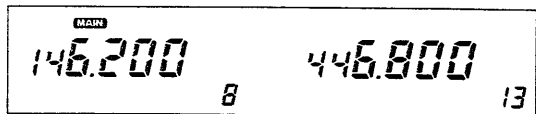
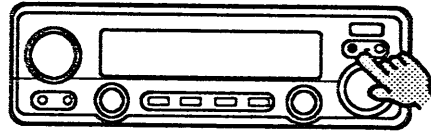

### CONVENIENT

Offset frequency, subaudible tone frequency, subaudible tone encoder ON/OFF setting and offset direction (+ or - duplex) are simultaneously transferred into the VFO. You need not set repeater data again.

If a memory or call channel contains an optional tone squelch setting, this setting is also transferred into the VFO.

## ■ Selecting a call channel

Each band has one call channel. Call channels are convenient for storing your most-often-used frequencies and are separate from the memory channels.

### 1. Select desired band.

Push [BAND] to select VHF or UHF.

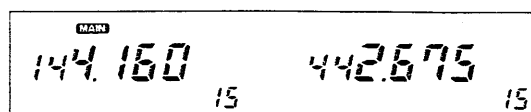
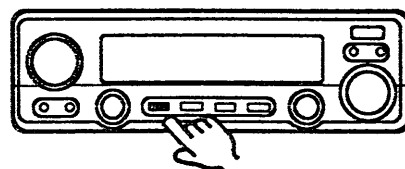

### 2. Select the call channel.

Push [M/CALL] once or twice to display the large "C."

- The large "C" indicates the call channel.

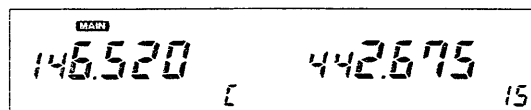
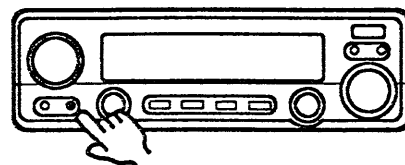

### 3. Return to the previous mode.

To return to VFO mode, push [V/MHz].

To return to MEMORY mode, push [M/CALL] again.

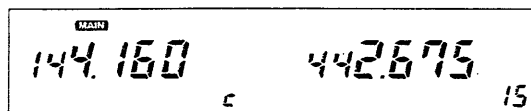
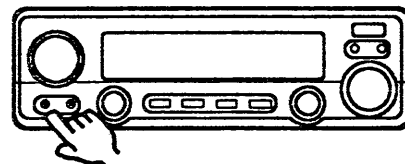

## ■ Programming a call channel

### 1. Select the call channel.

Select the desired band's call channel as described above.

- The large "C" appears.

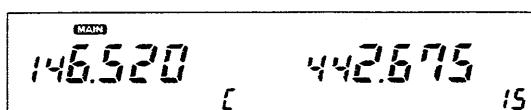
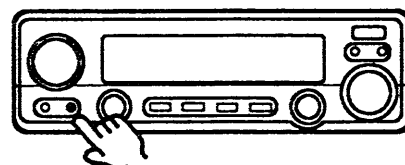

## 2. Set a frequency.

Push [V/MHz] to select VFO mode; then, set the desired frequency (and duplex information when required) to be programmed into the call channel.

- Be sure the small "c" is indicated.

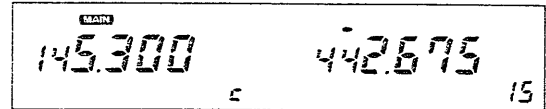
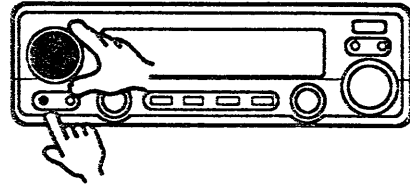

## 3. Program into the call channel.

Push and hold [MW] for 2 sec.

- Push [M/CALL] to select the call channel if you want to confirm the programming.

Push and hold [MW].

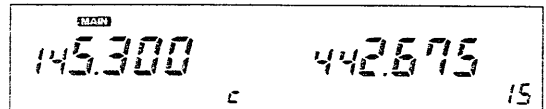
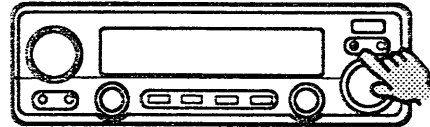

# ■ Transferring call channel contents

The contents of a call channel can be transferred into a VFO.

## 1. Select the call channel.

Select the desired band's call channel as described at left.

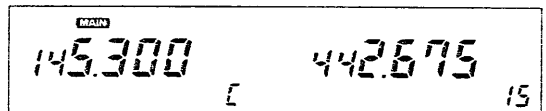
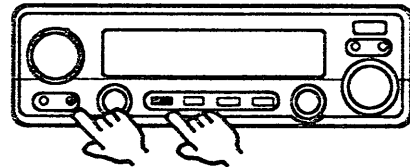

## 2. Transfer the contents.

Push and hold [MW] for 2 sec.

- The contents are transferred to VFO.
- The transceiver goes into VFO mode automatically.
- The large "C" changes to a small "c."

Push and hold [MW].

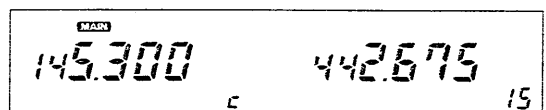
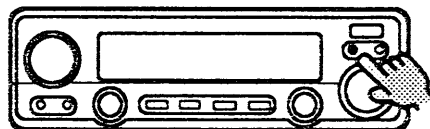

## Scan types

Scan functions are available for your convenience as described below.

Scans can be operated on the VHF and UHF bands independently.

**NOTE:** When the optional tone squelch is activated during scan, the scan stops only when a signal with the same tone is received.

### PROGRAMMED SCAN (p. 34)

Repeatedly scans between 2 user-programmed scan edges, memory channels A and B.

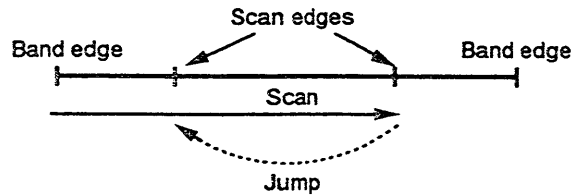

### • MEMORY SCAN (p. 35)

Repeatedly scans all memory channels except skip channels.

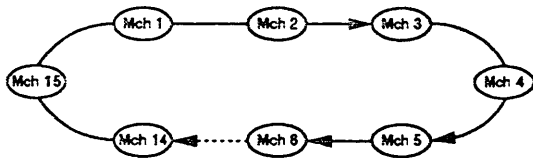

### • MEMORY SKIP FUNCTION (p. 36)

Allows the scan to skip unwanted channels that inconveniently stop scanning during memory scan.

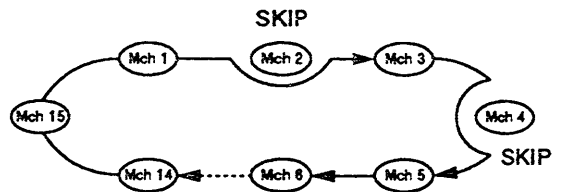

## Programming scan edges

### 1. Select memory channel "A."

Push [BAND] to select the desired band and then push [M/CALL] to select MEMORY mode.

Rotate the tuning control to select memory channel "A."

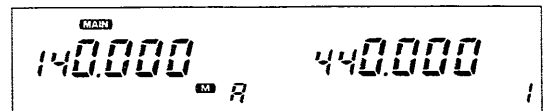
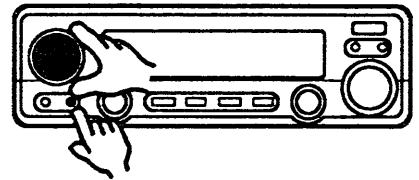

### 2. Program a scan edge.

Push [V/MHz] to select VFO mode; then, set a scan edge frequency.

Push and hold [MW] for 2 sec.

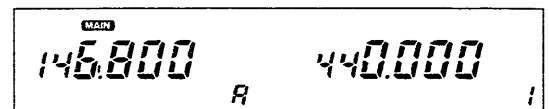
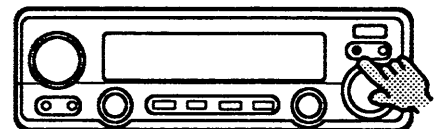

### 3. Program memory channel "b."

Push [M/CALL] to select MEMORY mode; then, rotate the tuning control to select memory channel "b."

Push [V/MHz] to select VFO mode; then, set the other scan edge frequency.

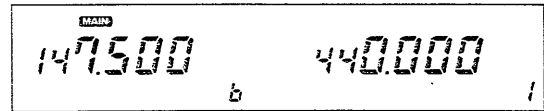

Push and hold [MW] for 2 sec.

## Programmed scan

### 1. Select VFO mode.

Push [BAND] to select the desired band and then push [V/MHz] to select VFO mode.

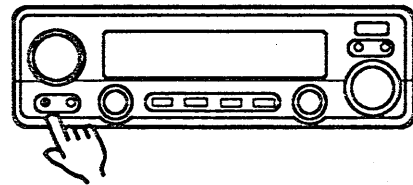

### 2. Set the squelch level.

Rotate VHF or UHF [SQL] until the noise disappears.

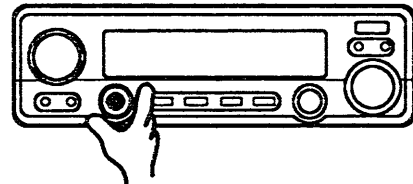

### 3. Start programmed scan.

Push and hold [UP] or [DN] on the microphone.

- Rotating the tuning control changes the scan direction.
- When receiving a signal, scan resumes in one of the following ways. (p. 37)
  - after pausing 5, 10 or 15 sec.
  - after the signal disappears.
  - after a signal appears. (when paused on a no-signal frequency)

Push and hold [UP] or [DN].



### 4. Stop the scan.

Push [UP] or [DN] on the microphone.

- When Up Switch Remote has been programmed, [DN] starts and stops the scan. In this case, use the tuning control for selecting the scan direction. (p. 41)

## 9 SCAN OPERATION

### Memory scan

#### 1. Select MEMORY mode.

Push [BAND] to select the desired band and then push [M/CALL] to select MEMORY mode.

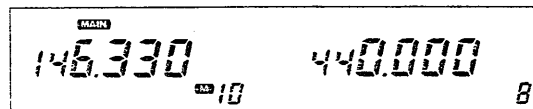
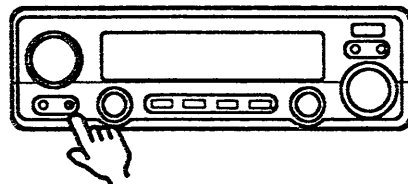

#### 2. Set the squelch level.

Rotate VHF or UHF [SQL] until the noise disappears.

Adjust [SQL].

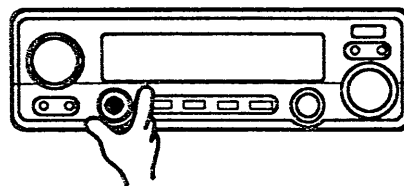

#### 3. Start memory scan.

Push and hold [UP] or [DN] on the microphone.

- Rotating the tuning control changes the scan direction.
- When receiving a signal, scan resumes in one of the following ways. (p. 37)
  - after pausing 5, 10 or 15 sec.
  - after the signal disappears.
  - after a signal appears. (when paused on a no-signal frequency)

Push and hold [UP] or [DN].

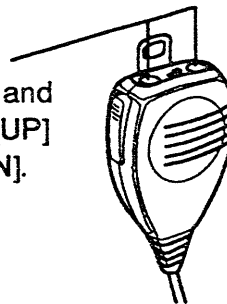

#### 4. Stop the scan.

Push [UP] or [DN] on the microphone.

- When Up Switch Remote has been programmed, [DN] starts and stops the scan. In this case, use the tuning control for selecting the scan direction. (p. 41)

Push [UP] or [DN].

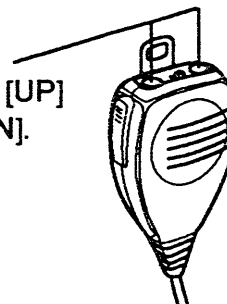

- When all or all but 1 memory channels are designated as skip channels, memory scan does not start even if [UP] or [DN] is pushed and held.

## Memory skip function

This function allows the scan to skip unwanted channels that inconveniently stop scanning during memory scan. This is useful to speedup the memory scan interval and is valid for memory scan watch (pgs. 38, 40).

### 1. Set skip memory channels.

*Set skip memory channels using SET mode as described below.*

### 2. Start memory skip scan.

*Start memory scan as described at left.*

### 3. Stop the scan.

*Push [UP] or [DN] on the microphone.*

#### USING SET MODE

##### • SETTING A MEMORY SKIP CHANNEL

1) Push [M/CALL] once or twice to select MEMORY mode.

- " **M** " and a memory channel number appear on the function display.

2) Select the memory channel to be set as a skip channel.

- Memory channels "A" and "b" cannot be set as skip channels.

3) Push [SET] several times until "-CH-" blinks on the function display.

- Refer to p. 12 for SET mode details.

4) Rotate the tuning control to illuminate the skip indicator.

- " **SKIP** " appears": The memory channel is skipped during memory scan.
- " **SKIP** " disappears": The memory channel is scanned during memory scan.

5) Push any switch except [SET] and [LOW] to set the condition and to exit SET mode.

MEMORY mode → SET mode  
V/U separate setting

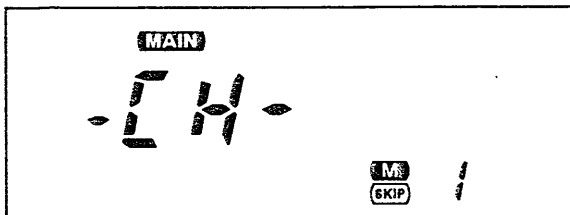

The display shows memory channel 1 is set as a skip channel.

## 9 SCAN OPERATION

### USING SET MODE

#### • SETTING A SCAN RESUME CONDITION

V/U separate setting

1) Push [SET] several times until "SC" appears on the function display as shown at right.

- Refer to p. 12 for SET mode details.

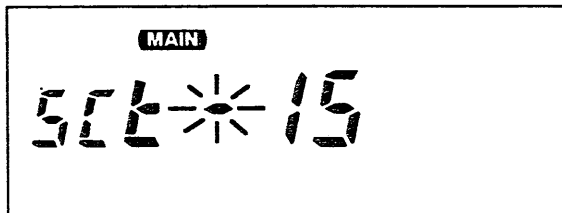

2) Rotate the tuning control to select the desired condition.

- SCt-5: Scan resumes 5 sec. after the scan stops.
- SCt-10: Scan resumes 10 sec. after the scan stops.
- SCt-15: Scan resumes 15 sec. after the scan stops.
- SCP-2: Scan pauses until a signal disappears and resumes after 2 sec.
- SCt-EP: Scan pauses at a frequency that is not busy and resumes 2 sec. after a signal appears. This is useful for finding unused frequencies.

3) Push any switch except [SET] and [LOW] to set the condition and to exit SET mode.



## Priority watch types

Every 5 sec. priority watch monitors a selected frequency while you operate on a VFO frequency. The watch resumes according to the selected scan resume condition. See page at left for setting. There are 3 types of priority watch as described below.

**NOTE:** When an optional tone squelch is programmed in the memory channel, the priority watch pauses only when a signal with the same tone is received.

- When "SCt-EP" is selected for the scan resume condition, the priority watch pauses on the no-signal channel. See page at left for details.

### MEMORY CHANNEL WATCH (p. 39)

While operating on a VFO frequency, priority watch checks for a signal in the selected memory channel every 5 sec.

- Skip memory channels can be selected.

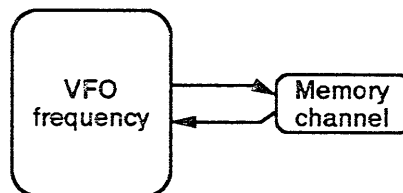

### MEMORY SCAN WATCH (p. 40)

While operating on a VFO frequency, priority watch checks for signals in each memory channel in sequence.

- The memory skip function can be used for shorter scanning intervals. See p. 36 for details.

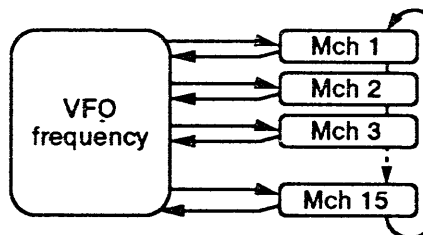

### CALL CHANNEL WATCH (p. 40)

While operating on a VFO frequency, priority watch checks for a signal in the call channel every 5 sec.

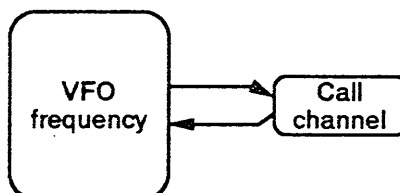

## Memory channel watch

### 1. Set VFO frequency.

Push [BAND] to select the desired band and then push [V/MHz] to select VFO mode.

Rotate the tuning control to set the operating frequency.

Rotate the tuning control.

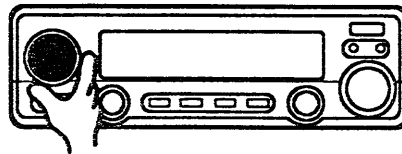

### 2. Set the squelch level.

Rotate VHF or UHF [SQL] until the noise disappears.

Adjust [SQL].

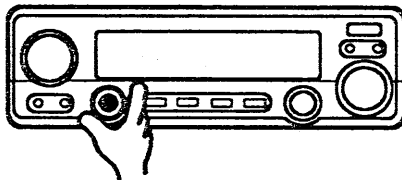

### 3. Select a memory channel.

Push [M/CALL]; then, rotate the tuning control to select the desired memory channel as a priority channel.

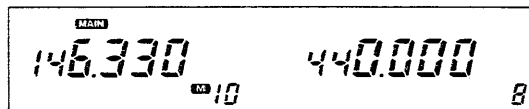
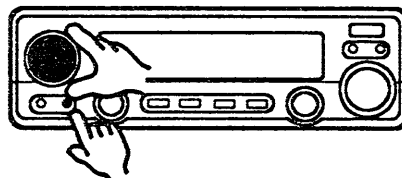

### 4. Start memory channel watch.

Push and hold [M/CALL/PRIO] until "PRIO" appears on the function display.

- When receiving a signal on the memory channel, pushing [M/CALL/PRIO] resumes the watch.

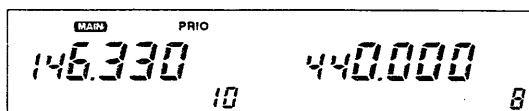
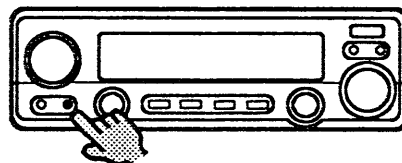

### 5. Stop the watch.

Push [M/CALL/PRIO] to cancel the watch.

- When receiving on the memory channel, push [M/CALL/PRIO] twice.

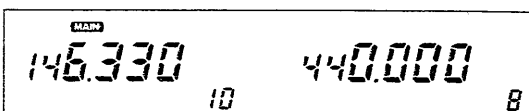
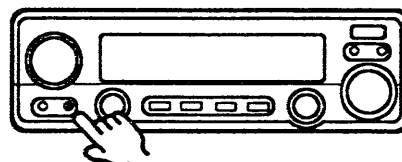

## Memory scan watch

### 1. Set VFO frequency and squelch level.

Set the operating frequency and squelch level as described at left.

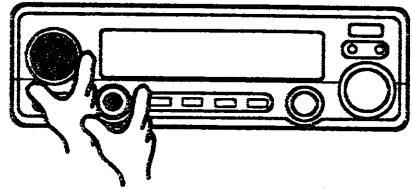

### 2. Start memory scan.

Push [M/CALL]; then, push and hold [UP] or [DN] on the microphone to start the memory scan.

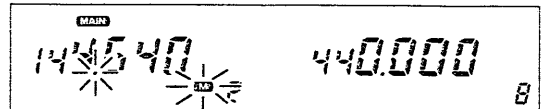

### 3. Start memory channel watch.

Push and hold [M/CALL/PRIO].

- Push [M/CALL/PRIO] to cancel the watch.
- When receiving on a memory channel, push [M/CALL/PRIO] twice.

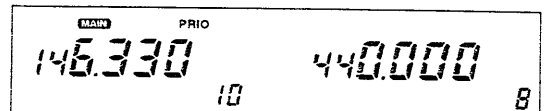
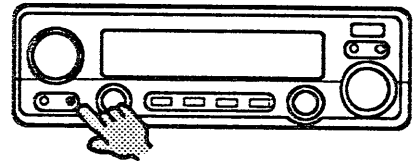

## Call channel watch

### 1. Set VFO frequency and squelch level.

Set the operating frequency and squelch level as described at left.

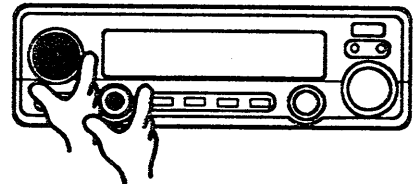

### 2. Select the call channel.

Push [M/CALL] once or twice to select the call channel. (Large "C" appears.)

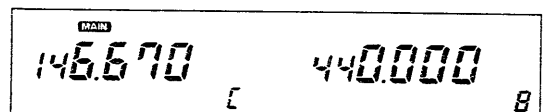

### 3. Start call channel watch.

Push and hold [M/CALL/PRIO].

- Push [M/CALL/PRIO] to cancel the watch.
- When receiving on the call channel, push [M/CALL/PRIO] twice.

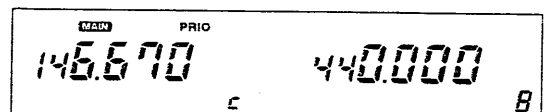
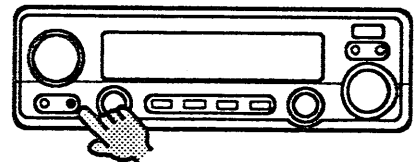

# 11 UP SWITCH REMOTE

## ■ Programming a function to [UP]

The [UP] switch on the microphone can be programmed to control one of the switches on the front panel. By using this function, you can easily and speedily access an often-used switch without stretching your arm.

- This function cannot be activated when optional DTMF remote is in standby. (pgs. 56~60)
- Once the [UP] switch is programmed, the [DN] switch functions as a scan start switch; and, the tuning control changes the scan direction.

### 1. Turn power OFF.

*Push [POWER] to turn power OFF.*

Push [POWER] OUT.

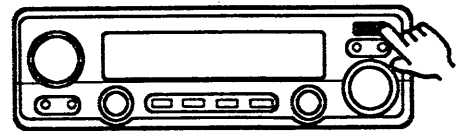

### 2. Set [LOCK] to the OFF position.

*Set [LOCK] on the microphone to the OFF position.*

Set [LOCK] to the OFF position.

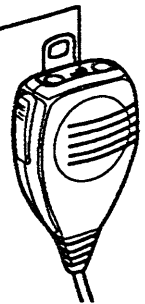

### 3. Program the function.

*While pushing and holding [UP] on the microphone and the desired switch on the front panel, turn power ON.*

- The [UP] switch functions as the desired switch including the secondary function (pushing and holding [UP]).

① Push and hold [UP] and the desired switch.



② Push [POWER].

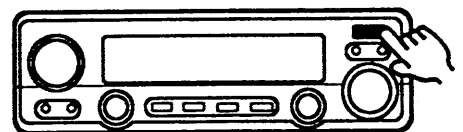

### Cancelling the function.

*To cancel this function, turn power OFF; then, while pushing and holding [UP], turn power ON.*

① Push and hold [UP].



② Turn power ON.



## ■ General description

Each function shown below is useful for calling a specific station or for standby from a specific station. To operate these functions, an optional UT-55 is necessary. See p. 10 for installation.

### • Pager

The pager function is a selective calling system using DTMF codes. With the pager, you can call any one or all the stations in your group, and you can receive a specified call from a station in your group. To use the pager function in your group, all stations need the pager function.

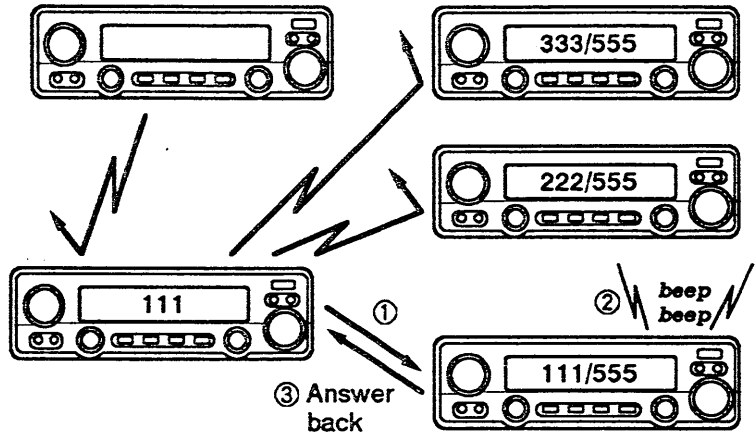

**PAGER SIMULATION: Personal call**

The transmit station sends a code consisting of a transmit code and the transmit station's ID code. If the transmit code matches the code programmed in the code channel of the receive station, the transceiver in the receive station informs the operator with beeps. For a personal call, the ID code of the receive station is used as the transmit code. For a group call, the group code is used as the transmit code.

The pager code for a call = Transmit code + "\*" + Transmit station's ID code.

The receive station can recognize the transmit station by the received ID code of the transmit station and can easily answer back because the received ID code is automatically programmed as a transmit code for answer back.

The pager code for answer back = Received ID code + "\*" + Receive station's ID code.

### • Code squelch

Code squelch allows communication with quiet standby since you will only receive calls from stations which know your ID code.

Prior to voice transmission, the ID code of the transmitting station is transmitted in order to open the receiving station's code squelch.

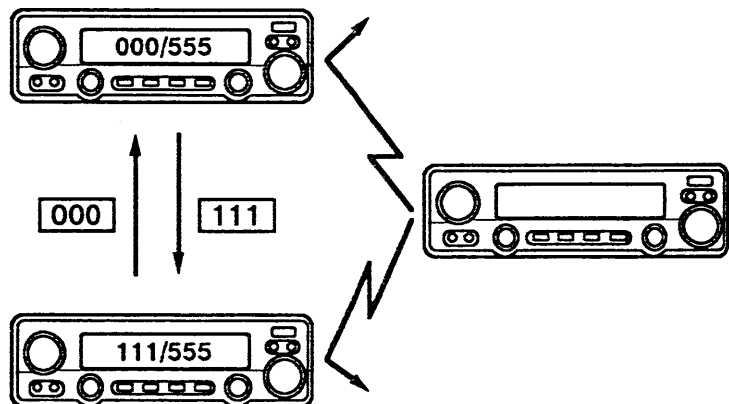

**CODE SQUELCH SIMULATION: ID code**

## Code channel

### • Before programming

The pager and code squelch functions require ID codes and a group code. These codes are 3-digit DTMF codes and must be written into the code channels before operation.

### • Code channel assignment

CODE CHANNEL NUMBER	ID OR GROUP CODE	"RECEIVE ACCEPT" OR "RECEIVE INHIBIT"
0	Your ID code	"Receive accept" only.
1 ~ 5	Other station's ID code	"Receive inhibit" should be programmed in each channel.
One of 1 ~ 5	Group code	"Receive accept" must be programmed.
P	Memory space*	"Receive inhibit" only.

\*Code channel P automatically memorizes an ID code when receiving a pager call. The contents in channel P cannot be programmed manually.

#### "RECEIVE ACCEPT" OR "RECEIVE INHIBIT"

Code channels 1~5 should be effectively programmed as "Receive accept" or "Receive inhibit."

- "Receive accept" ("SKIP" indicator is not illuminated) accepts pager calls when the transceiver receives a signal with a code the same as that in the code channel.
- "Receive inhibit" ("SKIP" indicator is illuminated) rejects calls when the transceiver receives a signal with a code the same as that in the code channel.

For example, the code channel that stores the group code should be programmed as "Receive accept." If the channel is programmed as "Receive inhibit," you cannot receive group calls.

The code channels that store other station's ID codes for a transmit code should be programmed as "Receive inhibit." If the channels are programmed as "Receive accept," personal calls for stations other than you will be received.

## ■ Programming a code channel

Programming can be performed on either band.

### 1. Activate the pager function.

Push [PGR/C SQL] to activate the pager function.

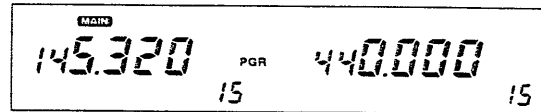

### 2. Call up a code channel.

Push [SET] to call up a code channel.  
 • Code channel number blinks.

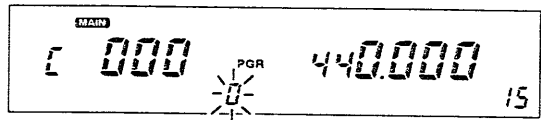

### 3. Select the code channel.

Rotate the tuning control to select the code channel number for programming.

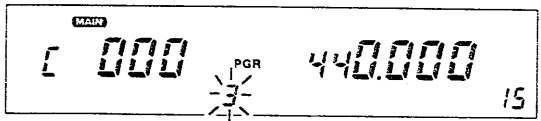

### 4. Program a code channel.

Push [SET] or [LOW] to select the digit to be programmed; then, rotate the tuning control to set the digit.

- Repeat this step until the code channel is completed.

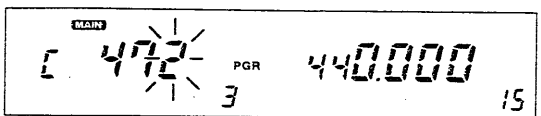

### 5. Select "accept" or "inhibit."

Push [PGR/C SQL] to select "receive accept" or "receive inhibit." See page at left for details.

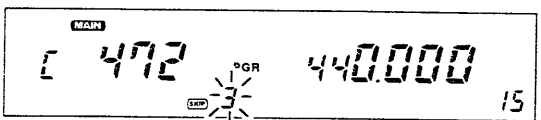

### 6. Program other code channels.

When writing into other code channels, push [SET] or [LOW] until the code channel number blinks; then repeat steps 3~5.

### 7. Exit the code channel.

Push any switches except [PGR/C SQL], [LOW] or [SET] to set the value and to return to the previous mode.

## ■ Pager operation — Calling a specific station

### 1. Set the operating frequency.

Push [BAND] to select the desired band; then, set the operating frequency.

- This function cannot be activated while accessing the SUB band.

Push [BAND], [V/MHz] then rotate the tuning control.

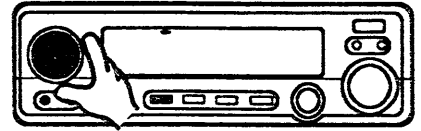

### 2. Activate the pager function.

Push [PGR/C SQL] to activate the pager function.

- An optional tone squelch can be used together with the pager function. (p. 50)

"PGR" appears.

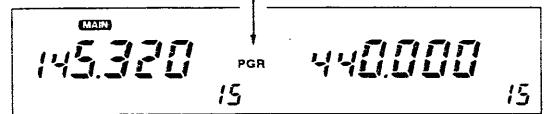

### 3. Select a code channel.

Push [SET]; then, rotate the tuning control to select the transmit code (another station's ID code or group code) from code channels 1~5. (p. 44)

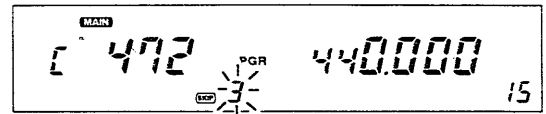

### 4. Transmit the pager code.

Push the PTT switch to transmit a 7-digit DTMF code (transmit code + "\*" + your ID code).

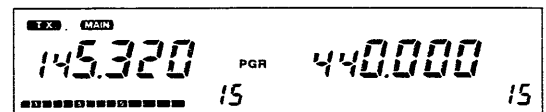

### 5. Wait for an answer back call.

Wait for an answer back call.

- When the transceiver receives an answer back call, the function display shows the other station's ID or group code.
- After confirming a connection, push [V/MHz]; then, push [PGR/C SQL] once to select code squelch or twice to select the non-selective calling system.

When called with your ID code:

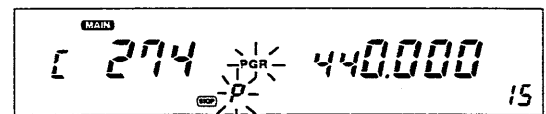

Other station's ID code appears.

When called with your group code:

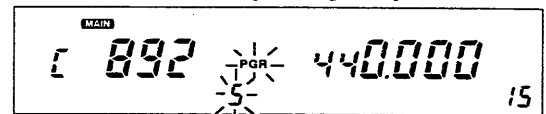

Group code appears.



# ■ Pager operation – Waiting for a specific station call

## 1. Set the operating frequency.

Push [BAND] to select the desired band; then, set the operating frequency.

- This function cannot be activated while accessing the SUB band.

Push [BAND], [V/MHz] then rotate the tuning control.



## 2. Activate the pager function.

Push [PGR/C SQL] to activate the pager function.

- An optional tone squelch can be used together with the pager function. (p. 50)

"PGR" appears.

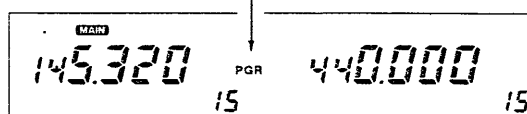

## 3. Wait for a call.

Wait for a call.

- When the transceiver receives a call, the function display shows the other station's ID or group code with a beep.
- To access the SUB band while waiting for a call, push and hold [BAND]. (p. 19)

When called with your ID code:

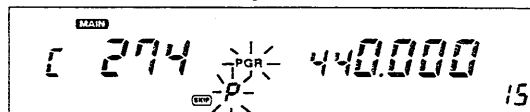

Other station's ID code appears.

When called with your group code:

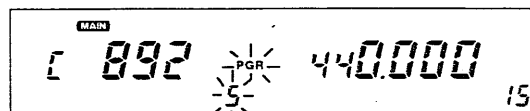

Group code appears.

## 4. Transmit an answer back call.

Push the PTT switch to send an answer back call.

- Your ID code is transmitted.

Push [PGR/C SQL] once to select code squelch or twice to select the non-selective calling system.

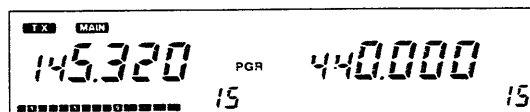

## ● Error information

When the transceiver receives an incomplete signal, the function display shows "E" and the last-used code or group code.

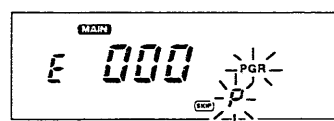

## Code squelch

### 1. Set the operating frequency.

Push [BAND], [V/MHz] then rotate the tuning control.

- This function cannot be activated while accessing the SUB band.

Push [BAND], [V/MHz] then rotate the tuning control.

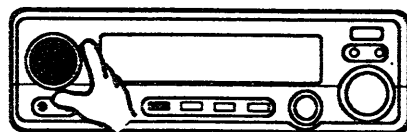

### 2. Activate the code squelch function.

Push [PGR/C SQL] once or twice to activate the code squelch function.

- An optional tone squelch can be used together with the code squelch function. (p. 50)

"C SQL" appears.

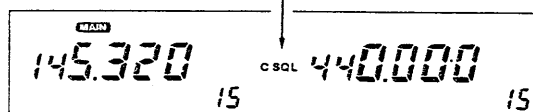

### 3. Select a code channel.

Push [SET]; then, rotate the tuning control to select the transmit code (another station's ID code or group code) from code channels 1~5 or P. (p. 44)

- Code channel P is set for the last pager-received station's code. (p. 43)

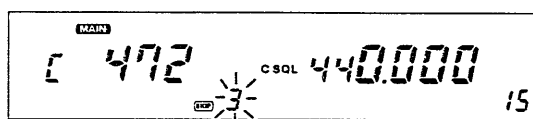

### 4. Operate the transceiver.

Operate the transceiver in the normal way (push [PTT] to transmit; release [PTT] to receive).

- A 3-digit transmit code is sent each time [PTT] is pushed.

Push [PTT] to transmit.

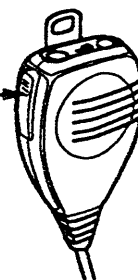

### 5. Cancel the code squelch function.

Push [PGR/C SQL] to cancel the code squelch and select the non-selective calling system.

Push [PGR/C SQL].

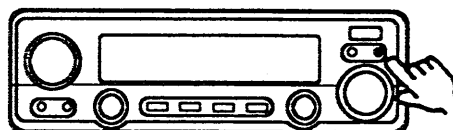



# 13 POCKET BEEP AND TONE SQUELCH

## ■ Pocket beep operation

This function can be activated on both bands simultaneously.

### 1. Set the operating frequency.

*Push [BAND] to select the desired band; then, set the operating frequency.*

Push [BAND], [V/MHz] then rotate the tuning control.

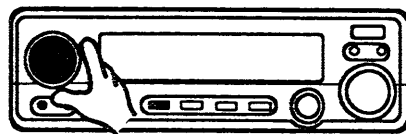

### 2. Set the tone frequency.

*Set the subaudible tone frequency using SET mode. See p. 27 for details.*

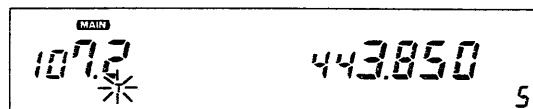

### 3. Activate the pocket beep function.

*Push and hold [DUP/TONE] for 2 sec. several times until "T SQL (100)" appears on the function display.*

- Turn OFF an optional pager or code squelch to activate the pocket beep. (p. 45~47)

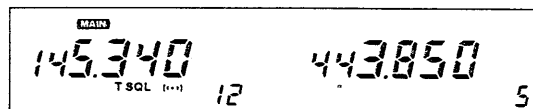

### 4. Wait for a call.

*When a signal including the correct tone is received, the transceiver emits beep tones for 30 sec. and flashes "(100)." .*

- To stop the beeps and flashing, push [PTT] briefly. Tone squelch is automatically selected.
- To contact the calling station, use tone squelch operation. (p. 50)

When called with correct tone:

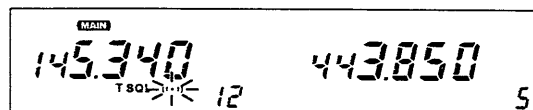

### 5. Cancel the function.

*Push and hold [DUP/TONE] for 2 sec. several times until "T SQL" disappears on the function display.*

#### • Calling a waiting station using pocket beep

A subaudible tone matched with the station's tone frequency is necessary. Use tone squelch (p. 50) or subaudible tone encoder (p. 26, U.S.A. version only).

## ■ Tone squelch

This function can be activated on both bands simultaneously.

### 1. Set the operating frequency.

*Push [BAND] to select the desired band; then, set the operating frequency.*

Push [BAND], [V/MHz] then rotate the tuning control.

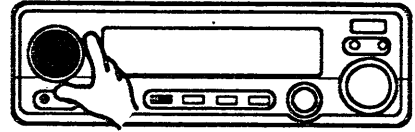

### 2. Set the tone frequency.

*Set the subaudible tone frequency using SET mode. See p. 27 for details.*

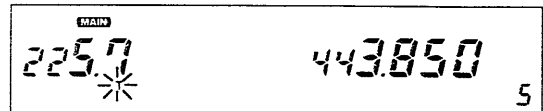

### 3. Activate the tone squelch function.

*Push and hold [DUP/TONE] for 2 sec. several times until "T SQL" appears on the function display.*

- An optional code squelch can be used together with the tone squelch function. (p. 47)

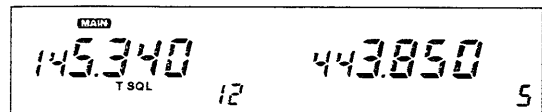

### 4. Operate the transceiver.

*Operate the transceiver in the normal way (push [PTT] to transmit; release [PTT] to receive).*

- The programmed subaudible tone is superimposed over the voice to open the tone squelch.
- To open the squelch manually, push and hold [MONI]. (The code squelch is turned OFF.)

Push [PTT] to transmit.

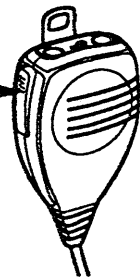

### 5. Cancel the function.

*Push and hold [DUP/TONE] for 2 sec. to cancel the function.*

Push and hold [DUP/TONE].

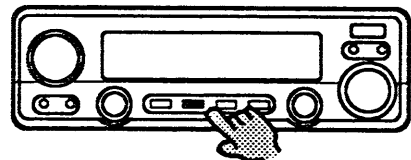

**NOTE:** Tone squelch with a tone frequency can be programmed in a memory channel. Therefore, SET mode is not necessary once a memory is programmed.

# 14 HM-56/A ADVANCED FUNCTIONS

The HM-56/A HAND MICROPHONE is equipped with 14 DTMF memory channels and a re-dialing function for auto dialing. Up to a 22-digit telephone number, etc., can be memorized into each memory channel. The HM-56/A is optional for non-U.S.A. versions.

**NOTE:** Set [LOCK] on the microphone to the OFF position to use the HM-56/A functions.

## Mode types

The HM-56/A has 4 different mode types as follows:

### ① NORMAL mode

A DTMF code is transmitted when a digit key is pushed.

### ② MEMORY WRITE mode

Used when writing DTMF codes into a DTMF memory channel in the HM-56/A.

- The active indicator blinks rapidly.

### ③ MEMORY READ mode

Used when reading DTMF codes from a DTMF memory channel in the HM-56/A.

- The active indicator lights continuously.

### ④ RE-DIAL mode

Used when recalling the last-transmitted DTMF codes.

- The active indicator blinks slowly.

## Writing a DTMF code

### 1. Select MEMORY WRITE mode.

Push [MW] on the microphone to select MEMORY WRITE mode.

- The active indicator blinks rapidly.

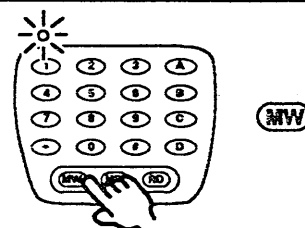

### 2. Select a DTMF memory channel.

While pushing and holding the PTT switch, push the desired DTMF memory channel number [1]~[0] or [A]~[D] on the microphone. Do not release the PTT switch until step 4.

- The active indicator goes out.

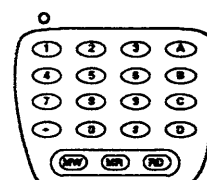

Push the desired digit key.

### 3. Enter the digits.

While keeping the PTT switch depressed, push the desired keys.

- Up to 22 digits can be memorized.

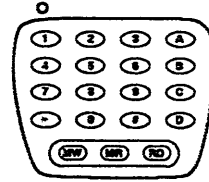

Push keys. (up to 22)

### 4. Write into the memory channel.

Release the PTT switch.

- The active indicator blinks rapidly.

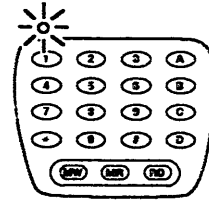

### 5. Write other memory channels.

To write other memory channels, repeat steps 2~4.

### 6. Exit MEMORY WRITE mode.

Push [MW] on the microphone to return to NORMAL mode.

- The active indicator goes out.



## ■ Transmitting memory data

### 1. Select MEMORY READ mode.

Push [MR] to select MEMORY READ mode.

- The active indicator lights.

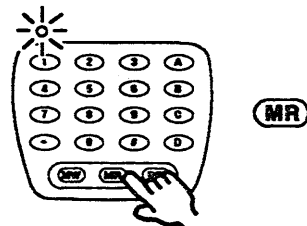

### 2. Select a DTMF memory channel.

Push the desired DTMF memory channel number [1]~[0] or [A]~[D].

- The memorized DTMF code is automatically transmitted.
- The active indicator blinks while transmitting.

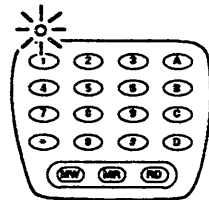

Push the desired digit key.

### 3. Exit MEMORY READ mode.

Push [MR] to return to NORMAL mode.

- The active indicator goes out.



## Memory data erasing

### 1. Select MEMORY WRITE mode.

Push [MW] on the microphone to select MEMORY WRITE mode.

- The active indicator blinks rapidly.

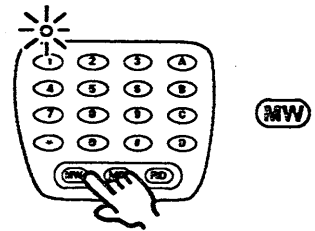

### 2. Select a DTMF memory channel.

While pushing and holding the PTT switch, push the desired DTMF memory channel number [1]~[0] or [A]~[D] on the microphone.

- The active indicator goes out.

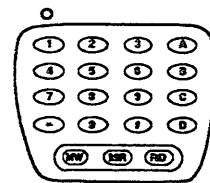

Push the desired digit key.

### 3. Erase the memory channel.

Release the PTT switch.

- The active indicator blinks rapidly.

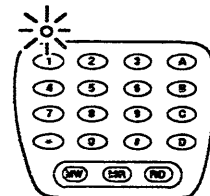

### 4. Exit MEMORY WRITE mode.

Push [MW] on the microphone to return to NORMAL mode.

- The active indicator goes out.



## Re-dial function

The HM-56/A automatically memorizes the last-transmitted DTMF code for re-dialing.

### • Manual re-dialing

- 1) Push and hold the PTT switch.
- 2) Push [RD] to transmit the last-transmitted DTMF code.
  - The active indicator blinks while transmitting the DTMF code.

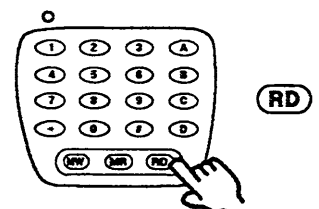

Push [RD] while transmitting.



• **Auto re-dialing**

The last-transmitted DTMF code can be automatically transmitted at each push of the PTT switch.

- 1) Push [RD] to select RE-DIAL mode.
  - The active indicator blinks slowly.
- 2) At each push of the PTT switch, the last-transmitted DTMF code is transmitted.
- 3) Push [RD] to return to NORMAL mode.
  - The active indicator goes out.

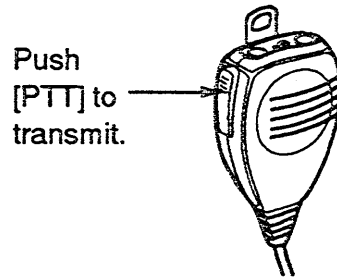
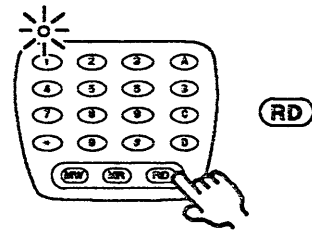

• **Writing a re-dial memory**

The last-transmitted DTMF codes are automatically written into a re-dial memory. You can manually write DTMF codes into the re-dial memory channel, if desired.

- 1) Push [MW] on the microphone to select MEMORY WRITE mode.
  - The active indicator blinks rapidly.
- 2) While pushing and holding the PTT switch, push [RD] on the microphone. Do not release the PTT switch until step 4.
  - The active indicator goes out.
- 3) While keeping the PTT switch depressed, push the desired keys.
  - Up to 22 digits can be memorized.
- 4) Release the PTT switch.
  - The active indicator blinks rapidly.
- 5) Push [MW] on the microphone to return to NORMAL mode.
  - The active indicator goes out.

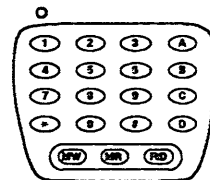
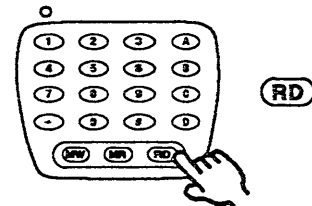
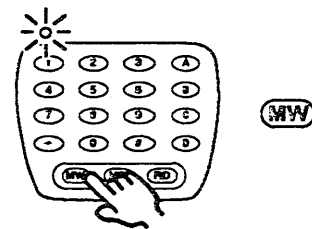

Push keys. (up to 22)

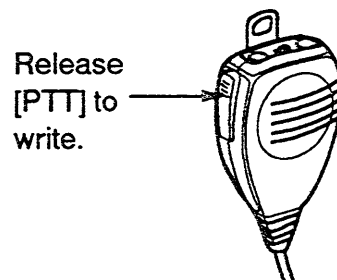

# 14 HM-56/A ADVANCED FUNCTIONS

## 1750 Hz tone call

Using the HM-56/A, you can access a repeater that requires a 1750 Hz tone.

### 1. Select MEMORY READ mode.

Push [MR] to select MEMORY READ mode.

- The active indicator lights.

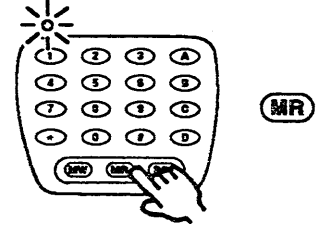

### 2. Transmit a 1750 Hz tone.

Transmit a 1750 Hz tone as follows:

- Push and hold [#] to transmit a 1750 Hz tone continuously.
- Push [\*] to transmit a 1750 Hz tone for approx. 0.5 sec.

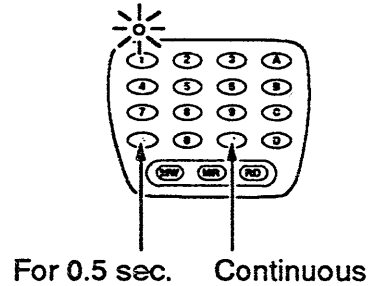

### 3. Exit MEMORY READ mode.

Push [MR] to return to NORMAL mode.

- The active indicator goes out.



## HM-56/A CPU resetting

**NOTE:** CPU resetting **CLEARs** all memorized information in the microphone.

### 1. Turn power OFF.

Push [POWER] to turn the transceiver power OFF.

Push [POWER] OUT.

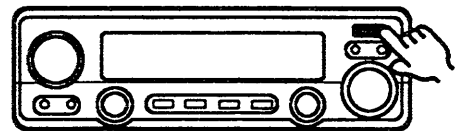

### 2. Reset the HM-56/A CPU.

While pushing [MW] and [MR] on the microphone, turn the transceiver power ON.

- ① Push and hold [MW] and [MR].
- ② Turn power ON.

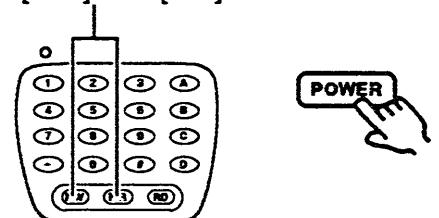

## ■ General description

The transceiver can be remotely controlled using DTMF signals. There are 2 remote control functions as follows.

- **Mic DTMF Remote** (pgs. 57, 58)  
HM-56/A and an optional UT-55 are necessary.
- **External DTMF Remote** (pgs. 59, 60)  
An optional UT-55 and a 144 MHz or 430 (440) MHz transceiver with a DTMF encoder are necessary.

Set the transceiver standby for remote control as described below.

### USING SET MODE

- **REMOTE STANDBY ON/OFF**  
(An optional UT-55 is necessary.)

V/U same setting

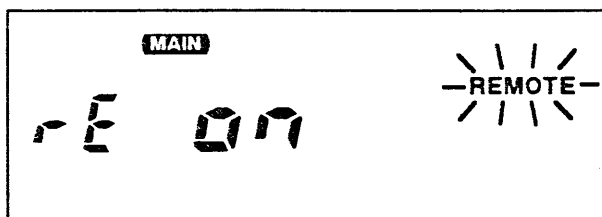

The display shows the remote standby is ON.

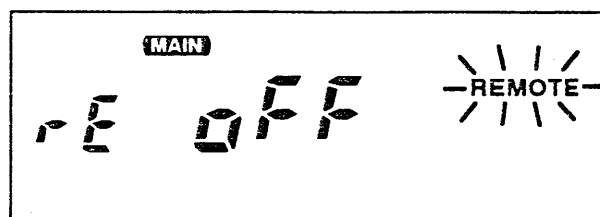

The display shows the remote standby is OFF.

- 1) Push [SET] several times until "rE on" or "rE off" appears on the function display as shown above.
  - Refer to p. 12 for SET mode details.
- 2) Rotate the tuning control to select the condition.
- 3) Push any switch except [SET] and [LOW] to set the condition and to exit SET mode.

# 15 OPTIONAL DTMF REMOTE

## ■ Mic DTMF Remote

To operate Mic DTMF Remote, an HM-56/A and an optional UT-55 are necessary. The HM-56/A is an optional microphone except for the U.S.A. version. Attach the supplied microphone sheet to the HM-56/A keyboard before operation.

### 1. Select standby for control.

Select standby for the remote control using SET mode. See p. 56 for details.

- "REMOTE" appears.

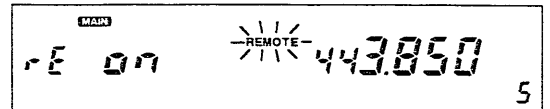

### 2. Activate Mic DTMF Remote.

Push [UP] on the microphone to activate Mic DTMF Remote.

- [LOCK] on the microphone must be set OFF.

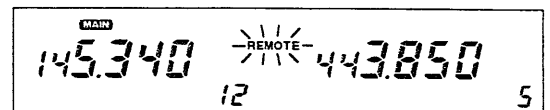

### 3. Control the transceiver.

Push the desired key on the microphone as described in the table at right.

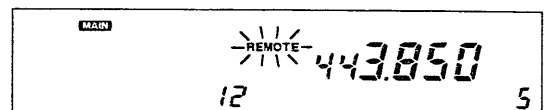

Display example when [D] is pushed in VFO mode.

### 4. Return to standby.

Push [UP] again to cancel the function.

- "REMOTE" stops blinking. The transceiver enters the standby condition for remote control.



### 5. Cancel standby for control.

Cancel standby for the remote control using SET mode. See p. 56 for details.

- "REMOTE" disappears.

- Up Switch Remote cannot be activated while "REMOTE" lights or blinks. (p. 41)
- The tuning control and all switches are locked while "REMOTE" blinks.

- Scan cannot operate while "REMOTE" blinks. [DN] starts scanning when "REMOTE" lights.

KEY	DESCRIPTION	KEY	DESCRIPTION
[1] (CALL)	Selects the call channel for the MAIN band.	[#] (UP)	Increases the operating frequency or memory channel in preset tuning steps.
[2] (MR)	Selects MEMORY mode for the MAIN band.	[*] (DOWN)	Decreases the operating frequency or memory channel in preset tuning steps.
[3] (VFO)	Selects VFO mode for the MAIN band.	[A] (CLR)	Clears input digits and retrieves the previous key input.
[4] (VHF)	Selects VHF for the MAIN band.	[B]	Used for External DTMF Remote. (p. 59)
[5] (UHF)	Selects UHF for the MAIN band.	[C] (SPEECH)	Announces the MAIN band frequency when an optional UT-66 is installed.
[6] (HIGH)	Selects high power for the MAIN band.	[D] (ENT)	Sets the transceiver to enter a frequency or memory channel number in 10 kHz tuning steps.
[7] (V • MONI)	Opens and closes the VHF squelch.	[0]~[9] (after pushing [D])	Enters a frequency up to the 10 kHz digit* <sup>1</sup> or enters memory channels (1~15, A and B* <sup>2</sup> ).
[8] (U • MONI)	Opens and closes the UHF squelch.		
[9] (LOW)	Selects low power 1 for the MAIN band.		
[0] (MUTE)	Mutes audio signals on both bands.		

\*<sup>1</sup> When the entered frequency is out of the frequency coverage, the input digit will be cleared.

\*<sup>2</sup> Push [1] then [6] for memory channel A; push [1] then [7] for memory channel B.

### CONVENIENT

The DTMF memory channel of the HM-56/A may be useful for Mic DTMF Remote. See pgs. 51~52 for writing a DTMF code.

**EXAMPLE:** Setting the operating frequency at 145.800 MHz.

- 1) Push [4]; Selects VHF band for the MAIN band.
- 2) Push [3]; Selects VFO mode.
- 3) Push [D]; Enters direct input condition.
- 4) Push [1], [4], [5], [8] and [0]; Frequency is set.

**EXAMPLE:** Setting the operating memory channel to 15 (UHF).

- 1) Push [5]; Selects UHF band for the MAIN band.
- 2) Push [2]; Selects MEMORY mode.
- 3) Push [D]; Enters direct input condition.
- 4) Push [1] and [5]; Memory channel is selected.

## External DTMF Remote

To operate External DTMF Remote, an optional UT-55 and a 144 MHz or 430 (440) MHz transceiver with a DTMF encoder are necessary.

### 1. Set frequencies for operation and control.

Set the *MAIN* band frequency for operation and the *SUB* band frequency for receiving of a DTMF control signal.

- An optional tone squelch function can be used for the *SUB* band to increase remote control reliability. (p. 50)

Push [BAND], [V/MHz] then rotate the tuning control.



### 2. Set a 3-digit password.

Program a 3-digit password into code channel 5, if required. (p. 44)

- The initial value of code channel 5 is "000." If you do not require the password, set the channel as "receive inhibit."

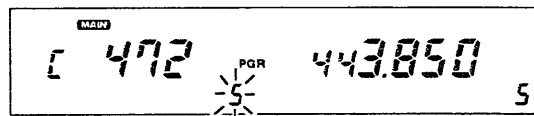

### 3. Prepare a transceiver used as a controller.

Set the operating frequency equal to the *SUB* band frequency of the IC-3230A/E/H.

- Turn ON the subaudible tone encoder and set the tone frequency when the IC-3230A/E/H uses an optional tone squelch function.

### 4. Select standby for control.

Select standby for the remote control using SET mode. See p. 56 for details.

- "REMOTE" appears.

### 5. Activate External DTMF Remote.

From the controller transceiver, transmit a DTMF code to activate External DTMF Remote as follows.

- ① When a password has been set, push [B], the 3-digit password and [#] (or "F").
  - ② When a password has not been set, push [B] and [#] (or "F").
- "REMOTE" and "SUB" blink.

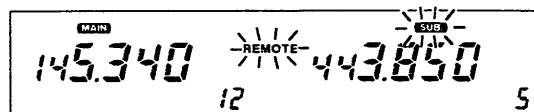

### 6. Control the transceiver.

Transmit the DTMF code as described below to control from the controller transceiver.

### 7. Return to standby.

To cancel the function, push [B] and [✳] (or "E").

- These will be transmitted as a DTMF code.
- "REMOTE" stops blinking and "SUB" disappears. The transceiver enters the standby condition for remote control.

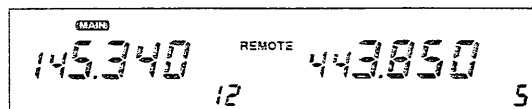

### 8. Cancel standby for control.

Cancel standby for the remote control using SET mode. See p. 56 for details.

- "REMOTE" disappears.

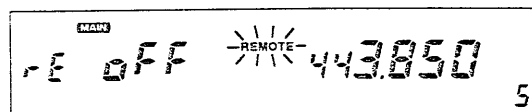

KEY	DESCRIPTION	KEY	DESCRIPTION
[B] + [#] (or F) or [B] + password + [#] (or F)	Activates External DTMF Remote.	[#] (or F) (UP)	Increases the operating frequency or memory channel in preset tuning steps.
[B] + [✳] (or E)	Returns to standby.	[✳] (or E) (DOWN)	Decreases the operating frequency or memory channel in preset tuning steps.
[1] (CALL)	Selects the call channel for the MAIN band.	[A] (CLR)	Clears input digits and retrieves the previous key input.
[2] (MR)	Selects MEMORY mode for the MAIN band.	[D] (ENT)	Sets the transceiver to enter a frequency or memory channel number in 10 kHz tuning steps.
[3] (VFO)	Selects VFO mode for the MAIN band.	[0]~[9] (after pushing [D])	Enters a frequency up to the 10 kHz digit*1 or enters memory channels (1~15, A and B*2).
[6] (HIGH)	Selects high power for the MAIN band.		
[9] (LOW)	Selects low power 1 for the MAIN band.		

\*1 When the entered frequency is out of the frequency coverage, the input digit will be cleared.

\*2 Push [1] then [6] for memory channel A; push [1] then [7] for memory channel B.

# 16 MAINTENANCE

## Troubleshooting

PROBLEM	POSSIBLE CAUSE	SOLUTION	REF.
<ul style="list-style-type: none"> <li>No power comes on.</li> </ul>	<ul style="list-style-type: none"> <li>Power connector has a poor contact.</li> <li>Polarity of the power connection is reversed.</li> <li>Blown fuse.</li> </ul>	<ul style="list-style-type: none"> <li>Check the connector pins.</li> <li>Reconnect the power cable observing the proper polarity.</li> <li>Check the cause, then replace the fuse.</li> </ul>	<p>—</p> <p>p. 8</p> <p>p. 62</p>
<ul style="list-style-type: none"> <li>No sound comes from the speaker.</li> </ul>	<ul style="list-style-type: none"> <li>The squelch is set too far clockwise.</li> <li>The optional tone or code squelch is turned ON.</li> </ul>	<ul style="list-style-type: none"> <li>Set [SQL] to the threshold point.</li> <li>Turn OFF the tone or code squelch.</li> </ul>	<p>p. 17</p> <p>pgs. 47, 50</p>
<ul style="list-style-type: none"> <li>Sensitivity is low and only strong signals are audible.</li> </ul>	<ul style="list-style-type: none"> <li>Antenna feedline or the antenna connector solder has a poor contact or is short circuited.</li> </ul>	<ul style="list-style-type: none"> <li>Check, and if necessary, replace the feedline or solder the antenna connector again.</li> </ul>	<p>p. 9</p>
<ul style="list-style-type: none"> <li>No contact possible with another station.</li> </ul>	<ul style="list-style-type: none"> <li>The transceiver is set to semi-duplex.</li> <li>The other station is using tone or code squelch.</li> </ul>	<ul style="list-style-type: none"> <li>Set to simplex.</li> <li>Turn ON the tone or code squelch. (UT-67 or UT-55 is necessary.)</li> </ul>	<p>p. 25</p> <p>pgs. 47, 50</p>
<ul style="list-style-type: none"> <li>Repeater cannot be accessed.</li> </ul>	<ul style="list-style-type: none"> <li>Wrong offset frequency is programmed.</li> <li>Wrong subaudible tone frequency is programmed.</li> </ul>	<ul style="list-style-type: none"> <li>Correct the offset frequency.</li> <li>Correct the subaudible tone frequency.</li> </ul>	<p>p. 26</p> <p>p. 27</p>
<ul style="list-style-type: none"> <li>Frequency cannot be set.</li> </ul>	<ul style="list-style-type: none"> <li>The lock function is activated.</li> <li>Priority watch is paused on the watching frequency.</li> </ul>	<ul style="list-style-type: none"> <li>Turn the function OFF.</li> <li>Push [M/CALL/PRIO] to resume the watch.</li> </ul>	<p>p. 13</p> <p>pgs. 39, 40</p>
<ul style="list-style-type: none"> <li>Scan does not operate.</li> </ul>	<ul style="list-style-type: none"> <li>Squelch is open.</li> <li>Scan edge A equals B (for programmed scan).</li> <li>All memory channels are programmed as skip channels (for memory scan).</li> <li>Priority watch is activated.</li> </ul>	<ul style="list-style-type: none"> <li>Set [SQL] at the threshold point.</li> <li>Reset the scan edges.</li> <li>Cancel the memory skip function in the desired channel.</li> <li>Turn the function OFF.</li> </ul>	<p>pgs. 34, 35</p> <p>pgs. 33, 34</p> <p>p. 36</p> <p>pgs. 39, 40</p>
<ul style="list-style-type: none"> <li>All programmed memories have been erased.</li> </ul>	<ul style="list-style-type: none"> <li>The CPU is malfunctioning.</li> <li>Backup battery is empty.</li> </ul>	<ul style="list-style-type: none"> <li>Reset the CPU.</li> <li>Send the transceiver to an authorized Icom Dealer or Service Center to replace the backup battery.</li> </ul>	<p>p. 62</p> <p>p. 62</p>



## ■ CPU resetting

The function display may occasionally display erroneous information, (e.g., when first applying power). This may be caused externally by static electricity or other factors.

If this problem occurs, turn power OFF. After waiting a few seconds, turn power ON again. If the problem continues, perform the following procedure.

**NOTE:** CPU resetting **CLEARs** all memory information, and initializes all values.

- 1) Turn power OFF.
- 2) While pushing [SET/LOCK] and [SPEECH/MW], turn power ON.
  - All segments appear on the function display, and the CPU is reset.

## ■ Fuse replacement

If the fuse blows or the transceiver stops functioning, find the source of the problem if possible, and replace the damaged fuse with a new, rated fuse (15 A) as shown in the diagram below.

### • REPLACING A FUSE

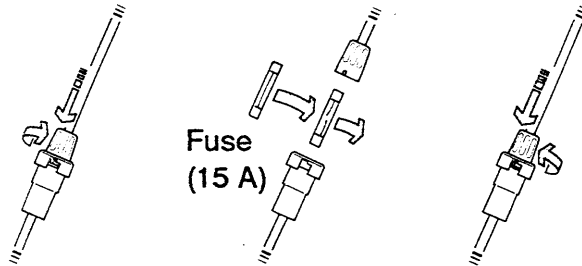

## ■ Backup batteries

The IC-3230A/E/H and HM-56/A are equipped with separate lithium backup batteries for retaining memory information.

The life of the lithium backup batteries is usually more than 5 years. When the batteries are exhausted, the transceiver operates normally but the CPU cannot retain memory information.

**NOTE:** DO NOT attempt to replace the backup batteries yourself. They can be replaced only by an authorized Icom Dealer or Service Center.

# 17 SPECIFICATIONS

		IC-3230A/E		IC-3230H	
		VHF	UHF	VHF	UHF
Frequency coverage	U.S.A.	Tx: 144~148	440~450	Tx: 144~148	440~450
		Rx: 136~174* <sup>1</sup>		Rx: 136~174* <sup>1</sup>	
	Asia	Tx: 144~148	430~440	Tx: 144~148	430~440
		Rx: 136~174* <sup>1</sup>		Rx: 136~174* <sup>1</sup>	
	Australia	144~148	430~440	144~148	430~440
	Europe	144~146	430~440	144~146	430~440
Italy	Tx: 144~148	Tx: 430~440	Tx: 144~148	Tx: 430~440	
	Rx: 136~174* <sup>1</sup>	Rx: 400~479* <sup>2</sup>	Rx: 136~174* <sup>1</sup>	Rx: 400~479* <sup>2</sup>	
(Unit: MHz)		* <sup>1</sup> Guaranteed range is 144.00~148.00 MHz. * <sup>2</sup> Guaranteed range is 430.00~440.00 MHz.			
Mode		FM			
Frequency stability		± 10 ppm			
Antenna impedance		50 Ω (nominal)			
Power supply requirement		13.8 V DC ± 15% (negative ground)			
Usable temperature range		-10 °C ~ +60 °C; +14 °F ~ +140 °F			
Dimensions (Projections not included)		140(W) × 40(H) × 165(D) mm 5.5(W) × 1.6(D) × 6.5(D) in			
Weight		1.25 kg; 2.8 lb			
Output power	High	25 W	45 W	35 W	
	Low 2	10 W	10 W		
	Low 1	1 W	5 W		
Modulation system		Variable reactance frequency modulation			
Max. frequency deviation		± 5 kHz			
Spurious emissions		Less than -60 dB			
Microphone impedance		600 Ω			
Current drain	High	7.0 A	8.0 A	10.5 A	10.5 A
	Low 2	4.5 A	5.0 A	5.5 A	6.0 A
	Low 1	2.5 A	3.0 A	4.0 A	4.5 A
at 13.8 V DC, typical					
Receive system		Double-conversion superheterodyne			
Intermediate frequencies	1st	17.2 MHz	30.85 MHz	17.2 MHz	30.85 MHz
	2nd	455 kHz			
Sensitivity		Less than 0.16 μV for 12 dB SINAD			
Squelch sensitivity		Less than 0.13 μV at threshold			
Selectivity		More than 15 kHz / -6 dB Less than 30 kHz / -60 dB			
Spurious response rejection		Less than -60 dB			
Audio output power		2.4 W at 10% distortion with an 8 Ω load			
Audio output impedance		8 Ω			
Current drain	Max. audio	1.8 A			
	Squelched	1.2 A			
at 13.8 V DC, typical					

All stated specifications are subject to change without notice or obligation.

**SP-7  
EXTERNAL SPEAKER**

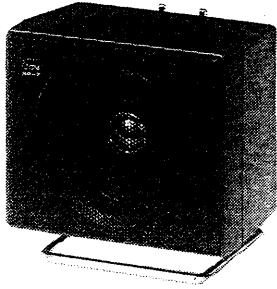

**SP-10  
EXTERNAL SPEAKER**

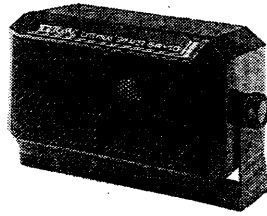

**SP-12  
EXTERNAL SPEAKER**

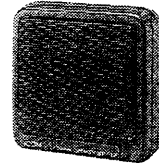

**SM-8  
DESKTOP MICROPHONE**

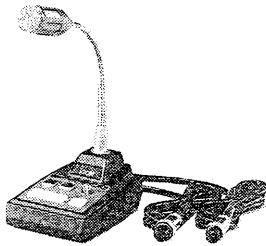

**SM-20  
DESKTOP MICROPHONE**



**HS-15 FLEXIBLE MOBILE  
MICROPHONE**

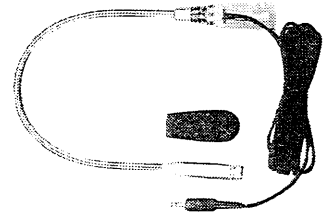

Used with the HS-15SB.

**AH-32 144/430 (440) MHz DUAL BAND  
ANTENNA**

Dual band mobile antenna.

Frequency range: 144~148 MHz  
430~450 MHz

Max. input power: 150 W

**AHB-32 TRUNK MOUNT**

Trunk mount with a coaxial cable for the AH-32.

**HM-56/A HAND MICROPHONE**

Has a DTMF function and 14 DTMF memory channels. Necessary for Mic DTMF Remote. Also has a 1750 Hz tone call function.

**HM-58 HAND MICROPHONE**

**HM-59 HAND MICROPHONE**

Has a 1750 Hz tone call function.

**HS-15SB SWITCHBOX**

For the HS-15.

**MB-27 MOBILE MOUNTING BRACKET**

Same as the supplied one.

**MB-34 JOINT PLATE**

Stacks with the IC-1201A/E, etc.

**OPC-044B DC POWER CABLE**

Same as the supplied one.

**IC-PS30 DC POWER SUPPLY**

13.8 V DC, 25 A.

**PS-45 DC POWER SUPPLY**

13.8 V DC, 8 A. For IC-3230A/E. OPC-102 is necessary. Not available for IC-3230H.

**SM-6 DESKTOP MICROPHONE**

**UT-55 DTMF ENCODER/DECODER UNIT**

Provides pager and code squelch functions. Necessary for Mic or External DTMF Remote.

**UT-66 VOICE SYNTHESIZER UNIT**

Announces the operating band frequency.

**UT-67 TONE SQUELCH UNIT**

Provides pocket beep and tone squelch functions. Also functions as a subaudible tone encoder.