

ICOM

INSTRUCTION MANUAL

UHF FM TRANSCEIVER

IC-449A
IC-449E



Icom Inc.

IMPORTANT

- (1) **READ THIS INSTRUCTION MANUAL CAREFULLY** before attempting operation. If you have any questions regarding operation, feel free to contact your nearest authorized Icom Dealer or Service Center.
- (2) **SAVE THIS INSTRUCTION MANUAL.** This instruction manual contains important safety and operating instructions for the IC-449A/E.

FOREWORD

Thank you for choosing the **IC-449A/E UHF FM TRANSCEIVER.**

This compact transceiver has numerous advanced functions and a vivid front panel with modern design that allows you easy operation while driving.

In this instruction manual, the display diagrams use the 440 MHz band frequencies of the U.S.A. version. Please note that 430 MHz band frequencies appear for other versions.

CAUTIONS

- (1) **NEVER** connect the transceiver to an AC outlet. This will ruin the transceiver.
- (2) **NEVER** connect more than 16 V DC power to the transceiver. Check the source voltage before connecting the power cable.
- (3) **NEVER** place the transceiver where normal operation of the vehicle may be hindered or where it could cause bodily injury.
- (4) **NEVER** allow children to touch the transceiver.
- (5) **DO NOT** install the transceiver where hot or cold air blows directly on it.
- (6) **DO NOT** use or place the transceiver in areas with temperatures below -10°C ($+14^{\circ}\text{F}$) or over $+60^{\circ}\text{C}$ ($+140^{\circ}\text{F}$), or in areas of direct sunlight, such as on the dashboard.
- (7) **BE CAREFUL!** The heatsink may become hot when operating the transceiver for long periods.

UNPACKING

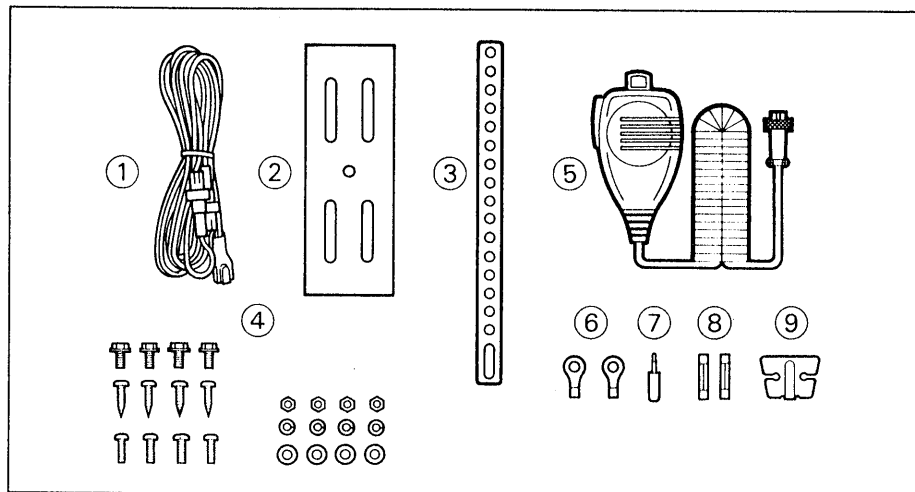

Qty.

① DC power cable (OPC-044B).....	1
② Mobile mounting bracket (MB-27).....	1
③ Support bracket	1
④ Screws, washers and nuts	1 set
⑤ Microphone*	1
⑥ Cable lugs	2
⑦ External speaker plug	1
⑧ Fuses (15 A).....	2
⑨ Microphone hanger	1

* U.S.A. version	:	HM-56
Australia version	:	HM-58
Europe version	:	HM-59

TABLE OF CONTENTS

IMPORTANT	i
FOREWORD	i
CAUTIONS	i
UNPACKING.....	ii
TABLE OF CONTENTS	ii
1. PANEL DESCRIPTION	1 ~ 6
2. INSTALLATION	7 ~ 9
3. MODE TYPES	10 ~ 11
4. BASIC OPERATIONS	12 ~ 15
5. PROGRAMMABLE REMOTE CONTROL FUNCTION	16
6. MEMORY AND CALL CHANNELS	17 ~ 20
7. SCAN FUNCTIONS	21 ~ 22
8. PRIORITY WATCH	23 ~ 24
9. HM-56 ADVANCED FUNCTIONS	25 ~ 28
10. SET MODE.....	29 ~ 33
11. OPTIONAL FUNCTIONS	34 ~ 40
12. TROUBLESHOOTING.....	41
13. MAINTENANCE	42
14. SPECIFICATIONS.....	43
15. OPTIONS.....	44

Front panel

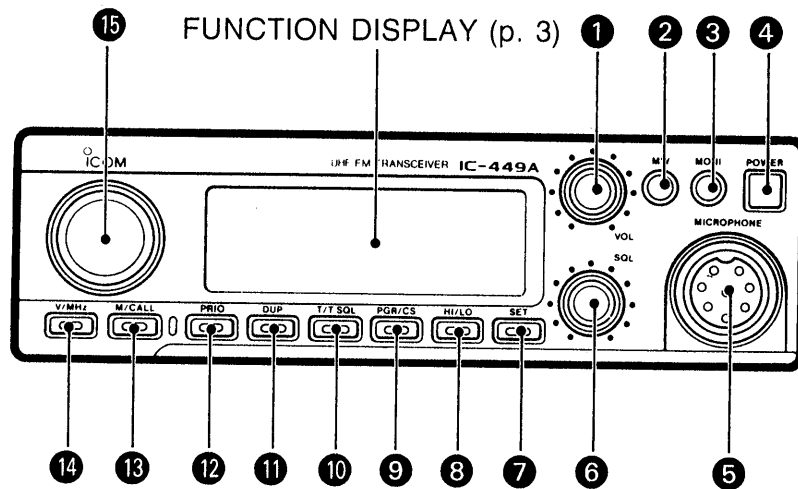

① VOLUME CONTROL [VOL]

Adjusts the audio output level. (p. 13)

② MEMORY WRITE SWITCH [MW]

- Programs a memory channel. (p. 17)
- Programs a call channel. (p. 20)
- Transfers the contents of a memory or call channel to the VFO. (p. 18)

③ MONITOR SWITCH [MONI]

- Opens the squelch while being pushed. (p. 13)
- During repeater operation, receives repeater input frequency while being pushed. (p. 15)

④ POWER SWITCH [POWER]

Turns the transceiver power ON and OFF. (p. 12)

⑤ MICROPHONE CONNECTOR [MICROPHONE]

Connects the supplied microphone or another suitable microphone. (p. 4)

The optional SM-6, SM-8 DESKTOP MICROPHONES, HS-15 FLEXIBLE MOBILE MICROPHONE and HS-15SB SWITCHBOX are available. (p. 44)

⑥ SQUELCH CONTROL [SQL]

Adjusts the squelch threshold level. (p. 13)

7 SET MODE SWITCH [SET]

- Selects SET mode and advances SET mode displays. (p. 29)
- Deactivates the tuning control and some switches when pushed and held. (p. 13)

8 TRANSMIT POWER SWITCH [HI/LO]

- Selects transmit output power. (p. 14)
- Reverses the SET mode display. (p. 29)

9 PAGER/CODE SQUELCH SWITCH [PGR/CS]

Activates the optional pager or code squelch function. (pgs. 38 ~ 40)

10 TONE SWITCH [T/T.SQL]

- Activates the subaudible tone encoder function.* (pgs. 15, 36)
- Activates the optional pocket beep or tone squelch function. (pgs. 35, 36)

* U.S.A. version : Built-in
Other versions : Optional

11 DUPLEX SWITCH [DUP]

- Selects simplex, – duplex or + duplex. (p. 15)
- Selects the memory split function. (p. 19)

12 PRIORITY SWITCH [PRIO]

Activates and cancels priority watch. (pgs. 23, 24)

13 MEMORY/CALL CHANNEL SWITCH [M/CALL]

- Selects MEMORY mode. (p. 17)
- Selects CALL CHANNEL mode. (p. 20)

14 VFO/MHz SWITCH [V/MHz]

- Selects VFO mode. (p. 12)
- Selects 1 MHz tuning steps. (p. 12)

15 TUNING CONTROL

- Changes the operating frequency. (p. 12)
- Changes the memory channel. (p. 17)
- Changes contents of SET mode displays. (pgs. 29 ~ 33)

■ Function display

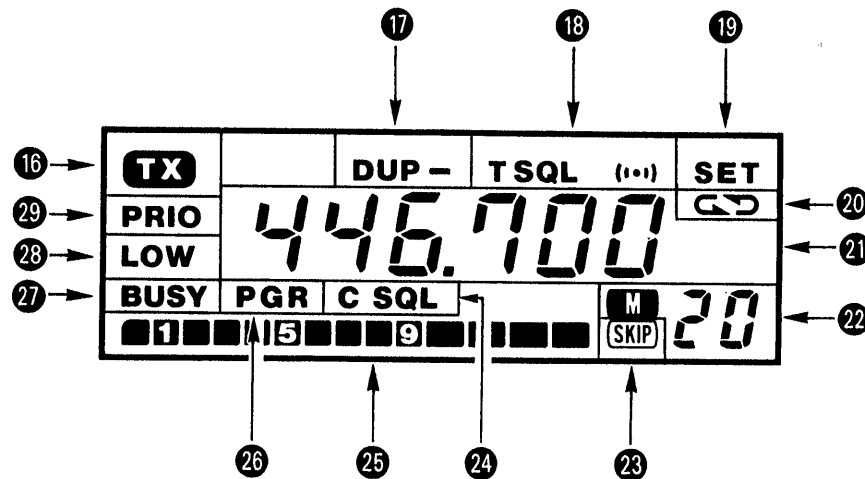

16 TRANSMIT INDICATOR

Appears while transmitting. (p. 14)

17 DUPLEX INDICATOR

- "DUP -" appears when - duplex is selected. (p. 15)
- "DUP" appears when + duplex is selected. (p. 15)

18 TONE INDICATOR

- "T" appears when the subaudible tone encoder function* is activated. (pgs. 15, 35)
- "T SQL (•••)" appears when the optional pocket beep function is activated. (p. 35)
- "T SQL" appears when the optional tone squelch function is activated. (p. 36)

*U.S.A. version : Built-in
Other versions : Optional

19 SET INDICATOR

Appears when SET mode is selected. (p. 29)

20 MEMORY SPLIT INDICATOR

Appears when a memory channel with the memory split function is selected. (p. 19)

21 FREQUENCY READOUT

Displays the operating frequency.

22 MEMORY INDICATOR AND MEMORY CHANNEL READOUT

- A memory channel number or small “c” appears while in VFO mode.
- “L” appears when the lock function is activated. (p. 13)
- “M” and memory channel number appear while in MEMORY mode. (p. 17)
- Large “C” appears while in CALL CHANNEL mode. (p. 20)

23 SKIP CHANNEL INDICATOR

Appears when a memory channel is programmed as a skip channel. (p. 32)

24 CODE SQUELCH INDICATOR

Appears when the optional code squelch function is activated. (p. 40)

25 S/RF INDICATOR

- Shows signal strength when receiving. (p. 13)
- Shows which output power for High or Low is selected when transmitting. (p. 14)

26 PAGER INDICATOR

Appears when the optional pager function is activated. (pgs. 38 ~ 40)

27 BUSY INDICATOR

Appears when the squelch opens. (p. 13)

28 LOW POWER INDICATOR

Appears when Low output power is selected. (p. 14)

29 PRIORITY INDICATOR

Appears during priority watch. (pgs. 23, 24)

Microphone connector

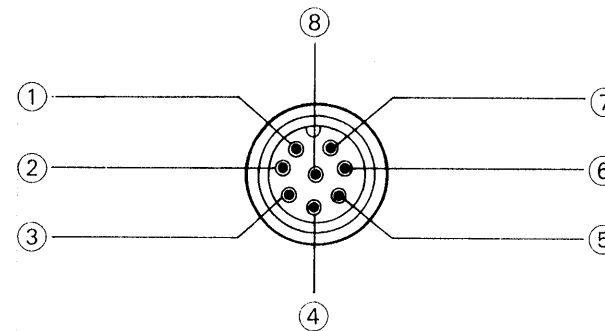

(Front panel view)

- | | |
|--------------------------|---------------------------|
| ① MIC (Microphone input) | ⑤ PTT |
| ② +8 V (8 V DC output) | ⑥ GND (PTT ground) |
| ③ MIC UD (Up/down input) | ⑦ GND (Microphone ground) |
| ④ NC (No connection) | ⑧ AF DETECTOR OUTPUT |

1 PANEL DESCRIPTION

■ Rear panel

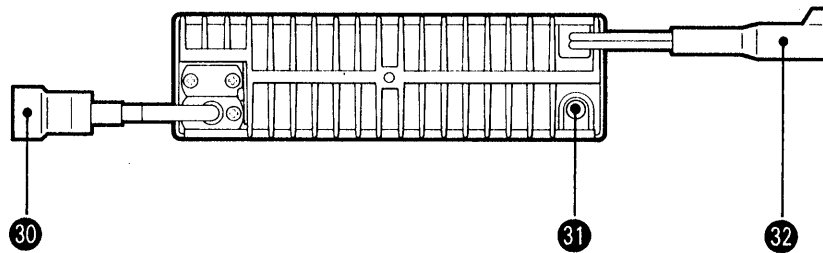

- 30 ANTENNA CONNECTOR [ANT 430 MHz]***
Connects a 50 Ω antenna with a type-N connector. (p. 9)
*U.S.A. version : [ANT 440 MHz]

- 31 EXTERNAL SPEAKER JACK [SP]**
Connects a 4~8 Ω speaker, if required.

The optional SP-7, SP-10 and SP-12 EXTERNAL SPEAKERS are available. (p. 44)

- 32 DC POWER CONNECTOR [DC 13.8 V]**
Connects 13.8 V DC using the supplied DC power cable. (p. 8)

The optional IC-PS30 AC POWER SUPPLY is available. (p. 44)

■ Microphone

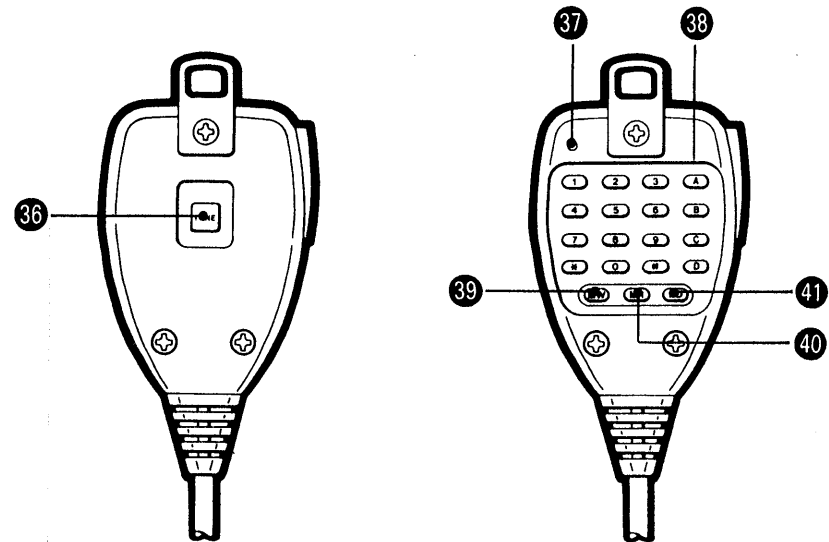
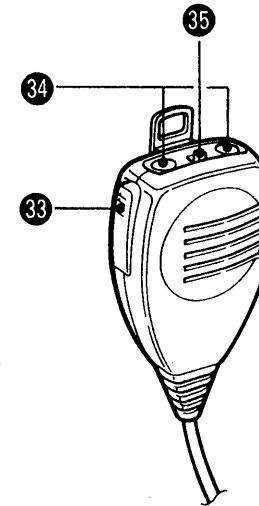

HM-59 rear panel

HM-56 rear panel

- **Top and side**

- 33 PTT SWITCH**

Push and hold to transmit. (p. 14)

- 34 FREQUENCY UP/DOWN SWITCHES [UP], [DN]**

- Push either switch to change the operating frequency. (p. 12)
- Push either switch to change a memory channel. (p. 17)
- Push and hold either switch to start scanning. (pgs. 21, 22)
- When the programmable remote control function is pre-programmed, [UP] activates the allocated function. (p. 16)

- 35 LOCK SWITCH [LOCK]**

Prevents accidental key entry of all keys except the PTT switch and [TONE] of the HM-59.

- **HM-59 rear panel**
(Europe version)

- 36 TONE CALL SWITCH [TONE]**

Push and hold to transmit a 1750 Hz tone call signal to access a repeater. (p. 15)

- **HM-56 rear panel**
(U.S.A. version)

- 37 ACTIVE INDICATOR**

Lights or blinks when a key is pushed or tone is being transmitted (pgs. 25 ~ 28)

- 38 DTMF KEYBOARD**

Produces DTMF codes for auto patch, repeater control, etc. (pgs. 15, 25 ~ 28)

- 39 MEMORY WRITE KEY [MW]**

Used when writing a DTMF code into a DTMF or re-dial memory channel. (pgs. 25 ~ 28)

- 40 MEMORY READ KEY [MR]**

Used when recalling and transmitting a DTMF code in a DTMF memory channel. (pgs. 25, 26)

- 41 RE-DIAL KEY [RD]**

Used when recalling and transmitting the last-transmitted DTMF code. (p. 27)

Location

Select a location which can support the weight of the transceiver and does not interfere with driving in any way. We recommend the location shown in the figure below.

NEVER place the transceiver where normal operation of the vehicle may be hindered or where it could cause bodily injury.

DO NOT place the transceiver where hot or cold air blows directly on it.

AVOID placing the transceiver in direct sunlight.

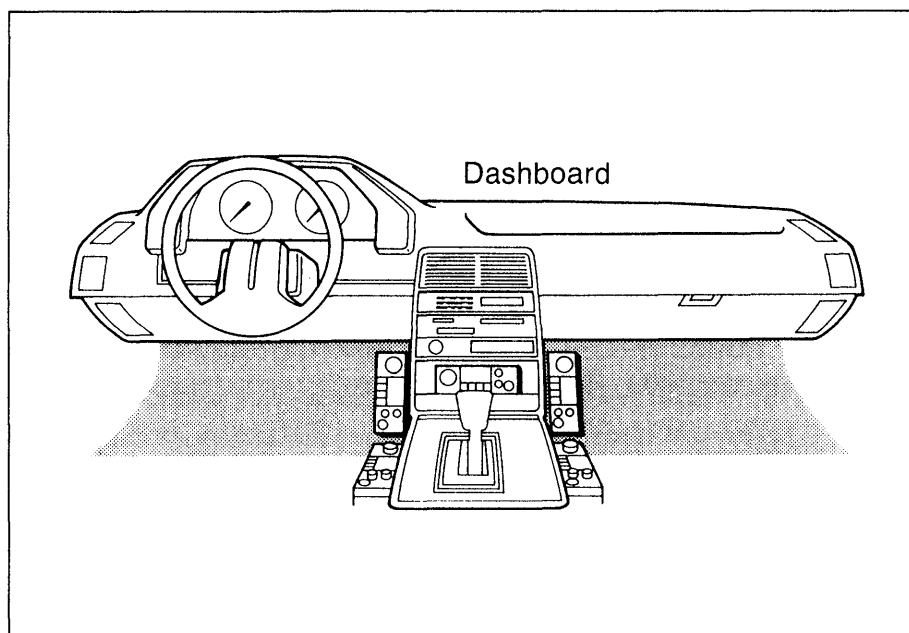

Mounting

- 1) Drill holes where the mounting bracket is to be installed.
- 2) Insert the supplied screws, nuts and washers through the mounting bracket and tighten.
- 3) To fix the transceiver securely, attach the supplied mounting support bracket to the rear panel, if required.
- 4) Adjust the angle for the clearest view of the function display.

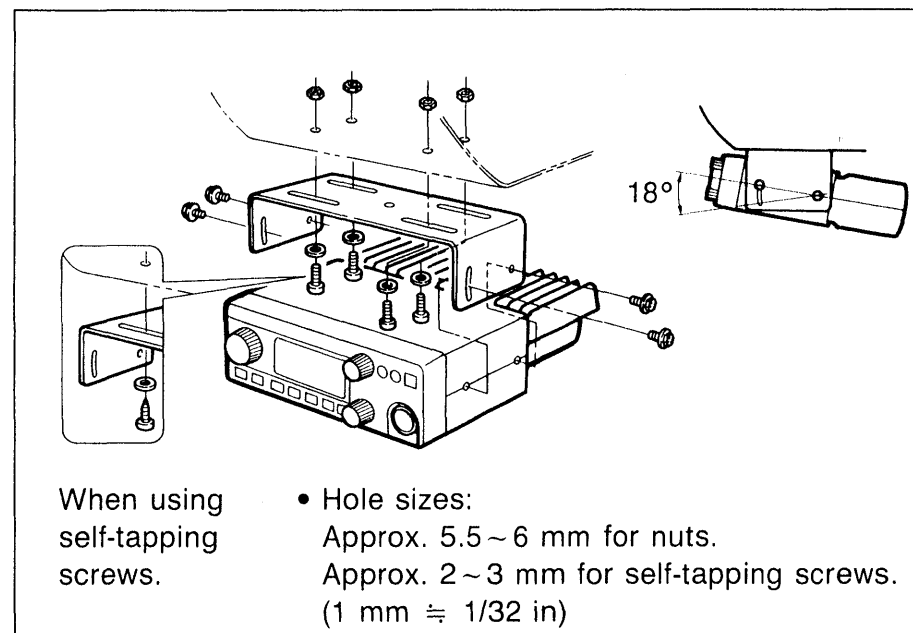

■ Battery connection

NEVER connect the transceiver directly to a 24 V battery.

DO NOT use the cigarette lighter socket for power connections.

To prevent voltage drops, solder or crimp the cable lug when connecting the DC power cable to the battery.

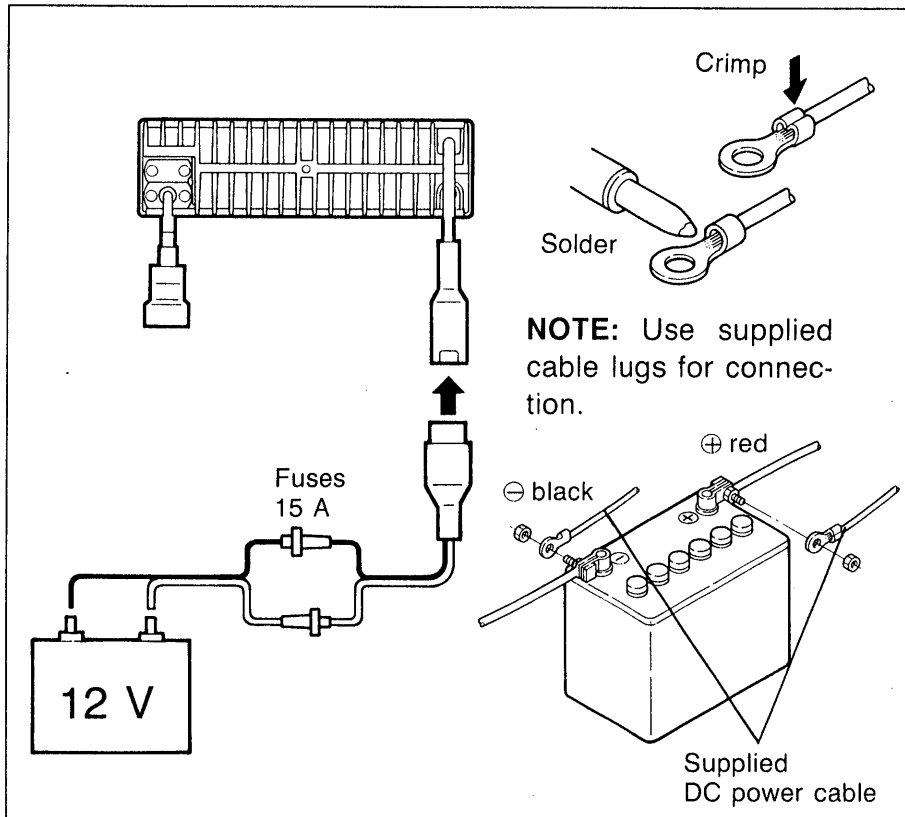

■ AC power supply connections

Use a 13.8 V DC power source more than 9.6 A capability.

Make sure the ground terminal of the AC power supply is grounded.

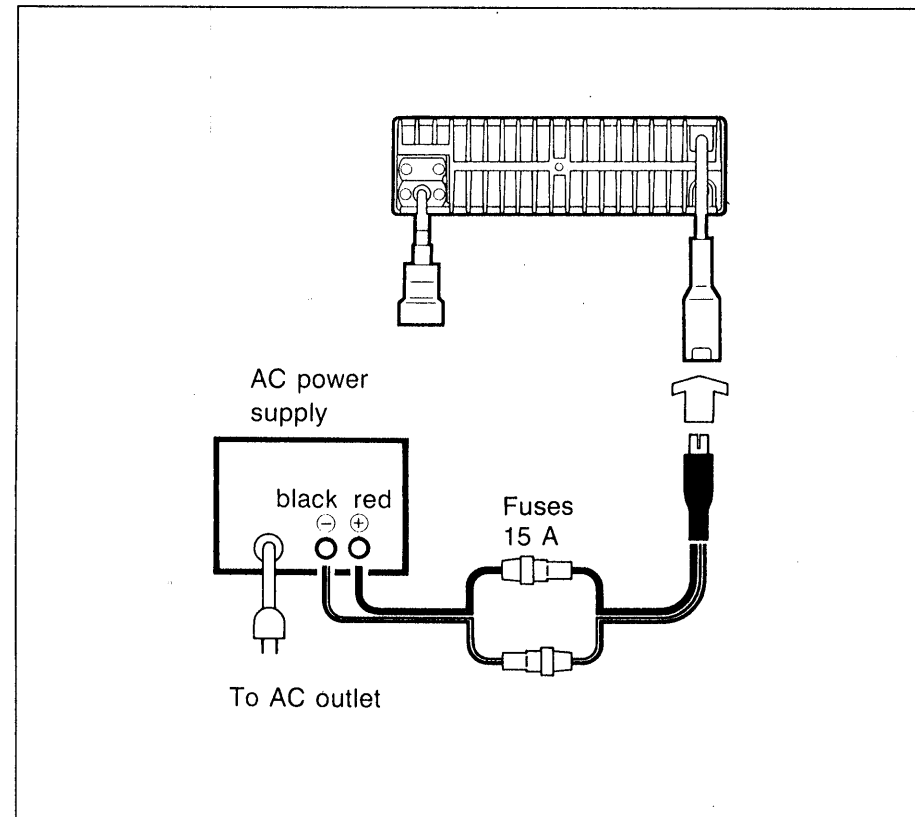

■ Antenna location

To obtain maximum performance from the transceiver, select a high-quality antenna and a good location.

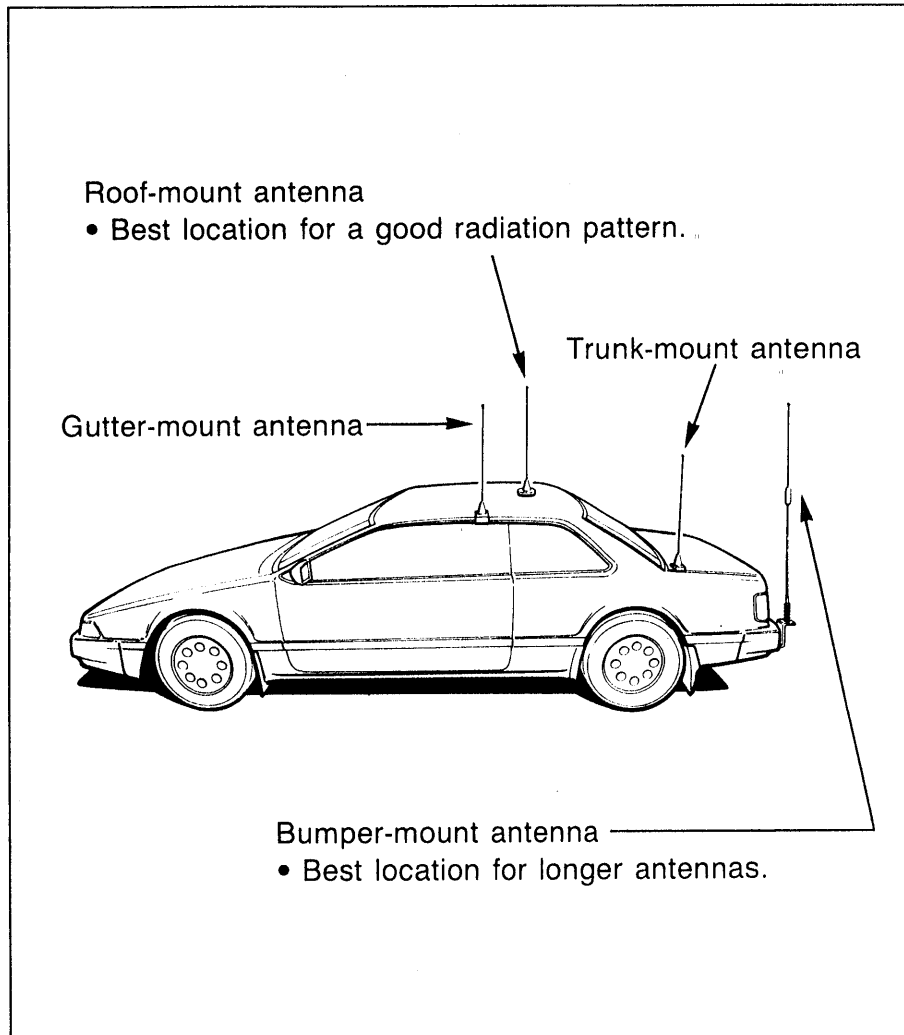

■ Antenna connector

A type-N antenna connector is used for the antenna cable connection.

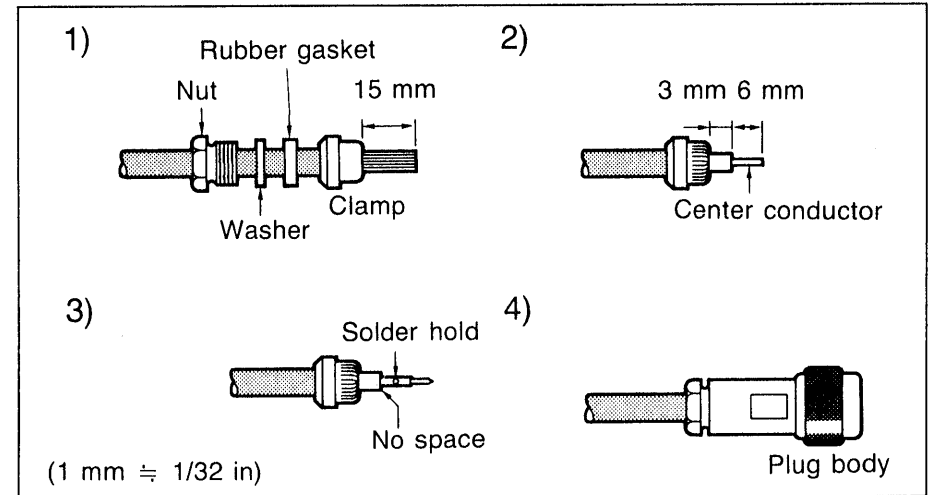

- 1) Slide parts as shown in the diagram 1) above. Cut the end of the cable evenly.
- 2) Strip the cable and fold the braid over the clamp. Evenly trim the braid ends.
- 3) Soft solder the center conductor. Install the pin and solder it.
- 4) Slide the plug body and tighten the nut.

■ 4 different modes

The IC-449A/E has 4 different modes for versatile multifunction operations.

- **VFO mode**

This mode is used for normal operations over the entire band.

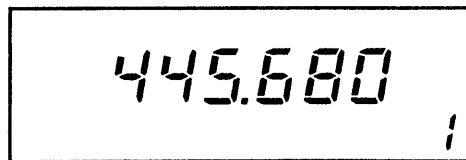

- **CALL CHANNEL mode**

This mode allows you to program your most-often-used frequency into a call channel. (p. 20)

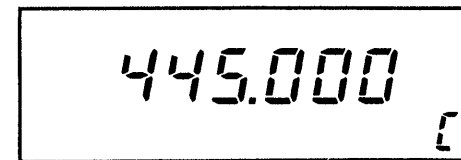

- **MEMORY mode**

This mode is used for operating the transceiver using memory channel contents. (p. 17) You can use 20 memory channels. Scan edge channels P1 and P2 are also available. (p. 21)

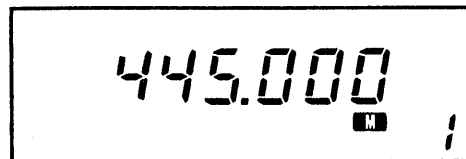

- **SET mode**

This mode is used to program data. (pgs. 29 ~ 33)

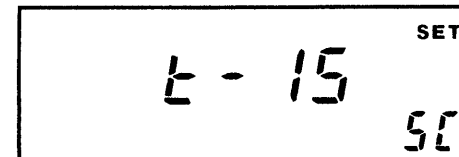

3 MODE TYPES

■ Mode construction chart

VFO, MEMORY and CALL CHANNEL modes are selectable according to the chart below.

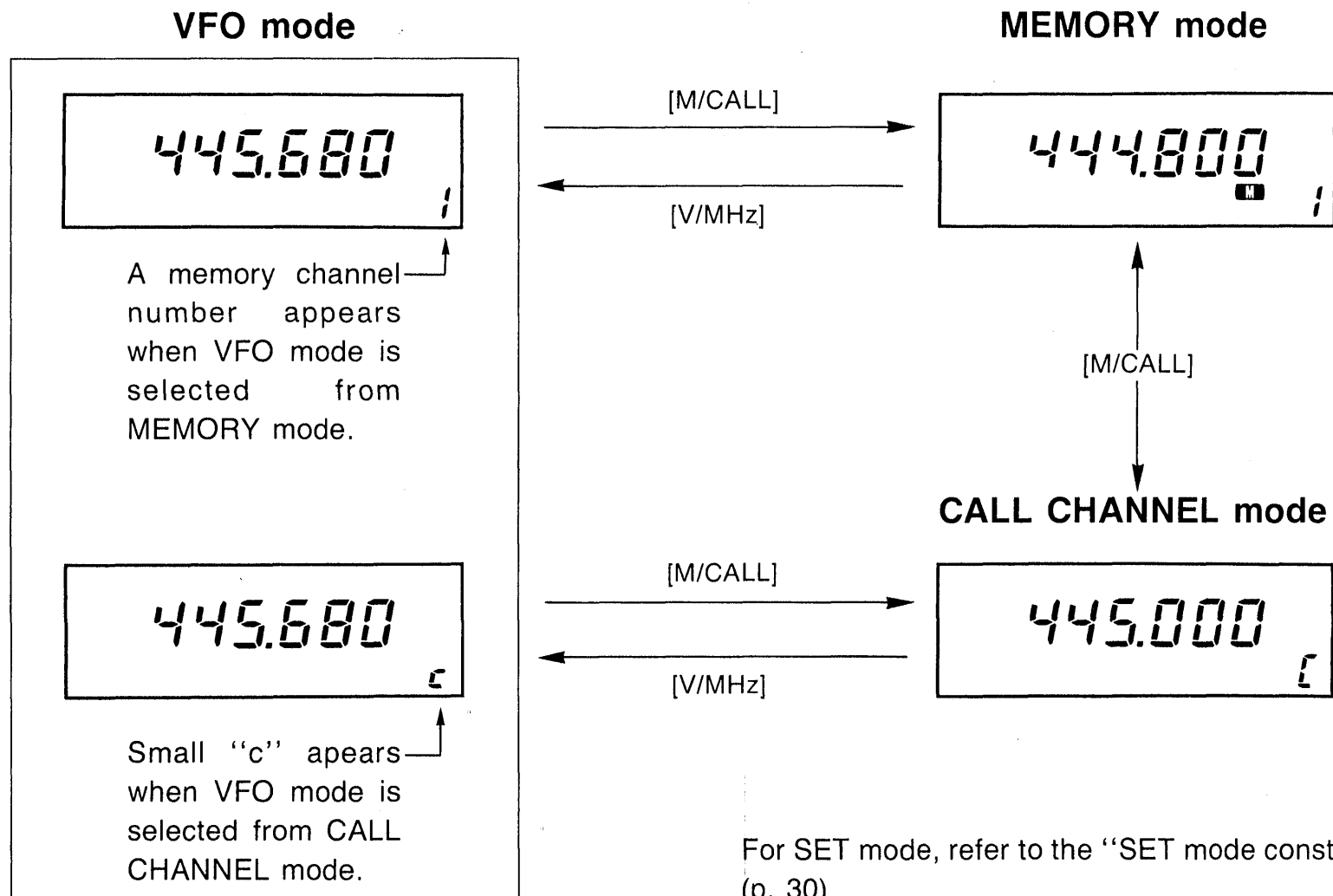

For SET mode, refer to the "SET mode construction chart." (p. 30)

■ Frequency setting

A frequency can be set with the tuning control, [UP] or [DN] on the microphone.

- 1) Push IN [POWER] to turn ON power.

NOTE: If “L,” “M” or large “C” appears, push the switches as follows:

- “L” : Push and hold [SET] until “L” disappears to cancel the lock function. (p. 13)

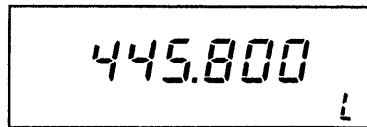

- “M” or large “C” : Push [V/MHz] several times until “M” or large “C” disappears to select VFO mode.

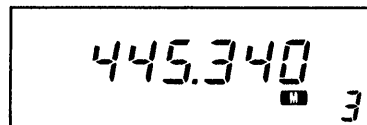
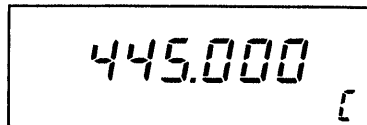

- 2) Rotate the tuning control, or push [UP] or [DN] on the microphone to select the operating frequency.
 - Select a tuning step in SET mode if desired. (p. 31)

NOTE: When the programmable remote control function is used, [UP] or [DN] on the microphone does not change the operating frequency. (p. 16)

- 3) To select the 1 MHz tuning steps, push [V/MHz].
 - Numerals below the decimal point disappear.
 - [UP] or [DN] on the microphone does not change the frequency in 1 MHz steps.

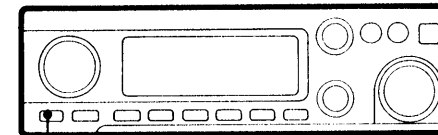

Push [V/MHz].

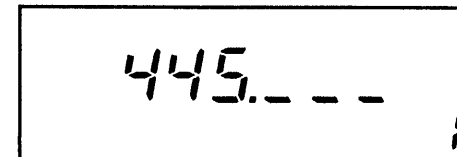

- 4) Push [V/MHz] again to return to the previous tuning step.
 - [UP] or [DN] also changes back to the previous tuning step.

■ Lock function ON/OFF

To prevent accidental changes, this function electronically locks the tuning control and switches on the front panel, [UP] and [DN] on the microphone.

- 1) Push and hold [SET] until "L" appears to lock.

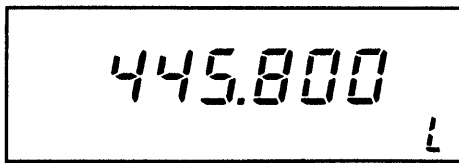
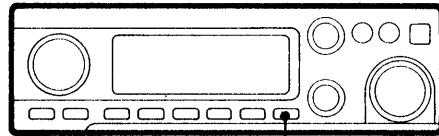

- 2) To cancel the lock function, push and hold [SET] until "L" disappears.

■ Receiving

- 1) Push IN [POWER] to turn ON power then rotate [SQL] to the maximum counterclockwise position.
 - "BUSY" appears.
- 2) Rotate [VOL] to the desired audio output level.
- 3) Rotate [SQL] clockwise until the noise disappears.
- 4) Set the desired frequency with the tuning control or with [UP] or [DN] on the microphone.
- 5) When a signal is received, audio is emitted.
 - "BUSY" appears.
 - The S/Rf indicator displays the relative signal strength.
- 6) To monitor the operating frequency momentarily, push [MONI] if required.
 - The squelch opens while [MONI] is pushed.

CONVENIENT

The following functions are available if required:

- AF tone High/Low selection (p. 33)
- RF attenuator ON/OFF selection (p. 33)

■ Transmitting

CAUTION: Transmitting without an antenna may damage the transceiver.

NOTE: To prevent interference, listen on the frequency before transmitting.

HM-56 only: Voice transmission is not possible while the active indicator on the HM-56 lights or blinks. (pgs. 25 ~ 28)

- 1) When "DUP -" or "DUP" appears on the function display, push [DUP] several times until it disappears to select simplex.

Be sure "DUP -" or "DUP" disappears.

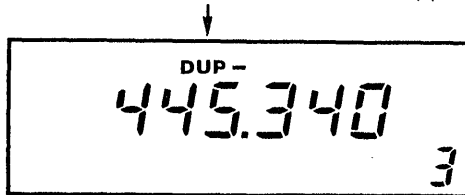

- 2) Push [HI/LO] to select output power.
 - "LOW" appears only when Low power is selected.
 - Set the Low power level in SET mode if required. (p. 33)

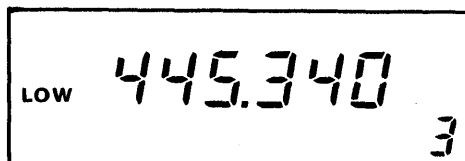

- 3) Push and hold the PTT switch on the microphone.
 - "TX" appears and the S/RF indicator shows the relative output power level.

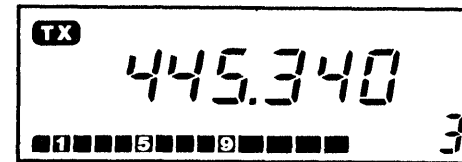

- 4) Speak into the microphone using your normal voice level.
 - DO NOT hold the microphone too closely to your mouth or speak too loudly. This may distort the signal.
- 5) Release the PTT switch to return to receiving.

■ Repeater operation

Select duplex when operating through a repeater. To access a repeater which requires a tone or DTMF codes, refer to instructions at right.

- 1) Push [DUP] once to set -duplex or push twice to set +duplex.
 - "DUP -" or "DUP" appears.
 - Refer to "Offset frequency selection" if required. (p. 31)

"DUP -"	: Transmit freq. =
	Receive freq. - Offset freq.
"DUP"	: Transmit freq. =
	Receive freq. + Offset freq.

- 2) Push and hold the PTT switch to transmit on the repeater input frequency.
 - "oFF" appears if the transmit frequency is outside of the transmitting frequency range. (p. 43)
- 3) To check the transmit frequency (repeater input frequency), push [MONI].
 - The squelch opens.
- 4) To return to simplex, push [DUP] several times until "DUP" or "DUP -" disappears.

• Subaudible tone

This function is already installed for the U.S.A. version. An optional UT-50 or UT-51 is required for other versions. (p. 34)

- 1) Set the subaudible tone frequency. (p. 31)
- 2) Push [T/T.SQL] until only "T" appears to turn ON the subaudible tone encoder.
- 3) The selected subaudible tone is transmitted when the PTT switch is pushed.

• DTMF codes (HM-56)

Push the DTMF keyboard on the microphone rear panel to access a repeater.

- A DTMF code is transmitted without pushing the PTT switch.

Refer to "HM-56 ADVANCED FUNCTIONS" for auto dialing and re-dialing functions. (pgs. 25 ~ 28)

• 1750 Hz tone call

- HM-59: Push and hold [TONE] on the microphone rear panel for approx. 1 ~ 3 sec. to access a repeater.
- HM-56: Refer to "HM-56 ADVANCED FUNCTION." (p. 28)

PROGRAMMABLE REMOTE CONTROL FUNCTION 5

By allocating your most-often-used function to [UP] on the microphone, you can remotely access the function.

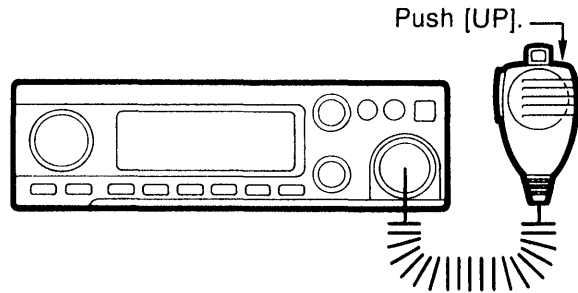

The following are example instructions for selecting MEMORY or CALL CHANNEL mode remotely.

While this function is used;

- [UP]: Selects the programmed function.
- [DN]: Starts the scan function.

1) Turn power OFF.

2) Set [LOCK] on the microphone in the OFF position.

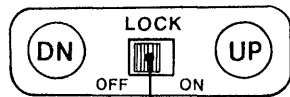

Set in the OFF position.

- 3) Push and hold [UP] and the desired switch you wish to allocate to [UP].
- In this case, push and hold [M/CALL].

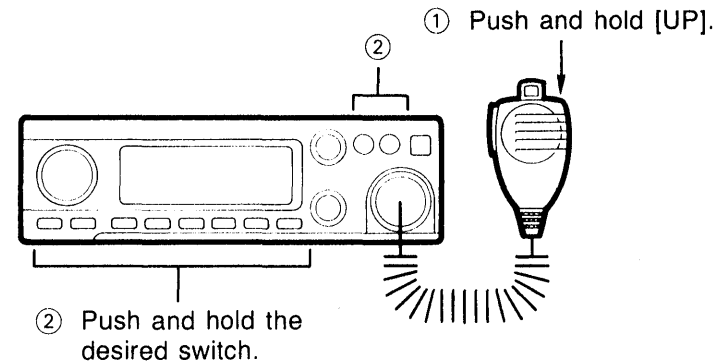

4) Turn power ON.

- The function selected by pushing and holding a switch in step 3 has been allocated to [UP].

5) The programmed function can be selected from [UP].

- In this case, MEMORY or CALL CHANNEL mode can be selected from [UP].

6) To cancel the function, turn power OFF, push and hold [UP], then turn power ON.

■ Memory operation

The transceiver has 20 memory channels.

CONVENIENT

Each memory channel independently stores an operating frequency, offset frequency, subaudible tone frequency and memory skip setting. (pgs. 31, 32)

• Memory reading

- 1) Push [M/CALL] 1 or 2 times to select MEMORY mode.
 - "M" appears.

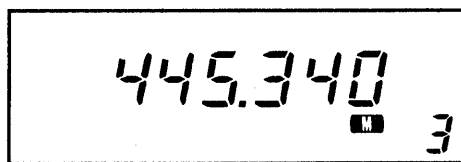

- 2) Rotate the tuning control or push [UP] or [DN] on the microphone to select the desired memory channel.
 - Memory channels P1 and P2 are scan edge channels for programmed scan. (p. 21)

NOTE: When the programmable remote control function is used, [UP] or [DN] does not change the memory channel. (p. 16)

- 3) Push [V/MHz] to return to VFO mode.

• Memory writing

- 1) Push [M/CALL] 1 or 2 times to select MEMORY mode.
 - "M" appears.
- 2) Rotate the tuning control or push [UP] or [DN] to select the desired memory channel.
- 3) Push [V/MHz] to select VFO mode.
 - "M" disappears.
- 4) Select the frequency to be programmed.
- 5) Push and hold [MW] for 2 sec.
 - 3 beeps alert you that the contents have been programmed into the memory channel.

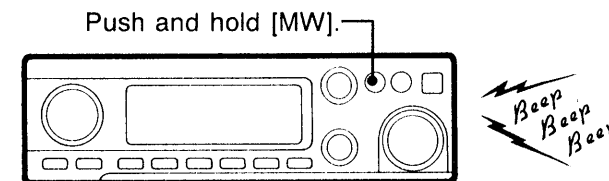

• Memory transferring

This function allows you to copy memory or call channel contents into the VFO. Memory or call channel contents will not be erased.

The function is especially useful when searching for signals around the memory or call channel frequencies.

- 1) Push [M/CALL] to select MEMORY or CALL CHANNEL mode.
- 2) In MEMORY mode, select the desired memory channel.
- 3) Push and hold [MW] for 2 sec.
 - 3 beeps alert you that memory or call channel contents have been transferred into the VFO.
 - The transceiver is now in VFO mode.

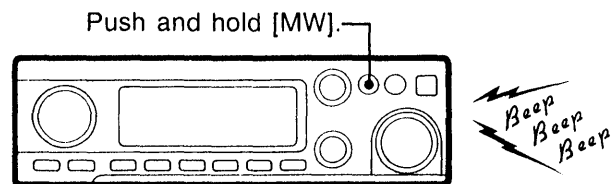

CONVENIENT

Offset frequency, subaudible tone frequency, subaudible tone encoder ON/OFF setting and offset direction (+ or - duplex) are simultaneously transferred into the VFO. You need not select a required repeater condition again.

If a memory or call channel contains a tone squelch setting, the setting is also transferred into the VFO.

Memory
channel
contents

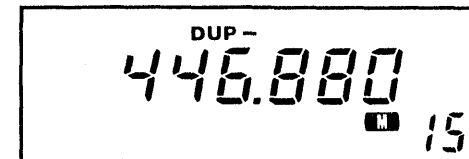

↓ Transferred.

VFO

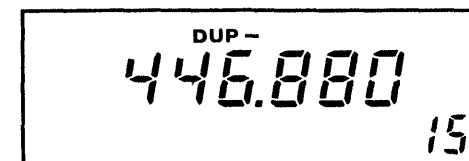

■ Memory split function

This function allows you to operate different frequencies for transmitting and receiving.

Unlike duplex mode operation, the transmit and receive frequencies can freely be programmed into a pair of odd-number and even-number memory channels.

NOTE: To enable you to use the function, push and hold [DUP] and [MONI] and turn ON power.

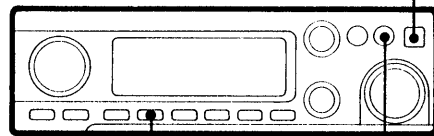

- This setting remains effective until the CPU is reset. (p. 42)

② Turn power ON.



① Push and hold [DUP] and [MONI].

- 1) Program the transmit frequency into an even-number memory channel and the receive frequency into an odd-number memory channel or vice versa.
 - Pairs of memory channels 1 and 2, 3 and 4, . . . or 19 and 20 can be used.

- 2) Select a memory channel that contains a receive frequency.
- 3) Push and hold [DUP] until “” appears.
 - “” shows that the memory split function is activated.
 - To receive another memory channel frequency, push and hold [MONI].

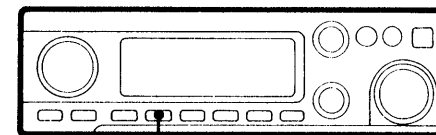

Push and hold [DUP].

“” appears.

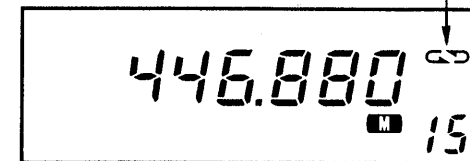

- 4) Push and hold the PTT switch.
 - The transceiver transmits on another memory channel frequency.
- 5) To cancel the function setting, push and hold [DUP] again until “” disappears.

■ Call channel operation

The transceiver has an independent CALL CHANNEL mode which provides easy selection of your most-often-used frequency.

• Call channel reading

- 1) Push [M/CALL] 1 or 2 times to select CALL CHANNEL mode.
 - Large "C" appears.
 - The tuning control is deactivated.



- 2) Push [V/MHz] or [M/CALL] to exit CALL CHANNEL mode.
 - [V/MHz] selects VFO mode. Small "c" appears.
 - [M/CALL] selects MEMORY mode. "M" appears.

CONVENIENT

Call channel contents can be copied into the VFO using the memory transfer function. (p. 18)

• Call channel programming

- 1) Push [V/MHz] to select VFO mode.
- 2) Select the frequency to be programmed.
 - Repeater or other information can be programmed. (p. 15)
- 3) Push [M/CALL] 1 or 2 times to select CALL CHANNEL mode.
 - Large "C" appears.
- 4) Push [V/MHz] to select VFO mode.
 - Small "c" appears.
- 5) Push and hold [MW] for 2 sec.
 - 3 beeps alert you that the contents have been programmed into the call channel.

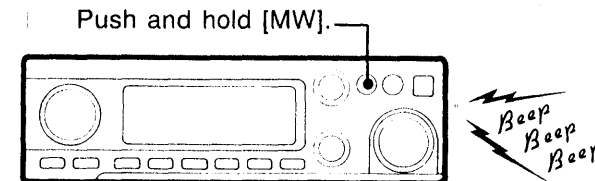

There are 2 different scan functions: programmed scan and memory scan. The memory skip function can be used with memory scan.

NOTE: While the programmable remote control function is used, the frequency setting, memory channel setting and scan functions cannot be activated from [UP]. (p. 16)

■ Programmed scan

This function repeatedly scans between a specified frequency range.

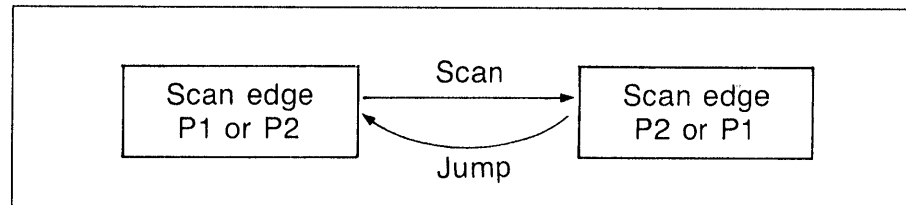

NOTE: Programmed scan does not function when:

- Priority watch is activated. (p. 23)
- Frequencies in scan edge channels P1 and P2 are equal.

When the optional tone squelch function is activated, scan is paused only when a signal with the pre-programmed tone is received. (p. 36)

- 1) Set scan edge frequencies into memory channels P1 and P2. (p. 17)
- 2) Select VFO mode.
- 3) Rotate [SQL] clockwise until noise disappears.
 - "BUSY" disappears.
- 4) Push and hold [UP] or [DN] on the microphone until the scan starts.
 - The decimal point blinks.

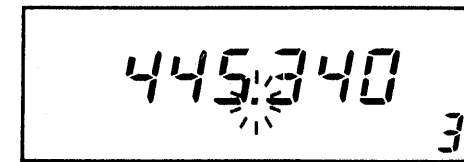

- 5) During scanning, the scanning direction can be changed by rotating the tuning control.
- 6) When receiving a signal, scan pauses.
 - The scan resume condition can be set in SET mode if required. (p. 32)
- 7) To cancel the scan, push [UP] or [DN] on the microphone again.

Memory scan

This function repeatedly scans memory channels except P1 and P2.

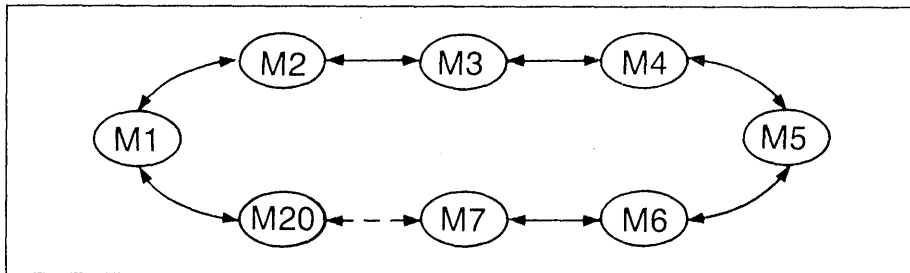

NOTE: Memory scan does not function when all or all except 1 of the memory channels have been programmed as skip channels. (p. 32)

- 1) Push 1 or 2 times [M/CALL] to select MEMORY mode.
 - “M” appears.

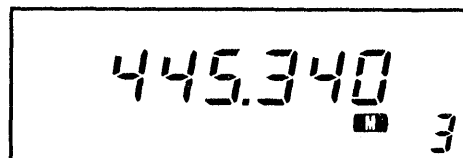

- 2) Rotate [SQL] clockwise until noise disappears.
 - “BUSY” disappears.

- 3) Push and hold [UP] or [DN] on the microphone until the scan starts.
 - “M” and the decimal point blink.

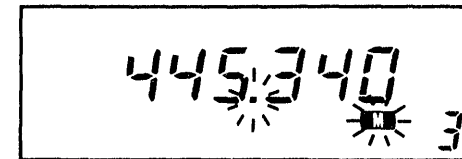

- 4) During scanning, the scanning direction can be changed by rotating the tuning control.
- 5) When receiving a signal, scan pauses.
 - The scan resume condition can be set in SET mode if required. (p. 32)
- 6) To cancel the scan, push [UP] or [DN] again.

CONVENIENT

To skip certain channels, use the memory skip function. (p. 32)

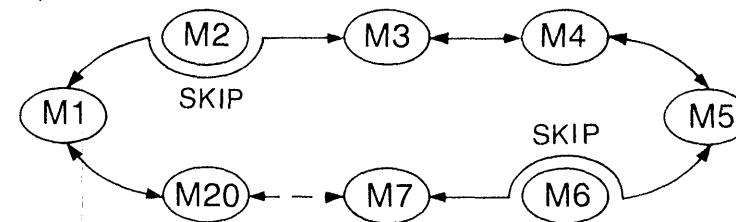

■ VFO ↔ memory or call channel

Every 5 sec., priority watch monitors a pre-programmed frequency while you operate on the VFO frequency.

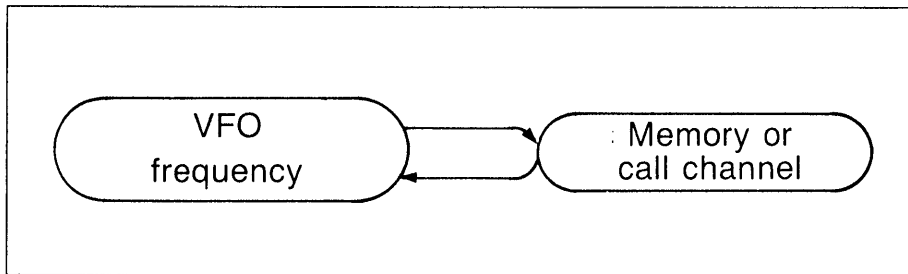

1) Select the desired operating frequency in VFO mode.

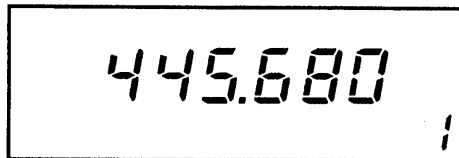

2) Select a memory channel or the call channel to be watched.

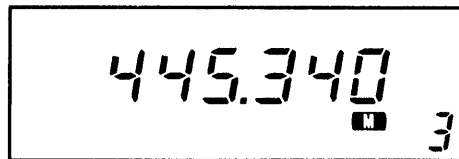

3) Push [PRIO] to start priority watch.

- "PRIO" appears.

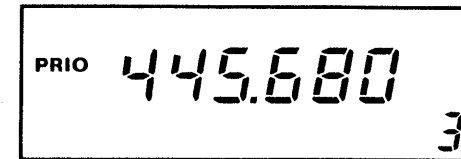

4) When a signal is received on the watching frequency (memory or call channel), priority watch pauses.

- "PRIO" blinks.
- The priority watch resume condition can be set in SET mode if required. (p. 32)

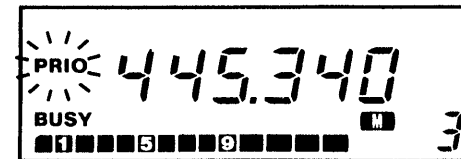

5) To cancel priority watch, push [PRIO] again when the VFO frequency appears.

■ VFO ↔ memory channels

Priority watch can also watch each memory channel at approx. 5 sec. consecutive intervals. The memory skip function can also be used. (p. 32)

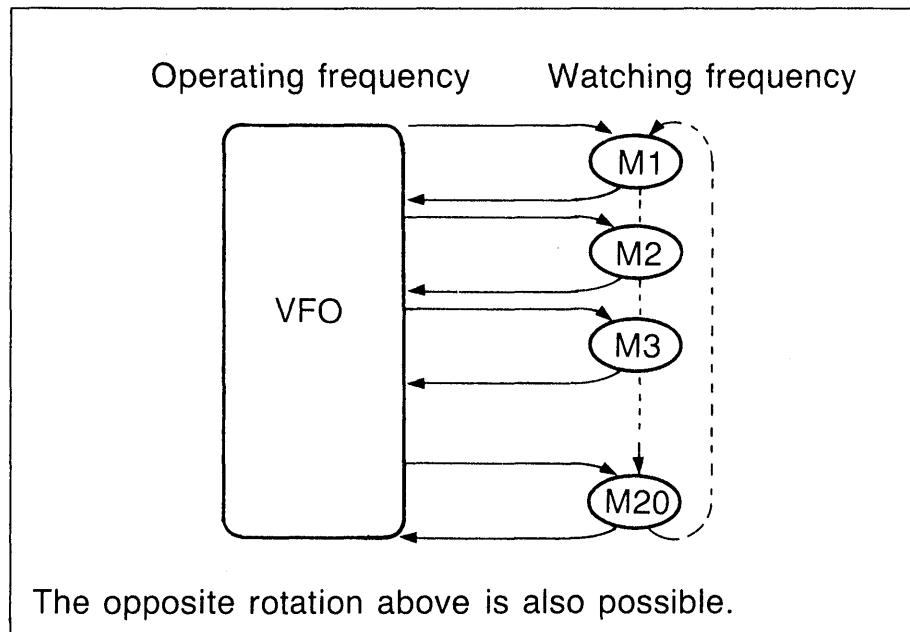

CONVENIENT

To skip certain channels, use the memory skip function. (p.32)

- 1) Select the desired operating frequency in VFO mode.
- 2) Push [M/CALL] 1 or 2 times to select MEMORY mode.

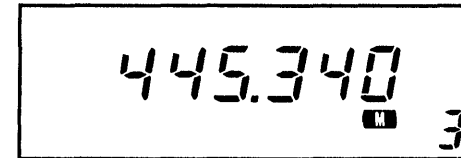

- 3) Push and hold [UP] or [DN] on the microphone until memory scan starts.
- 4) Push [PRIO] to start priority watch.
 - "PRIO" appears.
 - Memory channels change every 5 sec.
- 5) When a signal is received on the watching frequency (memory channel), priority watch pauses.
 - "PRIO" blinks.
 - The priority watch resume condition can be set in SET mode. (p. 32)

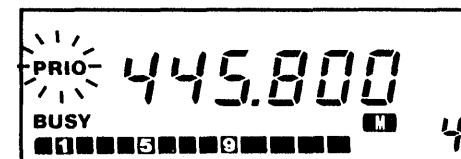

- 6) To cancel priority watch, push [PRIO] again when the VFO frequency appears.

The HM-56 HAND MICROPHONE is equipped with 14 DTMF code memory channels and a re-dialing function for auto dialing. Up to a 22-digit telephone number, etc. can be memorized into each memory channel.

NOTE: Set [LOCK] on the microphone to the OFF position to use HM-56 functions.

■ 3 modes

The HM-56 has 3 modes as follows:

• MEMORY WRITING mode

Used when writing DTMF codes into a DTMF code memory channel.

- The active indicator blinks fast.

• MEMORY READING mode

Used when reading DTMF codes from a DTMF code memory channel.

- The active indicator lights continuously.

• RE-DIALING mode

Used when recalling the last-transmitted DTMF codes.

- The active indicator blinks slowly.

■ Writing a DTMF code memory

Program a DTMF code memory channel as follows.

- 1) Push [MW] on the microphone to select the MEMORY WRITING mode.
 - The active indicator blinks.
- 2) While holding the PTT switch, push the desired DTMF code memory number from [1] to [D] on the keyboard. Keep pushing the PTT switch.
- 3) While pushing the PTT switch, push the desired keys. Enter a maximum of 22 digits.
- 4) Release the PTT switch.
- 5) Push [MW] on the microphone to memorize the code into the DTMF code memory channel.

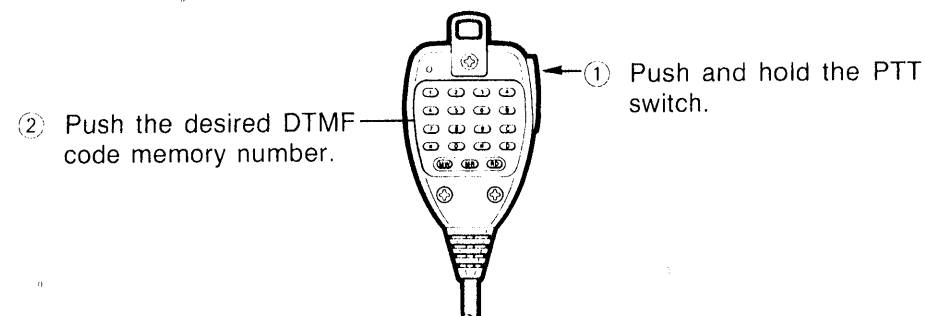

■ DTMF code memory erasing

- 1) Push [MW] on the microphone to select MEMORY WRITING mode.
 - The active indicator blinks.
- 2) While holding the PTT switch, push the desired DTMF code memory number [1] to [D] on the keyboard.

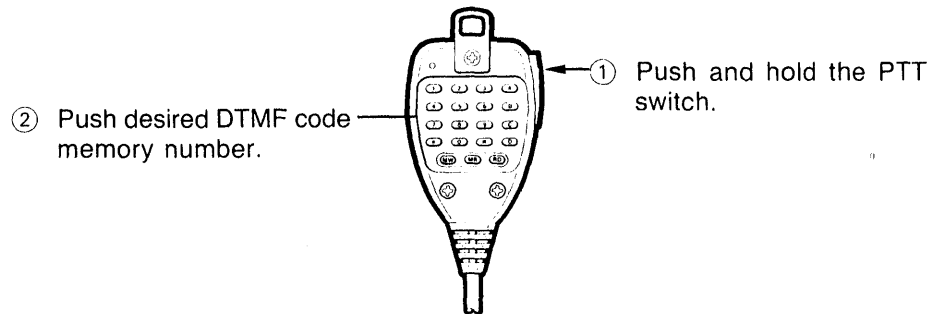

- 3) Release the PTT switch to erase the DTMF code.
- 4) Push [MW] on the microphone to return to normal use.

■ Transmitting a DTMF code memory

Programmed DTMF code memory contents are automatically transmitted.

- 1) Push [MR] to select MEMORY READ mode.
 - The active indicator lights.
- 2) Push the desired DTMF code memory number from [1] to [D].
 - The memorized DTMF code is automatically transmitted.
 - The active indicator blinks according to the DTMF code length.

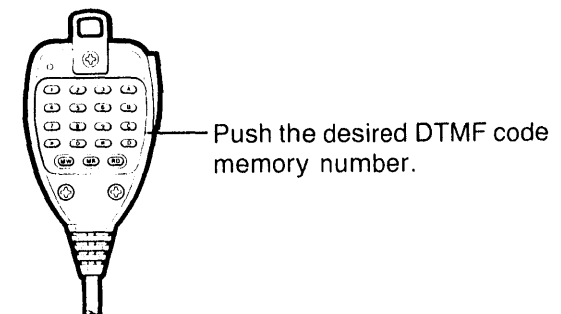

- 3) Push [MR] to cancel the function.
 - The active indicator goes out.

■ Re-dialing function

To allow you to transmit a previously transmitted DTMF code, the re-dial memory channel automatically memorizes the last-transmitted DTMF code sequences.

• Manual re-dialing

The last-transmitted DTMF code can be transmitted by manual key operation.

- 1) Push and hold the PTT switch.
- 2) Push [RD] to transmit the last-transmitted DTMF codes.
 - The active indicator blinks according to the DTMF code length.

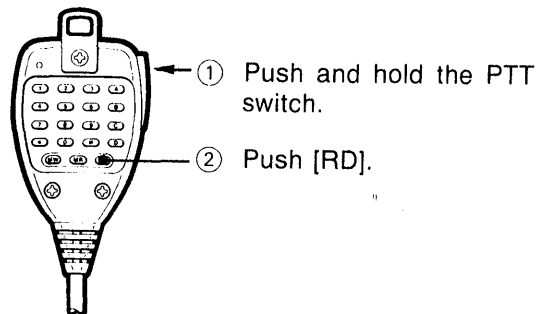

• Auto re-dialing

The last-transmitted DTMF code can be automatically transmitted at each push of the PTT switch.

- 1) Push [RD] to select RE-DIALING mode.
 - The active indicator blinks.
- 2) At each push of the PTT switch, the last-transmitted DTMF code is transmitted.
- 3) Push [RD] to cancel the function.
 - The active indicator goes out.

• Writing a re-dialing memory

The last-transmitted DTMF codes are automatically written into a re-dialing memory. If desired, you can manually write DTMF codes into the re-dial memory channel.

Push [RD] instead of the DTMF code memory number key in "Writing a DTMF code memory" step 2. (p. 25)

■ 1750 Hz tone call

Using the HM-56, you can access a repeater that requires a 1750 Hz tone.

- 1) Push [MR] on the microphone.
 - The active indicator lights.
- 2) Transmit a 1750 Hz tone as follows:
 - Push and hold [#] to transmit a 1750 Hz tone continuously.
 - Push [*] to transmit a 1750 Hz tone for approx. 0.5 sec.
- 3) Push [MR] again to cancel the function.
 - The active indicator goes out.

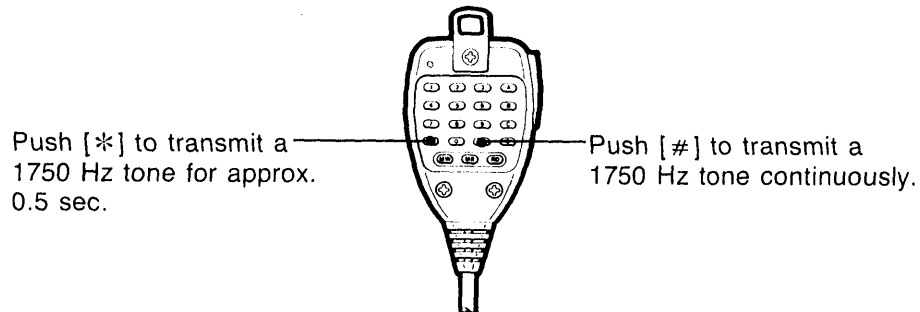

■ HM-56 CPU resetting

NOTE: When the following operation is performed, all programmed information in the HM-56 is erased.

- 1) Turn the transceiver power OFF.
- 2) Push and hold [MW] and [MR] on the microphone.

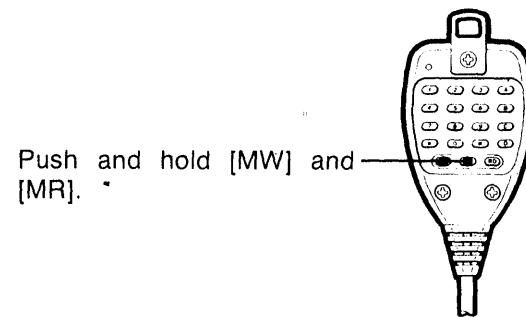

- 3) Turn power ON to reset the CPU in the microphone.

10 SET MODE

Depending on your operating conditions, the following selections are possible in SET mode.

- Subaudible tone frequency selection (p. 31)
- Offset frequency selection (p. 31)
- Tuning steps selection (p. 31)
- Beep tone ON/OFF selection (p. 31)
- Skip channel (p. 32)
- Scan resume condition selection (p. 32)
- Low output power level selection (p. 33)
- AF tone High/Low selection (p. 33)
- RF attenuator ON/OFF selection (p. 33)
- Intensity level selection (p. 33)

■ SET mode selection

NOTE: DO NOT push and hold [SET] continuously, or the lock function will be activated. (p. 13)

When SET mode is selected, begin programming within 30 sec. of each step. If programming is not performed within 30 sec., the transceiver automatically selects the last-used mode.

The following instructions will enter SET mode.

- 1) Some settings can be programmed only in the specified mode that was previously selected.
 - To select the tuning steps push [V/MHz] to select VFO mode. (p. 31)
 - To program a memory channel as a skip channel, push [M/CALL] to select MEMORY mode. (p. 32)
- 2) Push [SET] to select SET mode.
 - "SET" and the previously set position appear.
- 3) Push [SET] to advance or [HI/LO] to reverse the SET mode display. Select the desired display.
 - Refer to the SET mode construction charts. (p. 30)

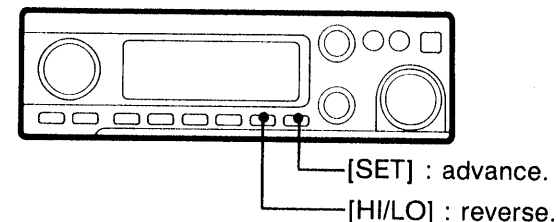

- 4) Rotate the tuning control to change contents of the SET mode display.
- 5) Push [M/CALL] to exit SET mode.
 - The transceiver reverts to the last-used mode.

SET mode construction chart

- *1: When starting from MEMORY mode
- *2: When starting from CALL CHANNEL mode
- *3: When starting from VFO mode

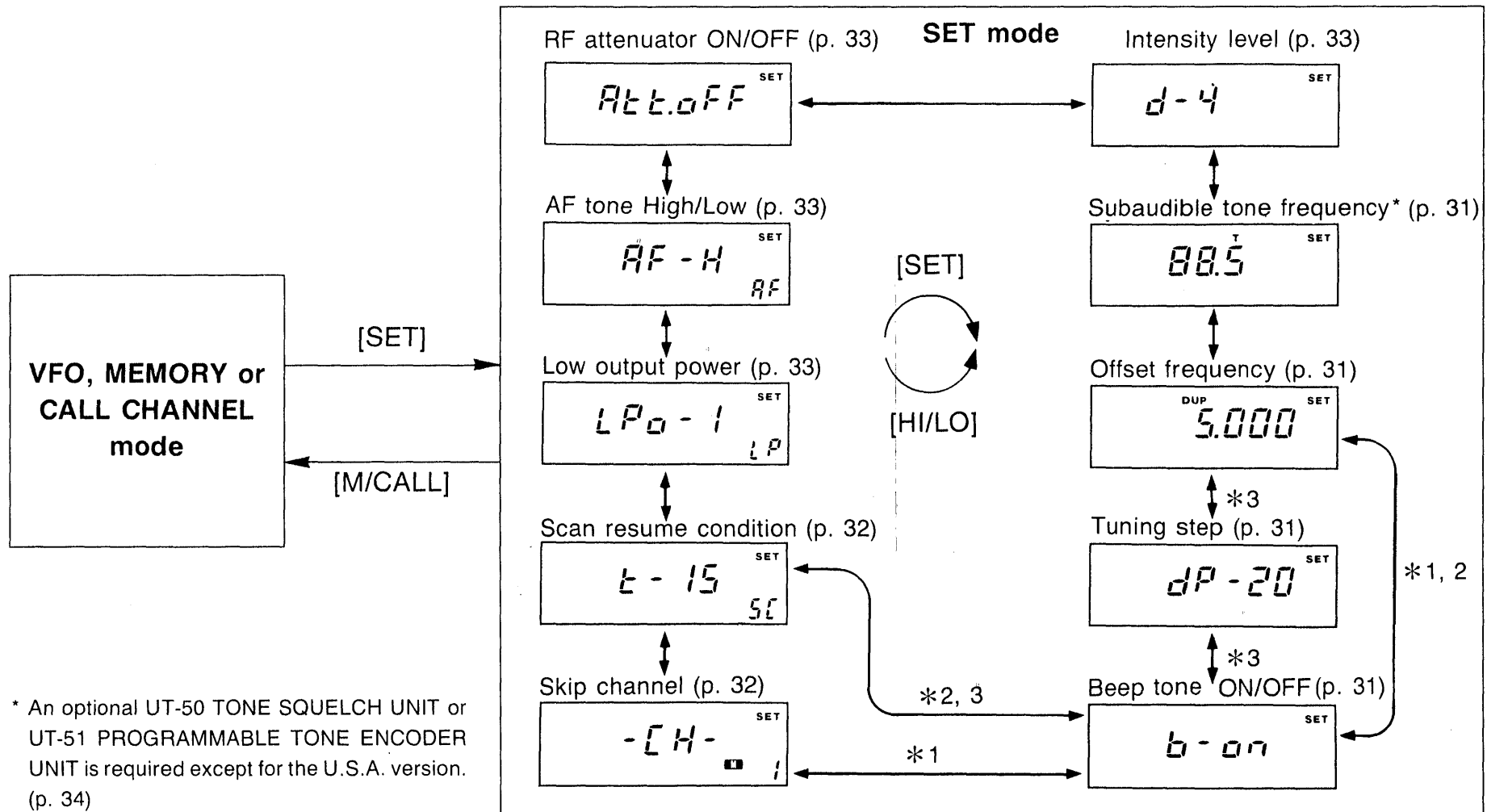

* An optional UT-50 TONE SQUELCH UNIT or UT-51 PROGRAMMABLE TONE ENCODER UNIT is required except for the U.S.A. version. (p. 34)

■ Subaudible tone frequency selection

To access a repeater that requires a subaudible tone, select one of the subaudible tone frequencies.

- 1) Push [SET] several times until "T" blinks.



- 2) Rotate the tuning control to select the desired subaudible tone frequency.
- 3) Push [M/CALL] to exit from SET mode.

■ Offset frequency selection

When duplex operation has been selected, the transceiver transmits on a frequency equal to the receive frequency plus or minus the offset frequency.

- 1) Push [SET] several times until "DUP" blinks.

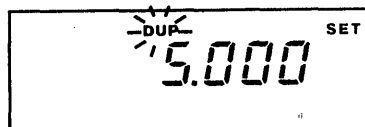

- 2) Rotate the tuning control to select the offset frequency in 25 kHz steps.
 - Push [V/MHz] to select 1 MHz tuning steps if desired. (p. 12)
- 3) Push [M/CALL] to exit from SET mode.

■ Tuning step selection

5, 10, 12.5, 15, 20 or 25 kHz tuning steps are selectable.

- 1) Select VFO mode.
- 2) Push [SET] until "dP-" blinks.
- 3) Rotate the tuning control to select the tuning step.
- 4) Push [M/CALL] to exit from SET mode.

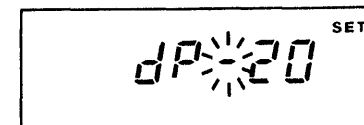

■ Beep tone ON/OFF selection

The transceiver emits a beep or beeps each time a switch is pushed. Turn the beep tones ON or OFF according to your preference.

- 1) Push [SET] several times until "b-" blinks.



- 2) Rotate the tuning control to select the beep tone ON or OFF.
 - b-on : Beep tone ON
 - b-off : Beep tone OFF
- 3) Push [M/CALL] to exit from SET mode.

■ Skip channel selection

Memory channels that you do not wish to scan during memory scan or priority watch can be specified as skip channels.

- 1) Select MEMORY mode.
 - "M" appears.

- 2) Rotate the tuning control to select the memory channel to be skipped.

- 3) Push [SET] several times until "- CH -" blinks.

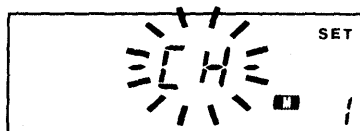

- 4) Rotate the tuning control to program the memory channel as a skip or non-skip channel.
 - "SKIP" appears when the memory channel is programmed as a skip channel.



- 5) Push [M/CALL] to exit from SET mode.

■ Scan resume condition selection

4 kinds of scan resume condition are selectable.

- 1) Push [SET] several times until "SC" blinks.

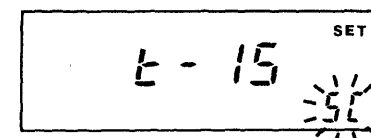

- 2) Rotate the tuning control to select the desired scan resume condition.

DISPLAY	DESCRIPTION
P-2	Scan pauses while a signal is received. Resumes approx. 2 sec. after the signal disappears.
t-5	Scan pauses when a signal is received. Resumes approx. 5, 10 or 15 sec. after the scan pauses.
t-10	
t-15	

- 3) Push [M/CALL] to exit from SET mode.

■ Low output power level selection

3 levels of Low output power are selectable.

- 1) Push [SET] several times until "LP" blinks.

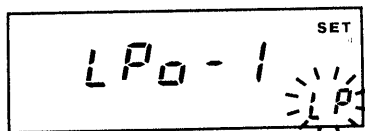

- 2) Rotate the tuning control to select the desired Low output power level.

DISPLAY	OUTPUT POWER	S/RF INDICATOR DURING TRANSMISSION
LPo-3	Approx. 20 W	■■■■■■■■
LPo-2	Approx. 10 W	■■■■■
LPo-1	Approx. 5 W	■■■

- 3) Push [M/CALL] to exit from SET mode.

■ AF tone High/Low selection

The receive audio tone can be set to High or Low depending on your preference.

- 1) Push [SET] several times until "AF" blinks.

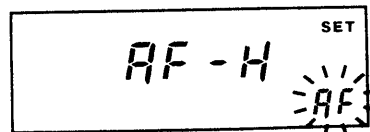

- 2) Rotate the tuning control to select AF tone High or Low.
 - H : High (normal). L : Low.

- 3) Push [M/CALL] to exit from SET mode.

■ RF attenuator ON/OFF selection

To prevent saturation of the RF circuit, sensitivity can be reduced depending on signal strength.

- 1) Push [SET] several times until "Att" blinks.

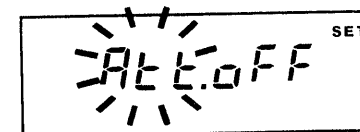

- 2) Rotate the tuning control to turn the RF attenuator ON or OFF.

- Att.on : Sensitivity is reduced by approx. 20 dB.
- Att.oFF : Normal sensitivity.

- 3) Push [M/CALL] to exit from SET mode.

■ Intensity level selection

4 kinds of intensities of the function display backlight are selectable for night-time operation.

- 1) Push [SET] until "d-" blinks.

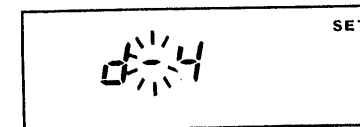

- 2) Rotate the tuning control to select the backlighting intensity d1 ~ d4.

- d-1 : The darkest intensity.
- d-4 : The brightest intensity.

- 3) Push [M/CALL] to exit from SET mode.

■ Optional unit installation

Install required optional units as follows:

CAUTION: Turn power OFF and disconnect the DC power cable before removing the top cover from the transceiver.

- 1) Remove 4 screws from the top cover and remove the top cover.
- 2) Connect the UT-50 TONE SQUELCH UNIT or UT-51 PROGRAMMABLE TONE ENCODER UNIT to J6 (10 pins) on the IC-449A/E MAIN UNIT.
 - For the U.S.A. version, connect the UT-50 instead of the built-in UT-51.

Connect the UT-55 DTMF ENCODER/DECODER UNIT to J7 (14 pins) on the IC-449A/E MAIN UNIT.

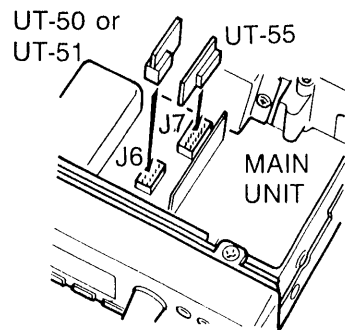

- 3) Replace the top cover and screws.

■ Selective calling system

By installing an optional UT-50 TONE SQUELCH UNIT or UT-55 DTMF ENCODER/DECODER UNIT, the transceiver provides the following convenient selective calling functions.

FUNCTION	DESCRIPTION	REQUIRED UNIT
Pocket beep	When the same subaudible tone as that preprogrammed is received, this function alerts you with 30 sec. beeps and “ (••) ” blinking.	UT-50
Tone squelch	When the same subaudible tone as that preprogrammed is received, the squelch opens. You can wait silently for a call only from the desired station.	UT-50
Pager	This function displays the received ID code with beeps. ID codes can be independently programmed for each station. You can call a specified station or group of stations.	UT-55
Code squelch	When the same ID code as that preprogrammed is received, the squelch opens. A group call is also possible.	UT-55

■ Subaudible tone encoder function

This function allows you to access a repeater that requires a subaudible tone.

The UT-51 PROGRAMMABLE TONE ENCODER UNIT is already installed for the U.S.A. version.

An optional UT-51 PROGRAMMABLE TONE ENCODER or UT-50 TONE SQUELCH UNIT is required for other versions. (p. 44)

- 1) Select the subaudible tone frequency required to access a repeater. (p. 31)
- 2) Push [T/T.SQL] several times until only "T" appears.
 - Access a repeater. (p. 15)

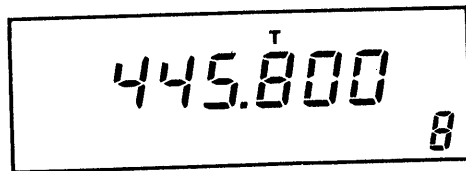

- 3) To cancel the function, push [T/T.SQL] several times until "T" disappears.

■ Pocket beep and tone squelch functions

NOTE: Using the pocket beep or tone squelch function when contacting other stations through a repeater may not be always possible since some repeaters are equipped with filters that filter out subaudible tones. The UT-50 does not include 97.4 Hz.

• Pocket beep operation

- 1) Select a subaudible tone frequency. (p. 31)
 - Select the same subaudible tone frequency for your station and other stations.
- 2) Push [T/T.SQL] several times until "T SQL (...)" appears.
 - To receive the operating frequency, push and hold [MONI] if required.

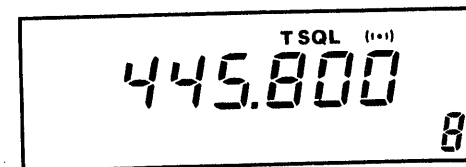

- 3) When the same subaudible tone as the pre-programmed tone is received, the transceiver emits 30 sec. beeps and “(••)” blinks.
 - “(••)” blinks continuously even after the 30 sec. beeps stop.

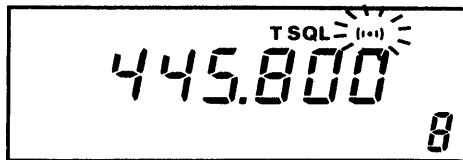
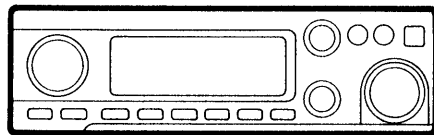

- 4) Push [T/T.SQL] or the PTT switch on the microphone to stop the beeps and blinking.
 - The transceiver automatically selects the tone squelch function.
- 6) To cancel the function, push [T/T.SQL] several times until “T SQL” or “T SQL (••)” disappears.

• Tone squelch operation

- 1) Select a subaudible tone frequency. (p. 31)
 - Select the same subaudible tone frequency for your station and other stations.
- 2) Push [T/T.SQL] several times until “T SQL” appears.

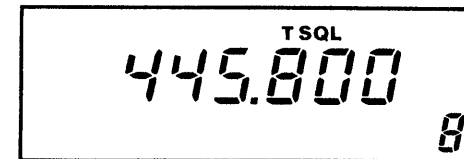

- 3) Operate the transceiver in the normal way.
 - To open the squelch manually, push and hold [MONI] if required.
- 4) When the same subaudible tone as the pre-programmed tone is received, the squelch opens.
- 5) To cancel the function, push [T/T.SQL] several times until “T SQL” or “T SQL (••)” disappears.
 - The function must be canceled for all stations.

CONVENIENT

Each memory and call channel stores a subaudible tone frequency and tone squelch ON/OFF settings. Just recall a memory or call channel, and tone squelch operation is possible.

■ Pager and code squelch functions

• Pre-operation

The pager and code squelch functions require codes to acknowledge the specified station. An optional UT-55 has code channels as shown in the chart at right.

Before operating the pager or code squelch function, the following contents must be determined for your group.

- The ID code of each transceiver and the group code for your group.
- Whether or not the code squelch function is to be used for communications after contact.

• Receive accept and inhibit

The purposes of the pager and code squelch functions are selective calling and standby. In order not to receive calls from other stations, the following settings are possible for code channels:

- Receive "accept": Receives calls that contain the same code in a code channel.
- Receive "inhibit": Ignores calls that do not contain the same code in a code channel.

• Code channel information

CODE CHANNEL	DESCRIPTION	INHIBIT OR ACCEPT
C0	Program your station's ID code.	"Accept" only.
C1 ~ C5	Program the other stations' ID codes or the group code.	Program "inhibit" for others station's ID code. Program "accept" for the group code.
CP*	Space for the received ID code.	"Inhibit" only.

* Code channel CP automatically memorizes an ID code when the transceiver receives another station's ID code or group code. The contents in code channel CP cannot be changed manually.

NOTE: Code channels C1 ~ C5 can be programmed with other stations' ID codes or group codes. We recommend that the same code channel be used for a group code.

• **Programming a code**

NOTE: Setting in each step must be performed within 30 sec. If setting is not performed, the transceiver automatically selects the last-used mode.

- 1) Push [PGR/CS] to select the pager function.
 - “PGR” appears.
- 2) Push [SET] to select the code programming condition.
 - Code channel number blinks.



- 3) Rotate the tuning control to select the desired code channel C0 ~ C5.
 - Program your station's ID code into code channel C0.
- 4) Push [SET] to select the desired digit.
 - The desired digit blinks.
 - Push [HI/LO] to select the last-programmed digit if required.

- 5) Rotate the tuning control to set the code number.



- 6) Repeat steps 4 and 5 to program all 3 digits.
- 7) Push [PGR/CS] to select the code channel as “accept” or “inhibit” channel.
 - “SKIP” appears when the code channel is programmed as an “inhibit” channel.
 - Channels C0 and CP cannot be programmed.

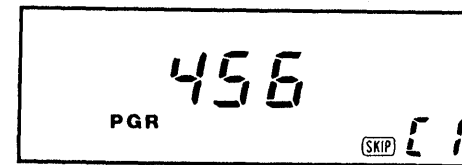

- 8) To program other code channels, push [SET] and repeat steps 3~7 if required.
- 9) Push [M/CALL] to exit from the code programming condition.

11 OPTIONAL FUNCTIONS

• Calling using the pager function

NOTE: As the pager function is a selective calling system, the function is not suitable for communication. Select normal operation or the code squelch function after contacting the desired station.

- 1) Push [PGR/CS] several times until "PGR" appears.

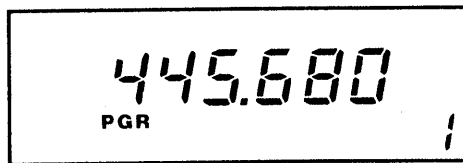

- 2) Push [SET] and rotate the tuning control to select the desired code channel C1 ~ C5 as follows:
 - Personal call: Calls only a specified station. Select the code channel that contains the desired station's ID code.
 - Group call: Calls all your group stations. Select the code channel that contains your group code.

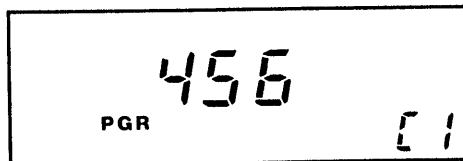

- 3) Push the PTT switch to call a station.
 - The transceiver automatically transmits a 7-digit DTMF code: "group code" + "*" + "your ID code."
- 4) When another station answers your station, the transceiver emits beeps.
 - The answering station's ID code or your group code appears. "PGR" and the code channel number blink.
- 5) After contacting the desired station push [V/MHz] and [PGR/CS] several times until "PGR" or "C SQL" disappears to cancel the pager function.
 - Select the code squelch function if desired. Refer to the page at right.

• Standby using the pager function

- 1) Push [PGR] several times until "PGR" appears.
- 2) When the transceiver receives a selected call, the transceiver emits beeps.
 - When called with your station's ID code: Another station's ID code appears. "CP" and "PGR" blink.
 - When called with group code: The group code appears. The code channel number that contains the group code and "PGR" blink.

Personal call

If receiving a code with your ID code, and the ID code of the calling station is "456."

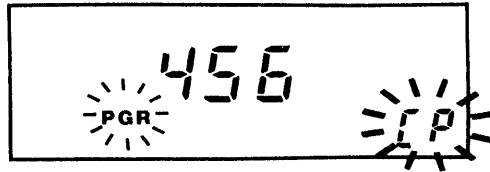

Group call

If the group code "222" is programmed in code channel 2.

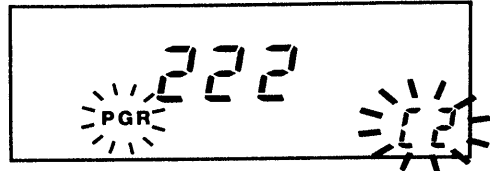

If the other station's ID code is not received completely because of interference etc., "E" appears.

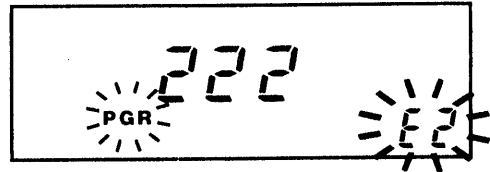

- 3) Push the PTT switch to answer the calling station.
 - The transceiver automatically transmits a 7-digit DTMF code.

Group call:
 "Group code" + "*" + "your ID code"

Personal call:
 "Another station's ID code" + "*" + "your ID code"
- 4) After contacting the desired station push [PGR/CS] several times until "PGR" or "C SQL" disappears to cancel the pager function.
 - Select the code squelch function if desired. Refer to the instructions at right.

• **Code squelch operation**

NOTE: When the pager function is selected and if "CP" appears, select the desired code channel again in step 2 below.

- 1) Push [PGR/CS] several times until "C SQL" appears.
- 2) Push [SET] and rotate the tuning control to select the code channel C0 ~ C5. Personal call or group call is possible. Refer to the page at left.
- 3) Push and hold the PTT switch.
 - The transceiver automatically transmits the selected code.
- 4) When the transceiver receives an ID code the same as one of the pre-programmed codes with "receive accept," the squelch opens.
 - Operate normally after the squelch opens.
- 5) To cancel the function, push [PGR/CS] until "PGR" or "C SQL" disappears.
 - The function must be canceled for both stations.

12 TROUBLESHOOTING

PROBLEM	POSSIBLE CAUSE	SOLUTION	REF.
1. Power does not turn ON.	<ul style="list-style-type: none"> • Blown fuse. 	<ul style="list-style-type: none"> • Check the cause, then replace the fuse. 	p. 42
2. No sound comes from the speaker.	<ul style="list-style-type: none"> • [SQL] is turned too far clockwise. • The optional selective call function is selected. 	<ul style="list-style-type: none"> • Set [SQL] to the squelch threshold level. • Cancel the function. 	p. 13 pgs. 35~40
3. No contact possible with another station.	<ul style="list-style-type: none"> • The transceiver is set to duplex. • Low output power is selected. 	<ul style="list-style-type: none"> • Select simplex. • Select High output power. 	p. 14 p. 14
4. Repeater cannot be accessed.	<ul style="list-style-type: none"> • The wrong offset frequency is programmed. • The wrong subaudible tone frequency is programmed. 	<ul style="list-style-type: none"> • Correct the offset frequency. • Correct the subaudible tone frequency. 	p. 31 p. 31
5. Frequency cannot be set.	<ul style="list-style-type: none"> • The lock function is activated. • MEMORY or CALL CHANNEL mode is selected. 	<ul style="list-style-type: none"> • Push and hold [SET] until "L" disappears. • Push [V/MHz] to select VFO mode. 	p. 13 p. 12
6. Scan does not operate.	<ul style="list-style-type: none"> • Squelch is open. • Frequencies in memory channels P1 and P2 are equal. • All or all except 1 memory channel were programmed as skip channels. 	<ul style="list-style-type: none"> • Set [SQL] to the threshold level. • Program memory channels P1 and P2 again. • Cancel the memory skip function in the desired memory channels. 	p. 13 p. 17 p. 32
7. All programmed settings have been erased.	<ul style="list-style-type: none"> • The backup battery is empty. • The CPU has been damaged by static. 	<ul style="list-style-type: none"> • Replace the backup battery. • Reset the CPU. 	p. 42 p. 42

■ IC-449A/E CPU resetting

If the function display occasionally displays erroneous information, the CPU should be reset before sending the transceiver to an Icom Dealer or Service Center.

NOTE: Resetting the CPU erases all programmed information.

Push and hold [SET] and [MW], then turn power ON.

- All indicators appear for 2 sec. and the IC-449A/E CPU has been reset.

■ Cleaning

When the transceiver becomes dusty or dirty, wipe it clean with a dry, soft cloth. Avoid the use of chemical agents such as benzine or alcohol as they may damage the surfaces of the transceiver.

■ Adjustment

Your transceiver has been thoroughly adjusted and checked at the factory before being shipped. Your transceiver warranty does not cover problems caused by unauthorized internal adjustments.

■ Fuse replacement

Locate the problem if possible before replacing a blown fuse.

- Fuse : 15 A

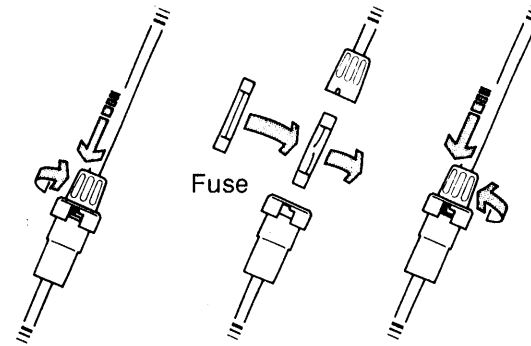

■ Backup batteries

The IC-449A/E and HM-56 have lithium backup batteries separately for retaining memory information.

The usual life of the backup batteries is approximately 5 years. When the battery is exhausted, the transceiver transmits and receives normally but the IC-449A/E and HM-56 cannot retain memory information.

NOTE: Battery replacement should be done by an authorized Icom Dealer or Service Center.

14 SPECIFICATIONS

■ GENERAL

- Frequency coverage :

Version	Frequency coverage
U.S.A.	440 ~ 450 MHz
Australia Europe	430 ~ 440 MHz
- Tuning steps : 5, 10, 12.5, 15, 20, 25 kHz or 1 MHz
- Number of memory channels : Memory channels 20
Call channel 1
Scan edge channels 2
- Mode : FM (F3)
- Antenna impedance : 50 Ω (unbalanced)
- Power supply requirement : 13.8 V DC \pm 15% (negative ground)
- Output power and current drain :

Transmit	High	9.5 A
	Low 3	7.0 A
	Low 2	5.0 A
	Low 1	4.0 A
Receive	Squelched	500 mA
	Max. audio output	800 mA
- Usable temperature range : $-10^{\circ}\text{C} \sim +60^{\circ}\text{C}$; $+14^{\circ}\text{F} \sim +140^{\circ}\text{F}$
- Frequency stability : ± 10 ppm
($-10^{\circ}\text{C} \sim +60^{\circ}\text{C}$; $+14^{\circ}\text{F} \sim +140^{\circ}\text{F}$)
- Dimensions : 140(W) x 40(H) x 155(D) mm
5.5(W) x 1.6(H) x 6.1(D) in
- Weight : 1.0 kg; 2.2 lb

■ TRANSMITTER

- Output power :

High	35 W
Low 3	Approx. 20 W
Low 2	Approx. 10 W
Low 1	Approx. 5 W
- Modulation system : Variable reactance frequency modulation
- Maximum frequency deviation : ± 5 kHz
- Spurious emissions : Less than -60 dB
- Microphone impedance : 600 Ω

■ RECEIVER

- Receive system : Double-conversion superheterodyne
- Intermediate frequencies : 1st 30.875 MHz 2nd 455 kHz
- Sensitivity : Less than 0.16 μV for 12 dB SINAD
- Squelch sensitivity : Less than 0.13 μV
- Spurious response rejection : More than 60 dB
- Audio output power : More than 2.4 W at 10% distortion with an 8 Ω load
- Audio output impedance : 8 Ω

All stated specifications are subject to change without notice or obligation.

SP-10 EXTERNAL SPEAKER

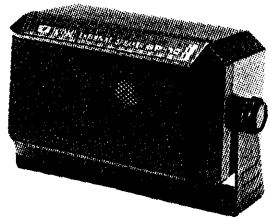

Compact and easy to install.

- Input impedance : 4 Ω
- Max. input power : 5 W

SP-12 EXTERNAL SPEAKER

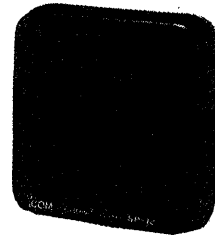

Slim-type speaker for mobile operation.

- Input impedance : 8 Ω
- Max. input power : 3 W

SP-7 EXTERNAL SPEAKER

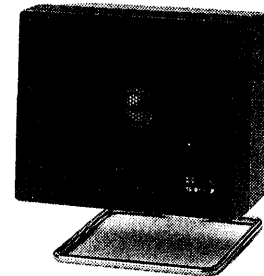

For base station operation.

- Input impedance : 8 Ω
- Max. input power : 5 W

IC-PS30 AC POWER SUPPLY

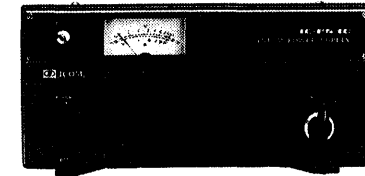

Equipped with 3 output connectors.

- Output voltage : 13.8 V
- Max. current drain : 25 A

HS-15 FLEXIBLE MOBILE MICROPHONE

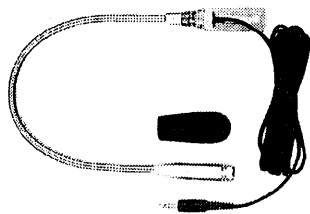

For all-around mobile operations. Used with the HS-15SB.

HS-15SB SWITCHBOX

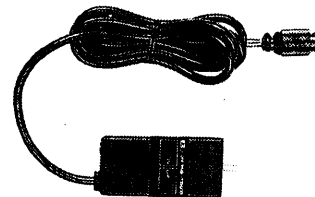

Transmit/receive switch for use with the HS-15.

SM-8 DESKTOP MICROPHONE

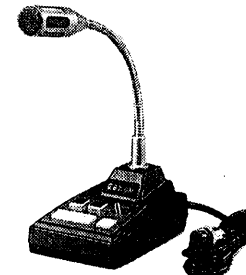

Up/down switches are included. Can be used with 2 Icom transceivers.

HM-56 HAND MICROPHONE
(with DTMF memory)

HM-58 HAND MICROPHONE

HM-59 HAND MICROPHONE

UT-50 TONE SQUELCH UNIT

UT-51 PROGRAMMABLE TONE
ENCODER UNIT

UT-55 DTMF ENCODER/DECODER
UNIT

OPC-044B DC POWER CABLE

SM-6 DESKTOP MICROPHONE

Easy-to-use goose-neck microphone.

Suitable for base station operation.

MB-27 MOBILE MOUNTING BRACKET

MB-34 JOINT PLATES

Stacks the IC-229 series transceivers.

The HM-56, HM-58, HM-59, MB-27 and OPC-044B are same type as supplied with the transceiver.

Count on us!

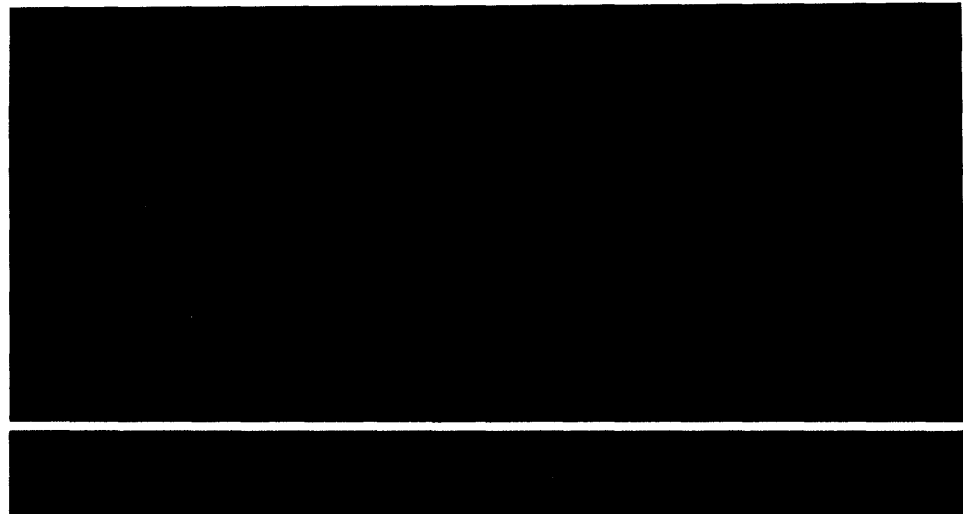

A-5113S-1EX
Printed in Japan
Copyright © 1990 by Icom Inc.

Icom Inc.
6-9-16, Kamihigashi, Hirano-ku, Osaka 547, Japan
