



SERVICE MANUAL

430MHz ALL MODE TRANSCEIVER

IC-475A

IC-475E

IC-475H

Downloaded by
RadioAmateur.EU

SCOPE OF THE SERVICE MANUAL

This service manual covers all service information related to the theoretical, physical, mechanical and electrical characteristics of the **IC-475A/E/H** 430MHz ALL MODE TRANSCEIVER.



ASSISTANCE

If you require assistance or further information regarding the operation, capability and servicing of the **IC-475A/E/H**, contact your nearest authorized ICOM Dealer or ICOM Service Center. Addresses are provided on the inside back cover for your convenience.

Eight separate versions of the **IC-475A/E/H** have been designed. This service manual covers every version. When using the manual each model can be referred to by the following assigned version numbers:

IC-475A/E Model

Version Number	Area
#06E	EUROPE
#08A	U.S.A.
#10A	AUSTRALIA
#12E	SWEDEN

IC-475H Model

Version Number	Area
#02H	EUROPE
#03H	U.S.A.
#04H	AUSTRALIA
#05H	SWEDEN

ORDERING REPLACEMENT PARTS

For faster, more efficient service include the following points when ordering parts or requesting information from your ICOM Service Center.

1. Equipment model and serial number
2. Schematic part identifier or service manual page number
3. Unit name and printed circuit board number (e.g., PA UNIT/B-1382B)
4. Component part number and name (e.g., 2SD880 Transistor)
5. Quantity required (e.g., 10pcs)

TABLE OF CONTENTS

SECTION 1	SPECIFICATIONS	1 — 1 ~ 2
SECTION 2	OUTSIDE AND INSIDE VIEWS	2 — 1 ~ 5
2-1	OUTSIDE VIEWS	2 — 1
2-2	INSIDE VIEWS	2 — 4
SECTION 3	BLOCK DIAGRAMS	3 — 1
SECTION 4	CIRCUIT DESCRIPTION	4 — 1 ~ 14
4-1	RECEIVER CIRCUITS	4 — 1
4-2	TRANSMITTER CIRCUITS	4 — 3
4-3	STANDBY CONTROL CIRCUIT	4 — 6
4-4	PLL CIRCUITS	4 — 6
4-5	LOGIC CIRCUITS	4 — 9
4-6	SWITCHING REGULATOR CIRCUIT (IC-475A/E ONLY)	4 — 14
SECTION 5	MECHANICAL PARTS AND DISASSEMBLY	5 — 1 ~ 7
5-1	FRAME DISASSEMBLY	5 — 1
5-2	FRONT PANEL DISASSEMBLY	5 — 2
5-3	REAR PANEL DISASSEMBLY	5 — 3
5-4	FRONT, LOGIC AND PLL UNITS CONNECTOR ASSEMBLY	5 — 4
5-5	FRONT, MAIN AND RF YGR UNITS CONNECTOR ASSEMBLY	5 — 5
5-6	PA AND REG UNITS CONNECTOR ASSEMBLY (IC-475A/E)	5 — 6
5-7	PA, CTRL AND FILTER UNITS CONNECTOR ASSEMBLY (IC-475H)	5 — 7
SECTION 6	MAINTENANCE AND ADJUSTMENT	6 — 1 ~ 25
6-1	PREPARATION BEFORE SERVICING	6 — 1
6-2	PLL ADJUSTMENT	6 — 2
6-3	FREQUENCY ADJUSTMENT	6 — 4
6-4	RECEIVER ADJUSTMENT	6 — 6
6-5	TRANSMITTER ADJUSTMENT (IC-475H)	6 — 12
6-6	TRANSMITTER ADJUSTMENT (IC-475A/E)	6 — 18
6-7	TONE ADJUSTMENT	6 — 24
SECTION 7	BOARD LAYOUTS	7 — 1 ~ 22
7-1	FRONT UNITS (1)	7 — 1
7-2	FRONT UNIT (2)	7 — 2
7-3	LOGIC AND SENSOR UNITS	7 — 4
7-4	PLL AND DDS UNITS	7 — 6
7-5	MAIN UNIT	7 — 8
7-6	RF YGR UNIT (IC-475A/E)	7 — 10
7-7	RF YGR UNIT (IC-475H)	7 — 12
7-8	REG UNIT (IC-475A/E ONLY)	7 — 14
7-9	PA UNIT (IC-475A/E)	7 — 16
7-10	CTRL UNIT (IC-475H ONLY)	7 — 18
7-11	PA UNIT (IC-475H)	7 — 20
7-12	FILTER UNIT (IC-475H ONLY)	7 — 22

SECTION 8	VOLTAGE DIAGRAMS	8 — 1 ~ 7
8-1	FRONT UNIT	8 — 1
8-2	LOGIC UNIT	8 — 2
8-3	PLL UNIT	8 — 3
8-4	MAIN UNIT	8 — 4
8-5	RF YGR UNIT	8 — 5
8-6	REG AND PA UNITS (IC-475A/E ONLY)	8 — 6
8-7	CTRL, PA AND FILTER UNITS (IC-475H ONLY)	8 — 7
SECTION 9	PARTS LIST	9 — 1 ~ 20

The SCHEMATIC DIAGRAM is attached at the end of this service manual.

SECTION 1 SPECIFICATIONS

GENERAL

- Frequency coverage : U.S.A. Versions (#08A, #03H) 430.0000~450.0000 MHz
Europe Versions (#06E, #02H) 430.0000~440.0000 MHz
Australia Versions (#10A, #04H) 430.0000~450.0000 MHz
Sweden Versions (#12E, #05H) 432.0000~438.0000 MHz
- Number of memory channels : 99 channels plus P1, P2 and CALL CHANNEL
- Antenna impedance : 50Ω unbalanced
- Frequency stability : ±5ppm (0°C~+50°C)
- Power supply requirement : #08A version 117V AC±10%
#06E, #10A and #12E versions 240V AC±10%
All versions 13.8V DC±15%
- Current drain (at 13.8V DC) : IC-475A/E
Transmitting HIGH (25W) Approx. 7.5 A
LOW (2.5W) Approx. 3.5 A
Receiving At maximum audio output Approx. 1.3 A
Squelched Approx. 1.1 A
IC-475H
Transmitting HIGH (75W) Approx. 20 A
LOW (10W) Approx. 8.0 A
Receiving At maximum audio output Approx. 1.3 A
Squelched Approx. 1.1 A
- Dimensions : IC-475A/E
241(244)mm(W)×95(108)mm(H)×239(295)mm(D)
IC-475H
241(244)mm(W)×95(108)mm(H)×239(277)mm(D)
Bracketed values include projections.
- Weight : IC-475A/E 6.3kg
IC-475H 6.0kg
- Usable temperature range : -10°C~+60°C

TRANSMITTER

- Emission modes : FM (F3), SSB (A3J), CW (A1)
- RF output power : IC-475A/E
2.5~25W continuously adjustable
IC-475H
10~75W continuously adjustable
- Modulation system : FM Variable reactance frequency modulation
SSB Balanced modulation
- Maximum frequency deviation : ±5kHz (FM mode)
- Spurious output : More than 60dB below peak output power
- Carrier suppression : More than 40dB below peak output power
- Unwanted sideband : More than 40dB down with 1000Hz AF input
- Microphone impedance : 600Ω

■ RECEIVER

- Receive system : Quadruple conversion superheterodyne (SSB, CW)
Triple conversion superheterodyne (FM)
- Receive modes : FM (F3), SSB (A3J), CW (A1)
- Intermediate frequencies : 1st 70.4515MHz (FM, SSB) 70.4506MHz (CW)
2nd 9.0115MHz (FM, SSB) 9.0106MHz (CW)
3rd 455kHz (All modes)
4th 9.0115MHz (SSB) 9.0106MHz (CW)
- Sensitivity (with a 50Ω load) : FM Less than 0.18μV for 12dB SINAD
Less than 0.25μV for 20dB NQL
SSB, CW Less than 0.1μV for 10dB S/N
- Squelch sensitivity : FM Less than 0.14μV
SSB Less than 0.56μV
- Selectivity : FM 15.0kHz/−6dB 30.0kHz/−60dB
SSB, CW 2.3kHz/−6dB 4.0kHz/−60dB
- Spurious response rejection : More than 70dB
- Audio output impedance : 8Ω
- Audio output power : More than 2W at 10% distortion with an 8Ω load
- RIT variable range : ±9.99kHz

SECTION 2 OUTSIDE AND INSIDE VIEWS

2-1 OUTSIDE VIEWS

2-1-1 FRONT PANEL

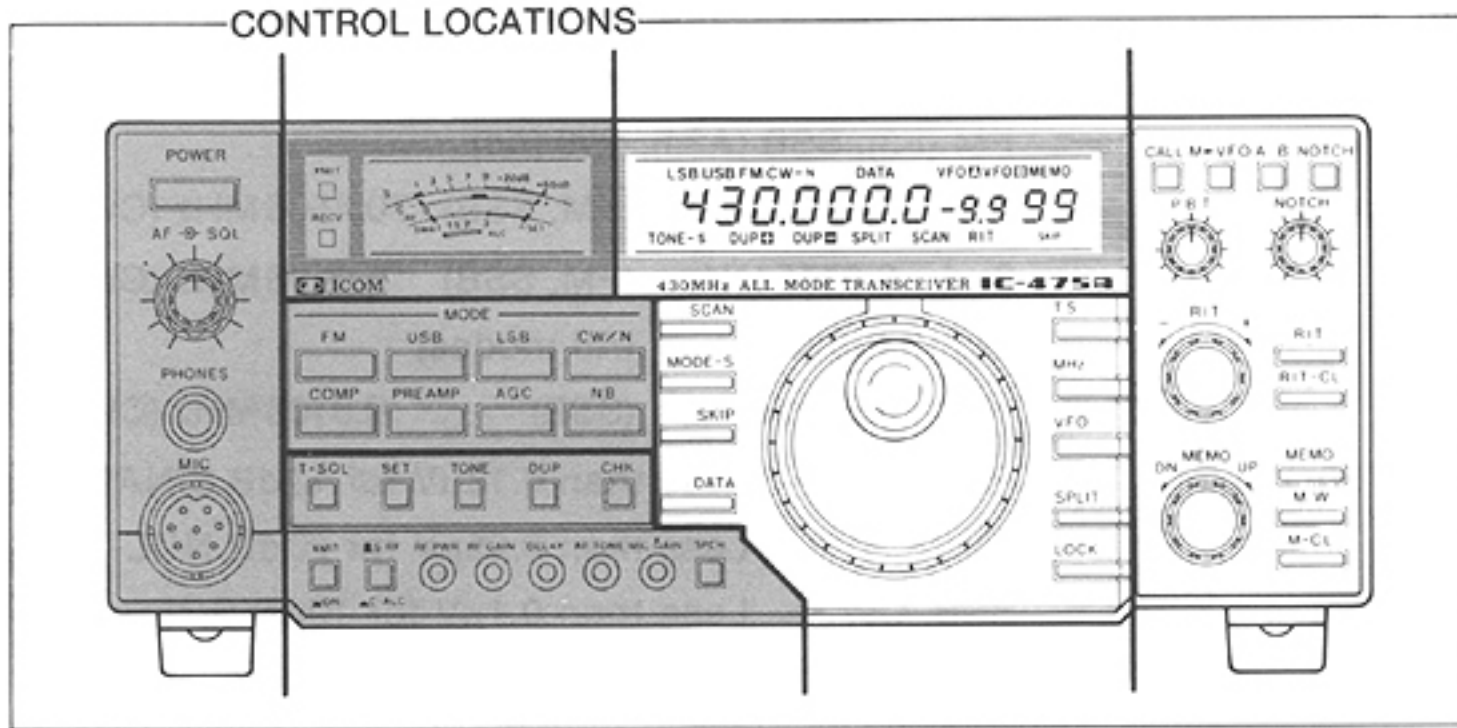

POWER SWITCH

AF GAIN CONTROL

SQUELCH CONTROL

PHONES JACK

MIC CONNECTOR

TRANSMIT INDICATOR

RECEIVE INDICATOR

METER

MODE SELECTOR SWITCHES

SPEECH COMPRESSOR SWITCH

PREAMP SWITCH

AGC SWITCH

NOISE BLANKER SWITCH

DUPLEX CHECK SWITCH

DUPLEX SWITCH

SUBAUDIBLE TONE FREQUENCY/

TONE CALL SWITCH

TONE SQUELCH SWITCH

TONE SET SWITCH

TRANSMIT/RECEIVE SWITCH

METER SWITCH

RF POWER CONTROL

RF GAIN CONTROL

CW DELAY CONTROL

AF TONE CONTROL

MIC GAIN CONTROL

SPEECH SWITCH

• FRONT PANEL (CONTINUED)

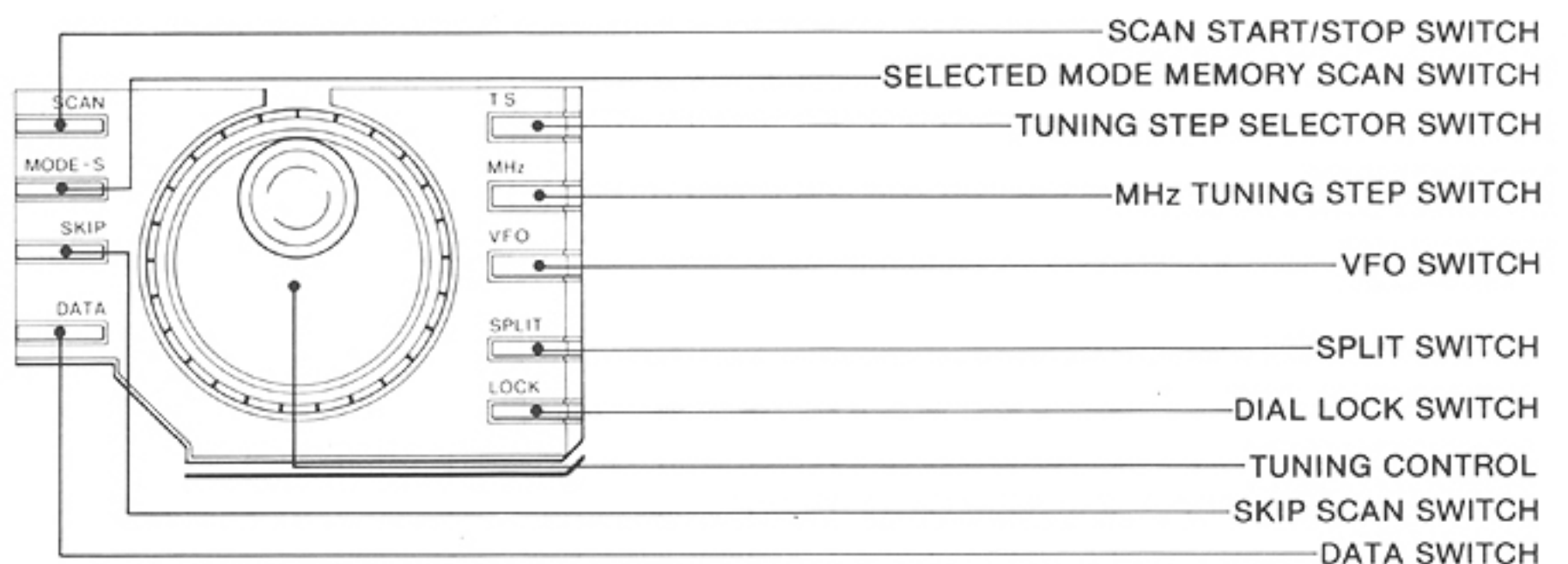
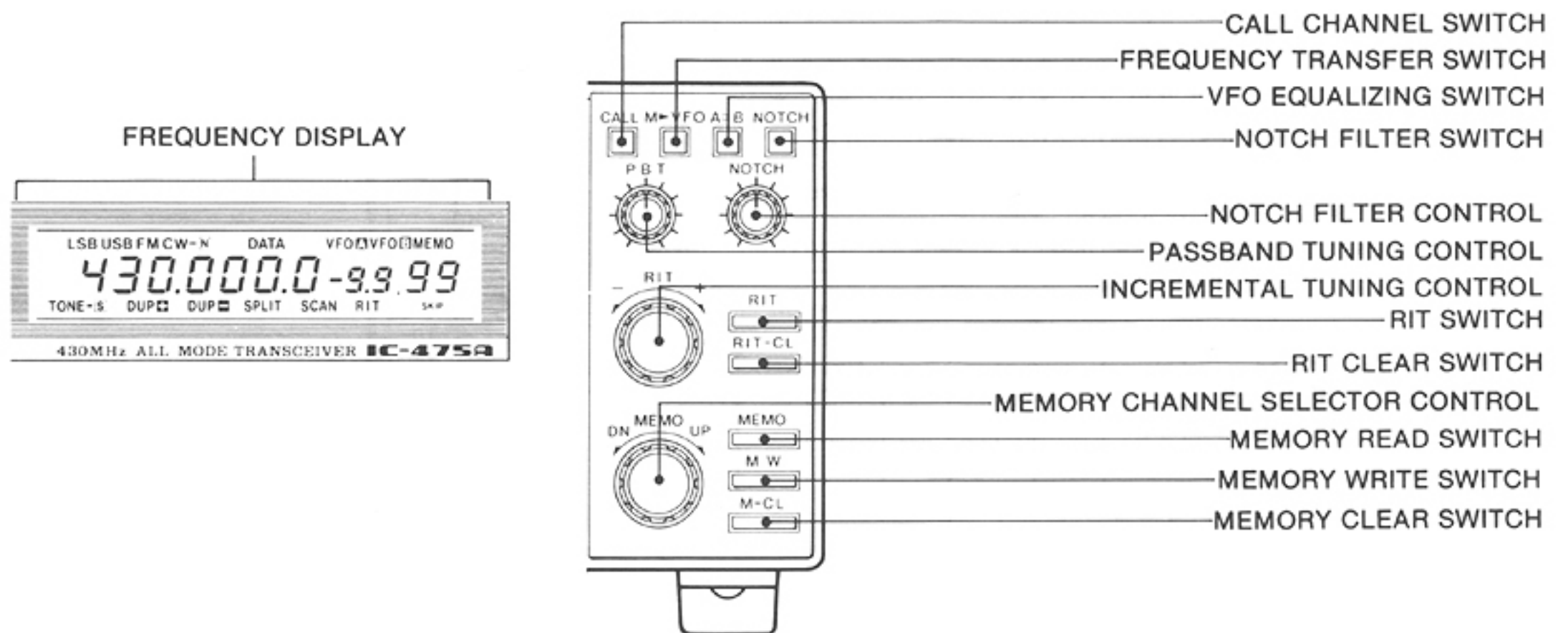
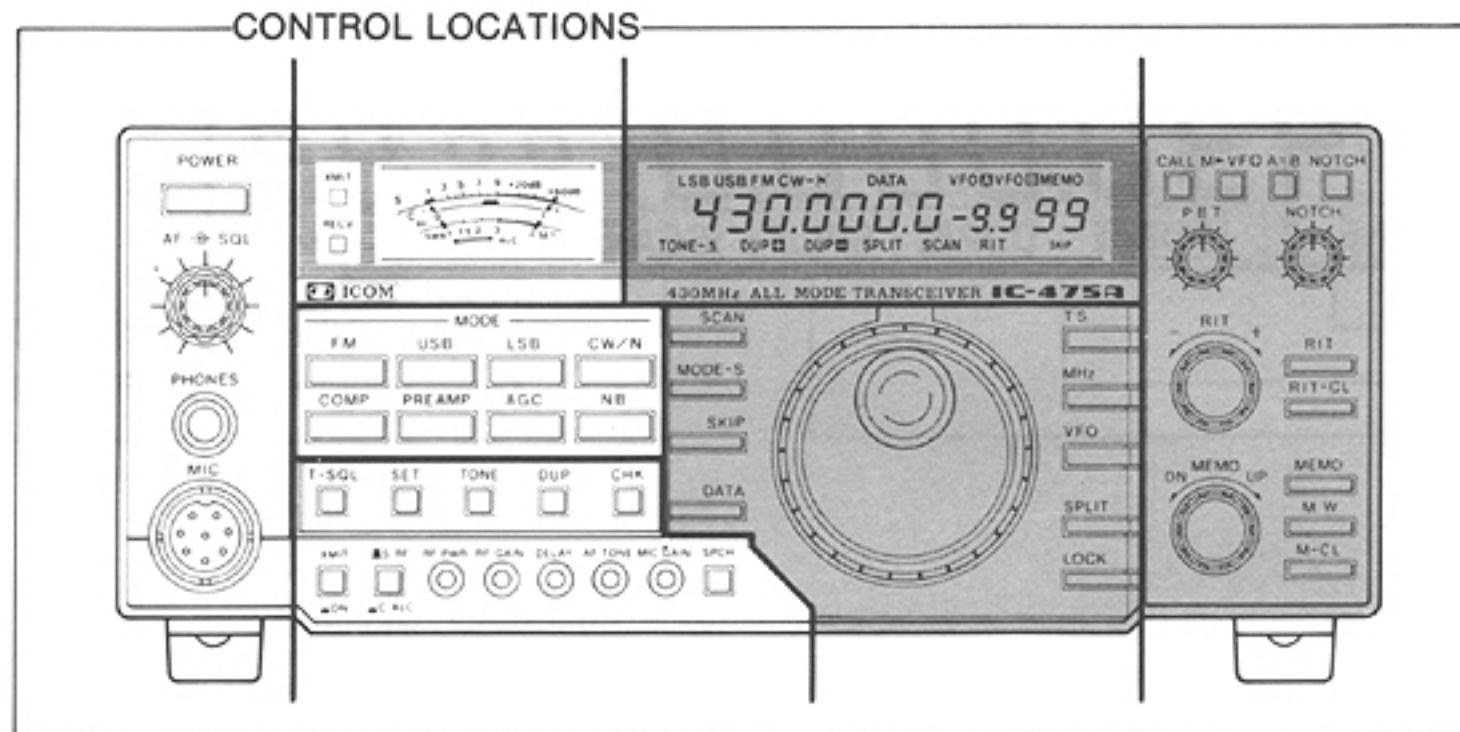

2-1-2 FREQUENCY DISPLAY

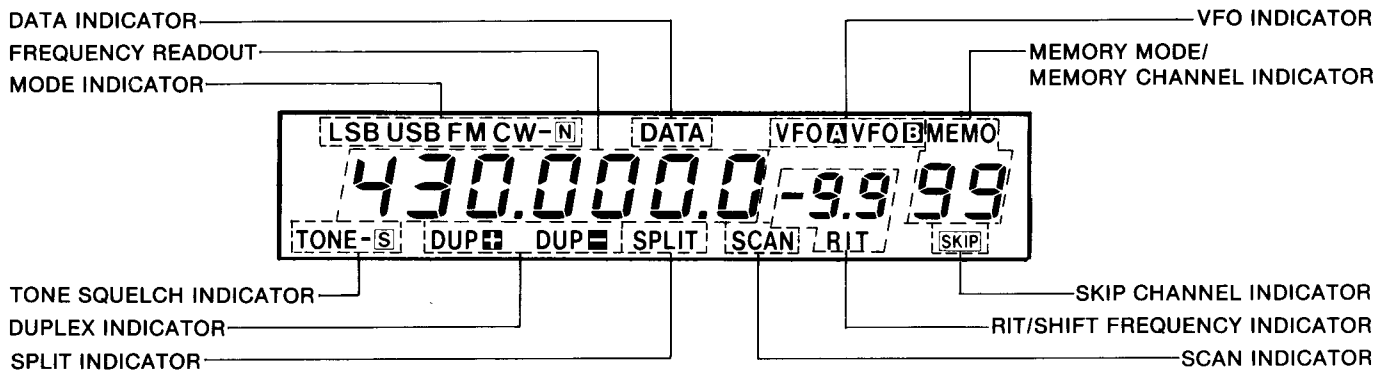

2-1-3 REAR PANEL

• IC-475A/E

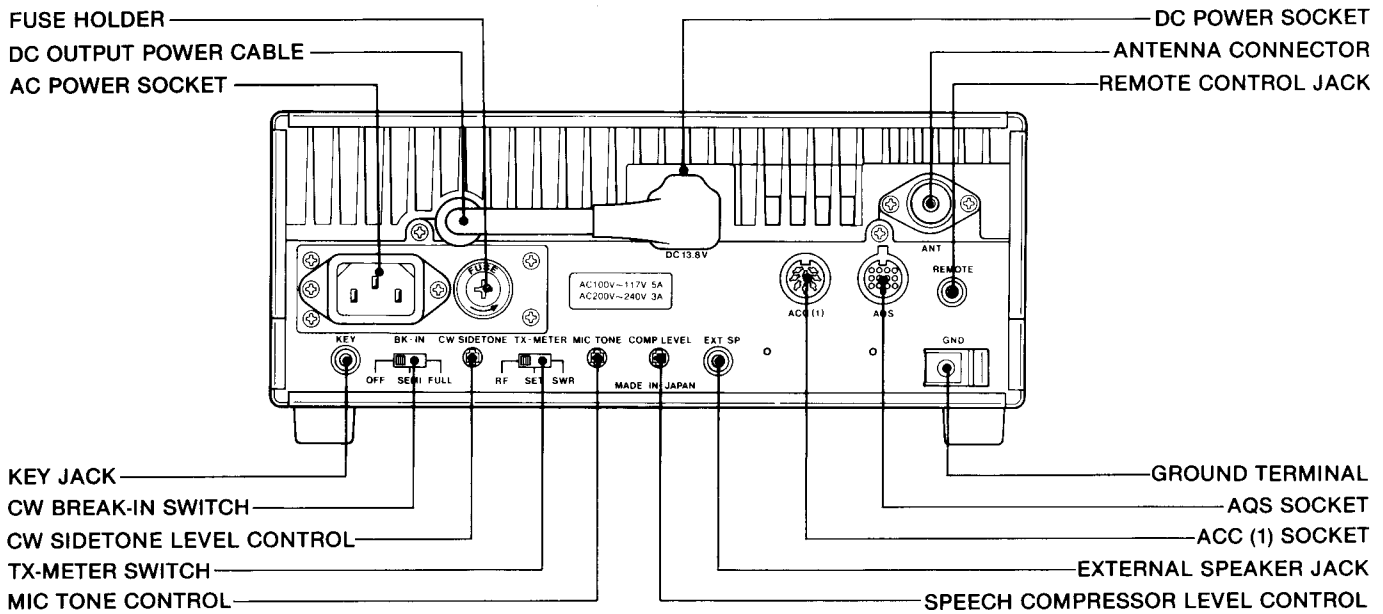

• IC-475H

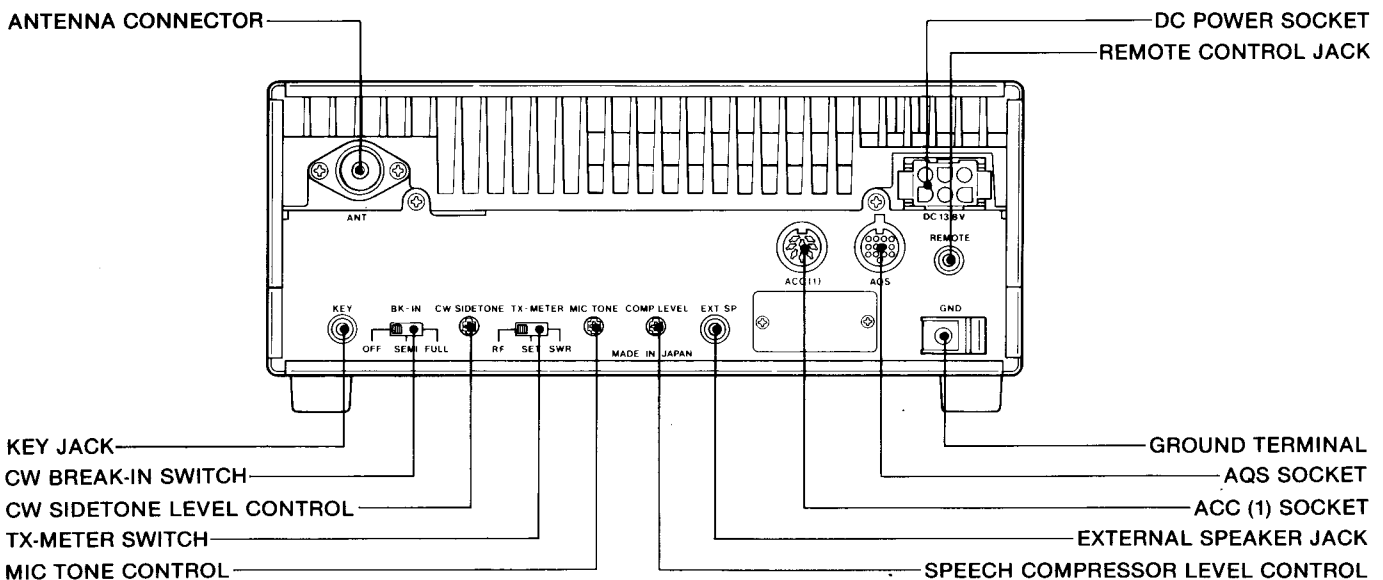

2-2 INSIDE VIEWS

2-2-1 PLL AND LOGIC UNITS

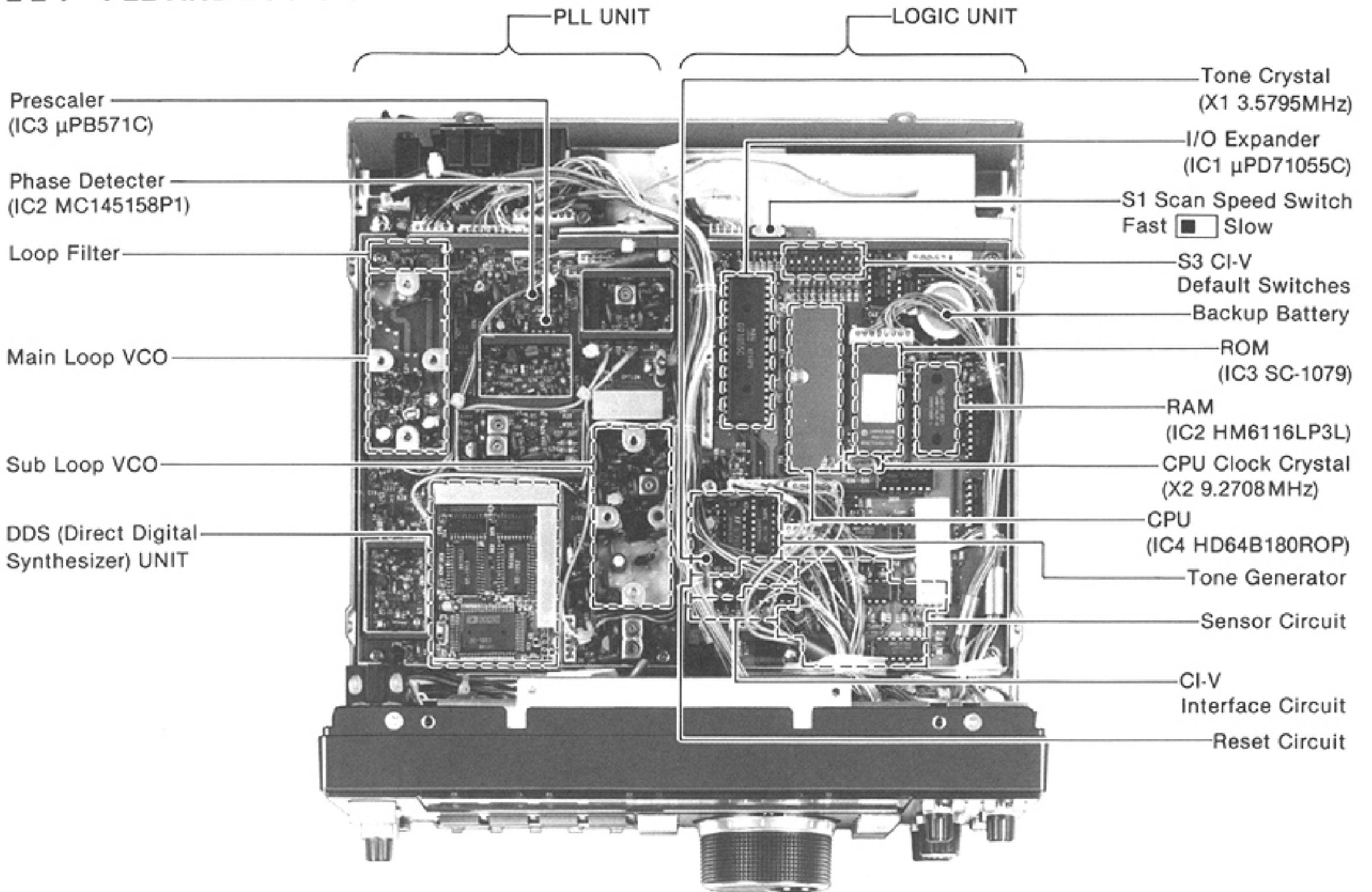

2-2-2 MAIN AND RF YGR UNITS

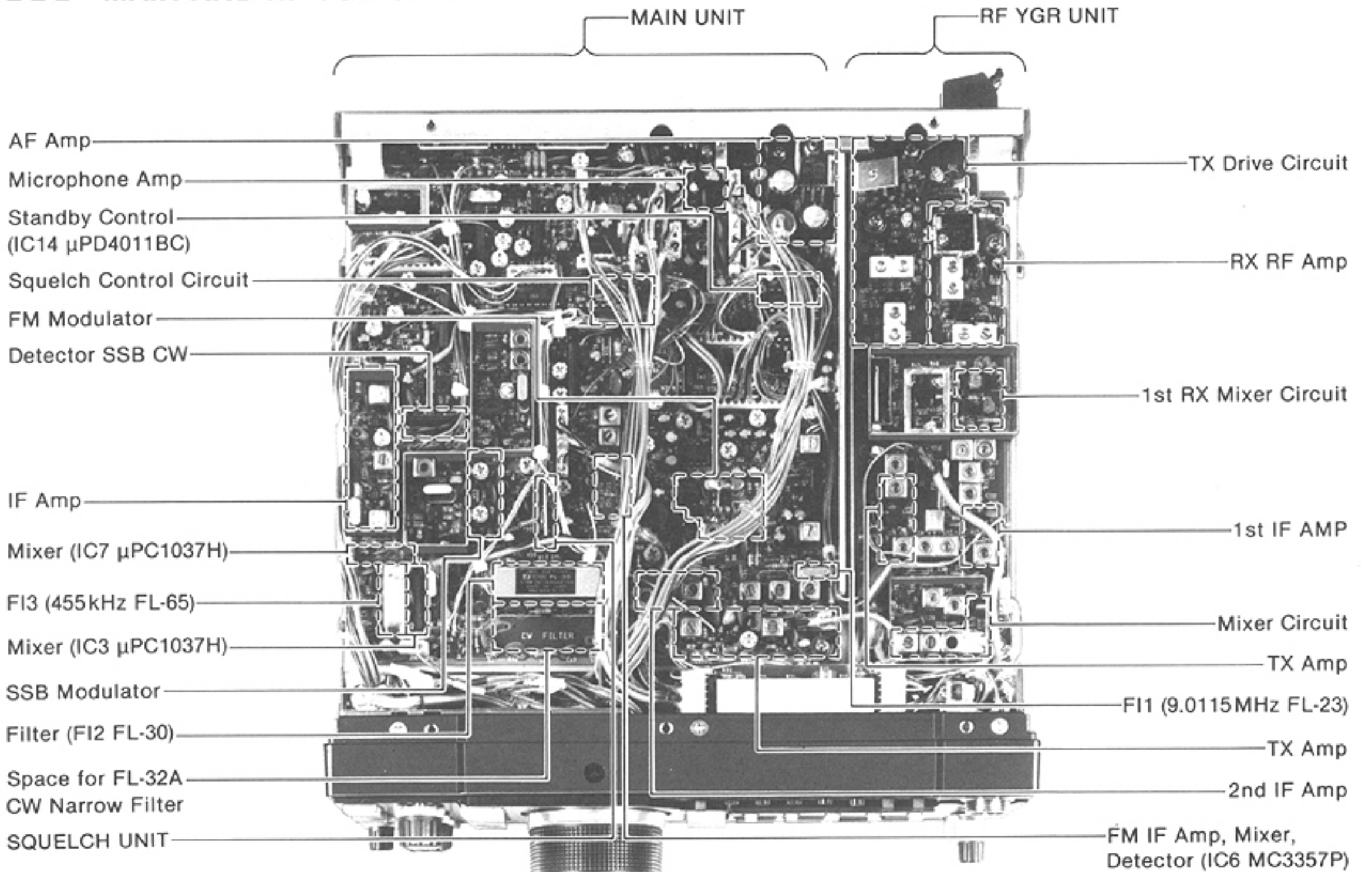

These pictures show the IC-475H model.

2-2-3 PA AND REG UNITS (IC-475A/E)

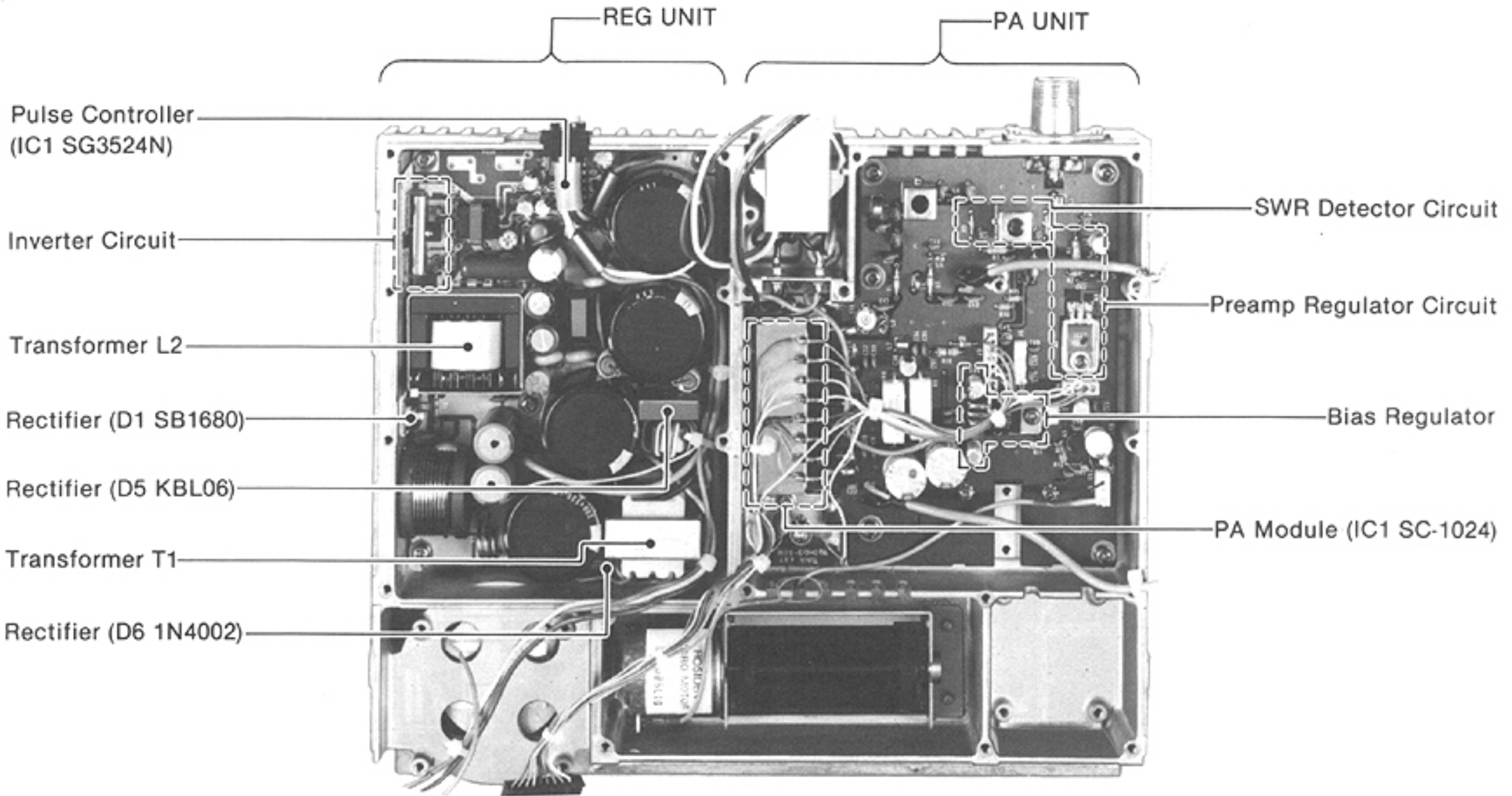

2-2-4 FILTER, CTRL AND PA UNITS (IC-475H)

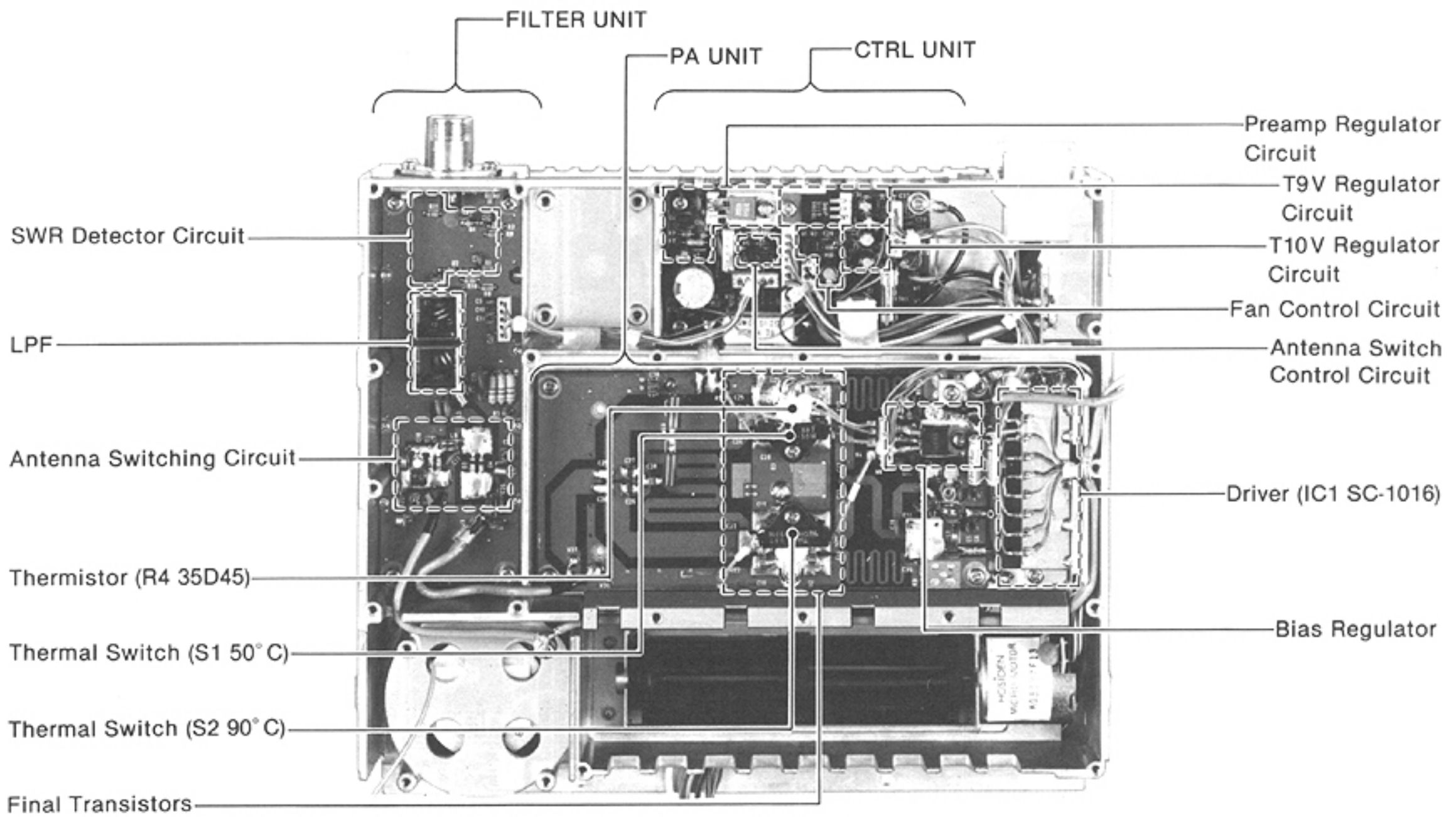

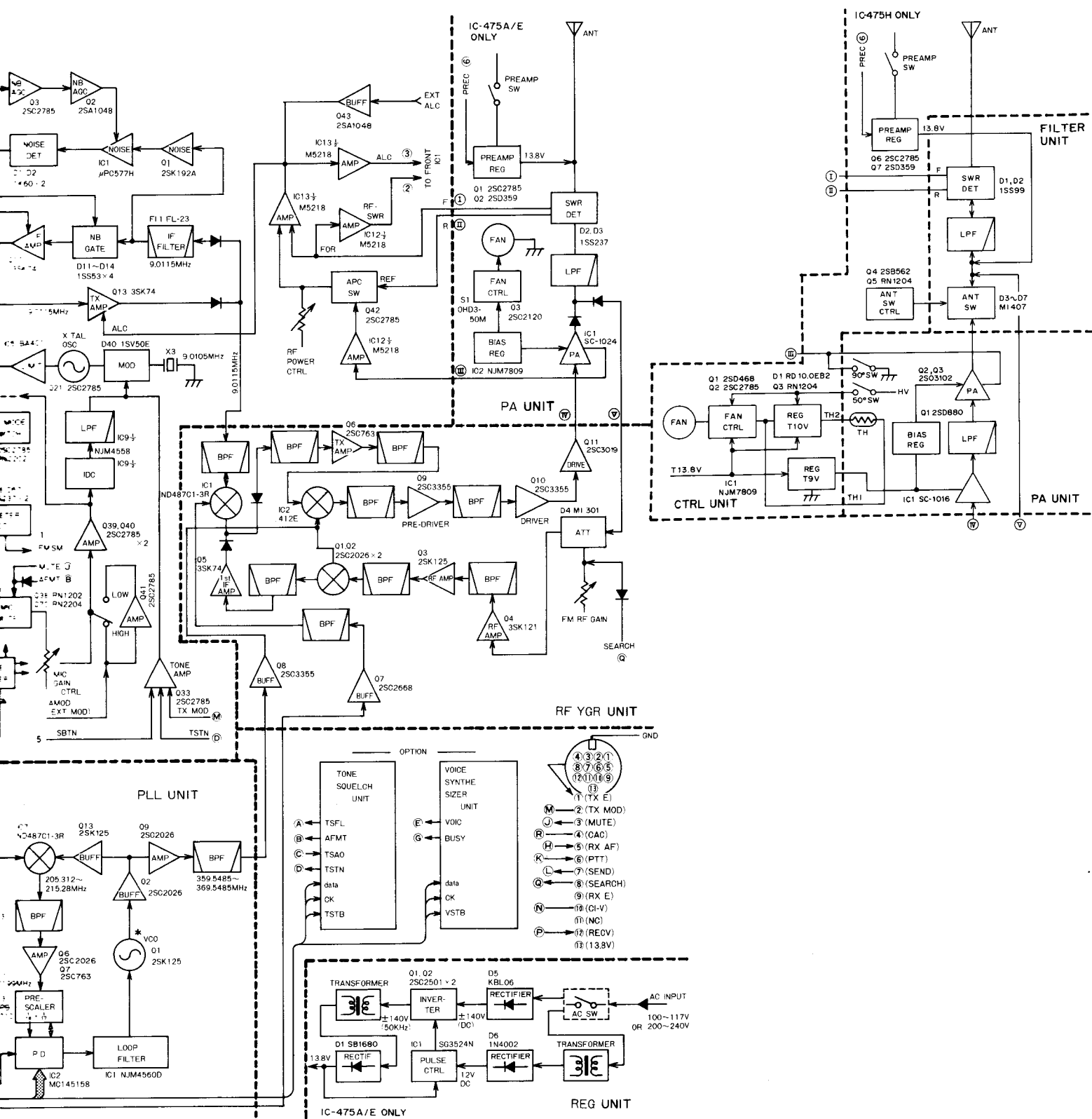

* VCO

VERSION	FREQUENCY
#02H, #06E	359.5485~369.5485MHz
#03H, #04H, #08A, #10A	359.5485~379.5485MHz
#05H, #12E	361.5485~367.5485MHz

SECTION 4 CIRCUIT DESCRIPTION

4-1 RECEIVER CIRCUITS

4-1-1 ANTENNA~MIXER CIRCUIT

This circuitry makes IF signals from receive signals.

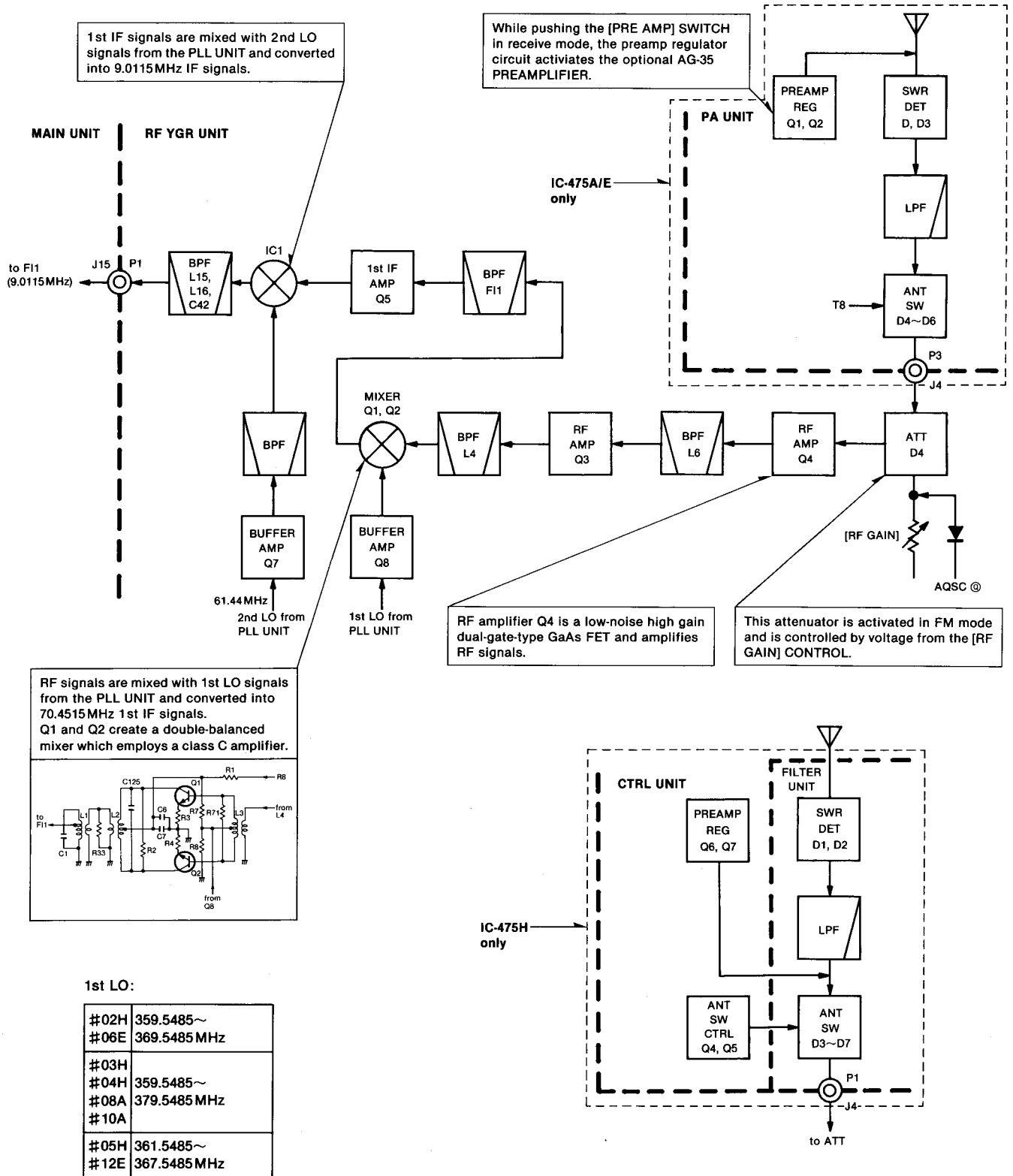
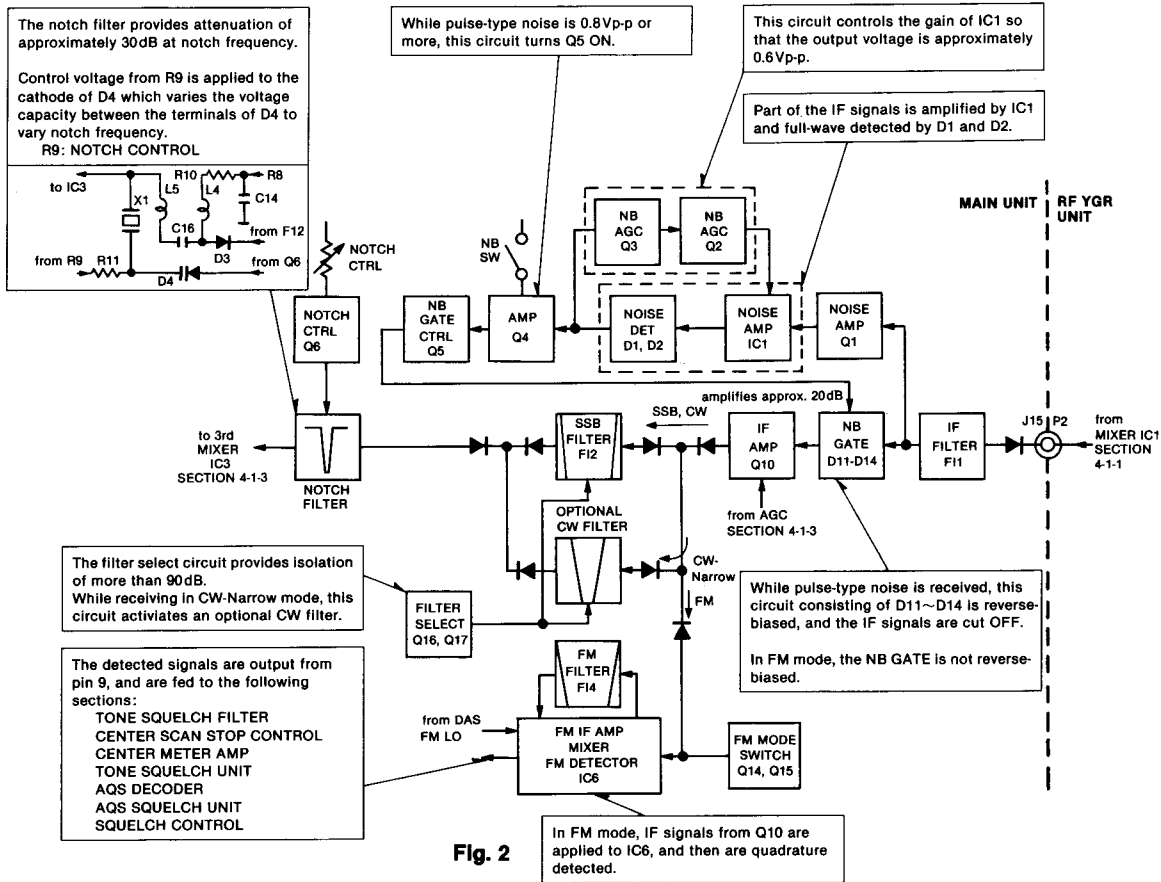

Fig. 1

4-1-2 NOISE BLANKER CIRCUIT~NOTCH FILTER, FM DETECTOR

This circuitry suppresses pulse-type noise from IF signals.
In FM mode, this circuitry makes AF signals from IF signals.



4-1-3 3rd MIXER CIRCUIT~AF AMP

In SSB or CW mode, this circuitry makes AF signals from IF signals.
In FM mode, AF signals from IC6 are amplified.

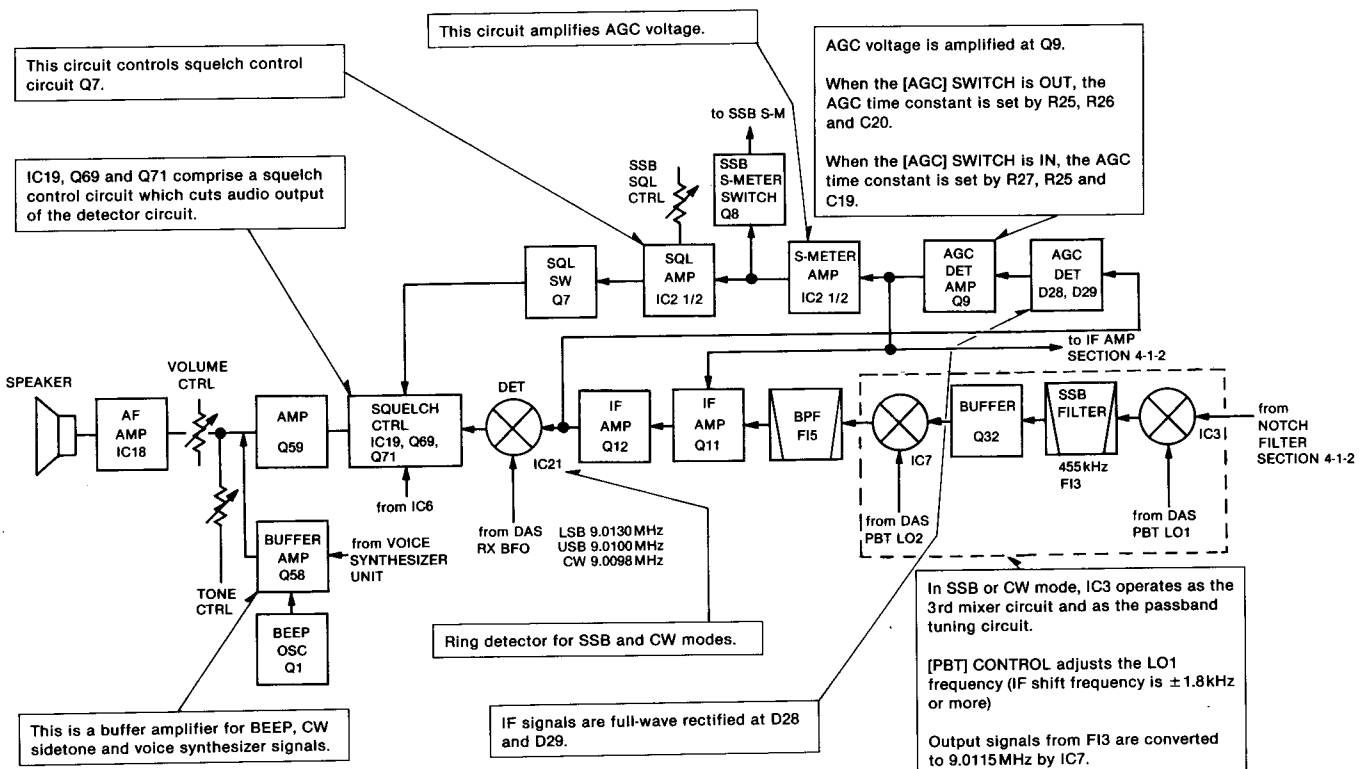

4-1-4 FM SQUELCH, FM S-METER AND CENTER METER CIRCUITS

In FM mode, this circuitry performs as FM squelch, FM S-meter and center meter drivers.

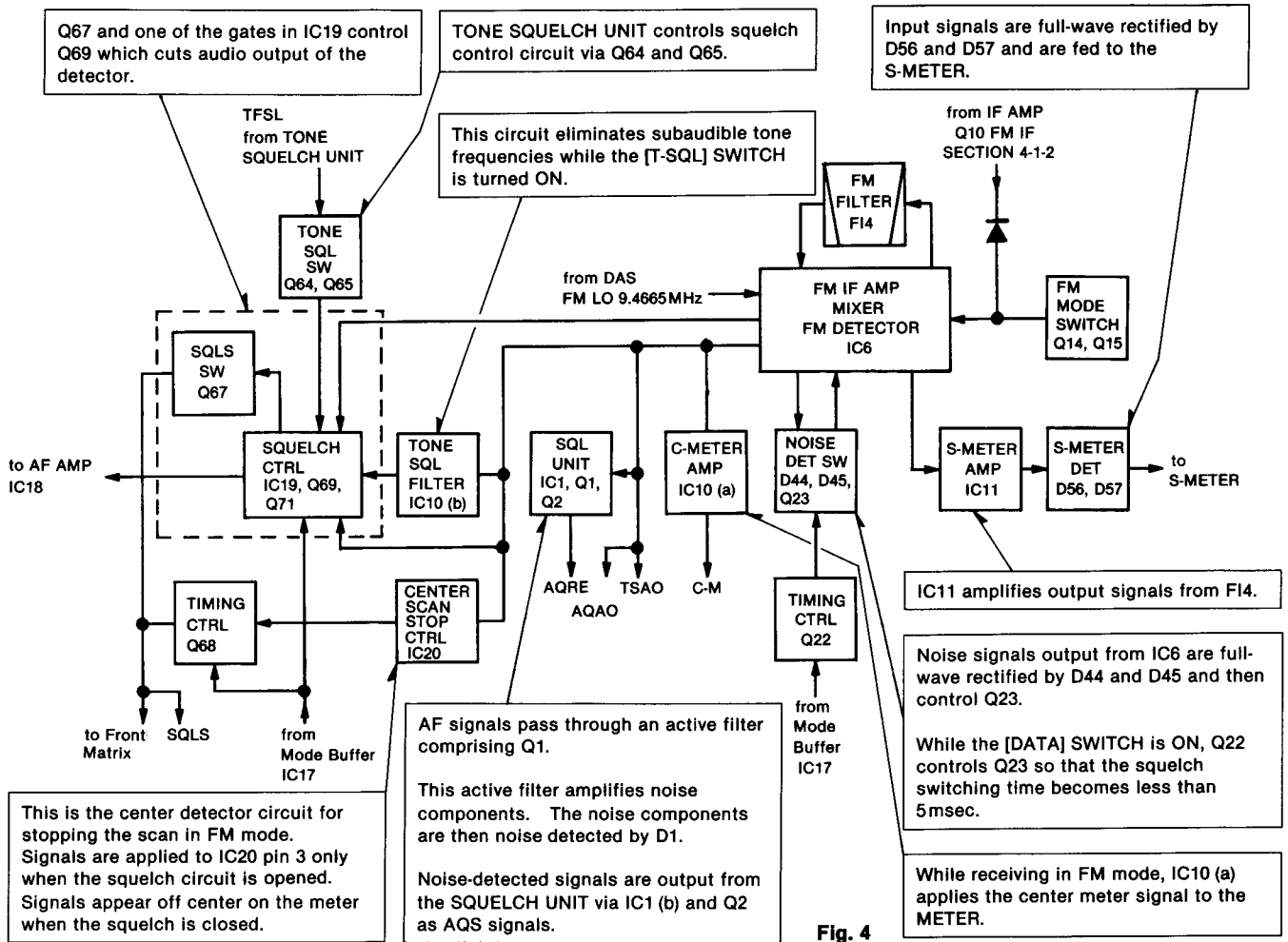

4-2 TRANSMITTER CIRCUITS

4-2-1 CW MODE (KEY~CW FILTER, SSB FILTER)

In CW mode, this circuitry makes transmit IF signals from CW keying signals.

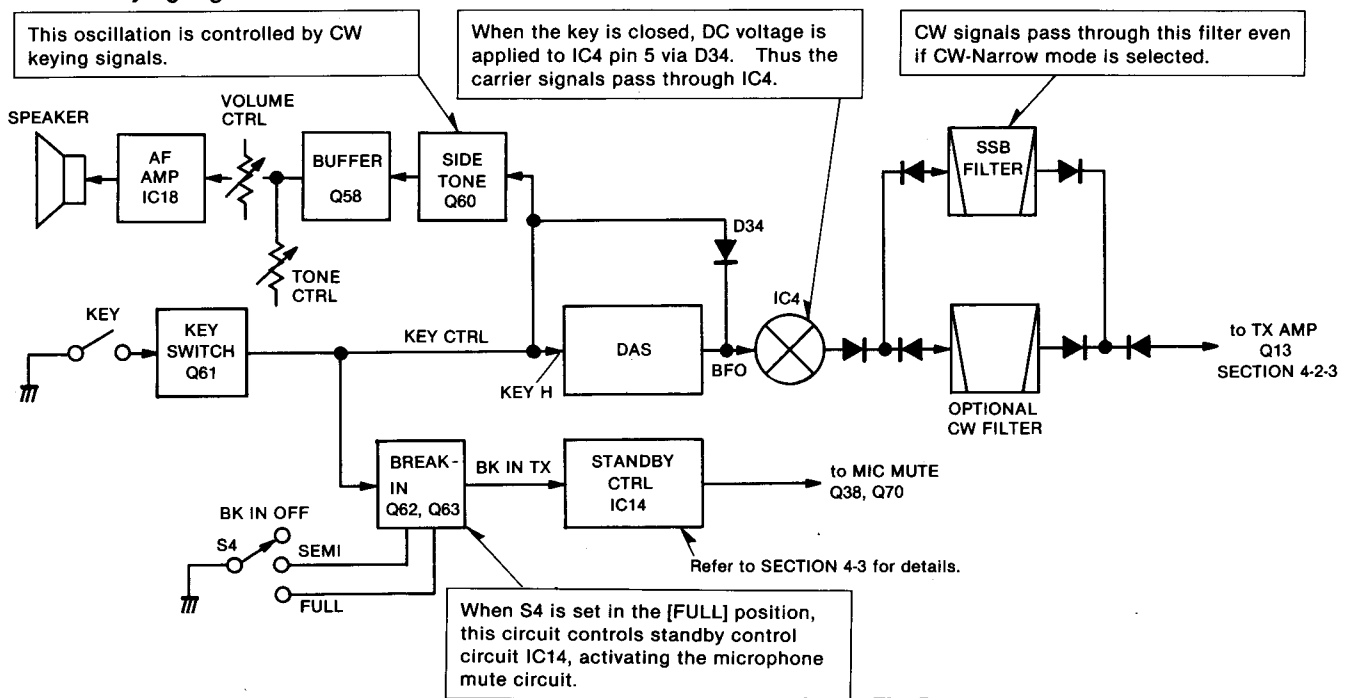

4-2-2 FM, SSB MODE (MICROPHONE~FM MODULATOR, SSB FILTER)

In FM or SSB mode, this circuitry makes transmit IF signals from microphone signals.

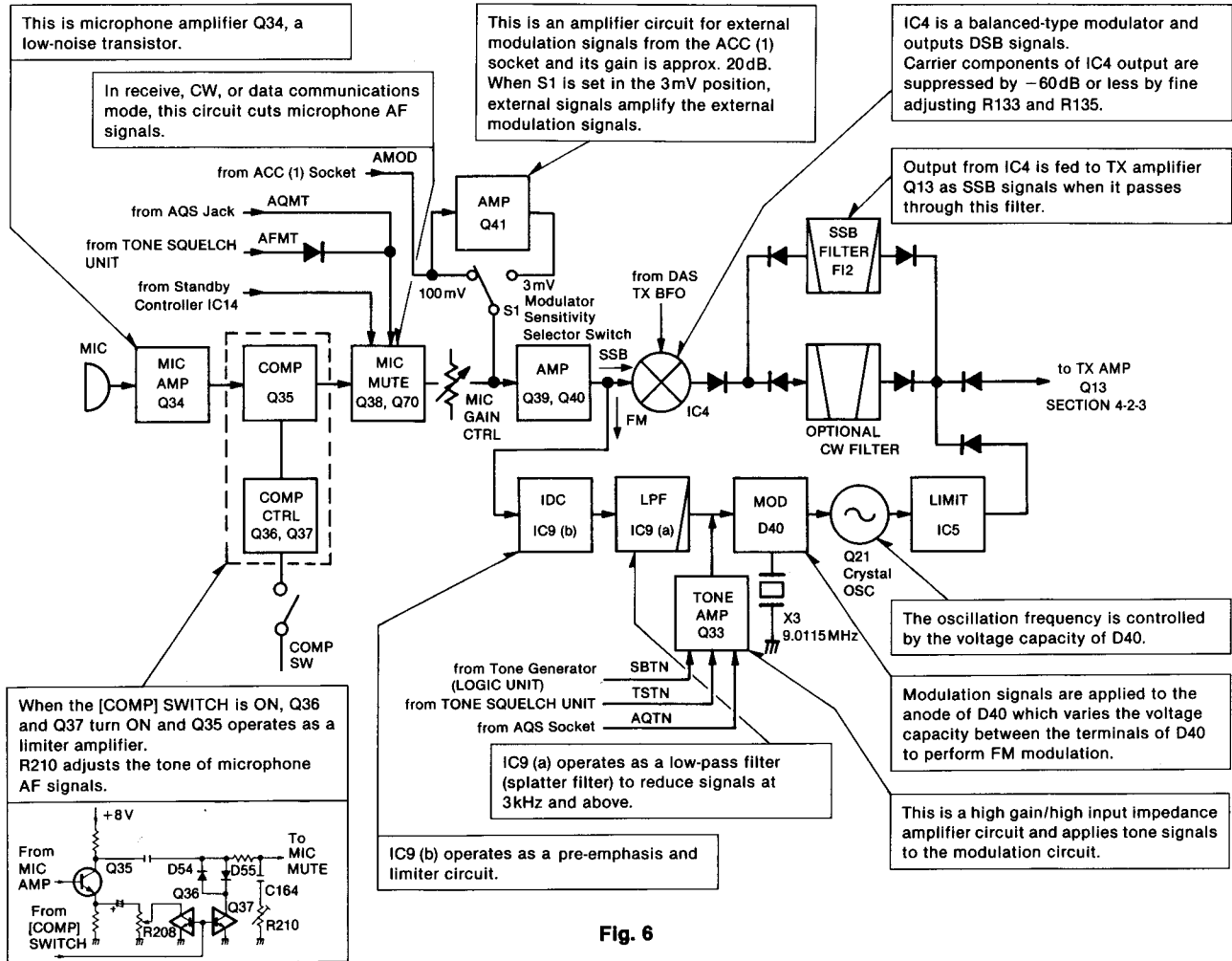

Fig. 6

4-2-3 TX AMP~DRIVE AMP

This circuitry makes 430MHz-band signals from IF signals.

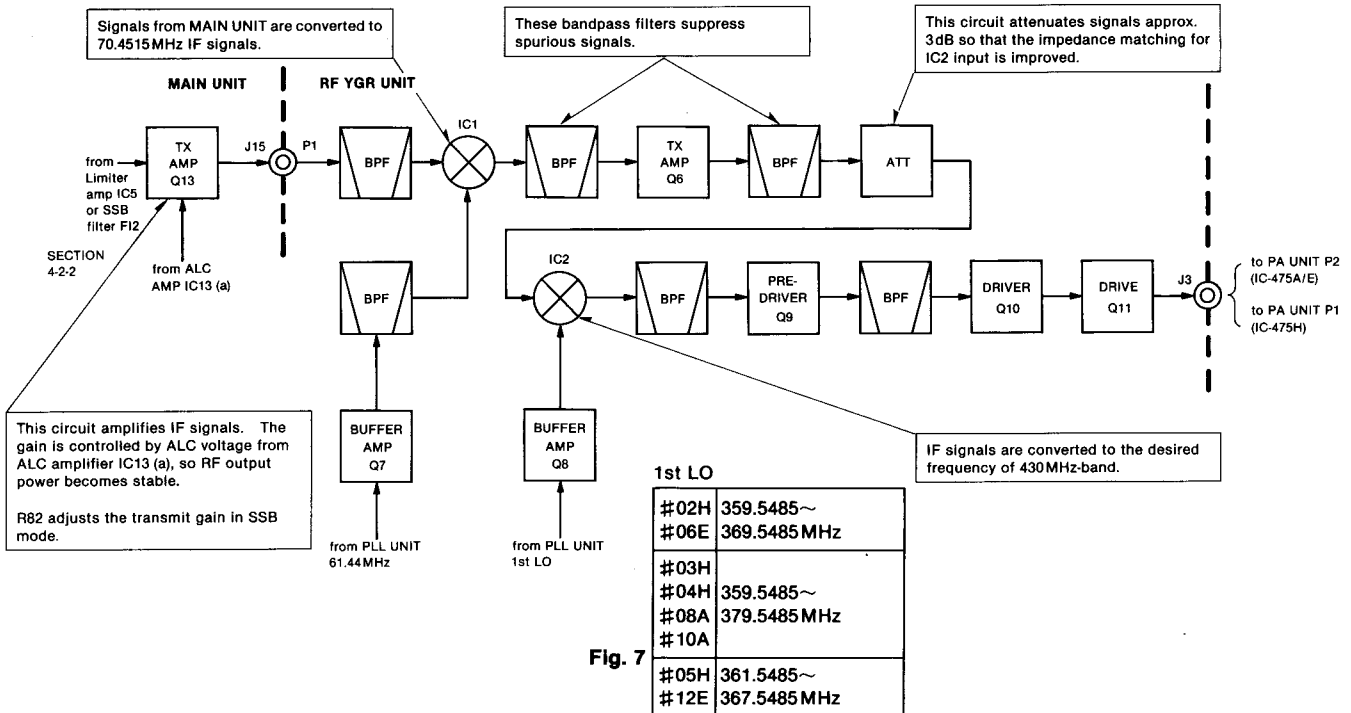

Fig. 7

4-2-4 DRIVER, PA~ANTENNA (IC-475A/E)

This circuitry makes RF signals from transmit IF signals.

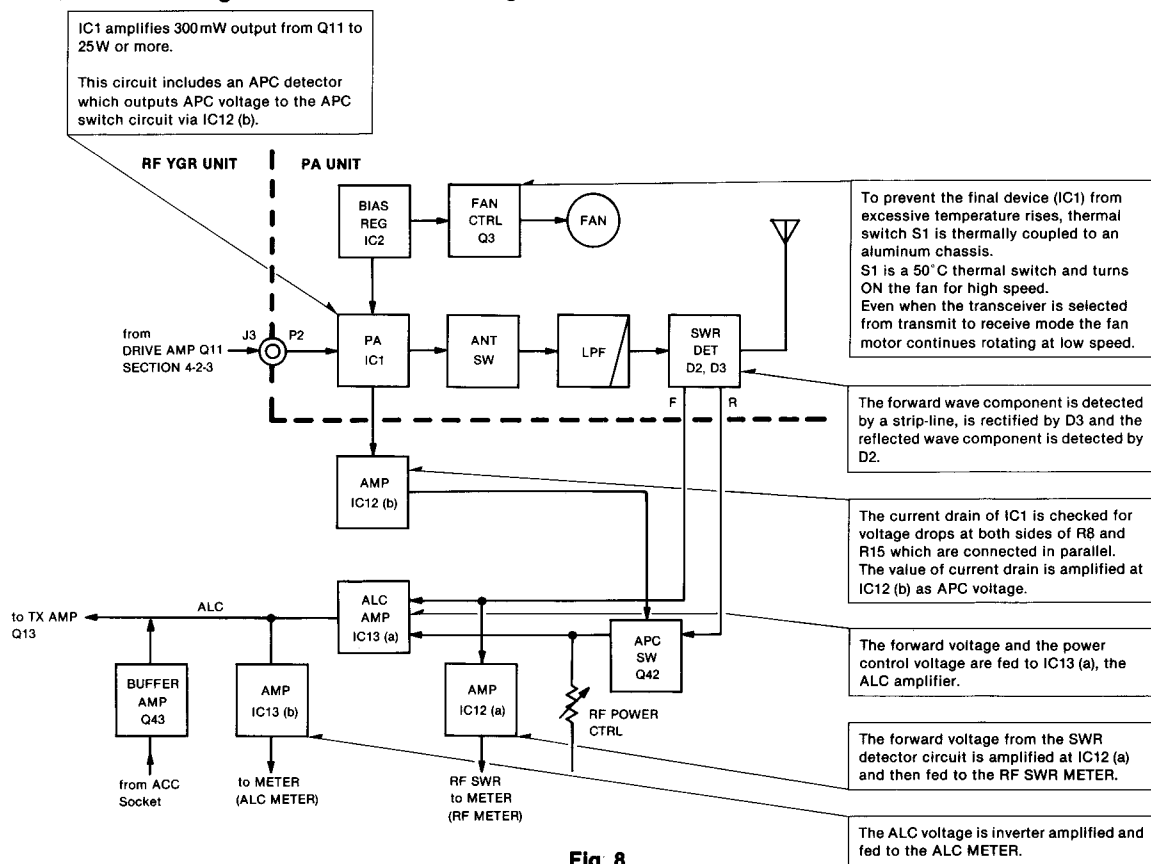

Fig. 8

(IC-475H)

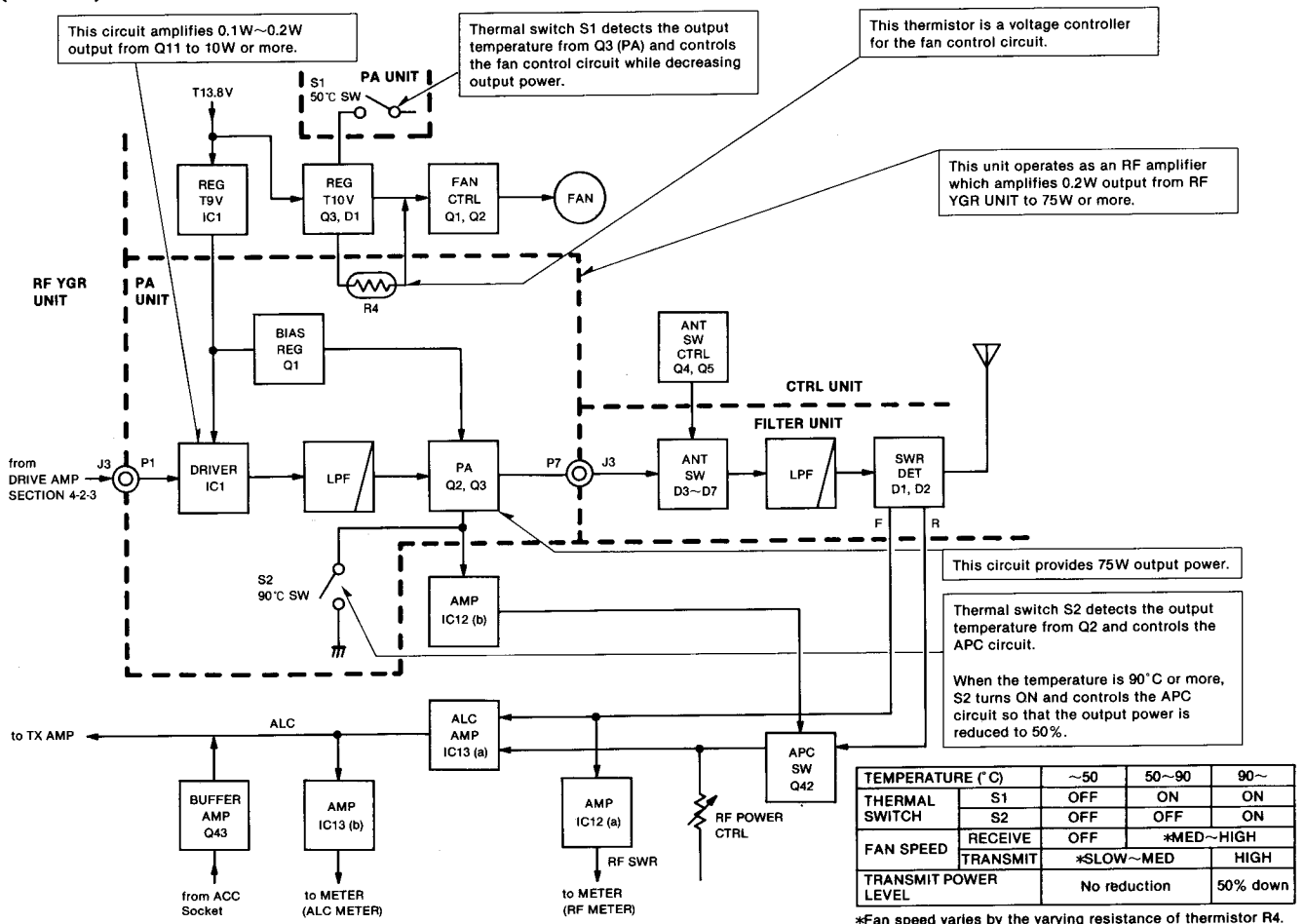

Fig. 9

4-3 STANDBY CONTROL CIRCUIT

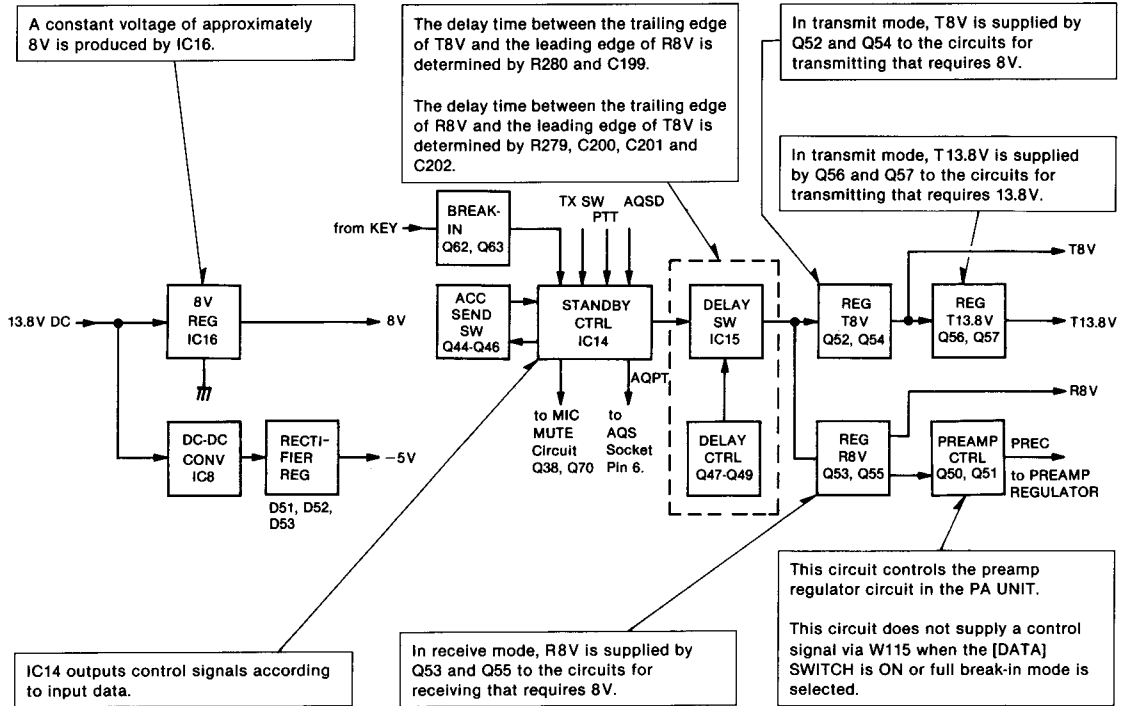

Fig. 10

4-4 PLL CIRCUITS

4-4-1 GENERAL

The PLL UNIT outputs two oscillator signals for the RF YGR UNIT: a variable 1st LO output and a fixed 2nd LO output.

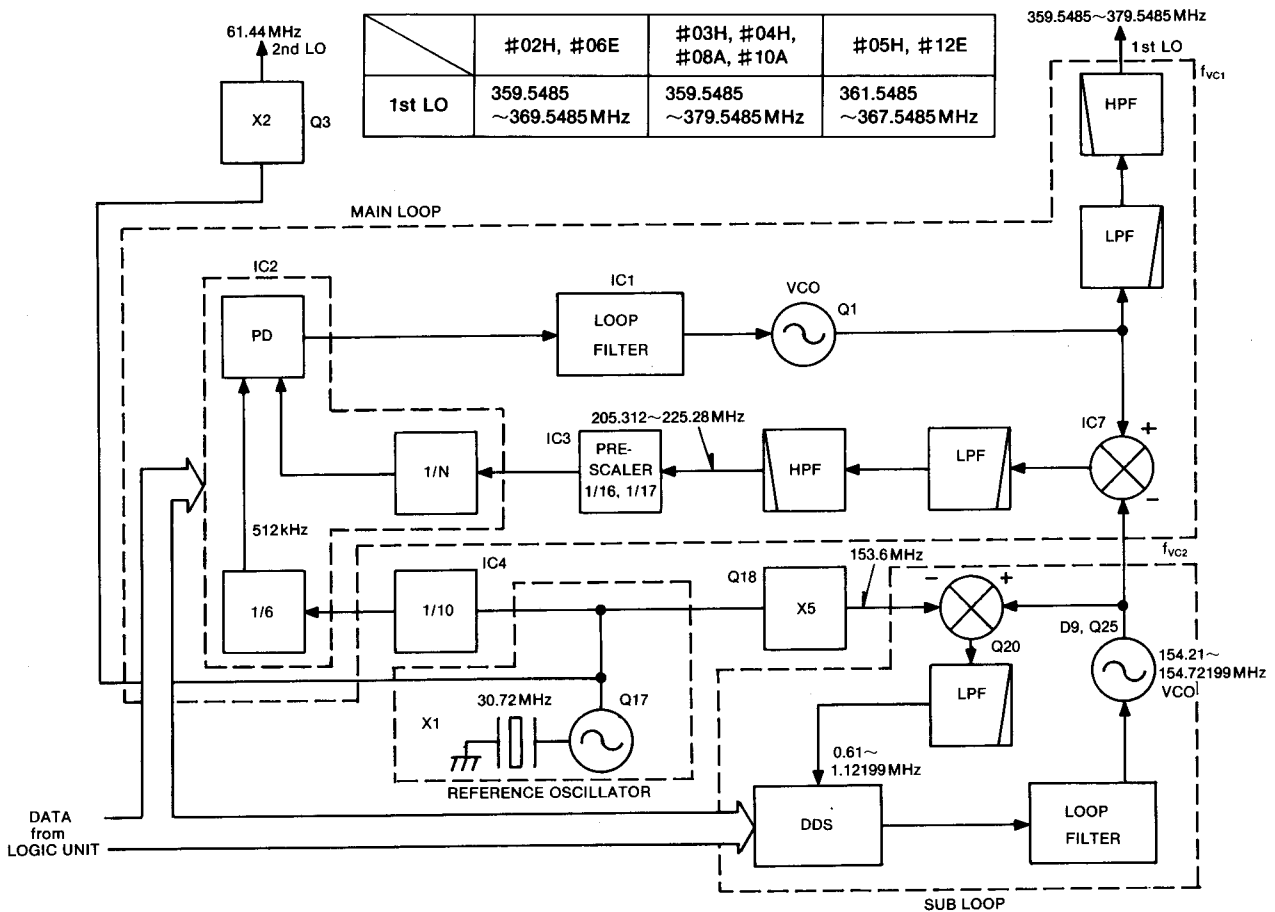

Fig. 11

4-4-2 REFERENCE OSCILLATOR CIRCUIT

The reference oscillator circuit generates a reference frequency for the PLL circuits.

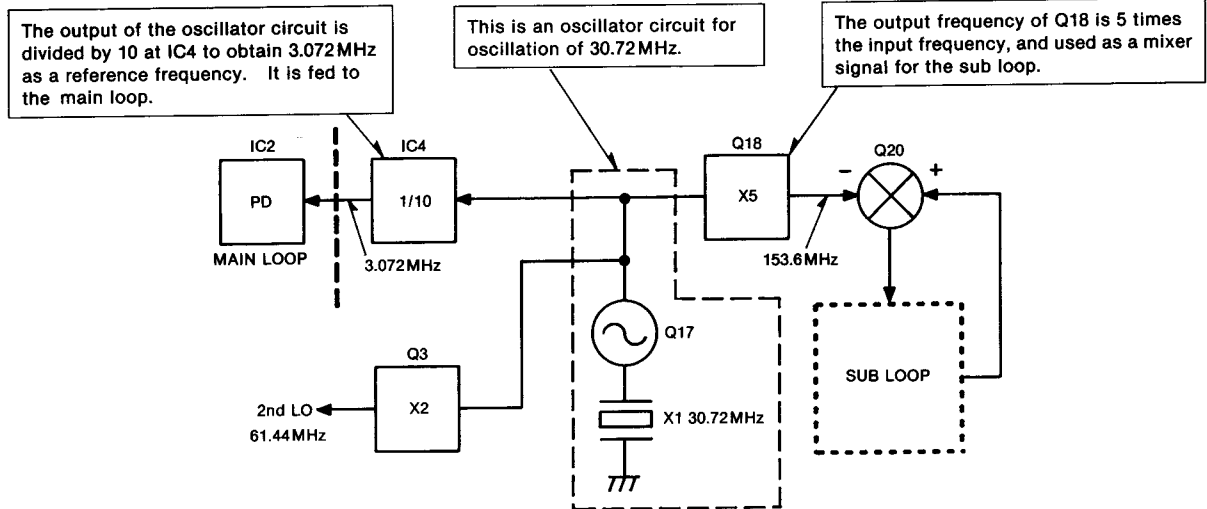

Fig. 12

4-4-3 MAIN LOOP

The main loop forms the PLL loop and supplies the 1st LO output. It consists of a combination of a pulse swallow system and mixer system.

Frequency changes are made by changing the f_{VC2} and N_1 . The reference frequency (f_r) is 512kHz, and the VCO is controlled in 512kHz steps by changing the dividing ratio N_1 of the programmable counter.

The VCO output frequency f_{VC1} is given as:

$$f_{VC1} = N_1 \times f_r + f_{VC2}$$

N_1 : Main loop N-data

f_r : PLL reference frequency

f_{VC2} : Sub loop frequency [MHz]

A frequency between this step (less than 512kHz) is obtained by f_{VC2} which controls VCO output frequency. The f_{VC1} can be changed in 10Hz steps over the 20MHz range.

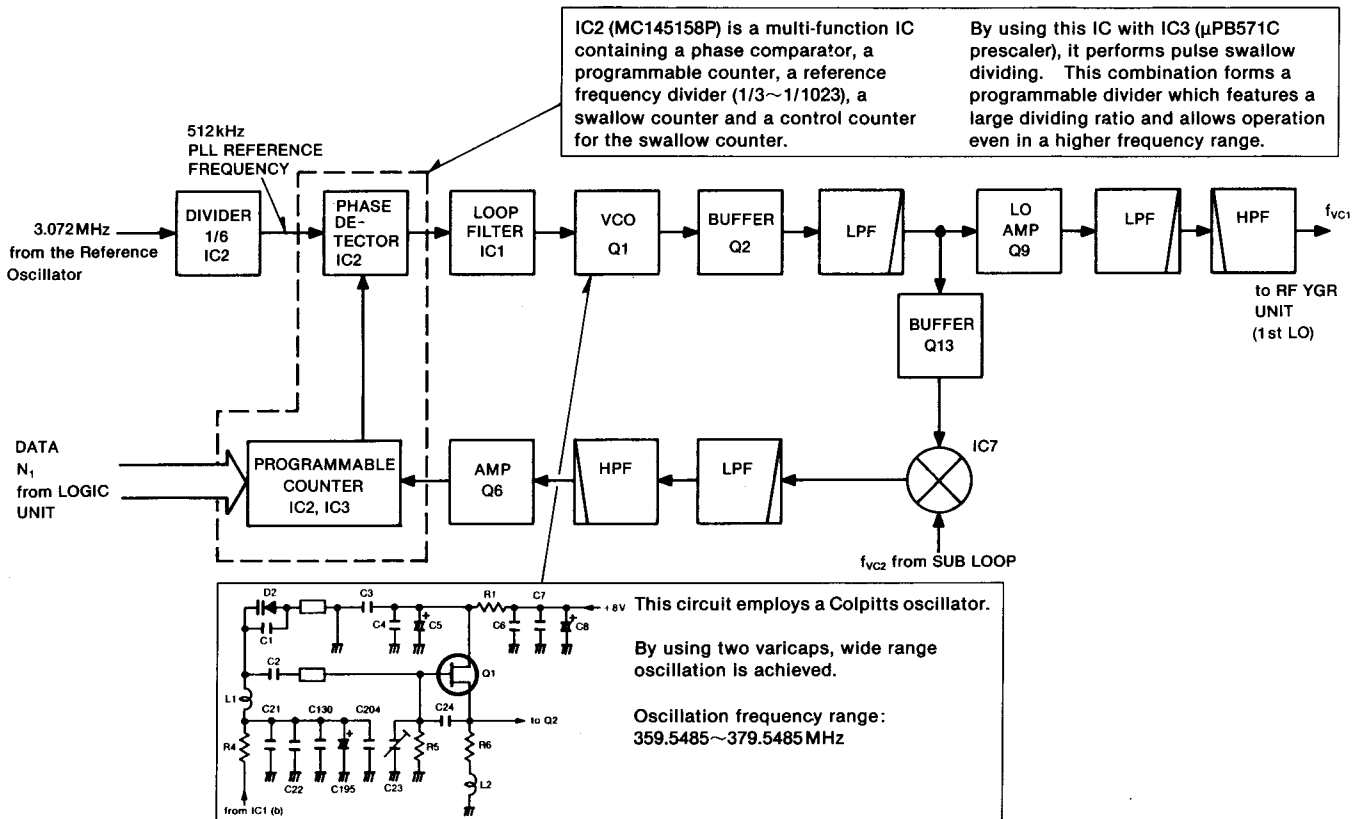

Fig. 13

4-4-4 SUB LOOP

The sub loop section comprises the DDS UNIT.

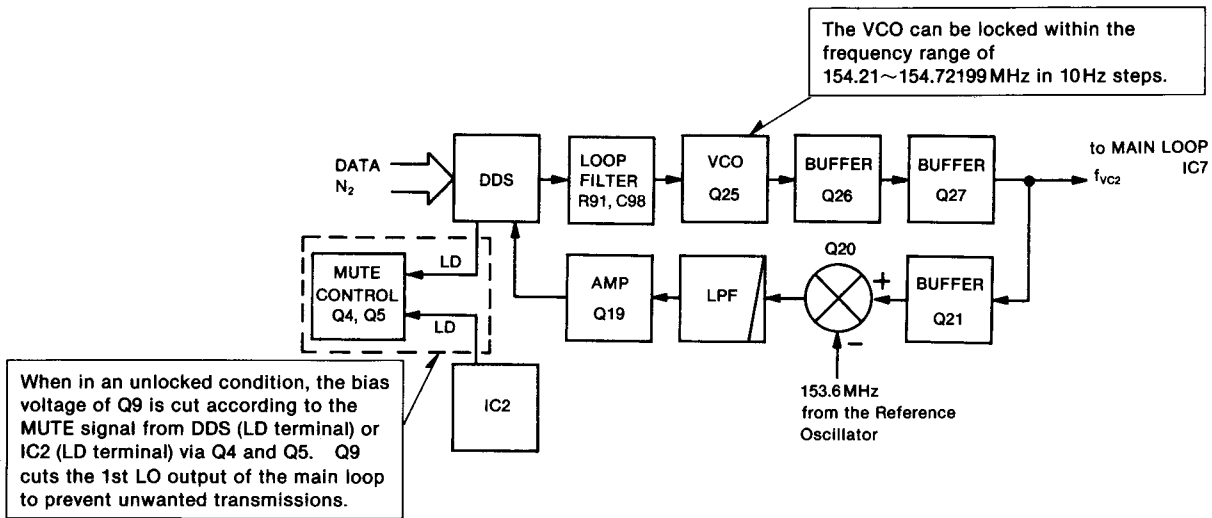

Fig. 14

4-4-5 DIRECT DIGITAL SYNTHESIZER (DDS) UNIT

The DDS circuit consists of 5 ICs.

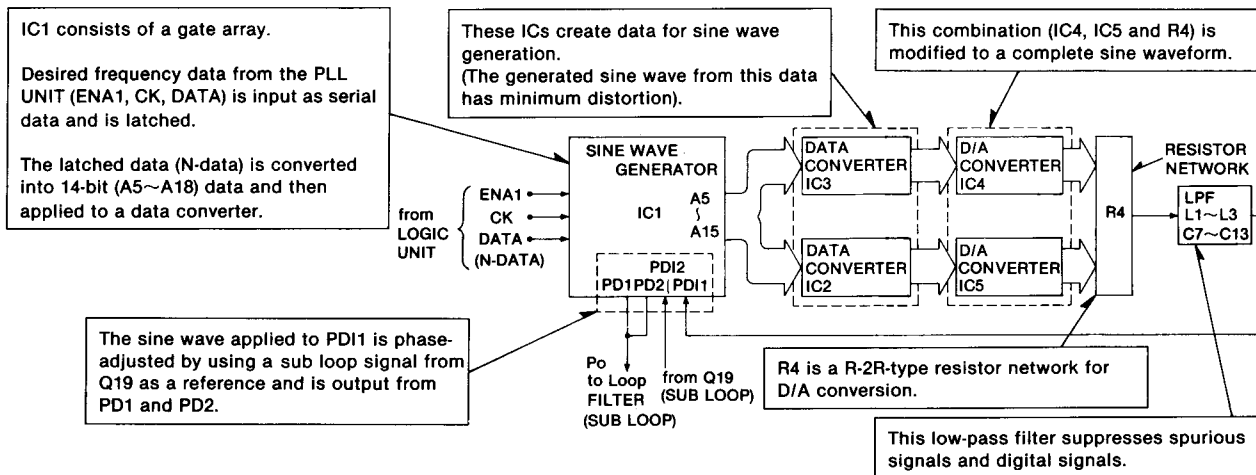

Fig. 15

4-4-6 PLL DATA

Data for setting the dividing ratios N_1 and N_2 of the programmable dividers are sent from the LOGIC UNIT. The data transfer is in binary code.

How to derive N-data

Since there are two locked loops, two kinds of N-data are necessary. Even if the output frequencies from the PLL circuits in all modes are the same, the display

frequencies are different depending on the operating mode.

For example, if the same frequency is displayed for FM mode, the frequency will be 900Hz lower in CW mode, 1.5kHz higher in USB mode and 1.5kHz lower in LSB mode.

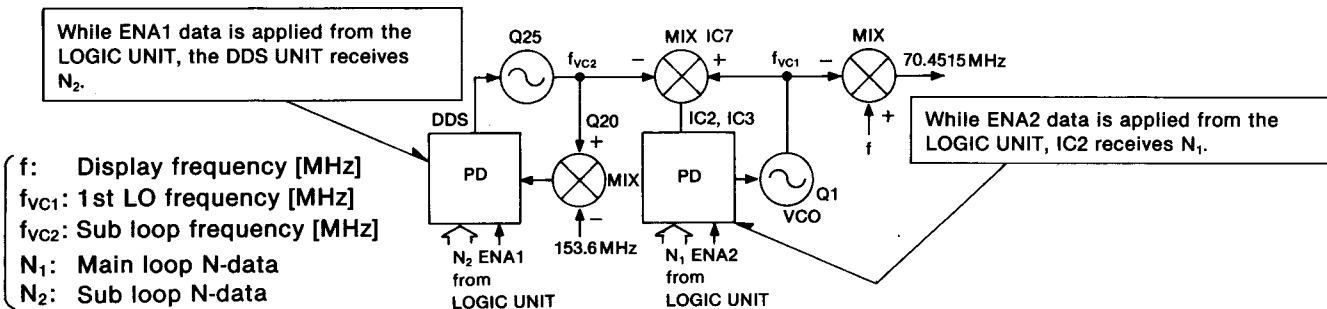

Fig. 16

To obtain N-data from the display frequency (fMHz), calculate using the following formulas.

<p>(a) FM mode</p> <p>Main loop N-data: N_1</p> $N_a = (f - 224.6615) \div 0.512$ <p style="margin-left: 40px;">↑ N_1 is the integer part of N_a.</p> <p>Sub loop N-data: N_2</p> $N_b = (f - 224.0515 - 0.512 \times N_1) \times 10^5$ <p style="margin-left: 40px;">↑ N_2 is the hexadecimal of N_b.</p> <p>example: 430.1234 MHz (Display frequency, in FM mode)</p> <p>Main loop N-data $N_a = (430.1234 - 224.6615) \div 0.512 \doteq 401.3$ $\therefore N_1 = 401$</p> <p>Sub loop N-data $N_b = (430.1234 - 224.0515 - 0.512 \times 401) \times 10^5$ $= 75990$ $\therefore N_2 = 128D6 \text{ (H)}$</p>	<p>(b) CW, LSB or USB mode</p> <p>Main loop N-data: N_1</p> $N_c = (f - 224.6615 - f_{\text{OFFSET}}) \div 0.512$ <p style="margin-left: 40px;">↑ N_1 is the integer part of N_c.</p> <p>Sub loop N-data: N_2</p> $N_d = (f - 224.0515 - 0.512 \times N_1 - f_{\text{OFFSET}}) \times 10^5$ <p style="margin-left: 40px;">↑ N_2 is the hexadecimal of N_d.</p> <div style="border: 1px solid black; padding: 5px; margin-top: 10px;"> <p>f_{OFFSET} of each mode:</p> <p>CW mode: $0.9 \times 10^{-3} \text{ MHz}$</p> <p>LSB mode: $1.5 \times 10^{-3} \text{ MHz}$</p> <p>USB mode: $-1.5 \times 10^{-3} \text{ MHz}$</p> </div>
--	--

4-5 LOGIC CIRCUITS

Functions of the LOGIC circuits include the control of frequency, the processing of mode signals, and data output for the PLL UNIT and DISPLAY UNIT. The LOGIC circuits are composed of an 8-bit CMOS CPU, a 2k-byte RAM, 16k-byte ROM and an I/O expander IC.

4-5-1 CPU

Functions are assigned to the pins of the CPU as shown at right. Pins which have no functions are left unconnected.

Addresses are assigned to ROM and RAM and to all other peripheral devices.

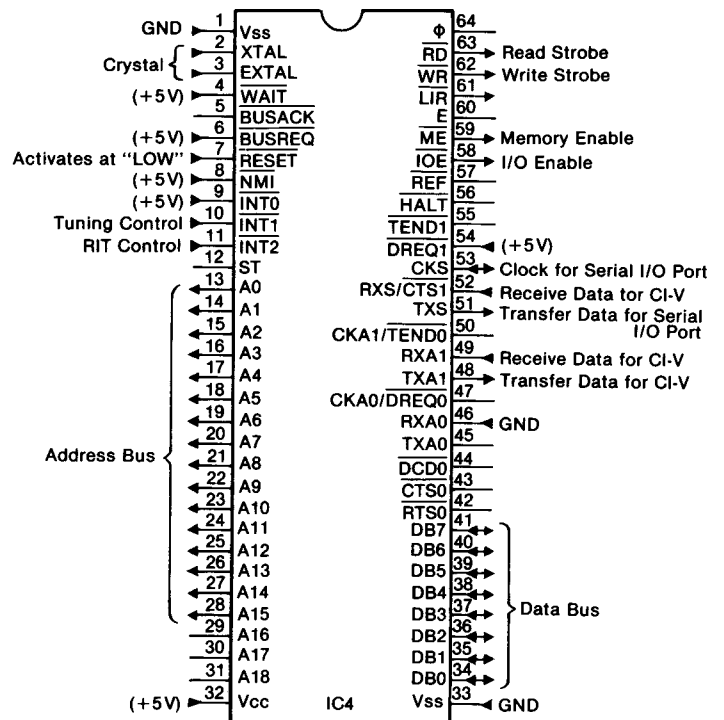

Fig. 17

4-5-2 RESET CIRCUIT

The reset circuit is connected as shown in Fig. 18 and supplies power from the power supply to reset IC4 and IC1.

The voltages at three points (A~D) change as shown on the graph in Fig. 18 as the voltage from the power supply changes (point A).

This is the sequence of the reset circuit operation.

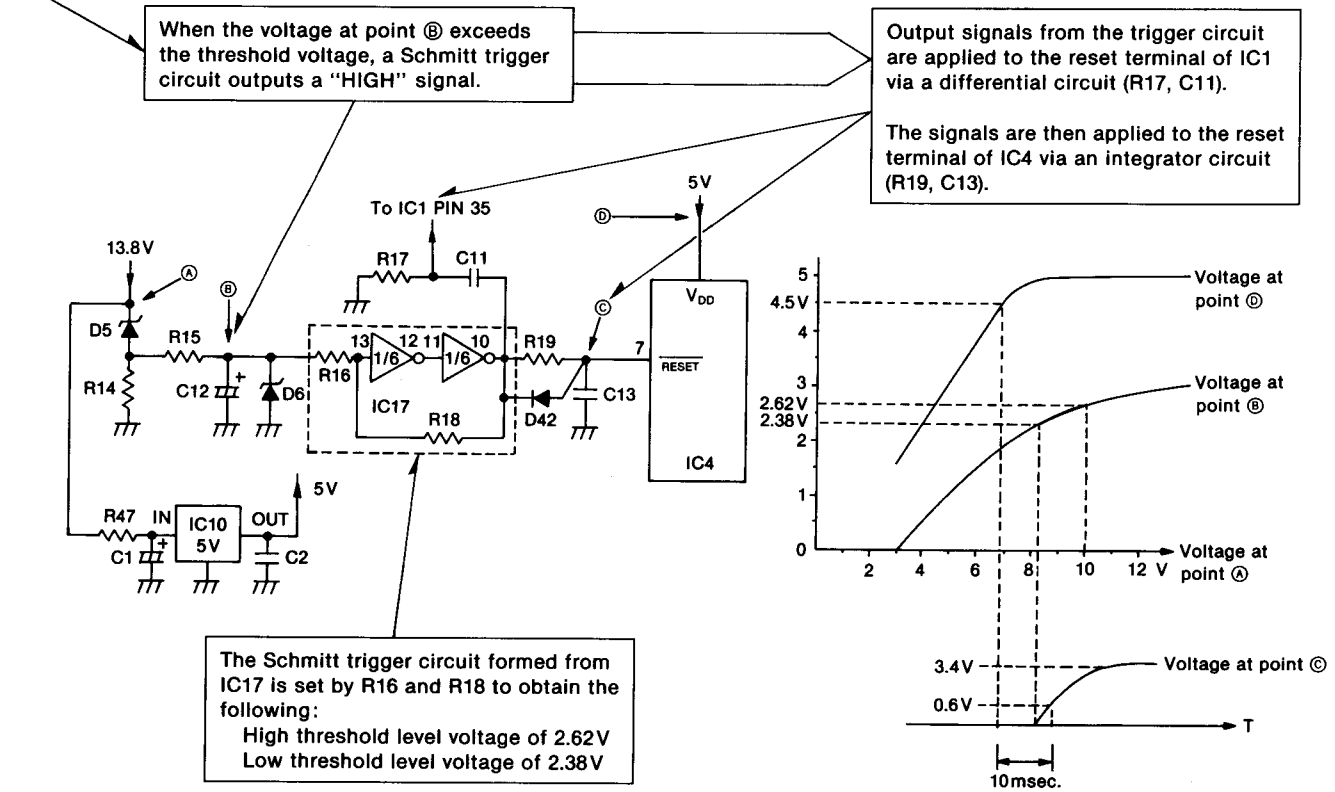

Fig. 18

4-5-3 MATRIX

MATRIX TABLE

	Y0	Y1	Y2	Y3	Y4	Y5	Y6	Y7	
		CALL	Mch UP	LSB	MIC CK	SIMP/DUP	BAND INITIAL 0	CI-V ADDRESS 0	DB0
		VFO A/B	Mch DOWN	USB	MIC U/D	CHECK	1	1	DB1
		MEMORY READ	RIT ON/OFF	CW/N	SKIP	SET	2	2	DB2
		A=B			MODE-S	TONE ON/OFF	3	3	DB3
	PITCH 0	MW	RIT CLEAR		SCAN SPEED	TONE SQL ON/OFF	4	4	DB4
	1	M ▶ VFO	SCAN S/S	FM		LOCK	CI-V DATA LENGTH	5	DB5
	2	M-CLEAR	SQL			SPCH START	CI-V BAUD RATE 0	6	DB6
	3	SPLIT	SEND	DATA		SPCH BUSY	1	CI-V TRANSCEIVE FLAG	DB7

Fig. 19

Y0 → DB4~DB7 (PITCH)

This matrix sets the frequency step tuning rate.

Y1 → DB0 (CALL)

This matrix is used for the [CALL] SWITCH.

Y1 → DB1 (VFO A/B)

This matrix selects VFO A or VFO B via the [VFO] SWITCH.

Y1 → DB2 (MEMORY READ)

This matrix is used for the [MEMORY] SWITCH.

Y1 → DB3 (A=B)

This matrix is used for the [A=B] SWITCH.

Y1 → DB4 (MW)

This matrix is used for the [MW] SWITCH.

Y1 → DB5 (M▶VFO)

This matrix is used for the [M▶VFO] SWITCH.

Y1 → DB6 (M-CLEAR)

This matrix is used for the [M-CL] SWITCH.

Y1 → DB7 (SPLIT)

This matrix is used for selecting the relationship of the two VFO frequencies.

Y2 → DB0, Y2 → DB1 (MEMO CH)

These matrices are used for the [MEMO] CHANNEL SELECTOR CONTROL.

Y2 → DB2 (RIT ON/OFF)

This matrix is used for the [RIT] SWITCH.

Y2 → DB4 (RIT CLEAR)

This matrix is used for the [RIT-CL] SWITCH.

Y2 → DB5 (SCAN START/STOP)

This matrix is used for the [SCAN] SWITCH.

Y2 → DB6 (SQL)

This matrix is for the SCAN TIMER function.

In PROGRAMMED SCAN or MEMORY CHANNEL SCAN mode, this matrix is activated.

When a signal is received, the scan stops and then starts again after 3 or 10 seconds. These times depend on the type of signal received.

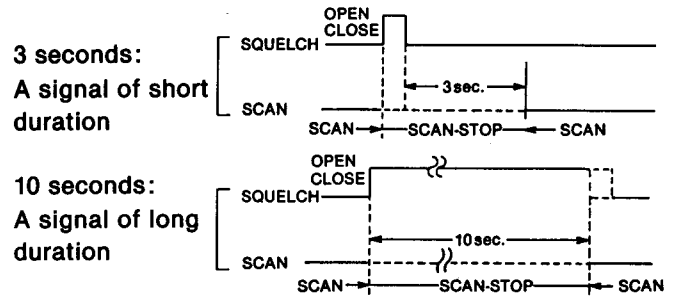

Fig. 20

Y2 → DB7 (SEND)

This matrix is used for switching the transceiver from transmit to receive mode and vice versa.

Y3 → DB0 (LSB)

Y3 → DB1 (USB)

Y3 → DB2 (CW/N)

Y3 → DB5 (FM)

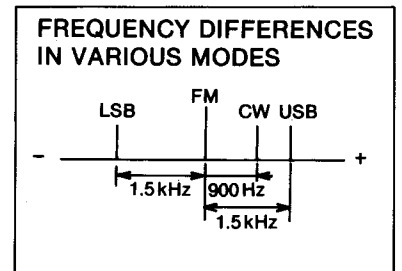

Fig. 21

Y3 → DB7 (DATA)

This matrix is used for the [DATA] SWITCH.

This matrix is for PACKET or AMTOR communications which require rapid receive and transmit switching times. (This matrix does not function in CW mode.)

• Transmit and receive switching time

[DATA] SWITCH	FM mode	SSB, CW mode
OFF	15~20msec.	20~25msec.
ON	approx. 3msec.	approx. 7msec.

NOTE: While the [DATA] SWITCH is ON, the optional AG-35 PREAMPLIFIER is not activated.

• Squelch close and open switching time

Squelch close → open:

[DATA] SWITCH	FM mode	SSB, CW mode
OFF	approx. 40msec.	approx. 15msec.
ON	approx. 4msec.	approx. 5msec.

Squelch open → close:

[DATA] SWITCH	FM mode	SSB, CW mode
OFF	approx. 350msec.	*1
ON	approx. 200msec.	

*1 These periods are varied by [AGC] SWITCH setting and receive signal strength.

Above times show time required for the squelch to open/close at the squelch threshold point.

• **MIC mute**

When the [DATA] SWITCH is turned ON the microphone signals are muted while transmit mode is selected using the [XMIT] SWITCH or the ACC SOCKET SEND line (except when using the microphone PTT SWITCH).

Y4 → DB0 (MIC CK), Y4 → DB1 (MIC UP/DOWN)

These matrices are used for changing frequencies by using the microphone with the UP/DOWN SWITCHES.

When the [DOWN] SWITCH is pushed, the matrix “Y4 → DB0” turns ON. When the [UP] SWITCH is pushed, the matrices “Y4 → DB0” and “Y4 → DB1” turn ON.

Y4 → DB2 (SKIP)

This matrix is used for the [SKIP] SWITCH.

Y4 → DB3 (MODE-S)

This matrix is used for the [MODE-S] SWITCH.

Y4 → DB4 (SCAN SPEED)

This matrix is used for the [SCAN SPEED] SWITCH.

Scan speed switch (S1)	Scan speed
Fast (ON)	20 channels/sec.
Slow (OFF)	10 channels/sec.

Y5 → DB0 (SIMP/DUP)

This matrix is used for selecting simplex or duplex mode operation.

Y5 → DB1 (CHECK)

This matrix is used for the [CHK] SWITCH.

Y5 → DB2 (SET)

This matrix is used for the [SET] SWITCH.

Y5 → DB3 (TONE ON/OFF)

(#08A, #03H)

This matrix is used for activating the built-in subaudible tone unit.

(#06A, #02H)

This matrix is used for transmitting the 1750 Hz tone call.

Y5 → DB4 (TONE-SQL ON/OFF)

This matrix is used for the [T-SQL] SWITCH.

Y5 → DB5 (LOCK)

This matrix is used for the [LOCK] SWITCH.

Y5 → DB6 (SPEECH START), Y5 → DB7 (SPEECH BUSY)

These matrices are used for the [SPCH] SWITCH.

Y6 → DB0~DB4 (BAND INITIAL)

These matrices determine frequency range, initial offset, etc., for each transceiver version.

Y6 → DB5 (CI-V DATA LENGTH)

This matrix is for the ICOM CI-V system.

When D25 is installed on the LOGIC UNIT, this matrix is in the ON position.

Y6 → DB5	CI-V DATA LENGTH
OFF	4-byte
ON	5-byte

Y6 → DB6, DB7 Y7 → DB0~DB7

Transmitters and receivers using the ICOM CI-V System exchange serial information in the PACKET format. The contents of a data PACKET can be changed by using the S3 switches (switches 1~10) on the LOGIC UNIT.

S3 SWITCHES (switches 1~10)

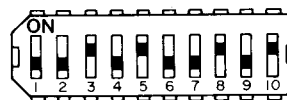

The S3 SWITCHES shown above are located on the LOGIC UNIT.

Fig. 22

Switches 1~7 (For setting an address with the transceiver):

These switches determine the transceiver's address number (00H~7FH).

Matrix configuration: Y7 → DB0~DB6

ICOM Standard address number:

MODEL	ADDRESS NUMBER	MODEL	ADDRESS NUMBER
IC-761	1EH (30)	*IC-751A	1CH (28)
IC-275A/E/H	10H (16)	*IC-751	1CH (28)
IC-475A/E/H	14H (20)	*IC-271A/E/H	20H (32)
IC-375A	12H (18)	*IC-471A/E/H	22H (34)
IC-575A/E/H	16H (22)	*IC-1271A/E	24H (36)
IC-735	04H (4)	*IC-R71A/E/D	1AH (26)
IC-R7000	08H (8)		

*Address numbers are fixed by the UX-14.

Bracketed figures () are decimals; figures marked with an H are hexadecimals.

Switch 8 (For setting a transceive flag):

The ON position sets a flag used for sending code data of transceive operations automatically when the frequency is changed. The receive code data is accepted regardless of whether the switch is ON or OFF.

Matrix configuration: Y7 → DB7

Switches 9 and 10 (For setting CI-V baud rate):

Baud (bps)	Switch 9	Switch 10
9600	OFF	OFF
4800	ON	OFF
1200	OFF	ON
300	ON	ON

Matrix configuration: Y6 → DB6, DB7

NOTE: The standard ICOM CI-V baud rate is 1200bps.

4-5-4 SENSOR CIRCUIT

The Sensor Circuit performs waveform shaping of the dial pulse from the 250 pulses/revolution sensor. The tuning speed selector section formed from IC17 automatically switches between normal speed and 4 times speed according to the number of generated pulses (varies according to whether the TUNING CONTROL is rotated quickly or slowly).

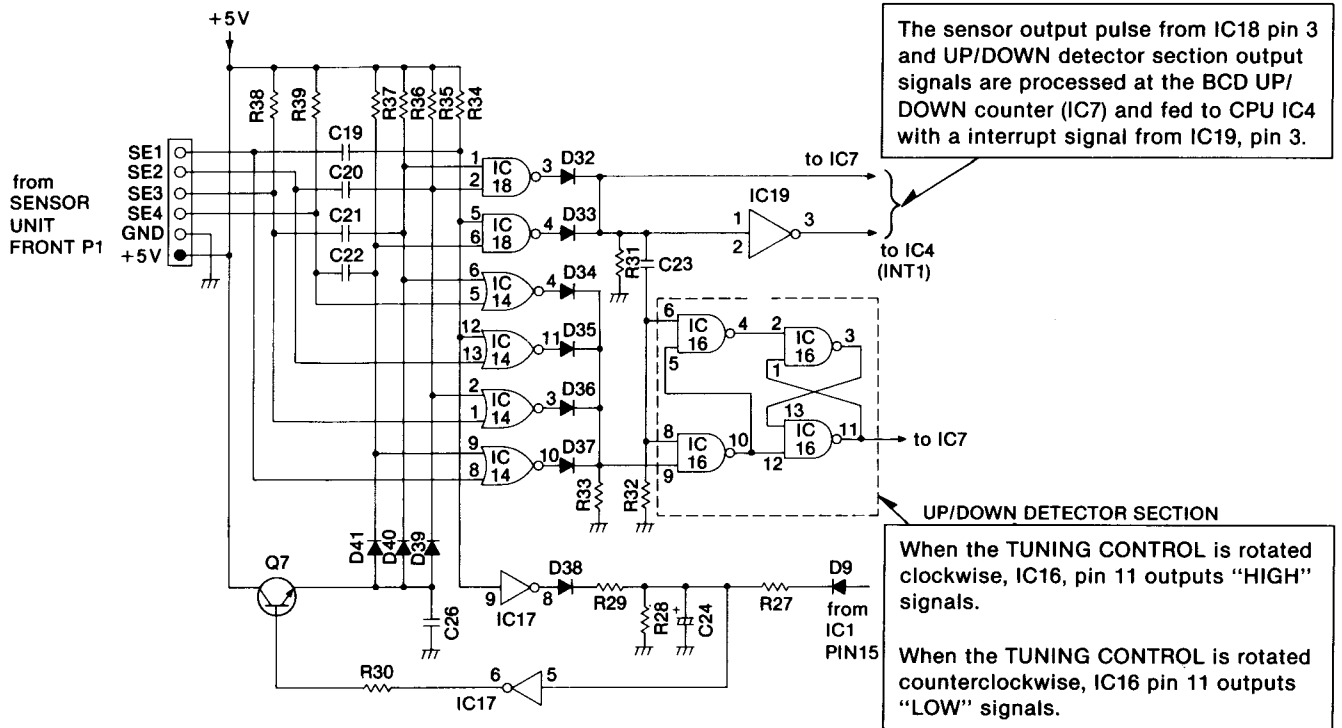

Fig. 23

4-5-5 RIT UP/DOWN SENSOR CIRCUIT

Pulse signals from the RIT SENSOR in the FRONT UNIT are fed to CPU IC4 via IC6 and through an RIT UP/DOWN sensor consisting of IC19 and IC15 with interrupt signals from IC18 at pin 11.

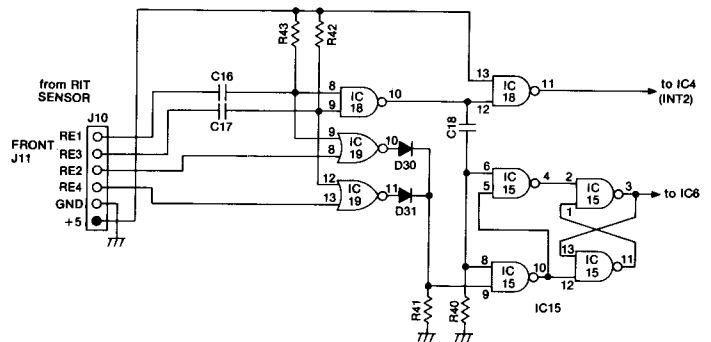

Fig. 24

4-6 SWITCHING REGULATOR CIRCUIT (IC-475A/E ONLY)

This circuit provides 13.8V DC (8A) output.

Pulse signals from pin 12 and pin 13 of IC1 are fed through transformer L2 to Q1 and Q2 alternately, so that $\pm 140V$ AC is fed to the primary side of transformer L2.

The output voltage at the secondary side of L2 is rectified by D1 and filtered by C10, C11, C21 and C12.
Thus 13.8V DC is output to P2.

AC output signals are full-wave rectified at D5 and applied to the inverter circuit.

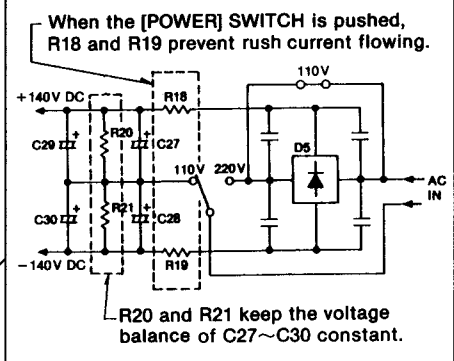

When the [POWER] SWITCH is pushed, R18 and R19 prevent rush current flowing.
R20 and R21 keep the voltage balance of C27~C30 constant.

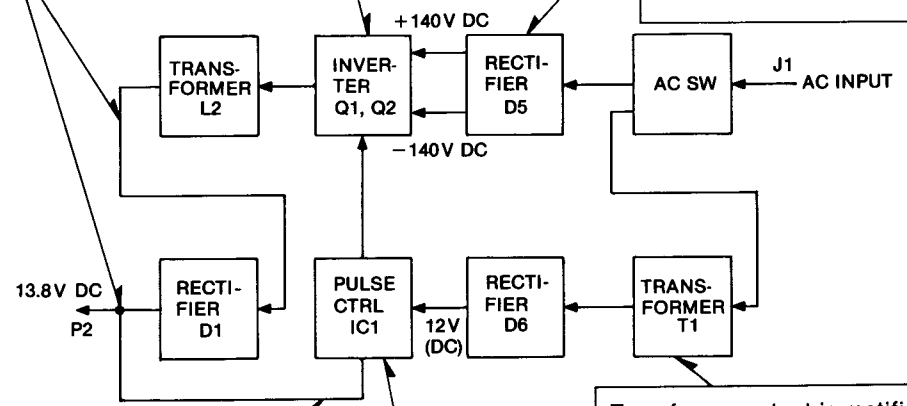

The output voltage is fed to IC1 for normal Vcc.

Transformer output is rectified at D6 and applied to IC1 at approx. 100msec. via time constant circuits C31 and R22.

After 100msec., the output voltage of this regulator circuit is used for IC1.

IC1 is a switching regulator IC chip and contains a 5V reference voltage circuit, oscillator circuit, comparator and two transistors for switching operation.

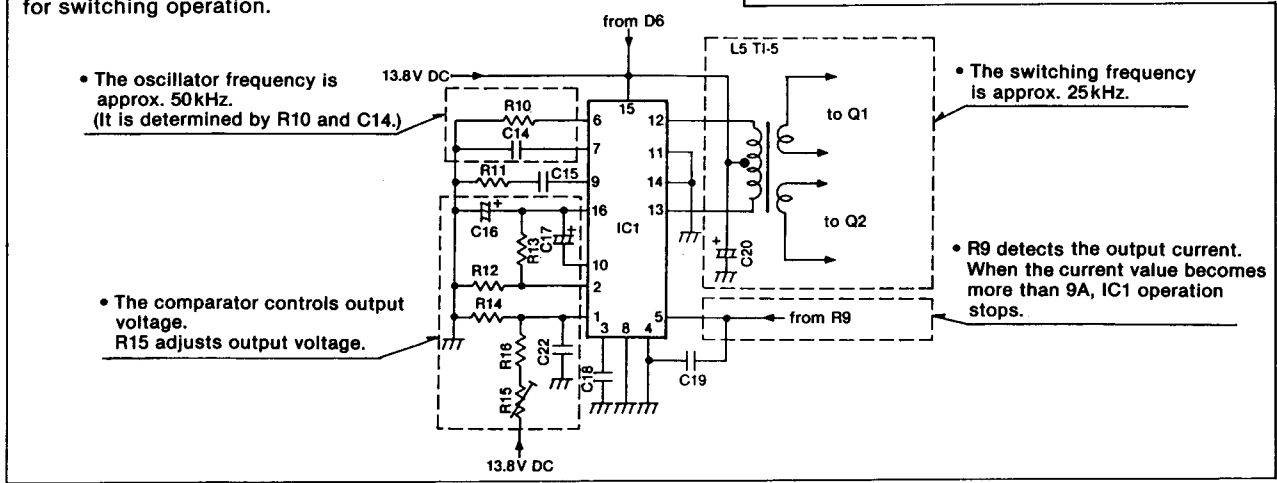

• The oscillator frequency is approx. 50kHz. (It is determined by R10 and C14.)

• The comparator controls output voltage. R15 adjusts output voltage.

• The switching frequency is approx. 25kHz.

• R9 detects the output current. When the current value becomes more than 9A, IC1 operation stops.

Fig. 25

SECTION 5 MECHANICAL PARTS AND DISASSEMBLY

5-1 FRAME DISASSEMBLY

1. Unscrew and remove the 12 screws labelled ① from the TOP COVER.
Remove the TOP COVER.
2. Unscrew and remove the 5 screws labelled ② from the BOTTOM COVER.
Remove the BOTTOM COVER.
3. Remove the hex socket screw labelled ③ from the TUNING CONTROL.
Pull out the forward controls from the FRONT PANEL.
4. Unscrew and remove the 5 screws labelled ④ from the FRONT PANEL.
Remove the FRONT PANEL.

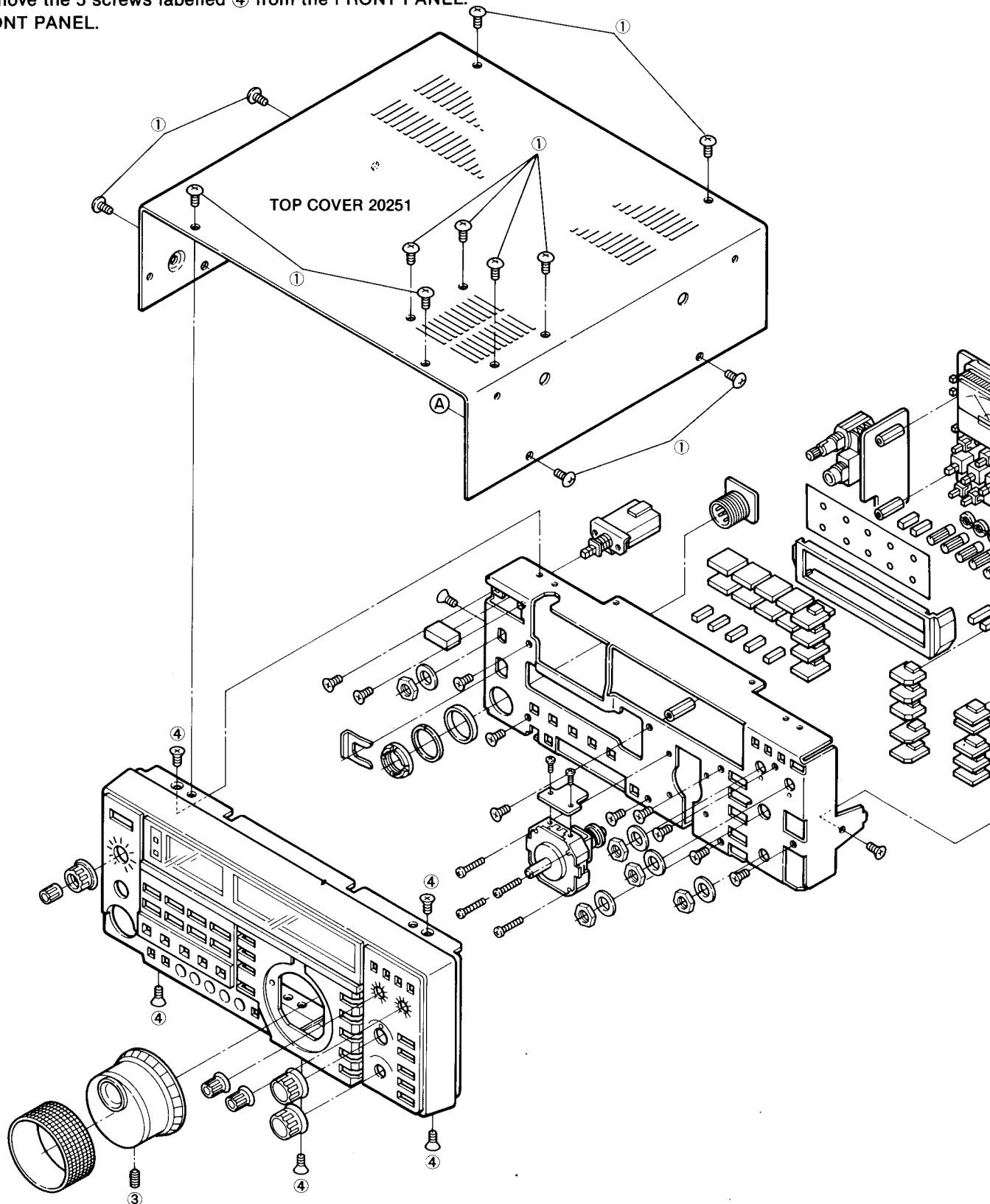

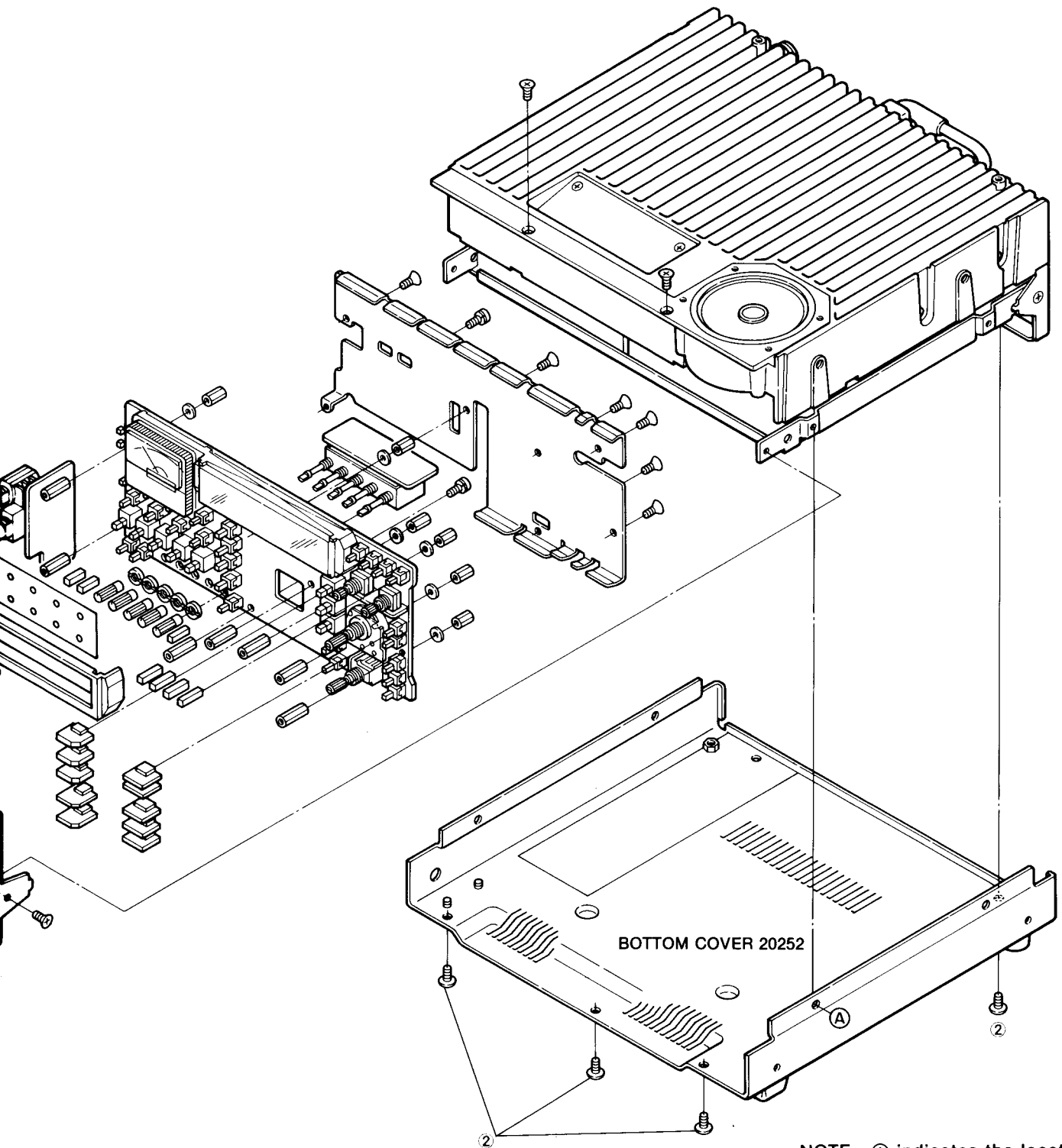

NOTE: Ⓐ indicates the location where the covers are attached.

5-2 FRONT PANEL DISASSEMBLY

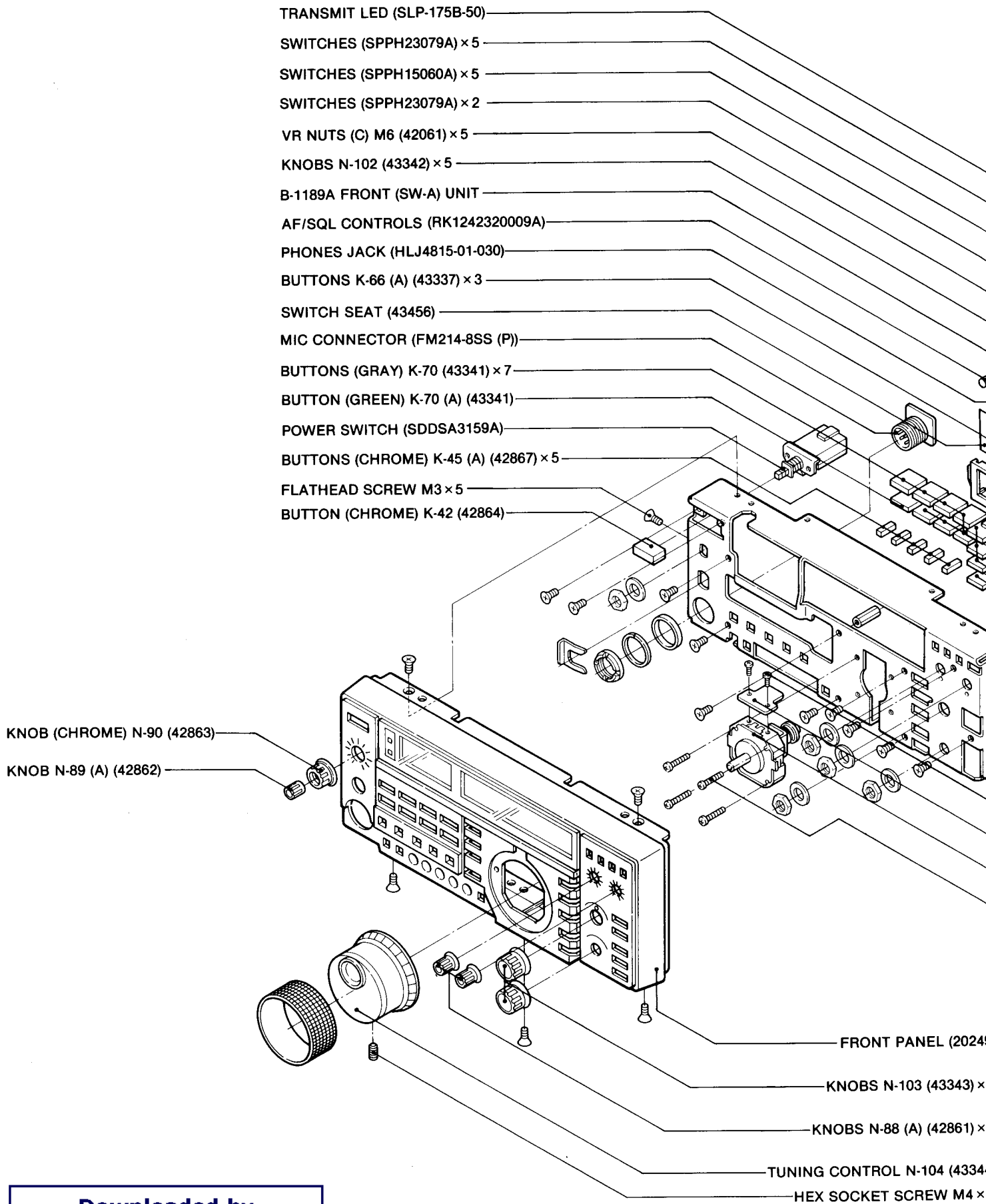

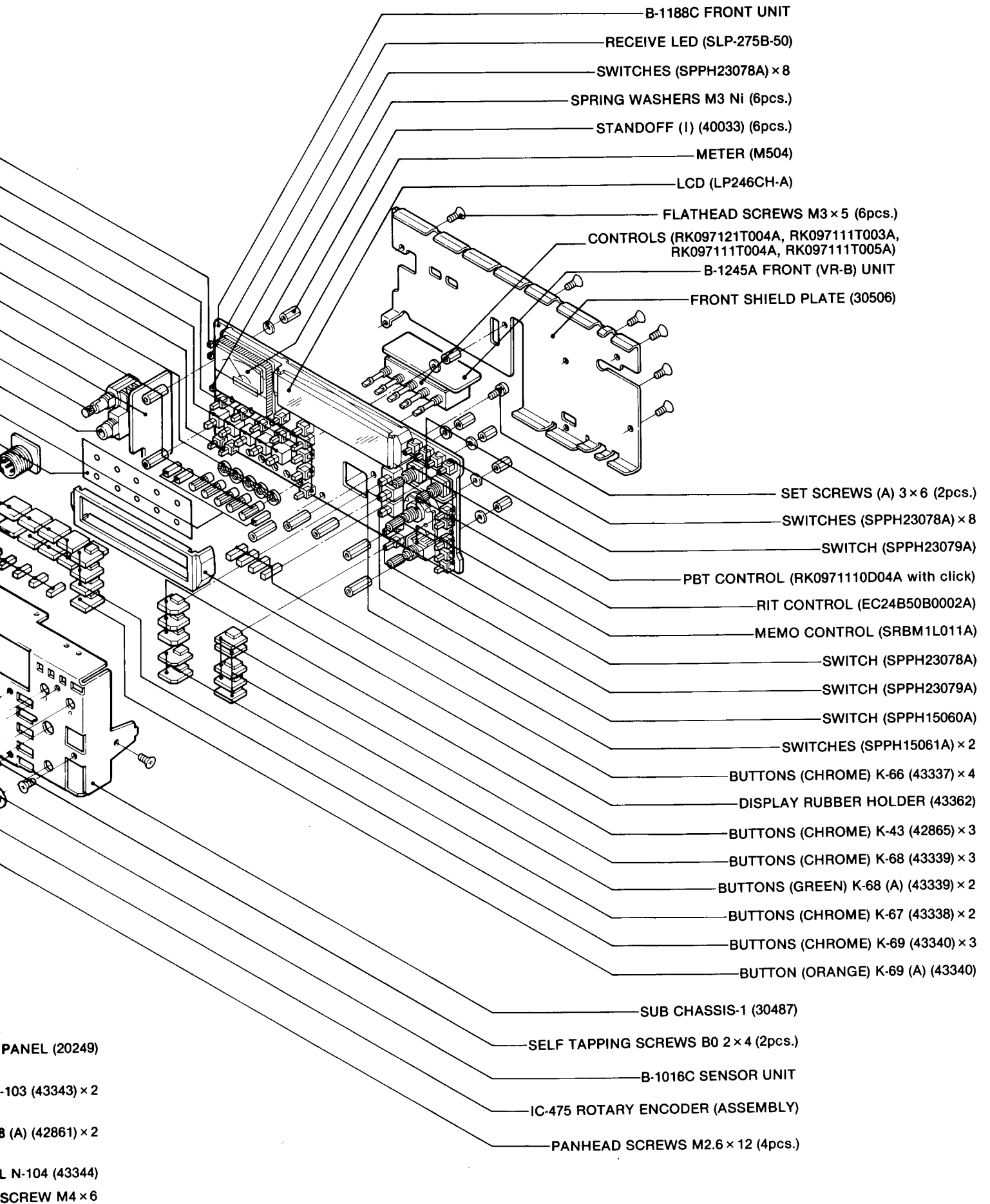

5-3 REAR PANEL DISASSEMBLY

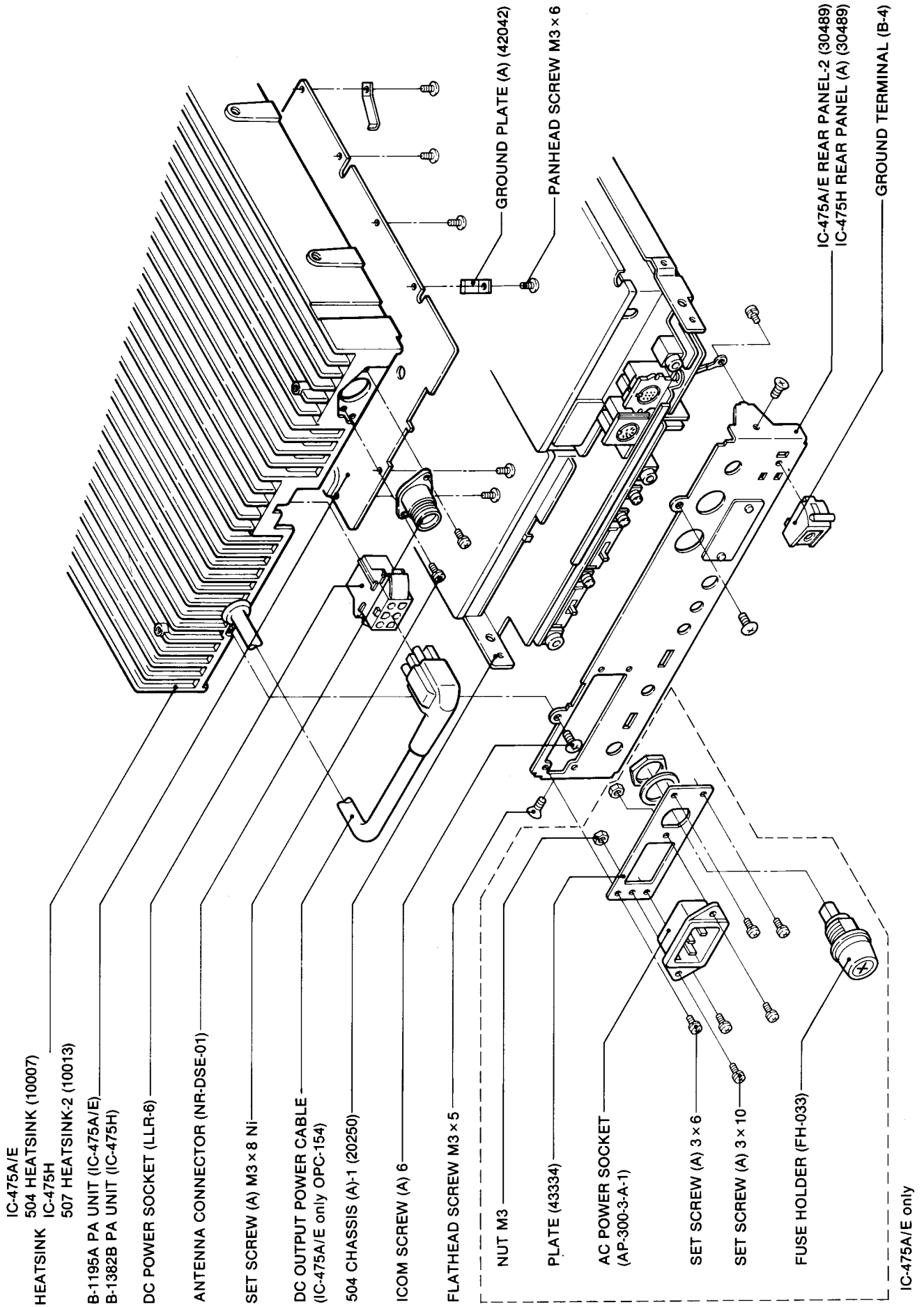

5-4 FRONT, LOGIC AND PLL UNITS CONNECTOR ASSEMBLY

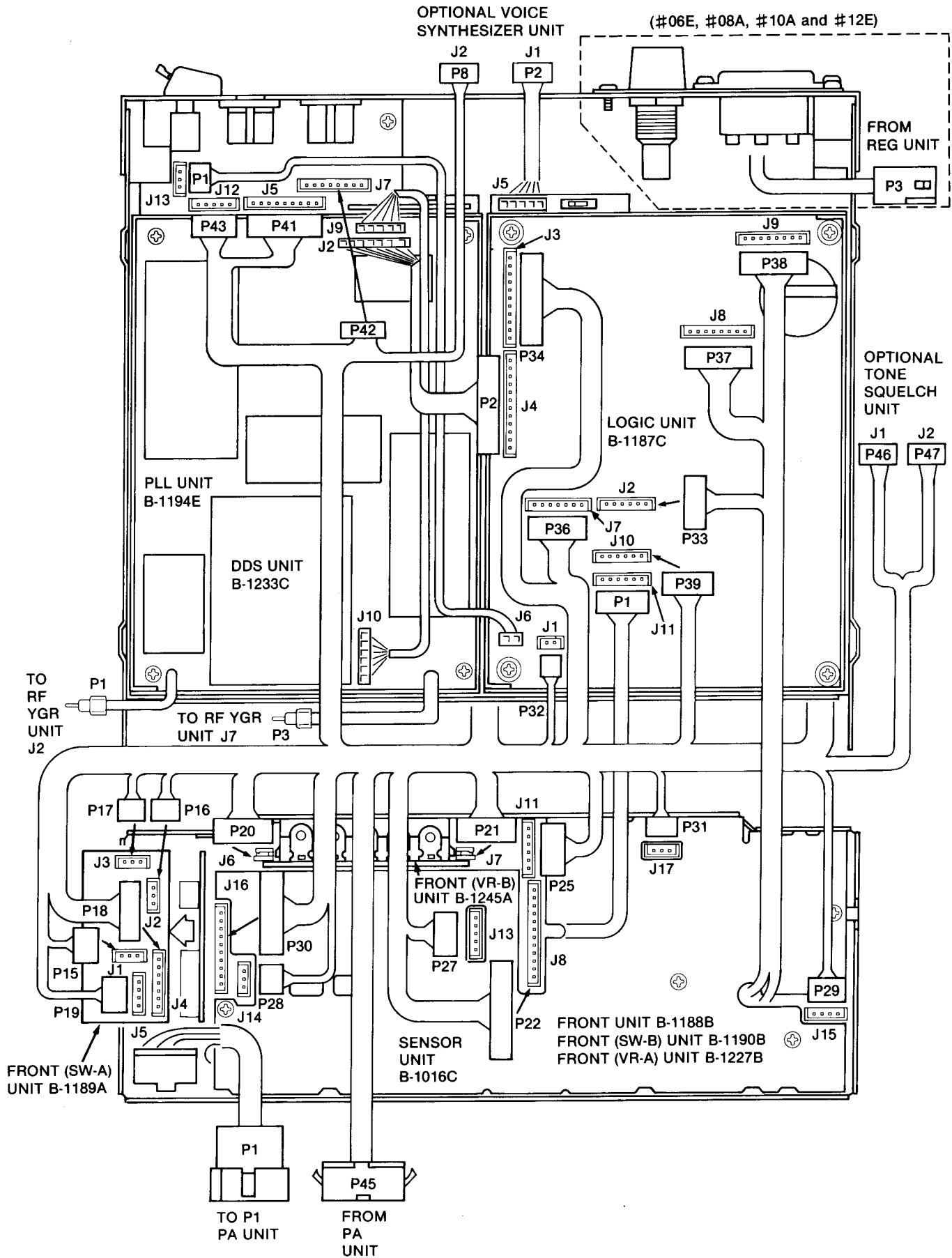

5-5 FRONT, MAIN AND RF YGR UNITS CONNECTOR ASSEMBLY

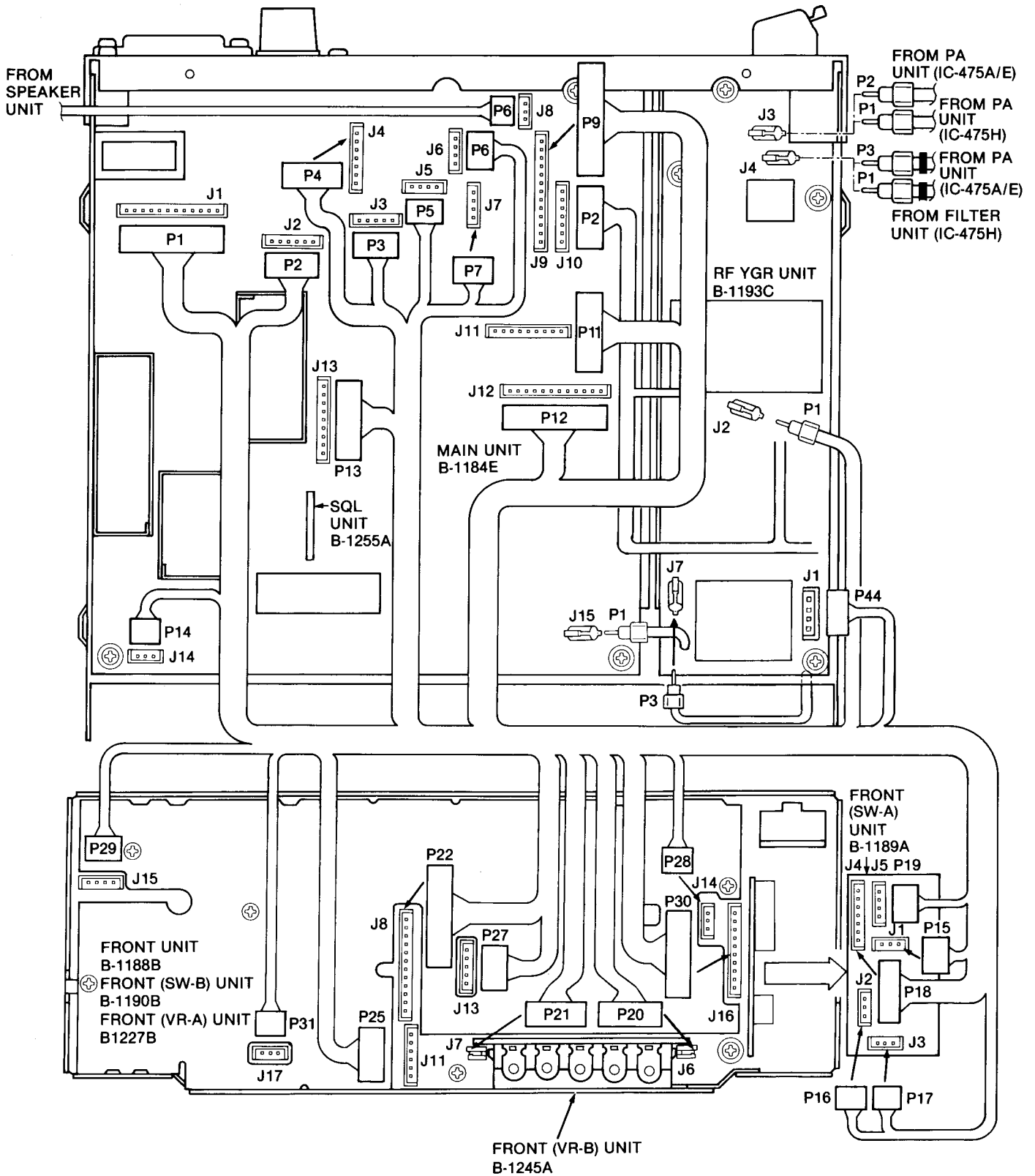

5-6 PA AND REG UNITS CONNECTOR ASSEMBLY (IC-475A/E)

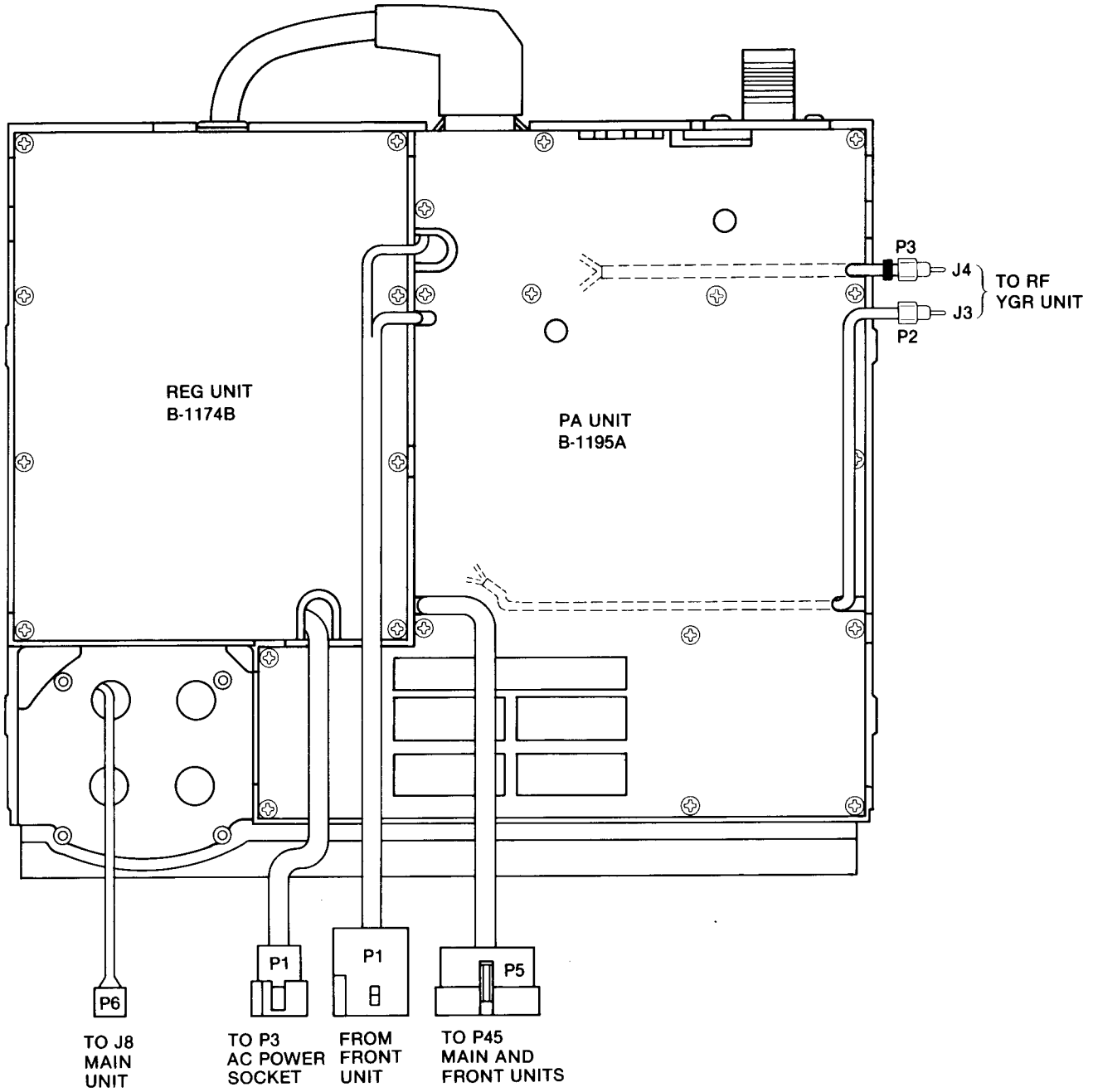

5-7 PA, CTRL AND FILTER UNITS CONNECTOR ASSEMBLY (IC-475H)

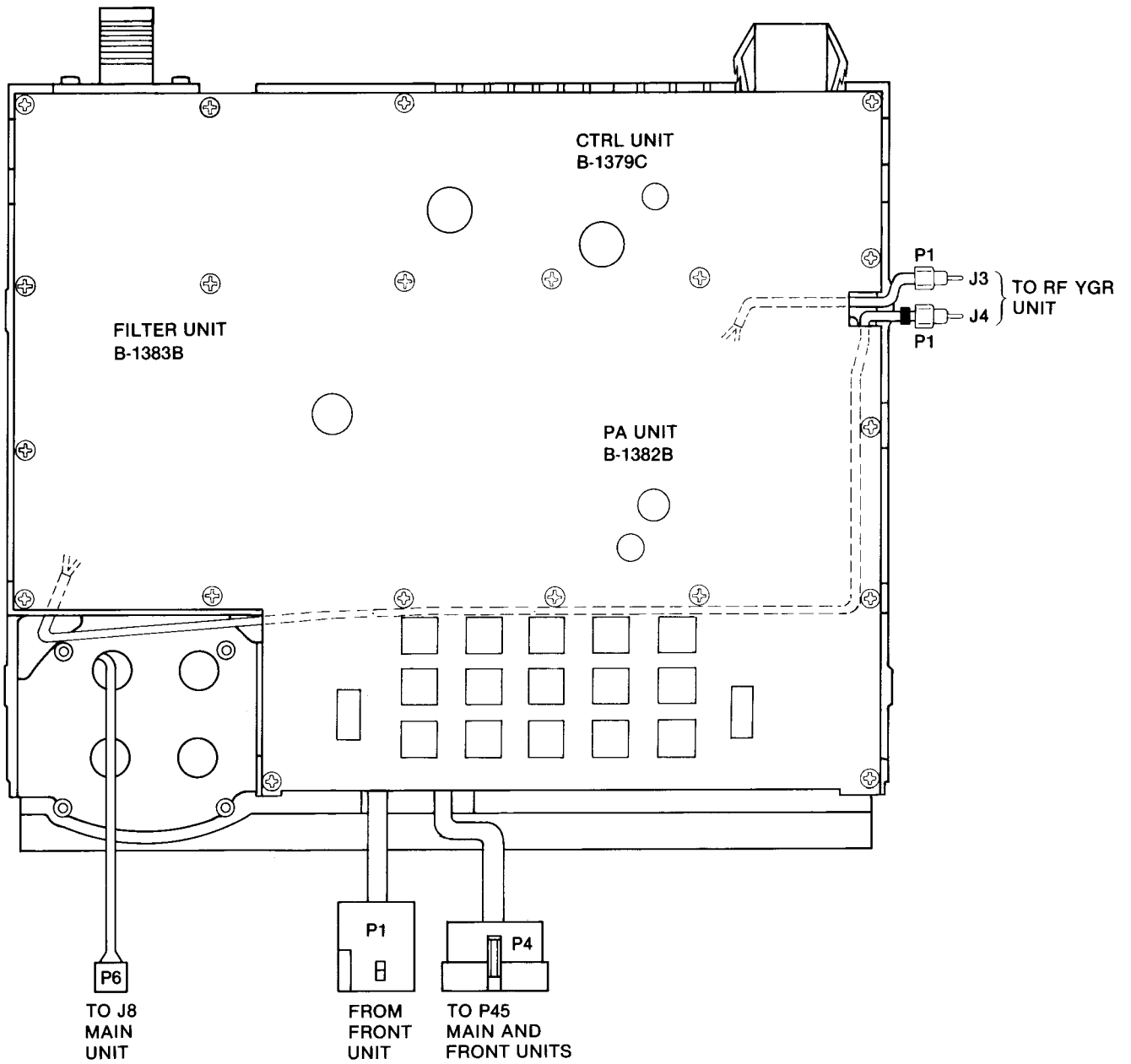

SECTION 6 MAINTENANCE AND ADJUSTMENT

6-1 PREPARATION BEFORE SERVICING

CAUTION: An external AC power supply should be used to connect the transceiver to a power source during testing.

1. Detach the power cord and turn OFF the POWER SWITCH before performing any work on the transceiver.
2. DO NOT turn the [PREAMP] SWITCH ON while a signal generator is connected to the ANTENNA CONNECTOR. DC voltage is generated and may damage the protector fuse of the signal generator.
3. DO NOT short circuit components while making adjustments.
4. Use an insulated tuning tool for all adjustments.
5. DO NOT force any of the variable components. Turn them slowly and smoothly.
6. Follow the instructions exactly. If an indicated result is not obtained, repeat the instruction until the correct result is obtained.
7. Check the condition of connectors, solder joints and screws when adjustments are complete. Make sure components DO NOT touch each other.
8. Confirm defective operation of the transceiver first when checking an out-of-service unit. Verify that external sources DO NOT cause the problem.
9. Use the correct tools and test equipment.
10. Remove the transceiver case as shown in SECTION 5-1.
11. For transmission problems, attach a dummy load to the ANTENNA CONNECTOR. For reception problems, attach an antenna or signal generator to the ANTENNA CONNECTOR. DO NOT transmit into the signal generator.
12. Recheck for the suspected malfunction with the POWER SWITCH ON.
13. Check the defective circuit. Measure the DC voltages of the collector, base and emitter of each transistor.
14. There are different versions of this transceiver. Adjustment procedures and results may differ for each version. Be sure to follow the correct procedure for the transceiver you adjust.

6-2 PLL ADJUSTMENT

TEST INSTRUMENTS REQUIRED	MEASUREMENT CONNECTION LOCATION
<p>(1) AC POWER SUPPLY</p> <ul style="list-style-type: none"> • Output voltage : 13.8V DC • Current capacity : 25A or more <p>(2) FREQUENCY COUNTER</p> <ul style="list-style-type: none"> • Frequency range : 0.1~500MHz • Frequency accuracy : ± 1 ppm or better • Sensitivity : 100mV or better <p>(3) RF VOLTMETER</p> <ul style="list-style-type: none"> • Frequency range : 0.1~500MHz • Measuring range : 0.01~10V <p>(4) DC VOLTMETER</p> <ul style="list-style-type: none"> • Input impedance : 50kΩ/DC or better <p>(5) OSCILLOSCOPE</p> <ul style="list-style-type: none"> • Frequency range : DC~20MHz • Measuring range : 0.01~10V 	

ADJUSTMENT	ADJUSTMENT CONDITIONS	MEASUREMENT		VALUE	ADJUSTMENT POINT		
		UNIT	LOCATION		UNIT	ADJUST	
DDS CLOCK FREQUENCY	1	• Frequency display: 435.0000MHz • Receive mode	DDS	Connect the frequency counter to IC4, pin 11.	5.24288MHz	DDS	C1
2nd LO FREQUENCY AND OUTPUT LEVEL	1	• Frequency display: 435.0000MHz • Receive mode	PLL	Connect the frequency counter to P3.	61.4400MHz	PLL	L22
	2			Terminate P3 to ground with a 50 Ω resistor. Connect the RF voltmeter to P3.	Adjust to maximum output. (-12~-8dBm)		
NOTE: After completing the adjustment, return P3 to its original condition.							
LPL LOCK VOLTAGE	1	• Frequency display: 430.4860MHz (#06E, #08A, #10A, #02H~#05H) 432.0220MHz (#12A, #05H) • FM mode	PLL	Connect the DC voltmeter to R91.	1V	PLL	C121
	2	• Frequency display: 430.4850MHz (#06E, #08A, #10A, #02H~#05H) 432.0210MHz (#12A, #05H) • FM mode			approx. 2V		
MULTIPLIER OUTPUT LEVEL	1	• Frequency display: 435.0000MHz • Receive mode	DDS	Connect the oscilloscope to J1, pin P1.	Adjust to maximum output.	PLL	L24, L25

PLL ADJUSTMENT (CONTINUED)

ADJUSTMENT	ADJUSTMENT CONDITIONS	MEASUREMENT		VALUE	ADJUSTMENT POINT	
		UNIT	LOCATION		UNIT	ADJUST
HPL LOCK VOLTAGE	1	PLL	Connect the DC voltmeter to R4.	2V (#06E, #08A, #10A, #02H~#04H) 2.2V (#12A, #05H)	PLL	C23
	2			approx. 3V		Verify

PLL AND DDS UNITS

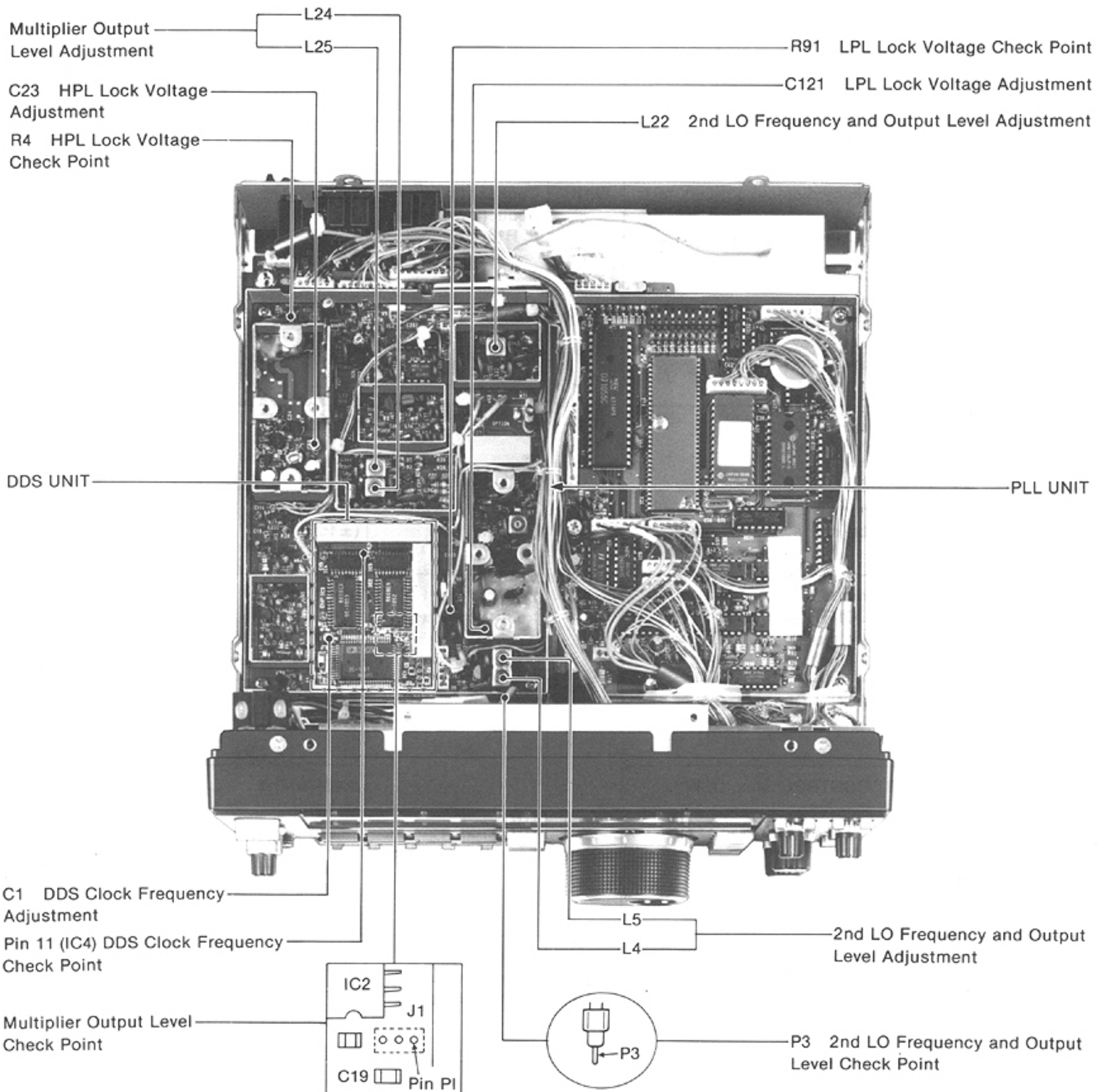

This picture shows the IC-475H model.

6-3 FREQUENCY ADJUSTMENT

TEST INSTRUMENTS REQUIRED		MEASUREMENT CONNECTION LOCATION					
<p>(1) AC POWER SUPPLY</p> <ul style="list-style-type: none"> • Output voltage : 13.8V DC • Current capacity : 25A or more <p>(2) FREQUENCY COUNTER</p> <ul style="list-style-type: none"> • Frequency range : 0.1~500MHz • Frequency accuracy : ±1 ppm or better • Sensitivity : 100mV or better 							
ADJUSTMENT	ADJUSTMENT CONDITIONS	MEASUREMENT		VALUE	ADJUSTMENT POINT		
		UNIT	LOCATION		UNIT	ADJUST	
BFO FREQUENCY	1	<ul style="list-style-type: none"> • Frequency display: 435.0000MHz • LSB mode • Receive mode 	MAIN	Connect the frequency counter to R186.	9.01300MHz	MAIN	C119
	2	<ul style="list-style-type: none"> • CW mode • Transmit mode • Connect a key to the KEY JACK and key down. 			9.01060MHz		L31
	3	<ul style="list-style-type: none"> • USB mode • Receive mode 			9.01000MHz		L30
	4	<ul style="list-style-type: none"> • CW mode • Receive mode 			9.00980MHz (±150Hz)		Verify
PBT FREQUENCY	1	<ul style="list-style-type: none"> • USB mode • PBT CONTROL: Center • Receive mode 	MAIN	Connect the frequency counter to R140.	9.46650MHz	MAIN	L28
	2	<ul style="list-style-type: none"> • PBT CONTROL: Max. CW 			9.46830MHz or higher		Verify
	3	<ul style="list-style-type: none"> • PBT CONTROL: Max. CCW 			9.46470MHz or lower		
	4	<ul style="list-style-type: none"> • PBT CONTROL: Center • FM mode 			9.46650MHz		R310
FM 2nd IF FREQUENCY	1	<ul style="list-style-type: none"> • FM mode • Transmit mode • R105 (MAIN): Max. CW 	MAIN	Connect the frequency counter to the cathode of D39.	9.01150MHz	MAIN	L19

CW: Clockwise CCW: Counterclockwise

MAIN UNIT

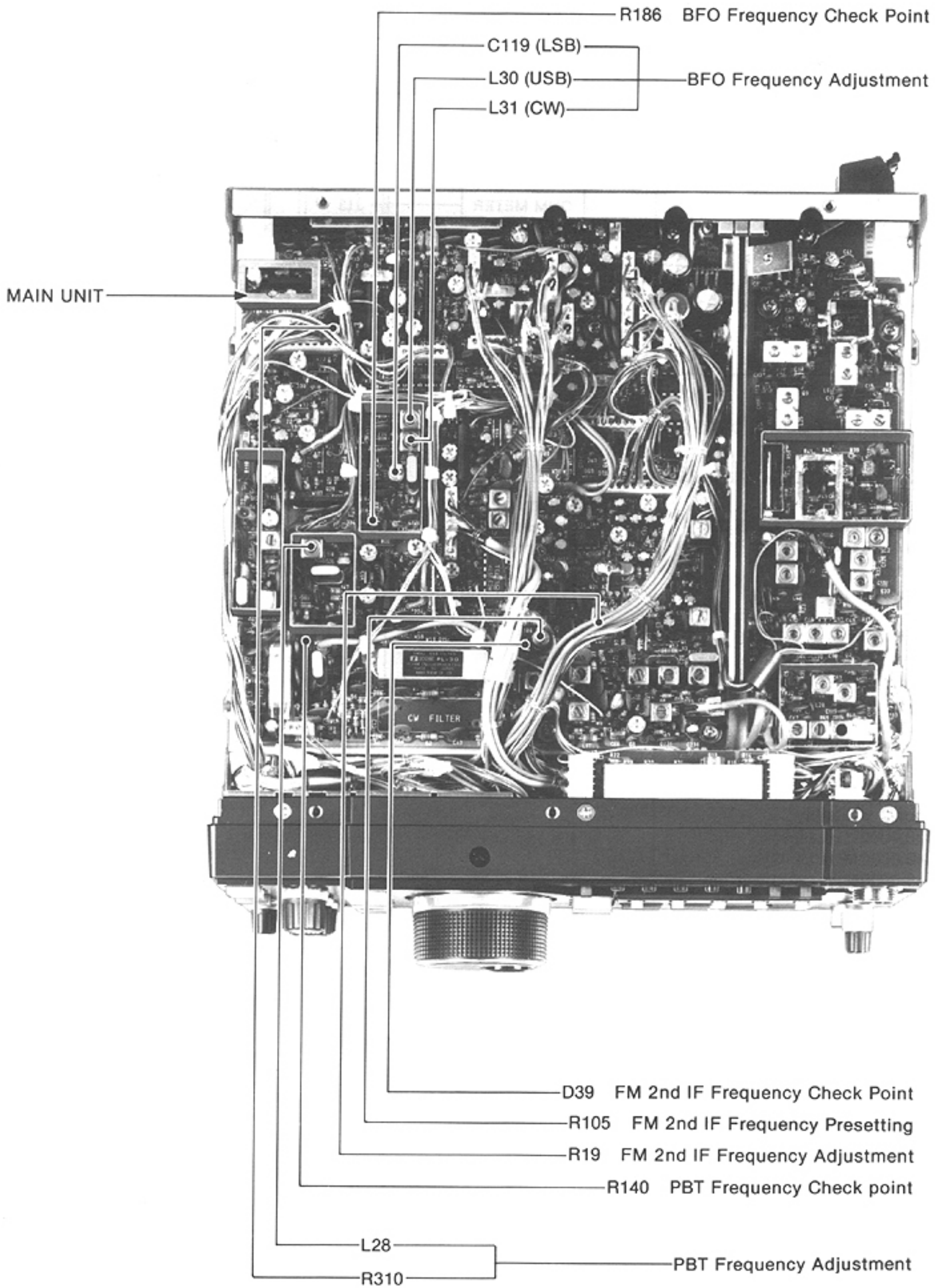

This picture shows the IC-475H model.

6-4 RECEIVER ADJUSTMENT

TEST INSTRUMENTS REQUIRED	MEASUREMENT CONNECTION LOCATION
<p>(1) AC POWER SUPPLY</p> <ul style="list-style-type: none"> • Output voltage : 13.8V DC • Current capacity : 25A or more <p>(2) STANDARD SIGNAL GENERATOR (SSG)</p> <ul style="list-style-type: none"> • Frequency range : 0.1~500MHz • Output level : -127~-17dBm (0.1μV~32mV) <p>(3) DC VOLTMETER</p> <ul style="list-style-type: none"> • Input impedance : 50kΩ/DC or better <p>(4) AC MILLI-VOLTMETER</p> <ul style="list-style-type: none"> • Measuring range : 10mV~10V <p>(5) EXTERNAL SPEAKER</p> <ul style="list-style-type: none"> • Impedance : 8Ω <p>(6) OHM METER</p> <p>(7) OSCILLOSCOPE</p> <ul style="list-style-type: none"> • Frequency range : DC~20MHz • Measuring range : 0.01~10V <p>(8) RF VOLTMETER (IC-475H ONLY)</p> <ul style="list-style-type: none"> • Frequency range : 0.1~500MHz • Measuring range : 0.01~10V 	

ADJUSTMENT	ADJUSTMENT CONDITIONS	MEASUREMENT		VALUE	ADJUSTMENT POINT		
		UNIT	LOCATION		UNIT	ADJUST	
FILTER (IC-475H ONLY)	1	<ul style="list-style-type: none"> • Frequency display: 435.0000 MHz (#02H, #05H) 440.0000 MHz (#03H, #04H) • FM mode • Receive mode • Apply an RF signal to the ANTENNA CONNECTOR. Level: -47dBm (1mV) Mod.: OFF 	FILTER	Terminate P1 to ground with a 50Ω resistor. Connect the RF voltmeter to P1.	Adjust to maximum output. (Less than 0.5dB attenuation)	FILTER	C18
	2					<ul style="list-style-type: none"> • Frequency display: 430.0000 MHz (#02H~#04H) 432.0000 MHz (#05H) • Frequency display: 438.0000 MHz (#05H) 440.0000 MHz (#02H) 450.0000 MHz (#03H, #04) 	Less than 0.8dB attenuation on both band edges.
NOTE: After completing the adjustment, return P1 to its original condition.							
FM RECEIVER	1	<ul style="list-style-type: none"> • Frequency display: 435.0000 MHz (#06E, #12E, #02H, #05H) 440.0000 MHz (#08A, #10A, #03H, #04H) • FM mode • Receive mode • RF GAIN CONTROL: Max. CW • PREAMP: OFF • NOTCH FILTER SWITCH: OFF • PBT CONTROL: Center • AF TONE CONTROL: Center • SQUELCH CONTROL: Max. CCW • Apply an RF signal to the ANTENNA CONNECTOR. Level: -97dBm (3.2μV) Dev.: ±5kHz Mod.: 1kHz 	FRONT PANEL	METER	Maximum	RF YGR	C68, C65, L2, L1, L11, L9, L10, L20, L21, L15, L16
						MAIN	L6, L7, L8, L9, L10
NOTE: Repeat above adjustment several times.							

CW: Clockwise CCW: Counterclockwise

MAIN AND RF YGR UNITS

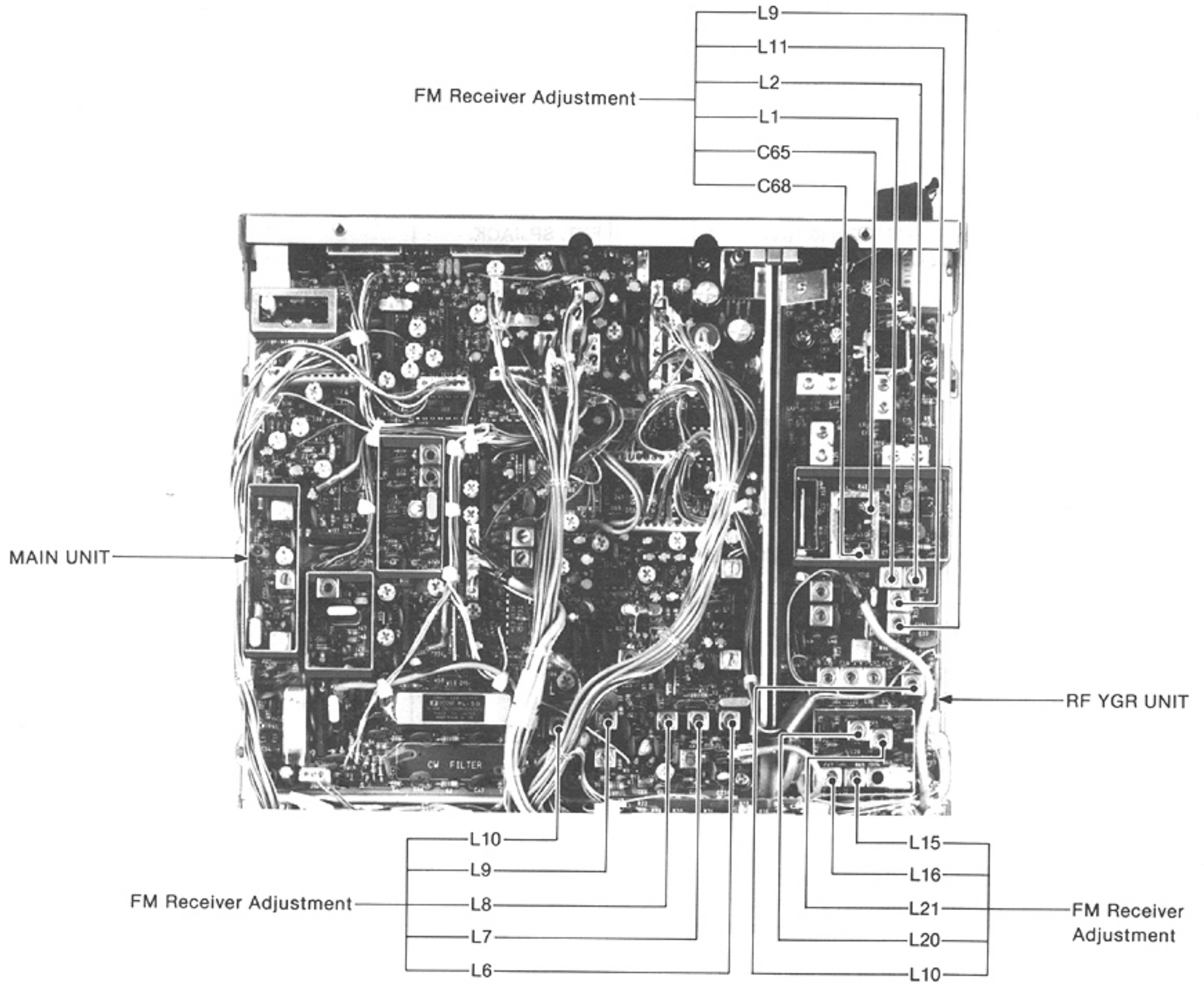

FILTER UNIT

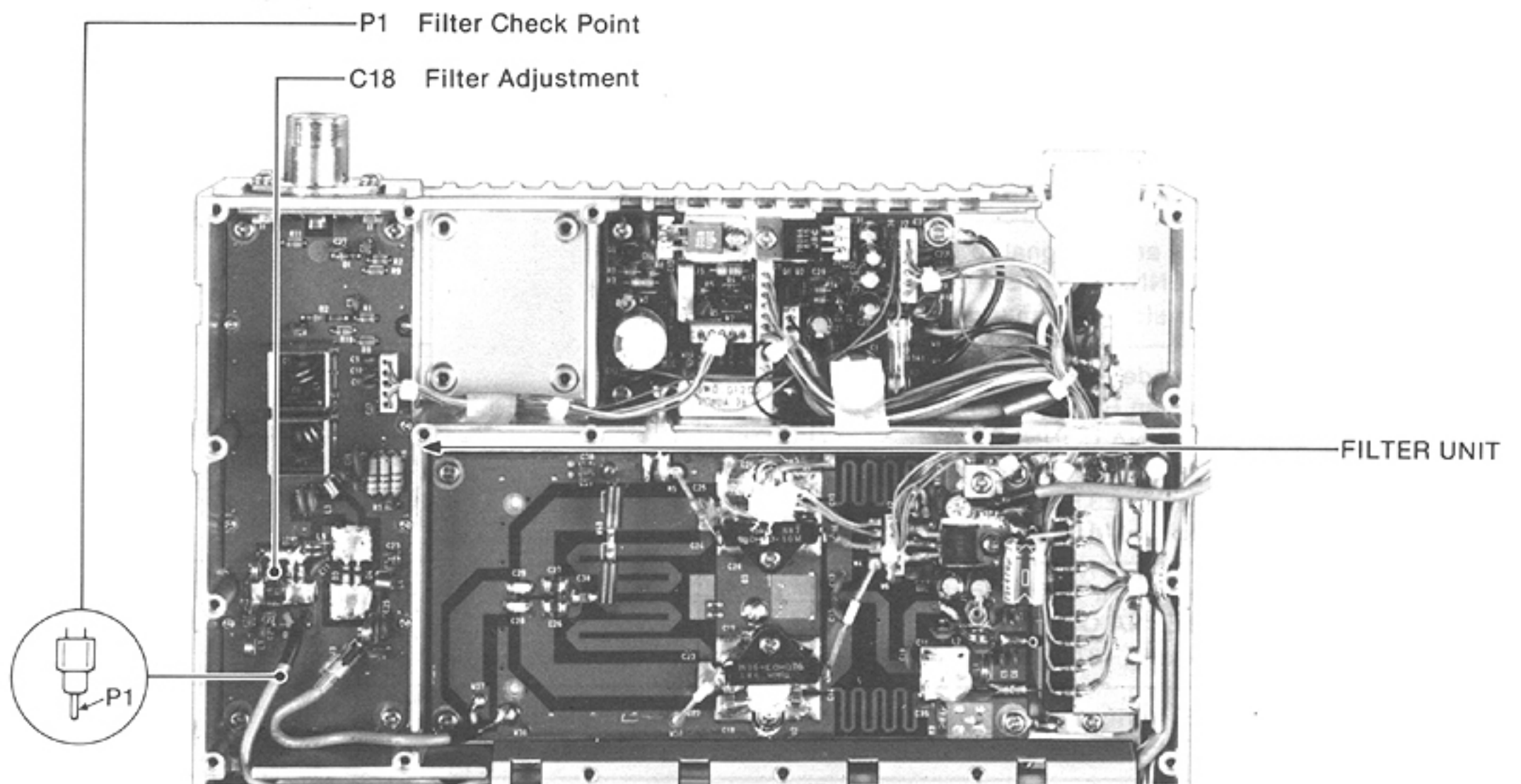

These pictures show the IC-475H model.

RECEIVER ADJUSTMENT (CONTINUED)

ADJUSTMENT	ADJUSTMENT CONDITIONS	MEASUREMENT		VALUE	ADJUSTMENT POINT		
		UNIT	LOCATION		UNIT	ADJUST	
SSB RECEIVER	1	<ul style="list-style-type: none"> • USB mode • Apply an RF signal to the ANTENNA CONNECTOR. Level: -127dBm ($0.1\mu\text{V}$) Mod.: OFF 	REAR PANEL	Connect the AC milli-voltmeter with an 8Ω load to the EXT. SP JACK.	Max. audio output	MAIN	L12, L13, L14
TOTAL GAIN	1	<ul style="list-style-type: none"> • USB mode • Apply an RF signal to the ANTENNA CONNECTOR. Level: -127dBm ($0.1\mu\text{V}$) Mod.: OFF 	REAR PANEL	Connect the AC milli-voltmeter with an 8Ω load to the EXT. SP JACK.	Max. audio output	FRONT PANEL	TUNING CONTROL
	2	<ul style="list-style-type: none"> • Apply an RF signal to the ANTENNA CONNECTOR. Level: -97dBm ($3.2\mu\text{V}$) Mod.: OFF • Apply no signal to the ANTENNA CONNECTOR. 			20dB S/N ratio	MAIN	R72
CENTER METER	1	<ul style="list-style-type: none"> • FM mode • Apply an RF signal to the ANTENNA CONNECTOR. Level: -77dBm ($32\mu\text{V}$) Mod.: OFF 	MAIN	Connect the DC voltmeter to W64.	3V	MAIN	L23
	2	<ul style="list-style-type: none"> • Apply an RF signal to the ANTENNA CONNECTOR. Level: -97dBm ($3.2\mu\text{V}$) Dev.: $\pm 3.5\text{kHz}$ Mod.: 1kHz • METER SWITCH: C • ALC • Adjust the applied signal frequency (approx. $+4\text{kHz}$ of the center freq.) to max. indication on the right side of the meter. 	FRONT PANEL	METER	80% of full scale		R121
	3	<ul style="list-style-type: none"> • Apply no signal to the ANTENNA CONNECTOR. 			Center		R120
NOTE: Repeat above adjustments 1 through 3 several times. Verify that the meter movement becomes 20%~80% when the applied frequency changes.							
S-METER	1	<ul style="list-style-type: none"> • USB mode • Apply an RF signal to the ANTENNA CONNECTOR. Level: -97dBm ($3.2\mu\text{V}$) Mod.: OFF 	FRONT PANEL	METER	S9 (S-scale)	MAIN	R24
	2	<ul style="list-style-type: none"> • Apply an RF signal to the ANTENNA CONNECTOR. Level: -47dBm (1mV) 			Full scale		R14
	3	<ul style="list-style-type: none"> • FM mode • Apply an RF signal to the ANTENNA CONNECTOR. 			Maximum (S-scale)		L36
	4	<ul style="list-style-type: none"> Level: -107dBm ($1\mu\text{V}$) Dev.: $\pm 3.5\text{kHz}$ Mod.: 1kHz 			S5 (S-scale)		R221
	5	<ul style="list-style-type: none"> • Apply an RF signal to the ANTENNA CONNECTOR. Level: -67dBm (0.1mV) 			Full scale		R222
NOTE: Verify that the meter balance on band edges is within $\pm 3\text{dB}$ in both USB and FM modes.							

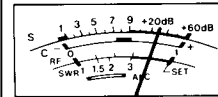

MAIN UNIT

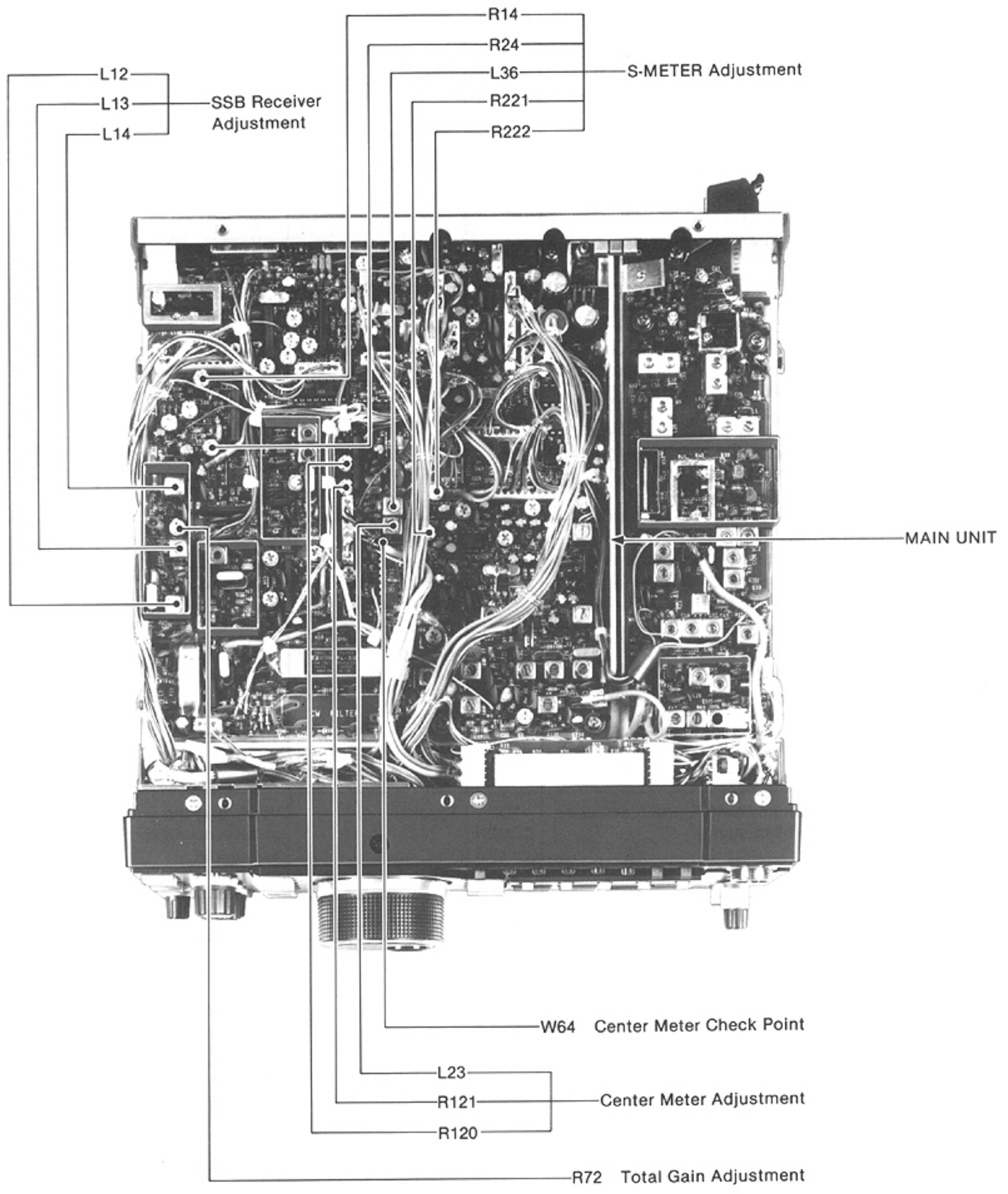

This picture shows the IC-475H model.

RECEIVER ADJUSTMENT (CONTINUED)

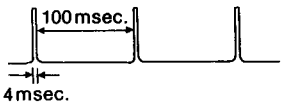
ADJUSTMENT		ADJUSTMENT CONDITIONS	MEASUREMENT		VALUE	ADJUSTMENT POINT	
			UNIT	LOCATION		UNIT	ADJUST
RF GAIN	1	<ul style="list-style-type: none"> • USB mode • Apply no signal to the ANTENNA CONNECTOR. • RF GAIN CONTROL: Max. CCW 	FRONT PANEL	METER	Full scale	MAIN	R29
	2	<ul style="list-style-type: none"> • FM mode • Apply an RF signal to the ANTENNA CONNECTOR. Level: -87dBm ($10\mu\text{V}$) Dev. : $\pm 3.5\text{kHz}$ Mod. : 1kHz • RF GAIN CONTROL: Max. CCW 					S5 (S-scale)
SQUELCH UNIT	1	<ul style="list-style-type: none"> • FM mode • Apply an RF signal to the ANTENNA CONNECTOR. Level: -125dBm ($0.13\mu\text{V}$) Mod. : OFF 	MAIN	Connect the ohm meter between J13, pin 9 and ground.	0Ω	MAIN	R323
	2	<ul style="list-style-type: none"> • Apply no signal to the ANTENNA CONNECTOR. 					∞
NOISE BALANKER	1	<ul style="list-style-type: none"> • USB mode • Apply an RF signal including the following pulse-type noise to the ANTENNA CONNECTOR. 	REAR PANEL	Connect the oscilloscope with an 8Ω load to the EXT. SP JACK.	Adjust to minimum waveform on the oscilloscope.	MAIN	L1, L2
BEEP TONE	1	<ul style="list-style-type: none"> • Push any switch which activates the beep sound. 	TOP COVER	Speaker	Verify that the level of beep sound is adjustable.	MAIN	R348
NOTE: Set R348 to center position after verification.							

CCW: Counterclockwise

MAIN UNIT

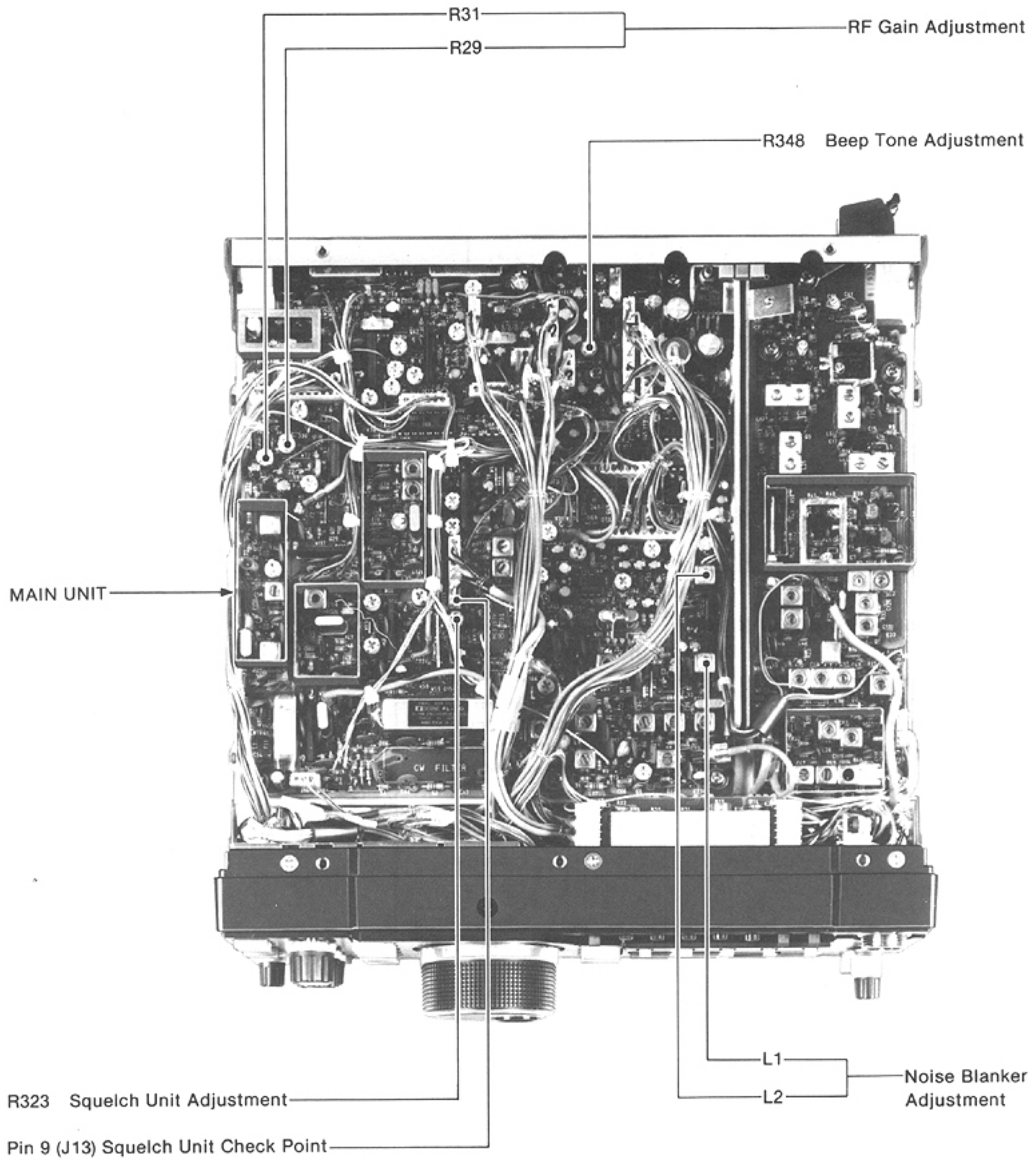

This picture shows the IC-475H model.

6-5 TRANSMITTER ADJUSTMENT (IC-475H)

TEST INSTRUMENTS REQUIRED	MEASUREMENT CONNECTION LOCATION
<p>(1) AC POWER SUPPLY</p> <ul style="list-style-type: none"> • Output voltage : 13.8V DC • Current capacity : 25A or more <p>(2) RF POWER METER (TERMINATED TYPE)</p> <ul style="list-style-type: none"> • Measuring range : 10~200W • Frequency range : 400~500MHz • Impedance : 50Ω • SWR : Less than 1:1.2 <p>(3) AMMETER</p> <ul style="list-style-type: none"> • Measurement capability : 1A <p>(4) AF GENERATOR (AG)</p> <ul style="list-style-type: none"> • Frequency range : 200~2000Hz • Output level : 0~50mV <p>(5) AC MILLI-VOLTMETER</p> <ul style="list-style-type: none"> • Measuring range : 2~50mV <p>(6) FM DEVIATION METER</p> <ul style="list-style-type: none"> • Frequency minimum : 500MHz • Measuring range : 0~±5kHz <p>(7) SPECTRUM ANALYZER</p>	

ADJUSTMENT	ADJUSTMENT CONDITIONS	MEASUREMENT		VALUE	ADJUSTMENT POINT			
		UNIT	LOCATION		UNIT	ADJUST		
IDLING CURRENT	1	<ul style="list-style-type: none"> • USB mode • Transmit mode • MIC GAIN CONTROL: Max. CCW 	PA	Desolder R1 (CTRL) and connect the ammeter between R1 and W40 (PA).	500mA	PA	R2	
NOTE: Resolder after making adjustment.								
FM OUTPUT POWER	1	<ul style="list-style-type: none"> • Frequency display: 435.0000MHz (#02H, #05H) 440.0000MHz (#03H, #04H) • FM mode • Transmit mode • S5 Power Selector Switch: High • RF POWER CONTROL: Max. CW • Apply an AF signal to the MIC CONNECTOR: 1kHz, 20mV. • W9 (MAIN): Connect a jumper wire between W9 and ground. 	REAR PANEL	Connect the RF power meter to the ANTENNA CONNECTOR.	Adjust to maximum output.	MAIN	L16, R82, L15	
							RF YGR	L33, L12, L17, L18, L19, C90, C95
							PA	C11
NOTE: After above adjustment, remove the jumper wire from W9.								

CW: Clockwise CCW: Counterclockwise

MAIN AND RF YGR UNITS

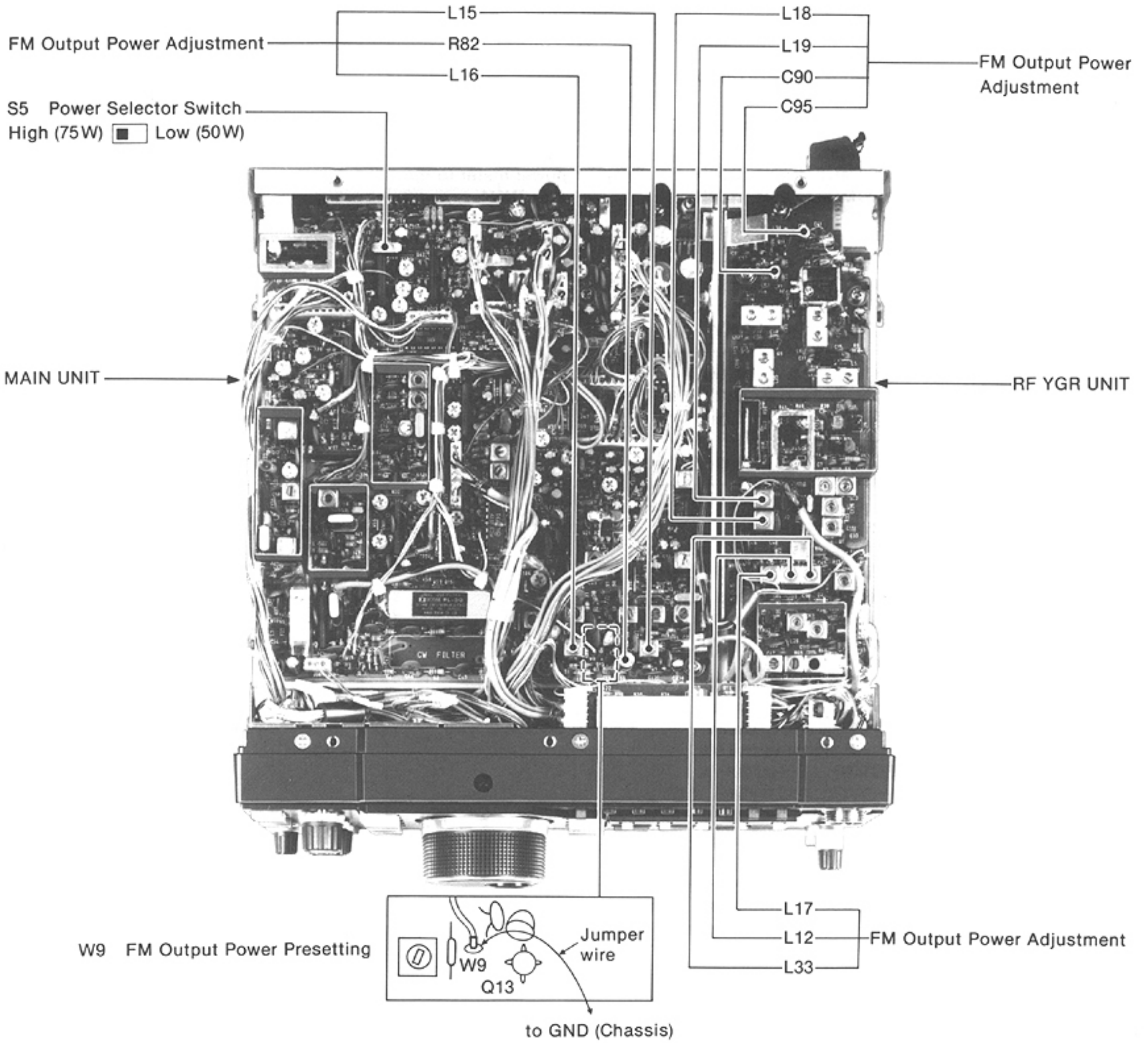

PA AND CTRL UNITS

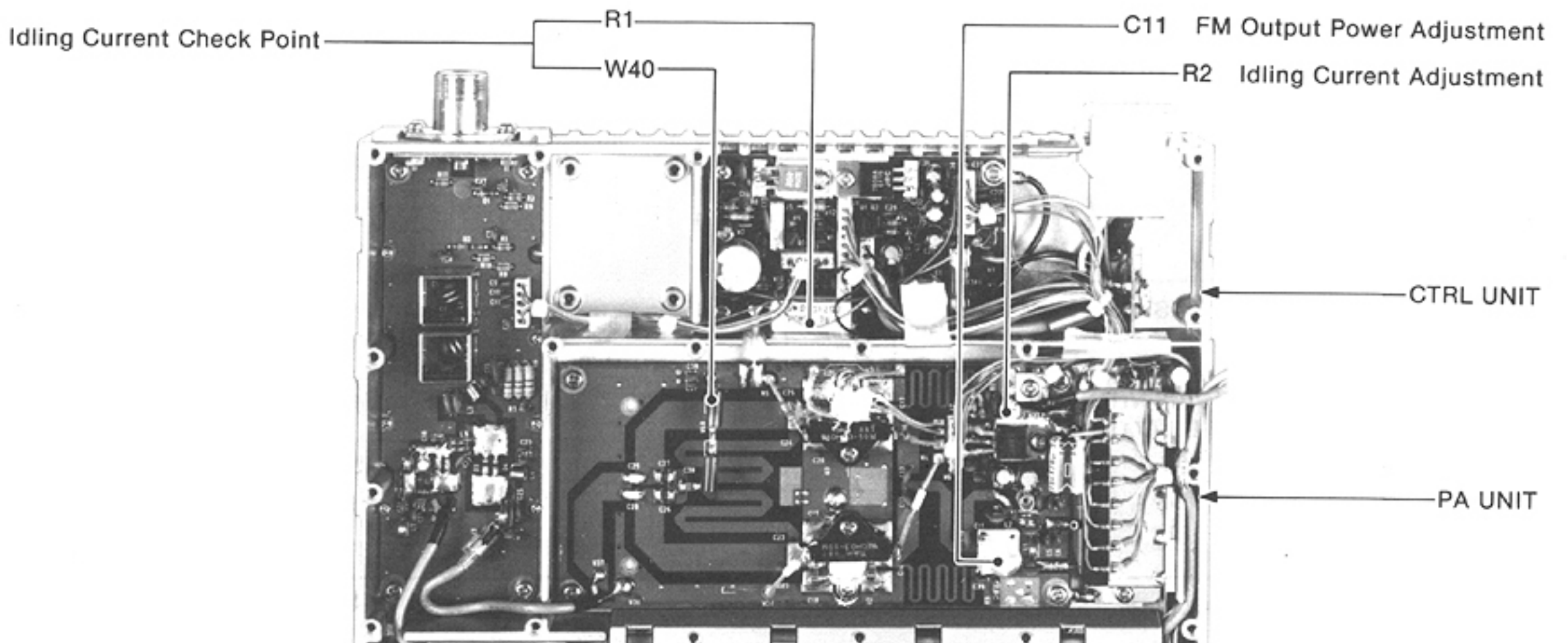

TRANSMITTER ADJUSTMENT (IC-475H) (CONTINUED)

ADJUSTMENT	ADJUSTMENT CONDITIONS	MEASUREMENT		VALUE	ADJUSTMENT POINT			
		UNIT	LOCATION		UNIT	ADJUST		
OUTPUT POWER	1	<ul style="list-style-type: none"> • Frequency display: 435.0000 MHz (#02H, #05H) 440.0000 MHz (#03H, #04H) • USB mode • Transmit mode • MIC TONE CONTROL: Center • MIC GAIN CONTROL: Center • Apply an AF signal to the MIC CONNECTOR: 1.5kHz, 2mV. 	REAR PANEL	Connect the RF power meter to the ANTENNA CONNECTOR.	40W	MAIN	R82	
	2	<ul style="list-style-type: none"> • Apply an AF signal to the MIC CONNECTOR: 1.5kHz, 20mV. • RF POWER CONTROL: Max. CW 			75W		R259	
	3	<ul style="list-style-type: none"> • RF POWER CONTROL: Max. CCW 			10W		R256	
	(SSB POWER BALANCE)	4			<ul style="list-style-type: none"> • Apply an AF signal to the MIC CONNECTOR: 300Hz, 2mV. • USB and LSB modes. • Adjust MIC GAIN CONTROL to a point where the power level is 7.5W. 		Adjust to the same output level on both modes.	C119
APC SET	1	<ul style="list-style-type: none"> • USB mode • Transmit mode • MIC TONE CONTROL: Center • MIC GAIN CONTROL: Center • Apply an AF signal to the MIC CONNECTOR: 1.5kHz, 20mV. • RF POWER CONTROL: Max. CW • R250: Max. CCW • R10 (CTRL): Connect a jumper wire between R10 and ground. 	REAR PANEL	Connect the RF power meter to the ANTENNA CONNECTOR.	40W	MAIN	R244	
NOTE: After above adjustment, remove the jumper wire from R10.								
ALC METER	1	<ul style="list-style-type: none"> • USB mode • Transmit mode • Apply an AF signal to the MIC CONNECTOR: 1.5kHz, 10mV. • METER SWITCH: C • ALC 	FRONT PANEL	METER	100% (ALC scale)	MAIN	R265	
RF METER (SET)	1	<ul style="list-style-type: none"> • FM mode • Transmit mode • Apply an AF signal to the MIC CONNECTOR: 1.5kHz, 20mV. • METER SWITCH: S • RF • TX-METER SWITCH: SET 	REAR PANEL	Connect the RF power meter to the ANTENNA CONNECTOR.	20W	FRONT PANEL	RF POWER CONTROL	
	2		FRONT PANEL	METER	SWR SET position	MAIN	R240	
	(SWR)	3	<ul style="list-style-type: none"> • TX-METER SWITCH: SWR 			Less than 1.2 (SWR scale)		Verify
	(RF)	4	<ul style="list-style-type: none"> • TX-METER SWITCH: RF • RF POWER CONTROL: Max. CW 			90% (RF scale)		R257

CW: Clockwise CCW: Counterclockwise

MAIN UNIT

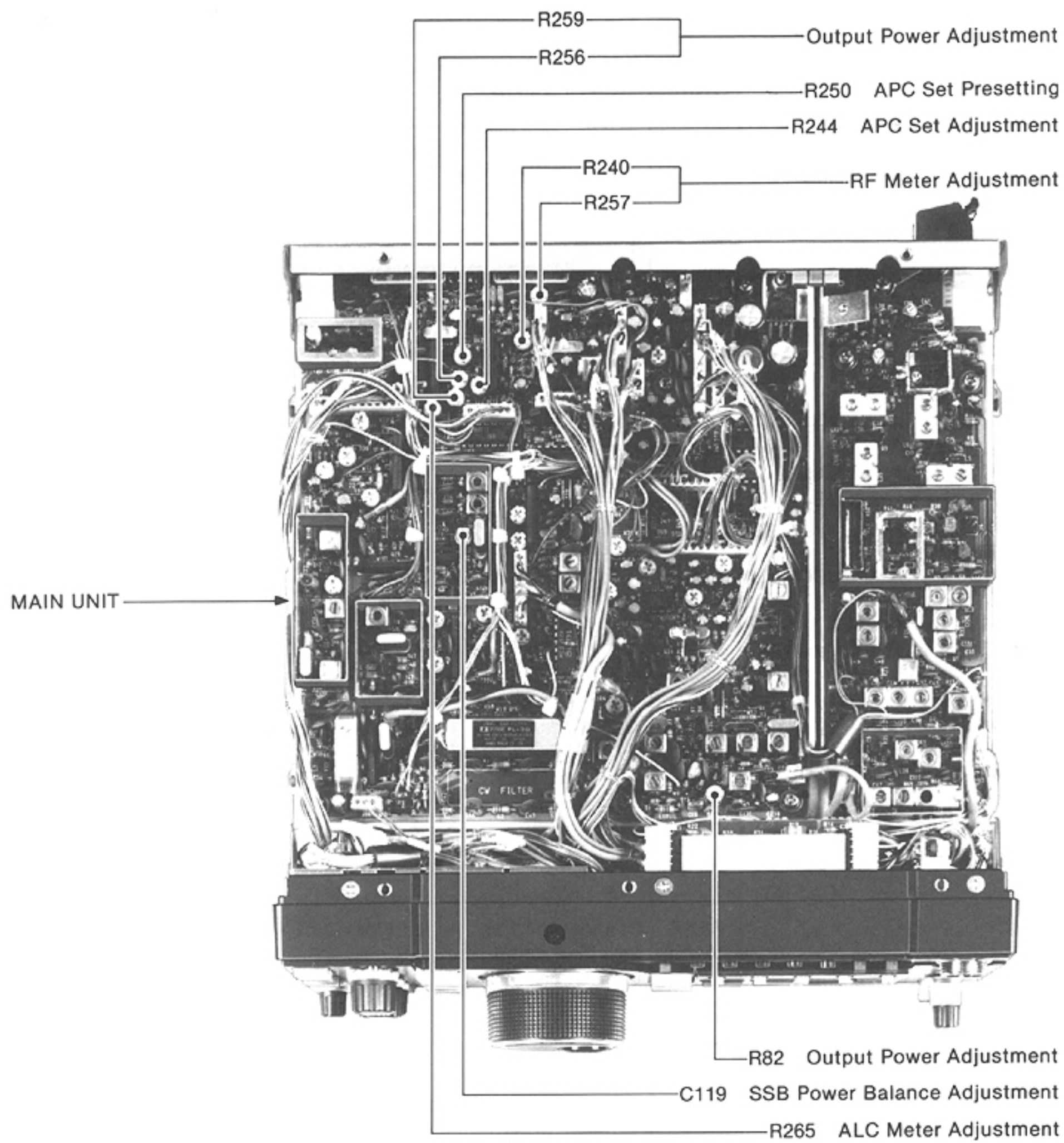

**Downloaded by
RadioAmateur.EU**

CTRL UNIT

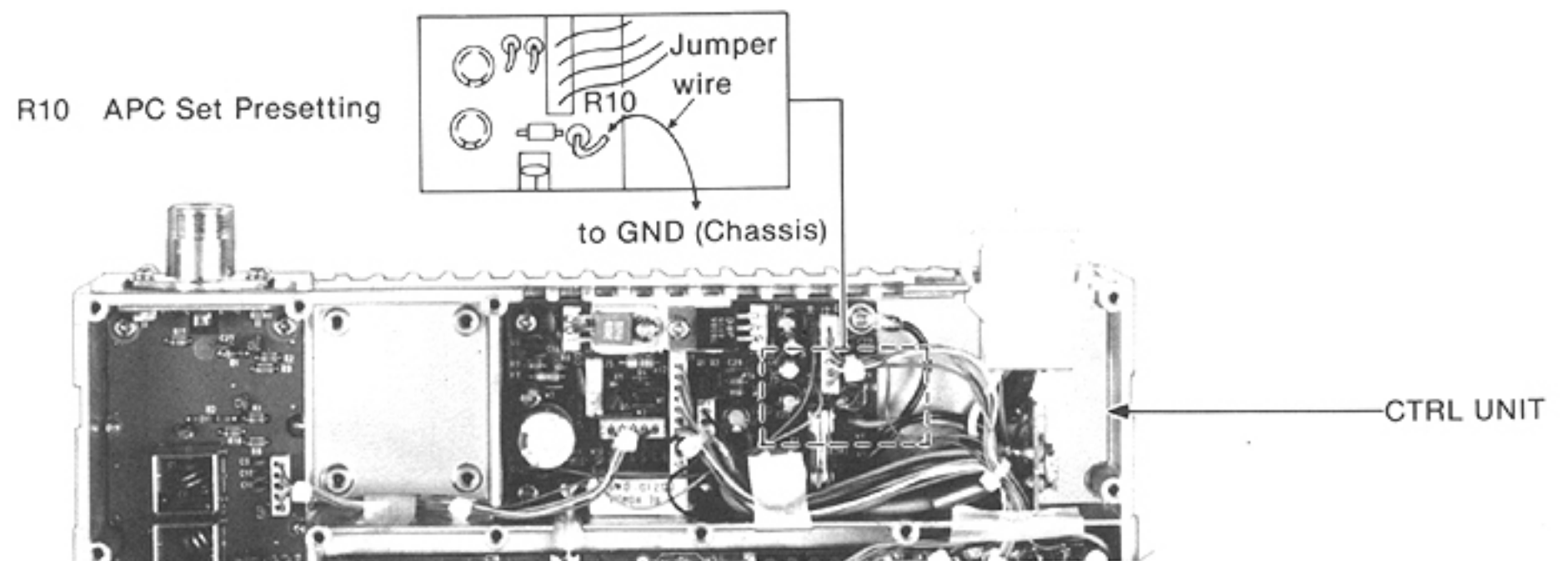

TRANSMITTER ADJUSTMENT (IC-475H) (CONTINUED)

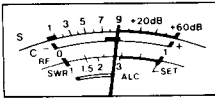
ADJUSTMENT		ADJUSTMENT CONDITIONS	MEASUREMENT		VALUE	ADJUSTMENT POINT	
			UNIT	LOCATION		UNIT	ADJUST
COMP LEVEL	1	<ul style="list-style-type: none"> • USB mode • Apply an AF signal to the MIC CONNECTOR: 1.5kHz, 5mV. 	REAR PANEL	Connect the RF power meter to the ANTENNA CONNECTOR.	40W	FRONT PANEL	MIC GAIN CONTROL
	2	<ul style="list-style-type: none"> • Apply an AF signal to the MIC CONNECTOR: 1.5kHz, 1.6mV. (10dB down) • COMP SWITCH: ON 				REAR PANEL	COMP LEVEL
FM DRIVE LEVEL	1	<ul style="list-style-type: none"> • Frequency display: 435.0000 MHz (#02H, #05H) 440.0000 MHz (#03H, #04H) • FM mode • Transmit mode • Apply no AF signal to the MIC CONNECTOR. • METER SWITCH: C • ALC • RF POWER CONTROL: Max. CW 	FRONT PANEL	METER	100% (ALC scale)	MAIN	R105
							
CW DRIVE LEVEL	1	<ul style="list-style-type: none"> • CW mode • Transmit mode • Connect a key to the KEY JACK and key down. • METER SWITCH: C • ALC 	FRONT PANEL	METER	100% (ALC scale)	MAIN	R137
FM DEVIATION	1	<ul style="list-style-type: none"> • FM mode • Transmit mode • MIC TONE CONTROL: Center • MIC GAIN CONTROL: Center • Apply an AF signal to the MIC CONNECTOR: 1kHz, 20mV. 	REAR PANEL	Connect the FM deviation meter to the ANTENNA CONNECTOR through an attenuator.	±4.8kHz	MAIN	R162
	2	<ul style="list-style-type: none"> • Apply an AF signal to the MIC CONNECTOR: 1kHz, 2mV. 			±3.5kHz		R173
CARRIER SUPPRESSION	1	<ul style="list-style-type: none"> • USB mode • Apply no AF signal to the MIC CONNECTOR. • Transmit mode • Select USB and LSB mode alternately. 	REAR PANEL	Connect the spectrum analyzer to the ANTENNA CONNECTOR through an attenuator.	Minimum carrier level (Less than -40dB) Same carrier level (USB and LSB mode)	MAIN	R133, R135

CW: Clockwise

MAIN UNIT

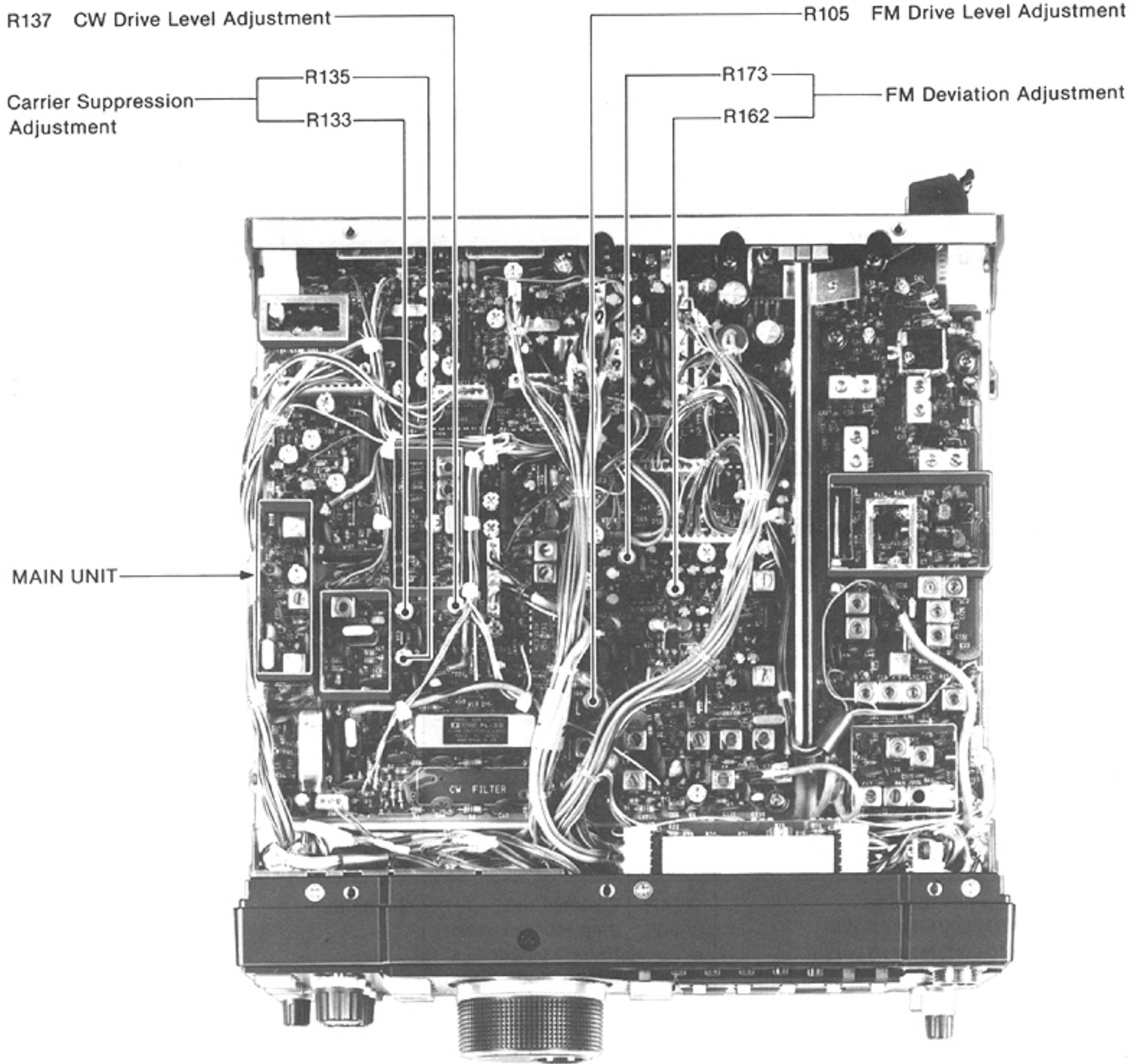

6-6 TRANSMITTER ADJUSTMENT (IC-475A/E)

TEST INSTRUMENTS REQUIRED	MEASUREMENT CONNECTION LOCATION
<p>(1) AC POWER SUPPLY</p> <ul style="list-style-type: none"> • Output voltage : 13.8V DC • Current capacity : 10A or more <p>(2) DC VOLTMETER</p> <ul style="list-style-type: none"> • Input impedance : 50kΩ/DC or better <p>(3) RF POWER METER (TERMINATED TYPE)</p> <ul style="list-style-type: none"> • Measuring range : 1~30W • Frequency range : 400~500MHz • Impedance : 50Ω • SWR : Less than 1:1.2 <p>(4) AMMETER</p> <ul style="list-style-type: none"> • Measurement capability : 10A <p>(5) AF GENERATOR (AG)</p> <ul style="list-style-type: none"> • Frequency range : 200~2000Hz • Output level : 0~50mV <p>(6) AC MILLI-VOLTMETER</p> <ul style="list-style-type: none"> • Measuring range : 2~50mV <p>(7) FM DEVIATION METER</p> <ul style="list-style-type: none"> • Frequency minimum : 500MHz • Measuring range : 0~±5kHz <p>(8) SPECTRUM ANALYZER</p>	

ADJUSTMENT	ADJUSTMENT CONDITIONS	MEASUREMENT		VALUE	ADJUSTMENT POINT		
		UNIT	LOCATION		UNIT	ADJUST	
FM OUTPUT POWER	1	<ul style="list-style-type: none"> • Frequency display: 435.0000 MHz (#06E, #12E) 440.0000 MHz (#08A, #10A) • FM mode • Transmit mode • RF POWER CONTROL: Max. CW • W9 (MAIN): Connect a jumper wire between W9 and ground. 	REAR PANEL	Connect the RF power meter to the ANTENNA CONNECTOR.	Adjust to maximum output.	MAIN	L16, R82, L15
	2	<ul style="list-style-type: none"> • Apply an AF signal to the MIC CONNECTOR: 1kHz, 20mV. 	MAIN	Connect the DC voltmeter to J4, pin 7.	Adjust to minimum output.	PA	R5
	3	<ul style="list-style-type: none"> • Frequency display: 438.0000 MHz (#12E) 440.0000 MHz (#06E) 450.0000 MHz (#08A, #10A) 	REAR PANEL	Connect the ammeter between the AC power supply and IC-475A/E.	Minimum		C11
NOTE: After above adjustment, remove the jumper wire from W9.							
OUTPUT POWER	1	<ul style="list-style-type: none"> • Frequency display: 435.0000 MHz (#06E, #12E) 440.0000 MHz (#08A, #10A) • USB mode • Transmit mode • MIC TONE CONTROL: Center • MIC GAIN CONTROL: Center • Apply an AF signal to the MIC CONNECTOR: 1.5kHz, 2mV. 	REAR PANEL	Connect the RF power meter to the ANTENNA CONNECTOR.	12.5W	MAIN	R82
	2	<ul style="list-style-type: none"> • Apply an AF signal to the MIC CONNECTOR: 1.5kHz, 20mV. • RF POWER CONTROL: Max. CW 			25W		R259
	3	<ul style="list-style-type: none"> • RF POWER CONTROL: Max. CCW 				2.5W	

CW: Clockwise CCW: Counterclockwise

MAIN AND RF YGR UNITS

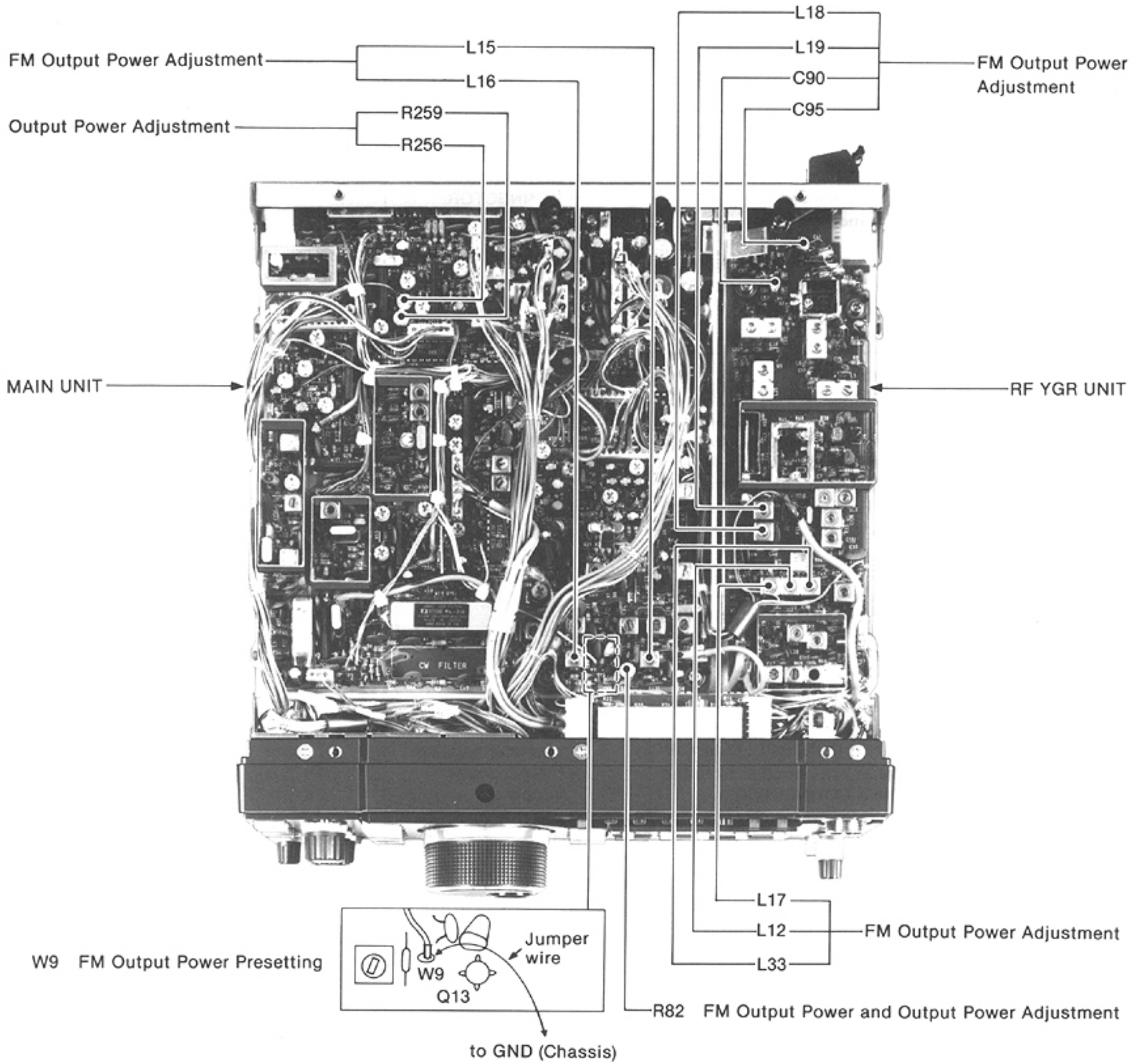

PA UNIT

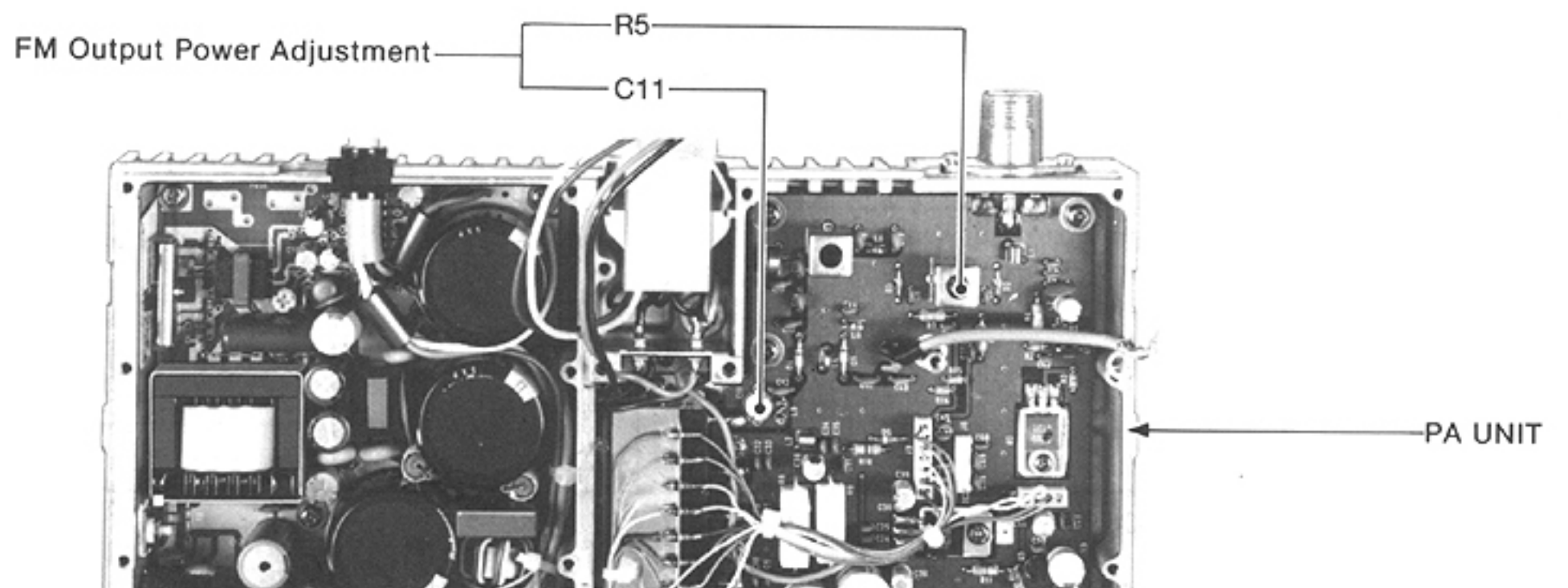

TRANSMITTER ADJUSTMENT (IC-475A/E) (CONTINUED)

ADJUSTMENT		ADJUSTMENT CONDITIONS	MEASUREMENT		VALUE	ADJUSTMENT POINT	
			UNIT	LOCATION		UNIT	ADJUST
SSB POWER BALANCE	1	<ul style="list-style-type: none"> • Frequency display: 435.0000MHz (#06E, #12E) 440.0000MHz (#08A, #10A) • USB and LSB mode. • Transmit mode. • Apply an AF signal to the MIC CONNECTOR: 300Hz, 2mV. • Adjust MIC GAIN CONTROL to a point where the power level is 2.5W. 	REAR PANEL	Connect the RF power meter to the ANTENNA CONNECTOR.	Adjust to same output level on both modes.	MAIN	C119
	2	<ul style="list-style-type: none"> • USB mode • Transmit mode • MIC TONE CONTROL: Center • MIC GAIN CONTROL: Center • Apply an AF signal to the MIC CONNECTOR: 1.5kHz, 20mV. • RF POWER CONTROL: Max. CW • R244: Max. CCW 	REAR PANEL	Connect the RF power meter to the ANTENNA CONNECTOR.	5W	MAIN	R250
APC SET	2	<ul style="list-style-type: none"> • AC POWER SUPPLY: 11.73V 			Turn R244 CW and adjust to a point just before the output power drops.		R244
	3	<ul style="list-style-type: none"> • FM mode • RF POWER CONTROL: Max. CW • Remove any connection from the ANTENNA CONNECTOR. 		Connect the ammeter between the AC power supply and IC-475A/E.	Less than 7.0A		Verify
ALC METER	1	<ul style="list-style-type: none"> • USB mode • Transmit mode • Apply an AF signal to the MIC CONNECTOR: 1.5kHz, 10mV. • METER SWITCH: C • ALC 	FRONT PANEL	METER	100% (ALC scale)	MAIN	R265
RF METER (SET)	1	<ul style="list-style-type: none"> • FM mode • Transmit mode • Apply an AF signal to the MIC CONNECTOR: 1.5kHz, 20mV. • METER SWITCH: S • RF • TX-METER SWITCH: SET 	REAR PANEL	Connect the RF power meter to the ANTENNA CONNECTOR.	10W	FRONT PANEL	RF POWER CONTROL
	2	<ul style="list-style-type: none"> • TX-METER SWITCH: SWR 	FRONT PANEL	METER	SWR SET position	MAIN	R240
(SWR)	3	<ul style="list-style-type: none"> • TX-METER SWITCH: SWR 			Less than 1.2 (SWR scale)		Verify
(RF)	4	<ul style="list-style-type: none"> • TX-METER SWITCH: RF • RF POWER CONTROL: Max. CW 			90% (RF scale)		R257

CW: Clockwise CCW: Counterclockwise

MAIN UNIT

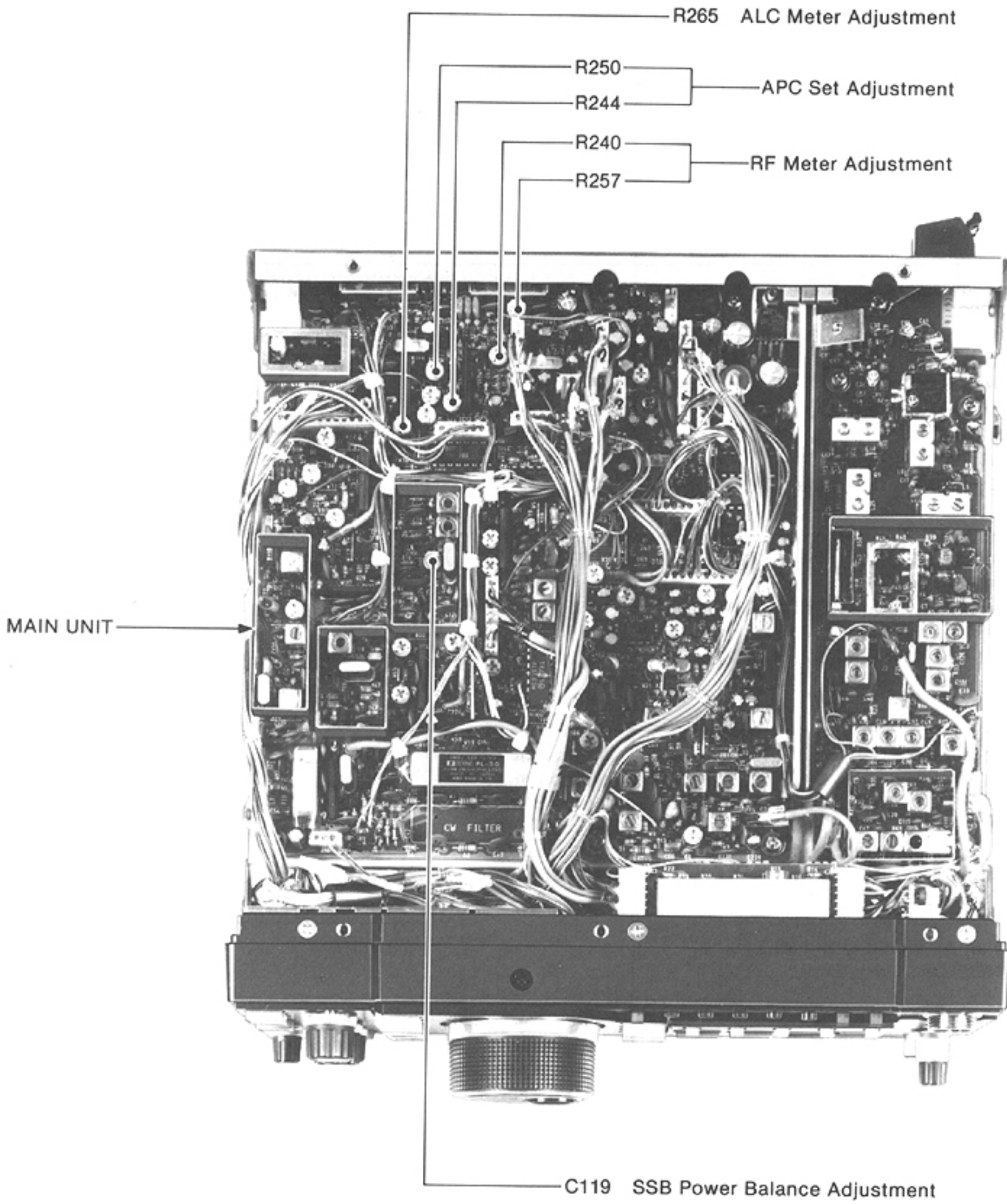

TRANSMITTER ADJUSTMENT (IC-475A/E) (CONTINUED)

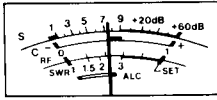
ADJUSTMENT		ADJUSTMENT CONDITIONS	MEASUREMENT		VALUE	ADJUSTMENT POINT	
			UNIT	LOCATION		UNIT	ADJUST
COMP LEVEL	1	<ul style="list-style-type: none"> • USB mode • Apply an AF signal to the MIC CONNECTOR: 1.5kHz, 5mV. 	REAR PANEL	Connect the RF power meter to the ANTENNA CONNECTOR.	12.5W	FRONT PANEL	MIC GAIN CONTROL
	2	<ul style="list-style-type: none"> • Apply an AF signal to the MIC CONNECTOR: 1.5kHz, 1.6mV. (10dB down) • COMP SWITCH: ON 					
FM DRIVE LEVEL	1	<ul style="list-style-type: none"> • Frequency display: 435.0000 MHz (#06E, #12E) 440.0000 MHz (#08A, #10A) • FM mode • Transmit mode • Apply no AF signal to the MIC CONNECTOR. • METER SWITCH: C • ALC • RF POWER CONTROL: Max. CW 	FRONT PANEL	METER	80% (ALC scale)	MAIN	R105
							
CW DRIVE LEVEL	1	<ul style="list-style-type: none"> • CW mode • Transmit mode • Connect a key to the KEY JACK and key down. • METER SWITCH: C • ALC 	FRONT PANEL	METER	80% (ALC scale)	MAIN	R137
FM DEVIATION	1	<ul style="list-style-type: none"> • FM mode • Transmit mode • MIC TONE CONTROL: Center • MIC GAIN CONTROL: Center • Apply an AF signal to the MIC CONNECTOR: 1 kHz, 20mV. 	REAR PANEL	Connect the FM deviation meter to the ANTENNA CONNECTOR through an attenuator.	±4.8kHz	MAIN	R162
	2	<ul style="list-style-type: none"> • Apply an AF signal to the MIC CONNECTOR: 1 kHz, 2mV. 			±3.5kHz		R173
CARRIER SUPPRESSION	1	<ul style="list-style-type: none"> • USB mode • Apply no AF signal to the MIC CONNECTOR. • Transmit mode • Select USB and LSB mode alternately. 	REAR PANEL	Connect the spectrum analyzer to the ANTENNA CONNECTOR through an attenuator.	Minimum carrier level (Less than -40dB) Same carrier level (USB and LSB mode)	MAIN	R133, R135

CW: Clockwise

MAIN UNIT

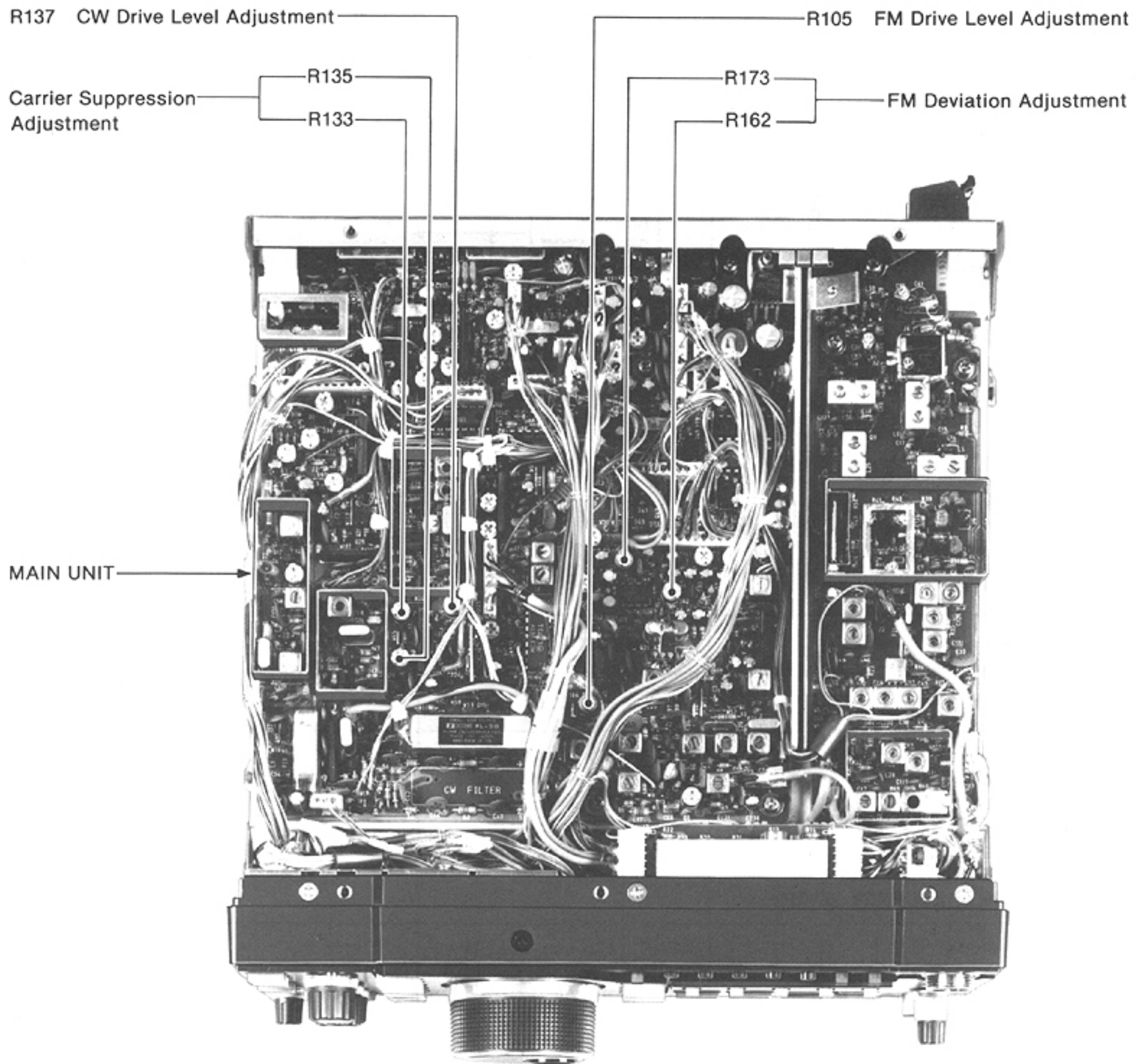

6-7 TONE ADJUSTMENT

TEST INSTRUMENTS REQUIRED	MEASUREMENT CONNECTION LOCATION
<p>(1) AC POWER SUPPLY</p> <ul style="list-style-type: none"> • Output voltage : 13.8V DC • Current capacity : 25A or more <p>(2) AF GENERATOR (AG)</p> <ul style="list-style-type: none"> • Frequency range : 200~3000Hz • Output level : 0~500mV <p>(3) AC MILLI-VOLTMETER</p> <ul style="list-style-type: none"> • Measuring range : 2~500mV <p>(4) FM DEVIATION METER</p> <ul style="list-style-type: none"> • Frequency minimum : 500MHz • Measuring range : 0~±5kHz 	<p style="text-align: center;">to QAS SOCKET PIN 2 (TX MOD) PIN 1 (GROUND)</p> <p style="text-align: center;">QAS SOCKET REAR PANEL VIEW</p> <p style="text-align: center;">TX MOD GROUND</p>

ADJUSTMENT	ADJUSTMENT CONDITIONS	MEASUREMENT		VALUE	ADJUSTMENT POINT	
		UNIT	LOCATION		UNIT	ADJUST
SUBAUDIBLE TONE	1 <ul style="list-style-type: none"> • Frequency display: 435.0000MHz • FM mode • Transmit mode • Apply no AF signal to the MIC CONNECTOR. • TONE SWITCH: ON • TONE FREQUENCY: 67.0Hz 	REAR PANEL	Connect the FM deviation meter to the ANTENNA CONNECTOR through an attenuator.	±0.5kHz (#08A, #10A, #03H, #04H)	LOGIC	R4
TONE CALL	1 <ul style="list-style-type: none"> • FM mode • Transmit mode • Apply no AF signal to the MIC CONNECTOR. • TONE SWITCH: ON 	REAR PANEL	Connect the FM deviation meter to the ANTENNA CONNECTOR through an attenuator.	±3.5kHz (#06E, #12E, #02H, #05H)	LOGIC	R4
AQS TONE	1 <ul style="list-style-type: none"> • FM mode • Transmit mode • Apply no AF signal to the MIC CONNECTOR. • Apply an AF signal to the AQS SOCKET, pin 2: 1.2kHz, 300mV (pin 1 is ground). 	REAR PANEL	Connect the FM deviation meter to the ANTENNA CONNECTOR through an attenuator.	±4kHz	MAIN	R152
TONE SQUELCH	1 <ul style="list-style-type: none"> • FM mode • Transmit mode • Apply no AF signal to the MIC CONNECTOR. • Connect P46 and P47 to UT-34 (option). • TONE SQUELCH SWITCH: ON • TONE FREQUENCY: 67.0Hz 	REAR PANEL	Connect the FM deviation meter to the ANTENNA CONNECTOR through an attenuator.	±0.5kHz	MAIN	R151

MAIN UNIT

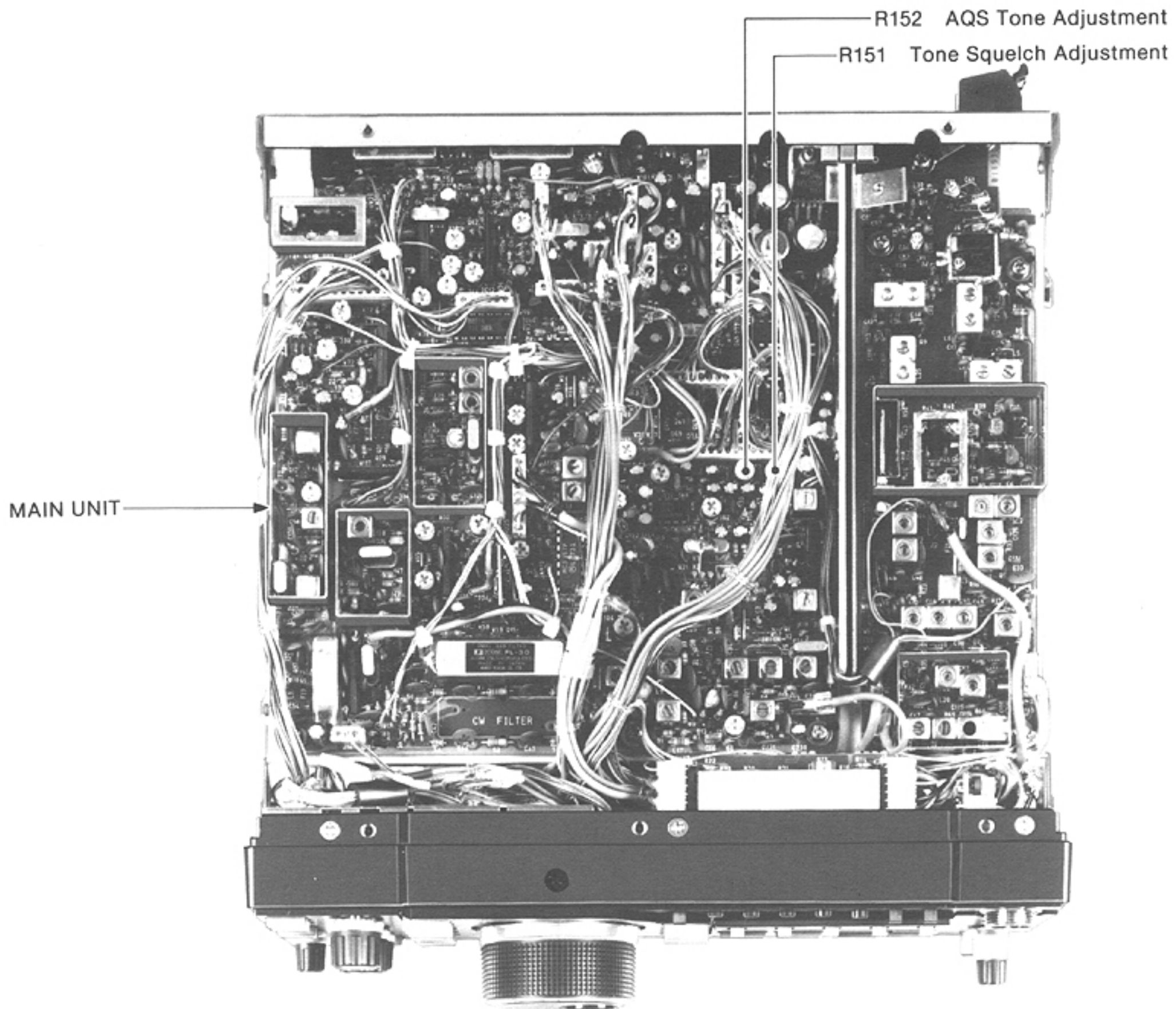

LOGIC UNIT

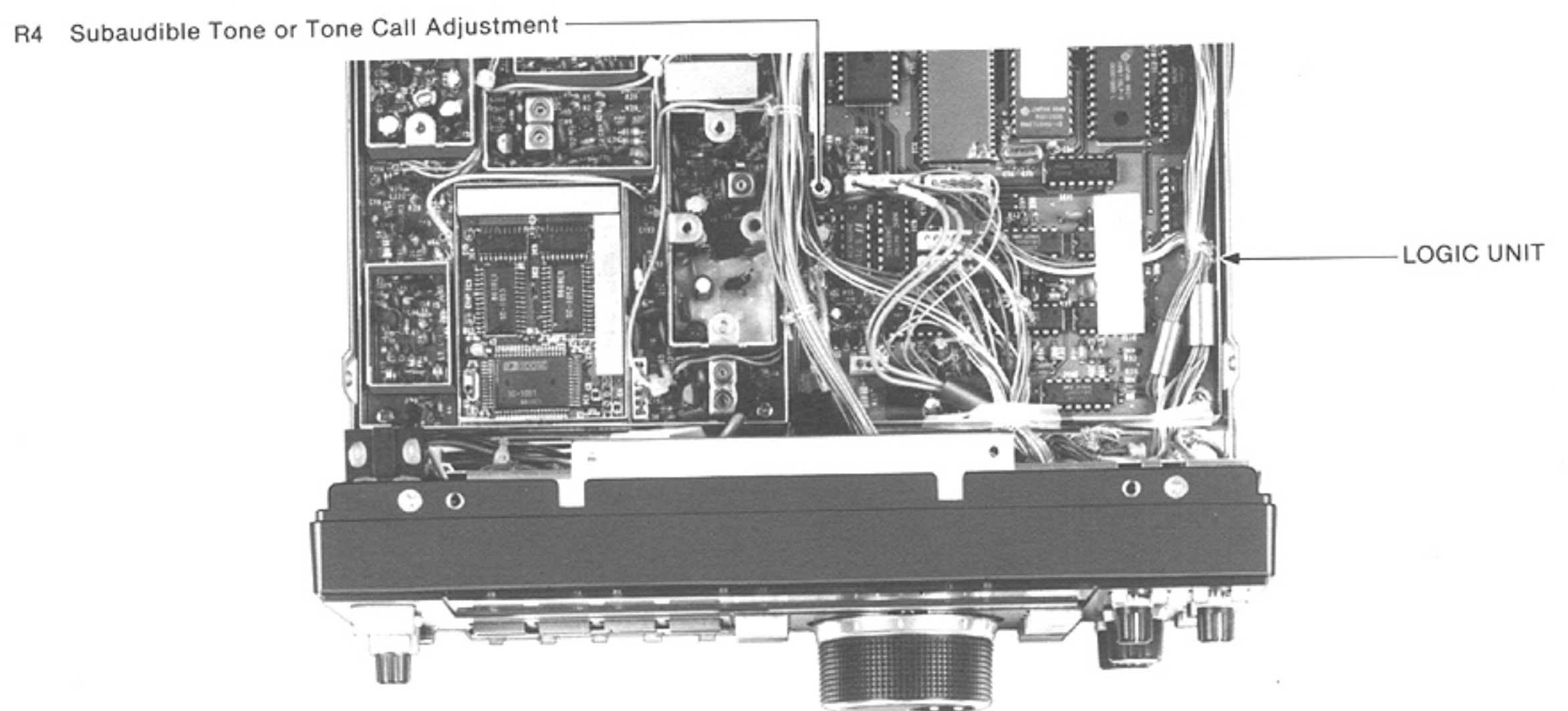

These pictures show the IC-475H model.

SECTION 7 BOARD LAYOUTS

7-1 FRONT UNITS (1)

• FRONT (SW-A) UNIT

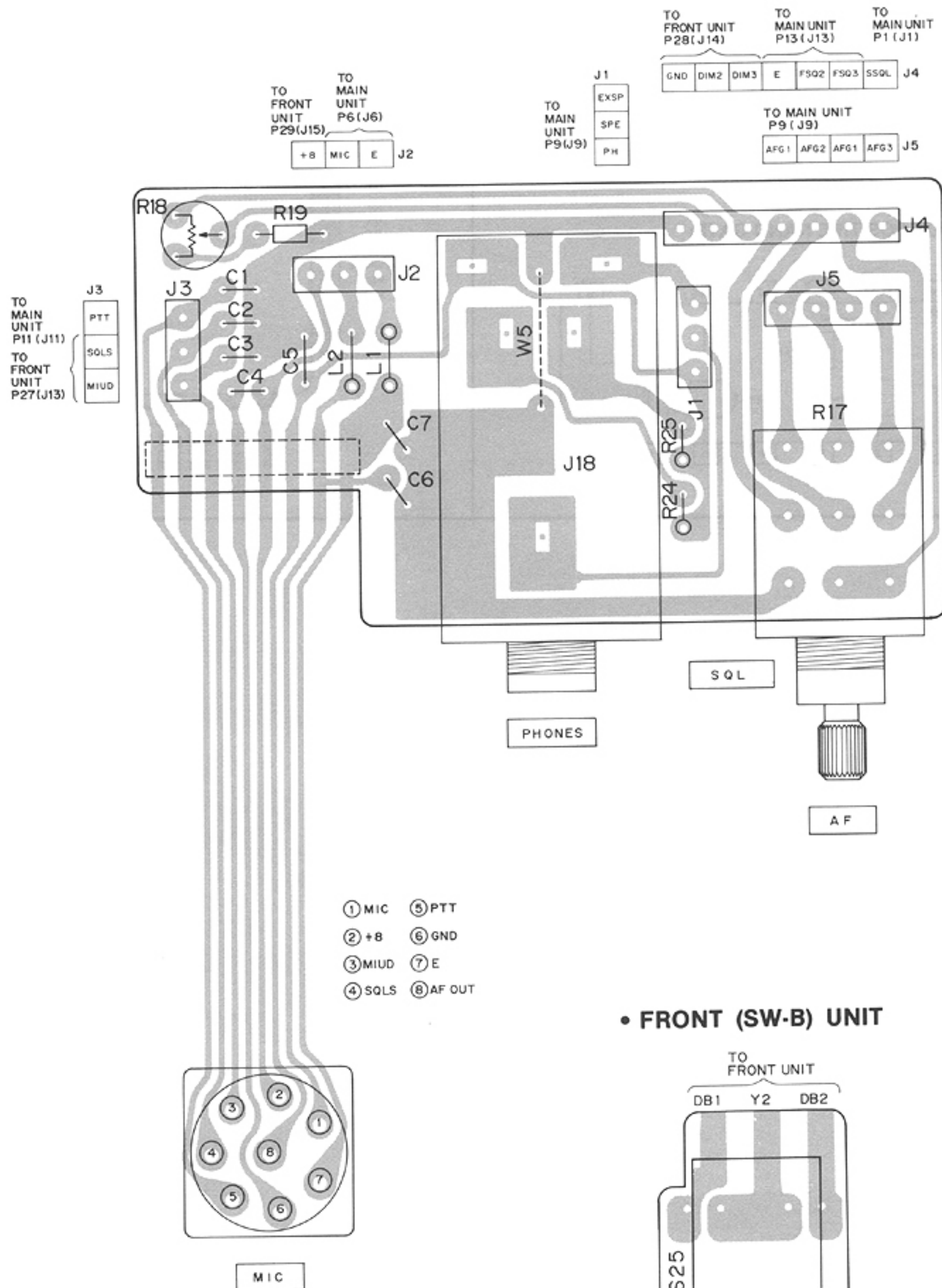

• FRONT (SW-B) UNIT

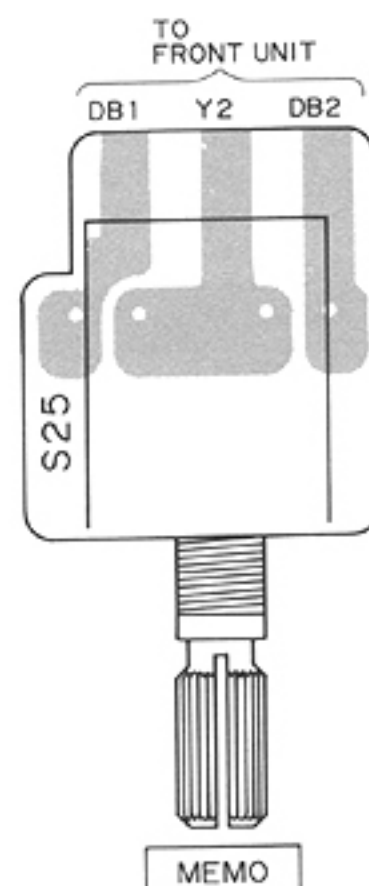

• FRONT (VR-A) UNIT

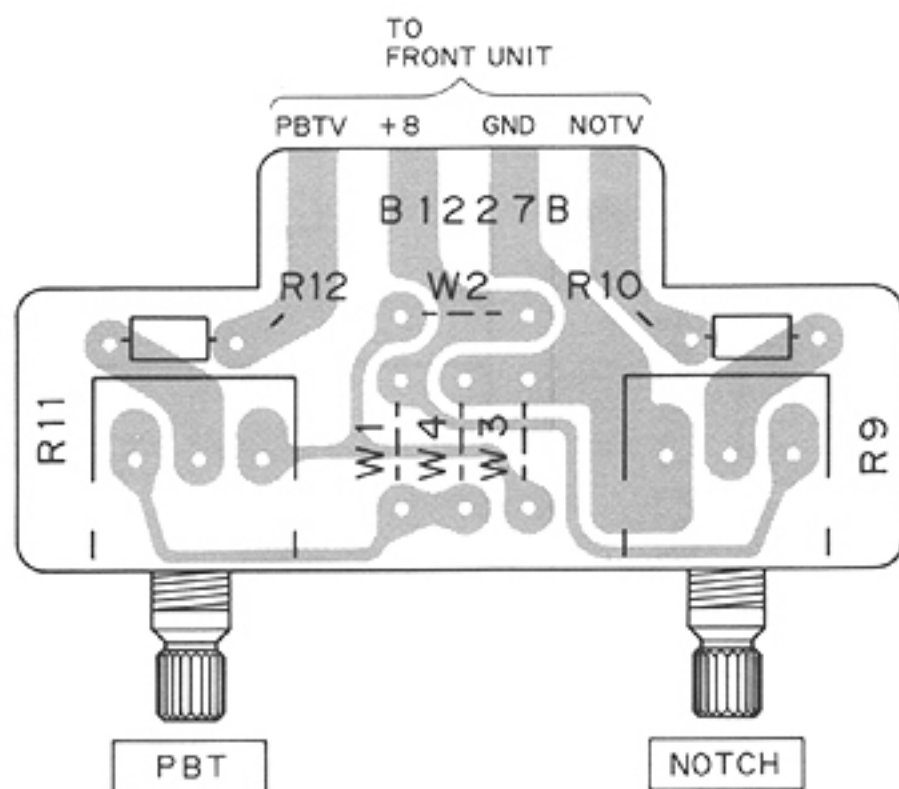

• FRONT (VR-B) UNIT

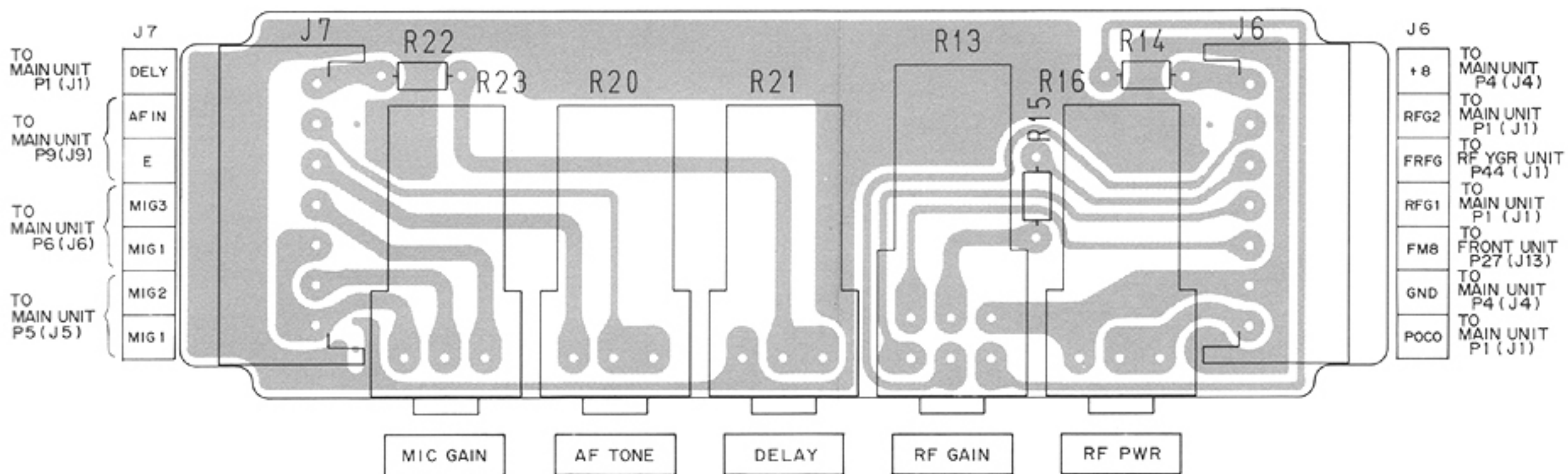

7-2 FRONT UNIT (2)

**μPD4066BC IC1
(QUAD BILATERAL SWITCHING)**

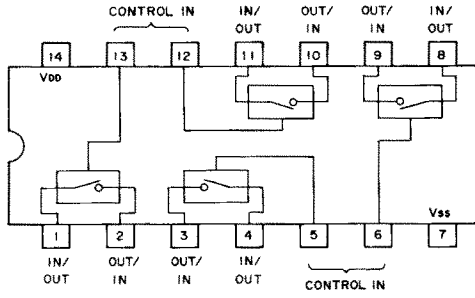

**μPD4011BC IC2
(QUAD 2-INPUT POSITIVE NAND GATE)**

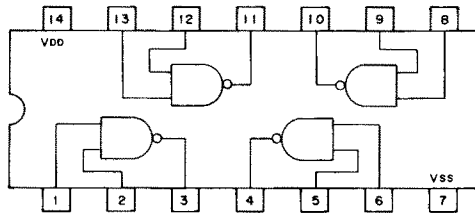

**HD61602 IC3
(LCD DRIVER)**

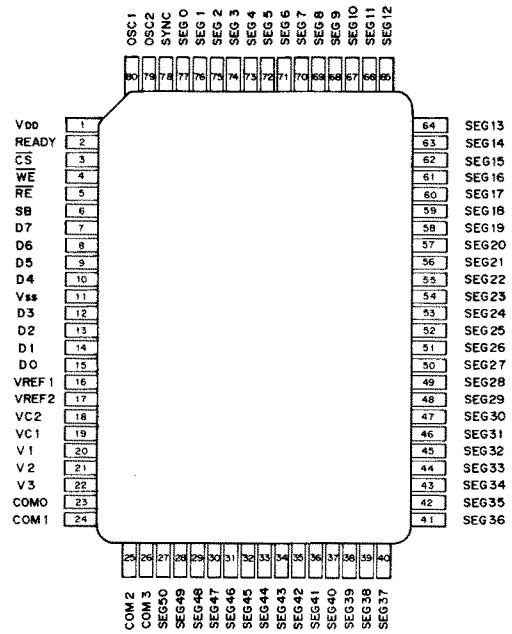

• FRONT UNIT

COMPONENTS SIDE

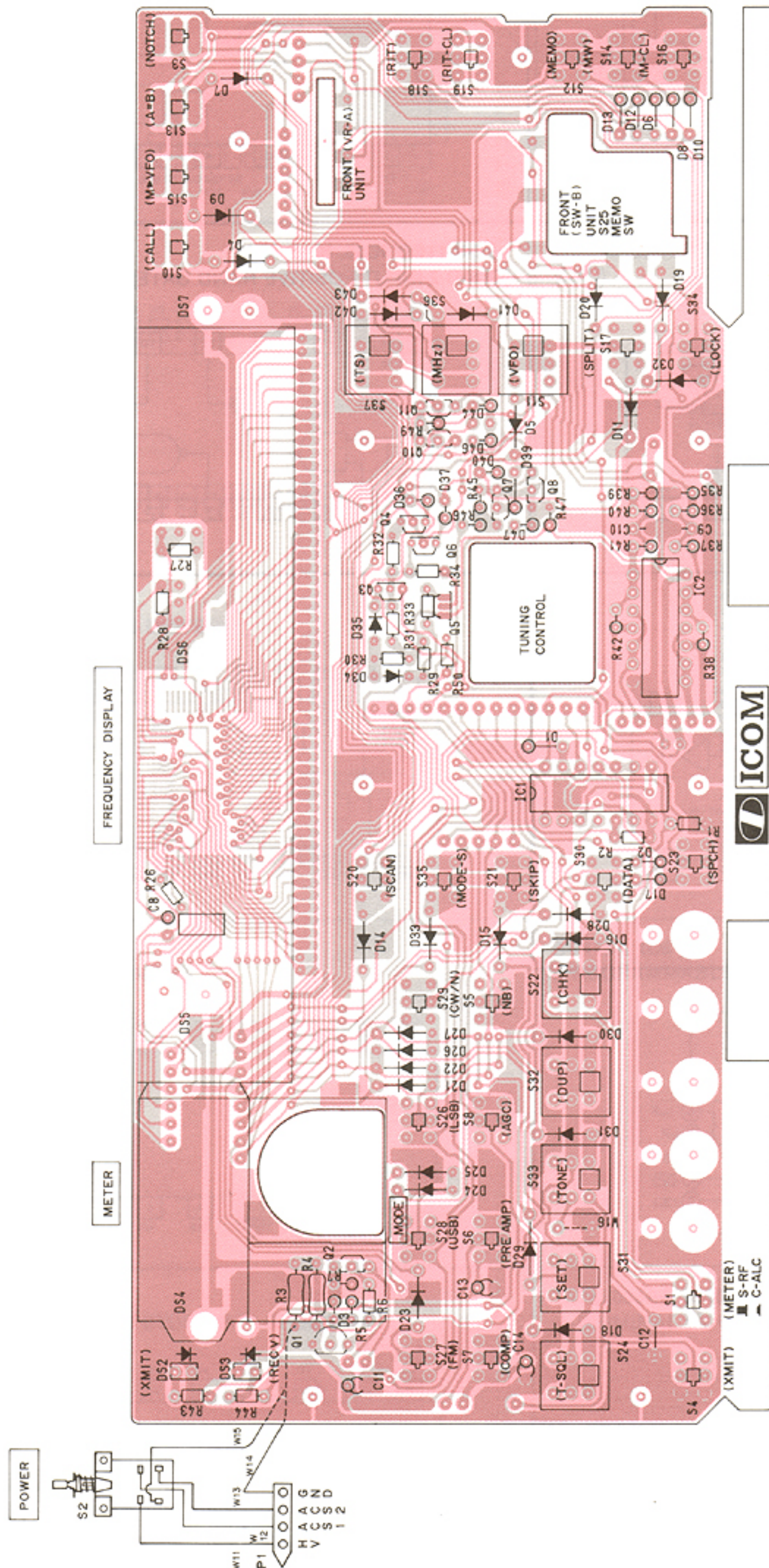

2SB562
Q1

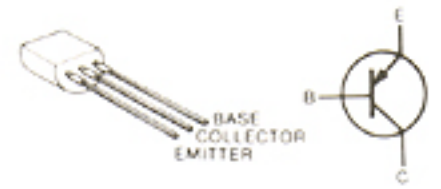

2SC2785
Q2, Q3, Q4, Q6, Q8, Q11

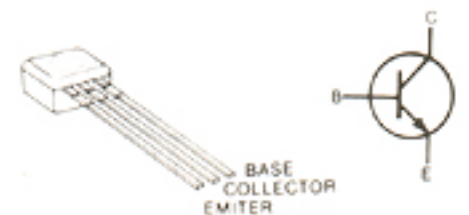

2SA1048
Q5, Q7



RN1204
Q10

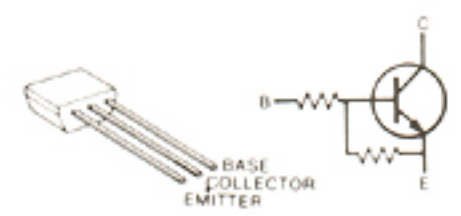

FOIL SIDE

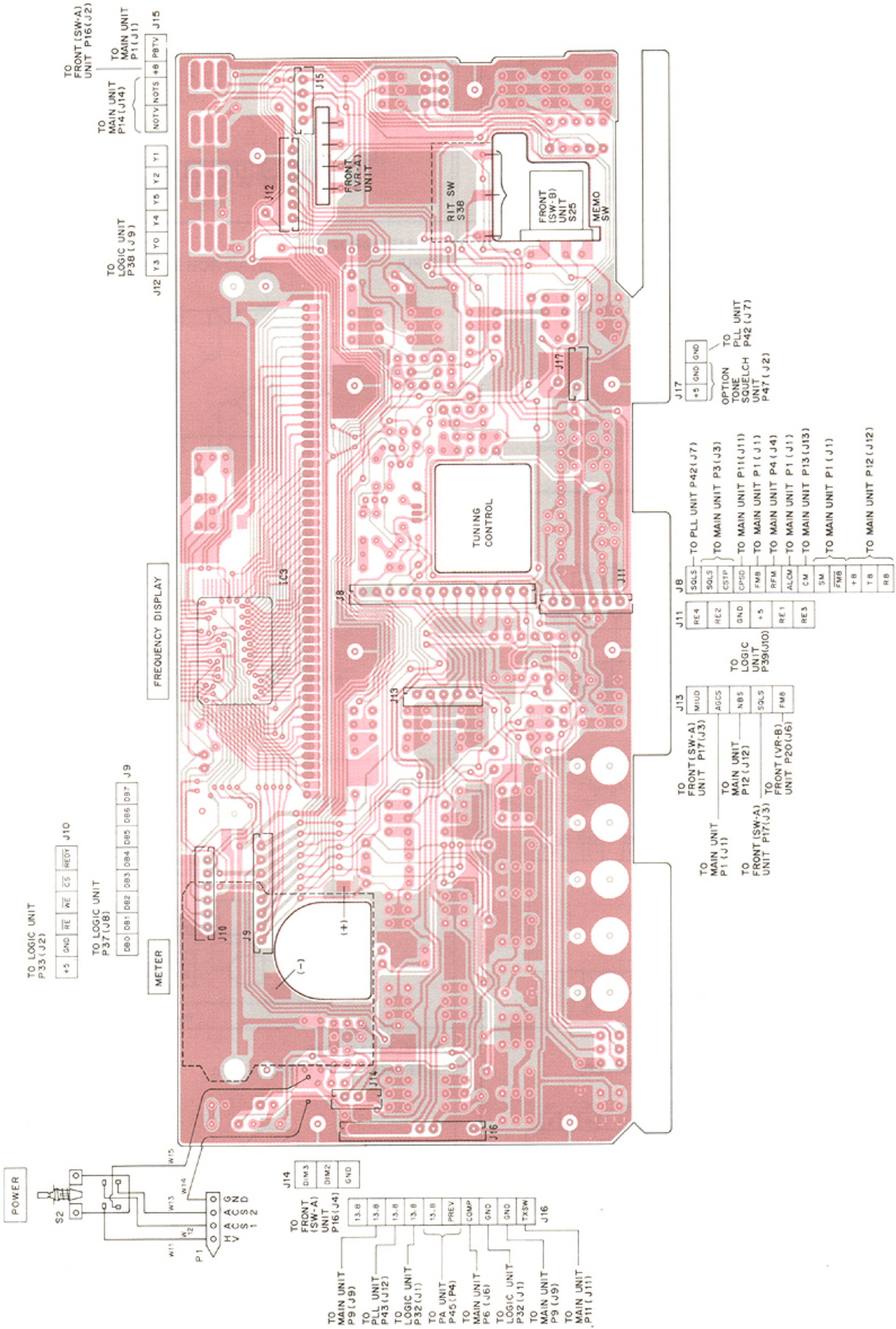

TO LOGIC UNIT
P33 (J2)

+5 GND RE WE CS RRDY J10

TO LOGIC UNIT
P37 (J8)

DB0 DB1 DB2 DB3 DB4 DB5 DB6 DB7 J9

METER

FREQUENCY DISPLAY

TO LOGIC UNIT
P38 (J9)

TO MAIN UNIT
P14 (J14)

TO FRONT (SW-A)
UNIT P16 (J2)

TO MAIN UNIT
P1 (J1)

NOTV NOTS +8 P8TV J15

J12 Y3 Y0 Y4 Y5 Y2 Y1

J14 DIM3 DIM2 GND

TO FRONT (SW-A) UNIT P16 (J4)

13.8

TO MAIN UNIT P9 (J9)

TO PLL UNIT P43 (J12)

TO LOGIC UNIT P32 (J1)

TO PA UNIT P45 (P4)

TO MAIN UNIT P6 (J6)

TO LOGIC UNIT P32 (J1)

TO MAIN UNIT P9 (J9)

TO MAIN UNIT P11 (J11)

TXSW J16

GND

GND

COMP

PREV

13.8

13.8

13.8

13.8

13.8

13.8

13.8

13.8

13.8

13.8

13.8

13.8

13.8

13.8

13.8

13.8

13.8

13.8

TO MAIN UNIT P1 (J1)

TO FRONT (SW-A) UNIT P17 (J3)

TO MAIN UNIT P12 (J12)

TO FRONT (SW-A) UNIT P17 (J3)

TO FRONT (VFR-B) UNIT P20 (J6)

MIUD

AGCS

NBS

SQLS

FM8

TO PLL UNIT P42 (J7)

TO MAIN UNIT P3 (J3)

TO MAIN UNIT P11 (J11)

TO MAIN UNIT P1 (J1)

TO MAIN UNIT P4 (J4)

TO MAIN UNIT P1 (J1)

TO MAIN UNIT P13 (J13)

TO MAIN UNIT P1 (J1)

TO MAIN UNIT P12 (J12)

+5 GND

OPTION TO PLL UNIT TONE SQUELCH P42 (J7)

UNIT P47 (J2)

RE4

RE2

GND

+5

TO LOGIC UNIT P39 (J10)

SQLS

SQLS

CSTP

CPSD

FM8

RFM

ALOM

CM

SM

FM8

+8

T8

RB

7-3 LOGIC AND SENSOR UNITS

μPD71055C IC1
(I/O EXPANDER)

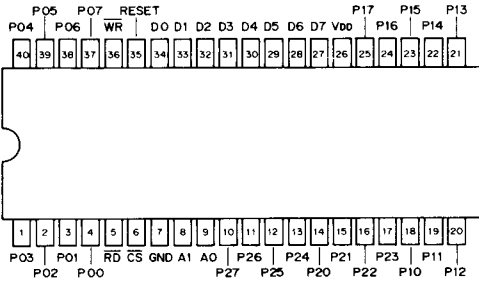

HM6116LP3L IC2
(RAM)

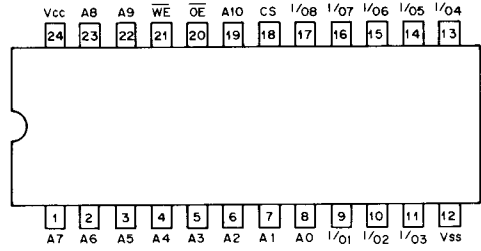

SC-1079 IC3
(ROM)

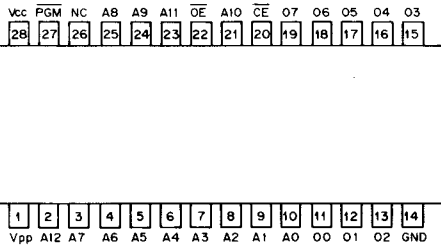

HD64B180ROP IC4
(CPU)

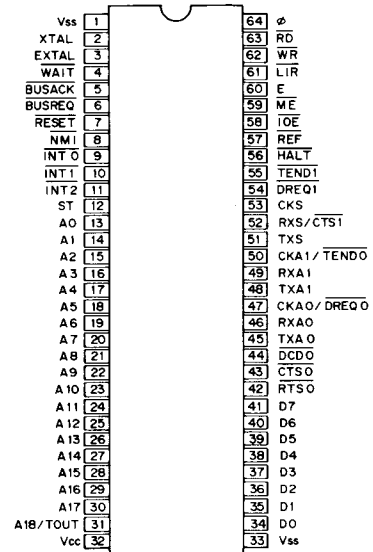

TC74HC244 IC5, IC6
(OCTAL 3-STATE BUS DRIVER)

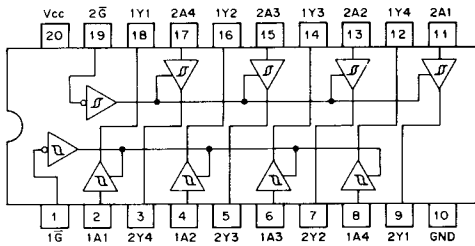

TC4510 IC7
(BCD UP/DOWN COUNTER)

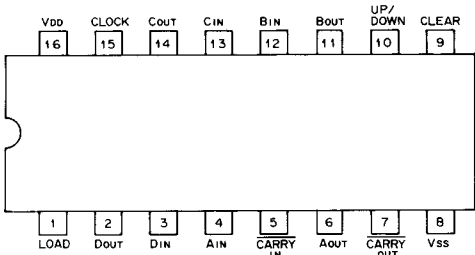

S-7116A IC8
(PROGRAMMABLE TONE GENERATOR)

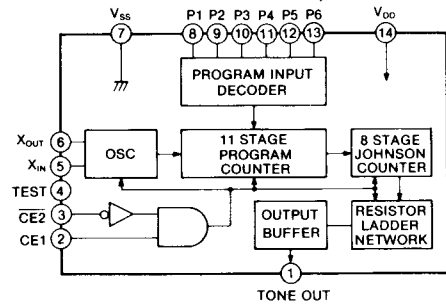

μPD4094BC IC9
(8-STAGE SHIFT AND STORE BUS REGISTER)

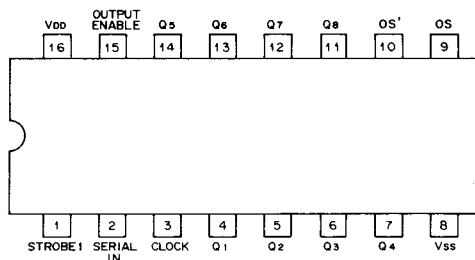

TA78L005AP IC10
(3-TERMINAL 5V REGULATOR)

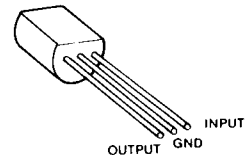

TC74HC32 IC11, IC12
(QUAD 2-INPUT POSITIVE OR GATE)

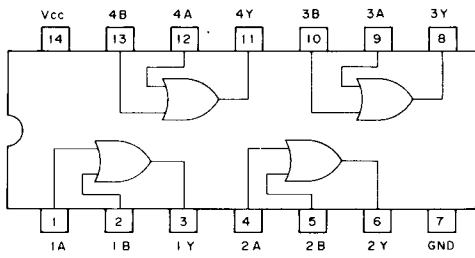

TC74HC00 IC13
(QUAD 2-INPUT NAND GATE)

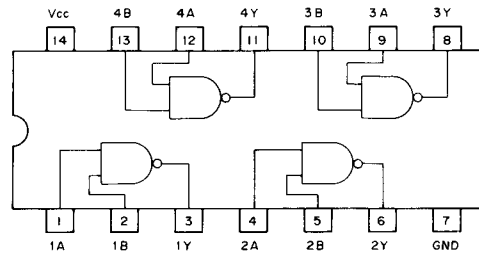

μPD4001BC IC14, IC19
(QUAD 2-INPUT POSITIVE NOR GATE)

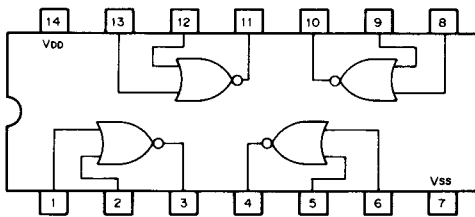

μPD4011BC IC15, IC16, IC18
(QUAD 2-INPUT POSITIVE NAND GATE)

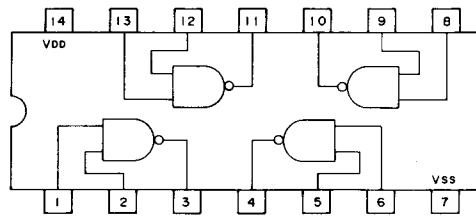

μPD4069UBC IC17
(HEX INVERTER)

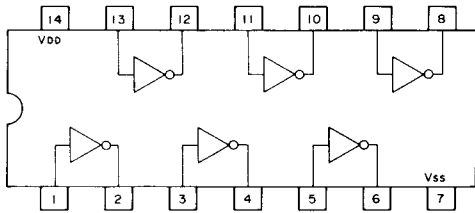

• LOGIC UNIT

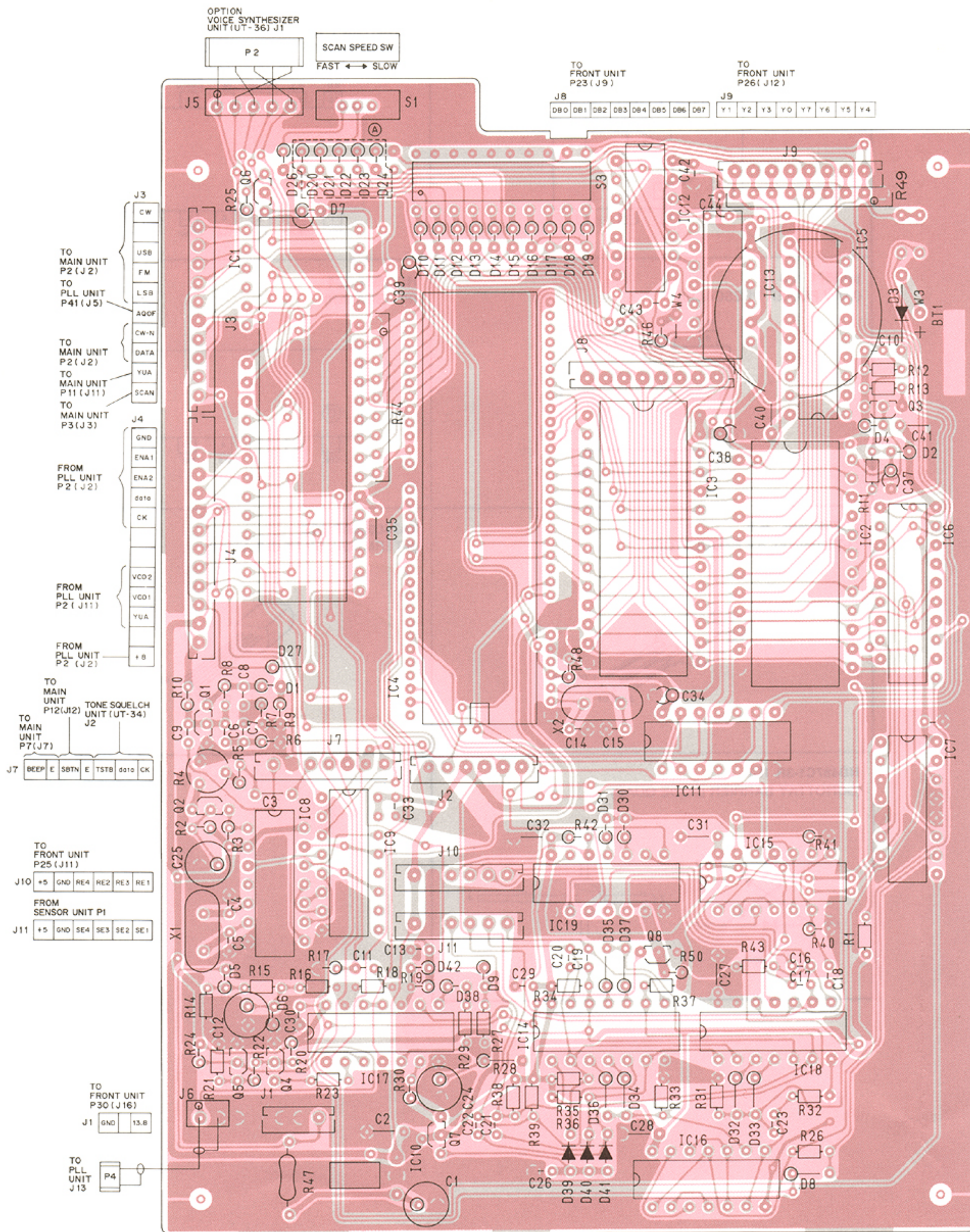

OPTION VOICE SYNTHESIZER UNIT (UT-36) J1

SCAN SPEED SW
FAST ← → SLOW

TO FRONT UNIT P23 (J9)

TO FRONT UNIT P26 (J12)

J8	DB0	DB1	DB2	DB3	DB4	DB5	DB6	DB7	J9	Y1	Y2	Y3	Y0	Y7	Y6	Y5	Y4
----	-----	-----	-----	-----	-----	-----	-----	-----	----	----	----	----	----	----	----	----	----

J3
TO MAIN UNIT P2 (J2)
TO PLL UNIT P41 (J5)
CW
USB
FM
LSB
AGOF
CW-N
DATA
YUA
SCAN

J4
FROM PLL UNIT P2 (J2)
GND
ENA1
ENA2
DATA
CK

J4
FROM PLL UNIT P2 (J11)
VCO2
VCO1
YUA

J2
FROM PLL UNIT P2 (J2)
+B

J7
TO MAIN UNIT P7 (J7)
TO MAIN UNIT P12 (J12)
TONE SQUELCH UNIT (UT-34) J2
REEP
E
SBTN
E
TSTB
DATA
CK

J10
TO FRONT UNIT P25 (J11)
+5
GND
RE4
RE2
RE3
RE1

J11
FROM SENSOR UNIT P1
+5
GND
SE4
SE3
SE2
SE1

J1
TO FRONT UNIT P30 (J16)
GND
13.B

J13
TO PLL UNIT J13
P4

• SENSOR UNIT

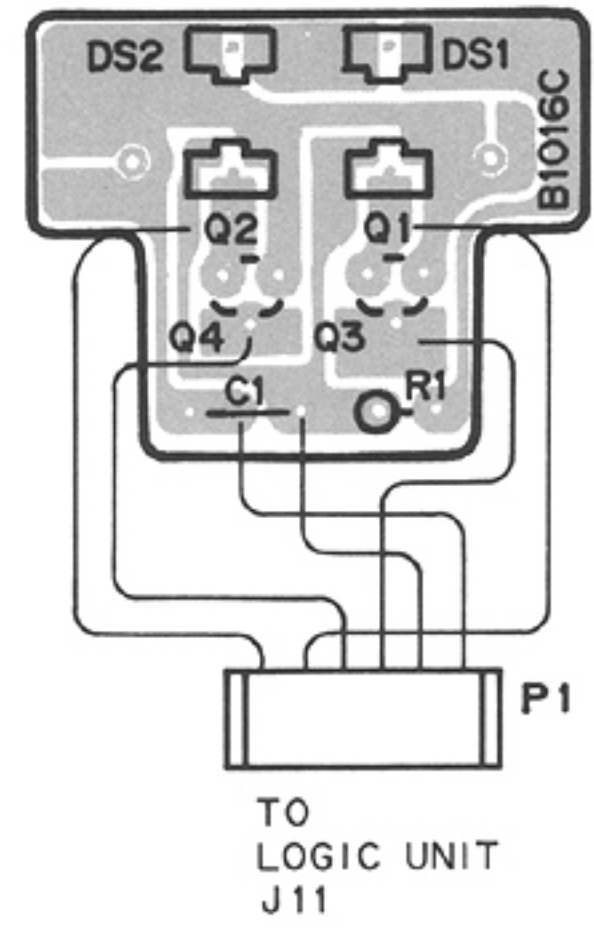

(A)

• IC-475A/E

Area	D20	D21	D22	D23	D24
#06E	X	X	X	O	O
#08A	O	O	X	O	X
#10A	X	O	X	O	X
#12E	O	O	O	X	O

• IC-475H

Area	D20	D21	D22	D23	D24
#02H	X	X	X	O	O
#03H	O	O	X	O	X
#04H	X	O	X	O	X
#05H	O	O	O	X	O

O: MOUNTING X: NO MOUNTING

2SC2785
Q1, Q2, Q3, Q4,
Q5, Q6, Q7

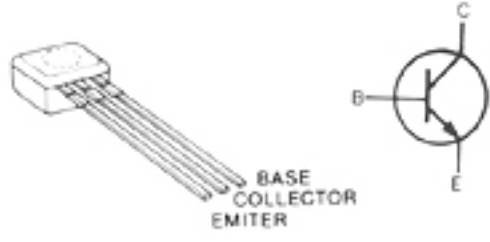

RN1204
Q8

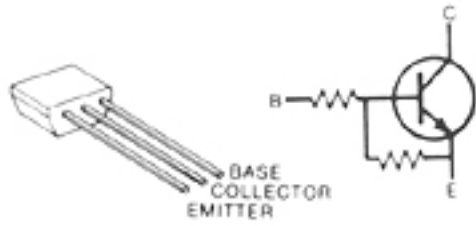

IS-433
Q1, Q2

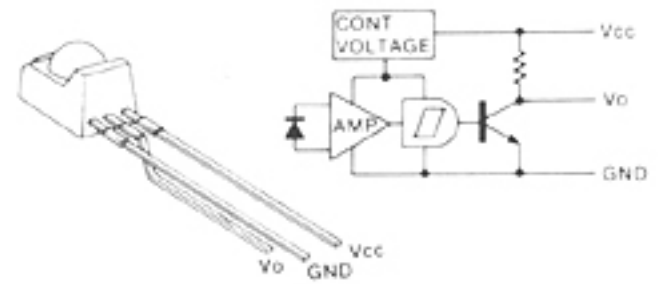

RN1204
Q3, Q4



TO FRONT UNIT
P24 (J10)

J2	GND	CS	+5	WE	RE	REDY

7-4 PLL AND DDS UNITS

• PLL UNIT

NJM4560DD IC1
(DUAL OPERATIONAL AMPLIFIER)

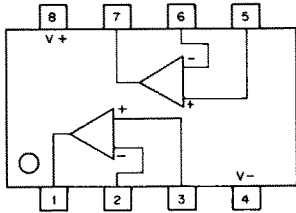

MC145158P1 IC2
(SERIAL INPUT PLL FREQUENCY SYNTHESIZER)

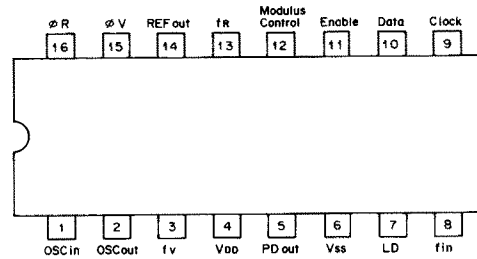

μPB571 IC3
(LOW POWER PRESCALER)

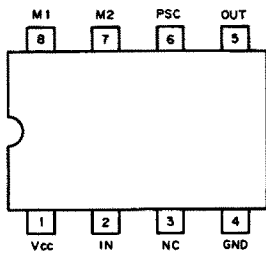

HD10551 IC4
(PRESCALER)

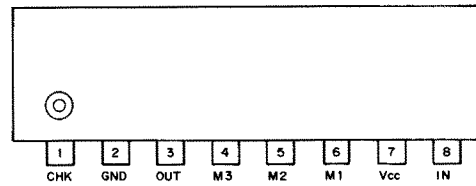

μA78M08UC IC5
(3-TERMINAL 8V REGULATOR)

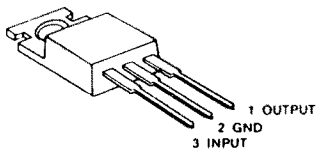

TA78L005AR IC6
(3-TERMINAL 5V REGULATOR)

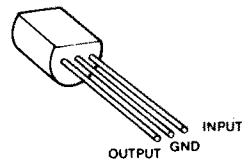

ND487C1-3R IC7
(SCHOTTKY BARRIER DIODE QUAD)

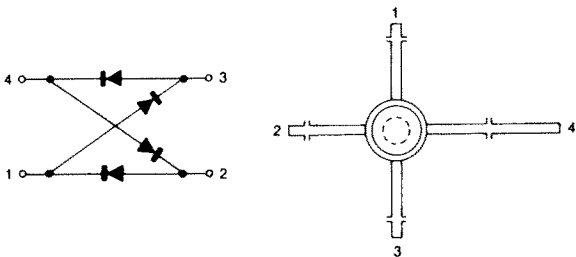

• PLL UNIT

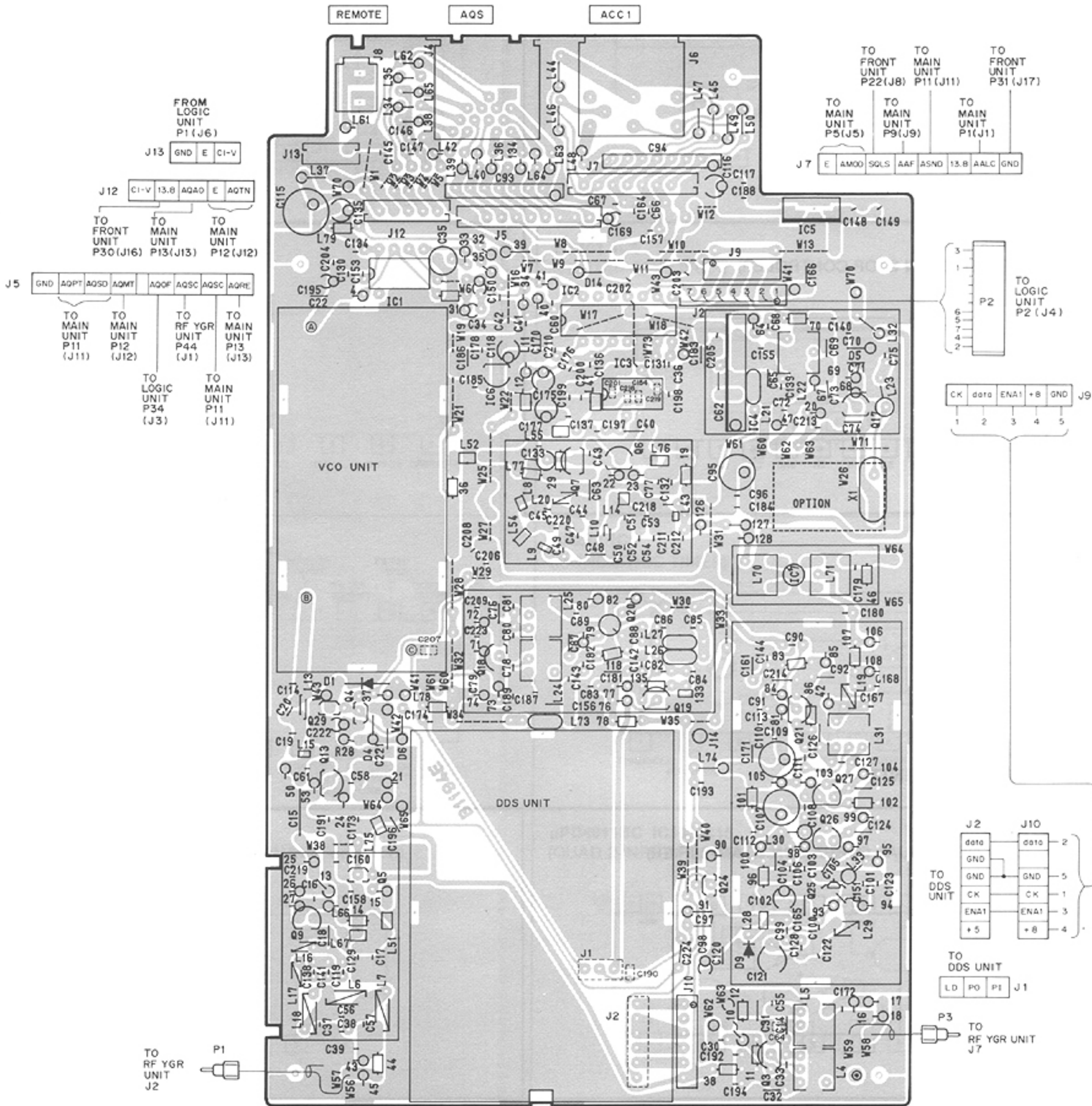

• DDS UNIT

2SK125
Q1, Q13

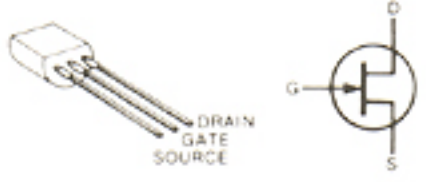

2SC383TM
Q17

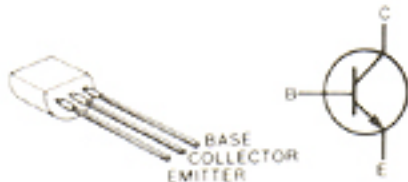

2SC2026
Q2, Q6, Q9



3SK74M
Q20

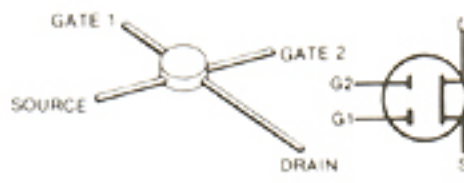

2SC763C
Q3, Q7, Q18, Q19,
Q21, Q26, Q27



2SC2785
Q24

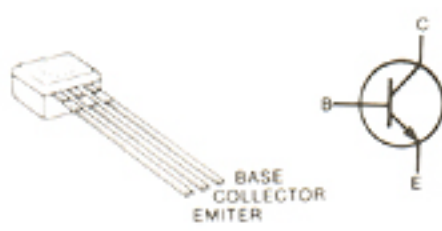

RN2204
Q4

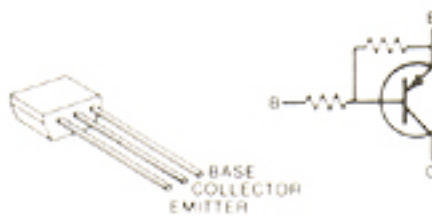

2SK192A
Q25

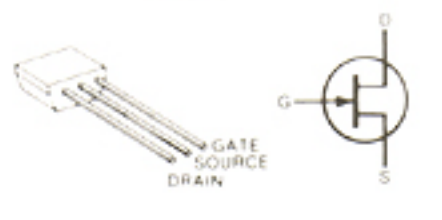

RN1202
Q5, Q29

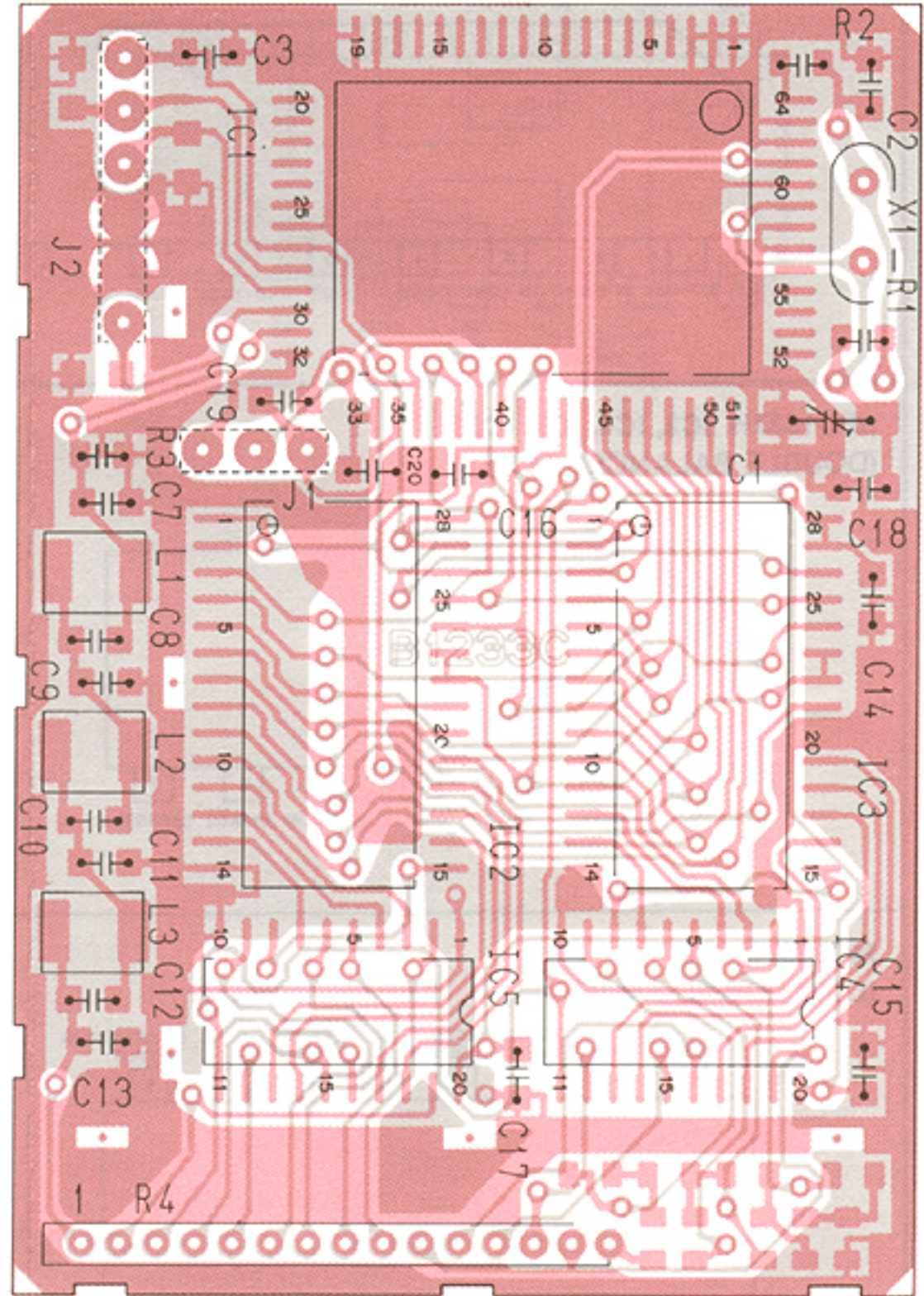
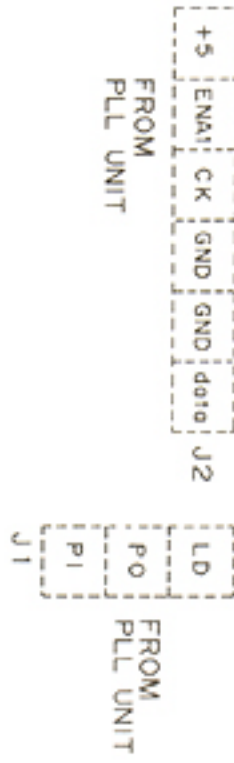

• VCO UNIT

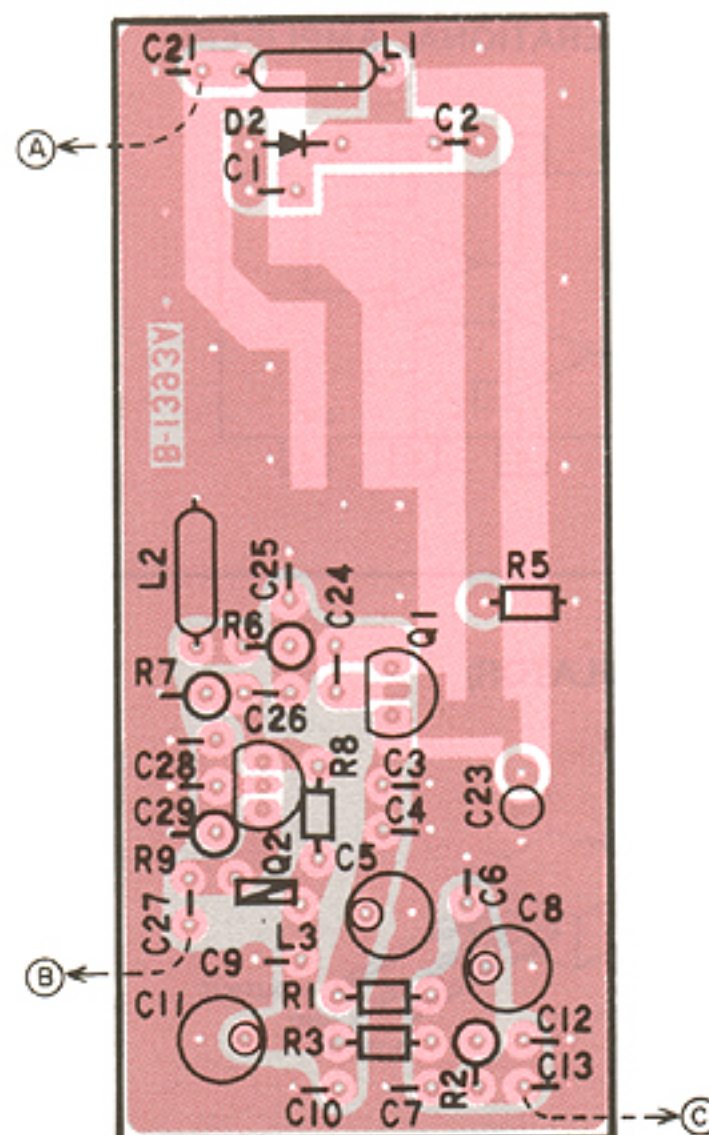

7-5 MAIN UNIT

• MAIN UNIT

μ PC577H IC1, IC11
(FM IF AMPLIFIER)

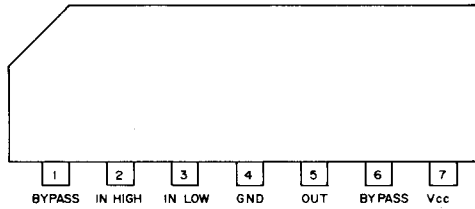

M5218L IC2, IC10, IC12, IC13
(LOW NOISE DUAL OPERATIONAL AMPLIFIER)

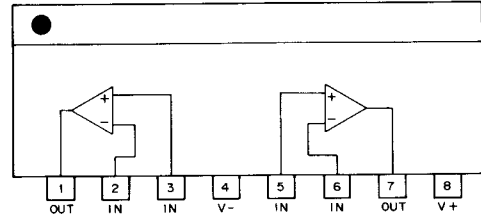

μ PC1037H IC3, IC4, IC7, IC21
(DOUBLE BALANCED MIXER)

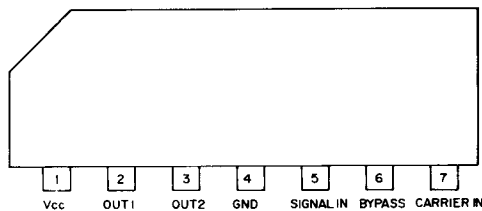

BA401 IC5
(LIMITER AMPLIFIER)

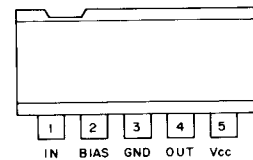

MC3357P IC6
(LOW POWER FM IF)

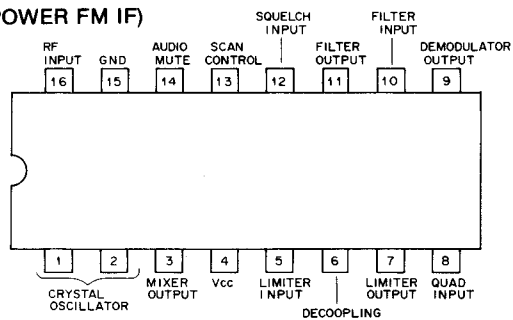

BA222 IC8
(MONOLITHIC TIMER)

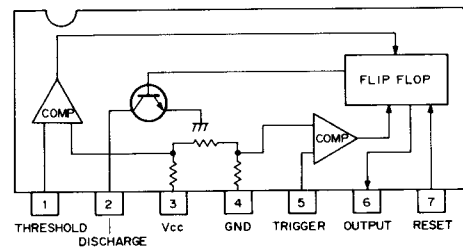

NJM4558D IC9
(LOW NOISE DUAL OPERATIONAL AMPLIFIER)

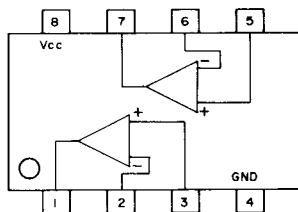

μ PD4011BC IC14, IC15
(QUAD 2-INPUT POSITIVE NAND GATE)

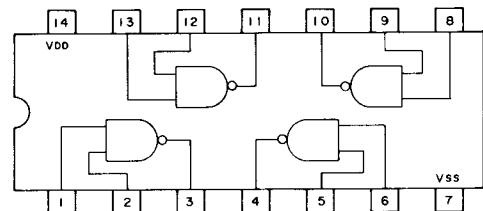

μ A7808 IC16
(3-TERMINAL 8V REGULATOR)

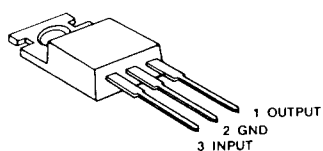

BA618 IC17
(DRIVER)

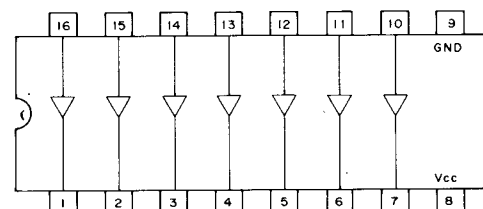

μPC2002H IC18
(AUDIO POWER AMPLIFIER)

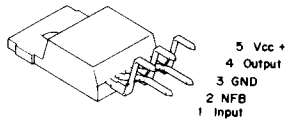

μPD4066BC IC19
(QUAD BILATERAL SWITCHING)

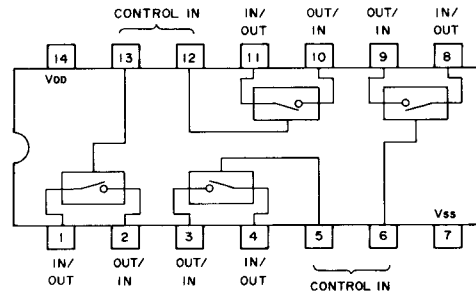

BA695 IC20
(CENTER SCAN STOP CONTROLLER)

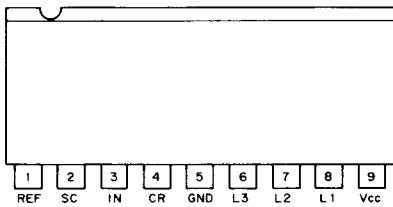

• SQUELCH UNIT

NJM4558M IC1
(LOW NOISE DUAL OPERATIONAL AMPLIFIER)

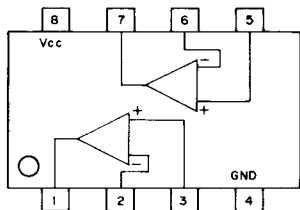

• MAIN UNIT

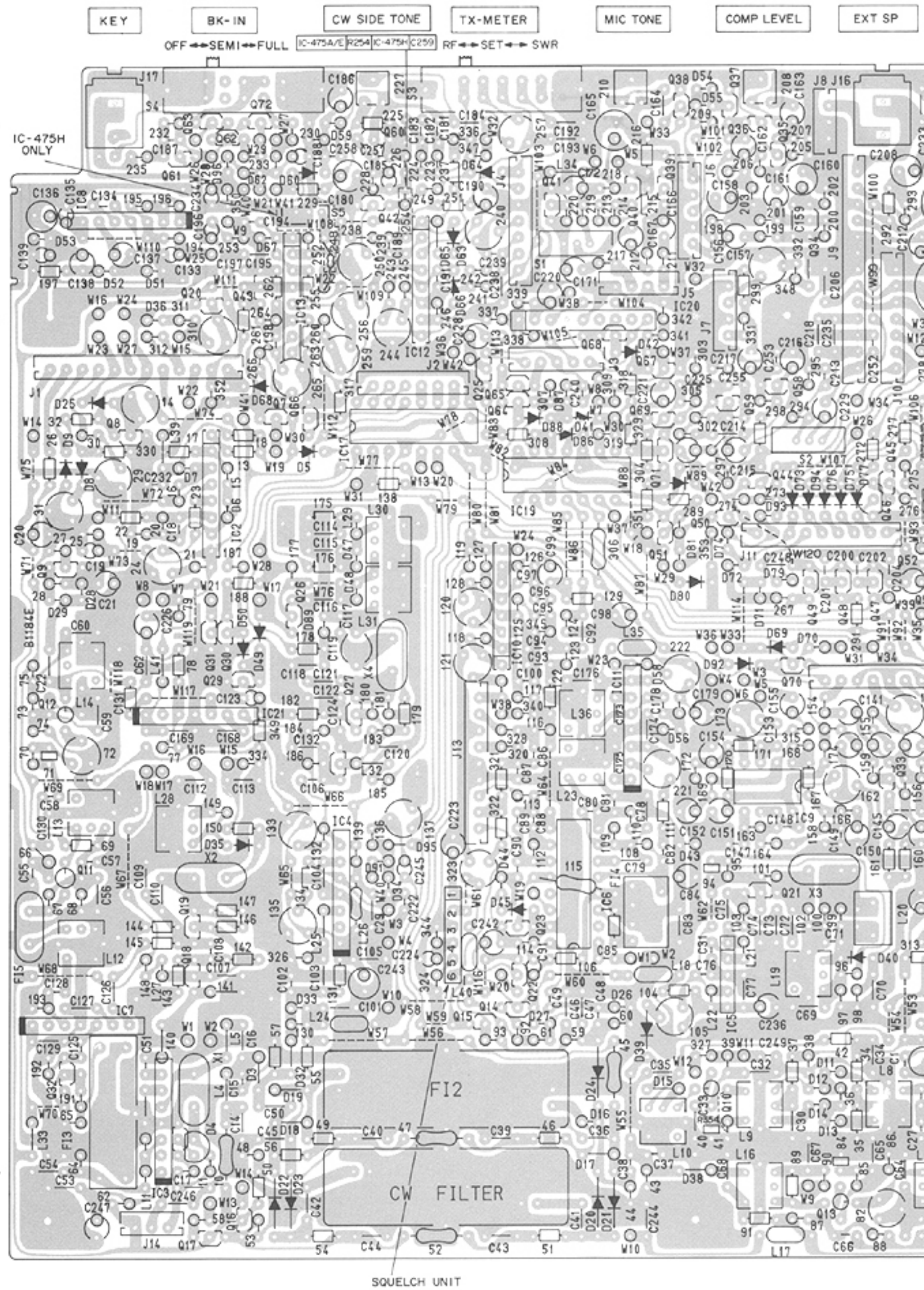
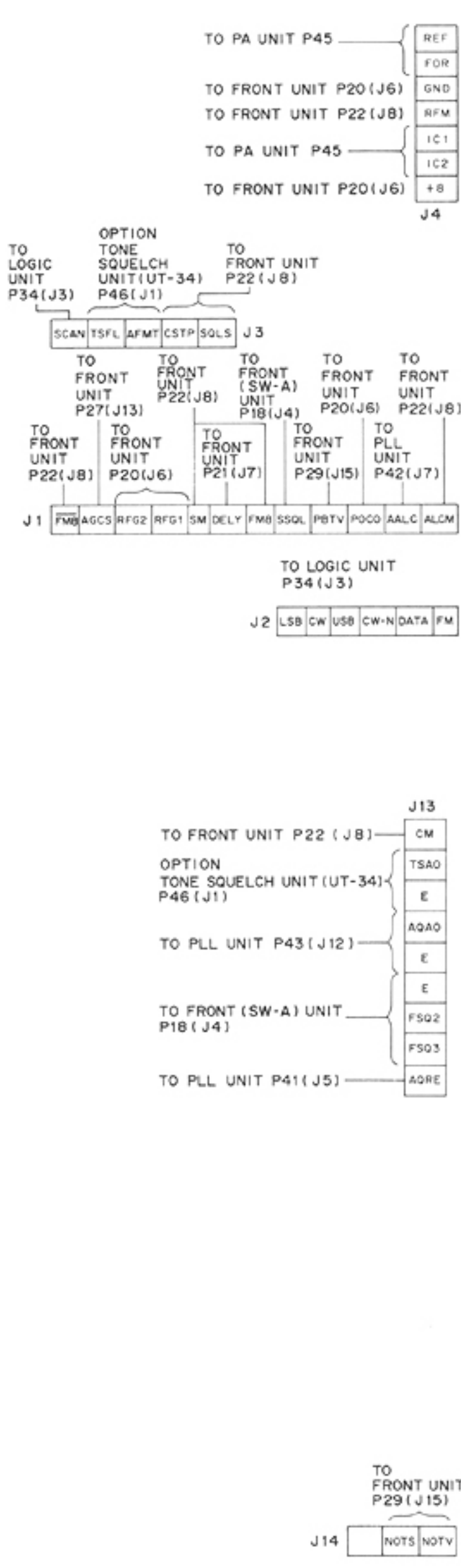

2SB596
Q57

2SD468
Q46, Q50, Q54,
Q55

RN1202
Q36, Q37, Q38,
Q49, Q51, Q56,
Q71

2SC1571
Q34

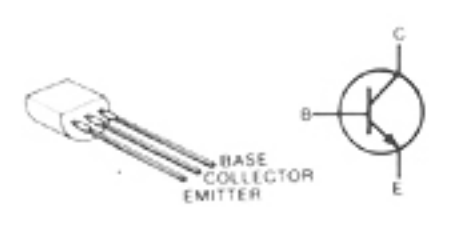
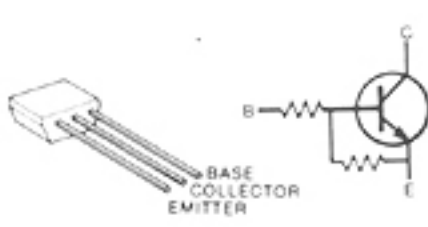
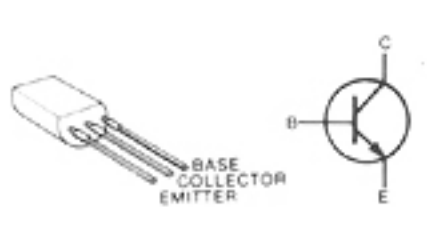
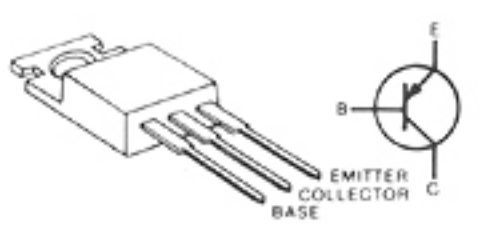

• SQUELCH UNIT

COMPONENTS SIDE

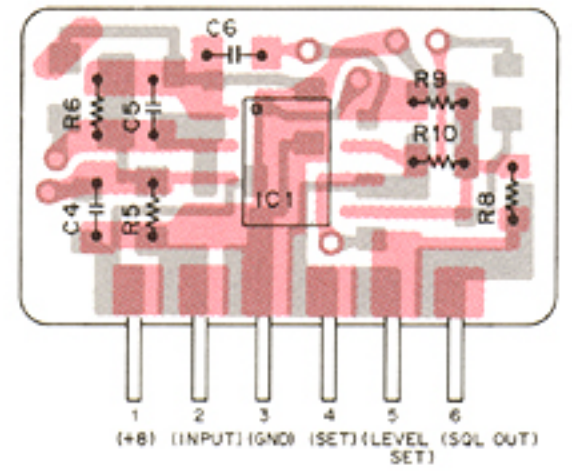

FOIL SIDE

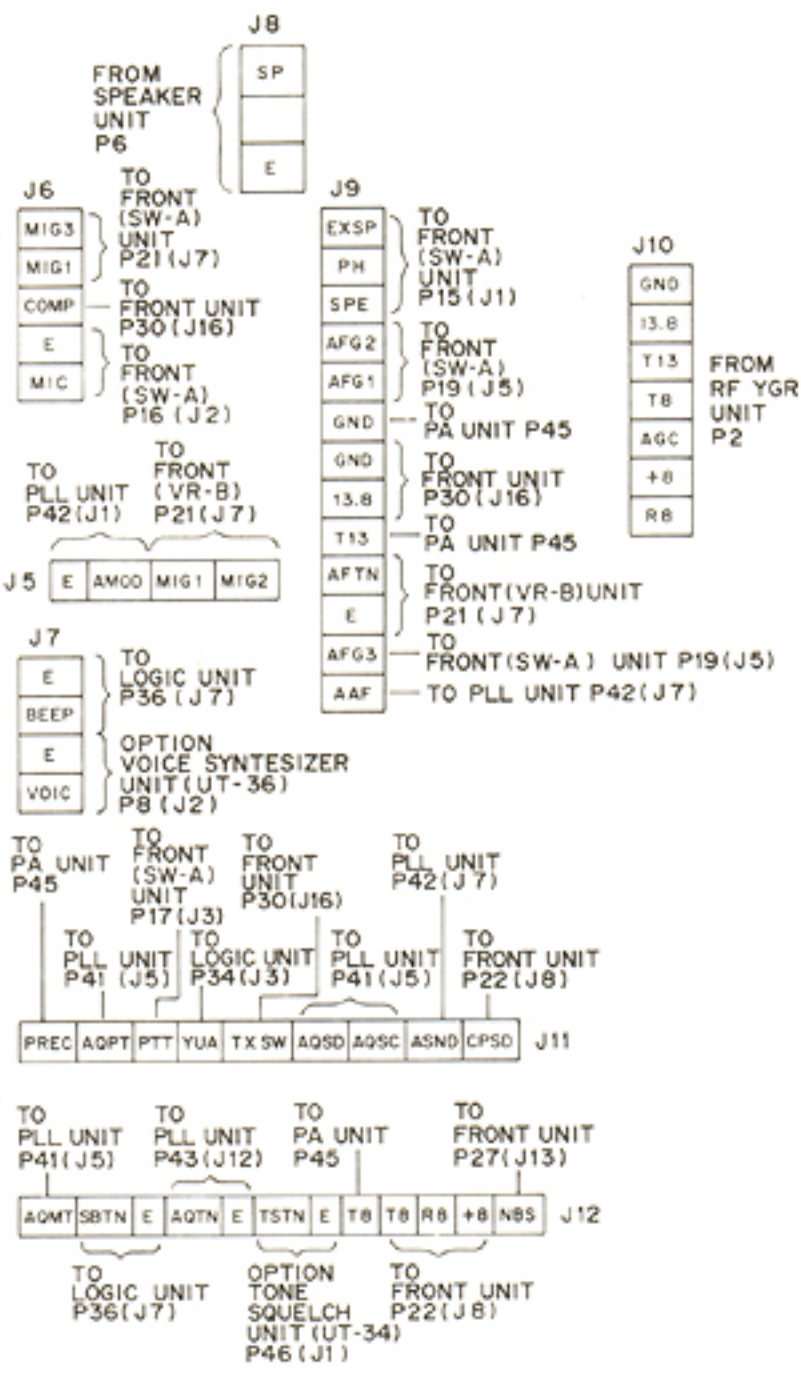
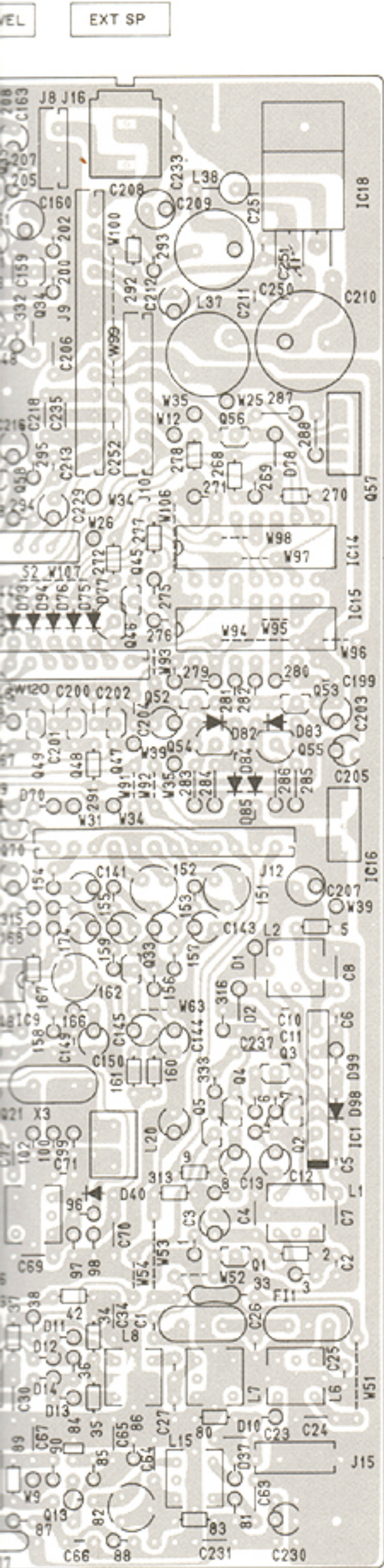
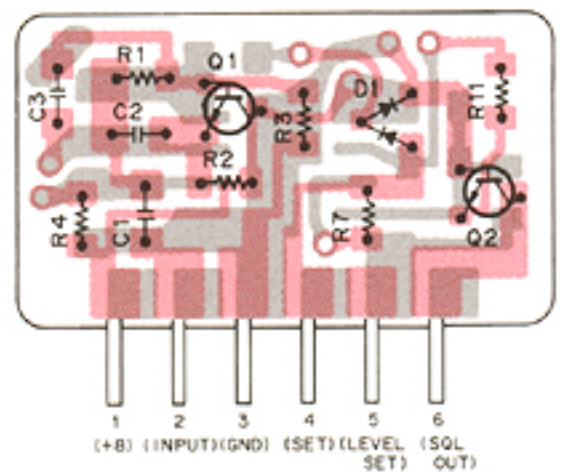

2SK192A
Q1



2SA1048
Q2, Q43, Q61



2SC2785
Q3, Q4, Q6, Q9, Q14, Q17, Q18, Q19, Q21, Q23, Q27, Q28, Q32, Q33, Q35, Q39, Q40, Q41, Q42, Q44, Q45, Q52, Q53, Q58, Q59, Q60, Q62, Q69

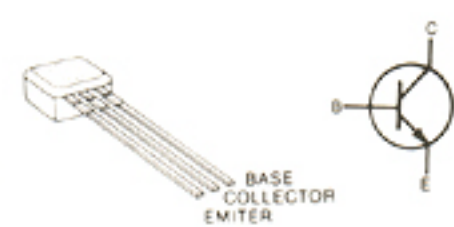

2SC2712
Q1

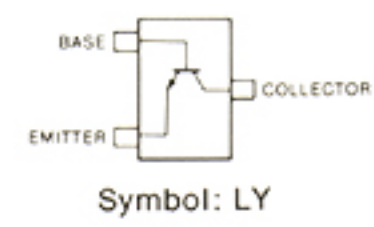

Symbol: LY

2SC3395
Q2

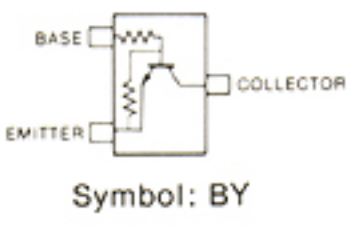

Symbol: BY

RN2202
Q5, Q15, Q16, Q65, Q72

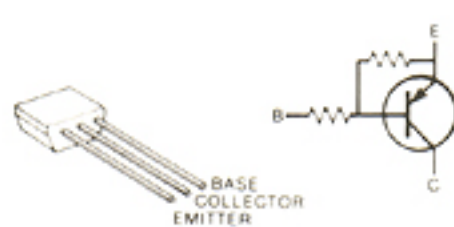

RN2204
Q22, Q68, Q70

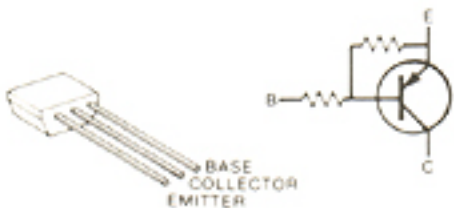

3SK74M
Q10, Q11, Q12, Q13



RN1204
Q7, Q8, Q20, Q25, Q26, Q29, Q30, Q31, Q47, Q48, Q63, Q64, Q66, Q67



7-6 RF YGR UNIT (IC-475A/E)

ND487C1-3R IC1
(SCHOTTKY BARRIER DIODE QUAD)

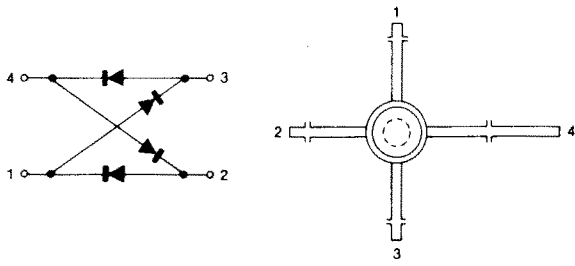

412E-H IC2
(DOUBLE BALANCED MIXER)

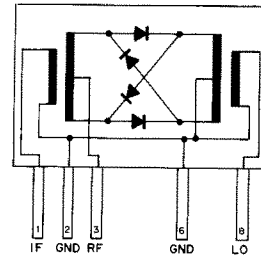

7-7 RF YGR UNIT (IC-475H)

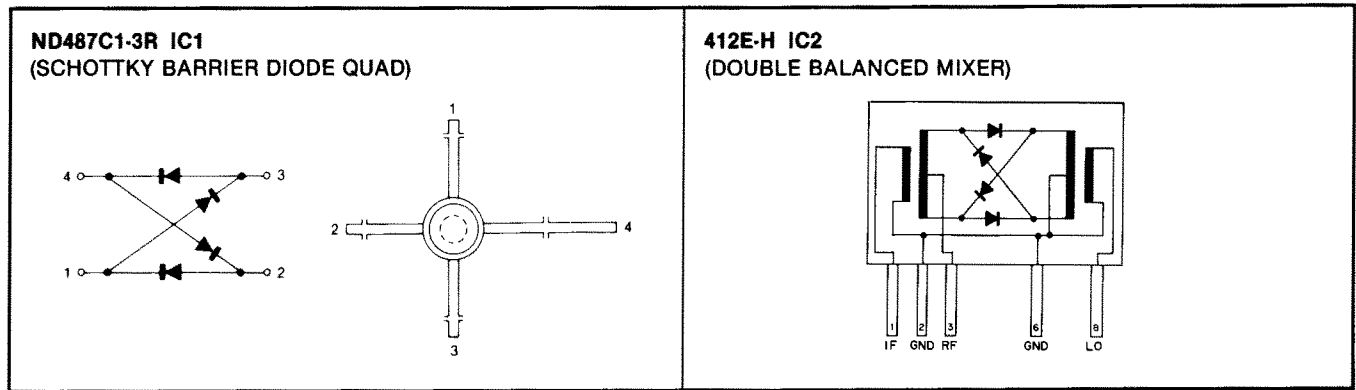

Downloaded by
RadioAmateur.EU

• RF YGR UNIT (IC-475H)

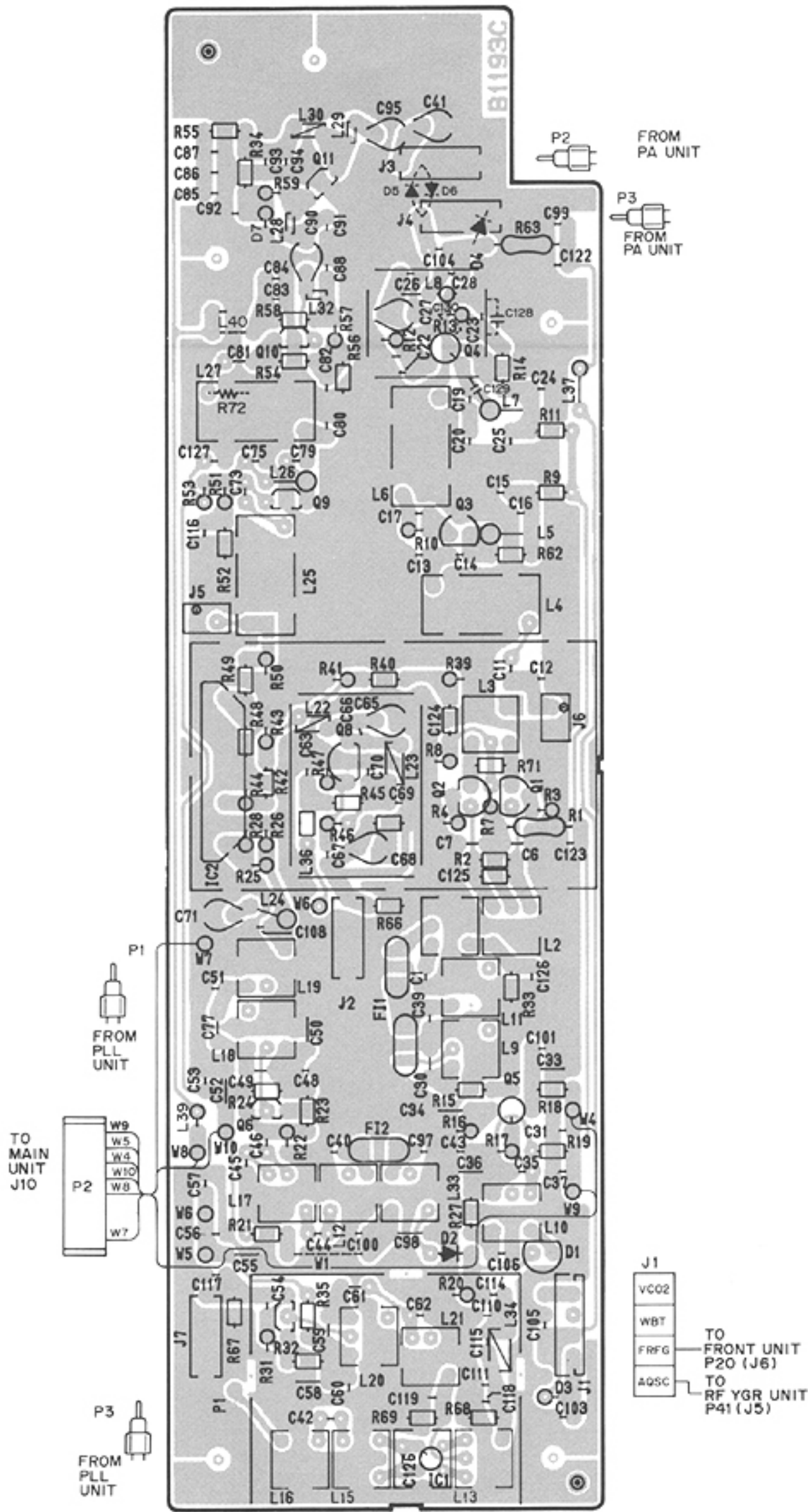

2SC2026
Q1, Q2



2SK125
Q3

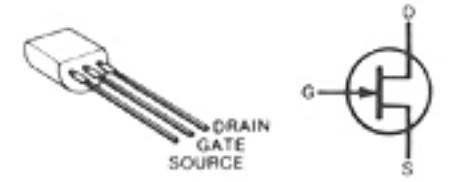

3SK129
Q4

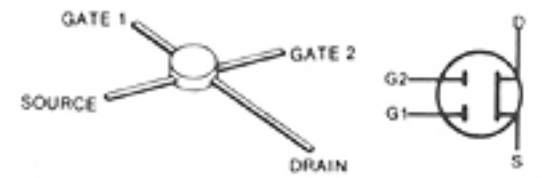

3SK74M
Q5

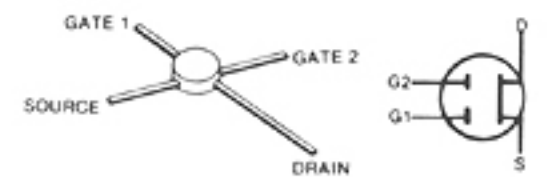

2SC763C
Q6



2SC2668
Q7

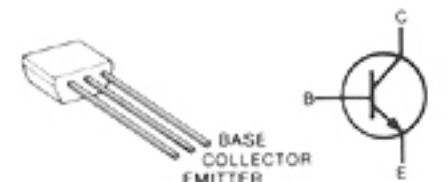

2SC3019
Q11

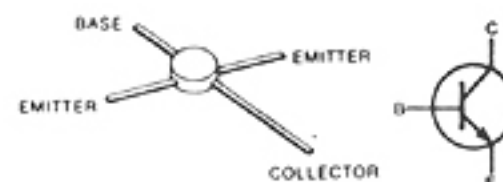

2SC3355
Q8, Q9, Q10



7-8 REG UNIT (IC-475A/E ONLY)

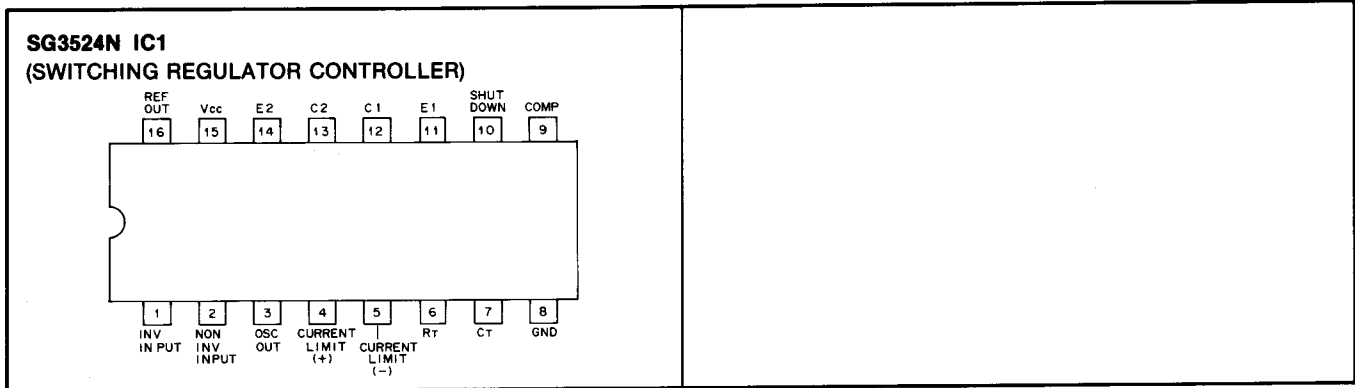

• REG UNIT (IC-475A/E ONLY)

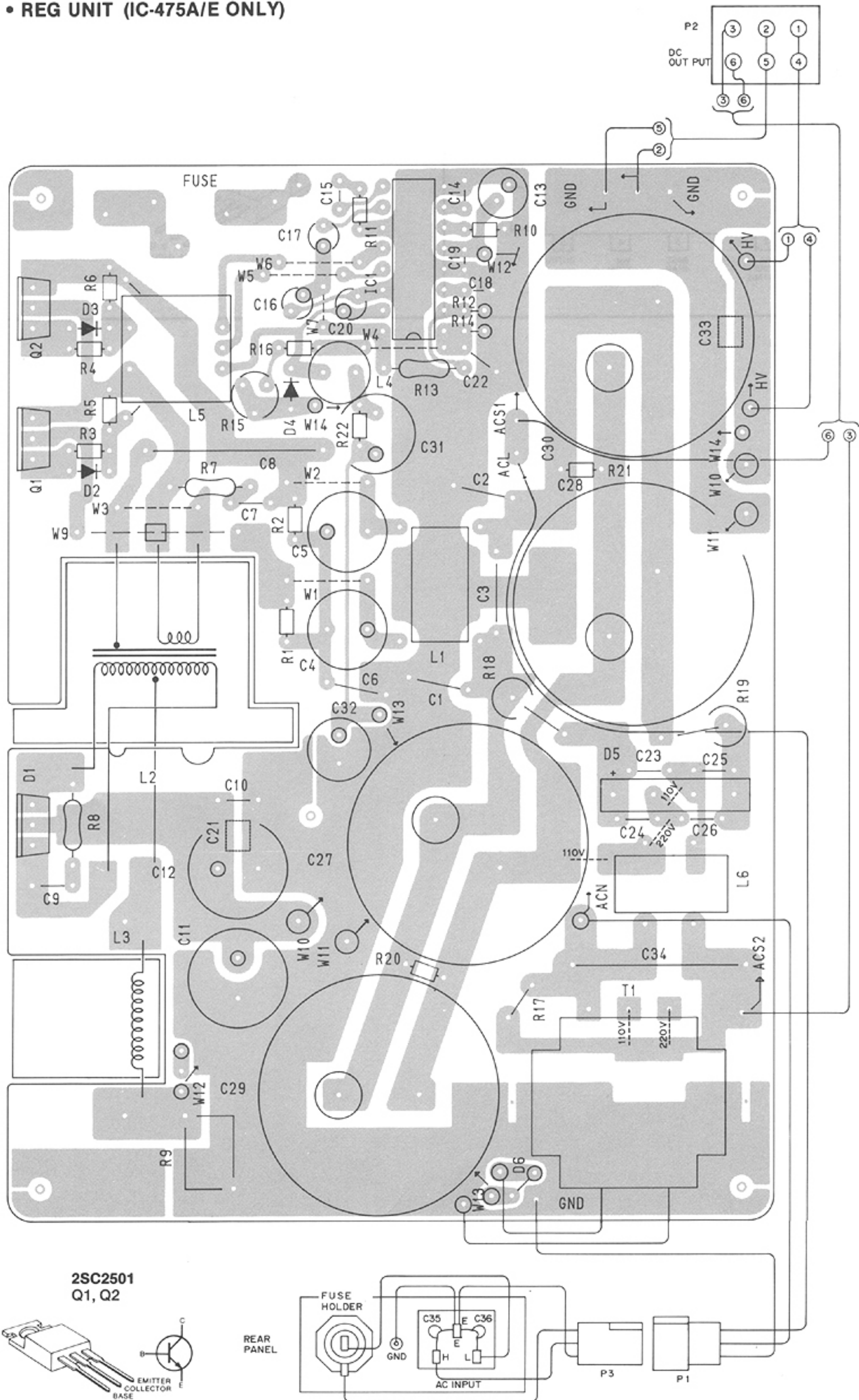

7-9 PA UNIT (IC-475A/E)

SC-1024 IC1
(POWER MODULE)

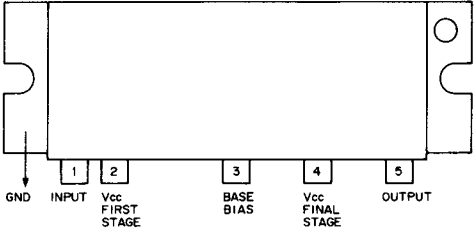

NJM7809A IC2
(3-TERMINAL 9V REGULATOR)

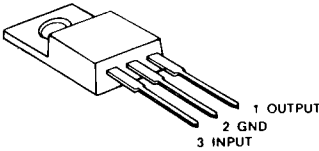

• PA UNIT (IC-475A/E)

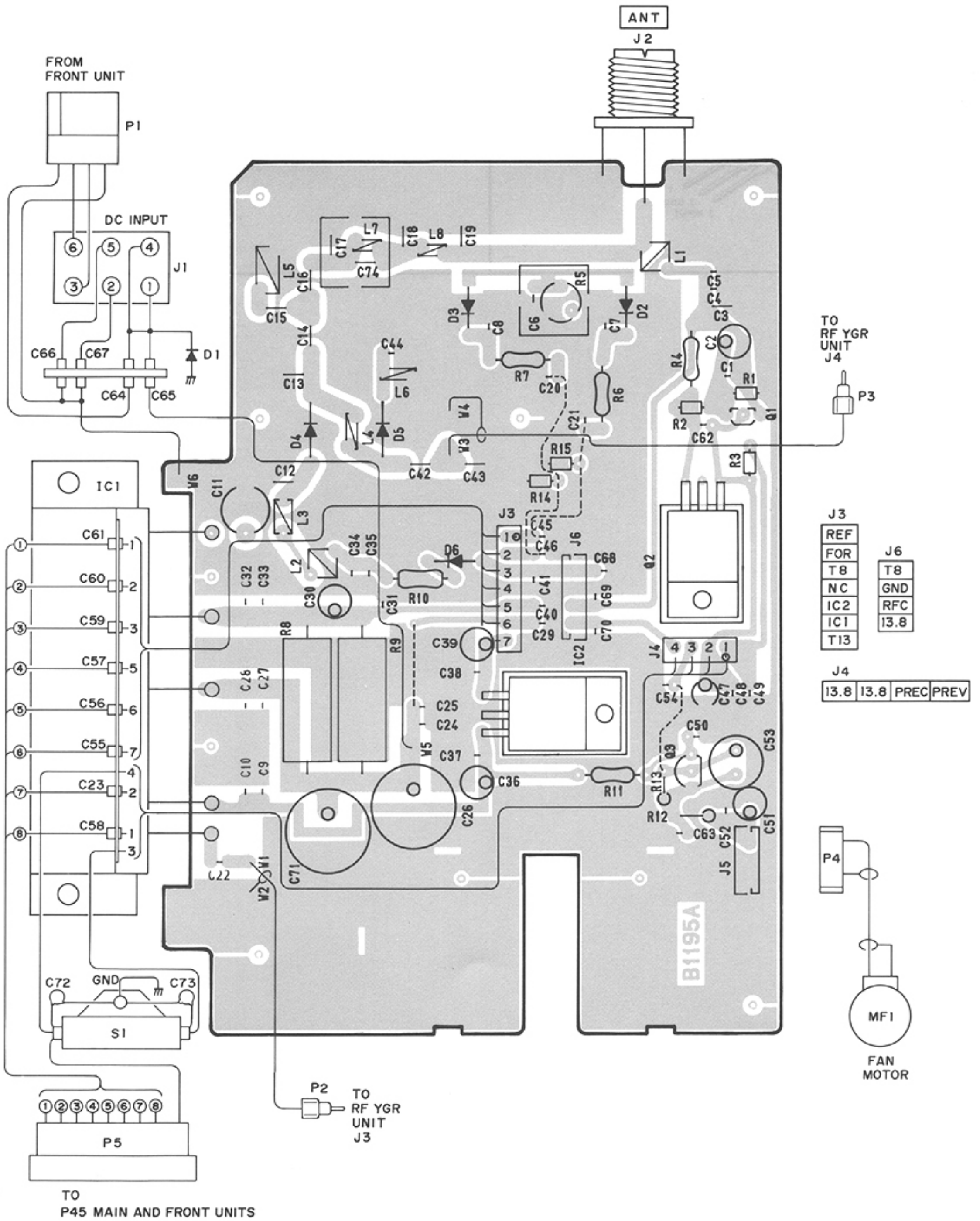

2SC2785
Q1

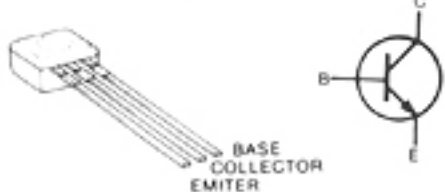

2SD359
Q2

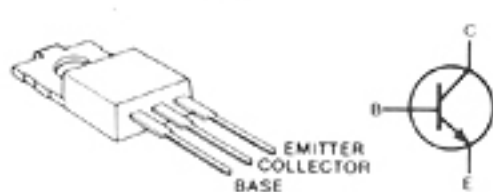

2SC2120
Q3

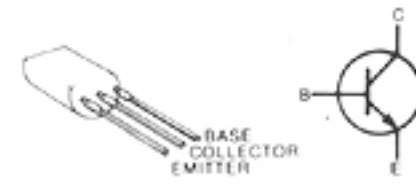

7-10 CTRL UNIT (IC-475H ONLY)

NJM7809A IC1
(3-TERMINAL 9V REGULATOR)

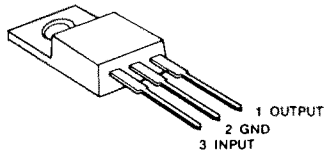

• CTRL UNIT (IC-475H ONLY)

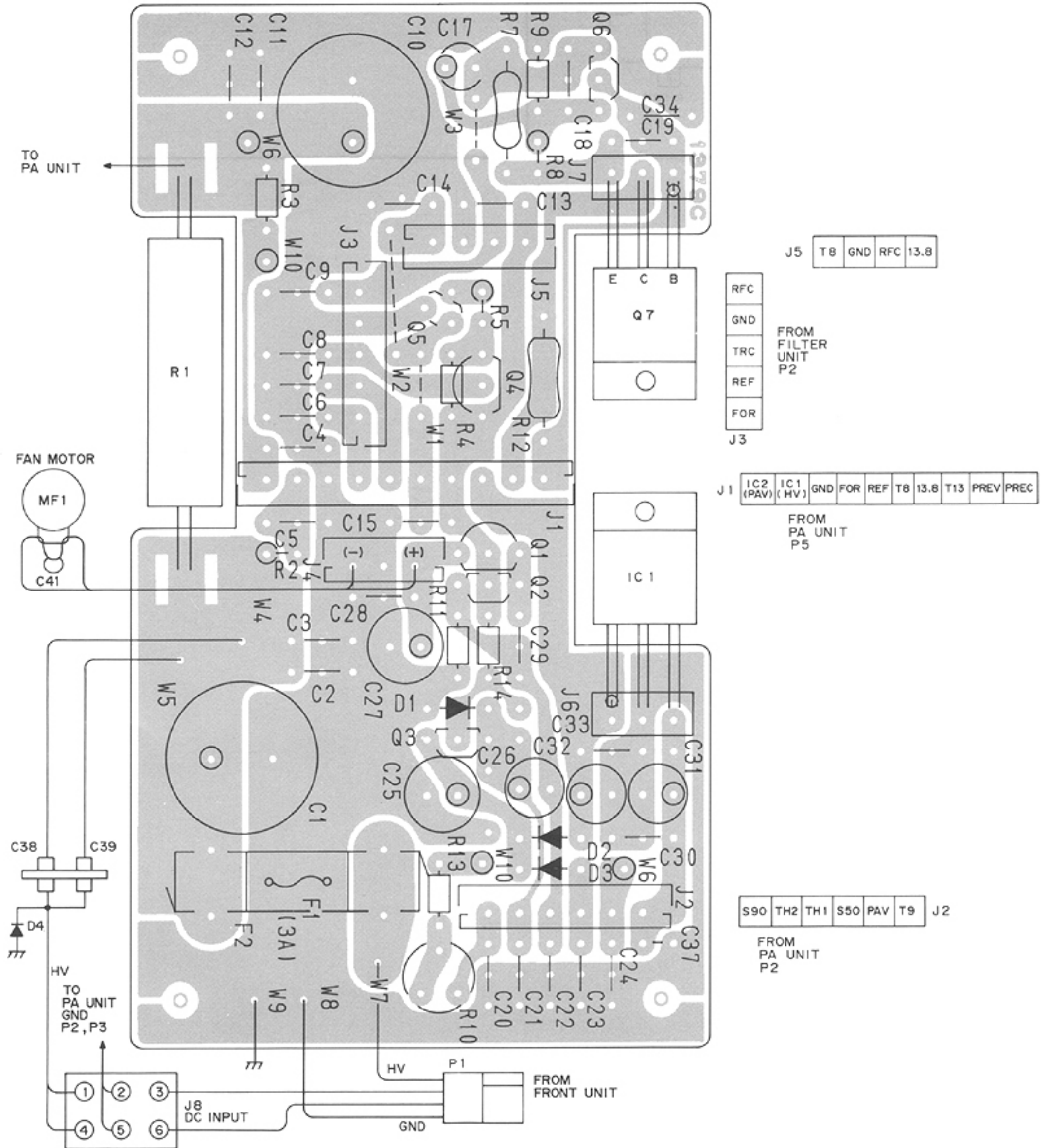

2SD468
Q1

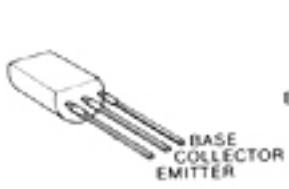

2SC2785
Q2, Q6



RN1204
Q3, Q5

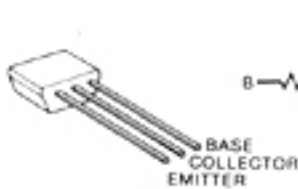

2SB562
Q4



2SD359
Q7

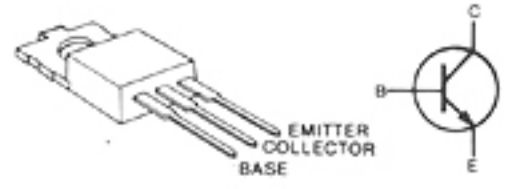

7-11 PA UNIT (IC-475H)

SC-1016 IC1
(POWER MODULE)

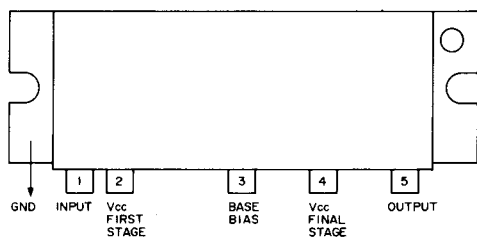

• PA UNIT (IC-475H)

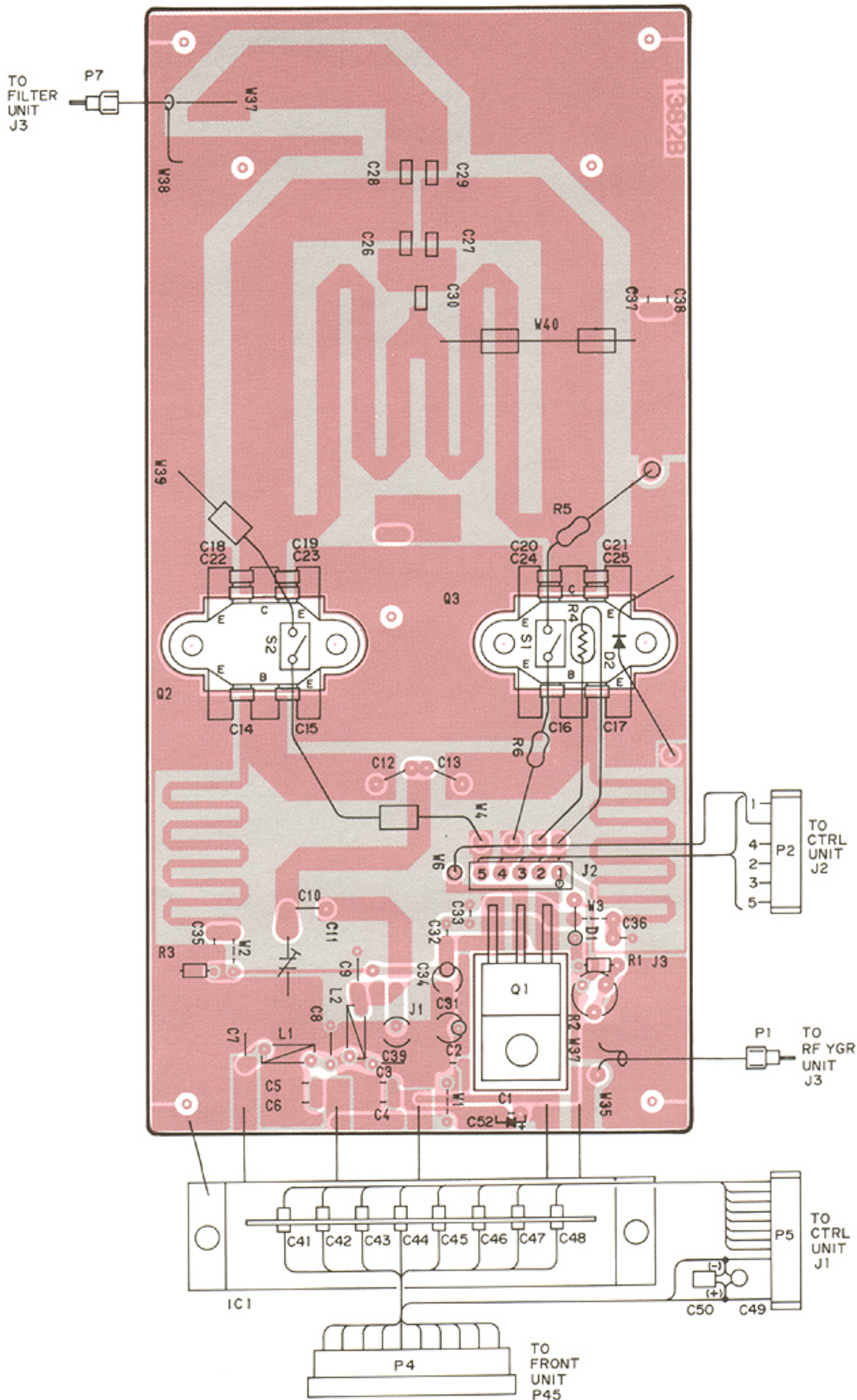

2SD880
Q1



2SC3102
Q2, Q3

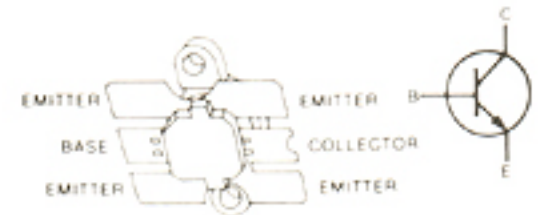

7-12 FILTER UNIT (IC-475H ONLY)

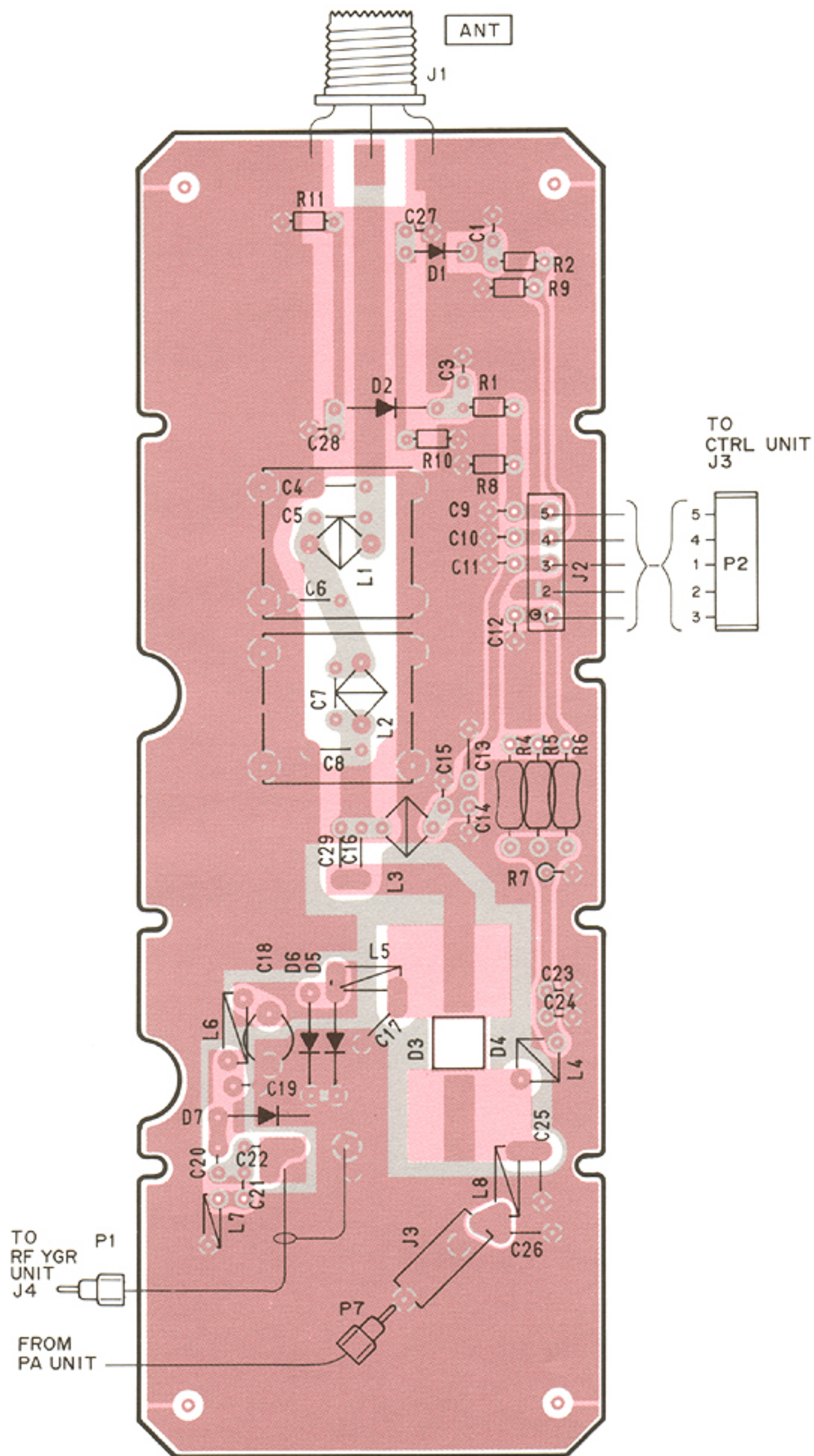

Downloaded by
RadioAmateur.EU

8-3 PLL UNIT

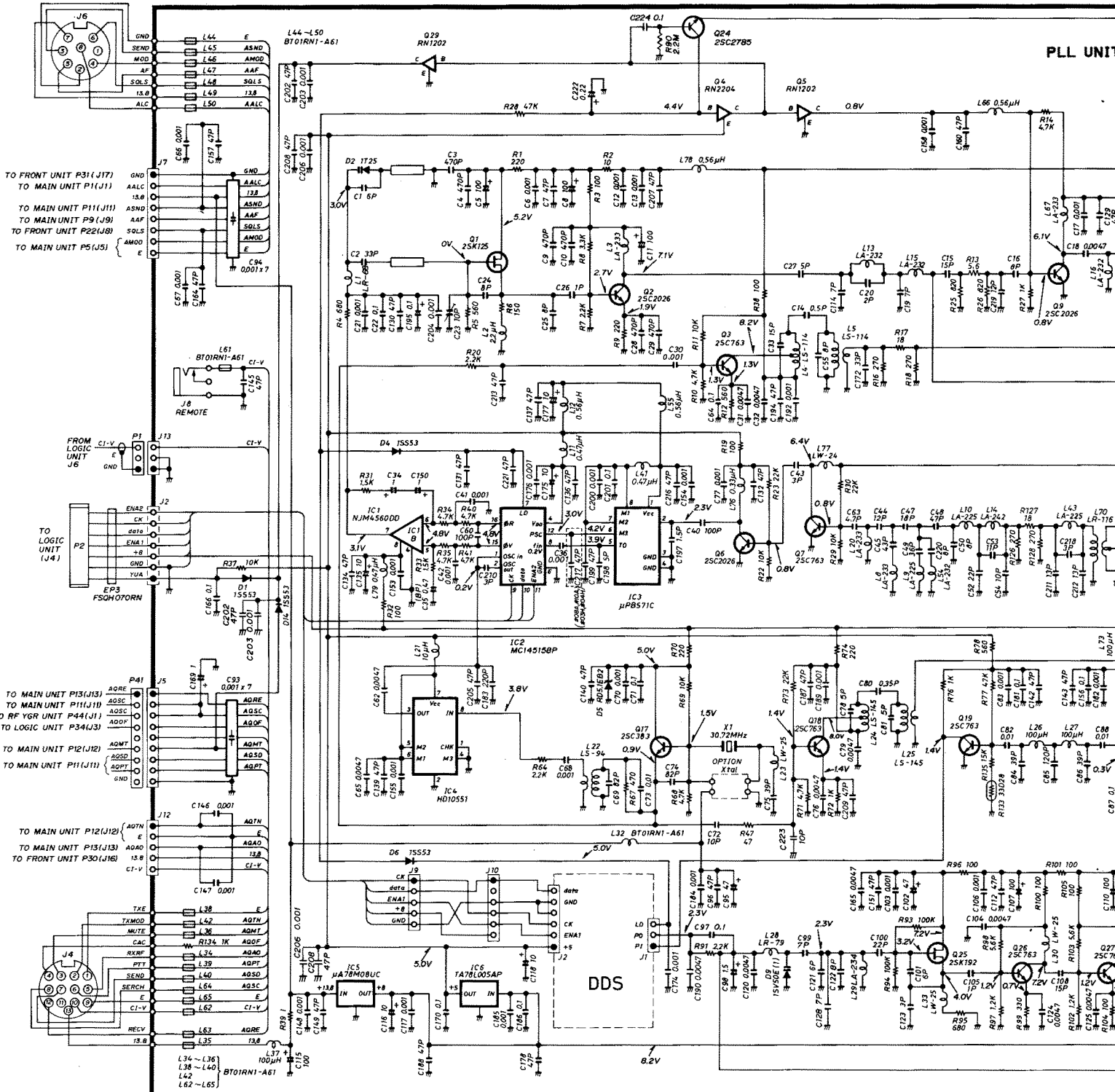

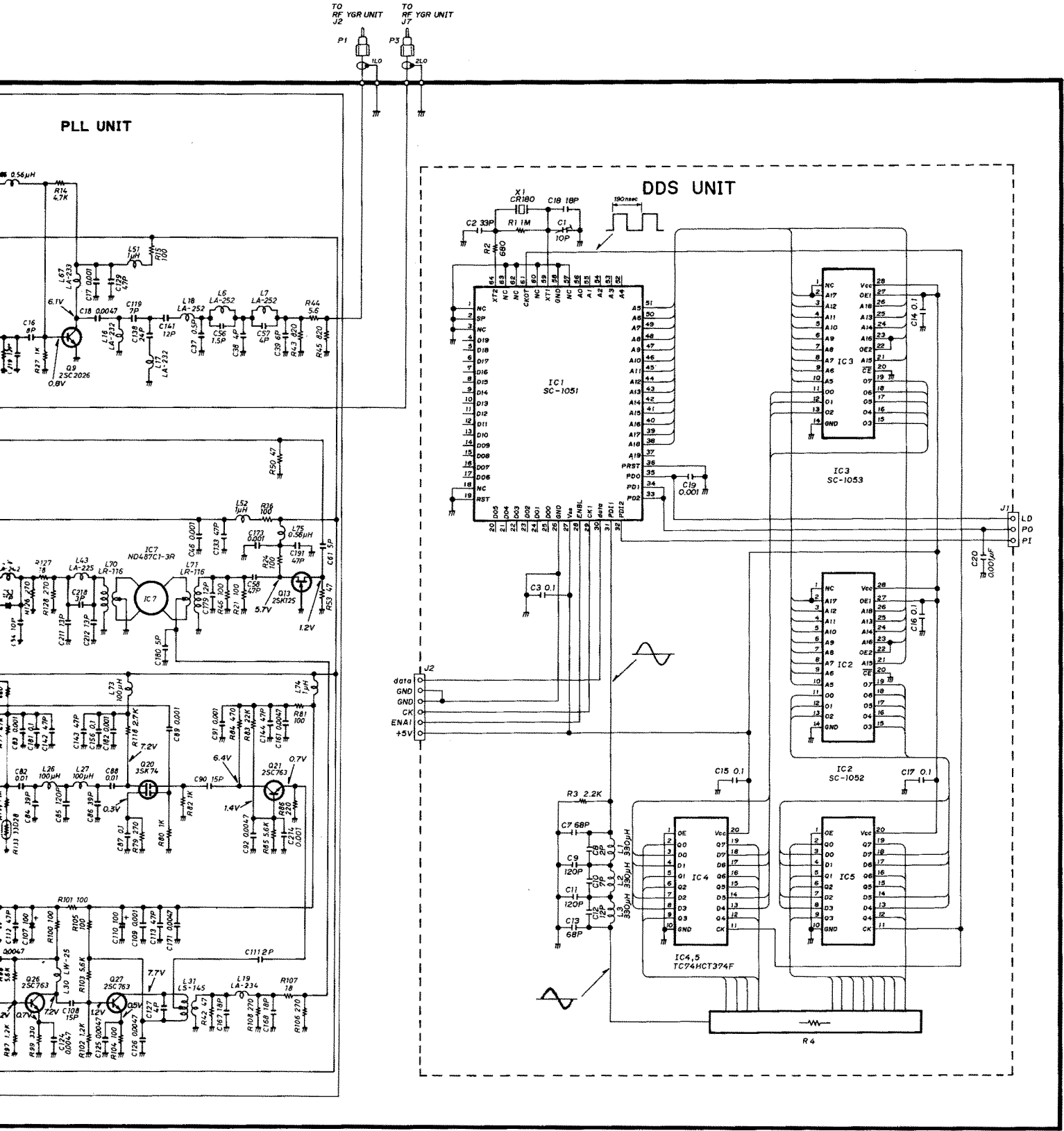

8-4 MAIN UNIT

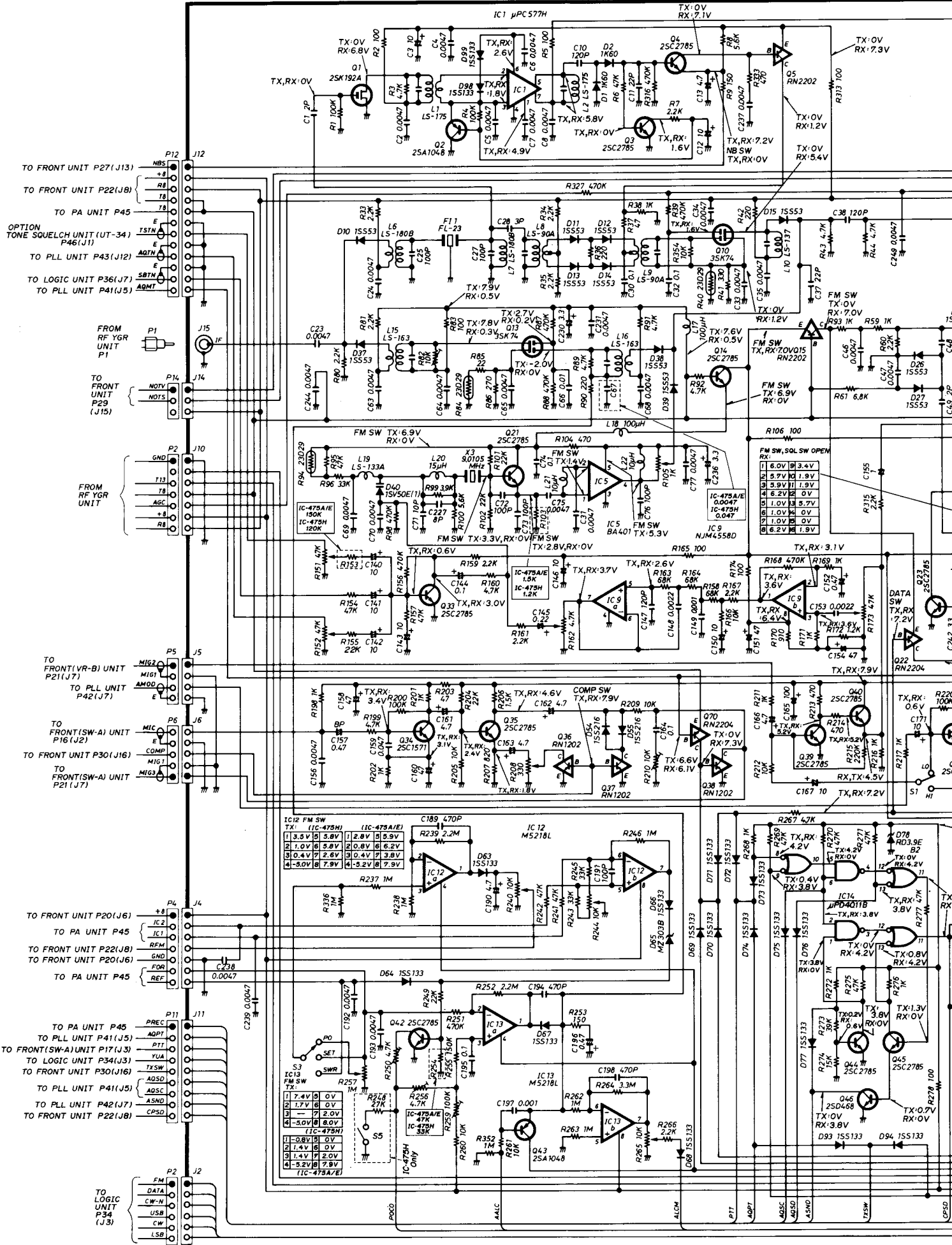

MAIN UNIT

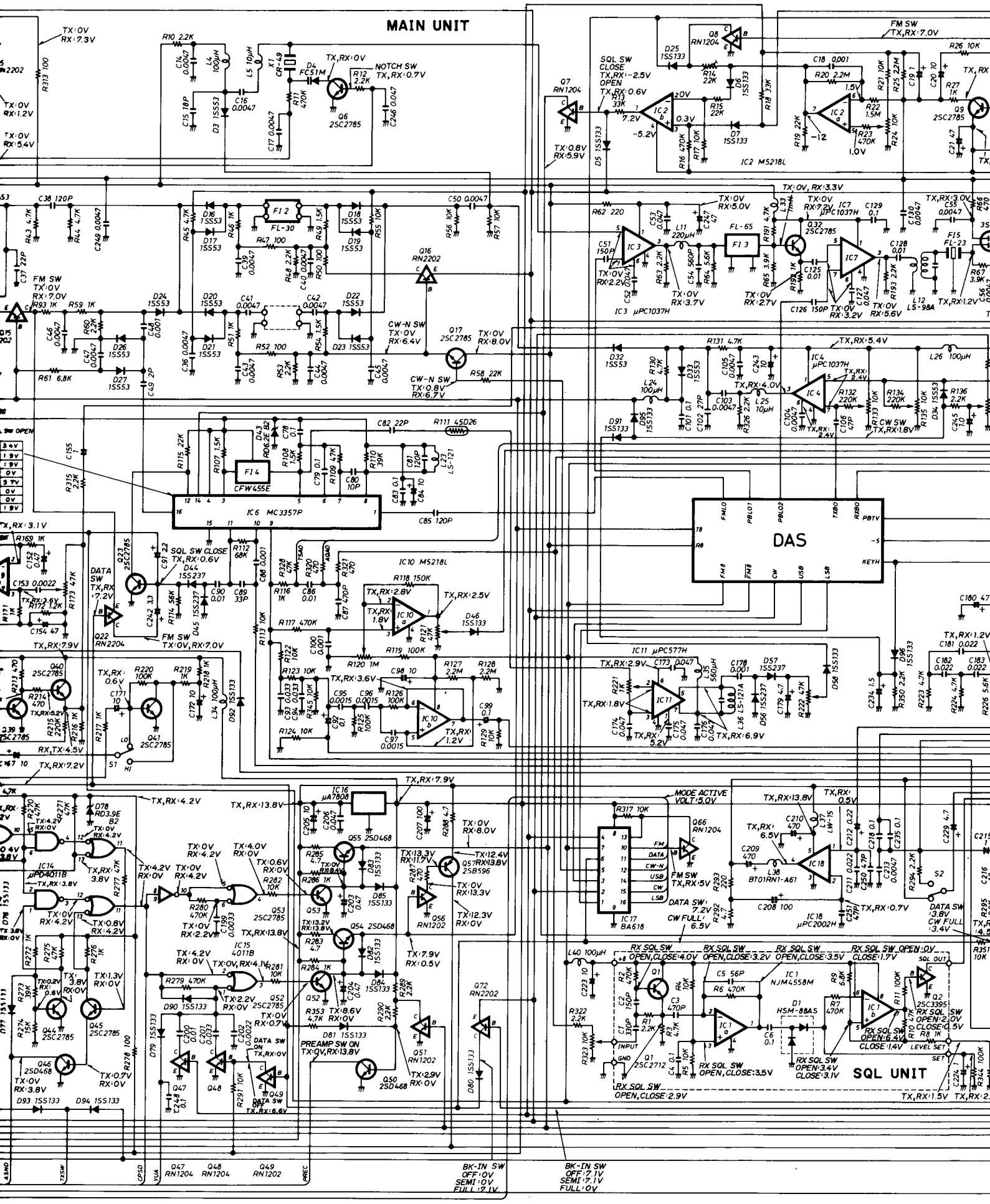

DAS

SQL UNIT

BK-IN SW
OFF: 0V
SEMI: 0.7V
FULL: 2.1V

BK-IN SW
OFF: 7.1V
SEMI: 7.1V
FULL: 0V

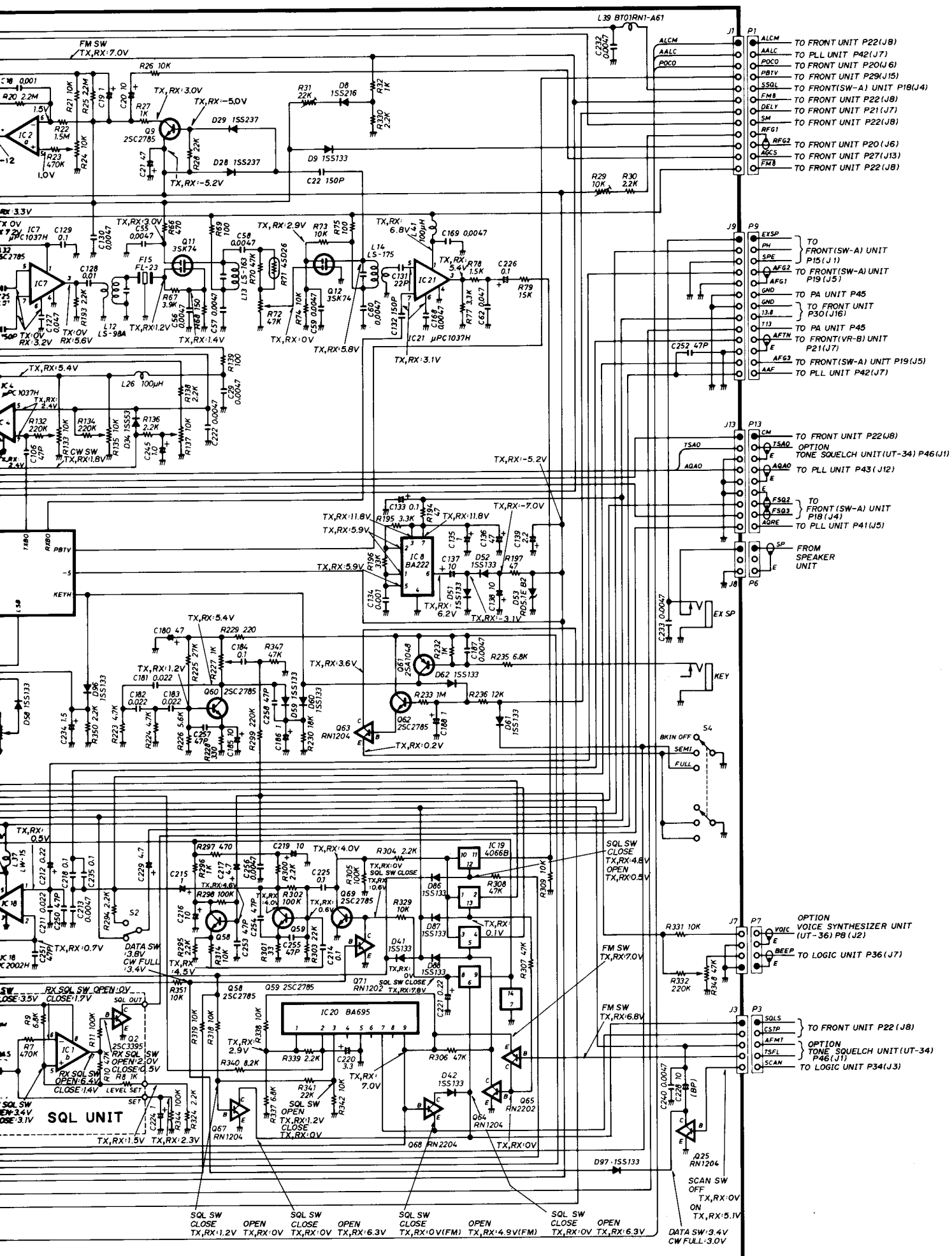

- J1 P1
 - ALCM TO FRONT UNIT P22(J8)
 - AALC TO PLL UNIT P42(J7)
 - POCO TO FRONT UNIT P20(J6)
 - PBTV TO FRONT UNIT P29(J15)
 - SSQL TO FRONT(SW-A) UNIT P18(J4)
 - FMB TO FRONT UNIT P22(J8)
 - DELY TO FRONT UNIT P21(J7)
 - SM TO FRONT UNIT P22(J8)
 - RF61 TO FRONT UNIT P22(J8)
 - RF62 TO FRONT UNIT P20(J6)
 - AGCS TO FRONT UNIT P27(J13)
 - FMB TO FRONT UNIT P22(J8)

- J9 P9
 - EXSP TO FRONT(SW-A) UNIT P15(J1)
 - PH TO FRONT(SW-A) UNIT P19(J5)
 - SPE TO FRONT(SW-A) UNIT P19(J5)
 - AF62 TO FRONT(SW-A) UNIT P19(J5)
 - AF61 TO FRONT(SW-A) UNIT P19(J5)
 - GND TO PA UNIT P45
 - GND TO FRONT UNIT P30(J16)
 - I38 TO FRONT(SW-A) UNIT P19(J5)
 - I13 TO PA UNIT P45
 - AFTM TO FRONT(VR-B) UNIT P21(J7)
 - AF63 TO FRONT(SW-A) UNIT P19(J5)
 - AAF TO PLL UNIT P42(J7)

- J13 P13
 - LCM TO FRONT UNIT P22(J8)
 - TS40 OPTION TONE SQUELCH UNIT(UT-34) P46(J11)
 - E TO PLL UNIT P43(J12)
 - AG40 TO PLL UNIT P43(J12)
 - E TO FRONT(SW-A) UNIT P18(J4)
 - FS02 TO FRONT(SW-A) UNIT P18(J4)
 - FS03 TO FRONT(SW-A) UNIT P18(J4)
 - TORE TO PLL UNIT P41(J5)
 - SP FROM SPEAKER UNIT

- J7 P7
 - OPTION VOICE SYNTHESIZER UNIT (UT-36) P8(J2)
 - VOIC TO LOGIC UNIT P36(J7)
 - BEEP TO LOGIC UNIT P36(J7)

- J3 P3
 - SOLS TO FRONT UNIT P22(J8)
 - C3TP TO FRONT UNIT P22(J8)
 - AFM1 TO FRONT UNIT P22(J8)
 - ISFL TO FRONT UNIT P22(J8)
 - SCAN TO LOGIC UNIT P34(J3)

8-6 REG AND PA UNITS (IC-475A/E ONLY)

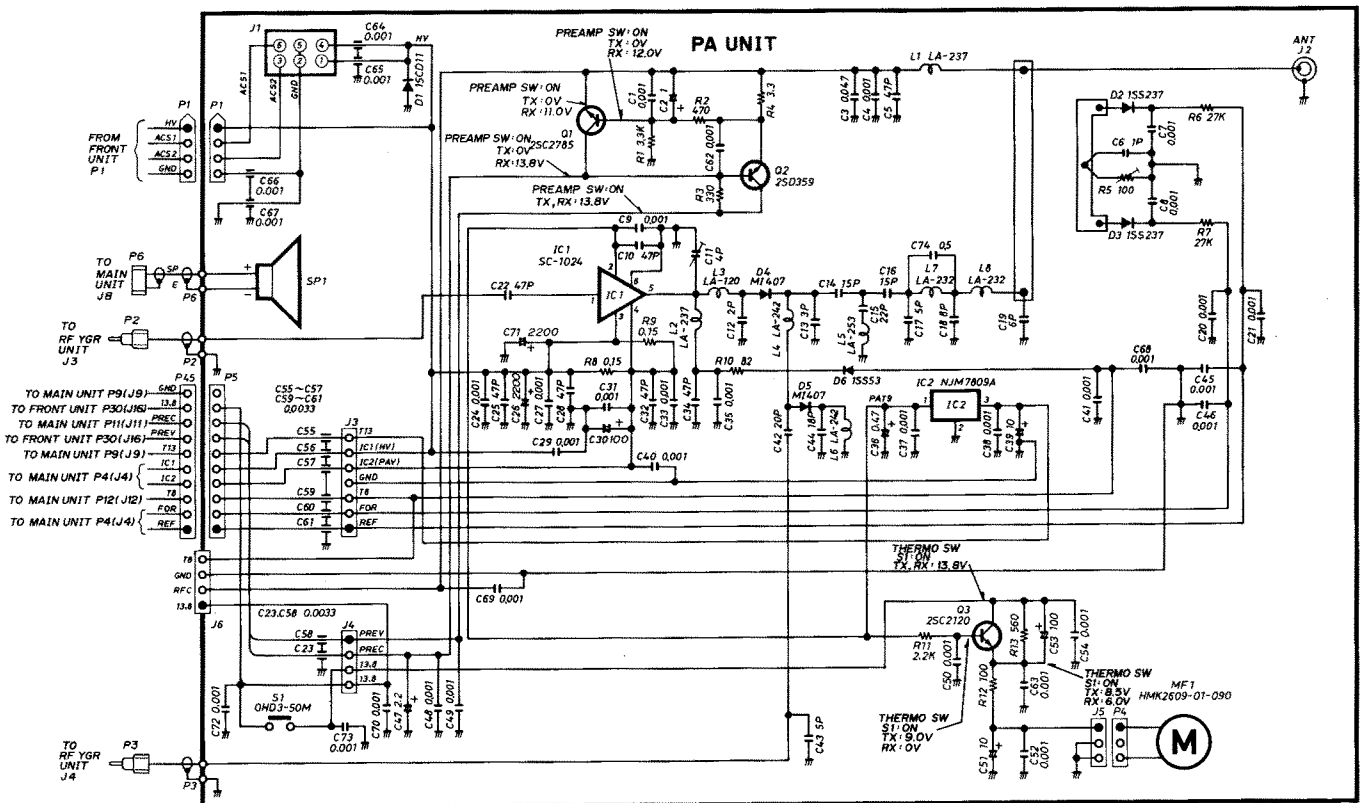
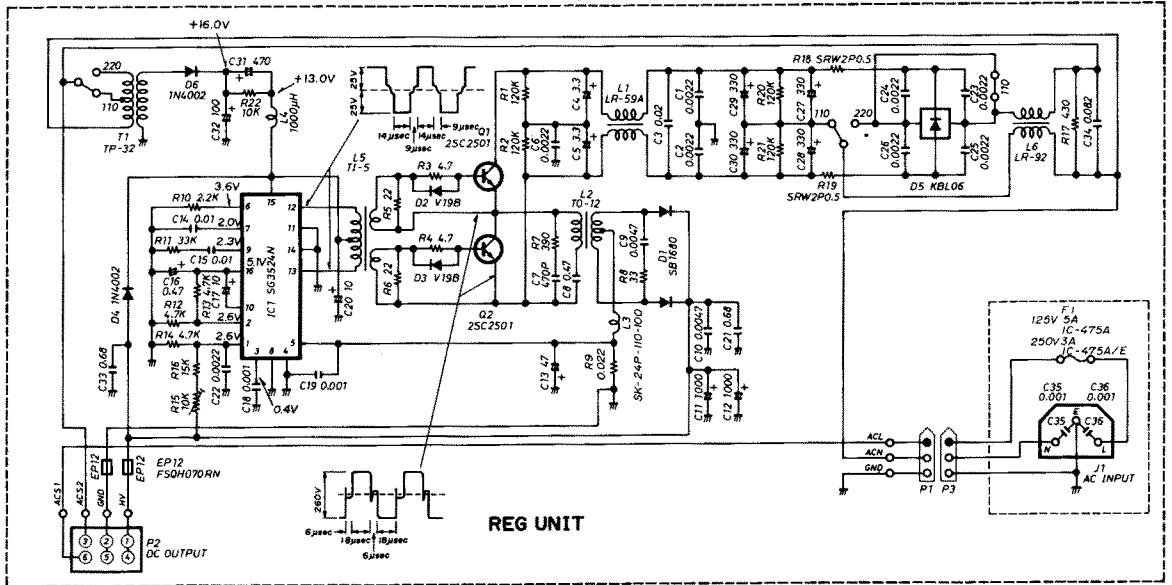

8-7 CTRL, PA AND FILTER UNITS (IC-475H ONLY)

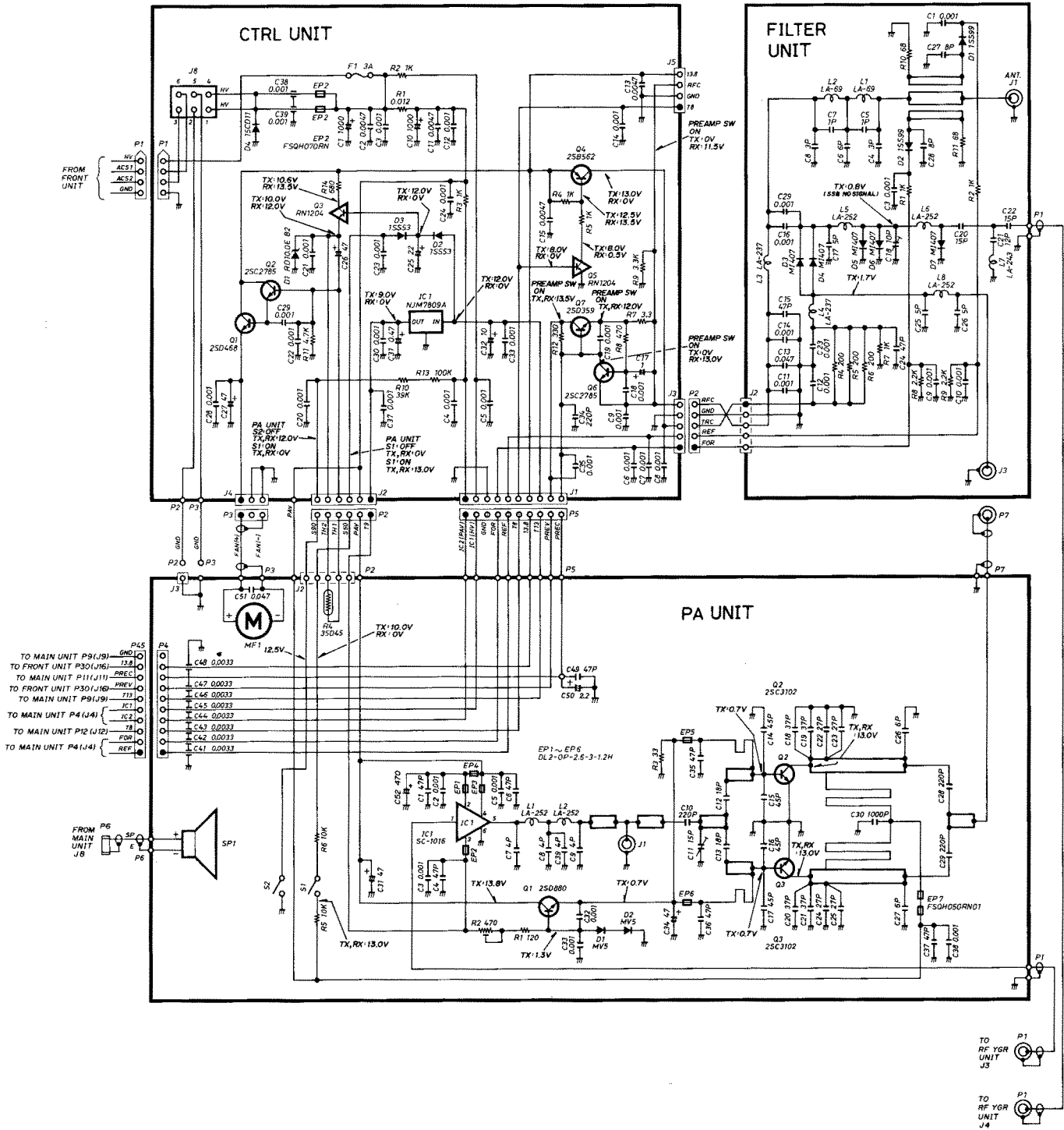

SECTION 9 PARTS LIST

[EF PARTS]

REF. NO.	DESCRIPTION	PART NO.
P1	Connector	EHR-12
P2	Connector	EHR-06
P3	Connector	EHR-05
P4	Connector	EHR-07
P5	Connector	EHR-04
P6	Connector	EHR-05
P7	Connector	EHR-04
P8	Connector	EHR-03
P9	Connector	EHR-13
P11	Connector	EHR-09
P12	Connector	EHR-12
P13	Connector	EHR-09
P14	Connector	EHR-03
P15	Connector	EHR-03
P16	Connector	EHR-03
P17	Connector	EHR-03
P18	Connector	EHR-07
P19	Connector	EHR-04
P20	Connector	EHR-07
P21	Connector	EHR-07
P22	Connector	EHR-13
P23	Connector	EHR-08
P24	Connector	EHR-06
P25	Connector	EHR-06
P26	Connector	EHR-06
P27	Connector	EHR-05
P28	Connector	EHR-03
P29	Connector	EHR-04
P30	Connector	EHR-10
P31	Connector	EHR-03
P32	Connector	EHR-03
P33	Connector	EHR-06
P34	Connector	EHR-10
P36	Connector	EHR-07
P37	Connector	EHR-08
P38	Connector	EHR-08
P39	Connector	EHR-06
P41	Connector	EHR-09
P42	Connector	EHR-08
P43	Connector	EHR-05
P44	Connector	EHR-04
P45	Connector	SMP-10V-B
P46	Connector	EHR-06
P47	Connector	EHR-05
J1	Connector	SQ-2054
EP1	Ferrite Bead	FSQH070RN

[FRONT UNIT]

REF. NO.	DESCRIPTION	PART NO.
IC1	IC	μPD4066BC
IC2	IC	μPD4011BC
IC3	IC	HD61602
Q1	Transistor	2SB562
Q2	Transistor	2SC2785 EF
Q3	Transistor	2SC2785 EF
Q4	Transistor	2SC2785 EF
Q5	Transistor	2SA1048 Y

[FRONT UNIT]

REF. NO.	DESCRIPTION	PART NO.
Q6	Transistor	2SC2785 EF
Q7	Transistor	2SA1048 Y
Q8	Transistor	2SC2785 EF
Q10	Transistor	RN1204
Q11	Transistor	2SC2785 EF
D1	Diode	1SS53
D2	Diode	1SS53
D3	Zener	RD8.2E B2
D4	Diode	1SS53
D5	Diode	1SS53
D6	Diode	1SS53
D7	Diode	1SS53
D8	Diode	1SS53
D9	Diode	1SS53
D10	Diode	1SS53
D11	Diode	1SS53
D12	Diode	1SS53
D13	Diode	1SS53
D14	Diode	1SS53
D15	Diode	1SS53
D16	Diode	1SS53
D17	Diode	1SS53
D18	Diode	1SS53
D19	Diode	1SS53
D20	Diode	1SS53
D21	Diode	1SS53
D23	Diode	1SS53
D24	Diode	1SS53
D26	Diode	1SS53
D28	Diode	1SS53
D29	Diode	1SS53
D30	Diode	1SS53
D31	Diode	1SS53
D32	Diode	1SS53
D33	Diode	1SS53
D34	Diode	1SS133
D35	Diode	1SS133
D36	Diode	1SS53
D37	Diode	1SS53
D39	Diode	1SS53
D40	Diode	1S953
D41	Diode	1SS53
D42	Diode	1SS53
D43	Diode	1SS53
D44	Diode	1SS53
D46	Diode	1SS53
D47	Diode	1SS216
L1	Coil	BT01RN1-A61
L2	Coil	BT01RN1-A61
R1	Resistor	47kΩ R20
R2	Resistor	47kΩ R20
R3	Resistor	100Ω R50X
R4	Resistor	100Ω R50X
R5	Resistor	5.6kΩ ELR20
R6	Resistor	1kΩ R20
R7	Resistor	1kΩ ELR20
R9	Variable Resistor	10kΩB RK097111000AA
R10	Resistor	1kΩ R20
R11	Variable Resistor	10kΩB RK0971110D04A
R12	Resistor	1kΩ R20
R13	Variable Resistor	10kΩB/1kΩB RK097121T004A
R14	Resistor	4.7kΩ R20
R15	Resistor	3.3kΩ R20
R16	Variable Resistor	10kΩB RK097111T005A

[FRONT UNIT]

REF. NO.	DESCRIPTION	PART NO.	
R17	Variable Resistor	10kΩB × 2/10kΩA	
			RK1242320009A
R18	Trimmer	4.7kΩ	RH0651CS3J2KA
R19	Resistor	470Ω	R20
R20	Variable Resistor	10kΩA	RK097111T004A
R21	Variable Resistor	1MΩB	RK097111T003A
R22	Resistor	47kΩ	R20
R23	Variable Resistor	10kΩB	RK097111T005A
R24	Resistor	100Ω	ELR20
R25	Resistor	100Ω	ELR20
R26	Resistor	330kΩ	R20
R27	Resistor	10kΩ	R20
R28	Resistor	10kΩ	R20
R29	Resistor	47kΩ	R20
R30	Resistor	2.2kΩ	R20
R31	Resistor	4.7kΩ	R20
R32	Resistor	47kΩ	R20
R33	Resistor	47kΩ	R20
R34	Resistor	47kΩ	R20
R35	Resistor	100kΩ	ELR20
R36	Resistor	120kΩ	ELR20
R37	Resistor	560kΩ	ELR20
R38	Resistor	1MΩ	ELR20
R39	Resistor	100kΩ	ELR20
R40	Resistor	120kΩ	ELR20
R41	Resistor	560kΩ	ELR20
R42	Resistor	1MΩ	ELR20
R43	Resistor	1kΩ	R20
R44	Resistor	1kΩ	R20
R45	Resistor	47kΩ	ELR20
R46	Resistor	47kΩ	ELR20
R47	Resistor	47kΩ	ELR20
R49	Resistor	47kΩ	ELR20
R50	Resistor	4.7kΩ	R20
C1	Ceramic	0.001μF	50V
C2	Ceramic	0.001μF	50V
C3	Ceramic	0.001μF	50V
C4	Ceramic	0.001μF	50V
C5	Ceramic	0.001μF	50V
C6	Ceramic	0.001μF	50V
C7	Ceramic	0.001μF	50V
C8	Electrolytic	2.2μF	50V MS5
C9	Ceramic	0.001μF	50V
C10	Ceramic	0.001μF	50V
C11	Barrier Layer	0.01μF	25V
C12	Ceramic	0.0047μF	50V
C13	Tantalum	1μF	35V DN
C14	Tantalum	1μF	35V DN
J1	Connector	B03B-EH-S	
J2	Connector	B03B-EH-S	
J3	Connector	B03B-EH-S	
J4	Connector	B07B-EH-S	
J5	Connector	B04B-EH-S	
J6	Connector	S07B-EH-S	
J7	Connector	S07B-EH-S	
J8	Connector	B13B-EH-S	
J9	Connector	B08B-EH-S	
J10	Connector	B06B-EH-S	
J11	Connector	B06B-EH-S	
J12	Connector	B06B-EH-S	
J13	Connector	B05B-EH-S	
J14	Connector	B03B-EH-S	
J15	Connector	B04B-EH-S	
J16	Connector	B10B-EH-S	
J17	Connector	B03B-EH-S	
J18	Connector	HLJ4815-01-030	
J19	Connector	FM214-8SS (P)	
P1	Connector	1490P-1	

[FRONT UNIT]

REF. NO.	DESCRIPTION	PART NO.
DS1	LCD	LP246CH-A
DS2	LED	SLP-175B-50
DS3	LED	SLP-275B-50
DS4	Lamp	HRS-7219A-Y2 30
DS5	Lamp	HRS-7219A-Y2 30
DS6	Lamp	HRS-7219A-Y2 30
DS7	Lamp	HRS-7219A-Y2 30
ME1	Meter	M504
S1	Switch	SPPH23079A (S.RF/C.ALC)
S2	Switch	SDDSA3159A (POWER)
S3	Switch	SPPH23079A (NOTCH)
S4	Switch	SPPH23079A (XMIT)
S5	Switch	SPPH23079A (NB)
S6	Switch	SPPH23079A (PRE AMP)
S7	Switch	SPPH23079A (COMP)
S8	Switch	SPPH23079A (AGC)
S10	Switch	SPPH23078A (CALL)
S11	Switch	SPPH15060A (VFO)
S12	Switch	SPPH23078A (MEMO)
S13	Switch	SPPH23078A (A=B)
S14	Switch	SPPH23078A (MW)
S15	Switch	SPPH23078A (M ▶ VFO)
S16	Switch	SPPH23078A (MEMO CL)
S17	Switch	SPPH23078A (SPLIT)
S18	Switch	SPPH23078A (RIT ON/OFF)
S19	Switch	SPPH23078A (RIT-CL)
S20	Switch	SPPH23078A (SCAN)
S21	Switch	SPPH23078A (SKIP)
S22	Switch	SPPH15060A (CHECK)
S23	Switch	SPPH23078A (SPEECH)
S24	Switch	SPPH15060A (T. SQL)
S25	Switch	SRBM1L011A (MEMO CH)
S26	Switch	SPPH23078A (LSB)
S27	Switch	SPPH23078A (FM)
S28	Switch	SPPH23078A (USB)
S29	Switch	SPPH23078A (CW/N)
S30	Switch	SPPH23078A (DATA)
S31	Switch	SPPH15060A (SET)
S32	Switch	SPPH15060A (DUP)
S33	Switch	SPPH15060A (TONE)
S34	Switch	SPPH23079A (LOCK)
S35	Switch	SPPH23079A (MODE-S)
S36	Switch	SPPH15061A (MHz)
S37	Switch	SPPH15061A (TS)
S38	Rotary Switch	EC24B50B0002A (RIT)
EP1	P.C. Board	B-1188C
EP2	P.C. Board	B-1189A
EP3	P.C. Board	B-1190B
EP4	P.C. Board	B-1031A
EP5	P.C. Board	B-1227B
EP6	P.C. Board	B-1245A
W6	Jumper	JPW-02A
W7	Jumper	JPW-02A
W8	Jumper	JPW-02A
W9	Jumper	JPW-02A
W10	Jumper	JPW-02A

[SENSOR UNIT]

REF. NO.	DESCRIPTION	PART NO.
Q1	Photo	IS-433
Q2	Photo	IS-433
Q3	Transistor	RN1204
Q4	Transistor	RN1204
R1	Resistor	220Ω ELR20
C1	Barrier Layer	0.01μF 25V UAT06V 103K
P1	Connector	EHR-06
DS1	LED	GL-430
DS2	LED	GL-430
EP1	P.C. Board	B-1016C

[LOGIC UNIT]

REF. NO.	DESCRIPTION	PART NO.
IC1	IC	μPD71055C
IC2	IC	HM6116LP3L
IC3	IC	SC-1079
IC4	IC	HD64B180ROP
IC5	IC	TC74HC244
IC6	IC	TC74HC244
IC7	IC	TC4510
IC8	IC	S-7116A
IC9	IC	μPD4094BC
IC10	IC	TA78L005AP
IC11	IC	TC74HC32
IC12	IC	TC74HC32
IC13	IC	TC74HC00
IC14	IC	μPD4001BC
IC15	IC	μPD4011BC
IC16	IC	μPD4011BC
IC17	IC	μPD4069UBC
IC18	IC	μPD4011BC
IC19	IC	μPD4001BC
Q1	Transistor	2SC2785 EF
Q2	Transistor	2SC2785 EF
Q3	Transistor	2SC2785 EF
Q4	Transistor	2SC2785 EF
Q5	Transistor	2SC2785 EF
Q6	Transistor	2SC2785 EF
Q7	Transistor	2SC2785 EF
Q8	Transistor	RN1204
D1	Diode	1SS53
D2	Diode	1S953
D3	Diode	1S953
D4	Diode	1S953
D5	Zener	RD5.1E B2
D6	Zener	RD3.0E B2
D7	Diode	1SS53
D8	Diode	1SS53
D9	Diode	1SS53
D10	Diode	1SS53
D11	Diode	1SS53
D12	Diode	1SS53
D13	Diode	1SS53
D14	Diode	1SS53

[LOGIC UNIT]

REF. NO.	DESCRIPTION	PART NO.
D15	Diode	1SS53
D16	Diode	1SS53
D17	Diode	1SS53
D18	Diode	1SS53
D19	Diode	1SS53
D20	Diode	1SS53
	(IC-475A/E #08A, #12E only)	
	(IC-475H #03H, #05H only)	
D21	Diode	1SS53
	(IC-475A/E #08A, #10A, #12E only)	
	(IC-475H #03H, #04H, #05H only)	
D22	Diode	1SS53
	(IC-475A/E #12A only)	
	(IC-475H #05H only)	
D23	Diode	1SS53
	(IC-475A/E #06E, #08A, #10A only)	
	(IC-475H #02H, #03H, #04H only)	
D24	Diode	1SS53
	(IC-475A/E #06E, #12E only)	
	(IC-475H #02H, #05H only)	
D26	Diode	1SS53
D27	Diode	1SS53
D30	Diode	1SS53
D31	Diode	1SS53
D32	Diode	1SS53
D33	Diode	1SS53
D34	Diode	1SS53
D35	Diode	1SS53
D36	Diode	1SS53
D37	Diode	1SS53
D38	Diode	1SS53
D39	Diode	1SS133
D40	Diode	1SS133
D41	Diode	1SS133
D42	Diode	1SS53
X1	Crystal	RF-4A3 FAA
X2	Crystal	RF-4A3 FAF (9.2708MHZ)
R1	Resistor	47kΩ R20
R2	Resistor	100Ω ELR20
R3	Resistor	47kΩ ELR20
R4	Trimmer	2.2kΩ RH0651CJ3J0CA
R5	Resistor	5.6kΩ ELR20
R6	Resistor	2.7kΩ ELR20
R7	Resistor	2.7kΩ ELR20
R8	Resistor	1MΩ ELR20
R9	Resistor	10kΩ ELR20
R10	Resistor	5.6kΩ ELR20
R11	Resistor	1kΩ R20
R12	Resistor	10kΩ R20
R13	Resistor	4.7kΩ R20
R14	Resistor	1.5kΩ R20
R15	Resistor	270Ω R20
R16	Resistor	47kΩ R20
R17	Resistor	100kΩ ELR20
R18	Resistor	1MΩ R20
R19	Resistor	1MΩ ELR20
R20	Resistor	100kΩ ELR20
R21	Resistor	47kΩ R20
R22	Resistor	47kΩ ELR20
R23	Resistor	10kΩ R20
R24	Resistor	47kΩ ELR20
R25	Resistor	47kΩ ELR20
R26	Resistor	47kΩ R20
R27	Resistor	10kΩ R20
R28	Resistor	3.3MΩ ELR25
R29	Resistor	10kΩ R20
R30	Resistor	10kΩ ELR20
R31	Resistor	47kΩ R20
R32	Resistor	47kΩ R20
R33	Resistor	47kΩ R20
R34	Resistor	47kΩ R20

[LOGIC UNIT]

REF. NO.	DESCRIPTION	PART NO.		
R35	Resistor	47kΩ	R20	
R36	Resistor	47kΩ	R20	
R37	Resistor	47kΩ	R20	
R38	Resistor	47kΩ	R20	
R39	Resistor	47kΩ	R20	
R40	Resistor	47kΩ	ELR20	
R41	Resistor	47kΩ	ELR20	
R42	Resistor	47kΩ	ELR20	
R43	Resistor	47kΩ	R20	
R44	Array	10kΩ	RMX-8	
R46	Resistor	10kΩ	ELR20	
R47	Resistor	22Ω	R50X	
R48	Resistor	10kΩ	ELR20	
R49	Array	10kΩ	RMX-8	
R50	Resistor	47kΩ	ELR20	
C1	Electrolytic	0.33μF	50V	MS7
C2	Barrier Layer	0.1μF	16V	
C3	Barrier Layer	0.1μF	16V	
C4	Ceramic	22pF	50V	
C5	Ceramic	22pF	50V	
C6	Barrier Layer	0.0047μF	25V	
C7	Barrier Layer	0.0047μF	25V	
C8	Barrier Layer	0.0047μF	25V	
C9	Ceramic	0.001μF	50V	
C10	Ceramic	47pF	50V	
C11	Barrier Layer	0.01μF	25V	
C12	Electrolytic	0.47μF	50V	MS7
C13	Barrier Layer	0.01μF	25V	
C14	Ceramic	30pF	50V	
C15	Ceramic	30pF	50V	
C16	Ceramic	0.001μF	50V	
C17	Ceramic	0.001μF	50V	
C18	Ceramic	100pF	50V	
C19	Ceramic	0.001μF	50V	
C20	Ceramic	0.001μF	50V	
C21	Ceramic	0.001μF	50V	
C22	Ceramic	0.001μF	50V	
C23	Ceramic	100pF	50V	
C24	Electrolytic	0.47μF	50V	MS7
C25	Electrolytic	47μF	16V	MS7
C26	Barrier Layer	0.01μF	25V	
C27	Ceramic	0.01μF	50V	FZ
C28	Ceramic	0.01μF	50V	FZ
C29	Barrier Layer	0.01μF	25V	
C30	Barrier Layer	0.01μF	25V	
C31	Ceramic	0.01μF	50V	FZ
C32	Ceramic	0.01μF	50V	FZ
C33	Barrier Layer	0.01μF	25V	
C34	Tantalum	1μF	16V	DN
C35	Ceramic	0.01μF	50V	FZ
C37	Tantalum	1μF	16V	DN
C38	Tantalum	1μF	16V	DN
C39	Tantalum	1μF	16V	DN
C40	Ceramic	0.01μF	50V	FZ
C41	Ceramic	0.01μF	50V	FZ
C42	Barrier Layer	0.01μF	25V	
C43	Ceramic	0.001μF	50V	
C44	Barrier Layer	0.01μF	25V	
J1	Connector	B03B-EH-S		
J2	Connector	B06B-EH-S		
J3	Connector	B10B-EH-S		
J4	Connector	B12B-EH-S		
J5	Connector	TLB-P05H-B1		
J6	Connector	TLB-P02H-B1		
J7	Connector	B07B-EH-S		
J8	Connector	B08B-EH-S		
J9	Connector	B08B-EH-S		
J10	Connector	B06B-EH-S		
J11	Connector	B06B-EH-S		

[LOGIC UNIT]

REF. NO.	DESCRIPTION	PART NO.
P1	Connector	EHR-03
P2	Connector	EHR-05
S1	Switch	SSSS31124A
S3	Switch	SCS-10A
BT1	Lithium Battery	BR2032-1T2
EP1	P.C. Board	B-1187C
EP2	Ferrite Bead	FSQH070RN
W3	Jumper	JPW-02A
W4	Jumper	JPW-02A

[PLL UNIT]

REF. NO.	DESCRIPTION	PART NO.
IC1	IC	NJM4560DD
IC2	IC	MC145158P1
IC3	IC	μPB571C
IC4	IC	HD10551
IC5	IC	μA78M08UC
IC6	IC	TA78L005AP
IC7	IC	ND487C1-3R
Q1	FET	2SK125
Q2	Transistor	2SC2026
Q3	Transistor	2SC763C
Q4	Transistor	RN2204
Q5	Transistor	RN1202
Q6	Transistor	2SC2026
Q7	Transistor	2SC763C
Q9	Transistor	2SC2026
Q13	FET	2SK125
Q17	Transistor	2SC383TM
Q18	Transistor	2SC763C
Q19	Transistor	2SC763C
Q20	FET	3SK74 M
Q21	Transistor	2SC763C
Q24	Transistor	2SC2785 EF
Q25	FET	2SK192A GR
Q26	Transistor	2SC763C
Q27	Transistor	2SC763C
Q29	Transistor	RN1202
D1	Diode	1SS53
D2	Varicap	1T25
D4	Diode	1SS53
D5	Zener	RD5.1E B2
D6	Diode	1SS53
D9	Varicap	1SV50E (1)
D14	Diode	1SS53
X1	Crystal	CR21 (30.72MHz)
L1	Coil	LR-68
L2	Coil	LAL03NA 2R2M
L3	Coil	LA-233
L4	Coil	LS-114
L5	Coil	LS-114
L6	Coil	LA-252

[PLL UNIT]

REF. NO.	DESCRIPTION	PART NO.
L7	Coil	LA-252
L8	Coil	LA-233
L9	Coil	LA-225
L10	Coil	LA-225
L11	Coil	LAL03NA R47M
L12	Coil	LAL02KR R56M
L13	Coil	LA-232
L14	Coil	LA-242
L15	Coil	LA-232
L16	Coil	LA-232
L17	Coil	LA-232
L18	Coil	LA-252
L19	Coil	LA-234
L20	Coil	LA-233
L21	Coil	LAL03NA 100K
L22	Coil	LS-94
L23	Coil	LW-25
L24	Coil	LS-145
L25	Coil	LS-145
L26	Coil	LAL03NA 101K
L27	Coil	LAL03NA 101K
L28	Coil	LR-79
L29	Coil	LA-234
L30	Coil	LW-25
L31	Coil	LS-145
L32	Coil	BT01RN1-A61
L33	Coil	LW-25
L34	Coil	BT01RN1-A61
L35	Coil	BT01RN1-A61
L36	Coil	BT01RN1-A61
L37	Coil	LAL04NA 101K
L38	Coil	BT01RN1-A61
L39	Coil	BT01RN1-A61
L40	Coil	BT01RN1-A61
L41	Coil	LAL02KR R47M
L42	Coil	BT01RN1-A61
L43	Coil	LA-225
L44	Coil	BT01RN1-A61
L45	Coil	BT01RN1-A61
L46	Coil	BT01RN1-A61
L47	Coil	BT01RN1-A61
L48	Coil	BT01RN1-A61
L49	Coil	BT01RN1-A61
L50	Coil	BT01RN1-A61
L51	Coil	LAL02KR 1R0M
L52	Coil	LAL02KR 1R0M
L54	Coil	LA-232
L55	Coil	LAL02KR R56M
L61	Coil	BT01RN1-A61
L62	Coil	BT01RN1-A61
L63	Coil	BT01RN1-A61
L64	Coil	BT01RN1-A61
L65	Coil	BT01RN1-A61
L66	Coil	LAL03NA R56M
L67	Coil	LA-233
L70	Coil	LR-116
L71	Coil	LR-116
L73	Coil	LAL03NA 101K
L74	Coil	LAL03NA 1R0M
L75	Coil	LAL02KR R56M
L76	Coil	LAL02KR R33M
L77	Coil	LW-24
L78	Coil	LAL02KR R56M
L79	Coil	LAL02KR R47M
R1	Resistor	220Ω R20
R2	Resistor	10Ω ELR20
R3	Resistor	100Ω R20
R4	Resistor	680Ω R20
R5	Resistor	560Ω R20
R6	Resistor	150Ω ELR20
R7	Resistor	2.2kΩ ELR20
R8	Resistor	3.3kΩ R20
R9	Resistor	220Ω ELR20

[PLL UNIT]

REF. NO.	DESCRIPTION	PART NO.
R10	Resistor	4.7kΩ ELR20
R11	Resistor	10kΩ R20
R12	Resistor	560Ω R20
R13	Resistor	5.6Ω ELR20
R14	Resistor	4.7kΩ R20
R15	Resistor	100Ω ELR20
R16	Resistor	270Ω ELR20
R17	Resistor	18Ω ELR20
R18	Resistor	270Ω ELR20
R19	Resistor	100Ω R20
R20	Resistor	2.2kΩ ELR20
R21	Resistor	100Ω ELR20
R22	Resistor	10kΩ ELR20
R23	Resistor	22kΩ ELR20
R24	Resistor	100Ω ELR20
R25	Resistor	820Ω ELR20
R26	Resistor	820Ω ELR20
R27	Resistor	1kΩ ELR20
R28	Resistor	47kΩ ELR20
R29	Resistor	10kΩ R20
R30	Resistor	22kΩ R20
R31	Resistor	1.5kΩ R20
R32	Resistor	100Ω ELR20
R33	Resistor	1.5kΩ ELR20
R34	Resistor	4.7kΩ ELR20
R35	Resistor	4.7kΩ ELR20
R36	Resistor	100Ω R20
R37	Resistor	10kΩ ELR20
R38	Resistor	100Ω R20
R39	Resistor	1Ω ELR25
R40	Resistor	4.7kΩ ELR20
R41	Resistor	4.7kΩ ELR20
R42	Resistor	47Ω ELR20
R43	Resistor	820Ω ELR20
R44	Resistor	5.6Ω R20
R45	Resistor	820Ω ELR20
R46	Resistor	100Ω R20
R47	Resistor	47Ω ELR20
R50	Resistor	47Ω ELR20
R53	Resistor	47Ω ELR20
R64	Resistor	2.2kΩ R20
R67	Resistor	470Ω ELR20
R68	Resistor	4.7kΩ ELR20
R69	Resistor	10kΩ ELR20
R70	Resistor	220Ω R20
R71	Resistor	4.7kΩ ELR20
R72	Resistor	1kΩ ELR20
R73	Resistor	22kΩ ELR20
R74	Resistor	220Ω ELR20
R76	Resistor	1kΩ ELR20
R77	Resistor	47kΩ ELR20
R78	Resistor	560Ω R20
R79	Resistor	270Ω ELR20
R80	Resistor	1kΩ ELR20
R81	Resistor	100Ω ELR20
R82	Resistor	1kΩ ELR20
R83	Resistor	22kΩ R20
R84	Resistor	470Ω ELR20
R85	Resistor	5.6kΩ ELR20
R86	Resistor	220Ω R20
R90	Resistor	2.2MΩ ELR20
R91	Resistor	2.2kΩ R25
R93	Resistor	100kΩ ELR20
R94	Resistor	100kΩ ELR20
R95	Resistor	680Ω ELR20
R96	Resistor	100Ω R20
R97	Resistor	1.2kΩ ELR20
R98	Resistor	5.6kΩ ELR20
R99	Resistor	330Ω ELR20
R100	Resistor	100Ω ELR20
R101	Resistor	100Ω R20
R102	Resistor	1.2kΩ R20
R103	Resistor	5.6kΩ ELR20
R104	Resistor	100Ω ELR20
R105	Resistor	100Ω ELR20

[PLL UNIT]

REF. NO.	DESCRIPTION	PART NO.		
R106	Resistor	270Ω	ELR20	
R107	Resistor	18Ω	R20	
R108	Resistor	270Ω	ELR20	
R118	Resistor	2.7kΩ	R20	
R126	Resistor	270Ω	ELR20	
R127	Resistor	18Ω	ELR20	
R128	Resistor	270Ω	ELR20	
R133	Resistor	33D28		
R134	Resistor	1kΩ	ELR20	
R135	Resistor	15kΩ	R20	
C1	Ceramic	6pF	50V	CH
C2	Ceramic	33pF	50V	CH
C3	Ceramic	470pF	50V	
C4	Ceramic	470pF	50V	
C5	Electrolytic	100μF	10V	MS7
C6	Ceramic	0.001μF	50V	
C7	Ceramic	47pF	50V	
C8	Electrolytic	100μF	10V	MS7
C9	Ceramic	470pF	50V	
C10	Ceramic	470pF	50V	
C11	Electrolytic	100μF	10V	MS7
C12	Ceramic	0.001μF	50V	
C13	Ceramic	0.001μF	50V	
C14	Ceramic	0.5pF	500V	
C15	Cylinder	15pF	UP125SL150J-NA	
C16	Ceramic	8pF	50V	
C17	Ceramic	0.001μF	50V	
C18	Cylinder	0.0047μF	EP050X472M-NA	
C19	Ceramic	7pF	50V	
C20	Ceramic	2pF	50V	
C21	Ceramic	0.001μF	50V	
C22	Barrier Layer	0.1μF	16V	
C23	Trimmer	10pF	CV38D1001	
C24	Ceramic	8pF	50V	CH
C25	Ceramic	8pF	50V	CH
C26	Ceramic	1pF	50V	CK
C27	Ceramic	5pF	50V	CH
C28	Ceramic	470pF	50V	
C29	Ceramic	470pF	50V	
C30	Ceramic	0.001μF	50V	
C31	Cylinder	0.0047μF	EP050X472M-NA	
C32	Ceramic	0.0047μF	50V	
C33	Ceramic	15pF	50V	
C34	Tantalum	1μF	35V	DN
C35	Electrolytic	0.47μF	50V	BP
C36	Ceramic	0.001μF	50V	
C37	Ceramic	0.5pF	50V	CK
C38	Ceramic	4pF	50V	CH
C39	Ceramic	6pF	50V	CH
C40	Cylinder	100pF	UP050B101K-NA	
C41	Ceramic	0.001μF	50V	
C42	Ceramic	0.001μF	50V	
C43	Ceramic	3pF	50V	
C44	Ceramic	12pF	50V	
C45	Ceramic	43pF	50V	
C46	Ceramic	0.001μF	50V	
C47	Ceramic	18pF	50V	
C48	Cylinder	47pF	UP050SL470J-NA	
C49	Ceramic	36pF	50V	
C50	Ceramic	8pF	50V	
C52	Ceramic	22pF	50V	
C53	Ceramic	11pF	50V	
C54	Ceramic	10pF	50V	
C55	Ceramic	8pF	50V	
C56	Ceramic	1.5pF	50V	CK
C57	Ceramic	4pF	50V	CH
C58	Ceramic	47pF	50V	
C60	Ceramic	100pF	50V	
C61	Ceramic	5pF	50V	
C62	Ceramic	0.0047μF	50V	
C63	Cylinder	4.7pF	UP050SL4R7K-NA	
C64	Ceramic	0.1μF	GRM40 F	
C65	Ceramic	0.0047μF	50V	

[PLL UNIT]

REF. NO.	DESCRIPTION	PART NO.		
C66	Ceramic	0.001μF	50V	
C67	Ceramic	0.001μF	50V	
C68	Ceramic	0.001μF	50V	
C69	Ceramic	82pF	50V	TH
C70	Ceramic	0.001μF	50V	
C71	Barrier Layer	0.1μF	16V	
C72	Ceramic	10pF	50V	
C73	Ceramic	DD106 F	103Z 50V02	
C74	Ceramic	82pF	50V	TH
C75	Ceramic	39pF	50V	CH
C76	Cylinder	0.0047μF	EP050X472M-NA	
C77	Ceramic	0.001μF	50V	
C78	Ceramic	5pF	50V	UJ
C79	Barrier Layer	0.0047μF	25V	
C80	Barrier Layer	0.35pF	50V	
C81	Ceramic	5pF	50V	UJ
C82	Barrier Layer	0.01μF	25V	BA
C83	Ceramic	0.001μF	50V	
C84	Ceramic	39pF	50V	
C85	Ceramic	120pF	50V	
C86	Ceramic	39pF	50V	
C87	Barrier Layer	0.1μF	16V	
C88	Barrier Layer	0.01μF	25V	BA
C89	Ceramic	0.001μF	50V	
C90	Ceramic	15pF	50V	
C91	Ceramic	0.001μF	50V	
C92	Ceramic	0.0047μF	50V	
C93	Array	0.001μF × 7	B8XC0114-32N	
C94	Array	0.001μF × 7	B8XC0114-32N	
C95	Electrolytic	47μF	16V	
C96	Ceramic	47pF	50V	
C97	Barrier Layer	0.1μF	16V	
C98	Tantalum	1.5μF	35V	DN
C99	Ceramic	7pF	50V	RH
C100	Ceramic	22pF	50V	CH
C101	Ceramic	6pF	50V	CH
C102	Electrolytic	47μF	10V	
C103	Ceramic	0.001μF	50V	
C104	Ceramic	0.0047μF	50V	
C105	Cylinder	1pF	UP050SL010M	
C106	Ceramic	0.001μF	50V	
C107	Electrolytic	100μF	10V	MS7
C108	Ceramic	15pF	50V	
C109	Ceramic	0.001μF	50V	
C110	Electrolytic	100μF	10V	MS7
C111	Ceramic	2pF	50V	
C112	Ceramic	47pF	50V	
C113	Ceramic	47pF	50V	
C114	Ceramic	7pF	50V	
C115	Electrolytic	100μF	16V	
C116	Electrolytic	10μF	16V	
C117	Ceramic	0.001μF	50V	
C118	Electrolytic	10μF	16V	
C119	Ceramic	7pF	50V	CH
C120	Ceramic	0.0047μF	50V	
C121	Trimmer	7pF	CVSSA0701	
C122	Ceramic	8pF	50V	SH
C123	Ceramic	3pF	50V	CJ
C124	Ceramic	0.0047μF	50V	
C125	Ceramic	0.0047μF	50V	
C126	Ceramic	0.0047μF	50V	
C127	Ceramic	4pF	50V	
C128	Ceramic	7pF	50V	CH
C129	Ceramic	47pF	50V	
C130	Ceramic	47pF	50V	
C131	Ceramic	47pF	50V	
C132	Ceramic	47pF	50V	
C133	Ceramic	47pF	50V	
C134	Ceramic	47pF	50V	
C135	Electrolytic	10μF	16V	MS7
C136	Ceramic	47pF	50V	
C137	Ceramic	47pF	50V	
C138	Ceramic	24pF	50V	
C139	Ceramic	47pF	50V	
C140	Ceramic	47pF	50V	

[PLL UNIT]

REF. NO.	DESCRIPTION	PART NO.		
C141	Ceramic	12pF	50V	CH
C142	Ceramic	47pF	50V	
C143	Ceramic	47pF	50V	
C144	Ceramic	47pF	50V	
C145	Ceramic	47pF	50V	
C146	Ceramic	0.001μF	50V	
C147	Ceramic	0.001μF	50V	
C148	Ceramic	0.001μF	50V	
C149	Ceramic	47pF	50V	
C150	Tantalum	1μF	35V	DN
C151	Ceramic	47pF	50V	
C153	Ceramic	0.001μF	50V	
C154	Monolithic	0.001μF	GRM40	
C155	Ceramic	0.001μF	50V	
C156	Barrier Layer	0.1μF	16V	
C157	Ceramic	47pF	50V	
C158	Ceramic	0.001μF	50V	
C160	Ceramic	47pF	50V	
C161	Ceramic	0.0047μF	50V	
C164	Ceramic	47pF	50V	
C165	Cylinder	0.0047μF	EP050 × 472M-NA	
C166	Barrier Layer	0.1μF	16V	
C167	Ceramic	18pF	50V	
C168	Ceramic	18pF	50V	
C169	Tantalum	1μF	16V	DN
C170	Barrier Layer	0.1μF	16V	
C171	Ceramic	0.0047μF	50V	
C172	Ceramic	33pF	50V	
C173	Ceramic	0.001μF	50V	
C174	Ceramic	0.001μF	50V	
C175	Electrolytic	10μF	16V	MS7
C176	Ceramic	0.001μF	50V	
C177	Electrolytic	10μF	16V	MS7
C178	Ceramic	47pF	50V	
C179	Ceramic	12pF	50V	
C180	Ceramic	5pF	50V	
C181	Barrier Layer	0.1μF	16V	
C182	Ceramic	0.001μF	50V	
C183	Ceramic	220pF	50V	
C184	Ceramic	0.001μF	50V	
C185	Ceramic	0.001μF	50V	
C186	Barrier Layer	0.1μF	16V	
C187	Ceramic	47pF	50V	
C188	Ceramic	47pF	50V	
C189	Ceramic	0.001μF	50V	
C190	Monolithic	0.0047μF	GRM40	
C191	Ceramic	47pF	50V	
C192	Ceramic	0.001μF	50V	
C194	Ceramic	47pF	50V	
C195	Tantalum	0.1μF	35V	DN
C197	Ceramic	1.5pF	50V	
C198	Ceramic	5pF	50V	
C199	Ceramic	47pF	50V	
C200	Ceramic	0.001μF	50V	
C201	Monolithic	0.1μF	GRM40 F	
C202	Ceramic	47pF	50V	
C203	Ceramic	0.001μF	50V	
C204	Ceramic	0.001μF	50V	
C205	Ceramic	47pF	50V	
C206	Ceramic	0.001μF	50V	
C207	Monolithic	47pF	GRM40	
C208	Ceramic	47pF	50V	
C209	Ceramic	47pF	50V	
C210	Ceramic	3pF	50V	
C211	Ceramic	13pF	50V	
C212	Ceramic	13pF	50V	
C213	Ceramic	47pF	50V	
C214	Cylinder	0.001μF	UP050B102K-NA	
C216	Monolithic	47pF	GRM40	
C217	Monolithic	47pF	GRM40	
	(IC-475A/E #08A, #10A)			
	(IC-475H #03H, #04H)			
C218	Ceramic	3pF	50V	
C219	Ceramic	12pF	50V	
C220	Ceramic	8pF	50V	

[PLL UNIT]

REF. NO.	DESCRIPTION	PART NO.	
C221	Cylinder	47pF	UP050SL470J-NA
C222	Tantalum	0.22μF	16V DN
	(IC-475A/E only)		
C222	Tantalum	0.22μF	35V DN
	(IC-475H only)		
C223	Ceramic	10pF	50V
C224	Barrier Layer	0.1μF	16V
J2	Connector	TLB-P07H-B1	
J4	Connector	TCS 5037-01-401	
J5	Connector	B09B-EH-S	
J6	Connector	TCS 4480-01-1111	
J7	Connector	B08B-EH-S	
J8	Connector	HSJ0807-01-010	
J9	Connector	TLB-P05H-B1	
J10	Connector	TLB-P06H-B1	
J12	Connector	B05B-EH-S	
J13	Connector	B03B-EH-S	
J14	Connector	RT-01T-1.3B	
P1	Connector	TMP-P01X-A1	
P2	Connector	EHR-12	
P3	Connector	TMP-P01X-A1	
EP1	P.C. Board	B-1194 E	
EP2	P.C. Board	B-1393A	
EP3	Ferrite Bead	FSQH070RN	
W8	Jumper	JPW-02A	
W10	Jumper	JPW-02A	
W13	Jumper	JPW-02A	
W26	Jumper	JPW-02A	
W39	Jumper	JPW-02A	
W73	Jumper	JPW-02A	

[DDS UNIT]

REF. NO.	DESCRIPTION	PART NO.	
IC1	IC	SC-1051	
IC2	IC	SC-1052	
IC3	IC	SC-1053	
IC4	IC	TC74HCT374F	
IC5	IC	TC74HCT374F	
X1	Crystal	CR180	
L1	Coil	LQN5N331K	
L2	Coil	LQN5N331K	
L3	Coil	LQN5N331K	
R1	Chip	1MΩ	MCR10
R2	Chip	680Ω	MCR10
R3	Chip	2.2kΩ	MCR10
R4	Array	GF5096	
C1	Trimmer	10pF	TZB04N100BA
C2	Monolithic	33pF	GRM40 CH
C3	Monolithic	0.1μF	GRM40 F
C7	Monolithic	68pF	GRM40
C8	Monolithic	2pF	GRM40
C9	Monolithic	120pF	GRM40

[DDS UNIT]

REF. NO.	DESCRIPTION	PART NO.	
C10	Monolithic	7pF	GRM40
C11	Monolithic	120pF	GRM40
C12	Monolithic	12pF	GRM40
C13	Monolithic	68pF	GRM40
C14	Monolithic	0.1μF	GRM40 F
C15	Monolithic	0.1μF	GRM40 F
C16	Monolithic	0.1μF	GRM40 F
C17	Monolithic	0.1μF	GRM40 F
C18	Monolithic	18pF	GRM40 UJ
C19	Monolithic	0.001μF	GRM40
C20	Monolithic	0.001μF	GRM40
J1	Connector	3022-03A	
J2	Connector	3022-06A	
EP1	P.C. Board	B-1233C	

[MAIN UNIT]

REF. NO.	DESCRIPTION	PART NO.
Q25	Transistor	RN1204
Q26	Transistor	RN1204
Q27	Transistor	2SC2785 EF
Q28	Transistor	2SC2785 EF
Q29	Transistor	RN1204
Q30	Transistor	RN1204
Q31	Transistor	RN1204
Q32	Transistor	2SC2785 EF
Q33	Transistor	2SC2785 EF
Q34	Transistor	2SC1571 G
Q35	Transistor	2SC2785 EF
Q36	Transistor	RN1202
Q37	Transistor	RN1202
Q38	Transistor	RN1202
Q39	Transistor	2SC2785 EF
Q40	Transistor	2SC2785 EF
Q41	Transistor	2SC2785 EF
Q42	Transistor	2SC2785 EF
Q43	Transistor	2SA1048 Y/GR
Q44	Transistor	2SC2785 EF
Q45	Transistor	2SC2785 EF
Q46	Transistor	2SD468 C
Q47	Transistor	RN1204
Q48	Transistor	RN1204
Q49	Transistor	RN1202
Q50	Transistor	2SD468 C
Q51	Transistor	RN1202
Q52	Transistor	2SC2785 EF
Q53	Transistor	2SC2785 EF
Q54	Transistor	2SD468 C
Q55	Transistor	2SD468 C
Q56	Transistor	RN1202
Q57	Transistor	2SB596 O
Q58	Transistor	2SC2785 EF
Q59	Transistor	2SC2785 EF
Q60	Transistor	2SC2785 EF
Q61	Transistor	2SA1048 Y/GR
Q62	Transistor	2SC2785 EF
Q63	Transistor	RN1204
Q64	Transistor	RN1204
Q65	Transistor	RN2202
Q66	Transistor	RN1204
Q67	Transistor	RN1204
Q68	Transistor	RN2204
Q69	Transistor	2SC2785 EF
Q70	Transistor	RN2204
Q71	Transistor	RN1202
Q72	Transistor	RN2202
D1	Diode	1K60
D2	Diode	1K60
D3	Diode	1SS53
D4	Varicap	FC51 M
D5	Diode	1SS133
D6	Diode	1SS133
D7	Diode	1SS133
D8	Diode	1SS216
D9	Diode	1SS133
D10	Diode	1SS53
D11	Diode	1SS53
D12	Diode	1SS53
D13	Diode	1SS53
D14	Diode	1SS53
D15	Diode	1SS53
D16	Diode	1SS53
D17	Diode	1SS53
D18	Diode	1SS53
D19	Diode	1SS53
D20	Diode	1SS53
D21	Diode	1SS53
D22	Diode	1SS53
D23	Diode	1SS53
D24	Diode	1SS53
D25	Diode	1SS133

[MAIN UNIT]

REF. NO.	DESCRIPTION	PART NO.
IC1	IC	μPC577H
IC2	IC	M5218L
IC3	IC	μPC1037H
IC4	IC	μPC1037H
IC5	IC	BA401
IC6	IC	MC3357P
IC7	IC	μPC1037H
IC8	IC	BA222
IC9	IC	NJM4558D
IC10	IC	M5218L
IC11	IC	μPC577H
IC12	IC	M5218L
IC13	IC	M5218L
IC14	IC	μPD4011BC
IC15	IC	μPD4011BC
IC16	IC	μA7808
IC17	IC	BA618
IC18	IC	μPC2002H
IC19	IC	μPD4066BC
IC20	IC	BA695
IC21	IC	μPC1037H
Q1	FET	2SK192A Y
Q2	Transistor	2SA1048 Y/GR
Q3	Transistor	2SC2785 EF
Q4	Transistor	2SC2785 EF
Q5	Transistor	RN2202
Q6	Transistor	2SC2785 EF
Q7	Transistor	RN1204
Q8	Transistor	RN1204
Q9	Transistor	2SC2785 EF
Q10	FET	3SK74M
Q11	FET	3SK74M
Q12	FET	3SK74M
Q13	FET	3SK74M
Q14	Transistor	2SC2785 EF
Q15	Transistor	RN2202
Q16	Transistor	RN2202
Q17	Transistor	2SC2785 EF
Q18	Transistor	2SC2785 EF
Q19	Transistor	2SC2785 EF
Q20	Transistor	RN1204
Q21	Transistor	2SC2785 EF
Q22	Transistor	RN2204
Q23	Transistor	2SC2785 EF

[MAIN UNIT]

REF. NO.	DESCRIPTION	PART NO.
D26	Diode	1SS53
D27	Diode	1SS53
D28	Diode	1SS237
D29	Diode	1SS237
D32	Diode	1SS53
D33	Diode	1SS53
D34	Diode	1SS53
D35	Varicap	1SV50E (1)
D36	Diode	1SS133
D37	Diode	1SS53
D38	Diode	1SS53
D39	Diode	1SS53
D40	Varicap	1SV50E (1)
D41	Diode	1SS133
D42	Diode	1SS133
D43	Zener	RD6.2E B2
D44	Diode	1SS237
D45	Diode	1SS237
D46	Diode	1SS133
D47	Diode	1SS53
D48	Diode	1SS53
D49	Diode	1SS133
D50	Diode	1SS133
D51	Diode	1SS133
D52	Diode	1SS133
D53	Zener	RD5.1E B2
D54	Diode	1SS216
D55	Diode	1SS216
D56	Diode	1SS237
D57	Diode	1SS237
D58	Diode	1SS133
D59	Diode	1SS133
D60	Diode	1SS133
D61	Diode	1SS133
D62	Diode	1SS133
D63	Diode	1SS133
D64	Diode	1SS133
D65	Zener	MZ303B
D66	Diode	1SS133
D67	Diode	1SS133
D68	Diode	1SS133
D69	Diode	1SS133
D70	Diode	1SS133
D71	Diode	1SS133
D72	Diode	1SS133
D73	Diode	1SS133
D74	Diode	1SS133
D75	Diode	1SS133
D76	Diode	1SS133
D77	Diode	1SS133
D78	Zener	RD3.9E B2
D79	Diode	1SS133
D80	Diode	1SS133
D81	Diode	1SS133
D82	Diode	1SS133
D83	Diode	1SS133
D84	Diode	1SS133
D85	Diode	1SS133
D86	Diode	1SS133
D87	Diode	1SS133
D88	Diode	1SS133
D89	Diode	1SS53
D90	Diode	1SS133
D91	Diode	1SS133
D92	Diode	1SS133
D93	Diode	1SS133
D94	Diode	1SS133
D95	Diode	1SS133
D96	Diode	1SS133
D97	Diode	1SS133
D98	Diode	1SS133
D99	Diode	1SS133
FL1	Monolithic	FL-23

[MAIN UNIT]

REF. NO.	DESCRIPTION	PART NO.
FI2	Monolithic	FL-30
FI3	Ceramic	FL-65
FI4	Ceramic	CFW455 E
FI5	Monolithic	FL-23
X1	Crystal	CR49 9.0145MHz
X2	Crystal	CR1 9.4665MHz
X3	Crystal	HC12/U 9.0105MHz
X4	Crystal	CR49 9.0145MHz
L1	Coil	LS-175
L2	Coil	LS-175
L4	Coil	LAL03NA 101K
L5	Coil	LAL03NA 100K
L6	Coil	LS-180B
L7	Coil	LS-180B
L8	Coil	LS-90A
L9	Coil	LS-90A
L10	Coil	LS-137
L11	Coil	LAL03NA 221K
L12	Coil	LS-98A
L13	Coil	LS-163
L14	Coil	LS-175
L15	Coil	LS-163
L16	Coil	LS-163
L17	Coil	LAL03NA 101K
L18	Coil	LAL03NA 101K
L19	Coil	LS-133A
L20	Coil	LAL03NA 150K
L21	Coil	LAL03NA 100K
L22	Coil	LAL03NA 100K
L23	Coil	LS-121
L24	Coil	LAL03NA 101K
L25	Coil	LAL03NA 100K
L26	Coil	LAL03NA 101K
L27	Coil	LAL03NA 101K
L28	Coil	LS-133A
L29	Coil	LAL03NA R27M
L30	Coil	LS-134
L31	Coil	LS-133A
L32	Coil	LAL03NA 101K
L33	Coil	LAL03NA 102K
L34	Coil	LAL03NA 101K
L35	Coil	LAL03NA 561K
L36	Coil	LS-121A
L37	Coil	LW-15
L38	Coil	BT01RN1-A61
L39	Coil	BT01RN1-A61
L40	Coil	LAL03NA 101K
L41	Coil	LAL03NA 101K
R1	Resistor	100kΩ ELR20
R2	Resistor	100Ω R20
R3	Resistor	4.7kΩ ELR20
R4	Resistor	100kΩ ELR20
R5	Resistor	100Ω R20
R6	Resistor	47kΩ ELR20
R7	Resistor	2.2kΩ ELR20
R8	Resistor	5.6kΩ ELR20
R9	Resistor	150Ω R20
R10	Resistor	2.2kΩ R25
R11	Resistor	470kΩ ELR20
R12	Resistor	2.2kΩ ELR20
R13	Resistor	33kΩ R20
R14	Trimmer	22kΩ RH0651CJ4J01A
R15	Resistor	22kΩ ELR20
R16	Resistor	470kΩ ELR20
R17	Resistor	10kΩ R20
R18	Resistor	33kΩ R20
R19	Resistor	22kΩ ELR20
R20	Resistor	2.2MΩ ELR20
R21	Resistor	10kΩ ELR20

[MAIN UNIT]

REF. NO.	DESCRIPTION	PART NO.
R22	Resistor	1.5MΩ R20
R23	Resistor	470kΩ R20
R24	Trimmer	10kΩ RH0651C14J2WA
R25	Resistor	2.2MΩ ELR20
R26	Resistor	10kΩ R20
R27	Resistor	1kΩ ELR20
R28	Resistor	22kΩ ELR20
R29	Trimmer	10kΩ RH0651C14J2WA
R30	Resistor	2.2kΩ ELR20
R31	Trimmer	22kΩ RH0651CJ4J01A
R32	Resistor	1kΩ R20
R33	Resistor	2.2kΩ R25
R34	Resistor	2.2kΩ R20
R35	Resistor	2.2kΩ R20
R36	Resistor	220Ω ELR20
R37	Resistor	47Ω R20
R38	Resistor	1kΩ ELR20
R39	Resistor	470kΩ ELR20
R40	Thermistor	23D29
R41	Resistor	330Ω ELR20
R42	Resistor	220Ω R20
R43	Resistor	4.7kΩ ELR20
R44	Resistor	4.7kΩ ELR20
R45	Resistor	4.7kΩ R25
R46	Resistor	1kΩ R20
R47	Resistor	100Ω R25
R48	Resistor	2.2kΩ ELR20
R49	Resistor	1.5kΩ R20
R50	Resistor	100Ω R20
R51	Resistor	1kΩ R20
R52	Resistor	100Ω R25
R53	Resistor	2.2kΩ ELR20
R54	Resistor	1.5kΩ R20
R55	Resistor	10kΩ R20
R56	Resistor	10kΩ R20
R57	Resistor	10kΩ R20
R58	Resistor	22kΩ ELR20
R59	Resistor	1kΩ ELR20
R60	Resistor	2.2kΩ ELR20
R61	Resistor	6.8kΩ ELR20
R62	Resistor	220Ω ELR20
R63	Resistor	2.2kΩ ELR20
R64	Resistor	5.6kΩ ELR20
R65	Resistor	3.9kΩ ELR20
R66	Resistor	470Ω ELR20
R67	Resistor	3.9kΩ ELR20
R68	Resistor	150Ω ELR20
R69	Resistor	100Ω R20
R70	Resistor	47kΩ ELR20
R71	Thermistor	45D26
R72	Trimmer	47kΩ RH0651CS4J25A
R73	Resistor	10kΩ ELR20
R74	Resistor	10kΩ ELR20
R75	Resistor	100Ω ELR20
R77	Resistor	3.3kΩ ELR20
R78	Resistor	1.5kΩ R20
R79	Resistor	15kΩ ELR20
R80	Resistor	2.2kΩ R20
R81	Resistor	2.2kΩ ELR20
R82	Trimmer	10kΩ RH0651C14J2WA
R83	Resistor	100Ω R20
R84	Thermistor	23D29
R85	Resistor	22Ω ELR20
R86	Resistor	270Ω ELR20
R87	Resistor	470kΩ ELR20
R88	Resistor	470kΩ ELR20
R89	Resistor	4.7kΩ R20
R90	Resistor	220Ω ELR20
R91	Resistor	4.7kΩ R20
R92	Resistor	4.7kΩ ELR20
R93	Resistor	1kΩ ELR20
R94	Thermistor	23D29
R95	Resistor	47kΩ ELR20
R96	Resistor	33kΩ ELR20
R98	Resistor	470kΩ ELR20

[MAIN UNIT]

REF. NO.	DESCRIPTION	PART NO.
R99	Resistor	3.9kΩ ELR20
R100	Resistor	5.6kΩ ELR20
R101	Resistor	22kΩ ELR20
R102	Resistor	22kΩ ELR20
R103	Resistor	1.5kΩ ELR20
	(IC-475A/E only)	
R103	Resistor	1.2kΩ ELR20
	(IC-475H only)	
R104	Resistor	470Ω R20
R105	Trimmer	1kΩ RH0651C13J1YA
R106	Resistor	100Ω R20
R107	Resistor	1.5kΩ R20
R108	Resistor	1.5kΩ ELR20
R109	Resistor	47kΩ ELR20
R110	Resistor	39kΩ ELR20
R111	Thermistor	45D26
R112	Resistor	68kΩ ELR20
R113	Resistor	10kΩ ELR20
R114	Resistor	56kΩ ELR20
R115	Resistor	22kΩ R20
R116	Resistor	1kΩ ELR20
R117	Resistor	470kΩ ELR20
R118	Resistor	150kΩ ELR20
R119	Resistor	100kΩ ELR20
R120	Trimmer	1MΩ RH0651C16J0RA
R121	Trimmer	47kΩ RH0651CS4J25A
R122	Resistor	10kΩ R20
R123	Resistor	10kΩ ELR20
R124	Resistor	10kΩ ELR20
R125	Resistor	100kΩ ELR20
R126	Resistor	100kΩ ELR20
R127	Resistor	2.2MΩ ELR20
R128	Resistor	2.2MΩ ELR20
R129	Resistor	10kΩ R20
R130	Resistor	4.7kΩ ELR20
R131	Resistor	4.7kΩ R20
R132	Resistor	220kΩ ELR20
R133	Trimmer	10kΩ RH0651C14J2WA
R134	Resistor	220kΩ R20
R135	Trimmer	10kΩ RH0651C14J2WA
R136	Resistor	2.2kΩ ELR20
R137	Trimmer	10kΩ RH0651C14J2WA
R138	Resistor	2.2kΩ R20
R139	Resistor	100Ω ELR20
R140	Resistor	100Ω R25
R141	Resistor	1kΩ R25
R142	Resistor	10kΩ R20
R143	Resistor	4.7kΩ R20
R144	Resistor	1.5kΩ R20
R145	Resistor	2.2kΩ R20
R146	Resistor	22kΩ R20
R147	Resistor	10kΩ R20
R148	Resistor	100Ω ELR20
R149	Resistor	10kΩ ELR20
R150	Resistor	100kΩ R20
R151	Trimmer	47kΩ RH0651CS4J25A
R152	Trimmer	47kΩ RH0651CS4J25A
R153	Resistor	150kΩ ELR20
	(IC-475A/E)	
R153	Resistor	120kΩ ELR20
	(IC-475H)	
R154	Resistor	47kΩ ELR20
R155	Resistor	22kΩ ELR20
R156	Resistor	470kΩ ELR20
R157	Resistor	47kΩ ELR20
R158	Resistor	68kΩ ELR20
R159	Resistor	2.2kΩ ELR20
R160	Resistor	4.7kΩ R20
R161	Resistor	2.2kΩ R20
R162	Trimmer	4.7kΩ RH0651CS3J2KA
R163	Resistor	68kΩ ELR20
R164	Resistor	68kΩ ELR20
R165	Resistor	100Ω ELR20
R166	Resistor	10kΩ ELR20
R167	Resistor	2.2kΩ R20

[MAIN UNIT]

REF. NO.	DESCRIPTION	PART NO.	
R168	Resistor	470kΩ	ELR20
R169	Resistor	1kΩ	ELR20
R170	Resistor	910Ω	R20
R171	Resistor	1kΩ	R20
R172	Resistor	1.2kΩ	ELR20
R173	Trimmer	47kΩ	RH0651CS4J25A
R174	Resistor	100Ω	ELR20
R175	Resistor	2.2kΩ	R20
R176	Resistor	2.2kΩ	R20
R177	Resistor	2.2kΩ	ELR20
R178	Resistor	2.2kΩ	R20
R179	Resistor	22kΩ	R20
R180	Resistor	22kΩ	ELR20
R181	Resistor	10kΩ	ELR20
R182	Resistor	2.2kΩ	R20
R183	Resistor	100kΩ	ELR20
R184	Resistor	47kΩ	R25
R185	Resistor	100Ω	ELR20
R186	Resistor	2.2kΩ	R25
R187	Resistor	22kΩ	ELR20
R188	Resistor	2.2kΩ	R20
R191	Resistor	4.7kΩ	ELR20
R192	Resistor	1kΩ	ELR20
R193	Resistor	2.2kΩ	ELR20
R194	Resistor	47Ω	ELR20
R195	Resistor	3.3kΩ	ELR20
R196	Resistor	33kΩ	ELR20
R197	Resistor	47Ω	R20
R198	Resistor	1kΩ	ELR20
R199	Resistor	4.7kΩ	ELR20
R200	Resistor	100kΩ	ELR20
R201	Resistor	1kΩ	ELR20
R202	Resistor	1kΩ	ELR20
R203	Resistor	47Ω	ELR20
R204	Resistor	22kΩ	ELR20
R205	Resistor	10kΩ	ELR20
R206	Resistor	1.5kΩ	ELR20
R207	Resistor	820Ω	ELR20
R208	Trimmer	330Ω	RH0652CN2J04A
R209	Resistor	10kΩ	ELR20
R210	Trimmer	10kΩ	RH0652C14J0FA
R211	Resistor	1kΩ	ELR20
R212	Resistor	10kΩ	ELR20
R213	Resistor	470Ω	ELR20
R214	Resistor	470Ω	ELR20
R215	Resistor	220kΩ	R20
R216	Resistor	1kΩ	R20
R217	Resistor	1kΩ	ELR20
R218	Resistor	1kΩ	ELR20
R219	Resistor	1kΩ	ELR20
R220	Resistor	100kΩ	ELR20
R221	Trimmer	1kΩ	RH0651C13J1YA
R222	Trimmer	47kΩ	RH0651CS4J25A
R223	Resistor	4.7kΩ	ELR20
R224	Resistor	4.7kΩ	ELR20
R225	Resistor	27kΩ	R20
R226	Resistor	5.6kΩ	ELR20
R227	Trimmer	1kΩ	RH0652C13J08A
R228	Resistor	330Ω	ELR20
R229	Resistor	220Ω	R20
R230	Resistor	18kΩ	ELR20
R232	Resistor	1kΩ	ELR20
R233	Resistor	1MΩ	ELR20
R235	Resistor	6.8kΩ	ELR20
R236	Resistor	12kΩ	ELR20
R237	Resistor	1MΩ	R20
R238	Resistor	1MΩ	ELR20
R239	Resistor	2.2MΩ	ELR20
R240	Trimmer	10kΩ	RH0651C14J2WA
R241	Resistor	47kΩ	ELR20
R242	Resistor	47kΩ	ELR20
R243	Resistor	33kΩ	ELR20
R244	Trimmer	10kΩ	RH0651C14J2WA
R245	Resistor	33kΩ	ELR20
R246	Resistor	1MΩ	ELR20

[MAIN UNIT]

REF. NO.	DESCRIPTION	PART NO.	
R248	Resistor (IC-475H only)	27kΩ	R20
R249	Resistor	22kΩ	ELR20
R250	Trimmer	4.7kΩ	RH0651CS3J2KA
R251	Resistor	470kΩ	R20
R252	Resistor	2.2MΩ	ELR20
R253	Resistor	150Ω	ELR20
R254	Resistor (IC-475A/E only)	47kΩ	ELR20
R254	Resistor (IC-475H only)	33kΩ	ELR20
R255	Resistor	150kΩ	R20
R256	Trimmer	4.7kΩ	RH0651CS3J2KA
R257	Trimmer	1MΩ	RH0651C16J0RA
R259	Trimmer	100kΩ	RH0651C15J1UA
R260	Resistor	10kΩ	ELR20
R261	Resistor	10kΩ	R20
R262	Resistor	1MΩ	R20
R263	Resistor	1MΩ	R20
R264	Resistor	3.3MΩ	R25
R265	Trimmer	10kΩ	RH0651C14J2WA
R266	Resistor	2.2kΩ	ELR20
R267	Resistor	4.7kΩ	ELR20
R268	Resistor	1kΩ	R20
R269	Resistor	47kΩ	ELR20
R270	Resistor	47kΩ	R20
R271	Resistor	47kΩ	ELR20
R272	Resistor	1kΩ	R20
R273	Resistor	39kΩ	ELR20
R274	Resistor	15kΩ	ELR20
R275	Resistor	47kΩ	ELR20
R276	Resistor	1kΩ	ELR20
R277	Resistor	47kΩ	R20
R278	Resistor	100Ω	R20
R279	Resistor	470kΩ	ELR20
R280	Resistor	470kΩ	ELR20
R281	Resistor	10kΩ	ELR20
R282	Resistor	10kΩ	ELR20
R283	Resistor	4.7Ω	ELR25
R284	Resistor	1kΩ	ELR25
R285	Resistor	4.7Ω	ELR25
R286	Resistor	1kΩ	ELR25
R287	Resistor	470Ω	ELR25
R288	Resistor	4.7Ω	ELR25
R289	Resistor	2.2kΩ	R20
R290	Resistor	2.2kΩ	ELR20
R291	Resistor	10kΩ	R20
R292	Resistor	4.7Ω	R20
R293	Resistor	220Ω	ELR20
R294	Resistor	2.2kΩ	ELR20
R295	Resistor	2.2kΩ	ELR20
R296	Resistor	1kΩ	R20
R297	Resistor	470Ω	ELR20
R298	Resistor	100kΩ	ELR20
R299	Resistor	220kΩ	R20
R300	Resistor	2.2kΩ	ELR20
R301	Resistor	33Ω	ELR20
R302	Resistor	100kΩ	ELR20
R303	Resistor	22kΩ	ELR20
R304	Resistor	2.2kΩ	R20
R305	Resistor	100kΩ	ELR20
R306	Resistor	47kΩ	R25
R307	Resistor	47kΩ	ELR20
R308	Resistor	47kΩ	R20
R309	Resistor	10kΩ	ELR20
R310	Trimmer	10kΩ	RH0421C14J0KA
R311	Resistor	2.2kΩ	ELR20
R312	Resistor	470kΩ	ELR20
R313	Resistor	100Ω	R20
R314	Resistor	10kΩ	ELR20
R315	Resistor	2.2kΩ	ELR20
R316	Resistor	470kΩ	ELR20
R317	Resistor	10kΩ	R20
R318	Resistor	10kΩ	R20
R319	Resistor	10kΩ	ELR20

[MAIN UNIT]

REF. NO.	DESCRIPTION	PART NO.	
R320	Resistor	470Ω	ELR20
R321	Resistor	470Ω	R20
R322	Resistor	2.2kΩ	R20
R323	Trimmer	10kΩ	RH0651C14J2WA
R324	Resistor	2.2kΩ	ELR20
R326	Resistor	2.2kΩ	ELR20
R327	Resistor	470Ω	ELR20
R328	Resistor	47kΩ	ELR20
R329	Resistor	10kΩ	R20
R330	Resistor	2.2kΩ	R20
R331	Resistor	10kΩ	ELR20
R332	Resistor	220kΩ	ELR20
R333	Resistor	470Ω	ELR20
R336	Resistor	1MΩ	ELR20
R337	Resistor	6.8kΩ	ELR20
R338	Resistor	10kΩ	ELR20
R339	Resistor	2.2kΩ	ELR20
R340	Resistor	8.2kΩ	ELR20
R341	Resistor	22kΩ	ELR20
R342	Resistor	10kΩ	ELR20
R344	Resistor	100kΩ	ELR20
R345	Resistor	10kΩ	ELR20
R347	Resistor	47kΩ	ELR20
R348	Trimmer	47kΩ	RH0651CS4J25A
R349	Resistor	47kΩ	ELR20
R349	Resistor (IC-475A/E only)	12kΩ	R20
R349	Resistor (IC-475H only)	12kΩ	R20
R350	Resistor	2.2kΩ	ELR20
R351	Resistor	10kΩ	R20
R352	Resistor	1MΩ	ELR20
R353	Resistor	4.7kΩ	ELR25
R354	Resistor	10kΩ	R20
C1	Ceramic	2pF	50V
C2	Barrier Layer	0.0047μF	25V
C3	Electrolytic	10μF	16V MS7
C4	Ceramic	0.0047μF	50V
C5	Barrier Layer	0.0047μF	25V
C6	Barrier Layer	0.0047μF	25V
C7	Ceramic	0.0047μF	50V
C8	Ceramic	0.0047μF	50V
C10	Ceramic	120pF	50V
C11	Ceramic	22pF	50V
C12	Electrolytic	10μF	16V MS7
C13	Electrolytic	4.7μF	25V MS7
C14	Ceramic	0.0047μF	50V
C15	Ceramic	18pF	50V
C16	Ceramic	0.0047μF	50V
C17	Ceramic	0.0047μF	50V
C18	Mylar	0.001μF	50V F2D
C19	Tantalum	1μF	35V DN
C20	Electrolytic	10μF	16V MS7
C21	Electrolytic	47μF	10V
C22	Ceramic	150pF	50V
C23	Ceramic	0.0047μF	50V
C24	Ceramic	0.0047μF	50V
C25	Ceramic	100pF	50V
C27	Ceramic	100pF	50V
C28	Ceramic	3pF	50V
C29	Ceramic	0.0047μF	50V
C30	Barrier Layer	0.1μF	16V
C31	Barrier Layer	0.0047μF	25V
C32	Barrier Layer	0.1μF	16V
C33	Ceramic	0.0047μF	50V
C34	Ceramic	0.0047μF	50V
C35	Ceramic	0.0047μF	50V
C36	Ceramic	0.0047μF	50V
C37	Ceramic	22pF	50V
C38	Ceramic	120pF	50V
C39	Ceramic	0.0047μF	50V
C40	Ceramic	0.0047μF	50V
C41	Ceramic	0.0047μF	50V
C42	Ceramic	0.0047μF	50V

[MAIN UNIT]

REF. NO.	DESCRIPTION	PART NO.	
C43	Ceramic	0.0047μF	50V
C44	Ceramic	0.0047μF	50V
C45	Ceramic	0.0047μF	50V
C46	Ceramic	0.0047μF	50V
C47	Ceramic	0.0047μF	50V
C48	Ceramic	0.001μF	50V
C49	Ceramic	2pF	50V
C50	Ceramic	0.0047μF	50V
C51	Ceramic	150pF	50V
C52	Barrier Layer	0.047μF	25V
C53	Barrier Layer	0.047μF	25V
C54	Barrier Layer	560pF	50V
C55	Mylar	0.0047μF	50V F2D
C56	Ceramic	0.0047μF	50V
C57	Barrier Layer	0.0047μF	25V
C58	Barrier Layer	0.0047μF	25V
C59	Ceramic	0.0047μF	50V
C60	Ceramic	0.0047μF	50V
C62	Barrier Layer	0.047μF	25V
C63	Ceramic	0.0047μF	50V
C64	Ceramic	0.0047μF	50V
C65	Ceramic	0.0047μF	50V
C66	Mylar	0.01μF	50V F2D
C67	Ceramic (IC-475A/E only)	0.0047μF	50V
C67	Barrier Layer (IC-475H only)	0.047μF	25V
C68	Ceramic	0.0047μF	50V
C69	Ceramic	0.0047μF	50V
C70	Ceramic	0.0047μF	50V
C71	Ceramic	10pF	50V
C72	Ceramic	100pF	50V CH
C73	Ceramic	100pF	50V CH
C74	Barrier Layer	0.1μF	16V
C75	Ceramic	0.0047μF	50V
C76	Ceramic	100pF	50V
C77	Ceramic	0.0047μF	50V
C78	Barrier Layer	0.1μF	16V
C79	Barrier Layer	0.1μF	16V
C80	Ceramic	10pF	50V
C81	Ceramic	120pF	50V SH
C82	Ceramic	22pF	50V
C83	Barrier Layer	0.1μF	16V
C84	Electrolytic	10μF	16V MS7
C85	Ceramic	22pF	50V
C86	Barrier Layer	0.01μF	25V
C87	Ceramic	470pF	50V
C88	Ceramic	0.001μF	50V
C89	Ceramic	33pF	50V
C90	Barrier Layer	0.01μF	25V
C91	Tantalum	2.2μF	16V DN
C92	Barrier Layer	0.1μF	16V
C93	Mylar	0.033μF	50V F2D
C94	Mylar	0.033μF	50V F2D
C95	Barrier Layer	0.0015μF	25V
C96	Barrier Layer	0.0015μF	25V
C97	Barrier Layer	0.0015μF	25V
C98	Electrolytic	10μF	16V MS7
C99	Electrolytic	0.1μF	50V MS7
C100	Ceramic	0.001μF	50V
C101	Barrier Layer	0.1μF	16V
C102	Ceramic	27pF	50V
C103	Ceramic	0.0047μF	50V
C104	Ceramic	0.0047μF	50V
C105	Ceramic	0.0047μF	50V
C106	Ceramic	47pF	50V
C107	Ceramic	0.0047μF	50V
C108	Ceramic	4pF	50V
C109	Ceramic	100pF	50V CH
C110	Ceramic	100pF	50V CH
C112	Ceramic	0.0047μF	50V
C113	Ceramic	0.0047μF	50V
C114	Ceramic	0.0047μF	50V
C115	Ceramic	0.0047μF	50V
C116	Ceramic	0.0047μF	50V

[MAIN UNIT]

REF. NO.	DESCRIPTION	PART NO.		
C117	Ceramic	39pF	50V	CH
C118	Ceramic	0.0047μF	50V	
C119	Trimmer	30pF	CV05E3001	
C120	Ceramic	0.0047μF	50V	
C121	Ceramic	220pF	50V	CH
C122	Ceramic	220pF	50V	CH
C123	Tantalum	0.47μF	35V	DN
C124	Ceramic	47pF	50V	
C125	Barrier Layer	0.01μF	25V	
C126	Ceramic	150pF	50V	
C127	Barrier Layer	0.047μF	25V	
C128	Barrier Layer	0.01μF	25V	
C129	Barrier Layer	0.1μF	16V	
C130	Ceramic	0.0047μF	50V	
C131	Cylinder	22pF	UP050SL220J-NA	
C132	Ceramic	150pF	50V	
C133	Tantalum	0.1μF	35V	DN
C134	Mylar	0.001μF	50V	F2D
C135	Tantalum	1μF	35V	DN
C136	Electrolytic	47μF	10V	MS9
C137	Electrolytic	10μF	16V	MS7
C138	Electrolytic	10μF	16V	MS7
C139	Tantalum	2.2μF	16V	DN
C140	Electrolytic	10μF	16V	MS7
C141	Electrolytic	10μF	16V	MS7
C142	Electrolytic	10μF	16V	MS7
C143	Electrolytic	10μF	16V	MS7
C144	Electrolytic	0.1μF	50V	MS7
C145	Electrolytic	0.22μF	50V	MS7
C146	Electrolytic	10μF	16V	MS7
C147	Ceramic	120pF	50V	
C148	Mylar	0.0022μF	50V	F2D
C149	Ceramic	0.001μF	50V	
C150	Electrolytic	10μF	16V	MS7
C151	Electrolytic	47μF	10V	
C152	Electrolytic	0.47μF	50V	MS7
C153	Mylar	0.0022μF	50V	F2D
C154	Electrolytic	47μF	10V	
C155	Electrolytic	1μF	50V	MS7
C156	Barrier Layer	0.0047μF	25V	
C157	Electrolytic	0.47μF	50V	BP
C158	Electrolytic	47μF	10V	
C159	Barrier Layer	0.047μF	25V	
C160	Electrolytic	47μF	10V	
C161	Electrolytic	4.7μF	25V	MS7
C162	Electrolytic	4.7μF	25V	MS7
C163	Electrolytic	4.7μF	25V	MS7
C164	Barrier Layer	0.1μF	16V	
C165	Electrolytic	100μF	10V	
C166	Electrolytic	4.7μF	25V	MS7
C167	Electrolytic	10μF	16V	MS7
C168	Ceramic	0.0047μF	50V	
C169	Ceramic	0.0047μF	50V	
C171	Electrolytic	10μF	16V	MS7
C172	Electrolytic	10μF	16V	MS7
C173	Barrier Layer	0.047μF	25V	
C174	Barrier Layer	0.047μF	25V	
C175	Barrier Layer	0.047μF	25V	
C176	Barrier Layer	0.047μF	25V	
C178	Barrier Layer	0.001μF	25V	
C179	Electrolytic	4.7μF	25V	MS7
C180	Electrolytic	47μF	10V	
C181	Mylar	0.022μF	50V	F2D
C182	Mylar	0.022μF	50V	F2D
C183	Mylar	0.022μF	50V	F2D
C184	Barrier Layer	0.1μF	16V	
C185	Tantalum	10μF	16V	DN
C186	Electrolytic	1μF	50V	MS7
C187	Barrier Layer	0.0047μF	25V	
C188	Tantalum	1μF	35V	DN
C189	Ceramic	470pF	50V	
C190	Electrolytic	4.7μF	25V	MS7
C191	Ceramic	100pF	50V	
C192	Ceramic	0.0047μF	50V	
C193	Ceramic	0.0047μF	50V	

[MAIN UNIT]

REF. NO.	DESCRIPTION	PART NO.		
C194	Ceramic	470pF	50V	
C195	Barrier Layer	0.1μF	16V	
C196	Tantalum	0.47μF	35V	DN
C197	Ceramic	0.001μF	50V	
C198	Ceramic	470pF	50V	
C199	Barrier Layer	0.0033μF	25V	
C200	Mylar	0.01μF	50V	F2D
C201	Mylar	0.033μF	50V	F2D
C202	Mylar	0.0022μF	50V	F2D
C203	Electrolytic	0.47μF	50V	MS7
C204	Electrolytic	0.47μF	50V	MS7
C205	Electrolytic	10μF	16V	MS7
C206	Barrier Layer	0.047μF	25V	
C207	Electrolytic	100μF	10V	
C208	Electrolytic	100μF	10V	
C209	Electrolytic	470μF	16V	
C210	Electrolytic	470μF	16V	
C211	Mylar	0.022μF	50V	F2D
C212	Electrolytic	0.22μF	50V	MS7
C213	Barrier Layer	0.0047μF	25V	
C214	Barrier Layer	0.1μF	16V	
C215	Electrolytic	1μF	50V	MS7
C216	Electrolytic	10μF	16V	MS7
C217	Electrolytic	4.7μF	25V	MS7
C218	Barrier Layer	0.1μF	16V	
C219	Electrolytic	10μF	16V	MS7
C220	Electrolytic	3.3μF	50V	MS7
C221	Electrolytic	0.22μF	50V	MS7
C222	Barrier Layer	0.0047μF	25V	
C223	Electrolytic	10μF	16V	MS7
C224	Tantalum	1μF	35V	DN
C225	Barrier Layer	0.1μF	16V	
C226	Electrolytic	0.1μF	50V	MS7
C227	Ceramic	8pF	50V	
C228	Electrolytic	10μF	16V	BP
C229	Electrolytic	4.7μF	25V	MS7
C230	Electrolytic	3.3μF	50V	MS7
C231	Ceramic	0.0047μF	50V	
C232	Barrier Layer	0.0047μF	25V	
C233	Ceramic	0.0047μF	50V	
C234	Tantalum	1.5μF	25V	DN
C235	Barrier Layer	0.1μF	16V	
C236	Electrolytic	3.3μF	50V	MS7
C237	Ceramic	0.0047μF	50V	
C238	Ceramic	0.0047μF	50V	
C239	Barrier Layer	0.0047μF	25V	
C240	Barrier Layer	0.0047μF	25V	
C242	Electrolytic	3.3μF	50V	MS7
C243	Electrolytic	10μF	16V	MS7
C244	Ceramic	0.0047μF	50V	
C245	Tantalum	1.0μF	35V	DN
C246	Barrier Layer	0.047μF	25V	
C247	Electrolytic	47μF	10V	
C248	Barrier Layer	0.1μF	16V	
C249	Barrier Layer	0.0047μF	25V	
C250	Ceramic	47pF	50V	
C251	Ceramic	47pF	50V	
C252	Ceramic	47pF	50V	
C253	Ceramic	47pF	50V	
C254	Ceramic	47pF	50V	
C255	Ceramic	47pF	50V	
C256	Ceramic	0.0047μF	50V	
C257	Ceramic	47pF	50V	
C258	Ceramic	47pF	50V	
J1	Connector	B12B-EH-S		
J2	Connector	B06B-EH-S		
J3	Connector	B05B-EH-S		
J4	Connector	B07B-EH-S		
J5	Connector	B04B-EH-S		
J6	Connector	B05B-EH-S		
J7	Connector	B04B-EH-S		
J8	Connector	B03B-EH-S		
J9	Connector	B13B-EH-S		

[MAIN UNIT]

REF. NO.	DESCRIPTION	PART NO.
J10	Connector	B07B-EH-S
J11	Connector	B09B-EH-S
J12	Connector	B12B-EH-S
J13	Connector	B09B-EH-S
J14	Connector	B03B-EH-S
J15	Connector	TMP-J01X-A2
J16	Connector	HSJ0807-01-010
J17	Connector	HSJ0807-01-010
S1	Switch	SSSS31124A
S2	Switch	SSSS31124A
S3	Switch	SSSU12209B
S4	Switch	SSSU12209B
S5	Switch (IC-475H only)	SSSS31124A
EP1	P.C. Board	B-1184E
W50	Jumper	JPW-02A
W51	Jumper	JPW-02A
W120	Jumper	JPW-02A

[SQL UNIT]

REF. NO.	DESCRIPTION	PART NO.
IC1	IC	NJM4558M
Q1	Transistor	2SC2712 Y
Q2	Transistor	2SC3395
D1	Diode	HSM88AS
R1	Chip	2.2kΩ MCR10
R2	Chip	470kΩ MCR10
R3	Chip	4.7kΩ MCR10
R4	Chip	10kΩ MCR10
R5	Chip	10kΩ MCR10
R6	Chip	470kΩ MCR10
R7	Chip	470kΩ MCR10
R8	Chip	1kΩ MCR10
R9	Chip	6.8kΩ MCR10
R10	Chip	47kΩ MCR10
R11	Chip	100kΩ MCR10
C1	Monolithic	330pF GRM40
C2	Monolithic	150pF GRM40
C3	Monolithic	470pF GRM40
C4	Monolithic	0.1μF GRM40 F
C5	Monolithic	56pF GRM40
C6	Monolithic	0.1μF GRM40 F
EP1	P.C. Board	B-1255A

[RF YGR UNIT]

REF. NO.	DESCRIPTION	PART NO.
IC1	IC	ND487C1-3R
IC2	IC	412E-H
Q1	Transistor	2SC2026
Q2	Transistor	2SC2026
Q3	FET	2SK125
Q4	FET (IC-475A/E only)	3SK121 Y
Q4	FET (IC-475H only)	3SK129
Q5	FET	3SK74 M
Q6	Transistor	2SC763C
Q7	Transistor	2SC2668 O
Q8	Transistor	2SC3355
Q9	Transistor	2SC3355
Q10	Transistor	2SC3355
Q11	Transistor	2SC3019
D1	Diode	1SV99
D2	Diode	1SS53
D3	Diode	1S953
D4	Diode	MI301
D5	Diode	1SS99
D6	Diode	1SS99
D7	Diode	1S953
FI1	Crystal	FL-64
FI2	Crystal	70M15A
L1	Coil	LS-254
L2	Coil	LS-145
L3	Coil	LR-145
L4	Coil (IC-475A/E #06E, #12E) (IC-475H #02H, #05H)	7HW252MX-1550A
L4	Coil (IC-475A/E #08A, #10A) (IC-475H #03H, #04H)	7HW252MXP-2241A
L5	Coil	LW-25
L6	Coil (IC-475A/E #06E, #12E) (IC-475H #02H, #05H)	7HW252MX-1550A
L6	Coil (IC-475A/E #08A, #10A) (IC-475H #03H, #04H)	7HW252MXP-2241A
L7	Coil	LW-25
L8	Coil	LA-159
L9	Coil	LS-254
L10	Coil	LS-114
L11	Coil	LS-254
L12	Coil	LS-254
L13	Coil	LR-178
L15	Coil	LS-90A
L16	Coil	LS-163
L17	Coil	LS-284
L18	Coil	LS-114
L19	Coil	LS-284
L20	Coil	LS-284
L21	Coil	LS-284
L22	Coil	LA-233
L23	Coil	LA-244
L24	Coil	LW-25
L25	Coil (IC-475A/E #06E, #12E) (IC-475H #02H, #05H)	7HW252MX-1550A
L25	Coil (IC-475A/E #08A, #10A) (IC-475H #03H, #04H)	7HW252MXP-2241A
L26	Coil	LW-17

[RF YGR UNIT]

REF. NO.	DESCRIPTION	PART NO.
L27	Coil (IC-475A/E #06E, #12E) (IC-475H #02H, #05H)	7HW252MX-1550A
L27	Coil (IC-475A/E #08A, #10A) (IC-475H #03H, #04H)	7HW252MXP-2241A
L28	Coil	LA-222
L29	Coil	LA-222
L30	Coil	LA-222
L32	Coil	LA-222
L33	Coil	LS-254
L34	Coil	LA-244
L36	Coil	LAL02KR 1R0M
L37	Coil	LAL03NA R47M
L39	Coil (IC-475H only)	LAL03NA 1R0M
L40	Coil (IC-475H only)	LAL02KR 1R0M
R1	Resistor	100Ω R25
R2	Resistor	560Ω R20
R3	Resistor	10Ω ELR20
R4	Resistor	10Ω ELR20
R7	Resistor	22kΩ ELR20
R8	Resistor	1kΩ ELR20
R9	Resistor	22Ω R20
R10	Resistor	47Ω ELR20
R11	Resistor	100Ω R20
R12	Resistor (IC-475A/E only)	82Ω ELR20
R12	Resistor (IC-475H only)	15Ω ELR20
R13	Resistor	33kΩ ELR20
R14	Resistor (IC-475A/E only)	100kΩ R20
R14	Resistor (IC-475H only)	2.7kΩ R20
R15	Resistor	22Ω R20
R16	Resistor	150Ω ELR20
R17	Resistor	1kΩ ELR20
R18	Resistor	1MΩ R20
R19	Resistor	47Ω R20
R20	Resistor	2.2kΩ ELR20
R21	Resistor	2.2kΩ R20
R22	Resistor	10kΩ ELR20
R23	Resistor	22kΩ R20
R24	Resistor	100Ω R20
R25	Resistor	18Ω R20
R26	Resistor	270Ω ELR20
R27	Resistor	2.2kΩ R20
R28	Resistor	270Ω R20
R31	Resistor	3.3kΩ ELR20
R32	Resistor	22kΩ R20
R33	Resistor	150Ω R20
R34	Resistor	2.2kΩ R20
R35	Resistor	100Ω R20
R40	Resistor	33Ω R20
R42	Resistor	33Ω R20
R43	Resistor	180Ω ELR20
R44	Resistor	180Ω R20
R45	Resistor	100Ω R20
R46	Resistor	4.7kΩ ELR20
R47	Resistor	1kΩ ELR20
R48	Resistor	820Ω R20
R49	Resistor	5.6Ω R20
R50	Resistor	820Ω ELR20
R51	Resistor	6.8kΩ ELR20
R52	Resistor	1kΩ R20
R53	Resistor	100Ω ELR20
R54	Resistor	220Ω R20
R55	Resistor	22Ω R20
R56	Resistor	1kΩ R20
R57	Resistor	8.2kΩ ELR20
R58	Resistor	100Ω R20

[RF YGR UNIT]

REF. NO.	DESCRIPTION	PART NO.
R59	Resistor	47Ω ELR20
R63	Resistor	4.7kΩ R25
R64	Resistor (IC-475A/E only)	1Ω ELR20
R66	Resistor	100Ω R20
R67	Resistor	100Ω R20
R68	Resistor	100Ω R20
R69	Resistor	100Ω R20
R71	Resistor	330Ω R20
C1	Ceramic	8pF 50V
C6	Ceramic	0.001μF 50V
C7	Ceramic	0.001μF 50V
C11	Ceramic (IC-475A/E #06E, #12E) (IC-475H #02H, #05H)	4pF 50V
C11	Ceramic (IC-475A/E #08A, #10A) (IC-475H #03H, #04H)	22pF 50V
C12	Ceramic (IC-475A/E #06E, #12E) (IC-475H #02H, #05H)	3pF 50V
C12	Ceramic (IC-475A/E #08A, #10A) (IC-475H #03H, #04H)	5pF 50V
C13	Ceramic	1pF 50V
C14	Ceramic	22pF 50V
C15	Ceramic	0.001μF 50V
C16	Ceramic	0.001μF 50V
C17	Ceramic (IC-475A/E #06E, #12E) (IC-475H #02H, #05H)	0.001μF 50V
C17	Ceramic (IC-475A/E #08A, #10A) (IC-475H #03H, #04H)	33pF 50V
C19	Ceramic	22pF 50V
C20	Ceramic	3pF 50V
C21	Ceramic	0.001μF 50V
C22	Ceramic	47pF 50V
C23	Ceramic	0.001μF 50V
C24	Ceramic	0.001μF 50V
C25	Ceramic	0.001μF 50V
C26	Ceramic	3pF 50V
C27	Trimmer	6pF CV38B0601
C28	Ceramic	12pF 50V
C30	Ceramic	8pF 50V
C31	Ceramic	0.001μF 50V
C33	Barrier Layer	0.1μF 16V
C34	Ceramic	0.0047μF 50V
C35	Ceramic	8pF 50V
C36	Ceramic	0.0047μF 50V
C37	Ceramic	0.001μF 50V
C39	Ceramic	8pF 50V
C40	Ceramic	8pF 50V
C42	Ceramic	2pF 50V
C43	Ceramic	0.001μF 50V
C44	Ceramic	33pF 50V
C45	Ceramic	6pF 50V
C46	Ceramic	39pF 50V
C48	Ceramic	0.001μF 50V
C49	Ceramic	6pF 50V
C50	Ceramic	0.0047μF 50V
C51	Ceramic	8pF 50V
C52	Ceramic	0.0047μF 50V
C53	Ceramic	0.001μF 50V
C54	Ceramic	22pF 50V
C55	Ceramic	0.0047μF 50V
C56	Ceramic	0.001μF 50V
C57	Ceramic	0.001μF 50V
C58	Ceramic	0.0047μF 50V
C59	Ceramic	10pF 50V
C60	Ceramic	0.001μF 50V
C61	Ceramic	2pF 50V
C62	Ceramic	10pF 50V

[RF YGR UNIT]

REF. NO.	DESCRIPTION	PART NO.
C63	Ceramic	470pF 50V
C65	Trimmer	10pF CV38D1001
C66	Ceramic	22pF 50V
C67	Ceramic	12pF 50V
C68	Trimmer	20pF CV38D2001
C69	Ceramic	0.001μF 50V
C70	Ceramic	0.001μF 50V
C71	Trimmer	10pF CV38D1001
C73	Ceramic	47pF 50V
C75	Ceramic	47pF 50V
C77	Ceramic	1pF 50V
C79	Ceramic	2pF 50V
	(IC-475A/E #06E, #12E)	
	(IC-475H #02H, #05H)	
C79	Ceramic	22pF 50V
	(IC-475A/E #08A, #10A)	
	(IC-475H #03H, #04H)	
C80	Ceramic	3pF 50V
	(IC-475A/E #06E, #12E)	
	(IC-475H #02H, #03H, #04H, #05H)	
C81	Ceramic	4pF 50V
	(IC-475A/E #06E, #12E)	
	(IC-475H #02H, #05H)	
C81	Ceramic	22pF 50V
	(IC-475A/E #08A, #10A)	
	(IC-475H #03H, #04H)	
C82	Ceramic	47pF 50V
C83	Ceramic	0.001μF 50V
C84	Ceramic	0.001μF 50V
C85	Ceramic	47pF 50V
C86	Ceramic	0.001μF 50V
C87	Ceramic	47pF 50V
C88	Ceramic	0.001μF 50V
C90	Trimmer	6pF CV38B0601
C91	Ceramic	2pF 50V
C92	Ceramic	47pF 50V
C93	Ceramic	0.001μF 50V
C94	Ceramic	47pF 50V
C95	Trimmer	20pF CV38D2001
C97	Ceramic	9pF 50V
C98	Ceramic	0.0047μF 50V
C99	Ceramic	0.001μF 50V
C100	Ceramic	0.001μF 50V
C101	Ceramic	0.001μF 50V
C103	Ceramic	0.001μF 50V
C104	Ceramic	0.001μF 50V
C106	Ceramic	0.001μF 50V
C108	Ceramic	47pF 50V
C110	Ceramic	56pF 50V
C111	Ceramic	56pF 50V
C114	Ceramic	0.001μF 50V
C115	Ceramic	22pF 50V
C117	Ceramic	47pF 50V
C118	Ceramic	47pF 50V
C119	Ceramic	47pF 50V
C120	Ceramic	68pF 50V
C122	Ceramic	47pF 50V
C123	Ceramic	47pF 50V
C124	Cylinder	100pF UP050B101K-NA
C125	Cylinder	33pF UP050SL330J-NA
C127	Ceramic	47pF 50V
C128	Ceramic	47pF 50V
C129	Ceramic	0.001μF 50V
	(IC-475A/E only)	
C130	Ceramic	0.5pF 50V
	(IC-475H only)	
J1	Connector	B04B-EH-S
J2	Connector	TMP-J01X-A2
J3	Connector	TMP-J01X-A2
J4	Connector	TMP-J01X-A2
J5	Connector	IMSA-9201B-1-02-T
J6	Connector	IMSA-9201B-1-02-T
J7	Connector	TMP-J01X-A2

[RF YGR UNIT]

REF. NO.	DESCRIPTION	PART NO.
P1	Connector	TMP-P01X-A1
P2	Connector	EHR-07
EP1	P.C. Board	B-1193C
EP2	Ferrite Bead	DL2-OP-2.6-3-1.2H
EP3	Ferrite Bead	FSQH070RN

[REG UNIT] (IC-475A/E ONLY)

REF. NO.	DESCRIPTION	PART NO.
IC1	IC	SG3524N
Q1	Transistor	2SC2501
Q2	Transistor	2SC2501
D1	Diode	SB1680 (ESAC85-009)
D2	Diode	V19B
D3	Diode	V19B
D4	Diode	1N4002
D5	Diode	KBL06
D6	Diode	1N4002
L1	Coil	LR-59A
L2	Coil	TO-12
L3	Coil	SK-24P-110-100
L4	Coil	FL7H 102J 1000μ
L5	Coil	TI-5
L6	Coil	LR-92
R1	Resistor	120kΩ R20
R2	Resistor	120kΩ R20
R3	Resistor	4.7Ω R20
R4	Resistor	4.7Ω R20
R5	Resistor	22Ω R20
R6	Resistor	22Ω R20
R7	Resistor	390Ω R25
R8	Resistor	33Ω R25
R9	Resistor	0.022Ω RA-1
R10	Resistor	2.2kΩ R20
R11	Resistor	33kΩ R20
R12	Resistor	4.7kΩ ELR20
R13	Resistor	4.7kΩ R25
R14	Resistor	4.7kΩ ELR20
R15	Trimmer	10kΩ RH0651C14J2WA
R16	Resistor	15kΩ R20
R17	Absorber	ERZ-C07DK431
R18	Resistor	SRW2P0.5
R19	Resistor	SRW2P0.5
R20	Resistor	120kΩ R20
R21	Resistor	120kΩ R20
R22	Resistor	10kΩ R20
C1	Ceramic	0.0022μF DE7100F222MAC400
C2	Ceramic	0.0022μF DE7100F222MAC400
C3	Ceramic	0.02μF 500V
C4	Electrolytic	3.3μF 200V 200UPA3R3VA-M
C5	Electrolytic	3.3μF 200V 200UPA3R3VA-M
C6	Ceramic	0.0022μF DE7100F222MAC400
C7	Ceramic	470pF 500V
C8	Metallized	0.47μF 400V 400MMW474K
C9	Ceramic	0.0047μF 50V
C10	Ceramic	0.0047μF 50V

[REG UNIT] (IC-475A/E ONLY)

REF. NO.	DESCRIPTION	PART NO.
C11	Electrolytic	1000µF 16V ECEA1CG102S
C12	Electrolytic	1000µF 16V ECEA1CG102S
C13	Electrolytic	47µF 16V
C14	Mylar	0.01µF 50V F2D
C15	Mylar	0.01µF 50V F2D
C16	Electrolytic	0.47µF 50V
C17	Electrolytic	10µF 16V
C18	Mylar	0.001µF 50V F2D
C19	Ceramic	0.001µF 50V
C20	Electrolytic	10µF 16V
C21	Monolithic	0.68µF 50V C76AF1H684Z
C22	Ceramic	0.0022µF 50V
C23	Ceramic	0.0022µF 500V
C24	Ceramic	0.0022µF 500V
C25	Ceramic	0.0022µF 500V
C26	Ceramic	0.0022µF 500V
C27	Electrolytic	330µF 200V 200 SXP 330
C28	Electrolytic	330µF 200V 200 SXP 330
C29	Electrolytic	330µF 200V 200 SXP 330
C30	Electrolytic	330µF 200V 200 SXP 330
C31	Electrolytic	470µF 25V
C32	Electrolytic	100µF 25V
C33	Monolithic	0.68µF 50V C76AF1H684Z
C34	Metallized	0.082µF 250VAC ECQ-U2A823MW
C35	Ceramic	0.001µF DE7090B102KAC400
C36	Ceramic	0.001µF DE7090B102KAC400
J1	Connector	AP-300-3-A-1-NI-BLACK
P1	Connector	1625-03P1
P2	DC Cord	OPC-154
P3	Connector	1625-03R1
F1	Fuse	F.G.M.B. 125V 5A (IC-475A/E #08A only)
F1	Fuse	F.G.M.B. 250V 3A (IC-475H #06E, #10A, #12E only)
F2	Fuse Holder	FH-033
T1	Transformer	TP-32
EP1	P.C. Board	B-1174B
EP12	Ferrite Bead	FSQH070RN
W9	Jumper	JPW-02A

[PA UNIT] (IC-475A/E ONLY)

REF. NO.	DESCRIPTION	PART NO.
IC1	IC	SC-1024
IC2	IC	NJM7809A
Q1	Transistor	2SC2785 FF/EF/KF
Q2	Transistor	2SD359
Q3	Transistor	2SC2120 Y
D1	Diode	15CD11
D2	Diode	1SS237
D3	Diode	1SS237
D4	Diode	MI407

[PA UNIT] (IC-475A/E ONLY)

REF. NO.	DESCRIPTION	PART NO.
D5	Diode	MI407
D6	Diode	1SS53
L1	Coil	LA-237
L2	Coil	LA-237
L3	Coil	LA-120
L4	Coil	LA-242
L5	Coil	LA-253
L6	Coil	LA-242
L7	Coil	LA-232
L8	Coil	LA-232
R1	Resistor	3.3kΩ R20
R2	Resistor	470Ω R20
R3	Resistor	330Ω R20
R4	Resistor	3.3Ω R50X
R5	Trimmer	100Ω RH0051C12J04A
R6	Resistor	27kΩ R25
R7	Resistor	27kΩ R25
R8	Resistor	0.15Ω RGB2
R9	Resistor	0.15Ω RGB2
R10	Resistor	82Ω R50X
R11	Resistor	2.2kΩ R25
R12	Resistor	100Ω ELR25
R13	Resistor	560Ω ELR25
C1	Ceramic	0.001µF 50V
C2	Electrolytic	1µF 50V
C3	Barrier Layer	0.047µF 25V
C4	Ceramic	0.001µF 50V
C5	Ceramic	47pF 50V
C6	Ceramic	1pF 50V CK
C7	Ceramic	0.001µF 50V
C8	Ceramic	0.001µF 50V
C9	Ceramic	0.001µF 50V
C10	Ceramic	47pF 50V
C11	Trimmer	4pF ECR-MN004Y13
C12	Ceramic	2pF 500V
C13	Ceramic	3pF 500V
C14	Ceramic	15pF 500V
C15	Ceramic	10pF 500V
C16	Ceramic	15pF 500V
C17	Ceramic	5pF 500V
C18	Ceramic	8pF 500V
C19	Ceramic	6pF 500V
C20	Ceramic	0.001µF 50V
C21	Ceramic	0.001µF 50V
C22	Ceramic	47pF 50V
C23	Feed Through	TF240-602SS332Z 50V
C24	Ceramic	0.001µF 50V
C25	Ceramic	47pF 50V
C26	Electrolytic	1000µF 16V SS
C27	Ceramic	0.001µF 50V
C28	Ceramic	47pF 50V
C29	Ceramic	0.001µF 50V
C30	Electrolytic	100µF 16V SS
C31	Ceramic	0.001µF 50V
C32	Ceramic	47pF 50V
C33	Ceramic	0.001µF 50V
C34	Ceramic	47pF 50V
C35	Ceramic	0.001µF 50V
C36	Electrolytic	0.47µF 50V
C37	Ceramic	0.001µF 50V
C38	Ceramic	0.001µF 50V
C39	Electrolytic	10µF 16V
C40	Ceramic	0.001µF 50V
C41	Ceramic	0.001µF 50V
C42	Ceramic	20pF 500V
C43	Ceramic	5pF 500V
C44	Ceramic	18pF 50V
C45	Ceramic	0.001µF 50V
C46	Ceramic	0.001µF 50V

[PA UNIT] (IC-475A/E ONLY)

REF. NO.	DESCRIPTION	PART NO.	
C47	Electrolytic	2.2μF	50V
C48	Ceramic	0.001μF	50V
C49	Ceramic	0.001μF	50V
C50	Ceramic	0.001μF	50V
C51	Electrolytic	10μF	16V MS7
C52	Ceramic	0.001μF	50V
C53	Electrolytic	100μF	16V
C54	Ceramic	0.001μF	50V
C55	Feed Through	TF240-602SS332Z	50V
C56	Feed Through	TF240-602SS332Z	50V
C57	Feed Through	TF240-602SS332Z	50V
C58	Feed Through	TF240-602SS332Z	50V
C59	Feed Through	TF240-602SS332Z	50V
C60	Feed Through	TF240-602SS332Z	50V
C61	Feed Through	TF240-602SS332Z	50V
C62	Ceramic	0.001μF	50V
C63	Ceramic	0.001μF	50V
C64	Feed Through	TF318-450 E 102 GMV	50V
C65	Feed Through	TF318-450 E 102 GMV	50V
C66	Feed Through	TF318-450 E 102 GMV	50V
C67	Feed Through	TF318-450 E 102 GMV	50V
C68	Ceramic	0.001μF	50V
C69	Ceramic	0.001μF	50V
C70	Ceramic	0.001μF	50V
C71	Electrolytic	2200μF	16V SS
C72	Ceramic	0.001μF	50V
C73	Ceramic	0.001μF	50V
C74	Ceramic	0.5pF	500V
J1	Connector	LLR-6	
J2	Connector	NR-DSE-01	
J3	Connector	TLB-P07H-B1	
J4	Connector	TLB-P04H-B1	
J5	Connector	B03B-EH-S	
J6	Connector	B04B-EH-S	
P1	Connector	1490R-1	
P2	Connector	TMP-P01X-A1	
P3	Connector	TMP-P01X-A1	
P4	Connector	EHR-03	
P5	Connector	SMR-10V-B	
P6	Connector	EHR-03	
S1	Thermal	OHD3-50M	
SP1	Speaker	065K1210810	
MF1	Motor	HMK2609-01-090	
EP1	P.C. Board	B-1195A	
EP4	Ferrite Bead	DL2-OP-2.6-3-1.2H	

[CTRL UNIT] (IC-475H ONLY)

REF. NO.	DESCRIPTION	PART NO.
IC1	IC	NJM7809A
Q1	Transistor	2SD468
Q2	Transistor	2SC2785 FF/EF/KF
Q3	Transistor	RN1204
Q4	Transistor	2SB562
Q5	Transistor	RN1204

[CTRL UNIT] (IC-475H ONLY)

REF. NO.	DESCRIPTION	PART NO.	
Q6	Transistor	2SC2785	FF/EF/KF
Q7	Transistor	2SD359	
D1	Diode	RD10.0E	B2
D2	Diode	1SS53	
D3	Diode	1SS53	
D4	Diode	15CD11	
R1	Resistor	CP5AJ0.012	
R2	Resistor	1kΩ	ELR20
R3	Resistor	1kΩ	R20
R4	Resistor	1kΩ	R20
R5	Resistor	1kΩ	ELR20
R7	Resistor	3.3Ω	R25
R8	Resistor	470Ω	ELR20
R9	Resistor	3.3kΩ	R20
R10	Resistor	39kΩ	R25
R11	Resistor	4.7kΩ	R20
R12	Resistor	330Ω	R50X
R13	Resistor	100kΩ	R20
R14	Resistor	680Ω	R20
C1	Electrolytic	1000μF	16V MS16
C2	Ceramic	0.0047μF	50V
C3	Ceramic	0.001μF	50V
C4	Ceramic	0.001μF	50V
C5	Ceramic	0.001μF	50V
C6	Ceramic	0.001μF	50V
C7	Ceramic	0.001μF	50V
C8	Ceramic	0.001μF	50V
C9	Ceramic	0.001μF	50V
C10	Electrolytic	1000μF	16V MS16
C11	Ceramic	0.0047μF	50V
C12	Ceramic	0.001μF	50V
C13	Ceramic	0.0047μF	50V
C14	Ceramic	0.001μF	50V
C15	Ceramic	0.0047μF	50V
C17	Electrolytic	1μF	50V
C18	Ceramic	0.001μF	50V
C19	Ceramic	0.001μF	50V
C20	Ceramic	0.001μF	50V
C21	Ceramic	0.001μF	50V
C22	Ceramic	0.001μF	50V
C23	Ceramic	0.001μF	50V
C24	Ceramic	0.001μF	50V
C25	Electrolytic	22μF	25V
C26	Electrolytic	47μF	10V
C27	Electrolytic	47μF	25V
C28	Ceramic	0.001μF	50V
C29	Ceramic	0.001μF	50V
C30	Ceramic	0.001μF	50V
C31	Electrolytic	0.47μF	50V MS7
C32	Electrolytic	10μF	16V MS7
C33	Ceramic	0.001μF	50V
C34	Ceramic	220pF	50V
C35	Ceramic	0.001μF	50V
C37	Ceramic	0.001μF	50V
C38	Feed Through	TF318-450 E 102 GMV	50V
C39	Feed Through	TF318-450 E 102 GMV	50V
J1	Connector	B10B-EH-S	
J2	Connector	B06B-EH-S	
J3	Connector	B05B-EH-S	
J4	Connector	B03B-EH-S	
J5	Connector	B04B-EH-S	
J6	Connector	TSL-P03P-V2	
J7	Connector	TSL-P03P-V2	
J8	Connector	LLR-6	
P1	Connector	1490R-1	

[CTRL UNIT] (IC-475H)

REF. NO.	DESCRIPTION	PART NO.
P2	Connector	2-S3.3
P3	Connector	2-S3.3
F1	Fuse	F.G.M.B 250V 3A
F2	Holder	F-429
EP1	P.C. Board	B-1379C
EP2	Ferrite Bead	FSQH070RN

[PA UNIT] (IC-475H)

REF. NO.	DESCRIPTION	PART NO.
C32	Ceramic	0.001μF 50V
C33	Ceramic	0.001μF 50V
C34	Electrolytic	47μF 25V
C35	Ceramic	47pF 50V
C36	Ceramic	47pF 50V
C37	Ceramic	47pF 50V
C38	Ceramic	0.001μF 50V
C39	Ceramic	4pF 500V
C41	Feed Through	TF240-602SS332Z 50V
C42	Feed Through	TF240-602SS332Z 50V
C43	Feed Through	TF240-602SS332Z 50V
C44	Feed Through	TF240-602SS332Z 50V
C45	Feed Through	TF240-602SS332Z 50V
C46	Feed Through	TF240-602SS332Z 50V
C47	Feed Through	TF240-602SS332Z 50V
C48	Feed Through	TF240-602SS332Z 50V
C49	Ceramic	47pF 50V
C50	Electrolytic	2.2μF 50V MS7
C51	Barrier Layer	0.047μF 25V
C52	Electrolytic	470μF 25V SS
J1	Connector	TMP-J01X-V2
J2	Connector	TLB-P05H-B1
J3	Connector	P-423
P1	Connector	TMP-P01X-A1
P2	Connector	EHR-06
P3	Connector	EHR-03
P4	Connector	SMR-10V-B
P5	Connector	EHR-10
P6	Connector	EHR-03
P7	Connector	TMP-P01X-A1
S1	Thermal	OHD3-50M
S2	Thermal	OHD3-90M
SP1	Speaker	C065K12I0810
MF1	Fan	HMK2605-01-130
EP1	Ferrite Bead	DL2-OP2.6-3-1.2H
EP2	Ferrite Bead	DL2-OP2.6-3-1.2H
EP3	Ferrite Bead	DL2-OP2.6-3-1.2H
EP4	Ferrite Bead	DL2-OP2.6-3-1.2H
EP5	Ferrite Bead	DL2-OP2.6-3-1.2H
EP6	Ferrite Bead	DL2-OP2.6-3-1.2H
EP7	Ferrite Bead	FSQH050RN1
EP15	P.C. Board	B-1382B
W4	Jumper	JPW-02A
W39	Jumper	JPW-02A

[PA UNIT] (IC-475H ONLY)

REF. NO.	DESCRIPTION	PART NO.
IC1	IC	SC-1016
Q1	Transistor	2SD880
Q2	Transistor	2SC3102
Q3	Transistor	2SC3102
D1	Diode	MV5
D2	Diode	MV5
L1	Coil	LA-252
L2	Coil	LA-252
R1	Resistor	120Ω R20
R2	Trimmer	470Ω RH0651CS2J1HA
R3	Resistor	33Ω R20
R4	Thermistor	35D45
R5	Resistor	10kΩ R25
R6	Resistor	10kΩ R25
C1	Ceramic	47pF 50V
C2	Ceramic	0.001μF 50V
C3	Ceramic	0.001μF 50V
C4	Ceramic	47pF 50V
C5	Ceramic	0.001μF 50V
C6	Ceramic	47pF 50V
C7	Ceramic	4pF 500V
C8	Ceramic	4pF 500V
C9	Ceramic	4pF 500V
C10	Ceramic	220pF 50V
C11	Trimmer	15pF TMC210SLD
C12	Ceramic	18pF 500V
C13	Ceramic	18pF 500V
C14	Ceramic	45pF UC232H0450F
C15	Ceramic	45pF UC232H0450F
C16	Ceramic	45pF UC232H0450F
C17	Ceramic	45pF UC232H0450F
C18	Ceramic	37pF UC232H0370F
C19	Ceramic	37pF UC232H0370F
C20	Ceramic	37pF UC232H0370F
C21	Ceramic	37pF UC232H0370F
C22	Ceramic	27pF UC232H0270F
C23	Ceramic	27pF UC232H0270F
C24	Ceramic	27pF UC232H0270F
C25	Ceramic	27pF UC232H0270F
C26	Ceramic	6pF UC232H0060D
C27	Ceramic	6pF UC232H0060D
C28	Ceramic	220pF GRH710CH221K
C29	Ceramic	220pF GRH710CH221K
C30	Ceramic	1000pF GR42-2CH102K
C31	Electrolytic	47μF 25V

[FILTER UNIT] (IC-475H ONLY)

REF. NO.	DESCRIPTION	PART NO.
D1	Diode	1SS99
D2	Diode	1SS99
D3	Diode	MI407
D4	Diode	MI407
D5	Diode	MI407
D6	Diode	MI407
D7	Diode	MI407
L1	Coil	LA-69
L2	Coil	LA-69
L3	Coil	LA-237
L4	Coil	LA-237
L5	Coil	LA-252
L6	Coil	LA-252
L7	Coil	LA-243
L8	Coil	LA-252
R1	Resistor	1kΩ R20
R2	Resistor	1kΩ R20
R4	Resistor	CRH100X R-02 J 201
R5	Resistor	CRH100X R-02 J 201
R6	Resistor	CRH100X R-02 J 201
R7	Resistor	1kΩ ELR20
R8	Resistor	2.2kΩ R20
R9	Resistor	2.2kΩ R20
R10	Resistor	68Ω R20
R11	Resistor	68Ω R20
C1	Ceramic	0.001μF 50V
C3	Ceramic	0.001μF 50V
C4	Ceramic	3pF 500V
C5	Ceramic	1pF 500V
C6	Ceramic	6pF 500V
C7	Ceramic	1pF 500V
C8	Ceramic	3pF 500V
C9	Ceramic	0.001μF 50V
C10	Ceramic	0.001μF 50V
C11	Ceramic	0.001μF 50V
C12	Ceramic	0.001μF 50V
C13	Barrier Layer	0.047μF 25V
C14	Ceramic	0.001μF 50V
C15	Ceramic	47pF 50V
C16	Ceramic	0.001μF 500V
C17	Ceramic	5pF 500V
C18	Trimmer	10pF CV38D1001
C20	Ceramic	15pF 50V
C21	Ceramic	12pF 50V
C22	Ceramic	15pF 50V
C23	Ceramic	0.001μF 50V
C24	Ceramic	47pF 50V
C25	Ceramic	5pF 500V
C26	Ceramic	5pF 500V
C27	Ceramic	8pF 50V
C28	Ceramic	8pF 50V
C29	Ceramic	0.001μF 500V
J1	Connector	NR-DS-01
J2	Connector	TLB-P05H-B1
J3	Connector	TMP-J01X-A2
P1	Connector	TMP-P01X-A1
P2	Connector	EHR-05
EP1	P.C. Board	B-1383B
EP2	P.C. Board	B-1546

**Downloaded by
RadioAmateur.EU**

Icom Inc.

6-9-16, Kamihigashi, Hirano-ku, Osaka 547, Japan
Phone: 06 793 5301
Fax : 06 793 0013
Telex : 05277822 ICOMTR J

Icom America Inc.

<Corporate Headquarters>
2380 116th Avenue N.E., Bellevue, WA 98004, U.S.A.
Phone : (206) 454-8155
Fax : (206) 454-1509
Telex : 152210 ICOM AMER BVUE

<Customer Service>
Phone : (206) 454-7619

<Regional Customer Service Centers>
3150 Premier Drive, Suite 126, Irving, TX 75063, U.S.A.
Phone : (214) 550-7525
Fax : (214) 550-7423

1777 Phoenix Parkway, Suite 201, Atlanta, GA 30349, U.S.A.
Phone : (404) 991-6166
Fax : (404) 991-6327

Icom Canada

A Division of Icom America Inc.
3071 #5 Road, Unit 9, Richmond, B.C., V6X 2T4, Canada
Phone : (604) 273-7400
Fax : (604) 273-1900

Icom (Europe) GmbH

Communication Equipment
Himmelgeister Str. 100, 4000 Düsseldorf 1, W. Germany
Phone : 0211 346047
Fax : 0211 333639
Telex : 8588082 ICOM D

Icom (Australia) Pty. Ltd.

Incorporated In Victoria
7 Duke Street, Windsor, Victoria, 3181, Australia
Phone : 03 529 7582
Fax : 03 529 8485
Telex : AA 35521 ICOM AS

Icom (UK) Ltd.

Unit 9, Sea St., Herne Bay, Kent, U.K.
Phone : 0227 363859
Fax : 0227 360155
Telex : 965179 ICOM G

Icom France S.a

120 Route de Revel, BP4063, 31029 Toulouse Cedex, France
Phone : 61. 20. 31. 49
Fax : 61. 34. 05. 91
Telex : 521515 ICOM FRA

Count on us!

Icom Inc.

6-9-16, Kamihigashi, Hirano-ku, Osaka 547, Japan

A-1031H-N

Printed in Japan

Copyright © 1989 by Icom Inc.