

SECTION I SPECIFICATIONS

GENERAL:

Number of Semi-Conductors	Transistor	16
	FET	8
	IC	7
	Diodes	38
Frequency Coverage	50 MHz--51 MHz	
Frequency Stability	$\pm 200\text{Hz/HR @}25^{\circ}\text{C}$	
Modulation Type	(A3J), (A1)	
Antenna Impedance	50 ohms unbalanced	
Power Supply	DC 13.8V $\pm 15\%$	
Current Drain	Negative Ground	
	Transmitting	
	A3J	Approx. 550mA
	A1	Approx. 700mA
	Receiving	
	at Max. Audio Output	
	Approx.	250mA
	with no signal	
	Approx.	120mA
	Dial Light	
	Approx.	40mA
Dimension	183mm X 61mm X 162 (H x W x D)	
Net Weight	2.1 Kgs including batteries	

TRANSMITTER:

Frequencies	50 MHz--51 MHz	
Modulation Type	A3J (USB) and A1	
RF Output Power	A3J	3W (PEP)
	A1	3W
Carrier Suppression	Better than 40 dB	
Opposite Side Band Suppression	Better than 40 dB/1KHz	
Spurious Radiation	Better than -60 dB	
Modulation System	Balanced Modulation	
SSB Producing System	Filter Type	
Microphone Impedance	600 ohms	

RECEIVER:

Frequencies	Same as Transmitter	
Modulation Type	A3J (USB) and A1	
Receiving System	Single Super Heterodyne	
Intermediate Frequency	10.7 MHz	
Sensitivity	0.5 μV at (S + N)/N 10 dB or better	
Spurious Response	Better than -60 dB	
Selectivity	± 1.2 KHz or better at - 6dB	
	± 2.4 KHz or better at - 60 dB	
Audio Output	More than 1W	
Audio Output Impedance	8 ohms	

SECTION II INTRODUCTION

Congratulations on the purchase of the IC-502, portable 6 meter SSB transceiver. The IC-502 was designed to be operable anywhere like most portables, but we also included features like a very effective noise blanker, RIT, S & RF meter, and a full 3 watts P & P output. A highly stable VFO allows operation between 50.0 and 51.0 MHz.

The aluminum die-cast frame provides a very strong yet light housing for the 2 circuit boards, and the aluminum sides snap off easily if service is ever necessary or to change the batteries.

The IC-502 operates on 9 inexpensive C cell batteries, or on an external 13.8V DC source. We recommend the IC-3PS for fixed station use which not only provides power for the IC-502, but also doubles as a stand and holder for the IC-50L 10 watt linear amplifier.

You can use the built-in whip antenna for portable use or another antenna connects to the external antenna connector on the back of the IC-502.

We are sure that you will have years of lasting enjoyment from your IC-502, manufactured by the leader in communication equipment: Inoue Communication Equipment Corporation.

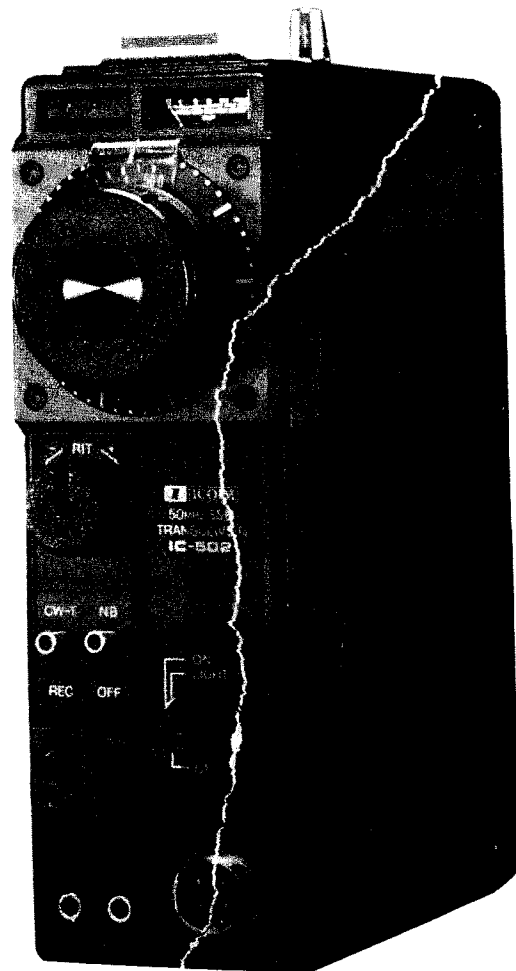

SECTION III ACCESSORIES

Various accessories are packed with your transceiver. Be sure not to overlook anything. Also it's a good idea to keep packing cartons in case of moving or it return for service is necessary.

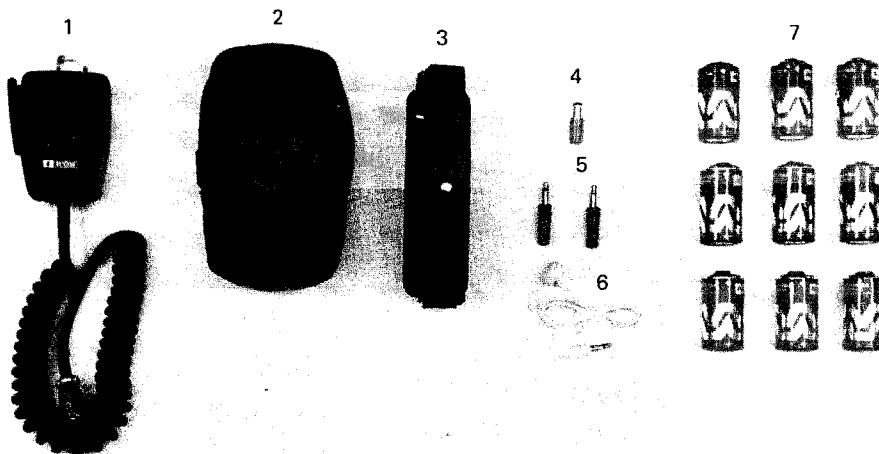

- | | | | |
|-----------------------|---|--------------------------------|---|
| 1. Dynamic Microphone | 1 | 5. Ext. Speaker Plug, Key Plug | 2 |
| 2. Microphone Case | 1 | 6. Earphone | 1 |
| 3. Sholder Strap | 1 | 7. Dry Cells Type "C" | 9 |
| 4. Power Supply Plug | 1 | | |

SECTION IV PRE-OPERATION

Battery installation

Place the function switch in the off position. Remove the side that covers the battery case and speaker. Carefully install the batteries in the manner shown on the bottom of the battery case. Take care in observing correct polarity.

Place the batteries on top of the ribbon so when the battries need to be removed a simple pull on the ribbon will make removal easier. Place batteries in the center column last. Do not force the batteries in place. With the batteries properly in place, carefully replace the side cover.

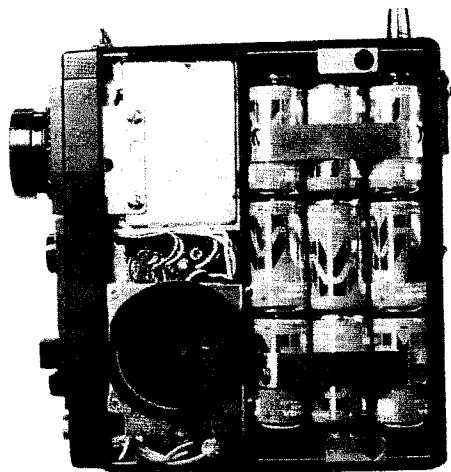

SECTION V DESCRIPTION OF CONTROLS AND CONNECTIONS

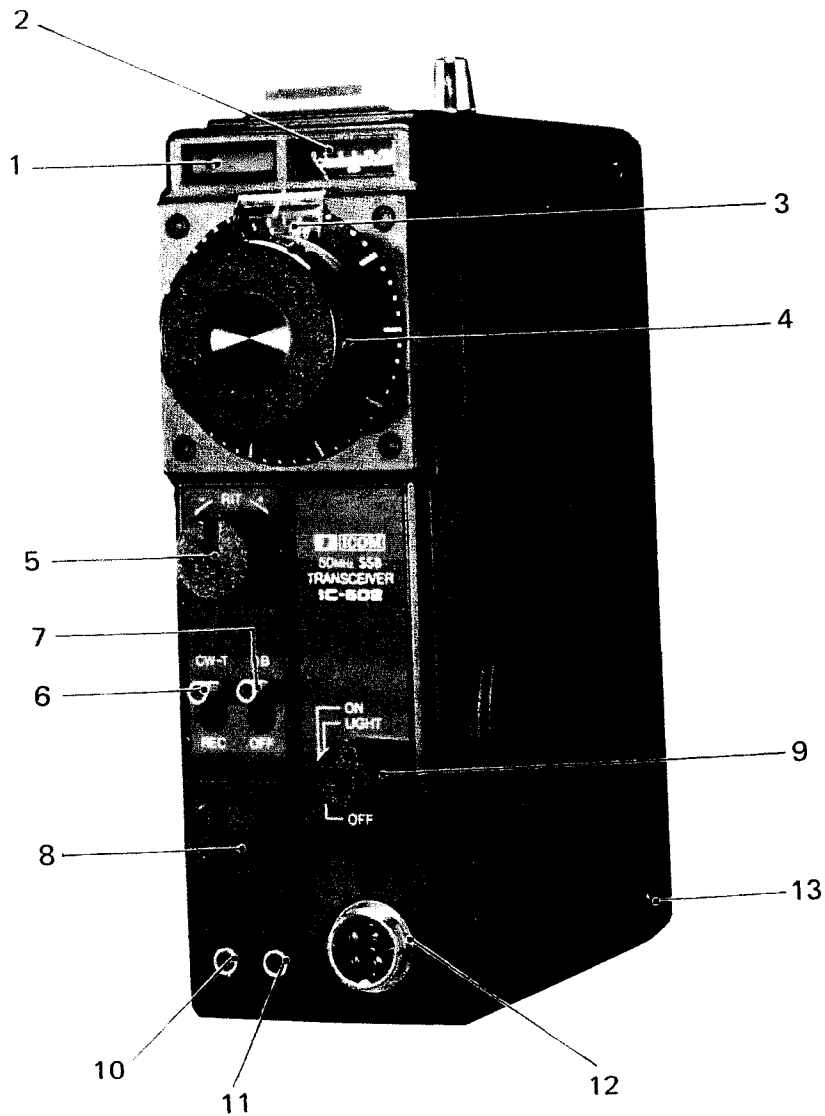

1. **Power indicator LED**
Shows when power is applied to the IC-502 and serves to indicate battery condition.
2. **S&RF meter**
Indicates the relative signal strength of received signals and output power of transmitted signals.
3. **Dial scale**
The dial is divided into 50KHz increments with a total coverage of 1MHz. The operating frequency is read on the dial.
4. **Tuning Knob**
Selects the Frequency.

5. RIT
Independently swings the receiver frequency $\pm 3\text{KHz}$ so that signals that are slightly off frequency may be tuned for clarity without affecting the transmitting frequency.
6. Mode Switch
In the CW-T position the transmitter will transmit when the CW key makes contact. In the REC position both SSB and CW signals can be received. In the CW-T position the microphone is deactivated from the circuit.
7. Noise Blanker Switch
In the NB position, the noise blanker is put into the circuit and noise pulses will be reduced.
8. Volume
Controls the audio output level.
9. Function Switch
Turns the power on and off and in the light position, on the meter light.
10. External speaker Jack
An external speaker can be connected here. The impedance of the speaker should be 8 ohms. With the external speaker connected, the built-in speaker will be disabled.
11. Key Jack
A key for CW transmission is connected here.
12. Microphone Connector
A 500 ohm microphone is connected here.
13. Snap-Locks
Convenient snap-locks hold the sides in place. To remove them for any service or to replace the batteries, simply pull out on the center of the snap-lockers and the cover can easily be removed. When replacing the covers be sure that you have placed the covers properly in the grooves provided, then push down on the center of the snap-lock. Note: At the time the sides are placed in the grooves, the snap-lock center must be pulled out.

14. Whip antenna
The built in whip antenna must be fully extended for best operation. Use care when expanding or compressing the antenna.
15. Microphone Hanger
When not in use, the mic can be placed here out of the way.
16. External Power Supply Jack
Any well regulated power supply with an output of 13.8 volts can be connected here instead of using the batteries installed. Inserting the power plug into the external power supply jack disables the internal battery source.
17. External Antenna receptable
An external antenna of 50 ohms impedance can be connected here. If an external antenna is used, the built-in whip should be completely collapsed.
18. Identification plate
States model number and serial number.

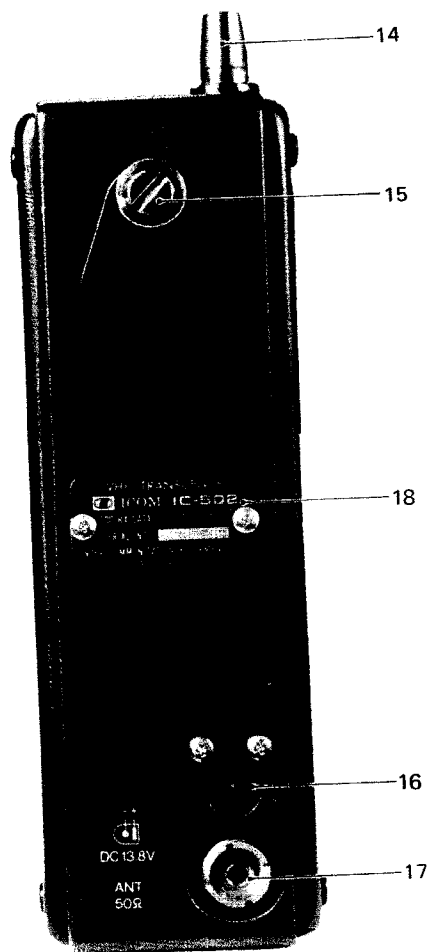

SECTION VI OPERATION

1. After the batteries have been installed, or the IC-502 is connected to an external source, turn the function switch on. If the surrounding light is too dim to see the S & SR meter, turn the switch to the LIGHT position, and the meter will be illuminated.
 2. Extend the whip antenna to its full length, or if you wish to use an external antenna, connect the cable to the EXT antenna connector on the back of the IC-502.
 3. Connect the microphone to the MIC jack on the front panel.
- 6

4. If you wish to use the CW mode of transmission, connect a key to the KEY jack on the front panel. You do not have to disconnect the microphone for CW operation.
5. Turn the tuning knob until you reach the desired frequency or a signal is heard. Adjust the volume control for a comfortable level of listening. If operating SSB, you may wish to place the Noise Blanking switch in the NB position. This activates the noise blanking circuit which will suppress noise pulses. After selecting the operating frequency, if the received signal seems to drift, adjust the RIT control until the signal is again clear. Avoid adjusting the tuning knob for this purpose, as to do so will also change your transmitting frequency.
6. For SSB operation, hold the microphone close to your mouth, push the PTT switch on the microphone, and speak in a clear normal tone of voice.

For CW operation, after connection of your KEY, place the Mode switch in the CW-T position and the IC-502 will transmit when the KEY contacts are closed. To receive, place the switch back in the REC position.

SECTION VII THEORY

CIRCUITS

Section IX shows a block diagram of the IC-502.

The receiving section is a single conversion super heterodyne with a 36MHz high-stability VFO as the local oscillator. The transmitting section is a single conversion system which employs a filter-type SSB generator using a 13.9985MHz crystal filter and the same local oscillator as the receiving section. A double-balanced mixer is used for the transmitting mixer to minimize spurious radiation. Although a portable unit, the IC-502 also features built-in circuits such as RIT, AGC, ALC, and an IF noise blanker.

The transceiver can be used with ease outdoors, in the car, or as a fixed station since it may be powered either with its self contained batteries (C size x 9) or with a 13.8V external source.

RECEIVING CIRCUIT

The signal from the whip antenna or antenna terminal passes through the harmonic filter, through the T/R switching diode D21 (MI301) amplified by RF amplifier Q2(MEM616) and is then fed to the mixer Q3(2SK19) gate.

The switching diode is turned on by T/R control Q1(2SA570) and D21 is turned on with forward voltage bias thus directing the input signal to Q2. During transmission, the Receiver section +9V goes to zero to turn off Q1, and forward voltage bias is not applied to D21, while at the same time, the transmit output is switched around Q2 to the antenna system. D21 is turned off as reverse bias is generated when the transmit signal is present.

The 36MHz local oscillator output is injected to mixer Q3's source. The resultant conversion is an IF Frequency of 13.9985MHz. The IF signal passes through the diode switch D1(BA244) which serves as both transmit-receive switch and noise blanker gate, the IF selectivity is obtained by the 13.9985MHz crystal filter, then passes the switching diode D4(BA244) and is amplified up to a suitable level by the IF amplifiers consisting of Q4 (MEM616), Q5(MEM616) and IC1(LA1221). The output of IC1 is applied to the demodulation and AGC circuits.

The demodulation circuit is a ring demodulator composed of D6 to D9(1N60's) which uses the 13.997MHz from the BFO to generate the resultant audio signal. Higher audio frequencies of the demodulated signal are cut off by a low-pass filter consisting of C43, L11 and C44.

The volume control (R-1) adjusts this output level which is fed to AF amplifier IC2 (μ PC575C2) x providing 1 watt of audio. The network R12 and D9 provides position bias to IC-2 for muting audio during transmit and silent transmit-receive switching.

NOISE BLANKER

A sample of the IF signal is picked up at the drain of mixer Q3, amplified by IC2 and IC3(LA1221's), and detected by D11(1N60). This detected output is separated into signal audio components, and pulse components (noise).

The signal component is amplified by Q7 (2SC945) and provides AGC control of IC2. The noise pulse component turns on Q6(2SC945), and, as long as noise exists, turns off D1 by grounding the anode of the noise blanker gate diode D1, thus the noise component is not transferred to the crystal filter.

AGC CIRCUIT

A part of the IF signal is picked up from the IF amplifier IC1 and passes through C70 and R49 to be detected by D13, D14(1S2473's) and D15(1N60). When no signal is received, bias voltage is applied to the base of AGC control Q11(2SC945) through R48, D13 and D15, and the potential at the emitter of Q11 goes to nearly zero.

In the presence of a signal, C66 which is connected to Q11 base is first negatively charged because D13 is turned on, and so Q11 is turned off. Also, C68 which is connected to Q11 emitter is negatively charged through D14 up to a voltage determined by the loop gain of each amplifier of RF and IF, and C68 is kept at the achieved voltage due to the absence of a discharge circuit.

When the signal diminishes, the negative voltage charged in C66 is gradually discharged through R48 and drops down to a voltage where Q11 is turned on. Then the negative voltage charged in C68 is rapidly discharged through Q11, thus the AGC time constant of an attack and slow release is effected.

TRANSMITTING CIRCUIT

The small electrical signal from the microphone is adjusted by the mike gain adjustment R4. Higher or lower frequencies outside desirable communication frequency range are attenuated by R8, C5 and C10, and the remaining frequencies are amplified by AF amplifier IC2(BA301). This AF signal and BFO output (13.997MHz) are fed to the balanced

modulator IC4(SN76514N). The resulting carrier suppressed double sideband signal is amplified by IF amplifier Q12(2SK49). The unwanted side band is then removed by the 13.9985MHz crystal filter where it passes through the diode switch D3(AB244) to become a 13.9985MHz SSB (USB) signal.

This 13.9985 signal passes the diode switch D2(BA244) to the transmit mixer IC5 (SN76514N). The L.O. of 36MHz from VFO unit is then combined to become the SSB (USB) signal of 50MHz. The transmit mixer IC5 is a double-balanced mixer, which minimizes spurious radiation.

In addition, the output circuits of IC5 and the 50MHz amplifier Q13(2SC383) provides a band-pass filtering which further minimizes spurious radiation. This 50MHz SSB signal is linearly amplified by Q18(2SC383), Q14(2SC730), and Q15(2SC1947) respectively. Higher harmonics are suppressed by the low-pass filter composed of L25, L26 and C130 to C136. The resultant output power is 3W PEP. PA Q15 idling current is adjusted by R70. It is preset at 30mA at the factory.

ALC CIRCUIT

The ALC (Automatic Level Control) circuit picks out a part of the drive stage Q14 output, rectifies it by D18(1S2473) and D19(1N60), and applies the obtained negative voltage to the transmit IF amplifier Q12 gate to control circuit gain.

CW TRANSMISSION

For CW transmission, the voltage exerted on AF amplifier IC2 is reduced at the same time the voltage to BFO frequency shift switch Q8's(2SC945) base is also reduced to turn it off so that C59 and C60 are in series as a part of the BFO crystal oscillator to shift the frequency about 1 KHz upward, which is within the crystal filter passband. Also, at this time, voltage is applied to the 5th pin of the balance modulator IC5 to upset carrier and the BFO frequency appears unsuppressed at the output. Consequently, these signals are amplified by the transmit IF amplifier Q12 and pass through the crystal filter, transmit mixer IC5 and forward as in the SSB mode. Keying is done by Q12 source and Q13 emitter.

COMMON CIRCUITS

BFO

The BFO is a non-adjustable oscillator using Q9(2SC945). The crystal unit X1 has a load capacity of 25pF and operates at 13.997MHz in the SSB mode. The change in BFO Frequency is explained under "CW transmission". The BFO output buffer is Q10(2SC945).

METER CIRCUIT

This circuit permits use of single meter as an S-meter during reception and as an output level meter during transmission.

A bridge circuit composed of R45 and R46 is connected to the power source, stabilized by Zener diode D24(WZ056), and the IF amplifier Q5 source. AGC voltage is generated by input signals reducing Q5's source voltage, thus unbalancing the bridge causing an up-scale meter reading.

The S-meter is adjusted for its zero point by R46, and for its full scale point by R47. For the output level meter, the output detection diode D20(1N60) is coupled with L24 to partly rectify the RF output, thus giving an upscale relative output indication.

The extent of the meter indication can be adjusted by changing the degree of coupling of D20 and L24.

POWER SOURCE AND TRANSMIT/RECEIVE CHANGE-OVER CIRCUIT

The power source voltage (13.8V) supplied from either built-in batteries or external power connected to J17.

This voltage is directly applied to the AF power amplifier IC1 in the receiver section as well as to the collector of Q13, Q14, Q15 and IC5 in the power amplifier section.

Other circuits are fed with voltage from the voltage regulation circuits. The voltage regulator circuit for the VFO unit, BFO, and AGC circuits, is derived from 13.8V to the Zener diode D3(XZ076) and power-source indicating lamp D-2 (light-emitting diode TLR-102), resulting in stabilized voltage of about 9.6V which becomes a reference level at D3's cathode. This voltage is applied to Q4's(2SC1209) base, and a regulated voltage of about 9V is available at its emitter.

The brightness of power-indicating lamp varies according to the power voltage when the power voltage drops a level under about 10V, the current to D3 and D-2 stops, then D-2 goes out. Thus the power voltage fluctuation and battery condition can be judged from the D-2 Display, voltage regulator. For the receiving section regulated voltage supply the reference voltage of D3 cathode is applied to Q1(2SC355) base through D1 (1SC2473), and a regulated voltage of about 9.5V is obtained at its emitter.

When transmitting, R28 is grounded by the microphone PTT switch or mode change-over switch (in the case of CW-T), to make Q1's base voltage zero and output voltage also zero. Likewise, for the transmit section regulated voltage, the reference voltage of D3 cathode is applied to Q3's(2SD355) base through D2(1S2473), and a regulated voltage of about 9.5V is obtained at its emitter.

During reception, since the PTT switch is not grounded, positive voltage is applied on the transmit/receive change-over control Q2(2SC945) base through R22 to turn on Q2, while the Q3 base is grounded through R22 and Q2, thus making the power voltage zero.

When transmitting, the PTT switch is grounded and the Q2 base is also grounded through D8(1N60) to turn off Q2 and apply the reference voltage to the Q3 base, and so a proper voltage is obtained. Also, the rise time for transmit/receive change-over is delayed by C21 and C22 respectively to prevent transmission signals from entering the receiving section during the change-over operation.

RIT CIRCUIT

During reception, positive voltage is applied to D7's(1S2473) cathode through D5 (1S2473) and R17 to turn off D7, and current flows through R3, D6(1S2473), R16, RIT control R-2 within the VFO unit. The voltage applied on D1(1S2688) of the VFO unit varies by adjusting the RIT control R-2, and D1's capacity varies accordingly, thus enabl-

ing the local oscillator frequency (receiving frequency) to be changed.

In the case of transmission, since the voltage on D7 cathode becomes zero to turn on D7 while positive voltage is applied to D6(1S2473) cathode at the same time through D4 (1S2473) and R15 to turn off D6, current flows through R3, D7, R18, and R19 all within the VFO unit. The voltage divided by R3 and by R18 and R19 is applied to D1, and so transmission can be made at dial-set frequencies irrespective of the position of RIT control R2. The receiving frequency at the RIT zero point can be corrected by adjusting R18.

VFO UNIT

Despite the relatively high frequency of 36MHz band being employed in the oscillator, high stability sufficient for SSB transmission and reception is achieved due to the use of a large variable condenser, complete temperature compensation, voltage stabilization, etc.

The oscillator circuit is a Colpitts type. Q1(MK10) enables the oscillator frequency to be varied by changing the variable condenser C2 capacity. In this oscillator, a range of 36 to 37MHz is produced and output is fed through to the buffer amplifiers Q2(MK10), Q3 (2SC710), and Q4(2SC710).

Spurious radiation in the output circuit is minimized by a filter composed of L5, C29, and C30. Though the regulated voltage for the oscillator is supplied at a level of about 9V from Q4 of the main unit, it is further stabilized by the constant-current circuit using Q5 (2SK19) and by the Zener diode D2(WZ056), and this voltage is supplied to Q1, Q2 and RIT circuit to further ensure sufficient frequency stability.

ADJUSTMENT OF VARIOUS SECTIONS

This set is completely adjusted and checked at the factory so that it functions correctly. During prolonged use, however, the preadjusted condition might be affected by wear of parts, etc. If it is necessary to make adjustments at some time to regain specified performance, the following procedure may be followed:

Remember that changes in capacitor or coils will be very small if any. Adjustments should not be attempted without adequate test equipment.

VFO UNIT ADJUSTMENT

1. **Measuring Instruments for Adjustment:**

- * RF voltmeter (with about 1V full scale capable of measuring at 51MHz)
- * Frequency counter (capable of measuring 40MHz)
- * Multimeter, 20Kohm per volt.

2. **Frequency Adjustment:**

Connect the frequency counter to J5 and J6 (ground side).

Set the RIT knob to the center (detent).

Turn the tuning knob to set the dial scale to "51.0", and adjust trimmer C3 to obtain "37.000MHz". Then set the dial scale to "50.0", and adjust L1 core to obtain "36.00MHz".

Repeat above adjustments as necessary until the end points are correct.

3. RIT Adjustment

In the receive mode connect the frequency counter to J5, set the RIT knob to the center (detent) then record the frequency. (The dial scale may be set at any position but do not change it during the adjustment).

Next, turn the MODE change-over switch to "CW-T" without connecting the key to the key jack, then read out the frequency. If it differs from the previously recorded frequency, adjust R18 on the main base plate to equalize both frequencies.

Repeat above adjustments to reduce the frequency difference between reception and transmission to under 100Hz.

TRANSMITTING SECTION ADJUSTMENT

1. Measuring Instruments for Adjustment

- * Terminal wattmeter (for about 10W full scale with 50ohm impedance)
- * Frequency counter
- * RF voltmeter
- * AF oscillator
- * AF millivoltmeter
- * Multimeter 20Kohm per volt

2. Final Stage Idle Current Adjustment

Turn the MODE change-over switch to "CW-T" without connecting the key to the key jack.

Remove the solder of C123 and W25, and connect the multimeter, which is set at 100mA range, between these points. Adjust R70 so that the current becomes 30mA.

After the adjustment, solder the leads of C123 and W25.

3. Coils Adjustment

Connect the wattmeter to the external antenna socket, and set the transmit/receive frequency at "50.5Hz".

With the MODE change-over switch turned to "CW-T", connect the key to the key jack and hold down the key, connect the RF voltmeter probe to Q13 base and adjust the cores of L13-L17 alternately for a maximum voltmeter reading.

4. Driving and Final Stage Adjustment

Make sure that the power voltage is 13.8V under the same condition as in 3, then fully turn the R65 rotor toward ground (opposite to panel face) and adjust L18, L19, C126, C127, C137 and C138 so that the watt meter indicates maximum (over 3W).

After this adjustment, adjust R65 so that the wattmeter indicates 3W.

Set multimeter to volt range and connect to check part R105.

Readjust L13-L19 cores for maximum indication.

5. RF Meter Adjustment

Move D20 with respect to L24(coupling) so that the meter indicates about 90% of full scale when the output is 3W at the completion of adjustment 4.

6. Carrier Frequency Adjustment

In the receive condition, connect the frequency counter to the R43 check-point, and adjust C57 so that the frequency becomes 13.997MHz. At this time, make sure that if the MODE change-over switch is turned to "CW-T", the frequency shifts about 1KHz upward. Then turn the MODE change-over switch to "REC" and connect the AF oscillator to the check point.

Ground the mike plug socket pin No.2 for SSB transmission, and set the AF oscillator oscillation frequency at 1.5KHz and adjust the output level so that transmission output is 2.5W. Keeping this output level unchanged, alternately change the audio oscillator frequency from 300Hz to 3KHz, and fine adjust C57 to equalize the transmission outputs.

7. **Mike Gain Adjustment**

Connect the AF oscillator between the mike plug socket pins No.1 and No.4 (toward ground) and set its frequency at 1.5KHz and output level at 6mV.

Ground the mike plug socket pin No.2 and connect the AF millivoltmeter (300mV range) to the R57 check point and adjust R4 so that the meter reads 150mV.

This adjustment can be slightly changed according to the use of microphone, strength of voice, condition of etc. Observation of a high frequency oscilloscope set to observe the output carrier would be helpful while using normal microphone procedures in order to achieve optimum waveform and quality.

RECEIVING SECTION ADJUSTMENT

1. **Measuring Instruments for Adjustment**

- * Standard signal generator (for 50MHz band)
- * AF millivoltmeter
- * Multimeter

2. **Sensitivity Adjustment**

With the receiving frequency set at 50.5MHz and the volume (vol) knob in a reasonable volume position, connect the standard signal generator to the antenna connector and the AF millivoltmeter (1V range) to the AF output terminals J3 and J4 (toward ground).

3. **S Meter Adjustment**

Adjust R46 so that the S meter indicates zero in the non-signal condition. Next, with the signal generator output level set at 90dB (μ V), adjust the frequency to the receiving frequency, and adjust R47 so that the S meter indicates full scale. After this adjustment is finished, lower the signal generator output level, and make sure that the signal generator output is within a range of 0dB \pm 3dB when the S meter indicates S5.

4. **Noise Blanker Adjustment**

Set the signal generator output level at about 30dB (μ V), and adjust the frequency to the receiving frequency. Making sure that beat is generated from the speaker, connect the multimeter (0.3V range) to the R36 check-point, and gradually lower the signal generator output level and adjust L21's core to a point where the tester indication is maximum.

Never transmit during this adjustment because it might burn out the signal generator attenuators.

Keeping the standard signal generator unmodulated, set the output level at about 1μ V + 30dB and adjust the generator frequency to the receiving frequency. As a beat is heard from the speaker, fine-adjust the signal generator frequency or receiving frequency so that the beat becomes about 1000Hz. Try to keep the beat at this frequency during the adjustment.

Next, adjust L1-L10 cores successively to maximize the AF millivoltmeter indication, and if the AF millivoltmeter becomes full-scale, lower the signal generator output level without converting the meter range or turning the volume knob, etc.

Repeat the adjustment until the AF millivoltmeter indicates over 800mV with the volume knob at maximum and S+N/N becomes over 10dB when the signal generator output level is -10dB (μV).

SECTION VIII INSIDE VIEW

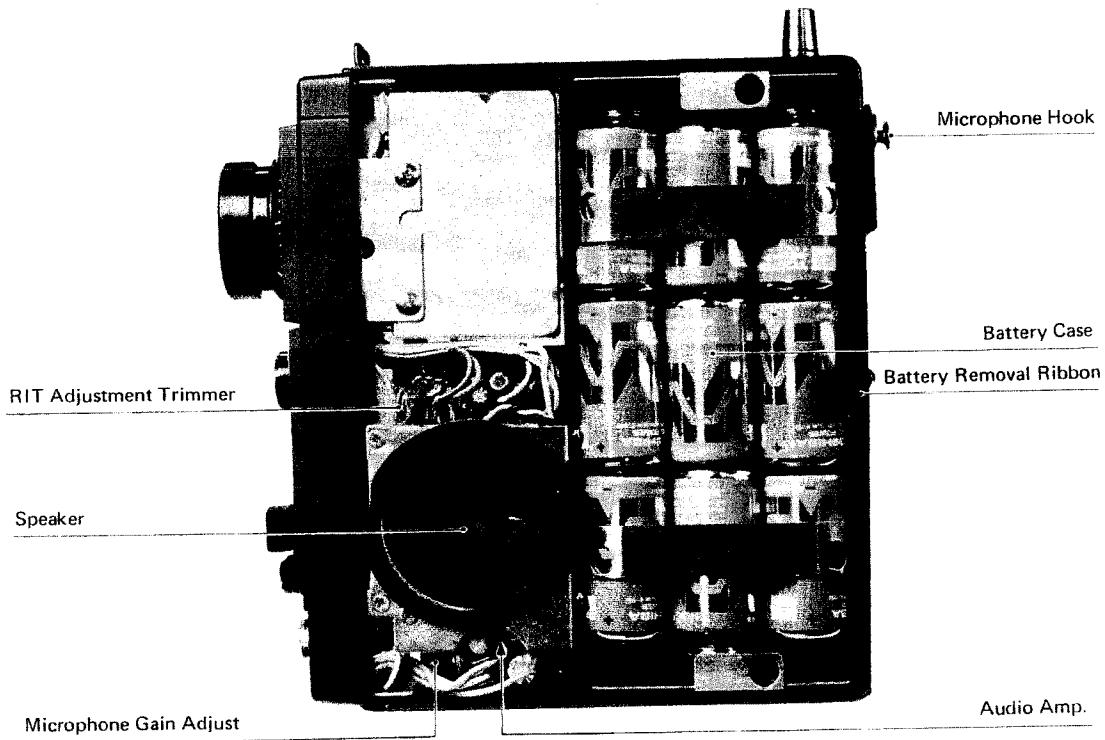
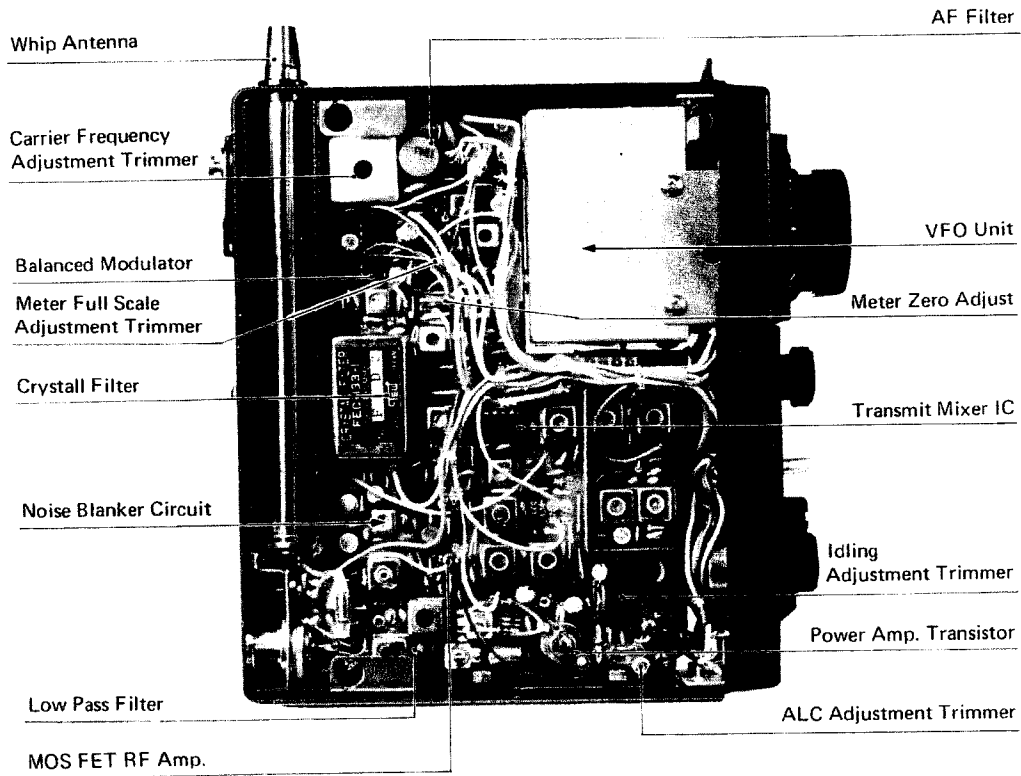

SECTION IX BLOCK DIAGRAM

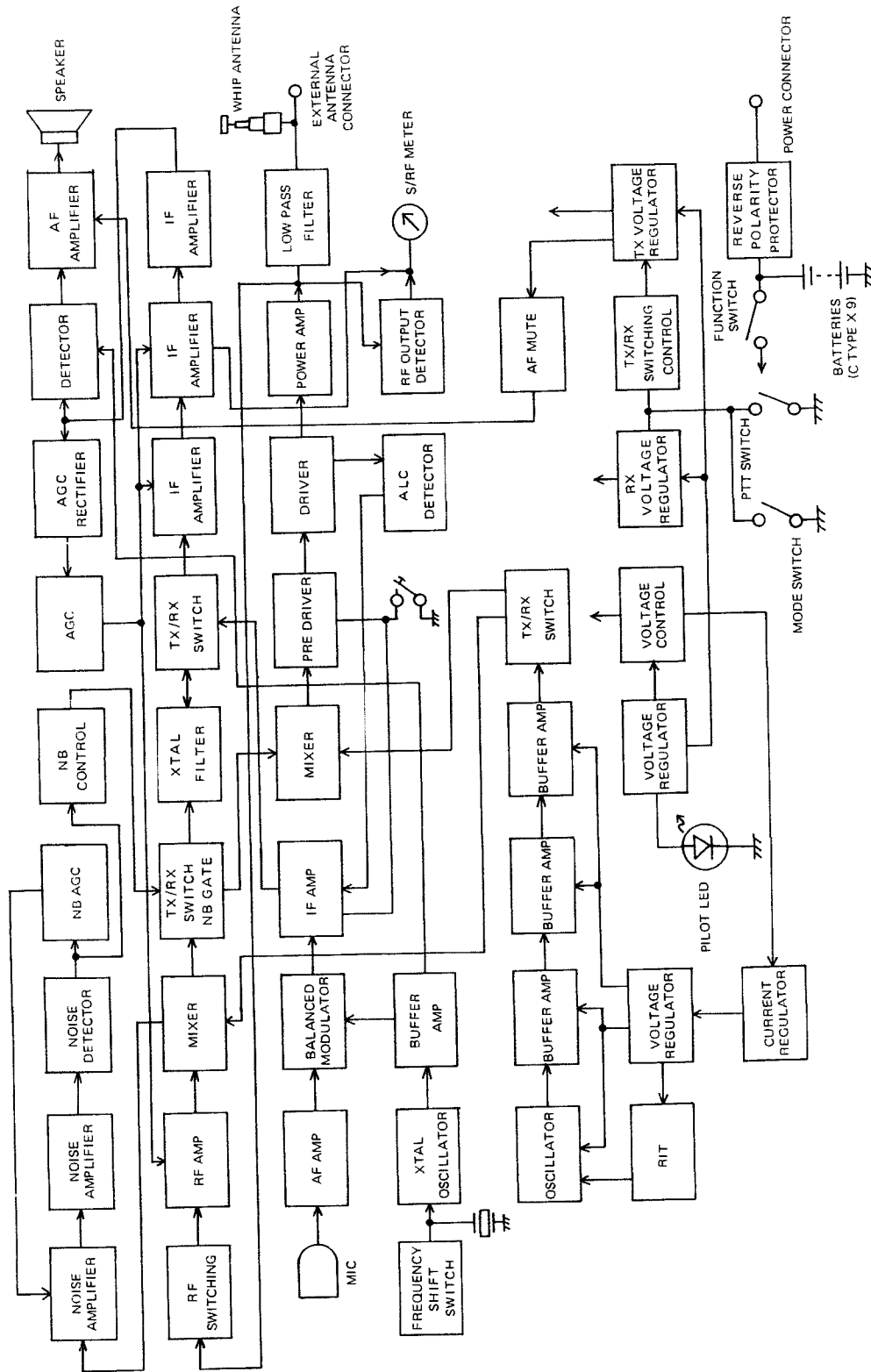

SECTION X PARTS LIST

MAIN		
Q1	Transistor	2SA750 (1)
Q2	Transistor Field Effect	MEM616-Y
Q3	Field Effect Transistor	2SK19-Y
Q4	Field Effect Transistor	MEM616-Y
Q5	Field Effect Transistor	MEM616-B
Q6	Transistor	2SC945-P
Q7	Transistor	2SC945-P
Q8	Transistor	2SC945-P
Q9	Transistor	2SC945-P
Q10	Transistor	2SC945-P
Q11	Transistor	2SC945-S
Q12	FET	2SK49 Hz
Q13	Transistor	2SC383
Q14	Transistor	2SC730
Q15	Transistor	2SC1947
IC1	Integrated Circuits	LA1221
IC2	Integrated Circuits	LA1221
IC3	Integrated Circuits	LA1221
IC4	Integrated Circuits	SN76514N
IC5	Integrated Circuits	SN76514N
D1	Diode	1SS53
D2	Diode	1SS53
D3	Diode	1SS53
D4	Diode	1SS53
D5	Diode	IN60
D6	Diode	IN60
D7	Diode	IN60
D8	Diode	IN60
D9	Diode	IN60
D11	Diode	IN60
D12	Diode	1S2473
D13	Diode	1S2473
D14	Diode	1S2473
D15	Diode	IN60
D16	Diode	1S1555
D17	Diode	1S1555
D18	Diode	1S2473
D19	Diode	IN60
D20	Diode	IN60
D21	Diode	MI301
D22	Diode	1SS53
D23	Diode	1SS53
D24	Diode	WZ 056
FL1	Xtal Filter	FEC-1331 13.9985MHz
X1	Xtal	HC18/U 13.997MHz
L1	Coil	LS-41A
L2	Coil	LS-50
L3	Coil	LS-50
L4	Coil	LS-50

L5	Coil	LS-56
L6	Coil	LS-56
L7	Coil	LS-66
L8	Coil	LS-66
L9	Coil	LS-66
L10	Coil	LS-68
L11	Coil	L104 Choke
L12	Coil	L101 Choke
L13	Coil	LS-67
L14	Coil	LS-67
L15	Coil	LS-78
L16	Coil	LS-50
L17	Coil	LS-50
L18	Coil	LS-50
L19	Coil	LS-50
L20	Coil	LR-8
L21	Coil	LS-56
L22	Coil	LA-3
L23	Coil	L101 Choke
L24	Coil	LA-24
L25	Coil	LA-96
L26	Coil	LA-96
R46	Trimmer	1K ohm FR10B
R47	Trimmer	5K ohm FR10B
R65	Trimmer	100K ohm FB10B
R70	Trimmer	500 ohm FR10B
C1	Ceramic Capacitor	0.01u Farad 50V
C2	Ceramic Capacitor	35p Farad 50V
C3	Ceramic Capacitor	0.01u Farad 50V
C4	Ceramic Capacitor	0.001u Farad 50V
C5	Ceramic Capacitor	0.01u Farad 50V
C6	Ceramic Capacitor	0.01u Farad 50V
C7	Ceramic Capacitor	10p Farad 50V
C8	Ceramic Capacitor	0.01u Farad 50V
C9	Ceramic Capacitor	10p Farad 50V
C10	Ceramic Capacitor	0.5p Farad 50V
C11	Ceramic Capacitor	0.5p Farad 50V
C12	Ceramic Capacitor	10p Farad 50V
C13	Ceramic Capacitor	0.011u Farad 50V
C14	Ceramic Capacitor	25p Farad 50V
C15	Ceramic Capacitor	0.01u Farad 50V
C16	Ceramic Capacitor	3p Farad 50V
C17	Ceramic Capacitor	25p Farad 50V
C18	Ceramic Capacitor	0.001u Farad 50V
C19	Ceramic Capacitor	0.01u Farad 50V
C20	Ceramic Capacitor	0.001u Farad 50V
C21	Ceramic Capacitor	0.01u Farad 50V
C22	Ceramic Capacitor	0.01u Farad 50V
C23	Ceramic Capacitor	0.01u Farad 50V
C24	Ceramic Capacitor	0.01u Farad 50V
C25	Ceramic Capacitor	0.01u Farad 50V
C26	Ceramic Capacitor	68p Farad 50V
C27	Ceramic Capacitor	0.001u Farad 50V
C28	Ceramic Capacitor	0.01u Farad 50V

C29	Ceramic Capacitor	0.01u Farad 50V
C30	Ceramic Capacitor	60p Farad 50V
C31	Ceramic Capacitor	0.01u Farad 50V
C32	Ceramic Capacitor	0.001u Farad 50V
C33	Ceramic Capacitor	0.01u Farad 50V
C34	Ceramic Capacitor	0.01u Farad 50V
C35	Ceramic Capacitor	0.01u Farad 50V
C36	Ceramic Capacitor	30p Farad 50V
C37	Ceramic Capacitor	0.01u Farad 50V
C38	Ceramic Capacitor	100p Farad 50V
C39	Ceramic Capacitor	60p Farad 50V
C40	Ceramic Capacitor	68p Farad 50V
C41	Ceramic Capacitor	0.01u Farad 50V
C42	Ceramic Capacitor	0.01u Farad 50V
C43	Milar	0.056u Farad 50V
C44	Milar	0.056u Farad 50V
C45	Semiconductive Capacitor	0.2u F 12V
C46	Ceramic Electrolytic	0.01u Farad 50V
C47	Electrolytic Capacitor	1uF/50V
C48	Ceramic	0.001u Farad 50V
C49	Ceramic	0.01u Farad 50V
C50	Ceramic	25p Farad 50V
C51	Ceramic	0.01u Farad 50V
C52	Ceramic	50p Farad 50V
C53	Ceramic	50p Farad 50V
C54	Ceramic	0.001u Farad 50V
C55	Ceramic	0.01u Farad 50V
C56	Ceramic	0.01u Farad 50V
C57	Trimmer	CVO 50 180
C58	Ceramic	15p Farad 50V
C59	Ceramic	25p Farad 50V
C60	Ceramic	68p Farad 50V
C61	Stycon	200p Farad 50V
C62	Stycon	100p Farad 50V
C63	Ceramic	0.01u Farad 50V
C64	Ceramic	50p Farad 50V
C65	Ceramic	35p Farad 50V
C66	Electrolytic Capacitor	4.7uF/25V
C67	Ceramic	0.01u Farad 50V
C68	Electrolytic Capacitor	1uF/50V
C69	Ceramic	0.01u Farad 50V
C70	Ceramic	0.001u Farad 50V
C71	Electrolytic Capacitor	4.7uF/25V
C72	Ceramic	0.01u Farad 50V
C73	Electrolytic Capacitor	10uF/16V
C74	Ceramic	0.01u Farad 50V
C75	Ceramic	0.01u Farad 50V
C76	Ceramic	25p Farad 50V
C77	Ceramic	0.01u Farad 50V
C78	Electrolytic Capacitor	10uF/16V
C79	Ceramic	0.001uF 50V
C80	Ceramic	0.01u F 50V
C81	Ceramic	0.01u F 50V
C82	Ceramic	0.01u F 50V
C83	Ceramic	0.01u F 50V
C84	Ceramic	25p F 50V

C85	Ceramic	0.001uF 50V
C86	Ceramic	0.01u F 50V
C87	Ceramic	0.01u F 50V
C88	Ceramic	0.001u F 50V
C89	Ceramic	0.01u F 50V
C90	Ceramic	10p F 50V
C91	Ceramic	0.01u F 50V
C92	Ceramic	50p F 50V
C93	Ceramic	8p F 50V
C94	Ceramic	0.35p F 50V
C95	Ceramic	10p F 50V
C96	Ceramic	68p F 50V
C97	Ceramic	0.01u F 50V
C98	Ceramic	0.01u F 50V
C99	Ceramic	0.01u F 50V
C100	Ceramic	10p F 50V
C101	Ceramic	0.01u F 50V
C102	Ceramic	1p F 50V
C103	Ceramic	7p F 50V
C104	Ceramic	50p F 50V
C105	Electrolytic Capacitor	10uF/16V
C106	Electrolytic Capacitor	10uF/16V
C107	Ceramic	0.01u F 50V
C108	Ceramic	0.01u Farad 50V
C109	Ceramic	0.01u Farad 50V
C110	Ceramic	0.04u Farad 50V
C111	Ceramic	0.01u Farad 50V
C112	Electrolytic Capacitor	0.47uF/50V
C113	Feed Through Ceramic	1000p F 50V
C114	Ceramic	15p 50V
C115	Ceramic	0.01u F 50V
C116	Ceramic	0.01u 50V
C117	Electrolytic Capacitor	10uF/16V
C118	Ceramic	0.01u F 50V
C119	Ceramic	0.01u F 50V
C120	Ceramic	60p F 50V
C121	Ceramic	0.01u F 50V
C122	Electrolytic Capacitor	10uF/16V
C123	Feed Through Ceramic	1000pF 50V
C124	Ceramic	0.01u F 50V
C125	Ceramic	15p F 50V
C126	Trimmer	CVE-50-11
C127	Trimmer	CVE-50-11
C128	Ceramic	0.01u F 50V
C129	Ceramic	0.01u F 50V
C130	Ceramic	40p F 50V
C131	Ceramic	20p F 50V
C132	Ceramic	40p F 50V
C133	Ceramic	40p F 50V
C134	Ceramic	7p F 50V
C135	Ceramic	0.5p F 50V
C136	Ceramic	50p F 50V
C137	Ceramic	200p F 50V
C138	Ceramic	0.04 F 50V
C139	Ceramic	0.001 F 50V

AMP		
Q1	Transistor	2SD355-E
Q2	Transistor	2SC945-P
Q3	Transistor	2SD355-E
Q4	Transistor	2SC1209-E
IC1	Integrated Circuits	uPC575C2
IC2	Integrated Circuits	BA-301
D1	Diode	1S2473
D2	Diode	1S2473
D3	Diode	XZ-076
D4	Diode	1S2473
D5	Diode	1S2473
D6	Diode	1S2473
D7	Diode	1S2473
D8	Diode	IN60
D9	Diode	1S1555
R4	Trimmer	500 ohm FR10
R18	Trimmer	10K ohm FR10
C1	Electrolytic Capacitor	1uF/16V
C2	Electrolytic Capacitor	4.7uF/16V
C3	Electrolytic Capacitor	47uF/16V
C4	Ceramic	0.001uF 50V
C5	Ceramic	0.001uF 50V
C6	Chemical Condenser	10u 16V
C7	Ceramic Condenser	0.2uF 12V
C8	Ceramic	0.04uF 50V
C9	Ceramic	0.01uF 50V
C10	Milar	0.002uF 50V
C11	Chemical Condenser	100u 10V
C12	Electrolytic Capacitor	10uF/16V
C13	Electrolytic Capacitor	47uF/6.3V
C14	Ceramic	500p F 50V
C15	Chemical Condenser	47u 16V
C19	Ceramic	0.01u F 50V
C20	Ceramic	0.01u F 50V
C21	Electrolytic Capacitor	10u F/16V
C22	Electrolytic Capacitor	10uF/16V
C23	Ceramic	0.01u F 50V
C24	Electrolytic Capacitor	4.2 u F/15V
VFO		
Q1	Transistor	MK10-2
Q2	Transistor	MK10-2
Q3	Transistor	2SC7100
Q4	Transistor	2SC7100
Q5	FET	2SK19BL
D1	Variable Capacitants	IS2688C
D2	Zenier Diode	WZ056
L1	Coil	LB-33A
L2	Choke Coil	L100
L3	Choke Coil	L101
L4	Choke Coil	L101

L5	Coil	LS-76
C1	Ceramic Condenser	30PF SH 50V
C2	Variable Capacitor	521C119
C3	Trimmer Condenser	TM1116-507
C4	Ceramic Condenser	10PE PH 50V
C5	Ceramic Condenser	10PF LH 50V
C6	Ceramic Condenser	3PF CH 50V
C7	Ceramic Condenser	40PF CH 50V
C8	Ceramic Condenser	40PF CH 50V
C9	Ceramic Condenser	.01uF 50V
C10	Ceramic Condenser	.01uF 50V
C11	Ceramic Condenser	.01uF 50V
C12	Ceramic Condenser	100PF CH 50V
C13	Ceramic Condenser	100PF CH 50V
C14	Ceramic Condenser	.01uF 50V
C15	Ceramic Condenser	2PF 50V
C16	Ceramic Condenser	5PF 50V
C17	Electrolytic Condenser	33uF 10V
C18	Ceramic Condenser	.01 uF 50V
C19	Ceramic Condenser	100PF 50V
C20	Ceramic Condenser	.01uF 50V
C21	Ceramic Condenser	.01uF 50V
C22	Ceramic Condenser	.01uF 50V
C23	Electrolytic Condenser	33uF 10V
C24	Ceramic Condenser	.001uF 50V
C25	Feed Through Condenser	.001uF TF342-2
C26	Feed Through Condenser	9PF UBC306SL
C27	Feed Through Condenser	.001uF TF342-2
C28	Feed Through Condenser	
C29	Ceramic	45P 50V
C30	Ceramic	10P 50V
C31	Ceramic	45P 50V

SECTION XI VOLTAGE CHART

Unit	Q No.	Mode	Transistor			F E T				Remarks
			(B)	(C)	(E)	(G1)	(G2)	(D)	(S)	
Main	Q1	R	8.2	8.9	8.9					NB-ON NB-ON CW-T
	Q1	T	0	0	0					
	Q2	R				0	4.8	9.0	0.3	
	Q3	R				0		9.0	1.5	
	Q4	R				0	4.2	8.8	0.4	
	Q5	R				0	5.4	8.8	0.65	
	Q6	R		6	0					
	Q7	R		0.005	2	0				
	Q8	R		0.7	0	E				
	Q8	T		0	0	E				
	Q9	R		5.0	7.0	4.4				
	Q10	R		4.4	7.0	3.8				
	Q11	R		0.05	E	0				
	Q11	T		0.05	E	0				
	Q12						0	8.1	8.1	
Q13	R		0	13.2	0					
Q13	T		1.0	13.0	0.3					
Q14	R		0	13.2	E					
Q14	T		0.7	13.2	E					
Q15	R		0	13.2	E					
Q15	T		0.7	13.2	E					
Amp Unit	Q1	R	9.9	12.2	9.2					
	Q1	T	0	13.0	0					
	Q2	R	0.65	0	E					
	Q2	T	0.23	9.8	E					
	Q3	R	0	13.2	0					
	Q3	T	9.8	11.3	9.2					
Q4	R	9.3	12.2	8.7						
VFO Unit	Q1	R				0		5.6	1.45	
	Q2	R				0		5.0	1.76	
	Q3	R	1.6	8.9	2.78					
	Q4	R	2.78	7.0	2.4					
	Q5	R				5.6		8.9	6.6	

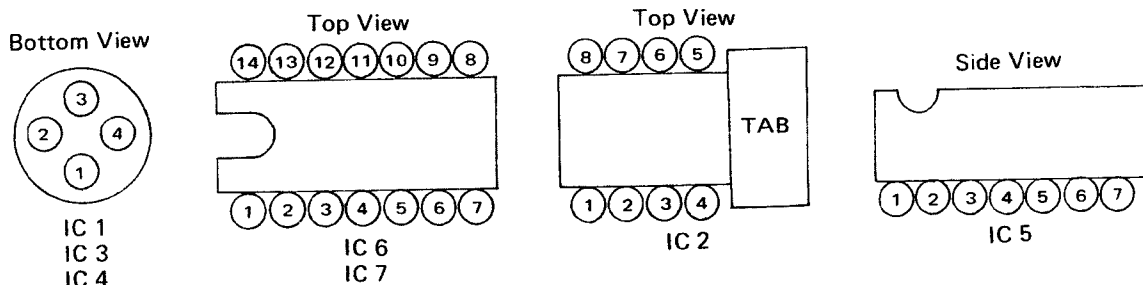

Unit	IC No.	Mode	Pin No.													
			1	2	3	4	5	6	7	8	9	10	11	12	13	14
Main	IC1	R	9.3	9.3	2.05	E										
	IC2	R	6.6	9.3	2.05	E										
	IC3	R	9.3	9.3	2.05	E										
	IC4	T	0	8.8	7.8	4.5	2.9	E	E	E	2.9	4.5	4.5	4.5	7.8	E
	IC5	T	0	8.4	6.0	5.5	4.2	E	E	E	4.7	5.4	5.5	5.5	6.0	E
Amp Unit	IC1	R	E	8.8	7.1	6.1	3.9	E	E	E	3.9	6.1	6.1	6.1	E	
	IC1	T	1.4	13.0	12.3	7.3	6.1	13.0	0.21	1.7						
	IC2	T	1.5	13.0	12.8	0	0.55	13.0	0	4.8						
			1.8	0.5	0.035	E	0.58	7.5	9.2							

Note: E = Ground