



INSTRUCTION MANUAL

VHF/UHF DIGITAL TRANSCEIVER

IC-E80D

Icom Inc.





FOREWORD

Thank you for purchasing this fine Icom product. We understand you have a choice of many different radios in the market place. Many hours of research and development went into the design of your IC-E80D, following Icom's philosophy of "technology first."

The IC-E80D VHF/UHF DIGITAL TRANSCEIVER is designed with Icom's superior technology and craftsmanship combining traditional analog technologies with the new digital technology, Digital Smart Technologies for Amateur Radio (D-STAR), for a balanced package.

With proper care, this product should provide you with years of trouble-free operation. We want to take a couple of moments of your time to thank you for making your IC-E80D your radio of choice, and hope you agree with Icom's philosophy of "technology first."

EXPLICIT DEFINITIONS

WORD	DEFINITION
 DANGER!	Personal death, serious injury or an explosion may occur.
 WARNING!	Personal injury, fire hazard or electric shock may occur.
CAUTION	Equipment damage may occur.
NOTE	Recommended for optimum use. No risk of personal injury, fire or electric shock.

FEATURES

- *DV mode (Digital voice + Low-speed data communication) operation-ready*
 - *Text message and call sign exchange*
 - *Transmitting position data with a GPS receiver*
- *GPS receiver connectable*
 - *Optional HM-189GPS is required*
- *DR (D-STAR Repeater) mode and repeater list allow you to operate a D-STAR repeater simply*
- *Splash-resistant construction (IPX4*)*
 - *Only when the supplied battery pack (or optional battery case), antenna and jack cover are attached.

IMPORTANT

READ ALL INSTRUCTIONS carefully and completely before using the transceiver.

SAVE THIS INSTRUCTION MANUAL— This instruction manual contains important operating instructions for the IC-E80D.

PRECAUTIONS

⚠ WARNING RF EXPOSURE! This device emits Radio Frequency (RF) energy. Caution should be observed when operating this device. If you have any questions regarding RF exposure and safety standards please refer to the Federal Communications Commission Office of Engineering and Technology's report on Evaluating Compliance with FCC Guidelines for Human Radio Frequency Electromagnetic Fields (OET Bulletin 65)

⚠ WARNING! NEVER hold the transceiver so that the antenna is very close to, or touching exposed parts of the body, especially the face or eyes, while transmitting. The transceiver will perform best if the microphone is 5 to 10 cm away from the lips and the transceiver is vertical.

⚠ WARNING! NEVER operate the transceiver with an earphone, headphones or other audio accessories at high volume levels. Hearing experts advise against continuous high volume operation. If you experience a ringing in your ears, reduce the volume level or discontinue use.

⚠ WARNING! NEVER operate the transceiver while driving a vehicle. Safe driving requires your full attention—anything less may result in an accident.

NEVER connect the transceiver to a power source of more than 16 V DC. This will ruin the transceiver.

NEVER connect the transceiver to a power source using reverse polarity. This will ruin the transceiver.

DO NOT operate the transceiver near unshielded electrical blasting caps or in an explosive atmosphere.

DO NOT push the PTT unless you actually intend to transmit.

BE CAREFUL! The transceiver will become hot when operating it continuously for long periods.

DO NOT use or place the transceiver in direct sunlight or in areas with temperatures below -20°C or above $+60^{\circ}\text{C}$.

Place the unit in a secure place to avoid inadvertent use by children.

DO NOT use harsh solvents such as benzene or alcohol to clean the transceiver, because they can damage the transceiver's surfaces.

PRECAUTIONS

KEEP away from heavy rain, and never immerse the IC-E80D in the water. The transceiver meets IPX4* requirements for splash resistance. However, once the transceiver has been dropped, splash resistance cannot be guaranteed because of possible damage to the transceiver's case or waterproof seal.

*Only when the supplied battery pack (or optional battery case), antenna and jack cover are attached.

NEVER operate or touch the transceiver with wet hands. This may result in an electric shock or may damage the transceiver.

Even when the transceiver power is OFF, a slight current still flows in the circuits. Remove the battery pack or batteries from the transceiver when not using it for a long time. Otherwise, the installed battery pack or batteries will become exhausted, and will need to be recharged or replaced.

• Important notes when using GPS receiver

Please do not use the HM-189GPS close to the transceiver's antenna. The transmit signal may cause GPS receiver malfunction.

Icom, Icom Inc. and the Icom logo are registered trademarks of Icom Incorporated (Japan) in the United States, the United Kingdom, Germany, France, Spain, Russia and/or other countries.

Microsoft, Windows and Windows Vista are registered trademarks of Microsoft Corporation in the United States and/or other countries.

SUPPLIED ACCESSORIES

The following accessories are supplied with the transceiver.

- ① Hand strap 1
- ② Antenna 1
- ③ Battery pack (BP-217) 1
- ④ Belt clip 1
- ⑤ Battery charger (BC-167ND)* 1

* Not supplied with some versions.

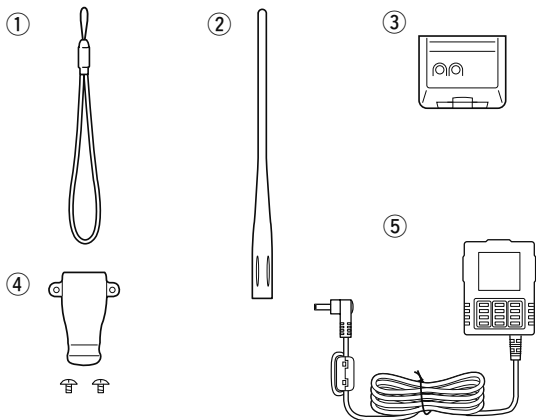

TABLE OF CONTENTS

FOREWORD	i
EXPLICIT DEFINITIONS	i
FEATURES	i
IMPORTANT	i
PRECAUTIONS	ii, iii
SUPPLIED ACCESSORIES	iv
TABLE OF CONTENTS	v–vii

1 ACCESSORY ATTACHMENT 1–2

■ Antenna	1
■ Belt clip	1
■ Hand strap	2
■ Battery pack	2

2 PANEL DESCRIPTION 3–9

■ Front, top and side panels	3
■ Function display	8

3 BATTERY CHARGING 10–15

■ Caution	10
■ Regular charging	12
■ Rapid charging	13
■ Optional battery case	14
■ Battery information	14
■ External DC power operation	15

4 BASIC OPERATION 16–28

■ Power ON	16
■ Setting audio volume	16

■ Setting squelch level	17
■ Monitor function	17
■ Mode selection	18
■ [DIAL] function assignment	20
■ Operating band selection	20
■ Setting a tuning step	22
■ Setting a frequency	22
■ Lock function	24
■ Receiving	24
■ Operating mode selection	25
■ Attenuator function	25
■ Transmitting	26
■ Transmit power selection	27
■ TV channel operation	27

5 REPEATER AND DUPLEX OPERATIONS 29–33

■ Repeater operation	29
■ Accessing a repeater	30
■ Duplex operation	32
■ 1750 Hz tone	33

6 DV MODE PROGRAMMING 34–46

■ About the D-STAR system	34
■ Call sign programming	36
■ Repeater list	39
■ Repeater list programming	40
■ Changing a repeater list	45
■ Clearing a repeater list	46

TABLE OF CONTENTS

7 DV MODE OPERATION.....47–76	<ul style="list-style-type: none"> ■ Digital mode operation.....47 ■ Current call sign setting.....47 ■ Receiving a D-STAR repeater.....48 ■ Received call sign.....49 ■ Copying the call sign.....51 ■ DR (D-STAR Repeater) mode operation.....53 ■ Calling CQ.....54 ■ Calling a specific station.....56 ■ Simplex operation in the VFO.....60 ■ Repeater operation in the VFO.....62 ■ Message operation.....68 ■ Automatic reply function.....70 ■ EMR communication.....71 ■ Break-in communication.....72 ■ Low-speed data communication.....74 ■ Other function in the DV mode.....76
8 GPS/GPS-A OPERATION77–90	<ul style="list-style-type: none"> ■ GPS operation.....77 ■ GPS-A operation.....90
9 MEMORY/CALL CHANNELS.....91–101	<ul style="list-style-type: none"> ■ General description.....91 ■ Selecting a memory channel.....92 ■ Selecting a call channel.....93 ■ Memory channel programming.....94 ■ Memory bank setting.....95 ■ Memory bank selection.....96 ■ Programming memory/bank/scan name.....97 ■ Selecting memory/bank name indication.....98 ■ Copying memory/call contents.....99 ■ Memory clearing.....100 ■ Erasing/transferring bank contents.....101
10 SCAN OPERATION102–110	<ul style="list-style-type: none"> ■ Scan types.....102 ■ Full/band/programmed scan.....104 ■ Scan edges programming.....105 ■ Memory scan.....106 ■ Memory bank scan.....107 ■ Skip channel/frequency setting.....108 ■ Scan resume condition.....110
11 PRIORITY WATCH.....111–114	<ul style="list-style-type: none"> ■ Priority watch types.....111 ■ Priority watch operation.....112
12 MENU SCREEN OPERATION.....115–142	<ul style="list-style-type: none"> ■ General.....115 ■ MENU screen indication and arrangement.....116 ■ Items list.....117 ■ DUP/TONE items (DUP.T).....119 ■ Scan items (SCAN).....121 ■ Set mode items (SET).....124 <ul style="list-style-type: none"> □ Function set mode items (FUNC).....124 □ Display set mode items (DISP).....128 □ Sounds set mode items (SOUNDS).....130 ■ DV set mode items (DV SET).....132 ■ GPS mode items (GPS).....136

1
2
3
4
5
6
7
8
9
10
11
12
13
14
15
16
17

TABLE OF CONTENTS

13 OTHER FUNCTIONS	143–159	16 OPTIONS	163–166
■ Programming a DTMF code	143	■ Optional HM-75A REMOTE CONTROL SPEAKER MICROPHONE	164
■ Transmitting a DTMF code	144	■ Optional HM-189GPS GPS SPEAKER MICROPHONE	166
■ Clearing a DTMF memory	145	17 CE	167–168
■ Confirming a DTMF memory	146	INDEX	169–175
■ Setting DTMF transfer speed	146		
■ Tone frequency and DTCS code	147		
■ Digital code and digital call sign setting	148		
■ Tone/DTCS squelch	150		
■ Digital squelch	151		
■ Pocket beep function	151		
■ DTCS polarity setting	152		
■ Tone scan	152		
■ Beep tones	153		
■ Dial speed acceleration	153		
■ Key lock effect	154		
■ Power save	154		
■ Auto power OFF	155		
■ Auto power ON	155		
■ Time-out timer	155		
■ PTT lock	155		
■ Display backlighting	156		
■ LCD contrast	156		
■ Cloning function	157		
■ Resetting	158		
14 TROUBLESHOOTING	160		
15 SPECIFICATIONS	161–162		

■ Antenna

Insert the supplied antenna into the antenna connector and screw down the antenna as shown below.

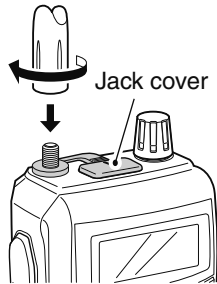

NEVER carry the transceiver by holding the antenna.

KEEP the jack cover attached when jack is not in use to protect the connector from dust and moisture.

✓ *For your information*

Third-party antennas may increase transceiver performance. An optional AD-92SMA ANTENNA CONNECTOR ADAPTER is available to connect an antenna that has a BNC connector.

■ Belt clip

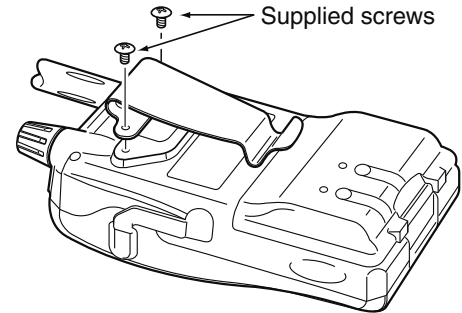

CAUTION:

USE the supplied screws only. Using screws longer than specified could damage the transceiver.

1 ACCESSORY ATTACHMENT

■ Hand strap

To facilitate carrying the transceiver, slide the hand strap through the loop on the top of the belt clip as illustrated below.

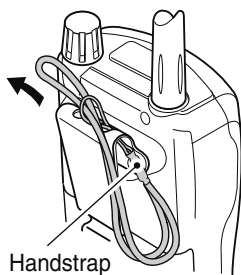

■ Battery pack

Attach the Li-Ion battery pack (BP-217) or battery case (BP-216) as illustrated below.

- Charge the Li-Ion battery pack before use. (pgs. 12, 13)

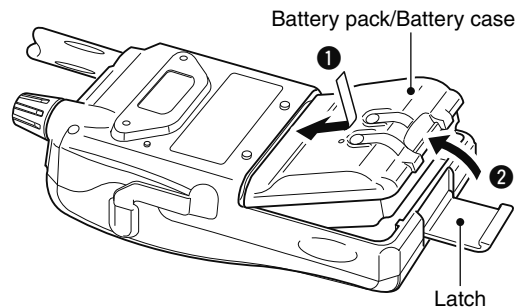

■ Front, top and side panels



1 ANTENNA CONNECTOR (p. 1)

Connects the supplied antenna.

- An optional AD-92SMA adapter (p. 163) is available for connecting an antenna with a BNC connector.

2 PTT SWITCH [PTT]

➤ Push and hold to transmit, release to receive. (p. 26)

- Push briefly, then push and hold to transmit a 1750 Hz tone burst. (p. 33)

3 TX/RX INDICATOR [TX/RX] (pgs. 24, 26)

Lights green while receiving a signal or when the squelch is open; lights red while transmitting.

4 SQUELCH KEY [SQL] (p. 17)

➤ Push and hold to open the squelch temporarily and monitor the operating frequency.

- While pushing and holding this key, rotate [DIAL] to adjust the squelch level.

5 MENU • LOCK KEY [MENU] (p. 115)

➤ Push to enter menu screen indication ON and OFF. (p. 115)

- Pushing [V/MHz] also exits from menu screen.

➤ Push and hold for 1 sec. to toggle the lock function ON and OFF. (p. 24)

6 POWER KEY [PWR]

Push and hold for 1 sec. to turn the transceiver power ON and OFF. (p. 16)

2 PANEL DESCRIPTION

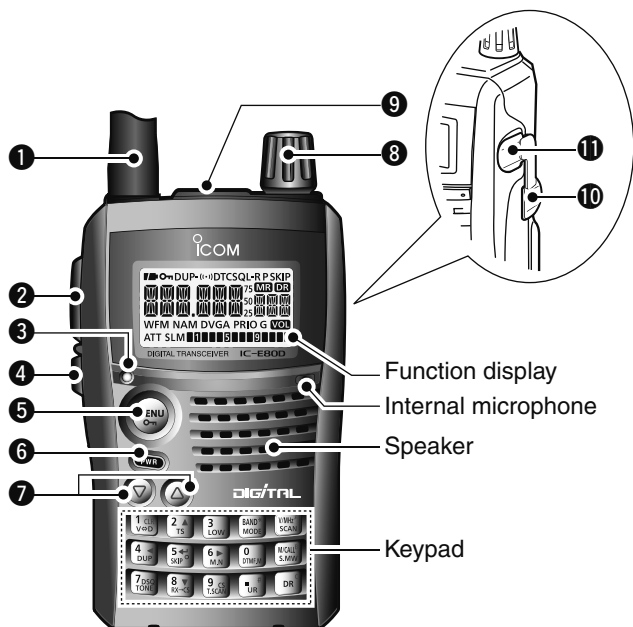

⑦ VOLUME CONTROL KEY [Δ]/[∇]

- ➔ Adjust audio volume level. (p. 16)
- ➔ [Δ] enters or sends the DTMF code 'D.' (pgs. 143–145)

⚡ The function of tuning control and volume control can be traded. See page 20 for details.

⑧ CONTROL DIAL [DIAL]

- ➔ Rotate to tune the operating frequency. (p. 22)
- ➔ During memory mode, rotate to select the memory channel. (pgs. 18, 92)
- ➔ While scanning, changes the scanning direction. (pgs. 53, 104, 106, 107)
- ➔ While pushing and holding [SQL], sets the squelch level. (p. 17)
- ➔ After pushing [BAND] during memory mode operation, selects the programmed bank. (p. 96)
- ➔ During menu screen operation, rotate to select the set items or values. (p. 115)

⚡ The function of tuning control and volume control can be traded. See page 20 for details.

⑨ EXTERNAL SPEAKER/MICROPHONE JACK [SP/MIC]

Connect a cloning cable, optional speaker microphone or headset, if desired.

See page 163 for a list of available options.

⚡ Be sure to turn power OFF before connecting/disconnecting optional equipment to/from the [SP/MIC] jack.

⑩ EXTERNAL DC IN JACK [DC IN]

- ➔ Connects the supplied wall charger, BC-167ND, to charge the attached battery pack. (p. 12)
- ➔ Connect an external DC power supply through the optional CP-12L, CP-19R or OPC-254L for external DC operation. (p. 15)

⑪ DATA JACK [DATA] (pgs. 74, 77, 157)

Connects a PC through the optional data communication cable, OPC-1529R, for low-speed data communication in the DV mode or cloning operation. The jack and cable are also used to connect a GPS receiver.

◇ KEYPAD



- ➔ Push to input numeral for frequency input, memory channel selection, etc.
- ➔ Push to enter or send the DTMF code. (pgs. 143–145)

1 • VOLUME/DIAL KEY [1] • [V⇔D](1)



- ➔ Numeral input and DTMF code: ‘1’
- ➔ Push and hold for 1 sec. to exchange the assigned functions between [DIAL] and [Δ]/[▽]. (p. 20)

2 • TUNING STEP KEY [2] • [TS](2)



- ➔ Numeral input and DTMF code: ‘2’
- ➔ Push and hold for 1 sec. to enter tuning step set mode. (p. 22)
- ➔ During menu screen operation or select memory write mode, push to select the set items or values. (p. 115)

3 • OUTPUT POWER KEY [3] • [LOW](3)



- ➔ Numeral input and DTMF code: ‘3’
- ➔ Push and hold for 1 sec. to select the output power. (p. 27)
 - Selects the transmit output power from high, mid, low and S-low.
 - While pushing and holding this key, [DIAL] rotation selects the output power.

4 • DUPLEX KEY [4] • [DUP](4)



- ➔ Numeral input and DTMF code: ‘4’
- ➔ Push and hold for 1 sec. to select minus duplex, plus duplex, and simplex operation. (p. 32)
 - “DUP-” (minus duplex), “DUP” (plus duplex) and no indication (simplex) appear in order.
 - While pushing and holding this key, [DIAL] rotation selects the duplex operation.
- ➔ During menu screen operation, push to select the upper layer. (p. 115)

2 PANEL DESCRIPTION

5 • SKIP KEY [5] • [SKIP](5)



- ➔ Numeral input and DTMF code: '5'
- ➔ Push and hold to turn the frequency skip function ON and OFF in the VFO mode, or set the memory channel as the following skip channel in memory mode in order. (pgs. 102, 108, 109)
 - "SKIP" appears when memory skip, "PSKIP" appears when frequency skip and no indication appears when non skip channel is set.
 - While pushing and holding this key, [DIAL] rotation selects the skip condition.
- ➔ During menu screen operation, push to enter or exit to/from the selected set items, etc. (p. 115)

6 • MEMORY NAME KEY [6] • [M.N](6)



- ➔ Numeral input and DTMF code: '6'
- ➔ Push and hold for 1 sec. to turn the memory or bank name indication ON and OFF. (p. 98)
 - While pushing and holding this key, [DIAL] rotation selects the memory or bank indication.
- ➔ During menu screen operation, push to select the lower layer. (p. 115)

7 • TONE/DIGITAL SQUELCH KEY

[7] • [TONE](7)/[DSQ](7)



- ➔ Numeral input and DTMF code: '7'
- ➔ During FM/FM-N mode operation, push and hold for 1 sec. to select repeater tone, tone squelch, tone squelch reverse, DTCS squelch, DTCS squelch reverse and no tone operation in sequence. (p. 150)

- Pocket beep function is available for tone squelch and DTCS squelch. (p. 151)

- ➔ During DV mode operation, push and hold for 1 sec. to select digital call sign squelch, digital code squelch and no squelch operation in sequence. (p. 151)

- Pocket beep function is available. (p. 151)

8 • RX CALL SIGN SET KEY [8] • [RX→CS](8)



- ➔ Numeral input and DTMF code: '8'
- ➔ During DV mode operation, push and hold for 1 sec. to set the received call signs (station and repeaters) to current call sign. (p. 50)
- ➔ During menu screen operation or select memory write mode, push to select the set items or values. (p. 115)

9 • TONE SCAN/CALL SIGN KEY

[9] • [T.SCAN](9)/[CS](9)



- ➔ Numeral input and DTMF code: '9'
- ➔ During FM/FM-N mode operation, push and hold for 1 sec. to start tone scan function. (p. 152)
- ➔ During DV mode operation (including the DR mode operation), push and hold for 1 sec. to enter the current call sign mode. (pgs. 48, 59)

0 • DTMF KEY [0] • [DTMF](0)



- ➔ Numeral input and DTMF code: '0'
- ➔ Push and hold for 1 sec. to select DTMF memory mode. (p. 143)

VFO/MHz • SCAN KEY [V/MHz] • [SCAN](V/MHz)



- ➔ DTMF code: 'A'
- ➔ Push to select the VFO mode. (p. 18)
- ➔ During the VFO mode operation, push to select 1 MHz and 10 MHz tuning steps. (p. 22)
- ➔ Push and hold for 1 sec. to enter scan type selection mode. (pgs. 104, 106, 107)
 - Push again to start the scan.
- ➔ Cancels numeral key input. (p. 23)
- ➔ During menu screen operation or select memory write mode, push to return to previous operating condition. (pgs. 94, 115)

MEMORY/CALL • SELECT MEMORY WRITE KEY [M/CALL] • [S.MW](M/CALL)



- ➔ DTMF code: 'B'
- ➔ Push to select memory mode, call channel and TV channel. (pgs. 18, 19, 27, 92, 93)
- ➔ Push and hold for 1 sec. to enter select memory write mode. (p. 94)

DR (D-STAR REPEATER) KEY [DR]



- ➔ DTMF code: 'C'
- ➔ Push to select the DR mode. (pgs. 19, 53, 54, 56)
- ➔ During DR mode operation, push to enter the access repeater selection.

VOLUME CONTROL (UP) KEY [Δ]



- ➔ DTMF code 'D.'
- ➔ Adjust audio volume level. (p. 16)

BAND • MODE KEY [BAND] • [MODE](BAND)



- ➔ DTMF code: '* (indication: E)'
- ➔ During the VFO mode operation, push to select an operating frequency band. (pgs. 20, 21)
- ➔ During memory mode operation, push to enter memory bank group selection. (p. 96)
- ➔ Push and hold for 1 sec. to select the operating mode. (p. 25)

■ • UR KEY [.] • [UR](.)



- ➔ DTMF code '# (indication: F).'
- ➔ Inputs MHz digit for frequency input.
- ➔ During DV mode operation (including the DR mode operation), push and hold for 1 sec. to enter the station call sign selection mode. (pgs. 60, 61)
 - Rotate [DIAL] to select the call sign.

During other than DV mode operation, pushing and holding this key enters the station call sign selection mode with changing the operating mode to the DV mode.

2 PANEL DESCRIPTION

■ Function display

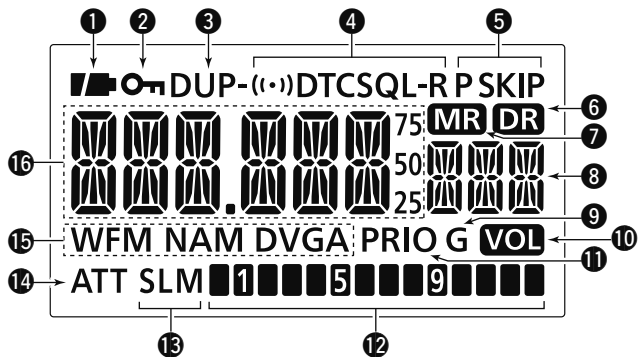

1 BATTERY INDICATOR (pgs. 12, 14)

- ➔ “” (battery indicators) appear when the battery pack is attached.
- ➔ “” appears when the battery cells/pack must be changed/charged.
- ➔ The indicators show “,” “” and “” in sequence while charging the attached battery pack.

2 KEY LOCK INDICATOR (p. 24)

- Appears when the key lock function is activated.

3 DUPLEX INDICATOR (p. 32)

- “DUP” appears when plus duplex, “DUP-” appears when minus duplex is selected.

4 TONE INDICATOR

• While operating in the FM/FM-N mode;

- ➔ “T” appears while the subaudible tone encoder is in use. (p. 30)
- ➔ “T SQL” appears while the tone squelch function is in use. (p. 150)
- ➔ “T SQL-R” appears while the reverse tone squelch function is in use. (p. 150)
- ➔ “DTCS” appears while the DTCS squelch function is in use. (p. 150)
- ➔ “DTCS -R” appears while the reverse DTCS squelch function is in use. (p. 150)
- ➔ “((·))” appears with the “T SQL” or “DTCS” indicator while the pocket beep function (with CTCSS or DTCS) is in use. (p. 151)

• While operating in the DV mode;

- ➔ “D SQL” appears while the digital call sign squelch function is in use. (p. 151)
- ➔ “CSQL” appears while the digital code squelch function is in use. (p. 151)
- ➔ “((·))” appears with the “D SQL” or “CSQL” indicator while the pocket beep function (with digital call sign or digital code squelch) is in use. (p. 151)

5 SKIP INDICATOR

- “SKIP” appears when the selected memory channel is set as a skip channel. (pgs. 108, 109)
- “PSKIP” appears when the displayed frequency is set as a skip frequency in memory mode. (pgs. 108, 109)
- “PSKIP” appears during the frequency skip scan function is ON in the VFO mode. (p. 102)

6 DR (D-STAR REPEATER) INDICATOR

(pgs. 19, 53, 54, 56)
Appears when the DR mode is selected.

7 MEMORY INDICATOR (pgs. 18, 92)

Appears when memory mode is selected.

8 MEMORY CHANNEL NUMBER INDICATOR

- Shows the selected memory channel number. (pgs. 18, 92)
- “C0” or “C1” appears when the call channel is selected. (pgs. 19, 93)
- “TV” appears when the TV channel is selected. (pgs. 19, 27)

9 GPS INDICATOR

- Appears while GPS function is in use.
- GPS indicator can be turned OFF in GPS.SET mode. (p. 137)
 - Stays ON when GPS receiver is connected and a valid position data is received.
 - Blinks when an invalid position data is received.

10 VOLUME INDICATOR (p. 20)

Appears when [DIAL] is assigned volume control, then [△]/[▽] are assigned tuning controls.

11 PRIORITY WATCH INDICATOR (pgs. 112–114)

Appears when priority watch is in use.

12 S/RF METER

- Shows the relative signal strength while receiving signals. (p. 24)
- Shows the output power level while transmitting. (pgs. 26, 27)

13 POWER INDICATOR (p. 27)

- “L” appears when low power is selected.
- “SL” appears when S-low power is selected.
- “M” appears when middle power is selected.
- No indicator appears when high power is selected.

14 ATTENUATOR INDICATOR (p. 25)

Appears when the RF attenuator is in use.

15 OPERATING MODE INDICATOR (p. 25)

- Shows the selected operating mode.
- DV, FM, FM-N, WFM and AM are available, depending on operating band.
 - “DVG” or “DV A” appears when GPS transmission or GPS-A transmission is selected in the DV mode. (p. 138)

16 FREQUENCY READOUT

- Displays a variety of information, such as operating frequency, set mode contents.
 - The decimal point blinks during scan.
- During memory mode operation, the programmed memory or memory bank name is displayed.

■ Caution

Misuse of Lithium-Ion batteries may result in the following hazards: smoke, fire, or the battery may rupture. Misuse can also cause damage to the battery or degradation of battery performance.

- ⚠ **DANGER!** Use and charge only specified Icom battery packs with Icom radios. Only Icom battery packs are tested and approved for use with Icom radios. Using third-party or counterfeit battery packs may cause smoke, fire, or cause the battery to burst.

◇ Battery caution

- ⚠ **DANGER! DO NOT** hammer or otherwise impact the battery. Do not use the battery if it has been severely impacted or dropped, or if the battery has been subjected to heavy pressure. Battery damage may not be visible on the outside of the case. Even if the surface of the battery does not show cracks or any other damage, the cells inside the battery may rupture or catch fire.
 - ⚠ **DANGER! NEVER** use or leave battery pack in areas with temperatures above +60°C. High temperature buildup in the battery, such as could occur near fires or stoves, inside a sun heated car, or in direct sunlight may cause the battery to rupture or catch fire. Excessive temperatures may also degrade battery performance or shorten battery life.
- ⚠ **DANGER! DO NOT** expose the battery to rain, snow, seawater, or any other liquids. Do not charge or use a wet battery. If the battery gets wet, be sure to wipe it dry before using.
 - ⚠ **DANGER! NEVER** incinerate a used battery pack since internal battery gas may cause it to rupture, or may cause an explosion.
 - ⚠ **DANGER! NEVER** solder the battery terminals, or **NEVER** modify the battery pack. This may cause heat generation, and the battery may burst, emit smoke or catch fire.
 - ⚠ **DANGER!** Use the battery only with the transceiver for which it is specified. Never use a battery with any other equipment, or for any purpose that is not specified in this instruction manual.
 - ⚠ **DANGER!** If fluid from inside the battery gets in your eyes, blindness can result. Rinse your eyes with clean water, without rubbing them, and see a doctor immediately.
 - **WARNING!** Immediately stop using the battery if it emits an abnormal odor, heats up, or is discolored or deformed. If any of these conditions occur, contact your Icom dealer or distributor.
 - **WARNING!** Immediately wash, using clean water, any part of the body that comes into contact with fluid from inside the battery.

- **WARNING! NEVER** put the battery in a microwave oven, high-pressure container, or in an induction heating cooker. This could cause a fire, overheating, or cause the battery to rupture.
- **CAUTION:** Always use the battery within the specified temperature range, -20°C to $+60^{\circ}\text{C}$. Using the battery out of its specified temperature range will reduce the battery's performance and battery life.
- **CAUTION:** Shorter battery life could occur if the battery is left fully charged, completely discharged, or in an excessive temperature environment (above $+50^{\circ}\text{C}$) for an extended period of time. If the battery must be left unused for a long time, it must be detached from the radio after discharging. You may use the battery until the battery indicator shows half-capacity, then keep it safely in a cool dry place at the following temperature range:
 - 20°C to $+50^{\circ}\text{C}$ (within a month).
 - 20°C to $+35^{\circ}\text{C}$ (within three months).
 - 20°C to $+20^{\circ}\text{C}$ (within a year).

◇ Charging caution



- **⚠ DANGER! NEVER** charge the battery pack in areas with extremely high temperatures, such as near fires or stoves, inside a sun-heated vehicle, or in direct sunlight. In such environments, the safety/protection circuit in the battery will activate, causing the battery to stop charging.
- **WARNING! DO NOT** charge or leave the battery in the battery charger beyond the specified time for charging. If the battery is not completely charged by the specified time, stop charging and remove the battery from the battery charger. Continuing to charge the battery beyond the specified time limit may cause a fire, overheating, or the battery may rupture.
- **WARNING! NEVER** insert the transceiver (battery attached to the transceiver) into the charger if it is wet or soiled. This could corrode the battery charger terminals or damage the charger. The charger is not waterproof.
- **CAUTION: DO NOT** charge the battery outside of the specified temperature range: 0°C to $+35^{\circ}\text{C}$. Icom recommends charging the battery at $+25^{\circ}\text{C}$. The battery may heat up or rupture if charged out of the specified temperature range. Additionally, battery performance or battery life may be reduced.

3 BATTERY CHARGING

■ Regular charging

Prior to using the transceiver for the first time, the battery pack must be fully charged for optimum life and operation.

◇ Battery indicators

The indicators show “”, “” and “” in sequence and “CHARGE” appears while charging (when the transceiver’s power is OFF). The indicators and “CHARGE” disappear when the battery pack is completely charged.

◇ Charging note

- Be sure to turn the transceiver power OFF. Otherwise the battery pack will not be charged completely or will take much longer to charge.
- External DC power operation becomes possible when using an optional CP-12L, CP-19R or OPC-254L. The attached battery pack is also charged simultaneously, except during transmit (see p. 15 for more details).
- The external DC power supply voltage must be between 10–16 V to charge the battery pack and for operation when using an optional OPC-254L.

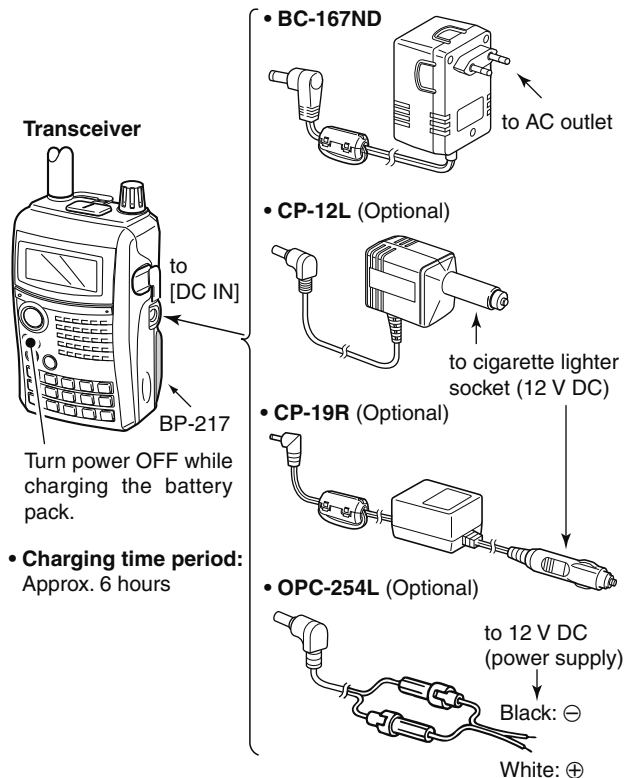

■ Rapid charging

The optional BC-139 provides rapid charging of the battery pack.

◇ Charging note

- Be sure to turn the transceiver power OFF.
Detach the battery pack from the transceiver then charge the battery pack by itself, or charge the battery with regular charging when the transceiver power cannot be turned OFF. Otherwise the battery pack will not be charged (charging indicator on the BC-139 blinks orange about 10 sec. after the battery pack is installed in BC-139).
- The desktop charger, BC-139, can only charge BP-217 battery packs. Other types of rechargeable battery, Ni-Cd or Ni-MH cannot be charged.
- If the charging indicator blinks orange, there may be a problem with the battery pack or charger. If this occurs, try charging the battery pack alone, without the transceiver, or try using the standard (non-rapid) charger. Contact your dealer if you have problems charging a new battery pack.
- The optional CP-12L and OPC-254L can be used instead of the supplied AC adapter. Connect one of these to the [DC 13.5V] jack in this case.

NOTE: If the charging indicator blinks orange for 10 sec. or more with the battery pack installed in the transceiver, try charging the BP-217 alone. You can also try charging the BP-217 alone using the standard (non-rapid) battery charger.

- **Charging period:** approx. 2.5 hours (with BP-217)

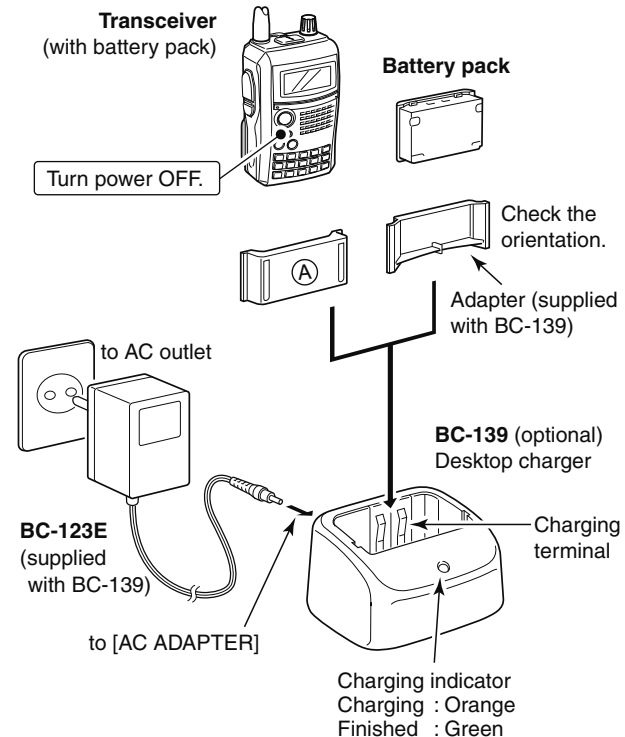

3 BATTERY CHARGING

■ Optional battery case

➤ Install 2 × LR6 (AA) size alkaline batteries into the optional BP-216 BATTERY CASE.

- Be sure to observe the correct polarity.

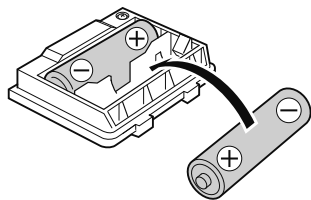

/// A built-in step-up converter in the BP-216 increases the voltage to 5 V DC.

/// Approx. 100 mW of output power is possible with the BP-216 operation. Also, no transmit output power selection (TX inhibit) is available.

/// Keep battery contacts clean. It's a good idea to clean battery terminals once a week.

◇ Battery information

The batteries may seem to have low capacity when used in low temperatures such as -10°C or below. Keep the batteries warm in this case.

◇ Battery replacement

When the batteries become exhausted, the function display may blink or have a lower contrast. In this cases, replace all batteries with new, same brand, alkaline batteries.

■ Battery information

◇ Battery life

The transceiver operates with the BP-217 Li-ion as follows. When operating in the DV mode, operating time may be shortened by one-half hour.

- **VHF band** : Approx. 6.5 hours
- **UHF band** : Approx. 6.0 hours (Tx: Rx: Stand-by=1: 1: 8)



/// Even when the transceiver power is OFF, a small current still flows in the radio. Remove the battery pack or case from the transceiver when not using it for a long time. Otherwise, the battery pack or installed batteries will become exhausted.

/// The battery protection function sets transceiver to Low power (0.5 W) automatically when temperature is 0°C or below. In this case, transmit power selections (Hi/Mid) are also disable.

◇ Battery indicator

The battery indicator, “,” appears only when the BP-217 Li-ion is attached to the transceiver.

/// The battery indicator does not appear when turning power ON after charging is completed without disconnecting the battery charger or external DC power.

Indication	Battery condition
	The battery has ample capacity.
	The battery is nearing exhaustion. Charging is necessary.

External DC power operation

An optional cigarette lighter cable (CP-12L or CP-19R; for 12 V cigarette lighter socket) or external DC power cable (OPC-254L) can be used for external power operation.

Operating note

- Power supply voltage must be between **10.0–16.0 V DC**. **NEVER CONNECT OVER 16 V DC** directly into the [DC IN] jack of the transceiver.
- **BE SURE** to use **CP-12L**, **CP-19R** or **OPC-254L** when connecting a regulated 12 V DC power supply.
- Use an external DC-DC converter to connect the transceiver through optional CP-12L, CP-19R or OPC-254L to a 24 V DC power source.
- The voltage of the external power supply must be within 10–16 V DC when using either CP-12L, CP-19R or OPC-254L, otherwise, use the battery pack.
- Disconnect the power cables from the transceiver when not using it. Otherwise, the vehicle battery will become exhausted.
- The power save function is deactivated automatically during external DC power operation.

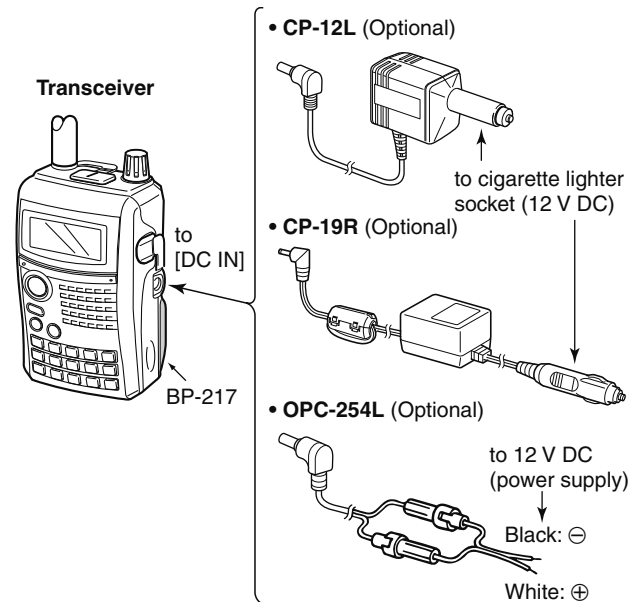

NOTE: Up to 5 W (approx.) of maximum output power is available when using external DC power. However, when the supplied voltage exceeds 14 V, the built-in protection circuit activates to reduce the transmit output power to 2.5 W (approx.).

4

BASIC OPERATION

■ Power ON

- ➔ Push and hold **[PWR]** for 1 sec. to turn power ON.
 - Push and hold **[PWR]** for 1 sec. to turn power OFF.

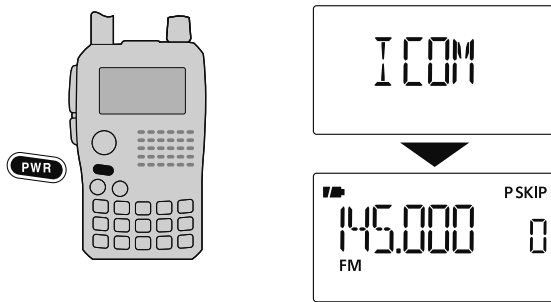

Opening message is selectable in DISP set mode (SET).

MENU ⇨ SET ⇨ DISP ⇨ **OPN.MSG** (p. 129)

■ Setting audio volume

- ➔ Push **[Δ]** or **[▽]** several times to adjust the audio level.
- If squelch is closed, push and hold **[SQL]** while setting the audio level.
- The display shows the volume level while setting.

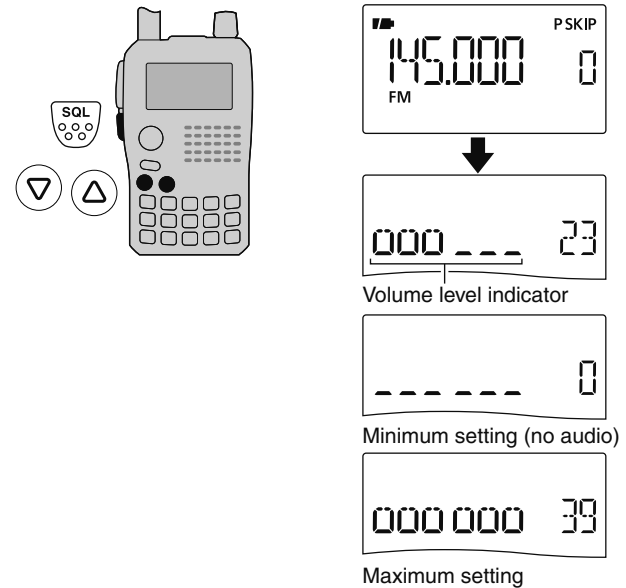

Beep level is adjustable in SOUNDS set mode (SET).

MENU ⇨ SET ⇨ SOUNDS ⇨ **BEEPLV** (p. 130)

■ Setting squelch level

The squelch circuit mutes the received audio signal depending on the signal strength. The transceiver has 9 squelch levels, a continuously open setting and an automatic squelch setting.

- ➔ While pushing and holding **[SQL]**, rotate **[DIAL]** to select the squelch level.
 - “LEVEL1” is loose squelch (for weak signals) and “LEVEL9” is tight squelch (for strong signals).
 - “AUTO” indicates automatic level adjustment by a noise pulse counting system.
 - “OPEN” indicates continuously open setting. (This selection is not available in the DV mode.)

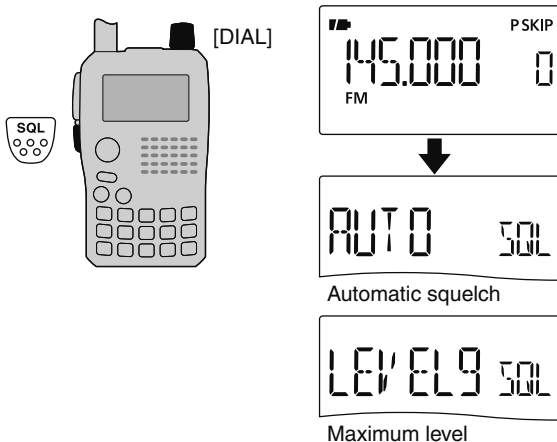

■ Monitor function

This function is used to listen to weak signals without disturbing the squelch setting or to open the squelch manually even when mute functions such as the tone squelch are in use.

- ➔ Push and hold **[SQL]** to monitor the operating frequency.
 - The 1st segment of the S-meter blinks.

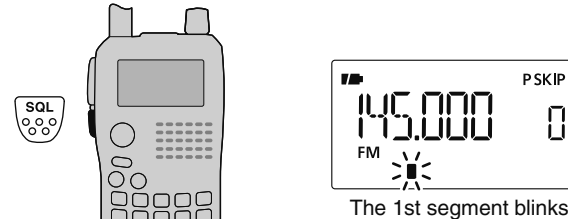

▨ The **[SQL]** key can be set to ‘sticky’ operation in FUNC set mode (SET). See page 125 for details.

MENU ⇨ SET ⇨ FUNC ⇨ **MONI** (p. 125)

4 BASIC OPERATION

■ Mode selection

◇ VFO mode

VFO mode is used to set the desired frequency.

➔ Push **[V/MHz]** to select the VFO mode.

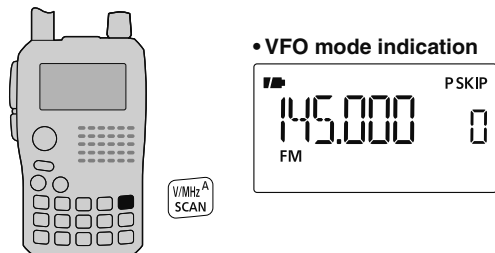

What is VFO?

VFO is an abbreviation of Variable Frequency Oscillator. Frequencies for both transmitting and receiving are generated and controlled by the VFO.

Set the attenuator function ON (p. 25) if the received signal is blocked by another radio transmitter when using a third party high-gain antenna.

◇ Memory mode

Memory mode is used for operation on memory channels which store programmed frequencies.

- ① Push **[M/CALL]** to select memory mode.
 - “**MR**” appears when memory mode is selected.
 - Push **[M/CALL]** several times to select call channels/TV* channels. Memory/Call/TV* channels can be selected in sequence.

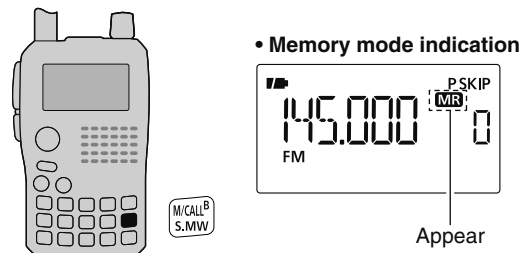

- ② Rotate **[DIAL]** to select the desired memory channel.
 - Only programmed memory channels can be selected.
 - Enter the memory channel directly to select the desired memory channel. (p. 92)
 - See p. 94 for memory programming details.

/// *Appears only when TV channels are programmed via the CS-80/880 (free download software).

◇ **Call/TV* channels**

Call channels are used for quick recall of most-often used frequencies.

/// *Appears only when TV channels are programmed via the CS-80/880 (free download software).

- ① Push **[M/CALL]** several times to select call channels/TV channels.
 - Memory/Call/TV channels can be selected in sequence.
- ② Rotate **[DIAL]** to select the desired channel.



M/CALL
S.MW

• **Call channel indication**



• **TV channel indication**



TV reception is available for analog TV broadcasting only, but it is not available for digital TV broadcasting.

◇ **DR (D-STAR Repeater) mode**

DR (D-STAR Repeater) mode is used for D-STAR repeater operation. In this mode, you can select the pre-programmed repeaters and UR call sign easily by using **[DIAL]**.

D-STAR is an abbreviation for Digital Smart Technologies for Amateur Radio.

- ① Push **[DR]** to select the DR mode.
 - “**DR**” appears when the DR mode is selected.



DR^C

• **DR mode indication**

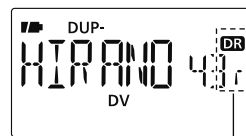

Appear

- ② Rotate **[DIAL]** to select the desired access repeater.
 - While rotating **[DIAL]**, S/R/F meter indicates group number.
 - Only programmed access repeaters in RPT-L menu can be selected. See p. 40 for RPT-L (repeater lists) programming details.

MENU ⇄ RPT-L ⇄ **ADD-L** (p. 40)

4 BASIC OPERATION

■ [DIAL] function assignment

The [DIAL] control can be used as an audio volume control instead of [△]/[▽] keys to suit your preference. However, when [DIAL] functions as an audio volume, [△]/[▽] keys function as tuning controls.

- ➔ Push and hold [V⇔D](1) for 1 sec. to toggle the dial function between tuning dial and audio volume.

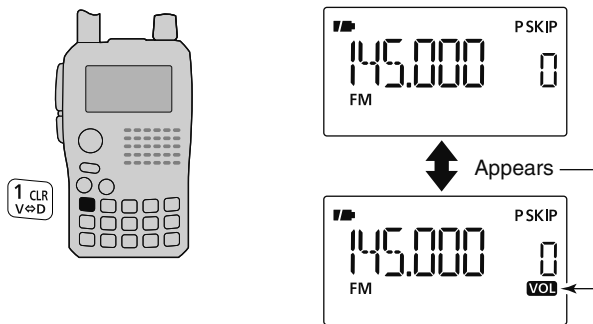

- The following functions are switched between [DIAL] and [△]/[▽].

[DIAL]	[△]/[▽]
Frequency, Memory channel, Squelch level, Scanning direction	Audio volume set

■ Operating band selection

The transceiver can receive the AM broadcast, HF bands, 50 MHz, FM broadcast, VHF air, 144 MHz, 300 MHz, 400 MHz or 800 MHz bands.

- ➔ In the VFO mode, push [BAND] several times to select the desired frequency band.
 - If the VFO mode is not selected, such as a memory channel/call channel/TV channel or the DR mode, push [V/MHz] to select the VFO mode first, then push [BAND] to select the desired band.

/// Available frequency bands are different depending on version. See the specification for details. (p. 161)

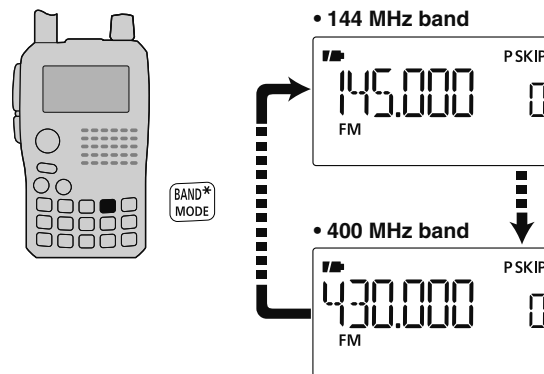

• Available frequency bands

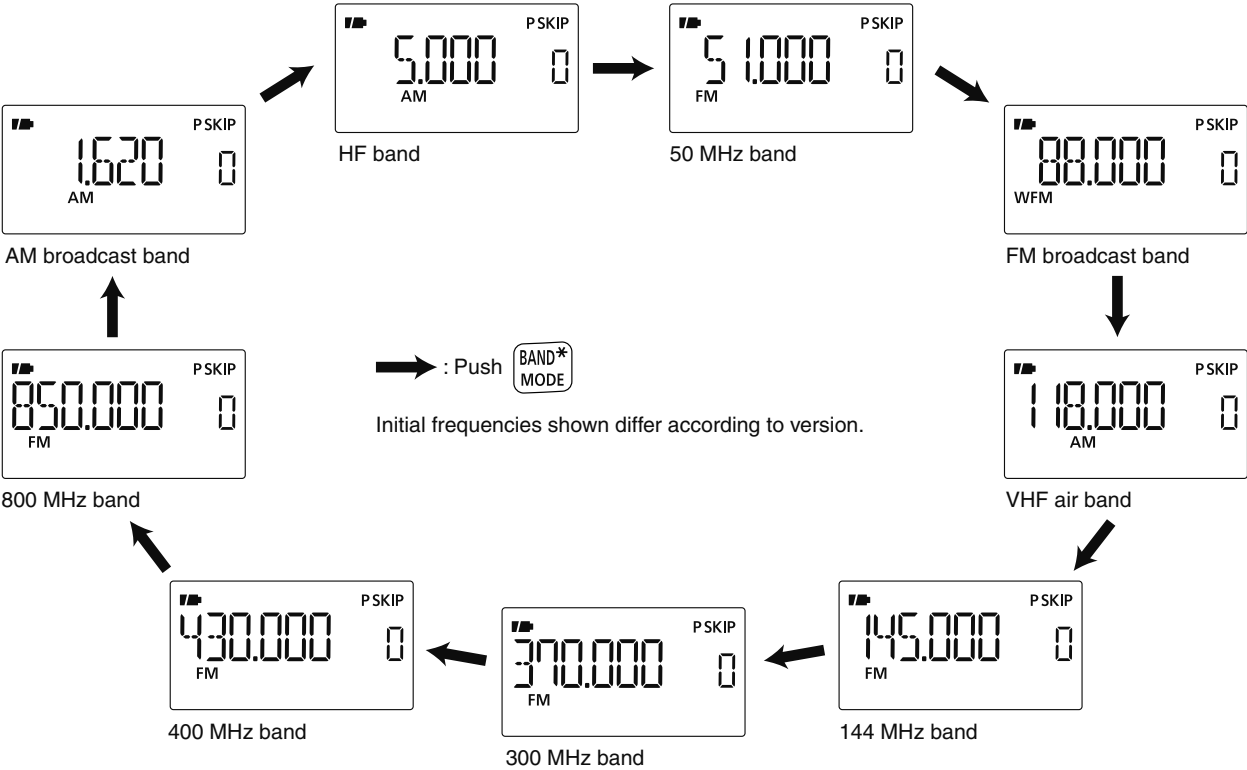

4 BASIC OPERATION

■ Setting a tuning step

The tuning step can be selected for each frequency band. The following tuning steps are available for the IC-E80D.

- 5.0 kHz* • 6.25 kHz* • 8.33 kHz† • 9.0 kHz‡ • 10.0 kHz
- 12.5 kHz • 15.0 kHz* • 20.0 kHz • 25.0 kHz • 30.0 kHz
- 50.0 kHz • 100.0 kHz • 125.0 kHz • 200.0 kHz

* Appears for bands below the 600 MHz only.

† Appears for the VHF air band only.

‡ Appears for the AM broadcast band only.

◇ Tuning step selection

- ① Push **[V/MHz]** to select the VFO mode, if necessary.
- ② Push **[BAND]** to select the desired frequency band.
- ③ Push and hold **[TS](2)** for 1 sec. to enter tuning step set mode.
 - While pushing and holding **[TS](2)**, rotating **[DIAL]** is also selectable tuning step.
- ④ Rotate **[DIAL]** to select the desired tuning step.
- ⑤ Push **[TS](2)** (or **[V/MHz]**) to return to the VFO mode.

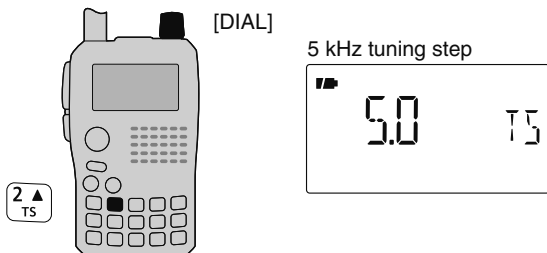

■ Setting a frequency

◇ Using the dial

- ① Push **[V/MHz]** to select the VFO mode, if necessary.
- ② Select the desired frequency band with **[BAND]**.
- ③ Rotate **[DIAL]** to select the desired frequency.
 - The frequency changes according to the preset tuning steps. See the previous content to set the tuning step.
 - When the VFO mode is selected, push **[V/MHz]** then rotate **[DIAL]** to change the frequency in 1 MHz steps, or push **[V/MHz]** again then rotate **[DIAL]** to change the frequency in 10 MHz steps. Push **[V/MHz]** again to cancel it.)



[DIAL] changes the frequency according to the selected tuning step.



After pushing **[V/MHz]** on VFO mode, **[DIAL]** changes the frequency in 1 MHz/10 MHz steps.

◇ Using the keypad

The frequency can be directly set via numeric keys.

- If a frequency outside the frequency range is entered, the previously displayed frequency is automatically recalled after entering last digit.

- ① Push [V/MHz] to select the VFO mode, if necessary.
- ② Enter the desired frequency via the keypad.

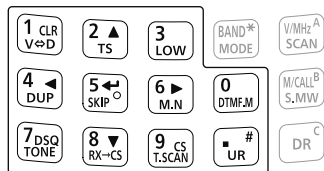

Depending on the tuning step setting, it may not be possible to input a 1 kHz digit. In this case, enter "0" as 1 kHz digit, then rotate [DIAL] to set the desired frequency.

• Entering 145.580 MHz

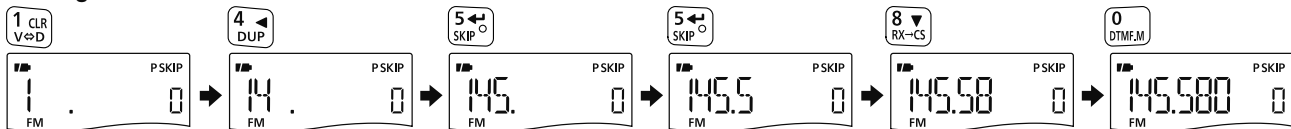

• Entering 79.300 MHz

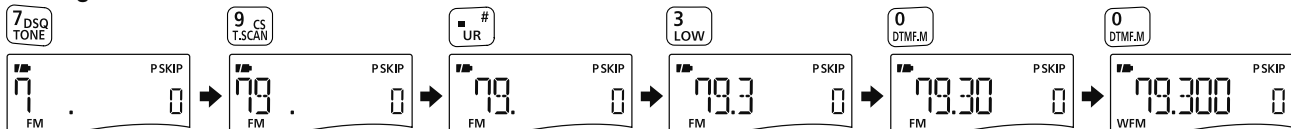

• Changing 100 kHz and below

Editing 145.580 MHz to 145.640 MHz

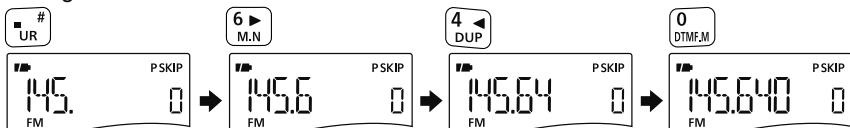

• Editing to 684 kHz



Push [V/MHz A SCAN] to cancel numeral key input.

4 BASIC OPERATION

■ Lock function

To prevent accidental frequency changes and unnecessary function access, use the lock function.

➔ Push and hold **[MENU]** for 1 sec. to turn the lock function ON and OFF.

- “**LOCK**” appears while the lock function is activated.
- **[PWR]**, **[Δ]**/**[▽]**, **[SQL]**, **[PTT]** and **[MENU]** are operable while the lock function is activated.
- The squelch control and volume control can be used while the lock function is in use with default setting. Either or both the squelch control and volume control can also be locked in the FUNC set mode.

MENU ⇨ SET ⇨ FUNC ⇨ **LOCK** (p. 127)

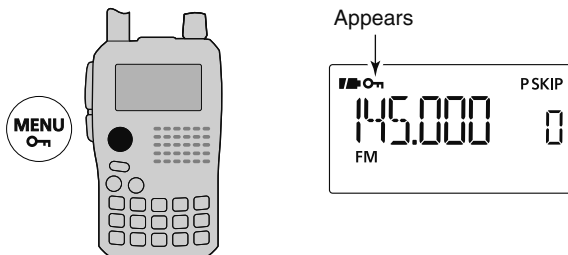

■ Receiving

Make sure a charged battery pack (BP-217) or brand new alkaline batteries (BP-216) are installed (pgs. 2, 14).

- ① Push and hold **[PWR]** for 1 sec. to turn power ON.
- ② Push **[Δ]** or **[▽]** to set the desired audio level. (p. 16)
 - The frequency display shows the volume level while setting.
- ③ Set the receiving frequency. (p. 23)
- ④ Set the squelch level. (p. 17)
 - While pushing and holding **[SQL]**, rotate **[DIAL]**.
 - The first click of **[DIAL]** indicates the current squelch level.
 - “LEVEL 1” is loose squelch (for weak signals) and “LEVEL 9” is tight squelch (for strong signals).
 - “AUTO” indicates automatic level adjustment by a noise pulse counting system.
 - Push and hold **[SQL]** to open the squelch manually.
- ⑤ When a signal is received:
 - Squelch opens and audio is output.
 - The S/R/F meter shows the relative signal strength level.

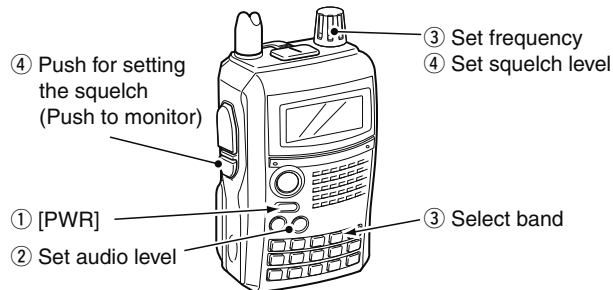

■ Operating mode selection

Operating modes are determined by the modulation of the radio signals. The transceiver has a total of 5 operating modes (FM, FM-N, WFM, AM and DV modes). The mode selection is stored independently for each band and memory channel.

Typically, AM mode is used for the AM broadcast stations (0.495–1.620 MHz) and air band (118–136.995 MHz), and WFM is used for FM broadcast stations (76–107.9 MHz).

- ➔ Push and hold **[MODE]**(BAND) for 1 sec. several times to select the desired operating mode.
 - While pushing and holding **[MODE]**(BAND), rotate **[DIAL]** is also available to select operating mode.

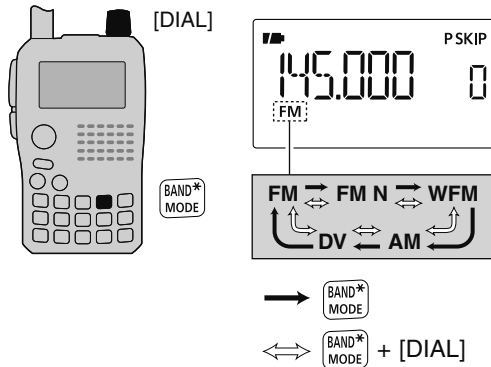

■ Attenuator function

The attenuator prevents distortion of a desired signal by very strong signals near the desired frequency or when very strong electric fields, such as from a broadcasting station, are present at your location. The attenuation is about 10 dB.

- ① Enter "ATT" in FUNC set mode (SET).

MENU ⇨ SET ⇨ FUNC ⇨ **ATT** (p. 124)
 (Push **[MENU]**), (Push **[▲]**(2)/**[▼]**(8), then push **[←]**(5).)

- ② Push **[▲]**(2) or **[▼]**(8) to select "ON" or "OFF".
- ③ Push **[←]**(5) (or **[▶]**(4)) to return to set mode, and push **[V/MHz]** to return to the frequency screen.
 - "ATT" appears on the function display when "ON" is selected.

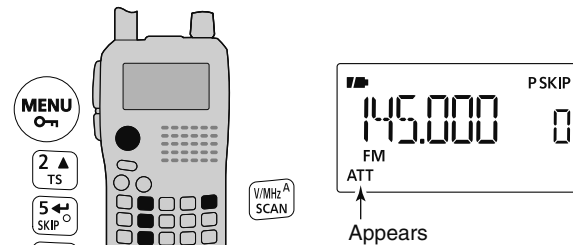

4 BASIC OPERATION

■ Transmitting

CAUTION: Transmitting without an antenna will damage the transceiver.

NOTE: To prevent interference, push and hold [SQL] to listen on the channel before transmitting.

- ① Set the operating frequency.
(p. 23)
 - Transmission is available on the 144 MHz/430 MHz amateur bands only.
 - Select output power if desired. See next page for details.
- ② Push and hold [PTT] to transmit.
 - Tx/Rx indicator lights red.
 - S/Rf meter shows the output power level.
- ③ Speak into the microphone using your normal voice level.
 - DO NOT hold the transceiver too close to your mouth or speak too loudly. This may distort your speech.
- ④ Release [PTT] to return to receive.

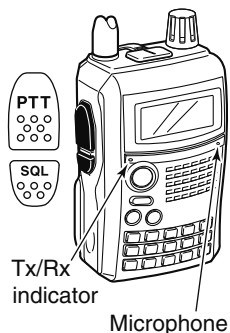

WARNING!

NEVER continuously transmit for long periods of time. When the transceiver is used for continuous prolonged transmission at high power, the transceiver radiates heat to protect itself from overheating and transceiver's chassis will become hot. This may cause a burn.

DO NOT operate the transceiver in a situation that will obstruct heat dissipation, especially if the transceiver is operated with an external power supply. Heat dissipation may be affected, and it may cause a burn, warp the casing or damage the transceiver.

NOTE: Transmit power set 2.5 W (MID) automatically when the transceiver radiates heat.

CONNECT the rated range voltage when using external power supply.

■ Transmit power selection

The transceiver has four output power levels to suit your operating requirements. S-Low output power during short-range communications may reduce the possibility of interference to other stations and will conserve battery power.

- ➔ Push and hold **[LOW]**(3) for 1 sec. to toggle the transmit output power between High (5W*), Mid (2.5 W*), Low (0.5 W*) and S-Low (0.1 W*). *approx.
- While pushing and holding **[LOW]**(3), rotate **[DIAL]** is also available to select transmit power.

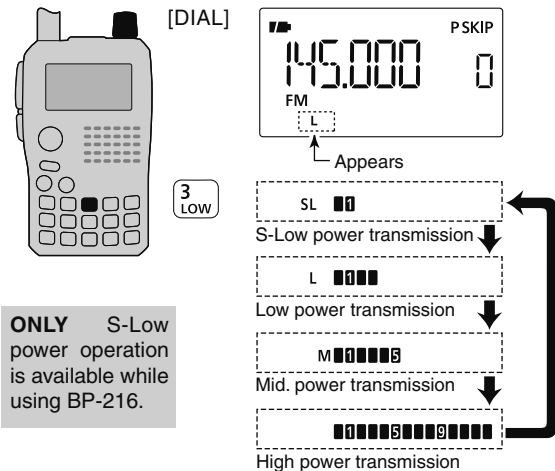

■ TV channel operation

TV channel operation is available only when TV channels are programmed using the CS-80/880 (free download software). (p. 163)

◇ TV channel receiving

- ① Push **[M/CALL]** several times to select TV channels.
 - “TV” and channel number appear.
- ② Rotate **[DIAL]** to select the desired channel.
 - While pushing and holding **[BAND]**, rotating **[DIAL]** selects the all channels including skip channel.

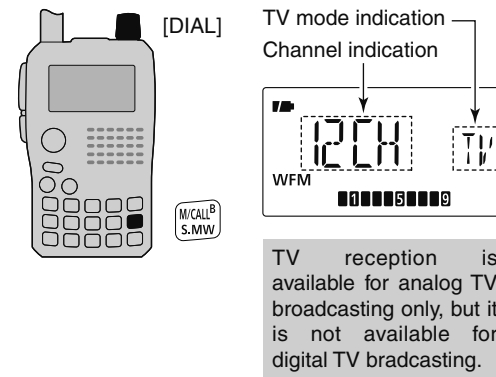

4 BASIC OPERATION

◇ Skip channel setting

Unwanted channels can be skipped for rapid selection, etc.

- ① Push **[M/CALL]** several times to select TV channels.
 - “TV” and channel number appear.
- ② Rotate **[DIAL]** to select the channel to be skipped.
 - To clear the skip setting, rotate **[DIAL]** while pushing and holding **[BAND]** to select a skip channel.
 - While pushing and holding **[SKIP]**(5), rotating **[DIAL]** also selects a skip channel.
- ③ Push and hold **[SKIP]**(5) for 1 sec. to toggle the skip setting ON and OFF.
 - “SKIP” appears when the channel is set as skip channel.

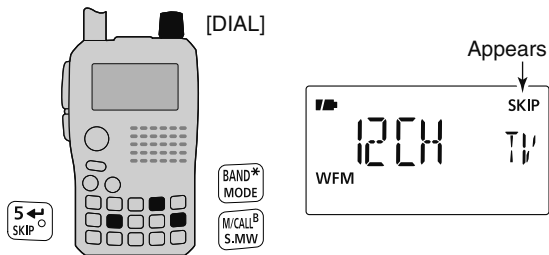

◇ Automatic TV channel programming

TV channels can be programmed automatically.

- ① Push **[M/CALL]** several times to select TV channels.
 - “TV” and channel number appear.
- ② Push and hold **[SCAN]**(V/MHz) for 1 sec. to start TV channel programming.
 - The programming will automatically stop after scanning all channels.

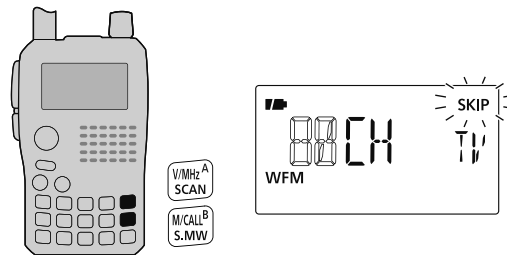

■ Repeater operation

Repeaters allow you to extend the operational range of your radio because a repeater has much higher output power than the typical transceiver.

Normally, a repeater has independent frequencies for each receiver and transmitter.

A subaudible tone may also be required to access a repeater.

Reference amateur radio handbooks and local ham magazines for details of local repeaters such as repeater input/output frequencies and locations.

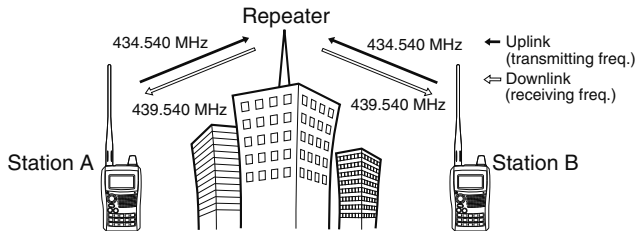

• Repeater operation flow chart

Step 1:

Step the desired band to operate the repeater.

Step 2:

Step the desired receive frequency (repeater output frequency).

Step 3:

Set the duplex (shift) direction (- duplex or +duplex).
- Set the frequency offset (amount of shift), if required.

Step 4:

Set the subaudible tone (repeater tone) encoder function ON.
- Set the subaudible tone frequency, if required.

• Repeater settings can be stored into a memory channel. (p. 94)

5 REPEATER AND DUPLEX OPERATIONS

■ Accessing a repeater

- ① Set the receive frequency (repeater output frequency).
- ② Set the shift direction of the transmit frequency. (DUP- or DUP; see p. 32 for details.)

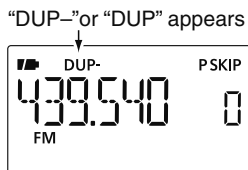

- ③ Push and hold **[TONE]**(7) for 1 sec. to activate the subaudible tone encoder, according to repeater requirements.
 - “T” appears.

Refer to p. 119 for tone frequency settings.

- ④ Push and hold **[PTT]** to transmit.
 - The displayed frequency automatically changes to the transmit frequency (repeater input frequency).
 - If “OFF” appears, check the frequency offset or shift direction. (p. 32)
- ⑤ Release **[PTT]** to receive.
- ⑥ Push and hold **[SQL]** to check whether the other station's transmit signal can be directly received or not.

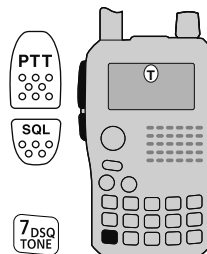

While receiving

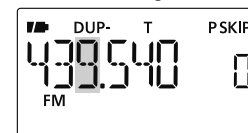

While transmitting



◇ Checking the repeater input signal

The transceiver can check whether the other station's transmit signal can be received directly or not, by listening on the repeater input frequency.

- ➔ Push and hold **[SQL]** to check whether the other station's transmit signal can be received directly or not.
 - When the other station's signal can be directly received, move to a non-repeater frequency to use simplex. (duplex OFF)

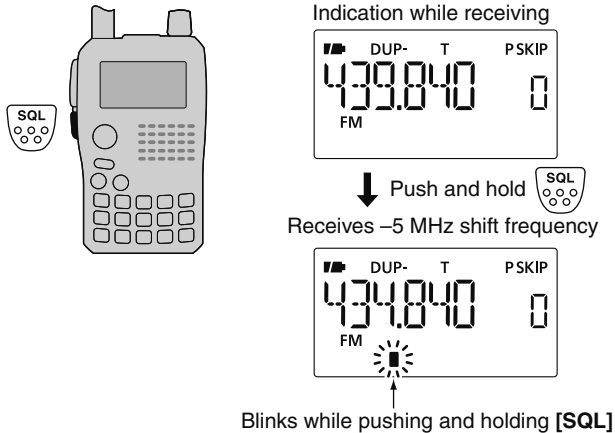

◇ Off band indication

If the transmit frequency is out of the amateur band, the off band indication, "OFF," appears on the display when **[PTT]** is pushed. Check the frequency offset or duplex direction in this case. (p. 32)

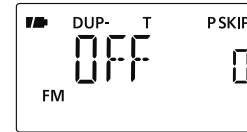

✓ CONVENIENT!

Tone scan function: When you don't know the subaudible tone used for a repeater, the tone scan is convenient for detecting the tone frequency.

- ➔ Push and hold **[T.SCAN]**(9) for 1 sec. to start the tone scan. See p. 152 for more information.

5 REPEATER AND DUPLEX OPERATIONS

■ Duplex operation

◇ Setting frequency offset

- ① Enter "OFFSET" in DUP.T menu.

MENU ⇨ DUP.T ⇨ **OFFSET** (p. 119)
(Push [MENU], (Push [▲](2)/[▼](8), then push [←](5).)

- ② Push [▲]/[▼] (or rotate [DIAL]) to set the frequency offset.

- ③ Push [←](5) to return to DUP.T menu, and then push [MENU] to return to the frequency screen.

Frequency offset setting

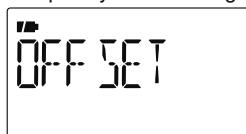

No frequency offset



5 MHz offset



◇ Setting duplex direction

- ➔ Push and hold [DUP](4) for 1 sec. to select "DUP-" (negative offset) or "DUP" (positive offset).

- "DUP-" or "DUP" indicates the transmit frequency for minus shift or plus shift, respectively.

- When frequency offset is 5 MHz

-Duplex example

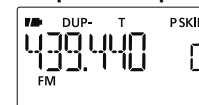

Receiving

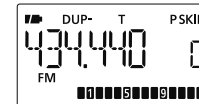

Transmitting

+Duplex example

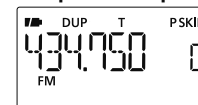

Receiving



Transmitting

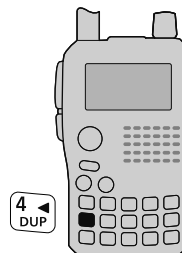

■ 1750 Hz tone

To access some European repeaters, the transceiver must transmit a 1750 Hz tone burst. For such European repeaters, perform the following.

- This tone can be used as a 'Call signal' in countries out of Europe.

- ① Push and hold **[DTMF.M]**(0) for 1 sec. to select DTMF memory.

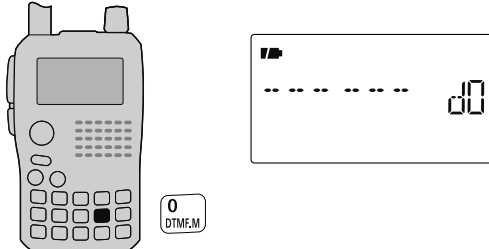

- ② Push **[▼]**(8) several times (or rotate **[DIAL]** counter-clockwise) until "T-CALL" appears.



- ③ Push **[←]**(5) to set.
- ④ Push **[V/MHz]** to exit DTMF memory.

- ⑤ Set the receive frequency (repeater output frequency).
- ⑥ Set the shift direction of the transmit frequency. (-DUP or +DUP; see p. 32 for details.)
- ⑦ While pushing **[PTT]**, push **[SQL]** to transmit a 1750 Hz tone burst signal.
 - If "OFF" appears, check the frequency offset or shift direction. (p. 32)
 - The displayed frequency automatically changes to the transmit frequency (repeater input frequency).
- ⑧ Push and hold **[PTT]** to transmit.
- ⑨ Release **[PTT]** to receive.
- ⑩ Push and hold **[SQL]** to check whether the other station's transmit signal can be received directly or not, by listening on the repeater input frequency.

✓ CONVENIENT!

- ① Set the receive frequency (repeater output frequency).
- ② Set the shift direction of the transmit frequency. (-DUP or +DUP; see p. 32 for details.)
- ③ Push **[PTT]** briefly, then push and hold **[PTT]** again for 1 to 2 sec. to transmit a 1750 Hz tone burst signal.
 - If "OFF" appears, check the frequency offset or shift direction. (p. 32)
 - The displayed frequency automatically changes to the transmit frequency (repeater input frequency).
- ④ Push and hold **[PTT]** to transmit; release to receive.

■ About the D-STAR system

In the D-STAR (Digital Smart Technologies for Amateur Radio) system, repeater linking via a 10 GHz backbone and/or internet gateway provides you with much wider coverage range during digital voice mode operation.

• D-STAR system outline

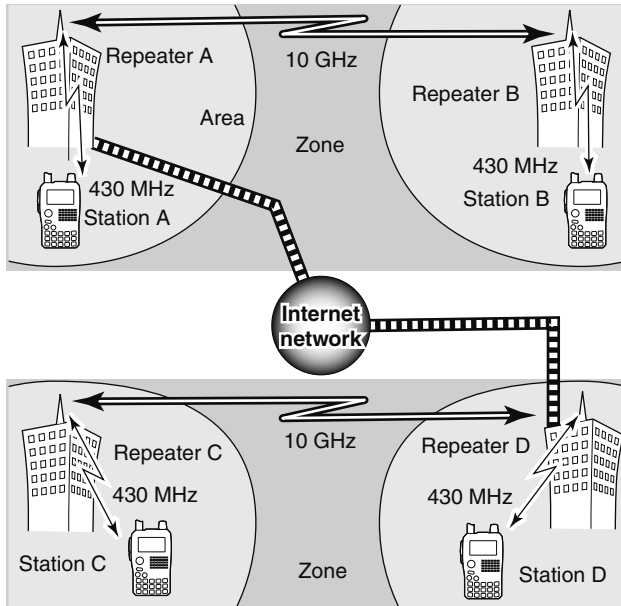

In traditional repeater operation, stations that are communicating must both be in the repeater's operating area. However, D-STAR repeaters can be linked via a 10 GHz backbone, as shown in the illustration at left. Using D-STAR, stations A and B can communicate even though they are in widely separated repeater operating areas.

Furthermore, D-STAR repeaters can be linked through an internet gateway, which can extend the communication range dramatically. For example, when station B uses the internet gateway connection, it can communicate with station C even though they are thousands of miles apart! By using the gateway connection, long distance communication is possible using 144 or 430 MHz digital voice!

In the D-STAR system, an independent repeater's operating area is called an Area and a group that of linked repeaters via a 10 GHz backbone is called a Zone.

About time-out timer function

The IC-E80D has a time-out timer function for digital repeater operation. The timer limits a continuous transmission to approx. 10 min. Warning beeps will sound approx. 30 sec. before time-out and then again immediately before time-out.

◇ System description

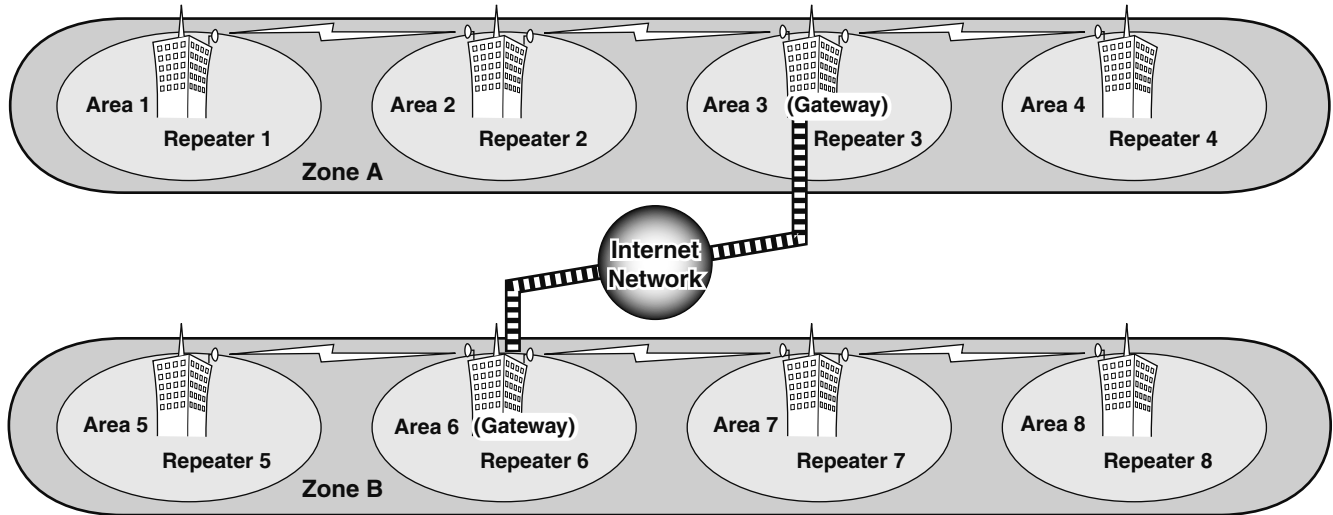

6

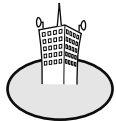

Area:

The Area is the communication range that is covered by a single repeater. The repeater is called an area repeater in the D-STAR system.



Zone:

The Zone is composed of several areas, that are linked by a 10 GHz microwave link. The areas 1 to 4 and 5 to 8 make up a zone in the example above.



Link repeater:

The microwave (10 GHz) link repeater provides to linking with another repeater site (Area) for zone construction.



Gateway repeater:

Gateway repeaters provide communications between different zones via the internet. Repeaters 3 and 6 are gateway repeaters in the example above.

6 DV MODE PROGRAMMING

■ Call sign programming

Four types of current call sign memory are available; "MY" (my call sign=your own call sign) "UR" (your call sign=other station call sign) "RPT1" (access repeater call sign) and "RPT2" (linked repeater call sign). Each call sign can be programmed with up to 8 characters.

In addition, "MY" can store up to 6 call signs, and "UR" can store up to 60 call signs in the call sign memory. Up to 300 repeater call signs can be stored in the repeater list.

◇ Your own call sign programming

Your own call sign must be programmed for both digital voice and low-speed data communications (including GPS transmission).

- 1 Enter "MY" in call sign screen.

MENU ⇨ CALL-S ⇨ *MY*
(Push [MENU] (1)), (Push [▲](2)/[▼](8), then push [←](5).)

- MY call sign screen is displayed.

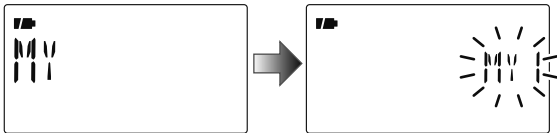

- 2 Push [▲](2) or [▼](8) to select the desired call sign memory, "MY1" to "MY6."

- 3 Push [▶](6) to enter call sign programming mode.
 - The 1st digit blinks.

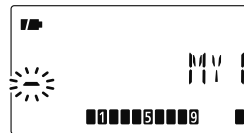

- 4 Push [▲](2) or [▼](8) to select the desired character or code.
 - Push [▶](6) to move the cursor right; push [◀](4) to move the cursor left.

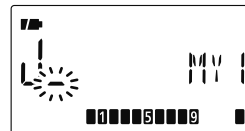

- 5 Repeat step 4 to enter your own call sign.
 - Up to an 8 digit of call sign can be set.
 - If an unwanted character is entered, push [▶](6) or [◀](4) to select the character, then push [CLR](1) to erase the selected character, or push and hold [CLR](1) for 1 sec. to erase all characters following the cursor.
 - To program a note (up to 4 characters, for operating radio type, area, etc.), go to step 6, otherwise go to step 8.
- 6 Push [▶](6) several times to set the cursor beside " / " indication.

- ⑦ Repeat step ④ (at previous page) to program the desired 4 character note.

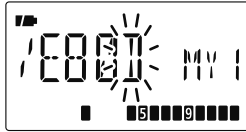

- ⑧ Push [←](5) to store the programmed call sign with note and return to call sign screen.



- ⑨ Push [MENU] to return to the frequency screen.

◇ Station call sign programming

Station call sign must be programmed to call a specific station as well as for repeater operation in both digital voice and low-speed data communications.

- ① Enter "UR" in call sign screen.

MENU ⇨ CALL-S ⇨ UR
(Push [MENU], (Push [▲](2)/[▼](8), then push [←](5).)

- UR call sign screen is displayed.

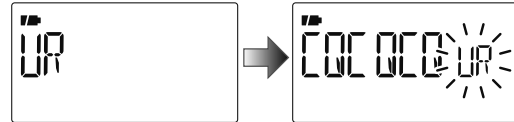

- ② Push [▲](2) or [▼](8) to select the desired call sign memory, "U01" to "U60."
③ Push [▶](6) to enter call sign programming mode.
• The 1st digit blinks.

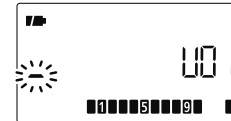

- ④ Push [▲](2) or [▼](8) to select the desired character or code.
• Push [▶](6) or [←](4) to move the cursor right or left, respectively.

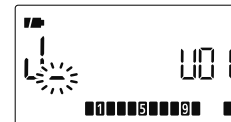

6 DV MODE PROGRAMMING

- Repeat step ④ to enter the desired station call sign.
 - Up to an 8 digit call sign can be set.
 - If an unwanted character is entered, push **[▶]**(6) or **[◀]**(4) to select the character, then push **[CLR]**(1) to erase the selected character, or push and hold **[CLR]**(1) for 1 sec. to erase all characters following the cursor.
- Push **[←]**(5) to store the programmed call sign and return to UR call sign screen.

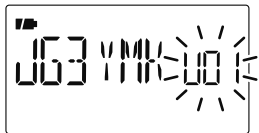

- Push **[MENU]** to return to the frequency screen.

✓ For your information

The IC-E80D has a call sign edit record function. When editing a call sign stored in a call sign memory (or regular memory/call channel), the default setting is to store the edited call sign into a blank channel automatically. (When all call sign memories are already programmed, the edited call sign will overwrite the selected channels call sign.)

The programmed call sign can be over-written when the setting of "EDIT R" (Edit record) is set to OFF or SEL. (p. 134)

However, you must manually over-write a reprogrammed call sign in regular memory/call channels (temporary operation without over-writing is possible).

◇ Current repeater call sign programming

"RPT1" or "RPT2" can store current call sign only, and repeater call signs must be stored in the repeater list (p. 39).

- Enter "RPT1" or "RPT2" in call sign screen.

MENU ⇨ CALL-S ⇨ **RPT1 or RPT2**
(Push **[MENU]**), (Push **[▲]**(2)/**[▼]**(8), then push **[←]**(5).)

- RPT1/RPT2 call sign screen is displayed.

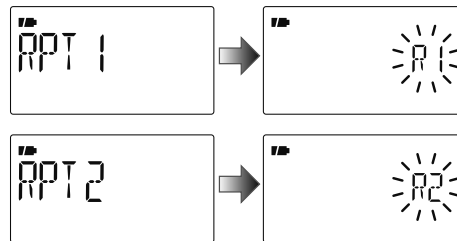

- Push **[▶]**(6) to enter call sign programming mode.
 - The 1st digit blinks.
- Push **[▲]**(2) or **[▼]**(8) to select the desired character or code.
 - Push **[▶]**(6) or **[◀]**(4) to move the cursor right or left, respectively.
- Repeat step ③ to enter the desired repeater call sign.
 - Up to an 8 digit call sign can be set.
 - If an unwanted character is entered, push **[▶]**(6) or **[◀]**(4) to select the character, then push **[CLR]**(1) to erase the selected character, or push and hold **[CLR]**(1) for 1 sec. to erase all characters following the cursor.
- Push **[←]**(5) to store the programmed call sign and returns to call sign screen.
- Push **[MENU]** to return to the frequency screen.

■ Repeater list

The IC-E80D can store up to 300 repeater call signs. The repeater list also stores the repeater name and access repeater setting, etc.

The outline of repeater list is follows:

- ① Selection for new repeater program or changing a list
- ② Selection for a programmed repeater lists
- ③ Repeater programming (Repeater name, Call sign, Gateway repeater call sign, Repeater group, etc.)
- ④ Access repeater programming (Down link frequency, Duplex direction, Frequency offset)

◇ Repeater list contents

The following information can be programmed into repeater lists:

- R-NAME (Repeater name) (pgs. 40, 44)
- CALL-S (Repeater call sign) (pgs. 40, 44)
- GW CAL (Gateway repeater's call sign) (pgs. 41, 45)
- GROUP (Repeater group) (p. 41)
- R1 USE (RPT1 use) (p. 42)

When R1 USE is selected YES, following contents appear.

- FREQ (Repeater output frequency) (p. 42)
- DUP (Duplex direction) (p. 43)
- OFF SET (Frequency offset) (p. 43)

NOTE: Repeater lists can be erased by static electricity, electric transients, etc. In addition, they can be erased by malfunction and during repairs. Therefore, we recommend that memory data be written down or be saved to a PC using the CS-80/880 CLONING SOFTWARE (free download).

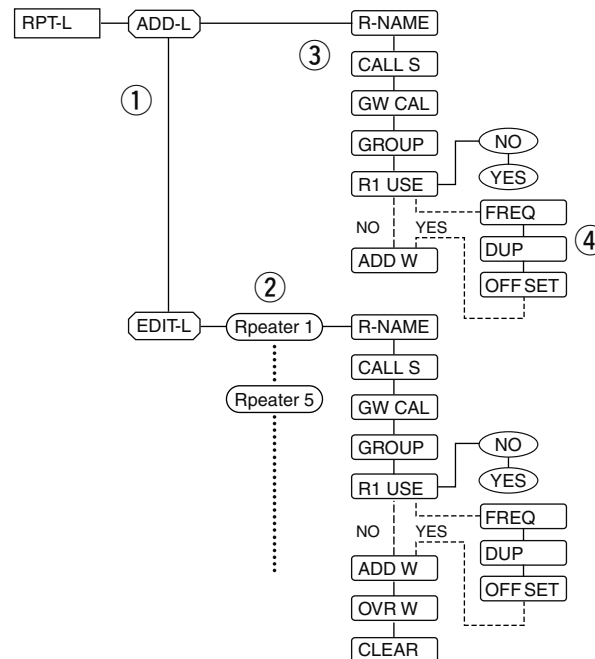

Repeater list programming

New repeater list programming

- Enter "ADD-L" in RPT-L menu.

MENU ⇨ RPT-L ⇨ **ADD-L**
 (Push [MENU] (5)), (Push [▲](2)/[▼](8), then push [←](5).)

- "R-NAME" appears.

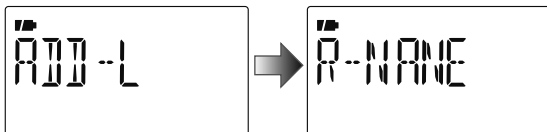

Repeater name programming (R-NAME)

- Push [←](5) to enter the repeater name programming state. See p. 44 for repeater name programming details.
 - Repeater name programming screen is displayed.

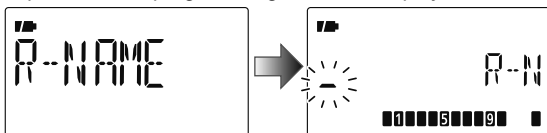

- Program the repeater name, then push [←](5) to exit the state.
 - Push [▲](2)/[▼](8) to select the desired character, number, symbol or space.
 - Push [▶](6)/[◀](4) to move the cursor right or left, respectively.
- Push [▲](2) or [▼](8) to select the next content (repeater call sign programming).

Repeater call sign programming (CALL S)

- Push [←](5) to enter the repeater call sign programming state. See p. 44 for repeater call sign programming details.

- Repeater call sign programming screen is displayed.

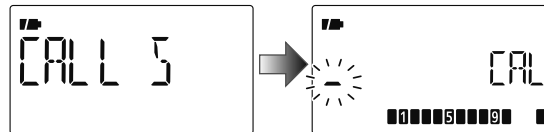

- Program the repeater call sign, then push [←](5) to exit the state.
 - Push [▲](2)/[▼](8) to select the desired character, number, symbol ('/' only) or space.
 - Push [▶](6)/[◀](4) to move the cursor right or left, respectively.
- Push [▲](2) or [▼](8) to select the next content (gateway repeater call sign programming).

✓ CONVENIENT!

After you program the repeater call sign, you can skip the other programming and store the list.

- Push and hold [S.MW](M/CALL) for 1 sec. to enter memory write state, then push [←](5) to store the list.



Gateway repeater call sign programming (GW CAL)

- ⑧ Push [←](5) to enter the gateway repeater call sign programming state. See p. 45 for gateway repeater call sign programming details.
 - Gateway repeater call sign programming screen is displayed.
 - Programmed repeater call sign is displayed and the 8th digit is automatically added or replaced to “G.”

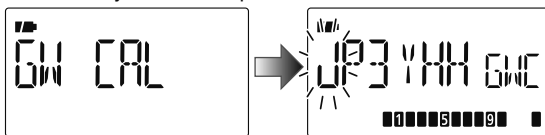

- ⑨ When the programmed repeater has gateway capability, push [←](5) to exit gateway repeater setting and skip to ⑫. Or when the programmed repeater has a different repeater for gateway communication, follow the next step ⑩.
 - When the repeater does not have a gateway repeater, follow the next step ⑩, too.
- ⑩ Program the other gateway repeater call sign, then push [←](5) to exit the state.
 - Push [▲](2)/[▼](8) to select the desired character, number, symbol (‘/’only) or space.
 - Push [▶](6)/[◀](4) to move the cursor right or left, respectively.
 - Up to an 8 digit call sign can be set, but 8th digit must be set to “G.”
 - When the repeater does not have a gateway repeater, but has several linked repeaters, in the same zone, assign a common name to all repeaters. (up to 7 digits). In this case, you must set the 8th digit to “ ” (blank).
- ⑪ Push [▲](2) or [▼](8) to select the next content (repeater group programming).

Repeater group programming (GROUP)

The IC-E80D has a total of 10 groups (0–9). You can assign and organize up 300 of repeater lists in the groups. Group selection is helpful for quick recall of the desired repeater.

- ⑫ Push [←](5) to enter the repeater group programming state.
 - Repeater group programming screen is displayed.
 - Selected group number appears and group indicator blinks.

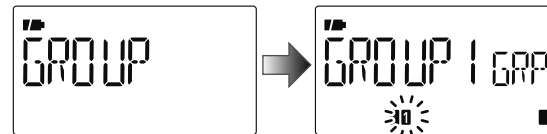

- ⑬ Push [▲](2) or [▼](8) to select the desired repeater group.
 - Selected group number appears and group indicator blinks.



- ⑭ Push [←](5) to set the repeater group and exit the state.
- ⑮ Push [▲](2) or [▼](8) to select the next content (access repeater setting).

6 DV MODE PROGRAMMING

Access repeater setting (R1 USE)

The programmed repeater lists are assigned to use for the access repeater (RPT1) or no in the DR mode. To use for RPT1, repeater frequency, duplex direction and frequency offset must be programmed.

- ⑩ Push [←](5) to enter the access repeater programming state.

- Access repeater programming screen is displayed.

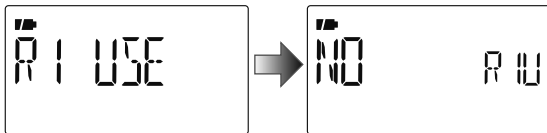

- ⑪ Push [▲](2) or [▼](8) to select “YES” or “NO.”

- When “NO” is selected, the repeater cannot be selected as the access repeater (RPT1) in the DR mode.
- When “YES” is selected, the repeater can be selected as the access repeater (RPT1) in the DR mode.

- ⑫ Push [←](5) to exit the state.

- ↳ When “NO” is selected at step ⑪, skip to step ⑬.

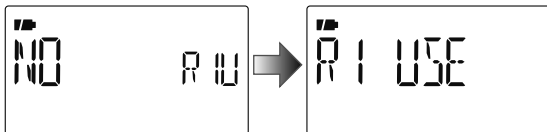

- ↳ When “YES” is selected at step ⑪, push [▲](2) or [▼](8) to select the access repeater (RPT1) programming. Follow the next step ⑭ to program the repeater.

Frequency programming (FREQ)

This content appears when R1 USE is selected YES.

- ⑭ Push [←](5) to enter the frequency programming state.

- Frequency programming screen is displayed.

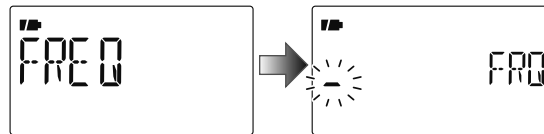

- ⑮ Push [▲](2) or [▼](8) to select the frequency band.

- The selected number blinks at 1st digit.
- Push [▶](6) to move the cursor right; push [←](4) to move the cursor left.
- Push and hold [CLR](1) for 1 sec. to clear the displayed frequency.



- ⑯ Repeat step ⑮ until the repeater frequency is set.

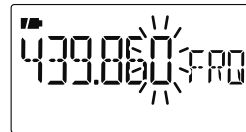

- ⑰ Push [←](5) to set the frequency and exit the state.

- ⑱ Push [▲](2) or [▼](8) to select the next content (duplex direction programming).

Duplex direction setting (DUP)

This content appears when R1 USE is selected YES.

- ②4 Push [↔](5) to enter the duplex direction setting state.
 - Duplex direction setting screen is displayed.

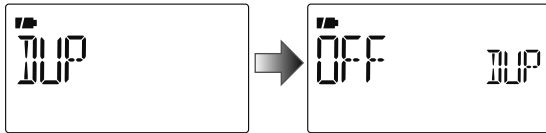

- ②5 Push [▲](2) or [▼](8) to select the duplex direction.

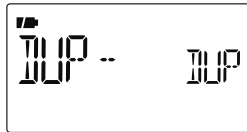

- ②6 Push [↔](5) to set the duplex direction and exit the state.
- ②7 Push [▲](2) or [▼](8) to select the next content (frequency offset programming).

Frequency offset programming (OFF SET)

This content appears when R1 USE is selected YES.

- ②8 Push [↔](5) to enter the frequency offset programming state.
 - Frequency offset programming screen is displayed.

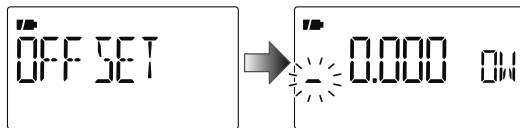

- ②9 Push [▲](2) or [▼](8) to select the frequency offset.
 - The selected number blinks.
 - Push [▶](6) to move the cursor right; push [◀](4) to move the cursor left.
 - Push and hold [CLR](1) for 1 sec. to clear the displayed frequency.



- ③0 Push [↔](5) to set the frequency offset and exit the state.

Storing the repeater list (ADD W)

- ③1 Push [▲](2) or [▼](8) to select the store operation.
- ③2 Push [↔](5) to enter storing state.
 - “ADD W OK?” appears.

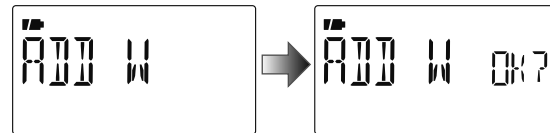

- ③3 Push [↔](5) again to store the list.

6 DV MODE PROGRAMMING

◆ Repeater name programming (R-NAME)

- 1 Push [**←**](5) to enter the repeater name programming state.
 - Repeater name programming screen is displayed.
 - The 1st digit blinks.

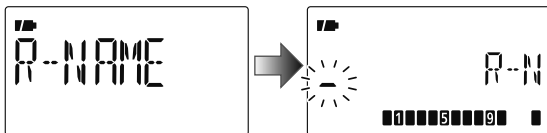

- 2 Push [**▲**](2) or [**▼**](8) to select the desired character, number, symbol or space.
 - The selected character blinks.
 - Push [**▶**](6) to move the cursor right; push [**◀**](4) to move the cursor left.
 - Push [**CLR**](1) to erase the selected character, or push and hold [**CLR**](1) for 1 sec. to erase all characters following the cursor.



- 3 Repeat step 2 until the desired repeater name is programmed.
 - Up to an 8 digit name can be set.
- 4 Push [**←**](5) to program the repeater name and exit the state.

◆ Repeater call sign programming (CALL S)

- 1 Push [**←**](5) to enter the repeater call sign programming state.
 - Repeater call sign programming screen is displayed.
 - The 1st digit blinks.

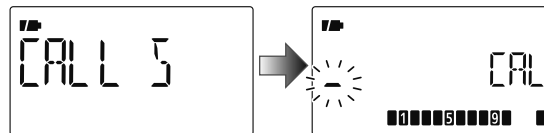

- 2 Push [**▲**](2) or [**▼**](8) to select the desired character, number or symbol ('/' only).
 - The selected character blinks.
 - Push [**▶**](6) to move the cursor right; push [**◀**](4) to move the cursor left.
 - Push [**CLR**](1) to erase the selected character, or push and hold [**CLR**](1) for 1 sec. to erase all characters following the cursor.

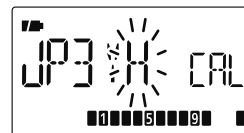

- 3 Repeat step 2 until the desired repeater call sign is programmed.
 - Up to an 8 digit call sign can be set.
- 4 Push [**←**](5) to program the repeater call sign and exit the state.

◆ Gateway repeater call sign programming (GW CALL)

- ① Push [←](5) to enter the gateway repeater call sign programming.
 - Gateway repeater call sign programming screen is displayed.
 - Programmed repeater call sign is displayed, then the 1st character blinks.
 - The 8th digit is automatically added or replaced to “G.”

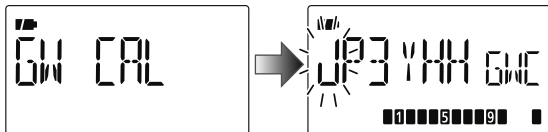

- ② Push [▲](2) or [▼](8) to select the desired character, number, symbol ('/' only) or space.
 - The selected character blinks.
 - Push [▶](6) to move the cursor right; push [◀](4) to move the cursor left.
 - Push [CLR](1) to erase the selected character, or push and hold [CLR](1) for 1 sec. to erase all characters following the cursor.
- ③ Repeat step ② until the desired repeater call sign is programmed.
 - Up to an 8 digit call sign can be set, but 8th digit must be set to “G.”



- ④ Push [←](5) to program the gateway repeater call sign and exit the state.

■ Changing a repeater list

You can edit the contents of a repeater list to correct errors or added information.

- ① Enter “EDIT-L” in RPT-L menu.

MENU ⇄ RPT-L ⇄ **EDIT-L**
 (Push [MENU] (5)), (Push [▲](2)/[▼](8), then push [←](5).)

- Programmed repeater name appears.

EDIT-L

➔

HAMA 12 EDIT

SKIP indicator
↓
SKIP

SKIP indicator shows the selected repeater can not be used as an access repeater (RPT1) in DR mode as follow reasons.

- “R1 USE” is set to “NO”
- Either “FREQ” (frequency) or “DUP” (duplex direction) has not been programmed

Push and hold 5 ←
SKIP for 1 sec. to select SKIP indicator ON or OFF when both of “FREQ” and “DUP” have been programmed.

- ② Push and hold [BAND] for 1 sec. to enter group selection, rotate [DIAL] to select the desired group (0–9), then push [BAND].
- ③ Push [▲](2) or [▼](8) to select the desired repeater list to be changed.

6 DV MODE PROGRAMMING

- ④ Push [←](5) to enter the list.

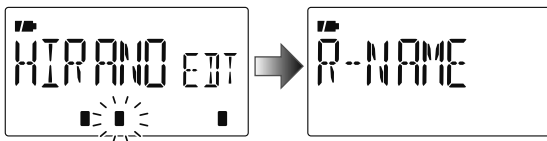

- ⑤ Push [▲](2) or [▼](8) to select the content to be changed, then push [←](5) to enter the content and reprogram the content (see pages 40–43 for new repeater list programming details).
- ⑥ After programming is finished, push [▲](2) or [▼](8) to select “ADD W” or “OVR W,” then push [←](5).

When “ADD W” is selected;

- “ADD W OK?” appears.

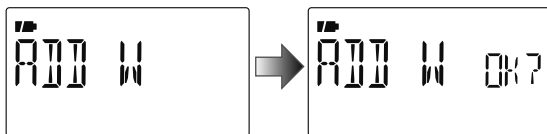

When “OVR W” is selected;

- “OVR W OK?” appears.

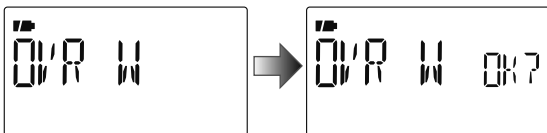

- ⑥ Push [←](5) again to store the list.

■ Clearing a repeater list

Contents of programmed list can be cleared (erased).

- ① Enter “EDIT-L” in RPT-L menu.

MENU ⇨ RPT-L ⇨ **EDIT-L**
(Push [MENU] (5)), (Push [▲](2)/[▼](8)), then push [←](5).

- Programmed repeater name appears.
- ② Push [▲](2) or [▼](8) to select the desired repeater list to be erased.
- Push and hold [BAND] for 1 sec. to enter group selection, rotate [DIAL] to select the desired group (0–9) then push [BAND].
- ③ Push [←](5) to enter the list.

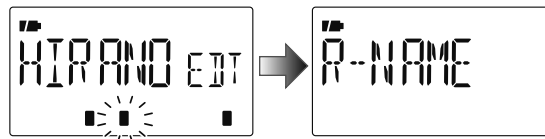

- ④ Push [▲](2) or [▼](8) to select “CLEAR,” then push [←](5).
- “CLEAR OK?” appears.

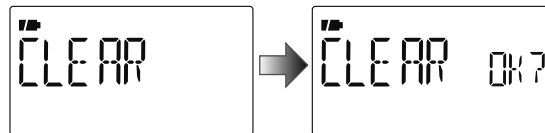

- ⑤ Push [←](5) again to clear the list.

■ Digital mode operation

The IC-E80D can be operated in digital voice mode and low-speed data operation for both transmit and receive. It can also be connected to a GPS receiver (compatible with an RS-232 output/NMEA format/4800 bps/9600 bps) to transmit/receive position data.

■ Current call sign setting

Set the current call sign for DV operation as follows.

- Enter "CALL-S" in MENU screen.

MENU ⇄ **CALL-S**

(Push [MENU] (9)), (Push [▲](2)/[▼](8), then push [←](5).)

- Call sign screen is displayed.

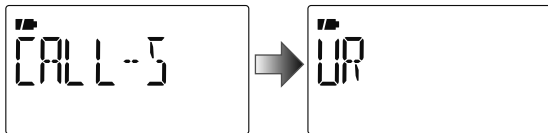

- Push [▲](2) or [▼](8) to select the desired call sign group, "UR," "RPT1," "RPT2" or "MY," then push [←](5).

- Current call sign is displayed.

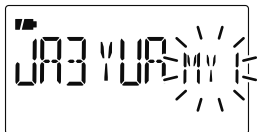

Quick entry

Push and hold [CS](9) for 1 sec. to enter the current call sign mode. See next page for details.

• Call sign group

UR : Station call signs (U01–U60), "CQCQCQ" (U--) or repeater CQ* (R-L) can be selected.

* '/' plus repeater call sign (R-L), '/' stands for "CQCQCQ"

RPT1 : "NOTUSE"* (R--) or repeater call signs (R-L) can be selected.

* Direct communication (NOT USE repeater)

RPT2 : "NOTUSE"* (R--) or repeater call signs (R-L) can be selected.

* Direct communication or using area repeater only (NOT USE linked repeater)

MY : My call signs (MY1–MY6) can be selected.

- Push [▲](2) or [▼](8) to select the desired call sign. Or push [▶](6) to enter the current call sign programming state (pgs. 36–38).

- When "UR," "RPT1" or "RPT2" is selected at step ②, push [BAND] several times to select the repeater call sign groups.

- When repeater call sign is selected, push and hold [CS](9) for 1 sec. to toggle the call sign and repeater name indications.

- Push [←](5) to set the selected call sign to the current call sign and exit the state.

- Repeat steps ② to ④ to set the other current call sign.

- Push [MENU] (9) to return to the frequency screen.

◇ Confirming current call sign

- Push and hold **[CS]**(9) for 1 sec. to enter the current call sign mode.
 - Current UR call sign is displayed.

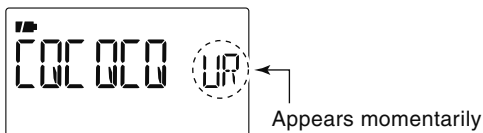

- Push **[▲]**(2) or **[▼]**(8) to select and confirm the other current call sign.
 - ("UR"), "R1," "R2" and "MY" appears in sequence.
 - When repeater call sign is selected, push and hold **[CS]**(9) for 1 sec. to toggle the call sign and repeater name indications.

When changing the call sign

- Push **[←]**(5) to enter the call sign selection mode.

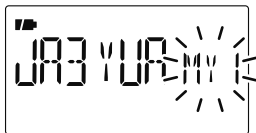

- Push **[▲]**(2) or **[▼]**(8) to select the desired call sign, then push **[←]**(5).
 - When "UR," "R1" or "R2" is selected, push **[BAND]** several times to select the repeater call sign groups.

- Push **[CS]**(9) again to return to the frequency screen.

■ Receiving a D-STAR repeater

When the IC-E80D receives a signal from a D-STAR repeater, it receives four call sign: caller's call sign, called call sign, repeater call sign 1 (the repeater that caller accessed), and repeater call sign 2 (the linked repeater). You can copy the received call signs to current call signs, and you can also reply to a call.

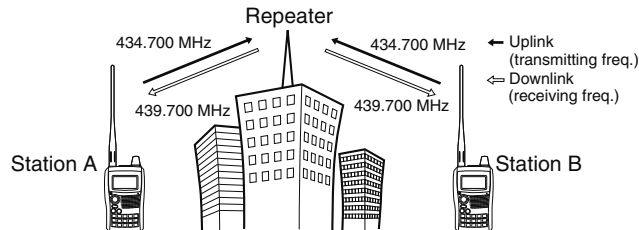

• Presetting

- Set the desired repeater frequency. (p. 23)
 - Select output power, if desired. (p. 27)
- Set the shift direction of the transmit frequency. (DUP- or DUP; see p. 32 for details.)
- Select the DV mode. (p. 25)
- When signal is received, display indicates received call sign.

See next page for information about received call signs.

■ Received call sign

When a call is received in the DV mode, the calling station and the repeater call signs being used can be stored into the received call record. The stored call signs are viewable in the following manner. Up to 20 calls can be recorded.

◇ Desired call record indication

- ① Enter RX call sign screen.

MENU ⇄ **RX CAL**
(Push [MENU] (5), (Push [▲](2)/[▼](8), then push [←](5).)

• RX call sign screen is displayed.

- ② Push [▲](2) or [▼](8) to select the desired record channel.
③ To confirm the received call, push [←](5) several times to select the desired call sign from CALLER, / (CALLER's note), CALLED, RXRPT1 and RXRPT2.

CALLER: The station call sign that made the call.

/: 4 character note with call sign that made the call.

CALLED: The station call sign called by the caller.

RXRPT1: The repeater call sign used by the caller station in the same zone, or gateway repeater call sign of the down link repeater when the caller station is in a different zone.

RXRPT2: The repeater call sign for down link repeater.

- ④ Push [MENU] (5) to return to the frequency screen.

✓ For your information

When receiving a call, the received station call sign is automatically displayed and scrolled in sequence on the frequency display.

This can be turned OFF in DV SET mode. (p. 134)

Call record channel

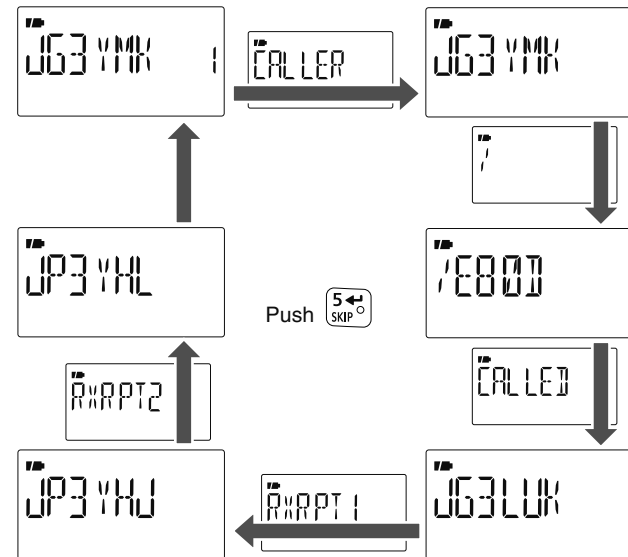

NOTE: When a call is received in the DV mode when the power save function is activated, the call sign may not be received correctly.

This is normal, not a malfunction, because the call sign information cannot be detected during power save.

Turn the power save function OFF (p. 125) if you want to receive a call sign correctly even in stand-by operation.

7 DV MODE OPERATION

◇ One-touch reply using the call record

The stored call signs in the call record can be used to the call.

- ① After receiving a call, push and hold **[RX→CS](8)** for 1 sec.

Or, while pushing and holding **[RX→CS](8)**, rotate **[DIAL]** to select the desired call record.

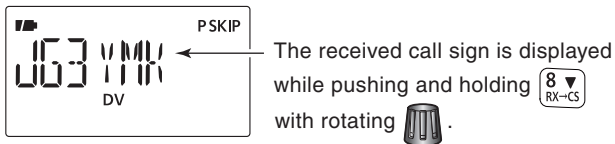

- Set your own call sign (MY) in advance. (pgs. 36, 47, 48)
- The call sign in “CALLER” is stored as “UR,” “RXRPT1” is stored as “R2” and “RXRPT2” is stored as “R1.”

NOTE: The display shows “-----” with error beeps, when a call sign has been received incorrectly. In this case, no call sign is set. See previous page ‘◇ Desired call record indication’ for checking the received call sign.

- ② Push **[PTT]** to transmit; release to receive.

• Selecting a call record via RX CAL screen

- ① Select the desired record channel as steps ① and ② on the previous page.
- ② Push and hold **[RX→CS](8)** for 1 sec. to copy the record channel to current call sign.
- ③ Push **[PTT]** to transmit; release to receive.

Important!

Setting call signs with the “One-touch reply using the call record” operation as at left are for temporary operation only. Therefore, the set call signs will be over-written when another call record is used to set call signs.

- Never saved into a call sign memory.

If you want to save the set call signs, see “Copying the call record contents into call sign memory” (p. 51) for details.

✓ For your information

When a call specifying your call sign is received, the call signs of the calling station and the repeater it is using can be automatically used for operation.

- When “CALL W (RX call sign auto write)” (p. 133) is set to “AUTO,” the station call sign in “CALLER” is set to “UR” automatically.
- When “RPT W (Repeater call sign auto write)” (p. 133) is set to “AUTO,” the repeater call sign in “RXRPT1” is stored as “R2” and “RXRPT2” is stored as “R1” automatically.

NOTE: The One-touch reply function can be used on the same network system, but it cannot be used over different network systems.

■ Copying the call sign

◇ Copying the call sign memory contents

This function is convenient when editing or modifying a part of the memorized call sign.

- ① During DV mode operation, enter call sign menu.

MENU ⇄ **CALL-S**
(Push [MENU] (), (Push [▲](2)/[▼](8), then push [←](5).)

- ② Push [▲](2) or [▼](8) to select “UR,” then push [←](5).
③ Push [▲](2) or [▼](8) to select the desired call sign channel to be copied.
• U01–U60 are available.

• When “AUTO” is set to “EDIT R” item

- ④ Push [▶](6) to select the call sign programming mode.
• The 1st digit of the selected call sign blinks.

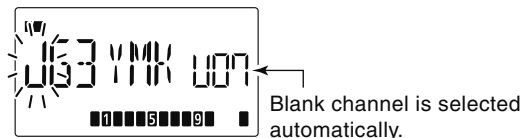

- ⑤ Modify the selected call sign as described in “Station call sign programming” (p. 37).
⑥ Push [←](5) to store the modified call sign into the selected blank channel.

NOTE:

Make sure that the “EDIT R” (EDIT RECORD) item in DV set mode is set to “AUTO” or “SEL” in advance. (p. 134)

NOTE: If no blank channel is available in the station call sign memory, select the desired call sign channel number as described in step ⑦ of “• When “SEL” is set to “EDIT R” item” below.

• When “SEL” is set to “EDIT R” item

- ④ Push [▶](6) to select the call sign programming mode.
• The 1st digit of the selected call sign blinks.
⑤ Modify the selected call sign as described in “Station call sign programming” (p. 37).
⑥ Push [←](5).
• Call sign channel number blinks.

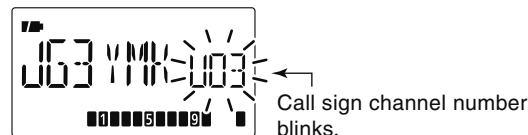

- ⑦ Push [▲](2) or [▼](8) to select the desired call sign channel to store.
⑧ Push [←](5) to store the modified call sign into the selected channel.

◇ Copying the call record contents into call sign memory

This is a way to copy the call record contents (“CALLER,” “RXRPT1” and “RXRPT2”) into call sign memory “UR” and repeater list “R-L” at the same time or individually.

- ① Enter RX CAL (RX call sign) mode.

MENU ⇨ **RX CAL**

(Push [MENU] (right arrow)), (Push [▲](2)/[▼](8), then push [←](5).)

- RX call sign screen is displayed.

- ② Push [▲](2) or [▼](8) to select the desired record channel.

- ③ Push [←](5) several times to select the desired call sign from CALLER, / (CALLER’s note), CALLED, RXRPT1 and RXRPT2.

CALLER : The station call sign that made the call.

/ : 4 character note with call sign that made the call.

CALLED : The station call sign called by the caller.

RXRPT1 : The repeater call sign used by the caller station in the same zone, or gateway repeater call sign of the down link repeater when the caller station is in a different zone.

RXRPT2 : The repeater call sign for down link repeater.

- ④ Push [▶](6) to enter copy select mode.

- Copy select screen is displayed.



- ⑤ Push [▲](2) or [▼](8) to select the desired call sign to be copied from “C ALL,” “C UR01”–“C UR60,” “C R-L” and “CLEAR.”

- “C ALL” selection won’t appear when either station call sign memory or repeater list has no blank channel.

- ⑥ Push [←](5) to copy the selected record’s contents into the appropriate call sign memory or repeater lists.

C ALL : Copy the caller call sign in “CALLER” to “UR” (station call sign memory) and the repeater call sign in “RXRPT1” / “RXRPT2” to the repeater lists. This selection won’t appear when either station call sign memory or repeater list has no blank channel.

C UR01– :

C UR60 : Copy the caller call sign in “CALLER” to “UR” (station call sign memory). This selection appears when entering the copy select mode (step ④) from “CALLER” only.

C R-L : Copy the repeater call sign in “RXRPT1” / “RXRPT2” to the repeater lists. This selection appears when entering the copy select mode (step ④) from “RXRPT1” or “RXRPT2” only.

CLEAR : Clear (erase) the selected call record contents.

- ⑦ Push [MENU] (right arrow) to return to the frequency screen.

■ DR (D-STAR Repeater) mode operation

DR (D-STAR Repeater) mode is used for D-STAR repeater operation. In this mode, you can select the pre-programmed repeaters and UR call sign by using [DIAL].

• DR mode operation flow chart

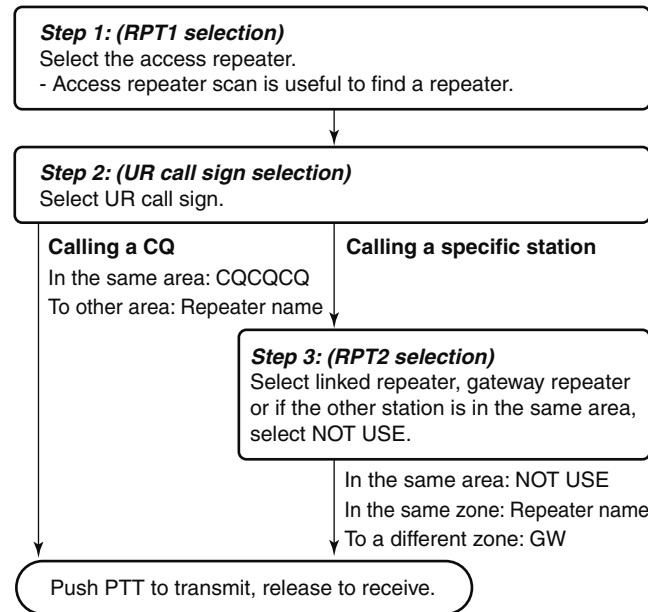

- Repeater settings can be stored into a memory channel.

◇ Access repeater scan

- ① Push [DR] to select the DR mode.
 - The DV mode is selected automatically.
- ② Push and hold [SCAN](V/MHz) for 1 sec. to start the scan.
 - The scan pauses when a signal is received.
 - Rotate [DIAL] to change the scanning direction, or to resume manually.
 - Push [V/MHz] to stop the scan.

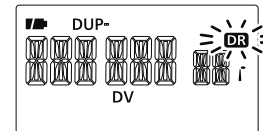

During access repeater scan

• Skip setting

Unwanted access repeater can be skipped for rapid selection or scan.

- ① Push [DR] to select the DR mode.
- ② Rotate [DIAL] to select the desired access repeater to be skipped.
 - Push and hold [BAND] for 1 sec. to enter group selection, rotate [DIAL] to select the desired group (0–9) then push [BAND].
 - While pushing and holding [SKIP](5), rotating [DIAL] selects a skip channel.
- ③ Push and hold [SKIP](5) for 1 sec. to toggle the skip setting ON and OFF.
 - “SKIP” appears when the channel is set as skip channel.

■ Calling CQ

• STEP 1 (RPT1 selection)

① Push [DR] to enter the DR mode.

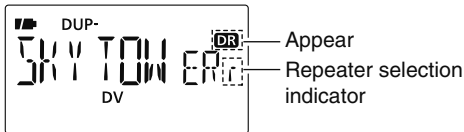

② Select the repeater group.

Selecting the repeater group

① Push and hold [BAND] for 1 sec., then rotate [DIAL] to select the desired repeater group.

- Only assigned groups from GRP 1–GRP 9 and GRP 0 are selectable.

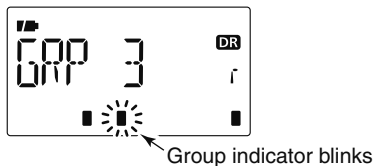

② Push [BAND] again to release the group selection.

- Push [0]–[9] to select the repeater group directly.

③ Rotate [DIAL] to select the access repeater.

- Only repeaters that have access repeater settings programmed are selectable.
- Group indicator appears momentarily when rotating [DIAL].
- Access repeater scan can be used for the selection. (p. 53)

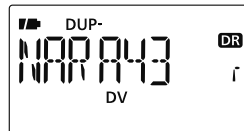

• STEP 2 (UR call sign selection)

④ Push and hold [UR](.) for 1 sec. to enter the UR call sign selection.

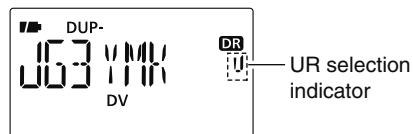

⑤ Select the group as step ②.

- Only assigned GRP 1–GRP 9, GRP 0, GRP UR and GRP CQ are selectable.
- UR call signs are selectable in GRP UR.
- “CQCQCQ” is selectable in GRP CQ.
- Push [BAND] several times to select “GRP UR,” “GRP CQ” and “GRP RP.”

◇ Calling CQ in the same area (Area CQ)

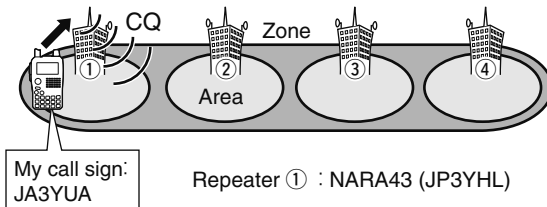

Continued instruction from step ⑤ on page 54.

- ⑥ Push **[BAND]** several times to select “GRP CQ,” then “CQCQCQ” is selected as UR call sign automatically.
 - The linked repeater (RPT2) setting is set to “NOT USE” automatically.
- ⑦ Push **[PTT]** to transmit; release to receive.

◇ Calling CQ to another area (Zone CQ/Different zone CQ)

• Calling CQ in the same zone (Zone CQ)

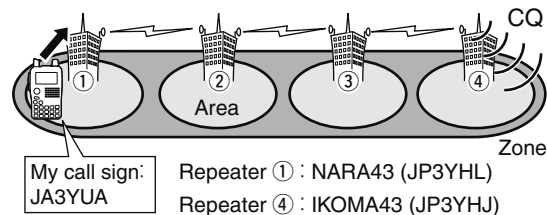

• Calling CQ to another zone (Different zone CQ)

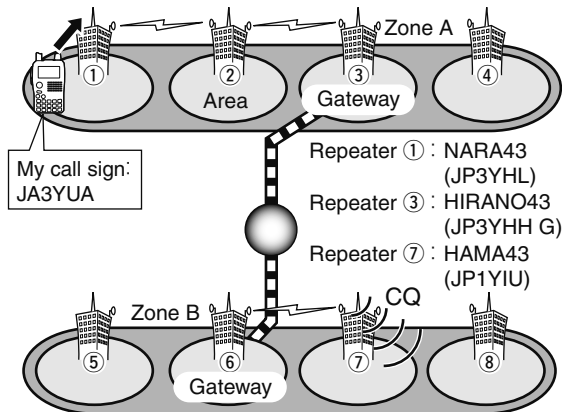

Continued instruction from step ⑤ on page 54.

- ⑥ Rotate **[DIAL]** to select a desired repeater name.
 - Push **[BAND]** several times to select “GRP RP” or push **[0]–[9]** to select the repeater group in advance.

Calling CQ in the same zone

The linked repeater (RPT2) is set to the selected repeater automatically.

Calling CQ to another zone

The linked repeater (RPT2) is set to the preset gateway repeater automatically.

- ⑦ Push **[PTT]** to transmit; release to receive.

■ Calling a specific station

• STEP 1 (RPT1 selection)

① Push [DR] to enter the DR mode.

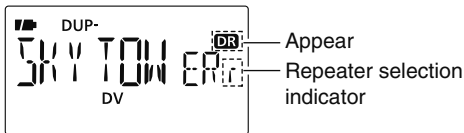

② Select the repeater group.

Selecting the repeater group

① Push and hold [BAND] for 1 sec., then rotate [DIAL] to select the desired repeater group.

- Only assigned groups from GRP 1–GRP 9 and GRP 0 are selectable.

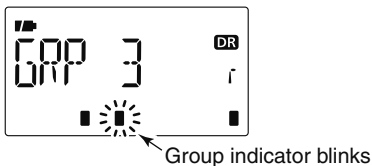

② Push [BAND] again to release the group selection.

- Push [0]–[9] to select the repeater group directly.

③ Rotate [DIAL] to select the access repeater.

- Only repeaters that have access repeater settings programmed are selectable.
- Group indicator appears momentarily when rotating [DIAL].
- Access repeater scan can be used for the selection. (p. 53)



• STEP 2 (UR call sign selection)

④ Push and hold [UR](.) for 1 sec. to enter the UR call sign selection.

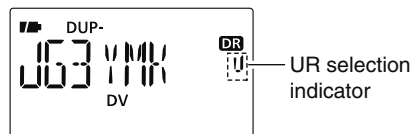

⑤ Rotate [DIAL] to select a specific station call sign.

- Push [BAND] several times to select “GRP UR” in advance.

◇ Calling a specific station in the same area (Area call)

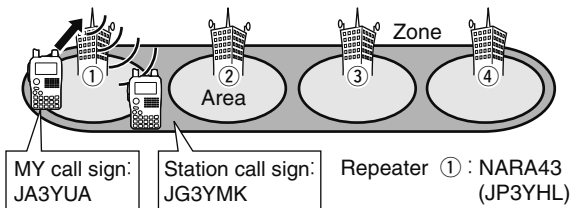

Continued instruction from step ⑤ on page 56.

• STEP 3 (RPT2 selection)

- ⑥ Push and hold [UR](.) for 1 sec. to enter the linked repeater (RPT2) selection.

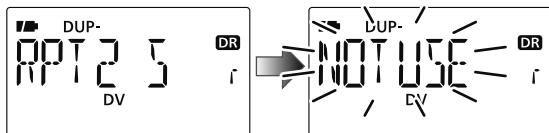

- ⑦ Rotate [DIAL] to select "NOT USE."

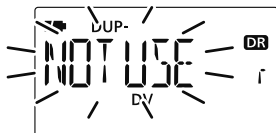

- ⑧ Push [UR](.) to exit the linked repeater selection.
 ⑨ Push [PTT] to transmit; release to receive.

◇ Calling a specific station in the same zone (Zone call)

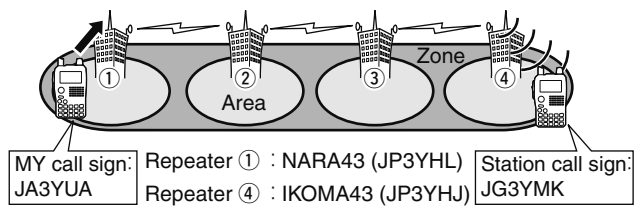

Continued instruction from step ⑤ on page 56.

• STEP 3 (RPT2 selection)

- ⑥ Push and hold [UR](.) for 1 sec. to enter the linked repeater (RPT2) selection.

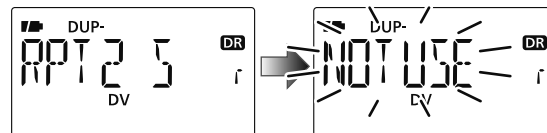

- ⑦ Rotate [DIAL] to select the specific linked repeater in the same zone.

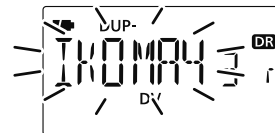

- ⑧ Push [UR](.) to exit the linked repeater selection.
 ⑨ Push [PTT] to transmit; release to receive.

7 DV MODE OPERATION

◇ Calling a specific station in another zone (Different zone call)

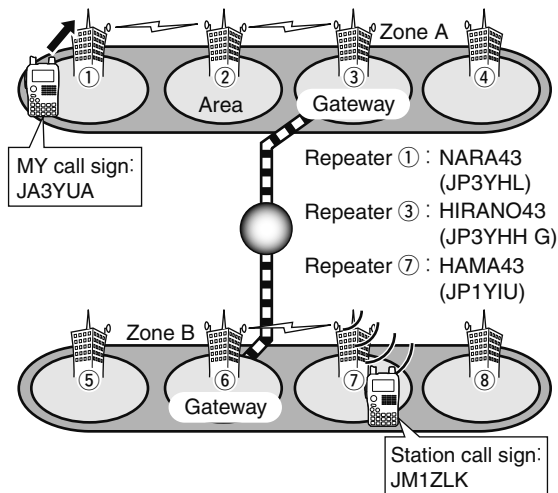

NOTE: If the other station has accessed the repeater at once, the D-STAR system will connect to the repeater automatically even you don't know where the station is (possible in the same area as you, or in the same zone or a different zone). In this case, you select "GW" as the RPT2 selection. The Auto gateway setting "GW SET" is helpful (p. 134).

Continued instruction from step ⑤ on page 56.

• STEP 3 (RPT2 selection)

⑦ Push and hold [UR](.) for 1 sec. to enter the linked repeater (RPT2) selection.

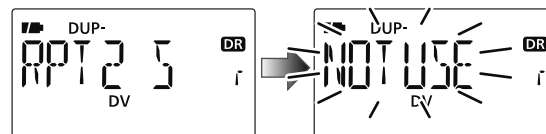

⑧ Rotate [DIAL] to select the preset gateway repeater "GW."
• Only the repeater that has gateway capability appear.

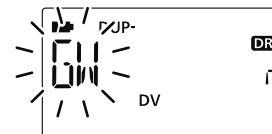

⑨ Push [UR](.) to exit the linked repeater selection.

⑩ Push [PTT] to transmit; release to receive.

◇ Confirming the setting

- ① Push and hold **[CS](9)** for 1 sec. to enter the setting confirmation screen.
 - Either UR, R1 or R2 call sign is displayed.

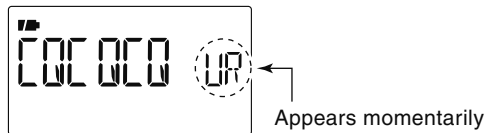

- ② Push **[▲](2)** or **[▼](8)** to select and confirm the other current call sign.
 - “UR,” “R1,” “R2,” “MY” and “FREQ” appears in sequence.
- ③ Push and hold **[CS](9)** for 1 sec. to toggle the name indication and call sign indication.
 - Name indication is available only for repeater call signs that have programmed repeater names.

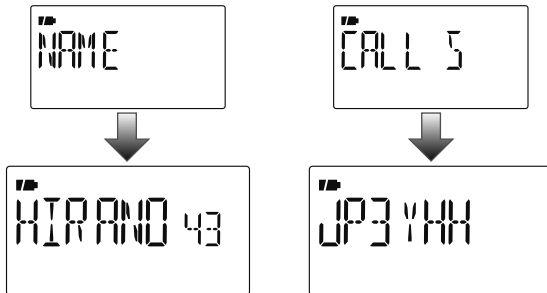

- ④ Push **[CS](9)** again to exit the setting confirmation screen.

◇ One-touch reply using the call record in the DR mode

The stored call signs in the call record can be used to the call. See p. 50 for “One-touch reply using the call record” (except the DR mode).

- ① After receiving a call, push and hold **[RX→CS](8)** for 1 sec.

Or, while pushing and holding **[RX→CS](8)**, rotate **[DIAL]** to select the desired call record.

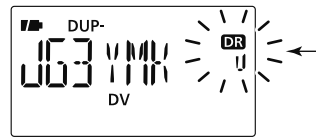

Blinks when the received call sign is displayed.

- The call sign in “CALLER” is stored as “UR.”
 - Error beeps sound when a call sign is received incorrectly, and no call sign is set in this case.
- ② Push **[PTT]** to transmit; release to receive.
 - ③ Push **[RX→CS](8)** again to return to the previous setting.
 - Push **[DR]**, **[UR](.)** or **[V/MHz]** also returns to the previous setting.

NOTE: If you want to save this temporary setting, push and hold **[S.MW](M/CALL)** for 1 sec., then rotate **[DIAL]** to select the desired memory channel, call channel or VFO. Then push and hold **[S.MW](M/CALL)** again to store the setting. (If you push and hold **[S.MW](M/CALL)** for 2 sec. at first pushing, the setting is stored to VFO automatically.)

■ Simplex operation in the VFO

◇ Sending CQ

- ① Set the desired frequency. (p. 23)
 - Select output power, if desired. (p. 27)
- ② Set the current call sign to your own call sign. (p. 47)
- ③ Set the current UR call sign. (p. 47)

UR call sign selection

- ① Push and hold [UR](.) for 1 sec. to enter UR call sign selection mode.
 - Push [BAND] several times to select “GRP CQ” (CQCQCQ) “GRP UR” (UR call sign memories) and “CS” (current call sign).
 - DV mode is automatically selected.
- ② Rotate [DIAL] to select “CQCQCQ.”



- ③ Push [UR](.) to return to the frequency screen.

- ④ Push and hold [PTT] to transmit and speak into the microphone at normal voice level.
 - Tx/Rx indicator lights red and the RF meter shows the output power.
 - “CQCQCQ” is displayed and scrolled in sequence on the frequency display depending on “TX CS” setting (p. 135).

- ⑤ Release [PTT] to return to receive.
 - The other station's call sign will be received.
 - Received call signs can be stored into the received call record automatically. See page 49 for details.

• Current call sign setting example (Simplex CQ)

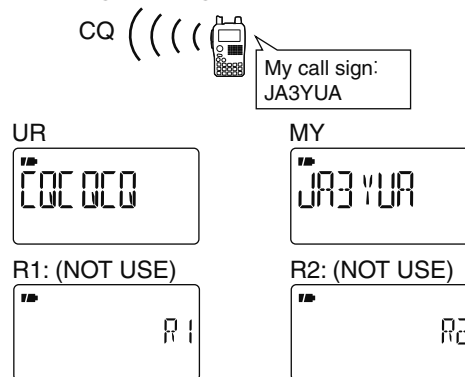

Confirmation

- ① Push and hold [CS](9) for 1 sec. to enter the current call sign mode.
 - Current UR call sign is displayed.
- ② Push [▲](2) or [▼](8) to select and confirm the other current call sign.
 - (“UR”), “R1,” “R2” and “MY” appears in sequence.

◇ Calling a specific station

- ① Set the desired frequency. (p. 23)
 - Select output power, if desired. (p. 27)
- ② Set the current call sign to your own call sign. (p. 47)
- ③ Set the current UR call sign. (p. 47)

UR call sign selection

- ① Push and hold **[UR]**(.) for 1 sec. to enter UR call sign selection mode.
 - Push **[BAND]** several times to select “GRP CQ” (CQCQCQ) “GRP UR” (UR call sign memories) and “CS” (current call sign).
 - DV mode is automatically selected.
- ② Rotate **[DIAL]** to select the specific station call sign.



- ③ Push **[UR]**(.) to return to the frequency screen.

- ④ Push and hold **[PTT]** to transmit and speak into the microphone at normal voice level.
 - Tx/Rx indicator lights red and the RF meter shows the output power.
 - UR call sign is displayed and scrolled on the frequency display depending on “TX CS” setting (p. 135).

- ⑤ Release **[PTT]** to return to receive.
 - The other station's call sign will be received.
 - Received call signs can be stored into the received call record automatically. See page 49 for details.

• Current call sign setting example (Simplex call)

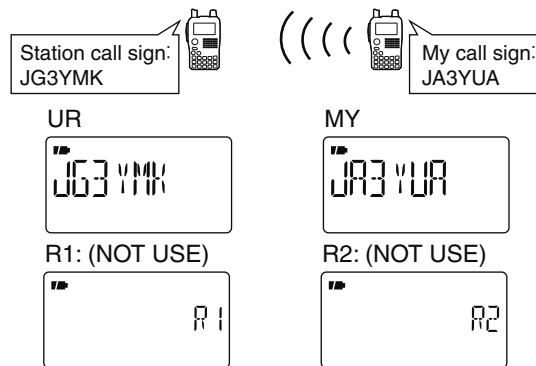

NOTE: The digital mode operation is vastly different from FM mode. One of the differences is that in digital mode the squelch does not function as in FM mode. Changing the squelch setting will not open it to hear the hiss of “white noise.” It only activates for digital squelch functions such as CSQL (Digital code squelch) or D SQL (Digital call sign squelch).

■ Repeater operation in the VFO

◇ Calling CQ in the same area (Area CQ)

- ① Set the desired repeater's frequency, offset and shift direction (pgs. 23, 32), then select the DV mode (p. 25).

Your own call sign (step ②) and station call sign (step ③) can also be set as same as repeater call signs in current call sign mode (step ④).

- ② Set the current call sign to your own call sign.
 • See pgs. 47, 48 for current call sign setting details.
- ③ Set the current station call sign as follows:
 ➔ Push and hold **[UR]**(.) for 1 sec. to enter UR call sign selection mode.
 • Push **[BAND]** several times to select "GRP CQ," then "CQC-QCQ" is selected automatically. Push **[UR]**(.) again.
- ④ Set the current repeater's call sign as follows:
 ① Push and hold **[CS]**(9) for 1 sec. to enter the current call sign mode.
 • UR call sign is displayed.
 • Push and hold **[CS]**(9) for 1 sec. to toggle the call sign and repeater name indications.
- ② Rotate **[DIAL]** to select "R1," access repeater's call sign, then push **[←]**(5) to enter the current call sign selection mode.
- ③ Rotate **[DIAL]** to select the desired access repeater's call sign, then push **[←]**(5) to set the call sign for "RPT1."
 • Return to the current call sign mode.

- ④ Rotate **[DIAL]** to select "R2," linked repeater's call sign, then push **[←]**(5) to set the current call sign selection mode.
 • "RPT2" call sign screen is displayed.
- ⑤ Rotate **[DIAL]** to select "NOT USE," then push **[←]**(5).
 • Return to the current call sign mode.
- ⑥ Push **[V/MHz]** to return to the frequency screen.
- ⑤ Push **[PTT]** to transmit; release to receive.
 • "CQCQCQ" is displayed and scrolled in sequence on the frequency display depending on "TX CS" setting (p. 135).

• Current call sign setting example

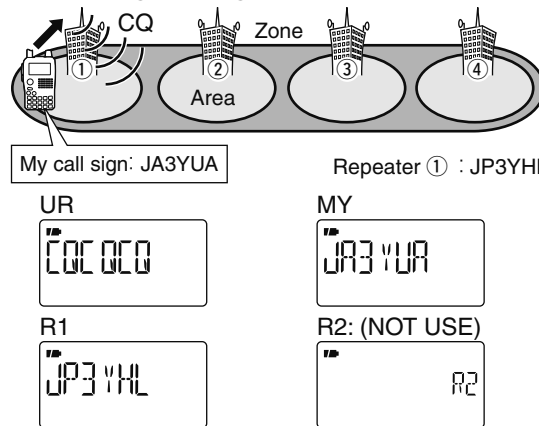

Pushing **[BAND]** selects the repeater group when selection.

◇ Calling a specific station in the same area (Area call)

- ① Set the desired repeater's frequency, offset and shift direction (pgs. 23, 32), then select the DV mode (p. 25).

Your own call sign (step ②) and station call sign (step ③) can also be set as same as repeater call signs in current call sign mode (step ④).

- ② Set the current call sign to your own call sign.
- See pgs. 47, 48 for current call sign setting details.
- ③ Set the current station call sign as follows:
- 1 Push and hold **[UR]**(.) for 1 sec. to enter UR call sign selection mode.
 - 2 Rotate **[DIAL]** to select the desired station call sign.
 - Push **[BAND]** several times to select "GRP UR" in advance.
 - 3 Push **[UR]**(.) again to return to the frequency screen.
- ④ Set the current repeater's call sign as follows:
- 1 Push and hold **[CS]**(9) for 1 sec. to enter the current call sign mode.
 - UR call sign is displayed.
 - Push and hold **[CS]** for 1 sec. to toggle the call sign and repeater name indications.
 - 2 Push **[▲]**(2) or **[▼]**(8) to select "R1," access repeater's call sign, then push **[←]**(5) to enter the current call sign selection mode.
 - 3 Push **[▲]**(2) or **[▼]**(8) to select the desired access repeater's call sign, then push **[←]**(5) to set the call sign for "RPT1."
 - Return to the current call sign mode.

Pushing **[BAND]** selects the repeater group when selection.

- 4 Push **[▲]**(2) or **[▼]**(8) to select "R2," linked repeater's call sign, then push **[←]**(5) to set the current call sign selection mode.
 - "RPT2" call sign screen is displayed.
 - 5 Push **[▲]**(2) or **[▼]**(8) to select "NOT USE," then push **[←]**(5).
 - Return to the current call sign mode.
 - 6 Push **[V/MHz]** to return to the frequency screen.
- ⑤ Push **[PTT]** to transmit; release to receive.
- UR call sign is displayed and scrolled in sequence on the frequency display depending on "TX CS" setting (p. 135).

• Current call sign setting example

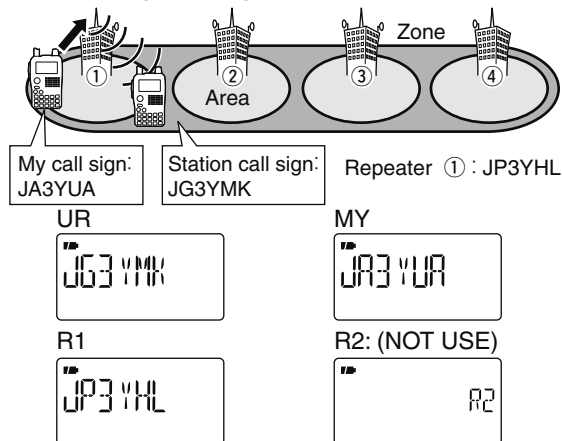

7 DV MODE OPERATION

◇ Calling CQ in the same zone (Zone CQ)

- ① Set the desired repeater's frequency, offset and shift direction (pgs. 23, 32), then select the DV mode (p. 25).

Your own call sign (step ②) and station call sign (step ③) can also be set as same as repeater call signs in current call sign mode (step ④).

- ② Set the current call sign to your own call sign.
 - See pgs. 47, 48 for current call sign setting details.
- ③ Set the current station call sign as follows:
 - ➔ Push and hold **[UR]**(.) for 1 sec. to enter UR call sign selection mode.
 - Push **[BAND]** several times to select "GRP CQ," then "CQC-QCQ" is selected automatically. Push **[UR]**(.) again.
- ④ Set the current repeater's call sign as follows:
 - ① Push and hold **[CS]**(9) for 1 sec. to enter the current call sign mode.
 - UR call sign is displayed.
 - Push and hold **[CS]**(9) for 1 sec. to toggle the call sign and repeater name indications.
 - ② Push **[▲]**(2) or **[▼]**(8) to select "R1," access repeater's call sign, then push **[←]**(5) to enter the current call sign selection mode.
 - ③ Push **[▲]**(2) or **[▼]**(8) to select the desired access repeater's call sign, then push **[←]**(5) to set the call sign for "RPT1."
 - Return to the current call sign mode.

Pushing **[BAND]** selects the repeater group when selection.

- ④ Push **[▲]**(2) or **[▼]**(8) to select "R2," linked repeater's call sign, then push **[←]**(5) to set the current call sign selection mode.
 - "RPT2" call sign screen is displayed.
- ⑤ Push **[▲]**(2) or **[▼]**(8) to select the desired repeater call sign in the same zone, then push **[←]**(5).
 - Return to the current call sign mode.
- ⑥ Push **[V/MHz]** to return to the frequency screen.
- ⑤ Push **[PTT]** to transmit; release to receive.
 - "CQCQCQ" is displayed and scrolled in sequence on the frequency display depending on "TX CS" setting (p. 135).

• Current call sign setting example

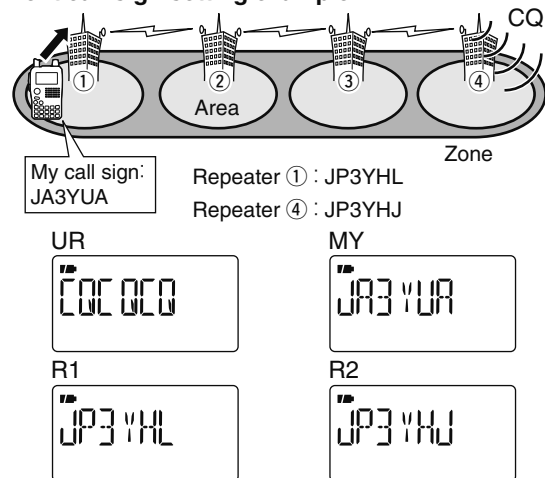

◇ Calling a specific station in the same zone (Zone call)

- ① Set the desired repeater's frequency, offset and shift direction (pgs. 23, 32), then select the DV mode (p. 25).

Your own call sign (step ②) and station call sign (step ③) can also be set as same as repeater call signs in current call sign mode (step ④).

- ② Set the current call sign to your own call sign.
- See pgs. 47, 48 for current call sign setting details.
- ③ Set the current station call sign as follows:
- 1 Push and hold **[UR]**(.) for 1 sec. to enter UR call sign selection mode.
 - 2 Rotate **[DIAL]** to select the desired station call sign.
 - Push **[BAND]** several times to select "GRP UR" in advance.
 - 3 Push **[UR]**(.) again to return to the frequency screen.
- ④ Set the current repeater's call sign as follows:
- 1 Push and hold **[CS]**(9) for 1 sec. to enter the current call sign mode.
 - UR call sign is displayed.
 - Push and hold **[CS]**(9) for 1 sec. to toggle the call sign and repeater name indications.
 - 2 Push **[▲]**(2) or **[▼]**(8) to select "R1," access repeater's call sign, then push **[←]**(5) to enter the current call sign selection mode.
 - 3 Push **[▲]**(2) or **[▼]**(8) to select the desired access repeater's call sign, then push **[←]**(5) to set the call sign for "RPT1."
 - Return to the current call sign mode.

Pushing **[BAND]** selects the repeater group when selection.

- 4 Push **[▲]**(2) or **[▼]**(8) to select "R2," linked repeater's call sign, then push **[←]**(5) to set the current call sign selection mode.
 - "RPT2" call sign screen is displayed.
 - 5 Push **[▲]**(2) or **[▼]**(8) to select the desired repeater call sign in the same zone, then push **[←]**(5).
 - Return to the current call sign mode.
 - 6 Push **[V/MHz]** to return to the frequency screen.
- ⑤ Push **[PTT]** to transmit; release to receive.
- UR call sign is displayed and scrolled in sequence on the frequency display depending on "TX CS" setting (p. 135).

• Current call sign setting example

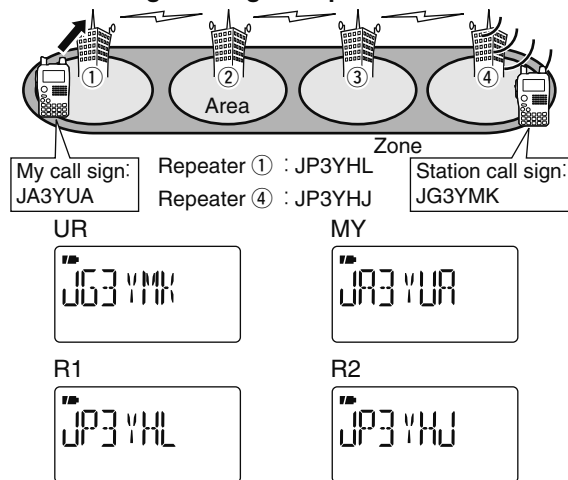

7 DV MODE OPERATION

◇ Calling CQ to another zone (Different zone CQ)

- ① Set the desired repeater's frequency, offset and shift direction (pgs. 23, 32), then select the DV mode (p. 25).
- ② Set the current call sign to your own call sign.
 - See pgs. 47, 48 for current call sign setting details.
- ③ Set the current station call sign and repeater call signs as follows:

- ① Push and hold **[CS]**(9) for 1 sec. to enter the current call sign mode.
 - UR call sign is displayed.
 - Push and hold **[CS]**(9) for 1 sec. to toggle the call sign and repeater name indications.

- ② Push **[←]**(5) to enter the current call sign selection mode.

- ③ Push **[▲]**(2) or **[▼]**(8) to select the desired repeater call sign, then push **[←]**(5) to set the call sign for "UR."
 - Return to the current call sign mode.

- ④ Push **[▲]**(2) or **[▼]**(8) to select "R1," access repeater's call sign, then push **[←]**(5) to enter the current call sign selection mode.

- ⑤ Push **[▲]**(2) or **[▼]**(8) to select the desired access repeater's call sign, then push **[←]**(5) to set the call sign for "RPT1."
 - Return to the current call sign mode.

- ⑥ Push **[▲]**(2) or **[▼]**(8) to select "R2," linked repeater's call sign, then push **[←]**(5) to enter the current call sign selection mode.
 - "RPT2" call sign screen is displayed.

- ⑦ Push **[▲]**(2) or **[▼]**(8) to select the specified gateway repeater call sign in the same zone, then push **[←]**(5).
 - Return to the current call sign mode.

- ⑧ Push **[V/MHz]** to return to the frequency screen.

- ④ Push **[PTT]** to transmit; release to receive.
 - UR call sign is displayed and scrolled in sequence on the frequency display depending on "TX CS" setting (p. 135).

• Current call sign setting example

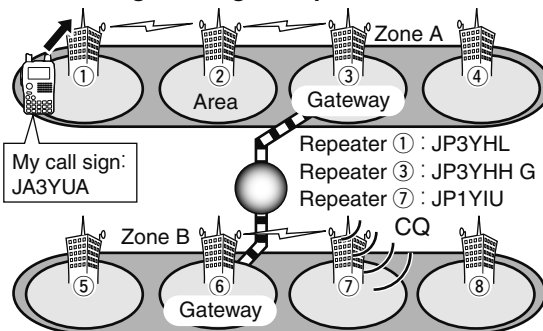

UR
" JP1YIU

MY
" JA3YUA

R1
" JP3YHL

R2
" JP3YHH G

Pushing **[BAND]** selects the repeater group when selection.

◇ Calling a specific station in another zone (Different zone call)

- ① Set the desired repeater's frequency, offset and shift direction (pgs. 23, 32), then select the DV mode (p. 25).
- ② Set the current call sign to your own call sign.
 - See pgs. 47, 48 for current call sign setting details.
- ③ Set the current station call sign and repeater call signs as follows:
 - ① Push and hold [CS](9) for 1 sec. to enter the current call sign mode.
 - UR call sign is displayed.
 - Push and hold [CS](9) for 1 sec. to toggle the call sign and repeater name indications.
 - ② Push [←](5) to enter the current call sign selection mode.
 - ③ Push [▲](2) or [▼](8) to select the desired station call sign, then push [←](5) to set the call sign for "UR."
 - Return to the current call sign mode.
 - ④ Push [▲](2) or [▼](8) to select "R1," access repeater's call sign, then push [←](5) to enter the current call sign selection mode.
 - ⑤ Push [▲](2) or [▼](8) to select the desired access repeater's call sign, then push [←](5) to set the call sign for "RPT1."
 - Return to the current call sign mode.
 - ⑥ Push [▲](2) or [▼](8) to select "R2," linked repeater's call sign, then push [←](5) to enter the current call sign selection mode.
 - "RPT2" call sign screen is displayed.

Pushing [BAND] selects the repeater group when selection.

- ⑦ Push [▲](2) or [▼](8) to select the specified gateway repeater call sign in the same zone, then push [←](5).
 - Return to the current call sign mode.
- ⑧ Push [V/MHz] to return to the frequency screen.
- ④ Push [PTT] to transmit; release to receive.
 - UR call sign is displayed and scrolled in sequence on the frequency display depending on "TX CS" setting (p. 135).

• Current call sign setting example

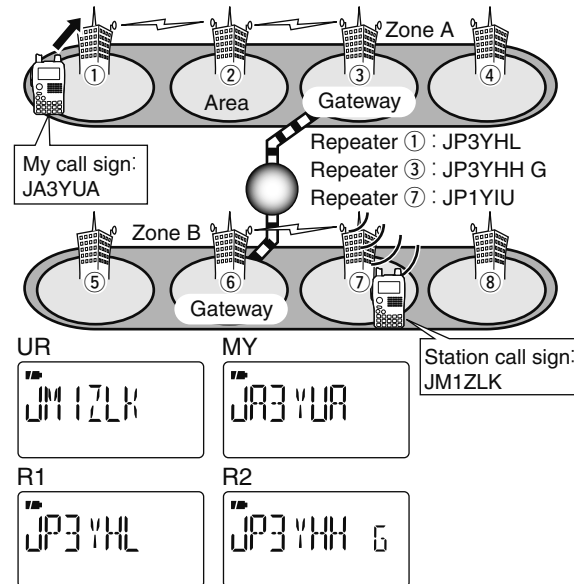

Message operation

◇ TX message programming

TX messages are available for up to 5 channels and each channel can be programmed with a message of up to 20 characters.

- Enter "TX MSG" in MESSAG (message) screen.

MENU ⇨ MESSAG ⇨ **TX MSG**
 (Push [MENU] (right)), (Push [▲](2)/[▼](8), then push [←](5).)

- TX MSG screen is displayed.
- Push [▲](2) or [▼](8) to select the desired transmit message channel.
 - TM1 to TM5 and OFF are available.
 - Previously message is displayed if programmed.
 - Push [▶](6) to select the message edit condition.
 - The 1st digit of the message blinks.



- Push [▲](2) or [▼](8) to select the desired character or symbol.
 - If an unwanted character is entered, push [▶](6) or [◀](4) to select the character, then push [CLR](1) to erase the selected character, or push and hold [CLR](1) for 1 sec. to erase all characters following the cursor.
 - Push [▶](6) to move the cursor right; push [◀](4) to move the cursor left.

- Repeat step ④ to enter the desired message.
 - Up to 20 character messages can be set.

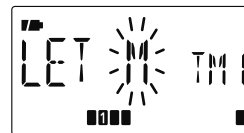

- Push [←](5) to store the message.
- Push [MENU] (right) to return to the frequency screen.

• Available characters

A	B	C	D	E	F	G	H	I	J	K	L	M	
(A)	(B)	(C)	(D)	(E)	(F)	(G)	(H)	(I)	(J)	(K)	(L)	(M)	

N	O	P	Q	R	S	T	U	V	W	X	Y	Z	
(N)	(O)	(P)	(Q)	(R)	(S)	(T)	(U)	(V)	(W)	(X)	(Y)	(Z)	

0	1	2	3	4	5	6	7	8	9				
(0)	(1)	(2)	(3)	(4)	(5)	(6)	(7)	(8)	(9)				

!	"	#	\$	%	&	'	()	*	+	,	-	
(!)	(")	(#)	(\$)	(%)	(&)	(')	(()	(*)	(+)	(,)	(-)	

.	/	:	;	<	=	>	?	@	[\]	^	_
(.)	(/)	(:)	(;)	(<)	(=)	(>)	(?)	(@)	([(\)	(])	(^)	(Space)

◇ Message Transmission

You can toggle the message transmission function ON (TM1–TM5) and OFF. When a message channel is selected, the transceiver transmits a pre-programmed text message. (default: OFF)

- ① Set the operating frequency, call signs and other settings, such as repeater operation, as desired.
- ② Enter “TX MSG” in MESSAG (message) screen.

MENU ⇨ MESSAG ⇨ **TX MSG**

(Push [MENU] (5), (Push [▲](2)/[▼](8), then push [←](5).)

- TX MSG screen is displayed.
- ③ Push [▲](2) or [▼](8) to select the desired transmit message channel.
 - TM1 to TM5 are available.
 - ④ Push [←](5) to set the message for transmission.
 - ⑤ Push [PTT] to transmit.
 - The message is transmitted each time when [PTT] is pushed.
 - The message is transmitted each 30 sec. automatically during continuous transmission.
 - ⑥ Release [PTT] to return to receive.

- ⑦ When the reply call with a message is received, the call sign and the message scrolls on the frequency display.

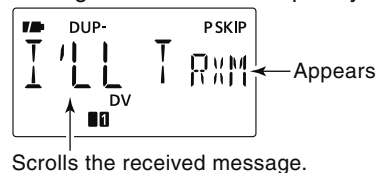

✓ For your information

The automatic received call sign and/or message indication can be turned OFF in DISP set mode, if desired.

- ➡ RX CS (RX CALL SIGN) (p. 134)
- ➡ RX MSG (RX MESSAGE) (p. 135)

NOTE: Only one message can be stored in the IC-E80D. The received message is cleared by turning power OFF, or overwritten when another message is received.

◇ RX message indication

The received message can also be checked in MESSAG (message) screen.

- ① Select "RX MSG" in MESSAG (message) screen.

MENU ⇨ MESSAG ⇨ **RX MSG**
 (Push [MENU] (5)), (Push [▲](2)/[▼](8), then push [←](5).)

- The received message is displayed.
- Push [▶](6) or [◀](4) to scroll the message.



- ② Push [▼](8) to display the station call sign (caller).

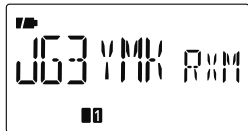

- ③ Push [←](5) several times to return to RX MSG screen.
 - Push [▶](6) or [◀](4) to scroll the call sign.
- ④ Push [MENU] (5) to return to the frequency screen.

■ Automatic reply function

The automatic reply function replies to calls by a station that specified your call sign.

◇ Automatic reply function setting

- ① Enter "REPLY" in DV SET mode.

MENU ⇨ DV SET ⇨ **REPLY** (p. 132)
 (Push [MENU] (5)), (Push [▲](2)/[▼](8), then push [←](5).)

- REPLY (auto reply) screen is displayed.

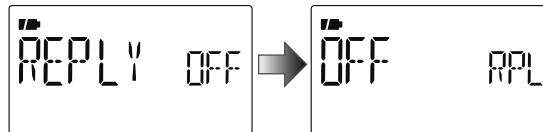

- ② Push [▲](2) or [▼](8) to turn the automatic reply function ON and OFF.
 - OFF**: Deactivate the automatic reply function. (default)
 - ON**: Reply to the call with your own call sign.
- ③ Push [←](5).
 - Returns to DV SET mode automatically.
- ④ Push [MENU] (5) to return to the frequency screen.

/// The Automatic reply function is turned OFF automatically, when a manual transmission (pushing [PTT]) is performed.

■ EMR communication

The EMR (Enhanced Monitor Receive) communication mode is available for digital mode operation. In the EMR communication mode, no call sign setting is necessary. When an EMR communication mode signal is received, the audio (voice) will be heard at the specified level even the volume setting level is set to minimum level, or digital call sign/digital code squelch is in use.

- ① Enter "EMR" in DV SET mode.

MENU ⇄ DV SET ⇄ **EMR**
 (Push [MENU] (), (Push [▲](2)/[▼](8), then push [←](5).)

- EMR screen is displayed.

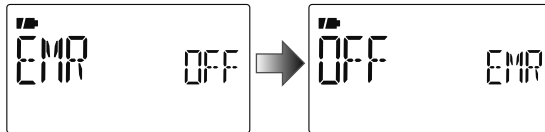

- ② Push [▲](2) or [▼](8) to turn the EMR communication mode ON and OFF.

OFF : EMR communication is set OFF. (default)

ON : EMR communication is set ON.

- When "ON" is selected, "EMR" appears instead of memory channel indication.

- ③ Push [←](5).

- Returns to DV SET mode.

- ④ Push [MENU] () to return to the frequency screen.

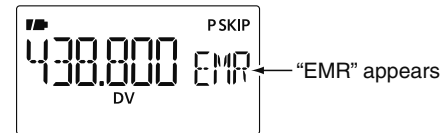

- ⑤ Push [PTT] to transmit.

- ⑥ Release [PTT] to return to receive.

NOTE: The EMR communication function is turned OFF automatically when turning transceiver's power OFF

■ Break-in communication

The break-in function allows you to break into a conversation, where the two original stations are communicating with call sign squelch enabled.

- ① While receiving an another station's communication, push and hold **[RX→CS]**(8) for 1 sec. to set the communicating station's call sign.
 - When a call sign has not been received correctly, error beeps sound and no call sign is set. Try to set the call sign of a communicating signal again, or set the call sign manually.
- ② Enter "BK" in DV SET mode.

MENU ⇄ DV SET ⇄ **BK**
 (Push **[MENU]**), (Push **[▲]**(2)/**[▼]**(8), then push **[←]**(5).)

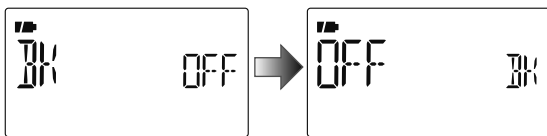

- BK screen is displayed.
- ③ Push **[▲]**(2) or **[▼]**(8) to turn the Break-in function ON and OFF.
 - When "ON" is selected, "BK" appears instead of memory channel indication
 - ④ Push **[←]**(5).
 - Returns to DV SET mode.

- ⑤ Push **[MENU]** to return to the frequency screen.

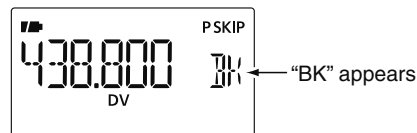

- ⑥ When both stations are in standby, push **[PTT]** to transmit a break-in call.
 - The programmed call sign station receives the break-in call as well as your call sign.
- ⑦ Wait for the reply call from the station who receives the break-in call.
- ⑧ After receiving the reply call, communicate normally.
- ⑨ To cancel the break-in function, turn the Break-in function OFF in the DV SET mode as steps ② to ⑤.

NOTE: The break-in function is turned OFF automatically when turning transceiver's power OFF

• How to use break-in?

While operating with the digital call sign squelch (p. 151), the squelch never opens (no audio sounds) even if a call is received, unless your own call sign (“MY”) is specified. However, when the call including the “BK ON” signal (break-in call) is received, the squelch will open and audio sounds even if the call is specified for another station.

• Station C calling to Station A with “BK OFF”

Station A and B are communicating using the digital call sign squelch.

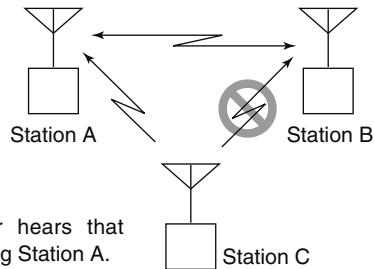

Station B never hears that Station C is calling Station A.

• Station C calling to Station A with “BK ON”

Station A and B are communicating using the digital call sign squelch.

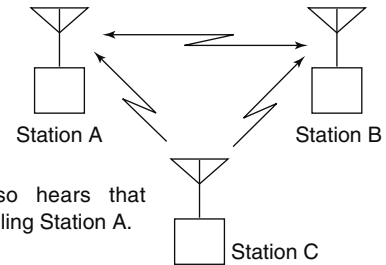

Station B also hears that Station C is calling Station A.

■ Low-speed data communication

In addition to the digital voice communication, low-speed data communication is available.

The optional OPC-1529R DATA COMMUNICATION CABLE and serial data communication software (purchase locally) are required in addition.

/// **NOTE:** Turn OFF "GPS-TX" (p. 138) in advance to operate the low-speed data communication.

◇ Connection

Connect the transceiver to your PC using with the optional OPC-1529R as illustrated below.

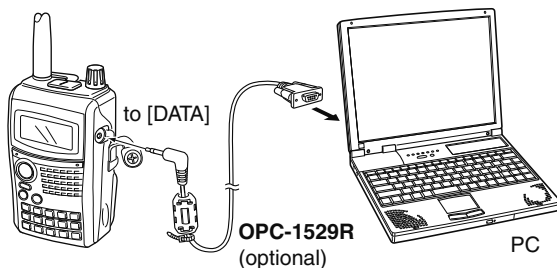

◇ Low-speed data communication application setting

Configure the low-speed data communication application as follows.

- Port : The same COM port number as IC-E80D's
- Baud rate : 9600/4800 bps (p. 127)
- Data : 8 bit
- Parity : None
- Stop : 1 bit
- Flow control : Xon/Xoff

◇ Low-speed data communication operation

/// **NOTE:** Confirm that in AUTO, the computer controls when [PTT] is activated to send data and the user doesn't have to operate the radio.

- ① Set the current call signs, etc. as described in "Current call sign setting" (p. 47), "Simplex operation in VFO" (p. 60) and "Repeater operation in VFO" (p. 62).
- ② Refer to the instructions of the low-speed data communication application.
- ③ To transmit data
 - At the same time as your voice audio, push and hold [PTT] to transmit while sending data from the PC. Release [PTT] to receive.
 - Under computer control, see Transmission condition setting at right.

◇ Transmission condition setting

- ① Enter "DATATX" in DV SET mode.

MENU ⇨ DV SET ⇨ **DATATX** (p. 132)
(Push [MENU], (Push [▲](2)/[▼](8), then push [←](5).)

- ② Push [▲](2) or [▼](8) to select "PTT" or "AUTO."
PTT : The input data from [DATA] are transmitted when pushing [PTT]. (default)
AUTO : The input data from [DATA] are transmitted automatically when the data are input.
- ③ Push [←](5) to return to DV SET mode, and push [MENU] to return to the frequency screen.

Other functions in the DV mode

◇ DV auto detect

The “DV” mode indicator and “FM” mode indicator blink when a non-DV signal is received during DV mode operation. When a signal other than the DV mode is received, the IC-E80D DV automatic detection switches to monitor in the FM mode.

- Enter “DV DET” in the DV SET mode.

MENU ⇨ DV SET ⇨ **DV DET** (p. 133)
 (Push [MENU] (5)), (Push [▲](2)/[▼](8), then push [←](5).)

- Push [▲](2) or [▼](8) to turn the DV automatic detect function ON and OFF.

OFF : “DV” blinks then “FM” also blinks, but the transceiver receives in the DV mode even if non-DV mode signals are received.

ON : “DV” blinks then “FM” also blinks, when the transceiver monitors the receiving signal in other than DV mode, the signal is in FM mode.

- Push [←](5) to return to the DV SET mode.
- Push [MENU] (5) to return to the frequency screen.

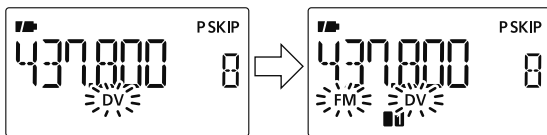

NOTE: The received FM audio may be distorted when receiving an FM signal with DV automatic detect function.

◇ Packet loss indication

While operating voice communication or low-speed data communication via the internet network from one zone to another zone, some packets may be lost due to network error (poor data throughput performance). In such a case, the IC-E80D displays “P-LOSS” instead of the frequency screen on the display to indicate Packet Loss has occurred.

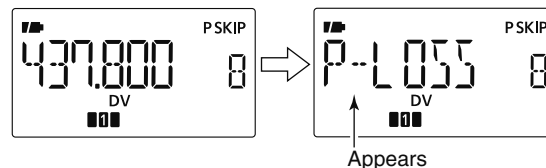

■ GPS operation

You can display GPS data when in FM, FM-N, WFM, AM and DV modes. You can also transmit GPS data when in the DV mode. To receive GPS data, connect an optional GPS speaker microphone (HM-189GPS) or connect a third-party GPS receiver* that has an RS-232C output and NMEA data format. Third-party GPS receivers connect to the IC-E80D's [DATA] jack.

In addition, the GPS message transmission is also available in GPS mode operation.

*Set "GPS-TX" to "DVG" or "DVA" at step ② of next page when connecting a 3rd party GPS receiver.

NOTE: The IC-E80D receives GPS data (position, etc.) from the HM-189GPS only when the IC-E80D is receiving. When transmitting, GPS data are not updated and the IC-E80D transmits the GPS data it received before you pushed [PTT].

• When connecting the HM-189GPS

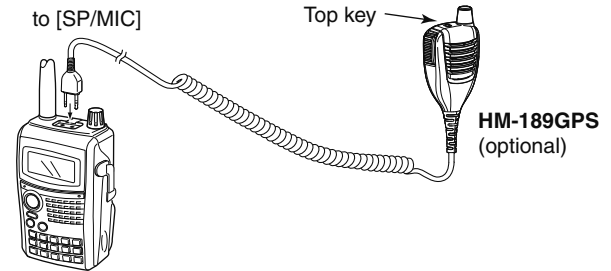

• When connecting the GPS receiver

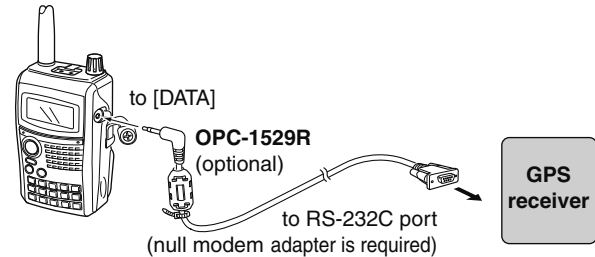

8 GPS/GPS-A OPERATION

◇ Sentence formatter setting

① Enter "GPS-TX" in GPS mode.

MENU ⇨ GPS ⇨ **GPS-TX**
(Push [MENU] (5)), (Push [▲](2)/[▼](8), then push [←](5).)

• GPS-TX screen is displayed.

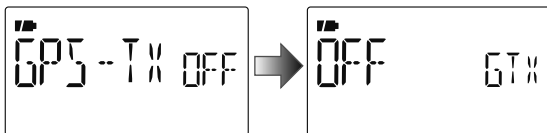

② Push [▲](2) or [▼](8) to select "DVG."

③ Push [←](5) to select GPS sentence screen.

④ Push [▲](2) or [▼](8) to select the desired GPS sentence, then push [←](5).

• A total of 6 sentences, RMC, GGA, GLL, GSA, VTG and GSV are available.

⑤ Push [▲](2) or [▼](8) to select to turn the sentence usage ON and OFF.

⑥ Push [←](5) to return to GPS sentence screen.

⑦ Repeat steps ④ to ⑥ to set another GPS sentence usage.

• Up to 4 GPS sentences are usable at the same time.

⑧ Push [MENU] (5) to return to the frequency screen.

NOTE:

Set the GSV sentence to OFF when sending the GPS message to conventional digital transceivers (IC-E2820, IC-E91, IC-V82, IC-U82).

The GSV sentence is incompatible with them. Those transceivers will not display GPS messages properly if sent as a GSV sentence from the IC-E80D.

◇ GPS message programming

- ① Enter "TX GPS" in MESSAG screen.

MENU ⇨ MESSAG ⇨ **TX GPS**
(Push [MENU] (5)), (Push [▲](2)/[▼](8), then push [←](5).)

- TX GPS screen is displayed.

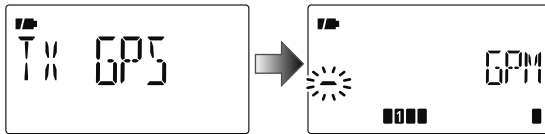

- ② Push [←](5) to select the message edit condition.
• The 1st digit of the message blinks.
- ③ Push [▲](2) or [▼](8) to select the desired character or symbol.
- ④ Push [▶](6) to select 2nd digit, then push [▲](2) or [▼](8) to select the desired character or code.
• Push [▶](6) to move the cursor right; push [◀](4) to move the cursor left.
• 2nd digit blinks (1st digit stops blinking).
- ⑤ Repeat step ④ to enter the desired message.
• Up to 20-character messages can be set.

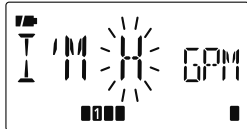

- ⑥ Push [←](5) to store the message.
- ⑦ Push [MENU] (5) to return to the frequency screen.

◇ GPS message automatic transmission

- ① Enter "GPS.ATX" in GPS mode.

MENU ⇨ GPS ⇨ **GPS.ATX** (p. 142)
(Push [MENU] (5)), (Push [▲](2)/[▼](8), then push [←](5).)

- GPS AUTO TX screen is displayed.

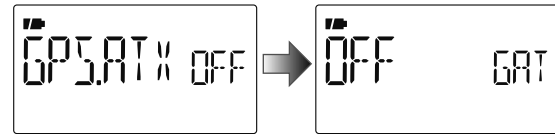

- ② Push [▲](2) or [▼](8) to select the desired position data transmitting interval from 5 sec., 10 sec., 30 sec., 1 min., 3 min., 5 min., 10 min., 30 min. and OFF.
• The GPS message is also transmitted if programmed.
- ③ Push [←](5) to return to GPS mode.
- ④ Push [MENU] (5) to return to the frequency screen.

⚠ **NOTE:** Your own call sign ("MY") must be set to activate the GPS automatic transmission.

[NOTICE]

"5SEC" cannot be selected when 4 GPS sentences are selected.

- Only use GPS message automatic transmission in simplex mode.
- Automatic GPS message transmission through a repeater may interfere with other communications.

8 GPS/GPS-A OPERATION

◇ Received GPS message indication

- ① Enter "RX GPS" in MESSAG screen.

MENU ⇨ MESSAG ⇨ **RX GPS**
(Push [MENU] (5)), (Push [▲](2)/[▼](8), then push [←](5).)

- RX GPS screen is displayed.

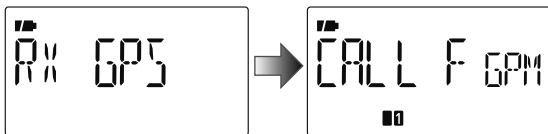

- ② Push [←](5) several times to scroll the message.
③ Push [←](5) to return to the MESSAG screen.
④ Push [MENU] (5) to return to the frequency screen.

◇ Position indication

- ① Enter "GPS.POS" in GPS mode.

MENU ⇨ GPS ⇨ **GPS.POS**
(Push [MENU] (5)), (Push [▲](2)/[▼](8), then push [←](5).)

- GPS POS screen is displayed.

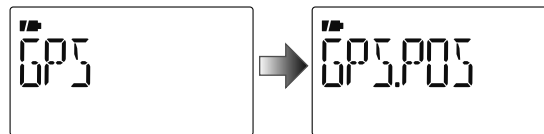

- ② Push [▲](2) or [▼](8) to select the position data indication.
- **MY POS** : Displaying own latitude and longitude.
 - **RX POS** : Displaying (caller) other station latitude and longitude.
 - **ELEVAT** : Displaying own elevation.
 - **TIME** : Displaying the time.
 - **DISTAN** : Displaying distance from (caller) other station.
 - **CALLER** : Displaying the call sign of (caller) other station.
- ③ Push [←](5) to enter the selection.
④ Push [←](5) to return to the "GPS.POS" screen. See "MY POS" and "RX POS" operations at next page.
⑤ Push [MENU] (5) to return to the frequency screen.

NOTE: Depending on the receiving conditions of the GPS signals, your elevation may change even though you are stationary.

• Selectable items

My position

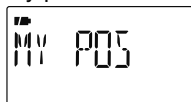

Received position

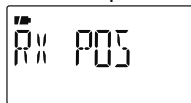

Elevation

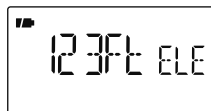
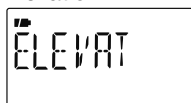

Time

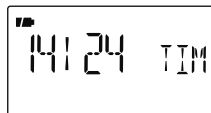

Distance

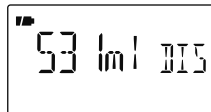
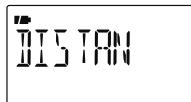

Caller

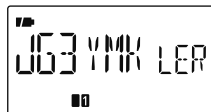
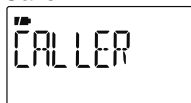

• Position indication

My position

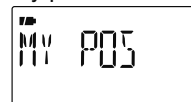

North or South



My position
35°45.00'N
135°35.00'E



S/R/F meter indicates the selection



East or West

Push ↑

Push ↓

Push ↓

These sample indications assume that "P FORM" is selected "mm.mm" and "UNITS" is selected "Ft/ml." (p. 136)

8 GPS/GPS-A OPERATION

◇ Saving own/received position data

① Enter "GPS.POS" in GPS mode.

MENU ⇨ GPS ⇨ **GPS.POS**
(Push [MENU] (5)), (Push [▲](2)/[▼](8), then push [←](5).)

- GPS POS screen is displayed.

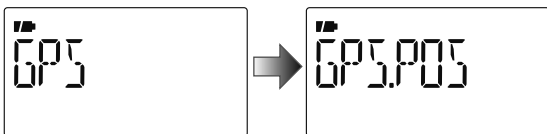

② Push [▲](2) or [▼](8) to select the position data indication.

- **MY POS** : Displaying own latitude and longitude.
- **RX POS** : Displaying (caller) other station latitude and longitude.
- **ELEVAT** : Displaying own elevation.
- **TIME** : Displaying the time.
- **DISTAN** : Displaying distance from (caller) other station.
- **CALLER** : Displaying the call sign of (caller) other station.

③ Push [←](5) to enter the selection.

④ Push and hold [S.MW](M/CALL) for 1 sec. to save the selected position data to GPS memory (G00).

- The M-CH number advances automatically in case the next M-CH already contains.
- 50 GPS M-CH are available.
- Push [M/CALL] to display stored position data.

◇ Displaying direction and forward

Displaying own direction, received station's direction and set position and direction in the GPS memory.

① Enter "D/F" in GPS mode.

MENU ⇨ GPS ⇨ **D/F**
(Push [MENU] (5)), (Push [▲](2)/[▼](8), then push [←](5).)

- D/F (Direction/Forward) screen is displayed.

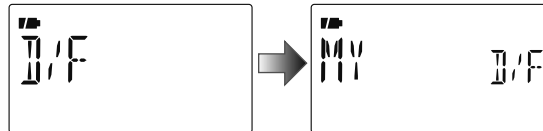

② Push [▲](2) or [▼](8) to select "MY," "RX" and "GPS.M"
[Indication items]

- **MY** : Displays own direction, elevation and the time.
- **RX** : Displays other station's direction and distance from own position.
- **GPS.M** : Displays the direction and distance from own position of alarm setting for the memorized position in the GPS memory.

③ Push [←](5) to enter the selection.

- 16 compass points are available.

④ Push [←](5) several times to select other information.

⑤ Push [MENU] (5) to return to the frequency screen.

• Direction indication example

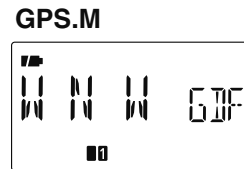
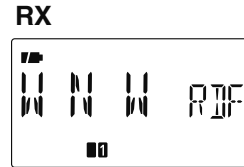
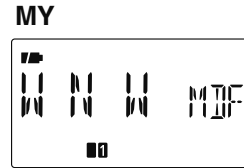
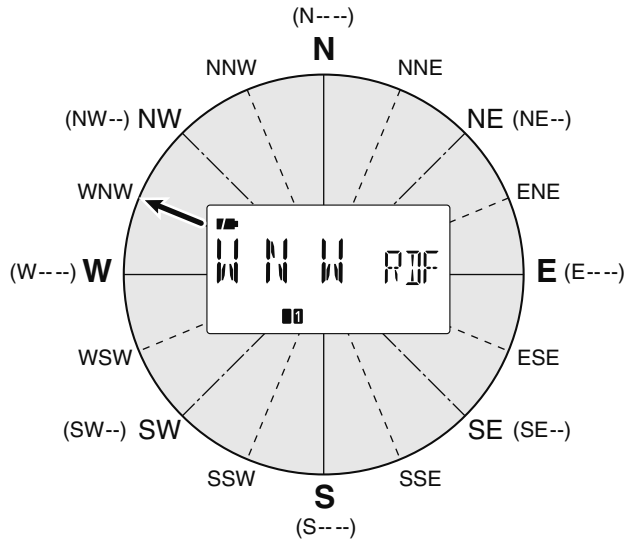

8 GPS/GPS-A OPERATION

◇ GPS data addition

① Enter "GPS.MEM" (GPS memory) in GPS mode.

MENU ⇨ GPS ⇨ **GPS.MEM**
(Push [MENU] (4)), (Push [▲](2)/[▼](8), then push [←](5).)

• GPS memory selection screen is displayed.

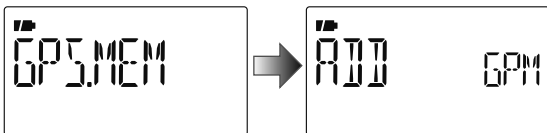

② Push [←](5) to enter the new GPS memory channel programming state.

③ Push [▲](2) or [▼](8) to select the desired items, "NAME," "TIME," "LAT" (LATITUDE) or "LON" (LONGITUDE), then push [▶](6) to edit the selected item.

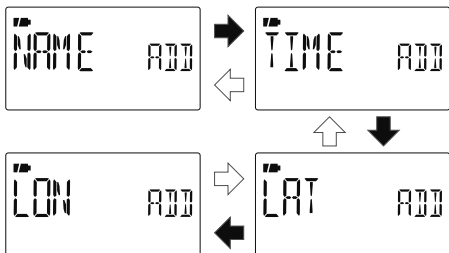

④ Push [▲](2) or [▼](8) to select the desired character or number.

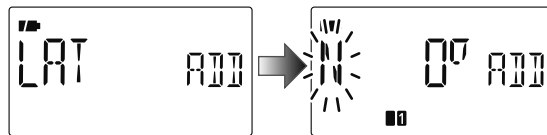

• Push [▶](6) to move the cursor right; push [◀](4) to move the cursor left.

⑤ Repeat step ④ to enter the desired latitude data, then push [←](5) to program the item.

⑥ Repeat steps ③ to ⑤ to program the other items.

• Up to a 6 character name can be programmed.

⑦ Push [←](5) to store the GPS data.

⑧ Push [MENU] (4) to return to the frequency screen.

◇ GPS alarm setting

GPS alarm sounds when your own position is close the specified position. This function can be set to use information from the received channel, a specified GPS memory channel or all GPS memory channels.

- ① Enter "ALM-CH" in GPS mode.

MENU ⇨ GPS ⇨ **ALM-CH**
 (Push [MENU] (5)), (Push [▲](2)/[▼](8), then push [←](5).)

- Alarm setting screen is displayed.

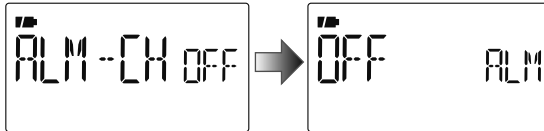

- ② Push [▲](2) or [▼](8) to select "RX," "CH," "ALL" or "OFF."

- "RX," "ALL," one of the memory channel can be selected.
- Skip next step ③ when RX, ALL or OFF is selected.

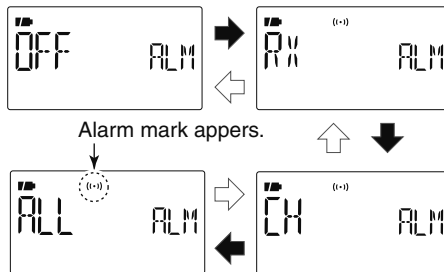

- ③ Push [←](5), then push [▲](2) or [▼](8) to select the desired memory channel.
- Memory name or channel number appears when the channel is selected.

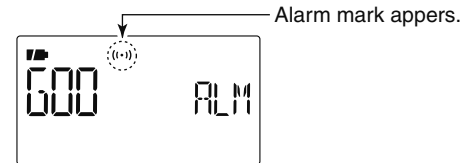

- ④ Push [←](5) to set the alarm function and return to ALM-CH (GPS memory) screen.
- ⑤ Push [MENU] (5) to return to the frequency screen.

✓ For your information!

- When "ALL" or memory channel is selected in step ②, the alarm function depends on "ALM1" setting in GPS mode (p. 88).
- When "RX" or "CH" is selected in step ②, the alarm function depends on "ALM2" setting in GPS mode (p. 89).

8 GPS/GPS-A OPERATION

◇ GPS alarm setting in GPS memory channel

GPS alarm setting for a specified GPS memory channel is available on GPS memory channel indication.

- ① Enter "GPS.MEM" in GPS mode.

MENU ⇨ GPS ⇨ **GPS.MEM**

(Push [MENU] (4)), (Push [▲](2)/[▼](8), then push [←](5).)

- GPS memory selection screen is displayed.

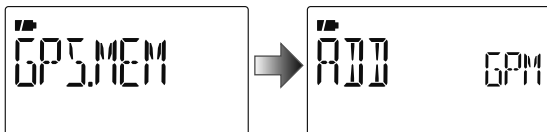

- ② Push [▲](2) or [▼](8) to select the desired memory channel.

- Memory name or channel number appears when the channel is selected.



- ③ Push [M/CALL] to switch the alarm function ON or OFF.

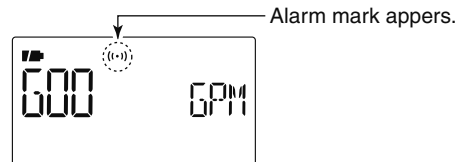

- ④ Push [←](4) to return to GPS.MEM (GPS memory) screen.

- ⑤ Push [MENU] (4) to return to the frequency screen.

✓ For your information!

- When a memory channel is selected in step ③, the alarm function depends on "ALM1" setting in GPS mode (p. 88).

◇ GPS memory clearing

• Clear all memory channels

- ① Enter "GPS.MEM" in GPS set mode.

MENU ⇄ GPS ⇄ **GPS.MEM**
(Push [MENU] (5)), (Push [▲](2)/[▼](8), then push [←](5).)

- GPS memory selection screen is displayed.

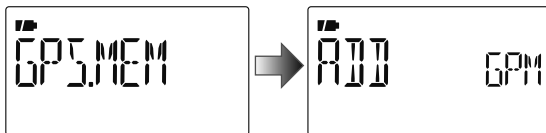

- ② Push [▲](2) or [▼](8) to select "CLEAR ALL," then push [←](5).

- "CLEAR OK?" appears.

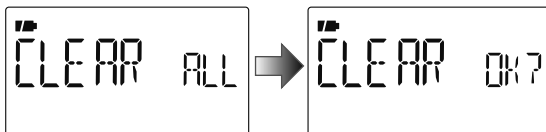

- ③ Push [←](5) again to clear all memory channels.
• 2 beep sounds, then all memory channels are cleared.
- ④ Push [◀](4) to return to GPS.MEM (GPS memory) screen.
- ⑤ Push [MENU] (5) to return to the frequency screen.

• Clear desired memory channel to be cleared

- ① Enter "GPS.MEM" in GPS set mode as described at left.
- ② Push [▲](2) or [▼](8) to select the desired GPS memory channel to be cleared, then push [▶](6).

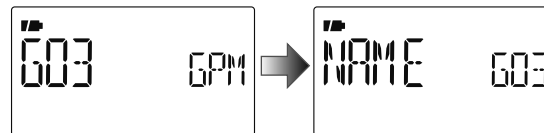

- ③ Push [▼](8) several times to select "CLEAR," then push [←](5).

- "CLEAR OK?" appears.

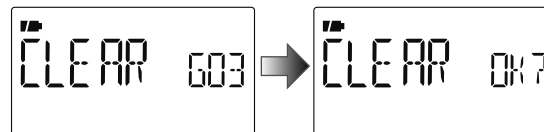

- ④ Push [←](5) again to clear the list.
• 2 beep sounds, then the selected memory channel is cleared.
• Remaining channels scroll up.

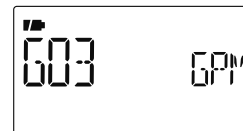

- ⑤ Push [◀](4) to return to GPS.MEM (GPS memory) screen.
- ⑥ Push [MENU] (5) to return to the frequency screen.

8 GPS/GPS-A OPERATION

◇ Alarm area 1

Sets GPS alarm active range from 00.08' to 59.99' in 00.01' steps. (default: 00.25')

① Enter "ALM1" in GPS set mode.

MENU ⇨ GPS ⇨ **ALM1**

(Push [MENU] (right arrow)), (Push [▲](2)/[▼](8), then push [←](5).)

• ALM1 setting screen is displayed.

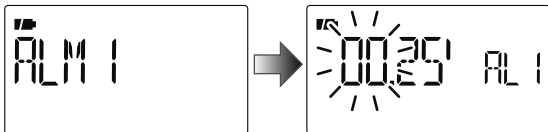

When "P FORM" (position format) (p. 136) is selected "mm.mm."

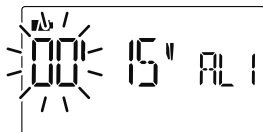

When "P FORM" (position format) (p. 136) is selected "mm.SS."

② Push [▲](2) or [▼](8) to set the desired alarm area.

• Push [▶](6) to move the cursor right; push [◀](4) to move the cursor left.

③ Push [←](5) to set the area.

④ Push [MENU] (right arrow) to return to the frequency screen.

▨ The alarm area 1 function is available when the "GPS ALARM" function ALL is ON.

• **Example:** Your position : 35°N/135°E
ALM AREA1 setting : 00.25' (default)

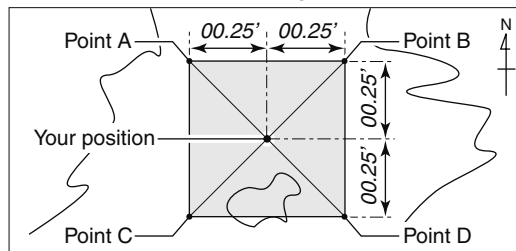

- Position of point A : 35°00.25'N/134°59.75'E
- Position of point B : 35°00.25'N/135°00.25'E
- Position of point C : 34°59.75'N/134°59.75'E
- Position of point D : 34°59.75'N/135°00.25'E

When the target position comes into the alarm area shown above, the GPS alarm sounds.

These sample indications assume that "P FORM" is selected "mm.mm." (p. 136)

◇ Alarm area 2

Selects GPS alarm active range from “BOTH,” “EXTEND” and “LIMIT” when “CH” or “RX” is selected at GPS alarm setting.

① Enter “ALM2” in GPS mode.

MENU → GPS → **ALM2**
(Push [MENU] (5), (Push [▲](2)/[▼](8), then push [←](5).)

• ALM2 setting screen is displayed.

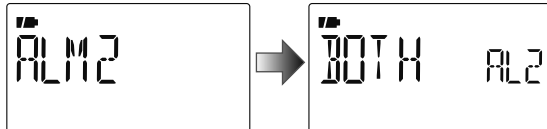

② Push [▲](2) or [▼](8) to select the desired alarm setting, then push [←](5) to set.

- **BOTH** : GPS alarm[†] will sound when a target position enters both 500 m* (547 Y)* and 1 km* (1094 Y)* range. (default)
- **EXTEND** : GPS alarm[‡] will sound when a target position enters 1 km* (1094 Y)* range.
- **LIMITE** : GPS alarm[‡] will sound when a target position enters 500 m* (547 Y)* range.

*Approximate

[†] One beep sounds when coming within 1 km (1094 Y) and three beep sounds when coming within 500 m (547 Y).

[‡] Three beep sounds.

③ Push [MENU] (5) to return to the frequency screen.

• **Example:**

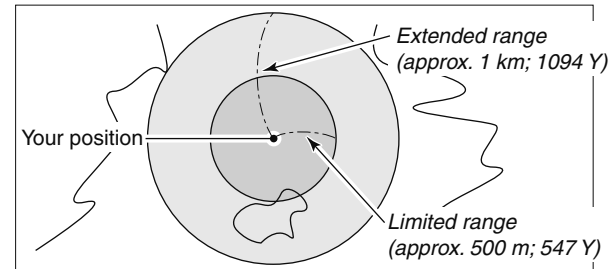

The target position definitions for Alarm area 2.

Alarm indication

When a target position comes into the alarm area, below indication appears.

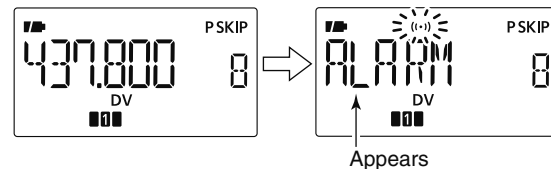

- Push any key to return to the frequency screen, but “(··)” indicator continues to blink in the area.

■ GPS-A operation

◇ GPS-A function

Set the following to activate the GPS-A function.

- ① Select the DV mode operation (p. 25)
- ② Select "GPS-TX" (GPS transmission mode) to DVA.
(p. 138)
- ③ Set "GPS.ATX" (GPS auto transmission timer). (p. 142)
- ④ Set the GPS-A set items. (pgs. 139–142)

◇ GPS-A code details

In GPS-A operation, following codes are transmitted to the PC connected to the IC-E80D. GPS-A code is based on APRS® code. (APRS®: Automatic Position Reporting System)

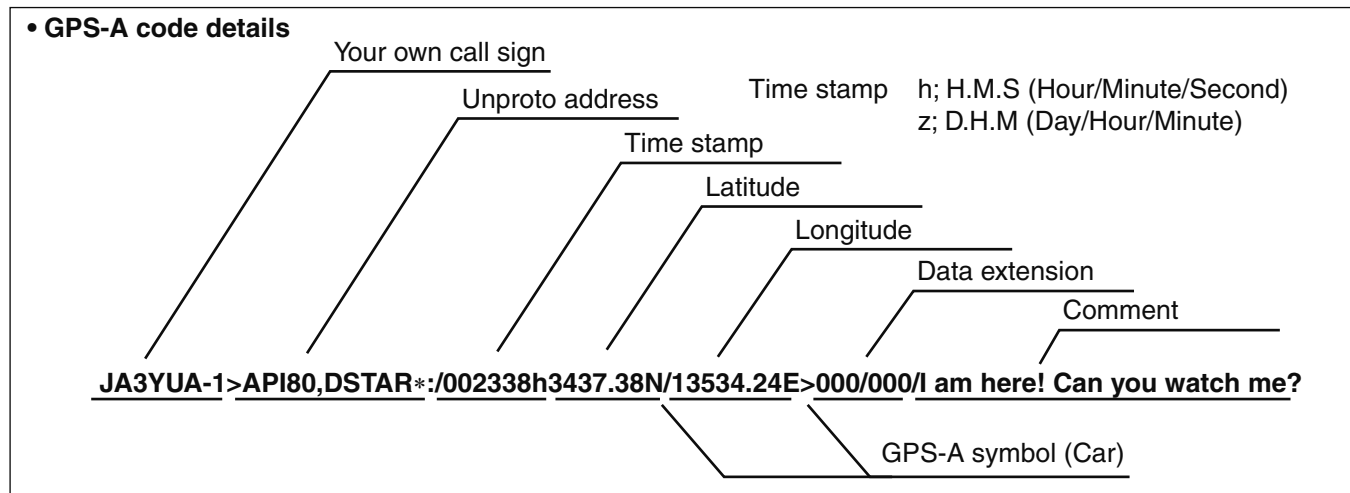

■ General description

The IC-E80D has 1050 memory channels, and 2 call channels. Memory channels include 50 scan edge memory channels (25 pairs) for storage of often-used frequencies.

Also, 26 memory banks, A to Z, are available in each band for storing groups of frequencies, etc. Up to 100 channels can be assigned to a bank.

◇ Memory channel contents

The following information can be programmed into memory channels:

- Operating frequency (p. 23)
- Operating mode (p. 25)
- Duplex direction (+DUP or -DUP) with a frequency offset (p. 32)
- Subaudible tone encoder (p. 30), tone squelch or DTCS squelch ON/OFF (p. 150)
- Subaudible tone frequency (p. 119), tone squelch frequency or DTCS code with polarity (pgs. 119, 120)
- Scan skip information (p. 108)
- Memory bank (p. 95)
- Memory name (p. 97)
- Tuning step (p. 22)
- Call sign squelch or Digital code squelch* (p. 148)
- Station call sign* (pgs. 37, 47)
- RPT1/RPT2 call sign* (pgs. 38, 47)

*Available for DV mode operation only.

NOTE:

Memory data can be erased by static electricity, electric transients, etc.

In addition, they can be erased by malfunction and during repairs.

Therefore, we recommend that memory data be written down or be saved to a PC using the CS-80/880 CLONING SOFTWARE (free download software).

■ Selecting a memory channel

◇ Using [DIAL]

- ① Push **[M/CALL]** to select memory mode.
 - Pushing **[M/CALL]** selects memory, call and TV* channels.
- ② Rotate **[DIAL]** to select the desired memory channel.
 - Only programmed channels are displayed.

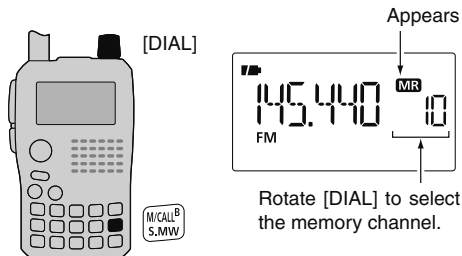

Rotate [DIAL] to select the memory channel.

/// *Appears only when TV channels are programmed via the CS-80/880 (free download software).

◇ Using the Numeral keys

- ① Push **[M/CALL]** to select memory mode.
 - Pushing **[M/CALL]** toggles memory, call and TV* channels.
- ② Use the numeral keys to enter 3 digits to select the desired memory channel.
 - The blank channels are also selectable.

- **Example— selecting memory channel “25”**
Push **[M/CALL]**, then push **[0]**, **[2]**, **[5]**.

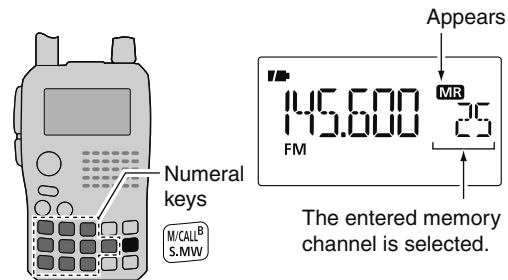

The entered memory channel is selected.

/// *Appears only when TV channels are programmed via the CS-80/880 (free download software).

■ Selecting a call channel

- ① Push **[M/CALL]** to select call channel mode.
 - Pushing **[M/CALL]** toggles memory, call and TV* channels.
- ② Rotate **[DIAL]** to select the desired call channel.
 - “C0” and “C1” are selectable.

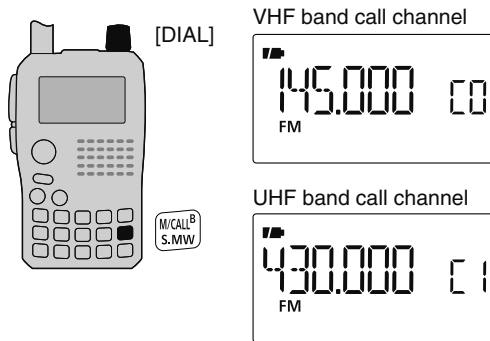

/// *Appears only when TV channels are programmed via the CS-80/880 (free download software).

Memory channel programming

- ① Push **[V/MHz]** to select the VFO mode.
- ② Set the desired frequency:
 - Select the desired band with **[BAND]**.
 - Set the desired frequency with **[DIAL]**.
 - Or set the desired frequency with keypad directly.

In this case, the band and frequency settings with **[BAND]** and **[DIAL]** as above are not required.

 - Set other data (e.g. frequency offset, duplex direction, tone squelch, current call signs, etc.), if desired.
- ③ Push and hold **[S.MW]**(M/CALL) for 1 sec. to enter select memory write mode.
 - 1 short and 1 long beep sound.
 - “**MR**” indication and memory channel number blink.
- ④ Rotate **[DIAL]** to select the desired channel.
 - Call channels (C0, C1), VFO and scan edge channels (0A/0B to 24A/24B), as well as regular memory channels, can be programmed in this way.
- ⑤ Push and hold **[S.MW]**(M/CALL) for 1 sec. to program.
 - 3 beeps sound.
 - Memory channel number automatically increases when continuing to push and hold **[S.MW]**(M/CALL) for 1 sec. after programming.

NOTE: Push **[V/MHz]** to cancel to program and exit select memory write mode before memory programming is finished.

[EXAMPLE]: Programming 145.440 MHz into memory channel 11 (blank channel).

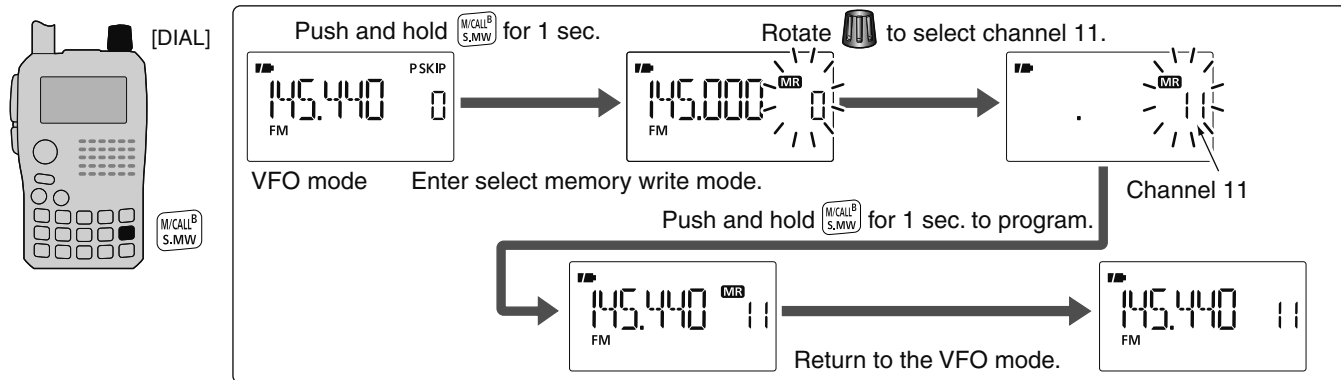

■ Memory bank setting

The IC-E80D has a total of 26 banks (A to Z). Memory channels 0 to 999 are assigned to any desired bank for easy memory management.

- ① Push and hold **[S.MW]**(M/CALL) for 1 sec. to enter select memory write mode.
 - 1 short and 1 long beep sound.
 - Memory channel number blinks.
- ② Rotate **[DIAL]** to select the desired memory channel.
- ③ Push **[▼]**(8) to select “BANK” setting.
 - Bank group and channel number are displayed if the selected memory channel has already been assigned to a bank.

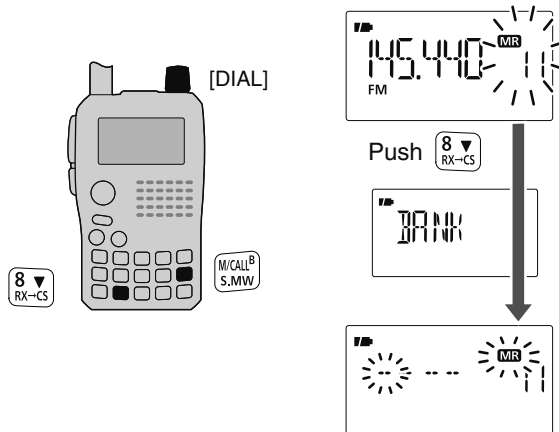

- ④ Rotate **[DIAL]** to select the desired bank group from “A” to “Z.”

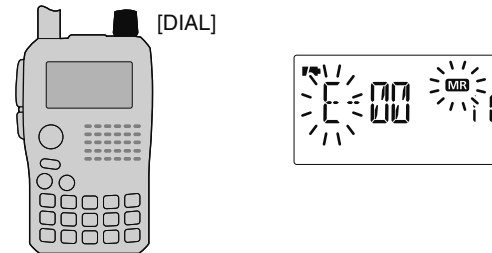

- ⑤ Push **[▶]**(6) to select the bank channel digit, then rotate **[DIAL]** to select the bank channel number from “00” to “99.”
 - Push **[◀]**(4) to return to the bank group selection, if desired.

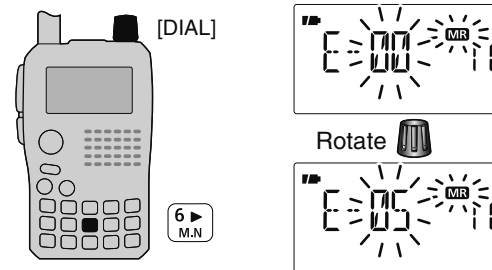

- ⑥ Push and hold **[S.MW]**(M/CALL) for 1 sec. to assign the channel to the bank.
 - Return to the previous indication before entering select memory write mode.

Memory bank selection

- ① Push **[M/CALL]** to select memory mode.
- ② Push **[BAND]** to enter the bank selection state.
- ③ Rotate **[DIAL]** to select the desired bank (A to Z), then push **[BAND]**.
 - Only programmed banks are displayed.
 - Also regular memory channel can be selected.

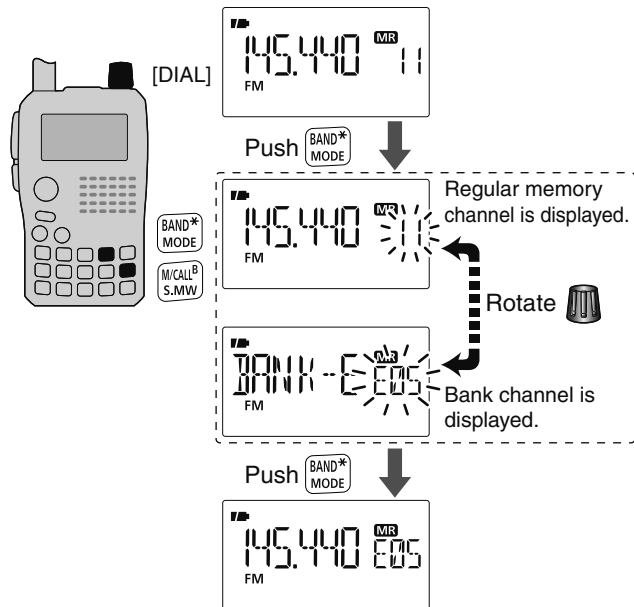

- ④ Rotate **[DIAL]** to select the bank channel.
 - Only programmed channels are displayed.



■ Programming memory/bank/scan name

Each memory channel can be programmed with an alphanumeric channel name for easy recognition and can be indicated independently by channel. Names can be a maximum of 8 characters. (Bank name is up to 6 characters.)

NOTE: Scan name indication can be turned ON or OFF in DISP set mode (SET). (p. 129)

- ① Push **[M/CALL]** to select memory mode.
- ② Push and hold **[S.MW](M/CALL)** for 1 sec. to enter select memory write mode.
 - 1 short and 1 long beep sound.
 - “**MR**” indication and memory channel number blink.
- ③ Rotate **[DIAL]** to select the desired memory channel.
 - Select call channels (C0 or C1) or scan edge channels (0A/0B to 24A/24B) to program a call channel name or scan name, respectively.
- ④ Push **[▲](2)** or **[▼](8)** several times to select “B NAME,” “M NAME” or “S NAME” when programming the bank name, the memory name or the scan name, respectively.
 - After selecting the name to be programmed, a cursor blinks for the first character.
- ⑤ Rotate **[DIAL]** to select the desired character.
 - The selected character blinks.
 - Push **[▶](6)** to move the cursor right; push **[◀](4)** to move the cursor left.
 - Push **[CLR](1)** to erase the selected character, or push and hold **[CLR](1)** for 1 sec. to erase all characters following the cursor.

- ⑥ Repeat step ⑤ until the desired channel name is programmed.
- ⑦ Push and hold **[S.MW](M/CALL)** for 1 sec. to set the name and exit channel name programming state.
 - 3 beeps sound.

NOTE: Only one bank name can be programmed into each bank. Therefore, the previously programmed bank name will be displayed when bank name indication is selected. Also, the programmed bank name is assigned for the other bank channels automatically.

◇ Available characters

R	D	C	J	E	F	G	H	I	J	K	L	M	
(A)	(B)	(C)	(D)	(E)	(F)	(G)	(H)	(I)	(J)	(K)	(L)	(M)	
N	O	P	Q	R	S	T	U	V	W	X	Y	Z	
(N)	(O)	(P)	(Q)	(R)	(S)	(T)	(U)	(V)	(W)	(X)	(Y)	(Z)	
0	1	2	3	4	5	6	7	8	9				
(0)	(1)	(2)	(3)	(4)	(5)	(6)	(7)	(8)	(9)				
	"	£	¢	¥	¤	'			¶	†		--	
(!)	(")	(#)	(\$)	(%)	(&)	(')	((()	(¶)	(†)	(.)	(-)	
	/				--								
(.)	(/)	(:)	(;)	(<)	(=)	(>)	(?)	(@)	([(\)	(])	(^)	(Space)

9 MEMORY/CALL CHANNELS

[EXAMPLE]: Programming the bank name “AIR” into the scan edge channel 3A.

During memory mode, rotate  to select scan edge channel 3A.
Rotate  to enter “A,” then push .





Push and hold  for 1 sec.





Enter select memory write mode.

Push  to select “B NAME*2.”

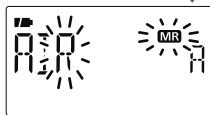

Enter “I” and “R” with  and .



Push and hold  for 1 sec. to program.

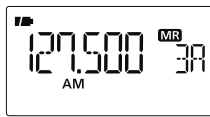

Select “M NAME” or “S NAME*1” when programming the memory name or the scan name, respectively.

*1 S NAME can be set for scan edge channels only.

*2 B NAME can be set for bank assigned channels only.

■ Selecting memory/bank name indication

During memory mode operation, either the programmed memory name or bank name can be displayed.

- ① Push **[M/CALL]** to select memory mode.
- ② Push and hold **[M.N](6)** to select display indication type from memory name, bank name and OFF.
 - While pushing and holding **[M.N](6)**, rotating **[DIAL]** is also available. (Name indication OFF ⇄ Memory Name indication ⇄ Bank name indication)

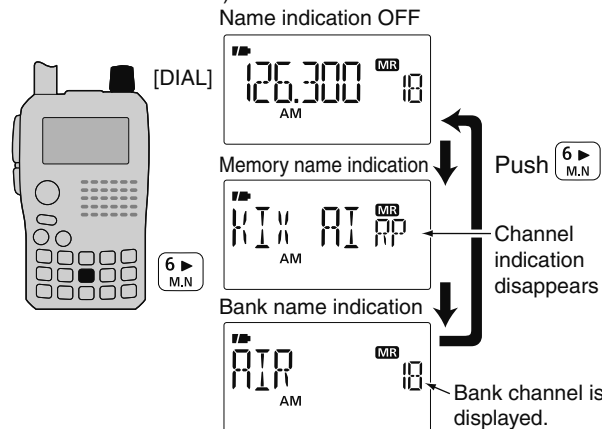

NOTE: The programmed scan name is displayed during the programmed scan selection.

■ Copying memory/call contents

This function transfers a memory channel's contents to VFO (or another memory/call channel). This is useful when searching for signals around a memory channel frequency and for recalling the frequency offset, subaudible tone frequency etc.

◇ Memory/call ↔ VFO

- ① Select the memory (call) channel to be copied.
 - ➔ Push **[M/CALL]** several times to select memory mode or call channel mode, then rotate **[DIAL]** to select the desired channel.
- ② Push and hold **[S.MW]**(M/CALL) for 1 sec. to enter select memory write mode.
 - 1 short and 1 long beep sound.
 - “**MR**” indication and memory channel number blink.
- ③ Rotate **[DIAL]** to select “VFO.”
- ④ Push and hold **[S.MW]**(M/CALL) for 1 sec. to write the selected channel contents to the VFO mode.
 - Returns to the VFO mode automatically.

Pushing and holding **[S.MW]**(M/CALL) for 2 sec. at step ②, will also copy the memory contents to VFO. In this case, steps ③ and ④ are not necessary.

◇ Memory/call ↔ memory/call

- ① Select the memory (call) channel to be copied.
 - ➔ Push **[M/CALL]** several times to select memory mode or call channel mode, then rotate **[DIAL]** to select the desired memory channel.
- ② Push and hold **[S.MW]**(M/CALL) for 1 sec. to enter select memory write mode.
 - 1 short and 1 long beep sound.
 - “**MR**” indication and memory channel number blink.
 - Do not hold **[S.MW]**(M/CALL) for more than 2 sec. otherwise the memory contents will be copied to VFO.
- ③ Rotate **[DIAL]** to select the target memory (call) channel.
- ④ Push and hold **[S.MW]**(M/CALL) for 1 sec. again to copy.



[DIAL] **[EXAMPLE]:** Copying memory channel 11 to VFO.

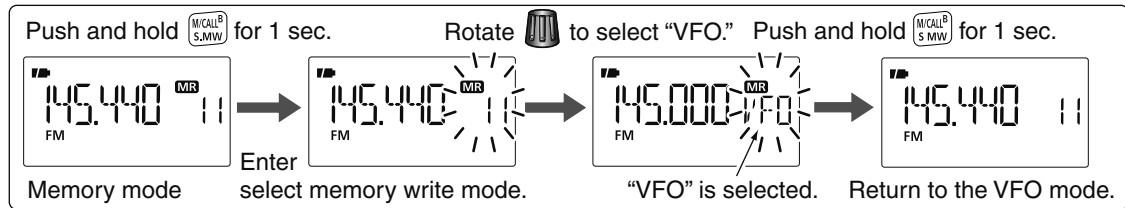

Memory clearing

Contents of programmed memories can be cleared (erased), if desired.

- ① Push and hold **[S.MW]**(M/CALL) for 1 sec. to enter select memory write mode.
 - 1 short and 1 long beeps sound.
 - Memory channel number blinks.
 - Do not hold **[S.MW]**(M/CALL) for more than 2 sec. otherwise the memory contents will be copied to VFO.
- ② Rotate **[DIAL]** to select the desired memory channel to be cleared.

- ③ Push **[▲]**(2) or **[▼]**(8) to select “CLEAR.”
- ④ Push and hold **[S.MW]**(M/CALL) for 1 sec. to clear the contents.
 - 3 beeps sound.
 - The cleared channel changes to blank channel
 - Return to select memory write mode.— Memory channel number blinks. Push **[VMHz]** to exit select memory write mode.

NOTE: Be careful!— the contents of cleared memories **CANNOT** be recalled.

[EXAMPLE]: Clearing memory channel 14.

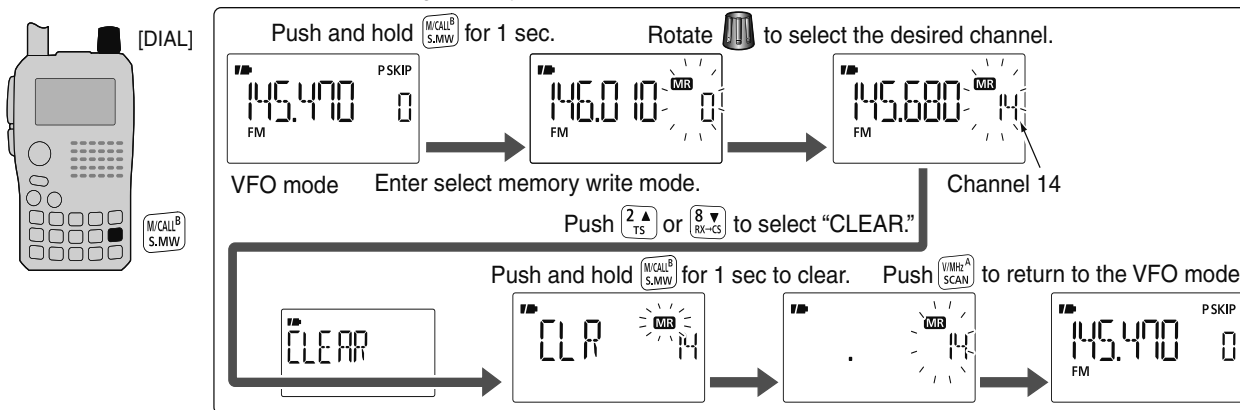

■ Erasing/transferring bank contents

The bank contents of programmed memory channels can be cleared or reassigned to another memory bank.

INFORMATION: Even if the memory bank contents are cleared, the memory channel contents still remain programmed.

- ① Select the desired bank contents to be transferred or erased from the bank. (p. 96)
 - ➔ Push **[BAND]** to enter memory bank selection state.
 - ➔ Rotate **[DIAL]** to select the desired memory bank group, then push **[BAND]**.
 - ➔ Rotate **[DIAL]** to select the bank channel.

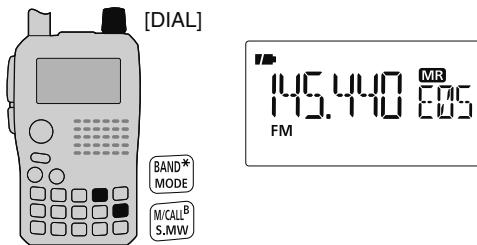

- ② Push **[S.MW]**(M/CALL) for 1 sec. to enter select memory write mode.
 - 1 short and 1 long beeps sound.
 - Displays the original memory channel number automatically, and then “**MR**” indication and memory channel number blink.
 - Do not hold **[S.MW]**(M/CALL) for more than 2 sec., otherwise the memory contents will be copied to VFO.

- ③ Push **[▲]**(2) or **[▼]**(8) several times to select “BANK.”

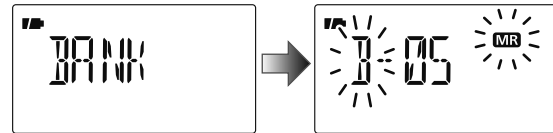

- ④ Push **[▶]**(6) to select the bank channels selection or push **[◀]**(4) to select the bank group selection to be transferred.
- ⑤ Rotate **[DIAL]** to select the desired bank group or channel.
 - Select “----” indication when erasing the contents from the bank.

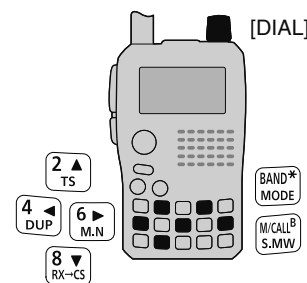

To transfer the bank contents to ch 11 in Bank B.

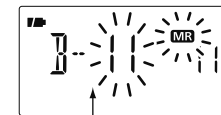

Bank channel is displayed.

To erase

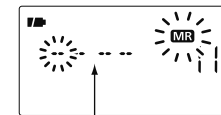

“----” is displayed.

- ⑥ Push **[S.MW]**(M/CALL) for 1 sec. to erase/transfer the bank contents.

10 SCAN OPERATION

■ Scan types

Scanning searches for signals automatically and makes it easier to locate new stations for contact or listening purposes.

FULL SCAN (p. 104)

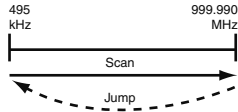

Repeatedly scans all frequencies over the entire band. Some frequency ranges are not scanned according to the frequency coverage of the transceiver's version.

SELECTED BAND SCAN

(p. 104)

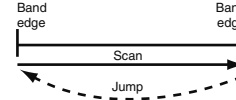

Repeatedly scans all frequencies over the entire selected band.

PROGRAMMED SCAN

(p. 104)

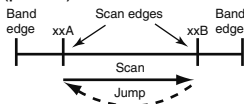

Repeatedly scans between two user-programmed frequencies. Used for checking for frequencies within a specified range such as repeater output frequencies, etc.

FREQUENCY/MEMORY SKIP FUNCTION

(p. 108)

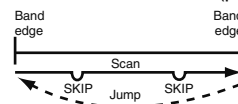

Skips unwanted frequencies or channels that inconveniently stop scanning. This setting can be turned ON or OFF by pushing and holding **[SKIP](5)** in memory mode.

PROGRAMMED LINK SCAN (pgs. 104, 123)

Repeatedly programmed scans user-programmed frequencies selected at P-LINK items in the menu mode.

The frequency skip scan function can be turned ON or OFF in the VFO mode. When this function is set to ON, the specified frequencies are skipped during VFO scan.

- "PSKIP" indicator appears in the VFO mode.

MEMORY (SKIP) SCAN

(pgs. 106, 108)

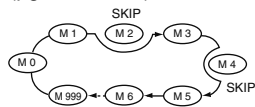

Repeatedly scans memory channels except those set as skip channel. Skip channels can be turned ON and OFF by pushing and holding [SKIP](5) in memory mode.

BAND MEMORY (SKIP) SCAN (p. 106)

Repeatedly scans memory channels in the same band as displayed band.

MODE MEMORY (SKIP) SCAN (p. 106)

Repeatedly scans memory channels in the same mode as displayed mode.

ALL/SELECTED BANK SCAN (p. 107)

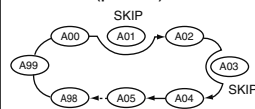

Repeatedly scans all bank channels or selected bank channels. The skip scan is also available.

BANK-LINK SCAN (pgs. 107, 122)

Repeatedly scans bank channels selected at BANK-LINK items in the menu mode.

10 SCAN OPERATION

■ Full/band/programmed scan

- ① Push **[V/MHz]** to select the VFO mode.
 - Select the desired frequency band with **[BAND]**, if desired.
- ② Set the squelch level.
- ③ Push and hold **[SCAN]**(V/MHz) for 1 sec. to enter the scanning type selection.
- ④ Rotate **[DIAL]** to select the desired scanning type.
 - “ALL” for full scan; “BAND” for band scan, “P-LINK x” for programmed link scan (x= 0 to 9), “PROGxx (or scan name if programmed)” for programmed scan (xx= 0 to 24; only programmed scan edge numbers are displayed), “DUP” (appears only when duplex operation is set) for duplex scan.

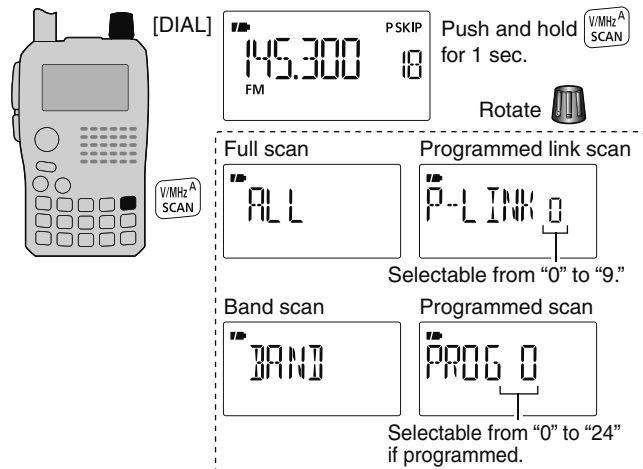

- ⑤ Push **[V/MHz]** to start the scan.
 - Scan pauses when a signal is received.
 - Rotate **[DIAL]** to change the scanning direction. This also causes the transceiver to resume scanning.
 - Push **[V/MHz]** to stop the scan.
 - Push **[BAND]** to change the band during band scan, or change the scan edge during programmed scan/program link scan.

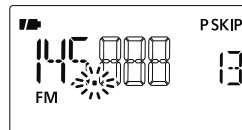

During full/band scan



During programmed scan

About the scanning steps: The selected tuning step in each frequency band (in the VFO mode) is used during scan.

Duplex scan function: Repeatedly scans two frequencies (transmission/reception) during duplex scan operation.

Scan name can be displayed instead of “P-LINK x” for program link scan (x= 0 to 9), “PROGxx” for programmed scan (xx= 0 to 24) when scan name is programmed and set to ON in DISP set mode.

MENU → SET → DISP → **SCAN N** (p. 129)

Scan name is not displayed during scan.

■ Scan edges programming

Scan edges can be programmed in the same manner as memory channels. Scan edges are programmed into scan edges, 0A/0B to 24A/24B, in memory channels.

- ① Push **[V/MHz]** to select the VFO mode.
- ② Set the desired frequency:
 - ➔ Select the desired band with **[BAND]**.
 - ➔ Set the desired frequency with **[DIAL]**.
 - ➔ Program different frequencies in “**A” and “**B” respectively.
 - ➔ Set other data (e.g. frequency offset, duplex direction, tone squelch, etc.), if desired.
- ③ Push and hold **[S.MW](M/CALL)** for 1 sec. to enter the select memory write mode.
 - 1 short and 1 long beeps sound.
 - “**MR**” indication and memory channel number blink.

- ④ Rotate **[DIAL]** to select the desired programmed scan edge channel from 0A to 24A.
- ⑤ Push and hold **[S.MW](M/CALL)** for 1 sec.
 - 3 beeps sound.
 - The other scan edge channel “B,” 0B to 24B, is automatically selected when continuing to push **[S.MW](M/CALL)** after programming.
- ⑥ To program a frequency for the other pair of scan edges, 0B to 24B, repeat steps ② and ④.
 - If the same frequency is programmed into a pair of scan edges, programmed scan will not function.

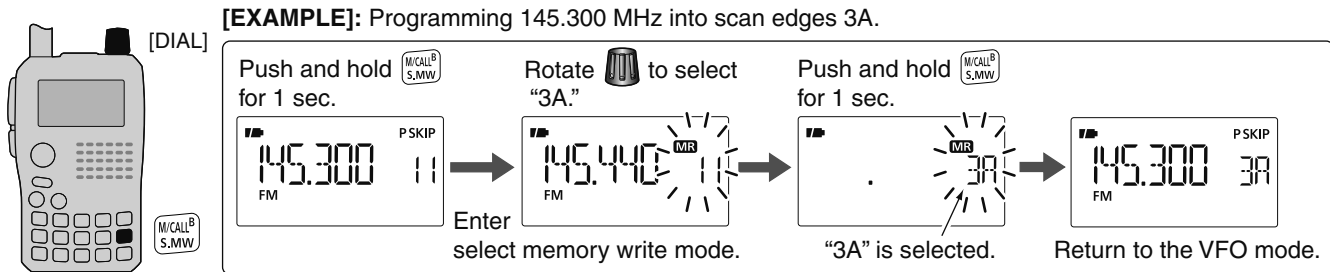

10 SCAN OPERATION

Memory scan

IMPORTANT!: To perform memory scan, 2 or more memory channels **MUST** be programmed, otherwise the scan will not start.

- 1 Push **[M/CALL]** several times to select memory mode.
- 2 Set the squelch level.
- 3 Push and hold **[SCAN]**(V/MHz) for 1 sec. to enter the scanning type selection.
- 4 Rotate **[DIAL]** to select the desired scanning type.
 - “ALL” for all memory scan; “BAND” for band memory scan, “MODE” for mode scan, “DUP” (appears only when duplex operation is set) for duplex scan.

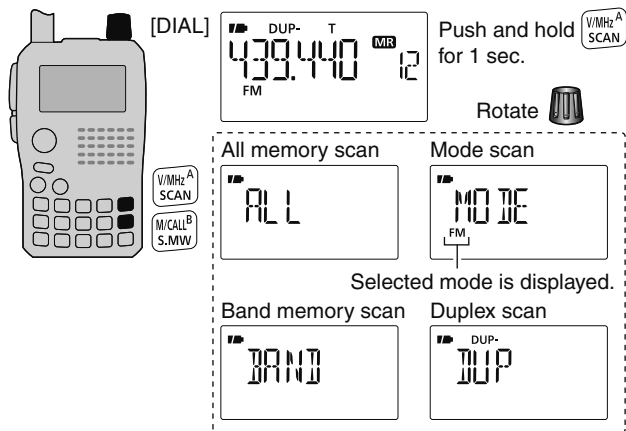

- 5 Push **[V/MHz]** to start the scan.
 - Scan pauses when a signal is received.
 - Rotate **[DIAL]** to change the scanning direction. This also causes the transceiver to resume scanning.
 - Push **[V/MHz]** to stop the scan.

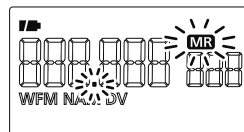

During memory scan

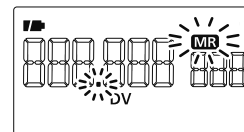

During mode scan

Band memory scan function: Repeatedly scans all memory channels programmed with any frequencies of the band programmed in the memory channel selected for scanning.

Mode scan function: Repeatedly scans all memory channels in which the same operating mode as the selected memory channel has been programmed.

Duplex scan function: Repeatedly scans two frequencies (transmission/reception) during duplex scan operation.

Memory bank scan

IMPORTANT!: To perform memory bank scan, 2 or more bank channels MUST be programmed, otherwise the scan will not start.

- ① Select memory bank mode.
 - ➔ Select memory mode with **[M/CALL]**.
 - ➔ Enter the bank selection state with **[BAND]**.
 - ➔ Set the desired bank (A to Z) with **[DIAL]**, then push **[BAND]**.
- ② Set the squelch level.
- ③ Push and hold **[SCAN]**(V/MHz) for 1 sec. to enter the scanning type selection.

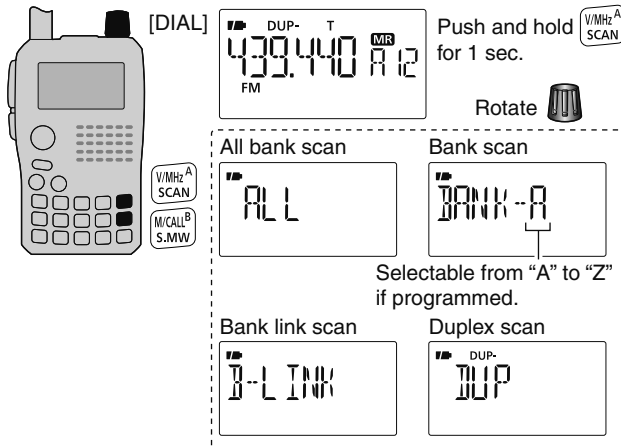

- ④ Rotate **[DIAL]** to select the desired scanning type.
 - “ALL” for all bank scan; “B-LINK” for bank link scan or “BANK-X” for bank scan (X= A to Z; programmed bank groups are only displayed.), “DUP” (appears only when duplex operation is set) for duplex scan.
- ⑤ Push **[V/MHz]** to start the scan.
 - Scan pauses when a signal is received.
 - Rotate **[DIAL]** to change the scanning direction. This also causes the transceiver to resume scanning.
 - Push **[V/MHz]** to stop the scan.
 - Push **[BAND]** to change the bank during bank scan.

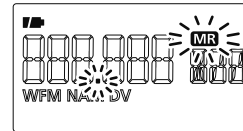

During all bank/bank link scan

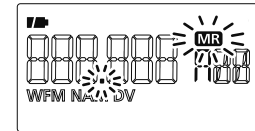

During bank scan

The bank-link setting can be changed in SCAN set mode. See page 122 for details.

Duplex scan function: Repeatedly scans two frequencies (transmission/reception) during duplex scan operation.

Memory bank scan skips any memory channels in the selected bank that are set to “SKIP” or “PSKIP”

Memory bank scan stops at the first channel when all channels in a bank are set to “SKIP” or “PSKIP”

10 SCAN OPERATION

■ Skip channel/frequency setting

Memory channels can be set to be skipped during memory skip scan. In addition, memory channels can be set to be skipped during both memory skip scan and frequency skip scan. This is useful to speed up the scan rate.

① Select a memory channel:

- Push **[M/CALL]** to select memory mode.
- Rotate **[DIAL]** to select the desired channel to be a skip channel/frequency.

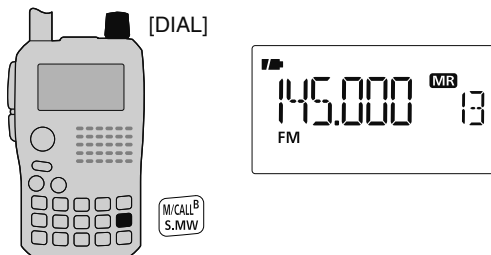

② Push and hold **[S.MW]**(M/CALL) for 1 sec. to enter select memory write mode.



③ Push **[▲]**(2) or **[▼]**(8) several times to select "SKIP."

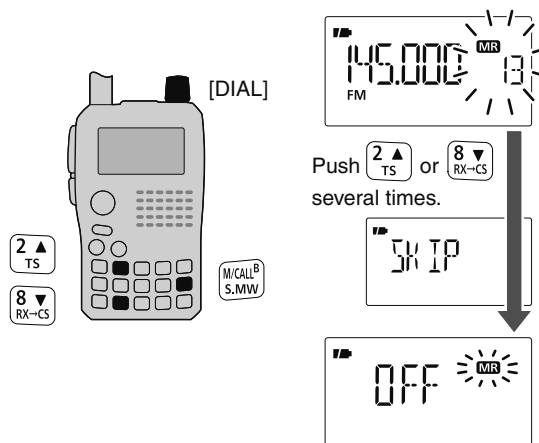

④ Rotate **[DIAL]** to select the skip condition from "SKIP," "PSKIP" or "OFF" for the selected channel.

- **PSKIP** : The channel is skipped during memory/bank scan and the programmed frequency is skipped during VFO scan, such as programmed scan.
- **SKIP** : The channel is skipped during memory or bank scan.
- **OFF** : The channel is scanned during any scan.

(Continue to the next page.)

- ⑤ Push and hold **[S.MW]**(M/CALL) for 1 sec. to store the skip condition into the memory.
- “SKIP” or “PSKIP” indicator appears, according to the skip selection in step ④.

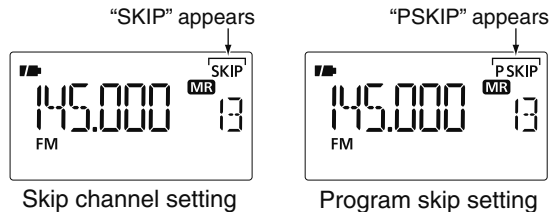

✓ CONVENIENT!

The skip setting can be set with the following operation.

- ① Select the desired memory channel to be set as a skip channel/frequency.
- ② While pushing **[SKIP]**(5), rotate **[DIAL]** to select the skip condition from “PSKIP,” “SKIP” and “OFF (no indication).”



✓ CONVENIENT!

During VFO scanning, such as programmed scan, the skip setting can be programmed into the highest blank memory channel which is automatically selected with the following operation.

- ① Start the VFO scan.
 - Push **[V/MHz]** to select the VFO mode.
 - Select the desired frequency band with **[BAND]**, if desired.
 - Set the squelch level.
 - While pushing and holding **[SCAN]**(V/MHz) for 1 sec. to enter scan type selection, then rotate **[DIAL]** to select the desired scan type.
 - “ALL” for full scan; “BAND” for band scan, “P-LINK x” for programmed link scan (x= 0 to 9), “PROGxx (or scan name if programmed)” for programmed scan (xx= 0 to 24; programmed scan edges numbers are only displayed), “DUP” for duplex scan.
 - Push **[SCAN]**(V/MHz) again to start the scan.
 - Scan pauses when a signal is received.
 - Rotate **[DIAL]** to change the scanning direction, or resumes manually.
- ② When scan pauses and you want to set the paused frequency as a skip frequency.
 - Push and hold **[SKIP]**(5) for 1 sec. to store the paused frequency into the highest blank memory channel.
 - While pushing and holding **[SKIP]**(5), scan pauses; and when releasing **[SKIP]**(5) scan resumes.

10 SCAN OPERATION

■ Scan resume condition

◇ Scan pause timer

The scan pauses when receiving signals according to the scan pause time. It can be set from 2 to 20 sec. or unlimited.

- ① Enter "PAUSE" in SCAN set mode.

MENU ⇄ SCAN ⇄ **PAUSE** (p. 121)
(Push [MENU] (5), (Push [▲](2)/[▼](8), then push [←](5).)

- ② Push [▲](2) or [▼](8) to select the desired scan pausing time from 2–20 sec. (2 sec. steps) or "HOLD."

- "2SEC"–"20SEC": Scan pauses for 2–20 sec. while receiving a signal.
- "HOLD" : Scan pauses on a received a signal until it disappears.

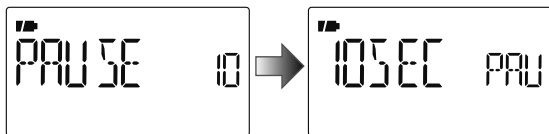

- ③ Push [←](5) to return to SCAN set mode.
④ Push [MENU] (5) to return to the frequency screen.

◇ Scan resume timer

The scan restarts after the signal disappears according to the resume time. It can be set from 0–5 sec. or unlimited.

- ① Enter "RESUME" in SCAN set mode.

MENU ⇄ SCAN ⇄ **RESUME** (p. 122)
(Push [MENU] (5), (Push [▲](2)/[▼](8), then push [←](5).)

- ② Push [▲](2) or [▼](8) to select the desired scan resume time from 0–5 sec. (1 sec. steps) and "HOLD."

- "0SEC" : Scan restarts immediately after the signal disappears.
- "1SEC"–"5SEC": Scan restarts 1–5 sec. after the signal disappears.
- "HOLD" : Scan remains paused on the received signal according to the scan pause timer even if it disappears. Rotate [DIAL] to resume manually.

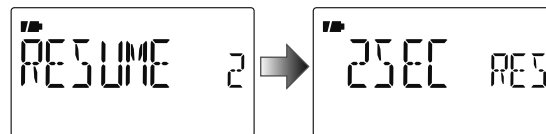

- ③ Push [←](5) to return to SCAN set mode.
④ Push [MENU] (5) to return to the frequency screen.

/// Scan resume timer must be set shorter than the scan pause timer, otherwise this timer does not activate.

■ Priority watch types

Priority watch checks for signals on the frequency every 5 sec. while operating on a VFO frequency or scanning (except DR mode watch). The transceiver has 4 priority watch types to suit your needs.

The watch resumes according to the selected scan resume condition. See page 110 for details.

NOTE: If the pocket beep function is activated, the transceiver automatically selects the tone squelch function when priority watch starts.

◇ About priority beep function

When receiving a signal on the priority frequency, you can be alerted with beeps and a blink “(•)”. This function can be activated when setting the priority watch function ON.

MEMORY/CALL CHANNEL WATCH

While operating on a VFO frequency, priority watch checks for a signal on the selected channel every 5 sec.

- A memory channel with skip information can be watched.

MEMORY SCAN WATCH

While operating on a VFO frequency, priority watch checks for signals on each memory channel in sequence.

- The memory skip function and/or memory bank scan is useful to speed up the scan.

VFO SCAN WATCH

While scanning in the VFO mode, priority watch checks for signals on the selected channel every 5 sec.

DR MODE WATCH

While operating in the DR mode, priority watch checks for a signal on the VFO frequency every 5 sec.

Priority watch operation

◆ Memory/call channel and memory scan watch

① Select the VFO mode; then, set an operating frequency.

② Select the channel(s) to be watched.

For memory channel watch:

Select the desired memory channel.

For call channel watch:

Select the desired call channel.

For memory scan watch:

➤ Select memory mode, or the desired bank group.

➤ Push and hold [SCAN](V/MHz) for 1 sec. to enter the scan type selection.

➤ Rotate [DIAL] to select the desired scan type, then push [SCAN](V/MHz) again to start memory/bank scan.

③ Enter "PRIO" in SCAN set mode.

MENU ⇄ SCAN ⇄ **PRIO** (p. 121)
 (Push [MENU] (p. 11)), (Push [▲](2)/[▼](8), then push [←](5).)

④ Push [▲](2) or [▼](8) to select "ON."

• Select "BELL" if the priority beep function is desired.

⑤ Push [MENU] (p. 11) to exit SCAN set mode and start the watch.

• "PRIO" indicator appears.

• The transceiver checks the memory/bank channel(s) or call channel every 5 sec.

• The watch resumes according to the selected scan resume condition. (p. 110)

⑥ Push [V/MHz] to cancel the watch.

• During priority watch

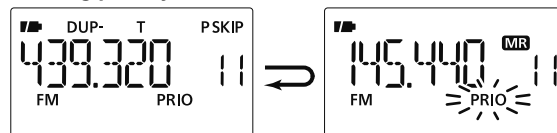

Monitors VFO frequency for 5 sec.

Pauses on a memory or call channel when a signal is received.

• During priority watch with priority beep

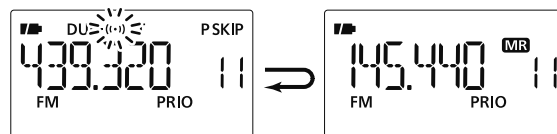

Emits beep and blinks "(*)" indicator when a signal is received on a memory or call channel.

◇ **VFO scan watch**

① Select the channel(s) to be watched.

For memory channel watch:

Select the desired memory channel.

For call channel watch:

Select the desired call channel.

For memory scan watch:

➔ Select memory mode, or the desired bank group.

➔ Push and hold **[SCAN]**(V/MHz) for 1 sec. to enter the scan type selection.

➔ Rotate **[DIAL]** to select the desired scan type, then push **[SCAN]**(V/MHz) again to start memory/bank scan.

② Enter "PRIO" in SCAN set mode.

MENU ⇄ SCAN ⇄ **PRIO** (p. 121)
 (Push **[MENU]**), (Push **[▲]**(2)/**[▼]**(8), then push **[←]**(5).)

③ Push **[▲]**(2) or **[▼]**(8) to select "ON."

• Select "BELL" if the priority beep function is desired.

④ Push **[MENU]** to exit SCAN set mode and start the watch.

• "PRIO" indicator appears.

⑤ Push and hold **[SCAN]**(V/MHz) for 1 sec. to enter scan type selection.

⑥ Rotate **[DIAL]** to select the desired scan type from "ALL," "BAND," "P-LINK x (x= 0-9)," "PROGxx (xx= 0-24)" and "DUP."

⑦ Push **[SCAN]**(V/MHz) to start the VFO scan watch.

- The transceiver checks the memory/bank channel(s) or call channel every 5 sec.
- The watch resumes according to the selected scan resume condition. (p. 110)

⑧ Push **[V/MHz]** to cancel the watch.

• **During priority watch**

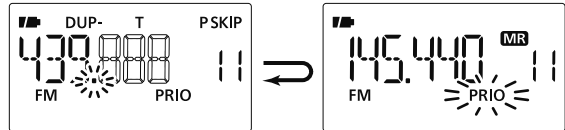

Searches VFO frequencies for 5 sec.

Pauses on a memory or call channel when a signal is received.

• **During priority watch with priority beep**

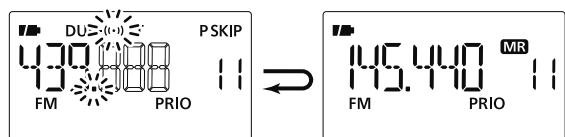

Emits beep and blinks "(*)" indicator when a signal is received on a memory or call channel.

11 PRIORITY WATCH

◇ DR mode/VFO watch

- ① Select the VFO mode; then, set an operating frequency.
- ② Push **[DR]** to enter the DR mode.
- ③ Select the access repeater to be watched.

For a specific repeater watch:

Select the desired access repeater.

For repeater scan watch:

Push and hold **[SCAN]**(V/MHz) for 1 sec. to start the access repeater scan.

- ④ Enter "PRIO" in SCAN set mode.

MENU ⇨ SCAN ⇨ **PRIO** (p. 121)

(Push **[MENU]**), (Push **[▲]**(2)/**[▼]**(8), then push **[←]**(5).)

- ⑤ Rotate **[DIAL]** to select "ON."
 - Select "BELL" if the priority beep function is desired.
- ⑥ Push **[MENU]** to exit SCAN set mode and start the watch.
 - "PRIO" indicator appears.
 - The transceiver checks the VFO mode every 5 sec.
 - The watch resume according to the selected scan resume condition. (p. 110)
- ⑦ Push **[V/MHz]** to cancel the watch.

• During priority watch

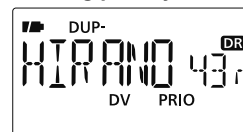

Monitors DR mode for 5 sec.



Pauses on a VFO mode when a signal is received.

• During priority watch with priority beep

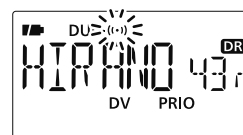

Emits beep and blinks "((•))" indicator when a signal is received on a VFO mode.

■ General

MENU screen is used for programming infrequently changed values or conditions of functions.

◇ Entering MENU screen and operation

[Example]: Set “KEY B (Key-touch beep)” to OFF.

- ① Push [MENU] to enter MENU screen.
 - “DUPT.,” “SCAN,” “SET,” “DV SET,” “CALL-S,” “RX CAL,” “MESSAGE,” “RPT-L” or “GPS” appears.
- ② Push [▲](2) or [▼](8) (or rotate [DIAL]) to select the desired menu group, then push [←](5) (or [→](6)).

- ③ When “SET” is selected, push [▲](2) or [▼](8) (or rotate [DIAL]) to select the desired function group, then push [←](5) (or [→](6)).
- ④ Push [▲](2) or [▼](8) to select the desired item, then push [←](5) (or [→](6)).
- ⑤ Push [▲](2) or [▼](8) (or rotate [DIAL]) to select the desired value or condition, then push [←](5) (or [→](6)) to return to the setting item selection mode.
- ⑥ Push [MENU] (or [V/MHz]) to return to the frequency screen, repeat steps ② to ④ to set another items.

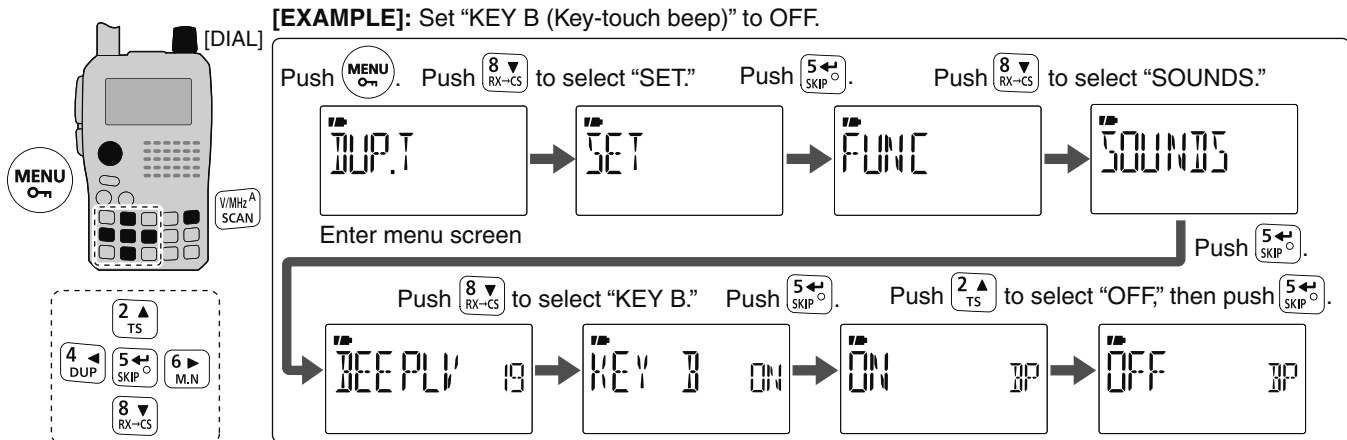

■ MENU screen indication and arrangement

MENU screen shows one of the following indication.

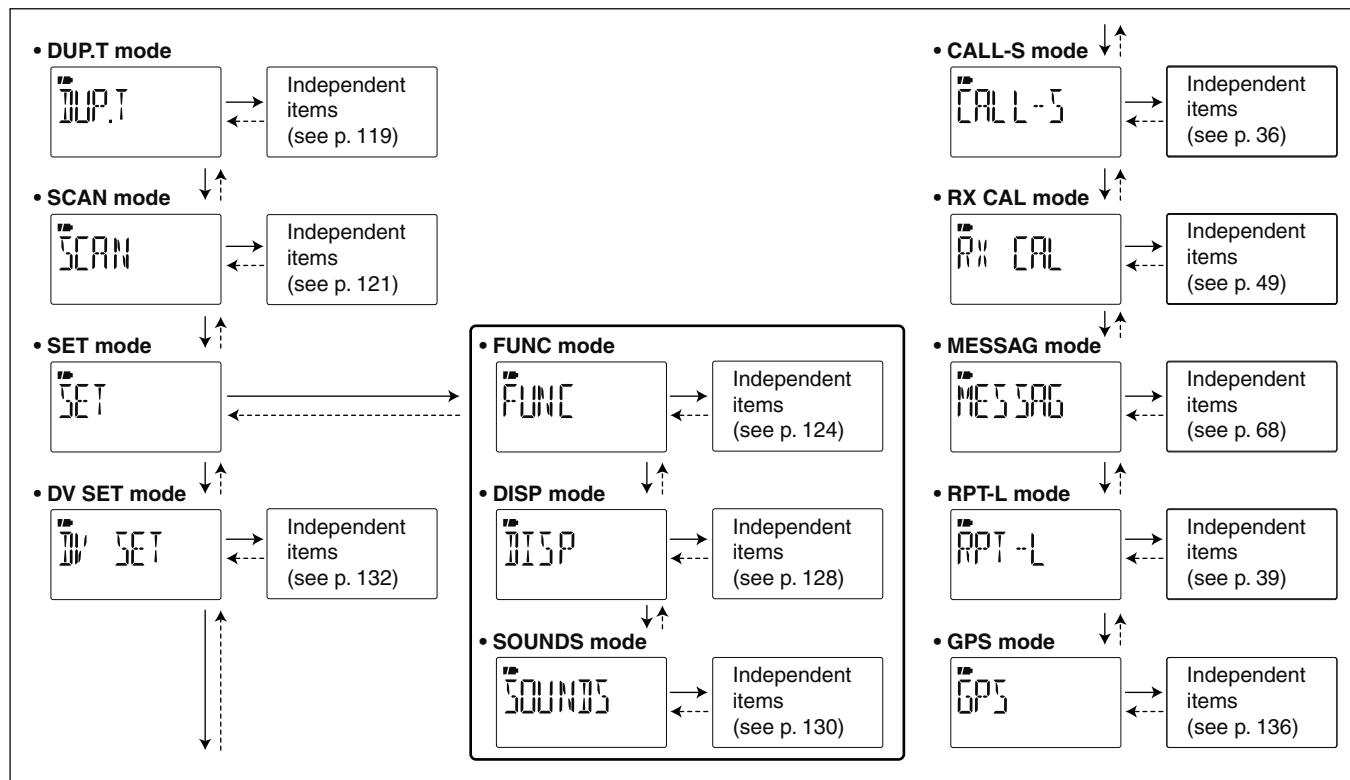

■ Items list

◇ DUP.T mode

Item indication	Ref.	Item indication	Ref.
OFF SET	p. 119	DTC S-P	p. 120
R TONE	p. 119	D CODE	p. 120
C TONE	p. 119	DTMF-S	p. 121
CODE	p. 120	DTMF-T	p. 121

◇ SCAN mode

Item indication	Ref.	Item indication	Ref.
PRIO	p. 121	D-LINK	p. 122
PAUSE	p. 121	P-LINK	p. 123
RESUME	p. 122		

◇ SET mode

◆ FUNC mode

Item indication	Ref.	Item indication	Ref.
ATT	p. 124	ACTIVE	p. 126
P SAVE	p. 125	LOCK	p. 127
MONI	p. 125	MIC	p. 127
PTT LK	p. 125	SPEED	p. 127
LK OUT	p. 126	AP OFF	p. 128
TOT	p. 126	AP ON	p. 128
DIAL S	p. 126		

◆ DISP mode

Item indication	Ref.	Item indication	Ref.
LIGHT	p. 128	SCAN N	p. 129
BUSY	p. 129	OPN.MSG	p. 129
CONT	p. 129		

◆ SOUNDS mode

Item indication	Ref.	Item indication	Ref.
DEEPLY	p. 130	STBY D	p. 130
KEY D	p. 130	EDGE D	p. 131
STOP D	p. 130		

◇ DV SET mode

Item indication	Ref.	Item indication	Ref.
REPLY	p. 132	GW SET	p. 134
DATATX	p. 132	RX CS	p. 134
D MONI	p. 132	TX CS	p. 135
D RPT	p. 133	RX MSG	p. 135
CALL W	p. 133	SCROLL	p. 135
RPT W	p. 133	DK	p. 135
DV DCT	p. 133	EMR	p. 136
EDIT R	p. 134		

12 MENU SCREEN OPERATION

◇ CALL-S mode

Item indication	Ref.	Item indication	Ref.
UR	p. 37	RPT2	p. 38
RPT1	p. 38	MY	p. 36

◇ RX CAL mode

See p. 49 for details.

◇ MESSAG mode

Item indication	Ref.	Item indication	Ref.
TX MSG	p. 68	TX GPS	p. 79
RX MSG	p. 70	RX GPS	p. 80

◇ RPT-L mode

Item indication	Ref.	Item indication	Ref.
ADD-L	p. 40	EDIT-L	p. 45

◇ GPS mode

Item indication	Ref.	Item indication	Ref.
GPS.SET	p. 136	ALM1	p. 88
GPS.POS	p. 80	ALM2	p. 89
D/F	p. 82	GPS-TX	p. 138
GPS.MEM	p. 84	GPS.ATX	p. 142
ALM-CH	p. 85		

• GPS.SET mode

Item indication	Ref.	Item indication	Ref.
P FORM	p. 136	INDIC	p. 137
UNITS	p. 136	GPS.OUT	p. 137
UTC.OFF	p. 137		

• Sentence formatter setting

Item indication	Ref.	Item indication	Ref.
AMC	p. 138	GSA	p. 138
GGA	p. 138	VTG	p. 138
GLL	p. 138	GSD	p. 138

• GPS-A mode

Item indication	Ref.	Item indication	Ref.
UNPROT	p. 139	SYMBOL	p. 141
DT EXT	p. 140	COMMEN	p. 141
TIME	p. 140		

■ DUP/TONE items (DUP.T)

◇ Frequency offset (OFFSET)

Sets the frequency offset for duplex (repeater) operation within the range of 0 to 159.995 MHz.

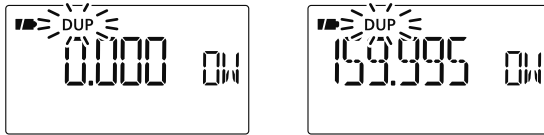

The default value may differ according to the selected frequency band (before accessing DUP.T set mode) and transceiver version.

▨ The selected tuning step in the VFO mode is used when setting the frequency offset.

◇ Repeater tone frequency (R TONE)

Selects subaudible tone frequency for accessing a repeater, etc. 50 tone frequencies (67.0–254.1 Hz) are available.

(default: 88.5)

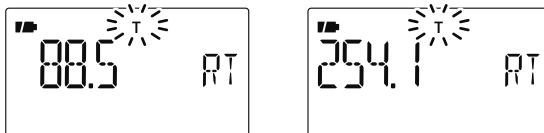

◇ TSQL frequency (C TONE)

Selects tone frequency for tone squelch or pocket beep operation from one of 50 available frequencies (67.0–254.1 Hz).

(default: 88.5)

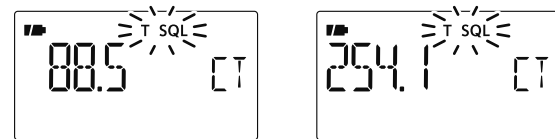

• Available subaudible tone frequencies

67.0	79.7	94.8	110.9	131.8	156.7	171.3	186.2	203.5	229.1
69.3	82.5	97.4	114.8	136.5	159.8	173.8	189.9	206.5	233.6
71.9	85.4	100.0	118.8	141.3	162.2	177.3	192.8	210.7	241.8
74.4	88.5	103.5	123.0	146.2	165.5	179.9	196.6	218.1	250.3
77.0	91.5	107.2	127.3	151.4	167.9	183.5	199.5	225.7	254.1

▨ The transceiver has 50 tone frequencies and consequently their spacing is narrow compared with units having 38 tones. Therefore, some tone frequencies may receive interference from adjacent tone frequencies.

12 MENU SCREEN OPERATION

◇ DTCS code (CODE)

Selects DTCS (both encoder/decoder) code for DTCS squelch operation. Total of 104 codes (023–754) are available.

(default: 023)

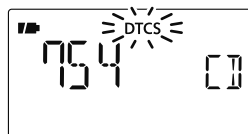

• Available DTCS codes

023	054	125	165	245	274	356	445	506	627	732
025	065	131	172	246	306	364	446	516	631	734
026	071	132	174	251	311	365	452	523	632	743
031	072	134	205	252	315	371	454	526	654	754
032	073	143	212	255	325	411	455	532	662	
036	074	145	223	261	331	412	462	546	664	
043	114	152	225	263	332	413	464	565	703	
047	115	155	226	265	343	423	465	606	712	
051	116	156	243	266	346	431	466	612	723	
053	122	162	244	271	351	432	503	624	731	

◇ DTCS polarity (DTCS-P)

Sets DTCS polarity from “BOTH N” (TX/RX: normal), “TN-RR” (TX: normal, RX: reverse), “TR-RN” (TX: reverse, RX: normal) and “BOTH R” (TX/RX: reverse).

(default: BOTH N)

DTCS code’s polarity for transmitting or receiving can be set by this item independently.



TX/RX: Normal polarity

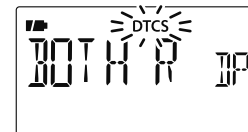

TX/RX: Reverse polarity

◇ Digital code (D CODE)

Sets the desired digital code for digital code squelch operation. Total of 100 codes (00–99) are available. (default: 00)

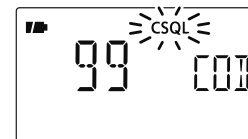
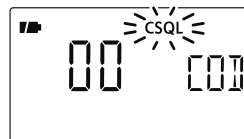

◇ DTMF speed (DTMF-S)

Select the desired DTMF transmission speed from 100 msec, 200 msec, 300 msec, 500 msec.

- 100 : 100 msec. interval; 5.0 characters per second (default)
- 200 : 200 msec. interval; 2.5 characters per second
- 300 : 300 msec. interval; 1.6 characters per second
- 500 : 500 msec. interval; 1.0 character per second



◇ DTMF TX key (DTMF-T)

Selects DTMF transmitting code when pushing and holding [PTT], then pushing one of the keypad buttons.

- KEY : [1]–[9], [0], [A], [B], [C], [D], [*] (indication: E) or [#] (indication: F) DTMF tones are transmitted when the key is pushed. (default)
- DTMF-M : The DTMF memory contents d0–dF are transmitted.

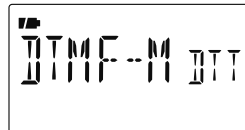
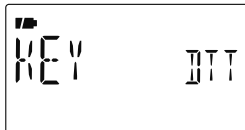

■ Scan items (SCAN)

◇ Priority watch (PRIO)

Activates priority watch or priority watch with alert (Bell).

- OFF : The priority watch is turned OFF. (default)
- ON : The transceiver checks the memory channel frequency every 5 sec.
- BELL : The transceiver checks the memory channel frequency every 5 sec. You can be alerted with beeps and blinking “(••)”.



◇ Scan pause timer (PAUSE)

Selects the scan pause time. When receiving signals, the scan pauses according to the scan pause timer.

- 2–20 SEC : Scan pauses for 2–20 sec. while receiving a signal in 2 sec. steps. (default: 10 sec.)
- HOLD : Scan pauses on a received signal until it disappears.



12 MENU SCREEN OPERATION

◇ Scan resume timer (RESUME)

Selects the scan resume time from a pause after the received signal disappears.

- 0 SEC : Scan resumes immediately after the received signal disappears.
- 1–5 SEC: Scan pauses 1–5 sec. after the received signal disappears. (default: 2 sec.)
- HOLD : Scan remains paused on the received signal according to the scan pause timer even if it disappears. Rotate [DIAL] to resume manually.



Scan resume timer must be set shorter than scan pause timer (previous item), otherwise this timer cannot be activated.

◇ Memory bank link function (B-LINK)

Sets the memory bank link function ON (default) and OFF. The link function provides continuous bank scan, scanning all channels in the selected banks during bank scan.

• Bank link setting

- ① Push [▲](2) or [▼](8) to select the bank that you want to change the link setting.

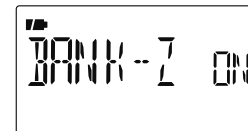
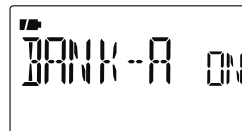

- ② Push [←](5) to enter bank setting.
- ③ Push [▲](2) or [▼](8) to select the setting.

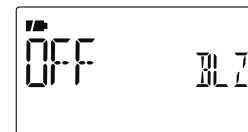
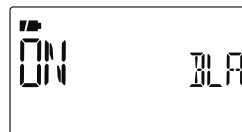

- ④ Push [←](5) to set and return to the BANK selection screen.
- ⑤ Push [▲](2) or [▼](8) to select next bank and repeat steps ② to ④, or push [MENU] to exit MENU screen operation.

◇ **Program scan link function (P-LINK)**

Sets the program scan link function. The link function provides continuous program scan in the selected program scan number during program scan.

Default settings for P-LINK P0 to P-LINK P9: PROG 1 to PROG 24 are linked and PROG 0 is no-linked.

• **Confirming program scan link**

- ① Push [▲](2) or [▼](8) to select the program scan link number that you want to confirm.



- ② Push [←](5) to enter the program scan link setting.
- ③ Push [▲](2) or [▼](8) several times to select "LINK."



- ④ Push [←](5), then push [▲](2) or [▼](8) to confirm the linked program scans. Push [←](5) to exit.

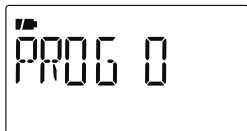

• **Program scan link setting**

- ① Push [▲](2) or [▼](8) to select the program scan link number that you want to change.



- ② Push [←](5) to enter the program scan link setting.
- ③ Push [▲](2) or [▼](8) several times to select the setting "ADD" or "CLEAR."



- When "ADD" is selected, only non-linked program scans are displayed. When "CLEAR" is selected, only linked program scans are displayed.

- ④ Push [←](5), then push [▲](2) or [▼](8) to select the desired program scan.



- ⑤ Push [←](5) to set the program scan link setting.
- ⑥ Repeat steps ④ and ⑤ to add or clear the program scan to/from the link, or push [MENU] to exit MENU screen operation.

12 MENU SCREEN OPERATION

• Program scan link name programming

- ① Push [▲](2) or [▼](8) to select the program scan link number for which you want to program a name.

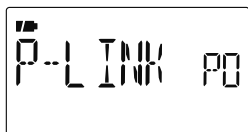

- ② Push [←](5) to enter the program scan link setting.
- ③ Push [▲](2) or [▼](8) several times to select "NAME".
- ④ Push [←](5) to enter the name programming.

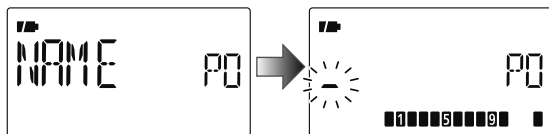

- ⑤ Push [▲](2) or [▼](8) to select the desired character, number, symbol or space; push [▶](6) or [◀](4) to move the cursor right or left, respectively.
- ⑥ Push [←](5) to program the repeater name and exit the state.
- ⑦ Push [MENU ⏪] to exit MENU screen operation.

■ Set mode items (SET)

□ Function set mode items (FUNC)

◇ Attenuator (ATT)

The attenuator prevents distortion of a desired signal by very strong RF signals near the desired frequency or when very strong electric fields, such as from a broadcasting station, are present at your location.

Select the attenuator function ON and OFF (default).

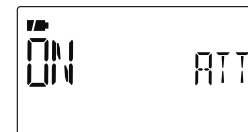
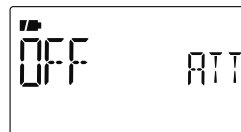

◇ Power save (P SAVE)

The power save function reduces the current drain to conserve battery power. This power save function can be turned OFF, if desired.

- “AUTO1” selects “1:4” duty ratio when receiving no signal for 5 sec., then “1:8” 60 sec. after that. (default)
- “AUTO2” suppresses the consumption of the battery by stopping the operation of a digital block of the DV mode in addition to the operation of AUTO1.

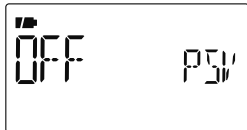

NOTE: Power save function is disabled when using the external power supply (more than 10 V DC) or if the Auto replay function is set to ON (p. 132).

◇ Monitor key action (MONI)

The monitor key, [SQL], can be set as a ‘sticky’ key. When set to the sticky condition, each push of [SQL] toggles the monitor function ON and OFF.

- PUSH: Push and hold [SQL] to monitor the frequency. (default)
- HOLD: Push [SQL] momentarily to monitor the frequency and push momentarily again to cancel it.

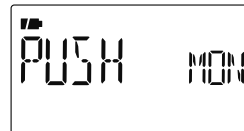

◇ PTT lock (PTT LK)

Turns the PTT lock function ON and OFF.

To prevent accidental transmissions, this function inhibits transmission by disabling [PTT]. (default: OFF)



12 MENU SCREEN OPERATION

◇ Busy lockout (LK OUT)

Turns the busy lockout function ON and OFF.

This function inhibits transmission while receiving a signal or when the squelch is open. (default: OFF)

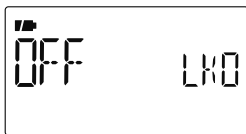

◇ Time-out timer (TOT)

To prevent accidental prolonged transmission, etc., the transceiver has a time-out timer. This function cuts transmission OFF after 1, 3, 5, 10, 15 or 30 min. of continuous transmission. This timer can be cancelled.

- OFF : The time-out timer is turned OFF. (default)
- 1 to 30 MIN : The transmission is cut OFF after the set period elapses.

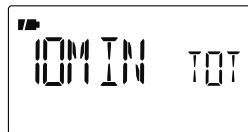
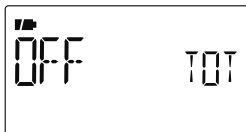

◇ Dial speed acceleration (DIAL S)

The dial speed acceleration automatically speeds up the tuning dial speed when rotating [DIAL] rapidly.

- OFF : The dial speed acceleration is turned OFF.
- ON : The dial speed acceleration is tuned ON. (default)



◇ Active band (ACTIVE)

Allows continuous frequency selection of the operating frequency across all bands.

- SINGLE : A single operating frequency can be selected within the current band. Push [BAND] for band selection in this case.
- ALL : The operating frequency can be selected continuously. (default)

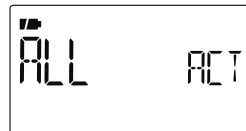

◇ **Key lock type (LOCK)**

While the key lock function is ON, [PWR], [PTT], [SQL], [VOL] and [MENU](Lock function only) can still be accessed. Accessible keys can be set to 1 of 4 groups.

- NORMAL: [PWR], [PTT], [SQL], [VOL] and [MENU] (Lock function only) accessible. (default)
- NO SQL : [PWR], [PTT], [VOL] and [MENU] (Lock function only) are accessible.
- NO VOL : [PWR], [PTT], [SQL] and [MENU] (Lock function only) are accessible.
- ALL : [PWR], [PTT] and [MENU] (Lock function only) are accessible.



◇ **Microphone simple mode (MIC)**

Microphone simple mode is used to change the function assignments for keys on the optional HM-75A REMOTE CONTROL SPEAKER-MICROPHONE. (p. 164)

- SIMPLE
- NORM-1 (default)
- NORM-2

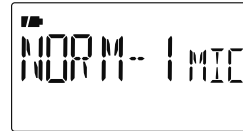

◇ **DATA speed (SPEED)**

Selects the data speed of [DATA] jack between 4800 bps and 9600 bps (default) for low-speed data communication in DV mode, GPS receiving, etc.



When 9600 bps is selected



When 4800 bps is selected

⚡ This setting does not change the cloning speed.

12 MENU SCREEN OPERATION

◇ Auto power OFF (AP OFF)

The transceiver can automatically turn itself OFF after a specified time period. Activating any control restarts the time-out period. The transceiver beeps before it turns OFF.

30 min., 60 min, 90 min, 120 min and OFF (default) can be specified. The specified time period is retained even when the transceiver is turned OFF by the auto power OFF function. To cancel the function, select "OFF" in this item.

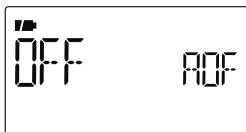

◇ Auto power ON (AP ON)

Auto power ON function turns the transceiver power ON automatically after passing the set time period from power OFF. Select the desired time period from 30 minutes to 24 hours in 30-minute steps, or select OFF to disable. (default: OFF)

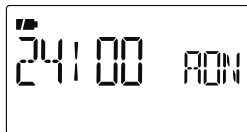
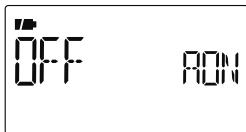

□ Display set mode items (DISP)

◇ Display backlighting (LIGHT)

The transceiver has display backlighting with a 5 sec. timer for night time operation. The display backlighting can be turned ON continuously or turned OFF, if desired.

- OFF : The backlight is turned OFF.
- ON : The backlight continuously lights ON.
- AUTO1 : Lights when an operation is performed, goes out after 5 sec. (default)
- AUTO2 : Lights when an operation is performed, goes out after 5 sec with a battery pack or battery case operation, or stays ON when using the external power supply (more than 10 V DC).

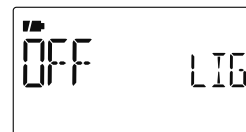

◇ **Busy LED (BUSY)**

The TX/RX indicator lights green while receiving a signal or when the squelch is open. This indication can be turned OFF to conserve the battery power, if desired.

- OFF : The indicator does not function even if a signal is received.
- ON : The indicator lights green while receiving a signal or when the squelch is open. (default)



◇ **LCD contrast (CONT)**

The contrast of the LCD can be selected from 4 levels.

- 1 (Low contrast) to 4 (High contrast) (default: 3)



Default (3)

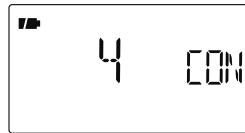

High contrast (4)

◇ **Scan name (SCAN N)**

The programmed scan, programmed link scan or bank name is displayed during the scan type selection.

- OFF : The programmed scan, programmed link scan or bank name is not displayed.
- ON : The programmed scan, programmed link scan or bank name is displayed. (default)



◇ **Opening message (OPN.MSG)**

The opening message indication that is displayed at power ON is selectable from Icom logo, my call sign or skipped.

- OFF : Opening message indication is skipped.
- LOGO : Icom logo is displayed at power ON. (default)
- CALL : The set my call sign is displayed at power ON.



When LOGO is selected



When Call sign is selected

12 MENU SCREEN OPERATION

□ Sounds set mode items (SOUNDS)

◇ Beep output level (BEEPLV)

Adjusts the key-touch beep tone level to the desired level within 39 levels. (default: 19)



Minimum level

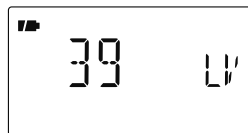

Maximum level

/// The key-touch beep (following item) must be set to ON to have a beep tone.

◇ Key-touch beep (KEY B)

Turns the key-touch beep ON or OFF. (default: ON)



Key-touch beep ON



Key-touch beep OFF

◇ Scan stop beep (STOP B)

Turns the scan stop beep function ON or OFF. (default: OFF)

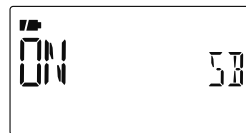

Scan stop beep ON

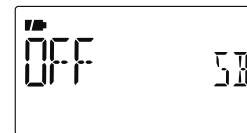

Scan stop beep OFF

◇ Standby beep (STBY B)

Turns the beep emission capability ON and OFF when the communicating station finishes transmitting or the receive signal disappears while in the digital mode operation.

(default: ON)

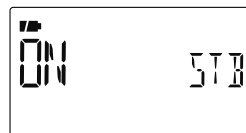

Stand by beep ON

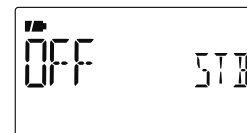

Stand by beep OFF

◇ Band edge beep (EDGE B)

Turns the beep emission capability ON and OFF when the frequency is changed over the band edge by rotating [DIAL].

(default: OFF)



Band edge beep ON



Band edge beep OFF

12 MENU SCREEN OPERATION

■ DV set mode items (DV SET)

◇ Auto reply (REPLY)

Use this function to reply to a station calling when you are away from the transceiver.

After a manual transmission (pushing [PTT]), the Auto Reply setting returns to OFF automatically.

- OFF : No reply is performed even if a call is received. (default)
- ON : Sets the caller's call sign and replies to the call with the programmed own call sign.

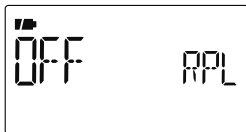

/// **NOTE:** When Auto reply is “ON,” the power save function (p. 125) is disabled to receive call sign signal properly.

◇ DV data TX (DATATX)

During low-speed data operation, auto data transmission function is available. This function activates to transmit automatically when the PC software sends data to the IC-E80D via the [DATA] jack. (default: PTT)

- PTT : Data from [DATA] transmits when [PTT] is pushed. (default)
- AUTO : Data from [DATA] transmits automatically.



◇ Digital monitor (D MONI)

Sets the desired monitoring mode during digital mode operation from “Auto,” “Digital” and “Analog.”

- AUTO : The transceiver sets monitoring mode to FM and DV according to the received signal. (default)
- DIGI : Monitors in DV mode.
- ANALOG : Monitors in FM mode.



◇ Digital repeater setting (D RPT)

When accessing a digital repeater that has a call sign is different than the transceiver's current call sign, the repeater call sign can be stored into "RPT1" automatically by reading the repeater's downlink signal. (default: ON)

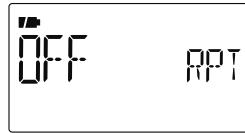

◇ RX call sign auto write (CALL W)

When your own individual station call is received, the calling station call sign can be automatically set in "UR" of the current call sign. (default: OFF)

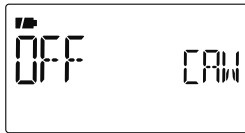

◇ Repeater call sign auto write (RPT W)

When your own individual station call is received via the D-STAR repeater, the repeater call sign can be set into "RPT1" and/or "RPT2" automatically by reading the repeater's downlink signal. (default: OFF)



/// The transceiver sets the received repeater call sign for operation, over-writing the current repeater call sign.

◇ DV auto detect (DV DET)

When a signal other than DV mode is received during DV mode operation, the transceiver has capability of automatic FM mode selection.

- OFF : Operating mode is fixed in DV. (default)
- ON : The transceiver automatically selects FM mode for temporary operation.



12 MENU SCREEN OPERATION

◇ Call sign edit record (EDIT R)

Selects call sign programming when the call sign is edited.

- OFF : The edited or corrected call sign overwrites the pre-programmed channel. A different channel cannot be selected.
- SEL : The edited or corrected call sign is programmed into the selected call sign memory.
- AUTO : The edited or corrected call sign is programmed into a blank channel automatically. (default)

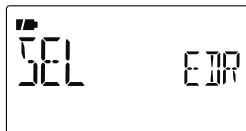

◇ Auto gateway setting (GW SET)

Turn the gateway auto set function ON or OFF for calling a specific station in the DR mode. This function enables the transceiver to set the pre-programmed gateway repeater as the linked repeater "RPT2" automatically.

- OFF : After selecting a specific station, the transceiver sets the same RPT2 as previous time. (default)
- AUTO : After selecting a specific station, the transceiver sets the pre-programmed gateway repeater as RPT2 automatically.

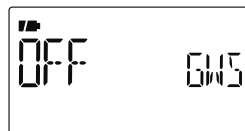

◇ RX call sign display (RX CS)

When a call is received, the calling station call sign can be displayed automatically. (default: AUTO)

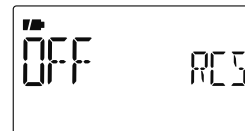

◇ **TX call sign display (TX CS)**

Selects call sign display function from YOUR, MY or OFF.
When this setting is set to YOUR or MY, the transceiver automatically displays the set station or your own call sign during DV mode transmission.
(default: YOUR)

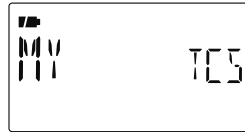

◇ **RX message display (RX MSG)**

Sets auto received message display function AUTO or OFF.
When this setting is set to AUTO, the transceiver automatically displays and scrolls the received message.
(default: AUTO)

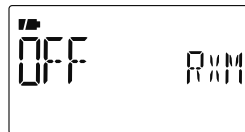
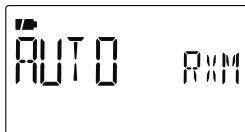

◇ **Scroll speed (SCROLL)**

Set the displayed message, call sign, etc. scrolling speed.

- FAST : Scroll speed is set to fast. (default)
- SLOW : Scroll speed is set to slow.



◇ **Break-in function (BK)**

The break-in function allows you to break into a conversation where the two original stations are communicating with call sign squelch enabled. See pages 72, 73 for details.

- OFF : The break-in function is set to OFF. (default)
- ON : The break-in function is set to ON.
- "BK" appears on the display.

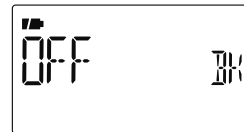

NOTE: The break-in function is turned OFF automatically when turning transceiver's power OFF.

12 MENU SCREEN OPERATION

◇ EMR function (EMR)

The EMR communication mode is available for digital mode operation. In the EMR communication mode, no call sign setting is necessary. When an EMR communication mode signal is received, the audio (voice) will be heard at the specified level even if the volume setting level is set to minimum level, or digital call sign/digital code squelch is in use. See page 71 for details.

- OFF : The EMR function is set to OFF. (default)
- ON : The EMR function is set to ON.
- "EMR" appears on the display.

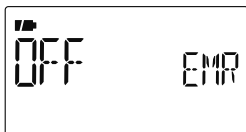

NOTE: The EMR communication function is turned OFF automatically when turning transceiver's power OFF

■ GPS mode items (GPS)

◇ GPS set mode items (GPS.SET)

◆ Position format (P FORM)

Selects the displaying position format from "mm.mm" (ddd°mm.mm') (default) and "mm.SS" (ddd°mm'ss").



When ddd°mm.mm' is selected

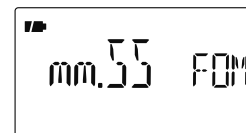

When ddd°mm'ss" is selected

◆ Units (UNITS)

Selects display units for distance and elevation to "m" or "Ft/ml." (default : m)



When "meter" is selected

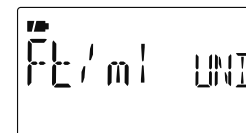

When "Feet/mile" is selected

◆ UTC offset (UTC.OFF)

Sets time difference from UTC (Universal Time Coordinated) from -12:00 to +12:00 range in 5 min. steps. (default: 0:00)



Set to -12:00 hour



Set to +12:00 hour

◆ GPS indication (INDIC)

Sets the GPS indicator ON and OFF. (default : ON)

- OFF : "G" indicator does not appear.
- ON : "G" indicator appears on the display when a GPS receiver is connected and a valid position data is received; blinks when invalid data.



GPS indication ON



GPS indication OFF

◆ GPS data out (GPS.OUT)

Enables transfer of GPS data received from an optional HM-189GPS to the [DATA] jack.

- OFF : Transceiver does not output the GPS data. (default)
- ON : Transceiver outputs the GPS data from [DATA] jack.



Data output is ON



Data output is OFF

12 MENU SCREEN OPERATION

◇ GPS-TX mode items (GPS-TX)

Sets the transmission of data from a connected GPS receiver ON and OFF.

When the position information is received from a connected GPS receiver and GPS.ATX (GPS Auto TX Timer) setting (p. 142) is set to a specific time, the transceiver automatically transmits the current position and message at the set interval.

- OFF : Transmitting position data is disabled. (default)
- DVG : Transmitting position data in GPS mode.
- DVA : Transmitting position data in GPS-A mode.

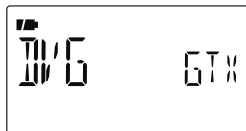
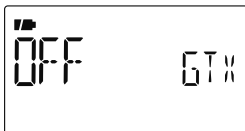

◆ Sentence formatter setting

- ① Select "DVG" in GPS-TX mode item, then push [←](5) to enter the sentence formatter selection.
- ② Push [▲](2) or [▼](8) to select the desired sentence formatter.
 - RMC, GGA, GLL, GSA, VTG and GSV are selectable.



RMC sentence

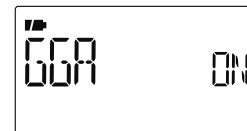

GGA sentence

- ③ Push [←](5) to enter the desired sentence formatter selection.
- ④ Push [▲](2) or [▼](8) to select the setting.
 - See right above for setting details.

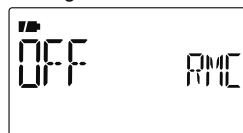

RMC sentence: OFF

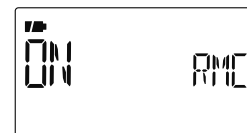

RMC sentence: ON

- ⑤ Push [←](5) to set ON/OFF.
- ⑥ Push [▲](2) or [▼](8) to select next sentence and repeat steps ② to ⑤, or push [MENU] to return to the frequency screen.
 - No more than four sentence formatters can be activate simultaneously.

(Continue to the next page.)

Continued (◆ Sentence formatter setting)

- RMC : (Default OFF)
Set RMC sentence ON or OFF.
- GGA : (Default ON)
Set GGS sentence ON or OFF.
- GLL : (Default OFF)
Set GLL sentence ON or OFF.
- GSA : (Default OFF)
Set GSA sentence ON or OFF.
- VTG : (Default OFF)
Set VTG sentence ON or OFF.
- GSV : (Default OFF)
Set GSV sentence ON or OFF.

◆ GPS-A set mode

Enter GPS-A set mode by selecting "DVA" in GPS-TX mode, then push [←](5). This set mode is available to set unproto address, data extension, time stamp, GPS-A symbol and comment.

• Unproto Address (UNPROT)

56 characters address can be entered for unproto address.

- ① Push [←](5) to enter the unproto address edit mode.
- ② Push [▲](2) or [▼](8) to select the desired character.
 - The selected character blinks.
 - Push [▶](6) to move the cursor right; push [◀](4) to move the cursor left.
 - Push [CLR](1) to erase the selected character, or push and hold [CLR](1) for 1 sec. to erase all characters following the cursor.
- ③ Repeat step ② until the desired unproto address is programmed.
- ④ Push [←](5) to program the unproto address and exit the unproto address edit mode.
- ⑤ Push [◀](4) to return to GPS-A set mode screen.



12 MENU SCREEN OPERATION

• DATA extension (DT EXT)

Sets the data extension capability to "CUR.SPD" (COURSE/SPEED) or OFF (default).

The transceiver's course and speed information is additionally transmitted with position data when "CUR/SPD" is selected.

/// **NOTE:** When "CUR/SPD" is selected, number of character for "COMMEN" (COMMENT) is limited to 36.

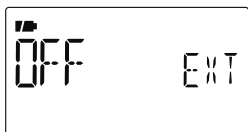

Set data extension to OFF

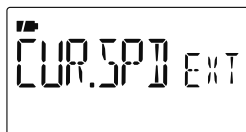

Set to course/speed

• Time stamp (TIME)

Selects transmitting time stamp type from DHM, HMS and OFF. This function transmits UTC (Universal Time Coordinated) time only.

- **OFF** : No time stamp is transmitted. (default)
- **DHM** : Time stamp in the format of Day, Hour and Minute is transmitted.
- **HMS** : Time stamp in the format of Hour, Minute and Second is transmitted.



Set time stamp to OFF



Set to Hour/Minute/Second

• GPS-A symbol (SYMBOL)

Selects the desired GPS-A symbol.

Available symbols: AMBU (Ambulance), BUS (Bus), FIRE (Fire Truck), BICYCL (Bicycle), YACHT (Yacht), HELI (Helicopter), AIRCRA (Small Aircraft), SHIP (Power Boat), CAR (Car): (default), MCYCLE (Motorcycle), BALLOO (Balloon), JEEP (Jeep), RV (Recreational Vehicle), TRUCK (Truck), VAN (Van) and OTHER (Other).

If "OTHER" is selected, set the desired symbol code as follows;

- ① Push [**←**](5) to begin the programming.
- ② Push [**▲**](2) or [**▼**](8) to select the 1st character from "A" and "/".
- ③ Push [**▶**](6) to select the 2nd digit.
- ④ Push [**▲**](2) or [**▼**](8) to select the 2nd digit character.
- ⑤ Push [**←**](5) to program the symbol code, then exit programming.
- ⑥ Push [**◀**](4) to return to GPS-A set mode screen.

When "OTHER" is selected, check the symbol codes of APRS® and set it correctly.

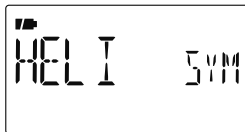

Helicopter is selected



Car is selected

• Comment (COMMENT)

Program up to a 43-character* comment. The programmed comment is transmitted with the GPS position data.

*Only 36 characters are available when "CUR/SPD" (COURSE/SPEED) is selected in DT EXT (Data extension).

- ① Push [**←**](5) to enter the programming.
- ② Push [**▲**](2) or [**▼**](8) to select the desired character.
 - The selected character blinks.
 - Push [**▶**](6) to move the cursor right; push [**◀**](4) to move the cursor left.
 - Push [**CLR**](1) to erase the selected character, or push and hold [**CLR**](1) for 1 sec. to erase all characters following the cursor.
- ③ Repeat step ② until the desired comment is programmed.
- ④ Push [**←**](5) to program the comment and exit comment programming.
- ⑤ Push [**◀**](4) to return to GPS-A set mode screen.

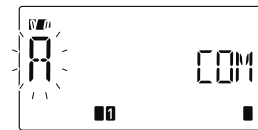
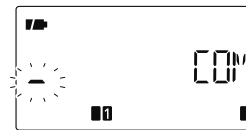

12 MENU SCREEN OPERATION

◇ GPS auto TX timer (GPS.ATX)

Selects the desired interval for automatic position transmission function from OFF (default), 5, 10, 30 second, 1, 3, 5, 10 and 30 minutes.

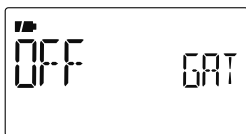

/// **NOTE:** When four sentence formatters are activated at the same time (“Sentence formatter setting” on pgs. 138, 139), “5SEC” cannot be selected.

■ Programming a DTMF code

DTMF codes are used for autopatching, accessing repeaters, controlling other equipment, etc. The transceiver has 16 DTMF memory channels (d0–d9, dA, dB, dC, dD, dE, dF) for storage of often-used DTMF codes of up to 24 digits.

- ① Push and hold **[DTMF.M]**(0) for 1 sec. to enter DTMF memory.

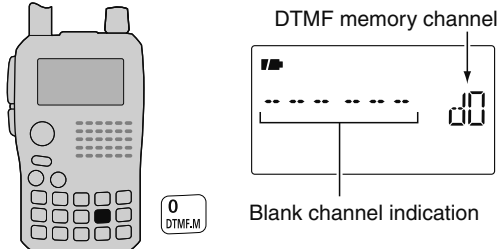

- ② Push **[▲]**(2) or **[▼]**(8) to select the desired DTMF memory channel.
- “T-CALL” appears when a 1750 Hz tone burst signal is selected. (p. 33)
 - Previously programmed DTMF code is displayed if programmed.

- ③ Push **[▶]**(6) to enter programming mode.

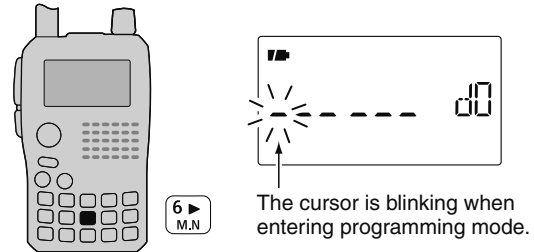

- ④ Push the desired keys to input the characters.

- **[0]–[9]** input “0”–“9;” **[A]**(V/MHz) inputs “A,” **[B]**(M/CALL) inputs “B;” **[C]**(DR) inputs “C;” **[D]**(△) inputs “D;” **[*]**(BAND) inputs “* (E)” and **[#]**(.) inputs “# (F).”
- Up to 24 digits can be programmed.

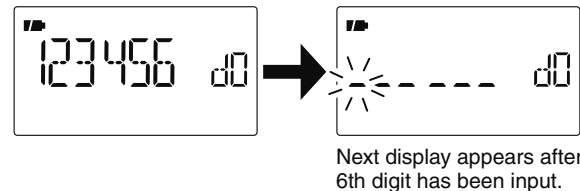

- ⑤ Repeat step ④ until the desired code is input.
- ⑥ Push **[MENU ◀▶]** to program the DTMF code and exit programming mode.
- Entering 24th digit automatically exits the programming mode.
- ⑦ Push **[V/MHz]** to exit DTMF memory.

■ Transmitting a DTMF code

◇ Transmitting from DTMF memory

The selected DTMF code is transmitted at each push of the [SQL] switch while transmitting.

▨ The transmitting speed at which DTMF memories send individual DTMF characters can be set in “DTMF-S” (DTMF SPEED) item. (p. 121)

- ① Set the desired frequency. (p. 23)
- ② Push and hold [DTMF.M](0) for 1 sec. to enter DTMF memory.
- ③ Push [▲](2) or [▼](8) to select the desired DTMF memory channel.
- ④ Push [←](5) to set the DTMF memory.
- ⑤ Push [V/MHz] to exit DTMF memory.
- ⑥ While pushing [PTT], push [SQL] to transmit the selected DTMF code.

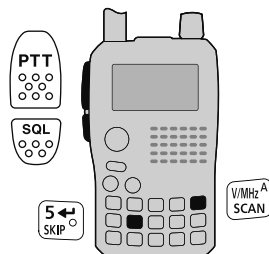

◇ Transmitting a DTMF memory via keypad

The selected DTMF memory can be transmitted via keypad directly while transmitting. Pushing [0]–[9], [A], [B], [C], [D], [#] or [*] to transmit DTMF memory channel (d0–d9, dA, dB, dC, dD, dE or dF) respectively.

- ① Set the desired frequency. (p. 23)
- ② Enter “DTMF-T” in DUP.T set mode.

MENU ⇄ DUP.T ⇄ **DTMF-T** (p. 121)
 (Push [MENU] (0-9)), (Push [▲](2)/[▼](8), then push [←](5).)

- ③ Push [▲](2) or [▼](8) to select DTMF transmitting key (DTMF-M) as below.

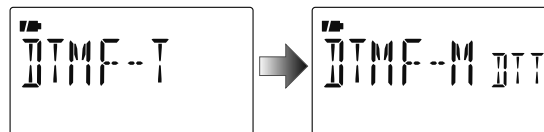

- ④ Push [←](5) (or [←](4)) to return to DUP.T set mode, and push [MENU] (0-9) to return to the frequency screen.
- ⑤ While pushing [PTT], push the desired key to transmit the selected DTMF memory.
 - [0]–[9], [A](V/MHz), [B](M/CALL), [C](DR), [D](△), [*](BAND) or [#](.) transmits “d0”–“d9,” “dA,” “dB,” “dC,” “dD,” “dE” or “dF.”

◇ Transmitting a DTMF code directly

DTMF code can be transmitted via keypad directly while transmitting.

- ① Set the desired frequency. (p. 23)
- ② Enter "DTMF-T" in DUP.T set mode.

MENU ⇨ DUP.T ⇨ **DTMF-T** (p. 121)
 (Push [MENU] (left arrow), (Push [▲](2)/[▼](8), then push [←](5).)

- ③ Push [▲](2) or [▼](8) to select DTMF transmitting key (KEY).
- ④ While pushing [PTT], push the desired keys to transmit the DTMF code.
 - [0]–[9] input "0"–"9," [A](V/MHz) inputs "A," [B](M/ CALL) inputs "B," [C](DR) inputs "C," [D](△) inputs "D," [*(BAND) inputs "*" and [#](.) inputs "#."

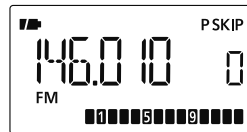
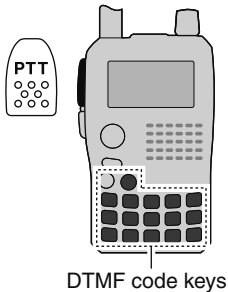

■ Clearing a DTMF memory

An unwanted DTMF memory can be cleared (erased).

- ① Push and hold [DTMF.M](0) for 1 sec. to enter DTMF memory mode.
- ② Push [▲](2) or [▼](8) to select the desired DTMF memory channel to be cleared.
- ③ Push and hold [CLR](1) for 1 sec. to clear the selected DTMF memory channel.

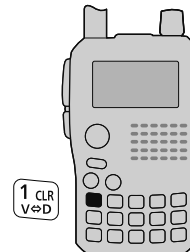

When entering DTMF programming mode.

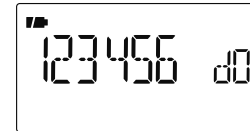

After clearing the DTMF memory.

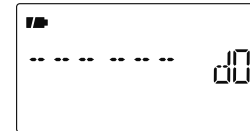

- ④ Push [V/MHz] to exit DTMF memory.

13 OTHER FUNCTIONS

■ Confirming a DTMF memory

A DTMF memory can be confirmed with a DTMF tone.

- ① Push and hold **[DTMF.M](0)** for 1 sec. to enter DTMF memory mode.
- ② Push **[▲](2)** or **[▼](8)** to select the desired DTMF memory channel.
- ③ Push **[SQL]** to confirm the DTMF memory contents.
- ④ Push **[V/MHz]** to exit DTMF memory.

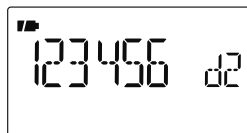
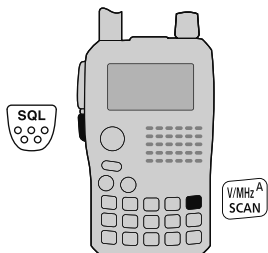

■ Setting DTMF transfer speed

The DTMF transfer speed can be selected.

- ① Enter "DTMF-S" in DUP.T set mode.

MENU ⇨ DUP.T ⇨ **DTMF-S** (p. 121)
(Push **[MENU ⏏]**), (Push **[▲](2)**/**[▼](8)**), then push **[←](5)**.)

- ② Push **[▲](2)** or **[▼](8)** to select DTMF transfer speed as below.
 - 100 : Transfer the DTMF tones at about 100 msec. per tone.
 - 200 : Transfer the DTMF tones at about 200 msec per tone.
 - 300 : Transfer the DTMF tones at about 300 msec per tone.
 - 500 : Transfer the DTMF tones at about 500 msec per tone.
- ③ Push **[←](5)** to return to DUP.T set mode, and push **[MENU ⏏]** to return to the frequency screen.

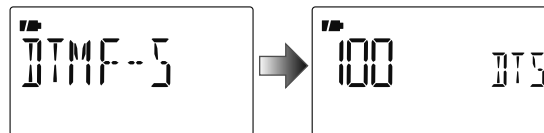

■ Tone frequency and DTCS code

◇ Subaudible (repeater) tone

Some repeaters require subaudible tones to be accessed. Subaudible tones are superimposed over your normal signal and must be set in advance.

◇ Tone and DTCS squelches

The tone squelch (CTCSS) or DTCS squelch opens only when receiving a signal containing a matching subaudible tone or DTCS code, respectively. You can silently wait for calls from group members using the same tone or code. Separate tone frequencies can be set for repeater and tone squelch/pocket beep operation.

◇ Reverse tone/DTCS squelch

The reverse tone/DTCS squelch is convenient if you want to ignore a specific signal. The transceiver mutes the squelch when a signal with the matched tone or code is received. "T SQL-R" / "DTCS-R" is displayed when the reverse tone/DTCS squelch is set.

◇ Pocket beep

These functions use subaudible tones or DTCS codes for calling and can be used as a "common pager" to inform you that someone has called while you were away from the transceiver.

◇ Setting subaudible tones for repeater or tone squelch

- ① Enter "R TONE" or "C TONE" in DUP.T set mode.

MENU ⇨ DUP.T ⇨ **R TONE** (p. 119)
(Push [MENU] (p. 119), (Push [▲](2)/[▼](8), then push [←](5).)

MENU ⇨ DUP.T ⇨ **C TONE** (p. 119)

- ② Push [▲](2) or [▼](8) to select the desired repeater or CTCSS tone frequency.
 - Each operating band and each memory channel have independent settings.
 - See page 119 for available tone frequencies for details.
- ③ Push [←](5) to return to DUP.T set mode, and push [MENU] (p. 119) to return to the frequency screen.



Repeater tone setting

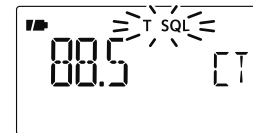

CTCSS tone setting

13 OTHER FUNCTIONS

■ Tone frequency and DTCS code (Continued)

◇ Setting DTCS code for DTCS squelch or beep

- ① Enter "CODE" (DTCS CODE) in DUP.T set mode.

MENU ⇨ DUP.T ⇨ **CODE** (p. 120)
(Push [MENU] (5), (Push [▲](2)/[▼](8), then push [←](5).)

- ② Push [▲](2) or [▼](8) to select the desired DTCS tone code.
- Each operating band and each memory channel have independent settings.
 - See page 118 for available DTCS codes for details.
- ③ Push [←](5) (or [↵](4)) to return to DUP.T set mode, and push [MENU] (5) to return to the frequency screen.

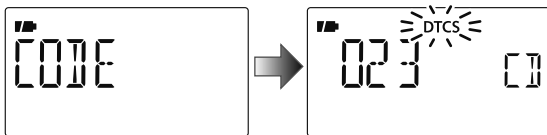

DTCS phase can be selected in "DTCS-P" (DTCS POLARITY) item. (p. 120)

■ Digital code and digital call sign setting

◇ Setting digital code for digital code squelch or beep

- ① Push and hold [MODE](BAND) for 1 sec. several times to select DV mode.
- ② Enter "D CODE" (DIGITAL CODE) in DUP.T set mode.

MENU ⇨ DUP.T ⇨ **D CODE** (p. 120)
(Push [MENU] (5), (Push [▲](2)/[▼](8), then push [←](5).)

- ③ Push [▲](2) or [▼](8) to select the desired digital code.
- Each operating band and each memory channel have independent settings.

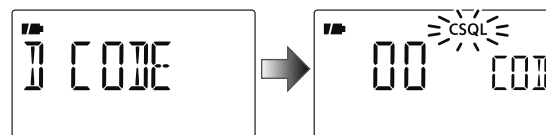

- ④ Push [←](5) to return to DUP.T set mode, and push [MENU] (5) to return to the frequency screen.

◇ Setting UR and MY call signs for digital call sign squelch or beep

- ① Push and hold [MODE](BAND) for 1 sec. several times to select DV mode.
- ② Enter “UR” in CALL-S set mode.

MENU ⇄ CALL-S ⇄ **UR** (p. 37)
 (Push [MENU] (), (Push [▲](2)/[▼](8), then push [←](5).)

- ③ Push [▲](2) or [▼](8) to select the desired call sign.
 - Input the call sign if the desired call sign is not stored in the transceiver. See p. 37 for detail.

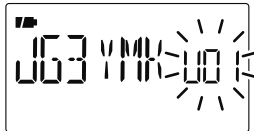

- ④ Push [←](5) to specify the call sign and then push [◀](4) to return to CALL-S set mode.
 - Push [◀](4) to return to CALL-S set mode without storing call sign.
- ⑤ Push [▲](2) three times to select “MY” in CALL-S set mode, then push [←](5) to enter “MY” setting.

MENU ⇄ CALL-S ⇄ **MY** (p. 36)
 (Push [MENU] (), (Push [▲](2)/[▼](8), then push [←](5).)

- ⑥ Push [▲](2) or [▼](8) to select the desired call sign.
 - Input the call sign if the desired call sign has not stored in the transceiver. See p. 36 for detail.
- ⑦ Push [←](5) to set call sign and push [MENU] () to return to the frequency screen.



IMPORTANT: Use digital code squelch when operating with more than 3 stations. Because the digital call sign squelch function recognizes “MY” (MY CALL SIGN) the digital call sign squelch function can be used when operating with only one station.

NOTE:

- The tone/DTCS code squelch opens sometimes when other stations communicate with adjacent tone frequency or DTCS code.
- In DV mode, if the IC-E80D does not receive “MY,” you will not hear audio even though the S-meter is moving.

13 OTHER FUNCTIONS

■ Tone/DTCS squelch

- ① Set the desired operating frequency on FM or FM-N mode, CTCSS tone and DTCS code.
- ② Push and hold **[TONE]**(7) for 1 sec. several times to activate the tone or DTCS squelch. (T SQL or DTCS)
 - Subaudible tone encoder “T,” pocket beep (tone squelch) “((•)) T SQL,” tone squelch “T SQL,” DTCS beep “((•)) DTCS,” DTCS squelch “DTCS,” tone squelch reverse “T SQL-R,” DTCS squelch reverse “DTCS-R” and no tone operation are activated in order.
 - Rotating **[DIAL]** while pushing **[TONE]**(7) also selects the tone functions.
- ③ Operate the transceiver in the normal way.
- ④ When the received signal includes a matching tone/code, the squelch opens and the signal can be heard.
 - When the received signal’s tone/code does not match, tone/DTCS squelch does not open, however, the S-indicator shows signal strength.
 - To open the squelch manually, push and hold **[SQL]**.

No tone operation

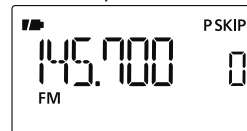

Subaudible tone encoder

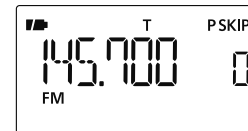

Pocket beep

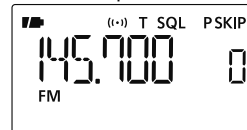

Tone squelch

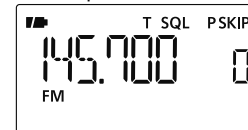

DTCS beep

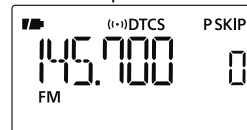

DTCS squelch



Tone squelch (reverse)

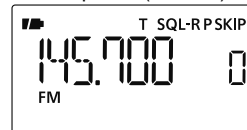

DTCS squelch (reverse)



■ Digital squelch

- ① Set the desired operating frequency on DV mode, Digital code and "MY" (MY CALL SIGN).
- ② Push and hold **[DSQ]**(7) for 1 sec. several times to activate the digital call sign or digital code squelch.
 - Digital call sign beep "DSQL ((·))," Digital call sign squelch "DSQL," Digital code beep "CSQL ((·))," Digital code squelch "CSQL," and no digital squelch operation are activated in order.
 - Rotating **[DIAL]** while pushing **[DSQ]**(7) also selects the digital squelch functions.
- ③ Operate the transceiver in the normal way.
- ④ When the received signal includes a matching call sign/code, the squelch opens and the signal can be heard.
 - When the received signal's call sign/code does not match, digital call sign/digital code squelch does not open, however, the S-indicator shows signal strength.
 - To open the squelch manually, push and hold **[SQL]**.

Digital call sign pocket beep

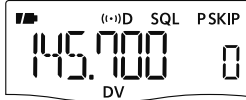

Digital call sign squelch



Digital code pocket beep

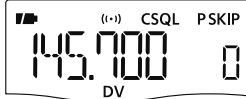

Digital code squelch



■ Pocket beep function

- ① Set the desired operating frequency.
- ② Set the desired CTCSS tone, DTCS code, Digital call sign or Digital code.
- ③ Push and hold **[TONE]**(7) or **[DSQ]**(7) for 1 sec. several times to activate the pocket beep, DTCS beep, Digital call sign beep or Digital code beep. ("((·)) T SQL," "((·)) DTCS," "((·)) D SQL" or "((·)) CSQL")
 - Rotating **[DIAL]** while pushing **[TONE]**(7)/**[DSQ]**(7) also selects the tone squelch or digital squelch functions.
- ④ When a signal with the correct tone, code, digital call sign or digital code is received, the transceiver emits beep tones for 30 sec. and blinks "((·))."
- ⑤ Push **[PTT]** to answer or push **[SQL]** to stop the beeps and blinking.

Pocket beep

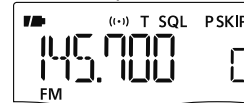

DTCS beep

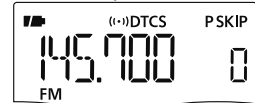

Digital call sign pocket beep

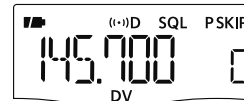

Digital code pocket beep

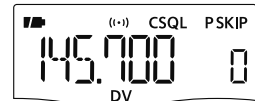

13 OTHER FUNCTIONS

■ DTCS polarity setting

- ① Enter “DTCS-P” in DUPT set mode.

MENU ⇨ DUPT ⇨ **DTCS-P** (p. 120)
(Push [MENU] (M)), (Push [▲](2)/[▼](8), then push [←](5).)

- ② Push [▲](2) or [▼](8) to select the desired DTCS polarity mode.
- **BOTH N** : Normal phase is used for both TX and RX. (Default)
 - **TN-RR** : Normal phase is used for TX; Reverse phase for RX.
 - **TR-RN** : Reverse phase is used for TX; Normal phase for RX.
 - **BOTH R** : Reverse phase is used for both TX and RX.

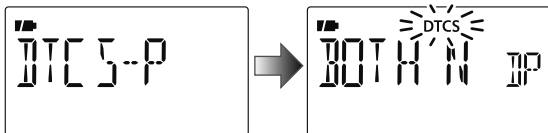

- ③ Push [←](5) (or [▲](4)) to return to DUPT set mode, and push [MENU] (M) to return to the frequency screen.

■ Tone scan

The transceiver can detect the subaudible tone frequency and DTCS code in a received signal. By monitoring a signal that is being transmitted on a repeater input frequency, you can determine the tone frequency required to access the repeater.

- ① Set the desired frequency on FM/FM-N mode or memory channel to be checked for a tone frequency or DTCS code.
- ② Push and hold [TONE](7) for 1 sec. several times to activate the repeater tone, tone squelch or DTCS squelch. (T, T SQL or DTCS)
- Rotating [DIAL] while pushing and holding [TONE](7) also selects the tone functions.
- ③ Push and hold [T.SCAN](9) for 1 sec. to start the tone scan.
- To change the scanning direction, rotate [DIAL].
- ④ When the tone frequency or DTCS code is decoded, the set mode contents are programmed with the frequency or code.
- The tone scan pauses for the set period in scan pause timer (p. 121) when a tone frequency or DTCS code is detected.
 - The decoded tone frequency is used for the repeater tone frequency when the tone squelch is OFF.
 - The decoded tone frequency is used for the tone squelch frequency when the tone squelch is ON.
 - The decoded DTCS code is used for the DTCS squelch code when the DTCS squelch is ON.

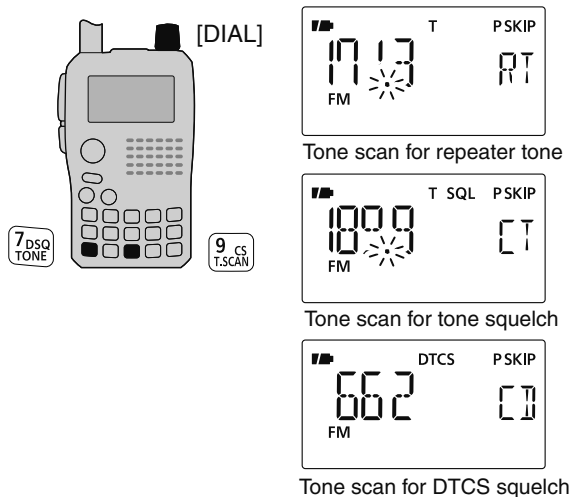

- ⑤ Push **[V/MHz]** to stop the scan.
- If the scan is cancelled before the transceiver detects the tone or code, the set mode contents are not changed.
 - The detected tone is used for temporary operation only. The stored tone setting in memory or call channel won't be changed.

NOTE: Tone frequency is over-written automatically when it corresponds with the scanning tone frequency in tone squelch mode. However, it is not over-written in memory or call channel mode.

■ Beep tones

You can select to have confirmation beeps sound at the push of a switch. The output level can be adjusted within 39 levels with “BEEPLV” in SOUNDS set mode (SET).

MENU ⇨ SOUNDS ⇨ **BEEPLV** (p. 130)
(Push **[MENU]**, (Push **[▲]**(2)/**[▼]**(8), then push **[←]**(5).)

You can select silent operation by turning beep tones OFF with “KEY B” in SOUNDS set mode (SET).

MENU ⇨ SOUNDS ⇨ **KEY B** (p. 130)
(Push **[MENU]**, (Push **[▲]**(2)/**[▼]**(8), then push **[←]**(5).)

■ Dial speed acceleration

The dial speed acceleration automatically speeds up the tuning dial speed when rotating **[DIAL]** rapidly.

This function can be turned ON and OFF with “DIAL S” (DIAL SPEED) in FUNC set mode (SET).

MENU ⇨ SET ⇨ FUNC ⇨ **DIAL S** (p. 126)
(Push **[MENU]**, (Push **[▲]**(2)/**[▼]**(8), then push **[←]**(5).)

13 OTHER FUNCTIONS

■ Key lock effect

While the lock function is ON, [PWR], [Δ]/[▽], [SQL] and [PTT] can still be accessed. Accessible switches can be set to one of 4 groups with "LOCK" in FUNC set mode (SET).

MENU ⇨ SET ⇨ FUNC ⇨ **LOCK** (p. 127)
(Push [MENU] (5)), (Push [▲](2)/[▼](8), then push [←](5).)

- "NORMAL" : [PWR], [Δ]/[▽], [SQL] and [PTT] are accessible.
- "NO SQL" : [PWR], [SQL] and [PTT] are accessible.
- "NO VOL" : [PWR], [Δ]/[▽], and [PTT] are accessible.
- "ALL": [PWR] and [PTT] are accessible.

■ Power save

The power save function reduces the current drain to conserve battery power.

The power save duty cycle, the ratio of receive circuit on to receive circuit off during standby, can be set to automatic1 (default), 1 : 4 (150 msec. : 600msec.), 1 : 8 (150 msec. : 1200msec.), automatic2, in addition stopping the operation of the digital block when in DV mode, or OFF with "P SAVE" in FUNC set mode (SET).

MENU ⇨ SET ⇨ FUNC ⇨ **P SAVE** (p. 125)
(Push [MENU] (5)), (Push [▲](2)/[▼](8), then push [←](5).)

- "AUTO1" selects "1:4" duty ratio when receiving no signal for 5 sec., then "1:8" 60 sec. after that.
- "AUTO2" suppresses the consumption of the battery by stopping the operation of the digital block when in DV mode in addition to the operation of AUTO1.

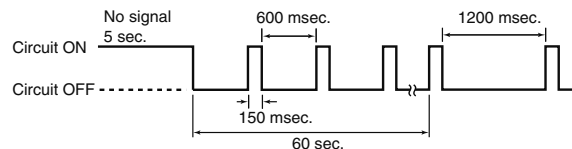

■ Auto power OFF

The transceiver can turn itself OFF automatically after a specified time. Activating a control restarts the time-out. The transceiver beeps before turning OFF.

120 min., 90 min., 60 min., 30 min. and OFF can be specified. The specified period is retained even when the transceiver is turned OFF by the auto power-off function. To cancel the function, select "OFF" in the auto power-off item in set mode.

This can be selected with "AP OFF" in FUNC set mode (SET).

MENU ⇨ SET ⇨ FUNC ⇨ **AP OFF** (p. 128)
(Push [MENU]), (Push [▲](2)/[▼](8), then push [←](5).)

■ Auto power ON

The transceiver can be set to automatically turn ON after a specified period. The timer can be selected within 30 min. to 24 hrs. in 30 min. steps. Once this timer turns the transceiver power ON, the auto power-on is automatically cancelled.

This can be selected with "AP ON" in FUNC set mode (SET).

MENU ⇨ SET ⇨ FUNC ⇨ **AP ON** (p. 128)
(Push [MENU]), (Push [▲](2)/[▼](8), then push [←](5).)

When operating with battery pack or case and the battery is exhausted, auto power-on does not function.
During standby, a small current still flows in the radio.

■ Time-out timer

To prevent accidental prolonged transmission, etc., the transceiver has a time-out timer. This timer cuts a transmission OFF after 1, 3, 5, 10, 15 or 30 min. of continuous transmission. This timer can be cancelled (default).

Approx. 10 sec. before the time-out timer is activated, the transceiver emits a beep tone as a warning.

This can be selected with "TOT" in FUNC set mode (SET).

MENU ⇨ SET ⇨ FUNC ⇨ **TOT** (p. 126)
(Push [MENU]), (Push [▲](2)/[▼](8), then push [←](5).)

■ PTT lock

To prevent accidental transmission, etc., the transceiver has a PTT lock function.

This can be selected with "PTT LK" in FUNC set mode (SET).

MENU ⇨ SET ⇨ FUNC ⇨ **PTT LK** (p. 125)
(Push [MENU]), (Push [▲](2)/[▼](8), then push [←](5).)

13 OTHER FUNCTIONS

■ Display backlighting

The transceiver has display backlighting with a 5 sec. timer for night time operation (AUTO1/AUTO2*). The display backlighting can be turned ON continuously or turned OFF, if desired.

* AUTO2 is same as AUTO1 with battery pack or batteries case operation, and display backlight stays ON when using the external power supply (more than 10 V DC).

MENU ⇨ SET ⇨ DISP ⇨ **LIGHT** (p. 128)
(Push [MENU] (5)), (Push [▲](2)/[▼](8), then push [←](5).)

■ LCD contrast

The contrast of the LCD can be selected from 4 levels.

MENU ⇨ SET ⇨ DISP ⇨ **CONT** (p. 129)
(Push [MENU] (5)), (Push [▲](2)/[▼](8), then push [←](5).)

■ Cloning function

The IC-E80D has transceiver-to-transceiver data cloning capability. This function is useful when you want to copy all of the programmed contents from one IC-E80D to another.

- An optional OPC-474 CLONING CABLE is required.

- ① Turn the transceiver's power OFF, then connect an optional OPC-474 between both [SP] jacks.

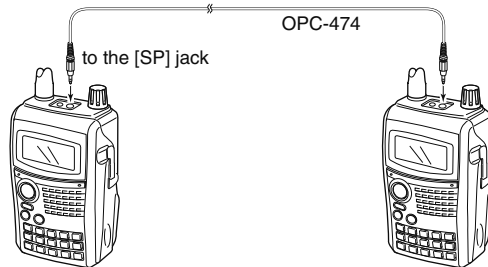

- ② While pushing [M/CALL] and [MENU , push and hold [PWR] for 1 sec. to enter cloning mode.

- "CLONE M" appears.

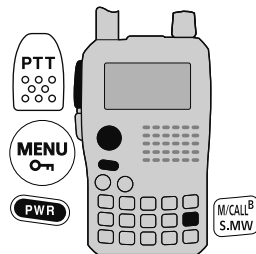

- ③ Push [PTT] on the "master" transceiver.
 - "CL OUT M" appears and the bar meter shows that cloning is taking place.
 - After the cloning is completed, the display returns to "CLONE M"
- ④ Push and hold [PWR] for 1 sec. to turn power OFF.

• Cloning using a personal computer

The CS-80/880 CLONING SOFTWARE (free download) is also available to clone/edit contents with a PC (for Microsoft® Windows® 2000/XP or Windows Vista®) using ICF format files. To connect the transceiver and a PC, either the optional data communication cable; OPC-1529R or cloning cable; OPC-478/478UC is required.

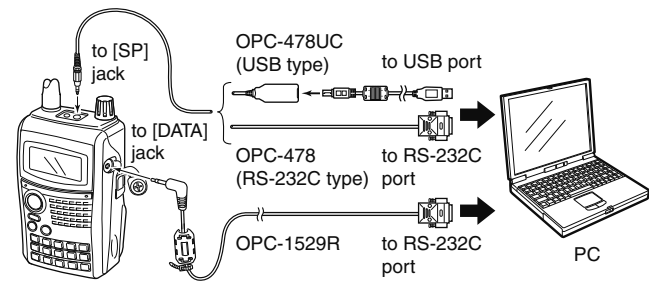

13 OTHER FUNCTIONS

■ Resetting

The display may occasionally display erroneous information (e.g. when first applying power). This may be caused externally by static electricity or by other factors.

If this problem occurs, turn power OFF. After waiting a few seconds, turn power ON again. If the problem persists, perform either or both procedures below.

• All reset

Reset the CPU before operating the transceiver for the first time, or if the internal CPU malfunctions due to static electricity, etc. All reset clears all programming and returns all settings to their factory defaults.

• Partial reset

Use Partial reset if you want to initialize the operating conditions (VFO frequency, VFO settings, set mode contents) without clearing the memory contents, call sign memories or repeater lists.

◇ All reset

- ① Push and hold **[PWR]** for 1 sec. to turn power OFF.
- ② Push and hold simultaneously **[V/MHz]**, **[M/CALL]** and **[△]**, then turn power ON to reset the CPU.
 - “CLEAR” appears when resetting the CPU (See the illustration below).

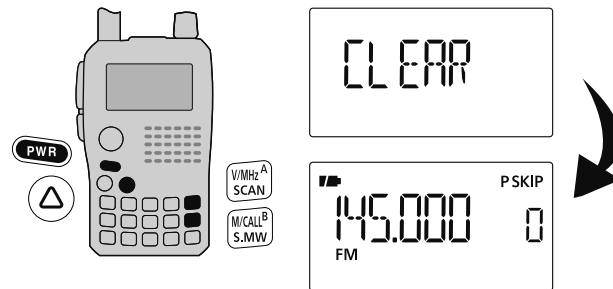

CAUTION: Resetting the CPU returns all programmed contents to their default settings.

◇ Partial reset

- ① Push and hold **[PWR]** for 1 sec. to turn power OFF.
- ② Push and hold **[V/MHz]**, then turn power ON to partially reset the transceiver.



NOTE: No message appears on the display after the partial reset is done.

14 TROUBLESHOOTING

If your transceiver seems to be malfunctioning, please check the following points before sending it to a service center.

PROBLEM	POSSIBLE CAUSE	SOLUTION	REF.
Transceiver will not power ON.	<ul style="list-style-type: none"> The batteries are exhausted. Loose connection of a battery pack (case). The battery polarity is reversed. 	<ul style="list-style-type: none"> Replace the batteries or charge the battery pack. Clean battery terminals. Check the battery polarity. 	<p>pgs. 2, 12–14 p. 14 p. 14</p>
No sound comes from the speaker.	<ul style="list-style-type: none"> Volume level is too low. External speaker is connected or cloning cable is inserted. 	<ul style="list-style-type: none"> Push [△] or [▽] to suitable level. Check the external speaker connection or remove the cloning cable. 	<p>p. 16 –</p>
Transmitting is impossible.	<ul style="list-style-type: none"> The batteries are exhausted. A frequency outside of the 144/430 MHz amateur bands is set. 	<ul style="list-style-type: none"> Replace the batteries or charge the battery pack. Reset the frequency within 144/430 MHz amateur bands. 	<p>pgs. 2, 12–14 pgs. 20, 161</p>
No contact possible with another station.	<ul style="list-style-type: none"> Different tone is selected with tone/DTCS squelch. 	<ul style="list-style-type: none"> Check the tone/DTCS using tone scan. 	<p>p. 152</p>
Frequency cannot be set.	<ul style="list-style-type: none"> The lock function is activated. Memory mode or call channel is selected. 	<ul style="list-style-type: none"> Push [MENU] for 1 sec. to cancel the function. Push [V/MHz] to set the VFO mode. 	<p>p. 24 p. 18</p>
Program scan function cannot start.	<ul style="list-style-type: none"> Memory mode or call channel is selected. Same frequencies are programmed both “*A” and “*B” of PROGRAM-CH. 	<ul style="list-style-type: none"> Push [V/MHz] to set the VFO mode. Programming different frequencies in “*A” and “*B” respectively. 	<p>p. 18 p. 105</p>
Memory scan function cannot start.	<ul style="list-style-type: none"> The VFO mode or call channel is selected. The programmed memory channel is only one. 	<ul style="list-style-type: none"> Push [M/CALL] to select memory mode. Program 2 or more memory channels. 	<p>p. 18 p. 94</p>
The displayed frequency is erroneous.	<ul style="list-style-type: none"> The CPU malfunctioned. External factors caused a fault. 	<ul style="list-style-type: none"> Reset the transceiver. Remove and reattach the battery pack or battery case. 	<p>pgs. 158, 159 p. 2</p>
Cannot charge the battery with BC-139 (LED blinks orange).	<ul style="list-style-type: none"> The transceiver's power is ON. The battery pack is fault electric discharge. 	<ul style="list-style-type: none"> Turn the transceiver's power OFF, or insert only the battery pack into the BC-139 to charge it. The battery pack is charged alone (without the transceiver) or regular charge is carried out. 	<p>p. 13 pgs. 12, 13</p>

◇ General

- Frequency coverage : (unit: MHz)

Version	TX	RX
EUR U.K.	144–146, 430–440	0.495–999.990* ¹
ITA	144–146, 430–434, 435–438	0.495–29.995* ² , 50–51* ² , 76–136.995* ² , 144–146, 430–434, 435–438
FRA	144–146, 430–440	0.495–29.995* ² , 50–52* ² , 76–136.995* ² , 144–146, 430–440

*¹Guaranteed 144–146 MHz and 430–440 MHz only, *²Not Guaranteed

- Mode : FM, FN-N, AM (Rx only), WFM (Rx only), DV
- No. of memory channels : 1052
(incl. 50 scan edges and 2 call channels)
- Usable temp. range : –20°C to +60°C
- Tuning steps : 5[‡], 6.25[‡], 8.33[‡], 9[‡], 10, 12.5, 15[‡], 20, 25, 30, 50, 100, 125 and 200 kHz
- Frequency stability : ±2.5 ppm (–20°C to +60°C)
- Power supply : 10.0–16.0 V DC for external DC power, or specified Icom's battery pack
- Digital transmission speed: 4.8 kbps
- Voice coding speed : 2.4 kbps
- Current drain (at 7.4 V DC) :
 - Tx High 144 MHz 1.8 A typical
 - 430 MHz 2.1 A typical
 - Tx Mid. 144 MHz 1.2 A typical
 - 430 MHz 1.5 A typical
 - Tx Low 144 MHz 0.6 A typical
 - 430 MHz 0.7 A typical
 - Tx S-Low 144 MHz 0.4 A typical
 - 430 MHz 0.4 A typical

- Rx Rated output 170 mA typical (FM)
215 mA typical (DV)
- Power save 30 mA typical (FM)
(Duty 1:4) 38 mA typical (DV)
standby 62 mA typical (FM)
106 mA typical (DV)

- Antenna connector : SMA (50 Ω)
- Dimensions : 58.4(W)×103(H)×34.2(D) mm
(projections not included)
- Weight (approx.) : 290 g (with antenna and BP-217)

◇ Transmitter

- Modulation system :
FM Variable reactance freq. modulation
DV (Digital) GMSK reactance freq. modulation
- Output power (at 7.4 V DC)
(Typical) : High 5.0 W, Mid. 2.5 W, Low 0.5 W,
S-Low 0.1 W
- Max. frequency deviation : ±5.0 kHz (FM wide: approx.)
±2.5 kHz (FM narrow: approx.)
- Spurious emissions : Less than –60 dBc at High/Mid.
Less than –13 dBm at Low/Slow
- Ext. mic. impedance : 2 kΩ

*Selectable depending on the operating frequency band.

All stated specifications are subject to change without notice or obligation.

15 SPECIFICATIONS

◇ Receiver

- Receive system :
 - Except WFM Double-conversion superheterodyne
 - WFM Triple-conversion superheterodyne
- Intermediate frequencies :
 - 1st 61.65 MHz/59.25 MHz (WFM only)
 - 2nd 450 kHz/13.35 MHz (WFM only)
 - 3rd 1.95 MHz (WFM only)
- Sensitivity (except spurious points):
 - FM (1 kHz/3.5 kHz Dev.; 12 dB SINAD)
 - 1.625–29.995 MHz 0.4 μ V typ.
 - 30.000–75.995 MHz 0.25 μ V typ.
 - 76.000–117.995 MHz 0.25 μ V typ.
 - 118.000–173.995 MHz 0.14 μ V typ.
 - 174.000–259.995 MHz 0.32 μ V typ.
 - 260.000–349.995 MHz 0.32 μ V typ.
 - 350.000–469.995 MHz 0.16 μ V typ.
 - 470.000–599.995 MHz 0.32 μ V typ.
 - 600.000–999.990 MHz 0.56 μ V typ.
 - WFM (1 kHz/52.5 kHz Dev.; 12 dB SINAD)
 - 76.000–108.000 MHz 1 μ V typ.
 - 175.000–221.995 MHz 1.8 μ V typ.
 - 470.000–770.000 MHz 2.5 μ V typ.
 - AM (1 kHz/30% Mod.; 10 dB S/N)
 - 0.495–4.995 MHz 1.3 μ V typ.
 - 5.000–29.995 MHz 0.56 μ V typ.
 - 118.000–137.000 MHz 0.5 μ V typ.
 - 222.000–246.995 MHz 0.79 μ V typ.
 - 247.000–329.995 MHz 1 μ V typ.
 - DV (PN9/GMSK 4.8kps; BER 1%)
 - VHF (Amateur band only) 0.22 μ V typ.
 - UHF (Amateur band only) 0.22 μ V typ.
- Audio output power : More than 300 mW at 10% distortion
(at 7.4 V DC) with an 8 Ω load
- Selectivity :
 - FM (Wide), AM More than 50 dB
 - FM (Narrow), DV More than 45 dB
 - WFM More than 300 kHz/–3 dB
Less than 700 kHz/–20 dB
- Ext. speaker connector : 3-conductor 3.5(d) mm; (1/8")/8 Ω
- Spurious and image rejection ratio :
 - VHF More than 60 dB
 - UHF More than 50 dB
(Intermediate freq.; More than 60 dB)
- Squelch Sensitivity (except spurious points):
 - FM (1 kHz/3.5 kHz Dev.)
 - 1.625–29.995 MHz 0.4 μ V typ.
 - 30.000–75.995 MHz 0.25 μ V typ.
 - 76.000–117.995 MHz 0.25 μ V typ.
 - 118.000–173.995 MHz 0.14 μ V typ.
 - 174.000–259.995 MHz 0.32 μ V typ.
 - 260.000–349.995 MHz 0.32 μ V typ.
 - 350.000–469.995 MHz 0.16 μ V typ.
 - 470.000–599.995 MHz 0.32 μ V typ.
 - 600.000–999.990 MHz 0.56 μ V typ.
 - WFM (1 kHz/52.5 kHz Dev.)
 - 76.000–108.000 MHz 1 μ V typ.
 - 175.000–221.995 MHz 1.8 μ V typ.
 - 470.000–770.000 MHz 2.5 μ V typ.
 - AM (1 kHz/30% Mod.)
 - 0.495–4.995 MHz 1.3 μ V typ.
 - 5.000–29.995 MHz 0.56 μ V typ.
 - 118.000–137.000 MHz 0.5 μ V typ.
 - 222.000–246.995 MHz 0.79 μ V typ.
 - 247.000–329.995 MHz 1 μ V typ.

- **BP-216** BATTERY CASE
Battery case for LR6 (AA) × 2 alkaline batteries.
- **BP-217** LI-ION BATTERY PACK
7.4 V/1500 mAh (Min.)/1580 mAh (Typ.) Lithium Ion battery pack. Battery life: 6.5 hrs. (approx.; VHF, FM, high power, Tx : Rx : Standby = 1:1:8)
- **BC-167ND** BATTERY CHARGER
For regular charging of battery packs. Charging time : Max. 6 hrs.
- **BC-139** DESKTOP CHARGER+**BC-123E** AC ADAPTER
Rapidly charges BP-217 LI-ION BATTERY PACK in approx. 2.5 hrs.
- **HM-189GPS** GPS SPEAKER-MICROPHONE
Allows you to operate in rainy condition; includes GPS receiver and antenna.
- **HM-75A** REMOTE CONTROL SPEAKER MICROPHONE
Allows you to remotely select operating channels, etc.
- **HM-131** SPEAKER-MICROPHONE
For operation while conveniently hanging the transceiver from your belt, etc.
- **HM-153/HM-166** EARPHONE-MICROPHONE
Ideal for hands-free operation: clip the HM-153/HM-166 (with integrated PTT switch) to your lapel or breast pocket. Allows you to operate in rainy condition.
- **HS-85** HEADSET WITH VOX/PTT UNIT
Hands-free headset with VOX control box.
- **SP-13** EARPHONE
Provides clear audio in noisy environments.
- **CP-12L** CIGARETTE LIGHTER CABLE WITH NOISE FILTER
- **CP-19R** CIGARETTE LIGHTER CABLE WITH DC-DC CONVERTER
Allows you to operate the transceiver through a 12 V cigarette lighter socket. You can also charge the attached battery pack (during stand-by only).
CP-19R: A built-in DC-DC converter provides an 11 V DC output.
- **OPC-254L** DC POWER CABLE
For operation and charging via an external power supply.
- **OPC-474** CLONING CABLE
Used for handheld-to-handheld cloning.
- **OPC-478/478UC** CLONING CABLE
Used for data cloning between transceiver and PC with CS-80/880 (free download software).
- **OPC-1529R** DATA COMMUNICATION CABLE
Allows low-speed data communication in DV mode, data cloning operation with CS-80/880 (free download software) or GPS operation with GPS receiver.
- **MB-86** SWIBEL BELT CLIP
Swivel belt clip is useful for easy attaching/detaching the transceiver to/from the belt.
- **LC-163** CARRYING CASE
Helps protect the transceiver from scratches, etc.
- **AD-92SMA** ANTENNA CONNECTOR ADAPTER
Allows you to connect an external antenna with a BNC connector.
- **CS-80/880** CLONING SOFTWARE (free download)
Use this software to program settings such as memory channels and set mode contents quickly and easily via your PC's RS-232C terminal (using OPC-1529R or OPC-478), or USB port (OPC-478UC). Either OPC-1529R, OPC-478 or OPC-478UC is required.

16 OPTIONS

■ Optional HM-75A REMOTE CONTROL SPEAKER MICROPHONE

The optional HM-75A allows you to remotely select operating frequencies, memory channels, etc.

Remote control functions can be selected from 3 settings. These can be selected with “MIC” in FUNC set mode (SET).

MENU ⇄ SET ⇄ FUNC ⇄ **MIC** (p. 127)
(Push [MENU] (1)), (Push [▲] (2)/[▼] (8), then push [←] (5).)

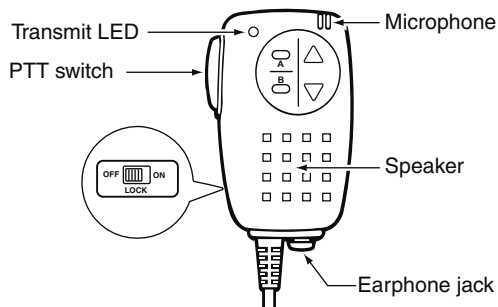

The HM-75A has a lock switch on the backside to prevent accidental frequency changes, etc.

/// Be sure to turn power OFF when plugging/unplugging the HM-75A to/from the [SP/MIC] jack.

• NORM-1: (default)

[A]	Selects band.
[B]	Toggles the VFO mode and memory mode.
[▲]	Frequency or memory channel “UP.”
[▼]	Frequency or memory channel “DOWN.”

• NORM-2:

[A]	Toggles the monitor function.
[B]	Toggles the VFO mode and memory mode.
[▲]	Frequency or memory channel “UP.”
[▼]	Frequency or memory channel “DOWN.”

• SIMPLE:

[A]	Toggles the monitor function.
[B]	Selects call channel.
[▲]	Selects memory channel 0 in memory mode.
[▼]	Selects memory channel 1 in memory mode.

SIMPLE mode can select only 3 channels and is useful for group operations during touring, etc.

/// The VFO mode cannot be selected via the microphone when SIMPLE mode is selected.

• COMMON (NORM-1/NORM-2/SIMPLE):

[A]	Transmits T-CALL (1750 Hz tone) while pushing [PTT].
[▲]	Volume "UP" while operating the monitor function.
[▼]	Volume "DOWN" while operating the monitor function.

- When transceiver is selected the DR mode:

[A]	Selects access repeater selection.
[B]	Selects UR call sign and linked repeater selection.
[▲]	Repeater selection or station call sign selection "UP."
[▼]	Repeater selection or station call sign selection "DOWN."

◇ DR mode operation using HM-75A

- ① Push [A] to enter the access repeater selection on the DR mode.

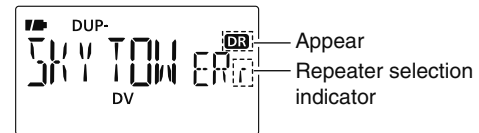

- ② Push [▲] or [▼] to select the access repeater.

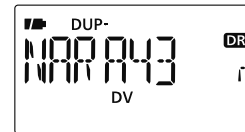

- ③ Push [B] to enter the UR call sign selection.

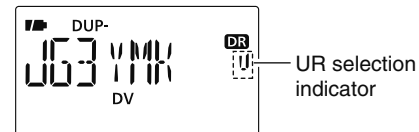

- ④ Push [▲] or [▼] to select UR call sign.
- ⑤ Push [B] to enter the linked repeater (RPT2) selection.
- ⑥ Push [▲] or [▼] to select the linked repeater.
- ⑦ Push [PTT] to transmit; release to receive.

16 OPTIONS

■ Optional HM-189GPS GPS SPEAKER MICROPHONE

The optional HM-189GPS has a built-in GPS receiver and allows you to operate the IC-E80D's GPS functions.

① TOP KEY

Push to turn the GPS receiver's power ON and OFF.

- Key illumination lights when GPS receiver is turned ON. Key illumination lights OFF when it's OFF.
- Key illumination blinks when GPS receiver receives GPS signals.

② PTT SWITCH

Push and hold to transmit; release to receive.

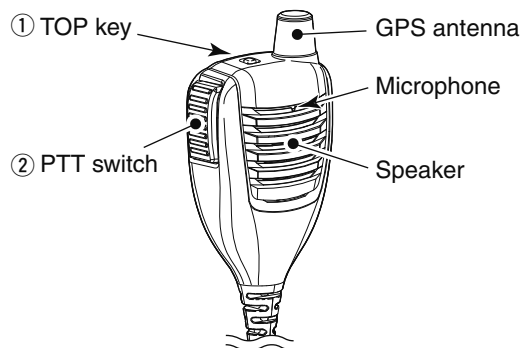

◇ GPS receiver power ON

- ① Turn the transceiver power OFF.
- ② Remove the rubber cap. from the [SP/MIC] jack.
- ③ Connect the HM-189GPS to the [SP/MIC] jack.
- ④ Turn the transceiver power ON, then push the top key of the HM-189GPS to turn the GPS receiver power ON.
 - Key illumination lights when GPS receiver is turned ON. "G" indicator blinks on the transceiver's display.
 - Key illumination blinks when GPS receiver receives GPS signals. Then "G" indicator stays ON on the transceiver's display.
- ⑤ Position, elevation, time, direction, etc. can be displayed. See Section 8 "GPS/GPS-A OPERATION" for details.

CAUTION: Turn transceiver power OFF before connecting/disconnecting HM-189GPS to/from the [SP/MIC] jack.

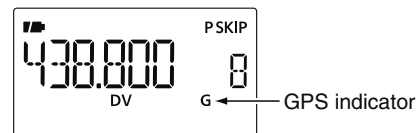

IMPORTANT

- When transmitting with a portable radio, hold the radio in a vertical position with its microphone 2.5 to 5 centimeters from your head and body.
- If you wear a portable two-way radio on your body, ensure that the antenna is at least 2.5 centimeters from your body when transmitting.



CE Versions of the IC-E80D which display the 'CE' symbol on the serial number seal, comply with the essential requirements of the European Radio and Telecommunication Terminal Directive 1999/5/EC.



This warning symbol indicates that this equipment operates in non-harmonised frequency bands and/or may be subject to licensing conditions in the country of use. Be sure to check that you have the correct version of this radio or the correct programming of this radio, to comply with national licensing requirements.

• List of Country codes (ISO 3166-1)

	Country	Codes		Country	Codes
1	Austria	AT	18	Liechtenstein	LI
2	Belgium	BE	19	Lithuania	LT
3	Bulgaria	BG	20	Luxembourg	LU
4	Croatia	HR	21	Malta	MT
5	Czech Republic	CZ	22	Netherlands	NL
6	Cyprus	CY	23	Norway	NO
7	Denmark	DK	24	Poland	PL
8	Estonia	EE	25	Portugal	PT
9	Finland	FI	26	Romania	RO
10	France	FR	27	Slovakia	SK
11	Germany	DE	28	Slovenia	SI
12	Greece	GR	29	Spain	ES
13	Hungary	HU	30	Sweden	SE
14	Iceland	IS	31	Switzerland	CH
15	Ireland	IE	32	Turkey	TR
16	Italy	IT	33	United Kingdom	GB
17	Latvia	LV			



We Icom Inc. Japan
1-1-32, Kamiminami, Hirano-ku
Osaka 547-0003, Japan

Declare on our sole responsibility that this equipment complies with the essential requirements of the Radio and Telecommunications Terminal Equipment Directive, 1999/5/EC, and that any applicable Essential Test Suite measurements have been performed.

Kind of equipment: **VHF/UHF DIGITAL TRANSCEIVER**

Type-designation: **IC-E80D**

Version (where applicable):

This compliance is based on conformity with the following harmonised standards, specifications or documents:

- i) EN 301 489-1 V1.6.1. (2005-09)
- ii) EN 301 489-15 V1.2.1. (2002-08)
- iii) EN 301 783-2 V1.1.1. (2000-09)
- iv) EN 60950-1 (2001): A11: 2004

DECLARATION OF CONFORMITY



Düsseldorf 6th Feb. 2009
Place and date of issue

Icom (Europe) GmbH
Himmelgeister straÙe 100
D-40225 Düsseldorf
Authorized representative name

Y. Furukawa
General Manager

Signature

Icom Inc.

- 1 -

1750 Hz tone 33

- A -

About the D-STAR system 34
 Access repeater scan 53
 Access repeater setting (R1 USE) 42
 Accessing a repeater 30
 Active band (ACTIVE) 126
 Alarm area 1 88
 Alarm area 2 89
 All reset 158
 Antenna 1
 Attenuator (ATT) 124
 Attenuator function 25
 Auto gateway setting (GW SET) 134
 Auto power OFF (AP OFF) 128, 155
 Auto power ON (AP ON) 128, 155
 Auto reply (REPLY) 70, 132
 Automatic reply function setting 70
 Automatic TV channel programming 28
 Available characters 68, 97
 Available DTCS code 120
 Available frequency bands 21
 Available subaudible tone frequency 119

- B -

Band edge beep (EDGE B) 131
 Band scan 104
 Battery caution 10
 Battery indicator 14
 Battery indicators 12
 Battery information 14
 Battery life 14
 Battery pack 2
 Battery replacement 14
 Beep output level (BEEPLV) 130
 Beep tones 153
 Belt clip 1
 Break-in function (BK) 72, 135
 Busy LED (BUSY) 129
 Busy lockout (LK OUT) 126

- C -

Call channel 19
 Call channel watch 112
 Call record channel 49
 Call record indication 49
 Call sign edit record (EDIT R) 134
 Call sign programming 36
 Calling a specific station 56
 Calling a specific station (in the VFO) 61
 Calling a specific station in another zone (Different zone call) 58, 67
 Calling a specific station in the same area (Area call) 57, 63
 Calling a specific station in the same zone (Zone call) 57, 65

INDEX

Calling CQ	54
Calling CQ in the same area (Area CQ)	55, 62
Calling CQ in the same zone (Zone CQ)	64
Calling CQ to another area (Different zone CQ)	55
Calling CQ to another area (Zone CQ)	55
Calling CQ to another zone (Different zone CQ)	66
Caution	10
Changing a repeater list (EDIT-L)	45
Charging caution	11
Charging note (Rapid charging)	13
Charging note (Regular charging)	12
Checking the repeater input signal	31
Clearing a DTMF memory	145
Clearing a repeater list (EDIT-L)	46
Cloning function	157
Comment (COMMENT)	141
Confirming a DTMF memory	146
Confirming current call sign	48
Confirming the setting (in the DR mode)	59
Connection for low-speed data communication	74
Copy the call record contents into call sign memory	52
Copy the call sign memory contents	51
Copying call channel contents	99
Copying memory channel contents	99
Copying the call sign	51
Current call sign setting	47
Current repeater call sign programming	38

– D –

DATA extension (DT EXT)	140
DATA speed (SPEED)	127
[DIAL] function assignment	20
Dial speed acceleration (DIAL S)	126, 153
Digital code (D CODE)	120
Digital code and digital call sign setting	148
Digital mode operation	47
Digital monitor (D MONI)	132
Digital repeater setting (D RPT)	133
Digital squelch	151
Direction indication example	83
Display backlighting (LIGHT)	128, 156
Display set mode items (DISP)	128
Displaying direction and forward	82
DR (D-STAR Repeater) mode	19
DR (D-STAR Repeater) mode operation	53
DR mode operation using HM-75A	165
DR mode/VFO watch	114
DTCS code (CODE)	120
DTCS polarity (DTCS-P)	120
DTCS polarity setting	152
DTMF speed (DTMF-S)	121
DTMF TX key (DTMF-T)	121
DUP/TONE items (DUP.T)	119
Duplex direction setting (DUP)	43
Duplex operation	32
DV auto detect (DV DET)	76, 133

DV data TX (DATATX) 132
 DV set mode items (DV SET) 132

- E -

EMR communication 71
 EMR function (EMR)..... 136
 Erasing bank contents 101
 Explicit definitions i
 External DC power operation 15

- F -

Features i
 Foreword..... i
 Frequency offset (OFFSET) 119
 Frequency offset programming (OFF SET)43
 Frequency programming (FREQ)42
 Front, top and side panels 3
 Full scan 104
 Function display..... 8
 Function set mode items (FUNC) 124

- G -

Gateway repeater call sign programming (GW CALL) 41, 45
 General (Menu screen)..... 115
 General description (Memory/Call channel)91
 GPS alarm setting85
 GPS alarm setting in GPS memory channel 86
 GPS auto TX timer (GPS.ATX) 142

GPS data addition84
 GPS data out (GPS.OUT) 137
 GPS indication (INDIC).....137
 GPS memory clearing87
 GPS message automatic transmission.....79
 GPS message programming 79
 GPS mode items (GPS) 136
 GPS operation 77
 GPS set mode items (GPS.SET)..... 136
 GPS-TX mode items (GPS-TX)..... 138
 GPS-A code details90
 GPS-A function.....90
 GPS-A operation90
 GPS-A set mode..... 139
 GPS-A symbol (SYMBOL)..... 141

- H -

Hand strap 2
 How to use break-in?..... 73

- I -

Important i, 167
 Items list (Menu screen) 117

- K -

Key lock effect..... 154
 Key lock type (LOCK) 127
 Key-touch beep (KEY B)..... 130

INDEX

- L -

LCD contrast (CONT)	129, 156
Lock function	24
Low-speed data communication application setting	74
Low-speed data communication	74
Low-speed data communication operation	74

- M -

Memory bank link function (B-LINK)	122
Memory bank scan	107
Memory bank selection	96
Memory bank setting	95
Memory channel contents	91
Memory channel programming	94
Memory channel watch	112
Memory clearing	100
Memory mode	18
Memory scan	106
Memory scan watch	112
MENU screen indication and arrangement	116
Message operation	68
Message transmission	69
Microphone simple mode (MIC)	127
Mode selection	18
Monitor function	17
Monitor key action (MONI)	125
"MY" call sign programming	36

- N -

New repeater list programming	40
-------------------------------------	----

- O -

Off band indication	31
One-touch reply using the call record	50
One-touch reply using the call record in the DR mode	59
Opening message (OPN.MSG)	129
Operating band selection	20
Operating mode selection	25
Operating note (external DC power operation)	15
Optional battery case	14
Optional HM-189GPS GPS SPEAKER MICROPHONE	166
Optional HM-75A REMOTE CONTROL SPEAKER MICROPHONE	165
Options	163
Other function in the DV mode	76

- P -

Packet loss indication	76
Partial reset	159
Pocket beep function	147, 151
Position format (P FORM)	136
Position indication	80
Power ON	16
Power save (P SAVE)	125, 154
Precautions	ii, iii
Priority watch (PRIO)	121
Priority watch operation	112

Priority watch types	111
Program scan link function (P-LINK)	123
Programmed scan	104
Programming a DTMF code	143
Programming memory bank name	97
Programming memory name	97
Programming scan name	97
PTT lock (PTT LK)	125, 155

– R –

Rapid charging	13
Received call sign	49
Received GPS message indication	80
Receiving	24
Receiving a D-STAR repeater	48
Regular charging	12
Repeater call sign auto write (RPT W)	133
Repeater call sign programming	38
Repeater call sign programming (CALL S)	40, 44
Repeater group programming (GROUP)	41
Repeater list	39
Repeater list contents	39
Repeater list programming	40
Repeater name programming (R-NAME)	40, 44
Repeater operation	29
Repeater operation in the VFO	62
Repeater tone frequency (R TONE)	119
Resetting	158
Reverse tone/DTCS squelch	147

RX call sign auto write (CALL W)	133
RX call sign display (RX CS)	134
RX message display (RX MSG)	135
RX message indication	70

– S –

Saving own position data	82
Saving received position data	82
Scan edges programming	105
Scan items (SCAN)	121
Scan name (SCAN N)	129
Scan pause timer (PAUSE)	110, 121
Scan resume condition	110
Scan resume timer (RESUME)	110, 122
Scan stop beep (STOP B)	130
Scan types	102
Scroll speed (SCROLL)	135
Selecting a call channel	93
Selecting a call record via RX CAL screen	50
Selecting a memory channel	92
Selecting memory bank name indication	98
Selecting memory name indication	98
Sending CQ (in the VFO)	60
Sentence formatter setting (GGA)	78, 138
Sentence formatter setting (GLL)	78, 138
Sentence formatter setting (GSA)	78, 138
Sentence formatter setting (GSV)	78, 138
Sentence formatter setting (RMC)	78, 138
Sentence formatter setting (VTG)	78, 138

INDEX

Set mode items (SET)	124
Setting a frequency.....	22
Setting a tuning step.....	22
Setting audio volume	16
Setting digital code for digital code squelch or beep	148
Setting DTCS code for DTCS squelch or beep	148
Setting DTMF transfer speed.....	146
Setting duplex direction	32
Setting frequency offset.....	32
Setting squelch level.....	17
Setting subaudible tones for repeater or tone squelch	147
Setting UR and MY call sign for digital call sign squelch or beep....	149
Simplex operation in the VFO.....	60
Skip channel setting	108
Skip channel setting (TV channel).....	28
Skip frequency setting	108
Sounds set mode items (SOUNDS)	130
Specifications	161, 162
Standby beep (STBY B)	130
Station call sign programming	37
Storing the repeater list (ADD W).....	43
Subaudible (repeater) tone.....	147
Supplied accessories.....	iv
System description (D-STAR system)	35

– T –

Time stamp (TIME).....	140
Time-out timer (TOT)	126, 155

Tone and DTCS squelches.....	147
Tone frequency and DTCS code	147
Tone scan	152
Tone/DTCS squelch.....	150
Transferring bank contents	101
Transmission condition setting.....	75
Transmit power selection	27
Transmitting	26
Transmitting a DTMF code	144
Transmitting a DTMF code directly	145
Transmitting a DTMF memory via keypad	144
Transmitting from DTMF memory	144
Troubleshooting	160
TSQL frequency (C TONE).....	119
Tuning step selection	22
TV channel	19
TV channel operation	27
TV channel receiving.....	27
TX call sign display (TX CS).....	135
TX message programming	68

– U –

Units (UNITS)	136
Unproto Address (UNPROT)	139
UR call sign programming	37
Using the dial (Frequency setting).....	22
Using the dial (Memory selection)	92
Using the keypad (Frequency setting)	23

Using the keypad (Memory selection) 92
UTC offset (UTC.OFF) 137
 - V -
VFO mode 18
VFO scan watch 113
 - Y -
Your own call sign programming..... 36

MEMO

MEMO

Count on us!

#02 Europe

<Intended Country of Use>	
<input checked="" type="checkbox"/>	AT
<input checked="" type="checkbox"/>	BE
<input checked="" type="checkbox"/>	CY
<input checked="" type="checkbox"/>	CZ
<input checked="" type="checkbox"/>	DK
<input checked="" type="checkbox"/>	EE
<input checked="" type="checkbox"/>	FI
<input type="checkbox"/>	FR
<input checked="" type="checkbox"/>	DE
<input checked="" type="checkbox"/>	GR
<input checked="" type="checkbox"/>	HU
<input checked="" type="checkbox"/>	IE
<input type="checkbox"/>	IT
<input type="checkbox"/>	LV
<input checked="" type="checkbox"/>	LT
<input checked="" type="checkbox"/>	LU
<input checked="" type="checkbox"/>	MT
<input checked="" type="checkbox"/>	NL
<input checked="" type="checkbox"/>	PL
<input checked="" type="checkbox"/>	PT
<input checked="" type="checkbox"/>	SK
<input checked="" type="checkbox"/>	SI
<input checked="" type="checkbox"/>	ES
<input checked="" type="checkbox"/>	SE
<input type="checkbox"/>	GB
<input type="checkbox"/>	IS
<input checked="" type="checkbox"/>	LI
<input type="checkbox"/>	NO
<input type="checkbox"/>	CH
<input checked="" type="checkbox"/>	BG
<input checked="" type="checkbox"/>	RO
<input type="checkbox"/>	TR
<input type="checkbox"/>	HR

#03 U.K.

<Intended Country of Use>	
<input type="checkbox"/>	AT
<input type="checkbox"/>	BE
<input type="checkbox"/>	CY
<input type="checkbox"/>	CZ
<input type="checkbox"/>	DK
<input type="checkbox"/>	EE
<input type="checkbox"/>	FI
<input type="checkbox"/>	FR
<input type="checkbox"/>	DE
<input type="checkbox"/>	GR
<input type="checkbox"/>	HU
<input type="checkbox"/>	IE
<input type="checkbox"/>	IT
<input type="checkbox"/>	LV
<input type="checkbox"/>	LT
<input type="checkbox"/>	LU
<input type="checkbox"/>	MT
<input type="checkbox"/>	NL
<input type="checkbox"/>	PL
<input type="checkbox"/>	PT
<input type="checkbox"/>	SK
<input type="checkbox"/>	SI
<input type="checkbox"/>	ES
<input type="checkbox"/>	SE
<input checked="" type="checkbox"/>	GB
<input type="checkbox"/>	IS
<input type="checkbox"/>	LI
<input type="checkbox"/>	NO
<input type="checkbox"/>	CH
<input type="checkbox"/>	BG
<input type="checkbox"/>	RO
<input type="checkbox"/>	TR
<input type="checkbox"/>	HR

#04 Italy

<Intended Country of Use>	
<input type="checkbox"/>	AT
<input type="checkbox"/>	BE
<input type="checkbox"/>	CY
<input type="checkbox"/>	CZ
<input type="checkbox"/>	DK
<input type="checkbox"/>	EE
<input type="checkbox"/>	FI
<input type="checkbox"/>	FR
<input type="checkbox"/>	DE
<input type="checkbox"/>	GR
<input type="checkbox"/>	HU
<input type="checkbox"/>	IE
<input checked="" type="checkbox"/>	IT
<input type="checkbox"/>	LV
<input type="checkbox"/>	LT
<input type="checkbox"/>	LU
<input type="checkbox"/>	MT
<input type="checkbox"/>	NL
<input type="checkbox"/>	PL
<input type="checkbox"/>	PT
<input type="checkbox"/>	SK
<input type="checkbox"/>	SI
<input type="checkbox"/>	ES
<input type="checkbox"/>	SE
<input type="checkbox"/>	GB
<input type="checkbox"/>	IS
<input type="checkbox"/>	LI
<input type="checkbox"/>	NO
<input type="checkbox"/>	CH
<input type="checkbox"/>	BG
<input type="checkbox"/>	RO
<input type="checkbox"/>	TR
<input type="checkbox"/>	HR

#06 France

<Intended Country of Use>	
<input type="checkbox"/>	AT
<input type="checkbox"/>	BE
<input type="checkbox"/>	CY
<input type="checkbox"/>	CZ
<input type="checkbox"/>	DK
<input type="checkbox"/>	EE
<input type="checkbox"/>	FI
<input checked="" type="checkbox"/>	FR
<input type="checkbox"/>	DE
<input type="checkbox"/>	GR
<input type="checkbox"/>	HU
<input type="checkbox"/>	IE
<input type="checkbox"/>	IT
<input type="checkbox"/>	LV
<input type="checkbox"/>	LT
<input type="checkbox"/>	LU
<input type="checkbox"/>	MT
<input type="checkbox"/>	NL
<input type="checkbox"/>	PL
<input type="checkbox"/>	PT
<input type="checkbox"/>	SK
<input type="checkbox"/>	SI
<input type="checkbox"/>	ES
<input type="checkbox"/>	SE
<input type="checkbox"/>	GB
<input type="checkbox"/>	IS
<input type="checkbox"/>	LI
<input type="checkbox"/>	NO
<input type="checkbox"/>	CH
<input type="checkbox"/>	BG
<input type="checkbox"/>	RO
<input type="checkbox"/>	TR
<input type="checkbox"/>	HR

A-6701D-1EU-0a

Printed in Japan

© 2009–2010 Icom Inc.

Printed on recycled paper with soy ink.

Icom Inc.

1-1-32 Kamiminami, Hirano-ku, Osaka 547-0003, Japan