

KENWOOD

150MHz QUAD TRACE READOUT OSCILLOSCOPE

CS-6020

100MHz QUAD TRACE READOUT OSCILLOSCOPE

CS-6010

INSTRUCTION MANUAL

KENWOOD CORPORATION

SAFETY

Symbol in This Manual

 This symbol indicates where applicable cautionary or other information is to be found.

Power Source

This equipment operates from a power source that does not apply more than 250 V rms between the supply conductors or between either supply conductor and ground. A protective ground connection by way of the grounding conductor in the power cord is essential for safe operation.

Grounding the Product

This equipment is grounded through the grounding conductor of the power cord. To avoid electrical shock, plug the power cord into a properly wired receptacle before connecting to the equipment input or output terminals.

Use the Proper Power Cord

Use only the power cord and connector specified for your product.

Use the Proper Fuse

To avoid fire hazard, use a fuse of the correct type.

Do not Operate in Explosive Atmospheres

To avoid explosion, do not operate this product in an explosive atmosphere.



Do not Remove Cover or Panel

To avoid personal injury, do not remove the cover or panel. Refer servicing to qualified personnel.

Voltage Conversion

If the power source is not applied to your product, contact your dealer. To avoid electrical shock, do not perform the voltage conversion.

CONTENTS

 SAFETY	2	5. TIME MEASUREMENTS	28
FEATURES	3	6. TIME DIFFERENCE MEASUREMENTS.....	29
SPECIFICATIONS	4	7. PULSE WIDTH MEASUREMENTS	30
 PRECAUTIONS.....	7	8. PULSE RISE TIME AND FALL TIME MEASUREMENTS.....	30
CONTROLS AND INDICATORS	9	9. PHASE DIFFERENCE MEASUREMENTS	32
FRONT PANEL.....	9	10. TIME RATIO MEASUREMENT USING CURSORS	33
REAR PANEL.....	16	11. FREQUENCY MEASUREMENTS.....	33
READOUT DISPLAY.....	17	12. RELATIVE MEASUREMENTS	34
OPERATING INSTRUCTIONS	19	13. APPLICATION OF X-Y OPERATION	36
INITIAL STARTING PROCEDURE.....	19	14. PULSE JITTER MEASUREMENTS	37
[1] NORMAL SWEEP OPERATION	19	15. SWEEP MAGNIFICATIONS	37
[2] MAGNIFIED SWEEP OPERATION.....	22	16. DELAYED SWEEP TIME MEASUREMENTS	38
[3] DELAYED SWEEP OPERATION.....	22	17. PULSE WIDTH MEASUREMENTS USING DELAYED SWEEP	39
[4] X-Y OPERATION	24	18. FREQUENCY MEASUREMENTS USING DELAYED SWEEP.....	39
[5] READOUT OPERATION	24	19. MEASUREMENTS OF PULSE REPETITION TIME...39	
[6] CURSOR MEASUREMENT OPERATION	26	20. USING DELAYED SWEEP FOR MEASUREMENTS OF RISETIMES AND FALLTIMES	40
APPLICATIONS	26	21. TIME DIFFERENCE MEASUREMENTS USING DELAYED SWEEP.....	40
PROBE COMPENSATION.....	26	22. QUAD-TRACE APPLICATIONS	41
TRACE ROTATION COMPENSATION.....	26	23. TRIGGER COUNTER OPERATION (CS-6020 only)..41	
1. DC VOLTAGE MEASUREMENT	26	ADJUSTMENT	43
2. MEASUREMENTS OF THE VOLTAGE BETWEEN TWO POINTS ON A WAVEFORM	27	 MAINTENANCE.....	45
3. ELIMINATION OF UNDESIRED SIGNAL COMPONENTS	28	ACCESSORIES	46
4. VOLTAGE RATIO MEASUREMENT USING CURSORS.....	28		

Note: This instruction manual is described for two models. Refer to item applied to your product.

FEATURES

The model CS-6020 and CS-6010 are a four-channel ten-trace oscilloscope with the readout function (with a calendar) that covers a wide bandwidth up to 150 MHz (CS-6010: 100 MHz). A 150-mm rectangular CRT display with inner graticule (acceleration voltage: CS-6020: 20 kV, CS-6010: 17 kV) offers high-brilliance waveform observation. It incorporates the trigger counter suitable for waveform observation of video and digital signals.

1. High vertical axis sensitivity of 1 mV/div. and wide bandwidth that covers fully specified frequency response at 5 mV/div.
2. Maximum sweep time of 2 ns/div. (at $\times 10$ magnification) offers high-speed waveform observation.
3. The trigger counter facilitates waveform observation of a specific line of video signals as well as timing for a series of digital circuit pulses. (CS-6020 only)
4. With the cross-range sweep time variable function, the SWEEP VARIABLE controls are continuously variable to both the lower- and higher-speed directions, and thus provide easy adjustment of the waveform with a changed sweep range. (All ranges can be continuously adjusted with the SWEEP VARIABLE controls only.)
5. The $\times 10$ MAG switch and SWEEP VARIABLE control are inactive for the A sweep in the delayed sweep mode; consequently, B sweep waveform can be compared with A sweep waveform in an easy-to-see condition.

6. Free vertical mode selection of CH1 to CH4 and ADD offers easy observation of waveform composed of a lot of signal components.
7. The readout function displays, in letters, each scale factor on the CRT, and eliminates troublesome range confirmation in observing waveform.
8. The cursor measurement mode displays, in letters, voltage difference, voltage ratio, time difference, time ratio, frequency, and phase difference, having been calculated by an observer, corresponding to movement of two cursors. It enables accurate waveform observation.
9. During single sweep waveform observation, the READOUT values and scale illumination are displayed once simultaneously with waveform display, which is suitable for photography.
10. Date and time display on the CRT facilitates data storage by photography.
11. The logic control system provides smooth and light-touch panel operation. The back-up function stores setting on the panel when the power is turned off.
12. The built-in fixing circuit provides automatic and stable synchronization and eliminates troublesome synchronizing operation even if waveform amplitude changes.
13. Both the TV frame and line signals are synchronized from small amplitude to large amplitude free from adjustment.
14. The trigger coupling HF_{REJ} function securely triggers signals with higher harmonics.

SPECIFICATIONS

		CS-6020	CS-6010
CRT		150 mm rectangular with internal graticule	
Acceleration Voltage		20 kV	17 kV
Display Area		8 × 10 div (1 div = 10 mm)	
VERTICAL AXIS (CH1 and CH2)			
Sensitivity		5 mV/div to 5 V/div ± 2% (10 °C to 35 °C) 1 mV/div to 2 V/div ± 4% (10 °C to 35 °C)	
Attenuator		12 steps, 1 mV/div to 5 V/div in 1-2-5 sequence Vernier control for fully adjustable sensitivity between steps	
Input Impedance		1 MΩ ± 1%, 20 pF ± 3 pF	
Frequency Response			
	5 mV/div to 5 V/div	DC; DC to 150 MHz, within -3 dB AC; 5 Hz to 150 MHz, within -3 dB	DC; DC to 100 MHz, within -3 dB AC; 5 Hz to 100 MHz, within -3 dB
	1 mV/div, 2 mV/div	DC; DC to 20 MHz, within -3 dB AC; 5 Hz to 20 MHz, within -3 dB	
Rise Time		2.3 nsec or less (5 mV/div to 5 V/div) 17.5 nsec or less (1 mV/div, 2 mV/div)	3.5 nsec or less (5 mV/div to 5 V/div) 17.5 nsec or less (1 mV/div, 2 mV/div)
Signal Delay Time		More than 10 nsec on the CRT screen	
Crosstalk		-40 dB or less (at 1 kHz)	
Operating Modes	CH1	CH1 single trace display, and dual to quad trace display in combination with other channel (s)	
	CH2	CH2 single trace display, and dual to quad trace display in combination with other channel (s)	
	CH3	CH3 single trace display, and dual to quad trace display in combination with other channel (s)	
	CH4	CH4 single trace display, and dual to quad trace display in combination with other channel (s)	
	ADD	CH1 + (±CH2) added display, and dual to quad trace display in combination with other channel (s)	
	ALT	Dual to quad trace alternating	
	CHOP	Dual to quad trace chopped	
Channel Polarity		Normal or inverted, channel 2 only inverted	
Bandwidth Limiting		Approx. 20 MHz	
Chop Frequency		Approx. 500 kHz	
Delay Time Difference		CH1 to CH2 ; 0.5 nsec or less CH1, CH2 to CH3, CH4 ; 1 nsec or less	
Non-distorted Maximum Amplitude		More than 8 div (DC to 150 MHz)	More than 8 div (DC to 100 MHz)
⚠ Maximum Input Voltage		800 Vp-p or 400 V (DC + AC peak)	
VERTICAL AXIS (CH3 and CH4)			
Sensitivity		0.1 V/div, 0.5 V/div, ± 2% (10 °C to 35 °C)	
Input Impedance		1 MΩ ± 1%, 20 pF ± 3 pF	
Coupling Method		DC coupling	
Frequency Response		DC to 150 MHz, within -3 dB	DC to 100 MHz, within -3 dB
Rise Time		2.3 nsec or less (at 150 MHz)	3.5 nsec or less (at 100 MHz)
⚠ Maximum Input Voltage		800 Vp-p or 400 V (DC + AC peak)	
HORIZONTAL AXIS (Input thru CH2)			
Operating Modes		With HORIZ. MODE switch, X-Y operation is selectable CH1 to CH4 and ADD ; Y axis CH2 ; X axis	
Sensitivity		Same as vertical axis (CH2)	
Input Impedance		Same as vertical axis (CH2)	
Frequency Response	DC	DC to 2 MHz, within -3 dB	
	AC	5 Hz to 2 MHz, within -3 dB	
X-Y Phase Difference		3° or less at 100 kHz	
⚠ Maximum Input Voltage		Same as vertical axis (CH2)	

		CS-6020		CS-6010	
SWEEP					
Type	A	A sweep			
	A INT B	B sweep waveform is displayed as an intensified portion of the A sweep.			
	ALT	A sweep (intensified for duration of B sweep) and B sweep (delayed sweep) alternating			
	B	B sweep			
	X-Y	X-Y oscilloscope			
Sweep Time	A	20 ns/div to 0.5 s/div, $\pm 2\%$ (10 °C to 35 °C), in 23 ranges, in 1-2-5 sequence Vernier control provides fully adjustable sweep time all ranges.			
	B	20 ns/div to 5 ms/div, $\pm 2\%$ (10 °C to 35 °C), in 17 ranges, in 1-2-5 sequence Vernier control provides fully adjustable sweep time all ranges.			
Sweep Magnification		$\times 10$ (ten times) $\pm 5\%$ (A and B)			
Linearity		20 ns/div to 0.5 s/div : $\pm 3\%$ ($\pm 5\%$, at $\times 10$ MAG)			
Holdoff		Continuously variable for A sweep from NORM to more than five times			
Trace Separation		B sweep can be separated from A sweep up to 4 divisions downward, continuously adjustable.			
Delay Method		Continuous delay, Trigger delay and Trigger count			
Delay Time		Continuous delay, Trigger delay ; 0.2 to 10 times of A SWEEP TIME/DIV set value (5,000 count fullscale)			
Trigger Count		1 to 1,000 count, Max. usable frequency; 10 MHz		—	
Delay Accuracy		$\pm (1\% \text{ of set value} + 2\% \text{ of fullscale}) - (0 \text{ to } 100 \text{ ns})$			
Delay Jitter		1/20,000 (A sweep: at 1 ms/div, B sweep: at 1 μ s/div)			
TRIGGERING					
A Trigger Modes		AUTO, NORM, SINGLE, FIX			
A Trigger Source	V. MODE	Triggered by input signal selected with VERTICAL MODE selector			
	CH1	Triggered by CH1 vertical axis input signal			
	CH2	Triggered by CH2 vertical axis input signal			
	CH3	Triggered by CH3 vertical axis input signal			
	CH4	Triggered by CH4 vertical axis input signal			
	LINE	Triggered by line frequency			
A Trigger Coupling		AC, NOISE _{REJ} , HF _{REJ} , DC, TV FRAME, TV LINE			
A Trigger Level		$\pm 90^\circ$ adjustable			
A Trigger Polarity		+/-			
B Trigger Modes		Starts After Delay, B Triggerable After Delay and TRIG COUNT	Starts After Delay, B Triggerable After Delay		
B Trigger Source	CH1	Triggered by CH1 vertical axis input signal			
	CH2	Triggered by CH2 vertical axis input signal			
	CH3	Triggered by CH3 vertical axis input signal			
	CH4	Triggered by CH4 vertical axis input signal			
B Trigger Coupling		AC, NOISE _{REJ} , HF _{REJ} , DC, TV LINE			
B Trigger Level		$\pm 90^\circ$ adjustable			
B Trigger Polarity		+/-			
Trigger Sensitivity	COUPLING	FREQUENCY RANGE	MINIMUM SYNC AMPLITUDE	FREQUENCY RANGE	MINIMUM SYNC AMPLITUDE
	DC	DC to 50 MHz	1 div	DC to 50 MHz	1 div
		DC to 150 MHz	1.5 div	DC to 100 MHz	1.5 div
	AC	20 Hz to 50 MHz	1 div	20 Hz to 50 MHz	1 div
		20 Hz to 150 MHz	1.5 div	20 Hz to 100 MHz	1.5 div
	NOISE _{REJ}	Two times of minimum sync amplitude.			
	HF _{REJ}	Increased minimum sync amplitude for above 30 kHz.			
	TV FRAME	1 div (140 IRE)			
TV LINE	1 div (140 IRE)				
AUTO: Same as above specification for above 50 Hz			FIX: Same as above specification for above 40 Hz.		

		CS-6020	CS-6010
Jitter		0.5 nsec or less at 150 MHz at 2 ns/div sweep rate ($\times 10$ MAG on)	0.5 nsec or less at 100 MHz at 2 ns/div sweep rate ($\times 10$ MAG on)
INTENSITY MODULATION			
Input signal		TTL level (more than 2 Vp-p), positive voltage decreases brightness	
Input Impedance		Approx. 10 k Ω	
Usable Frequency Range		DC to 10 MHz	
Δ Maximum Input Voltage		50 V (DC + AC peak)	
VERTICAL AXIS OUTPUT (CH1 only)			
Output voltage		Approx. 50 mVp-p/div (into 50 Ω load)	
Output Impedance		Approx. 50 Ω	
Frequency Response		100 Hz to 150 MHz, within -3 dB (at into 50 Ω)	100 Hz to 100 MHz, within -3 dB (at into 50 Ω)
TRACE ROTATION		Electrical, adjustable from front panel	
CALIBRATION VOLTAGE		1 V p-p $\pm 1\%$, Positive square wave, 1 kHz $\pm 3\%$	
READOUT			
Calendar		Year/Month/Day/O'clock/Minute Clock accuracy; ± 2 min./month Battery life: About 30,000 hours (at room temperature)	
Set Value		CH1-CH4 scale factor (with probe detection), GND, AC/DC, V-UNCAL, ADD, INVERT, BW, A and B sweep scale factor (magnification conversion), SWEEP VARIABLE UNCAL, X-Y (CH2-X), DELAY TIME, TRIG. COUNT	CH1-CH4 scale factor (with probe detection), GND, AC/DC, V-UNCAL, ADD, INVERT, BW, A and B sweep scale factor (magnification conversion), SWEEP VARIABLE UNCAL, X-Y (CH2-X), DELAY TIME
Cursor Mode	$\Delta V1$	Voltage difference between ΔREF and Δ cursors on a CH1 scale factor basis	
	$\Delta V2$	Voltage difference between ΔREF and Δ cursors on a CH2 scale factor basis	
	ΔT	Time difference between ΔREF and Δ cursors on the basis of sweep scale factor	
	$1/\Delta T$	Frequency between ΔREF and Δ cursors on the basis of sweep scale factor	
		RATIO: Voltage ratio and time ratio between ΔREF and Δ cursors, supposing 5-division on the CRT as 100%	
	PHASE: Phase difference between ΔREF and Δ cursors, supposing 5-division on the CRT as 360 $^\circ$		
Cursor Measurement	Resolution	10 bits	
	Measurement accuracy	$\pm 3\%$	
	Measurement range	Vertical direction: ± 3.6 div or more from the CRT center Horizontal direction: ± 4.6 div or more from the CRT center	
POWER REQUIREMENT			
Line Voltage		100 V/120 V/220 V/240 V AC $\pm 10\%$	
Line Frequency		50/60 Hz	
Power Consumption		Maximum 75 W	
DIMENSIONS (W\timesH\timesD)		310 (332) \times 150 (163) \times 400 (448) mm () dimensions include protrusion from basic outline dimensions	
WEIGHT		Approx. 9.6 kg	
ENVIRONMENTAL			
Within Specifications		10 $^\circ$ C to 35 $^\circ$ C, 85% max. relative humidity	
Full Operation		0 $^\circ$ C to 40 $^\circ$ C, 85% max. relative humidity	
ACCESSORIES SUPPLIED			
Probe		PC-31 (READOUT compatible probe) $\times 2$ Attenuation.....1/10 Input impedance.....10 M Ω $\pm 1\%$, 14 pF $\pm 10\%$	
Replacement Fuse		1.2 A $\times 2$, 0.8 A $\times 2$	
Instruction Manual		1	

* Circuit and rating are subject to change without notice due to developments in technology.

PRECAUTIONS

SAFETY

Before connecting the instrument to the power source, carefully read the following information, then verify that the power cord and power line fuse are ones for your power line. The instrument's rear panel has a fuse holder on the left of the AC inlet terminal (the fuse holder also serves as a voltage selector). The value under the triangle ▼ marked on the holder indicates the line voltage set for the instrument. If the power cord is not applied with the correct voltage, there is a danger from electric shock.

- When converting the voltage, refer to the Maintenance section.

Line voltage

This instrument operates using ac-power input voltages that 100/120/220/240 V at frequencies from 50 Hz to 60 Hz.

Power cord

The ground wire of the 3-wire ac power plug places the chassis and housing of the oscilloscope at earth ground. Do not attempt to defeat the ground wire connection or float the oscilloscope; to do so may pose a great safety hazard. The appropriate power cord is supplied by an option that is specified when the instrument is ordered.

The optional power cords are shown as follows in Fig. 1.

Line fuse

The fuse holder is located on the rear panel and contains the line fuse. Verify that the proper fuse is installed by replacing the line fuse.

EQUIPMENT PROTECTION

1. Never use the instrument in the following conditions where:
 - 1) The instrument is exposed to direct sunlight.
 - 2) The temperature and humidity is too high.
 - 3) Much mechanical vibrations are produced.
 - 4) The instrument is exposed to explosive gas.
2. Never allow a small spot of high brilliance to remain stationary on the screen for more than a few seconds. The screen may become permanently burned. A spot will occur only when the scope is set up for X-Y operation and no signal is applied. Either reduce the intensity so the spot is barely visible, switch back to normal sweep operation when no signal is applied, or set up the scope for spot blanking.
3. Never cover the ventilating holes on the top of the oscilloscope, as this will increase the operating temperature inside the case.
4. Never apply more than the maximum rating to the oscilloscope inputs.

▲ CH1 to CH4: 800 Vp-p or 400 V (DC + AC peak)
Z axis: 50 V (DC + AC peak)

Never apply external voltage to the oscilloscope output terminals.

5. Always connect a cable from the earth ground (GND) jack of the oscilloscope to the chassis of the equipment under test. Without this caution, the entire current for the equipment under test may be drawn through the probe clip leads under certain circumstances. Such conditions could also pose a safety hazard, which the ground cable will prevent.
6. Always use the probe ground clips for best results. Do not use an external ground wire in lieu of the probe ground clips, as undesired signals may be introduced.
7. Operation adjacent to equipment which produces strong ac magnetic fields should be avoided where possible. This includes such devices as large power supplies, transformers, electric motors, etc., that are often found in an industrial environment. Strong magnetic shields can exceed the practical CRT magnetic shielding limits and result interference and distortion.
8. Probe compensation adjustment matches the probe to the input of the scope. For best results, compensation of probe should be adjusted initially, then the same probe always used with the input of scope. Probe compensation should be readjusted whenever a probe from a different scope is used. (See page 26)
9. When turning on and off the POWER switch repeatedly, keep an interval of about 5 seconds. Faster on and off operation may cause malfunction to the instrument.
10. Do not use the provided PC-31 probe with other measuring equipment because it incorporates a terminal for READOUT detection which might damage the other equipment.
11. The calendar, clock, and set values on the panel are backed up by a built-in battery. If the battery is about to expire its life, "BATT. DOWN" is displayed on the calendar and clock display, and data set with controls on the panel are not stored but initialized. The battery should be replaced. As to battery replacement, please inquire at our distributor where you purchased the instrument.

Note:

Initial Setting

VERTICAL MODE	: CH1
AC-DC coupling	: AC
TRIGGERING MODE	: AUTO
TRIGGERING SOURCE	: VERT or CH1
TRIGGERING COUPLING	: AC
HORIZONTAL MODE	: A
The other switches are all off	
CH1 VOLTS/DIV	: 50 mV/div
SWEEP TIME	: 50 μ s/div





Plug configuration	Power cord and plug type	Factory installed instrument fuse	Line cord plug fuse
	North American 120 volt/60 Hz Rated 15 amp (12 amp max; NEC)	1.2 A, 250 V Fast blow 6 × 30 mm	None
	Universal Europe 220 volt/50 Hz Rated 16 amp	0.8 A, 250 V T. lag 5 × 20 mm	None
	U.K. 240 volt/50 Hz Rated 13 amp	0.8 A, 250 V Fast blow 6 × 30 mm	0.8 A Type C
	Australian 240 volt/50 Hz Rated 10 amp	0.8 A, 250 V Fast blow 6 × 30 mm	None
	North American 240 volt/60 Hz Rated 15 amp (12 amp max; NEC)	0.8 A, 250 V Fast blow 6 × 30 mm	None
	Switzerland 240 volt/50 Hz Rated 10 amp	0.8 A, 250 V Fast blow 6 × 30 mm	None

Fig. 1 Power Input Voltage Configuration

CONTROLS AND INDICATORS

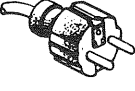
FRONT PANEL

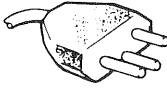
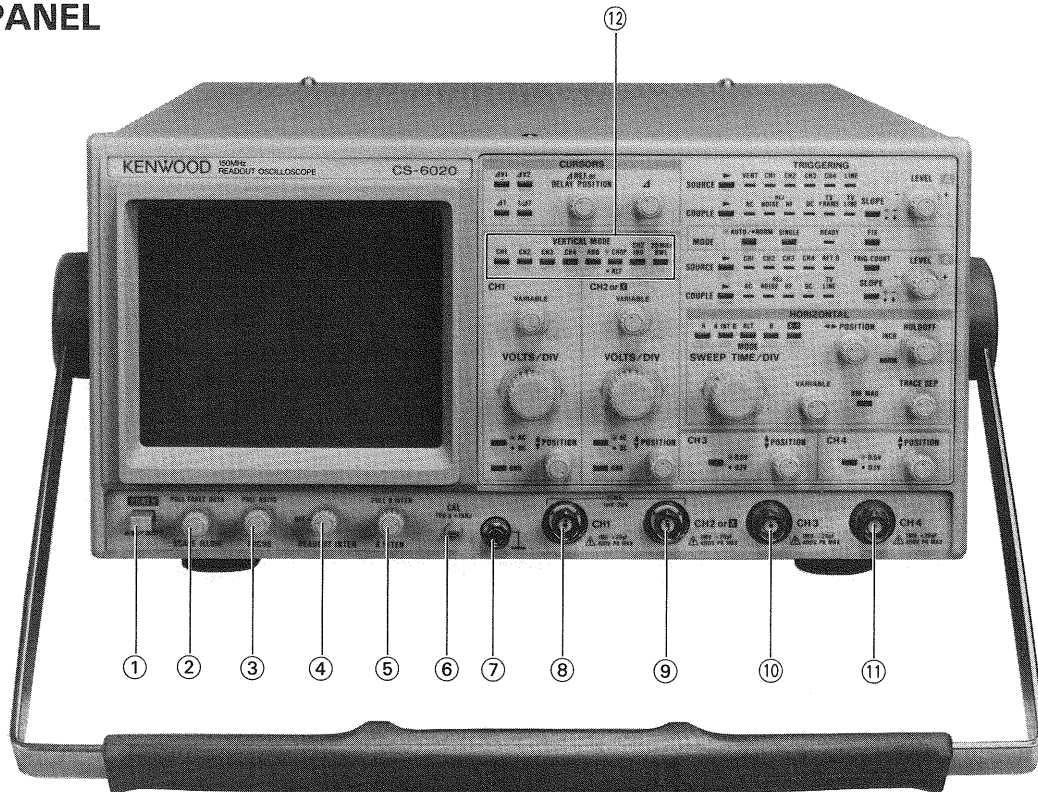

Fig. 2

- ① **POWER Switch**
Depressing this switch supplies power. Another pressing (switch released) turns off power.
- ② **SCALE ILLUM/PULL TRACE ROTA Control**
SCALE ILLUM: Controls intensity of the graticule on the CRT.
If the illumination is too bright, halation may be caused in photography. In such a case, rotate this knob to control intensity.
Note: If the MODE selector (46) is set to SINGLE, the scale illumination lights up for approx. 1 second for every sweep.
TRACE ROTA: Changes inclination of the horizontal trace line. Used when the trace is tilted by terrestrial magnetism, etc.
- ③ **FOCUS/PULL ASTIG Control**
FOCUS: Adjusts the focus for optimum waveform observation.
ASTIG: Adjusts, in the pulled-out position, astigmatism of the trace or spot for optimum waveform observation. The spot is round if astigmatism is properly adjusted.
- ④ **READOUT INTEN Control**
Adjusts intensity of the READOUT values. Full clockwise rotation maximizes intensity. Full counterclockwise rotation turns off the readout function and disappears READOUT values.
- ⑤ **A INTEN/PULL B INTEN Control**
A INTEN: Controls intensity of the A sweep trace line. Also controls intensity of X-Y operation.
B INTEN: Controls intensity of the B sweep trace line, in pulled-out position.
- ⑥ **CAL 1 Vp-p ≈ 1 kHz Terminal**
Outputs 1 kHz positive square wave of 1.0 Vp-p for calibration. Prior to using this terminal, be sure to compensate a probe prior to be used. If improperly compensated, it will not provide correct measurement.
- ⑦ **Ground Terminal/Binding post**
Ground terminal of the instrument.
- ⑧ **CH1 Input Jack**
Vertical axis input terminal of channel 1. Also serves as the Y-axis input terminal in the X-Y operation.
- ⑨ **CH2 or X Input Jack**
Vertical axis input terminal of channel 2. Also serves as the X-axis and Y-axis input terminal in the X-Y operation.
- ⑩ **CH3 Input Jack**
Vertical axis input terminal of channel 3. Also serves as the Y-axis input terminal in the X-Y operation.
- ⑪ **CH4 Input Jack**
Vertical axis input terminal of channel 4. Also serves as the Y-axis input terminal in the X-Y operation.
- ⑫ **VERTICAL MODE Switches**
Select operation modes of the vertical axis. By pressing a switch, the corresponding LED lights up to indicate that the mode is selected. By pressing a lighting switch, its LED goes out and the mode becomes unselected.
CH1 : The channel-1 input signal is displayed on the CRT.
CH2 : The channel-2 input signal is displayed on the CRT.

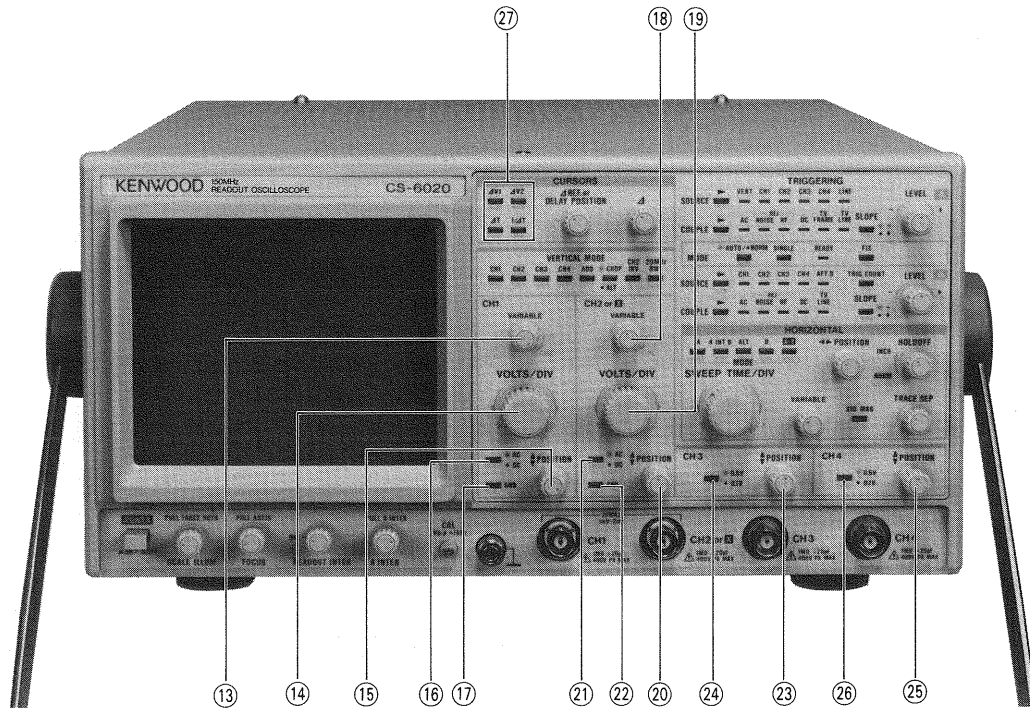

Fig. 3

- CH3 : The channel-3 input signal is displayed on the CRT.
- CH4 : The channel-4 input signal is displayed on the CRT.
- ADD : Algebraic sum of channel-1 and channel-2 signals is displayed on the CRT. If the CH2 INV is selected, difference of channel-1 and channel-2 signals is displayed.
- CHOP/ALT : Pressing the switch turns on the LED and selects chopping operation, which displays channels alternately at approx. 500 kHz in the multi-trace mode. Chopping is suitable for observation of slow sweep time. Another press of the switch turns off the LED and selects ALT operation, which displays channels alternately in the multi-trace mode every time the trigger signal is input. ALT operation is suitable for observation of fast sweep time.
NOTE: Chopping is not activated in the single-trace mode. If multi-trace chopping operation is changed into the single-trace operation, the CHOP LED goes out. It lights up and chopping is activated when the multi-trace operation is selected again.
- CH2 INV : Pressing the switch turns on the LED and inverts polarity of the channel-2 signal. Another press of the switch turns off the LED and restores the normal polarity.
- 20 MHz BWL: Pressing the switch turns on the LED and limits the bandwidth to approx. 20 MHz. Another press of the switch turns off the LED and restores the specified bandwidth.

- ⑬ **CH1 VARIABLE Control**
Fine adjustment of the channel-1 axis vertical attenuation for continuous variation between ranges selected with the VOLT/DIV control. Full clockwise rotation to the CAL position calibrates the attenuator. Also serves as a fine adjustment of the Y-axis attenuation in the X-Y operation.
- ⑭ **CH1 VOLTS/DIV Control**
Channel-1 vertical axis attenuator for setting vertical axis sensitivity from 1 mV/div. to 5 V/div. in 1-2-5 sequence (from 10 mV/div. to 50 V/div. if the probe PC-31 compatible with the readout function is used). Setting the CH1 VARIABLE control ⑬ to the CAL position provides calibrated vertical axis sensitivity. Also serves as an attenuator of the Y-axis in the X-Y operation. For the vertical axis sensitivity, confirm the READOUT display on the CRT.
- ⑮ **CH1 \updownarrow POSITION Control**
Adjusts vertical position of channel-1 waveform displayed on the CRT. Also used to adjust the Y-axis position in the X-Y operation.
- ⑯ **CH1 AC-DC Switch**
Selects coupling of the channel-1 vertical axis input signal. Also serves as the Y-axis input selector in the X-Y operation. Pressing the switch turns on the LED and eliminates DC component from the input signal to make AC input available (AC coupling). Another press of the switch turns off the LED and make DC input available (DC coupling), enabling signals with DC components to be observed.
NOTE: If the GND switch LED ⑰ is on, input signal is isolated from the vertical amplifier, and the vertical amplifier input is grounded.

- ⑰ **CH1 GND Switch**
Pressing the switch turns on the LED, isolates the channel-1 input signal from the vertical amplifier, and grounds the vertical amplifier input. By this, the ground voltage can be checked. Another press of the switch turns off the LED and supplies the channel-1 input signal to the vertical amplifier.
- ⑱ **CH2 VARIABLE Control**
Fine adjustment of the channel-2 vertical axis attenuation. Provides the same function as the CH1 VARIABLE control ⑬. Also serves as a fine attenuation adjustment of the X-axis and Y-axis in the X-Y operation.
- ⑲ **CH2 VOLTS/DIV Control**
Channel-2 vertical axis attenuator. Provides the same function as the CH1 VOLTS/DIV control ⑭. Also serves as an attenuator of the X-axis and Y-axis in the X-Y operation.
- ⑳ **CH2 \updownarrow POSITION Control**
Adjusts vertical position of channel-2 waveform displayed on the CRT. Also used to adjust the Y-axis position in the X-Y operation.
NOTE: In the X-Y operation, position of the X-axis is adjusted with the $\blacktriangleleft\blacktriangleright$ POSITION control ⑳.
- ㉑ **CH2 AC-DC Switch**
Selects coupling of the channel-2 vertical input signal. Also serves as the input selector of the X-axis and Y-axis in the X-Y operation. Provides the same function as the CH1 AC-DC switch ⑯.
- ㉒ **CH2 GND Switch**
Pressing the switch turns on the LED, isolates the channel-2 input signal from the vertical amplifier, and grounds the vertical amplifier input. By this, the ground voltage can be checked. Another press of the switch turns off the LED and supplies the channel-2 input signal to the vertical amplifier.
- ㉓ **CH3 \updownarrow POSITION Control**
Adjusts vertical position of channel-3 waveform displayed on the CRT. Also used to adjust the Y-axis position in the X-Y operation.
- ㉔ **CH3 0.5 V/0.1 V Switch**
Pressing the switch turns on the LED and sets the vertical axis sensitivity to 0.5 V/div. Another press of the switch turns off the LED and sets the vertical axis sensitivity to 0.1 V/div. Also serves as the Y-axis attenuator in the X-Y operation.
- ㉕ **CH4 \updownarrow POSITION Control**
Adjusts vertical position of channel-4 waveform displayed on the CRT. Also used to adjust the Y-axis position in the X-Y operation.
- ㉖ **CH4 0.5 V/0.1 V Switch**
Vertical attenuator of channel 4. Provides the same function as the CH3 0.5 V/0.1 V switch ㉔ for channel 4.
- ㉗ **CURSORS Switches**
Selects the cursor measurement modes.
If four LEDs are off, the cursor measurement mode is deactivated; the cursor, cursor measurement mode, and cursor measurement value are not displayed on the CRT.
To deactivate the cursor measurement mode, press a lighting switch.
NOTE: The cursor measurement is impossible for some items, depending on combination of the VERTICAL MODE ⑫ and HORIZONTAL MODE ⑳ switches. For details, refer to operating instructions.
 $\Delta V1$: Activates $\Delta V1$ and $\Delta V3$ cursor measurement. Cursor measurement is activated when any of CH1, CH3, and ADD of the VERTICAL MODE switches ⑫ is selected. Order of measurement priority of these three channels is CH1, CH3, and ADD. Two horizontal cursors are displayed on the CRT. Voltage difference and voltage ratio of these cursors are displayed posterior to the cursor measurement mode in the upper right of the CRT. The $\Delta V1$ cursor is used for voltage difference measurement, if the CH1 VARIABLE control ⑬ is set to the CAL position. A value calculated according to setting of the CH1 VOLTS/DIV control ⑭ is displayed posterior to the $\Delta V1$. Voltage ratio is measured if the CH1 VARIABLE control ⑬ is not set to the CAL position; a value calculated supposing 5 div. as 100% is displayed posterior to the RATIO.
In the $\Delta V3$ cursor measurement, a value calculated according to setting of the CH3 0.5 V/0.1 V is displayed posterior to the $\Delta V3$.
If the ADD of the VERTICAL MODE switches ⑫ is selected, voltage difference ($\Delta V1$) is measured under the condition where the CH1 VOLTS/DIV control ⑭ and CH2 VOLTS/DIV control ⑲ are set to the same level as well as the VARIABLE control ⑬ and ⑱ are set to CAL. Otherwise, voltage ratio (RATIO) is measured.
If the Δ cursor is below the Δ REF cursor, a negative (-) value is displayed.
 $\Delta V2$: Activates $\Delta V2$ and $\Delta V4$ cursor measurement when CH2 or CH4 of the VERTICAL MODE switches ⑫ is selected. Order of measurement priority of these two channels is CH2 and CH4. Two horizontal cursors are displayed on the CRT. Voltage difference and voltage ratio of these cursors are displayed posterior to the cursor measurement mode in the upper right of the CRT. The $\Delta V2$ cursor is used for voltage difference measurement, if the CH2 VARIABLE control ⑱ is set to CAL position. A value calculated according to setting of the CH2 VOLTS/DIV control ⑲ is displayed posterior to the $\Delta V2$. Voltage ratio is measured if the CH2 VARIABLE control ⑱ is not set to the CAL position; a value calculated supposing 5 div. as 100% is displayed posterior to the RATIO.
In the $\Delta V4$ cursor measurement, a value calculated according to setting of the CH4 0.5 V/0.1 V switch is displayed posterior to the $\Delta V4$.
If the Δ cursor is below the Δ REF cursor, a negative (-) value is displayed.

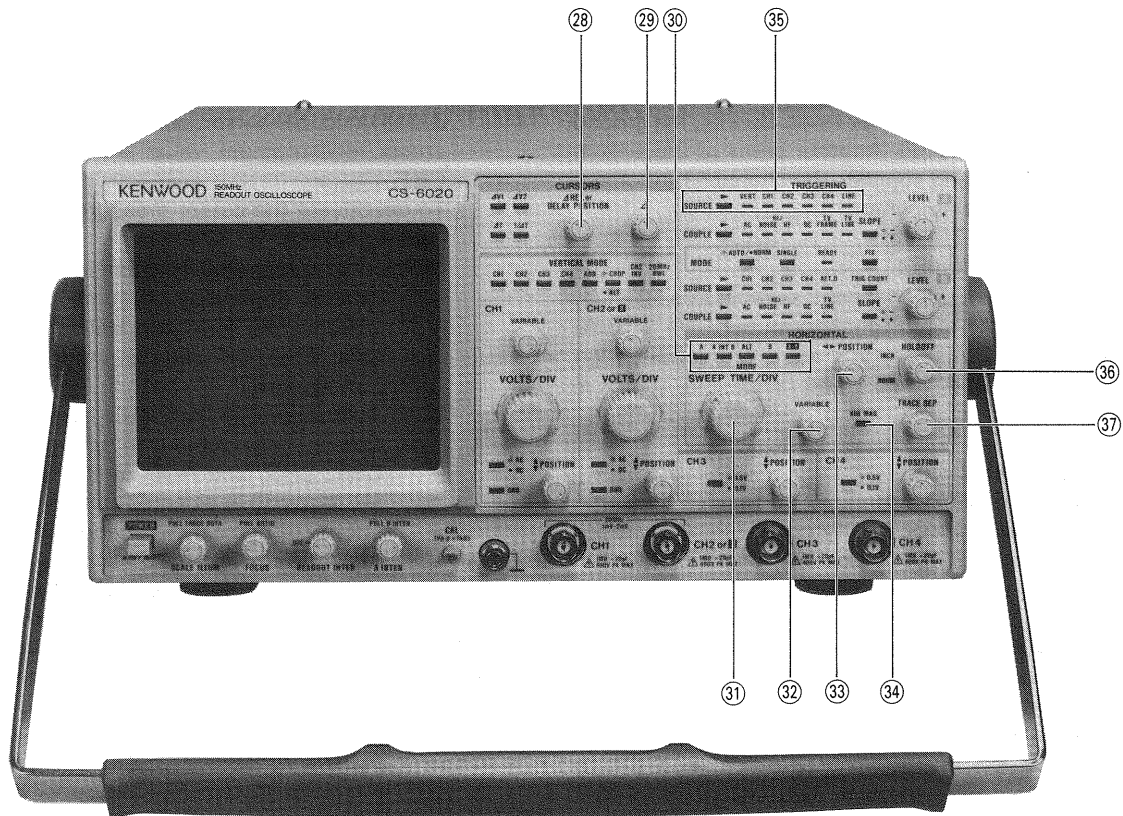

Fig. 4

NOTE: If X-Y of the HORIZONTAL MODE switches ③① is selected, ΔV_2 is used for voltage difference and voltage ratio measurement of the X-axis. Thus, vertical cursors are displayed.

ΔT : This switch functions when A and B of the HORIZONTAL MODE switches ③① are selected. Two vertical cursors are displayed on the CRT. Time difference and time ratio of these cursors are displayed posterior to the cursor measurement mode in the upper right of the CRT.

Time difference is measured, if the SWEEP VARIABLE control ③② is set to the CAL position. A value calculated according to setting of the SWEEP TIME/DIV control ③① is displayed posterior to the ΔT . Time ratio is measured if the SWEEP VARIABLE control ③② is not set to the CAL position; a value calculated supposing 5 div. as 100% is displayed posterior to the RATIO.

If the Δ cursor is on the left of the Δ REF cursor, a negative (-) value is displayed.

$1/\Delta T$: This switch functions when A and B of the HORIZONTAL MODE switches ③① are selected. Two vertical cursors are displayed on the CRT. Frequency between these two cursors and their phase difference are displayed posterior to the cursor measurement mode in the upper right of the CRT.

Frequency is measured, if the SWEEP VARIABLE control ③② is set to the CAL position. A value calculated according to setting of the SWEEP TIME/DIV control ③① is displayed posterior to the $1/\Delta T$. Phase difference is measured if the SWEEP VARIABLE control is not set to the CAL position; a value calculated supposing 5 div. as 360° is displayed posterior to the PHASE.

If the Δ cursor is on the left of the Δ REF cursor, a negative (-) value is displayed. Frequency, however, is displayed in the absolute value.

②⑧ **Δ REF/DELAY POSITION Control**

Shifts the reference cursor (fine broken line) of the two cursors displayed on the CRT in the cursor measurement. Clockwise rotation shifts the cursor up or to the right. Counterclockwise rotation shifts it down or to the left. In the delayed sweep mode, this control is used for moving the delay position as well as counting with the TRIG COUNT.

NOTE: To display the delay time and delay count value in the delayed sweep mode, deactivate the cursor measurement mode selector switches.

Rapid rotation of this control knob may cause improper operation. Thus, rotate it slowly.

②⑨ **Δ Control**

Shifts the measurement cursor (rough broken line) of the two cursors displayed on the CRT in the cursor measurement. Clockwise rotation shifts the cursor up or to the right. Counterclockwise rotation shifts it down or to the left.

NOTE: Rapid rotation of this control knob may cause improper operation. Thus, rotate it slowly.

③① **HORIZONTAL MODE Switches**

Selects operation modes of the horizontal axis. Pressing a switch turns on its LED, which indicates that the switch is selected.

A: Activates the A sweep only.

A INT B: Increases intensity of a B sweep portion on A sweep waveform. Intensity of the A sweep and B sweep is controlled with the A INTEN/PULL B INTEN ⑤.

ALT: Displays A sweep and B sweep (delayed sweep) alternately. Intensity of a B sweep portion displayed on A sweep waveform is increased.

B: Activates the B sweep only.

X-Y: The CS-6020 functions as an oscilloscope using CH1, CH2, CH3, or CH4 as the Y-axis and CH2 as the X-axis.

NOTE: Since the B sweep does not provide the automatic free running function, no waveform is displayed if not triggered. Be sure to trigger the B sweep with the B LEVEL ④3.

③1 SWEEP TIME/DIV Control

Sets sweep time of the A sweep and B sweep.

If A of the HORIZONTAL MODE switches ③0 is selected, this control selects the A sweep time in 1-2-5 steps in 23 ranges from 20 ns/div. to 0.5 s/div. Clockwise rotation changes sweep time toward 20 ns/div. Counterclockwise rotation changes it toward 0.5 s/div.

If A INT B, ALT, or B of the HORIZONTAL MODE switches ③0 is selected, it selects the B sweep time in 1-2-5 steps in 17 ranges from 20 ns/div. to 5 ms/div. Sweep time shall be checked on the CRT.

The B sweep time is not longer than the A sweep time.

If X-Y of the HORIZONTAL MODE switches is selected, A and B SWEEP TIME/DIV range displays disappear, and instead CH2-X is displayed.

③2 SWEEP VARIABLE Control

Fine adjustment of A sweep time and B sweep time. This control provides continuous variation from low-speed to high-speed sweep (Cross-Range Variable Function).

It adjusts the A sweep time if A of the HORIZONTAL MODE switches ③0 is selected, while adjusts B sweep time if A INT B, ALT, or B of the HORIZONTAL MODE switches is selected. It does not function if X-Y is selected.

In the UNCAL (ibration) condition, a ">" is displayed just before A SWEEP TIME/DIV display on the CRT, if the VARIABLE control functions as the A Sweep Variable control (i.e., A of the HORIZONTAL switches is selected). Likewise, in the UNCAL condition, it is displayed before B SWEEP/DIV, if the VARIABLE functions as the B Sweep Variable control (i.e., A INT B, ALT, or B of the HORIZONTAL switches is selected).

To change the UNCAL to CAL(ibration) condition, rotate the SWEEP TIME/DIV control ③1.

NOTE: Even if the A sweep is in the UNCAL condition, changing setting of the HORIZONTAL MODE switches from A into the delayed sweep mode (A INT B, ALT, or B) automatically establishes the A sweep in the CAL condition. The UNCAL condition can be restored by selecting A switch again. Rapid rotation of this control knob may cause improper operation. Rotate it slowly.

③3 ◀ ▶ POSITION Control

Moves waveform in the horizontal direction for horizontal position adjustment. Also adjusts the X-axis position in the X-Y operation.

NOTE: Rapid rotation of this control knob may cause improper operation. Rotate it slowly.

③4 × 10 MAG Switch

Pressing the switch turns on the LED and decouples the sweep time. Another press of the switch turns off the LED and restores the normal mode.

This switch has the following functions depending on setting of the HORIZONTAL MODE switches ③0.

A: A sweep only. × 10 MAG is selectable.

A INT B: × 10 MAG is not selectable.

ALT: B sweep only. × 10 MAG is selectable.

B: B sweep only. × 10 MAG is selectable.

X-Y: × 10 MAG is not selectable.

NOTE: Under the condition where A, ALT, or B of the HORIZONTAL MODE switches is selected and the × 10 MAG is depressed, pressing A INT B or X-Y establishes the normal mode automatically. If A, ALT, or B is selected again, the × 10 MAG mode is restored.

③5 A TRIGGERING SOURCE (A SOURCE) Selector Switch and LEDs

Selects a trigger source of A sweep. Every press of the ▶ switch advances a selected LED from left to right in sequence. Next to LINE, VERT is selected. (A selected LED advances at the interval of approx. 0.5 second by keeping pressing the switch.)

NOTE: If VERT is selected, any LED of CH1 to CH4 also lights up (depending on setting of the VERTICAL MODE switches ⑫).

VERT: Trigger source of A sweep is selected with the VERTICAL MODE switches ⑫. It is selected in the following order of priority, if more than one of the VERTICAL MODE switches is selected.

CH1 → CH2 → CH3 → CH4 → ADD (CH1)

NOTE: If ADD of the VERTICAL MODE switches ⑫ is selected in the single trace mode, CH1 is displayed as A SOURCE.

CH1: A sweep is triggered by channel-1 vertical axis input signal.

CH2: A sweep is triggered by channel-2 vertical axis input signal.

CH3: A sweep is triggered by channel-3 vertical axis input signal.

CH4: A sweep is triggered by channel-4 vertical axis input signal.

LINE: Triggered by commercial frequency.

A COUPLING ③8 switch is fixed to AC. If another trigger source is selected, previous condition is restored.

NOTE: If A COUPLING ③8 switch is set to TV FRAME or TV LINE, LINE of the A SOURCE switch cannot be selected.

③6 HOLD OFF Control

Adjusts the interval between sweep operations. Clockwise rotation from the NORM position, i.e., full counterclockwise position, increases the hold-off time. Full clockwise rotation provides variation more than five times.

③7 TRACE SEP(aration) Control

Counterclockwise rotation moves down the B sweep trace line by approx. 4 div. with respect to the A sweep trace line. This control functions when ALT or B of the HORIZONTAL MODE switches ③0 is selected.

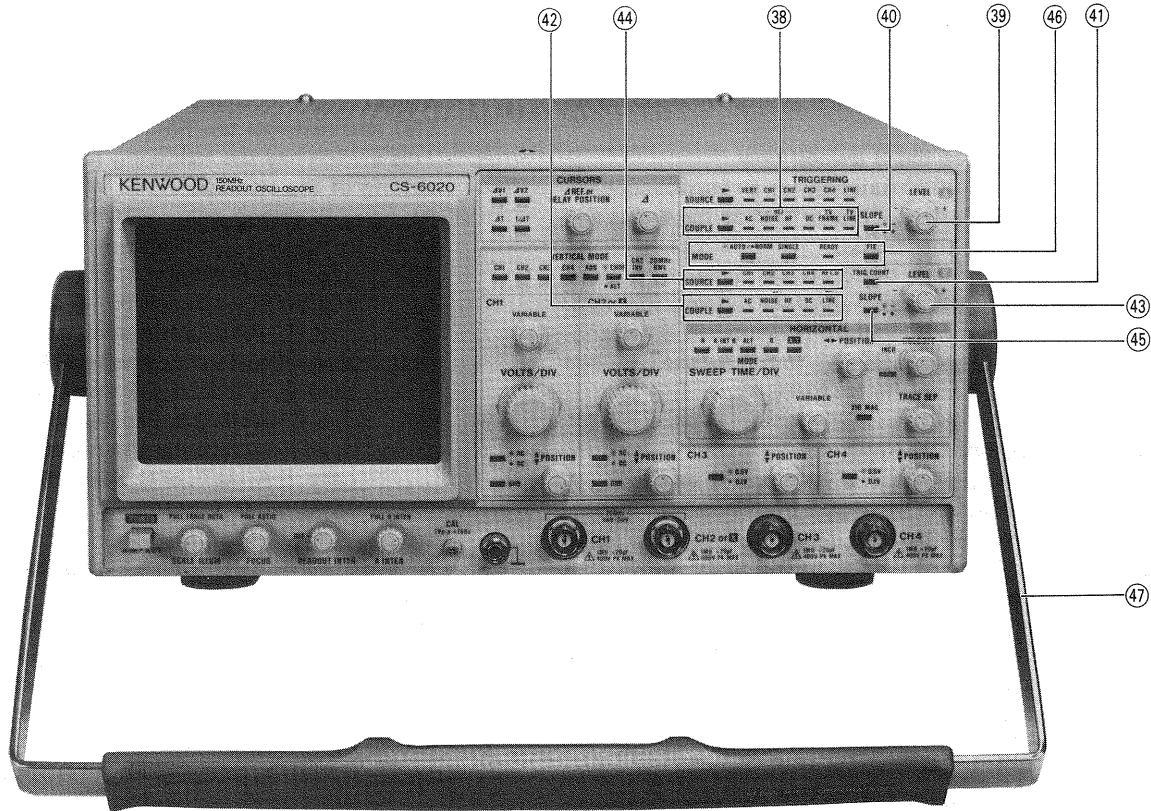

Fig. 5

③⑧ **A TRIGGERING COUPLING (A COUPLING) Selector Switch and LEDs**

Switch Selects coupling types of the A sweep trigger signal. Every press of the ► switch advances a selected LED from left to right in sequence. Next to TV LINE, AC is selected. (A selected LED advances at the interval of approx. 0.5 second by keeping pressing the switch.)

AC: The A sweep trigger signal is applied to the trigger circuit by AC coupling. DC component is eliminated.

NOISE_{REJ}: The A sweep trigger signal with reduced trigger sensitivity is applied to the trigger circuit. Therefore, trigger signal with noises mixed can cause triggering stably.

HF_{REJ}: The A sweep trigger signal is applied to the trigger circuit via a low-pass filter. Since high-frequency components are attenuated, low-frequency signals can be triggered stably.

DC: The A sweep trigger signal is applied to the trigger circuit by DC coupling, enabling triggering including DC component.

TV FRAME: Triggered by the vertical synchronizing signal of the video signals.

TV LINE: Triggered by the horizontal synchronizing signal of the video signals.

③⑨ **A TRIGGERING LEVEL (A LEVEL) Control**

Trigger level control of A sweep. Sets a sweep start point on a slope of the trigger signal waveform. Trigger level adjustment is unnecessary if the A COUPLING ③⑧ switch is set to TV FRAME or TV LINE, or TRIGGERING MODE ④⑥ switches is set to FIX.

④② **A TRIGGERING SLOPE (A SLOPE) Switch**

Selects triggering polarity of the A sweep. Pressing the switch turns on the LED and selects triggering at the trailing edge of input waveform. Another press of the switch turns off the LED and selects triggering at the leading edge of input waveform.

④① **TRIG COUNT Switch (CS-6020 only)**

Functions in the delayed sweep mode (A INT B, ALT, or B of the HORIZONTAL MODE switch ③⑩ is selected). Pressing the switch turns on the LED and displays COUNT as well as a count value posterior to the COUNT in the upper right of the CRT. This count value is set with the DELAY POSITION control ②⑧ within the range from 1 to 1000. Clockwise rotation of the control increases the value. Number of pulses of a channel selected with the B SOURCE switch ④④ is counted from the point when the A sweep starts. When the number of pulses reaches the preset value, the B sweep starts. Another press of the switch turns off the LED and restores the triggered delay mode.

④③ **B TRIGGERING COUPLING (B COUPLING) Selector Switch and LEDs**

Selects coupling types of the B sweep trigger signal. Every press of the ► switch advances a selected LED from left to right in sequence. Next to DC, AC is selected. Fixed, however, to TV LINE if TV FRAME or TV LINE of the A COUPLING switch ③⑧ is selected. (A selected LED advances at the interval of approx. 0.5 second by keeping pressing the switch.)

Selection of the B COUPLING switch possible only when the A INT B, ALT, or B of the HORIZONTAL MODE switches ③⑩ is selected. In such a case, the previous condition is displayed on the LED.

If the A or X-Y of the HORIZONTAL MODE switches is selected, LED goes out and selection is disabled.

- AC: The B sweep trigger signal is applied to the trigger circuit by AC coupling. DC component is eliminated.
- NOISE REJ: The B sweep trigger signal with reduced trigger sensitivity is applied to the trigger circuit. Therefore, trigger signal with noises can cause triggering stably.
- HF REJ: The B sweep trigger signal is applied to the trigger circuit via a low-pass filter. Since high-frequency components are attenuated, low-frequency signals can be triggered stably.
- DC: The B sweep trigger signal is applied to the trigger circuit by DC coupling, enabling triggering including DC component.
- TV LINE: Triggered by the horizontal synchronizing signal of the video signals.

④③ B TRIGGERING LEVEL (B LEVEL) Control

Trigger level control of B sweep. Sets a sweep start point on a slope of the trigger signal waveform. Trigger level adjustment is unnecessary if the B COUPLING switch ④③ is set to TV LINE, or TRIGGERING MODE switches ④⑥ is set to FIX.

④④ B TRIGGERING SOURCE (B SOURCE) Selector Switch and LEDs

Selects a trigger source of B sweep. Every press of the ► switch advances a selected LED from left to right in sequence. Next to AFT.D, CH1 is selected. (A selected LED advances at the interval of approx. 0.5 second by keeping pressing the switch.)

CH1: B sweep is triggered by channel-1 vertical axis input signal.

CH2: B sweep is triggered by channel-2 vertical axis input signal.

CH3: B sweep is triggered by channel-3 vertical axis input signal.

CH4: B sweep is triggered by channel-4 vertical axis input signal.

AFT.D: The B Start After Delay sweep mode is selected. B sweep starts after a delay time set with the A SWEEP TIME/DIV ③① and DELAY POSITION control ③⑧ has passed.

NOTE: If any of CH1 to CH4 is selected, the triggered delay mode is selected: B sweep is triggered by the first trigger pulse after a delay time set with the DELAY POSITION control. A question mark (?) is displayed posterior to DELAY on the CRT.

④⑤ B TRIGGERING SLOPE (B SLOPE) Switch

Selects triggering polarity of the B sweep. Pressing the switch turns on the LED and selects triggering at the trailing edge of input waveform. Another press of the switch turns off the LED and selects triggering at the leading edge of input waveform.

NOTE: If the TV FRAME or LINE of the A COUPLING switch ③⑧ is selected, the B SLOPE is set to the same condition as the A SLOPE. If the A COUPLING switch ③⑧ is set to another one, the previous condition is restored.

④⑥ TRIGGERING MODE (TRIG MODE) Selector Switches and LEDs

Switches and LEDs used to select the trigger operation modes.

AUTO/NORM: Pressing the switch turns on the LED and selects the automatic mode. Sweep is triggered by the trigger signal. Absence of the trigger signal causes free running and displays a trace line.

Another press of the switch turns off the LED and selects the normal mode. Sweep is triggered by the trigger signal. Different from AUTO, however, no trace line is displayed if appropriate trigger signal is provided.

SINGLE: Pressing the switch turns on the LED and selects the single sweep mode. In this mode, the A sweep and B sweep cannot be observed simultaneously.

This switch also serves as the reset switch for the single sweep mode. To reset setting of the single sweep mode, press the AUTO/NORM switch to set to AUTO.

READY: By pressing the SINGLE switch in the single sweep mode, the ready state is selected and the LED lights up, which remains lighting until sweep is completed.

FIX: Pressing the switch turns on the LED and the A sweep trigger level is fixed. In this case, triggering is made regardless of A LEVEL control ③⑨ setting.

Another press of the switch turns off the LED and restores the normal condition.

NOTE: In the single sweep mode, the Δ REF or DELAY POSITION, Δ , ◀▶ POSITION, and SWEEP VARIABLE controls are not operable. The clock correction mode can also be unselectable.

④⑦ Carrying Handle

This carrying handle is fixable at every 15 degrees for horizontal or tilted installation of the instrument. The attached probe holder shall be put on the metal portion of the handle.

REAR PANEL

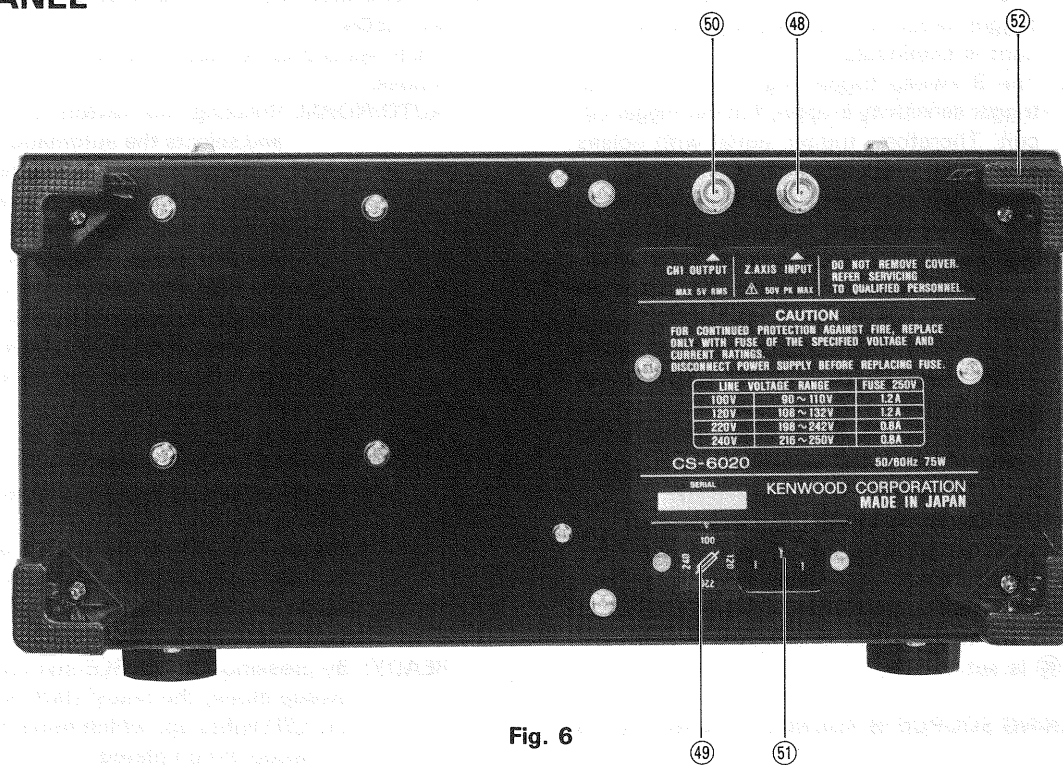

Fig. 6

- ④⑧ **Z AXIS INPUT Jack**
Input of the external intensity modulation. Positive voltage reduces intensity, and TTL-level voltage activates intensity modulation.
- ④⑨ **Fuse Holder and Line Voltage Selector**
1.2 A fuse is built in for 100/120 V areas. 0.8 A fuse is built in for 200/240 V areas.
Before changing the line voltage setting, unplug the AC cable. For line voltage selection, refer to the maintenance instructions in this manual.
- ⑤⑩ **CH1 OUTPUT Jack**
Outputs channel-1 vertical signal by AC coupling. Used to measure frequency, etc. by connecting a counter to it. Frequency measurement using a counter may be influenced by noises, resulting in improper frequency display. In such a case, change the VOLTS/DIV setting to another range or CH1 VARIABLE control ⑬ to a position other than CAL. Cascade connection of the channel 1 and channel 2 is impossible.

- ⑤① **AC Connector**
Connector for AC power supply.
- ⑤② **Cable Hooks**
Used to roll up the AC cable for transportation or storage. Also serve as the base for vertical installation.

READOUT DISPLAY

[1] DISPLAY POSITIONS

The calendar, each scale factor, cursor measurement values, etc. are displayed in the following positions of the CRT.

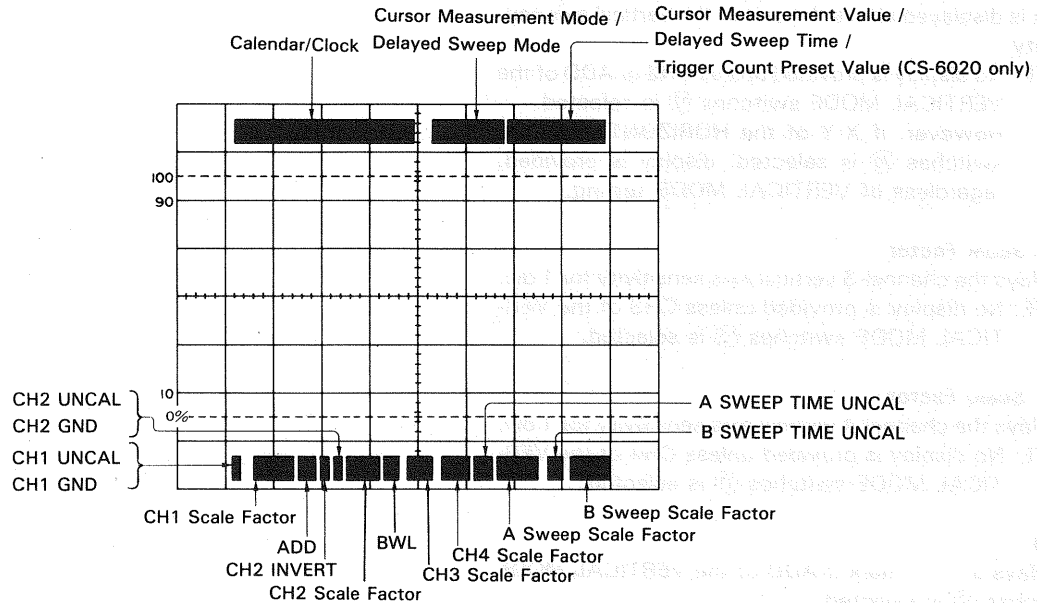

Fig. 7

[2] DISPLAY FUNCTIONS

1 Calendar/Clock

Displays the calendar and clock values in the order of Month, Day, Year, O'clock, and Minute.

Month: JAN, FEB, MAR, APR, MAY, JUN, JUL, AUG, SEP, OCT, NOV, & DEC

Day: 01 to 31

Year: 00 to 99

O'clock: 00 to 23

Minute: 00 to 59

The above can be set with A and X-Y of the HORIZONTAL MODE switches (30) and the SWEEP TIME/DIV control knob. (Refer to the adjustment instruction.)

2 Cursor Measurement Mode/Delayed Sweep Mode

Displays the cursor measurement mode depending on combination of the CURSORS and VARIABLE control setting.

$\Delta V1$, $\Delta V2$, $\Delta V3$, $\Delta V4$, ΔT , $1/\Delta T$, RATIO, PHASE

The delayed sweep mode is also displayed in the same position.

Triggered delay: DELAY?

Continuous delay: DELAY

Trigger count: COUNT

3 Cursor Measurement Value/Delayed Sweep Time/Trigger Count Preset Value (CS-6020 only)

In the cursor measurement, a measured value using two cursors is displayed.

In the $1/\Delta T$ measurement, a "?" is displayed before the cursor measurement value to indicate that the measured value is invalid, when two cursors get close to each other and measurement reaches the limit.

In the delayed sweep, delayed sweep time is displayed.

In the trigger count, a counted value is displayed.

4 CH1 Scale Factor

Displays the channel-1 vertical axis sensitivity for 1 div. In the UNCAL condition, a ">" is displayed before the channel-1 vertical axis sensitivity. If channel 1 is grounded, however, a "~" mark is displayed but no ">" is displayed even in the UNCAL condition.

If the AC-DC switch is set to AC for channel 1, a "~" mark is displayed above the unit of the vertical axis sensitivity.

NOTE: No display is provided unless CH1 or ADD of the VERTICAL MODE switches (12) is selected.

5 CH2 Scale Factor

Displays the channel-2 vertical axis sensitivity for 1 div. In the UNCAL condition, a ">" is displayed before the channel-2 vertical axis sensitivity. If channel-2 is grounded, however, a "∞" mark is displayed but no ">" is displayed even in the UNCAL condition.

If the AC-DC switch is set to AC for channel 2, a "~" mark is displayed above the unit of the vertical axis sensitivity.

NOTE: No display is provided unless CH2 or ADD of the VERTICAL MODE switches ⑫ is selected. However, if X-Y of the HORIZONTAL MODE switches ⑩ is selected, display is provided, regardless of VERTICAL MODE setting.

6 CH3 Scale Factor

Displays the channel-3 vertical axis sensitivity for 1 div.

NOTE: No display is provided unless CH3 of the VERTICAL MODE switches ⑫ is selected.

7 CH4 Scale Factor

Displays the channel-4 vertical axis sensitivity for 1 div.

NOTE: No display is provided unless CH4 of the VERTICAL MODE switches ⑫ is selected.

8 ADD

Displays a "+" mark if ADD of the VERTICAL MODE switches ⑫ is selected.

9 CH2 Invert

Displays a "↓" mark if CH2 INV of the VERTICAL MODE switches ⑫ is selected.

10 A Sweep Scale Factor

Displays a range of the A sweep set with the SWEEP TIME/DIV control ⑩.

Displays a ">" before the A sweep range if the A SWEEP TIME/DIV control ⑩ is set to the UNCAL condition.

11 B Sweep Scale Factor

Displays a range of the B sweep set with the SWEEP TIME/DIV control ⑩.

Displays a ">" before the B sweep range if the B SWEEP TIME/DIV control ⑩ is set to the UNCAL condition.

NOTE: If X-Y of the HORIZONTAL MODE switches ⑩ is selected, A and B scale factors disappear and "CH2-X" is displayed.

OPERATING INSTRUCTIONS

INITIAL STARTING PROCEDURE

Prior to turning on power, set each control as shown above in advance. Setting of other switches and controls in the power off condition has no relation with operation. For details of switches and controls, refer to section "CONTROLS AND INDICATORS".

Prior to using the probe, read through the manual attached to it as well as "Probe Compensation" in application examples in this manual.

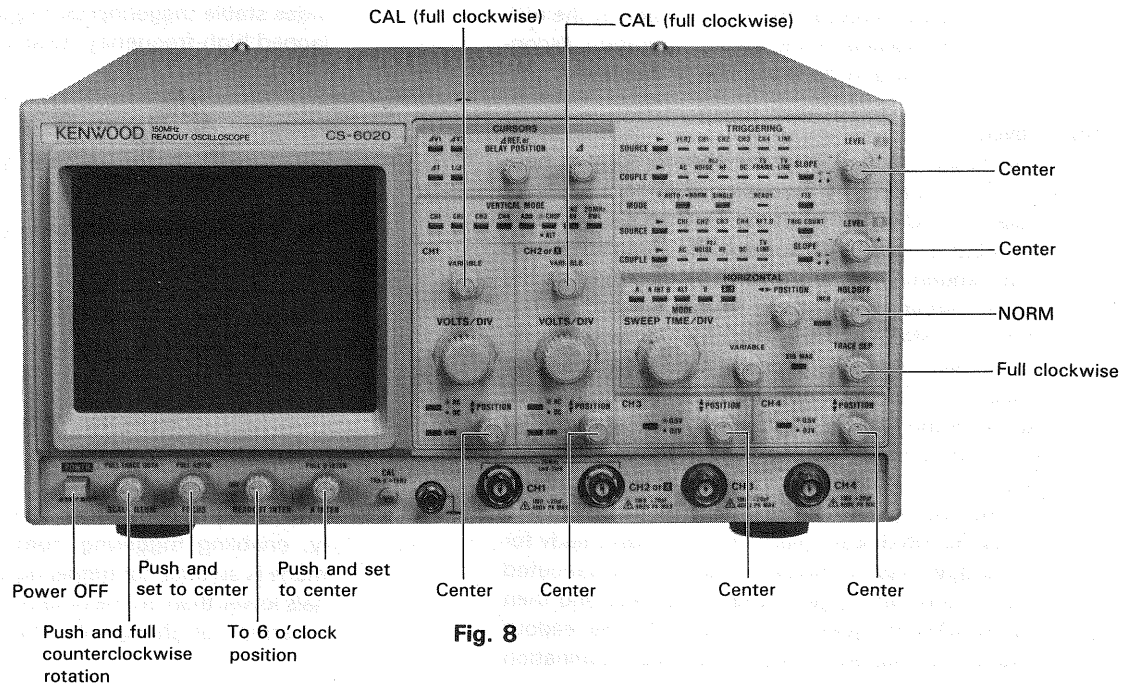

Fig. 8

[1] NORMAL SWEEP DISPLAY

1. Pressing the POWER switch ① turns on power. LEDs on the front panel light in the same setting before turning off power.

Then, set each mode as follows:

- VERTICAL MODE ⑫: CH1
- CURSORS ⑳: All off
- HORIZONTAL MODE ⑳: A
- A SOURCE ⑳: VERT (CH1)
- A COUPLE ⑳: AC
- A SLOPE ⑳: +
- TRIG MODE ④⑥: AUTO (FIX goes out.)
- × 10 MAG ④④: Off
- CH1, 2 AC-DC ①⑥, ②①: AC
- CH1, 2 GND ①⑦, ②②: Off

2. The trace line appears in the CRT center. If it is not in the center, adjust it to the center with the \updownarrow POSITION ⑮ and $\leftarrow \rightarrow$ POSITION control ③③.

Then, adjust intensity with INTENSITY control ⑤. Also adjust focus with the FOCUS control ③ if necessary.

3. Supply signal to the CH1 input connector ⑧, and control the CH1 VOLTS/DIV ⑭ and SWEEP TIME/DIV control ③① so that waveform of a proper size is displayed. By pressing CH2 of the VERTICAL MODE switches ⑫ and supplying signal to the CH2 input connector ⑨, channel-2 input signal is displayed on the CRT in the same manner as channel-1.

Channel-3 and channel-4 signals can be displayed on the CRT in the same manner.

By pressing ADD of the VERTICAL MODE switches ⑫, composite waveform of channel-1 and channel-2 signals (algebraic sum of them) is displayed on the CRT. By selecting CH2 INV under this state, algebraic difference

of channel-1 and channel-2 signals (CH1 - CH2) is displayed.

Sensitivity of the ADD mode equals the set value of the VOLTS/DIV control if the CH1 VOLTS/DIV and CH2 VOLTS/DIV are set to the same value.

If ALT of the VERTICAL MODE switches ⑫ is selected, every sweep operation displays selected channels of CH1 to CH4 and ADD alternately.

4. If waveform to be observed cannot be triggered due to wavering or the trigger point is to be moved, carry out trigger adjustment described below.

Trigger Operation

For waveform observation of input signal, the sweep circuit must be triggered properly to obtain stationary waveform.

(1) TRIGGERING MODE Switches

a) AUTO

If AUTO of the TRIG MODE switches ④⑥ is selected, the sweep circuit runs free when no trigger signal is supplied, facilitating confirmation of the GND level, etc.

If the trigger signal is supplied, the AUTO mode allows the trigger point to be set with the LEVEL and SLOPE for observation, like the normal trigger operation. The sweep circuit also runs free when the trigger point exceeds the trigger range, resulting in wavering of waveform.

NOTE: The AUTO sweep mode cannot be triggered if frequency of input signal is lower than 50 Hz. For such signals, use the normal sweep mode.

b) NORMAL

The normal sweep mode allows the trigger point to be set with the LEVEL and SLOPE, like the AUTO sweep mode. It is used to observe input signals of frequency lower than 50 Hz as well as signals with low repetition frequency.

NOTE: If no trigger signal is supplied or the trigger point exceeds the trigger range in the normal sweep mode, sweep operation discontinues and no trace line is displayed.

c) SINGLE

The single mode is used for photography of non-cyclic waveform by sweeping it once.

Select AUTO or NORM of the TRIG MODE switches (46), input a signal with approx. the same amplitude and frequency as the signal to be displayed as the trigger signal, and set the trigger level.

Press the SINGLE of the TRIG MODE switches (46). Once SINGLE is selected, the readout values and scale illumination disappear. Pressing the SINGLE turns on the READY LED, which indicates the instrument is ready for the trigger signal. This LED goes out on completion of A sweep. After confirming the above, apply the signal to be observed and press the SINGLE to make the instrument ready for the trigger signal. Sweep operation is executed once when the trigger signal is applied, and then the READY LED goes out. At this time, the readout values are displayed and the scale illumination lights up instantaneously.

NOTE: If several channels are selected with the VERTICAL MODE switches (12), they cannot be observed in the ALT mode. Set the CHOP/ALT switch to CHOP in such a case.

with noises, this mode provides stable triggering.

c) HF_{REJ}

Trigger signal is supplied to the trigger circuit via a low-pass filter to cut off high-frequency components (higher than 30 kHz). Thus, triggering is done by low-frequency components only. This mode provides stable triggering for trigger signals with overlapped high-frequency noises as shown in Fig. 9.

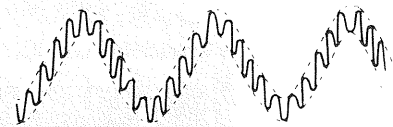

Waveform with overlapped high-frequency noises

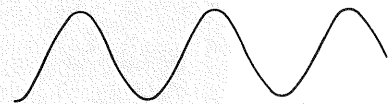

Trigger signal in HF_{REJ} mode

Fig. 9

d) DC

Trigger signal and trigger circuit are coupled directly, enabling triggering from direct current. This mode is suitable for triggering of low-frequency signals lower than 20 Hz or ramp waveform with slow repetition or change like the direct current.

e) TV FRAME, TV LINE

To observe the video signals, setting the A COUPLING (38) to TV FRAME causes the vertical synchronizing signal to trigger, and setting to TV LINE causes the horizontal synchronizing signal to trigger. These triggering operations are stable, regardless of setting of the A LEVEL (39). If polarity of the synchronizing pulses is negative, set the A SLOPE (40) to negative (-). If it is positive, set the A SLOPE (40) to positive (+).

If A INT B, ALT, or B of the HORIZONTAL MODE switches (30) is selected, the B COUPLING (42) is automatically set to TV LINE.

Besides, the B SLOPE is set to the same state as the A SLOPE.

Set the SLOPE as follows:

(2) SOURCE

Trigger signal to be used is selected with the A SOURCE switches (35). If the A SOURCE switch is set to VERT, triggering is made by a signal of a lower channel number selected with the VERTICAL MODE switches (12). If any of CH1 to CH4 of the A SOURCE is selected, triggering is made by the signal of the selected channel, regardless of setting of the VERTICAL MODE switches (12).

If the A SOURCE switch is set to LINE, triggering is made by the commercial frequency.

(3) COUPLE Switch

The A COUPLING switches (38) is used to select coupling methods of the trigger signal.

a) AC

Selects AC (capacitive) coupling. DC component in the trigger signal is eliminated, and triggering is done by AC signals. This coupling is conveniently used for ordinary measurement since it provides stable triggering independent of DC component. However, if frequency of the trigger signal is lower than 20 Hz, trigger signal level is reduced, causing difficulty in triggering.

b) NOISE_{REJ}

Trigger signal with reduced trigger sensitivity is supplied to the trigger circuit. For trigger signals

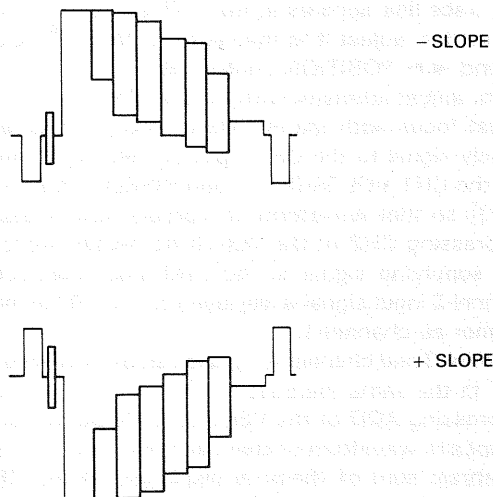

Fig. 10

(4) LEVEL Controls and SLOPE Switches

Trigger point of waveform is adjusted with the LEVEL controls and SLOPE switches. Fig. 11 shows the setting relationship between the LEVEL and SLOPE for trigger point adjustment. Level of the trigger point shall be adjusted as necessity requires.

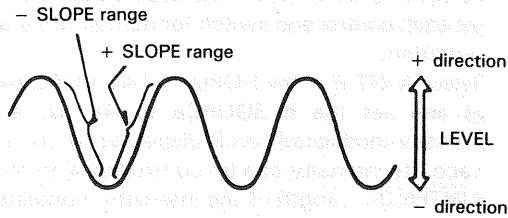

Fig. 11

(5) FIX Switch

Selecting FIX of the TRIG MODE switches (46) enables waveform to be triggered close to its center, eliminating troublesome trigger level adjustment.

If the trigger level is set on one side of the signal with NORM of the TRIG MODE switches (46) selected as shown in (a) or (b), Fig. 12, lowering of the input signal causes displacement of the trigger point, resulting in immediate stoppage of sweep operation.

If FIX of the TRIG MODE switches (46) is selected, the trigger level is always set close to the waveform center automatically even though amplitude changes (Fig. 11-(c)), resulting in stable triggering, regardless of setting of the LEVEL controls (39), (43). Besides, abrupt changing the input signal from square wave into pulse wave usually causes the trigger point to shift to the negative (-) side of the wave extremely, unless the trigger level is re-adjusted as shown in (2) and (3), Fig. 13-(a). Consequently, if input signal changes into pulse wave under the condition where the trigger point has been set on the negative side of the square wave as shown in (1), Fig. 13-b, sweep may stop due to displacement of the trigger point. To avoid such a trouble, set the TRIG MODE (46) to FIX; signals are always triggered close to the wave center, enabling stable waveform observation (Fig. 13-(c)).

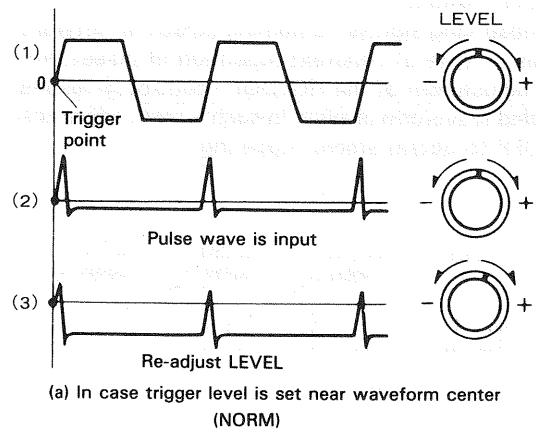

(a) In case trigger level is set near waveform center (NORM)

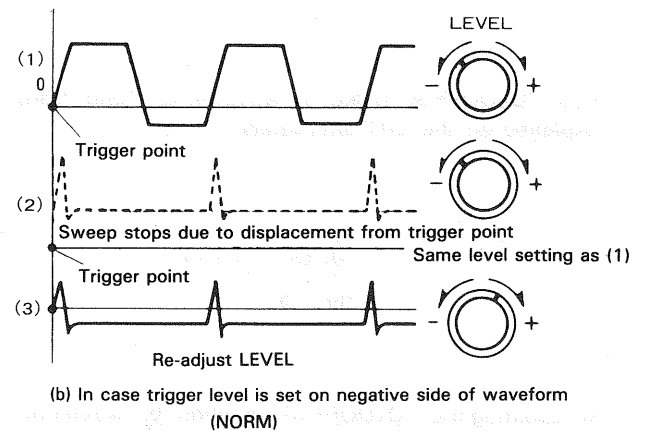

(b) In case trigger level is set on negative side of waveform (NORM)

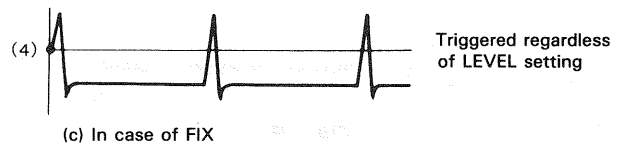

(c) In case of FIX

Fig. 13

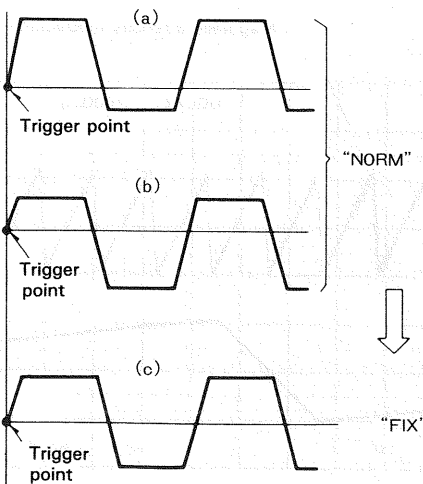

Fig. 12

(6) HOLDOFF Control

When observing signals containing pulses at different intervals in spite of constant repetition of pulses, improper adjustment of the HOLDOFF control (36) results in doubled waveform display. In such a case, adjust the HOLDOFF to obtain stable triggering.

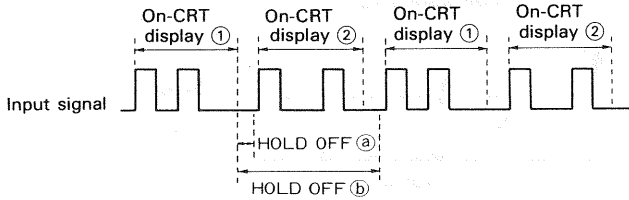

Fig. 14

If the HOLDOFF is set like (a), waveforms ① and ② are displayed on the CRT alternately.

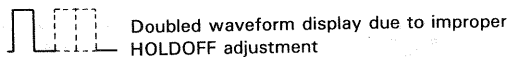

Fig. 15

By adjusting the HOLDOFF to condition (b), waveform ① only is displayed on the CRT.



Fig. 16

[2] SWEEP MAGNIFICATION

When observing a part of waveform by expanding the time axis, quickening the sweep time may exclude the part to be observed from the CRT. The sweep magnification is used in such a case for proper observation. Move a part to be observed to the CRT center with the ◀ ▶ POSITION control knob (33). Pressing then the × 10 MAG switch (34) turns on the LED and magnifies the part tenfold. The sweep time of the readout values displayed on the CRT is decupled. NOTE: Sweep magnification is impossible if A INT B or X-Y of the HORIZONTAL MODE switches is selected.

[3] DELAYED SWEEP

The A sweep and B sweep are used for delayed sweep magnification.

1. Continuous Delay (Start After Delay)

The continuous delayed sweep can activate delayed sweep operation from any point of A sweep.

- Select of the HORIZONTAL MODE switches (30) and set each control and switch for normal waveform observation.
- Select A INT B of the HORIZONTAL MODE switches (30) and set the B SOURCE to AFT.D. A bright intensity-modulated part is displayed on the A sweep trace. Its intensity can be controlled with the PULL B INTEN (5). Length of the intensity-modulated part to be magnified depends on setting of the B SWEEP TIME/DIV control (magnification ratio). Move the intensity-modulation part to a part to be magnified with the DELAY POSITION (28). The delay time is displayed in the upper right of the CRT.

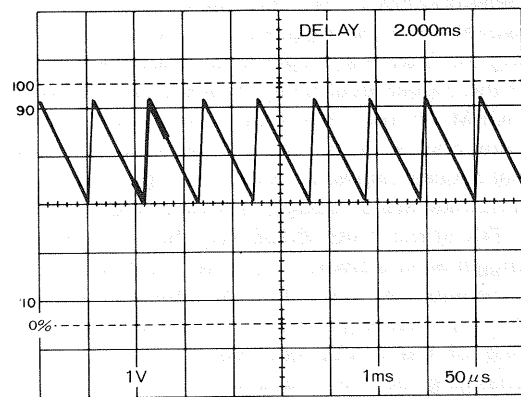

Fig. 17

- By setting the HORIZONTAL MODE switches to ALT, two trace lines of the A sweep and B sweep are displayed alternately, enabling magnified and non-magnified parts to be observed simultaneously. If trace lines of the A sweep and B sweep are hard to be observed due to overlapping, control the TRACE SEP (37) to shift the B sweep waveform to an easy-to-see position.

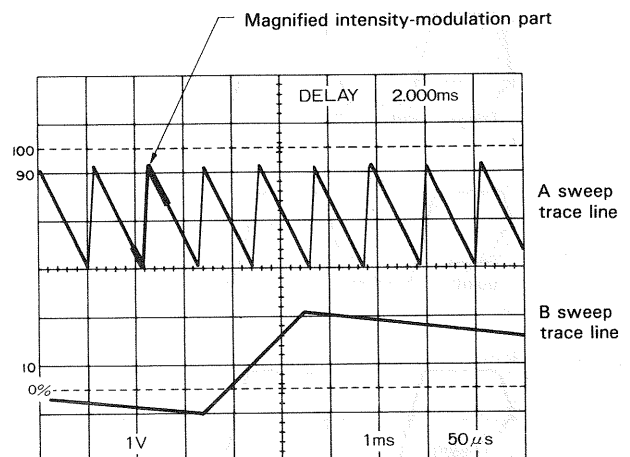

Fig. 18

- d) By setting the HORIZONTAL MODE switches ⑩ to B, the A sweep waveform disappears, and the intensity-modulation part on the A sweep trace line is magnified on the CRT.

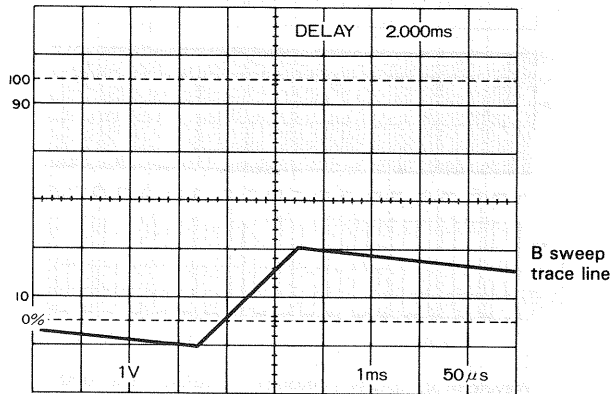

Fig. 19

- NOTE:
- Delayed sweep is impossible for 0.2 div. from the A sweep start point.
 - In the Start After Delay, increasing magnification will cause delay jitters. In such a case, use the triggered delay described below.

2. Triggered Delay

Set the B SOURCE switches ④ to any of CH1 to CH4. (TRIG. COUNT goes out.) The B sweep starts at the first trigger pulse after the delay time set with the DELAY POSITION ⑫ has passed. Set the trigger level of the B sweep with the B LEVEL control ④.

Since the B sweep of triggered delayed sweep operation starts at the first trigger signal after the delay time displayed on the CRT, the displayed delay time serves as reference only. A "?" is displayed posterior to DELAY on the CRT to indicate to that effect.

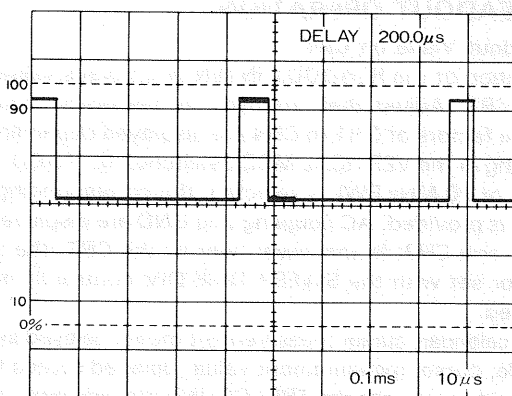

Though the delay time, 200μs, is set at the point of 2 div., the trigger point after it is at the point of 4.3 div.; consequently, the part from 4.3 div. is intensity-modulated (for magnification).

Fig. 20

3. TRIG COUNT Switch (CS-6020 only)

The TRIG COUNT switch is conveniently used for delayed sweep of signals whose number of pulses is already-known such as the video signal, digital signal, etc.

- Select A of the HORIZONTAL MODE switches ⑩, and set each switch and control knob for normal waveform observation.
- Set the HORIZONTAL MODE switches to A INT B, and select a channel to be observed (CH1 to CH4) with the B SOURCE switch.
- Activate the TRIG COUNT switch (LED lights up) and deactivate the cursor measurement mode; "COUNT" is displayed in the upper right of the CRT and a count value is displayed following it.

- On completion of the above setting, rotate the DELAY POSITION control ⑫ to set the count value to 1. Then, rotate the B LEVEL ④ to display intensity-modulation part on the CRT. If the A SLOPE and B SLOPE are set to the same value, the start point of the intensity modulation changes depending on setting of the A LEVEL ③ and B LEVEL ④, which shall be set as follows:

NOTE: The trigger counter regards the B sweep trigger point next to the A sweep trigger point as "0" (not displayed) and the following B trigger point as "1".

If the count value is set to 1, the relationship of these trigger points is as follows:

i) A SLOPE: +, B SLOPE: -

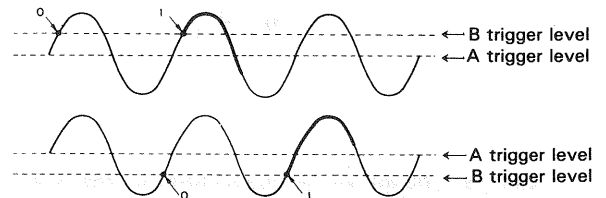

ii) A SLOPE: +, B SLOPE: -

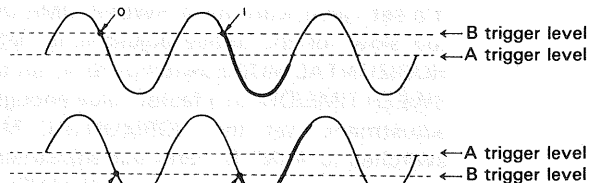

iii) A SLOPE: -, B SLOPE: +

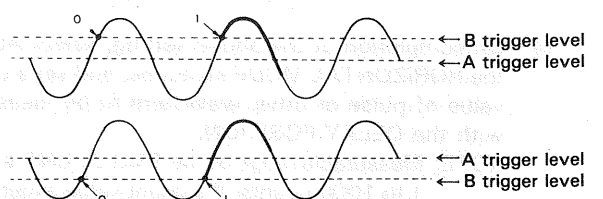

iv) A SLOPE: -, B SLOPE: -

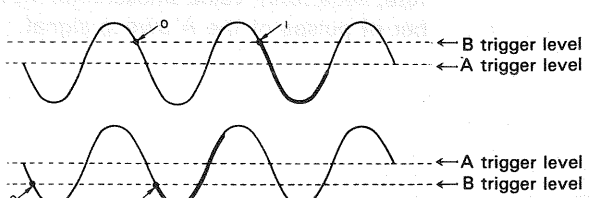
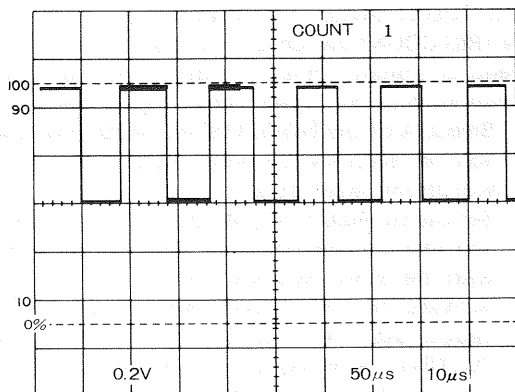
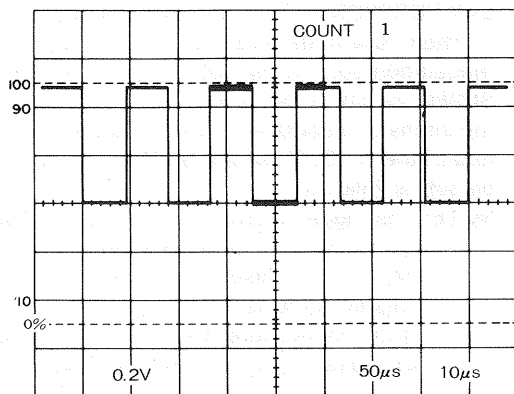

Fig. 21



A LEVEL Setting



B LEVEL setting

Fig. 22

Example: The above example shows a case where both the A SLOPE and B SLOPE are set to positive (+).

If a set value with the A SWEEP TIME/DIV is too slow for the above adjustment, set the HORIZONTAL MODE switches to A, set the A SWEEP TIME/DIV to a faster value enough for adjustment, set the HORIZONTAL MODE switches to A INT B, carry out adjustment to obtain the condition shown in "B LEVEL Setting" above, and then set the A SWEEP TIME/DIV to a slower value again.

- e) On completion of the above setting, select ALT of the HORIZONTAL MODE switches, and set a count value of pulse or other waveform to be measured with the DELAY POSITION.

NOTE: Measurable range of the TRIG COUNT is from 1 to 1000 counts. If a count value larger than the number of pulses of the A sweep signal is set, the B sweep is not displayed. Therefore, set a count value smaller than the number of pulses of the A sweep signal.

Example: Measurement at count value of 100

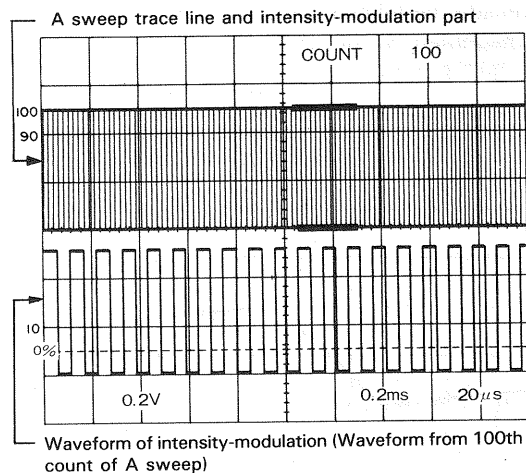

Waveform of intensity-modulation (Waveform from 100th count of A sweep)

Fig. 23

[4] X-Y OPERATION

Operation as an X-Y oscilloscope provides phase difference measurement, etc.

Select X-Y of the HORIZONTAL MODE switches (30). Output signal from the CH2 or X connector is used as the X-axis (horizontal axis).

Adjust positions of the X-axis and Y-axis with the ◀ ▶ POSITION control (33) and the CH1 ↕ POSITION to CH4 ↕ POSITION controls (15), (20), (23), and (25) respectively.

Sensitivity of the X-axis is adjusted with the CH2 VOLTS/DIV and VARIABLE controls in the X-Y operation. That of the Y-axis is adjusted with the VOLTS/DIV and VARIABLE controls for channels 1 to 4.

When X-Y is selected, the VOLTS/DIV value of channel 2 is displayed on the CRT; the sweep range disappears and CH2-X is displayed instead. All LEDs of TRIGGERING indication go out.

[5] READOUT OPERATION

1. Readout Value on CRT

Rotation of the READOUT INTEN (4) displays values on the CRT. Adjust their intensity as necessity requires. Scale factors of CH1 to CH4 are displayed depending on setting of the VERTICAL MODE switches (12). If ADD, CH2 INV, or 20 MHz BWL is selected, the corresponding display is provided. AC coupling and GND are displayed for CH1 and CH2. In the lower right of the CRT, the scale factor set with the SWEEP TIME/DIV control (31) is displayed.

The calendar, cursor measurement mode, delayed sweep mode, cursor measurement value, delayed sweep time, and set value with the TRIG COUNT are displayed in the upper part of the CRT.

NOTE: The calendar and clock are not displayed on the CRT if their functions are deactivated. For their setting, refer to the maintenance and adjustment instructions.

If the readout values are displayed, a real-time waveform may be intensity-modulated. In such a case, rotate the READOUT INTEN control (4) fully counterclockwise; the readout function is deactivated and intensity-modulation on the real-time wave disappears.

2. Cursor Measurement

ΔV1: By selecting CH1 of the VERTICAL MODE (12) and V1 of the CURSORS (27), two horizontal cursors are displayed on the CRT, and voltage difference between the two cursors is calculated based on setting of the CH1 VOLTS/DIV (14) and displayed in the upper right of the CRT. If the CH1 VARIABLE (13) is not set to the CAL position, voltage ratio is displayed.

Move cursors to positions to be measured with the ΔREF (28) and Δ (29).

ΔV2: By selecting CH2 of the VERTICAL MODE (12) and ΔV2 of the CURSORS (27), voltage difference or voltage ratio between cursors based on setting of the CH2 VOLTS/DIV (19) is displayed in the upper right of the CRT, similarly to ΔV1 measurement.

ΔV3: By selecting CH3 of the VERTICAL MODE (12), with CH2 unselected, as well as ΔV1 of the CURSORS (27), two horizontal cursors are displayed, and voltage difference between the cursors calculated based on setting of the CH3 0.5 V/0.1 V (24) is displayed in the upper right of the CRT.

ΔV4: By selecting CH4 of the VERTICAL MODE (12), with CH2 unselected, as well as ΔV2 of the CURSORS (27), voltage difference between the cursors calculated based on setting of the CH4 0.5 V/0.1 V (26) is displayed in the upper right of the CRT.

ΔT: By selecting ΔT of the CURSORS (27), two vertical cursors are displayed on the CRT and time difference between cursors calculated based on the sweep scale factor in the lower right of the CRT is displayed in the upper right of the CRT. If the SWEEP TIME is not the CAL condition, time ratio is displayed.

1/ΔT: By selecting 1/ΔT of the CURSOR (27), two vertical cursors are displayed on the CRT and frequency between cursors calculated based on the sweep scale factor in the lower right of the CRT is displayed in the upper right of the CRT. If the SWEEP TIME is not the CAL condition, phase difference is displayed.

[6] CURSOR MEASUREMENT

1. ΔV Cursor Measurement Mode with VERTICAL MODE Switches (12) ΔV1 to ΔV4 cursor measurement modes are selected depending on setting of the VERTICAL MODE switches (12) shown below. For example, if the channel-2 single-trace is selected under the condition where CH1 of the VERTICAL MODE (12) and ΔV1 of the CURSORS have been selected, the cursor measurement mode changes from ΔV1 into ΔV2 automatically. If an unselectable cursor measurement mode is selected, the LED of the mode keeps lighting for approx. 1 second and then the previous state is restored.

In the cursor measurement mode ΔV1, order of the vertical mode priority is CH1, CH3, and ADD. In the cursor measurement mode ΔV2, the order of priority is CH2 and CH4. The cursor measurement mode is set to that of higher priority.

VERTICAL MODE (12)	CORSORS MODE (27)	Cursor Measurement Mode
CH1 CH3*2 ADD only	ΔV1	ΔV1 or RATIO*1 ΔV3 ΔV1 or RATIO*3
CH2 CH4*4	ΔV2	ΔV2 or RATIO*5 ΔV4

*1: RATIO is displayed if the CH1 VARIABLE (13) is not set to the CAL position.

*2: ΔV3 measurement mode is impossible if CH1 of the VERTICAL MODE is selected.

*3: RATIO is displayed if the CH1 VOLTS/DIV and CH2 VOLTS/DIV are set to different ranges.

*4: ΔV4 measurement mode is impossible if CH2 of the VERTICAL MODE is selected.

*5: RATIO is displayed if the CH2 VARIABLE (16) is not set to the CAL position.

The order of priority of the cursor measurement modes is CH1 → CH3 → ADD in the ΔV1 mode, while CH2 → CH4 in the ΔV2 mode. The cursor measurement mode can be set to one of higher priority.

2. ΔT and 1/ΔT Cursor Measurement Modes with HORIZONTAL MODE Switches (12)

If the delayed sweep (A INT B, ALT, B) is selected with the HORIZONTAL MODE switches, the cursor measurement mode is deactivated, and DELAY TIME as well as TRIG COUNT are displayed.

a) In case A of HORIZONTAL MODE switches is selected
The normal cursor measurement mode can be executed.

b) In case A INT B, ALT, or X-Y of the HORIZONTAL MODE switches is selected
The ΔT and 1/ΔT cursor measurement modes are impossible. The LED lights up for approx. 1 second by a press of the switch, and then goes out to indicate that pressing the switch is invalid.

c) In case B of HORIZONTAL MODE switches is selected
The ΔT and 1/ΔT cursor measurement modes are possible. Pressing the switch turns on the LED to indicate that the mode has been selected and displays the cursor measurement mode on the CRT. Deactivating the cursor measurement mode displays DELAY TIME or TRIG COUNT again.

APPLICATIONS

PROBE COMPENSATION

For accurate measurement, the probe should be compensated before starting measurement, as follows:

- 1) Connect the probe to the INPUT connector, and adjust each control for normal sweep display.
- 2) Connect the probe to the CAL terminal on the front panel. Adjust the SWEEP TIME/DIV so that several cycles of the signal from CAL are displayed.
- 3) Adjust the probe trimmer to obtain the optimum compensation for the waveform on the CRT.

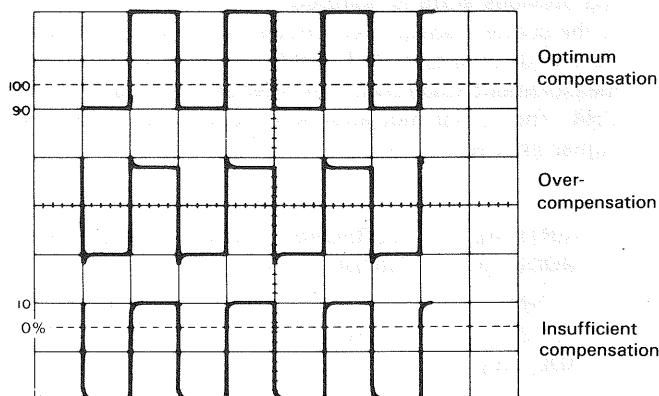

Fig. 24

TRACE ROTATION COMPENSATION

Rotation of the trace line from the horizontal graduation line may cause measurement errors.

Adjust controls for normal sweep display. Press the GND switch and set the TRIG MODE switch to AUTO. Adjust the \updownarrow POSITION control so that the trace overlaps the center horizontal graduation line. If the trace is tilted, align it with the horizontal graduation line with the TRACE ROTA control on the front panel.

1. DC Voltage Measurement

DC voltage measurement consists of normal procedures and cursor measurement procedures.

(1) Normal Procedures

The following describes normal procedures for DC level measurement of waveform:

- 1) Apply the signal to be measured to the INPUT connector. Select the channel to be used with the VERTICAL MODE, set the AC-DC to DC, deactivate the GND switch, and adjust controls for normal sweep display. Then, adjust the VOLTS/DIV and SWEEP TIME/DIV to obtain proper waveform display. Set the VARIABLE used channel and SWEEP TIME to the CAL condition.
- 2) Select AUTO of the TRIG MODE switches and press the GND switch. The trace line indicates the GND level (reference level). Using the \updownarrow POSITION control, adjust the trace position to the desired reference level. Do not change this setting once made.
- 3) Set the AC-DC switch to DC to observe the waveform including DC component. If the reference level or VOLTS/DIV setting is inappropriate, waveform may not be displayed on the CRT. If so, readjust the VOLTS/DIV and/or \updownarrow POSITION.

- 4) Adjust the $\blacktriangleleft\blacktriangleright$ POSITION to bring the point of the waveform to be measured to the center vertical graduation line.
- 5) Measure the vertical distance between the reference level and the point to be measured. (The reference level can be rechecked by pressing the GND switch.) Multiply the distance measured above by the VOLTS/DIV setting to gain the voltage to be determined. When the 10:1 probe is used, also decouple the voltage. Voltage above and below the reference level are positive and negative voltages, respectively.

- ① When using PC-31 or direct measurement
DC level = (Vertical distance in divisions) \times (VOLTS/DIV setting)
- ② When using 10:1 probe
DC level = (Vertical distance in divisions) \times (VOLTS/DIV setting) \times 10

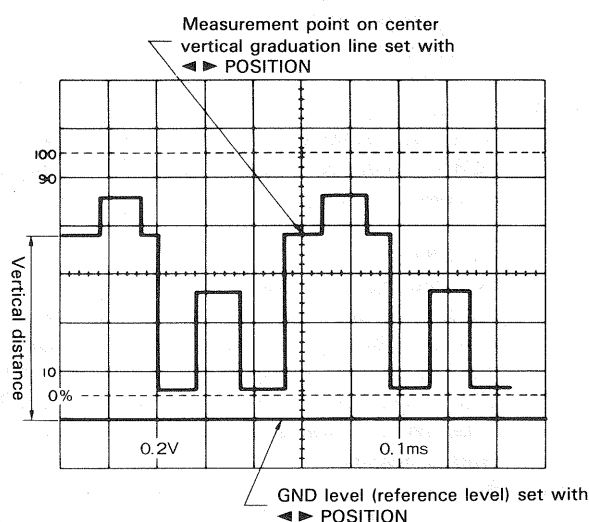

Fig. 25

[EXAMPLE]

In the example shown in Fig. 25, the measurement point is 3.8 divisions from the reference GND level. If VOLTS/DIV is 0.2 V, the voltage to be determined is:

$$\text{DC level} = 3.8 \text{ (div)} \times 0.2 \text{ (V/div)} = 0.76 \text{ V}$$

(2) Cursor Measurement Procedures

- 1) Make the GND trace displayed according to items 1) and 2) of the normal procedures above.
- 2) Select a desired cursor mode of Δ V1 to Δ V4 according to a channel to be used.
- 3) Align the Δ REF cursor (reference line) to the GND trace line.
- 4) Set the AC-DC switch to DC.
- 5) Align the Δ cursor to a point to be measured.
- 6) Measured value is displayed following to a cursor mode display of Δ V1 to Δ V4.

When the attached probe PC-31 is used, measured value including the attenuation ratio is displayed. However, if a probe used is not compatible with the readout function, measured value is multiplied by the attenuation ratio. If the Δ cursor is below the Δ REF cursor, a minus sign (-) is displayed to indicate that voltage is negative.

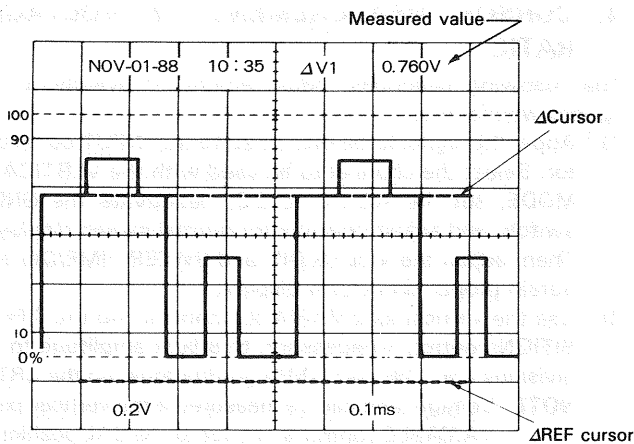

Fig. 26

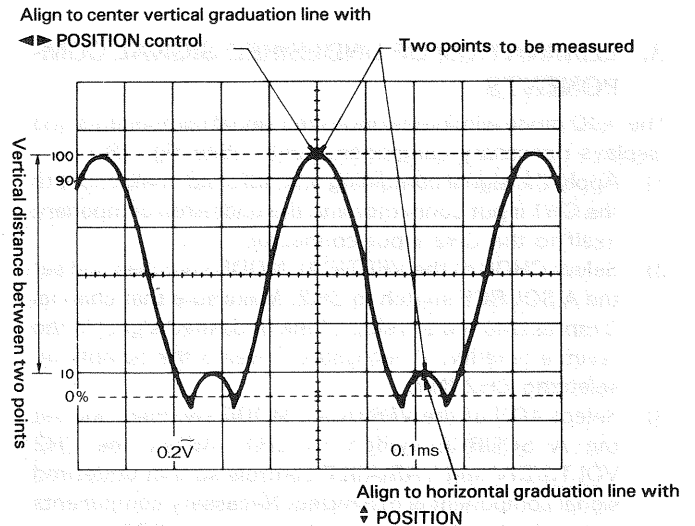

Fig. 27

2. MEASUREMENT OF VOLTAGE BETWEEN TWO POINTS ON A WAVEFORM

(1) Normal Procedures

The following describes normal procedures for measuring voltage between two points on a waveform or peak-to-peak voltage:

- 1) Apply the signal to be measured to the INPUT connector. Select the channel to be used with the VERTICAL MODE, set the AC-DC switch to DC, deactivate the GND switch, and adjust controls for normal sweep display. Then, adjust the VOLTS/DIV and SWEEP TIME/DIV to obtain proper waveform display. Set the SWEEP TIME to the CAL condition.
- 2) Align one point to be measured to a horizontal graduation line with the POSITION control and bring another point within the display range of CRT.
- 3) Adjust the POSITION to bring the latter to the center vertical graduation line.
- 4) Measure the vertical distance between the two points. Multiply the distance measured above by the VOLTS/DIV setting to gain voltage to be determined. When the 10:1 probe is used, also decouple the voltage.

- ① When using PC-31 or direct measurement.

$$\text{Voltage between two points} = (\text{Vertical distance in divisions}) \times (\text{VOLTS/DIV setting})$$

- ② When using 10:1 probe

$$\text{Voltage between two points} = (\text{Vertical distance in divisions}) \times (\text{VOLTS/DIV setting}) \times 10$$

[EXAMPLE]

In the example shown in Fig. 27, vertical distance between two points to be measured is 4.5 divisions. If VOLTS/DIV is 0.2 V/div and the 10:1 probe is used, the voltage to be determined is:

$$\text{Voltage between two points} = 4.5 (\text{div}) \times 0.2 (\text{V/div}) \times 10 = 9.0 \text{ V}$$

(2) Cursor Measurement Procedures

- 1) Display the waveform to be measured according to item 1) of the normal procedures above.
- 2) Select a desired cursor mode of ΔV1 to ΔV4 according to a channel to be used.
- 3) Align the ΔREF cursor to the lower point to be measured. Align the Δcursor to the upper point.
- 4) Measured value is displayed following the selected cursor mode display of ΔV1 to ΔV4.

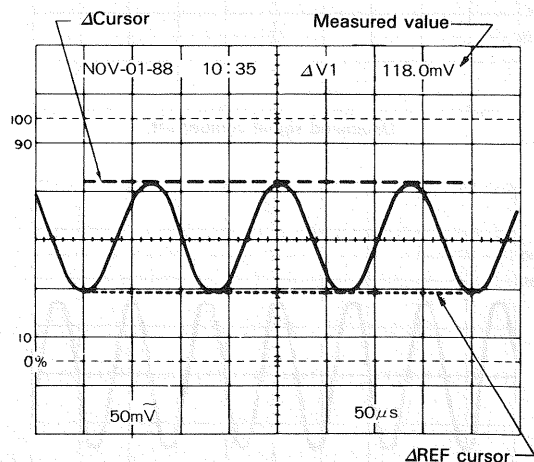
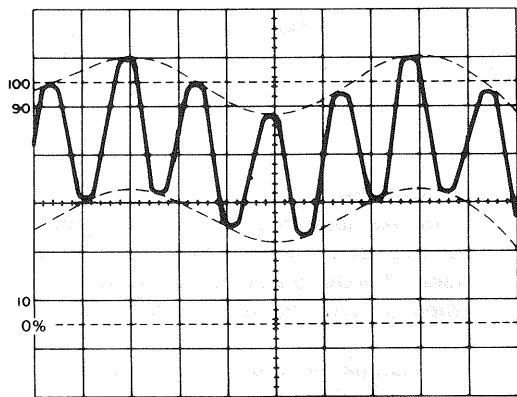

Fig. 28

3. ELIMINATION OF UNDESIRE SIGNAL COMPONENTS

The ADD mode eliminates undesired signal components and displays necessary components only. (See Fig. 29.)

- 1) Apply the signal containing an undesired component to the CH1 input connector and the undesired component itself to the CH2 input connector.
- 2) Select CHOP of the VERTICAL MODE switches and set the A SOURCE switch to CH2. Make sure that channel 2 represents the envelop of the undesired signal in the reverse polarity. If necessary, reverse the polarity by selecting CH2 INV.
- 3) Select ADD of the VERTICAL MODE switches and set the A SOURCE switch to CH1. Adjust the CH2 VOLTS/DIV and VARIABLE controls so that undesired signal component is minimized. Necessary components to be observed remain displayed on the CRT.



Signal containing undesired component
(Dotted lines indicate envelop of undesired component)

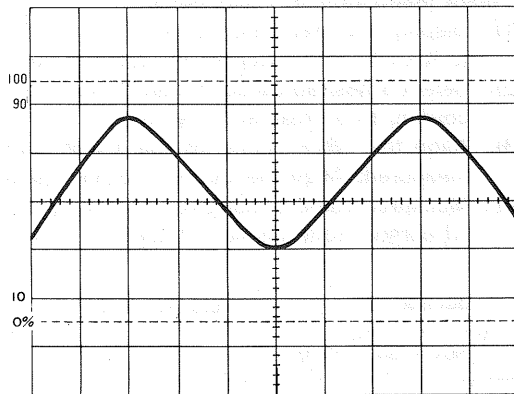

Undesired signal component

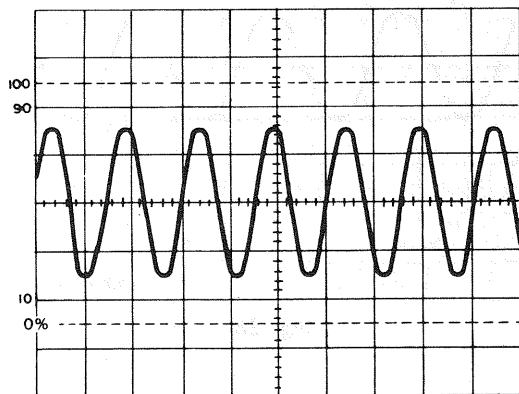

Necessary signal free of unnecessary component

Fig. 29

4. CURSOR MEASUREMENT OF VOLTAGE RATIO

The following describes measurement of overshoot of square waves, etc.

- 1) Apply the signal to be measured to the INPUT connector. Select the channel to be used with the VERTICAL MODE, set the AC-DC to DC, deactivate the GND switch, and adjust controls for normal sweep display. Then, adjust the VOLTS/DIV and SWEEP TIME/DIV to obtain proper waveform display.
- 2) Use the vertical axis VARIABLE control and the POSITION control, if necessary, to adjust amplitude to 5 divisions (i.e., 0% and 100% graduations) on the CRT. **NOTE:** Voltage ratio can be measured if the vertical axis VARIABLE control is not set to the CAL position.
- 3) Select a desired cursor mode $\Delta V1$ or $\Delta V2$ according to a channel to be used. **NOTE:** Voltage ratio cursor measurement is impossible if CH3 or CH4 is selected.
- 4) Align the ΔREF cursor to the 100% graduation.
- 5) Align the Δ cursor to an overshoot point to be measured.
- 6) Voltage ratio of the overshoot supposing 5 divisions as 100% is displayed in percentage following RATIO in the upper right of the CRT.

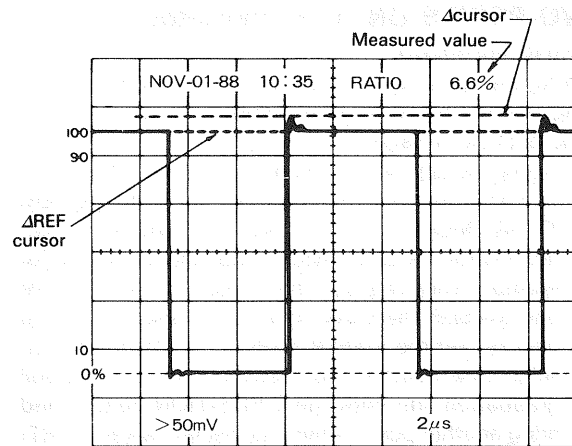

Fig. 30

5. TIME MEASUREMENT

(1) Normal Procedures

The following describes normal procedures for measuring time between two points on a waveform. Calculation is based on the SWEEP TIME/DIV setting and the horizontal distance between the two points.

- 1) Apply the signal to be measured to the INPUT connector. Select the channel to be used with the VERTICAL MODE, set the AC/DC to DC, deactivate the GND switch, and adjust controls for normal sweep display. Then, adjust the VOLTS/DIV and SWEEP TIME/DIV to obtain proper waveform display. Set the VARIABLE of each channel and SWEEP TIME to the CAL condition.
- 2) Align one of the points to a vertical graduation line with the POSITION control. Then, align another point to the center horizontal graduation line with the POSITION control.
- 3) Measure the horizontal distance between these two points. Multiply this distance by setting of the SWEEP TIME/DIV control.

$$\text{Time} = \text{Horizontal distance (div)} \times \text{SWEEP TIME/DIV setting}$$

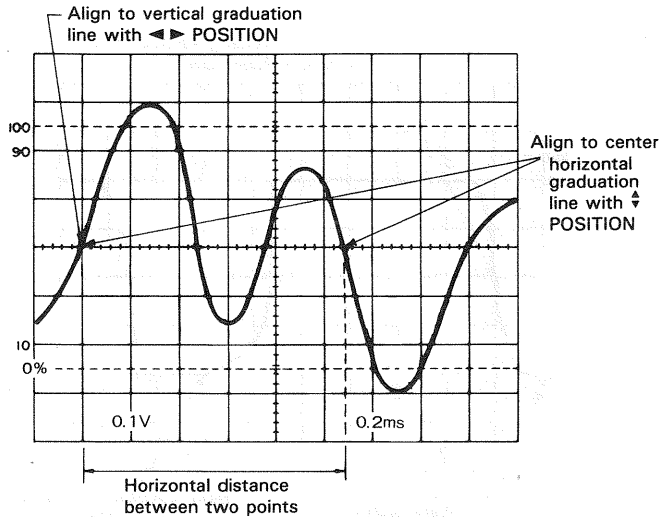

Fig. 31

[EXAMPLE]

In the example shown in Fig. 31, the horizontal distance between the two points is 5.4 divisions. If the SWEEP TIME/DIV is 0.2 ms/div, time to be determined is:
 $\text{Time} = 5.4 \text{ (div)} \times 0.2 \text{ (ms/div)} = 1.08 \text{ ms}$

6. TIME DIFFERENCE MEASUREMENT

(1) Normal Procedures

The following describes normal procedures for measuring time difference between two signals synchronized to each other:

- 1) Apply two signals to CH1 and CH2 input connectors. Select ALT or CHOP of the VERTICAL MODE switches. Generally, ALT is used for high-frequency signals, while CHOP is used for low-frequency signals.
- 2) Set each control for normal sweep display. Select the faster of the two signals as the A SOURCE (reference signal), and adjust the VOLTS/DIV and SWEEP TIME/DIV to obtain easy-to-see waveform display. Set the VARIABLE of each channel and SWEEP TIME to the CAL condition.
- 3) Set the waveform to the center with each \blacktriangleup POSITION control. Then, set the reference signal to a vertical graduation line with the $\blacktriangleleft \blacktriangleright$ POSITION control.
- 4) Measure the horizontal distance between the two signals. Multiply this distance by the SWEEP TIME/DIV setting.

$$\text{Time} = \text{Horizontal distance (div)} \times \text{SWEEP TIME/DIV setting}$$

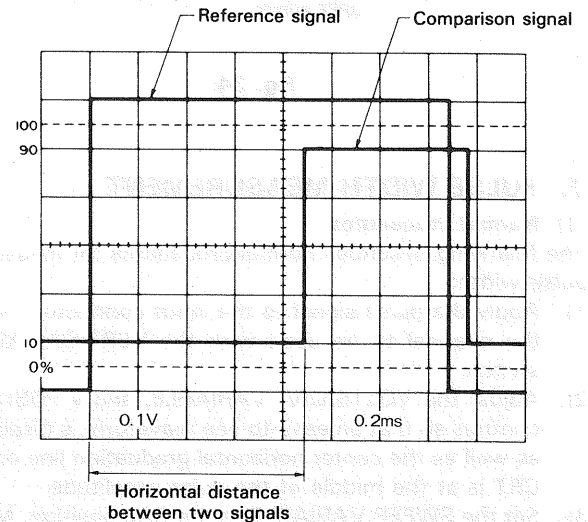

Fig. 33

[EXAMPLE]

In the example shown in Fig. 33, measured horizontal distance between two signals is 4.4 divisions. If the SWEEP TIME/DIV setting is 0.2 ms/div,
 $\text{Time difference} = 4.4 \text{ (div)} \times 0.2 \text{ (ms/div)} = 0.88 \text{ ms}$

(2) Cursor Measurement Procedures

- 1) Display the waveform to be measured in an easy-to-see position according to the normal procedures above.
- 2) Select the ΔT cursor mode with the CURSORS.
- 3) Align the ΔREF cursor to the left of the two points to be measured, and the Δ cursor to the right.
- 4) Measured value is displayed following ΔT in the upper right of the CRT.

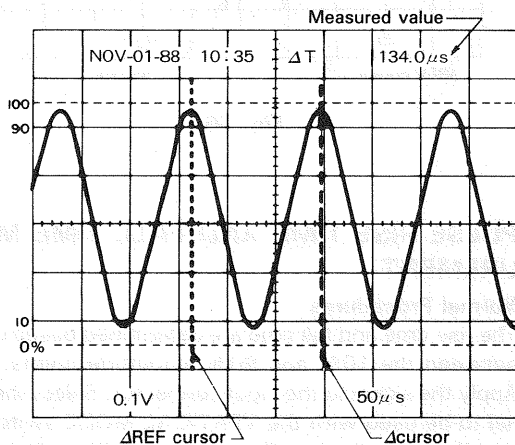

Fig. 32

(2) Cursor Measurement Procedures

- 1) Display the waveform to be measured in an easy-to-see position according to the normal procedures above.
- 2) Select the ΔT cursor mode with the CURSORS.
- 3) Align the ΔREF cursor to the left of the two points to be measured, and the Δ cursor to the right.
- 4) Measured value is displayed following ΔT in the upper right of the CRT.

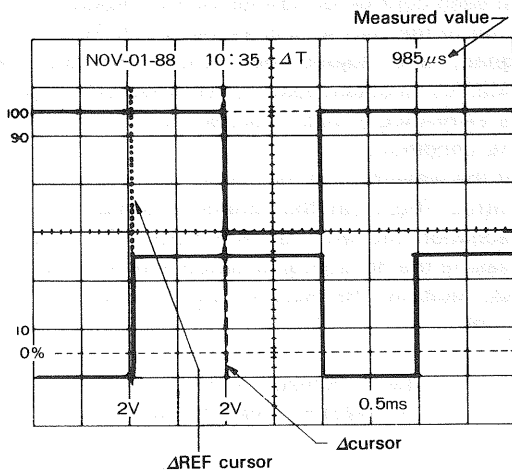

Fig. 34

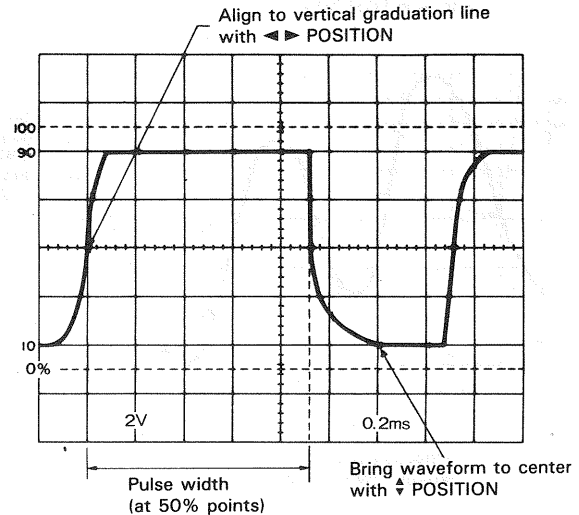

Fig. 35

(2) Cursor Measurement Procedures

- 1) Display the waveform to be measured in an easy-to-see position according to the normal procedures above.
- 2) Select the ΔT cursor mode with the CURSORS.
- 3) Align the ΔREF cursor to the left edge of the pulse to be measured, and the Δ cursor to the right edge.
- 4) Measured value is displayed following ΔT in the upper right of the CRT.

7. PULSE WIDTH MEASUREMENT

(1) Normal Procedures

The following describes normal procedures for measuring pulse width:

- 1) Apply the pulse signal to the input connector. Select the channel to be used with the VERTICAL MODE switch.
- 2) Adjust the VOLTS/DIV, VARIABLE, and \uparrow POSITION controls so that an easy-to-see waveform is displayed as well as the center horizontal graduation line on the CRT is at the middle of the pulse amplitude.
- 3) Set the SWEEP VARIABLE to the CAL position. Multiply the horizontal distance by the SWEEP TIME/DIV setting. Measure the distance between two points on the pulse waveform which cross the center horizontal line.

$$\text{Pulse width} = \text{Horizontal distance (div)} \times \text{SWEEP TIME/DIV setting}$$

[EXAMPLE]

In the example shown in Fig. 35, the horizontal distance of the center horizontal line segment crossing the pulse waveform is 4.6 divisions. If the SWEEP TIME/DIV setting is 0.2 ms/div,

$$\begin{aligned} \text{Pulse width} &= 4.6 \text{ (div)} \times 0.2 \text{ (ms/div)} \\ &= 0.92 \text{ ms} \end{aligned}$$

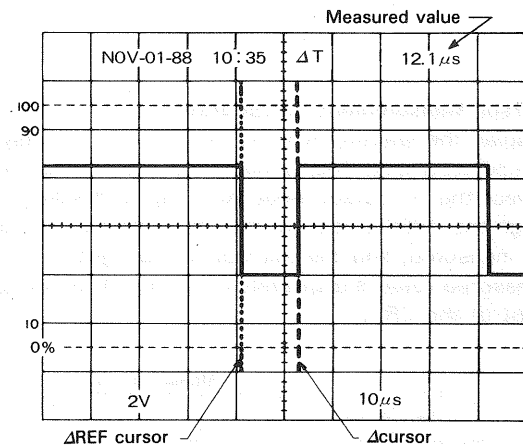

Fig. 36

8. PULSE RISE TIME AND FALL TIME MEASUREMENT

(1) Normal Procedures

The rise time and fall time are determined based on time between the 10% and 90% amplitude points.

- 1) Apply the signal to the input connector. Select the channel to be used with the VERTICAL MODE switch. Adjust the waveform peak-to-peak height to 5 divisions with the VOLTS/DIV and VARIABLE controls.
- 2) Adjust each control for normal sweep display. Center the waveform with the \uparrow POSITION control. Set the SWEEP TIME/DIV to as fast point as possible. Set the SWEEP TIME to CAL.

- 3) Adjust the 10% point to a vertical graduation line with the ◀▶ POSITION control. Measure the horizontal distance between the 10% and 90% points. Multiply this horizontal distance by the SWEEP TIME/DIV setting.

NOTE: The CRT provides graduation lines representing 0, 10, 90, and 100%, where 5 divisions = 100%. These lines should be used for this measurement.

$$\text{Rise time} = \text{Horizontal distance (div)} \times \text{SWEEP TIME setting}$$

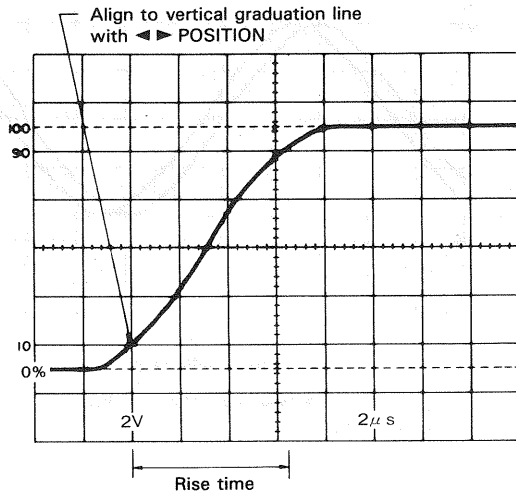

Fig. 37

[EXAMPLE]

In the example shown in Fig. 00, measured horizontal distance is 3.3 divisions. If SWEEP TIME/DIV setting is $2 \mu\text{s/div}$,

$$\text{Rise time} = 3.3 (\text{div}) \times 2 (\mu\text{s/div}) = 6.6 \mu\text{s}$$

Rise time and fall time can also be measured by changing item 3) above as follows:

- 4) Adjust the 10% point to the center vertical graduation line with the ◀▶ POSITION, and measure the horizontal distance to the point that crosses the center horizontal line. Let this distance be D_1 . Then, adjust the 90% point to the center vertical graduation line with the ◀▶ POSITION, and measure the horizontal distance to a point that crosses the horizontal graduation line likewise. Let this distance be D_2 .

The total horizontal distance is then $D_1 + D_2$. Multiply this total distance by the SWEEP TIME/DIV setting.

$$\text{Rise time} = (D_1 + D_2)(\text{div}) \times \text{SWEEP TIME/DIV setting}$$

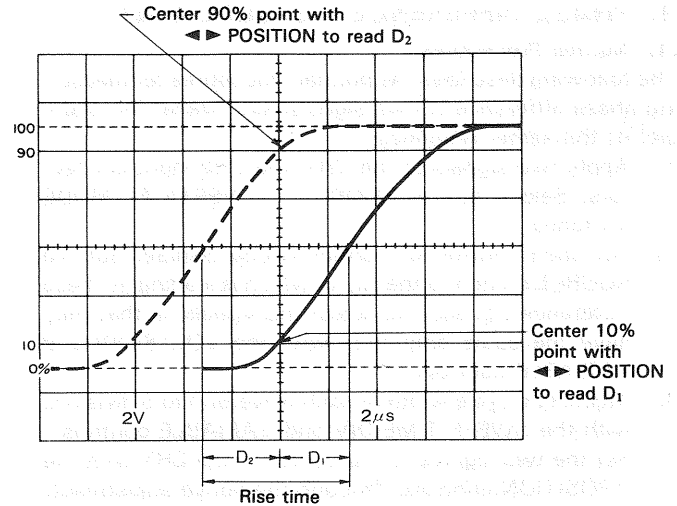

Fig. 38

[EXAMPLE]

In the example shown in Fig. 00, the measured D_1 is 1.6 divisions while D_2 is 1.4 divisions. If SWEEP TIME/DIV setting is $2 \mu\text{s}$,

$$\text{Rise time} = (1.6 + 1.4)(\text{div}) \times 2 (\mu\text{s/div}) = 6 \mu\text{s}$$

(2) Cursor Measurement Procedures

- 1) Adjust amplitude of the displayed waveform to 5 divisions through the normal procedures above. Control the ▲ POSITION so that the crest and trough of the wave are set to the 0% and 100% points respectively.
- 2) Select the ΔT cursor mode with the CURSORS.
- 3) Align the ΔREF cursor to the point where the waveform to be measured crosses the 10% graduation line and the Δ cursor to the point where the waveform crosses the 90% graduation line.
- 4) Measured value is displayed following ΔT in the upper right of the CRT.

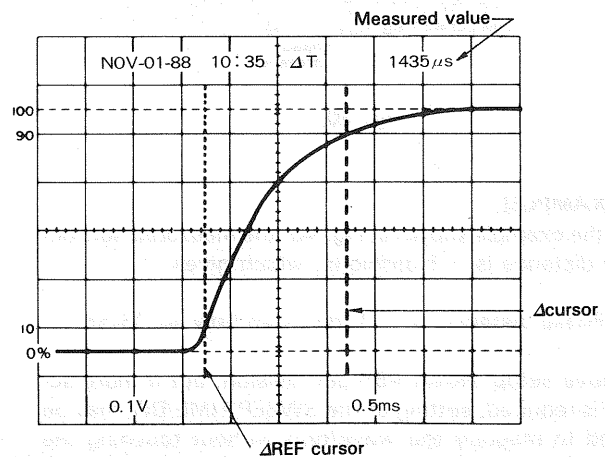

Fig. 39

9. PHASE DIFFERENCE MEASUREMENT

(1) Normal Procedures

The following describes the normal procedures for measuring phase difference of two signals (sine wave, for example) of the same frequency.

- 1) Apply two signals to the CH1 and CH2 input connectors. Select ALT or CHOP of the VERTICAL MODE switches.
- 2) Set each control for normal sweep display. Set the SOURCE switch to the signal which is leading in phase (reference signal), and adjust the signals so that they have the same amplitude with the VOLTS/DIV and VARIABLE controls.
- 3) Adjust one cycle width of each waveform to 8 divisions with the SWEEP TIME/DIV and VARIABLE controls. Set the two signals to the center of the CRT with the POSITION controls. Through the above adjustment, one division now represents 45° ($360^\circ/8 \text{ div}$). Thus, the sweep coefficient is given as $45^\circ/\text{div}$.
- 4) Measure the horizontal distance between the corresponding points on the two waveforms, and multiply the distance by the sweep coefficient ($45^\circ/\text{div}$).

$$\text{Phase difference (deg)} = \text{Horizontal distance (div)} \times 45^\circ/\text{div}$$

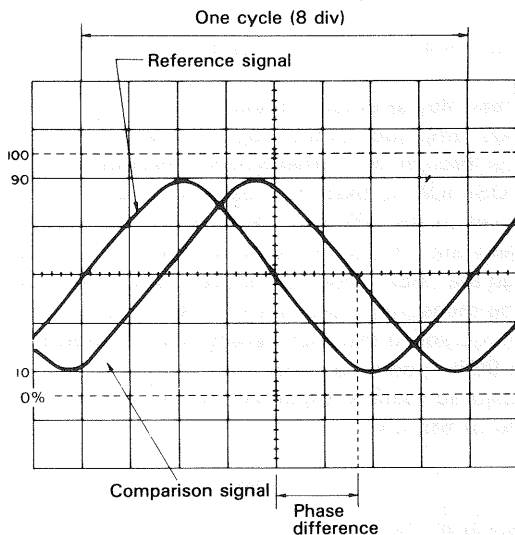

Fig. 40

[EXAMPLE]

In the example shown in Fig. 40, the measured horizontal distance is 1.7 divisions, which gives

$$\text{Phase distance} = 1.7 (\text{div}) \times 45^\circ/\text{div} = 76.5^\circ$$

The above setup allows 45° per division, but if more accuracy is required, setting of the SWEEP TIME/DIV may be changed to magnify the waveform without touching the VARIABLE control. If necessary, the TRIGGERING LEVEL control can be readjusted.

In this method, the phase difference can be determined as shown below from the relationship between the SWEEP TIME/DIV setting for 8 div/cycle and new SWEEP TIME/DIV setting made for better accuracy.

Phase difference

= Horizontal distance of new sweep range (div)

$\times 45^\circ/\text{div}$

$\times \frac{\text{new SWEEP TIME/DIV setting}}{\text{original SWEEP TIME/DIV setting}}$

For easy operation, use " $\times 10 \text{ MAG}$ ", which provides the sweep coefficient of 4.5° .

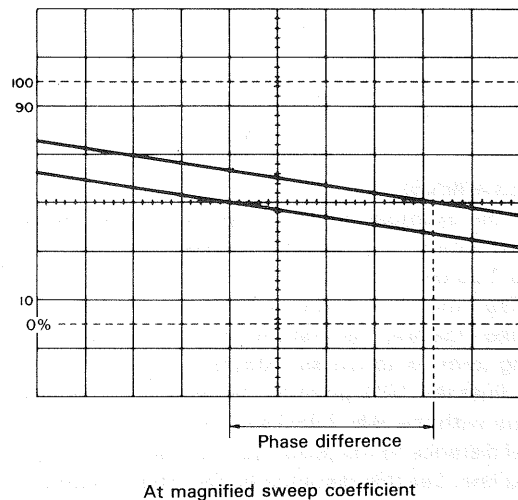
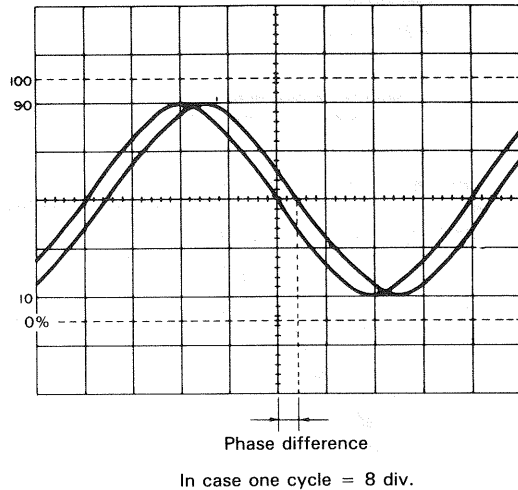

Fig. 41

(1) Cursor Measurement Procedures

- 1) Bring the waveform to be measured to an easy-to-see position according to items 1) and 2) of the normal procedures.
- 2) Adjust the one cycle width of each waveform to 5 divisions with the SWEEP TIME/DIV and VARIABLE controls. Bring the two signals to the center of the CRT with the POSITION controls.
- 3) Select the $1/\Delta T$ cursor mode with the CURSORS.
NOTE: Phase difference can be measured when the SWEEP TIME is not set to CAL.
- 4) Adjust the ΔREF cursor to the point where the signal with the leading phase crosses the center horizontal graduation line, and adjust the Δ cursor to the point where the signal with the delayed phase crosses the center horizontal graduation line.
- 5) Measured phase difference is displayed following PHASE in the upper right of the CRT.

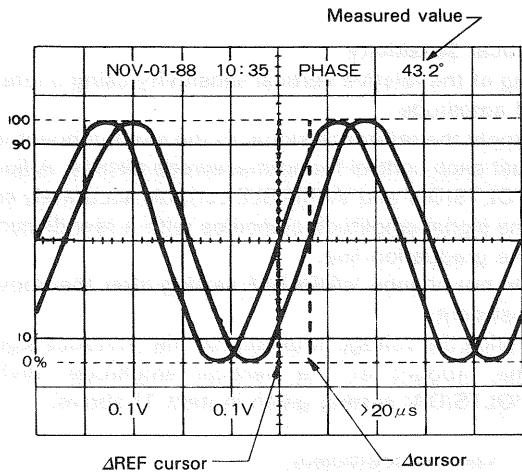

Fig. 42

10. TIME RATIO MEASUREMENT

The following describes procedures for measuring duty ratio of square waves, etc.

- 1) Apply the signal to the input connector. Select the channel to be used with the VERTICAL MODE, set the AC/DC switch to DC, deactivate the GND switch, and adjust each control for the normal sweep display. Then, adjust the VOLTS/DIV and SWEEP TIME/DIV to obtain proper waveform observation.
- 2) Adjust the one cycle width of the signal to 5 divisions with the SWEEP TIME VARIABLE. If necessary, use the ◀ ▶ POSITION.
- 3) Select the ΔT cursor mode with the CURSORS.
NOTE: Time ratio can be measured if the SWEEP TIME is not set to CAL.
- 4) Adjust the Δ REF cursor to the left of the points to be measured and the Δ cursor to the right.
- 5) Measured duty ratio supposing 5 divisions as 100% is displayed in percentage following RATIO in the upper right of the CRT.

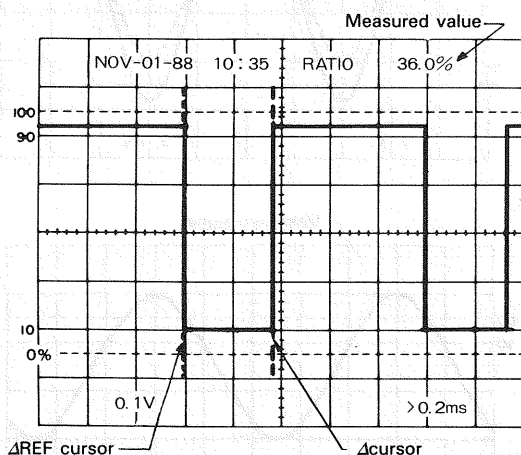

Fig. 43

11. FREQUENCY MEASUREMENT

(1) Normal Procedures

Since frequency is a reciprocal of a period, it can be determined by measuring time of one cycle.

- 1) Measure time of one cycle according to the procedures mentioned in section 5 TIME MEASUREMENT. The measured time is a period of the signal.
- 2) Calculate a reciprocal of the measured time to determine frequency as follows:

$$\text{Frequency} = \frac{1}{\text{Period}}$$

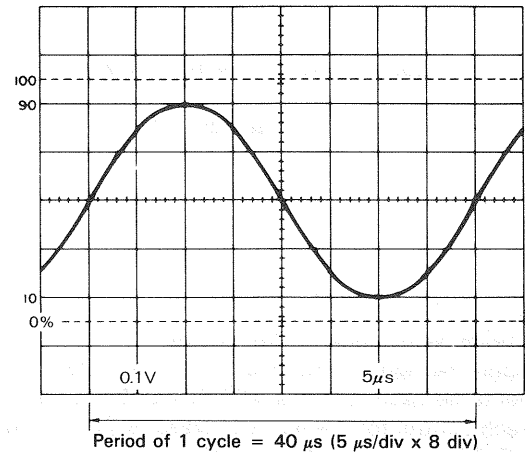

Fig. 44

[EXAMPLE]

Supposing the measured period is $40 \mu\text{s}$ and SWEEP TIME/DIV setting is $5 \mu\text{s}/\text{div}$ in the example shown in Fig. 00,

$$\text{Frequency} = \frac{1}{40 \times 10^{-6}} = 2.5 \times 10^4 = 25 \text{ kHz}$$

The above method shows how to determine frequency based on a measured period of a cycle. Frequency can also be determined by counting the number of cycles on the CRT.

- 1) Apply the signal to the input connector. Select the channel to be used with the VERTICAL MODE, and adjust each control for the normal sweep display. Set the VARIABLE used channel and SWEEP TIME to CAL condition.
- 2) Count the number of cycles between any vertical graduation lines. Find time of the cycles from the horizontal distance between the lines and SWEEP TIME/DIV setting. Multiply a reciprocal of the time by the number of cycles. This method, however, will cause measurement errors for signals with a few number of cycles.

$$\text{Frequency} = \frac{\text{Number of cycles}}{\text{Horizontal distance} \times \text{SWEEP TIME/DIV setting}}$$

[EXAMPLE]

In the example shown in Fig. 45, 10 cycles cover 7 divisions.

If SWEEP TIME/DIV setting is $5 \mu\text{s}/\text{div}$,

$$\text{Frequency} = \frac{10}{7 (\text{div}) \times 5 (\mu\text{s}/\text{div})} \cong 285.7 \text{ kHz}$$

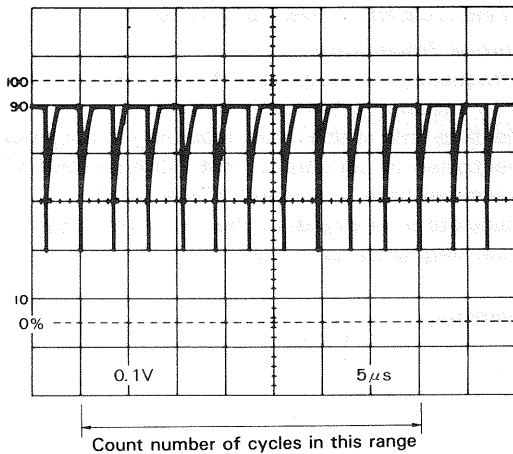

Fig. 45

(2) Cursor Measurement Procedures

- 1) Apply the signal to the input connector. Select the channel to be used with the VERTICAL MODE, and adjust each control for the normal sweep display. Adjust the VOLTS/DIV and SWEEP TIME/DIV to obtain proper waveform display. Set the VARIABLE used channel and SWEEP TIME to CAL condition.
- 2) Select the 1/ΔT cursor mode with the CURSORS.
- 3) Adjust the ΔREF cursor to the left of the points to be measured and the Δcursor to the right.
- 4) Measured value is displayed following 1/ΔT in the upper right of the CRT.

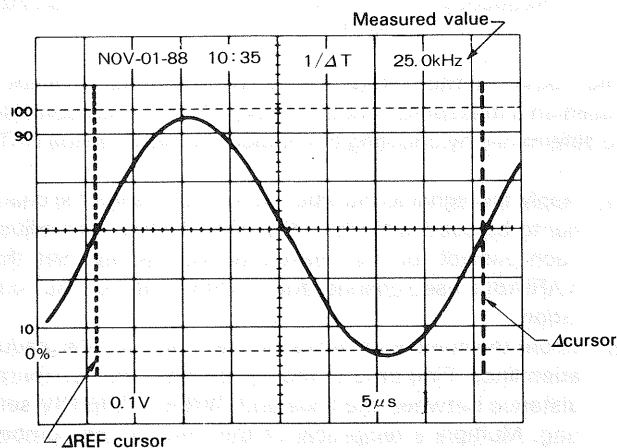

Fig. 46

12. RELATIVE MEASUREMENT

If the frequency and amplitude of the reference signal are known, voltage and frequency of an unknown signal can be measured without use of the VOLTS/DIV and SWEEP TIME/DIV controls. This measurement uses the relative unit determined by the reference signal for measurement of an unknown signal.

*** Vertical Sensitivity**

Setting of the relative vertical sensitivity using a reference signal amplitude

- 1) Apply the reference signal to the input connector. Adjust each control for normal sweep display. Adjust the VOLTS/DIV and VARIABLE controls accurately so that the signal amplitude coincides with a few divisions of the graduation line. Do not change VARIABLE setting after the above adjustment.
- 2) Divide the voltage amplitude of the reference signal by the product of the vertical amplitude (div) and VOLTS/DIV setting given in item 1) above.

$$\text{Vertical coefficient} = \frac{\text{Reference signal voltage (V)}}{\text{Vertical amplitude (div) x VOLTS/DIV setting}}$$

- 3) Discontinue applying the reference signal and apply the unknown signal to the input connector. Adjust the VOLTS/DIV to obtain proper waveform observation. Measure the waveform amplitude, and calculate the voltage of the unknown signal using the following equation:

$$\text{Voltage of unknown signal} = \text{Vertical distance (div) x vertical coefficient} \times \text{VOLTS/DIV setting}$$

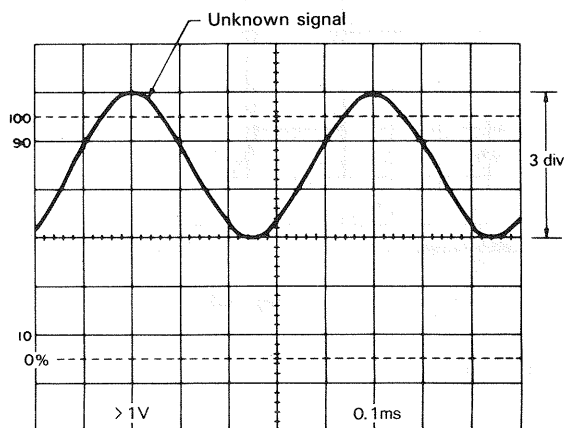
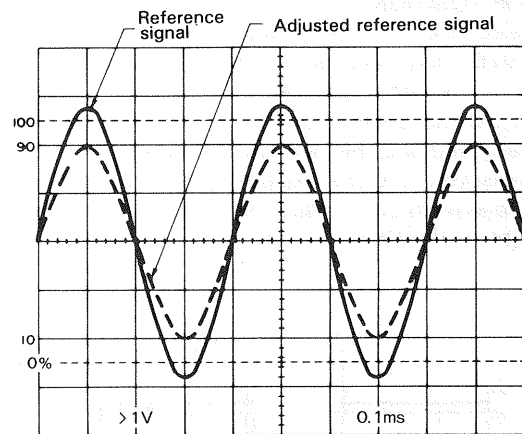

Fig. 47

[EXAMPLE]

In the example shown in Fig. 47, the VOLTS/DIV setting is 1 V/div and the reference signal is 2 Vrms. Adjust the VARIABLE so that the amplitude of the reference signal is 4 div.

$$\text{Variable coefficient} = \frac{2 \text{ Vrms}}{4 \text{ (div)} \times 1 \text{ (V/div)}} = 0.5$$

Then, measure the unknown signal. Supposing the vertical amplitude is 3 divisions,
Effective value of the unknown signal

$$= 3 \text{ (div)} \times 0.5 \times 1 \text{ (V/div)} = 1.5 \text{ Vrms}$$

*** Period**

Setting of relative sweep coefficient using reference frequency

- 1) Apply the reference signal to the input connector. Adjust each control for normal sweep display. Then, adjust the VOLTS/DIV and VARIABLE to obtain proper waveform observation. Adjust the SWEEP TIME/DIV and VARIABLE controls accurately so that one cycle width coincides with a few divisions of the graduation line. Do not change VARIABLE setting after the above adjustment.
- 2) Divide the period of the reference signal frequency by the product of the horizontal distance (in divisions) and SWEEP TIME/DIV setting given in item 1) above.

$$\text{Horizontal coefficient} = \frac{\text{Period of reference signal (sec)}}{\text{Horizontal distance (div)} \times \text{SWEEP TIME/DIV setting}}$$

- 3) Discontinue applying the reference signal and apply the unknown signal to the input connector. Adjust the SWEEP TIME/DIV for easy observation. Measure the horizontal distance of one cycle and calculate the period of the unknown signal using the following equation:

$$\text{Period of unknown signal} = \text{Horizontal distance (div)} \times \text{horizontal coefficient} \times \text{SWEEP TIME/DIV setting}$$

[EXAMPLE]

In the example shown in Fig. 48, SWEEP TIME/DIV setting is 0.1 ms/div and a reference signal of 1.75 kHz is applied. Adjust the VARIABLE so that the distance of one cycle is 5 divisions.

$$\text{Horizontal coefficient} = \frac{1}{5 \text{ (div)} \times 0.1 \text{ (ms/div)}} = \frac{1}{0.5 \text{ (ms)}} = 2 \text{ (ms/div)}$$

The unknown signal is then measured. If the horizontal distance is 7 divisions,

$$\text{Pulse width} = 7 \text{ (div)} \times 2 \text{ (ms/div)} = 14 \text{ ms}$$

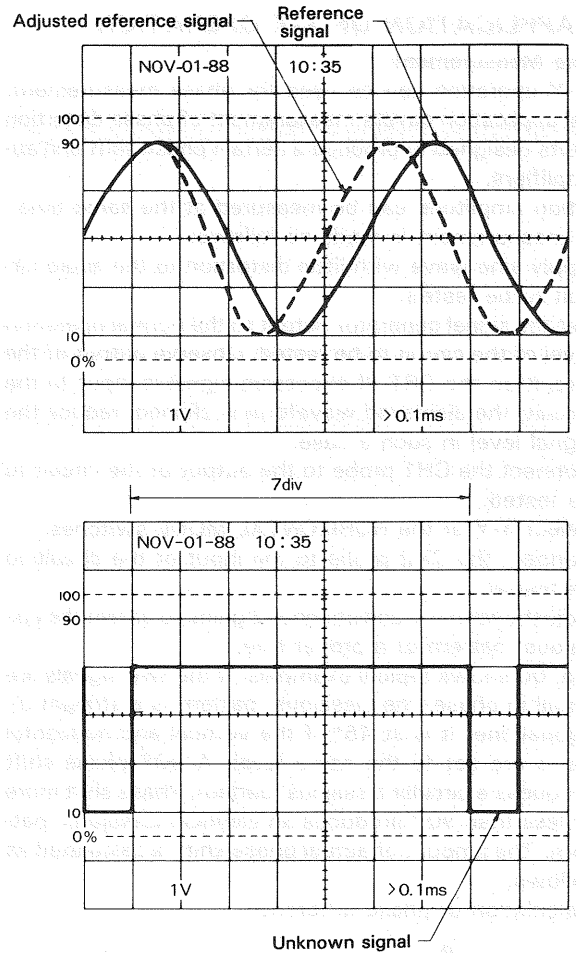

Fig. 48

13. APPLICATION OF X-Y OPERATION

* Phase Measurement

The X-Y operation can be used for phase measurement. Typical application covers measurement of phase distortion in circuits designed to produce a certain phase shift and audio amplifiers.

Distortion amplitude can be measured at the same time. Phase measurement is made as follows:

- 1) Apply sine wave with little distortion to the audio circuit to be tested.
- 2) Set the signal generator output to the normal operation level of the circuit to be tested. Observe output of the circuit on the CRT. If excessive signal is input to the circuit, the displayed waveform is clipped; reduce the signal level in such a case.
- 3) Connect the CH1 probe to the output of the circuit to be tested.
- 4) Select X-Y of the HORIZONTAL MODE switches.
- 5) Connect the CH2 probe to the input of the circuit to be tested.
- 6) Adjust channel-1 and channel-2 gains to obtain the Lissajous' pattern of a proper size.
- 7) Fig. 00 shows typical examples. If the two signals are equal in phase, the Lissajous' pattern is a straight diagonal line. It is at 45° if the vertical and horizontal gains are set to the same level. A 90° phase shift produces a circular Lissajous' pattern. Phase shift more or less than 90° produces an elliptical Lissajous' pattern. The amount of actual phase shift is calculated as follows:

Calculation of phase difference:

$$\sin \phi = \frac{B}{A} \quad \text{Where } \phi = \text{phase angle}$$

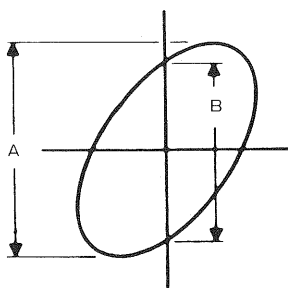

Fig. 49

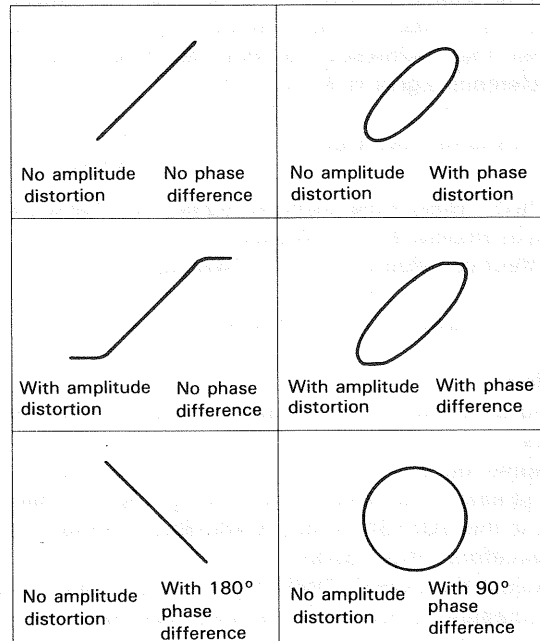

Fig. 50 Typical Display of Phase Measurement

* Frequency Measurement

In addition to the phase measurement, frequency can be measured from the Lissajous' pattern.

- 1) Apply sine wave of known frequency to the CH2 input connector of the oscilloscope. Select X-Y of the HORIZONTAL MODE switches.
- 2) Connect the CH1 probe to the unknown signal.
- 3) Adjust the channel-1 and channel-2 gains.
- 4) The resulting Lissajous' pattern shows the ratio between the two frequencies.

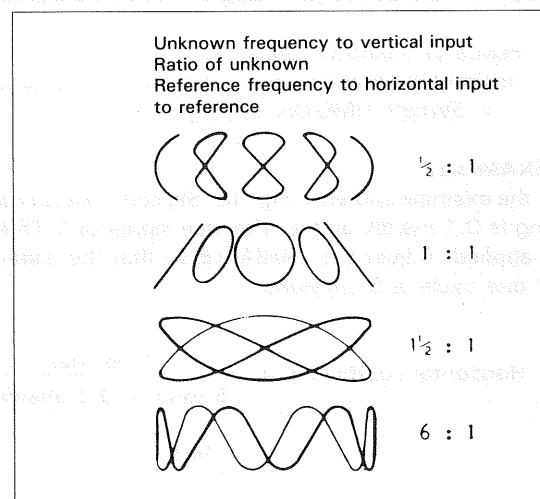

Fig. 51 Lissajous' Pattern used for Frequency Measurement

14. PULSE JITTER MEASUREMENT

Pulse jitter can be measured as follows:

(1) Normal Procedures

- 1) Apply the signal to the input connector. Select the channel to be used with the VERTICAL MODE. Adjust each control for normal sweep display. Then, adjust the VOLTS/DIV control to obtain proper waveform display. Especially, the trigger-related controls must be carefully adjusted for stable display. Set the A SWEEP TIME to CAL.
- 2) Select A INT B of the HORIZONTAL MODE switches. Set the B SOURCE to AFT.D. Adjust the DELAY POSITION so that the pulse to be measured is intensity-modulated.
- 3) Adjust the B SWEEP TIME/DIV so that the whole portion where jitters are produced is intensity-modulated.
- 4) Select B of the HORIZONTAL MODE switches. Measure the horizontal deviation of the jittered pulses. Time of jitters can be determined by multiplying this horizontal distance by B SWEEP TIME/DIV setting.

$$\text{Pulse jitter} = \frac{\text{Horizontal distance of jitters (div)}}{\text{B SWEEP TIME/DIV setting}}$$

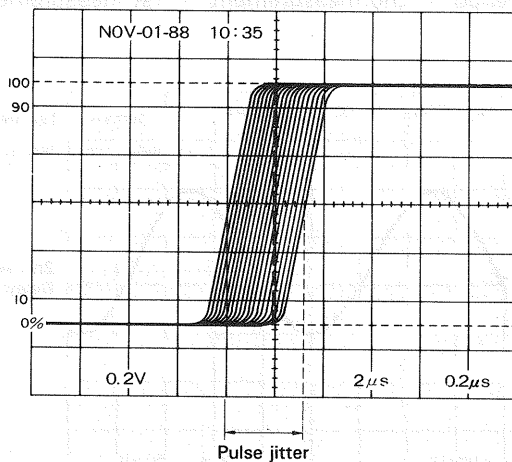

Fig. 52

[EXAMPLE]

In the example shown in Fig. 52, the jitter width is 1.6 divisions. If B SWEEP TIME/DIV setting is $0.2 \mu\text{s}$.

$$\text{Pulse jitter} = 1.6 (\text{div}) \times 0.2 (\mu\text{s}) = 0.32 \mu\text{s}$$

(2) Cursor Measurement Procedures

- 1) Display the waveform to be measured on the CRT according to items 1) to 3) of the normal procedures.
- 2) Select B of the HORIZONTAL MODE switches. Also select the ΔT cursor mode.
- 3) Adjust the ΔREF cursor to the left of the two points to be measured and the Δ cursor to the right.
- 4) Measured value is displayed following ΔT in the upper right of the CRT.

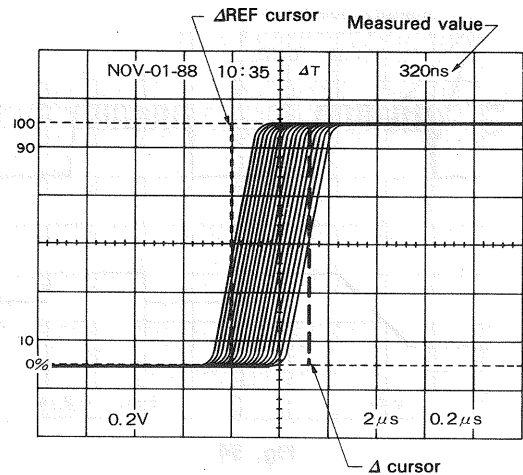

Fig. 53

15. Sweep Magnification

The apparent magnification of the delayed sweep operation depends on setting of the A and B SWEEP TIME/DIV controls.

- 1) Apply the signal to the input connector. Select the channel to be used with the VERTICAL MODE. Adjust each control for normal sweep display. Adjust the VOLTS/DIV to obtain proper waveform display.
- 2) Adjust the A SWEEP TIME/DIV to display several cycles of waveform on the CRT. Then, set the B SOURCE switch to AFT.D. By selecting then A INT B of the HORIZONTAL MODE switches, the part to be magnified is intensity-modulated and displayed brilliantly.
- 3) Move the intensity-modulation part to the part to be magnified with the DELAY POSITION. Adjust the B SWEEP TIME/DIV so that the whole part to be magnified is intensity-modulated.
- 4) Select ALT or B of the HORIZONTAL MODE switches. Move the waveform to an easy-to-see position with the Δ POSITION and TRACE SEP controls.
- 5) Time measurement can be executed under the condition where the B sweep trace is displayed in the same manner as the A sweep. Setting of the B SWEEP TIME/DIV is the sweep ratio for this measurement. To find the apparent magnification of the magnified waveform, divide A SWEEP TIME/DIV setting by B SWEEP TIME/DIV setting.

Apparent magnification of sweep ratio

$$= \frac{\text{A SWEEP TIME/DIV setting}}{\text{B SWEEP TIME/DIV setting}}$$

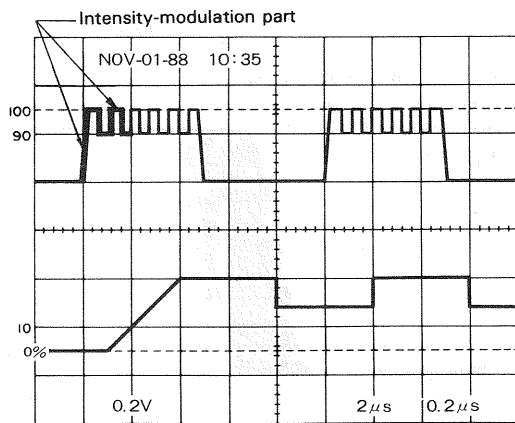

Fig. 54

[EXAMPLE]

In the example shown in Fig. 54, if A SWEEP TIME/DIV setting is $2 \mu\text{s}$ and B SWEEP TIME/DIV setting is $0.2 \mu\text{s}$.

$$2 \times 10^{-6}$$

Apparent magnification =

$$= 10$$

$$0.2 \times 10^{-6}$$

In the above delayed sweep magnification, raising the apparent magnification will produce delayed jitters. To obtain stable display, reset the selected AFT.D of the B SOURCE and carry out measurement in the trigger mode (CH1 to CH4).

- 1) Carry out adjustment in items 1) to 3) above.
- 2) Reset AFT.D of the B SOURCE. Set the B SOURCE to the same source signal as that of the A SOURCE. Adjust the B LEVEL to obtain stable display of the intensity-modulated part.
- 3) Select ALT or B of the HORIZONTAL MODE switches. The apparent magnification can be determined as mentioned in the above section.

16. MEASUREMENT OF DELAYED SWEEP TIME

Using the B sweep operation, time can be measured accurately.

- 1) Apply the signal to the input connector. Select the channel to be used with the VERTICAL MODE. Adjust each control for normal sweep display. Adjust the VOLTS/DIV to obtain proper waveform display. Set the A SWEEP TIME to CAL.
- 2) Adjust the A SWEEP TIME/DIV to display the part to be measured. Select A INT B of the HORIZONTAL MODE switches. Set the B SOURCE switch to AFT.D. Then, adjust the B SWEEP TIME/DIV to minimize the intensity-modulation part.
- 3) Adjust the \updownarrow POSITION so that the waveform crosses the center horizontal graduation line. Adjust the DELAY POSITION so that the intensity-modulation part is in contact with the center horizontal graduation line. Make a record of a measured value following DELAY in the upper right of the CRT.
- 4) Adjust the DELAY POSITION so that the intensity-modulation part coincides with the same point on the next waveform. Subtract the first measurement from the second measurement to determine the period of the waveform.

$$\text{Period} = 2\text{nd measurement} - 1\text{st measurement}$$

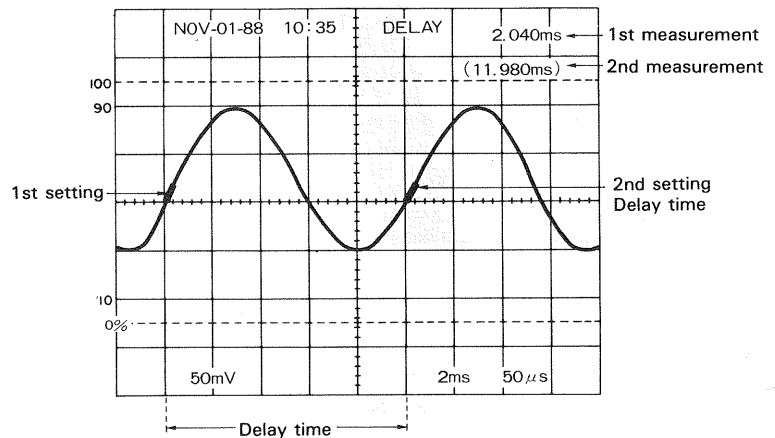

Fig. 55

[EXAMPLE]

In the example shown in Fig. 55, if the first measurement is 2.040 ms, the second measurement is 11.980 ms, and A SWEEP TIME/DIV setting is 2 ms.

$$\text{Period} = 11.980 - 2.040 = 9.940 \text{ ms}$$

17. PULSE WIDTH MEASUREMENT USING DELAYED SWEEP

High-accuracy pulse width can be measured in the same manner as the time measurement.

- 1) Apply the pulse signal to the input connector. Select the channel to be used with the VERTICAL MODE.
- 2) Adjust each control for normal sweep display. Adjust the VOLTS/DIV, VARIABLE, and \updownarrow POSITION so that the pulse waveform can be easily observed and the center horizontal graduation line is in the center of amplitude of the pulse. Set the A SWEEP TIME to CAL.
- 3) Rotate the A SWEEP TIME/DIV to display the part to be measured. Select A INT B of the HORIZONTAL MODE switches, and set the B SOURCE switch to AFT.D. Adjust the B SWEEP TIME/DIV to minimize the intensity-modulation part.
- 4) Adjust the DELAY POSITION so that the intensity-modulation part is in contact with the center horizontal graduation line. Make a record of a measurement displayed following DELAY in the upper right of the CRT.
- 5) Adjust the DELAY POSITION so that the trailing edge of the pulse is intensity-modulated in contact with the center horizontal graduation line. Determine the pulse width by subtracting the first measurement from the second measurement.

$$\text{Pulse width} = \text{2nd measurement} - \text{1st measurement}$$

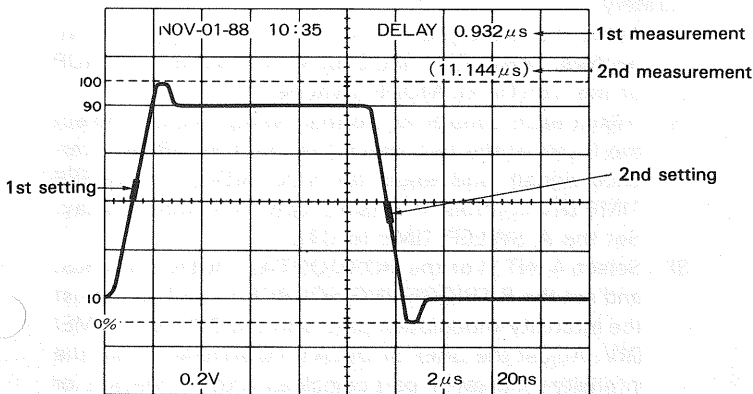

Fig. 56

[EXAMPLE]

In the example shown in Fig. 56, if the first measurement is $0.932 \mu\text{s}$, the second measurement is $11.144 \mu\text{s}$, and A SWEEP TIME/DIV setting is $2 \mu\text{s}$.

$$\text{Pulse width} = 11.144 - 0.932 = 10.212 \mu\text{s}$$

18. FREQUENCY MEASUREMENT USING DELAYED SWEEP

Since frequency is a reciprocal of a period, it can be determined by measuring time of one cycle.

- 1) Measure the period in the time measurement procedures using the delayed sweep mentioned above.
- 2) Calculate a reciprocal of the measured period to determine frequency as follows:

$$\text{Frequency} = \frac{1}{\text{Period}}$$

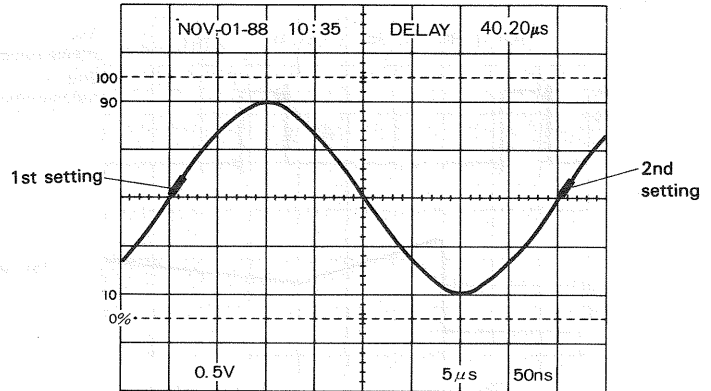

Fig. 57

[EXAMPLE]

Supposing the measured period is $40.20 \mu\text{s}$ in the example shown in Fig. 57,

$$\text{Frequency} = \frac{1}{40.20 \times 10^{-6}} = 24.88 \text{ kHz}$$

19. PULSE REPETITION TIME MEASUREMENT

The pulse repetition time can be measured accurately using the delayed sweep operation.

- 1) Apply the signal to the input connector. Select the channel to be used with the VERTICAL MODE. Adjust each control for normal sweep display. Adjust the VOLTS/DIV control to obtain proper waveform display.
- 2) Rotate the A SWEEP TIME/DIV to display more than two cycles of waveform. Select A INT B of the HORIZONTAL MODE switches, and set the B TRIGGERING SOURCE switch to AFT.D. Set the B SWEEP TIME/DIV to as fast value as possible.
- 3) Adjust the DELAY POSITION so that the intensity-modulation part coincides with the first pulse. Select ALT of the HORIZONTAL MODE switches, and adjust the B sweep trace to an easy-to-see position with the TRACE SEP control.
- 4) Adjust the pulse to a proper vertical graduation line with the DELAY POSITION, and make a record of the measurement displayed following DELAY in the upper right of the CRT.
- 5) Adjust the second pulse to the same vertical graduation line as in the above item with the DELAY POSITION. The pulse repetition time can be determined by subtracting the first measurement from the second measurement.

$$\text{Repetition time} = \text{2nd measurement} - \text{1st measurement}$$

Read measurements when AFT.D B sweep traces ① and ② are adjusted to same position

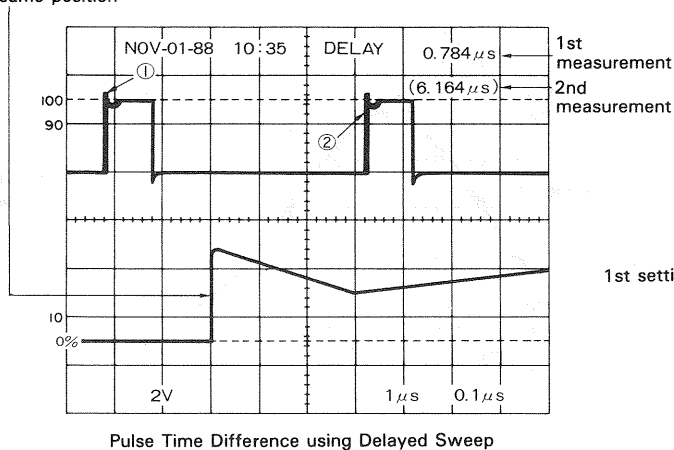

Fig. 58

[EXAMPLE]

In the example shown in Fig. 58, if the first measurement is $0.784 \mu\text{s}$ and the second measurement is $6.164 \mu\text{s}$.

$$\text{Repetition time} = 6.164 - 0.784 = 5.38 \mu\text{s}$$

20. RISE AND FALL TIME MEASUREMENT USING DELAYED SWEEP

(1) Normal Procedures

The rise time and fall time are determined based on time between the 10% and 90% amplitude points.

- 1) Apply the signal to the input connector. Select the channel to be used with the VERTICAL MODE switch. Adjust the waveform peak-to-peak height to 5 divisions with the VOLTS/DIV and VARIABLE controls.
- 2) Adjust each control for normal sweep display. Center the waveform with the POSITION control. Set the SWEEP TIME/DIV to as fast point as possible. Set the A SWEEP TIME to CAL.
- 3) Select A INT B of the HORIZONTAL MODE switches, and set the B SOURCE to AFT.D. Adjust the B SWEEP TIME/DIV to minimize the intensity-modulation part.
- 4) Adjust the DELAY POSITION so that the 10% point on the waveform is intensity-modulated. Make a record of the measurement following DELAY in the upper right of the CRT.
- 5) Then, adjust the DELAY POSITION so that the 90% point on the waveform is intensity-modulated. The rise time and fall time can be determined by subtracting the first measurement from the second measurement.

$$\text{Rise (fall) time} = \text{2nd measurement} - \text{1st measurement}$$

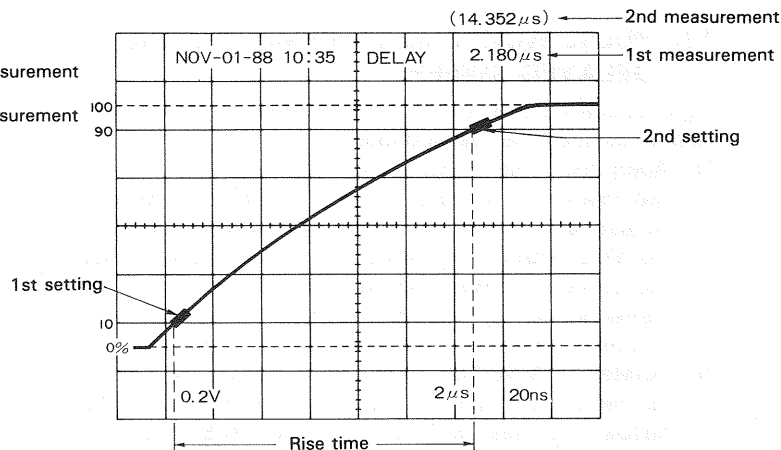

Fig. 59

[EXAMPLE]

In the example shown in Fig. 59, the first measurement (10% point) is $2.180 \mu\text{s}$ and the second measurement (90% point) is $14.352 \mu\text{s}$,

$$\text{Rise time} = 14.352 - 2.180 = 12.172 \mu\text{s}$$

21. TIME DIFFERENCE MEASUREMENT USING DELAYED SWEEP

Using the delayed sweep operation, time difference of signals synchronized with each other can be measured accurately.

- 1) Apply the two signals to the CH1 and CH2 input connectors. Select CH1 and CH2 as well as ALT or CHOP of the VERTICAL MODE switches.
- 2) Adjust each control for normal sweep display. Select the faster of the two signals as the A SOURCE (reference signal), and adjust the VOLTS/DIV and SWEEP TIME/DIV controls to obtain proper waveform display. Set the A SWEEP TIME to CAL.
- 3) Select A INT B of the HORIZONTAL MODE switches, and set the B TRIGGERING SOURCE to AFT.D. Adjust the intensity-modulation part with the B SWEEP TIME/DIV. Adjust the ΔREF or DELAY POSITION so that the intensity-modulation part coincides with the leading (or trailing) edge of the reference pulse.
- 4) Select ALT of the HORIZONTAL MODE switches. Adjust the B sweep trace to an easy-to-see point with the TRACE SEP control.
- 5) Adjust the DELAY POSITION so that the corresponding part of the comparison signal is set to the same segment of the vertical graduation line.

Time difference can be determined by subtracting the measurement of the reference signal displayed following DELAY in the upper right of the CRT from measurement of the comparison signal displayed following DELAY.

$$\text{Time difference} = \text{Measurement of comparison signal} - \text{measurement of reference signal}$$

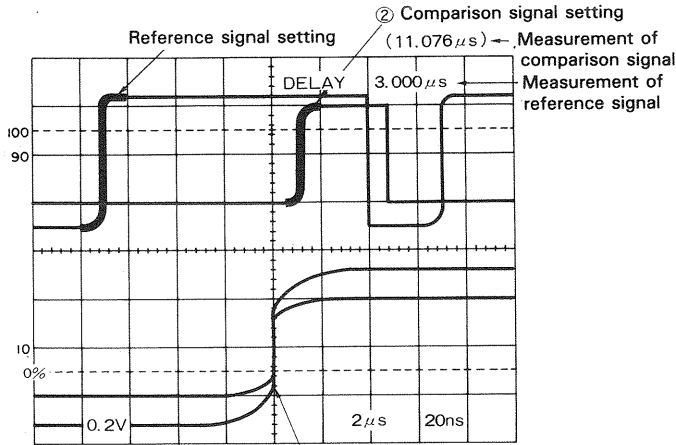

Read measurements when AFT.D B sweep traces 1 and 2 are adjusted to same position

Fig. 60

[EXAMPLE]

In the example shown in Fig. 60, if the measurement of the reference signal is $3.000 \mu\text{s}$ and the measurement of the comparison signal is $11.076 \mu\text{s}$.

$$\text{Time difference} = 11.076 - 3.000 = 8.076 \mu\text{s}$$

22. APPLICATION OF MULTI-TRACE OPERATION

The CS-6020 provides calibrated sensitivity and wide frequency bandwidth up to 150 MHz for CH1 to CH4. The CH3 and CH4 trigger signals are output from the pre-amplifier, and can be used as the external trigger signals for CH1 and CH2. In addition, the CS-6020 can be used as a quadri-trace oscilloscope.

It features the following applications:

- 1 Checking timing of logic signals
- 2 Monitoring video signals
- 3 Measurement of gain and phase characteristics of audio signals

The following describes, among others, how to check timing of logic signals:

Example of timing display of logic signals

Setting of controls

VERTICAL MODE: CH1, CH2, CH3, CH4,
A SOURCE: CH3
HORIZONTAL MODE: A

* In this case, the signal is triggered by channel-3 signal with the longest period for stable synchronization.

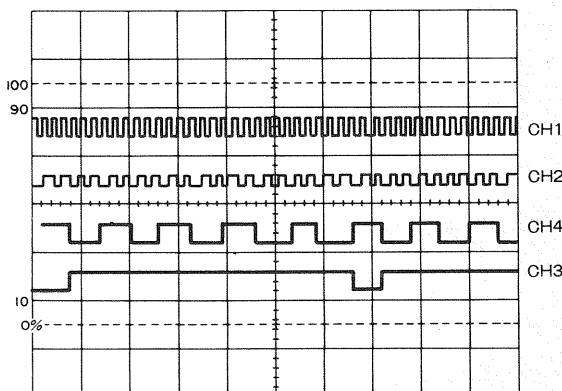

Fig. 61

If ALT of the HORIZONTAL MODE switches is selected in the above example, traces of the main sweep and delayed sweep are displayed on the CRT simultaneously. The intensity-modulated part of the main sweep is magnified, enabling details to be observed.

Example of simultaneous display of main sweep and delayed sweep (at $\times 10$ magnification)

Setting of controls

VERTICAL MODE: CH1, CH2, CH3, CH4
A SOURCE: CH3
B SOURCE: AFT.D

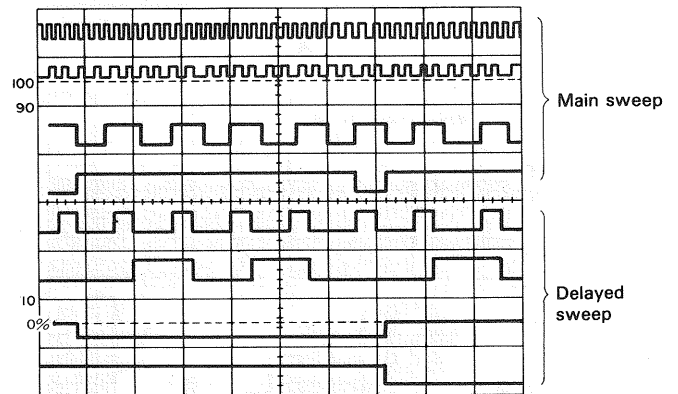

Fig. 62

23. TRIGGER COUNTER APPLICATIONS (CS-6020 only)

(1) Observation of TV Signals

- 1) Apply the signal to the input connector. Select the channel to be used with the VERTICAL MODE switch. Adjust each control for normal sweep display. Then, adjust the VOLTS/DIV control to obtain proper waveform display.

Set the A VARIABLE to CAL.

[EXAMPLE]

Setting of controls

Input signal: CH1
VERTICAL MODE: CH1
HORIZONTAL MODE: A
A SOURCE: VERT (CH1) or CH1
A COUPLE: TV FRAME
A SWEEP TIME/DIV: 5 ms

- 2) Select A INT B of the HORIZONTAL MODE switches. Set the B SOURCE switch to the same channel as the A SOURCE. (In the above example, the B SOURCE shall be set to CH1.) The B COUPLING is automatically set to TV LINE.
- 3) Press the TRIG COUNT switch, and set a desired count value with the Δ REF or DELAY POSITION.

NOTE: The trigger counter counts all of the equalizing pulses, vertical synchronizing pulses, and horizontal synchronizing pulses of the TV signals. Thus, the actual line No. is different from the reading of the trigger counter.

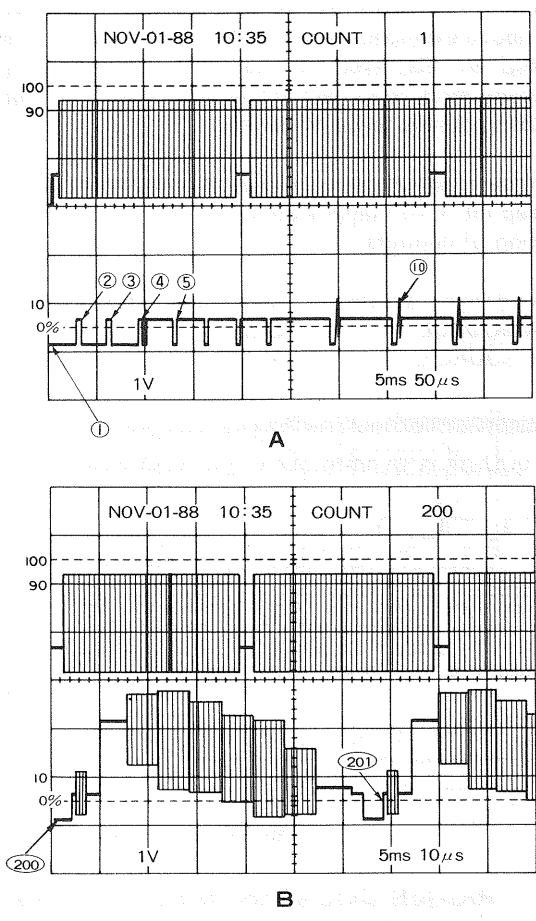

Fig. 63

[EXAMPLE]

The above example shows an example of TV FRAME observation with the trigger counter set to 1. If the count value is changed to 2, 3, 4, 5, and so on, the B sweep starts from point 2, 3, 4, 5, ... , respectively. The above drawings represent the 200th count of the image signal from count 1.

ADJUSTMENT

HOW TO CHANGE SETTING OF READOUT CALENDAR AND CLOCK

To turn on and off the calendar and clock display or change their setting, follow the procedures below.

- (1) Press A and X-Y of the HORIZONTAL MODE switches (shaded switches in the figure) simultaneously. (For functions of the HORIZONTAL MODE switches, refer to section 00.) LEDs in the A and X-Y switches light up. If this condition is left without executing any of operations (2), (3), and (5) below, the previous state is restored after approx. 5 seconds automatically.

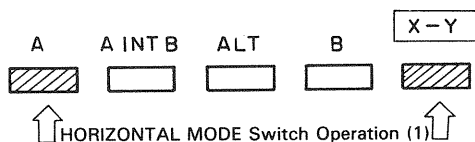

Fig. 64

- (2) To turn off the calendar and clock display, press B of the HORIZONTAL MODE switches (shaded switch in the figure) after operation (1).

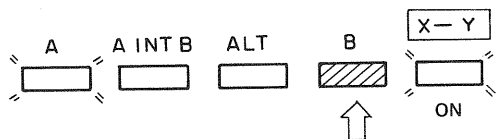

Fig. 65

- (3) To turn on the calendar and clock display again, press B of the HORIZONTAL MODE switches (shaded switch in the figure) after operation (1).
- (4) To correct the calendar and clock setting, follow the steps below. The calendar and clock display must be turned on for this correction.

- (1) Press A INT B switch (shaded switch in the figure) after operation (1). "Month" of the calendar and clock display flashes.

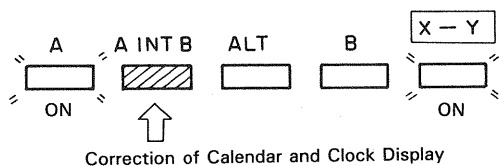

Fig. 66

- (2) Rotate the SWEEP TIME/DIV control to set a proper month.
- (3) Pressing the X-Y switch shifts the flashing position to the right. The second digit of the "Day" of the display now flashes.
- (4) Set the second digit of the "Day" by rotating the SWEEP TIME/DIV control.
- (5) Repeat operations (3) and (4) to set proper values to the first digit of the "Minute".
- (6) On completion of setting up to the first digit of the "Minute", press the X-Y switch again. Correction of the calendar and clock display is completed, and the previous state is restored. "Minute" is counted from 0 second at this time.

Example: Correction of Calendar and Clock Display.

- (1) Make "Month" display flash.

"JAN" - 22 - 78 15 : 38



Flashing

- (2) Set "Month".

"NOV" - 22 - 78 15 : 38



Flashing

- (3) Shift flashing position to the right.

NOV - "2"2 - 78 15 : 38



Flashing

- (4) Set second digit of "Day".

NOV - "1"2 - 78 15 : 38



Flashing

- (5) Shift flashing position to the right.

- (6) Set second digit of "Year".

NOV - 15 - "8"8 15 : 38



Flashing

- (7) Shift flashing position to the right.

- (8) Repeat setting up to first digit of "Minute".

NOV - 15 - 88 15 : 3"5"



Flashing

- (9) Correction of calendar and clock is completed.

NOTE: After operation (1) or during correction of the calendar and clock display, switches and controls on the panel cannot function properly. If switch or control operation is required, complete correction.

NOTE: Beware of the following instructions when correcting the calendar and clock display:

- ① If FEB(ruary) is selected under the condition where "30" or "31" is set in the "Day" display, it changes into "01".

Example: "FEB" - 30 - 88
 ↑
 Flashing
 (Shift flashing position rightward.)

FEB - "0"1 - 88
 ↑
 Flashing (Changed to 01)

- ② If a 30-day month (APR, JUN, SEP, NOV) is selected under the condition where the second digit of the "Day" is set to 3, the first digit of the "Day" cannot be changed and remains 0.

Example: APR - 3"0" - 88
 ↑
 Flashing
 (First digit of Day is not changed)

- ③ If a 31-day month (JAN, MAR, MAY, JUL, AUG, OCT, DEC) is selected under the condition where the second digit of the "Day" is set to 3, the first digit of the "Day" is set to 0 and 1 alternately.

Example: JAN - 3"0" - 88
 ↑
 Flashing
 (Rotation of SWEEP TIME/DIV control cannot set other figures than 0 and 1.)

- ④ If the second digit of the "Day" is set to 0, its first digit cannot be set to 0.

- ⑤ If the "Day" is set to 31 or more, except for FEB, the number is changed into 30 automatically.

Example: JAN - "2"5 - 88
 ↑
 Flashing
 (If second digit of "Day" is set to 3.)

JAN - 3"0" - 88
 ↑
 Flashing (Changed to 30)

- ⑥ If any impossible time is set, it is changed into "20".

Example: "1"8 : 00
 ↑
 Flashing
 (If second digit of "O'clock" is set to "2".)

2"0" : 00
 ↑
 Flashing (Changed to 20)

INSTRUMENT BULLETIN
 1. The instrument is designed to be used in a laboratory or office environment. It is not intended for use in a hazardous or explosive atmosphere.
 2. The instrument is designed to be used in a laboratory or office environment. It is not intended for use in a hazardous or explosive atmosphere.
 3. The instrument is designed to be used in a laboratory or office environment. It is not intended for use in a hazardous or explosive atmosphere.

4. The instrument is designed to be used in a laboratory or office environment. It is not intended for use in a hazardous or explosive atmosphere.
 5. The instrument is designed to be used in a laboratory or office environment. It is not intended for use in a hazardous or explosive atmosphere.
 6. The instrument is designed to be used in a laboratory or office environment. It is not intended for use in a hazardous or explosive atmosphere.

7. The instrument is designed to be used in a laboratory or office environment. It is not intended for use in a hazardous or explosive atmosphere.
 8. The instrument is designed to be used in a laboratory or office environment. It is not intended for use in a hazardous or explosive atmosphere.
 9. The instrument is designed to be used in a laboratory or office environment. It is not intended for use in a hazardous or explosive atmosphere.

10. The instrument is designed to be used in a laboratory or office environment. It is not intended for use in a hazardous or explosive atmosphere.
 11. The instrument is designed to be used in a laboratory or office environment. It is not intended for use in a hazardous or explosive atmosphere.
 12. The instrument is designed to be used in a laboratory or office environment. It is not intended for use in a hazardous or explosive atmosphere.

13. The instrument is designed to be used in a laboratory or office environment. It is not intended for use in a hazardous or explosive atmosphere.
 14. The instrument is designed to be used in a laboratory or office environment. It is not intended for use in a hazardous or explosive atmosphere.
 15. The instrument is designed to be used in a laboratory or office environment. It is not intended for use in a hazardous or explosive atmosphere.

16. The instrument is designed to be used in a laboratory or office environment. It is not intended for use in a hazardous or explosive atmosphere.
 17. The instrument is designed to be used in a laboratory or office environment. It is not intended for use in a hazardous or explosive atmosphere.

MAINTENANCE

⚠ Caution : Read this page carefully to keep your safety.

For Electric Shock Protection:

Be sure to disconnect the power cable from the socket before conducting the following operation.

REPLACING THE FUSE

In case the fuse has blown, locate the cause. If the fuse itself is the cause, replace it as follows:

1. Pull the plug of the power cord from the power outlet.
2. Remove the fuse holder in the rear panel using a standard screwdriver (see Fig. 67).
3. Take out the blown fuse, and in its place, insert a new fuse.
4. Set the label of your line voltage to the mark ▼, then plug the fuse holder containing the new fuse into the rear panel.

CHANGING THE SUPPLY VOLTAGE

Remove the fuse holder in the rear panel using a standard screwdriver. Then set the label of your line voltage to the mark ▼ and plug the fuse holder back into place. When changing the supply setting from 100/120 V to 220/240 V, change the 1.2 A fuse for a 0.8 A one. (see Fig. 67)
(The following example shows a case the selector is set to 100 V)

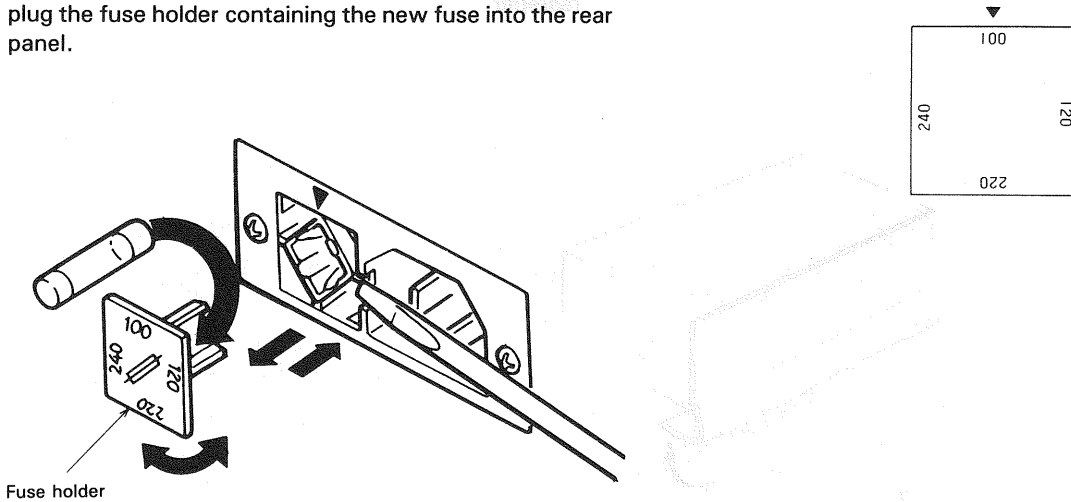

Fig. 67

ACCESSORIES

STANDARD ACCESSORIES INCLUDED

Probe (PC-31) (for READ OUT)	W03-2301-05
Attenuation.....	1/10
Input Impedance	10 M Ω , 14 pF \pm 10%
Instruction Manual	B50-7671-10
Replacement Fuse	
1.2 A	F05-1224-05
0.8 A	F05-8015-05
0.8 AT (Time lag)	F05-8013-05

OPTIONAL ACCESSORIES

Probe Pouch (MC-78)	Y87-1600-00
---------------------------	-------------

This soft vinyl pouch attaches to the top side oscilloscope housing and provides storage space for two probes and the operators manual. Install the probe pouch as follow;

1. Unsnap the probe pouch from the retainer plate.
2. Align the retainer plate with 4 holes on the top side of the case, with 4 snaps at the top.
3. Attach the 4 corners of the retainer plate to the oscilloscope case with the 4 nylon rivets supplied.
4. Attach the pouch to the retainer plate using the snap fastener.

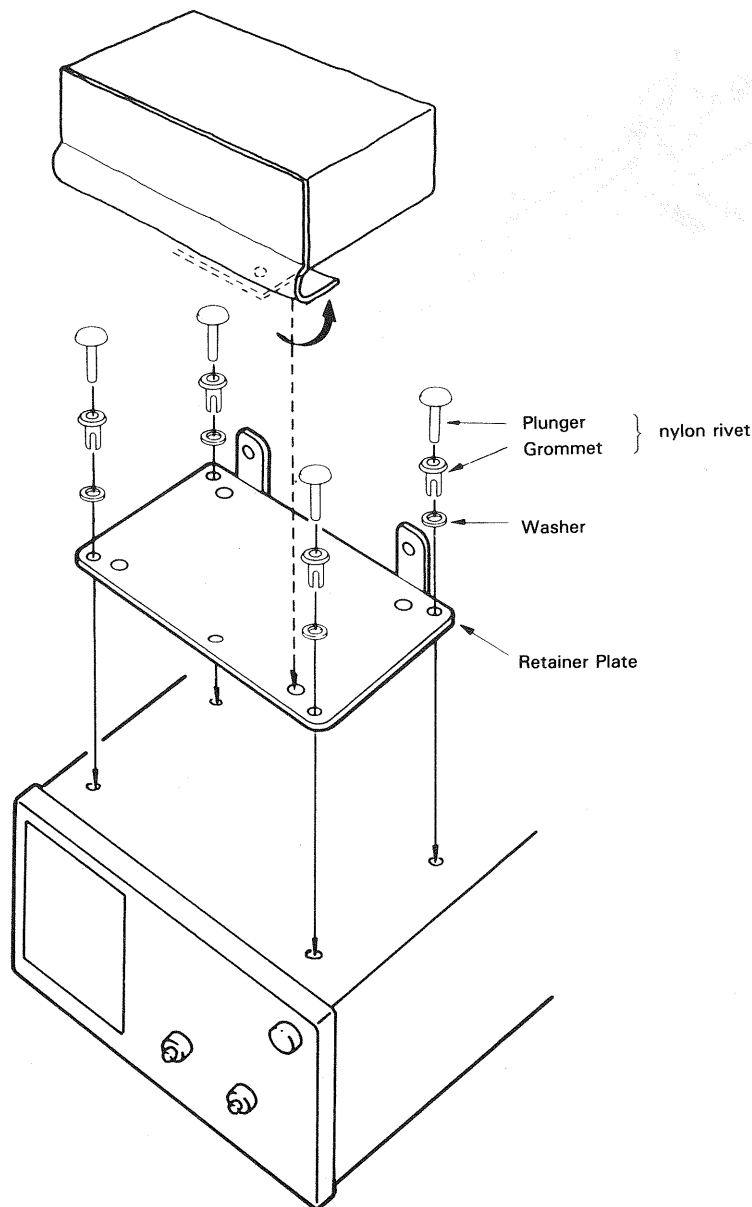

Fig. 68

MEMO

A MEMORANDUM OF
KENWOOD CORPORATION
175 KENNEDY DRIVE, BOSTON, MASS. 02148

MEMO

A product of
KENWOOD CORPORATION
17-5, 2-chome, Shibuya, Shibuya-ku, Tokyo 150, Japan
