

 **KENWOOD**

*K. W. Lehman*

K. W. LEHMAN  
25 ADRIENNE AVE  
1016 GLENASHLEY DURBAN  
2020 S.A.



# **REMOTE VARIABLE FREQUENCY OSCILLATOR**

## **Model VFO-820**

**OPERATING MANUAL**

## CONTENTS

SECTION 1	INSTALLATION .....	3
SECTION 2	OPERATING CONTROLS .....	4
SECTION 3	OPERATION .....	6
SECTION 4	CIRCUIT DESCRIPTION .....	8
SECTION 5	MAINTENANCE AND ALIGNMENT .....	9
SCHEMATIC DIAGRAM .....		11
SPECIFICATION .....		12

## INTRODUCTION

The VFO-820 is a solid state remote VFO which matches the Kenwood TS-820. It is designed for use with the TS-820 on the amateur bands between 1.8 and 30.0 MHz. When connected to the transceiver, the VFO-820 allows VFO controlled cross-channel operation (the use of separate frequencies for transmission and reception).

All VFO power, signals, and switching are supplied through a single interconnecting cable. A build-in RIT circuit, with a light-emitting-diode indicator, allows receiver incremental tuning with the remote VFO.

Light-emitting-diodes on the VFO and transceiver show which equipment is controlling operation. All of the VFO switching functions are controlled by the VFO-820

The VFO-820 uses the same high stability, low distortion VFO circuit found in the TS-820.

# SECTION 1. INSTALLATION

## 1.1 UNPACKING

Remove the VFO-820 from its shipping box and packing material and examine it for visible damage. If the equipment has been damaged in shipment, save the box and packing material and notify the transportation company immediately. It is a good idea to save the box and packing in any case because they are very useful for shipping or moving the equipment.

The following accessories should be included with the VFO:

- 1 Operating Manual
- 1 Transceiver Interconnecting Cord
- 1 Non-slip Rubber
- 2 Plastic Extension Feet with Screws
- 1 Grounding Cable

## 1.2 OPERATING LOCATION

As with any solid state electronic equipment the VFO-820 should be kept free from extremes of heat and humidity. Choose an operating location that is dry and cool, and avoid operating the VFO in direct sunlight.

## 1.3 CABLING (See Figure 1)

### INTERCONNECTING CORD

Set the TS-820's FUNCTION switch to VFO and connect the EXT. VFO connector of the TS-820 to the VFO OUT connector of the VFO-820, using the interconnecting cord provided with the VFO. Be certain the transceiver and VFO are turned off when they are connected because transients could damage the circuits.

**Save the jumpered VFO plug supplied with the TS-820. The plug is necessary for operation of the transceiver without the external VFO.**

### GROUND

Connect the VFO-820's GND lug to the GND lug on the TS-820. Grounding improves the stability and output of the VFO.

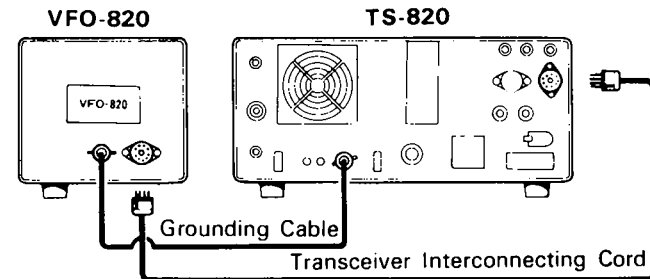

Fig. 1 Connection with the TS-820

# SECTION 2. OPERATING CONTROLS

## 2.1 FRONT PANEL CONTROLS (See Figure 2)

### FUNCTION SWITCH (1 on Figure 2)

This 4-position rotary switch selects which VFO controls what function.

OFF — The VFO-820 does not operate.

REC — The VFO-820 operates only for receiving.

REC/XMIT — The VFO-820 operates during reception and transmission.

XMIT — The VFO-820 operates only for transmission.

### SUB-DIAL (2 on Figure 2)

The sub-dial is turned with the main tuning knob to select the operating frequency of the transceiver. It is calibrated at 50 kHz intervals from 0-500 kHz.

### MAIN TUNING DIAL SCALE (3 on Figure 2)

Newly developed, unique mono-scale graduated in 1 kHz permits direct readouts of frequencies over the range of 0 to 500 kHz.

The operating frequency of the VFO-820 is determined by adding the frequency shown on the band switch, and the dial scale.

### MAIN TUNING KNOB (4 on Figure 2)

This control turns the VFO and dial scale to select the frequency to be added to the band frequency to establish the transceiver's operating frequency.

Four turns of the knob are equivalent to about 100 kHz.

### RIT CONTROL KNOB (5 on Figure 2)

When the RIT switch is pressed on, this potentiometer tunes the VFO-820's receive frequency. The RIT circuit allows the operator to tune the receive frequency more than  $\pm 2$  kHz without changing the transmit frequency.

At the zero (mid-point) position the receive frequency is the same as when the RIT circuit is turned off.

### RIT SWITCH (6 on Figure 2)

This push-button switch turns the RIT (Receiver Incremental Tuning) circuit on and off. With the switch depressed, the circuit is activated and the RIT indicator is lighted. The RIT control can then adjust the receiver frequency independently of the transmit frequency.

### VFO INDICATOR (7 on Figure 2)

This light-emitting-diode is illuminated when the VFO-820's VFO circuit is operating to control transmission or reception.

### RIT INDICATOR (8 on Figure 2)

This light-emitting-diode is illuminated when the RIT circuit is turned on, showing that the transmit and receive frequencies may be different.

## 2.2 REAR PANEL CONTROLS (See Figure 3)

### VFO OUT CONNECTOR (1 on Figure 3)

This connector is attached to the TS-820's EXT. VFO connector to control all of the operating functions.

### GND LUG (2 on Figure 3)

Use this lug to ground the VFO-820 to the transceiver.

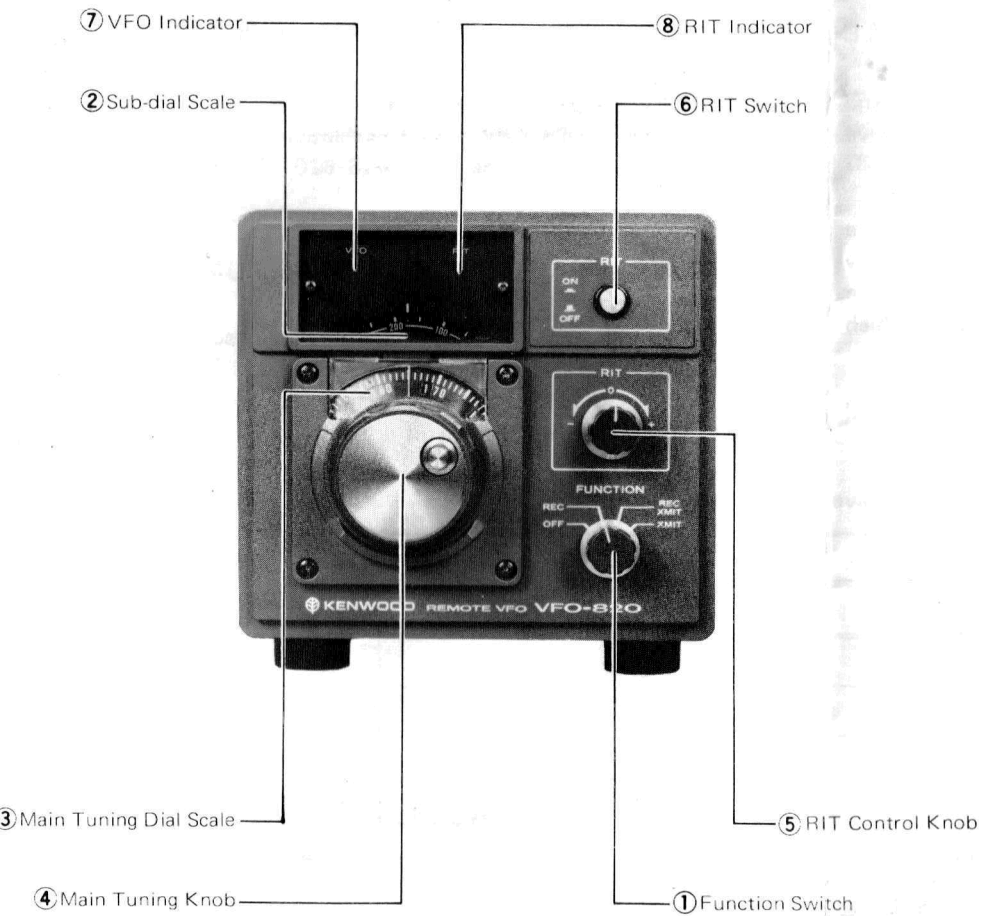

**Fig. 2 Front Panel View**

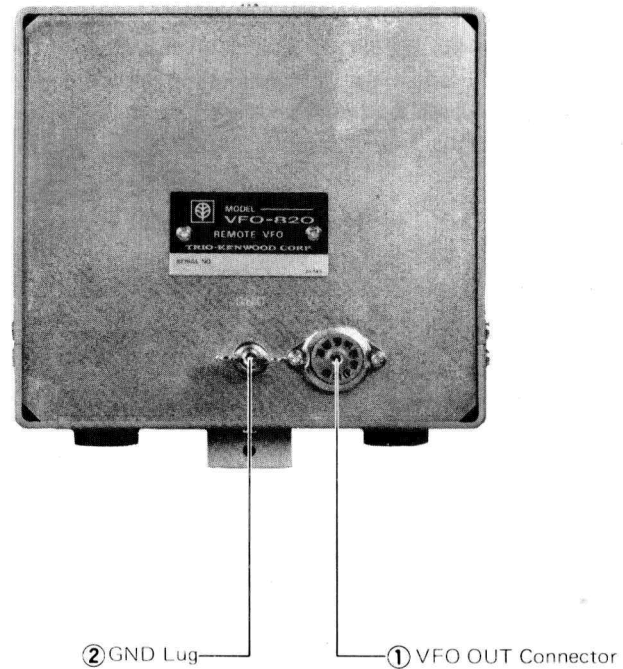

**Fig. 3 Rear Panel View**

# SECTION 3. OPERATION

## 3.1 GENERAL DESCRIPTION

Make the interconnections described in Section 1.3 with the transceiver and VFO off. Set the TS-820's FUNCTION switch to VFO for normal transceive operation.

The function of each VFO is controlled by the FUNCTION switch on the VFO-820 and the FUNCTION switch on the TS-820. Tables 1 and 2 show what possible operating and calibrating possibilities are available. The light-emitting-diode indicators on the VFO and on the transceiver show which circuit is controlling operation.

## 3.2 CALIBRATION AND DIAL READING

See the TS-820's operating manual for information on reading the operating frequency. Table 2 shows the possible calibrating functions. The VFO-820 is calibrated in the same manner as the TS-820.

## 3.3 RIT (RECEIVER INCREMENTAL TUNING)

See the RIT section in the TS-820 manual for a full description of RIT. The RIT control on the VFO allows receiver tuning when the VFO-820 is controlling the receive function. The RIT circuit must be turned on by the RIT switch. The RIT indicator will show when the circuit is turned on.

Table 1. VFO-820 — TS-820 Switch Settings for Transceive Operation.

VFO-820 FUNCTION SWITCH	VFO FUNCTION	TS-820 FUNCTION SWITCH			
		VFO	VFO-R	FIX-R	FIX
OFF	Transmit VFO	TS-820	Fixed Oscillator	TS-820	Fixed Oscillator
	Receive VFO	TS-820	TS-820	Fixed Oscillator	Fixed Oscillator
REC	Transmit VFO	TS-820	Fixed Oscillator	TS-820	Fixed Oscillator
	Receive VFO	VFO-820	VFO-820	Fixed Oscillator	Fixed Oscillator
REC/XMIT	Transmit VFO	VFO-820	Fixed Oscillator	VFO-820	Fixed Oscillator
	Receive VFO	VFO-820	VFO-820	Fixed Oscillator	Fixed Oscillator
XMIT	Transmit VFO	VFO-820	Fixed Oscillator	VFO-820	Fixed Oscillator
	Receive VFO	TS-820	TS-820	Fixed Oscillator	Fixed Oscillator

### 3.4 CROSS CHANNEL OPERATION

Use Table 1 for a description of which switch settings to use for each kind of operation. The station gives complete flexibility for cross channel operation and fixed channel operation. The light-emitting-diode indicators show that VFO is operating.

### 3.5 NON-SLIP RUBBER

When your VFO-820 is placed on a table or the like, insert the supplied non-slip rubber into the tapped hole at the right foot as viewed from the front. This prevents VFO-820 from slipping on the table during operation.

**TABLE 2. Calibration Functions of the VFO-820 and TS-820**

VFO-820 FUNCTION SWITCH	TS-820 FUNCTION SWITCH		
	CAL-25 kHz	CAL-RMT	CAL-FIX
OFF	Calibrate TS-820 to marker signal	Calibrate TS-820 to VFO-820	Calibrate TS-820 to fixed channel
REC	Calibrate VFO-820 to marker signal	Calibrate TS-820 to VFO-820	Calibrate VFO-820 to fixed channel
REC/XMIT	Calibrate VFO-820 to marker signal	Calibrate TS-820 to VFO-820	Calibrate VFO-820 to fixed channel
XMIT	Calibrate TS-820 to marker signal	Calibrate TS-820 to VFO-820	Calibrate TS-820 to fixed channel

# SECTION 4. CIRCUIT DESCRIPTION

## 4.1 GENERAL INFORMATION

The VFO-820 consists of a VFO unit, a switch board, and an indicator board mounted on the main chassis. Figure 4 shows the block diagram of the VFO.

## 4.2 VFO UNIT (X40-1110-00)

The VFO unit is the same as the VFO unit of the TS-820. The circuit is a Clapp oscillator using field effect transistors, combined with a three-stage transistorized buffer amplifier, for stability against load fluctuations.

The oscillator frequency ranges from 5.0 to 5.5 MHz. The angular displacement of the main tuning dial is reduced through a series of gears so that one revolution of the knob is equivalent to about 25 kHz.

The RIT circuit allows tuning of the receive frequency without changing the transmit frequency.

## 4.3 INDICATOR BOARD (X54-1180-01)

This board controls the light emitting diode indicators. When the VFO-820 is controlling operation the VFO light is turned on. When the RIT circuit is switched on the RIT indicator is lighted.

## 4.4 SWITCH BOARD (X41-1080-00)

This board holds the control circuit, FUNCTION switch, and control relay.

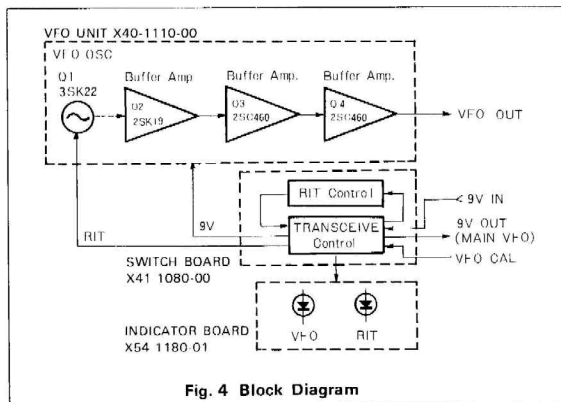

Fig. 4 Block Diagram



# SECTION 5. MAINTENANCE AND ALIGNMENT

## 5.1 ALIGNMENT

The VFO-820 is carefully aligned and tested before it leaves the factory and should require no further adjustment. In fact, the VFO circuit is quite delicate and should not be serviced without sophisticated test equipment.

## 5.2 REMOVING THE COVER

Remove the one top screw and the six side screws and pull the top cover off. All circuits can be reached for servicing by removing the top cover. The bottom is a sealed chassis and can not be removed.

## 5.3 RIT ZERO

Push the RIT switch to ON and turn the RIT control to the zero marking. Receive a 25 kHz marker signal from the TS-820 and tune for about a 1000 Hz tone. Push the RIT switch off. If the RIT circuit is correctly adjusted, the tone will be the same frequency with RIT on and off. Figure 5 shows adjustment of the RIT circuit. If necessary, adjust VR1 until the frequency does not vary.

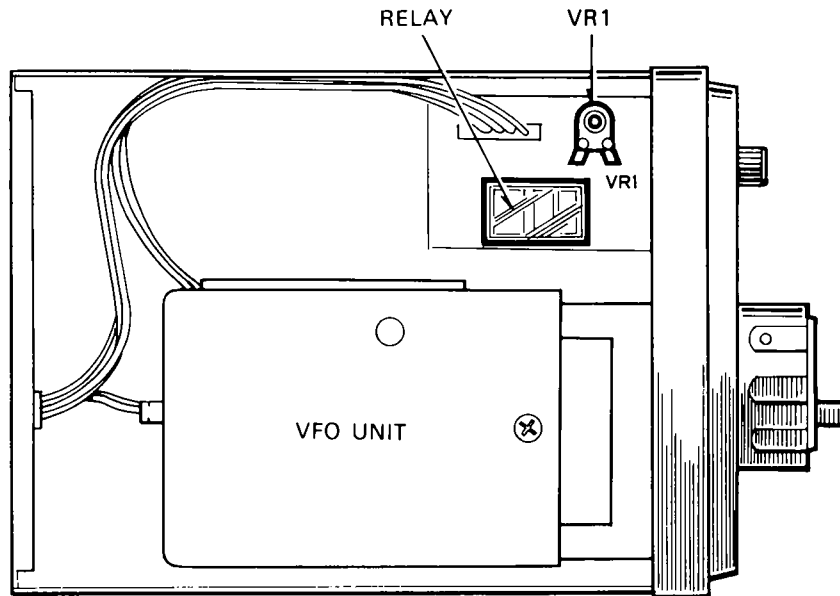

Fig. 5 RIT Adjustment

## 5.4 INSTALLING THE EXTENSION FEET

Figure 6 shows how to install the extension feet on the VFO-820

## 5.5 SERVICE PARTS

Be sure to use replacement parts of equal or better ratings when servicing the VFO.

When ordering replacement or spare parts for your equipment, be sure to specify the following information:

Model number and serial number of the equipment—Schematic number of the part and the board number on which the part is located.

Should it ever be necessary to return the equipment for repair be sure to pack it very carefully and include a full description of the problems involved.

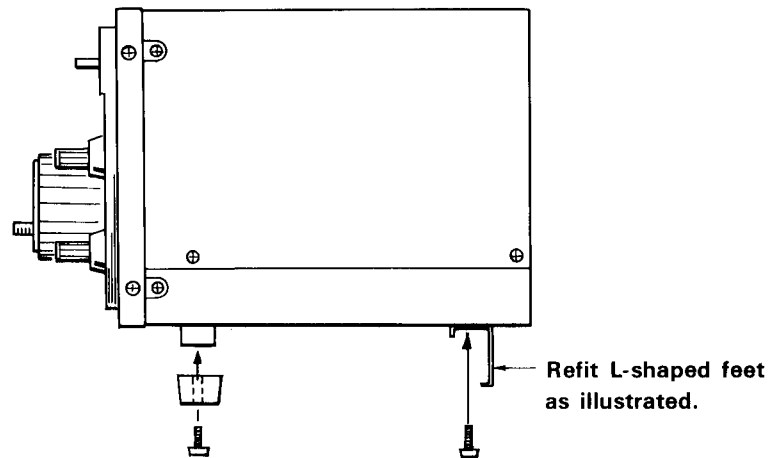
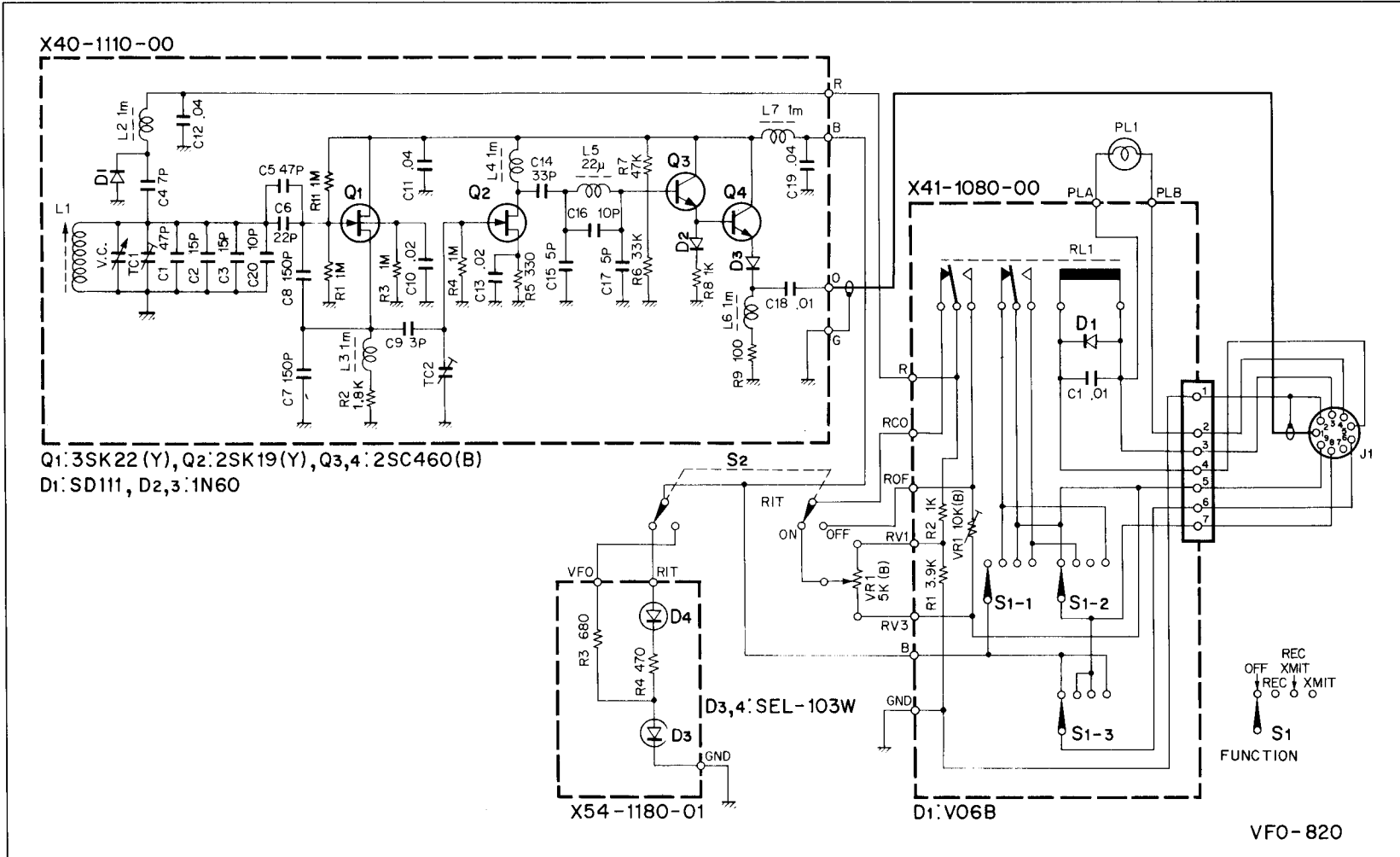

Fig. 6 How to Install the Extension Feet

# SCHEMATIC DIAGRAM



# SPECIFICATIONS

**OSCILLATION FREQUENCY:**

5.0 to 5.5 MHz

**OSCILLATION CIRCUIT:**

VFO: Clapp Oscillator.

**OUTPUT VOLTAGE:**

1 volt  $\pm 3$  db (across a 470 ohm load).

**FREQUENCY STABILITY:**

Within  $\pm 100$  Hz per 30 minutes after 3 minutes of warm-up.

**SOLID STATE COMPONENT:**

2 transistors.

2 FET's

6 diodes.

**POWER REQUIREMENTS:**

The VFO-820 receives power from the TS-820.

12.6 VAC, 40 ma. 12.6 VDC, 40 ma. 9.0 VDC, 25 ma.

**DIMENSIONS:**

6.5" wide  $\times$  6.0" high  $\times$  7.5" deep (excluding feet).

**WEIGHT:**

6.6 lbs. (shipping weight 8.36 lbs.)



A product of

**TRIO-KENWOOD CORPORATION**

6-17, 3-chome, Aobadai, Meguro-ku, Tokyo 153, Japan