

KENWOOD

TS-890S

INSTRUCTION MANUAL

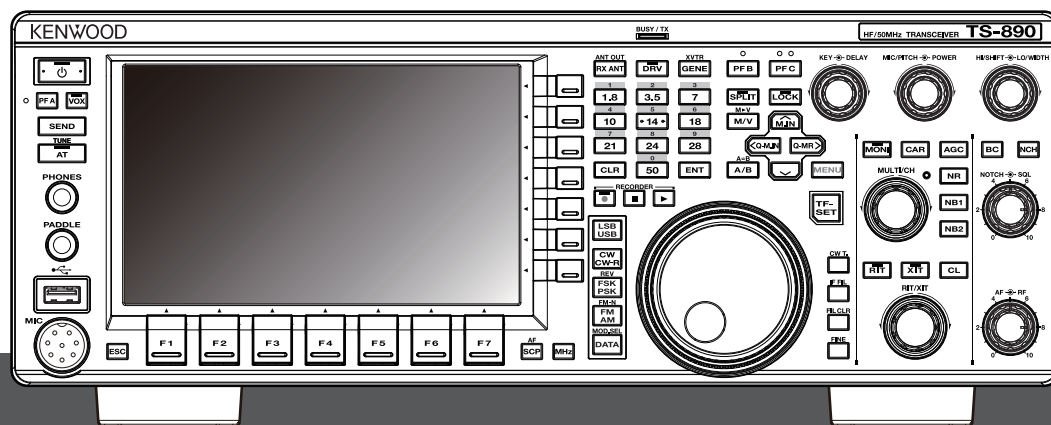

JVCKENWOOD Corporation



BEFORE USING

Thank You

Thank you for choosing this **KENWOOD** TS-890S transceiver.

FEATURES

- A high-end and practical transceiver with superior reception performance that exceeds its class, with multiple functions and with a feel of TS-990S
- Incorporates a 7" TFT color display for comfortable centralized control of operations using various information: auto scroll mode, filter scope, TX digital meter, etc.
- Top-class reception performance
Covers all frequency bands by means of down conversion method. Equipped with standard 15 kHz, 6 kHz, 2.7 kHz and 500 Hz roofing filters (and a 270 Hz option)
- HF + 50 MHz + 70 MHz (E type)
- 100 W heavy duty output power
- Built-in automatic antenna tuner (relay system, high speed matching)
- SSB, CW, FSK (RTTY), PSK31 (BPSK/QPSK), PSK63 (BPSK), AM, FM
- Capable of FSK, PSK31/63 as well as CW decoding/encoding
- Equipped with two 32-bit floating-point arithmetic DSPs for transmission and reception and scope display
- Equipped with LAN, USB and COM ports
- External display connection (via DVI-I connector)
- Capable of remote control operation (direct IP connection) without using a host PC. Radio Control Program (ARCP-890) and Radio Host Program (ARHP-890) are also provided free as before
- Supports USB audio. The speaker and the microphone of a PC can be used during the USB audio operation by using the USB Audio Controller (ARUA-10) freeware.

Supplied Accessories

The following accessories are supplied with the transceiver. After carefully unpacking the transceiver, identify the accessories listed in the table.

Item	Quantity		
	K Type	E Type	
DC power cable	1	1	
7-pin DIN plug (For REMOTE connector)	1	1	
13-pin DIN plug (For ACC2 connector)	1	1	
Fuse 4 A	1	1	
Fuse 25 A	1	1	
Instruction Manual	English	1	1
	French	1	1
	Spanish	–	1
	Italian	–	1
	German	–	1
	Dutch	–	1
Schematic diagram	3	3	
Warranty Card	1	1	



- We recommend you keep the box and packing materials in case you need to repack the transceiver in the future.
- Do not put the plastic bag used for packing of this equipment on the place which reaches a small child's hand. It will become a cause of suffocation if it wears flatly.

Market Codes

K Type : The Americas

E Type : Europe

The market code is shown on the carton box.

Refer to the specifications for information on the available operating frequencies.

Copyrights for This Manual

- JVC KENWOOD Corporation shall own all copyrights and other intellectual properties for the product and the software and for all manuals and documents attached to the product and the software.
- A user is required to obtain approval from JVC KENWOOD corporation, in writing, prior to redistributing this document on a personal web page or via packet communication.
- A user is prohibited from assigning, renting, leasing or reselling the document.
- JVC KENWOOD Corporation does not warrant that quality and functions described in this manual comply with each user's purpose of use and, unless specifically described in this manual, JVC KENWOOD Corporation shall be free from any responsibility for any defects and indemnities for any damages or losses.

Software Copyrights

The title to and ownership of copyrights for software, including but not limited to the firmware that may be distributed individually, to be embedded in KENWOOD product memories, are reserved for JVC KENWOOD Corporation.

Any modifying, reverse engineering, copying, reproducing or disclosing on an Internet website of the software is strictly prohibited.

A user is required to obtain approval from JVC KENWOOD corporation, in writing, prior to redistributing this manual on a personal web page or via packet communication. Furthermore, any reselling, assigning or transferring of the software is also strictly prohibited without embedding the software in KENWOOD product memories.

Software License Agreement

Software License Agreement contains the terms and conditions of use of the software embedded in or used with the transceiver. A user is entitled to use the software subject to the acceptance and agreement of this Software License Agreement by the user. Also, this Software License Agreement stipulates the terms and conditions of use of this software embedded in or used with the transceiver, and a user has the right to use the transceiver with the software embedded subject to the applicable laws and regulations, the description and defined in this manual and the warranty card.

The Software License Agreement can be displayed in the menu below. (Refer to Chapter 3 for operation of menu.)

Advanced menu [24] "Software License Agreement"

Important Notices Concerning the Software License Agreement

The software embedded in this transceiver consists of a multiple number of and individual software components. Title to and ownership of copyrights for each software component is reserved for JVC KENWOOD Corporation and the respective bona fide holder.

This product employs the software component in accordance with the End User License Agreement (hereinafter referred to as the "EULA") stipulated by JVC KENWOOD Corporation and/or the respective bona fide holder.

There is free software stipulated and governed by the "EULA", and this, a distribution condition of the software component in the executable format under the terms and conditions contained in the GNU General Public License or Lesser General Public License (hereinafter referred to as the "GPL/LGPL"), requires to make the source code for the relevant software components available. Access the URL below for details of the software component stipulated in the "GPL/LPGL".

<http://www2.jvckenwood.com/gpl/index.html>

Important notice about software can be displayed in the menu below. (Refer to Chapter 3 for operation of menu.)

Advanced menu [25] "Important Notices concerning Free Open Source"

About the GPL/ LPGL License

The GPL / LGPL license agreement can be displayed in the menu below. (Refer to Chapter 3 for operation of menu.)

Advanced menu [26] "About Various Software License Agreements"

This product includes "Ubiquitous QuickBoot™" technology developed by Ubiquitous Corp. Ubiquitous QuickBoot™ is a trademark of Ubiquitous Corp. Copyright © 2018 Ubiquitous Corp. All rights reserved.



Copyrights for Recorded Audio

The broadcast content recorded in this transceiver may not be reused, except for the personal use, without prior consent of the right holder under the copyright laws.

Trademarks

KENWOOD is a registered trade mark of JVC KENWOOD Corporation.

All other product names referenced herein are trademarks or registered trademarks of their respective manufacturers. Marks such as ™ and ® are omitted in the text of body.

Indemnity

- JVC KENWOOD Corporation takes all appropriate measures to ensure all descriptions in this manual are accurate; however, this manual may still contain typographical errors ("typos") and expressions that are misleading. JVC KENWOOD Corporation is entirely free from any responsibilities arising from any losses or damages caused by such typos or expressions. JVC KENWOOD Corporation has the right to change or improve the product specifications, etc., described in this manual without prior notice. JVC KENWOOD Corporation is entirely free from any responsibilities for any losses or damages caused by such changes and improvements.
- JVC KENWOOD Corporation is entirely free from any responsibilities for any failures, damages or losses arising from, or in connection with, use of the transceiver with or connected to any external equipment.
- JVC KENWOOD Corporation does not warrant that the quality and functions described in this manual comply with your purpose of use and, unless specifically described in this manual, JVC KENWOOD Corporation shall be free from any responsibilities for any defects and indemnities for any damages or losses. Selection and installation of any external equipment shall be done at your own risk. You are fully responsible for the use and effects of external equipment.
- JVC KENWOOD Corporation shall be free from any responsibilities for any incidental losses or damages, such as missing communications or call opportunities caused by a failure or performance error of the transceiver.

Your Queries about External Devices or PC Connected to the Transceiver

JVC KENWOOD Corporation are pleased to answer, within the scope of corporate efforts we can provide, your queries about your operation of this transceiver. Please bear in mind that we cannot answer any and all technical questions regarding methods of connection to, configuration for and operation of any external device and PC beyond our knowledge.

Handling Your Important Data

There is always a risk of losing your important data due to transceiver failure, occurrence of an unforeseen contingency, erroneous operation or faulty behavior of the transceiver. The data, such as the operating information, recorded audio, messages, configuration data, logs, etc., must be backed up as necessary by yourself and stored in the external storage device such as a USB flash drive.

Precautions

Please observe the following precautions to prevent fire, personal injury, and transceiver damage:

- Connect the transceiver only to a power source as described in this manual or as marked on the transceiver itself.
- Route all power cables safely. Ensure the power cables can neither be stepped upon nor pinched by items placed near or against the cables. Pay particular attention to locations near AC receptacles, AC outlet strips, and points of entry to the transceiver.
- Take care not to drop objects or spill liquid into the transceiver through enclosure openings. Metal objects, such as hairpins or needles, inserted into the transceiver may contact voltages resulting in serious electrical shocks. Never permit children to insert any objects into the transceiver.
- Do not attempt to defeat methods used for grounding and electrical polarization in the transceiver, particularly involving the power input cable.
- Adequately ground all outdoor antennas for this transceiver using approved methods. Grounding helps protect against voltage surges caused by lightning. It also reduces the chance of a build-up of static charge.

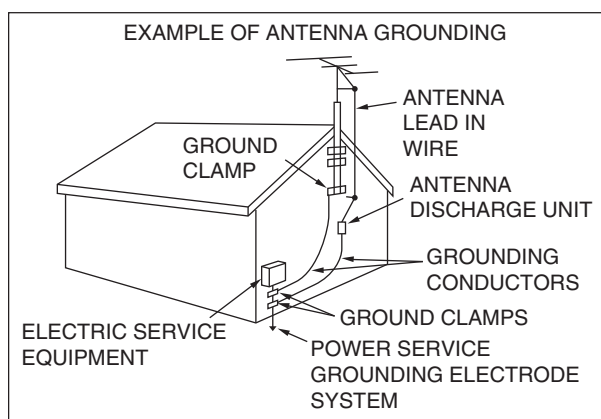

- Minimum recommended distance for an outdoor antenna from power lines is one and one-half times the vertical height of the associated antenna support structure. This distance allows adequate clearance from the power lines if the support structure fails for any reason.
- Locate the transceiver so as not to interfere with its ventilation. Do not place books or other equipment on the transceiver that may impede the free movement of air. Allow a minimum of 10 cm (4 inches) between the rear of the transceiver and the wall or operating desk shelf.
- Do not use the transceiver near water or sources of moisture. For example, avoid use near a bathtub, sink, swimming pool, or in a damp basement or attic.
- The presence of an unusual odor or smoke is often a sign of trouble. Immediately turn the power OFF and remove the power cable. Contact a **KENWOOD** service station or your dealer for advice.

- Locate the transceiver away from heat sources such as a radiator, stove, amplifier or other devices that produce substantial amounts of heat.
- Do not use volatile solvents such as alcohol, paint thinner, gasoline, or benzene to clean the cabinet of the transceiver. Use only a clean cloth with warm water or a mild detergent.
- Disconnect the input power cable from the power source when the transceiver is not used for long periods of time.
- Remove the transceiver's enclosure only to do accessory installations described in this manual or accessory manuals. Follow provided instructions carefully, to avoid electrical shocks. If unfamiliar with this type of work, seek assistance from an experienced individual, or have a professional technician do the task.
- Enlist the services of qualified personnel in the following cases:
 - a) The power supply or plug is damaged.
 - b) Objects have fallen into or liquid has spilled into the transceiver.
 - c) The transceiver has been exposed to rain.
 - d) The transceiver is operating abnormally or performance has seriously degraded.
 - e) The transceiver has been dropped or the enclosure damaged.
- Do not place the unit in excessively dusty and/or humid areas, nor on unstable surfaces.
- HF/ 50/ 70 MHz mobile antennas are larger and heavier than VHF/ UHF antennas. Therefore, use a strong and rigid mount to safely and securely install the HF/ 50/ 70 MHz mobile antenna.
- Do not put the plastic bag used for packing of this equipment on the place which reaches a small child's hand. It will become a cause of suffocation if it wears flatly.
- Turn the transceiver power off in the following locations: In explosive atmospheres (flammable gas, dust particles, metallic powders, grain powders, etc.)

About Liquid Crystal Display

- Brightness of the LCD screen may appear uneven and flickering may occur depending on the content displayed. This is not a malfunction.
- The LCD is manufactured using high-density technology to achieve more than 99.99 % of effective pixels. Less than 0.01 % of the pixels may not be lit or may remain lit all the time. This is not a malfunction.
- When using this product in a cold region or when the temperature of this unit or its surroundings is extremely low, it may take a few minutes for the LCD to reach the normal level of brightness after turning on the power. This is not a malfunction. When this occurs, turn off the power and allow the surrounding environment to reach the ambient temperature (10 °C to 30 °C or 32°F to 86°F) before using the unit.
- If you accidentally damaged the LCD display and the liquid in the LCD display splashes and gets into your eyes or mouth, rinse thoroughly with water immediately and seek medical attention. And if the liquid splashes on your clothes or skin, wipe off immediately with alcohol etc. Leaving it as is will harm your skin or damage your clothes.

BEFORE USING

Notice to the User

One or more of the following statements may be applicable for this equipment.

FCC WARNING

This equipment generates or uses radio frequency energy. Changes or modifications to this equipment may cause harmful interference unless the modifications are expressly approved by the party responsible/ JVC KENWOOD. The user could lose the authority to operate this equipment if an unauthorized change or modification is made.

INFORMATION TO THE DIGITAL DEVICE USER REQUIRED BY THE FCC

This equipment has been tested and found to comply with the limits for a Class B digital device, pursuant to Part 15 of the FCC Rules. These limits are designed to provide reasonable protection against harmful interference in a residential installation.

This equipment generates, uses and can generate radio frequency energy and, if not installed and used in accordance with the instructions, may cause harmful interference to radio communications. However, there is no guarantee that the interference will not occur in a particular installation. If this equipment does cause harmful interference to radio or television reception, which can be determined by turning the equipment off and on, the user is encouraged to try to correct the interference by one or more of the following measures:

- Reorient or relocate the receiving antenna.
- Increase the separation between the equipment and receiver.
- Connect the equipment to an outlet on a circuit different from that to which the receiver is connected.
- Consult the dealer for technical assistance.

This product is designed for connection to an IT power distribution system.

Notification

This equipment complies with the essential requirements of Directive 2014/53/EU.

Restrictions

This equipment requires a licence and is intended for use in the countries below.



AT	BE	DK	FI	FR	DE	GR	IS	IE
IT	LI	LU	NL	NO	PT	ES	SE	CH
GB	CY	CZ	EE	HU	LV	LT	MT	PL
SK	SI	BG	RO	HR	TR			

ISO3166

Information on Disposal of Old Electrical and Electronic Equipment and Batteries (applicable for countries that have adopted separate waste collection systems)



Products and batteries with the symbol (crossed-out wheeled bin) cannot be disposed as household waste.



Old electrical and electronic equipment and batteries should be recycled at a facility capable of handling these items and their waste byproducts.

Contact your local authority for details in locating a recycle facility nearest to you.

Proper recycling and waste disposal will help conserve resources whilst preventing detrimental effects on our health and the environment.

Firmware Copyrights

The title to and ownership of copyrights for firmware embedded in KENWOOD product memories are reserved for JVC KENWOOD Corporation.

Bu ürün 28300 sayılı Resmî Gazete'de yayımlanan Atık Elektrikli ve Elektronik Eşyaların Kontrolü Yönetmeliğe uygun olarak üretilmiştir.

Eski Elektrikli ve Elektronik Cihazların ve Pillerin İmhası Hakkında Bilgi (ayrı atık toplama sistemlerine sahip olan ülkelerde geçerlidir)



Bu sembolü (üzeri çizili çöp bidonu) içeren ürün ve piller evsel atık çöpleri ile birlikte atılamaz.



Kullanılmış elektrikli ve elektronik cihaz ve piller, bu tür maddeleri ve bunların yan ürünlerini iş lemeye elverişli bir geri kazanım tesisine gönderilmelidir.

Size en yakın geri kazanım tesisinin konumunu öğrenmek üzere yerel yetkililerinize danışın.

Doğru geri kazanım ve atık uzaklaştırma yöntemleri, sadece öz kaynakların korunmasına yardımcı olmakla kalmayıp ayrıca sağlığımıza ve çevreye olacak zararlı etkilerini engellemeye yardımcı olur.

This device complies with Industry Canada license exempt RSS standard(s). Operation is subject to the following two conditions : (1) this device may not cause interference, and (2) this device must accept any interference, including interference that may cause undesired operation of the device.

CONTENTS

BEFORE USING

CONTENTS

1 INSTALLATION AND CONNECTION

Installation	1-1
Antenna Installation and Connection	1-1
Ground Connection	1-1
Installation of Lightning Arrestors	1-1
Connection of Regulated DC Power Supply	1-1
Using the Auxiliary Support	1-1
Torque Adjustment with Tuning Control	1-2
Connection of Accessories (Front Panel)	1-2
Connection of Accessories (Rear Panel)	1-3
PC Connection for Data Communication	1-4
Virtual COM Port	1-5
Terminal Descriptions	1-6

2 NAMES AND FUNCTIONS OF PARTS

Front Panel	2-1
Panel Key Behavior	2-1
List of Function Key Behaviors (Standard Mode Screen)	2-4
Rear Panel	2-7
Microphone (Optional)	2-8
Screen	2-9

3 MENU

Menu Operation	3-1
Calling Up a Menu	3-1
Calling Up a Sub-Menu	3-1
Advanced Menu	3-1
Common Menu Screen Operations	3-2
Exiting the Menu	3-2
Switching between the CONFIG A and CONFIG B Operating Environments	3-2
Menu Items	3-3

4 BASIC OPERATIONS

Turning ON/OFF the Power	4-1
Screen Display Settings	4-1
Changing the Background Color	4-1
Changing the Type of Function Key Display	4-1
Changing the Frequency Display Font Type	4-1
Dimmer	4-2
Switching the Brightness Level	4-2
Adjusting the Dimmer Level	4-2
Adjusting AF Gain	4-2
Adjusting RF Gain	4-2
Adjusting the Squelch Level	4-2
Selecting VFO A/ B	4-3
Selecting an Operating Band	4-3
Changing the Number of Band Memories	4-3
Selecting an Operating Mode	4-4
SSB (LSB-USB) Mode	4-4
CW/ CW-R Mode	4-4
FSK/ FSK-R/ PSK/ PSK-R Mode	4-4
FM/ AM Mode	4-4
DATA Mode	4-4
Auto Mode	4-4
Turning ON/OFF Auto Mode	4-4
Configuring Auto Mode Frequency Points	4-5
Adjustment of Frequencies	4-5
Adjustment Using the Tuning Control	4-5
Adjustment Using the Microphone Key	4-5
FINE Tuning	4-5

Configuring the Number of Steps per Revolution of the Tuning Control	4-5
Configuring the Fast Forward Rate of the Tuning Control	4-5
Configuring the Sensitivity for Starting the Fast Forward Operation	4-5
Frequency Adjustment Using the [MULTI/CH] Control	4-6
Rounding the Frequency	4-6
Configuring the Frequency Step Size of the [MULTI/CH] Control	4-6
Switching the AM Broadcast Frequency in 9 kHz Steps	4-6
Adjusting Frequency in MHz Steps	4-6
Configuring the Frequency Step Size in MHz	4-6
Direct Input of Frequency Value	4-6
Frequency Input History	4-7
Frequency Lock	4-7
Selecting the Frequency Lock Function Behavior	4-7
Transmission	4-8
Audio Transmission	4-8
CW Transmission	4-8
Adjusting Microphone Gain	4-8
Adjusting TX Output Power	4-8
Fine Adjustment of TX Output Power	4-8
TX Output Power Limiter	4-9
Turning ON/OFF TX Output Power Limiter	4-9
Configuring the TX Output Power Limiter	4-9
Meter	4-9
Changing the Meter Type	4-9
Changing the Meter Type from the Menu	4-9
Changing the Meter Type via Touchscreen Operation	4-9
Switching between TX Meters	4-9
FM Mode S-meter Sensitivity	4-10
Analog Meter Response	4-10
Meter with Peak Hold	4-10
S Meter Scale	4-10
TX Meter (Digital)	4-10
Switching the Antenna	4-10
RX Antenna	4-10
Drive Output (DRV)	4-11
Turning ON/OFF Drive Output	4-11
Adjusting the Drive Output Level	4-11
Built-in Antenna Tuner	4-11
Impedance Matching with the Antenna	4-11
Preset	4-12
Holding Transmission at the End of Antenna Tuning	4-12
Switching Antenna Tuner Behavior during Reception	4-12
Configuring the Built-in Antenna Tuner Behavior for Each Band ...	4-12
Connecting the External Antenna Tuner AT-300	4-12

5 COMMUNICATING AIDS

Split Operation	5-1
Direct Input of Frequency Difference Specified by DX Station	5-1
Turning the Tuning Control to Search for a TX Frequency	5-1
Δ F Display	5-1
Changing the split frequency using the [RIT/XIT] control	5-1
Configuring the Band Direct Key during Split Operation	5-2
TF-SET (Setting the TX Frequency)	5-2
AGC	5-2
Switching the AGC Time Constant	5-3
Adjusting the AGC Time Constant Preset Value	5-3
AGC OFF	5-3
AGC Quick Recovery	5-3
RX Equalizer	5-4
Turning ON/OFF RX Equalizer	5-4
Selecting an RX Equalizer Characteristic	5-4
Adjusting the Equalizer Characteristics	5-4
Copying Equalizer Data	5-5
Saving Equalizer Data	5-5
Reading Equalizer Data	5-5

CONTENTS

Preamplifier	5-6	Saving RTTY Communication Logs	5-18
RX Monitor	5-6	Adjusting the RTTY Decode Threshold Level	5-18
SWL (BCL) Mode	5-6	FFT Scope/X-Y Scope Display Setting	5-18
Band Switching in the SWL Mode (VFO Mode)	5-6	FFT Scope Waveform Averaging	5-18
Transmission in Data Mode	5-7	Selecting a Waterfall Display Type	5-19
Transmission via PTT Switch, SS Terminal and SEND	5-7	Tracking Speed/Density Level of X-Y Scope	5-19
Transmission via DATA PTT or DATA SEND	5-7	Transmitting Character Strings Using USB Keyboard	5-19
RIT/XIT	5-7	Transmitting the Input Character String Immediately	5-19
RIT (Receiver Incremental Tuning)	5-7	Temporarily Placing Character Strings in the Character String Buffer before Transmission	5-19
RIT Shift	5-7	RTTY Message Memory	5-20
XIT (Transmitter Incremental Tuning)	5-7	Registering RTTY Messages	5-20
XIT Shift	5-7	Configuring Auto TX/RX for the RTTY Message Memory	5-20
Adjusting the Carrier Level	5-8	Transmitting Character Strings from the RTTY Message Memory	5-21
Operation in CW Mode	5-8	Settings Related to RTTY Encode/Decode	5-21
CW Break-in	5-8	Enabling Decode UOS (Unshift on Space)	5-21
Turning ON/OFF Break-in	5-8	Newline Code Setting	5-21
Adjusting the Break-in Mode and Break-in Delay Time	5-8	Diddle Operation	5-21
Adjusting the Sidetone and Pitch Frequency	5-9	Encode UOS	5-21
Adjusting the Sidetone Volume	5-9	Sending a Newline Code at the Start or End of a Transmission	5-21
CW Rise Time	5-9	RTTY Parameters	5-21
Auto Zero-in (CW Auto Tune)	5-9	Configuring the Mark Frequency	5-21
CW BFO Sideband	5-9	Configuring the RTTY Shift Width	5-21
CW Automatic Transmission from SSB Mode	5-9	Frequency Reverse in RTTY Mode	5-22
Frequency Offset when Shifting from SSB to CW Mode	5-9	Operating RTTY (FSK) Using an External Device	5-22
Encoding/Decoding Morse Code	5-10	When connecting to a PC (using the USB port)	5-22
Displaying the CW Communication Screen	5-10	When connecting to other external devices (using the ACC 2 connector)	5-22
Operating the CW Communication Screen	5-10	RTTY (FSK) Keying Polarity Setting	5-22
Indicator Displays	5-10	Audio Peak Filter	5-22
Adjusting the Decode Threshold Level	5-11	PSK Operation	5-22
Decode Filter	5-11	Displaying the PSK Communication Screen	5-22
Transmitting Character Strings via USB Keyboard Operation	5-11	Switching between the FFT Scope and Vectorscope Display ...	5-22
Encoding Character Strings Using the CW Message Memory	5-12	Operating the PSK Communication Screen	5-23
Paddle Operation on CW Communication Screen	5-12	Indicator Displays	5-23
Paddle Operation when the Character String Buffer is Empty	5-12	Saving PSK Communication Logs	5-23
Paddle Operation during Encoding of Character Strings in the Character String Buffer	5-12	Adjusting the PSK Decode Threshold Level	5-23
Saving CW Communication Logs	5-12	FFT Scope/Vectorscope Display Setting	5-24
Electronic Keyer	5-13	FFT Scope Waveform Averaging	5-24
Selecting the PADDLE Jack Behavior	5-13	Selecting a Waterfall Display Type	5-24
Selecting the KEY Jack Behavior	5-13	Vectorscope	5-24
Operation Mode of the Electronic Keyer	5-13	AFC (Automatic Frequency Control)	5-24
Reversing Dot and Dash	5-13	Configuring the AFC Tuning Range	5-24
Mic Paddle Mode	5-13	NET	5-24
Adjusting the Keying Speed	5-13	Switching between BPSK and QPSK	5-24
Changing the Weighting	5-14	Switching between PSK31 and PSK63	5-25
Weight Ratio Reverse	5-14	Transmitting Character Strings from USB Keyboard	5-25
CW Message Memory	5-14	Transmitting the Input Character String Immediately	5-25
Switching the Method of Registering CW Messages	5-14	Temporarily Placing Character Strings in the Character String Buffer before Transmission	5-25
Registering CW Messages via Text Input	5-14	PSK Message Memory	5-26
Registering CW Messages via Paddle Operation	5-15	Registering Messages	5-26
Contest Number	5-15	Configuring Auto TX/RX for the PSK Message Memory	5-26
Configuring the Starting Contest Number (Text Input Only)	5-15	Transmitting Character Strings from the PSK Message Memory ..	5-27
Selecting a Method for Sending out Contest Number (Text Input Only)	5-16	Settings Related to PSK	5-27
Selecting a Channel for Counting up the Contest Numbers (Text Input Only)	5-16	Configuring the PSK Tone Frequency	5-27
Decrementing the Contest Number (Text Input Only)	5-16	Reversing the Direction of Phase Change in the QPSK Mode ..	5-27
Playing/Transmitting CW Messages	5-16	PSK Operation Using a PC	5-27
Repeat Playback of CW Messages	5-16	Communication Log	5-27
Configuring the Repeat Playback Interval	5-17	Selecting a Log File Format	5-27
Interrupt Keying	5-17	Displaying a Time Stamp	5-28
Deleting a CW Message	5-17	Selecting a Time Stamp Type	5-28
RTTY Operation	5-17	Selecting a Clock Type	5-28
Displaying the RTTY Communication Screen	5-17	Editing the Communication Log File	5-28
Switching between the FFT Scope and X-Y Scope Display	5-17	Operation in FM Mode	5-28
Operating the RTTY Encode/Decode Screen	5-18	Adjusting Microphone Gain during Operation in FM Mode	5-28
Indicator Displays	5-18	Operation in Narrow FM Mode	5-29
		Operating the FM Repeater	5-29
		Configuring the Tone Signal	5-29

Selecting a Tone	5-29	Marker Shift	7-3
Configuring the Tone Frequency	5-29	Shifting the Marker	7-3
Tone Frequency Scan	5-29	Changing the Shift Position of Marker Shift	7-3
CTCSS Operation	5-30	Expand	7-4
Selecting CTCSS	5-30	Scope Range of Each Band (Fixed Mode)	7-4
Configuring the CTCSS Frequency	5-30	Switching the Scope Range	7-4
CTCSS Frequency Scan	5-30	Configuring the Scope Range	7-4
Cross Tone	5-30	Marker Centering (Scope Mode)	7-5
Selecting Cross Tone	5-30	Notification on Exceeding the Lower or Upper Limit (Fixed Mode)	7-5
Configuring the TX/RX Tones	5-30	Selecting Relative or Absolute Frequency Display for the Grid (Center Mode)	7-5
6 REJECTING INTERFERENCE		Displaying Tuning Assist Line (SSB Only)	7-5
Attenuator	6-1	Configuring the Gradation of the Waterfall	7-5
Switching the RX Filter Band Characteristics	6-1	Touchscreen Tuning	7-6
Switching the RX Filter (A, B, C)	6-1	Turning ON/OFF Touchscreen Tuning	7-6
Configuring the Selectable Types of RX Filters	6-1	Correction steps for touchscreen tuning	7-6
Filter Scope	6-1	Turning ON/OFF Step Correction	7-6
Configuring the RX Filter	6-2	TX/RX Frequency Marker Display	7-6
Selecting a Roofing Filter	6-2	Registering Frequency Marker	7-6
Switching the IF Filter Shape	6-2	Deleting a Registered Frequency	7-7
Switching the AF Filter Type	6-2	Turning ON/OFF Marker Function	7-7
Configuring the Behavior of the HI/SHIFT and LO/WIDTH Controls (SSB/SSB-DATA Only)	6-3	Displaying the Maximum Value in the Waveform	7-7
Changing the Cutoff Frequency	6-3	Turning ON/OFF Maximum Value Display	7-7
Changing the Passband Width and Shift Amount	6-4	Configuring the Hold Type	7-7
Preset Passband Characteristics	6-5	Pausing the Waveform Display	7-7
Audio Peak Filter in the CW Mode	6-5	Averaging of Spectrum Scope Waveform	7-7
Turning ON/OFF Audio Peak Filter	6-5	Displaying the TX Signal Waveform	7-7
Switching the Passband Characteristics	6-5	Audio Scope	7-8
Shifting the Passband Width	6-5	Displaying the Audio Scope	7-8
Configuring the Peak Gain	6-6	Switching the Audio Scope Display Type	7-8
Audio Peak Filter in the FSK Mode	6-6	Switching the Spectrum Scope Attenuator	7-8
Noise Blanker	6-6	Switching the Display Frequency Span of the Spectrum Scope	7-8
Turning ON/OFF Noise Blanker 1/2	6-6	Switching the Oscilloscope Level	7-8
Adjusting the NB1 Level	6-6	Switching the Sweep Time	7-8
NB2	6-7	Pausing the Audio Scope	7-8
Configuring the NB2 Effect Level (Type A)/ NB2 Pulse Sensitivity Level (Type B)	6-7	8 TRANSMIT FUNCTIONS	
Configuring the Blanking Duration (Type B Only)	6-7	Configuration of the Input Path of TX Audio	8-1
Configuring the NB2 Attenuation Level (Type B Only)	6-7	Switching the Audio Source Input	8-1
Notch Filter	6-8	VOX (Voice-Operated Transmit)	8-1
Turning ON/OFF Notch Filter	6-8	Turning ON/OFF VOX Function	8-1
Switching the Notch Filter Bandwidth	6-8	Selecting Audio Source Input for Data VOX	8-2
Noise Reduction	6-8	Adjusting VOX Gain	8-2
Turning ON/OFF Noise Reduction	6-8	Adjusting the Anti VOX Gain Level	8-2
Configuring the NR1 Effect Level	6-9	Adjusting VOX Delay Time	8-3
Configuring the NR2 Correlation Time	6-9	VOX Voice Delay	8-3
Beat Canceler	6-9	TX Monitor	8-3
Turning ON/OFF Beat Canceler	6-9	Adjusting the TX Monitor Level	8-3
DSP Monitor	6-9	Speech Processor	8-4
Assigning DSP Monitor to PF Key	6-9	Turning ON/OFF Speech Processor	8-4
Expanding the Passband Width Using DSP Monitor	6-9	Configuring the Speech Processor Input Level	8-4
7 SCOPE FUNCTIONS		Configuring the Speech Processor Output Level	8-4
Bandscope	7-1	Configuring the Speech Processor Effect	8-4
Displaying the Bandscope	7-1	TX Filter	8-5
Switching the Bandscope Display Type	7-1	Changing the TX Filter Bandwidth	8-5
Adjusting the Reference Level	7-2	Configuring the Low Cutoff Frequency in the SSB/AM Mode	8-5
Switching the Bandscope Attenuator	7-2	Configuring the High Cutoff Frequency in the SSB/AM Mode	8-5
Configuring the Speed of Waterfall Drop	7-2	Configuring the Low Cutoff Frequency in the SSB-DATA/AM-DATA Mode	8-5
Waterfall Display during Tuning (Center Mode)	7-2	Configuring the High Cutoff Frequency in the SSB-DATA/AM-DATA Mode	8-5
Reduced Bandscope Display	7-2	Displaying the Filter Scope during Transmission	8-5
Switching the Scope Display Mode	7-3	TX Equalizer	8-5
Switching the Display Frequency Span	7-3	Turning ON/OFF TX Equalizer	8-5
		Selecting a Frequency Characteristic for the TX Equalizer	8-6

CONTENTS

Adjusting the TX Equalizer	8-6	Registering a Name for a Voice Message	12-2
Copying the TX Equalizer Settings	8-6	Playing Back a Voice Message	12-2
Saving the TX Equalizer Settings	8-7	Adjusting the Playback Volume	12-2
Reading the TX Equalizer Settings	8-7	Sending a Voice Message	12-3
TX Tuning	8-8	Deleting a Voice Message	12-3
Adjusting TX Output Power during TX Tuning	8-8	Configuring the Time Interval for Repeated Transmission	12-3
Timeout Timer (TOT)	8-8	Recording/Playing Voice Communication	12-3
ID Beep	8-8	Manual Recording	12-3
9 MEMORY CHANNELS		Full-time Recording	12-4
Displaying the Memory Channel List	9-1	Configuring the Maximum Duration for Full-time Recording	12-4
Registering Operating Frequency Data to a Memory Channel	9-2	Saving Full-time Recording Audio	12-4
Configuring the Operating Data through Direct Frequency Entry	9-2	Audio Recording in Tandem with Squelch	12-4
Memory Channel Mode	9-2	Quick Playback	12-4
Operating in the Memory Channel Mode	9-2	Adjusting the Playback Volume	12-4
Direct Entry of a Memory Channel Number	9-2	Audio Recording File Screen	12-4
Changing the Memory Channel Temporarily	9-3	Playing Back an Audio File	12-5
Changing the Frequency Temporarily	9-3	Renaming an Audio File	12-6
Copying the Operating Data of a Memory Channel	9-3	Deleting an Audio File	12-6
Memory Shift (Memory → VFO)	9-3	13 VOICE GUIDANCE	
Selecting a Memory Channel and Copying to VFO	9-3	Voice Guidance	13-1
Copying Data from the Memory Channel List Screen to VFO	9-3	Adjusting the Voice Guidance Volume	13-1
Channel-to-Channel Copying	9-3	Adjusting the Voice Guidance Speed	13-1
Configuring the Program Scan Frequency Range	9-4	Configuring the Voice Guidance Language	13-1
Erasing Memory Channels	9-4	Auto Voice Guidance	13-1
Registering a Memory Channel Name	9-4	Voice 1	13-2
Quick Memory Channels	9-5	Voice 2	13-12
Registering a Quick Memory Channel	9-5	Voice 3	13-12
Calling up a Quick Memory Channel	9-5	14 CLOCK DISPLAY/TIMER	
Configuring the Number of Quick Memory Channels	9-5	Configuring Date and Time	14-1
Erasing a Quick Memory Channel	9-5	Displaying the Clock Menu Screen	14-1
Memory Shift (Quick Memory → VFO)	9-6	Configuring the Local Clock Date	14-1
10 SCAN		Configuring the Local Clock Time	14-1
Program Scan	10-1	Configuring the Local Clock Time Zone	14-1
Starting the Program Scan (VFO Scan)	10-1	Configuring the Auxiliary Clock Time Zone	14-2
Configuring the Program Scan (VFO Scan) Frequency Range	10-1	Registering an Auxiliary Clock Identifier	14-2
Switching the Scan Speed	10-2	Configuring the Date Display Format	14-2
Program Slow Scan	10-2	Configuring the Clock Display	14-2
Turning ON/OFF Program Slow Scan	10-2	Clock Correction Using NTP (Network Time Protocol)	14-2
Configuring the Frequency Points for Program Slow Scan	10-2	Displaying the Auto Correction Configuration Screen	14-2
Configuring the Segment for Program Slow Scan	10-3	Configuring the NTP Server Address	14-3
Scan Hold	10-3	Turning ON/OFF Auto Clock Correction	14-3
Memory Scan	10-3	Correcting the Date and Time Manually	14-3
Performing Memory Scan	10-3	Timer	14-4
Configuring All-channel Scan and Group Scan	10-3	Configuring the Program Timer	14-4
Memory Channel Lockout	10-4	Pausing Program Timer Operation	14-6
Quick Memory Scan	10-4	Sleep timer	14-6
Configuring the Conditions for Resuming Scan	10-4	Configuring the Sleep Timer	14-6
11 USB/FILE MANAGEMENT		Pausing the Sleep Timer	14-6
Managing Different File Types	11-1	APO (Automatic Power Off)	14-6
USB/File Management Menu	11-2	15 NETWORK/KNS OPERATION	
Configuring the Destination for Saving Files	11-2	LAN	15-1
Saving Settings Data	11-2	Configuring the IP Address	15-1
Reading Settings Data	11-3	Viewing the MAC Address	15-2
Changing the Name of Files Stored in the Built-in Memory	11-4	KNS Operation	15-2
Copying Files to a PC	11-4	Configuring for KNS Operation	15-3
Deleting Files (Built-in Memory)	11-5	LAN Connection Settings	15-3
Formatting a USB Flash Drive	11-5	Administrator Settings	15-3
Copying Files to a USB Flash Drive	11-5	Built-in VoIP Function	15-4
Safely Removing the USB Flash Drive	11-6	Audio Input/Output Level of Built-in VoIP	15-4
12 VOICE MESSAGE/AUDIO FILE		Built-in VoIP Jitter Absorption Buffer	15-4
Recording/Playing a Voice Message	12-1	Prohibition of Remote Volume Control	15-4
Recording a Voice Message	12-1	KNS Communication Log	15-5

KNS User Registration	15-5	USB Keying	16-12
KNS Users List	15-5	Decoded Character Output	16-12
Registering User Information	15-5	Turning ON/OFF Decoded Character Output	16-12
Editing User Information	15-6	Configuring the Baud Rate of the Virtual COM (Enhanced)	
Deleting a User	15-6	Connector	16-12
Remote Operation by Registered User	15-6	Controlling the Linear Amplifier	16-13
Session Time	15-6	Connection	16-13
KNS Welcome Message	15-6	TL-922 Connection	16-13
		General Linear Amplifier Connection	16-13
16 OTHER FUNCTIONS		Linear Amplifier Menu Screen	16-14
Configuring the Power-on Message	16-1	Turning ON/OFF Linear Amplifier	16-14
Configuring the Screen Saver	16-1	Linear Amplifier TX Control	16-14
Configuring the Screen Saver Type	16-1	Turning ON/OFF Linear Amplifier TX Delay	16-14
Saving Images for Use by Type 3 Screen Saver	16-1	Linear Amplifier TX Delay Time	16-14
Configuring the Time for Launching the Screen Saver	16-1	Linear Amplifier Relay Control	16-14
Configuring the Displayed Screen Saver Text	16-2	External ALC Voltage of Linear Amplifier	16-14
Configuring the Long-press Behavior of Keys	16-2	Operating the Transverter/Exciter	16-15
Configuring the Beep Volume	16-2	Connecting to a Transverter	16-15
PF Keys (Programmable Function Keys)	16-2	Turning off Power Down during Transverter Operation	16-15
Assigning Functions to PF Keys (Front Panel)	16-2	Displaying the Operating Frequency Configured for the Transverter	16-15
Assigning Functions to PF Keys (Microphone)	16-2	Configuring the Operating Frequency of the Transverter	16-15
Assigning Functions to the PF Keys (KEYPAD Jack)	16-3	Antenna Output for External Receivers	16-16
List of Assignable Functions	16-3	Emergency Call (K Type Only)	16-16
PC Control	16-5	Crossband Repeater	16-16
Configuring the COM/USB (Rear Panel) Baud Rate	16-5	Connection	16-16
Configuring the USB Keyboard	16-5	Operation	16-17
Sending Message from the USB Keyboard	16-5	Sky Command System II	16-17
Selecting a USB Keyboard Language	16-5	Sky Command System II Diagram	16-17
Configuring the Time for Activating Key Repeat	16-5	Preparation	16-17
Configuring the Key Repeat Speed	16-5	Starting Sky Command System II Operation	16-18
Saving a Screen Shot	16-6	TS-890S + TH-D7A/ TH-D72(A/E)/ TM-D700A/ TM-D710/G(A/E)/	
Configuring Output to an External Meter	16-6	TM-V71A + RC-D710 (Transporter) Setup	16-18
Configuring the Output Signal Format of the External Meter	16-6		
Configuring the External Meter Output Level	16-6	17 MAINTENANCE AND ADJUSTMENT	
External Monitor Output	16-7	Reset	17-1
Configuring the External Monitor Resolution	16-7	Firmware Update	17-1
Configuring Audio Input/Output	16-7	Firmware Version Check	17-1
Configuring the USB Connector Input/Output Signal	16-7	Calibration of Internal Reference Frequency	17-2
Configuring the Audio Signal Input Level	16-7	Adjusting the Touchscreen	17-3
Configuring the Audio Signal Output Level	16-7	Adjusting the Display Color	17-3
Configuring the ACC 2 Connector Input/Output Signal	16-7	Replacing the Fuse	17-4
Configuring the Audio Signal Input Level	16-7	Replacing the Fuse of the External Antenna Tuner	17-4
Configuring the Audio Signal Output Level	16-7	Replacing the Fuse of the DC Power Cable	17-4
Configuring the TX Monitor Level for External Audio Output	16-7		
Configuring Audio Mixing for the External Audio Output Connector	16-7	18 TROUBLESHOOTING	
Switching the Reference Signal	16-8	General Information	18-1
Switching the CTCSS Mute Operation	16-8	Service	18-1
Configuring the SQL Control Signal	16-8	Service Note	18-1
Configuring the Logic of PSQ	16-8	Cleaning	18-1
Configuring the PSQ Output Conditions	16-8	Troubleshooting	18-2
Switching the COM Connector Signal	16-8	Problems Related to Reception and Transmission	18-2
Split Transfer	16-9	Problems Related to Data Communication, PC and Network	18-5
Connection	16-9	Troubles Related to Recording and Playback	18-8
Split Transfer A	16-9	Error Messages	18-9
Configuration	16-9	Warning Messages	18-11
Operation	16-10	Internal Beats	18-12
Muting the Sub-receiver	16-10	Spurious Signals on the Bandscope	18-12
Split Transfer B	16-10		
TX Inhibit	16-11	19 OTHERS	
Packet Cluster Tuning	16-11	Optional Accessories	19-1
Connection	16-11	Installing the YG-82CN-1 Roofing Filter	19-1
Receiving Packet Cluster Data	16-11	Specifications	19-2
Control of External Devices	16-12		
TX Inhibit in Busy State (when Squelch is Open)	16-12		
Reversing the PKS Signal Polarity	16-12		



1 INSTALLATION AND CONNECTION

Installation

- ! Do not lift this transceiver by holding the **Tuning** control or other control knobs on the front panel or the connectors on the rear panel. Doing so may result in injury or damage of the control knobs.

Antenna Installation and Connection

The antenna system is made up of the antenna, coaxial cables and a ground terminal. Installing the antenna system carefully and properly helps to optimize the performance of the transceiver.

- Make use of a correctly-adjusted 50 Ω antenna, 50 Ω coaxial cables and appropriate connectors. Make sure that all connections are cleaned and free of dirt before fastening them.
- Match the impedance of the coaxial cable and antenna such that SWR is 1:1.5 or lower.
- A high SWR may lower the TX output power, thereby causing radio interference with electrical appliances such as radio and TV as well as failure of this transceiver.
- If reports on signal distortion are received, this means the transceiver may not be transmitting efficiently.

- !
 - Transmitting without connecting the antenna may damage this transceiver. Before transmission, connect an antenna or a 50 Ω dummy load to this transceiver.
 - The protection circuit of this transceiver will be activated if the SWR of the antenna exceeds 1.5. Use an antenna with a low SWR.
 - When an RX antenna that makes use of semiconductors (such as an active antenna) is connected, transmission or antenna tuning must not be performed. Doing so supplies power to the antenna and may damage the semiconductor circuit of the antenna.

Ground Connection

Connect to the ground terminal correctly to avoid risks such as electric shock.

First of all, bury one or multiple ground bars or a large copper sheet in the ground and connect them to the GND terminal of this transceiver. Use a thick conducting wire or a cut copper band that is as short as possible for this connection.

- !
 - Gas pipes, conduit pipes for power distribution, plastic water pipes and the like must not be used for grounding. Not only are they ineffective for grounding, they may also result in accidents or fire.

Installation of Lightning Arrestors

- To prevent fire, electric shock, malfunctioning and injury due to lightning, install a coaxial lightning arrester.
- Besides installing a coaxial lightning arrester, disconnect the cable of the antenna from this transceiver if lightning is anticipated.

Connection of Regulated DC Power Supply

- !
 - Make sure to turn off the power of the regulated DC power supply before connecting the DC power cord.
 - Do not insert the power plug of the regulated DC power supply into the AC outlet until all the connections are complete.

A DC 13.8 V regulated DC power supply is needed for using this transceiver. It cannot be connected directly to an AC outlet. Use the supplied DC power cord to connect this transceiver to the regulated DC power supply.

- The current capacity needed for the regulated DC power supply is 22.5 A and above. Use one with sufficient current capacity.

1 Connect the DC power cord to the regulated DC power supply.

Connect the red wire to the “+” terminal and the black wire to the “-” terminal.

2 Next, connect the DC power cord to the DC 13.8 V power connector of this transceiver.

Insert the cord fully into the power connector.

Using the Auxiliary Support

An auxiliary support is stored inside the front leg of this transceiver. Pull it toward you if you want the panel to face slightly upwards.

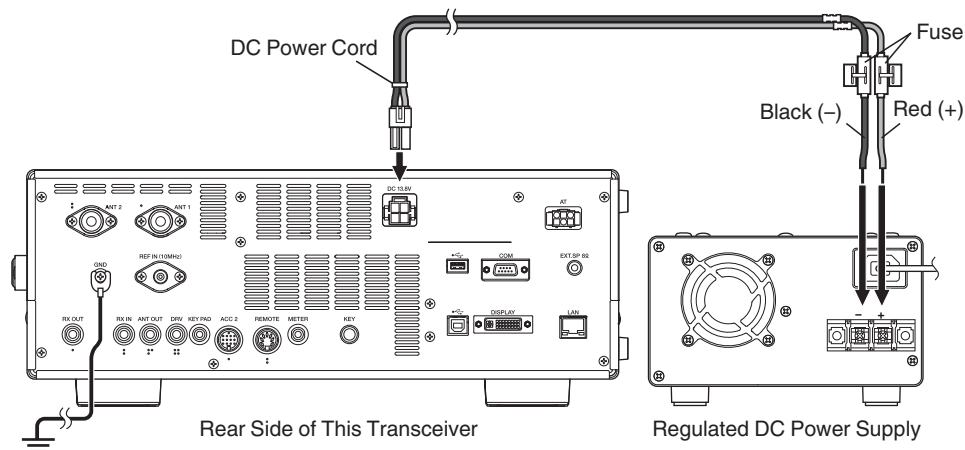
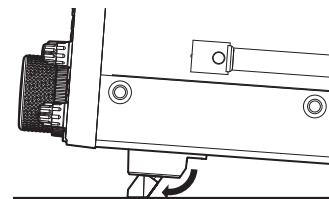

1 INSTALLATION AND CONNECTION

Torque Adjustment with Tuning Control

The **Tuning** control allows the rotational torque (weight) to be adjusted according to the user's preference. With the ring at the base of the **Tuning** control fixed, turning the **Tuning** control to the right increases the rotational torque, while turning to the left decreases it.

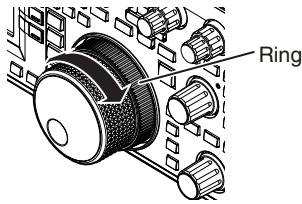

Paddle (PADDLE)

For CW operation using the built-in electronic keyer, connect a keyer paddle to the PADDLE jack. A $\Phi 6.3$ mm three-pronged plug is used for the paddle. Also, a straight key can be connected to the PADDLE jack. In this case, change the setting of Menu [5-00] to "Straight Key". (Refer to Chapter 3 for details on menu operation.)

USB Flash Drive/ USB Keyboard

For connecting a commercially available USB flash drive or USB keyboard. Plug the USB flash drive or USB keyboard firmly into the (USB-A) connector.



- Do not remove the USB flash drive while reading or writing files or while the USB flash drive is being accessed by this transceiver. Also, do not turn off the power of this transceiver.
- Always remove the USB flash drive after executing "Safely Removing the USB Flash Drive" (11-6) to prevent data in the USB flash drive from being damaged. (USB/File Management Menu "Safe Removal of USB Flash Drive")
- A USB flash drive or USB keyboard can be connected to the connector on the front panel and rear panel respectively.

Connection of Accessories (Front Panel)

Headphones (PHONES)

Monaural and stereo headphones (4 to 32Ω , standard: 8Ω /plug: $\Phi 6.3$ mm) can be used with this transceiver.

When headphones are connected, sound will not be output from the built-in speakers (or optional external speakers). The following optional headphones are compatible with this transceiver.

●HS-5 ●HS-6



- The volume may be louder for headphones with a higher impedance.
- The audio output is monaural even when stereo headphones are connected.

Microphone (MIC)

Microphones with an impedance of 250Ω to 600Ω can be used. Insert the microphone plug fully into the MIC connector of this transceiver and tighten it firmly using the fastening ring.

The following microphones (sold separately) are compatible with this transceiver.

●MC-43S ●MC-60A ●MC-90 ●MC-47

The following microphones are not compatible with this transceiver.

●MC-44 ●MC-44DM ●MC-45 ●MC-45DM



- Production of the MC-47 microphone has been discontinued.

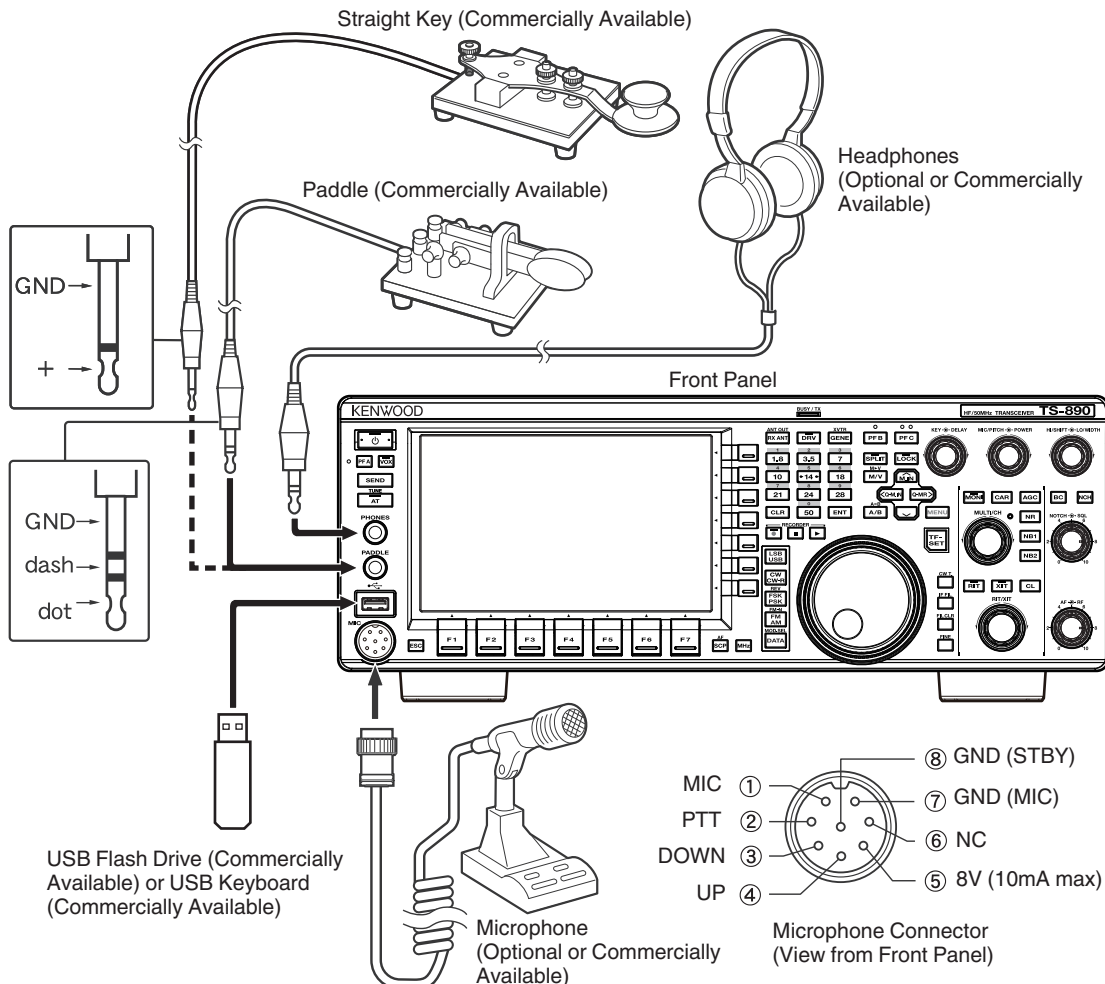

Connection of Accessories (Rear Panel)

- Do not connect a cable exceeding 3 m (9.8 feet) to the following connectors. Doing so may affect proper operation due to signal attenuation.
 - KEY jack
 - ACC 2 connector
 - REMOTE connector
 - METER jack
 - DRV connector
 - KEYPAD jack
 - COM connector
 - EXT.SP jack
 - DISPLAY connector
 - LAN connector
 - PHONES jack
 - PADDLE jack
 - MIC connector
 - USB connector

Key for CW (KEY)

For CW operation without using the built-in electronic key, connect the plug of an electronic key, bug key, external electronic keyer or PC keyer to the KEY jack. Use a $\Phi 3.5$ mm two-pronged plug. Positive keying needs to be used for external electronic keyers and PC keyers. Use a shielded cable to connect the key and this transceiver.

- For more detailed explanation on the built-in keyer, refer to "Electronic Keyer". (5-13)

USB Flash Drive/USB Keyboard ()

For connecting a commercially available USB flash drive or USB keyboard. Plug the USB flash drive or USB keyboard firmly into the (USB-A) connector.

- A USB flash drive or USB keyboard can be connected to the connector on the front panel and rear panel respectively.

Keypad (KEYPAD)

For connecting a self-made PF keypad.

External Speaker (EXT. SP 8 Ω)

For connecting an external speaker.

- The EXT. SP 8 Ω is used exclusively for connecting an external speaker. Due to the loud audio output, hearing may be impaired when headphones are used. Do not connect headphones.

External Display (DISPLAY)

Connect this transceiver with an external display using a commercially available DVI cable. Doing so enables information displayed on the screen of this transceiver to be shown on the external display.

- Use an external display with a resolution of 800 x 600 or 848 x 480.
- This transceiver supports digital and analog outputs.
- If the display to connect uses a D-sub terminal, make use of a commercially available DVI/D-Sub conversion adapter.

External Meter (METER)

For connecting a commercially available meter.

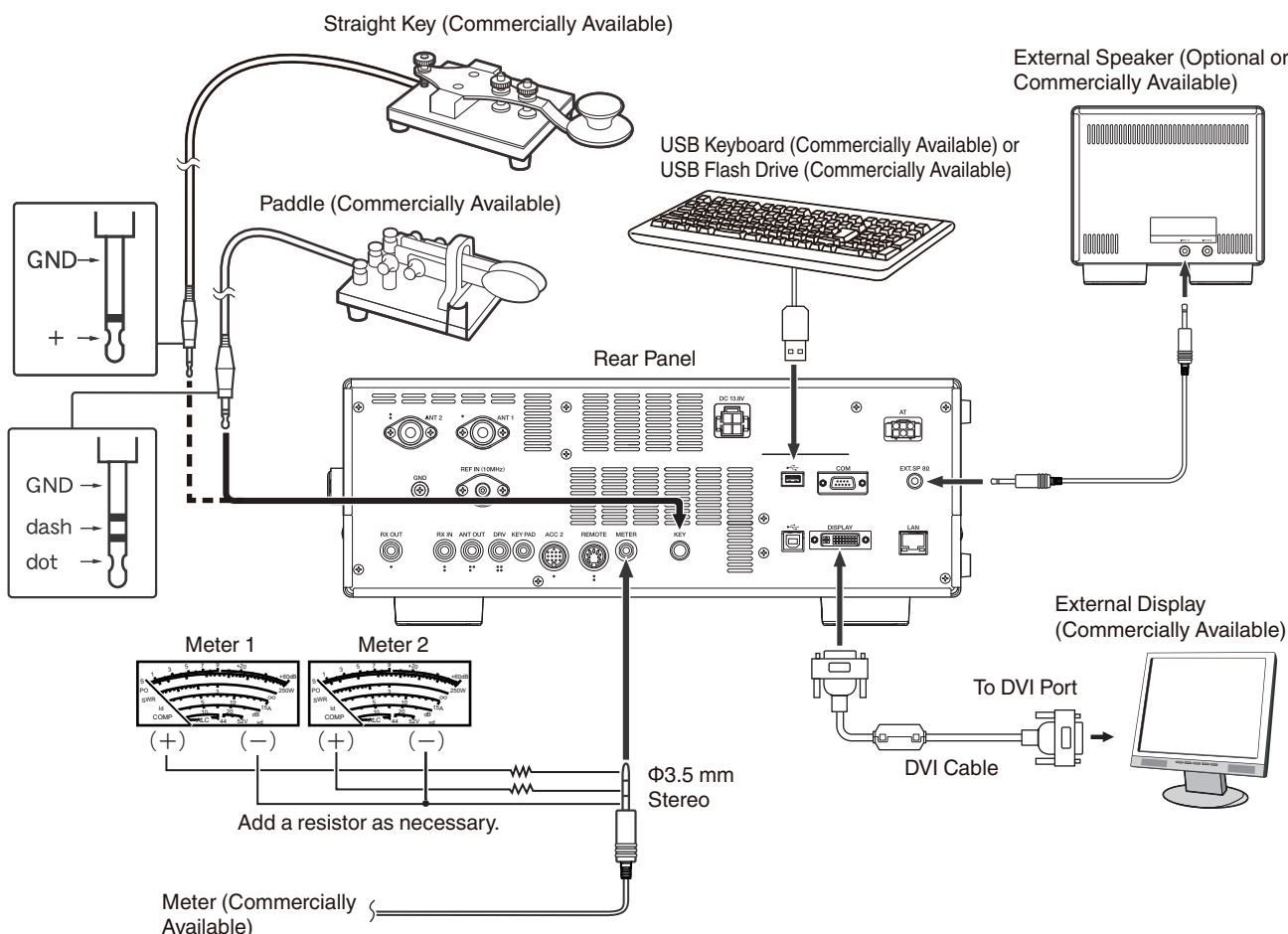

1 INSTALLATION AND CONNECTION

PC Connection for Data Communication

This transceiver is equipped with data communication connectors (USB and ACC2) for exchanging audio signals with the auxiliary equipment and connectors (USB and COM) for controlling using PC commands when performing data communication with an external device such as a PC as the auxiliary equipment.

To make use of data communication such as RTTY (AFSK), PSK31, SSTV, JT65 and FT8 using data communication software that employs the sound function of a PC and with this transceiver configured to the DATA mode (SSB-DATA, FM-DATA, AM-DATA), set up the connection as follows.

- When using the USB audio function: connect to the PC using a USB cable. Data communication with only the USB cable connection is possible by making use of data VOX or PC commands (“TX1;” to start transmission and “RX;” to end transmission) to switch between transmission and reception. (For details on the configuration of the input sound source in the DATA mode and the VOX function, refer to page 8-1.)
- When using an ACC 2 connector: connect the audio output line of the PC to pin 11 (ANI) of the ACC 2 connector and the audio input line of the PC to pin 3 (ANO). Pin 9 (PKS) of the ACC 2 connector, data VOX or PC commands (“TX1;” to start transmission and “RX;” to end transmission) are used to switch between transmission and reception.
- When controlling using PC command, connect to the PC with a RS-232C straight cable or a USB cable. To connect with a USB cable, use the virtual COM (Standard) port. For more details, please refer to “[Virtual COM Port](#)” (1-5).
- For performing RTTY keying by connecting to a PC (or other external devices) while this transceiver is configured to the FSK mode, please refer to “[Operating RTTY \(FSK\) Using an External Device](#)” (5-22).

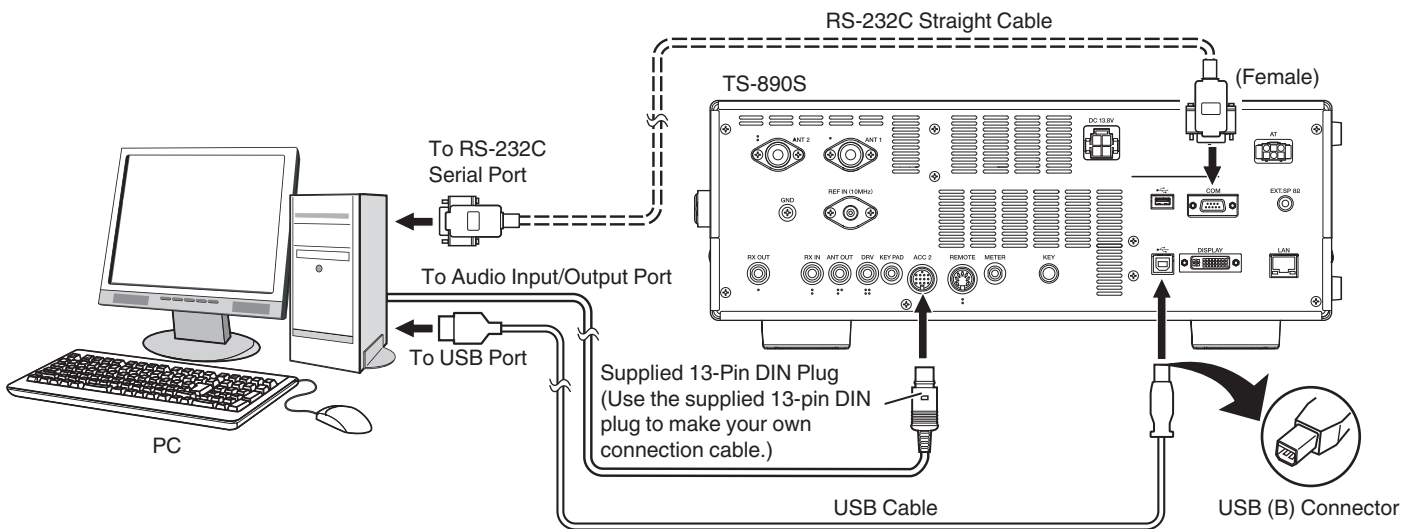

Configure the transceiver as follows according to the method of connection with the PC, the specification of the software used for data communication and the settings, etc.

■ Baud Rate Configuration for PC Control

Configure the baud rate of the COM/USB port used for PC control as follows.

* Refer to “[Configuring the COM/USB \(Rear Panel\) Baud Rate](#)” (16-5).

When using the USB port: Configure in Menu [7-01] “Baud Rate (Virtual Standard COM)”.

When using the COM port: Configure in Menu [7-00] “Baud Rate (COM Port)”.

■ Audio Source Input Configuration

Configure the audio source input for data transmission via PC commands in the SSB-DATA mode as follows.

* Refer to “[Configuration of the Input Path of TX Audio](#)” (8-1).

1) Press and hold [DATA] to display the audio source input screen.

2) Press [DATA] to switch from “Data Mode Off” to “Data Mode On”.

Check the “Rear” setting under “Audio Input” for “DATA SEND (PF)” under “TX Method”.

When using the USB audio function: Configure to “USB Audio” (default).

When using the ACC 2 connector: Configure to “ACC 2”.

■ RX Level Adjustment

Adjust the audio output level for receiving via data communication as necessary by using the sound setting (recording device) on the PC or using the following menus on the transceiver.

* Refer to “[Configuring Audio Input/Output](#)” (16-7).

When using the USB audio function: Configure in Menu [7-08] “USB: Audio Output Level”.

When using the ACC 2 connector: Configure in Menu [7-09] “ACC 2: Audio Output Level”.

■ TX Level Adjustment

Adjust the audio input level for transmitting via data communication as necessary by using the sound setting (playback device) on the PC or using the following menus on the transceiver.

* Refer to “[Configuring Audio Input/Output](#)” (16-7).

When using the USB audio function: Configure in Menu [7-06] “USB: Audio Input Level”.

When using the ACC 2 connector: Configure in Menu [7-07] “ACC 2: Audio Input Level”.

■ Configuration for Switching the RX Bandwidth

Configure the setting as follows to switch the RX bandwidth by cutting off the high or low frequencies within the frequency range of 0 Hz to 5000 Hz even in the SSB-DATA mode, in the same way as in SSB mode, during operations such as FT8.

* Refer to “Configuring the Behavior of the HI/SHIFT and LO/WIDTH Controls (SSB/SSB-DATA Only)” (6-3).

Configure in Menu [6-12] “Filter Control in SSB-DATA Mode (High/Low and Shift/Width)”. Select “High & Low Cut”.



- USB cable and RS-232C straight cable are not supplied with this transceiver. Please purchase commercially available cables.
- Delays may occur when using USB audio, and there may also be audio interruptions depending on the performance and load of the PC.
- Place this transceiver far enough from the PC so that noise will not be picked up.
- For data communication software settings, refer to the instruction manual or Help file of the software in use.

Virtual COM Port

PC command control using the virtual COM port and USB keying control using the RTS/DTR signal of the virtual COM port can be performed by connecting this transceiver and the PC using a USB cable.

- To use the virtual COM port, Windows 10, Windows 8.1 or Windows 7 is required. (as of January, 2019)
 - Install the virtual COM port driver on the PC before connecting the USB cable. Download the driver from the following URL.
http://www.kenwood.com/i/products/info/amateur/software_download.html
 - There are 2 types of virtual COM port on this transceiver, namely virtual COM (Standard) port and virtual COM (Enhanced) port.
 - The COM port numbers of the virtual COM (Standard) port and virtual COM (Enhanced) port on the PC can be checked using the following way.
 - Open the Device Manager in Windows.
 - Connect this transceiver and the PC using a USB cable. The following 2 COM ports are displayed in “Ports (COM & LPT)” in the Device Manager.
“Silicon Labs CP210x USB to UART Bridge (COM x)”
“Silicon Labs CP210x USB to UART Bridge (COM y)”
- x and y are numbers. The numbers vary depending on the PC environment used. The following is the display example of the virtual COM ports on this transceiver assigned to COM3 and COM4.



- Double-click on these in the Device Manager to display the respective Properties windows.
- Select the “Details” tab and then select “Location paths” from the Property drop-down menu.
- Move the mouse cursor to the top line displayed in the “Value” column and check the number in the parenthesis on the right end of the character string.

The port displayed with the number (1) is the virtual COM (Standard) port of this transceiver.
The port displayed with the number (2) is the virtual COM (Enhanced) port of this transceiver.
The following is the display example of the Properties window of each COM port when the virtual COM (Standard) port and the virtual COM (Enhanced) port are assigned to COM3 and COM4 respectively.

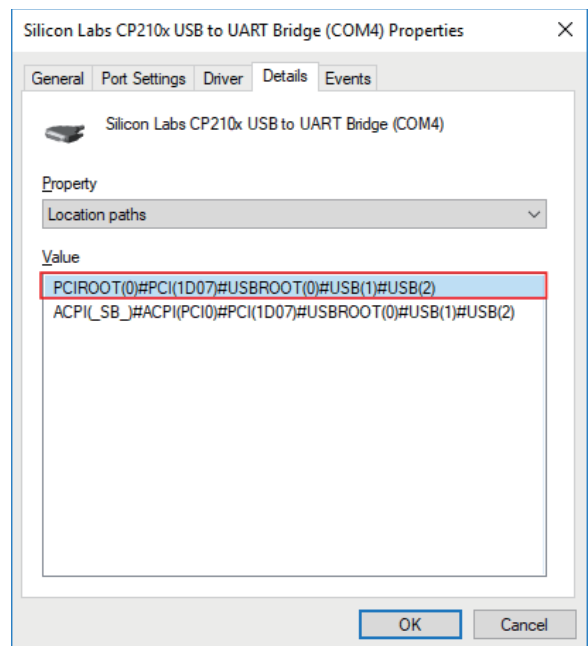
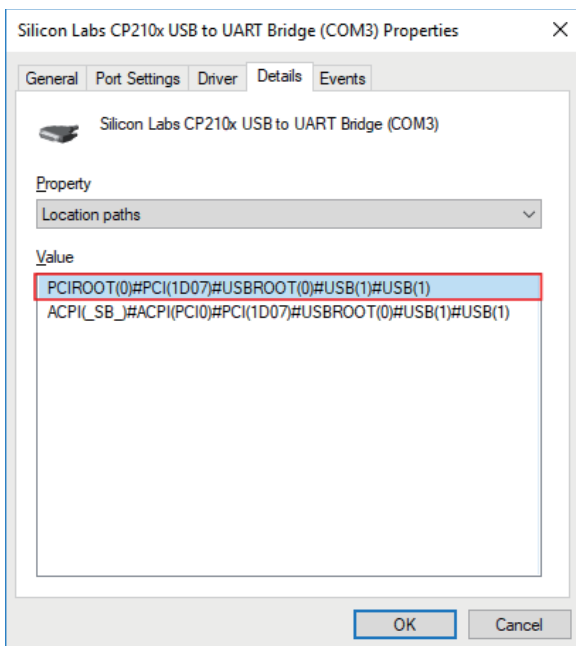

1 INSTALLATION AND CONNECTION

Terminal Descriptions

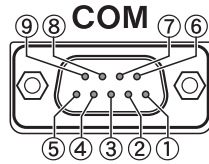

COM Connector

Pin No.	Pin Name	Function	Input/Output
1	NC	No connection	—
2	RXD	Sends serial data from this transceiver to RXD on the PC.	O
3	TXD	Receives serial data from TXD on the PC to this transceiver.	I
4	NC	No connection	—
5	GND	Signal ground	—
6	NC	No connection	—
7	RTS	Sends signal from RTS on the PC to this transceiver. If the PC is unable to accept incoming data, an “L” level signal is output from the PC to this transceiver and data will not be sent in this case.	I
8	CTS	Sends signal from this transceiver to CTS on the PC. If this transceiver is unable to accept incoming data, an “L” level signal is output from this transceiver to the PC and input of incoming data will be forbidden.	O
9	NC	No connection	—

REMOTE

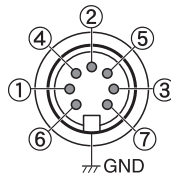

GND :
Connect to metal shield.

REMOTE Connector

Pin No.	Pin Name	Function	Input/Output
1	SPO	Speaker out	O
2	COM	Common terminal of the built-in relay for linear amplifier control	I/O
3	SS	PTT input • Sends signal by grounding the SS terminal.	I
4	MKE	Make terminal of the built-in relay for linear amplifier control • The make terminal can be connected to the common terminal during transmission by configuring “ Internal Relay Control ” (16-14) of the linear amplifier menu. Rated control capacity of relay contact: 2 A/ 30 V DC (resistance load) Maximum allowable voltage of relay contact: 220 V DC, 250 V AC	I/O
5	BRK	Break terminal of the built-in relay for linear amplifier control • The break terminal can be connected with the common terminal when the latter is not connected to a make terminal. Rated control capacity of relay contact: 2 A/ 30 V DC (resistance load) Maximum allowable voltage of relay contact: 220 V DC, 250 V AC	I/O
6	ALC	ALC input from the linear amplifier • This is a negative input. The ALC circuit starts to operate from an input of approximately -4 V (which can be changed from the Linear Amplifier menu).	I
7	LKY	Linear amplifier control output • The output logic during transmission can be configured using “ Keying Logic ” (16-14) of the linear amplifier menu. “Active High”: Outputs DC 12 V during transmission. The maximum output current is 100 mA. “Active Low”: Switches to the “L” level (GND and short) during transmission. When an external bias is applied while receiving is in progress, the signal switches to the “H” level. Voltage and current not higher than DC 50 V and 100 mA respectively can be controlled.	O

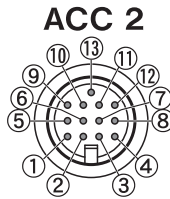

ACC 2 Connector

Pin No.	Pin Name	Function	Input/Output
—	NC	No connection	—
2	RTTY	RTTY control terminal (FSK key input)	I
3	ANO	Audio output <ul style="list-style-type: none"> Connect to the audio input of a PC or an external device such as a PC connection interface. The audio output level is independent of the AF volume control knob on the front panel. The audio output level can be adjusted in Menu [7-09]. Adjust it to an appropriate level. When the audio output level is configured to the default value of “50” in Menu [7-09], the peak-to-peak voltage is approximately 0.5 V p-p in the case of standard modulation signals. Altering the audio output level between “0” and “100” changes the peak-to-peak voltage level between approximately 0 Vp-p and 1.2 Vp-p. (Impedance 10 kΩ) 	O
4	GND	Signal ground	—
5	PSQ	Squelch control output <ul style="list-style-type: none"> Connect to the squelch input of an external device such as a PC connection interface. When squelch is open: Low impedance When squelch is closed: High impedance 	O
6	MET 1	Meter level output 1	O
7	NC	No connection	—
8	GND	Signal ground	—
9	PKS	PTT input for data communication (DATA SEND) <ul style="list-style-type: none"> Connect to the PTT output of an external device such as a PC connection interface. Signal can be transmitted by connecting the PKS terminal to GND. The PKS terminal mutes unnecessary modulation input signals during transmission. Refer to Configuration of the Input Path of TX Audio (8-1). 	I
10	MET2	Meter level output 2	O
11	ANI	Audio input for data communication <ul style="list-style-type: none"> Connect to the audio output of a PC or an external device such as a PC connection interface. The audio input level is independent of MIC GAIN on the front panel. The audio input level can be adjusted in Menu [7-07]. Standard modulation can be obtained with an input of approximately 10 mVrms in the default setting of “50” in Menu [7-09]. Altering the audio input level between “0” and “100” changes the standard modulation input level between approximately “almost no modulation” and approx. 1 mVrms. (Impedance 10 kΩ) 	I
12	GND	Signal ground	—
13	SS	PTT input <ul style="list-style-type: none"> This is the same terminal as pin 2 (SS terminal) of the MIC connector on the front panel and pin 3 (SS terminal) of the REMOTE connector. It has the same behavior as pressing [SEND] on the front panel. Signal can be transmitted by connecting the SS terminal to GND. The SS terminal mutes unnecessary modulation input signals during transmission. Refer to Configuration of the Input Path of TX Audio (8-1). 	I

1 INSTALLATION AND CONNECTION

AT

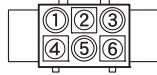

EXT. AT Connector

Pin No.	Pin Name	Function	Input/Output
1	GND	Signal ground	—
2	TT	EXT.AT connector (TTI/TTO)	I/O
3	GND	Signal ground	—
4	NC	No connection	—
5	TS	EXT.AT connector (TSI/TSO)	I/O
6	14S	DC 13.8 V power supply for EXT.AT (4 A max.)	O

MIC

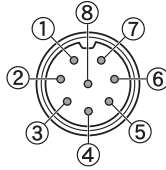

MIC Connector

Pin No.	Pin Name	Function	Input/Output
1	MIC	MIC signal input	I
2	SS	MIC standby (PTT) control	I
3	MD	MIC DOWN control	I
4	MU	MIC UP control	I
5	8 A	DC 8 V power supply for MIC (10 mA max.)	O
6	NC	No connection	—
7	MSG	MIC ground	—
8	MCG	Signal ground	—

2 NAMES AND FUNCTIONS OF PARTS

Front Panel

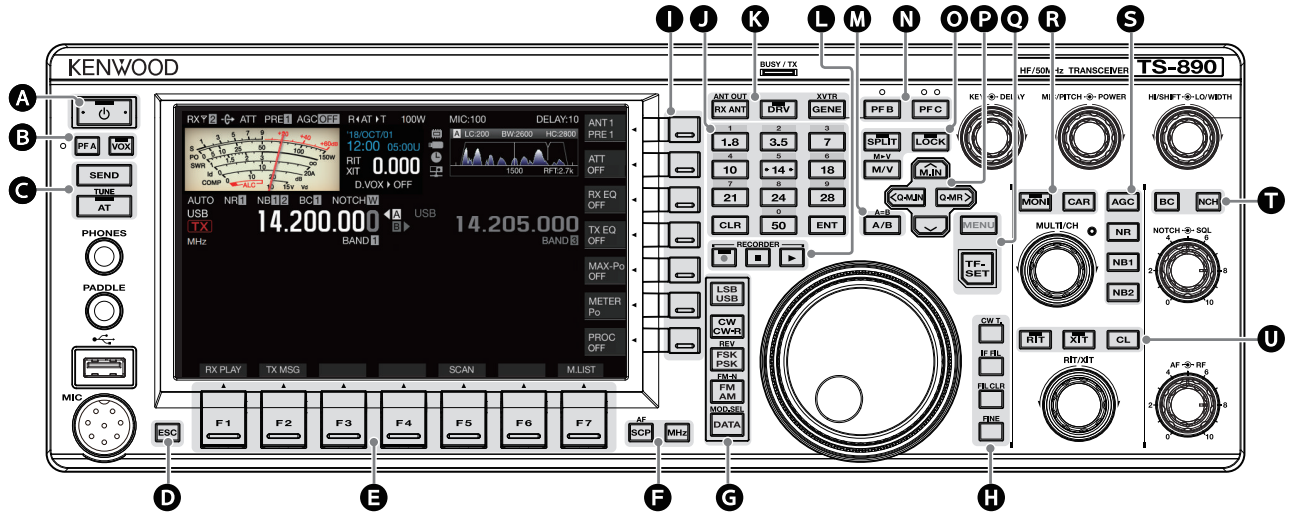

Panel Key Behavior

	Key	Behavior	Refer to	
A	[⏻]	Press	Turns on the power.	4-1
		Press and hold	Turns off the power.	
B	[PF A]	Press	Activates the registered function.	16-2
	[VOX]	Press		
C	[SEND]	Press and hold	Displays the VOX configuration screen.	8-2
	[AT]	Press	Starts/ends transmission.	4-8
D	[ESC]	Press	Turns ON/OFF the antenna tuner.	4-11
		Press and hold	Starts antenna tuning.	
E	[F1] to [F7] (Horizontally Arrayed F)	Press	Exits the configuration screen.	-
F	[SCP]	Press	Activates the function according to the key guide at the bottom of the screen. (Henceforth represented as F1 [XXX] to F7 [XXX] in this manual.) Refer to "List of Function Key Behaviors (Standard Mode Screen)" for functions of the F key on the normal screen.	2-4
		Press and hold	Displays the bandscope. Switches the scope screen.	
G	[MHz]	Press	Displays the audio scope. Switches between bandscope and audio scope.	7-1 7-8
	[LSB/USB]	Press	Turns ON/OFF the MHz step function.	4-6
G	[CW/CW-R]	Press	Switches between the LSB and USB modes.	4-4
	[FSK/PSK]	Press	Switches between the CW and CW-R modes.	4-4
G	[FM/AM]	Press	Switches between the FSK and PSK modes.	4-4
		Press and hold	Switches between reverse and normal in the FSK/PSK mode.	
G	[DATA]	Press	Switches between the FM and AM modes.	4-4
		Press and hold	Switches between FM narrow and FM normal.	
G	[DATA]	Press	Switches the DATA mode.	4-4
		Press and hold	Displays the input source configuration screen for the TX audio.	

2 NAMES AND FUNCTIONS OF PARTS

	Key		Behavior	Refer to
H	[CW T.]	Press	Activates the CW auto tune function.	5-9
	[IF FIL]	Press	Switches between receiver (RX) filters A, B and C.	6-1
		Press and hold	Displays the RX Filter screen.	6-2
	[FIL CLR]	Press	Restores the passband of the RX filter that has been changed to the preset value.	6-5
	[FINE]	Press	Turns ON/OFF the FINE-tuning function.	4-5
I	[] to [] (Vertically Arrayed F)		Activates the function according to the key guide on the right side of the screen. (Henceforth represented as F [XXX] in this manual.) Refer to "List of Function Key Behaviors (Standard Mode Screen)" for functions of the F key on the normal screen.	2-4
J	[0 (50)] to [9 (28)]	Press	For selecting a frequency band and switching band memory.	4-3
	[CLR]	Press	Cancels the direct frequency input mode.	-
	[ENT]	Press	Turns on the direct frequency input mode.	4-6
K	[RX ANT]	Press	Turns ON/OFF the RX antenna.	4-10
		Press and hold	Turns ON/OFF the antenna output function for the external receiver.	16-16
	[DRV]	Press	Turns ON/OFF the drive output function.	4-11
	[GENE]	Press	For selecting a general coverage band such as 70 MHz (E type), 135 kHz, 475 kHz, MW broadcast band, and 5 MHz.	4-3
Press and hold		Turns ON/OFF the transverter function.	16-15	
L	[●]	Press	Starts, pauses or resumes manual recording.	12-3
		Press and hold	Saves the constantly recorded audio file.	12-4
	[■]	Press	Stops audio recording or playback.	12-3 12-4
	[▶]	Press	Starts, pauses or resumes playback.	12-4
M	[A/B]	Press	Switches between VFO A and VFO B.	4-3
		Press and hold	Aligns the frequency and mode of VFO A and VFO B.	5-1
N	[PF B]	Press	Activates the registered function.	16-2
		Press and hold		
	[PF C]	Press	Activates the registered function.	16-2
		Press and hold		
O	[SPLIT]	Press	Turns ON/OFF the split mode.	5-1
		Press and hold	Starts configuration of the frequency for split operation.	5-1
	[LOCK]	Press	Turns ON/OFF the frequency lock function.	4-7
	[M/V]	Press	Switches between the memory channel and VFO mode.	9-2
Press and hold		Copies the memory channel data and quick memory channel data to VFO.	9-3	

	Key		Behavior	Refer to
P	[^ M.IN]	Press	Displays the memory channel list screen.	9-2
			Registers a memory channel.	9-2
			Switches the menu mode item.	3-1
	[<Q-M.IN]	Press	Registers a quick memory channel.	9-5
			Confirms the content selected in menu mode.	3-1
	[Q-MR>]	Press	Calls up a quick memory channel.	9-5
Press and hold		The parameter setting in the menu mode can now be changed.	3-1	
	[v]	Press	Switches the menu mode item.	3-1
Q	[MENU]	Press	Turns ON/OFF the menu mode.	3-1
	[TF-SET]	Press	Turns ON/OFF TF-SET. (ON while it is being pressed.)	5-2
R	[MONI]	Press	Turns ON/OFF the TX monitor function.	8-3
		Press and hold	Displays the TX monitor level configuration screen.	8-3
	[CAR]	Press	Displays or closes the carrier level configuration screen.	5-8
S	[AGC]	Press	Switches the AGC time constant [FAST, MID, SLOW].	5-3
		Press and hold	Displays or closes the AGC configuration screen.	5-3
	[NR]	Press	Switches the mode of the noise reduction function [OFF/NR1/NR2].	6-8
		Press and hold	Displays the NR1 configuration screen. (When Noise Reduction 1 is ON) Displays the NR2 configuration screen. (When Noise Reduction 2 is ON)	6-9
	[NB1]	Press	Turns ON/OFF the Noise Blanker 1.	6-6
		Press and hold	Displays the NB1 configuration screen.	6-6
	[NB2]	Press	Turns ON/OFF the Noise Blanker 2.	6-6
Press and hold		Displays the NB2 configuration screen.	6-7	
T	[BC]	Press	Switches the mode of the beat canceler function [OFF/BC1/BC2].	6-9
	[NCH]	Press	Turns ON/OFF the notch filter.	6-8
		Press and hold	Switches the bandwidth of the notch filter [Normal, Middle, Wide].	6-8
U	[RIT]	Press	Turns ON/OFF the RIT function.	5-7
		Press and hold	Shifts the RX frequency via RIT.	5-7
	[XIT]	Press	Turns ON/OFF the XIT function.	5-7
		Press and hold	Shifts the TX frequency via XIT.	5-7
	[CL]	Press	Clears the RIT or RIT/XIT frequency.	5-7

2 NAMES AND FUNCTIONS OF PARTS

List of Function Key Behaviors (Standard Mode Screen)

Function Keys (Vertically Arrayed)

	Key Guide		Behavior	Refer to
F	[ANT/PRE]	Press	Switches the preamplifier. (OFF/ PRE 1/ PRE 2)	5-6
		Press and hold	Switches between "ANT 1" and "ANT 2".	4-10
	[ATT]	Press	Switches the attenuation level of the attenuator. (OFF/ 6 dB/ 12 dB/ 18 dB)	6-1
		Press and hold	Switches in the reverse order.	6-1
	[RX EQ]	Press	Turns ON/OFF the RX equalizer.	5-4
		Press and hold	Displays the RX equalizer configuration screen.	5-4
	[TX EQ]	Press	Turns ON/OFF the TX equalizer.	8-5
		Press and hold	Displays the TX equalizer configuration screen.	8-5
	[MAX-Po]	Press	Turns ON/OFF the TX output power limiter.	4-9
		Press and hold	Displays the TX output power limiter configuration screen.	4-9
	[METER]	Press	Switches the meter display.	4-9
	[PROC]	Press	Turns ON/OFF the speech processor.	8-4
		Press and hold	Displays the Speech Processor configuration screen.	8-4

Function Keys (Horizontally Arrayed)

	Key Guide		Behavior	Refer to
F1	[RX PLAY]	Press	Displays the audio recording file screen.	12-4
F2	[TX MSG]	Press	Displays the voice message screen. (Displayed in the SSB, AM and FM modes.)	12-1
	[KEYER]	Press	Displays the CW message screen. (Displayed in the CW mode.)	5-14
F3	[DECODE]	Press	Displays the communication screen. (Displayed in the CW, FSK and PSK modes.)	5-10 5-22 5-22
F4	[TONE]	Press	Switches in the sequence of: "TONE" → "CTCSS" → "CROSS TONE". (Displayed in the FM mode.)	5-29
		Press and hold	Displays the TONE frequency, CTCSS frequency or cross tone configuration screen.	5-30
F5	[SCAN]	Press	Starts/stops scanning.	10-1 10-3
		Press and hold	Displays the VFO/Program Scan segment screen. (Displayed in the VFO mode.)	10-1
			Displays the memory scan group screen. (Displayed in the memory channel mode.)	10-3
F6	[M ► VFO]	Press	Shifts the memory. (Displayed in the memory channel and quick memory channel modes.)	9-3 9-6
F7	[M.LIST]	Press	Displays the memory channel list.	9-1

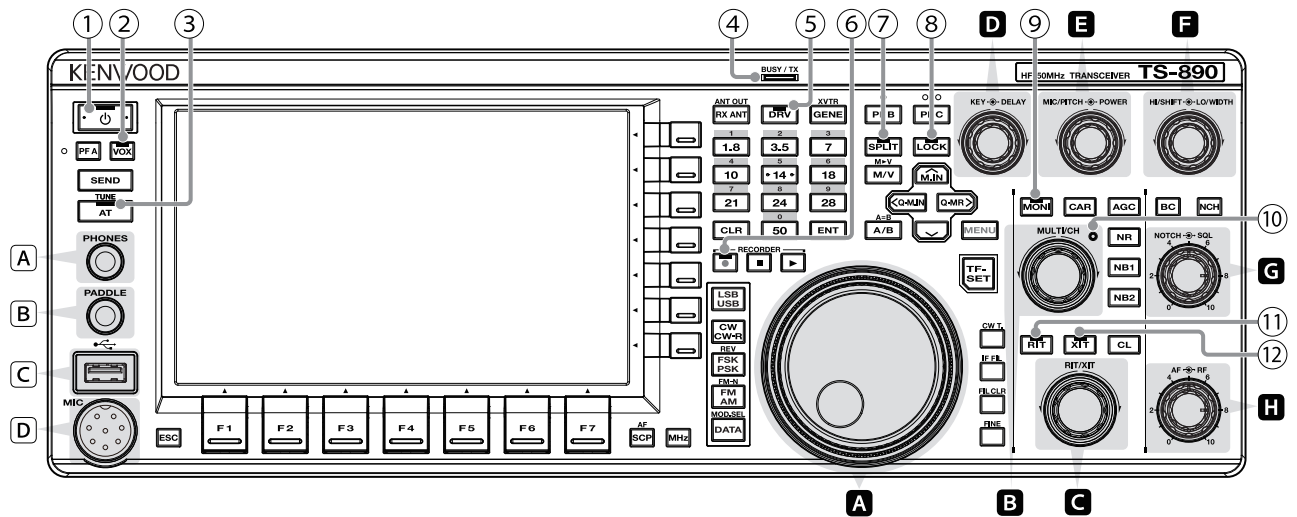

List of Control Knob Behaviors

Control	Behavior	Refer to
A Tuning	Aligns the TX and RX frequencies.	4-5
B [MULTI/CH]	Switches the frequency at a fast speed. (Available in the VFO mode.)	4-5
	Switches the channel number. (Available in the memory channel and quick memory channel modes.)	9-2
	Switches the item to configure or configured value. (Available when a configuration screen is displayed.)	3-1
C [RIT/XIT]	Changes the RIT/XIT frequency.	5-7
D [KEY]	Adjusts the keying speed.	5-13
	[DELAY]	Adjusts the break-in delay time. (When the TX mode is configured to CW.) Adjusts the VOX delay time. (When the TX mode is configured to SSB, FM or AM.)
E [MIC/PITCH]	Adjusts the microphone gain. (When the TX mode is configured to SSB or AM.)	4-8
	Adjusts the sidetone/pitch frequency. (When the TX mode is configured to CW.)	5-9
	[POWER]	Adjusts the speech processor output level. (When the speech processor is ON.) Changes the TX output power level.
F [HI/SHIFT]	Changes the RX filter (high cutoff frequency or SHIFT frequency).	6-3
	[LO/WIDTH]	Changes the RX filter (low cutoff frequency or WIDTH frequency).
G [NOTCH]	Adjusts the notch frequency.	6-8
	[SQL]	Adjusts the squelch level.
H [AF]	Adjusts the receiving volume.	4-2
	[RF]	Adjusts the RF gain.

2 NAMES AND FUNCTIONS OF PARTS

List of LED Behaviors

	LED	Behavior
①	[POWER]	When power is OFF: light off
		When power is ON: lights up in green
		When power is OFF with timer activated: lights up in orange
		When timer is starting up: blinks in orange
②	[VOX]	Lights up when the VOX function is enabled.
③	[AT]	Lights up when the antenna tuner is ON.
		Blinks during antenna tuning.
④	[BUSY/TX]	Lights up in green when squelch opens upon receiving a signal.
		Lights up in red when transmission is in progress.
⑤	[DRV]	Lights up when drive output is ON.
⑥	[REC]	Lights up during manual recording (including when recording is paused). Blinks for 1 second at the start of saving the constantly recorded audio.
⑦	[SPLIT]	Lights up in the split mode.
		Blinks during configuration of the split frequency.
⑧	[LOCK]	Lights up when the frequency lock function is enabled.
⑨	[MONI]	Lights up when the TX monitor function is enabled.
⑩	[MULTI/CH]	Lights up when a configuration screen is displayed (when adjustments can be made using the [MULTI/CH] control).
⑪	[RIT]	Lights up when the RIT function is enabled.
⑫	[XIT]	Lights up when the XIT function is enabled.

Connectors and Jacks

	Name	Description
A	<PHONES> Jack	Jack for connecting to headphones.
B	<PADDLE> Jack	Jack for connecting a paddle while running in the CW mode.
C	<USB-A> Connector	Connector for connecting a USB flash drive or USB keyboard.
D	<MIC> Connector	Connector for connecting a microphone.

Rear Panel

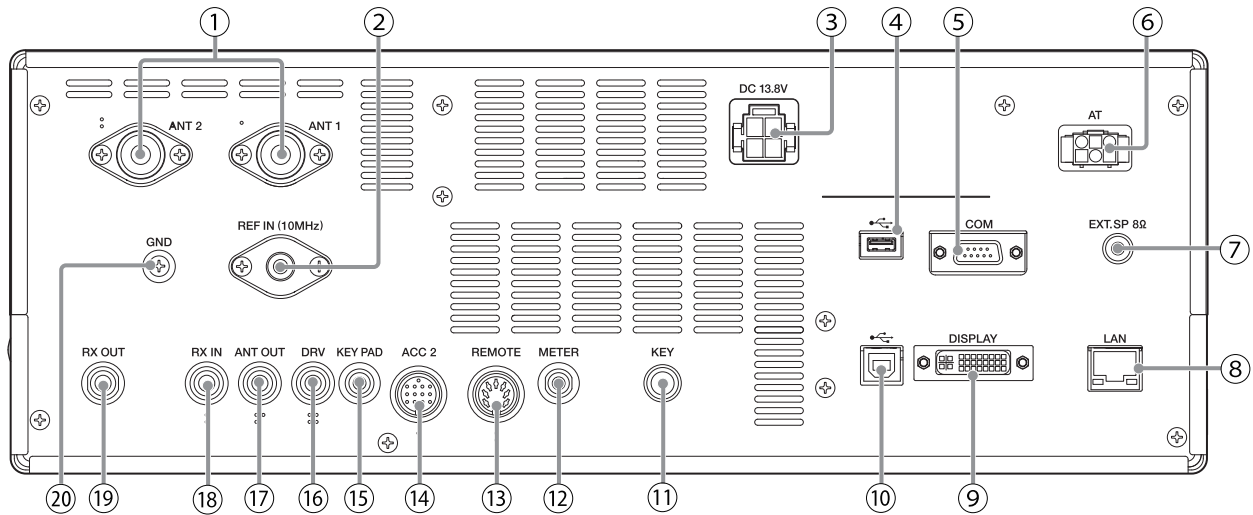

Connectors and Jacks on the Rear Panel

No.	Name	Description	Remarks
①	<ANT 1> Connector <ANT 2> Connector	M-type coaxial connector for connecting the antenna.	
②	<REF IN (10MHz)> Connector	For input of 10 MHz signals when using an external reference frequency.	<ul style="list-style-type: none"> • Input impedance: 50 Ω • Input: 0 dBm ±10 dB
③	<DC13.8V> Connector	For connecting a regulated DC power supply.	
④	<USB-A> Connector	Connector for connecting a USB flash drive or USB keyboard.	
⑤	<COM> Connector	RS-232C connector for connecting a PC or external device.	
⑥	<AT> Connector	Connector for controlling an external antenna tuner.	
⑦	<EXT.SP> Jack	For connecting an external speaker.	
⑧	<LAN> Connector	Connector for connecting a PC or LAN when running with the KNS (KENWOOD NETWORK COMMAND SYSTEM) or for automatic correction of the clock time.	
⑨	<DISPLAY> Connector	DVI-I connector for connecting an external monitor. Both analog and digital signals can be output.	
⑩	<USB-B> Connector	Connector for connecting a PC. It is used to control this transceiver using the ARCP-890 as well as to input and output signals for transmission and reception via the digital communication application of a PC. It can be switched between transmission and reception by changing the menu setting and keying.	
⑪	<KEY> Jack	For connecting an electronic key (straight key, bug key, external electronic key, etc.) when running in the CW mode. This can be configured to a jack for paddle connection in the menu.	
⑫	<METER> Terminal	For connecting a commercially available meter.	<ul style="list-style-type: none"> • Output impedance: 4.7 Ω • Allowable open-end voltage output: 0 to 5 V
⑬	<REMOTE> Connector	For connecting a linear amplifier. (Use the supplied 7-pin DIN plug for the connection.)	
⑭	<ACC 2> Connector	For connecting an external device such as an auxiliary equipment for data communication. (Use the supplied 13-pin DIN plug for the connection.)	
⑮	<KEYPAD> Jack	For connecting a self-made PF keypad.	
⑯	<DRV> Connector	For connecting a transverter or linear amplifier.	<ul style="list-style-type: none"> • Output impedance: 50 Ω • Output: Approx. 1 mW (0 dBm)
⑰	<ANT OUT> Connector	For connecting devices such as an external receiver.	
⑱	<RX IN> Connector	For connecting an RX antenna, external bandpass filter, transverter and the like.	
⑲	<RX OUT> Connector	For connecting an external bandpass filter and the like.	
⑳	<GND> Terminal	For connecting a ground wire.	

2 NAMES AND FUNCTIONS OF PARTS

Microphone (Optional)

① PTT (Push-to-talk) Switch

Switches to the transmitting state while this switch is being pressed. Releasing the switch restores the transceiver to the receiving state.

② UP/ DOWN Keys

For scrolling up/down the items in one of the following modes, such as scrolling up/down the VFO frequencies. Pressing and holding down the key enables continuous scrolling. It can also be configured for use as a PF key.

- VFO mode: Scrolls up/down the VFO frequencies
- Memory channel mode: Scrolls up/down the memory channel numbers
- Memory scroll mode: Scrolls up/down the memory scroll numbers
- Mic paddle mode: For paddle (dot/dash) input
- Menu mode: Displays the previous or next option

③ LOCK Key (MC-60A/ MC-90 only)

Pressing this key activates the key lock and switches to the transmitting state. Pressing it again restores the key to the original position and switches to the receiving state.

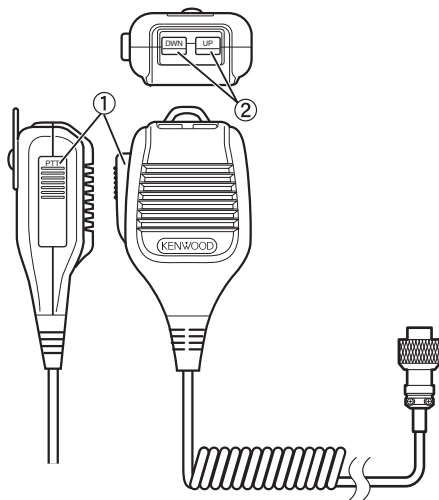

MC-43S

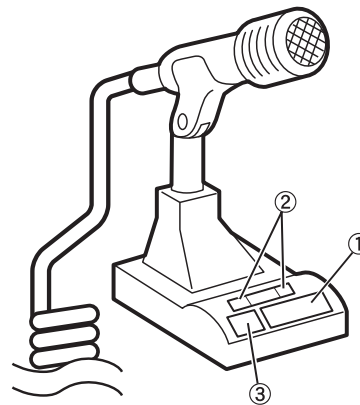

MC-60A/MC-90



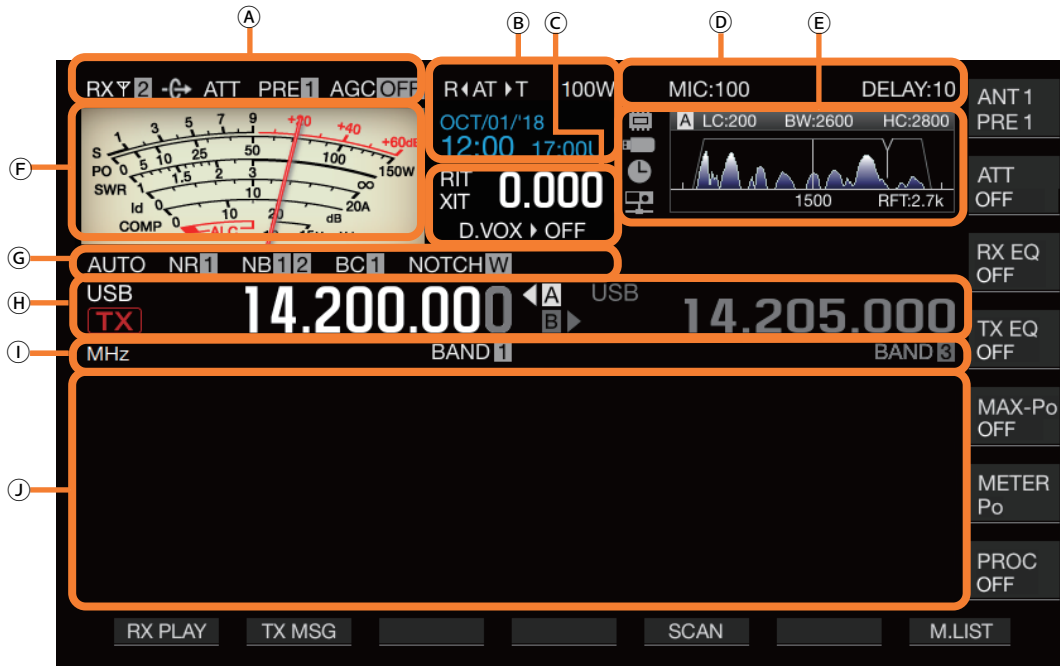



Screen





















Area	Display	Description	Refer to
A	RX	Appears when an RX antenna is functioning.	4-10
	Y1	Displays the antenna number. Switches the antenna number accordingly when the antenna is switched.	4-10
	←	Appears when antenna output for the external receiver is functioning.	16-16
	ATT	Appears when the receiving attenuator is configured to “6 dB”, “12 dB” or “18 dB”.	6-1
	PRE 1 PRE 2	Appears when the receive preamplifier 1 is ON. Appears when the receive preamplifier 2 is ON.	5-6
	AGCOFF AGC-F AGC-M AGC-S	Appears when AGC is OFF. Appears when AGC is configured to FAST. Appears when AGC is configured to MID. Appears when AGC is configured to SLOW.	5-2
	TONE	Appears when Tone is ON.	5-29
	CT	Appears when CTCSS is ON.	5-30
	CROSS	Appears when Cross Tone is ON.	5-30

2 NAMES AND FUNCTIONS OF PARTS

Area	Display	Description	Refer to
B	R<AT>T	Displays the antenna tuner function and operating status. <<R<AT>T>> lights up when the antenna tuner is ON during reception. <<R<AT>T>> blinks while antenna tuning is in progress.	4-11
	XVTR	Appears when the transverter is ON.	16-15
	TX TUNE	Blinks while TX tuning is ON.	8-8
	100W	Displays the TX output power level. (Not displayed when the TX output power destination is drive output (DRV).) Displayed in yellow when the output power is limited by the TX output power limiter function.	4-8
	100%	Displays the drive output level. (Displayed when drive output is ON.)	4-11
	30WPM	Displays the keying speed. Turning the [KEY SPEED] control displays the keying speed (4 to 60 words/minute) in the TX output power area for 2 seconds.	5-13
	01/JAN/'18	Displays the date of the local clock. The date can be displayed in the UK, US or Japanese format.	14-1
	10:00 01:00U	Displays the time (24-hour format). Left: Displays the time of the local clock. Right: Displays the time of the auxiliary clock (indicated by the character "U" at the end).	14-1
C	RIT	Appears when the RIT function is enabled.	5-7
	XIT	Appears when the XIT function is enabled.	
	0.000	Displays the RIT or XIT frequency (between -9.999 and 9.999 kHz).	
	D.VOX▶OFF	Appears according to the input path of the TX audio selected by the data VOX function. OFF: Appears when sound is not input from all paths. ACC 2: Appears when ACC 2 is used as the audio source input. USB: Appears when USB AUDIO is used as the audio source input. LAN: Appears when LAN is used as the audio source input.	8-2
D	MIC:100 PROC OUT:50	Displays the microphone gain. (Displayed when the speech processor is OFF) Displays the speech processor output level. (Displayed when the speech processor is ON)	4-8 8-4
	DELAY:10 FULL-BK	Displays the VOX delay time when the transmitting end is in the SSB, AM or FM mode. Displays the break-in delay time when the transmitting end is in the CW mode. "FULL-BK" is displayed during full break-in.	8-3 5-8

Area	Display	Description	Refer to
E		This is an icon of the internal memory. The icon blinks when writing image data to the built-in memory during screen capture. The icon is displayed in red when the remaining space is running low.	16-6
		The icon starts to blink when a USB flash drive is connected, and lights up when the USB flash drive is recognized by this transceiver. The icon blinks when writing image data to the USB flash drive during screen capture. The icon is displayed in red when the remaining space is running low.	11-2 16-6
		Appears when the timer function is enabled.	14-4
		Appears when a KNS user is connected to this transceiver.	15-2
	A B C	Displays the selected RX filter (A, B or C).	6-1
	LC:200 WIDTH:2600	Displays the low cutoff frequency of the RX filter. Displays the WIDTH frequency of the RX filter.	6-3
	BW:2600	Displays the bandwidth of the RX filter.	
	HC:2800 SHIFT:1500	Displays the high cutoff frequency of the RX filter. Displays the shift frequency of the RX filter.	
		Displays the position of the notch frequency when the notch filter is ON.	6-8
		Displays the IF filter passband. Displays the audio spectrum of the RX or TX audio.	6-1 8-5
	1500	Displays the center indicator. <ul style="list-style-type: none"> Indicates the pitch frequency when in the CW mode. Indicates the center frequency of the passband when in the FSK or PSK mode. Indicates the center frequency of the horizontal axis that is currently displayed when in the SSB, FM or AM mode. 	5-9 5-17 5-22
	RFT:2.7k	Displays the selected bandwidth for the roofing filter.	6-2
F		Meter display <ul style="list-style-type: none"> This can be switched to an analog or digital display. Display of the information on the TX meter can be switched when an analog meter is displayed. 	4-9
G	AUTO	Appears when the auto mode is ON.	4-4
	NR1 NR2	Appears when Noise Reduction 1 (NR1) is ON. Appears when Noise Reduction 2 (NR2) is ON.	6-8
	NB1 NB2 NB1 2	Appears when Noise Blanker 1 (NB1) is ON. Appears when Noise Blanker 2 (NB2) is ON. Appears when both Noise Blanker 1 and 2 are ON.	6-6
	BC1 BC2	Appears when Beat Canceler 1 (BC1) is ON. Appears when Beat Canceler 2 (BC2) is ON.	6-9
	NOTCHW NOTCHM NOTCHN	Appears when the notch filter is ON and "Wide" is selected for the bandwidth. Appears when the notch filter is ON and "Middle" is selected for the bandwidth. Appears when the notch filter is ON and "Narrow" is selected for the bandwidth.	6-8
	SPLIT	Appears during split operation.	5-1

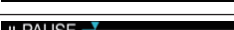
2 NAMES AND FUNCTIONS OF PARTS

Area	Display	Description	Refer to
Ⓚ		Displays the mode that is currently running. “-D” is displayed when in the data mode. “-R” is displayed when in the reverse mode.	4-4
		Appears while receiving in the TX band. Appears while transmitting in the TX band.	–
		Appears when configuring the frequency of the VFO mode or auto mode.	–
		Displays the entry history when the frequency entry mode is started up in the VFO mode.	4-7
		Appears when transmitting or receiving operation information that is called up from the memory channel. The memory channel numbers displayed are from 00 to 99, P0 to P9 and E0 to E9.	9-1
		Displays the quick memory channel mode. Displays one of the quick memory channel numbers from Q0 to Q9.	9-5
		Displays the VFO A/B and memory channel status that is being used during simplex or split operation.	–
		Displays the frequency used. (The frequency display on the right is grayed out during simplex operation.)	–
Ⓛ		Appears when the MHz step function is enabled.	4-6
		Displays the name of the memory channel.	9-4
		Displays the scanning speed (when in a mode other than FM).	10-2
		Appears during program scanning, memory scanning or quick memory scanning.	10-1
		Appears during program slow-scan.	10-2
		Appears when CW auto tuning is running.	5-9
		Displays the band memory number according to the memory that is being called up.	4-3
		Appears when a channel to be locked out is selected.	10-4
		Displays the difference between the transmission frequency and reception frequency.	5-1
		Appears during playback.	12-4
		Appears while playback is paused.	
	Appears during recording.	12-3	
Ⓝ	Configuration Screen Bandscope	Displays the configuration screen or bandscope. This area is usually left blank.	–

3 MENU

Menu Operation

The settings of the different functions of this transceiver can be changed from the menu. It can also be used to switch the operating environment. There is also a list of frequently used menu items as well as “sub-menus” that are sorted by function.

Calling Up a Menu

1 Press [MENU] to display the menu screen.



2 Press F2 [▲] / F3 [▼] or [^M.IN] / [v] to select a group.

3 Press F4 [SELECT] to display the menu items of the selected group.

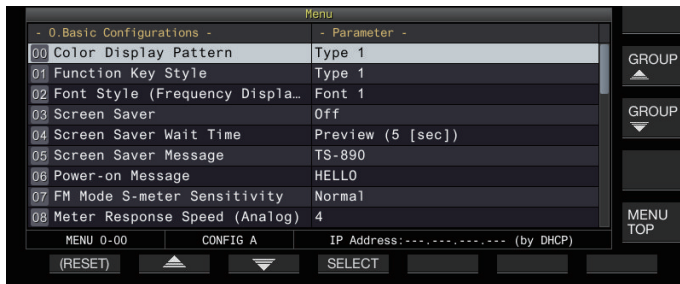

4 Press F2 [▲] / F3 [▼] or [^M.IN] / [v], or turn the [MULTI/CH] control to select the desired menu item.

- Pressing F [GROUP ▲] / F [GROUP ▼] changes the group. (Refer to 3-3 Menu Items.)
- Pressing F [MENU TOP] returns the menu screen to the top.

5 Press F4 [SELECT] or [Q-MR>]. The parameter setting can now be changed.

6 Press F4 [-] / F5 [+] or [^M.IN] / [v], or turn the [MULTI/CH] control to select the setting value.

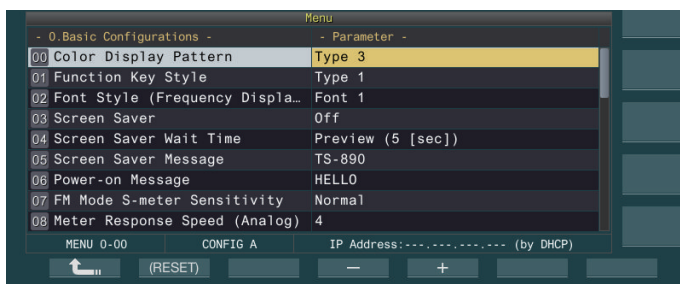

- The setting switches to a different setting.
- To restore the default setting of the selected menu, press and hold F2 [(RESET)].

7 Press F1 [↵] or [<Q-M.IN]. The selected content is confirmed.

8 Press [MENU] or [ESC] to exit the menu screen.

In the subsequent descriptions on the menus, the expression “Configure in Menu [X-XX] 'Xxxx xxxx xxxxx'” will be used. (Example: Configure in Menu [3-06] “MHz Step”)

Calling Up a Sub-Menu

1 Press [MENU] to display the menu screen.

The function keys of the sub-menu are displayed on the right side of the screen.

2 Press F [MORE] to switch between sub-menu selection 1 and 2.

3 Press the desired function key. The following sub-menus are displayed.

Sub-Menu	Key Guide	Behavior
Sub-Menu Selection 1		
Reset	RESET	Displays the Reset menu screen.
Advanced	ADV.	Displays the Advanced Menu screen.
Linear Amplifier	LINEAR AMP	Displays the Linear Amplifier menu screen.
Dimmer	DIMMER n	Short press: Switches the dimmer. Long press: Displays the Dimmer menu screen.
SWL	SWL	Displays the horizontal dial screen.
USB/File	USB /FILE	Displays the USB/File Management menu screen.
MORE	MORE	Switches to sub-menu selection 2.
Sub-Menu Selection 2		
Clock	CLOCK	Displays the Clock menu screen.
LAN	LAN	Displays the LAN menu screen.
Auto Mode	AUTO MODE	Displays the Auto Mode menu screen.
KNS	KNS	Displays the KNS menu screen.
Timer	TIMER	Short press: Switches the paused state of a timer. Long press: Displays the Timer menu screen.
Frequency Marker	F.MKR xxx	Short press: Switches the marker display. Long press: Displays the Frequency Marker menu screen.
MORE	MORE	Switches to sub-menu selection 1.

Advanced Menu

In the subsequent descriptions on the advanced menus, the expression “Configure in Advanced Menu [XX] 'Xxxx xxxx xxxxx'” will be used. (Example: Configure in Advanced Menu [9] “Antenna Tuner Operation per Band”)

Common Menu Screen Operations

- Pressing **F [MENU TOP]** returns the menu screen to the top.
- Pressing **F [GROUP ▲]** / **F [GROUP ▼]** switches the group.
- The menu item can be selected in the following ways.
 - Turn the **[MULTI/CH]** control.
 - Press **F2 [▲]** / **F3 [▼]**.
 - Press **[^ M.IN]** / **[v]**.
 - Press **[UP]** or **[DOWN]** on the microphone.
- The setting value in the Parameter field can be selected in the following ways.
 - Turn the **[MULTI/CH]** control.
 - Press **[UP]** or **[DOWN]** on the microphone.
 - Press **F4 [-]** / **F5 [+]**.
 - Press **[^ M.IN]** / **[v]**.
 - Press **[◀]** / **[▶]**.
- Pressing and holding **[(RESET)]** restores the altered setting value to the default setting.
- Pressing **F [MORE]** switches the key guide display.
- Pressing **F [○○○ TOP]** when configuring the sub-menu returns the sub-menu screen to the top.

Exiting the Menu

To exit configuration or editing on the menu screen or to end the configuration of a menu item halfway, follow the steps below. The menu screen closes and the display returns to the normal screen.

● Press [MENU] or [ESC].

- ✎ It is possible to reset only the menu settings.
- The menu items or default values may be altered.
- When editing the screen saver message or power-on message, pressing **[MENU]** will not exit the menu screen.

Switching between the CONFIG A and CONFIG B Operating Environments

“Operating environment” refers collectively to values configured in the menu as well as the different settings data for operation. Two different types of operating environment are available on this transceiver: CONFIG A and CONFIG B. Both CONFIG A and CONFIG B have the same functions and they can be configured independently of each other. For example, it is possible to configure CONFIG A for DX and CONFIG B for rag chew and switch easily between them.

1 Press [MENU] to display the menu screen.

The current operating environment (CONFIG A or CONFIG B) is displayed in the status bar of the menu screen. Also, data of the operating environment can be saved to and read from a transceiver or USB flash drive.

2 Press F7 [CONFIG].

A message appears.

- Press **F7 [CANCEL]** to return to the Menu screen.

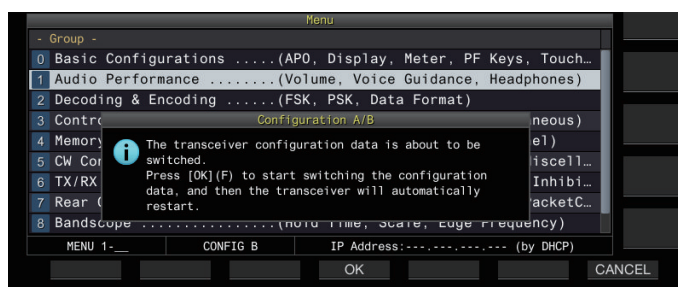

3 Press F4 [OK].

- Switches from CONFIG A to CONFIG B or vice versa, and this transceiver automatically restarts after switching is complete.

- ✎ The following are common settings between CONFIG A and B.
 - Number of quick memory channels
 - Baud rate of COM port
 - Baud rate of USB connector (virtual COM port) on the rear panel
 - Decoded character output
- Information and data other than those below are common between CONFIG A and B.
 - Advanced menu settings
 - LAN menu settings
 - Clock menu settings
 - Linear amplifier menu settings
 - Timer menu settings
 - Memory channel data (including quick memory and slow scan point data)
 - CW/RTTY/PSK message memory data
 - Band memory (frequency and mode)
 - Broadcast band memory data
 - Antenna selection (including drive output selection and antenna output selection for external receiver)
 - Preset data of antenna tuner
 - Internal audio file data of recording function (wav file)
 - Voice message memory data (wav file)
- If the operating environment is switched while the quick memory is called up by pressing **[Q-MR>]** (quick memory), the quick memory settings will be discarded before the operating environment switches.

Menu Items

Menu

- 0. Basic Configurations -					
Menu	Display	Description	Setting Value	Default	Refer to
Display					
0-00	Color Display Pattern	Display color type	Type 1/ Type 2/ Type 3	Type 1	4-1
0-01	Function Key Style	Type of function key display	Type 1/ Type 2/ Type 3	Type 1	4-1
0-02	Font Style (Frequency Display)	Font type (frequency display)	Font 1/ Font 2/ Font 3/ Font 4/ Font 5	Font 1	4-1
0-03	Screen Saver	Screen saver	Off/ Type 1/ Type 2/ Type 3/ Display Off	Off	16-1
0-04	Screen Saver Wait Time	Wait time for screen saver	Preview (5 [sec])/ 5/ 15/ 30/ 60 [min]	Preview (5 [sec])	16-1
0-05	Screen Saver Message	Screen saver message	Up to 10 alphanumeric characters	TS-890	16-1
0-06	Power-on Message	Power on message	Up to 15 alphanumeric characters	HELLO	16-1
Meter					
0-07	FM Mode S-Meter Sensitivity	FM S meter sensitivity	Normal/ High	Normal	4-10
0-08	Meter Response Speed (Analog)	Analog meter response	1 to 4 (1 step)	3	4-10
0-09	Meter Display Pattern	Meter type	Digital/ Analog (White)/ Analog (Black)	Analog (White)	4-9
0-10	Meter Display Peak Hold	Meter with peak hold	Off/ On	On	4-10
0-11	S-Meter Scale	S meter scale	Type 1/ Type 2	Type 1	4-10
0-12	TX Digital Meter	TX meter (digital)	Off/ On	Off	4-10
Key					
0-13	Long Press Duration of Panel Keys	Duration for pressing and holding a key	200 to 2000 [ms] (100 [ms] step)	500 [ms]	16-2
0-14	Touchscreen Tuning	Touchscreen tuning	Off/ On	On	7-6
0-15	PF A: Key Assignment	Function assignment to [PF A] key	Refer to PF (Programmable Function).	VOICE1	16-2
0-16	PF B: Key Assignment	Function assignment to [PF B] key	Refer to PF (Programmable Function).	VOICE2	16-2
0-17	PF C: Key Assignment	Function assignment to [PF C] key	Refer to PF (Programmable Function).	VOICE3	16-2
0-18	External PF 1: Key Assignment	Function assignment to [PF 1] on the keypad	Refer to PF (Programmable Function).	Message Memory CH 1	16-3
0-19	External PF 2: Key Assignment	Function assignment to [PF 2] on the keypad	Refer to PF (Programmable Function).	Message Memory CH 2	16-3
0-20	External PF 3: Key Assignment	Function assignment to [PF 3] on the keypad	Refer to PF (Programmable Function).	Message Memory CH 3	16-3
0-21	External PF 4: Key Assignment	Function assignment to [PF 4] on the keypad	Refer to PF (Programmable Function).	Message Memory CH 4	16-3
0-22	External PF 5: Key Assignment	Function assignment to [PF 5] on the keypad	Refer to PF (Programmable Function).	Message Memory CH 5	16-3
0-23	External PF 6: Key Assignment	Function assignment to [PF 6] on the keypad	Refer to PF (Programmable Function).	Message Memory CH 6	16-3
0-24	External PF 7: Key Assignment	Function assignment to [PF 7] on the keypad	Refer to PF (Programmable Function).	Message Memory CH 7	16-3
0-25	External PF 8: Key Assignment	Function assignment to [PF 8] on the keypad	Refer to PF (Programmable Function).	Message Memory CH 8	16-3
0-26	Microphone PF 1: Key Assignment	Function assignment to [PF 1] on the microphone	Refer to PF (Programmable Function).	A/B, A=B	16-3

3 MENU

- 0. Basic Configurations -					
Menu	Display	Description	Setting Value	Default	Refer to
Display					
0-27	Microphone PF 2: Key Assignment	Function assignment to [PF 2] on the microphone	Refer to PF (Programmable Function).	SPLIT	16-2
0-28	Microphone PF 3: Key Assignment	Function assignment to [PF 3] on the microphone	Refer to PF (Programmable Function).	M/V, M▶V	16-2
0-29	Microphone PF 4: Key Assignment	Function assignment to [PF 4] on the microphone	Refer to PF (Programmable Function).	MONI	16-2
0-30	Microphone DOWN: Key Assignment	Function assignment to [DOWN] on the microphone	Refer to PF (Programmable Function).	DWN Key (Microphone)	16-2
0-31	Microphone UP: Key Assignment	Function assignment to [UP] on the microphone	Refer to PF (Programmable Function).	UP Key (Microphone)	16-2
0-32	Automatic Power Off	APO (Automatic Power Off)	Off/ 60/ 120/ 180 [min]	Off	16-2
- 1. Audio Performance -					
Menu	Display	Description	Setting Value	Default	Refer to
Volume					
1-00	Beep Volume	Volume of beep tone	Off/ 1 to 20 (1 step)	10	16-2
1-01	Voice Message Volume (Play)	Playback volume of voice message	Off/ 1 to 20 (1 step)	10	12-2
1-02	Sidetone Volume	Sidetone volume	Off/ 1 to 20 (1 step)	10	5-9
Voice Guide					
1-03	Voice Guidance Volume	Voice guide volume	Off/ 1 to 20 (1 step)	10	13-1
1-04	Voice Guidance Speed	Voice guide speed	1 to 4 (1 step)	1	13-1
1-05	User Interface Language (Voice Guidance & Messages)	Language of voice guide and message display	English/ Japanese	English	13-1
1-06	Automatic Voice Guidance	Automatic voice guide	Off/ On	Off	13-1
- 2. Decoding & Encoding -					
Menu	Display	Description	Setting Value	Default	Refer to
FSK Decoding					
2-00	FFT Scope Averaging (RTTY Decode)	Averaging on the FFT scope (RTTY Decode)	0 to 9 (1 step)	0	5-24
2-01	RX UOS	RX unshift-on-space	Off/ On	On	5-21
2-02	Newline Code	New line code selection (during reception)	CR+LF/ All	All	5-21
2-03	Diddle	Diddle	Off/ Blank Code/ Letters Code	Blank Code	5-21
2-04	TX UOS	TX unshift-on-space	Off/ On	On	5-21
2-05	Automatic Newline Insertion	Automatic new line code insertion	On/ Off	On	5-21
FSK Key					
2-06	FSK Spacing	FSK shift width	170/ 200/ 425/ 850 [Hz]	170 [Hz]	5-21
2-07	FSK Keying Polarity	FSK keying polarity	Off/ On	Off	5-22
2-08	FSK Tone Frequency	FSK tone frequency	1275/ 2125 [Hz]	2125 [Hz]	5-21
2-09	RTTY Tuning Scope	Scope display for checking FSK tuning	FFT Scope/ X-Y Scope	FFT Scope	5-18
PSK Decoding					
2-10	FFT Scope Averaging (PSK Decode)	Averaging on the FFT scope (PSK Decode)	0 to 9 (1 step)	0	5-18
2-11	PSK AFC Tuning Range	Tuning range for PSK AFC	±15/ ±8 [Hz]	±15 [Hz]	5-24
2-12	PSK Tone Frequency	PSK tone frequency	1.0/ 1.5/ 2.0 [kHz]	1.5 [kHz]	5-27
2-13	PSK Tuning Scope	Scope display for checking PSK tuning	FFT Scope/ X-Y Scope	FFT Scope	5-18
Common					
2-14	CW/ RTTY/ PSK Log File Format	File format for saving CW/RTTY/ PSK logs	html/ txt	txt	5-27
2-15	CW/ RTTY/ PSK Time Stamp	CW/ RTTY/ PSK time stamp	Off/ Time Stamp/ Time Stamp + Frequency	Time Stamp + Frequency	5-27
2-16	Clock (CW/ RTTY/ PSK Time Stamp)	Clock selection for CW/ RTTY/ PSK time stamp	Local Clock/ Secondary Clock	Local Clock	5-27
2-17	Waterfall when Tuning (RTTY/ PSK Audio Scope)	Selection of RTTY/ PSK waterfall display type	Straight/ Follow	Straight	5-19 5-24

- 3. Controls Configurations -					
Menu	Display	Description	Setting Value	Default	Refer to
Control Rate					
3-00	Frequency Rounding Off (Multi/ Channel Control)	Rounds off the frequency of the [MULTI/CH] control	Off/ On	On	4-6
3-01	SSB Mode Frequency Step Size (Multi/ Channel Control)	SSB frequency step size	0.5/ 1/ 2.5/ 5/ 10 [kHz]	1 [kHz]	4-6
3-02	CW/FSK/PSK Mode Frequency Step Size (Multi/Channel Control)	CW/ FSK/ PSK frequency step size	0.5/ 1/ 2.5/ 5/ 10 [kHz]	0.5 [kHz]	4-6
3-03	FM Mode Frequency Step Size (Multi/ Channel Control)	FM frequency step size	5/ 6.25/ 10/ 12.5/ 15/ 20/ 25/ 30/ 50/ 100 [kHz]	10 [kHz]	4-6
3-04	AM Mode Frequency Step Size (Multi/ Channel Control)	AM frequency step size	5/ 6.25/ 10/ 12.5/ 15/ 20/ 25/ 30/ 50/ 100 [kHz]	5 [kHz]	4-6
3-05	9 kHz Step in AM Broadcast Band (Multi/ Channel Control)	Steps of the [MULTI/CH] control in the BC band (AM)	Off/ On	K type: Off E type: On	4-6
3-06	MHz Step	MHz step	100/ 500/ 1000 [kHz]	1000 [kHz]	4-6
3-07	Tuning Control: Number of Steps per Revolution	Number of steps per revolution of the Tuning control	250/ 500/ 1000 [Step]	1000 [Step]	4-6
3-08	Tuning Speed Control	Fast forward rate of the Tuning control	Off/ 2 to 10 (1 step)	Off	4-6
3-09	Tuning Speed Control Sensitivity	Sensitivity of the Tuning control for starting the fast forward operation	1 to 10 (1 step)	5	4-6
3-10	Lock Function	Frequency lock function	Frequency Lock/ Tuning Control Lock	Frequency Lock	4-6
3-11	Number of Band Memories	Number of band memories	1/ 3/ 5	3	4-3
3-12	Split Frequency Offset by RIT/XIT Control	Changing the split frequency using the [RIT/XIT] control	Off/ TX Frequency Offset while RX/ RX Frequency Offset while TX/ Both	Off	5-1
3-13	Band Direct Keys in Split Mode	Band direct key during split operation	RX Band/ RX Band and Cancel Split Mode/ RX/ TX Band	RX Band	5-1

- 4. Memory Channels & Scan -					
Menu	Display	Description	Setting Value	Default	Refer to
Memory					
4-00	Number of Quick Memory Channels	Number of quick memory channels	3/ 5/ 10 [ch]	5 [ch]	9-5
4-01	Temporary Change (Memory Channel Configurations)	Temporary change of memory frequency	Off/ On	Off	9-3
Scan					
4-02	Program Slow Scan	Program slow scan	Off/ On	On	10-2
4-03	Program Slow Scan Range	Range of program slow scan	100/ 200/ 300/ 400/ 500 [Hz]	300 [Hz]	10-3
4-04	Scan Hold	Scan Hold	Off/ On	Off	10-3
4-05	Scan Resume	Scan resume condition	Time-operated/ Carrier-operated	Time-operated	10-4

- 5. CW Configurations -					
Menu	Display	Description	Setting Value	Default	Refer to
Jack Terminals					
5-00	Paddle Jack Configuration (Front)	PADDLE jack (front panel) function setting	Straight Key/ Paddle/ Paddle (Bug Key Mode)	Paddle	5-13
5-01	Key Jack Configuration (Rear)	KEY jack (rear panel) function setting	Straight Key/ Paddle/ Paddle (Bug Key Mode)	Straight Key	5-13
Mode					
5-02	Electronic Keyer Squeeze Mode	Operation mode of the electronic keyer	Mode A/ Mode B	Mode B	5-13
5-03	Dot and Dash Reversed Keying	Switches between dot and dash paddle	Off/ On	Off	5-13
5-04	Paddle (Microphone Up/Down Keys)	Paddle ([UP] and [DOWN] keys on microphone)	Off/ On	Off	5-13
5-05	CW BFO Sideband	CW BFO sideband	USB/ LSB	USB	5-9

3 MENU

- 5. CW Configurations -					
Menu	Display	Description	Setting Value	Default	Refer to
Weight and Timing					
5-06	Automatic CW TX with Keying in SSB Mode	CW transmission by keying in the SSB mode	Off/ On	Off	5-9
5-07	Carrier Frequency Offset (SSB Mode to CW Mode)	Carrier frequency correction when shifting from the SSB mode to CW mode	Off/ On	Off	5-9
5-08	CW Keying Weight Ratio	Keyer weight	Automatic/ 2.5 to 4.0 (0.1 step)	Automatic	5-13
5-09	CW Keying Reversed Weight Ratio	Reverse keying auto weight ratio	Off/ On	Off	5-13
5-10	Interrupt Keying	Insert keying	Off/ On	Off	5-17
Memory					
5-11	CW Message Entry	Method for registering CW message	Text String/ Paddle	Paddle	5-14
5-12	Contest Number	Contest number	001 to 9999 (1 step)	001	5-15
5-13	Contest Number Format	Contest number style	Off/ 190 to ANO/ 190 to ANT/ 90 to NO/ 90 to NT	Off	5-15
5-14	Channel Number (Count-up Message)	Specifies the channel used for the count-up message	Off/ Channel 1 to Channel 8	Off	5-15
5-15	CW Rise Time	CW rise time	1/ 2/ 4/ 6 [ms]	6 [ms]	5-9
5-16	CW/ Voice Message Retransmit Interval Time	Repeat interval for retransmitting CW/voice message	0 to 60 [s] (1 [s] step)	10 [s]	5-17 12-3
- 6. TX/RX Filters & Misc. -					
Menu	Display	Description	Setting Value	Default	Refer to
Message					
6-00	Playback Time (Full-time Recording)	Playback time for constantly recorded audio	Last 10/ Last 20/ Last 30 [s]	Last 30 [s]	12-4
6-01	Recording with Squelch	Audio recording in tandem with squelch	Off/ On	On	12-4
TX Management					
6-02	Time-out Timer	Maximum continuous transmission time (Timeout timer)	Off/ 3/ 5/ 10/ 20/ 30 [min]	Off	8-8
6-03	TX Inhibit	Inhibits transmission	Off/ On	Off	16-11
6-04	Transmit Power Step Size	Fine adjustment of TX output power	1/ 5 [W]	5 [W]	4-8
6-05	ID Beep	ID beep	Off/ 1 to 30 [min] (1 step)	Off	8-8
Filter					
6-06	TX Filter Low Cut (SSB/AM)	Low cutoff frequency of the TX filter (SSB/AM)	10/ 100/ 200/ 300/ 400/ 500 [Hz]	100 [Hz]	8-5
6-07	TX Filter High Cut (SSB/AM)	High cutoff frequency of the TX filter (SSB/AM)	2500/ 2600/ 2700/ 2800/ 2900/ 3000/ 3500/ 4000 [Hz]	2900 [Hz]	8-5
6-08	TX Filter Low Cut (SSB-DATA/AM-DATA)	Low cutoff frequency of the TX filter (SSB-DATA/AM-DATA)	10/ 100/ 200/ 300/ 400/ 500 [Hz]	100 [Hz]	8-5
6-09	TX Filter High Cut (SSB-DATA/AM-DATA)	High cutoff frequency of the TX filter (SSB-DATA/AM-DATA)	2500/ 2600/ 2700/ 2800/ 2900/ 3000/ 3500/ 4000 [Hz]	2900 [Hz]	8-5
6-10	RX Filter Numbers	Number of RX filters	2/ 3	3	6-1
6-11	Filter Control in SSB Mode (High/Low and Shift/Width)	Switches between high cutoff/low cutoff and WIDTH/ SHIFT (SSB)	High & Low Cut/ Shift & Width	High & Low Cut	6-3
6-12	Filter Control in SSB-DATA Mode (High/Low and Shift/Width)	Switches between high cutoff/low cutoff and WIDTH/ SHIFT (SSB-DATA)	High & Low Cut/ Shift & Width	Shift & Width	6-3
6-13	VOX Voice Delay (Microphone)	Audio delay in the VOX mode (MIC)	Off/ Short/ Middle/ Long	Middle	8-3
6-14	VOX Voice Delay (Except Microphone)	Audio delay in the VOX mode (excluding MIC)	Off/ Short/ Middle/ Long	Middle	8-3
6-15	Delta Frequency Display	ΔF display setting	Off/ On	On	5-1

- 7. Rear Connectors -					
Menu	Display	Description	Setting Value	Default	Refer to
Baud Rate					
7-00	Baud Rate (COM Port)	Baud rate of COM connector	4800/ 9600/ 19200/ 38400/ 57600/ 115200 [bps]	9600 [bps]	16-5
7-01	Baud Rate (Virtual Standard COM)	Baud rate of virtual COM (Standard) connector	9600/ 19200/ 38400/ 57600/ 115200 [bps]	115200 [bps]	16-5
7-02	Baud Rate (Virtual Enhanced COM)	Baud rate of virtual COM (Enhanced) connector	9600/ 19200/ 38400/ 57600/ 115200 [bps]	115200 [bps]	16-12
7-03	Decoded Character Output	Decoded character output	Off/ On	Off	16-12
Data transfer					
7-04	Quick Data Transfer	Quick data transfer	Off/ A (TX/RX)/ A (Sub RX)/ B	Off	16-9
7-05	Overwrite Location (Quick Data Transfer)	Destination for data via quick data transfer	VFO/ Quick Memory	Quick Memory	16-9
Audio input					
7-06	USB: Audio Input Level	USB audio input level	0 to 100 (1 step)	50	16-7
7-07	ACC 2: Audio Input Level	Audio input level of ACC 2 connector	0 to 100 (1 step)	50	16-7
Audio output					
7-08	USB: Audio Output Level	USB audio output level	0 to 100 (1 step)	100	16-7
7-09	ACC 2: Audio Output Level	Audio output level from ACC 2 connector	0 to 100 (1 step)	50	16-7
7-10	TX Monitor Level (Rear Connectors)	TX monitor level output to the rear panel connector	Linked/ 0 to 20 (1 step)	Linked	16-7
7-11	Audio Output Type (Rear Connectors)	Format of audio output from the rear panel connector	All/ Received Audio only	All	16-7
- 8. Bandscope -					
Menu	Display	Description	Setting Value	Default	Refer to
Common					
8-00	Bandscope Display during TX	Bandscope display during transmission	Off/ On	Off	7-7
8-01	TX Audio Waveform Display	Waveform display for transmitted audio	On/ Off	On	8-5
8-02	Bandscope Maximum Hold	Maximum hold time	10 [s]/ Continuous	10 [s]	7-7
8-03	Waterfall when Tuning (Center Mode)	Waterfall display during tuning (center mode)	Straight/ Follow	Straight	7-2
8-04	Waterfall Gradation Level	Gradation setting of the waterfall	1 to 10 (1 step)	7	7-5
8-05	Tuning Assist Line (SSB Mode)	Auxiliary tuning line display (SSB only)	Off/ 300/ 400/ 500/ 600/ 700/ 800/ 1000/ 1500/ 2210 [Hz]	Off	7-5
8-06	Frequency Scale (Center Mode)	Frequency scale in the center mode	Relative Frequency/ Absolute Frequency	Relative Frequency	7-5
8-07	Touchscreen Tuning Step Correction (SSB/ CW/ FSK/ PSK)	Correction steps for touchscreen tuning	Off/ On	On	7-6
- 9. USB Keyboard -					
Menu	Display	Description	Setting Value	Default	Refer to
USB keyboard					
9-00	Send Message by Function Keys	Function key settings of USB keyboard	Off/ On	On	16-5
9-01	Keyboard Language	USB keyboard language	Japanese/ English (US)/ English (UK)/ French/ French (Canadian)/ German/ Portuguese/ Portuguese (Brazilian)/ Spanish/ Spanish (Latin American)/ Italian	English (US)	16-5
9-02	Repeat Delay Time	Key repeat delay time for USB keyboard	1 to 4 (1 step)	2	16-5
9-03	Repeat Speed	Key repeat speed for USB keyboard	1 to 32 (1 step)	1	16-5

3 MENU

Advanced Menu Items

Menu	Display	Description	Setting Value	Default	Refer to
0	Indication Signal Type (External Meter 1)	Target of external meter output 1	Automatic/ TX Power/ ALC/ Drain Voltage (Vd)/ Compression Level (COMP)/ Current (Id)/ SWR	TX Power	16-6
1	Indication Signal Type (External Meter 2)	Target of external meter output 2	Automatic/ TX Power/ ALC/ Drain Voltage (Vd)/ Compression Level (COMP)/ Current (Id)/ SWR	Automatic	16-6
2	Output Level (External Meter 1)	Level of external meter output 1	0 to 100 [%] (1 step)	50 [%]	16-6
3	Output Level (External Meter 2)	Level of external meter output 2	0 to 100 [%] (1 step)	50 [%]	16-6
4	Reference Signal Source	Switches the reference signal	Internal/ External	Internal	16-8
5	Reference Oscillator Calibration	Adjusts the frequency of the reference oscillator	-500 to +500 (1 step)	0	17-2
6	TX Power Down with Transverter Enabled	Powers down the transverter function	Off/ On	On	16-15
7	TX Hold After Antenna Tuning	Holds transmission at the end of antenna tuning	Off/ On	Off	4-12
8	Antenna Tuner during RX	Antenna tuner behavior while receiving	Off/ On	Off	4-12
9	Antenna Tuner Operation per Band	Antenna tuner behavior for each band	Off/ On	Off	4-12
10	Microphone Gain (FM Mode)	FM microphone gain	0 to 100 (1 step)	50	5-28
11	PKS Polarity Reverse	Reversing of PSK polarity	Off/ On	Off	16-12
12	TX Inhibit While Busy	Inhibits transmission while in the BUSY state	Off/ On	Off	16-12
13	CTCSS Unmute for Internal Speaker	Mute behavior of CTCSS	Mute/ Unmute	Mute	16-8
14	PSQ Logic State	SQL control signal logic	Low/ Open	Low	16-8
15	PSQ Reverse Condition	SQL output conditions	Off/ Busy/ Sql/ Send/ Busy-Send/ Sql-Send	Sql	16-8
16	PSQ/ PKS Pin Assignment (COM Connector)	PSQ/PKS mode setting	Off/ On	Off	16-8
17	Virtual Standard COM Port - RTS	RTS settings of virtual COM port (Standard)	Flow Control/ CW Keying/ RTTY Keying/ PTT/ DATA SEND	Flow Control	16-12
18	Virtual Standard COM Port - DTR	DTR settings of virtual COM port (Standard)	Off/ CW Keying/ RTTY Keying/ PTT/ DATA SEND	Off	16-12
19	Virtual Enhanced COM Port - RTS	RTS settings of virtual COM port (Standard)	Off/ CW Keying/ RTTY Keying/ PTT/ DATA SEND	Off	16-12
20	Virtual Enhanced COM Port - DTR	RTS settings of virtual COM port (Standard)	Off/ CW Keying/ RTTY Keying/ PTT/ DATA SEND	Off	16-12
21	External Display	External display output	Off/ On	On	16-7
22	Resolution (External Display)	Resolution settings of external display	800 x 600/ 848 x 480	800 x 600	16-7
23	Touchscreen Calibration	Touchscreen adjustment	-	-	17-3
24	Software License Agreement	Software license of this transceiver	-	-	i
25	Important Notices concerning Free Open Source	Ways to obtain open source resources used by this transceiver	-	-	ii
26	About Various Software License Agreements	Licenses related to software used by this transceiver	-	-	ii
27	Firmware Version	Firmware version used by this transceiver	-	-	17-1

Reset Menu Items

Display	Description	Refer to
Menu Reset	Menu reset	17-1
Memory Channel Reset	Memory channel reset	
VFO Reset	VFO reset	
Standard Reset (The Clock, TX Inhibit, and Transmit Power Upper Limit will not be reset)	Standard reset	
Full Reset	Full reset	

Linear Amplifier Menu Items

Display	Description	Setting Value	Default	Refer to
Band	Target bands of the linear amplifier menu	HF/ 50M/ 70M (E type)	HF	16-14 16-14
Linear Amplifier	Linear amplifier ON/OFF	Off/ On	Off	
Keying Logic	Linear amplifier TX control	Active Low/ Active High	Active Low	
TX Delay	Linear amplifier TX delay ON/OFF	Off/ On	Off	
TX Delay Time (CW/FSK/PSK)	Linear amplifier TX delay time (CW/FSK/PSK)	5/ 10/ 15/ 20/ 25/ 30/ 35/ 40 [ms]	15 [ms]	
TX Delay Time (SSB/FM/AM)	Linear amplifier TX delay time (SSB/FM/AM)	5/ 10/ 15/ 20/ 25/ 30/ 35/ 40/ 45/ 50 [ms]	35 [ms]	
Internal Relay Control	Linear amplifier relay control	Off/ On	Off	
External ALC Voltage	Linear amplifier external ALC voltage	-1/ -2/ -3/ -4/ -5/ -6/ -7/ -8/ -9/ -10/ -11/ -12 [V]	-4 [V]	

Dimmer Menu Items

Dimmer	Display	Description	Setting Value	Default	Refer to
1	Display	Screen brightness	5 to 100 (5-step)	100	4-2
	LED	LED brightness	5 to 100 (5-step)	100	
2	Display	Screen brightness	5 to 100 (5-step)	75	
	LED	LED brightness	5 to 100 (5-step)	75	
3	Display	Screen brightness	5 to 100 (5-step)	50	
	LED	LED brightness	5 to 100 (5-step)	50	
4	Display	Screen brightness	0 to 100 (5-step)	25	
	LED	LED brightness	5 to 100 (5-step)	25	

USB/File Management Menu Items

Display	Description	Setting Value	Default	Refer to
Safe Removal of USB Flash Drive	Removes the USB flash drive safely	-	-	11-6
Read Configuration Data	Reads transceiver settings data	-	-	11-3
Save Configuration Data	Saves transceiver settings data	-	-	11-2
Copy Files to PC (via USB cable)	Copies files to PC (via USB cable)	-	-	11-4
Copy Files to USB Flash Drive	Copies files to USB flash drive	-	-	11-5
Read Image Files for Screen Saver (Type 3)	Reads images for screen saver	-	-	16-1
Delete Files (Internal Memory)	Deletes files stored in the internal memory of the transceiver	-	-	11-5
File Storage Location	Configures the destination for saving files	Internal Memory/ USB Flash Drive	Internal Memory	11-2
Format USB Flash Drive	USB flash drive format	-	-	11-5

3 MENU

Clock Menu Items

Menu	Display	Description	Setting Value	Default	Refer to
0.Date and Time					
0-00	Date (Local Clock)	Date of the local clock	Year: '18 (2018) to '99 (2099) Month: JAN/ FEB/ MAR/ APR/ MAY/ JUN/ JUL/ AUG/ SEP/ OCT/ NOV/ DEC Day: 01 to 31	Year: '18 Month: JAN Day: 01	14-1
0-01	Time (Local Clock)	Time of the local clock	00:00 to 23:59 (hour: 00 to 23, minute: 00 to 59)	00:00	
0-02	Timezone (Local Clock)	Time zone of the local clock	UTC -14:00 to UTC ±00:00 to UTC +14:00 (15-minute step)	UTC +00:00	
0-03	Timezone (Secondary Clock)	Time zone of the auxiliary clock	UTC -14:00 to UTC ±00:00 to UTC +14:00 (15-minute step)	UTC +00:00	
0-04	Secondary Clock Identification Letter	Auxiliary clock identifier	Single character (A to Z)	U	
0-05	Date Display Format	Date display format	MMM/DD/'YY, DD/MMM/'YY, 'YY/ MMM/ DD	K type: MMM/ DD/'YY E type: DD/ MMM/'YY	14-2
0-06	Clock Display	Clock display setting	Off/ Local Clock/ Secondary Clock/ Both	Both	
1.Automatic Time Correction					
1-00	Clock Correction using the NTP Server	Automatic clock setting (NTP)	Off/ On	Off	14-3
1-01	NTP Server Address	NTP server address	Up to 50 alphanumeric characters	Blank	

LAN Menu Items

Menu	Display	Description	Setting Value	Default	Refer to
0	DHCP	DHCP	Off/ On	On	15-1
1	IP Address	IP address	1.0.0.0 to 223.255.255.255	192.168.1. 100	
2	Subnet Mask	Subnet mask	0.0.0.0 to 255.255.255.252	255.255.255. 0	
3	Default Gateway	Default gateway	1.0.0.0 to 223.255.255.255	Blank	
4	Primary DNS Server	Primary DNS server	1.0.0.0 to 223.255.255.255	Blank	
5	Secondary DNS Server	Secondary DNS server	1.0.0.0 to 223.255.255.255	Blank	
6	MAC Address	MAC address	-	Fixed value for each transceiver	

Timer Menu Items

Display	Description	Setting Value	Default	Refer to
Programmable Timer				
Timer Mode	Type of program timer behavior	Off/ Power-on/ Power-off/ Power-on/ off/ Record	Off	14-4
Repeat	Repeat setting for program timer behavior	Off/ On	Off	
Day of the Week - Sun	Day of week setting for activating program timer - Sun	Check/ Uncheck	Check	
Day of the Week - Mon	Day of week setting for activating program timer - Mon	Check/ Uncheck	Check	
Day of the Week - Tue	Day of week setting for activating program timer - Tue	Check/ Uncheck	Check	
Day of the Week - Wed	Day of week setting for activating program timer - Wed	Check/ Uncheck	Check	
Day of the Week - Thu	Day of week setting for activating program timer - Thu	Check/ Uncheck	Check	
Day of the Week - Fri	Day of week setting for activating program timer - Fri	Check/ Uncheck	Check	
Day of the Week - Sat	Day of week setting for activating program timer - Sat	Check/ Uncheck	Check	
Power-on Time	Program timer operation time start	00:00 to 23:59	00:00	
Power-off Time	Program timer operation time end	00:00 to 23:59	00:00	
Frequency/Mode	Frequency during program timer operation	30.000 kHz to 59.999.999 MHz	14.000.000	14-4
	Mode during program timer operation	LSB/ USB/ CW/ CW-R/ PSK/ PSK-R/ FSK/ FSK-R/ FM/ AM/ LSB-DATA/ USB-DATA/ FM-DATA/ AM-DATA	USB	
Sleep Timer				
Sleep Timer	Sleep timer	Off/ 5/ 10/ 15/ 30/ 60/ 90/ 120 [min]	Off	14-6

Auto Mode Menu Items

Display	Description	Setting Value	Default	Refer to
Auto Mode	Auto mode ON/OFF status	Auto Mode Off/ Auto Mode On	Auto Mode Off	4-4
Frequency	Frequency category of auto mode (#0)	30.000 kHz to 59.999990 MHz	9.5 MHz	
Mode	Mode of auto mode (#0)	LSB/ USB/ CW/ CW-R/ PSK/ PSK-R/ FSK/ FSK-R/ FM/ AM/ LSB-DATA/ USB-DATA/ FM-DATA/ AM-DATA	LSB	

3 MENU

KNS Menu Items

Menu	Display	Description	Setting Value	Default	Refer to
0	KNS Operation (LAN Connector)	KNS operation (LAN connection)	Off/ On (LAN)/ On (Internet)	Off	15-3
1	Administrator ID	KNS administrator ID	1 to maximum 32 alphanumeric characters	Blank	
2	Administrator Password	KNS administrator password	1 to maximum 32 alphanumeric characters	Blank	
3	Built-in VoIP	Built-in VoIP function	Off/ On	On	15-4
4	Audio Input Level (VoIP)	VoIP outgoing audio input level	0 to 100 (1 step)	50	
5	Audio Output Level (VoIP)	VoIP incoming audio output level	0 to 100 (1 step)	100	
6	VoIP Jitter Buffer	VoIP jitter absorption buffer	80/ 200/ 500/ 800 [ms]	80 [ms]	
7	Speaker Mute	Speaker mute	Off/ On	Off	
8	Access Log	Log function	Off/ On	Off	15-6
9	Registered Users' Remote Operation	Remote operation by registered user	Off/ On	Off	
10	Session Time	Session time	1 [min]/ 2 [min]/ 3 [min]/ 5 [min]/ 10 [min]/ 15 [min]/ 20 [min]/ 30 [min]/ 40 [min]/ 50 [min]/ 60 [min]/ 90 [min]/ 120 [min]/ Unlimited	Unlimited	
11	KNS Welcome Message	KNS welcome message	Up to 128 single-byte alphanumeric characters	Blank	

Frequency Marker Menu Items

Display	Description	Setting Value	Default	Refer to
Frequency	Marker frequency (#0 to 49)	30.000 kHz to 59.999.999 MHz	-	7-7

4 BASIC OPERATIONS

Turning ON/OFF the Power

Check to ensure that the connections are correct before turning on the power of the regulated DC power supply.

1 Press [⏻].

When the power turns on, the [⏻] LED lights up in green. The message screen (“KENWOOD”, “HELLO”) is displayed, followed by the frequency display.



2 Press and hold [⏻].

The power is turned off.



- The message screen “HELLO” can be changed. (Menu [0-06] “Power-on Message”)
- When a voltage that exceeds approximately DC 18 V is applied, the overvoltage protection circuit is activated and the power is turned off automatically.
- When the temperature of this transceiver or the surroundings is extremely low, it may take a while before the screen reaches the normal level of brightness.



- To prevent damage of the internal data, do not turn off the regulated DC power supply while leaving the power of the TS-890S on.

Current Flow when Power is OFF

When the power of the external power supply is ON, a small amount of electric current is flowing even when the power of this transceiver is OFF. The amount of current that flows through when power is OFF varies depending on whether this transceiver is connected to a PC or connected for KNS operation.

PC Connection via USB	KNS Operation Setting		
	Off	On (LAN) LAN MODE	On (Internet) WAN MODE
No	Approx. 4 mA	Approx. 35 mA	Approx. 165 mA
Yes	Approx. 105 mA	Approx. 135 mA	Approx. 235 mA

- Refer to (1-4) for details on connecting to a PC and (15-2) for details on KNS operation.

Screen Display Settings

The background color of the screen, function key guide display and font type for the frequency display can be changed.

Changing the Background Color

A background color for the screen can be chosen from the three choices available.

● Configure in Menu [0-00] “Color Display Pattern”

Setting Value	Type 1 (default)/ Type 2/ Type 3
---------------	----------------------------------

- Type 1: Black
- Type 2: Blue
- Type 3: Dark green

Changing the Type of Function Key Display

A function key display can be chosen from the three choices available.

● Configure in Menu [0-01] “Function Key Style”

Setting Value	Type 1 (default)/ Type 2/ Type 3
---------------	----------------------------------

- Type 1: Standard
- Type 2: Gradation
- Type 3: Illuminated

Changing the Frequency Display Font Type

A font type for the frequency display can be chosen from the five choices available.

● Configure in Menu [0-02] “Font Style (Frequency Display)”

Setting Value	Font 1 (default)/ Font 2/ Font 3/ Font 4/ Font 5
---------------	--

- Font 1: Type 1 fonts
- Font 2: Type 2 fonts
- Font 3: Type 1 italic fonts
- Font 4: Type 2 italic fonts
- Font 5: 7-segment fonts

4 BASIC OPERATIONS

Dimmer

Below are steps to adjust the brightness of the screen and LEDs.

Switching the Brightness Level

The preset brightness of the screen and LEDs can be adjusted according to the surrounding conditions.

- 1 Press **[MENU]**.
- 2 Press **F [DIMMER]**.
 - If **F [DIMMER]** is not displayed, press **F [MORE]** to display **F [DIMMER]**.
Pressing **F [DIMMER]** each time switches the dimmer setting in the following sequence: “DIMMER 1” → “DIMMER 2” → “DIMMER 3” → “DIMMER 4”.
- 3 Press **[MENU]** or **[ESC]** to end the process.

Adjusting the Dimmer Level

Each of the preset values for “Dimmer 1”, “Dimmer 2”, “Dimmer 3” and “Dimmer 4” can be configured to a different value for “Display” (screen) and “LED” respectively.

- 1 Press **[MENU]**.
- 2 Press **F [DIMMER]**.
 - If **F [DIMMER]** is not displayed, press **F [MORE]** to display **F [DIMMER]**.
- 3 Press and hold **F [DIMMER]**.
The Dimmer configuration screen appears.

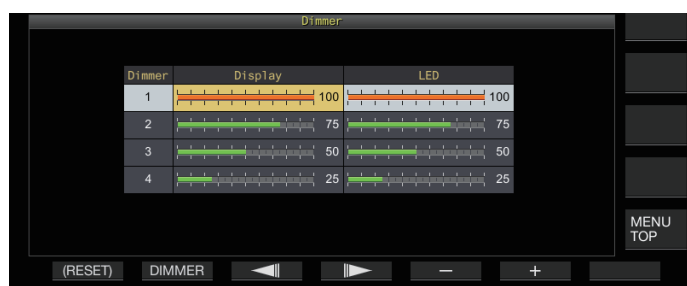

- 4 Press **F2 [DIMMER]** to select a dimmer preset.
- 5 Press **F3 [◀|||]/ F4 [||▶]** to select “Display” or “LED”.
- 6 Press **F5 [-]/ F6 [+]** or turn **[MULTI/CH]** to change the setting value.
The setting values and default values are shown below.

Dimmer	Display	Setting Value	Default
1	Display	5 to 100 (5-step)	100
	LED	5 to 100 (5-step)	100
2	Display	5 to 100 (5-step)	75
	LED	5 to 100 (5-step)	75
3	Display	5 to 100 (5-step)	50
	LED	5 to 100 (5-step)	50
4	Display	0 to 100 (5-step)	25
	LED	5 to 100 (5-step)	25

- Configuring “Display” for “Dimmer 4” to “0” and exiting the menu turns off the lights on the screen completely. Pressing **[MENU]** at this time temporarily switches the screen brightness to the condition when the setting value of “Display” is “5” and allows the information displayed to be checked.

- 7 Press **[MENU]** or **[ESC]** to end the process.

Adjusting AF Gain

Below are the steps to adjust the volume so that sound can be heard from the speaker.

- Turn the **[AF]** control.
Turning the control to the right raises the volume, while turning to the left lowers it.
 - If no sound is heard or if only a light noise-like sound is heard even when the **[AF]** control is turned all the way to the right, the squelch may be closed. Adjust the squelch level in this case.



- The volume of the beep sound, sidetone and announcement cannot be adjusted using the **[AF]** control.

Adjusting RF Gain

Below are the steps to adjust the gain of the RF amplifier. Under normal circumstances, turn the **[RF]** control all the way to the right. To enhance clarity when there is external noise or interference by other stations, turn the control slightly to the left to lower the gain level.

- Turn the **[RF]** control.
 - Start by checking the peak scale of the S meter, followed by turning the **[RF]** control in the anti-clockwise direction without lowering the peak value of the S meter. Doing so attenuates signals weaker than this level and eases reception from the desired station.
 - Depending on the type of antenna, gain level and band condition, better effect may sometimes be achieved by turning the **[RF]** control slightly to the left rather than all the way to the right.



- In the FM mode, turning the **[RF]** control does not change the gain level. Under normal circumstances, turn the **[RF]** control all the way to the right.

Adjusting the Squelch Level

Below are steps to adjust the threshold level for squelch, a function for eliminating noise that is heard when receiving a frequency with no signal.

- Turn the **[SQL]** control.
Configure the squelch level to the position where noise disappears. When squelch opens upon receiving a signal, the **[BUSY/TX]** LED lights up in green.



- The position of the **[SQL]** control at which noise disappears varies according to the strength of the noise and surrounding conditions such as temperature.
- The position of the control knob at which noise disappears also varies depending on whether this transceiver is in the FM mode or in other modes.

Selecting VFO A/B

This transceiver is equipped with two VFOs, A and B. The two VFOs operate independently of each other, and thus can be configured to different frequencies and modes. Additionally, one VFO can be configured to the TX frequency and the other to the RX frequency.

● **Press [A/B].**

Pressing [A/B] each time switches between “VFO A” and “VFO B”. The currently selected VFO is indicated as <<◀[A]>> or <<◀[B]>>.

- Pressing and holding down [A/B] configures both “VFO A” and “VFO B” to the same frequency and mode.

Selecting an Operating Band

Below are steps to select the frequency bandwidth to use. A different frequency bandwidth can be selected for VFO A and VFO B. By using the numeric keypad or [GENE] key, it is possible to call up an amateur frequency between 1.8 MHz and 50 MHz or a general band frequency such as 70 MHz (E type), 135 kHz, 475 kHz, MW broadcast band, and 5 MHz at one touch.

- This transceiver comes with a band memory feature that is able to store up to 5 pairs of frequencies and modes (3 pairs in the default setting) that were used most recently for each band.

● **Press [1 (1.8)] to [0 (50)] or [GENE].**

- Pressing one of the above keys saves the current VFO frequency and mode and calls up the next memory band at the same time. Pressing the key each time switches to the next band memory in sequence from band memory 1 to band memory 5.
- Frequencies that are out of the range of the band memory will not be stored.
- The default values for each of the band memories are as follows.

K Type

Band/ Frequency (MHz)/ Mode	Default Setting (MHz)/Mode				
	Band Memory 1	Band Memory 2	Band Memory 3	Band Memory 4	Band Memory 5
1.8 MHz/ 1.62 to 2	1.8/ CW	1.81/ CW	1.82/ CW	1.83/ CW	1.84/ CW
3.5 MHz/ 3 to 4	3.5/ LSB	3.6/ LSB	3.7/ LSB	3.8/ LSB	3.9/ LSB
7 MHz/ 6.5 to 7.5	7.0/ LSB	7.05/ LSB	7.1/ LSB	7.15/ LSB	7.2/ LSB
10 MHz/ 10 to 10.5	10.1/ CW	10.11/ CW	10.12/ CW	10.13/ CW	10.14/ CW
14 MHz/ 13.5 to 14.5	14.0/ USB	14.1/ USB	14.15/ USB	14.20/ USB	14.25/ USB
18 MHz/ 18 to 19	18.068/ USB	18.1/ USB	18.11/ USB	18.15/ USB	18.16/ USB
21 MHz/ 20.5 to 21.5	21.0/ USB	21.1/ USB	21.15/ USB	21.2/ USB	21.3/ USB
24 MHz/ 24 to 25	24.89/ USB	24.92/ USB	24.94/ USB	24.96/ USB	24.98/ USB
28 MHz/ 27.5 to 30	28/ USB	28.3/ USB	28.5/ USB	29/ FM	29.3/ FM
50 MHz/ 50 to 54	50/ USB	50.125/ USB	50.2/ USB	51/ FM	52/ FM
General/ 0.030 to 60	0.1357/ CW	0.472/ CW	1/ AM	5.3305/ USB	5.4035/ USB

E Type

Band/ Frequency (MHz)	Default Setting (MHz)/Mode				
	Band Memory 1	Band Memory 2	Band Memory 3	Band Memory 4	Band Memory 5
1.8 MHz/ 1.62 to 2	1.83/ CW	1.84/ CW	1.85/ CW	1.81/ CW	1.82/ CW
3.5 MHz/ 3 to 4	3.5/ LSB	3.55/ LSB	3.6/ LSB	3.65/ LSB	3.7/ LSB
7 MHz/ 6.5 to 7.5	7.0/ LSB	7.05/ LSB	7.1/ LSB	7.15/ LSB	7.2/ LSB
10 MHz/ 10 to 10.5	10.1/ CW	10.11/ CW	10.12/ CW	10.13/ CW	10.14/ CW
14 MHz/ 13.5 to 14.5	14.0/ USB	14.1/ USB	14.15/ USB	14.20/ USB	14.25/ USB
18 MHz/ 18 to 19	18.068/ USB	18.1/ USB	18.11/ USB	18.15/ USB	18.16/ USB
21 MHz/ 20.5 to 21.5	21.0/ USB	21.1/ USB	21.15/ USB	21.2/ USB	21.3/ USB
24 MHz/ 24 to 25	24.89/ USB	24.92/ USB	24.94/ USB	24.96/ USB	24.98/ USB
28 MHz/ 27.5 to 30	28/ USB	28.3/ USB	28.5/ USB	29/ FM	29.3/ FM
50 MHz/ 50 to 54	50/ USB	50.15/ USB	50.2/ USB	51/ FM	52/ FM
General/ 0.030 to 74.8	70.1/ USB	0.1357/ CW	0.472/ CW	0.999/ AM	5.2585/ USB



- When the number of band memories is reduced, the change will be applied when the band memory is switched.

Changing the Number of Band Memories

The number of band memories can be changed.

● **Configure in Menu [3-11] “Number of Band Memories”**

Setting Value	1/ 3 (default)/ 5
---------------	-------------------

4 BASIC OPERATIONS

Selecting an Operating Mode

Below are steps to select an operating mode. It is also possible to configure the operating mode to DATA mode for data communication.

SSB (LSB-USB) Mode

● Press [LSB/USB].

Pressing [LSB/USB] each time switches between "LSB" and "USB".



CW/ CW-R Mode

● Press [CW/ CW-R].

Pressing [CW/ CW-R] each time switches between "CW" and "CW-R".



FSK/ FSK-R/ PSK/ PSK-R Mode

● Press [FSK/PSK].

Pressing [FSK/PSK] each time switches between "FSK" and "PSK".

- Pressing and holding down [FSK/PSK] each time in the respective modes switches the reverse mode (FSK-R or PSK-R).

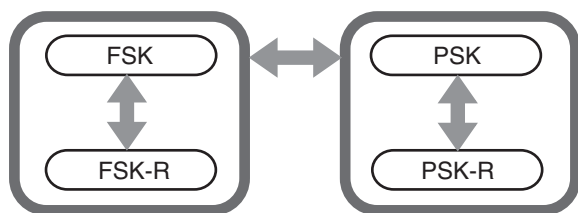

FM/ AM Mode

● Press [FM/AM].

Pressing [FM/AM] each time switches between "FM" and "AM".

- While in the FM mode, pressing and holding down [FM/AM] each time switches between "FM" and "FMN" (FM Narrow).

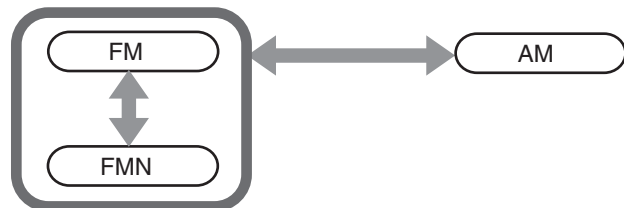

- The mode and DATA mode settings are stored in the band memory.
- FM narrow and normal settings are stored in each of the following band: HF/ 50 MHz/ 70 MHz (E type).

DATA Mode

This is a mode for performing data communication by connecting an external device.

1 Press the mode key to configure to FM, AM or SSB (LSB/USB) mode.

2 Press [DATA].

Pressing [DATA] each time switches between "DATA OFF" and "DATA ON".

	DATA OFF	DATA ON
During LSB Mode	LSB	LSB-D
During USB Mode	USB	USB-D
During FM Mode	FM	FM-D
During FMN Mode	FMN	FMN-D
During AM Mode	AM	AM-D



- Turn OFF the speech processor before performing data communication.
- Settings such as the method of standby and muting audio input path that is not used during transmission can be configured for each of the DATA OFF and DATA ON statuses.

Auto Mode

By configuring the auto mode frequency point and the corresponding operating mode in advance, the operating mode will switch automatically when the frequency exceeds the auto mode frequency point after it has been changed.

- Auto mode is a convenient function that allows automatic switching of the operating mode according to the band plan.
- Up to 32 points can be configured for the auto mode frequency.

Turning ON/OFF Auto Mode

1 Press [MENU].

2 Press F [AUTO MODE] to display the Auto Mode screen.

- If F [AUTO MODE] is not displayed, press F [MORE].

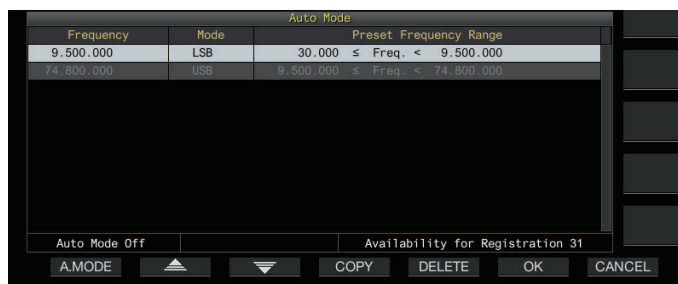

3 Pressing F1 [A.MODE] each time switches the Auto Mode to ON or OFF.

When the Auto Mode is turned ON, <<AUTO>> is displayed. This display disappears when Auto Mode is turned OFF.

Configuring Auto Mode Frequency Points

- 1 **Display the Auto Mode screen.**
- 2 **Turn the Tuning control to select a frequency point.**
Align the frequency of the selected band with the frequency to register.
- 3 **Press the Mode key or press and hold down the key to switch to the mode to which the band is to be registered.**
- 4 **Press F4 [COPY] to copy the frequency and mode.**
 - The frequency and mode of the selected band is imported into the list as a new classification.
 - To delete a registered classification, press F2 [▲] / F3 [▼] or turn the [MULTI/CH] control to select the row to delete, followed by pressing F5 [DELETE] to delete the row. Doing so shifts up the classifications after the deleted row in the list.
- 5 **Repeat the steps from 2 to 5 to configure the frequency and mode for all the points.**
- 6 **Press F6 [OK].**
- 7 **Press [MENU] or [ESC] to end the process.**
 - When the Auto Mode is turned ON, the mode that is assigned to the respective channels will be automatically selected. In the SSB mode, LSB mode will be selected for frequencies below 10.1 MHz, and USB mode will be selected for frequencies that are 10.1 MHz or higher.
 - The table below shows an example when auto mode frequency is configured to the HF/50/70 MHz band.

Frequency	Mode	Preset Frequency Range
1.620 MHz	AM	30 kHz ≤ f < 1.62 MHz
2.000 MHz	CW	1.62 MHz ≤ f < 2.0 MHz
3.500 MHz	LSB	2.0 MHz ≤ f < 3.5 MHz
3.525 MHz	CW	3.5 MHz ≤ f < 3.535 MHz
10.100 MHz	LSB	3.535 MHz ≤ f < 10.1 MHz
10.150 MHz	CW	10.1 MHz ≤ f < 10.15 MHz
14.000 MHz	USB	10.15 MHz ≤ f < 14.0 MHz
14.070 MHz	CW-R	14.0 MHz ≤ f < 14.07 MHz
14.112 MHz	FSK	14.07 MHz ≤ f < 14.112 MHz
18.068 MHz	USB	14.112 MHz ≤ f < 18.068 MHz
18.110 MHz	CW	18.068 MHz ≤ f < 18.11 MHz
21.000 MHz	USB	18.11 MHz ≤ f < 21.0 MHz
21.070 MHz	CW	21.0 MHz ≤ f < 21.07 MHz
21.125 MHz	FSK-R	21.07 MHz ≤ f < 21.125 MHz
21.150 MHz	CW	21.125 MHz ≤ f < 21.15 MHz
24.890 MHz	USB	21.15 MHz ≤ f < 24.89 MHz
24.930 MHz	CW	24.89 MHz ≤ f < 24.93 MHz
28.000 MHz	USB	24.93 MHz ≤ f < 28.0 MHz
28.070 MHz	CW	28.0 MHz ≤ f < 28.07 MHz
28.150 MHz	FSK	28.07 MHz ≤ f < 28.15 MHz
28.200 MHz	CW	28.15 MHz ≤ f < 28.2 MHz
29.000 MHz	USB	28.2 MHz ≤ f < 29.0 MHz
30.000 MHz	FM-DATA	29.0 MHz ≤ f < 30.0 MHz
50.000 MHz	USB	30.0 MHz ≤ f < 50.0 MHz
50.100 MHz	CW	50.0 MHz ≤ f < 50.1 MHz
51.000 MHz	USB	50.1 MHz ≤ f < 51.0 MHz
52.000 MHz	FM	51.0 MHz ≤ f < 52.0 MHz
–	USB	52.0 MHz ≤ f < 60.0 MHz (K type) 52.0 MHz ≤ f < 74.8 MHz (E type)

Adjustment of Frequencies

The steps to adjust the TX and RX frequencies are described below.

Adjustment Using the Tuning Control

- Turn the Tuning control to increase or decrease the frequency.

Adjustment Using the Microphone Key

- Press the [UP] or [DWN] key on the microphone to increase or decrease the frequency.

FINE Tuning

The step frequency of the Tuning control can be configured to one-tenth of the step size. Doing so allows fine-tuning of the frequency.

- Press [FINE].
Pressing [FINE] each time toggles FINE tuning between ON and OFF.



- When fine tuning is set to OFF, the 1 Hz digit frequency display will be grayed out. When in the FM or AM mode, both the 10 Hz and 1 Hz digits are grayed out. Setting fine tuning to ON turns off the gray-out display and shows the frequency in full up to the 1 Hz digit.
- Depending on the operating frequency, the 1 Hz digit display may not gray out on the operating frequency display of the converter even when fine tuning is set to OFF.

Configuring the Number of Steps per Revolution of the Tuning Control

The number of steps per revolution of the Tuning control can be changed.

- Configure in Menu [3-07] “Tuning Control: Number of Steps per Revolution”

Setting Value	250/ 500/ 1000 (default) [Step]
---------------	---------------------------------

Configuring the Fast Forward Rate of the Tuning Control

This function enables the speed of frequency change to increase by 2 to 10 times with respect to the speed of turning when the Tuning control is turned at a fast speed.

- Configure in Menu [3-08] “Tuning Speed Control”

Setting Value	Off (default)/ 2 to 10 (1 step)
---------------	---------------------------------

Configuring the Sensitivity for Starting the Fast Forward Operation

Configuring this to a larger value increases the sensitivity for starting the fast forward operation.

- Configure in Menu [3-09] “Tuning Speed Control Sensitivity”

Setting Value	1 to 5 (default) to 10 (1 step)
---------------	---------------------------------

4 BASIC OPERATIONS

Frequency Adjustment Using the [MULTI/CH] Control

Turning the [MULTI/CH] control enables the frequency to be changed quickly. The frequency increases or decreases in increments based on the configured step size.

- Turn the [MULTI/CH] control to increase or decrease the frequency.

The default frequency per step is 1 kHz in the SSB mode, 0.5 kHz in the CW/ FSK/ PSK mode, 5 kHz in the AM mode and 10 kHz in the FM mode.

Rounding the Frequency

When the frequency is adjusted by turning the [MULTI/CH] control, the new frequency is automatically rounded to the integer multiple of the step size. Rounding of the frequency can also be disabled.

- Configure in Menu [3-00] “Frequency Rounding Off (Multi/Channel Control)”

Setting Value	Off/ On (default)
---------------	-------------------

Configuring the Frequency Step Size of the [MULTI/CH] Control

The frequency per step when the [MULTI/CH] control is turned can be configured or changed to a different value for each mode.

SSB Mode

- Configure in Menu [3-01] “SSB Mode Frequency Step Size (Multi/Channel Control)”

Setting Value	0.5/ 1 (default)/ 2.5/ 5/ 10 [kHz]
---------------	------------------------------------

CW/ FSK/ PSK Mode

- Configure in Menu [3-02] “CW/FSK/PSK Mode Frequency Step Size (Multi/Channel Control)”

Setting Value	0.5 (default)/ 1/ 2.5/ 5/ 10 [kHz]
---------------	------------------------------------

FM Mode

- Configure in Menu [3-03] “FM Mode Frequency Step Size (Multi/Channel Control)”

Setting Value	5/ 6.25/ 10 (default)/ 12.5/ 15/ 20/ 25/ 30/ 50/ 100 [kHz]
---------------	--

AM Mode

- Configure in Menu [3-04] “AM Mode Frequency Step Size (Multi/Channel Control)”

Setting Value	5 (default)/ 6.25/ 10/ 12.5/ 15/ 20/ 25/ 30/ 50/ 100 [kHz]
---------------	--

Switching the AM Broadcast Frequency in 9 kHz Steps

In the BC band (medium frequency band) from 522 kHz to 1710 kHz and LF band (long frequency band) from 153 kHz to 279 kHz, the RX frequency can be adjusted in steps of 9 kHz by turning the [MULTI/CH] control.

- Configure in Menu [3-05] “9 kHz Step in AM Broadcast Band (Multi/Channel Control)”

Setting Value	Off (K type: default)/ On (E type: default)
---------------	---

Adjusting Frequency in MHz Steps

The frequency can be adjusted in units of MHz.

- 1 Press [MHz].

Pressing [MHz] each time toggles the MHz step function between ON and OFF.

When the function is turned ON, << [MHz] >> lights up.

- 2 Turn the [MULTI/CH] control while the function is turned ON.

The frequency increases or decreases according to the MHz frequency step configured in Menu [3-06].

Configuring the Frequency Step Size in MHz

- Configure in Menu [3-06] “MHz Step”

Setting Value	100/ 500/ 1000 (default) [kHz]
---------------	--------------------------------

Direct Input of Frequency Value

If the desired frequency is far apart from the current frequency value, the fastest way is to input the frequency value directly using the numeric keypad.

- 1 Press [ENT].

A screen to input the frequency for the operable band appears with all the frequency digits displayed as “-”.



2 Key in a frequency value using the numeric keypad.

- “.” changes into a numeric value when a numeric key is pressed and a value can be input starting from the highest-order digit.
- To enter 1.82 MHz, press [0/50], [1/1.8], [8/24] followed by [2/3.5], and press [ENT] when input is complete.
- To enter a frequency lower than 6 MHz for K type transceivers, start by keying in a “0”.
- To enter a frequency lower than 8 MHz for E type transceivers, start by keying in a “0”.
- Pressing [CLR] halfway through the input process clears the input and restores the VFO frequency display before the input.



- During fine tuning, a frequency up to 59.99999 MHz can be input (input of 60 MHz is not allowed).
- Pressing [ENT] halfway through the input process fills the remaining digits with “0” and completes the input.
- When a frequency value out of the TX and RX range is input, an alarm tone is output and the input value is automatically cleared.
- If the first input value is between 0 and 5, input starts from the 10 MHz digit. If the first input value is between 6 and 9, input starts from the 1 MHz digit.
- “0” that is entered up to the 10 Hz digit will not appear as “0” in the display.
- Inputting a frequency value automatically switches RIT and XIT to OFF but does not clear the offset frequency.
- When fine tuning is OFF, the smallest digit for input is the 10 Hz digit in modes other than AM and FM, and 100 Hz in the AM and FM mode.
- When in the auto mode, the mode switches automatically after input of frequency is complete.

Frequency Input History

The latest 10 frequency values that were input using the numeric keypad are stored in the transceiver. To use the same frequency value, it is possible to retrieve it from the history.

1 Press [ENT] to enable input of a frequency value.

“.” is displayed for all digits of the frequency value.

2 Turn the [MULTI/CH] control to display the history.

- Frequency values that were previously entered and the record number (E0 to E9) are displayed. The first frequency value shown is the most recent input.
- Turning the control to the right jumps to the subsequent record numbers in ascending order. The larger the record number, the older the record.



3 Press [ENT] to configure the selected frequency to VFO.



- When 10 frequency values have been registered, the oldest input in the history will be deleted when another frequency value is registered.

Frequency Lock

The frequency lock function disables operation of specific keys or control knobs to prevent the frequency from being altered accidentally due to erroneous operation of the key or control knobs.

● Press [LOCK] to lock the frequency value.

The [LOCK] LED lights up in orange. Pressing [LOCK] again while in the locked state cancels the locked state. The following operations are disabled when frequency lock is turned on.

- Frequency tuning
- Change of memory channel
- Change of quick memory channel
- Direct input of frequency value
- Registration of memory channel
- Starting program scan or VFO scan
- Starting memory scan or quick memory scan
- Switching between the VFO and memory channel modes
- Frequency band selection
- Memory shift
- Configuring the frequencies for VFO A and VFO B to the same value
- Switching between VFO A and VFO B
- Mode selection
- Switching to FINE tuning
- CW auto tune
- Quick memory channel mode switch
- Registration of quick memory channel
- Touchscreen tuning



- When “Tuning Control Lock” is selected in Menu [3-10], only the **Tuning** control will be locked.

Selecting the Frequency Lock Function Behavior

It is possible to lock only the **Tuning** control in the frequency lock function.

● Configure in Menu [3-10] “Lock Function”

Setting Value	Frequency Lock (default)/ Tuning Control Lock
----------------------	---

Frequency Lock: Locks both **Tuning** control and [MULTI/CH] control.

Tuning Control Lock: Locks only the **Tuning** control.

4 BASIC OPERATIONS

Transmission

Audio Transmission

- 1 Press and hold the [PTT] key on the microphone or press the [SEND] key.

The transmitting status is activated and the [BUSY/TX] LED lights up in red.

- 2 Speak into the microphone in the normal tone and loudness.

- 3 Release the [PTT] key on the microphone or press the [SEND] key.

Doing so restores the receiving status.

CW Transmission

Performing the following steps when a key or paddle is connected enables transmission in the CW mode.

- 1 Press [CW/ CW-R] to select CW mode.
- 2 Press [VOX] to enable break-in.
- 3 Operate the keyer or paddle.

Adjusting Microphone Gain

Microphone gain can be adjusted in the SSB or AM mode as follows while referring to the ALC meter display.

- 1 Press and hold the [PTT] key on the microphone or press the [SEND] key.

- The transmitting status is activated and the [BUSY/TX] LED lights up in red.

- 2 Speak into the microphone in the normal tone and loudness.

- 3 Turn the [MIC/PITCH] control to adjust the microphone gain level.

Microphone gain is displayed as "MIC:nnn" at the top of the screen. [nnn: 0 to 100]

PRE 1 AGC OFF 100W MIC:100 DELAY:10 ANT 1

When in the SSB mode

Turn the [MIC/PITCH] control while speaking into the microphone. The ALC meter fluctuates according to the volume level. Ensure that the maximum level does not exceed the ALC zone during the adjustment.

When in the AM mode

Turn the [MIC/PITCH] control while speaking into the microphone. Adjust in such a way that the PWR meter fluctuates slightly according to the volume level.

- 4 Release the [PTT] key on the microphone or press the [SEND] key.

Depending on the squelch level setting, the [BUSY/TX] LED may light up in green or go off.

- Speak into the microphone in the normal tone and loudness. Make sure that your mouth is not too close to the microphone and do not speak too loudly. Doing so may increase the extent of distortion, thus causing audibility to deteriorate at the receiving end.
- To use a speech processor, refer to "Speech Processor" (8-4).
- Note that the output level tend to be larger when a microphone with a built-in AF amplifier is used.
- Microphone gain in the FM mode can be configured in Advanced Menu [10] "Microphone Gain (FM Mode)".

Adjusting TX Output Power

Maintain a TX output power level that is as low as possible while ensuring that communication can be carried out smoothly. Doing so reduces the likelihood of interference with other stations. The TX output power level can also be adjusted while transmission is in progress.

- Turn the [POWER] control to adjust the TX output power.

Turning the [POWER] control to the right increases the output level, while turning it to the left reduces the output level. The selectable range varies with the band and mode in use as follows.

	Other than AM	AM
HF Band	5 to 100 [W]	5 to 25 [W]
50 MHz Band	5 to 100 [W]	5 to 25 [W]
70 MHz Band (E type)	5 to 50 [W]	5 to 12.5 [W]



- Output is displayed in a step size of 1 W. An output of 12.5 W will be shown as "12 W".

Fine Adjustment of TX Output Power

It is possible to alter the step size when the [POWER] control is turned.

- Configure in Menu [6-04] "Transmit Power Step Size"

Setting Value	1 [W]/ 5 (default) [W]
---------------	------------------------

1[W]: Adjusts the TX output level in a step size of 1 W.

5[W]: Adjusts the TX output level in a step size of 5 W (e.g., 5, 10, 15...).

TX Output Power Limiter

The TX output power limiter can be used to limit the TX output power. This is a function to prevent the TX output power level from exceeding the preconfigured level for each band when the [POWER] control is turned. It can also be used to limit TX output power only in the DATA mode with a specific band.

Turning ON/OFF TX Output Power Limiter

- **Press F [MAX-Po].**
Pressing F [MAX-Po] each time toggles the TX output power limiter function between ON and OFF.
 - When the TX output power limiter is turned ON, pressing F [MAX-Po] displays the confirmation screen for turning off the TX output power limiter.
 - Pressing [F4](OK) turns off the TX output power limiter function. Pressing [F7](CANCEL) or [ESC] cancels the operation.



Configuring the TX Output Power Limiter

- 1 Press and hold F [MAX-Po] to display the TX output power limiter screen.



- 2 Press F4 [◀] / F5 [▶] to select a frequency band.
- 3 Press F2 [▲] / F3 [▼] to select the TX output power to limit.
Select the TX output power item to limit as follows.
Max Power Limit: For configuring the TX output power limit during transmission.
• The TX output power limit can be configured separately for the SSB, CW, FSK/PSK, FM/AM and DATA modes.
TX Tune Power: For configuring the TX output power limit during TX tuning.
- 4 Press F6 [-] / F7 [+] or turn the [MULTI/CH] control to select a limit value for TX output power.
• To restore the default setting, press and hold F1 [(RESET)].
- 5 Press and hold F [MAX-Po] or press [ESC] to end the process.

- ✎ A different TX output power limit cannot be configured for the antenna connectors (antenna 1/2).
- ✎ If Advanced Menu [6] "TX Power Down with Transverter Enabled" is configured to "On", the F [MAX-Po] and watt display at the right edge of the screen will disappear when the transverter or drive output is turned ON.

Meter

The meter displays the measured reading of the S meter during reception and that of the selected meter during transmission.

Changing the Meter Type

A digital meter and two types of analog meters are available for selection.

Changing the Meter Type from the Menu

- **Configure in Menu [0-09] "Meter Display Pattern"**

Setting Value	Digital/ Analog (White) (default)/ Analog (Black)
---------------	---

Changing the Meter Type via Touchscreen Operation

- **Touch the meter display area while an analog or digital meter is displayed**
Touching the screen each time switches the meter in the following sequence: "Digital" → "Analog (White)" → "Analog (Black)".
 - When in the compressed mode, touching the meter will not change the display.

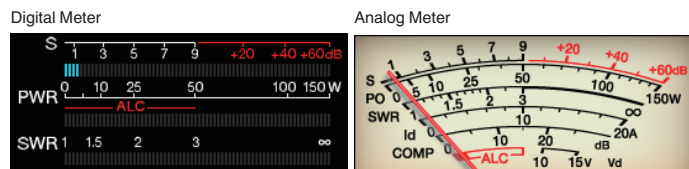

Switching between TX Meters

- **Press F [METER].**
Press F [METER] each time switches the display as follows according to the meter type.
Analog meter display when the TX meter (digital) is OFF:
"Po" → "SWR" → "Id" → "COMP"* → "ALC" → "Vd" → ...
Display at the bottom of the TX meter (digital) when the TX meter (digital) is ON:
"SWR" → "Id" → "COMP"* → "Vd" → "TEMP" → ...
The last line of the display in the digital meter display mode:
"SWR" → "Id" → "COMP"* → "Vd" → "TEMP" → ...
When a mini digital meter is displayed:
"Po" → "SWR" → "Id" → "COMP"* → "ALC" → "Vd" → "TEMP" → ...

Po	Indicates the TX output power. (Output power at the peak)
SWR	Indicates the standing wave ratio which reflects the matching status of the antenna.
COMP	Indicates the amount of TX audio amplitude that is compressed by the speech processor.
ALC	Indicates the ALC level.
Id	Indicates the drain current of the final FET.
Vd	Indicates the voltage of the final FET.
TEMP	Indicates the temperature of the internal circuit.

- ✎ An external meter can also be used to display the signal level by connecting an analog meter to the METER terminal on the rear panel.
- *: COMP meter can only be selected when the speech processor is ON.

4 BASIC OPERATIONS

FM Mode S-meter Sensitivity

The default deflection type in the FM mode is the same as that in the other modes. Selecting “High” switches the transceiver to the same deflection type (high sensitivity) as our conventional models.

● Configure in Menu [0-07] “FM Mode S-Meter Sensitivity”

Setting Value	Normal (default)/ High
---------------	------------------------

- This function is available when Menu [0-11] “S-Meter Scale” is configured to “Type 1”.

Analog Meter Response

Configure the response speed of the analog meter indicator.

● Configure in Menu [0-08] “Meter Response Speed (Analog)”

Setting Value	1 to 3 (default) to 4 (1 step)
---------------	--------------------------------

Meter with Peak Hold

Display the peak hold of the digital meter.

● Configure in Menu [0-10] “Meter Display Peak Hold”

Setting Value	Off/ On (default)
---------------	-------------------

S Meter Scale

Switch the type of deflection for the S meter.

● Configure in Menu [0-11] “S-Meter Scale”

Setting Value	Type 1 (default)/ Type 2
---------------	--------------------------

Type 1: Same scale as our HF products.

Type 2: Initial deflection is more sensitive compared to Type 1.

- Additional notes for “Type 2”
 - The S meter indicator will appear deflected at all times when there is external noise.
 - The movement may not be smooth as it is a pseudo representation of the S meter deflection.
 - Narrowing the RF gain may disrupt the continuity from S0 to S4.

TX Meter (Digital)

In addition to the analog meter display, a two-tiered digital meter can also be displayed at the same time.



● Configure in Menu [0-12] “TX Digital Meter”

Setting Value	Off (default)/ On
---------------	-------------------

- The TX meter (digital) only appears in the analog meter display mode.
- The TX meter (digital) is displayed in a two-tiered bar format. ALC is shown at the upper level, while the display at the lower level varies according to the setting of the **F [METER]** digital meter.
- During transmission, the analog meter always displays the TX output power.

Switching the Antenna

Switch the antenna that is connected to the antenna connector. The ANT 1/2, RX ANT and DRV settings are automatically stored in the antenna band memory. When the same band is selected subsequently, the same antenna will be selected automatically.

● Press and hold **F [ANT/PRE]**.

Pressing and holding **F [ANT/PRE]** switches the option between “ANT 1” and “ANT 2”.

- When “ANT 1” is selected, << **F1** >> is displayed. When “ANT 2” is selected, << **F2** >> is displayed.

Selectable Antenna Frequency Range (MHz)	
0.03 to 0.522	10.5 to 14.5
0.522 to 2.5	14.5 to 18.5
2.5 to 4.1	18.5 to 21.5
4.1 to 6.9	21.5 to 25.5
6.9 to 7.5	25.5 to 30.0
7.5 to 10.5	30.0 to 60.0
	60.0 to 74.8 (E type)

RX Antenna

Select an RX antenna.

To use an RX antenna such as an HF low-band Beverage antenna or a directional loop antenna, connect it to the RX IN terminal on the rear panel. The input impedance is 50 Ω. A self-made or commercially available BPF or trap filter can also be inserted between the RX IN and RX OUT terminals.

● Press **[RX ANT]**.

Pressing **[RX ANT]** each time enables or disables the RX antenna of the selected band.

When the RX antenna is enabled, << **RX** >> is displayed on the screen.

Drive Output (DRV)

The allowable output frequency ranges from the drive output (DRV) are the 135 kHz band (135.700 kHz to 137.799 kHz), 475 kHz band (472.000 kHz to 478.999 kHz) and the amateur bands between 1.9 and 50/70 MHz. The output impedance is 50 Ω and output level is approximately 1 mW (0 dBm).

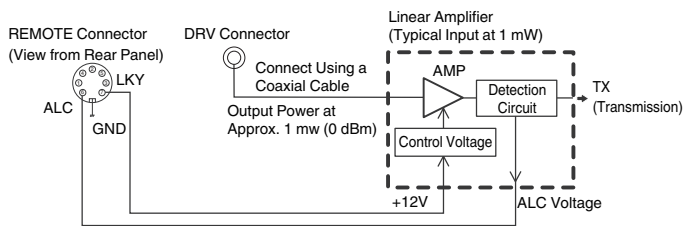

Turning ON/OFF Drive Output

● Press [DRV].

Pressing [DRV] each time toggles drive output between ON and OFF.

- When drive output is ON, the [DRV] LED lights up in green.
- During output from the DRV terminal, TX signals will not be output from the ANT 1 and ANT 2 connectors.
- Transmission from the DRV terminal will not be displayed on the PWR meter. ALC (automatic level control) can be operated by inputting ALC voltage from an external device to the ALC terminal of the REMOTE connector. The operating status will be displayed on the meter in this case. The DRV output level is not controlled when there is no ALC voltage input. As such, the output level is determined according to the MIC input or [CAR] control settings.



- Pay careful attention to the connection when making use of drive output as described above.

Adjusting the Drive Output Level

● Turn the [POWER] control.

“nnn%” is displayed according to the selected drive output level. [nnn: 5 to 100]

- A different drive output level can be configured for the AM and modes other than the AM mode.
- The resolution [1% / 5%] for changing the drive output level can be switched using the Menu 6-04 “Transmit Power Step Size” setting.

Band/Mode		Setting Value	Default
HF	CW/FSK/PSK/SSB/FM/SSB-DATA/FM-DATA	5 to 100 [%] (1 step or multiples of 5)	100
	AM/AM-DATA	5 to 25 [%] (1 step or multiples of 5)	25
50M	CW/FSK/PSK/SSB/FM/SSB-DATA/FM-DATA	5 to 100 [%] (1 step or multiples of 5)	100
	AM/AM-DATA	5 to 25 [%] (1 step or multiples of 5)	25
70M (E Type)	CW/FSK/PSK/SSB/FM/SSB-DATA/FM-DATA	5 to 100 [%] (1 step or multiples of 5)	100
	AM/AM-DATA	5 to 25 [%] (1 step or multiples of 5)	25

Built-in Antenna Tuner

It is important to ensure that the impedance of the coaxial cable and that of the antenna coincide with each other. An external antenna tuner or the built-in antenna tuner is used to adjust the impedance between the antenna and this transceiver.

Impedance Matching with the Antenna

1 Select a TX frequency.

2 Press and hold F [ANT/PRE] to select an antenna.

- When an external antenna tuner is connected to the ANT 1 connector, select ANT 2 if the built-in antenna tuner is to be used.
- The built-in antenna tuner cannot be used with ANT 1 when it is connected to an external antenna tuner.

3 Press and hold [AT] to perform tuning.

- The transceiver switches to the CW mode and starts tuning. TX output power is automatically configured to 10 W and the SWR meter will be selected as the TX meter.
- <<[R][AT][T]>> and [AT] LED will start to blink. <<[R]>> blinks when the antenna tuner is ON during reception.
- To undo the tuning, press [AT] again.
- If the SWR (standing wave ratio) of the antenna is extremely high (10:1 and above), an alarm tone (“SWR” in the Morse code) will be output, and the built-in antenna tuner will be disabled.
- Adjust the antenna to lower the SWR before restarting the tuning operation.

4 Check to ensure that tuning is complete.

- When tuning is completed successfully, a Morse code tone “T” is output.
- When tuning is complete, the blinking <<[R][AT][T]>> and [AT] LED become lit in solid light. <<[R]>> blinks when the antenna tuner is ON during reception.
- If matching is not achieved for a duration of 20 seconds, an alarm tone will be output (continuous output of “5” in the Morse code). When this occurs, check the SWR meter and press [AT] to stop tuning when the SWR value is low.



- Tuning of the built-in antenna tuner will not be performed outside the permitted TX frequency range.
- During transmission, pressing and holding [AT] starts the tuning.
- If matching is not achieved for a duration of 60 seconds, tuning will end automatically. When this occurs, the antenna tuner circuit turns OFF, <<[R][AT][T]>> will disappear, and the [AT] LED will go off.
- If tuning does not end automatically even though the SWR of the antenna 3:1 or lower, adjust the antenna system to lower the SWR and try to perform tuning again.
- The SWR may not reach 1:1 even though tuning has ended.

4 BASIC OPERATIONS

Preset

The tuning results can be stored as preset information in the built-in antenna tuner according to the preset frequency categories. When the built-in antenna tuner is ON, the preset information that corresponds to the current TX frequency is automatically configured for the built-in antenna tuner.

● Press [AT].

- <<[AT] [M]>> appears on the screen. When the antenna tuner is ON while receiving, <<[RX]>> is displayed. The preset information that corresponds to the current TX frequency is configured for the built-in antenna tuner.
- When the TX frequency is altered, the preset information that corresponds to the preset frequency category is automatically configured for the built-in antenna tuner.
- To turn off the built-in antenna tuner, press [AT] again.

Preset Frequency Categories for Built-in Antenna Tuner (MHz)	
0.030 ≤ f < 1.850	14.100 ≤ f < 14.500
1.850 ≤ f < 2.500	14.500 ≤ f < 18.500
2.500 ≤ f < 3.525	18.500 ≤ f < 21.150
3.525 ≤ f < 3.575	21.150 ≤ f < 21.500
3.575 ≤ f < 3.725	21.500 ≤ f < 25.500
3.725 ≤ f < 4.100	25.500 ≤ f < 28.300
4.100 ≤ f < 6.900	28.300 ≤ f < 29.000
6.900 ≤ f < 7.050	29.000 ≤ f < 30.000
7.050 ≤ f < 7.100	30.000 ≤ f < 51.000
7.100 ≤ f < 7.500	51.000 ≤ f < 52.000
7.500 ≤ f < 10.500	52.000 ≤ f < 53.000
10.500 ≤ f < 14.100	53.000 ≤ f < 60.000
60.000 ≤ f < 74.800 (E type)	

Holding Transmission at the End of Antenna Tuning

Transmission can be held after antenna tuning has ended.

● Configure in Advanced Menu [7] “TX Hold After Antenna Tuning”

Setting Value	Off (default)/ On

Off: Returns to receiving state after antenna tuning has ended.
On: Continues 10 [W] transmission in the CW mode after antenna tuning has ended.

- When transmission is held after antenna tuning has ended, the held status will be canceled when transmission operations such as [SEND] or PF [DATA SEND] is performed or when [AT] is pressed.

Switching Antenna Tuner Behavior during Reception

Signals received may be made to pass through the built-in antenna tuner. Turning ON this function may help to reduce reception interference from other distant frequencies.

● Configure in Advanced Menu [8] “Antenna Tuner during RX”

Setting Value	Off (default)/ On

Off: Signals received do not pass through the built-in antenna tuner.
On: Signals received pass through the built-in antenna tuner.

- When full break-in is ON in the CW mode, the antenna tuner will function during reception regardless of the above setting.
- If the TX and RX frequencies are different during split operation, the antenna tuner will not function during reception regardless of the above setting.

Configuring the Built-in Antenna Tuner Behavior for Each Band

Two options to either store the ON/OFF status of the built-in antenna tuner separately for each band category or to store the same status for all bands are available.

● Configure in Advanced Menu [9] “Antenna Tuner Operation per Band”

Setting Value	Off (default)/ On

Off: Stores the same ON/OFF status of the built-in antenna tuner for all bands.

On: Stores the ON/OFF status of the built-in antenna tuner for each band category.

Connecting the External Antenna Tuner AT-300

To use the external antenna tuner AT-300, connect it to the ANT 1 connector and AT connector.

- AT-300 will not function if it is connected to the ANT 2 connector. AT connector is a control terminal that is used exclusively for AT-300. It cannot be used to control other external antenna tuners. When an external antenna tuner other than AT-300 is connected, make use of TX tuning.

- AT-300 cannot be used with the 50/70 MHz band. When using a 50/70 MHz band antenna, connect it to the ANT 2 connector.
- When AT-300 is connected to the AT connector and ANT 1 is used, the signal bypasses the built-in antenna tuner circuit.
- Production of the AT-300 has been discontinued.

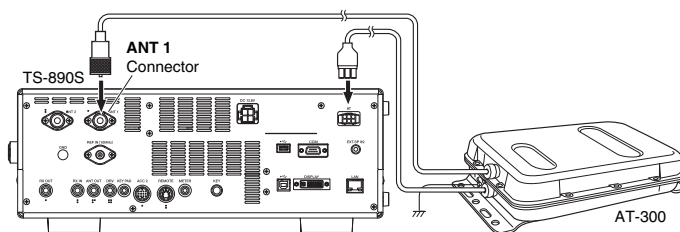

5 COMMUNICATING AIDS

Split Operation

The same frequency is used for both reception and transmission during normal communication. Select either VFO A or VFO B in this case. However, depending on the circumstances, a different frequency may be chosen for reception and transmission. In this case, it is necessary to use two VFOs. This is known as “split operation”. “Split operation” is used in cases such as when using an FM repeater or when calling a DX station.

1 Press [SPLIT].

<< [SPLIT] >> lights up when the transceiver enters the split mode.



2 Press [A/B] to select “VFO A” or “VFO B”.

The value on the left is the RX frequency. (Indicated by ◀ [A] in the example)

The value on the right is the TX frequency. (Indicated by ▶ [B] in the example)

3 Select a frequency.

- To copy a selected VFO frequency to the other VFO, press and hold [A/B].

4 Press [A/B] to select the other VFO.

5 Select a frequency.

Exiting Split Operation

6 Press [SPLIT].

The transceiver switches to the simplex mode and the light for << [SPLIT] >> goes off.

Direct Input of Frequency Difference Specified by DX Station

To directly configure the frequency difference between the frequency specified by the DX station and the RX frequency, perform the steps below while receiving signals from the DX station.

1 Press and hold [SPLIT].

- << [SPLIT] >> starts to blink.

2 Enter the frequency specified by the DX station in units of kHz.

To exit the configuration process, press [CLR].

If the frequency specified by the DX station is a positive value, enter the specified frequency in units of kHz using the numeric keypad.

If the frequency specified by the DX station is a negative value, enter a “0” at the beginning of the frequency value.

For example, if “+5 kHz” is specified, enter “5”. If “-5 kHz” is specified, enter “0” followed by “5”.

After input is complete, the TX frequency is configured and split operation is now enabled.

- << [SPLIT] >> changes from a blinking to a solid display.

Turning the Tuning Control to Search for a TX Frequency

To search for a TX frequency by turning the **Tuning** control, perform the steps below while receiving signals from the DX station.

1 Press and hold [SPLIT].

- << [SPLIT] >> starts to blink.

2 Turn the Tuning control to search for a TX frequency.

To exit the configuration process, press [CLR].

3 Press [SPLIT].

The frequency that is found in step 2 is configured as the TX frequency and split operation is now enabled.

- << [SPLIT] >> changes from a blinking to a solid display.

ΔF Display

This item displays the difference between the RX frequency and TX frequency during split operation.



● Configure in Menu [6-15] “Delta Frequency Display”

Setting Value	Off/ On (default)
---------------	-------------------

- When the ΔF display is ON, << [ΔF] >> is displayed below the TX frequency display during split operation.
- When << [ΔF] >> is displayed below the TX frequency, the band memory number on the right will not be displayed.
- When RIT or XIT is ON, the ΔF value is the difference between the TX frequency and the RX frequency with the RIT or XIT frequency added.

Changing the split frequency using the [RIT/XIT] control

While in the split mode with the RIT/XIT function set to OFF, the split frequency can be adjusted by turning the [RIT/XIT] control.

● Configure in Menu [3-12] “Split Frequency Offset by RIT/XIT Control”

Setting Value	Off (default)/ TX Frequency Offset while RX/ RX Frequency Offset while TX/ Both
---------------	---

TX Frequency Offset while RX: Split transmission frequency can be adjusted while receiving. While receiving signals from a DX station, turning the [RIT/XIT] control changes the TX frequency in advance to the frequency specified by the target station.

RX Frequency Offset while TX: Split reception frequency can be adjusted while transmitting. While one’s own station is transmitting as a DX station, turning the [RIT/XIT] control changes the RX frequency in advance to the frequency specified for the target station.

Both: Enables both the above.



- Adjustment of the split frequency using this function is disabled during TF-SET.

Configuring the Band Direct Key during Split Operation

Three options are available for selection with regard to the behavior when the band direct key is pressed during split operation.

● Configure in Menu [3-13] “Band Direct Keys in Split Mode”

Setting Value	RX Band (default)/ RX Band and Cancel Split Mode/ RX/ TX Band
---------------	---

RX Band: Changes the receiving band.

RX Band and Cancel Split Mode: Changes the receiving band and cancels the split mode.

RX/TX Band:

- Changes both the receiving and transmitting bands at the same time.
- The transmitting band and receiving band is assigned with the same memory number.
- Each band can be adjusted while maintaining the split status.

TF-SET (Setting the TX Frequency)

TF-SET is a function for temporarily switching the TX frequency and RX frequency. Signals can be received at one’s own frequency while the TF-SET switch is pressed and held down, and the TX frequency can also be changed in this state. Doing so allows checking of whether there is interference in the newly-selected TX frequency.

- A call is made to the target station when there is no interference and at the right timing to ensure smooth communication with DX stations that are receiving calls from a large number of stations. In other words, the communication status of the DX station in the presence of interfering signals are taken into consideration and transmission is carried out using the TF-SET function at the instant when the DX station is in the receiving state and there is no transmission from other stations. Putting this function to good use enables communication with a larger number of DX stations.

- 1 Configure the split operation frequency.**
- 2 Press and hold [TF-SET].**
The TX frequency and RX frequency are switched.
- 3 Turn the Tuning control while pressing and holding [TF-SET], or press [UP]/[DWN] on the microphone.**
Signals are received at the new TX frequency.
- 4 Release [TF-SET].**
Reception starts at the original RX frequency.



- Adjustment of the split frequency using the [RIT/XIT] control is disabled during TF-SET.
- Turning on the frequency lock before using the TF-SET function helps to prevent the transceiver from losing communication with the DX station due to erroneous operation.

AGC

AGC (Automatic Gain Control) is a function for controlling the IF gain automatically so as to minimize fluctuations in the strength of the signal that is being received.

- The AGC time constant is configured to FAST, MID or SLOW according to the receiving status and operation mode (other than FM mode).
- The digital AGC circuit of this transceiver divides the time constant into 20 levels from SLOW to FAST, with “1” being the fastest and “20” the slowest.
- Generally, the time constant is configured to a fast time constant in the CW and FSK modes where fluctuations in the signal strength are well defined, and a slow time constant is used in the SSB and AM modes where changes are gradual.
- However, a fast time constant is also useful in the SSB and AM modes to perform tuning quickly or when receiving weak signals.
- AGC can also be turned off.
- A different default time constant for AGC is configured for each mode as shown below.

Default AGC Time Constant Setting

Mode	Setting	Display
SSB	SLOW	AGC-S
SSB-DATA	SLOW	
CW	FAST	AGC-F
FSK	FAST	
PSK	FAST	
AM	SLOW	AGC-S
AM-DATA	SLOW	

Switching the AGC Time Constant

- 1 Select a mode other than FM.
- 2 Press [AGC] to select an AGC time constant.
Pressing [AGC] each time switches the selection in the following sequence: "AGC-F" → "AGC-M" → "AGC-S".



Adjusting the AGC Time Constant Preset Value

- 1 Press and hold [AGC] to display the AGC configuration screen.



- 2 Press F3 [AGC] or [AGC] to select "FAST", "MID" or "SLOW".
- 3 Press F4 [-]/ F5 [+] or turn the [MULTI/CH] control to change the AGC time constant.

Setting Value	1 to 20
---------------	---------

The AGC time constant is fastest when it is configured to "1", and slowest when configured to "20".

- The default AGC time constant values in the respective operation modes are as follows.

Mode	FAST	MID	SLOW
SSB	9	12	14
SSB-DATA	9	12	14
CW	9	12	14
FSK	7	11	14
PSK	7	11	14
AM	9	13	16
AM-DATA	9	13	16

- 4 Press and hold [AGC] or press [ESC] to end the process.

AGC OFF

Turns off AGC according to the status of the signals received. RF gain is fixed when AGC is set to OFF, which makes it easier to hear weak signals in some cases.

- If AGC is turned OFF while the S meter is deflecting due to the signal, sound may be output to the speaker or headphones at an unexpectedly loud volume.

Turn the [RF] control to turn down the RF gain level in advance. After turning off AGC, adjust RF gain by turning the [RF] control until the signal can be heard clearly. To turn off AGC, perform the steps below.

- 1 Press and hold [AGC] to display the AGC configuration screen.
- 2 Press and hold F6 [(OFF)] to configure AGC to OFF. <<AGCOFF>> lights up and the preset value display area is grayed out.
- 3 Press and hold [AGC] or press [ESC] to end the process.

AGC Quick Recovery

This function performs recovery from the suppression that occurs when the RX signal contains pulse noise.

- 1 Press and hold [AGC] to display the AGC configuration screen.
- 2 Press F2 [PULSE] to display the AGC Quick Recovery configuration screen.

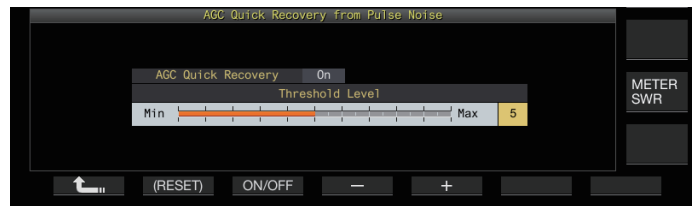

- 3 Press F3 [ON/OFF] to set the function to "On".
- 4 Press F4 [-]/ F5 [+] or turn the [MULTI/CH] control to change the threshold level.
Configuring to a larger value activates this function when signal level difference between the RX signal and pulse noise is small.

Setting Value	1 to 5 (default) to 10
---------------	------------------------

- This function may not be effective for pulse noise occurring in short time interval.
- Configuring to a value with a high threshold level may cause the transceiver to malfunction and distort the RX audio depending on the condition of the RX signal.

- 5 Press and hold [AGC] or press [ESC] to end the process.

5 COMMUNICATING AIDS

RX Equalizer

This function allows the sound quality to be altered by adjusting the characteristics of the RX frequency. 6 types of RX equalizer are available, which can be configured separately for each mode. A set of equalizer characteristics can be configured freely for each of the options between “User 1” and “User 3”.

Turning ON/OFF RX Equalizer

- **Press F [RX EQ].**
Pressing **F [RX EQ]** each time toggles the RX equalizer between ON and OFF.

Selecting an RX Equalizer Characteristic

- 1 Press and hold **F [RX EQ]** to display the RX Equalizer configuration screen.

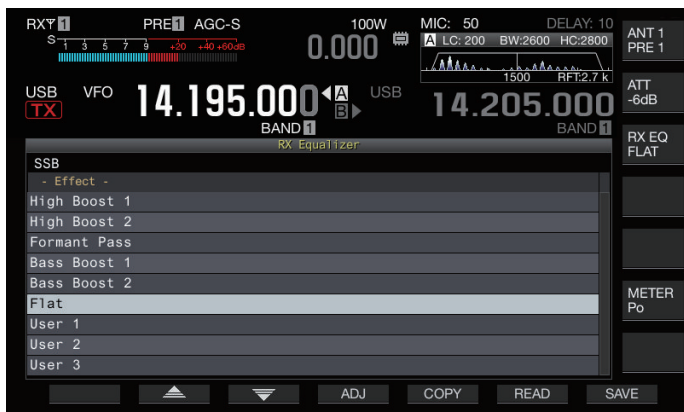

- 2 Press **F2[▲] / F3[▼]** or turn the **[MULTI/CH]** control to select an equalizer characteristic. The selected equalizer characteristic turns on.

Characteristic	Purpose
High Boost 1 (HB1)	Boosts the high frequency component. This is effective for audio sound that contains a low frequency component.
High Boost 2 (HB2)	Boosts the high frequency component. The low frequency attenuation level for this option is half of that of the High Boost 1 option.
Formant Pass (FP)	This option attenuates frequency components that is outside the audio bandwidth so that the audio can be heard more clearly.
Bass Boost 1 (BB1)	Boosts the low frequency component. This is effective for audio sound that contains a high frequency component.
Bass Boost 2 (BB2)	Boosts the low frequency component. The low frequency is further boosted compared to Bass Boost 1.
Flat (FLAT)	This option has a flat frequency response.
User 1 (U1)	Frequency characteristics can be adjusted according to the user's preferences and stored in the options between User 1 and User 3. The flat frequency characteristic is selected in the default setting.
User 2 (U2)	
User 3 (U3)	

- 3 Press and hold **F [RX EQ]** or press **[ESC]** to end the process.

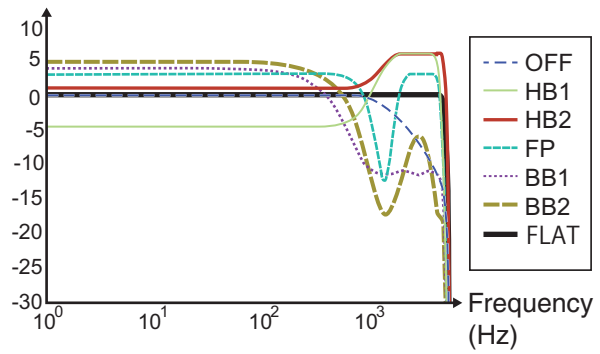

RX Characteristic Curve

- When the RX DSP equalizer is set to ON, the effect (“HB1”/“HB2”/“FP”/“BB1”/“BB2”/“FLAT”/“U1”/“U2”/“U3”) is displayed at the lower end of the key guide.
- When the RX DSP equalizer is OFF, “OFF” is displayed at the lower end of the key guide.

Adjusting the Equalizer Characteristics

The equalizer characteristics can be customized according to the user's preferences. Also, the customized characteristics can be stored as user-defined settings.

- 1 Press and hold **F [RX EQ]** to display the RX Equalizer configuration screen.
- 2 Select an equalizer characteristic.
- 3 Press **F4 [ADJ]** to display the RX Equalizer Adjustment screen.



- 4 Press **F3[◀|||] / F4[|||▶]** to select the frequency to adjust.
- 5 Press **F5 [-] / F6 [+]** or turn the **[MULTI/CH]** control to adjust the frequency level.
 - Touching a point on the RX Equalizer Adjustment screen selects the corresponding band and changes the frequency to the selected level. An alternative way is to touch a rough point followed by fine-tuning in steps 3 and 4.
 - Pressing and holding **F2 [(RESET)]** resets all the frequency levels to the default setting.
- 6 Press and hold **F [RX EQ]** or press **[ESC]** to end the process.

- Besides the User 1 to User 3 options, the equalizer characteristics of the other options can also be altered on the RX Equalizer Adjustment screen.
- If the configured level of the RX DSP equalizer deviates from the configured level of the adjacent frequency, the desired amount of attenuation may not be obtained.

Copying Equalizer Data

The customized equalizer characteristics can be copied to one of the options from “User 1” to “User 3”.

- 1 Press and hold F [RX EQ] to display the RX Equalizer configuration screen.
- 2 Press F2[▲] / F3[▼] to select the equalizer to save.
 - Pressing F4 [ADJ] on the RX Equalizer screen displays the RX Equalizer Adjustment screen. Equalizer data can be copied from either the RX Equalizer screen or RX Equalizer Adjustment screen.
- 3 Press F5 [COPY].
A message appears prompting you to confirm the destination to copy the equalizer characteristics.
 - Pressing F7 [CANCEL] ends the equalizer data copy operation without copying and restores the display to the RX Equalizer screen or RX Equalizer Adjustment screen.

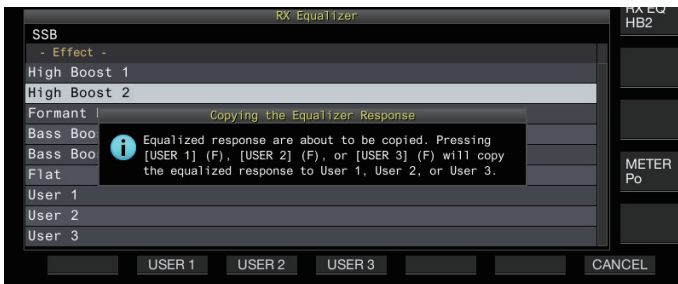

- 4 Press F2 [USER 1], F3 [USER 2] or F4 [USER 3] to specify the destination to copy the data to.
The equalizer selected in step 2 is copied to “USER 1”, “USER 2” or “USER 3”.
 - After copy is complete, the message to confirm the destination for copying the equalizer characteristics disappears and the display is restored to the RX equalizer screen or RX equalizer adjustment screen.
- 5 Press and hold F [RX EQ] or press [ESC] to end the process.

Saving Equalizer Data

Multiple sets of customized DSP equalizer settings data can be created and saved.

- Before doing so, configure the destination for saving the data in “File Storage Location” of the “USB/File Management Menu” to “Internal Memory” or “USB Flash Drive”. (See 11-2)
 - To save the data to a USB flash drive, insert a USB flash drive formatted using this transceiver into (USB-A).
- 1 Press and hold F [RX EQ] to display the RX Equalizer configuration screen.
 - 2 Press F2[▲] / F3[▼] to select the equalizer to save.
 - 3 Press F7 [SAVE].
A message indicating that saving is complete is displayed.



- 4 Press F4 [OK].
- 5 Press and hold F [RX EQ] or press [ESC] to end the process.



- The saved file is named in the “yyymmdd_hhmmss” format. The extension of the saved file is “equ”. (Example) If the date is 10:20:30 a.m., February 15, 2018: 20180215_102030.equ
- The name of the destination folder is as follows. (The name varies depending on the destination for saving files.)
 - USB flash drive: “KENWOOD\TS-890\SETTINGS \RX_EQ”
 - Built-in memory: “SETTINGS\RX_EQ”
- When removing the USB flash drive, make sure to execute “Safely Removing the USB Flash Drive” (11-6).

Reading Equalizer Data

RX DSP equalizer data that is saved in the internal memory or USB flash drive can be read.

- To read the data from a USB flash drive, insert the USB flash drive containing the RX equalizer data into (USB-A).
- 1 Press and hold F [RX EQ] to display the RX Equalizer configuration screen.
 - 2 Press F2[▲] / F3[▼] to select the equalizer to read.
 - 3 Press F6 [READ] to display the screen for selecting the file to read.

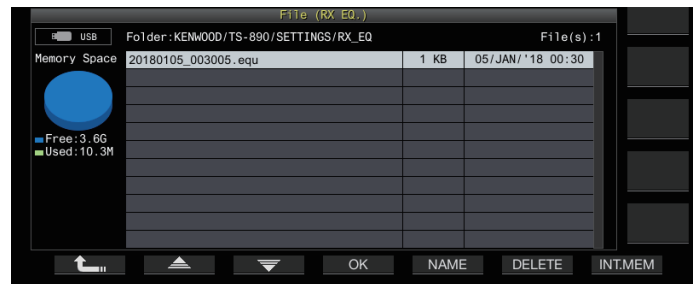

- 4 Select the file to read.
 - To read data from the internal memory, press F7 [INT.MEM].
 - To read data from the USB flash drive, press F7 [USB.MEM]. (If a USB flash drive is not connected, a message screen will appear prompting you to get ready the USB flash drive.)
 - Pressing F5 [NAME] allows the file name to be changed.
 - Pressing F6 [DELETE] displays a message to confirm deletion of the file. Pressing F4 [OK] deletes the file.
- 5 Press F2[▲] / F3[▼] to select the RX equalizer data file to read.
Alternatively, the RX equalizer data file can also be selected by turning the [MULTI/CH] control.
- 6 Press F4 [OK].
 - After the RX equalizer data has been read successfully, a message indicating that reading is complete is displayed.
- 7 Press F4 [OK] again.
- 8 Press and hold F [RX EQ] or press [ESC] to end the process.

Preamplifier

The preamplifier can be configured to one of the two options: low gain type that places priority on IMD (PRE 1) and high gain type that places priority on sensitivity (PRE 2).

● Press F [ANT/PRE].

Pressing F [ANT/PRE] each time switches the selection in the following sequence: “PRE 1” → “PRE 2” → “OFF”.

- The preamplifier selection is stored for each antenna selection band.
- The default values are as follows.
Less than 7.5 MHz: OFF
7.5 MHz to less than 21.5 MHz: PRE 1
More than 21.5 MHz: PRE 2

RX Monitor

If weak signals are received while the squelch is closed, the signals tend to be interrupted. Also, you may sometimes want to monitor the condition of the RX frequency while in the CTCSS standby state. In this case, the RX monitor is used to open the squelch temporarily.

“RX Monitor” (Menu [0-15] to [0-31]) can be assigned to a PF key. While the PF key that is assigned with “RX Monitor” is pressed and held down, the squelch opens and the RX frequency can be monitored. The RX monitor turns OFF once the key is released. Scanning is paused while PF [RX Monitor] is pressed.

SWL (BCL) Mode

The SWL (BCL) mode is intended for SWL (Short Wave Listening) and BCL (Broadcast Listening) by displaying the horizontal dial of the “9R-59” communications receiver on the screen.

1 Press [MENU].

2 Press F [SWL] to display the SWL screen.

- If F [SWL] is not displayed, press F [MORE].

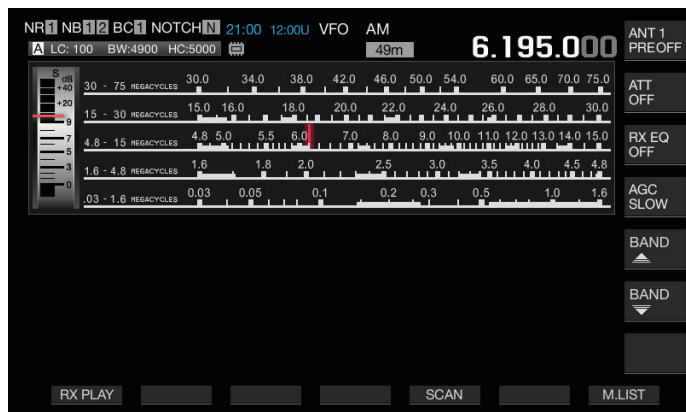

3 Press [MENU] followed by F [SWL].

Returns to the normal screen.



- Switching to the SWL mode is not possible while the transverter is ON.
- An indicator is not displayed if a memory channel that is not registered is being called up.

- Restrictions are applied to the following functions in the SWL mode.

Function	Status
Transmission	Disabled
Sending of voice message	Disabled
Decoding/Encoding	Disabled
Sending of CW message	Disabled
TX output power limiter	Disabled
Meter switching	Disabled
TX filter switching	Disabled
Turning ON transverter	Disabled
FM tone	Disabled
Antenna tuning	Disabled
Configuration of the TX equalizer and related settings	Disabled

Band Switching in the SWL Mode (VFO Mode)

● Press F [BAND ▲] / F [BAND ▼].

- The “broadcast/meter band” is displayed when the frequency falls within the band range. The preset broadcast bands are shown in the table below.

Broadcast/Meter Band	Lower Limit [kHz]	Upper Limit [kHz]	Default [kHz]/ Mode
LW	145	285	145
MW	525	1705	525
120 m	2300	2495	2300
90 m	3200	3400	3200
60 m	4750	5060	4750
49 m	5900	6200	5900
41 m	7200	7450	7200
31 m	9400	9900	9400
25 m	11600	12100	11600
21 m	13570	13870	13570
19 m	15100	15800	15100
16 m	17480	17900	17480
15 m	18900	19020	18900
13 m	21450	21850	21450
11 m	25670	26100	25670

AM

- The band segments of the SWL mode that is preconfigured on this transceiver are represented in a slightly different way compared to conventional meter bands. Different band segments are used so as to achieve wider coverage to include the broadcast bands of the different regions and other bands.

Transmission in Data Mode

Transmission via PTT Switch, SS Terminal and SEND

Switch transmission by making use of the [PTT] switch on the microphone, SS terminal of the REMOTE connector and [SEND] on the front panel. Under normal circumstances, the microphone audio is transmitted via this operation.

- This transceiver continues to transmit signals while [PTT] on the microphone is pressed and held down.
- This transceiver transmits signals when the SS terminal of the REMOTE connector is short-circuited to GND.
- Pressing [SEND] each time toggles between transmission and reception.

Transmission via DATA PTT or DATA SEND

DATA PTT (PKS terminal of ACC 2 connector) or the PF key that is assigned with "DATA SEND" is used to switch between transmission and reception. For more details, please refer to "PF Keys (Programmable Function Keys)" (16-2).

This function comes in handy when transmitting audio or data from an external device.

This operation transmits normal audio signals or audio signals that are input to the ANI terminal of the ACC 2 connector. A different audio path can be specified. For more details, please refer to "Configuration of the Input Path of TX Audio" (8-1).

- This transceiver continues to transmit signals while DATA PTT (PKS terminal of the ACC 2 connector) is short-circuited to GND.
- Pressing the PF key that is assigned with "DATA SEND" toggles between transmission and reception.

RIT/XIT

RIT (Receiver Incremental Tuning)

RIT is a function for fine-tuning only the RX frequency in 10 Hz steps within the ± 9.99 kHz range without altering the TX frequency. This is used such as when the TX frequency of the station that this transceiver is communicating with has become slightly deviated.

- When the FINE mode is ON, the offset frequency of RIT switches to a step size of 1 Hz. RIT functions in the same way in all modes as well as when VFO or the memory channel mode is in use.

1 Press [RIT].

The [RIT] LED lights up and the RIT offset frequency is displayed.

2 Turn the [RIT/XIT] control.

Fine-tune the RX frequency for RIT.

- To clear the offset frequency for RIT, press [CL]. The RIT offset frequency value is reset to 0.

3 Press [RIT] to end the process.

RIT is turned off. The RX frequency is restored to the value prior to performing step 1.

RIT Shift

This is a function for setting the frequency adjusted with RIT to a RX band.

● Press and hold [RIT].

The RX frequency that is adjusted using RIT is set to an RX band. The RIT frequency is then cleared and the RIT function is turned off.

XIT (Transmitter Incremental Tuning)

XIT is a function that can be used to fine-tune the TX frequency in 10 Hz steps within the ± 9.99 kHz range without altering the RX frequency.

- When the FINE mode is ON, the offset frequency of XIT switches to a step size of 1 Hz.

1 Press [XIT].

The [XIT] LED lights up and the XIT offset frequency is displayed.

2 Turn the [RIT/XIT] control.

Fine-tune the TX frequency for XIT.

- To clear the offset frequency for XIT, press [CL]. The XIT offset frequency value is reset to 0.

3 Press [XIT] to end the process.

XIT is turned off. The TX frequency is restored to the value prior to performing step 1.

XIT Shift

This is a function for shifting from operation using XIT to the split mode at one touch.

● Press and hold [XIT].

When the TX frequency that is adjusted using XIT is set to a TX band, the operation switches to the split mode at the same time. The XIT frequency is then cleared and the XIT function is turned off.



- If the frequency is changed in the entry mode, the RIT/XIT function is automatically turned off.

5 COMMUNICATING AIDS

Adjusting the Carrier Level

The steps to adjust the carrier level in the CW, FSK, PSK and AM modes are as follows.

- 1 Press **[CAR]** to display the Carrier Level configuration screen.

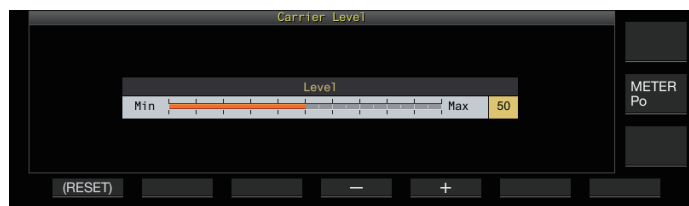

- 2 Transmit in the CW, FSK, PSK or AM mode.
- 3 Press **F4 [-]**/ **F5 [+]** or turn the **[MULTI/CH]** control to adjust the carrier level while referring to the ALC meter.

Setting Value	0 to 50 (default) to 100 (1 step)
---------------	-----------------------------------

- CW/ FSK mode: Adjust the carrier level while ensuring that the ALC meter reading does not exceed the ALC zone.
- AM/ PSK mode: Adjust the carrier level until the ALC meter needle starts to deflect.
- SSB/ FM mode: The carrier level value is fixed. (Cannot be adjusted)

- 4 Press **[CAR]** or **[ESC]** to end the process.

- Note that the TX output will be disabled if the setting value of carrier level is "0".

Operation in CW Mode

In the world of amateur radio, there is active communication in the CW mode. This is because this mode of communication consumes less power than SSB, and can be regarded as the simplest type of digital communication that combines the use of "dots" and "dashes".

- The built-in electronic keyer of this transceiver offers a wide variety of functions to support the operation of the users. For more details, please refer to "[Electronic Keyer](#)" (5-13).

- 1 **Select band and frequency.**
Select a frequency band and configure the frequency.
- 2 Press **[CW/ CW-R]** to select CW mode.
- 3 Press **[SEND]** to transmit.
- 4 **Operate the electronic keyer or paddle to transmit a Morse code signal.**
While transmission is in progress, a sidetone for monitoring the Morse code of one's own station can be heard. The frequency of the sidetone changes in tandem with the pitch frequency.
- 5 **After the Morse code is transmitted, press [SEND] to end the transmission.**

This transceiver is restored to the receiving state.

- The sidetone volume can be adjusted in Menu [1-02] "Sidetone Volume".

CW Break-in

Break-in is a convenient function that places this transceiver in the TX mode simply by switching to the key-down state when in the CW mode, and restores this transceiver to the RX mode upon switching to the key-up state. Break-in is divided into 2 types, full break-in and semi break-in.

Full Break-in

Switches this transceiver from the TX mode to the RX mode at almost the same time as the key-up operation.

Semi Break-in

This transceiver does not return to the RX mode immediately after the key-up operation, but remains in the TX mode and switches to the RX mode only after the preconfigured delay time has elapsed.

Turning ON/OFF Break-in

- Press **[VOX]**.
Pressing **[VOX]** each time toggles break-in between the ON and OFF states.
 - When break-in is ON, the **[VOX]** LED lights up.

Adjusting the Break-in Mode and Break-in Delay Time

- 1 Press **[VOX]** to set break-in to ON.
- 2 Turn the **[DELAY]** control to adjust the delay time after key-up.

Setting Value	FULL-BK/ 50 to 500 (default) to 1000 [ms] (50 step)
---------------	---

- Turn the **[DELAY]** control all the way to the left, and the full break-in mode is activated when "FULL-BK" is displayed.
- Turning the control to the right lengthens the delay time while turning the control to the left shortens it.
- "FULL-BK" or "DELAY:nn" ([nn: 1 to 20 (equivalent to 50ms to 1000ms)]) is displayed at the top right corner of the filter information area.

- 3 **Operate the electronic keyer or paddle.**
Transmission/reception is repeated automatically according to the dot and dash Morse code.

- Before using this transceiver in combination with a linear amplifier, check whether the linear amplifier supports full break-in. If its compatibility with full break-in is unknown or if it is not compatible, operate using the semi break-in mode.
- Full break-in and semi break-in cannot be used at the same time.

Adjusting the Sidetone and Pitch Frequency

- During key-down in the CW mode, a tone can be heard from the speaker of this transceiver. This tone is known as a sidetone. When this tone is heard, it means it is possible to monitor the Morse code transmitted by one's own station.
- In the CW mode for direct keying of the carrier, a BFO (beat frequency oscillator) is needed to convert the carrier wave into audible sound. The difference in frequency between the BFO and carrier wave can be heard in the form of a beat. This difference in frequency is called RX pitch.
- Both the sidetone and the RX pitch have the same frequency.

● Turn the [MIC/PITCH] control.

Configure to a sidetone frequency that can be heard most clearly. Turning the [MIC/PITCH] control to the right increases the frequency, while turning the control to the left decreases it.

Setting Value	300 to 700 (default) to 1100 [Hz] (5-step)
---------------	--

Adjusting the Sidetone Volume

● Configure in Menu [1-02] "Sidetone Volume"

Setting Value	Off/ 1 to 10 (default) to 20 (1 step)
---------------	---------------------------------------



- Sidetone volume like the playback volume of the CW message cannot be altered using the [AF] control.

CW Rise Time

The rise time of CW refers to the time interval from key-down to the point where the output waveform reaches the highest peak.

● Configure in Menu [5-15] "CW Rise Time"

Setting Value	1/ 2/ 4/ 6 (default) [ms]
---------------	---------------------------

- The default setting (6 [ms]) is suited for low-speed to medium-speed keying. For high-speed keying, configure to "4 [ms]", "2 [ms]" or "1 [ms]".

Auto Zero-in (CW Auto Tune)

This function automatically tunes the TX frequency to coincide with the RX frequency of the target station in order to communicate with a station receiving in the CW mode.

- 1 Turn the Tuning control and adjust roughly until the RX audio of CW can be heard.
- 2 Press [CW T.] to set auto zero-in (CW auto tune) to ON.



- <<CW TUNE>> starts to blink.
- The TX frequency is automatically adjusted to match the RX frequency of the target station, and the pitch of the RX signal coincides with the sidetone and RX pitch frequency.
- After auto zero-in (CW auto tune) has ended, <<CW TUNE>> disappears. If auto zero-in (CW auto tune) cannot be started up, the frequency is restored to the original value.



- Using auto zero-in (CW auto tune) allows tuning up to ± 50 Hz from the RX frequency of the target station.
- Auto zero-in (CW auto tune) may not be successful when the keying speed at the receiving station is slow, when there is interference or when the signals are weak.
- When RIT is ON, auto zero-in (CW auto tune) functions with respect to the frequency shifted using RIT.
- The operable range of auto zero-in (CW auto tune) varies depending on the status of reception. For example, if the DSP filter width is 500 Hz, auto zero-in (CW auto tune) will function with respect to RX signals within an approximate RX pitch frequency range of ± 300 Hz.

CW BFO Sideband

This is a function for switching CW (USB) and CW-R (LSB) with CW (LSB) and CW-R (USB).

Example: Set the CW carrier point to LSB so that the CW RX tone rises at the same time when the frequency is raised.

● Configure in Menu [5-05] "CW BFO Sideband"

Setting Value	USB (default)/ LSB
---------------	--------------------

CW Automatic Transmission from SSB Mode

When the menu below is configured to ON and paddle or key-down of the electronic keyer is performed during operation in the SSB mode, the SSB mode switches automatically to the CW mode and transmission is enabled in the CW mode. The mode switches automatically from USB to CW or LSB to CW-R.

- Upon shifting from the SSB mode to the CW mode, carrier frequency offset will function even when "Carrier Frequency Offset (SSB Mode to CW Mode)" is set to OFF. For this reason, to call a station that transmitted a CW after the CW is received during operation in the SSB mode, this can be done easily using the paddle or electronic keyer operation.

● Configure in Menu [5-06] "Automatic CW TX with Keying in SSB Mode"

Setting Value	Off (default)/ On
---------------	-------------------

- Menu [5-06] "Automatic CW TX with Keying in SSB Mode" does not function during transmission and when in the split mode.

Frequency Offset when Shifting from SSB to CW Mode

Upon switching to the CW mode to communicate with a station that transmitted a CW after the CW signal is received during operation in the SSB mode, it is usually necessary to correct the frequency by turning the Tuning control slightly. However, turning on this function enables the frequency to be corrected automatically.

● Configure in Menu [5-07] "Carrier Frequency Offset (SSB Mode to CW Mode)"

Setting Value	Off (default)/ On
---------------	-------------------

Encoding/Decoding Morse Code

Below are the steps to decode the RX signals of CW and display them as character strings on the screen. Details of the transmitted CW signals are also displayed as character strings.

Displaying the CW Communication Screen

- 1 Set to the CW mode.
- 2 Press F3 [DECODE] to display the CW communication screen.
 - If F3 [DECODE] is not displayed in the key guide, press [ESC] to exit the configuration screen and bandscope.

Decoding in Progress (Decodes and Displays the Received Signal)



Encoding in Progress (Analyzes and Displays the Transmission Code)

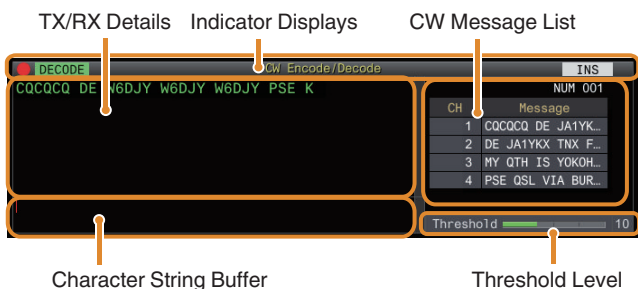

Indicator Displays

Indicates the status of the function.

TX/RX Details

Displays the character strings that are transmitted or received.

Character String Buffer

Displays the character strings to be transmitted.

CW Message List

Displays the fixed phrases that are registered in the CW message memory. The number of channels displayed varies according to the display screen size. (Standard: 4CH; Expanded: 8CH)

Threshold Level

Displays the adjustment value of the decode threshold level.

Operating the CW Communication Screen

Key	Behavior
F1 [MORE]	Switches the key guide.
F2 [X]	Clears the characters of the character string buffer one at a time. Pressing and holding down the key clears the characters continuously.
F3 [CLEAR]	Clears the character strings of the character string buffer area. Pressing and holding down the key clears the information inside the TX/RX details display area all at once.
F4 [START]	Starts encoding of the character strings in the character string buffer.
F4 [STOP]	Stops encoding and returns to the decoding state.
F5 [DEC.FIL]	Switches the decoding filter.
F6 [THLD]	Switches to the threshold level configuration mode.
F7 [EXTEND]	Enlarges the size of the CW communication screen. Pressing it again restores the screen to the standard size.
F2 [CH 1]/F2 [CH 5]	Copies the character strings registered in CH 1/CH 5 of the CW message memory to the character string buffer.
F3 [CH 2]/F3 [CH 6]	Copies the character strings registered in CH 2/CH 6 of the CW message memory to the character string buffer.
F4 [CH 3]/F4 [CH 7]	Copies the character strings registered in CH 3/CH 7 of the CW message memory to the character string buffer.
F5 [CH 4]/F5 [CH 8]	Copies the character strings registered in CH 4/CH 8 of the CW message memory to the character string buffer.
F7 [NEXT]	Replaces F2 [CH 1] to F5 [CH 4] with F2 [CH 5] to F5 [CH 8].
F2 [LOG]	Turns ON/OFF the communication log function. Pressing and holding this key displays the screen for selecting a log file that is saved.
F3 [PAUSE]	Pauses update of the TX/RX details display. Pressing the key again resumes the update.
F4 [QUICK]	Turns ON/OFF the quick mode.
F5 [DEC.OFF]	Stops decoding.
F5 [DEC.ON]	Resumes the decode function.
F6 [CW.MSG]	Switches to the CW message screen.
F6 [CW.DEC]	Switches to the CW communication screen.

Indicator Displays

Display	Behavior
	Appears when the log function is ON.
	Appears when the log function is ON and in the standby mode.
	Appears when signal decoding is in progress.
	Appears when encoding the character strings in the TX character string buffer.
	Appears when the decode function is stopped or disabled.
	Appears when CW message is configured to the repeat setting.
	Appears during the repeat interval of the CW message.
	Appears when the quick mode is ON.
	Appears when in the insert mode.
	Appears when it is a count-up trigger message of the contest number.

- Eight code abbreviations are supported, namely BT, AR, AS, HH, SK, KN, BK and SN.
- The code abbreviation received is displayed in 2 alphabets. For example, when “AR” (code with no space between “A” and “R”) is received, “AR” is displayed.
- The codes might not be decoded correctly depending on the signal quality.
- If the keying speed of the target signal changes halfway, the characters immediately before or after the change cannot be decoded correctly.
- Characters that cannot be decoded are indicated using an underscore (_).
- Time stamp and frequency information can be added to the TX/RX details display area. (5-28)
- This transceiver does not support Japanese characters.
- Press [Page Up] / [Page Down] on the USB keyboard to scroll through the information displayed in the TX/RX details display area.
- Noise Reduction 1, Noise Reduction 2, audio peak filter and RX DSP equalizer do not function during CW decoding.

Adjusting the Decode Threshold Level

The threshold value for the signal strength to activate decoding can be adjusted as follows. Raising the threshold level may reduce erroneous detection due to noise.

- 1 Press F6 [THLD] in the CW communication screen to switch to the threshold level configuration mode.
 - If F6 [THLD] is not displayed in the key guide, press F1 [MORE] to toggle the key guide display.



- 2 Press F4 [-]/ F5 [+] or turn the [MULTI/CH] control to select a threshold level.

Setting Value	1 to 10 (default) to 30 (1-step)
---------------	----------------------------------

- Adjust the threshold value in the ascending order according to the receiving status of noise, for example. Start from a small value between the range of 1 to 30 and configure the threshold value to a point where reception is good.
 - Pressing and holding F2 [(RESET)] resets the threshold level to the default setting.
- 3 Press F1 [↑] to end the process.

Decode Filter

A decode filter (narrow-band filter used exclusively for decoding) can be used when there is significant interference or noise while decoding the Morse code.

- Press F5 [DEC.FIL] in the CW communication screen.
 - If F5 [DEC.FIL] is not displayed in the key guide, press F1 [MORE] to toggle the key guide display. Pressing F5 [DEC.FIL] each time switches the decode filter mode (Off/Normal/ Narrow).
 - The selected mode is displayed for about 2 seconds.

Transmitting Character Strings via USB Keyboard Operation

Text input by the USB keyboard can be transmitted in Morse code.

- 1 Connect the USB keyboard (commercially available) to this transceiver.
- 2 Press F4 [QUICK].
 - If F4 [QUICK] is not displayed in the key guide, press F1 [MORE] to toggle the key guide display. Press F4 [QUICK] each time toggles the quick mode between ON and OFF.
 - << QUICK >> appears when the quick mode is ON.
- 3 Enter a character string using the USB keyboard.

When Quick Mode is ON:

The characters entered using the USB keyboard appear in the character string buffer and encoding starts immediately.

When Quick Mode is OFF:

The characters entered using the USB keyboard appear in the character string buffer. To start encoding, press [Enter] on the USB keyboard or the F4 [START] key.

- Sending a character string using the USB keyboard while the update of TX/RX details display is paused cancels the paused state.
- The maximum number of characters that can be entered in the character string buffer is 4300 characters.
- To send a consecutive code (code abbreviation), input the characters after inputting “~” (tilde). The characters are encoded as a consecutive code until a space is inserted.
- For example, when “~ HH” and “~ OSO” are input, they become the code abbreviations for correction code and emergency communication respectively.
- To start encoding from a consecutive code while quick mode is ON, input the first character of the consecutive code within the time interval equivalent to 7 dots (space between words) after inputting “~” (tilde).

Encoding Character Strings Using the CW Message Memory

Fixed phrases can be registered in the CW message memory for use during transmission.

- Use the CW message memory when transmitting a fixed phrase. Otherwise, the USB keyboard can also be used to input the character string.

● Press F2 [CH 1] to F5 [CH 4] or F2 [CH 5] to F5 [CH 8] in the CW communication screen.

- If F2 [CH 1] to F5 [CH 4] or F2 [CH 5] to F5 [CH 8] are not displayed in the key guide, press F1 [MORE] to toggle the key guide display.
- Press F7 [NEXT] to switch between F2 [CH 1] to F5 [CH 4] and F2 [CH 5] to F5 [CH 8].

The phrase registered in the corresponding message channel is displayed in the character string buffer and encoding starts immediately.



- If a character string already exists in the character string buffer, encoding starts after the fixed phrase is added to the end of the character string.
- If encoding of a character string is already in progress, the fixed phrase is added to the end of the character string and encoding will continue.
- A space is inserted before the fixed phrase when it is added to the end of an existing character string.
- Message CH supports only messages registered via text input. (Even when “Paddle” is selected for registering messages in the menu, the message CH information registered via text input using the USB keyboard is displayed on the CW communication screen.)
- If the message displayed in the message list is too long to fit into the display range, this will be indicated by a “...” display to the right of the truncated message.

Encoding Operation of Message Channel with Repeat Function Enabled

- Upon pressing the key that corresponds to a message channel for which the repeat function is enabled, << [REPEAT] >> lights up.
- After encoding of the character strings in the character string buffer is complete, the transceiver switches to the “repeat wait” mode. After the specified time interval has elapsed, the same character strings of the channel for which the repeat function is enabled is encoded again, and this process goes on.
- << [WAIT] >> lights up while in the “repeat wait” mode.
- When the specified time interval after entering the “repeat wait” state has elapsed, << [WAIT] >> disappears and encode operation resumes.
- Pressing F4 [STOP] or [ESC] on the USB keyboard stops the encoding operation or “repeat wait” state and returns the transceiver to the decoding state.
- While << [REPEAT] >> is illuminated, character strings cannot be added using the USB keyboard or the F2 [CH 1] to F5 [CH 4] keys.
- While << [REPEAT] >> is illuminated, characters cannot be deleted using the backspace key of the USB keyboard or the F2 [X] key.

Contest Number Behavior

- To use a contest number, “%N” needs to be embedded in the message of the message channel.
- The “%N” portion will be substituted with the current contest number during encoding.
- The contest number is counted up after all the contents in the character string buffer are encoded.

Paddle Operation on CW Communication Screen

Morse code that is input via paddle operation (straight key, bug key, etc.) can be converted into text and displayed on the screen. This function can also be used to practice the input of Morse code.

Paddle Operation when the Character String Buffer is Empty

- When break-in is ON, the Morse code input is transmitted and information that is keyed is displayed in the TX details display area character by character.
- When break-in is OFF, the Morse code input is not transmitted and information that is keyed is displayed in the character string buffer character by character.



- Encoding does not start even when the quick mode is set to ON.
- Encoding does not start even when characters are added using the USB keyboard after the character strings that are added via paddle operation.
- To enable encoding of the character strings displayed in the character string buffer, press F4 [START] or [Enter] on the USB keyboard.

Paddle Operation during Encoding of Character Strings in the Character String Buffer

- When Interrupt Keying is ON, encoding of character strings is temporarily stopped and resumes only after keying is complete.
- When Interrupt Keying is OFF, encoding of character strings is stopped.
- If the signals input via paddle operation are codes that cannot be converted into text, the characters are not displayed.

Saving CW Communication Logs

The CW, RTTY and PSK communication screens can be saved using the communication log function. Please refer to “Communication Log” on page 5-27.

Electronic Keyer

This transceiver comes with a built-in electronic keyer that can be used simply by connecting a paddle to the PADDLE jack on the front panel. Depending on the settings, it can also be used as a bug key (semi-auto electronic keyer).

- A straight key can also be connected to the PADDLE jack.

Selecting the PADDLE Jack Behavior

Select the device to be connected to the PADDLE jack.

● Configure the behavior in Menu [5-00] “Paddle Jack Configuration (Front)”

Setting Value	Straight Key/ Paddle (default)/ Paddle (Bug Key Mode)
---------------	---

Selecting the KEY Jack Behavior

For operation in the CW mode without using the built-in electronic keyer, connect the plug of a straight key, bug key, external electronic keyer or PC keyer to the “KEY” jack. The built-in electronic keyer can also be used by connecting a paddle to the “KEY” jack.

Select the device to be connected to the “KEY” jack on the rear panel.

● Configure in Menu [5-01] “Key Jack Configuration (Rear)”

Setting Value	Straight Key (default)/ Paddle/ Paddle (Bug Key Mode)
---------------	---



- Connect a PC keyer or an external electronic keyer with a positive-polarity wire using a shield wire.
- Behavior when Paddle (Bug Key Mode) is selected
 - While dots are combined according to the usual keyer, dashes are keyed while the paddle is pressed.
 - The keying speed is variable, but the message memory function does not work.
- When both dot and dash are configured to ON at the same time, priority is given to dash.

Operation Mode of the Electronic Keyer

2 operation modes of the built-in electronic keyer are available for selection (A or B).

● Configure in Menu [5-02] “Electronic Keyer Squeeze Mode”

Setting Value	Mode A/ Mode B (default)
---------------	--------------------------

Mode A: When both paddles are open, code transmission ends after the code elements (dot or dash) are transmitted. Both dot and dash memory are not active.

Mode B: When both paddles are open, code transmission ends after a dash (or dot) is transmitted following the dot (or dash) that is currently being transmitted. Both dot and dash memory are active.

Reversing Dot and Dash

It is possible to reverse dot and dash of the paddle without having to rewire the electronic keyer. Reversing the position for operating the paddle according to the operator’s preferences or dominant hand helps to ease keying.

● Configure in Menu [5-03] “Dot and Dash Reversed Keying”

Setting Value	Off (default)/ On
---------------	-------------------

- Dot and dash is reversed when this function is set to “On”.



- This setting applies to both the mic paddle mode and paddle that is connected to the PADDLE or KEY jack.

Mic Paddle Mode

The [UP] and [DOWN] keys of the microphone is used in place of the paddle for keying.

● Configure in Menu [5-04] “Paddle (Microphone Up/Down Keys)”

Setting Value	Off (default)/ On
---------------	-------------------

- When this is “On”, keying can be performed using the [UP] and [DOWN] keys of the microphone.



- Response will be slower in the mic paddle mode compared to the normal paddle operation.
- In the default setting, the [DOWN] key is assigned with dot and the [UP] key with dash.

Adjusting the Keying Speed

The keying speed of the electronic keyer can be adjusted freely. To ensure that CW is transmitted precisely, it is necessary to adjust the keying speed according to the skill level of the user. Also, it is recommended that the keying speed be as closely aligned as possible with the CW speed of the target station.

● Turn the [KEY] control to adjust the keying speed.

The keying speed can be adjusted within the range of 4 to 60 [wpm] (20 to 300 characters/minute).

- Turning the [KEY] control to the right increases the keying speed, while turning the control to the left slows it down.
- The keying speed is displayed while the [KEY] control is being operated.
- After operating the [KEY] control, the TX output power display shows the keying speed for a duration of 2 seconds.



- Only dots are supported in the bug key mode.

5 COMMUNICATING AIDS

Changing the Weighting

The electronic keyer allows the dot-dash weighting to be adjusted automatically. Weighting is the ratio of the dash length to the dot length.

- 2 weighting modes are available for selection: the “auto weighting” mode changes the ratio automatically in tandem with the keying speed, while the ratio is fixed in the “manual weighting” mode and not affected by the keying speed.
- When [2.5] (1:2.5) to [4.0] (1:4) is selected, the dot-dash weight ratio is fixed regardless of the keying speed.

● Configure in Menu [5-08] “CW Keying Weight Ratio”

Setting Value	Automatic (default)/ 2.5 to 4.0 (0.1 step)
---------------	--

- When this is configured to “Automatic”, the keying speed and weight ratio settings are as follows.

Adjusting the Keying Speed	Weight
4 to 24	1:2.8
25 to 44	1:3.0
45 to 60	1:3.2

Weight Ratio Reverse

When the weighting mode is configured to “Automatic”, increasing the keying speed increases the weight ratio. Configuring the menu below to ON decreases the weight ratio when the keying speed increases.

● Configure in Menu [5-09] “CW Keying Reversed Weight Ratio”

Setting Value	Off (default)/ On
---------------	-------------------

- When weight reverse is enabled in the “Automatic” weighting mode, the keying speed and weight ratio settings are as follows.

Adjusting the Keying Speed	Weight
4 to 24	1:3.2
25 to 44	1:3.0
45 to 60	1:2.8

CW Message Memory

This transceiver comes with memory channels that can store up to 8 CW messages. In addition to paddle operation, a message can be registered by entering a text using the USB keyboard or via operating this transceiver.

- CW message memory channels come in handy for messages that are repeatedly transmitted as registering the messages in advance allows them to be used repeatedly such as during contest.

Switching the Method of Registering CW Messages

A method for registering messages can be selected from the options below.

● Configure in Menu [5-11] “CW Message Entry”

Setting Value	Text String/ Paddle (default)
---------------	-------------------------------

Text String: Registers messages using text strings.

Paddle: Registers messages via paddle operation.

Registering CW Messages via Text Input

Check to ensure that the CW message registration method in Menu [5-11] is configured to “Text String”, followed by performing the steps below to register a CW message. CW messages can be stored in any of the channels from 1 to 8.

1 Press F2 [KEYER] to display the CW Message screen (for text input).



- When this transceiver is in a mode other than CW, F2 [KEYER] is not displayed in the key guide. Press [CW/CW-R].
- If the channel to register the CW message is not displayed in the key guide, press F1 [MORE]. Doing so switches the key guide.

2 Press and hold F2 [CH 1] to F5 [CH 4] or F2 [CH 5] to F5 [CH 8] to select the channel to register the CW message.

The CW message edit screen is displayed.

- Pressing F7 [NEXT] each time switches between F2 [CH 1] to F5 [CH 4] and F2 [CH 5] to F5 [CH 8].

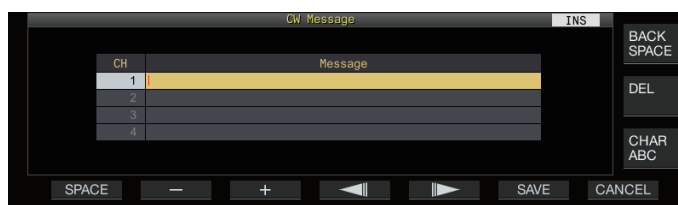

3 Use the function keys, [MULTI/CH] control or USB keyboard to enter a CW message.

- Enter a message that contains not more than 50 characters. The default setting is blank.

Key	Behavior
F1 [SPACE]	Inserts a space.
F2 [-]/ F3 [+]	Selects a character.
F4 [◀]/ F5 [▶]	Moves the cursor.
F [BACK SPACE]	Deletes the character to the left of the cursor.
F [DEL]	Deletes the character to the right of the cursor.
F [CHAR]	Switches the type of character to edit. Pressing the key each time switches the selection in the following sequence: ABC (upper case) → !"# (symbols) → ABC (upper case)

- Pressing F7 [CANCEL] returns the display to the CW message screen without registering the input message.
- When "%N" is saved as part of a CW message, this will be substituted with a contest number during transmission.
- A continuous text string that is input after "~" and up to that before an inserted space becomes a consecutive code such as AR or BT.
- Characters that can be input are as follows.

A	B	C	D	E	F	G	H	I	J	K	L	M
N	O	P	Q	R	S	T	U	V	W	X	Y	Z
0	1	2	3	4	5	6	7	8	9			
/	?	.	,	'	()	:	=	+	-	_	"
@	~	%	<	>								Space

4 Press F6 [SAVE] to save the CW message.

Registering CW Messages via Paddle Operation

Check to ensure that the CW message registration method in Menu [5-11] is configured to "Paddle", followed by performing the steps below to register a CW message. CW messages can be stored in any of the channels from 1 to 8.

1 Press F2 [KEYER] to display the CW Message screen.



2 Press and hold F2 [CH 1] to F5 [CH 4] or F2 [CH 5] to F5 [CH 8] to select the channel to register the CW message.

A message prompting registration of a CW message is displayed.

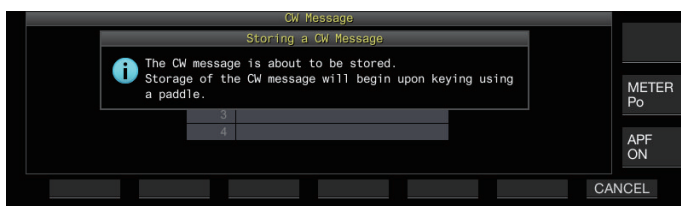

- While in the input standby mode, pressing F7 [CANCEL] returns the display to the CW message screen without registering the message.

3 Register a CW message via keying with a paddle.

When keying using a paddle starts, the display switches to a CW message (paddle) registration screen. Continuing keying in this state registers the CW message. During registration of a CW message, memory usage (%) is displayed on the screen.

- If paddle operation is not performed during the registration process, a space will be inserted at every interval equivalent to 7 dots.

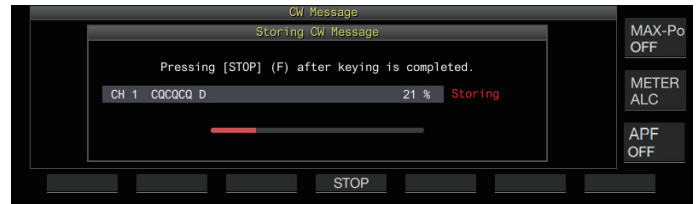

4 Press F6 [STOP] to end registration of the CW message.

- The display returns to the CW Message screen.
- If the memory is used up (indicated as 100%), the CW message registration process ends automatically even when it is still in progress.
- Morse code that is input is converted into text strings and displayed in the channel list of the CW Message screen.



- For channels that do not contain any CW message, the corresponding channel numbers are displayed in gray.
- CW messages cannot be registered if the PADDLE or KEY jack is not configured to the PADDLE mode. Operate the paddle to register a CW message.
- The Morse code displayed in the channel list uses the same functions as "Decoding Morse code". For this reason, the spacing may be wider or different characters may be displayed depending on the habit and the speed of the operator performing the keying.
- The "*" symbol and code abbreviations are also displayed in the same way as "Decoding Morse code".
- Japanese texts can be registered but will not be displayed correctly.

Contest Number

Configuring the Starting Contest Number (Text Input Only)

The starting contest number can be configured when the contest numbers are 3-digit serial numbers that run from 001 (001 method).

● Configure in Menu [5-12] "Contest Number"

Setting Value	001 (default) to 9999 (1 step)
---------------	--------------------------------

Selecting a Method for Sending out Contest Number (Text Input Only)

When a CW message that contains a "%N" input is transmitted, numeric values "1", "9" and "0" are converted into alphabets "A", "N" and "O" (or "T") respectively in the Morse code format and sent out as a contest number.

● Configure in Menu [5-13] "Contest Number Format"

Setting Value	Off (default)/ 190 to ANO/ 190 to ANT/ 90 to NO/ 90 to NT
---------------	---

Coding Example

Option	Text String Sent out as Contest Number	Output Code
190 to ANO	190	ANO (·- -· - -)
190 to ANT		ANT (·- -· -)
90 to NO	90	NO (-· - -)
90 to NT		NT (-· -)

Selecting a Channel for Counting up the Contest Numbers (Text Input Only)

The CW message channel for which contest numbers are counted up can be registered using this setting.

● Configure in Menu [5-14] "Channel Number (Count-up Message)"

Setting Value	Off (default)/ Channel 1 to Channel 8
---------------	---------------------------------------

Decrementing the Contest Number (Text Input Only)

If communication is not established after a contest number is sent to the receiving station, the contest number that is sent next will be decremented (reduced) by 1.

1 Press F2 [KEYER] to display the CW Message screen.



2 Press F7 [NEXT] to select a channel group for which the contest numbers are to be displayed.

- << [CH] >> is displayed beside the channel for counting up the contest number, and F6 [-1] is displayed in the key guide.
- Pressing F7 [NEXT] each time switches between F2 [CH 1] to F5 [CH 4] and F2 [CH 5] to F5 [CH 8].

3 Press F6 [-1] to reduce the contest number by 1.

- When the setting of the channel for counting up the contest number in Menu [5-14] is configured to "Off", << [CH] >> is not displayed and F6 [-1] is also not shown in the key guide.

Playing/Transmitting CW Messages

This transceiver can be configured as follows to play back or transmit a registered CW message. The CW message screen and function key displays are different when Menu [5-11] "CW Message Entry" is configured to "Paddle" and when it is configured to "Text String". Descriptions in this manual are based on the "Paddle" setting, but the steps are the same when it is configured to "Text String". Also, a CW message needs to be registered in advance before it can be played back or transmitted.

1 Press F2 [KEYER] to display the CW Message screen.

2 To play back a CW message, press [VOX] to set break-in to OFF.

- When break-in is set to OFF, the [VOX] LED light goes off.
- To transmit a CW message, set break-in to ON. When break-in is set to ON, the [VOX] LED lights up.

3 Press F2 [CH 1] to F5 [CH 4] or F2 [CH 5] to F5 [CH 8] to select a CW message.

- Playback or transmission starts. To cancel the operation, press F5 [STOP].



- When Menu [5-14] "Channel Number (Count-up Message)" is configured to a setting other than "Off", the contest number is added immediately after playback or transmission of the CW message for the selected channel has ended.
- Operating the paddle while Menu [5-10] "Interrupt Keying" is "On" pauses playback or transmission of the message memory. After paddle operation has ended, playback or transmission resumes from the paused state. Operating the paddle while "Off" is configured stops playback or transmission of the message memory.
- To transmit a CW message without using break-in, press [SEND] instead of performing step 2.

Repeat Playback of CW Messages

● Press F4 [REPEAT].

Pressing F4 [REPEAT] each time toggles the repeat function between ON and OFF.

- When the repeat mode is ON, << [REPEAT] >> lights up for the selected CW message memory.

Configuring the Repeat Playback Interval

The time interval for repeating playback of a CW message can be configured.

● **Configure in Menu [5-16] “CW/Voice Message Retransmit Interval Time”**

Setting Value	0 to 10 (default) to 60 [s] (1 step)
---------------	--------------------------------------

Configuring to a larger value lengthens the playback interval.

Interrupt Keying

Operating the paddle while playback or transmission of a CW message is in progress allows the CW message playback or transmission process to be interrupted for the Morse code input using the paddle to be inserted.

● **Configure in Menu [5-10] “Interrupt Keying”**

Setting Value	Off (default)/ On
---------------	-------------------

Deleting a CW Message

The steps to delete a CW message that is registered in Channel 1 to Channel 8 are as follows.

- 1 Press F2 [KEYER] to display the CW Message screen.
- 2 Select a channel number that contains the CW message to delete.
- 3 Press and hold F5 [(DELETE)] to delete the CW message.

RTTY Operation

This transceiver comes with a built-in demodulator for RTTY operation, a RX decoder and a TX encoder. It is possible to operate in RTTY (FSK) independently by combining the use of a commercially available USB keyboard. Also, it is possible to operate in the RTTY mode by connecting an external device.

- ! Before operating in the RTTY mode, adjust the carrier level while checking the ALC meter.

Displaying the RTTY Communication Screen

- 1 Press [FSK/PSK] to select RTTY (FSK) mode.
 - 2 Press F3 [DECODE].
- The RTTY communication screen appears.

Text Display Area + FFT Scope



Text Display Area + X-Y Scope



Switching between the FFT Scope and X-Y Scope Display

The display toggles between the FFT scope and X-Y scope each time the scope display is touched.

- ! The RTTY communication screen will not be displayed if Menu [2-06] “FSK Spacing” is not configured to “170 [Hz]”.
- Noise Reduction 1, Noise Reduction 2, Beat Canceler 1, Beat Canceler 2, audio peak filter and RX DSP equalizer do not function during decoding of RTTY messages.

The layout of the RTTY communication screen is as follows.

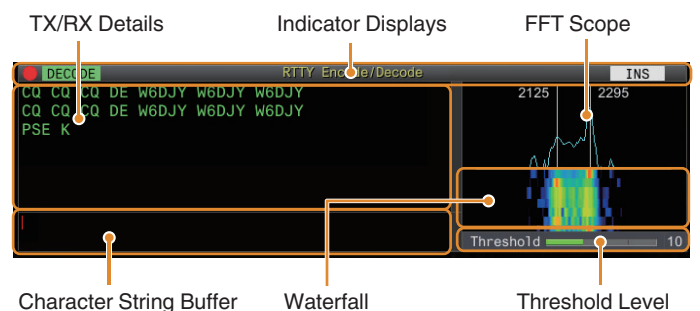

Indicator Displays

Indicates the status of the function.

TX/RX Details

Displays the character strings that are transmitted or received.

Character String Buffer

Character strings to be transmitted.

5 COMMUNICATING AIDS

FFT Scope

The audio FFT scope is used for viewing the tuning status. The two vertical lines on the left and right represent the mark and space frequencies respectively. Adjust the tuning frequency while receiving a signal such that the two peaks overlap evenly with the two lines.

Waterfall

The waterfall is a time-series display of the RX signal spectrum which functions in tandem with the FFT scope. The entire waterfall display can also be shifted in tandem with changes in the RX frequency.

X-Y Scope

The X-Y scope displays the tuning status in the RTTY (FSK) mode as a cross pattern. The cross patterns bisect at right angles (90 degrees) when this transceiver is correctly tuned to the signal.

Threshold Level

Displays the threshold value of the RX signal level for decoding.



Operating the RTTY Encode/Decode Screen

The following operations are enabled when the RTTY communication screen opens.

- Pressing the **[Page Up]** or **[Page Down]** key scrolls the display of the TX or RX details.

Key	Behavior
F1 [MORE]	Switches the key guide.
F3 [PAUSE]	Pauses update (drawing) of the TX/RX details display area. Pressing the key again resumes the update (drawing).
F4 [LOG]	Turns ON/OFF the communication log function. Pressing and holding this key displays the screen for selecting a log file that is saved.
F4 [(CLEAR)]	Pressing and holding the key clears the text displayed on the TX/RX details screen.
F5 [THLD]	Switches to the threshold level configuration mode.
F5 [MEMORY]	Switches to the RTTY Message screen.
F6 [X-Y LEV]	Switches between the speed and density of the X-Y scope.
F7 [EXTEND]	Enlarges the size of the RTTY communication screen. Pressing it again restores the screen to the standard size.

Indicator Displays

Display	Behavior
	Appears when the communication log function is ON.
	Appears when the communication log function is ON and in the standby mode.
DECODE	Appears when signal decoding is in progress.
ENCODE	Appears when encoding the characters in the TX buffer.
DECODE	Appears when the decode function is stopped or disabled.
WAIT	Appears when transmitting the message memory.
INS	Appears when in the insert mode.
OVRWR.	Appears when in the overwrite mode.

Saving RTTY Communication Logs

The CW, RTTY and PSK communication screens can be saved using the communication log function. Please refer to “Communication Log” on page 5-27.

Adjusting the RTTY Decode Threshold Level

Noise that occurs when there is no signal may sometimes be erroneously detected as text, which results in the display of unwanted text. To reduce the occurrence of such issues, adjust the threshold level.

- Raise the threshold level when there is frequent erroneous detection due to noise.

1 Press F5 [THLD].

The threshold level setting can now be adjusted.



2 Press F4 [-]/ F5 [+] or turn the [MULTI/CH] control to adjust the level.

Setting Value	1 to 10 (default) to 30 (1 step)
---------------	----------------------------------

- Adjust the threshold value in the ascending order according to the receiving status of noise, for example. Start from a small value between the range of 1 to 30 and configure the threshold value to a point where reception is good.
- To restore the default setting, press and hold **F2 [(RESET)]**.

3 Press F1 [

FFT Scope/X-Y Scope Display Setting

The tuning scope displayed on the RTTY communication screen can be switched to an “FFT scope” or “X-Y scope” display.

● Configure in Menu [2-09] “RTTY Tuning Scope”

Setting Value	FFT Scope (default)/ X-Y Scope
---------------	--------------------------------

- The display toggles between the “FFT Scope” and “X-Y Scope” each time the scope display on the screen is touched.

FFT Scope Waveform Averaging

The waveform displayed on the FFT scope can be averaged. Averaging of the waveform reduces random noise and makes observation of the target signal easier.

● Configure in Menu [2-00] “FFT Scope Averaging (RTTY Decode)”

Setting Value	0 (default) to 9 (1 step) (minimum to maximum averaging)
---------------	--

Selecting a Waterfall Display Type

● **Configure in Menu [2-17] “Waterfall when Tuning (RTTY/PSK Audio Scope)”**

Setting Value	Straight (default)/ Follow
---------------	----------------------------

Straight: Uses a straight line to show transition in the level of the target signal displayed on the waterfall when the RX frequency is altered.

Follow: Tracks and displays the latest FFT scope level at the portion where the waterfall starts flowing when the RX frequency is altered.

Tracking Speed/Density Level of X-Y Scope

Switch between the speed and density of the X-Y scope.

● **Press F6 [XY LEV.]**

Pressing **F6 [XY LEV.]** each time switches the level. The tracking speed is displayed on the X-Y scope display.

Setting Value	Lv1/ Lv2 (default)/ Lv3
---------------	-------------------------

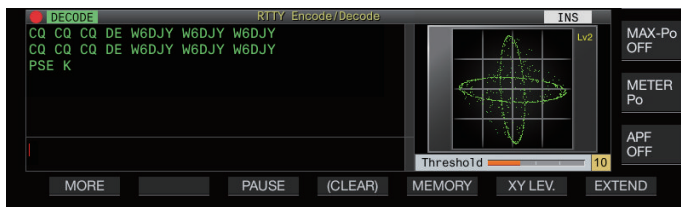

Transmitting Character Strings Using USB Keyboard

A commercially available USB keyboard can be used to input and transmit character strings.

Transmitting the Input Character String Immediately

1 Connect the USB keyboard to (USB-A).

2 Press F3 [DECODE] to display the RTTY communication screen.

3 Press [F12] on the USB keyboard to enter the TX mode.

The [BUSY/TX] LED lights up in red, and << **ENCODE** >> is displayed in the status bar.

4 Enter a character string using the USB keyboard.

- The input character string is displayed in the character string buffer and transmitted immediately.
- In the character string buffer, the color of the individual characters change successively once they are transmitted.
- Characters that have been transmitted appear successively in the TX/RX details display area.

5 Press [F12] on the USB keyboard to end transmission.



- If there remain characters in the character string buffer that are not transmitted when [F12] is pressed in step 5, << **WAIT** >> is displayed in the status bar. After transmission of all the character strings is complete, the transceiver switches to the RX mode and the light of the [BUSY/TX] LED and << **WAIT** >> display go off.

Temporarily Placing Character Strings in the Character String Buffer before Transmission

1 Connect the USB keyboard to (USB-A).

2 Press F3 [DECODE] to display the RTTY communication screen.

3 Enter a character string using the USB keyboard.
The input character string is displayed and temporarily placed in the character string buffer.

4 Press [F12] on the USB keyboard to send out the character string.

- Character strings that are stored in the character string buffer are sent out by this transceiver.
- Upon entering the TX mode, the [BUSY/TX] LED lights up in red, and << **ENCODE** >> is displayed in the status bar.
- In the character string buffer, the color of the individual characters change successively once they are transmitted. Character strings that have been transmitted appear successively in the TX/RX details display area.

5 Press [F12] on the USB keyboard to end transmission.



- If there remain characters in the character string buffer that are not transmitted when [F12] is pressed in step 5, << **WAIT** >> is displayed in the status bar. After transmission of all the character strings is complete, the transceiver switches to the RX mode and the light of the [BUSY/TX] LED and << **WAIT** >> display go off.
- Pressing [ESC] while transmission of the character strings is in progress switches this transceiver to the RX mode. Transmission of the character strings stops, and character strings in the character string buffer that are not yet transmitted are cleared.
- Time stamp and frequency information can be added to the TX or RX data that is displayed in the TX details display area. Refer to “[Displaying a Time Stamp](#)” (5-28).
- Sending a character string using the USB keyboard while the TX/RX display is paused by pressing **F3 [PAUSE]** cancels the paused state.
- The character strings that can be placed temporarily in the character string buffer can contain a maximum of 4300 characters.
- Alphanumeric characters and symbols that can be input using a USB keyboard are as follows.

A	B	C	D	E	F	G	H	I	J	K	L	M	N
O	P	Q	R	S	T	U	V	W	X	Y	Z	0	1
2	3	4	5	6	7	8	9	!	“	#	\$	&	'
()	.	,	-	?	:	;	/	Space	Line Break			

5 COMMUNICATING AIDS

RTTY Message Memory

Fixed phrases that are often used in the RTTY mode can be registered in advance as an RTTY message in the RTTY message memory. Configuring a message to be saved to auto transmission (Auto TX) or auto reception (Auto RX) enables the RTTY message to be transmitted via simple operation. Up to 8 types of RTTY messages can be registered to Channels 1 to 8 in the memory.

Registering RTTY Messages

1 Press F5 [MEMORY] on the RTTY communication screen to display the RTTY Message screen.

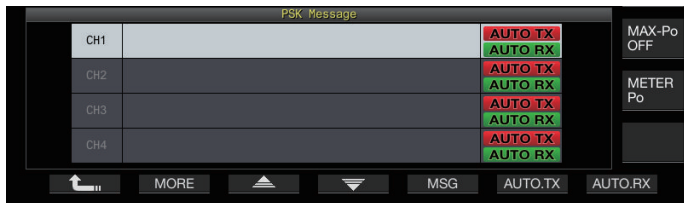

- 2 Press F3[▲] / F4[▼] or turn the [MULTI/CH] control to select the channel for saving the RTTY message.
- 3 Press F5 [MSG] to enter the RTTY message memory edit mode.

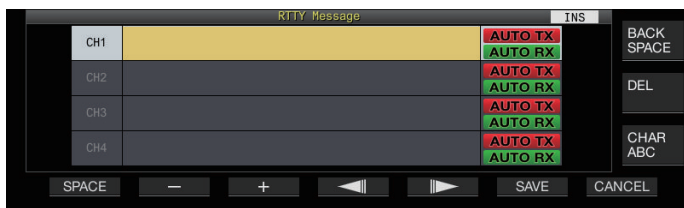

4 Use the function keys, [MULTI/CH] control or USB keyboard to enter a character string.

Key	Behavior
F1 [SPACE]	Inserts a space.
F2 [-]/ F3 [+]	Selects a character.
F4 [◀]/ F5 [▶]	Moves the cursor.
F [BACK SPACE]	Deletes the character to the left of the cursor.
F [DEL]	Deletes the character to the right of the cursor.
F [CHAR]	Switches the type of character to edit. Pressing the key each time switches the selection in the following sequence: ABC (upper case) → !"# (symbols) → ABC (upper case)

5 Press F6 [SAVE] to save the RTTY message.

- Pressing F7 [CANCEL] discards the content that is currently being edited and exits the character string input mode.
- Alphanumeric characters and symbols that can be input (up to 70 characters)

A	B	C	D	E	F	G	H	I	J	K	L	M	N
O	P	Q	R	S	T	U	V	W	X	Y	Z	0	1
2	3	4	5	6	7	8	9	!	"	#	\$	&	'
()	.	,	-	?	:	;	/	Space	Line Break			

Configuring Auto TX/RX for the RTTY Message Memory

The transmission and reception behavior can be configured when an RTTY message memory channel is selected.

- Auto TX places this transceiver in the TX mode before transmitting a message when a message memory channel is selected, and maintain the TX mode after all messages have been sent out.
- For auto RX, pressing [F12] after selecting a message memory channel for transmission places this transceiver in the TX mode. When the message is sent out, this transceiver is automatically restored to the RX mode.
- Combining auto TX and auto RX enables both transmission and reception to be performed automatically.

1 Press F3[▲] / F4[▼] or turn the [MULTI/CH] control to select the message for auto TX/RX.

2 Press F6 [AUTO.TX] to set auto TX to ON.

<< **AUTO TX** >> is displayed to the right of the RTTY message.



- When auto TX is set to OFF, the << **AUTO TX** >> display goes off, and the RTTY message of the channel is temporarily placed in the character string buffer but not transmitted automatically.

3 Press F7 [AUTO.RX] to set auto RX to ON.

<< **AUTO RX** >> is displayed to the right of the RTTY message.

- When auto RX is set to OFF, the << **AUTO RX** >> display goes off, and this transceiver is not restored to the RX mode after the RTTY message for the channel has been sent out.



- To send an RTTY message for which "AUTO TX" is configured to "OFF", select the channel in which the RTTY message is stored. Check to ensure that the character string (RTTY message) is forwarded to the character string buffer, followed by pressing [F12] on the USB keyboard.
- To switch this transceiver to the RX mode after transmitting an RTTY message for which "AUTO RX" is set to OFF, press [F12] on the USB keyboard after the RTTY message has been sent out.

Transmitting Character Strings from the RTTY Message Memory

A message that is registered in the RTTY message memory can be transmitted as follows.

- 1 Press **F5 [MEMORY]** to display the RTTY Message screen.



- 2 Press **F3 [CH 1]** to **F6 [CH 4]** or **F3 [CH 5]** to **F6 [CH 8]** to select the channel that contains the message to be transmitted.

The RTTY message of the channel corresponding to the function key is being transmitted automatically.

- If the channel guide is not displayed, press **F2 [MORE]**.
- Pressing **F7 [NEXT]** each time switches between **F3 [CH 1]** to **F6 [CH 4]** and **F3 [CH 5]** to **F6 [CH 8]**.
- After transmitting the RTTY message that is indicated by an << **AUTO RX** >> display beside it, this transceiver returns to the RX mode.

Settings Related to RTTY Encode/Decode

Enabling Decode UOS (Unshift on Space)

If a space character is included in the RTTY signal that is received, the character following the space can be forcibly interpreted as a character code (alphabet).

In RTTY, garbled characters may appear due to the signal strength or noise. To avoid this from happening as much as possible, the character after a space character is interpreted as a more frequently used character code (alphabet).

- **Configure in Menu [2-01] "RX UOS"**

Setting Value	Off/ On (default)
---------------	-------------------

On: Encodes space characters.

Off: Does not encode space characters.

- To receive a numeric value or symbol that immediately follows a space character, turn off the UOS function.

Newline Code Setting

Configure the newline code when receiving an RTTY signal.

- **Configure in Menu [2-02] "Newline Code"**

Setting Value	CR+LF/ All (default)
---------------	----------------------

All: Inserts a line break for every newline code.

CR+LF: Inserts a line break only when a CR+LF code is received.

Diddle Operation

Diddle allows the user to select the type of code to transmit when the characters to be sent run out during transmission in the RTTY (FSK) mode.

- **Configure in Menu [2-03] "Diddle"**

Setting Value	Off/ Blank Code (default)/ Letters Code
---------------	---

Off: Does not send out a character code.

Blank Code: Sends out a space character.

Letters Code: Sends out a character code.

Encode UOS

This is used for sending out a numeric value or symbol that immediately follows a space during transmission in the RTTY (FSK) mode. Enabling this function allows the receiving station to recognize the code that comes after a space as a numeric value or symbol, thus reducing the occurrence of garbled characters.

- **Configure in Menu [2-04] "TX UOS"**

Setting Value	Off/ On (default)
---------------	-------------------

On: Uses encode UOS.

Off: Does not use encode UOS.

Sending a Newline Code at the Start or End of a Transmission

A newline code (CR+LF) can be sent out when RTTY encode/decode starts or ends. A line break is inserted before and after the RTTY message on the decode screen of the receiving station, which makes it easier to identify the transmitted RTTY message.

- **Configure in Menu [2-05] "Automatic Newline Insertion"**

Setting Value	Off/ On (default)
---------------	-------------------

On: Sends out a newline code.

Off: Does not send out a newline code.

RTTY Parameters

Configuring the Mark Frequency

Configure the frequency of the mark signal that is used for communication in the RTTY (FSK) mode. The 1275 Hz frequency is referred to as a low tone, and the 2125 Hz frequency as a high tone. The high tone is used under normal circumstances.

- **Configure in Menu [2-08] "FSK Tone Frequency"**

Setting Value	1275/ 2125 (default) [Hz]
---------------	---------------------------

Configuring the RTTY Shift Width

The difference between the mark signal frequency and space signal frequency is called shift width. Configure the shift width during communication in the RTTY mode.

- **Configure in Menu [2-06] "FSK Spacing"**

Setting Value	170 (default)/ 200/ 425/ 850 [Hz]
---------------	-----------------------------------

- RTTY shift width cannot be altered when the RTTY communication screen is open.
- When the shift width in RTTY exceeds 170 Hz, the audio peak filter for the selected band cannot be set to ON.



- To operate in the RTTY mode using the built-in demodulator, encoder and decoder of this transceiver, configure the setting to "170 [Hz]".

5 COMMUNICATING AIDS

Frequency Reverse in RTTY Mode

Decoding cannot be performed correctly when the RTTY signal received is in the reverse state (frequencies of the mark signal and space signal are reversed). When this occurs, press and hold **[FSK/PSK]** to reverse the RTTY signal received so that the reverse signal can be decoded.

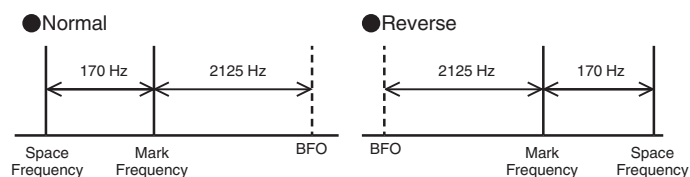

Operating RTTY (FSK) Using an External Device

To operate in the RTTY mode using a PC or other external devices (such as RTTY device or PC connection interface) instead of the built-in encoder and decoder functions of this transceiver while this transceiver is configured to the RTTY (FSK) mode, connect using the USB port or ACC 2 connector on the rear panel of this transceiver.

When connecting to a PC (using the USB port)

- RTTY keying: Configure the USB keying function to “RTTY Keying”.
- TX control: Use PC commands (“TX;” to start transmission and “RX;” to end transmission). Or configure the USB keying function to “PTT”.
- Audio output: Select “USB AUDIO CODEC” for the recording device using the sound setting on the PC.
For more details on the USB keying function, please refer to “USB Keying” (16-12).

When connecting to other external devices (using the ACC 2 connector)

- RTTY keying: Connect pin 2 (RTTY) of the ACC 2 connector to the keying output line of the external device.
- TX control: Connect pin 13 (SS) of the ACC 2 connector to the TX control (PTT) line of the external device.
- Audio output: Connect pin 3 (ANO) of the ACC 2 connector to the demodulation input line of the external device.
* For more details on the ACC 2 connector, please refer to “ACC 2 Connector” (1-7).

For more details on other connections and settings, please refer to “PC Connection for Data Communication” (1-4).

RTTY (FSK) Keying Polarity Setting

● Configure in Menu [2-07] “FSK Keying Polarity”

Setting Value	Off (default)/ On
---------------	-------------------

- Configure the RTTY keying polarity according to the specifications of the external device. When Menu [2-07] “FSK Keying Polarity” is configured to “Off” and pin 2 (RTTY) is short-circuited to GND, signals are transmitted at the mark frequency configured in Menu [2-08] “FSK Tone Frequency”.
- When Menu [2-07] “FSK Keying Polarity” is configured to “On”, signals are transmitted as space signals with the mark frequency shifted by the amount configured in Menu [2-06] “FSK Spacing”.

Audio Peak Filter

Using the audio peak filter may help to improve the decodability of RTTY messages when operating in the RTTY (FSK) mode with this transceiver connected to an external device.

- **Press F [APF] to set the audio peak filter to ON.**
 - When audio peak filter is turned on, “ON” is displayed in the lower row of **F [APF]**.
 - When audio peak filter is turned off, “OFF” is displayed in the lower row of **F [APF]**.

PSK Operation

This transceiver is equipped with a built-in demodulator, encoder and decoder for operating in the PSK31 and PSK63 modes. Operation in the PSK31 or PSK63 mode can be performed easily by connecting a commercially available USB keyboard. PSK can also be operated using a data communication software program that makes use of the sound function of a PC.



- When transmitting in the PSK mode, adjust the carrier until the ALC meter starts to deflect.
- When an external device is used, adjust the audio signal level from the external device, followed by adjusting the ALC meter until it starts to deflect.

Displaying the PSK Communication Screen

- 1 Press **[FSK/PSK]** to select PSK mode.
- 2 Press **F3 [DECODE]**.
The PSK communication screen appears.

Text Display Area + FFT Scope

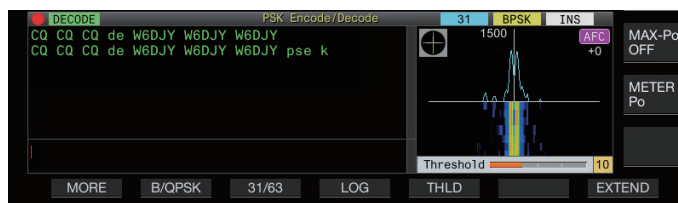

Text Display Area + Vectorscope

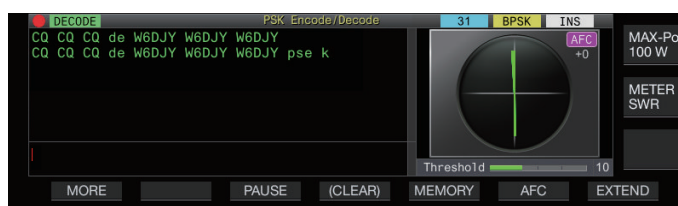

Switching between the FFT Scope and Vectorscope Display

The display toggles between the “FFT scope” and “Vector Scope” each time the scope display on the screen is touched.



- Noise Reduction 1, Noise Reduction 2, Beat Canceled 1, Beat Canceled 2 and RX DSP equalizer do not function during decoding of PSK messages.

The layout of the PSK communication screen is as follows.

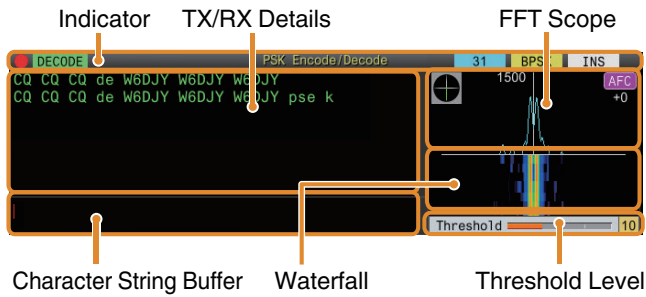

Indicator

Indicates the status of the function.

TX/RX Details

Displays the character strings that are transmitted or received.

Character String Buffer

Character strings to be transmitted.

FFT Scope

The audio FFT scope is used for viewing the tuning status. If there are multiple signals in the band, the target signal is tuned such that it becomes a 1500 Hz tone. Zero-in needs to be performed accurately in the PSK mode. Zero-in the target signal while monitoring the FFT scope and vectorscope.

Waterfall

Displays the transition in the spectrum of the TX audio signal in tandem with the FFT scope.

Vectorscope

The vectorscope indicates the way in which the PSK signals received are tuned. It comes in handy when tuning to the signal of the target station while monitoring the waveform on the vectorscope.

Threshold Level

Displays the threshold value of the RX signal input level for decoding.

Operating the PSK Communication Screen

The following operations are enabled when the PSK communication screen opens.

- Pressing the [Page Up] or [Page Down] key scrolls the display of the TX or RX details.

Key	Behavior
F1 [MORE]	Switches the key guide.
F2 [B/QPSK]	Switches between the BPSK and QPSK modes.
F3 [31/63]	Switches between the PSK31 and PSK63 modes.
F3 [PAUSE]	Pauses update (drawing) of the TX/RX details display area. Pressing the key again resumes the update (drawing).
F4 [LOG]	Turns ON/OFF the communication log function. Pressing and holding this key displays the screen for selecting a log file that is saved.
F4 [(CLEAR)]	Pressing and holding the key clears the text displayed on the TX/RX details screen.
F5 [THLD]	Switches to the threshold level configuration mode.
F5 [MEMORY]	Switches to the PSK Message screen.
F6 [AFC]	Switches the AFC function.
F7 [EXTEND]	Enlarges the size of the PSK communication screen. Pressing it again restores the screen to the standard size.

Indicator Displays

Display	Behavior
	Appears when the communication log function is ON.
	Appears when the communication log function is ON and in the standby mode.
	Appears when signal decoding is in progress.
	Appears when encoding the character strings in the TX character string buffer.
	Appears when the decode function is stopped or disabled.
	Appears when transmitting the auto standby channel during transmission of the message memory.
	Displays the baud rate.
	Displays the communication mode.
	Appears when in the insert mode.
	Appears when in the overwrite mode.
	Appears when AFC is ON. Displays the difference in frequency at the bottom.
	Appears when NET is ON.

Saving PSK Communication Logs

The CW, RTTY and PSK communication screens can be saved using the communication log function. Please refer to “Communication Log” on page 5-27.

Adjusting the PSK Decode Threshold Level

Noise that occurs when there is no signal may sometimes be erroneously detected as text, which results in the display of unwanted text. To reduce the occurrence of such issues, adjust the threshold level. Raise the threshold level when there is frequent erroneous detection due to noise.

1 Press F5 [THLD].

The threshold level setting can now be adjusted.

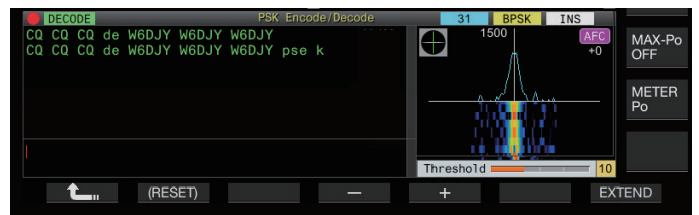

2 Press F4 [-]/ F5 [+] or turn the [MULTI/CH] control to adjust the level.

Setting Value	1 to 10 (default) to 30 (1 step)
---------------	----------------------------------

- Adjust the threshold value in the ascending order according to the receiving status of noise, for example. Start from a small value between the range of 1 to 30 and configure the threshold value to a point where reception is good.

3 Press F1 [↑] to end the process.

5 COMMUNICATING AIDS

FFT Scope/Vectorscope Display Setting

The tuning scope displayed on the PSK communication screen can be switched to an “FFT scope” or “vectorscope” display.

● Configure in Menu [2-13] “PSK Tuning Scope”

Setting Value	FFT Scope (default)/ Vector Scope
---------------	-----------------------------------

- The display toggles between the “FFT scope” and “Vector Scope” each time the scope display on the screen is touched.

FFT Scope Waveform Averaging

The waveform displayed on the FFT scope can be averaged. Averaging of the waveform reduces random noise and makes observation of the target signal easier.

● Configure in Menu [2-10] “FFT Scope Averaging (PSK Decode)”

Setting Value	0 (default) to 9 (1 step) (minimum to maximum averaging)
---------------	--

Selecting a Waterfall Display Type

● Configure in Menu [2-17] “Waterfall when Tuning (RTTY/PSK Audio Scope)”

Setting Value	Straight (default)/ Follow
---------------	----------------------------

Straight: Uses a straight line to show transition in the level of the target signal displayed on the waterfall when the RX frequency is altered.

Follow: Tracks and displays the latest FFT scope level at the portion where the waterfall starts flowing when the RX frequency is altered.

Vectorscope

Turn the **Tuning** control to perform tuning such that the emission lines displayed on the vectorscope radiate from the center into the same direction.

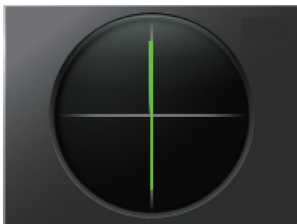

In Tune (BPSK)

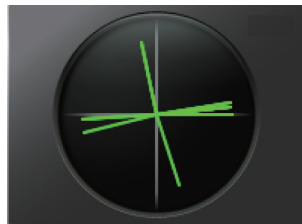

In Tune (QPSK)

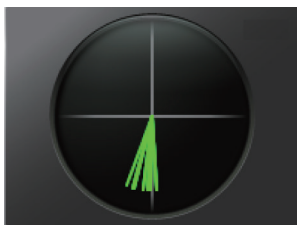

Idle Signal of BPSK or QPSK

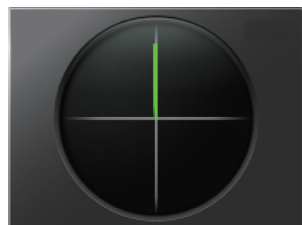

Unmodulated Carrier Signal

- Make use of the fine-tuning function if there is difficulty in performing tuning.
- While transmission is in progress, the vectorscope does not function and points to the 12 o'clock direction.

AFC (Automatic Frequency Control)

The AFC (Automatic Frequency Control) function can be used to tune the PSK signal that is being received.

● Press F6 [AFC] to set the AFC function to “On”.

- Pressing **F6 [AFC]** each time toggles the option in the following sequence: “OFF” → “AFC ON” → “AFC&NET ON” → “OFF”.
- When the AFC function is ON, the << **AFC** >> display lights up. The amount of frequency correction made by the AFC function is displayed below “AFC”.
- Pressing and holding **F6[AFC]** while the AFC function is ON increases or decreases the displayed frequency which indicates the amount of correction made by the AFC function.

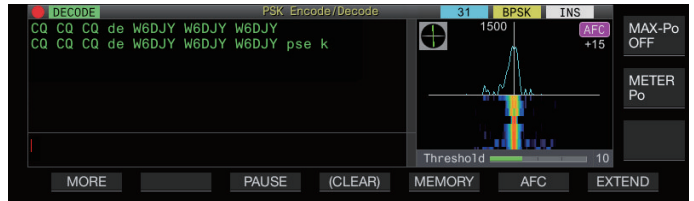

Configuring the AFC Tuning Range

Configure the frequency range for tuning the PSK signals that are received using the AFC function.

● Configure in Menu [2-11] “PSK AFC Tuning Range”

Setting Value	±8/ ±15 (default) [Hz]
---------------	------------------------

NET

The NET function transmits signals by applying the frequency that is automatically tuned by AFC.

● Press F6 [AFC] to select “AFC & NET”.

- Pressing **F6 [AFC]** each time toggles the option in the following sequence: “OFF” → “AFC function ON” → “AFC function & NET function ON” → “OFF”.
- << **AFC** >> and << **NET** >> light up.

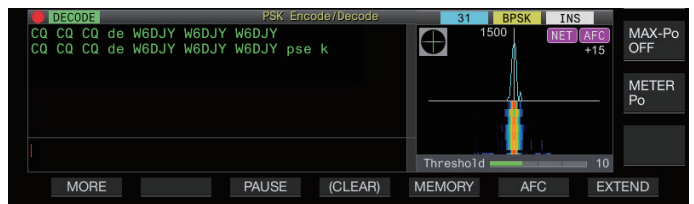

Switching between BPSK and QPSK

The PSK mode is further divided into 2 sub-modes, namely BPSK and QPSK. BPSK is the more commonly used mode. QPSK excels at correcting errors and boasts a higher decoding rate than BPSK.

● Press F2 [B/QPSK].

Pressing the key each time toggles the mode between BPSK and QPSK. The display to the right of the status bar toggles between << **BPSK** >> and << **QPSK** >> when the mode is switched.



- This is fixed at BPSK when the PSK63 mode is selected.

Switching between PSK31 and PSK63

This transceiver supports PSK31 as well as PSK63. The latter has a transfer rate that is twice that of the BPSK mode. Perform the following step to toggle between PSK31 and PSK63.

● Press F3 [31/63].

It is possible to toggle between BPSK31 and BPSK63 or between QPSK31 and QPSK63. The display to the right of the status bar toggles between << 31 >> and << 63 >> when the mode is switched.



● This is fixed at BPSK when the PSK63 mode is selected.

Transmitting Character Strings from USB Keyboard

A commercially available USB keyboard can be used to input and transmit character strings.

Transmitting the Input Character String Immediately

1 Connect the USB keyboard to (USB-A).

2 Press F3 [DECODE] to display the PSK communication screen.

3 Press [F12] on the USB keyboard to switch this transceiver to the TX mode.

The [BUSY/TX] LED lights up in red, and << ENCODE >> is displayed in the status bar.

4 Enter a character string using the USB keyboard.

- The input character string is displayed in the character string buffer and transmitted immediately.
- In the character string buffer, the color of the individual characters change successively once they are transmitted.
- Characters that have been transmitted appear successively in the TX/RX details display area.

5 Press [F12] on the USB keyboard to switch this transceiver to the RX mode.



● If there remain characters in the character string buffer that are not transmitted when [F12] is pressed in step 5, << WAIT >> is displayed in the status bar. After transmission of all the character strings is complete, the transceiver switches to the RX mode and the light of the [BUSY/TX] LED and << WAIT >> display go off.

Temporarily Placing Character Strings in the Character String Buffer before Transmission

1 Connect the USB keyboard to (USB-A).

2 Press F3 [DECODE] to display the PSK communication screen.

3 Enter a character string using the USB keyboard.
The input character string is stored temporarily in the character string buffer.

4 Press [F12] on the USB keyboard to send out the character string that is stored in the character string buffer.

- Upon entering the TX mode, the [BUSY/TX] LED lights up in red, and << ENCODE >> is displayed in the status bar.
- In the character string buffer, the color of the individual characters change successively once they are transmitted.

5 Press [F12] on the USB keyboard to switch this transceiver to the RX mode.



- If there remain characters in the character string buffer that are not transmitted when [F12] is pressed in step 5, << WAIT >> is displayed in the status bar. After transmission of all the character strings is complete, the transceiver switches to the RX mode and the light of the [BUSY/TX] LED and << WAIT >> display go off.
- Pressing [ESC] while transmission of the character strings is in progress switches this transceiver to the RX mode. Transmission of the character strings stops, and character strings in the character string buffer that are not yet transmitted are cleared.
- Time stamp and frequency information can be added to the TX or RX data that is displayed in the TX/RX details display area.
- Sending a character string using the USB keyboard while the TX/RX display is paused by pressing F3 [PAUSE] cancels the paused state.
- The character strings that can be placed temporarily in the character string buffer can contain a maximum of 4300 characters.
- Characters and symbols that can be input using a USB keyboard are as follows.

A	B	C	D	E	F	G	H	I	J	K	L	M	N	O
P	Q	R	S	T	U	V	W	X	Y	Z				
0	1	2	3	4	5	6	7	8	9					
a	b	c	d	e	f	g	h	i	j	k	l	m	n	o
p	q	r	s	t	u	v	w	x	y	z				
À	Á	Â	Ã	Ä	Å	Æ	Ç	È	É	Ê	Ë	Ì	Í	Î
Ī	Ī	Ñ	Ō	Ó	Ô	Õ	Ö	Ø	Ù	Ú	Û	Ü	Ý	Þ
à	á	â	ã	ä	å	æ	ç	è	é	ê	ë	ì	í	î
ï	ð	ñ	ò	ó	ô	õ	ö	ø	ù	ú	û	ü	ý	þ
ÿ	ß													
!	"	#	\$	%	&	'	()	*	+	,	-	.	/
:	;	<	=	>	?	@	[\]	^	_	`	{	
}	~	ı	¢	£	¤	¥	¦	§	¨	©	ª	«	¬	®
¯	°	±	²	³	´	µ	¶	•	,	¹	º	»	¼	½
¾	¿	No	÷									Space	Line Break	

- The chart above shows the characters and symbols that can be input when “English” is selected in Menu [9-01]. To input Japanese characters, please download and refer to the Japanese instruction manual from our website.

5 COMMUNICATING AIDS

PSK Message Memory

Fixed phrases that are often used in the PSK mode can be registered in advance as a message in the message memory. Adding the auto TX and auto RX functions to the fixed phrases enables messages to be sent out via simple operation.

- Up to 8 types of messages can be registered.

Registering Messages

- 1 Press **F3** [DECODE] to display the PSK communication screen.
- 2 Press **F5** [MEMORY] to display the PSK Message screen.

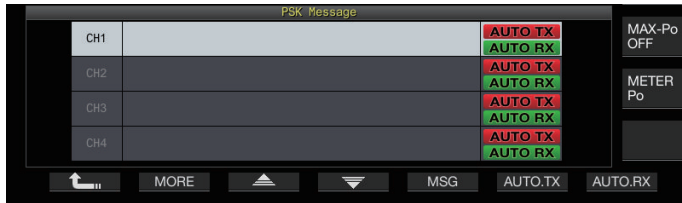

- 3 Press **F3** [▲] / **F4** [▼] or turn the [MULTI/CH] control to select the channel for registering the message.
 - If **F3** [▲] and **F4** [▼] are not displayed in the key guide, press **F2** [MORE] to toggle the key guide display.
- 4 Press **F5** [MSG].

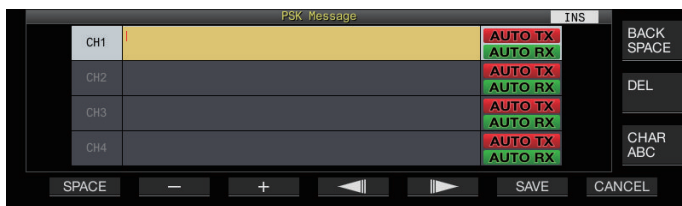

- 5 Use the function keys, [MULTI/CH] control or USB keyboard to enter a character string.

Key	Behavior
F1 [SPACE]	Inserts a space.
F2 [-] / F3 [+]	Selects a character.
F4 [◀] / F5 [▶]	Moves the cursor.
F [BACK SPACE]	Deletes the character to the left of the cursor.
F [DEL]	Deletes the character to the right of the cursor.
F [CHAR]	Switches the type of character to edit. Pressing the key each time switches the selection in the following sequence: ABC (upper case) → abc (lower case) → !"# (symbols) → ABC (upper case)

- Pressing **F7** [CANCEL] discards the content that is currently being edited and exits the character string input mode.

- 6 Press **F6** [SAVE] to save the edited message.

Configuring Auto TX/RX for the PSK Message Memory

The transmission and reception behavior can be configured when a PSK message memory channel is selected.

- Auto TX places this transceiver in the TX mode before transmitting a message when a message memory channel is selected, and maintain the TX mode after all messages have been sent out.
- For auto RX, pressing [**F12**] after selecting a message memory channel for transmission places this transceiver in the TX mode. When the message is sent out, this transceiver is automatically restored to the RX mode.
- Combining auto TX and auto RX enables both transmission and reception to be performed automatically.

- 1 Press **F3** [DECODE] to display the PSK communication screen.
- 2 Press **F5** [MEMORY] to display the PSK Message screen.
- 3 Press **F3** [▲] / **F4** [▼] or turn the [MULTI/CH] control to select the channel containing the message for auto TX/RX.
- 4 Press **F6** [AUTO.TX] to set auto TX to ON.
 << **AUTO TX** >> is displayed to the right of the PSK message.



- When auto TX is set to OFF, the << **AUTO TX** >> display goes off, and the PSK message of the channel is temporarily placed in the character string buffer but not transmitted automatically.

- 5 Press **F7** [AUTO.RX] to set auto RX to ON.
 << **AUTO RX** >> is displayed to the right of the PSK message.
 - When auto RX is set to OFF, the << **AUTO RX** >> display goes off, and this transceiver is not restored to the RX mode after the PSK message for the channel has been sent out.



- To sent a PSK message for which "AUTO TX" is set to ON, select the channel in which the PSK message is stored. Check to ensure that the character string (PSK message) is forwarded to the character string buffer, followed by pressing [**F12**] on the USB keyboard.
- To switch this transceiver to the RX mode after transmitting a PSK message for which "AUTO RX" is set to OFF, press [**F12**] on the USB keyboard after the PSK message has been sent out.

Transmitting Character Strings from the PSK Message Memory

A message that is registered in the PSK message memory can be transmitted as follows.

- 1 Press **F3 [DECODE]** to display the PSK communication screen.
- 2 Press **F5 [MEMORY]** to display the PSK Message screen.



- 3 Press **F3 [CH 1]** to **F6 [CH 4]** or **F3 [CH 5]** to **F6 [CH 8]** to select the channel that contains the message to be transmitted.

The PSK message of the channel corresponding to the function key is being transmitted automatically.

- However, the PSK message will not be transmitted automatically if auto TX is set to OFF.
- If the channel guide is not displayed, press **F2 [MORE]**.
- Pressing **F7 [NEXT]** each time switches between **F3 [CH 1]** to **F6 [CH 4]** and **F3 [CH 5]** to **F6 [CH 8]**.
- After transmitting the PSK message that is indicated by an << **AUTO RX** >> display beside it, this transceiver returns to the RX mode.

Settings Related to PSK

Configuring the PSK Tone Frequency

Configure the tone frequency when signals are received in the PSK mode.

- **Configure in Menu [2-12] “PSK Tone Frequency”**

Setting Value	1.0/ 1.5 (default)/ 2.0 [kHz]
---------------	-------------------------------

Reversing the Direction of Phase Change in the QPSK Mode

- When the QPSK signal received cannot be decoded correctly, try decoding with the BFO frequency switched from the LSB side to the USB side.
- Decoding cannot be performed correctly when the BFO frequency of the PSK signal received is in the reverse state (frequencies of the lower and upper sidebands are reversed).
- Pressing and holding the **[FSK/PSK]** mode key enables reverse signals to be decoded.

PSK Operation Using a PC

For details on operation in the PSK mode using a data communication software program that makes use of the sound function of a PC instead of the built-in encoder and decoder functions of this transceiver while this transceiver is configured to the SSB-DATA mode, please refer to “[PC Connection for Data Communication](#)” (1-4).

- As audio from an external input cannot be transmitted in the PSK mode, make use of the SSB or SSB-DATA mode.
- Alternatively, audio from an external device can also be transmitted using the DATA VOX function.

Communication Log

The CW, RTTY and PSK communication screens can be saved using the communication log function.

- Before doing so, configure the destination for saving the data in “File Storage Location” of the “[USB/File Management Menu](#)” (11-2) to “Internal Memory” or “USB Flash Drive”.
- To save the data to a USB flash drive, insert a USB flash drive formatted using this transceiver into (USB-A).

- 1 Set to the CW, RTTY (FSK) or PSK mode.
- 2 Press **F3 [DECODE]** to display the corresponding communication screen.
- 3 Press **F4 [LOG]** to set the communication log function to “On”.

Pressing **F4 [LOG]** each time toggles the communication log function between ON and OFF.

- “Log: On” appears on the communication screen for about 1 second when the communication log function is ON, and “Log: Off” is displayed for about 1 second when the function is OFF.
- When the communication log function is functioning in the ON mode, the communication log ON indicator is displayed on the title bar.
- When the communication log function is ON and the transceiver is in the standby mode, “○” is displayed on the title bar. (When there is insufficient space in the USB flash drive or when a USB flash drive is not inserted when the destination for saving the logs is configured to a USB flash drive.)



- The file name is made up of the date and time in numerical format together with an underscore. The extension of the file is based on the selection made in Menu [2-14] “CW/RTTY/PSK Log File Format”. The date and time is expressed in the following sequence: `yyyymmdd_hhmmss`.
 - (Example)
 - If the date is 10:20:30 a.m., February 15, 2018: `20180215_102030.txt`
- The file is stored in the following folder.
 - CW: `KENWOOD\TS-890\DECODE\CW`
 - RTTY: `KENWOOD\TS-890\DECODE\RTTY`
 - PSK: `KENWOOD\TS-890\DECODE\PSK`
- When removing the USB flash drive, make sure to execute “[Safely Removing the USB Flash Drive](#)” (11-6).

Selecting a Log File Format

Select a format for the log file to be saved.

- **Configure in Menu [2-14] “CW/RTTY/PSK Log File Format”**

Setting Value	html/ txt (default)
---------------	---------------------

html: Saves the log file in the html format.

txt: Saves the log file in the text format.

5 COMMUNICATING AIDS

Displaying a Time Stamp

A time stamp is inserted when there is a change in the encoding or decoding status.

Selecting a Time Stamp Type

It is possible to select whether to display only the time stamp or to display both the time stamp and frequency.

● Configure in Menu [2-15] “CW/RTTY/PSK Time Stamp”

Setting Value	Off/ Time Stamp/ Time Stamp+Frequency (default)
---------------	---

Off: Does not display a time stamp.

Time Stamp: Displays only the time stamp.

Time Stamp+Frequency: Displays both the time stamp and frequency.

Selecting a Clock Type

Configure the clock for displaying the time stamp to a “Local Clock” or “Secondary Clock”.

● Configure in Menu [2-16] “Clock (CW/RTTY/PSK Time Stamp)”

Setting Value	Local Clock (default)/ Secondary Clock
---------------	--

- When encoding or decoding starts, a line break and time stamp will be inserted before displaying the encoded or decoded character string.

Editing the Communication Log File

1 In the CW communication screen, press and hold F2 [LOG]. In the RTTY and PSK communication screens, press and hold F4 [LOG].

The screen for selecting log file appears.

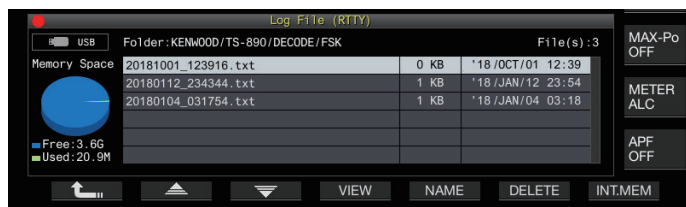

2 Press F2[▲]/ F3[▼] to select a file.

- Pressing F4 [VIEW] displays the log information of the selected file.



- To read data from the internal memory, press F7 [INT.MEM].
- To read data from the USB flash drive, press F7 [USB.MEM]. (If a USB flash drive is not connected, a message will appear prompting you to get ready the USB flash drive.)
- Pressing F5 [NAME] allows the file name to be changed.
- Pressing F6 [DELETE] displays a message to confirm deletion of the file. Pressing F4 [OK] deletes the file.

Operation in FM Mode

Operating in the FM mode enables high-quality voice communication as well as communication that is noise-resistant. Communication in the FM mode is also supported on the 29 MHz, 50 MHz and 70 MHz (E type) bands. To communicate with a distant station for which communication cannot be established directly, do so via a repeater.

Adjusting Microphone Gain during Operation in FM Mode

- Adjust the frequency.
- Press [FM/AM/FM-N] to select FM mode.
- Press [MENU].
- Press F [ADV.] to display the Advanced Menu screen.
 - If F [ADV.] is not displayed, press F [MORE] to display F [ADV.].
- Select Advanced Menu [10] “Microphone Gain (FM Mode)”.
- Press [SEND], or press and hold [PTT] on the microphone.

This transceiver is placed in the TX mode and a level meter is displayed.
- Speak into the microphone in the normal tone and loudness.
- Press F4 [-]/ F5 [+] or turn the [MULTI/CH] control to adjust the microphone gain.

Setting Value	0 to 50 (default) to 100 (1 step)
---------------	-----------------------------------

- Adjust the microphone gain level such that the peak value of the level meter falls within the zone.
- Press [SEND] or release [PTT] on the microphone. Doing so places this transceiver in the RX mode.
 - Press F1 [↑].



- When using a microphone with a low sensitivity such as the MC-90, adjust the microphone gain to a higher level.
- When a microphone with a low sensitivity is used, the modulation factor may stabilize by setting the speech processor to ON.

Operation in Narrow FM Mode

It is possible to switch to a narrow bandwidth during operation in the FM mode. The occupied bandwidth and maximum modulation factor are shown in the table below. Selecting FM Narrow according to the modulation factor of the target station helps to avoid distortion and deterioration in the clarity of the RX audio.

Mode	Occupied Bandwidth	Maximum Modulation Factor
FM (Wide)	16 kHz or lower	±5 kHz or lower
FM Narrow	10 kHz or lower	±2.5 kHz or lower

- **Press and hold [FM/AM].**
Pressing and holding [FM/AM] each time switches between “FM” and “FMN (Narrow)”.



Operating the FM Repeater

Switching this transceiver to split operation and turning on the tone signal while in the FM mode enables this transceiver to be used in the repeater operation mode.

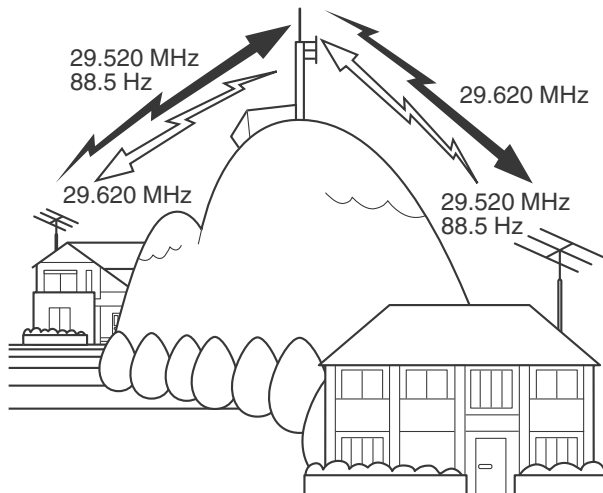

Configuring the Tone Signal

- Registering the tone settings to a memory channel and calling up the frequency or operation information from the memory channel eliminates the need to configure the tone frequency each time. For more details on the memory channel settings, please refer to “MEMORY CHANNELS” (9-1).
- The tone frequency may vary depending on the country or region this transceiver is being used.

Selecting a Tone

- **Press F4 [TONE] to select “TONE”.**
Pressing F4 [TONE] each time toggles the tone signal selection in the following sequence: “TONE” → “CTCSS (CT)” → “CROSS” → Blank (deselected).



Configuring the Tone Frequency

- 1 Press and hold F4 [TONE] while “TONE” is selected to display the FM Tone Frequency screen.

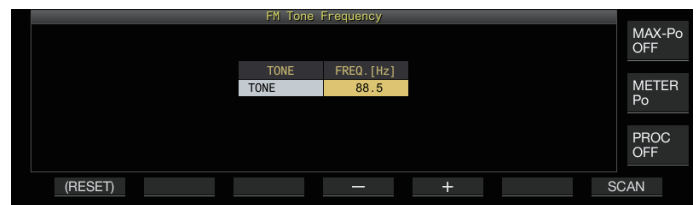

- 2 Press F4 [-]/ F5 [+] or turn the [MULTI/CH] control to select the tone frequency.

Tone Frequency (Hz)						
67.0	88.5	114.8	151.4	177.3	203.5	250.3
69.3	91.5	118.8	156.7	179.9	206.5	254.1
71.9	94.8	123.0	159.8	183.5	210.7	1750
74.4	97.4	127.3	162.2	186.2	218.1	
77.0	100.0	131.8	165.5	189.9	225.7	
79.7	103.5	136.5	167.9	192.8	229.1	
82.5	107.2	141.3	171.3	196.6	233.6	
85.4	110.9	146.2	173.8	199.5	241.8	

- The default setting is “88.5 Hz”.
- To restore the default setting, press and hold F1 [(RESET)].

- 3 Press [ESC] to end the process.

Tone Frequency Scan

Tone frequency that is contained in signals received in the FM mode can be searched and displayed with the following steps. This is useful when there is a need to know the tone frequency of the repeater station.

- 1 Press and hold F4 [TONE] while “TONE” is selected to display the FM Tone Frequency screen.
- 2 Press F7 [SCAN] to start tone frequency scan.
 - Scanning stops when a tone frequency is detected, and the frequency is displayed in the “FREQ. [Hz]” field.
 - Pressing F7 [SCAN] while tone frequency scan is in progress stops the scan operation. Pressing F7 [SCAN] again resume scanning.
 - The scan operation stops when the RX signal is interrupted during tone frequency scan. Scanning resumes when a RX signal is detected by this transceiver.
- 3 Press [ESC] to end the process.

5 COMMUNICATING AIDS

CTCSS Operation

CTCSS is the abbreviation for Continuous Tone Coded Squelch System. It is used to add a CTCSS tone frequency that is determined in advance with the target station to the audio signal to be transmitted. When the CTCSS tone frequency contained in the RX signal received from the target station coincides with the CTCSS tone frequency of one's own station, the squelch opens and the RX audio can be heard.

- A different value can be selected for CTCSS tone frequency and tone frequency, but CTCSS and tone cannot be used concurrently.
- CTCSS tone frequency: Squelch opens upon receiving a CTCSS tone for which the FM wave is superimposed with the same CTCSS tone frequency as that configured on this transceiver.
- During CTCSS frequency scan, it is possible to detect the CTCSS tone frequency that is contained in the RX signal.
- When a signal is received while CTCSS tone frequency scan is in progress, the RX audio can be heard even when the CTCSS tone frequency does not coincide with that configured on this transceiver.

Selecting CTCSS

- **Press F4 [TONE] to select "CTCSS (CT)".**
Pressing **F4 [TONE]** each time toggles the tone signal selection in the following sequence: "TONE" → "CTCSS (CT)" → "CROSS" → Blank (deselected).



Configuring the CTCSS Frequency

- 1 Press and hold **F4 [TONE]** while "CTCSS" is selected to display the FM Tone Frequency screen.

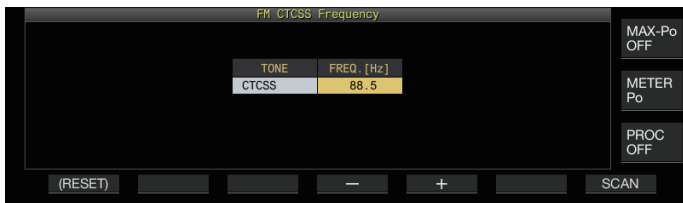

- 2 Press **F4 [-]** / **F5 [+]** or turn the **[MULTI/CH]** control to select the CTCSS frequency.

CTCSS Frequency (Hz)						
67.0	88.5	114.8	151.4	177.3	203.5	250.3
69.3	91.5	118.8	156.7	179.9	206.5	254.1
71.9	94.8	123.0	159.8	183.5	210.7	
74.4	97.4	127.3	162.2	186.2	218.1	
77.0	100.0	131.8	165.5	189.9	225.7	
79.7	103.5	136.5	167.9	192.8	229.1	
82.5	107.2	141.3	171.3	196.6	233.6	
85.4	110.9	146.2	173.8	199.5	241.8	

- The default setting is "88.5 Hz".
- To restore the default setting, press and hold **F1 [(RESET)]**.

- 3 Press **[ESC]** to end the process.

CTCSS Frequency Scan

CTCSS frequency that is contained in signals received in the FM mode can be searched and displayed with the following steps. This is useful when there is a need to know the CTCSS frequency of the mobile station.

- 1 Press and hold **F4 [TONE]** while "CTCSS" is selected to display the CTCSS Frequency screen.
- 2 Press **F7 [SCAN]** to start tone frequency scan.
 - Scanning stops when a CTCSS frequency is detected, and the frequency is displayed in the "FREQ. [Hz]" field.
 - Pressing **F7 [SCAN]** while CTCSS frequency scan is in progress stops the scan operation. Pressing **F7 [SCAN]** again resume scanning.
 - The scan operation stops when the RX signal is interrupted during CTCSS frequency scan. Scanning resumes when a RX signal is detected by this transceiver.
- 3 Press **[ESC]** to end the process.

Cross Tone

Make use of cross tone for communication with a repeater that requires a different tone for transmission to the repeater (uplink) and reception from the repeater (downlink).

- Cross Tone frequency uses the tone frequency during transmission and the CTCSS frequency during reception.
- The tone squelch operates using the CTCSS frequency during reception, while the preconfigured tone frequency is used to transmit a tone during transmission.

Selecting Cross Tone

- **Press F4 [TONE] to select "CROSS".**
Pressing **F4 [TONE]** each time toggles the tone signal selection in the following sequence: "TONE" → "CTCSS (CT)" → "CROSS" → Blank (deselected).



Configuring the TX/RX Tones

- 1 Press and hold **F4 [TONE]** while "CROSS" is selected to display the FM Cross Tone Frequency screen.

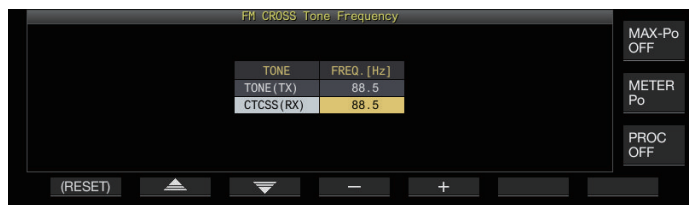

- 2 Press **F2 [▲]** / **F3 [▼]** to select "TONE (TX)" or "CTCSS (RX)".
- 3 Press **F4 [-]** / **F5 [+]** or turn the **[MULTI/CH]** control to select the tone frequency or CTCSS frequency.
 - To restore the default setting of the selected row, press and hold **F1 [(RESET)]**.
- 4 Press **[ESC]** to end the process.

6 REJECTING INTERFERENCE

Attenuator

The attenuator is a function for attenuating the RX signals. If there is interference due to strong signals near the target signal, turning on the attenuator helps to reduce interference caused by nearby frequencies.

It is also effective in situations where the RX audio is distorted when the RX signal is too strong. This transceiver comes with three different types of attenuators.

● Press F [ATT].

Pressing F [ATT] each time switches the attenuation level.

Setting Value	Off (default)/ 6 dB/ 12 dB/ 18 dB
---------------	-----------------------------------

- Pressing and holding F [ATT] each time switches the options in the reverse sequence.
- The attenuation level is stored for each antenna selection band.
- The status of the attenuator (attenuation level) is displayed in the key guide.



Switching the RX Filter Band Characteristics

Switching the RX Filter (A, B, C)

The setting for the band characteristics of the RX filter on this transceiver can be switched at one touch according to the operating status to one of the three types (A, B or C).

- The band characteristics are configured by combining the roofing filter or IF and AF filter, high cutoff/low cutoff and WIDTH/SHIFT. A different RX filter setting (A, B or C) can be stored for each of the SSB, CW, FSK, PSK, FM and AM modes.

● Press [IF FIL].

Pressing [IF FIL] each time switches the RX filter in the order of "A", "B" and "C".

- The selected filter is displayed at the top left of the filter scope.



The RX filter does not switch to Type C if Menu [6-10] "RX Filter Numbers" below is configured to "2".

Configuring the Selectable Types of RX Filters

The selectable types of RX filters can be configured to three (A, B and C) or two (A and B).

Configure in Menu [6-10] "RX Filter Numbers"

Setting Value	2/ 3 (default)
---------------	----------------

Filter Scope

The following information is displayed on the filter scope screen.

- Selected RX filter (A, B or C)
- Image of the RX filter passband characteristics (trapezoid)
- Audio spectrum of the RX audio
- Parameters including the IF filter passband width
- Pitch frequency in the CW mode
- Notch point of the notch filter
- Passband width of the roofing filter

SSB

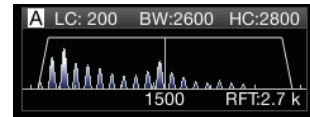

CW

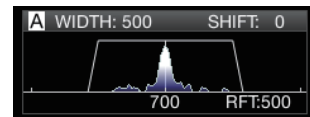

FSK

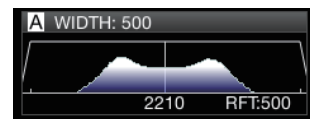

PSK

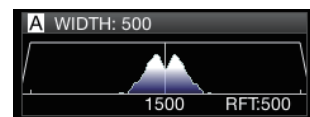

AM/FM

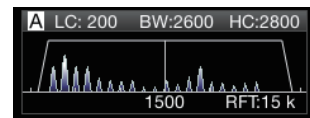

- The audio spectrum is not shown on the filter scope while the audio scope screen is displayed.
- The audio spectrum is not shown on the filter scope while the RTTY/PSK communication screen is displayed.
- An out-of-range marker ◀▶ is displayed when the image of the passband cannot be displayed within the display area because the shift amount of the filter in the CW mode is large.
- The audio spectrum is usually displayed within the image of the passband. However, it may be displayed beyond the image of the passband if there are excessively high input signals.
- When the notch filter is ON, the indicator representing the notch point is displayed in white. The indicator is displayed in white when the notch point is on the positive side of the carrier wave in the AM mode. If the notch point moves towards the minus side of the carrier wave, the indicator changes to orange and moves from the left edge of the screen to the right edge.

6 REJECTING INTERFERENCE

Configuring the RX Filter

The steps to configure the settings for the different types of RX filters are as follows.

Selecting a Roofing Filter

A roofing filter helps to reduce strong interference signals that are next to the target signal.

- 1 Press and hold [IF FIL] to display the RX Filter screen.

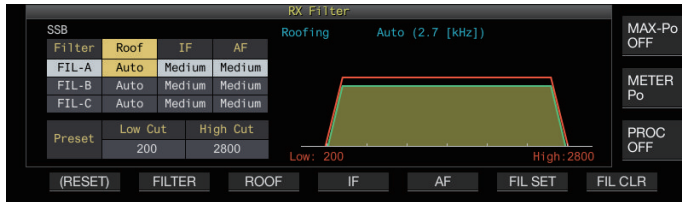

- 2 Press [IF FIL] or F2 [FILTER] to select an RX filter (FIL-A/B/C).

- 3 Press F3 [ROOF].

Pressing F3 [ROOF] each time switches the passband width.

Setting Value	Auto (default)/ 270/ 500/ 2.7 k/ 6 k/ 15 k [Hz]
---------------	---

Auto: A roofing filter with a bandwidth wider than the passband width of the DSP filter is automatically selected using high cutoff/low cutoff or Width/Shift. (If there are 2 or more bandwidths that satisfy the conditions, the narrower one is selected.)

- In the AM mode, a 6 kHz roofing filter is automatically selected if the high cutoff frequency is 3 kHz or lower, and a 15 kHz roofing filter is selected if the high cutoff frequency is higher than 3 kHz.
- In the FM mode, the option is fixed at 15 kHz and cannot be changed.
- 270 Hz is available for selection when the optional YG-82CN-1 is attached.
- Pressing and holding F3 [ROOF] each time switches the options in the reverse sequence.
- The passband width can also be altered by turning the [MULTI/CH] control.
- "RFT:xxxx" is displayed at the bottom right of the filter scope. [xxxx:270/ 500/ 2.7k/ 6k/ 15k]

- 4 Press and hold [IF FIL] or press [ESC] to end the process.



- The IF passband width for the AM mode is twice the value of the high cutoff frequency. Example: If the frequency is 3,000 Hz, the IF passband width will be 6 kHz.

Switching the IF Filter Shape

3 types of IF filter shapes are available for selection according to the condition of interference and operation.

- 1 Press and hold [IF FIL] to display the RX Filter screen.

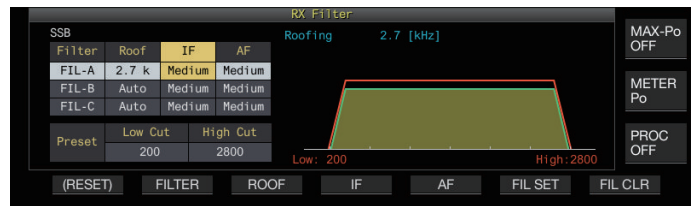

- 2 Press [IF FIL] or F2 [FILTER] to select an RX filter.

- 3 Press F4 [IF].

Pressing F4 [IF] each time switches the shape of the filter.

Setting Value	Medium (default)/ Soft/ Sharp
---------------	-------------------------------

- Pressing and holding F4 [IF] each time switches the options in the reverse sequence.
- The filter shape can also be altered by turning the [MULTI/CH] control.
- The IF filter option is displayed as "-" and cannot be altered in the FM mode.

- 4 Press and hold [IF FIL] or press [ESC] to end the process.

Switching the AF Filter Type

3 types of audio frequency passbands are available for selection.

- 1 Press and hold [IF FIL] to display the RX Filter screen.

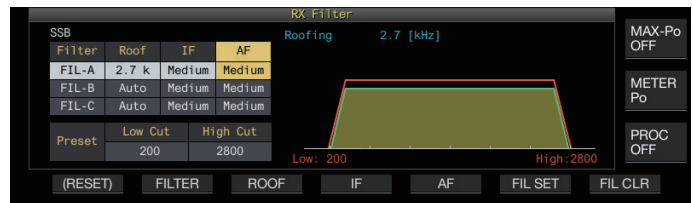

- 2 Press [IF FIL] or F2 [FILTER] to select an RX filter.

- 3 Press F5 [AF].

Pressing F5 [AF] each time switches the shape of the IF filter.

Setting Value	Medium (default)/ Wide/ Narrow
---------------	--------------------------------

- Pressing and holding F5 [AF] each time switches the options in the reverse sequence.

- 4 Press and hold [IF FIL] or press [ESC] to end the process.

Configuring the Behavior of the HI/SHIFT and LO/WIDTH Controls (SSB/SSB-DATA Only)

The high cutoff/low cutoff selection in the SSB mode and Shift/Width selection in the SSB-DATA mode are preconfigured in the default setting, but they can be changed in the menu.

SSB Mode

- **Configure in Menu [6-11] “Filter Control in SSB Mode (High/Low and Shift/Width)”**

Setting Value	High & Low Cut (default)/ Shift & Width
---------------	---

SSB-DATA Mode

- **Configure in Menu [6-12] “Filter Control in SSB-DATA Mode (High/Low and Shift/Width)”**

Setting Value	High & Low Cut/ Shift & Width (default)
---------------	---

Changing the Cutoff Frequency

In the SSB, AM and FM modes, the passband width of the filter can be altered by changing the cutoff frequency (low or high). The passband width can be changed so that the interfering signal falls outside the bandwidth of the filter.

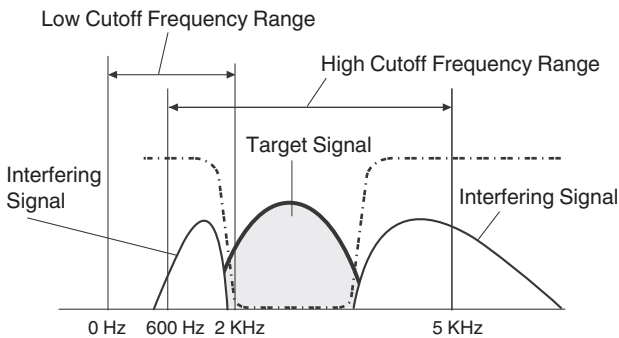

- 1 Press the mode key to select LSB, USB, FM or AM mode.
- 2 Press and hold [IF FIL] to display the RX Filter screen.
- 3 Turn the [HI/SHIFT] or [LO/WIDTH] control.
 - Turning the [HI/SHIFT] control to the right increases the cutoff frequency (high) while turning the control to the left decreases the frequency.
 - Turning the [LO/WIDTH] control to the right increases the cutoff frequency (low) while turning the control to the left decreases the frequency.
 - The amount of change and the filter shape are displayed on the filter scope and RX Filter screen.

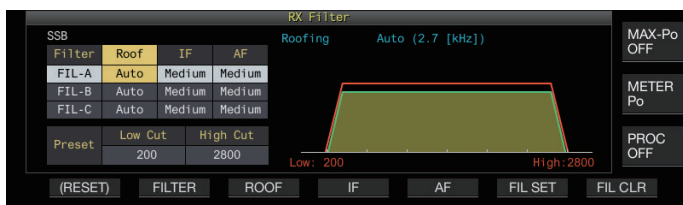

- 4 Press and hold [IF FIL] or press [ESC] to end the process.

Mode	Low Cutoff Frequency (Hz)	High Cutoff Frequency (Hz)
	Setting Value	Setting Value
SSB/ SSB-DATA	0/ 50/ 100 to 200 (default) to 2000 (100-step)	600 to 2800 (default) to 3000 (100-step)/ 3400/ 4000/ 5000
AM/ AM-DATA	0/ 100 (default)/ 200/ 300	2000 to 3000 (100-step)/ 3500/ 4000/ 5000 (default)
FM/ FM-DATA	0/ 50/ 100 to 200 (default) to 1000 (100-step)	1000 to 2800 (default) to 3000 (100-step)/ 3400/ 4000/ 5000

- When configured to “Auto”, a roofing filter with a bandwidth wider than the passband width of the DSP filter is selected using high cutoff/low cutoff or Width/Shift.
- When “Auto” is configured in the AM mode, a 6 kHz roofing filter is automatically selected if the high cutoff frequency is 3 kHz or lower, and a 15 kHz roofing filter is selected if the high cutoff frequency is higher than 3 kHz.
- In the FM mode, the option is fixed at 15 kHz and cannot be changed.
- When the low cutoff frequency is increased until it reaches the high cutoff frequency, the high cutoff frequency will also change at the same time while keeping the passband width at 0 Hz.
- When the high cutoff frequency is decreased until it reaches the low cutoff frequency, the low cutoff frequency will also change at the same time while keeping the passband width at 0 Hz.

6 REJECTING INTERFERENCE

Changing the Passband Width and Shift Amount

When in the CW or SSB-DATA mode, the passband width and shift amount of the DSP filter can be altered. When in the RTTY (FSK) or PSK mode, the passband width can be changed. The passband width can be changed so that the interfering signal falls outside the bandwidth of the filter.

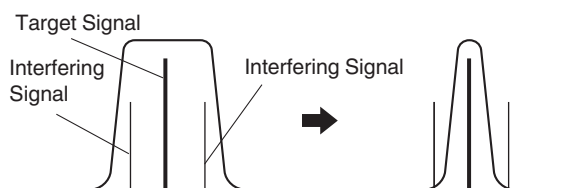

1 Press the mode key to select CW, USB-DATA, LSB-DATA, FSK or PSK mode.

2 Press and hold [IF FIL] to display the RX Filter screen.

3 Turn the [LO/WIDTH] control to change the passband width.

Turning the control to the right widens the passband width, while turning to the left narrows it.

4 Turn the [HIGH/SHIFT] control to shift the frequency band.

Turning the control to the right shifts the frequency to the high bandwidth, while turning to the left shifts it to the low bandwidth.

- The shift frequency band cannot be adjusted in the FSK and PSK modes.
- The amount of change and the filter shape are displayed on the filter scope and RX Filter screen.

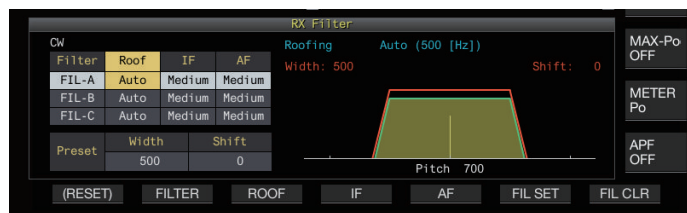

Mode	Passband Width (Hz)	Shift Frequency (Hz)	
	Setting Value	Setting Value	Step
SSB/ SSB-DATA	50/ 80/ 100/ 150/ 200/ 250/ 300/ 350/ 400/ 450/ 500/ 600/ 700/ 800/ 900/ 1000/ 1100/ 1200/ 1300/ 1400/ 1500/ 1600/ 1700/ 1800/ 1900/ 2000/ 2100/ 2200/ 2300/ 2400/ 2500/ 2600 (default)/ 2700/ 2800/ 2900/ 3000	50 to 1500 (default) to 2500	50
CW	50/ 80/ 100/ 150/ 200/ 250/ 300/ 350/ 400/ 450/ 500 (default)/ 600/ 700/ 800/ 900/ 1000/ 1500/ 2000/ 2500	-800 to 0 (default) to +800	10
FSK	250/ 300/ 350/ 400/ 450/ 500 (default)/ 1000/ 1500	-	
PSK	50/ 80/ 100/ 150/ 200/ 250/ 300/ 350/ 400/ 450/ 500 (default)/ 600/ 700/ 800/ 900/ 1000/ 1200/ 1400/ 1500/ 1600/ 1800/ 2000/ 2200/ 2400/ 2600/ 2800/ 3000	-	

5 Press and hold [IF FIL] or press [ESC] to end the process.

Preset Passband Characteristics

The frequently-used filter settings (high cutoff, low cutoff and WIDTH/SHIFT) can be preset according to the style in which this transceiver is used.

- 1 Press and hold [IF FIL] to display the RX Filter screen.

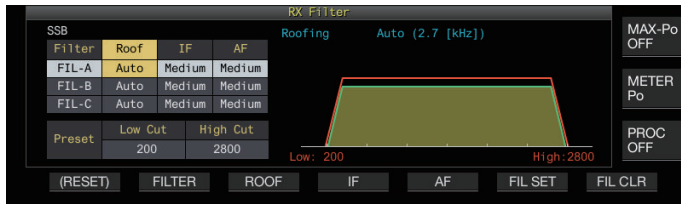

- 2 Press [IF FIL] or F2 [FILTER] to select an RX filter.
- 3 Press F6 [FIL SET].
The current filter settings (high cutoff, low cutoff and WIDTH/SHIFT) are stored as the preset values.
 - When preset values are applied, the values will be highlighted in the display for approximately 0.5 seconds.
 - Pressing F7 [FIL CLR] restores the passband width changed using the [HI/SHIFT] and [LO/WIDTH] controls to the preset value.
- 4 Press and hold F [IF FIL] or press [ESC] to end the process.

Audio Peak Filter in the CW Mode

During reception in the CW mode, if the signal intelligibility deteriorates due to noise or other reasons, allowing the RX signal to pass through the bandwidth with the pitch frequency as the center frequency helps to improve the intelligibility of the RX signal.

Turning ON/OFF Audio Peak Filter

- 1 Select CW mode.
- 2 Press F [APF].
 - Pressing F [APF] each time toggles the audio peak filter of the selected band between ON and OFF.
 - When audio peak filter is on, "ON" is displayed on the key guide. "OFF" is displayed when the audio peak filter is turned off.

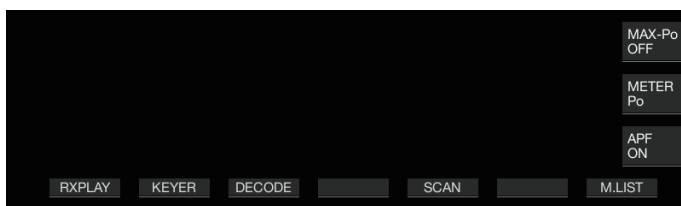

Switching the Passband Characteristics

3 types frequency passbands are available for selection for the audio peak filter.

- 1 Select CW mode.
- 2 Press and hold F [APF] to display the audio peak filter (APF) screen.

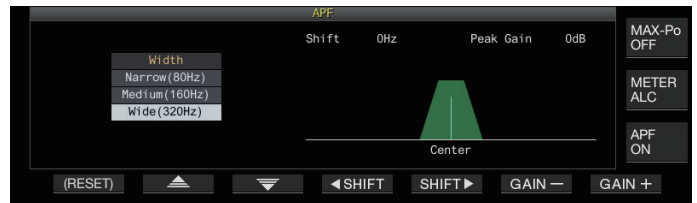

- 3 Press F2[▲] / F3[▼] to select a passband width.

Setting Value	Wide (320Hz)/ Medium (160Hz) (default)/ Narrow (80Hz)
---------------	---

- 4 Press and hold F [APF] or press [ESC] to end the process.

Shifting the Passband Width

Shifting the passband width of the audio peak filter helps to avoid interference with nearby frequencies.

- 1 Select CW mode.
- 2 Press and hold F [APF] to display the audio peak filter (APF) screen.

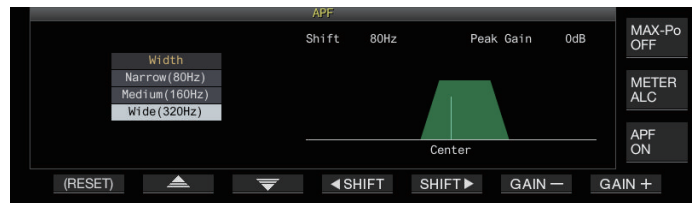

- 3 Press F2[▲] / F3[▼] to select the passband width to be shifted.
- 4 Press F4[◀SHIFT] or F5[SHIFT▶], or turn the [MULTI/CH] control to shift the passband width.

Setting Value	-200 to 0 (default) to +200 [Hz] (5-step)
---------------	---

- The shift amount of the passband width is ±200 Hz with the pitch frequency as the center frequency.
 - The selected passband width for the audio peak filter shifts from the pitch frequency toward a higher or lower bandwidth.
- 5 Press and hold F [APF] or press [ESC] to end the process.

6 REJECTING INTERFERENCE

Configuring the Peak Gain

To further enhance the target CW signal, raise the gain level.

- 1 Select CW mode.
- 2 Press and hold F [APF] to display the audio peak filter (APF) screen.
- 3 Press F6 [GAIN +] or F7 [GAIN -] to adjust the gain level.

Setting Value	0dB (default) to +6dB
---------------	-----------------------

- 4 Press and hold F [APF] or press [ESC] to end the process.

Audio Peak Filter in the FSK Mode

When receiving signals in the FSK mode, allowing both the mark and space frequencies to have a peak help to reduce the occurrence of garbled characters, thus improving the decodability. This audio peak filter is compatible with the high tone (mark frequency of 2125 Hz) as well as the low tone (mark frequency of 1275 Hz).

- 1 Select FSK mode.
- 2 Press F [APF].
 - Pressing F [APF] each time toggles the audio peak filter of the selected band between ON and OFF.
 - When audio peak filter is on, "ON" is displayed on the key guide. "OFF" is displayed when the audio peak filter is turned off.

- When the shift width in RTTY exceeds 170 Hz, the audio peak filter for the selected band cannot be set to ON.
- Internally demodulated signals are not processed for the audio filter in the FSK mode.
- The passband cannot be shifted for the audio peak filter in the FSK mode.

Noise Blanker

The noise blanker is used to reduce pulse noise. This transceiver is equipped with two types of noise blankers: NB1 that employs analog signal processing and NB2 that performs DSP (digital signal processing) at the IF level. Furthermore, two types of NB2 with different operating principles are available for selection. NB1 and NB2 can be selected for use according to the noise conditions. They can also be employed at the same time.

- Noise blanker cannot be used in the FM mode.

Turning ON/OFF Noise Blanker 1/2

- Press [NB1] or [NB2].

Pressing [NB1] or [NB2] each time toggles noise blanker 1 and noise blanker 2 respectively between ON and OFF.

 - When noise blanker 1 or 2 is ON, <<NB1|>> or <<NB2|>> is displayed on the screen.
 - When both noise blanker 1 and 2 are ON, <<NB1|2|>> is displayed on the screen.



Adjusting the NB1 Level

- 1 Press and hold [NB1] to display the Noise Blanker 1 configuration screen.

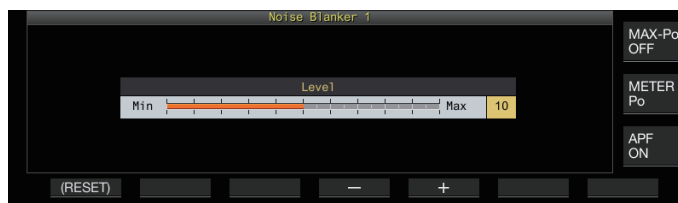

- 2 Press F4 [-] or F5 [+], or turn the [MULTI/CH] control to change the level.

Setting Value	1 to 10 (default) to 20 (1 step)
---------------	----------------------------------

- Configuring to a larger value reduces the noise further.

- Configuring the noise blanker level to a larger value may cause the transceiver to malfunction and distort the RX audio depending on the condition of the RX signal or interfering signal.

- 3 Press and hold [NB1] or press [ESC] to end the process.

NB2

NB2 is a function for blanking pulse noise with a long pulse width which cannot be blanked by NB1. NB2 is further divided into Type A and Type B, which can be employed according to the circumstances. NB2 can also be used together with NB1.

Type A

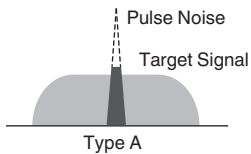

Type A suppresses mainly the pulse noise without blanking the target signal. The level of the effect (Level) can be adjusted.

- As pulse noise remains after blanking when “Type A” is used, pulse noise might be audible when the target signal is strong or when there is strong interference within the passband. Even in such a situation, it has the effect of bringing up the target signal when AGC gain is low due to pulse noise.
- “Type A” is most effective in cases where weak target signals are buried in strong pulse noise.

Type B

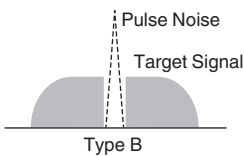

As with NB1, Type B blanks the pulse noise together with target signal. The pulse sensitivity level (Level), blanking duration (Width) and attenuation level (Depth) can be adjusted.

- When pulse noise with a long pulse width is blanked using “Type B”, the time interval for which the target signal is removed becomes longer due to the long blanking time, and this causes the silence period to stand out.

- Press and hold [NB2] to display the Noise Blanker 2 configuration screen.
- Press F6 [TYPE]. Pressing F6 [TYPE] each time toggles the screen between “Type A” and “Type B”.

Type A Screen

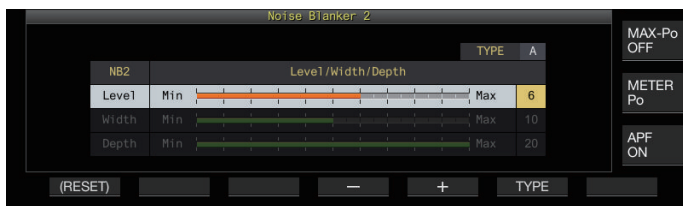

Type B Screen

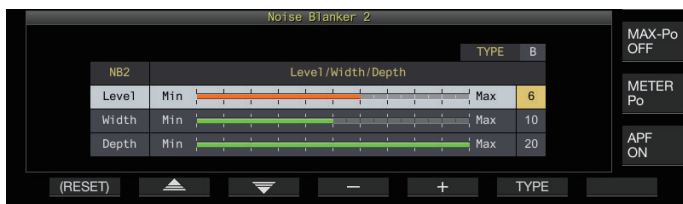

- Press and hold [NB2] or press [ESC] to end the process.

- Pressing and holding [NB2] displays the noise blanker 2 screen which shows the current type in use.
- The default setting is “Type A”.
- Type selection can be configured separately for audio mode (SSB/AM (including DATA mode)) and non-audio mode (CW/FSK/PSK).

Configuring the NB2 Effect Level (Type A)/ NB2 Pulse Sensitivity Level (Type B)

- Press and hold [NB2] to display the Noise Blanker 2 configuration screen.
- While the Type B screen is displayed, press F2 [▲]/ F3 [▼] to select “Level”.
- Press F4 [-]/ F5 [+] or turn the [MULTI/CH] control to change the level.

Setting Value	1 to 6 (default) to 10 (1 step)
---------------	---------------------------------

- Type A: Configuring to a larger value reduces the noise further.
 - Type B: Configuring to a larger value blanks pulse noises with small level difference from the RX signal.
- Press and hold [NB2] or press [ESC] to end the process.

- Configuring to a value with a higher level of noise blanker effect may cause the transceiver to malfunction and distort the RX audio depending on the condition of the RX signal or interfering signal.

Configuring the Blanking Duration (Type B Only)

- Press and hold [NB2] to display the Noise Blanker 2 configuration screen.
- While the Type A screen is displayed, press F6 [TYPE] to switch to Type B.
- Press F2 [▲]/ F3 [▼] to select “Width”.
- Press F4 [-]/ F5 [+] or turn the [MULTI/CH] control to change the blanking duration.

Setting Value	1 to 10 (default) to 20 (1 step)
---------------	----------------------------------

- Configuring to a larger value lengthens the blanking time.
- Press and hold [NB2] or press [ESC] to end the process.

Configuring the NB2 Attenuation Level (Type B Only)

- Press and hold [NB2] to display the Noise Blanker 2 configuration screen.
- While the Type A screen is displayed, press F6 [TYPE] to switch to Type B.
- Press F2 [▲]/ F3 [▼] to select “Depth”.
- Press F4 [-]/ F5 [+] or turn the [MULTI/CH] control to change the attenuation level.

Setting Value	1 to 20 (default) (1 step)
---------------	----------------------------

- Configuring to a larger value increases the attenuation level.
- Press and hold [NB2] or press [ESC] to end the process.

6 REJECTING INTERFERENCE

Notch Filter

Notch filter is capable of suppressing beat interference at the IF level. It can be employed to eliminate beat noise and bring up weak signals or during operation while checking the noise condition. The notch filter can be used in the SSB, CW, FSK, PSK and AM modes.

Turning ON/OFF Notch Filter

1 Press [NCH].

Pressing [NCH] each time toggles the notch filter between ON and OFF.

- When the notch filter is ON, "NOTCH" is displayed on the screen.
- When notch filter is ON, an indicator showing the notch point is displayed in the RX filter passband characteristics inside the filter scope.



2 Turn the [NOTCH] control.

Adjust the notch frequency to the point where beat or interference is to be suppressed.

- The notch point indicator moves as the notch frequency changes.



- Once the notch point has been set in the CW mode, altering the PITCH and SHIFT values will not change the notch point set for beat suppression.

Switching the Notch Filter Bandwidth

The bandwidth of the stopband for the notch filter can be configured to normal, middle or wide. The middle and wide stopbands are wider than the bandwidth of the normal stopband by two and three times respectively.

● Press and hold [NCH].

Pressing and holding [NCH] each time switches the bandwidth and changes the display as follows.

<< [NOTCH N] >> (Normal) → << [NOTCH M] >> (Middle) → << [NOTCH W] >> (Wide)

Noise Reduction

This transceiver comes with two types of noise reduction functions NR1 and NR2 which are effective for reducing continuous noise. When NR1 is used, the optimal method is activated according to the mode in use.

Noise Reduction 1 (NR1)

- In the SSB, FM and AM modes, noise reduction uses a spectrum subtraction system that places focus on the clarity.
- In the CW, FSK and PSK modes, noise reduction employs an LMS filter system that emphasizes the periodic signal.
- The noise reduction effect for NR1 can be adjusted.

Noise Reduction 2 (NR2)

- NR2 employs an SPAC system for all modes which extracts the periodic signal. This system detects periodic signals that are contained in the RX signals, connects the detected periodic signals and plays them as part of the RX audio. For this reason, this method is effective for signals with a single frequency such as CW signals.
- NR2 allows configuration to the optimal RX conditions by varying the autocorrelation time for periodic signal detection.
- NR2 is most effective in the CW mode. (Use of NR1 is recommended for modes other than CW.)



- Beat signals are also suppressed when NR1 is used in the SSB, FM and AM modes as it suppresses stationary signals. This is a theoretical behavior and not a malfunction.
- When NR2 is set to ON in the SSB mode, the signal clarity may deteriorate, or pulse noise or distortion may occur. This is a theoretical behavior and not a malfunction.
- NR2 cannot be used in the FM mode.

Turning ON/OFF Noise Reduction

1 Press [NR].

Pressing [NR] each time toggles the option in the following sequence: "NR1" → "NR2" → "OFF".

- When NR1 or NR2 is ON, << [NR 1] >> or << [NR 2] >> is displayed on the screen.



- NR1 and NR2 cannot be turned on at the same time.

Configuring the NR1 Effect Level

- 1 Press [NR] to select Noise Reduction 1.
- 2 Press and hold [NR] to display the Noise Reduction 1 effect level configuration screen.

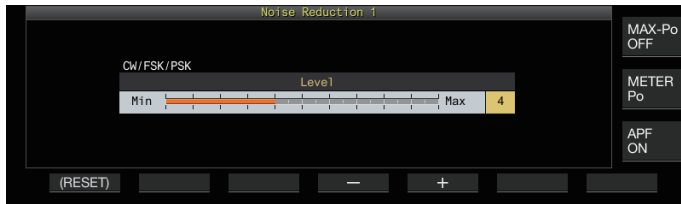

- 3 Press F4 [-]/ F5 [+] or turn the [MULTI/CH] control to change the level of effect.

Setting Value	1 to 5 (default) to 10 (1 step)
---------------	---------------------------------

- For NR1, configuring to a larger value reduces the noise further. However, as the impact on the RX audio also gets stronger if the effect level is excessively high, adjust it to an appropriate level.
- 4 Press and hold [NR] or press [ESC] to end the process.

Configuring the NR2 Correlation Time

- 1 Press [NR] to select Noise Reduction 2.
- 2 Press and hold [NR] to display the NR2 Time Constant configuration screen.

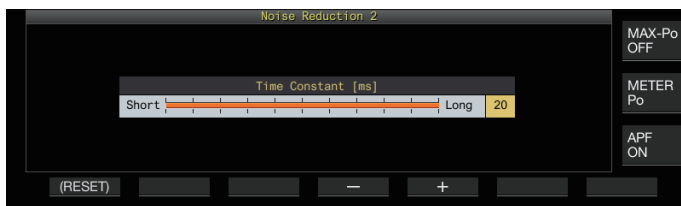

- 3 Press F4 [-]/ F5 [+] or turn the [MULTI/CH] control to change the correlation time.

Setting Value	2 to 20 (default) [ms] (2-step)
---------------	---------------------------------

- As the optimal correlation time varies with the RX signal and noise type when NR2 is used, configure the correlation time while receiving the signals.
- 4 Press and hold [NR] or press [ESC] to end the process.

 NR2 adjusts the correlation time for periodic signal extraction. It is different from NR1, which adjusts the effect level.

Beat Canceled

Beat canceler is capable of suppressing multiple periodic interfering signals (beats) within the RX bandwidth through digital processing at the AF level. This function can be used in the SSB, AM and FM modes.

Turning ON/OFF Beat Canceled

- Press [BC]. Pressing [BC] each time switches the beat canceler mode in the following sequence: “Beat Canceled 1” → “Beat Canceled 2” → “OFF”.
 - When beat canceler 1 or beat canceler 2 is ON, <<[BC1]>> or <<[BC2]>> is displayed on the screen.
 - Beat canceler 1 suppresses weak beats and continuous beats. Beat canceler 2 suppresses intermittent beats such as CW signals.



 Although the beat canceler suppresses the overall auditory beat, the gain of the target signal cannot be recovered using the AGC function. Thus, if the beat signal is larger than the target signal, using a notch filter activates the AGC function to enhance the clarity of the target signal.

DSP Monitor

DSP monitor is a function for temporarily expanding the passband width of the IF filter and AF filter via DSP in order to monitor the signal condition of nearby frequencies such as when receiving a specific frequency using a filter with a narrow passband width during contesting.

Assigning DSP Monitor to PF Key

- Register “DSP MONITOR” in Menu [0-15] “PF A: Key Assignment” to Menu [0-31] “Microphone UP: Key Assignment”

Expanding the Passband Width Using DSP Monitor

- Press and hold down the PF key that is assigned with the DSP monitor function. The passband width of the filter is expanded while the key is held down.
 - During DSP monitoring, the audio peak filter is forcibly turned OFF.



7 SCOPE FUNCTIONS

Bandscope

With the signal strength represented on the vertical axis and frequency on the horizontal axis, the bandscope provides a visual representation of the condition of the RX frequency band.

- The bandscope of this transceiver comes in the following 3 modes.

Auto Scroll Mode: A mode where the lower and upper frequency limits of the frequency band to be displayed are fixed, and the scope range scrolls automatically when the marker exceeds the lower or upper limit of the scope range.

Fixed mode: A mode where the lower and upper frequency limits of the frequency band to be displayed are fixed for each amateur band.

Center mode: A mode where the RX frequency is always at the center of the horizontal axis.

- By displaying a waterfall below the spectrum scope display, the RX frequency, surrounding conditions as well as transition in the signal strength over time can be viewed.
- The vertical axis of the waterfall display represents time while the horizontal axis represents frequency.
- Signal strength in the waterfall display is represented in a gradation of color in the order of green to blue (weak), red to yellow (medium) and white (strong). The amount of color change with respect to the signal strength can be altered in the menu. Refer to “Configuring the Gradation of the Waterfall” (7-5).
- The speed of the waterfall drop can be changed to 4 different speed levels. Refer to “Configuring the Speed of Waterfall Drop” (7-2).
- When the waterfall is displayed, the height of the spectrum scope display is reduced to one-third of the original size.
- The filter passband is constantly represented by a translucent display in the bandscope.

Displaying the Bandscope

- **Press [SCP] to display the scope screen.**
Pressing and holding [SCP] each time toggles the display between “Bandscope” and “Audio Scope”.

Bandscope

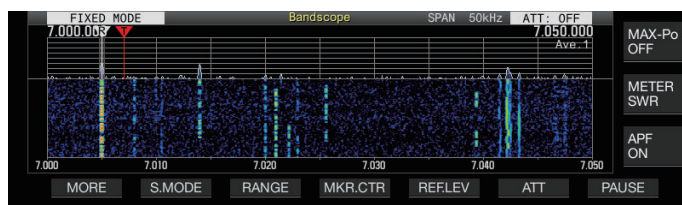

Audio Scope

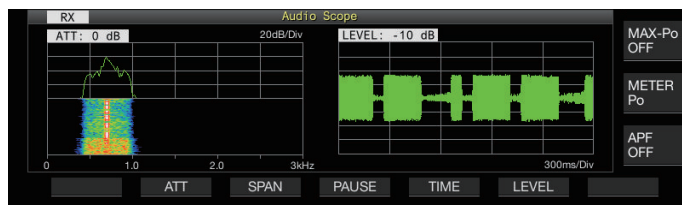

Switching the Bandscope Display Type

- 1 **Display the bandscope.**
- 2 **Press [SCP].**
Pressing [SCP] each time switches the selection in the following sequence.

“Spectrum scope + Waterfall” (Standard size)

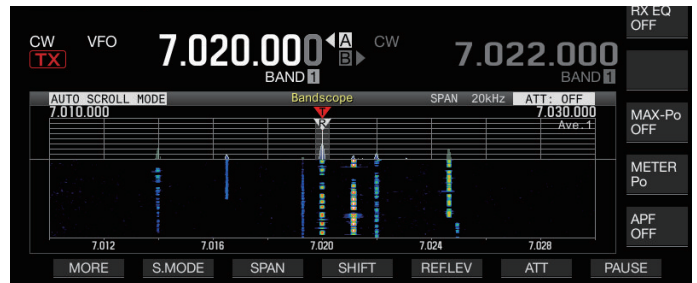

“Spectrum scope + Waterfall” (Enlarged size)

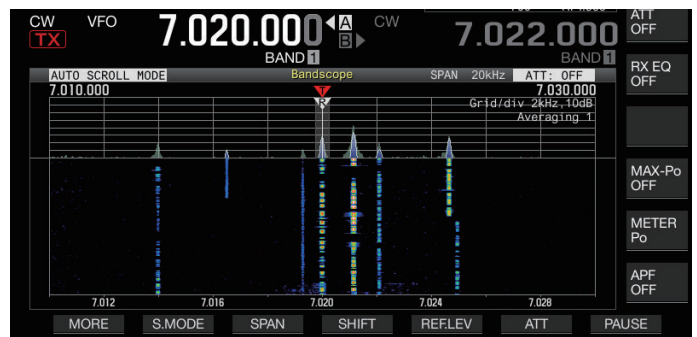

“Spectrum scope only” (Standard size)

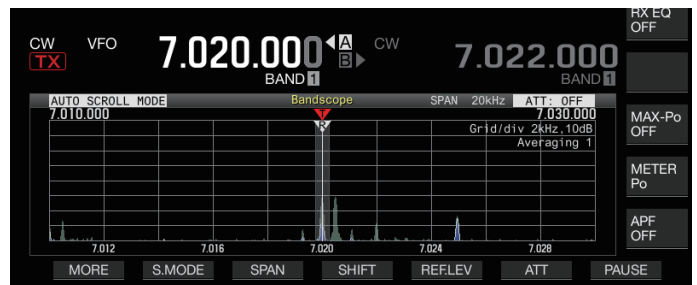

No scope display (ends scope display)

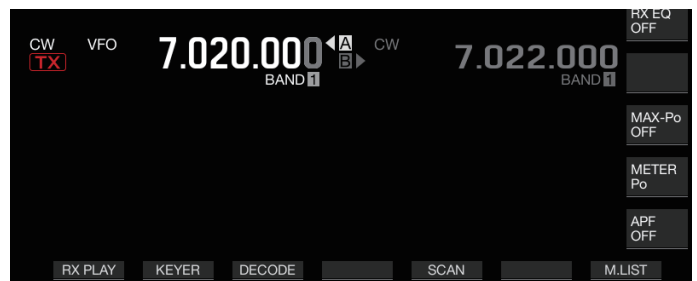

- While a bandscope is displayed, pressing [ESC] ends the bandscope display.

7 SCOPE FUNCTIONS

Adjusting the Reference Level

Adjust the reference level of the bandscope to make it easier to distinguish the target signal from the noise.

- 1 Press **F5 [REF.LEV]** to display the setting value of the reference level at the center of the bandscope screen.
 - If **F5 [REF.LEV]** is not displayed, press **F1 [MORE]** to display **F5 [REF.LEV]**.
- 2 Turn the **[MULTI/CH]** control to adjust the reference level while observing the spectrum scope waveform and waterfall color level on the bandscope screen.

Setting Value	-20 to 0 (default) to +10 dB (0.5 dB step)
---------------	--

- 3 Press **F5 [REF.LEV]** to end adjustment of the reference level.

- The reference level is slightly compensated for each span internally on this transceiver so that the view of the waterfall does not change even when the display frequency span switches. For this reason, the height of the waveform on the spectrum scope also changes gradually when the span switches.
- The adjustment value of the reference level is stored for each amateur band.

Switching the Bandscope Attenuator

If the target signal cannot be identified on the bandscope screen even after adjusting the reference level due to the excessively high input signals, attenuate the input level to the bandscope by switching to a different attenuator for the bandscope.

- 1 Press **F6 [ATT]** to switch to a different attenuator.
 - If **F6 [ATT]** is not displayed, press **F1 [MORE]** to display **F6 [ATT]**.
- Pressing **F6 [ATT]** each time switches the attenuator.

Setting Value	Off (default)/ 10 dB/ 20 dB/ 30 dB
---------------	------------------------------------

- Pressing and holding **F6 [ATT]** each time switches the options in the reverse sequence.
- The current attenuator level setting is displayed at the top of the bandscope.

- “SCP OVF” (scope overflow) may be displayed in the toolbar of the bandscope screen if the input to the bandscope becomes excessive. In such cases, press **F6 [ATT]** to configure the attenuator for the bandscope to lower the input level to the bandscope.
- Switching the attenuator for the bandscope does not affect the RX sensitivity.
- The setting value of the bandscope attenuator is stored for each amateur band.

Configuring the Speed of Waterfall Drop

The speed at which the waterfall is flowing can be selected from the options available.

- 1 Press **F1 [MORE]** followed by **F4 [SPEED]**. Pressing **F4 [SPEED]** each time switches the flow speed.

Setting Value	Speed1/ Speed2/ Speed3/ Speed4 (default)
---------------	--

- After altering the speed, “Speed n” is displayed in the waterfall area for about 1 second.
- Pressing and holding **F4 [SPEED]** switches the options in the reverse sequence.

Waterfall Display during Tuning (Center Mode)

This is a function for switching the behavior of the waterfall display when the frequency is altered in the center mode.

- 1 Configure in Menu [8-03] “Waterfall when Tuning (Center Mode)”

Setting Value	Straight (default)/ Follow
---------------	----------------------------

Straight: Pauses the target signal level traces displayed on the waterfall and moves the traces horizontally across the screen when the frequency is altered.

Follow: Tracks and displays the latest FFT level at the portion where the waterfall starts flowing when the frequency is altered.

Reduced Bandscope Display

A small bandscope (with a waterfall display) can be displayed on screens such as those for the different settings, RTTY communication and PSK communication.

- 1 Display the menu, configuration modes except equalizer configuration and the RTTY/PSK communication screen.
- 2 Press **[SCP]**. A small bandscope is displayed.

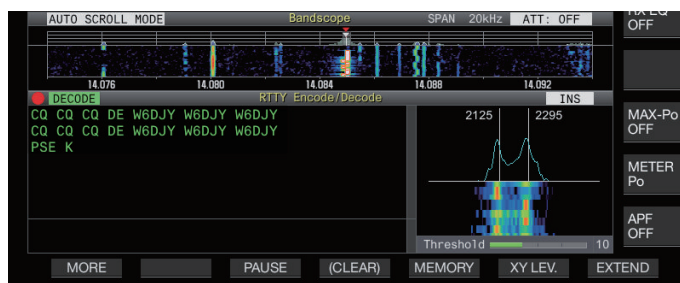

- While the reduced bandscope is displayed, the horizontally arrayed F keys are switched to the function keys of the configuration screen and thus the bandscope settings cannot be changed.

Switching the Scope Display Mode

- 1 Display the bandscope screen.
- 2 Press F2 [S.MODE].
 - If F2 [S.MODE] is not displayed, press F1 [MORE] to display F2 [S.MODE].

Pressing F2 [S.MODE] each time switches the selection to “Auto Scroll Mode”, “Fixed Mode” and “Center Mode” in sequence.

Auto Scroll Mode (AUTO SCROLL MODE)

Moves the marker of the tuning frequency to within the scope range. If the lower or upper limit of the display range is exceeded, the scope range is automatically scrolled by half a screen.

Fixed Mode (FIXED MODE)

Moves the marker of the tuning frequency to within the scope range preconfigured for each amateur band. Up to 3 scope ranges can be preconfigured for one amateur band.

Center Mode (CENTER MODE)

The marker of the tuning frequency is normally fixed at the center.

Auto Scroll Mode

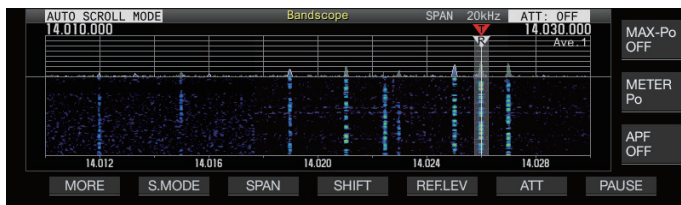

Fixed Mode

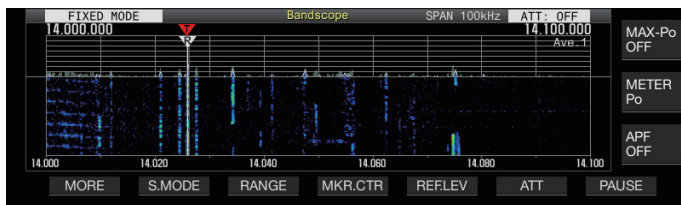

Center Mode

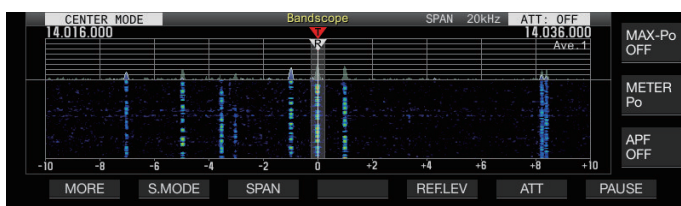

Switching the Display Frequency Span

When the bandscope is displayed in the Auto Scroll mode or Center mode, the display frequency span (the width between the lower and upper frequency limits in the bandscope screen) can be adjusted.

- Press F3 [SPAN].
 - If F3 [SPAN] is not displayed, press F [MORE] to display F3 [SPAN].
- Pressing F3[SPAN] each time switches the frequency span.

Setting Value	5kHz/ 10kHz/ 20kHz/ 30kHz/ 50kHz/ 100kHz/ 200kHz/ 500kHz
----------------------	--

- The display frequency span can be configured separately for audio mode (SSB/AM/FM (including DATA mode)) and non-audio mode (CW/FSK/PSK).
- The default settings of the audio mode and non-audio mode are “50Hz (± 25Hz)” and “10kHz (± 5Hz)” respectively.
- Pressing and holding F3[SPAN] each time switches the options in the reverse sequence.
- The selected display frequency span is displayed in the toolbar of the bandscope screen as “SPAN 50kHz”, for example.

Marker Shift

This function shifts the scope range in the auto scroll mode operation so that the marker is displayed at an easy to observe position.

Shifting the Marker

- Press F4 [SHIFT].
 - If F4 [SHIFT] is not displayed, press F [MORE] to display F4 [SHIFT].
- The marker shifts close to the preset shift position (default value is center).



- Depending on the relationship between the RX frequency and the span, deviation of 1 grid to the left or right may occurred in the shift operation.

Changing the Shift Position of Marker Shift

- 1 Press and hold F4 [SHIFT].
 - If F4 [SHIFT] is not displayed, press F [MORE] to display F4 [SHIFT].

The transceiver enters the shift position configuration mode. The value indicating the position of the selected vertical grid line is displayed.
- 2 Move the shift position to the desired position using the [MULTI/CH] control.
 - Pressing and holding F4 [SHIFT] moves the shift position to the center.
- 3 Press F4 [SHIFT].

The transceiver exits the shift position configuration mode.



- When observing the condition of the frequency calling the DX station or the condition in the RX passband during digital communication such as FT8, change the shift position of the marker to display the RX frequency marker at the edge. Doing so widens the width for displaying the signal compared to when the marker is near the center.

7 SCOPE FUNCTIONS

Expand

This function expands the frequency range for spectral analysis to prevent the waterfall display from being interrupted when the frequency is changed while in the auto scroll mode or center mode (when the waterfall display during tuning is configured to "Straight").

● Press F1 [MORE] followed by F2 [EXPAND].

Pressing F2 [EXPAND] each time toggles the expand function between ON and OFF.

- When the expand function is ON, "Expand" is displayed below the lower frequency limit display.
- When the expand function is ON, the image becomes slightly grainy.

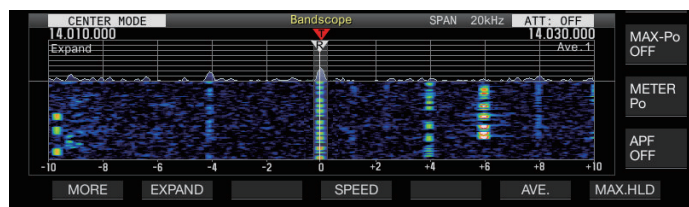

Scope Range of Each Band (Fixed Mode)

The steps to configure the scope range for each of the amateur bands when the bandscope is displayed in the Fixed mode are described below. Three types of scope range are available for selection for each band.

Switching the Scope Range

● Press F3 [RANGE].

- If F3 [RANGE] is not displayed, press F [MORE] to display F3 [RANGE].

Pressing F3 [RANGE] each time switches the scope range.

Setting Value	Range No.1 (default)/ Range No.2/ Range No.3
---------------	--

Configuring the Scope Range

1 Press and hold F3 [RANGE] to display the screen for configuring the scope range in the Fixed mode.

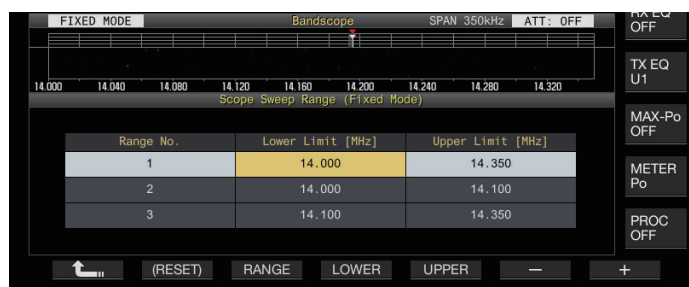

2 Press F3 [RANGE] to select the scope range "Range No.1", "Range No.2" and "Range No.3".

3 Press F4 [LOWER] or F5 [UPPER] to select the frequency to adjust.

4 Press F6 [-]/ F7 [+] or turn the [MULTI/CH] control to select the frequency.

- Details of the configurable frequency range are shown in the table below.

Band	Configurable Frequency Range [MHz]	Range No.	Default Lower Limit [MHz]	Default Upper Limit [MHz]
LF Band	$0.03 \leq f < 0.300$	1	0.130	0.140
		2	0.130	0.140
		3	0.130	0.140
MF Band1	$0.300 \leq f < 0.522$	1	0.470	0.480
		2	0.470	0.480
		3	0.470	0.480
MF Band2	$0.522 \leq f < 1.705$	1	0.750	1.250
		2	0.750	1.250
		3	0.750	1.250
1.8 MHz Band	$1.705 \leq f < 2.000$	1	1.800	2.000
		2	1.800	1.840
		3	1.840	2.000
3.5 MHz Band	$2.000 \leq f < 4.000$	1	3.500	4.000
		2	3.500	3.600
		3	3.600	4.000
5 MHz Band	$4.000 \leq f < 6.000$	1	5.000	5.500
		2	5.000	5.500
		3	5.000	5.500
7 MHz Band	$6.000 \leq f < 8.000$	1	7.000	7.300 (K type) 7.200 (E type)
		2	7.000	7.125 (K type) 7.050 (E type)
		3	7.125 (K type) 7.050 (E type)	7.300 (K type) 7.200 (E type)
10 MHz Band	$8.000 \leq f < 11.000$	1	10.100	10.150
		2	10.100	10.130
		3	10.130	10.150
14 MHz Band	$11.000 \leq f < 15.000$	1	14.000	14.350
		2	14.000	14.150 (K type) 14.100 (E type)
		3	14.150 (K type) 14.100 (E type)	14.350
18 MHz Band	$15.000 \leq f < 20.000$	1	18.068	18.168
		2	18.068	18.110
		3	18.110	18.168
21 MHz Band	$20.000 \leq f < 22.000$	1	21.000	21.450
		2	21.000	21.200 (K type) 21.150 (E type)
		3	21.200 (K type) 21.150 (E type)	21.450

Band	Configurable Frequency Range [MHz]	Range No.	Default Lower Limit [MHz]	Default Upper Limit [MHz]
24 MHz Band	$22.00 \leq f < 26.00$	1	24.890	24.990
		2	24.890	24.930
		3	24.930	24.990
28 MHz Band	$26.00 \leq f < 30.00$	1	28.000	28.500
		2	28.000	28.300 (K type) 28.200 (E type)
		3	28.300 (K type) 28.200 (E type)	28.800 (K type) 28.700 (E type)
50 MHz Band	$30.00 \leq f < 60.00$	1	50.000	50.500
		2	50.000	50.100
		3	50.100	50.300
70 MHz Band (E Type)	$30.00 \leq f < 74.80$	1	70.000	70.500
		2	70.000	70.250
		3	70.250	70.500

Marker Centering (Fixed Mode)

The scope range can be shifted temporarily with the display frequency span maintained such that the marker of the selected amateur band is displayed near the center (within one grid to the left or right from the center).

● **Press F4 [MKR.CTR].**

- If F4 [MKR.CTR] is not displayed, press F [MORE] to display F4 [MKR.CTR].

The scope range is shifted with the frequency span maintained.

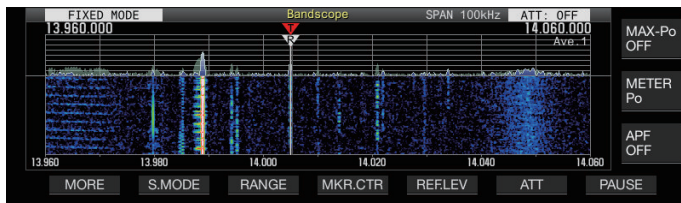

- Changes in the lower and upper frequency limits due to the marker centering operation are temporary, and does not alter the preconfigured lower and upper frequency limits of the scope band in question.

Notification on Exceeding the Lower or Upper Limit (Fixed Mode)

If the marker frequency falls outside the display range of the bandscope when a frequency marker is displayed on the bandscope in the Fixed mode, a display appears to inform the user that the marker has moved out of the bandscope range.

A “<” icon appears at the left edge of the bandscope screen if the marker frequency value is smaller than the lower frequency limit, and a “>” appears at the right edge if the marker frequency value is larger than the upper frequency limit.

The markers indicating that the lower or upper limit is exceeded are color coded as follows.

White: RX frequency
Red: TX frequency

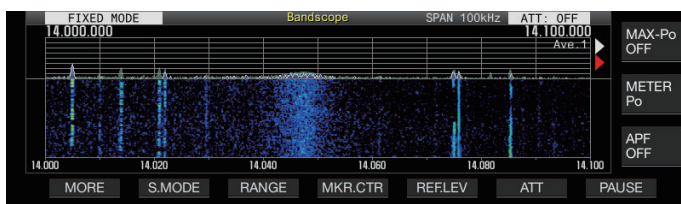

Selecting Relative or Absolute Frequency Display for the Grid (Center Mode)

During carrier point center display in the Center mode, the mode of frequency scale display at the bottom of the bandscope can be switched to one of the options available.

● **Configure in Menu [8-06] “Frequency Scale (Center Mode)”**

Setting Value	Relative Frequency (default)/ Absolute Frequency
---------------	--

Relative Frequency: The frequency scale display at the bottom of the scope area represents the relative frequency from the center of the scope.

Absolute Frequency: The frequency scale display at the bottom of the scope area represents the absolute frequency.

Displaying Tuning Assist Line (SSB Only)

A tuning auxiliary line (yellow) referred to as assist line can be displayed parallel to the RX frequency marker during operation in the SSB mode.

Set the assist line at 400 Hz to 500 Hz (near the peak of a typical frequency spectrum of a human voice) for voice communication and at the frequency of the subcarrier for data communication. Zero-in can be performed easily by adjusting the assist line to the strongest point of the spectrum on the waterfall.

● **Configure in Menu [8-05] “Tuning Assist Line (SSB Mode)”**

Setting Value	Off (default)/ 300/ 400/ 500/ 600/ 700/ 800/ 1000/ 1500/ 2210 [Hz]
---------------	--

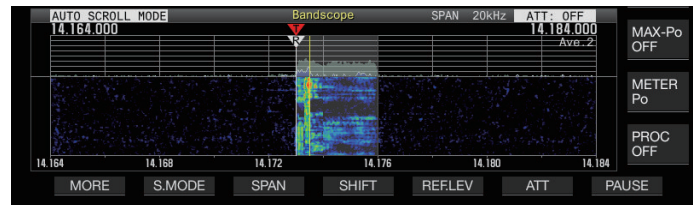

- This function works in the Center mode only when Menu [8-03] “Waterfall when Tuning (Center Mode)” is configured to “Straight”.
- The tuning assist line is displayed on the upper side with respect to the carrier point in the case of USB and on the lower side in the case of LSB.

Configuring the Gradation of the Waterfall

The amount of color change with respect to the signal strength in the waterfall display can be configured from a scale of 1 to 10.

Configuring a larger value increases the amount of color change making it easier to find weak signals. Configuring a smaller value reduces the amount of color change making it easier to observe strong signals.

● **Configure in Menu [8-04] “Waterfall Gradation Level”**

Setting Value	1 to 7 (default) to 10 (1 step)
---------------	---------------------------------

7 SCOPE FUNCTIONS

Touchscreen Tuning

This function enables signals to be received by touching the desired point in the spectrum scope display area or waterfall display area.

- When in the Auto Scroll mode and Fixed mode, touching a point moves the marker to the corresponding frequency.
- When in the Center mode, touching a point sets the corresponding frequency as the center frequency.

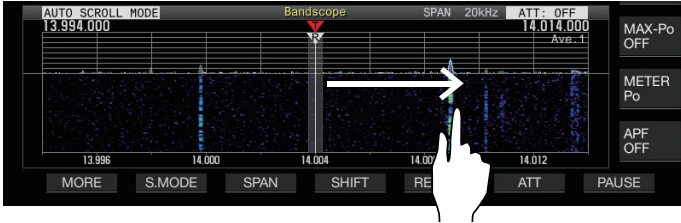

Turning ON/OFF Touchscreen Tuning

● Configure in Menu [0-14] “Touchscreen Tuning”

Setting Value	Off/ On (default)
---------------	-------------------

- The following operations are prohibited even when touchscreen tuning is ON.
 - When the frequency lock function is ON.
 - When the memory channels are empty or when temporary change of memory channels is disabled.
 - When an area outside the frequency range of the memory channel for specific band segments is touched.
 - During transmission.
 - When the TX frequency is received by TF-SET while only XIT is ON during simplex operation.

Correction steps for touchscreen tuning

● Touch with a finger on the corresponding point in the spectrum scope or waterfall display screen where signal is to be received.

- Step correction is performed according to the frequency step size of the [MULTI/CH] control configured in Menu [3-01] to [3-05] for each mode.
- Touching and holding in the CW mode activates the CW auto tune function.
- Step correction is always performed in the FM/AM mode.
- For the SSB/CW/FSK/PSK mode, configure to turn ON/OFF the step correction operation in Menu [8-7] as follows.

Turning ON/OFF Step Correction

Configure to turn ON/OFF the step correction operation during touchscreen tuning in the SSB/ CW/ FSK/ PSK mode.

● Configure in Menu [8-07] Touchscreen Tuning Step Correction (SSB/ CW/ FSK/ PSK)

Setting Value	Off/On (default)
---------------	------------------

TX/RX Frequency Marker Display

The positions of the TX and RX frequencies are indicated as markers on the bandscope screen. During split operation, the TX frequency can be changed easily by moving the TX frequency marker to the desired frequency while monitoring the bandscope screen.

The markers are color coded as follows.

- White: RX Frequency
- Red: TX Frequency

- The RX frequency before TF-SET is performed appears as purple line while [TF-SET] is pressed.

Registering Frequency Marker

When a preferred frequency (up to 50 entries) is registered to the frequency marker list, the registered frequency is indicated by a marker on the bandscope (white dotted line). Registering the edge frequency of the frequency band used in a band plan or during contesting makes it easier to check the edge frequency on the bandscope.

- 1 Press [MENU].
- 2 Press and hold F [F.MKR] to display the Frequency Marker list screen.
 - If F [F.MKR] is not displayed, press F [MORE] to display F [F.MKR].



- 3 Align with the frequency to register.
- 4 Press F4 [ADD] to register.
 - The current VFO frequency is added to the list.
 - When RIT is ON, the display frequency with RIT added is registered.
 - The list is automatically sorted in ascending order starting from the lowest frequency.
 - If the frequency to be added is already registered, it will not be registered twice and there will be no response even when F4 [ADD] is pressed.
 - If there are already 50 frequency entries in the list, the frequency will not be registered and pressing F4 [ADD] will have no response.

Deleting a Registered Frequency

- 1 Press F2 [▲]/ F3 [▼] or turn the [MULTI/CH] control to select the frequency to delete.
- 2 Press and hold F5 [(DELETE)] to delete.

Turning ON/OFF Marker Function

- 1 Press [MENU].
- 2 Press F [F.MKR].
 - If F [F.MKR] is not displayed, press F [MORE] to display F [F.MKR].
 - Pressing F [F.MKR] each time toggles the marker function between ON and OFF.

Displaying the Maximum Value in the Waveform

The maximum value of the waveform shown on the spectrum scope screen can be displayed to get a better grasp of the signal status.

Turning ON/OFF Maximum Value Display

- Press F1 [MORE] followed by F7 [MAX.HLD]. Pressing F7 [MAX.HLD] each time toggles the maximum value display between ON and OFF.

Configuring the Hold Type

Select the method of displaying the maximum value of the waveform.

- Configure in Menu [8-02] “Bandscope Maximum Hold”

Setting Value	10 [s] (default)/ Continuous
---------------	------------------------------

10 [s]: Maximum value information is cleared after 10 seconds.
Continuous: Maximum value information is not cleared.

- ✎ The maximum value information is cleared automatically if the range of the span displayed changes regardless of whether “10 [s]” or “Continuous” is selected.

Pausing the Waveform Display

The waveform display on the bandscope screen can be paused.

- Press F7 [PAUSE] to pause the waveform display.
 - When the waveform display is paused, << PAUSE >> is displayed on the screen.

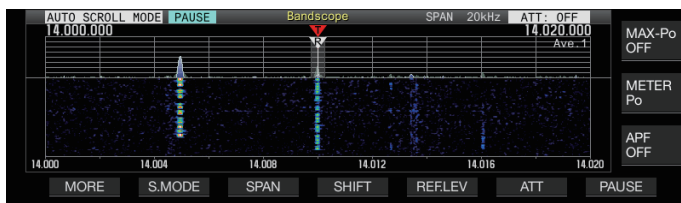

- Pressing F7 [PAUSE] again cancels the paused state.

Averaging of Spectrum Scope Waveform

Averaging the waveform on the spectrum scope smoothens the changes in the waveform display making it easier to observe the intermittent signals.

- Press F1 [MORE], then press F6 [AVE.] to switch the averaging level.
 - Pressing F6 [AVE.] each time switches the selection in the following sequence: “Off” (averaging disabled) → “1” (minimum) → “2” → “3” (maximum) → “Off”. The averaging level selected is displayed at the top right corner of the grid.
 - Pressing and holding F6 [AVE.] each time switches the options in the reverse sequence.
 - The averaging level can be configured separately for audio mode (SSB/AM/FM (including DATA mode)) and non-audio mode (CW/FSK/PSK).
 - The default settings of the audio mode and non-audio mode are “2” and “1” respectively.

Displaying the TX Signal Waveform

A waveform for the TX signal can be displayed when a bandscope for transmission is displayed in the Center mode.

- Configure in Menu [8-00] “Bandscope Display during TX”

Setting Value	Off (default)/ On
---------------	-------------------

On: Displays the TX waveform in the bandscope while transmission is in progress.

Off: Does not display the waveform in the bandscope while transmission is in progress.

- ✎ The setting for this function cannot be switched while transmission is in progress.

7 SCOPE FUNCTIONS

Audio Scope

The TX/RX audio can be displayed on an “audio scope screen” where a spectrum scope and an oscilloscope are displayed as well as on a “multi scope screen” where a reduced display of the bandscope appears at the top together with the “audio scope screen”.

Displaying the Audio Scope

● Press and hold [SCP] to display the Audio Scope screen.

Pressing and holding [SCP] each time toggles the display between “Audio Scope” and “Bandscope”.

Audio Scope Screen

Left: Spectrum scope
Right: Oscilloscope

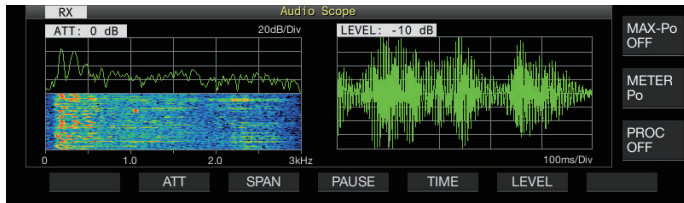

Switching the Audio Scope Display Type

1 Display the Audio Scope screen.

2 Press [SCP].

Pressing [SCP] each time switches the selection in the following sequence.

“Audio Scope screen”



“Multi Scope screen”



No scope display (ends scope display)

Multi Scope Screen

Top: Reduced bandscope display

Left: Spectrum scope

Right: Oscilloscope

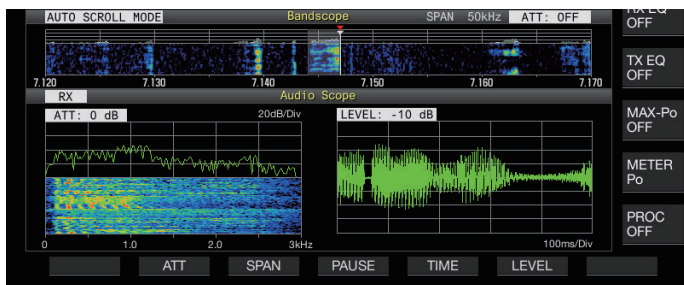

3 Press [ESC] to end the display.

Switching the Spectrum Scope Attenuator

By switching the attenuator for the spectrum scope, the spectrum display can be adjusted to a level that is easy to see.

● Press F2 [ATT].

Pressing F2 [ATT] each time switches the attenuator.

Setting Value	Off (default)/ 10 dB/ 20 dB/ 30 dB
---------------	------------------------------------

- Pressing and holding F2 [ATT] each time switches the options in the reverse sequence.
- The current setting is displayed at the top of the spectrum scope.

Switching the Display Frequency Span of the Spectrum Scope

The display frequency span of the spectrum scope can be configured to 3 kHz or 8 kHz. Configure the display frequency span to an appropriate setting according to the filter band setting and frequency to observe.

● Press F3 [SPAN].

Pressing F3 [SPAN] each time toggles the span between “3 kHz (default)” and “8 kHz”.

Display when 3 kHz is selected

Display when 8 kHz is selected

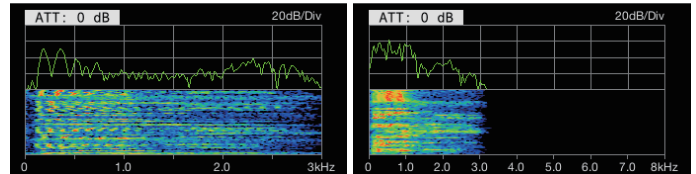

Switching the Oscilloscope Level

By switching the vertical level of the oscilloscope, the amplitude of the waveform can be adjusted to a size that is easy to see.

● Press F6 [LEVEL].

Pressing F6 [LEVEL] each time switches the level.

Setting Value	0 dB (default)/ -10 dB/ -20 dB/ -30 dB
---------------	--

- Pressing and holding F6 [LEVEL] each time switches the options in the reverse sequence.
- The current setting is displayed at the top of the oscilloscope.

Switching the Sweep Time

Switching the sweep time of the oscilloscope alters the time range of the oscilloscope display. The sweep time can be adjusted according to the status of the signal to be observed.

● Press F5 [TIME].

Pressing F5 [TIME] each time switches the sweep time.

Setting Value	1 ms/ Div/ 3 ms/ Div/ 10 ms/ Div/ 30 ms/ Div/ 100 ms/ Div (default)/ 300 ms/ Div
---------------	--

- Pressing and holding F5 [TIME] each time switches the options in the reverse sequence.
- The sweep time is displayed at the bottom of the oscilloscope.

Pausing the Audio Scope

When the waveform displayed on the Audio Scope screen is paused, the waveform is maintained until it is unpaused. The audio scope can be paused to enable analysis of the waveform without being interrupted whenever the display is refreshed.

● Press F4 [PAUSE] to pause the waveform display.

- When the waveform display is paused, << PAUSE >> is displayed and both the spectrum scope on the left and the oscilloscope on the right stop refreshing temporarily.
- Pressing F4 [PAUSE] again cancels the paused state.

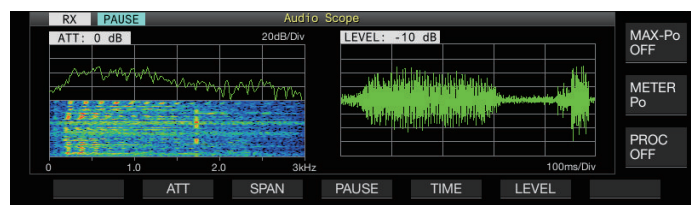

8 TRANSMIT FUNCTIONS

Configuration of the Input Path of TX Audio

The method for transmitting the audio source that is input to the MIC connector on the front panel as well as the ACC 2, (USB-B) and LAN connectors on the rear panel of this transceiver can be configured.

Audio Source Input	Description
MIC	Inputs the microphone audio when MIC is set to ON.
ACC 2	Inputs audio signal from the device connected to the ACC 2 connector when ACC 2 is set to ON.
USB Audio	Inputs audio signal from the connected PC when USB Audio is set to ON.
LAN	Inputs audio signal from the audio device connected via LAN when LAN is set to ON.

Switching the Audio Source Input

The steps to configure the audio (audio source input) to transmit via PTT/SS/SEND and DATA PTT/DATA SEND are as follows.

- A separate setting can be configured when DATA mode is in the OFF and ON status.

1 Press and hold [DATA] to display the audio source input screen.

The current ON/OFF status of the DATA mode at the transmitting end is displayed at the top left corner.



2 Press F2 [▲], F3 [▼], F4 [◀] or F5 [▶] to select the item to configure; “SEND/PTT” and “DATA SEND (PF)” for “TX Method” (row) and “Front” and “Rear” for “Audio Input” (column).

3 Press F6 [SELECT] or turn the [MULTI/CH] control to change the setting value.

- Pressing and holding F1 [(RESET)] restores both audio input settings of the selected method of transmission to the default values.
- The default setting varies as follows when DATA mode is in the ON and OFF status.

Setting Item		Setting Value	Default
DATA OFF	SEND/ PTT	Front	Off/ MIC
		Rear	Off/ ACC 2/ USB Audio/ LAN
	DATA SEND (PF)	Front	Off/ MIC
		Rear	Off/ ACC 2/ USB Audio/ LAN
DATA ON	SEND/ PTT	Front	Off/ MIC
		Rear	Off/ ACC 2/ USB Audio/ LAN
	DATA SEND (PF)	Front	Off/ MIC
		Rear	Off/ ACC 2/ USB Audio/ LAN

4 Press and hold [DATA] or press [ESC] to end the process.



- Note that some setting combinations might trigger unintended transmission by this transceiver. Also, when this transceiver is connected to a PC or another audio source via USB audio, LAN or ACC 2 and when DATA VOX is ON, sound that is emitted by the audio source might trigger transmission by this transceiver.



- These are common settings for the SSB, AM and FM modes. Although settings can also be changed during operation while the operation mode at the transmitting end is configured to CW, PSK or FSK, the settings that are displayed on the screen are those when DATA mode is in the OFF status.

VOX (Voice-Operated Transmit)

VOX (voice) is a function that automatically starts transmission when the user speaks into the microphone and returns to the receiving status when voice input stops. After speaking into the microphone, insert a short pause before returning to the receiving status.

- For Data VOX, data that is input from an audio source other than the MIC connector can also be transmitted in the same way.

Tuning ON/OFF VOX Function

The VOX function switches automatically between transmission and reception based on audio input from the microphone in the SSB, FM or AM mode.

● Press [VOX].

Pressing [VOX] each time toggles the VOX function between ON and OFF.

When the VOX function is ON, the [VOX] LED lights up in green.



- During transmission using the VOX function, audio input from the microphone is transmitted regardless of the audio source input settings.
- If transmission and reception are not performed automatically when the VOX function is set to ON, try adjusting the VOX gain level, increasing the distance between the microphone and the speaker, move closer to the microphone when speaking or turn down the volume level for incoming calls. If the above methods do not work, use a headphone.

8 TRANSMIT FUNCTIONS

Selecting Audio Source Input for Data VOX

The transmission status can be activated automatically when data audio beyond a certain level is input from the ANI terminal of the ACC 2 connector,  (USB-A or USB-B) or LAN connector on the rear panel of this transceiver in the SSB, FM or AM mode. This function is known as Data VOX.

The audio source input that is activated with the Data VOX function can be switched using the steps below.

1 Press and hold [DATA] to display the audio source input screen.

2 Press F7 [D.VOX].

Pressing F7 [D.VOX] each time switches the Data VOX audio source.

Setting Value	Off (default)/ ACC 2/ USB Audio/ LAN
---------------	--------------------------------------

- “OFF”, “ACC 2”, “USB” or “LAN” is displayed to the right of “D.VOX” at the top of the screen.

3 Press and hold [DATA] or press [ESC] to end the process.



- If this transceiver is left connected to an audio source such as a PC when Data VOX is configured to an audio source input setting other than “OFF”, this transceiver may be placed in the transmission state by the signals from the audio source.
- When this transceiver is to be left connected to the audio source, set the Data VOX audio source input to OFF to prevent transmission that is unintended.

Configuration Example

Transmission via PTT by modulating signals from MIC in the SSB mode or transmission via DATA VOX by modulating signals from a PC via USB Audio in the SSB-DATA mode.

Settings when DATA mode is OFF:

- SEND/PTT Front: MIC, Rear: Off
- DATA SEND (PF) Front: Off, Rear: USB Audio
- DATA VOX: Off

Settings when DATA mode is ON:

- SEND/PTT Front: MIC, Rear: Off
- DATA SEND (PF) Front: Off, Rear: USB Audio
- DATA VOX: USB Audio

Adjusting VOX Gain

VOX gain of the VOX function allows the VOX gain level to be adjusted according to the loudness of the audio input from the MIC connector or the noise in the surroundings.

VOX gain of the input data from the ANI terminal of the ACC 2 connector,  (USB-A or USB-B) or LAN connector on the rear panel of this transceiver can be adjusted in the Data VOX mode.

1 Press and hold [VOX] to display the VOX configuration screen.



On the VOX configuration screen, the horizontal rows represent the audio source input while the vertical columns represent the setting item.

2 Press F2 [] / F3 [] to select the audio source input (horizontal row).

Select the audio source input row to adjust from “MIC”, “ACC 2”, “USB” and “LAN”.

3 Press F4 [] / F5 [] to select the “VOX GAIN”.

4 Press F6 [-]/ F7 [+] or turn the [MULTI/CH] control to adjust the VOX level.

Input signal from the audio source selected in step 2, and adjust the level to activate transmission when audio signals are input.

Setting Value	0 to 10 (default) to 20 (1 step)
---------------	----------------------------------

5 Press and hold [VOX] or press [ESC] to end the process.



The VOX configuration screen ends when the transmitting end is configured to a mode (non-audio mode) other than SSB, AM and FM mode.

Adjusting the Anti VOX Gain Level

When the VOX function is ON, transmission may be activated by the playback sound from the speaker in some cases in addition to audio from the microphone. Speaker sound may be transmitted if the speaker volume is configured to a high level. This function can be used to prevent unintended transmission by configuring the anti VOX level to adjust the lower limit for activating the VOX function with respect to the playback sound from the speaker.

1 Press and hold [VOX] to display the VOX configuration screen.

2 Press F2 [] / F3 [] to select the audio source input.

3 Press F4 [] / F5 [] to select “ANTI VOX”.

4 Press F6 [-]/ F7 [+] or turn the [MULTI/CH] control to adjust the sensitivity of the anti VOX gain.

Adjust the sensitivity of the anti VOX level so that transmission will not be activated by the playback sound from the speaker.

Setting Value	0 to 20 (1 step)
---------------	------------------

- The smaller the anti VOX gain value, the more susceptible the transceiver is to playback sound from the speaker.
- The default settings are as follows.
 - Microphone: 10
 - ACC 2: 0
 - USB: 0
 - LAN: 0

5 Press and hold [VOX] or press [ESC] to end the process.



- When a headphone is connected to the PHONES connector, the VOX function (transmission) will not be activated by the speaker audio regardless of the audio source and anti VOX level settings.
- Anti VOX gain applies to audio sources other than Data VOX.
- The speaker output level is compared with the ANTI VOX level for any input line.

Adjusting VOX Delay Time

During transmission of audio or data using the VOX function, the transceiver may sometimes be restored to the receiving state, and the end of the audio that is clipped off may not be transmitted as a result. To prevent this from occurring, the delay time can be adjusted to insert an appropriate pause before switching from the transmitting to the receiving state.

- 1 Press and hold [VOX] to display the VOX configuration screen.
- 2 Press F2 [▲] / F3 [▼] to select the audio source input (horizontal row).
Select the audio source input row to adjust from “MIC”, “ACC 2”, “USB” and “LAN”.
- 3 Press F4 [◀] / F5 [▶] to select the “VOX DELAY”.
- 4 Press F6 [-] / F7 [+] or turn the [MULTI/CH] control to select the delay time.
Input signal from the audio source selected in step 2, and adjust the delay time before returning to the receiving state after audio input has ended.

Setting Value	0 to 10 (default) to 20 (1 step)
---------------	----------------------------------

- When “MIC” is selected, adjust the delay time while speaking into the microphone.
 - The delay time for “MIC” can also be adjusted by turning the [DELAY] control.
- 5 Press and hold [VOX] or press [ESC] to end the process.

VOX Voice Delay

When the VOX function is ON, there may be a time lag before transmission begins after voice input has started. For this reason, the beginning part of the audio may be clipped off. To prevent this phenomenon from occurring wherever possible, a VOX voice delay time can be configured between the timing when transmission is activated and before audio signals are sent out.

When using a microphone as the audio source input for transmission:

- **Configure in Menu [6-13] “VOX Voice Delay (Microphone)”**

When using devices other than a microphone as the audio source input for transmission:

- **Configure in Menu [6-14] “VOX Voice Delay (Except Microphone)”**

Setting Value	Off/ Short/ Middle (default)/ Long
---------------	------------------------------------

TX Monitor

TX audio can be monitored while transmission is in progress. This is a convenient tool for checking the effect of the speech processor or TX equalizer. In the FSK and PSK modes, FSK and PSK signals transmitted by this transceiver can be monitored.

- **Press [MONI] to turn the TX monitor ON or OFF**
The [MONI] LED lights up in green when the TX monitor is turned on.
 - The ON/OFF status of the TX monitor and monitor level are stored in the memory for each of the mode groups below. During split operation, the mode at the transmitting end will be monitored.
 - SSB/ FM/ AM
 - SSB-DATA/ FM-DATA/ AM-DATA
 - FSK/ PSK
 - Each time there is a change in the mode, the transceiver switches back to the TX monitor ON/OFF status stored in each group. TX monitor is always OFF in the CW mode.

Adjusting the TX Monitor Level

The volume level when monitoring the TX audio can be adjusted.

- 1 Press and hold [MONI] to display the TX Monitor Level configuration screen.

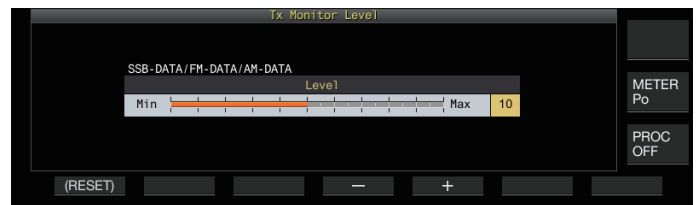

- 2 Press F4 [-] / F5 [+] or turn the [MULTI/CH] control to select the TX monitor level.

Setting Value	0 to 10 (default) to 20 (1 step)
---------------	----------------------------------

- 3 Press and hold [MONI] or press [ESC] to end the process.



- Feedback may occur when a speaker is used in the SSB, AM or FM mode. Make use of a headphone instead.
- Transmission of CW messages cannot be monitored using the TX monitor. To monitor CW messages, make use of CW sidetone.
- In the FM, FSK and PSK modes, the audio of the TX monitor may differ from the audio of the signal that is actually transmitted.

8 TRANSMIT FUNCTIONS

Speech Processor

In the SSB mode, TX output power varies according to the loudness of the audio from the transmitting transceiver, which may sometimes cause audibility to deteriorate at the receiving transceiver. A speech processor can be used in this case to compress signals via digital signal processing to raise the average power.

Similarly, using the speed processor in the AM or FM mode stabilizes the degree of modulation regardless of the loudness of the audio from the transmitting transceiver and helps to enhance intelligibility.

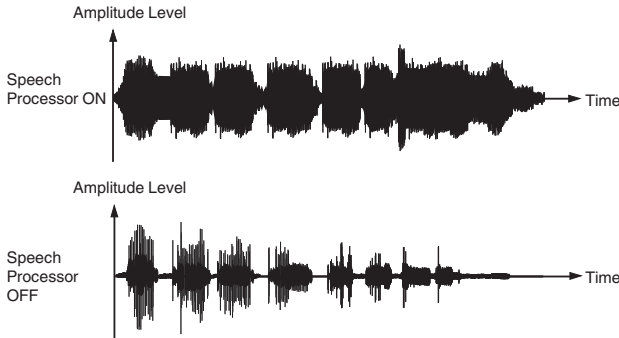

Turning ON/OFF Speech Processor

1 Press the mode key to select either SSB, AM or FM mode.

2 Press F [PROC].

Pressing F [PROC] each time toggles the speech processor between ON and OFF.

- When the speech processor is set to ON, "PROC OUT:nnn" is displayed at the top of the screen. [nnn: 0 to 100]



- The speech processor also functions with respect to audio input from the ANI terminal of the ACC 2 connector or the (USB-B) connector on the rear panel of this transceiver.

Configuring the Speech Processor Input Level

1 Press and hold F [PROC] to display the Speech Processor configuration screen

SSB/SSB-DATA/AM/AM-DATA Mode

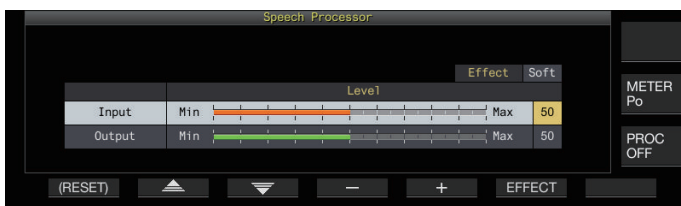

FM/FM-DATA Mode

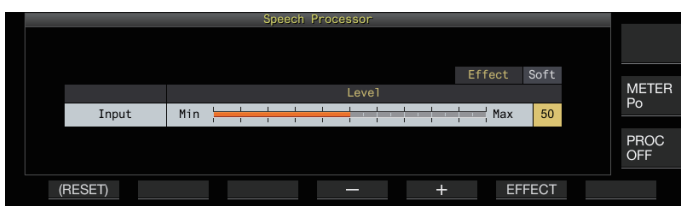

- Switching the mode at the transmitting end to a non-audio mode while the Speech Processor configuration screen is displayed ends the Speech Processor configuration screen.

2 Press F2 [▲]/ F3 [▼] to select "Input".

3 Press F4 [-]/ F5 [+] or turn the [MULTI/CH] control to adjust the input level.

Setting Value 0 to 50 (default) to 100 (1 step)

4 Press and hold F [PROC] or press [ESC] to end the process.



- The speech processor input level is used to adjust the input level of the mixed audio between the audio source input configured for microphone gain and that configured on the audio source input screen.
- Switching the mode at the transmitting end to a non-audio mode while the Speech Processor configuration screen is displayed ends the Speech Processor configuration screen.

Configuring the Speech Processor Output Level

1 Press and hold F [PROC] to display the Speech Processor configuration screen.

2 Press F2 [▲]/ F3 [▼] to select "Output".

- "Output" is not displayed when the transmitting transceiver is in the FM mode.

3 Press F4 [-]/ F5 [+] or turn the [MULTI/CH] control to adjust the output level.

- The output level can also be adjusted by turning the [MIC/ PITCH] control.

Setting Value 0 to 50 (default) to 100 (1 step)

4 Press and hold F [PROC] or press [ESC] to end the process.



- Configuring the output to a level that is too high causes distortion to occur in the TX signals and deterioration in the radio wave quality as a result.
- The speech processor output level is applied to both the audio input from the microphone as well as the audio source configured on the audio source input screen.
- The speech processor output level is fixed and not changeable in the FM mode.

Configuring the Speech Processor Effect

It is possible to configure how TX signals are to be processed by the speech processor.

● Press F6 [EFFECT].

Pressing F6 [EFFECT] each time switches the effect type.

Setting Value Soft (default)/ Hard

Hard: Places priority on raising the average power although signals may remain distorted.

Soft: Places priority on reducing the level of distortion with minimal effect on raising the average power.



- The speech processor effect selected is the same in each mode.

TX Filter

Configure the bandwidth of the SSB/AM or SSB-DATA/AM-DATA TX filter to a low cutoff frequency or a high cutoff frequency.

Changing the TX Filter Bandwidth

- ⚠ Please make use of the TX filter while ensuring that the occupied bandwidth in the SSB mode falls within the permitted range as stipulated by the relevant laws.

Configuring the Low Cutoff Frequency in the SSB/AM Mode

- **Configure in Menu [6-06] “TX Filter Low Cut (SSB/AM)”**

Setting Value	10/ 100 (default)/ 200/ 300/ 400/ 500 [Hz]
---------------	--

Configuring the High Cutoff Frequency in the SSB/AM Mode

- **Configure in Menu [6-07] “TX Filter High Cut (SSB/AM)”**

Setting Value	2500/ 2600/ 2700/ 2800/ 2900 (default)/ 3000/ 3500/ 4000 [Hz]
---------------	---

Configuring the Low Cutoff Frequency in the SSB-DATA/AM-DATA Mode

- **Configure in Menu [6-08] “TX Filter Low Cut (SSB-DATA/AM-DATA)”**

Setting Value	10/ 100 (default)/ 200/ 300/ 400/ 500 [Hz]
---------------	--

Configuring the High Cutoff Frequency in the SSB-DATA/AM-DATA Mode

- **Configure in Menu [6-09] “TX Filter High Cut (SSB-DATA/AM-DATA)”**

Setting Value	2500/ 2600/ 2700/ 2800/ 2900 (default)/ 3000/ 3500/ 4000 [Hz]
---------------	---

Displaying the Filter Scope during Transmission

During transmission, an image of the passband for the TX filter and the spectrum of the TX audio can be displayed on the filter scope.

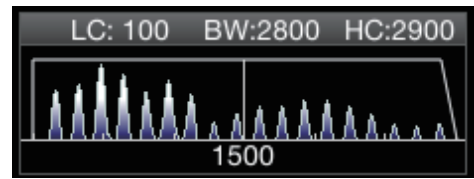

- **Configure in Menu [8-01] “TX Audio Waveform Display”**

Setting Value	Off/ On (default)
---------------	-------------------

On: Displays an image of the passband for the TX filter and the audio spectrum of the TX audio on the filter scope during transmission in the SSB/FM/AM mode.

Off: The filter scope area maintains the last display during transmission and the waveform is not displayed.

- ✎ During transmission in the CW, PSK and FSK modes, the image of the filter passband characteristics during reception is maintained. In modes other than those above, an image of the filter passband characteristics is displayed based on the HI/LO cut setting of the TX filter. In the FM (including DATA) mode, an image of the passband characteristics for the fixed filter is displayed.
- When the Audio Scope screen is displayed, the audio spectrum in the filter scope is not displayed.
- The setting for this function cannot be switched while transmission is in progress.
- When HI/SHIFT or LO/WIDTH is operated during transmission while the filter scope display during transmission is ON, the setting value of the RX filter changes and the RX filter display appears temporarily.

TX Equalizer

This item can be used to alter the frequency characteristics of the TX audio via DSP sound processing. It enables correction of the microphone frequency characteristics as well as transmission in the audio quality according to the audio properties or user’s preferences.

Turning ON/OFF TX Equalizer

- 1 Press the mode key to select either SSB, AM or FM mode.**
- 2 Press F [TX EQ].**
Pressing **F [TX EQ]** each time toggles the TX equalizer between ON and OFF.

- ✎ The TX equalizer turns OFF automatically when this transceiver is configured to a mode other than SSB, AM or FM.

8 TRANSMIT FUNCTIONS

Selecting a Frequency Characteristic for the TX Equalizer

This transceiver comes with 6 types of frequency characteristics for the TX equalizer. In addition, there are 3 other types that can be customized according to the user's preferences. A selection can be made from these options.

- 1 Press and hold F [TX EQ] to display the TX Equalizer screen.

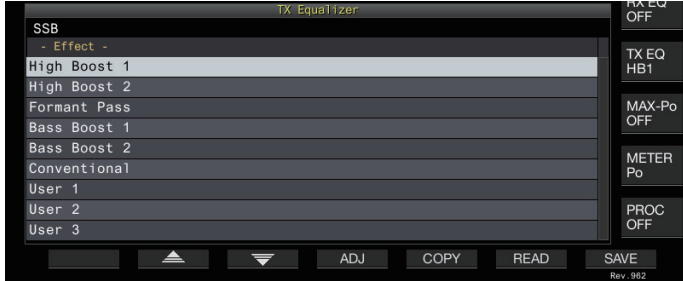

- 2 Press F2 [▲]/F3 [▼] or turn the [MULTI/CH] control to select a characteristic.

- Make a selection based on the equalizer effects in the table below.

Effects	Purpose
High Boost 1 (HB1)	Boosts the high frequency component. This is effective for audio sound that contains a low frequency component.
High Boost 2 (HB2)	Boosts the high frequency component. The low frequency attenuation level for this option is half of that of the HB1 option.
Formant Pass (FP)	This option attenuates frequency components that is outside the audio bandwidth so that the audio can be heard more clearly.
Bass Boost 1 (BB1)	Boosts the low frequency component. This is effective for audio sound that contains a high frequency component.
Bass Boost 2 (BB2)	Boosts the low frequency component. The low frequency is further boosted compared to BB1.
Conventional (C)	Applies a 3 dB boost to the frequency range of 600 Hz or higher. This is suited for communication that attenuates gradually as it approaches the low frequency range.
User 1 (U1)	Frequency characteristics can be adjusted according to the user's preferences and stored in the options between User 1 and User 3. The flat frequency characteristic is selected in the default setting.
User 2 (U2)	
User 3 (U3)	

- 3 Press and hold F [TX EQ] or press [ESC] to end the process.

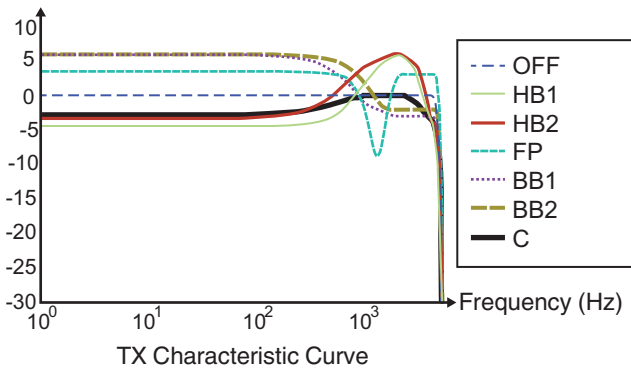

Adjusting the TX Equalizer

The frequency characteristics of the TX equalizer can be adjusted to produce the desired sound quality.

- 1 Press and hold F [TX EQ] to display the TX Equalizer screen.
- 2 Press F2 [▲]/F3 [▼] or turn the [MULTI/CH] control to select a characteristic.
- 3 Press F3 [ADJ] to display the TX Equalizer Adjustment screen.

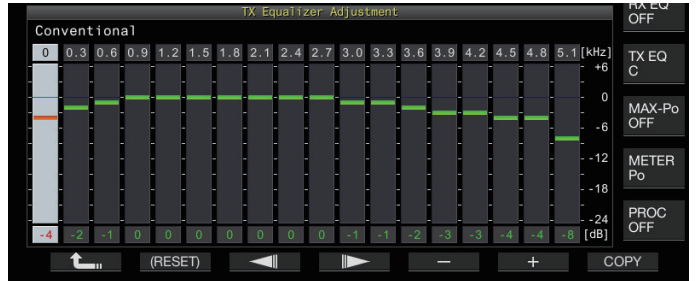

- 4 Press F3 [◀|||]/F4 [|||▶] to select the frequency band to adjust.
- 5 Press F5 [-]/F6 [+] or turn the [MULTI/CH] control to adjust the level of each frequency band.
 - Touching a point on the RX Equalizer Adjustment screen selects the corresponding band and changes the frequency to the selected level.
 - An alternative way is to touch a rough point followed by fine-tuning in steps 3 and 4.
 - Pressing and holding F2 [(RESET)] resets all the frequency levels to the default setting.
- 6 Press and hold F [TX EQ] or press [ESC] to end the process.

Copying the TX Equalizer Settings

Equalizer effects that are configured according to the user's preferences can be copied and saved as user-defined settings.

- 1 Press and hold F [TX EQ] to display the TX Equalizer screen.
- 2 Press F2 [▲]/F3 [▼] or turn the [MULTI/CH] control to select a characteristic.



- 3 Press F5 [COPY].
A message with instructions on how to specify the destination for saving the settings is displayed.

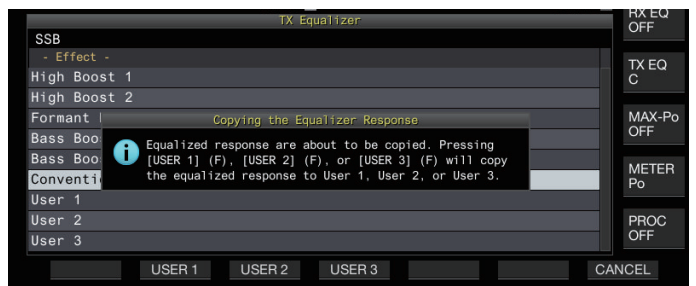

- To copy after adjusting the TX equalizer settings, press **F5 [COPY]** on the TX Equalizer Adjustment screen.
- Press **F2 [USER1]**, **F3 [USER2]** or **F4 [USER3]** to specify the destination for saving the settings.
 - Copying of the TX equalizer settings is complete and the display returns to the TX Equalizer screen.
 - Pressing **F7 [CANCEL]** returns the display to the TX Equalizer screen without copying the settings.
 - Press and hold **F [TX EQ]** or press **[ESC]** to end the process.

Saving the TX Equalizer Settings

- The steps to write the TX equalizer settings data are as follows.
- Before doing so, configure the destination for saving the data in “File Storage Location” of the “USB/File Management Menu” (11-2) to “Internal Memory” or “USB Flash Drive”.
 - To save the data to a USB flash drive, insert a USB flash drive formatted using this transceiver into (USB-A).

- Press and hold **F [TX EQ]** to display the TX Equalizer screen.
- Press **F2 [▲]** / **F3 [▼]** or turn the **[MULTI/CH]** control to select a characteristic.



- Press **F7 [SAVE]**.
A message indicating that saving is complete is displayed.

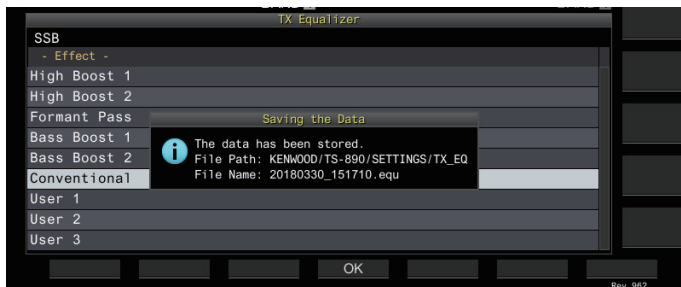

- Press **F4 [OK]**.
- Press and hold **F [TX EQ]** or press **[ESC]** to end the process.

- The saved file is named in the “yyyymmdd_hhmmss” format. The extension of the saved file is “equ”. (Example) If the date is 10:20:30 a.m., February 15, 2018: 20180215_102030.equ
- The name of the destination folder is as follows. (The name varies depending on the destination for saving files.)
USB flash drive: “KENWOOD\TS-890\SETTINGS\RX_EQ”
Built-in memory: “SETTINGS\RX_EQ”
- When removing the USB flash drive, make sure to execute “Safely Removing the USB Flash Drive” (11-6).

Reading the TX Equalizer Settings

- The steps to read the TX equalizer settings that are saved in the internal memory or USB flash drive are as follows.
- To read data from a USB flash drive, insert the USB flash drive containing the TX equalizer data into (USB-A).

- Press and hold **F [TX EQ]** to display the TX Equalizer screen.
- Press **F2 [▲]** / **F3 [▼]** or turn the **[MULTI/CH]** control to select an equalizer characteristic to read.



- Press **F6 [READ]** to display the File (TX EQ.) screen.
 - The File (TX Equalizer) screen appears.

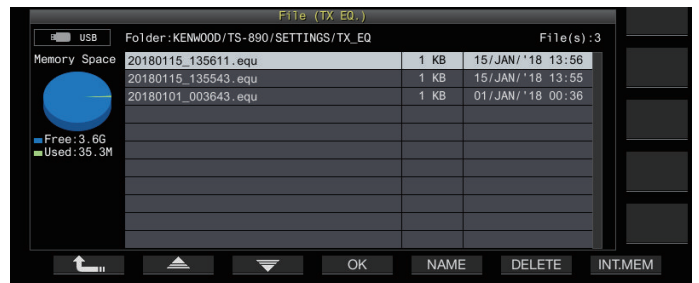

- To read data from the internal memory, press **F7 [INT.MEM]**.
- To read data from the USB flash drive, press **F7 [USB.MEM]**.
- Pressing **F1 [↶]** exits data file selection and returns the display to the TX Equalizer screen.
- Pressing **F6 [DELETE]** displays a message to confirm deletion of the file. Pressing **F4 [OK]** deletes the file.
- Pressing **F5 [NAME]** allows the file name to be changed.

- Press **F2 [▲]** / **F3 [▼]** or turn the **[MULTI/CH]** control to select a file.
- Press **F4 [OK]** to read the settings data.
 - A “reading” message appears while reading is in progress, which changes to a “reading complete” message when reading is complete.
- Press **F4 [OK]**.
- Press and hold **F [TX EQ]** or press **[ESC]** to end the process.

- When removing the USB flash drive, make sure to execute “Safely Removing the USB Flash Drive” (11-6).
- The settings data read will be overwritten even if the equalizer type of the setting application destination selected in step 2 varies from the equalizer type of the setting application source selected in step 3.

8 TRANSMIT FUNCTIONS

TX Tuning

This is a function that transmits constant output carrier continuously regardless of the current TX mode. It is used for purposes such as adjusting external antenna tuners or linear amplifiers.

Assign TX tuning (“TX Tune 1” or “TX Tune 2”) to a PF key. For more details, please refer to “PF Keys (Programmable Function Keys)” (16-2).

toggling between transmission and reception each time the key is pressed:

- 1 Press the PF key that is assigned with “TX Tune 1”.**
 - Transmits with a continuous carrier in the CW mode.
 - << **TX TUNE** >> starts to blink.
 - The meter switches to SWR.
- 2 Press the PF key that is assigned with “TX Tune 1” again.**
 - Stops transmission and returns to the original mode.

Activating transmission only while the key is pressed:

- 1 Press the PF key that is assigned with “TX Tune 2”.**
 - Transmits in the CW mode while the key is pressed.
 - << **TX TUNE** >> starts to blink.
 - The meter switches to SWR.
- 2 Release the PF key that is assigned with “TX Tune 2”.**
 - Stops transmission and returns to the original mode.

Adjusting TX Output Power during TX Tuning

- 1 Press and hold F [MAX-Po] to display the Transmit Power Limit screen.**



- 2 Press F4 [◀|||] / F5 [||▶] to select a frequency band.** The settings of the selected frequency band column can be changed.
- 3 Press F2 [▲] / F3 [▼] to select the “TX Tune Power” (horizontal row).**
- 4 Press F6 [-] / F7 [+] or turn the [MULTI/CH] control to select a TX output power.**

Setting Value	5 to 10 (default) to 100 [W] (1-step)
---------------	---------------------------------------

- 5 Press and hold F [MAX-Po] or press [ESC] to end the process.**

Timeout Timer (TOT)

This function forcibly stops transmission and restores the receiving status when the preconfigured TX time is exceeded.

- **Configure in Menu [6-02] “Time-out Timer”**

Setting Value	Off (default)/ 3/ 5/ 10/ 20/ 30 [min]
---------------	---------------------------------------

ID Beep

During continuous transmission via the [SEND] key, [PTT] on the microphone or the SS/PKS function on the rear panel, a beep tone (ID ID “ · · - · · · · · - · · ”) is output whenever the preconfigured duration from the time transmission starts is exceeded.

- **Configure in Menu [6-05] “ID Beep”**

Setting Value	Off (default)/ 1 to 30 [min] (1 step)
---------------	---------------------------------------



- The transceiver may not function as intended in some cases as it may return to the receiving state during CW break-in or VOX transmission.

9 MEMORY CHANNELS

This transceiver comes with 120 memory channels, each of which can be used for registering operating data.

The 120 memory channels are divided into 3 types which are assigned respectively with the following channel numbers: 00 to 99, P0 to P9 and E0 to E9. Below is a general outline of the respective memory channel types.

00 to 99 (standard memory channels):

For registering operating data that are frequently used.

P0 to P9 (memory channels for specific band segments):

For registering programmable VFO or program scan frequency ranges.

E0 to E9 (expanded memory channels):

These can be used in the same way as the standard memory channels.

Data that can be registered in each of the memory channels are as follows.

Operating Data	Channel	
	00 to 99/ E0 to E9	P0 to P9
RX Frequency	Yes	Yes (Simplex)
TX Frequency	Yes	
RX Mode	Yes	Yes (Simplex)
TX Mode	Yes	
Split Operation	Yes	No
Start Frequency	No	Yes
End Frequency	No	Yes
Tone/CTCSS/Cross Tone	Yes	Yes
Tone Frequency	Yes	Yes
CTCSS Frequency	Yes	Yes
Memory Name	Yes	Yes
Lockout	Yes	Yes

Displaying the Memory Channel List

Settings registered in a memory channel can be displayed on the Memory Channel List screen. The channel for registering operating frequency data or the channel to use can be selected on the Memory Channel List screen.

Memory channels can be assigned with names on this screen. A memory channel can be selected on the Memory Channel List screen.

1 Press F7 [M.LIST] to display the Memory Channel List screen.

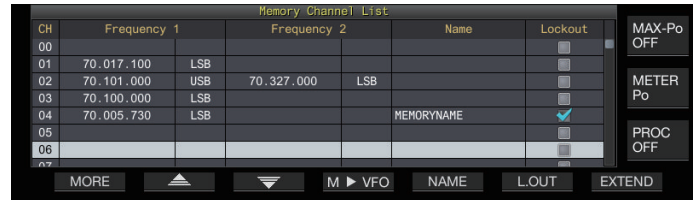

- The selected memory channel is indicated in white color. When registering data to the memory channel, it changes into a pink display.
- Pressing **F7 [EXTEND]** enlarges the Memory Channel List screen display. Pressing it again restores the screen to the original size.

2 Press F2 [\blacktriangle] / F3 [\blacktriangledown] or turn the [MULTI/CH] control to select a memory channel.

Operating frequency data that are displayed on the Memory Channel List screen are as follows.

Operating Data	Description
CH	Displays the channel number. 00 to 99: standard memory channels P0 to P9: memory channels for specific band segments E0 to E9: expanded memory channels
Frequency 1	Registers a single frequency and mode for simplex channels. (Simplex operation frequency or radio station frequency) Registers the RX frequency and mode during split operation for split channels. Registers the start frequency and mode of a band segment for memory channels assigned to specific band segments.
Frequency 2	This is left blank in the case of simplex channels. Registers the TX frequency and mode during split operation for split channels. Registers the end frequency and mode of a band segment for memory channels assigned to specific band segments.
Name	Displays the name of the memory channel.
Lockout	Displays the lockout status of the respective memory channels. Memory scan is not performed for channels selected with a check mark.

9 MEMORY CHANNELS

Registering Operating Frequency Data to a Memory Channel

The steps to register the frequency and mode to the memory channel are as follows.

- To register a split channel, press [SPLIT] to switch to the split mode and operate accordingly.

- 1 **Configure the frequency and mode to register.**
- 2 **Press F7 [M.LIST] to display the Memory Channel List screen.**
- 3 **Press [^ M.IN].**
- 4 **Press F2 [▲] / F3 [▼] or turn the [MULTI/CH] control to select the memory channel for registering the operating data.**
 - Choose a memory channel from 00 to 99 or E0 to E9.
- 5 **Press [^ M.IN] or F4 [M.IN] to register the operating data.**
 - Pressing F1 [CANCEL] or [ESC] exits the Memory Channel List screen without registering the operating data to the memory channel.

Configuring the Operating Data through Direct Frequency Entry

The numeric keypad can be used to register a frequency to a memory channel or make changes to an operating data that is already registered to a memory channel. This is handy for adjusting the frequency to a station with a fixed frequency.

- 1 **Turn the [MULTI/CH] control to select the memory channel (00 to 99 or E0 to E9) for registering the operating data.**
- 2 **Press [ENT] to enable use of the numeric keypad.**
 - The frequency entry mode starts up in the corresponding band with all the frequency digits appearing as “-”.
 - To change the operating mode, press the mode key.

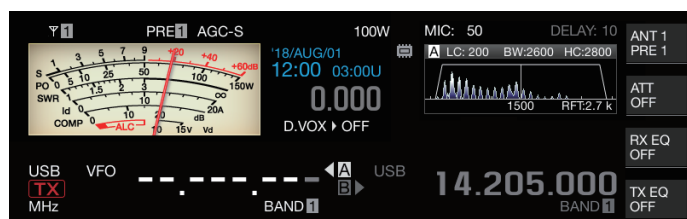

- 3 **Key in a frequency value using the numeric keypad.**
 - “-” changes into a numeric value when a numeric key is pressed and a value can be input starting from the highest-order digit.
 - To enter 1.82 MHz, press [0/50], [1/1.8], [8/24] followed by [2/3.5], and press [ENT] when input is complete.
 - To enter a frequency lower than 6 MHz for K type transceivers, start by keying in a “0”.
 - To enter a frequency lower than 8 MHz for E type transceivers, start by keying in a “0”.
 - Pressing [CLR] clears the input and exits the frequency entry mode.
- 4 **Press [ENT] to register the operating data.**

The operating data is now registered to the memory channel selected in step 2.

Memory Channel Mode

An operating data can be called up from a memory channel for transmission or reception. Operating data such as the TX and RX frequencies, mode and tone can be changed temporarily.

Operating in the Memory Channel Mode

Follow the steps below to call up the operating data of a memory channel. Operating data that is registered in the memory channel selected on the memory channel list is called up.

- 1 **Pressing [M/V] in the VFO mode to switch to the memory channel mode.**

The selected band switches to the operating data that is registered in the memory channel on the memory channel list, and the memory channel number that is used is displayed on the screen.



- 2 **Press [UP] or [DOWN] on the microphone or turn the [MULTI/CH] control to switch to the target memory channel.**
- 3 **Pressing [M/V] again exits the memory channel mode.**

The transceiver returns to the VFO mode.

Direct Entry of a Memory Channel Number

A memory channel number can be selected by pressing the corresponding number on the numeric keypad.

- 1 **Enter the tens digit of the memory channel using the numeric keypad.**
 - The tens digit of the channel number is being entered for the selected band while the ones digit appears as “-”.
- 2 **Enter the ones digit of the memory channel using the numeric keypad.**
 - The operating data corresponding to the entered number is called up and the channel number entry mode ends.
 - Pressing [CLR] clears the input and exits the channel number entry mode.

Changing the Memory Channel Temporarily

During operation in the memory channel mode, it is possible to change the frequency and mode temporarily without affecting the registered memory channel settings.

Changing the Frequency Temporarily

Follow the steps below to change the frequency temporarily.

1 Configure Menu [4-01] “Temporary Change (Memory Channel Configurations)” to “On”.

Setting Value	Off (default)/ On
---------------	-------------------

2 Press [M/V] to switch to the memory channel mode.

3 Turn the Tuning control to alter the frequency.

To register a frequency that has been changed, store it in a different memory channel.



- For memory channels assigned to specific band segments, changing the frequency or mode alters the operating data that is registered in the corresponding memory channel regardless of this setting.
- Operating data related to the operating mode and FM tone can be altered temporarily regardless of this setting.

Copying the Operating Data of a Memory Channel

Operating data of a memory channel can be copied to a VFO or another memory channel.

Memory Shift (Memory → VFO)

The operating data of a memory channel can be copied to a VFO. It comes in handy when the frequency to use is near the frequency registered in a memory channel.

Selecting a Memory Channel and Copying to VFO

1 Turn the [MULTI/CH] control in the memory channel mode to select a memory channel.

2 Press and hold [M/V], or press F6 [M ► VFO] to copy the operating data to the VFO.

The operating data of the selected memory channel is copied to the VFO.

- The transceiver exits the memory channel mode and enters the VFO mode.
- When the operating data is temporarily changed, the altered operating data is copied to the VFO.
- Operating data of memory channels assigned to specific band segments cannot be copied to a VFO.
- Operating data that is registered in “Frequency 1” is copied to the VFO.
- Performing memory shift of a split memory channel copies the information of Frequency 1 to VFO A and that of Frequency 2 to VFO B and switches the VFO mode to the split state.

Copying Data from the Memory Channel List Screen to VFO

1 Press F7 [M.LIST] to display the Memory Channel List screen.

2 Press F2 [▲] / F3 [▼] or turn the [MULTI/CH] control to select a memory channel.

3 Press and hold [M/V], or press F4 [M ► VFO] to copy the operating data to the VFO.

- After operating data is copied to a VFO, the data at the source will be erased.
- The transceiver exits the memory channel mode and enters the VFO mode.
- Operating data of memory channels assigned to specific band segments cannot be copied to a VFO.
- When in the VFO mode, operating data that is registered in the memory channel selected on the Memory Channel List screen is copied to the VFO.

Channel-to-Channel Copying

Operating data of a memory channel can also be copied to another memory channel. This is useful in cases such as when sorting the registered memory channels in a certain sequence.

1 Press F7 [M.LIST] to display the Memory Channel List screen.

2 Press F2 [▲] / F3 [▼] or turn the [MULTI/CH] control to select the memory channel for which the operating data is to be copied.

3 Press F6 [COPY] to copy the operating data.

- The memory channel that is being copied changes into a pink display.

4 Press F2 [▲] / F3 [▼] or turn the [MULTI/CH] control to select the memory channel for registering the copied operating data.

5 Press F4 [M.IN] to end the process.

- Operating data of the memory channel selected in step 2 is copied to the memory channel selected in step 4.
- Pressing F1 [CANCEL] or [ESC] ends the operation without copying the operating data.



- Operating data of the standard memory channels (00 to 99) and expanded memory channels (E0 to E9) cannot be copied to memory channels assigned to specific band segments (P0 to P9). The same applies to copying from memory channels for specific band segments to standard and expanded memory channels.
- Operating data cannot be copied from memory channels that are not registered with operating data.

9 MEMORY CHANNELS

Configuring the Program Scan Frequency Range

The frequency range for programmable VFO or program scan can be registered to the memory channels from P0 to P9. Register the start frequency and end frequency in advance to enable changes to the frequency or scanning operation within a specific range. For more details on program scan, please refer to Chapter 10.

- 1 When in the VFO mode, turn the Tuning or [MULTI/CH] control to align the VFO frequency with the frequency at which to start scanning.
- 2 Press [∧ M.IN] to display the Memory Channel List screen.
- 3 Press F2 [▲] / F3 [▼] or turn the [MULTI/CH] control to select the memory channel (P0 to P9) for registering the frequency range.
- 4 Press F4 [M.IN] or [∧ M.IN] to register the start frequency.
The start frequency is registered to "Frequency 1".
- 5 Turn the Tuning or [MULTI/CH] control to align the VFO frequency with the end frequency.
- 6 Press F4 [M.IN] or [∧ M.IN] to register the end frequency.
The end frequency is registered to "Frequency 2" and the transceiver exits the Memory Channel List screen.

Erasing Memory Channels

Data from a registered memory channel can be erased.

- 1 Press F7 [M.LIST] to display the Memory Channel List screen.
- 2 Press F2 [▲] / F3 [▼] or turn the [MULTI/CH] control to select a memory channel to be erased.
- 3 Press and hold F4 [(CLEAR)] to erase the operating data.

- When the operating data of a memory channel is erased during operating in the memory channel mode, the corresponding channel number will be maintained but there will be no registered data inside.
- To erase all the memory channels, perform memory channel reset.

Registering a Memory Channel Name

Each memory channel can also be assigned with a name. The name should contain not more than 10 characters (alphanumeric characters and symbols).

- 1 Press F7 [M.LIST] to display the Memory Channel List screen.
- 2 Press F2 [▲] / F3 [▼] or turn the [MULTI/CH] control to select the memory channel to be named.
- 3 Press F4 [NAME].
- 4 Use the function keys, [MULTI/CH] control or USB keyboard to enter a name.
 - Enter a name that contains not more than 10 characters.

Key	Behavior
F1 [SPACE]	Inserts a space.
F2 [-] / F3 [+]	Selects a character.
F4 [◀] / F5 [▶]	Moves the cursor.
F [BACK SPACE]	Deletes the character to the left of the cursor.
F [DEL]	Deletes the character to the right of the cursor.
F [CHAR]	Switches the type of character to edit. Pressing the key each time switches the selection in the following sequence: ABC (upper case) → abc (lower case) → !"# (symbols) → ABC (upper case)

CH	Frequency 1	Frequency 2	Name	Lockout	INS
00	14.195.000	14.205.000	DUAL		
01					
02					
03					
04					
05					
06					
07					

- 5 Press F6 [SAVE] to register the name.
 - Pressing F7 [CANCEL] returns the display to the Memory Channel List screen without assigning a name to the memory channel.

- Characters that can be used are characters that can be input using the keyboard selected in menu [9-01] "Keyboard Language (USB Keyboard)".
- Quick memory channels cannot be assigned with a name.
- Only memory channels that contain registered operating data can be assigned a name.

Quick Memory Channels

Quick memory is a function that enables speedy registration of temporary data without specifying a memory channel. For example, this function is useful for registering the operating data of the mobile station that this transceiver communicates with when moving within a specific band to search for a DX station. A quick memory channel can be called up only during operation in the VFO mode. The following types of operating data can be registered to a quick memory channel.

- Frequency/mode of VFO A and VFO B
- TX and RX functions
- Status of the RIT function
- Status of the XIT function
- RIT/XIT frequency
- Status of the FINE-tuning function
- Status of the noise blanker
- Noise reduction status
- Status of the beat canceler
- Status of the notch filter function
- RX filter

Registering a Quick Memory Channel

Up to 10 quick memory channels (Q0 to Q9) can be registered on this transceiver. The latest operating data that is registered is assigned to “Q0”. Whenever operating data is newly registered, the current registered data in “Q0” will be shifted to “Q1”, while the newly-registered data will occupy the “Q0” channel.

● Press [**<Q-M.IN**] to register the operating data to the quick memory channel.

- When in the VFO mode, pressing [**<Q-M.IN**] registers the operating data to the channel 0.
- When in the quick memory channel mode, pressing [**<Q-M.IN**] registers the operating data to the selected quick memory channel.
- Each time new operating data is registered, the currently-registered data will be shifted to the next larger channel number.



- When the memory channel mode is active, pressing [**<Q-M.IN**] does not register data to a quick memory channel.
- If all the quick memory channels are occupied with registered data, pressing [**<Q-M.IN**] erases the oldest operating data which is stored in the largest quick memory channel number.

Calling up a Quick Memory Channel

Follow the steps below to call up a registered quick memory channel.

1 Press [**Q-MR>**] to call up the operating data from the quick memory channel.

Displays the quick memory channel number.

2 Turn the [**MULTI/CH**] control to switch the quick memory channel.

- Pressing [**Q-MR>**] again exits the quick memory channel mode and returns the transceiver to the VFO mode.



- When data is retrieved from a memory channel for use or when operating data is not registered to the quick memory channel, pressing [**Q-MR>**] does not call up the quick memory channel.
- Temporary changes can be made to the frequency and other operating data without affecting the operating data that is registered in the quick memory channel. To register the operating data after changes are made, press [**<Q-M.IN**] to register it to a quick memory.

Configuring the Number of Quick Memory Channels

This transceiver comes with 10 quick memory channels (Q0 to Q9). However, it is possible to customize the number of quick memory channels for registering data.

● Configure in Menu [4-00] “Number of Quick Memory Channels”

Setting Value	3/ 5 (default)/ 10 [ch]
---------------	-------------------------



- When the number of quick memory channels is reduced from a larger to a smaller number, registered data that exceeds the smaller number of channels will be erased.
- The preconfigured number of quick memory channels cannot be changed when a quick memory channel is being called up.

Erasing a Quick Memory Channel

Follow the steps below to erase all registered operating data from the quick memory channels.

1 Press [**Q-MR>**] to call up a quick memory channel.

2 Press and hold [**Q-MR>**].

A message appears which prompts the user to confirm deletion of all the operating data in the quick memory channels.

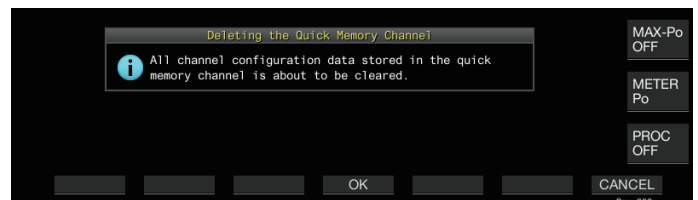

3 Press F4 [**OK**] to erase the operating data.

- Operating data is erased from the quick memory channels and the transceiver switches to the VFO mode.
- Pressing F7 [**CANCEL**] clears the confirmation message without erasing the operating data from the quick memory channels.

9 MEMORY CHANNELS

Memory Shift (Quick Memory → VFO)

Follow the steps below to copy the operating data of a quick memory channel to the VFO.

- 1 Press [Q-MR>] to call up a quick memory channel.**
- 2 Turn the [MULTI/CH] control to select the quick memory channel for which the operating data is to be copied.**
- 3 Press and hold [M/V], or press F6 [M ► VFO].**
 - Operating data is copied from the quick memory channel to the VFO and the transceiver switches to the VFO mode.
 - When the operating data is temporarily changed, the altered operating data is copied to the VFO.

10 SCAN

Scan is a function that searches for signals by automatically altering the frequency. This transceiver makes use of the following scan methods to search for signals.

Scan Type		Purpose
Normal Scan	Program Scan	Performs scan in the frequency ranges that are registered in the memory channels for specific band segments (P0 to P9).
	VFO Scan	Performs scan on the entire RX frequency band. When Program Scan is set to OFF for all the memory channels for specific band segments, Program Scan switches automatically to VFO Scan. However, when VFO Scan is selected, VFO Scan is performed even when not all channels are set to OFF.
Scan Using Memory Channels	All-Channel Scan	Scans all Memory channels from 00 to 99, P0 to P9, and E0 to E9.
	Group Scan	Scans the grouped memory channels.
	Quick Memory Scan	Scans the Quick Memory channels.

Program Scan

Program Scan performs scan between the range specified by the start and end frequencies which are registered in the each of memory channels for specific band segments (P0 to P9).

- Configure the frequency range for Program Scan in the memory channels for specific band segments (P0 to P9). Up to 10 frequency ranges that are transmitted by specific stations can be preconfigured. Enabling standby in a nearby frequency makes it easy to perform tuning to a specific station when the station starts communication in the preconfigured frequency range.



- Program Scan performs scan between the start and end frequencies of a memory channel for specific band segments and moves to the next channel after scanning of the specified frequency range has ended.
- While scanning is in progress, turning the **Tuning** or **[MULTI/CH]** control allows the frequency to be changed quickly. The same operation can also be used to change the scanning direction.
- Scanning is performed in the ascending order from low to high frequency. Configuring the end frequency to a value smaller than the start frequency by turning the **Tuning** or **[MULTI/CH]** control reverses the scanning direction (high to low frequency).
- Scanning is performed based on the step frequency of the **Tuning** control when in the SSB, CW, FSK and PSK modes, while it is based on the step frequency of the **[MULTI/CH]** control when in the FM mode, and fixed at 100 Hz in the AM mode.
- Scanning stops when signals are received while performing Program Scan (VFO Scan) in the FM mode or during Memory Scan (All-channel Scan or Group Scan) or Quick Memory Scan regardless of the operating mode. For more information on the conditions to resume scanning, please refer to “[Configuring the Conditions for Resuming Scan](#)” (10-4).
- During standby for the CTCSS tone in the FM mode, scan stops only when there is a matching CTCSS tone.
- When the **[SQL]** control is turned to the right to a level that far exceeds the squelch threshold while in the FM mode, scanning may not stop even at a channel where a signal is present. Configure the squelch level to a point that is near the squelch threshold.

Starting the Program Scan (VFO Scan)

- 1 Press **[M/V]** to switch to VFO mode.
- 2 Press **F5 [SCAN]** to start program scan (VFO scan).
 - Pressing **F5 [SCAN]** again or **[ESC]** ends the Program Scan (VFO Scan).



Configuring the Program Scan (VFO Scan) Frequency Range

Scanning can be configured to the frequency range specified in the memory channels for specific band segments (Program Scan) or the entire RX frequency band (VFO Scan). To perform Program Scan, register the memory channels for specific band segments.

- 1 Press **[M/V]** to switch to VFO mode.
- 2 Press and hold **F5 [SCAN]** to display the VFO/Program Scan configuration screen.

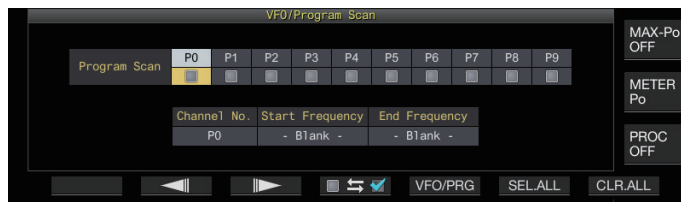

- 3 Press **F5 [VFO/PROG]** to display the Program Scan segment screen.
- 4 Press **F2 [◀|||]/ F3 [|||▶]** to select a memory channel for specific band segments.
- 5 Press **F4 [☐ ↔ ☑]** to select whether to scan the memory channel for specific band segments.
 - Pressing **F4 [☐ ↔ ☑]** each time selects (performs scan) or deselects (does not perform scan) the checkbox.
 - When performing VFO Scan, deselect the checkboxes for all the memory channels for specific band segments or press **[VFO/PRG]** to switch the display to “VFO SCAN”.
 - Pressing **F6 [SEL.ALL]** selects the checkboxes for all the memory channels for specific band segments.
 - Pressing **F7 [CLR.ALL]** deselects the checkboxes for all the memory channels for specific band segments.
- 6 Press **[ESC]** to end the process.

- Examples on the configuration of Program Scan and VFO Scan:
 - Configure the memory channels for specific band segments such that the checkboxes for P1, P3 and P5 are selected. Next, press **F5 [SCAN]**. Program Scan starts and scanning is performed in the frequency range registered for the respective channels.
 - Configure the memory channels for specific band segments such that all the checkboxes are deselected and press **F [SCAN]**. Or press **[VFO/PRG]** to switch the display to "VFO SCAN". VFO Scan is performed on the entire RX frequency band.
 - The checkbox will remain deselected for memory channels that do not contain any operating data. These checkboxes cannot be selected.
 - For more details on registering memory channels for specific band segments, please refer to "Configuring the Program Scan Frequency Range" on page 9-4.

Switching the Scan Speed

The time interval for switching the Program Scan (VFO Scan) frequency can be configured in modes other than FM.

1 Press F3 [-] or F4 [+] while Program Scan (or VFO Scan) is in progress.

The scan speed is shown below the frequency display.



The frequency switching interval changes as follows.

Scan Speed Display	Frequency Switching Interval
SCAN-SPD1	10 ms
SCAN-SPD2	30 ms
SCAN-SPD3	100 ms
SCAN-SPD4	150 ms
SCAN-SPD5	200 ms
SCAN-SPD6	250 ms
SCAN-SPD7	300 ms
SCAN-SPD8	350 ms
SCAN-SPD9	400 ms

Program Slow Scan

Program Slow Scan is a function that extends the frequency switching interval (performs scan more slowly) using the preconfigured frequency for performing Program Scan (frequency point) and the frequencies before and after this point (segment). Switching slowly between the specified frequency (frequency point) and the corresponding segment allows the communication status to be checked in detail.

- To perform Program Slow Scan, register a frequency range to a memory channel for specific band segments in advance.

Turning ON/OFF Program Slow Scan

To combine the use of Program Slow Scan while Program Scan is running, set Program Slow Scan to ON in advance.

- When scanned frequency falls in the segment for Program Slow Scan during Program Scan, "SCAN-SLOW" is displayed on the screen and the speed of frequency switching slows down.

Configure in Menu [4-02] "Program Slow Scan"

Setting Value	Off/ On (default)
---------------	-------------------

Configuring the Frequency Points for Program Slow Scan

The frequency points for extending the frequency switching interval during Program Slow Scan can be configured as follows.

- Up to 5 frequency points can be configured for each memory channel assigned to specific band segments (P0 to P9).
- To configure the frequency points, register a band segment to a memory channel for specific band segments in advance.

- Press **[M/V]** to switch to the memory channel mode.
- Press **F7 [M.LIST]** to display the Memory Channel List screen.



- Press **F2 [▲]** or **F3 [▼]**, or turn the **[MULTI/CH]** control to select a memory channel for specific band segments.

- Press **F5 [SLW.SCN]** to display the Program Slow Scan screen.

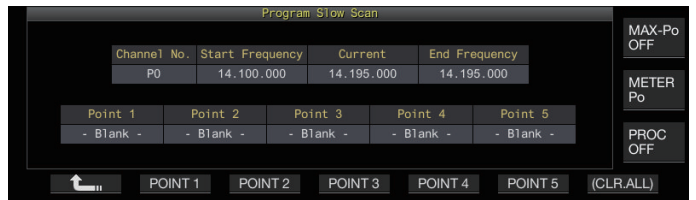

5 Turn the Tuning control and align the “Current” frequency as the frequency point for Program Slow Scan.

6 Press any of the function keys (F2 [POINT 1] to F6 [POINT 5]) to configure the center point of the preferred frequency range to perform Program Slow Scan.

- Pressing and holding the key clears the frequency point that is stored.
- Pressing and holding F7 [(CLR ALL)] clears all the frequency points.

7 Press F1 [↶] to exit the Program Slow Scan screen.

The display returns to the Memory Channel List screen.

8 Press [ESC] to exit the Memory Channel List screen.



- Pressing a function key (F2 [Point 1] to F6 [POINT 5]) that already contains a frequency point overwrites the frequency point with the new input.
- When configuring a frequency point, frequencies that are smaller than 10 Hz are rounded off.

Configuring the Segment for Program Slow Scan

The frequency switching interval during Program Scan slows down in the preconfigured segment that contains frequencies before and after the frequency point for Program Slow Scan.

● **Configure in Menu [4-03] “Program Slow Scan Range”**

Setting Value	100/ 200/ 300 (default)/ 400/ 500 [Hz]
---------------	--

- For example, when 500 [Hz] is selected, the frequency switching interval is extended to a range of ± 500 Hz from the frequency point.

Scan Hold

While Program Scan (VFO Scan) is performed in a mode other than FM, changing the frequency by turning the Tuning or [MULTI/CH] control pauses the scan operation for 5 seconds. Signals can be received temporarily without stopping the scan operation.

● **Configure in Menu [4-04] “Scan Hold”**

Setting Value	Off (default)/ On
---------------	-------------------

When Scan Hold is set to “On”, signals are received with Program Scan paused for 5 seconds.

Memory Scan

Memory Scan allows the registered memory channel to be automatically switched at a specific time interval for scanning. There are 2 types of Memory Scan modes. All-channel Scan performs scan on all the memory channels that are registered with operating data, while Group Scan performs scan on a selected group among the memory channels.

Performing Memory Scan

1 Press [M/V] to switch to the memory channel mode.

2 Press F5 [SCAN] to start memory scan.

- Turning the [MULTI/CH] control allows the scan channel to jump rapidly to the next or previous channels.
- Pressing F5 [SCAN] again or pressing [ESC] ends Memory Scan.
- The scan direction is fixed at the ascending order.



- The frequency switching interval during Memory Scan is 400 ms. However, when a CTCSS tone is received in the FM mode, the frequency switching interval is extended to 600 ms. During Memory Scan, “SCANNING” is displayed instead of the scan speed.

Configuring All-channel Scan and Group Scan

1 Press [M/V] to switch to the memory channel mode.

2 Press and hold F5 [SCAN] to display the Memory Scan group screen.



3 Press F2 [◀||] or F3 [||▶] to select a memory group.

4 Press F4 [☐ ↔ ☑] or turn the [MULTI/CH] control to select whether to start scanning of the memory channels belonging to a memory group.

- Pressing F4 [☐ ↔ ☑] each time selects (performs scan) or deselects (does not perform scan) the checkbox.
- When performing All-channel Scan, select the checkboxes for all the memory groups.
- Pressing F6 [SEL.ALL] selects the checkboxes for all memory groups.
- Pressing F7 [CLR.ALL] deselects the checkboxes for all memory groups.
- Memory channels are classified into memory groups as follows. The classification of the memory groups and channels cannot be altered.

Group	Memory Channel	Group	Memory Channel
0	00 to 09	6	60 to 69
1	10 to 19	7	70 to 79
2	20 to 29	8	80 to 99
3	30 to 39	9	90 to 99
4	40 to 49	P	P0 to P9
5	50 to 59	E	E0 to E9

5 Press [ESC] to end the process.

- ✎ Pressing **F5 [SCAN]** does not start the scan operation when the memory groups to be scanned are configured as follows.
 - When the checkboxes for all the memory groups are deselected.
 - When operating data is not stored in the memory channels of a memory group, even if the checkboxes of the memory group are selected.
 - When all the memory channels belonging to a memory group are locked out, even if the checkboxes of the memory group are selected.
- Examples on the configuration of All-channel Scan and Group Scan:
 - When the checkboxes for Memory Groups 1 and 5 are selected, pressing **F5 [SCAN]** activates Group Scan. In this case, scan is performed on the memory channels included in Memory Groups 1 and 5.
 - When the checkboxes for all memory groups are selected, pressing **F5 [SCAN]** activates All-channel Scan.

Memory Channel Lockout

Selected memory channels can be omitted (locked out) in advance before performing Memory Scan.

- 1 Press **F7 [M.LIST]** to display the Memory Channel List.
- 2 Press **F2 [▲]** or **F3 [▼]**, or turn the **[MULTI/CH]** control to select a memory channel.
- 3 Press **F6 [L.OUT]** to lock out the memory channel.
 - Lockout is applied to memory channels for which the “Lockout” checkbox is selected.
 - Pressing **F6 [L.OUT]** again cancels the lockout mode.
 - “L.OUT” lights up in the standard mode screen and compression mode screen.

CH	Frequency 1	Frequency 2	Name	Lockout
00				<input type="checkbox"/>
01	70.017.100			<input type="checkbox"/>
02	70.101.000	70.327.000		<input type="checkbox"/>
03	70.100.000			<input type="checkbox"/>
04	70.005.730		MEMORYNAME	<input checked="" type="checkbox"/>
05				<input type="checkbox"/>
06				<input type="checkbox"/>
07				<input type="checkbox"/>

- 4 Press **[ESC]** to end the process.

Quick Memory Scan

Quick Memory Scan allows the registered quick memory channel to be automatically switched at a specific time interval for scanning.

- 1 Press **[Q-MR>]** to call up a quick memory channel.



- 2 Press **F5 [SCAN]** to start quick memory scan.
 - Turning the **[MULTI/CH]** control allows the scan channel to jump rapidly to the next or previous channels.
 - Pressing **F5 [SCAN]** again or pressing **[ESC]** ends Quick Memory Scan.
 - The scan direction is fixed at the ascending order.

Configuring the Conditions for Resuming Scan

Scanning stops when signals are received while performing Program Scan (VFO Scan) in the FM mode or during Memory Scan or Quick Memory Scan regardless of the operating mode.

- The conditions for resuming the scan operation after it has stopped can be configured.

Time-operated (Time-operated mode):

Pauses scan for 3 seconds after signals are received. Continues to pause scan for another 3 seconds if signal reception is still in progress after 3 seconds. Scan operation resumes after this interval even if reception is still ongoing. (The maximum duration for pausing scan using the time-operated mode is 6 seconds.)

Carrier-operated (Carrier-operated mode):

Pauses scan while signals are received. Scan operation resumes when signals are not received for a duration of 2 seconds.

- **Configure in Menu [4-05] “Scan Resume”**

Setting Value	Time-operated (default)/ Carrier-operated
---------------	---

11 USB/FILE MANAGEMENT

Managing Different File Types

The following data can be stored as files on this transceiver.

- Settings data of the transceiver
- Settings data of TX and RX equalizers
- Audio data of manual and full-time recordings
- Audio data of timer recordings
- Screen capture image data (can be stored but cannot be displayed on this transceiver)
- CW, RTTY and PSK communication log data
- KNS communication log data (can be stored but cannot be displayed on this transceiver)

Destination for Saving Files

Files are stored in the built-in memory of the transceiver (maximum capacity of 1 GB) in the default setting. However, settings can be changed for files to be saved to a USB flash drive that is connected to the transceiver.

Copying Files Stored in the Built-in Memory to an External Source

Files that are stored in the built-in memory of the transceiver can be copied to a PC that is connected to this transceiver via a USB cable.

Folder Configuration of the Built-in Memory

When copying files to a PC via a USB cable, the built-in memory of the transceiver is recognized on the PC as a removable device with the name "TS-890". The folder configuration of the "TS-890" removable device is as follows.

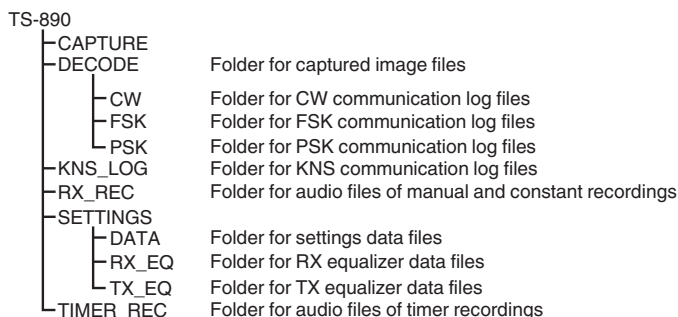

- All the folders above are read-only files. They cannot be edited or deleted on the PC.
- Among the folders above, only those selected by the operations in "Copying Files to a PC" (see 11-4) will appear under "TS-890" removable device.

Folder Configuration of the USB Flash Drive

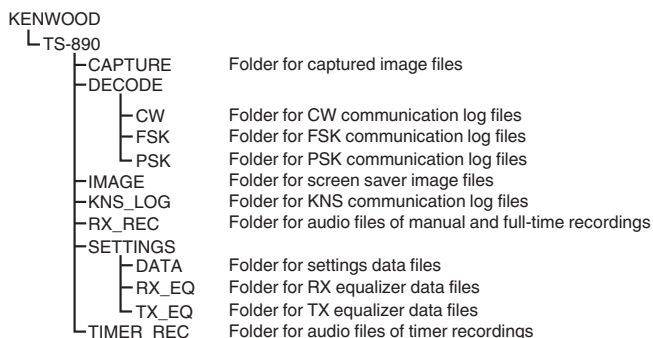

Image Files for Use as Screen Savers

Write image files to be used as screen savers (Type 3) in advance to the "Folder for screen saver image files (IMAGE)" of the USB flash drive such as via a PC before loading them into the built-in memory of the transceiver.



- For more details on the method of configuration, please refer to "Configuring the Screen Saver". (16-1)

Saving Files (For Both USB Flash Drive and Built-in Memory)

- When the date and time are not configured in the CLOCK menu, the recorded date and time when the file is saved is determined with the timing at which this transceiver is powered on as January 1, 2018, 0:00.
- A maximum number of 255 files can be stored in each folder. When trying to save files that exceed this number, an error occurs and a screen showing "Insufficient Memory Size" is displayed.
- If the USB flash drive is write-protected when writing files to the USB flash drive, an error occurs and a screen showing "Insufficient Memory Size" is displayed.

Compatible USB Flash Drives

- This transceiver does not come supplied with a USB flash drive. Use a commercially available USB flash drive.
- The USB flash drive needs to be formatted by this transceiver before it can be used. After formatting is complete, a folder is automatically created in the USB flash drive. (Formatted to FAT32)
- When formatting is performed, any file that exists on the USB flash drive will be erased. To prevent data from being lost, back up the necessary files to devices such as a PC before formatting.
- When a compatible USB flash drive is connected to this transceiver, any data that is not found in the folder configuration will be automatically created.
- If multiple USB flash drives are connected to this transceiver at the same time, only the first USB flash drive that is recognized can be used.



- A USB flash drive and USB keyboard can also be connected at the same time via a USB hub.
- The USB-A connector of this transceiver supports the USB 1.1 standard. The USB flash drive is capable of running at the Full Speed (maximum 12 Mbps) transfer rate.
- We do not provide guarantee with regard to the operation and power supply of all USB devices that are commercially available.
- When using an extension cable, make use of one that complies with the USB standard with a length not longer than 3 m.
- If the power consumption of the connected device exceeds the allowable current of this transceiver (0.5 A), a "USB bus power error screen" is displayed.
- This transceiver does not support security-enabled USB flash drives.

USB/File Management Menu

Configuring the Destination for Saving Files

Follow the steps below to select the destination for saving files such as the transceiver data and audio recordings.

- 1 Press [MENU].
- 2 Press F [USB/FILE] to display the USB/File Management menu screen.
 - If F [USB/FILE] is not displayed, press F [MORE] to display F [USB/FILE].

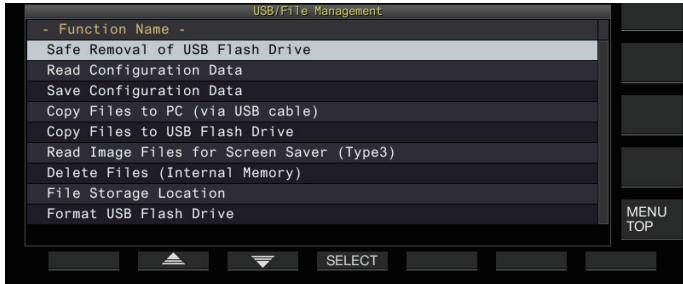

- 3 Press F2 [▲] / F3 [▼] to select “File Storage Location”.
- 4 Press F4 [SELECT].
- 5 Press F4 [-] / F5 [+] or turn the [MULTI/CH] control to select the destination for saving the files.

Setting Value	Internal Memory (default)/ USB Flash Drive
---------------	--

Internal Memory: Saves files to the built-in memory of the transceiver.

USB Flash Drive: Saves files to a USB flash drive.

- 6 Press [ESC] to end the process.



- The destination for saving files cannot be changed while manual recording or CW/RTTY/PSK communication log recording is in progress. Pressing F4 [SELECT] in this case displays a “File destination change error” on the screen.

Saving Settings Data

Settings data or audio data created using this transceiver can also be written to the built-in memory or a USB flash drive.

- To save the data to a USB flash drive, insert a USB flash drive formatted using this transceiver into (USB-A).
- <<[]>> starts to blink when a USB flash drive is connected, and <<[]>> lights up when the USB flash drive is recognized by this transceiver.

- 1 Press [MENU].
- 2 Press F [USB/FILE] to display the USB/File Management menu screen.
 - If F [USB/FILE] is not displayed, press F [MORE] to display F [USB/FILE].
- 3 Press F2 [▲] / F3 [▼] to select “Save Configuration Data”.
- 4 Press F4 [SELECT].
File saving starts.
 - While file saving is in progress, a “processing” screen is displayed on the screen. (This is not displayed if the duration of the saving process is very short.)
- 5 When the “data saving complete screen” is displayed, press F4 [OK].
- 6 Press [ESC] to end the process.





- The settings data contains the data of all settings that are currently configured on this transceiver. However, the following are excluded.
 - Data that are stored in the operating environment (CONFIG A or B) that is not currently selected.
 - Screen capture image files
 - Audio data files of manual recordings, full-time recordings and timer recordings
 - Settings data files of TX and RX equalizers
 - CW/TTY/PSK communication log files
 - KNS communication log files
 - Image files for screen savers (Type 3)
- The destination folder cannot be selected.
 - USB flash drive: “\KENWOOD\TS-890\SETTINGS\DATA”
 - Built-in memory: “\SETTINGS\DATA”
- The extension of the saved file is “dat”.
- The saved file is assigned with a name using the date and time in the following format: “yyyymmdd_hhmmss.dat”.
- (Example)
 - 20180215_102030.dat (File that is saved on February 15, 2018, 10:20:30 a.m.)
- To save files to a USB flash drive, check the following in advance.
 - The USB flash drive is formatted by this transceiver.
 - The USB flash drive is correctly inserted into this transceiver.
 - There is sufficient free space on the USB flash drive.
 - The USB flash drive is not write-protected or the file system is not corrupted.
- If there is insufficient memory, “Insufficient Memory Size” is displayed on the screen.
- If the USB flash drive is removed while files are being saved to it, “Saving to USB flash drive unsuccessful” is displayed on the screen.
- If the USB flash drive for saving files to is write-protected, “Insufficient Memory Size” is displayed on the screen.



Reading Settings Data

Follow the steps below to read the settings data file of the transceiver that is stored in the built-in memory or a USB flash drive.

- To read data from a USB flash drive, insert the USB flash drive containing the settings data into  (USB-A).

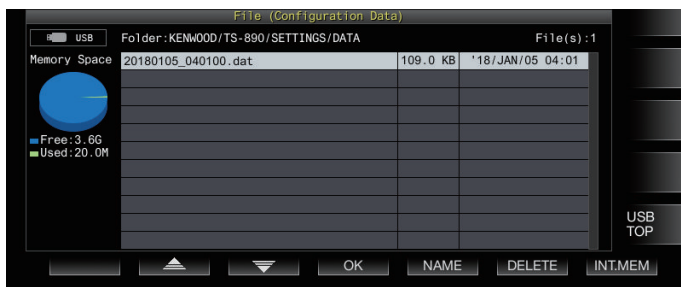
- Press [MENU].
- Press F [USB/FILE] to display the USB/File Management menu screen.
 - If F [USB/FILE] is not displayed, press F [MORE] to display F [USB/FILE].
- Press F2 [] / F3 [] to select “Read Configuration Data”.
- Press F4 [SELECT].
A screen for selecting the file (DATA) to read appears.



- Information of the location to read files from (built-in memory or USB flash drive) that was last selected on this screen is displayed. However, if a USB flash drive is not connected or cannot be correctly recognized, information of the built-in memory will be displayed.
 - If no file is found, “No file is found.” is displayed on the screen.
- Select the file to read.
 - To read data from the internal memory, press F7 [INT.MEM].
 - To read data from the USB flash drive, press F7 [USB.MEM]. (If a USB flash drive is not connected, a message will appear prompting you to get ready the USB flash drive.)
 - Pressing F5 [NAME] allows the file name to be changed.
 - Pressing F6 [DELETE] displays a message to confirm deletion of the file. Pressing F4 [OK] deletes the file.
 - Press F2 [] / F3 [] or turn the [MULTI/CH] control to select the settings data file to read.
 - Press F4 [OK] to display the selection screen (DATA) for reading the data.
 - Pressing F7 [CANCEL] ends the operation without reading a file.

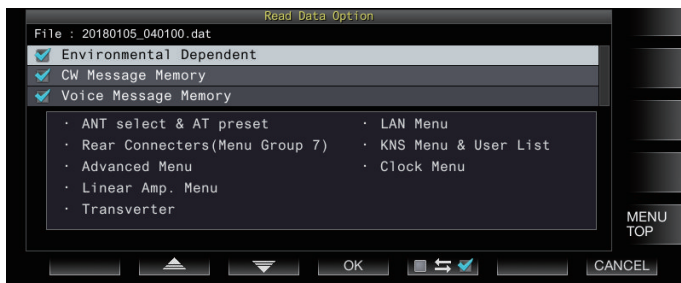

- Press F2 [] or F3 [], or turn the [MULTI/CH] control to select a function group to read.

- Press F5 [] to select the checkbox to the left of the settings data name.
 - Pressing F5 [] again deselects the checkbox. (Settings data will not be read.)

- Repeat steps 8 and 9 to select the corresponding checkboxes for the settings data to read.

- Press F4 [OK] to start reading the files.
Reading of settings data files with a check mark starts. When reading starts, a reading in progress screen is displayed.
 - Pressing F7 [CANCEL] exits the file selection screen without starting reading and returns the display to the USB/File Management menu screen.
 - After the settings data files have been read successfully, a message indicating that reading is complete is displayed.

- Press F4 [OK] to end the process.
This transceiver reboots automatically.

- Data that are not created by this transceiver cannot be read.
- The following function groups can be excluded from the reading process.
 - “Environmental Dependent” data (settings data that are dependent on the installation environment)
 - Antenna selection data and preset data of antenna tuner
 - Settings for items in menu group 6 (settings related to the rear terminals)
 - Advanced menu settings
 - Linear amplifier menu settings
 - Transverter settings
 - LAN menu settings
 - KNS menu settings and KNS registered users’ list
 - Clock menu settings
 - “CW/RTTY/PSK Message Memory” data (CW/RTTY/PSK message memory)
 - “Voice Message Memory” data (voice message data)
- If the settings data file is saved in a transceiver with a newer firmware version, pressing F4 [OK] in step 7 will result in an error. A “data reading error screen due to mismatch between new and old firmware versions” is displayed and reading is not executed.
- If the settings data file is corrupted, pressing F4 [OK] in step 7 will result in an error. A “file reading NG screen” is displayed and reading is not executed.
- If data mismatch is detected after reading a settings data file, a “corrupted data is detected screen” is displayed. When this occurs, pressing F4 [OK] runs a full reset and reboots this transceiver.

11 USB/FILE MANAGEMENT

Changing the Name of Files Stored in the Built-in Memory

The file name of the settings data that is stored on the transceiver can be changed by the user to ease identification.

- 1 Press [MENU].
- 2 Press F [USB/FILE] to display the USB/File Management menu screen.
 - If F [USB/FILE] is not displayed, press F [MORE] to display F [USB/FILE].
- 3 Press F2 [▲] / F3 [▼] to select “Read Configuration Data”.
- 4 Press F4 [SELECT] to display the screen for selecting the file (DATA) to read.

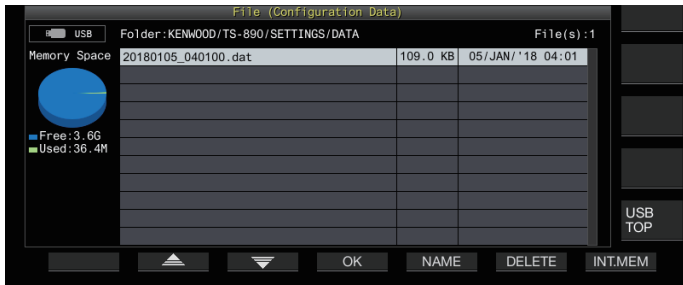

- 5 Press F5 [NAME].
The file name edit screen is displayed.
- 6 Use the function keys and the [MULTI/CH] control to edit the file name.
 - Enter a name that contains not more than 255 characters.

Key	Operation
F1 [SPACE]	Inserts a space.
F2 [-] / F3 [+]	Selects a character.
F4 [◀] / F5 [▶]	Moves the cursor.
F [BACK SPACE]	Deletes the character to the left of the cursor.
F [DEL]	Deletes the character to the right of the cursor.
F [CHAR]	Switches the type of character to edit. Pressing the key each time switches the selection in the following sequence: ABC (upper case) → abc (lower case) → !"# (symbols) → ABC (upper case)

- 7 Press F6 [SAVE] to save the file name.
 - Pressing F7 [CANCEL] discards the edited information and returns the display to the USB/File Management menu screen.
- 8 Press [ESC] to end the process.

Copying Files to a PC

Files that are stored in the built-in memory of this transceiver can be copied to a PC.

- Connect the USB-B connector on the rear panel of this transceiver to a PC using a commercially available USB cable. (See 1-4)

- 1 Press [MENU].
- 2 Press F [USB/FILE] to display the USB/File Management menu screen.
 - If F [USB/FILE] is not displayed, press F [MORE] to display F [USB/FILE].
- 3 Press F2 [▲] / F3 [▼] to select “Copy Files to PC (via USB Cable)”.
- 4 Press F4 [SELECT].
A screen for selecting the files to copy is displayed.



- 5 Press F2 [▲] / F3 [▼] or turn the [MULTI/CH] control to select the items to copy.
- 6 Press F5 [☐ ↔ ☑] to select the checkbox to the left of the settings data name.
 - Pressing F5 [☐ ↔ ☑] again deselects the checkbox. (Files are not copied.)
 - Pressing F6 [CLR.ALL] deselects all the checkboxes.
 - Select at least 1 item to copy from the following.

Display	Description
Configuration Files	Settings data file
Audio Files (RX_REC)	Audio files of manual and full-time recordings
Audio Files (TIMER_REC)	Audio files of timer recordings
Equalizer Files (TX_EQ)	TX equalizer data files
Equalizer Files (RX_EQ)	RX equalizer data files
Communication Log Files (CW)	CW communication log files
Communication Log Files (FSK)	RTTY communication log files
Communication Log Files (PSK)	PSK communication log files
Screen Captured Files	Screen capture image files
KNS Log Files	KNS communication log files

- 7 Press F4 [OK].
A screen indicating “preparing to copy” is displayed. A “confirmation tone” is output once the copy preparation is completed and a “PC on copy standby screen” is displayed. Then, a removable device with the name “TS-890” appears on the PC.



- When the built-in memory is selected as the destination for saving files and while manual recording or CW/RTTY/PSK communication log recording is in progress, selecting a file to copy followed by pressing **F4 [OK]** will result in an error and an “unable to copy” message will be displayed.
- Pressing **F7 [CANCEL]** while the “preparing to copy” screen is displayed starts the cancel copy operation. When the cancel copy operation is complete, the display returns to the USB/File Management menu screen.
- After the “preparing to copy” screen is displayed, a “confirmation tone” is output once the copy preparation is completed and a copy standby screen is displayed on the PC. Then, a removable device with the name “TS-890” appears on the PC.
- When a remote user is logged in via the KNS function and the communication log is set to ON, selecting “KNS Log Files” and pressing **F4 [OK]** will result in an error and an “unable to copy” message will be displayed.

8 Access the removable device named “TS-890” from the PC and copy the files or folders to the PC.

9 After copy is complete, remove the removable device (“TS-890”) safely from the PC.



- The files may not be copied successfully if the proper steps to remove the device safely from the PC are not observed.

10 Press F4 [EXIT].

A confirmation screen on the batch deletion of files is displayed. Items for which the checkboxes are selected on the screen for selecting the files to copy can be deleted from the built-in memory.

- Pressing and holding **F4 [(DELETE)]** executes the file deletion operation.
- Pressing **F7 [KEEP]** leaves the files intact and returns the display to the USB/File Management menu screen.

11 Press [ESC] to end the process.

Deleting Files (Built-in Memory)

Follow the steps below to delete settings data or audio data from the built-in memory. Deletion will apply to the function folders that contain the corresponding files.

- 1 Press [MENU].**
- 2 Press F [USB/FILE] to display the USB/File Management menu screen.**
 - If F [USB/FILE] is not displayed, press F [MORE] to display F [USB/FILE].
- 3 Press F2 [▲] / F3 [▼] to select “Delete Files (Internal Memory)”.**
- 4 Press F4 [SELECT].**

A screen for selecting the files to delete is displayed.



- 5 Press F2 [▲] / F3 [▼] or turn the [MULTI/CH] control to select the items to delete.**
- 6 Press F5 [☐ ↔ ☑] to select the checkbox to the left of the settings data name.**
 - Pressing **F5 [☐ ↔ ☑]** again deselects the checkbox. (Files are not deleted.)
 - Pressing **F6 [CLR.ALL]** deselects all the checkboxes.
 - Select at least 1 item to delete.
 - Pressing **F7 [CANCEL]** returns the display to the USB/File Management menu screen.
- 7 Press F4 [OK].**

A file deletion confirmation screen is displayed.
- 8 Press F4 [OK].**

File deletion starts.

 - Pressing **F7 [CANCEL]** returns the display to the file deletion confirmation screen without deleting the files.
- 9 Press [ESC] to end the process.**



- When the built-in memory is selected as the destination for saving files and the item to be deleted coincides with an item for which manual recording or CW/RTTY/PSK communication log recording is in progress, pressing **F4 [OK]** will result in an error and an “unable to delete” message will be displayed.
- When a remote user is logged in via the KNS function and the communication log is set to ON, selecting “KNS Log Files” as an item to delete and pressing **F4 [OK]** will result in an error and an “unable to delete” message will be displayed.

Formatting a USB Flash Drive

The USB flash drive needs to be formatted by this transceiver before it can be used. USB flash drives cannot be recognized if they are not formatted by this transceiver.



- Formatting a USB flash drive using this transceiver erases all data that exist in the USB flash drive. As such, make sure to save the necessary data to a PC or other external data storage devices before deleting.

- 1 Insert the USB flash drive into the (USB-A) connector.**

<< [USB-A] >> starts to blink and lights up when the USB flash drive is recognized by this transceiver.
- 2 Select “Format USB Flash Drive” in the USB/File Management menu.**
- 3 Press F4 [SELECT] to start formatting.**
 - A message to confirm the start of the formatting process is displayed.
 - Pressing **F7 [CANCEL]** ends the operation without formatting the USB flash drive.
- 4 Press F4 [OK].**

When formatting is complete, the display returns to the USB/File Management menu screen.

Copying Files to a USB Flash Drive

Files that are stored in the built-in memory of this transceiver can be copied to a USB flash drive.

- Insert a USB flash drive formatted using this transceiver into (USB-A).
- 1 Press [MENU].**
 - 2 Press F [USB/FILE] to display the USB/File Management menu screen.**
 - If F [USB/FILE] is not displayed, press F [MORE] to display F [USB/FILE].

11 USB/FILE MANAGEMENT

3 Press F2 [▲] / F3 [▼] to select “Copy Files to USB Flash Drive”.

4 Press F4 [SELECT].

A screen for selecting the files to copy is displayed.



5 Press F2 [▲] or F3 [▼], or turn the [MULTI/CH] control to select the items to copy.

6 Press F5 [☐ ↔ ☑] to select the checkbox to the left of the settings data name.

- Pressing F5 [☐ ↔ ☑] again deselects the checkbox. (Files are not copied.)
- Pressing F6 [CLR.ALL] deselects all the checkboxes.
- The items that can be copied are the same as those in the table in “Copying Files to a PC”. Select at least 1 item.

7 Press F4 [OK].

Copy starts and a copy in progress screen is displayed.

After file copying is complete, a confirmation screen on the batch deletion of files is displayed.

Items for which the checkboxes are selected on the screen for selecting the files to copy can be deleted from the built-in memory.

- Pressing and holding F4 [(DELETE)] executes the file deletion operation.
- Pressing F7 [KEEP] leaves the files intact and returns the display to the USB/File Management menu screen.

8 Press [ESC] to end the process.

- ! If the number of files exceeds 255 while copy is in progress, the copy operation stops.
- ! When removing the USB flash drive, make sure to execute “Safely Removing the USB Flash Drive” (11-6).

- ✎ If the same file on the source location is also found in the destination USB flash drive, the latter file will be overwritten.
- ! If there is insufficient memory in the USB flash drive for all the files to be copied, pressing F4 [OK] will result in an error and “Insufficient Memory Size” will be displayed on the screen.
- ! Pressing F7 [CANCEL] while copying is in progress starts the cancel copy operation. When the cancel copy operation is complete, the display returns to the USB/File Management menu screen.
- ! While manual recording or CW/RTTY/PSK communication log recording is in progress, selecting a file to copy followed by pressing F4 [OK] will result in an error and an “unable to copy” message will be displayed.
- ! When a remote user is logged in via the KNS function and the communication log is set to ON, selecting “KNS Log Files” and pressing F4 [OK] will result in an error and an “unable to copy” message will be displayed.

Safely Removing the USB Flash Drive

When removing a USB flash drive from this transceiver, make sure to follow the steps below to remove the device safely. Failure to do so may result in the damage of the USB flash drive, settings data files and audio data files or malfunction of this transceiver.

1 Press [MENU].

2 Press F [USB/FILE] to display the USB/File Management menu screen.

- If F [USB/FILE] is not displayed, press F [MORE] to display F [USB/FILE].

3 Press F2 [▲] / F3 [▼] to select “Safe Removal of USB Flash Drive”.

4 Press F4 [SELECT].

A message on the safe removal of the USB flash drive is displayed.



- Pressing F7 [CANCEL] ends the operation without performing the safe removal of the USB flash drive.

5 Press F4 [OK].

Safe removal starts.

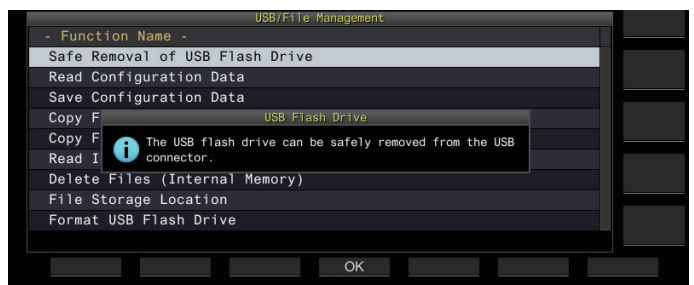

6 Press F4 [OK].

The USB flash drive can now be removed.

7 Press [ESC] to end the process.

12 VOICE MESSAGE/AUDIO FILE

Recording/Playing a Voice Message

This transceiver comes with a function for recording, playing and transmitting standard voice messages as well as a function for recording and playing audio that is transmitted or received. Voice messages can be recorded to a maximum of 6 channels. Messages recorded with a microphone can also be transmitted.

- This is handy during DX-pedition or contest operation where repeated calls need to be made over a long period of time or for adjusting an antenna or transceiver by transmitting a test radio wave. The maximum recording time is 100 seconds. In other words, recording to all the channels is possible up to a duration of 100 seconds in total.

Recording a Voice Message

Follow the steps below to record a voice message to a voice message channel (TX CH 1 to TX CH 6).

- 1 Press the mode key to select either SSB, FM or AM mode.
- 2 Press F2 [TX MSG] to display the Voice Message screen.

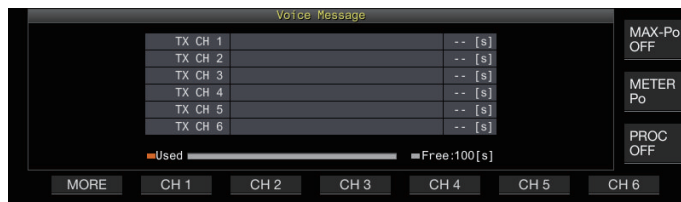

- 3 Press and hold the function key (F2 [CH 1] to F7 [CH 6]) corresponding to the channel for storing the voice message.

A message to confirm the start of voice message recording appears.

- If F2 [CH 1] to F7 [CH 6] is not displayed, press F1 [MORE].



- 4 Press F2 [REC IN].

- Pressing F2 [REC IN] each time switches the audio input path.

Setting Value	MIC (default)/ ACC 2/ USB/ LAN
---------------	--------------------------------

- To adjust the recording level, turn the [MIC] control. Adjust the recording level while monitoring the peak recording level on the recording level meter such that the peak does not show in the red zone.
- Pressing F7 [CANCEL] ends the recording.

- 5 Press and hold F4 [REC].

Recording continues and the recording time of the voice message is displayed while F4 [REC] is pressed and held down.



- 6 Releasing F4 [REC] ends the recording and saves the voice message.



- Recording ends automatically when the total recording time of all channels exceeds 100 seconds even when the F4 [REC] key is still pressed down.
- This transceiver does not allow continuous voice message recording using multiple channels.
- When a new message is recorded, the voice message that already exists on the channel will be overwritten.

12 VOICE MESSAGE/AUDIO FILE

Registering a Name for a Voice Message

Recorded voice messages can be assigned with a name.

- 1 Press **F2 [TX MSG]** to display the Voice Message screen.

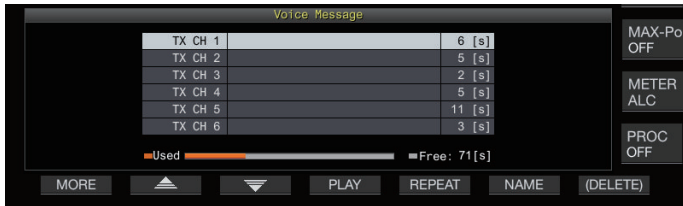

- 2 Select the voice message to name.

- 3 Press **F6 [NAME]**.

Doing so enables editing of the voice message name.

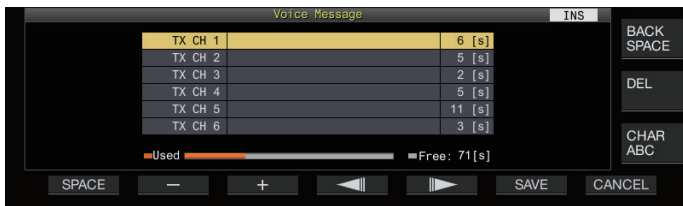

- 4 Use the function keys, [MULTI/CH] control or USB keyboard to input the characters.

Key	Operation
F1 [SPACE]	Inserts a space.
F2 [-]/ F3 [+]	Selects a character.
F4 [◀]/ F5 [▶]	Moves the cursor.
F [BACK SPACE]	Deletes the character to the left of the cursor.
F [DEL]	Deletes the character to the right of the cursor.
F [CHAR]	Switches the type of character to edit. Pressing the key each time switches the selection in the following sequence: ABC (upper case) → abc (lower case) → !"# (symbols) → ABC (upper case)

- 5 Press **F6 [SAVE]** to save the name of the voice message.

- Pressing **F7 [CANCEL]** discards the input characters and exits the editing mode for the voice message name.

Playing Back a Voice Message

Follow the steps below to play back a recorded voice message.

- 1 Select a voice message channel to play back.
- 2 Press **F4 [PLAY]** to play back the voice message. The voice message playback screen appears.

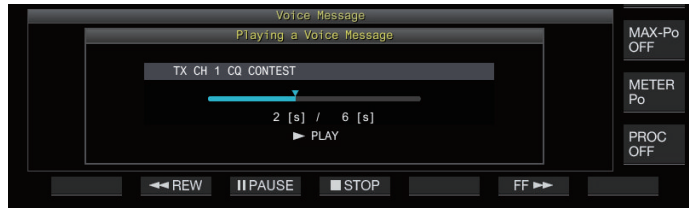

The following operations are possible while a voice message is being played back.

Operation	Behavior
Press and hold F6 [FF] [▶▶].	Fast forwards the voice message. <ul style="list-style-type: none"> • Release the key to resume playback at the normal speed.
Press and hold F2 [◀◀] [REW].	Rewinds the voice message. <ul style="list-style-type: none"> • Release the key to resume playback at the normal speed.
Press F3 [] [PAUSE].	Pauses the voice message.
Press F3 [▶] [PLAY] while playback is paused	Resumes playback from the position where it was paused.
Press F4 [■] [STOP].	Stops the playback of voice message.
Press [ESC].	Closes the Voice Message screen and ends the playback.

Adjusting the Playback Volume

Configure the volume level when playing back a voice message.

- **Configure in Menu [1-01] "Voice Message Volume (Play)"**

Setting Value	Off/ 1 to 10 (default) to 20 (1 step)
---------------	---------------------------------------

Configuring to a larger value raises the volume level. Selecting "Off" mutes the playback sound.



- When TX monitor is ON, the voice message is output as the TX monitor audio so the volume changes in tandem with the TX monitor level.
- For more details on adjusting the TX monitor level, please refer to (8-3).

Sending a Voice Message

A recorded voice message can be transmitted while it is being played back.

- 1 Press F2 [TX MSG] to display the Voice Message screen.
- 2 Press and hold the function key (F2 [CH 1] to F7 [CH 6]) corresponding to the channel that contains the voice message to be transmitted.
 - A voice message playback screen is displayed, and the voice message is transmitted.



- Turning the [MIC/PITCH] control while transmission of a voice message is in progress enables the gain level of the microphone used exclusively for the voice message to be adjusted.
- The following operations are possible while a voice message is being transmitted.

Operation	Behavior
Press F5 [REPEAT].	Plays back and transmits the voice message repeatedly. Pressing F5 [REPEAT] again ends repeat playback and transmission, and returns this transceiver to the RX mode. <ul style="list-style-type: none"> • <<↺>> lights up while repeat playback is in progress. • The time interval for repeating the transmission can be configured.
Press F4 [STOP].	Stops transmission of the voice message and closes the voice message transmission screen.
Press [ESC].	Closes the Voice Message screen and ends transmission of the voice message.

Deleting a Voice Message

Follow the steps below to delete a recorded voice message.

- 1 Select a channel that contains the voice message to be deleted.

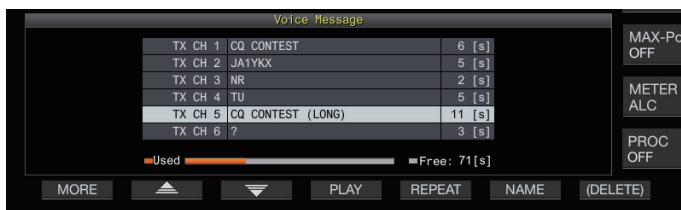

- 2 Press and hold F7 [(DELETE)] to delete the selected voice message.

Configuring the Time Interval for Repeated Transmission

The time interval for repeating playback of a voice message can be configured.

- Configure in Menu [5-16] “CW/Voice Message Retransmit Interval Time”

Setting Value	0 to 10 (default) to 60 [s] (1 step)
---------------	--------------------------------------

Configuring to a larger value lengthens the playback interval.

Recording/Playing Voice Communication

This transceiver can be used to record voice communication or play back the recordings. Recording functions that can be used on this transceiver are as follows.

Manual Recording

- Voice recordings up to 9 hours per file can be stored in the built-in memory of this transceiver. As the built-in memory is also used by other functions, the maximum recording time varies depending on the remaining space available.
- Voice data up to 18 hours per file can be recorded when a USB flash drive is used. If recording continues for a duration longer than 18 hours per file, a new file will be created upon reaching 18 hours and recording will continue.

Full-time Recording

This recording function records the most recent voice data up to the last 30 seconds to an audio file.

Timer Recording (USB Flash Drive Only)

This function records audio based on the preconfigured duration and conditions. For more details on the timer recording operation, please refer to “Timer” (14-4).

- If DC power is turned off during recording, the saving of the file recorded at that time is not guaranteed. To turn off the power during recording, do so using [⏻] on the front panel.

Manual Recording

The [●] and [■] keys can be used to start or stop recording of communication using this transceiver.

- 1 Press [●] to start recording.

- “● REC” appears on the screen and the [REC] LED lights up.



- 2 Press [■] to end the recording.

- “● REC” disappears from the screen and the [REC] LED light goes off.

- When the remaining memory at the destination for storing the file runs out while recording is in progress, a “recording end” tone is output and the recording ends automatically.

12 VOICE MESSAGE/AUDIO FILE

Full-time Recording

This recording function records the most recent communication audio up to the last 30 seconds. This allows the user to check the content of the most recent voice communication.

Configuring the Maximum Duration for Full-time Recording

- **Configure in Menu [6-00] “Playback Time (Full-time Recording)”**

Setting Value	Last 10/ Last 20/ Last 30 (default) [s]
---------------	---

Saving Full-time Recording Audio

- **Press and hold [●].**
 - The [REC] LED starts to blink for about 1 second.
 - The most recent audio until [●] is pressed and held down is recorded to the built-in memory or USB flash drive according to the preconfigured maximum duration (number of seconds) for full-time recording.

- ✎ Pressing **F1 [RX PLAY]** does not activate full-time recording if manual recording is in progress.
- When the remaining memory at the destination for storing the file is running out, a “Insufficient memory space” message is displayed on the screen and recording ends automatically.
- When audio recording in tandem with squelch is ON and the squelch has never been opened, pressing and holding [●] does not activate the recording.

Audio Recording in Tandem with Squelch

Recording of the RX audio can be activated in tandem with the squelch operation.

- **Configure in Menu [6-01] “Recording with Squelch”**

Setting Value	Off/ On (default)
---------------	-------------------

Off: Performs recording even when a signal is not received.
On: Performs recording only when the squelch opens. (Closing the squelch while recording is in progress pauses the recording operation.)

- ✎ When “Recording with Squelch” is enabled, the “● REC” remains lit even when the squelch is closed. Also, the “● REC” remains lit even if the squelch has not opened at all. (In this case, a file will not be generated when recording ends.)

Quick Playback

This function allows playback of the most recent manual recording or full-time recording audio file.

Playback

- **Press [▶] to play back the most recent audio file.**
 - “▶PLAY” and the playback progress bar appear.



- The selected audio file is played back when the audio file screen is displayed.

Pausing Playback

- **Press [⏸] during playback to pause the audio file.**
 - <<⏸>> lights up.



Pressing [▶] again resumes the playback.

Stopping Playback

- **Press [■] to stop playback of the audio file.**
 - The light of “▶PLAY” and that of the playback progress bar goes off.

Adjusting the Playback Volume

Turn the [AF] control to adjust the playback volume.

Audio Recording File Screen

Audio files saved via manual recording, full-time recording or timer recording can be operated on this screen.



Playing Back an Audio File

Follow the steps below to play back audio files that are stored in the built-in memory or a USB flash drive.

To use a USB flash drive, insert it into  (USB-A) in advance and check to ensure that it is recognized by this transceiver.

- 1 Press **F1 [RX PLAY]** to display the audio recording file screen.
- 2 Press **F7 [INT.MEM]** or **F7 [USB.MEM]** to toggle between the screens for the built-in memory and USB flash drive.
 - Pressing **F7 [INT.MEM]** displays the audio file (built-in memory) screen. "Internal" is shown on the screen.
 - Pressing **F7 [USB.MEM]** displays the audio file (USB flash drive) screen. "USB" is shown on the screen.
 - To change the folder to browse, press **F1 [FOLDER]**.
 - Files recorded using the timer-recording reservation function are stored in the **TIMER_REC** folder, while all other recordings are stored in the **RX_REC** folder.
- 3 Press **F2 [▲]** / **F3 [▼]** or turn the **[MULTI/CH]** control to select the audio file to play back.
- 4 Press **F4 [PLAY]** or **[▶]** to play back the audio file.

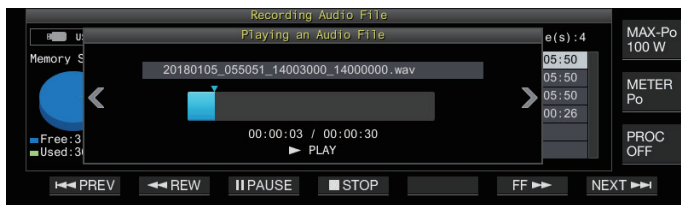

The following operations are possible while an audio file is being played back.

Operation	Behavior
Press and hold F5 [FF ▶▶] .	Fast forwards the audio file. Release the key to resume playback at the normal speed.
Press and hold F2 [◀◀ REW] .	Rewinds the audio file. Release the key to resume playback at the normal speed.
Press F3 [PAUSE] .	Pauses the audio file. Pressing F3 [▶ PLAY] while playback is paused resumes playback from the position where it was paused.
Press F7 [NEXT ▶▶] .	Plays back from the beginning of the audio file that immediately precedes the audio file that is current playing.
Press F1 [◀◀ PREV] twice quickly.	Plays back from the beginning of the audio file that immediately follows the audio file that is current playing.
Press F1 [◀◀ PREV] once.	Plays back the currently playing audio file again from the beginning.
Press F4 [■ STOP] .	Stops playback of the audio file.
Press [ESC] .	Exits the audio file playback screen and audio recording file list screen.
Turn [MULTI/CH] .	Cueing is possible when 2 or more audio files are saved.



- RX audio is muted during playback of an audio file. Transmission is also disabled.
- The playback position can be changed by touching the progress bar while playing an audio file.
- When removing the USB flash drive, make sure to execute "Safely Removing the USB Flash Drive" (11-6).

12 VOICE MESSAGE/AUDIO FILE

Renaming an Audio File

The name of audio files saved via manual recording, full-time recording or timer recording can be changed.

- 1 Press F1 [RX PLAY] to display the audio recording file screen.
- 2 Press F2[▲]/ F3[▼] or turn the [MULTI/CH] control to select the audio file for which the name is to be changed.
- 3 Press F5 [NAME].



- 4 Use the function keys, [MULTI/CH] control or USB keyboard to enter a name.

Key	Operation
F1 [SPACE]	Inserts a space.
F2 [-]/ F3 [+]	Selects a character.
F4 [◀]/ F5 [▶]	Moves the cursor.
F [BACK SPACE]	Deletes the character to the left of the cursor.
F [DEL]	Deletes the character to the right of the cursor.
F [CHAR]	Switches the type of character to edit. Pressing the key each time switches the selection in the following sequence: ABC (upper case) → abc (lower case) → !"# (symbols) → ABC (upper case)

- 5 Press F6 [SAVE] to save the file name.
 - Pressing F7 [CANCEL] discards the information entered and exits the audio file name input mode.



- When removing the USB flash drive, make sure to execute "Safely Removing the USB Flash Drive" (11-6).

Deleting an Audio File

Follow the steps below to delete audio files that are stored in the built-in memory or a USB flash drive.

To use a USB flash drive, insert it into  (USB-A) in advance and check to ensure that it is recognized by this transceiver.

- 1 Press F1 [RX PLAY] to display the audio file screen.
- 2 Press F2[▲]/ F3[▼] or turn the [MULTI/CH] control to select the audio file to delete.
- 3 Press F6 [DELETE].

A message to confirm deletion of the file is displayed.
- 4 Press F4 [OK] to delete the audio file.
 - Pressing F7 [CANCEL] returns the display to the audio file screen without deleting the audio file.

13 VOICE GUIDANCE

This transceiver comes with a voice guidance that sends out a voice notification of the operating status that is displayed on the screen.

The voice guidance content is described in the following style in this manual.

Voice	The actual voice guidance content is enclosed in quotation marks (" ").
Numeric values and alphabets	Content of the voice guidance is described collectively using numeric values and alphabets.
Options	The actual voice guidance content is listed up using []. Each option is separated from the other by a slash (/), and only one of the options will be uttered at a time.

Voice Guidance

Pressing the PF key that is assigned with the voice guidance function outputs a guidance voice on the operating status from the built-in speaker.

The following 4 types of voice guidance are available.

VOICE1

Announces the current frequency and operating status. The default setting is [PF A].

VOICE2

Announces the status of the S meter and power meter. The default setting is [PF B].

VOICE3

Announces the status of the meter selected in **F [METER]** except for the power meter. The default setting is [PF C].

Auto Announce

Announces automatically when a specific operation is performed or upon entering a specific status. The default setting is "OFF".

Adjusting the Voice Guidance Volume

Adjust the volume level of the voice guidance. When the voice guidance volume is set to OFF, pressing the corresponding PF key does not output a voice guidance announcement from this transceiver.

● Configure in Menu [1-03] "Voice Guidance Volume"

Setting Value	Off/ 1 to 10 (default) to 20 (1 step)
---------------	---------------------------------------

- Configuring to a larger value raises the volume level.

Adjusting the Voice Guidance Speed

Adjust the speed of the announcement.

● Configure in Menu [1-04] "Voice Guidance Speed"

Setting Value	1 (default) to 4 (1 step)
---------------	---------------------------

- The larger the value, the faster the speed of the announcement. (1:1x (normal speed), 2:1.15x, 3:1.3x, 4:1.45x)



- Increasing the voice guidance speed may sometimes cause the audibility to deteriorate depending on the content of the announcement.

Configuring the Voice Guidance Language

The voice guidance language can be configured to English or Japanese.

● Configure in Menu [1-05] "User Interface Language (Voice Guidance & Messages)"

Setting Value	English (default)/ Japanese
---------------	-----------------------------

Auto Voice Guidance

When auto voice guidance is set to ON, a voice guidance is automatically output when a specific operation is performed.

● Configure in Menu [1-06] "Automatic Voice Guidance"

Setting Value	Off (default)/ On
---------------	-------------------



- When this function is in the OFF status, turning on the power of this transceiver while pressing down the [PF A] key turns on [Auto Voice Guidance].
 - When auto voice guidance is ON, voice guidance is output in the following sequence.
 - *1 : Announces the VFO ("A" or "B") that is currently operating.
 - *2 : "X" is uttered when XIT is ON, "R" is uttered when RIT is ON, and "XR" is announced followed by the RIT/XIT frequencies when both XIT and RIT are ON. The numeric values of the "RIT/XIT frequencies" are announced in sequence starting from the kHz digit. "Point" is uttered after the kHz value. If the frequency is a negative value, "Minus" is uttered at the beginning.
 - *3 : [USB/ LSB/ CW/ FSK/ PSK/ FM/ AM/ USB Data/ LSB Data/ CW Reverse/ FSK Reverse/ PSK Reverse/ FM Data/ AM Data]
 - *4 : When in the SWL mode, "SWL" is added to the beginning of the announcement.

Operation on This Transceiver	Key Operation	Content of Voice Guidance
When powering on	-	Announces the data used for operation regardless of the status of the setting screen. Refer to "Voice 1" (13-2).
Switching between VFO A and VFO B	[A/B]	Outputs announcements according to the operating status after switching. Refer to "Voice 1" (13-2).
Switching between the VFO mode and memory channel mode	[M/V]	
Memory shift	[M ▶ V] F [M ▶ VFO]	Announces the data used for operation. Refer to "Voice 1" (13-2).
Switching to the quick memory channel mode	[Q-MR>]	Announces the details of the quick memory channel mode. Refer to "Voice 1" (13-2).
Switching of the memory channel in the memory mode (except when the Memory Channel List screen is displayed)	Turn [MULTI/CH]	Blank channel: "Channel" + Number + "Blank"
		Simplex mode: "Channel" + Number + Frequency + ([X/ R/ XR] + RIT/XIT Frequency) *2
		Split mode: "Channel" + Number + "Split" + Frequency + ([X/ R/ XR] + RIT/XIT Frequency) *2

Operation on This Transceiver	Key Operation	Content of Voice Guidance
Switching of quick memory channel	Turn [MULTI/CH]	Simplex mode: "Quick" + Number + [A/ B] ¹ Frequency + ([X/ R/ XR] + RIT/XIT Frequency) ²
		Split mode: "Quick" + Number + "Split" + [A/ B] ¹ Frequency + ([X/ R/ XR] + RIT/XIT Frequency) ²
Entering a frequency using the numeric keypad	[ENT]	"Enter"
Entering a channel number using the numeric keypad	Press a key on the numeric keypad	Numeric value that is entered
Switching the frequency entry history	Turn [MULTI/CH]	Frequency entry history
Switching frequency lock	[LOCK]	"Lock" + [On/ Off]
Switching split operation	[SPLIT]	"Split" + [On/ Off]
Configuring split frequency via numeric keypad operation	Press and hold [SPLIT]	"Split" + "Enter"
	When [0] is first pressed	"Minus"
	Numeric keypad	"TX" + [Plus/ Minus] + Numeric value that is entered + "Kilohertz" * Pressing the keys from [1] to [9] adds a "Plus" utterance, while pressing [0] + ([1] to [9]) adds a "Minus" utterance.
When configuration of the split frequency using the Tuning control is complete	[SPLIT] (After configuration using the Tuning control)	"TX" + Finalized TX frequency
Changing the low cutoff frequency	Turn [LO/ WIDTH]	"Low" + Frequency
Changing the width	Turn [LO/ WIDTH]	"Width" + Options
Changing the high cutoff frequency	Turn [HI/SHIFT]	"High" + Options
Changing the shift frequency	Turn [HI/SHIFT]	"Shift" + Options
Changing the TX output power	Turn [POWER]	<ul style="list-style-type: none"> When drive output is ON: TX power + Value When drive output is OFF: When the transverter is ON and "TX Power Down with Transverter Enabled" is "On": "TX power" + 5 In all other cases: "TX power" + Value (The value shows a value up to the TX output power limit if the TX output power limiter is operating.)
[MIC/PITCH] control operation	Turn [MIC/ PITCH]	<ul style="list-style-type: none"> When adjusting microphone gain: "Mic. Gain" + Value When adjusting the speech processor output level: "Processor" + "Out" + Value * No voice is output during adjustment of the sidetone/pitch frequency.

Operation on This Transceiver	Key Operation	Content of Voice Guidance
[DELAY] control operation	Turn [DELAY]	<ul style="list-style-type: none"> When adjusting the break-in delay time: "Full" + "Break-in" in the case of FULL-BK DELAY: "Break-in delay" + Displayed value in the case of 1 to 20 When adjusting VOX delay: "VOX delay" + Value
[KEY] control operation	Turn [KEY]	<ul style="list-style-type: none"> When adjusting the keying speed: Keying speed + Value
Timer function ON/OFF operation	F [TIMER]	"Timer" + [On/ Off]
Dimmer switching	F [DIMMER] F2 [DIMMER]	"D" + Numeric value (single digit)
Antenna switching	F [ANT]	"Antenna" + Number
Band Direct selection	Band Direct keys (including operation of [GENE])	Frequency
Calling up the preconfigured emergency frequency	PF [Emergency Frequency]	"Emergency" + Frequency
Meter switching	F [METER]	Analog meter display (TX digital meter OFF): [Power/ SWR/ ID/ Processor/ ALC/ VD]
		Analog meter display (TX digital meter ON): [SWR/ ID/ Processor/ VD/ TMP]
		Digital meter display: [SWR/ ID/ Processor/ VD/ TMP]
		Mini digital meter display: [Power/ SWR/ ID/ Processor/ ALC/ VD/ TMP]
Error/warning messages	(none)	Error or warning + Number * For more details on the number, please refer to "Error Messages" (18-9) and "Warning Messages" (18-11).

Voice 1

Voice 1 announces the displayed frequency, channel number, details of the respective configuration modes as well as the status of menu settings.

Announces the digits of the VFO and memory channel frequencies which are higher than 10 Hz when fine tuning is OFF. "Point" is uttered after announcing the MHz digits. When a channel that does not contain any operating data is selected during memory scroll, "Blank" is uttered.

- **Press the PF key that is assigned with "VOICE1".**
Announces the operating status. Announces the setting value while configuration is in progress on the configuration screen.



- Pressing the PF key that is assigned with "VOICE1", "VOICE2" or "VOICE3" during the announcement stops the announcement.
- Altering the frequency by turning the **Tuning** or **[MULTI/CH]** control during an announcement stops the announcement.
- For more details on how to change the assignment of PF keys, please refer to "PF Keys (Programmable Function Keys)" (16-2).
- Announcement is not output while scanning is in progress.

Pressing “VOICE1” outputs an announcement as follows. The content of the announcement varies with the screen that is being displayed.

Announcements Related to Operating Frequency (Including Content of Auto Announcements)

Screen	Operation/Status	Content of Announcement
VFO mode ^{*4}	Simplex mode	[A/ B] ¹ Frequency + ([X/ R/ XR] + RIT/XIT Frequency) ^{*2}
	Split mode	“Split” + [A/ B] ¹ Frequency + ([X/ R/ XR] + RIT/XIT Frequency) ^{*2}
Memory channel mode ^{*4}	Blank channel	“Channel” + Number + “Blank”
	Simplex mode	“Channel” + Number + Frequency + ([X/ R/ XR] + RIT/XIT Frequency) ^{*2}
	Split mode	“Channel” + Number + Frequency + ([X/ R/ XR] + RIT/XIT Frequency) ^{*2}
Quick memory channel mode ^{*4}	Simplex mode	“Quick” + Number + [A/ B] + Frequency + ([X/ R/ XR] + RIT/XIT Frequency) ^{*2}
	Split mode	“Quick” + Number + “Split” + [A/ B] ¹ Frequency + ([X/ R/ XR] + RIT/XIT Frequency) ^{*2}
During frequency entry	Before numeric keypad input	Enter
	Input in progress	The numeric value that is most recently input (“Point” is also uttered after announcing the MHz digits. A pause is inserted for the kHz digit.)
	During confirmation	[A/ B] + Frequency
	When entry is canceled	No announcement
	When entry history is selected	Frequency entry history
During entry of memory channel no.	During 1-digit input	“Enter” + Number
	During 2-digit input	1st digit + 2nd digit + [Frequency/Blank]
When configuring the split frequency	Pressing and holding SPLIT	“Split” + “Enter”
	When [0] is first pressed	“Minus”
	When the numeric keypad ([1] to [9]) is operated	“TX” + [Plus/ Minus] ¹ + Numeric value that is entered + “Kilohertz” * Pressing the keys from [1] to [9] adds a “Plus” utterance, while pressing [0] + ([1] to [9]) adds a “Minus” utterance.

Announcements during Display of Configuration Screens (Including Content of Auto Announcements)

Screen	Operation/Status	Content of Announcement
Auto mode	Screen launch	“Auto” + Frequency at the top of the list + Mode ^{*3}
	When [VOICE1] is pressed	“Auto” + Frequency
	When a selection is made	Selected frequency + Mode ^{*3}
	When frequency is copied to the list	“Copy” + Copied frequency + Mode ^{*3}
	Switching between ON/OFF	“Auto” + [On/ Off]
AGC settings	When screen is displayed or when [VOICE1] is pressed	“AGC” + [Fast/ Middle/ Slow/ Off] (+ Value)
	When value is changed	Value
	When AGC speed is switched	[Fast/ Middle/ Slow] + Value
	AGC OFF	“AGC” + “Off”
Equalizer	When screen is displayed or when [VOICE1] is pressed	[RX/TX] + “Equalizer” + (HB1/ HB2/ FP/ BB1/ BB2/ F/ C/ U1/ U2/ U3)
	When a selection is made via key operation	[HB1/ HB2/ FP/ BB1/ BB2/ F/ C/ U1/ U2/ U3]
Equalizer adjustment	When screen is displayed or when [VOICE1] is pressed	[RX/TX] + “Equalizer” + “Adjustment”
	When a selection is made	[0/0.3/0.6/0.9/1.2/1.5/1.8/2.1/2.4/2.7/3.0/3.3/3.6/3.9/4.2/4.5/4.8/5.1] (+ [+/-]) + Value + dB ([+/-] is not uttered when it is 0 dB.)
	When value is changed via key operation	(+/-) + Value + dB ([+/-] is not uttered when it is 0 dB)
	Initialization	No announcement
Confirmation of equalizer copy	When screen is displayed or when [VOICE1] is pressed	“Copy” + “Are you Sure?”

13 VOICE GUIDANCE

Screen	Operation/Status	Content of Announcement
Selection of file to read	When the RXEQ screen is displayed or when [VOICE1] is pressed	"File" + "List" + "RX" + "Equalizer"
	When the TXEQ screen is displayed or when [VOICE1] is pressed	"File" + "List" + "TX" + "Equalizer"
	When the DATA screen is displayed or when [VOICE1] is pressed	"File" + "List" + "Data"
	When a selection is made	Year + Month + Day + Time (Announces the time stamp of the file)
	When the file deletion confirmation screen is displayed or when [VOICE1] is pressed	"Delete" + "Are you Sure?"
	Name editing	"Edit"
	When the file browsing location is changed	[USB/ Internal]
Selection of data to read (DATA)	When screen is displayed or when [VOICE1] is pressed	"Read" + "Data" + "Selection"
	When a selection is made (environment-dependent)	"ENV" + [On/ Off]
	When a selection is made (CW)	"CW" + "Message" + [On/ Off]
	When a selection is made (voice message)	"Voice" + "Message" + [On/ Off]
	Switching between ON/OFF	[On/ Off]
Processing (without CANCEL key)	When screen is displayed or when [VOICE1] is pressed	"Please wait" (Announcement is not output when reading data with RXEQ/TXEQ.)
Data reading complete	When screen is displayed or when [VOICE1] is pressed	"Completed"
Request to get ready the USB flash drive	When screen is displayed or when [VOICE1] is pressed	"USB" + "Connect"
Data saving complete	When screen is displayed or when [VOICE1] is pressed	"Completed"
TX audio source input settings	When screen is displayed or when [VOICE1] is pressed	"Moduration-Source" + [Mic. + PTT/ Data + PTT]
	Switching method of transmission	[Mic. + PTT/ Data + PTT]
	Specification of audio input line (Front/Rear) (</>)	[F/ R]
	Front input selection F4 [SELECT]	[Off/ Mic.]
	Rear input selection F4 [SELECT]	[Off/ ACC 2/ USB/ LAN]
	Switching DATA VOX between ON/OFF	"Data" + "VOX" + [Off/ ACC two/ USB/ LAN]
VOX level configuration	When screen is displayed or when [VOICE1] is pressed	[VOX gain/ Anti- + VOX gain/ VOX delay] + [Mic./ ACC two/ USB/ LAN] + Value
	Switching of audio source input	[Mic./ ACC two/ USB/ LAN]
	Switching the parameter to configure	[VOX gain/ Anti- + VOX gain/ VOX delay]
	Increasing or decreasing the setting value	Value
	Reset to default value	No announcement
TX output power limiter configuration	When screen is displayed or when [VOICE1] is pressed	[TX power + Limit + [SSB/ CW/ FSK PSK/ FM AM/ Data]/ [TX Tune] + Band + Value The band is [1.8/ 3.5/ 5/ 7/ 10/ 14/ 18/ 21/ 24/ 28/ 50] + "Mega Hertz"
	TX output power type selection	[TX power + Limit + [SSB/ CW/ FSK PSK/ FM AM/ Data] / TX Tune]
	Band selection	[1.8/ 3.5/ 5/ 7/ 10/ 14/ 18/ 21/ 24/ 28/ 50/ 70] + "Mega Hertz"
	Increasing or decreasing TX output power	Value
	Reset to default value	No announcement
Speech processor configuration	When screen is displayed or when [VOICE1] is pressed	"Processor" + [Soft/Hard] + [In/Out] + Value
	Effect selection	[Soft/ Hard]
	Switching between "Input" and "Output"	[In/ Out]
	Increasing or decreasing the value	Value

Screen	Operation/Status	Content of Announcement
CW message (paddle version)	When screen is displayed or when [VOICE1] is pressed (deselected)	"CW" + "Message"
	When screen is displayed or when [VOICE1] is pressed (selected)	"Channel" + Number (+ "Repeat") (+ "Blank")
	Switching of repeat mode	"Repeat" + [Off/ On]
	Switching of channel	Number + "Repeat" + "Blank"
	Switching of playback list	No announcement
	Delete	No announcement
Standby for CW message (paddle) registration	When screen is displayed or when [VOICE1] is pressed	No announcement
During CW message registration	When [VOICE1] is pressed	No announcement
CW message (text version)	When screen is displayed or when [VOICE1] is pressed (deselected)	"CW" + "Message"
	When screen is displayed or when [VOICE1] is pressed (selected)	"Channel" + Number (+ "Repeat") (+ "Blank") (+ Contest number)
	Switching of repeat mode	"Repeat" + [Off/ On]
	Switching of channel	Number (+ "Repeat") (+ "Blank") (+ Contest number)
	Switching of playback list	No announcement
	Delete	No announcement
	Subtraction of contest number	Contest numbers
	Channel message editing	"Edit"
RTTY communication	When screen is displayed or when [VOICE1] is pressed	"RTTY" + "Communication"
PSK communication	When screen is displayed or when [VOICE1] is pressed	"PSK" + "Communication"
RTTY/PSK message	When screen is displayed or when [VOICE1] is pressed (deselected)	[RTTY/ PSK] + "Message"
	When screen is displayed or when [VOICE1] is pressed (deselected)	"Channel" + Number + "Auto" + "TX" + "RX"
	Switching of channel	Number
	AUTO TX mode switching	"Auto" + "TX" + [Off/ On]
	AUTO RX mode switching	"Auto" + "RX" + [Off/ On]
	Message editing (including when [VOICE1] is pressed)	"Message" + "Edit"
Log file selection	When screen is displayed or when [VOICE1] is pressed	In the case of log file selection screen (CW): "Log" + "File" + "CW" In the case of log file selection screen (RTTY): "Log" + "File" + "RTTY" In the case of log file selection screen (PSK): "Log" + "File" + "PSK"
	When a selection is made	Year (2018 to 2099) + Month + Day + Time
	File deletion confirmation	"Delete" + "Are you Sure?"
	Name editing	"Edit"
	When the file browsing location is changed	[USB/ Internal]
Log View	When screen is displayed or when [VOICE1] is pressed	"Log" + "View"
FM tone frequency configuration	When screen is displayed or when [VOICE1] is pressed	"Tone" + Frequency
	Change in frequency	Frequency
	Start of TONE scanning During TONE scanning or when [VOICE1] is pressed	"Tone" + "Scan"
	End of TONE scanning	Frequency
FM CTCSS frequency configuration	When screen is displayed or when [VOICE1] is pressed	"CTCSS" + Frequency
	Change in frequency	Frequency
	Start of CTCSS scanning During CTCSS scanning or when [VOICE1] is pressed	"CTCSS" + "Scan"
	End of CTCSS scanning	Frequency

13 VOICE GUIDANCE

Screen	Operation/Status	Content of Announcement
FM cross tone frequency configuration	When screen is displayed or when [VOICE1] is pressed	"Cross-Tone" + [Tone/ CTCSS] + Frequency
	TONE/CTCSS switching	[Tone/ CTCSS]
	Change in frequency	Frequency
RX filter configuration	When screen is displayed or when [VOICE1] is pressed	"RX" + "Filter" + [A/ B/ C] + [R/ IF/ AF] + Options
	Switching of filter	[A/ B/ C]
	Switching of roofing filter	[Auto/ 270 + Hertz/ 500 + Hertz/ 2.7 + Kilohertz/ 6 + Kilohertz/ 15 + Kilohertz]
	Switching of shape factor	[Soft/ Medium/ Sharp]
	Configuring or clearing preset passband characteristics	No announcement
	Switching of audio filter width	[Narrow/ Medium/ Wide]
Audio peak filter configuration	When screen is displayed or when [VOICE1] is pressed	"APF" + [Narrow/ Medium/ Wide]
	When a selection is made	[Narrow/ Medium/ Wide]
	Switching of shift frequency	"Shift" (+ [+/-]) + Value + "Hertz"
	Switching of gain level	"Gain" (+ [+]) + Value + "dB"
NB1/ NR1/ NR2 level configuration	When screen is displayed or when [VOICE1] is pressed	"Noise blanker" + "1" + Value "Noise reduction" + "1" + Value "Noise reduction" + "2" + Value
	Reset to default value	No announcement
	Switching of setting value	Value
NB2 level configuration	When screen is displayed or when [VOICE1] is pressed	"Noise blanker" + "2" + "A" + Value or "Noise blanker" + "2" + "B" + "Level" + Value or "Noise blanker" + "2" + "B" + "Width" + Value or "Noise blanker" + "2" + "B" + "Depth" + Value
	Switching of type	[A/ B]
	When a selection is made	[Level/ Width/ Depth]
	Reset to default value	No announcement
	Switching of value	Value
(Standard size) Bandscope + Waterfall	When screen is displayed or when [VOICE1] is pressed	"Bandscope"
(Standard size) Bandscope screen	When screen is displayed or when [VOICE1] is pressed	"Bandscope"
(Enlarged size) Bandscope + Waterfall	When screen is displayed or when [VOICE1] is pressed	"Bandscope"
Audio scope	When screen is displayed or when [VOICE1] is pressed	"Audio scope"
Multi scope Bandscope (upper screen)/ audio scope (lower screen)	When screen is displayed or when [VOICE1] is pressed	"Audio scope"

Screen	Operation/Status	Content of Announcement
Memory channel list	When screen is displayed or when [VOICE1] is pressed	During normal selection Blank channel: "Memory" + "List" + Number + "Blank" Simplex mode: "Memory" + "List" + Number + Frequency Split mode: "Memory" + "List" + Number + "Split" + Frequency During selection of data writing destination Blank channel: "Memory" + "In" + Number + "Blank" Simplex mode: "Memory" + "In" + Number + Frequency Split mode: "Memory" + "In" + Number + "Split" + Frequency
	When a selection is made	Blank channel: Number + "Blank" Simplex mode: Number + Frequency Split mode: Number + "Split" + Frequency
	Registration or pasting of data	No announcement
	Input of start frequency for specific band segments (Input of end frequency)	"End" + "Frequency" + Current frequency
	Erasing channel data	No announcement
	Name input	"Edit"
	Lockout mode switching	"Lockout" + [On/ Off]
Confirmation for deletion of all quick memory data	When screen is displayed or when [VOICE1] is pressed	"Quick memory" + "Clear" + "Are you Sure?"
Group configuration for Memory Scan	When screen is displayed or when [VOICE1] is pressed	"Memory" + "Scan" + "Group" + Number + [On/ Off]
	When a selection is made	Number + [On/ Off]
	Switching between ON/OFF	[On/ Off]
	Switching between All ON/All OFF	"Select" + "All" "Clear" + "All"
Configuration of segment for Program Scan	When screen is displayed or when [VOICE1] is pressed	Program Scan: "Program" + "Scan" + "Channel" + Number + [On/ Off] VFO Scan: "VFO" + "Scan"
	When a selection is made	Number + [On/ Off]
	Switching between ON/OFF	[On/ Off]
	Switching between VFO Scan/ Program Scan	[VFO + Scan/ Program + Scan]
	Switching between All ON/All OFF	"Select" + "All" "Clear" + "All"
Configuration of Program Slow Scan points	When screen is displayed or when [VOICE1] is pressed	"Program" + "Slow" + "Scan" + Operating frequency
	During configuration of point frequency	No announcement
	Batch delete	"Clear" + "All"
Voice message	When screen is displayed or when [VOICE1] is pressed	"Voice" + "Message"
	When the editing screen is displayed or when [VOICE1] is pressed	Blank channel: "Message" + Number + "Blank" Registered channel: "Message" + Number (+ "Repeat")
	Switching of channel to edit	Blank channel: Number + "Blank" Registered channel: Number (+ "Repeat")
	Switching of repeat mode	"Repeat" + [Off/ On]
	Deletion	No announcement
	Name registration (Including when [VOICE1] is pressed)	"Edit"
Voice message recording standby	When screen is displayed or when [VOICE1] is pressed	"Record" + [Mic./ ACC two/ USB/ LAN]
	Switching of audio source input	[Mic./ ACC two/ USB/ LAN]

13 VOICE GUIDANCE

Screen	Operation/Status	Content of Announcement
Recording file (built-in memory)	When screen is displayed or when [VOICE1] is pressed	When browsing audio files: "Audio" + "File" When browsing audio files of timer recordings: "Audio" + "File" + "Timer"
	When a selection is made	Year (2018 to 2099) + Month + Day + Time
	Folder switching (recording file/timer)	When browsing the built-in memory: Same as when a screen is displayed When browsing the USB flash drive: Refer to "When a screen is displayed" in "Recording file (USB flash drive)"
	Switching memory	Same as when the recording file (USB flash drive) screen is displayed However, if the USB flash drive is not connected, refer to the "Request to get ready the USB flash drive" screen
	File deletion confirmation (Including when [VOICE1] is pressed)	"Delete" + "Are you Sure?"
	Editing of file name	"Edit"
	Request to get ready the USB flash drive (Including when [VOICE1] is pressed)	"USB" + "Connect"
Recording file (USB flash drive)	When screen is displayed or when [VOICE1] is pressed	When browsing audio files: "Audio" + "File" + "USB" When browsing audio files of timer recordings: "Audio" + "File" + "USB" + "Timer"
	When a selection is made	Year (2018 to 2099) + Month + Day + Time
	Switching memory	Refer to the Recording file (built-in memory) screen
	Folder switching (between TIMER_REC and RXREC)	When browsing a USB flash drive: Same as when a screen is displayed When browsing the built-in memory: Refer to "When a screen is displayed" in "Recording file (built-in memory)"
	File deletion confirmation (Including when [VOICE1] is pressed)	"Delete" + "Are you Sure?"
	Name editing	"Edit"
LAN menu	When screen is displayed or when [VOICE1] is pressed	"LAN" + "Menu" + Item number (1 digit) + Settings
	Switching of setting item	Item number (1 digits) + Settings
	Start of setting value editing, movement of selection, input of setting value	Value of selected position
	Switching of setting item (Related to address)	Item number (1 digit) + nnn + "Point" + nnn + "Point" + nnn + "Point" + nnn However, content is as follows when nnn is blank: Item number (1 digit) + "Blank"
	Switching of setting item (Related to ID/Pass)	Item number (1 digit)
	Start of setting value editing, movement of selection (related to address)	Value of selected position
	Input of setting value (related to address)	Numeric value that is entered
	Selection of setting value (related to address)	Selected value
CLOCK menu top	When a screen is displayed	"Clock" + "Menu" + "Group" + Group number (1 digit)
	Group selection	Number
CLOCK menu items display	When screen is displayed or when [VOICE1] is pressed	"Clock" + "Menu" + Item number (2 digit) + Settings
	Item selection	Item number (2 digits) + Settings
	Start of Date and Time configuration	"Edit"
	Start of configuration	No announcement
	Change in setting value	Description
Acquisition of NTP date/time data	When a screen is displayed	"Clock" + "Update"
Acquisition of NTP date/time data is complete	When screen is displayed or when [VOICE1] is pressed	"Completed"
Acquisition of NTP date/time data failed	When screen is displayed or when [VOICE1] is pressed	"Error" + Number
Timer configuration	When screen is displayed or when [VOICE1] is pressed	"Programmable" + "Timer" + Options
	When the sleep timer settings are changed	"Sleep Timer" + Options

Screen	Operation/Status	Content of Announcement
Program timer configuration	When screen is displayed or when [VOICE1] is pressed	"Programmable" + "Timer" + [On/ Off] "Programmable" + "Timer" + "Repeat" + [On/ Off] "Programmable" + "Timer" + Day + [On/ Off] "Programmable" + "Timer" + "Mode" + [Timer Off/ On/ Off/ Both/ Record] "Programmable" + "Timer" + "Start" + "Hour" + Numeric value (2 digits) "Programmable" + "Timer" + "Start" + "Minute" + Numeric value (2 digits) "Programmable" + "Timer" + "End" + "Hour" + Numeric value (2 digits) "Programmable" + "Timer" + "End" + "Minute" + Numeric value (2 digits) "Programmable" + "Timer" + Frequency + Timer RX mode
	When a selection is made	Announces the status of the selected position "Timer" + [On/ Off] "Repeat" + [On/ Off] Day + [On/ Off] "Mode" + [Timer Off/ On/ Off/ Both/ Record] "Start" + "Hour" + Numeric value (2 digits) "Start" + "Minute" + Numeric value (2 digits) "End" + "Hour" + Numeric value (2 digits) "End" + "Minute" + Numeric value (2 digits) Frequency + Timer RX mode
	When a setting value is input	Numeric value that is entered
	Switching between ON/OFF	[On/ Off]
	Mode switching	[Timer Off/ On/ Off/ Both/ Record]
	Change in selected setting ([MULTI/CH] control/F4[+]/F5[-]/numeric keypad)	Description
	Program timer configuration is complete	When screen is displayed or when [VOICE1] is pressed
Menu top	When screen is displayed or when [VOICE1] is pressed	"Menu" + "Group" + Group number (1 digit)
	Group selection	"Group" + Group number (1 digit)
	Upon entering SWL mode	"SWL" + "On"
	When SWL mode is OFF	"SWL" + "Off"
Menu items display	When screen is displayed or when [VOICE1] is pressed	"Menu" + Group number (1 digit) + Item number (2 digits) + Setting
	When a menu is selected	Item number (2 digits) + Settings
	During start of parameter editing (Including when [VOICE1] is pressed)	"Edit"
	When a setting value is selected	No announcement
	When a setting value is altered	Selected value
	[GROUP ▲]	"Group" + Group number (1 digit)
	[GROUP ▼]	"Group" + Group number (1 digit)
USB/file management menu	When screen is displayed or when [VOICE1] is pressed	Announces the selected function item "USB" + "File" + "Menu" + [Remove/ Read + Configuration/ Save + Configuration/ Copy + File + PC/ Copy + File + USB/ Read + File/ Delete + File/ File + Save/ Format]
	When an item is selected	[Remove/ Read + Configuration/ Save + Configuration/ Copy + File + PC/ Copy + File + USB/ Read + File/ Delete + File/ File + Save/ Format]
Selection of destination to save files	When screen is displayed or when [VOICE1] is pressed	"File" + "Save" + [Internal/ USB]
	When switching the selection option	[Internal/ USB]
Selection of items to copy	When screen is displayed or when [VOICE1] is pressed	Announces the selected function item "Copy" + "File" + "Select" + [Configuration/ Audio/ Timer + Audio/ TX + Equalizer/ RX + Equalizer/ CW + Log/ RTTY + Log/ PSK + Log/ S + C/ KNS + Log]
	When an item is selected	[Configuration/ Audio/ Timer + Audio/ TX + Equalizer/ RX + Equalizer/ CW + Log/ RTTY + Log/ PSK + Log/ S + C/ KNS + Log]
	Switching between check and uncheck	[Off/ On]

13 VOICE GUIDANCE

Screen	Operation/Status	Content of Announcement
Selection of items to delete	When screen is displayed or when [VOICE1] is pressed	Announces the selected function item "Delete" + "File" + "Select" + [Configuration/ Audio/ Timer + Audio/ TX + Equalizer/ RX + Equalizer/ CW + Log/ RTTY + Log/ PSK + Log/ S + C/ KNS + Log]
	When an item is selected	[Configuration/ Audio/ Timer + Audio/ TX + Equalizer/ RX + Equalizer/ CW + Log/ RTTY + Log/ PSK + Log/ S + C/ KNS + Log] * S+C: Screen Captured Files
	Switching between check and uncheck	[Off/ On]
Formatting confirmation	When screen is displayed or when [VOICE1] is pressed	"Format" + "Are you Sure?"
When "formatting in progress" screen is displayed or during other ongoing processes in general	When screen is displayed or when [VOICE1] is pressed	"Please wait"
Unmount confirmation	When screen is displayed or when [VOICE1] is pressed	"Remove" + "Are you Sure?"
Unmount is complete	When screen is displayed or when [VOICE1] is pressed	"Completed"
RESET menu items display	When screen is displayed or when [VOICE1] is pressed	"Menu Reset" "Memory Channel Reset" "VFO Reset" "Standard Reset" "Full Reset"
Standard reset confirmation	When screen is displayed or when [VOICE1] is pressed	"Standard Reset" + "Are you Sure?"
Full reset confirmation	When screen is displayed or when [VOICE1] is pressed	"Full Reset" + "Are you Sure?"
VFO reset confirmation	When screen is displayed or when [VOICE1] is pressed	"VFO Reset" + "Are you Sure?"
Memory reset confirmation	When screen is displayed or when [VOICE1] is pressed	"Memory Channel Reset" + "Are you Sure?"
Menu reset confirmation	When screen is displayed or when [VOICE1] is pressed	"Menu Reset" + "Are you Sure?"
Reset in progress	When screen is displayed or when [VOICE1] is pressed	"Please wait"
Advanced menu items display	When screen is displayed or when [VOICE1] is pressed	"Advanced" + "Menu" + Item number (from 1 digit)
	When a selection is made	Item number (from 1 digits) + Settings
Advanced menu adjustment	When screen is displayed or when [VOICE1] is pressed	No announcement
	Change in setting value	Value
Touchscreen adjustment in progress	When screen is displayed (No voice is output when [VOICE1] is pressed)	"Touchscreen" + "Calibration"
Advanced menu license display	When screen is displayed or when [VOICE1] is pressed	"License"
Version display for advanced menu firmware	When screen is displayed or when [VOICE1] is pressed	Numeric value + "Point" + 2-digit numeric value
Switching of operating environment data	When screen is displayed or when [VOICE1] is pressed	"A" + Waiting time + "B" + "Are you Sure?"
Error/warning message	When screen is displayed or when [VOICE1] is pressed	[Error/ Warning] + Number
AGC quick recovery configuration	When screen is displayed or when [VOICE1] is pressed	"AGC Quick Recovery" + [Off/ On] (+ Value)
	Switching between ON/OFF	[On/ Off]
	Change in threshold level	Value
Carrier level configuration	When screen is displayed or when [VOICE1] is pressed	"Carrier" + Value
	Change in carrier level	Value
TX monitor level configuration	When screen is displayed or when [VOICE1] is pressed	"TX monitor" + Value
	Change in TX monitor level	Value

Screen	Operation/Status	Content of Announcement
CW communication	When screen is displayed or when [VOICE1] is pressed	"CW" + "Communication"
	Contest number decrement	Subtracted contest number
Scope range configuration in Fixed mode	When screen is displayed or when [VOICE1] is pressed	"Bandscope" + "Configuration"
TX output power limiter OFF confirmation	When screen is displayed or when [VOICE1] is pressed	"TX power" + "Limit" + "Off" + "Are you Sure?"
Dimmer configuration	When screen is displayed or when [VOICE1] is pressed	"D" + "Menu" + Value (0 to 100) * D: Dimmer
	When the position to configure is selected (When F3 [◀]/ F4 [▶] is pressed)	[D/L] + Value *D: Display/ L: LED
	Altering of value	Value
Linear amplifier menu configuration	When screen is displayed or when [VOICE1] is pressed	"Linear Amplifier" + Target bands of linear amplifier menu + Function name of focusing position + Setting
	Band selection	[HF/ 50/ 70 (E type only)] + "Mega Hertz"
	Linear amplifier ON/OFF	[Off/On]
	Linear amplifier TX control	[Low/ High]
	Linear amplifier TX delay ON/OFF	[Off/ On]
	Linear amplifier TX delay time (CW/FSK/PSK)	[5/ 10/ 15/ 20/ 25/ 30/ 35/ 40]
	Linear amplifier TX delay time (SSB/AM/FM)	[5/ 10/ 15/ 20/ 25/ 30/ 35/ 40/ 45/ 50]
	Linear amplifier relay control	[Off/ On]
	Linear amplifier external ALC voltage	[-1/ -2/ -3/ -4/ -5/ -6/ -7/ -8/ -9/ -10/ -11/ -12]
KNS information	When screen is displayed or when [VOICE1] is pressed	"KNS" + "Connect" + [Off / User name]
KNS configuration	When screen is displayed or when [VOICE1] is pressed When a selection is made	"KNS" + "Configuration" + Item number (from 1 digit) + Settings
KNS Users List	When screen is displayed or when [VOICE1] is pressed	"KNS" + "User" + "List" + User name of selected item*
	When a selection is made	User name of selected item* * The registered user name is uttered one character at a time. Characters that cannot be uttered will be inserted with a pause. Blank is uttered if a user name is not registered.
KNS user registration	When screen is displayed or when [VOICE1] is pressed	"KNS" + "User" + "List" + User name of selected item*
	When a selection is made	Name of selected item* * The content of the announcement for the item name is as follows. "User Name": "User" "Password": "PASS" (utters 1 character at a time) "Description" : "D" "RX Only": "RX" + [Off/ On] "Disabled": "Disable" + [Off/ On]
	Switching between check and uncheck	[Off/ On]
Frequency marker list	When screen is displayed or when [VOICE1] is pressed	"Frequency" + "Marker" + "List" + [ON/OFF] + [Blank / Frequency] * "Blank" if no data is registered. Frequency when data is registered.
	When a selection is made	[Blank / Marker + Frequency]
Calling up the preconfigured emergency frequency	When screen is displayed or when [VOICE1] is pressed	"Emergency" + "Frequency"
Confirmation for batch deletion of files	When screen is displayed or when [VOICE1] is pressed	"All" + "Delete" + "Are you sure?"
File deletion confirmation	When screen is displayed or when [VOICE1] is pressed	"Delete" + "Are you sure?"



- For more details on the option numbers when configuring the PF keys, please refer to "[List of Assignable Functions](#)" (16-3). When the higher order digit of the menu number or memory channel number is "0", "0" will also be uttered.
- When the setting screen overlaps with messages on errors, warnings and other information, announcement will be output for the error, warning or information message.
- Frequency value in the VFO mode is announced in sequence starting from the highest order digit that is being displayed. "Point" is uttered as a delimiter for MHz.

13 VOICE GUIDANCE

Voice 2

Pressing the key that is assigned with "VOICE2" announces the S meter and power meter values. For example, "S5" or "20 dB" will be announced in this case.

● **Press [PF B] or the PF key that is assigned with "VOICE2".**

Announces the S meter and power meter values.



- Pressing the PF key that is assigned with "VOICE1", "VOICE2" or "VOICE3" during the announcement stops the announcement.
- For more details on how to change the assignment of PF keys, please refer to "PF Keys (Programmable Function Keys)" (16-2).
- Even while an analog meter is displayed, the "VOICE2" announcement changes according to the level when a digital meter is displayed (dot: 0 to 70).

Content that is announced in the VOICE2 mode is as follows.

S meter		Power Meter	
Level	Content of Announcement	Level	Content of Announcement
0	S 0	0	P 0
1 to 4	S 1	1 to 5	P 5
5 to 8	S 2	6 to 10	P 10
9 to 12	S 3	11 to 14	P 17.5
13 to 16	S 4	15 to 19	P 25
17 to 20	S 5	20 to 27	P 37.5
21 to 24	S 6	28 to 35	P 50
25 to 28	S 7	36 to 47	P 75
29 to 32	S 8	48 to 59	P 100
33 to 36	S 9	60 to 65	P 125
37 to 41	10 dB	66 to 70	P 150
42 to 47	20 dB	-	-
48 to 52	30 dB	-	-
53 to 58	40 dB	-	-
59 to 64	50 dB	-	-
65 to 70	60 dB	-	-

Voice 3

Pressing the key that is assigned with "VOICE3" announces the meter values.

● **Press [PF C] or the PF key that is assigned with "VOICE3".**

Announces the meter value at the time when the key is pressed.



- VOICE3 makes announcement only during transmission.
- Pressing the PF key that is assigned with "VOICE1", "VOICE2" or "VOICE3" during the announcement stops the announcement.
- For more details on how to change the assignment of PF keys, please refer to "PF Keys (Programmable Function Keys)" (16-2).
- Even while an analog meter is displayed, the "VOICE3" announcement changes according to the level when a digital meter is displayed (dot: 0 to 70).
- When the meter selected is PWR meter, the announcement is the same as that of the PWR meter in VOICE2.
- Pressing [VOICE3] while the voice message recording standby screen or the voice message recording in progress screen is displayed announces the value (recording level) of the "Recording Level Meter".
- Pressing [VOICE3] during configuration of the microphone gain in Advanced Menu [10] announces the value of the level meter.

Content that is announced in the VOICE3 mode is as follows.

SWR Meter		COMP Meter		ALC Meter	
Level	Content of Announcement	Level	Content of Announcement	Level	Content of Announcement
0 to 1	R 1.0	0	C 0 dB	0	A 0
2	R 1.1	1 to 9	C 5 dB	1 to 2	A 1
3 to 4	R 1.2	10 to 19	C 10 dB	3 to 4	A 2
5	R 1.3	20 to 34	C 15 dB	5 to 6	A 3
6 to 7	R 1.4	35 to 50	C 20 dB	7 to 8	A 4
8 to 9	R 1.5	51 to 57	C 25 dB	9 to 10	A 5
				11 to 12	A 6
10 to 11	R 1.6	58 onwards	C OVER	13 to 14	A 7
12 to 13	R 1.7			15 to 16	A 8
14 to 15	R 1.8			17 to 18	A 9
16 to 17	R 1.9			19 to 20	A 10
18 to 21	R 2.0			21 to 22	A 11
22 to 27	R 2.5			23 to 24	A 12
28 to 36	R 3.0			25 to 26	A 13
37 to 42	R 4.0			27 to 28	A 14
43 to 47	R 5.0			29 to 30	A 15
48 onwards	R OVER			31 to 32	A 16
				33 to 34	A 17
				35 onwards	A OVER

ID Meter		TEMP Meter		VD Meter	
Level	Content of Announcement	Level	Content of Announcement	Level	Content of Announcement
0 to 9	I 2.5	0 to 25	T LOW	Up to 46	V LOW
10 to 17	I 5	26 to 60	T MIDDLE	47 to 48	V 10
18 to 26	I 7.5	61 onwards	T HIGH	49 to 51	V 11
27 to 35	I 10			52 to 55	V 12
36 to 44	I 12.5			56 to 58	V 13
45 to 52	I 15			59 to 61	V 14
53 to 60	I 17.5			62 to 64	V 15
61 onwards	I 20			65 onwards	V HIGH

Recording Level Meter/ Audio Lever Meter during FM Microphone Gain Configuration	
Level	Content of Announcement
0	L 0
1 to 2	L 1
3 to 4	L 2
5 to 6	L 3
7 to 8	L 4
9 to 10	L 5
11 to 12	L 6
13 to 14	L 7
15 to 16	L 8
17 to 18	L 9
19 to 20	L 10
21 to 22	L 11
23 to 24	L 12
25 to 26	L 13
27 to 28	L 14
29 to 30	L 15
31 to 32	L 16
33 to 34	L 17
35 onwards	L OVER

14 CLOCK DISPLAY/TIMER

Configuring Date and Time

This transceiver can display 2 types of clocks.

Local Clock

Displays the current date and time.

Auxiliary Clock

Displays information such as the UTC clock.

Displaying the Clock Menu Screen

- 1 Press [MENU] to display the menu screen.
- 2 Press F [CLOCK] to display the Clock menu screen.
 - If F [CLOCK] is not displayed, press F [MORE] to display F [CLOCK].

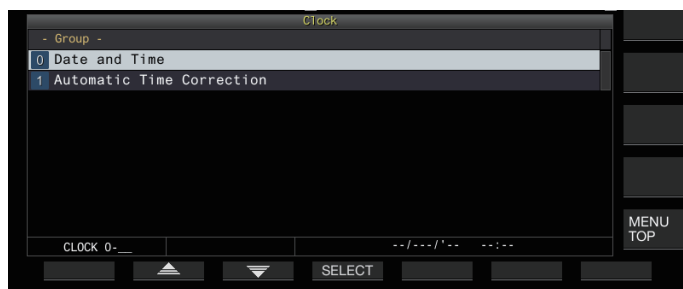

- 3 Select Clock Menu [0] "Date and Time".
- 4 Press F4 [SELECT].
The date/time configuration screen is displayed.



- Pressing F7 [CANCEL] while the date and time configurations for Local Clock is still in progress discards the settings and returns the display to the Date and Time configuration screen.

Configuring the Local Clock Date

The date of the local clock that is used for display or the time stamp in files can be configured as follows.

- 1 Select Clock Menu [00] "Date (Local Clock)".
- 2 Press F4 [EDIT].
- 3 Use the function keys and the [MULTI/CH] control to select the date.

Key	Behavior
F2 [-]/ F3 [+]	Selects a setting value.
[MULTI/CH]	
F4 [◀]/ F5 [▶]	Moves the cursor.

- The date and time is displayed in the parameter field of the Clock screen according to the "Date Display Format" setting.
- The local clock cannot be configured when the auto time correction function using the NTP server is ON.

- 4 Press F6 [OK].

Configuring the Local Clock Time

Follow the steps below to configure the local clock time. This is usually configured to the local time of the location where this transceiver is being operated.

- 1 Select Clock Menu [01] "Time (Local Clock)".
- 2 Press F4 [EDIT].
- 3 Use the numeric keypad, function keys and the [MULTI/CH] control to configure the time.
A numeric value can be entered by pressing the corresponding key on the numeric keypad.

Key/Control	Behavior
F2 [-]/ F3 [+]	Selects a setting value.
[MULTI/CH]	
F4 [◀]/ F5 [▶]	Moves the cursor.

- 4 Press F6 [OK].

Configuring the Local Clock Time Zone

Follow the steps below to configure the time zone of the local clock.

- 1 Select Clock Menu [02] "Timezone (Local Clock)".
- 2 Press F4 [SELECT].
- 3 Press F2 [-]/ F3 [+] or turn the [MULTI/CH] control to select the time zone of the local clock.

Setting Value	Behavior
UTC-14:00 to UTC+00:00 (default) to UTC +14:00 (15min/step)	

- 4 Press F6 [OK].

14 CLOCK DISPLAY/TIMER

Configuring the Auxiliary Clock Time Zone

Follow the steps below to configure the time zone of the auxiliary clock.

- 1 Select Clock Menu [03] “Timezone (Secondary Clock)”.
- 2 Press F4 [SELECT].
- 3 Press F2 [-]/ F3 [+] or turn the [MULTI/CH] control to select the time zone of the local clock.

Setting Value	UTC-14:00 to UTC+00:00 (default) to UTC+14:00 (15min/step)
---------------	--

- 4 Press F6 [OK].

Registering an Auxiliary Clock Identifier

The auxiliary clock can be assigned with a single alphabet as an identifier.

- 1 Select Clock Menu [04] “Secondary Clock Identification Letter”.
- 2 Press F4 [EDIT].
- 3 Press F2 [-]/ F3 [+] or turn the [MULTI/CH] control to select an identifier character.
 - “U” is used in the default setting, which stands for “Coordinated Universal Time (UTC)”.
- 4 Press F6 [OK].

Configuring the Date Display Format

The date display format can be configured as follows.

- 1 Select Clock Menu [05] “Date Display Format”.
- 2 Press F4 [SELECT].
- 3 Select the preferred date display format.

Setting Value	MMM/DD/YY (K type: default)/ DD/MMM/YY (E type: default)/ YY/MMM/DD
---------------	---

- 4 Press F6 [OK].

Configuring the Clock Display

Follow the steps below to configure the types and number of clocks to display.

- 1 Select Clock Menu [06] “Clock Display”.
- 2 Press F4 [SELECT].
- 3 Select the preferred time display format.

Setting Value	Off/ Local Clock/ Secondary Clock/ Both (default)
---------------	---

Off: Does not display the clock.

Local Clock: Displays only the local clock.

Secondary Clock: Displays only the secondary clock.

Both: Displays both the local clock and secondary clock.

- 4 Press F6 [OK].

Clock Correction Using NTP (Network Time Protocol)

The NTP server can be used to correct the clock time automatically. This is done by applying the date and time acquired from the NTP server to the built-in clock of this transceiver.

The following configuration procedures are needed to make use of the NTP function.

- Connect this transceiver to a network such as a home LAN via a LAN cable.
- To make use of an NTP server on WAN, allow communication to be established via the Network Time Protocol Port (port 123). For a home LAN that uses a broadband router, ensure that port 123 of the broadband router is open.
- Configure the network and IP address on this transceiver. For more details on the method of configuration, please refer to “LAN” (15-1).
- Configure the address of the NTP server.
- Configure the NTP server address of the time zone configured for the local clock on this transceiver. For more details on the method of configuration, please refer to “Configuring the NTP Server Address” (14-3).

Displaying the Auto Correction Configuration Screen

- 1 Press [MENU] to display the menu screen.
- 2 Press F [CLOCK] to display the Clock menu screen.
 - If F [CLOCK] is not displayed, press F [MORE] to display F [CLOCK].
- 3 Select Clock Menu [1] “Automatic Time Correction”.
- 4 Press F4 [SELECT].
The auto correction configuration screen is displayed.

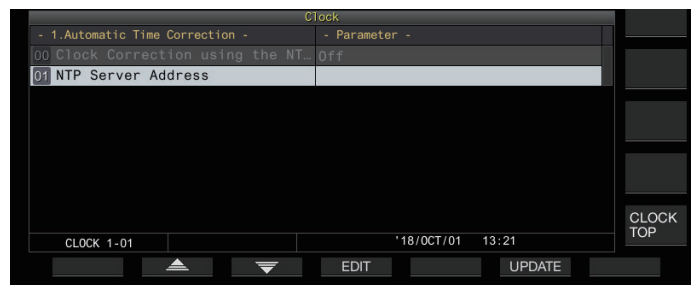

Configuring the NTP Server Address

Follow the steps below to configure the address of the NTP server.

- 1 Select Clock Menu [01] “NTP Server Address”.
- 2 Press F4 [EDIT].

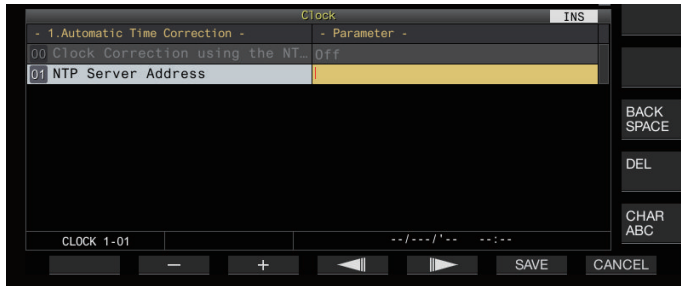

- 3 Use the function keys, [MULTI/CH] control or USB keyboard to enter the address of the NTP server.

Key	Behavior
F2 [-]/ F3 [+]	Selects a character.
F4 [◀ / F5 [▶]	Moves the cursor.
F [BACK SPACE]	Deletes the character to the left of the cursor.
F [DEL]	Deletes the character to the right of the cursor.
F [CHAR]	Switches the type of character to edit. Pressing the key each time switches the selection in the following sequence: ABC (upper case) → abc (lower case) → !"# (symbols) → ABC (upper case)

- 4 Press F6 [SAVE] to save the address.
 - Pressing F7 [CANCEL] discards the input and restores this transceiver to the NTP server address setting input mode.



- The response time of the NTP server varies depending on the condition of the network and the NTP server.
- Search for the NTP server address using “NTP server” as the keyword.

Turning ON/OFF Auto Clock Correction

The date and time that is configured for the clock of this transceiver can be corrected by communicating automatically with the NTP server.

- 1 Select Clock Menu [00] “Clock Correction using the NTP Server”.
- 2 Press F4 [SELECT].

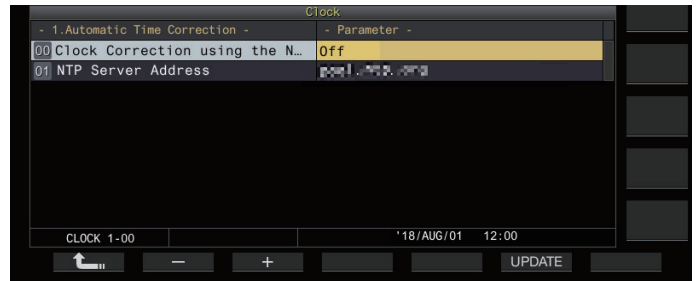

- 3 Press F2 [-]/ F3 [+] to set auto correction to “On” or “Off”.

When auto correction is set to “On”, communication is established automatically with the NTP server when the power (⏻) of this transceiver is turned on and correction of the clock’s date and time is performed. If the power (⏻) of this transceiver is left on, auto correction is performed at an interval of approximately 24 hours. The default setting is “Off”.

- 4 Press F6 [OK].

Correcting the Date and Time Manually

The date and time that is configured for the clock of this transceiver can be corrected by connecting this transceiver manually to the NTP server.

- 1 Select Clock Menu [1] “Automatic Time Correction”.
- 2 Press F4 [SELECT].

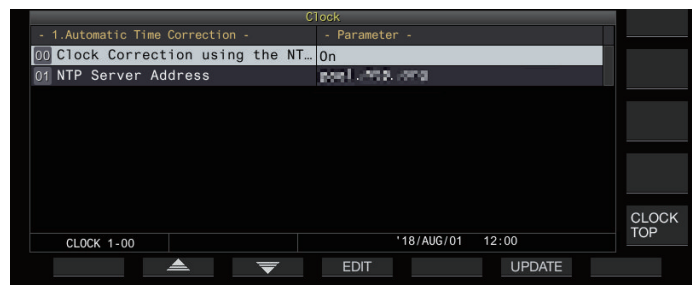

- 3 Press F6 [UPDATE].

Communication with the NTP server starts, and the date and time configured for the clock of this transceiver is corrected. After correction is complete, a message is displayed to notify the user that communication with the NTP server has ended.

 - Pressing F7 [CANCEL] while acquiring the date and time via NTP stops the acquisition process.



- The NTP server is a public server, please refrain from accessing it frequently.

Timer

This transceiver supports programmed operation using the following timer functions. The frequency and mode can be configured in the Program Timer screen.

Power ON (Program Timer Configuration Screen)

Turns on this transceiver with the preconfigured frequency and mode at the preconfigured timing.

Power OFF (Program Timer Configuration Screen)

Turns off this transceiver at the preconfigured time.

Power ON and Power OFF (Program Timer Configuration Screen)

Turns on or off this transceiver with the preconfigured frequency and mode and at the preconfigured timing.

Timer Recording (Program Timer Configuration Screen)

Records RX audio to the built-in memory or a USB flash drive during the interval between the preconfigured Power-on and Power-off time.

Sleep Timer (Timer Configuration Screen)

Turns off this transceiver after the preconfigured duration has elapsed.

APO (Auto Power Off) (Menu [0-32])

Turns off this transceiver if there is no key or control operation for the preconfigured duration.

Configuring the Program Timer

Follow the steps below to configure the timing for powering on and off this transceiver as well as the operation of the program timer.

- 1 Press [MENU].
- 2 Press and hold F [TIMER] to display the Timer configuration screen.
 - If F [TIMER] is not displayed, press F [MORE] to display F [TIMER].



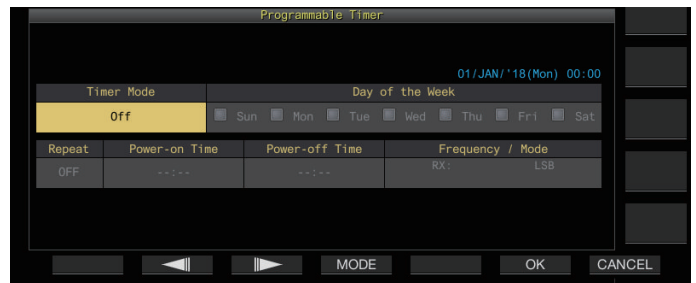

- 3 Press F3 [PROG] to display the Programmable Timer configuration screen.



- 4 Press F2 [◀|||]/ F3 [|||▶] to select the setting item.
- 5 Use the function keys and the [MULTI/CH] control to configure the program timer.

Setting Item	Configuration Method
Timer Mode	Press F4 [MODE] to select a timer operation. <ul style="list-style-type: none"> • Power-on: Turns on this transceiver at the preconfigured time. • Power-off: Turns off this transceiver at the preconfigured time. • Power-on/off: Turns on this transceiver for the preconfigured time. • Record: Performs recording for the preconfigured time. • Off: Disables timer function.
Repeat	Press F4 [ON/OFF] to toggle the repeat mode between ON and OFF. <ul style="list-style-type: none"> • On: Operates the timer at the preconfigured days every week. • Off: Operates the timer only once at the preconfigured day.

Setting Item	Configuration Method
Day of the Week	Press F4 [  ] to program the timer operation on a specific day of the week. <ul style="list-style-type: none"> Timer operation is enabled only on the days for which the corresponding checkbox is selected.
Power-on Time/ Power-off Time	Press F4 [-]/ F5 [+] or the numeric keypad, or turn the [MULTI/CH] control to configure the time for turning on and off this transceiver using the timer. <ul style="list-style-type: none"> Configure the time to a value between “00:00” and “23:59”. When “Power-on” is selected, the power-on time can be configured. When “Power-off” is selected, the power-off time can be configured.
Frequency/ Mode	Press F5 [COPY] to configure the frequency and mode to start up in by the timer. <ul style="list-style-type: none"> Turn the Tuning or [MULTI/CH] control or use the Band or Mode key to change the current receiving VFO or memory channel and align it with the frequency/mode for performing reception when the program timer is activated. Press F5 [COPY] every time when changing the frequency or mode to start up by the timer.

6 Press **F6** [**OK**].

The “configuration complete” screen appears.

- The programmed timer operation is now enabled. (<<  >> lights up.)

7 Press **F6** [**OK**].





Returns to the Timer menu screen.

8 Press [**ESC**] to end the process.

9 If the timer (excluding Power-off timer) is set to ON, press [] to power off this transceiver.

- If a timer mode other than “Off” is configured, the [POWER] LED lights up in orange.



- Before pressing **F5** [**COPY**] to copy the operating data that is registered in the memory channel, press and hold **[M>V]** to shift the operating data of the memory channel to VFO.
- Configure settings other than frequency and mode before pressing **F5** [**COPY**] in step 4.
- When programming the timer recording function, there must be an interval of at least 1 minute from the time recording starts (Power-on time) to the time recording ends (Power-off time). Otherwise, programmed recording cannot be performed.
- Timer recording up to a duration of 4 hours can be configured.
- Program timer can be configured even when **F6** [**OK**] in step 4 is pressed after the preconfigured interval has elapsed.
- To record audio to a USB flash drive, insert the USB flash drive into the (USB-A) connector on the front panel after configuring the timer recording settings and before recording starts. Use a USB flash drive that is formatted by this transceiver and one with sufficient remaining space.
- Timer recording does not start unless this transceiver is powered off.
- When the power of this transceiver is OFF, the [POWER] LED starts blinking 1 minute before timer recording starts, and pressing [] in this state does not power on this transceiver.
- If the power of this transceiver is not in the OFF state when timer recording is ON, a message will be displayed 3 minutes and 1 minute before timer recording starts. Press [] to turn off the power of this transceiver.
- The [POWER] LED light remains orange during timer recording, while the [REC] LED lights up in red.
- To cancel timer recording after the [POWER] LED starts blinking and before timer recording starts, press and hold [] for 4 seconds.
- While timer recording is in progress, all other operations are disabled until timer recording stops. To cancel timer recording, press [] and follow the displayed message to press and hold down **F4** [**(BREAK)**].
- If the sleep timer is configured, the operation of the program timer function will be temporarily disabled.
- If the power-off time configured in APO is earlier, the power of the transceiver is turned off by the APO function.

Pausing Program Timer Operation

The program timer can be paused while the timer is running.

- Power shutdown at the Power-off time
- Start of timer recording
- Power shutdown by the sleep timer

After the program timer is paused, pressing **F [TIMER]** resumes the program timer operation.

● Press F [TIMER].

<<🕒>> goes off, and countdown by the sleep timer or program timer is paused.

Pressing **F [TIMER]** again illuminates <<🕒>> and resumes countdown by the sleep timer or program timer.

Sleep timer

Sleep timer is a function for powering off this transceiver after the preconfigured interval has elapsed.

Configuring the Sleep Timer

1 Press [MENU].

2 Press and hold F [TIMER] to display the Timer configuration screen.

- If **F [TIMER]** is not displayed, press **F [MORE]** to display **F [TIMER]**.



3 Press F5 [SLEEP] and select the duration before powering off this transceiver.

<<🕒>> lights up.

Setting Value	Off (default)/ 5/ 10/ 15/ 30/ 60/ 90/ 120 [min]
---------------	---

- Select "Off" if the sleep timer is not used.

4 Press [ESC] to end the process.

Pausing the Sleep Timer

The sleep timer can be paused while the timer is running.

● Press F [TIMER].

<<🕒>> goes off, and automatic power-off by the sleep timer is temporarily disabled.



- Pressing **F [TIMER]** again disables or resumes both the sleep timer and programmable timer.
- If the power-off time configured in APO is earlier, the power of the transceiver is turned off by the APO function.

APO (Automatic Power Off)

APO is a function that powers off this transceiver when there is no key or control operation in the RX mode for the preconfigured time interval. "CHECK" is output in the Morse code from the speaker 1 minute before the power of this transceiver turns off.

● Configure in Menu [0-32] "Automatic Power Off"

Setting Value	Off (default)/ 60/ 120/ 180 [min]
---------------	-----------------------------------



- Upon reaching the preconfigured APO time, a timer power off screen is displayed and the power shuts down after 10 seconds. Operating any of the keys while the timer power off screen is displayed turns off the APO setting.

15 NETWORK/KNS OPERATION

LAN

Configure the LAN settings if the clock is to be corrected by connecting this transceiver to the NTP server. Establish a LAN connection from this transceiver using an Ethernet (LAN) cable (straight type).

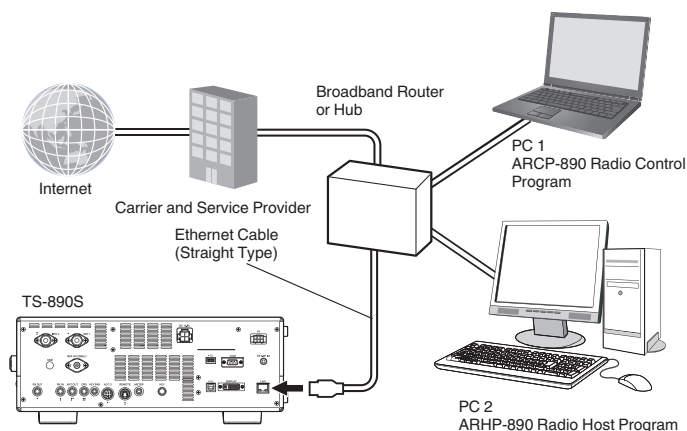

When operating this transceiver via the KNS (KENWOOD NETWORK COMMAND SYSTEM), configure the IP address, administrator ID and password. For operations using KNS, please refer to “KNS Operation” (15-2).

To access this transceiver through access via the network, log in with the preconfigured ID and password.

Configuring the IP Address

DHCP, which is the abbreviation for Dynamic Host Configuration Protocol, is a means for acquiring network information (IP address, DNS server, gateway, etc.) from the DHCP server. Besides acquiring the IP address manually, this DHCP can also be used to configure the IP address.

Configuring the IP Address Automatically (Using DHCP)

- 1 Press [MENU].
- 2 Press F [LAN] to display the LAN menu item list screen.
 - If F [LAN] is not displayed, press F [MORE] to display F [LAN].
- 3 Press F2 [▲], F3 [▼] or turn the [MULTI/CH] control to select LAN Menu [0] “DHCP”.
- 4 Press F4 [SELECT].

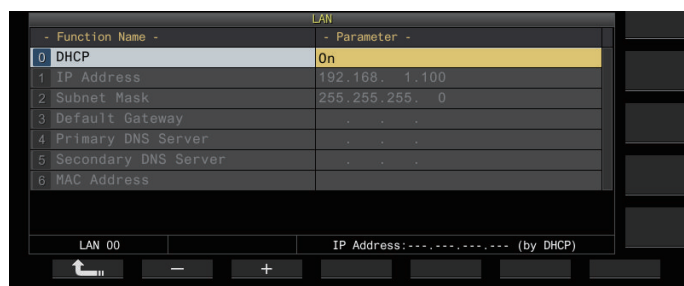

- 5 Press F2 [-]/ F3 [+] to select “On”.
The default setting is “On”.
- 6 Press F1 [↵].

Configuring the IP Address Manually (Without Using DHCP)

- 1 Select LAN Menu [0] “DHCP”.
- 2 Press F4 [SELECT].
- 3 Press F2 [-]/ F3 [+] to select “Off”.

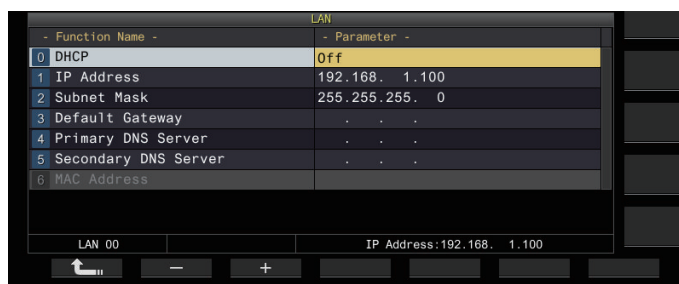

- 4 Press F1 [↵].
- 5 Press F2 [▲]/ F3 [▼] to select LAN Menu [1] “IP Address”.
- 6 Press F4 [EDIT].
- 7 Press F4 [◀|||]/ F5 [|||▶] to select an address block (set of 3 digits) to input.
- 8 Press F2 [-], F3 [+] or a key on the numeric keypad, or turn the [MULTI/CH] control to increase or decrease the 3-digit value of the address block.
- 9 Press F4 [◀|||]/ F5 [|||▶] to select the next 3 digits.
Repeat steps 8 to 9 to configure the IP address.
- 10 Press F6 [OK].
- 11 Press F2 [▲]/ F3 [▼] to select LAN Menu [2] “Subnet Mask”.
Repeat steps 3 to 10 to configure the subnet mask ([2]). Follow the same steps to configure default gateway ([3]), primary DNS server ([4]) and secondary DNS server ([5]).

Description	Setting Range	Default
DHCP	Off/ On	On
IP Address	1.0.0.0 to 223.255.255.255	192.168.1.100
Subnet Mask	0.0.0.0 to 255.255.255.252	255.255.255.0
Default Gateway	1.0.0.0 to 223.255.255.255	Blank
Primary DNS Server	1.0.0.0 to 223.255.255.255	Blank
Secondary DNS Server	1.0.0.0 to 223.255.255.255	Blank



- This transceiver does not support IPv6.
- This transceiver supports ping and other ICMP responses.
- The Ethernet standard used on this transceiver is 100BASE-TX. Use a commercially available cable that is Category 5 (Cat5) or higher.
- When connecting to a hub or broadband router, make use of a commercially available straight cable.
- Turn off the power of this transceiver and the device to connect to before connecting the cable.
- Even when the IP address is acquired automatically, IP address cannot be configured in an environment where a DHCP server is not used.
- When the IP address is acquired automatically, the IP address, subnet mask, default gateway, primary DNS server and secondary DNS server are grayed out and a parameter cannot be input.
- When an IP address is automatically acquired and configured for this transceiver, the configured IP address is displayed in the IP address setting.
- Setting DHCP to ON updates the parameter. If an address is not acquired, the address field will remain blank.
- The address may not be acquired immediately after DHCP is set to ON.
- Even when the IP address is configured while DHCP is OFF, this IP address will be displayed when DHCP is set to ON.

Viewing the MAC Address

The MAC address of this transceiver which is necessary for its operation via LAN can be identified in this menu item.

● Check LAN Menu [6] “MAC Address”.

The MAC address of this transceiver can be identified here. This menu item is intended for viewing only, and the setting in LAN Menu [6] “MAC Address” cannot be altered.

KNS Operation

KNS (KENWOOD NETWORK COMMAND SYSTEM) is a collective term that refers to the system for remotely operating a KENWOOD transceiver via the network such as the Internet or LAN. Operation using this system is referred to as “KNS operation”.



- The ARCP-890 and other related programs for remote operations, and “TS-890S KENWOOD NETWORK COMMAND SYSTEM Setting Manual” can be downloaded from the URL below.
http://www.kenwood.com/i/products/info/amateur/software_download.html
- This manual describes only the explanation on the areas of the transceiver configuration. For details on specific configurations, please refer to “TS-890S KENWOOD NETWORK COMMAND SYSTEM Setting Manual”.

System Configuration Overview

Basic Configuration for Remote Operation through the Internet

To operate the TS-890S remotely through the Internet using KNS, configure the system as shown in Figure 1.

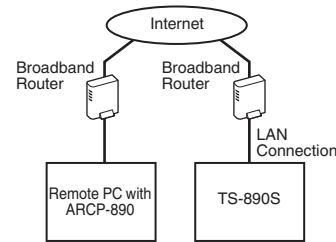

Figure 1: Basic System Configuration

Under this configuration, the TS-890S performs login authentication of the remote user (administrator and registered user) operating the ARCP-890, followed by control command communication after authentication is complete. Voice communication is carried out by the TS-890S and ARCP-890 via the built-in VoIP.



- Administrator refers to the owner of or person in charge of managing the transceiver. Registered user refers to a user other than the administrator who is authorized to operate this transceiver remotely via KNS. A registered user needs to be registered in advance by the administrator to the KNS users list in the TS-890S.

Configuration when Using ARVP-10 or a Non-KENWOOD VoIP for Voice Communication

When using ARVP-10 or a non-KENWOOD VoIP application software program for voice communication, configure the system as shown in Figure 2.

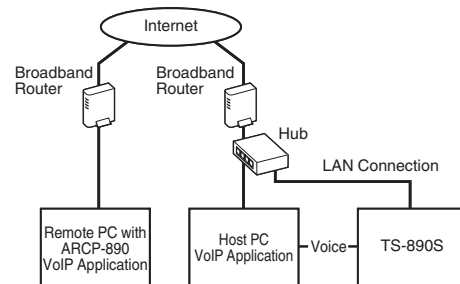

Figure 2: System Configuration when Using a Non-KENWOOD VoIP Application

Under this configuration, voice communication between the remote PC and host PC is carried out using the ARVP-10 or a non-KENWOOD VoIP application software. Voice communication between the host PC and the TS-890S is carried out using the USB audio function (via USB cable connection) or by extracting analog audio output signal (ANO) and analog audio input signal (ANI) from the ACC 2 connector, followed by connecting to the audio input/output connector of the PC sound card. The configuration of components other than that for voice communication are the same as the basic configuration.

Configuration Using ARHP-890

To manage remote users and perform login authentication using ARHP-890 as with the TS-990S, TS-590S, and TS-590SG, configure the system as shown in Figure 3.

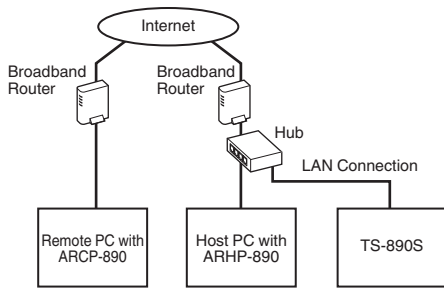

Figure 3: System Configuration for Remote User Management and Login Authentication via ARHP

Under this configuration, the registered users list is managed by the ARHP-890. ARHP-890 performs login authentication of the remote user, while at the same time logs in to the TS-890S as an administrator. After logging in, command communication and voice communication between the TS-890S and ARCP-890 are relayed.

- The built-in VoIP of TS-890S is used for voice communication (ARVP-10 or a non-KENWOOD VoIP can also be used for voice communication).



- It is necessary to configure the settings to transmit incoming control commands and VoIP data via Internet from the broadband router to each device. Please refer to the "TS-890S KENWOOD NETWORK COMMAND SYSTEM Setting Manual".

Configuration for KNS Operation in a Home LAN Environment

To operate the TS-890S remotely in a home LAN environment, configure the system as shown in Figure 4.

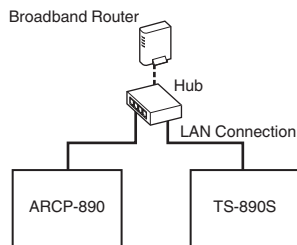

Figure 4: KNS System Configuration in a Home LAN Environment

Under this configuration, ARCP-890 logs in to the TS-890S as an administrator (login as a registered user is also possible).

- The built-in VoIP of TS-890S is used for voice communication. It is also possible to make use of the USB audio function by connecting a USB cable (ARUA-10 is needed).
- Another alternative option is to extract analog audio output signal (ANO) and analog audio input signal (ANI) from the ACC 2 connector and connect to the audio input/output connector of the PC sound card.

Configuring for KNS Operation

LAN Connection Settings

Follow the steps below to configure the LAN connection environment for KNS operation.

1 Press [MENU].

2 Press F [KNS].

The KNS status screen for confirming the settings is displayed.

- If F [KNS] is not displayed, press F [MORE] to display F [KNS].

3 Press F4 [CONFIG].

The KNS configuration screen appears.

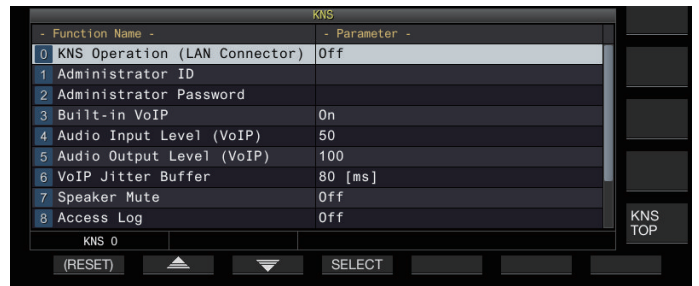

4 Press F2 [▲]/ F3 [▼] to select KNS Menu [0] "KNS Operation (LAN Connector)".

5 Press F4 [SELECT].

6 Press F2 [-]/ F3 [+] to select the setting.

Setting Value	Off (default)/ On (LAN)/ On (Internet)
---------------	--

On (LAN): When operating KNS in a home LAN environment.

On (Internet): When operating KNS via the Internet.

- Pressing F [KNS TOP] returns the display to the KNS status screen.



- The KNS Operation cannot be changed to a value other than "Off" without first configuring the administrator settings

Administrator Settings

Administrator refers to the owner of the radio equipment (manager of the radio equipment in the case of a club station).

- To connect the transceiver to LAN and perform remote operation from a PC via LAN, login authentication is needed. An administrator ID and password are configured for the transceiver in advance by the administrator, which are then used to log in to the transceiver from ARCP-890.
- Upon logging in with the administrator ID, the KNS menu can be operated from ARCP-890.

1 Select KNS Menu [1] "Administrator ID" and KNS Menu [2] "Administrator Password".

2 Press F4[EDIT].

15 NETWORK/KNS OPERATION

3 Use the function keys, [MULTI/CH] control or USB keyboard to enter a character string.

Key	Behavior
F1 [SPACE]	Inserts a space.
F2 [-]/ F3 [+]	Selects a character.
F4 [◀]/ F5 [▶]	Moves the cursor.
F [BACK SPACE]	Deletes the character to the left of the cursor.
F [DEL]	Deletes the character to the right of the cursor.
F [CHAR]	Switches the type of character to edit. Pressing the key each time switches the selection in the following sequence: ABC (upper case) → !"# (symbols) → ABC (upper case)

4 Press F6 [SAVE] to save the administrator ID and password.

- Each of the ID and password must not be longer than 32 characters.



- When the KNS Operation is ON, the KNS "Administrator ID" and "Administrator Password" cannot be edited or reset.

Built-in VoIP Function

Follow the steps below to configure whether to use the built-in VoIP function for voice communication between the remote PC and transceiver during KNS operation.

Set this function to ON (default setting) to use the built-in VoIP function for voice communication between the remote PC and transceiver. Set this function to OFF when using ARVP-10 or a non-KENWOOD VoIP software program.

- Select KNS Menu [3] "Built-in VoIP".
- Press F4 [SELECT].
- Press F2 [-]/ F3 [+] to select "On" or "Off".

Setting Value	Off/ On (default)
---------------	-------------------



- When the setting is changed while a connection is established (logged in), the new setting will be applied at the next connection.
- When using the built-in VoIP, check the following settings as well. For more details, please refer to the "TS-890S KENWOOD NETWORK COMMAND SYSTEM Setting Manual".
 - Check that the TX operation setting in the modulation line selection for ARCP-890 matches the audio input of the modulation line configured on this transceiver.
 - Check that audio input of the modulation line configured on this transceiver in the "Switching the Audio Source Input" (8-1) section matches the TX operation setting selected in the modulation line selection for ARCP-890.

Audio Input/Output Level of Built-in VoIP

The audio input and output level when using the VoIP can be adjusted as follows. Use the default setting under normal circumstances.

- Select KNS Menu [4] "Audio Input Level (VoIP)" and KNS Menu [5] "Audio Output Level (VoIP)".
- Press F4 [SELECT].
- Press F2 [-]/ F3 [+] to select the level.

Setting Value	0 to 50 (default: Menu 4) to 100 (default: Menu 5) (1 step)
---------------	---

Built-in VoIP Jitter Absorption Buffer

Follow the steps below to adjust this item when there is a problem with the voice quality of VoIP. Selecting a shorter time reduces the audio delay but noise is more likely to occur due to missing audio packets or the like. Selecting a longer time increases the audio delay but noise occurrence due to missing audio packets or the like is potentially reduced. Set the value as small as possible within a range that does not affect the operation.

- Select KNS Menu [6] "VoIP Jitter Buffer".
- Press F4 [SELECT].
- Press F2 [-]/ F3 [+] to select a jitter absorption time.

Setting Value	80 (default)/ 200/ 500/ 800 [ms]
---------------	----------------------------------



- When the setting is changed while the built-in VoIP is in use, the new setting will be applied the next time VoIP is used.

Prohibition of Remote Volume Control

This is the function to mute the speaker of the transceiver during remote operation via KNS. Use this function during remote operation to stop the audio output from the speaker of the transceiver.

- Select KNS Menu [7] "Speaker Mute".
- Press F4 [SELECT].
- Press F2 [-]/ F3 [+] to select "On" or "Off".

Setting Value	Off (default)/ On
---------------	-------------------

KNS Communication Log

Logs recording communication with remote station during KNS operation can be recorded to a file.

- 1 Select KNS Menu [8] "Access Log".
- 2 Press F4 [SELECT].
- 3 Press F2 [-]/ F3 [+] to select "On".
 - When a USB flash drive is selected as the destination for storing the file, create a communication log file in the "\KENWOOD\TS-890\KNS_LOG" folder and record the logs to this file.
 - When the built-in memory is selected as the destination, the communication log file is saved to "\KNS_LOG" in the built-in memory.
 - The log file is named kns_log.csv.
 - It is possible to switch the destination for storing the communication log files from the built-in memory to "\KENWOOD\TS-890\KNS_LOG" in the USB flash drive. (Please refer to "Configuring the Destination for Saving Files" (11-2))
 - If writing of the KNS communication log failed due to insufficient memory (including the case where the destination for writing data to is the USB flash drive and the USB flash drive is not recognized), a message indicating that writing has failed appears on the KNS information screen.

KNS User Registration

Follow the steps below to register a new KNS user.

KNS Users List

This is a list of the registered users.

- 1 Press [MENU].
- 2 Press F [KNS] to display the KNS status screen.
 - If F [KNS] is not displayed, press F [MORE] to display F [KNS].
- 3 Press F7 [U.LIST] to display the KNS Users List screen.



Registering User Information

- 1 Press F6 [ADD] to display the user registration screen.

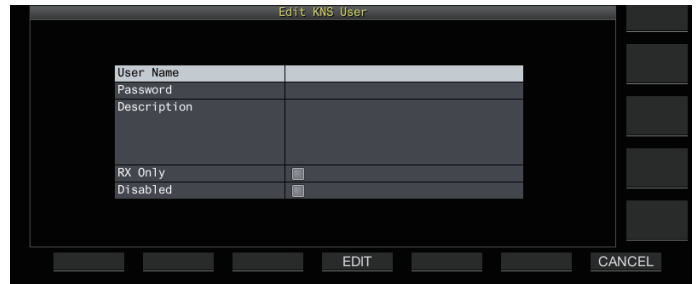

- 2 Press F2[▲]/ F3[▼] to select the item to register.
- 3 Press F4 [EDIT].
 - For the "User Name", "Password" and "Description" fields, use the function keys, [MULTI/CH] control or USB keyboard to enter a character string.

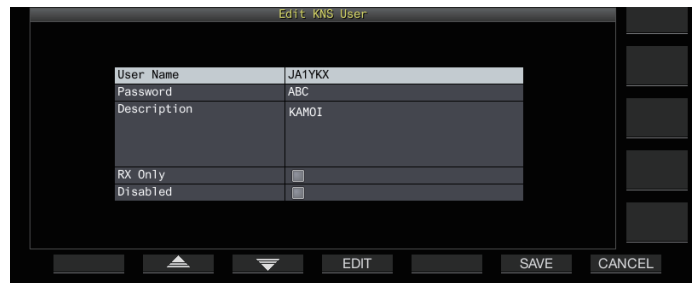

- 4 After input is complete, press F6[OK].
 - The edited information is now set.
 - Up to 32 characters can be entered for "User Name" and "Password", and up to 128 characters for "Description".
 - A maximum of 100 users can be registered.
 - The "User Name" and "Password" fields must be entered.
 - Input of a user name that is already registered is not allowed.
 - Both "User Name" and "Password" are case-sensitive.

Key	Behavior
F1 [SPACE]	Inserts a space.
F2 [-]/ F3 [+]	Selects a character.
F4 [◀]/ F5 [▶]	Moves the cursor.
F [BACK SPACE]	Deletes the character to the left of the cursor.
F [DEL]	Deletes the character to the right of the cursor.
F [CHAR]	Switches the type of character to edit. Pressing the key each time switches the selection in the following sequence: ABC (upper case) → !"# (symbols) → ABC (upper case)

- The "RX Only" and "Disabled" options can be selected or deselected using F4 [☐ ↔ ☑].
- 5 Press F6 [SAVE] to complete the registration.
 - Pressing F7 [CANCEL] discards information that is input on the user registration screen and returns the display to the KNS Users List screen.

Editing User Information

- 1 Press F7 [U.LIST] to display the KNS Users List screen.
- 2 Press F2[▲]/F3[▼] to select the user to edit.
- 3 Press F4 [EDIT] to display the user registration screen.
Follow the same steps for registering a new user to edit the user information.

Deleting a User

- 1 Press F7 [U.LIST] to display the KNS Users List screen.
- 2 Press F2[▲]/F3[▼] to select the user to delete.
- 3 Press and hold F5 [(DELETE)].
Information registered for the selected user is deleted, and all users below are shifted upward to replace the deleted row.

-  Information that is altered or deleted will take effect at the next login.

Remote Operation by Registered User

A registered user may be authorized by the administrator to remotely operate the transceiver using KNS.

- 1 Select KNS Menu [9] “Registered Users' Remote Operation”.
- 2 Press F4 [SELECT].
- 3 Press F2 [-]/ F3 [+] to select “On” or “Off”.
On: Authorizes login by a registered user. However, this excludes users for which the “Disabled” checkbox is selected in the user information.
Off: Prohibits login by a registered user. Only the administrator is allowed to log in in this setting.
 - <<[]>> lights up when a registered user is logged in.
 - When someone is already logged in, another remote user (regardless of an administrator or registered user) cannot log in.
 - If connection is lost while the transceiver is in the TX mode, the transmission ends automatically.

Session Time

The maximum duration for a registered user to log in and use the transceiver can be configured as follows.

- 1 Select KNS Menu [10] “Session Time”.
- 2 Press F4 [SELECT].
- 3 Press F2 [-]/ F3 [+] to select a time.

Setting Value	1 [min]/ 2 [min]/ 3 [min]/ 5 [min]/ 10 [min]/ 15 [min]/ 20 [min]/ 30 [min]/ 40 [min]/ 50 [min]/ 60 [min]/ 90 [min]/ 120 [min]/ Unlimited (default)
---------------	--

-  There is no time restriction when the administrator is logged in.
- The altered settings of the information will take effect at the next login.

KNS Welcome Message

A text message notification for the remote user can be written to the transceiver in advance and displayed on the ARCP-890 used by the remote user.

A text message notification from a remote user to other remote users can be written to the transceiver via remote operation.

- 1 Select KNS Menu [11] “KNS Welcome Message”.
- 2 Press F4 [EDIT].
- 3 Use the function keys, [MULTI/CH] control or USB keyboard to enter a character string.

Key	Behavior
F1 [SPACE]	Inserts a space.
F2 [-]/ F3 [+]	Selects a character.
F4 [◀]/ F5 [▶]	Moves the cursor.
F [BACK SPACE]	Deletes the character to the left of the cursor.
F [DEL]	Deletes the character to the right of the cursor.
F [CHAR]	Switches the type of character to edit. Pressing the key each time switches the selection in the following sequence: ABC (upper case) → !"# (symbols) → ABC (upper case)

- 4 Press F6 [SAVE] to save the message.

-  This message can be rewritten by the administrator or a registered user via command access.

16 OTHER FUNCTIONS

Configuring the Power-on Message

A power-on message can be displayed on the screen after the power of this transceiver is turned on and before it starts up. A text message such as the call sign can be configured as the power-on message according to the user's preferences.

● Configure in Menu [0-06] "Power-on Message"

Use the function keys, [MULTI/CH] control or USB keyboard to enter a message.

- Enter a message that contains not more than 15 characters. The default setting is "HELLO".

Key	Behavior
F1 [SPACE]	Inserts a space.
F2 [-]/ F3 [+]	Selects a character.
F4 [◀]/ F5 [▶]	Moves the cursor.
F [BACK SPACE]	Deletes the character to the left of the cursor.
F [DEL]	Deletes the character to the right of the cursor.
F [CHAR]	Switches the type of character to edit. Pressing the key each time switches the selection in the following sequence: ABC (upper case) → abc (lower case) → !"# (symbols) → ABC (upper case)
F6 [SAVE]	Registers the edited characters.

Configuring the Screen Saver

A screen saver is launched automatically if this transceiver is not operated for a duration as configured in the time for activating the screen saver.

This transceiver comes with 3 types of screen savers. Configuring to the Type 2 screen saver allows a manually input text to be displayed on the screen.

Configuring the Screen Saver Type

The type of screen saver to use can be selected as follows.

● Configure in Menu [0-03] "Screen Saver"

Setting Value	Off (default)/ Type 1/ Type 2/ Type 3/ Display Off
---------------	--

Type 1: Displays only an image.

Type 2: Displays both image and text.

Type 3: Displays an image stored in the built-in memory.

- When screen saver is set to "Display Off", the backlight of the screen turns off and output to an external display is also turned off temporarily after a specific period of inactivity.



- The screen saver display can be cleared by operating any key or control or touching the screen of this transceiver.
- If images for used by Type 3 are not saved, the screen saver cannot be displayed even when Type 3 is selected.

Saving Images for Use by Type 3 Screen Saver

Follow the steps below to save the image to display as the Type 3 screen saver from a USB flash drive to the built-in memory of the transceiver.

- Image files that are used as the screen saver must be of the jpg or jpeg extension with a resolution not higher than 20 megapixels (1920 × 1080 pixels).

- 1 Copy the images into the "KENWOOD\TS-890\IMAGE" folder of the USB flash drive using a PC.
- 2 Connect the USB flash drive to this transceiver.
- 3 Press [MENU].
- 4 Press F [USB/FILE] to display the USB/File Management menu screen.
 - If F [USB/FILE] is not displayed, press F [MORE] to display F [USB/FILE].
- 5 Press F2 [▲]/ F3 [▼] to select "Image Files for Screen Saver (Type 3)".
- 6 Press F4 [SELECT].
A confirmation screen on the reading of image files is displayed.
 - Pressing F7 [CANCEL] returns the display to the USB/File Management menu screen without starting the reading.
- 7 Press F4 [OK].
The reading of files starts.



- When image files are imported into the built-in memory of the transceiver, all images that were previously imported will be erased. (Please note that if the specified folder of the USB flash drive that is imported is empty, all image files in the built-in memory of the transceiver will be erased.)
- The display sequence during a slideshow follows the sequence of the character codes (ISO-8859-1). For instance, when files are named in running numbers, they will be displayed in the ascending order as follows: 001_aaa.jpg, 002_bbb.jpg, 003_ccc.jpg.



All image data that are imported to the built-in memory of the transceiver will be erased when standard reset or full reset is performed.

Configuring the Time for Launching the Screen Saver

The timing for launching the screen saver after the keys or controls are last operated can be configured on this transceiver.

● Configure in Menu [0-04] "Screen Saver Wait Time"

Setting Value	Preview (5 [sec]) (default)/ 5 [min]/ 15 [min]/ 30 [min]/ 60 [min]
---------------	--

16 OTHER FUNCTIONS

Configuring the Displayed Screen Saver Text

When Type 2 screen saver is selected, a text to be displayed on the screen can be manually input. The input text will be displayed at random positions on the screen when the screen saver is activated.

● Configure in Menu [0-05] “Screen Saver Message”

Use the function keys, [MULTI/CH] control or USB keyboard to enter a message.

- Enter a message that contains not more than 10 characters. The default text is “TS-890”.

Key	Behavior
F1 [SPACE]	Inserts a space.
F2 [-]/ F3 [+]	Selects a character.
F4 [◀]/ F5 [▶]	Moves the cursor.
F [BACK SPACE]	Deletes the character to the left of the cursor.
F [DEL]	Deletes the character to the right of the cursor.
F [CHAR]	Switches the type of character to edit. Pressing the key each time switches the selection in the following sequence: ABC (upper case) → abc (lower case) → !”# (symbols) → ABC (upper case)
F6 [SAVE]	Registers the edited characters.

Configuring the Long-press Behavior of Keys

Select the length of the response time when a key is pressed and held down.

● Configure in Menu [0-13] “Long Press Duration of Panel Keys”

Setting Value	200 to 500 (default) to 2000 [ms] (100 [ms] step)
---------------	---

Configuring the Beep Volume

A beep tone is output when a key is operated or activated. Selecting “OFF” mutes the beep tone.

● Configure in Menu [1-00] “Beep Volume”

Setting Value	Off/ 1 to 10 (default) to 20 (1 step)
---------------	---------------------------------------

PF Keys (Programmable Function Keys)

The PF keys can be assigned with different functions of this transceiver. Assigning frequently-used functions or menus to the PF keys allows these functions or menus to be invoked quickly simply by pressing the corresponding key.

PF keys that can be assigned with frequently-used functions are largely divided into those for access to the menu screens, the front panel keys, and those for access to the memory channels. For more details, please refer to “List of Assignable Functions” (16-3).

PF keys that can be assigned with a function are as follows.

PF Keys on the Front Panel:

[PF A], [PF B], [PF C]

PF Keys on the Microphone:

MIC [PF 1] to MIC [PF 4], MIC [DWN], MIC [UP]

External PF Keys (Self-made PF Keys by Users):

EXT [PF 1] to EXT [PF 8]

Assigning Functions to PF Keys (Front Panel)

There are 3 keys on the front panel that can be assigned with functions.

● Configure using one of the menus between [0-15] “PF A: Key Assignment” and [0-17] “PF C: Key Assignment”.

Assigning Functions to PF Keys (Microphone)

When one of the microphones below or a self-made selector is connected to the MIC connector on the front panel, up to 6 functions can be assigned to the PF keys.

MC-43S: MIC [DWN], MIC [UP]

MC-47: MIC [PF 1] to MIC [PF 4], MIC [DWN], MIC [UP]

MC-60S8: MIC [DWN], MIC [UP]

MC-90: MIC [DWN], MIC [UP]

● Configure using one of the menus between [0-26] “Microphone PF 1: Key Assignment” and [0-31] “Microphone UP: Key Assignment”.

- To create a self-made selector, please refer to the circuit diagram below.

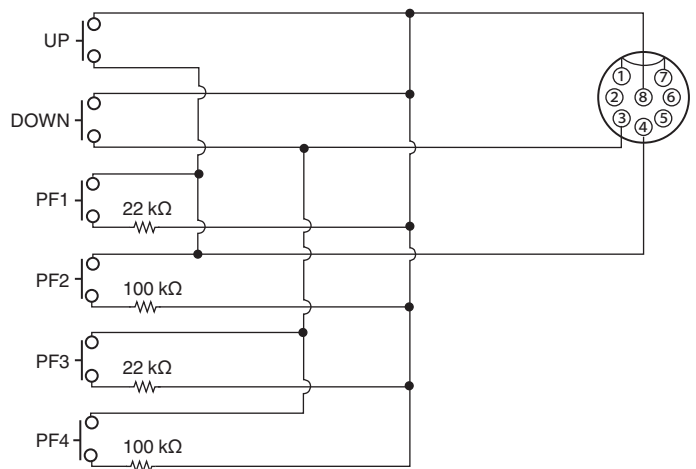

- Production of the MC-47 microphone has been discontinued.

Assigning Functions to the PF Keys (KEYPAD Jack)

The KEYPAD jack on the rear panel can be used to connect a self-made selector.

- **Configure using one of the menus between [0-18] “External PF 1: Key Assignment” and [0-25] “External PF 8: Key Assignment”.**

To create a self-made PF keypad, please refer to the circuit diagram below.

∅3.5 mm plug

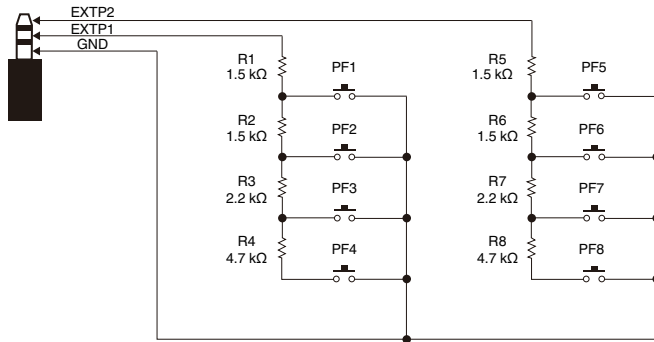

List of Assignable Functions

Parameter	Behavior of Assigned Functions	
MENU 0-00 ⋮ MENU 9-03	Press	Calls up or closes Menu No. 0-0 ⋮ Calls up or closes Menu No. 9-03
ADVANCED MENU 0 ⋮ ADVANCED MENU 27	Press	Calls up or closes Advanced Menu No. 00 ⋮ Calls up or closes Advanced Menu No. 27
A/B, A=B	Press	Switches between VFO A and VFO B
	Press and hold	Combines VFO A and VFO B
AGC	Press	Switches AGC constant to FAST/MID/SLOW
	Press and hold	Starts up or exits the AGC configuration screen
AGC OFF	Press	Switches AGC to ON or OFF
ANT	Press	Switches ANT
APF	Press	Switches audio peak filter to ON or OFF
	Press and hold	Starts up or exits the audio peak filter configuration screen
AT	Press	Switches antenna tuner to ON or OFF
	Press and hold	Starts tuning
ATT	Press	Selection of attenuator
Band Direct (1.8 MHz)	Press	Band Direct selection (1.8 MHz band)
Band Direct (3.5 MHz)	Press	Band Direct selection (3.5 MHz band)

Parameter	Behavior of Assigned Functions	
Band Direct (7 MHz)	Press	Band Direct selection (7 MHz band)
Band Direct (10 MHz)	Press	Band Direct selection (10 MHz band)
Band Direct (14 MHz)	Press	Band Direct selection (14 MHz band)
Band Direct (18 MHz)	Press	Band Direct selection (18 MHz band)
Band Direct (21 MHz)	Press	Band Direct selection (21 MHz band)
Band Direct (24 MHz)	Press	Band Direct selection (24 MHz band)
Band Direct (28 MHz)	Press	Band Direct selection (28 MHz band)
Band Direct (50 MHz)	Press	Band Direct selection (50 MHz band)
BC	Press	Beat Cancel selection (OFF/BC1/BC2)
Capture	Press	Captures a screen shot
CAR	Press	Starts up or exits the carrier level configuration screen
CL	Press	Clears RIT/XIT
Contest Number Decrement	Press	Contest number decrement
CW T.	Press	Starts or stops CW auto tune
CW/CW-R	Press	Switches CW/CW-R mode (sideband)
DATA	Press	Switches DATA mode to ON or OFF
	Press and hold	Starts up or exits the TX audio source input configuration screen
DATA SEND	Press	Transmits the audio source configured on the TX audio source input configuration screen (→ TX audio input setting corresponding to the method of transmission)
DATA VOX	Press	Switches DATA VOX (OFF/ACC 2/USB/LAN)
DIMMER	Press	Switches the dimmer Starts up or exits the dimmer configuration screen
DOWN Key (Microphone)	Press	Decreases the frequency (in VFO mode) Moves to a smaller channel number (in memory channel mode) Moves down the menu or to a smaller setting value (on menu configuration screen)
DRV	Press	Switches drive output to ON or OFF
DSP Monitor	Press and hold	Switches DSP monitor (widens the IF filter to the maximum) to ON or OFF <This behavior is only applicable when the key is pressed and held down>
Emergency Frequency	Press	Calling up the preconfigured emergency frequency
ESC	Press	Exits the configuration screen
Extended Memory Channel	Press	Calls up expanded memory channel 0
FIL CLR	Press	Resets the RX filter to the preset state
FINE	Press	Switches the FINE-tuning function to ON or OFF
FM/AM	Press	Switches between the FM and AM modes
	Press and hold	Switches between FM narrow and FM normal

16 OTHER FUNCTIONS

Parameter	Behavior of Assigned Functions	
FSK/PSK	Press	Switches between the FSK and PSK modes
	Press and hold	Switches to the reverse mode
GENE	Press	Band Direct selection (GENE)
	Press and hold	Switches the transverter to ON or OFF
IF FIL	Press	Switches between RX filters A, B and C
	Press and hold	Starts up or exits the RX filter configuration screen
LOCK	Press	Switches the frequency lock function to ON or OFF
LSB/USB	Press	Switches between the LSB and USB modes
M.IN	Press	Starts up the memory scroll mode and registers a memory channel
M/V, M>V	Press	Switches between memory and VFO
	Press and hold	Memory shift
MAX-Po	Press	Switches the TX output power limiter to ON or OFF
	Press and hold	Starts up or exits the TX output power limit configuration screen
Message Memory CH 1	Press	Starts transmission of CW/RTTY/PSK message 1
Message Memory CH 2	Press	Starts transmission of CW/RTTY/PSK message 2
Message Memory CH 3	Press	Starts transmission of CW/RTTY/PSK message 3
Message Memory CH 4	Press	Starts transmission of CW/RTTY/PSK message 4
Message Memory CH 5	Press	Starts transmission of CW/RTTY/PSK message 5
Message Memory CH 6	Press	Starts transmission of CW/RTTY/PSK message 6
Message Memory CH 7	Press	Starts transmission of RTTY/PSK message 7
Message Memory CH 8	Press	Starts transmission of RTTY/PSK message 8
METER	Press	Switches the meter type
MHz	Press	Switches to the MHz mode
MONI	Press	Switches the TX monitor function to ON or OFF
Mute (Sub Receiver)	Press	Switches the sub-receiver audio mute to ON or OFF (use for Split Transfer B)
NB1	Press	Switches NB1 to ON or OFF
	Press and hold	Starts up or exits the NB1 level configuration screen
NB2	Press	Switches NB2 to ON or OFF
	Press and hold	Starts up or exits the NB2 level configuration screen
NCH	Press	Switches the notch filter to ON or OFF
NR	Press	Switches the noise reduction mode (NR1/NR2/OFF)
	Press and hold	Starts up or exits the NR1 level configuration screen or NR2 level configuration screen
PLAY	Press	Starts or pauses playback of a file recording
PRE	Press	Preamplifier selection
PROC	Press	Switches the speech processor to ON or OFF
	Press and hold	Starts up or exits the speech processor configuration screen

Parameter	Behavior of Assigned Functions	
Q-M.IN	Press	Registers to a quick memory
Q-MR	Press	Calls up a quick memory
	Press and hold	Deletes all quick memory data
REC	Press	Starts or pauses manual recording
	Press and hold	Writes full-time recording data to a file
RIT	Press	Switches RIT to ON or OFF
RX ANT	Press	Switches the RX antenna to ON or OFF
	Press and hold	Switches the antenna output for the external receiver to ON or OFF
RX EQ	Press	Switches the RX DSP equalizer to ON or OFF
	Press and hold	Starts up or exits the RX equalizer screen
RX Monitor	Press	Switches the RX monitor to ON or OFF
	Press and hold	Switches the RX monitor (squelch forcibly opened) to ON or OFF <only while the key is pressed and held down>
Safe Removal of USB Flash Drive	Press	Unmounts the USB flash drive
SCAN	Press	Starts or stops scanning
	Press and hold	Starts up or exits VFO/Program Scan segment configuration screen/Memory Scan group configuration screen
SCP	Press	Switches to the SCOPE screen
SEND	Press	Enables or disables the TX mode
SPLIT	Press	Switches split operation to ON or OFF
	Press and hold	Starts configuration of the frequency for split operation
STOP	Press	Stops recording or playback
SWL	Press	Switches SWL display mode to ON or OFF
TF-SET	Press	Switches TF-SET to ON or OFF
TX EQ	Press	Turning ON/OFF TX Equalizer
	Press and hold	Starts up or exits the TX equalizer screen
TX TUNE1	Press	Starts or ends TX Tune 1
TX TUNE2	Press and hold	Starts or ends TX Tune 2 <This behavior is only applicable when the key is pressed and held down>
UP Key (Microphone)	Press	Increases the frequency (in VFO mode) Moves to a larger channel number (in memory channel mode) Moves up the menu or to a larger setting value (on menu configuration screen)
VOICE1	Press	Starts the voice guide (VOICE1 function)
VOICE2	Press	Starts the voice guide (VOICE2 function)
VOICE3	Press	Starts the voice guide (VOICE3 function)
VOX	Press	Switches VOX to ON or OFF
	Press and hold	Starts up or exits the VOX configuration screen
XIT	Press	Switches XIT to ON or OFF
Off	Press	Does not assign any function

PC Control

The ARCP-890 radio control program, ARHP-890 radio host program, ARUA-10 USB audio control program and PC commands are used to control this transceiver or to enable the use of a PC speaker or microphone.

- This manual describes only the procedures for configuring the baud rate of the COM/USB port used for PC control. For more details on the necessary preparations and method of operation, please refer to the descriptions of the respective program software (Help text) and PC command list.
- To control this transceiver via USB cable connection, download the virtual COM port driver.
- To output the RX audio from the PC speaker using the USB audio function or transmit the audio input to the PC microphone, download the ARUA-10 audio controller. (In principle, delay occurs when USB audio is used. Make use of it for communication where time lag does not constitute an issue.)
- The abovementioned program, virtual COM port driver and PC command list can be downloaded from the website below.
http://www.kenwood.com/i/products/info/amateur/software_download.html



- Make sure not to connect this transceiver and the PC with the USB cable until the installation of the virtual COM port driver downloaded from the above URL is completed.
- If this transceiver is connected to the PC without installing the virtual COM port driver, a wrong driver that is not compatible with this transceiver may be installed and communication with the PC may not be established properly. To prevent a wrong driver from being installed, the virtual COM port driver must be installed before connecting to the PC.
- Before connecting this transceiver with a PC, make sure to turn off the power of this transceiver.
- The USB function of this transceiver complies with the USB 2.0 standard. (USB audio complies with USB Audio Class 1.0.)

Configuring the COM/USB (Rear Panel) Baud Rate

This is used to configure the baud rate of the COM/USB port used for PC control.

- **Configure in Menu [7-00] “Baud Rate (COM Port)” (COM) or Menu [7-01] “Baud Rate (Virtual Standard COM)” (USB)**

COM

Setting Value	4800/ 9600 (default)/ 19200/ 38400/ 57600/ 115200 [bps]
---------------	---

USB

Setting Value	9600/ 19200/ 38400/ 57600/ 115200 (default) [bps]
---------------	---



- To use the baud rate of 38400, 57600 or 115200 bps, configure the baud rate of the RS-232C port of the PC you are using to a high speed.
- When using the ARCP-890, use a transfer rate that is as fast as possible.
- To display the bandscope at the normal speed during remote control of this transceiver using the ARCP-890 and ARHP-890, it is necessary to use an even higher baud rate. Connect a home LAN to the LAN connector on the rear panel.

Configuring the USB Keyboard

A USB keyboard can be used by connecting it to the (USB-A) port on the front or rear panel. It can be used to transmit or play back the voice or message assigned to a function key or to enter and transmit a text in the RTTY (FSK) or PSK mode.

When connected to this transceiver, the USB keyboard can be used for text input. The behavior (key repeat) when a key on the USB keyboard is pressed and held can also be configured.

Sending Message from the USB Keyboard

When this transceiver is configured as follows, a voice or message can be sent out by pressing the corresponding function key on the USB keyboard.

- When message sending from the USB keyboard is ON
- A voice or message has been assigned to a function key on the USB keyboard

- **Configure in Menu [9-00] “Send Message by Function Keys”**

Setting Value	Off/ On (default)
---------------	-------------------



- When 2 USB keyboards are connected, only the one that is first connected to this transceiver is recognized.
- Channels not registered with a message cannot be selected.
- Message in the CW, FSK or PSK mode is sent out according to the settings of the channel in which the message is registered.
- While in the CW, FSK or PSK mode, a message can be sent out when the RTTY communication screen is displayed.

Selecting a USB Keyboard Language

Configure the type of USB keyboard (language or region) that is connected to this transceiver.

- **Configure in Menu [9-01] “Keyboard Language”**

Setting Value	Japanese/ English(US) (default)/ English(UK)/ French/ French(Canadian)/ German/ Portuguese/ Portuguese(Brazilian)/ Spanish/ Spanish(Latin American)/ Italian
---------------	--

Configuring the Time for Activating Key Repeat

Configure the time interval before activating the key repeat operation of the USB keyboard.

- **Configure in Menu [9-02] “Repeat Delay Time”**

Setting Value	1 to 2 (default) to 4 (1 step)
---------------	--------------------------------

Configuring the Key Repeat Speed

Configure the key repeat speed of the USB keyboard.

- **Configure in Menu [9-03] “Repeat Speed”**

Setting Value	1 (default) to 32 (1 step)
---------------	----------------------------

Saving a Screen Shot

This transceiver comes with a screen capture function to capture an image of the screen display and save the image data in the PNG format (.png) to the built-in memory or a USB flash drive.

1 Assign “Capture” to a PF key.

- To save the image data to a USB flash drive, insert a USB flash drive into  (USB-A).

2 Press PF [Capture].

- The memory icon being selected as the storage destination blinks. A shot of the screen is captured at the same time when the key is pressed, and the captured data is saved to a USB flash drive. The directory of the storage destination is “KENWOOD\TS-890\CAPTURE”.
- When removing the USB flash drive, make sure to execute “Safely Removing the USB Flash Drive” (11-6).



- The saved file is named as follows.
yyymmdd_hhmmss.png
(Example)
20180215_102030.png
(When the screen shot is saved on February 15, 2018, 10:20:30 a.m.)
- When saving the screen capture to a USB flash drive, check the following in advance.
The USB flash drive is formatted by this transceiver. The USB flash drive is correctly inserted into this transceiver.
There is sufficient free space on the USB flash drive. The USB flash drive is not write-protected or the file system is not corrupted.
- A screen shot can also be captured and saved by pressing [Print Screen] on the USB keyboard.
- A screen shot cannot be captured when the screen saver is active.
- When screen capture fails, an error tone is output.
- It might take some time before the captured image is written to a USB flash drive. If there is an attempt to safely remove the USB flash drive, a message will be displayed asking the user to wait until the captured image file is saved to the USB flash drive before attempting to remove it.

Configuring Output to an External Meter

The TX or RX signal level can be displayed by connecting an analog meter to the METER terminal on the rear panel of this transceiver. A different output signal format can be configured for each of External Meter 1 and External Meter 2.

The signal to be output to the external meter during transmission can be configured as follows. During reception, the signal strength will be output as signals to the external meter.

Output rating of METER terminal:

Voltage: 0 to 5 V (no load)

Impedance: 4.7 kΩ

Configuring the Output Signal Format of the External Meter

Configure the signal that is output from the METER terminal to the external meter.

- **Configure in Advanced Menu [0] “Indication Signal Type (External Meter 1)” (External Meter 1) or Advanced Menu [1] “Indication Signal Type (External Meter 2)” (External Meter 2)**

Setting Value	Automatic (default: External Meter 2)/ TX Power (default: External Meter 1)/ ALC/ Drain Voltage (Vd)/ Compression Level (COMP)/ Current (Id)/ SWR
---------------	---

Automatic: Outputs the S meter level during reception, and the signal level or meter value displayed on F [METER] during transmission.

TX Power: Outputs the TX output power value.

ALC: Outputs the ALC level.

Drain Voltage (Vd): Outputs the drain voltage of the final FET.

Compression Level (COMP): Outputs the degree of audio signal enhancement by the speech processor.

Current (Id): Outputs the drain current of the final FET.

SWR: Outputs the standing wave ratio (SWR).

Configuring the External Meter Output Level

External Meter 1 and External Meter 2 can be configured to different signal levels that are output from this transceiver according to the rating of the external meter that is connected to the METER terminal.

- **Configure in Advanced Menu [2] “Output Level (External Meter 1)” (level of external meter output 1) or Advanced Menu [3] “Output Level (External Meter 2)” (level of external meter output 2)**

Setting Value	0% to 50% (default) to 100% (1 step)
---------------	--------------------------------------

- At “100%”, the voltage is 5 V.

External Monitor Output

Connecting an external monitor to the DISPLAY connector enables the image displayed on the screen of this transceiver to be displayed on the external monitor at the same time.

● Configure in Advanced Menu [21] “External Display”

Setting Value	Off/ On (default)
---------------	-------------------

Configuring the External Monitor Resolution

The resolution of the external monitor that is connected to the DISPLAY connector can be configured.

● Configure in Advanced Menu [22] “Resolution (External Display)”

Setting Value	800 x 600 (default)/ 848 x 480
---------------	--------------------------------



- When the resolution of the external monitor is changed, a resolution switch screen will appear for approximately 5 seconds before the change is applied.

Configuring Audio Input/Output

Configuring the USB Connector Input/Output Signal

The input/output level of the audio signal when an external device is connected to the (USB-B) connector on the rear panel can be configured.

Configuring the Audio Signal Input Level

Configure the audio input level for the (USB-B) connector on the rear panel.

● Configure in Menu [7-06] “USB: Audio Input Level”

Setting Value	0 to 50 (default) to 100 (1 step)
---------------	-----------------------------------

Configuring the Audio Signal Output Level

Configure the audio output level for the (USB-B) connector on the rear panel.

● Configure in Menu [7-08] “USB: Audio Output Level”

Setting Value	0 to 100 (default) (1 step)
---------------	-----------------------------



- When using a Windows PC, wait for the PC to recognize this transceiver, then select Control Panel → Hardware and Sound → Sound → Recording → Microphone (USB Audio CODEC) → Properties, followed by selecting “2 channel”.
- Windows is a registered trademark of Microsoft Corporation in the United States and other countries.

Configuring the ACC 2 Connector Input/Output Signal

The input/output level of the audio signal when an external device is connected to the ACC 2 connector on the rear panel can be configured.

Configuring the Audio Signal Input Level

Configure the level of audio signal input to the ACC 2 connector on the rear panel.

● Configure in Menu [7-07] “ACC 2: Audio Input Level”

Setting Value	0 to 50 (default) to 100 (1 step)
---------------	-----------------------------------

Configuring the Audio Signal Output Level

Configure the input/output level of the audio signal when an external device is connected to the ACC 2 connector on the rear panel.

● Configure in Menu [7-09] “ACC 2: Audio Output Level”

Setting Value	0 to 50 (default) to 100 (1 step)
---------------	-----------------------------------

Configuring the TX Monitor Level for External Audio Output

Configure the level of the TX monitor audio that is output from the rear connector.

● Configure in Menu [7-10] “TX Monitor Level (Rear Connectors)”

Setting Value	Linked (default)/ 0 to 20 (1 step)
---------------	------------------------------------

- Configuring to “Linked” changes the level in tandem with the level configured during TX monitor level adjustment.

Configuring Audio Mixing for the External Audio Output Connector

Configure whether to mix the audio produced by this transceiver with the RX audio that is output from the (USB-B) connector and ANO terminal of the ACC 2 connector.

● Configure in Menu [7-11] “Audio Output Type (Rear Connectors)”

Setting Value	All (default)/ Received Audio only
---------------	------------------------------------

All: Enables output of beep tone, voice guidance, audio of voice message memory and recorded audio or sidetone.

Received Audio Only: Select this setting when having an external device decode the digital modulation signals.

- When the RX audio is mixed with the beep tone, voice guidance or error tone emitted from this transceiver, the command response or error tone produced by this transceiver can also be heard at a remote location during, for example, KNS (KENWOOD NETWORK COMMAND SYSTEM) operation with this transceiver installed at a remote location.



- Audio output to LAN is used for the purpose of listening to the audio output from the transceiver speaker on a remote PC during remote operation. As such, audio sound as the beep sound is always mixed regardless of the setting in this menu.

Switching the Reference Signal

External frequency input (10 MHz) from the REF IN connector on the rear panel can be used as the reference frequency of this transceiver. The input impedance is 50 Ω.

- Inputting a reference signal with a high degree of accuracy from an external source to this transceiver and using it as the reference frequency helps to enhance the frequency accuracy of this transceiver.
- The standard input level is 0 dBm ±10 dB.

● Configure in Advanced Menu [4] “Reference Signal Source”

Setting Value	Internal (default)/ External
---------------	------------------------------

Internal: Uses the built-in reference signal transmitter of this transceiver.

External: Uses the external frequency input from the REF IN connector as the reference frequency.

- ! This transceiver may not function properly if the reference input level from the external source is low or if there is deviation in the frequency.
- Please refer to (17-2) for the adjustment of internal reference frequency.

Switching the CTCSS Mute Operation

● Configure in Advanced Menu [13] “CTCSS Unmute for Internal Speaker”

Setting Value	Mute (default)/ Unmute
---------------	------------------------

- When combining the use of CTCSS to prevent unwanted signals such as noise from being transmitted from the base station to the Internet while operating this transceiver as a VoIP amateur radio base station, configure to “Unmute” so that the status of the operating frequency can be verified. Doing so outputs all RX audio signals from the speaker regardless of the matching status of the CTCSS frequency. Only RX signals with a matching CTCSS frequency are output from the ACC 2/USB port.

Configuring the SQL Control Signal

When operating this transceiver with an external device such as PC connected to the ACC 2 connector on the rear panel, the status of the SQL control signal for the PSQ pin of the ACC 2 connector can be configured.

Configuring the Logic of PSQ

Configure the SQL control signal logic of the PSQ pin.

● Configure in Advanced Menu [14] “PSQ Logic State”

Setting Value	Low (default)/ Open
---------------	---------------------

- Configure to “Open” to enable the VoIP application installed on the PC to detect a busy state even when the power of this transceiver is OFF. Also, configure the busy detection logic of the VoIP application so that it matches that of this transceiver.

Configuring the PSQ Output Conditions

Configure the transition in the status of the SQL control signal output from the PSQ pin.

● Select Advanced Menu [15] “PSQ Reverse Condition”.

Setting Value	Off/ Busy/ Sql (default)/ Send/ Busy-Send/ Sql-Send
---------------	---

- The PSK behavior in each of the setting is as follows.

Setting Value	Behavior
Off	Fixed in the low (inactive) state.
Busy	Switches the SQL control signal to the high (active) state regardless of the matching status of the CTCSS frequency received.
Sql	When CTCSS is ON, SQL control signal switches to the high state when the CTCSS received matches the CTCSS configured on this transceiver. When CTCSS is OFF, SQL control signal switches to the high state when a signal is received by this transceiver regardless of the matching status of CTCSS.
Send	Switches the SQL control signal to the high state when this transceiver transmits a signal.
Busy-Send	Switches the SQL control signal to the high state when this transceiver transmits or receives a signal.
Sql-Send	Switches the SQL control signal to the high state in the same way as when the setting is configured to “Sql” and “Send”.

Switching the COM Connector Signal

The CTS/RTS terminal of the COM connector on the rear panel can be configured such that it operates in the same way as the PSQ/PKS terminal of the ACC 2 connector.

1 Configure in Advanced Menu [16] “PSQ/PKS Pin Assignment (COM Connector)”.

Setting Value	Off (default)/ On
---------------	-------------------

Off: The COM connector processes both the CTS and RTS signals.

On: The signals of the CTS and RTS pins of the COM connector are replaced by PSQ and PKS signals respectively.

- A message to confirm the behavior of the COM connector is displayed.

2 Reboot this transceiver.

After this transceiver reboots, the new settings are applied.

The behavior of the output signal of each setting is as follows.

	COM Connector on Rear Panel		PC
Off (CTS/RTS)	Pin 2: RxD	➔	RxD
	Pin 3: TxD	➜	TxD
	Pin 8: CTS	➔	CTS
	Pin 7: RTS	➜	RTS
	Pin 5: GND		GND
On (PSQ/PKS)	TxD (stopped state)	➔	RxD
	RxD (stopped state)	➜	TxD
	Pin 8: PSQ	➔	CTS
	Pin 7: PKS	➜	RTS
	Pin 5: GND		GND

Split Transfer

This function allows frequency information to be transferred by connecting another transceiver to this transceiver as a sub-receiver. There are two modes for this function: Split Transfer A and Split Transfer B.

Split Transfer A

This function transfers information on the TX VFO frequency and mode during split operation from the transceiver (TX/RX end) to the transceiver that functions as a sub-receiver. This is a convenient function for simultaneous dual-frequency reception by having the sub-receiver receive the split frequencies from the TX/RX end. The sub-receiver also supports the standby function.

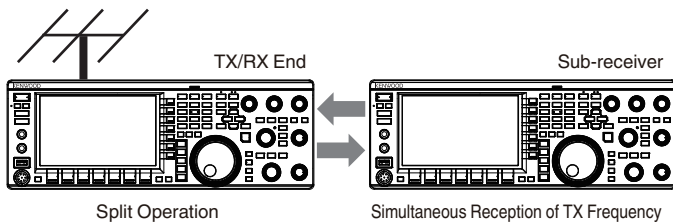

The usable transceiver models are TS-890S, TS-590SG and TS-590S. TS-590S can be used only as a sub-receiver.



- Firmware update is needed when TS-590S/ TS-590G is used as a sub-receiver.
- The TS-590G series can also be used as a transceiver at the TX/RX end for Split Transfer A. Firmware update is necessary regardless of whether it is used as a sub-receiver or a transceiver at the TX/RX end.
- Some functions may not be usable during split transfer between the TS-890 series and another transceiver due to differences in the specifications.

Split Transfer B

This mode is used for connecting another transceiver to this transceiver as a sub-receiver during two-man operation while contesting. This is a convenient function that allows the sub-operator at the sub-receiver end to transfer frequency and mode information to the main operator at the TX/RX end. Operating data can be transferred by the following transceiver models.

- TS-890S
- TS-990S
- TS-590S
- TS-590SG
- TS-480 series
- TS-2000 series
- TS-570 series
- TS-870S



- Some functions may not be usable during split transfer between this transceiver and another transceiver.

Connection

Connect the 2 transceivers to enable transfer of frequency data and sharing of antenna.



- Cables for connection need to be prepared separately by the user.

Connection for Data Transfer:

Connect the COM connector of the 2 transceiver units using a RS-232C cross cable (female-female).

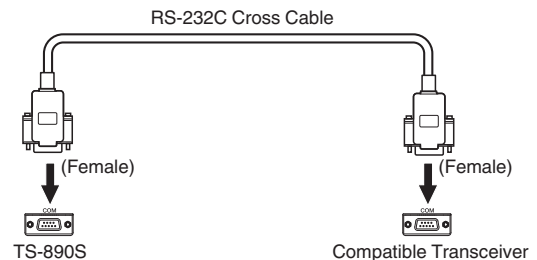

Connection for Antenna Sharing:

Connect the ANT OUT connector at the TX/RX end to the ANT or RX IN connector at the sub-receiver end using a coaxial cable. Turn on the ANT OUT function at the TX/RX end. Select the connected ANT connector at the sub-receiver end or make use of the RX ANT function.

Split Transfer A

Below is an example of using this transceiver at both the TX/RX end and sub-receiver end in the standard settings. Before using the TS-590SG/ TS-590S as a sub-receiver, please read through the instruction manual and update documents.

Configuration

Using TS-890S at the TX/RX End

- 1 Enable this transceiver to function as a TX/RX end transceiver.**
Select "A (TX/RX)" in Menu [7-04] "Quick Data Transfer".
- 2 Configure the baud rate to 115200 bps.**
Select "115200 [bps]" in Menu [7-00] "Baud Rate (COM Port)".
- 3 Set to the VFO mode.**
If the transceiver is in the memory channel or quick memory channel mode, switch it to the VFO mode.

Using TS-890S as a Sub-receiver

- 1 Enable this transceiver to function as a sub-receiver.**
Select "A (Sub RX)" in Menu [7-04] "Quick Data Transfer".
- 2 Configure the baud rate to 115200 bps.**
Select "115200 [bps]" in Menu [7-00] "Baud Rate (COM Port)".
- 3 Set to the VFO mode.**
If the transceiver is in the memory channel or quick memory channel mode, switch it to the VFO mode.
- 4 Set to simplex mode.**



- This transceiver functions only at the transfer rate of 115200 [bps].
- It does not function in the memory channel and quick memory channel modes.
- This function cannot be used in the split mode.

Operation

1 Transfer the TX frequency and mode information during split operation from the TX/RX end to the sub-receiver end.

By pressing **[SPLIT]** at the TX/RX end to switch to the split mode, the TX frequency and mode information is transferred to the VFO of the sub-receiver and enables the TX frequency to be received by the sub-receiver.

Subsequently, when there is a change in the TX frequency at the TX/RX end, the new TX frequency information will be transferred automatically, and the RX frequency at the sub-receiver will be adjusted accordingly. Below are some examples.

- When the TX frequency is changed using the XIT function
- When the RX band and TX band are changed at the same time using the Band Direct key ("RX/ TX Band" needs to be selected in advance in Menu [3-13] "Band Direct Keys in Split Mode".)
- When the split TX frequency is changed via operation of the **[RIT/XIT]** control ("TX Frequency Offset while RX" needs to be selected in advance in Menu [3-12] "Split Frequency Offset by RIT/XIT Control".)

2 Change the RX frequency and mode that are transferred from the TX/RX end at the sub-receiver end.

The frequency and mode that are transferred to the sub-receiver end can be adjusted independently without affecting the value at the TX/RX end.

To restore the state where the frequency matches with the TX frequency at the TX/RX end, press **[SPLIT]** at the TX/RX end to reactivate the split function.

3 Transfer the frequency detected at the sub-receiver end to the TX frequency at the TX/RX end.

Pressing **[<Q-M.IN]** at the sub-receiver end transfers the current frequency and mode information to the TX VFO at the TX/RX end.



- Upon transmission from the TX/RX end, the sub-receiver switches to the standby mode.
- The transceiver at the sub-receiver end is inhibited from transmission.
- When XIT at the TX/RX end is ON, the XIT frequency is added to the frequency to be transferred.
- When RIT at the sub-receiver end is ON, the RIT frequency is added to the frequency to be transferred.
- The transceiver at the TX/RX end is unable to receive the frequency and mode information from the sub-receiver if it is not configured to the split mode.
- The transceiver at the TX/RX end is able to receive the frequency and mode information from the sub-receiver even when it is in the frequency lock mode.

Muting the Sub-receiver

The RX audio at the sub-receiver can be muted by the TX/RX end.

1 Assign "Mute (Sub Receiver)" to a PF key at the TX/RX end.

2 Press PF [Mute (Sub Receiver)].

The RX audio at the sub-receiver end is muted.

- Pressing the **PF [Mute (Sub Receiver)]** key again unmutes the RX audio.

Split Transfer B

This function supports the "split transfer" function on models before the TS-890S. It allows existing users of the "split transfer" function to continue using it after changing to TS-890S. Follow the steps below to operate this transceiver. To combine the use of a transceiver other than this transceiver, please refer to the instruction manual of the model to be used.

Using TS-890S at the Sub-receiver End (Master)

1 Turn ON Split Transfer B.

Select "B" in Menu [7-04] "Quick Data Transfer".

2 Tune to the frequency of the party to communicate with in the VFO mode.

Operate the **Tuning** control to tune to the frequency of the party to communicate with.

3 Transfer the frequency and mode information to the TX/RX end.

Pressing **[<Q-M.IN]** saves the frequency and mode information to channel 0 of the quick memory and transfers it to quick memory channel 0 or VFO at the TX/RX end.

Using TS-890S at the TX/RX End (Slave)

1 Turn ON Split Transfer B.

Select "B" in Menu [7-04] "Quick Data Transfer".

2 Configure whether frequency and mode information transferred from the sub-receiver is to be received by the quick memory channel or VFO.

Select "VFO" or "Quick Memory" in Menu [7-05] "Overwrite Location (Quick Data Transfer)".

3 Receive frequency and mode information from the sub-receiver.

Upon receiving frequency and mode information that are transferred from the sub-receiver, channel 0 of the quick memory or VFO is updated according to the setting in step 2.



- Configure the 2 transceivers that are connected to each other to the same COM connector baud rate.
- To prevent malfunction, reboot both transceivers after configuring the settings.
- When using this transceiver as a sub-receiver, configure Menu [6-03] "TX Inhibit" to "On" to prevent erroneous transmission.
- The transceiver at the TX/RX end is able to receive the frequency and mode information from the sub-receiver even when it is in the frequency lock mode.

TX Inhibit

This function prevents erroneous transmission. When TX Inhibit is ON, this transceiver does not carry out transmission even when [PTT] on the microphone is pressed.

The RX audio also becomes inaudible while [PTT] is pressed.

Inhibit transmission in the following cases.

- When you want to operate the master transceiver unit as a receive-only unit during operation in the Split Transfer B mode. Transmission is not carried out even when this is attempted using the master transceiver. Audio is also not output.
- When you do not wish to transmit signals to the host transceiver while controlling the transceiver via PC using KNS (KENWOOD NETWORK COMMAND SYSTEM).

● Configure in Menu [6-03] "TX Inhibit"

Setting Value	Off (default)/ On



- When TX Inhibit is ON, RX audio is muted when the SS terminal signal level of the ACC 2 connector is low. RX audio is also muted while [PTT] is pressed as the signal level of the SS terminal becomes low.
- When TX Inhibit is ON, tuning cannot be performed by the antenna tuner.
- When using this transceiver as a receive-only unit at all times, configure this setting to "On" to prevent erroneous transmission.

Packet Cluster Tuning

Packet cluster tuning can be performed by connecting TM-D710(A/E), TM-D710G(A/E), RC-D710, TM-D700(A/E) or TH-D72(A/E) to this transceiver.

Connection

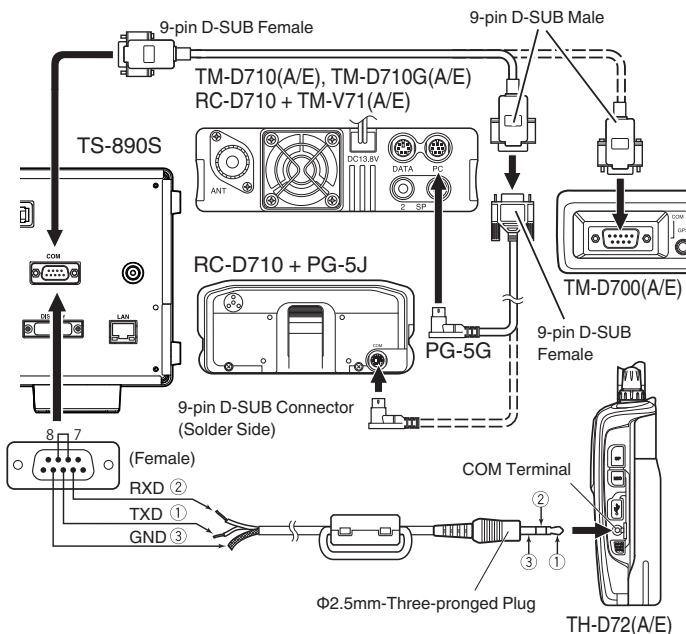

Receiving Packet Cluster Data

Follow the steps below to operate TM-D710(A/E)/RC-D710/TM-D700(A/E)/TH-D72(A/E).

- 1 Switch to the APRS or Navitra mode to receive the DX packet cluster data.
- 2 Display the DX packet cluster and align the cursor with the frequency to tune to.
- 3 Press the corresponding key to output the frequency value selected in step 2.

The operating frequency (VFO) is configured based on the packet cluster data received if the frequency is configurable by this transceiver.

- TM-D710(A/E), TM-D710G(A/E), RC-D710: [TUNE] key
- TM-D700(A/E): [MHz] key
- TH-D72(A/E): [MENU] key



- In the VFO mode, the operating frequency (VFO) that is currently in use is configured. In the memory channel mode, the most recent operating frequency (VFO) is configured.
- Only the RX data sent from TM-D710(A/E)/TM-D710G(A/E)/RC-D710/TM-D700(A/E)/TH-D72(A/E) is supported.
- DX packet cluster data cannot be sent out automatically to this transceiver.
- For TM-D700(A/E), version G 2.0 or later is required to use this function.
- Production of the TM-D710(A/E), RC-D710 and TM-D700(A/E) have been discontinued.
- For more details on the operation information of the DX packet cluster, please search for information available on other sources.

16 OTHER FUNCTIONS

Control of External Devices

TX Inhibit in Busy State (when Squelch is Open)

When transmission is inhibited in the busy state, pressing [SEND] on the front panel or [PTT] on the microphone does not execute transmission while this transceiver is busy.

● Configure in Advanced Menu [12] “TX Inhibit While Busy”

Setting Value	Off (default)/ On
---------------	-------------------

Reversing the PKS Signal Polarity

Short-circuiting the PKS terminal to GND places this transceiver in the TX mode. This polarity can be reversed according to the device to be connected.

● Configure in Advanced Menu [11] “PKS Polarity Reverse”

Setting Value	Off (default)/ On
---------------	-------------------

Off: Short-circuiting the PKS terminal of the ACC 2 connector to GND places this transceiver in the TX mode.

On: Applying a voltage of 3 V to 5 V to the PKS terminal of the ACC 2 connector places this transceiver in the TX mode.

USB Keying

This function is compatible with PC applications for controlling the different behaviors including CW keying, RTTY frequency shift and PTT/SEND (TX/RX switching) using the RTS/DTR signal of the COM port.

It allows the above behaviors to be assigned to the RTS and DTR signals of the 2 virtual COM ports (Standard and Enhanced) during USB connection.

Off: Disabled

Flow Control: Behaves as a hardware flow control signal for command communication.

CW Keying: Behaves as a CW keying signal.

RTTY Keying: Behaves as an RTTY frequency shift key signal.

PTT: Behaves in the same way as PTT (SEND).

DATA SEND: Behaves in the same way as DATA SEND (PKS).

● Configure in Advanced Menu [17] “Virtual Standard COM Port – RTS”

Setting Value	Flow Control (default)/ CW Keying/ RTTY Keying/ PTT/ DATA SEND
---------------	--

● Configure in Advanced Menu [18] “Virtual Standard COM Port – DTR”, [19] “Virtual Enhanced COM Port – RTS” or [20] “Virtual Enhanced COM Port – DTR”

Setting Value	Off (default)/ CW Keying/ RTTY Keying/ PTT/ DATA SEND
---------------	---



- To switch the COM port or exit the application in the PC application for performing transmission on the transceiver using the USB keying function, be sure to complete the transmission before doing so. Otherwise transmission error may occur on the transceiver.
- If the COM port for outputting the USB keying signal is not selected (open) in the PC application that is using the USB keying function, the signal for USB keying may be accidentally transmitted. Press [⏻] to turn off the power of this transceiver or disable the USB keying function temporarily until the preparation on the PC application is completed.



- “RTTY Keying” can only be configured for 1 out of the 4 signals (duplicate configuration is not allowed).
- When this menu is configured to “RTTY Keying” (during RTTY operation via USB keying), RTK of the ACC 2 connector will be disabled.
- Please use the latest virtual COM port driver.

Decoded Character Output

This function outputs characters decoded by the built-in decoder of CW/ RTTY/ PSK from the virtual COM port (Enhanced). The baud rate is also variable.

Turning ON/OFF Decoded Character Output

● Configure in Menu [7-03] “Decoded Character Output”

Setting Value	Off (default)/ On
---------------	-------------------

Configuring the Baud Rate of the Virtual COM (Enhanced) Connector

● Configure in Menu [7-02] “Baud Rate (Virtual Enhanced COM)”

Setting Value	9600/ 19200/ 38400/ 57600/ 115200 (default) [bps]
---------------	---

Controlling the Linear Amplifier

This section describes the procedures for configuring the control signal and TX/RX delay when using a linear amplifier. Outputs of the mechanical relay (MKE, BRK, COM) and semiconductor switch (RL) are output to the REMOTE connector on the rear panel, which allows users to combine the use of this transceiver with their linear amplifier. The control signal status and whether to enable TX delay time can be configured on the menu screen. HF band, 50 MHz band and 70 MHz band (E type only) can be configured separately.

Connection

- Use the supplied 7-pin DIN plug to make your own connection cable.

TL-922 Connection

Connect terminal no. 2 (COM) of the REMOTE connector to GND of TL-922, and terminal no.4 (MKE) of the REMOTE connector to RL CONT of TL-922. Connect terminal No. 6 (ALC) of the REMOTE connector to ALC OUT of TL-922.

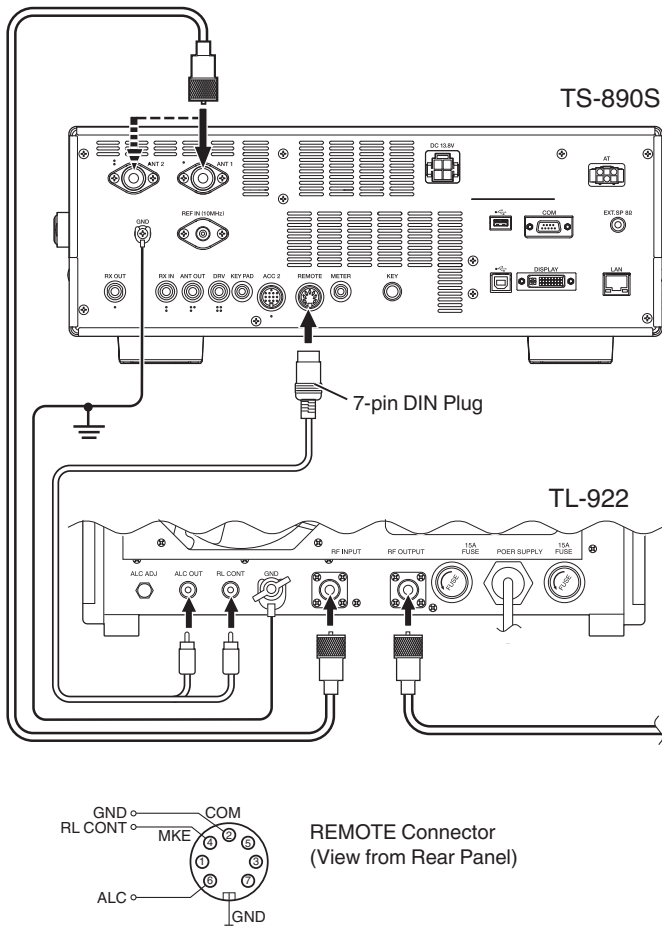

General Linear Amplifier Connection

Follow the diagram below to connect a commercially available linear amplifier.

- The ALC circuit of this transceiver starts to operate from an ALC output voltage of approximately -4 V (which can be changed from the Linear Amplifier menu) from the linear amplifier. To enhance the stability of the output and ALC operation, it is recommended that the TX output power limiter function be configured.
- For more details on connection with a linear amplifier, please refer to the instruction manual of the linear amplifier to be used.

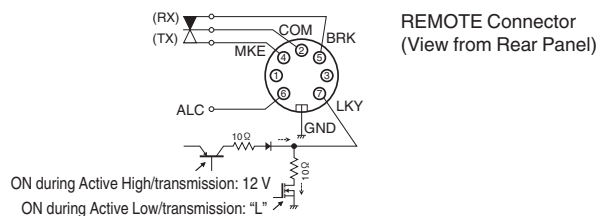
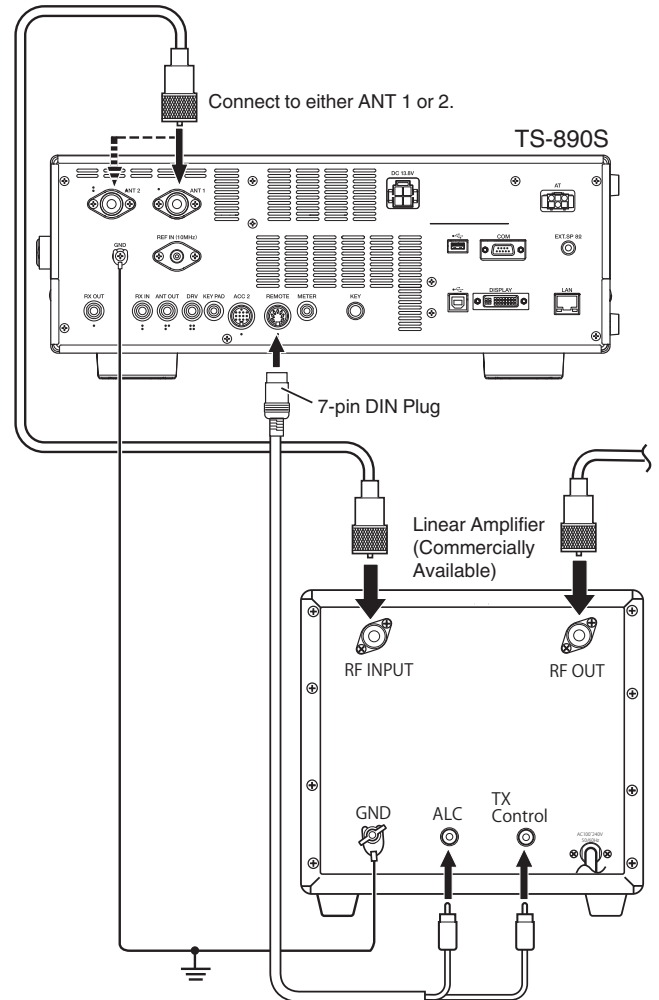

- The method for controlling linear amplifiers varies with the type of linear amplifier in use. There are some linear amplifiers that place this transceiver in the TX mode once the control terminal is connected to GND. When using such types of linear amplifiers, connect terminal no. 2 (COM) of the REMOTE connector to GND of the linear amplifier, and terminal no. 4 (MKE) of the REMOTE connector to the control terminal of the linear amplifier.

16 OTHER FUNCTIONS

Linear Amplifier Menu Screen

- 1 Press [MENU].
- 2 Press F [LINEAR AMP] to display the Linear Amplifier menu screen.
 - If F [LINEAR AMP] is not displayed, press F [MORE] to display F [LINEAR AMP].



- 3 Press F6 [BAND] to switch to the target band. Pressing F6 [BAND] each time toggles the selection to “HF Band”, “50 MHz Band” and “70 MHz Band” (E type only) in sequence.
- 4 Press F2 [▲] / F3 [▼] to select the setting item.
- 5 Press F4 [-] / F5 [+] or turn the [MULTI/CH] control to select the setting value.
 - The following settings are recommended when using the TL-922 (discontinued).

Settings Menu	TL-922
Linear Amplifier	On
Keying Logic	Active Low
TX Delay	On
TX Delay Time (CW/FSK/PSK)	15
TX Delay Time (SSB/FM/AM)	35
Internal Relay Control	On
External ALC Voltage	-6 [V]

- 6 Press [MENU] or [ESC] to end the process.
 - Pressing F [MENU TOP] returns the display to the menu top screen.

Turning ON/OFF Linear Amplifier

Switch the linear amplifier function for each target band to ON or OFF.

- Configure “Linear Amplifier” in Linear Amplifier Menu

Setting Value	Off (default)/ On
---------------	-------------------

Linear Amplifier TX Control

TX control of the linear amplifier without using relay control can be performed via the 7-pin LKY terminal of the REMOTE connector. This function is used for TX control when using a linear amplifier that supports full break-in.

- Configure “Keying Logic” in Linear Amplifier Menu

Setting Value	Active Low (default)/ Active High
---------------	-----------------------------------

Turning ON/OFF Linear Amplifier TX Delay

Delay the switching operation by the transmission system of this transceiver when there is a long time lag before transmission starts on the linear amplifier in use.

- Configure “TX Delay” in Linear Amplifier Menu

Setting Value	Off (default)/ On
---------------	-------------------



- When the TX delay of the linear amplifier is ON, TX delay time is added to the time from when transmission is started until the radio wave is output (usually about 15 ms).

Linear Amplifier TX Delay Time

The TX delay time when using a linear amplifier can be configured separately for the CW/FSK/PSK and SSB/FM/AM modes.

CW/FSK/PSK Mode

- Configure “TX Delay Time (CW/FSK/PSK)” in Linear Amplifier Menu

Setting Value	5/ 10/ 15 (default)/ 20/ 25/ 30/ 35/ 40 [ms]
---------------	--

SSB/FM/AM Mode

- Configure “TX Delay Time (SSB/FM/AM)” in Linear Amplifier Menu

Setting Value	5/ 10/ 15/ 20/ 25/ 30/ 35 (default)/ 40/ 45/ 50 [ms]
---------------	--

Linear Amplifier Relay Control

When using a linear amplifier that requires TX control via a mechanical relay, the built-in mechanical relay terminals of this transceiver (pin 4 MKE terminal, pin 5 BRK terminal, pin 2 COM terminal of the REMOTE connector) are used.

- Configure “Internal Relay Control” in Linear Amplifier Menu

Setting Value	Off (default)/ On
---------------	-------------------

On: Activates the following relay control.

- The MKE terminal is connected to the COM terminal during transmission.
- The BRK terminal is connected to the COM terminal when there is no transmission.

Off: Relay control is not activated and the BRK terminal remains connected to the COM terminal at all times.



- When using a linear amplifier that does not require control via a mechanical relay, configure to “Off” to minimize the relay sound.

External ALC Voltage of Linear Amplifier

Adjust the response of the ALC terminal (pin 6) of the REMOTE connector on this transceiver according to the linear amplifier in use.

- Configure “External ALC Voltage” in Linear Amplifier Menu

Setting Value	-1/ -2/ -3/ -4 (default)/ -5/ -6/ -7/ -8/ -9/ -10/ -11/ -12 [V]
---------------	---

- Under normal circumstances, make adjustments on the linear amplifier without changing the default setting.

Operating the Transverter/Exciter

This is a handy function when combining this transceiver with a transverter that can be used to convert the operating frequency of the exciter (this transceiver) to a different frequency. For details on the procedures for connecting the exciter with a transverter, please refer to the instruction manual of the transverter in use.



- Some functions on this transceiver are not usable when a transverter is used.



- Turn off the power of both this transceiver and the transverter before connecting them. Check the connection between this transceiver and the transverter before turning on the power of both devices.

Connecting to a Transverter

There are 2 ways of connecting the exciter with a transverter. The first is via the ANT connector (for both TX and RX and output is fixed at 5 W), while the other is via the RX IN connector (RX input) and DRV connector (drive output). Both types of connection allow the frequency display of this transceiver to be changed to the operating frequency display of the transverter.

To input a signal exceeding 5 W from the ANT connector to the transverter, set the TX output power limit during transverter operation to OFF in Advanced Menu [6] "TX Power Down with Transverter Enabled".

Connecting to the RX IN and DRV Connectors

- Connect the transverter to the RX IN and DRV connectors.
- Press [RX ANT] to set reception from the RX IN connector to ON.
 <<RX>> is displayed.
- Press [DRV] to set output from the DRV connector to ON.
 The [DRV] LED lights up in green.

Connecting to the ANT Connector

- Connect the transverter to the ANT connector.
- Press [RX ANT] to set reception from the RX IN connector to OFF.
 <<ANT>> is displayed.
- Press [DRV] to set output from the DRV connector to OFF.
 <<[DRV]>> LED goes off.



- When the RX IN and DRV connectors are selected, transmission and reception via the ANT connector are disabled.

Turning off Power Down during Transverter Operation

When the RF input level of the transverter is 5 W or higher and signal of 5 W or higher is output from the ANT connector to the transverter, configure Power Down while the transverter is in use to "Off" (turn off fixed output at 5 W).

- Configure in Advanced Menu [6] "TX Power Down with Transverter Enabled"

Setting Value	Off/ On (default)



- When "Off" is selected, a maximum power of 100 W is supplied to the device that is connected to the ANT connector. This may damage the connected device or cause it to malfunction so switching the power down setting is entirely at your own risk.

Displaying the Operating Frequency Configured for the Transverter

When the transverter is ON, the last digit of the frequency display is not shown and the operating frequency configured for the transverter is displayed.

- Turn the Tuning control to select an operating frequency for the exciter (this transceiver).
 The transverter converts this frequency for output. Configure the frequency such that it falls within the transmission range.
- Press and hold [GENE] to set the transverter to ON.
 <<XVTR>> is displayed and the frequencies that can be configured for the transverter are displayed.
- Press and hold [GENE] again.
 The transverter is now OFF.



- Some functions on this transceiver are not usable when a transverter is used.

Configuring the Operating Frequency of the Transverter

- Press and hold [GENE] to set the transverter to ON.
 <<XVTR>> is displayed.
- Press [ENT] to enable input of a frequency value.
- Enter the output frequency of the transverter using the numeric keypad.
- Press [ENT] to confirm the input.
 Instead of the actual operating frequency of this transceiver, the output frequency of the transverter is now displayed.

Operation Example: Operation by entering a 28 MHz signal to a 430 MHz transverter

- Connect a 430 MHz transverter to this transceiver.
- Configure the RX frequency of this transceiver to "28.000.000".
- Press and hold [GENE] to set the transverter to ON.
- Press [ENT] for band selection using the numeric keypad.
- Next, enter "430.000.00" and press [ENT].
- Turn the Tuning or [MULTI/CH] control on this transceiver to select a frequency.

16 OTHER FUNCTIONS

Antenna Output for External Receivers

When this function is ON, the RX signal that enters the transceiver from the currently selected antenna (ANT 1, ANT 2 or RX ANT) is split along the way. A part of the split signal is input to the RX circuit, while the other part to the ANT OUT terminal.

- **Press and hold [RX ANT] to set the antenna output for external receiver to ON or OFF.**
 - When it is ON, << [RX ANT] >> lights up.

- When the antenna output function is used, the RX sensitivity and gain lower by approximately 3 dB due to signal loss in the splitter.
- During transmission, there is a very slight amount of output leakage due to internal isolation (approximately -20 dBm in the 50 MHz band).
- The ON/OFF status of the antenna output function is stored separately for the HF band and 50/70 MHz band.

Emergency Call (K Type Only)

Section 97.401(d) of the regulations governing amateur radio in the United States permit emergency amateur communications on 5167.5 kHz by stations in or within 92.6 km of the state of Alaska. This frequency is for use only when the immediate safety of human life and/or property are threatened, and is never to be used for routine communications.

Press **[EMERGENCY]** to change to the Emergency channel (5167.5 kHz/ USB).

- **[EMERGENCY]** can be assigned to a PF key.
 - When entering Emergency mode, "EMERGENCY" momentarily appears on the screen.
- RIT/XIT turns OFF automatically when entering Emergency mode.
 - The transceiver will not switch to the Emergency channel if you are using the constant recorder and are either transmitting, receiving a voice call, or receiving a CW call.

Crossband Repeater

If you have a KENWOOD FM transceiver (K type) with a 6 pin mini DIN connector, you can set up the TS-890S transceiver and the FM transceiver as a crossband repeater. The FM transceiver will receive signals you transmit from the additional VHF or UHF transceiver when both transceivers are set with the same frequency. The signal is then routed to the TS-890S transceiver and retransmitted on the frequency you have set on the TS-890S transceiver. Likewise, signals received on the TS-890S transceiver are routed to the FM transceiver and retransmitted to the transceiver you have with you, allowing you to hear the received call in a distant location.

- For the repeater function to operate, the squelch levels of both transceivers (TS-890S and FM transceiver) must be adjusted properly so that no background noise can be heard; the transmission is controlled by monitoring the squelch status only.

Connection

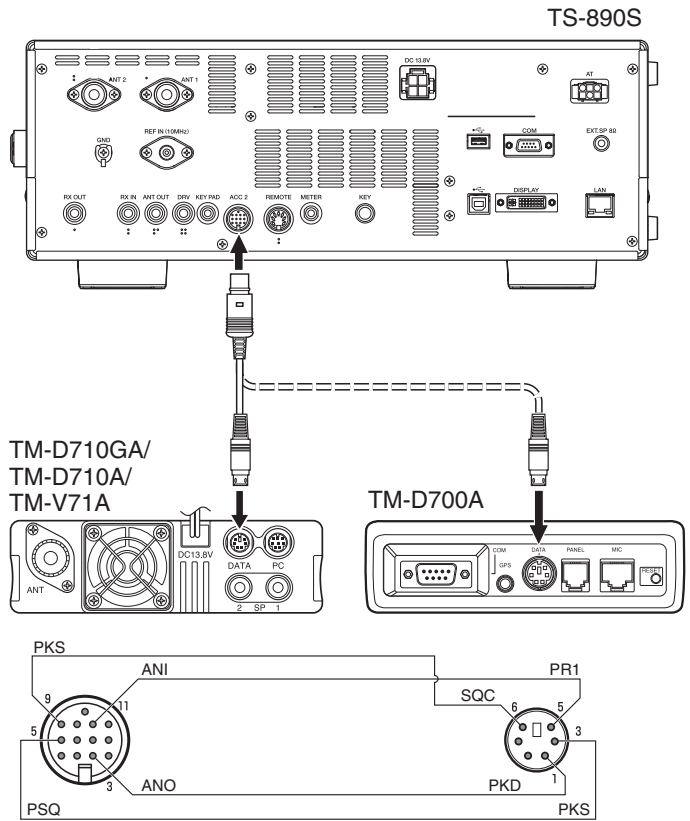

Operation

The crossband repeater function uses 2 frequency bands to receive and transmit signals. When a signal is received on one band, it is retransmitted on the other band.

- 1 **Select a transmission/reception VHF or UHF frequency on the FM transceiver.**
- 2 **Confirm the PTT icon is visible on the crossband repeater frequency on the FM transceiver.**
- 3 **Select the same frequency for the terminal transceiver.**
- 4 **Select a HF/50 MHz frequency on the TS-890S transceiver.**
- 5 **Adjust the squelch threshold level so that both the TS-890S and FM transceivers mute.**
- 6 **On the TS-890S, press [MENU], then access Advanced Menu [11] (PKS Polarity Reverse) and [12] (TX Inhibit While Busy).**
- 7 **Select "On".**
 - When the TS-890S transceiver's squelch opens, the FM transceiver simultaneously retransmits the incoming audio signal on the VHF or UHF frequency.
 - When the FM transceiver's squelch opens, the TS-890S transceiver retransmits the incoming audio signal on the HF/50 MHz frequency.
- 8 **Access Menu [7-07] (ACC2: Audio Input Level) and [7-09] (ACC2: Audio Output Level) and adjust the input/ output audio level.**
- 9 **To quit the FM repeater operation, disconnect the interface cable between the transceivers, then access Advanced Menu [11] and [12] on the TS-890S transceiver and select "Off".**

Sky Command System II

Sky Command System II allows you to remotely control the TS-890S transceiver from a separate location.

- If you have more than 2 TH-D7A/ TH-D72(A/E)/ TM-D710/G(A/E)/ TM-V71A + RC-D710/ TM-D700A transceivers, you can perform Sky Command System II operation to remotely control your TS-890S transceiver.
- You will use one transceiver (TH-D7A, TH-D72(A/E)/ TM-D710/G(A/E), TM-V71A + RC-D710, or TM-D700A) as a remote control unit, called a "Commander". The other VHF/ UHF transceiver (TH-D7A, TH-D72(A/E)/ TM-D710/G(A/E), TM-V71A + RC-D710, or TM-D700A) with the TS-890S transceiver is called the "Transporter". This TH-D7A, TH-D72(A/E)/ TM-D710/G(A/E), TM-V71A + RC-D710, or TM-D700A transceiver will function as an interface between the Commander (a remote control unit) and the band of the TS-890S transceiver.
- This system allows you, for example, to watch for and hunt DX while washing your car, or to operate the HF transceiver while relaxing in your car, living room, or patio, instead of actually operating inside your shack.



- Operation of Sky Command System II may not be permitted in certain countries. Check your local laws before operating.

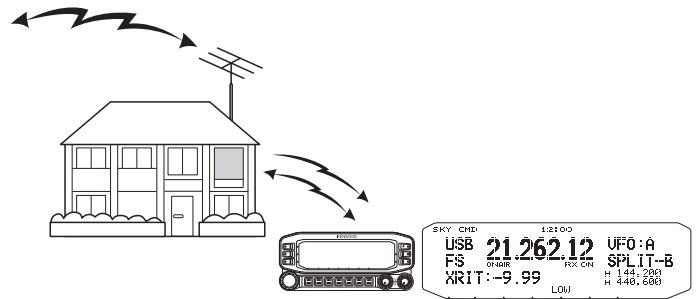

Sky Command System II Diagram

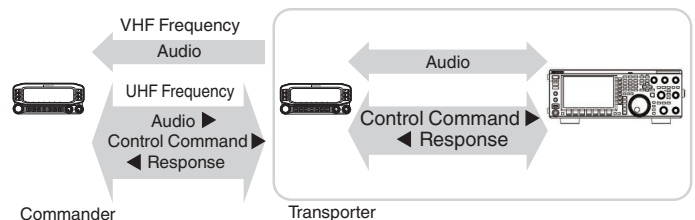

Preparation

Although you can use a TH-D7A, TH-D72(A/E)/ TM-D710/G(A/E), TM-V71A + RC-D710, or TM-D700A transceiver as a "Commander" (an external remote control unit), the following procedure shows how to set up your TS-890S and TH-D7A, TH-D72(A/E)/ TM-D710/G(A/E), TM-V71A + RC-D710, or TM-D700A transceivers as a "Transporter" at a base station and the TH-D72(A/E)/ TM-D710/G(A/E), TM-V71A + RC-D710, or TM-D700A transceiver as a "Commander".

16 OTHER FUNCTIONS

Starting Sky Command System II Operation

After you have completed setting up the following, you can start Sky Command System II operation. Without programming these parameters, you cannot use Sky Command System II.

TS-890S + TH-D7A/ TH-D72(A/E)/ TM-D700A/ TM-D710/G(A/E)/ TM-V71A + RC-D710 (Transporter) Setup

- 1** Configure the TH-D7A, TH-D72(A/E)/ TM-D710/G(A/E), TM-V71A + RC-D710, or TM-D700A as a “Transporter” and connect all the necessary cables to the TS-890S transceiver.
- 2** Select a frequency on the TS-890S transceiver.
- 3** On the TS-890S, press [MENU], then access Menu [7-00] (Baud Rate (COM Port)).
- 4** Select the desired communication speed.
- 5** Select the same communication parameters to match the TH-D7A, TH-D72(A/E)/ TM-D710/G(A/E), TM-V71A + RC-D710, or TM-D700A transceiver.
- 6** Press [MENU] to exit Menu mode.
- 7** Configure and start the Transporter mode on the TH-D7A, TH-D72(A/E)/ TM-D710/G(A/E), TM-V71A + RC-D710, or TM-D700A transceiver.
 - Refer to the respective instruction manuals of the TH-D7A, TH-D72(A/E)/ TM-D710/G(A/E), TM-V71A + RC-D710, or TM-D700A for information on how to connect, configure, and operate the transceivers for Sky Command System II.

17 MAINTENANCE AND ADJUSTMENT

Reset

Settings data that are stored on this transceiver can be saved easily to another data storage media. Also, when overwriting settings saved in the memory of this transceiver with new settings, 5 types of reset options are available which can be chosen freely according to the user's intentions.

Menu Reset:

Resets only the settings configured in the menu.

- The settings for TX inhibit, clock menu, LAN menu, advanced menu, linear amplifier menu, KNS menu, dimmer menu, timer menu and auto mode are not reset.

Memory Channel Reset:

Resets the settings data of the memory channels and quick memory channels.

VFO Reset:

Resets only the VFO information.

Standard Reset:

Resets the settings data while partially retaining the settings of this transceiver.

Full Reset:

Resets all settings to the factory settings.

 All image data that are stored in the built-in memory of the transceiver will be erased after Full Reset.

-  • Data of the memory channels and quick memory channels, menu data, antenna tuner preset values, auto mode frequency setting and the different level settings will not be reset during VFO Reset.
- When any of the reset options starts, all the past settings data will be erased. Thus, make sure to perform reset after saving the settings to another data storage media.
- In Menu [1-06], the default setting for auto voice guide is configured to OFF. When performing a reset other than Memory Channel Reset and VFO Reset, the settings in Menu [1-06] are reset and auto voice guide will not be output.

The transceiver is reset as follows.

- 1 Press [MENU].
- 2 Press F [RESET] to display the Reset screen.
 - If F [RESET] is not displayed, press F [MORE] to display F [RESET].

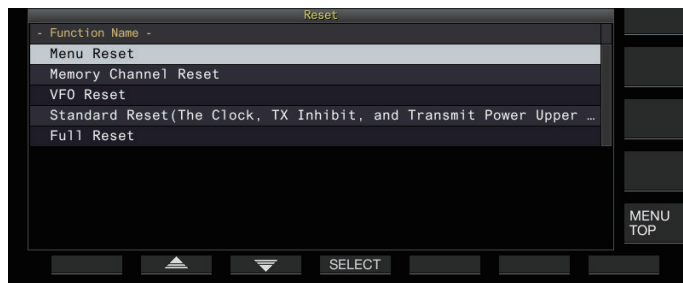

- 3 Press F2 [▲] / F3 [▼] or turn the [MULTI/CH] control to select a reset type.

- 4 Press F4 [SELECT].

A message to confirm the start of the reset process is displayed.



- Pressing F7 [CANCEL] clears the reset confirmation message without starting reset.

- 5 Press F4 [RESET].

Reset is performed and this transceiver reboots automatically.



- When this transceiver cannot be operated properly or the screen cannot be displayed properly when the power is turned on, press [A/B] and [CLR] while turning on the power to perform Full Reset. A "Full Reset in progress" message is displayed and all settings are reset to the factory settings.

Firmware Update

There are occasions when the firmware is updated following additions or enhancements made to the functions. The latest firmware version can be obtained from the following website.

http://www.kenwood.com/i/products/info/amateur/software_download.html

For more details on firmware update, please visit the website.

Firmware Version Check

Check the current firmware version before updating the firmware.

- Check in Advanced Menu [27] "Firmware Version"

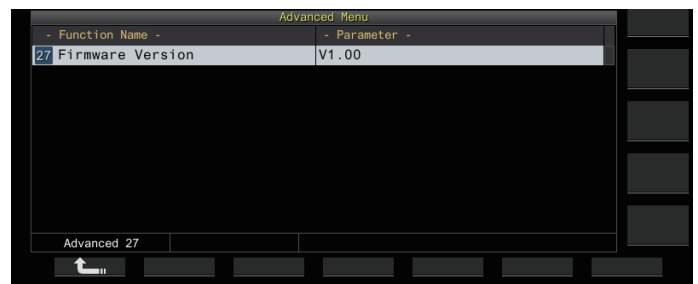

- If a "firmware update failed" screen constantly appears while update is in progress, this could be due to system failure. Please contact KENWOOD service center.

Calibration of Internal Reference Frequency

The internal reference frequency of this transceiver is preadjusted at the factory. However, if calibration of the internal reference frequency is necessary due to changes over time or other reasons, this can be done by receiving WWVH (Hawaii), WWV (Colorado), BPM (Xi'an) or other types of standard radio wave.

First of all, follow the steps below to set this transceiver to the mode for receiving the standard radio wave signals. The following is an example of the calibration procedure when the pitch frequency is 700 Hz.

- 1 Press [CW/ CW-R] to select CW mode.
- 2 Press [RIT] to turn off the RIT function.
- 3 Press [VOX] to turn off break-in.
 - If semi break-in is turned on, press [VOX] to turn it off.
 - If full break-in is turned on, turn the [DELAY] control to select a value other than full break-in.
- 4 Turn the [AF] control to move to the 12 o'clock position.
- 5 Turn the [MIC/PITCH] control to adjust the pitch to a level for easy listening.

Turn the [MIC/PITCH] control until the pitch frequency reading shows "700".
- 6 Turn the [LO/WIDTH] and [HI/SHIFT] controls.

Turn the [HI/SHIFT] control until the shift frequency (SHIFT) becomes "0", followed by turning the [LO/WIDTH] control to adjust the bandwidth (WIDTH) to "1000".

 For details on the REF I/O connector settings, please refer to "Switching the Reference Signal" (16-8).

Calibration Procedure

Once the preparation is complete, follow the steps below to configure the internal reference frequency of this transceiver.

- 1 **Receive the standard radio wave signals.**

To receive 10 MHz standard radio wave signals, turn the **Tuning** control to adjust the value to exactly "10.000.00". A 700 Hz beat is heard.

$$f_{AF} = \frac{f_{\text{display [MHz]}}}{19.2 \text{ [MHz]}} \times \Delta f_{\text{reference}} + 700 \text{ [Hz]}$$

$\Delta f_{\text{reference}}$: Reference Frequency Shift

Adjust such that the received beat is audible on the CW pitch frequency.

- 2 Press [MENU].

- 3 Press F [ADV.] to display the Advanced Menu screen.
 - If F [ADV.] is not displayed, press F [MORE] to display F [ADV.].
- 4 Select Advanced Menu [5] "Reference Oscillator Calibration".
- 5 Press F4 [SELECT].

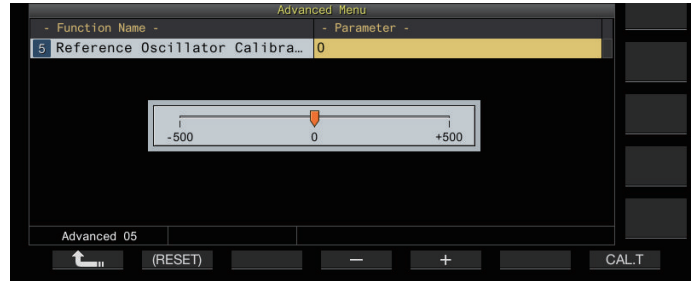

- 6 Press F7 [CAL.T.].

A 700 Hz calibration sidetone is generated. This sidetone overlaps with the RX audio and a double beat is formed by the difference in frequency.

If the double beat is not clearly audible, turn the [AF] control to adjust the RX audio.

$$f_{\text{sidetone}} = 700 \text{ [Hz]} \pm 8 \text{ [ppm]} (700 \pm 0.006 \text{ [Hz]})$$

- 7 Press the F4 [-]/ F5 [+] or turn the [MULTI/CH] control.
 - Perform adjustment until the cycle of the double beat between the RX beat and sidetone reaches the maximum and the double beat is no longer audible. At this point, the difference in frequency between the RX audio and sidetone is at the minimum level.
 - To restore the default setting, press and hold F2 [(RESET)].
- 8 Release F7 [CAL.T.].
- 9 Press [ESC] to end the process.

 If the signal used for calibration falls outside the range of the reference signal input from an external source (-10 dBm to +10 dBm) or frequency accuracy (10 MHz \pm 10 ppm), the internal reference frequency may not be calibrated correctly.

Adjusting the Touchscreen

Follow the steps below to adjust the contact points on the touchscreen to prevent false recognition when touching the touchscreen. Adjust the touchscreen if the frequency of false recognitions has increased with time.

- 1 Select Advanced Menu [23] “Touchscreen Calibration”.
- 2 Press F4 [SELECT].
- 3 Touch the “+” marks that are displayed on the screen in sequence.

A “+” mark is displayed in sequence at the four corners of the screen. After touching all the “+” marks at the four corners and the center, touchscreen adjustment is complete and the Advanced menu screen is displayed.

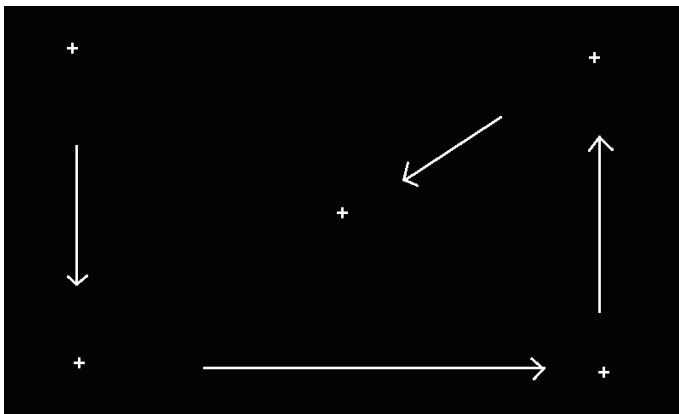

- Touchscreen adjustment cannot be performed during transmission.
- Touchscreen adjustment cannot be stopped halfway. Make sure to touch the “+” marks at the four corners and the center in sequence.
- If touchscreen adjustment is interrupted due to unforeseen circumstances such as power outage, perform the adjustment again.

Adjusting the Display Color

The color tone of the display can be adjusted as follows.

- 1 Turn off the power of this transceiver.
- 2 Pressing and holding [CLR] while turning on the power displays the display color adjustment screen.

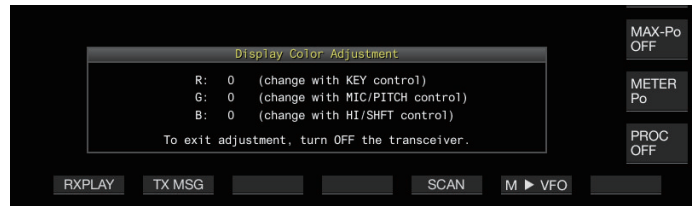

- 3 Use the controls below to adjust the color.

Control	Behavior
[KEY]	Changes the red level. (Turning the [DELAY] control resets the value to “0”.)
[MIC/PITCH]	Changes the green level. (Turning the [POWER] control resets the value to “0”.)
[HI/SHIFT]	Changes the blue level. (Turning the [LO/WIDTH] control resets the value to “0”.)
Setting Value	-15 to 0 (default) to +15 (1 step)

- 4 Turn off the power of this transceiver.



- When this transceiver is operated with a control other than those above, the display color adjustment screen disappears temporarily and the adjusted color tone can be previewed on the normal screen.

17 MAINTENANCE AND ADJUSTMENT

Replacing the Fuse

- The circuit of this transceiver for connecting to an external antenna tuner comes with a fuse. If the fuse blows while using the external antenna tuner, replace the fuse after addressing the cause.
- There is also a fuse in the DC power cable. Similarly, if this fuse blows, replace it after addressing the cause.

Replacing the Fuse of the External Antenna Tuner

- 1 Unplug the DC power cable.
- 2 Remove the screws (x12) at the bottom case and remove the bottom case.
- 3 Remove the screws (x8) at the top case and remove the top case.
- 4 Remove the screws (x14) securing the shield plate on the top case and remove the shield plate.
- 5 Replace the fuse (4 A).

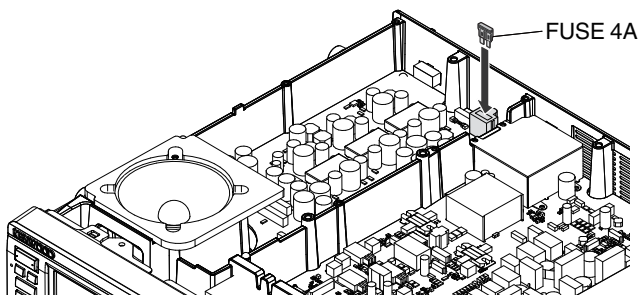

- 6 Install the shield plate.
- 7 Install the top case.
- 8 Install the bottom case.



- If only the top case is removed, scratches may result when aligning it with the bottom case during the assembly.
- The 4 A fuse that comes supplied with this transceiver is to be used for the external antenna tuner. Do not use a fuse other than the one supplied.



- Be careful not to misplace the screw after it is removed.
- Be careful when handling the case to prevent being injured by the edges.

Replacing the Fuse of the DC Power Cable

Open the fuse cover and replace the fuse (25 A).

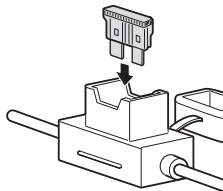

- The 25 A fuse that comes supplied with this transceiver is to be used for the DC power cable. Do not use a fuse other than the one supplied.

18 TROUBLESHOOTING

General Information

Your transceiver has been factory aligned and tested to specification before shipment. Under normal circumstances, the transceiver will operate in accordance with these operating instructions. All adjustable trimmers, coils, and resistors in the transceiver are preset at the factory. They should only be readjusted by a qualified technician who is familiar with this transceiver and has the necessary test equipment. Attempting service or alignment without factory authorization may void the transceiver warranty.

When operated properly, the transceiver will provide years of service and enjoyment without requiring further realignment. The information in this section gives some general service procedures requiring little or no test equipment.

Service

If it is ever necessary to return the equipment to your dealer or service center for repairs, pack the transceiver in its original box and packing material. Include a full description of the problems experienced. Include both your telephone number and fax number (if available) along with your name and address in case the service technician needs to call for further information while investigating your problem. Don't return accessory items unless you feel they are directly related to the service problem. Please do not send subassemblies or printed circuit boards. Send the complete transceiver.

You may return your transceiver for service to the authorized **KENWOOD** dealer from whom you purchased it or any authorized **KENWOOD** service center. A copy of the service report will be returned with the transceiver.

Tag all returned items with your name and call sign for identification. Please mention the model and serial number of the transceiver in any communication regarding the problem.

Service Note

If you desire to correspond on a technical or operational problem, please make your note short, complete, and to the point. Help us help you by providing the following:

- Model and serial number of equipment
- Question or problem you are having
- Other equipment in your station pertaining to the problem
- Meter readings
- Other related information (Menu setup, mode, frequency, key sequence to induce malfunction, etc.)



- Do not pack the equipment in crushed newspapers for shipment. Extensive damage may result during rough handling or shipping.



- Record the date of purchase, serial number, and dealer from whom the transceiver was purchased.
- For your own information, retain a written record of any maintenance performed on the transceiver.
- When claiming warranty service, please include a photocopy of the bill of sale or other proof-of-purchase showing the date of sale.

Cleaning

The keys, controls, and case of the transceiver are likely to become soiled after extended use. Remove the controls from the transceiver and clean them with a neutral detergent and warm water. To clean the case, use a neutral detergent (no strong chemicals) and a damp cloth.

18 TROUBLESHOOTING

Troubleshooting

Check the following before requesting for repair of the transceiver.

Problems Related to Reception and Transmission

Symptom	Probable Cause	Corrective Action	Refer to
Power does not turn on when [P] is pressed.	The power switch of the regulated DC power supply is not turned on.	Set the power switch to ON.	4-1
	The DC power cable is not correctly connected.	Check the DC power cable to ensure that the polarity is correct. (Red: +, black: -)	1-1
	The DC power cable is not fully inserted.	Ensure that the cable is fully inserted.	1-1
	The fuse of the DC power cable is blown.	Address the cause of the blown fuse and replace it with a new fuse according to the designated capacity.	17-4
	A voltage exceeding the 13.8 V DC $\pm 15\%$ range is applied.	Check the output voltage of the regulated DC power supply and configure it to the rated voltage (DC 13.8 V).	1-1
The screen is not displayed normally when this transceiver is powered on.	The microcomputer is malfunctioning.	Reset this transceiver.	17-1
A backup data damage detected screen is displayed.	The initialization data was not configured correctly for some unknown reason.	Press F4 [OK] on the "backup data damage detected screen" to perform Full Reset again.	
Signals cannot be received even when an antenna is connected. The RX sensitivity is low.	The squelch is closed.	Turn the [SQL] control and adjust accordingly.	4-2
	The attenuator is ON.	Set the attenuator to OFF.	6-1
	The preamplifier is OFF.	Set the preamplifier to ON.	5-6
	The antenna 1/2 selection is wrong.	Select the correct antenna.	4-10
	RX ANT is ON.	Check whether RX ANT is set to ON.	4-10
	Unable to perform tuning even though the antenna tuner is ON.	Press and hold [AT] to perform tuning. Alternatively, stop the tuning operation.	4-11
	The gain level is lowered using the [RF] control.	Turn the [RF] control all the way to the right.	4-2
	The transverter settings are not correctly configured.	If the transverter is ON, check whether the settings are correctly configured and whether it is functioning properly.	16-15
	The transverter is ON.	If the transverter is ON, check whether it is functioning properly.	16-15
Signals received are not correctly demodulated.	The operating mode is incorrectly selected.	Try switching to a different mode.	4-4
	The AGC function settings are not correctly configured.	Configure the AGC function settings correctly.	5-2
The frequency does not change when the [RIT/XIT] control is turned.	The RIT/XIT function is OFF.	Press [RIT] or [XIT] .	5-7
The cutoff frequency of the RX audio in the SSB mode is extremely high or extremely low.	The RX DSP filter settings are not suitable for operation.	Change them to the appropriate settings.	6-2
There is significant distortion in the audio.	The AGC function is OFF.	Set the AGC function to ON, or turn the [RF] control to adjust RF gain.	5-2
	The [AF] control is set to a loud volume level.	Turn the [AF] control to adjust the volume.	4-2
No sound is output from the speaker.	The [AF] control is turned all the way to the left.	Turn the [AF] control to the right.	4-2
	The [SQL] control is turned all the way to the right.	Turn the [SQL] control to the left.	4-2
	Headphones are connected.	Unplug the headphones.	1-2
	CTCSS is set to ON in the FM mode.	Set CTCSS to OFF.	5-30
The S meter deflection is small in the FM mode.	The S meter sensitivity level is low.	Configure the S meter sensitivity to "High" in Menu [0-07].	4-10
"SCP.OVF" is displayed on the bandscope.	The bandscope is receiving excessive signal.	Use the attenuator for the bandscope.	7-1

Symptom	Probable Cause	Corrective Action	Refer to
There is no TX output power. The level of TX output power is low.	The microphone connector is not fully inserted.	Insert the microphone connector fully.	1-2
	The antenna connector is not properly connected.	Connect the antenna properly.	2-6
	The microphone gain level is turned down.	Adjust the microphone gain.	4-8
	The TX output power is set to the minimum level.	Adjust the TX output power.	4-8
	High-temperature protection is activated.	End the transmission and allow the temperature of this transceiver to go down.	
	The carrier level is low.	Turn the [CAR] control on the Carrier Level configuration screen until the pointer of the ALC meter falls within the appropriate range.	5-8
	The speech processor output level is low.	Turn the [MIC/PITCH] control until the pointer of the ALC meter falls within the appropriate range.	8-4
	The TX audio source used for transmission is different from the input path of the TX audio source input.	Check the input path of the TX audio to be modulated.	8-1
	Drive output (DRV) is enabled.	Press [DRV] to switch off drive output.	4-11
	The straight key or paddle is not correctly connected.	Check the connection.	1-2 1-3
	The transverter function is turned on.	Press and hold [GENE] to cancel the transverter function.	16-15
There is no transmission. The PWR meter is not displayed.	This transceiver is transmitting in a band (135 kHz or 475 kHz) that is not compatible with the output from the antenna connector.	Press [DRV] to output from the DRV connector (drive output).	16-15
	The [PTT] switch is locked while it is ON when a desk microphone is used.	Turn off the PTT lock.	2-8
	The frequency has deviated from the amateur band.	Set the frequency to an amateur band.	4-3
Significant background noise can be heard when there is no sound during transmission in the SSB and AM modes.	TX Inhibit is ON.	Configure TX Inhibit to "Off" in Menu [6-03].	16-11
	Microphone gain is too high.	Carry out audio transmission while monitoring the ALC meter and adjust the microphone gain such that a small amount of ALC voltage is applied.	4-8
The VOX function is not functioning.	The input level setting of the speech processor is high.	Turn the [MIC/PITCH] control until the pointer of the COMP meter falls within the appropriate range.	8-4
	The VOX gain setting is too low.	Adjust the VOX gain.	8-1
Transmission starts by itself when this transceiver is not operated.	The anti VOX gain setting is too high.	Adjust the anti VOX gain.	8-2
	The VOX function is ON or the VOX gain level is not properly adjusted.	Set the VOX function to OFF or adjust the VOX gain level.	8-1
	The signal level of the TX audio source that is input from the rear panel terminal is high.	Lower the level of the signal input.	
The receiving station has reported that the audio sound is distorted or clipped.	Audio signal is input from a connector for which the audio source setting of the TX audio is enabled and the same audio source is also specified for Data VOX.	Set Data VOX to OFF or review the audio source setting before adjusting the VOX gain level.	8-1
	Microphone gain is high.	Use the TX monitor function or adjust the microphone gain while having the receiving station monitor the transmission.	4-8
	The input level of the speech processor is high.	Use the TX monitor function or adjust the speech processor input level while having the receiving station monitor the transmission.	8-4

18 TROUBLESHOOTING



Symptom	Probable Cause	Corrective Action	Refer to
The linear amplifier is not functioning.	The REMOTE connector is not properly connected.	Reconnect the connector properly.	16-13
	The audio source selected in Data VOX is different from the audio source input, or the input level of the input signal is low.	Check the Data VOX settings or check the input level of the input signal.	
	Control relay of the linear amplifier is turned off.	Configure to a setting suitable for the linear amplifier, such as "Active High + Relay Control" for "Keying Logic" in the Linear Amplifier menu.	16-14
When a linear amplifier is used for full break-in operation in the CW mode, the SWR may deteriorate suddenly or an abnormal ALC voltage may be applied when the linear amplifier starts up.	The linear amplifier in use requires some time to start up (TL-922, etc.).	Operate in the semi break-in mode by configuring to a setting that includes an appropriate delay time for the linear amplifier, such as "Active High + Relay Control" for "Keying Logic" in the Linear Amplifier menu.	16-13
AT-300 is not functioning.	It is connected to antenna input connector 2 (ANT 2).	Connect it to antenna input connector 1 (ANT 1).	4-12
	The fuse inside this transceiver is blown.	Check the fuse, address the cause and replace the blown fuse with a new one.	17-4
Modulation is too shallow. (FM mode)	Microphone gain is low.	Configure the microphone gain in Advanced Menu [10].	5-28
When a commercially available power meter is used, the TX output power reading for SSB is low compared to the other modes.	The peak power of SSB is not correctly measured.	To ensure correct measurement of the peak power for SSB, the use of devices such as an oscilloscope which are capable of displaying instantaneous waveforms is recommended. Commercially available power meters may not be able to measure the peak power fully in some cases. Please use them as reference values.	
Transmission is still held after AT tuning is complete.	TX hold after AT tuning is configured to ON.	Configure TX hold after AT tuning to OFF in Advanced Menu [7].	4-12
VFO scan does not start.	Program Scan is selected.	Configure all the settings for memory channels P0 to P9 to OFF in the Program Scan/VFO Scan configuration mode. Alternatively, press [VFO/PRG] to select VFO Scan.	10-1
Memory Scan is not functioning.	No data is registered in the memory channels.	Register data to the memory channels.	9-2
Group Scan is not functioning.	No data is registered in the memory channels within the group.	Register data to the memory channels of the corresponding group number.	10-3
	All the memory channels within the group are locked out.	Cancel the lockout for the memory channels to be scanned.	10-4
Memory Scan is only performed on specific channels.	Group Memory Scan is selected.	Reconfigure or cancel the group selection.	10-3
Voice guidance does not start automatically.	Auto voice guidance is OFF.	Configure auto voice guidance to "On" in Menu [1-06].	13-1
Voice guidance is not output automatically after Full Reset is performed.	Menu [1-06] is configured to "Off".	Turn on the power while pressing [PF A] , or configure Menu [1-06] to "On".	13-1
The [POWER] LED is blinking and the power of this transceiver does not turn on.	This transceiver is preparing to activate the program timer operation.	Wait for the program timer operation to start. To stop the program timer operation, press [⏻] for 4 seconds.	14-4
Program timer is not activated.	The timer operation is not configured to ON.	Check whether the timer operation has been temporarily turned off (<< [⏻] >> goes off) by pressing F [TIMER] after the timer operation is configured to ON.	14-4
A firmware version confirmation screen is displayed and this transceiver does not start up.	The firmware of this transceiver cannot be detected.	Rewrite the firmware. If the same symptom persists after rewriting the firmware, please send an inquiry to KENWOOD service center together with the number that is displayed at the bottom right corner of the message.	17-1
Firmware cannot be updated.	The name of the zip file is changed.	Update the firmware without changing the name of the zip file. The file name may be changed if the file is downloaded to the PC multiple times.	
	The zip file is uncompressed.	Update the firmware without uncompressing the zip file.	

Problems Related to Data Communication, PC and Network

Symptom	Probable Cause	Corrective Action	Refer to
Errors and retries occur frequently during transmission in the DATA mode.	The audio output level of the auxiliary equipment is too high and modulation signals are distorted as a result.	Lower the output of the auxiliary equipment such that the ALC zone is not exceeded.	
	The audio input sensitivity of the data communication terminal on this transceiver does not match the input signal.	Adjust the audio input sensitivity of the data communication terminal in menus [7-06] (USB) and [7-07] (ACC 2) such that the ALC zone is not exceeded.	16-7
	High-frequency signal sneaks in and causes distortion of the modulation signals. a. The auxiliary equipment uses the same regulated DC power supply as this transceiver. b. The antenna SWR is high. c. High-frequency signal from the antenna is induced by this transceiver. d. High-frequency signal sneaks in due to the high audio input sensitivity of the ACC 2 connector.	Introduce measures to prevent high-frequency signal from sneaking in. a. Use a different power supply for the auxiliary equipment and this transceiver. b. Perform antenna matching again. c. Try changing the earth of the antenna, this transceiver and the auxiliary equipment. d. Lower the audio input sensitivity of the ACC 2 connector in Menu [7-07].	16-7
Audio input to the data communication terminal is not transmitted.	The audio source input path setting does not match the terminal in use.	Press and hold [DATA] to configure the settings on the DATA mode audio source input screen.	8-1
	The method of transmission is not appropriate.	Transmit signals using one of the following methods. a. Transmit by controlling the PKS terminal of the ACC 2 connector. b. Transmit using the [PF] key configured for the DATA SEND function. c. Transmit using the "TX1;" PC command.	1-7 16-2 1-4 16-5
	The level of the audio input to the data communication terminal is low.	Raise the audio output level of the connected auxiliary equipment, or raise the audio input level of the terminal in use in menus [7-06] (USB) and [7-07] (ACC 2).	16-7
Errors occur frequently during reception in the DATA mode.	Decoding cannot be performed as the audio output level of the data communication terminal on this transceiver does not match the input level of the auxiliary equipment.	Adjust the audio output level of the terminal in use in menus [7-08] (USB) and [7-09] (ACC 2).	16-7
	There is multi-path distortion or fading at short intervals. (The RX signal strength is not necessarily the best when it is strongest.)	When using a beam antenna, change the orientation of the antenna to look for a position that is less likely to cause errors.	
Unable to communicate with ARCP-890 or ARHP-890 using the COM port.	The baud rates do not match each other.	Check the baud rate of the TS-890S and ARCP-890.	16-5
	The COM port is unable to handle CTS/RTS.	Configure Advanced Menu [16] "PSQ/PKS Pin Assignment (COM Connector)" so that the COM port can handle CTS/RTS.	16-8
Unable to communicate with ARCP-890 or ARHP-890 using the USB port.	The driver is not installed on the PC.	Download the driver from our website and install it on the PC.	16-5
	The correct driver is not installed on the PC because the PC is connected to this transceiver before the driver is installed.	Reinstall the driver.	16-5
	The baud rates do not match each other.	Check the baud rate of the TS-890S and ARCP-890.	16-5
	① Flow control is not configured. ② The COM ports of PC and ARCP/ARHP are not matching.	① Check that Advanced Menu [17] "Virtual Standard COM Port - RTS" is configured to "Flow Control". ② Check that the COM port number assigned by the Device Manager of the OS for communication between this transceiver and ARCP/ARHP is the same as the number specified by ARCP/ARHP. (ARCP/ARHP uses the Standard COM port number displayed in the Device Manager of the OS.)	1-5 16-12

18 TROUBLESHOOTING

Symptom	Probable Cause	Corrective Action	Refer to
Unable to communicate with ARCP-890/ARHP-890 using the LAN port. (For operation within the LAN)	<ul style="list-style-type: none"> ① The IP address cannot be acquired. ② The IP address of this transceiver is not configured in ARCP/ARHP. ③ The administrator ID, password and the LAN connection are not configured. ④ The users to be connected are not registered in the KNS user list. 	<ul style="list-style-type: none"> ① Same corrective actions as the “Clock correction by the NTP server is not performed.” (18-6) symptom. ② Configure the IP address of this transceiver in the ARCP/ARHP. ③ Configure the administrator ID, password and “KNS Operation (LAN Connector)” in the KNS menu. ④ Register the information to the KNS user list. 	<ul style="list-style-type: none"> 15-1 15-3 15-5
Unable to perform PC keying in the CW mode using the USB port. Or unable to transmit.	<ul style="list-style-type: none"> ① CW keying is not configured. ② PTT is not configured. ③ The PC application settings are wrong. 	<ul style="list-style-type: none"> ① Configure Advanced Menu [20] “Virtual Enhanced COM Port - DTR” to CW keying. ② Configure Advanced Menu [19] “Virtual Enhanced COM Port - RTS” to PTT. ③ Reconfigure the PC application settings as follows. <ul style="list-style-type: none"> a. Check that the COM port number assigned by the Device Manager of the OS for communication between this transceiver and the PC application is the same as the number specified by the PC application. b. Check that the keying output and PTT output are the same as those configured in ① and ② respectively. 	<ul style="list-style-type: none"> 16-12
Unable to perform PC keying in the RTTY mode using the USB port. Or unable to transmit.	<ul style="list-style-type: none"> ① RTTY keying is not configured. ② PTT is not configured. ③ The PC application settings are wrong. 	<ul style="list-style-type: none"> ① Configure Advanced Menu [20] “Virtual Enhanced COM Port - DTR” to RTTY keying. ② Configure Advanced Menu [19] “Virtual Enhanced COM Port - RTS” to PTT. ③ Reconfigure the PC application settings as follows. <ul style="list-style-type: none"> a. Check that the COM port number assigned by the Device Manager of the OS for communication between this transceiver and the PC application is the same as the number specified by the PC application. b. Check that the keying output and PTT output are the same as those configured in ① and ② respectively. 	<ul style="list-style-type: none"> 16-12
When this transceiver is connected to a PC with a USB cable, the COM port number assigned to the PC becomes larger.	When our transceiver (TH-D72/TS-590S/TS-590SG/TS-990S/TS-890S/TH-D74) is connected to a USB port that is different from the previously connected port, the OS will assign a new COM port.	With our transceiver unit connected to the PC, delete the unwanted COM port number from “Device Manager” of the OS. For more details, please refer to the website below. http://www.kenwood.com/i/products/info/amateur/software_download.html	/
Clock correction by the NTP server is not performed.	The IP address cannot be acquired.	Check whether the DHCP of this transceiver is configured to ON. Check whether the DHCP server function on the broadband router is configured to ON or whether it is functioning normally.	<ul style="list-style-type: none"> 14-3
	The NTP server address is not configured.	Configure the NTP server address.	<ul style="list-style-type: none"> 14-3
	NTP information is not transmitted from WAN.	Open the port of communication devices such as the broadband router to ensure that the port used for communicating with the NTP server is not blocked.	<ul style="list-style-type: none"> 14-3
	LAN cable is not connected.	Check the LAN cable connection.	<ul style="list-style-type: none"> 2-7
Date and time cannot be configured.	Auto clock correction is ON.	Set auto clock correction to OFF.	<ul style="list-style-type: none"> 14-3

Symptom	Probable Cause	Corrective Action	Refer to
The USB flash drive cannot be recognized.	The USB flash drive is not formatted by this transceiver.	Format on this transceiver.	11-5
	Poor connection.	Connect the USB flash drive.	1-2
	The USB flash drive is security-enabled.	This transceiver does not support security-enabled USB flash drive.	11-1
	The USB flash drive is damaged.	Check on the PC to determine whether the USB flash drive connected to this transceiver is functioning properly.	
	The USB flash drive in use does not conform to the USB specifications.	Use a USB flash drive that conforms to the USB specifications.	11-1
	Multiple USB flash drive devices are connected.	Use only the USB flash drive that is first recognized by this transceiver.	
Unable to write files to the USB flash drive.	The file system of the USB flash drive is corrupted.	Format on this transceiver.	11-5
	The USB flash drive is write-protected.	Remove the write protection.	
	The USB flash drive is not formatted by this transceiver.	Format on this transceiver.	11-5
	Poor connection.	Reconnect the USB flash drive.	1-2
	The USB flash drive is security-enabled.	This transceiver does not support security-enabled USB flash drive.	11-1
	The USB flash drive is damaged.	Check on the PC to determine whether the USB flash drive connected to this transceiver is functioning properly.	
	The USB flash drive in use does not conform to the USB specifications.	Use a USB flash drive that conforms to the USB specifications.	11-1
	The file system of the USB flash drive is corrupted.	Format on this transceiver.	11-5
	There is no remaining space available.	Use a USB flash drive with sufficient remaining space.	
There are too many files in a folder.	Not more than 255 files can be stored in each folder. Delete the unwanted files and before saving.	11-1	
USB flash drive formatting failed.	Formatting of the USB flash drive started while <<  >> was blinking and formatting failed.	Follow the procedures in “Safely Removing the USB Flash Drive” (11-6) to safely remove the USB flash drive followed by inserting it again to format it.	11-5
Steps to safely remove the USB flash drive failed.	Safe removal failed for some unknown reason.	Turn off the power of this transceiver and remove the USB flash drive. Some data may not be saved depending on the data processing status of this transceiver.	11-1
<<  >> continues to blink for several minutes.	The USB flash drive is not recognized by this transceiver.	Format on this transceiver.	11-5
No output to the external monitor.	The output of the external display is OFF.	Configure the output of the external display to ON in Advanced Menu [21].	16-7
No output to the external monitor during startup.	Depending on the specifications of the monitor in use, delay in the display may occur when this transceiver is powered on.	Wait for the startup screen of this transceiver to disappear.	
No output to the external monitor.	“Display Off” is selected for the screen saver type.	Configure the screen saver type to “Off”.	
RX audio from the PC cannot be heard (during USB/ACC 2 connection).	The microphone setting on the OS is configured to monaural.	When using a Windows PC, wait for the PC to recognize this transceiver, then select Control Panel → Hardware and Sound → Sound → Recording → Microphone (USB Audio CODEC) → Properties, followed by selecting “2 channel”.	

18 TROUBLESHOOTING

Troubles Related to Recording and Playback

Symptom	Probable Cause	Corrective Action	Refer to
A message is displayed when [⏻] is pressed during timer recording.	Timer recording is in progress.	To stop timer recording and allow this transceiver to be operated, press and hold F4 [(BREAK)]. To continue with timer recording, press [⏻].	14-4
A file is created after executing timer recording but the RX audio cannot be heard.	The mute function is ON when timer recording is performed.	Check whether the mute function is ON when timer recording is performed. RX audio will not be recorded if mute is ON.	14-4
Voice messages cannot be recorded.	The input path for the audio is not correctly configured.	Check on the voice message recording standby screen to ensure that the audio input path is correct and the level is not too high or too low.	12-1
The voice message repeat interval is not functioning.	An attempt has been made to execute repeat interval for playing back voice messages only.	Repeat interval functions during playback with transmission. It does not function during playback without transmission.	12-2
	Repeat is turned off.	Configure repeat to ON for the channel to repeat.	12-3
RX audio can only be recorded for 30 seconds.	Full-time recording is enabled.	Full-time recording records only up to 30 seconds regardless of the destination for saving the file.	12-4
WAV files cannot be played.	The format is not supported by this transceiver.	The format supported by this transceiver is as follows. No. of channels: 1 (monaural), No. of bits: 16, sampling frequency: 16 kHz	
The playback volume is very soft.	The [AF] control is turned all the way to the left.	Turn the [AF] control to the right to adjust the volume.	4-2

Error Messages

The following error messages are displayed when an abnormality is detected on this transceiver. Follow the steps described for each error message to resolve the problem.

ID	Message	Description/Corrective Action
0012	Configurations for the Local Clock have not been completed. (ERR: 0012) Associated functions cannot be used until the timer configurations have been completed.	Appears when attempting to launch the program timer while a local clock is not configured. Configure the local clock in Clock menus [00] to [03].
0015	Connection to an NTP server has failed. (ERR: 0015) Ensure that the NTP server address and the network have been correctly configured.	Appears when date/time data cannot be successfully acquired from the NTP server. Follow the instructions in the error message.
001B	A file is invalid. (ERR: 001B)	Appears when a file error is detected while reading a file that contains the RX equalizer, TX equalizer and settings data.
001C	An error occurred while a file was being read from a USB flash drive. (ERR: 001C)	Appears when a file error is detected while reading a file stored in the USB flash drive that contains the RX equalizer, TX equalizer and settings data.
002F	A USB flash drive cannot be detected. (ERR: 002F) Failure to detect the USB flash drive may be caused by the following: <ul style="list-style-type: none"> The USB flash drive is not correctly connected to a USB connector. The USB flash drive is not in the specified format. The USB flash drive must be formatted in the "USB/File Management" screen. 	Appears when some unknown problem has occurred on the USB flash drive. Follow the instructions in the error message.
0030	An error occurred while a file is being written to an internal memory area or a USB flash drive. (ERR: 0030)	Appears when the file name is duplicated or an unexpected error has occurred. Follow the instructions in the error message.
003B	Failure in Deleting of a File. (ERR: 003B)	Appears when the deletion of file failed. Make sure the USB flash drive is not write-protected.
003C	Safe Removal of USB Flash Drive was failed. (ERR: 003C) The data file may not be stored onto the USB flash drive. Turn OFF the DC power supply, and then disconnect the USB flash drive.	Appears when some problem has occurred while unmounting the USB flash drive. Follow the instructions in the error message.
003E	A failure in detecting the firmware file will terminate the firmware updating process. (ERR: 003E) The termination of the firmware update may be caused by the following: <ul style="list-style-type: none"> The firmware file is not stored in the specified folder. The USB flash drive is not in the specified format. The USB flash drive must be formatted in the "USB/File Management" screen. The newer version firmware has already been applied to the transceiver. The firmware file is not legitimate. Restart the transceiver and then execute the firmware update again from the beginning.	Appears when some unknown problem has occurred while reading the firmware file. Follow the instructions in the error message.
003F	The selected file cannot be read by this transceiver with the earlier version firmware installed. (ERR: 003F) Update the transceiver firmware using the latest version of the firmware.	Appears when attempting to read a settings file written by a transceiver installed with a new firmware using a transceiver with an old firmware. Follow the instructions in the error message.
0040	A failure in updating the firmware terminates the firmware updating process. (ERR: 0040) Refer to "Troubleshooting" in the instruction manual.	Appears when some unknown problem has occurred while rewriting the firmware file.
0046	The storage location cannot be changed while an audio recording. (ERR: 0046)	Appears when attempting to change the destination for saving the file while manual recording is in progress.
0047	The storage location cannot be changed while a CW QSO log recording. (ERR: 0047)	Appears when attempting to change the destination for saving the file while CW communication log recording is in progress.
0048	The storage location cannot be changed while a RTTY QSO log recording. (ERR: 0048)	Appears when attempting to change the destination for saving the file while RTTY communication log recording is in progress.

18 TROUBLESHOOTING

ID	Message	Description/Corrective Action
0049	The storage location cannot be changed while a PSK QSO log recording. (ERR: 0049)	Appears when attempting to change the destination for saving the file while PSK communication log recording is in progress.
004D	Audio files cannot be copied while an audio recording. (ERR: 004D)	Appears when attempting to copy files to a PC or USB while manual recording is in progress.
004E	Communication log files (CW) cannot be copied while a CW QSO log recording. (ERR: 004E)	Appears when attempting to copy files to a PC or USB while CW communication log recording is in progress.
004F	Communication log files (RTTY) cannot be copied while a RTTY QSO log recording. (ERR: 004F)	Appears when attempting to copy files to a PC or USB while RTTY communication log recording is in progress.
0050	Communication log files (PSK) cannot be copied while a PSK QSO log recording. (ERR: 0050)	Appears when attempting to copy files to a PC or USB while PSK communication log recording is in progress.
0051	KNS log files cannot be copied while a KNS log recording. (ERR: 0051)	Appears when attempting to copy files to a PC or USB while KNS log recording is in progress.
0055	Audio files cannot be deleted while an audio recording. (ERR: 0055)	Appears when attempting to delete files while manual recording is in progress.
0056	Communication log files (CW) cannot be deleted while a CW QSO log recording. (ERR: 0056)	Appears when attempting to delete files while CW communication log recording is in progress.
0057	Communication log files (RTTY) cannot be deleted while a RTTY QSO log recording. (ERR: 0057)	Appears when attempting to delete files while RTTY communication log recording is in progress.
0058	Communication log files (PSK) cannot be deleted while a PSK QSO log recording. (ERR: 0058)	Appears when attempting to delete files while PSK communication log recording is in progress.
0059	KNS log file cannot be deleted while a KNS log recording. (ERR: 0059)	Appears when attempting to delete files while KNS log recording is in progress.
005B	Copying was aborted due to the number of files exceeded 255 in the destination folder. (ERR: 005B) Reduce the number of files in UBS flash drive and then copy again.	Appears when the number of files at the copy destination has exceeded the maximum limit of 255 files while copy is in progress.
005C	The selected file cannot be read because the market code is different. (ERR: 005C)	The transceiver type does not match the transceiver type that created the settings data file.
0103	The current sourced from the USB connector exceeds the upper limit value. (ERR: 0103) Remove the USB device and then restart the transceiver.	Appears when overcurrent is detected at the USB connector. Disconnect unused USB devices.
0105	PLL unlock was detected. (ERR: 0105) Refer to "Troubleshooting" in the instruction manual.	Perform Full Reset. If PLL unlock is still detected after Full Reset, note down the error message number (ERR:0105) and send an inquiry to KENWOOD service center.
0107	No reference signal has been detected. (ERR: 0107) Ensure that the reference signal has been sourced to the REF IN (10 MHz) connector.	Appears when there is no reference signal input from an external source. Check whether there is signal input to the REF IN terminal and whether the level of the signal is high enough.
0109	Corruption of the data was detected. (ERR: 0109) Executing the Full Reset will initialize the transceiver to the defaults. Press [OK] (F) to start the Full Reset.	Appears when damage is found in the backup data. Press F [OK] to perform Full Reset.
010A to 010F, 0110 to 0115	A DSP error was detected. (ERR: 010A to 010F, 0110 to 0115) Refer to "Troubleshooting" in the instruction manual.	Perform Full Reset. If the same error message appears again after Full Reset, note down the error message number (ERR: 010A to 010F, 0110 to 0115) and send an inquiry to KENWOOD service center.
0117	A hardware error was detected. (ERR: 0117) Refer to "Troubleshooting" in the instruction manual.	Perform Full Reset. If the same error message appears again after Full Reset, note down the error message number (ERR:0117) and send an inquiry to KENWOOD service center.

-  • Turn off the power of the regulated DC power supply after "A system error has occurred." message is displayed.
- If error occurs frequently, try updating to the latest firmware. If the same problem persists, this transceiver could be faulty. Please contact KENWOOD service center.

Warning Messages

The following warning messages are displayed in the event of an erroneous operation or when a problem on this transceiver is detected. Follow the steps described for each warning message to resolve the problem. If "Troubleshooting" is indicated in the warning message or when the problem cannot be resolved, please refer to the list of error messages and "Troubleshooting" (18-2).

ID	Message	Description/Corrective Action
000C	This audio file cannot be reproduced. (WR: 000C)	Appears when the format of the wav file is not supported by this transceiver. Check the file format on a PC to see if the file is in the wav format that can be played on this transceiver.
0031	Due to insufficient memory of the data storage or the write protection of the USB flash drive, the data storing process was terminated. (WR: 0031) Ensure that there is sufficient memory and that data storage has been enabled.	Appears when the maximum number of files in each folder has been exceeded, insufficient memory space or writing forbidden is detected when writing a file.
0032	Selects the days of the week. (WR: 0032)	Appears when [OK] is pressed with all the days of the week unchecked on the program timer configuration screen.
0033	A maximum of 4 hours of recording time can be configured. (WR: 0033) Ensure that the Power-on Time and Power-off time are appropriate.	Appears when [OK] is pressed with the time limit exceeded when configuring the Power-on Time and Power-off Time on the program timer configuration screen.
0034	The same clock time cannot be configured for both the Power-on Time and Power-off Time. (WR: 0034) Ensure that the Power-on Time and Power-off Time are appropriate.	Appears when [OK] is pressed with an invalid time range configured for this transceiver on the program timer configuration screen.
0039	Failure in formatting of a USB flash drive has been detected. (WR: 0039) The failure may be caused by one or more of the following: <ul style="list-style-type: none"> • The write protected USB flash drive is connected to a USB connector. • The USB flash drive is not correctly connected to a USB connector. • The security-protected USB flash drive is connected to a USB connector. 	Appears when formatting of the USB flash drive failed. Follow the instructions in the message.
0043	The file cannot be accessed while recording data. (WR: 0043)	Appears when attempting to read a log file for which recording is currently in progress.
004A	Select copy item. (WR: 004A)	Appears when attempting to copy files to a PC with all the files unchecked on the screen for selecting the files to copy.
0053	Select delete item. (WR: 0053)	Appears when attempting to delete files while all the files are unchecked on the screen for selecting the files to delete.
0101	The Programmable Timer is about to start recording the received audio. (WR: 0101) The recording can begin if the transceiver has been turned OFF. If the USB flash drive has selected as the file storage location, connect a USB flash drive to the USB connector before recording starts.	Appears when the power of this transceiver is turned on approximately 3 minutes and 1 minute before timer recording starts. Follow the instructions in the message.
0102	Recording by the Programmable Timer. (WR: 0102) To stop recording, press and hold [(BREAK)] (F).	Appears when [⏻] is pressed and held down during timer recording while the screen is turned off.
0104	High temperature has been detected in the transmitter. Refer to "Troubleshooting" in the instruction manual (WR: 0104). To prevent the transmitter from being damaged, the transmit power has been reduced to 5 W.	Stop the transmission and allow the temperature of this transceiver to go down.
0106	Very high temperature has been detected in the transceiver. Refer to "Troubleshooting" in the instruction manual (WR: 0106). Transmission capability is disabled until the transceiver cools down.	Is the ambient temperature of this transceiver high (such as when the transceiver is exposed to direct sunlight)? Please operate it in a well-ventilated place.

Internal Beats

Internal beats may occur within some of the amateur band frequencies. This is due to the frequency configuration of this transceiver and is not a malfunction.

Example: 29.699 MHz, 51.957 MHz, 53.784 MHz, etc.

Spurious Signals on the Bandscope

Signals that are unrelated to the RX signals may sometimes appear on the bandscope (waterfall). These are internal beats due to the frequency configuration of this transceiver and is not a malfunction. Adjusting the reference level or attenuator of the bandscope may sometimes help to minimize the appearance of spurious signals.

19 OTHERS

Optional Accessories

- ARCP-890..... Radio Control Program (Freeware)
- ARHP-890..... Radio Host Program (Freeware)
- ARVP-10..... VoIP Program (Freeware)
- ARUA-10..... USB Audio Controller (Freeware)
- SP-890..... External Speaker
- YG-82CN-1..... 270 Hz CW Filter
- HS-5..... Open-air Headphones
- HS-6..... Light Weight Headphones
- MC-43S..... Hand Microphone
- MC-60A..... Desk-top Microphone
- MC-90..... Desk-top Microphone
- PS-60..... Regulated DC Power Supply (22.5 A)



- The ARCP-890 Radio Control Program, ARHP-890 Radio Host Program, ARVP-10 VoIP Program and ARUA-10 USB Audio Controller can be downloaded from the following website.
http://www.kenwood.com/i/products/info/amateur/software_download.html
- Optional accessories that can be used along with this transceiver may from time to time be added or discontinued. Refer to the catalog for details of the optional accessories.

Installing the YG-82CN-1 Roofing Filter

1 Remove the bottom case.

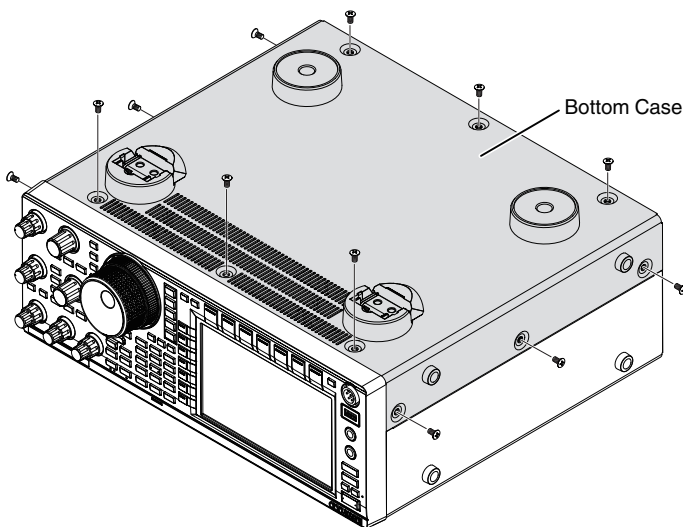

2 Remove the shield plate of the TX/RX unit.

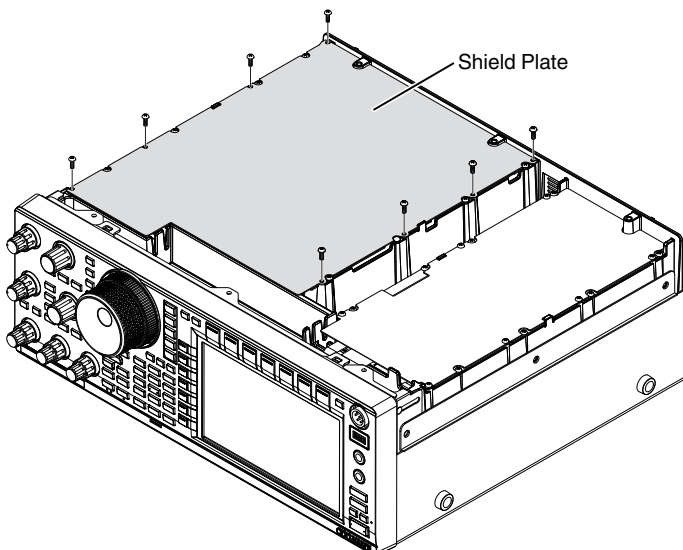

3 Insert YG-82CN-1 into the socket.

- There is a supplied filter on the board panel and the 3 sockets for YG-82CN-1 are located just in front of it.



- Align the direction of the supplied filter with that of the KENWOOD logo (● mark at the top left) and insert the pins at the bottom of the YG-82CN-1 board into the sockets.
- Align the pins at the bottom of the YG-82CN-1 board with the sockets and insert YG-82CN-1.



- To remove YG-82CN-1, hold the YG-82CN-1 board at the two sides and pull it out.

4 Stick the cushion that is supplied with YG-82CN-1 on the shield plate of the TX/RX unit.

Stick the cushion at the location indicated by the guide on the back of the shield plate.

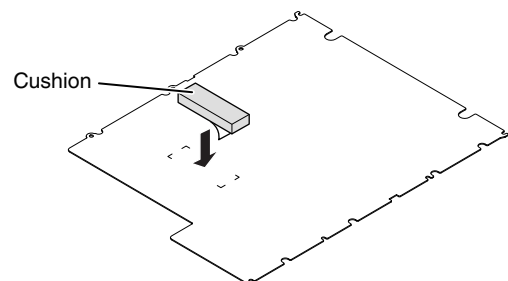

5 Install the shield plate of the TX/RX unit and the bottom case.

19 OTHERS

Specifications

General		
Frequency range (Transmitter) (E type: Refer to applicable Amateur Radio regulations to your country.)	160 m band	1.8 to 2.0 MHz (K type)/ 1.81 to 2.0 MHz (E type)
	80 m band	3.5 to 4.0 MHz (K type)/ 3.5 to 3.8 MHz (E type)
	60 m band	5.1675 MHz (K type) 5.25 to 5.45 MHz
	40 m band	7.0 to 7.3 MHz (K type)/ 7.0 to 7.2 MHz (E type)
	30 m band	10.1 to 10.15 MHz
	20 m band	14.0 to 14.35 MHz
	17 m band	18.068 to 18.168 MHz
	15 m band	21.0 to 21.45 MHz
	12 m band	24.89 to 24.99 MHz
	10 m band	28.0 to 29.7 MHz
	6 m band	50.0 to 54.0 MHz (K type)/ 50.0 to 52.0 MHz (E type)
	4 m band	70.0 to 70.5 MHz (E type)
Frequency range (Receiver)		0.13 to 30 MHz, 50 to 54 MHz, 70.0 to 70.5 MHz (E type) VFO: Continuous 30 kHz to 60 MHz/ 74.8 MHz (E type)
Mode		J3E (SSB)/ A1A (CW)/ A3E (AM)/ F3E (FM)/ F1B (FSK)/ G1B (PSK)
Frequency stability		±0.1 ppm (0°C to +50°C)
Antenna impedance		50 Ω
Antenna tuner load range		16.7 Ω to 150 Ω
Supply voltage		DC 13.8 V ±15%
Ground		Negative ground
Current drain	TX	22.5 A or less
	RX (No signal)	2.5 A or less
Operating Temperature		0°C to +50°C (+32 °F to +122 °F)
Dimensions	Without projections	W 396.0 × H 141.3 × D 340.0 mm (W 15.59 x H 5.56 x D 13.38 inches)
	With projections	W 409.6 × H 158.3 × D 387.4 mm (W 16.13 x H 6.23 x D 15.25 inches)
Weight		Approx. 15.8 kg (34.83 lbs)
Transmitter		
Output Power (AM)		HF/50 MHz: Max 100 W / Min 5 W, (Max 25 W / Min 5 W) 70 MHz: Max 50 W / Min 5 W, (Max 12.5 W / Min 5 W)
Modulation		SSB: Balanced, AM: Low Power, FM: Reactance
Maximum frequency deviation (FM)		Wide: ±5 kHz or less, Narrow: ±2.5 kHz or less
Spurious emissions		HF: -50 dB or less 50 MHz: -63 dB or less 70 MHz: -60 dB or less
Carrier suppression		60 dB or more
Unwanted sideband suppression		60 dB or more
Transmit frequency response		Within -6 dB (100 to 2900 Hz)
Microphone impedance		600 Ω
XIT variable range		±9.999 kHz

Receiver		
Circuit type		Double Superheterodyne
Intermediate frequency	1st IF	8.248 MHz
	2nd IF	24 kHz (except FM), 36 kHz (FM)
Sensitivity (Typical)	SSB/ CW/ FSK/ PSK (S/N 10 dB)	0.5 μ V (0.13 to 0.522 MHz) 4 μ V (0.522 to 1.705 MHz) 0.2 μ V (1.705 to 24.5 MHz) 0.13 μ V (24.5 to 30.0 MHz) 0.13 μ V (50.0 to 54.0 MHz) 0.13 μ V (70.0 to 70.5 MHz)
	AM (S/N 10 dB)	6.3 μ V (0.13 to 0.522 MHz) 31.6 μ V (0.522 to 1.705 MHz) 2 μ V (1.705 to 24.5 MHz) 1.3 μ V (24.5 to 30.0 MHz) 1.3 μ V (50.0 to 54.0 MHz) 1.3 μ V (70.0 to 70.5 MHz)
	FM (12 dB SINAD)	0.22 μ V (28.0 to 30.0 MHz) 0.22 μ V (50.0 to 54.0 MHz) 0.22 μ V (70.0 to 70.5 MHz)
Squelch sensitivity	SSB/ CW/ FSK/ PSK/ AM	5.6 μ V or less (0.13 to 0.522 MHz) 18.0 μ V or less (0.522 to 1.705 MHz) 1.8 μ V or less (1.705 to 30 MHz) 1.1 μ V or less (50.0 to 54.0 MHz) 1.1 μ V or less (70.0 to 70.5 MHz)
	FM	0.2 μ V or less (28.0 to 30.0 MHz) 0.2 μ V or less (50.0 to 54.0 MHz) 0.2 μ V or less (70.0 to 70.5 MHz)
Image Rejection Ratio		70 dB or more (HF), 60 dB or more (50/ 70 MHz)
If Rejection Ratio		70 dB or more
Selectivity	SSB	2.6 kHz or more (-6 dB), 4.4 kHz or less (-60 dB)
	CW/ FSK/ PSK	500 Hz or more (-6 dB), 1.2 kHz or less (-60 dB)
	AM	6.0 kHz or more (-6 dB), 12.0 kHz or less (-50 dB)
	FM	12.0 kHz or more (-6 dB), 25.0 kHz or less (-50 dB)
RIT variable range		\pm 9.999 kHz
Notch filter attenuation		70 dB or more
Beat cancel attenuation		40 dB or more
Audio output		1.5 W or more (8 Ω)
Audio output impedance		4 Ω to 8 Ω



- Electronic specifications apply only to amateur bands.
- RX sensitivity drops in the vicinity of the 1st IF frequency (8.248 MHz) due to IF trapping.
- Specifications are subject to change without notice due to advancements in technology.

KENWOOD

CE