

440MHz FM TRANSCEIVER

TM-421A

430MHz FM TRANSCEIVER

TM-421A

TM-421ES

TM-421E

144MHz FM TRANSCEIVER

TM-221A

TM-221ES

TM-221E

INSTRUCTION MANUAL

**Downloaded by
RadioAmateur.EU**

CONTENTS

Thank you for purchasing the new TM-421/221 transceiver. Please read this Instruction Manual carefully before placing your transceiver in service. This unit has been carefully engineered and manufactured to rigid quality standards, and should give you satisfactory and dependable operation for many years.

This Instruction Manual covers the following models:

- TM-421A : 440 MHz FM transceiver (35W)
(U.S.A. version only)
- TM-421A : 430 MHz FM transceiver (35W)
(Other markets)
- TM-421ES : 430 MHz FM transceiver (35W)
(U.K. and European markets)
- TM-421E : 430 MHz FM transceiver (10W)
(U.K. and European markets)
- TM-221A : 144 MHz FM transceiver (45W)
(U.S.A. and other markets)
- TM-221ES : 144 MHz FM transceiver (45W)
(U.K. and European markets)
- TM-221E : 144 MHz FM transceiver (10W)
(U.K. and European markets)

When there are differences in operation, separate instructions will be given for each model. Illustrations show the TM-221A.

The following explicit definitions apply in this manual:

Note : If disregarded, inconvenience only, no risk of equipment damage or personal injury.

Caution : Equipment damage may occur, but not personal injury.

TM-421ES/221ES MODEL IDENTIFICATION NOTES.

Please note that these model numbers do not appear on the front panel of the radio. It will appear on the Model Number Plate on the bottom of the radio and on the shipping box. The front panel will only say TM-421E or TM-221E.

1. BEFORE OPERATION	3
2. SPECIFICATIONS AND ACCESSORIES	4
2-1. SPECIFICATIONS.....	4
2-2. ACCESSORIES	5
3. INSTALLATION INSTRUCTIONS	6
3-1. INSTALLATION.....	6
3-2. CONNECTIONS.....	6
4. OPERATION	8
4-1. CONTROL FUNCTIONS	8
4-2. RECEPTION.....	10
4-3. TRANSMISSION	11
4-4. TONE FREQUENCY SELECTION	11
4-5. MEMORY.....	12
4-6. SCAN	13
4-7. TONE SQUELCH (CTCSS).....	14
4-8. REPEATER	14
5. MAINTENANCE AND ADJUSTMENT	16
5-1. GENERAL INFORMATION	16
5-2. SERVICE.....	16
5-3. CLEANING	16
5-4. IN CASE OF DIFFICULTY.....	16
5-5. MICROPROCESSOR BACKUP LITHIUM BATTERY REPLACEMENT	17
5-6. ORDERING SPARE PARTS.....	17
5-7. ADJUSTMENTS.....	17
6. OPTIONAL ACCESSORIES	18
6-1. TSU-5 PROGRAMMABLE TONE DECODER UNIT	18
6-2. OTHER ACCESSORIES	18
7. BLOCK DIAGRAM AND CIRCUIT DIAGRAM	21
7-1. BLOCK DIAGRAM	21
7-2. CIRCUIT DIAGRAM	23
8. REFERENCE	25
8-1. ANTENNA	25
8-2. MOBILE INSTALLATION HINTS.....	26

1. BEFORE OPERATION

Safety precautions

Never remove the case unless specified in this Instruction Manual. If the internal parts are touched accidentally, a serious electric shock might occur.



Never touch internal parts.

If a metal object, such as a hair pin or a needle, comes into contact with the power socket on the rear panel, a dangerous electric shock may result. For family with children, never permit children to put anything, especially metal, inside this unit.



Touching the power plug when your hands are wet may result in a serious electric shock.



Never touch with wet hands.

Never pull, bend or extend the power cord. This could damage the power cord, resulting in a broken cord or short circuit.

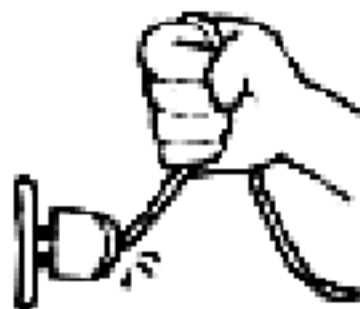

Always grasp the plug.

In case of abnormal smell

If an abnormal smell or smoke is detected, immediately turn the power OFF and pull out the power cord. Contact your dealer or nearest Service Station.



Notes on installation

Do not place the unit in a place which is exposed to direct sunlight, near a heating appliance, etc.

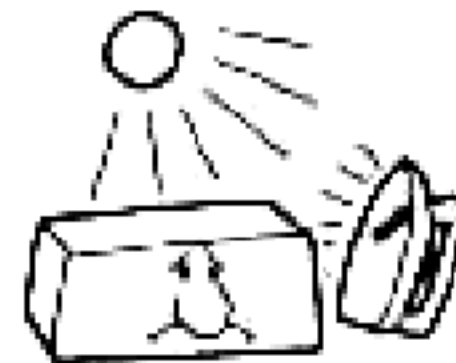

Do not store or use the unit in a dusty location or in a moist atmosphere. Select a location where air is well ventilated.



To maintain good ventilation, do not put records or a tablecloth on the unit. Place the unit at least 10 cm away from the walls.



Choose a location that is relatively free from vibration.



Cleaning

Do not use volatile solvents such as alcohol, paint thinner, gasoline, benzine, etc. to clean the cabinet. Use a silicone cloth or a clean dry cloth.



Silicone cloth Thinner Benzine

2. SPECIFICATIONS AND ACCESSORIES

2-1. SPECIFICATIONS

Specifications		Model						
		TM-421A	TM-421ES	TM-421E	TM-221A	TM-221ES	TM-221E	
General	Frequency range	440 to 450 MHz (U.S.A. version) 430 to 440 MHz			144 to 148 MHz	144 to 146 MHz		
	Mode	F3E (FM)						
	Antenna impedance	50 ohms						
	Operating temperature	- 20°C to + 60°C (- 4°F to 140°F)						
	Power requirements	13.8 VDC ± 15%						
	Ground	Negative						
	Current drain	Transmit mode (Max.)	8.5 A		3.2 A	9.5 A		2.6 A
		Receive mode with no input signal	0.4 A					
	Frequency stability	Better than $\pm 10 \times 10^{-6}$						
	Dimensions (Projections included, W x H x D mm)	141 x 42 x 193		141 x 42 x 154	141 x 42 x 193		141 x 42 x 154	
Weight	1.2 kg		1.0 kg	1.2 kg		1.0 kg		
Output power *	HI	35 W		10 W	45 W		10 W	
	LOW	Approx. 5 W Adjustable up to out 20W		Approx. 1 W	Approx. 5 W Adjustable up to out 30W		Approx. 1 W	
Modulation	Reactance modulation							
Spurious radiation	Less than - 80 dB							
Max. frequency deviation	± 5 kHz							
Audio distortion (at 60% modulation)	Less than 3%							
Microphone impedance	500 to 600 ohms							
Circuitry	Double conversion superheterodyne							
Intermediate frequency	21.6 MHz/455 kHz			10.695 MHz/ 455 kHz	10.7 MHz/455 kHz			
Sensitivity (12 dB SINAD)	Less than 0.18 μ V							
Selectivity	- 6 dB: More than 12 kHz, - 60 dB: Less than 26 kHz							
Spurious response	Better than 65 dB			Better than 70 dB				
Squelch sensitivity	Less than 0.1 μ V							
Output (5% distortion)	More than 2 W across 8 ohms load							
External speaker impedance	8 ohms							

Notes:

1. Circuit and ratings are subject to change without notice due to advancement in technology.

2. * : Recommended duty cycle:
1 minute : Transmission
3 minutes : Reception

**Downloaded by
RadioAmateur.EU**

2-2. ACCESSORIES

Please unpack your new transceiver carefully, and confirm that the accessories listed below are included in the box. If any of the items is missing contact the dealer where the radio was purchased.

MC-48B DTMF microphone (U.S.A. only)	T91-0359-05	1 ea.
Dynamic microphone	T91-0365-15	1 ea.
Microphone hook (U.S.A. only)	J20-0319-24	1 ea.
Self tapping screw (U.S.A. only)	N46-3010-46	2 ea.
Mobile mounting kit		
Bracket	J29-0416-03	1 ea.
SEMS screw	N09-1530-05	4 ea.
Self tapping screw	N09-0335-05	4 ea.
Flat washer		4 ea.
Stacking plate (TM-421A/421ES/421E only)	J21-4147-14	2 ea.
DC power cable	E30-2053-05	1 ea.
Fuse (10A) for TM-421A/421ES/221A/221ES	F05-1031-05	1 ea.
Fuse (5A) for TM-421E	F05-5022-05	1 ea.
Fuse (4A) for TM-221E	F05-4022-05	1 ea.
Instruction manual	850-8148-00	1 copy
Warranty card (U.S.A. only)		1 ea.

After unpacking

Shipping container:

Save the boxes and packing in the event your unit needs to be transported for remote operation, maintenance, or service.

3. INSTALLATION INSTRUCTIONS

3-1. INSTALLATION

3-1-1. Mounting Bracket

When installing the transceiver in a vehicle consider the ease of operation and safety when selecting the location for the mounting bracket.

1. Install the bracket using the supplied flat washers (4 pcs.) and self tapping screws (4 pcs.)
2. Attach the transceiver temporarily using the SEMS screws (4 pcs.)
3. The angle of the bracket may be adjusted to any of 5 possible viewing angles. Select the desired angle.
4. Hold the transceiver in place and tighten the 4 SEMS screws using a wrench or screwdriver.

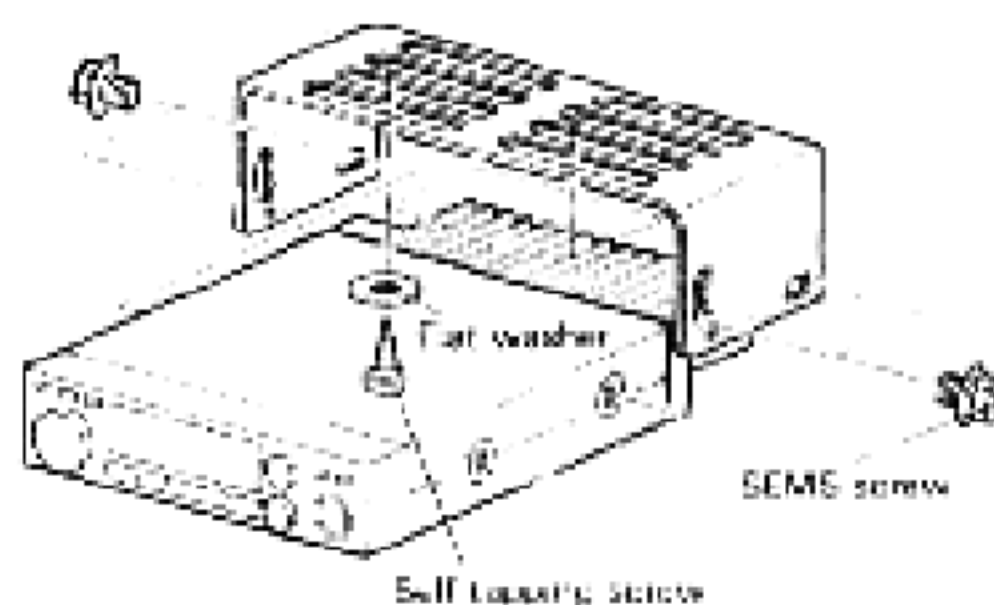

3-1-2. Stacking Plate (TM-421A/421ES/421E only)

To stack the TM-421A/421ES/421E with the TM-221A/221ES/221E, connect them with the supplied stacking plate.

Only one mounting bracket will be required so save the other bracket and mounting hardware for future use.

Select the lower pair of mounting holes on the bracket as shown in the accompanying diagram when securing the lower radio.

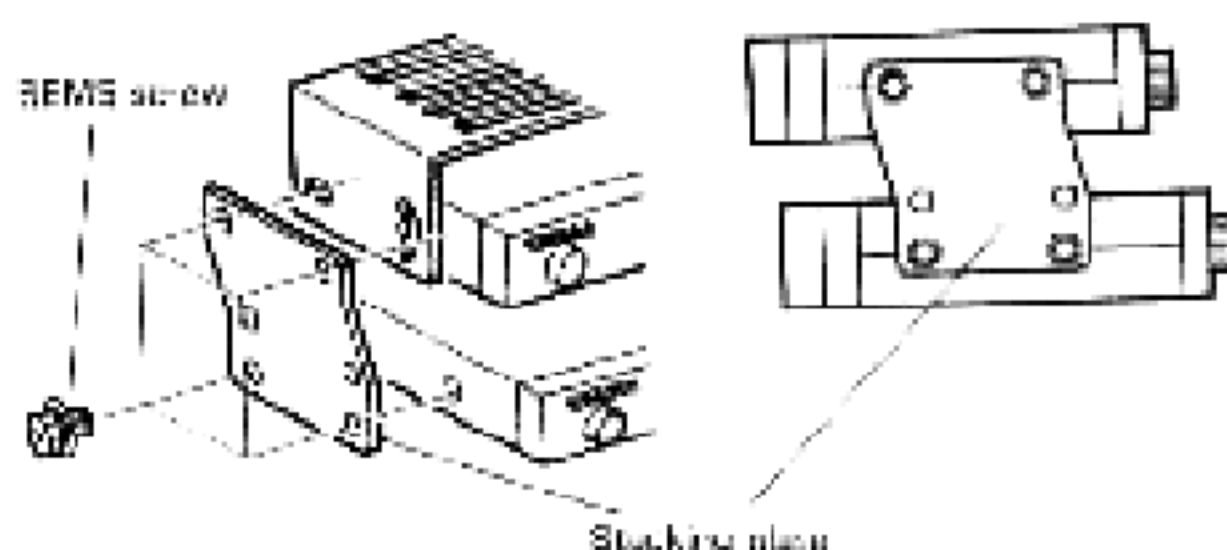

3-2. CONNECTIONS

3-2-1. Precautions

1. Never connect the AC cable to the AC outlet until all connections have been made.
2. Before connecting and disconnecting the power connector, be sure to turn off the POWER switches of both the transceiver and the DC power supply.
3. Observe polarity of the DC power cable. The transceiver operates on 13.8 VDC, negative ground. Battery polarity must be correct. The power cable is color coded:
Red - + (Positive) polarity
Black - - (Negative) polarity

- When installing the transceiver in a vehicle, consider ease of operation and safety when selecting the installation location.

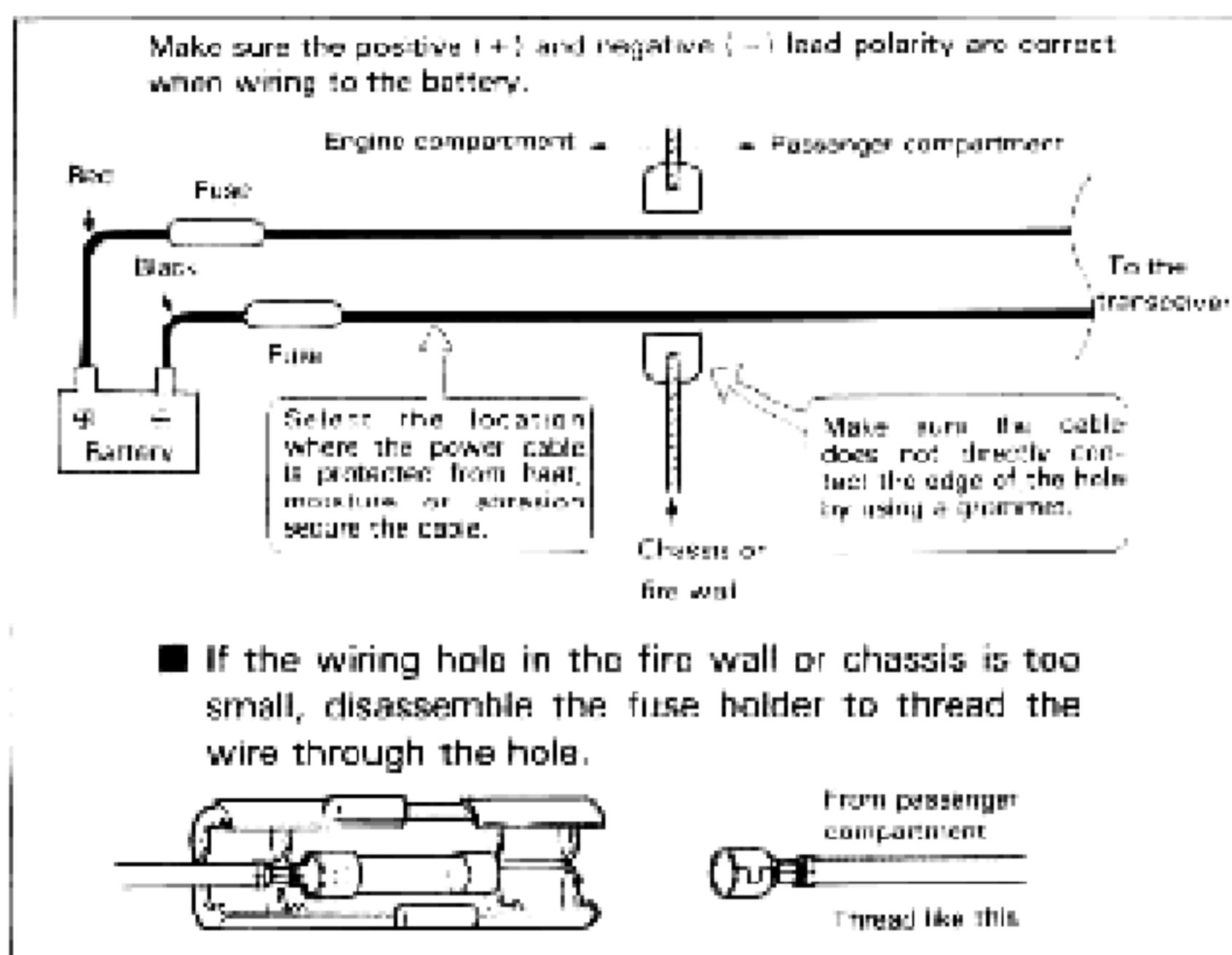

Cautions:

1. Before installing the power cable, be sure to remove the negative lead from the battery for safety.
2. After installation and wiring, be sure to double check for correct installation before reconnecting the negative lead to the battery terminal.
3. If the fuse opens, be sure to check that each conductor has not been damaged by short-

circuiting, etc.

Then replace with a new fuse of the same rating.

4. After completing the wiring, wrap the fuse holder with heat resistant tape to protect against heat and moisture.
5. Do not remove the fuse even if the power cable is too long.

B. Ignition Noise

The transceiver has been designed to suppress ignition noise; however, if excessive noise is present, it may be necessary to use suppressor spark plugs (with resistors).

3-2-3. Fixed Station

A regulated DC power supply (13.8 VDC) is required. The PS-430 and the PS-50 are recommended.

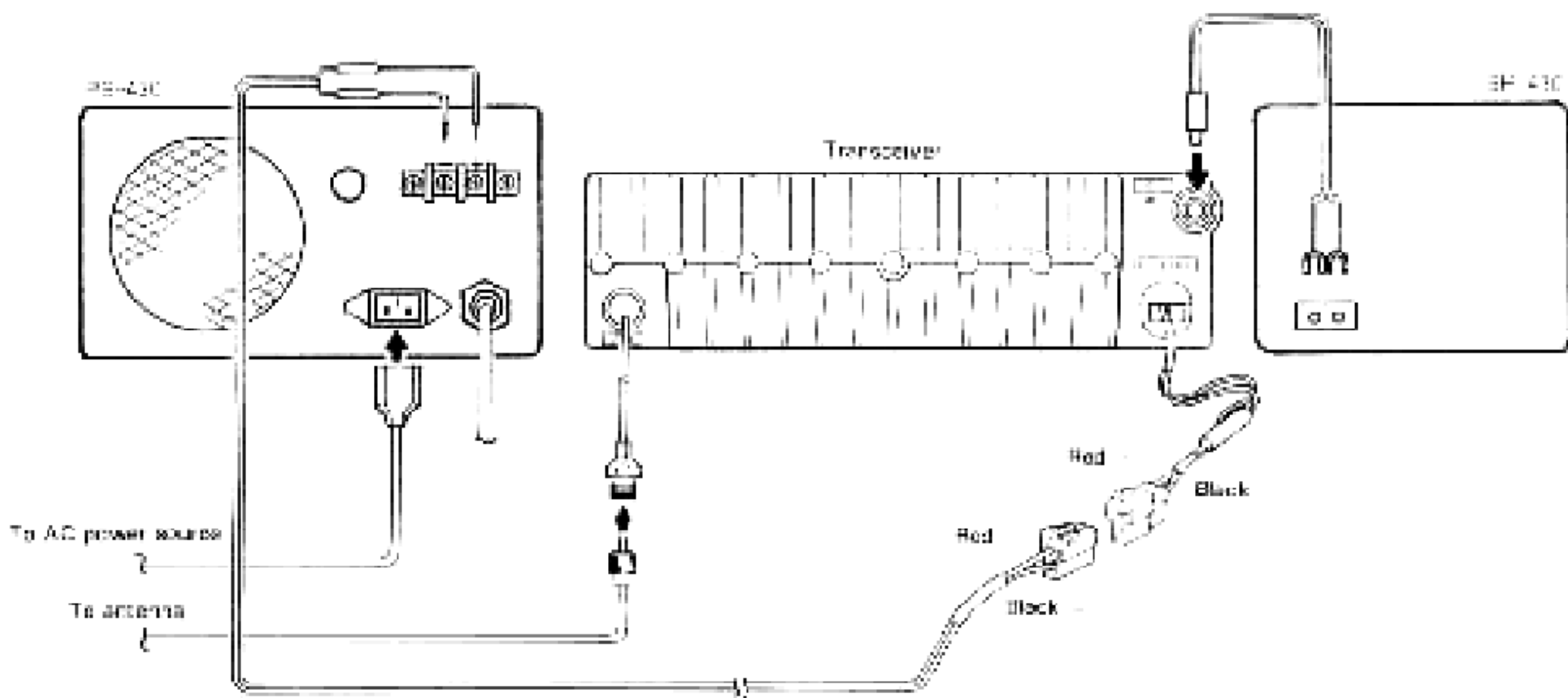

3-2-4. Antenna

The type of antenna that is used will greatly affect the performance of the transceiver. Use a properly adjusted antenna, of good quality, to enable your transceiver to perform at its best. The antenna input impedance is 50 ohms. Use 50-ohm coaxial cable such as RG-8U or 8D-2V for this connection. If the antenna is far from the transceiver the use of low loss coaxial cable, such as RG-8U is recommended. Match the impedance of the coaxial cable and that of the antenna so that the SWR is less than 1.5 to 1.

The protection circuit in the transceiver will activate if the SWR is particularly poor (greater than 3 to 1). High SWR value will cause transmitter output to drop, and may lead to TVI or BCI reports.

Caution:

For protection against fire, electric shock, personal injury, or damage to the radio, use a lightning arrester in your antenna lines.

4. OPERATION

4-1. CONTROL FUNCTIONS

4-1-1. Front Panel

(The TM-221A front panel is used for illustration purposes.)

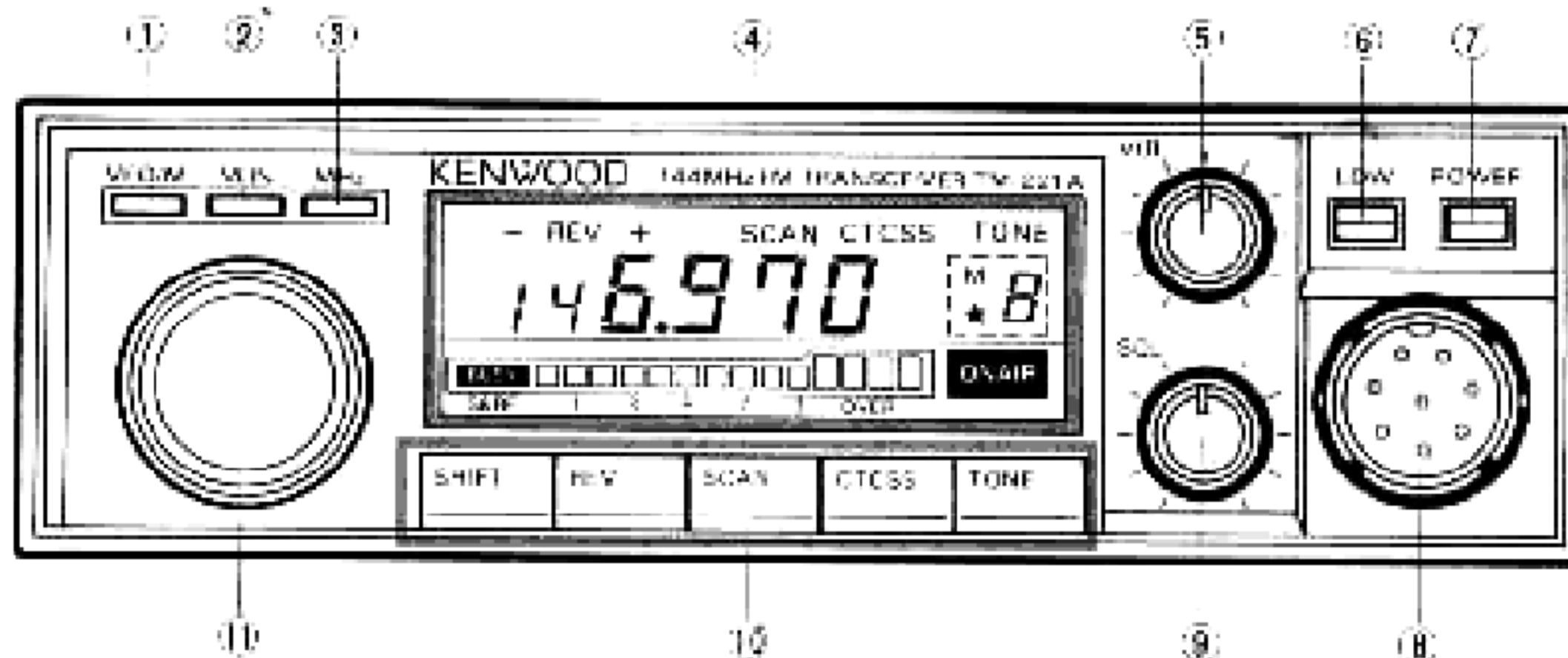

① VFO/M (VFO/Memory Channel) key

This key is used to switch between the VFO and Memory Channel modes.

② M.IN (Memory In) key

This key is used to enter a frequency, offset, etc. in to the desired Memory Channel. The key is used during VFO operations only. When this key is pressed during memory operations the contents of the memory are transferred to the VFO and switch the set back to the VFO mode.

This key is also used when programming the offset, offset frequency, tone frequency, and CTCSS decode.

③ MHz key

Used to change frequencies rapidly. During VFO operations, pressing this key will cause the kHz digits to disappear from the display. Rotating the TUNING control will then change the frequency in 1 MHz steps.

This function will be released by pressing any key or microphone PTT switch except the LOW (HI/LOW) and POWER switches. This function is also canceled 5 seconds after the last input from the TUNING control.

④ Display Panel

The LCD displays operation information such as transmit/receive frequencies, memory channel information, offset, tone frequency etc. See page 9 for additional information.

⑤ VOL (Volume) control

Turn the control clockwise to increase the volume and turn the control counterclockwise to decrease the volume.

⑥ LOW (HI/LOW) switch

This switch is used to select the desired transmitter output power level.

⑦ POWER switch

Press to turn on. Press again to turn off.

⑧ MICROPHONE connector

Plug the standard or optional microphone into this jack.

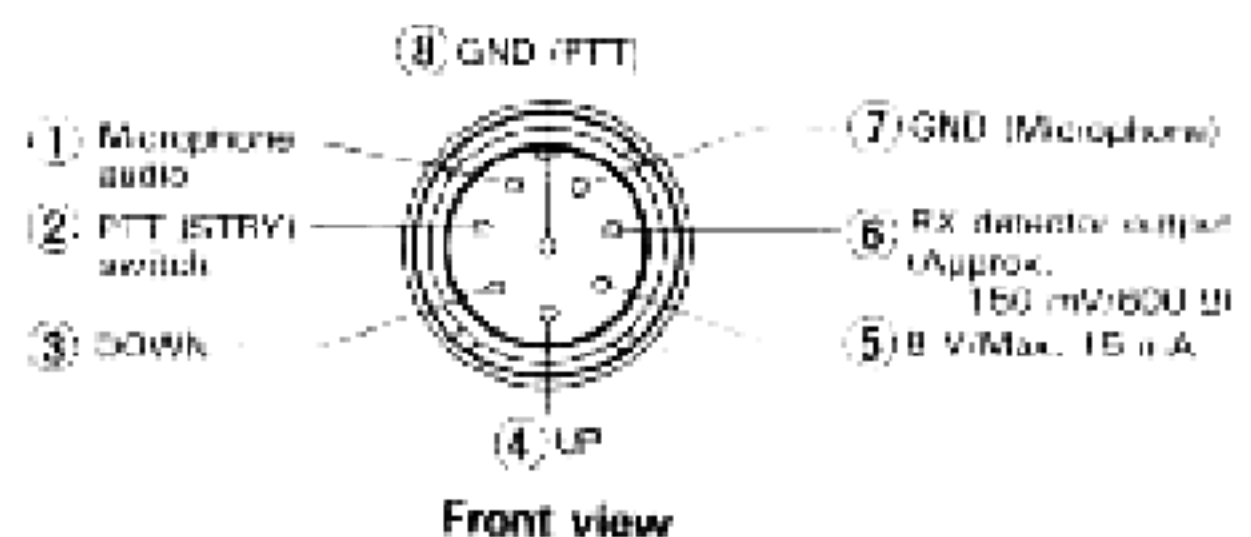

⑨ SQL (Squelch) control

The SQL control is used to eliminate noise during no signal periods. Normally this control is adjusted clockwise until the noise just disappears, and the BUSY indicator goes off. (Threshold level) For scan operations this control must be set to the threshold point. When an incoming signal is weak or unstable, readjust the SQL control for optimum reception.

⑩ Function keys

See Section B. Function Keys on page 9.

⑪ TUNING (VFO) control

This control is used to select the desired transmit/receive frequency, Memory Channel, Frequency Step, Tone Frequency (TM 421A/221A only), and Scan Direction.

A. Display Panel

With the TM-421A/221A

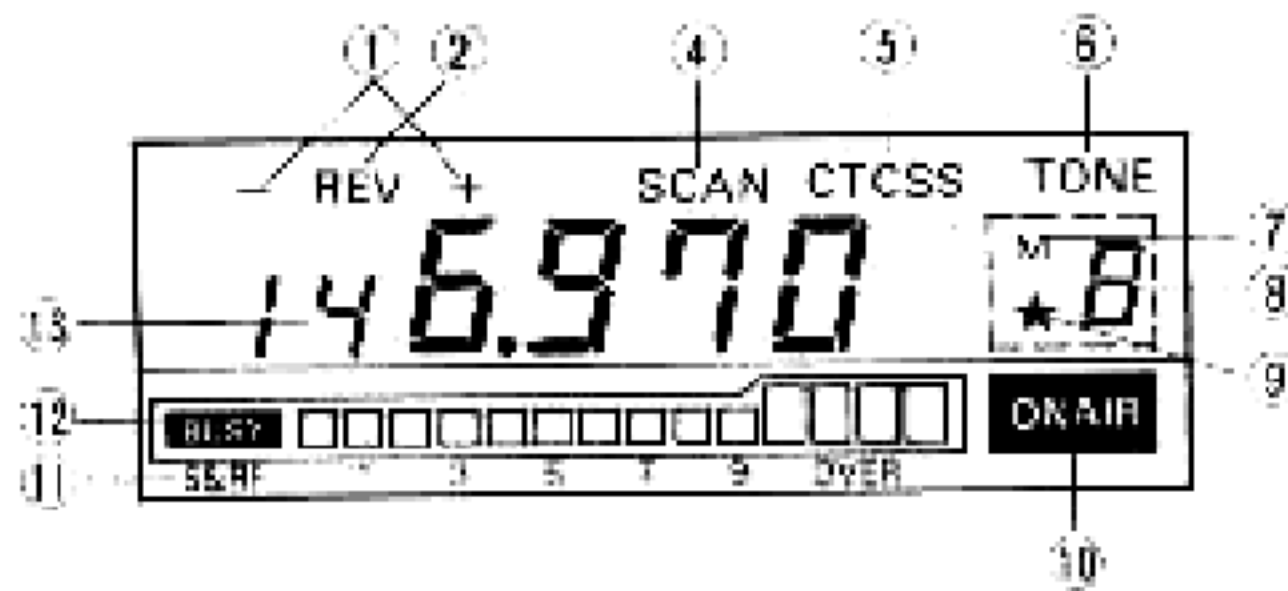

With the TM-421ES/421E/221ES/221E

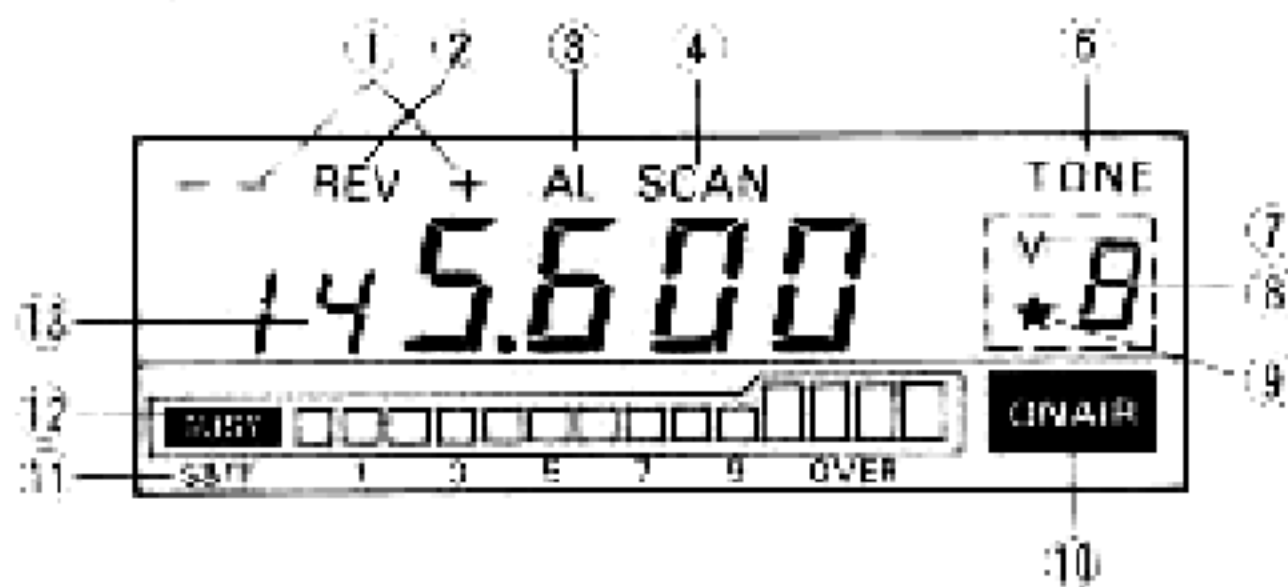

① SHIFT indicator

Turns on during repeater offset operations. See Section 4-8 REPEATER for additional information on this indicator.

② REV (Reverse) indicator

Turns on when the reverse function has been selected.

③ AL (Alert) Indicator (TM-421ES/421E/221ES/221E only)

Turns on when the alert function has been selected.

④ SCAN display

Turns on to indicate the scan function has been selected.

⑤ CTCSS (Continuous Tone Coded Squelch System) indicator (TM-421A/221A only)

Turns on to indicate the CTCSS function is active.

⑥ TONE display (Excludes TM-421ES/421E/221ES/221E European versions)

Turns on to indicate the tone function is active.

⑦ M (Memory In) indicator

On whenever the M.IN key has been depressed.

⑧ Memory Channel Number display

Indicates the selected Memory Channel Number.

⑨ ★ indicator

The ★ indicator indicates the Memory Channel currently display will be skipped during Memory Channel scan.

⑩ ON AIR indicator

On during transmit operations.

⑪ S & RF meter

This level meter indicates the relative receive input signal strength or transmitter RF output. During low power operations this meter functions as a microphone input level meter to check for proper microphone operation.

⑫ BUSY indicator

On whenever the squelch is open.

⑬ Frequency Display

Displays the transmit/receive frequency, Frequency Step, or Tone Frequency (TM-421A/221A only).

B. Function Keys

With the TM-421A/221A

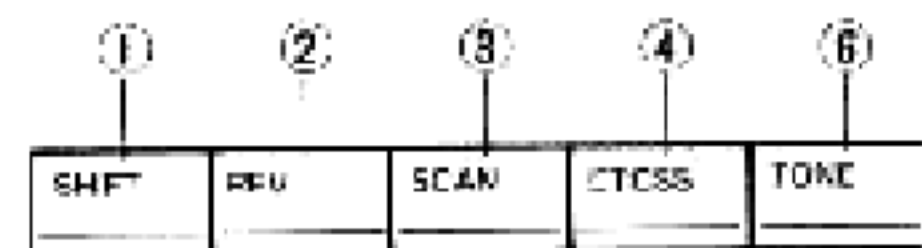

With the TM-421ES/421E/221ES/221E

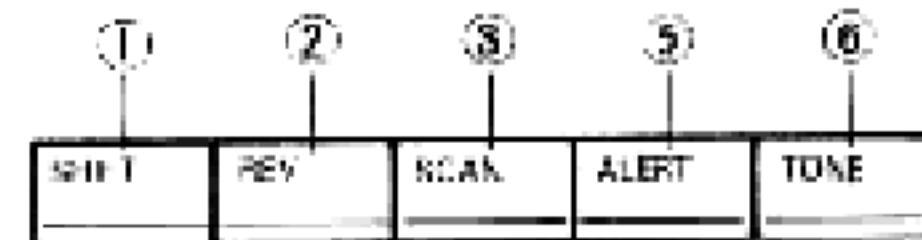

① SHIFT key

The SHIFT key is used to select the desired transmitter offset during repeater operations. When the key is pressed, the shift modes cycle from + to - (- to - - (European version)) to simplex (no indicator). (See Section 4-8 REPEATER)

② REV (Reverse) key

When the REV key is depressed it is used to reverse the transmit/receive frequencies during repeater operations.

(With the TM-421A/221A)

This will allow you to check the input of the repeater or to operate on a reverse repeater pair.

(With the TM-421ES/421E/221ES/221E)

This will allow you to check the input of the repeater. Transmission is inhibited when the REVERSE key is engaged.

③ SCAN key

Press the SCAN key to initiate scanning, press again to cancel scan. For additional information on this function refer to Section 4-6 SCAN.

④ CTCSS (Continuous Tone Coded Squelch System) key (TM-421A/221A only)

Refer to Section 4-7 TONE SQUELCH (CTCSS) for additional information on this key.

⑤ **ALERT key (TM-421ES/421E/221ES/221E only)**
This switch is used to activate the priority alert function. See Section 4-6-7 Priority Alert for additional information on this function.

⑥ **TONE key**
Activates the tone circuit for repeater control. This key is also used to open the squelch of a distant station who has activated its CTCSS key. Refer to Sections 4-7 TONE SQUELCH (CTCSS) and 4-8 REPEATER for additional information on this control.

4-1-2. Rear Panel

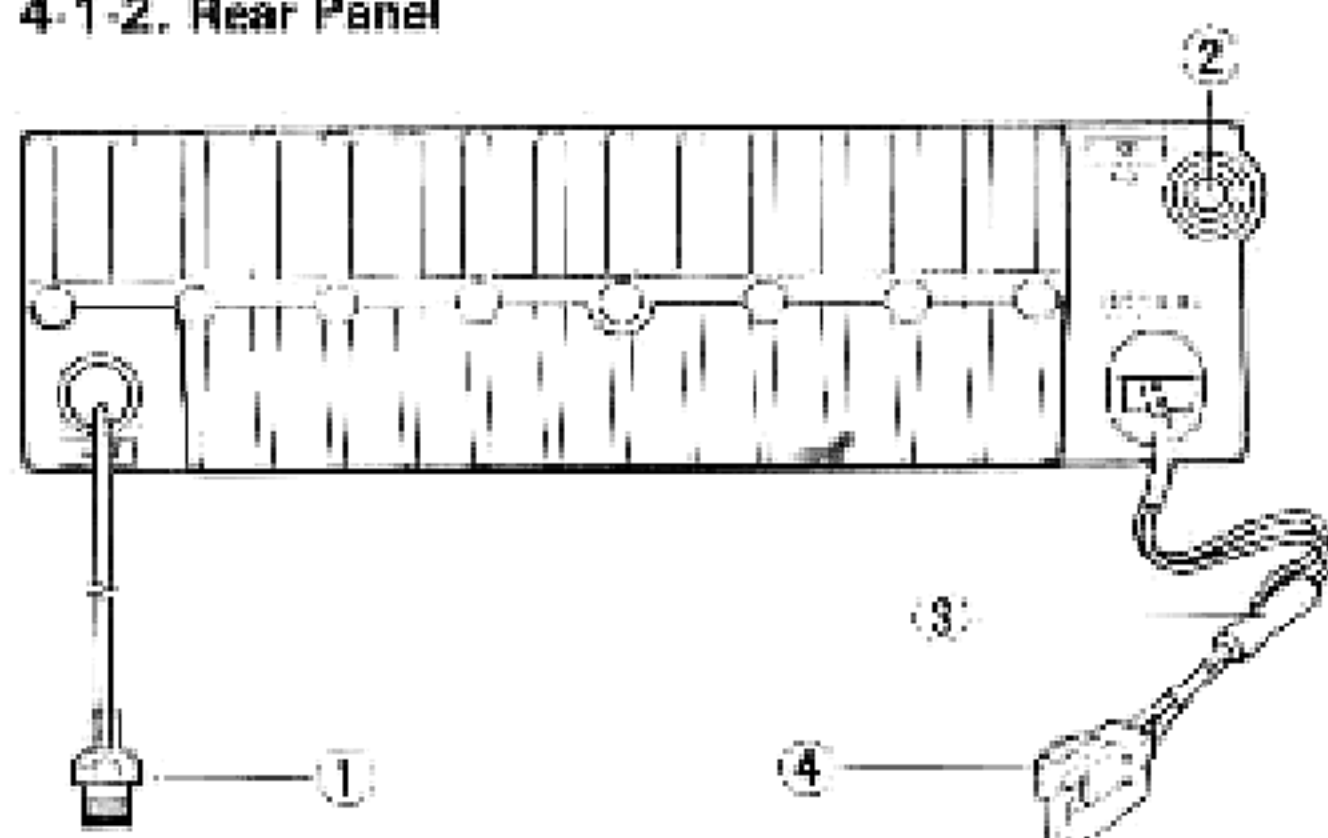

① **ANT (Antenna) connector**
Attach an antenna with an impedance of 50 ohms to this connector (PL-259).

② **SP (Speaker) jack**
This jack is for connection of an 8-ohm external speaker.

③ **Fuse holder**
Contains one of the following fuses:
 TM-421A/421ES/221A/221ES : 10A
 TM-421E : 5A
 TM-221E : 4A

④ **13.8 VDC power input connector**
Connect the supplied DC Power Cable to this connector. Pay close attention to the polarity (the DC Power Cable is color-coded; red is positive and black is negative), when connecting the cable to the power source.

4-1-3. Microphone

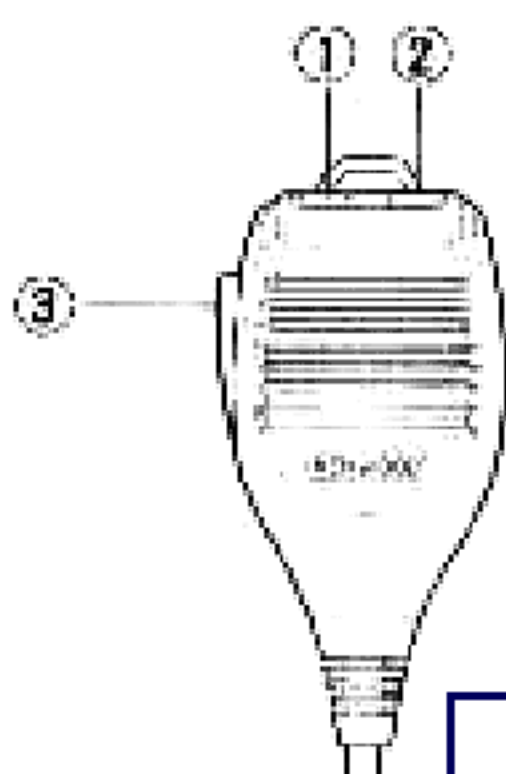

TM-421A/221A U.S.A. version only

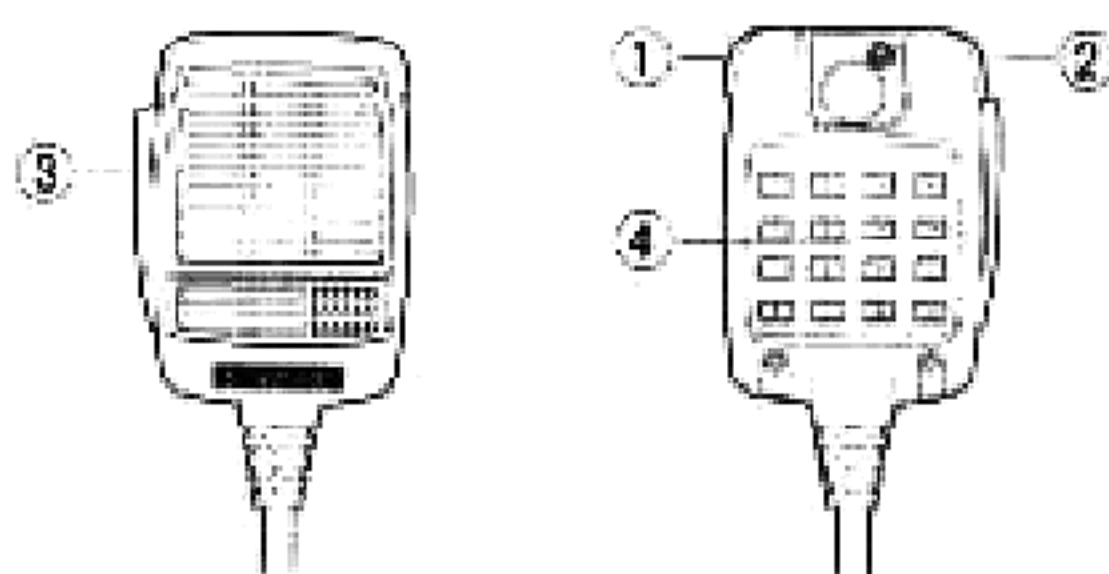

① and ② **UP/DWN (Up/Down) switches**
These switches are used to step the VFO frequency or Memory Channel up and down. The frequency will change continuously if the switches are pressed and held.

③ **PTT (Push To Talk) switch**
The transceiver will be placed into transmit whenever this switch is pressed. Operations such as scanning will be cleared when this switch is pressed.

④ **16-Tone DTMF Keypad (U.S.A. version only)**
Used to activate the DTMF encoder. See Section 4-8 REPEATER for additional information on this item.

4-2. RECEPTION

4-2-1. Initial Control Settings

1. Connect the power supply and antenna and then set the switches and controls as follows:

POWER switch : OFF
 POWER switch of the DC power supply (Fixed Station) : OFF
 VOL control : Full counterclockwise
 SQL control : Full counterclockwise

Note the initial factory delivered settings for Frequency, Tone Frequency, Memory Channel and Frequency Step are shown in the accompanying table.

Model	TM-421A	TM-421ES TM-421E	TM-221A	TM-221ES TM-221E
VFO Frequency	430.000 MHz U.S.A. version 430.000 MHz	430.000 MHz	144.000 MHz	
Frequency step	25 kHz		5 kHz	12.5 kHz
Memory Channel	Channel 0			
Memory Channel	430.000 MHz U.S.A. version 430.000 MHz	430.000 MHz	144.000 MHz	
Tone Frequency	88.5 Hz	—	88.5 Hz	—

2. Turn on the DC power supply and then press the POWER switch on the radio; the display will indicate a frequency.
3. Adjust the VOL control clockwise until a signal or noise is heard.
4. Rotate the TUNING control and select an open channel. Then turn the SQL control clockwise until the noise just disappears.
5. Select the desired frequency using the TUNING control or UP/DWN switches on the microphone. If a signal is received, the BUSY indicator will turn on and the S-meter will deflect.
6. To turn off the transceiver, turn off the transceiver's POWER switch before you turn off the power supply, or if in a vehicle, before you stop the engine.

4-2-2. Frequency Selection

The desired operating frequency and the Memory Channel may be selected by using either the TUNING control or the microphone UP/DWN switches. Press the VFO/M key to alternate between the VFO and the Memory Channel modes.

4-2-3. Frequency Step Selection

The frequency step can be selected by using the following procedure:

1. Press the VFO/M key to select the VFO mode.
2. Press the M.IN key and then the ~~SHIFT~~ key. Whenever the M.IN key is pressed, the M indicator will turn on. You must complete the desired action within 5 seconds, or the M indicator will turn off. If the indicator goes off, you must press the M.IN key again.
3. Select the desired frequency step using the TUNING control or the microphone UP/DWN switches. The figure below shows how the TUNING control and UP/DWN switches will increase or decrease in size.

Turn the TUNING control counterclockwise or press the microphone UP switch.



Turn the TUNING control clockwise or press the microphone DWN switch.



With the TM-421A/421ES/421E

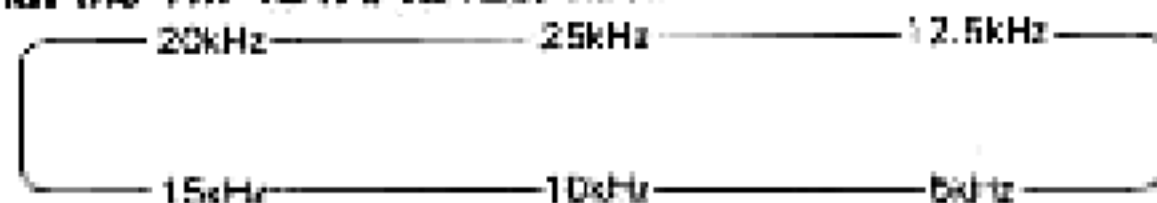

With the TM-221A



With the TM-221ES/221E

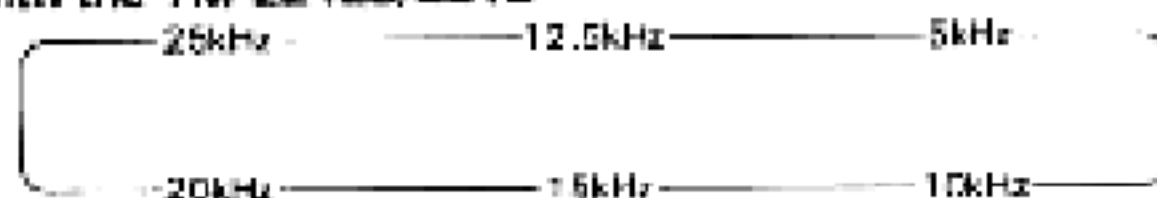

4. To return to the normal receive frequency, press any key except the LOW or the POWER switches, or turn the TUNING control.

4-2-4. Confirmation Tones

An audible tone will sound whenever the TUNING control is rotated (except in the VFO and Memory Channel modes), or any keys or the microphone UP/DWN switches are depressed. If you do not want this audio confirmation, press the M.IN and then the CTCSS (ALERT with the U.K. and European versions) key. Whenever the M.IN key is pressed, the M indicator will turn on. You must complete the desired action within 5 seconds, or the M indicator will turn off. If the indicator goes off, you must press the M.IN key again.

To restore the confirmation tone press the M.IN and then the CTCSS (ALERT) key again.

4-3. TRANSMISSION

Cautions:

1. Ensure that an antenna with a low standing wave ratio (SWR) is attached to the antenna connector before attempting to transmit. Failure to provide proper termination may result in damage to the final amplifier section.
2. Always check to ensure the frequency is clear before transmitting.

- REV
1. Select the desired operating frequency using any of the methods described above.
 2. Check the frequency to see if it is occupied before you transmit.
 3. Press the microphone PTT switch. The ON AIR indicator will light.
 4. Speak into the microphone. The recommended distance to the microphone is 2 inches (5 cm). Talking too far away may result in reports of weak audio.
 5. Release the microphone PTT switch to return to the receive mode. The ON AIR indicator should go out.

4-4. TONE FREQUENCY SELECTION (TM-421A/221A only)

1. To select the Tone Frequency press the M.IN key and then the TONE key. The Display Panel will indicate a Tone Frequency. Whenever the M.IN key is pressed, the M indicator will turn on. You must complete the desired action within 5 seconds, or the M indicator will turn off. If the indicator goes off, you must press the M.IN key again.
2. Select the desired Tone Frequency using the UP/DWN switches on the microphone or the TUNING control.
3. Press any key or the PTT switch on the microphone to return to the receiver frequency display. A Tone will be transmitted whenever the PTT switch is depressed.

Available CTCSS Tone Frequencies

Hz	Hz	Hz
67.0	114.8	192.8
71.9	118.8	203.5
74.4	123.0	210.7
77.0	127.3	218.1
79.7	131.8	225.7
82.5	136.5	233.6
85.4	141.3	241.8
88.5	146.2	250.3
91.5	151.4	
94.8	156.7	
97.4	162.2	
100.0	167.9	
103.5	173.8	
107.2	179.9	
110.9	186.2	

4-5. MEMORY

4-5-1. Microprocessor Reset

A lithium battery is contained in the transceiver to retain memory. Turning off the POWER switch, disconnecting the power cable, or a power failure will not erase memory. The battery should last for approximately five years. For replacement information please refer to Section 5-5 MICROPROCESSOR BACKUP LITHIUM BATTERY REPLACEMENT.

4-5-2. Microprocessor Initialization

When you want to erase all programmed data, or if the display should show erroneous information, you should reset (initialize) the microprocessor using the following procedure.

1. Turn the POWER switch off.
2. Press and hold the VFO/M and the M.IN keys and turn on the POWER switch.



3. Release the VFO/M and the M.IN key; the M indicator and the Memory Channel Number will display for approximately 5 seconds after you release the keys.

4-5-3. Memory Channel

This transceiver provides 14 Memory Channels (0-9, A-d). In addition to serving as a normal memory channel some of the Memory Channels serve a dual purpose to specify other parameters. The functions of these Memory Channels are described below.

- * Memory Channel 1 is used to store the frequency for the Priority Alert function. (TM-421ES/421E/221ES/221E only)

- * Memory Channel A is used to store the lower limit for the Programmable Band Scan function.
- * Memory Channel b is used to store the upper limit for the Programmable Band Scan function.
- * Memory Channel C and d are used to store odd split repeater data.

4-5-4. Memory Channel Contents

Each Memory Channel is capable of storing:

- Frequency
- SHIFT status
- REV status
- TONE status (European versions excluding)
- Tone Frequency (TM-421A/221A only)
- CTCSS status and Tone Frequency (TM-421/221A only)

4-5-5. Memory Entry

A. Memory Channels 0-9, A and b (Simplex/Standard Offsets)

1. Press the VFO/M key to select the VFO mode.
2. Select the desired operating frequency, and SHIFT.
3. Select the CTCSS key if tone squelch is desired. (TM-421A/221A Only)
4. Press the TONE key if required. (European version excluded)
5. Select the desired Tone Frequency. See Section 4-4. TONE FREQUENCY SELECTION. If CTCSS (Tone Squelch) has been selected, the Tone function will be automatically activated. (TM-421A/221A only).
6. Press the M.IN key. The Memory Channel Number display will light.
7. Select the desired Memory Channel using the TUNING control or the microphone UP/DWN switches. You must do this within 5 seconds of pressing the M.IN key (Step 6), or the M indicator will turn off. If the indicator goes off, you must press the M.IN key again.
8. Press the M.IN key within 5 seconds of selecting the Memory Channel. If the indicator goes off, you must press the M.IN key again in order to complete the desired function.

B. Odd Split Memory Channels C and d

1. Enter the desired receiver frequency as described in Section 4-5-5-A above, in Memory Channel C or d.
2. Select the desired transmitter frequency using the TUNING control or the microphone UP/DWN switches.
3. Press the M.IN key again to store the data.
4. Press the M.IN key to terminate the operation.

4-5-6. Memory Shift (Transferring Data from Memory Channel to the VFO)

1. Press the VFO/M key to select the Memory Channel mode.
2. Select the desired Memory Channel. If an Odd Split Memory Channel (C or d) is selected, only the receive data will be transferred.
3. Press the M.IN key and then the VFO/M key to transfer the data.

4-6. SCAN

The following scan options are available:

Programmable Band Scan (VFO mode)

Memory Channel Scan (Memory Channel mode)

4-6-1. Programmable Band Scan

The scan frequency range is determined by the frequencies stored in Memory Channels A and B. The frequency stored in Memory Channel A must be lower than the frequency stored in Memory Channel B for Programmable Band Scan to function properly. If the frequency in Memory Channel A is equal to or greater than the frequency stored in Memory Channel B, scan will proceed over the entire tuning range of the radio.

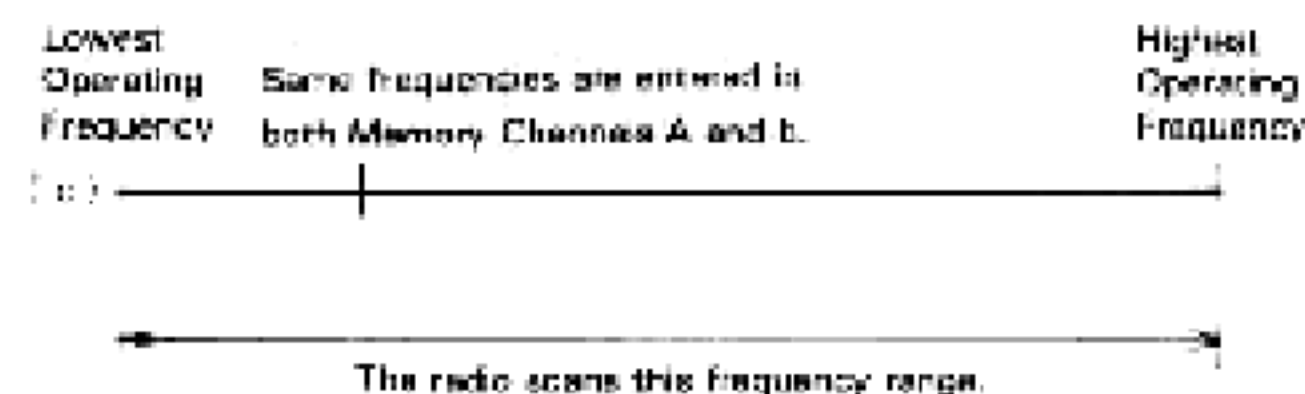
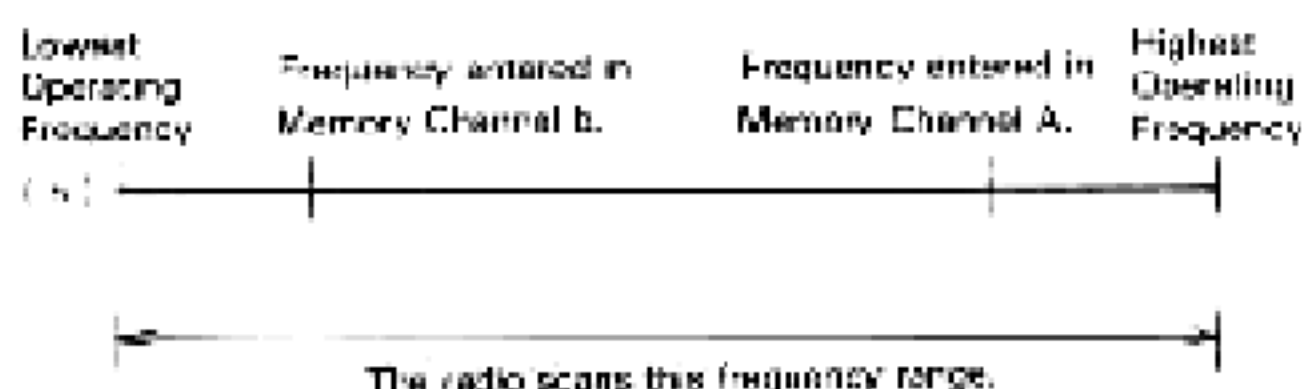
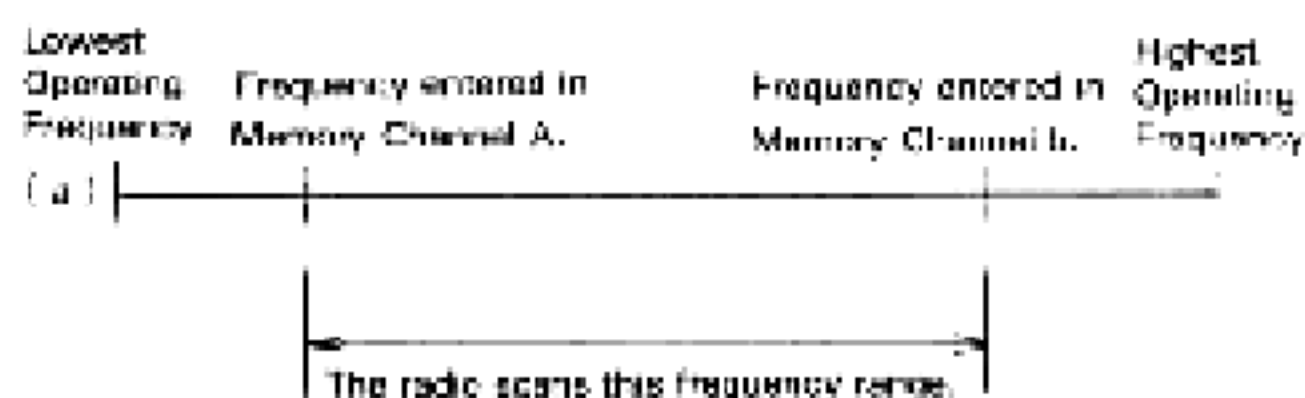

1. Before pressing the SCAN key, adjust the SQL control to the threshold level.
2. Determine the desired scan frequency range and enter the frequencies into Memory Channels A and B.
3. Press the VFO/M key to select the VFO mode.
4. Press the SCAN key to initiate scan.

4-6-2. Memory Channel Scan

1. Press the VFO/M key to select the Memory Channel mode.
2. Press the SCAN key to initiate scan.

4-6-3. Scan Direction

Scanning begins in the direction that corresponds to the direction that the TUNING control was last turned, or with respect to which of the microphone UP/DWN switches was last depressed. If you pressed the UP switch before initiating scan, scan will proceed in a positive direction. If the DWN switch was pressed scan will tune down in frequency.

4-6-4. Scan Hold

The transceiver will stop on a busy channel and then resume after a 5-second delay. You must cancel scan operations to remain on the channel. See Section 4-6-5.

4-6-5. Scan Release

To clear scanning, press any key such as the SCAN key, microphone PTT or UP/DWN switch, or rotate the TUNING control, except LOW (HI/LO) or POWER switch.

4-6-6. Memory Channel Lockout

The Memory Channel Lockout function allows you to temporarily skip unwanted Memory Channels during the Memory Channel Scan mode.

1. Press the VFO/M key to select the Memory Channel mode.
2. Select the Memory Channel that you want to skip using the TUNING control or the UP/DWN switches.
3. Press the M.IN and then the SCAN key. Whenever the M.IN key is pressed, the M indicator will turn on. You must complete the desired action within 5 seconds, or the M indicator will turn off. If the indicator goes off, you must press the M.IN key again. A star (★) will appear to the left of the Memory Channel Number. This indicates the Memory Channel will be skipped during scan operations.
4. To cancel the Memory Channel Lockout press the M.IN key and then the SCAN key.

4-6-7. Priority Alert (TM-421ES/421E/221ES/221E only)

Memory Channel 1 will be checked at approximately 5-second intervals to check for activity. If the frequency is occupied, a beep will sound. If the audio confirmation function has been turned OFF, no beep will sound, even if Memory Channel 1 is busy.

Pressing the ALERT key will switch this function off and on.

4-7. TONE SQUELCH (CTCSS) (TM-421A/221A only)

4-7-1. Tone Squelch Operation Initiated by the Distant Station.

This function requires the use of the optional TSU-5 Programmable Tone Decoder Unit. This function allows you to remain squelched until the proper Tone Frequency is received. If you are on a busy repeater this can be quite an aid.

1. Press the CTCSS key. The CTCSS indicator will light in the Display Panel.
2. Your radio will now remain squelched until the proper code is received. You should ensure all the stations you wish to communicate with use the same Tone Frequency. Please note that the 97.4 Hz Tone does not function for decode purposes. Please see Section 4-4 TONE FREQUENCY SELECTION for programming the CTCSS Tone Frequency.
3. To release the Tone Squelch function (normal noise activated squelch), press the CTCSS key again. The CTCSS indicator should go out on the Display Panel.

4-7-2. To Open the Tone Squelch of a Distant Station

Even if the optional TSU-5 Programmable Tone Decoder Unit is not installed, your radio can open the Tone Squelch of a distant station.

1. Press the CTCSS key. The CTCSS indicator will light in the Display Panel.
2. Select the same Tone Frequency between the stations you wish to communicate. See Section 4-4 TONE FREQUENCY SELECTION.
3. Press the microphone PTT switch.
4. To release the Tone Squelch function, press the CTCSS key again. The CTCSS indicator should go out on the Display Panel.

144.00	145.10	145.50	146.00	146.40	146.60	147.00	147.40	147.60	148.00	
S	S	-	S	+	S	-	+	S	-	S

S: Simplex Channel

4-8-2. Offset Direction

To select the desired transmitter offset direction press the SHIFT key. Each time you press the key the radio will advance from one offset to the other, i.e. "+" to "-" ("-" to "--" with European version) to no offset (simplex).

4-8-3. Reverse Function

Some repeaters utilize a "Reverse Pair", i.e. the transmit/receive frequencies are exactly the reverse of another repeater. For example repeater A uses 146.000 for a transmit frequency (OUTPUT) and 146.600 for receive (INPUT). Repeater B uses 146.000 for its receive and 146.600 for its

4-8. REPEATER

4-8-1. Transmitter Offsets

All amateur radio repeaters utilize a separate receiver and transmitter section. The receiver frequency may be either above or below the transmitter frequency. For most repeater's offsets are as follows:

Model	Display + -(*)	- --(+)
TM-421A	+ 5 MHz	- 5 MHz
TM-421ES/421E European market	- 1.6 MHz *	- 7.6 MHz *
TM-421ES/421E U.K. market	+ 1.6 MHz	- 1.6 MHz
TM-221A/221ES/221E	+ 600 kHz	600 kHz

This transceiver allows you to store the frequency, and offset direction in Memory Channels 0-9, and A-b, or you can select these functions directly from the keyboard.

The TM-221A has been programmed according to the standard ARRL Band Plan, regarding transmitter offsets.

Please see the enclosed chart for additional information. You can, of course, override this by using the SHIFT function, if desired.

transmit frequency. It would be inconvenient to have to reprogram the radio each time if you were in range of both repeaters.

The REV key has been provided to allow you to reverse the transmit and receive frequencies.

To use the Reverse function press the REV key. The REV indicator will light in the Display Panel to remind you that you are working a reverse repeater pair.

To return to normal offsets press the REV key again. This function is also useful to check the input frequency of the repeater, so that you can determine if you are within simplex communications range.

(With the TM-421ES/421E/221ES/221E)

Transmission is inhibited when the REVERSE key is engaged.

4-8-4. Tone Operations

Some repeaters require the use of a control signal to activate the repeater. Several versions are currently in use worldwide.

(With the TM-421A/221A)

Subaudible tones are sometimes used. In the United States 38 different subaudible tone frequency selections are possible. (See Section 4-4 TONE FREQUENCY SELECTION)

(With the TM-421ES/421E/221ES/221E)

In Europe a 1750 Hz tone is used in transmit. Press the TONE key to transmit the access tone, then press the PTT switch.

In the United Kingdom a 1750 Hz tone burst at the beginning of each transmission is used.

Since use of this tone is required in the Europe and the United Kingdom, an 1750 Hz tone encoder is included as standard equipment.

4-8-5. Autopatch (U.S.A. only)

Some repeaters offer a service known as autopatch. This allows you to dial a telephone number from your radio and carry out a telephone conversation, much like a car telephone, or cellular telephone. This function requires the use of a DTMF (Dual Tone Multi Frequency) pad. In addition to the normal 12 keys that are found on your telephone the MC-48B microphone also provides 4 additional keys, A, B, C, and D. These keys are required by some repeater systems for various control functions. You should check with the control operator of your repeater to determine if their use is required. A chart is provided that lists the tones that are generated when you press each key.

1. To activate the DTMF pad, press and hold the PTT switch.
2. Now press the keys just as you would dial a telephone.
3. The radio will remain keyed for about 2 seconds after you press each number, so you can release the PTT switch without unkeying the radio.

AUDIO TONES

High Tone (Hz) \ Low Tone (Hz)	1209	1336	1477	1633
697	1	2	3	A
770	4	5	6	B
852	7	8	9	C
941	*	0	#	D

5. MAINTENANCE AND ADJUSTMENT

5-1. GENERAL INFORMATION

Your transceiver has been factory aligned and tested to specification before shipment. Under normal circumstances the transceiver will operate in accordance with these operating instructions. All adjustable trimmers and coils in your transceiver were preset at the factory and should only be readjusted by a qualified technician with proper test equipment. Attempting service or alignment without factory authorization can void the transceiver's warranty. When operated properly, the transceiver will provide many years of service without requiring realignment. The information in this section gives some general service procedures which can be accomplished without sophisticated test equipment.

5-2. SERVICE

Should it ever become necessary to return the equipment to your dealer or service center for repair, pack it in its original box and packing, and include a full description of the problems involved. Also include your telephone number. You need not return accessory items unless directly related to the service problem.

Service note:

Dear OM, if you desire to correspond on a technical or operational problem, please make your note short, complete, and to the point, and PLEASE make it readable.

Please list: Model and Serial Number

The problem you are having.

Please give sufficient detail to diagnose. Information such as other equipment in the station, meter readings and anything else you feel might be useful in attempting diagnosis.

5-4. IN CASE OF DIFFICULTY

5-4-1. Receive

SYMPTOM	PROBABLE CAUSE	ACTION
Indicator does not light and data is not displayed when power switch is pressed.	1. Wrong power polarity. 2. Fuse is blown.	1. Connect red to "+" and black to "-". 2. Replace with the specified fuse after repairing the cause. For the fuse rating, see Sections 2-2 and 4-1-2.
Display is dark.	Power voltage is low.	Check voltage for 13.8 VDC \pm 15%.
No sound from the speaker. No signal can be received.	1. VOL control is turned too far counterclockwise. 2. Squelch is closed 3. PTT switch of microphone is pressed setting the unit in the transmit mode. 4. CTCSS is operating.	1. Turn the VOL control. 2. Turn the SQL control counterclockwise. 3. Turn PTT switch off. 4. Press the CTCSS key.
Scan fails.	Improper scan control setting, such as SQL control adjustment.	See Section 4-8.
Memory can not be backed up.	Backup battery voltage is low.	See Section 5-5.

Caution:

Do not pack the equipment in crushed newspapers for shipment. Extensive damage may result during shipment.

Notes:

1. Record the Date of Purchase, Serial Number and Dealer from whom purchased.
2. For your own information, retain a written record of any maintenance performed on the unit.
3. When claiming warranty service, please include a photocopy of the bill of sale, or other proof of purchase showing the date of sale must accompany the radio.

5-3. CLEANING

The knobs, front panel and cabinet of the transceiver are likely to become soiled after extended use. The knobs should be removed from the transceiver and cleaned with a neutral soap and warm water. Use a neutral soap (no harsh chemicals) and a damp cloth to clean the cabinet and front panel.

5-4-2. Transmit

SYMPTOM	PROBABLE CAUSE	ACTION
No output.	1. Microphone jack is not plugged in. 2. Poor antenna connection.	1. Plug jack in. 2. Connect antenna securely.
Can not access to repeater.	1. Setting of the TONE, SHIFT, REV keys are wrong 2. Wrong Tone Frequency is selected.	1. Refer to Section 4-8. 2. Refer to Section 4-4.

5-5. MICROPROCESSOR BACKUP LITHIUM BATTERY REPLACEMENT

Lithium battery replacement should be performed by an authorized KENWOOD service facility; either your KENWOOD dealer, or the factory, since this unit contains CMOS type circuitry.

Notes:

1. When the lithium battery is replaced, the microprocessor must be reset, using the procedure in Section 4-5-2.
2. When the lithium battery fails, the radio's microcoded functions are not affected. Only information stored in memory will be cleared.

5-6. ORDERING SPARE PARTS

When ordering replacement or spare parts for your equipment, be sure to specify the following:
Model and serial number of your transceiver.
Schematic number of the part. Printed circuit board number on which the part is located, part number and name, if known, and quantity desired. Part numbers for most replacement parts is contained in the service manual (available as an option from your dealer).

5-7. ADJUSTMENTS

5-7-1. Cover Removal

Caution:

1. Before removing the top cover, turn the power supply and radio POWER switches off, and disconnect the Power Cable.
 2. Do not pinch wiring when closing the cover.
1. Loosen the four screws on both the right and left sides.
 2. Remove the four screws attaching the top cover. Remove the top cover and set aside.
 3. Reverse steps 1 and 2 to reassemble the radio.

5-7-2. Low Power Output

Adjust VR7 on PC board to adjust the output of the transceiver in the low power position. The adjustment range is 1 to 30 watts on the TM-221A/221ES and 1 to 20 watts on the TM-421A/421ES.

5-7-3. Microphone Gain

Adjust VR3 on PC board to the desired level.

Caution:

Too much microphone gain can cause reports of audio of audio distortion.

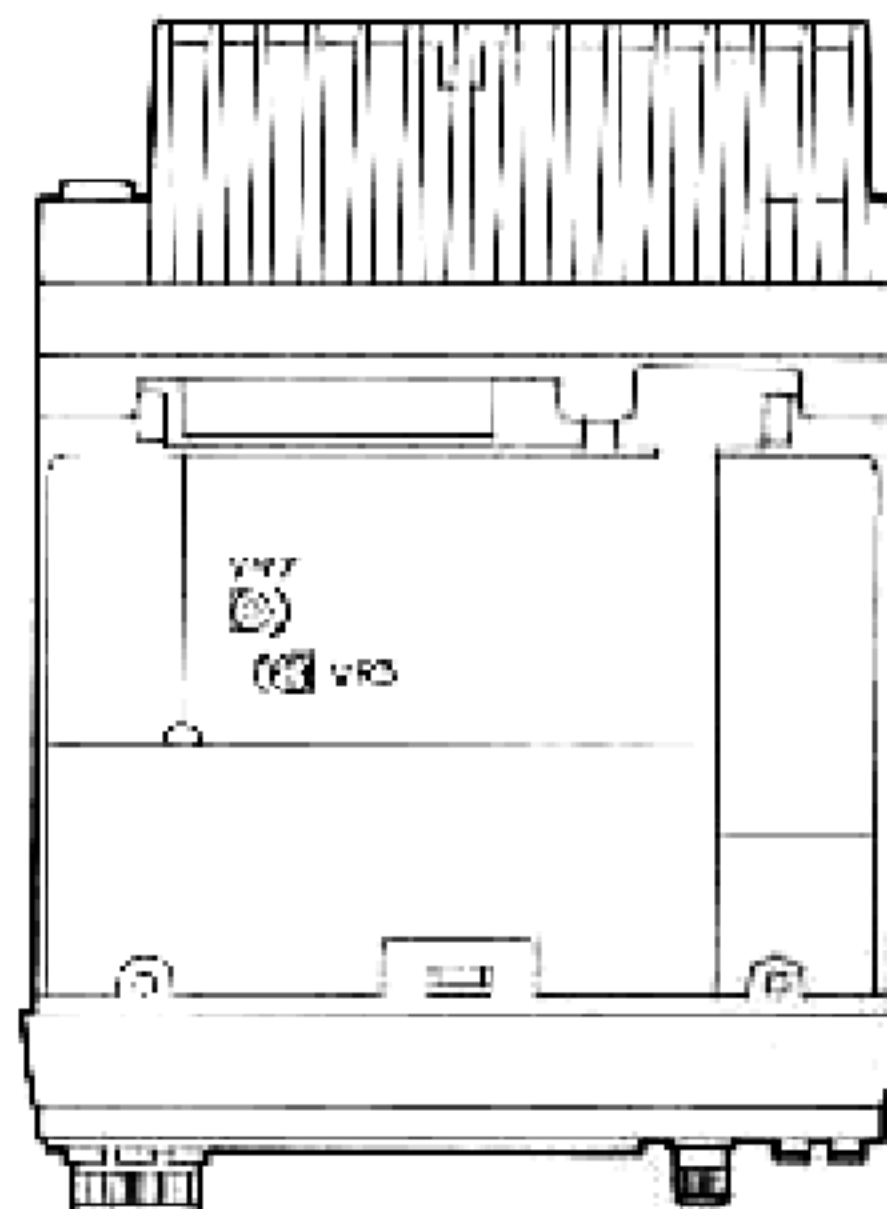

6. OPTIONAL ACCESSORIES

6-1. TSU-5 PROGRAMMABLE TONE DECODER UNIT (TM-421A/221A only)

Caution:

1. Before removing the top cover, turn the power supply and radio POWER switches off, and disconnect the Power Cable.
2. Do not pinch wiring when closing the cover.

Installation

1. Loosen the four screws on both the right and left sides.
2. Remove the four screws attaching the top cover. Remove the top cover and set aside.
3. Temporarily set the speaker aside.
4. Remove the jumper as shown in the illustration.
5. Connect the 7-pin connector to the TSU-5 as shown in the accompanying illustration.
6. Install the TSU-5 using the two screws provided.
7. Route the 2-pin connector attached to the TSU-5 as shown in the accompanying illustration, and attach it to the same plug that the jumper wire was removed from in step 3.
8. Replace the speaker. Make sure that the chassis fits in the guides on the back of the speaker assembly.
9. Attach the top cover using four screws.
10. Tighten the four side screws.

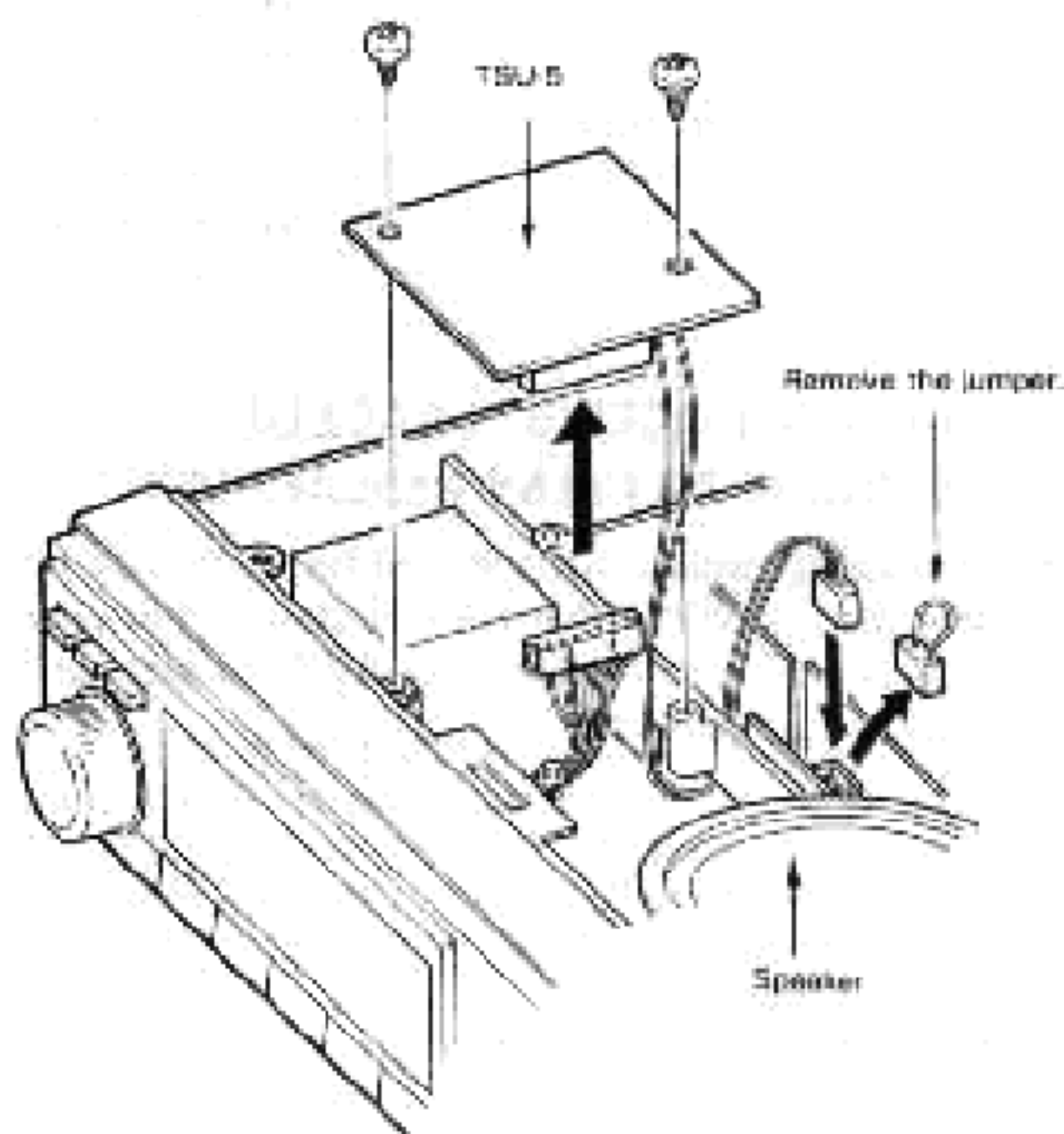

6-2. OTHER ACCESSORIES

■ PS-50 HEAVY DUTY DC POWER SUPPLY

May be used with the TM-421A/421ES/421E/221A/221ES/221E for stable operation.

■ PS-430 DC POWER SUPPLY

May be used with the TM-421A/421ES/421E/221A/221ES/221E for stable operation.

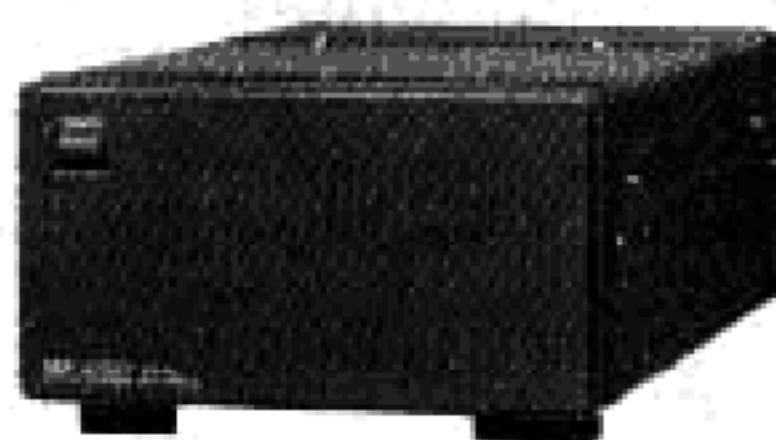

PS-50

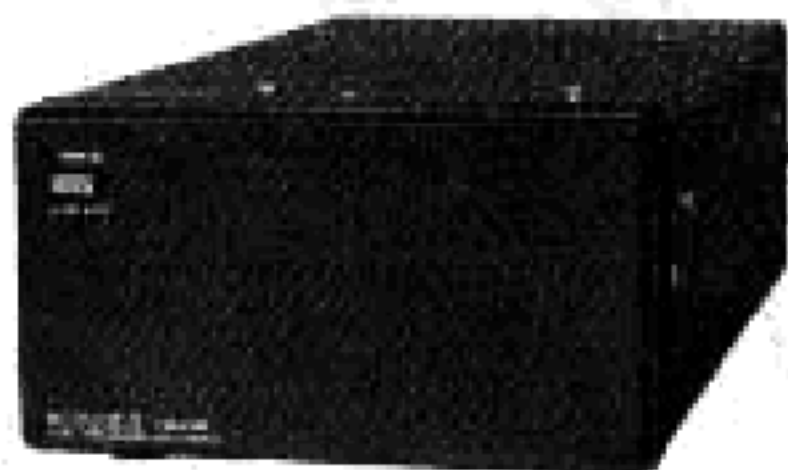

PS-430

■ SP-430 EXTERNAL SPEAKER

The SP-430 is an attractive, compact external speaker. This low-distortion speaker provides clear reproduction of the high-quality audio obtained from the transceiver.

■ SP-50 MOBILE SPEAKER (8 ohms)

Compact and smart high quality external speaker provides flexibility of installation for maximum convenience.



SP-430



SP-50

■ **SP-40 COMPACT MOBILE SPEAKER (4 ohms)**

■ **MC-85 MICROPHONE (8-pin)**

The MC-85 is a unidirectional high-class electret condenser microphone provided with the output selective switch, audio level compensation circuit, low cut filter, level meter, PTT and LOCK switches.

■ **MC-80 MICROPHONE (8-pin)**

The MC-80 is an omnidirectional electret condenser microphone provided with UP/DOWN switches, volume adjustment for output level, PTT and LOCK switches, built-in pre-amplifier.

■ **MC-60A MICROPHONE (8-pin)**

The zinc die-cast base provides high stability, and the MC-60A is complete with PTT and LOCK switches, UP/DOWN switches, and impedance selector switch and a built-in pre-amplifier.

■ **MC-55 MOBILE MICROPHONE (8-pin)**

The MC-55 provides UP/DOWN switches, LED display for switching transmit or receive, adjustable microphone gain, automatic receive returning circuit (approx. 5 minutes) and many functions.



SP-40



MC-80



MC-60A

■ **MC-48B AUTOPATCH UP/DOWN HAND MICROPHONE (8-pin)**

The MC-48B is 16-key autopatch Up/Down microphone with PTT switch, Encodes 16 autopatch tones. UP/DOWN switches provide step frequency change, or initiate band scan in the appropriate direction, if held depressed momentarily.

■ **MB-201 MOBILE MOUNT**

The mobile mount MB-201 allows easy installation and removal of the TM-421A/421ES/421E/221A/221ES/221E.

■ **PG-2N DC POWER CABLE**

■ **PG-3B DC LINE NOISE FILTER**

May be used with the TM-421A/421ES/421E/221A/221ES/221E to suppress ignition noise.

■ **SW-200A/200B SWR/POWER METER (supplied with a coupler)**

SW-200A supplied with SWC-1. SW-200B supplied with SWC-2. Selectable peak-reading/RMS. SWR/POWER meters cover 1.8-150 MHz (SW-200A), 140-450 MHz (SW-200B) in range of 0-20/200W, full scale for base station use.



MC-55



MC-48B



SW-200A/200B

■ SW-100A/100B SWR/POWER METER

Compact and lightweight SWR/POWER/VOLT meters cover 1.8 ~ 150 MHz (SW-100A), 140 ~ 450 MHz (SW-100B) in range of 150W full scale for mobile use.

■ SWT-1/SWT-2 ANTENNA TUNING UNIT

The SWT-1 (2m band) and the SWT-2 (70 cm band) are an antenna tuning unit designed for use in conjunction with an SWR/POWER meter to allow efficient transmission. This unit is especially convenient for monitoring SWR, using a KENWOOD SWR/POWER meter.

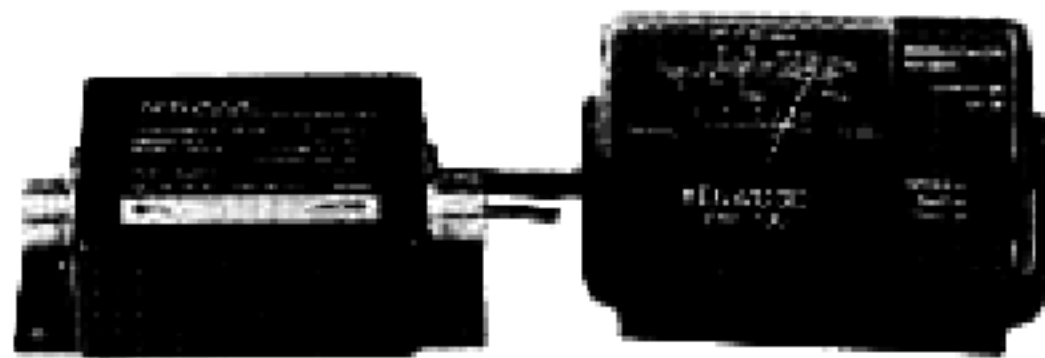

SW-100A/100B



SWT-1/SWT-2

■ RC-10 REMOTE CONTROLLER

The RC-10 Remote Controller provides the following functions.

1. Direct entry of the desired Transmit/Receive Frequencies using the numeric keypad.
2. Transmit/Receive Frequency or Memory Channels up or down control.
3. 16-key autopatch operation.
4. Volume control
5. Squelch on or off control.
6. When connected to two transceivers allows duplex communications. For additional information, please refer to the Instruction Manual provided with the RC-10.

■ HS-7 MICRO HEADPHONES (16 ohms)



HS-7

Downloaded by
RadioAmateur.EU

8. REFERENCE

8-1. ANTENNA

8-1-1. Fixed Station

Various types of fixed station antennas are commercially available. Select your antenna according to available space and intended application.

Transceiver performance depends largely on the

type of antenna used. For fixed station operation there are ground plane antennas (omnidirectional) and Yagi antennas (unidirectional). The Yagi antenna is suitable for DX (Long distance) operation or communication with a specific party.

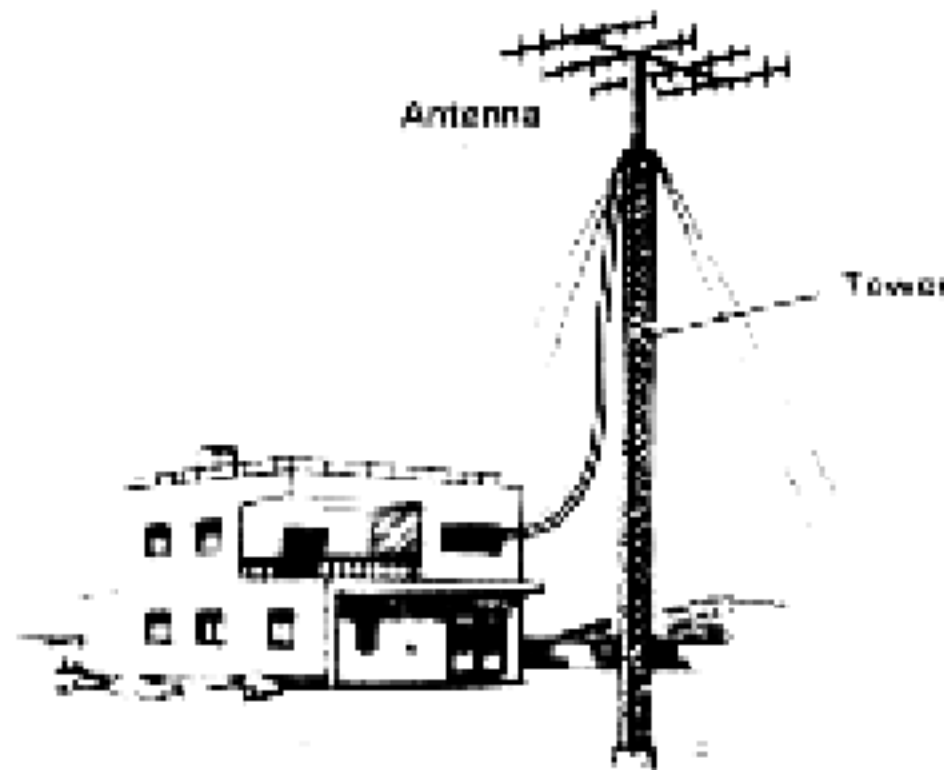
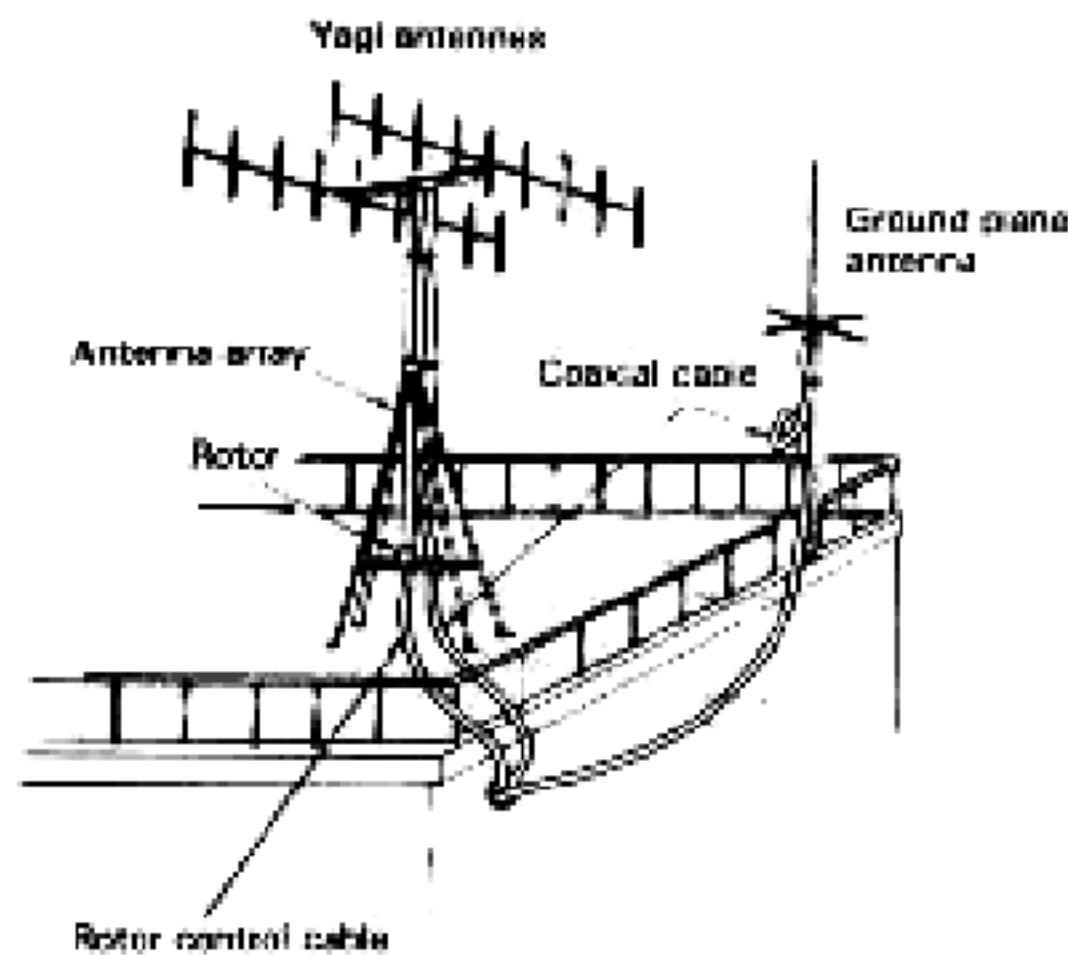

8-1-2. Mobile

Various types of antennas for UHF/VHF mobile operation are available. Please consult your dealer for information on these antennas.

Note:

For gutter-mount installation, the antenna bracket must be grounded to the car body as shown below. Attach the antenna securely, referring to the antenna installation instructions provided with the antenna.

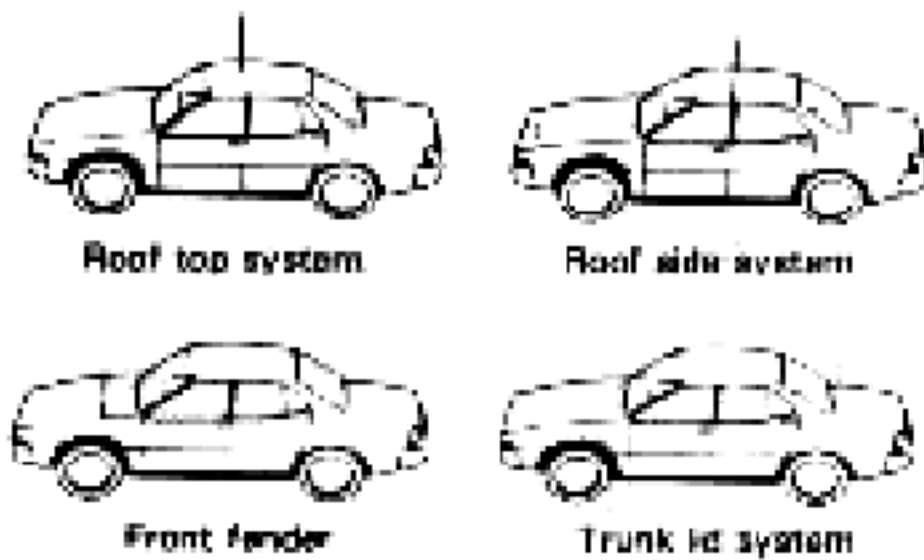

Installation for mobile operation

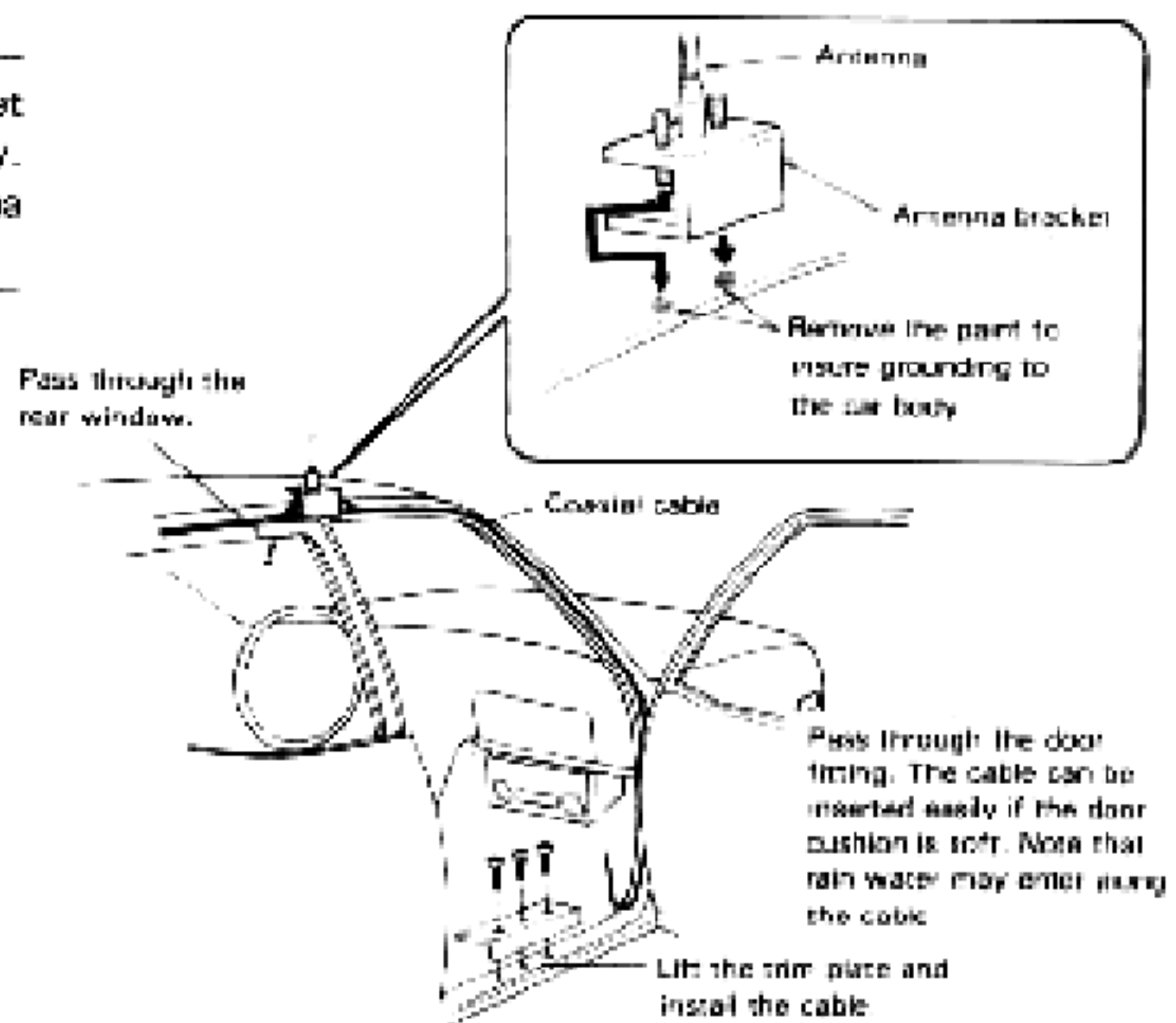

Coax. cable routing

8-2. MOBILE INSTALLATION HINTS

8-2-1. Noise Reduction

In motor vehicles, noise is generated by the ignition system. Other sources of noise include the wiper and heater motors.

It is imperative that some preventive measures be taken to reduce the noise to the lowest possible level.

(a) Antenna location selection

Since ignition noise is generated by the vehicles engine, the antenna must be installed as far from the engine as possible.

(b) Bonding

The component parts of motor vehicles, such as the engine, transmission, muffler system, accelerator, etc., are coupled to one another at DC and low frequencies, but are isolated at high frequencies. By connecting these parts using heavy, braided ground straps, ignition noise can be reduced. This connection is called bonding".

(c) Use ignition suppressor cable or suppressor spark plugs

Noise can be reduced by using spark plugs with internal resistors, or resistive suppressor ignition cable.

8-2-2. Battery Capacity

The power system of a motor vehicle is comprised of a battery and an alternator (which generates power while the engine is running) to supply current to loads or to charge the battery.

Since the transceiver draws high current during transmit, care should be exercised so the power system is not overloaded. When using the transceiver, the following points should be observed from the viewpoint of battery maintenance:

(a) Turn the transceiver OFF when the lights, heater, wipers and other high-draw accessories are used.

(b) Avoid transceiver operation when the engine is not running.

(c) If necessary, use an ammeter and/or a voltmeter to check battery condition.

**Downloaded by
RadioAmateur.EU**

**Model TM-421A/421ES/421E/221A/221ES/
221E**

Serial No. _____

Date of Purchase _____

Dealer _____

KENWOOD CORPORATION

Shinjogishi Shibuya Building, 17-5, 2-chome Shibuya, Shibuya-ku, Tokyo 150, Japan

TRIO-KENWOOD COMMUNICATIONS

Post Office Box 7066, Compton, California 90224, U.S.A.

KENWOOD COMMUNICATIONS

DIVISION OF KENWOOD ELECTRONICS DEUTSCHLAND GMBH

Rennrücker Str. 15, 6056 Heusenstamm, West Germany

KENWOOD ELECTRONICS BENELUX NV

Leuvensesteenweg 504, B-1930 Zaventem, Belgium

KENWOOD ELECTRONICS AUSTRALIA PTY. LTD.

4E Woodcock Place, Lane Cove, N.S.W. 2066, Australia