

7-11-79  
S# 710225



Downloaded by  
RadioAmateur.EU

# 6m ALL MODE TRANSCEIVER

## Model TS-600

### OPERATING MANUAL

---

#### CONTENTS

	SPECIFICATIONS .....	2
SECTION 1.	FEATURES.....	3
SECTION 2.	INSTALLATION.....	4
2-1.	Accessories	
2-2.	Operating Location	
2-3.	Power Supply Connection	
2-4.	Microphone	
2-5.	MIC Hook	
SECTION 3.	OPERATING CONTROLS .....	5
3-1.	Front Panel Controls	
3-2.	Rear Panel Controls	
SECTION 4.	OPERATING INSTRUCTIONS .....	8
4-1.	Reception	
4-2.	Transmission	
4-3.	Frequency Calibration	
4-4.	Reading the Frequencies	
4-5.	Operating with Fixed Channels	
4-6.	How to Use RIT	
4-7.	Mobile Operation with External DC Power Supply	
SECTION 5.	ALIGNMENT .....	14
	TS-600 SCHEMATIC DIAGRAM .....	15
	BLOCK DIAGRAM .....	16

# TS-600 SPECIFICATIONS

## SPECIFICATIONS

TRANSMIT/RECEIVE FREQUENCY RANGE . . . . .	50 ~ 54 MHz
MODE . . . . .	SSB, FM, CW, AM
RF OUTPUT . . . . .	10 watts for SSB, CW and FM 5 watts for AM
ANTENNA IMPEDANCE . . . . .	50Ω (unbalanced)
CARRIER SUPPRESSION . . . . .	Better than 40 dB
SIDE-BAND SUPPRESSION . . . . .	Better than 40 dB
SPURIOUS RADIATION . . . . .	Less than - 60 dB
MAX. FREQUENCY DEVIATION (FM) . . . . .	± 5 kHz
MODULATION . . . . .	Balanced modulation for SSB Variable reactance frequency shift for FM Low power modulation for AM
MICROPHONE . . . . .	Dynamic microphone, 500Ω
AUDIO FREQUENCY RESPONSE . . . . .	400 ~ 2600 Hz, within -9 dB
POWER CONSUMPTION . . . . .	Transmit mode: 95W (AC 120/220), 4A (DC 13.8V), max. Receive mode (no signal): 45W (AC 120/220V), 0.8A (DC 13.8V)
POWER REQUIREMENTS . . . . .	AC 120/220V, 50/60 Hz DC 12V ~ 16V (13.8V as reference)
DIMENSIONS . . . . .	278(W) x 124(H) x 325(D) mm
WEIGHT . . . . .	11 kg
RECEIVING SYSTEM . . . . .	SSB, CW: Single-superheterodyne AM, FM: Double-superheterodyne
INTERMEDIATE FREQUENCY . . . . .	SSB, CW, . . . 10.7 MHz FM, AM: 1st IF . . . 10.7 MHz 2nd IF: . . . 455 kHz
RECEIVING SENSITIVITY . . . . .	SSB, CW: S/N = 10 dB or better at 0.25μV FM: S/N = 30 dB or better at 1μV 20 dB noise quieting = Less than 0.4μV AM: S/N = 10 dB or better at 0.5μV
IMAGE RATIO . . . . .	Better than 70 dB
IF REJECTION . . . . .	Better than 70 dB
PASS-BAND WIDTH . . . . .	SSB, CW: More than 2.4 kHz at -6 dB AM: More than 4 kHz at -6dB FM: More than 12 kHz at -6 dB
RECEIVER SELECTIVITY . . . . .	SSB, CW: Less than 4.8 kHz at -60 dB AM: Less than 12 kHz at -40 dB FM: Less than 32 kHz at -60 dB
SQUELCH SENSITIVITY . . . . .	0.25μV
AUDIO OUTPUT . . . . .	More than 2.5W at 4Ω load (10% distortion)
RECEIVER LOAD IMPEDANCE . . . . .	8Ω
FREQUENCY STABILITY . . . . .	Within ± 2 kHz during one hour after one minute of warm-up, and within 150 Hz during any 30 minute period thereafter.

The above specifications are subject to change without notice for improvement.

## SECTION 1. TS-600 FEATURES

1. The Model TS-600 is a fully solid-state, all-mode amateur band transceiver designed to provide high quality communications on SSB, FM, AM and CW bands.
2. Basically engineered for fixed station operation but is also used for mobile station operation because of the employment of AC/DC two-way power system.
3. The single and doubleconversion type transceiver incorporates its own built-in VFO that continuously covers the frequency range of 50.00 to 54.00MHz in 4 bands.
4. A newly developed two-speed dial mechanism facilitates tuning: MAIN TUNING knob (inner) for closer tuning covers a change of 25kHz by one complete rotation, and QUICK TUNING knob (outer) covers a change of 100kHz similarly. You can tune in quickly with pin-point accuracy. This feature is very useful in receiving SSB signals.
5. The main dial is graduated at 1kHz intervals and provides accurate readings up to 100kHz, while the sub-dial is graduated at 50 and 100kHz intervals for reading frequencies up to 1MHz per rotation.
6. A total of 20 fixed channels (5 channels for each band) for all-mode operation. All the necessary crystal oscillator elements are available as optional accessories. Each of working channels can be visually checked by the KENWOOD's unique channel indicator.
7. A noise blanker (NB) circuit of the type normally found in many other HF products of our make is included to eliminate pulse noise such as ignition noise.
8. For improved FM-mode operation, a squelch circuit combined with a noise detector circuit and Schmidt circuit is added to the FM unit.
9. A tuner which uses a voltage variable capacitor is built in the receiver RF stage to minimize cross-talk and spurious interference, and a high "Q" tuning circuit in the antenna input stage for excellent selectivity.
10. Speaker output is free from distortion because of the use of amplification type AGC circuit. Signals transmitted are accompanied by little or no splutter and free from distortion thanks to the adoption of ALC circuit. The AGC circuit comprises such time-constant element that this constant is "slow" in SSB mode but "fast" in FM, AM or CW mode.
11. The built-in marker signal circuit enables you to calibrate the tuning dial precisely at 100kHz intervals. By setting the CALIBRATE switch to ON' the receiver RF input circuit is disabled, thus permitting frequency calibration without being disturbed by external signals.
12. The unique "S" meter provides accurate reading without causing "scale-out" even when unusually strong FM signal comes in. By manipulating the center meter switch, this meter functions as a center meter (tuning meter) for pin-point tuning of FM stations.
13. The built-in RIT circuit is very useful during reception, particularly in SSB and CW modes. It is designed to be used for both VFO and fixed channel operations.
14. The transceiver operates on AC 120/220V or on DC 13.8V. It includes DC voltage multiplier of our own development, contributing much to the space-saving design of the model.
15. Significant improvements are embodied in the panel design for making this transceiver much easier to control and use. Dials and knobs are of more advanced type in visual and functional senses. Meter illumination and pilot lighting are included assuming night-time use of the transceiver.
16. Visual aspects are taken as an important criterion in the designing of this transceiver. Mechanical features too have been treated similarly, with particular emphasis on their reliability.
17. For assuring easier access to the internals, the transceiver enclosure or case is in two parts, complete with special mechanical details to allow the front-control panel to be detached. The final unit is also arranged so that it can be removed from the rear panel.
18. VOX operation is also available. The transceiver has provision for connection of VOX-3 obtained from KENWOOD as optional accessory.

# SECTION 2. INSTALLATION

## 2-1. ACCESSORIES

The Model TS-600 transceiver is supplied with the following accessories. After unpacking, check the accessories against the list:

Operating manual	1
RCA plug connector	2
Feet with screws	2
Fuse: 1A (AC 220V)	1
2A (AC 120V)	1
3A (DC 12V)	1
5A (DC cord)	1
Microphone with hook, 500 ohm	1
AC power cord with connector	1
DC power cord with connector	1
VOX plug (installed)	1
Speaker plug	1

## 2-2. OPERATING LOCATION

As with any solid-state electronic equipment, the place of use must be discriminated with the TS-600, in order to avoid subjecting to extremes of ambient conditions.

A well-ventilated, dry place, where the transceiver will not be exposed to direct sunlight, should be selected. The TS-600 has a heat sink in its rear panel; be sure to install the transceiver so that there is a proper clearance at the rear and bottom. For better heat dissipation, keep it away from a wall. This precaution also applies when the transceiver is operated on the companion's seat in a car.

When you wish to use the transceiver in a car, you may put it on the seat but sure to secure some heat dissipating clearance under and behind it and to make proper provisions for protecting it against shocks.

## 2-3. POWER SUPPLY CONNECTION

The TS-600 is designed to operated on AC 120/220V or DC 13.8V. Switching between AC and DC is accomplished by replacing the power cord. The DC power cord is color coded (red for "+" and black for "-"). When connecting power cord, be sure to observe the following points:

1. Turn off the power switch and set the standby switch REC position.
2. When replacing power cord, disconnect it from the AC socket (or battery). Care should be used to prevent electrical shocks when connecting the AC power cord.

Each power cord is equipped with a 4-P plug complete with a stopper. When inserting the plug to the transceiver, be sure to press down the stopper with your finger and engage it into the latch on the transceiver side.

To pull the cord off the transceiver, push down the stopper to disengage it from the latch and the give a pull to the cord end. (See Fig. 1)

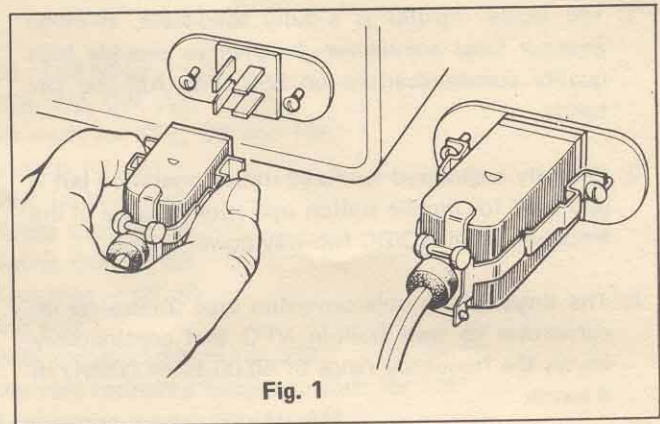

Fig. 1

## 2-4. MICROPHONE

The microphone supplied with this transceiver is a 500-ohm impedance one designed specially for radio equipment of this class. Any other microphone may be used provided that its type and characteristic are suited to the transceiver. The optimum impedance of a microphone is anywhere between 500 and 600 ohms. For connection of microphone, refer to Fig. 2.

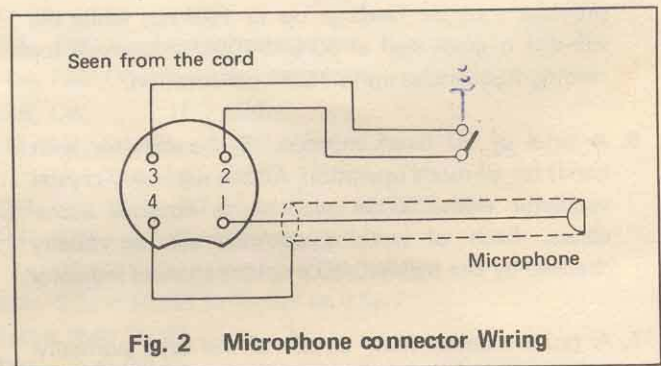

Fig. 2 Microphone connector Wiring

## 2-5. MIC HOOK

Attach a microphone hook to the case following the instructions give in Fig. 3. The hook is furnished with the equipment.

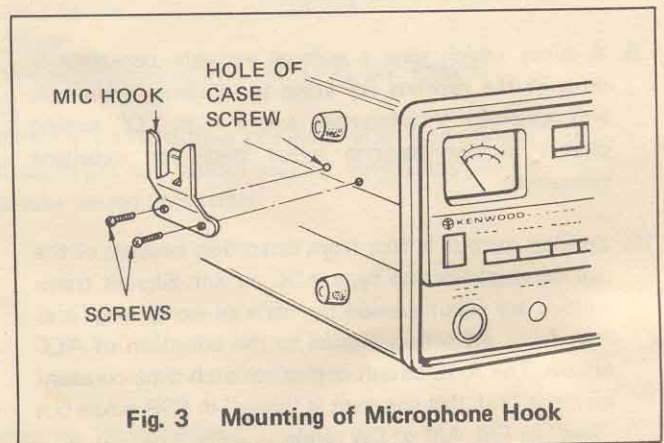
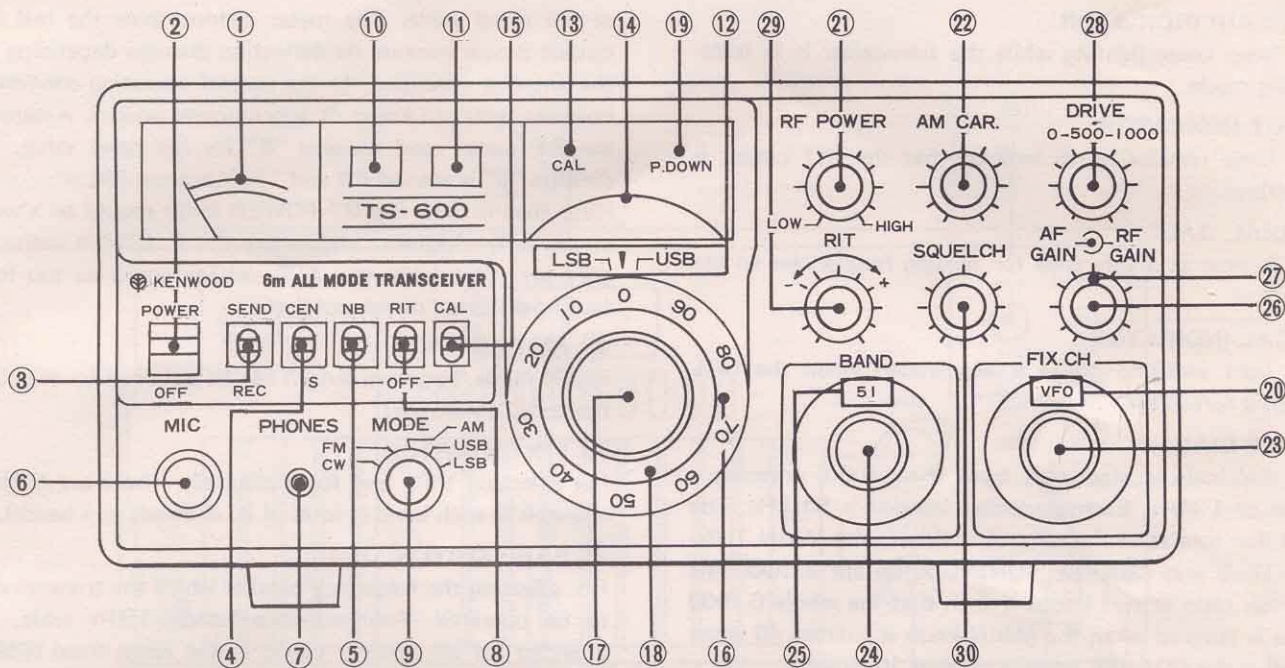

Fig. 3 Mounting of Microphone Hook

## SECTION 3. OPERATING CONTROLS



### 3-1. FRONT PANEL CONTROLS

#### ① METER

This meter has three functions. During reception, it serves as an "S" meter indicating the strength of received signal on a scale graduated from 1 to 9, 9 + 20dB and 9 + 40dB. During transmission, the meter indicates the strength of RF output signal.

The meter also functions as a center meter (Tuning meter) during FM reception when the METER switch is set to the CEN position.

#### ② POWER SWITCH

The power to the transceiver is turned on by flipping the power switch to the up position, and turned off at the down position.

#### ③ STANDBY SWITCH

This is a 2-position switch the SEND position is for transmission and the REC position for reception. With the switch in the REC position, the transceiver automatically shifts from receiving mode to transmitting mode if the microphone PTT switch is set to ON. Do not leave the transceiver in transmitting mode when the transmitting circuit is out of adjustment, as it may result in damage to the transceiver.

#### ④ METER SWITCH

By manipulating this switch during FM reception, the meter functions as an "S" meter or a center meter. In other receiving modes, the meter functions as "S" meter regardless of the position of the switch.

#### ⑤ NB (noise blanker) Switch

Turning on this switch will suppress pulse type noises due

to ignition systems of nearby cars. Noiseless audio output can be obtained even when receiving signals are weak.

#### ⑥ MICROPHONE JACK

For connection of microphone. This jack has terminals for both microphone input and PTT circuit.

#### ⑦ PHONES JACK

For connection of headphone with impedance of 8 to 16 ohms. Plugging the headphone will shut off the speaker.

#### ⑧ RIT SWITCH

For on-off control of the RIT (receiver incremental tuning) circuit.

#### ⑨ MODE SWITCH

By using this switch, any of the following five modes can be selected:

##### **CW (sending key):**

Morse-code telegraphic communications (A1)

##### **FM (frequency modulation):**

Communications with FM waves (F3)

##### **USB (upper side band):**

Communications with "upper side band" waves. For operation in 50 MHz 6-meter band, the international practice calls for the use of USB (A3J).

##### **LSB (lower side band):**

Communications with "lower side band" waves (A3J).

##### **AM (amplitude modulation):**

Communications with "upper side band" waves. For operation in 50 MHz 6-meter band, the international wow-like audio output.

#### ⑩ ON AIR INDICATOR

This lamp keeps lighting while the transceiver is in transmitting mode.

#### ⑪ RIT INDICATOR

This lamp remains on to indicate that the RIT circuit is operating.

#### ⑫ DIAL GAUGE

This is used as a reference for reading frequencies on the main dial.

#### ⑬ CAL INDICATOR

This light emitting diode is illuminated when the CAL switch is turned on.

#### ⑭ SUB-DIAL

The dial scale is graduated from 0 to 1000, covering a width of 1 MHz. Each graduated interval is 50 kHz. The scale disc rotates in the same direction as the MAIN TUNING knob and COARSE TUNING knob are turned. The rotation ratio of two knobs is such that the whole 0-1000 range is covered when the MAIN knob is rotated 40 times or when the COARSE knob is rotated 10 times.

#### ⑮ CAL SWITCH

This switch allows the receive frequencies to be calibrated at intervals of 100 kHz when the transceiver is in receive mode.

**NOTE:** The transceiver stops operating when the CAL switch is ON.

#### ⑯ MAIN DIAL

This dial scale is graduated at 1 kHz intervals.

#### ⑰ MAIN TUNING KNOB (inner)

For setting the transceiver to the desired operating frequency. One rotation of this knob changes the frequency by 25 kHz.

#### ⑱ COARSE TUNING KNOB

Another name of this knob is the "fast-change" tuning knob. The gear ratio in the mechanical link between this knob and VFO is so small that you can quickly locate your desired frequency. One rotation of the knob corresponds to a change of 100 kHz.

#### ⑲ P. DOWN INDICATOR

This light emitting diode is illuminated when the RF POWER knob is turned counterclockwise from its fully clockwise position.

#### ⑳ CHANNEL INDICATOR

This lamp indicator comes on when VFO or a fixed channel oscillator is in operation. During fixed channel operation, this indicator instantly tells whether your desired channel is loaded with a crystal oscillator element.

#### ㉑ RF POWER KNOB

Turning this knob counterclockwise can reduce the RF output power down to 1W or below. With the knob at the fully clockwise end (RF POWER switch turned on), it is

at the rated value. The meter cannot show the real RF output power because its deflection changes depending on the antenna condition. In the normal operating condition, however, you can know of approximate powers. Assuming the RF meter read division "8" for the rated value, the division "5" is around 5W and "1.5" around 1W.

Note that in SSB the RF POWER knob should be always at the fully clockwise end where the P. DOWN indicator goes off. Otherwise, the ALC voltage could be too low, causing distorted power output.

#### ㉒ AM CAR KNOB

In AM mode, optimum output can be obtained by adjusting the knob. (Max. 5W)

#### ㉓ FIX CH SWITCH

For selecting VFO and fixed channels. There are 5 fixed channels in each band (a total of 20 channels in 4 bands).

#### ㉔ BAND SWITCH

For selecting the frequency band at which the transceiver is to be operated. Four selective bands, 1MHz wide, are provided for all amateur bands in the range from 50MHz to 54MHz.

#### ㉕ BAND INDICATOR

Indicates the frequency band of 50, 51, 52, 53MHz at which the transceiver is operated.

#### ㉖ AF GAIN KNOB (INNER)

This adjusts the gain of the receiving audio amplifier. A clockwise turn of the knob will increase the audio output.

#### ㉗ RF GAIN KNOB (OUTER)

For adjusting the gain of the RF amplifier in the receiver section. With this control turned to extreme clockwise position, the gain is maximized, and vice versa. The "S" meter indicates the gain set by this control. If the pointer of the "S" Meter is at "9", then radio waves of lower than "9" level will be attenuated. This feature emphasizes the wanted signal and suppresses the unwanted signal to produce a clear output. The RF gain can be directly read on the "S" meter.

#### ㉘ DRIVE KNOB

For turning the RF driver and MIX input coil for best reception and the output circuit of the HET mixer for best transmission. This control adjusts the electronic tuning circuit designed for simultaneous tuning in transmit-receive operation. This knob provides a broad curve for peak tuning. Note when the VFO indicator is at "500", the DRIVE knob is to be set to the center, or in the twelve o'clock direction. Turn it right or left for tuning according as the VFO frequency is higher or lower than "500".

#### ㉙ RIT KNOB

This knob is used to fine adjust the receiving frequency when the RIT circuit is ON.

It adjusts the receive frequency without changing the

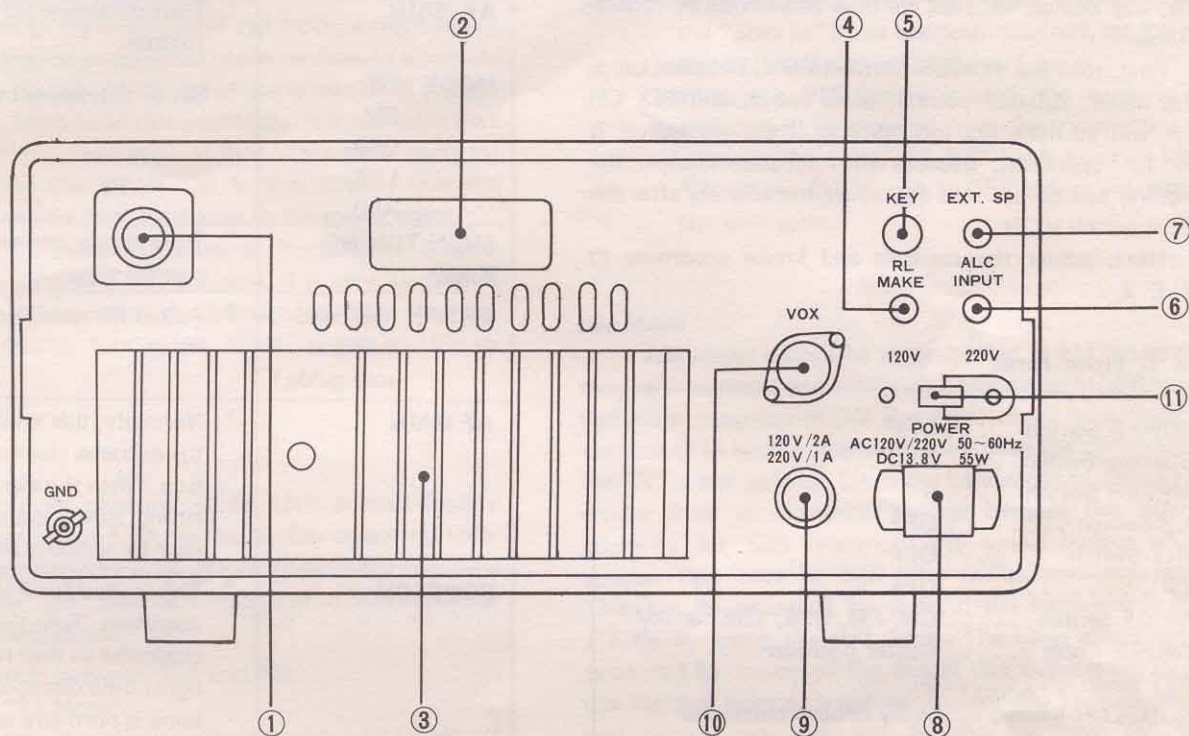

### 3-2. REAR PANEL CONTROLS

**① ANT TERMINAL**

For connection of antenna.

**② NAME PLATE**

TS-600 serial number is marked on this plate.

**③ HEAT SINK (FOR TRANSMITTER FINAL STAGE)**

For protection of transistors from overheating.

**④ RL-MAKE TERMINAL (RELAY TERMINAL)**

This terminal should be OFF during reception, and should be grounded during transmission.

**⑤ KEY JACK**

This jack is used for operating the transceiver in CW mode. Connect an external telegraphic key device.

**⑥ ALC-INPUT TERMINAL**

External ALC terminal.

**⑦ EXT SP TERMINAL**

For connection of an external speaker.

**⑧ POWER CORD JACK**

For connection of the supplied AC power cord (or DC power cord).

**⑨ AC FUSE HOLDER**

For AC power fuse (primary). (120V→2A or 220V→1A)

**⑩ VOX SOCKET**

For connection of a voice control unit. When VOX unit is not connected, be sure to insert the 9-pin MT plug into the socket.

Failure to observe this precaution will cause the standby relay to be inoperative and thus the transceiver cannot be set in the transmitting mode, also, the RF input circuit cannot be turned off at the ON position of the CAL switch.

**⑪ AC POWER SELECT SWITCH**

Set this switch to your local AC voltage, 120V or 220V.

**Note:** Always disconnected power supply before setting the switch.

# SECTION 4. OPERATING INSTRUCTIONS

## 4-1. RECEPTION

After connecting the power cord, antenna, microphone, key device, etc., set controls and knobs by following Table 1.

First, turn the POWER switch to ON. The pilot lamps in the meter, sub-dial pointer, band switch and FIX CH switch will all light up, indicating that the transceiver is ready for operation. Because of solid-state design, the transceiver can be put into operation immediately after the POWER switch is ON.

Next, adjust the controls and knobs according to TABLE 2.

**Table 1. Front Panel**

POWER Switch . . . .	OFF
Standby Switch . . . .	REC
METER Switch . . . .	S
NB Switch . . . . .	OFF
RIT Switch . . . . .	OFF
CAL . . . . .	OFF
MODE Switch . . . . .	CW, FM, USB, LSB, or AM
DRIVE Knob . . . . .	Center position
RIT Knob . . . . .	0
SQUELCH Knob . . . .	Fully counterclockwise
RF GAIN Knob . . . .	Fully clockwise
AF GAIN Knob . . . .	Fully counterclockwise
BAND Switch . . . . .	Desired receiving band
FIX CH Switch . . . .	VFO

The foregoing techniques are common to all modes of operation. Each mode, however, calls for special techniques of its own. Such special techniques will be discussed for each of the five modes.

### CW Mode (How to use RIT)

With RIT switch turned off, position MAIN DIAL in such a way that the incoming CW signal will beat at 900 Hz. Under this condition, you can "zero in" your operating frequency to the frequency of incoming CW signal.

Similarly, if the other party calls back with 900 Hz beat tone in response to your call signal, it means that the transceiver of the other party is in "zero in" status. Should the other party call back with a beat tone off 900 Hz or should you want to communicate with a beat frequency of your choice, turn on RIT switch and adjust RIT knob to obtain the desired beat.

**Table 2**

Controls and Knobs	Adjustment and Setting
<b>AF GAIN</b>	* Turn clockwise for suitable volume
<b>MODE (CW, FM, USB, LSB, AM)</b>	* Set at the desired mode.
<b>MAIN TUNING Knob</b>	* Turn slowly and set for clearest signal
<b>DRIVE</b> (use band marks as easy guide.)	* Adjust for maximum sensitivity.
<b>AF GAIN</b>	* Normally, this knob is set at the extreme clockwise position. When the signal is very strong, turn it counterclockwise for suitable gain.
<b>SQUELCH</b>	* This is used for FM mode of operation. Turn the knob clockwise so that noise at no-signal time disappears. This knob is normally set at a position where noise just disappears.
<b>RIT</b>	* With the RIT switch ON, turn the knob in either direction and only the receive frequency will be varied. Refer to paragraph "How to Use RIT".

### FM Mode

Set the MAIN dial for optimum reception. By setting the METER switch to the CEN position, the meter functions as a center meter (center frequency indicated). Turn the MAIN dial so that the center meter indicates "0" while receiving the other party's signal. In this way, the transmit frequency will coincide with the receive frequency.

Next, set the METER switch to the S position and the meter will indicate the strength of the incoming signal. If, in this case, the meter pointer fluctuates in response to the sound in the speaker, turn the MAIN dial a little (a few kHz) in either direction until the meter indication is stabilized (meter is stabilized if no fading exists).

Since the TS-600 is so designed that the IF circuit for SSB forms a part of the "S" meter indication circuit for FM, the "S" provides logarithmic indications for FM waves



and is free from saturation even when the input signal strength is very high, thus eliminating the need for calibration for each mode of operation.

Since the IF band is wide in FM mode, a slight deviation of frequency does not affect the reception. In transmitting operation, however, the other party could be using a fixed channel. Because of this possibility, it is advisable that you "zero in" your frequency to that of the other party by properly setting the MAIN dial in the manner that the center meter pointer may deflect up to the center space.

If the "S" meter continues to fluctuate or if satisfactory audio output is not available, it is very likely that the other party is sending the message on SSB. You can easily check this by turning the MODE switch to USB or LSB position.

### SSB Mode

Of the single sideband mode, USB is traditionally more often used than LSB. As far as the operating technique is concerned, there is no difference between two.

Generally, the "zero in" technique in SSB mode requires a little experience.

#### A. Discrimination between SSB and FM

##### (1) Use of "S" Meter

If the "S" meter indication is steady (meter pointer almost stops), the incoming signal is FM; otherwise, it is SSB.

##### (2) Use of MODE Switch

If a clear signal is heard at the FM position of the MODE switch, the signal is FM. The sound in SSB mode is not heard at this position of the switch.

##### (3) Use of Beat Noise

In FM mode, a beat noise will be heard between the words of signals being received. In SSB mode, no beat noise is heard.

**Note:** In the case of AM waves, a beat noise will be heard during non-modulation time even in SSB mode.

#### B. Dial Setting

When the receiving signal is found to be SSB by the above method A, in USB first set the MAIN dial a few kHz below the receiving frequency (turn the dial 2 or 3 divisions counterclockwise). You will hear a high pitch sound such as is heard from a magnetic recording tape set in the fast-forward mode. Turn the dial clockwise for higher frequency and the sound will become clearer. Set the dial at the position where the sound is heard most clearly (this is the "zero in" point).

**Note: 1** The "zero in" point can be easily located because the sound loses its clarity suddenly when the dial passes away from the "zero in" point.

If a clear sound cannot be heard even by following the above procedure, it may be an indication that the signal is LSB. Set the MODE switch to LSB position. In this case,

the method of setting the MAIN dial should be performed in reverse order.

- Note:**
1. If the frequency of the other party is deviated after the "zero in" point has been obtained, set the RIT switch to ON and adjust the RIT knob.
  2. When the RIT feature is used, the receiving frequency will be deviated from the transmitting frequency. Therefore, the RIT knob must be set to "0" or the RIT switch to OFF before you start to transmit again.

### AM Mode

AM waves cannot be demodulated in FM mode; also, they will be heard as a continuous beat noise in SSB mode. Optimum reception of AM signal is secured by turning the transceiver in such a way as to maximize the deflection of the "S" meter pointer. Since the bandwidth of the receiver crystal filter is somewhat narrow because this filter is primarily for SSB reception, the sound output of the speaker may have its high pitch components suppressed. This can be remedied by shifting the receive frequency a little by using the RIT knob. The same effect can be produced by means of the MAIN dial but the use of this dial for that purpose is not recommendable because, should you do so, you will not be able to "zero in" your transmit frequency to the frequency of the other party.

Where your transceiver and that of the other party are both TS-600, it should be noted that, in AM mode, the transmit carrier frequency is 10.7006 MHz which is lower than the receive carrier frequency by 600 Hz.

Accordingly, you first "zero in" your frequency to that of the other party by adjusting your MAIN dial and send out the signal, to which the other party will respond after possibly changing his frequency. If he should do so, the pointer of your "S" meter then would deflect down from the initial maximum level indication; this drop must not be interpreted as a sign of trouble. In such a case, you are expected to re-match your frequency to the new incoming frequency by using your RIT knob with the RIT switch set to ON (refer to Fig. 4 on page 10.)

## 4-2. TRANSMISSION

Before transmitting, perform all the necessary procedures for optimum reception. Make sure that the radio waves you have selected does not interfere with other radio stations.

Adjust the controls and knobs (DRIVE knob, microphone VR, etc.) for transmission of good quality signals. Connect a 50-ohm dummy load or antenna to the transceiver before starting to adjust the various controls. The use of dummy load is recommended because this prevents

the emission of disturbing signals. Use the dummy load, which is sized to dissipate about 20 watts of transmitter power. The tuning procedure should be completed within the least time possible from the viewpoint of the life of the transceiver. Set the controls and knobs as shown in Table 3 below.

**Table 3. Initial settings of control on front panel**

Standby Switch . . . .	REC
RIT Switch . . . . .	OFF
MODE Switch . . . . .	CW
RF POWER Knob . . .	Fully clockwise
RF GAIN Knob . . . .	Fully clockwise
DRIVE Knob . . . . .	Center position
RIT Knob . . . . .	0
AF GAIN Knob . . . .	Set for proper volume on reception
SQUELCH Knob . . . .	Set for optimum squelch effect
BAND Switch . . . . .	50
FIX CH Switch . . . .	VFO

**CW Mode**

Turn BAND switch to your desired frequency (50 ~ 54 MHz). After turning MODE switch to CW position, shift STANDBY switch from REC to SEND position just to make sure that the meter pointer deflects and ON AIR lamp lights up, and then move back this switch to REC position.

Under this condition, move STANDBY switch to SEND side and rotate DRIVE knob for maximum deflection

of the meter pointer deflection further. Repeat this manner a few times.

The foregoing procedure should be carried out rapidly, without unnecessary long delay at each step. If the telegraphic key device has already been connected to the transceiver during adjustments, the device should be set in the "key-down" condition. Having adjusted the transceiver as above, you are now ready to use the key for CW communication.

CW transmissions are automatically monitored through the speaker of the transceiver. The audio gain of the sidetone can be adjusted with the knob when the top lid of the transceiver case is removed. (See Fig. 6.)

**Other Modes**

When the transceiver is properly adjusted for operation in CW mode, it is ready for use in other modes (FM, LSB, USB and AM). Connect the microphone and speak after shifting the STANDBY switch to SEND position. Your voice will now be transmitted.

Microphone gain adjustment for FM and SSB (USB, LSB) can be made by the gain adjusters which become accessible when the top lid of the transceiver case is removed. The optimum setting position of these adjusters is about the midway position of their turning range (see Fig. 6). The microphone gain should preferably be reduced as small as possible to assure good quality of transmission.

**PTT (push-to-talk) Operation**

By connecting the supplied microphone or any other microphone equipped with PTT switch, the transceiver is readily used for PTT operation. For communication, depress PTT switch with STANDBY switch left in the REC position.

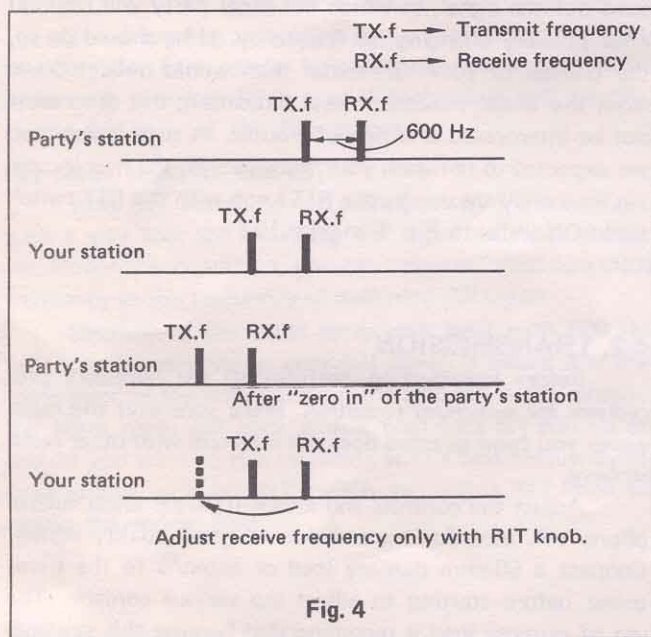

**4-3. FREQUENCY CALIBRATION (Fig. 7)**

To read correct frequencies, the MAIN dial must be calibrated previously by using the 100 kHz marker unit built in the transceiver. The marker unit is operative when the CAL switch is set to ON. During the operation of the marker unit, the higher harmonics can be received over the entire band exactly at 100 kHz intervals. In this instance, the RF input circuit (relay) is deenergized and, therefore, external waves are scarcely received.

**Frequency Calibration for USB**

By rotating MAIN TUNING knob clockwise the beat tone of the marker unit changes from high to low pitch and

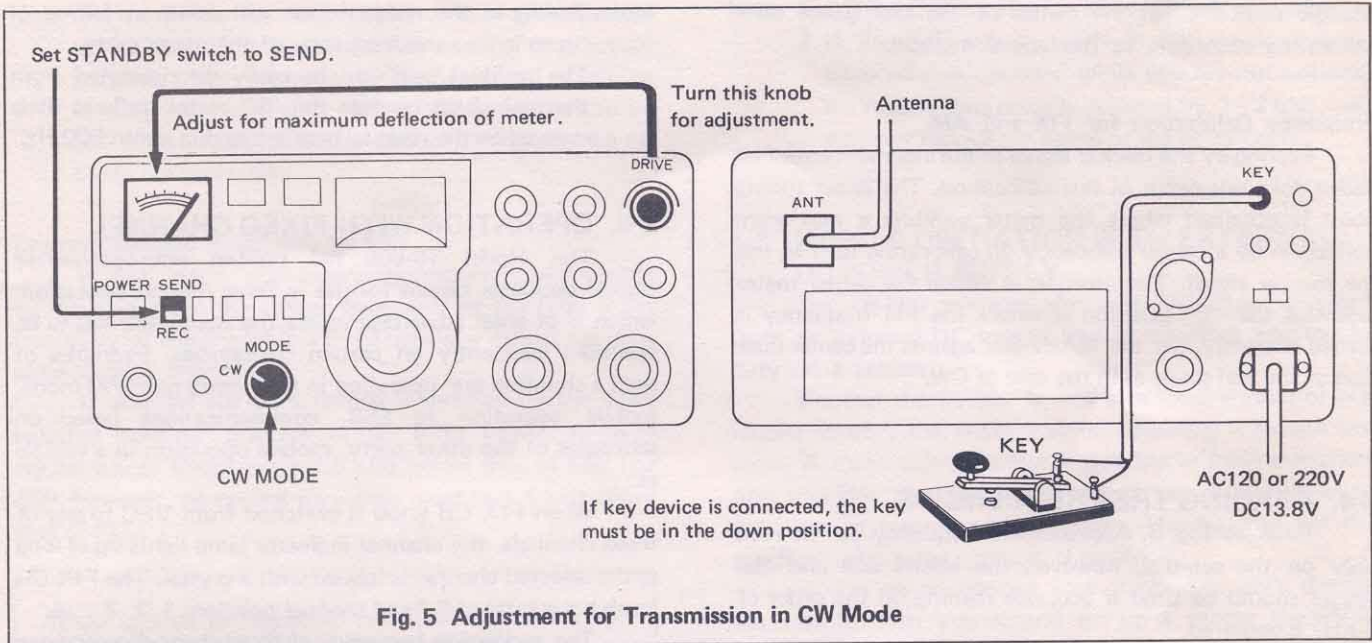

finally disappears at zero-beat position. Hold the MAIN TUNING knob at this position, and displace the MAIN dial to bring the "0" graduation mark to the USB dial gauge (see Fig. 7-a).

**Note:** The MAIN dial scale and its knob are held together by means of a spring and normally move together, but one can be displaced relative to the other by overcoming the friction due to the spring force when the knob is pressed lightly and turned.

**Frequency Calibration for LSB**

The method for LSB is similar to the above method for USB' the difference being that the knob is to be turned counterclockwise for "zero-beat". Match the "0" mark on the MAIN dial to the LSB dial gauge (see Fig. 7-b).

**Note:** Calibration for both USB and LSB is unnecessary; when the dial is calibrated for either one, it will automatically cover the other one.

**Frequency Calibration for CW**

The transmit frequency for this mode is about 900 Hz below that for the calibrated position for LSB. For calibration, simply set the "0" mark on MAIN dial against the

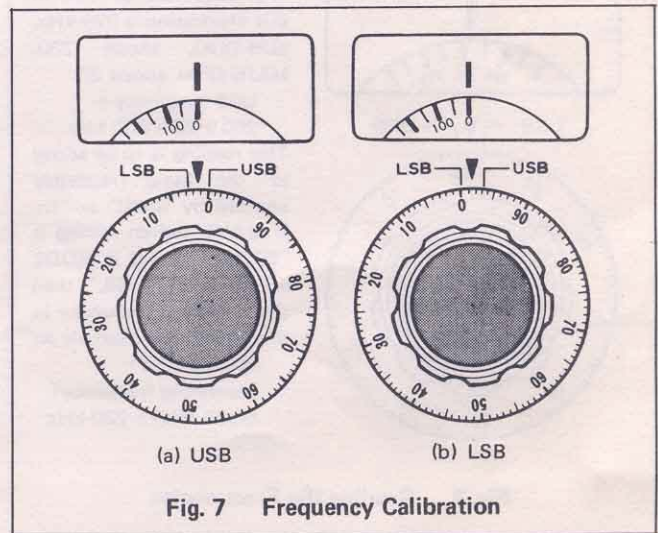
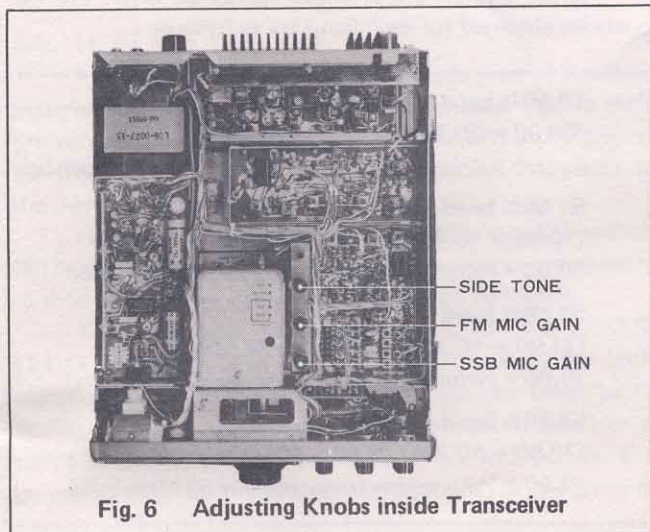

triangle mark "▼" at the center of the dial gauge after calibrating according to the above method.

#### Frequency Calibration for FM and AM

Beating by the marker signal in the manner mentioned above does not occur in this calibration. The exact tuning point is obtained where the meter exhibits a maximum deflection by a carrier frequency. In calibrating for FM, use the marker signal. The position at which the center meter indicates the "0" position is where the FM frequency is turned correctly. Set the MAIN dial against the center position of the dial gauge as in the case of CW.

#### 4.4. READING THE FREQUENCIES

Refer to Fig. 8. Approximate frequency can be read only on the sub-dial; however, the MAIN dial and dial gauges should be used if accurate reading on the order of 1 kHz is required.

When your transceiver is to be operated on CW mode, vary the beat frequency by turning the MAIN TUNING knob from lower side to higher side (clockwise rotation) while receiving the desired signal from the other party. Reduce the beat to zero by so turning the knob, and then rotate the knob downward (counterclockwise rotation) to obtain a beat frequency of about 900 Hz. Under this condition, read the frequency on the MAIN dial by referring to the triangle mark "▼". Note that a beat frequency is present on both sides of the "zero-beat" point; one is a strong main beat and the other is a weak residual beat. Be sure to go by the main beat in your turning operation.

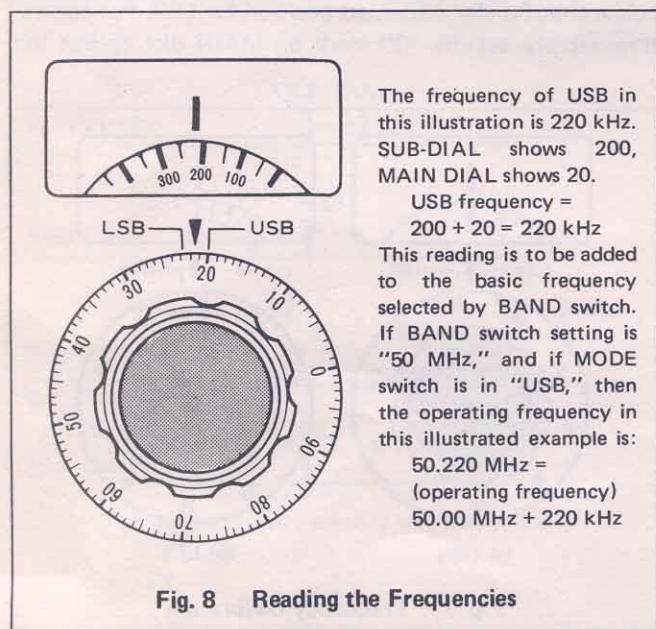

**Note:** Tuning in the residual beat will result in failure of "zero in" to the frequency of the other party.

The residual beat can be easily discriminated from the main beat because the "S" meter deflects little even when the residual beat is tuned in about 900 Hz.

#### 4-5. OPERATION WITH FIXED CHANNEL

The Model TS-600 has built-in semi-synthesizer crystal oscillator circuit for use in fixed channel operation, which is of great advantage where the transceiver has to be operated frequently on certain frequencies. Examples of such a situation are: operation in frequently used FM mode, mobile operation in SSB, communications based on schedules of the other party, mobile operation in a vehicle etc.

When FIX CH knob is switched from VFO to any of fixed channels, the channel indicator lamp lights up as long as the selected channel is loaded with a crystal. The FIX CH knob has a total of 5 fixed channel position: 1, 2, 3, ..., 5.

The oscillation frequency of fixed channel crystal can be obtained from the following formula:

#### Crystal Oscillator Frequency for FM, AM and CW

$$\text{Crystal oscillator frequency (MHz)} = (69.90 - 10.7) - X$$

X = Desired operating frequency (MHz)

69.90 (MHz) = Heterodyne frequency for 50 MHz band

10.70 (MHz) = Transmitter IF frequency

The TS-600 employs a MIX (synthesis) system. If crystals are arranged for 50 MHz band (50 – 51 MHz), they are also used for 51 MHz (51 – 52 MHz), 52 MHz (52 – 53 MHz) and 53 MHz (53 – 54 MHz), bands by switching the BAND switch, where the three places of decimals of the "MHz" figure remains the same.

When crystals are arranged for 50.20 MHz, the frequencies obtained for each band are as follows:

**50 MHz band**  
 $(69.90 - 10.70) - 50.20 = 9.00 \text{ MHz}$   
 (crystal oscillator frequency)

**51 MHz band**  
 $(70.90 - 10.70) - 9.00 = 51.20 \text{ MHz}$   
 70.90 = Heterodyne frequency for 51 MHz band

**52 MHz band**  
 $(71.90 - 10.70) - 9.00 = 52.20 \text{ MHz}$   
 71.90 = Heterodyne frequency for 52 MHz band

**53 MHz band**  
 $(72.90 - 10.70) - 9.00 = 53.20 \text{ MHz}$   
 72.90 = Heterodyne frequency for 53 MHz band

**Note:** The transmitter carrier oscillator gives an IF frequency of 10.7006 MHz in CW or AM mode. For practical purposes, the fractional 600 Hz is too small to require a correction by means of the crystals to be put in the fixed oscillator circuit, and should be no cause for correction.

#### Crystal Oscillator Frequency for SSB

In SSB mode, your operating frequency will deviate by 1.5 kHz from the center frequency of the filter if the frequency of the crystal in a fixed oscillator circuit happens to be equal to that of FM.

If you use the USB (which is dictated by the international amateur practice in 50 MHz band), select a crystal whose frequency is 1.5 kHz below that of FM. For LSB, however, the crystal frequency must be 1.5 kHz above that of FM.

When crystals are arranged for 50.05 MHz of USB, the crystal oscillator frequency is as follows:  
 $(69.900 - 10.700) - 50.05 - 0.0015 = 9.1485$   
MHz (crystal oscillator frequency)  
0.0015 stands for 1.5 kHz.

**Note:** When the crystal oscillator frequency is 8.200 MHz, the operating frequencies at 50, 51 and 52 MHz bands are 51.000, 52.000 and 53.000 MHz respectively and, therefore, cause no problems. However, if the same crystals are used for 53 MHz band, the operating frequency is 54.000 MHz, care should be used not to transmit with this 54 MHz frequency. Similarly, if the oscillator frequency is 9.200 MHz the operating frequency is 50.00 MHz at 50 MHz band; do not transmit with this 50 MHz frequency.

#### 4-6. HOW TO USE RIT

The term "RIT" is a simplified expression of Receiver Incremental Tuning. The RIT feature enables you to shift the receive frequency by about  $\pm 2$  kHz without changing the transmit frequency, adjusting the receive frequency to the deviated frequency of the other party.

Here is how to use RIT: Turn ON the RIT switch (RIT indicator lamp will light). Tune your receive frequency to that of the other party by adjusting the RIT knob.

The transceiver tuned this way is off the TRANSMIT frequency (one and the same frequency for both transmission and reception). To call out the other party during two-way communication when your transceiver is tuned as above, you must turn OFF the RIT switch. The procedures for RIT operation for each mode are given in Paragraph 4-1 RECEPTION.

**Note:** 1. RIT is effective also for fixed channel operation.

2. If the RIT switch is ON in SSB mode and the transceiver is operated while you are not noticing the receive frequency is deviated by 1-2 kHz, you may not receive the signal of the other party.

#### 4-7. MOBILE OPERATION WITH EXTERNAL DC POWER SUPPLY

The TS-600 operates also with DC 13.8V supplied from an external DC source, and is therefore adapted to duty on a vehicle.

Whether the TS-600 is used as a fixed station or as a mobile station, the techniques of operating it remain the same. A more enjoyable use is possible in mobile application provided that you device one or two provisions as to the place or manner of installation. The place of use depends on where the operator is seated.

If you are to operate your transceiver while driving the vehicle, then you should set up a proper mounting bracket right beside the driver's seat. You may locate the transceiver at the companion's seat provided that is secured firmly by means of seat belt or the like so that it is prevented from falling down.

#### Power Capacity

The TS-600 draws about 4 amperes maximum when it is working with full power. This much current is easily supplied by any automobile battery. When the power is supplied from such a battery, it is recommended that the transceiver be operated while the automobile engine is in operation, in order to prevent over-discharge of the battery.

**Note:** For safe driving of automobile, it is preferable that the transceiver be operated on fixed channels (prepare necessary crystal oscillators).

# SECTION 5. ALIGNMENT

Your Model TS-600 is factory adjusted prior to shipment and no further adjustments are required. However, if any trouble is encountered, please send it to your dealer.

### Frequency Adjustment

When fixed channel crystal oscillators are added in the transceiver, adjust their frequencies as outlined below (the relationship between the markings on the FIX CH knob and the crystal oscillator sockets are shown in Fig. 9):

1. Remove the two screws securing the top face of the case. Pull up the two grommets and open the top lid.
2. Connect a frequency counter to the point TP2 in HET unit (X50-1360-00). The frequency counter should be capable of reading up to 10 MHz.
3. Adjust the trimmers (TC1 ~ TC5) corresponding to the newly used crystal oscillator sockets to produce the desired oscillator frequencies. (refer to Paragraph 4-5 "Operation with Fixed Channels").

Table 6

$f_o$ (MHz)	..... crystal oscillator frequency for FM, AM, and CW.
$f_{USB}$ (MHz)	... crystal oscillator frequency for USB
$f_{LSB}$ (MHz)	... crystal oscillator frequency for LSB.
$x$ (MHz)	..... desired operating frequency

	$f_o$ (MHz)	$f_{USB}$ (MHz)	$f_{LSB}$ (MHz)
50 MHz BAND	$(69.90 - 10.70) - X$	$f_o - 0.0015$	$f_o + 0.0015$
51 MHz BAND	$(70.90 - 10.70) - X$	$f_o - 0.0015$	$f_o + 0.0015$
52 MHz BAND	$(71.90 - 10.70) - X$	$f_o - 0.0015$	$f_o + 0.0015$
53 MHz BAND	$(72.90 - 10.70) - X$	$f_o - 0.0015$	$f_o + 0.0015$

\* Specifications for Crystal Oscillator Unit (option)

Type: HC-25/U

Order of oscillation wave: Fundamental wave

Frequency: 8.200 ~ 9.200 MHz

Oscillation circuit: C1 meter

Oscillating condition: 32 pf (parallel capacity)/25Ω or less (effective resistance)

Electrical characteristics:

\* Operating temperature

-20°C ~ +60°C

\* Allowable frequency deviation

Within  $\pm 3 \times 10^{-5}$  (25°C)

\* Frequency vs. temperature characteristic:

Within  $\pm 3 \times 10^{-5} + (0 \sim 50^\circ\text{C})$

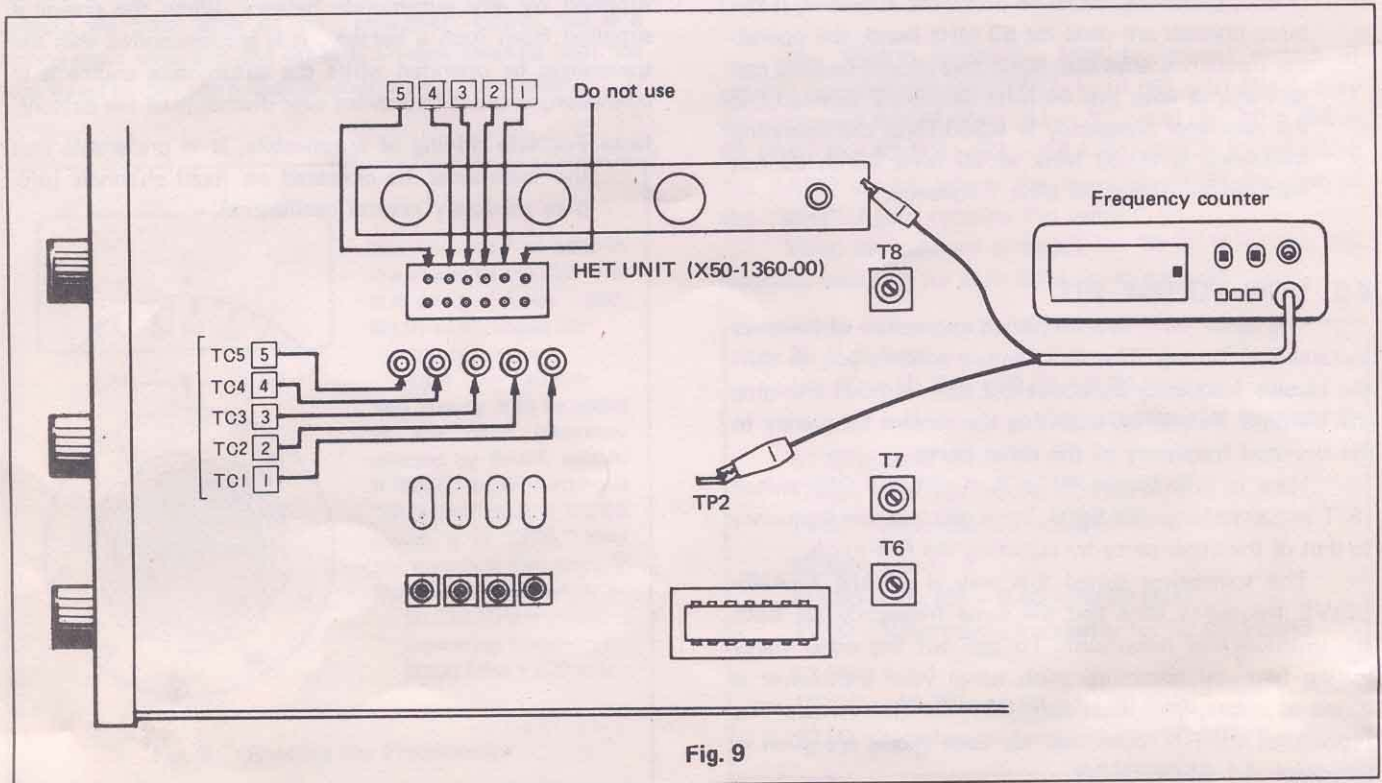

Fig. 9

# TS-600 SCHEMATIC DIAGRAM

