

KENWOOD

144 MHz FM Transceiver
430/440 MHz FM Transceiver

TH-22A/22AT/22E

TH-42A/42AT/42E

INSTRUCTION MANUAL

KENWOOD CORPORATION

©B62-0501-10(K, P, E, T, X, M)
12 11 10 09 08 07 06 05 04 03 02

Models Covered by this Manual:

- TH-22A : 144 MHz FM transceiver
(Australia/ General)
- TH-22AT : 144 MHz FM transceiver
(U.S.A./ Canada/ General)
- TH-22E : 144 MHz FM transceiver (Europe)
- TH-42A : 430 MHz FM transceiver (General)
- TH-42AT : 430 MHz FM transceiver (General)
440 MHz FM transceiver
(U.S.A./ Canada)
- TH-42E : 430 MHz FM transceiver (Europe)

The TH-42 series is used for all illustrations, and the 430 MHz band is used for all LCD example displays.

Notice to the user:



ATTENTION (U.S.A. Only)

Nickel-Cadmium battery must be recycled or disposed of properly. State laws may vary regarding the handling and disposal of Nickel-Cadmium batteries. Please contact your Authorized KENWOOD Dealer for more information.

One or more of the following statements may be applicable to this equipment.

FCC WARNING

This equipment generates or uses radio frequency energy. Changes or modifications to this equipment may cause harmful interference unless the modifications are expressly approved in the instruction manual. The user could lose the authority to operate this equipment if an unauthorized change or modification is made.

INFORMATION TO THE DIGITAL DEVICE USER REQUIRED BY THE FCC

This equipment has been tested and found to comply with the limits for a Class B digital device, pursuant to Part 15 of the FCC Rules. These limits are designed to provide reasonable protection against harmful interference in a residential installation.

This equipment generates, uses and can generate radio frequency energy and, if not installed and used in accordance with the instructions, may cause harmful interference to radio communications. However, there is no guarantee that the interference will not occur in a particular installation. If this equipment does cause harmful interference to radio or television reception, which can be determined by turning the equipment off and on, the user is encouraged to try to correct the interference by one or more of the following measures:

- Reorient or relocate the receiving antenna.
- Increase the separation between the equipment and receiver.
- Connect the equipment to an outlet on a circuit different from that to which the receiver is connected.
- Consult the dealer for technical assistance.

THANK YOU

We are grateful you decided to purchase this KENWOOD FM transceiver. The TH-22/TH-42 series of handhelds were developed to satisfy the requirement for a small handheld that's simple to operate yet has superior performance across the band. Users of this series of handhelds will discover the transceiver's Menu Set-up method for feature configuration recently incorporated in other KENWOOD products.

KENWOOD believes that the compact size coupled with the reasonable cost will guarantee your satisfaction with this product.

PRECAUTIONS

Please observe the following precautions to prevent fire, personal injury, and transceiver damage:

- Do not transmit with high output power for extended periods. The transceiver may overheat.
- When using an external power supply, connect the recommended DC cable (option) to the DC IN jack on the transceiver.
- When connecting the transceiver to a cigarette lighter socket in a mobile, use the recommended cigarette lighter cable (option).

- Before recharging a mobile battery, unplug the cigarette lighter cable from the lighter socket. Voltage spikes sometimes present during charging can damage the transceiver.
- Do not recharge the NiCd battery pack for more than 15 hours (PB-33: 30 hours) with an external power supply. Switching ON the power supply begins recharging the battery pack automatically.
- Do not expose the transceiver to long periods of direct sunlight or place the transceiver close to heating appliances.
- Do not place the transceiver in excessively dusty or humid areas, or on unstable surfaces.
- If an abnormal odor or smoke is detected coming from the transceiver, turn OFF the power immediately. Contact a KENWOOD service station or your dealer.
- Do not modify this transceiver unless instructed by this manual or by some other approved KENWOOD communication.

CAUTION: *The recommended transceiver duty cycle is 1 minute of transmission and 3 minutes of reception. Longer transmissions or extended operation in the High power mode may cause the back of the transceiver to get hot. Do not place the transceiver where the heat sink (rear panel) might come in contact with plastic or vinyl surfaces.*

CONTENTS

FEATURES	1	DIRECT KEYPAD FREQUENCY ENTRY	16
ACCESSORIES	1	1 MHZ STEP FREQUENCY CHANGE	17
CONVENTIONS FOLLOWED IN THIS MANUAL ..	2	KEY LOCK	17
BATTERY INFORMATION	3	UNLOCKING ENC/SQL CONTROL	18
NiCd BATTERY PACK (PB-32/PB-34)	3	BEEP TONE ON/OFF	18
Recharging	3	TRANSMITTING	19
Installing/Removing the Battery Pack	3	SELECTING OUTPUT POWER	19
INSTALLING/REMOVING MANGANESE OR		TIME-OUT TIMER (TOT)	19
ALKALINE BATTERIES	4	INHIBITING THE TRANSMITTER	20
BATTERY VOLTAGE LEVEL	5	BUSY FREQUENCY LOCK-OUT	20
BATTERY OPERATING TIME (HOURS)	5	MEMORY CHANNELS	21
YOUR FIRST QSO	6	STORING DATA IN MEMORY	21
GETTING ACQUAINTED	7	Simplex Memory Channels	21
ORIENTATION	7	Split Memory Channels	22
KEYS, CONTROLS, SWITCHES,		RECALLING MEMORY CHANNELS	23
INDICATORS	8	Using the ENC/SQL Control	23
JACKS AND CONNECTORS	9	Using the Keypad	23
DISPLAY	10	MEMORY → VFO TRANSFERS	23
MENU SET-UP	12	ERASING MEMORY CHANNELS	24
RECEIVING	13	CALL CHANNEL	24
SWITCHING POWER ON/OFF	13	Recalling Call Channel	24
SQUELCH THRESHOLD LEVEL	13	Changing Call Channel Contents (Simplex)	25
SELECTING FREQUENCY STEP SIZE	14	Changing Call Channel Contents (Split)	25
Changes in Displayed Frequencies	15	CHANNEL DISPLAY FUNCTION	25
		INITIALIZING MEMORY	26
		VFO Reset (Partial)	26
		Memory Reset (Full)	26

OPERATING THROUGH REPEATERS	27	SAVING POWER	39
TRANSMITTER OFFSETS	27	BATTERY SAVER	39
SELECTING OFFSET DIRECTION	27	AUTOMATIC POWER OFF (APO)	39
AUTOMATIC TRANSMIT OFFSET	28	CONTINUOUS TONE CODED SQUELCH	
U.S.A. and Canada Versions	28	SYSTEM (CTCSS)	40
European Version	28	SELECTING CTCSS FREQUENCIES	40
Canceling Automatic Offset	29	USING CTCSS	40
SELECTING OFFSET VALUES MANUALLY ..	29	DUAL TONE SQUELCH SYSTEM (DTSS)	41
REVERSE FUNCTION	30	ACTIVATING DTSS	41
TONE ACCESS	30	STORING DTSS CODES	42
AUTOPATCH	31	DTSS AND REPEATERS	42
Activating the Keypad	31	PAGE	43
DUAL TONE MULTI-FREQUENCY (DTMF)		OVERVIEW	43
MEMORY	32	PAGE CODE MEMORY	43
Making DTMF Calls	32	STORING PAGE CODES	43
Storing DTMF Numbers	32	CALLING	44
Confirming Stored DTMF Numbers	33	RECEIVING	45
Transmitting Stored DTMF Numbers	34	Receiving a Call with your Station Code	45
Activating DTMF Transmit Hold	34	Receiving a Call with a Group Code	45
SCAN	35	PAGE CODE AND REPEATERS	46
SCAN RESUME METHODS	36	LOCKING-OUT CODES	46
Time-Operated Scan	36	AUTO PAGE CANCEL	47
Carrier-Operated Scan	36	OPEN PAGE	47
SELECTING THE SCAN RESUME METHOD ..	36	TONE ALERT	48
MEMORY SCAN	37	ACTIVATING TONE ALERT	48
Locking-Out Memory Channels	37		
VFO SCAN	38		
CALL/VFO SCAN	38		
CALL/MEMORY SCAN	38		

REMOTE CONTROL	49
REMOTE CONTROL USING SMC-33 OR SMC-34	49
CONNECTING EQUIPMENT FOR REMOTE CONTROL	50
PACKET OPERATION	51
MAINTENANCE	52
GENERAL INFORMATION	52
SERVICE	52
SERVICE NOTE	53
CLEANING	53
TROUBLESHOOTING	54
OPTIONAL ACCESSORIES	58
INSTALLING OPTIONS	60
INSTALLING THE CTCSS UNIT (TSU-8)	60
INSTALLING THE SPEAKER-MIC JACK STRAIN RELIEF	61
CONNECTING OPTIONAL EQUIPMENT	62
SPECIFICATIONS	63
GLOSSARY	64
QUICK REFERENCE GUIDE	71

FEATURES

- Easier to handle due to the thinner profile, smaller size, and lighter weight. Encourages a "take-it-anywhere" philosophy.
- High power output produced from low input voltage means the NiCd battery pack is more compact than previous handhelds.
- Innovative Menu Set-up method combines sophisticated features with simple operation; only frequently-used keys are placed on the front and side panels.

ATTENTION! Some transceiver versions are not equipped with a keypad as standard equipment; however, your dealer can install this optional accessory. Functions requiring the keypad cannot be used if no keypad is installed.

ACCESSORIES

Before beginning to learn the functions of your transceiver, check the accessories list below against equipment received to be sure everything listed is included in your package.

Accessory	Part Number	Quantity
Antenna TH-22	T90-0472-XX	1
TH-42	T90-0473-XX	1
Hand strap	J69-0327-XX	1
Belt hook	J29-0465-XX	1
Jack protector cap	B09-0335-XX	1
Cable tie	J61-0422-XX	1
Screws	N35-3004-XX	2
Washers	F29-0435-XX	2
NiCd battery pack PB-32 ¹ (6 V, 600 mAh)	W09-0826-XX	1
PB-34 ² (9.6 V, 600 mAh)	W09-0825-XX	1
Battery case (BT-9) ²	- -	1
Battery charger (BC-17) U.S./Canada	W08-0437-XX	1
Europe (excluding U.K.)	W08-0440-XX	1
United Kingdom	W08-0438-XX	1
Australia	W08-0439-XX	1
General market	W08-0441-XX	1
AC plug adapter ²	E19-0254-XX	1
Instruction manual	B62-0501-XX	1
Warranty card (U.S./ Canada/ Europe)	- -	1

¹ Excluding some General market versions.

² Some General market versions only.

When you have everything checked out, you are ready for "YOUR FIRST QSO" {page 6}. Review this section and be on the air within minutes. Other sections follow in a logical order to help you efficiently learn the potential of this transceiver.

CONVENTIONS FOLLOWED IN THIS MANUAL

The writing conventions described below have been followed to simplify key stroke instructions and avoid unnecessary repetition. This format is less confusing for the reader. Reviewing the following information now will reduce your learning period. That means less time will be spent reading this manual; more time will be available for operating.

Note:

- ▶ *Basic procedures are numbered sequentially to guide you step-by-step. Additional information pertaining to a step, but not essential to complete the procedure, is provided in bulleted form following many steps for further guidance.*
- ▶ *Most procedures require that you enter a final key stroke that acts as a terminator for the procedure. You can, if you prefer, simply wait for approximately 10 seconds rather than enter this final key entry.*

INSTRUCTION	MEANING	WHAT TO DO
Press [KEY1] + [KEY2].	Press the keys simultaneously.	Press and hold KEY1 down, then press KEY2 .
Press [KEY1], [KEY2].	Press the keys in sequence.	Press KEY1 momentarily, release KEY1 , then press KEY2 .
Press [KEY] + POWER ON.	Press the key while powering the transceiver.	With the transceiver power OFF, press and hold KEY , then turn ON the transceiver power.
Press [F] (1 s).	Press the Function key for longer than 1 second.	Press and hold the Function key until the "F" indicator on the display begins flashing.
Press [KEY] (1 s).	Press the key for longer than 1 second.	Press and hold KEY until the function begins.

BATTERY INFORMATION

NiCd BATTERY PACK (PB-32/PB-34)

You must charge the battery pack before you can use it. The pack is delivered uncharged to provide you with the greatest number of charge/discharge cycles. It takes several charge/discharge cycles before achieving the full battery pack capacity. After storing the pack for more than 2 months, recharge it before use.

■ Recharging

Insert the plug from the BC-17 charger into the DC IN jack on the right side of the transceiver. Then plug the charger AC plug into an AC wall outlet. Do not charge the battery for more than 15 hours. Exceeding the recommended charge period shortens the useful life of the pack and adversely affects battery performance.

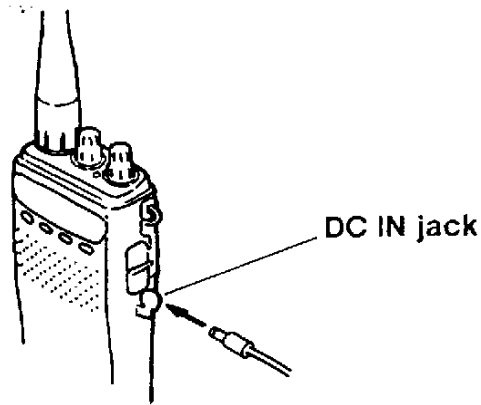

Note:

- ▶ Recharging should be done within an ambient temperature between 5°C to 40°C (41°F to 104°F). Recharging outside this range may not fully charge the battery.
- ▶ If the entire display is blinking, or if turning **PWR/VOL** clockwise does not power the transceiver, recharge the battery pack.
- ▶ The BC-17 charger is designed to recharge only PB-32, PB-34, PB-30 (option), or PB-33 (option). Never use the BC-17 to recharge other types of batteries.

■ Installing/Removing the Battery Pack

Insert the battery pack into the bottom of the transceiver, and push in until the tab on the pack locks in place.

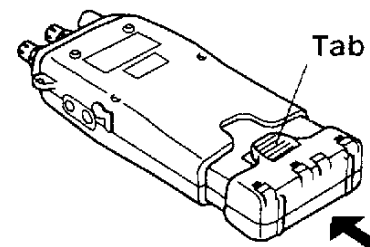

To remove the battery pack, simultaneously press the tab on the back of the pack while pulling out the pack from the transceiver.

INSTALLING/REMOVING MANGANESE OR ALKALINE BATTERIES

(Some General Market Versions)

A fully-charged NiCd battery pack allows optimum performance of your transceiver especially for long transmissions or extended operation. However, when a NiCd battery pack is not available, use high quality alkaline batteries. If manganese batteries are used, it is recommended that transmissions be made only with the "L" or "EL" transmitter output power.

- 1 To remove the battery case, simultaneously press the tab on the back of the case while pulling out the case from the transceiver.

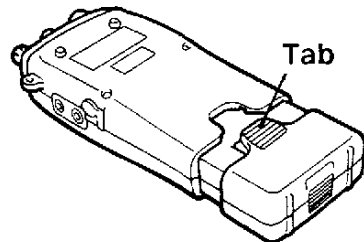

- 2 Open the battery case by simultaneously pressing on the locking tab on the bottom of the case while pulling the two case halves apart.

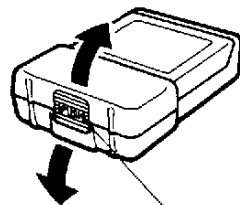

Locking tab

- 3 Insert 4 AA manganese or alkaline batteries in the case half with metal contacts making sure the + and - end of each battery is as shown.

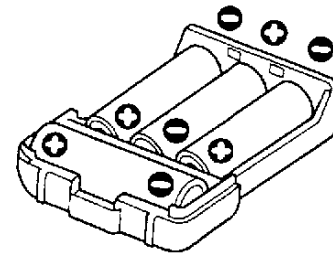

- If replacing batteries, remove the old batteries first by lifting up on each battery end. Never discard old batteries in fire as extremely high temperatures can cause batteries to explode.
- 4 Insert the two small alignment tabs on the other half of the case into their matching holes in the case half containing the batteries. Press the case halves together until the tab on the case bottom locks in place.

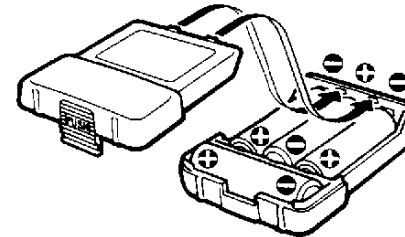

Note:

- ▶ Install only alkaline or manganese batteries in the battery case. Installing NiCd batteries in the battery case will cause an electrical short that generates heat and damages either the battery case or transceiver.
- ▶ Remove the batteries from the battery case if your transceiver will not be used for a long time.

- 5 Insert the battery case into the bottom of the transceiver, and push in until the tab on the case locks in place.

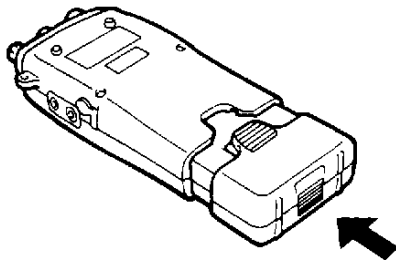

CAUTION: Do not install the battery pack or batteries in a hazardous environment where sparks could cause an explosion.

BATTERY VOLTAGE LEVEL

The horizontal bars on the Display show the relative battery voltage while transmitting using "EL" output power. Recharge or replace the batteries as necessary using the accompanying diagrams as reference.



	New Battery	Discharged Battery
NiCd Battery (PB-30)	■■■■■	■■
NiCd Battery (PB-32/ 33)	■■■■■■■	■■■■■
NiCd Battery (PB-34)	■■■■■■■■■	■■■■■■■■■
Alkaline Battery	■■■■■■■	■■

BATTERY OPERATING TIME (HOURS)

Models	Batteries	Transmitter Output Power		
		High	Low "L"	Economic Low "EL"
TH-22A TH-22AT TH-22E	PB-30	5.5	8.5	12
	PB-32	4	8.5	12
	PB-33	8	17	24
	PB-34	3.5	8.5	12
	Alkaline	18	28	40
TH-42A TH-42AT TH-42E	PB-30	4.5	8	12
	PB-32	3.5	8	12
	PB-33	7	16	24
	PB-34	3	8	12
	Alkaline	15	24	40

- 6 seconds Transmit, 6 seconds Receive, 48 seconds Standby (AF output 0.2 W / 8 ohms)
- Battery Saver ON

YOUR FIRST QSO

If you tend to discard instruction manuals along with the packaging material...please don't. The 4 steps below will get you on the air in your first **QSO** within minutes to allow you to experience the exhilaration that comes with opening a brand new transceiver.

After spreading the word to your best buddies that you are now "handy-active", settle back in your most comfortable operating chair with this manual and your favorite drink for an hour or two. The time spent will be worthwhile.

- 1 Install a new set of batteries or a charged battery pack {page 3}. Holding the provided antenna at its base, twist the antenna onto the BNC connector until you feel the antenna click in place.
- 2 Turn the **PWR/VOL** control clockwise to the 11 o'clock position.

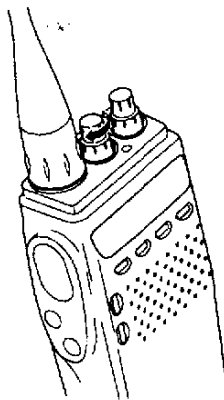

- 3 Turn the **ENC/SQL** control to select a frequency.

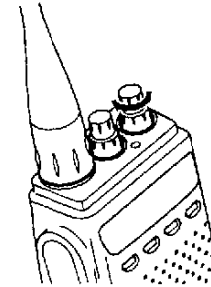

- If accessing a repeater, press **[F]**, **[REV]** to select a standard positive transmit offset. Repeat to select a negative offset.
 - If a subaudible tone is required to access the repeater, see page 30.
- 4 When the frequency is clear, press **[PTT]** and begin communicating.
 - Release **[PTT]** to receive.

CAUTION: *Transmitting with the supplied antenna near other electronic equipment can interfere with that equipment. Also, transmitting near a regulated power supply not specified may cause the power supply to output an extremely high voltage that could damage both your transceiver and any other equipment connected to the supply.*

GETTING ACQUAINTED

ORIENTATION

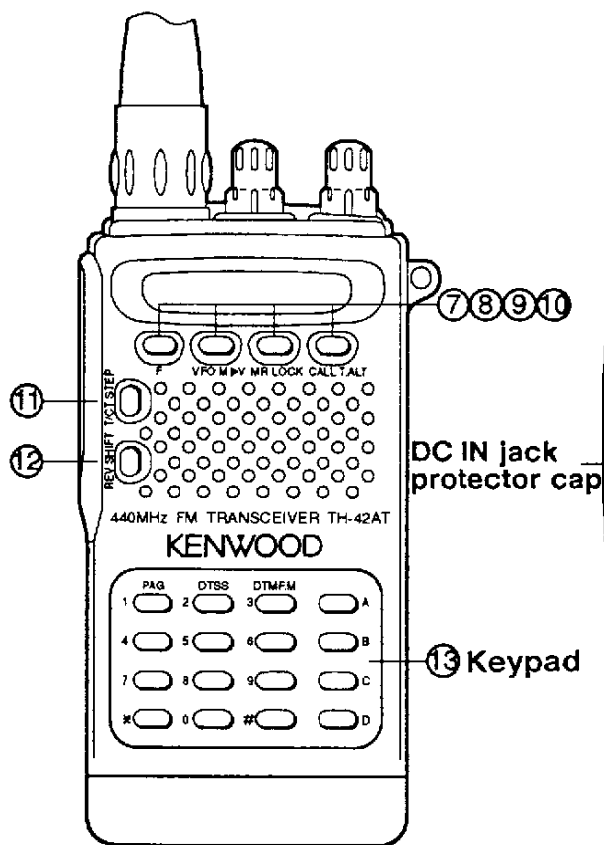
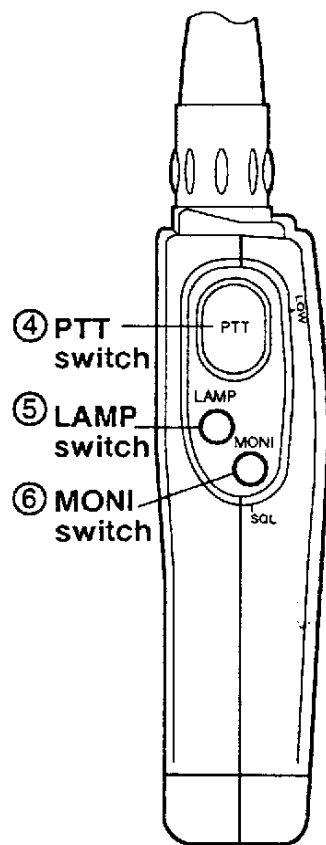

TH-42AT
The keypad is an option for General market versions.

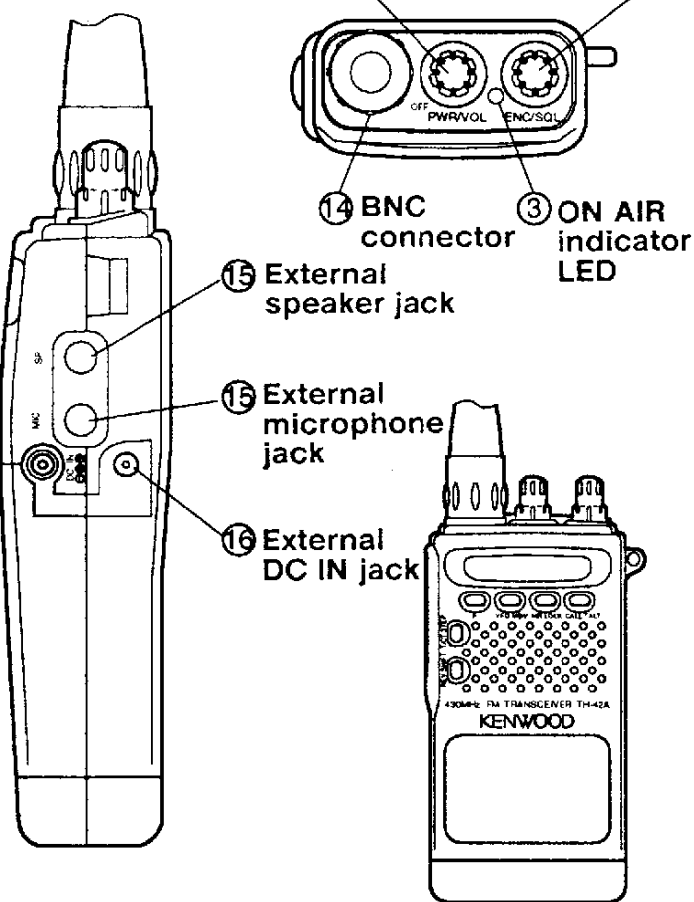
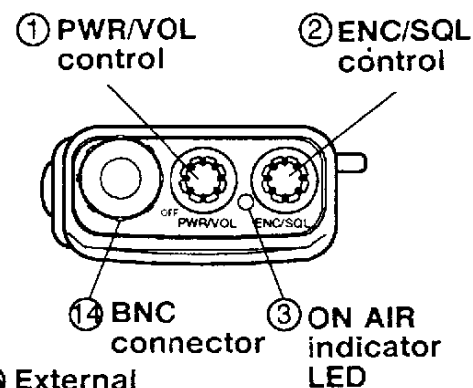

TH-42A/42E (Keypad optional)

The purpose of the following sections is to describe basic functions. Please refer to later sections for greater detail.

KEYS, CONTROLS, SWITCHES, INDICATORS

① **PWR/VOL** (Power/Volume) control

Turn the control clockwise until it clicks to switch ON the transceiver. To switch OFF the transceiver, turn counterclockwise to OFF.

Turning the control clockwise after switching ON the transceiver increases the volume.

② **ENC/SQL** (Encoder/Squelch) control

Select operating frequencies, frequency steps, memory channels, transmit offsets, Tone frequencies, menu items, and use to reverse scan direction. Also, use to manually set the receiver squelch threshold level.

③ **ON AIR** indicator LED

Lights when **[PTT]** is pressed while a frequency within the transmit band is selected.

④ **PTT** (Push-To-Talk)

Hold down to transmit. Release to receive.

⑤ **LAMP**

Press to illuminate the display. The display remains lit while **[LAMP]** is held down. Approximately 5 seconds after releasing **[LAMP]**, the light goes OFF if no other key is pressed. Pressing any key except **[LAMP]** while the display is lit restarts the 5 second timer. Otherwise, pressing **[LAMP]** turns OFF the light immediately. To latch the light ON, press **[F]**, **[LAMP]**. The display remains lit until **[LAMP]** is pressed again.

⑥ **MONI** (Monitor)

Hold down to monitor the operating frequency even when noise squelch, CTCSS, DTSS, Page, or Tone Alert is ON. "BUSY" appears on the display while **MONI** is held down. Also, use in combination with the **ENC/SQL** control to manually set the receiver squelch threshold level.

⑦ **F** (Function)

Use in combination with dual function keys to select the alternate key function. Also, use to select Memory Storage and 1 MHz Step.

⑧ **VFO**

Press to select the VFO.

⑨ **MR** (Memory Recall)

Press to select Memory Recall.

⑩ CALL

Press to recall the Call channel.

⑪ T/CT (Tone/CTCSS)

Press to switch between Tone and CTCSS functions.

⑫ REV (Reverse)

Press to reverse the transmit and receive frequencies. This is particularly useful when monitoring a repeater to check the signal strength of a station on its transmit frequency.

⑬ Keypad

Use to input numeric data such as frequencies, memory channel numbers, etc. Also, use to input numbers when sending DTMF digits and to control DTSS, Page, and DTMF memory functions.

JACKS AND CONNECTORS

⑭ BNC connector

Attach the supplied antenna.

⑮ External microphone/speaker jacks

Connect an external microphone, speaker or speaker-microphone if desired. When using the transceiver with any of these accessories, take care not to let water enter the speaker jack or microphone jack.

⑯ External DC IN jack

Connect the BC-17 wall charger in order to charge the transceiver's rechargeable battery pack.

Connect the optional PG-2W DC power cable if an external power supply is used. The supply voltage must be in the range from 5 V to 16 V.

Connect the optional PG-3J cigarette lighter cable when using a cigarette lighter socket as a power source during mobile operation.

DISPLAY

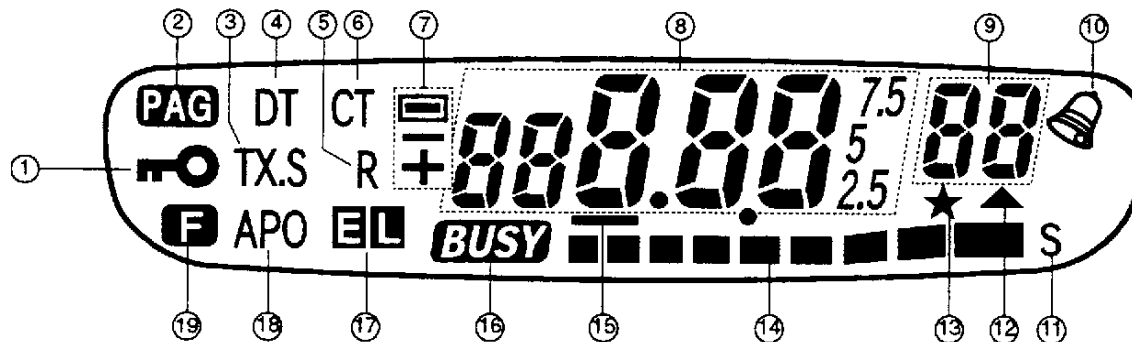

①

Appears when Key Lock is ON. Most keys and the **ENC/SQL** control are disabled if this function is activated. The **ENC/SQL** control lock can be bypassed.

② **PAG**

Appears when Page is ON. Allows you to Page other stations that have the Page function on their transceivers.

③ **TX.S**

Appears when Transmit Inhibit is ON. No transmissions can be made.

④ **DT**

Appears when the Dual Tone Squelch System is ON. You can use your transceiver for sending and receiving digitally-addressed transmissions.

⑤ **R**

Appears when the Reverse function is ON. Transmit and receive frequencies are reversed.

⑥ **T** or **CT**

Appears when the subaudible tone encoder ("T") is ON, or when the Continuous Tone Coded Squelch System ("CT") is ON.

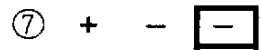

Displays the transmit offset direction in relation to the receive frequency.

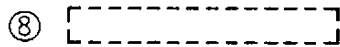

Displays the operating frequency, frequency step, Tone frequency, and current menu settings.

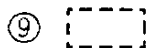

Displays the current memory channel selected when using Memory Recall.



Appears when Tone Alert is ON. Flashes when a signal is received.



Appears when Battery Saver is ON.



Appears when the selected memory channel contains data while using Memory Store.



Appears when the selected channel or Page code is locked-out. While memory scanning, the transceiver does not stop on locked-out channels. During Page operation, the squelch does not open for locked-out codes.



While receiving, displays the relative signal strength of received signals. While transmitting, displays the relative battery level.



Blinks to indicate the 1 MHz step function is ON.



Appears when the squelch is open due to a received signal (or noise) that is greater in strength than the squelch threshold level.



Appears when the transmit output power is set to Low ("L") or Economic Low ("EL"). Neither indicator appears when High power is selected.



Appears when Automatic Power Off is ON.



Appears when [F] is pressed. Indicates that the alternate function of dual function keys can be used now.

MENU SET-UP

Many of the features on the transceiver are selected by means of a configurable menu system. This system reduces the number of keys and controls without eliminating important features. To change the configuration of a Menu item, use the following procedure:

1 Press **[CALL] + POWER ON** to enter Menu Set-up.

- 2 Turn the **ENC/SQL** control to select the menu item to be changed.
 - The current selection appears.
- 3 Each time **[CALL]** is pressed, the different selections available appear on the display.
- 4 Press any key other than **[CALL]**, **[LAMP]**, or **[MONI]** to exit Menu Set-up and save the selection viewed last on the display.

The table below lists the configurable menu items:

Menu No.	Description	Selections	Default	Reference Page
01	Battery Saver	ON/OFF	ON	39
02	Automatic Power Off (APO)	ON/OFF	ON	39
03	Scan Resume: Time-operated (TO), Carrier-operated (CO)	TO/CO	TO	36
04	Keypad Beep	ON/OFF	ON	18
05	Transmit Inhibit	ON/OFF	OFF	20
06	Tuning Encoder Lock	ON/OFF	OFF	18
07	Automatic Transmit Offset	ON/OFF	ON ¹	28
08	DTSS/Page Transmit delay	350 ms / 550 ms	350 ms	42 and 46
09	DTMF Transmit Hold (2 s)	ON/OFF	OFF	34
10	Open Page	ON/OFF	OFF	47
11	Auto Page Cancel	ON/OFF	OFF	47
12	Channel Display	ON/OFF	OFF	25
13	Time-out Timer (TOT)	30/ 60/ 90/ 180/ 900 s	900 s	19
14	Busy Frequency Lock-out	ON/OFF	OFF	20

¹ TH-22AT (U.S.A. and Canada), TH-22E only

Note: While accessing Menu Set-up, waiting for longer than 10 seconds without entering any data ends the set-up operation automatically and returns you to the previous display.

RECEIVING

SWITCHING POWER ON/OFF

To switch ON your transceiver, turn the **PWR/VOL** control clockwise and set it at the 11 o'clock position. Various indicators, including a receive frequency, appear on the display. Due to the automatic squelch feature, no sound will be heard from the speaker until you receive a call.

Use the same control to adjust the volume more precisely while receiving your first call, or press **[MONI]** and adjust the **PWR/VOL** control to set the background noise to a comfortable level. Pressing **[MONI]** always allows you to listen to activity on the selected frequency as long as this key is held down.

To switch OFF the transceiver, turn the **PWR/VOL** control counterclockwise until it clicks at the OFF position.

SQUELCH THRESHOLD LEVEL

The receiver squelch is automatically controlled by the transceiver's microcomputer based on the measured noise level. However, you can override the microcomputer setting, if you wish.

- 1 Turn the **ENC/SQL** control to select a frequency that is not busy.
- 2 Press **[F]**, **[MONI]**.
 - The current squelch threshold level appears.
 - The default is "5".

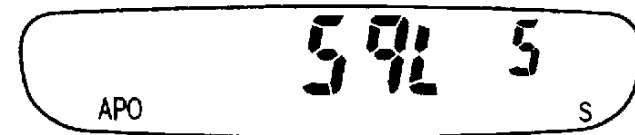

- 3 Turn the **ENC/SQL** control to select the desired level (0 to 9).
 - 0: Selects lowest threshold level (squelch open).
 - 9: Selects highest threshold level.
- 4 Press any key other than **[LAMP]** or **[MONI]**.

SELECTING FREQUENCY STEP SIZE

Choosing the correct step size when operating is essential in order to select your exact operating frequency with the **ENC/SQL** control. The best step size is the largest step that will still allow you to use the **ENC/SQL** control to select all frequencies on which you plan to operate. Using the best step size reduces the time required to select new frequencies with the **ENC/SQL** control; operating becomes easier.

Version	Default (kHz)	
	TH-22	TH-42
Canada U.S.A.	5	25
Australia Europe General	12.5	25

- 1 Press **[VFO]** to select the VFO.
- 2 Press **[F]**, **[T/CT]**.
 - The current frequency step appears.

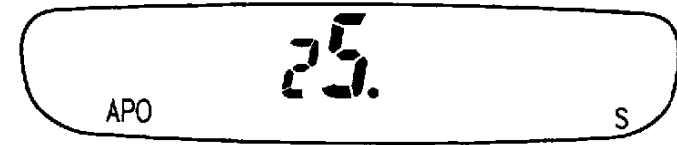

- 3 Turn the **ENC/SQL** control to switch between available frequency steps.
 - As you turn the **ENC/SQL** control clockwise or counterclockwise, the following selections appear:

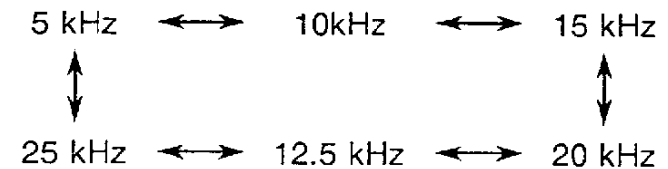

- 4 Press any key other than **[LAMP]** or **[MONI]**.
 - The new step size is stored, and the previous display is restored.

Note: The step size can be set separately for the VFO, Call channel, and memory channels.

■ **Changes in Displayed Frequencies**

Changing between step sizes may result in a change of the displayed frequency. When a change occurs, and by how much, is shown in the accompanying charts.

For example, assume 144.995 MHz is displayed with a 20 kHz step size selected. Changing to a 25 kHz step size alters the displayed frequency to 144.975 MHz.

5, 10, 15 or 20 kHz Step Size		→	12.5 or 25 kHz Step Size	
Displayed Frequency (10 kHz/ 1 kHz)			Displayed Frequency (10 kHz/ 1 kHz)	
00, 05, 10, 15			00	
20, 25, 30, 35			25	
40, 45, 50, 55			50	
60, 65, 70, 75, 80, 85, 90, 95			75	

12.5 or 25 kHz Step Size		→	5, 10, 15 or 20 kHz Step Size	
Displayed Frequency (10 kHz/ 1 kHz/ 500 Hz)			Displayed Frequency (10 kHz/ 1 kHz)	
00			00	
12.5			10	
25			20	
37.5			30	
50			50	
62.5			60	
75			70	
87.5			80	

DIRECT KEYPAD FREQUENCY ENTRY

This function is available only on transceivers equipped with a DTMF keypad. Entering the desired frequency directly via the keypad can be the fastest way of selecting a different frequency especially when a small frequency step has been selected. If the new frequency is hundreds of kHz or more from the current frequency, and you don't have the new frequency stored in any memory channels, use direct entry.

- 1 Press **[VFO]** to select the VFO.
- 2 Enter the desired frequency using the numeric keys.
 - For versions with receiver coverage wider than 10 MHz, the 10 MHz digit must be entered. Otherwise, begin entering from the 1 MHz digit.
 - When the current step size is 5 kHz, 10 kHz, 15 kHz, or 20 kHz, enter numeric values down to the 1 kHz digit. Enter either 0 or 5 for the 1 kHz digit.
 - When the current step size is 12.5 kHz or 25 kHz, entering the 10 kHz digit completes frequency setting. The 10 kHz and subsequent digits are set according to which key is pressed for the 10 kHz digit as shown in the chart.
 - Except for the 1 kHz digit, entering a digit that is outside the allowable range causes the nearest digit within range to be displayed. For the 1 kHz digit, pressing **[0]** to **[4]** selects "0" and pressing **[5]** to **[9]** selects "5".

10 kHz key	Frequency (kHz)	10 kHz key	Frequency (kHz)
0	00	5	50
1	12.5	6	62.5
2	25	7	75
3	37.5	8	87.5
4	37.5	9	87.5

Note:

- ▶ If any key other than **[0]** to **[9]**, **[MONI]**, or **[LAMP]** is pressed, or if the next entry is not made within 10 seconds, the previous frequency will be restored.
- ▶ If **[VFO]** is pressed while entering the frequency, the new data is accepted for the digits entered and the previous data remains unchanged for the digits not yet entered.
- ▶ Turning the **ENC/SQL** control while entering the frequency cancels the new numeric data entered, and raises or lowers the previously displayed frequency.

1 MHZ STEP FREQUENCY CHANGE

The 1 MHz Step feature allows rapid frequency excursions up or down the band with a minimum of key strokes.

- 1 Press **[VFO]** to select the VFO.
- 2 Press **[F]**.
 - The bar located under the 1 MHz digit begins blinking.

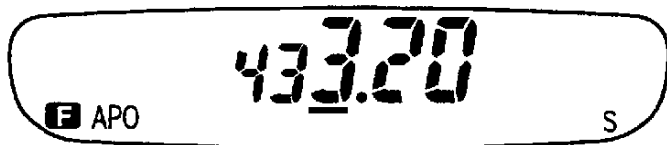

- 3 Turn the **ENC/SQL** control to select the desired MHz digit.
- 4 Press **[F]** to restore the previous frequency step.

KEY LOCK

Occasionally, you may want to lock the keys and the **ENC/SQL** control to prevent accidentally changing any transceiver settings.

Press **[F]**, **[MR]**.

- The "key" icon appears when lock is ON.

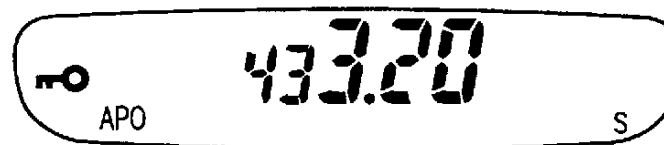

- Each time this key combination is pressed, the keys and the **ENC/SQL** control toggle between locked and unlocked.

The following keys function normally even when Key Lock is ON:

[MONI]

[LAMP]

[PTT]

[T/CT] (Only TH-22E/TH-42E with 1750 Hz selected)

Also, microphone PF keys function normally with Key Lock activated; however, no new functions can be assigned to the PF keys until Key Lock is turned OFF. Refer to page 50 for identification of the microphone PF keys and further information.

UNLOCKING ENC/SQL CONTROL

If you only want to lock the keys but not the **ENC/SQL** control when Key Lock is activated, that is possible too.

- 1 Press **[CALL] + POWER ON** to select Menu Set-up.
- 2 Turn the **ENC/SQL** control to select Menu No. 06.
 - The current status of **ENC/SQL** control lock appears.
 - The default is "OFF".

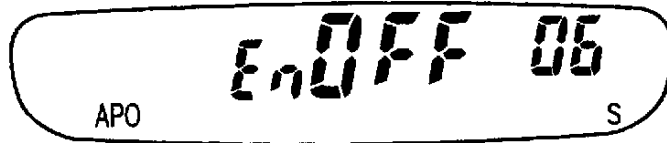

- 3 Press **[CALL]** to select "ON" or "OFF".
 - OFF: Locks **ENC/SQL** control with keys.
 - ON : Does not lock **ENC/SQL** control with keys.
- 4 Press any key other than **[CALL]**, **[LAMP]**, or **[MONI]** to exit Menu Set-up.

BEEP TONE ON/OFF

The transceiver beeps each time you press a key on the transceiver with the exception of **[MONI]**, **[LAMP]**, and **[PTT]**. Pressing **[PTT]** generates a beep if your transmit frequency is outside the transmit band. Beep volume can be varied by turning the **PWR/VOL** control. If you prefer, you can cancel the beep for silent operation.

- 1 Press **[CALL] + POWER ON** to enter Menu Set-up.
- 2 Turn the **ENC/SQL** control to select Menu No. 04.
 - The current beep status appears.
 - The default is "ON".



- 3 Press **[CALL]** to select "OFF" or "ON".
 - OFF: Disables Keypad Beep.
 - ON : Enables Keypad Beep.
- 4 Press any key other than **[CALL]**, **[LAMP]**, or **[MONI]** to exit Menu Set-up.

Note: When Tone Alert is switched ON while the Beep function is OFF, an audible alarm does not sound when a signal is received.

TRANSMITTING

SELECTING OUTPUT POWER

It's wise, and required by law, to select the lowest power that allows reliable communication. This saves battery power which extends battery life, and lowers the risk of interfering with others on the band.

Press **[F]**, **[PTT]**.

- The default is High power (no indicator appears).
- Each time this key combination is pressed, the transmit output power changes as below:

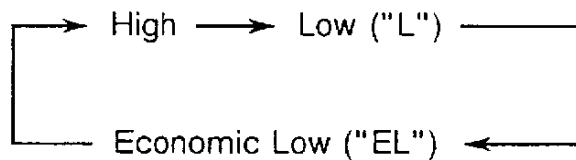

Batteries	High	"L"	"EL"
PB-30	1.8 W	0.5 W	0.05 W ¹
PB-32/33	3.0 W ²	0.5 W	0.05 W ¹
PB-34	5.0 W	0.5 W	0.05 W ¹
Alkaline	1.5 W	0.5 W	0.05 W ¹
Manganese	1.5 W	0.5 W	0.05 W ¹

¹ TH-42A/AT/E: 0.03 W

² TH-42A/AT/E: 2.5 W

Note:

- ▶ *The transmit output power cannot be changed while transmitting.*
- ▶ *The horizontal bars that appear on the display while transmitting indicate the relative battery level.*

TIME-OUT TIMER (TOT)

It is sometimes necessary or desirable to restrict a single transmission to a specific maximum time. This feature can be useful when accessing repeaters to prevent repeater time-outs, or when particularly trying to conserve battery power. Select the most appropriate timer value for your operating habits.

- 1 Press **[CALL]** + **POWER ON** to select Menu Set-up.
- 2 Turn the **ENC/SQL** control to select Menu No. 13.
 - The current timer value appears.
 - The default is "900".

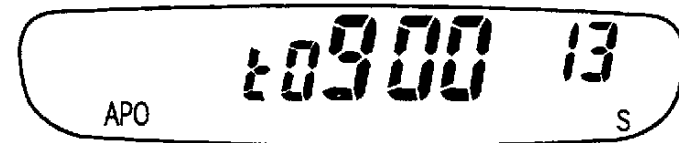

- 3 Press **[CALL]** repeatedly to cycle through the timer values available.
 - You can choose 30 s, 60 s, 90 s, 180 s, or 900 s.
- 4 Press any key other than **[CALL]**, **[LAMP]**, or **[MONI]** to exit Menu Set-up.

When TOT times out, the transceiver automatically returns to Receive. To resume transmitting, release and then press **[PTT]** again.

INHIBITING THE TRANSMITTER

The transmit function can be disabled to prevent unauthorized individuals from transmitting, or to eliminate the risk of yourself accidentally transmitting.

- 1 Press **[CALL]** + **POWER ON** to select Menu Set-up.
- 2 Turn the **ENC/SQL** control to select Menu No. 05.
 - The current Transmit Inhibit status appears.
 - The default is "OFF".



- 3 Press **[CALL]** to select "OFF" or "ON".
 - OFF: Enables transmitter ("TX.S" disappears).
 - ON : Inhibits transmitter ("TX.S" appears).
- 4 Press any key other than **[CALL]**, **[LAMP]**, or **[MONI]** to exit Menu Set-up.

If **[PTT]** is pressed while Transmit Inhibit is ON, your transceiver beeps and will not transmit. The **PTT** switch on any microphone configured for remote control with this transceiver also will be disabled. On TH-22E/TH-42E versions, the 1750 Hz tone cannot be transmitted while Transmit Inhibit is activated.

BUSY FREQUENCY LOCK-OUT

A method of inhibiting the transmitter when the current receive frequency is busy is provided. This feature can help to eliminate "doubling" (simultaneous transmissions) with other stations.

- 1 Press **[CALL]** + **POWER ON** to enter Menu Set-up.
- 2 Turn the **ENC/SQL** control to select Menu No. 14.
 - The current Busy Frequency Lock-out status appears.
 - The default is "OFF".

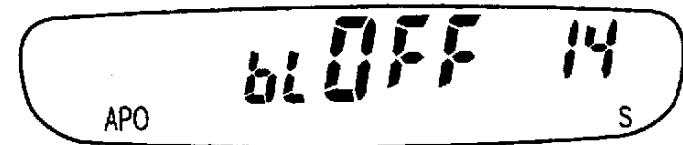

- 3 Press **[CALL]** to select "OFF" or "ON".
 - OFF: Enables transmitter on a busy frequency.
 - ON : Inhibits transmitter on a busy frequency.
- 4 Press any key other than **[CALL]**, **[LAMP]**, or **[MONI]** to exit Menu Set-up.

MEMORY CHANNELS

A total of 40 memory channels (0 to 39) are available for storing frequencies and related data. Each memory channel can be used either as a simplex channel or split channel. Alternatively, a standard or non-standard frequency offset and offset direction required for using repeaters can be stored. Refer to "OPERATING THROUGH REPEATERS" {page 27}.

The data listed below can be stored in each memory channel:

Parameter	Simplex Channel	Split Channel
RX frequency	YES	YES
TX frequency		YES
Tone (CTCSS) frequency	YES	YES
Tone / CTCSS status	YES	YES
Frequency step	YES	YES
Shift status, REV status	YES	N/A
DTSS code, DTSS status	YES	YES

YES: Can be stored in memory

N/A : Not applicable

STORING DATA IN MEMORY

There are 2 methods of storing transmit/receive frequencies and associated data in memory channels depending on the relationship of the transmit and receive frequencies:

- Simplex memory channels:
RX frequency = TX frequency
- Split memory channels:
RX frequency \neq TX frequency

■ Simplex Memory Channels

- 1 Select the desired frequency and associated data (Tone, CTCSS, DTSS, etc.) using the VFO, Memory Recall or the Call channel.
- 2 Press **[F]** (1 s) to select Memory Storage.
- 3 Select the desired memory channel using the **ENC/SQL** control.

4 Press [MR].

- The selected frequency and associated data are stored in the memory channel.
- If the memory channel selected in the previous step already contained data, the new data overwrites the previous data.
- The previous mode is restored.

The "▲" symbol under the channel number indicates the following:

- Symbol ON : Channel contains data.
- Symbol blinking : Channel empty.



■ Split Memory Channels

- 1 After storing the receive frequency using "Simplex memory channels" instructions in the preceding section, select the desired transmit frequency.
- 2 Press [F] (1 s) to select Memory Storage.
- 3 Turn the **ENC/SQL** control to select the memory channel containing the receive frequency.
- 4 Press [PTT] + [MR].
 - The selected transmit frequency is stored in the memory channel, and the previous mode is restored.
 - If the memory channel selected does not contain a receive frequency, your transceiver beeps and restores the previous mode.
 - Associated data such as Tone status/frequency, frequency step, and DTSS status/code are not overwritten. However, transmit shift status and Reverse status data are erased.

RECALLING MEMORY CHANNELS

■ Using the ENC/SQL Control

- 1 Press **[MR]**.
 - The memory channel used last is recalled.
 - If all memory channels are empty, your transceiver beeps and Memory Recall is not selected.
- 2 Turn the **ENC/SQL** control to select the desired memory channel.
 - Clockwise : Increases the channel number.
 - Counterclockwise : Decreases the channel number.
 - Empty memory channels cannot be recalled.

■ Using the Keypad

- 1 Press **[MR]**.
 - The memory channel used last is recalled.
- 2 Enter a 2-digit number (00 to 39) to select the desired memory channel.
 - Empty memory channels cannot be recalled.

Note: When a split memory channel is recalled, "F" appears on the display to the left of the receive frequency. Press **[REV]** to display the transmit frequency.

MEMORY → VFO TRANSFERS

Transferring the contents of a memory channel or the Call channel to the VFO can be useful if you wish to search for other stations or a clear frequency near the selected memory channel or Call channel frequency. This is a quick operation that will be used frequently, especially if you enjoy exploring the band.

- 1 Press **[MR]** to select Memory Recall, or **[CALL]** to select the Call channel.
- 2 Recall the desired memory channel using the **ENC/SQL** control.
 - This step is not necessary if the Call channel was selected.
- 3 Press **[F]**, **[VFO]**.
 - The complete contents of the memory channel or the Call channel are copied to the VFO.
 - A transmit frequency from a split memory channel or split Call channel is not transferred to the VFO.

ERASING MEMORY CHANNELS

Although it is possible to overwrite existing data in any of the memory channels with new data, at times you may wish to clear data from memory channels without entering new data. It's convenient to clear channels no longer used so you can identify channels that are free for memorizing new frequencies.

- 1 Press **[MR]** to select Memory Recall.
- 2 Select the desired memory channel using the **ENC/SQL** control or numeric keys.
- 3 Switch OFF the power.
- 4 Press **[MR] + POWER ON**.
 - The contents of the memory channel are erased and transferred to the VFO. The VFO is selected.

CALL CHANNEL

The Call channel can be used to store any frequency within your transceiver operating range that you wish to make your main operating frequency. No matter what mode the transceiver is in, the Call channel always can be selected quickly. You may wish to dedicate the Call channel on a group-wide basis as an emergency channel only to be used for urgent communications. In this case, Call Scan {page 38} will be useful.

■ Recalling Call Channel

Press **[CALL]** to retrieve the contents of the Call channel.

- If **[CALL]** is pressed again, the previous mode is restored.
- The **ENC/SQL** control does not function while the Call channel is selected.

The Call channel defaults are as follows:

Version	Default (MHz)	
	TH-22	TH-42
Canada U.S.A.	144.000	440.000
Australia Europe General	144.000	430.000

The contents of the Call channel cannot be deleted; however, you can overwrite old data with new data as described below.

■ Changing Call Channel Contents (Simplex)

- 1 Select the desired frequency and associated data (Tone, CTCSS, DTSS, etc.) using the VFO or Memory Recall.
- 2 Press [F] (1 s) to select Memory Storage.
- 3 Press [CALL].
 - The selected frequency and associated data are stored in the Call channel, and the previous mode is restored.

■ Changing Call Channel Contents (Split)

- 1 After storing the receive frequency using "Changing Call channel contents (Simplex)" instructions in the preceding section, select the desired transmit frequency.
- 2 Press [F] (1 s) to select Memory Storage.
- 3 Press [PTT] + [CALL].
 - The selected transmit frequency is stored in the Call channel, and the previous mode is restored.

CHANNEL DISPLAY FUNCTION

When this function is switched ON, the transceiver selects Memory Recall and displays only a memory channel number instead of a frequency. During emergency drills and emergency communications, or when participating in communications for important events, channelized operations can increase operating efficiency and maintain security of communications if required.

- 1 Press [CALL] + POWER ON to select Menu Set-up.
- 2 Turn the ENC/SQL control to select Menu No. 12.
 - The current Channel Display status appears.
 - The default is "OFF".



- 3 Press [CALL] to select "OFF" or "ON".
 - OFF: Turns OFF Channel Display.
 - ON : Turns ON Channel Display.
- 4 Press any key other than [CALL], [LAMP], or [MONI] to exit Menu Set-up.

Note:

- ▶ *Channel Display can be used only when data has been stored in at least 1 memory channel.*
- ▶ *Certain functions cannot be used if Channel Display is activated. The following chart identifies these functions:*

Non-functional with Channel Display ON	Page Ref.	Non-functional with Channel Display ON	Page Ref.
VFO	-	Memory channel save	21
Call channel	24	Call channel save	25
VFO scan	38	Manual offset select	29
Call scan	38	Memory channel erase	24
Memory → VFO transfer	23	Memory reset	26
Frequency step size change	14	VFO reset	26
1 MHz step	17		

INITIALIZING MEMORY

If your transceiver seems to be malfunctioning, initializing the memory may resolve the problem.

Remember that initializing the memory channels requires that you re-enter any memory channel data again after the reset if you wish to use those channels. On the other hand, if you want to erase all data from all channels, initialization is a quick way to do this.

■ VFO Reset (Partial)

To initialize only the VFO, press **[VFO] + POWER ON**.

- When **[VFO]** is released, the VFO resets.

■ Memory Reset (Full)

To initialize the memory channels, press **[F] + POWER ON**.

- When **[F]** is released, the memories reset.

Factory Default Settings

Version	TH-22 Defaults			TH-42 Defaults		
	VFO Freq.	Freq. Step	Tone Freq.	VFO Freq.	Freq. Step	Tone Freq.
Canada U.S.A.	144.000	5 kHz	88.5 Hz	440.000	25 kHz	88.5 Hz
Australia	144.000	12.5 kHz	88.5 Hz	430.000	25 kHz	88.5 Hz
Europe	144.000	12.5 kHz	1750 Hz	430.000	25 kHz	1750 Hz
General	144.000	12.5 kHz	88.5 Hz	430.000	25 kHz	88.5 Hz

OPERATING THROUGH REPEATERS

TRANSMITTER OFFSETS

All Amateur Radio voice repeaters use a separate receive and transmit frequency. The transmit frequency may be higher or lower than the receive frequency but the difference in frequencies will be a standard amount, or "standard split". Most repeater configurations fall into one of the following categories:

Offset Direction	TH-22A/AT/E	TH-42A/AT	TH-42E
+	+ 600 kHz	+ 5 MHz	+ 1.6 MHz
-	- 600 kHz	- 5 MHz	- 1.6 MHz
<div style="border: 1px solid black; display: inline-block; padding: 2px;">-</div> -	N/A	N/A	- 7.6 MHz

N/A: Not applicable

Whether using the VFO, Memory Recall, or the Call channel, the transmit offset direction and amount can be changed.

SELECTING OFFSET DIRECTION

This function sets the transmit frequency either higher (+) or lower (-) than the receive frequency by a fixed amount. Refer to "Selecting Offset Values Manually" {page 29} if you want to change the offset amount.

Press [F], [REV].

- The default is "simplex" (no offset).
- Each time this key combination is pressed, the offset changes as follows:

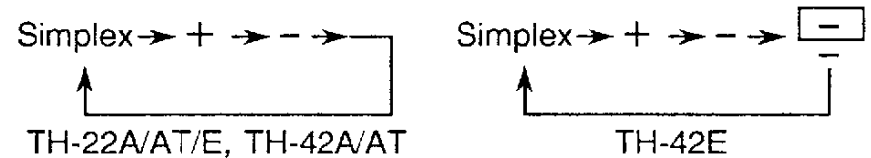

If the offset transmit frequency falls outside the transmit band, transmit is inhibited until the transmit frequency is brought within the band by one or more of the following methods:

- Move the receive frequency further inside the band.
- Reduce the offset amount ("Selecting Offsets Manually" {page 29}).
- Reverse the offset direction.

AUTOMATIC TRANSMIT OFFSET

■ U.S.A. and Canada Versions

Automatic Offsets for the TH-22AT sold in these markets are programmed according to the standard ARRL (American Radio Relay League) Band Plan for repeater offset direction. You can override this programming by following the "Selecting Offset Direction" procedure in the preceding section. Contact your national Amateur Radio association to obtain up-to-date band plans that explain band usage by mode and activity.

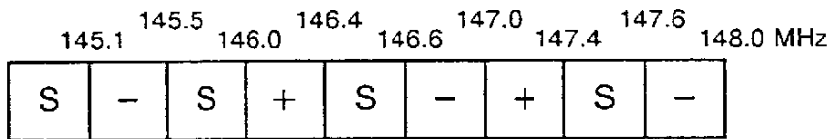

S: Simplex

■ European Version

The TH-22E Automatic Offset is programmed as follows:

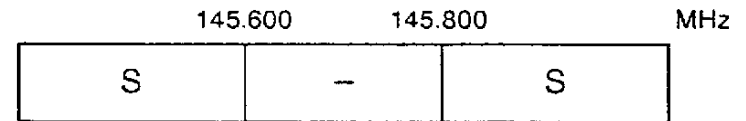

S: Simplex

While Automatic Offset is ON, a manually assigned offset is only effective until the frequency is changed. After Automatic Offset is turned OFF, a manually assigned offset remains effective even after the frequency is changed.

■ Canceling Automatic Offset

Automatic Offset can be canceled as described below:

- 1 Press **[CALL] + POWER ON** to enter Menu Set-up.
- 2 Turn the **ENC/SQL** control to select Menu No. 07.
 - The current Automatic Offset status appears.
 - The default is "ON" for TH-22 versions sold in the U.S.A., Canada and Europe.



- 3 Press **[CALL]** to select "OFF" or "ON".
 - OFF: Cancels Automatic Offset.
 - ON : Restores Automatic Offset.
- 4 Press any key other than **[CALL]**, **[LAMP]**, or **[MONI]** to exit Menu Set-up.

Note: After turning ON Automatic Offset again, or after transferring memory channel contents to the VFO, the feature resumes functioning when a new frequency is selected.

SELECTING OFFSET VALUES MANUALLY

To change the amount of offset, use the following procedure:

- 1 Press **[F] (1 s), [REV]**.
- 2 Turn the **ENC/SQL** control to select the desired value.
 - The values range from 0.00 MHz to 99.95 MHz in 50 kHz steps.
- 3 Press any key other than **[MONI]** or **[LAMP]** to store the selected value.
 - The previous mode is restored.

Remember the following points before altering the offset:

- The TH-42E offset can be changed from the default 1.6 MHz value; however, the 7.6 MHz value is not configurable.
- It is not possible to set different offset values for the VFO and memory channels.
- The new manually selected value will be used even if Automatic Offset is switched ON.

REVERSE FUNCTION

Each time [REV] is pressed, the receive frequency is switched with the transmit frequency. When used while monitoring a repeater, it's possible to check the signal strength of a station accessing the repeater. If the station's signal is strong, it's best to move to a simplex frequency to continue the contact and free-up the repeater.

- If reversal would place the receive frequency outside the receiver frequency range, an error beep sounds when [REV] is pressed. No reversal occurs.
- If the transmit frequency would go out of the transmitter frequency range if [PTT] were pressed, then pressing [PTT] causes an error beep and Receive is selected.
- Reverse cannot be activated while [PTT] is held down.
- Automatic Offset cannot be used while Reverse is ON.

TONE ACCESS

Each time [T/CT] is pressed, the Tone and CTCSS functions are changed as follows:

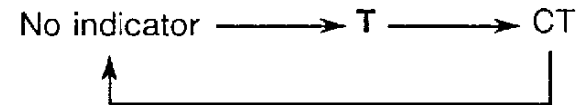

No indicator : Subaudible tone not transmitted and tone squelch not functional.

T : Subaudible tone transmitted.

CT : Subaudible tone transmitted and tone squelch functional.

Note:

- ▶ "CT" will appear if [T/CT] is pressed when the TSU-8 CTCSS module is not installed: however, CTCSS will not function.

TH-22E/TH-42E only

- ▶ When [T/CT] is pressed with 1750 Hz selected, 1750 Hz tones are transmitted. "T" appears during this period. Releasing [T/CT] stops transmission and "T" goes OFF.
- ▶ If [T/CT] is pressed when any frequency other than 1750 Hz is selected, Tone will switch ON and OFF.
- ▶ When 1750 Hz is selected while Tone is OFF, pressing [T/CT] does not change the Tone/CTCSS status. When 1750 Hz is selected while Tone or CTCSS is ON, 'T' or "CT" goes OFF.

Often a Tone frequency is required to access repeaters. For example, 88.5 Hz may be needed in the U.S.A. or Canada, and 1750 Hz is used in Europe. The Tone frequencies listed below can be selected. On the TH-22E/TH-42E, 1750 Hz also can be selected.

No.	Freq. (Hz)	No.	Freq. (Hz)	No.	Freq. (Hz)	No.	Freq. (Hz)
01	67.0	11	97.4	21	136.5	31	192.8
02	71.9	12	100.0	22	141.3	32	203.5
03	74.4	13	103.5	23	146.2	33	210.7
04	77.0	14	107.2	24	151.4	34	218.1
05	79.7	15	110.9	25	156.7	35	225.7
06	82.5	16	114.8	26	162.2	36	233.6
07	85.4	17	118.8	27	167.9	37	241.8
08	88.5	18	123.0	28	173.8	38	250.3
09	91.5	19	127.3	29	179.9		
10	94.8	20	131.8	30	186.2		

The following procedure allows you to select any of the available tones.

- 1 Press **[F]** (1 s), **[T/CT]**.
- 2 Turn the **ENC/SQL** control to select the desired Tone frequency.
- 3 Press any key other than **[MONI]** or **[LAMP]** to store the selected value.

AUTOPATCH (U.S.A. and Canada Versions)

Some repeaters offer a service called Autopatch. This feature allows you to dial a telephone number from your transceiver and carry on a telephone conversation. This repeater function cannot be used for commercial transactions, but it can save lives when used appropriately during emergencies.

Autopatch requires the use of a DTMF (Dual Tone Multi-Frequency) keypad. The keypad includes the 12 keys found on your telephone plus an additional 4 keys (A, B, C, D). These additional keys are required for various control operations by some repeater systems.

■ Activating the Keypad

- 1 Press and hold **[PTT]**.
- 2 Press keys in sequence to transmit tones.
 - To generate single-frequency tones for test purposes, press **[MONI]** before pressing a single key from **[1]** to **[8]**.

DTMF Tones

Freq. (Hz)	1209	1336	1477	1633
697	1	2	3	A
770	4	5	6	B
852	7	8	9	C
941	*	0	#	D

Single-Frequency Tones

Key	Freq. (Hz)	Key	Freq. (Hz)
1	697	5	1209
2	770	6	1336
3	852	7	1477
4	941	8	1633

Note: Some repeaters require a special key sequence to activate Autopatch. Check with the control operator.

DUAL TONE MULTI-FREQUENCY (DTMF) MEMORY

This function is available only on transceivers equipped with a DTMF keypad.

■ Making DTMF Calls

To make a DTMF call, hold down [PTT] and press [0] to [9], [A], [B], [C], [D], [*], or [#].

- The microphone is muted and the corresponding DTMF tones are transmitted. You can monitor the tones as they are sent by listening to the speaker audio.
- If two keys are pressed, only the tone combination for the key pressed first is sent.

■ Storing DTMF Numbers

To store a DTMF number in dedicated DTMF memory channels 1 to 5, follow the procedure below:

- 1 Press [F] (1 s), [3] to select DTMF Storage.

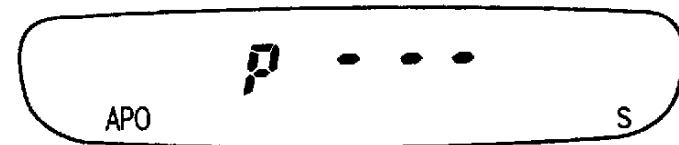

2 Enter the desired DTMF digits using the keypad (15 digits maximum).

- If incorrect data is entered, press [VFO] and enter the correct data from the beginning.
- To abort data entry, press [CALL]. The previous mode is restored.

3 Press [MR], [1] to [5].

- Only press a single number corresponding to the desired DTMF memory channel.
- The previous mode is restored.

■ Confirming Stored DTMF Numbers

1 Press [F], [3].

- The following display appears:

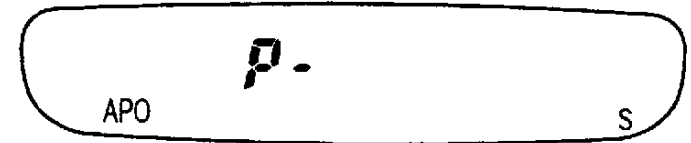

2 Enter the DTMF memory channel (1 to 5) that contains the DTMF number.

- The stored DTMF digits are displayed.
- Selecting a DTMF memory channel that has no DTMF number stored causes the previous display to be restored.

■ Transmitting Stored DTMF Numbers

To transmit a stored DTMF number, use the following procedure:

1 Press **[PTT]** + **[CALL]** and continue holding **[PTT]** down.

- The following display appears:



2 Enter the DTMF memory channel (1 to 5) that contains the DTMF number to be transmitted.

- The stored DTMF digits are displayed as they are transmitted.
- Transmission continues until all digits are sent. Releasing **[PTT]** will not interrupt the digits being sent or stop transmission.
- Selecting a DTMF memory channel that has no DTMF number stored causes the previous display to be restored.

■ Activating DTMF Transmit Hold

It's easier to enter a long string of digits if you don't have to hold down **[PTT]** while entering the digits. Your transceiver remains in the transmit state for 2 seconds after pressing each key when this function is activated.

1 Press **[CALL]** + **POWER ON** to enter Menu Set-up.

2 Turn the **ENC/SQL** control to select Menu No. 09.

- The current Transmit Hold status appears.
- The default is "OFF".

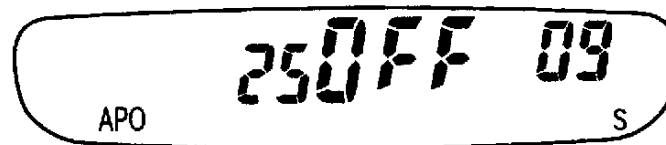

3 Press **[CALL]** to select "OFF" or "ON".

- OFF: Disables Transmit Hold.
- ON : Enables Transmit Hold.

4 Press any key other than **[CALL]**, **[LAMP]**, or **[MONI]** to exit Menu Set-up.

SCAN

Scan is a useful feature for hands-off monitoring of your favorite frequencies. After becoming comfortable with how to use all 4 types of scan, the monitoring flexibility gained will increase your operating efficiency.

The 4 types of scan are as follows:

Scan Type	Purpose
Memory Scan	Quick Activity update of your favorite frequencies.
VFO Scan	General update on band activity.
Call/VFO Scan	Monitor the Call channel plus any VFO frequency.
Call/Memory Scan	Monitor the Call channel plus your favorite frequency.

If PF keys on a microphone being used for remote control of your transceiver are assigned the UP/DOWN functions, scan direction can be reversed using these PF keys. Refer to page 50 for identification of the microphone PF keys and further information.

Note:

- ▶ *If Page or Tone Alert is ON, Scan will not function.*
- ▶ *For CTCSS operation, Scan stops and the squelch opens only for signals that contain the same CTCSS tone that is stored in your transceiver.*
- ▶ *For DTSS operation, Scan stops for any signal received; however, the squelch opens only for signals that contain the same DTSS code that is stored in your transceiver.*
- ▶ *When both CTCSS and DTSS are ON, Scan stops for signals that contain the matching CTCSS tone. However, the squelch opens only when the matching DTSS code is received.*

SCAN RESUME METHODS

When using Scan, it's necessary to decide under what condition you want your transceiver to continue scanning after detecting and stopping for a signal. You can choose Time-operated Scan or Carrier-operated Scan. The default is Time-operated Scan.

■ Time-Operated Scan

Your transceiver stops scanning after detecting a signal, remains there for approximately 5 seconds, and then continues to scan even if the signal is still present.

■ Carrier-Operated Scan

Your transceiver stops scanning after detecting a signal and remains on the same frequency until the signal drops out. There is a 2 second delay between signal drop-out and scan resumption to allow time for any responding stations to begin transmitting.

SELECTING THE SCAN RESUME METHOD

Use the following procedure to switch your transceiver between Time-operated Scan and Carrier-operated Scan.

- 1 Press **[CALL] + POWER ON** to enter Menu Set-up.
- 2 Turn the **ENC/SQL** control to select Menu No. 03.
 - The current Scan Resume status appears.
 - The default is "TO" (time-operated scan).

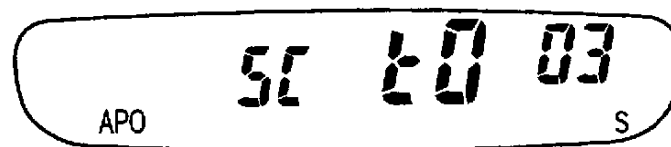

- 3 Press **[CALL]** to select either "TO" or "CO".
- 4 Press any key other than **[CALL]**, **[LAMP]**, or **[MONI]** to exit Menu Set-up.

Note: Holding **[MONI]** down while scanning halts Scan regardless whether Time-operated or Carrier-operated Scan is selected. Resume scanning by releasing **[MONI]**.

MEMORY SCAN

Memory Scan allows all memory channels containing data to be scanned.

- 1 Press **[MR]** (1 s).
 - Scan starts with the channel last recalled, then ascends up through the memory channels.
- 2 To reverse the scan direction and scan down through the memory channels, turn the **ENC/SQL** control counterclockwise.
 - Upward scan : Turn **ENC/SQL** clockwise.
 - Downward scan: Turn **ENC/SQL** counterclockwise.
- 3 To cancel Memory Scan, press any key other than **[MONI]** or **[LAMP]**.

At least 2 memory channels must contain data for Scan to function. Also, at least 2 memory channels must not be locked-out.

■ Locking-Out Memory Channels

Occasionally, you may wish to skip over specific memory channels while scanning.

- 1 Press **[MR]** to select Memory Recall.
- 2 Select the desired memory channel using the **ENC/SQL** control or the numeric keys that you wish to lock-out.
- 3 Press **[F]** (1 s), **[LAMP]** to lock-out the selected channel.
 - The "★" icon appears when a channel is locked-out.

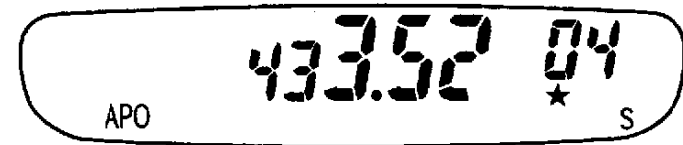

- Each time this key combination is pressed, the lock-out status toggles ON and OFF for the selected channel.
- The default is "OFF" (not locked out).

VFO SCAN

VFO Scan allows you to scan all frequencies tunable with the VFO using the currently selected frequency step size.

- 1 Press **[VFO]** (1 s).
 - Scan starts at the frequency currently displayed, then ascends upward.
- 2 To reverse the scan direction and scan down in frequency, turn the **ENC/SQL** control counterclockwise.
 - Upward scan : Turn **ENC/SQL** clockwise.
 - Downward scan: Turn **ENC/SQL** counterclockwise.
- 3 To cancel VFO scan, press any key other than **[MONI]** or **[LAMP]**.

CALL/VFO SCAN

Use Call/VFO Scan to monitor both the Call channel and the current VFO frequency.

- 1 Press **[VFO]**.
- 2 Press **[CALL]** (1 s).
- 3 To cancel Call/VFO Scan, press any key other than **[MONI]** or **[LAMP]**.

CALL/MEMORY SCAN

Use Call/Memory Scan to monitor both the Call channel and the memory channel last used.

- 1 Press **[MR]**.
- 2 Press **[CALL]** (1 s).
- 3 To cancel Call/Memory Scan, press any key other than **[MONI]** or **[LAMP]**.

SAVING POWER

BATTERY SAVER

Battery Saver becomes active when the squelch is closed and no key is pressed for more than 5 seconds. This feature becomes passive whenever any key is pressed or the squelch is opened. Once the squelch closes and 5 seconds pass with no further key entries, Battery Saver becomes active again.

Battery Saver does not function while scanning.

Activate Battery Saver by using the following procedure:

- 1 Press **[CALL]+ POWER ON** to enter Menu Set-up.
- 2 Turn the **ENC/SQL** control to select Menu No. 01.
 - The current Battery Saver status appears.
 - The default is "ON".

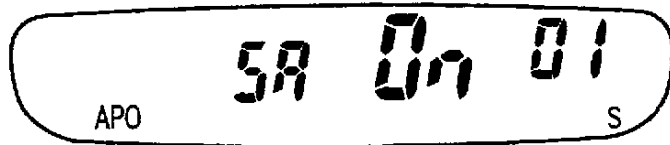

- 3 Press **[CALL]** to select "OFF" or "ON".
 - OFF: Turns OFF Battery Saver ("S" disappears).
 - ON : Turns ON Battery Saver ("S" appears).
- 4 Press any key other than **[CALL]**, **[LAMP]**, or **[MONI]** to exit Menu Set-up.

AUTOMATIC POWER OFF (APO)

After 1 hour elapses with no key entries, APO turns OFF the power; however, 1 minute before the power turns OFF, the APO indicator begins blinking and an audio tone sounds. When the power is turned OFF by APO, the frequency disappears from the display, however, "APO" remains blinking.

If the receiver squelch opens or any keys are pressed during the 1 hour period while APO is ON, the timer resets. When the squelch closes or key entry stops, the 1 hour timer begins counting again from 0. APO does not turn OFF the power if Tone Alert is ON.

Activate APO by using the following procedure:

- 1 Press **[CALL]+ POWER ON** to enter Menu Set-up.
- 2 Turn the **ENC/SQL** control to select Menu No. 02.
 - The current APO status appears.
 - The default is "ON".

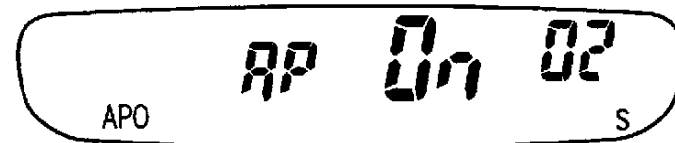

- 3 Press **[CALL]** to select "OFF" or "ON".
 - OFF: Turns OFF APO ("APO" disappears).
 - ON : Turns ON APO ("APO" appears).
- 4 Press any key other than **[CALL]**, **[LAMP]**, or **[MONI]** to exit Menu Set-up.

To restore power after APO has been activated, turn the **PWR/VOL** control.

CONTINUOUS TONE CODED SQUELCH SYSTEM (CTCSS)

The CTCSS feature is available only when a TSU-8 CTCSS unit is installed.

CTCSS functions by using subaudible tones that are superimposed on a transmitted signal to control a receiver's squelch. When used in combination with the noise squelch, CTCSS provides a simple method to selectively choose which stations will be heard. This transceiver offers a total of 38 standardized CTCSS frequencies.

Monitoring is less tiring when using CTCSS since you hear only those stations on a particular frequency that are transmitting the CTCSS tone that you have selected.

SELECTING CTCSS FREQUENCIES

Refer to the chart of frequencies available and the procedure for selecting the desired frequency on page 31.

USING CTCSS

To switch ON CTCSS, repeatedly press [T/CT] until "CT" appears on the display. Each time [T/CT] is pressed, the display changes as below:

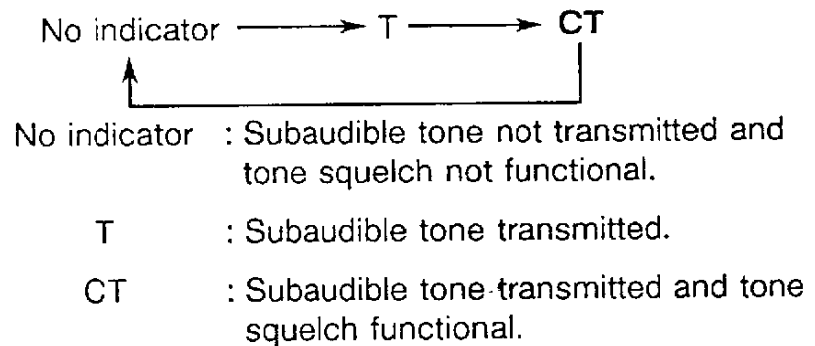

After switching ON the CTCSS function, the squelch will not open until a signal is received that has the selected CTCSS Tone superimposed on the signal.

To disable CTCSS, press [T/CT] again.

Note:

- ▶ "CT" will appear if [T/CT] is pressed when the TSU-8 CTCSS unit is not installed; however, CTCSS will not function.
- ▶ When using DTSS or Page with CTCSS, the squelch opens only if the correct CTCSS tone is received and the received DTSS or Page code matches the code stored in your transceiver.
- ▶ TH-22E/TH-42E:
Selecting the 1750 Hz tone inhibits CTCSS operation. In addition, selecting 1750 Hz switches CTCSS OFF automatically if this function is ON at the time. As soon as any Tone frequency other than 1750 Hz is selected, the previous CTCSS status (ON or OFF) is restored.

DUAL TONE SQUELCH SYSTEM (DTSS)

DTSS is available only on transceivers equipped with a DTMF keypad.

DTSS provides a more refined method than CTCSS to selectively communicate with specific stations. A total of 1000 3-digit DTMF (Dual Tone Multi-Frequency) codes are available to be used as addresses for stations with which you wish to communicate. These codes can be changed easily and regularly as required. Due to the quantity of different codes, large networks can be set up that use DTSS for selective calling and receiving. By including group codes in the network plan, sub-groups within the network can be contacted without disturbing others monitoring the same frequency.

If your needs are simpler, DTSS also serves a useful purpose when you only wish direct communication with a few close friends on your favorite frequency. A good example of this application is at hamventions when a particular frequency can be virtually unusable due to overcrowding. If your group switches ON DTSS, your squelch only opens when a call with your private address or the group address is received. If no signal is received for more than 2 seconds after DTSS has opened the squelch, the squelch then closes. Anytime you wish to monitor all activity on the channel, you simply switch OFF the DTSS function.

ACTIVATING DTSS

To switch ON the DTSS function, press [F], [2].

- "DT" appears when DTSS is ON.

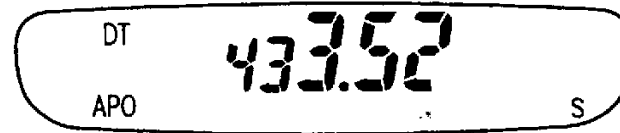

- Each time this key combination is pressed, DTSS toggles ON and OFF.

Note:

- ▶ When [F], [2] is pressed with Page ON, Page is automatically switched OFF, and DTSS is switched ON.
- ▶ Both DTSS status and a DTSS code can be stored in a memory channel or the Call channel. Further, when recalling either a memory channel or the Call channel with DTSS status ON while using the VFO with Page switched ON, Page is given priority and the DTSS status switches OFF.
- ▶ The microphone is inhibited while the DTSS code is transmitted.
- ▶ It's advisable to turn OFF Battery Saver when you use DTSS.

PAGE

OVERVIEW

Page is available only on transceivers equipped with a DTMF keypad.

Similar to DTSS, Page uses DTMF codes to address a single station or a group of stations. Page is useful when waiting to receive a call from a specific station. A common group Page code and individual codes should be agreed on in advance. You can select codes from the range 000 to 999 inclusive.

Unlike DTSS, Page offers the added benefit of identifying who called you. The calling station's code appears on the target transceiver's display. If called with an individual code, the individual caller code appears; if called with a group code, the group code appears. This characteristic of Page helps reduce the activity level on a frequency when operators are temporarily absent from their stations. There is no longer a need for repeated calls when your target station is not listening. On return to his or her operating position, their transceiver display will show your station code. They will know immediately that you called.

PAGE CODE MEMORY

The transceiver has 8 Page code memories in total.

- A : Stores your station code.
- 0 : Stores the calling station's code. The transceiver automatically stores this code while in Receive. You can also use the stored code to respond to the other station.
- 1 to 6 : Stores group codes or local station codes.

STORING PAGE CODES

To save the desired Page codes, use the following procedure:

- 1 Press [F], [1] to switch ON Page.
 - "PAG" appears when Page is ON.

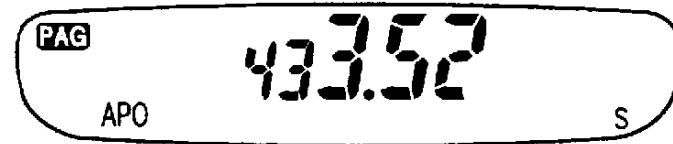

2 Press [F] (1 s), [1].

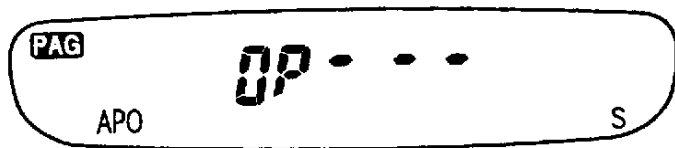

3 Turn the **ENC/SQL** control to select Page memory A.

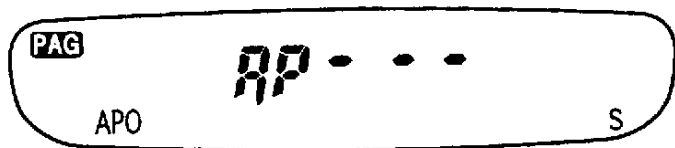

4 Enter your station code (000 to 999) using the numeric keys.

- This entry stores your station code in Page memory A.

5 Select Page memory 1 to 6 by turning the **ENC/SQL** control.

6 Enter a 3-digit group code or individual station code you wish to program using the numeric keys.

- To restore the frequency display, press [VFO], [MR], [CALL], [T/CT], or [REV].

7 To store additional group or individual codes, repeat Steps 5 and 6.

You can immediately use the group code or individual station code that was stored or selected last.

CALLING

1 Tune to the prearranged frequency.

2 Press [F], [1] to switch ON Page.

- "PAG" appears.
- Each time this key combination is pressed, Page toggles ON and OFF.

3 Press [F] (1 s), [1] to select Code Select.

4 Turn the **ENC/SQL** control to select the Page memory where the desired group code or individual station code has been stored.

- If you have not stored the desired Page code in a memory from 1 to 6, select memory 0 and store the Page code at this time.

5 Press and hold [PTT], then call the other station after the code transmission completes.

- The group code (or individual station code) and your station code are transmitted.

Note:

- ▶ When Page is ON, Scan cannot be used.
- ▶ When Page is ON, choosing the VFO, the Call channel, or a memory channel does not affect the Page status. Page remains ON.
- ▶ When Page is switched ON while DTSS is ON, DTSS is switched OFF automatically.

RECEIVING

- 1 Tune to the prearranged frequency.
- 2 Press **[F]**, **[1]** to switch ON Page.
 - "PAG" appears.

You are ready to receive a call addressed with your station code or a group code. If no signal is received for more than 2 seconds after a Page has opened the squelch, the squelch then closes.

■ Receiving a Call with your Station Code

When a signal is received encoded with your individual code, the squelch opens and you hear an alert tone from the speaker. In addition, the display shows "OP" and the calling station's code.

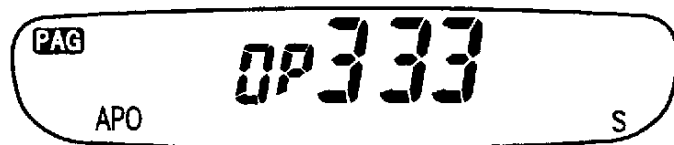

Press **[PTT]** while "PAG" is blinking to respond to the calling party.

■ Receiving a Call with a Group Code

When a signal is received encoded with the correct group code, the squelch opens and you hear an alert tone from the speaker. In addition, the display shows the received group code and in which memory (1 to 6) that group code has been stored.

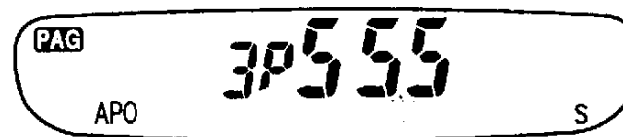

Press **[PTT]** while "PAG" is blinking to respond to the calling party.

Note:

- ▶ "E" appears on the display if your transceiver fails to receive the Page code correctly.
- ▶ The microphone is inhibited while the Page code is transmitted.
- ▶ It's advisable to turn OFF Battery Saver when you use Page.

PAGE CODE AND REPEATERS

Pressing [PTT] transmits the Page code after a short delay. This delay helps avoid losing Page data when using repeaters with long response times that may miss receiving a portion of the Page code.

The delay time is 350 ms during simplex operation.

When using transmit offset or split operation, you can change 350 ms (default) to 550 ms.

- 1 Press [CALL] + **POWER ON** to enter Menu Set-up.
- 2 Turn the **ENC/SQL** control to select Menu No. 08.
 - The current delay time is displayed.

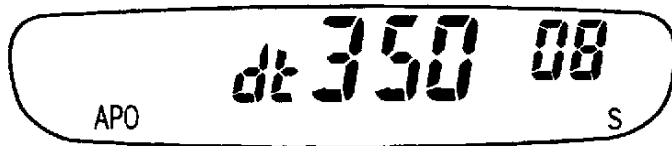

- 3 Press [CALL] to select "350" or "550".
- 4 Press any key other than [CALL], [LAMP], or [MONI] to exit Menu Set-up.

LOCKING-OUT CODES

The following explains how to inhibit the transceiver from receiving specific Page codes. Although the codes are locked-out from the receiver, the transmitter still transmits a Page on the locked out channels.

- 1 Press [F], [1].
 - "PAG" appears.
- 2 Press [F] (1 s), [1] to select Code Select.
- 3 Turn the **ENC/SQL** control to display the Page code to be locked-out.
- 4 Press [F] (1 s), [LAMP].
 - A "★" icon on the display indicates the Page code is locked-out.

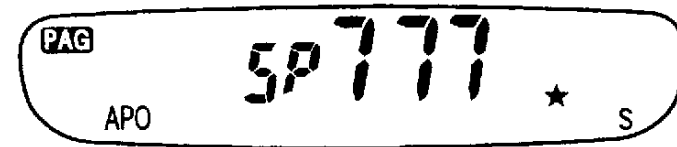

- Each time this key combination is pressed, the selected Page code is locked-out and unlocked alternately.

Note: You cannot lock-out memory 0 that stores the calling station's code.

AUTO PAGE CANCEL

After successfully paging another station, it is useful to turn OFF Page to eliminate sending a Page code each time you transmit. Auto Page Cancel handles this situation automatically when a station you called responds using the correct Page code to open your transceiver's squelch. On your next transmission, your transceiver then switches OFF your transceiver's Page function.

- 1 Press **[CALL]+ POWER ON** to enter Menu Set-up.
- 2 Turn the **ENC/SQL** control to select Menu No. 11.
 - The current Page Cancel status appears.
 - The default is "OFF".

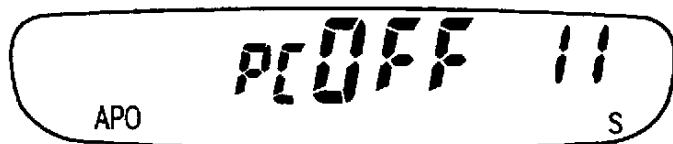

- 3 Press **[CALL]** to select "OFF" or "ON".
 - OFF: Does not affect Page status.
 - ON : Switches OFF Page after transmission.
- 4 Press any key other than **[CALL]**, **[LAMP]**, or **[MONI]** to exit Menu Set-up.

OPEN PAGE

When both this function and Page are ON, any signal opens the squelch; however, if a correct Page code is received, the calling station's code appears on the display. This feature is beneficial when you want to generally monitor activity on a frequency but you want to be especially sure not to miss a friend's call.

- 1 Press **[CALL]+ POWER ON** to enter Menu Set-up.
- 2 Turn the **ENC/SQL** control to select Menu No. 10.
 - The current Open Page status appears.
 - The default is "OFF".

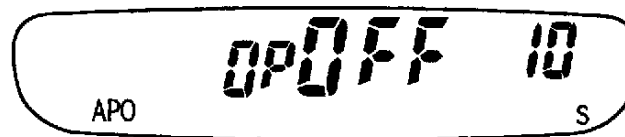

- 3 Press **[CALL]** to select "OFF" or "ON".
 - OFF: Noise squelch functions.
 - ON : Open Page functions.
- 4 Press any key other than **[CALL]**, **[LAMP]**, or **[MONI]** to exit Menu Set-up.

TONE ALERT

Tone Alert provides an audible alarm to indicate when someone is transmitting on the frequency you are monitoring.

Tone Alert is an effective partner with CTCSS, Page, or DTSS. When the correct signaling comes through, your transceiver beeps to alert you of an incoming call from a specific station.

ACTIVATING TONE ALERT

- 1 Tune to the prearranged frequency.
- 2 Activate CTCSS, Page, or DTSS if you want to use these together with Tone Alert.
- 3 Press [F], [CALL].
 - The "bell" icon appears.

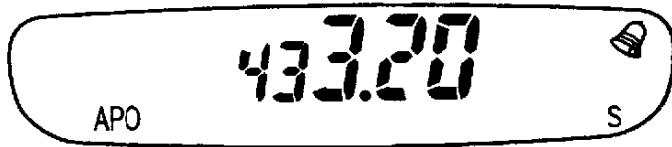

- Each time this key combination is pressed, Tone Alert toggles ON and OFF.

- 4 When the correct signal is received, the transceiver beeps and the "bell" icon begins blinking.

- The Display shows the number of hours and minutes elapsed after the signal was received. After 100 hours pass, the displayed time resets, and counting continues from 00.00. Each time a new signal is received, the time resets to 00.00.

- 5 When the "bell" icon is blinking, exit Tone Alert by pressing [PTT].

- TH-22E/TH-42E: Pressing [T/CT] also cancels this function.

Note:

- ▶ If Tone Alert is ON, APO does not turn the power OFF.
- ▶ If Tone Alert is ON, there is no speaker output except the beep tone.
- ▶ When a signal is received with the Beep function OFF, the "bell" icon blinks, but an alarm tone is not generated.
- ▶ For Tone Alert to function correctly with CTCSS, the incoming signal must be present for approximately 1 second.
- ▶ If Tone Alert is ON, Scan cannot be used.
- ▶ For Tone Alert to function correctly with DTSS or Page, the correct code must accompany the incoming signals.

REMOTE CONTROL

REMOTE CONTROL USING SMC-33 OR SMC-34

The optional SMC-33 or SMC-34 can be used to remotely control the transceiver for added convenience. The default assignments for the [1], [2], and [3] keys on these options are the functions of the [VFO], [MR], and [CALL] keys respectively on the transceiver (1: VFO, 2: MR, 3: CALL). These keys are referred to as PF keys.

Use the default assignments without further change or, if you prefer, customize the key functions using the following procedure:

- 1 Make sure that Key Lock is turned OFF on the transceiver.
- 2 On the option, press [1], [2], or [3] + POWER ON.

Example: Press [1] + POWER ON.



- 3 Press the transceiver key(s) for the function that you wish to assign to the option key pressed in Step 2.

The assignment is completed. Repeat the same procedure if you wish to assign different functions to the other keys on the option.

Assignable functions are listed below:

Function	Key Entry	Function	Key Entry
VFO select	[VFO]	Tone Alert ON/OFF	[F], [CALL]
Memory recall	[MR]	Squelch set	[F], [MONI]
Call channel recall	[CALL]	Frequency step	[F], [T/CT]
Monitor ON/OFF	[MONI]	Page ON/OFF	[F], [1]
Frequency select (UP)	ENC/SQL clockwise	DTSS ON/OFF	[F], [2]
Frequency select (DWN)	ENC/SQL counterclockwise	DTMF memory read	[F], [3]
Reverse ON/OFF	[REV]	Lamp ON/OFF	[LAMP]
Tone/CTCSS ON/OFF	[T/CT]	Lamp latch ON/OFF	[F], [LAMP]
Memory transfer	[F], [VFO]	TX power select	[F], [PTT]
Key Lock ON/OFF	[F], [MR]	TX offset direction	[F], [REV]

Note:

- ▶ Turn OFF the transceiver power before connecting the option.
- ▶ Locking the transceiver keys with Key Lock does not lock the [1], [2], and [3] keys on the options.
- ▶ Option keys [1], [2], and [3] are not functional while transmitting.

CONNECTING EQUIPMENT FOR REMOTE CONTROL

Make connections as below when controlling equipment remotely.

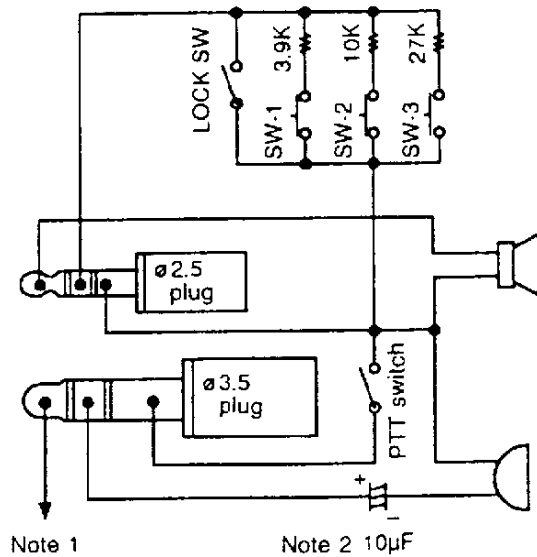

Note 1: Voltage is developed across the 220 Ω resistor in the 3 V line. (When 2 mA flows, about 2.5 V is developed.)

Note 2: A 10 μ F capacitor is not required in the following cases. Make direct connections.

- When the other equipment has DC blocking capacitors.
- When a two-terminal condenser microphone is used.

PACKET OPERATION

One of the most exciting benefits of owning a handy FM transceiver nowadays is the ability to use it for VHF or UHF packet radio. Due to the small size of the TH-22/TH-42 series handhelds, they are particularly handy for mobile or portable packet operation. By using a small laptop computer to control any of the widely available Terminal Node Controllers (TNC), and interfacing the TNC to your transceiver via the external microphone and speaker jacks, you may be surprised at how compact and lightweight a digital station can be. Operating packet while on the road from a campsite or hotel can be a great way to meet others with common interests when in a new area or city. Newcomers to digital communications will be surprised to discover what they have been missing.

Similarly, by connecting a home computer or dumb terminal, which you may have in your shack already, to your TNC/transceiver assembly, you can become active on packet with little further monetary investment.

In either case, connecting to one of the many stations with gateways to HF or satellite links can give you national and worldwide messaging capability from your station with nothing more than your handheld for the communications link.

Refer to "CONNECTING OPTIONAL EQUIPMENT" {page 62} for basic connection information for the external microphone and speaker jacks. Consult your TNC instruction manual for additional information about connecting a TNC to your transceiver. Much reference material is available for getting started in digital communications from any store that handles Amateur Radio equipment.

Note: This transceiver is not recommended for 9600 bps Packet operation since using the microphone/speaker jacks as an interface may not provide reliable operation at this high transmission speed.

MAINTENANCE

GENERAL INFORMATION

Your transceiver has been factory aligned and tested to specification before shipment. Under normal circumstances, the transceiver will operate in accordance with these operating instructions. All adjustable trimmers, coils and resistors in the transceiver were preset at the factory. They should only be readjusted by a qualified technician who is familiar with this transceiver and has the necessary test equipment. Attempting service or alignment without factory authorization can void the transceiver warranty.

When operated properly, the transceiver will provide years of service and enjoyment without requiring further realignment. The information in this section gives some general service procedures requiring little or no test equipment.

SERVICE

If it is ever necessary to return the equipment to your dealer or service center for repair, pack the transceiver in its original box and packing material. Include a full description of the problems experienced. Include your telephone number along with your name and address in case the service technician needs to call for further explanation while investigating your problem. Don't return accessory items unless you feel they are directly related to the service problem.

You may return your transceiver for service to the authorized KENWOOD Dealer from whom you purchased it or any authorized KENWOOD service center. A copy of the service report will be returned with the transceiver. Please do not send subassemblies or printed circuit boards. Send the complete transceiver.

Tag all returned items with your name and call sign for identification. Please mention the model and serial number of the transceiver in any communication regarding the problem.

SERVICE NOTE

Dear YL/OM,

If you desire to correspond on a technical or operational problem, please make your note short, complete, and to the point. Help us help you by providing the following:

- 1 Model and serial number of equipment
- 2 Question or problem you are having
- 3 Other equipment in your station pertaining to the problem
- 4 Meter readings
- 5 Other related information

CAUTION: *Do not pack the equipment in crushed newspapers for shipment! Extensive damage may result during rough handling or shipping.*

Note:

- ▶ *Record the date of purchase, serial number and dealer from whom the transceiver was purchased.*
- ▶ *For your own information, retain a written record of any maintenance performed on the transceiver.*
- ▶ *When claiming warranty service, please include a photocopy of the bill of sale, or other proof of purchase showing the date of sale.*

CLEANING

The keys, controls and case of the transceiver are likely to become soiled after extended use. Remove the controls from the transceiver and clean them with a neutral detergent and warm water. Use a neutral detergent (no strong chemicals) and a damp cloth to clean the case.

TROUBLESHOOTING

The problems described in this table are commonly encountered operational malfunctions. These types of difficulties are usually caused by improper hook-up, accidental incorrect control settings, or operator error due to incomplete programming, and are not caused by a circuit failure. Please review this table, and the appropriate section(s) of this Instruction Manual, before assuming your transceiver is defective.

Problem Symptom	Probable Cause	Corrective Action
Nothing appears on the display when the transceiver is switched ON (PWR/VOL control turned clockwise), or the entire display is blinking ON and OFF.	<ol style="list-style-type: none"> 1 Low supply voltage 2 If using optional DC cable: <ol style="list-style-type: none"> a) Bad power cable or connections b) Open power supply fuse 	<ol style="list-style-type: none"> 1 Recharge the battery pack or replace the batteries. 2 <ol style="list-style-type: none"> a) Check power cable and connections, then repair/replace as necessary. b) Investigate the cause for the open fuse. Replace the fuse.
No sound comes from the speaker.	Noise squelch is closed since no stations are on frequency.	None necessary. The speaker output is muted automatically if no signals are being received. Press [MONI] to override the noise squelch and verify no stations are on frequency {page 13}.

Continued

Problem Symptom	Probable Cause	Corrective Action
No sound comes from the speaker; stations are on frequency.	<ol style="list-style-type: none"> 1 The squelch threshold level is set too high. 2 DTSS is ON ("DT" is visible); DTSS codes that you are receiving are different from the code set in your transceiver. 3 Page is ON ("PAG" is visible); Page codes that you are receiving are different from those set in your transceiver. 4 If the TSU-8 CTCSS option is installed, CTCSS is ON ("CT" is visible); CTCSS tones that you are receiving are different from the CTCSS tone frequency set in your transceiver. 5 Tone Alert is ON ("Bell" icon is visible). 	<ol style="list-style-type: none"> 1 Reset the squelch threshold level {page 13}. 2 To monitor activity, press [F], [2] to turn OFF DTSS or press [MONI] {page 13}. To contact the stations, review the "DTSS" section {page 41}. 3 To monitor activity, press [F], [1] to turn OFF Page or press [MONI] {page 13}. To contact the stations, review the "Page" section {page 43}. 4 To monitor activity, press [T/CT] to turn OFF CTCSS or press [MONI] {page 13}. To contact the stations, review the "CTCSS" section {page 40}. 5 Press [F], [CALL] to turn OFF Tone Alert {page 48}.
Most controls do not function.	<ol style="list-style-type: none"> 1 Key Lock is ON ("Lock" icon is visible). 2 Tone Alert is ON ("Bell" icon is visible). 	<ol style="list-style-type: none"> 1 Press [F], [MR] to turn OFF Key Lock {page 17}. 2 Press [F], [CALL] to turn OFF Tone Alert {page 48}.
Memory channels cannot be recalled.	There is no data stored in any of the memory channels.	Review "STORING DATA IN MEMORY" {page 21}.

Continued

Problem Symptom	Probable Cause	Corrective Action
The display shows indicators that are not described in this instruction manual or digits are incomplete. Or, functions do not work as described.	The transceiver needs to be reset.	Review "INITIALIZING MEMORY" {page 26}.
The ENC/SQL control will not select the exact frequency desired.	The current frequency step needs to be changed.	Select a new frequency step as explained in "SELECTING FREQUENCY STEP SIZE" {page 14}.
Memory Scan does not check some or any frequencies stored in your memory channels.	Some or all channels are locked-out as indicated by the "★" icon on the display under the channel number when these channels are selected.	Unlock the channels that you want scanned. Review "Locking-Out Memory Channels" {page 37}.
The transceiver will not transmit. A beep is heard each time [PTT] is pressed.	A frequency outside the transmit band of the transceiver is selected.	Select a frequency inside the transmit band. Consult "SPECIFICATIONS" {page 63}.
The transceiver switches OFF for no apparent reason.	The Automatic Power Off function is ON.	Turn the APO function OFF {page 39}.

Continued

Battery Case
BT-9



Wall Charger
BC-17



Rapid Charger
KSC-14



DC Cable
PG-2W

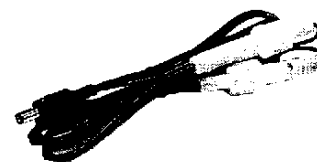

Filtered Cigarette Lighter Cable
PG-3J



Hand Strap
HB-2

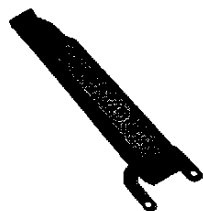

Swivel Mount
BH-6



Water-resistant bag
WR-2

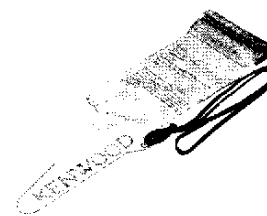

Soft Case (for PB-30 & PB-32)
SC-37



Soft Case (for PB-30 & BT-9)
SC-38



Soft Case (for PB-33 & PB-34)
SC-39



Soft Case with Shoulder Belt
SC-40

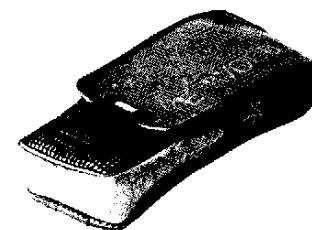

INSTALLING THE SPEAKER-MIC JACK STRAIN RELIEF

When using the SMC-31, SMC-32, SMC-33, or SMC-34 options, you should install the cable tie supplied with the transceiver to act as a strain relief for the option cable.

- 1 Remove the speaker-microphone jack protector cap and the transceiver handle.
 - Store the items in a safe place for use when you remove your option.
- 2 Plug the option connector into the speaker-microphone jack.
- 3 Wrap the cable tie around the option cable approximately 4 to 5 cm from the option connector. Insert the cable tie end into its clasp and pull the cable tie end until the tie is snugly holding the option cable.
 - The tie end should be pointing away from the side of the transceiver.

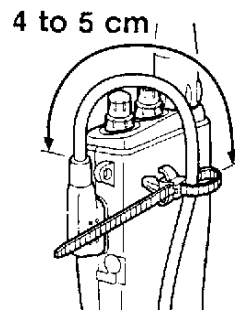

- 4 Cut off the end of the cable tie.
 - If you plan to remove the tie and re-use it again later, do not cut the tie flush with the clasp. Leave at least 1 or 2 cm protruding through the clasp.
 - Removing the cable tie is done by inserting a wire, such as a paper clip, into the latching tab in the cable tie clasp while pushing the cable tie end out of the clasp.

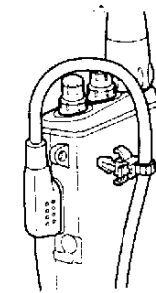

- 5 Insert the support stud on the cable tie into the handle loop on the side of the transceiver. Press in securely.

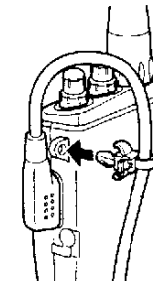

CONNECTING OPTIONAL EQUIPMENT

When connecting an external speaker, an external microphone, or other equipment such as a TNC for packet radio to the speaker or microphone jack, refer to the diagram below:

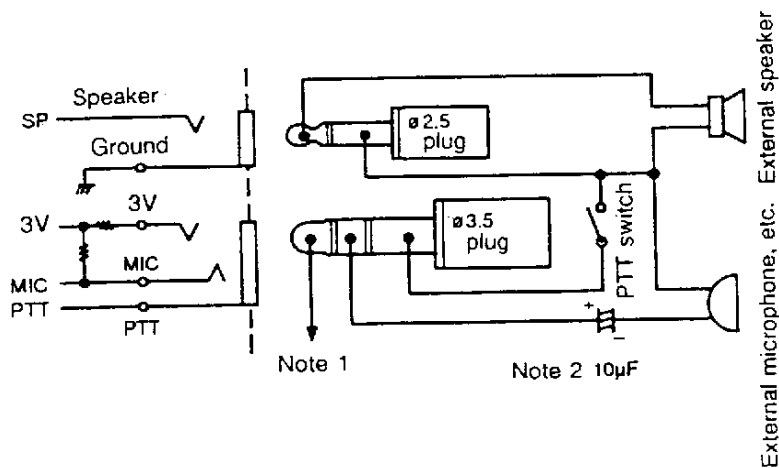

Note 1: Voltage is developed across the 220 Ω resistor in the 3 V line. (When 2 mA flows, about 2.5 V is developed.)

Note 2: A 10 μ F capacitor is not required in the following cases. Make direct connections.

- When the other equipment has DC blocking capacitors.
- When a two-terminal condenser microphone is used.

CAUTION: To connect an external 24 V power source via a DC-DC converter, only use a PG-3J Cigarette Lighter cable.

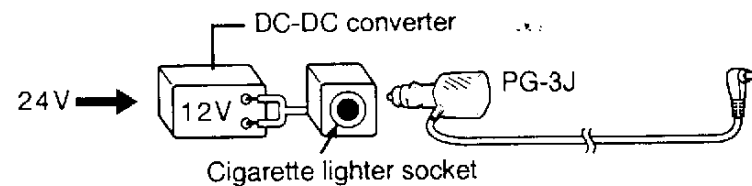
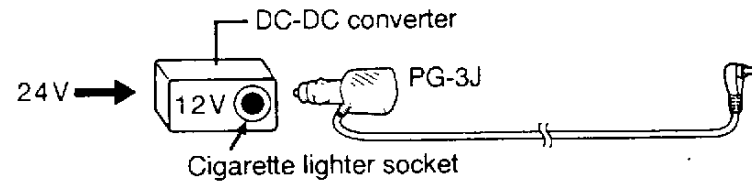

CAUTION: NEVER use a PG-2W DC cable in this situation; doing so may cause a fire.

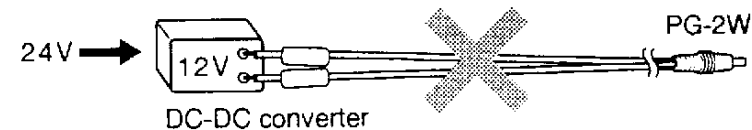

SPECIFICATIONS

		TH-22A/22AT/22E	TH-42A/42AT/42E
General			
Frequency range			
U.S./Canada		144 to 148 MHz	438 to 450 MHz
Europe		144 to 146 MHz	430 to 440 MHz
Australia		144 to 148 MHz	—
General market		144 to 148 MHz ¹	430 to 440 MHz
Mode		F2, F3 (FM)	
Usable temperature range		-20°C to +60°C	
Rated Voltage	External power supply (DC IN)	5.0 to 16.0 V(13.8 V)	
	Battery terminals	4.0 to 15.0 V (6.0V)	
Current	Receive with no signal	Average 45 mA	Average 45 mA
	Battery Saver ON	Approx. 15 mA	Approx. 15 mA
	Transmit with H, 13.8V	Approx. 1.3 A	Approx. 1.6 A
	Transmit with H, 6.0V	Approx. 1.3 A	Approx. 1.6 A
	Transmit with L, 6.0V	Approx. 0.5 A	Approx. 0.5 A
	Transmit with EL, 6.0V	Approx. 250mA	Approx. 250mA
Grounding method		Negative ground	
Dimensions (W x H x D)		56 × 116.5 × 24.5 mm	
Dimensions (projections included)		65 × 130.5 × 29.8 mm	
Weight ²		Approx. 290 g	
Microphone impedance		2 kΩ	
Antenna impedance		50 Ω	

¹ Some versions have reduced RX and TX range: 144 to 146 MHz

² Antenna, hand strap, belt hook, and PB-32 included

		TH-22A/22AT/22E	TH-42A/42AT/42E
Transmitter			
Power output	H, 13.8 V	Approx. 5 W	
	H, 6.0 V	Approx. 3 W	Approx. 2.5 W
	L, 6.0 V	Approx. 0.5 W	
	EL, 6.0 V	Approx. 30 mW	
Modulation		Reactance	
Maximum frequency deviation		± 3.5 kHz to ± 5 kHz	
Spurious emissions		-60 dB or less	
Receiver			
Circuitry		Double conversion superheterodyne	
1st intermediate frequency		45.05 MHz	
2nd intermediate frequency		455 kHz	
Sensitivity (12 dB SINAD)		-16 dB _μ 0.16 μV or less	-15 dB _μ 0.18 μV or less
Squelch sensitivity		-20 dB _μ (0.1 μV) or less	
Selectivity (-6 dB)		12 kHz or more	
Selectivity (-40 dB)		28 kHz or less	
Audio output (10% distortion)		200 mW or higher (8 Ω load)	

Specifications are subject to change without notice due to developments in technology, and are guaranteed within Amateur bands only.

GLOSSARY

1 MHz Step

A function that steps the transceiver up or down in frequency by exactly 1 megahertz and increments or decrements the MHz digit by 1. The function works in a circular fashion. If a 1 megahertz step places the new frequency outside the transceiver band limit, the transceiver sets the MHz digit such that the new frequency is inside the opposite band limit.

APO (Automatic Power Off)

A function that automatically turns OFF the transceiver after some period of inactivity. The purpose is to prevent a forgetful operator from accidentally discharging the transceiver's battery supply.

Auto Page Cancel

A function that automatically switches OFF the Page function after Page codes have been transmitted. The purpose is to avoid sending Page codes at the start of every transmission.

Automatic Transmit Offset

This function is for repeater users. It automatically selects the correct transmit frequency offset (both direction and amount) according to established band plans.

Autopatch

A service available widely in the U.S.A. and Canada that allows portable or mobile stations to access the public switched network by connecting through a local repeater. Telephone numbers are sent via DTMF signals by using the keypad. Only non-commercial communication is authorized.

Battery Saver

An energy-saving function that reduces power consumption after 5 seconds of inactivity. The function makes possible longer times between battery charges.

BNC

A threadless connector universally used at VHF and lower UHF frequencies. The connection is secured by a quarter-twist of the male connector.

Beep Tone

A selectable function that generates a tone each time a key is pressed to provide audible confirmation that the key was actually pressed, or to provide an error tone to indicate an error condition exists.

Busy Frequency Lock-out

A function that automatically prevents transmission on a frequency that is busy.

Call channel

A frequency intended for establishing contact with other stations. A transceiver key is dedicated to the Call channel so the frequency can be recalled quickly.

Call/Memory Scan

A scan function that allows alternate monitoring of the Call channel and the current memory channel. The current memory channel is the memory channel selected or used last. See "Scan".

Call/VFO Scan

A scan function that allows alternate monitoring of the Call channel and the current VFO frequency. The current VFO frequency is the frequency selected or used last while in VFO mode. See "Scan".

Channel Display

A function that shows only the memory channel number on the display instead of both the frequency and the memory channel number.

CO (Carrier-operated) Scan

When scanning, Scan stops at all carriers received and resumes 2 seconds after the carrier stops.

CTCSS (Continuous Tone Coded Squelch System)

Also referred to as Tone Squelch. A method of receiver squelch control that uses a subaudible tone superimposed by the transmitter on the transmitted signal. Only signals received with a subaudible tone that matches the tone selected at the receiver can open the receiver squelch.

CTCSS frequency

The subaudible frequencies used by CTCSS.

Default settings

The values selected for VFO frequency, Call channel frequency, frequency step, etc. by the transceiver after it is reset. All transceivers are shipped from the factory with default settings.

DTMF (Dual Tone Multi-Frequency) signal

A signal created by combining two discrete audio frequencies. Generally used for sending digits for repeater control or Autopatch applications.

DTMF Transmit Hold

A function that keeps the transmitter keyed while DTMF signals are sent. The function eliminates the need to hold PTT while pressing individual keys to send the DTMF signals.

DTSS (Dual Tone Squelch System)

A squelch control system that relies on a burst of data from the transmitter to open the receiver squelch. Only when the transmitted code matches the code programmed in the receiver will the squelch open.

DTSS Transmit Delay

The delay intentionally introduced at the transmitter to delay transmission of DTSS codes after PTT is pressed. The delay can improve the reliability of DTSS when communicating with a receiver with slow response time.

Dual function keys

Transceiver keys assigned with two functions. This method reduces the number of keys or controls necessary which allows greater reduction in transceiver size.

Encoder (ENC/SQL control)

The control that alters the transceiver VFO frequency. See "Frequency step".

Encoder Lock

A function that disables the ENC/SQL control.

Frequency step

The size of frequency change produced when the ENC/SQL control is turned one position while in VFO mode.

Group code

When using Page, a group will commonly agree on a single code that will be used for calls targeted for all members. This code is the Group code. See "Individual code".

Individual code

When using Page, each station must be assigned a unique code that no other station uses. This is the Individual code. Only the squelch of the targeted station will open when a transmission with this Individual code is made. See "Group code".

Key Lock

A function that disables almost all keys and controls on the transceiver. The purpose is to avoid accidentally changing settings on the transceiver.

Keypad

The collection of keys used to send DTMF signals and select DTSS and Page codes.

Locked-out channel

An electronically marked memory channel that will be skipped during Memory Scan. This is a quick way to configure your Memory Scan without actually erasing data from memory channels that you may wish to keep.

Memory channel

A "storage" location where you record an operating frequency and many other associated parameters for quick recall later. Normally, all commonly used frequencies including those of local repeaters would be saved in memory channels to eliminate manually selecting frequently-used frequencies.

Memory Recall

A function that fetches a previously saved operating frequency and associated data. See "Memory channel".

Memory Scan

A function that monitors sequentially all programmed memory channels that are not locked-out. See "Scan".

Memory Storage

A function that saves an operating frequency and associated data into a memory channel. See "Memory channel".

Memory → VFO Transfer

A function that records the current memory channel data into the VFO plus selects VFO mode. This transfer action does not affect the data stored in the memory channel.

Menu Set-up

This is a newer term introduced with the creation of a Menu system for configuring transceiver features. Menu Set-up allows functions to be turned ON or OFF, or values to be set, through software rather than physical keys or controls. Once you learn how to access the Menu, the standardized method of configuring features simplifies operation.

MHz Step

See "1 MHz Step".

Microphone PF (Programmable Function) keys

Keys located on some microphones that can have transceiver functions assigned to them. Key assignments can be changed as necessary.

Monitor

A function that overrides any squelch systems being used so activity on a frequency can be heard. This is handy to quickly listen to a frequency without actually changing the squelch setting or disabling the squelch system.

NiCd

Abbreviation for nickel-cadmium. This refers to the material used to make rechargeable battery packs used in modern transceivers.

Non-standard offset

Refers to a transmit frequency offset used to access repeaters that is some value or direction other than that stipulated by existing band plans for a particular region. See "Transmit offset".

Open Page

When used in conjunction with Page, all signals received will open the receiver squelch. However, for signals encoded with a Page code, the calling station's Page code appears on the target transceiver's display.

Page

A function that allows one station to signal another by sending a transmission encoded with a Page code that only opens the squelch of a receiver with the same code selected. The calling station's code identifier appears on the target station's display after a successful Page.

Page code memory

A memory channel dedicated to storing only Page codes. See "Page".

Page Transmit Delay

The delay intentionally introduced at the transmitter to delay transmission of Page codes after PTT is pressed. The delay can improve the reliability of Page when communicating with a receiver with slow response time.

PTT (Push-to-talk)

Refers to the non-latching switch that changes the transceiver from Receive to Transmit mode.

QSO

Refers to a contact between two Amateur stations.

Repeater

A station, usually installed in a central location at a high elevation, designed to receive and re-transmit signals. The purpose of a repeater is to increase the receive and transmit range of stations able to access the repeater.

Reset (initialization)

The act of restarting the transceiver microcomputer. Depending on the type of reset done, some or all memory may be erased and set to default values. A reset can be done as a last resort when the transceiver appears to be malfunctioning.

Reverse

A function that switches the transmit and receive frequencies.

Scan

The general term for several functions that allow a series of frequencies or memories to be monitored sequentially and automatically without intervention by the operator.

Simplex channel

Refers to a communications channel where the receive and transmit frequencies are the same.

Split channel

Refers to a communications channel where the receive and transmit frequencies are not the same.

Squelch

A function that automatically mutes a receiver's speaker output when no receive signal is present. Functions most reliably when communicating via full carrier modes such as FM.

Squelch threshold level

The receive level at which a receiver's speaker output is muted. This level is usually adjustable, either manually or automatically by the transceiver microcomputer.

Standard offset

Refers to a transmit frequency offset used to access repeaters that is equal to the amount and direction stipulated by existing band plans for a particular region. See "Transmit offset".

Subaudible tone

A low-frequency non-audible signal superimposed on a transmitted signal for the purpose of accessing some types of repeaters.

SWR (standing wave ratio)

An antenna that is not correctly matched in impedance with a transmission line and transmitter will reflect some portion of the transmitted signal back toward the transmitter. This causes a standing wave pattern to develop. The ratio of maximum to minimum voltage (VSWR) on the transmission line when such a condition exists is commonly referred to as the SWR.

TO (Time-operated) Scan

When scanning, scan stops at all carriers received and resumes after 5 seconds.

Tone Alert

A function that alerts an operator via a visual and audible alarm when the receiver squelch opens.

Tone frequency

See "Subaudible tone".

TOT (Time-out Timer)

A function that automatically forces a transceiver from Transmit back to Receive after timer expiration.

Transmit Inhibit

A function that stops a transceiver from transmitting. The function has no effect on the receiver or receive functions.

Transmit offset (shift)

All Amateur voice repeaters operate on separate transmit and receive frequencies. Transmit offset refers to the amount that a transmit frequency is different from a receive frequency. See "Transmit offset direction".

Transmit offset (shift) direction

Refers to the direction, either plus (+) or minus (-), that a transmit frequency is with respect to a receive frequency. Both the direction and amount of offset must be selected correctly to access a repeater. See "Transmit offset".

Tuning Encoder Lock

See "Encoder Lock".

VFO (variable frequency oscillator) mode

The mode that allows any individual frequency to be selected within the range of the VFO only restricted by frequency step limitations. When in VFO mode, frequencies are selected using the ENC/SQL control.

VFO Scan

A function that monitors sequentially all frequencies that can be selected using the ENC/SQL control while in VFO mode. See "Scan".

QUICK REFERENCE GUIDE

This guide assumes your transceiver is currently in VFO mode.

Function	Menu No.	Action	Page
Power ON/OFF	- -	PWR/VOL	13
Automatic Power Off (APO) ON/OFF	02	Menu Set-up (After APO turns transceiver OFF: PWR/VOL)	39
Autopatch	- -	See DTMF and DTMF Memory	31
Battery Saver ON/OFF	01	Menu Set-up	39
Beep Tone ON/OFF	04	Menu Set-up	18
Call Channel			
• Store simplex	- -	Select data → [F](1 s) → [CALL]	25
• Store split	- -	Store RX data → Select TX frequency → [F](1 s) → [PTT] + [CALL]	25
• Recall	- -	[CALL]	24
• Transfer (Call > VFO)	- -	[CALL] → [F], [VFO]	23
Channel Display ON/OFF	12	Menu Set-up	25
CTCSS			
• Select	- -	[F](1 s), [T/CT] → ENC/SQL → [VFO] ¹	31
• ON/OFF	- -	ON: [T/CT], [T/CT] OFF: [T/CT]	40

Continued

Function	Menu No.	Action	Page
DTMF			
• Transmit	--	[PTT] + DTMF key	32
• Transmit Hold	09	Menu Set-up	34
DTMF Memory			
• Store	--	[F](1 s), [3] → Enter number → [MR], [1] to [5]	32
• Confirm	--	[F], [3] → [1] to [5]	33
• Transmit	--	[PTT] + [CALL] → [1] to [5]	34
DTSS			
• Store	--	[F], [2] → [F](1 s), [2] → Enter code	42
• Delay (split)	08	Menu Set-up	42
• ON/OFF	--	[F], [2]	41
Frequency			
• Step	--	[F], [T/CT] → ENC/SQL → [VFO] ¹	14
• 1 MHz Step	--	[F] → ENC/SQL → [F]	17
Key Lock			
• ON/OFF	--	[F], [MR]	17
• ENC/SQL Lock ON/OFF	06	Menu Set-up	18

Continued

Function	Menu No.	Action	Page
Memory			
• Store simplex	--	Select data → [F](1 s) → ENC/SQL → [MR]	21
• Store split	--	Store RX data → Select TX frequency → [F](1 s) → ENC/SQL → [PTT] + [MR]	22
• Recall	--	[MR] → ENC/SQL or Numeric Keys (2 digits)	23
• Transfer (Memory > VFO)	--	[MR] → ENC/SQL → [F], [VFO]	23
• Erase	--	[MR] → ENC/SQL → POWER OFF → [MR] + POWER ON	24
• Reset (Full)	--	[F] + POWER ON	26
Menu Set-up	--	[CALL] + POWER ON → ENC/SQL → [CALL] → [VFO] ²	12
Page			
• Store	--	[F], [1] → [F](1 s), [1] → ENC/SQL (AP) → Enter your code → ENC/SQL (1P to 6P) → Enter target code → [VFO] ³	43
• Call	--	[F], [1] → [F](1 s), [1] → ENC/SQL → [PTT]	44
• ON/OFF	--	[F], [1]	43
• Code Lock-out	--	[F],[1] → [F](1 s), [1] → ENC/SQL → [F](1 s), [LAMP]	46
• Auto Cancel	11	Menu Set-up	47
• Open Page	10	Menu Set-up	47
• Delay (split)	08	Menu Set-up	46
Remote Control	--	Option [KEY] + POWER ON → Transceiver [KEY]	49

Continued

Function	Menu No.	Action	Page
Repeaters			
• TX Offset direction	--	[F], [REV]	27
• Auto TX Offset Cancel	07	Menu Set-up	29
• TX Offset amount	--	[F](1 s), [REV] → ENC/SQL → [VFO] ¹	29
• Reverse ON/OFF	--	[REV]	30
• Tone ON/OFF	--	ON: [T/CT] OFF: [T/CT], [T/CT]	30
• Tone select	--	[F](1 s), [T/CT] → ENC/SQL → [VFO] ¹	31
Reset			
• VFO (Partial)	--	[VFO] + POWER ON	26
• Memory (Full)	--	[F] + POWER ON	26
Scan			
• Scan Resume	03	Menu Set-up	36
• Scan Pause/Continue	--	Pause: Hold [MONI] Continue: Release [MONI]	36
• Memory Scan	--	Start: [MR](1 s) → ENC/SQL Stop: [VFO] ¹	37
• Memory Lock-out ON/OFF	--	[MR] → ENC/SQL → [F](1 s), [LAMP]	37
• VFO Scan	--	Start: [VFO](1 s) → ENC/SQL Stop: [VFO] ¹	38
• Call/VFO Scan	--	Start: [VFO] → [CALL](1 s) Stop: [VFO] ¹	38
• Call/Memory Scan	--	Start: [MR] → [CALL](1 s) Stop: [VFO] ¹	38

Continued

Function	Menu No.	Action	Page
Squelch threshold	--	[F], [MONI] → ENC/SQL → [VFO] ¹	13
Tone Alert ON/OFF	--	ON: [F], [CALL] OFF (before call): [F], [CALL] OFF (after call): [PTT] TH-22E/TH-42E: Also [T/CT]	48
Transmitting			
• Busy Frequency Lock-out ON/OFF	14	Menu Set-up	20
• Power output	--	[F], [PTT]	19
• Time-out Timer (TOT)	13	Menu Set-up	19
• TX Inhibit ON/OFF	05	Menu Set-up	20
VFO			
• Select	--	[VFO]	14
• Reset (Partial)	--	[VFO] + POWER ON	26

¹ Any key other than [LAMP] or [MONI]

² Any key other than [LAMP], [MONI], or [CALL]

³ [VFO], [MR], [CALL], [T/CT], or [REV]

KENWOOD