

KENWOOD

144/440MHz FM DUAL BANDER

TM-721A

144/430MHz FM DUAL BANDER

TM-721A

TM-721E

---

# INSTRUCTION MANUAL

KENWOOD CORPORATION

©PRINTED IN JAPAN B50-8225-00(K, M, T, W)(T)  
89/12 11 10 9 8 7 6 5 4 3 2 1 88/12 11 10 9 8 7 6 5 4 3 2

Downloaded by   
  
**Amateur Radio Directory**

Thank you for purchasing this new transceiver.

**IMPORTANT:** \_\_\_\_\_

Please read this instruction manual carefully before placing your transceiver in service.

**SAVE THIS INSTRUCTION MANUAL.**

**CAUTION:** \_\_\_\_\_

Long transmission or extended operation in the HI power mode might cause the rear of this transceiver to get warm. Do not place the transceiver where the heat sink (rear panel) might come in contact with plastic or vinyl surfaces.

The following explicit definitions apply in this manual:

**Note** : If disregarded, inconvenience only, no risk of equipment damage or personal injury.

**Caution** : Equipment damage may occur, but not personal injury.

**Illustrations show the TM-721A.**

# CONTENTS

<b>1. BEFORE OPERATION</b> .....	<b>4</b>
<b>2. SPECIFICATIONS and ACCESSORIES</b> .....	<b>6</b>
<b>3. INSTALLATION INSTRUCTIONS</b> .....	<b>7</b>
<b>4. OPERATION</b> .....	<b>10</b>
OPERATING CONTROLS	
RECEIVER OPERATION.....	<b>15</b>
Reception	
Frequency Selection.....	<b>16</b>
Frequency Step Selection.....	<b>17</b>
A.B.C. (Automatic Band Change) .....	<b>18</b>
Beep Tone	
TRANSMITTER OPERATION .....	<b>19</b>
REPEATER OPERATION.....	<b>20</b>
Transmitter Offsets	
Reverse Function	
Tone Operation	
Autopatch (U.S.A. version only).....	<b>21</b>
MEMORY .....	<b>22</b>
Microprocessor Memory Back-up	
Microprocessor Initialization	
Memory Channel	
Memory Contents	
Memory Entry .....	<b>23</b>
Simplex/Normal SHIFT	
Odd Split Channel	
Call Channel.....	<b>25</b>
Memory Recall	
Memory Shift	

SCAN .....	<b>26</b>
Scan Options	
Programmable Band Scan/Band Scan	
Memory Channel Scan	
Hold Resume Programming	
Priority Alert .....	<b>27</b>
Memory Channel Lockout	
<b>5. BLOCK DIAGRAM</b>	
<b>and SCHEMATIC DIAGRAM</b> .....	<b>another sheet</b>
<b>6. MAINTENANCE</b> .....	<b>28</b>
In Case of Difficulty .....	<b>29</b>
<b>7. OPTIONAL ACCESSORIES</b> .....	<b>31</b>
CTCSS unit TSU-6 (U.S.A. version) .....	<b>33</b>
REMOTE CONTROLLER RC-10.....	<b>34</b>
<b>8. REFERENCE</b> .....	<b>37</b>

# 1. BEFORE OPERATION

## Safety precautions

Never remove the case unless instructed to do so in this Instruction Manual. If the internal parts are touched accidentally, a serious electric shock might occur.

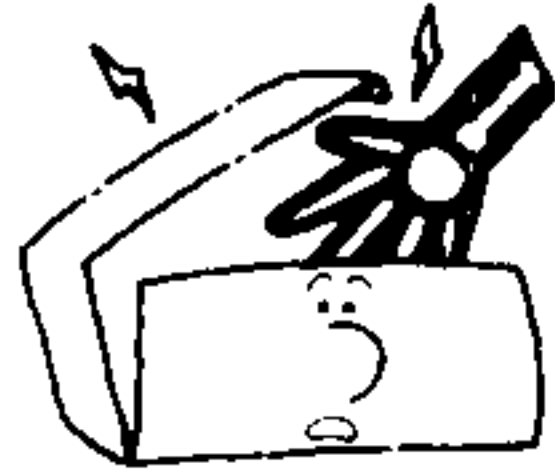

Never touch internal parts.

If a metal object, such as a hair pin or a needle, comes into contact with the power socket on the rear panel, a dangerous electric shock may result. Never permit children to put anything, especially metal objects, inside this unit.



The power requirement is 13.8 VDC.

Never attempt connection to a 24 VDC source.

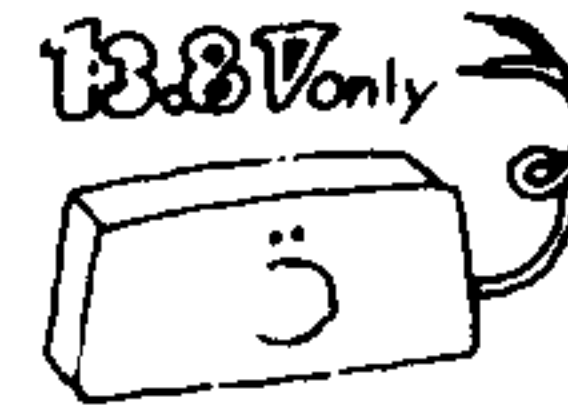

## DC Power Supply:

Touching the power plug when your hands are wet may result in a serious electric shock.

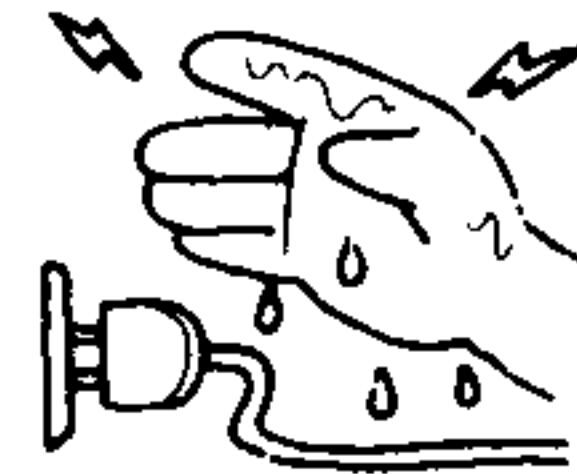

Never touch with wet hands.

## DC Power Supply:

Never pull, bend or extend the power cord. This could damage the power cord, resulting in a broken cord or short-circuit.

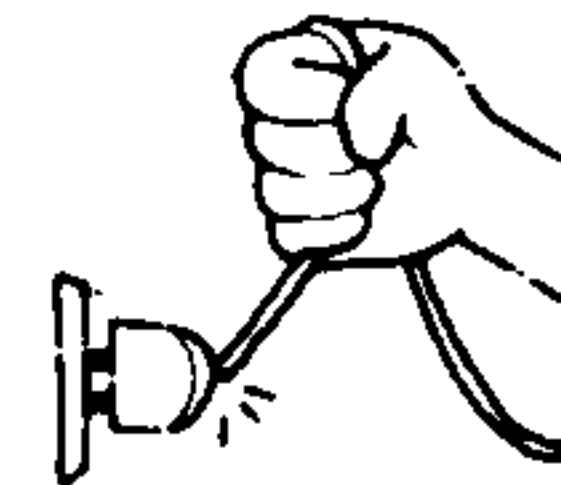

Always grasp the plug.

## Installation notes

Do not place this unit in a location that is exposed to direct sunlight, near a heating appliance, etc.

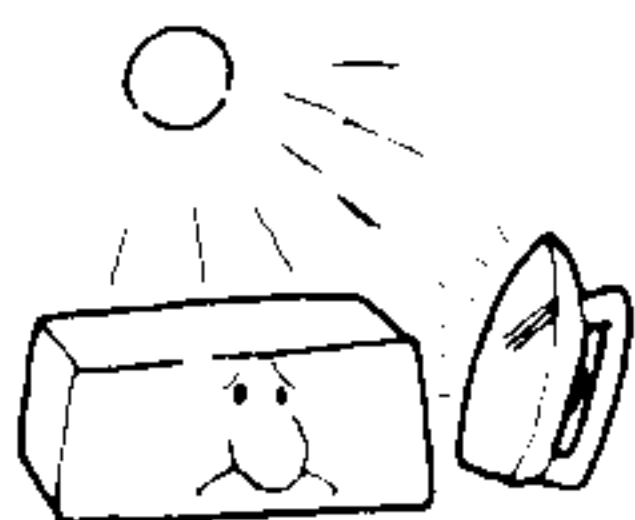

Do not store or use the unit in a dusty location or in a moist atmosphere. Select a location where there is good ventilation.

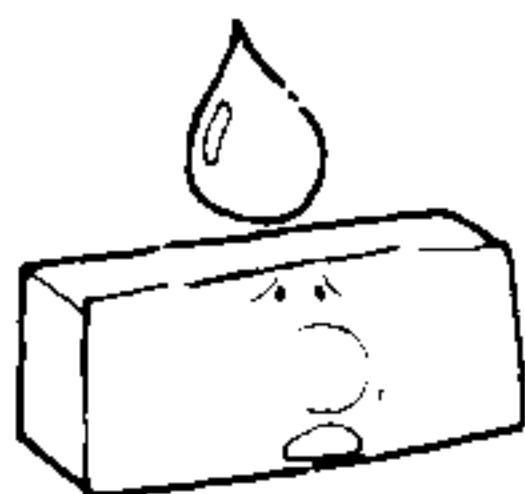

## In case of an abnormal odor

If an abnormal odor or smoke is detected, immediately turn the power OFF and pull out the power cord. Contact your dealer or nearest Service Station.

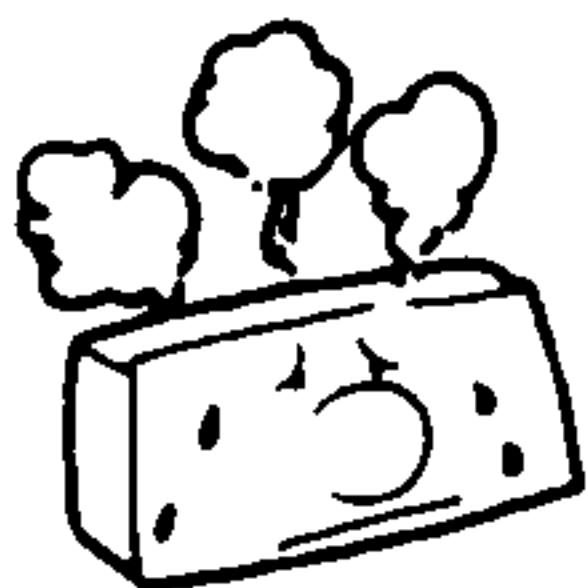

To maintain good ventilation, do not put books or papers on the unit. Position the unit at least 10 cm away from the walls.



Choose a location that is relatively free from vibration.

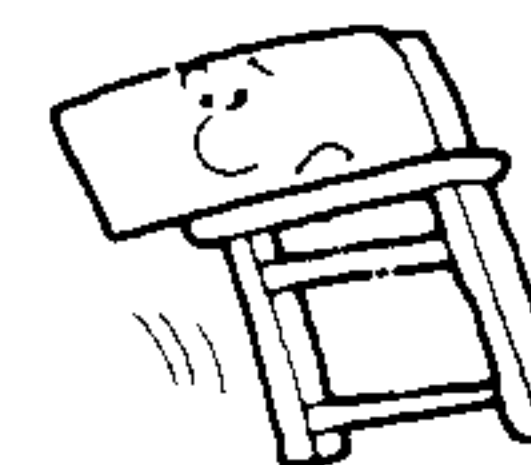

## Cleaning

Do not use volatile solvents such as alcohol, paint thinner, gasoline, benzene, etc. to clean the cabinet. Use a silicone cloth or a clean dry cloth.



Silicone cloth Thinner Benzene

# 2. SPECIFICATIONS AND ACCESSORIES

## 2-1. SPECIFICATIONS

Model		TM-721A		TM-721E	
		U.S.A. version	Other markets version		
General	Specifications				
	Frequency range		144 to 148 MHz 438 to 450 MHz	144 to 148 MHz 430 to 440 MHz	144 to 146 MHz 430 to 440 MHz
	Mode		F3E (FM)		
	Antenna impedance		50 ohms		
	Power requirements		13.8 VDC ± 15%		
	Ground		Negative		
	Current drain	Transmit mode (Max.)		9.5 A	
		Receive mode with no signal		0.6 A	
	Operating temperature		-20°C to +60°C (-4°F to +140°F)		
	Dimensions (W x H x D) (Projections included)		150 x 50 x 219 mm (5.9" x 2" x 8.6")		
Weight		1.8 kg (3.97 lbs)			
Transmitter	Output power*	HI	144 MHz: 45 W, 430/440 MHz: 35 W		
		LOW	5 W		
	Modulation		Reactance modulation		
	Spurious radiation		Less than -60 dB		
	Maximum frequency deviation		± 5 kHz		
	Audio distortion (at 60% modulation)		Less than 3% (300 to 3000 Hz)		
Microphone impedance		500 to 600 ohms			
Receiver	Circuitry		Double conversion superheterodyne		
	Intermediate frequency	U.S.A. version	144 MHz: 16.9 MHz/455 kHz, 440 MHz: 21.6 MHz/455 kHz		
		Other market	144 MHz: 10.7 MHz/455 kHz, 430 MHz: 30.825MHz/455 kHz		
	Sensitivity(12 dB SINAD)		144 MHz: Less than 0.2 μV, 430/440 MHz: Less than 0.16 μV		
	Selectivity		-6 dB: More than 12 kHz, -60 dB: Less than 24 kHz		
	Spurious response		Better than 60 dB		
	Squelch sensitivity		Less than 0.09 μV		
	Output		More than 2 W across 8 ohms load (5% distortion)		
External speaker impedance		8 ohms			

### Notes:

1. Circuit and ratings are subject to change without notice due to advancement in technology.
2. \* : Recommended duty cycle:  
1 minute : Transmission, 3 minutes : Reception

## 2-2. ACCESSORIES

Unpack your new transceiver carefully, and confirm that the accessories listed below are included in the box.

### MC-48B DTMF Microphone

(U.S.A. only) .....T91-0359-05....1 ea.

or

Dynamic Microphone .....T91-0365-15....1 ea.

Microphone Hook (U.S.A. only) ...J20-0319-24 ....1 ea.

Self tapping Screw (U.S.A. only) .N46-3010-46....2 ea.

### Mobile Mounting Kit

Bracket .....J29-0418-03 ....1 ea.

SEMS Screw .....N09-1530-05....4 ea.

Self tapping Screw .....N09-0335-05....4 ea.

Flat Washer .....4 ea.

DC Power Cable .....E30-2111-05 ....1 ea.

Fuse (10A).....F05-1031-05 ....1 ea.

Instruction Manual.....B50-8225-00...1 copy

Warranty Card .....1 ea.

### After unpacking

Shipping container:

Save the boxes and packing in the event your unit needs to be transported for remote operation, maintenance, or service.

Downloaded by   
  
Amateur Radio Directory



# 3. INSTALLATION INSTRUCTIONS

## 3-1. INSTALLATION

### Mounting Bracket

When installing the transceiver in a vehicle consider the ease of operation and safety when selecting the location for the mounting bracket.

1. Install the bracket using the supplied flat washers and self tapping screws (4 pcs. each).

2. Attach the transceiver loosely using the SEMS screws (4 pcs.).

3. The angle of the bracket may be adjusted to any of 9 possible viewing angles. Select the desired angle. (Fig. 2)

4. Hold the transceiver in place and tighten the 4 SEMS screws using a wrench or screwdriver.

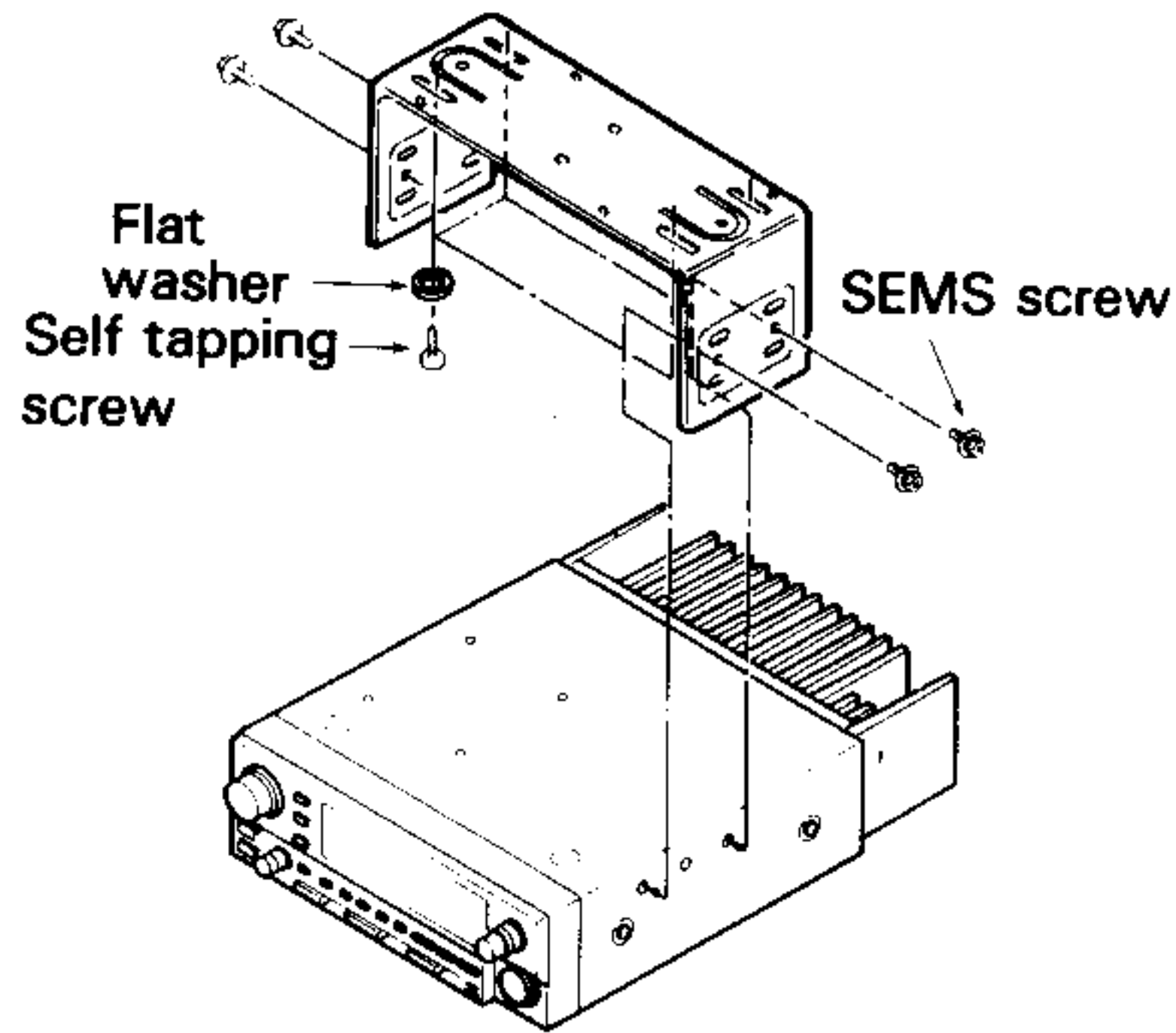

Fig. 1

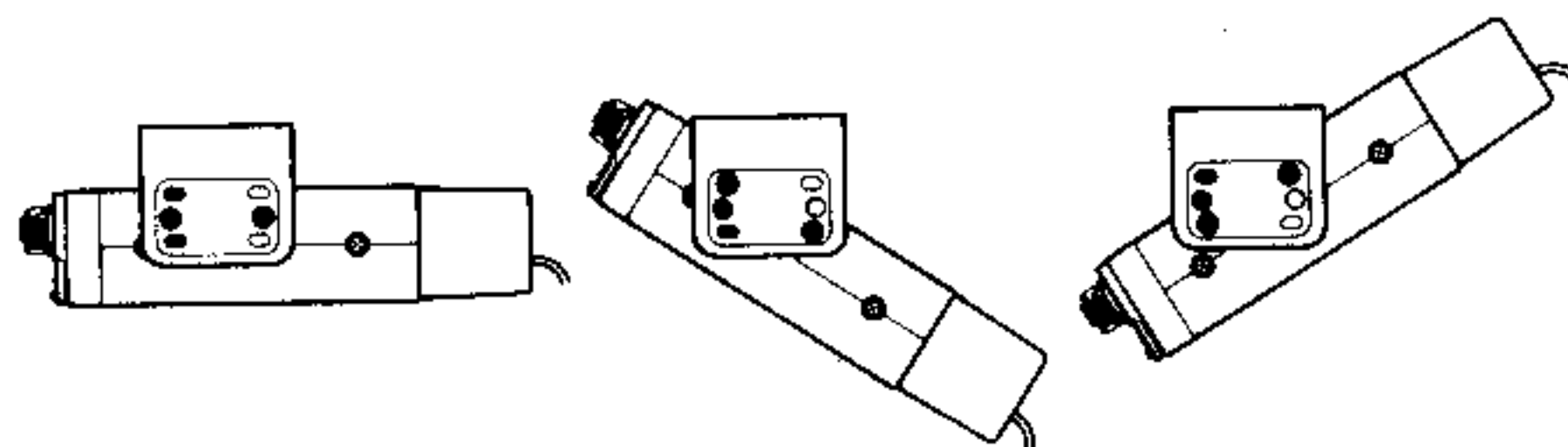
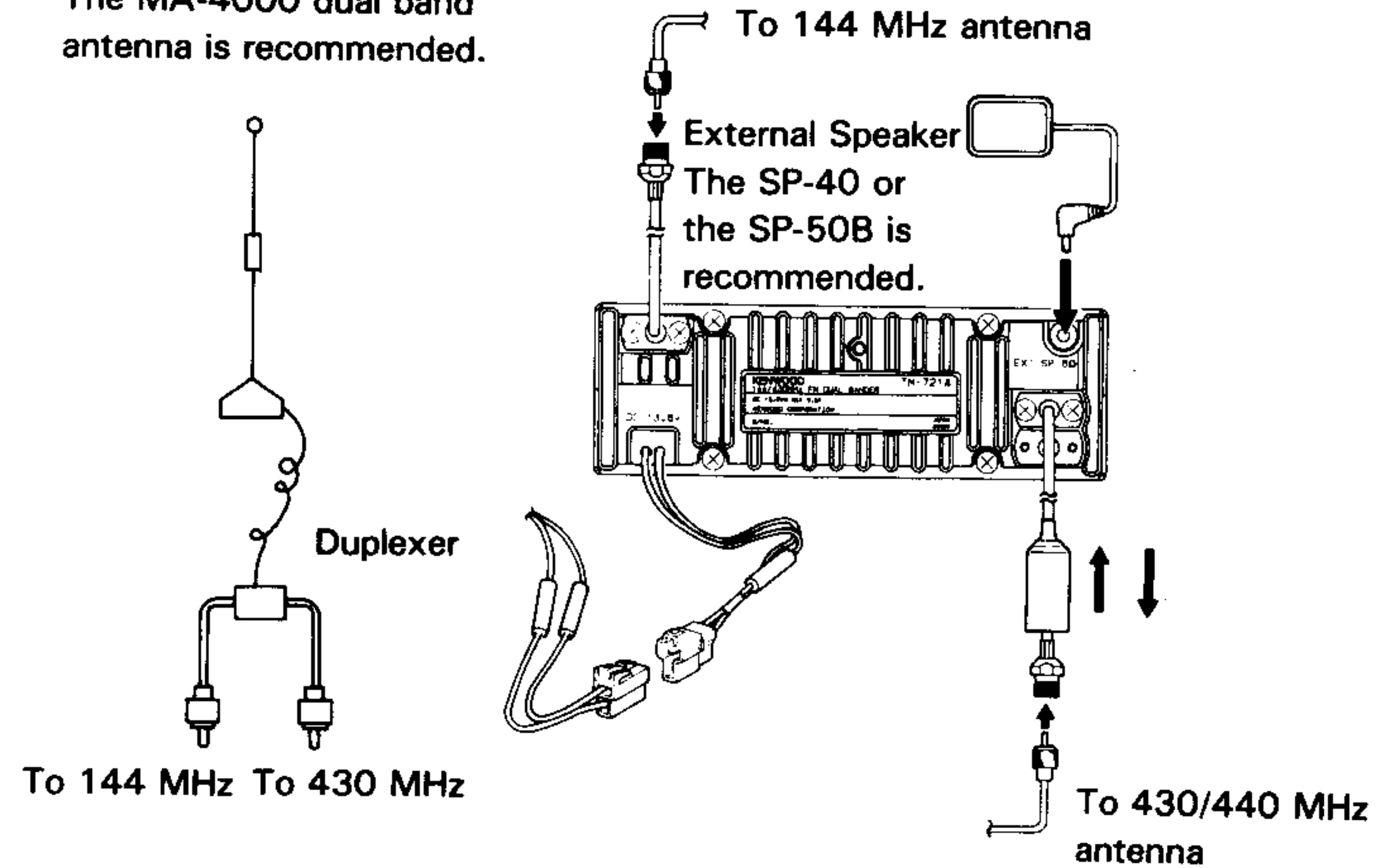

Fig. 2

## 3-2. CONNECTIONS

### 3-2-1. Mobile Installations

The MA-4000 dual band antenna is recommended.



### Cautions:

1. Before installing the power cable, be sure to remove the negative lead from the battery for safety.
2. After installation and wiring, be sure to double check for correct installation before reconnecting the negative lead to the battery terminal.
3. If the fuse opens, be sure to check that each conductor has not been damaged by short-circuiting, etc. Then replace with a new fuse of the same rating.
4. After completing the wiring, wrap the fuse holder with heat resistant tape to protect against heat and moisture.
5. Do not remove the fuse even if the power cable is too long.

## A. Battery Connections

Connect the power cable directly to the battery terminals. Use of the cigarette lighter socket can lead to poor connection, and result in poor performance. Pay close attention to the polarity of the cables when connecting them to the battery.

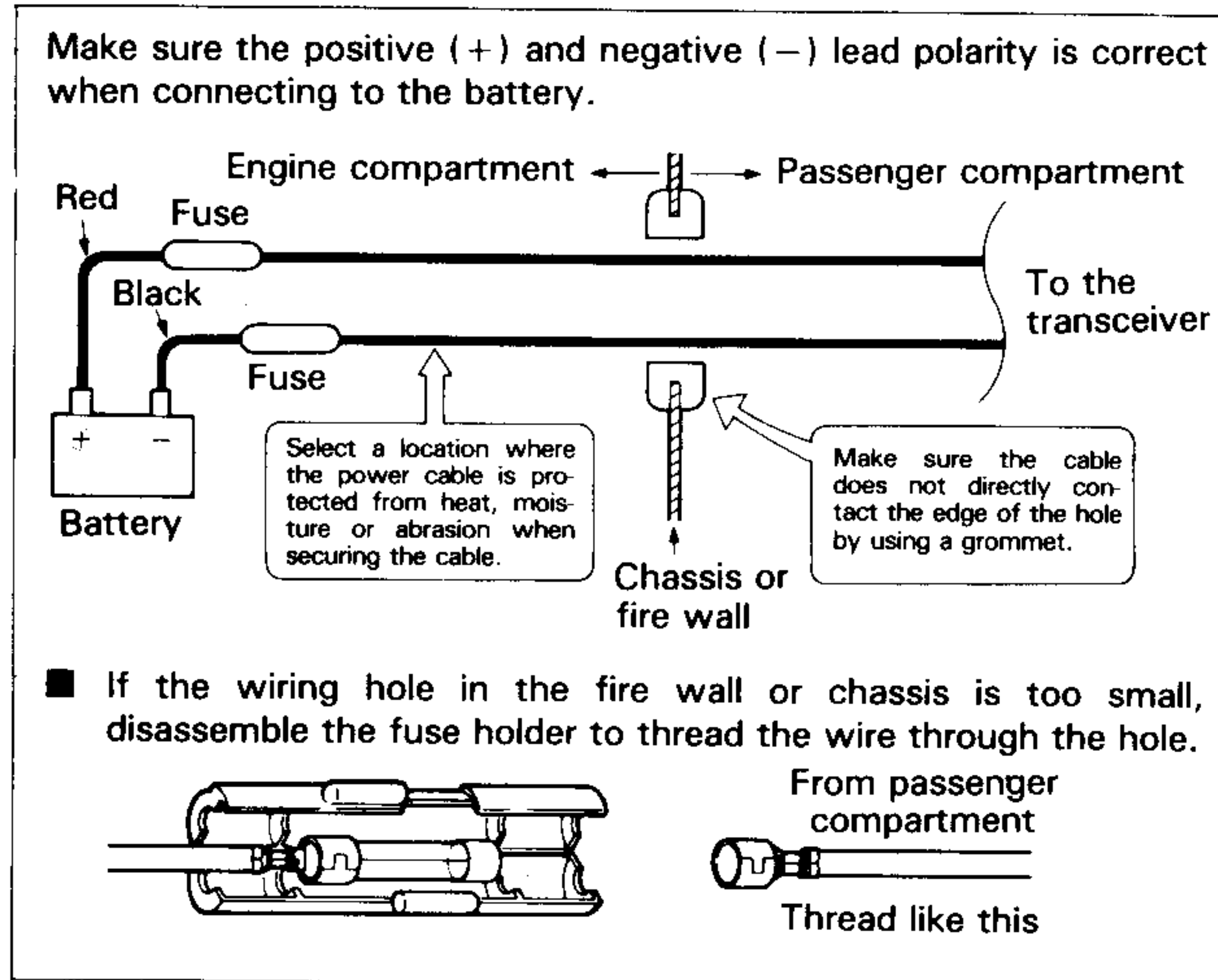

## B. Ignition Noise

This transceiver has been designed to suppress ignition noise; however, if excessive noise is present, it may be necessary to use suppressor spark plugs (with resistors).

## 3-2-2. Fixed Station

A regulated DC power supply (13.8 VDC capable of supplying at least 10 Amperes) is required. The PS-430 and the PS-50 are recommended.

### CAUTION:

1. Never connect the AC power cable to the AC outlet until all other connections have been made.
2. Before connecting and disconnecting the power connector, be sure to turn off the POWER switches of both the transceiver and the DC power supply.
3. Observe polarity of the DC power cable. The transceiver operates on 13.8 VDC, negative ground. Battery polarity must be correct. The power cable is color coded:  
Red → + (Positive polarity)  
Black → - (Negative polarity)

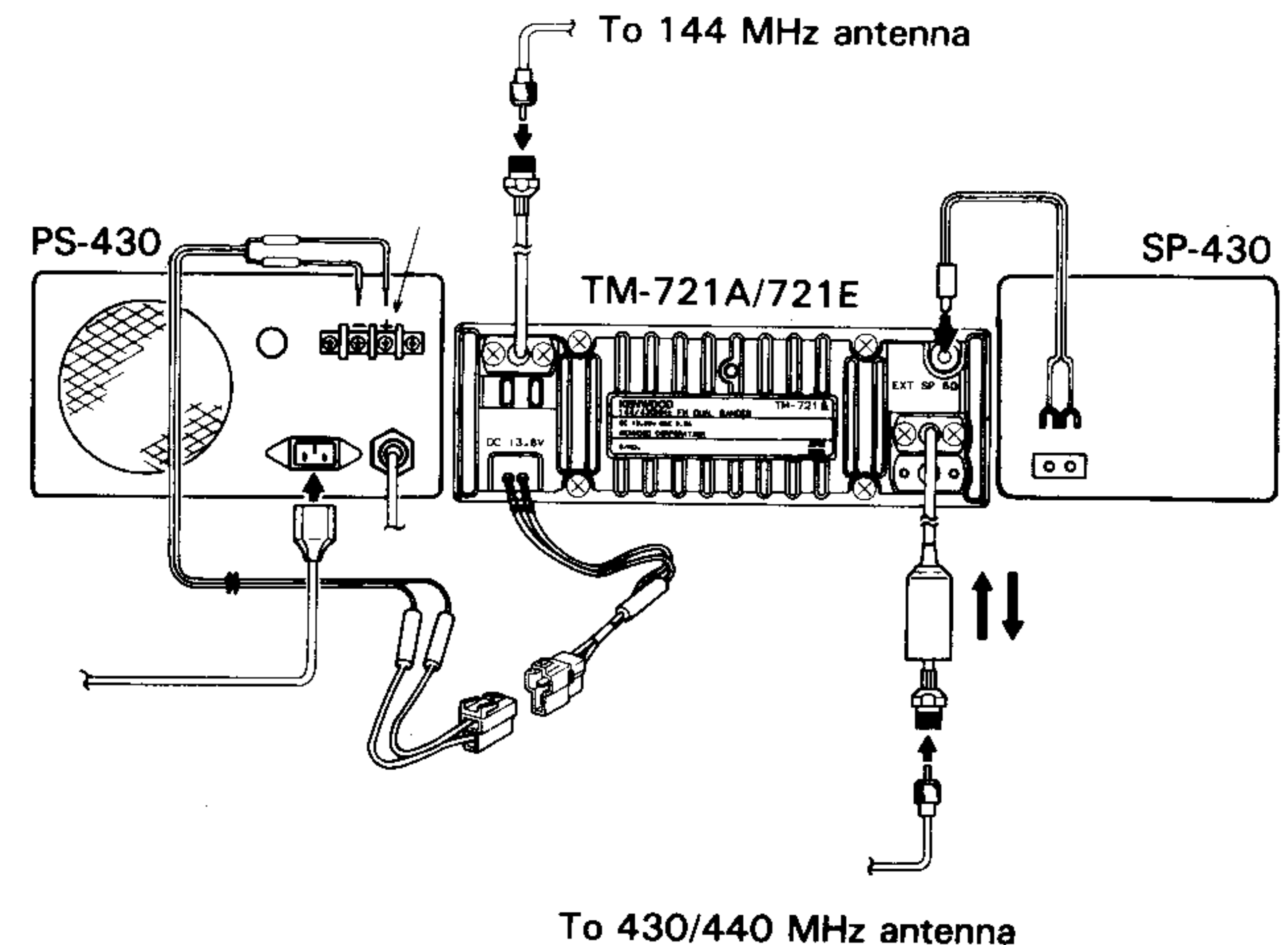



### **3-2-3. Antenna**

The type of antenna that is used will greatly affect the performance of the transceiver. Use a properly adjusted antenna, of good quality, to enable your transceiver to perform at its best. The antenna input impedance is 50 ohms. Use 50-ohm coaxial cable such as RG-8U or 8D-2V for this connection. If the antenna is far from the transceiver the use of low loss coaxial cable, such as RG-8U is recommended. Match the impedance of the coaxial cable and that of the antenna so that the SWR is less than 1.5 to 1. The protection circuit in the transceiver will activate if the SWR is particularly poor (greater than 3 to 1).

High SWR values will cause the transmitter output to drop, and may lead to TVI or BCI reports.

**Caution:** \_\_\_\_\_

For protection against fire, electric shock, personal injury, or damage to the radio, use a lightning arrester in your antenna lines.

---

# 4. OPERATION

## 4-1. OPERATING CONTROLS

### 4-1-1. Front Panel

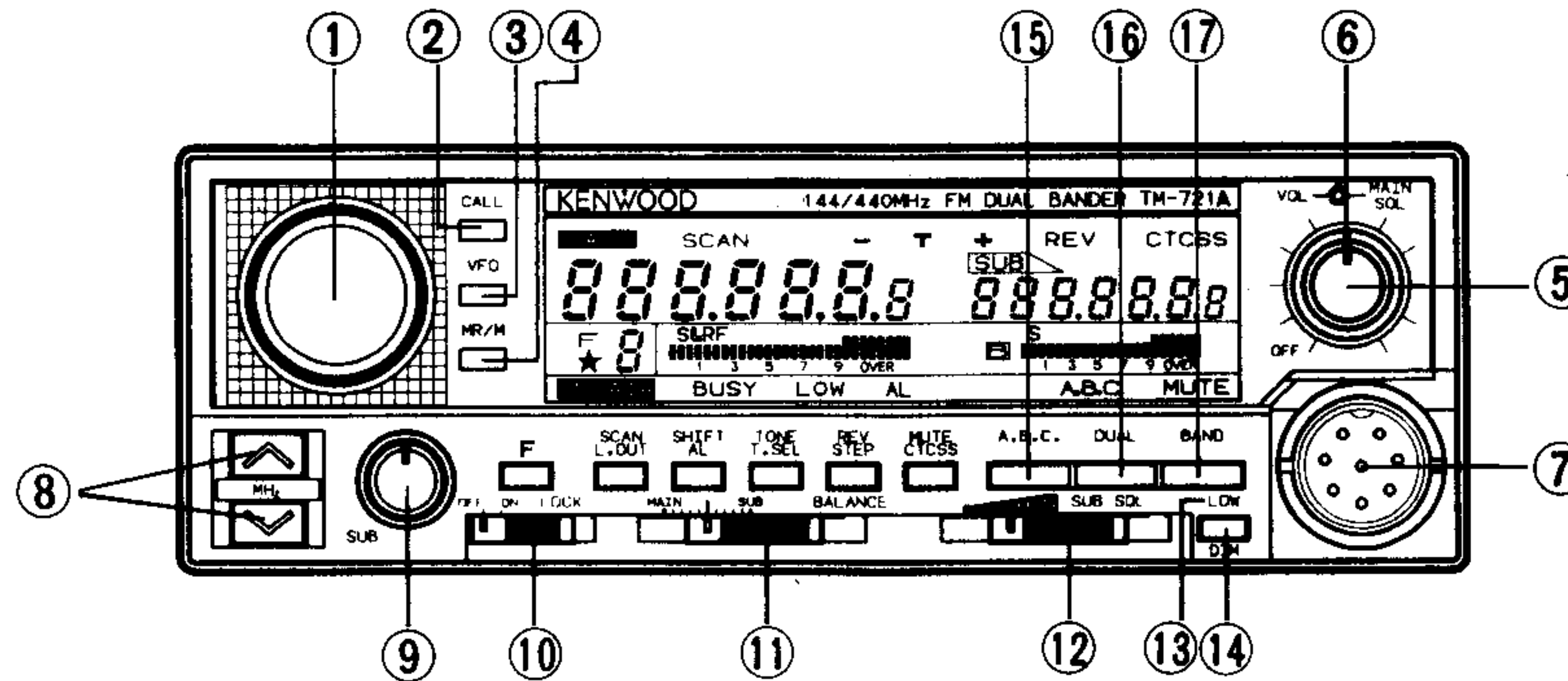

- ① **Main Tuning control**  
This control is used to select the desired transmit/receive frequency, Memory Channel, Frequency Step, Tone Frequency, and Scan direction of the MAIN frequency band.
- ② **CALL key (TM-721A)**  
The CALL key selects the CALL channel of the MAIN frequency band. The frequency has been factory-set as follows, but may be reset to any desired frequency. (See CALL Channel P25.)  
U.S.A. version ; 440.000/144.000  
Other market ; 430.000/144.000
- TONE key (TM-721E)**  
**European version:** This key is used to transmit a Tone signal. When the key is depressed the repeater control signal of 1750 Hz is activated.  
**U.K. version:** This key is used to activate the 1750 Hz tone burst.
- ③ **VFO key**  
This key is used to return to VFO operation after operating in the MR (Memory Recall), or CALL Channel mode (TM-721A only).
- ④ **MR/M key**  
This key is used to select Memory Recall operation after operating in the VFO or CALL channel mode. The MAIN Tuning control may be used to select the desired memory channel in this mode.
- ⑤ **VOL control/Power switch**  
The volume control and power switch are combined. Rotating the control clockwise will turn ON the transceiver. Advancing the control further clockwise will increase the total volume of two bands. The BALANCE control proportions the volume among the two bands.
- ⑥ **MAIN SQL control**  
This control is used to select the desired SQL threshold level of the MAIN frequency band.

- ⑦ **Microphone connector**  
Plug the standard or optional microphone into this jack.

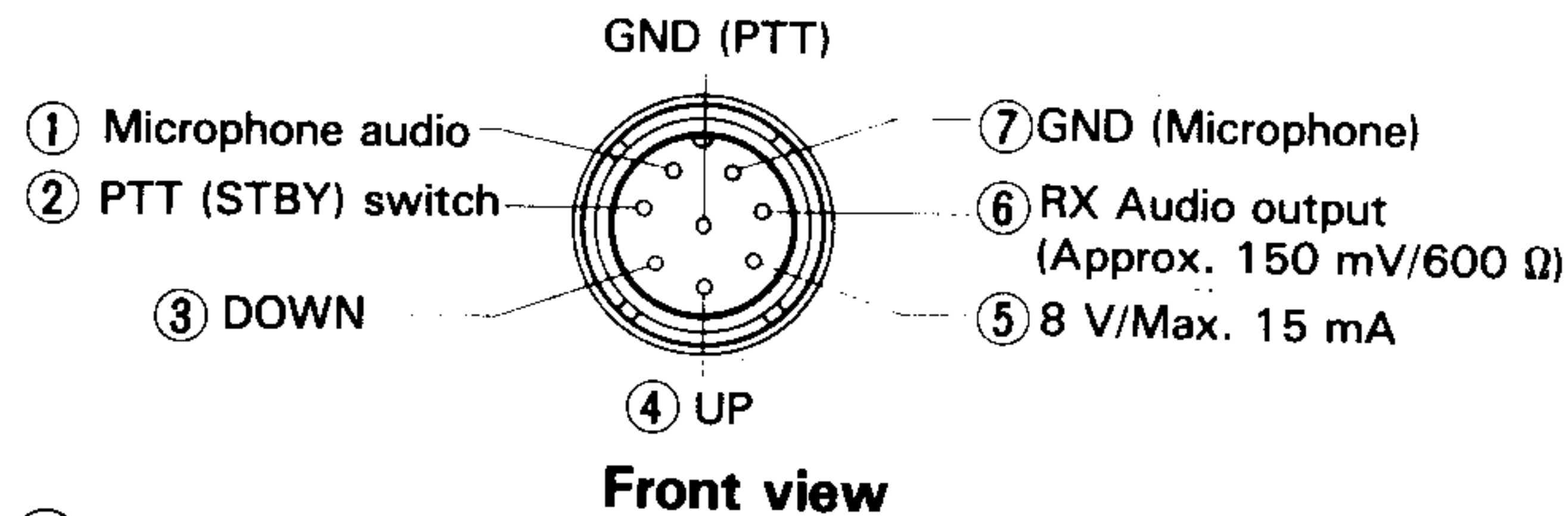

- ⑧ **MHz key**  
This key is used to change frequency in 1 MHz steps during VFO operations. Pressing and holding the key will continuously change the frequency in 1 MHz steps.
- ⑨ **Sub Tuning control**  
This control is used to select the desired receive frequency and Memory channel of the SUB band.
- ⑩ **LOCK switch**  
This key will deactivate all functions except the PTT switch.
- ⑪ **BALANCE control**  
This control proportions the total audio volume among the two bands.  
MAIN position : Audio only from the MAIN band  
Center position : Equal audio from both bands  
SUB position : Audio only from the SUB band
- ⑫ **SUB SQL control**  
This control is used to select the desired SQL threshold level of the SUB band.
- ⑬ **LOW key**  
This key is used to select the transmit output power level as follows:  
HI (no indicator) : 144 MHz:45 W/430 MHz:35 W  
LOW : 5 W

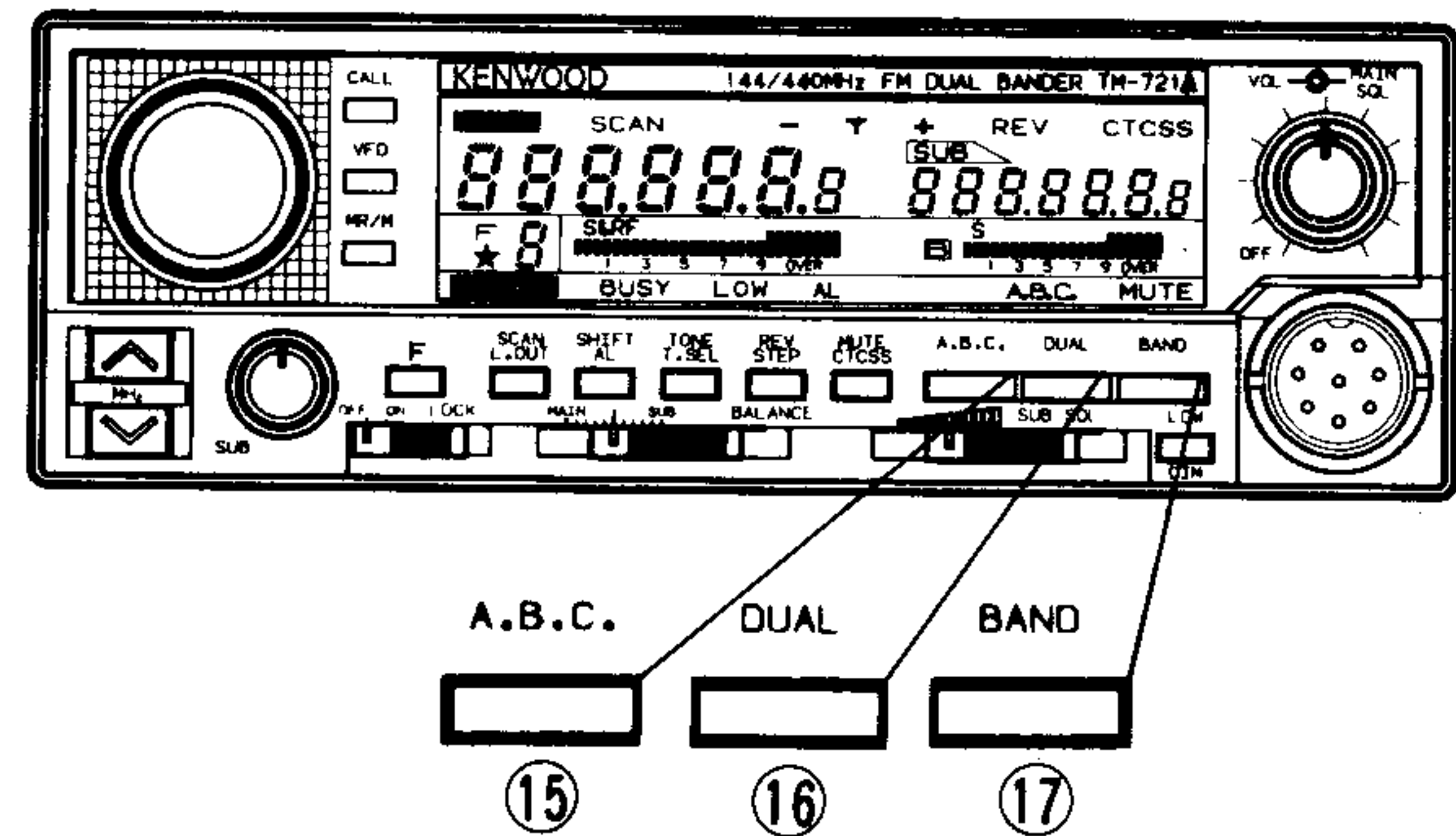

- ⑭ **DIM key**  
This key is used to select either high or low intensity of both the LCD display and control's illuminations. For the key to function, it must be pressed within 5 seconds after pressing the F key.
- ⑮ **A.B.C. (Automatic Band Change)**  
When this key is pressed, the contents of the SUB band will be transferred to the MAIN band whenever a signal is received at the SUB band antenna, which is strong enough to open the squelch. The contents of the MAIN band are transferred to the SUB band at the same time.
- ⑯ **DUAL band**  
This key is used to turn the SUB band ON or OFF.
- ⑰ **BAND key**  
This key is used to change the contents of the MAIN band.

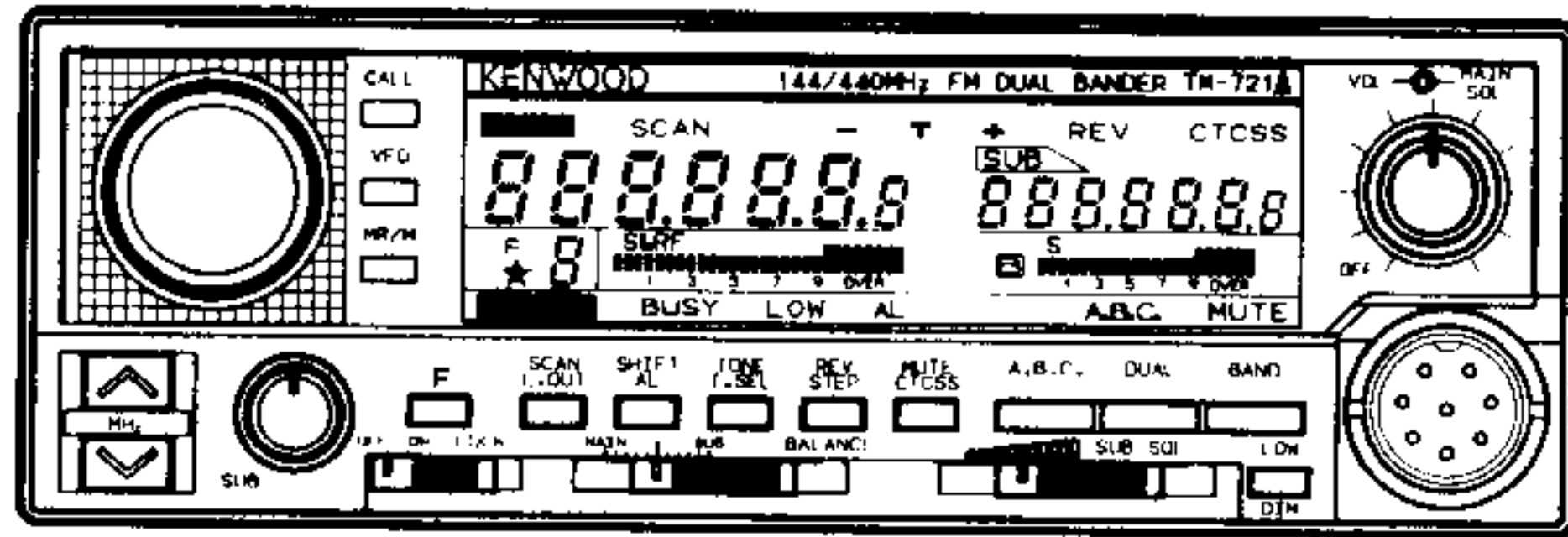

### TM-721A

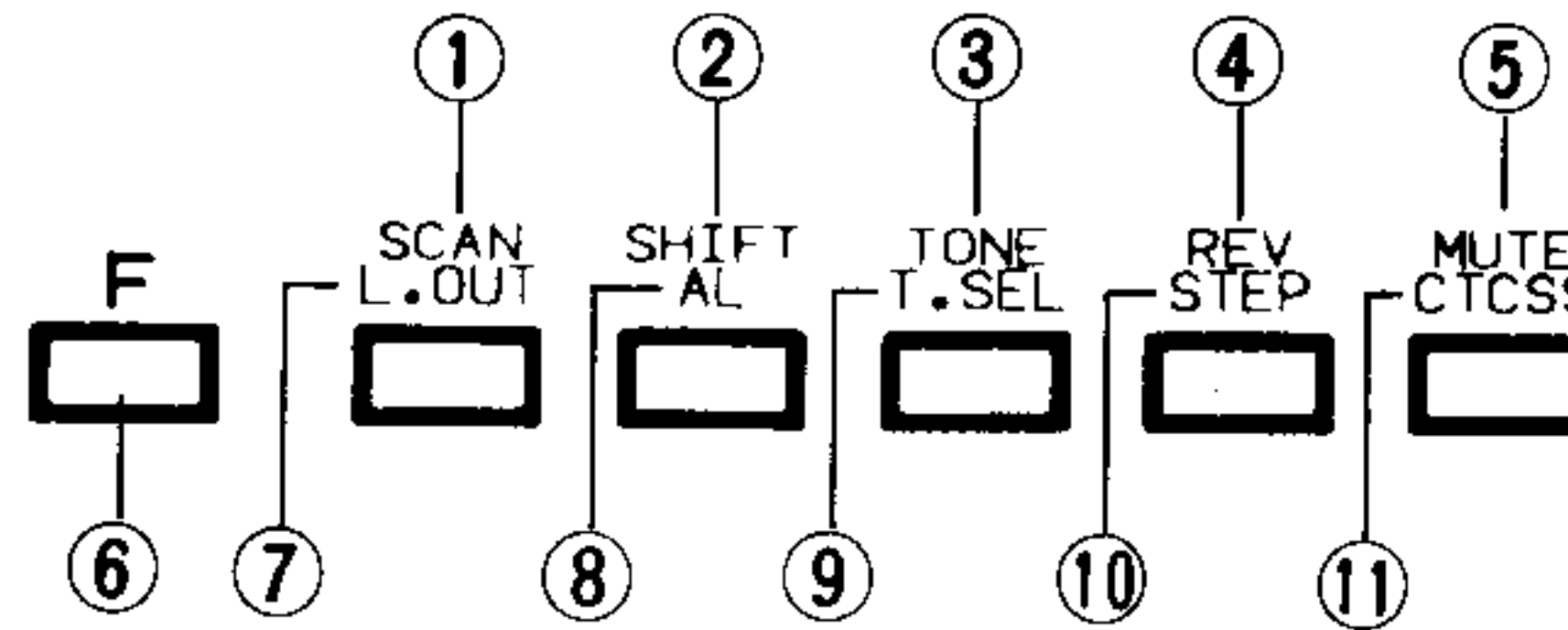

### TM-721E

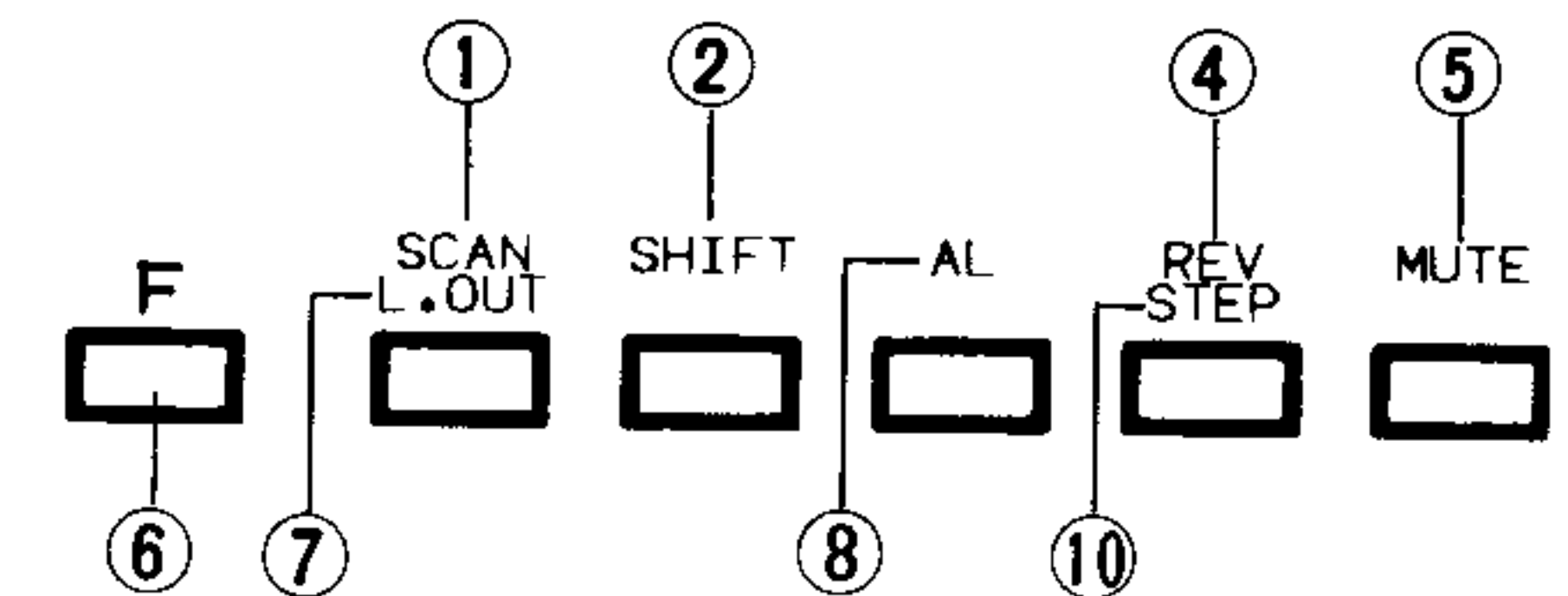

#### ① SCAN Key

This key is used to start or stop scanning.

#### ② SHIFT key

This key is used to select the desired transmitter offset during repeater operations. When the key is pressed the shift mode cycles from + to - [- to - - (European version)] to simplex (no indicator).

#### ③ TONE key (TM-721A only)

This key is used to activate the subaudible tone encoder.

#### ④ REV key

This key is used to reverse the transmit/receive frequencies during repeater operations. This will allow you to check the input of the repeater or to operate on a reverse repeater pair.

#### ⑤ MUTE key

This key is used to reduce the volume of the SUB band (Approximately 20 dB).

⑥ The F key is activate these keys below for 5 seconds after pressing the key, and during the "F" indicator is ON.

#### ⑦ L. OUT key

This key is used to temporarily skip unwanted Memory Channels during the Memory Channel Scan mode.

#### ⑧ AL key

This key is used to check Memory Channel 1 at approx. 5 second intervals. If the channel is busy, a beep will sound. TM-721E need not pressing the F key to activate the AL key.

#### ⑨ T. SEL key (TM-721A only)

This key is used to switch to the tone frequency selection mode. The MAIN Tuning control can then be used to select the desired tone frequency.

#### ⑩ STEP key

This key is used to switch to the frequency selection mode during VFO operation. The MAIN Tuning control can then be used to select the desired frequency step.

#### ⑪ CTCSS key (TM-721A only)

**With the TSU-6:** This key is used to activate the CTCSS function. Pressing the BAND key to transfer the contents of the SUB band to the MAIN band will release the CTCSS function. Tone will be ON during transmitting.  
**Without the TSU-6:** The CTCSS function does not actuate even if the indicator is ON.

## LCD display

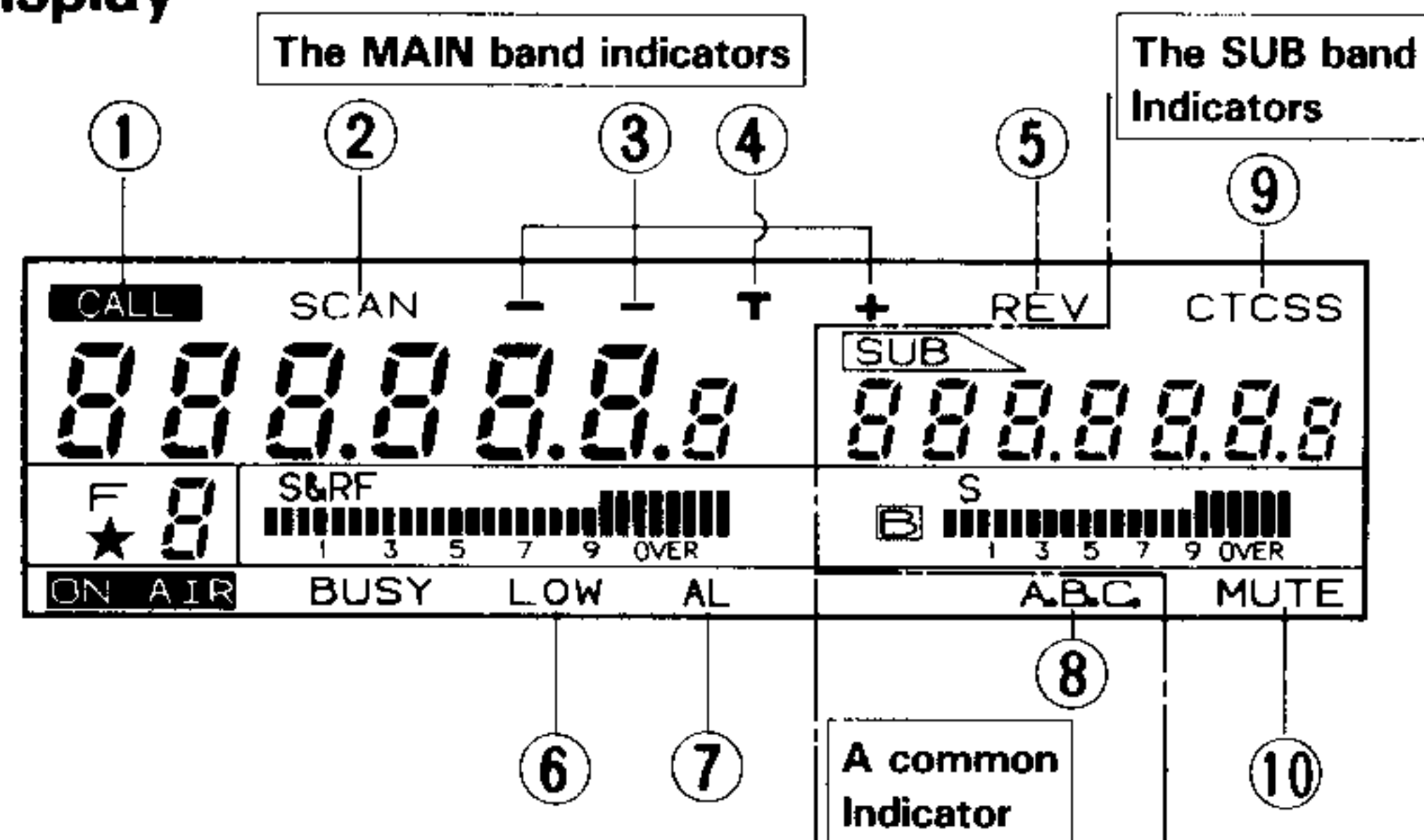

### The MAIN band Indicators

Displays the operating frequency to the nearest kHz, the frequency step, and/or the tone frequency (TM-721A only).

This level meter indicates the relative receive input signal strength or transmitter RF output.

ON whenever the squelch is open.  
ON during transmit.

- ① **CALL** ON when the CALL channel is ON.
- ② **SCAN** ON when Scanning.
- ③ **- +**  
**- -** Displays the selected transmitter off-set direction.
- (TM-721E European version)
- ④ **T** ON when the Tone function is active.
- ⑤ **REV** ON when the Reverse function is active.

- ⑥ **LOW** Indicates low power has been selected.
- ⑦ **AL** ON when the Priority Alert system is active.

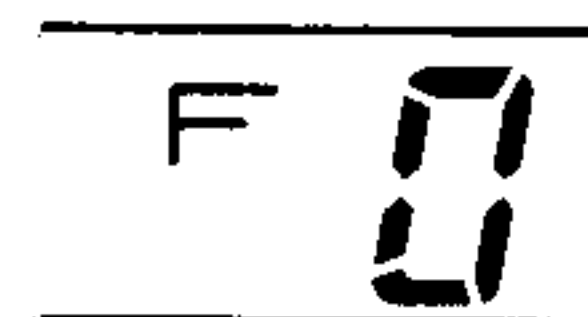

ON whenever the F key is depressed. (Always displays the last Memory Channel number that had been selected.)



Displays the current Memory Channel number. The ★ indicator is ON when the Memory channel will be skipped during Memory Channel Scan.

### A common indicator

- ⑧ **A.B.C.** ON when the A.B.C. (Automatic Band Change) function is ON.

### The SUB band indicators

Displays the receive frequency.

Indicates relative signal strength during reception.

ON whenever the squelch is ON.

- ⑨ **CTCSS** (TM-721A only) ON when the CTCSS function is active.
- ⑩ **MUTE** ON when the volume of the SUB band is reduced.



#### 4-1-2. Rear Panel

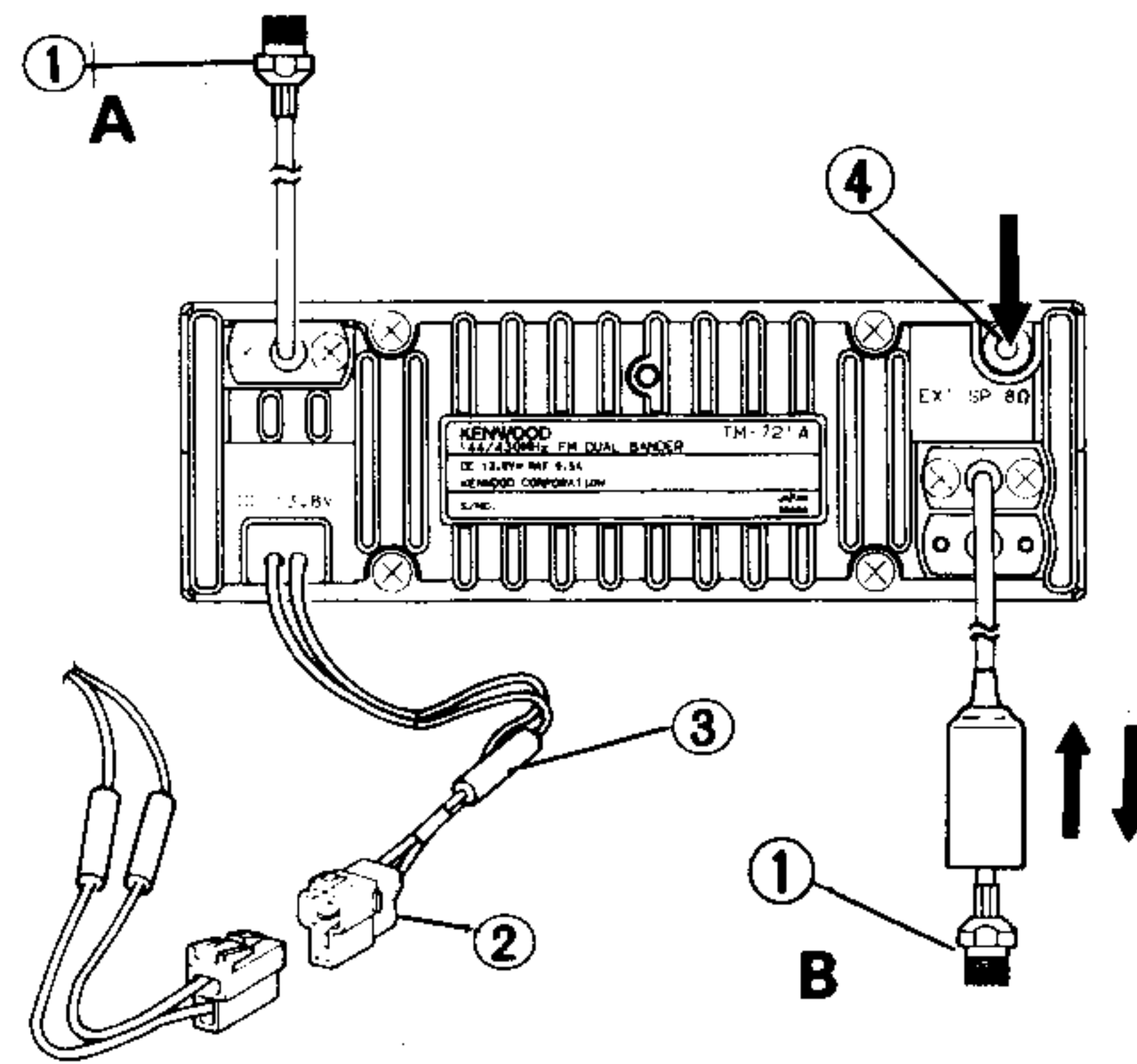

- ① **ANT (Antenna) connector**  
Attach an antenna with an impedance of 50 ohms to this connector (PL-259).  
A for 144 MHz  
B for 430 MHz, 440 MHz
- ② **13.8 VDC power input connector**  
Connect the supplied DC Power Cable to this connector. Pay close attention to the polarity (the DC Power Cable is color-coded; red is positive and black is negative), when connecting the cable to the power source.
- ③ **Fuse holder**  
Contains a fuse (10A)
- ④ **SP (Speaker) jack**  
This jack is for connection of an 8-ohm external speaker.

#### 4-1-3. Microphone

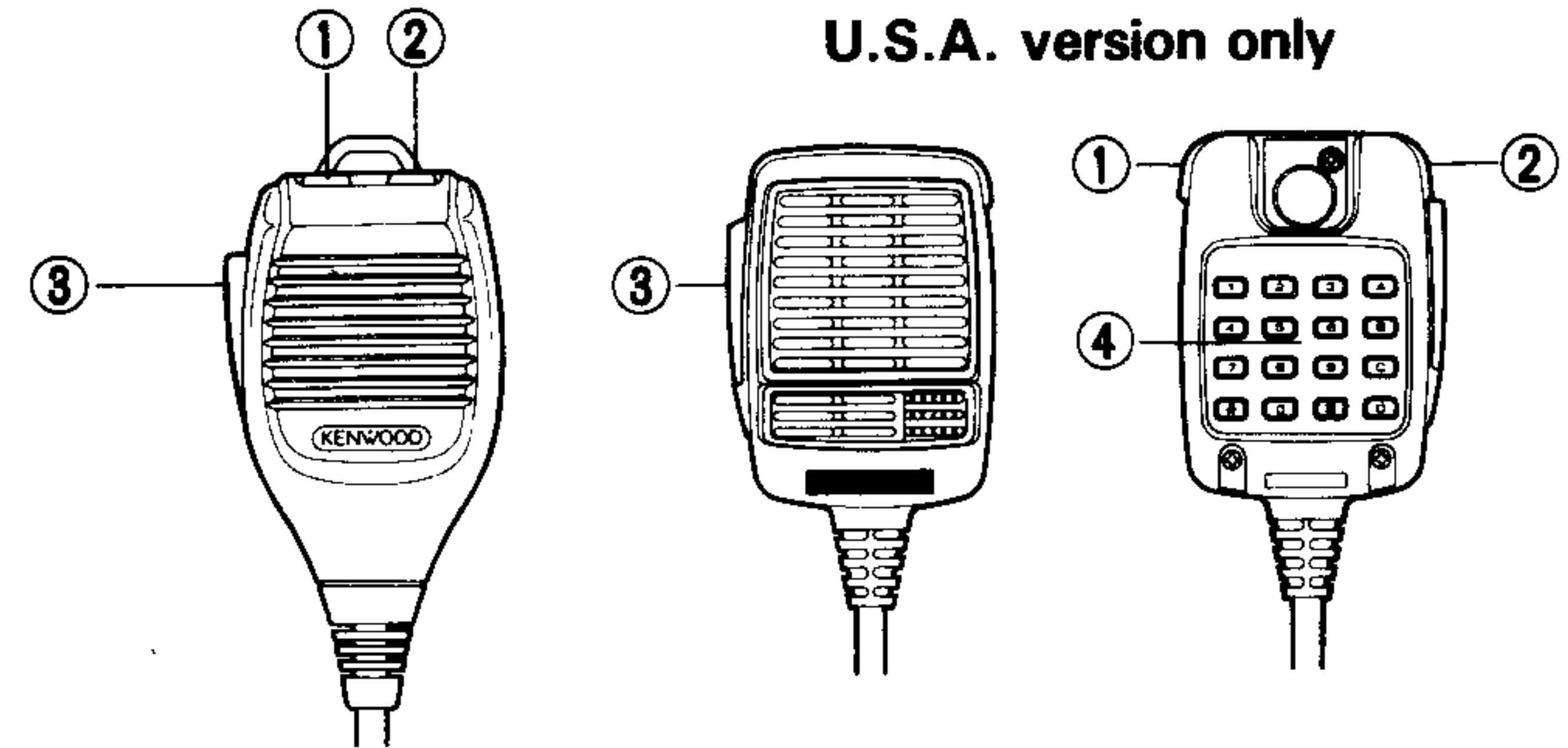

- ① and ② **UP/DWN (Up/Down) switches**  
These switches are used to step the VFO frequency or Memory Channel up and down. The frequency will change continuously if the switches are pressed and held.
- ③ **PTT (Push To Talk) switch**  
The transceiver will be placed into transmit whenever this switch is pressed. Operations such as scanning will be cleared when this switch is pressed.
- ④ **16-Tone DTMF Keypad (U.S.A. version only)**  
Used to activate the DTMF encoder. See Section 4-4 REPEATER for additional information on this item.

## 4-2. RECEIVER OPERATION

The transceiver will supply audio confirmation whenever a function is activated. (See BEEP TONE page 18.)

### 4-2-1. Reception

1. Connect the power supply and antennas, and then set the switches and controls as follows:

POWER (VOL) control: OFF (Fully counterclockwise)  
POWER switch of the DC power supply (Fixed Station)  
: OFF  
MAIN SQL control : Fully counterclockwise  
SUB SQL control : Full left  
BALANCE control : Full left (MAIN)  
LOCK switch : OFF

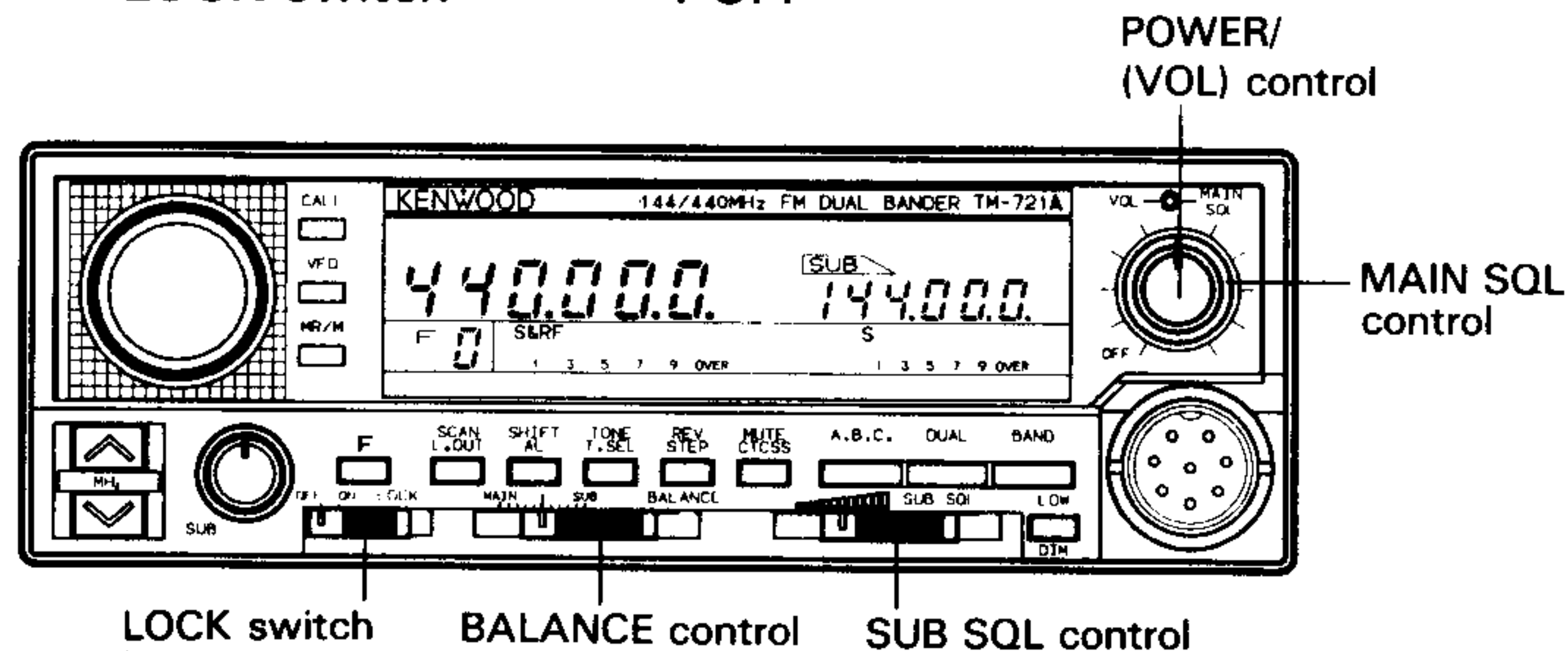

Fig. 1

2. Turn ON the DC power supply and then turn the transceiver's power switch ON. The display panel will indicate as shown in Fig. 1. Additionally some control and key lights will turn on.

**Note:** \_\_\_\_\_

If the display is not as shown Fig. 1 reset the microprocessor using the procedure give in Microprocessor memory Initialization Page 22.

3. Turn the VOL control clockwise until a signal or noise from MAIN band frequency is heard.
4. Rotate the MAIN Tuning control and select an open channel. Then, turn the MAIN SQL control clockwise until the noise disappears and the BUSY indicator goes OFF (Threshold point).
5. Slide the BALANCE control full right (SUB).
6. Rotate the SUB Tuning control and select an open channel. Then slide the SUB SQL control to the right until the noise disappears and the [B] indicator goes OFF.

**Dual band reception** (Simultaneous reception on both bands)

1. Slide the BALANCE control to the middle.
2. Select the desired frequencies in each band. When each signal is received, the BUSY or the [B] indicator will turn ON and each S-meter will deflect.
3. To distribute volume among MAIN band and SUB band, slide the BALANCE control to the desired point. The VOL control regulate the amount volume of two bands.

**Single band reception**

Press the DUAL key. The SUB band frequency display will turn off.

**Caution:** \_\_\_\_\_

Turn off the transceiver's POWER switch before you turn off the power supply, or if in a vehicle, before you stop the engine.

## 4-2-2. Frequency Selection

Frequency can be changed in the VFO mode. The selected frequencies of the main band can be stored in the Memory channels, and the Call channel (TM-721A only).

(See Memory Entry page 23, CALL CHANNEL page 25.)

You can select the VFO mode, MEMORY Recall mode, and CALL Channel mode using the following keys.

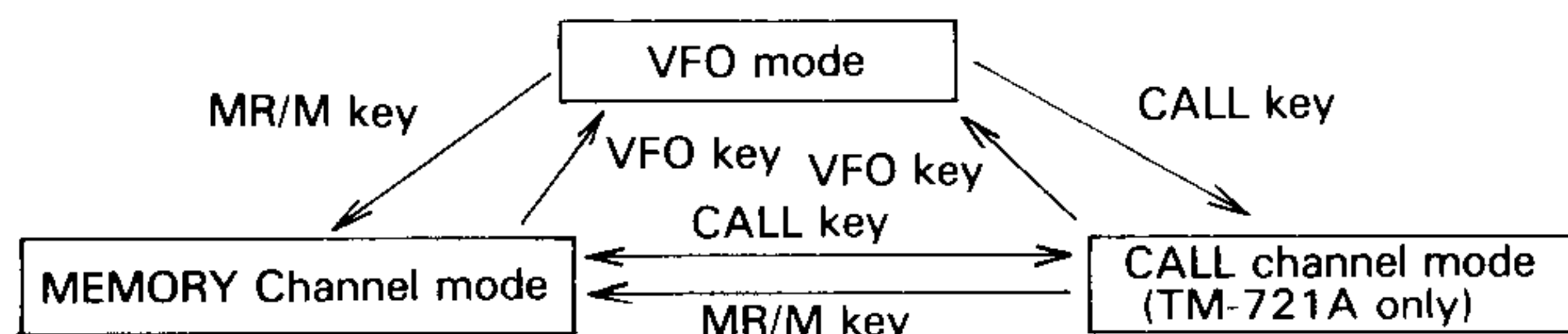

It is impossible to change the mode directly in the SUB band.

It is possible to transfer the mode of the MAIN band to/from SUB band.

### Exchange the Band

Press the BAND key. Each time the BAND key is pressed, the contents of the SUB band are exchanged with the MAIN band.

## ■ MAIN BAND

### ● VFO mode

1. Press the VFO key to select the VFO mode.
2. Rotate the MAIN Tuning control, MHz keys, or Microphone UP/DWN switches to select the desired frequency.

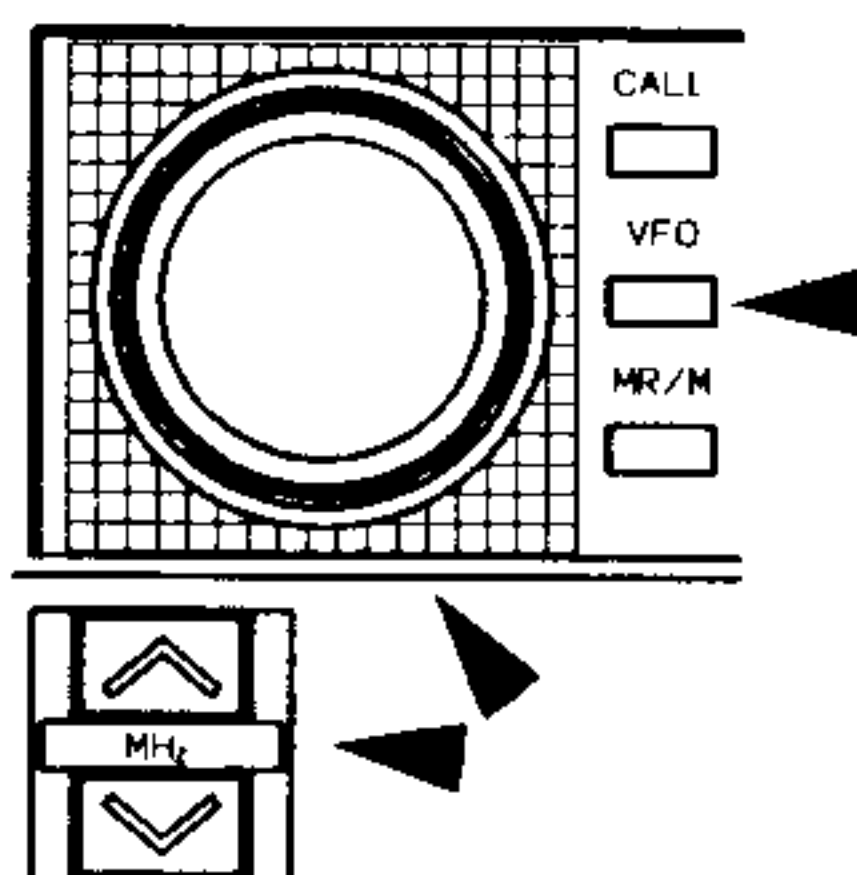

### ● Memory Recall mode

1. Press the MR/M key. The previously selected memory channel will be displayed on the LCD display.
2. Rotate the MAIN Tuning control or Microphone UP/DWN switches to select the desired Memory Channel.
3. To return to the VFO mode press the VFO key.

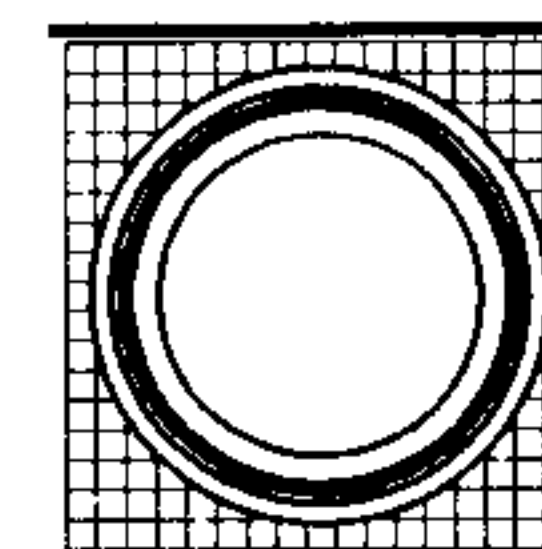
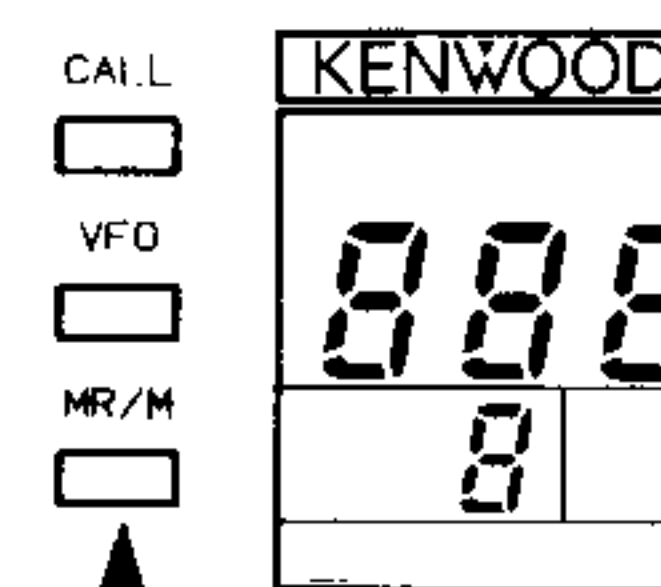

### ● CALL Channel mode (TM-721A only)

1. Press the CALL key to select the CALL Channel mode. The CALL indicator and the call channel frequency are displayed on the LCD display.
2. To return to the previous mode press the CALL key again.

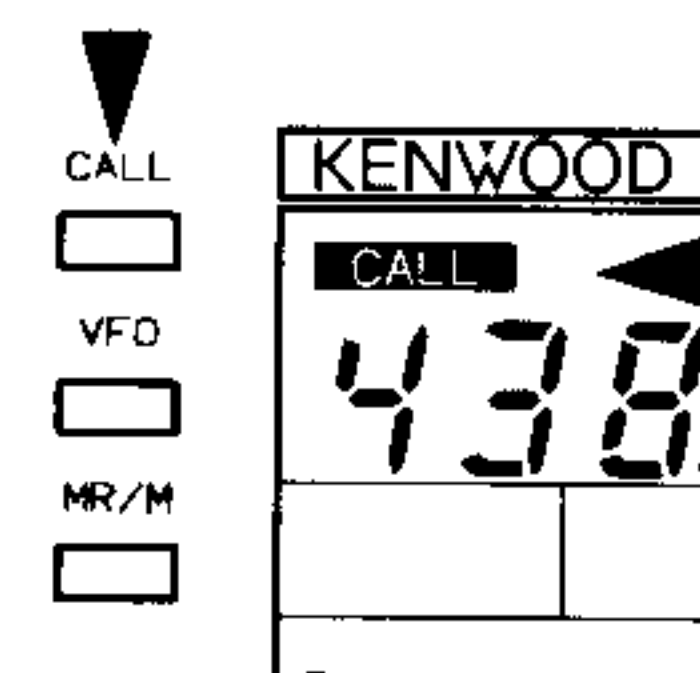

### Note:

The Memory Channel number will not disappear during the CALL channel mode, if the call channel is selected from the MR mode.

## ■ SUB BAND

- If the current frequency is in VFO mode; Rotate the SUB Tuning control to select the desired frequency.
- If the current frequency is in MR mode; Rotate the SUB Tuning control to select the desired Memory Channel. (The Channel number is not displayed.)



- Current frequency is in CALL Channel mode (TM-721A only); Frequency can not be changed in the SUB band. (The CALL Channel indicator is not displayed.)

### 4-2-3. Frequency Step Selection

The frequency step is factory-set to the following;

	TM-721A	TM-721E
144 MHz Band	5 kHz	12.5 kHz
430/440 MHz Band	25 kHz	25 kHz

The frequency step can be selected by using the following procedures:

#### MAIN Band

1. Press the VFO key to select the VFO mode. If you are already in the VFO mode you can skip this step.
2. Press the F key. The F indicator will be displayed on the LCD display. Press the REV/STEP key within 5 seconds. (If the indicator goes off, you must press the F key again.) The current frequency step will be displayed on the LCD display.

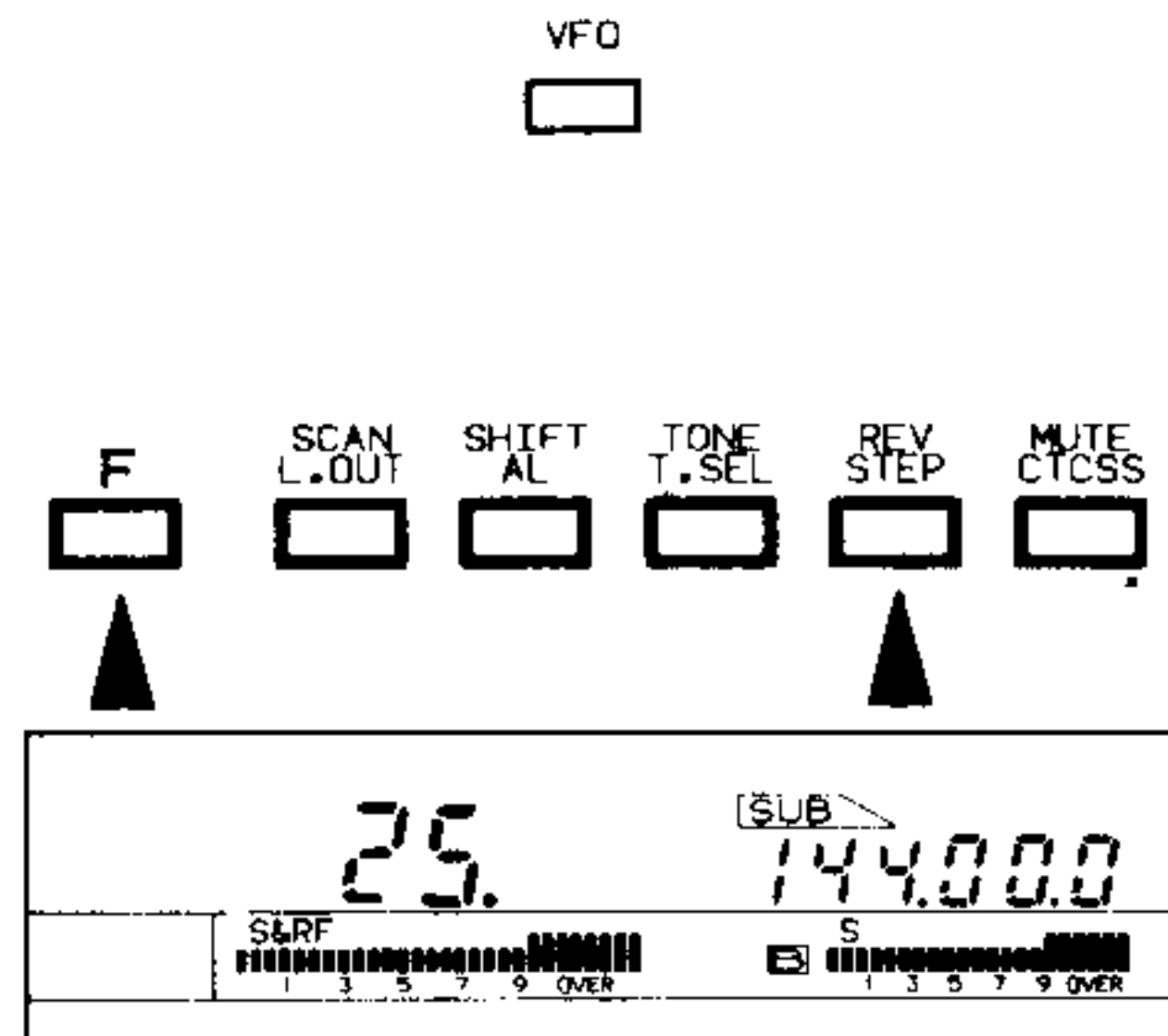

3. Rotate the Tuning control or press the Microphone UP/DWN switch to select the desired frequency step. The accompanying figure shows how the Tuning control will increase or decrease the step size.
4. To complete the Frequency step selection press the VFO key or any other key. Automatically return 5 seconds of the selection.

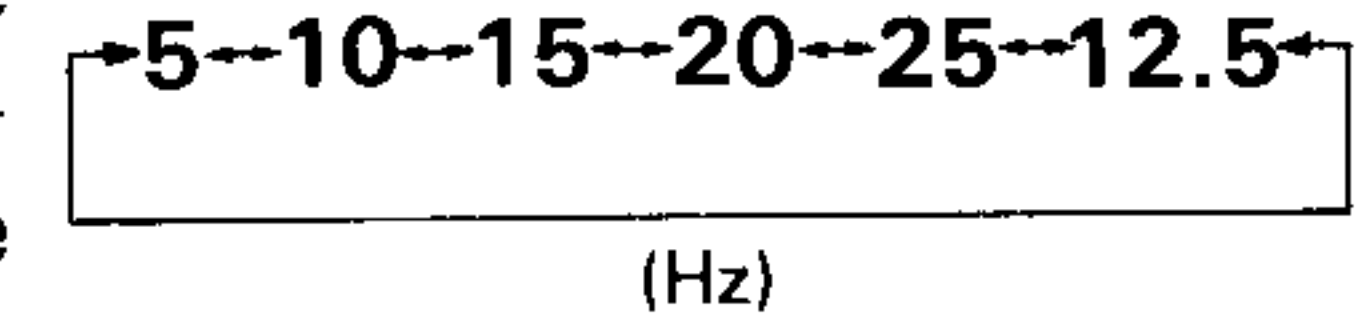
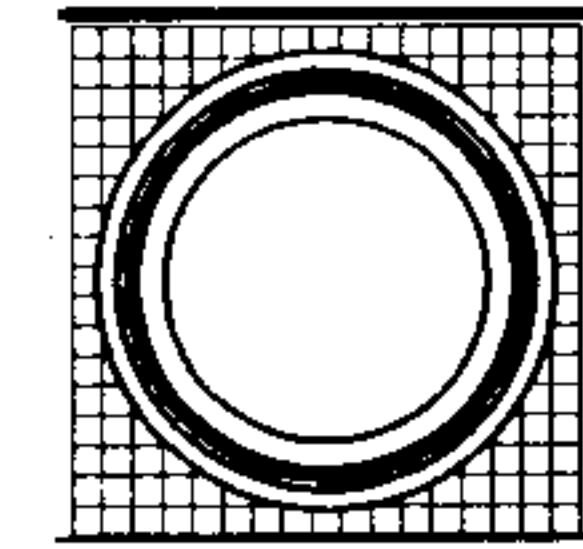

	MAIN Tuning control	Microphone UP/DWN switches
→	Rotate clockwise	Press UP key
←	Rotate counter-clockwise	Press DWN key

#### SUB Band

It is impossible to select the Frequency Step directly while in the SUB Band. It is possible to transfer the selected Frequency Step of the MAIN band to the SUB band. Press the BAND key.



#### 4-2-4. A.B.C. (Automatic Band Change)

The A.B.C. function allows you to exchange the contents of SUB band to the MAIN band automatically whenever a signal is received in the SUB band and SUB squelch is open.

1. Press the A.B.C. key.

The A.B.C. indicator will turn on displayed in the LCD display.

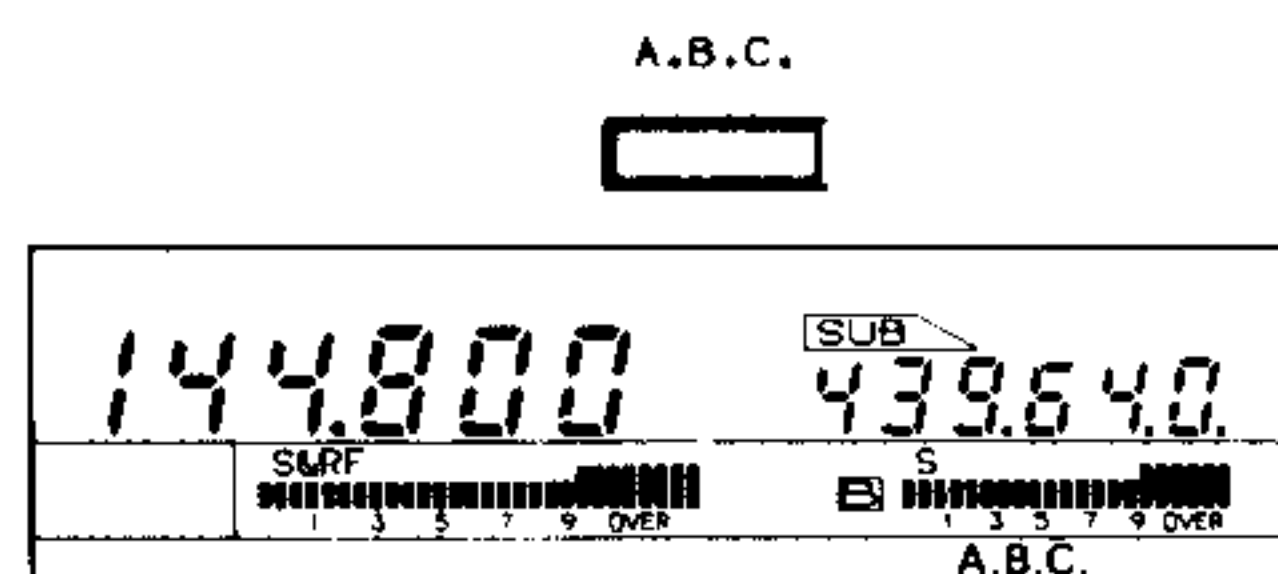

2. As soon as a signal is received in the SUB band, exchange the bands. \*

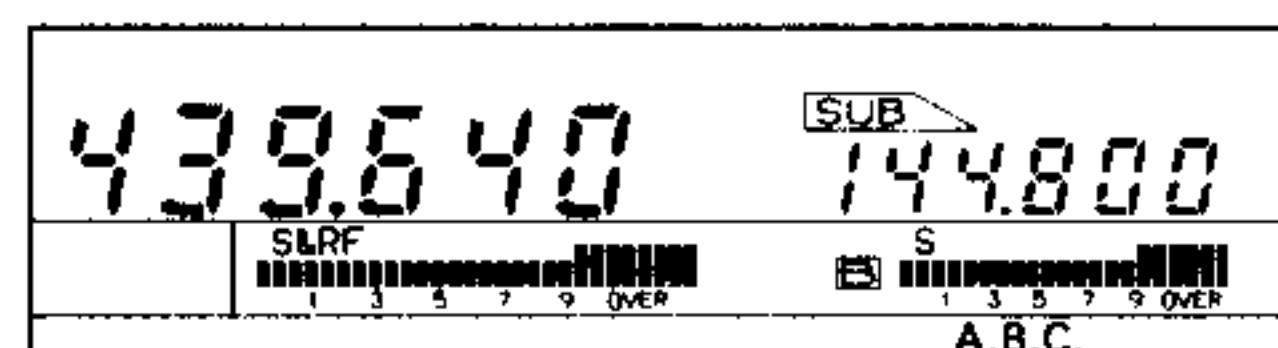

If press the PTT switch, A.B.C. function is released.

If does not press the PTT switch 3 seconds after the signal goes off, the MAIN band return to SUB band.

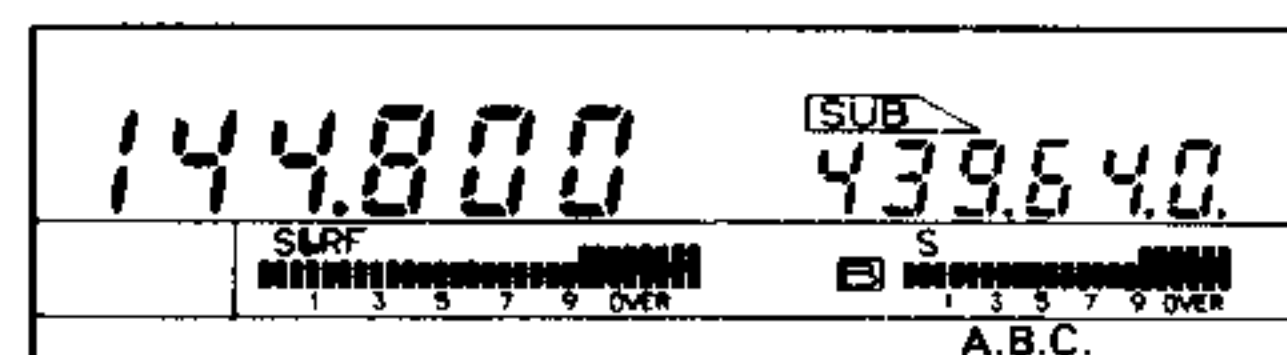
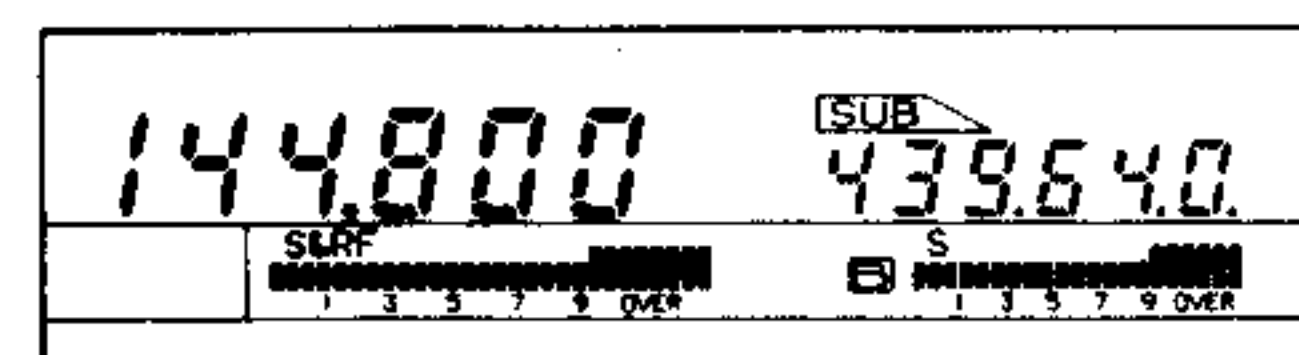

#### 4-2-5. BEEP TONE

If you would not like audio confirmation when a function is activated, turn the POWER switch OFF. Then press and hold the MUTE key and turn ON the power switch, then release the mute key.

Repeating this procedure will turn the function back ON.

The transceiver supplies audio confirmation according to the accompanying chart.

Scale	Frequency (Hz)	Key operation
A	440.00	CALL, REV, TONE, CTCSS, F, SCAN, L.OUT, AL, A.B.C., MUTE, DIM:OFF
A #	466.16	144 MHz MAIN BAND, SUB BAND OFF, LOW POWER ON
B	493.88	SCAN STOP
C	523.25	VFO MODE SELECTION
C #	554.37	- OFFSET
D	587.33	SIMPLEX
D #	622.26	+ OFFSET
E	659.25	MR MODE SELECTION
F	698.46	To complete the MEMORY Entry To complete the CTCSS Frequency selection
F #	739.98	430 MHz selection, SUB BAND ON, HI POWER ON
G	783.98	CALL, REV, TONE, CTCSS, SCAN, L.OUT, AL, A.B.C., MUTE ON
G #	830.61	MEMORY CHANNEL, Tone frequency, Frequency step selection
A	880.00	F mode, Split channel ON
A #	932.33	Band change during A.B.C.
F	1396.91	Key operation without effect

#### Caution:

\* The Tuning controls are not effective during this exchange.



## 4-3. TRANSMITTER OPERATION

### Caution:

1. Ensure that an antenna with a low standing wave ratio (SWR) is attached to the antenna connector before attempting to transmit. Failure to provide proper termination may result in damage to the final amplifier section.
2. Always check to ensure the frequency is clear before transmitting.

### Note:

The use of LOW power is recommended, whenever possible, to avoid interfering with other stations.

### Transmit

1. Select the desired operating frequency in the MAIN band using any of the methods previously discussed.
2. Check the frequency to see if it is occupied before you transmit.
3. Press the PTT switch. The ON AIR indicator will light, and the RF meter will deflect to the right.

### Note:

If you have selected the LOW power position, the low indicator will appear in the display and the RF meter will only deflect slightly. When HI power has been selected the RF meter will swing full scale.

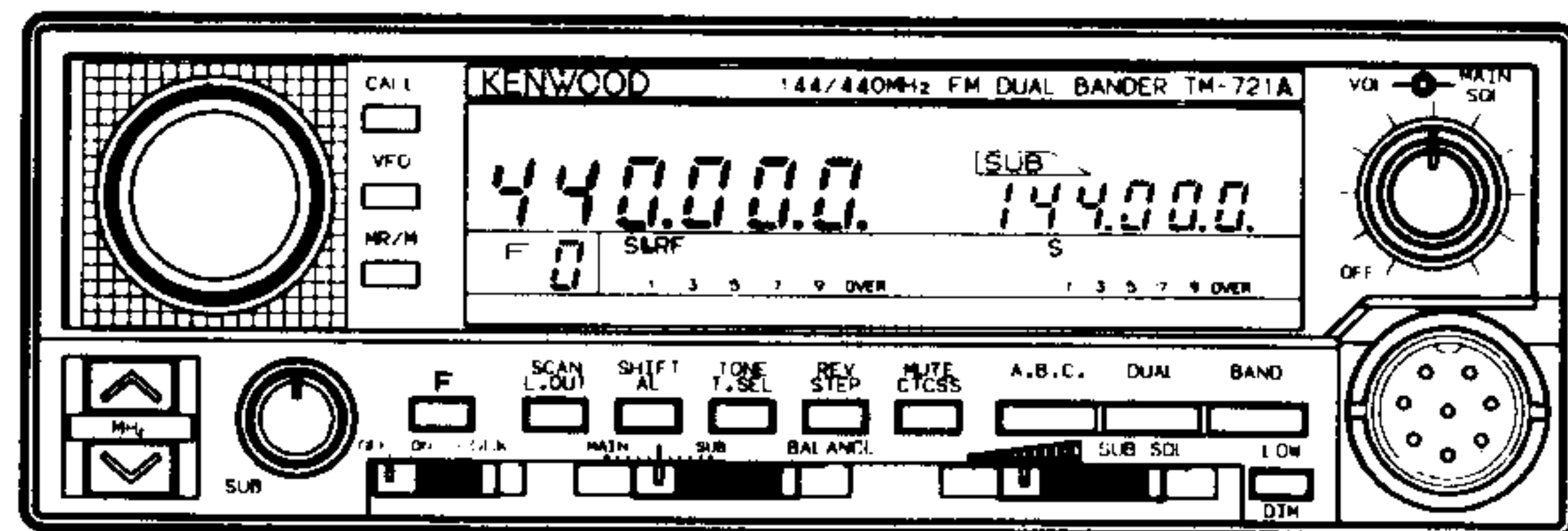

4. Speak into the microphone. The recommended distance to the microphone is 5 cm (2 inches).

### Note:

Talking closer may result in overdeviation of your transmit signal, which might be reported as a loss of clarity or of an excessively wide transmit signal. Talking too far away may result in reports of weak audio.

5. Release the PTT switch to return to the receive mode. The ON AIR indicator should go out, and the RF meter will return to zero.

### Duplex Operation

Pushing the PTT switch on the microphone allows the simultaneous reception in the SUB band frequency and sending in a MAIN band frequency.

### Note:

With certain relationship between the sending and receiving frequencies, the receiver sensitivity may be suppressed.

Downloaded by   
  
Amateur Radio Directory

## 4-4. REPEATER OPERATION

### 4-4-1. TRANSMITTER OFFSETS

All amateur radio repeaters utilize a separate receiver and transmitter section. The receiver frequency may be either above or below the transmitter frequency.

For most repeaters offsets are as follows:

Band	144 MHz	430/440 MHz		
Model Display	TM-721A TM-721E	TM-721A	TM-721E	
			European version	U.K. version
+	+ 600 kHz	+ 5 MHz		+ 1.6 MHz
-	- 600 kHz	- 5 MHz	- 1.6 MHz	- 1.6 MHz
-			- 7.6 MHz	

#### ● Offset Direction

To select the desired transmitter offset direction press the SHIFT key. Each time you press the key the transceiver will advance from one offset to the other, i.e. + to - ( - to - with European version) to no offset (simplex).

The transceiver allows you to store the frequency, and offset in memory, or you can select these functions directly from the keyboard.

### 4-4-2. REVERSE FUNCTION

Some repeaters utilize a "Reverse pair", i.e. the transmit/receive frequencies are exactly the reverse of another repeater. For example repeater A uses 146.000 for a transmit frequency (OUTPUT) and 146.600 for receive (INPUT). Repeater B uses 146.000 for its receive and 146.600 for its transmit frequency. It would be inconvenient to have to reprogram the transceiver each time if you were in range of both repeaters.

The REV key allows you to reverse the transmit and receive frequencies. To use the REVERSE function press the REV key. The offset indicator ( + or - / - or - ) will flash OFF and ON in the display to remind you that you are working a reverse repeater pair.

To return to normal offsets press the REV key again. This function is also useful to check the input frequency of the repeater, so that you can determine if you are within SIMPLEX communications range.

### 4-4-3. TONE OPERATION

Some repeaters require the use of a control signal to activate the repeater. Several versions are currently in use worldwide.

In the United States sub-audible tones are sometimes used. With the TH-721A, 38 different sub-audible tone frequency selections are possible.

With the use of the optional sub-audible tone encoder/decoder (TSU-6) also allows for CTCSS (Tone Squelch) operations. When this option is activated the squelch of the SUB band will only open when the proper sub-audible tone is received.

In Europe a 1750 Hz tone is used in transmit. Press and hold the TONE key to transmit the access tone, then press the PTT switch.

In the United Kingdom a 1750 Hz tone burst at the beginning of each transmission is used. Press the Tone key.

Since use of this tone is required in the Europe and the United Kingdom, and 1750 Hz tone encoder is included as standard equipment.

● **Tone Activation (TM-721A only)**

To activate the TONE function depress the TONE key.

The T indicator will appear in the display to signify the tone has been activated. To turn the tone OFF press the TONE key again.

**Tone frequency selection**

1. Press the F key and then TONE/T.SEL key.

The current tone frequency will be displayed.

2. Rotate the MAIN Tuning control or press the Microphone UP/DWN switches until the desired tone frequency appears in the display.

3. To turn to the normal frequency display, press the TONE key, any one of the keys, or Microphone PTT switch. Or automatically release return after 5 seconds of the selection.

**Tone Frequency**

67.0 Hz	107.2 Hz	167.9 Hz
71.9 Hz	110.9 Hz	173.8 Hz
74.4 Hz	114.8 Hz	179.9 Hz
77.0 Hz	118.8 Hz	186.2 Hz
79.7 Hz	123.0 Hz	192.8 Hz
82.5 Hz	127.3 Hz	203.5 Hz
85.4 Hz	131.8 Hz	210.7 Hz
88.5 Hz	136.5 Hz	218.1 Hz
91.5 Hz	141.3 Hz	225.7 Hz
94.8 Hz	146.2 Hz	233.6 Hz
( 97.4 Hz)	151.4 Hz	241.8 Hz
100.0 Hz	156.7 Hz	250.3 Hz
103.5 Hz	162.2 Hz	

**Note:** 97.4 Hz is available only for encode.

**4-4-4. AUTOPATCH (U.S.A. version only)**

Some repeaters offer a service known as autopatch. This allows you to dial a telephone number from your transceiver and carry out a telephone conversation, much like a car telephone, or cellular telephone. This function requires the use of a DTMF (Dual Tone Multi Frequency) pad. In addition to the normal 12 keys that are found on your telephone the MC-48B microphone also provides 4 additional keys, A, B, C, and D. These keys are required by some repeater systems for various control functions. You should check with the control operator of your repeater to determine if their use is required. A chart is provided that lists the tones that are generated when you press each key.

1. To activate the DTMF pad, press and hold the PTT switch.
2. Now press the keys just as you would dial a telephone.
3. The transceiver will remain keyed for about 2 seconds after you press each number, so you can release the PTT switch without unkeying the transceiver.

**Note:**

Some repeaters will require a special sequence of keys to activate the Autopatch. Again you should check with the control operator of your repeater for this sequence.

**Audio tones (Hz)**

Column Row	1209	1336	1477	1633
697	1	2	3	A
770	4	5	6	B
852	7	8	9	C
941	*	0	#	D

## 4-5. MEMORY

### 4-5-1. Microprocessor memory back-up

A lithium battery is contained in the transceiver to retain memory. Turning off the POWER switch, disconnecting the power cable, or a power failure will not erase the memory. The battery should last for approximately five years. When the battery discharges, an erroneous display may appear in the display.

Lithium battery replacement should be performed by an authorized KENWOOD service facility; either your KENWOOD dealer, or the factory, since this unit contains CMOS type circuitry.

### 4-5-2. Microprocessor Initialization

- Initial state of the microprocessor from the factory.

		MAIN BAND	SUB BAND
VFO		430/440	144
Memory Channel 0 ~ 9, A ~ d		430/440	144
CALL Channel TM-721A only	(U.S.A version)	440	144
	(other market)	430	144

(MHz)

#### ● Microprocessor Initialization

When you want to erase all programmed data, or if the display should show erroneous information, you should initialize (reset) the microprocessor using the following procedure.

1. Turn the POWER switch off.
2. Press and hold the F key and turn on the POWER switch.

3. Release the F key; the F indicator and Memory Channel Number "0" will display for approximately 5 seconds after you release the keys.

### 4-5-3. Memory Channel

This transceiver provides 14 Memory Channels (0-9, A-d). In addition to serving as a normal memory channel some of the Memory Channels serve a dual purpose to specify other parameters. The functions of these Memory Channels are described below.

- \* Memory Channel 1 is used to store the frequency for the Priority Alert function.
- \* Memory Channel A is used to store the lower limit for the Programmable Band Scan function.
- \* Memory Channel b is used to store the upper limit for the Programmable Band Scan function.
- \* Memory Channel C and d are used to store odd split repeater data.

### 4-5-4. Memory Contents

Each Memory Channel is capable of storing;

Model	TM-721A			TM-721E	
	0~9, A, b	C, d	CALL	0~9, A, b	C, d
Frequency data	○	○	○	○	○
Tone Frequency data	○	○	○	X	X
Tone ON/OFF	○	○	○	X	X
SHIFT status	○	X	○	○	X
REVERSE ON/OFF	○	X	○	X	X



### 4-5-5. Memory Entry

Memory Entry must be done in MAIN band.

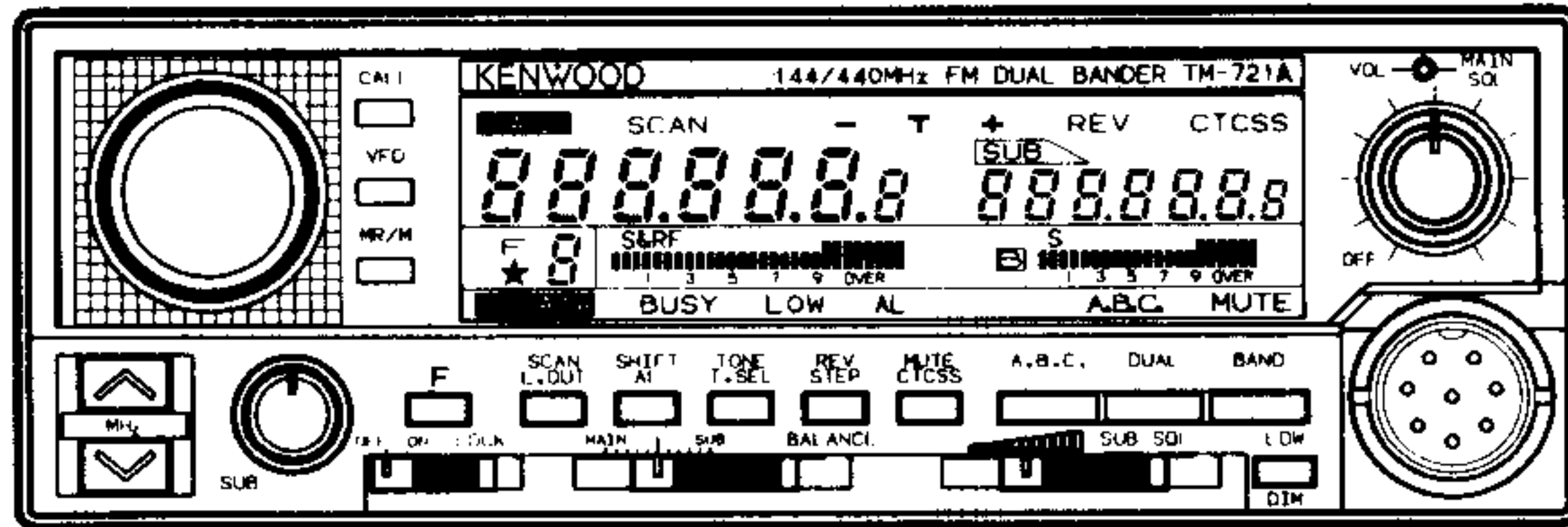

#### ■ Simplex/Normal SHIFT (M.ch 0 ~ 9, A and b)

1. Press the VFO key to select the VFO mode.
2. Select the desired operating frequency, offset, tone frequency, etc. (For example 146.100 MHz + shift)

VFO

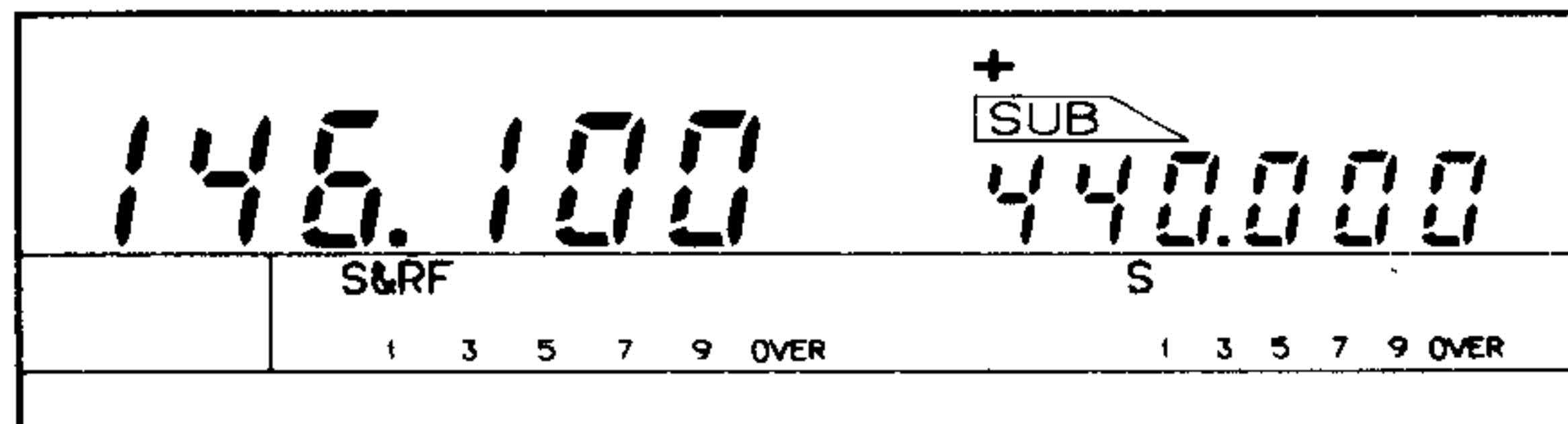
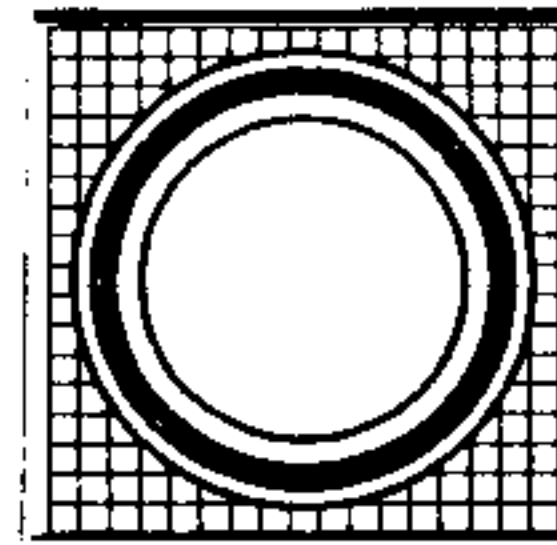

F

3. Press the F key. The F indicator and the memory channel indicator will light. (For example ch 8.)

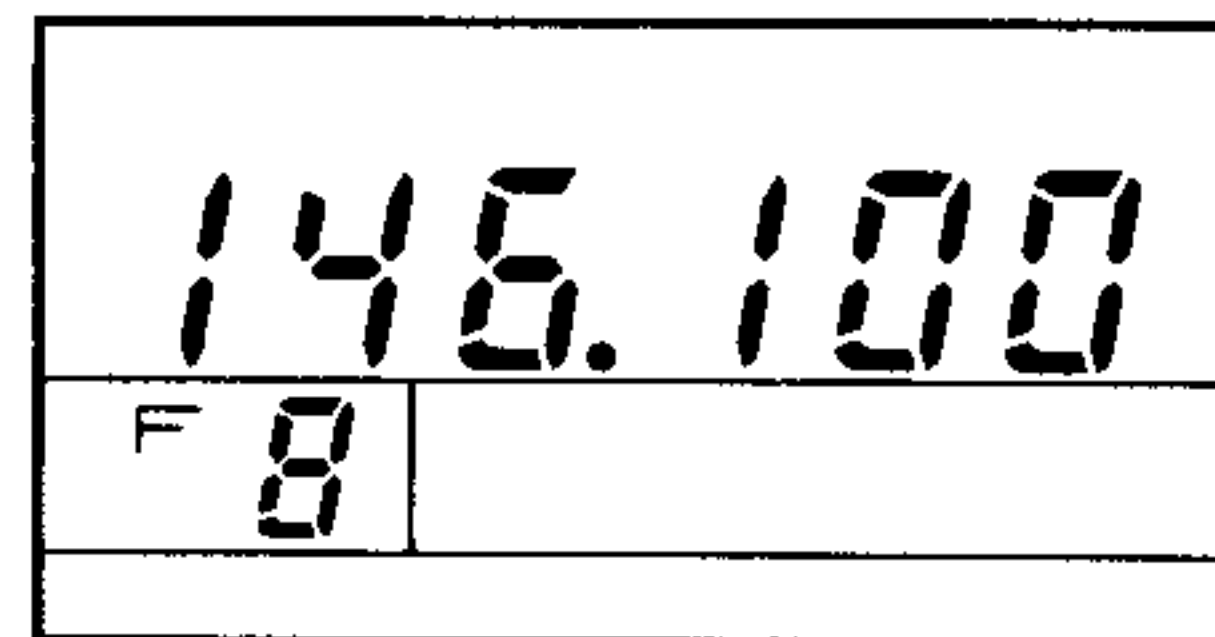

4. Select the desired Memory Channel using the MAIN Tuning control or the microphone UP/DWN switches.

**Note:**

You must do this within 5 seconds of pressing the F key, or the F indicator will turn off. If the indicator goes off, you must press the F key again.

5. Press the MR/M key within 5 seconds of selecting the Memory Channel.

**Note:**

If the indicator goes off, you must press the F key again in order to complete the desired function.

After pressing the MR/M key the F indicator and the Memory Channel number will turn OFF, and the transceiver will return to the VFO mode.

#### ■ Odd Split Channels (M.ch C, and d)

1. Press the VFO key to select the VFO mode.
2. Select the desired receiving frequency, Tone frequency, etc. (For example 147.430 MHz)

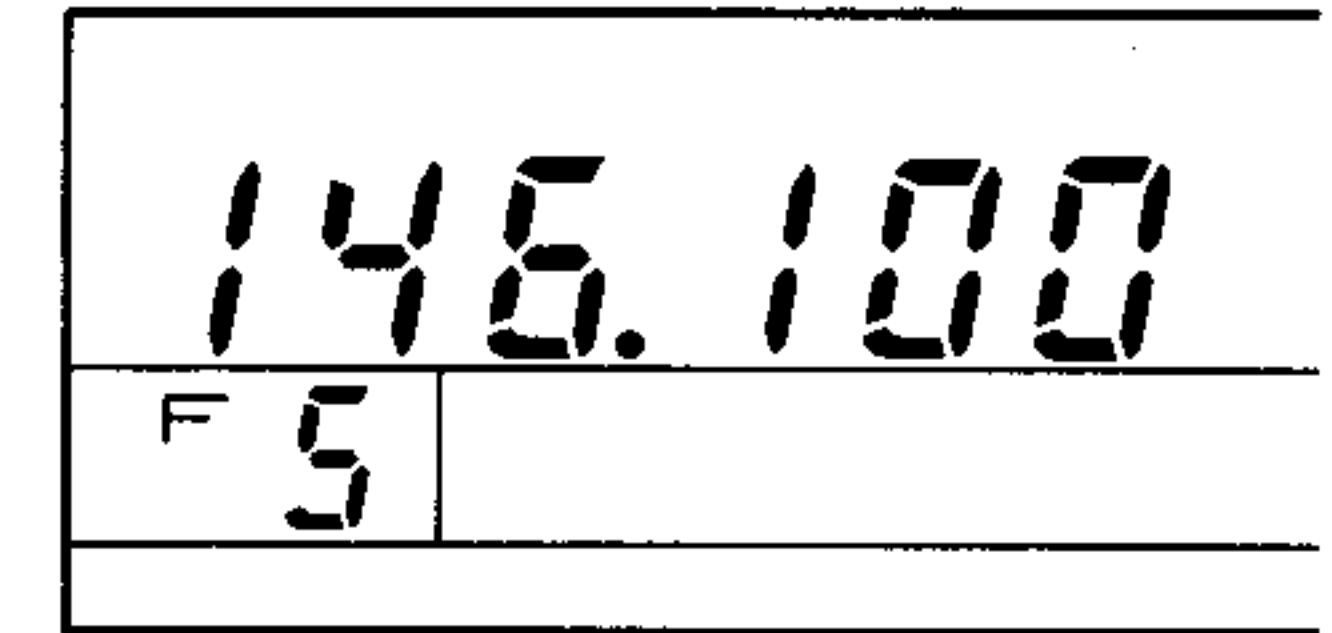
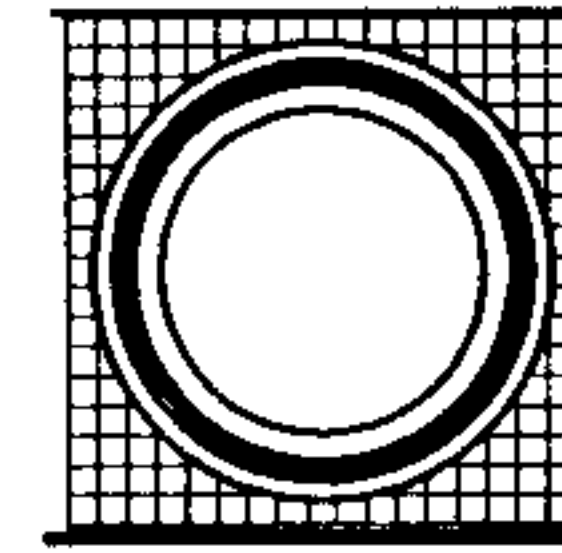

MR/M

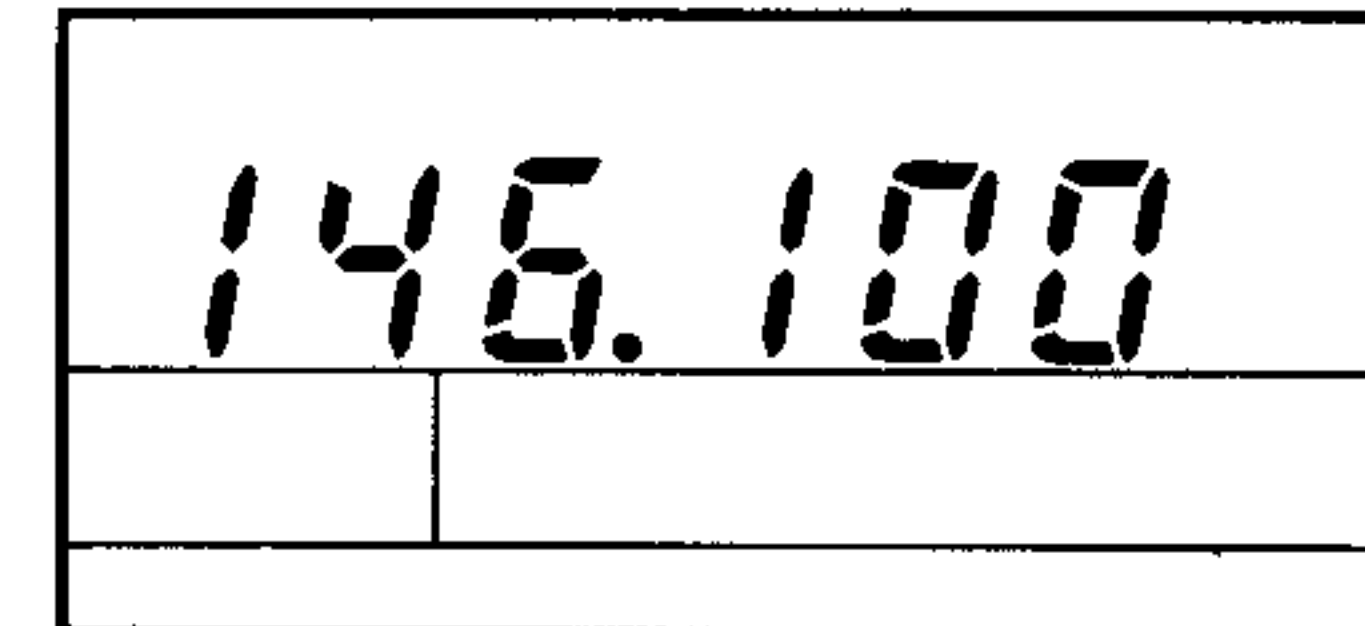

VFO

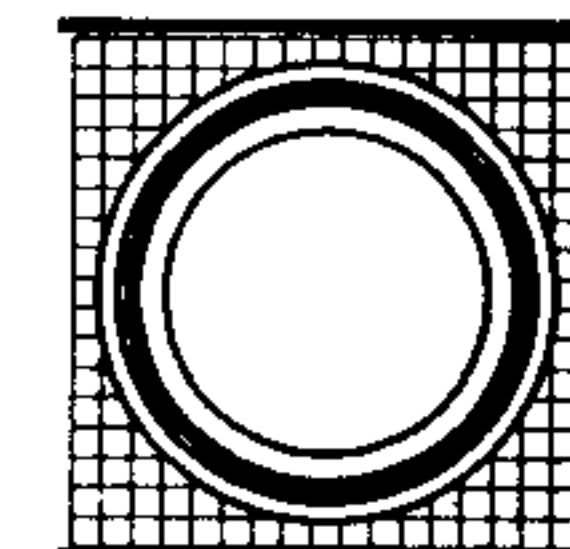



- Press the F key. The F indicator and the memory channel indicator will appear. (For example 5 ch)
- Select Memory Channel C or d using the MAIN Tuning control or the microphone UP/DWN switches. (For example ch d)

**Note:** \_\_\_\_\_

You must do this within 5 seconds of pressing the F key, or the F indicator will turn off. If the indicator goes off, you must press the F key again.

- Press the MR/M key within 5 seconds of selecting Memory Channel C or d.

**Note:** \_\_\_\_\_

If the indicator goes off, you must press the F key again.

After pressing the MR/M key the F indicator will remain on and the Memory Channel number will turn off.

- Within 5 second of pressing the MR/M key, select the transmitting frequency

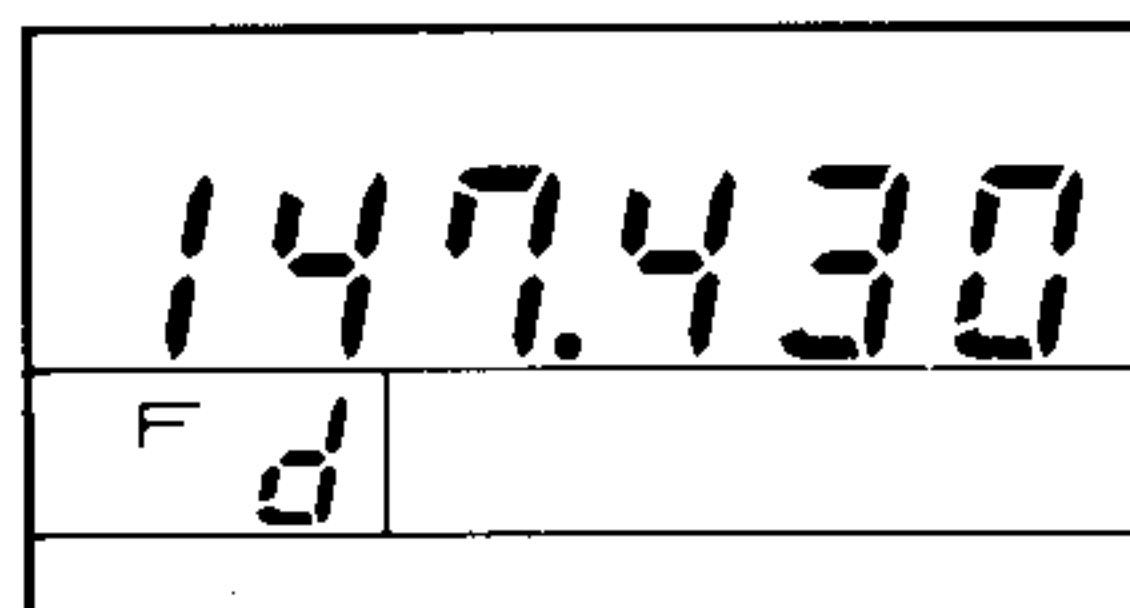
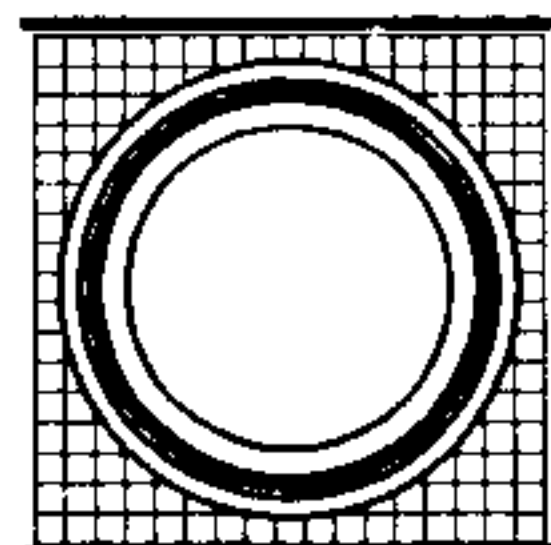
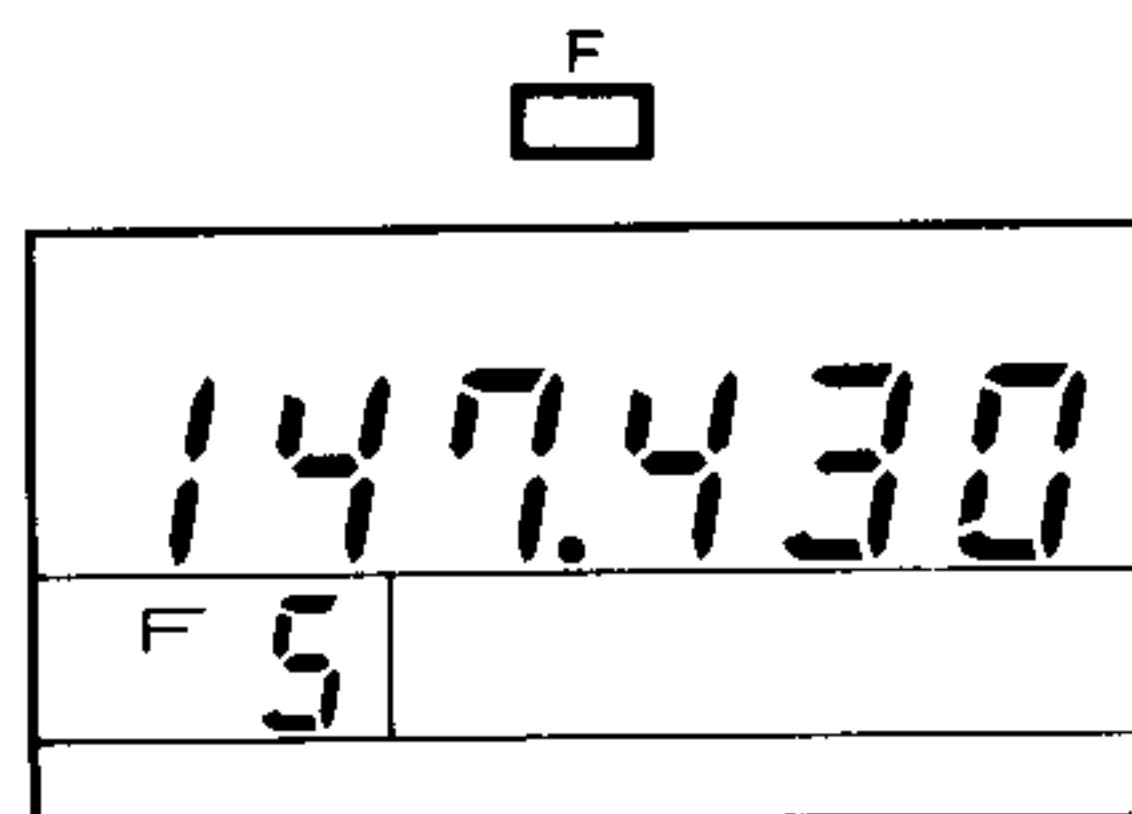

MR/M

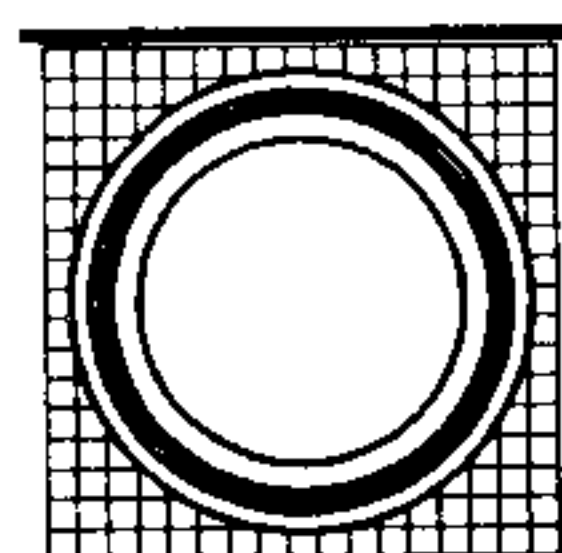
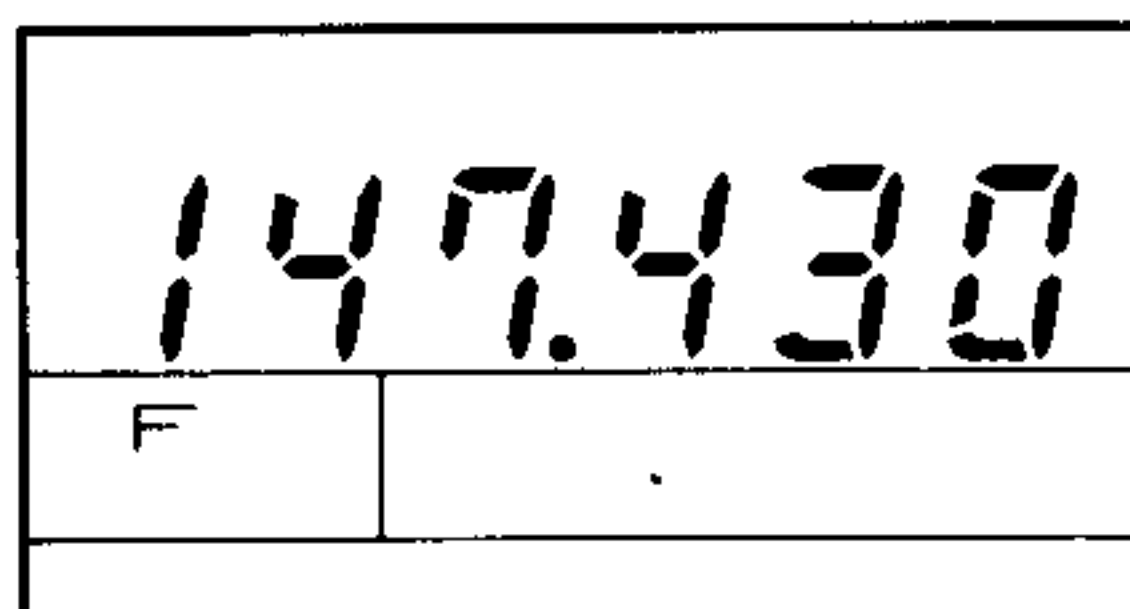

using the MAIN Tuning control or the microphone UP/DWN switches. (For example 146.430 MHz)

- Press the MR/M key within 5 seconds of selecting the transmitting frequency. The F indicator goes off signaling Split Memory Channel Entry is complete.

- To confirm the contents of the Split Memory press the MR/M key and recall the desired channel (cord). The receiving frequency will appear in the display.

- Press the REV key or microphone PTT switch. The transmitting frequency will appear in the display.

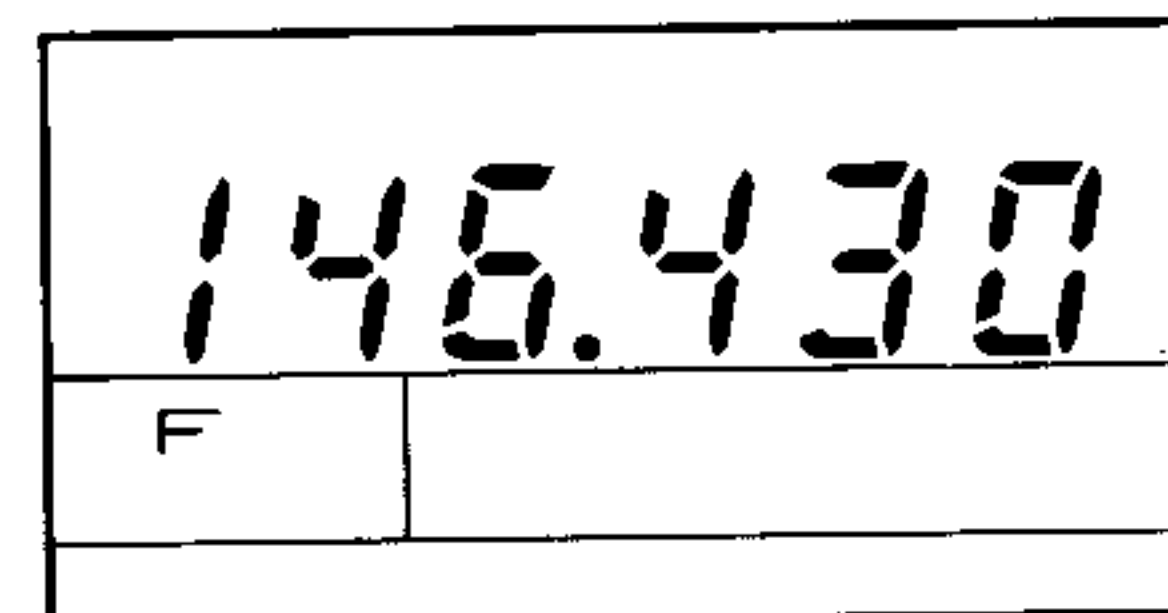

MR/M

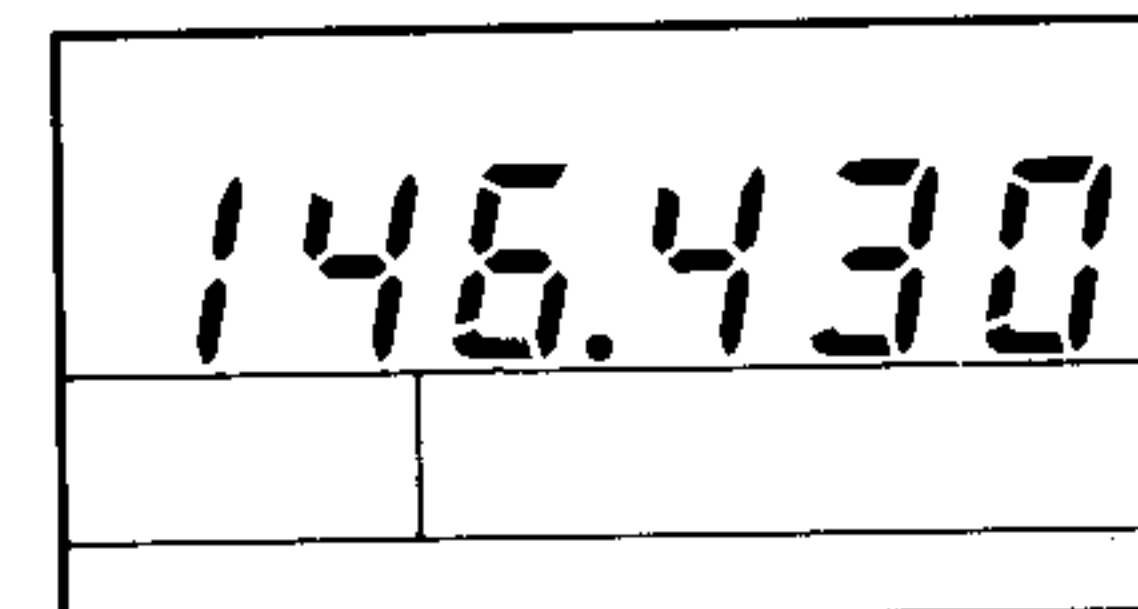

MR/M

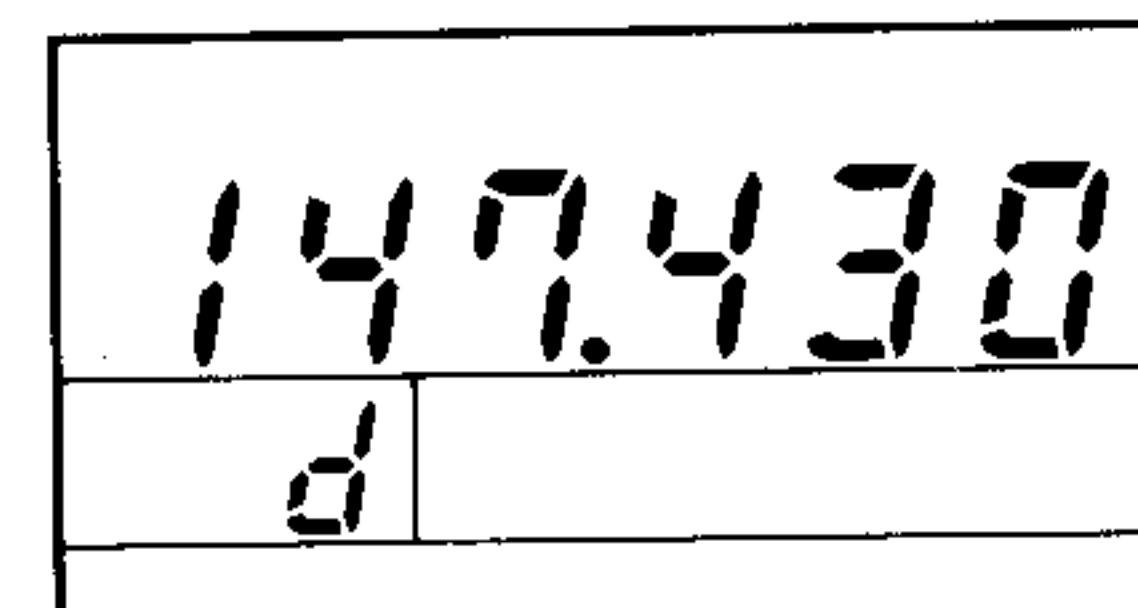

REV STEP

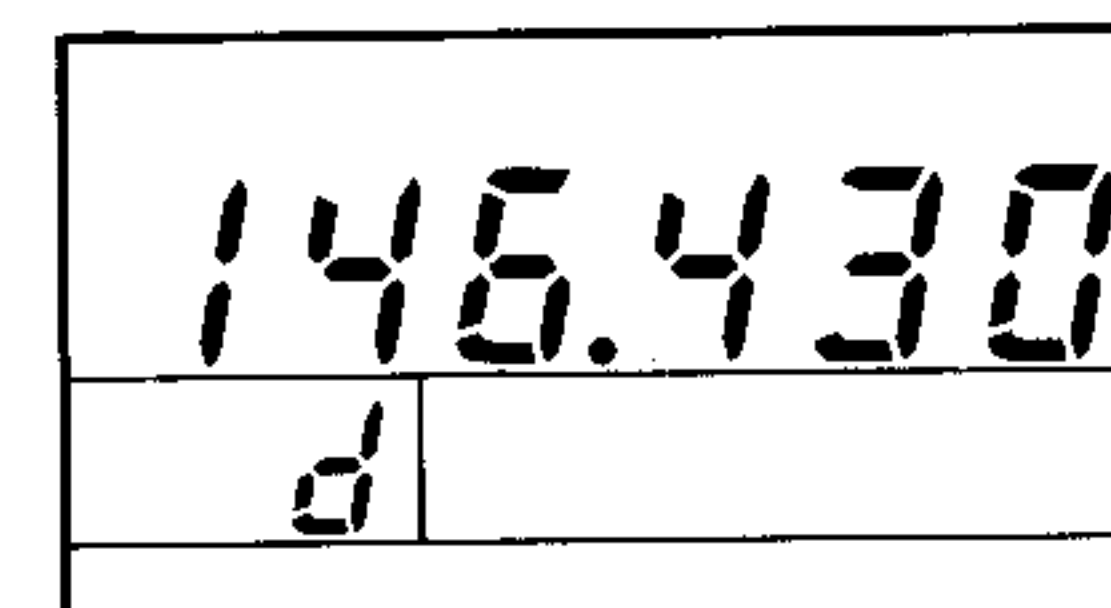

### ■ CALL Channel (TM-721A only)

1. Press the VFO key to select the VFO mode.
2. Select the desired operating frequency, offset, tone frequency, etc. (For example 146.520 MHz)

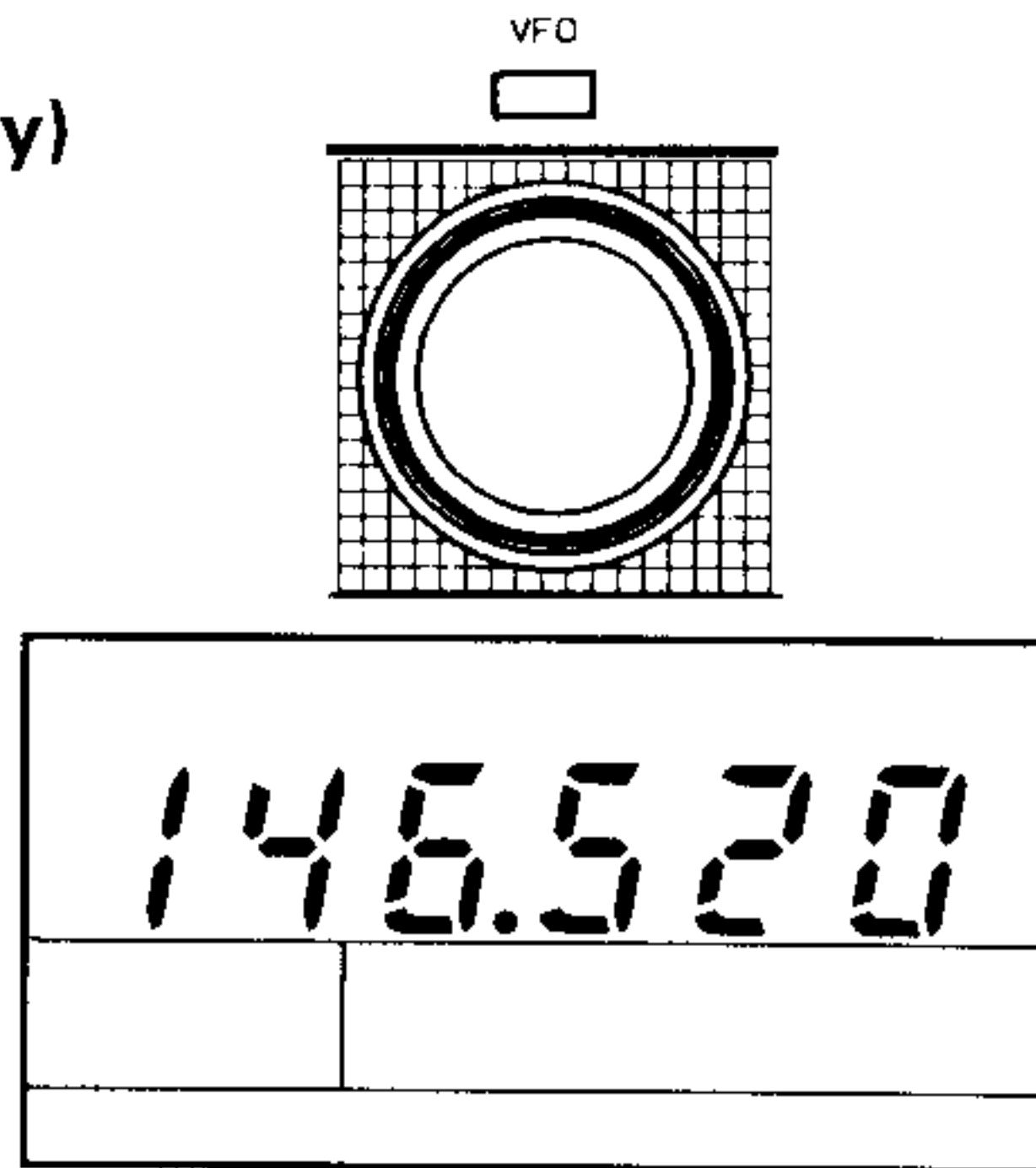

3. Press the F key. The F indicator and the memory channel indicator will light. (For example ch d)

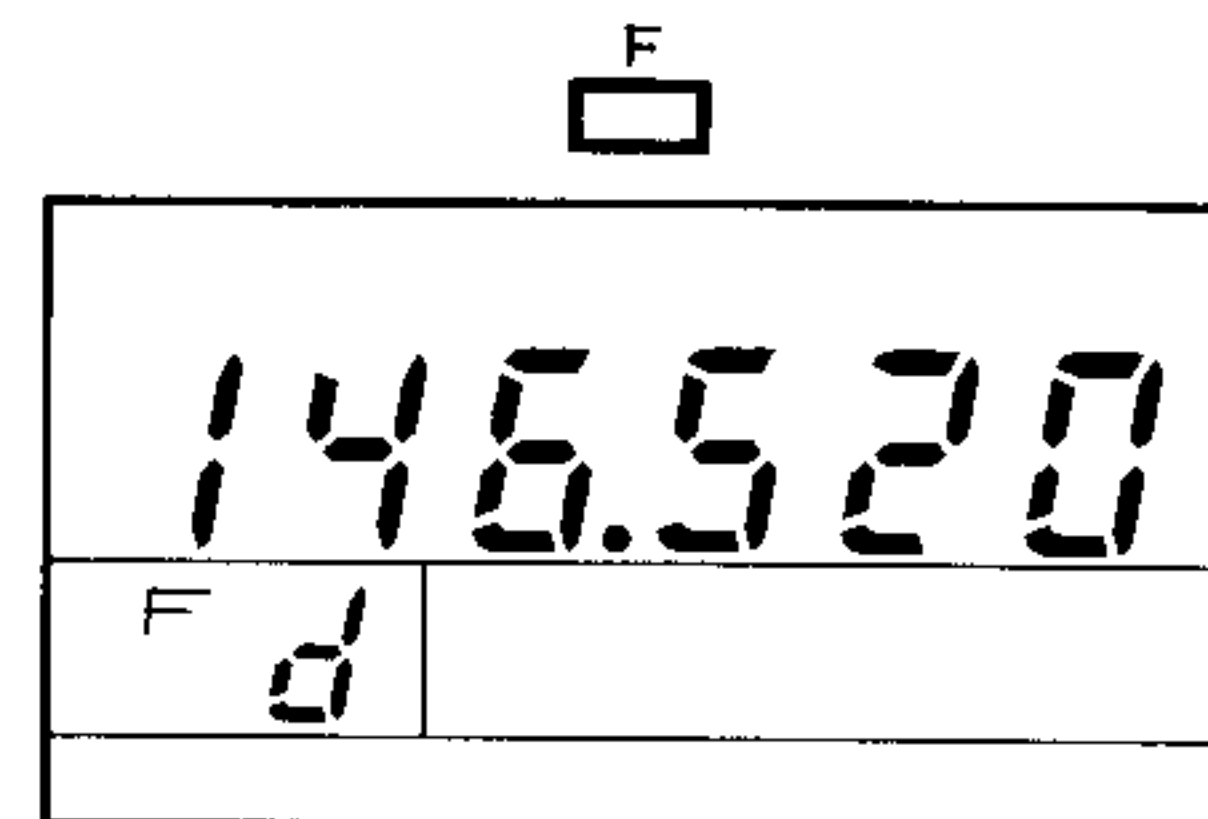

4. Press the CALL key within 5 seconds of pressing the F key. The F indicator and the Memory Channel number will turn off.

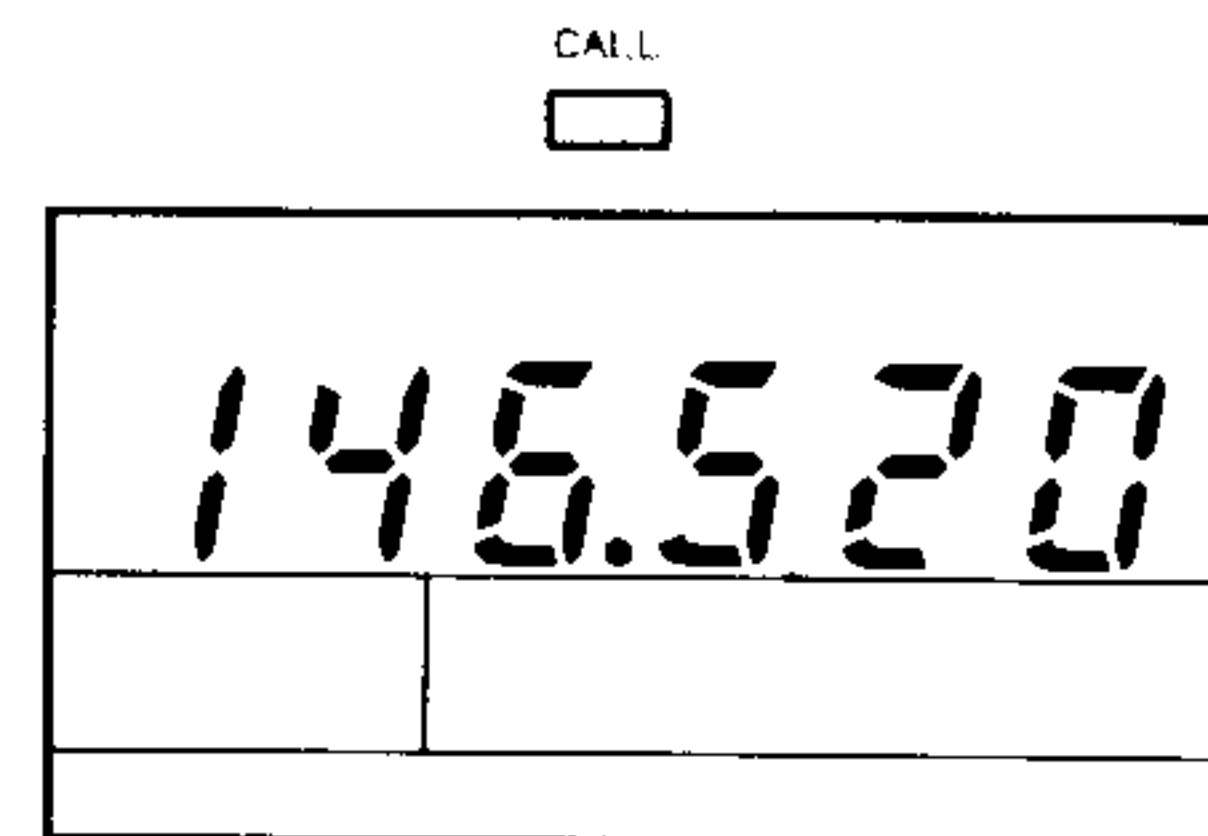

5. To confirm the CALL channel contents press the CALL key and select the Channel. The NEW CALL channel will appear.

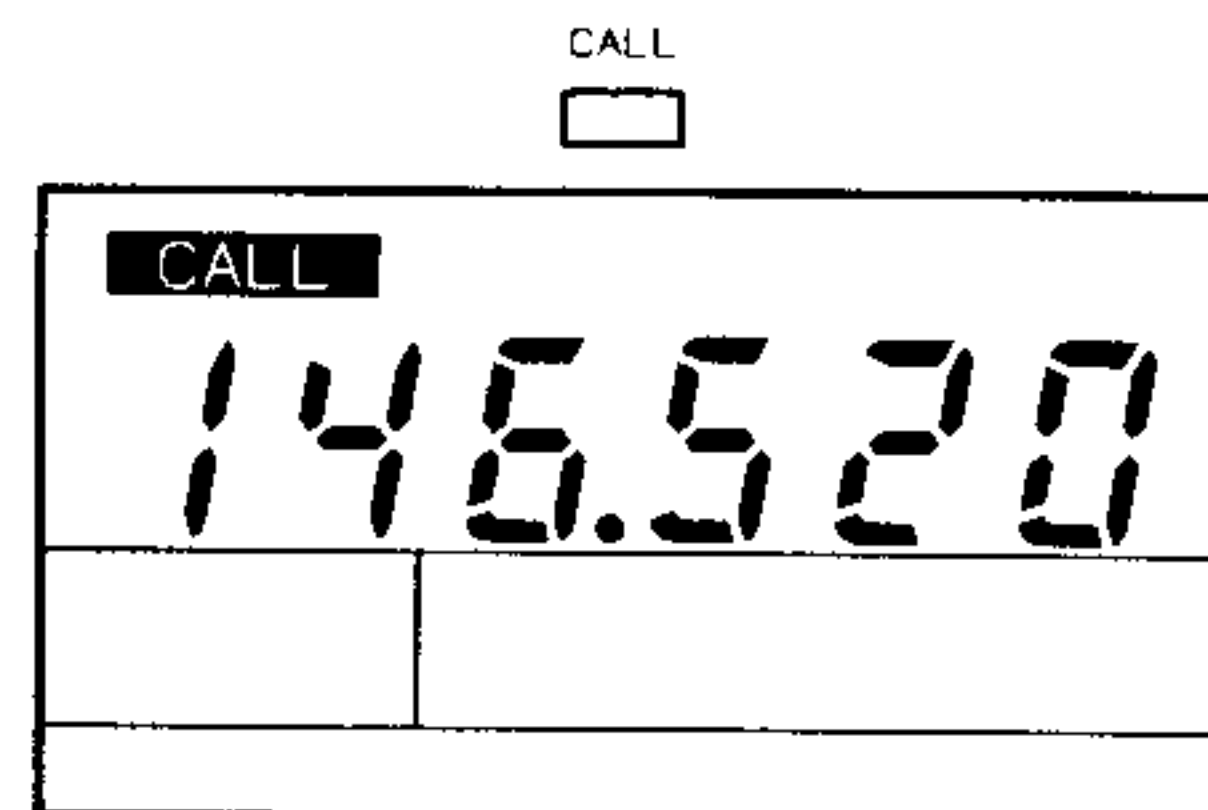

### 4-5-6. Memory Recall

Please refer to Frequency Selection page 16.

### 4-5-7. Memory Shift

This feature copies memory channel or CALL channel data to the VFO.

This will allow you to after these frequencies without changing the actual contents of the memory or CALL channel.

1. Press the F key. The F indicator and the memory channel indicator will appear. (For example 146.100 MHz CH. 8)

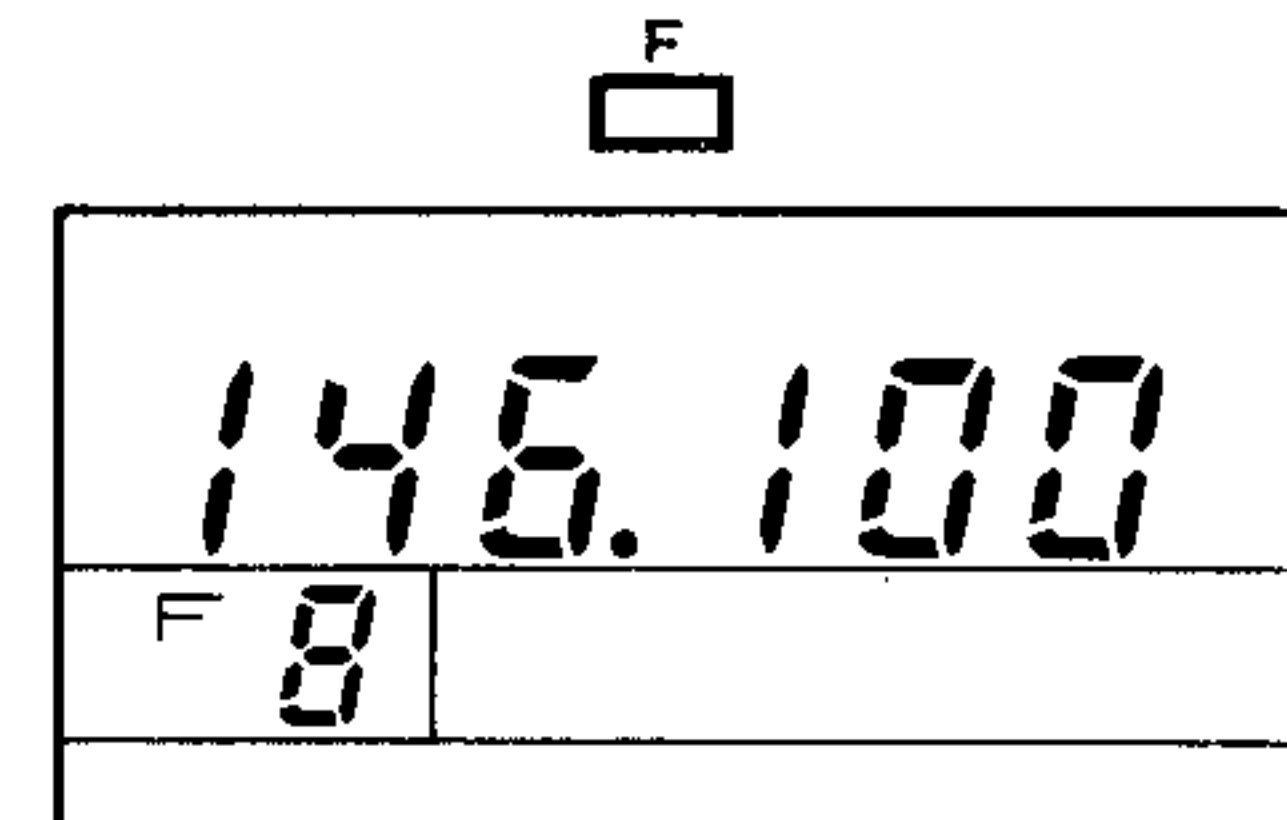

2. Press the VFO key within 5 seconds of pressing the F key.

**Note:** \_\_\_\_\_  
If the indicator goes off, you must press the F key again.

The data is copied to the VFO mode.

**Note:** \_\_\_\_\_  
If an Odd split Memory Channel (C or d) is selected, only the receive data will be copied.

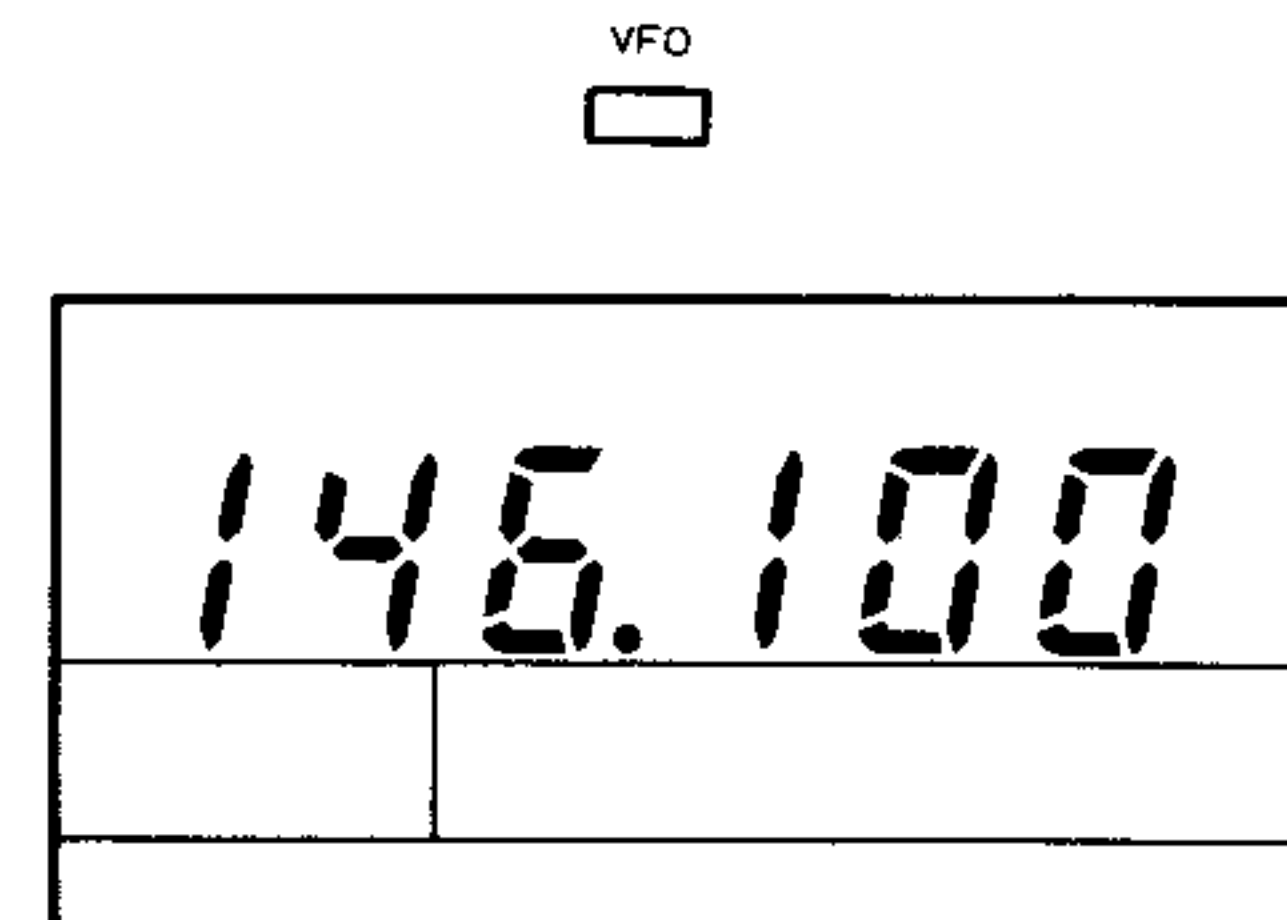

## 4-6. SCAN

### 4-6-1. Scan Options

The following scan options are available:

#### PROGRAMMABLE BAND SCAN

The Scan frequency range is determined by the frequencies stored in Memory Channels A and b. (VFO mode)

#### BAND SCAN

Scan proceeds over the entire band (VFO mode).

#### MEMORY CHANNEL SCAN

Scan proceeds thru those memory channels that actually have data entered and have not been locked out. (Memory Channel Mode)

### 4-6-2. PROGRAMMABLE BAND SCAN/BAND SCAN

1. The lower scan limit must be stored in Memory channel A. The higher scan limit must be stored in Memory channel b.

**Caution:** \_\_\_\_\_  
If the frequency in Memory Channel A is equal to or greater than the frequency stored in Memory channel b scan will proceed over the entire band "BAND SCAN".

(For the Memory Entry, refer to MEMORY ENTRY page 23.)

2. Press the VFO key to select the VFO mode.
3. Adjust the SQL control to the threshold point.
4. Select a VFO frequency between the two scan limits.
5. Press the SCAN key to initiate scan. The SCAN indicator will light as a visual reminder that the transceiver is scanning.
6. Scan will begin in an upwards direction. You can reverse the direction by rotating the MAIN Tuning control

counterclockwise, or by pressing the microphone UP/DWN switch. The scan step size depends upon the current step programming.

7. Scan will stop whenever a signal is received (that activates the BUSY indicator) for a limited time.
8. Press the PTT switch or the SCAN key to clear scanning.

### 4-6-3. MEMORY CHANNEL SCAN

1. Press the MR/M key to select the Memory Channel mode.
2. Adjust the SQL control to the threshold point.
3. Press the SCAN key to initiate scan. The SCAN indicator will light as a visual reminder that the transceiver is scanning.
4. Scan will begin at the current memory channel and proceed sequentially. i.e. M1→M2→M3 etc.
5. Scan will stop whenever a signal is received (that activates the BUSY indicator) for a limited time.
6. Press the PTT switch or the SCAN key to clear scanning.

### 4-6-4. HOLD/RESUME programming

The transceiver will stop on a busy channel.

Scan will resume approximately 5 seconds afterwards even if the station is still present.

#### 4-6-5. Priority Alert

Memory channel 1 will be checked at approximately 5 second intervals to check for activity when this function is selected.

1. Enter the frequency that you wish to monitor in memory channel 1 of the MAIN BAND (See Memory Entry page 23).
2. Adjust the SQL control to the threshold point.
3. With the TM-721A; Press the F key and then SHIFT/AL key.

With the TM-721E; Press the AL key.

“AL” indicator will appear on the LCD display.

If the channel is busy, a beep will sound.

**Note:** \_\_\_\_\_

1. If the audio confirmation function has been turned OFF, no beep will sound, even if Memory Channel 1 is busy.
  2. During the period channel 1 is being monitored, only the beep will sound.
- 
4. With the TM-721A; Press the F key and then SHIFT/AL key again.  
With the TM-721E; Press the AL key again.  
“AL” will disappear, disabling the Priority Alert function.

#### 4-6-6. Memory Channel Lockout

The Memory Channel Lockout function allows you to temporarily skip unwanted Memory Channels during Memory Channel Scan.

1. Press the MR/M key to select the Memory Channel mode.

2. Select the Memory Channel that you wish to skip by using the MAIN Tuning control or the microphone UP/DWN switches.

3. Press the F key and then the SCAN/L.OUT key. Whenever the F key is pressed, the F indicator will turn ON.

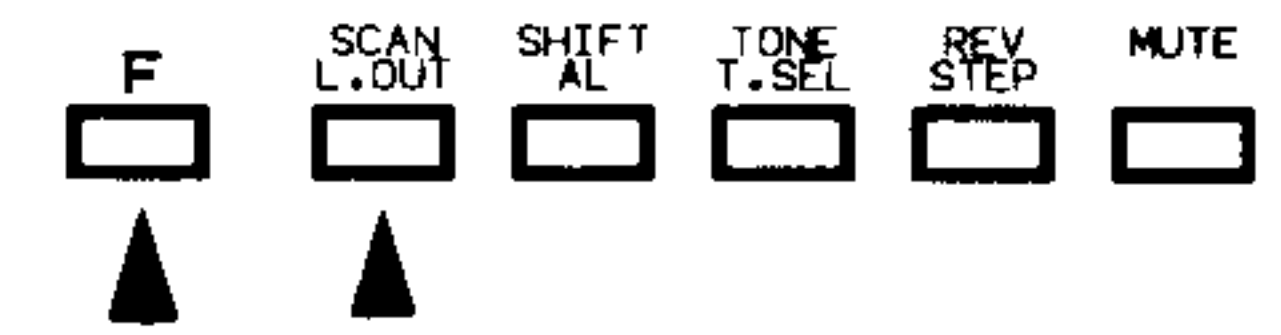

**Note:** \_\_\_\_\_  
You must complete the desired action within 5 seconds, or the F indicator will turn OFF. If the indicator goes off, you must press the F key again.

A star (★) will appear to the left of the Memory Channel number. This indicates the Memory Channel will be skipped during Memory Channel Scan operations.

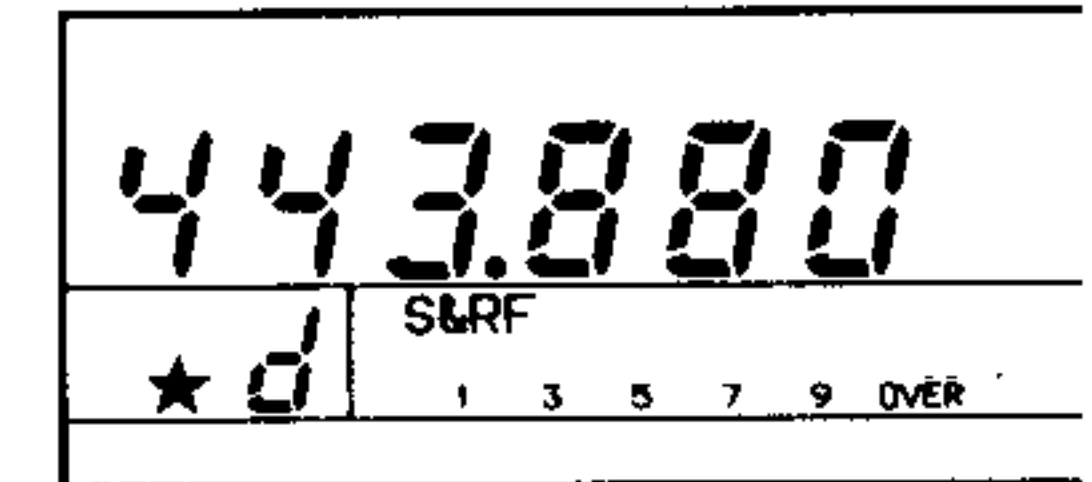

4. Repeat steps 2 and 3 to lock out any other Memory Channels that you want to skip.
5. To cancel the lockout, select the desired Memory Channel as described in steps 1, 2, and 3 above. The star (★) will go out. The Memory Channel will now be scanned normally.

## 5. BLOCK DIAGRAM and SCHEMATIC DIAGRAM

Another sheet

# 6. MAINTENANCE

## 6-1. GENERAL INFORMATION

Your transceiver has been factory aligned and tested to specification before shipment. Under normal circumstances the transceiver will operate in accordance with these operating instructions. All adjustable trimmers and coils in your transceiver were preset at the factory and should only be readjusted by a qualified technician with proper test equipment.

Attempting service or alignment without factory authorization can void the transceiver's warranty.

When operated properly, the transceiver will provide many years of service without requiring realignment. The information in this section gives some general service procedures which can be accomplished without sophisticated test equipment.

## 6-2. SERVICE

Should it ever become necessary to return the equipment to your dealer or service center for repair, pack it in its original box and packing, and include a full description of the problems involved. Also include your telephone number. You need not return accessory items unless directly related to the service problem.

**Caution:** \_\_\_\_\_

Do not pack the equipment in crushed newspapers for shipment. Extensive damage may result, during shipment.

---

**Service note:** \_\_\_\_\_

Dear OM, if you desire to correspond on a technical or operational problem, please make your note short, complete, and to the point, and PLEASE make it readable.

Please list: Model and Serial Number

The problem you are having.

Please give sufficient detail to diagnose. Information such as other equipment in the station, meter readings and anything else you feel might be useful in attempting diagnosis should be included.

---

**Notes:** \_\_\_\_\_

1. Record the Date of Purchase, Serial Number and Dealer from whom purchased.
  2. For your own information, retain a written record of any maintenance performed on the unit.
  3. When claiming warranty service, a photocopy of the bill of sale, or other proof of purchase showing the date of sale must accompany the radio.
- 

## 6-3. CLEANING

The knobs, front panel and cabinet of the transceiver are likely to become soiled after extended use. The knobs should be removed from the transceiver and cleaned with a neutral soap and warm water. Use a neutral soap (no harsh chemicals) and a damp cloth to clean the cabinet and front panel.



## 6-4. IN CASE OF DIFFICULTY

The problems described in this table are failures caused, in general, by improper operation or connection of the transceiver, not by defective components. Examine and check according to the following table.

Symptom	Probable cause	Corrective action
Indicators do not light and no receiver noise is heard when the POWER switch is turned on.	<ol style="list-style-type: none"> <li>1. Bad power cable or connections.</li> <li>2. Blown power supply fuse.</li> </ol>	<ol style="list-style-type: none"> <li>1. Check cables and connections.</li> <li>2. Check for the cause of the blown fuse and replace the fuse.</li> </ol>
No sound from the speaker. No signal can be received.	<ol style="list-style-type: none"> <li>1. Squelch is closed.</li> <li>2. In the wrong position BALANCE key position.</li> <li>3. With the TSU-6: (TM-721A only) CTCSS is operating.</li> </ol>	<ol style="list-style-type: none"> <li>1. Turn the SQL control counterclockwise.</li> <li>2. Readjust the BALANCE key.</li> <li>3. Press the F key and then MUTE/CTCSS key to turn off the CTCSS.</li> </ol>
No transmitter output	<ol style="list-style-type: none"> <li>1. Microphone jack is not plugged in.</li> <li>2. Poor antenna connection.</li> </ol>	<ol style="list-style-type: none"> <li>1. Plug jack in.</li> <li>2. Connect antenna securely.</li> </ol>
Signals from the SUB band cannot be controlled by VOL control.	<ol style="list-style-type: none"> <li>1. MUTE is ON.</li> <li>2. BALANCE key is switched to MAIN position.</li> </ol>	<ol style="list-style-type: none"> <li>1. Press the MUTE key to clear MUTE.</li> <li>2. Set the BALANCE key to center position.</li> </ol>
Weak signal cannot be received.	<ol style="list-style-type: none"> <li>1. Poor antenna connection.</li> </ol>	<ol style="list-style-type: none"> <li>1. Connect antenna securely.</li> </ol>
Display is dark.	<ol style="list-style-type: none"> <li>1. Power voltage is low.</li> <li>2. The DIM key had been pressed.</li> </ol>	<ol style="list-style-type: none"> <li>1. Check voltage for 13.8 VDC <math>\pm</math> 15%.</li> <li>2. Press the F key and the LOW/DIM key.</li> </ol>
No control works.	<ol style="list-style-type: none"> <li>1. LOCK is ON.</li> <li>2. During A.B.C. operation, being exchanging the bands each other.</li> </ol>	<ol style="list-style-type: none"> <li>1. Set the Lock key to OFF position.</li> <li>2. See A.B.C. Page 18.</li> </ol>

Symptom	Probable cause	Corrective action
Frequency of the sub band is not changed by turning the SUB Tuning control.	<ol style="list-style-type: none"> <li>1. The frequency is that of the call channel.</li> <li>2. The frequency is that of the Memory Channel, and all memories have the same contents.</li> </ol>	<ol style="list-style-type: none"> <li>1. Press the BAND key, VFO key, and then BAND key again to change the contents of the SUB band to that of the VFO frequency.</li> <li>2. Press the BAND key, MR/M-key, and then enter the desired frequency to each memory channels. Then press the BAND key to return to SUB band.</li> </ol>
Programmable band scan fails during 12.5 kHz VFO step.	<ol style="list-style-type: none"> <li>1. The frequencies stored in Memory Channels A and/or b are not in 12.5 kHz step.</li> </ol>	<ol style="list-style-type: none"> <li>1. Make even the frequency steps.</li> </ol>
Memory cannot be backed up.	Backup battery voltage is low.	See Microprocessor memory back-up page 22.

# 7. OPTIONAL ACCESSORIES

## 7-1. ACCESSORIES

### ■ MA-4000 DUAL BAND ANTENNA

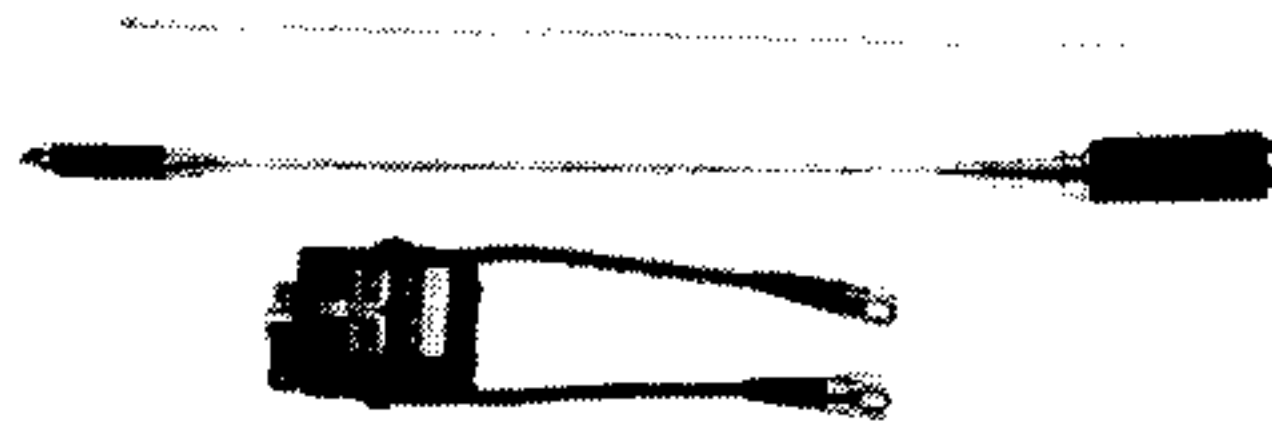

### ■ MC-60A MICROPHONE (8-pin)

The zinc die-cast base provides high stability. The MC-60A is complete with PTT and LOCK switches, UP/DOWN switches, impedance selector switch and a built-in pre-amplifier.



### ■ SP-40 COMPACT MOBILE SPEAKER (4 ohms)



### ■ MC-48B AUTOPATCH UP/DOWN HAND MICROPHONE (8-pin)

The MC-48B provides 16 autopatch tones. UP/DWN switches provide step frequency change, or initiate band scan in the appropriate direction, if held depressed momentarily.

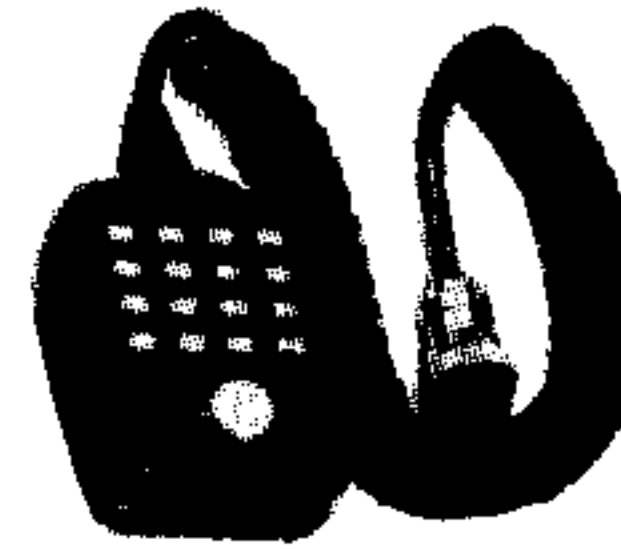

### ■ MC-80 MICROPHONE (8-pin)

The MC-80 is an omnidirectional electret condenser microphone that is provided with UP/DOWN switches, volume adjustment for output level, PTT and LOCK switches, and a built-in pre-amplifier.



### ■ SP-50B MOBILE SPEAKER (8 ohms)

Compact and smart, high quality external speaker provides flexibility of installation for maximum convenience.

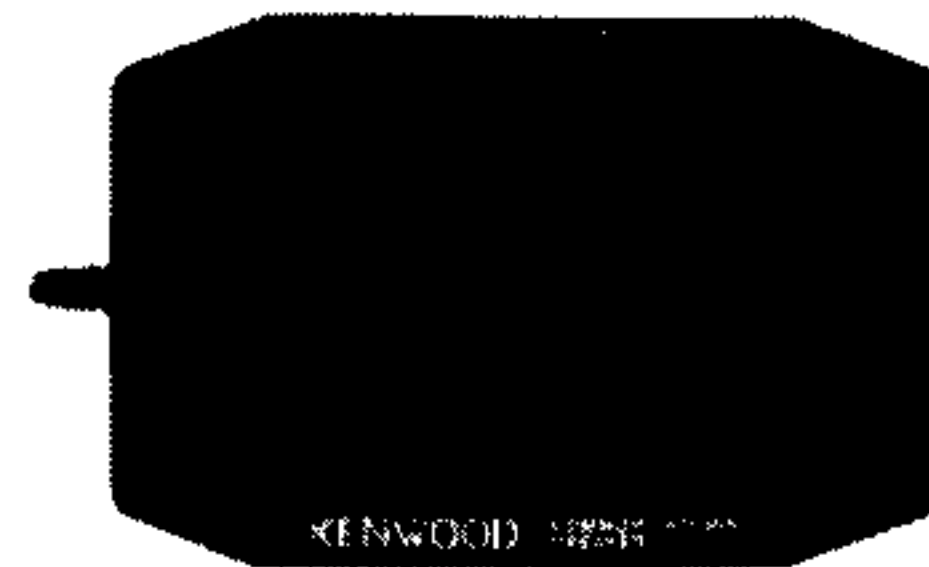

### ■ MC-55 MOBILE MICROPHONE (8-pin)

The MC-55 provides UP/DOWN switches, LED display for switching transmit or receive, adjustable microphone gain, automatic timeout circuit (approx. 5 minutes) and many other functions.



### ■ MC-85 MICROPHONE (8-pin)

The MC-85 is a unidirectional high-class electret condenser microphone provided with an output selector switch, audio level compensation circuit, low cut filter, level meter, PTT and LOCK switches.



### ■ SP-430 EXTERNAL SPEAKER

The SP-430 is an attractive, compact external speaker. This low-distortion speaker provides clear reproduction of the high-quality audio obtained from the transceiver.

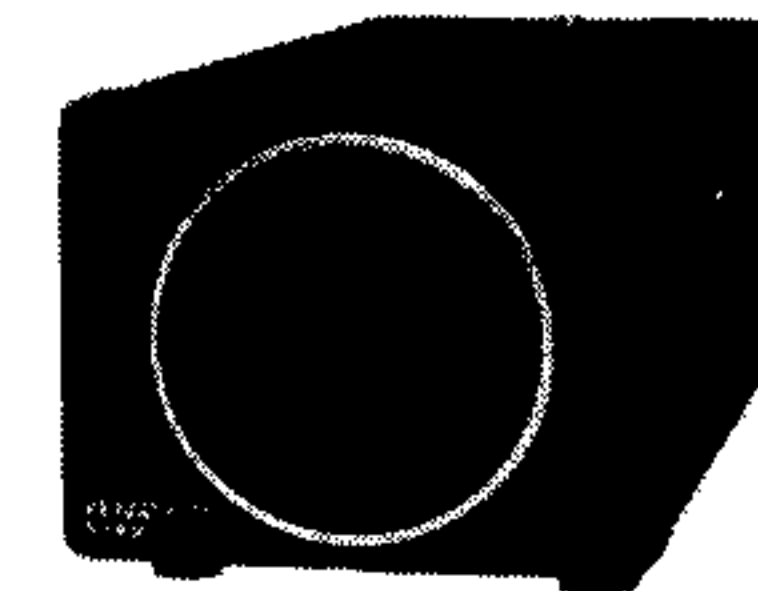

■ PS-430 DC POWER SUPPLY

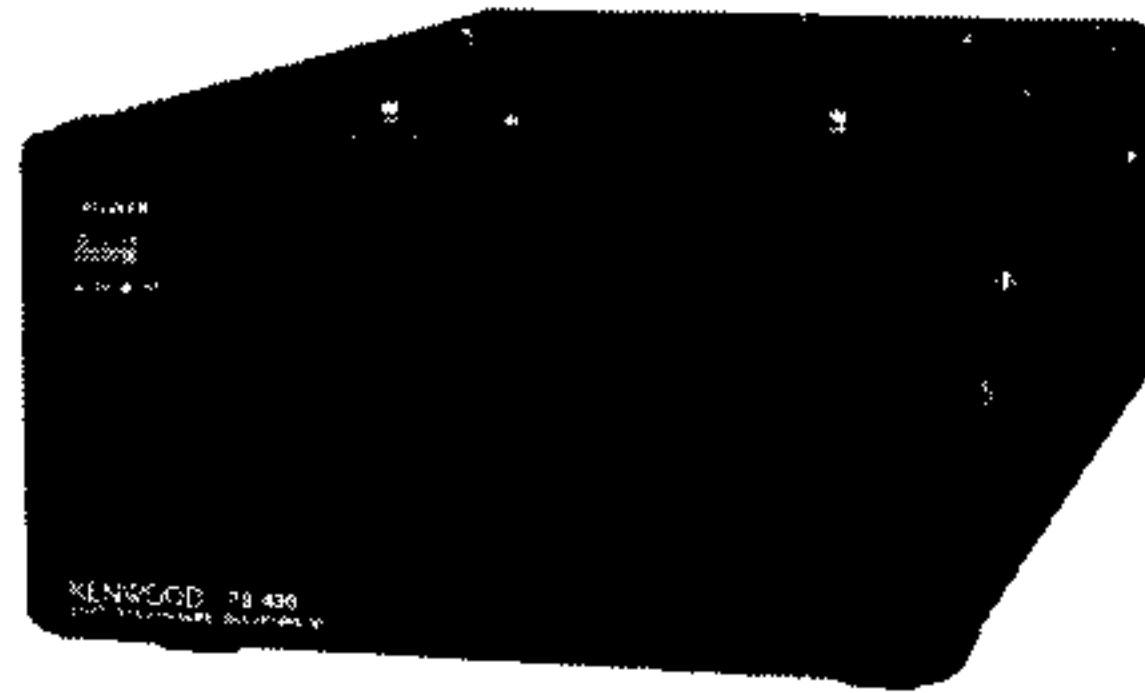

■ PS-50 HEAVY DUTY DC POWER SUPPLY

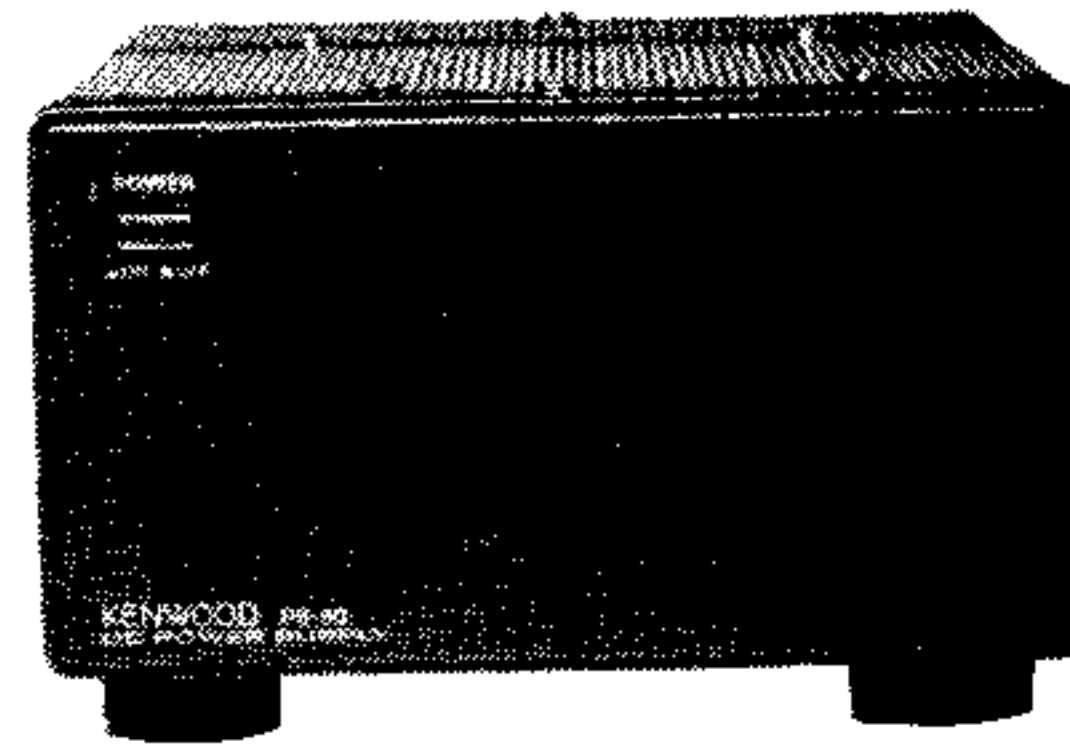

■ MB-11 MOBILE MOUNTING BRACKET

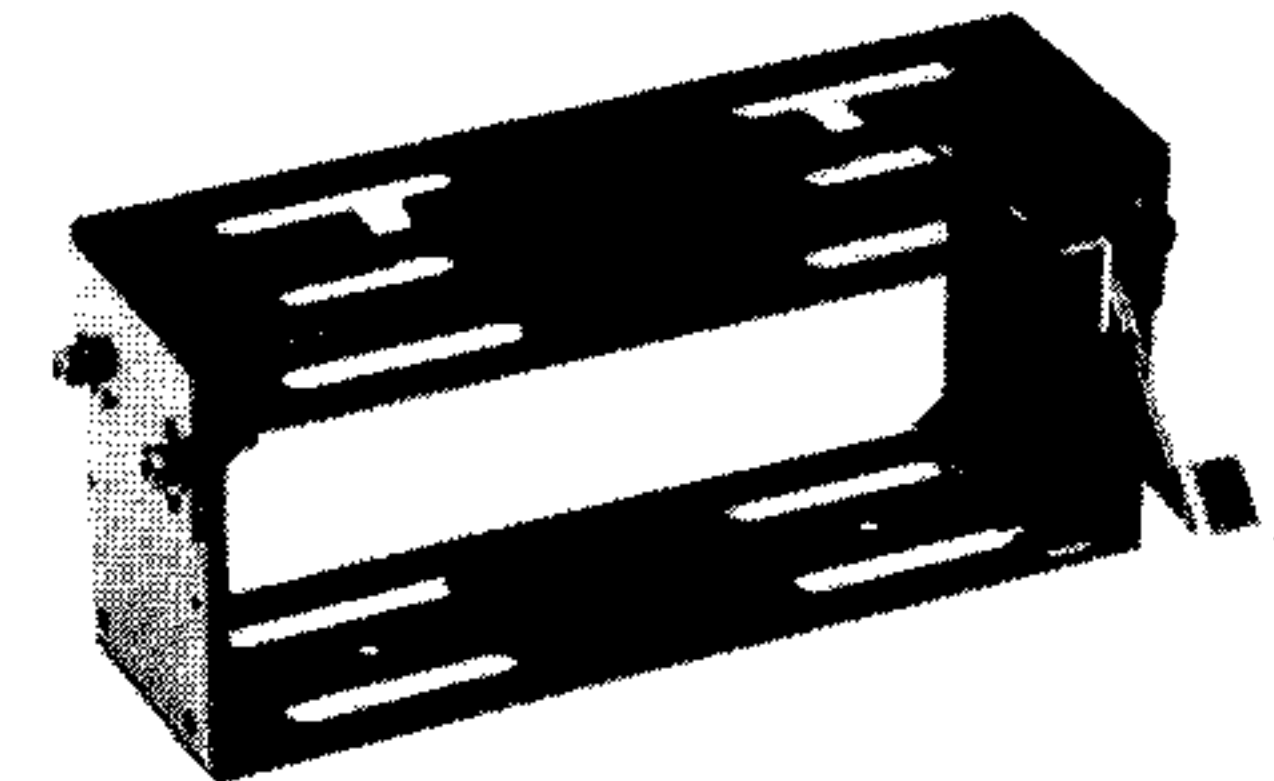

■ SW-100B SWR/POWER METER

Compact and lightweight SWR/POWER/VOLT meter cover 140~450 MHz in range of 150 W full scale for mobile use.



■ SW-200B SWR/POWER METER  
(supplied with a coupler)

Selectable peak-reading/RMS. SWR/POWER meters cover 140~450 MHz in range of 0~20/200W, full scale for base station use.



■ RC-10 REMOTE CONTROLLER

The RC-10 Remote Controller provides the following functions.

1. Direct entry of the desired Transmit/Receive Frequencies using the numeric keypad.
2. Transmit/Receive Frequency or Memory Channels up or down control.
3. 16-key autopatch operation.
4. Volume control
5. Squelch on or off control.
6. When connected to two transceivers allows duplex communications.

For additional information, please refer to the Instruction Manual provided with the RC-10.

■ PG-2N DC POWER CABLE

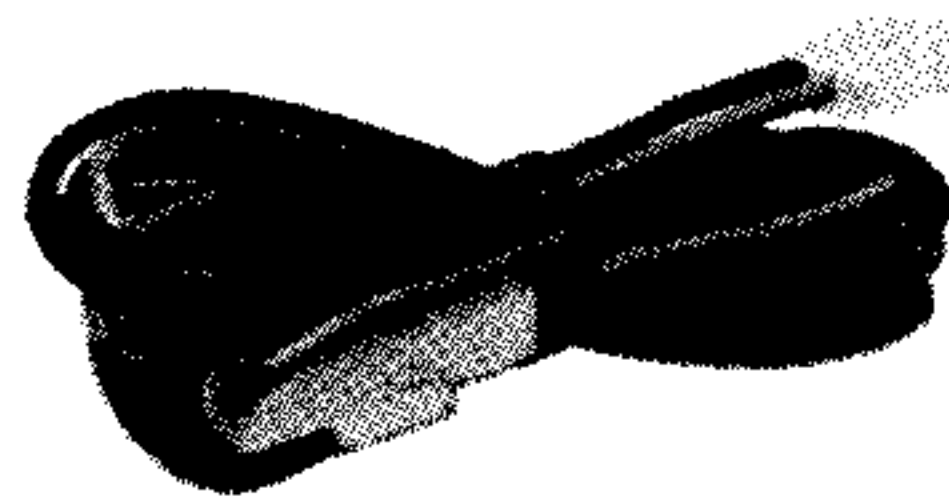

■ PG-3B DC LINE NOISE FILTER

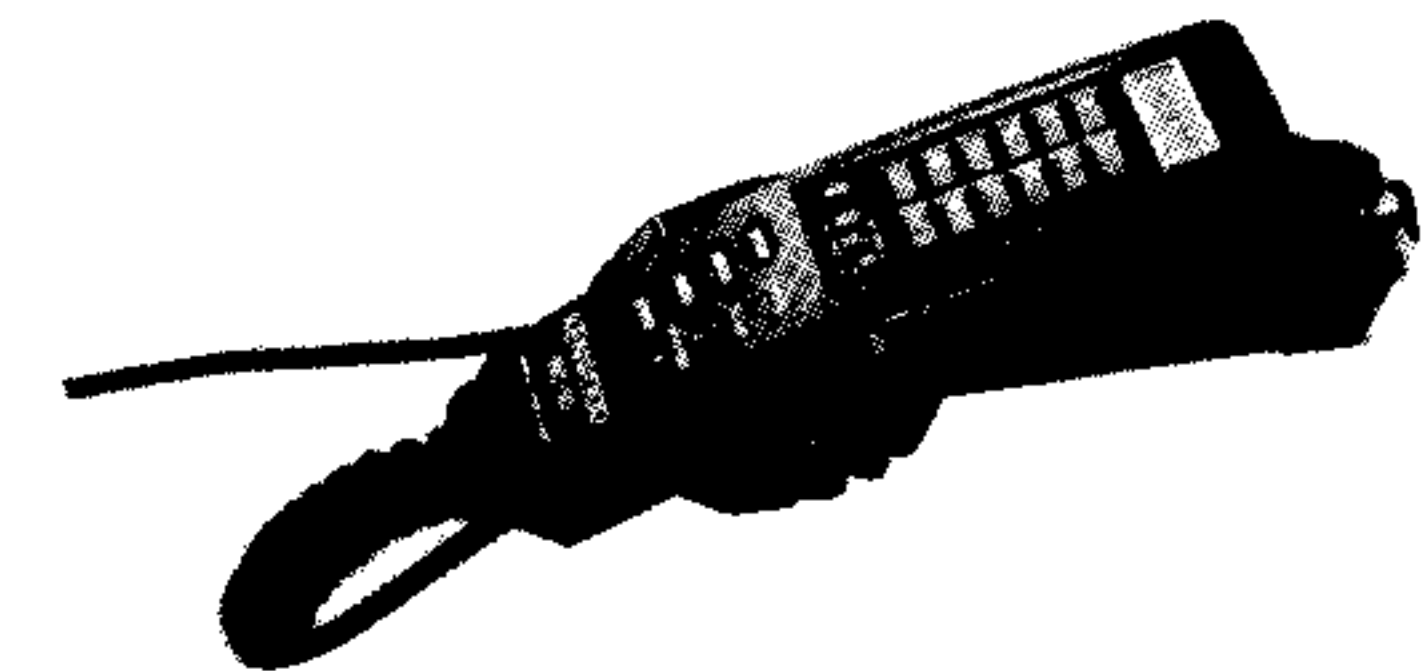
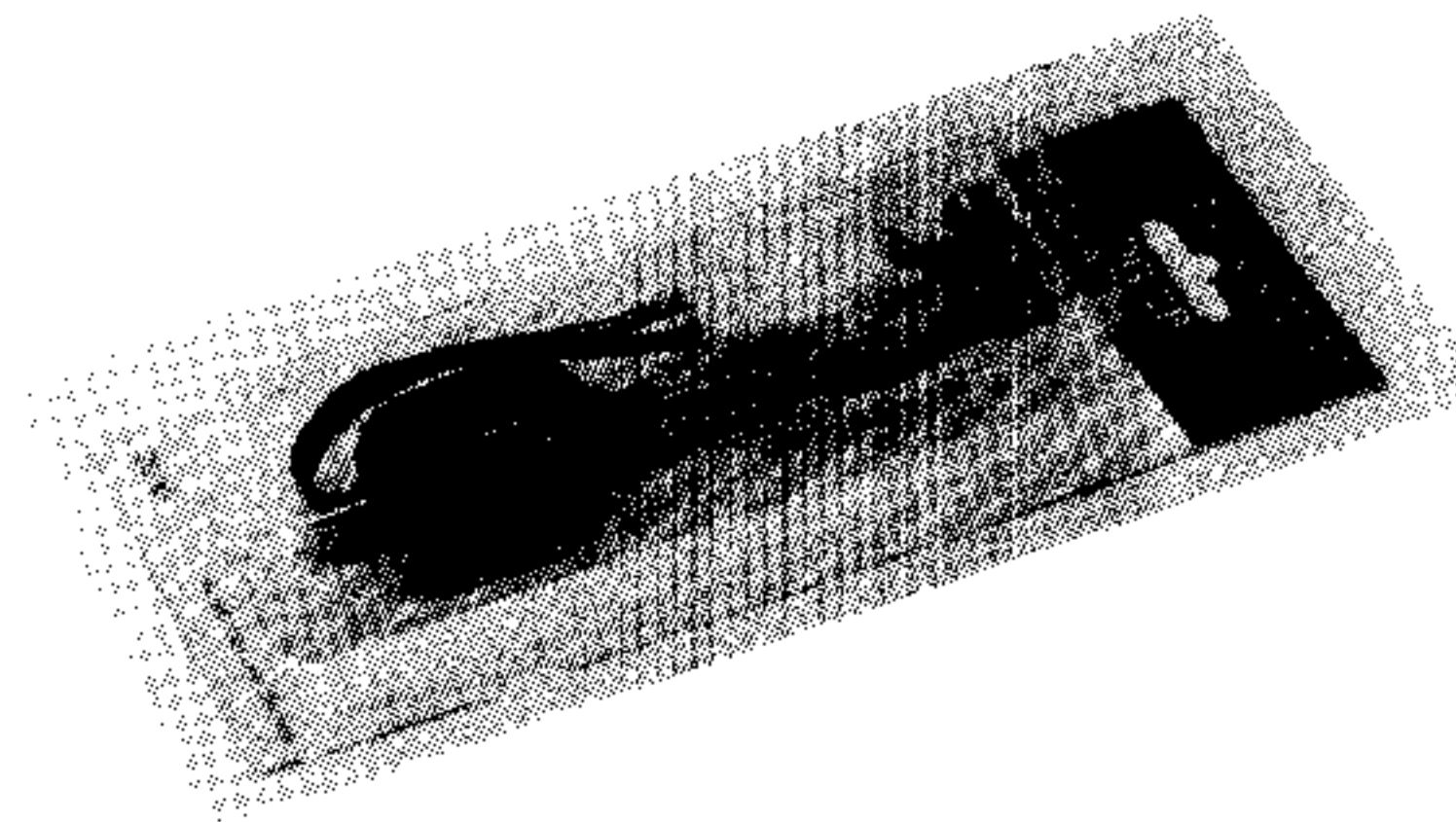

## 7-2. CTCSS unit TSU-6 (TM-721A only)

The use of the optional sub-audible tone decoder TSU-6 allows for CTCSS (Tone squelch) operations. When this option is activated the squelch of the SUB band will only open when the proper sub-audible tone is received.

### 7-2-1. Installation

#### Caution:

Before installation, be sure to disconnect the DC power cord, or damage may result to the transceiver or the unit.

1. Loosen the 2x2 side screws.
2. Remove the 2 screws securing the Top cover.
3. Remove the 2 screws securing the rear panel.
4. Gently remove the top cover. Be sure not to disconnect the wire to speaker.
5. Remove the backing from the cushion (small) that was provided the TSU-6 and attach it to the back of the TSU-6. (Fig. 2)
6. Attach the cable from TSU-6 as shown in the diagram. (Fig. 3)
7. Remove the backing from the other side of the

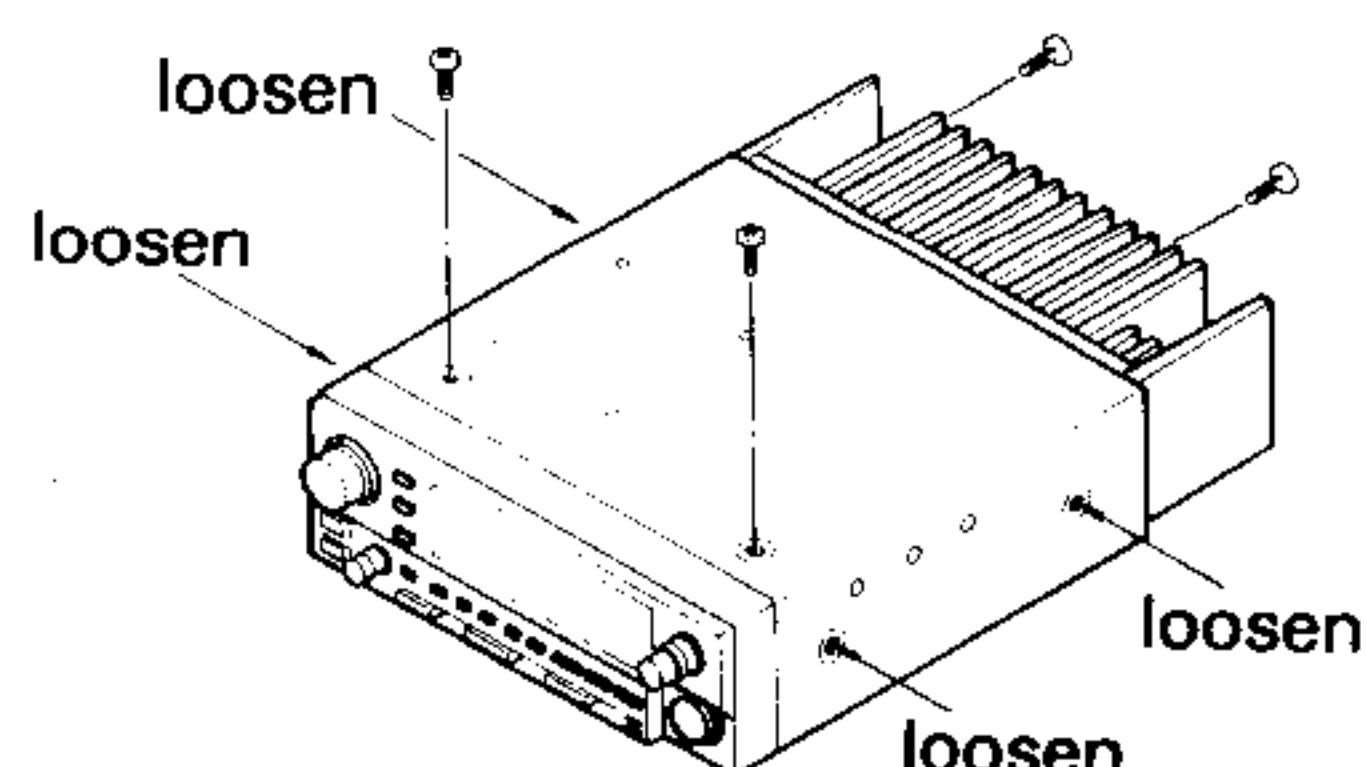

Fig. 1

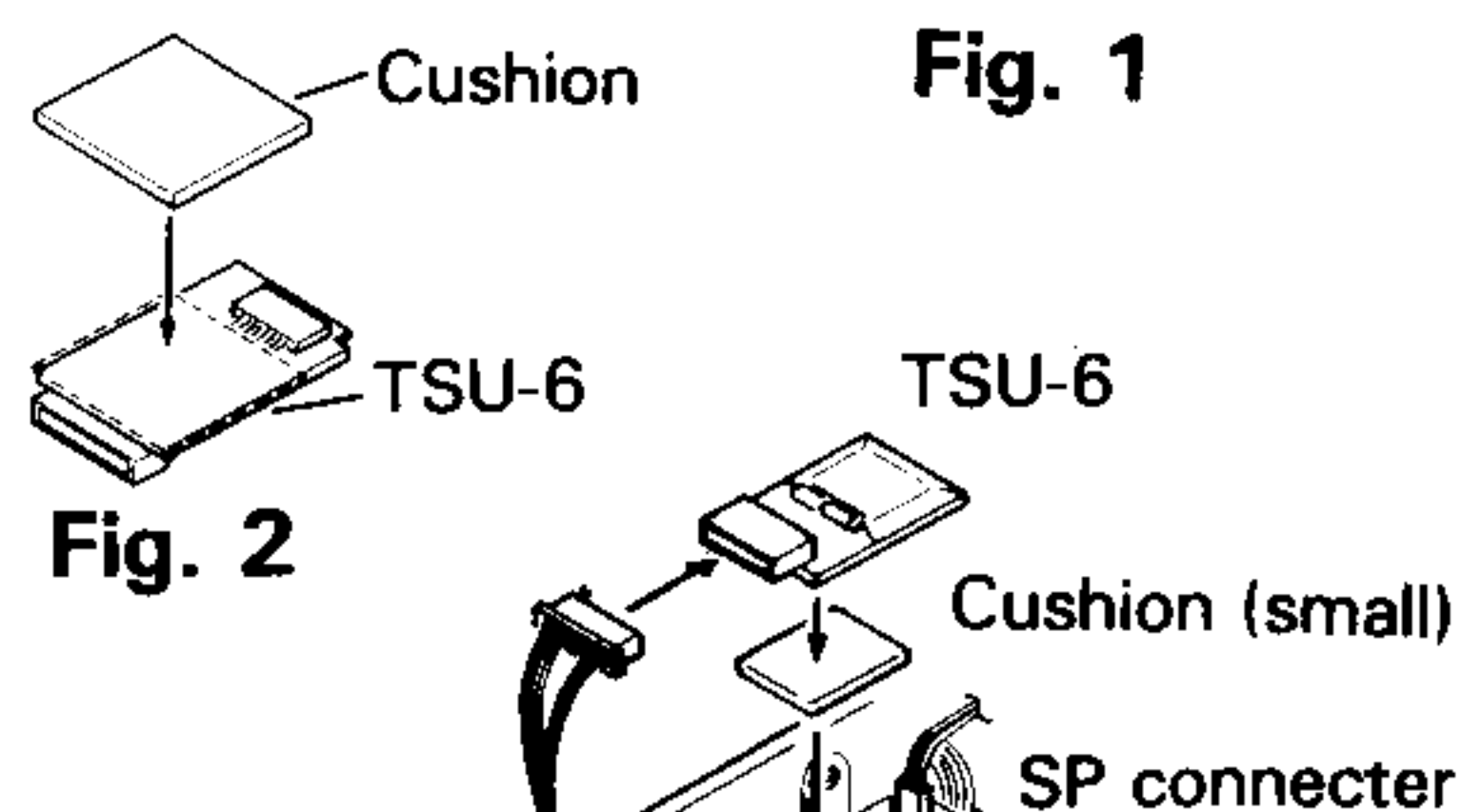

Fig. 2

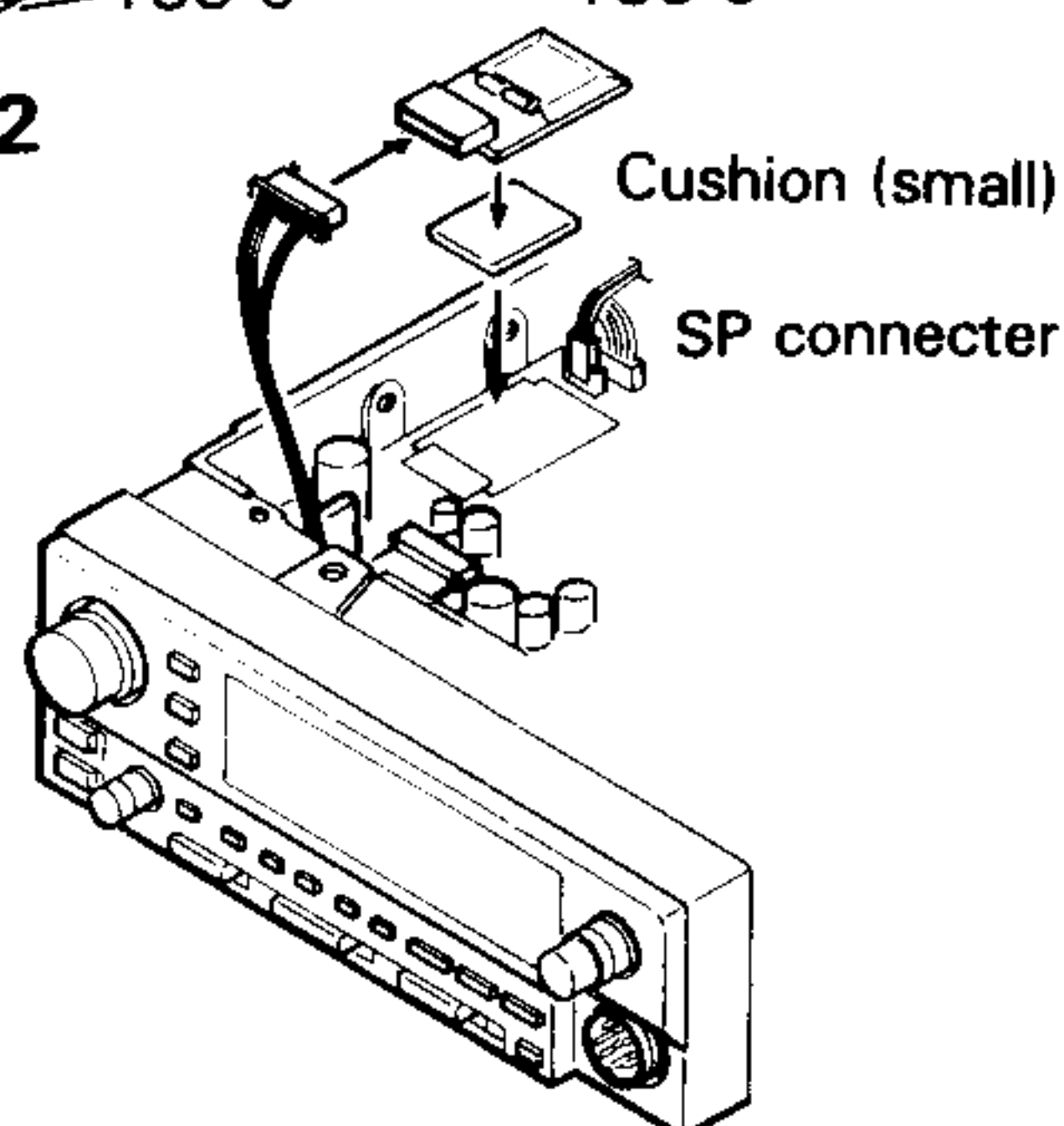

Fig. 3

8. Route the wiring as shown in the diagram. (Fig. 4)

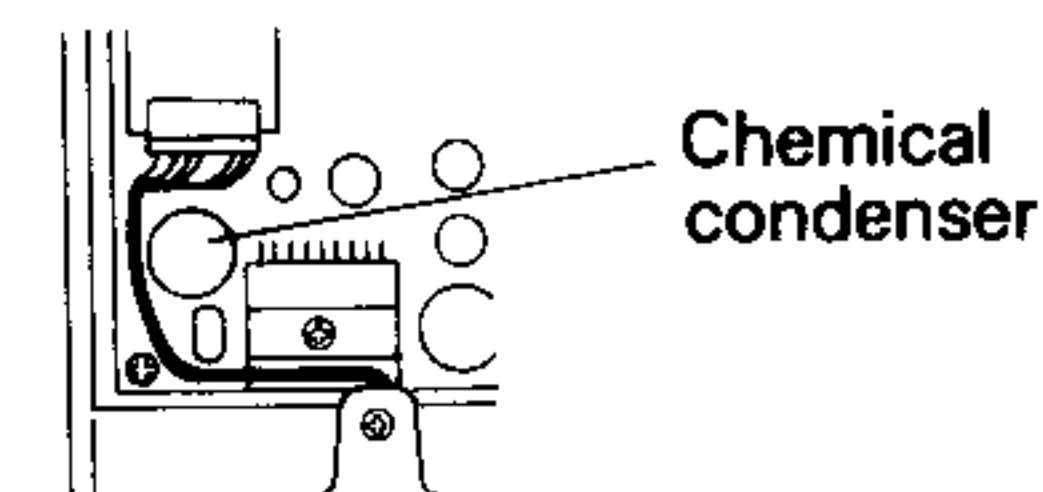

Fig. 4

9. Replace the covers and tighten the screws to complete the installation.

### 7-2-2. Operation

1. Press the VFO key to select the VFO mode.
2. Rotate the MAIN Tuning control, MHz key, or Microphone UP/DWN switches to select the desired frequency. (For example 146.520 MHz)
3. Press the F key and then TONE/T.SEL key. The current tone frequency will be displayed.

Rotate the MAIN Tuning control or press the Microphone UP/DWN switches until the desired tone frequency appears in the display.

4. Press the VFO key to return the VFO mode.

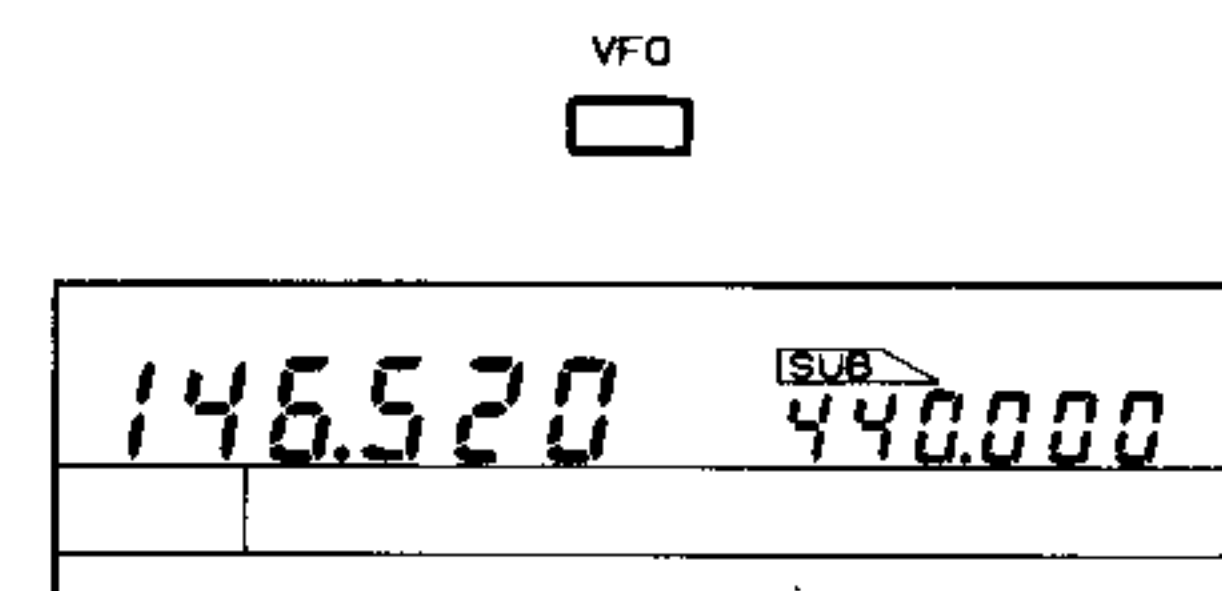
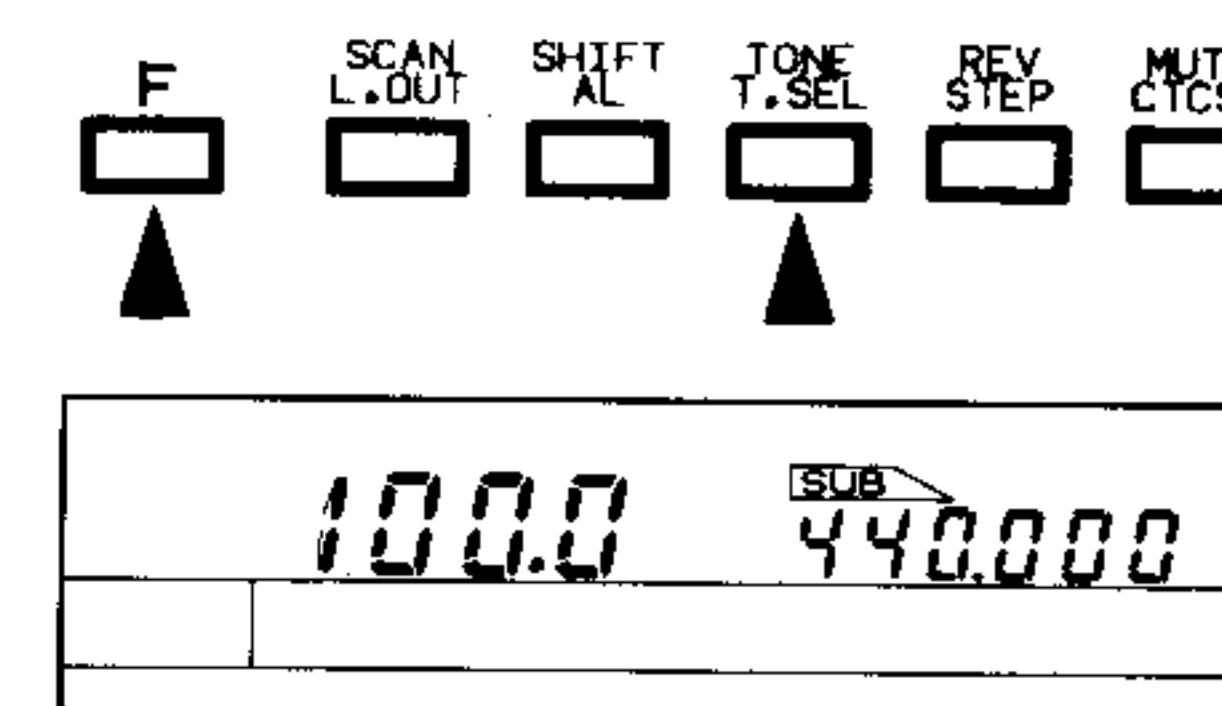
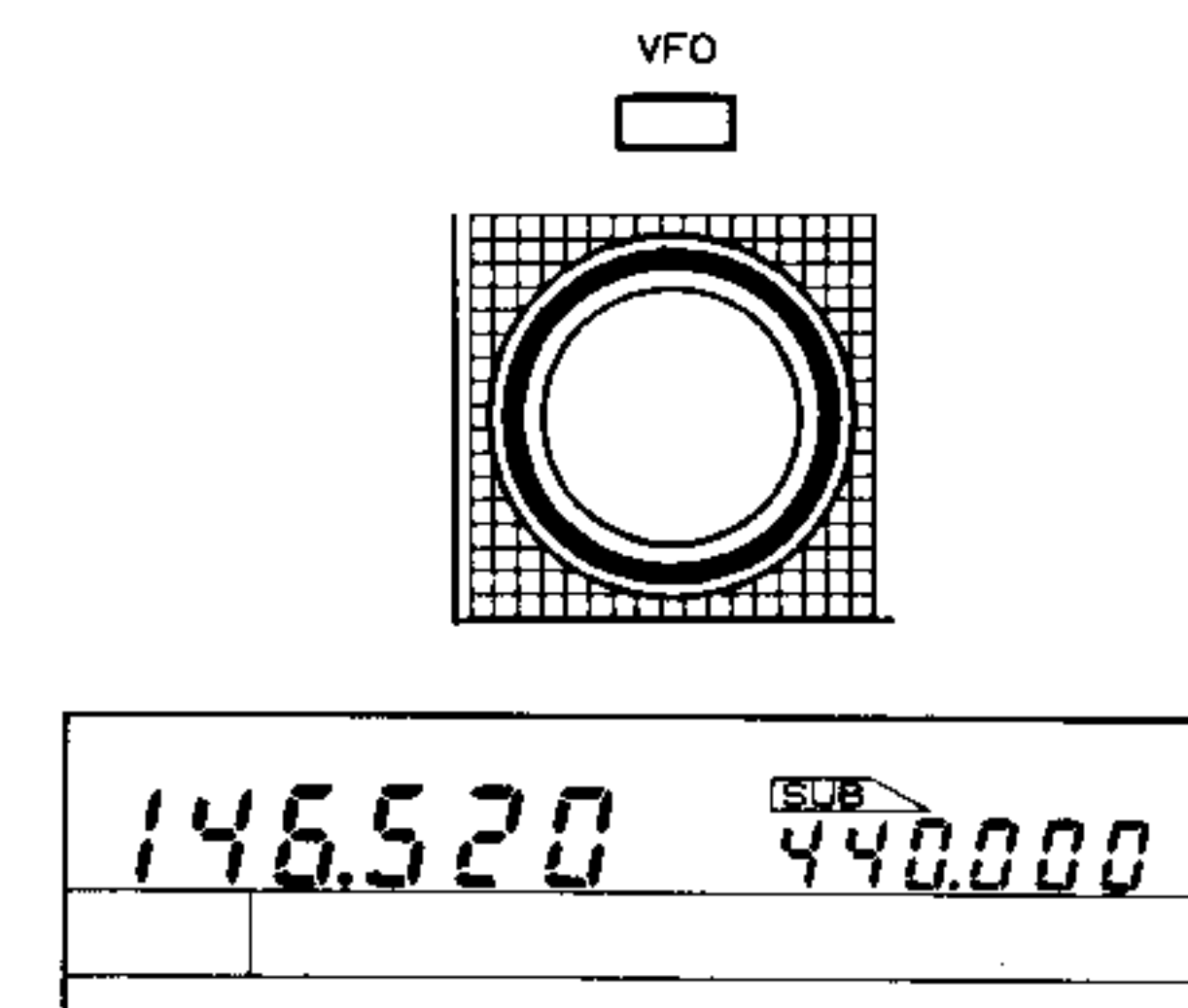



- Press the BAND key to transfer the data to the SUB band.

**Note:**

The CTCSS function is active only in the SUB band.

- Place the BALANCE control in the dual receive position.
- Slide the SUB SQL control to the threshold point.
- Press the F key. The F indicator will light. Press the MUTE/CTCSS key within 5 seconds of pressing the F key. The "CTCSS" indicator will light.

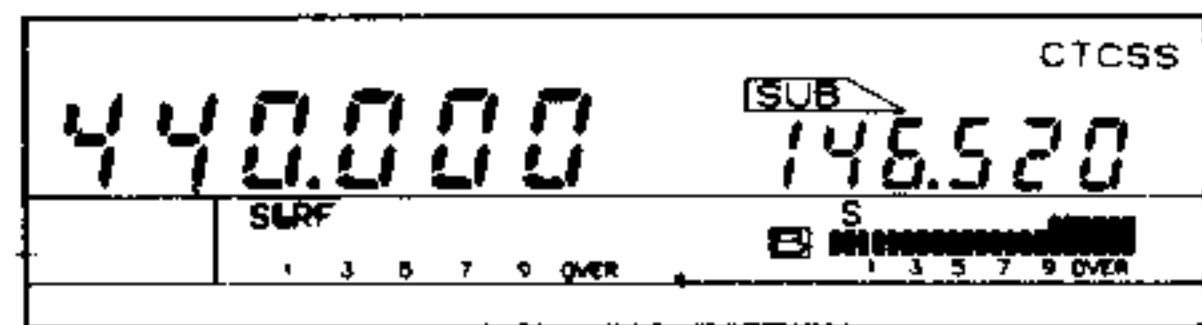
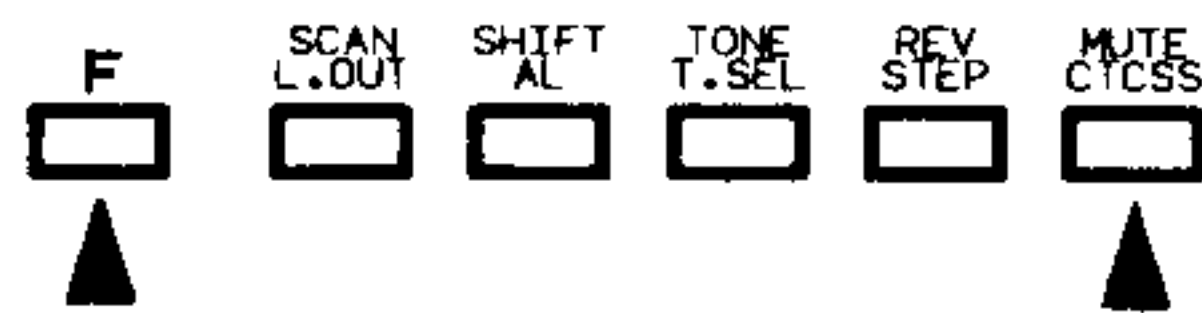
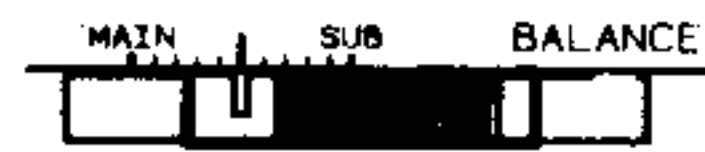
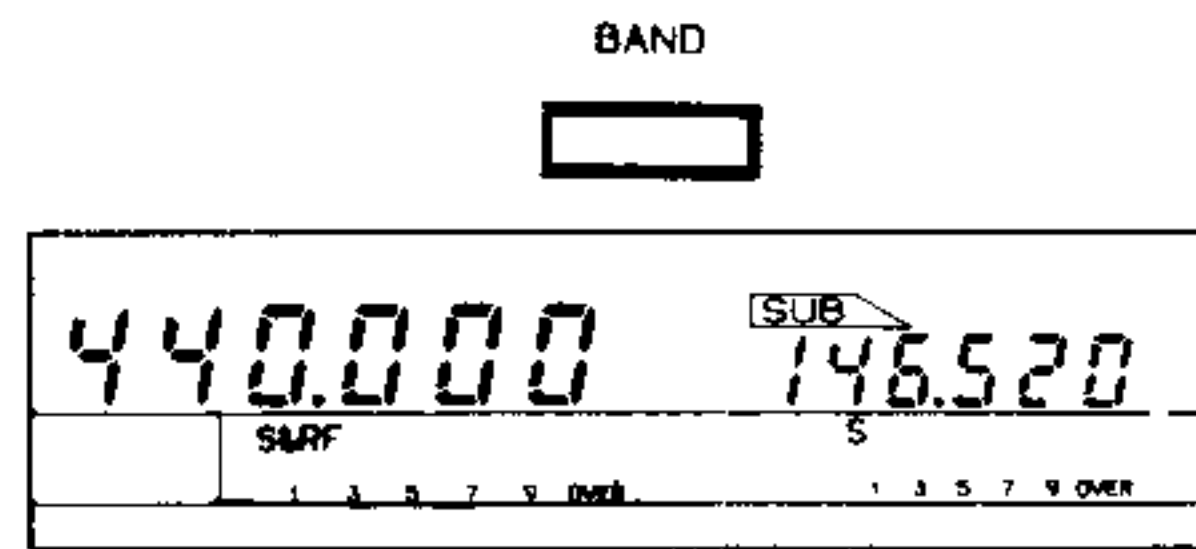

**In combination with A.B.C.**

When used in combination with A.B.C. function, you can easily transmit (from the MAIN band) to the station that is using CTCSS.

(Refer to page 18)

**Note:**

97.4 Hz is not available for decode.

A.B.C.

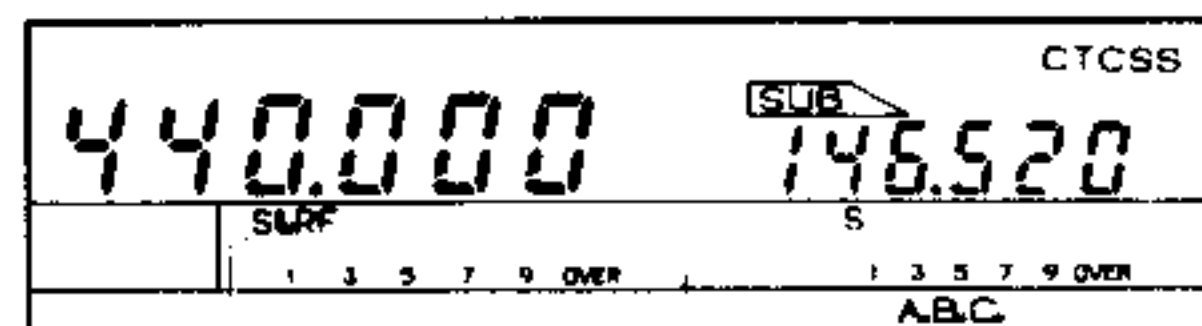

## 7-3. REMOTE CONTROLLER RC-10

### 7-3-1. Connection

Ensure the transceiver and the RC-10 are turned OFF before making the connection.

#### Single Transceiver

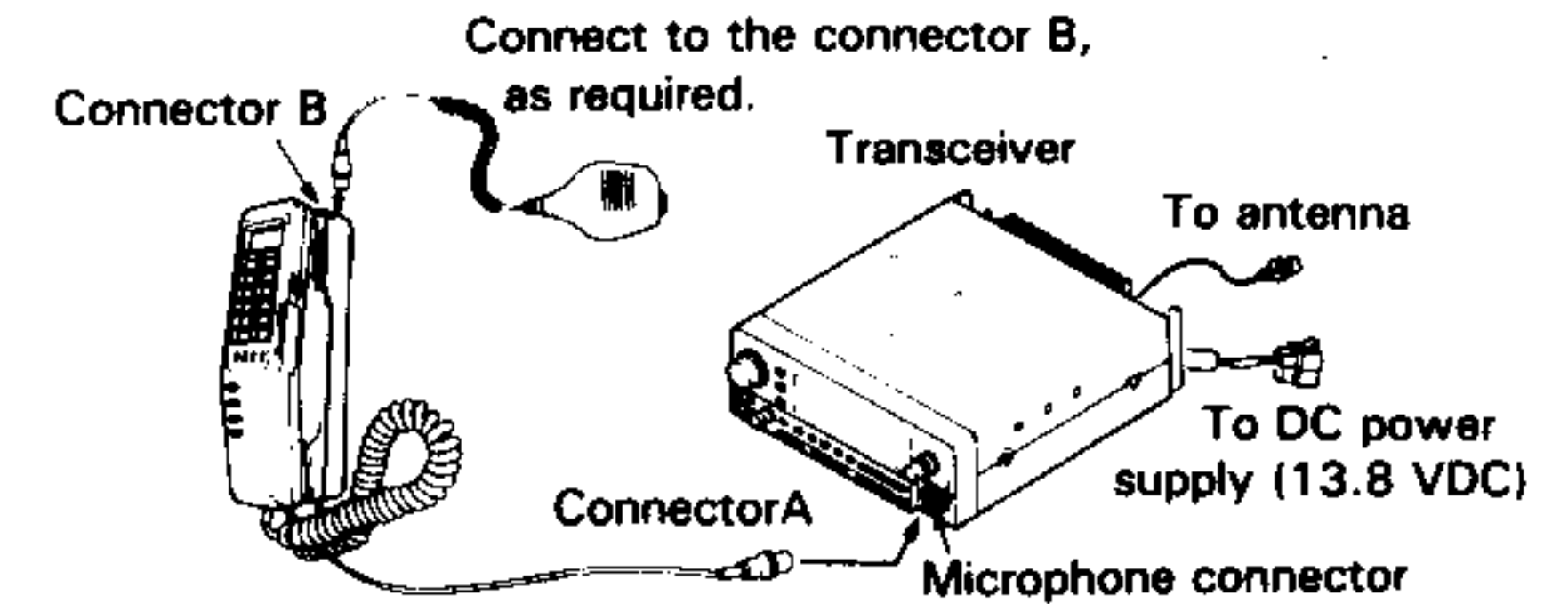

#### Two Transceivers

Use the optional PG-4G extension cord for connection to the second transceiver.

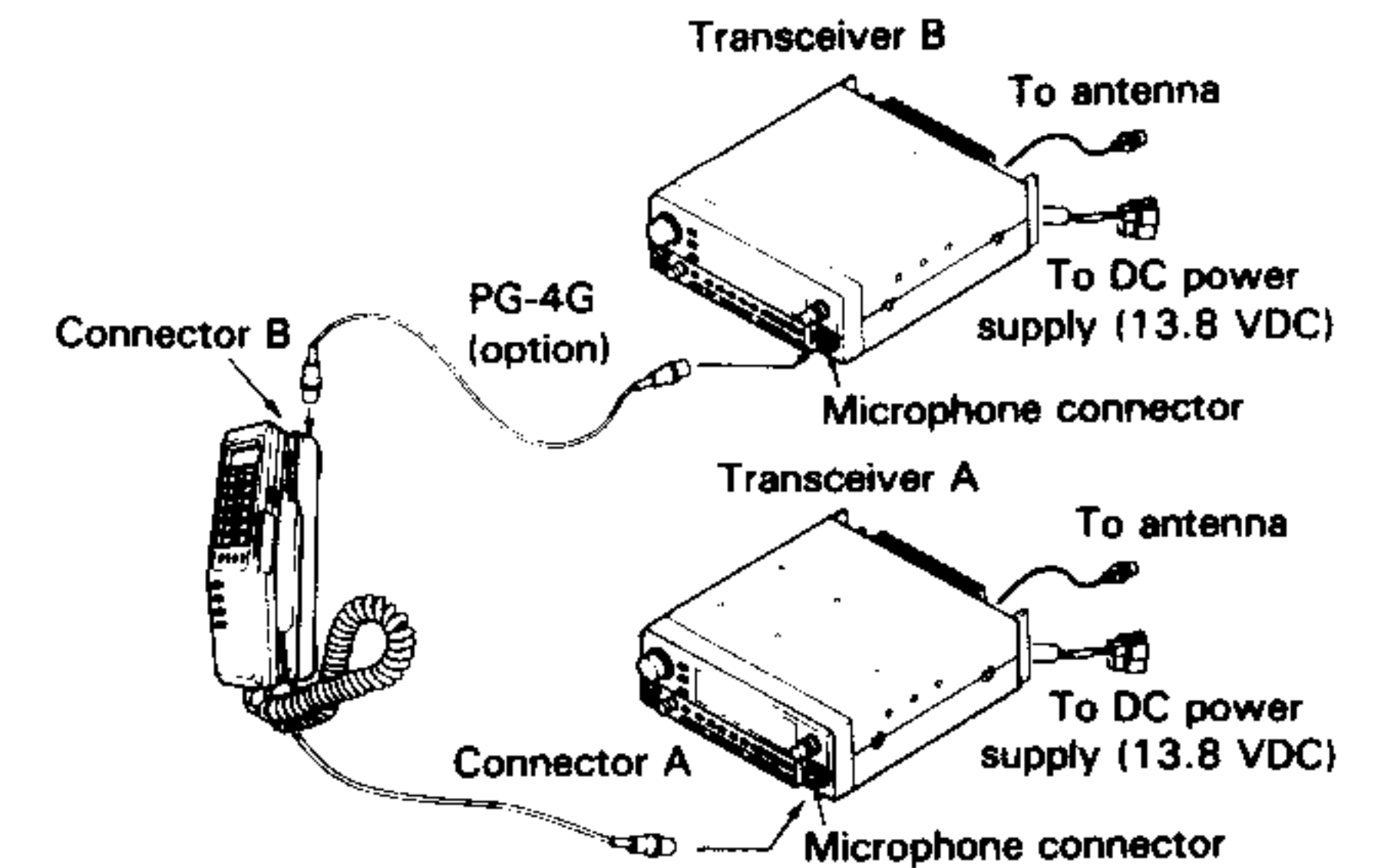

Attach the ground lead to the front holes on the side of the transceivers using the SEMS screws supplied with the transceiver to reduce the possibility of alternator noise.

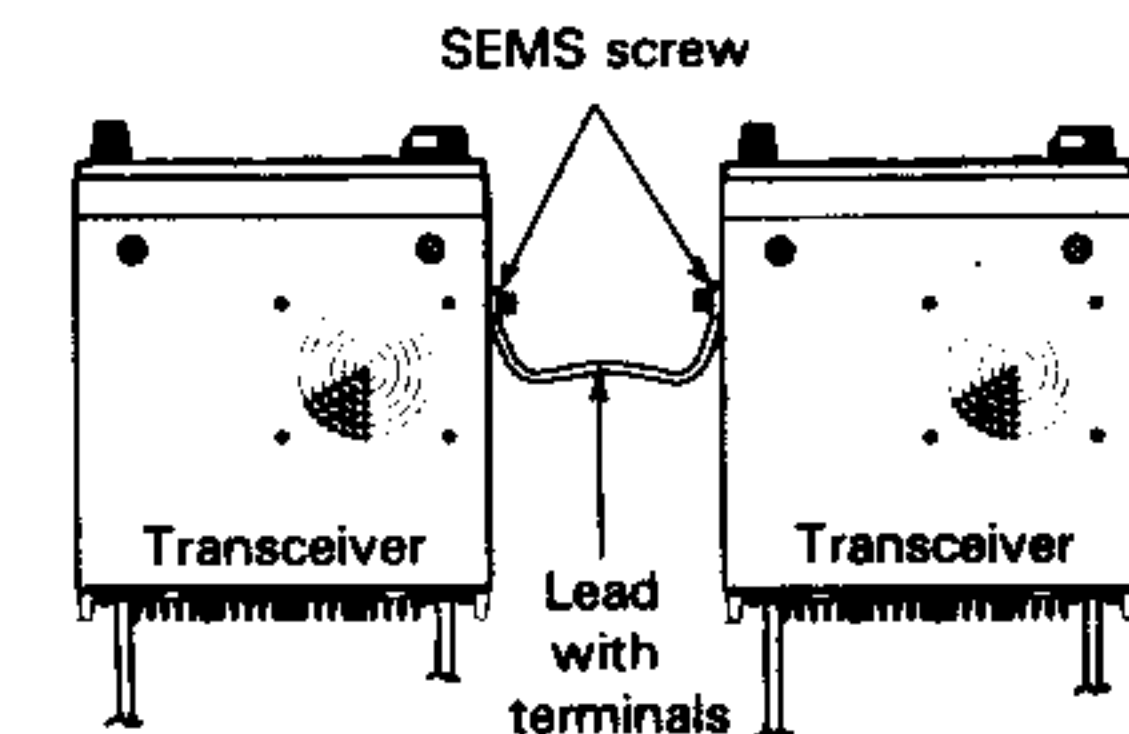

## 7-3-2. Reception

1. Set the switches and controls as follows:

- POWER (VOL) control : OFF (Fully counterclockwise)
- POWER switch of the DC power supply (Fixed Station)  
: OFF
- MAIN SQL control : Fully counterclockwise
- LOCK switch : OFF

2. Set the RC-10 switches as the follows:

- VOL MAIN/RMT switch : MAIN
- Volume selection switch : minimum

3. Turn on the DC power supply and then turn the transceiver ON. The display panels will indicate as shown below.

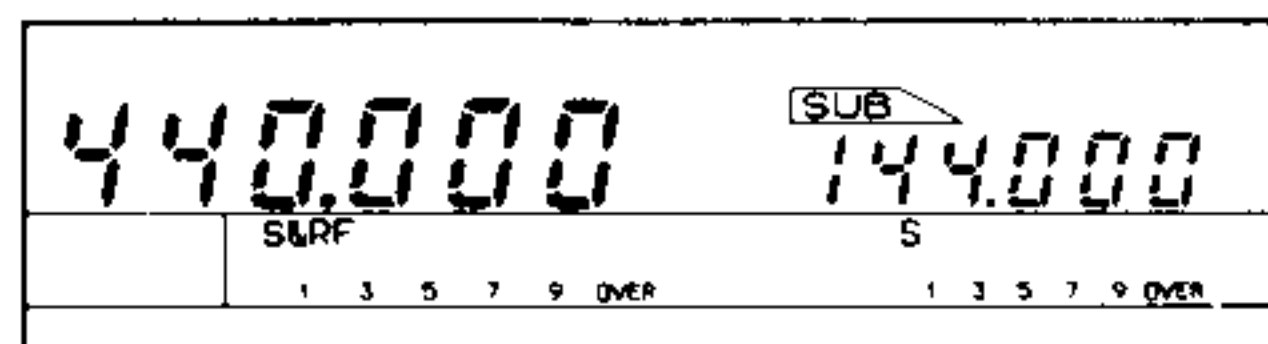

TM-721A/721E

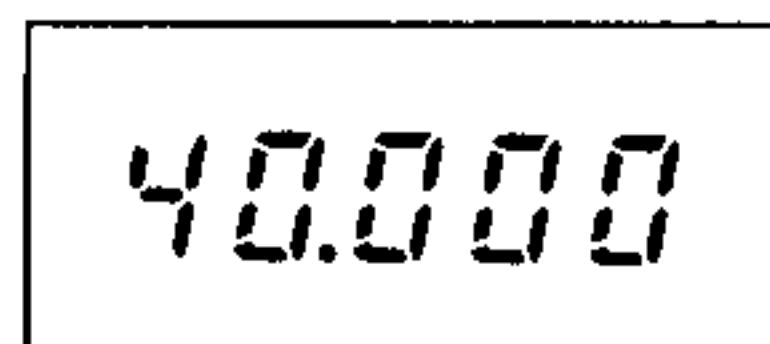

RC-10

4. Noise or a signal will be heard from the RC-10 speaker. Select the desired volume level with the volume selection switch, on the side of the RC-10 handset.

**Note:** \_\_\_\_\_

RC-10 receives only from TM-721A/721E MAIN band.

5. Place the VOL MAIN/RMT switch to RMT. Noise or a signal can be heard from the TM-721A/721E speaker. Adjust the volume with the VOLUME ▲/▼ keys on the RC-10 handset.

**Note:** \_\_\_\_\_

The VOL control of TM-721A/721E is not effective during RMT operation.

6. Rotate the MAIN Tuning control and select an open channel. The RC-10 numeric keys may also be used to select a frequency.
7. Turn the MAIN SQL control clockwise until the noise disappears and the BUSY indicator goes OFF (Threshold point) on the TM-721A/721E.
8. Select the desired frequency, VOL, and MAIN/RMT position.

**Note:** \_\_\_\_\_

Turn off the transceiver's POWER switch before you turn off the power supply.

## 7-3-3. Duplex operations with a single transceiver.

**Note:** \_\_\_\_\_

It is impossible to operate duplex operations if the transceiver is operating as follows.

- 1 Single Bander
- 2 A.B.C.

Example:

1. To select a receive frequency in the MAIN Band, and a transmitter frequency in the SUB Band.

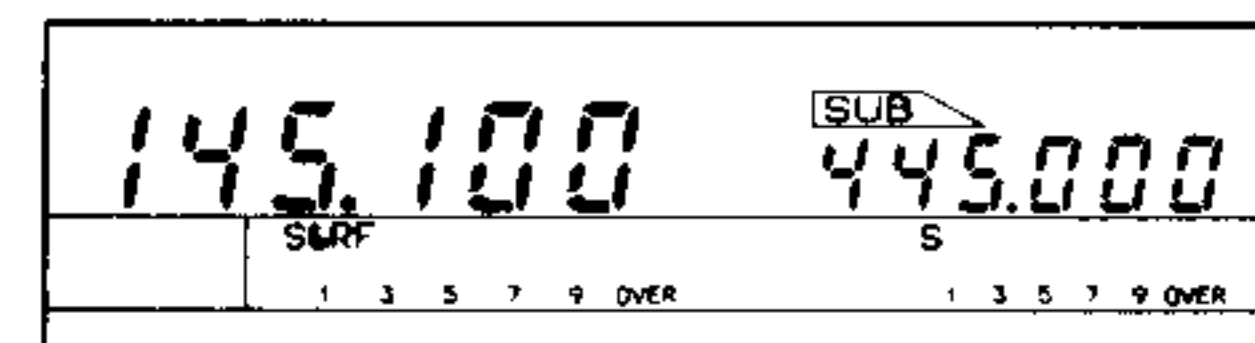

TM-721A/721E

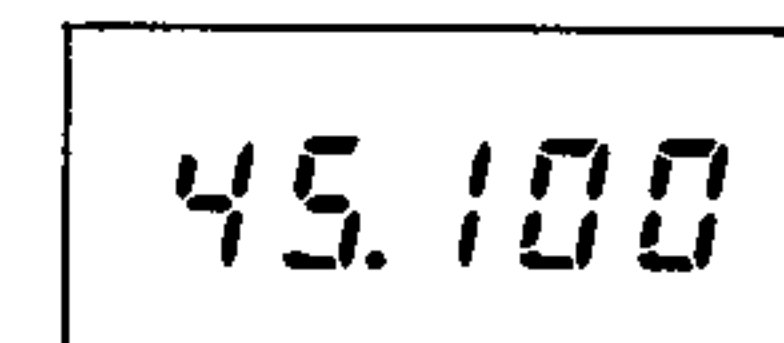

RC-10

2. Press the F key and then 1 key of the RC-10. Press the PTT switch to transmit. The LCD display of the RC-10 displays the transmitter frequency that is the SUB band frequency.

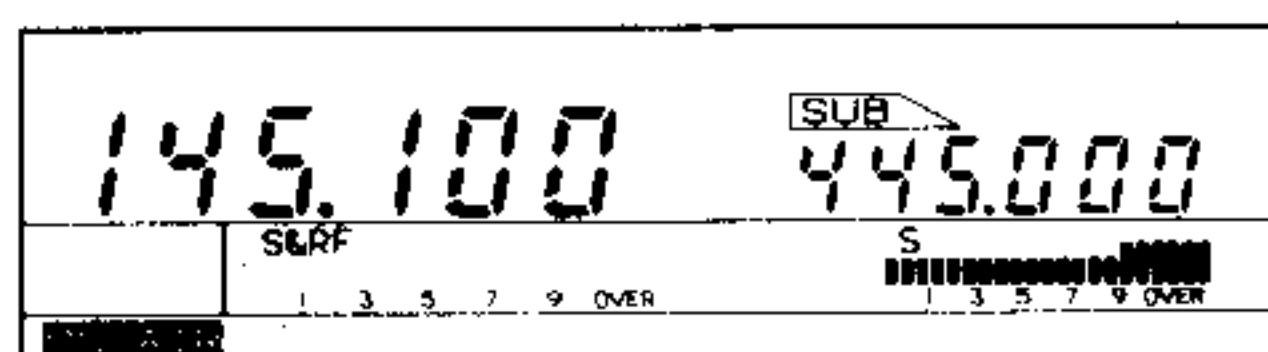

TM-721A/721E

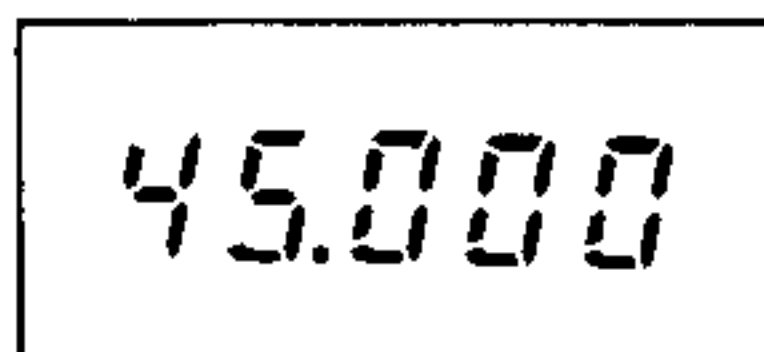

RC-10

**Note:**

The **DUP** indicator of the RC-10 is not ON with single transceiver duplex operation.

During the DUPLEX operation with a single transceiver, the LCD display of the transceiver indicates as follows:

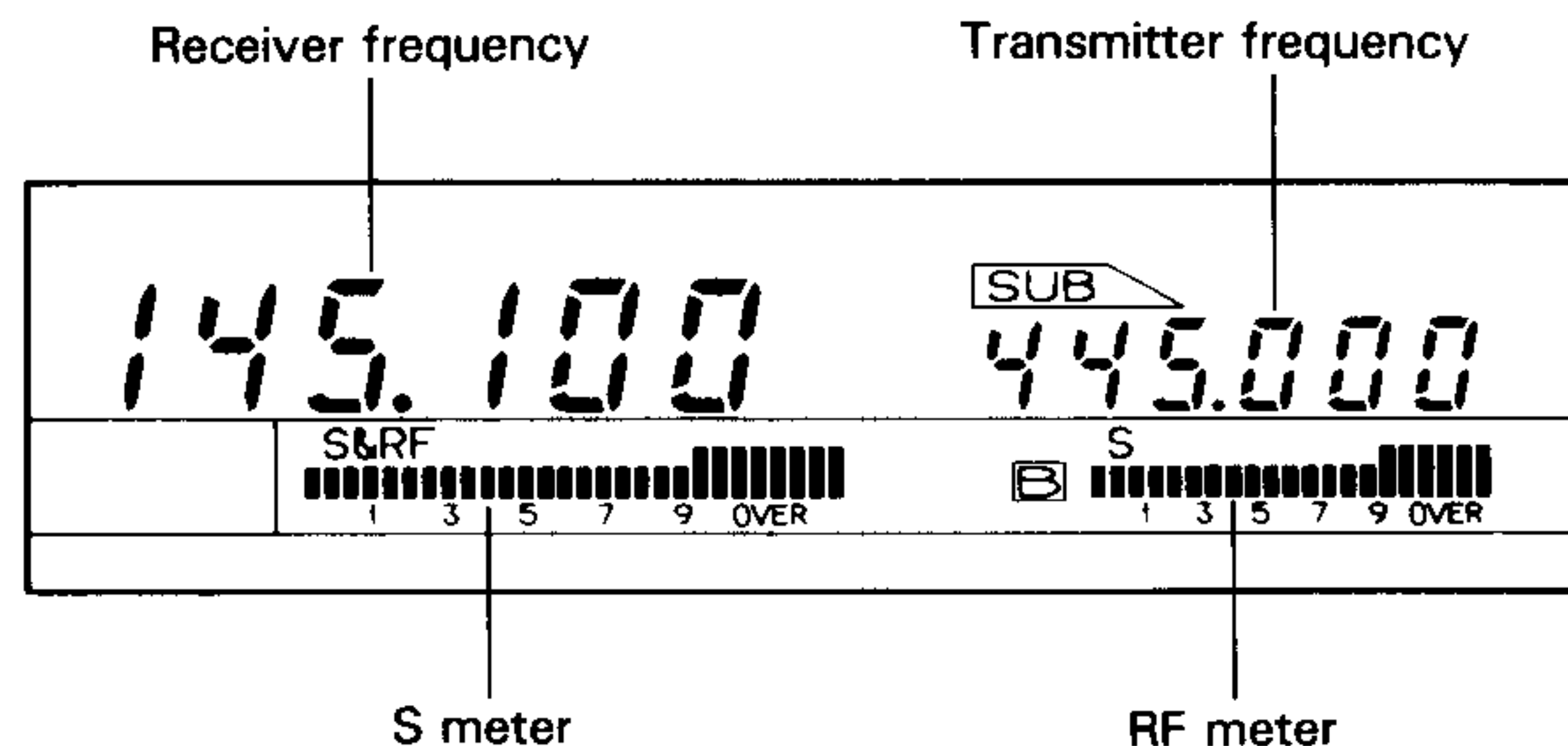

3. To release Duplex operation, press the F key and then 1 key of the RC-10 again.

**Note:**

1. The TONE frequency is selected in the MAIN band.
2. During the DUPLEX operations, speaker output depends upon the following SQL conditions.
 

SQL is closed:	No signal or noise is heard.
SQL is opened:	The receiving signal or noise of the MAIN Band is heard.

SQL is controlled by the MAIN SQL control of the transceiver.

SQL can be controlled by pressing the F key and then the 2 key of the RC-10.

**7-3-4. Function Selection**

The various control functions of the RC-10 when used with the TM-721A/721E are as follows:

Key operations	Function
F then 1	Control duplex operation with single transceiver (ON/OFF)
F then 2	SQL OFF/ON control
F then 3	Shift selection
F then 4	Reverse ON/OFF
F then 5	Tone frequency of the MAIN Band (ON /OFF)
F then 6	CTCSS ON/OFF
F then 7	Memory Channel Lock out (ON/OFF)
F then 8	Key Lock (RC-10 only)
F then 0	Duplex Operation with two transceivers ON/OFF
F then VFO	CALL Channel ON/OFF
F then SCAN	Exchange the MAIN band and SUB band data

Refer to the RC-10 Instruction Manual for other operations.

Downloaded by   
  
 Amateur Radio Directory

# 8. REFERENCE

## 8-1. ANTENNA

### 8-1-1. Fixed Station

Various types of fixed station antennas are commercially available. Select your antenna according to available space and intended application.

Transceiver performance depends largely on the type of antenna used. For fixed station operation there are ground

plane antennas (omnidirectional) and Yagi antennas (unidirectional). The Yagi antenna is suitable for DX (Long distance) operation or communication with a specific party.

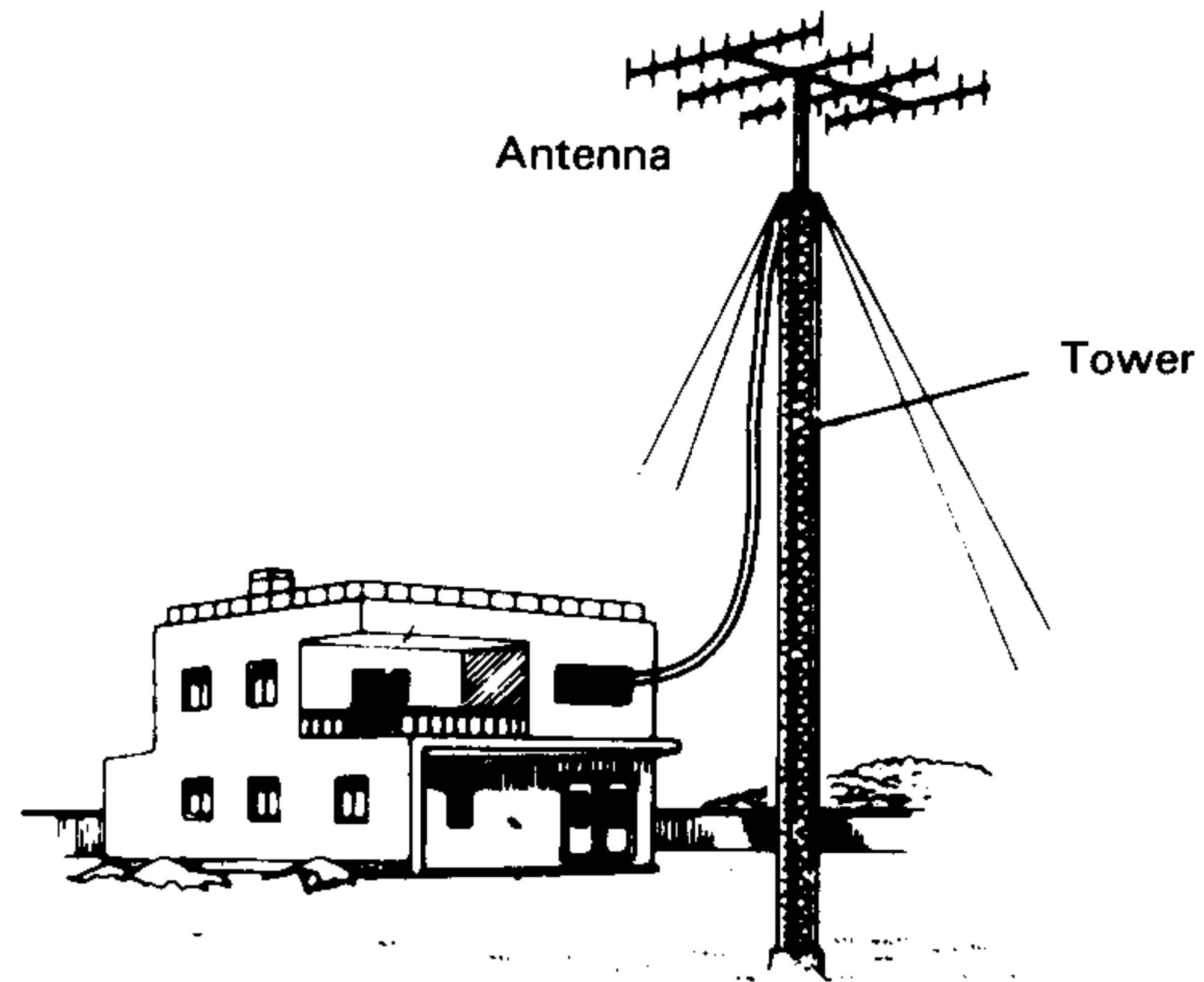
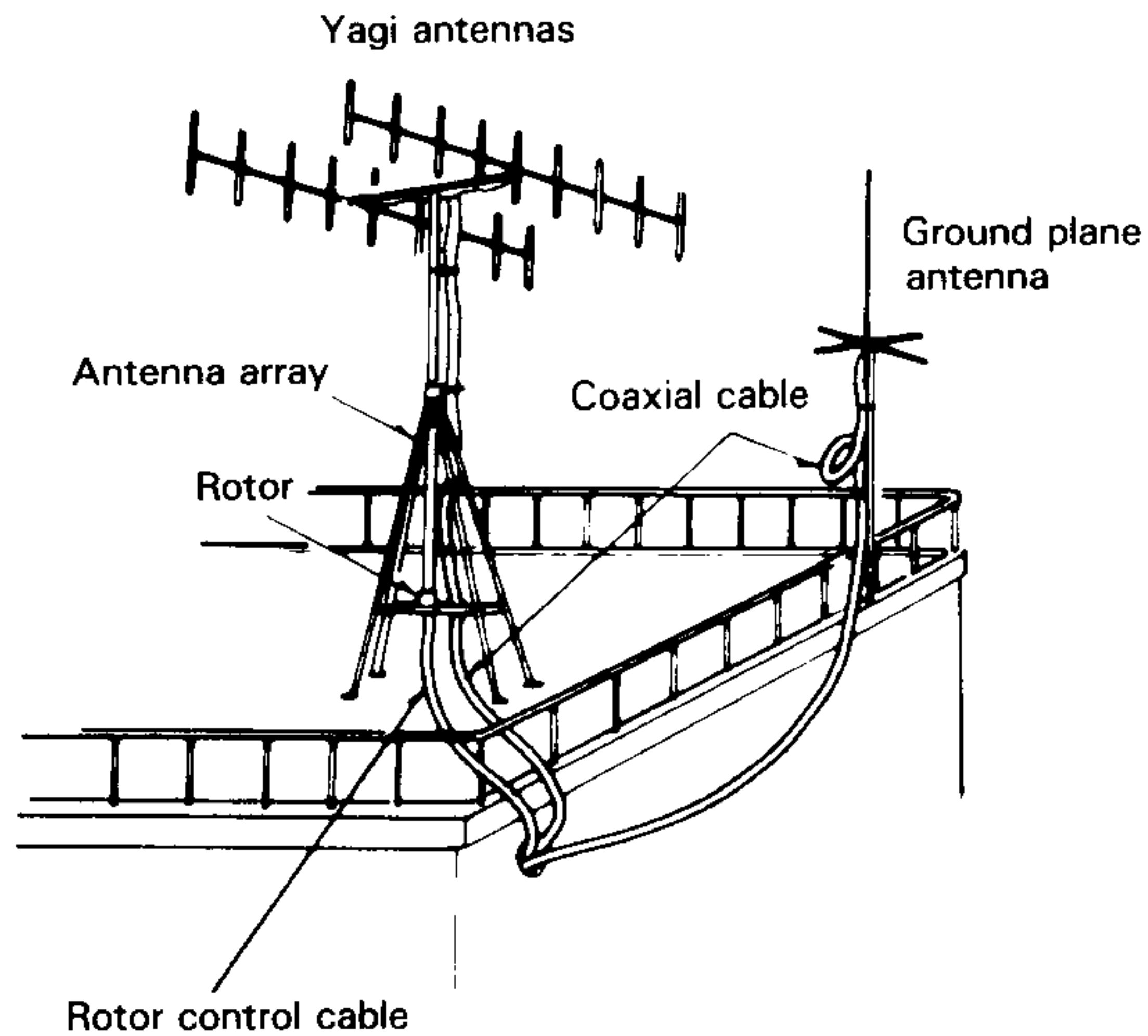

## 8-1-2. Mobile

Various types of antennas for UHF/VHF mobile operation are available. Please consult your dealer for information on these antennas.

### Note:

For gutter-mount installation, the antenna bracket must be grounded to the car body as shown in the accompanying diagram. Attach the antenna securely, referring to the antenna installation instructions provided with the antenna.

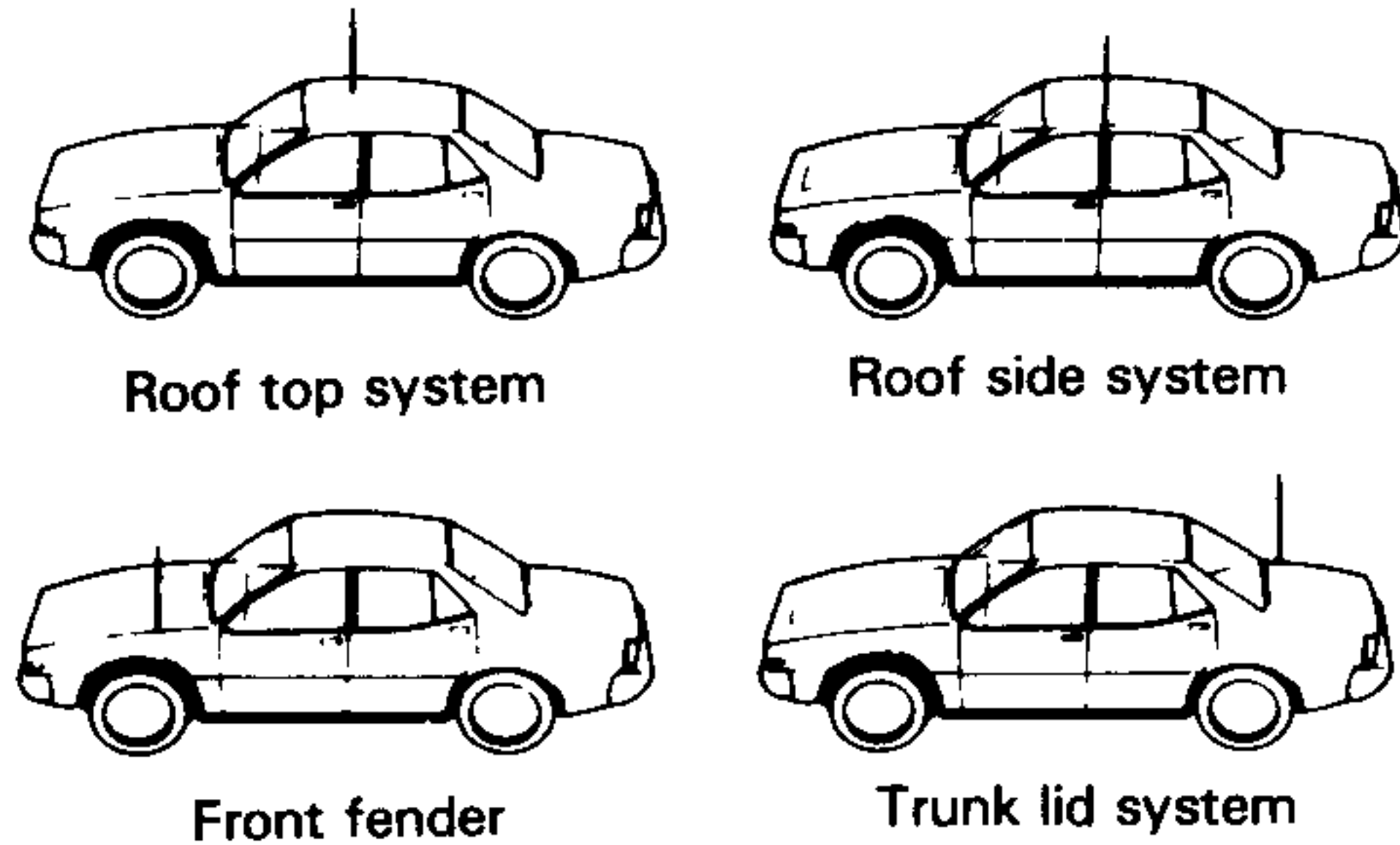

Installation for mobile operation

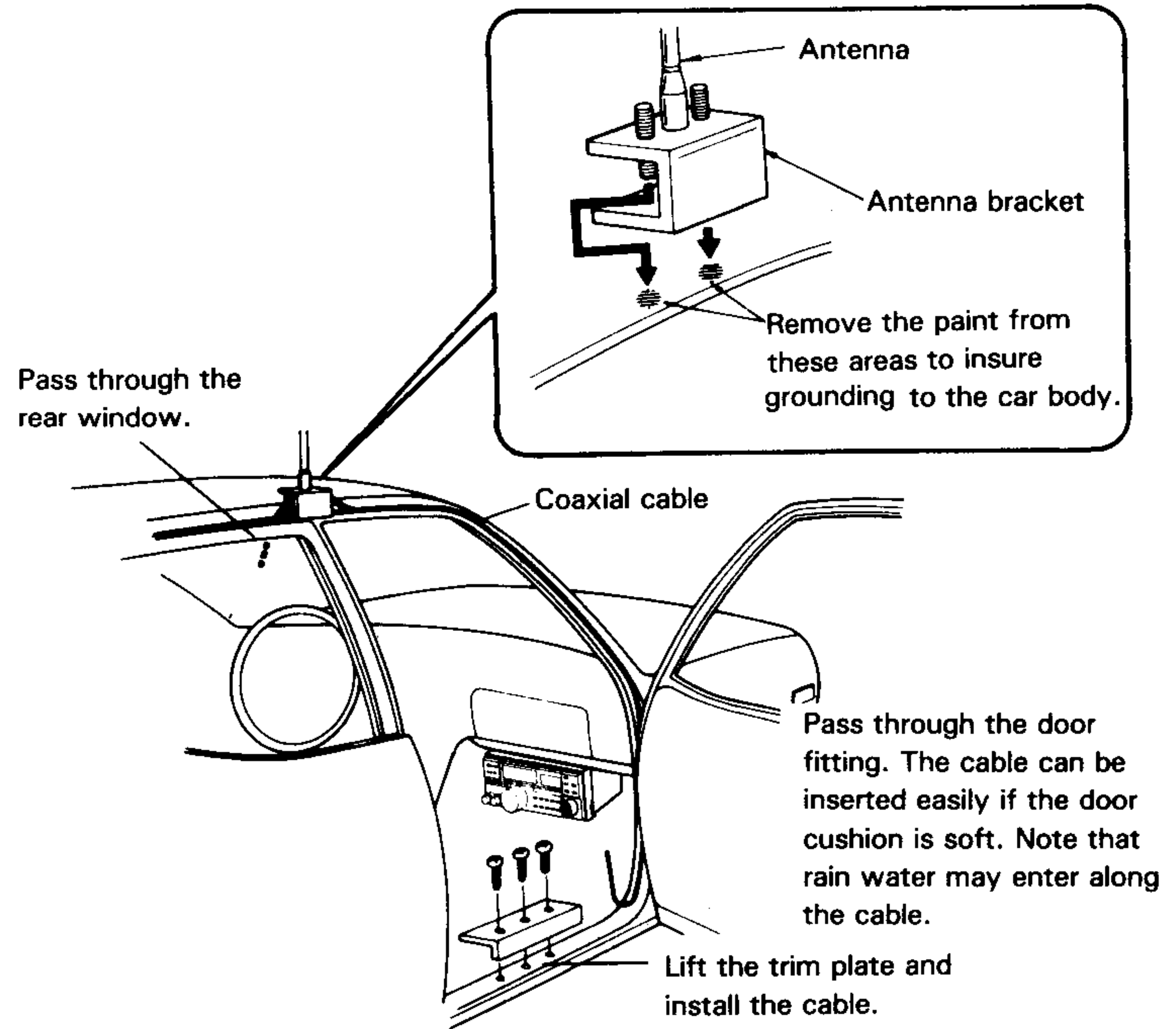

Coax. cable routing



## 8-2. MOBILE INSTALLATION HINTS

### 8-2-1. Noise Reduction

In motor vehicles, noise is generated by mainly the ignition system. Other sources of noise include the wiper and heater motors.

It is imperative that some preventive measures be taken to reduce the noise to the lowest possible level.

#### (a) Antenna location selection

Since ignition noise is generated by the vehicles engine, the antenna must be installed as far from the engine as possible.

#### (b) Bonding

The component parts of motor vehicles, such as the engine, transmission, muffler system, accelerator, etc., are coupled to one another at DC and low frequencies, but are isolated at high frequencies. By connecting these parts using heavy, braided ground straps, ignition noise can be reduced. This connection is called "bonding".

#### (c) Use ignition suppressor cable or suppressor spark plugs

Noise can be reduced by using spark plugs with internal resistors, or resistive suppressor ignition cable.

### 8-2-2. Battery capacity

The power system of a motor vehicle is comprised of a battery and an alternator (which generates power while the engine is running) to supply current to the various loads or to charge the battery.

Since the transceiver draws high current during transmit, care should be exercised so the power system is not overloaded. When using the transceiver, the following points should be observed from the viewpoint of battery maintenance:

- (a) Turn the transceiver OFF when the lights, heater, wipers and other high-draw accessories are used.
- (b) Avoid transceiver operation when the engine is not running.
- (c) If necessary, use an ammeter and/or a voltmeter to monitor battery condition.