

# KENWOOD

# INSTRUCTION MANUAL

144/440 MHz FM DUAL BANDER

## TM-D700A

144/430 MHz FM DUAL BANDER

## TM-D700A

144/430 MHz FM DUAL BANDER

## TM-D700E



KENWOOD CORPORATION

© B62-1228-20 (K,E,M)  
09 08 07 06 05 04 03 02 01

## THANK YOU!

We are grateful you decided to purchase this **KENWOOD** FM transceiver. **KENWOOD** always provides Amateur Radio products which surprise and excite serious hobbyists. This transceiver is no exception. This time **KENWOOD** presents a mobile with a built-in TNC to make data communications much more convenient than before. **KENWOOD** believes that this product will satisfy your requirements on both voice and data communications.

## MODELS COVERED BY THIS MANUAL

The models listed below are covered by this manual.

**TM-D700A:** 144/440 MHz FM Dual Bander  
(U.S.A./ Canada)

**TM-D700E:** 144/430 MHz FM Dual Bander  
(Europe)

**TM-D700A:** 144/430 MHz FM Dual Bander  
(General market)

## FEATURES

This transceiver has the following main features:

- Has a built-in TNC which conforms to the AX.25 protocol. With a portable computer, allows you to enjoy Packet operation quite easily.
- Includes a program for dealing with data formats supported by Automatic Packet/ Position Reporting System (APRS®).

- Is capable of receiving packet data on one band while receiving audio on the other band.
- Enhanced Programmable Memory (PM) channels store virtually entire current operating environments for your quick recall.
- Contains a total of 200 memory channels to program frequencies and other various data. Allows each memory channel to be named using up to 8 alphanumeric and special ASCII characters.
- “Visual Scan” graphically and simultaneously shows the conditions of up to 181 frequency channels.
- Continuous Tone Coded Squelch System (CTCSS) or Digital Code Squelch (DCS) rejects unwanted calls from other stations.
- The separate front panel can be mounted in a convenient different place from the main unit.
- Equipped with an easy-to-read large LCD with alphanumeric display capability.
- Enhances the functions of an optional VC-H1 Interactive Visual Communicator designed for plug-and-play color slow-scan television (SSTV).
- Utilizes Sky Command System II designed to control a **KENWOOD** HF transceiver at a remote location (U.S.A./ Canada only).

## NOTICES TO THE USER

One or more of the following statements may be applicable:

### **FCC WARNING**

*This equipment generates or uses radio frequency energy. Changes or modifications to this equipment may cause harmful interference unless the modifications are expressly approved in the instruction manual. The user could lose the authority to operate this equipment if an unauthorized change or modification is made.*

### **INFORMATION TO THE DIGITAL DEVICE USER REQUIRED BY THE FCC**

*This equipment has been tested and found to comply with the limits for a Class B digital device, pursuant to Part 15 of the FCC Rules. These limits are designed to provide reasonable protection against harmful interference in a residential installation.*

*This equipment generates, uses and can generate radio frequency energy and, if not installed and used in accordance with the instructions, may cause harmful interference to radio communications. However, there is no guarantee that the interference will not occur in a particular installation. If this equipment does cause harmful interference to radio or television reception, which can be determined by turning the equipment off and on, the user is encouraged to try to correct the interference by one or more of the following measures:*

- Reorient or relocate the receiving antenna.
- Increase the separation between the equipment and receiver.
- Connect the equipment to an outlet on a circuit different from that to which the receiver is connected.
- Consult the dealer for technical assistance.

When condensation occurs inside the transceiver:

*Condensation may occur inside the transceiver in such a case where the room is warmed using a heater on cold days or where the transceiver is quickly moved from a cold room to a warm room. When condensation occurs, the microcomputer and/or the transmit/receive circuits may become unstable, resulting in transceiver malfunction. If this happens, turn OFF the transceiver and just wait for a while. When the condensed droplets disappear, the transceiver will function normally.*

## PRECAUTIONS

Please observe the following precautions to prevent fire, personal injury, and transceiver damage:

- When operating mobile, do not attempt to configure your transceiver while driving because it is simply too dangerous.
- Be aware of local laws pertaining to the use of headphones/headsets while driving on public roads. If in doubt, do not wear headphones while mobiling.
- Do not transmit with high output power for extended periods. The transceiver may overheat.
- Do not modify this transceiver unless instructed by this manual or by **KENWOOD** documentation.
- Do not expose the transceiver to long periods of direct sunlight nor place the transceiver close to heating appliances.
- Do not place the transceiver in excessively dusty areas, humid areas, wet areas, nor on unstable surfaces.
- If an abnormal odor or smoke is detected coming from the transceiver, turn OFF the power immediately. Contact a **KENWOOD** service station or your dealer.
- The transceiver is designed for a 13.8 V power source. Never use a 24 V battery to power the transceiver.

# CONTENTS

SUPPLIED ACCESSORIES .....	1	<b>CHAPTER 4 OPERATING BASICS</b>	
CONVENTIONS FOLLOWED IN THIS MANUAL .....	1	SWITCHING POWER ON/OFF .....	19
<b>CHAPTER 1 PREPARATION</b>		ADJUSTING VOLUME .....	19
MOBILE INSTALLATION .....	2	SELECTING A BAND .....	19
Main Unit Installation .....	2	SELECTING A FREQUENCY .....	20
Front Panel Installation .....	3	ADJUSTING SQUELCH .....	20
FIXED STATION INSTALLATION .....	4	TRANSMITTING .....	21
MODULAR PLUG CABLE CONNECTION .....	4	Selecting Output Power .....	21
DC POWER CABLE CONNECTION .....	5	<b>CHAPTER 5 MENU SET-UP</b>	
Mobile Operation .....	5	MENU ACCESS .....	22
Fixed Station Operation .....	6	MENU CONFIGURATION .....	23
Replacing Fuses .....	7	<b>CHAPTER 6 OPERATING THROUGH REPEATERS</b>	
ANTENNA CONNECTION .....	7	PROGRAMMING OFFSET .....	29
ACCESSORY CONNECTIONS .....	8	Selecting Offset Direction .....	29
External Speakers .....	8	Selecting Offset Frequency .....	29
Microphone .....	8	Activating Tone Function .....	30
<b>CHAPTER 2 YOUR FIRST QSO</b>		Selecting a Tone Frequency .....	30
<b>CHAPTER 3 GETTING ACQUAINTED</b>		AUTOMATIC REPEATER OFFSET .....	31
FRONT PANEL .....	10	TRANSMITTING A 1750 Hz TONE .....	32
MAIN UNIT- FRONT .....	12	REVERSE FUNCTION .....	33
MAIN UNIT-REAR .....	12	AUTOMATIC SIMPLEX CHECK (ASC) .....	33
MICROPHONE .....	13	TONE FREQ. ID .....	34
INDICATORS .....	14	<b>CHAPTER 7 MEMORY CHANNELS</b>	
BASIC TRANSCEIVER MODES .....	15	SIMPLEX & REPEATER OR ODD-SPLIT	
BUTTON FUNCTION DISPLAY .....	16	MEMORY CHANNEL? .....	35
BAND A & B .....	17	STORING SIMPLEX FREQUENCIES OR	
TX BAND AND CONTROL BAND .....	17	STANDARD REPEATER FREQUENCIES .....	36
MIC KEYPAD DIRECT ENTRY (MC-53DM ONLY) ..	18		

STORING ODD-SPLIT REPEATER FREQUENCIES .....	36
RECALLING A MEMORY CHANNEL .....	37
CLEARING A MEMORY CHANNEL .....	37
NAMING A MEMORY CHANNEL .....	38
CALL CHANNEL .....	39
Recalling the Call Channel .....	39
Reprogramming the Call Channel .....	39
MEMORY-TO-VFO TRANSFER .....	40
CHANNEL DISPLAY .....	40
PARTIAL OR FULL RESET? .....	41
<b>CHAPTER 8 PROGRAMMABLE MEMORY (PM)</b>	
PROGRAMMABLE INFORMATION .....	42
APPLICATION EXAMPLES .....	43
STORING IN PM CHANNELS .....	44
RECALLING A PM CHANNEL .....	44
AUTO PM CHANNEL STORE .....	45
PM CHANNEL RESET .....	45
<b>CHAPTER 9 SCAN</b>	
VISUAL SCAN .....	47
Selecting the Number of Channels .....	47
Using Visual Scan .....	48
SELECTING SCAN RESUME METHOD .....	49
VFO SCAN .....	50
MEMORY SCAN .....	50
Locking Out a Memory Channel .....	51
GROUP SCAN .....	51

PROGRAM SCAN .....	52
Setting Scan Limits .....	52
Using Program Scan .....	53
MHz SCAN .....	53
CALL/VFO SCAN .....	54
CALL/MEMORY SCAN .....	54
<b>CHAPTER 10 CONTINUOUS TONE CODED SQUELCH SYSTEM (CTCSS)</b>	
USING CTCSS .....	55
CTCSS FREQ. ID .....	56
<b>CHAPTER 11 DIGITAL CODE SQUELCH (DCS)</b>	
USING DCS .....	57
DCS CODE ID .....	58
<b>CHAPTER 12 DUAL TONE MULTI-FREQUENCY (DTMF) FUNCTIONS (WITH MC-53DM ONLY)</b>	
MANUAL DIALING .....	59
DTMF Monitor .....	59
AUTOMATIC DIALER .....	60
Storing a DTMF Number in Memory .....	60
Transmitting a Stored DTMF Number .....	61
Selecting TX Speed .....	61
Selecting Pause Duration .....	61
<b>CHAPTER 13 PROGRAMMABLE FUNCTION (PF) KEYS</b>	
<b>CHAPTER 14 AUXILIARY FUNCTIONS</b>	
DIRECT FREQUENCY ENTRY (WITH MC-53DM ONLY) .....	63
CHANGING FREQUENCY STEP SIZE .....	64
PROGRAMMABLE VFO .....	64

DISPLAY DIMMER .....	65
AUTO DIMMER CHANGE .....	65
DISPLAY CONTRAST ADJUST .....	65
POSITIVE/ NEGATIVE REVERSAL .....	65
BLANKING A BAND DISPLAY .....	66
AUTOMATIC BAND CHANGE (A.B.C.) .....	66
TRANSCEIVER LOCK .....	67
ALL-CONTROL LOCK .....	67
CHANGING MULTI-FUNCTION BUTTON LABELS .....	67
S-METER SQUELCH .....	68
Squelch Hang Time .....	68
CHANGING BEEP VOLUME .....	69
KEY BEEP ON/ OFF .....	69
SWITCHING FM/AM MODE .....	69
ADVANCED INTERCEPT POINT (AIP) .....	69
TIME-OUT TIMER (TOT) .....	70
AUTOMATIC POWER OFF (APO) .....	70
POWER-ON MESSAGE .....	71
DISPLAY DEMONSTRATION .....	71
CHANGING SPEAKER CONFIGURATIONS .....	72
SPEAKER MUTE .....	72
CHANGING TX/RX DEVIATION (TM-D700E ONLY) .....	72

**CHAPTER 15** MICROPHONE CONTROL  
(WITH MC-53DM ONLY)

**CHAPTER 16** WIRELESS REMOTE CONTROL  
(U.S.A./ CANADA ONLY)

PREPARATION .....	74
CONTROL OPERATION .....	75

**CHAPTER 17** SKY COMMAND II  
(U.S.A./ CANADA ONLY)

CONNECTING THE TRANSPORTER WITH THE HF TRANSCEIVER .....	77
PREPARATION FLOW .....	78
PROGRAMMING CALL SIGNS .....	79
PROGRAMMING A TONE FREQUENCY .....	79
CONTROL OPERATION .....	80

**CHAPTER 18** REPEATER FUNCTION  
(U.S.A./ CANADA ONLY)

**CHAPTER 19** VS-3 VOICE SYNTHESIZER (OPTIONAL)

**CHAPTER 20** OPTIONAL ACCESSORIES

**CHAPTER 21** INSTALLING OPTIONS

INSTALLING THE VS-3 VOICE SYNTHESIZER UNIT .....	85
INSTALLING THE PG-4X EXTENSION CABLE KIT .....	85

**CHAPTER 22** MAINTENANCE

GENERAL INFORMATION .....	87
SERVICE .....	87
SERVICE NOTE .....	87
CLEANING .....	87
TROUBLESHOOTING .....	88

**SPECIFICATIONS**

**INDEX**

## SUPPLIED ACCESSORIES

A market area code (K, E, or M4) can be found on the label attached to the package box.

Accessory	Part Number	Quantity
Microphone		
K: MC-53DM	T91-0615-XX	1
E/ M4: MC-45	T91-0396-XX	1
DC power cable	E30-2111-XX	1
Transceiver fuse (15 A)	F51-0017-XX	1
Front panel mounting bracket (one pair)	J29-0663-XX J29-0664-XX	1 1
Main-unit mounting bracket	J29-0628-XX	1
Microphone hanger (K only)	J19-1526-XX	1
Screw set for main unit		
K <sup>1</sup>	N99-0382-XX	1
E/ M4	N99-0331-XX	1
Screw set for front panel	N99-2014-XX	1
Modular plug cable	E30-3391-XX	1
Cable with a 2.5 mm (1/10") 3-conductor plug <sup>2</sup>	E30-3400-XX	1
Cushion <sup>3</sup>	J02-0488-XX	4
Warranty card (U.S.A./ Canada/ Europe only)	—	1
Instruction manual		
Main	B62-1228-XX	1
Specialized Communications	B62-1273-XX	1

<sup>1</sup> The screw set includes screws for attaching the microphone hanger {page 8}.

<sup>2</sup> See the separate manual, "SPECIALIZED COMMUNICATIONS" {page 10}.

<sup>3</sup> See page 4.

## CONVENTIONS FOLLOWED IN THIS MANUAL

The writing conventions described below have been followed to simplify instructions and avoid unnecessary repetition.

Instruction	What to do
Press <b>[KEY]</b> .	Press and release <b>KEY</b> .
Press <b>[KEY]</b> (1 s).	Press and hold <b>KEY</b> for 1 second or longer.
Press <b>[KEY1]</b> , <b>[KEY2]</b> .	Press <b>KEY1</b> momentarily, release <b>KEY1</b> , then press <b>KEY2</b> .
Press <b>[F]</b> (1 s), <b>[KEY]</b> .	Press and hold <b>[F]</b> for 1 second or longer, then press <b>KEY</b> .
Press <b>[KEY1]+[KEY2]</b> .	Press and hold <b>KEY1</b> , then press <b>KEY2</b> .
Press <b>[KEY]+POWER ON</b> .	With transceiver power OFF, press and hold <b>KEY</b> , then turn ON the transceiver power by pressing <b>[PWR]</b> .

# PREPARATION

## 1 MOBILE INSTALLATION

This transceiver asks you to install the front panel and main unit at separate positions. Select safe, convenient locations inside your vehicle that minimize danger to your passengers and yourself while the vehicle is in motion. Consider installing the units at appropriate positions so that knees or legs will not strike them during sudden braking of your vehicle. Try to pick well-ventilated locations that are shielded from direct sunlight.

**Note:** Unlike the previous **KENWOOD** mobile transceivers, this transceiver does not allow the front panel and main unit to be joined.

### ■ Main Unit Installation

- 1 Install the mounting bracket in the vehicle using the supplied self-tapping screws and flat washers. There are 4 screws and 4 washers supplied.
  - The bracket must be installed so that the 3 screw holes on the edge of each bracket side are facing backward.

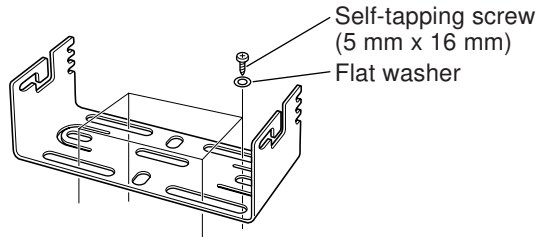

- 2 Position the transceiver, then insert and tighten the supplied hexagon SEMS screws and flat washers. There are 2 screws and 2 washers supplied for each side of the bracket.
  - Double check that all hardware is tightened to prevent vehicle vibration from loosening the bracket or transceiver.

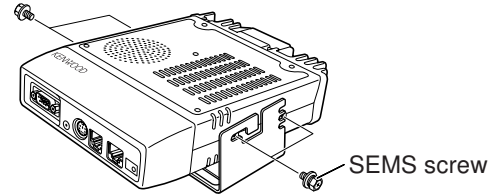

- Determine the appropriate angle of the main unit, using the 3 screw holes on the rear edge of each bracket side.

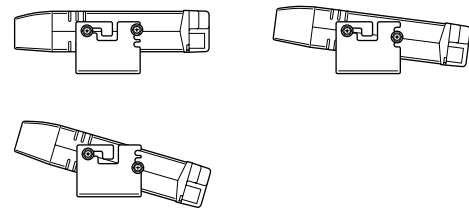



## ■ Front Panel Installation

- 1 Assemble the mounting brackets using the supplied 2 hexagon SEMS screws and 2 flat washers.
  - Do not completely tighten the screws in this step.

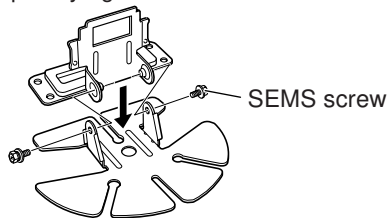

- 2 Peel off the paper backing from the rear of the bracket.

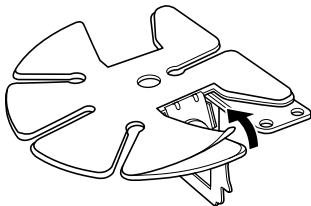

- 3 Position the bracket in the vehicle, then install it securely using the supplied 3 self-tapping screws and 3 flat washers.

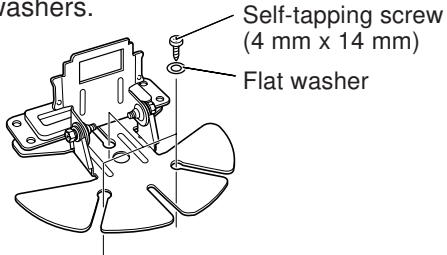

- 4 Position the grooves on the front panel over the bracket tabs.

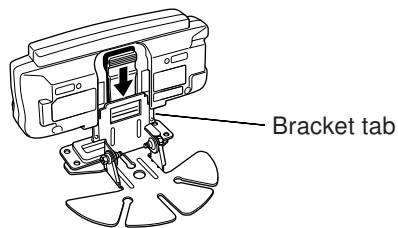

- 5 Slide the front panel down until its locking tab clicks.

- The tab on the front panel must be completely locked by the bracket; otherwise vehicle vibration may cause the front panel to drop off the bracket.

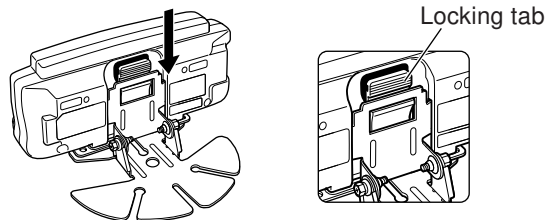

- 6 Determine the angle of the front panel, then completely tighten the 2 SEMS screws on the bracket.

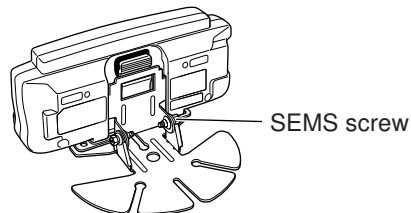

## FIXED STATION INSTALLATION

- 1 When placing the main unit on such a surface as a desk top, use the supplied cushions to prevent the surface from being scratched. Attach the 4 pieces of cushions to the specified positions on the rear of the main unit.

**Note:** Attach all the cushions to the flat surface on the main unit; otherwise the installation will be unstable or the cushions may come off easily.

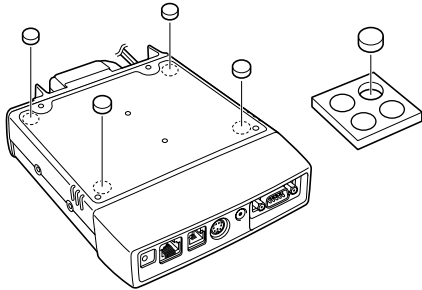

## MODULAR PLUG CABLE CONNECTION

Use the supplied modular plug cable to connect the front panel to the main unit. Connect the 4-pin plug to the front panel and 6-pin plug to the main unit.

**Note:** The 6-pin plug is wider than the 4-pin plug.

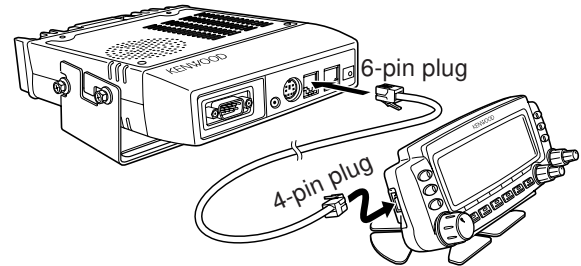

## DC POWER CABLE CONNECTION

### ■ Mobile Operation

The vehicle battery must have a nominal rating of 12 V. Never connect the transceiver to a 24 V battery. Be sure to use a 12 V vehicle battery that has sufficient current capacity. If the current to the transceiver is insufficient, the display may darken during transmission, or transmit output power may drop excessively.

- 1 Route the DC power cable supplied with the transceiver directly to the vehicle's battery terminals using the shortest path from the transceiver.
  - If using a noise filter, it should be installed with an insulator to prevent it from touching metal on the vehicle.
  - It is recommended not to use the cigarette lighter socket since some cigarette lighter sockets introduce an unacceptable voltage drop.
  - If the power cable must be routed through a hole in the vehicle chassis or body, for example in the firewall at the front of the passenger compartment, use a rubber grommet to protect the cable from abrasion. Dismantle the fuse holder to pass the cable through the firewall.

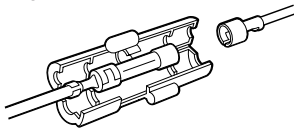

- The entire length of the cable must be dressed so it is isolated from heat, moisture, and the engine secondary (high voltage) ignition system/ cables.

- 2 After the cable is in place, wind heat-resistant tape around the fuse holder to protect it from moisture. Tie down the full run of cable.
- 3 To prevent the risk of short circuits, disconnect other wiring from the negative (-) battery terminal before connecting the transceiver.
- 4 Confirm the correct polarity of the connections, and attach the power cable to the battery terminals; red connects to the positive (+) terminal, black connects to the negative (-) terminal.
  - Use the full length of the cable without cutting off excess even if the cable is longer than required. In particular, never remove the fuse holders from the cable.

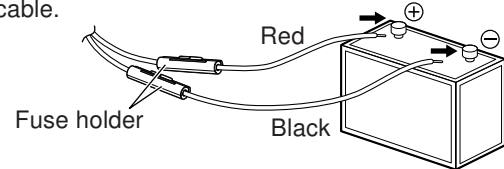

- 5 Reconnect any wiring removed from the negative terminal.
- 6 Connect the DC power cable to the transceiver's power supply connector.
  - Press the connectors firmly together until the locking tab clicks.

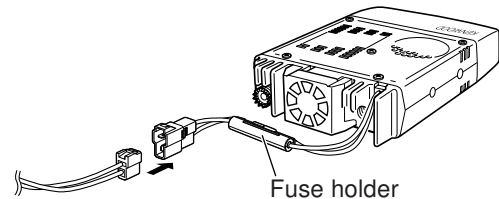

**1**

## ■ Fixed Station Operation

In order to use this transceiver for fixed station operation, you will need a separate 13.8 V DC power supply that must be purchased separately. The recommended current capacity of your power supply is 12 A.

1 Connect the DC power cable to the regulated DC power supply and check that polarities are correct (Red: positive, Black: negative).

- DO NOT directly connect the transceiver to an AC outlet.
- Use the supplied DC power cable to connect the transceiver to a regulated power supply.
- Do not substitute a cable with smaller gauge wires.

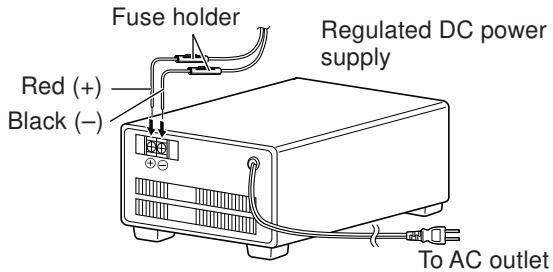

2 Connect the transceiver's DC power connector to the connector on the DC power cable.

- Press the connectors firmly together until the locking tab clicks.

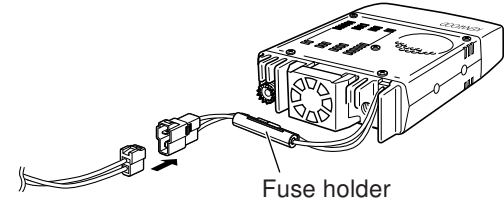

### Note:

- ◆ For your transceiver to fully exhibit its performance capabilities, the following optional power supply is recommended: PS-33 (20.5 A, 25% duty cycle).
- ◆ Before connecting the DC power supply to the transceiver, be sure to switch the transceiver and the DC power supply OFF.
- ◆ Do not plug the DC power supply into an AC outlet until you make all connections.

## ■ Replacing Fuses

If the fuse blows, determine the cause, then correct the problem. After the problem is resolved, replace the fuse. If newly installed fuses continue to blow, disconnect the power cable and contact your authorized **KENWOOD** dealer or an authorized **KENWOOD** service center for assistance.

Fuse Location	Fuse Current Rating
Transceiver	15 A
Supplied Accessory DC Power Cable	20 A



CAUTION

Only use fuses of the specified type and rating; otherwise the transceiver could be damaged.

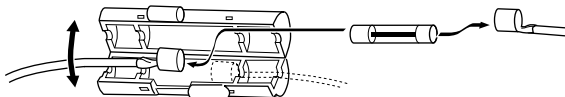

**Note:** If you use the transceiver for a long period when the vehicle battery is not fully charged, or when the engine is OFF, the battery may become discharged, and will not have sufficient reserves to start the vehicle. Avoid using the transceiver under these conditions.

## ANTENNA CONNECTION

Before operating, you must first install an efficient, well-tuned antenna. The success of your installation will depend largely on the type of antenna and its correct installation. The transceiver can give excellent results if the antenna system and its installation are given careful attention.

You should choose a 50  $\Omega$  impedance antenna to match the transceiver input impedance. Use low-loss coaxial feed line that also has a characteristic impedance of 50  $\Omega$ . Coupling the antenna to the transceiver via feed lines having an impedance other than 50  $\Omega$  reduces the efficiency of the antenna system, and can cause interference to nearby broadcast television receivers, radio receivers, and other electronic equipment.



CAUTION

- ◆ Transmitting without first connecting an antenna or other matched load may damage the transceiver. Always connect the antenna to the transceiver before transmitting.
- ◆ All fixed stations should be equipped with a lightning arrester to reduce the risk of fire, electric shock, and transceiver damage.

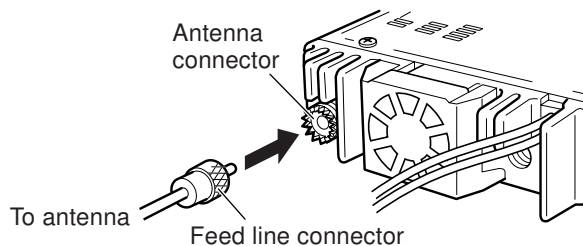

## ACCESSORY CONNECTIONS

### 1 ■ External Speakers

If you plan to use external speakers, choose speakers with an impedance of  $8 \Omega$ . The external speaker jacks accept a 3.5 mm (1/8") mono (2-conductor) plug. Recommended speakers include the SP-50B.

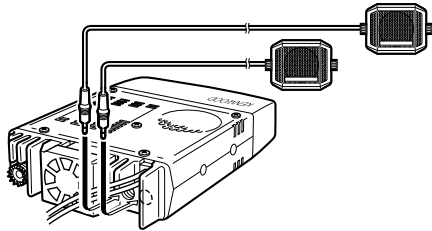

### ■ Microphone

To communicate in the voice modes, connect a 600  $\Omega$  microphone equipped with an 8-pin modular plug into the modular socket on the front of the main unit. Press firmly on the plug until the locking tab clicks.

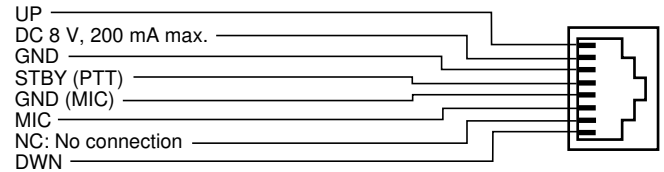
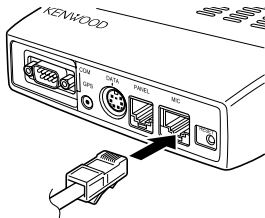

For the U.S.A./ Canada version, a microphone hanger is supplied. Attach the hanger to an appropriate position using the screws included in the screw set.

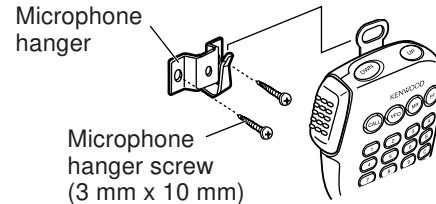

# YOUR FIRST QSO

If you tend to discard instruction manuals along with the packaging material .....please don't. The 7 steps given here will get you on the air in your first QSO right away. So, you can enjoy the exhilaration that comes with opening a brand new transceiver.

After trying the rig for a while, settle back in your most comfortable operating chair with this manual and your favorite drink for an hour or two. The time spent will be worthwhile.

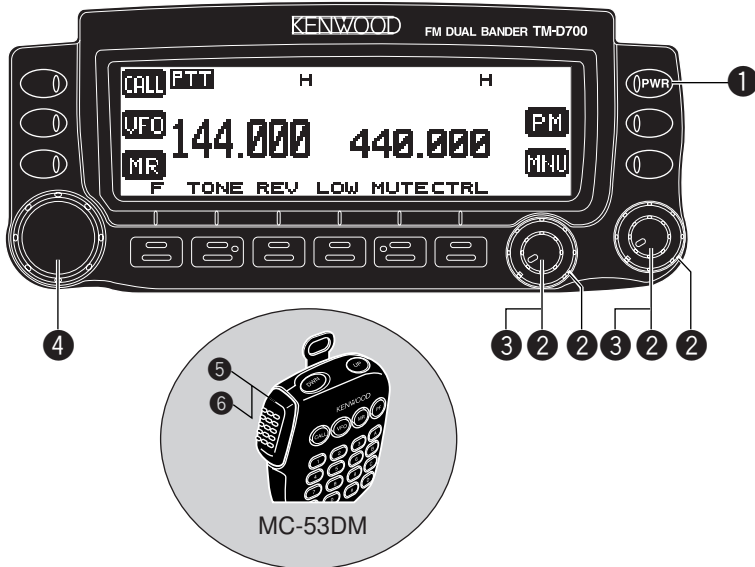

**1** Switch ON the DC power supply, then press the **PWR** switch.

**2**

**2** Turn the **VOL** and **SQL** controls to approximately 9 o'clock.

**3** Press [**BAND SEL**] to select the VHF or UHF band.

**4** Turn the **Tuning** control to select a frequency.

**5** Press and hold Mic [**PTT**], then speak in a normal tone of voice.

**6** Release Mic [**PTT**] to receive.

**7** Repeat steps **5** and **6** to continue communication.

## FRONT PANEL

**3** *Note: This section describes only the main functions of the front panel controls and buttons. For the functions not described here, you will find explanations in the appropriate sections of the manual.*

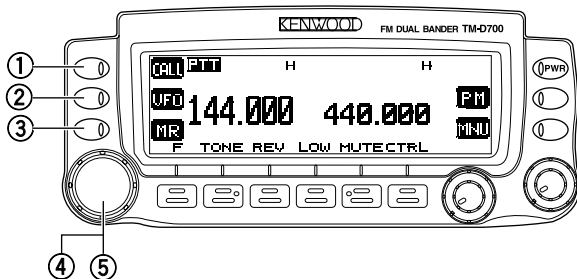

### ① CALL button

Recalls the Call channel {page 39}. Also starts or stops Call/VFO Scan {page 54} when in VFO mode, or Call/Memory Scan {page 54} when in Memory Recall mode.

### ② VFO button

Selects the VFO mode. In this mode you can change the operating frequency, using the **Tuning** control or Mic **[UP]/ [DWN]**. Also provides:

- VFO Scan start to scan the entire VFO range {page 50}.
- Program Scan start to scan a programmed range of frequencies {page 52}.

### ③ MR button

Selects the Memory Recall mode {page 37}. In this mode you can change memory channels, using the **Tuning** control or Mic **[UP]/ [DWN]**. Also starts Memory Scan {page 50}.

### ④ Tuning control

When turned, selects:

- Operating frequencies when in VFO mode {page 20}.
- Memory channels when in Memory Recall mode {page 37}.
- Menu Nos. when in Menu mode {page 22}.

This control is used for various other selections.

When an up-arrow (↑) and down-arrow (↓) are visible as button labels, the **Tuning** control functions in exactly the same way as the up- and down-arrow keys.

### ⑤ MHz button

When pressed, selects the MHz mode. In this mode you can change the operating frequency in 1 MHz steps or 10 MHz steps {page 20}, using the **Tuning** control or Mic **[UP]/ [DWN]**. Also starts MHz Scan {page 53}.



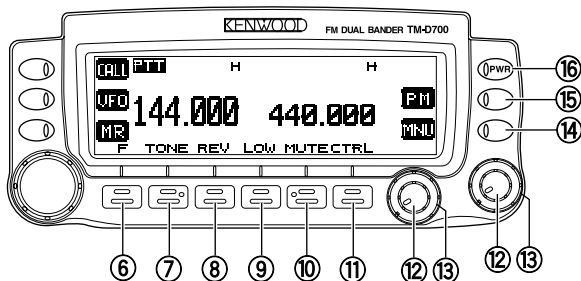

### ⑥ F (Function) button

Allows you to select the different functions that are available using the multifunction buttons.

### ⑦ TONE button

Activates the Tone {page 30}, CTCSS {page 55}, or DCS function {page 57}.

### ⑧ REV button

Switches the transmit frequency and receive frequency when operating with an offset {page 29} or an odd-split memory channel {page 36}.

### ⑨ LOW button

Selects High, Medium, or Low transmit output power {page 21}.

### ⑩ MUTE button

Mutes the speaker allocated to the control band {page 72}.

### ⑪ CTRL button

Selects the band that you can control using the front panel buttons or the microphone keys {page 17}.

### ⑫ VOL controls/ BAND SEL buttons

When turned, adjusts the level of receive audio from the speaker {page 19}. Turn the left control (band A) or the right control (band B) depending on which band you want to operate.

When pressed, these buttons select the desired TX band. Press the left button (band A) or the right button (band B) depending on which band you want to select.

For band A and B, see page 17.

### ⑬ SQL control

When turned, adjusts the squelch level {page 20}. This allows you to mute speaker output while no signals are present.

### ⑭ MNU button

Selects the Menu mode {page 22}.

### ⑮ PM button

Selects the Programmable Memory (PM) mode {page 44}.

### ⑯ PWR switch

Switches the transceiver ON or OFF {page 19}.

## MAIN UNIT- FRONT

3

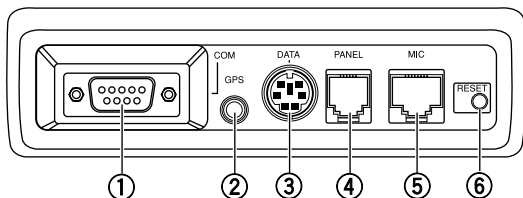

### ① COM connector

Accepts a DB-9 female connector for connecting to a computer. See the separate manual, "SPECIALIZED COMMUNICATIONS" {page 2}.

### ② GPS jack

Accepts a 2.5 mm (1/10") 3-conductor plug for connecting to a GPS receiver. See the separate manual, "SPECIALIZED COMMUNICATIONS" {page 10}.

### ③ DATA connector

Accepts a 6-pin mini DIN plug for connecting to an external TNC or an optional VC-H1. See the separate manual, "SPECIALIZED COMMUNICATIONS" {pages 2 and 35}.

### ④ PANEL connector

Insert one end of the supplied modular plug cable for connecting the front panel {page 4}.

### ⑤ MIC connector

Insert the modular plug on the microphone cable until the locking tab clicks {page 8}.

### ⑥ RESET button

Press for 1 second or longer to perform Full Reset {page 41}. No confirmation message appears. Use this switch when the microcomputer and/or the memory chip malfunction because of ambient factors.

**Note:** With the transceiver power ON, do not connect cables to or remove from the front panel of the main unit.

## MAIN UNIT- REAR

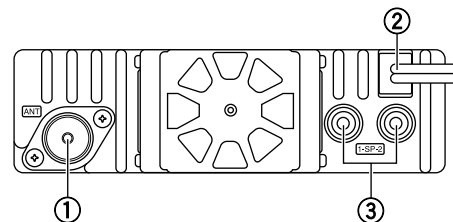

### ① Antenna connector

Connect an external antenna {page 7}. When making test transmissions, connect a dummy load in place of the antenna. The antenna system or load should have an impedance of 50  $\Omega$ . The TM-D700E accepts a male N-type connector and other versions accept a male PL-259 connector. This transceiver has only one antenna connector because of a built-in duplexer.

### ② Power Input 13.8 V DC cable

Connect a 13.8 V DC power source. Use the supplied DC power cable {pages 5 and 6}.

### ③ Speaker jacks

If you wish, connect an optional external speaker for clearer audio. These jacks accept a 3.5 mm (1/8") mono (2-conductor) plug. See page 8.

## MICROPHONE

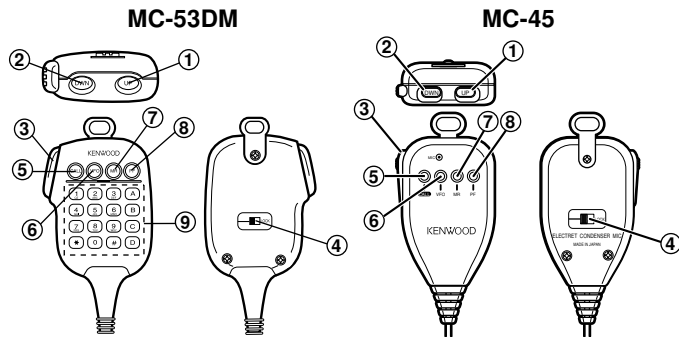

① **UP button**

② **DWN button**

Raises or lowers the operating frequency, the memory channel number, the menu number, etc. Holding either button down causes the action to be repeated. Also, switches between values for functions with multiple choices.

③ **PTT (Push-to-Talk) switch**

Press and hold to transmit, then release to receive.

④ **LOCK switch**

Locks all microphone keys except **[PTT]** and (if equipped) the DTMF keypad.

⑤ **CALL key**

⑥ **VFO key**

⑦ **MR key**

Identical to the front panel **CALL**, **VFO** and **MR** buttons. These keys can be reprogrammed, if desired {page 62}.

⑧ **PF key**

Depending on which function you select in Menu 1–8–1 (PF1), the function of this key differs. Refer to “PROGRAMMABLE FUNCTION (PF) KEYS” {page 62}.

⑨ **DTMF keypad (MC-53DM only)**

The 16-key keypad is used for DTMF functions {page 59}, or to directly enter an operating frequency {page 63}, a memory channel number {page 37}, a tone frequency {page 30}, or a CTCSS frequency {page 56}. The keypad is also available to program a memory channel name {pages 38 and 60}, Power-ON message {page 71}, or other character strings.

## INDICATORS

On the display you will see various indicators that show what you have selected.

3

Indicator	What You Selected	What You Press to Cancel	Ref. Page
<b>T</b>	Tone function	[TONE], [TONE], [TONE]	30
<b>CT</b>	CTCSS	[TONE], [TONE]	55
<b>DCS</b>	DCS	[TONE]	57
<b>+</b>	Plus offset direction	[F], [SHIFT], [F], [SHIFT] (TM-D700E: one more [F], [SHIFT])	29
<b>-</b>	Minus offset direction	[F], [SHIFT] (TM-D700E: one more [F], [SHIFT])	29
<b>=</b>	Minus offset direction (-7.6 MHz) <sup>1</sup>	[F], [SHIFT]	29
<b>R</b>	Reverse	[REV]	33
<b>T</b>	Automatic Simplex Check	[REV]	33
<b>H</b>	High transmit power	Default	21
<b>M</b>	Medium transmit power	[LOW], [LOW] to select the default	21
<b>L</b>	Low transmit power	[LOW] to select the default	21

<sup>1</sup> TM-D700E only

Indicator	What You Selected	What You Press to Cancel	Ref. Page
<b>*</b>	Locked-out memory channel	Use Menu 1–4–3.	51
<b>A.B.C.</b>	Auto Band Change	[F], [A.B.C.]	66
<b>LOCK</b>	Transceiver Lock	[F], [MHz]	67
<b>ALL LOCK</b>	All-control Lock	[MHz]+ POWER ON, then [F], [MHz]	67
<b>MUTE</b>	Speaker Mute	[MUTE]	72
<b>TNC PKT</b>	Packet mode	[F] (1 s), [TNC]	(4)
<b>TNC APRS</b>	APRS mode	[F] (1 s), [TNC], [F] (1 s), [TNC]	(11)
<b>N</b>	Narrow transmit deviation <sup>1</sup>	Use Menu 1–3–6.	72

<sup>1</sup> TM-D700E only

For the shaded indicators, see the separate manual, “SPECIALIZED COMMUNICATIONS”.

When you receive a signal:



- “BUSY” appears when the squelch {page 20} is open.
- The S-meter shows the strength of received signals.

## BASIC TRANSCEIVER MODES

This section introduces you to the basic modes you can select.

### VFO mode

Press **[VFO]** to select. You can change the operating frequency using the **Tuning** control or Mic **[UP]/ [DWN]**.

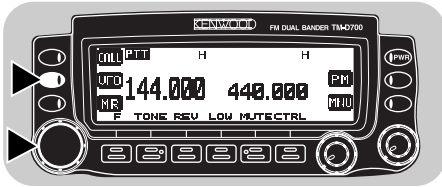

### Memory Recall mode

Press **[MR]** to select. You can change memory channels, using the **Tuning** control or Mic **[UP]/ [DWN]**, where you stored frequencies and related data. Refer to “MEMORY CHANNELS” {page 35}.

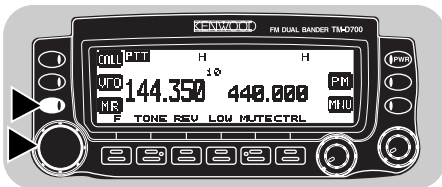

### Programmable Memory (PM) mode

Press **[PM]** to select. You can select the transceiver environment, by pressing **[1]** to **[5]**, that you stored in PM channels. Refer to “PROGRAMMABLE MEMORY (PM)” {page 42}.

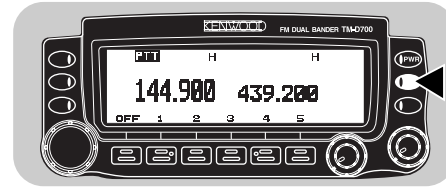

### Menu mode

Press **[MNU]** to select. You can change Menu Nos. using the **Tuning** control or **[↑]/ [↓]**. Refer to “MENU SET-UP” {page 22}.

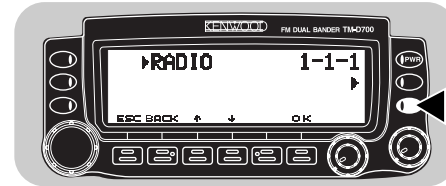

### APRS mode/ Packet mode

Press **[F]** (1 s), **[TNC]** to select APRS mode. Press **[F]** (1 s), **[TNC]** again to select Packet mode. In APRS mode, you can receive and transmit APRS packets. In Packet mode, you can send commands to the built-in TNC from a personal computer. Refer to the separate manual, “SPECIALIZED COMMUNICATIONS” {pages 4 and 11}.



APRS mode

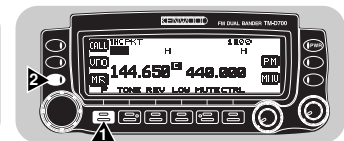

Packet mode

## BUTTON FUNCTION DISPLAY

The functions of the 6 buttons below the display can be identified through the labels shown at the bottom of the display. After pressing [F] or [F] (1 s), pressing [F] ([OFF]) again restores the basic state.

3

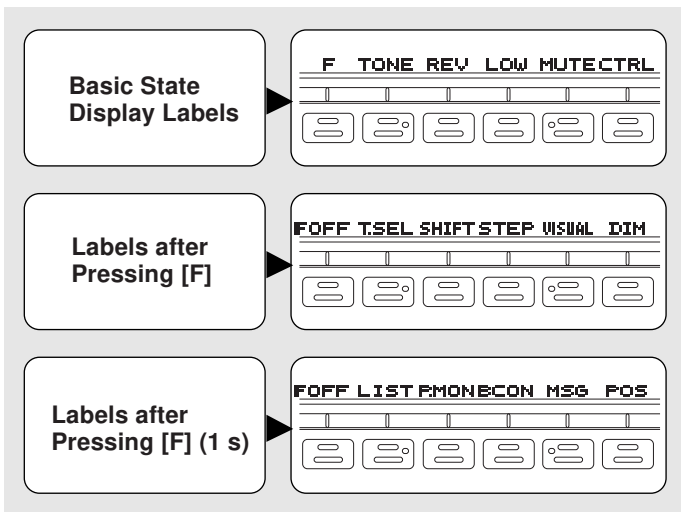

### Note:

- ◆ When selecting Programmable Memory (PM) mode, you will see different labels. See "Programmable Memory (PM) mode" (page 15).
- ◆ You can also select different combinations of buttons labels. See "CHANGING MULTI-FUNCTION BUTTON LABELS" (page 67).

The labels of the 5 buttons beside the display are shown at the left end or right end of the display. These labels will change depending on the current mode.

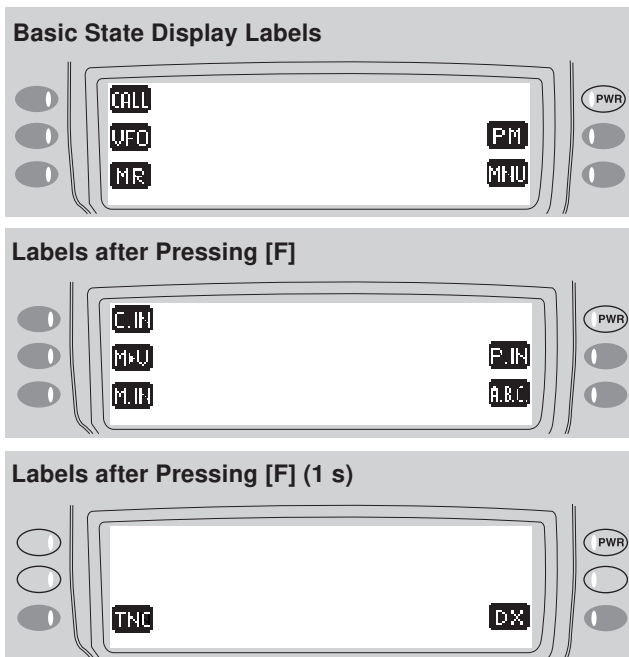

## BAND A & B

In this manual, the band recalled at the left on the display is referred to as band A, and the band at the right is called band B. In band A you can recall a 144 MHz band (default) or a 440 (or 430) MHz sub-band. In band B you can recall a 440 (or 430) MHz band (default) or a 144 MHz sub-band. On the U.S.A./ Canada version, you can also recall a 118 MHz, 220 MHz, or 300 MHz sub-band in band A, and a 300 MHz or 1.2 GHz sub-band in band B. This transceiver is capable of simultaneously receiving on bands A and B.

Press the left or right **[BAND SEL]** to select band A or B. To recall the sub-band, press **[F]**, then the same **[BAND SEL]**. The following diagram shows how the bands are switched on a TM-D700E.

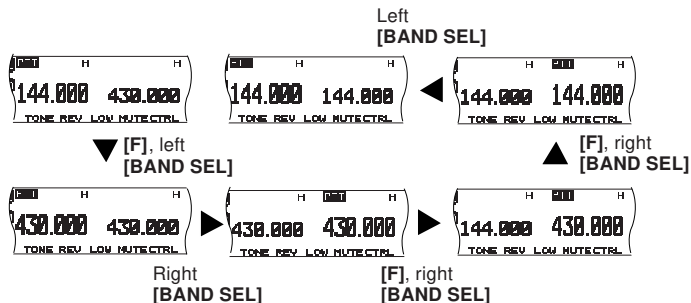

### Note:

- ◆ You cannot recall a sub-band in Memory Recall mode. First press **[VFO]** to select VFO mode.
- ◆ You cannot recall the UHF sub-band in band A and the VHF sub-band in band B at the same time.
- ◆ The 118 MHz, 220 MHz, 300 MHz, or 1.2 GHz sub-band cannot be used for transmitting.
- ◆ For the range of each band, see “SPECIFICATIONS” {page 90}.

## TX BAND AND CONTROL BAND

What confuses you on this radio first could be the ideas of the TX band and Control band. To avoid confusion, please note the differences between the TX band and the Control band.

3

### TX Band

Press the left **[BAND SEL]** (band A) or the right **[BAND SEL]** (band B) to select. “PTT” on the display shows which band (A or B) is currently selected as the transmit (TX) band. You can use the TX band to transmit signals or to control the transceiver.

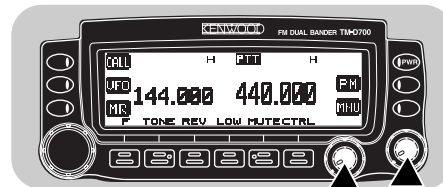

### Control Band

Press **[CTRL]** to select. On the display “Ctrl” appears to show which band (A or B) is currently selected as the Control band. Use this function when you want to control the band which is not currently set as the TX band. After selecting the Control band, you cannot control the TX band.

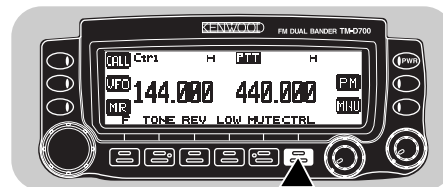

## MIC KEYPAD DIRECT ENTRY (MC-53DM ONLY)

The keypad on the MC-53DM allows you to make various entries depending on which mode the transceiver is in.

- In VFO or Memory Recall mode, use the Mic keypad to select a frequency {page 63} or memory channel number {page 37}. In Tone or CTCSS freq. Select mode, use the keypad to select a Tone frequency {page 30} or CTCSS frequency {page 56}. First press the Mic PF key programmed as the ENTER key {page 62}.

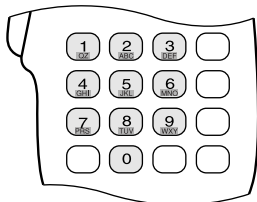

To manually send a DTMF number, press and hold Mic **[PTT]**, then press the DTMF keys on the Mic keypad {page 59} in sequence.

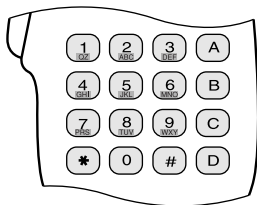

You can also use the Mic keypad to program a memory channel name {pages 38 and 60}, Power-ON message {page 71}, or other character strings. Each press of a Mic key switches entry of characters as below. You can always use Mic **[A]** as **[→]**, **[B]** as **[←]**, **[C]** as **[DEL]**, and **[D]** as **[OK]**.

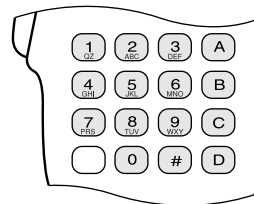

1	q	z	1	Q	Z			6	m	n	o	6	M	N	O	
2	a	b	c	2	A	B	C	7	p	r	s	7	P	R	S	
3	d	e	f	3	D	E	F	8	t	u	v	8	T	U	V	
4	g	h	i	4	G	H	I	9	w	x	y	9	W	X	Y	
5	j	k	l	5	J	K	L	0	Space	0						
#	?	!	'	.	,	-	/	&	#	%	(	)	<	>	;	:
	"	@														

When programming call signs for the Sky Command II {page 79}, pressing Mic **[0]** selects only "0" and pressing Mic **[#]** selects only "-".



# OPERATING BASICS

## SWITCHING POWER ON/OFF

- 1 Switch ON the DC power supply.
  - If operating mobile, skip this step.
- 2 Press the **PWR** switch to switch ON the transceiver.

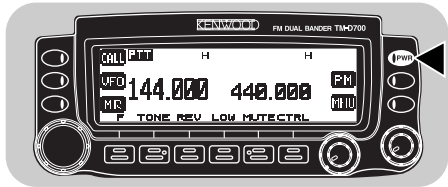

- 3 To switch OFF the transceiver, press the **PWR** switch again.
- 4 If operating as a fixed station, switch OFF the DC power supply.
  - You may skip step 3. After switching ON the transceiver, you can switch it OFF or ON using only the power switch on the DC power supply.

## ADJUSTING VOLUME

Turn the **VOL** control clockwise to increase the audio level and counterclockwise to decrease the audio level.

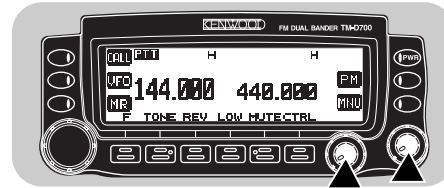

- If background noise is inaudible because of the Squelch function, press the Mic PF key assigned the Monitor function {page 62}, then adjust the **VOL** control. Press the PF key again to cancel the Monitor function.

4

## SELECTING A BAND

Press the left [**BAND SEL**] to select band A, or the right [**BAND SEL**] to select band B.

- “PTT” moves to the selected band.

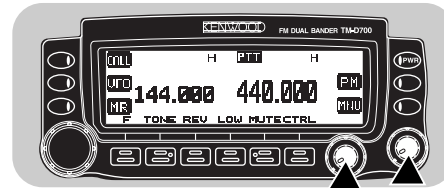

- For band A and B, see page 17.

## SELECTING A FREQUENCY

- 1 Press **[VFO]** to select VFO mode.

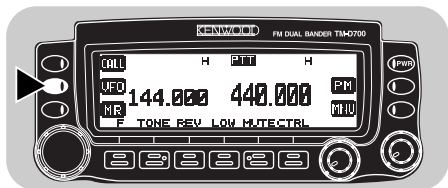

- 2 To increase the frequency, turn the **Tuning** control clockwise or press Mic **[UP]**.

To decrease the frequency, turn the **Tuning** control counterclockwise or press Mic **[DWN]**.

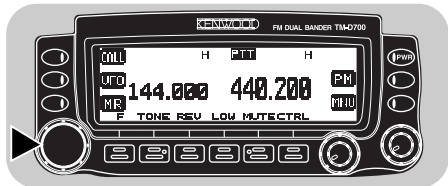

- Pressing and holding Mic **[UP]/ [DWN]** causes the frequency to step repeatedly.
- To change frequencies in steps of 1 MHz, press **[MHz]** (**Tuning** control) first. Pressing **[MHz]** again cancels this function.
- To change frequencies in steps of 10 MHz, press **[F]+[MHz]** first. Pressing **[F]** cancels the 10 MHz function; pressing **[MHz]** starts the 1 MHz function.

If using a MC-53DM, you can also use its keypad to select frequencies. See “DIRECT FREQUENCY ENTRY (WITH MC-53DM ONLY)” {page 63}.

## ADJUSTING SQUELCH

The purpose of the Squelch is to mute the speaker when no signals are present. With the squelch level correctly set, you will hear sound only when actually receiving signals. The higher the squelch level selected, the stronger the signals must be to receive. The appropriate squelch level depends on ambient RF noise conditions.

Turn the **SQL** control when no signals are present. Select the squelch level at which the background noise is just eliminated.

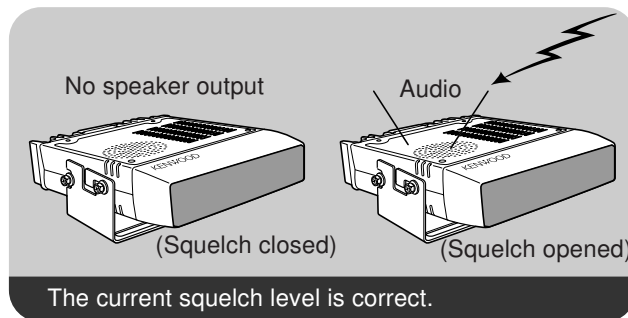
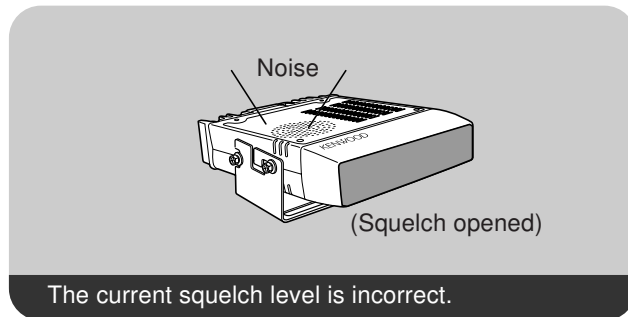

## TRANSMITTING

- 1 To transmit, press and hold Mic [PTT] and speak into the microphone in a normal tone of voice.
  - “ON AIR” and the RF power meter appear.

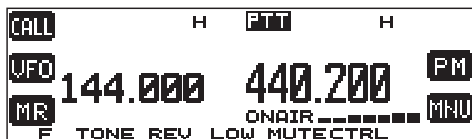

- Speaking too close to the microphone, or too loudly, may increase distortion and reduce intelligibility of your signals at the receiving station.
- The RF power meter shows the relative transmit output power.

- 2 When you finish speaking, release Mic [PTT].

**Time-Out Timer:** Holding down Mic [PTT] for more than 10 minutes causes the transceiver to generate a beep and stop transmitting. Release, then press Mic [PTT] to resume transmitting. You may change the time-out time to 3 or 5 minutes {page 70}.

## ■ Selecting Output Power

It's wise to select lower transmit power if communication is still reliable. This lowers the risk of interfering with others on the band. When operating from battery power, you will enjoy more operating time before a charge is necessary.

Press [LOW] to select high (“H”), medium (“M”), or low (“L”) power. The default is high.

- You can program a different power for band A and B.



### CAUTION

- ◆ Do not transmit at high output power for an extended period of time. The transceiver could overheat and malfunction.
- ◆ Continuous transmission causes the heat sink to overheat. Never touch the heat sink when it may be hot.

**Note:** When the transceiver overheats because of ambient high temperature or continuous transmission, the protective circuit may function to lower transmit output power.

# MENU SET-UP

The Menu system on this transceiver consists of 3 levels.

5

Level 1	1															
Level 2	1				2				3							
Level 3	1	2	3	4	5	1	2	3	4	5	1	2	3	4	5	6

└─ Menu 1-3-1

## MENU ACCESS

- 1 Press **[MNU]** to enter Menu mode.
  - The current level 1 No. blinks.

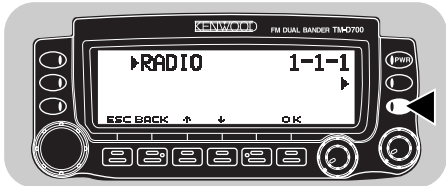

- 2 Press **[↑]/[↓]** to select the appropriate level 1 No.

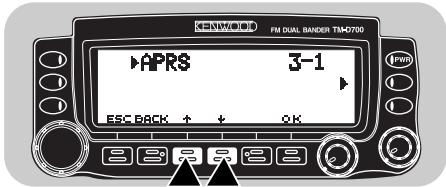

- 3 Press **[OK]**.
  - The current level 2 No. blinks.
- 4 Press **[↑]/[↓]** to select the appropriate level 2 No.

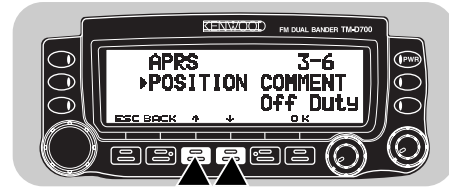

- To move back to level 1, press **[BACK]**.
  - To exit Menu mode, press **[ESC]**.
- 5 Press **[OK]**.
  - 6 For Menu 1-1 to 1-9 and 1-A, repeat steps 4 and 5 to select level 3.
  - 7 Press **[↑]/[↓]** to select a parameter.
    - The procedure in this step differs depending on which menu item you selected. See the appropriate sections in the manual.
  - 8 Press **[OK]** to complete the setting.
  - 9 Press **[MNU]** to exit Menu mode.

## MENU CONFIGURATION

The shaded Menu Nos. are described in the separate manual, "SPECIALIZED COMMUNICATIONS".

Level 1		Level 2		Level 3		Selections	Default	Ref. page
1	RADIO	1	DISPLAY	1	Power-ON Message	See reference page.	HELLO !!	71
				2	Contrast	Level 1 (min.) ~ 16 (max.)	Level 8	65
				3	Reverse mode	Positive/ Negative	Positive	65
				4	Auto Dimmer Change	ON/ OFF	OFF	65
				5	Multi-function button	Mode 1/ 2/ 3	Mode 1	67
		2	AUDIO	1	Beep volume	Level 1 (min.) ~ 7 (max.)/ OFF	Level 5	69
				2	Key Beep	ON/ OFF	ON	69
				3	Speaker configuration	Mode 1/ 2	Mode 1	72
				4	Voice Synthesizer <sup>1</sup>	English/ APRS only/ Japanese/ OFF	OFF	83
				5	Voice volume <sup>1</sup>	Level 1 (min.) ~ 7 (max.)	Level 5	83
		3	TX/RX	1	Programmable VFO	See reference page.	—	64
				2	S-meter Squelch	ON/ OFF	OFF	68
				3	Squelch hang time	125 / 250 / 500 msec./ OFF	OFF	68
				4	FM/ AM mode	FM/ AM	See reference page.	69
				5	Advanced Intercept Point	ON/ OFF	OFF	69
				6	TX/ RX deviation <sup>2</sup>	Wide/ Narrow	Wide	72

<sup>1</sup> Only with an optional VS-3 unit installed

<sup>2</sup> TM-D700E only

Level 1		Level 2		Level 3		Selections	Default	Ref. page
1	RADIO	4	MEMORY	1	Auto PM Channel Store	ON/ OFF	ON	45
				2	Channel Display	ON/ OFF	OFF	40
				3	Memory Channel Lockout	ON/ OFF	OFF	51
				4	Memory channel name	See reference page.	—	38
		5	DTMF	1	Number Store	See reference page.	—	60
				2	TX speed	Fast/ Slow	Fast	61
				3	Pause	100/ 250/ 500/ 750/ 1000/ 1500/ 2000 msec.	500 msec.	61
		6	TNC	1	Data band	See reference page.	Band A	(5)
				2	DCD sense	A & B bands/ Data (RX) band	Data (RX) band	(5)
				3	Time	See reference page.	—	(12)
				4	Date	See reference page.	—	(12)
				5	Time zone	See reference page.	—	(13)
		7	REPEATER	1	Offset frequency	0.00 ~ 29.95 MHz in steps of 50 kHz	See reference page.	29
				2	Automatic Repeater Offset	ON/ OFF	ON	31
				3	Call Button Function	Call/ 1750 Hz TX	Call	32
				4	TX Hold	ON/ OFF	OFF	32
				5	Repeater Hold <sup>1</sup>	ON/ OFF	OFF	82
				6	Repeater function <sup>1</sup>	Locked-band/ Cross-band/ OFF	OFF	82

<sup>1</sup> U.S.A./ Canada only

Level 1		Level 2		Level 3		Selections	Default	Ref. page
1	RADIO	8	MIC	1	Mic PF Key	See reference page.	A/B	62
				2	Mic MR Key	See reference page.	MR	62
				3	Mic VFO Key	See reference page.	VFO	62
				4	Mic CALL Key	See reference page.	CALL <sup>1</sup>	62
				5	Microphone Control	ON/ OFF	OFF	73
				6	DTMF Monitor	ON/ OFF	OFF	59
		9	AUX	1	Scan Resume	Time-Operated/ Carrier-Operated/ Seek	Time-Operated	49
				2	Number of Channels for Visual Scan	31/ 61/ 91/ 181	61	47
				3	Automatic Power Off (APO)	ON/ OFF	OFF	70
				4	Time-Out Timer (TOT)	3/ 5/ 10 minutes	10 minutes	70
				5	COM port <sup>2</sup>	9600/ 19200/ 38400/ 57600 bps	9600 bps	(4)
				6	Data port	1200/ 9600 bps	1200 bps	(5)
				7	Reset	See reference page.	—	41
		A	REMOTE CON <sup>3</sup>	1	Secret code	See reference page.	000	74
				2	Acknowledgement	ON/ OFF	OFF	75
				3	Remote Control	ON/ OFF	OFF	75

5

<sup>1</sup> TM-D700E: 1750 Hz Tone

<sup>2</sup> After changing the selection, switch the transceiver OFF, then ON.

<sup>3</sup> U.S.A./ Canada only

Level 1		Level 2		Selections	Default	Ref. page
2	SSTV	1	My call sign	See reference page.	—	(36)
		2	Color for call sign	White/ Black/ Blue/ Red/ Magenta/ Green/ Cyan/ Yellow	White	(37)
		3	Message	See reference page.	—	(36)
		4	Color for message	White/ Black/ Blue/ Red/ Magenta/ Green/ Cyan/ Yellow	White	(37)
		5	RSV report	See reference page.	—	(36)
		6	Color for RSV report	White/ Black/ Blue/ Red/ Magenta/ Green/ Cyan/ Yellow	White	(37)
		7	Superimposition Execute	See reference page.	—	(37)
		8	SSTV mode	See reference page.	—	(38)
		9	VC-H1 Control	ON/ OFF	OFF	(38)
3	APRS	1	My call sign	See reference page.	—	(17)
		2	GPS receiver	Not used/ NMEA/ NMEA96	Not used	(10)
		3	Waypoint	See reference page.	OFF	(15)
		4	My position	See reference page.	—	(19)
		5	Position Ambiguity	1/ 2/ 3/ 4 digits/ OFF	OFF	(26)
		6	Position comment	See reference page.	Off Duty	(20)
		7	Reception restriction distance	10 ~ 2500 in steps of 10/ OFF	OFF	(26)
		8	Station icon	See reference page.	—	(18)
		9	Status text	See reference page.	—	(21)



Level 1		Level 2		Selections	Default	Ref. page
3	APRS	A	Status text transmit rate	See reference page.	OFF	(25)
		B	Packet path	See reference page.	RELAY,WIDE	(23)
		C	Packet transmit method	Manual/ PTT/ Auto	Manual	(25)
		D	Packet transmit interval	0.2/ 0.5/ 1/ 2/ 3/ 5/ 10/ 20/ 30 minutes	3 minutes	(25)
		E	Group code	See reference page.	APK101	(22)
		F	Beep	Mine/ All new/ All/ OFF	All	(14, 29)
		G	Unit for distance	Mile/ Kilometer	Kilometer <sup>1</sup>	(16)
		H	Unit for temperature	°F/ °C	°C <sup>1</sup>	(16)
		I	Data band	See reference page.	Band A	(13)
		J	Packet transfer rate	1200/ 9600 bps	1200 bps	(13)
		K	Digipeater	ON/ OFF	OFF	(27)
		L	Digipeating path	See reference page.	RELAY	(27)
		M	Auto Answer Reply	ON/ OFF	OFF	(33)
		N	Reply message	See reference page.	—	(33)
O	Bulletin group	See reference page.	—	(34)		
P	Message group	See reference page.	—	(34)		
4	SKY CMD (U.S.A./ Canada)	1	Commander call sign	See reference page.	—	79
		2	Transporter call sign	See reference page.	—	79
		3	Tone frequency	See reference page.	88.5 Hz	79
		4	Sky Command mode	Commander/ Transporter/ OFF	OFF	78

<sup>1</sup> U.S.A./ Canada: Mile and °F

# OPERATING THROUGH REPEATERS

Repeaters, which are often installed and maintained by radio clubs, are usually located on mountain tops or other elevated locations. Generally they operate at higher ERP (Effective Radiated Power) than a typical station. This combination of elevation and high ERP allows communications over much greater distances than communications without using repeaters.

**6** Most repeaters use a receive and transmit frequency pair with a standard or non-standard offset (odd-split). In addition, some repeaters must receive a tone from the transceiver to allow it to access. For details, consult your local repeater reference.

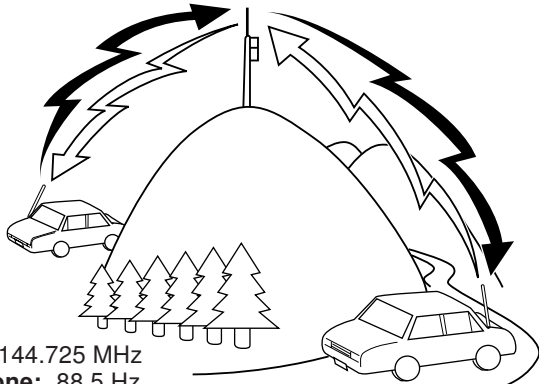

**TX:** 144.725 MHz  
**TX tone:** 88.5 Hz  
**RX:** 145.325 MHz

**TX:** 144.725 MHz  
**TX tone:** 88.5 Hz  
**RX:** 145.325 MHz

## Offset Programming Flow

- 1 Select a band.
- 2 Select a receive frequency.
- 3 Select an offset direction.
- 4 Select an offset frequency.  
(Only when programming odd-split repeater frequencies)
- 5 Activate the Tone function.  
(If necessary)
- 6 Select a tone frequency.  
(If necessary)

If you store the above data in a memory channel, you need not reprogram every time. See “MEMORY CHANNELS” {page 35}.

## PROGRAMMING OFFSET

First select band A or B by pressing the left or right [BAND SEL]. To recall the sub-band next, press [F], then the same [BAND SEL].

### ■ Selecting Offset Direction

Select whether the transmit frequency will be higher (+) or lower (–) than the receive frequency.

Press [F], [SHIFT] to switch the offset direction.

- “+” or “–” appears to indicate which offset direction is selected.

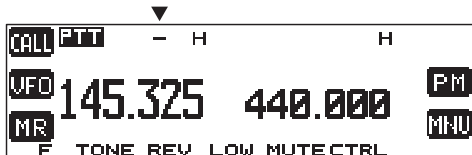

- To program –7.6 MHz offset on the TM-D700E (UHF only), repeatedly press [F], [SHIFT] until “=” appears.

If the offset transmit frequency falls outside the allowable range, transmitting is inhibited. Use one of the following methods to bring the transmit frequency within the band limits:

- Move the receive frequency further inside the band.
- Change the offset direction.

**Note:** While using an odd-split memory channel or transmitting, you cannot change the offset direction.

### ■ Selecting Offset Frequency

To access a repeater which requires an odd-split frequency pair, change the offset frequency from the default which is used by most repeaters. The default offset frequency on the VHF band is 600 kHz no matter which market version; the default on the UHF band is 5 MHz (TM-D700A) or 1.6 MHz (TM-D700E).

- 1 Press [MNU] to enter Menu mode.
- 2 Press [↑]/[↓] to select “RADIO (1–)”, then press [OK].
- 3 Press [↑]/[↓] to select “REPEATER (1–7–)”, then press [OK].
- 4 Press [↑]/[↓] to select “OFFSET FREQUENCY (1–7–1)”, then press [OK].



- 5 Press [↑]/[↓] to select the appropriate offset frequency.
  - The selectable range is from 0.00 MHz to 29.95 MHz in steps of 50 kHz.
- 6 Press [OK] to complete the setting.
- 7 Press [MNU] to exit Menu mode.

**TM-D700E Only:** If you have selected “=” for the offset direction, you cannot change the default (7.6 MHz).

**Note:** After changing the offset frequency, the new offset frequency will also be used by Automatic Repeater Offset.

## ■ Activating Tone Function

Press **[TONE]** to activate the Tone function.

- “T” appears when the Tone function is ON.



- Each press of **[TONE]** changes the selection as Tone → CTCSS → DCS → No selection.

### Note:

- ◆ You cannot use the Tone function with the CTCSS or DCS function.
- ◆ You need to activate the Tone function only when selecting one of the 38 standard frequencies. The selection you make here will not affect transmission of a 1750 Hz tone.

## ■ Selecting a Tone Frequency

**Note:** The procedures for transmitting a 1750 Hz tone are described on page 32.

1 Press **[TONE]** to activate the Tone function.

- “T” appears when the Tone function is ON.

2 Press **[F]**, **[T.SEL]**.

- The current tone frequency appears and blinks. The default is 88.5 Hz.



3 Press **[↑]** **[↓]** to select the appropriate tone frequency.

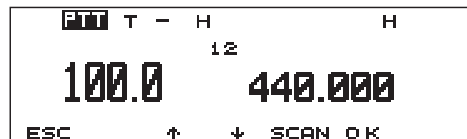

4 Press **[OK]** to complete the setting.

No.	Freq. (Hz)	No.	Freq. (Hz)	No.	Freq. (Hz)	No.	Freq. (Hz)
01	67.0	11	97.4	21	136.5	31	192.8
02	71.9	12	100.0	22	141.3	32	203.5
03	74.4	13	103.5	23	146.2	33	210.7
04	77.0	14	107.2	24	151.4	34	218.1
05	79.7	15	110.9	25	156.7	35	225.7
06	82.5	16	114.8	26	162.2	36	233.6
07	85.4	17	118.8	27	167.9	37	241.8
08	88.5	18	123.0	28	173.8	38	250.3
09	91.5	19	127.3	29	179.9		
10	94.8	20	131.8	30	186.2		

If using a MC-53DM, you can also use its keypad to select a tone frequency. First program one of the Mic PF keys as the ENTER key {page 62}. In step 2, press **[ENTER]**, then enter 01 to 38 shown in the table. To select 79.7 Hz, for example, press **[ENTER]**, **[0]**, **[5]**.

## AUTOMATIC REPEATER OFFSET

This function automatically selects an offset direction, according to the frequency that you select on the VHF band. The transceiver is programmed for offset direction as shown below. To obtain an up-to-date band plan for repeater offset direction, contact your national Amateur Radio association.

### U.S.A. and Canada versions

This complies with the standard ARRL band plan.

144.0    145.5    146.4    147.0    147.6  
145.1    146.0    146.6    147.4    148.0 MHz

S	-	S	+	S	-	+	S	-
---	---	---	---	---	---	---	---	---

S: Simplex

### European versions

144.0                                    145.6    145.8    146.0 MHz

S		-	S
---	--	---	---

S: Simplex

**Note:** Automatic Repeater Offset does not function when Reverse is ON. However, pressing **[REV]** after Automatic Repeater Offset has selected an offset (split) status, exchanges the receive and transmit frequencies.

- 1 Press **[MNU]** to enter Menu mode.
- 2 Press **[↑]**/**[↓]** to select “RADIO (1-)”, then press **[OK]**.
- 3 Press **[↑]**/**[↓]** to select “REPEATER (1-7-)”, then press **[OK]**.
- 4 Press **[↑]**/**[↓]** to select “AUTO OFFSET (1-7-2)”, then press **[OK]**.



- 5 Press **[↑]**/**[↓]** to switch the function ON (default) or OFF.
- 6 Press **[OK]** to complete the setting.
- 7 Press **[MNU]** to exit Menu mode.

## TRANSMITTING A 1750 Hz TONE

Most of the repeaters in Europe require that a transceiver transmit a 1750 Hz tone. On a TM-D700E, simply pressing Mic **[CALL]** causes it to transmit a 1750 Hz tone. It is also possible to program **[CALL]** on the front panel as a button for transmitting a 1750 Hz tone.

- 1 Press **[MNU]** to enter Menu mode.
- 2 Press **[↑]/[↓]** to select “RADIO (1–)”, then press **[OK]**.
- 3 Press **[↑]/[↓]** to select “REPEATER (1–7–)”, then press **[OK]**.
- 4 Press **[↑]/[↓]** to select “1750 KEY (1–7–3)”, then press **[OK]**.



- 5 Press **[↑]/[↓]** to select “1750”.
- 6 Press **[OK]** to complete the setting.
- 7 Press **[MNU]** to exit Menu mode.
  - “1750” appears in place of “CALL” as the button label.

### Note:

- ◆ All market versions allow the above selection in Menu 1–7–3.
- ◆ All market versions allow any Mic PF key to be assigned the 1750 Hz Tone function {page 62}.
- ◆ The transceiver continuously transmits a 1750 Hz tone until you release Mic **[CALL]** or **[CALL]**.

Some repeaters in Europe must receive continuous signals for a certain period of time, following a 1750 Hz tone. This transceiver is also capable of remaining in the transmit mode for 2 seconds after transmitting a 1750 Hz tone.

- 1 Press **[MNU]** to enter Menu mode.
- 2 Press **[↑]/[↓]** to select “RADIO (1–)”, then press **[OK]**.
- 3 Press **[↑]/[↓]** to select “REPEATER (1–7–)”, then press **[OK]**.
- 4 Press **[↑]/[↓]** to select “TX HOLD (1–7–4)”, then press **[OK]**.



- 5 Press **[↑]/[↓]** to switch the function ON (or OFF).
- 6 Press **[OK]** to complete the setting.
- 7 Press **[MNU]** to exit Menu mode.

### Note:

- ◆ All market versions allow the above selection in Menu 1–7–4.
- ◆ While remaining in the transmit mode, the transceiver does not continuously transmit a 1750 Hz tone.

## REVERSE FUNCTION

The reverse function exchanges a separate receive and transmit frequency. So, while using a repeater, you can manually check the strength of a signal that you receive directly from the other station. If the station's signal is strong, both stations should move to a simplex frequency and free up the repeater.

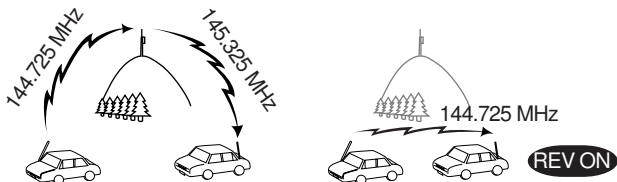

TX: 144.725 MHz TX: 144.725 MHz TX: 144.725 MHz TX: 145.325 MHz  
 RX: 145.325 MHz RX: 145.325 MHz RX: 145.325 MHz RX: 144.725 MHz

Press **[REV]** to switch the Reverse function ON (or OFF).

- “R” appears when the function is ON.



### Note:

- ◆ If pressing **[REV]** places the transmit frequency outside the allowable range, then pressing Mic **[PTT]** causes an error beep to sound; transmission is inhibited.
- ◆ If pressing **[REV]** places the receive frequency outside the allowable range, an error beep sounds and no reversal occurs.
- ◆ Automatic Repeater Offset does not function while Reverse is ON.
- ◆ You cannot switch Reverse ON or OFF while transmitting.

## AUTOMATIC SIMPLEX CHECK (ASC)

While using a repeater, ASC periodically monitors the strength of a signal that you receive directly from the other station. If the station's signal is strong enough to allow direct contact without a repeater, the ASC indicator on the display begins blinking.

Press **[REV]** (1 s) to switch the function ON.

- The ASC indicator appears when the function is ON.



- While direct contact is possible, the ASC indicator blinks.
- To quit the function, press **[REV]**.

### Note:

- ◆ Pressing Mic **[PTT]** causes the ASC indicator to quit blinking.
- ◆ ASC does not function if your transmit and receive frequencies are the same (simplex operation).
- ◆ ASC does not function while scanning.
- ◆ Activating ASC while using Reverse switches Reverse OFF.
- ◆ If you recall a memory channel or the Call channel that contains Reverse ON status, ASC is switched OFF.
- ◆ ASC causes receive audio to be momentarily intermitted every 3 seconds.

## TONE FREQ. ID

This function scans through all tone frequencies to identify the incoming tone frequency on a received signal. You may use the function to find which tone frequency is required by your local repeater.

- 1 Press **[TONE]** to switch ON the Tone function.
  - “T” appears when the Tone function is ON.
- 2 Press **[F]**, **[T.SEL]**.
  - The current tone frequency appears and blinks.
- 3 Press **[SCAN]** to activate the Tone Freq. ID.  
“T SCAN” appears and blinks.

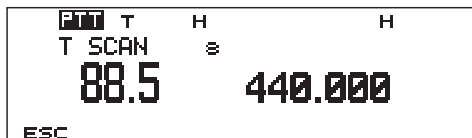

- Scan starts when signals are received.
- To reverse the scan direction, turn the **Tuning** control clockwise (upward scan) or counterclockwise (downward scan). You can also press Mic **[UP]/ [DWN]**.
- To quit the function, press **[ESC]**.
- When the tone frequency is identified, the identified frequency appears and blinks.

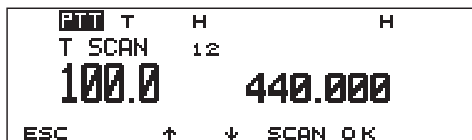

- 4 Press **[OK]** to program the identified frequency in place of the currently set tone frequency.
  - The Tone function will be remained ON. You may press **[TONE]** to switch the Tone function OFF.
  - Press **[ESC]** if you do not want to program the identified frequency.
  - Press **[SCAN]** while the identified frequency is blinking, to resume scanning.



# MEMORY CHANNELS

In memory channels, you can store frequencies and related data that you often use. Then you need not reprogram those data every time. You can quickly recall a programmed channel by simple operation. A total of 200 memory channels are available for bands A and B.

## SIMPLEX & REPEATER OR ODD-SPLIT MEMORY CHANNEL?

You can use each memory channel as a simplex & repeater channel or as an odd-split channel. Store only one frequency to use as a simplex & repeater channel or two separate frequencies to use as an odd-split channel. Select either application for each channel depending on the operations you have in mind.

Simplex & repeater channel allows:

- Simplex frequency operation
- Repeater operation with a standard offset (If an offset direction is stored)

Odd-split channel allows:

- Repeater operation with a non-standard offset

**Note:**

- ◆ *Not only can you store data in memory channels, but you can also overwrite existing data with new data.*
- ◆ *If you have recalled a memory channel on the non-control band (A or B), you cannot select the same channel on the control band to program data.*

The data listed below can be stored in each memory channel:

Parameter	Simplex & Repeater	Odd-split
Receive frequency	Yes	Yes
Transmit frequency		Yes
Tone frequency	Yes	Yes
Tone ON	Yes	Yes
CTCSS frequency	Yes	Yes
CTCSS ON	Yes	Yes
DCS code	Yes	Yes
DCS ON	Yes	Yes
Offset direction	Yes	N/A
Offset frequency	Yes	N/A
Reverse ON	Yes	N/A
Frequency step size	Yes	Yes
Memory channel lockout	Yes	Yes
Memory channel name	Yes	Yes
FM/ AM mode selection	Yes	Yes

Yes: Can be stored in memory.

N/A: Cannot be stored in memory.

## STORING SIMPLEX FREQUENCIES OR STANDARD REPEATER FREQUENCIES

- 1 Select the desired band.
- 2 Press **[VFO]**.
- 3 Select the desired frequency.
- 4 If storing a standard repeater frequency, select the following data:
  - Offset direction {page 29}
  - Tone ON, if necessary {page 30}
  - Tone frequency, if necessary {page 30}

If storing a simplex frequency, you may select other related data (CTCSS ON, CTCSS freq., etc.).

- 5 Press **[F]**.
  - A memory channel number appears and blinks.
  - “**D**” indicates the current channel is empty while “**▶**” indicates the channel contains data.



- 6 Turn the **Tuning** control, or press Mic **[UP]/ [DWN]**, to select the desired memory channel.
- 7 Press **[M.IN]**.

## STORING ODD-SPLIT REPEATER FREQUENCIES

Some repeaters use a receive and transmit frequency pair with a non-standard offset. If you store two separate frequencies in a memory channel, you can operate on those repeaters without programming the offset frequency and direction.

- 1 Select the desired receive frequency and related data by using steps 1 to 4 given for simplex or standard repeater frequencies.
- 2 Press **[F]**.
- 3 Turn the **Tuning** control, or press Mic **[UP]/ [DWN]**, to select the desired memory channel.
- 4 Press **[M.IN] (1 s)**.
  - “**±**” appears.

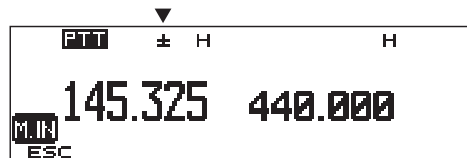

- 5 Select the desired transmit frequency.
- 6 Press **[M.IN]**.

### Note:

- ◆ When you recall an odd-split memory channel, “**±**” appears on the display. To confirm the transmit frequency, press **[REV]**.
- ◆ Transmit Offset status and Reverse status are not stored in an odd-split memory channel.

## RECALLING A MEMORY CHANNEL

- 1 Select band A or B.
- 2 Press **[MR]** to enter Memory Recall mode.
  - The memory channel used last is recalled.

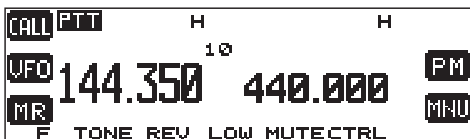

- 3 Turn the **Tuning** control, or press Mic **[UP]/ [DWN]**, to select the desired memory channel.
  - You cannot recall an empty memory channel.
  - To restore VFO mode, press **[VFO]**.

If using a MC-53DM, you can also use its keypad to recall a desired memory channel. First program one of the Mic PF keys as the ENTER key {page 62}. In Memory Recall mode press **[ENTER]**, then enter the channel number. To recall channel 3, for example, press **[ENTER]**, **[0]**, **[0]**, **[3]**.

### Note:

- ◆ When you recall an odd-split memory channel, "±" appears on the display. Press **[REV]** to display the transmit frequency.
- ◆ After recalling a memory channel, you may program data such as Tone or CTCSS. These settings, however, are cleared once you select another channel or the VFO mode. To permanently store the data, overwrite the channel contents {page 36}.

## CLEARING A MEMORY CHANNEL

Use the following procedure to clear an individual memory channel. Full Reset {page 41} is a quick way to clear all memory channels.

- 1 Recall the desired memory channel.
- 2 Switch OFF the power to the transceiver.
- 3 Press **[MHz]** (**Tuning control**)+ **POWER ON**.
  - A confirmation message appears.

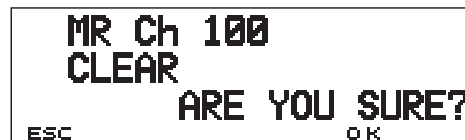

- To quit clearing the memory channel, press **[ESC]**.
- 4 Press **[OK]**.

### Note:

- ◆ If you have recalled a memory channel on the non-control band (A or B), you cannot select the same channel on the control band to clear.
- ◆ When in Channel Display mode, you cannot clear any memory channel.

## NAMING A MEMORY CHANNEL

You can name memory channels using up to 8 alphanumeric characters. When you recall a named memory channel, its name appears above the frequency. Names can be call signs, repeater names, cities, names of people, etc.

- 1 Recall the desired memory channel.
- 2 Press **[MNU]** to enter Menu mode.
- 7** 3 Press **[↑]/[↓]** to select “RADIO (1–)”, then press **[OK]**.
- 4 Press **[↑]/[↓]** to select “MEMORY (1–4–)”, then press **[OK]**.
- 5 Press **[↑]/[↓]** to select “MEMORY NAME (1–4–4)”, then press **[OK]**.
  - The display for entering a memory name appears; the first digit blinks.



- 6 Turn the **Tuning** control to select the first digit.
  - You can enter alphanumeric characters plus special ASCII characters.
- 7 Press **[→]**.
  - The cursor moves to the next digit.

- 8 Repeat steps 6 and 7 to enter up to 8 digits.

<b>CHAR</b>	Switches among the sets of alphanumeric characters, accented letters (TM-D700E only), and special ASCII characters.		
<b>A/a</b>	Switches between small and capital letters.	<b>BACK</b>	Cancels Memory Name Entry.
<b>DEL</b>	Deletes the digit at which the cursor is blinking.	<b>←</b>	Causes the cursor to move backward.
<b>INS</b>	Inserts the currently selected character.	<b>CLR</b> (left BAND SEL)	Clears all digits and backs the cursor to the first digit.

- 9 Press **[OK]** to complete the setting.

- 10 Press **[MNU]** to exit Menu mode.

The keypad on the MC-53DM also is available to enter alphanumeric characters in step 6. See page 18.

### Note:

- ◆ You can also name the Program Scan (page 52) and DTMF (page 60) channels, but you cannot name the Call channel (page 39).
- ◆ You can assign names only to memory channels in which you have stored frequencies and related data.
- ◆ The stored names can be overwritten by repeating steps 1 to 10.
- ◆ The stored names also are erased by clearing memory channels.

## CALL CHANNEL

The Call channel can always be selected quickly no matter what mode the transceiver is in. For instance, you may use the Call channel as an emergency channel within your group. In this case, the Call/VFO scan {page 54} will be useful.

The default frequency stored in the Call channel is 144.000 MHz for the VHF band. The default on the UHF band is 440.000 MHz or 430.000 MHz depending on the market versions. The Call channel can be reprogrammed either as a simplex & repeater or odd-split channel.

**Note:** Unlike channels 1 to 200 the call channel cannot be cleared.

### ■ Recalling the Call Channel

- 1 Select the desired band.
- 2 Press **[CALL]** to recall the Call channel.
  - “CALL” appears.

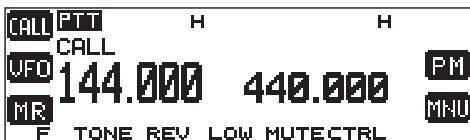

- To restore the previous mode, press **[CALL]** again.

### ■ Reprogramming the Call Channel

- 1 Select the desired band.
- 2 Press **[VFO]**.
- 3 Select the desired frequency and related data (Tone, CTCSS, etc.).
  - When you program the Call channel as an odd-split channel, select a receive frequency.
- 4 Press **[F]**, **[C.IN]**.
  - The selected frequency and related data are stored in the Call channel.
  - The previous mode is restored.
  - When programming as an odd-split channel, press **[F]**, **[C.IN]** (1 s) instead; “±” appears.

To also store a transmit frequency, proceed to the next step.

- 5 Select the desired transmit frequency.
- 6 Press **[C.IN]**.
  - The transmit frequency is stored in the Call channel, and the previous mode is restored.

#### **Note:**

- ◆ *Transmit Offset status and Reverse status are not stored in an odd-split Call channel.*
- ◆ *To store data other than frequencies, select the data in step 3 not step 5.*

## MEMORY-TO-VFO TRANSFER

You may sometimes want to search for other stations or a clear frequency, near the frequency stored in a memory channel or the Call channel. In this case first transfer the contents of a memory channel or the Call channel to the VFO.

- 1 Recall the desired memory channel or the Call channel.
- 2 Press [F], [M▶V].
  - The entire contents of the memory channel or the Call channel are copied to the VFO.

### Note:

- ◆ A transmit frequency from an odd-split memory channel or odd-split Call channel is not transferred to the VFO. To transfer a transmit frequency, press [REV], then press [F], [M▶V].
- ◆ Lockout status and memory names are not copied from a memory channel to the VFO.
- ◆ If you recall the Call channel in step 1, simply turning the **Tuning Control** or pressing Mic [UP]/[DWN] also transfers the contents to the VFO. The frequency, however, is changed by one step.

## CHANNEL DISPLAY

When in this mode, the transceiver displays only memory channel numbers (and memory names if stored) instead of frequencies.

- 1 Press [MNU] to enter Menu mode.
- 2 Press [↑]/[↓] to select “RADIO (1–)”, then press [OK].
- 3 Press [↑]/[↓] to select “MEMORY (1–4–)”, then press [OK].
- 4 Press [↑]/[↓] to select “CHANNEL DISPLAY (1–4–2)”, then press [OK].



- 5 Press [↑]/[↓] to switch the function ON (or OFF).
- 6 Press [OK] to complete the setting.
- 7 Press [MNU] to exit Menu mode.

**Note:** You cannot switch this function ON unless you can recall any channel on both bands A and B.

When in Channel Display mode, you cannot use the following functions:

Sub-band Select	VFO Select	VFO Scan
Memory Store	PM Store	PM Recall
Memory-to-VFO Transfer	Partial/ Full/ PM Reset	Frequency Step Size Change
1/ 10 MHz Step Change	All-control Lock	

## PARTIAL OR FULL RESET?

If your transceiver seems to be malfunctioning, initializing the transceiver may resolve the problem. Use Full Reset to initialize all settings that you have customized. Partial (VFO) Reset does not initialize the following settings:

Memory channels	Memory channel names
Memory channel lockout	Call channels
Program scan channels	PM channels
DTMF memory channels	DTMF memory channel names

Some of the VFO factory defaults are listed below:

Parameter	Band A	Band B
VFO freq.	144.000 MHz	440.000 MHz (U.S.A./ Canada) or 430.000 MHz
Freq. step	5 kHz (U.S.A./ Canada) or 12.5 kHz	25 kHz
Tone freq.	88.5 Hz	88.5 Hz

- 1 Press **[MNU]** to enter Menu mode.
- 2 Press **[↑]/ [↓]** to select “RADIO (1–)”, then press **[OK]**.
- 3 Press **[↑]/ [↓]** to select “AUX (1–9–)”, then press **[OK]**.
- 4 Press **[↑]/ [↓]** to select “RESET (1–9–7)”, then press **[OK]**.



- 5 Press **[↑]/ [↓]** to select Partial (VFO) Reset, PM Reset {page 45}, or Full Reset, then press **[OK]**.
  - A confirmation message appears.
  - Press **[ESC]** to quit resetting.
- 6 Press **[OK]**.

After switching the power OFF, you may press **[VFO]+ POWER ON** for Partial Reset, or **[MR]+ POWER ON** for Full Reset. This allows you to skip steps 1 to 5.

You can also use the RESET button to perform Full Reset. See page 12.

*Note: When in All-control Lock or Channel Display mode, you cannot perform Partial Reset nor Full Reset.*

## PROGRAMMABLE MEMORY (PM)

Programmable Memory (PM) stores virtually all settings currently set on the transceiver. This transceiver provides 5 PM channels to store 5 sets of transceiver configurations. Later you can quickly recall one of these, depending on the operations in your mind or the operating environment.

### PROGRAMMABLE INFORMATION

- 8** The following settings can be separately stored for band A and B:

VFO frequency	VFO mode
Memory Recall mode	Call Channel mode
Offset direction	Offset frequency
Reverse ON	Automatic Simplex Check
Tone ON	Tone frequency
CTCSS ON	CTCSS frequency
DCS ON	DCS code
Upper frequency limit (for Programmable VFO)	Lower frequency limit (for Programmable VFO)
Frequency step size	FM/ AM mode
Wide/ narrow TX deviation <sup>1</sup>	

<sup>1</sup> TM-D700E only

The following settings are shared by both band A and B:

TX band	Control band
Transmit output power	Auto Band Change
Display Dimmer	Many of the menu selections under RADIO (1-) <sup>1</sup>
Most of the menu selections under SSTV (2-) <sup>1</sup>	Most of the menu selections under APRS (3-) <sup>1</sup>
Most of the menu selections under SKY COMMAND (4-) <sup>1,2</sup>	

<sup>1</sup> The menu items listed below will not be stored:

- 1-4-1, Auto PM Channel Store
- 1-4-3, Memory Channel Lockout
- 1-4-4, Memory channel name
- 1-5-1, DTMF Number Store
- 1-6-3, Time
- 1-6-4, Date
- 1-7-6, Repeater function
- 1-9-5, COM port
- 1-9-7, Reset
- 1-A-3, Remote Control
- 2-8, SSTV mode
- 3-4, My position
- 3-9, Status text
- 4-4, Sky Command mode

<sup>2</sup> U.S.A./ Canada only



## APPLICATION EXAMPLES

The following are examples of how you might use Programmable Memory. These examples may not represent applications useful to you, but you will understand the flexibility of this function.

### Situation 1

You share your transceiver with other members in your family or club. However, each individual has personal preferences for how they like to set various functions. You have to keep changing many settings each time you use the transceiver.

### Solution

Because 5 PM channels are available, up to 5 persons can separately program the transceiver and store their customized environment. Then each person can quickly change to his or her favorite settings, simply by recalling a PM channel. It is too much trouble to change back the settings after somebody else has reconfigured them. So this application may avoid having a feature-rich transceiver but never using many useful features.

### Situation 2

While operating mobile on the way to work every morning, you prefer a silent transceiver that does not interrupt the morning calm. In addition, you feel that a bright display is a waste of electricity in sunlight. At night when driving home, you realize the Beep function truly serves a purpose and you feel it is nice to see a bright display after dark.

### Solution

In two PM channels, store the same operating data such as frequency, offset, tone, etc., and store different settings for the Display Dimmer and Beep functions. Then you can quickly recall the best settings for day or night operating.

### Situation 3

You cannot figure out how you can make the transceiver exit the current mode.

### Solution

Simply recall PM channel 1 that contains an exact copy of the transceiver default environment. You will not lose the contents of any memory channels.

## STORING IN PM CHANNELS

- 1 Confirm that the following conditions have been satisfied:
  - The transceiver is in the receive mode.
  - Scan is not being used.
  - Microphone Control is OFF.
- 2 Configure the transceiver as you like.
  - For the items that can be stored, see page 42.
- 3 Press **[F]**, **[P.IN]**.
  - The PM channel numbers 1 to 5 appear and blink at the bottom of the display.

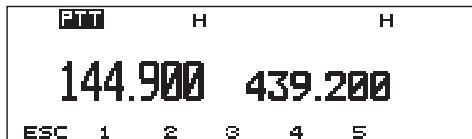

- 4 Press **[1]** to **[5]** corresponding to the desired PM channel.
  - The settings listed in page 42 are stored in the PM channel.

## RECALLING A PM CHANNEL

- 1 Press **[PM]**.
  - The PM channel numbers 1 to 5 appear at the bottom of the display.

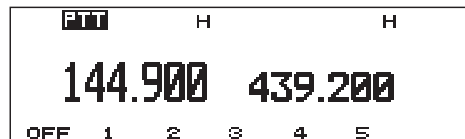

- 2 Press **[1]** to **[5]** corresponding to the desired PM channel.
  - The contents of the selected channel are recalled.
  - The current PM channel number appears at the upper right corner. "▶" before "PM" indicates that Auto PM Store mode {page 45} has been selected.
  - To exit PM Recall mode, press **[PM]**, then press **[OFF]**.

**Note:** You cannot recall a PM channel while transmitting.

## AUTO PM CHANNEL STORE

After you recalled a PM channel, this function automatically overwrites the current PM channel with the present operating environment when:

- You recall another PM channel.
- You press **[OFF]**.
- You switch OFF the transceiver.

The factory default of this function is ON.

- 1 Press **[MNU]** to enter Menu mode.
- 2 Press **[↑]/[↓]** to select “RADIO (1–)”, then press **[OK]**.
- 3 Press **[↑]/[↓]** to select “MEMORY (1–4–)”, then press **[OK]**.
- 4 Press **[↑]/[↓]** to select “AUTO PM STORE (1–4–1)”, then press **[OK]**.

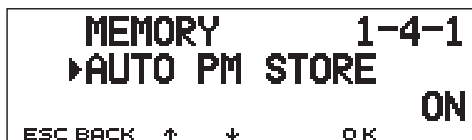

- 5 Press **[↑]/[↓]** to switch the function ON (default) or OFF.
- 6 Press **[OK]** to complete the setting.
- 7 Press **[MNU]** to exit Menu mode.

## PM CHANNEL RESET

If you want to reprogram the PM channels from the beginning, reset all the PM channels to the factory defaults.

- 1 Press **[PM]+ POWER ON**.

- A confirmation message appears.



- Press **[ESC]** to quit resetting.

- 2 Press **[OK]**.

You can also use Menu 1–9–7 (RESET) to reset the PM channels. See page 41.

# SCAN

Scan is a useful feature for hands-off monitoring of your favorite frequencies. Becoming comfortable with all types of Scan will increase your operating efficiency.

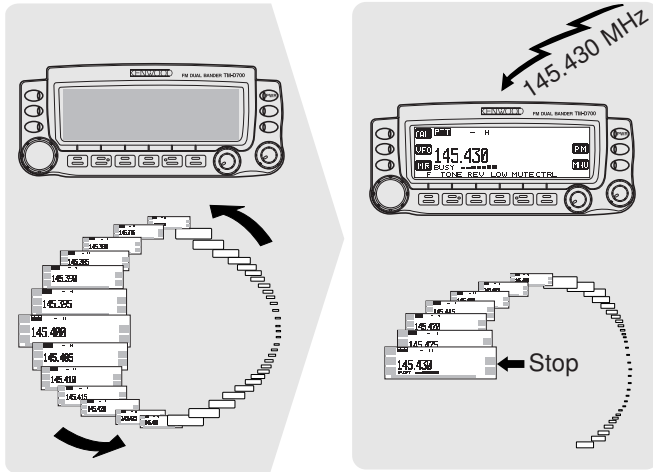

This transceiver provides the following types of scans plus Visual Scan (page 47). Visual Scan graphically and simultaneously shows how frequencies in a specific range are busy.

Scan Type	Scan Range
VFO Scan	All frequencies tunable on the band
Memory Scan	Frequencies stored in the memory channels
Group Scan	Frequencies stored in the memory channels which belong to the specified group
Program Scan	All frequencies in the range selected on the band
MHz Scan	All frequencies within a 1 MHz range
Call/VFO Scan	Call channel plus the current VFO frequency
Call/Memory Scan	Call channel plus the selected memory channel

## Note:

- ◆ Adjust the squelch level before using Scan. Selecting a squelch level too low could cause Scan to stop immediately.
- ◆ While using CTCSS or DCS, Scan stops for any signal received; however, you will hear audio only when the signal contains the same CTCSS tone or DCS code that you selected.
- ◆ When using S-meter Squelch, Scan stops when the received signal strength matches or exceeds the S-meter setting. Scan resumes 2 seconds after the signal level drops below the S-meter setting.
- ◆ Pressing and holding Mic [PTT] causes Scan to temporarily stop if it is functioning on a non TX band.
- ◆ Starting Scan switches OFF the Automatic Simplex Check.

## VISUAL SCAN

While you are receiving, Visual Scan allows you to monitor frequencies near the current operating frequency. Visual Scan graphically and simultaneously shows how all frequencies in the selected range are busy. You will see up to 21 segments, for each channel, that represent 7 S-meter levels (3 segments per level).

You will determine the scan range by selecting the center frequency and the number of channels. The default number of channels is 61.

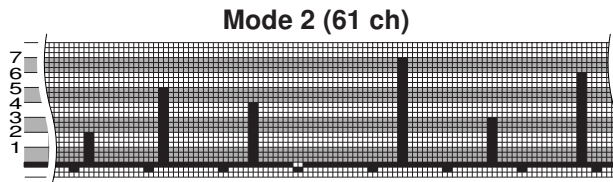
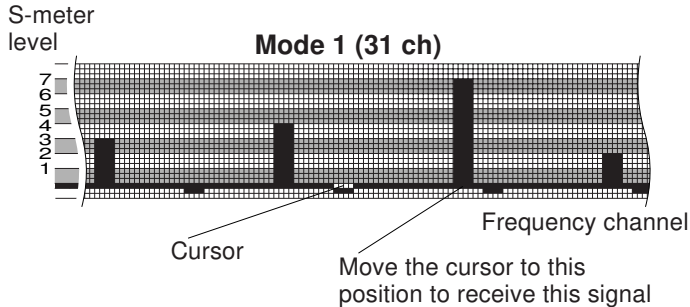

## ■ Selecting the Number of Channels

- 1 Press **[MNU]** to enter Menu mode.
- 2 Press **[↑]/ [↓]** to select “RADIO (1–)”, then press **[OK]**.
- 3 Press **[↑]/ [↓]** to select “AUX (1–9–)”, then press **[OK]**.
- 4 Press **[↑]/ [↓]** to select “VISUAL SCAN (1–9–2)”, then press **[OK]**.



- 5 Press **[↑]/ [↓]** to select 31, 61 (default), 91, or 181.
- 6 Press **[OK]** to complete the setting.
- 7 Press **[MNU]** to exit Menu mode.

## ■ Using Visual Scan

- 1 Select the desired band.
- 2 Turn the **Tuning** control, or press Mic **[UP]/[DWN]**, to select the operating frequency.
  - This frequency will also be used as the center frequency.
- 3 Press **[F]**, **[VISUAL]** to start Visual Scan.



- To halt Scan, press **[PAUSE]**. "PAUSE" appears and blinks. Press **[PAUSE]** again to resume.
- 4 To change the operating frequency, turn the **Tuning** control or press Mic **[UP]/[DWN]**.
  - The displayed frequency changes and the cursor moves.
  - Press **[SET]** to use the changed operating frequency as the center frequency.
  - Press **[RESET]** to restore the previous operating frequency.
- 5 To quit Visual Scan, press **[ESC]**.

### Note:

- ◆ If you start Visual Scan in Memory Recall mode, the memory channel frequencies will be scanned.
- ◆ If you start Visual Scan after recalling the Call channel, the call channel frequency will be used as the center frequency.
- ◆ If the frequency range specified for Program Scan or Program VFO is narrower than the range specified for Visual Scan, the range for Program Scan or VFO will be used for Visual Scan.
- ◆ Visual Scan stops while transmitting.
- ◆ Starting Visual Scan switches Automatic Band Change OFF.
- ◆ If you start Visual Scan in one of the following conditions, you cannot receive in the current operating frequency. To use this frequency, press **[PAUSE]** to halt Scan.
  - Memory Recall or Call Channel mode
  - A frequency in the 118, 220, or 1200 MHz band was selected in VFO mode.
- ◆ Depending on conditions, Visual Scan and the conventional S-meter may indicate different signal strength levels.

## SELECTING SCAN RESUME METHOD

The transceiver stops scanning at a frequency (or memory channel) on which a signal is detected. It then continues scanning according to which resume mode you select. You can choose one of the following modes. The default is Time-operated mode.

- **Time-Operated mode**

The transceiver remains on a busy frequency (or memory channel) for approximately 5 seconds, and then continues to scan even if the signal is still present.

- **Carrier-Operated mode**

The transceiver remains on a busy frequency (or memory channel) until the signal drops out. There is a 2 second delay between signal drop-out and scan resumption.

- **Seek mode**

The transceiver remains on a busy frequency (or memory channel) even after the signal drops out and does not automatically resume scanning.

**Note:** To temporarily stop scanning and monitor weak signals, press the Mic PF key assigned the Monitor function {page 62}. Press the PF key again to resume scanning.

- 1 Press **[MNU]** to enter Menu mode.
- 2 Press **[↑]**/**[↓]** to select “RADIO (1–)”, then press **[OK]**.
- 3 Press **[↑]**/**[↓]** to select “AUX (1–9–)”, then press **[OK]**.
- 4 Press **[↑]**/**[↓]** to select “SCAN RESUME (1–9–1)”, then press **[OK]**.



- 5 Press **[↑]**/**[↓]** to select Time-Operated (default), Carrier-Operated, or Seek.
- 6 Press **[OK]** to complete the setting.
- 7 Press **[MNU]** to exit Menu mode.

## VFO SCAN

VFO Scan monitors all frequencies tunable on the band, using the current frequency step size.

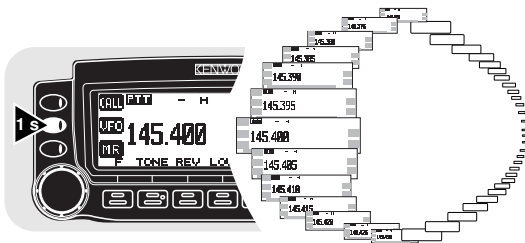

9

- 1 Select the desired band.
- 2 Press **[VFO]** (1 s).
  - Scan starts at the frequency currently displayed.
  - The 1 MHz decimal blinks while scanning is in progress.
  - To reverse the scan direction, turn the **Tuning** control clockwise (upward scan) or counterclockwise (downward scan). You can also press Mic **[UP]/ [DWN]**.
- 3 To quit VFO Scan, press **[VFO]** again.

## MEMORY SCAN

Use Memory Scan to monitor all memory channels programmed with frequency data.

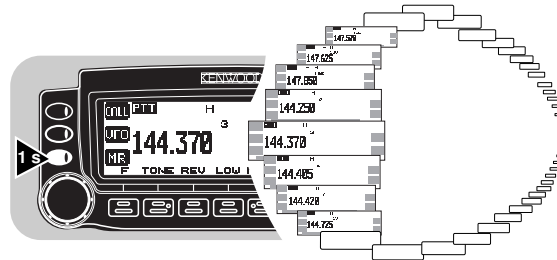

- 1 Select band A or B.
- 2 Press **[MR]** (1 s).
  - Scan starts with the channel last recalled.
  - The 1 MHz decimal blinks while scanning is in progress.
  - To reverse the scan direction, turn the **Tuning** control clockwise (upward scan) or counterclockwise (downward scan). You can also press Mic **[UP]/ [DWN]**.
- 3 To quit Memory Scan, press **[MR]** again.

### Note:

- ◆ At least 2 or more memory channels must contain data and must not be locked out.
- ◆ The L0 to L9 and U0 to U9 memory channels are not scanned.
- ◆ You can also start Memory Scan when in Channel Display mode. While Scan is being interrupted, the channel number blinks.



## ■ Locking Out a Memory Channel

Select memory channels that you prefer not to monitor while scanning.

- 1 Recall the desired memory channel.
- 2 Press **[MNU]** to enter Menu mode.
- 3 Press **[↑]/ [↓]** to select “RADIO (1–)”, then press **[OK]**.
- 4 Press **[↑]/ [↓]** to select “MEMORY (1–4–)”, then press **[OK]**.
- 5 Press **[↑]/ [↓]** to select “LOCKOUT (1–4–3)”, then press **[OK]**.

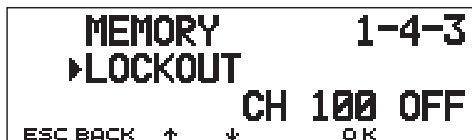

- 6 Press **[↑]/ [↓]** to switch Lockout ON (or OFF).
- 7 Press **[OK]** to complete the setting.
- 8 Press **[MNU]** to exit Menu mode.
  - A star appears to indicate the channel has been locked out.

**Note:** The L0 to L9 and U0 to U9 memory channels cannot be locked out.

## GROUP SCAN

For the purpose of Group Scan, the 200 memory channels are divided into 10 groups, with each group containing 20 channels. Group Scan monitors only the 20 channels which belong to the specified group. The channels are grouped as below:

Nos. 1 ~ 20	Nos. 101 ~ 120
Nos. 21 ~ 40	Nos. 121 ~ 140
Nos. 41 ~ 60	Nos. 141 ~ 160
Nos. 61 ~ 80	Nos. 161 ~ 180
Nos. 81 ~ 100	Nos. 181 ~ 200

- 1 Recall one of the memory channels in the desired group.
- 2 Press **[MHz]** (**Tuning control**) (1 s).
  - Scan starts with the channel last recalled.
  - The 1 MHz decimal blinks while scanning is in progress.
  - To reverse the scan direction, turn the **Tuning** control clockwise (upward scan) or counterclockwise (downward scan). You can also press Mic **[UP]/ [DWN]**.
- 3 To quit Group Scan, press **[MHz]** again.

### **Note:**

- ◆ At least 2 or more memory channels in the specified group must contain data and must not be locked out.
- ◆ You can also start Group Scan when in Channel Display mode. While Scan is being interrupted, the channel number blinks.

## PROGRAM SCAN

Program Scan is identical with VFO Scan except that you select the frequency range of the scan.

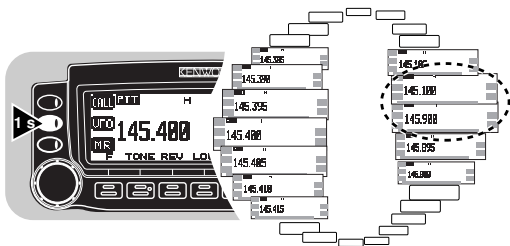

9

### ■ Setting Scan Limits

You can store up to 10 scan ranges in memory channels L0/U0 to L9/U9.

- 1 Select the desired band.
- 2 Press **[VFO]**.
- 3 Select the desired frequency as the lower limit.
- 4 Press **[F]**.
  - A memory channel number appears and blinks.
- 5 Turn the **Tuning** control, or press Mic **[UP]/[DWN]**, to select a channel in the range L0 to L9.



- 6 Press **[M.IN]**.
  - The lower limit is stored in the channel.
- 7 Select the desired frequency as the upper limit.
- 8 Press **[F]**.
- 9 Turn the **Tuning** control, or press Mic **[UP]/[DWN]**, to select a matching channel in the range U0 to U9.
  - If you have selected for example L3 in step 5, select U3.



- 10 Press **[M.IN]**.
  - The upper limit is stored in the channel.

To confirm the stored scan limits, press **[MR]**, then select the L and U channels.

#### **Note:**

- ◆ The lower limit must be lower in frequency than the upper limit.
- ◆ The lower and upper frequency step sizes must be equal.
- ◆ The lower and upper limits must be selected on the same band.

## ■ Using Program Scan

- 1 Select the appropriate band.
- 2 Press **[VFO]** .
- 3 Select a frequency equal to or between the programmed scan limits.
- 4 Press **[VFO] (1 s)**.
  - Scan starts at the frequency currently displayed.
  - The 1 MHz decimal blinks while scanning is in progress.
  - To reverse the scan direction, turn the **Tuning** control clockwise (upward scan) or counterclockwise (downward scan). You can also press Mic **[UP]/[DWN]**.
- 5 To quit Program Scan, press **[VFO]** again.

### Note:

- ◆ If the step size of the current VFO frequency differs from that of the programmed frequencies, VFO scan starts instead of Program Scan.
- ◆ If the step size differs between the lower limit and the upper limit, VFO scan starts instead of Program Scan.
- ◆ If the current VFO frequency is within more than one programmed scan range, the range stored in the smallest channel number is used.

## MHz SCAN

MHz Scan monitors a 1 MHz segment of the band, using the current frequency step size. The current 1 MHz digit determines the limits of the scan. For example, if the current frequency is 145.400 MHz, then the scan range would be from 145.000 MHz to 145.995 MHz. The exact upper limit depends on the current frequency step size.

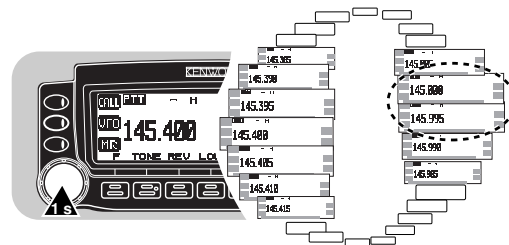

- 1 Select the desired band.
- 2 Press **[VFO]** to select VFO mode.
- 3 Select a frequency within the desired 1 MHz segment.
- 4 Press **[MHz] (Tuning control) (1 s)**.
  - Scan starts at the frequency currently displayed.
  - The 1 MHz decimal blinks while scanning is in progress.
  - To reverse the scan direction, turn the **Tuning** control clockwise (upward scan) or counterclockwise (downward scan). You can also press Mic **[UP]/[DWN]**.
- 5 To quit MHz Scan, press **[MHz]** again.

## CALL/VFO SCAN

Use Call/VFO Scan to monitor both the Call channel and the current VFO frequency on the selected band.

- 1 Select the desired band.
- 2 Press **[VFO]**.
- 3 Select the desired frequency.
- 4 Press **[CALL] (1 s)** to start Call/VFO Scan.
  - The 1 MHz decimal blinks while scanning is in progress.
- 5 To quit Call/VFO Scan, press **[CALL]** again.

9

## CALL/MEMORY SCAN

Use Call/Memory Scan to monitor both the Call channel and the desired memory channel.

- 1 Recall the desired memory channel.
- 2 Press **[CALL] (1 s)** to start Call/Memory Scan.
  - The 1 MHz decimal blinks while scanning is in progress.
  - The Call channel on the same band as of the selected memory channel is used for Scan.
- 3 To quit Call/Memory Scan, press **[CALL]** again.

**Note:** *The memory channel last used is scanned even if it has been locked out.*

# CONTINUOUS TONE CODED SQUELCH SYSTEM (CTCSS)

You may sometimes want to hear calls from only specific persons. The Continuous Tone Coded Squelch System (CTCSS) allows you to ignore (not hear) unwanted calls from other persons who are using the same frequency. First select the same CTCSS tone as selected by the other persons in your group. A CTCSS tone is subaudible and is selectable from among the 38 standard tone frequencies.

**Note:** CTCSS does not cause your conversation to be private. It only relieves you from listening to unwanted conversations.

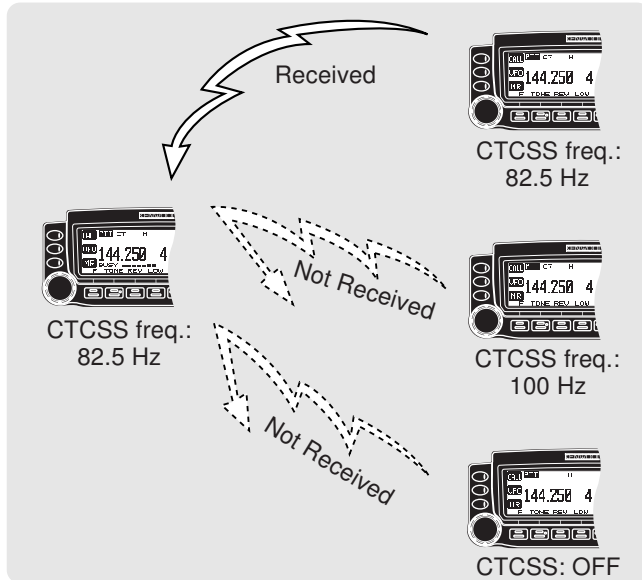

## USING CTCSS

- 1 Press the left or right **[BAND SEL]** to select band A or B.
  - If necessary, press **[F]**, then the same **[BAND SEL]** to recall the sub-band.
- 2 Press **[TONE]** to activate the CTCSS function.
  - “CT” appears when the CTCSS function is ON.
  - Each press of **[TONE]** changes the selection as Tone → CTCSS → DCS → No selection.
- 3 Press **[F]**, **[T.SEL]**.
  - The current CTCSS frequency appears and blinks.



- 4 Press **[↑]**/**[↓]** to select a CTCSS frequency.
  - The selectable frequencies are the same as for the tone frequency. See the table given in “Selecting a Tone Frequency” {page 30}.
- 5 Press **[OK]** to complete the setting.

You will hear calls only when the selected tone is received. To answer the call, press and hold Mic **[PTT]**, then speak into the microphone.

Skip steps 3 to 5 if you have already programmed the appropriate CTCSS frequency.

If using a MC-53DM, you can also use its keypad to select a CTCSS frequency. First program one of the Mic PF keys as the ENTER key {page 62}. In step 3, press **[ENTER]**, then enter 01 to 38 shown in the table {page 30}. To select 79.7 Hz, for example, press **[ENTER]**, **[0]**, **[5]**.

**Note:**

- ◆ You can select a separate tone frequency for the CTCSS and Tone functions.
- ◆ You cannot use the CTCSS with the Tone or DCS function.
- ◆ If you select a high tone frequency, receiving audio or noise that contains the same frequency portions may cause CTCSS to function incorrectly. To prevent noise from causing this problem, select an appropriate noise squelch level {page 20}.

## 10 CTCSS FREQ. ID

This function scans through all CTCSS frequencies to identify the incoming CTCSS frequency on a received signal. You may find it useful when you cannot recall the CTCSS frequency that the other persons in your group are using.

- 1 Press **[TONE]** to switch ON the CTCSS function.
  - “CTCSS” appears when the CTCSS function is ON.
- 2 Press **[F]**, **[T.SEL]**.
  - The current CTCSS frequency appears and blinks.

3 Press **[SCAN]** to activate the CTCSS Freq. ID.

- “CT SCAN” appears and blinks.

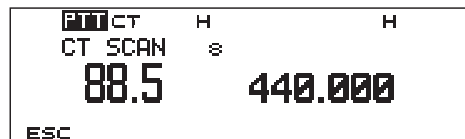

- Scan starts when signals are received.
- To reverse the scan direction, turn the **Tuning** control clockwise (upward scan) or counterclockwise (downward scan). You can also press Mic **[UP]/ [DWN]**.
- To quit the function, press **[ESC]**.
- When the CTCSS frequency is identified, the identified frequency appears and blinks.

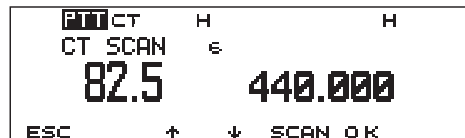

4 Press **[OK]** to program the identified frequency in place of the currently set CTCSS frequency.

- The CTCSS function will be remained ON. You may press **[TONE]** to switch the CTCSS function OFF.
- Press **[ESC]** if you do not want to program the identified frequency.
- Press **[SCAN]** while the identified frequency is blinking, to resume scanning.

**Note:** Received signals are audible while scanning is in progress.

# DIGITAL CODE SQUELCH (DCS)

Digital Code Squelch (DCS) is another application which allows you to ignore (not hear) unwanted calls. It functions the same way as CTCSS. The only differences are the encode/ decode method and the number of selectable codes. For DCS, you can select from 104 different codes listed in the table.

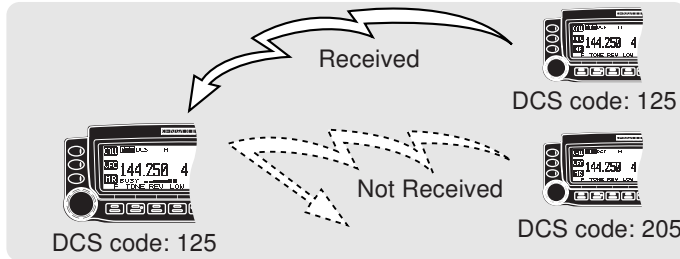

023	065	132	205	255	331	413	465	612	731
025	071	134	212	261	332	423	466	624	732
026	072	143	223	263	343	431	503	627	734
031	073	145	225	265	346	432	506	631	743
032	074	152	226	266	351	445	516	632	754
036	114	155	243	271	356	446	523	654	
043	115	156	244	274	364	452	526	662	
047	116	162	245	306	365	454	532	664	
051	122	165	246	311	371	455	546	703	
053	125	172	251	315	411	462	565	712	
054	131	174	252	325	412	464	606	723	

## USING DCS

- 1 Press the left or right **[BAND SEL]** to select band A or B.
  - If necessary, press **[F]**, then the same **[BAND SEL]** to recall the sub-band.
- 2 Press **[TONE]** to activate the DCS function.
  - “DCS” appears when the DCS function is ON.
  - Each press of **[TONE]** changes the selection as Tone → CTCSS → DCS → No selection.
- 3 Press **[F]**, **[T.SEL]**.
  - The current DCS code appears and blinks.



- 4 Press **[↑]** / **[↓]** to select a DCS code, then press **[OK]**.

You will hear calls only when the selected code is received. To answer the call, press and hold Mic **[PTT]**, then speak into the microphone.

**Note:** You cannot use the DCS with the Tone or CTCSS function.

## DCS CODE ID

This function scans through all DCS codes to identify the incoming DCS code on a received signal. You may find it useful when you cannot recall the DCS code that the other persons in your group are using.

- 1 Press **[TONE]** to switch ON the DCS function.
  - “DCS” appears when the DCS function is ON.
- 2 Press **[F]**, **[T.SEL]**.
  - The current DCS code appears and blinks.
- 3 Press **[SCAN]** to activate the DCS CODE ID.
  - “DCS SCAN” appears and blinks.

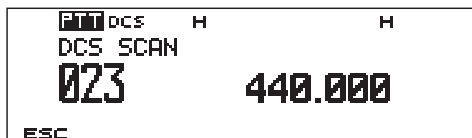

- Scan starts when signals are received.
- To reverse the scan direction, turn the **Tuning** control clockwise (upward scan) or counterclockwise (downward scan). You can also press Mic **[UP]/ [DWN]**.
- To quit the function, press **[ESC]**.
- When the DCS code is identified, the identified code appears and blinks.

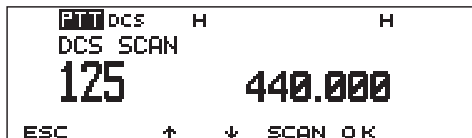

- 4 Press **[OK]** to program the identified code in place of the currently set code.
  - The DCS function will be remained ON. You may press **[TONE]** to switch the DCS function OFF.
  - Press **[ESC]** if you do not want to program the identified code.
  - Press **[SCAN]** while the identified code is blinking, to resume scanning.

**Note:** Received signals are audible while scanning is in progress.



# DUAL TONE MULTI-FREQUENCY (DTMF) FUNCTIONS (WITH MC-53DM ONLY)

The keys on the Mic keypad function as DTMF keys; the 12 keys found on a push-button telephone plus 4 additional keys (A, B, C, D). This transceiver provides 10 dedicated memory channels. You can store a DTMF number (16 digits max.) with a memory name (8 digits max.) in each of the channels to recall later for a quick call.

Some repeaters in the U.S.A. and Canada offer a service called Autopatch. You can access the public telephone network via such a repeater by sending DTMF tones. For further information, consult your local repeater reference.

## MANUAL DIALING

Manual Dialing requires only two steps to send DTMF tones.

- 1 Press and hold Mic [PTT].
- 2 Press the keys in sequence on the Mic keypad to send DTMF tones.
  - The corresponding DTMF tones are transmitted.

Freq. (Hz)	1209	1336	1477	1633
697	1	2	3	A
770	4	5	6	B
852	7	8	9	C
941	*	0	#	D

## ■ DTMF Monitor

When pressing the Mic DTMF keys, you will not hear DTMF tones from the speaker. You can also make the speaker output DTMF tones each time you press a DTMF key.

Access Menu 1-8-6 (DTMF MONITOR) and select "ON".



## AUTOMATIC DIALER

If you use the 10 dedicated memory channels to store DTMF numbers, you need not remember a long string of digits.

### ■ Storing a DTMF Number in Memory

**Note:** Audible DTMF tones from other transceivers near you (or from your own speaker) may be picked up by your microphone. If so, you may fail to correctly program a DTMF number.

- 1 Press **[MNU]** to enter Menu mode.
- 2 Select Menu 1–5–1 (STORE), then press **[OK]**.
- 3 Press **[↑]**/**[↓]** to select from channels 0 to 9, then press **[OK]**.
  - The display for entering a memory name appears; the first digit blinks.
  - To skip naming the channel, press **[OK]** again. You can jump to step 8.



- 4 Turn the **Tuning** control to select a character.
  - You can enter alphanumeric characters plus special ASCII characters.
- 5 Press **[→]**.
  - The cursor moves to the next digit.

- 6 Repeat steps 4 and 5 to enter up to 8 digits.

<b>CHAR</b>	Switches among the sets of alphanumeric characters, accented letters (TM-D700E only), and special ASCII characters.		
<b>A/Δ</b>	Switches between small and capital letters.	<b>BACK</b>	Cancels Memory Name Entry.
<b>DEL</b>	Deletes the digit at which the cursor is blinking.	←	Causes the cursor to move backward.
<b>INS</b>	Inserts the currently selected character.	<b>CLR</b> (left BAND SEL)	Clears all digits and backs the cursor to the first digit.

- 7 Press **[OK]**.
  - The cursor moves to the start of the next field.



- 8 Press the keys in sequence on the Mic keypad to enter a DTMF number with up to 16 digits.
  - You may turn the **Tuning** control then **[→]** to select each digit. Select a space if you want to include a pause.
- 9 Press **[OK]** to complete the programming.
- 10 Press **[MNU]** to exit Menu mode.

You can confirm the stored DTMF number by using steps 1 to 3.

The keypad on the MC-53DM also is available to enter alphanumeric characters in step 4. See page 18.

## ■ Transmitting a Stored DTMF Number

- 1 Press Mic [PTT]+ Mic [PF].

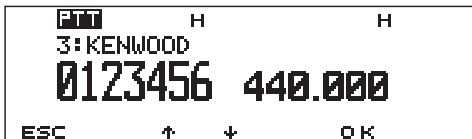

- 2 Release only Mic [PF], then press Mic [UP]/[DWN] to select the desired DTMF memory channel.
- 3 While still holding Mic [PTT], press [0] to [9] corresponding to the channel number.
  - The number stored in the channel scrolls across the display accompanied by DTMF tones from the speaker.
  - After transmission, the frequency display is restored.

## ■ Selecting TX Speed

Some repeaters may not respond correctly if a DTMF number is transmitted at fast speed. If this happens, change the DTMF number transmission speed from Fast (default) to Slow.

In Menu mode, access Menu 1–5–2 (TX SPEED) and select “Slow”.



## ■ Selecting Pause Duration

You can also change pause duration stored in memory channels; the default is 500 msec.

In Menu mode, access Menu 1–5–3 (PAUSE) and select from 100, 250, 500, 750, 1000, 1500, and 2000 msec.



## PROGRAMMABLE FUNCTION (PF) KEYS

The Programmable Function keys are **[PF]**, **[MR]**, **[VFO]**, and **[CALL]** located on the face of the microphone. These keys have the following default functions:

<b>[PF]</b> (PF1)	Band Select
<b>[MR]</b> (PF2)	Memory Recall
<b>[VFO]</b> (PF3)	VFO Select
<b>[CALL]</b> (PF4)	Call Channel Select (TM-D700E: 1750 Hz Tone TX)

If you prefer, you can change the defaults to the following key functions:

Key Function	Ref. Page	Key Function	Ref. Page	Key Function	Ref. Page
A/B	17	REV	33	STEP	64
MONITOR	19	LOW	21	VISUAL	48
ENTER	30,37, 56,63	MUTE	72	DIM	65
VOICE	83	CTRL	17	SUB-BAND SEL	17
1750	32	PM IN	44	DX	(6)
PM	44	A.B.C.	66	TNC	(4,6,11)
MENU	22	M▶V	40	LIST	(15)
VFO	15	M. IN	36	P. MON	(26)
MR	37	C. IN	39	BCON	(25,32)
CALL	39	LOCK	67	MSG	(30 ~ 32)
MHz	20	T. SEL	30,55,57	POS	(19,20)
TONE	30,55,57	SHIFT	29	PWR (PF1only)	19

For the shaded functions, see the separate manual, "SPECIALIZED COMMUNICATIONS".

- 1 Press **[MNU]** to enter Menu mode.
- 2 Press **[↑]**/ **[↓]** to select "RADIO (1-)", then press **[OK]**.
- 3 Press **[↑]**/ **[↓]** to select "MIC (1-8-)", then press **[OK]**.
- 4 Press **[↑]**/ **[↓]** to select "PF1 (1-8-1)" to "PF4 (1-8-4)", then press **[OK]**.



- 5 Press **[↑]**/ **[↓]** to select the desired function.
- 6 Press **[OK]** to complete the setting.
- 7 Press **[MNU]** to exit Menu mode.

After switching the power OFF, you may press Mic **[PF]**+ **POWER ON**. This allows you to skip steps 1 to 4. Press Mic **[MR]**, **[VFO]**, or **[CALL]** instead of **[PF]** as necessary.

**Note:**

- ◆ Without an optional VS-3 unit installed or with OFF selected in Menu 1-2-4 (VOICE), pressing the PF key programmed with Voice causes the transceiver to announce the current frequency using beeps of different frequencies.
- ◆ To restore the default functions, perform Full Reset (page 41).

# AUXILIARY FUNCTIONS

## DIRECT FREQUENCY ENTRY (WITH MC-53DM ONLY)

If the desired operating frequency is far from the current frequency, using the Mic keypad is the quickest way to change frequency. First program one of the Mic PF keys as the ENTER key {page 62},

- 1 Press the left or right **[BAND SEL]** to select band A or B.
  - If necessary, press **[F]**, then the same **[BAND SEL]** to recall the sub-band.
- 2 Press **[VFO]**.
- 3 Press Mic **[ENTER]**.
  - The display for Direct Frequency Entry appears.



- 4 Press the numeric keys in sequence on the keypad.

### Note:

- ◆ The 1 kHz and subsequent digits are corrected according to which key is pressed for the 1 kHz digit.
- ◆ Entering a digit that is outside the allowable range causes the nearest digit within range to be displayed.
- ◆ You cannot enter a frequency in a band which cannot be recalled on the current band.

If you press Mic **[VFO]** while entering a frequency, the new data is accepted for the digits entered and the previous data remains unchanged for the digits not yet entered.

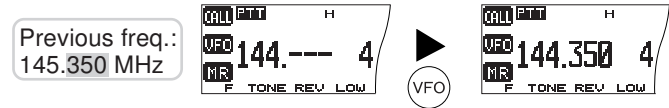

**Note:** The 1 kHz and subsequent digits may be corrected depending on combinations of the previous frequency and the current frequency step size.

If you press Mic **[ENTER]** while entering a frequency, the new data is accepted for the digits entered and 0 is programmed for the digits not yet entered.

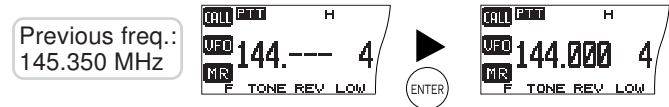

## CHANGING FREQUENCY STEP SIZE

Choosing the correct step size is essential in order to select your exact frequency using the **Tuning** control or Mic **[UP]/ [DOWN]**. The default step size on the 144 MHz band is 5 kHz (U.S.A./ Canada) or 12.5 kHz. The default on the 440/430 MHz band is 25 kHz no matter which market version. For the U.S.A./ Canada version, the default on the 118, 220, or 300 MHz band is 12.5 kHz and the default on the 1.2 GHz band is 25 kHz.

- 1 Press the left or right **[BAND SEL]** to select band A or B.
  - If necessary, press **[F]**, then the same **[BAND SEL]** to recall the sub-band.
- 2 Press **[VFO]**.
- 3 Press **[F]**, **[STEP]**.
  - The current step size appears and blinks.

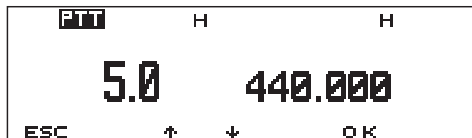

- 4 Press **[↑]/ [↓]** to select the desired step size.
  - The selectable step sizes are 5, 6.25, 10, 12.5, 15, 20, 25, 30, 50, and 100 kHz.
- 5 Press **[OK]** to complete the setting.

**Note:** Changing between step sizes may correct the displayed frequency. For example, if 144.995 MHz is displayed with a 5 kHz step size selected, changing to a 12.5 kHz step size corrects the displayed frequency to 144.9875 MHz.

## PROGRAMMABLE VFO

If you always check frequencies within a certain range, set upper and lower limits for frequencies that are selectable using the **Tuning** control or Mic **[UP]/ [DOWN]**. For example, if you select 145 MHz for the lower limit and 146 MHz for the upper limit, the tunable range will be from 145.000 MHz to 146.995 MHz.

- 1 Press the left or right **[BAND SEL]** to select band A or B, then press **[VFO]**.
  - If necessary, press **[F]**, then the same **[BAND SEL]** to recall the sub-band.
- 2 Press **[MNU]**, select Menu 1–3–1 (PROGRAMMABLE VFO), then press **[OK]**.
  - The current lower frequency limit blinks.



- 3 Press **[↑]/ [↓]** to select the desired lower frequency limit, then press **[OK]**.
  - The current upper frequency limit blinks.
- 4 Press **[↑]/ [↓]** to select the desired upper frequency limit, then press **[OK]**.
- 5 Press **[MNU]** to exit Menu mode.

### Note:

- ◆ You cannot program the 100 kHz and subsequent digits.
- ◆ The exact 100 kHz and subsequent digits of the upper limit depend on the frequency step size selected.

## DISPLAY DIMMER

You can manually change the display illumination to suit the lighting conditions where you are operating.

### 1 Press [F], [DIM].

- The current illumination level appears and blinks; The default is level 1.

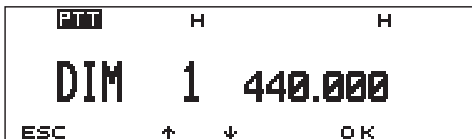

### 2 Press [↑]/[↓] to select from 5 levels, including OFF.

### 3 Press [OK] to complete the setting.

**Note:** Selecting OFF automatically switches Auto Dimmer Change ON.

## AUTO DIMMER CHANGE

This function increases the display intensity one step brighter for approximately 5 seconds when you press a front panel button or Mic key, or turn the **Tuning** control. No change occurs if you have selected the brightest level. Access Menu 1-1-4 (AUTO DIMMER) and select "ON".



## DISPLAY CONTRAST ADJUST

The display visibility changes depending on ambient conditions, for example between daytime and nighttime. When you find the display is not clear, use this function to select the optimum display contrast.

Access Menu 1-1-2 (CONTRAST) and select from levels 1 to 16. The default is level 8.



**Note:** The display contrast may be affected by a change in temperature. Adjust the contrast as necessary.

## POSITIVE/ NEGATIVE REVERSAL

You can change the display status between Negative and Positive (default) using Menu 1-1-3 (REVERSE MODE).



## BLANKING A BAND DISPLAY

If you have no plans to use band A or B, quit frequency display on the unused band. This saves power consumption and makes it simpler to read the information you need.

Press the left **[BAND SEL]** (1 s) to blank band B, or the right **[BAND SEL]** (1 s) to blank band A.



To restore Dual-band mode, press the same **[BAND SEL]** (1 s).

**Note:** You cannot operate the blanked band nor use this band to receive or transmit.

14

## AUTOMATIC BAND CHANGE (A.B.C.)

A.B.C. will temporarily switch the RX only band to the TX band immediately after a signal is received on the RX only band. This function allows you to reply to a caller without manually selecting the correct band.

Press **[F]**, **[A.B.C]** to switch the function ON (or OFF).

- "A.B.C." appears when the function is ON.



- Pressing **[BAND SEL]** or Mic **[PTT]** also cancels A.B.C.
- The original TX band is restored 2 seconds after signals drop out.

### **Note:**

- ◆ You cannot use A.B.C. when in Single-band mode. After activating A.B.C., changing from Dual-band mode to Single-band mode switches OFF the A.B.C.
- ◆ After activating A.B.C., starting Visual Scan deactivates A.B.C. Canceling Visual Scan reactivates A.B.C.



## TRANSCEIVER LOCK

Transceiver Lock is suitable for a typical mobile installation where you alter most functions with your microphone. This Lock disables all functions excluding the following:

<b>PWR</b> switch	<b>[F]</b>	<b>[F], [MHz]</b>
<b>SQL</b> controls	<b>VOL</b> controls	Mic keys

Press **[F]**, **[MHz]** to switch the function ON (or OFF).

- “LOCK” appears when the function is ON.

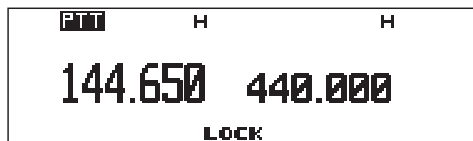

## ALL-CONTROL LOCK

All-control Lock is ideal when you have no plans to transmit but you want to monitor a specific frequency. This Lock disables all functions excluding power ON/OFF and All-control Lock ON/OFF.

After switching Transceiver Lock ON, switch OFF the transceiver, then press **[MHz]+ POWER ON** to switch the function ON (or OFF).

- “ALL LOCK” appears when the function is ON.

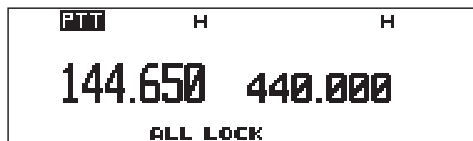

## CHANGING MULTI-FUNCTION BUTTON LABELS

The functions to be frequently used may differ among persons. You can change the defaults of the 5 buttons located below the display.

Access Menu 1–1–5 (KEY FUNC) and select mode 1 (default), 2, or 3.



Mode 1					
<b>[KEY]</b>	TONE	REV	LOW	MUTE	CTRL
<b>[F], [KEY]</b>	T.SEL	SHIFT	STEP	VISUAL	DIM
<b>[F] (1 s), [KEY]</b>	LIST	P.MON	BCON	MSG	POS
Mode 2					
<b>[KEY]</b>	T.SEL	SHIFT	STEP	VISUAL	DIM
<b>[F], [KEY]</b>	LIST	P.MON	BCON	MSG	POS
<b>[F] (1 s), [KEY]</b>	TONE	REV	LOW	MUTE	CTRL
Mode 3					
<b>[KEY]</b>	LIST	P.MON	BCON	MSG	POS
<b>[F], [KEY]</b>	TONE	REV	LOW	MUTE	CTRL
<b>[F] (1 s), [KEY]</b>	T.SEL	SHIFT	STEP	VISUAL	DIM

## S-METER SQUELCH

S-meter Squelch causes the squelch to open only when a signal with the same or greater strength than the S-meter setting is received. This function relieves you from constantly resetting the squelch when receiving weak stations that you have no interest in.

- 1 Select the desired band.
- 2 Press **[MNU]** to enter Menu mode.
- 3 Select 1-3-2 (S-METER SQUELCH), then press **[OK]**.



- 4 Press **[↑]/ [↓]** to switch the function ON (or OFF).
- 5 Press **[OK]** to complete the setting.
- 6 Press **[MNU]** to exit Menu mode.
  - The S-meter setting segments appear.

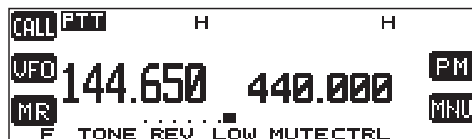

- 7 To select the desired S-meter setting, turn the left (band A) or right (band B) **SQL** control depending on which band you selected.

## ■ Squelch Hang Time

When using S-meter Squelch, you may want to adjust the time interval between when the received signals drop and when the squelch closes.

Access Menu 1-3-3 (SQUELCH HANG TIME) and select from OFF (default), 125, 250, and 500 msec.



## CHANGING BEEP VOLUME

The transceiver beeps each time you press a front panel button or Mic key, or when it receives appropriate APRS or DX cluster data. You can change the beep volume or turn it off.

Access Menu 1-2-1 (BEEP VOLUME) and select the volume from levels 1 to 7 and OFF. The default is level 5.



## KEY BEEP ON/ OFF

If you are distracted by beeps generated when pressing a front panel button or Mic key, switch OFF the Key Beep. The transceiver will beep only when it receives appropriate APRS or DX cluster data.

Access Menu 1-2-2 (KEY BEEP) and select "OFF".



**Note:** After selecting OFF, you will still hear TOT and APO alarms.

## SWITCHING FM/AM MODE

This transceiver is also capable of receiving (not transmitting) in AM on band A. The default mode on the 118 MHz band is AM while the default on the 144, 220, 300, or 440 MHz band is FM. After recalling the desired band on band A, access Menu 1-3-4 (FM/AM MODE) and switch between FM and AM.



- The 1 MHz decimal becomes elongated when AM is selected.

**Note:** You cannot switch between FM and AM to receive on band B.

## ADVANCED INTERCEPT POINT (AIP)

The VHF band is often crowded in urban areas. AIP helps eliminate interference and reduce audio distortion caused by intermodulation. You may use this function when operating on the VHF band. Access Menu 1-3-5 (VHF AIP) and select "ON".



**Note:**

- ◆ This transceiver does not allow you to use the AIP on the UHF band.
- ◆ Switching ON the AIP also affects the VHF sub-band on band B.

## TIME-OUT TIMER (TOT)

It is sometimes necessary or desirable to restrict a single transmission to a specific maximum time. You may use this function to prevent repeater time-outs when accessing repeaters, or to conserve battery power.

When TOT times out, the transceiver generates beeps and automatically returns to receive mode. To resume transmitting, release and then press Mic **[PTT]** again.

Access Menu 1-9-4 (TOT) and select 3, 5, or 10 (default) minutes for the TOT time.



## AUTOMATIC POWER OFF (APO)

Automatic Power Off is a background function that monitors whether any buttons or keys have been pressed, or whether the **Tuning** control has been turned. After 3 hours pass with no operations, APO turns OFF the power. However, 1 minute before the power turns OFF, "APO" appears and blinks, and a series of warning tones sound.

Access Menu 1-9-3 (APO) and select "ON".

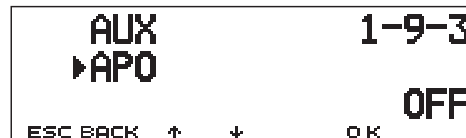

**Note:** If any settings are changed during the 3 hour period while APO is ON, the timer resets. When you stop changing the settings, the timer begins counting again from 0.

## POWER-ON MESSAGE

Each time you switch the transceiver ON, “HELLO !!” appears and stays for approximately 2 seconds. You can program your favorite message in place of the factory default.

- 1 Press **[MNU]** to enter Menu mode.
- 2 Select Menu 1–1–1 (POWER-ON MSG), then press **[OK]**.
  - The display for entering a message appears; the first digit blinks.



- 3 Turn the **Tuning** control to select a character.
  - You can enter alphanumeric characters plus special ASCII characters.
- 4 Press **[→]**.
  - The cursor moves to the next digit.
- 5 Repeat steps 3 and 4 to enter up to 8 digits.

<b>CHAR</b>	Switches among the sets of alphanumeric characters, accented letters (TM-D700E only), and special ASCII characters.		
<b>A/a</b>	Switches between small and capital letters.	<b>BACK</b>	Cancels Message Entry.
<b>DEL</b>	Deletes the digit at which the cursor is blinking.	<b>←</b>	Causes the cursor to move backward.
<b>INS</b>	Inserts the currently selected character.	<b>CLR</b> (left BAND SEL)	Clears all digits and backs the cursor to the first digit.

6 Press **[OK]** to complete the setting.

7 Press **[MNU]** to exit Menu mode.

The keypad on the MC-53DM also is available to enter alphanumeric characters in step 3. See page 18.

## DISPLAY DEMONSTRATION

By initiating this function, various preprogrammed displays appear. You still can normally use the transceiver in this mode. Pressing a front panel button or Mic key, or turning the **Tuning** control restores the operating display immediately. If there is no button/key entry or **Tuning** control adjustment for approximately 10 seconds, the transceiver reverts back to Demonstration mode.

Press **[F]+ POWER ON** to switch the function ON (or OFF).

## CHANGING SPEAKER CONFIGURATIONS

This transceiver has two speaker jacks. You can enjoy a variety of speaker configurations by using one or two external speakers. Access Menu 1–2–3 (SPEAKER) and select mode 1 (default) or 2, depending on how the internal and/or external speakers should function.



Connection	Mode	Band A	Band B
Only SP1 jack connected with an external speaker	Mode 1	External	External
	Mode 2	External	External
Only SP2 jack connected with an external speaker	Mode 1	External	Internal
	Mode 2	Internal	External
Both SP1 and SP2 jacks connected with external speakers	Mode 1	External 2	External 1
	Mode 2	External 1	External 2

## SPEAKER MUTE

While receiving or transmitting on the TX band, you may not want to hear audio received on the other band. Use this function to mute the speaker allocated to that band (not TX band).

Press **[MUTE]** to switch the function ON (or OFF).

- “MUTE” appears when the function is ON.

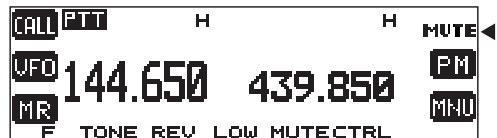

## CHANGING TX/RX DEVIATION (TM-D700E ONLY)

This transceiver is capable of switching between wide and narrow deviations to receive or transmit. After selecting the desired band, access Menu 1–3–6 (WIDE/NARROW) and switch between Wide (default) and Narrow.



- When Narrow is selected, “N” appears beside the frequency.

**Note:** Do not select Narrow for the band configured as a data band. The selection of Narrow is invalid on the data band.

## MICROPHONE CONTROL (WITH MC-53DM ONLY)

You can change numerous transceiver settings by operating the Mic DTMF keys. To activate this function, access Menu 1–8–5 (MIC CONTROL) and select “ON”.



The following table shows what function is switched ON and OFF or which setting is changed, by pressing the DTMF keys.

1	Visual Scan	9	Squelch Adjustment <sup>2,3</sup>
2	Tone/ CTCSS/ DCS	0	TX Power Change
3	Reverse	A	Enter
4	1 MHz Step Change	B	Control Band Select
5	Monitor	C	Repeater
6	Frequency Readout by Beeps <sup>1</sup>	D	[F] key
7	Volume Change <sup>2,3</sup>	*	Down <sup>4</sup>
8	Speaker Mute	#	Up <sup>4</sup>

<sup>1</sup> The transceiver announces the displayed information if you have installed an optional VS-3 unit and selected “English” in Menu 1–2–4 (VOICE) {page 83}.

<sup>2</sup> After entering the selection mode, press [\*] or [#] to change the level or selection.

<sup>3</sup> Both Volume Change and Squelch Adjustment cannot be activated at the same time.

<sup>4</sup> Both Volume Change and Squelch Adjustment must be OFF to change the tone or frequency step using this key.

You can also make the following settings by pressing [D] first (ex. [D], then [2]).

2	Tone (or CTCSS) Frequency/ DCS Code Select <sup>1</sup>	8	Sub-band Select
3	Offset Direction Select	D	Multi-function Mode Cancel
5	DTMF Keypad Lock	*	Down
6	DTMF Keypad Unlock	#	Up
7	Band A/ B Select		

<sup>1</sup> After entering the selection mode, press [\*] or [#] to change the level or selection.

Before pressing [D], [2], press [2] to activate the Tone, CTCSS, or DCS function.

Press [OK] on the front panel of the transceiver to complete the setting.

**Note:** Audible DTMF tones from other transceivers near you may be picked up by your MC-53DM microphone. If so, this could prevent the function from working correctly.

## WIRELESS REMOTE CONTROL (U.S.A./ CANADA ONLY)

If you also have a compatible **KENWOOD** handy transceiver, you may use it as a remote control for this mobile transceiver. You will control one band on the mobile while sending DTMF tones to the other band from the handheld. This function will be useful, for example, when you want to control the mobile from a location outside your vehicle.

### Note:

- ◆ As a remote control, you can also use a handy transceiver which does not have a remote control function but a DTMF function. You, however, must manually send DTMF tones for control code strings. Skip steps 1 and 3 in "PREPARATION".
- ◆ The FCC rules permit you to send control codes only on the 440 MHz band.

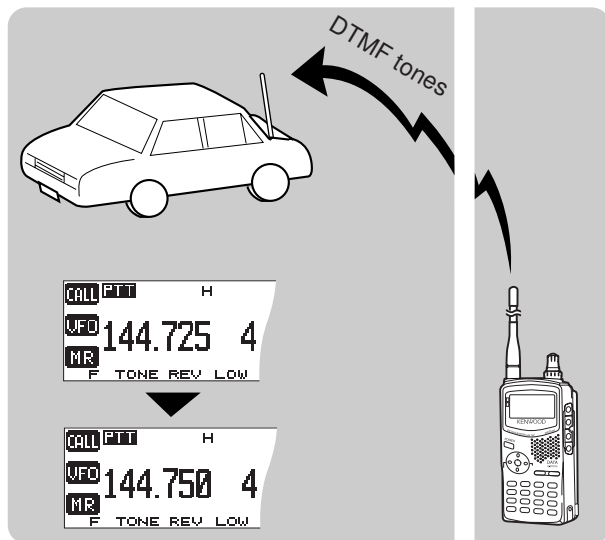

## PREPARATION

Let us assume band A (VHF) of the mobile transceiver will be controlled.

On the handy transceiver:

- 1 Program a 3-digit secret number.
  - For the programming method, see the instruction manual for the handheld.
  - If using a TH-D7A, see "WIRELESS REMOTE CONTROL" on its instruction manual.
- 2 Select the transmit frequency on the UHF band.
- 3 Make the handheld enter Remote Control mode.
  - For the method, see the instruction manual for the handheld. If not described, consult your dealer.

On the mobile transceiver:

- 4 Access Menu 1-A-1 (CODE), and select the same secret number as you selected in step 1.



- Turn the **Tuning** control to select each digit. Press [**→**] (or [**←**]) to move the cursor to the next (or previous) digit.
- You can also press Mic [0] to [9] in sequence to enter 3 digits.



- 5 Select the receive frequency on band B (UHF).
  - Mate this frequency with the transmit frequency on the handheld.
- 6 Select band A (VHF) as the TX band or Control band {page 17}.
- 7 To cause the mobile to send a control acknowledgment to the handheld, access Menu 1-A-2 (ANSWER BACK) and select "ON".



- DTMF tones which represent the secret number will be used as an acknowledgment.
- 8 Access Menu 1-A-3 (CONTROL) and select "ON".
    - "REMOTE CON" and "LOCK" appear when the mobile enters Remote Control mode.

## CONTROL OPERATION

When in Remote Control mode, the DTMF keys of the handheld will function as shown in the table. Each time you press the desired key, the handheld will automatically enter transmit mode and send the corresponding command to the mobile.

**Note:** If using a handheld without a remote control function, manually send "AXXX#YA#" where "XXX" is a 3-digit secret number and "Y" is a single-digit control command. If you do not add "A#" to the end, you can skip sending "AXXX#" next time; however, the mobile may be accidentally controlled by other stations.

1	REV ON	9	MR
2	TO NE ON	0	LOW
3	CTCSS ON	A	ENTER
4	REV OFF	B	TO NE SEL
5	TO NE OFF	C	REPEATER ON
6	CTCSS OFF	D	REPEATER OFF
7	CALL	*	DOWN
8	VFO	#	UP

To change the transmit/ receive frequency:

([VFO] → [ENTER] → [0] ~ [9] (enter the necessary digits) → [ENTER]) or ([VFO] → [UP]/ [DOWN])

To recall a memory channel:

([MR] → [ENTER] → [0] ~ [9] (enter the necessary digits) → [ENTER]) or ([MR] → [UP]/ [DOWN])

To change the tone (or CTCSS) frequency:

([TONE SEL] → [0] ~ [9] (enter 2 digits; ex. [0], [5]) → [TONE SEL])

- Use Nos. 01 to 38 shown in the table in page 30.
- First activate the Tone or CTCSS function. You can select a separate tone frequency for the Tone and CTCSS functions.

**Note:** When in Remote Control mode, you can perform only the following operations on the mobile transceiver.

- Transmit
- Answer Back ON/ OFF
- Secret Number Change
- Partial/ Full Reset (with RESET button)

# SKY COMMAND II (U.S.A./ CANADA ONLY)

The Sky Command II allows remote control of a TS-570D, TS-570S, or TS-870S HF transceiver. Besides the HF transceiver, this system requires two transceivers capable of working the Sky Command II. This transceiver and TH-D7A handhelds are currently available. You will use one transceiver as a control station called "Commander". The transceiver connected with the HF transceiver is called "Transporter". It will function as an interface between the Commander and the HF transceiver. This system allows you, for example, to watch for and hunt DX while washing your car, or to operate the HF transceiver while relaxing in your car, living room, or patio, instead of in your shack.

The Commander and Transporter transfer audio and commands as below:

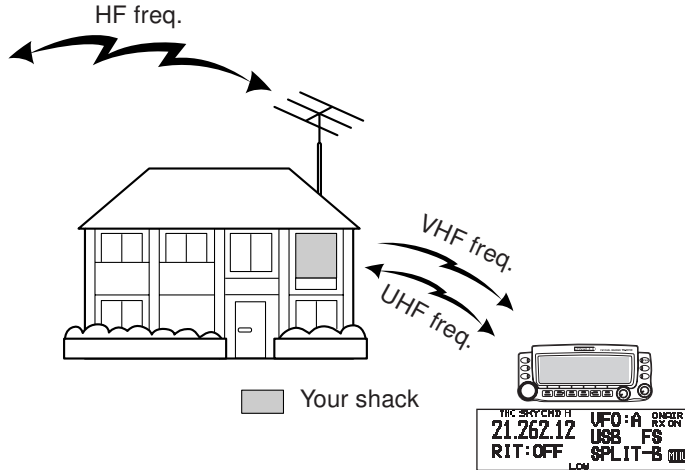
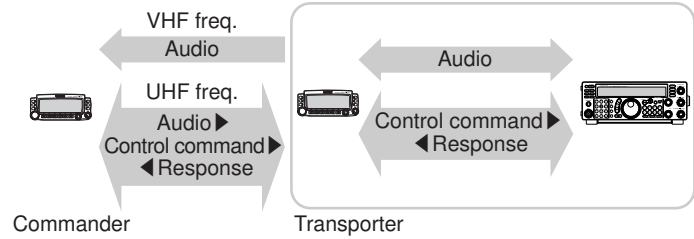

## CONNECTING THE TRANSPORTER WITH THE HF TRANSCEIVER

In order to connect the transporter to the HF transceiver, you need to prepare three cables by yourself. For the connection between the COM connectors on the two transceivers, you may use a commercially available RS-232-C cross-wired cable.

### Note:

- ◆ Switch OFF both the Transporter and HF transceiver before making the connection.
- ◆ The Transporter automatically transmits its call sign in Morse at regular intervals because of legal requirements; therefore, transmit sidetone must be output from the HF transceiver. On TS-570D or TS-570S, do not select "OFF" in Menu 21. On TS-870S, use the **MONI** control to adjust the sidetone volume.
- ◆ When the Transporter is too close to the HF transceiver, unwanted feedback may cause malfunction.
- ◆ Do not share a regulated power supply between the Transporter and the HF transceiver. Unwanted feedback may cause malfunction.

TM-D700A

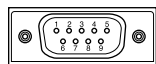

COM connector on TM-D700A

HF transceiver

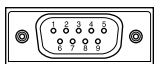

COM connector on HF transceiver

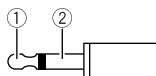
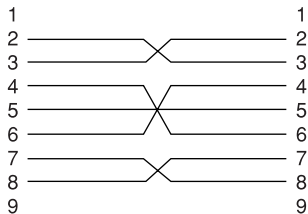

To 3.5 mm (1/8") speaker jack

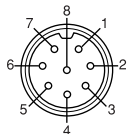
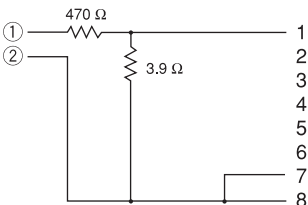

MIC connector on HF transceiver

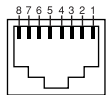

MIC connector on TM-D700A

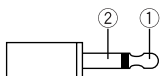
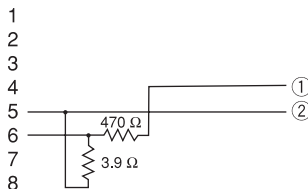

To EXT SP jack

- 1 UP
- 2 8 V DC
- 3 GND
- 4 STBY (PTT)
- 5 GND (MIC)
- 6 MIC
- 7 NC
- 8 DWN

## PREPARATION FLOW

The following steps should guide you to a good start of Sky Command operation. First connect the Transporter to the HF transceiver {page 77}.

**1** On the Commander and Transporter Select the same VHF and UHF frequencies.

**2** On the Commander Access Menu 4-1 to program a call sign (9 digits max.) for the Commander {page 79}.

- You may enter your exact call sign; ex. WD6BQD.

**3** On the Commander Access Menu 4-2 to program a call sign (9 digits max.) for the Transporter {page 79}.

- This call sign must be different from the one for the Commander. So you may add SSID characters; ex. WD6BQD-1.

**17** **4** On the Transporter Access Menu 4-1 to program the same call sign as you entered in step **2** {page 79}.

**5** On the Transporter Access Menu 4-2 to program the same call sign as you entered in step **3** {page 79}.

**6** On the Commander and Transporter Access Menu 4-3 and select the tone frequency {page 79}.

- Select the same tone frequency on both transceivers.
- For the selectable frequencies, see the table given on page 30.

**7** On the Commander Access Menu 4-4 and select "COMMANDER".

- "PUSH [ 0 ] KEY TO START COMMANDER!!" appears.

**8** On the Transporter Access Menu 4-4 and select "TRANSPORTER".

Now the Commander and Transporter are in Sky Command mode. For operations in this mode, see "CONTROL OPERATION" on page 80. First switch ON the HF transceiver and press **[SYNC]** on the Commander. To exit the Sky Command mode, access Menu 4-4 and select "OFF".

### Note:

- ◆ Unless you program call signs, you cannot select "COMMANDER" or "TRANSPORTER" using Menu 4-4.
- ◆ On the HF transceiver, select 9600 bps and 1 stop bit (default) using the Menu Set-up function.
- ◆ Adjust the audio level on both the Transporter and HF transceiver while listening to audio output from the Commander. An appropriate position of the AF control on the HF transceiver might be in the range, 8:30 to 9:00.
- ◆ To distinguish your various stations or nodes, you can have up to 15 Secondary Station IDentifiers (SSIDs); ex. WD6BQD-1 to WD6BQD-15. You always have to put a dash between your call sign and SSID number.

## PROGRAMMING CALL SIGNS

The built-in TNCs of the Commander and Transporter communicate each other when you send a control command from the Commander. So you must program different call signs (9 digits max.) on these transceivers as the IDs of the TNCs.

Use the following Menu Nos. to program call signs:

On Commander		
4-1	CMD CALLSIGN	Call sign for Commander
4-2	TRP CALLSIGN	Call sign for Transporter
On Transporter		
4-1	CMD CALLSIGN	Call sign for Commander
4-2	TRP CALLSIGN	Call sign for Transporter

- 1 Press **[MENU]** to enter Menu mode.
- 2 Select "4-1 (CMD CALLSIGN)" or "4-2 (TRP CALLSIGN)", then press **[OK]**.
  - The callsign entry field appears; the first digit blinks.

ABC 123 SKY COMMAND 4-1  
 ▶CMD CALLSIGN  
 ▶OCALL

BACK DEL ← → INS OK CLR

ABC 123 SKY COMMAND 4-2  
 ▶TRP CALLSIGN  
 ▶OCALL

BACK DEL ← → INS OK CLR

- 3 Turn the **Tuning** control to select a character.
  - You can enter 0 to 9, A to Z, and -.

- 4 Press **[→]**.
  - The cursor moves to the next digit.
- 5 Repeat steps 3 and 4 to enter up to 9 digits.

<b>BACK</b>	Cancels entry of a call sign.	<b>DEL</b>	Deletes the digit at which the cursor is blinking.
<b>←</b>	Causes the cursor to move backward.	<b>INS</b>	Inserts the currently selected character.
<b>CLR</b>	Clears all digits and backs the cursor to the first digit.		

- 6 Press **[OK]** to complete the setting.
- 7 Press **[MENU]** to exit Menu mode.

The keypad on the MC-53DM also is available to enter alphanumeric characters in step 3. See page 18.

## PROGRAMMING A TONE FREQUENCY

On receiving a tone from the Commander, the Transporter causes the HF transceiver to enter Transmit mode. On both the Commander and Transporter, access Menu 4-3 (TONE FREQUENCY) and select the desired, same tone frequency.

ABC 123 SKY COMMAND 4-3  
 ▶TONE FREQUENCY  
 88.5 Hz

ESC BACK ↑ ↓ OK

## CONTROL OPERATION

When in the Sky Command mode, the Mic keys of the Commander will function as below. First switch ON the HF transceiver and press Mic **[0]** on the Commander.

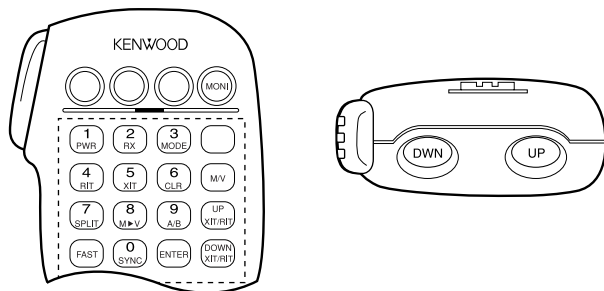

Each time you press the desired key, the Commander will automatically enter transmit mode and send the corresponding control command to the Transporter.

To switch ON/ OFF the HF transceiver	Press Mic <b>[1]</b> .
To change the frequency or memory channel on the HF transceiver	Press Mic <b>[UP]/ [DWN]</b> .
To transmit audio on an HF frequency	Press and hold Mic <b>[PTT]</b> , then speak into the microphone.
To receive audio on an HF frequency	Press Mic <b>[2]</b> .
To monitor the UHF band on the Commander	Press the Mic PF key assigned the Monitor function.

Mic Key	Function
<b>1</b>	Power ON/ OFF
<b>2</b>	HF frequency receive ON/ OFF
<b>3</b>	Modulation mode switch
<b>4</b>	RIT ON/ OFF
<b>5</b>	XIT ON/ OFF
<b>6</b>	RIT offset or XIT offset clear
<b>7</b>	Split-frequency ON/ OFF
<b>8</b>	Transfer from Memory to VFO
<b>9</b>	In VFO mode: VFO A/ VFO B switch In Memory Recall mode: no change
<b>0</b>	Current settings retrieve (from HF transceiver)
<b>B</b>	VFO/ Memory Recall mode switch
<b>C</b>	XIT/ RIT offset frequency increase
<b>D</b>	XIT/ RIT offset frequency decrease
<b>*<sup>1</sup></b>	In LSB, USB, or CW mode: 10 Hz/ 1 kHz switch In FM or AM mode: 1 kHz/ 10 kHz switch
<b>#<sup>2</sup></b>	In VFO mode: frequency entry ON In Memory Recall mode: channel number entry ON

<sup>1</sup> "FS" appears when you select 1 kHz step (LSB/ USB/ CW) or 10 kHz step (FM/ AM).

<sup>2</sup> After pressing Mic **[#]**, press Mic **[0]** to **[9]** to enter a frequency or memory channel number.

When Mic [0] is pressed, the Commander shows the current settings of the HF transceiver as below:

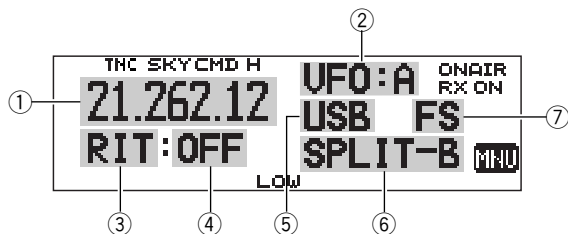

- ① HF frequency
- ② VFO: A, VFO: B,  
MR: 00 ~ 99 (memory channel number)
- ③ RIT, XIT
- ④ OFF, -9.99 ~ +9.99
- ⑤ LSB, USB, CW, FM, or AM
- ⑥ SPLIT-A: VFO A is used for transmitting.  
SPLIT-B: VFO B is used for transmitting.  
SPLIT-M: A memory channel is used for transmitting.
- ⑦ "FS" appears when Mic [ ✖ ] is pressed.

**Note:**

- ◆ After pressing [MENU], you can access only Menu 4-4.
- ◆ The Transporter will transmit its call sign in Morse every 10 minutes, using the 144 MHz band.
- ◆ The APO timer does not operate on the transceiver with Transporter ON.

## REPEATER FUNCTION (U.S.A./ CANADA ONLY)

This transceiver is capable of receiving signals on one band and retransmitting signals on the other band. This function repeats signals originating from one band, using the other band. For example, a signal received on band A (VHF) is retransmitted on band B (UHF). Similarly, a signal received on band B (UHF) is retransmitted on band A (VHF).

Access Menu 1-7-6 (REPEATER) and select Locked-band Repeater or Cross-band Repeater. The default is "OFF".



- "PTT" blinks when in the Locked-band or Cross-band Repeater mode.

### Locked-band Repeater

The transceiver always uses the same band to receive or transmit a signal as a repeater. Before accessing Menu 1-7-6, select one band as the TX band and the other band as the control band.

### Cross-band Repeater

If receiving a signal on the TX band, the transceiver switches the current RX only band to the TX band. Before accessing Menu 1-7-6, select the same band as the TX and control bands.

If necessary, you can cause this transceiver to remain in the transmit mode for 500 ms after signals drop. Access Menu 1-7-5 (REPEATER HOLD) and select "ON".



### Note:

- ◆ You cannot activate the Repeater function after recalling the same frequency band (VHF or UHF) on band A and B, or while blanking a band display.
- ◆ Activating the Repeater function switches OFF Automatic Band Change (A.B.C.) or Automatic Simplex Check (ASC).
- ◆ The Time-Out Timer is locked at 3 minutes.
- ◆ After activating the Repeater function, you cannot access Menu Nos. other than 1-7-5 and 1-7-6.



## VS-3 VOICE SYNTHESIZER (OPTIONAL)

Install the optional VS-3 unit to use this function {page 85}. Each time you change the transceiver mode, such as VFO or Memory Recall, the transceiver automatically announces the new mode. In order to use the installed VS-3 unit, access Menu 1–2–4 (VOICE) and select “English”. The default is OFF. For “APRS ONLY” selectable in this menu number, see the separate manual, “SPECIALIZED COMMUNICATIONS” {page 28}.

The table below shows what the transceiver automatically announces when it enters a new mode.

Key Pressed	New Mode	Announcement
[VFO]	VFO	“VFO”
[MR]	Memory Recall	“MR”
[CALL]	Call Channel	“Call”
[PM]	Programmable Memory	“PM”
[MNU]	Menu	“Menu” and current menu number
[BAND SEL]	New TX/ Control band	“A” or “B”, current frequency, and current TX power <sup>1</sup>
Mic PF key programmed with Enter {page 62} <sup>2</sup>	Keypad Direct Entry	“Enter” (and numerics as entered)

<sup>1</sup> When pressed in Memory Recall mode, the transceiver announces “A” or “B”, the channel number, “channel”, the frequency, and the TX power. When in Call channel mode, the transceiver announces “A” or “B”, “call”, the frequency, and the TX power..

<sup>2</sup> When pressed in VFO or Memory Recall mode.

You can also press Mic [6] in Microphone Control mode {page 73} or the PF key programmed with Voice {page 62}. The transceiver announces the displayed information as follows depending on the current mode.

VFO	VFO frequency on the current band beginning with the 100 MHz digit (MHz decimal point: “point”)
Memory Recall	Channel number, “channel”, and the frequency For the L or U channels, “low” or “up”, the channel number, and the frequency
Channel Display	Channel number and “channel”. For the L or U channels, “low” or “up” and the channel number
Call Channel Recall	“Call” and the frequency
Menu	Menu number (with Voice key only)
Tone freq., CTCSS freq, DCS code select	Current Tone freq., CTCSS freq, or DCS code

In order to change the volume of voice output, access Menu 1–2–5 (VOICE VOLUME) and select from levels 1 to 7. The default is level 5.

**Note:** While using Transceiver Lock, the transceiver makes an announcement only when pressing Mic [6] in Microphone Control mode or the PF key programmed with Voice. When in All-control Lock mode, pressing these keys simply causes an error beep to sound; the transceiver does not make an announcement in any case.

## OPTIONAL ACCESSORIES

**PS-33**  
Regulated DC  
Power Supply



**SP-50B**  
Communications  
Speaker



**VS-3**  
Voice Synthesizer  
Unit



**VC-H1**  
Interactive Visual  
Communicator



**PG-2N**  
DC Power Cable



**PG-3B**  
DC Line Noise Filter



**PG-4X**  
Extension Cable  
Kit



**PG-5A**  
Data Cable



**MC-45**  
Multi-function  
Microphone



**MC-53DM**  
Multi-function  
Microphone with DTMF



**MC-80**  
Desktop Microphone  
(MJ-88 required)



**MJ-88**  
Microphone Plug  
Adapter



**MJ-89**  
Modular Plug  
Microphone Switch



# INSTALLING OPTIONS

## INSTALLING THE VS-3 VOICE SYNTHESIZER UNIT



Always switch off the power and unplug the DC power cable first.

- 1 Remove the 6 screws from the lower cover of the main unit.

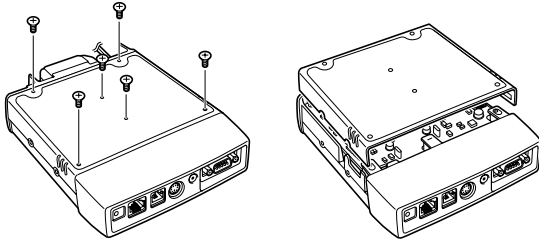

- 2 Hold the VS-3 unit with the component side facing upward, and insert the VS-3 connector into the corresponding transceiver connector; the component side must not face downward.

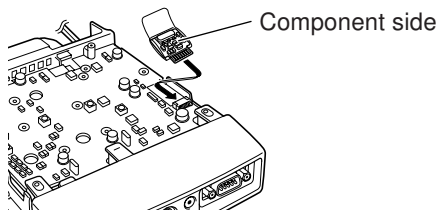

- 3 Replace the lower cover (6 screws).

## INSTALLING THE PG-4X EXTENSION CABLE KIT

The PG-4X kit is available to extend the various connection cables. For the cable connections, see the next page. With two sets of PG-4X kits, you can extend the cables to the maximum length.

The PG-4X kit also includes noise filters, modular plug adapter cushions, and cable clamps. The following diagrams illustrate how to install these accessories.

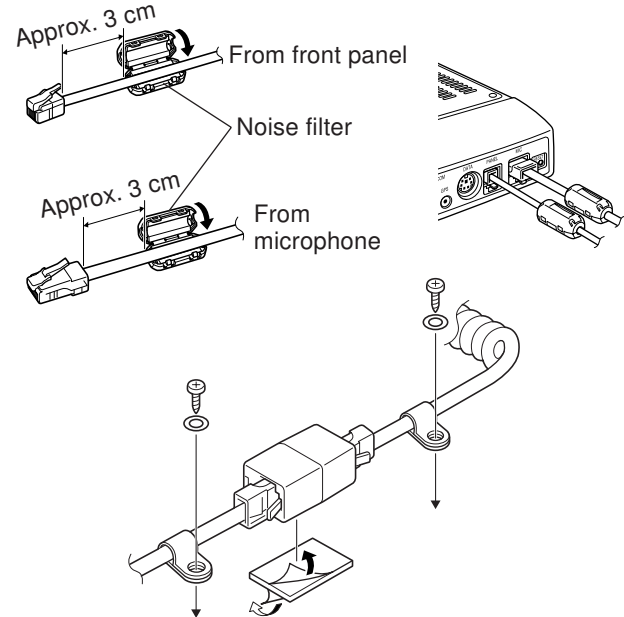

## Connections Using One Set of PG-4X Kit

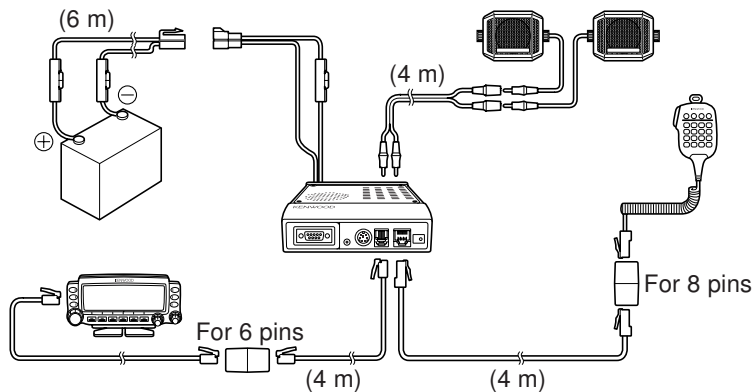

## Connections Using Two Sets of PG-4X Kits

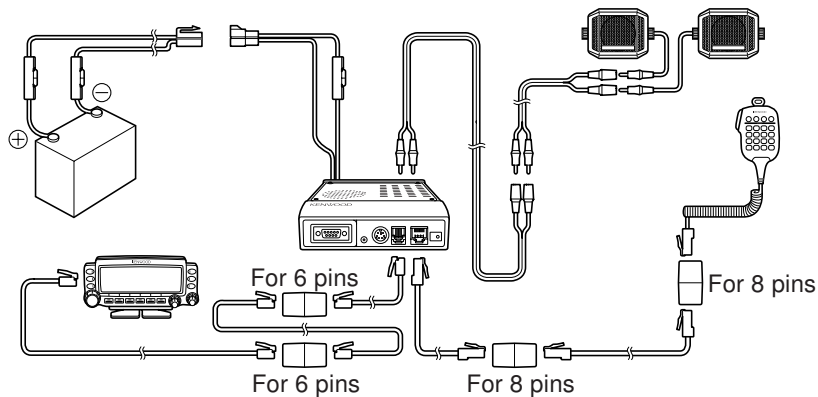

**Note:** Always connect the 4-pin plug on the modular plug cable supplied with the transceiver to the front panel.

## GENERAL INFORMATION

This product has been factory aligned and tested to specification before shipment. Attempting service or alignment without factory authorization can void the product warranty.

## SERVICE

When returning this product to your dealer or service center for repair, pack it in its original box and packing material. Include a full description of the problem(s) experienced. Include your telephone number along with your name and address in case the service technician needs to call you; if available, include also your fax number and e-mail address. Don't return accessory items unless you feel they are directly related to the service problem.

You may return this product for service to the authorized **KENWOOD** dealer from whom you purchased it, or any authorized **KENWOOD** service center. Please do not send subassemblies or printed circuit boards. Send the complete product. A copy of the service report will be returned with the product.

## SERVICE NOTE

If you desire to correspond on a technical or operational problem, please make your note legible, short, complete, and to the point. Help us help you by providing the following:

- Model and serial number of equipment
- Question or problem you are having
- Other equipment in your station pertaining to the problem



### CAUTION

*Do not pack the equipment in crushed newspapers for shipment! Extensive damage may result during rough handling or shipping.*

### Note:

- ◆ *Record the date of purchase, serial number and dealer from whom this product was purchased.*
- ◆ *For your own information, retain a written record of any maintenance performed on this product.*
- ◆ *When claiming warranty service, please include a photocopy of the bill of sale, or other proof-of-purchase showing the date of sale.*

## CLEANING

To clean the case of this product, use a neutral detergent (no strong chemicals) and a damp cloth.

## TROUBLESHOOTING

The problems described in this table are commonly encountered operational malfunctions and are usually not caused by circuit failure.

Problem	Probable Cause	Corrective Action	Page Ref.
The transceiver will not power up after connecting a 13.8 V DC power supply and pressing the <b>PWR</b> switch. Nothing appears on the display.	<b>1</b> The power cable was connected backwards.	<b>1</b> Connect the supplied DC power cable correctly: Red → ( + ); Black → ( - ).	5, 6
	<b>2</b> One or more of the power cable fuses are open.	<b>2</b> Look for the cause of the blown fuse(s). After inspecting and correcting any problems, install a new fuse(s) with the same ratings.	7
	<b>3</b> The modular plug cable was not correctly connected.	<b>3</b> Correctly connect the modular plug cable between the front panel and main unit.	4
The display is too dim, even though you selected a high dimmer level.	The supply voltage is too low.	The supply voltage requirement is 13.8 V DC ±15% (11.7 V to 15.8 V DC). If the input voltage is outside this range, recharge your battery, adjust your regulated power supply, and/or check all power cable connections.	—
The frequency cannot be selected by turning the <b>Tuning</b> control or by pressing Mic <b>[UP]/ [DWN]</b> .	Memory Recall was selected.	Press <b>[VFO]</b> .	15
Most buttons/keys and the <b>Tuning</b> control do not function.	One of the Lock functions is ON.	Unlock all of the Lock functions.	67
Memory channels cannot be selected by turning the <b>Tuning</b> control or by pressing Mic <b>[UP]/ [DWN]</b> .	No data has been stored in any memory channels.	Store data in some memory channels.	36

Problem	Probable Cause	Corrective Action	Page Ref.
You cannot transmit even though you press Mic <b>[PTT]</b> .	<ol style="list-style-type: none"> <li data-bbox="432 118 871 197"><b>1</b> The microphone plug was not inserted completely into the front panel connector.</li> <li data-bbox="432 208 871 309"><b>2</b> You selected a transmit offset that places the transmit frequency outside the allowable transmit frequency range.</li> <li data-bbox="432 320 871 376"><b>3</b> The built-in TNC (or an external TNC if connected) was transmitting.</li> </ol>	<ol style="list-style-type: none"> <li data-bbox="887 118 1414 197"><b>1</b> Switch OFF the power, then insert the microphone plug until the locking tab clicks in place.</li> <li data-bbox="887 208 1414 264"><b>2</b> Press <b>[F]</b>, <b>[SHIFT]</b> repeatedly so neither “+” nor “-” is visible.</li> <li data-bbox="887 320 1414 376"><b>3</b> Press Mic <b>[PTT]</b> after the TNC finished transmission.</li> </ol>	<p data-bbox="1445 118 1477 141">8</p> <p data-bbox="1445 208 1477 230">29</p> <p data-bbox="1445 320 1477 342">—</p>
The Commander fails to display the status of the HF transceiver.	<ol style="list-style-type: none"> <li data-bbox="432 387 871 465"><b>1</b> You did not correctly program call signs on the Commander and Transporter.</li> <li data-bbox="432 477 871 555"><b>2</b> You did not select the correct communication parameters on the HF transceiver.</li> <li data-bbox="432 566 871 639"><b>3</b> You selected communications speed other than 9600 bps in Menu 1–9–5 (COM PORT).</li> </ol>	<ol style="list-style-type: none"> <li data-bbox="887 387 1414 465"><b>1</b> On both the Commander and Transporter, access Menu 4–1 and 4–2 to program the correct call signs.</li> <li data-bbox="887 477 1414 533"><b>2</b> On the HF transceiver, select 9600 bps and 1 stop bit using the Menu Setup function.</li> <li data-bbox="887 566 1414 589"><b>3</b> Access Menu 1–9–5 to select “9600 bps”.</li> </ol>	<p data-bbox="1445 387 1477 409">79</p> <p data-bbox="1445 477 1477 499">78</p> <p data-bbox="1445 566 1477 589">25</p>
You cannot transmit audio from the HF transceiver.	You did not select the same tone frequency on the Commander and Transporter.	On both the Commander and Transporter, access Menu 4–3 to select the same tone frequency.	79
Operating the Commander simply causes it to output an error beep and does not allow you to control the HF transceiver.	<ol style="list-style-type: none"> <li data-bbox="432 740 871 846"><b>1</b> Too large distance between the Commander and Transporter prevents correct data communications.</li> <li data-bbox="432 857 871 936"><b>2</b> Bad radio wave conditions prevent control commands from being correctly transmitted.</li> </ol>	<ol style="list-style-type: none"> <li data-bbox="887 740 1414 824"><b>1</b> Operate the Commander within a distance that allows the two transceivers to show a full-scale S-meter reading.</li> <li data-bbox="887 857 1414 913"><b>2</b> Press <b>[SYNC]</b> occasionally to read the status of the HF transceiver.</li> </ol>	<p data-bbox="1445 740 1477 762">—</p> <p data-bbox="1445 857 1477 880">80</p>
You cannot hear audio received by the HF transceiver.	You switched ON the CTCSS on the 144 MHz band of the Commander.	Press <b>[TONE]</b> to switch OFF the CTCSS.	55

## SPECIFICATIONS

Specifications are subject to change without notice due to advancements in technology.

General		VHF Band	UHF Band
Frequency range	U.S.A./ Canada <sup>1</sup>	144 ~ 148 MHz	438 ~ 450 MHz
	Europe	144 ~ 146 MHz	430 ~ 440 MHz
	General market	144 ~ 146 MHz	430 ~ 440 MHz
Mode		F3E (FM), F1D (GMSK), F2D (FSK)	
Antenna impedance		50 Ω	
Usable temperature range		-20°C ~ +60°C (-4°F ~ +140°F)	
Power supply		13.8 V DC ±15% (11.7 ~ 15.8 V)	
Grounding method		Negative ground	
Current	Transmit (max.)	11.5 A or less	10.0 A or less
	Receive (at 2 W output)	1.0 A or less	
Frequency stability (-10°C ~ +50°C)		Within ±3 ppm	
Dimensions (W x H x D projections not included)	Front panel	140 x 60 x 33 mm/ 5.51" x 2.36" x 1.30"	
	Main unit	140 x 40 x 195 mm/ 5.51" x 1.57" x 7.68"	
Weight	Front panel	Approx. 180 g/ 6.3 oz	
	Main unit	Approx. 1.2 kg/ 2.6 lb	

<sup>1</sup> Band A receive range: 136 ~ 200 MHz, 118 ~ 136 MHz (sub), 200 ~ 300 MHz (sub), 300 ~ 400 MHz (sub), 400 ~ 470 MHz (sub)

Band B receive range: 400 ~ 524 MHz, 136 ~ 175 MHz (sub), 300 ~ 400 MHz (sub), 800 ~ 1300 MHz (sub/ excluding specific frequency ranges)



Transmitter		VHF Band	UHF Band
Power output	High	50 W	35 W
	Medium	Approx. 10 W	
	Low	Approx. 5 W	
Modulation		Reactance	
Spurious emissions		-60 dB or less	
Maximum frequency deviation		±5 kHz	
Audio distortion (at 60% modulation)		3% or less	
Microphone impedance		600 Ω	

Receiver		VHF Band	UHF Band
Circuitry		Double conversion superheterodyne	
Intermediate frequency (1st/ 2nd)		38.85 MHz/ 450 kHz	45.05 MHz/ 455 kHz
Sensitivity (12 dB SINAD)	VHF or UHF band	0.16 μV or less	
	Sub VHF or UHF band	0.25 μV or less	
Selectivity (-6 dB)		12 kHz or more	
Selectivity (-40 dB)		28 kHz or less	
Squelch sensitivity		0.1 μV or less	
Audio output (8 ohms, 5% distortion)		2 W or higher	
Audio output impedance		8 Ω	

**Note:** Receiver specifications apply only when using the main VHF or UHF band. They do not apply to the sub VHF or UHF band.

# INDEX

Advanced Intercept Point (AIP) .....	69	Frequencies, Selecting		Offset		MHz .....	53
Automatic Band Change (A. B. C.) .....	66	Microphone [UP]/ [DOWN] ..	20	Automatic Repeater .....	31	Program .....	52
Automatic Power Off (APO) .....	70	Tuning Control .....	20	Direction .....	29	Time-Operated Resume ..	49
Automatic Simplex Check (ASC) .....	33	Frequency Step Size .....	64	Frequency .....	29	VFO .....	50
Autopatch .....	59	Fuses, Replacing .....	7	Power-ON Message .....	71	Visual .....	47
Channel Display .....	40	Keypad Direct Entry		Programmable Function		Sky Command II .....	76
Continuous Tone Coded Squelch System (CTCSS)		CTCSS Freq. Number .....	56	(PF) Keys .....	62	Speaker	
Freq. ID .....	56	Frequency .....	63	Programmable Memory (PM)		Configurations, changing ..	72
Using .....	55	Memory Channel		Auto Storing .....	45	Mute .....	72
Digital Code Squelch (DCS)		Number .....	37	Recalling .....	44	Squelch	
Code ID .....	58	Tone Freq. Number .....	30	Resetting .....	45	Adjusting .....	20
Using .....	57	Lock		Storing .....	44	S-meter .....	68
Display		All-control Lock .....	67	Programmable VFO .....	64	Switching FM/AM .....	69
Blanking .....	66	Transceiver Lock .....	67	Repeater Access .....	28	Time-Out Timer (TOT) .....	70
Contrast .....	65	Memory Channels		Repeater Function		Tone	
Demonstration .....	71	Call Channel, Changing ....	39	Cross-band .....	82	Activating .....	30
Dimmer, Changing .....	65	Call Channel, Recalling ....	39	Locked-band .....	82	Freq. ID .....	34
Reversal .....	65	Clearing .....	37	Reset		Selecting .....	30
Dual Tone Multi-Frequency (DTMF) Functions		Locking Out .....	51	Full (Memory) .....	41	Transmit Output Power .....	21
Making Calls .....	59	Naming .....	38	Partial (VFO) .....	41	TX/RX Deviation .....	72
Pause Duration .....	61	Recalling .....	37	Programmable Memory		Voice Synthesizer (VS-3) .....	83
Storing Numbers .....	60	Storing, Odd-split .....	36	(PM) .....	45	Volume	
Transmitting Stored		Storing, Simplex .....	36	Reverse Function .....	33	Audio .....	19
Numbers .....	61	Transfer to VFO .....	40	Scan		Beep .....	69
TX Speed .....	61	Menu		Call/Memory .....	54	Wireless Remote Control .....	74
		Access .....	22	Call/VFO .....	54		
		Configuration .....	23	Carrier-Operated			
		Microphone Control .....	73	Resume .....	49		
				Group .....	51		
				Memory .....	50		

KENWOOD