

PHILCO



SERVICE

WORLD-WIDE WITH THE ARMED FORCES

PHILCO TRAINING MANUAL for

RADIO TRANSMITTING SETS

AN/ART-13 A

AN/ART-13

NAVY MODELS

ATC

ATC-1

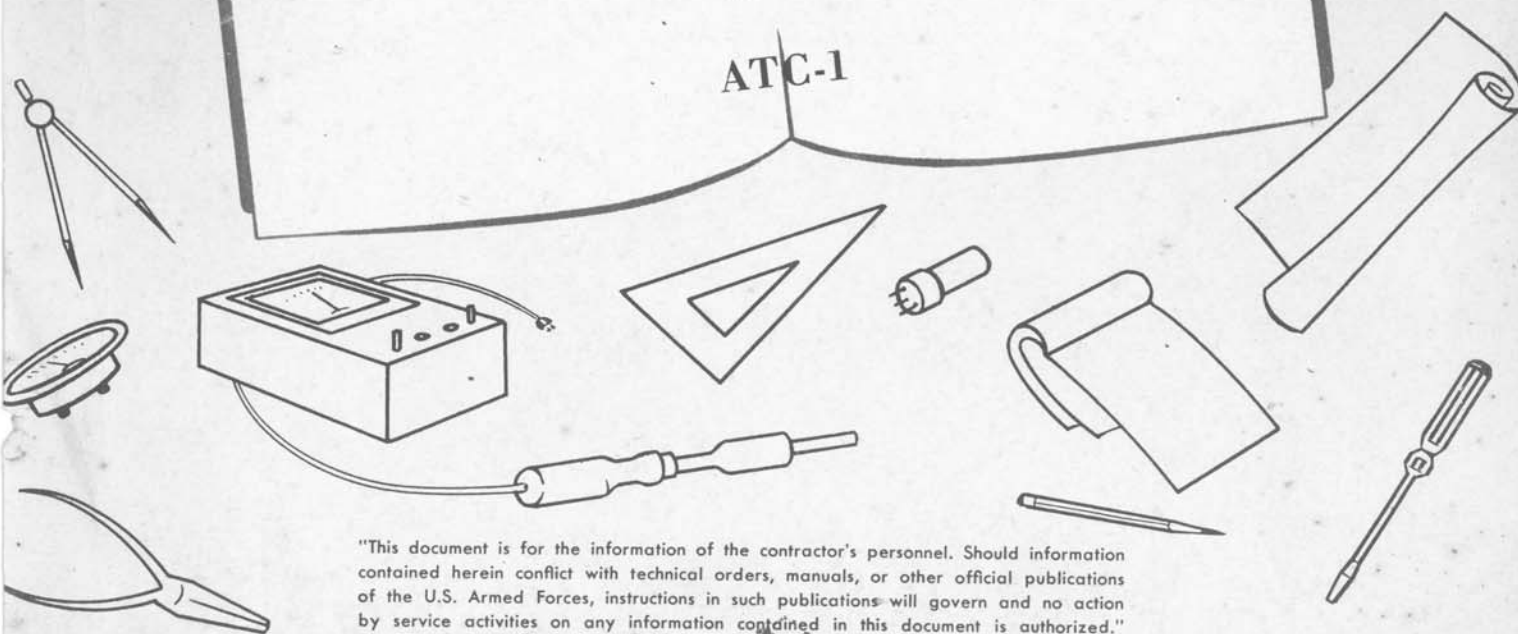

"This document is for the information of the contractor's personnel. Should information contained herein conflict with technical orders, manuals, or other official publications of the U.S. Armed Forces, instructions in such publications will govern and no action by service activities on any information contained in this document is authorized."

COURSE OUTLINE

<i>SUBJECT</i>	<i>TIME ALLOTTED (HRS.)</i>	<i>PAGE</i>
Lecture 1, Introductory Information	1/4	5
Lecture 2, General Description	1 3/4	6
Experiment No. 1, Physical Identification	1	19
Lecture 3, Functional Block Analysis	1	19
Experiment No. 2, Major Test Points	1	21
Lecture 4, Circuit Analysis of the Low-Frequency Oscillator	3/4	22
Experiment No. 3, Tuning, Alignment, and Trouble Shooting of the Low-Frequency Oscillator	1 1/2	25
Lecture 5, Circuit Analysis of the High-Frequency Oscillator	3/4	27
Experiment No. 4, Tuning, Alignment, and Trouble Shooting of the High-Frequency Oscillator	1 1/2	29
Lecture 6, Circuit Analysis of the Frequency-Multiplier Circuits	1 1/4	31
Experiment No. 5, Alignment and Trouble Shooting of the Multiplier Unit	1	34
Lecture 7, Circuit Analysis of the Power-Amplifier and High-Frequency Output Circuits	1 1/2	36
Experiment No. 6, Tuning, Adjustment, and Trouble Shooting of the Power-Amplifier and High-Frequency Output Circuits	2	40
Lecture 8, Circuit Analysis of the Low-Frequency Output Circuits	1/2	43
Experiment No. 7, Tuning and Trouble Shooting of the Low-Frequency Output Circuits	1	45
Lecture 9, Circuit Analysis of the Audio-Amplifier Circuits	3/4	46
Experiment No. 8, Trouble Shooting of the Audio-Amplifier Unit	1	49
Lecture 10, Circuit Analysis of the Modulator	1/4	50
Experiment No. 9, Trouble Shooting of the Modulator Circuits	3/4	51
Lecture 11, Circuit Analysis of the MCW-CFI Circuits	1 1/4	52
Experiment No. 10, Adjustment, Alignment, and Trouble Shooting of the MCW-CFI Unit	1	57
Review No. 1	4	58

COURSE OUTLINE (Cont.)

<i>SUBJECT</i>	<i>TIME ALLOTTED (HRS.)</i>	<i>PAGE</i>
Examination No. 1	2	59
Examination No. 1 Review	1	60
Lecture 12, Circuit Analysis of the Power-Supply and D-C Metering Circuits	1	60
Experiment No. 11, Power-Supply and D-C Metering Circuits	$\frac{3}{4}$	63
Lecture 13, Analysis of the Power-Control Circuits	2	64
Experiment No. 12, Power-Control Circuits	1	68
Lecture 14, Analysis of the Emission-Selection Circuits	$\frac{1}{2}$	69
Experiment No. 13, Emission-Selection Circuits	$\frac{3}{4}$	71
Lecture 15, Analysis of the Frequency-Band-Selection Circuits	$\frac{3}{4}$	72
Experiment No. 14, Frequency-Band-Selection Circuits	$\frac{3}{4}$	73
Lecture 16, Analysis of the Keying and Disabling Circuits	$\frac{3}{4}$	74
Experiment No. 15, Keying and Disabling Circuits	$\frac{1}{2}$	76
Lecture 17, Analysis of the Autotune System	4	77
Experiment No. 16, The Autotune System	4	83
Lecture 18, Alignment and Adjustment	2	86
Experiment No. 17, Alignment and Adjustment	2	87
Lecture 19, Trouble Shooting	4	87
Experiment No. 18, Trouble Shooting	4	102
Lecture 20, Preventive Maintenance	$\frac{1}{4}$	102
Experiment No. 19, Preventive Maintenance	$\frac{3}{4}$	103
Lecture 21, Special Information	$\frac{1}{4}$	103
Review No. 2	4	104
Final Review	3	104
Final Examination	6	104
Final-Examination Review	2	105
Total	$73\frac{3}{4}$	

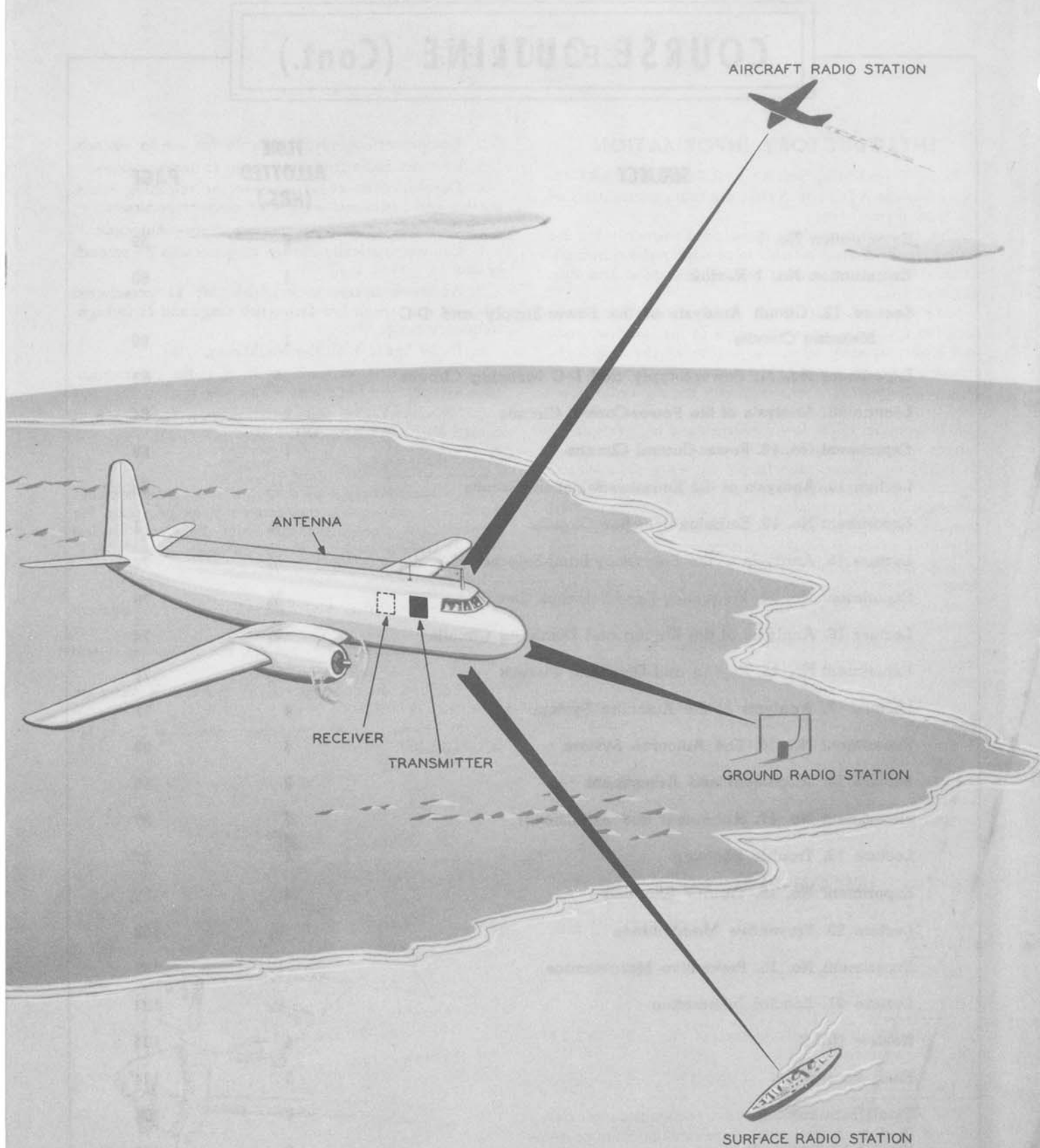

Figure 1. Application of Radio Transmitting Set AN/ART-13A or AN/ART-13 (Navy Model ATC-1 or ATC)

LECTURE 1

INTRODUCTORY INFORMATION

Radio Transmitting Sets AN/ART-13A, AN/ART-13, Navy Models ATC, and ATC-1 are radio transmitters of the same general type.

This type of transmitter is intended primarily for use in military and naval aircraft to provide radio communications with other aircraft and with ground and ship radio stations.

Most types of military and naval aircraft must have facilities for radio communications in the low-frequency and high-frequency ranges as well as in the very-high-frequency range. Prior to the use of the AN/ART-13 type of equipment, it was necessary for the radio operator to re-tune the transmitter to the various transmission frequencies in the low-frequency and high-frequency ranges, or to make use of several transmitters, each tuned to a different transmission frequency. To avoid both the loss of time in re-tuning transmitters and the additional weight of extra transmitters, the AN/ART-13 type of transmitting equipment was developed. Its basic advantage over previous types of aircraft radio transmitters is its provision for automatically changing transmission frequency, in 25 seconds or less under normal conditions, by use of an automatic mechanism known as the Autotune. Autotune operation is available for 11 preselected frequencies, one of which may be in the low-frequency range and the other 10 in the high-frequency range.

The application of this equipment is that of a transmitter in a radio communications system in which one terminal is located in an aircraft. Figure 1 illustrates such a system. When Radio Transmitting Set AN/ART-13A is installed in an aircraft with Radio Receiver BC-348 and other associated equipment, the complete equipment is named Radio Set AN/ARC-8.

2. Equipment intended primarily for use in aircraft.
3. Provides radio communications to other stations.
4. Developed to avoid necessity of re-tuning transmitters and additional weight of extra transmitters.
5. Basic advantage over previous types—Autotune.
6. Can automatically change frequency in 25 seconds or less.
7. Autotune operation available for 11 preselected frequencies—one in low-frequency range and 10 in high-frequency range.
8. Draw figure 1 on the blackboard.
9. Application—transmitter in a radio communications system.
10. AN/ART-13A with Radio Receiver BC-348 is named Radio Set AN/ARC-8.

CONCLUSIONS

The basic advantage of this equipment over previous types of aircraft radio transmitters is its provision for automatically changing transmission frequency in less than 25 seconds under normal conditions.

ORAL QUIZ

1. Why was the AN/ART-13 type of equipment developed?
2. In what length of time can the Autotune system change transmission frequency?
3. For how many preselected frequencies is Autotune operation available?
4. What two major components make up Radio Set AN/ARC-8?

LESSON PLAN No. 1

TIME ALLOTTED: ¼ HR.

SUBJECT

Introductory information.

OBJECTIVE

To provide an over-all picture of the AN/ART-13 type of equipment.

INTRODUCTION

The AN/ART-13 type of radio transmitter was developed to eliminate a serious disadvantage common to most types of airborne radio transmitters.

SUBJECT MATERIAL

1. Radio Transmitting Sets AN/ART-13A, AN/ART-13, Navy Models ATC, and ATC-1 are radio transmitters of the same general type.

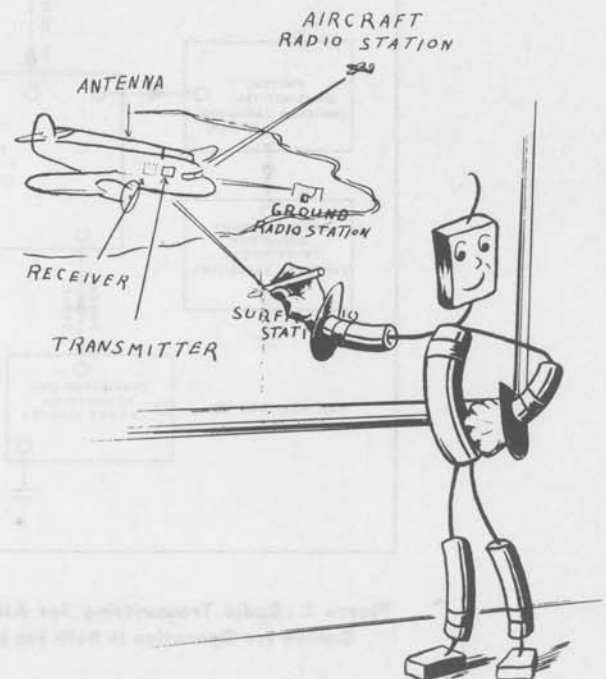

LECTURE 2

GENERAL DESCRIPTION

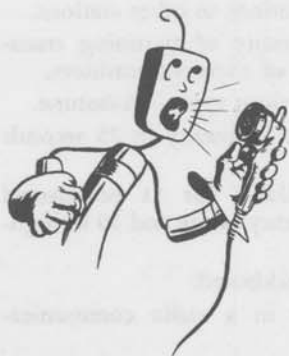

The AN/ART-13 type of equipment is capable of amplitude-modulated transmission by voice, modulated-continuous-wave telegraphy (MCW), and continuous-wave telegraphy (CW), with a nominal carrier output of 100 watts. The frequency range of Radio Transmitting Set AN/ART-13A is 200 kc. to 600 kc., and 2.0 mc. to 18.1 mc. The

frequency range of Radio Transmitting Set AN/ART-13 and Navy Models ATC and ATC-1 is 200 kc. to 1500 kc., and 2.0 mc. to 18.1 mc. The r-f power delivered to normal aircraft antennas varies considerably over these frequency ranges. To prevent arcing from points of high r-f potential at altitudes of 25,000 to 40,000 feet, the power output is automatically reduced to approximately one half of the full value when the aircraft in which this equipment is installed reaches an altitude of 20,000 to 25,000 feet.

The total weight of Radio Transmitting Set AN/ART-

13A, AN/ART-13, Navy Model ATC, or ATC-1 installed in an aircraft is approximately 150 pounds.

Radio Transmitting Set AN/ART-13A consists of the following seven major physical units:

<i>Official Nomenclature</i>	<i>Functional Title</i>
Radio Transmitter T-47A/ART-13	Transmitter
Dynamotor Unit DY-17/ART-13A	Power Supply
Control Unit C-87/ART-13	Pilot's Control Box
Antenna Loading Unit CU-32/ART-13A	Loading Coil
Antenna Shunt Capacitor CU-24/ART-13	Antenna Capacitor
Switch SA-46/ART-13A	Antenna Capacitor Switch
Switch SA-13/U	Antenna Change-over Switch

A block diagram of the units, cabled for operation in both the high-frequency and low-frequency bands, is shown in figure 2. Figure 3 shows the units cabled for operation in the high-frequency band, only.

Radio Transmitting Set AN/ART-13 consists of the following eight major physical units:

Radio Transmitter T-47/ART-13	Transmitter
Dynamotor Unit DY-11/ART-13, DY-12/ART-13, DY-12A/ART-13, or DY-17/ART-13	Power Supply
Control Unit C-87/ART-13	Pilot's Control Box
Antenna Loading Coil CU-25/ART-13 or CU-26/ART-13	Loading Coil

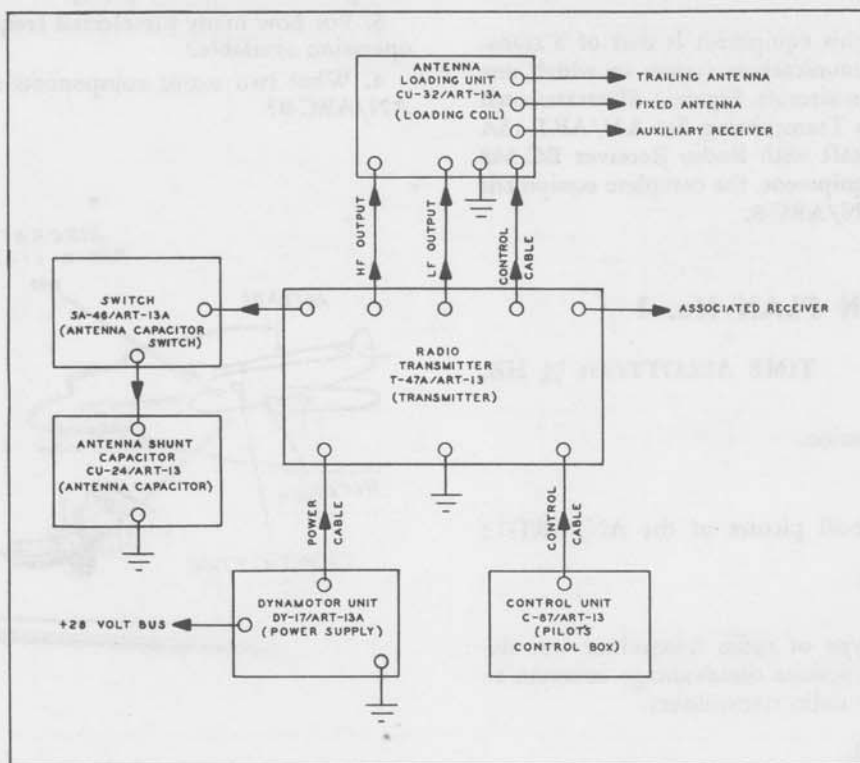

Figure 2. Radio Transmitting Set AN/ART-13A, Block Diagram of Physical Units Cabled for Operation in Both the High-Frequency and Low-Frequency Bands

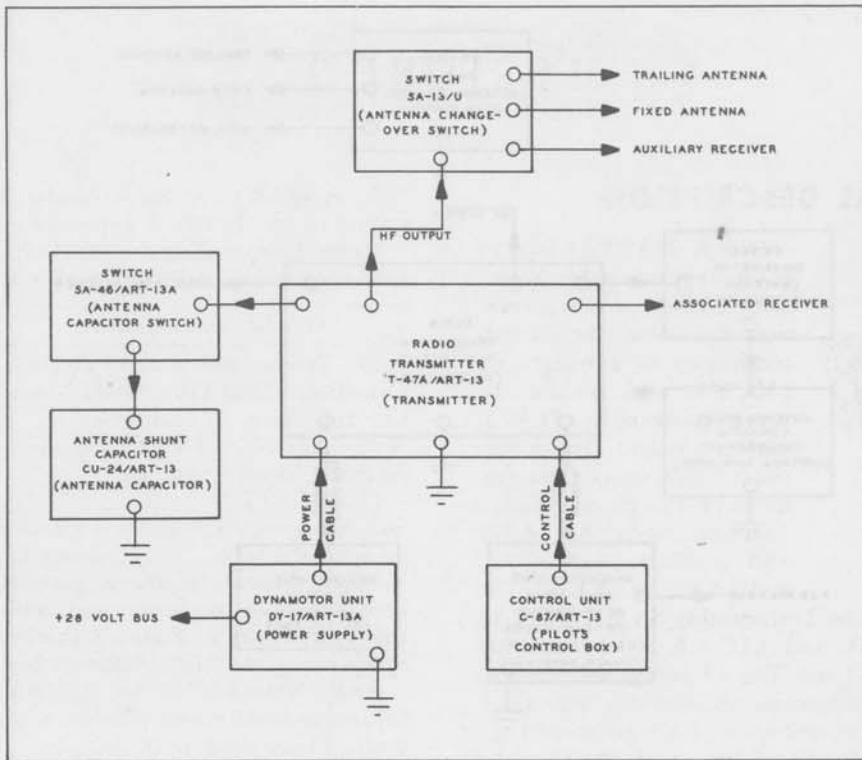

Figure 3. Radio Transmitting Set AN/ART-13A, Block Diagram of Physical Units Cabled for Operation in the High-Frequency Band Only

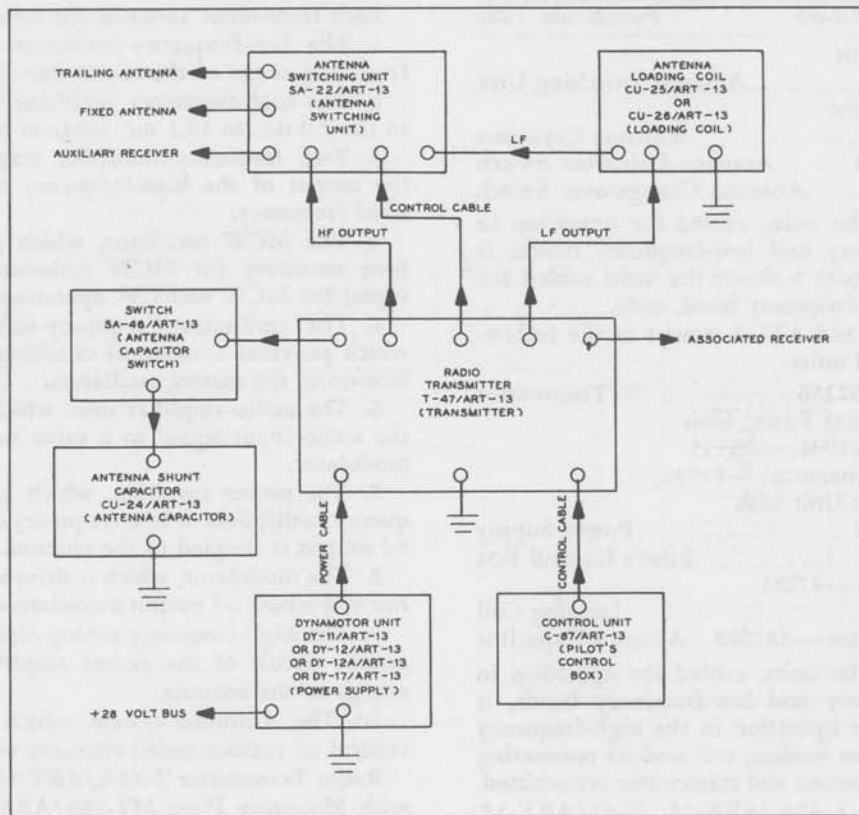

Figure 4. Radio Transmitting Set AN/ART-13, Block Diagram of Physical Units Cabled for Operation in Both the High-Frequency and Low-Frequency Bands

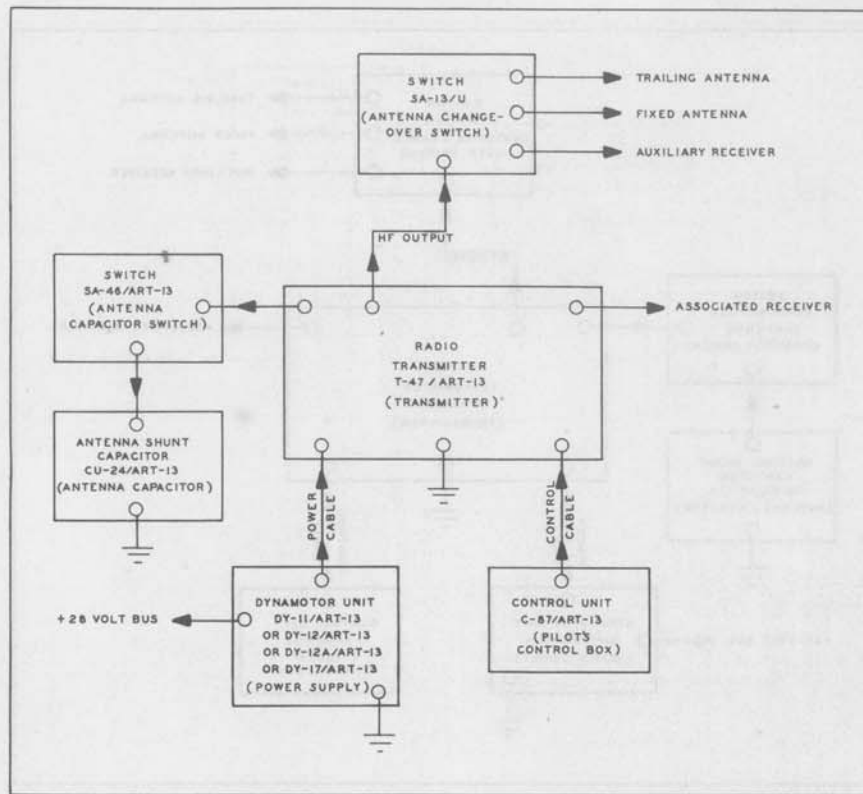

Figure 5. Radio Transmitting Set AN/ART-13, Block Diagram of Physical Units Cabled for Operation in the High-Frequency Band Only

Official Nomenclature	Functional Title
Antenna Switching Unit SA-22/ART-13	Antenna Switching Unit
Antenna Shunt Capacitor CU-24/ART-13	Antenna Capacitor
Switch SA-46/ART-13	Antenna Capacitor Switch
Switch SA-13/U	Antenna Change-over Switch

A block diagram of the units, cabled for operation in both the high-frequency and low-frequency bands, is shown in figure 4. Figure 5 shows the units cabled for operation in the high-frequency band, only.

Navy Models ATC and ATC-1 consist of the following five major physical units:

Radio Transmitter —52286	Transmitter
Dynamotor Unit —23333 with Dynamotor —21931, —23333 Power Unit with Dynamotor —21932, or —23333-A Power Unit with Dynamotor —21932	Power Supply
Control Unit —23330	Pilot's Control Box
Antenna Loading Coil —47281 or —47282	Loading Coil
Antenna Shunt Capacitor —481628	Antenna Capacitor

A block diagram of the units, cabled for operation in both the high-frequency and low-frequency bands, is shown in figure 6. For operation in the high-frequency band, only, the antenna loading coil and its connecting wires to the trailing antenna and transmitter are omitted.

Radio Transmitter T-47A/ART-13, T-47/ART-13, or —52286 (unmounted and with all cables and plugs removed) is 23⁵/₈" long, 11⁵/₈" high, and 15¹/₈" deep, over-all. The external appearance of these transmitters is shown in figures 7 and 8.

Each transmitter contains the following:

1. The low-frequency oscillator, which extends the frequency range of the transmitter below 2.0 mc.
2. The high-frequency oscillator, from which output in the 2.0 mc. to 18.1 mc. range is derived.
3. Two frequency-multiplier stages, which multiply the output of the high-frequency oscillator to the desired frequency.
4. The MCW oscillator, which generates the audio tone necessary for MCW emission, and the sidetone signal for MCW and CW operation.
5. The calibration-frequency-indicator (CFI) unit, which provides a means of checking the frequency calibration of the master oscillators.
6. The audio-amplifier unit, which raises the level of the audio input signal to a value sufficient to drive the modulator.
7. The power amplifier, which is driven by the frequency multipliers or low-frequency oscillator, and whose r-f output is coupled to the antenna.
8. The modulator, which is driven by the audio amplifier and whose a-f output modulates the power amplifier.
9. The high-frequency tuning circuits, which tune the output circuit of the power amplifier, and couple r-f energy to the antenna.
10. The Autotune system, which provides automatic control of various tuned elements of the transmitter.

Radio Transmitter T-47A/ART-13 is usually equipped with Mounting Plate MT-283/ART-13, which rests on Mounting Base MT-284/ART-13. The mounting plate is attached to the underside of the transmitter, and the mounting base is installed in the aircraft at the desired location. The transmitter is mounted by setting it on the

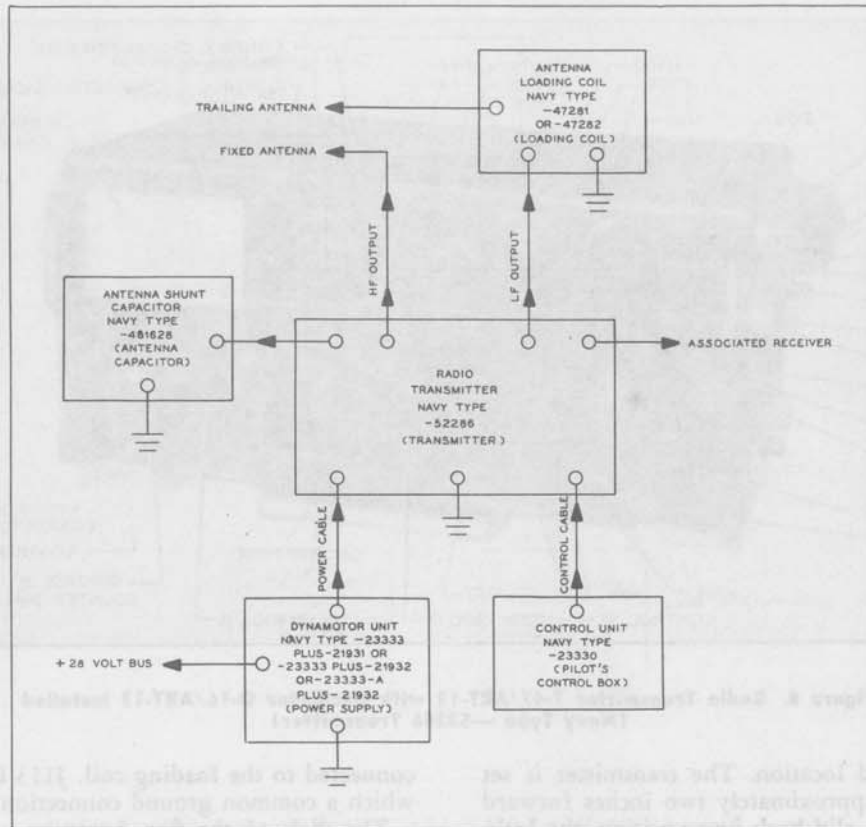

Figure 6. Radio Transmitting Set Navy Model ATC or ATC-1, Block Diagram of Physical Units Cabled for Operation in Both the High-Frequency and Low-Frequency Bands. For Operation in the High-Frequency Band Only, the Antenna Loading Coil is Omitted

mounting base with the channels engaged, sliding it backwards to engage the holding pins, tightening the locking knobs on the front of the base, and using safety wire to lock the knobs in position.

Radio Transmitter T-47/ART-13 is usually equipped with two channel shock mounts and a perforated metal tray, which rest on two Mounting Bases MT-161/ART-13. The mounting bases are installed in the

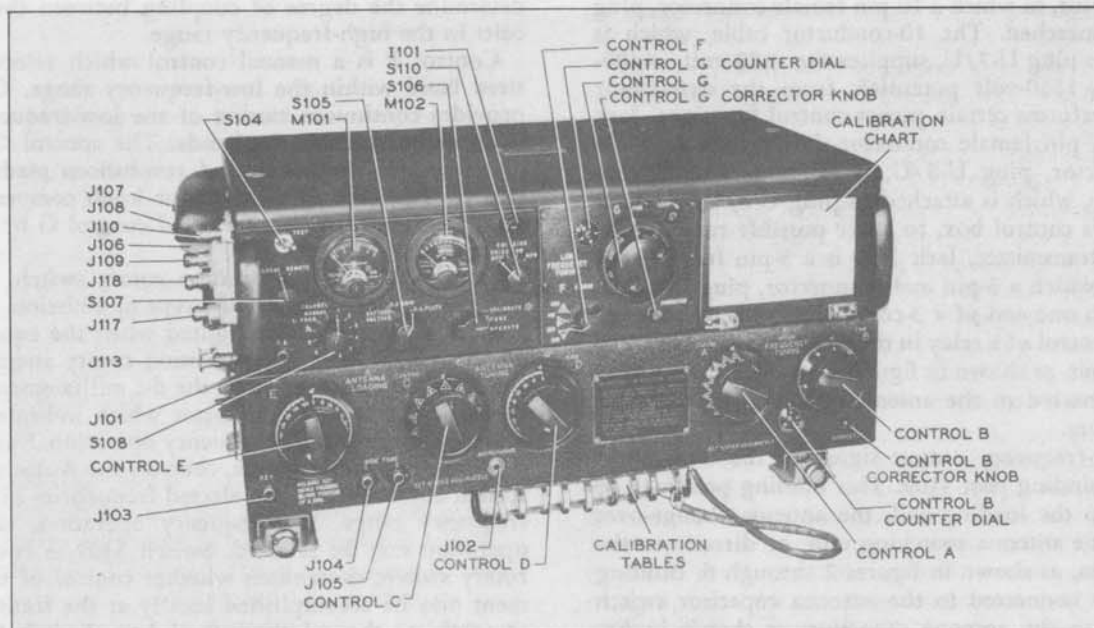

Figure 7. Radio Transmitter T-47A/ART-13 with Oscillator O-17/ART-13A Installed

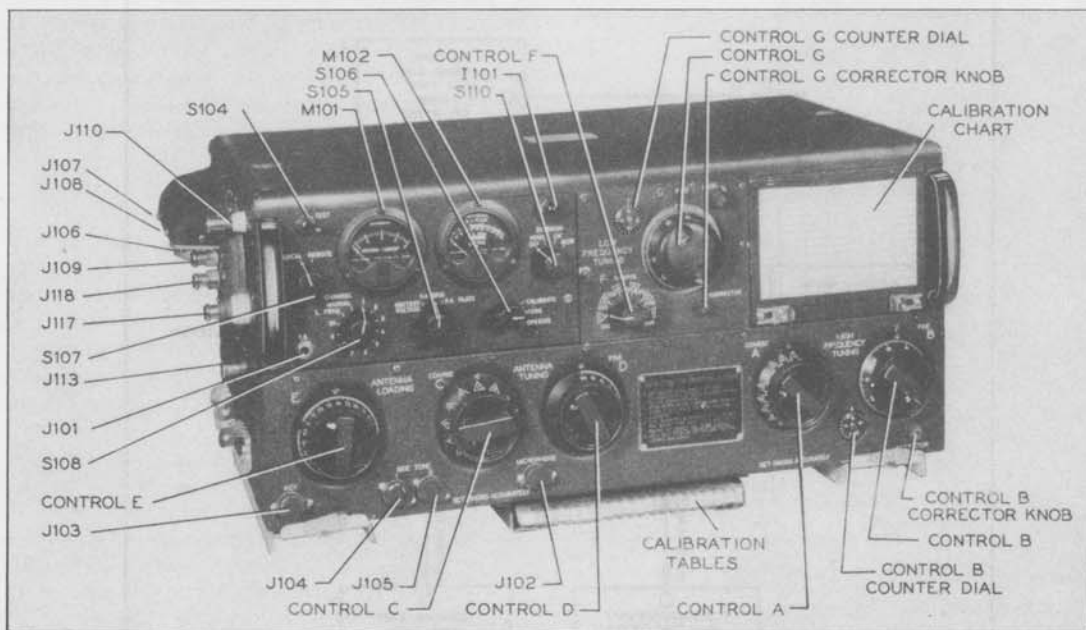

Figure 8. Radio Transmitter T-47/ART-13 with Oscillator O-16/ART-13 Installed (Navy Type —52286 Transmitter)

aircraft at the desired location. The transmitter is set on top of the bases approximately two inches forward of its proper position, slid back into position, the locking knobs on the front of the transmitter tightened, and the knobs fastened with safety wire. Navy Type —52286 Transmitter is equipped with the same type of mounting as Radio Transmitter T-47/ART-13.

The transmitter must be installed in a position which will permit the controls and dials to be easily reached and read in flight. For proper ventilation, a 5-inch air space must be allowed above the case, and a 2-inch air space behind and on each end of the case; the 1-inch spacing below the case must not be restricted.

As shown in figures 7 and 8, jack J108 is a 10-pin male connector, to which a 10-pin female connector, plug U-7/U, is attached. The 10-conductor cable, which is connected to plug U-7/U, supplies the +28-volt, +400-volt, and +1150-volt potentials from the dynamotor unit, and performs certain power-control functions. Jack J106 is a 27-pin female connector, into which a 27-pin male connector, plug U-8/U, is inserted. The 27-conductor cable, which is attached to plug U-8/U, connects to the pilot's control box, to make possible remote control of the transmitter. Jack J107 is a 3-pin female connector into which a 3-pin male connector, plug U-11/U, connected to one end of a 3-conductor cable, is plugged to permit control of a relay in the loading coil or antenna switching unit, as shown in figures 2 and 4. Binding post J110 is connected to the antenna terminal of the associated receiver.

The high-frequency output signal of the transmitter appears at binding post J109. This binding post may be connected to the loading coil, the antenna change-over switch, or the antenna switching unit, or directly to the fixed antenna, as shown in figures 2 through 6. Binding post J118 is connected to the antenna capacitor switch or directly to the antenna capacitor, as shown in figures 2 through 6. Binding post J117, at which the low-frequency output signal of the transmitter appears, is

connected to the loading coil. J113 is a binding post to which a common ground connection is made.

The dials of the five Autotune units are located on the front panel. Control A is a band switch that determines which one of the 12 bands in the high-frequency range will be used, or selects operation in the low-frequency range. Control B provides continuous tuning of the high-frequency oscillator and multipliers within each of the 12 high-frequency bands. The control B counter dial indicates the number of revolutions made by control B. The control B corrector knob compensates for small errors in the calibration of control B by mechanical means. Controls C, D, and E tune the output circuit of the power amplifier and antenna circuit, and determine the degree of coupling between the two circuits in the high-frequency range.

Control F is a manual control which selects the desired band within the low-frequency range. Control G provides continuous tuning of the low-frequency oscillator within each of its bands. The control G counter dial indicates the number of revolutions made by control G. The control G corrector knob compensates for small errors in the calibration of control G by mechanical means.

Switch S110, a four-position rotary switch, turns the equipment on and selects the type of emission. Indicator I101 is a lamp which is lighted when the equipment is on. Switch S106, a three-position rotary switch, selects the circuits to be metered by the d-c milliammeter, M102. Meter M101 is an r-f ammeter which indicates the antenna current for high-frequency operation. Switch S108, a 12-position rotary switch, controls the Autotune system so that any one of 10 preselected frequencies in the high-frequency range, low-frequency operation, or manual operation may be selected. Switch S107, a two-position rotary switch, determines whether control of the equipment may be accomplished locally at the transmitter or remotely at the pilot's control box. Switch S104 is a normally open toggle switch which keys the transmitter when operated.

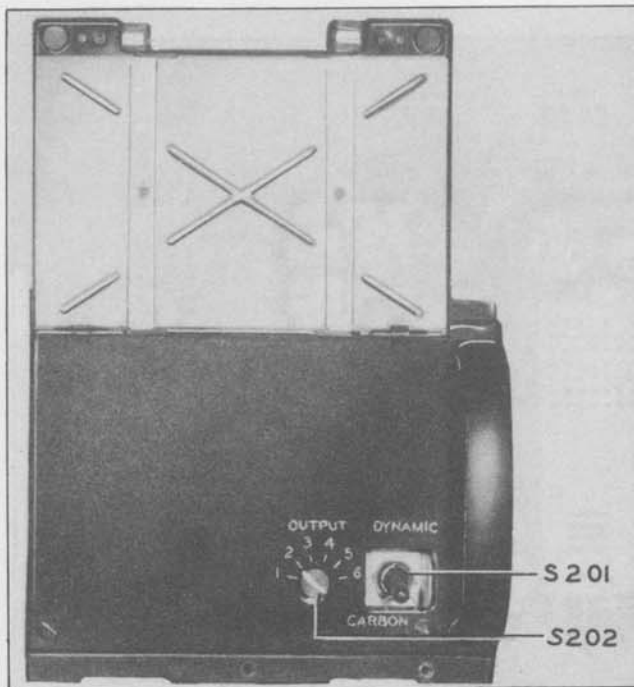

Figure 9. Microphone Selector Switch and Sidetone Output Switch

Jack J101 is a two-contact phone jack for the throttle-switch plug. Jack J103 is a two-contact phone jack for the telegraph-key plug. Jacks J104 and J105 are two-contact phone jacks into which headsets may be plugged for sidetone monitoring and frequency calibration. Jack J102 is a three-contact phone jack for the microphone plug.

As shown in figures 7, 8, and 9, the calibration chart is mounted on a hinged panel, which may be raised to provide access to switches S201 and S202. Switch S201 is a double-throw toggle switch for selecting the type of microphone which may be used. Switch S202, a six-position rotary switch, controls the level of the sidetone output signal.

The top cover of the transmitter is removed by loosening two screws, one located on each side, and lifting up the cover. Top views of the transmitter interior are shown in figures 10 and 11.

The transmitter contains three major assemblies that are equipped with multiterminal plugs to permit removal of the assemblies without unsoldering any connections. These assemblies are the low-frequency-oscillator, audio-amplifier, and MCW-CFI units, and are shown removed in figure 10.

The low-frequency oscillator may be freed from its mounting as follows: Remove the connector wire from the right side of the oscillator. Remove the seven panel screws, and loosen the top screws on the Autotune front-cover plate. Remove the JAN-813 power-amplifier tube, V104, from its socket. Insert a screwdriver through the ventilating holes in the back of the transmitter, and remove the screws that hold the back of the unit. Raise the rear edge of the low-frequency-oscillator unit to free the front panel from the Autotune cover plate, and lift the unit until the connector plug is free. Radio Transmitter T-47/ART-13 is equipped with Oscillator O-16/ART-13, which tunes the 200-kc. to 1500-kc. frequency range. Navy Type —52286 Transmitter is equipped with an identical low-frequency oscillator. Radio Transmitter T-47A/ART-13 is equipped with Oscillator O-17/ART-13A, which tunes from 200 kc. to 600 kc. A top view of this low-frequency oscillator, with the cover removed, is shown in figure 12.

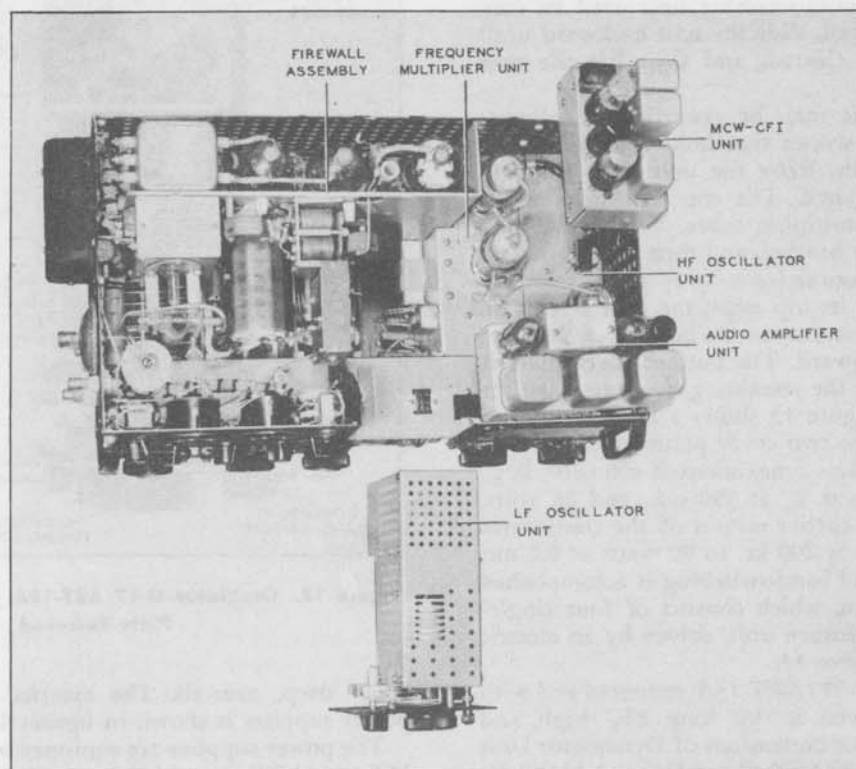

Figure 10. Removable Assemblies of AN/ART-13 Type Transmitter

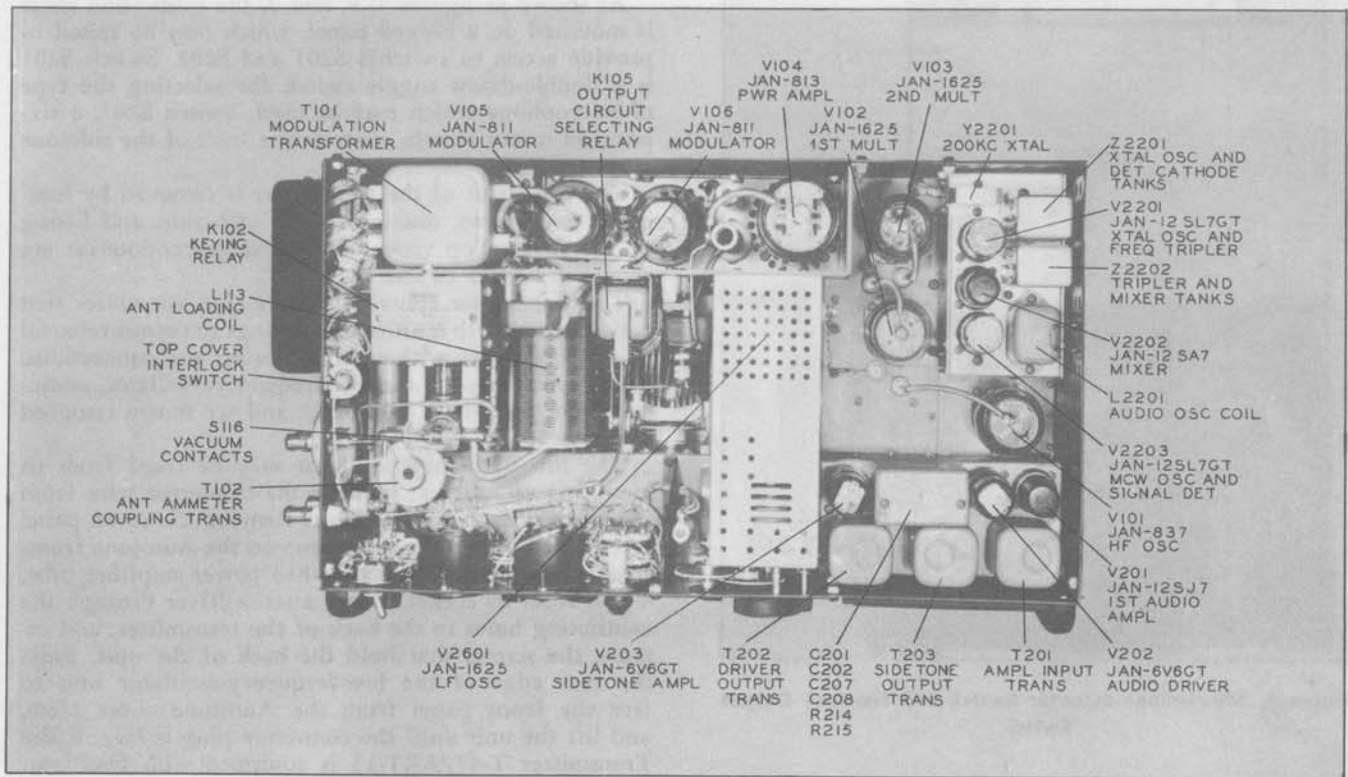

Figure 11. Radio Transmitter T-47A/ART-13, Top View, Showing Top-Cover Plate Removed

The audio-amplifier unit may be removed from the transmitter as follows: Loosen the two large screws that hold the unit to the main transmitter chassis. Remove the JAN-837 high-frequency-oscillator tube, V101, from its socket. Raise the audio-amplifier unit until its connector plug is disengaged, slide the unit backward until the cabinet studs are cleared, and then lift the unit upward.

The MCW-CFI unit may be removed as follows: Loosen the two large screws that hold the unit to the main transmitter chassis. Raise the unit until the connector plug is disengaged. Tilt the unit toward the JAN-1625 frequency multiplier tubes, V102 and V103, until it clears the cover bracket, and then lift it upward.

To remove the Autotune-front-cover plate, take out the eight screws along its top edge, the four screws on each side, and the five screws on the bottom of the case; then pull the plate forward. The bottom cover plate is removed by taking out the remaining five screws on the bottom of the case. Figure 13 shows a bottom view of the transmitter with the two cover plates removed.

The transmitter requires a maximum of 400 volts, d. c., at 400 ma., 1150 volts, d. c., at 350 ma., and 28 volts, d. c., at 10 amps. The carrier output of the transmitter varies from four watts at 200 kc. to 90 watts at 9.0 mc.

Automatic tuning and band-switching is accomplished by the Autotune system, which consists of four single-turn units and one multiturn unit, driven by an electric motor, as shown in figure 13.

Dynamotor Unit DY-17/ART-13A, mounted and with plugs and cables removed, is 7 $\frac{1}{8}$ " long, 8 $\frac{7}{8}$ " high, and 12 $\frac{3}{8}$ " deep, over-all. The dimensions of Dynamotor Unit DY-11/ART-13, DY-12/ART-13, or DY-12A/ART-13, or the corresponding Navy model, mounted and with plugs and cables removed, are 7 $\frac{1}{8}$ " long, 9" high, and

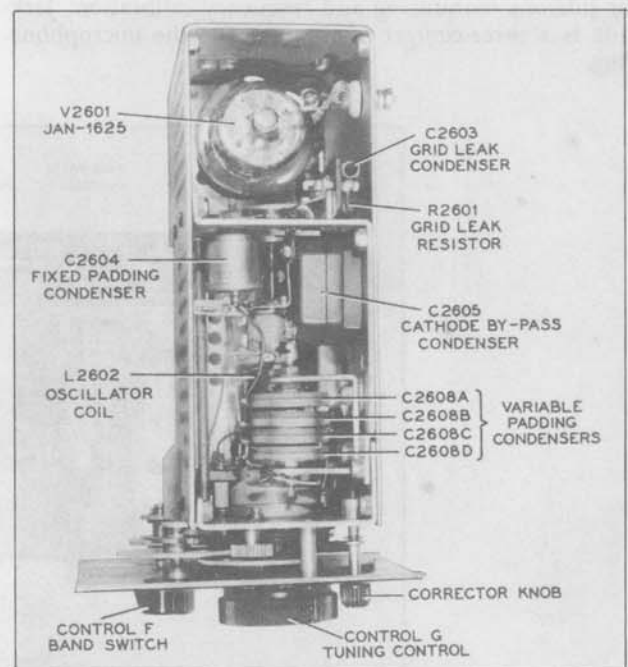

Figure 12. Oscillator O-17/ART-13A, Showing Top-Cover Plate Removed

12 $\frac{1}{2}$ " deep, over-all. The external appearance of the power supplies is shown in figures 14 and 15.

The power supplies are equipped with Mounting Plate MT-164/ART-13, which is mounted in the aircraft at the desired location. To mount the power supply, set it on the mounting plate, slide it backward until the

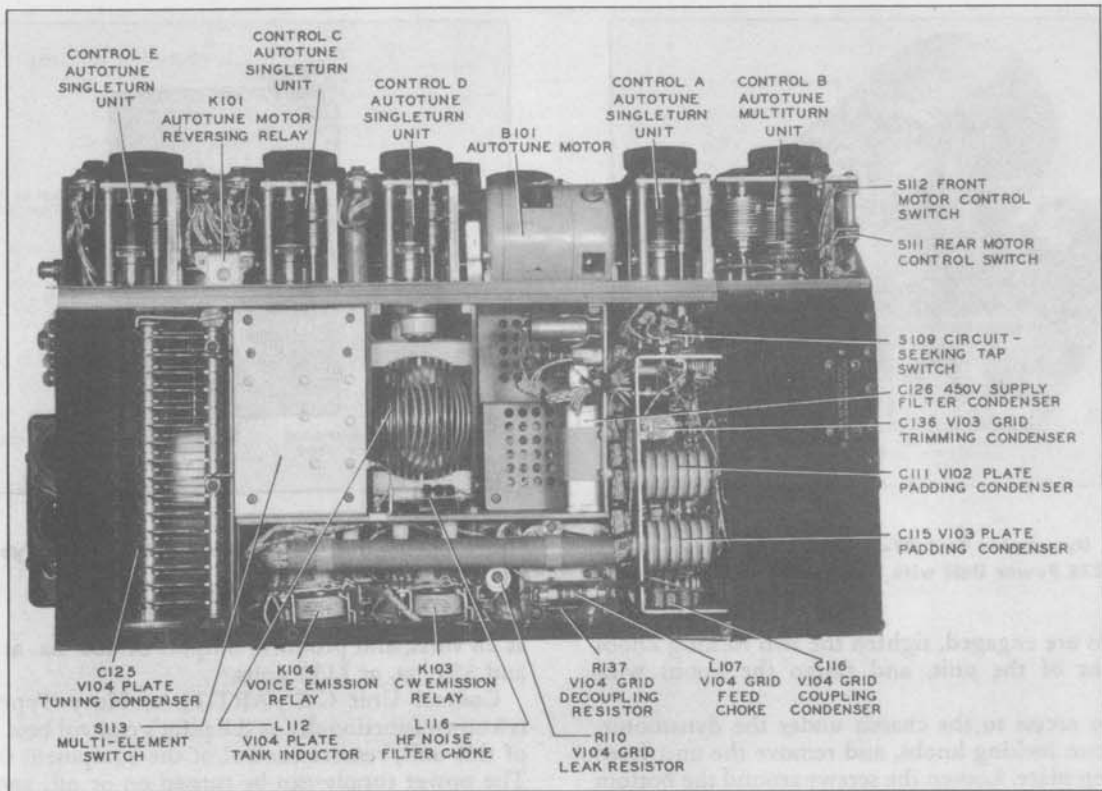

Figure 13. Radio Transmitter T-47A/ART-13, Showing Bottom-Cover Plate Removed

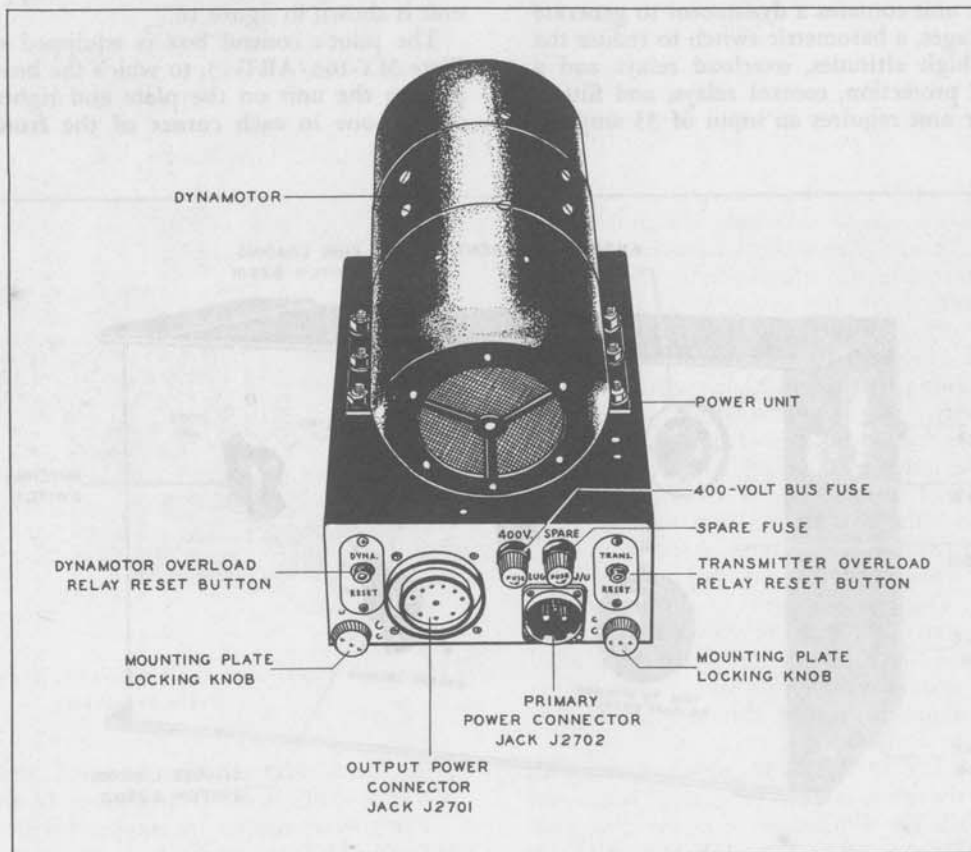

Figure 14. Dynamotor Unit DY-17/ART-13A

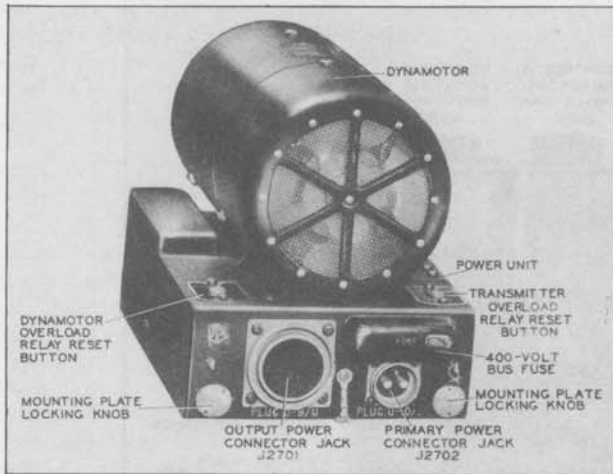

Figure 15. Dynamotor Unit DY-11/ART-13 or Navy Type —23333 Power Unit with Dynamotor —21931

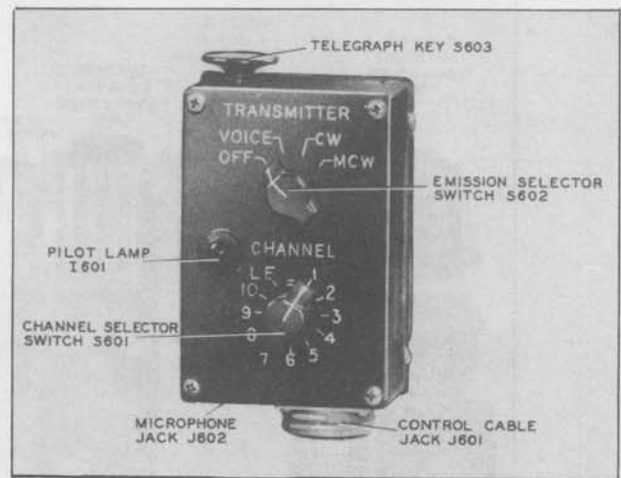

Figure 16. Control Unit C-87/ART-13 or Navy Type —23330

holding pins are engaged, tighten the two locking knobs on the front of the unit, and fasten the knobs with safety wire.

To obtain access to the chassis under the dynamotor, loosen the two locking knobs, and remove the unit from the mounting plate. Loosen the screws around the bottom rim of the chassis, and remove the bottom cover plate. To obtain access to the brushes and commutators of the dynamotor, remove the two end covers by loosening the three screws which are accessible on the rounded surface of the unit.

The dynamotor unit contains a dynamotor to generate the necessary voltages, a barometric switch to reduce the high voltage at high altitudes, overload relays and a fuse for overload protection, control relays, and filters.

The dynamotor unit requires an input of 33 amperes

at 28 volts, and produces outputs of 400 ma. at 400 volts and 350 ma. at 1150 volts.

Control Unit C-87/ART-13 or Navy Type —23330 is known functionally as the pilot's control box. By means of this unit, remote control of the equipment is possible. The power supply can be turned on or off, and the type of emission and any one of the 11 preset transmission frequencies can be selected.

The pilot's control box, mounted and with its plugs, cord, and cable removed, is 3 1/2" long, 6 5/32" high, and 3 5/16" deep, over-all. The external appearance of this unit is shown in figure 16.

The pilot's control box is equipped with Mounting Plate MT-163/ART-13, to which the box is mounted by placing the unit on the plate and tightening the four screws, one in each corner of the front panel. Space

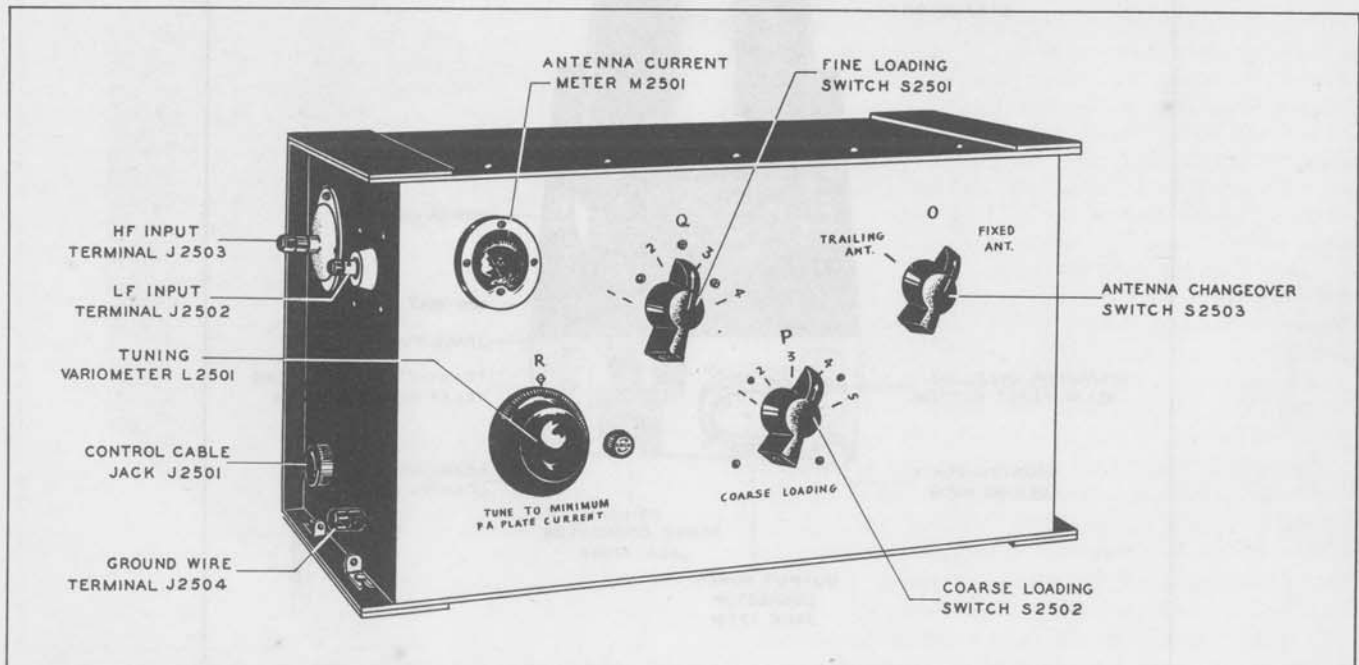

Figure 17. Antenna Loading Unit CU-32/ART-13A

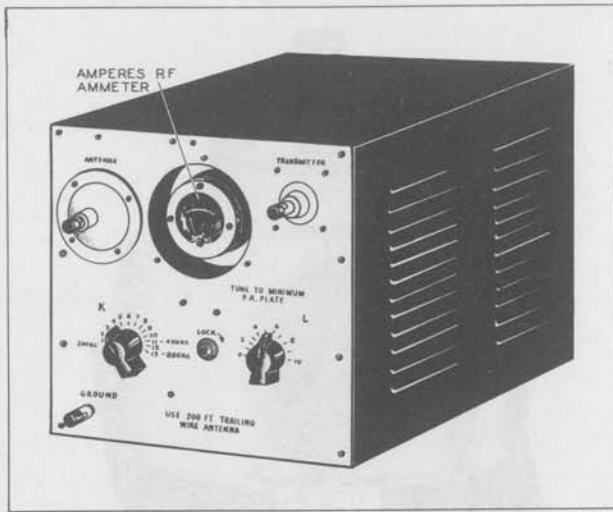

Figure 18. Antenna Loading Coil CU-25/ART-13 or Navy Type —47281

must be provided above the unit for operation of the telegraph key. The front-panel controls must be accessible. The back cover plate of the control box may be removed by taking out the two screws on each side of the case, near the rear mounting surface.

Antenna Loading Unit CU-32/ART-13A contains an antenna tuning network, an antenna-loading-circuit relay, and an antenna-selector switch. This network tunes either a fixed or trailing-wire antenna, 30 to 200 feet in length, throughout the 200-kc. to 600-kc. frequency range. The loading coil, unmounted and with all cables and plugs removed, is 24 $\frac{5}{8}$ " long, 12" high, and 13" deep, over-all. The unit is shown in figure 17.

Antenna Loading Unit CU-32/ART-13A is equipped with Mounting Plate MT-198/ART-13A. The loading coil is attached to the mounting plate, by means of snap slides, in any one of three positions—above, below, or in front of the plate, whichever is more practicable. The mounting plate is mounted in the aircraft by means of four $\frac{1}{4}$ " screws. The loading coil is placed in position on the mounting plate, and the four snap slides are closed and secured with tie wire. The leads to the fixed antenna, trailing antenna, and high-frequency input terminal must have at least $1\frac{1}{2}$ " clearance from metallic objects, and the lead to the low-frequency input terminal must have at least $\frac{3}{4}$ " clearance.

Located on the right side of the loading coil (not visible in figure 17) are the trailing-antenna jack, J2506, the fixed-antenna jack, J2507, and the auxiliary-receiver jack, J2505.

The cover plate may be removed from the loading coil by removing all of the screws along the top and back panel surface edges and lifting up the cover.

Antenna Loading Coil CU-25/ART-13 or Navy Type —47281 contains a tuning network which is capable of tuning a trailing antenna, 200 feet long, throughout the 200-kc. to 600-kc. frequency range, and fixed antennas in the upper portion of that frequency range. This loading coil, with all wires removed, is 10" long, 9 $\frac{3}{8}$ " high, and 11-11/16" deep, over-all. The unit is illustrated in figure 18.

To mount Antenna Loading Coil CU-25/ART-13, use the holes on either of the two sides, top, bottom, or rear

of the case. First, remove the front panel by taking out the panel screws and pulling the panel forward. Since all unit components are mounted to the front panel, this leaves the case free for mounting. A clearance of at least 11 $\frac{1}{8}$ " must be allowed in front of the mounted unit to permit removal of the unit from the case.

Antenna Loading Coil CU-26/ART-13 or Navy Type —47282 contains a tuning network capable of tuning a trailing antenna 150 feet long within the 1100-kc. to 1500-kc. frequency range, and 200 feet long to a minimum frequency of 500 kc. It will tune fixed antennas within a limited frequency range. This loading coil, unmounted and with all wires detached, is 4" long, 7" high, and 7 $\frac{3}{4}$ " deep, over-all. This unit is shown in figure 19.

Antenna Loading Coil CU-26/ART-13 is equipped with Mounting Plate MT-162/ART-13, which also serves as the left cover plate of the unit. To mount the unit, loosen the four captive screws on the right side of the unit, fasten the plate to the aircraft structure, and remount the unit on the mounting plate.

Antenna Switching Unit SA-22/ART-13 contains the antenna selector switch and the low-frequency relay which are required for use with Antenna Loading Coil CU-25/ART-13 or CU-26/ART-13. This switching unit, mounted and with all plugs and cables removed, is 13 $\frac{3}{4}$ " long, 9 $\frac{1}{2}$ " high, and 7 $\frac{1}{8}$ " deep, over-all. It is shown in figure 20.

The antenna switching unit is equipped with Mounting Plate FT-142, which is mounted in the aircraft at the desired location. The antenna switching unit is attached to the mounting by means of four snap slides. These slides are secured with safety wire.

Antenna Shunt Capacitor CU-24/ART-13 or Navy Type —481628 consists of three individual 25-mmf. ca-



Figure 19. Antenna Loading Coil CU-26/ART-13 or Navy Type —47282

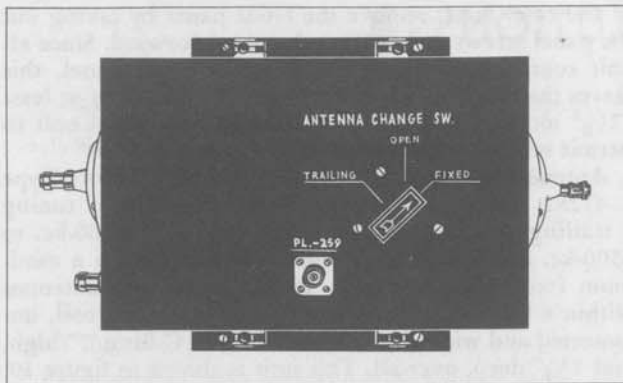

Figure 20. Antenna Switching Unit SA-22/ART-13

capacitors mounted on a plate, and is used when operating with a short fixed antenna in the 2.0-mc. to 3.0-mc. frequency range. The antenna condenser is 5" long, 4 $\frac{1}{8}$ " deep, and 4" high, over-all. It is shown in figure 21. There are four holes in the base plate for direct mounting to the aircraft structure.

Switch SA-46/ART-13 is a single-pole, single-throw knife switch with high stand-off insulators, and is used to connect the antenna capacitor to the transmitter, when needed. The switch is 6" long, 4" high, and 2" deep, over-all. There are eight holes in the base for direct mounting.

Switch SA-13/U is a double-pole, double-throw knife switch with high stand-off insulators, and is used for antenna change-over when the transmitter is cabled for high-frequency operation, only. It is 9 $\frac{1}{2}$ " long, 4" high, and 4 $\frac{3}{8}$ " deep, over-all. There are 12 holes in the base for direct mounting.

LESSON PLAN No. 2

TIME ALLOTTED: 1 $\frac{3}{4}$ HR.

SUBJECT

General description.

OBJECTIVE

To describe the AN/ART-13 type of equipment.

INTRODUCTION

The AN/ART-13 type of radio transmitter is a medium power equipment, capable of transmission in both the low-frequency and high-frequency bands by voice, MCW, and CW emission, using amplitude modulation.

SUBJECT MATERIAL

1. Nominal carrier-output power and frequency range.
2. Arc-over protection at high altitudes.
3. Total weight of equipment.
4. Draw figure 2 on the blackboard. Explain.
5. Modify to figure 3. Explain.
6. Modify to figure 4. Explain.
7. Modify to figure 5. Explain.
8. Modify to figure 6. Explain.
9. Place equipment to be studied in view of students.
10. For each physical unit, explain the following:
 - a. Official nomenclature and functional title.
 - b. Over-all dimensions.

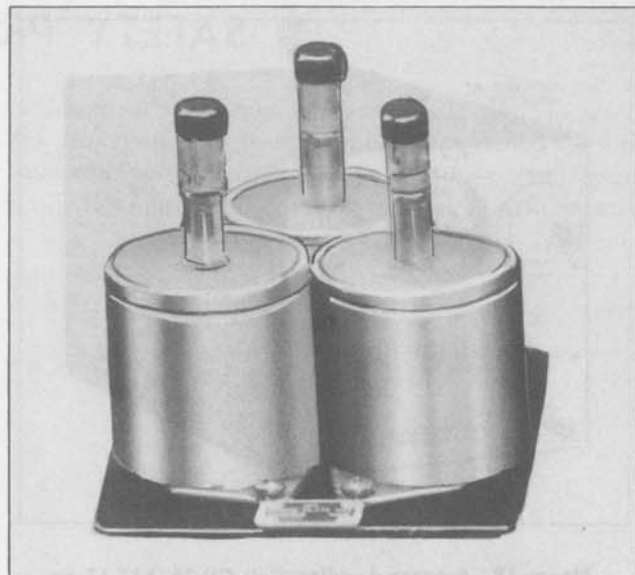

Figure 21. Antenna Shunt Capacitor CU-24/ART-13 or Navy Type -481628

- c. Installation and mounting details.
- d. Location and purpose of each socket, jack, and connector.
- e. Location and purpose of each control, switch, meter, and indicating lamp.
- f. Method of removing cover plates.
- g. Major-unit subassemblies and their functions.
- h. Location and purpose of each protective device.
- i. Input and output characteristics.
- j. Mechanical subassemblies.

CONCLUSIONS

A typical installation of the AN/ART-13 type equipment may consist of from five to eight major physical units, intercabled for operation in both the high-frequency and low-frequency bands or for operation in the high-frequency band, only.

ORAL QUIZ

1. What are the frequency ranges of the AN/ART-13A, AN/ART-13, ATC, and ATC-1?
2. By what means is arcing prevented at high altitudes?
3. What is the total weight of the equipment?
4. Give the functional titles of the five major physical units which are common to all models of this equipment.
5. How many Autotune units are there in the transmitter?
6. What three assemblies are readily removable from the transmitter?
7. What d-c voltages are required by the transmitter?
8. What are the upper and lower limits of carrier-output power over the frequency range?
9. What type of loading coil must be used for operation in the 600-kc. to 1500-kc. frequency range?
10. What are the two types of loading coils which may be used for operation in the 200-kc. to 600-kc. frequency range?
11. Under what conditions is the antenna capacitor used?

▶ SAFETY PRECAUTIONS ◀

It is the duty of all personnel engaged in the installation, operation, and maintenance of this equipment, or engaged in the training of other personnel on this equipment, to become familiar with the following safety precautions:

1. Do not rely on safety devices such as interlocks and high-voltage relays.
2. Use rubber gloves at all times.
3. Keep your feet clear of objects on the floor.
4. Stand on a good rubber mat.

5. Keep one hand behind you, or in your pocket.
6. Have another person, qualified in first aid for electrical shock, present at all times.
7. Use shorting stick (see illustration).
8. Use approved fuse pullers.

Remember that men are always injured or killed by high-voltage equipment which is assumed to be off. Take nothing for granted. Make certain that the power is off by securing the power-line switch in its OFF position.

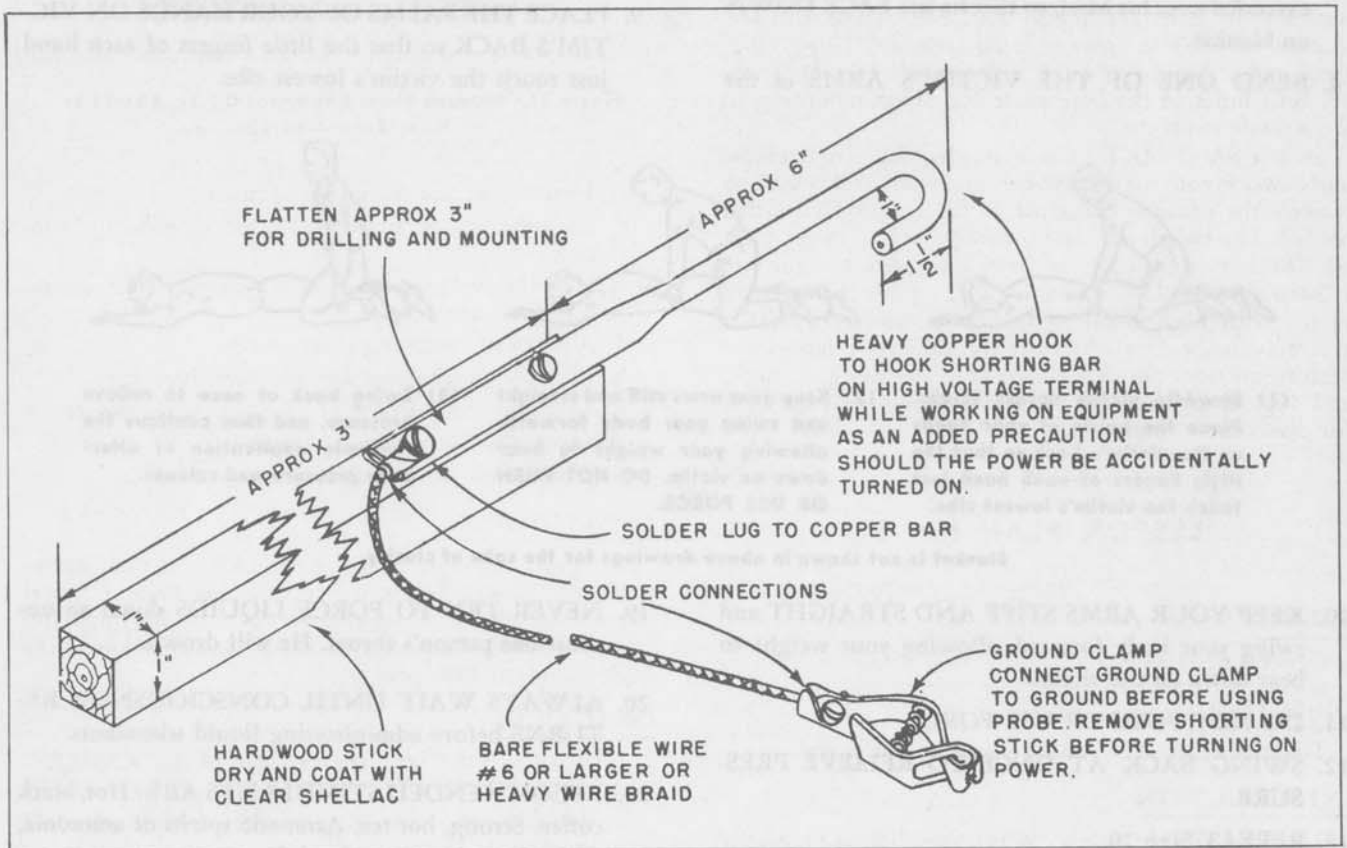

▶ FIRST AID ◀

Do These Three Things First in Any Emergency Requiring First Aid

1. Send for a doctor or carry the victim to a doctor.
2. Keep victim warm, quiet, and flat on his back.
3. If breathing has stopped, apply artificial respiration. Stop all serious bleeding.

When, from any cause whatever, breathing has stopped, apply artificial respiration immediately and continue **WITHOUT STOPPING** until normal breathing

returns, or a doctor pronounces the victim dead. **SPEED IN BEGINNING ARTIFICIAL RESPIRATION IS ESSENTIAL.**

▶ FIRST AID (Cont.) ◀

The Prone Pressure Method of Artificial Respiration

If Due to Electric Shock

1. PROTECT YOURSELF with DRY insulating material.
2. BREAK THE CIRCUIT by opening the power switch or pulling the victim free of the live conductor. DON'T TOUCH THE VICTIM WITH YOUR BARE HANDS UNTIL THE CIRCUIT IS BROKEN.
3. SPREAD DRY BLANKET ON THE GROUND, and roll victim to center of blanket with his arms extended over his head, so that he lies FACE DOWN on blanket.
4. BEND ONE OF THE VICTIM'S ARMS at the

elbow and rest victim's cheek on the back of his hand.

5. REMOVE FALSE TEETH, gum, candy, tobacco, food, etc., from victim's mouth.
6. LOOSEN ALL TIGHT CLOTHING, as belts or collars.
7. COVER VICTIM LOOSELY by wrapping the ends of the blanket around him.
8. STRADDLE VICTIM across thighs.
9. PLACE THE PALMS OF YOUR HANDS ON VICTIM'S BACK so that the little fingers of each hand just touch the victim's lowest ribs.



(1) Straddle victim across thighs. Place the palms of your hands on the victim's back so that the little fingers of each hand just touch the victim's lowest ribs.



(2) Keep your arms stiff and straight and swing your body forward, allowing your weight to bear down on victim. DO NOT PUSH OR USE FORCE.

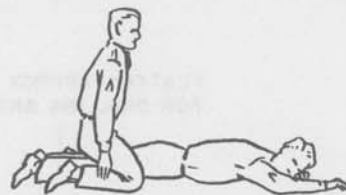

(3) Swing back at once to relieve pressure, and then continue the rhythmic application of alternate pressure and release.

Blanket is not shown in above drawings for the sake of clarity.

10. KEEP YOUR ARMS STIFF AND STRAIGHT and swing your body forward, allowing your weight to bear down on the victim.
11. DO NOT PUSH OR USE FORCE.
12. SWING BACK AT ONCE TO RELIEVE PRESSURE.
13. REPEAT Step 10.
14. REPEAT Step 12.
15. CONTINUE as above, maintaining a steady rhythm until victim regains consciousness or is pronounced dead by a doctor.
16. CONTINUE ARTIFICIAL RESPIRATION even after victim begins to breathe, and until he becomes conscious.
17. IF BREATHING STOPS AGAIN, continue artificial respiration at once.
18. DO NOT GIVE UP HOPE of reviving the victim. Four hours or more of continuous application of artificial respiration may be required before consciousness returns.
19. NEVER TRY TO FORCE LIQUIDS down an unconscious person's throat. He will drown.
20. ALWAYS WAIT UNTIL CONSCIOUSNESS RETURNS before administering liquid stimulants.
21. RECOMMENDED STIMULANTS ARE: Hot, black coffee. Strong, hot tea. Aromatic spirits of ammonia, one teaspoonful to a glass of water.
22. GIVE ONLY ONE STIMULANT, which should be sipped slowly.
23. ALCOHOLIC DRINKS are not recommended, unless absolutely nothing else is available.
24. WHEN VICTIM HAS RETURNED TO CONSCIOUSNESS, allow him to lie quietly where he is for at least one hour, taking care that he is well covered and free from worry.
25. IF POSSIBLE, CARRY, OR HAVE HIM CARRIED TO A DOCTOR.

EXPERIMENT No. 1

TIME ALLOTTED: 1 HR.

SUBJECT

Physical identification.

OBJECTIVE

To become familiar with the physical characteristics of the AN/ART-13 type of transmitting equipment.

EQUIPMENT REQUIRED

One or more Radio Transmitting Sets AN/ART-13A, AN/ART-13, Navy Model ATC, or Navy Model ATC-1. One set of cables and wiring for each transmitting set.

INSTRUCTIONS

It is highly desirable that a sufficient number of equipments be available so that no more than two students may be required to work on each. The major physical units of the equipments should be properly intercabled. In the interests of safety, the power source should not be connected for this experiment.

PROCEDURE

1. List the major physical units by official nomenclature and functional titles.

2. Draw a physical block diagram of the equipment showing the cabling between units. Identify each unit, cable, plug, jack, and connector in the diagram.

3. Make a pictorial sketch of each major physical unit. Label each connector, socket, plug, control, switch, meter, knob, fuse, binding post, and indicating lamp with its reference symbol and functional title.

4. Remove the cover plates from each unit in accordance with the instructions in Lecture 2.

5. Draw a series of plan sketches illustrating the interior of each unit. Identify each clearly visible major component with its reference symbol and functional title.

6. Replace all cover plates on the units.

CONCLUSIONS

1. What is the maximum number of revolutions that can be made by control B?

2. Where is the microphone selector switch located?

3. Why are there two separate scales on the dial of control E?

4. Where is the 400-volt bus fuse located?

5. How is access to the variable padding capacitors in the low-frequency oscillator gained?

6. How is access to the variable padding capacitors in the frequency multipliers gained?

7. How is access to the variable padding capacitors in the high-frequency oscillator gained?

8. What is the means of mechanical coupling between the Autotune motor and the line shaft?

LECTURE 3

FUNCTIONAL BLOCK ANALYSIS

The functional block diagrams of Radio Transmitting Set AN/ART-13A, AN/ART-13, Navy Models ATC, and ATC-1 are shown on Wall Chart No. 1. A study of these diagrams will aid in understanding the operation of the equipment.

There are two sources of r-f oscillations: the low-frequency oscillator, and the high-frequency oscillator. Both of these master oscillators are electron-coupled, and inherently possess good frequency stability.

When the transmitter is operating in the low-frequency range, the output of the low-frequency oscillator drives the power amplifier, directly. For operation in the 2.0-mc. to 6.0-mc. frequency range, the power amplifier is driven by the first frequency multiplier, which doubles the frequency of the high-frequency oscillator (1000 kc. to 1510 kc.) for the 2.0-mc. to 3.0-mc. range, triples it for the 3.0-mc. to 4.0-mc. range, and quadruples it for the 4.0-mc. to 6.0-mc. range. The second frequency multiplier functions as a frequency tripler at all times. It drives the power amplifier in the 6.0-mc. to 18.1-mc. range by tripling the output of the first frequency multiplier (2.0 mc. to 6.04 mc.).

When Radio Transmitting Set AN/ART-13A is operated in the 200-kc. to 600-kc. frequency range, the power amplifier is tuned, and its output is coupled to the antenna, by circuit elements contained in the antenna load-

ing unit. When Radio Transmitting Set AN/ART-13, or Navy Model ATC or ATC-1 is operated in the 200-kc. to 1500-kc. frequency range, the power amplifier is tuned, and its output is coupled to the antenna, by circuit elements contained in the antenna loading coil and antenna switching unit, if used. In all models, the power-amplifier high-frequency-tuning and antenna-loading circuits are self-contained in the transmitter.

Radio-frequency energy from the low-frequency antenna-loading circuits reaches the antenna through the contacts of the break-in relay and the antenna switch. Connection is made through the break-in-relay contacts when the transmitter is tuned for low-frequency operation and keyed.

The break-in-relay contacts and the vacuum contacts connect the antenna to the associated receiver when the transmitter is in the unkeyed condition. When the transmitter is tuned for high-frequency operation, the antenna is connected to the vacuum contacts through the break-in-relay contacts at all times. The circuit from the antenna to the high-frequency antenna-loading circuits is completed through the vacuum contacts when the transmitter is keyed.

The antenna switch, which is operated manually, serves to connect either the fixed or trailing-wire antenna to the transmitter. Also, this switch will connect the unused antenna to any auxiliary receiver located in the aircraft.

Switch SA-45/ART-13, when closed, shunts Capacitor CU-24/AKT-13A, CU-24/ART-13, or Navy Type—481628 across the output of the high-frequency antenna-loading circuits for operation in the 2.0-mc. to 3.0-mc. frequency range when the antenna is less than 60 feet in length.

When the transmitter is operated on voice, the output of the microphone is amplified by the first audio-amplifier stage. The output of the amplifier is coupled to the audio driver stage, which has sufficient power output to drive the modulator stage. The modulator develops enough audio power to modulate the output of the power amplifier 90 per cent or greater at all frequencies.

The sidetone amplifier takes a portion of the output of the audio driver, amplifies it, and drives either a loud-speaker or headset. This circuit permits monitoring of the voice or code modulation of the transmitter carrier. It also provides a means of listening to the output of the CFI unit for use in checking the frequency calibration of the master oscillators.

The MCW oscillator, located in the MCW-CFI unit, produces the 1000-cycle tone which is used to modulate the carrier when the transmitter is operated on MCW. This tone is fed into the first audio amplifier, and appears at the output of the sidetone amplifier when the transmitter is keyed on CW or MCW to permit monitoring of code transmission.

Also located in the MCW-CFI unit is the calibration frequency indicator, which is used in checking the frequency calibration of the master oscillators. In the 8Q-2 MCW-CFI unit, the calibration frequency indicator consists of four major circuits: crystal oscillator, mixer, frequency tripler, and signal detector. The crystal oscillator operates at 200 kc. and its output is injected into the mixer. Only the 50-kc. component of the mixer output is fed to the frequency tripler since the plate circuit of the mixer is tuned to 50 kc. This 50-kc. signal appears at the output of the frequency tripler as a 150-kc. signal, which is also injected into the mixer. The 50-kc. difference frequency, generated in the mixer by the beating of the 200-kc. crystal-oscillator output with the 150-kc. frequency-tripler output, serves to sustain excitation of the tripler, and also is fed to the signal detector. The outputs of the master oscillators are introduced into the signal detector, and audio beat notes appear in the output signal at various intervals throughout the frequency ranges of the two master oscillators. These beat notes are amplified by the first audio amplifier, audio driver, and sidetone amplifier, and are audible at the headset or loud-speaker.

In the 8Q-1 MCW-CFI unit, the CFI unit consists of a crystal-oscillator circuit and mixer circuit. The crystal oscillator operates at 200 kc. and its output is introduced into the mixer circuit by means of the electron stream in the vacuum tube common to both circuits. The outputs of the master oscillators are injected into the mixer, and audio beat notes appear in the output signal at various intervals throughout the frequency ranges of the two master oscillators. These beat notes are amplified by the first audio amplifier, audio driver, and sidetone amplifier, and are audible at the headset or loud-speaker.

The control unit, or pilot's control box, permits operation of the equipment from a remote position, such as the pilot's compartment of an aircraft. This unit provides means for turning the transmitting set on and off, selecting the type of emission, and selecting the transmission frequency. A telegraph key is mounted on the unit for keying the transmitter on CW and MCW. A microphone

may be plugged into the control unit for operation on voice.

Power is supplied to the equipment by the dynamotor unit. It provides 1150 volts (750 volts at high altitudes) for the high-voltage plate circuits, 400 volts for the low-voltage plate and screen circuits, and 28 volts for the filament, relay, and carbon-microphone circuits. The dynamotor unit requires an input voltage of 28 volts.

For CW or MCW emission, the master oscillator in use, the power amplifier, and the MCW oscillator are keyed.

Major test point ① checks the operation of the power supply; major test point ②, the high-frequency circuits; major test point ③, the low-frequency circuits; and major test point ④, the audio-frequency circuits.

LESSON PLAN No. 3

TIME ALLOTTED: 1 HR.

SUBJECT

Functional block analysis of the AN/ART-13 type of transmitting equipment.

OBJECTIVE

To analyze the operation of the equipment by means of a functional block diagram.

INTRODUCTION

This equipment consists of four major functional sections: the power supply, the high-frequency circuits, the low-frequency circuits, and the audio-frequency circuits.

SUBJECT MATERIAL

1. Display Wall Chart No. 1.
2. Describe the two master oscillators.
3. Explain the action of the first frequency multiplier.
4. Explain the action of the second frequency multiplier.
5. Trace the signal path from master oscillator to power amplifier for:

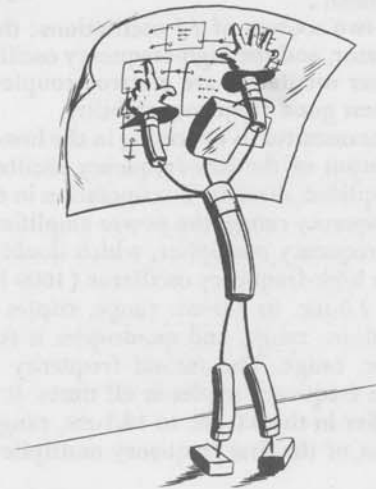

- a. Low-frequency operation.
- b. High-frequency operation in the 2.0-mc. to 6.0-mc. range.

- c. High-frequency operation in the 6.0-mc. to 18.1-mc. range.
6. Describe the power-amplifier tuning and antenna-loading circuits for:
 - a. Low-frequency operation.
 - b. High-frequency operation.
7. Explain the action of the break-in relay and antenna switch for:
 - a. Low-frequency operation.
 - b. High-frequency operation.
8. Trace the complete signal path from master oscillator to antenna for:
 - a. Low-frequency operation.
 - b. High-frequency operation in the 2.0-mc. to 6.0-mc. range.
 - c. High-frequency operation in the 6.0-mc. to 18.1-mc. range.
9. Explain the application of the antenna shunt capacitor.
10. For voice operation, trace the signal path of the audio signal from the microphone to the modulator, describing the function of each block.
11. Describe the two uses of the sidetone amplifier.
12. Explain how the MCW oscillator is utilized in MCW and CW operation.
13. Describe the action of the CFI unit.
14. State the purpose of the pilot's control box and describe its functions.
15. State the input and output voltages of the power supply.
16. Point out the three functional blocks which are keyed for CW and MCW emission.
17. Point out the four major test points and name the major functional sections which each one checks.

CONCLUSIONS

Trouble in the equipment may be localized to any one of four major functional sections by making tests at four major test points.

ORAL QUIZ

1. What type of circuit is incorporated in the master oscillators?
2. What is the frequency range of the high-frequency oscillator?
3. For a transmission frequency of 15 mc., how many times is the frequency multiplied in the first frequency multiplier?
4. In what major physical unit are the high-frequency power-amplifier-tuning and antenna-loading circuits located?
5. What is the purpose of the break-in relay?
6. What is the purpose of the vacuum contacts?
7. Name two purposes of the antenna switch.
8. Under what conditions of antenna length and operating frequency is the use of the antenna shunt capacitor required?
9. What is the percentage modulation capability of this equipment?
10. Is the MCW oscillator in use when the equipment is operating on CW?
11. What value of plate voltage is supplied to the high-voltage plate circuits at high altitudes?
12. What three functional circuits are keyed on CW?
13. What major functional section is tested at major test point 4?

EXPERIMENT No. 2

TIME ALLOTTED: 1 HR.

SUBJECT

Major test points in the AN/ART-13 type of equipment.

OBJECTIVE

To become familiar with the locations of, and the normal indications present at, the major test points.

EQUIPMENT REQUIRED

One or more Radio Transmitting Sets AN/ART-13A, AN/ART-13, Navy Model ATC, or Navy Model ATC-1.

For each transmitting set:

- One set of cables and wiring.
- One 28-volt power source capable of delivering 35 amperes.
- One suitable antenna (or dummy).
- Two carbon or dynamic microphones.
- One telegraph key.
- One headset.
- One d-c voltmeter with 1500-volt range.
- One neon lamp, if Antenna Loading Coil CU-26/ART-13 or —47282 is used.

INSTRUCTIONS

Intercable serviceable equipment units normally, and connect to a suitable antenna (or dummy) and the power source. Plug a headset into SIDETONE 1 jack and a telegraph key into KEY jack. Plug one microphone into the jack on the transmitter and the other one into the jack on the pilot's control box. Make certain that the equipment is functioning properly on one frequency in the low-frequency range, one in the 2.0-mc. to 6.0-mc. range, and one in the 6.0-mc. to 18.1-mc. range. Operate the LOCAL-REMOTE switch to LOCAL and the EMIS-SION switch to OFF. CAUTION! Dangerously high voltages are present in this equipment.

PROCEDURE

1. Remove the top-cover plate from the transmitter and make a sketch of the plan view of the transmitter and its associated units.
2. Draw arrows on the sketch showing the path of the r-f signal when the equipment is operating in:
 - a. The low-frequency range.
 - b. The 2.0-mc. to 6.0-mc. range.
 - c. The 6.0-mc. to 18.1-mc. range.
3. Draw arrows on the sketch showing the path of the a-f signal when the equipment is operating on:
 - a. Voice.
 - b. MCW.
4. Major test point 1 is located at terminal No. 5 of the modulation transformer, T101. This is the lower rear terminal on the side adjacent to the JAN-811 modulator tube, V105. Connect the positive lead of the d-c

voltmeter, set to the 1500-volt range, to this test point; connect the negative lead to ground. Operate the EMISSION switch to CW, and the power-level switch to OPERATE. If an interlock switch is used for the top-cover plate, depress it manually. Operate the TEST switch. The d-c voltmeter should read 1150 volts, indicating that the power supply is functioning. Operate the EMISSION switch to OFF and disconnect the voltmeter leads.

5. Major test point ② is the antenna-current ammeter, M101, located on the front panel of the transmitter. Operate the EMISSION switch to CW, and the CHANNEL switch to the position corresponding to the operative transmission frequency in the 2.0-mc. to 6.0-mc. range. Operate the TEST switch. The antenna-current ammeter will show the presence of antenna current, indicating that the high-frequency r-f circuits in use are functioning. The magnitude of this current flow is dependent upon the type of antenna and the transmission frequency. Operate the CHANNEL switch to the position corresponding to the operative transmission frequency in the 6.0-mc. to 18.1-mc. range. Operate the TEST switch. The antenna-current ammeter will show the presence of antenna current, indicating that the second frequency multiplier, as well as the high-frequency r-f circuits previously checked, is functioning. Release the TEST switch.

6. Major test point ③ is the R-F AMPERES meter on Antenna Loading Unit CU-32/ART-13A, the AMPERES R-F meter on Antenna Loading Coil CU-25/ART-13 or —47281, or the ANTENNA terminal on Antenna Loading Coil CU-26/ART-13 or —47282. Operate the EMISSION switch to CW and the CHANNEL switch to L. FREQ. Operate the TEST switch.

The ammeter on Antenna Loading Unit CU-32/ART-13A, or Antenna Loading Coil CU-25/ART-13 or —47281 will show the presence of antenna current, indicating that the low-frequency r-f circuits are functioning. A neon lamp held near or touching the ANTENNA terminal on Antenna Loading Coil CU-26/ART-13 or —47282 will glow, indicating that the low-frequency r-f circuits are functioning.

7. Major test point ④ is the d-c milliammeter, M102, located on the front panel of the transmitter. Operate the EMISSION switch to VOICE, and the meter switch to P.A. PLATE. Depress the microphone button and speak into the microphone. The needle of the d-c milliammeter, M102, should fluctuate in the red area above the light shaded area marked CW, indicating that the audio-frequency circuits are functioning. Operate the EMISSION switch to MCW. Operate the TEST switch. The needle of the d-c milliammeter, M102, should be over

the light shaded area marked MCW, indicating that the MCW oscillator, as well as the audio-frequency circuits previously checked, is functioning.

8. Operate the EMISSION switch to CW and operate the telegraph key. Notice the presence of the sidetone signal in the headset. Repeat with the EMISSION switch in the MCW position. Operate the EMISSION switch to VOICE. Use the microphone and notice the presence of the sidetone signal in the headset.

9. Operate the EMISSION switch to VOICE, and the power-level switch to CALIBRATE. Notice the setting of control G. Unlock control G and adjust it to the nearest check point as indicated by the calibration table. Notice the presence of the audio beat note in the headset. Return control G to its original setting and lock. Operate the power-level switch to OPERATE.

10. Operate the LOCAL-REMOTE switch to REMOTE. Notice that the EMISSION and CHANNEL switches on the pilot's control box now control the equipment, and that the two corresponding switches on the transmitter have no effect. Operate the telegraph key and microphone of the pilot's control box and notice the normal indications in the transmitter.

CONCLUSIONS

1. Name the functional blocks that are probably at fault if abnormal indications are obtained at:

- Major test point ①.
- Major test point ②.
- Major test point ③.
- Major test point ④.

2. Which functional block would probably be at fault if the indication obtained at major test point ② is normal when operating in the 2.0-mc. to 6.0-mc. range, but abnormal when operating in the 6.0-mc. to 18.1-mc. range?

3. Which functional block would probably be at fault if the indication obtained at major test point ④ is normal when operating on voice, but abnormal when operating on MCW?

4. Name the functional blocks that are probably at fault if an abnormal indication is obtained at major test point ③, but a beat note is heard in the headset when the EMISSION switch is operated to CALIBRATE and control G is adjusted to the nearest check point as indicated by the calibration table?

5. Can the equipment be set to the calibrate condition from the pilot's control box?

LECTURE 4

CIRCUIT ANALYSIS OF THE LOW-FREQUENCY OSCILLATOR

The low-frequency oscillator is the source of r-f oscillations for the transmitter in the low-frequency range. This oscillator is shown in block form on Wall Chart No. 1, and in schematic form in figure 22. It is of the neutralized electron-coupled Colpitts type making use of

a type JAN-1625 vacuum tube. The electrical characteristics of the JAN-1625 are the same as those of the JAN-807 except that the JAN-1625 has a 12.6-volt heater.

Oscillator O-17/ART-13A tunes the 200-kc. to 600-kc. frequency range in three bands:

- 200 kc. to 285 kc.
- 285 kc. to 415 kc.
- 415 kc. to 600 kc.

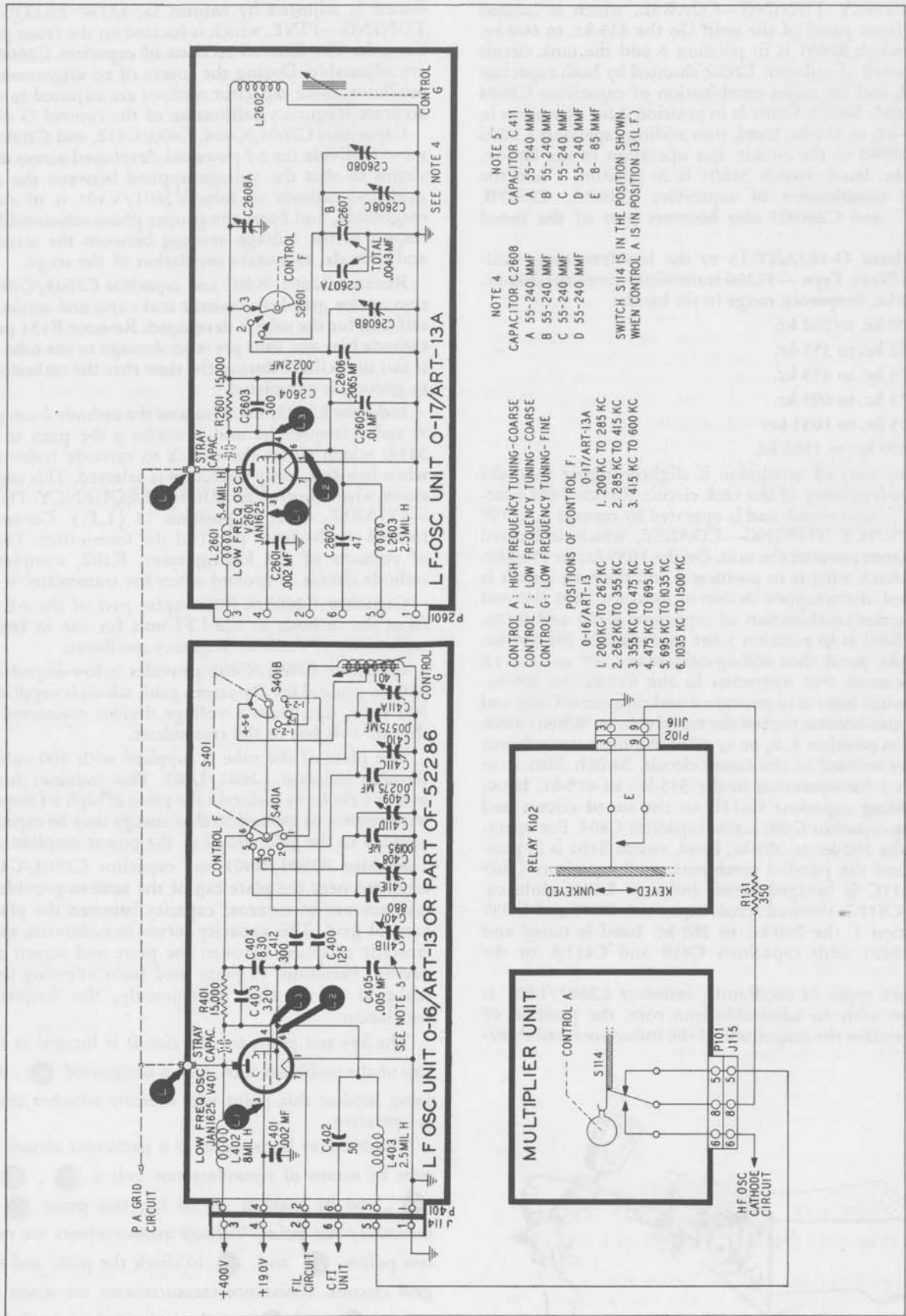

Figure 22. Low-Frequency-Oscillator Circuit

The frequency of oscillation is slightly higher than the resonant frequency of the tank circuit. Switch S2601 functions as a band switch and is operated by control F, LOW FREQUENCY TUNING—COARSE, which is located on the front panel of the unit. On the 415-kc. to 600-kc. band, switch S2601 is in position 3 and the tank circuit is composed of inductor L2602 shunted by both capacitor C2608A and the series combination of capacitors C2604 and C2605. Switch S2601 is in position 2 for operation in the 285-kc. to 415-kc. band, thus adding capacitors C2606 and C2608B to the circuit. For operation in the 200-kc. to 285-kc. band, switch S2601 is in position 1 and the parallel combination of capacitors C2607A, C2607B, C2608C, and C2608D also becomes part of the tuned circuit.

Oscillator O-16/ART-13 or the low-frequency oscillator in Navy Type—52286 transmitter tunes the 200-kc. to 1500-kc. frequency range in six bands:

1. 200 kc. to 262 kc.
2. 262 kc. to 355 kc.
3. 355 kc. to 475 kc.
4. 475 kc. to 695 kc.
5. 695 kc. to 1035 kc.
6. 1035 kc. to 1500 kc.

The frequency of oscillation is slightly higher than the resonant frequency of the tank circuit. Switch S401 functions as a band switch and is operated by control F, LOW FREQUENCY TUNING—COARSE, which is located on the front panel of the unit. On the 1035-kc. to 1500-kc. band, switch S401 is in position 6 and the tank circuit is composed of the tapped section of inductor L401 shunted by the series combination of capacitors C404 and C405. Switch S401 is in position 5 for operation in the 695-kc. to 1035-kc. band, thus adding capacitors C407 and C411E to the circuit. For operation in the 475-kc. to 695-kc. band, switch S401 is in position 4 and capacitors C408 and C411D also become part of the tuned circuit. When switch S401 is in position 3, 2, or 1, all of the turns on inductor L401 are utilized in the tuned circuit. Switch S401 is in position 3 for operation in the 355-kc. to 475-kc. band, thus adding capacitor C411B to the tuned circuit and shunting capacitor C400 across capacitor C404. For operation in the 262-kc. to 355-kc. band, switch S401 is in position 2 and the parallel combination of capacitors C409 and C411C is bridged across inductor L401 while capacitor C412 is shunted across capacitors C404 and C400. In position 1, the 200-kc. to 262-kc. band is tuned and switch S401 adds capacitors C410 and C411A to the circuit.

In both types of oscillators, inductor L2602/L401 is equipped with an adjustable iron core, the position of which governs the magnitude of the inductance and there-

fore provides the means by which continuous frequency control, within each of the various frequency bands, is accomplished. The position of the iron core in this inductor is adjusted by control G, LOW FREQUENCY TUNING—FINE, which is located on the front panel of the unit. The lettered sections of capacitor C2608/C411 are adjustable. During the course of r-f alignment of the oscillator, these capacitor sections are adjusted to achieve accurate frequency calibration of the control G dial.

Capacitors C2604/C404, C400, C412, and C2605/C405 serve to divide the r-f potential developed across the tank circuit so that the voltage applied between the control grid and cathode of tube V2601/V401 is of sufficient magnitude, and bears the proper phase relationship with respect to the voltage existing between the screen grid and cathode, to sustain oscillation of the stage.

Resistor R2601/R401 and capacitor C2603/C403 function as the grid-leak resistor and capacitor across which self bias for the tube is developed. Resistor R131 provides cathode bias and thus prevents damage to the tube should it fail to oscillate during the time that the cathode circuit to ground is completed.

Inductor L2603/L403 isolates the cathode from ground at radio frequencies and provides a d-c path to switch S114, which closes the circuit to cathode resistor R131 when low-frequency operation is selected. This condition exists when control A, HIGH FREQUENCY TUNING—COARSE, is set to position 13 (L.F.). Control A is located on the front panel of the transmitter. The E set of contacts of the keying relay, K102, completes the cathode circuit to ground when the transmitter is keyed.

Capacitor C2602/C402 couples part of the r-f energy from the cathode to the CFI unit for use in frequency calibration of the low-frequency oscillator.

Capacitor C2601/C401 provides a low-impedance r-f path to ground for the screen grid, which is supplied with 190 volts, d.c., from a voltage divider connected across the 400-volt bus in the transmitter.

The plate of the tube is supplied with 400 volts, d.c., through inductor L2601/L402. This inductor functions as an r-f choke to maintain the plate at high r-f impedance with respect to ground so that energy may be capacitively coupled to the grid circuit of the power amplifier.

Resistor R2601/R401 and capacitor C2603/C403 are mounted near the plate cap of the tube to provide a certain amount of external capacity between the plate and control grid. This capacity serves to neutralize the electrostatic coupling between the plate and screen grid to prevent variations in plate load from affecting the control-grid circuit and, consequently, the frequency of oscillation.

The key test point for the circuit is located at the top cap of the oscillator tube, and is designated **L**. A neon lamp held at this point will indicate whether the stage is operative.

Trouble may be isolated to a particular circuit of the tube by means of secondary test points **L₁**, **L₂**, and **L₃**, and by making use of key test point **L** as a secondary test point. Voltage measurements are made at test points **L** and **L₁** to check the plate and screen-grid circuits. Resistance measurements are made at test points **L₂** and **L₃** to check the cathode and control-grid circuits.

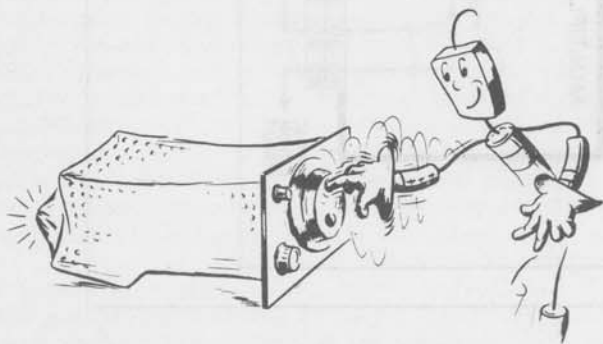

LESSON PLAN No. 4

TIME ALLOTTED: 1/2 HR.

SUBJECT

Low-frequency oscillator.

OBJECTIVE

To analyze the low-frequency-oscillator circuit.

INTRODUCTION

The source of r-f oscillations for the transmitter in the low-frequency range is a stable master oscillator.

SUBJECT MATERIAL

1. Display Wall Chart No. 1 and briefly review the action of the low-frequency oscillator.
2. Display Wall Chart No. 2 and point out the low-frequency-oscillator circuit on the schematic diagram.
3. On the blackboard, draw the circuit elements which are external to the oscillator circuit as shown in figure 22.
4. State the type oscillator circuit and vacuum tube utilized.
5. List the limits of each band in the frequency range on the blackboard.
6. Point out the circuit elements of the tuned circuit which are in use for each band.
7. Describe the manner in which continuous frequency control is obtained.
8. Demonstrate the operation of controls A, F, and G on the equipment.
9. Show the location of the variable padding capacitors on the oscillator unit.
10. Explain how positive feedback voltage is applied to the control grid.
11. State the functions of the grid-leak resistor, grid-leak capacitor, and cathode resistor.
12. Trace the circuit from cathode to ground.
13. Point out the capacitor which couples an r-f signal to the CFI unit.
14. Describe the screen-grid and plate circuits.
15. Explain why the grid-leak capacitor and resistor are mounted near the plate cap of the tube.
16. Point out the key test point in the circuit and explain its use.
17. Point out the secondary test points and explain their use.
18. Point out the locations of the test points on the oscillator unit.

CONCLUSIONS

An inoperative condition of the low-frequency oscillator may be detected by the use of one key test point. Trouble in the unit may be isolated to any one of the four individual circuits of the tube by making tests at four secondary test points.

ORAL QUIZ

1. What type of circuit is employed in low-frequency oscillator?
2. What is the purpose of control F?
3. What physical component does control G operate?
4. What is the purpose of the variable padding capacitors?
5. To which position must control A be set to enable

switch S114 to provide a d-c path from the cathode to the cathode resistor?

6. Is the oscillator operative when the transmitter is in the unkeyed state?

7. If no reading is obtained when a d-c voltmeter is connected between secondary test point L_1 and ground, which circuit element in the low-frequency-oscillator unit is probably defective?

8. What would be the likely cause of a zero d-c voltage reading at test point K ?

9. Name two conditions which could cause an infinite resistance measurement between test point L_3 and ground.

10. If the d-c resistance of the cathode r-f choke is 50 ohms, what would be the normal resistance measurement between test point L_2 and ground? (Assume that the contacts of switch S114 and contacts E of relay K102 are closed.)

EXPERIMENT No. 3

TIME ALLOTTED: 1 1/2 HR.

SUBJECT

Tuning, alignment, and trouble shooting of the low-frequency oscillator.

OBJECTIVE

To become familiar with the tuning, alignment, and trouble shooting of the low-frequency oscillator.

EQUIPMENT REQUIRED

One or more AN/ART-13 type of transmitting sets with accessory components as listed in Experiment No. 2.

For each transmitting set:

One d-c voltmeter with 250-volt and 750-volt ranges.

One ohmmeter.

One neon lamp.

One short ruler, if Oscillator O-17/ART-13A is used.

INSTRUCTIONS

Intercable, connect, and plug in the units and accessory components as in Experiment No. 2. Operate the LOCAL-REMOTE switch to LOCAL, and the power-level switch to CALIBRATE. Operate the EMISSION switch to VOICE and the CHANNEL SWITCH to MANUAL. Always approach dial settings in a clockwise direction. Refer to the Trouble-Shooting Supplement for the placement of troubles in the equipment.

PROCEDURE

1. Adjust control C to position 8, control A to position 13 (L.F.), and control F to position 1 (200 kc. to 285 kc./200 kc. to 262 kc.). Refer to the calibration table which is applicable for the type oscillator and MCW-CFI units in use and note the control G setting for the 250-kc. crystal-check point. Unlock control G and rotate it back and forth about this setting until zero beat is heard in the headset. By means of the corrector knob, move the index line to the setting of control G specified in the calibration table for the 250-kc. check point.

2. Refer to the calibration table and note the control G setting for 248 kc. Adjust control G to this setting and lock. This completes the tuning procedure of the low-

frequency oscillator for this frequency. The oscillator may be tuned to any other frequency in its range in the same manner by using the check point and settings of controls F and G listed in the calibration table. Operate the EMISSION switch to OFF.

3. Note the type of oscillator in use, and perform the applicable portion of the following procedure:

a. If Oscillator O-17/ART-13 is used:

(1) Remove the top-cover plate from the transmitter. Remove the top-cover plate from the low-frequency oscillator. Turn control G to its extreme counterclockwise position. Operate the corrector knob so that the index line is directly above the center of control G. Using the short ruler, notice that the tuning slug extends $3/16$ " out of the rear of inductor L2602. This is the normal amount of protrusion of the slug when control G is in its extreme counterclockwise position.

(2) Notice that the zero mark on the dial is very close to the index line. When it is not close to the index line, the following alignment is required: Loosen the Bristo setscrews on the small spur gear mounted on the control G shaft just behind the front panel. Hold the dial-drive-mechanism gear train stationary, rotate control G until the $3/16$ " measurement is obtained, and tighten the setscrews. Loosen the two setscrews in the control G knob. Hold the gear train stationary, rotate the knob until the zero mark is over the index line, and tighten the setscrews.

(3) Notice the location of the four lettered sections of capacitor C2608 and the small indented metal lips which project from the side of the rounded edge of each section. These lips may be reached with an insulated tool inserted through the slot in the top-cover plate of the oscillator unit. Each capacitor section may be adjusted by pushing one of its lips in a lateral direction.

(4) When the oscillator requires alignment, the following operations are necessary: Replace the top-cover plate on the oscillator unit and operate the EMISSION switch to VOICE. Adjust controls F and G to the settings specified by the calibration table for 600 kc., 350 kc., and 250 kc., in turn. Manually depress the top-cover interlock, if used. Adjust capacitor C2608A for zero beat in the headset for 600 kc.; adjust capacitor C2608B for zero beat for 350 kc.; and adjust capacitors C2608C and C2608D for zero beat for 250 kc.

b. If Oscillator O-16/ART-13 is used:

(1) Operate EMISSION switch to VOICE, and control F to position 6 (1035 kc. to 1500 kc.). Operate the corrector knob so that the index line is directly above the center of control G. Adjust control G to 1073 and rotate it back and forth until zero beat is heard in the headset. Lock the dial. Notice that the index line is very close to the setting of 1073 on the dial of control G. Remove the top-cover plate from the transmitter. Remove the top-cover plate from the oscillator unit. When the index line is not close to 1073, the following operations are necessary: Loosen the two setscrews that hold the control G knob to the shaft, rotate the knob until the dial setting is 1073, and tighten the setscrews.

(2) Rotate control G to its extreme counterclockwise position and notice that the zero mark is very close to the index line. When it is not close to the index line, the following operations are necessary: Loosen the two setscrews on the counter-dial-mechanism collar attached to the control G shaft. Hold the mechanism stationary at zero, rotate the control G knob to zero, and tighten the setscrews.

(3) Notice the location of the five lettered sections of capacitor C411 and the small indented metal lips which

project from the side of the rounded edge of each section. These lips may be reached with an insulated tool inserted through the numbered slots in the top-cover plate of the oscillator unit. Each capacitor section may be adjusted by pushing one of its lips in a lateral direction.

(4) When the oscillator requires alignment, the following operations are necessary: Replace the top-cover plate on the oscillator unit. Operate the EMISSION switch to VOICE. Set control F to positions 5 (695 kc. to 1035 kc.), 4 (475 kc. to 695 kc.), 3 (355 kc. to 475 kc.), 2 (262 kc. to 355 kc.), and 1 (200 kc. to 262 kc.), in turn, with control G adjusted to the crystal-check point nearest to a setting of 1000 for each band. Manually depress the top-cover interlock, if used. Adjust capacitor C411E (slot 5) for zero beat in the headset on band 5; capacitor C411D (slot 4), for band 4; capacitor C411C (slot 3), for band 3; capacitor C411B (slot 2), for band 2; and capacitor C411A (slot 1), for band 1.

4. Operate the meter switch to P.A. GRID, and the EMISSION switch to VOICE. Rotate control G through its complete range (20 revolutions) for each position of control F and observe the d-c milliammeter, M102. Notice that the reading is between 90 and 120 over the entire frequency range.

5. Remove the top-cover plate from the oscillator. Hold a neon lamp near or touching key test point L , the top cap of the oscillator tube. CAUTION! HIGH VOLTAGE! Notice that the neon lamp glows, indicating that the low-frequency oscillator is operative.

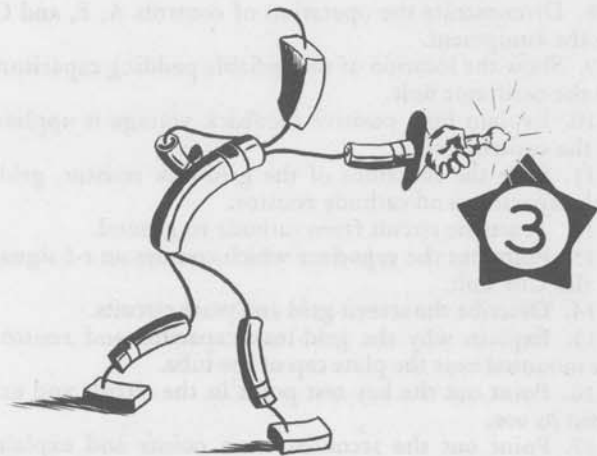

6. Connect the negative lead of the d-c voltmeter (set to the 750-volt range) to ground, and the positive lead to test point L , the top cap of the oscillator tube. Notice that the reading is approximately 420 volts. This test point provides a check of the plate circuit of the oscillator.

7. Operate the EMISSION switch to OFF. Disconnect the top-cap lead from the connector on the right side of the oscillator case. Remove the tube from the socket. Operate the EMISSION switch to VOICE. CAUTION! High voltage is present at the connector on the right side of the case. View the tube socket from the top and notice that two of the seven socket holes are larger than the remaining five. The socket holes are numbered from one through seven, in a counterclockwise direction when viewing the socket from the top, starting with one of the larger holes as No. 1 and ending with the other larger hole as No. 7. Socket hole 3 is secondary test point L_1 .

Connect the negative lead of the d-c voltmeter (set to the 250-volt range) to ground, and the positive lead to test point **L₁**. Notice that the reading is approximately 210 volts. This test point provides a check of the screen circuit of the oscillator.

8. Operate the EMISSION switch to OFF. Remove the fuse from the power supply. Operate the EMISSION switch to VOICE. Connect one lead of the ohmmeter (set to the low-resistance range) to ground, and the other lead to test point **L₂**, hole 6 in the tube socket of the low-frequency oscillator. CAUTION! Do not connect the lead to hole 7 or the ohmmeter may be damaged. Notice that the reading is approximately 400 ohms. This test point provides a check of the cathode circuit of the oscillator.

9. Operate the EMISSION switch to OFF. Connect one lead of the ohmmeter (set to the medium-resistance range) to ground, and the other lead to test point **L₃**, hole 4 in the tube socket of the oscillator. Notice that the reading is approximately 15,000 ohms. This test point provides a check of the control-grid circuit of the oscillator.

10. Replace the fuse in the power supply. Replace the low-frequency-oscillator tube in its socket. Reconnect the top-cap lead to its connector and the top cap of the oscillator tube. Replace the top-cover plates on the oscillator and transmitter.

11. Request the instructor to place a defect in the low-frequency oscillator. Making use of tests at the test points, isolate the trouble to the individual tube circuit at fault. By means of visual inspection and further voltage or resistance measurements, as required, locate the defect and correct it.

12. Request the instructor to place another defect in the low-frequency oscillator. Making use of tests at the test points, isolate the trouble to the individual tube circuit at fault. By means of visual inspection and further voltage or resistance measurements, as required, locate the defect and correct it. Restore the transmitting set to its original condition.

CONCLUSIONS

1. Is the means by which the control G corrector knob compensates for small errors in the dial calibration of control G mechanical or electrical?

2. What are two possible causes of a zero-voltage reading at test point **L₁**?

3. What is the value of voltage present at tube-socket hole 7 in the low-frequency-oscillator unit when the tube is removed?

4. Name at least two causes of a zero-resistance measurement at test point **L₃**.

LECTURE 5

CIRCUIT ANALYSIS OF THE HIGH-FREQUENCY OSCILLATOR

The high-frequency oscillator is the source of r-f oscillations for the transmitter in the high-frequency range. This oscillator is shown in block form on Wall Chart No. 1, and in schematic form in figure 23. It is of the electron-coupled Colpitts type, making use of a type JAN-837 vacuum tube.

This oscillator tunes the 1000-kc. to 1510-kc. frequency range in two bands:

1. 1000 kc. to 1200 kc.
2. 1200 kc. to 1510 kc.

The frequency of oscillation is slightly higher than the resonant frequency of the tank circuit. Switch S101 functions as a band switch, and is operated by control A, HIGH FREQUENCY TUNING—COARSE, which is located on the front panel of the transmitter. On the 1200-kc. to 1510-kc. band, switch S101 is in its open position and the tank circuit is composed of inductor L101 shunted by capacitor C134 and the series-parallel combination of capacitors C102, C103, C104, and C105 (382 mmf. total). For operation in the 1000-kc. to 1200-kc. band, switch S101 is closed and capacitors C101 and C135 are added to the tuned circuit.

Inductor L101 is equipped with an adjustable iron core, the position of which governs the magnitude of its inductance and, therefore, provides the means by which

continuous frequency control, within each of the two bands, is accomplished. The position of the iron core in this inductor is adjusted by control B, HIGH FREQUENCY TUNING—FINE, which is located on the front panel of the transmitter. Capacitors C134 and C135 are variable padders. During the course of r-f alignment of the oscillator, these capacitors are adjusted to achieve accurate frequency calibration of the control B dial.

The series-parallel combination of capacitors C102, C103, and C104 (413 mmf. total), in conjunction with capacitor C105, serve to divide the r-f potential developed across the tank circuit so that the voltage applied between the control grid and cathode of tube V101 is of sufficient magnitude, and bears the proper phase relationship with respect to the voltage existing between the screen grid and cathode, to sustain oscillation of the stage.

Resistor R101 and capacitor C103 function as the grid-leak resistor and condenser across which self bias for the tube is developed. Resistor R131 provides cathode bias and thus prevents damage to the tube should it fail to oscillate during the time that the cathode circuit to ground is completed.

Inductor L102 isolates the cathode from ground at radio frequencies, and provides a d-c path to switch S114, which closes the circuit to the cathode resistor, R131, when high-frequency operation is selected. This condition exists when control A, HIGH FREQUENCY TUNING—COARSE, is set to any of its first 12 positions. The E

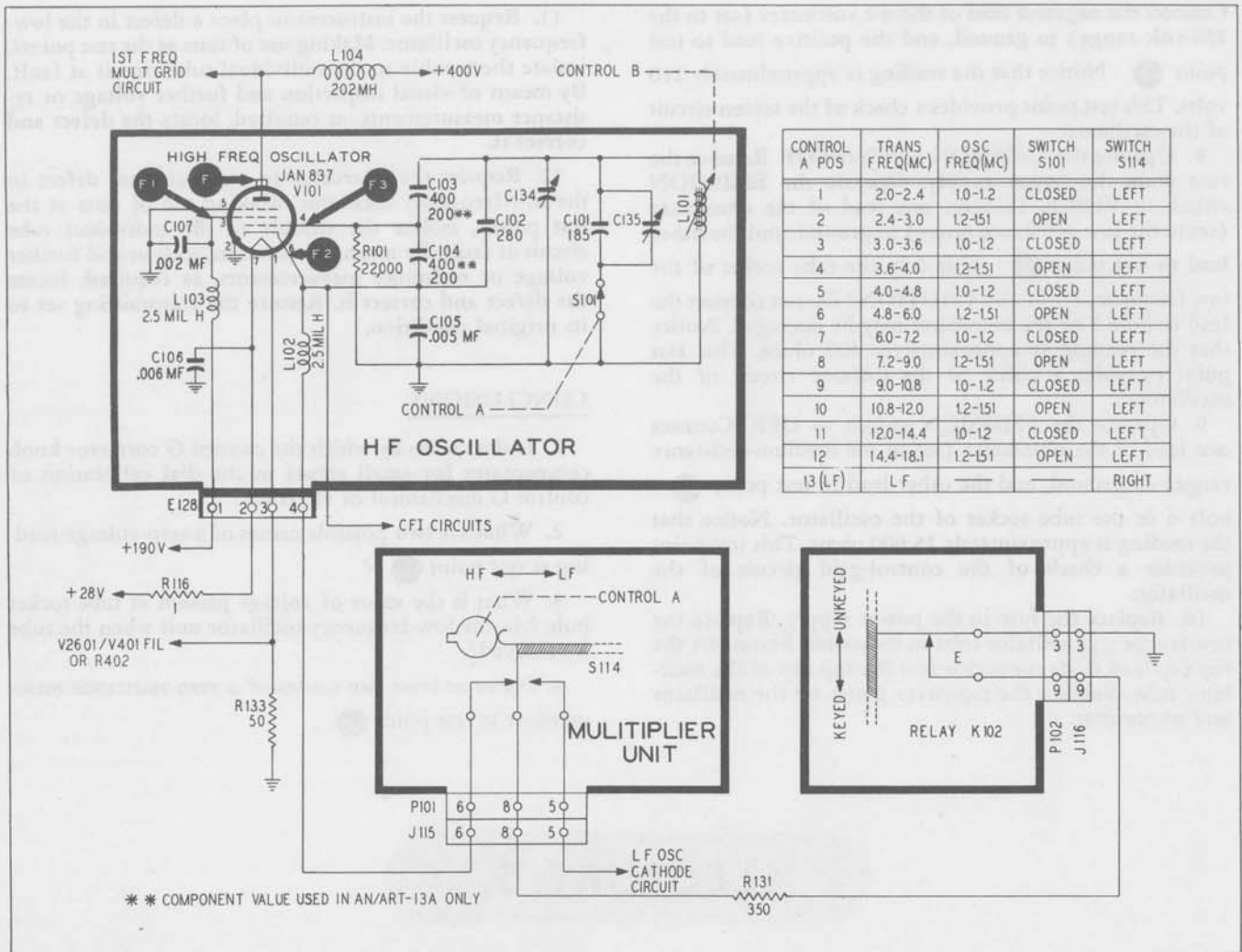

Figure 23. High-Frequency-Oscillator Circuit

set of contacts of the keying relay, K102, completes the cathode circuit to ground when the transmitter is keyed.

Part of the r-f energy existing at the cathode is coupled to the CFI circuits for use in frequency calibration of the high-frequency oscillator.

Capacitor C107 provides a low-impedance r-f path to ground for the screen grid. Inductor L103 provides r-f isolation of the screen grid from the 190-volt bus in the transmitter.

The plate of the tube is supplied with 400 volts, d.c., through inductor L104. This inductor functions as an r-f choke to maintain the plate at high r-f impedance with respect to ground so that energy may be capacitively coupled to the grid circuit of the first frequency multiplier.

The top cap of the oscillator tube is the key test point for the circuit, and is designated **F**. A neon lamp held at this point will indicate whether the stage is operative. Trouble may be isolated to a particular circuit of the tube by means of secondary test points **F1**, **F2**, and **F3**, and by making use of key test point **F** as a secondary test point. Voltage measurements are made at test points **F** and **F1** to check the plate and screen-grid circuits. Resistance measurements are made at test points **F2** and **F3** to check the cathode and control-grid circuits.

LESSON PLAN No. 5

TIME ALLOTTED: ¾ HR.

SUBJECT

High-frequency oscillator.

OBJECTIVE

To analyze the high-frequency-oscillator circuit.

INTRODUCTION

The source of r-f oscillations for the transmitter in the high-frequency range is a stable master oscillator.

SUBJECT MATERIAL

1. Display Wall Chart No. 1 and briefly review action of high-frequency oscillator.
2. Display Wall Chart No. 2 and point out the high-frequency-oscillator circuit on the schematic diagram.
3. On the blackboard, draw the circuit elements which are external to the oscillator circuit as shown in figure 23.
4. State the type oscillator circuit and vacuum tube utilized.
5. List the frequency limits of each of the two bands on the blackboard.

6. Point out the circuit elements of the tuned circuit which are in use for each band.

7. Describe the manner in which continuous frequency control is obtained.

8. Demonstrate the operation of controls A and B on the equipment.

9. Show the location of the small cover plate on the bottom of the transmitter through which access to the variable padding capacitors on the oscillator unit is gained.

10. Explain how positive feedback voltage is applied to the control grid.

11. State the functions of the grid-leak resistor, grid-leak capacitor, and cathode resistor.

12. Trace the d-c circuit from cathode to ground.

13. Point out the connection which couples the r-f signal to the CFI circuits.

14. Describe the screen-grid and plate circuits.

15. Point out the key test point in the circuit and explain its use.

16. Point out the secondary test points and explain their use.

17. Point out the locations of the test points on the oscillator unit.

CONCLUSIONS

An inoperative condition of the high-frequency oscillator may be detected by the use of one key test point. Trouble in the unit may be isolated to any one of the four individual circuits of the tube by making tests at four secondary test points.

ORAL QUIZ

1. What type of circuit is employed in the high-frequency oscillator?

2. What is the purpose of control A?

3. What physical component does control B operate?

4. What is the purpose of the variable padding capacitors?

5. Which positions of control A enable switch S114 to provide a d-c path from the cathode to the cathode resistor?

6. Is the oscillator operative when the transmitter is in the unkeyed state?

7. If no reading is obtained when a d-c voltmeter is connected between secondary test point **F1** and ground, which circuit elements in the high-frequency-oscillator unit are probably defective?

8. What would be the likely cause of a zero-d-c voltage reading at test point **F**?

9. Name two conditions which could cause an infinite-resistance measurement between test point **F3** and ground.

10. If the d-c resistance of the cathode r-f choke is 50 ohms, what is the normal resistance measurement between test point **F2** and ground? (Assume that the contacts of switch S114 and contacts E of relay K102 are closed.)

EXPERIMENT No. 4

TIME ALLOTTED: 1½ HR.

SUBJECT

Tuning, alignment, and trouble shooting of the high-frequency oscillator.

OBJECTIVE

To become familiar with the tuning, alignment, and trouble shooting of the high-frequency oscillator.

EQUIPMENT REQUIRED

One or more AN/ART-13 type of transmitting sets with accessory components as required in previous experiments.

For each transmitting set:

One d-c voltmeter with 250-volt and 750-volt ranges.

One ohmmeter.

One neon lamp.

INSTRUCTIONS

Intercable, connect, and plug in the units and accessory components as in previous experiments. Operate the LOCAL-REMOTE switch to LOCAL, and the power-level switch to CALIBRATE. Operate the EMISSION switch to VOICE, and the CHANNEL switch to MANUAL. Always approach dial settings in a clockwise direction. Refer to the Trouble-Shooting Supplement for the placement of troubles in the equipment.

PROCEDURE

1. Adjust control C to position 1, control A to position 1 (2.0 mc. to 2.4 mc.), and control B to 843.0 (transmission frequency: 2.2 mc.; oscillator frequency: 1.1 mc.). Rotate control B back and forth about this setting until zero beat is heard in the headset. By means of the corrector knob, move the index line to the setting of 843.0.

2. Adjust control B to 869.0 (2207 kc.) and lock. This completes the tuning procedure of the high-frequency oscillator for this frequency. The oscillator may be tuned to any other frequency in its range in the same manner by using the check point and settings of controls A and B listed in the calibration table. Operate the EMISSION switch to OFF.

3. Remove the cover plate from the right side of the transmitter, and the small cover plate on the bottom of the high-frequency-oscillator unit. Operate the EMISSION switch to VOICE. Adjust control A to position 2 (2.4 mc. to 3.0 mc.), and control B to 60.0 (transmission frequency: 2.4 mc.; oscillator frequency: 1.2 mc.). Rotate control B back and forth about this setting until zero beat is heard in the headset. By means of the corrector knob, move the index line to a position directly over the center of control B. Notice that the index line is very close to the setting of 60.0 on the dial of control B. When it is not close to 60.0, the following operations are necessary: Adjust control G to 60.0 and hold it fixed. Loosen the nut on the rear of the control G lead screw; rotate the oscillator tuning slug slowly, with a pair of padded-jaw pliers, until zero beat is heard in the headset; and tighten the nut on the rear of the lead screw.

4. Adjust control B to 1910.0 (transmission frequency: 3.0 mc.; oscillator frequency: 1.5 mc.) and rotate it about this setting until zero beat is heard in the headset. Notice that the index line is very close to the setting of 1910.0 on



the dial of control B. When it is not very close to this setting, the following operations are necessary: Adjust control B to 1910.0 and adjust capacitor C134, the variable padder nearer to the rear of the oscillator unit, for zero beat in the headset.

5. Adjust control B to 981.4 (transmission frequency: 2.7 mc.; oscillator frequency: 1.35 mc.) and rotate it about this setting until zero beat is heard in the headset. Notice that the index line is within five dial divisions of 981.4. When this tolerance of five dial divisions is not obtained, the oscillator should be re-aligned at 2.4 mc. and 3.0 mc. until the midband error is less than five dial divisions.

6. Adjust control A to position 1 (2.0 mc. to 2.4 mc.) and control B to 100.1 (transmission frequency: 2.0 mc.; oscillator frequency: 1.0 mc.). Rotate control B back and forth about this setting until zero beat is heard in the headset. Notice that the index line is very close to the setting of 100.1 on the dial of control B. When it is not close to this setting, the following operations are necessary: Adjust control B to 100.1 and adjust capacitor C135, the variable padder nearer to the front of the oscillator unit, for zero beat in the headset.

7. Adjust control B to 1578.9 (transmission frequency: 2.4 mc.; oscillator frequency: 1.2 mc.) and rotate control B about this setting until zero beat is heard in the headset. Notice that the index line is within five dial divisions of 1578.9. When the tolerance of five dial divisions is not obtained, the oscillator should be re-aligned at 2.4 mc., 3.0 mc., and 2.0 mc. until the error is less than five dial divisions.

8. Operate the EMISSION switch to OFF. Replace the cover plate on the right side of the transmitter, and the small cover plate on the bottom of the high-frequency-oscillator unit.

9. Operate the EMISSION switch to VOICE. Hold a neon lamp near or touching key test point **F**, the top cap of the oscillator tube. CAUTION! HIGH VOLTAGE! Notice that the neon lamp glows, indicating that the high-frequency oscillator is operative.

10. Connect the negative lead of the d-c voltmeter (set to the 750-volt range) to ground, and the positive lead to test point **F**, the top cap of the high-frequency-

oscillator tube. Notice that the reading is approximately 410 volts. This test point provides a check of the plate circuit of the oscillator.

11. Operate the EMISSION switch to OFF. Remove the top-cap lead from the oscillator tube. Remove the oscillator tube from its socket. Operate the EMISSION switch to VOICE. CAUTION! High voltage is present on the clip of the top-cap lead. Connect the negative lead of the d-c voltmeter (set to the 250-volt range) to ground, and the positive lead to test point **F1**, high-frequency-oscillator tube-socket hole 3. Notice that the reading is approximately 200 volts. This test point provides a check of the screen circuit of the oscillator.

12. Operate the EMISSION switch to OFF. Remove the fuse from the power supply. Operate the EMISSION switch to VOICE. Connect one lead of the ohmmeter (set to the low-resistance range) to ground, and the other lead to test point **F2**, hole 6 in the tube socket of the high-frequency oscillator. CAUTION! Do not connect the lead to hole 7 or the ohmmeter may be damaged. Notice that the reading is approximately 400 ohms. This test point provides a check of the cathode circuit of the oscillator.

13. Operate the EMISSION switch to OFF. Connect one lead of the ohmmeter (set to the medium-resistance range) to ground, and the other lead to test point **F3**, hole 4 in the tube socket of the oscillator. Notice that the reading is approximately 22,000 ohms. This test point provides a check of the control-grid circuit of the oscillator.

14. Replace the fuse in the power supply. Replace the high-frequency-oscillator tube in its socket. Replace the top-cap lead on the oscillator tube. Replace the top-cover plate on the transmitter.

15. Request the instructor to place a trouble in the equipment. By means of tests at the test points, visual inspection, and further voltage and resistance measurements, as required, locate the trouble and correct it. Restore the transmitting set to its original condition.

CONCLUSIONS

1. After the high-frequency oscillator has been aligned at 2.4 mc. and 3.0 mc., why is it necessary to check the calibration at 2.7 mc.?

2. What would be the likely cause of a zero-voltage reading at test point **F**?

3. What are two possible causes of a zero-voltage reading at test point **F1**?

4. What is the value of voltage present at tube-socket hole 7 in the high-frequency-oscillator unit when the tube is removed?

5. What would be the likely cause of a zero-resistance measurement at test point **F2**?

6. What defect would cause an infinite-resistance measurement at test point **F3**?

7. What common trouble in the low-frequency oscillator will render the high-frequency oscillator inoperative?

LECTURE 6

CIRCUIT ANALYSIS OF THE FREQUENCY-MULTIPLIER CIRCUITS

The frequency-multiplier circuits provide excitation of the power amplifier in the 2.0-mc. to 18.1-mc. range by multiplying the output frequency of the high-frequency oscillator. The two frequency-multiplier stages are shown in block form on Wall Chart No. 1, and in schematic form in figure 24.

The first frequency multiplier is a class-C r-f stage

which functions alternately as a frequency doubler, tripler, and quadrupler. It makes use of a type JAN-1625 vacuum tube.

R-f energy is coupled from the untuned plate circuit of the high-frequency oscillator to the grid circuit of the first frequency multiplier through capacitor C108. Grid bias is developed across resistor R102 due to d-c grid-current flow. Resistor R103 functions as a parasitic suppressor.

The cathode is connected to ground through switch S114 and resistor R130 when the transmitter is operat-

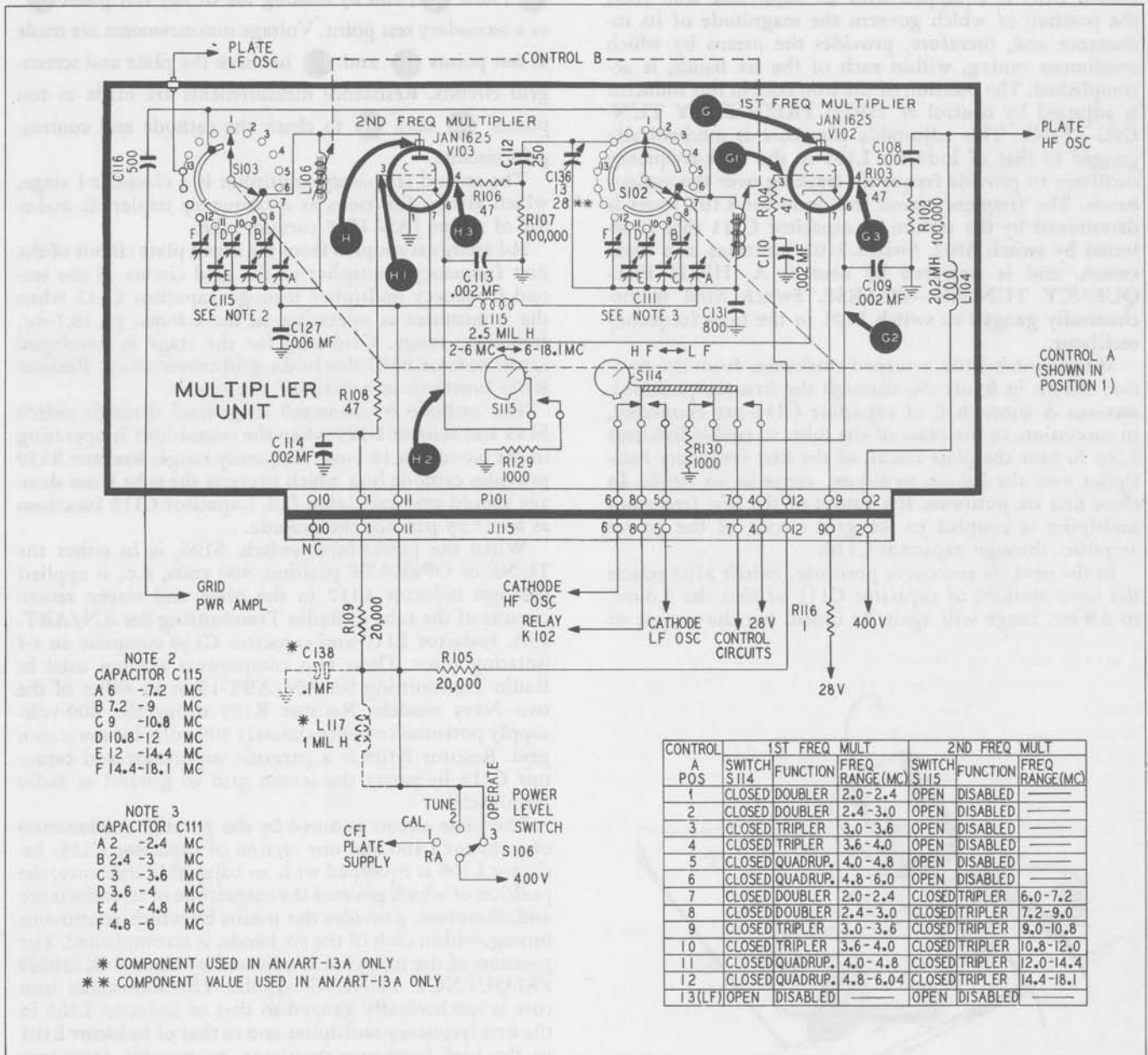

Figure 24. Frequency-Multiplier Circuits

ing in the 2.0-mc. to 18.1-mc. frequency range. Resistor R130 provides cathode bias which protects the tube from damage should grid excitation fail. Capacitor C109 functions as an r-f by-pass for the cathode.

When the power-level switch, S106, is in either the TUNE or OPERATE position, 400 volts, d.c., is applied through inductor L117 to the plate and screen return circuits of the tube in Radio Transmitting Set AN/ART-13A. Inductor L117 and capacitor C138 comprise an r-f isolating filter. These two components are not used in Radio Transmitting Set AN/ART-13 or in either of the two Navy models. Resistor R105 drops the 400-volt-supply potential to approximately 300 volts for the screen grid. Resistor R104 is a parasitic suppressor and capacitor C110 by-passes the screen grid to ground at radio frequencies.

The plate circuit is tuned by the parallel combination of inductor L105 and one section of capacitor C111. Inductor L105 is equipped with an adjustable iron core, the position of which governs the magnitude of its inductance and, therefore, provides the means by which continuous tuning, within each of the six bands, is accomplished. The position of the iron core in this inductor is adjusted by control B, HIGH FREQUENCY TUNING—FINE. This adjustable iron core is mechanically ganged to that of inductor L101 in the high-frequency oscillator to provide frequency tracking over the various bands. The frequency band that inductor L105 tunes is determined by the section of capacitor C111 that is selected by switch S102. Switch S102 functions as a band switch, and is operated by control A, HIGH FREQUENCY TUNING—COARSE. Switch S102 is mechanically ganged to switch S101 in the high-frequency oscillator.

When switch S102 is turned clockwise, from the position shown in figure 24, through the first six positions, sections A through F of capacitor C111 are connected, in succession, to the plate of the tube, to enable inductor L105 to tune the plate circuit of the first frequency multiplier over the 2.0-mc. to 6.0-mc. range in six bands. In these first six positions, the output of the first frequency multiplier is coupled to the grid circuit of the power amplifier through capacitor C116.

In the next six successive positions, switch S102 selects the same sections of capacitor C111 so that the 2.0-mc. to 6.0-mc. range will again be tuned, but the output of

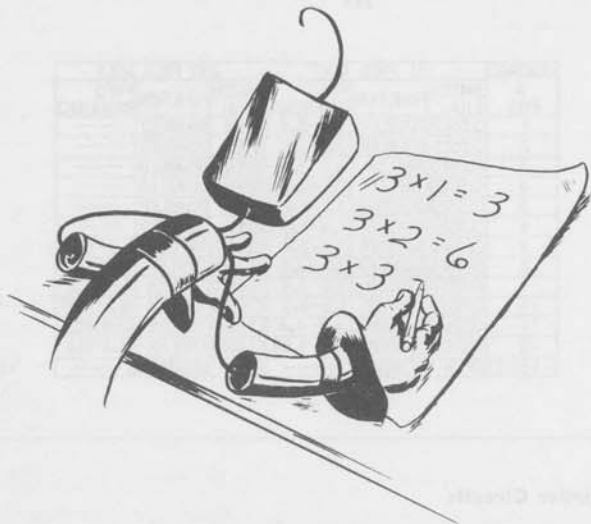

the first frequency multiplier is now coupled to the grid circuit of the second frequency multiplier through capacitor C112. In these second six positions, variable capacitor C136 is shunted across the plate circuit of the first frequency multiplier, to compensate for the difference in input capacitances of the power-amplifier and second-frequency-multiplier stages.

Inductor L115 provides r-f isolation of the plate return from the power-supply circuits and capacitor C131 furnishes a low-impedance r-f path to ground for the plate return.

The top cap of the first-frequency-multiplier tube is the key test point for the circuit, and is designated G_1 . A neon lamp held at this point will indicate whether the stage is operative. Trouble may be isolated to a particular circuit of the tube by means of secondary test points G_2 , G_3 , and G_4 , and by making use of key test point G_5 as a secondary test point. Voltage measurements are made at test points G_1 and G_2 to check the plate and screen-grid circuits. Resistance measurements are made at test points G_3 and G_4 to check the cathode and control-grid circuits.

The second frequency multiplier is a class-C r-f stage, which always functions as a frequency tripler. It makes use of a type JAN-1625 vacuum tube.

R-f energy is coupled from the tuned plate circuit of the first frequency multiplier to the grid circuit of the second frequency multiplier through capacitor C112 when the transmitter is operating in the 6.0-mc. to 18.1-mc. frequency range. Grid bias for the stage is developed across resistor R107 due to d-c grid-current flow. Resistor R106 functions as a parasitic suppressor.

The cathode is connected to ground through switch S115 and resistor R129 when the transmitter is operating in the 6.0-mc. to 18.1-mc. frequency range. Resistor R129 provides cathode bias which protects the tube from damage should grid excitation fail. Capacitor C113 functions as an r-f by-pass for the cathode.

When the power-level switch, S106, is in either the TUNE or OPERATE position, 400 volts, d.c., is applied through inductor L117 to the plate and screen return circuits of the tube in Radio Transmitting Set AN/ART-13A. Inductor L117 and capacitor C138 comprise an r-f isolating filter. These two components are not used in Radio Transmitting Set AN/ART-13 or in either of the two Navy models. Resistor R109 drops the 400-volt-supply potential to approximately 300 volts for the screen grid. Resistor R108 is a parasitic suppressor and capacitor C114 by-passes the screen grid to ground at radio frequencies.

The plate circuit is tuned by the parallel combination of inductor L106 and one section of capacitor C115. Inductor L106 is equipped with an adjustable iron core, the position of which governs the magnitude of its inductance and, therefore, provides the means by which continuous tuning, within each of the six bands, is accomplished. The position of the iron core is adjusted by control B, HIGH FREQUENCY TUNING—FINE. This adjustable iron core is mechanically ganged to that of inductor L105 in the first frequency multiplier and to that of inductor L101 in the high-frequency oscillator, to provide frequency tracking over the various bands. The frequency band that inductor L106 tunes is determined by the section of capacitor C115 that is selected by switch S103. Switch

S103 functions as a band switch, and is operated by control A, HIGH FREQUENCY TUNING — COARSE. Switch S103 is mechanically ganged to switch S102 in the first frequency multiplier and switch S101 in the high-frequency oscillator.

When switch S103 is turned clockwise, from the position shown in figure 24, through the first six positions, no connection is made from the plate of the tube to any of the sections of capacitor C115 or to capacitor C116.

In the next six consecutive positions, switch S103 connects sections A through F of capacitor C115, in succession, to the plate of the tube and thus enables inductor L106 to tune the plate circuit of the second frequency multiplier over the 6.0-mc. to 18.1-mc. range in six bands. In these second six positions, the output of the second frequency multiplier is coupled to the grid circuit of the power amplifier through capacitor C116.

When switch S103 is in position 13, the output of the low-frequency oscillator is connected to the grid circuit of the power amplifier through capacitor C116. Capacitor C127 furnishes a low-impedance r-f path to ground for the plate return.

The top cap of the second-frequency-multiplier tube is the key test point for the circuit, and is designated H . A neon lamp held at this point will indicate whether the stage is operative. Trouble may be isolated to a particular circuit of the tube by means of secondary test points H_1 , H_2 , and H_3 , and by making use of key test point H as a secondary test point. Voltage measurements are made at test points H and H_1 to check the plate and screen-grid circuits. Resistance measurements are made at test points H_2 and H_3 to check the cathode and control-grid circuits.

LESSON PLAN No. 6

TIME ALLOTTED: 1¼ HR.

SUBJECT

Frequency-multiplier circuits.

OBJECTIVE

To analyze the frequency-multiplier circuits.

INTRODUCTION

In order to drive the power amplifier at the transmission frequency in the high-frequency range, it is necessary to multiply the output frequency of the high-frequency oscillator.

SUBJECT MATERIAL

1. Display Wall Chart No. 1 and briefly review the action of the two frequency multipliers.
2. Display Wall Chart No. 2 and point out the frequency-multiplier circuits on the schematic diagram.
3. On the blackboard, draw the supplementary chart and the circuit elements which are external to the multiplier unit, as shown in figure 24.
4. State the three functions of the first frequency multiplier, and the type vacuum tube utilized.
5. State the functions of the blocking capacitor and the two resistors in the control-grid circuit.
6. Explain the action of switch S114, making reference to both the supplementary chart and the schematic dia-

gram; state the functions of the cathode resistor and capacitor.

7. Describe the plate and screen-grid d-c supply circuits.

8. Describe the manner in which continuous tuning of the first frequency multiplier, and frequency tracking with the high-frequency oscillator, are realized.

9. Explain the action of switch S102 as it is operated to each of its 13 positions.

10. State the purpose of capacitor C136.

11. Explain the functions of inductor L115 and capacitor C131.

12. Point out the key test point in the circuit and explain its use.

13. Point out the secondary test points and explain their use.

14. Point out the locations of the test points on the multiplier unit.

15. State the single function of the second frequency multiplier, and the type vacuum tube utilized.

16. State the functions of the blocking capacitor and the two resistors in the control-grid circuit.

17. Explain the action of switch S115, making reference to both the supplementary chart and the schematic diagram; state the functions of the cathode resistor and capacitor.

18. Describe the plate and screen-grid d-c supply circuits.

19. Describe the manner in which continuous tuning of the second frequency multiplier, and frequency tracking with the first frequency multiplier and high-frequency oscillator, are realized.

20. Explain the action of switch S103 as it is operated to each of its 13 positions.

21. Point out the key test point in the circuit and explain its use.

22. Point out the secondary test points and explain their use.

23. Point out the locations of the test points on the multiplier unit.

CONCLUSIONS

An inoperative condition of either frequency-multiplier stage may be detected by the use of one key test point. Trouble in either stage may be isolated to any one of the four individual circuits of the tube by making tests at four secondary test points.

ORAL QUIZ

1. For which four frequency bands does the first frequency multiplier function as a frequency doubler?
2. Is the first frequency multiplier operative when the power-level switch is in the CALIBRATE position?
3. Are the six sections of the plate tuning capacitor adjustable?
4. Is the first frequency multiplier operative when the transmitter is tuned to a frequency in the high-frequency range, but is in the unkeyed state?
5. What would be the probable cause of a subnormal voltage reading at test point G_1 ?
6. Which circuit element in the multiplier unit is likely to cause a positive d-c voltage to exist between test point G_3 and ground?
7. A d-c voltmeter is connected between test point H_1 and ground, and the second-frequency-multiplier tube is

removed from its socket. The voltmeter is set to the 750-volt range, the meter sensitivity is 1000 ohms/volt, and the d-c voltage present at pin 11 of plug P101 is 430 volts. What is the approximate reading indicated by the voltmeter?

8. In which position is it logical to set control A when making a resistance measurement between test point H2 and ground?

EXPERIMENT No. 5

TIME ALLOTTED: 1 HR.

SUBJECT

Alignment and trouble shooting of the multiplier unit.

OBJECTIVE

To become familiar with the alignment and trouble shooting of the multiplier unit.

EQUIPMENT REQUIRED

One or more AN/ART-13 type of transmitting sets with accessory components as listed in previous experiments.

For each transmitting set:

- One d-c voltmeter with 750-volt range.
- One ohmmeter.
- One neon lamp.
- One shorted plug (single circuit, with 1/4" barrel).

INSTRUCTIONS

Intercable, connect, and plug in the units and accessory components as in previous experiments. Always approach dial settings in a clockwise direction. Refer to the Trouble-Shooting Supplement for the placement of troubles in the equipment.

PROCEDURE

1. Make certain that the LOCAL-REMOTE switch is at LOCAL, and the EMISSION switch is OFF. Set the transmitter on its rear surface and remove the bottom-cover plate.

2. Notice the locations of capacitor C115 (the stack of ceramic sections nearer the rear of the unit), capacitor C111 (the stack of ceramic sections nearer the front of the unit), and capacitor C136 (the trimmer near the front of the unit). Notice that the sections of capacitors C111 and C115 are lettered A through F, from right to left, as viewed from the bottom when the unit is resting on its rear surface.

3. When the multiplier unit requires alignment, the following operations are necessary:

a. Operate the LOCAL-REMOTE switch to LOCAL, and the power-level switch to TUNE. Operate the EMISSION switch to CW, and the CHANNEL switch to MANUAL. Operate control A to position 6 (4.8 mc. to 6.0 mc.), and the meter switch to P.A. GRID. Adjust control B to 1100.4 (5478 kc.) and insert a shorted plug into the KEY jack.

b. Adjust section F of the first-multiplier padding capacitor, C111, for maximum reading of meter M102. Check the output frequency of the first frequency multiplier by means of a suitable wavemeter. A reading of approximately 5478 kc. assures that the plate circuit of the first frequency multiplier is tuned to the correct

harmonic (the fourth) of the output frequency (1369.5 kc.) of the high-frequency oscillator.

c. Rotate control B through its complete range (20 revolutions) and observe the d-c milliammeter, M102. The normal indications are a noticeable drop in meter reading at the extreme ends of the range, but no sharp dip at any intermediate point. (The nominal meter reading must be within the light-shaded area marked P.A. GRID.)

d. If sharp meter dips are present, readjust section F of capacitor C111 until these dips are reasonably broad.

e. If it is not possible to broaden the dips by readjusting capacitor section C111F, remove the cover plate from the right side of the transmitter. Locate the first-multiplier plate-tuning inductor, L105 (the lower inductor in the rear compartment of the high-frequency-oscillator unit). Loosen the locking nut on the tuning slug of inductor L105, and change the position of the slug very slightly. Tighten the locking nut.

f. Broaden the meter dips by readjusting capacitor section C111F and, if necessary, by readjusting the tuning slug of inductor L105.

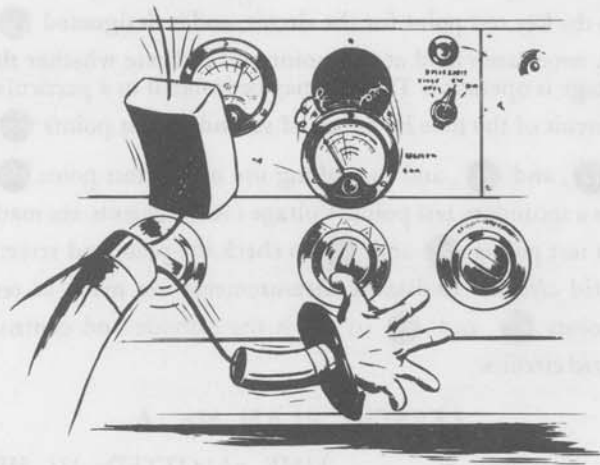

g. With control B set to 1100.4, operate control A to positions 5, 4, 3, 2, and 1, in turn, and adjust the corresponding sections of capacitor C111 (E through A, in order) for a maximum reading of milliammeter M102, and no sharp dips at intermediate points. Remove the key-shorting plug before each change in position of control A, and replace it after the change is made. Do not make any further adjustments of the tuning slug in inductor L105. Check the output frequency of the first multiplier on each band with a wavemeter to ascertain that the plate is tuned to the correct harmonic of the output frequency of the high-frequency oscillator.

h. Remove the key-shorting plug and operate control A to position 12 (14.4 mc. to 18.1 mc). Adjust control B to 1100.4. Replace the key-shorting plug.

i. Adjust section F of the second-multiplier padding capacitor, C115, and trimmer capacitor C136 for maximum reading of meter M102. Check the output frequency of the second frequency multiplier by means of a suitable wavemeter. A reading of 16,434 kc. assures that the plate circuit of the second frequency multiplier is tuned to the correct harmonic (the third) of the output frequency (5478 kc.) of the first frequency multiplier, and that trimmer capacitor C136 has not detuned the plate circuit of the first frequency multiplier to an incorrect harmonic of the high-frequency oscillator.

j. Rotate control B through its complete range (20 revolutions) and observe the d-c milliammeter, M102. The normal indications are a noticeable drop in meter reading at the extreme ends of the range, but no sharp dip at any intermediate point. (The nominal meter reading must be within the light-shaded area marked P.A. GRID.)

k. If sharp meter dips are present, readjust section F of capacitor C115 until these dips are reasonably broad.

l. If it is not possible to broaden the dips by readjusting capacitor section C115F, locate the second-multiplier plate-tuning inductor, L106 (the upper inductor in the rear compartment of the high-frequency-oscillator unit). Loosen the locking nut on the tuning slug of inductor L106, and change the position of the slug very slightly. Tighten the locking nut.

m. Broaden the meter dips by readjusting capacitor section C115F and, if necessary, by readjusting the tuning slug of inductor L106.

n. With control B set to 1100.4 for each band, operate control A to positions 11, 10, 9, 8, and 7, in turn, and adjust the corresponding sections of capacitor C115 (E through A, in order) for a maximum reading of milliammeter M102, and no sharp meter dips at intermediate points. Remove the key-shortening plug before each change in position of control A, and replace it after the change is made. Do not make any further adjustments of the tuning slug of inductor L106. Check the output frequency of the second frequency multiplier on each band with a wavemeter to ascertain that the plate is tuned to the correct harmonic of the output frequency of the first frequency multiplier. Operate the EMISSION switch to OFF, and replace the cover plate on the right side of the transmitter.

4. Set the transmitter in its normal position, and remove the top-cover plate. Operate the power-level switch to TUNE, and control A to position 7 (6.0 mc. to 7.2 mc.). Adjust control B to 1100.4, and operate the EMISSION switch to VOICE.

5. Manually depress the top-cover interlock, if used, and operate the TEST switch. Hold a neon lamp near or touching key test point G, the top cap of the first-frequency-multiplier tube, and then near or touching key test point H, the top cap of the second-frequency-multiplier tube. Notice that the neon lamp glows, indicating that both multiplier stages are operative.

6. Connect the negative lead of the d-c voltmeter (set to the 750-volt range) to ground, and the positive lead to test point G. Notice that the reading is approximately 430 volts. This test point provides a check of the plate circuit of the first frequency multiplier.

7. Connect the negative lead of the d-c voltmeter (set to the 750-volt range) to ground, and the positive lead to test point H. Notice that the reading is approximately 420 volts. This test point provides a check of the plate circuit of the second frequency multiplier.

8. Operate the EMISSION switch to OFF. Remove the top-cap leads from the multiplier tubes, and remove both tubes from their sockets. Operate the EMISSION switch to VOICE. CAUTION! High voltage is present on the clips of the top-cap leads. Connect the negative lead of the d-c voltmeter (set to the 750-volt range) to ground, and the positive lead to test point G1, contact 3 of the

first-multiplier-tube socket. Notice that the reading is approximately 420 volts. This test point provides a check of the screen circuit of the first frequency multiplier.

9. Change the connection of the positive lead of the d-c voltmeter to test point H1, contact 3 of the second-multiplier-tube socket. Notice that the reading is approximately 420 volts. This test point provides a check of the screen circuit of the second frequency multiplier.

10. Operate the EMISSION switch to OFF. Connect one lead of the ohmmeter (set to the medium-resistance range) to ground, and the other lead to test point G2, contact 6 of the first-multiplier-tube socket. Notice that the reading is approximately 1000 ohms. This test point provides a check of the cathode circuit of the first frequency multiplier.

11. Change the connection of the ungrounded lead of the ohmmeter to test point H2, contact 6 of the second-multiplier-tube socket. Notice that the reading is approximately 1000 ohms. This test point provides a check of the cathode circuit of the second frequency multiplier.

12. Change the connection of the ungrounded lead of the ohmmeter (set to the high-resistance range) to test point G3, contact 4 of the first-multiplier-tube socket. Notice that the reading is approximately 100,000 ohms. This test point provides a check of the control-grid circuit of the first frequency multiplier.

13. Change the connection of the ungrounded lead of the ohmmeter to test point H3, contact 4 of the second-multiplier-tube socket. Notice that the reading is approximately 100,000 ohms. This test point provides a check of the control-grid circuit of the second frequency multiplier.

14. Replace the multiplier tubes in their sockets and reconnect the top-cap leads.

15. Request the instructor to place a trouble in the equipment. By means of tests at the test points, visual inspection, and further voltage and resistance measurements, as required, locate the trouble and correct it.

16. Restore the transmitting set to its original condition.

CONCLUSIONS

1. Is it advisable to attempt alignment of the multiplier unit without a wavemeter?

2. Why are the two multiplier-plate-tuning inductors located in the high-frequency-oscillator unit?

3. Why is it necessary to remove the key-shortening plug before changing the position of control A?

4. If the transmitter functions normally on a transmission frequency of 3.0 mc., but not on 9.0 mc., in which stage does the trouble probably exist?

5. Will an open filament in the low-frequency-oscillator tube affect the operation of the transmitter in the high-frequency range?

6. It is desired to operate the transmitter on a frequency of 4.0 mc., but it is found that the first-frequency-multiplier tube is too weak to permit operation. If no replacement tubes are available, what simple procedure will restore normal operation on this frequency?

7. If the low-frequency-oscillator tube is defective and no replacement tubes are available, how can normal operation on a frequency of 500 kc. be obtained?

LECTURE 7

CIRCUIT ANALYSIS OF THE POWER-AMPLIFIER AND HIGH-FREQUENCY OUTPUT CIRCUITS

The power amplifier is a class-C r-f amplifier, making use of a type JAN-813 vacuum tube. This amplifier delivers a maximum of 90 watts of carrier power to the output circuits when it is driven by the second frequency multiplier, first frequency multiplier, or low-frequency oscillator. No frequency multiplication is accomplished in the power-amplifier stage; it is excited at the trans-

mission frequency throughout the frequency range of the transmitting set.

The high-frequency output circuits consist of inductive and capacitive elements, which may be connected as a "Pi" or "L" network. The purposes of these networks are to tune the power-amplifier-plate and antenna circuits to resonance, and to provide a controllable degree of coupling between them, for operation of the transmitter in the 2.0-mc. to 18.1-mc. frequency range.

The power-amplifier and high-frequency output circuits are shown in block form on Wall Chart No. 1, and in schematic form in figure 25.

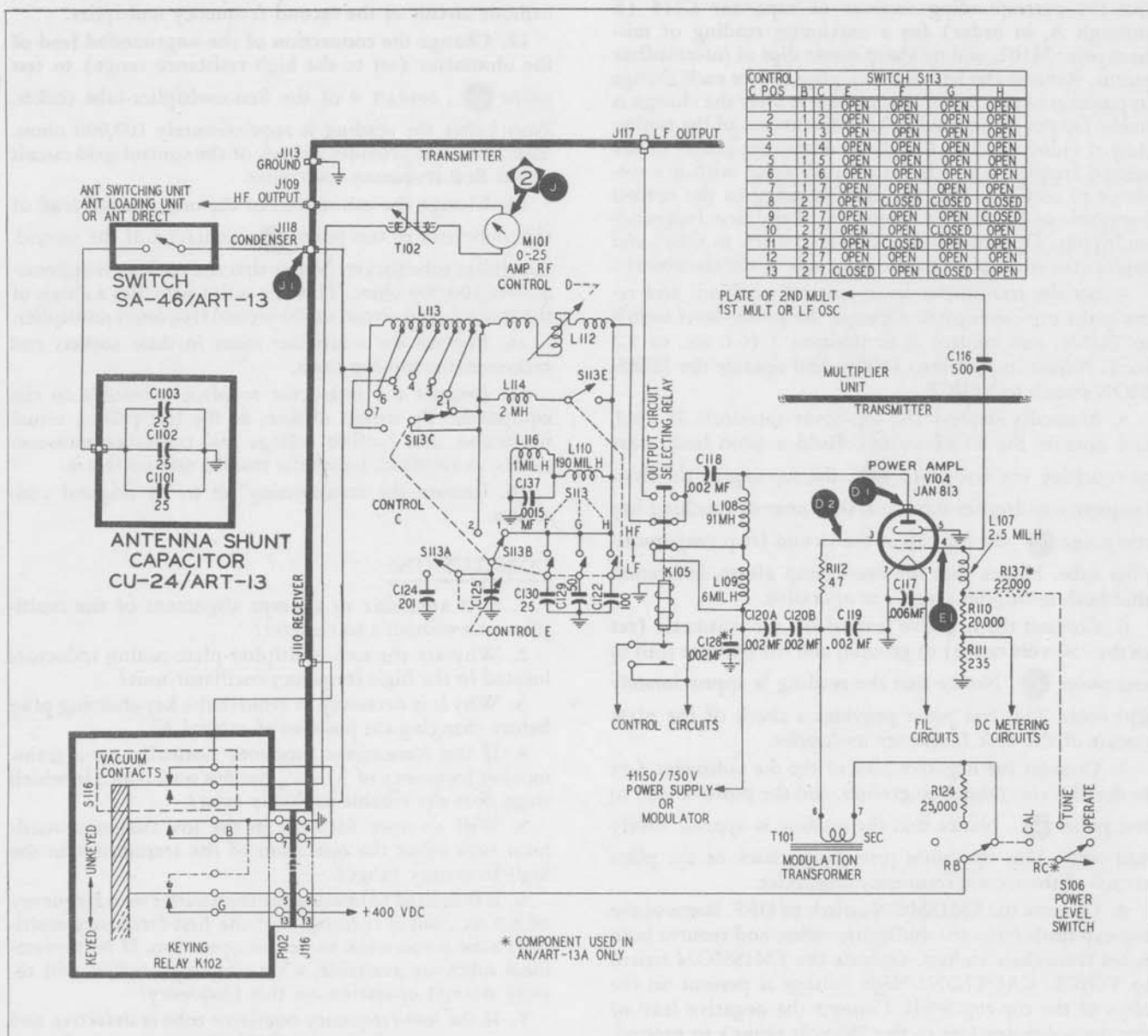

Figure 25. Power Amplifier and High-Frequency Output Circuits

Radio-frequency energy is coupled to the power-amplifier grid circuit through capacitor C116. Inductor L107 serves as a grid-feed r-f choke. Grid bias for the tube is developed across resistors R110 and R111. That portion of the bias voltage which is developed across resistor R111 is measured by the d-c metering circuits to obtain a relative indication of the power-amplifier grid current. The filament is by-passed for r.f. by capacitor C117, and is heated by a 10-volt potential derived from the 28-volt d-c bus.

Capacitor C119 by-passes the screen grid to ground at radio frequencies, and resistor R112 serves as a parasitic suppressor. Capacitors C120A, C120B, and C128 function as plate-supply r-f filters.

In the high-frequency range, L108 acts as the plate-feed choke, and the output of the power amplifier is coupled to the high-frequency output circuits through capacitor C118 and the middle pair of contacts of the output-circuit selecting relay, K105. Inductor L109 is shorted by the bottom pair of contacts of relay K105.

In the low-frequency range, relay K105 removes the short circuit from inductor L109, and the plate-feed choke consists of the series combination of inductors L108 and L109. Relay K105 also disconnects the output of the power amplifier from the high-frequency output circuits, and connects the output to the low-frequency output circuits (terminal J117).

Both the screen grid and plate of the power amplifier are modulated when voice or MCW emission is selected for the transmitter. When the transmitter is keyed, a d-c potential of 400 volts is applied to the arm of section RB of the power-level switch, S106. This arm is connected to ground when the transmitter is in the unkeyed state. When switch S106 is in the OPERATE position, a d-c potential of 400 volts is applied to the screen circuit of the power amplifier through secondary winding 6-7 of the modulation transformer, T101, as the transmitter is keyed. This screen-supply voltage is reduced by resistor R124, when switch S106 is in the TUNE position, to pre-

vent tube damage for off-resonance conditions. When switch S106 is at CALIBRATE, the power amplifier is disabled by the application of the negative bias voltage, developed in the grid circuit, to the screen circuit through resistor R137.

In the high-frequency output circuits, inductor L110 functions as a static-drain choke for the output-circuit shunt capacitors and the antenna. The parallel combination of inductor L116 and capacitor C137 forms a high-frequency noise filter for the antenna circuit.

Capacitor C125 is of the variable type, and is permitted to make almost a full revolution. Therefore, at the extreme counterclockwise position, the plates are fully meshed; at the center position, the plates are completely unmeshed; and at the extreme clockwise position, the plates are fully meshed, again. Switch S113A is operated by a cam, mounted on the rotor shaft of capacitor C125. When the rotor of capacitor C125 is between its extreme counterclockwise and middle positions, switch S113A is open; when the rotor is between the middle and extreme clockwise positions, switch S113A is closed. Capacitor C124 is shunted across capacitor C125 when switch S113A is closed. The angular position of the rotor of capacitor C125 is determined by control E, ANTENNA LOADING.

Control C, ANTENNA TUNING—COARSE, has 13 positions, and actuates switch S113. The supplementary chart in figure 25 shows the condition of each of the various cam-operated sections of switch S113, for each position of control C.

When control C is in any of its first seven positions, the output circuit is an "L" network, as shown in figure 26, in which the shunt element consists of capacitors C125 and C124, and the series element is made up of inductors L112 and L113. Coarse control of the series inductance is provided by switch section S113C, which selects the various tapped sections of inductor L113. Fine control of the series inductance is furnished by the variometer, L112. The rotor of the variometer is operated

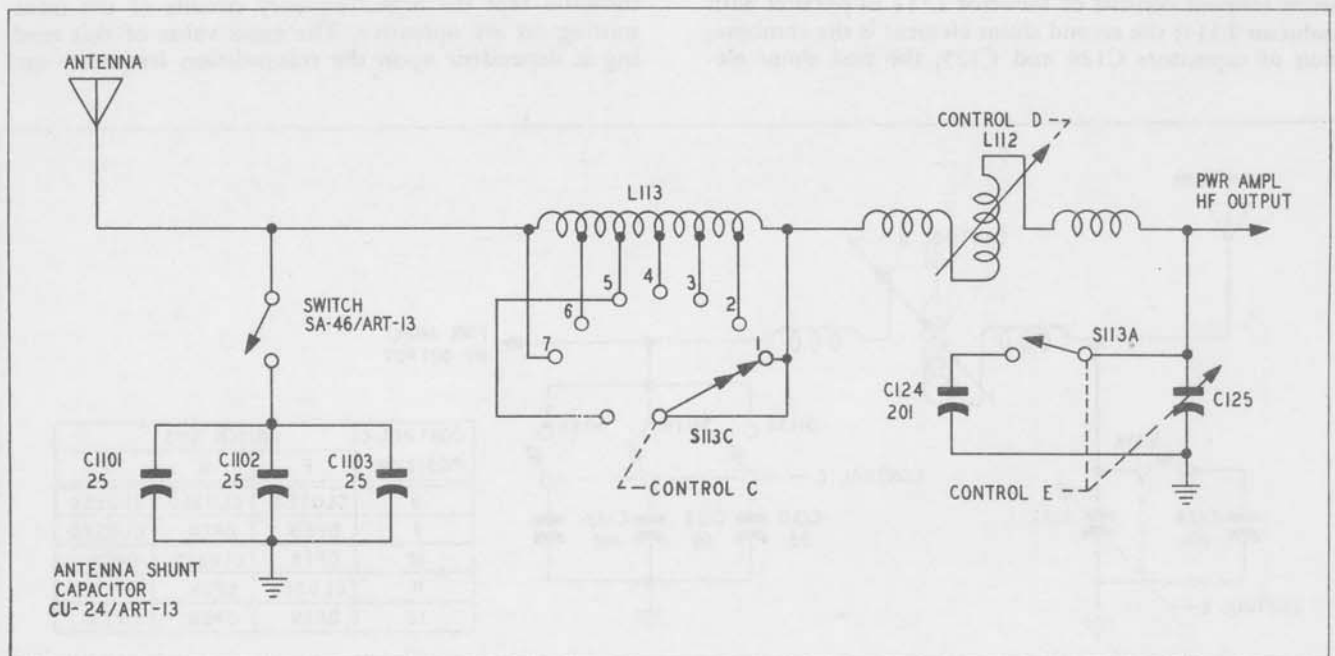

Figure 26. High-Frequency Output Circuit for Positions 1 through 7 of Control C

by control D, ANTENNA TUNING—FINE. Control E varies the shunt capacity by controlling capacitor C125 and switch S113A.

For a given transmission frequency and antenna length, where the power-amplifier plate circuit and the antenna may be resonated with control C in any of the first seven positions, there are a number of combinations of values of series inductance and shunt capacity which will accomplish resonance. However, each of these combinations provides a different degree of coupling between the power amplifier and the antenna.

When the length of the antenna is less than approximately 60 feet, and the transmission frequency is in the 2.0-mc. to 3.0-mc. range, it is necessary to use one or more sections of the antenna shunt capacitor (by closing the antenna capacitor switch, SA-46/ART-13) in order to achieve power-amplifier resonance. However, there will be a reduction in the power delivered to the antenna when the transmitter is tuned to frequencies higher than that which requires the use of sections of the antenna shunt capacitor.

As shown in figure 27, when control C is in any position from 8 through 11, switch section S113C remains at position 7, which shorts inductor L113, and switch section S113B is in position 2. Thus, the output circuit is a "Pi" network, in which the first shunt element consists of one or more of capacitors C122, C129, and C130; the series element consists of inductor L112; the second shunt element is made up of capacitors C125 and C124. In position 12, control C opens sections F, G, and H of switch S113, and the output circuit is an "L" network.

For a given transmission frequency and antenna length, where the power-amplifier plate circuit and the antenna may be resonated with control C in any position from 8 through 12, there are a number of combinations of values of series inductance and shunt capacity which will accomplish resonance. However, each of these combinations provides a different degree of coupling between the power amplifier and the antenna.

As shown in figure 28, when control C is in position 13, the output circuit is a "Pi" network, in which the series element consists of inductor L112 in parallel with inductor L114; the second shunt element is the combination of capacitors C124 and C125; the first shunt ele-

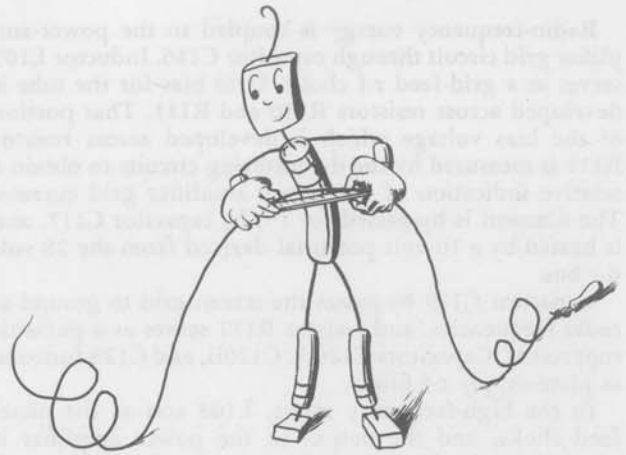

ment is capacitor C129. As in previous positions of control C, the various combinations of series inductance and shunt capacity, which accomplish resonance, result in different degrees of coupling to the antenna.

As shown in figure 25, connection is made from the high-frequency output circuits to the high-frequency output terminal, J109, through the vacuum contacts, S116, of the keying relay, K102, and the antenna-ammeter coupling transformer, T102, when the transmitter is keyed. The antenna ammeter, M101, indicates the relative amount of r-f current flowing through the antenna. The associated-receiver terminal, J110, is connected to terminal J109 through the vacuum contacts, S116, when the transmitter is in the unkeyed state. Terminal J110 is connected to ground through contacts B of the keying relay, K102, when the transmitter is keyed. Thus, the transmitter and receiver make use of the same antenna, and break-in operation is permitted.

The antenna ammeter, M101, is the major test point for the high-frequency circuits of the transmitter, and is designated ②. A normal reading of antenna current indicates that the high-frequency circuits of the transmitting set are operative. The exact value of this reading is dependent upon the transmission frequency and

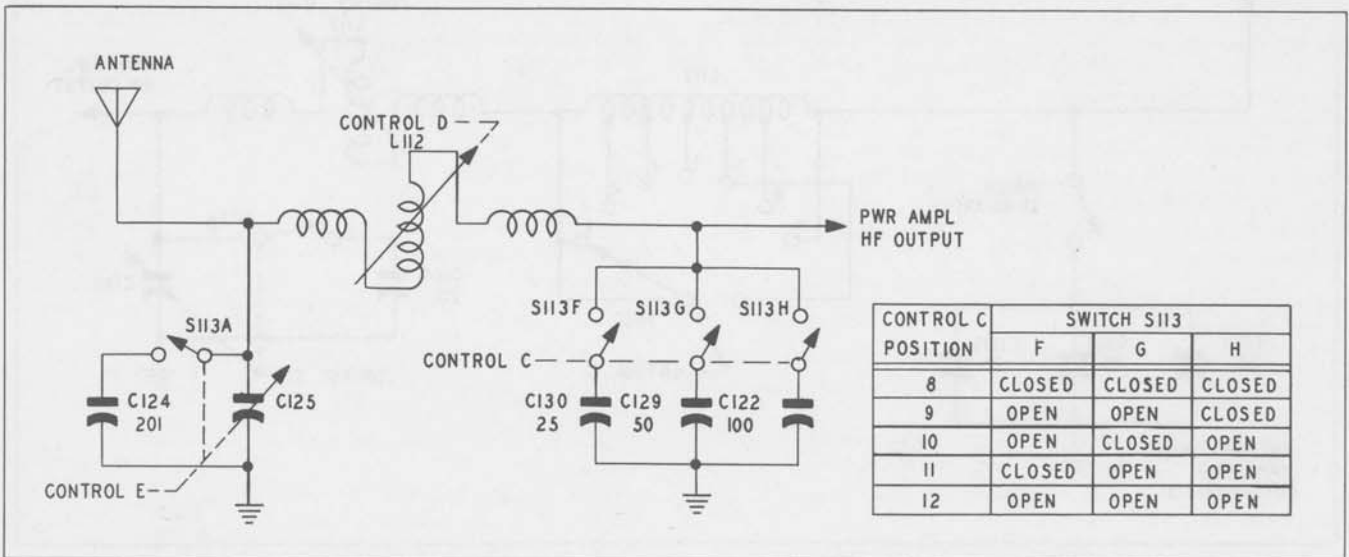

Figure 27. High-Frequency Output Circuit for Positions 8 through 12 of Control C

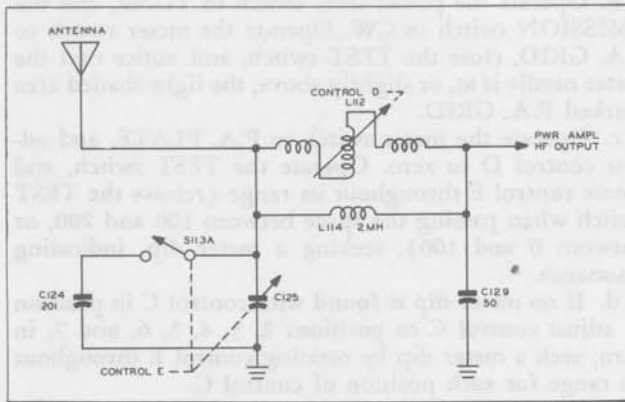

Figure 28. High-Frequency Output Circuit for Position 13 of Control C

antenna length. The antenna ammeter is also designated key test point **J**, which is used in the trouble-shooting procedure to determine whether faulty operation of the output circuits is caused by a trouble in the transmitter or in an external unit. A neon-lamp test is made at secondary test point **J1** to isolate trouble in the high-frequency output circuits either to the vacuum contacts and associated circuits or to the tuning and loading circuits. Voltage measurements are made at secondary test points **D1** and **D2**, as shown in figure 25, to check the plate and screen-grid d-c supply circuits. A check of the grid circuit is made by means of a resistance measurement at test point **E1**.

LESSON PLAN No. 7

TIME ALLOTTED: 1½ HR.

SUBJECT

Power-amplifier and high-frequency output circuits.

OBJECTIVE

To analyze the power-amplifier and high-frequency output circuits.

INTRODUCTION

The power-amplifier stage is excited by any one of three vacuum-tube stages. This amplifier delivers a maximum of 90 watts of carrier power to the output circuits, which tune and couple the power-amplifier-plate and antenna circuits.

SUBJECT MATERIAL

1. Display Wall Chart No. 1 and briefly review the action of the power-amplifier and high-frequency output circuits.
2. Display Wall Chart No. 2 and point out the power-amplifier and high-frequency output circuits.
3. State the type circuit and vacuum tube utilized in the power-amplifier stage.
4. Illustrate the flexibility of the high-frequency output circuits by drawing an example of each of the basic networks, "Pi" and "L", on the blackboard.

5. Name the three functions of the high-frequency output circuits.

6. Draw the input circuit of the power amplifier, as shown in figure 25, on the blackboard, and state the functions of the blocking capacitor, the r-f choke, and the two grid resistors. State the purpose of the filament condenser.

7. Explain the plate and screen return circuits.

8. Describe the action of relay K105 in conjunction with inductors L108 and L109.

9. Trace the screen circuit for each position of switch S106 when the transmitter is in both the keyed and unkeyed conditions.

10. State the purposes of inductors L110 and L116, and capacitor C137.

11. Describe the action of switch S113A as control E is operated, explain the effect upon the circuit, and point out the two sets of scales on the control E dial.

12. Draw the supplementary chart shown in figure 25 on the blackboard.

13. Explain the operation of the high-frequency output circuits for each position of control C by making use of simplified schematic diagrams, drawn on the blackboard, as shown in figures 26, 27, and 28.

14. Trace the signal path from the output circuits to terminal J109 when the transmitter is keyed.

15. Explain how break-in operation is afforded by connecting the antenna terminal of the associated receiver to terminal J110 on the transmitter.

16. Point out the major, key, and secondary test points and explain their use.

17. Point out the locations of the test points on the equipment.

CONCLUSIONS

The operation of the power-amplifier and high-frequency output circuits is checked by the use of one key test points and four secondary test points.

ORAL QUIZ

1. What type of vacuum tube is utilized in the power-amplifier stage?
2. At what frequency is the power amplifier excited for a transmission frequency of 10.0 mc.?
3. The high-frequency output circuits may be connected as either one of two types of networks. What are they?
4. Why is it necessary to add inductor L109 to the plate circuit when operating on low frequency?
5. If the d-c grid current is 10 ma. when the power level switch is at CALIBRATE, what value of negative voltage is applied to the screen grid? (Assume AN/ART-13A connections.)
6. Why is it necessary to incorporate a static-drain choke in the antenna circuit of a transmitter, particularly the airborne-type of transmitter?

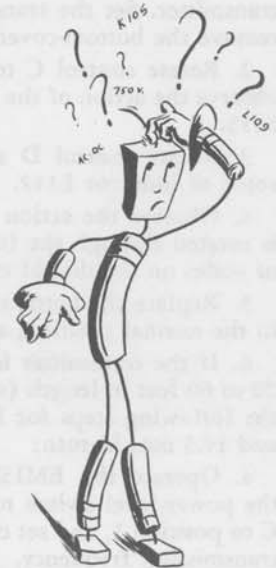

EXPERIMENT No. 6

TIME ALLOTTED: 2 HR.

SUBJECT

Tuning, adjustment, and trouble shooting of the power-amplifier and high-frequency output circuits.

OBJECTIVE

To become familiar with the tuning, adjustment, and trouble shooting of the power-amplifier and high-frequency output circuits.

EQUIPMENT REQUIRED

One or more AN/ART-13 type of transmitting sets with accessory components as listed in previous experiments.

For each transmitting set:

One d-c voltmeter with 750-volt and 1500-volt ranges.

One ohmmeter.

One neon lamp.

One thin tool with a notch at one end, for keying-relay adjustment.



INSTRUCTIONS

Intercable, connect, and plug in the units and accessory components as in previous experiments. Always approach dial settings in a clockwise direction. Refer to the Trouble-Shooting Supplement for the placement of troubles in the equipment.

PROCEDURE

1. Operate the LOCAL-REMOTE switch to LOCAL, and the EMISSION switch to VOICE. Operate the CHANNEL switch to MANUAL. When the Autotune system completes the cycle, operate the EMISSION switch to OFF. Remove the top-cover plate from the transmitter. Set the transmitter on its rear surface and remove the bottom-cover plate.

2. Rotate control C to each of the 13 positions and observe the action of the cam-operated sections of switch S113.

3. Rotate control D and note the movement of the rotor of inductor L112.

4. Observe the action of switch S113A, as control E is rotated through the full range. Examine the two sets of scales on the dial of control E.

5. Replace the bottom-cover plate. Set the transmitter in the normal position, and replace the top-cover plate.

6. If the transmitter is connected to a fixed antenna, 20 to 60 feet in length (or equivalent dummy), perform the following steps for frequencies of 2.1 mc., 7.0 mc., and 17.5 mc., in turn:

a. Operate the EMISSION switch to VOICE, and the power-level switch to CALIBRATE. Adjust control C to position 1, and set controls A and B for the desired transmission frequency.

b. Operate the power-level switch to TUNE, and the EMISSION switch to CW. Operate the meter switch to P.A. GRID, close the TEST switch, and notice that the meter needle is at, or slightly above, the light-shaded area marked P.A. GRID.

c. Operate the meter switch to P.A. PLATE, and adjust control D to zero. Operate the TEST switch, and rotate control E throughout its range (release the TEST switch when passing the space between 100 and 200, or between 0 and 100), seeking a meter dip, indicating resonance.

d. If no meter dip is found with control C in position 1, adjust control C to positions 2, 3, 4, 5, 6, and 7, in turn; seek a meter dip by rotating control E throughout its range for each position of control C.

e. If resonance is found with control C in any position from 1 through 7, operate the power-level switch to OPERATE. Load the power amplifier by increasing the setting of control D in steps, and return the circuit to resonance with control E, for each step. If it is impossible to obtain a reading (at the minimum point of the resonance dip) within the light-shaded area marked CW on the meter before control D is advanced to a setting of 100, proceed as follows: Rotate control D to zero, adjust control C to the next higher position, and return the circuit to resonance with control E (providing control C is not in position 8). Increase the setting of control D in steps, and reresonate the circuit with control E, for each step. Continue this procedure until the resonance dip occurs at a meter reading within the light-shaded area marked CW, or until position 8 of control C is reached, whichever is first. If the power amplifier can be loaded sufficiently, make fine adjustments of controls D and E until the minimum point of the resonance dip coincides with a reading of 100 on the meter.

f. If the condition of resonance, or a meter reading of 100 at resonance, cannot be obtained before control C is set to position 8, proceed as follows: Operate the power-level switch to TUNE, leave control C at position 8, set control E to zero, and seek resonance with control D.

g. If resonance is not obtained with control C in position 8, adjust control C to positions 9, 10, 11, 12, and 13, in turn, and seek resonance with control D.

h. If resonance is not obtained with control C in any position from 8 through 13, proceed as follows: Leave control C at position 13, adjust control D to 100, and seek resonance with control E.

i. If resonance is found with control C in any position from 8 through 13, proceed as follows: Operate the power-level switch to OPERATE. Load the power amplifier by increasing the setting of control E in steps, reresonating with control D, for each step, until the resonance dip falls within the light-shaded area marked CW on the meter. Make fine adjustments of controls D and E until the minimum point of the resonance dip coincides with a reading of 100 on the meter.

j. If resonance cannot be obtained by performing the foregoing steps, proceed as follows: Connect one section of the antenna shunt capacitor to the COND. terminal on the transmitter (through switch SA-46/ART-13, if used). Operate the power-level switch to TUNE, adjust control C to position 1, and repeat steps c, d, and e of the foregoing procedure. If resonance still cannot be obtained, repeat the procedure with two sections of the antenna shunt capacitor and, if necessary, with all three sections.

k. To make certain that the output circuits are not tuned to a harmonic of the desired transmission fre-

quency, check the final setting of controls C, D, and E against the approximate settings listed in the antenna tuning and loading tables. They should be in reasonable agreement.

7. When the transmitter is connected to a trailing antenna installed in an aircraft, the following operations are performed while the aircraft is on the ground:

a. Connect the ANT. terminal on the transmitter to ground, using a short lead.

b. Operate the EMISSION switch to VOICE, and the power-level switch to CALIBRATE. Adjust control C to position 1, and set controls A and B for the desired transmission frequency.

c. Operate the power-level switch to TUNE, and the EMISSION switch to CW. Operate the meter switch to P.A. GRID, close the TEST switch, and notice that the meter needle is at, or slightly above, the light-shaded area marked P.A. GRID.

d. Operate the meter switch to P.A. PLATE, and adjust control D to zero. Operate the TEST switch, and seek resonance (indicated by a meter dip) by rotating control E throughout its range (release the TEST switch when passing the space between 100 and 200, or between 0 and 100).

e. If no meter dip is found with control C in position 1, adjust control C to positions 2, 3, 4, 5, 6, and 7, in turn; seek resonance by rotating control E throughout its range for each position of control C.

f. If resonance is not found with control C in any position from 1 through 7, adjust control C to position 8, set control E to zero, and seek resonance with control D.

g. If resonance is not obtained with control C in position 8, adjust control C to positions 9, 10, 11, 12, and 13, in turn, and seek resonance with control D.

h. If resonance is not obtained with control C in any position from 8 through 13, leave control C at position 13, adjust control D to 100, and seek resonance with control E.

i. When resonance is obtained, release the TEST switch, remove the connection from the ANT. terminal to ground and reconnect the proper wire to the ANT. terminal.

8. When the transmitter is connected to a trailing antenna installed in an aircraft, the following operations are performed while the aircraft is airborne:

a. If the transmission frequency is in the 2.0-mc. to 5.0-mc. frequency range, reel out the antenna to its full length (200 feet); if in the 5.0-mc. to 10.0-mc. range, reel out to 100 feet; if in the 10.0-mc. to 18.1-mc. range, reel out to 75 feet.

b. Operate the TEST switch, and reel in the antenna until resonance is indicated by the meter. Set the power-level switch to OPERATE.

c. If resonance was found with control C in any position from 1 through 7, load the power amplifier by increasing the setting of control D in steps, and return the circuit to resonance with control E, for each step. If it is not possible to obtain a reading within the light-shaded area marked CW on the meter before control D is advanced to a setting of 100, proceed as follows: Rotate control D to zero, adjust control C to the next higher position, and return the circuit to resonance with control E (pro-

viding control C is not in position 8). Increase the setting of control D in steps, and reresonate the circuit with control E, for each step. Continue this procedure until the resonance dip occurs at a meter reading within the light-shaded area marked CW, or until position 8 of control C is reached, whichever is first. If the power amplifier can be loaded sufficiently, make fine adjustments of controls D and E until the minimum point of the resonance dip coincides with a reading of 100 on the meter.

d. If resonance was found with control C in any position from 8 through 13, load the power amplifier by increasing the setting of control E in steps, and reresonate with control D, for each step, until the resonance dip falls within the light-shaded area marked CW on the meter. Make fine adjustments of controls D and E until the minimum point of the resonance dip coincides with a reading of 100 on the meter.

9. Operate the EMISSION switch to OFF, and remove the top-cover plate from the transmitter.



10. Notice that the vacuum contacts, S116, are contained in a glass envelope, which is mounted on the front panel of the keying relay, K102. When it is necessary to replace the vacuum contacts (due to a cracked or leaky glass bulb, or badly burned contacts), the following operations are necessary:

a. Loosen the setscrews which hold the wire connectors to the fixed-contact terminals, and remove the connectors.

b. Loosen the base-clamp stud and remove the glass vacuum tube by pulling it up.

c. Place the rubber gasket in position and insert the new vacuum switch in the socket. Spread the two wires which form the wire actuating arm about 1/32" with a screwdriver. Securely engage the movable switch arm, which extends out of the bottom of the glass bulb, between the two wires of the actuating arm.

d. Tighten the base-clamp stud. Replace the wire connectors on the fixed-contact terminals, and tighten the setscrews.

e. Loosen the setscrew on the split collar at the end of the glass operating arm which connects the vacuum switch to the case of the keying relay. Rotate the split collar slowly until the movable contact of the vacuum switch is resting firmly against the fixed contact which connects to the RECEIVER terminal on the transmitter. Hold the collar in this position, and tighten the setscrew.

11. Remove the top-cover plate from the keying relay by removing the two Phillips screws.

12. Inspect the interior of the keying relay. Notice the double row of contacts near the top. Notice that all of the movable-contact arms are attached to a thick bakelite plate located in the center of the case. By using a thin tool, with a notch at one end so that it will fit over the bakelite plate, operate the relay armature, manually, by moving the bakelite plate laterally. Notice that, as the bakelite plate is moved, all of the movable contact arms in the relay, and the movable arm in the vacuum switch, also move.

13. Notice that, as the bakelite plate is moved from the unoperated position to the operated position, the following contact actions occur, in succession, with a definite interval of bakelite-plate movement separating the actions:

a. The three normally closed contacts in the keying relay open.

b. The movable contact of the vacuum contacts breaks connection with the fixed contact which is connected to the RECEIVER terminal.

c. The movable contact of the vacuum contacts makes connection to the opposite fixed contact.

d. The five normally open contacts in the relay close.

14. When it is necessary to make the timing adjustment of the vacuum contacts, proceed as follows: Loosen the two studs that hold the horseshoe-shaped yoke to the relay case; rotate the adjusting screw that can be seen through the hole on the side of the case on which is mounted plug P102, as required; and tighten the studs. Check the sequence of contact actions, and repeat the adjustment, if necessary. Replace the top-cover plate on the keying relay.

15. Manually depress the top-cover interlock, if used, and tune and load the transmitter on a transmission frequency of 7.0 mc. Note the reading of the antenna ammeter (major test point ② , key test point ⑤). Connect one section of the antenna shunt capacitor to the COND. terminal, and retune the transmitter on the same frequency. Notice that the new reading of the antenna ammeter is less than the previous one.

16. Key the transmitter and hold a neon lamp near or touching the COND. terminal (secondary test point ①) of the transmitter. Notice that the lamp glows.

17. Operate the power-level switch to TUNE. Connect the negative lead of the d-c voltmeter (set to the 1500-volt range) to ground, and the positive lead to test point ⑥ , the top cap of the power-amplifier tube. Manually depress the top-cover interlock, if used, and operate the TEST switch. Notice that the reading is approximately 1150 volts.

18. Operate the EMISSION switch to OFF. Remove

the top-cap lead from the power-amplifier tube, and remove the tube from the socket. Operate the EMISSION switch to CW, and the power-level switch to OPERATE. CAUTION! High voltage exists at the clip of the power-amplifier top-cap lead. Connect the negative lead of the d-c voltmeter (set to the 750-volt range) to ground, and the positive lead to test point ⑦ , contact 3 of the power-amplifier-tube socket. Manually operate the top-cover interlock, if used, and close the TEST switch. Notice that the reading is approximately 420 volts.

19. Operate the EMISSION switch to OFF. Connect one lead of the ohmmeter to ground, and the other lead to test point ⑧ , contact 4 of the power-amplifier-tube socket. Notice that the reading is approximately 20,000 ohms. Replace the power-amplifier tube in the socket, and reconnect the top-cap lead.

20. Request the instructor to place a trouble in the equipment. By making use of the test points, visual inspection, and further voltage and resistance measurements, as required, isolate and locate the trouble, and correct it. Restore the transmitting set to its original condition.

CONCLUSIONS

1. Why is it necessary to release the TEST switch when passing the space between 100 and 200, or between 0 and 100, on the dial of control E?

2. Why is it necessary to operate the power-level switch to TUNE before proceeding with the tuning procedure?

3. What sacrifice is made when one or more sections of the antenna shunt capacitor are used?

4. What is the result of tuning the output circuits to a harmonic of the desired transmission frequency?

5. When the transmitter is connected to a trailing antenna, a short lead is connected from the ANT. terminal to ground and preliminary tuning adjustments of controls C, D, and E are made while the aircraft is on the ground. Why do the settings of controls C, D, and E, so obtained, roughly approximate the final settings used in flight?

6. Is it necessary to make use of the antenna shunt capacitor when the transmitter is operating into a trailing antenna?

7. What is the result of the fact that the five normally open contacts, in the keying relay, close before the movable contact on the vacuum contacts makes connection to the fixed contact which is connected to the COND. terminal?

8. When the transmission frequency is 10.0 mc., a zero reading at test point ② may be caused by trouble in any one of which four vacuum-tube stages?

9. Name at least four possible causes of an abnormal indication at test point ① .

10. Describe one simple method of checking resistor R132 in the AN/ART-13A without removing the transmitter bottom-cover plate.

11. If resistor R124 is open, what symptoms are noted in the equipment? Which test point may be used to isolate this condition?

LECTURE 8

CIRCUIT ANALYSIS OF THE LOW-FREQUENCY OUTPUT CIRCUITS

In Antenna Loading Unit CU-32/ART-13A, the low-frequency output circuits consist of series inductors and shunt capacitors whose purposes are to tune the power-amplifier-plate and antenna circuits to resonance, and to provide coupling between them, when the transmitter is operating within the 200-kc. to 600-kc. frequency range.

The low-frequency output circuits are shown in block form on Wall Chart No. 1, and in schematic form in figure 29. (Schematic-diagram data on the antenna switching unit and the two antenna loading coils were not available at the time of writing.)

The low-frequency output circuits form an equivalent parallel-resonant circuit in which the parallel combination of capacitors C2501 and C2502 compose the capacitive branch; the inductive branch is made up of the series combination of inductors L2501 and L2502, and the antenna (which is capacitive since it is less than a quarter wavelength long). The inductance in the inductive branch is adjusted so that the net reactive component of the series inductors (inductive reactance) and the antenna (capacitive reactance) is an inductive reactance approximately equal to the nonadjustable capacitive reactance in the capacitive branch. This satisfies the condition of resonance, but no provision is made for adjusting the

degree of coupling between the power amplifier and the antenna, since the loading of the power amplifier to normal aircraft antennas (30 to 200 feet in length) in the low-frequency range is almost invariably equal to, or less than, the maximum amount allowable.

Inductor L2501 is of the variometer type and the rotor is operated by control R, TUNE TO MINIMUM P.A. PLATE CURRENT, to provide fine control of the series inductance. Coarse control of the series inductance is accomplished by switches S2501 and S2502, which select taps on inductors L2501 and L2502. These switches are actuated by controls Q and P, FINE LOADING and COARSE LOADING, respectively.

The series inductance is connected to the antenna through the vacuum contacts, S2504, of the break-in relay, K2501, and the contacts of either section C or B of the antenna switch, S2503. The arm of the vacuum contacts, S2504, of relay K2501 is in the position opposite to that shown in figure 29, when the transmitter is keyed while operating within the 200-kc. to 600-kc. frequency range. Sections A and D of the antenna switch, S2503, connect the antenna not being used by the transmitter to terminal J2505, which may be connected to an auxiliary receiver.

Resistors R2501 through R2505 are connected in series to form a 9-megohm bleeder, which drains off the static charge that tends to accumulate on the antenna and capacitors C2501 and C2502. The antenna ammeter, M2501,

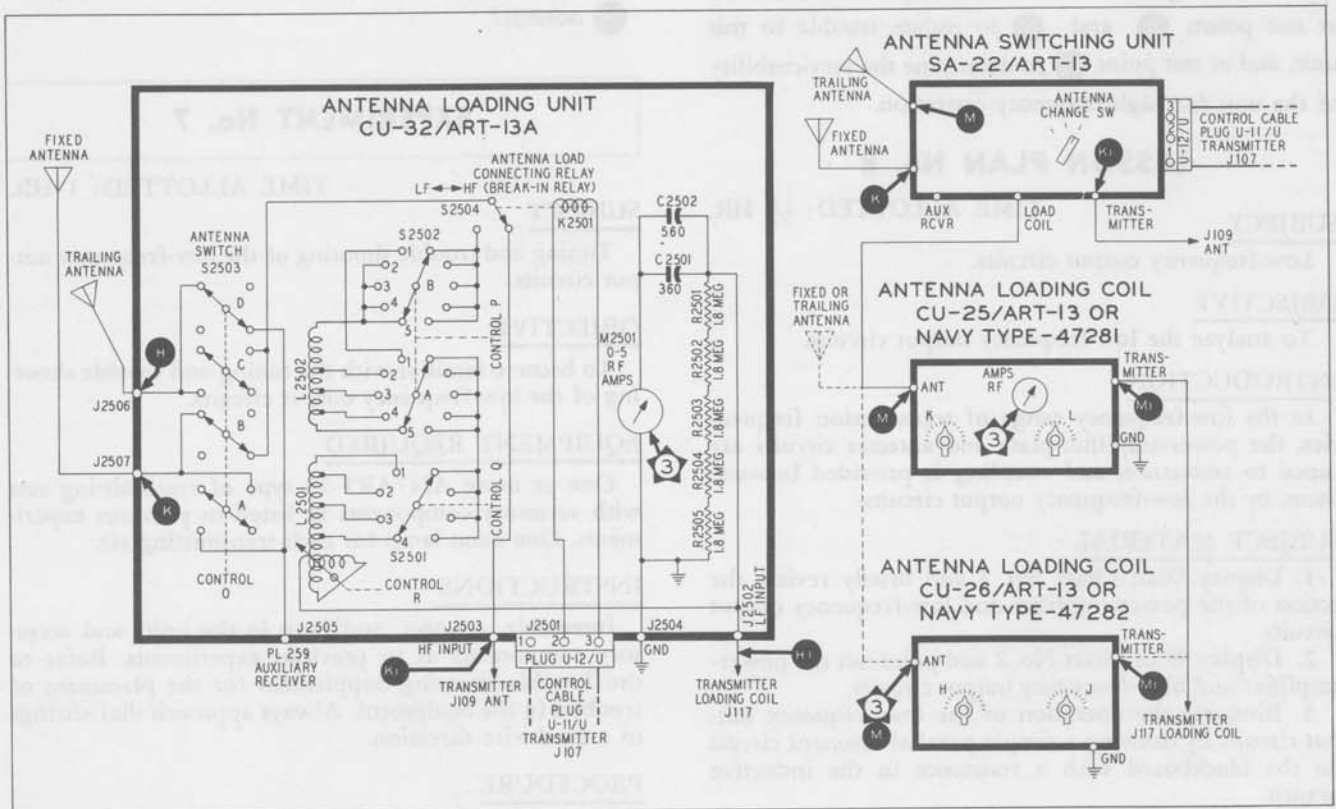

Figure 29. Low-Frequency Output Circuits

indicates the relative amount of antenna current by measuring the r-f current flowing in the capacitive branch of the tuned circuit.

The antenna ammeter, designated major test point $\textcircled{3}$, provides an over-all check of the low-frequency circuits of the transmitting set. Neon-lamp tests are made at test points \textcircled{H} and $\textcircled{H_1}$ to check the operation of the loading coil in the low-frequency range. Similar tests are made at test points \textcircled{K} and $\textcircled{K_1}$ to check the operation of the loading coil in the high-frequency range.

Similar antenna tuning circuits are contained in Antenna Loading Coils CU-25/ART-13 (Navy Type —47281) and CU-26/ART-13 (Navy Type —47282). The CU-25/ART-13 type of loading coil tunes a 200-foot trailing antenna throughout the 200-kc. to 600-kc. frequency range, and a fixed antenna in the upper portion of the frequency range. The CU-26/ART-13 type of loading coil tunes a 150-foot trailing antenna throughout the frequency range of 1100 kc. to 1500 kc., and a 200-foot trailing antenna throughout the 500-kc. to 1100-kc. frequency range. In these two types of loading coils, major test point $\textcircled{3}$ checks the over-all operation of the low-frequency circuits of the transmitting set; for the CU-25/ART-13 type, visual observation of the AMPERES RF meter is made; for the CU-26/ART-13 type, a neon-lamp check is made at the ANTENNA terminal. In both types, neon-lamp checks are made at test points \textcircled{M} and $\textcircled{M_1}$ to isolate trouble to the coil unit.

The functions of a break-in relay and an antenna switch are provided by Antenna Switching Unit SA-22/ART-13 when either the CU-25/ART-13 or the CU-26/ART-13 type of loading coil is used. Neon-lamp checks are made at test points \textcircled{K} and $\textcircled{K_1}$ to isolate trouble to this unit, and at test point \textcircled{M} to determine the serviceability of the unit for high-frequency operation.

LESSON PLAN No. 8

SUBJECT TIME ALLOTTED: 1/2 HR.

Low-frequency output circuits.

OBJECTIVE

To analyze the low-frequency output circuits.

INTRODUCTION

In the low-frequency range of transmission frequencies, the power-amplifier-plate and antenna circuits are tuned to resonance, and coupling is provided between them, by the low-frequency output circuits.

SUBJECT MATERIAL

1. Display Wall Chart No. 1 and briefly review the action of the power-amplifier and low-frequency output circuits.
2. Display Wall Chart No. 2 and point out the power-amplifier and high-frequency output circuits.
3. Illustrate the operation of the low-frequency output circuits by drawing a simple parallel-resonant circuit on the blackboard with a resistance in the inductive branch.
4. Modify the simple circuit by adding a series capacitor in the inductive branch, and explain.

5. Describe the manner in which the low-frequency output circuits are adjusted and point out the control knobs on the equipment.

6. Explain the action of the antenna switch and break-in relay.

7. State the purposes of resistors R2501 through R2505 and the antenna ammeter.

8. Point out the test points in the circuit and explain their use.

9. Point out the locations of the test points on the equipment.

10. Describe the similarities and differences in the antenna loading unit, the two types of loading coils, and the antenna switching unit.

CONCLUSIONS

The operation of the low-frequency circuits of the transmitting set is checked by the use of one major test point, located in the low-frequency output circuits. The operation of the low-frequency output circuits is checked by means of two key test points and two secondary test points.

ORAL QUIZ

1. When the low-frequency output circuits and the antenna circuit are considered together, what type of circuit do they form?

2. When the low-frequency output circuits are considered alone, what type of network do they resemble, "Pi" or "L"?

3. If it is desired to connect the fixed antenna to the auxiliary receiver, to which position is the antenna switch operated?

4. If the antenna ammeter is open, is the indication at test point $\textcircled{H_1}$ normal? Is the indication at test point \textcircled{H} normal?

EXPERIMENT No. 7

TIME ALLOTTED: 1 HR.

SUBJECT

Tuning and trouble shooting of the low-frequency output circuits.

OBJECTIVE

To become familiar with the tuning and trouble shooting of the low-frequency output circuits.

EQUIPMENT REQUIRED

One or more AN/ART-13 type of transmitting sets with accessory components as listed in previous experiments. One neon lamp for each transmitting set.

INSTRUCTIONS

Intercable, connect, and plug in the units and accessory components as in previous experiments. Refer to the Trouble-Shooting Supplement for the placement of troubles in the equipment. Always approach dial settings in a clockwise direction.

PROCEDURE

1. Make certain that the EMISSION switch is at OFF. Remove the cover plate from the loading coil (and the

antenna switching unit, if used). Examine the contents of the unit. Operate the panel controls and notice the effect upon the internal components. Replace the cover plates.

2. If Radio Transmitting Set AN/ART-13A is used, perform the following steps for frequencies of 200 kc., 400 kc., and 600 kc., in turn:

a. Operate the LOCAL-REMOTE switch to LOCAL, and the EMISSION switch to VOICE. Operate the power-level switch to CALIBRATE, and the CHANNEL switch to MANUAL. When the Autotune system completes the cycle, adjust control C to position 8, and control A to position 13 (L.F.). Set controls F and G for the desired transmission frequency.

b. Operate the power-level switch to TUNE, and the EMISSION switch to CW. Operate the meter switch to P.A. GRID, and close the TEST switch. Notice that the meter needle is at, or slightly above, the light-shaded area marked P.A. GRID.

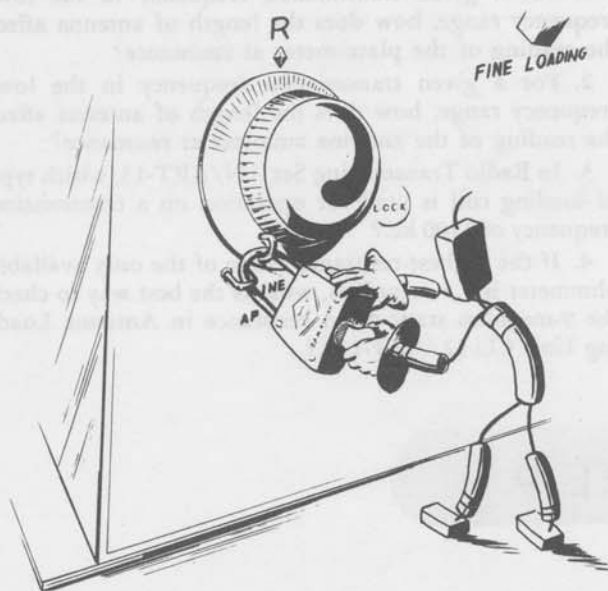

c. Operate the meter switch to P.A. PLATE, and adjust control P (on the antenna loading unit) to position 1. Place control Q at position 1, unlock control R, and adjust it to zero.

d. Operate the TEST switch, and seek resonance (indicated by a plate-meter dip) by rotating control R throughout its range.

e. If no meter dip is found with control Q in position 1, adjust control Q to positions 2, 3, and 4, in turn; seek a meter dip by rotating control R throughout its range, for each position of control Q.

f. If no meter dip is found with control P in position 1, adjust control P to positions 2, 3, 4, and 5, in turn. For each position of control P, set control Q to each of its positions, in turn, and seek resonance by rotating control R throughout its range.

g. When resonance is found, set control R in the position which results in a minimum reading of the plate meter. Operate the power-level switch to OPERATE. Readjust control R for a minimum reading of the plate meter, and lock. For normal operation, the plate meter may indicate any value from 10 to 120 at resonance, depending upon the transmission frequency and length of antenna. Notice the indication of the antenna ammeter

on the loading unit. This reading is also dependent upon transmission frequency and antenna length.

h. This completes the tuning procedure for this frequency. The same procedure is followed when tuning to other frequencies in the 200-kc. to 600-kc. range.

3. If Radio Transmitting Set AN/ART-13, or Navy Model ATC or ATC-1 is used, cable Antenna Loading Coil CU-25/ART-13, or Navy Type —47281, to the transmitter and the antenna (or antenna switching unit, if used). Perform the following steps for frequencies of 200 kc., 400 kc., and 600 kc., in turn:

a. Operate the LOCAL-REMOTE switch to LOCAL, and the EMISSION switch to VOICE. Operate the power-level switch to CALIBRATE, and the CHANNEL switch to MANUAL. When the Autotune system completes the cycle, adjust control C to position 8, and control A to position 13 (L.F.). Set controls F and G for the desired transmission frequency.

b. Operate the power-level switch to TUNE, and the EMISSION switch to CW. Operate the meter switch to P.A. GRID, and close the TEST switch. Notice that the meter needle is at, or slightly above, the light-shaded area marked P.A. GRID.

c. Operate the meter switch to P.A. PLATE, and set control K (on the loading coil) to position 1. Unlock control L and adjust it to zero.

d. Operate the TEST switch, and seek resonance (indicated by a plate-meter dip) by rotating control L throughout its range.

e. If no meter dip is found with control K in position 1, adjust control K to positions 2 through 13, in turn. For each position of control K, seek a meter dip by rotating control L throughout its range.

f. When resonance is found, set control L in the position which results in a minimum reading of the plate meter. Operate the power-level switch to OPERATE. Readjust control L for a minimum reading of the plate meter, and lock. For normal operation, the plate meter may indicate any value from 10 to 110 at resonance, depending upon the transmission frequency and length of antenna. Notice the indication of the antenna ammeter on the loading coil. This reading is also dependent upon transmission frequency and antenna length.

g. This completes the tuning procedure for this frequency. The same procedure is followed when tuning to other frequencies in the 200-kc. to 600-kc. range.

4. If Radio Transmitting Set AN/ART-13, or Navy Model ATC or ATC-1 is used, cable Antenna Loading Coil CU-26/ART-13, or Navy Type —47282, to the transmitter and the antenna (or antenna switching unit, if used). Perform the following steps for frequencies of 600 kc., 1000 kc. and 1500 kc., in turn:

a. Operate the LOCAL-REMOTE switch to LOCAL, and the EMISSION switch to VOICE. Operate the power-level switch to CALIBRATE, and the CHANNEL switch to MANUAL. When the Autotune system completes the cycle, adjust control C to position 8, and control A to position 13 (L.F.). Set controls F and G for the desired transmission frequency.

b. Operate the power-level switch to TUNE, and the EMISSION switch to CW. Operate the meter switch to P.A. GRID, and close the TEST switch. Notice that the meter needle is at, or slightly above, the light-shaded area marked P.A. GRID.

c. Operate the meter switch to P.A. PLATE, and set control H (on the loading coil) to position 1. Unlock control J and adjust it to zero.

d. Operate the TEST switch, and seek resonance (indicated by a plate-meter dip) by rotating control J throughout its range.

e. If no meter dip is found with control H in position 1, adjust control H to positions 2 through 7, in turn; for each position of control H, seek a meter dip by rotating control J throughout its range.

f. When resonance is found, set control J in the position which results in a minimum reading of the plate meter. Operate the power-level switch to OPERATE. Readjust control J for a minimum reading of the plate meter, and lock. For normal operation, the plate meter may indicate any value from 10 to 110 at resonance, depending upon the transmission frequency and length of antenna.

g. This completes the tuning procedure for this frequency. The same procedure is followed when tuning to other frequencies in the 600-kc. to 1500-kc. range.

5. If Radio Transmitting Set AN/ART-13A is used, tune the equipment to any frequency in the low-frequency range. Make neon-lamp checks at test points H_1 (the TRAILING ANTENNA terminal on the loading unit) and H_2 (the L.F. INPUT terminal on the loading unit). Tune the equipment to any frequency in the high-frequency range. Make neon-lamp checks at test points K_1 (the FIXED ANTENNA terminal) and K_2 (the H.F. INPUT terminal).

6. If Radio Transmitting Set AN/ART-13, or Navy Type ATC or ATC-1, is used, tune the equipment to any frequency in the low-frequency range. Make neon-lamp checks at test points M (the ANTENNA terminal on

the loading coil) and M_1 (the TRANSMITTER terminal). If the antenna switching unit is also used, make a neon-lamp check at test point M (the TRAILING WIRE terminal on the switching unit). Tune the equipment to any frequency in the high-frequency range. Make neon-lamp checks at test points K_1 (the FIXED WIRE terminal on the switching unit) and K_2 (the TRANSMITTER terminal).

7. Request the instructor to place a trouble in the equipment. By making use of the test points, visual inspection, and further voltage and resistance measurements, as required, isolate and locate the trouble, and correct it. Restore the transmitting set to its original condition.

CONCLUSIONS

1. For a given transmission frequency in the low-frequency range, how does the length of antenna affect the reading of the plate meter at resonance?

2. For a given transmission frequency in the low-frequency range, how does the length of antenna affect the reading of the antenna ammeter at resonance?

3. In Radio Transmitting Set AN/ART-13, which type of loading coil is used for operation on a transmission frequency of 1100 kc.?

4. If the highest-resistance range of the only available ohmmeter is 2.5 megohms, what is the best way to check the 9-megohm static-drain resistance in Antenna Loading Unit CU-32/ART-13A?

LECTURE 9

CIRCUIT ANALYSIS OF THE AUDIO-AMPLIFIER CIRCUITS

The primary purpose of the audio-amplifier circuits is to raise the level of the audio-input signal (audio tone or speech) to a value sufficient to drive the modulator stage. The secondary purpose of these circuits is to provide a sidetone signal (beat note, audio tone, or speech). The audio-amplifier circuits are shown in block form on Wall Chart No. 1, and in schematic form in figure 30.

The audio-amplifier circuits consist of three vacuum-tube stages—the first audio amplifier, the audio driver, and the sidetone amplifier.

The first audio amplifier operates as a singled-ended class A voltage amplifier. The purpose of this amplifier is to raise the level of the input signal to a value sufficient to excite the audio driver.

With the EMISSION switch at VOICE, the microphone selector switch, S201, at CARBON, and the power-level switch, S106, at OPERATE, the input-circuit elements of the first audio amplifier are connected as shown in figure 31A. Microphone current is supplied through resistors R201 and R202, which limit the current to a suitable value. Capacitor C201 functions as an audio filter. The signal voltage developed by the microphone is attenuated by the voltage divider made up of resistors R203

and R204, so that the input voltage to the first audio amplifier is approximately the same as that when a dynamic microphone is used without these resistors. See figure 31C. This arrangement is required, since the output voltage of a dynamic microphone is much less than that of a carbon type. Resistors R216, R204, and R203 limit the direct current flowing through the primary winding of the input transformer, T201, to one milliamper (maximum rated), for transformer protection when a carbon microphone is not connected and the microphone selector switch is at CARBON.

With the EMISSION switch at VOICE, the microphone-selector switch, S201, at CARBON, and the power-level switch, S106, at TUNE, the input-circuit elements are connected as shown in figure 31B. Resistor R134 is shunted across the primary winding of transformer T201 to reduce the input signal to the amplifier. This provision prevents overmodulation of the power amplifier, and damage to components in the modulator stage. Overmodulation is prevented in the same manner when the microphone-selector switch is at DYNAMIC, as shown in figure 31D.

With the EMISSION switch at MCW and the power-level switch, S106, at OPERATE, the output of the MCW oscillator is fed to the primary winding of transformer T201, through the contacts of section FC of the power-

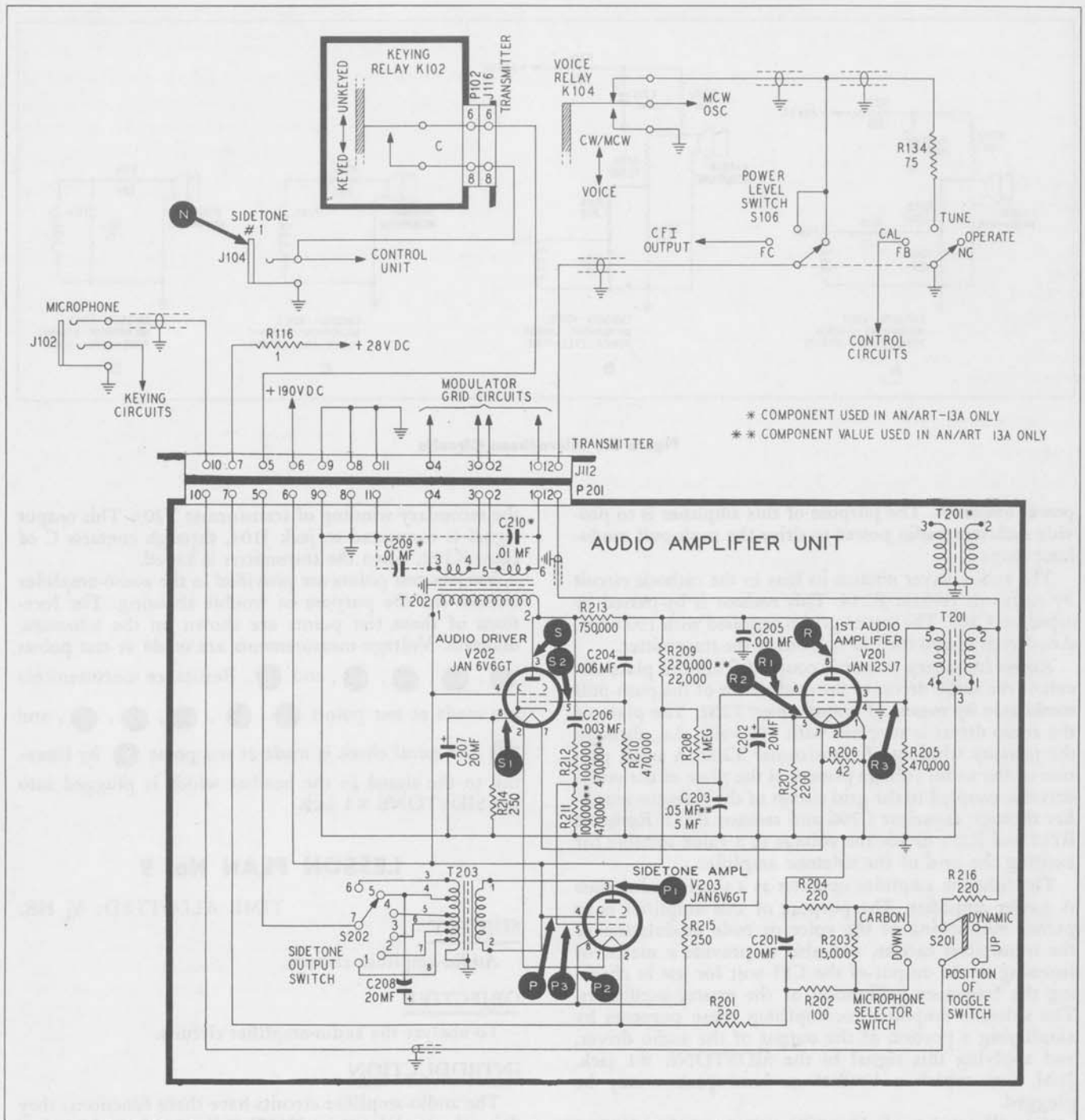

Figure 30. Audio-Amplifier Circuits

level switch, S106, and the voice relay, K104. When the power-level switch is at TUNE, resistor R134 is shunted across the primary winding of transformer T201, to reduce the input signal. When the EMISSION switch is at CALIBRATE, the output of the CFI unit is fed to the primary winding of transformer T201, through the contacts of section FC of switch S106.

Transformer T201 couples the audio-input signal to the grid of the first-audio-amplifier tube, V201. The transformer provides a voltage gain to the grid circuit, and matches the low-impedance input circuit to the high-impedance grid circuit. Resistor R205 provides resistive loading for the transformer secondary winding.

Resistor R207 furnishes cathode bias for the tube, and is by-passed for audio frequencies by capacitor C202. Resistor R208 and capacitor C203 act as the screen dropping resistor and audio by-pass, respectively.

Resistor R209 functions as the plate-load resistor, and capacitor C205 by-passes the high audio and stray radio frequencies. Capacitor C204 couples the output signal of the stage to the grid circuit of the audio driver. Resistor R213 couples a small portion of the output signal of the audio driver back to the plate circuit of the first audio amplifier, to provide inverse feedback in the audio-driver stage.

The audio driver operates as a single-ended class A

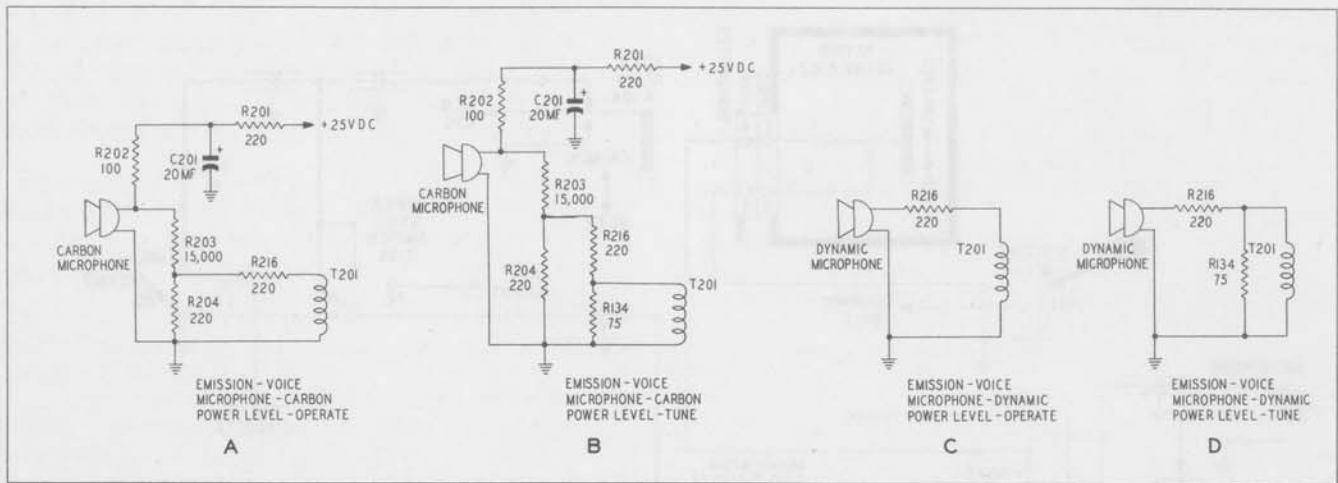

Figure 31. Microphone Circuits

power amplifier. The purpose of this amplifier is to provide sufficient audio power to drive the push-pull modulator stage.

The audio driver obtains its bias in the cathode circuit by means of resistor R214. This resistor is by-passed by capacitor C207. The screen grid is supplied with 190 volts, d.c., directly from the 190-volt bus in the transmitter.

Audio-frequency power is coupled from the plate circuit of the audio driver to the grid circuit of the push-pull modulator by means of transformer T202. The plate of the audio driver is supplied with 190 volts, d.c., through the primary winding of transformer T202. A small portion of the audio voltage present at the plate of the audio driver is coupled to the grid circuit of the sidetone amplifier through capacitor C206 and resistor R212. Resistors R212 and R211 divide the voltage to a value suitable for exciting the grid of the sidetone amplifier.

The sidetone amplifier operates as a single-ended class A power amplifier. The purpose of this amplifier is to permit monitoring of the voice or code modulation of the transmitter carrier, and also to provide a means of listening to the output of the CFI unit for use in checking the frequency calibration of the master oscillators. The sidetone amplifier accomplishes these purposes by amplifying a portion of the output of the audio driver, and applying this signal to the SIDETONE #1 jack, J104, into which a headset or loud-speaker may be plugged.

A small portion of the audio voltage at the plate of the audio driver is applied to the grid circuit of the sidetone amplifier, through capacitor C206 and resistor R212. Resistor R215, which is not by-passed, functions as a cathode-bias resistor, and provides a certain amount of inverse feedback. The screen grid is supplied with 190 volts, d.c., directly from the 190-volt bus in the transmitter.

The plate is supplied with 190 volts, d.c., through the primary winding of transformer T203. This transformer feeds the output of the sidetone amplifier to the SIDETONE #1 jack, J104, through the contacts of the sidetone output switch, S202, and the keying relay, K102. Additional inverse feedback is accomplished by applying a portion of the output of the amplifier to the cathode through capacitor C208.

The sidetone output switch, S202, permits control of the output volume by selecting any one of six taps on

the secondary winding of transformer T203. This output signal is connected to jack J104, through contacts C of relay K102, when the transmitter is keyed.

Various test points are provided in the audio-amplifier circuits for the purpose of trouble shooting. The locations of these test points are shown on the schematic diagram. Voltage measurements are made at test points

P, P₁, R, R₁, and S. Resistance measurements are made at test points P₂, P₃, R₂, R₃, S₁, and S₂. An aural check is made at test point N by listening to the signal in the headset which is plugged into the SIDETONE #1 jack.

LESSON PLAN No. 9

TIME ALLOTTED: ¾ HR.

SUBJECT

Audio-amplifier circuits.

OBJECTIVE

To analyze the audio-amplifier circuits.

INTRODUCTION

The audio-amplifier circuits have three functions: they drive the modulator on MCW and voice operation; they furnish a sidetone signal for CW, MCW, and voice operation; they permit listening to the output of the CFI unit for calibration purposes.

SUBJECT MATERIAL

1. Display Wall Chart No. 1 and briefly review the action of the three vacuum-tube stages which are contained in the audio-amplifier circuits.
2. Display Wall Chart No. 2 and point out the audio-amplifier circuits.
3. State the type circuit and vacuum tube utilized in the first audio amplifier.
4. Draw figure 31A on the blackboard, and explain.
5. Modify to figure 31B, and explain.
6. Draw figure 31C on the blackboard, and explain.
7. Modify to figure 31D, and explain.

8. Describe how the outputs of the MCW oscillator and CFI units are applied to the input of the first audio amplifier.

9. Explain the purpose of each circuit element in the first-audio-amplifier stage.

10. Describe the operation of the audio-driver stage.

11. By means of a blackboard sketch, show how an a-f signal is coupled from the audio driver to the sidetone amplifier.

12. Explain the operation of the sidetone amplifier.

13. Point out the locations of the microphone-selector switch and sidetone-output switch on the equipment.

14. Describe the test points in the audio-amplifier circuits, and point out their locations on the equipment.

CONCLUSIONS

Four Key test points and eight Secondary test points facilitate the trouble shooting of the audio-amplifier unit.

ORAL QUIZ

1. Study the input circuits of the first audio amplifier; what is the approximate voltage ratio of the signal output of the carbon microphone to that of the dynamic microphone?

2. If the audio impedance of the primary winding of the input transformer, T201, is 75 ohms, by what fraction is the input to the audio amplifier reduced when the power-level switch is changed from the OPERATE position to the TUNE position?

3. If the audio impedance of the secondary winding of the input transformer is 125,000 ohms, what is the voltage gain from the input circuit to the grid circuit of the first audio amplifier?

4. What is the voltage ratio of the signal present at the plate of the audio driver to the signal present at the grid of the sidetone amplifier?

5. What would be the result if the negative terminal of capacitor C208 were connected to ground, instead of tap 5 of transformer T203?

6. Does operation of switch S202 affect the amplitude of the audio signal reaching the modulator grid circuit?

EXPERIMENT No. 8

SUBJECT

TIME ALLOTTED: 1 HR.

Trouble shooting of the audio-amplifier unit.

OBJECTIVE

To become familiar with the trouble shooting of the audio-amplifier unit.

EQUIPMENT REQUIRED

One or more AN/ART-13 type of transmitting sets with accessory components as listed in previous experiments.

For each transmitting set:

One d-c voltmeter with 250-volt range.

One ohmmeter.

INSTRUCTIONS

Intercable, connect, and plug in the units and accessory components as in previous experiments. Refer to the Trouble-Shooting Supplement for the placement of troubles in the equipment. Always approach dial settings in a clockwise direction.

PROCEDURE

1. Make certain that the LOCAL-REMOTE switch is at LOCAL, and the EMISSION switch is OFF. Unlock the calibration-chart hinged panel, and raise. Notice the locations of the microphone-selector and sidetone-output switches.

2. Remove the top-cover plate from the transmitter. Remove the audio-amplifier unit from the transmitter. View the unit from the bottom and inspect the various internal components. Replace the audio-amplifier unit and the transmitter top-cover plate.

3. Tune the equipment to a frequency in the 6.0-mc. to 7.2-mc. frequency band. Operate the EMISSION switch to CW and MCW, in turn. Listen to the signal in the headset, while keying the transmitter.

4. Make certain that the microphone-selector switch is in the position corresponding to the type of microphone in use. Operate the EMISSION switch to VOICE. With the microphone button depressed, speak into the microphone and listen to the signal in the headset.

5. Operate the EMISSION switch to MCW. Key the transmitter and listen to the signal in the headset, while operating the sidetone-output switch throughout its range.

6. Operate the EMISSION switch to OFF. Remove the top-cover plate from the transmitter. Remove all three tubes from the audio-amplifier unit. Operate the EMISSION switch to VOICE. Connect the negative lead of the d-c voltmeter (set to the 250-volt range) to ground; close the TEST SWITCH; and manually depress the top-cover interlock, if used. Connect the positive lead of the voltmeter to each of the following test points, and notice the normal readings: P, 200 volts; P₁, 200 volts; R, 110 volts; R₁, 40 volts; S, 200 volts.

NOTE: The normal readings specified for test points R and R₁ are valid only when a 1000-ohms-per-volt meter, set to the 250-volt range, is used.

7. Operate the EMISSION switch to OFF. Connect one lead of the ohmmeter to ground; connect the other lead to each of the following test points, and notice the normal readings: (ohmmeter set to the low-resistance range) P₂, 250 ohms; S₁, 250 ohms; (ohmmeter set to the medium-resistance range) R₂, 2200 ohms; R₃, 4000 ohms; (ohmmeter set to the high-resistance range) P₃, 100,000 ohms (470,000 ohms for AN/ART-13A); S₂, 470,000 ohms.

8. Request the instructor to place a trouble in the equipment. By means of tests at the test points, visual inspection, and further voltage and resistance measurements, as required, isolate and locate the trouble, and correct it. Restore the transmitting set to its original condition.

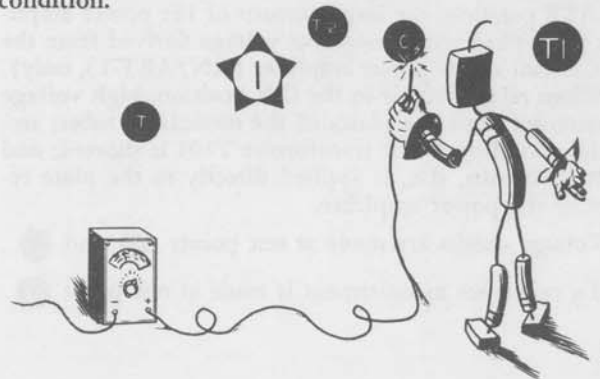

CONCLUSIONS

1. A carbon microphone is plugged into the MICROPHONE jack, the microphone-selector switch is in the DYNAMIC position, and operation of the equipment is attempted on voice; what are the trouble symptoms?

2. It is desired to operate the transmitter on voice, but it is found that the audio-driver tube is too weak to

permit operation. If no replacement tubes are available, what simple procedure will restore normal operation on voice?

3. If the first-audio-amplifier tube is defective, can the high-frequency oscillator be calibrated?

4. Is a sidetone signal heard when the audio-driver tube is defective?

LECTURE 10

CIRCUIT ANALYSIS OF THE MODULATOR

The modulator is driven by the audio driver and, when the transmitter is operating on voice or MCW, modulates the r-f carrier output of the power amplifier 90% or greater, at all transmission frequencies. The modulator is shown in block form on Wall Chart No. 1, and in schematic form in figure 32. It is a zero-bias, class B, push-pull power amplifier. Since the power amplifier utilizes a beam-power-type tube, it is necessary to use both plate and screen-grid modulation in order to achieve a high level of distortionless modulation.

Audio-frequency power is coupled to the grid circuit of the modulator through transformer T202. Capacitors C209 and C210 by-pass the high audio and stray radio frequencies. The grid return of each tube is connected to the negative side of the filament.

When the transmitter is operating on MCW or voice, the CW relay, K103, is in its MCW/voice position, and applies 1150/750 volts, d.c., to the plates of the modulator tubes through the primary winding of the modulation transformer, T101. Also, 1150/750 volts, d.c., is applied to the plate return of the power amplifier through the 4-5 secondary winding of transformer T101.

When the power-level switch, S106, is in the OPERATE position, the screen return of the power amplifier is supplied with 400 volts, d.c., through the 6-7 secondary winding of transformer T101, the contacts of section RB of the power-level switch, S106, and contacts F of the keying relay, K102. Since audio power is transferred through transformer T101, the plate and screen supply voltages applied to the power amplifier will vary in accordance with the audio signal.

When the power-level switch, S106, is in the TUNE position, the voltage applied to the screen return of the power amplifier is reduced by resistor R124.

When the power-level switch, S106, is in the CALIBRATE position, the screen return of the power amplifier is supplied with a negative voltage derived from the grid circuit of the power amplifier (AN/ART-13, only).

When relay K103 is in the CW position, high voltage is removed from the plates of the modulator tubes; secondary winding 4-5 of transformer T101 is shorted; and 1150/750 volts, d.c., is applied directly to the plate return of the power amplifier.

Voltage checks are made at test points T_1 and T_2 , and a resistance measurement is made at test point T_3 .

LESSON PLAN No. 10

TIME ALLOTTED: 1/4 HR.

SUBJECT

Modulator.

OBJECTIVE

To analyze the modulator circuits.

INTRODUCTION

Modulation of the power amplifier is accomplished by the modulator.

SUBJECT MATERIAL

1. Display Wall Chart No. 1 and briefly review the action of the modulator.
2. Display Wall Chart No. 2 and point out the modulator circuits.
3. State the type circuit and vacuum tubes utilized.
4. Explain why it is necessary to apply the modulating signal to both the plate and screen grid of the power amplifier.
5. Describe how the modulator is excited.
6. Explain the operation of the circuit for both positions of the CW relay, and for all three positions of the power-level switch.
7. Point out the test points in the circuit and on the equipment, and explain their use.

CONCLUSION

One key and two secondary test points are located in the modulator circuits for checking the operation of that stage.

ORAL QUIZ

1. How is the modulator disabled when the transmitter is operating on CW?
2. What potential is applied to the screen return of the power amplifier when the power-level switch is at OPERATE and the transmitter is in the unkeyed condition?

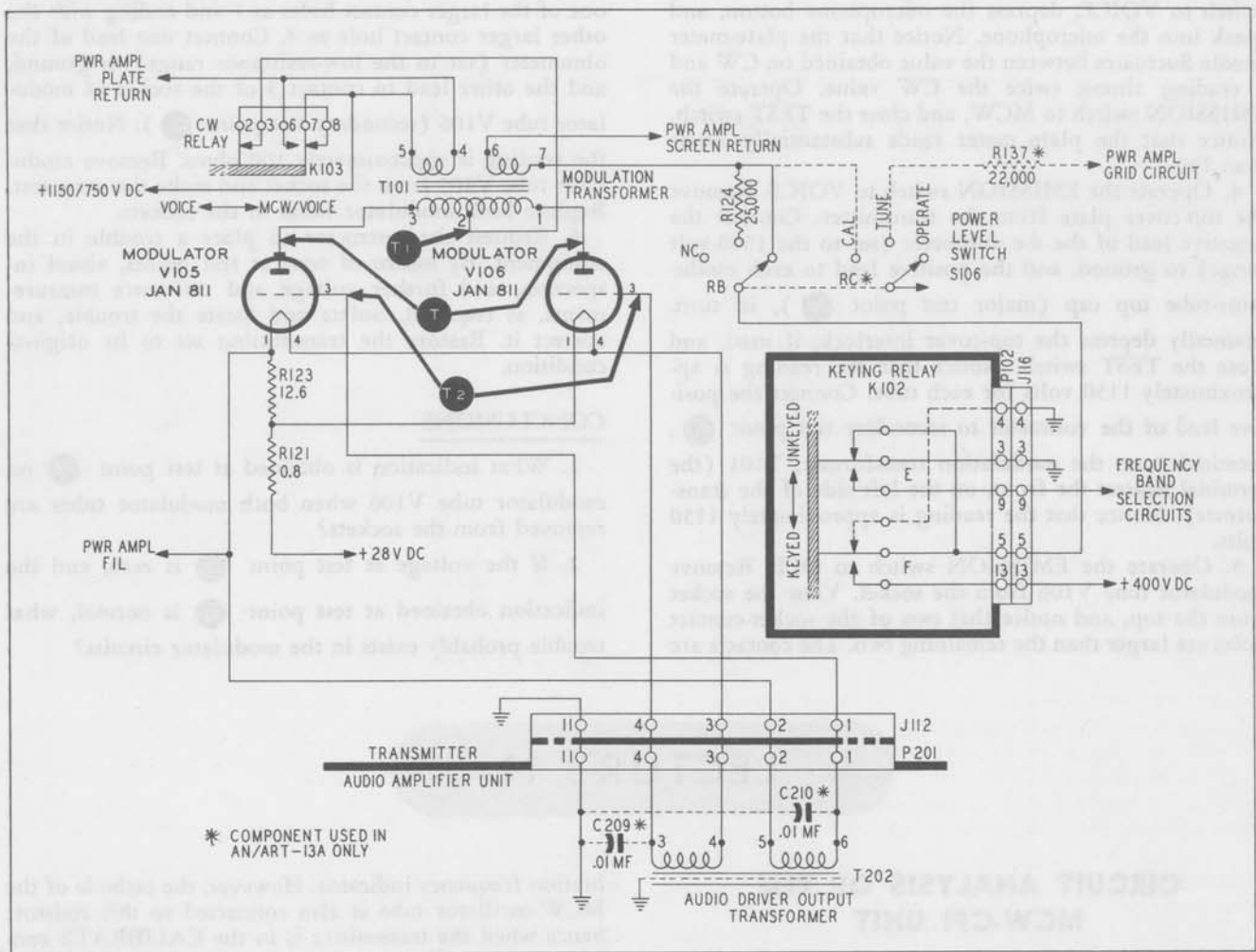

Figure 32. Modulator Circuits

EXPERIMENT No. 9

TIME ALLOTTED: $\frac{3}{4}$ HR.

SUBJECT

Trouble shooting of the modulator circuits.

EQUIPMENT REQUIRED

One or more AN/ART-13 type of transmitting sets with accessory components as listed in previous experiments.

For each transmitting set:

One d-c voltmeter with 1500-volt range.

One ohmmeter.

INSTRUCTIONS

Intercable, connect, and plug in the units and accessory components as in previous experiments. Refer to the Trouble-Shooting Supplement for the placement of troubles in the equipment. Always approach dial settings in a clockwise direction.

PROCEDURE

1. Make certain that the LOCAL-REMOTE switch is at LOCAL, and the EMISSION switch is OFF. Remove the top-cover plate from the transmitter. Locate the modulator tubes, V105 and V106, and the modulation transformer, T101. Replace the transmitter top-cover plate.

2. Tune the transmitter to a frequency in the 6.0-mc. to 7.2-mc. range. Operate the EMISSION switch to VOICE, and the meter switch to P.A. PLATE. (As covered in Lecture 3 and Experiment No. 2: the d-c milliammeter, M102, is major test point 4, when the meter switch is at P.A. PLATE; this test point checks the operation of the audio-frequency circuits.) Operate the TEST switch, and notice that the plate meter reads within the light-shaded area marked CW. Depress the microphone button and speak into the microphone. Notice that the plate-meter needle fluctuates in the red area above the light-shaded area marked CW. Operate the EMISSION switch to MCW, and close the TEST switch. Notice that the plate meter reads within the light-shaded area marked MCW.

3. Tune the equipment to a frequency in the low-frequency range which results in a plate-meter reading

substantially lower than 100. Operate the EMISSION switch to VOICE, depress the microphone button, and speak into the microphone. Notice that the plate-meter needle fluctuates between the value obtained on CW and a reading almost twice the CW value. Operate the EMISSION switch to MCW, and close the TEST switch. Notice that the plate meter reads substantially lower than 190.

4. Operate the EMISSION switch to VOICE. Remove the top-cover plate from the transmitter. Connect the negative lead of the d-c voltmeter (set to the 1500-volt range) to ground, and the positive lead to each modulator-tube top cap (major test point τ), in turn. Manually depress the top-cover interlock, if used, and close the TEST switch. Notice that the reading is approximately 1150 volts for each tube. Connect the positive lead of the voltmeter to secondary test point τ_1 , terminal 2 on the modulation transformer, T101 (the terminal nearest the front, on the left side of the transformer). Notice that the reading is approximately 1150 volts.

5. Operate the EMISSION switch to OFF. Remove modulator tube V106 from the socket. View the socket from the top, and notice that two of the socket-contact holes are larger than the remaining two. The contacts are

numbered in a counterclockwise direction, starting with one of the larger contact holes as 1 and ending with the other larger contact hole as 4. Connect one lead of the ohmmeter (set to the low-resistance range) to ground, and the other lead to contact 3 of the socket of modulator tube V106 (secondary test point τ_2). Notice that the reading is approximately 100 ohms. Remove modulator tube V105 from the socket and make the same test. Replace both modulator tubes in the sockets.

6. Request the instructor to place a trouble in the equipment. By means of tests at test points, visual inspection, and further voltage and resistance measurements, as required, isolate and locate the trouble, and correct it. Restore the transmitting set to its original condition.

CONCLUSIONS

1. What indication is obtained at test point τ_2 on modulator tube V106 when both modulator tubes are removed from the sockets?

2. If the voltage at test point τ is zero, and the indication obtained at test point τ_1 is normal, what trouble probably exists in the modulator circuits?

LECTURE 11

CIRCUIT ANALYSIS OF THE MCW-CFI UNIT

The MCW-CFI unit contains two groups of circuits: (1) the MCW oscillator and (2) the calibration frequency indicator (or CFI unit). The MCW oscillator generates a 1000-cycle tone, and is the source of the modulating signal for MCW operation and of the side-tone signal for CW and MCW operation. The calibration frequency indicator is the means of checking the frequency calibration of both the low-frequency oscillator and the high-frequency oscillator.

The MCW oscillator and calibration frequency indicator are shown in block form on Wall Chart No. 1, and in schematic form in figures 33 and 34.

In the MCW-CFI 8Q-2 unit, the MCW oscillator utilizes one triode section of a type JAN-12SL7GT vacuum tube (V2203) in a Hartley-type circuit. The tank circuit consists of inductor L2201 and capacitor C2212B, and is resonant at 1000 c.p.s. The inductor is tapped to provide positive feedback from the plate to the grid circuit of the tube.

The plate of the oscillator is shunt-fed with d-c voltage by means of the voltage divider consisting of resistors R2211 and R2212. Capacitor C2212A couples a-f energy from the plate of the tube to the tank circuit, but prevents inductor L2201 from shorting the d-c plate voltage to ground. Each time the transmitter is keyed, d-c voltage is applied to the plate circuit, causing the stage to oscillate.

Capacitor C2210 and resistor R2204 furnish grid-leak bias for the tube. Resistor R2217 functions primarily as the cathode-bias resistor for the mixer tube in the cali-

bration frequency indicator. However, the cathode of the MCW-oscillator tube is also connected to this resistor; hence when the transmitter is in the CALIBRATE condition and the CFI mixer fails to receive excitation at the first grid, a weak tone signal will be heard in the headset, indicating an inoperative crystal oscillator.

Capacitor C2214 is shunted across the grid-cathode circuit of the MCW oscillator to prevent spurious oscillation of the MCW oscillator at very-high audio frequencies or radio frequencies.

The audio signal is taken from the MCW-oscillator-grid circuit via the voltage divider made up of resistors R2215 and R2201. Resistor R2201 is of the variable type (rheostat) so that the level of the output signal may be adjusted. The slotted end of the shaft of this rheostat is located behind the removable snap button on the rear surface of the unit. The rheostat is adjusted to regulate the percentage modulation of the transmitter r-f carrier output on MCW emission. When the voice relay, K104, is in the MCW/CW position (deenergized) and the power-level switch, S106, is in the TUNE or OPERATE position, the output signal of the MCW oscillator is applied to the input circuit of the first audio amplifier. When the power-level switch is in the TUNE position, resistor R135 is shunted across rheostat R2201, to reduce the level of the output signal of the MCW oscillator.

Resistor R113 and capacitor C121A form a filter for contacts F of the keying relay, K102. The values of capacitor C2212A and resistors R2212 and R2211 (time constant, five milliseconds) limit the maximum satisfactory keying speed of the transmitter on MCW to 30 w.p.m. Above this speed, the waveform of the modulating signal is poor, resulting in "muddy" keying.

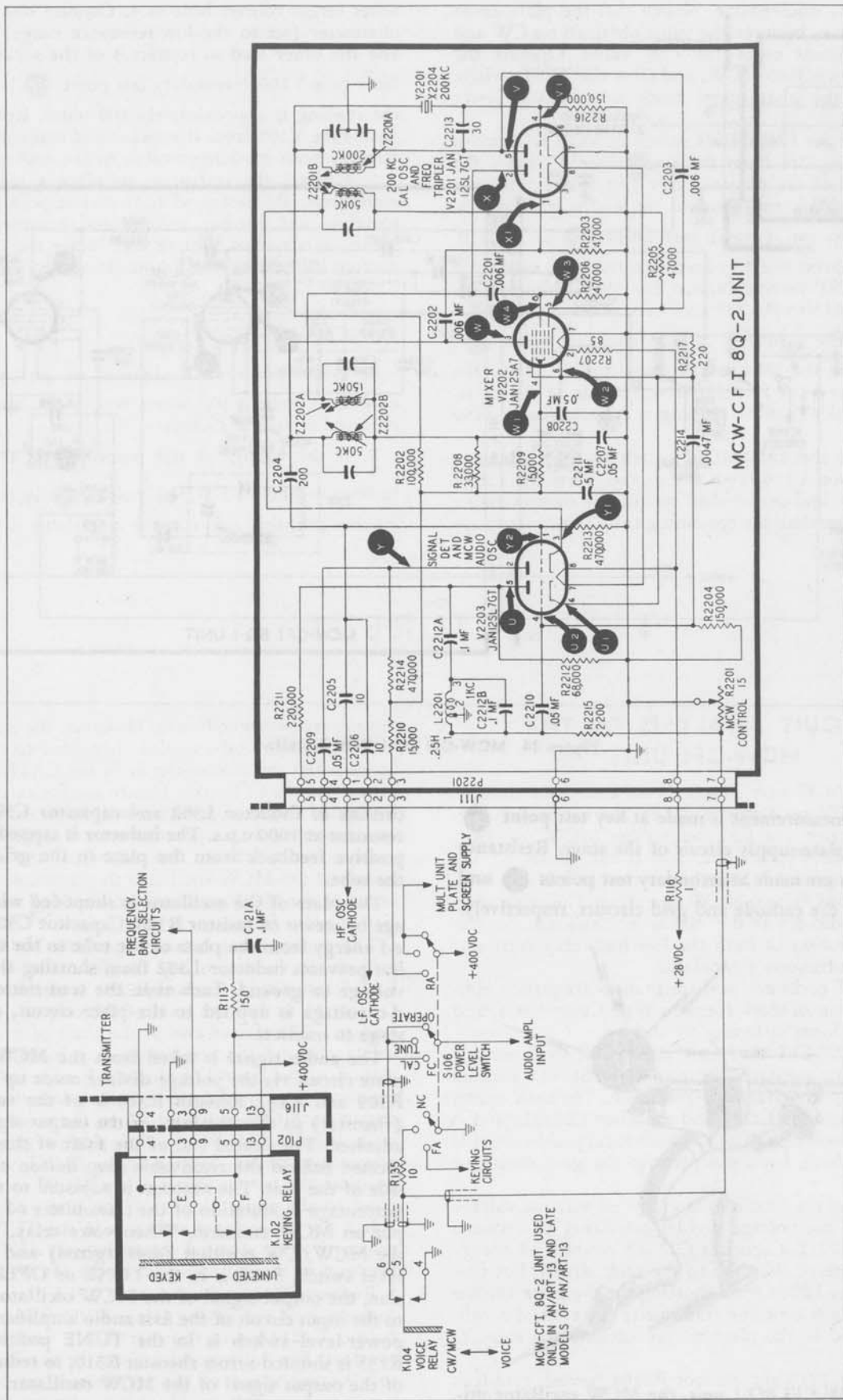

Figure 33. MCW-CFI 8Q-2 Unit Circuits

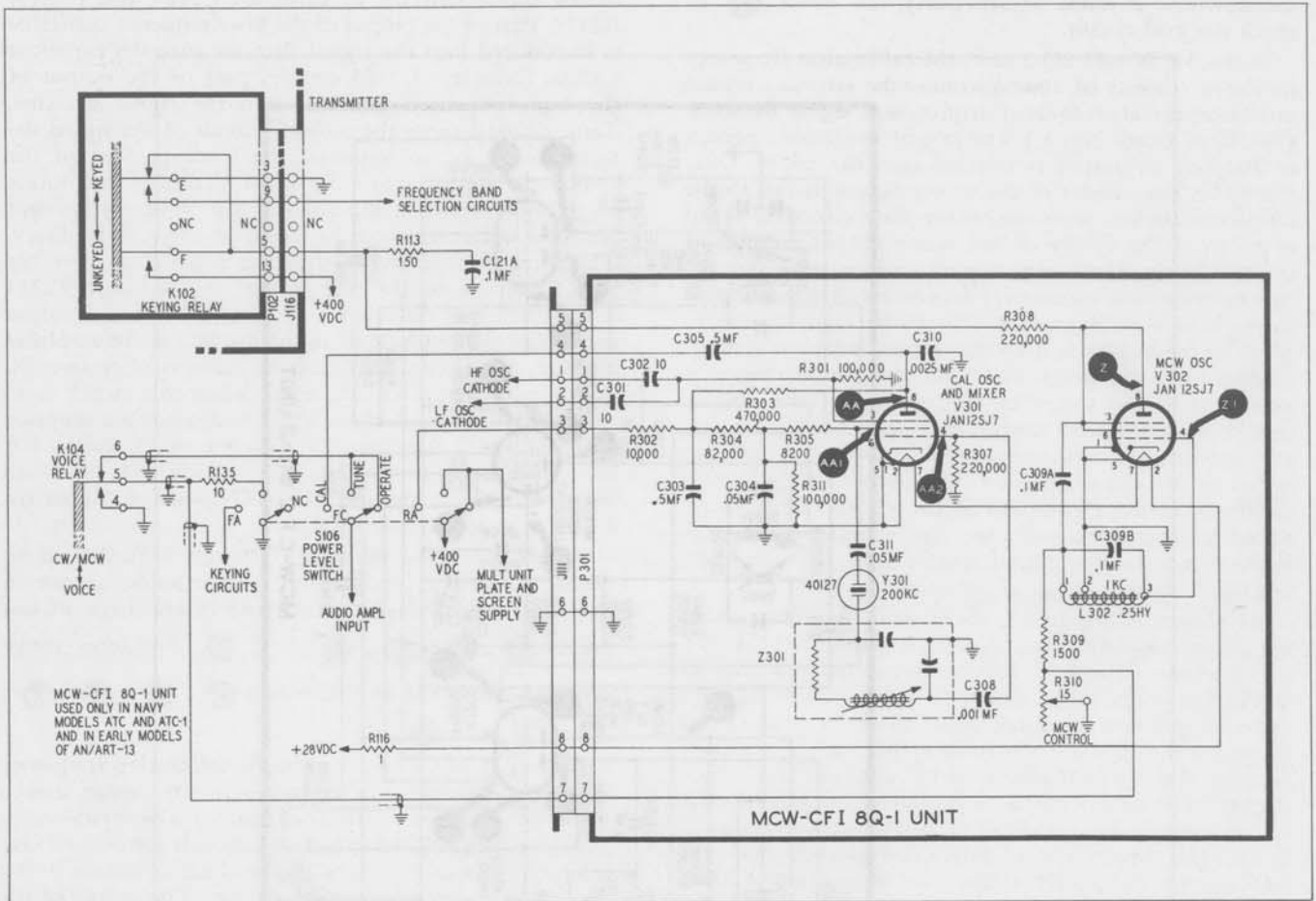
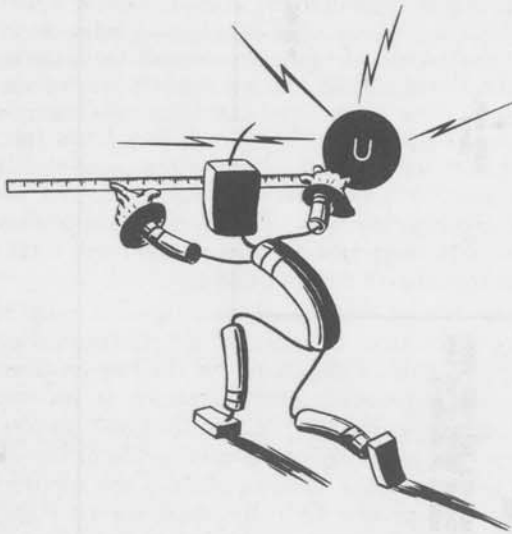

Figure 34. MCW-CFI 8Q-1 Unit Circuits

A voltage measurement is made at key test point **U** to check the plate-supply circuit of the stage. Resistance measurements are made at secondary test points **U1** and **U2** to check the cathode and grid circuits, respectively.



In the MCW-CFI 8Q-1 unit, the MCW oscillator utilizes a type JAN-12S J7 vacuum tube (V302), connected as a triode, in a Hartley-type circuit. The tank circuit

consists of inductor L302 and capacitor C309B, and is resonant at 1000 c.p.s. The inductor is tapped to provide positive feedback from the plate to the grid circuit of the tube.

The plate of the oscillator is shunt-fed with d-c voltage by means of resistor R308. Capacitor C309A couples a-f energy from the plate of the tube to the tank circuit, but prevents inductor L302 from shorting the d-c plate voltage to ground. Each time the transmitter is keyed, d-c voltage is applied to the plate circuit, causing the stage to oscillate.

The audio signal is taken from the MCW-oscillator-plate circuit via the voltage divider made up of resistors R309 and R310. Resistor R310 is of the variable type (rheostat) so that the level of the output signal may be adjusted. The slotted end of the shaft of this rheostat is located behind the removable snap button on the right side of the unit. The rheostat is adjusted to regulate the percentage modulation of the transmitter r-f carrier output on MCW emission. When voice relay, K104, is in the MCW/CW position (deenergized) and the power-level switch, S106, is in the TUNE or OPERATE position, the output signal of the MCW oscillator is applied to the input circuit of the first audio amplifier. When the power-level switch is in the TUNE position, resistor R135 is shunted across rheostat R310, to reduce the level of the output signal of the MCW oscillator.

A voltage measurement is made at key test point **U2** to check the plate-supply circuit of the stage. A resistance

measurement is made at secondary test point $\textcircled{z1}$ to check the grid circuit.

In the MCW-CFI 8Q-2 unit, the calibration frequency indicator consists of four vacuum-tube circuits: crystal oscillator, mixer, frequency tripler, and signal detector. (See Wall Chart No. 1.) The crystal oscillator operates at 200 kc.; its output is injected into the mixer. Only the 50-kc. component of the mixer output is fed to the frequency tripler, since the mixer-plate circuit is tuned to 50 kc. (The whole of the mixer output consists of the 200-kc. oscillator signal plus random tube and circuit noises whose component frequencies are distributed throughout a wide range.) This 50-kc. signal is multiplied by the tripler to a 150-kc. signal, which is also introduced into the mixer. The 50-kc. difference frequency, generated in the mixer by the beating of the 200-kc. oscillator output with the 150-kc. frequency-tripler output, serves to sustain excitation of the tripler and also is fed to the signal detector. The output of the master oscillator whose calibration is being checked is introduced into the signal detector. Audio beat notes appear in the detector output signal at various intervals throughout the frequency range of the master oscillator.

As shown in figure 33, the crystal oscillator makes use of one triode section of V2201, a type JAN-12SL7GT vacuum tube. Crystal Y2201 maintains the frequency of oscillation practically constant at 200 kc. Tank Z2201A provides positive feedback from plate to grid circuit (through the crystal); variation of the natural resonant frequency of the tank affects the frequency of oscillation, slightly. The natural resonant frequency of tank Z2201A is controllable by means of a tuning-slug adjustment screw. The slotted end of this screw extends from the left side of the Z2201 shield can, near the top (this shield can is the one nearest the rear of the unit). This screw is labelled 200 and A, on the can. Resistor R2216 functions as the grid-leak resistor. The capacity between the crystal and the holder plates serves as the grid-leak capacitor. Capacitor C2213 increases the frequency stability of the oscillator by minimizing the effect of variations of grid-to-plate capacity within the tube. Resistor R2202 is the plate decoupling resistor through which the d-c supply voltage is applied. Capacitor C2203 couples r-f energy from the crystal-oscillator plate to the first grid of the mixer tube, V2202.

Resistor R2205 is the coupling resistor for the first grid of the mixer tube. Bias for the stage is developed across resistor R2217 in the cathode circuit. The screen grid is by-passed by capacitor C2208, and receives d-c voltage through resistor R2209. The plate of the tube is tuned to 50 kc. by tank Z2202B. Tank Z2202B is adjusted by means of the screw, whose slotted end extends from the left side of the Z2202 shield can (this shield can is the one in the middle of the unit). This screw is labelled 50 on the can. Part of the 50-kc. output of the mixer is fed to the grid of the frequency tripler through capacitor C2202, and is developed across resistor R2203. Tank Z2202A tunes the plate circuit of the tripler to 150 kc. The adjustment screw for this tank is labelled 150 on the shield can in the middle of the unit. Capacitor C2201 and resistor R2206 provide coupling of the tripler output to the third grid of the mixer tube. The common plate return of the frequency-tripler and mixer tubes is by-passed by capacitor C2207. Resistor R2208 reduces the voltage applied to the plates of the frequency-tripler and mixer tubes.

The 50-kc. output of the mixer is coupled to the grid

of the signal detector by capacitor C2204 and resistor R2213. Part of the output of the low-frequency oscillator is introduced into the signal detector through capacitor C2206. Capacitor C2205 couples part of the output of the high-frequency oscillator into the signal detector. Tank Z2201B tunes the cathode circuit of the signal detector to 50 kc. to minimize the loading effect of the unbiased detector upon the plate circuit of the mixer stage, and to aid in eliminating the 50-kc. component from the detector output by means of negative feedback. The adjustment screw for this tank is labelled 50 on the shield can nearest the rear of the unit. Resistor R2214 is the plate load resistor for the detector. The a-f output is coupled to the input circuit of the first audio amplifier through capacitor C2209 and the contacts of section FC of the power-level switch, S106, when this switch is in the CALIBRATE position. The CFI circuits are supplied with 400 volts, d.c., through the contacts of section RA of switch S106 and decoupling resistor R2210, when this switch is in the CALIBRATE position. Capacitor C2211 is a decoupling filter.

Trouble shooting of the CFI circuits is facilitated by means of the key and secondary test points shown in the schematic. Voltage measurements are made at test points \textcircled{v} , \textcircled{w} , $\textcircled{w1}$, \textcircled{x} , and \textcircled{y} . Resistance measurements are made at test points $\textcircled{v1}$, $\textcircled{w2}$, $\textcircled{w3}$, $\textcircled{w4}$, $\textcircled{x1}$, $\textcircled{y1}$, and $\textcircled{y2}$.

In the MCW-CFI 8Q-1 unit, the calibration frequency indicator consists of a crystal-oscillator circuit and a mixer circuit. (See Wall Chart No. 1.) The crystal oscillator operates at 200 kc., and its output is introduced into the mixer circuit by means of the electron stream in the vacuum tube common to both circuits. The output of the master oscillator whose calibration is being checked is injected into the mixer. Audio beat notes appear in the mixer output signal at various intervals throughout the frequency range of the master oscillator.

As shown in figure 34, the crystal oscillator makes use of the control and screen grids of V301, a type JAN-12SJ7 vacuum tube, in a triode-connected circuit. Crystal Y301 maintains the frequency of oscillation practically constant at 200 kc. Tank Z301 provides positive feedback from the virtual plate (actually the screen) to the grid circuit (through the crystal). Tank Z301 is controllable by means of a tuning-slug adjustment screw. The slotted end of this screw extends from the right side of the shield can located on the left side of the top of the unit. The screw is adjusted for maximum oscillator output. Resistor R307 and capacitor C308 function as grid-leak resistor and capacitor, respectively. Blocking capacitor C311 provides a low-impedance r-f path from the screen to the tank. The screen is supplied with d-c voltage through voltage divider R304 and R311 and decoupling filter R305 and C304.

The 200-kc. crystal-oscillator signal is coupled to the plate of the mixer by means of the electron stream within the tube. Part of the output of the low-frequency oscillator is introduced into the mixer at the suppressor through capacitor C301. Capacitor C302 couples part of the output of the high-frequency oscillator into the mixer via the suppressor. Resistor R301 is the suppressor load resistor. Capacitor C310 by-passes the r-f signal at the plate. The a-f output is coupled to the input circuit of the first audio amplifier through capacitor C305 and the contacts of section FC of the power-level switch, S106,

when this switch is in the CALIBRATE position. The CFI circuits are supplied with 400 volts, d.c., through the contacts of section RA of switch S106 and decoupling resistor R302, when this switch is in the CALIBRATE position. Capacitor C303 is a decoupling filter.

Voltage measurements are made at test points **AA** and **AA1** to check the plate and screen supply circuits, respectively. Resistance measurements are made at test points **AA2** and **AA3** to check the grid and suppressor circuits, respectively.

LESSON PLAN No. 11

TIME ALLOTTED: 1¼ HRS.

SUBJECT

MCW-CFI unit.

OBJECTIVE

To analyze the MCW-CFI unit.

INTRODUCTION

The MCW-CFI unit contains the MCW oscillator, which generates the 1000-cycle tone necessary for CW and MCW operation. The MCW-CFI unit contains the calibration frequency indicator, which is the means of checking the frequency calibration of both master oscillators.

SUBJECT MATERIAL

1. Display Wall Chart No. 1 and briefly review the action of the MCW oscillator in the MCW-CFI 8Q-2 unit.
2. Display Wall Chart No. 2 and point out the 8Q-2 MCW oscillator circuit on the schematic diagram.
3. State the type oscillator circuit and tube utilized.
4. Trace the circuit, explaining the operation, and stating the purpose of each circuit element.
5. Point out the location of rheostat R2201 on the MCW-CFI unit.
6. Point out the test points on the schematic diagram and on the unit, and explain their use.
7. Refer to Wall Chart No. 1 and briefly review the action of the MCW oscillator in the MCW-CFI 8Q-1 unit.
8. Refer to Wall Chart No. 2 and point out the 8Q-1 MCW oscillator circuit on the schematic diagram.
9. State the type circuit and tube utilized.
10. Trace the circuit, explaining the operation, and stating the purpose of each circuit element.
11. Point out the location of rheostat R310 on the MCW-CFI unit.
12. Point out the test points on the schematic diagram and on the unit, and explain their use.
13. Refer to Wall Chart No. 1 and briefly review the action of the calibration frequency indicator in the MCW-CFI 8Q-2 unit.
14. Refer to Wall Chart No. 2 and point out the 8Q-2 calibration-frequency-indicator circuits on the schematic diagram.
15. State the type tube and circuit utilized in the crystal-oscillator circuit.
16. Trace the crystal-oscillator circuit, explaining the operation, and stating the purpose of each circuit element.
17. Point out the location of the Z2201A adjustment screw on the unit.

18. Trace the mixer circuit, explaining the operation, and stating the purpose of each circuit element.

19. Point out the location of the Z2202B adjustment screw on the unit.

20. Trace the frequency-tripler circuit, explaining the operation, and stating the purpose of each circuit element.

21. Point out the location of the Z2202A adjustment screw on the unit.

22. Trace the signal-detector circuit, explaining the operation, and stating the purpose of each circuit element.

23. Point out the location of the Z2201B adjustment screw on the unit.

24. Point out the test points on the schematic diagram and on the unit, and explain their use.

25. Refer to Wall Chart No. 1 and briefly review the action of the calibration frequency indicator in the MCW-CFI 8Q-1 unit.

26. Refer to Wall Chart No. 2 and point out the 8Q-1 calibration-frequency-indicator circuits on the schematic diagram.

27. State the type tube and circuit utilized in the crystal-oscillator circuit.

28. Trace the crystal-oscillator circuit, explaining the operation, and stating the purpose of each circuit element.

29. Point out the location of the Z301 adjustment screw on the unit.

30. Trace the mixer circuit, explaining the operation, and stating the purpose of each circuit element.

31. Point out the test points on the schematic diagram and on the unit, and explain their use.

CONCLUSIONS

Trouble shooting of the MCW-CFI 8Q-2 unit is facilitated by means of five key test points and ten secondary test points. Trouble shooting of the MCW-CFI 8Q-1 unit is facilitated by means of two key test points and four secondary test points.

ORAL QUIZ

1. What type of oscillator circuit is employed in the MCW oscillator?
2. By what means is the level of the MCW-oscillator output signal adjusted?
3. Name the four vacuum-tube circuits contained in the calibration-frequency-indicator of the MCW-CFI 8Q-2 unit.
4. What is the output frequency of the mixer in the MCW-CFI 8Q-2 unit?
5. In the MCW-CFI 8Q-2 unit, assume that the output frequency of the crystal oscillator is 200 kc. and the plate circuit of the mixer is tuned to 49 kc., allowing only the 49-kc. component of the mixer output to reach the input of the frequency tripler. What is the frequency of the signal at the plate of the mixer, produced by the action of the frequency tripler, crystal oscillator, and mixer? Is excitation of the tripler sustained?
6. In the MCW-CFI 8Q-2 unit, assume that the output frequency of the crystal oscillator is 199 kc. What is the fourth harmonic of the output frequency of the mixer?
7. What is the crystal frequency in the MCW-CFI 8Q-1 unit?
8. In the MCW-CFI 8Q-2 unit, which two harmonic frequencies zero beat at the 250-kc. crystal-check point?
9. In the MCW-CFI 8Q-1 unit, which two harmonic frequencies zero beat at the 250-kc. crystal-check point?

EXPERIMENT No. 10

TIME ALLOTTED: 1 HR.

SUBJECT

MCW-CFI unit.

OBJECTIVE

To become familiar with the adjustment, alignment, and trouble shooting of the MCW-CFI unit.

EQUIPMENT REQUIRED

One or more AN/ART-13 type of transmitting sets with accessory components as listed in previous experiments.

For each transmitting set:

- One d-c voltmeter with 750-volt and 250-volt ranges.
- One ohmmeter.

INSTRUCTIONS

Intercable, connect, and plug in the units and accessory components as in previous experiments. Always approach dial settings in a clockwise direction. Refer to the Trouble-Shooting Supplement for the placement of troubles in the equipment.

PROCEDURE

1. Make certain that the LOCAL-REMOTE switch is at LOCAL, and the EMISSION switch is OFF. Remove the top-cover plate from the transmitter. Remove the MCW-CFI unit from the transmitter and inspect the components visible underneath the unit. Notice the location of the MCW control rheostat. View the unit from the top. If the unit is of the 8Q-2 type, notice the locations of the four tuning-slug adjustment screws, two on each of the shield cans near the crystal. If the unit is of the 8Q-1 type, notice the location of the single tuning-slug adjustment screw on the shield can between the two vacuum tubes. Replace the unit in the transmitter.

2. When the MCW oscillator requires adjustment, it is necessary to perform the following operations:

a. Remove the top-cover and right-end cover plates from the transmitter. Remove the snap button from the side of the MCW-CFI unit.

b. Tune the transmitter to 2400 kc., and load the power amplifier so that the minimum point of the resonance dip on the P.A. PLATE meter is 100 for CW emission.

c. Operate the EMISSION switch to MCW. Manually depress the top-cover interlock, if used, and close the TEST switch. Adjust the rheostat (R2201 or R310) on the MCW-CFI unit until the plate meter reads 190. Restore the transmitting set to its original condition.

3. When the MCW-CFI unit is of the 8Q-2 type and the CFI unit requires alignment, it is necessary to perform the following operations:

a. Make certain that the LOCAL-REMOTE switch is at LOCAL, and the EMISSION switch is OFF. Remove the top-cover plate from the transmitter. Remove the MCW-CFI unit from the transmitter. Connect an extension cable between jack J111 on the transmitter and plug P201 on the MCW-CFI unit.

b. Connect a vacuum-tube voltmeter between pin 4 (crystal-oscillator grid) of tube V2201 and ground. Set the equipment controls so that the transmitter is in the

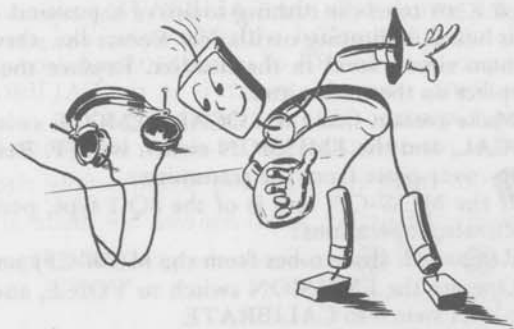

CALIBRATE condition with control A in position 1 (2.0 mc. to 2.4 mc.).

c. Listen to the headset output. Rotate the 200 tuning-slug adjustment screw (crystal oscillator) on tank Z2201 and observe the reading of the vacuum-tube voltmeter. Notice the broad maximum swing of the meter. Measure the width of this swing by counting the number of revolutions of the adjustment screw. Adjust the screw to the mid-point of the maximum swing by turning it one-half this number of revolutions beyond the point at which maximum swing is just approached. If a harsh rushing sound is heard as the adjustment screw approaches or departs from the position of maximum meter swing, rotate the 150 adjustment screw (tripler) on tank Z2202 until this noise disappears.

d. Rotate control B until a clearly audible beat note is heard, and note the dial setting. Continue to rotate control B until the next beat note, of the same volume as the first, is heard, and note the dial setting. Refer to the calibration table and determine whether the two beat notes are 100 kc. apart within a tolerance of 25 dial divisions.

e. If the interval between the two beat notes is 100 kc. (within 25 dial divisions), listen for maximum sidetone signal while adjusting the following: the 50 screw (signal detector) on tank Z2201; the 50 screw (mixer) on tank Z2202; the 150 screw (tripler) on tank Z2202. Repeat these three adjustments, in the same order. Repeat step c.

f. If the interval between the two beat notes is greater than 100 kc.: rotate the 50 screw (mixer) on tank Z2202 three turns counterclockwise; rotate the 150 screw (tripler) on tank Z2202 clockwise until a harsh rushing sound appears and disappears; repeat step d.

g. If the interval between the two beat notes is less than 100 kc.: rotate the 50 screw (mixer) on tank Z2202 three turns clockwise; rotate the 150 screw (tripler) on tank Z2202 counterclockwise until a harsh rushing sound appears and then disappears; repeat step d.

h. Turn the equipment on and off several times by operating the power-level switch back and forth between the CALIBRATE and TUNE positions. Observe whether the needle of the vacuum-tube voltmeter rises quickly to the peak value, indicating positive crystal oscillation. If necessary, rotate the 200 screw (crystal oscillator) on tank Z2201 to improve crystal starting.

i. Operate the EMISSION switch to OFF. Remove the extension cable. Replace the MCW-CFI unit. Replace the top-cover plate on the transmitter.

4. When the MCW-CFI unit is of the 8Q-1 type and the CFI unit requires alignment, it is necessary to perform the following operations:

a. Set the equipment controls so that the transmitter is in the CALIBRATE condition. Remove the top-cover plate from the transmitter.

b. Manually depress the top-cover interlock, if used. Listen to the headset output. Rotate the adjustment screw

on tank Z301 until the rushing sound of the crystal oscillator is heard, indicating oscillation. Rotate the screw for maximum signal level in the headset. Replace the top-cover plate on the transmitter.

5. Make certain that the LOCAL-REMOTE switch is at LOCAL, and the EMISSION switch is OFF. Remove the top-cover plate from the transmitter.

6. If the MCW-CFI unit is of the 8Q-2 type, perform the following operations:

a. Remove all three tubes from the MCW-CFI unit.

b. Operate the EMISSION switch to VOICE, and the power-level switch to CALIBRATE.

c. Connect the negative lead of the d-c voltmeter to ground, and notice the normal readings as the positive lead is connected to each of the following test points:

(set the voltmeter to the 250-volt range) **U**, contact 5

of socket X2203, 85 volts; (set the voltmeter to the 750-volt range) **V**, contact 5 of socket X2201, 370 volts;

W, contact 3 of socket X2202, 400 volts; **W1**, contact 4

of socket X2202, 410 volts; **X**, contact 2 of socket

X2201, 400 volts; **Y**, contact 2 of socket X2203, 260

volts. NOTE: The normal readings are valid only when a 1000-ohms-per-volt d-c voltmeter, set to the ranges specified, is used.

d. Operate the EMISSION switch to OFF.

e. Connect one lead of the ohmmeter to ground, and notice the normal readings as the other lead is connected to each of the following test points: (set the ohmmeter

to the low-resistance range) **U1**, contact 6 of socket

X2203, 220 ohms; (set the ohmmeter to the high-resistance

range) **U2**, contact 4 of socket X2203, 150,000

ohms; **V1**, contact 4 of socket X2201, 150,000 ohms; (set

the ohmmeter to the low-resistance range) **W2**, contact

6 of socket X2202, 220 ohms; (set the ohmmeter to the

high-resistance range) **W3**, contact 5 of socket X2202,

47,000 ohms; **W4**, contact 8 of socket X2202, 47,000

ohms; **X1**, contact 1 of socket X2201, 47,000 ohms;

(set the ohmmeter to the low-resistance range) **Y1**, con-

tact 3 of socket X2203, 28 ohms; (set the ohmmeter to

the high-resistance range) **Y2**, contact 1 of socket

X2203, 470,000 ohms.

f. Replace the tubes in the MCW-CFI unit. Replace the top-cover plate on the transmitter.

7. If the MCW-CFI unit is of the 8Q-1 type, perform the following operations:

a. Remove both tubes from the MCW-CFI unit.

b. Operate the EMISSION switch to VOICE, and the power-level switch to CALIBRATE.

c. Connect the negative lead of the d-c voltmeter to ground, and notice the normal readings as the positive lead is connected to each of the following test points:

(set the voltmeter to the 750-volt range) **Z**, contact 8

of socket X302, 330 volts; **AA**, contact 8 of socket X301,

260 volts; (set the voltmeter to the 250-volt range) **AA1**,

contact 6 of socket X301, 220 volts. NOTE: The normal

readings are valid only when a d-c voltmeter of 1000

ohms-per-volt sensitivity, set to the ranges specified, is used.

d. Operate the EMISSION switch to OFF.

e. Connect one lead of the ohmmeter to ground, and notice the normal readings as the other lead is connected to each of the following test points: (set the ohmmeter to the low-resistance range) **Z1**, contact 4 of socket

X302, 47 ohms; (set the ohmmeter to the high-resistance

range) **AA2**, contact 4 of socket X301, 220,000 ohms;

AA3, contact 3 of socket X301, 100,000 ohms.

f. Replace the tubes in the MCW-CFI unit. Replace the top-cover plate on the transmitter.

8. Request the instructor to place a trouble in the equipment. By means of tests at test points, visual inspection, and further voltage and resistance measurements, as required, isolate and locate the trouble, and correct it. Restore the transmitting set to its original condition.

CONCLUSIONS

1. What is the result of adjusting the MCW control rheostat so that the plate meter reads well over 190 for MCW emission?

2. Why is it impossible to use a conventional d-c voltmeter for the alignment of the 8Q-2 calibration frequency indicator?

3. Why is it a good plan to use an extension cable when aligning the MCW-CFI 8Q-2 unit?

4. Considering that the output frequency of the 8Q-2 CFI mixer is 50 kc., why do two successive beat notes of the same volume occur at a 100-kc. interval, as indicated by the control B dial, when control A is in position 1 (2.0 mc. to 2.4 mc.)?

5. What is the cause of the rushing sound in the headset when the crystal oscillator in the MCW-CFI 8Q-1 unit is oscillating?

6. In the MCW-CFI 8Q-2 unit, a check at which test point reveals that capacitor C2209 is shorted?

7. In the MCW-CFI 8Q-2 unit, the indication noted at test point **U2** is 220 ohms. What is the probable cause of trouble?

8. In the MCW-CFI 8Q-2 unit, capacitor C2211 is shorted. At which test points are abnormal indications noted?

9. In the MCW-CFI 8Q-1 unit, the reading of a d-c voltmeter connected to test point **Z** is 380 volts. What is the probable cause of trouble?

10. In the MCW-CFI 8Q-1 unit, the reading of a d-c voltmeter connected to test point **AA1** is 150 volts. What is the most likely cause of trouble?

REVIEW No. 1

Display Wall Charts No. 1 and No. 2 and review the salient points contained in Lectures 1 through 11 and Experiments No. 1 through No. 10, by orally interrogating the students. The normal time allotment for this review is four hours.

Beginning with Lesson Plan No. 1, state each question contained in the Oral Quiz of each Lesson Plan and each question contained in the Conclusions of each Experiment, in turn. Fully explain the answers to those questions which cause the students difficulty. Permit the students to ask questions of their own. Allow classroom discussion on questions, within reasonable limits of time. Make a written note of each question on which the students indicate a general weakness.

EXAMINATION No. 1

Examination No. 1 covers the material contained in Lectures 1 through 11 and Experiments No. 1 through No. 10. The normal time allotment for this examination is two hours.

Do not permit the students to refer to any material while answering the questions in Part I of the examination. Display Wall Charts No. 1 and No. 2 before presenting Part II of the examination.

PART I

1. Why was the AN/ART-13 type of equipment developed?
2. What is the total weight of the equipment?
3. Give the functional titles of the five major physical units which are common to all models of this equipment.
4. What three assemblies are readily removable from the transmitter?
5. What d-c voltages are required by the transmitter?
6. Where is the microphone selector switch located?
7. For a transmission frequency of 14 mc., how many times is the frequency multiplied in the first frequency multiplier?
8. Under what conditions of antenna length and operating frequency is the use of the antenna shunt capacitor required?
9. What is the percentage modulation capability of the equipment?
10. Is the MCW oscillator in use when the equipment is operating on CW?
11. Can the equipment be set to the calibrate position from the pilot's control box?
12. What type of circuit is employed in the low-frequency oscillator?
13. What type of circuit is employed in the high-frequency oscillator?
14. Is the first frequency multiplier operative when the power-level switch is in the CALIBRATE position?
15. Will an open filament in the low-frequency-oscillator tube affect the operation of the transmitter in the high-frequency range?
16. What type of vacuum tube is utilized in the power-amplifier stage?
17. At what frequency is the power amplifier excited for a transmission frequency of 9.0 mc.?
18. The high-frequency output circuits may be connected as either one of two types of networks. What are they?
19. If the antenna switch on the antenna loading unit (or antenna switching unit) is in the TRAILING ANTENNA (or TRAILING WIRE) position, to which antenna is the associated receiver connected by the antenna switch?
20. From which electrode in the audio driver tube does the sidetone amplifier obtain its input signal?
21. What visual check indicates whether the modulator is operative?
22. What type of oscillator circuit is employed in the MCW oscillator?
23. By what means is the level of the MCW-oscillator signal adjusted?

24. Why is it impossible to use a conventional d-c voltmeter in the alignment of the calibration frequency indicator in the MCW-CFI 8Q-2 unit?

25. Why is it a good plan to make use of an extension cable when aligning the 8Q-2 CFI unit?

PART II

1. Which functional block is probably at fault if the indication obtained at major test point ② is normal when operating in the 2.0-mc. to 6.0-mc. range, but abnormal when operating in the 6.0-mc. to 18.1-mc. range?
 - a. First frequency multiplier.
 - b. Second frequency multiplier.
 - c. High-frequency oscillator.
2. Which functional blocks are probably at fault if an abnormal indication is obtained at major test point ③ , but a beat note is heard in the headset when the EMIS-
SION switch is operated to CALIBRATE and control G is adjusted to the nearest check point as indicated by the calibration table?
 - a. The power amplifier or low-frequency output circuits.
 - b. The power amplifier or high-frequency output circuits.
 - c. The power amplifier or low-frequency oscillator.
3. What is the value of d-c voltage at tube-socket contact 7 in the low-frequency-oscillator unit, when the tube is removed?
 - a. 21 volts.
 - b. 28 volts.
 - c. 12.6 volts.
4. What is the likely cause of a zero-resistance measurement at test point F2 ?
 - a. Shorted switch S101.
 - b. Shorted capacitor C103.
 - c. Shorted inductor L101.
5. A d-c voltmeter is connected between test point H1 and ground, and the second-frequency-multiplier tube is removed from its socket. The voltmeter is set to the 750-volt range, the meter sensitivity is 1000 ohms per volt, and the d-c voltage at pin 11 of plug P101 is 430 volts. What is the approximate reading indicated by the voltmeter?
 - a. 430 volts.
 - b. 420 volts.
 - c. 410 volts.
6. It is necessary to operate the transmitter on a frequency of 4.0 mc., but the first-frequency-multiplier tube is too weak to permit operation. If no replacement tubes are available, what simple procedure will restore normal operation on this frequency?
 - a. Interchange the low-frequency-oscillator tube with that of the high-frequency oscillator.
 - b. Interchange the second-frequency-multiplier tube with that of the low-frequency oscillator.
 - c. Interchange the first and second frequency-multiplier tubes.
7. What is the d-c potential on the screen of the power amplifier when the power-level switch is in the TUNE position, and the transmitter is in the unkeyed state?
 - a. Zero.
 - b. +400 volts.
 - c. -200 volts.

8. If capacitor C203 is shorted, at which test point is an abnormal indication obtained?

- a. R .
- b. R1 .
- c. S .

9. Contacts 2-3 on the CW relay, K103, are bad (do not make connection). What is the trouble symptom?

- a. Weak and distorted modulation of the carrier output on MCW and voice emission.
- b. No modulation of the carrier output on MCW and voice emission.
- c. No carrier output on MCW and voice emission.

10. The MCW-CFI unit is removed from the transmitter. Which trouble symptom will be observed?

- a. The equipment operates on voice, but not on CW or MCW.
- b. The equipment operates on CW, but not on voice or MCW.

c. The equipment operates on MCW, but not on voice or CW.

d. The equipment operates on voice and MCW, but not on CW.

e. The equipment operates on voice and CW, but not on MCW.

f. The equipment does not operate.

REVIEW OF EXAMINATION No. 1

Display Wall Charts No. 1 and No. 2 and review, orally, the questions on Examination No. 1. The normal time allotment for this review is one hour.

State each question contained in Examination No. 1, in turn. Fully explain the answers to those questions which cause the students difficulty. Permit the students to ask questions of their own. Allow classroom discussion on questions, within reasonable limits of time. Make a written note of each question on which the students indicate a general weakness.

LECTURE 12

CIRCUIT ANALYSIS OF THE POWER SUPPLY AND D-C METERING CIRCUITS

The secondary power requirements of the transmitting set are met by the power supply. The power supply is shown in block form on Wall Chart No. 1, and in schematic form in figure 35. (Dynamotor Unit DY-17/ART-13A and the associated circuits have been chosen for purposes of analysis. Since the other models of the power supply are practically identical, electrically, they need not be analyzed, separately.)

The power supply contains a dynamotor and certain control, filter, and protective components; it requires an input of 28 volts at 33 amperes, and delivers outputs of +400 volts at 400 ma. and +1150 volts at 350 ma. (All current values are maximum ratings.) The 28-volt bus is connected through the power supply to the transmitter. The 1150-volt output is automatically reduced to 750 volts, at high altitudes.

The dynamotor is equipped with a shunt-field winding, connected between the 28-volt bus and ground, and a series-field winding, connected between the 28-volt bus and the motor-armature winding, M. (When the armature and field windings of a motor or generator are so connected, it is generally described as being compound wound.) Generator-armature winding G1 develops 400 volts at 750 ma., and generator-armature winding G2 develops 750 volts at 350 ma. When these two generator-armature windings are connected in series (low-altitude connection), a maximum of 350 ma. of the 750-ma. output of winding G1 is drawn by the 1150-volt circuits in the transmitter, leaving 400 ma. available for the 400-volt circuits.

The transmitter is supplied with 28 volts, d.c., through the contacts of the transmitter-overload relay, K2705, and the contacts of the primary-power contactor, K2702. Relay K2705 is a thermally operated overload relay which protects the equipment from damage due to overloads;

its contacts are opened when the current flow exceeds 10 amperes. The relay is reset by depressing the TRANS. RESET button located on the right side of the dynamotor-unit front panel.

The dynamotor is supplied with 28 volts, d.c., through the contacts of the dynamotor-overload relay, K2706, inductor L2701, and the contacts of the dynamotor-input relay, K2703. Relay K2706 is a thermally operated overload relay, which protects the dynamotor from damage due to overload; its contacts are opened when the current flow exceeds 35 amperes. The relay is reset by depressing the DYNA. RESET button located on the left side of the dynamotor-unit front panel.

Capacitors C2701 and C2702 and inductor L2701 form an input filter for the dynamotor. Capacitors C2712, C2713, C2714, C2715, and C2716 are brush filters. Capacitor C2717 prevents the generation of high-frequency noise pulses ("hash") in the field windings.

Inductors L2702, L2703, and L2704 serve as high-frequency chokes. Capacitors C2703 and C2706 are the

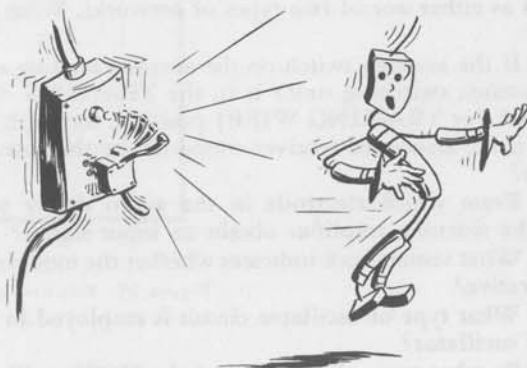

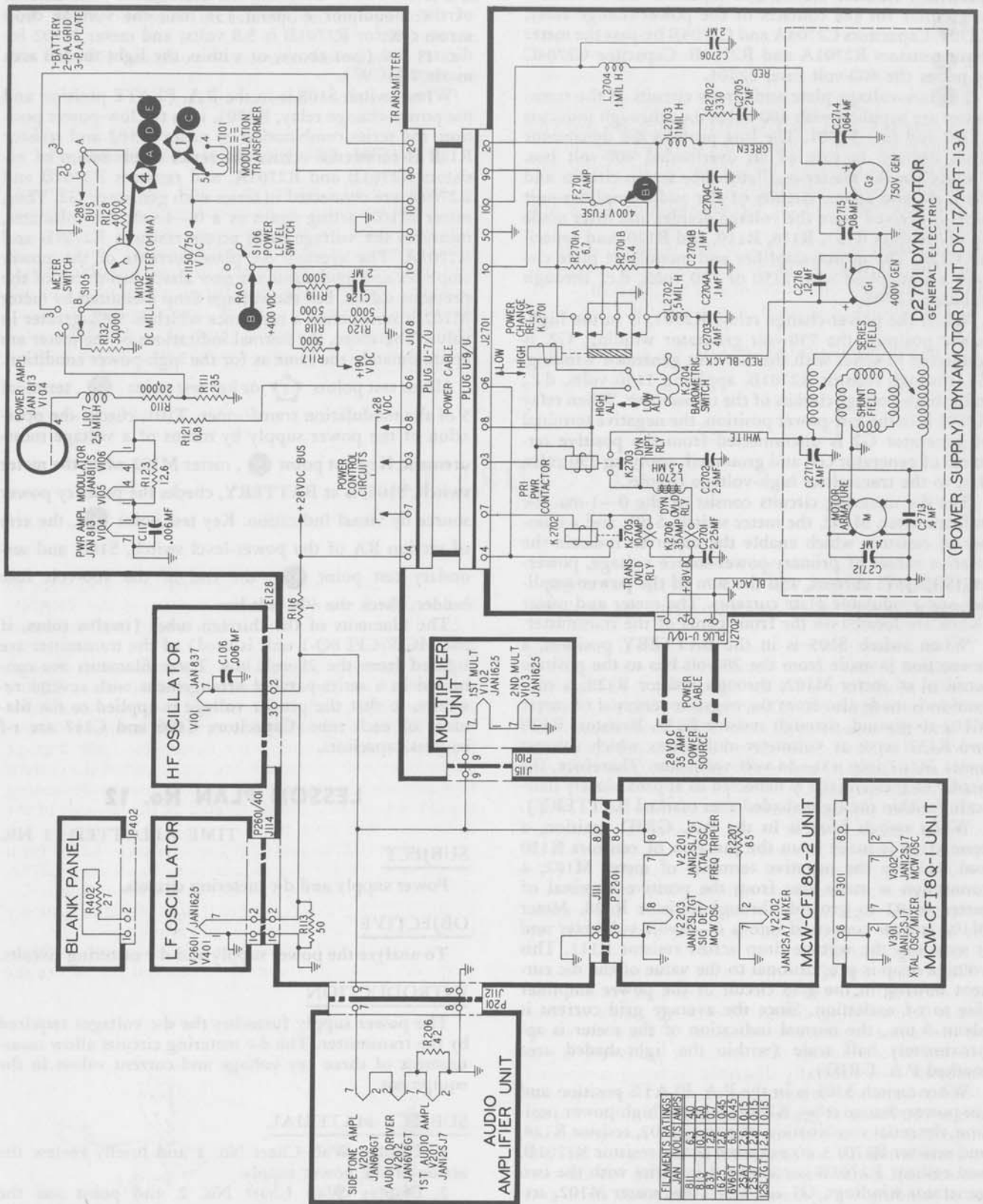

Figure 35. Power-Supply and D-C Metering Circuits

400-volt-supply and 1150-volt-supply ripple filters, respectively. Resistor R2702 and capacitor C2705 form a surge filter for the contacts of the power-change relay, K2701. Capacitors C2704A and C2704B by-pass the meter shunt resistors R2701A and R2701B. Capacitor C2704C by-passes the 400-volt fuse, F2701.

The low-voltage plate and screen circuits of the transmitter are supplied with 400 volts, d.c., through inductor L2702 and fuse F2701. The fuse protects the dynamotor from damage in case of an overloaded 400-volt bus. Voltage for the master-oscillator-tube screen circuits and the plate and screen circuits of the audio-amplifier-unit tubes is derived from the voltage divider and filter made up of resistors R117, R118, R119, and R120, and capacitor C126. The power-amplifier and modulator plate circuits are supplied with 1150 or 750 volts, d.c., through inductor L2704.

When the power-change relay, K2701, is in the high-power position, the 750-volt generator winding, G2, is connected in series with the 400-volt generator winding, G1, through resistor R2701B, applying 1150 volts, d.c., to the high-voltage circuits of the transmitter. When relay K2701 is in the low-power position, the negative terminal of generator G2 is disconnected from the positive terminal of generator G1, and grounded, applying 750 volts, d.c., to the transmitter high-voltage circuits.

The d-c metering circuits consist of the 0—1-ma. d-c milliammeter, M102, the meter switch, S105, and a number of resistors which enable the meter to indicate the relative values of primary-power-source voltage, power-amplifier-grid current, and the sum of the power-amplifier and modulator plate currents. The meter and meter switch are located on the front panel of the transmitter.





When switch S105 is in the BATTERY position, a connection is made from the 28-volt bus to the positive terminal of meter M102, through resistor R128; a connection is made also from the negative terminal of meter M102 to ground, through resistor R132. Resistors R128 and R132 serve as voltmeter-multipliers which convert meter M102 into a 0—54-volt voltmeter. Therefore, the needle of meter M102 is deflected to approximately half-scale (within the light-shaded area marked BATTERY).

When switch S105 is in the P.A. GRID position, a connection is made from the junction of resistors R110 and R111 to the negative terminal of meter M102; a connection is made also from the positive terminal of meter M102 to ground, through resistor R128. Meter M102 is now converted into a 0—4-volt voltmeter and it measures the voltage drop across resistor R111. This voltage drop is proportional to the value of the d-c current flowing in the grid circuit of the power amplifier due to r-f excitation. Since the average grid current is about 8 ma., the normal indication of the meter is approximately half scale (within the light-shaded area marked P.A. GRID).

When switch S105 is in the P.A. PLATE position and the power-change relay, K2701, is in the high-power position, the series combination of meter M102, resistor R128, and resistor R2701A is connected across resistor R2701B, and resistor R2701B is connected in series with the two generator windings, G1 and G2. Thus, meter M102, acting as a 0—4-volt d-c voltmeter, measures the voltage drop across resistor R2701B. The amount of current flowing through resistor R2701B is equal to the sum of the power-amplifier and modulator plate currents. On CW emission, the average d-c plate current is about 150 ma. (the modulator is disabled); the voltage drop across resistor R2701B is 2 volts; and meter M102 indicates half-

scale deflection (within the light-shaded area marked CW). On MCW emission, the average d-c plate current of the modulator is about 135 ma.; the voltage drop across resistor R2701B is 3.8 volts; and meter M102 indicates 190 (just above, or within, the light-shaded area marked MCW).

When switch S105 is in the P.A. PLATE position and the power-change relay, K2701, is in the low-power position, the series combination of meter M102 and resistor R128 is connected across the series combination of resistors R2701B and R2701A, and resistors R2701B and R2701A are connected in series with generator G2. Thus, meter M102, acting again as a 0—4-volt d-c voltmeter, measures the voltage drop across resistors R2701B and R2701A. The average d-c plate currents of the power amplifier and modulator are now about two-thirds of the previous values, but the voltage drop measured by meter M102 is now across a resistance which is 50% greater in value. Therefore, the normal indications of the meter are approximately the same as for the high-power condition.

Major test points  or key test point , terminal 5 of the modulation transformer, T101, checks the operation of the power supply by means of a voltage measurement. Key test point , meter M102 when the meter switch, S105, is at BATTERY, checks the primary power source by visual indication. Key test point , the arm of section RA of the power-level switch, S106, and secondary test point , the end of the 400-volt fuse holder, check the 400-volt bus.

The filaments of the thirteen tubes (twelve tubes, if the MCW-CFI 8Q-1 unit is used) of the transmitter are lighted from the 28-volt bus. These filaments are connected in a series-parallel arrangement with several resistors, so that the proper voltage is applied to the filament of each tube. Capacitors C106 and C117 are r-f by-pass capacitors.

LESSON PLAN No. 12

TIME ALLOTTED: 1 HR.

SUBJECT

Power supply and d-c metering circuits.

OBJECTIVE

To analyze the power supply and d-c metering circuits.

INTRODUCTION

The power supply furnishes the d-c voltages required by the transmitter. The d-c metering circuits allow measurement of three key voltage and current values in the equipment.

SUBJECT MATERIAL

1. Display Wall Chart No. 1 and briefly review the action of the power supply.
2. Display Wall Chart No. 2 and point out the power supply and d-c metering circuits on the schematic diagram.
3. State the maximum input voltage and current values for the power supply; state the maximum output voltage and current values.
4. Explain the dual field-winding connections in the dynamotor.

5. State the voltage and current ratings of the two generator windings of the dynamotor.

6. Explain the current distribution of generator G1 for the low-altitude (high-power) condition.

7. Trace the 28-volt bus from the primary power source to the transmitter, explaining the function of each intervening component.

8. Trace the 28-volt bus from the primary power source to the dynamotor, explaining the function of each intervening component.

9. Point out the locations of the two reset buttons on the unit.

10. Point out the various high-frequency noise-filter inductors and capacitors in the circuit.

11. Point out the two ripple filters for the power supply, and the surge filter for relay K2701.

12. Trace the 400-volt bus from the dynamotor to the transmitter, explaining the function of each intervening component.

13. Point out the location of the 400-volt bus fuse on the unit.

14. Trace the 1150-volt bus from the dynamotor to the transmitter, explaining the function of each intervening component.

15. Explain the action of the power-change relay, K2701, for each of its two positions.

16. State the circuit elements which make up the d-c metering circuits and name the three positions of the meter switch.

17. Trace and explain the circuit when switch S105 is in the BATTERY position.

18. Trace and explain the circuit when switch S105 is in the P.A. GRID position.

19. Trace and explain the circuit when switch S105 is in the P.A. PLATE position, and relay K2701 is in the high-power position.

20. Trace and explain the circuit when switch S105 is in the P.A. PLATE position, and relay K2701 is in the low-power position.

21. Point out the test points in the schematic diagram and on the unit, and explain their use.

22. Trace the filament circuits, showing how each tube receives the proper filament voltage; make use of the supplementary chart contained in figure 35 (draw chart on the blackboard).

CONCLUSIONS

The power-supply circuits are checked by means of one major test point, three key test points, and one secondary test point. The d-c metering circuits provide measurements of the primary-power-source voltage, the power-amplifier-grid current, and the sum of the power-amplifier and modulator plate currents.

ORAL QUIZ

1. Which two circuit components protect the dynamotor unit from damage?

2. Which circuit component exercises primary control over the power-change relay, K2701?

3. What is the maximum amount of current that may be drawn from generator winding G1 when relay K2701 is in the low-power position?

4. What is the current rating of fuse F2701?

5. If the d-c voltage at terminal 1 of jack J108 is 400 volts and the d-c voltage at the junction of resistor R119 and capacitor C126 is 190 volts, what is the d-c current flowing in the 190-volt bus?

6. If the dynamotor-overload relay is open, is the indication at test point **A** abnormal?

7. If the 400-volt fuse, F2701, is blown, at which test point is the indication abnormal?

8. If the indications at both test points **B** and **B1** are abnormal (zero voltage), and the indication at test point **A** is normal, what is the logical check to make next?

9. The filament-current rating of the type JAN-811 vacuum tube is 4.0 amperes. The filament-current rating of the type JAN-813 vacuum tube is 5.0 amperes. What is the value of voltage across resistor R123?

10. The filament-voltage rating of the type JAN-1625 vacuum tube is 12.6 volts. What is the value of current flowing through resistor R113?

EXPERIMENT No. 11

TIME ALLOTTED: $\frac{3}{4}$ HR.

SUBJECT

Power-supply and d-c metering circuits.

OBJECTIVE

To become familiar with the preventive maintenance and trouble shooting of the power-supply and d-c metering circuits.

EQUIPMENT REQUIRED

One or more AN/ART-13 type of transmitting sets with accessory components as in previous experiments. One d-c voltmeter with 750-volt and 1500-volt ranges for each transmitting set.

INSTRUCTIONS

Intercable, connect, and plug in the units and accessory components as in previous experiments. Refer to the Trouble-Shooting Supplement for the placement of troubles in the equipment. Always approach dial settings in a clockwise direction.

PROCEDURE

1. Make certain that the LOCAL-REMOTE switch is at LOCAL, and the EMISSION switch is OFF. Disconnect the primary power source from the transmitting set by removing plug U-10/U from the dynamotor unit.

2. Remove the two end covers from the dynamotor unit.

a. Inspect the brush-housing assemblies, one located at each end. Notice the locations of the 28-volt and 750-volt commutators and brushes (at the end near the connector plugs), and the 400-volt commutator and brushes (at the opposite end).

b. *Lubrication of the dynamotor unit is not required.*

c. When brushes are removed for inspection, they must be replaced in the same position, or excessive sparking (with the inherent generation of high-frequency noise or "hash") will result. If the brushes are marked with a polarity symbol, they must be installed with the marked surface facing the corresponding marking on the dynamotor frame. Brushes which are less than $\frac{1}{4}$ " in length must be replaced.

d. Dusty commutators (due to the normal wear of the brushes and commutators) are cleaned by a compressed-air stream, and then wiped with a clean cloth saturated with a nonflammable non-electrolytic solvent, such as carbon tetrachloride.

e. Replace the end covers on the dynamotor unit.

3. Set the dynamotor unit on its rear surface. Remove the bottom-cover plate. Inspect the components mounted under the chassis (this chassis is frequently named the power-control unit, to distinguish it from the dynamotor proper). Notice, particularly, the holder for fuse F2701, the transmitter-overload relay, K2705, the primary-power contactor, K2702, the power-change relay, K2701, the barometric switch, K2704, the dynamotor-input relay, K2703, and the dynamotor-overload relay, K2706. Notice the operation of the two locking knobs mounted on the front panel. Replace the bottom-cover plate on the unit and set it in the normal position.

4. Reconnect the power source. Remove the top-cover plate from the transmitter. Major test point 1 (or key test point C) is located at terminal 5 of the modulation transformer, T101 (the lower rear terminal on the side adjacent to the JAN-811 modulator tube, V105). Connect the positive lead of the d-c voltmeter (set to the 1500-volt range) to this test point, and the negative lead to ground. Operate the power-level switch to TUNE, and the EMISSION switch to VOICE. CAUTION! HIGH VOLTAGE! Manually depress the top-cover interlock, if used, and close the TEST switch. Notice that the d-c voltmeter reads 1150 volts, indicating that the power supply is functioning. Operate the EMISSION switch to OFF, and disconnect the d-c voltmeter.

5. Operate the EMISSION switch to VOICE, and the meter switch to BATTERY. For this condition, the d-c milliammeter, M102, is key test point A . Notice that the meter reads within the light-shaded area marked BATTERY, indicating that the voltage of the primary power source is correct, and that the primary 28-volt circuit in the power supply is complete.

6. Connect the positive lead of the d-c voltmeter (set to the 750-volt range) to key test point B , the arm terminal (terminal with longest clip) of the top rear section, RA, of the power-level switch, S106; connect the negative lead to ground. Manually depress the top-cover

interlock, if used, and close the TEST switch. Notice that the d-c voltmeter reads 410 volts, indicating that the 400-volt bus circuit is normal.

7. Operate the EMISSION switch to OFF. Remove the fuse from the power supply. Connect the positive lead of the d-c voltmeter (set to the 750-volt range) to secondary test point B1 , one end of the fuse holder; connect the negative lead to ground. Operate the EMISSION switch to VOICE. Manually depress the top-cover interlock, if used, and close the TEST switch. Notice that the d-c voltmeter reads 440 volts. This test point (B1) is used in conjunction with test point B to isolate trouble in the 400-volt bus circuit to either the power supply or transmitter. Operate the EMISSION switch to OFF. Replace the fuse.

8. Request the instructor to place a trouble in the equipment. By means of test points, visual inspection, and further voltage and resistance measurements, as required, isolate and locate the trouble, and correct it. Restore the transmitting set to its original condition.

CONCLUSIONS

1. To what length (minimum allowable) may the dynamotor brushes wear before replacement is necessary?
2. What is the result of using an abrasive such as emery cloth to clean the commutators of the dynamotor?
3. What is the result of removing a brush from the dynamotor, and then replacing it in the reverse position?
4. If the indication obtained at test point 1 is zero, which test point is the logical one to make a test at next?
5. The indication at test point B is zero, but the indication at test point B1 is normal. What is the probable trouble?
6. The indications at test points A and B are normal, but the indication at test point C is zero. The plugs and connectors of the power cable to the transmitter are secure. What check is the logical one to make next?
7. The multiplier tubes are lighted, but the high-frequency-oscillator tube is not. The high-frequency-oscillator tube is checked and found to be serviceable. What is the probable cause of trouble?

LECTURE 13

ANALYSIS OF THE POWER-CONTROL CIRCUITS

The power-control circuits consist essentially of a number of switches and relays, which permit control of the power supply, either from the front panel of the transmitter or from the front panel of the pilot's control box. These circuits are shown in the schematic diagram in figure 36.

With the exception of relays K2705 and K2706, the single contactor and all relays in the equipment operate on 28 volts, d.c. Relays K2705 and K2706 are thermally operated overload relays which serve to protect the equip-

ment from damage due to excessive electrical power consumption. The normally closed contacts of these relays open when an overload occurs. These relays are restored to the normally closed condition by depressing the reset buttons on the dynamotor unit.

The contacts of barometric switch K2704 are normally open. The contacts close when the aircraft in which this equipment is installed reaches an altitude of 20,000 to 25,000 feet, while climbing; the contacts re-open when the aircraft reaches approximately the same altitude, while descending. This contact movement is accomplished through the "accordion" action of a sealed diaphragm, in which the air pressure is constant. The diaphragm

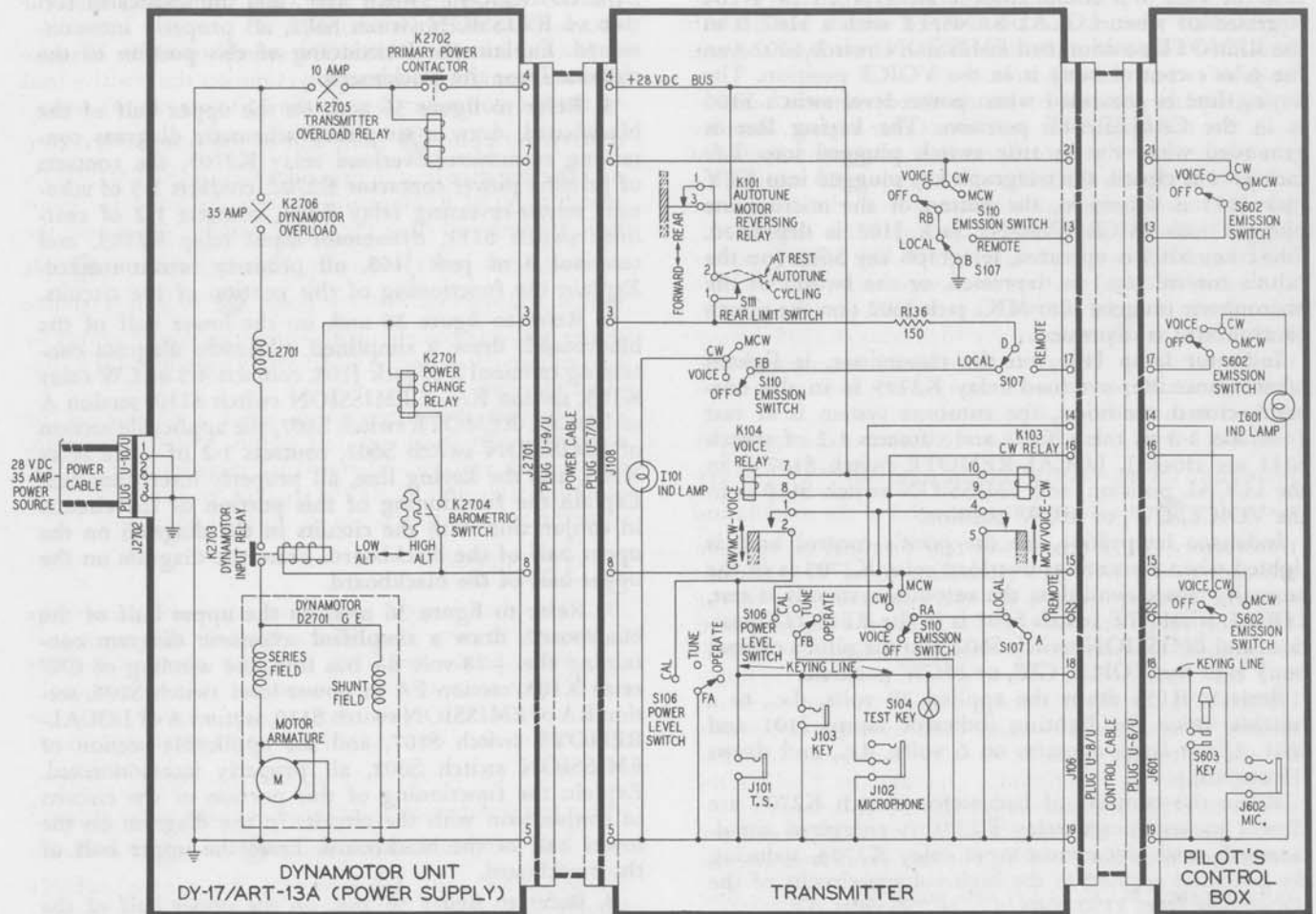

Figure 36. Power-Control Circuits

expands when the pressure of the surrounding air is less than that within the diaphragm (as is the case at high altitudes); the diaphragm contracts when the pressure of the surrounding air is greater than that within the diaphragm (as is the case at low altitudes). One contact of the switch is fixed in position; the other contact is attached to the diaphragm.

28 volts, d.c., is applied to the transmitter when primary power contactor K2702 is energized. Contactor K2702 is energized when transmitter-overload relay K2705 is in the normally closed condition, LOCAL-REMOTE switch S107 is in the LOCAL position, and EMISSION switch S110 (located on the transmitter) is in the VOICE, CW, or MCW position. Also, contactor K2702 is energized when transmitter-overload relay K2705 is in the normally closed condition, LOCAL-REMOTE switch S107 is in the REMOTE position, and EMISSION switch S602 (located on the pilot's control box) is in the VOICE, CW, or MCW position.

28 volts, d.c., is applied to the dynamotor when dynamotor-overload relay K2706 is in the normally closed condition and dynamotor-input relay K2703 is energized. Relay K2703 is energized when transmitter-overload relay K2705 is in the normally closed condition, primary power contactor K2702 is energized, the autotune system is at rest (contacts 1-3 of relay K101 and

contacts 1-2 of switch S111 are closed), and terminal 8 of jack J108 is connected to ground.

Terminal 8 of jack J108 is grounded when contacts 4-5 of CW relay K103 are closed. Contacts 4-5 of relay K103 are closed when the relay is energized. Relay K103 is energized when terminal 9 of the relay is grounded. Terminal 9 of relay K103 is grounded when power-level switch S106 is in the CALIBRATE position. Also, terminal 9 of relay K103 is grounded when LOCAL-REMOTE switch S107 is in the LOCAL position and EMISSION switch S110 is in the CW position. Also, terminal 9 of relay K103 is grounded when LOCAL-REMOTE switch S107 is in the REMOTE position and EMISSION switch S602 is in the CW position.

Terminal 8 of jack J108 is grounded when LOCAL-REMOTE switch S107 is in the LOCAL position and EMISSION switch S110 is in the MCW position. Also, terminal 8 of jack J108 is grounded when LOCAL-REMOTE switch S107 is in the REMOTE position and EMISSION switch S110 is in the MCW position.

Terminal 8 of jack J108 is grounded when contacts 1-2 of voice relay K104 are closed and the keying line is grounded. Contacts 1-2 of relay K104 are closed when the relay is energized. Relay K104 is energized when terminal 8 of the relay is grounded. Terminal 8 of relay K104 is grounded when LOCAL-REMOTE switch S107

is in the LOCAL position and EMISSION switch S110 is in the VOICE position. Also, terminal 8 of relay K104 is grounded when LOCAL-REMOTE switch S107 is in the REMOTE position and EMISSION switch S602 (on the pilot's control box) is in the VOICE position. The keying line is grounded when power-level switch S106 is in the CALIBRATE position. The keying line is grounded when the throttle switch plugged into T.S. jack J101 is closed, the telegraph key plugged into KEY jack J103 is depressed, the button of the microphone plugged into MICROPHONE jack J102 is depressed, TEST key S104 is operated, telegraph key S603 (on the pilot's control box) is depressed, or the button of the microphone plugged into MIC. jack J602 (on the pilot's control box) is depressed.

Indicator lamp I101, on the transmitter, is lighted when transmitter-overload relay K2705 is in the normally closed condition, the autotune system is at rest (contacts 1-3 of relay K101 and contacts 1-2 of switch S111 are closed), LOCAL-REMOTE switch S107 is in the LOCAL position, and EMISSION switch S110 is in the VOICE, CW, or MCW position.

Indicator lamp I601, on the pilot's control box, is lighted when transmitter-overload relay K2705 is in the normally closed condition, the autotune system is at rest, LOCAL-REMOTE switch S107 is in the REMOTE position, and EMISSION switch S602 (on the pilot's control box) is in the VOICE, CW, or MCW position.

Resistor R136 drops the applied 28 volts, d.c., to a suitable value for lighting indicator lamps I101 and I601. (Each lamp operates on 6 volts, d.c., and draws .15 ampere.)

When the contacts of barometric switch K2704 are closed, power-change relay K2701 is energized simultaneously with dynamotor-input relay K2703, reducing the potential applied to the high-voltage circuits of the transmitter from 1150 volts, d.c., to 750 volts, d.c.

Table 1 summarizes the effect of the panel controls of the equipment upon the power-supply circuits.

LESSON PLAN No. 13

TIME ALLOTTED: 2 HRS.

SUBJECT

Power-control circuits.

OBJECTIVE

To analyze the power-control circuits.

INTRODUCTION

Control of the power supply is accomplished from either the front panel of the transmitter or the pilot's control box.

SUBJECT MATERIAL

1. Display Wall Chart No. 2 and point out the locations of the various circuit elements which are contained in the power-control circuits.

2. Explain the action of the two overload relays, K2705 and K2706.

3. Explain the operation of barometric switch K2704.

4. Refer to figure 36 and, on the blackboard, draw a simplified schematic diagram containing transmitter-overload relay K2705, primary power contactor K2702,

section RB of EMISSION switch S110, section B of LOCAL-REMOTE switch S107, and the applicable section of EMISSION switch S602, all properly interconnected. Explain the functioning of this portion of the circuits. Erase the blackboard.

5. Refer to figure 36 and, on the upper half of the blackboard, draw a simplified schematic diagram containing transmitter-overload relay K2705, the contacts of primary power contactor K2702, contacts 1-3 of autotune motor-reversing relay K101, contacts 1-2 of rear-limit switch S111, dynamotor-input relay K2703, and terminal 8 of jack J108, all properly interconnected. Explain the functioning of this portion of the circuits.

6. Refer to figure 36 and, on the lower half of the blackboard, draw a simplified schematic diagram containing terminal 8 of jack J108, contacts 4-5 of CW relay K103, section RA of EMISSION switch S110, section A of LOCAL-REMOTE switch S107, the applicable section of EMISSION switch S602, contacts 1-2 of voice relay K104, and the keying line, all properly interconnected. Explain the functioning of this portion of the circuits in conjunction with the circuits in the diagram on the upper half of the blackboard. Erase the diagram on the upper half of the blackboard.

7. Refer to figure 36 and, on the upper half of the blackboard, draw a simplified schematic diagram containing the +28-volt d-c bus line, the winding of CW relay K103, section FA of power-level switch S106, section RA of EMISSION switch S110, section A of LOCAL-REMOTE switch S107, and the applicable section of EMISSION switch S602, all properly interconnected. Explain the functioning of this portion of the circuits in conjunction with the circuits in the diagram on the lower half of the blackboard. Erase the upper half of the blackboard.

8. Refer to figure 36 and, on the upper half of the blackboard, draw a simplified schematic diagram containing the +28-volt d-c bus line, the winding of voice relay K104, section RA of EMISSION switch S110, section A of LOCAL-REMOTE switch S107, and the applicable section of EMISSION switch S602, all properly interconnected. Explain the functioning of this portion of the circuits in conjunction with the circuits in the diagram on the lower half of the blackboard. Erase the whole blackboard.

9. Refer to figure 36 and, on the blackboard, draw a simplified schematic diagram containing the keying line, section FA of power-level switch S106, T.S. jack J101, KEY jack J103, MICROPHONE jack J102, TEST key S104, telegraph key S603, and MIC. jack J602, all properly interconnected. Explain the functioning of this portion of the circuits. Erase the blackboard.

10. Refer to figure 36 and, on the blackboard, draw a simplified schematic diagram containing the +28-volt d-c bus line, contacts 1-3 of autotune motor-reversing relay K101, contacts 1-2 of rear limit switch S111, resistor R136, section D of LOCAL-REMOTE switch S107, section FB of EMISSION switch S110, the applicable section of EMISSION switch S602, and indicator lamps I101 and I601, all properly interconnected. Explain the functioning of this portion of the circuits. Erase the blackboard.

11. Refer to figure 36 and, on the blackboard, draw a simplified schematic diagram containing the winding of dynamotor-input relay K2703, the winding of power-change relay K2701, and barometric switch K2704, all

TABLE 1
EFFECT OF THE PANEL CONTROLS ON THE POWER-SUPPLY CIRCUITS

PANEL CONTROLS										POWER APPLIED TO			
Transmitter Reset Button	Dynamotor Reset Button	Local-Remote Switch	Transmitter Emission Switch	Control-Unit Emission Switch	Autotune System Condition	Power-Level Switch	Keying Line Condition	Transmitter 28-Volt Input	Dynamotor 28-Volt Input	Transmitter Indicator Lamp	Control-Unit Indicator Lamp		
Out	Out	** ** *	** ** *	** ** *	** ** *	** ** *	** ** *	No	No	No	No		
Out	In	** ** *	** ** *	** ** *	** ** *	** ** *	** ** *	No	No	No	No		
In	Out	LOCAL	OFF	** ** *	** ** *	** ** *	** ** *	No	No	No	No		
In	Out	LOCAL	VOICE, CW, or MCW	** ** *	At Rest	** ** *	** ** *	Yes	No	Yes	No		
In	Out	LOCAL	VOICE, CW, or MCW	** ** *	Cycling	** ** *	** ** *	Yes	No	No	No		
In	Out	REMOTE	** ** *	OFF	** ** *	** ** *	** ** *	No	No	No	No		
In	Out	REMOTE	** ** *	VOICE, CW, or MCW	At Rest	** ** *	** ** *	Yes	No	No	Yes		
In	Out	REMOTE	** ** *	VOICE, CW, or MCW	Cycling	** ** *	** ** *	Yes	No	No	No		
In	In	LOCAL	OFF	** ** *	** ** *	** ** *	** ** *	No	No	No	No		
In	In	LOCAL	VOICE	** ** *	At Rest	CALIBRATE	** ** *	Yes	Yes	Yes	No		
In	In	LOCAL	VOICE	** ** *	At Rest	TUNE or OPERATE	Not Grounded	Yes	No	Yes	No		
In	In	LOCAL	VOICE	** ** *	At Rest	TUNE or OPERATE	Grounded	Yes	Yes	Yes	No		
In	In	LOCAL	VOICE	** ** *	Cycling	** ** *	** ** *	Yes	No	No	No		
In	In	LOCAL	CW or MCW	** ** *	At Rest	** ** *	** ** *	Yes	Yes	Yes	No		
In	In	LOCAL	CW or MCW	** ** *	Cycling	** ** *	** ** *	Yes	No	No	No		
In	In	REMOTE	** ** *	OFF	** ** *	** ** *	** ** *	No	No	No	No		
In	In	REMOTE	** ** *	VOICE	At Rest	CALIBRATE	** ** *	Yes	Yes	No	Yes		
In	In	REMOTE	** ** *	VOICE	At Rest	TUNE or OPERATE	Not Grounded	Yes	No	No	Yes		
In	In	REMOTE	** ** *	VOICE	At Rest	TUNE or OPERATE	Grounded	Yes	No	No	Yes		
In	In	REMOTE	** ** *	VOICE	At Rest	TUNE or OPERATE	Grounded	Yes	Yes	No	Yes		
In	In	REMOTE	** ** *	VOICE	Cycling	** ** *	** ** *	Yes	No	No	No		
In	In	REMOTE	** ** *	CW or MCW	At Rest	** ** *	** ** *	Yes	Yes	No	Yes		
In	In	REMOTE	** ** *	CW or MCW	Cycling	** ** *	** ** *	Yes	No	No	No		

* * * Indicates button, switch, or condition of system or line has no effect.

properly interconnected. Explain the functioning of this portion of the circuits.

12. Refer to TABLE 1 and, on the blackboard, tabulate the information contained in the upper half of the first four columns of the chart. Allow the students sufficient time to record this information. Erase the blackboard. Repeat this process for the lower half of the first four columns, and the upper and lower halves of the second four columns. Write the headings of the last four columns across the top of the blackboard. Instruct the students to study their notes or Wall Chart No. 3 and determine whether the word "Yes" or "No" is correct for each line under the column headings on the blackboard. Permit classroom discussion on these conclusions, within reasonable limits of time.

CONCLUSIONS

Proper operation of the power-control circuits is determined by means of an operational check; that is, by operating the panel controls and noting the effect upon equipment performance.

ORAL QUIZ

1. What causes the contacts of the barometric switch to close?
2. The transmitter-overload relay is open. Can 28-volt power be applied to the dynamotor by operating certain panel controls?
3. The dynamotor-overload relay is open. Can 28-volt power be applied to the transmitter by operating certain panel controls?
4. Is either indicator lamp lighted when the autotune system is cycling?
5. The EMISSION switch on the pilot's control box is OFF and the LOCAL-REMOTE switch is at REMOTE. Can the equipment be turned on by means of any other control on the front panel of the transmitter?
6. Both overload relays are closed. The LOCAL-REMOTE switch is at LOCAL and the transmitter EMISSION switch is at VOICE. The autotune system is at rest and the power-level switch is at OPERATE. Is the dynamotor running? Is the transmitter indicator lamp lighted?
7. Both overload relays are closed. The LOCAL-REMOTE switch is at REMOTE and the control-unit EMISSION switch is at VOICE. The autotune system is cycling and the power-level switch is at TUNE. The TEST key is operated. Is the dynamotor running? Is the control-unit indicator lamp lighted?
8. Both overload relays are closed. The LOCAL-REMOTE switch is at LOCAL and the transmitter EMISSION switch is at CW. The autotune system is at rest. Is the dynamotor running? The telegraph key on the pilot's control box is depressed. Is the transmitter keyed?

EXPERIMENT No. 12

TIME ALLOTTED: 1 HR.

SUBJECT

Power-control circuits.

OBJECTIVE

To become familiar with the operational check of the power-control circuits.

EQUIPMENT REQUIRED

One or more AN/ART-13 type of transmitting sets with accessory components as listed in previous experiments.

INSTRUCTIONS

Intercable, connect, and plug in the units and accessory components as in previous experiments. Refer to the Trouble-Shooting Supplement for the placement of troubles in the equipment.

PROCEDURE

1. Make certain that the LOCAL-REMOTE switch is at LOCAL, and the EMISSION switch is OFF. Set the transmitter on its rear surface, and remove the bottom-cover plate. Examine the CW relay, K103, and the voice relay, K104, located near the rear center of the chassis.
2. Remove the Autotune-cover plate and examine the rear-limit switch, S111, located on the multiturn unit (control B). Examine the motor-reversing relay, K101, located between controls E and C. Replace the Autotune-cover plate and the bottom-cover plate. Set the transmitter in the normal position.
3. Operate the meter switch to BATTERY, and the transmitter EMISSION switch to VOICE. Observe that the d-c milliammeter indicates the presence of 28-volt power in the transmitter. Observe that the transmitter indicator lamp is lighted, but that the control-unit indicator lamp is unlighted. Operate the power-level switch to CALIBRATE. Notice that the dynamotor is running (listen for the characteristic whining sound).
4. When the power-level switch is operated to the TUNE or OPERATE position, notice that the dynamotor stops running, but that it starts running again when the TEST key (or any one of the other switches or keys on the keying line) is operated. Notice that the control-unit EMISSION and CHANNEL switches have no effect upon the equipment operation, but that the control-unit telegraph key and microphone switch do cause the dynamotor to run when they are operated, even though the LOCAL-REMOTE switch is at LOCAL.
5. Operate the transmitter CHANNEL switch to L. FREQ., momentarily, and then back to MANUAL. Notice that the transmitter indicator lamp is unlighted, that the dynamotor is at rest, and that operation of the power-level switch or TEST key has no effect, when the Autotune system is cycling.
6. Operate the transmitter EMISSION switch to CW. Notice that the transmitter indicator lamp is lighted, and that the dynamotor is running. Cycle the Autotune system, and notice that the transmitter indicator lamp is unlighted, and that the dynamotor is at rest, when the Autotune system is cycling. Notice that the same is true when the EMISSION switch is at MCW.
7. Operate the LOCAL-REMOTE switch to REMOTE and make similar observations of the d-c milliammeter, dynamotor, and transmitter and control-unit indicator lamps, while operating the two EMISSION switches, the power-level switch, and the TEST key (or other keying-line switch or key).
8. Request the instructor to place a trouble in the equipment. By means of an operational check, visual

inspection, and further voltage and resistance measurements, as required, isolate and locate the trouble, and correct it. Restore the transmitting set to its original condition.

CONCLUSIONS

1. Contacts 1-2 of Autotune rear-limit switch S111 do not make proper connection. What are the trouble symptoms?
2. None of the components of the pilot's control box has any effect upon the equipment operation, although

the LOCAL-REMOTE switch is in the REMOTE position. What is the most likely cause of trouble?

3. The transmitter indicator lamp is burned out. The LOCAL-REMOTE switch is at REMOTE, and the control-unit EMISSION switch is at VOICE. The Autotune system is at rest and both overload relays are closed. Is the control-unit indicator lamp lighted?

4. Improper operation of the equipment is traced to an open dynamotor-overload relay. The DYNA. RESET button is depressed, but it immediately snaps out, when released. What is the next logical step to perform?

LECTURE 14

ANALYSIS OF THE EMISSION-SELECTION CIRCUITS

The emission-selection circuits consist essentially of four switches and two relays, which permit control of the emission of the transmitter, from the front panel of the transmitter, or from the front panel of the pilot's control box. These circuits are shown in the schematic diagram in figure 37.

Only the output of the microphone in use excites the input of the first-audio amplifier when power-level switch S106 is at TUNE or OPERATE and contacts 5-6 of voice relay K104 are open. These contacts are open when the relay is energized, which occurs when the LOCAL-REMOTE switch is at LOCAL and transmitter EMISSION switch S110 is at VOICE, or when the LOCAL-REMOTE switch is at REMOTE and control-unit EMISSION switch S602 is at VOICE.

The output of the MCW oscillator is applied to the input of the first-audio amplifier when power-level switch S106 is at TUNE or OPERATE and contacts 5-6 of voice relay K104 are closed. These contacts are closed when the relay is de-energized, which occurs when the LOCAL-REMOTE switch is either at LOCAL or REMOTE and the corresponding EMISSION switch is at CW or MCW.

The output of the CFI unit is applied to the input of the first-audio amplifier when power-level switch S106 is at CALIBRATE, irrespective of the positions of either the EMISSION switch or the LOCAL-REMOTE switch.

The modulator is made operative for voice or MCW by the application of the +1150/750-volt d-c potential to the plate return (terminal 2 of modulation transformer T101), through contacts 7-8 and 2-3 of CW relay K103. These contacts are closed when the relay is de-energized. This occurs when the power-level switch is at TUNE or OPERATE, LOCAL-REMOTE switch S107 is at LOCAL, and transmitter EMISSION switch S110 is at VOICE or MCW, or when the power-level switch is at TUNE or OPERATE, LOCAL-REMOTE switch S107 is at REMOTE, and control-unit EMISSION switch S602 is at VOICE or MCW.

The modulator is disabled when the +1150/750-volt d-c potential is removed from the plate return, by the opening of contacts 2-3 and 7-8 of CW relay K103 when this relay is energized. Relay K103 is energized for

each of the following conditions: (1) when power-level switch S106 is at CALIBRATE; (2) when the LOCAL-REMOTE switch is at LOCAL and transmitter EMISSION switch S110 is at CW; (3) when the LOCAL-REMOTE switch is at REMOTE and control-unit EMISSION switch S602 is at CW.

The power amplifier can be modulated when the +1150/750-volt d-c potential is applied to the plate return of this stage through winding 4-5 of modulation transformer T101. The high voltage is applied when CW relay K103 is de-energized, allowing contacts 6-7 to open.

The power amplifier cannot be modulated when the +1150/750-volt d-c potential is applied directly to the plate return. The high voltage is applied by the closing of contacts 6-7 of relay K103 when this relay is energized.

The supplementary chart in figure 37 summarizes the action of the panel controls upon the emission-selection circuits.

LESSON PLAN No. 14

TIME ALLOTTED: 1/2 HR.

SUBJECT

Emission-selection circuits.

OBJECTIVE

To analyze the emission-selection circuits.

INTRODUCTION

Control of the type of transmitter emission is accomplished from either the front panel of the transmitter or the pilot's control box. Four switches and two relays make up the emission-selection circuits. These circuits determine three circuit conditions: (1) whether the input of the first-audio amplifier is excited by the microphone output, the MCW-oscillator output, or the CFI-unit output; (2) whether the modulator is operative or disabled; and (3) whether the +1150/750-volt d-c potential is applied to the plate return of the power amplifier through the modulation transformer or through a direct connection.

PANEL CONTROLS				INPUT CIRCUIT 1ST AUDIO AMPLIFIER	MODULATOR	+1150/750 VDC APPLIED TO PLATE RETURN OF PWR AMPL
POWER LEVEL SWITCH	LOCAL REMOTE SWITCH	TRANSMITTER EMISSION SWITCH	CONTROL UNIT EMISSION SWITCH			
TUNE OR OPERATE	LOCAL	VOICE	---	MIC	OPERATIVE	THROUGH T101
TUNE OR OPERATE	LOCAL	CW	---	MCW	DISABLED	DIRECT
TUNE OR OPERATE	LOCAL	MCW	---	MCW	OPERATIVE	THROUGH T101
TUNE OR OPERATE	REMOTE	---	VOICE	MIC	OPERATIVE	THROUGH T101
TUNE OR OPERATE	REMOTE	---	CW	MCW	DISABLED	DIRECT
TUNE OR OPERATE	REMOTE	---	MCW	MCW	OPERATIVE	THROUGH T101
CALIBRATE	---	---	---	CFI	DISABLED	DIRECT

--- INDICATES SWITCH HAS NO EFFECT

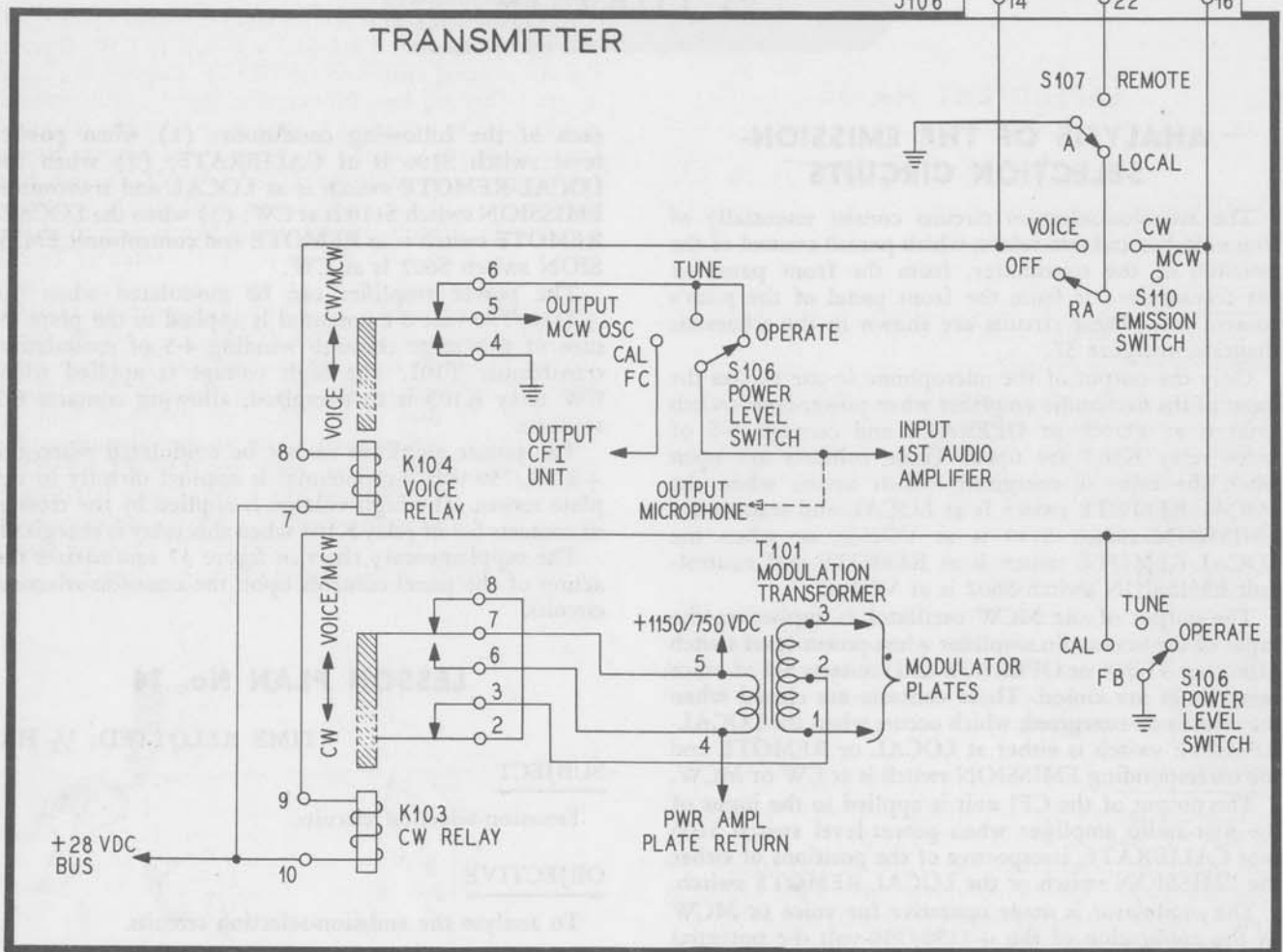
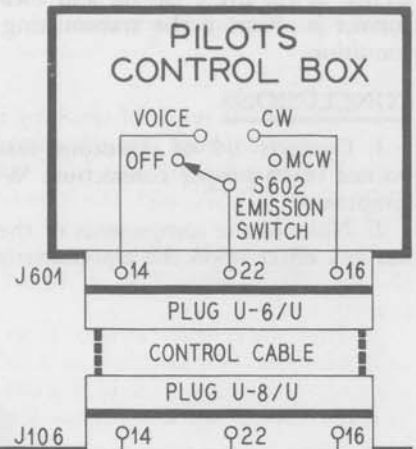

Figure 37. Emission-Selection Circuits

SUBJECT MATERIAL

1. Display Wall Chart No. 2, and point out the locations of the various circuit elements which are contained in the emission-selection circuits.
2. On the blackboard, draw the schematic diagram contained in figure 37.
3. Explain how the microphone, MCW-oscillator, and CFI-unit outputs are selected for excitation of the first-audio amplifier.

4. Point out the circuit conditions which determine whether the modulator is operative or disabled.
5. Trace the plate-return circuit of the power amplifier for the conditions of modulation and no modulation.
6. On the blackboard, draw the supplementary chart contained in figure 37. Summarize the actions of the emission-selection circuits.

CONCLUSIONS

Proper operation of the emission-selection circuits is

determined by means of an operational check; that is, by operating the panel controls and noting the effect upon equipment performance.

ORAL QUIZ

1. What is the result of speaking into the microphone with the (microphone) switch depressed, when LOCAL-REMOTE switch S107 is at LOCAL, EMISSION switch S110 is at MCW, and the power-level switch is at OPERATE?

2. Is the +1150/750-volt d-c potential applied to the modulator when CW emission is selected for the transmitter?

3. The power-level switch is at CALIBRATE, the LOCAL-REMOTE switch is at LOCAL, and the transmitter EMISSION switch is at VOICE. Is the modulator disabled? What signal is present in the sidetone output?

EXPERIMENT No. 13

TIME ALLOTTED: $\frac{3}{4}$ HR.

SUBJECT

Emission-selection circuits.

OBJECTIVE

To become familiar with the operational check of the emission-selection circuits.

EQUIPMENT REQUIRED

One or more AN/ART-13 type of transmitting sets with accessory components as listed in previous experiments. One d-c voltmeter with 1500-volt range, for each transmitting set.

INSTRUCTIONS

Intercable, connect, and plug in the units and accessory components as in previous experiments. Refer to the Trouble-Shooting Supplement for the placement of troubles in the equipment. Always approach dial settings in a clockwise direction.

PROCEDURE

1. Make certain that the LOCAL-REMOTE switch is at LOCAL, and the EMISSION switch is OFF. Remove the top-cover plate from the transmitter. Connect the positive lead of the d-c voltmeter (set to the 1500-volt range) to the top cap of one of the modulator tubes, and the negative lead to ground.

2. Operate the transmitter EMISSION switch to VOICE, and the power-level switch to TUNE. Manually depress the top-cover interlock, if used, and close the TEST switch. Notice that the d-c voltmeter reads approximately 1150 volts. Operate the EMISSION switch to CW, and notice that the d-c voltmeter reads zero. Operate the EMISSION switch to MCW, and notice that the d-c voltmeter reads approximately 1150 volts. Repeat this observation with the LOCAL-REMOTE switch at REMOTE, as the control-unit EMISSION switch is operated to each of the positions. Repeat the process with the power-level switch at OPERATE.

3. Operate the power-level switch to CALIBRATE. Notice that the d-c voltmeter reads zero, independent of

the positions of the LOCAL-REMOTE switch, EMISSION switch, and TEST key.

4. Operate the LOCAL-REMOTE switch to LOCAL, and the transmitter EMISSION switch to OFF. Disconnect the d-c voltmeter, and replace the transmitter top-cover plate.

5. Tune the transmitter to a frequency in the 6.0-mc. to 7.2-mc. band. Operate the power-level switch to OPERATE, and the EMISSION switch to VOICE. Operate the meter switch to P.A. PLATE. Depress the microphone button and speak into the microphone. Notice that the d-c milliammeter needle fluctuates in the red area of the meter. Listen to the sidetone output. Repeat the observations with the LOCAL-REMOTE switch at REMOTE, and the control-unit EMISSION switch at VOICE, as the control-unit microphone is operated. Repeat the process with the power-level switch at TUNE. (D-c milliammeter reading is lower.)

6. Operate the LOCAL-REMOTE switch to LOCAL, and the transmitter EMISSION switch to CW. Operate the power-level switch to OPERATE. Depress the transmitter telegraph key. Notice that the d-c milliammeter needle rises to a reading of 100, each time the telegraph key is depressed. Listen to the sidetone output. Repeat the observations with the LOCAL-REMOTE switch at REMOTE, and the control-unit EMISSION switch at CW, as the control-unit telegraph key is depressed. Repeat the process with the power-level switch at TUNE. (D-c milliammeter reading is lower.)

7. Operate the LOCAL-REMOTE switch to LOCAL, and the transmitter EMISSION switch to MCW. Operate the power-level switch to OPERATE. Depress the transmitter telegraph key. Notice that the d-c milliammeter needle rises to a reading of 190, each time the telegraph key is depressed. Listen to the sidetone output. Repeat the observations with the LOCAL-REMOTE switch at REMOTE, and the control-unit EMISSION switch at MCW, as the control-unit telegraph key is depressed. Repeat this process with the power-level switch at TUNE. (D-c milliammeter reading is lower.)

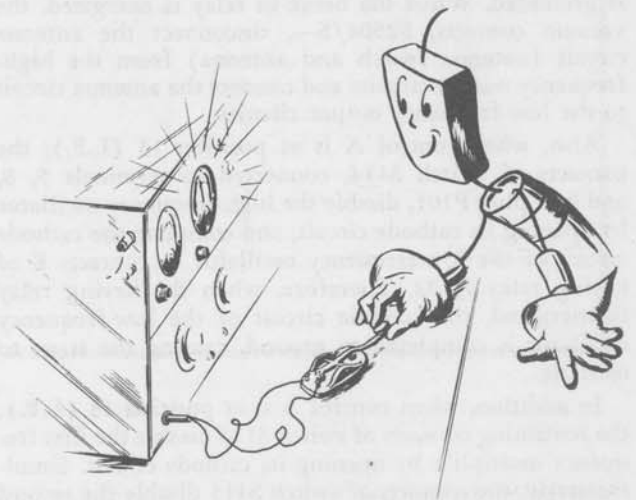

8. Operate the power-level switch to CALIBRATE. Notice that the d-c milliammeter reads zero, independent of the positions of the switches and key. Listen to the sidetone output as control B is rotated through a crystal-check point.

9. Request the instructor to place a trouble in the equipment. By means of an operational check, visual

inspection, and further voltage and resistance measurements, as required, isolate and locate the trouble, and correct it. Restore the transmitting set to its original condition.

CONCLUSIONS

1. It is found that operation on voice is normal when using the control-unit microphone. However, when the

transmitter microphone is used, a tone signal is present in the sidetone output, instead of a speech signal. Assuming that the switches are in the correct positions for each case, what is the most likely cause of the trouble?

2. The arm of section RA of EMISSION switch S110 does not make connection with the CW contact when the switch is in the CW position. What are the trouble symptoms?

LECTURE 15

ANALYSIS OF THE FREQUENCY-BAND-SELECTION CIRCUITS

The frequency-band-selection circuits are essentially a "switch-relay" group of components. The operation of these components is dependent upon the frequency band selected for the equipment. Subsequently, the components make the proper connections, among the various transmitting-set circuits, for operation on the desired frequency band.

When control A, HIGH FREQUENCY TUNING—COARSE, is at position 13 (L.F.), switch S114 shorts terminals 4 and 7 of plug P101, which energizes the output-circuit selecting relay, K105. The contacts of relay K105 disconnect the output of the power amplifier from the high-frequency output circuits, and connect the power-amplifier output to the low-frequency output circuits. Also, the contacts of relay K105 remove the short from across inductor L109, and connect +28 volts, d.c., to one terminal of the break-in relay, K2501/K-01, located in the antenna loading or switching unit. Therefore, the break-in relay is energized when the keying line is grounded. When the break-in relay is energized, the vacuum contacts, S2504/S—, disconnect the antenna circuit (antenna switch and antenna) from the high-frequency output circuits and connect the antenna circuit to the low-frequency output circuits.

Also, when control A is at position 13 (L.F.), the contacts of switch S114, connected to terminals 5, 8, and 6 of plug P101, disable the high-frequency oscillator by opening its cathode circuit, and complete the cathode circuit of the low-frequency oscillator to contacts E of keying relay K102. Therefore, when the keying relay is energized, the cathode circuit of the low-frequency oscillator is completed to ground, causing the stage to oscillate.

In addition, when control A is at position 13 (L.F.), the remaining contacts of switch S114 disable the first frequency multiplier by opening its cathode circuit. Simultaneously, the contacts of switch S115 disable the second frequency multiplier by opening its cathode circuit.

When control A is in any position from 1 through 12 (2.0 mc. to 18.1 mc.), relay K105 switches the output of the power amplifier from the low-frequency output circuits to the high-frequency output circuits, and places a short across inductor L109. The break-in relay connects the antenna circuit to the high-frequency output circuits (regardless of the keying-line condition). Switch S114

disables the low-frequency oscillator, allows the high-frequency oscillator to be keyed, and renders the first frequency multiplier operative.

In addition, when control A is in any position from 1 through 6 (2.0 mc. to 6.0 mc.), switch S115 disables the second frequency multiplier; when control A is in any position from 7 through 12 (6.0 mc. to 18.1 mc.), switch S115 renders the second frequency multiplier operative.

LESSON PLAN No. 15

TIME ALLOTTED: $\frac{3}{4}$ HR.

SUBJECT

Frequency-band-selection circuits.

OBJECTIVE

To analyze the frequency-band-selection circuits.

INTRODUCTION

The frequency-band-selection circuits (as controlled by control A, HIGH FREQUENCY TUNING—COARSE, and the condition of the keying line) serve to disable or render operative certain vacuum-tube stages and make the proper power-amplifier-output and antenna-circuit connections, for operation on the desired frequency band.

SUBJECT MATERIAL

1. Display Wall Chart No. 1 and point out the blocks which are affected by the frequency-band-selection circuits.

2. Display Wall Chart No. 2 and point out the locations of the various circuit elements which are contained in the emission-selection circuits.

3. On the blackboard, draw the schematic diagram contained in figure 39.

4. Trace the circuit and explain the operation when control A is at position 13 (L.F.).

5. Trace the circuit and explain the operation when control A is in any position from 1 through 6 (2.0 mc. to 6.0 mc.).

6. Trace the circuit and explain the operation when control A is in any position from 6 through 12 (6.0 mc. to 18.1 mc.).

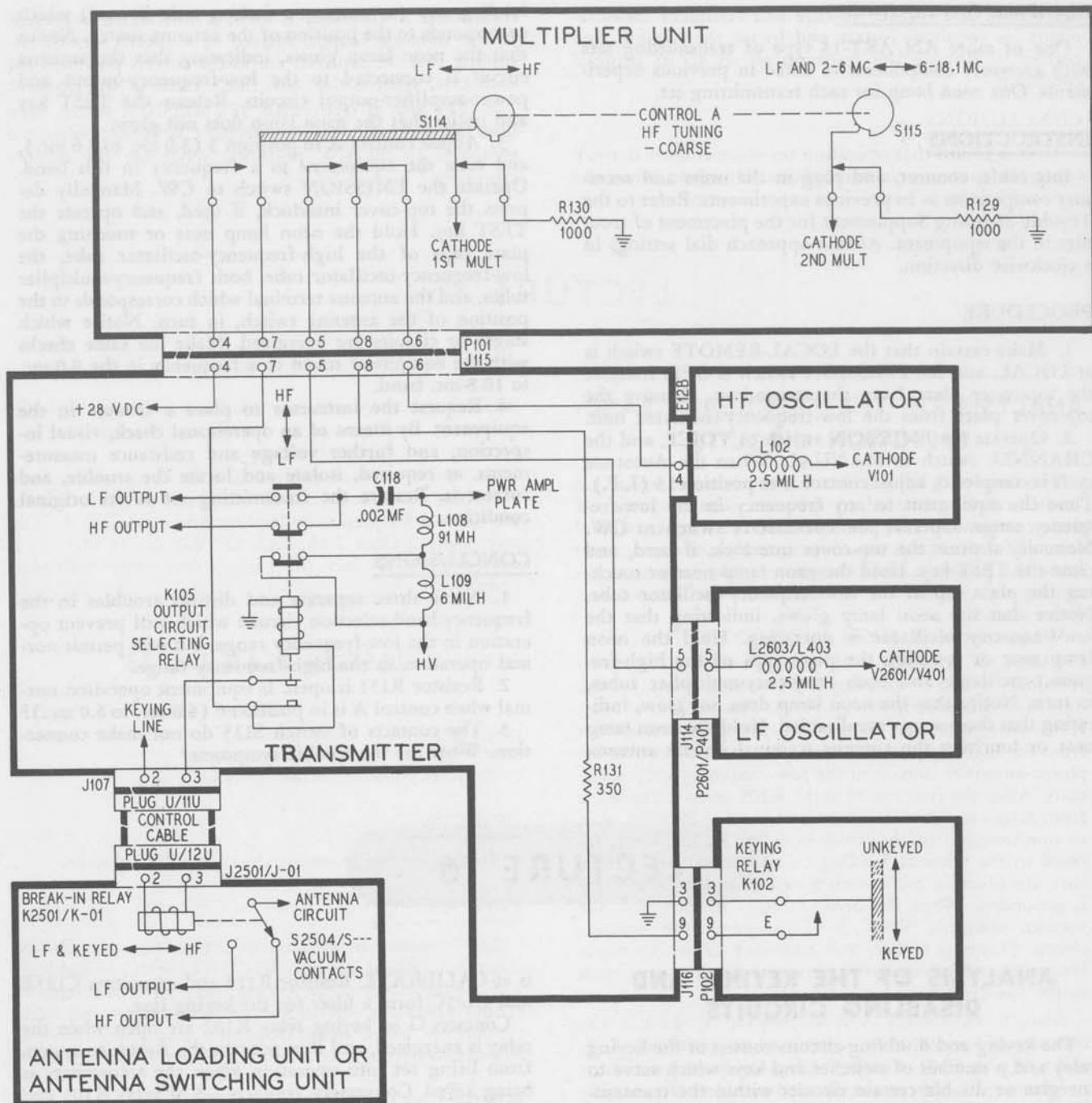

Figure 38. Frequency-Band Selection Circuits

CONCLUSIONS

Proper operation of the frequency-band-selection circuits is determined by means of an operational check; that is, by operating the panel controls and noting the effect upon equipment performance.

ORAL QUIZ

1. When control A is at position 1 (2.0 mc. to 2.4 mc.), does the operation of the telegraph key or microphone switch have any effect upon the break-in relay?
2. What two vacuum-tube stages are disabled when control A is in position 6 (4.8 mc. to 6.0 mc.)?
3. At which position of control A is the first frequency multiplier disabled?

EXPERIMENT No. 14

TIME ALLOTTED: ¾ HR.

SUBJECT

Frequency-band-selection circuits.

OBJECTIVE

To become familiar with the operational check of the frequency-band-selection circuits.

EQUIPMENT REQUIRED

One or more AN/ART-13 type of transmitting sets with accessory components as listed in previous experiments. One neon lamp for each transmitting set.

INSTRUCTIONS

Intercable, connect, and plug in the units and accessory components as in previous experiments. Refer to the Trouble-Shooting Supplement for the placement of troubles in the equipment. Always approach dial settings in a clockwise direction.

PROCEDURE

1. Make certain that the LOCAL-REMOTE switch is at LOCAL, and the EMISSION switch is OFF. Remove the top-cover plate from the transmitter. Remove the top-cover plate from the low-frequency-oscillator unit.
2. Operate the EMISSION switch to VOICE, and the CHANNEL switch to MANUAL. When the Autotune cycle is completed, adjust control A to position 13 (L.F.). Tune the equipment to any frequency in the low-frequency range. Operate the EMISSION switch to CW. Manually depress the top-cover interlock, if used, and close the TEST key. Hold the neon lamp near or touching the plate cap of the low-frequency-oscillator tube. Notice that the neon lamp glows, indicating that the low-frequency oscillator is operating. Hold the neon lamp near or touching the plate caps of the high-frequency-oscillator and both frequency-multiplier tubes, in turn. Notice that the neon lamp does not glow, indicating that these stages are disabled. Hold the neon lamp near or touching the antenna terminal on the antenna

loading unit (or antenna switching unit, if used) which corresponds to the position of the antenna switch. Notice that the neon lamp glows, indicating that the antenna circuit is connected to the low-frequency-output and power-amplifier-output circuits. Release the TEST key and notice that the neon lamp does not glow.

3. Adjust control A to position 3 (3.0 mc. to 3.6 mc.), and tune the equipment to a frequency in this band. Operate the EMISSION switch to CW. Manually depress the top-cover interlock, if used, and operate the TEST key. Hold the neon lamp near or touching the plate caps of the high-frequency-oscillator tube, the low-frequency-oscillator tube, both frequency-multiplier tubes, and the antenna terminal which corresponds to the position of the antenna switch, in turn. Notice which stages or circuits are energized. Make the same checks with the equipment tuned to a frequency in the 9.0-mc. to 10.8-mc. band.

4. Request the instructor to place a trouble in the equipment. By means of an operational check, visual inspection, and further voltage and resistance measurements, as required, isolate and locate the trouble, and correct it. Restore the transmitting set to its original condition.

CONCLUSIONS

1. Name three separate and distinct troubles in the frequency-band-selection circuits which will prevent operation in the low-frequency range, but will permit normal operation in the high-frequency range.
2. Resistor R131 is open. Is equipment operation normal when control A is in position 6 (4.8 mc. to 6.0 mc.)?
3. The contacts of switch S115 do not make connection. What are the trouble symptoms?

LECTURE 16

ANALYSIS OF THE KEYING AND DISABLING CIRCUITS

The keying and disabling circuits consist of the keying relay and a number of switches and keys which serve to energize or disable certain circuits within the transmitting set to provide positive keying of the equipment. These circuits are shown in the schematic diagram in figure 39.

When power is applied to the transmitter, +28 volts, d.c., is applied to contact 3 of the Autotune motor-reversing relay, K101. Contacts 1-3 of relay K101 and contacts 1-2 of Autotune rear-limit switch S111 are closed when the Autotune system is at rest. The contacts of switch S113D are closed when control C, ANTENNA TUNING—COARSE, is set accurately at any one of its positions (dial mark and index line exactly opposite each other). Therefore, when the Autotune system is at rest and control C is at any of its positions, +28 volts, d.c., is applied to terminal 15 of plug P102. Under these conditions, the keying relay, K102, is energized when terminal 14 of plug P102 is grounded. This terminal is grounded when any of the keying switches or keys is closed or operated, or when the power-level switch, S106,

is at CALIBRATE. Resistor R114 and capacitors C121B and C121C form a filter for the keying line.

Contacts G of keying relay K102 are open when the relay is energized, and thus prevent the Autotune system from being set into operation when the transmitter is being keyed. Conversely, contacts 1-3 of relay K101 and contacts 1-2 of switch S111 prevent the transmitter from being keyed when the Autotune system is cycling. Also,

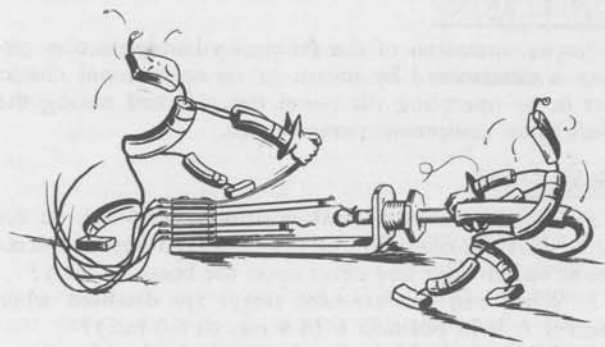

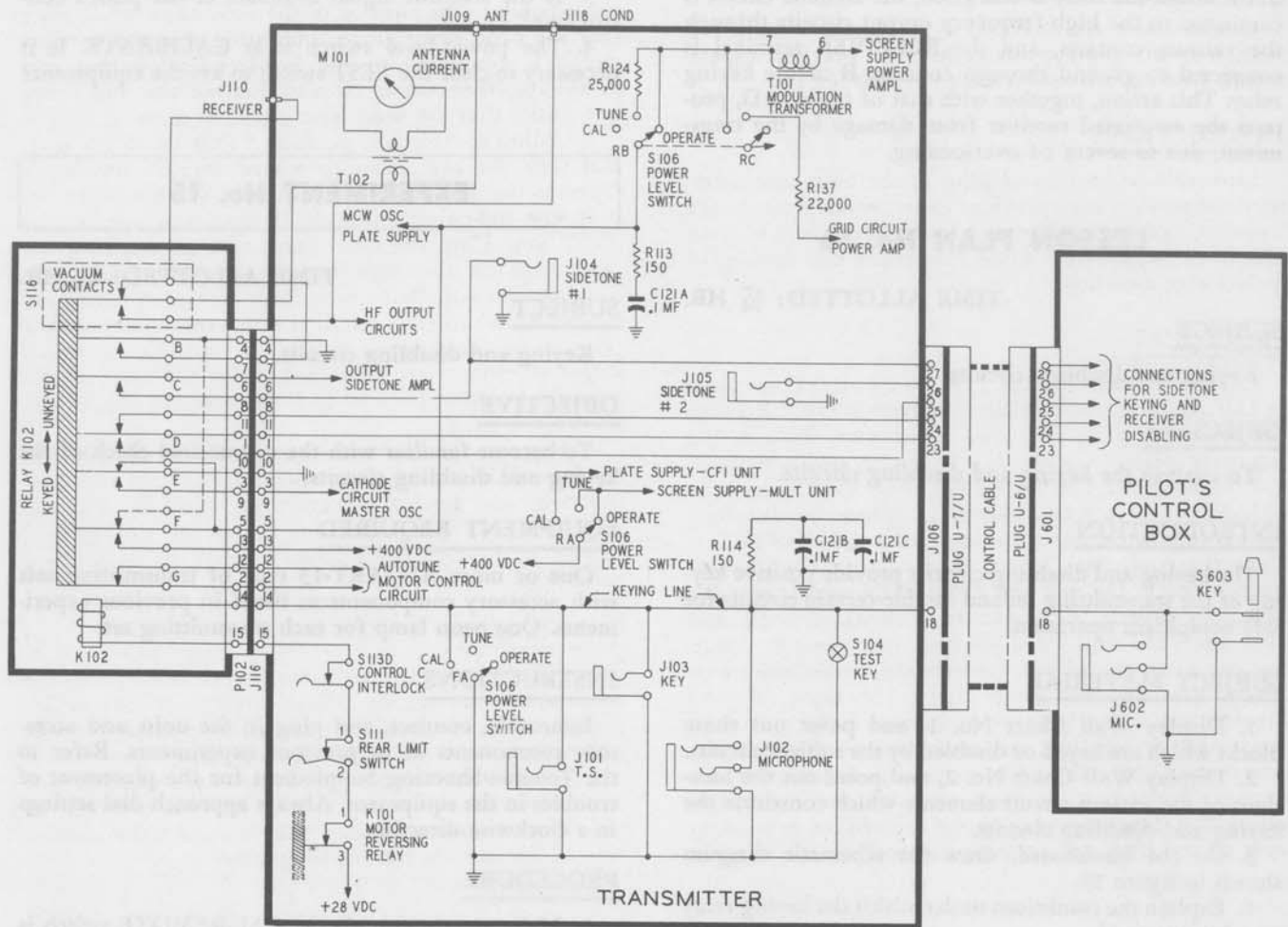

Figure 39. Keying and Disabling Circuits

switch S113D prevents the transmitter from being keyed when control C is between any two successive positions. All of these interlocking circuits are protective in purpose.

Contacts F of relay K102 apply +400 volts, d.c., to the plate-supply circuit of the MCW oscillator when the relay is energized, and ground the plate-supply circuit when the relay is de-energized. When the power-level switch, S106, is at OPERATE, contacts F of relay K102 apply +400 volts, d.c., to the screen-supply circuit of the power amplifier when the relay is energized, and ground the screen-supply circuit when the relay is de-energized. When switch S106 is at TUNE, contacts F of relay K102 apply +400 volts, d.c., to the screen-supply circuit of the power amplifier through dropping resistor R124 when the relay is energized, and ground it when the relay is de-energized. When switch S106 is at CALIBRATE, the power amplifier is disabled by section RC of the switch, which connects the negative d-c voltage present in the power-amplifier-grid circuit to the screen-supply circuit through isolating resistor R137. Resistor R113 and capacitor C121A form a filter for contacts F of the keying relay.

Contacts E of relay K102 key the master oscillator that is in use (determined by control A) by completing the oscillator-cathode circuit to ground.

Contacts D of relay K102 provide both normally open

and normally closed contacts which may be used to disable the associated receiver in synchronism with transmitter keying, thus permitting break-in operation. (Receivers are usually disabled by interrupting the plate-supply potential applied to the r-f and i-f vacuum-tube stages.)

Contacts C of relay K102 interrupt the audio signal fed to the SIDETONE 1 jack, J104, in synchronism with transmitter keying. Terminals 26 and 27 of jack J601 may be connected with a jumper to provide audio output at the SIDETONE 2 jack, J105, or the sidetone signal may be monitored at the pilot's control box by connection between terminal 27 and ground (terminal 19).

When the power-level switch S106 is at TUNE or OPERATE, section RA of the switch maintains the CFI unit disabled, and applies +400 volts, d.c., to the screen-supply circuits of the multiplier unit, rendering the two multiplier stages operative. When switch S106 is at CALIBRATE, section RA of the switch disables the multiplier unit, and applies +400 volts, d.c., to the plate-supply circuits of the CFI unit, placing the unit into operation.

Contacts B of relay K102 function in conjunction with the vacuum contacts, S116. When the relay is de-energized, the antenna circuit (externally connected to ANT. terminal J109) is connected to the RECEIVER terminal, J110, through the contacts of vacuum switch

S116. When the relay is energized, the antenna circuit is connected to the high-frequency output circuits through the vacuum contacts, and the RECEIVER terminal is connected to ground through contacts B of the keying relay. This action, together with that of contacts D, protects the associated receiver from damage by the transmitter, due to severe r-f overloading.

LESSON PLAN No. 16

TIME ALLOTTED: $\frac{3}{4}$ HR.

SUBJECT

Keying and disabling circuits.

OBJECTIVE

To analyze the keying and disabling circuits.

INTRODUCTION

The keying and disabling circuits provide positive keying of the transmitting set and disable certain circuits for safe equipment operation.

SUBJECT MATERIAL

1. Display Wall Chart No. 1, and point out those blocks which are keyed or disabled by the subject circuits.
2. Display Wall Chart No. 2, and point out the locations of the various circuit elements which constitute the keying and disabling circuits.
3. On the blackboard, draw the schematic diagram shown in figure 39.
4. Explain the conditions under which the keying relay may be energized.
5. Enumerate the various circuit elements which ground the keying line.
6. Explain the double-interlocking arrangement between the Autotune and keying circuits. Explain the control D interlock.
7. Explain the functioning of contacts F of the keying relay.
8. Describe the method of keying the master oscillators.
9. Show how keying-relay contacts D may be interconnected with the associated receiver to permit break-in operation.
10. Point out how the SIDETONE 2 jack is utilized.
11. Review the action of section RA of the power-level switch.
12. Review the action of the vacuum contacts and contacts B of the keying relay.

CONCLUSIONS

Proper operation of the keying and disabling circuits is determined by means of an operational check; that is, by operating the panel controls and noting the effect upon equipment performance.

ORAL QUIZ

1. Can the Autotune system be set into operation when the control C interlock is open?
2. Contacts F of the keying relay are defective. Which vacuum-tube stages are affected?

3. Is the sidetone signal available at the pilot's control box?

4. The power-level switch is at CALIBRATE. Is it necessary to close the TEST switch to key the equipment?

EXPERIMENT No. 15

TIME ALLOTTED: $\frac{1}{2}$ HR.

SUBJECT

Keying and disabling circuits.

OBJECTIVE

To become familiar with the operational check of the keying and disabling circuits.

EQUIPMENT REQUIRED

One or more AN/ART-13 type of transmitting sets with accessory components as listed in previous experiments. One neon lamp for each transmitting set.

INSTRUCTIONS

Intercable, connect, and plug in the units and accessory components as in previous experiments. Refer to the Trouble-Shooting Supplement for the placement of troubles in the equipment. Always approach dial settings in a clockwise direction.

PROCEDURE

1. Make certain that the LOCAL-REMOTE switch is at LOCAL, and the EMISSION switch is OFF. Remove the top-cover plate from the transmitter. Remove the top-cover plate from the low-frequency oscillator.
2. Tune the equipment to a frequency in the 6.0-mc. to 7.2-mc. range. Operate the EMISSION switch to CW, and the power-level switch to OPERATE. Manually depress the top-cover interlock, if used, and key the equipment by operating the transmitter telegraph key. Hold the neon lamp near or touching the plate caps of the high-frequency-oscillator and power-amplifier tubes, and at the ANT. terminal on the transmitter, in turn. Notice that, at each of these points, the neon lamp flashes on and off in accordance with the keying. Make the same observations with the transmitter tuned to a frequency in the low-frequency range. Make the neon-lamp tests at the plate caps of the low-frequency-oscillator and power-amplifier tubes.
3. Hold the telegraph key down and attempt to cycle the Autotune system.
4. Cycle the Autotune system, operate the telegraph key, and make neon-lamp tests while the system is cycling.
5. Adjust control C to a setting midway between two successive positions. Operate the telegraph key and note whether the equipment is being keyed by visual observation of the vacuum contacts on the keying relay.
6. Request the instructor to place a trouble in the equipment. By means of an operational check, visual inspection, and further voltage and resistance measurements, as required, isolate and locate the trouble, and correct it. Restore the transmitting set to its original condition.

CONCLUSIONS

1. Resistor R113 is open. What operational check indicates the presence of trouble?
2. Resistor R114 is open. What undesirable effect is noted?

3. It is found that the transmitter keying is not positive on CW; that is, the presence of a weak carrier signal is noted when the telegraph key is up. What defect in the keying circuits can cause this trouble?

LECTURE 17

ANALYSIS OF THE AUTOTUNE SYSTEM

The basic advantage of the AN/ART-13 type of aircraft radio transmitting equipment over previous types is its provision for automatically changing the transmission frequency in 25 seconds or less under normal conditions. This provision avoids the loss of the radio operator's time in re-tuning transmitters and the additional weight of extra transmitters.

The automatic provision is realized through the use of an electro-mechanical arrangement known as the Autotune—an electrically controlled means of mechanically adjusting the angular position of an assembly such as a variable capacitor, variometer, rotary switch, cam-operated switch, or tuning slug. (The usual tuning slug is a threaded iron rod whose depth of penetration into the core of a solenoid type of inductor is adjustable. The rod is threaded through one or more fixed nuts. Therefore, rotating the threaded iron rod in either direction changes its position and, consequently, the value of inductance of the coil.)

In the AN/ART-13 type of transmitting set, the Autotune system adjusts the angular positions of controls A, B, C, D, and E, as shown in illustration I of Wall Chart No. 3.

The shaft of control A, HIGH FREQUENCY TUNING—COARSE, is mechanically coupled to cam-operated switches S101, S114, and S115 and rotary switches S102 and S103.

The shaft of control B, HIGH FREQUENCY TUNING—FINE, is mechanically coupled to the tuning slugs of inductors L101, L105, and L106.

The shaft of control C, ANTENNA TUNING—COARSE, is mechanically coupled to cam-operated switches S113B, S113D, S113E, S113F, S113G, and S113H and to rotary switch S113C.

The shaft of control D, ANTENNA TUNING—FINE, is mechanically coupled to variometer L112.

The shaft of control E, ANTENNA LOADING, is mechanically coupled to variable capacitor C125 and cam-operated switch S113A.

Controls A, C, D, and E require a maximum change in angular position of one revolution and are positioned by a type of Autotune assembly known as a *singleturn* unit. Control B, however, requires a maximum change in angular position of 20 revolutions and is positioned by a type of Autotune assembly known as a *multiturn* unit.

The Autotune system can be adjusted so that automatic change of transmission frequency to any one of eleven predetermined "channel" frequencies is accomplished by operation of the CHANNEL switch on either the trans-

mitter or pilot's control box. One of these channel frequencies may lie in the low-frequency range and the remaining ten in the high-frequency range, or all eleven frequencies may lie in the high-frequency range. The channel frequencies need not bear any special order of succession in relation to the positions of the CHANNEL switch, although the system is normally adjusted so that the low channel frequency is selected when the CHANNEL switch is operated to L. FREQ. (if Autotune operation on a transmission frequency in the low-frequency range is desired). Due to the design of the singleturn and multiturn units, manual operation of the controls is possible only when the Autotune system is cycled by operating the CHANNEL switch to MANUAL; the system cannot be adjusted so that manual operation is selected by operating the CHANNEL switch to any other position.

As shown in illustration I of Wall Chart No. 3, the mechanical portion of the Autotune system is powered by the Autotune motor, B101, which is reversible. The line shaft is driven in either angular direction, by the Autotune motor, through the coupling of the sprocket chain (chain drive). Each of the four singleturn units (they position controls A, C, D, and E) is driven by a singleturn worm mounted on the line shaft. The multiturn unit (which positions control B) is driven by multiturn worms 1 and 2, which are also mounted on the line shaft.

As shown in illustration II of Wall Chart No. 3, the singleturn worm (of a representative-type singleturn unit) meshes with the slip-clutch worm gear, to which is fastened the cam-drum-drive gear and the slip-clutch band. The slip-clutch band drives the slip-clutch drum (friction drive) to which the stop-ring-drum shaft is fastened. The cam-drum-drive gear drives the cam-drum spur gear through the idler gear.

The front piece of the single-tooth ratchet is fastened to the cam-drum spur gear (both elements are free to turn on the cam-drum shaft). The rear piece of the single-tooth ratchet is fastened to the cam-drum shaft. The single-tooth ratchet drives the cam-drum shaft counterclockwise, only.

As shown in illustration V of Wall Chart No. 4, the stop-ring-drum assembly contains 12 stop rings with spacers between adjacent rings. A portion of the front circular section of the drum assembly serves as the manual stop ring. The spacers and the home-stop ring are keyed to the stop-ring-drum shaft; this prevents angular movement of the spacers or ring on the shaft. The 10 numbered stop rings and the L-F stop ring are free to rotate when the locking bar on the singleturn dial is loosened (turned counterclockwise). Since the

spacers cannot turn on the shaft, the adjustment of any one stop ring to a given angular position does not change the positions of the adjacent rings, which may have been previously adjusted. When the locking bar is tightened (turned clockwise), a front-to-back pressure is applied to the stop-ring-drum assembly, thereby fixing all of the stop rings at their adjusted angular positions with respect to the shaft.

As shown in the same illustration, the cam-drum assembly contains 12 slotted cams rigidly mounted on the cam-drum shaft, with the adjacent slots staggered 30°. The 10 numbered cams, the L-F cam, and the manual cam make up the 12 slotted cams. The home-stop cam, which is not slotted, is located between the fourth and fifth numbered cams.

The illustration also shows the contours of the various stop rings and cams, when viewed from the front. The numeral designations of the stop rings and cams correspond to the numbers on the CHANNEL switch.

As shown in illustration II of Wall Chart No. 3 and illustrations I and II of Wall Chart No. 4, there are 13 pawls pivoted on a shaft located between the stop-ring-drum and cam-drum shafts. A spring acts upon each of the pawls. 12 of the pawls, and their respective springs, operate in conjunction with the 10 numbered stop rings and cams, the L-F stop ring and cam, and the manual stop ring and cam. The home-stop pawl and spring operate in conjunction with the home-stop ring and cam.

As shown in illustrations I and II of Wall Chart No. 4, when the CHANNEL switch is operated to one of the numbered positions, or to the L. FREQ. or MANUAL position, the Autotune system is first set into forward movement. When the system is in forward movement, the singleturn worms rotate in such a direction as to drive the singleturn stop-ring drums and cam drums in a counterclockwise direction through their respective slip clutches and single-tooth ratchets.

The upper half of illustration I of Wall Chart No. 4 shows the action of a numbered pawl or the L-F pawl with its respective stop ring and cam when the CHANNEL switch is operated to one of the numbered positions or to the L. FREQ. position. The lower half of the illustration shows the simultaneous action of the home-stop pawl with its stop ring and cam under the same conditions.

At times A and B, the stop-ring drum (also, the singleturn dial and tuned element) is being driven in a counterclockwise direction by the slip clutch, and the cam drum is being driven in a counterclockwise direction by the single-tooth ratchet. The two drums are free to turn since both the pawl heel and pawl toe ride in and out of the indents (or slots) on the stop ring and cam; the rise on the home-stop ring has not yet engaged the home-stop pawl.

At time C, the rise on the home-stop ring engages the home-stop pawl, arresting the counterclockwise rotation of the stop-ring drum (at the extreme counterclockwise position). The cam drum continues to be driven in a counterclockwise direction.

Time D is the instant before the Autotune motor reverses. The stop-ring drum is still held at the extreme counterclockwise position by the home-stop pawl, causing the slip-clutch band to slip around the slip-clutch drum. The cam drum is still being driven counterclockwise by the single-tooth ratchet. The pawl heel has just been pushed into the slot on the cam by the pawl spring. The pawl toe now rides on the rim of the stop ring.

Between times D and E, the Autotune motor is reversed by the circuit-seeking tap switch. The motor reversal is indicated by the vertical broken line in the illustration.

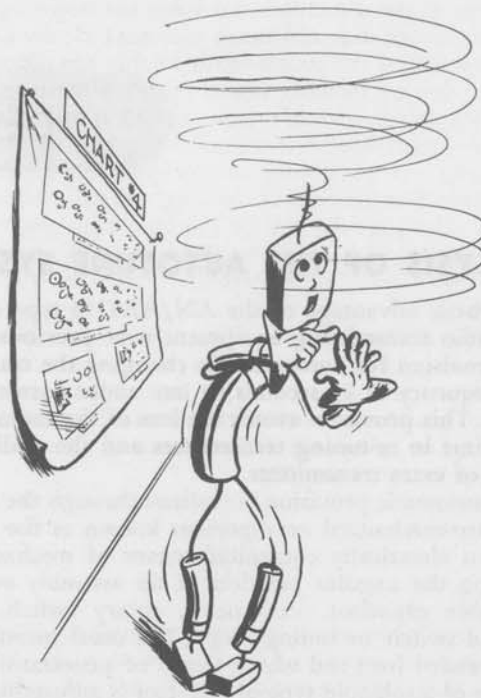

NOTE

The successive contacts on the circuit-seeking tap switch (a rotary switch) are angularly spaced 30° apart, the same angular separation as between the slots of the adjacent cams on the cam drum. The arm of the tap switch rotates in synchronism with the cam drums of the Autotune units, since the switch arm is operated by an extension of the cam-drum shaft of control A. The rotating arm of the tap switch is angularly phased so that a pawl heel of each Autotune unit is pushed into the slot of its respective cam when the switch arm is within 3° of the angular position at which it makes connection with one of its contacts. Therefore, the particular pawl (in each Autotune unit) whose heel is resting in the slot of its respective cam at the instant the Autotune motor reverses, is determined by the contact of the tap switch that reverses the motor. The particular contact of the tap switch that reverses the Autotune motor is determined by the position of the CHANNEL switch.

The cam drum of each Autotune unit is synchronized with the cam drum of each of the other four units by the single-tooth ratchet. The ratchet is constructed so that the front piece (or driving member) engages the rear piece (or driven member) only when the two members are at the same particular angular position with respect to each other, and the driving member is rotating counterclockwise (system in forward movement). The two members do not engage each other when the driving member is rotating clockwise.

Rigid mechanical coupling exists between the line shaft and the driving member of each Autotune-unit single-tooth ratchet. The system is adjusted so that the driving

members of all of the single-tooth ratchets are in accurate angular synchronism. Therefore, the driven members of the ratchets, and the cam drums to which they are fastened, are rotating in accurate angular synchronism at time D in illustration I of Wall Chart No. 4.

At time E, the slip clutch is driving the stop-ring drum (and singleturn dial and tuned element) clockwise. The two members of the single-tooth ratchet are disengaged since the driving member (front piece) is rotating clockwise. The driven member (rear piece) is stationary because the pawl heel is resting in the slot of the cam, preventing any possibility of clockwise movement due to spurious friction within the single-tooth ratchet. The pawl is riding on the rim of the stop ring preparatory to engagement with its indent. The rise on the home-stop ring is moving out of engagement with the home-stop pawl.

At time F, the pawl toe is pushed into the indent on the stop ring, stopping the clockwise rotation of the stop-ring drum (and singleturn dial and tuned element) at the final position. The slip clutch and the single-tooth ratchet are slipping and will continue to do so until the Autotune motor is stopped.

NOTE

The final position of the tuned element is determined by the angular setting of the selected stop ring with respect to the stop-ring-drum shaft. In practice, the setting is made by performing the following steps: Cycle the system to the desired channel by operating the CHANNEL switch. Loosen the locking bar on the dial, rotate the dial to a position a few degrees counterclockwise of the desired final setting, then rotate the dial clockwise to the desired setting. If the desired setting is passed, the dial must be rotated again to a position a few degrees counterclockwise of the desired setting and the setting approached again. Tighten the locking bar while holding the dial at the desired position.

Approaching the final setting in a clockwise direction is extremely important because there is a small amount of angular play between the pawl toe and the two sides of the stop-ring indent when they are engaged. This results in a certain degree of dial backlash. However, since the stop-ring-drum shaft is driven to the final position in a clockwise direction, since the engagement with the pawl toe is positive, and since there is clockwise torque maintained on the stop ring, even after the motor is stopped, the angular play between the pawl toe and stop-ring indent does not affect the accuracy of repositioning (provided the stop-ring is originally adjusted by approaching the final setting in a clockwise direction). It can readily be seen that a dial-repositioning error equal to this angular play results when the final dial setting is approached in a counterclockwise direction. The inherent accuracy of the Autotune unit is of a very high order and can be realized in practice through the use of proper adjustment techniques.

The upper half of illustration II of Wall Chart No. 4 shows the action of the manual pawl of a representative-type singleturn unit with its cam and stop ring, when the CHANNEL switch is operated to MANUAL. The

lower half of the illustration shows the simultaneous action of the home-stop pawl with its cam and stop ring under the same conditions.

At time A, the stop-ring drum (and the singleturn dial and tuned element) is being driven counterclockwise by the slip clutch, and the cam drum is being driven counterclockwise by the single-tooth ratchet. The two drums are free to turn since the pawl heel can ride in and out of the slot on the cam and the stop ring is circular in contour; the rise on the home-stop ring has not yet engaged the home-stop pawl.

At time B, the rise on the home-stop ring engages the home-stop pawl, arresting the counterclockwise rotation of the stop-ring drum (at the extreme counterclockwise position). The cam drum continues to be driven in a counterclockwise direction.

Time C is the instant before the Autotune motor reverses. The stop-ring drum is still held at the extreme counterclockwise position by the home-stop pawl, compelling the slip-clutch band to slip around the slip-clutch drum. The cam drum is still being driven counterclockwise by the single-tooth ratchet. The pawl heel has just been pushed into the slot on the cam by the pawl spring. The pawl toe now rides on the rim of the stop ring.

Between times C and D, the motor is reversed by the circuit-seeking tap switch, as in the case of numbered or L-F selection.

At time D, the slip clutch is driving the stop-ring drum (and the singleturn dial and tuned element) clockwise. The two members of the single-tooth ratchet are disengaged since the driving member is rotating clockwise. The driven member is stationary since the pawl heel is resting on the cam slot, preventing any possibility of clockwise movement due to spurious friction within the single-tooth ratchet. The pawl toe is riding on the rim of the stop ring. The rise on the home-stop ring has moved out of engagement with the home-stop pawl and is moving clockwise.

At time E, the rise on the home-stop ring is approaching the home-stop pawl. The position of the cam-drum has not changed from that at time D.

At time F, the rise on the home-stop ring engages the home-stop pawl, arresting the clockwise rotation of the stop-ring drum (and the singleturn dial and tuned element) at the extreme clockwise position. The slip clutch and the single-tooth ratchet are slipping and will continue to do so until the Autotune motor is stopped.

Following time F, the Autotune motor is stopped, and a small clockwise torque is maintained on the stop-ring drum. Since the manual stop ring is circular in contour, the singleturn dial may be rotated to any point within the range of one complete revolution, to adjust the position of the tuned element, manually. The dial is free to rotate in either direction within the limits of one complete revolution, as allotted by the home-stop pawl and stop ring. The small clockwise torque on the stop-ring drum is not sufficient to prevent this adjustment, or to alter the adjustment after it has been made.

As shown in illustrations III and V of Wall Chart No. 3, multiturn worm 2 meshes with the cam-drum worm gear, which is fastened to the front piece (driving member) of the single-tooth ratchet. The rear piece (driven member) of the ratchet is fastened to the cam-drum shaft. The single-tooth ratchet drives the cam-drum shaft counterclockwise only.

Multiturn worm 1 meshes with the stop-ring-drum worm gear, to which is fastened the stop-ring-drum spur gear and the slip-clutch band. The stop-ring-drum shaft

is fastened to the slip-clutch drum, which is driven by the slip-clutch band.

The counter-drum drive gear is also fastened to the slip-clutch drum. The counter-drum shaft is fastened to the counter-drum spur gear, and is driven in a direction opposite to that of the stop-ring drum by the counter-drum drive gear and the two idler gears.

The counter drum rotates about $\frac{1}{23}$ as fast as the stop-ring drum. The cam drum rotates twice as fast as the stop-ring drum.

As shown in illustration III of Wall Chart No. 3, the front and rear limit switches are actuated by the switch operating arm which is threaded on the limit-switch drive shaft. The limit-switch drive shaft is rotated by the limit-switch-drive-shaft spur gear, which is driven by the stop-ring-drum spur gear.

As shown in illustration VI of Wall Chart No. 4, the stop-ring-drum assembly contains 12 stop rings with spacers between adjacent rings. The spacers and the home-stop ring are keyed to the stop-ring-drum shaft, which prevents angular movement. The 10 numbered stop rings and the L-F stop ring are free to rotate when the locking bar is loosened (turned counterclockwise). Since the spacers cannot turn on the shaft, the adjustment of any one stop ring to a given angular position does not change the position of the adjacent rings, which may have been previously adjusted. When the locking bar is tightened (turned clockwise), a front-to-back pressure is applied to the stop-ring-drum assembly, thereby locking all of the stop rings at their adjusted angular positions with respect to the shaft. A portion of the front circular section of the drum assembly serves as the manual stop ring.

As shown in the same illustration, the cam-drum assembly contains 12 slotted cams rigidly mounted on the cam-drum shaft, with adjacent slots staggered 30° . The 10 numbered cams, the L-F cam, and the manual cam make up these 12 slotted cams. The home-stop cam, which is not slotted, is located behind the L-F cam.

As shown in the same illustration, the counter drum contains 11 slotted cams and one cam with a rise on its rim, all of which are separated by spacers. The 10 numbered counter cams and the L-F counter cam make up the 11 slotted cams. The home-stop counter cam is the one with the rise on its rim. The spacers and the home-stop counter cam are keyed to the counter-drum shaft, which prevents angular movement. A portion of the front circular section of the counter drum serves as the manual counter cam. The anvil disc is mounted behind the home-stop counter cam, and the flat arm of the anvil projects over all of the counter cams. A disc-type spring is located behind the anvil disc and maintains a front-to-back pressure on the counter-drum assembly. This pressure serves to keep the counter cams at their adjusted positions, and permits the home-stop counter cam to move the anvil in either angular direction, within the limits set by the anvil stop arm (not shown).

The illustration also shows the contours of the various stop rings, cams, and counter cams, when viewed from the front. The numeral designations of the stop rings, cams, and counter cams correspond to the numbers on the CHANNEL switch.

As shown in Illustration III of Wall Chart No. 3 and illustrations III and IV of Wall Chart No. 4, there are 13 pawls pivoted on a shaft located near the cam-drum shaft and equidistant from the stop-ring-drum and counter-drum shafts. A pawl spring acts upon each of these pawls. Eleven of these pawls, and their respective springs,

operate in conjunction with 10 numbered stop rings, cams, and counter cams, and the L-F stop ring, cam, and counter cam. The manual pawl and spring operate in conjunction with the manual cam and stop ring. The home-stop pawl and spring operate in conjunction with the home-stop counter cam and stop ring.

As shown in illustration V of Wall Chart No. 3 and illustrations III and IV of Wall Chart No. 4, when the CHANNEL switch is operated to one of the numbered positions, or to the L. FREQ. or MANUAL position, the Autotune system is first set into forward movement. When the system is in forward movement, multiturn worm 1 drives the stop-ring drum counterclockwise, through the slip clutch, and the counter drum clockwise, through the idler gears. Also, multiturn 2 drives the cam drum counterclockwise, through the single-tooth ratchet.

The upper half of illustration III of Wall Chart No. 4 shows the action of a numbered pawl or the L-F pawl with its respective stop ring, cam, and counter cam, when the CHANNEL switch is operated to one of the numbered positions or to the L. FREQ. position. The lower half of the illustration shows the simultaneous action of the home-stop pawl with its stop ring and counter cam, under the same conditions.

At time A, the stop-ring drum (and the multiturn dial and tuned element) is being driven counterclockwise by the slip clutch; the cam drum is being driven counterclockwise by the single-tooth ratchet, and the counter-cam drum is being driven clockwise by the idler gears. All three drums are free to rotate since the pawl heel can ride in and out of the slot on the cam. The anvil, being pushed to its clockwise position by the counter-drum rotation, prevents the pawl tail from engaging the indent on the counter cam. The pawl toe is prevented from engaging the stop-ring indent either by the action of the pawl heel riding on the rim of the cam or (when the cam slot is adjacent to the pawl heel) by the action of the anvil limiting the counterclockwise movement of the pawl. The rise on the home-stop counter cam has not yet engaged the arm of the home-stop pawl, permitting the rise on the home-stop ring to clear the two prongs of the home-stop pawl.

At time B, the rise on the home-stop counter cam engages the arm of the home-stop pawl, moving the lower prong of the home-stop pawl up into the path of the rise on the home-stop ring to arrest the counterclockwise rotation of the stop-ring drum and the clockwise rotation of the counter drum. The cam drum continues to be driven counterclockwise.

Time C is the instant before the Autotune motor reverses. The stop-ring drum and counter drum are still held at the extreme counterclockwise position by the home-stop pawl, compelling the slip-clutch band to slip around the slip-clutch drum. The cam drum is still being driven counterclockwise by the single-tooth ratchet. The pawl heel has just been pushed into the slot on the cam by the pawl spring. The pawl tail rests against the anvil.

Between times C and D, the motor is reversed by the circuit-seeking tap switch, as indicated by the vertical broken line in the illustration.

At time D, the system is in rear movement. The slip clutch is driving the stop-ring drum (and the multiturn dial and tuned element) clockwise, and the idler gears are driving the counter drum counterclockwise. The two members of the single-tooth ratchet are disengaged, since the driving member (front piece) is rotating clockwise. The driven member (rear piece) is stationary because the pawl heel is resting in the slot of the cam, preventing

any possibility of clockwise movement due to spurious friction within the single-tooth ratchet. The pawl toe is riding on the rim of the stop ring. The anvil is in the counterclockwise position, out of the path of the pawl tail. The pawl tail has engaged the indent of the counter cam, stopping the rotation of that particular cam (there is no rigid coupling between the counter cams and the counter-cam shaft, but only friction due to axial spring pressure). The rise on the home-stop counter cam is moving out of engagement with the home-stop pawl.

At time E, the pawl toe is pushed into the indent on the stop ring, stopping the clockwise rotation of the stop-ring drum and the counterclockwise rotation of the counter drum at their final positions. The slip clutch and the single-tooth ratchet are slipping, and will continue to do so until the Autotune motor is stopped.

Following time E, the Autotune motor is stopped, and a small clockwise torque is maintained on the stop-ring drum, to reduce the tendency of any violent jarring motion to move the dial out of adjustment.

The upper half of illustration IV of Wall Chart No. 4 shows the action of the manual pawl with its stop ring and cam, when the CHANNEL switch is operated to MANUAL. The lower half of the illustration shows the simultaneous action of the home-stop pawl with its stop ring and counter cam, under the same conditions.

At time A, the stop-ring drum is being driven counterclockwise by the slip clutch; the cam drum is being driven counterclockwise by the single-tooth ratchet; the counter-cam drum is being driven clockwise by the idler gears. All three drums are free to rotate since the pawl heel can ride in and out of the slot on the cam; the stop ring is circular in contour; the rise on the home-stop counter cam has not yet engaged the arm of the home-stop pawl.

At time B, the rise on the home-stop counter cam engages the arm of the home-stop pawl, moving the lower prong of the home-stop pawl up into the path of the rise on the home-stop ring to stop the counterclockwise rotation of the stop-ring drum and the clockwise rotation of the counter drum. The cam drum continues to be driven counterclockwise.

Time C is the instant before the Autotune motor reverses. The stop-ring drum is still held at the extreme counterclockwise position by the home-stop pawl. The cam drum is still being driven counterclockwise by the single-tooth ratchet. The pawl heel has just been pushed into the slot on the cam by the pawl spring.

Between times C and D, the motor is reversed by the circuit-seeking tap switch, as in the case of numbered or L-F selection.

At time D, the system is in rear movement. The slip clutch is driving the stop-ring drum clockwise, and the idler gears are driving the counter drum counterclockwise. The two members of the single-tooth ratchet are disengaged, and the cam drum is stationary. The rise on the home-stop counter cam is moving out of engagement with the home-stop pawl.

At time E, the rise on the home-stop counter cam engages the arm of the home-stop pawl, moving the upper prong down into the path of the rise on the home-stop ring to stop the clockwise rotation of the stop-ring drum and the counterclockwise rotation of the counter drum. The stop-ring drum, multiturn dial, and tuned element are at their final positions, the extreme clockwise limit.

Following time E, the single-tooth ratchet and the slip clutch continue to slip until the motor is stopped. After the motor is stopped, the tuned element may be positioned manually, since the manual stop ring has no in-

dent, and is free to rotate in either direction within the limits of 20 complete revolutions, as allotted by the home-stop pawl.

Illustration IV of Wall Chart No. 3 is a schematic diagram of the electrical circuit of the Autotune system. The circuit components, shown in this schematic, provide electrical control of the mechanical actions.

The Autotune motor, B101, is a reversible electric motor which operates on 28 volts, d.c., and is controlled by the limit switches, S111 and S112, and the motor-reversing relay, K101.

The field of the motor is energized by 28 volts, d.c., at all times. When the Autotune system is at rest, motor-reversing relay K101 is de-energized, since there is no path to ground for terminal 11 of the relay. However, d-c power is applied to the armature winding of the motor through the motor-torque-retainer resistor, R115, which allows just enough current flow to provide a position-retaining torque on the stop-ring drums of all of the Autotune units.

The diagram shows the condition of the circuit when the Autotune system is at rest on channel 3. When the CHANNEL switch, S108, is operated to any of the other positions, a path to ground is provided for terminal 11 of relay K101, through the circuit-seeking tap switch, S109, and relay K101 is energized. Contacts 5 and 6 of the relay close and hold the relay energized until the forward limit switch, S112, is opened. The balance of the relay contacts remove the motor-torque-retainer resistor, R115, from the circuit, and reverse the polarity of the d-c voltage applied to the motor armature, so that the motor drives the Autotune units in a counterclockwise direction. As soon as the Autotune units begin to rotate, the switch-operating arm on the multiturn unit starts to move forward, allowing the rear-limit switch, S111, to assume its unoperated position, as shown by the dotted line in the diagram.

When switch S111 is in the unoperated position, d-c power to the keying relay, K102, and dynamotor input relay, K2703/K501, is interrupted, preventing the transmitter from being keyed while the Autotune system is cycling. Switch S111 also shorts the torque-retainer resistor, R115.

The motor continues to drive all of the Autotune units in a counterclockwise direction, allowing them to reach their extreme counterclockwise positions, as limited by their respective home-stop pawls. Contacts 5 and 6 of relay K101 prevent the circuit-seeking tap switch, S109, from reversing the Autotune motor, by de-energizing relay K101, as the open segment of switch S109 passes the selected channel, until after switch S112 is operated.

After the forward limit switch, S112, is operated by the switch-operating arm on the multiturn unit, the Autotune motor continues to drive the cam drums on all of the Autotune units in a counterclockwise direction until the open segment of the circuit-seeking tap switch, S109, which is coupled to the cam drum of control A, is at the same position as the CHANNEL switch, S108. At this instant, the synchronized cam drums of all of the Autotune units are at the positions where the pawl heels of the selected pawls have just been pushed into their respective slots on the cams. Since switch S112 is open, the motor-reversing relay, K101, is de-energized; the contacts on the relay reverse the polarity of the d-c voltage applied to the Autotune motor armature, so that all of the Autotune units are driven in a clockwise direction. When the motor begins to rotate in rear movement, the switch-

operating arm moves toward the rear, allowing the forward limit switch, S112, to close.

As the Autotune units are driven clockwise, the stopping drums are positioned to their final settings, and are stopped by the action of the pawls against the various stop rings and cams. The motor continues to rotate until the switch-operating arm operates the rear limit switch, S111, at which time the motor is stopped by the removal of the short across the motor-torque-retainer resistor, R115, due to the opening of contacts 1 and 2 of switch S111. Contacts 2 and 3 of switch S111 close, applying power to the dynamotor input relay, K2703/K501, and the keying relay, K102, thus permitting the carrier to be turned on. The Autotune cycle is complete and the system is at rest. The motor-torque-retainer resistor, R115, permits a small amount of current to flow through the motor armature, maintaining a small clockwise torque on all of the stop-ring drums, which holds all tuned elements in their final positions.

When LOCAL-REMOTE switch, S107, is at REMOTE, channel control is shifted to the CHANNEL switch, S601, on the pilot's control box. Switch S601 performs the same function in the pilot's control box as the CHANNEL switch, S108, does in the transmitter.

The complete Autotune cycle is shown in block-diagram form on Wall Chart No. 1.

LESSON PLAN No. 17

TIME ALLOTTED: 4 HRS.

SUBJECT

Autotune system.

OBJECTIVE

To analyze the Autotune system.

INTRODUCTION

The Autotune system is an electrically controlled means of mechanically adjusting the angular position of assemblies such as variable capacitors, variometers, rotary switches, cam-operated switches, and tuning slugs.

SUBJECT MATERIAL

1. Display Wall Chart No. 3.
2. Point out illustration I, and state the tuned elements which are positioned by each Autotune control.
3. Explain the difference between an Autotune singleturn unit and a multiturn unit.
4. State the number of frequencies for which Autotune operation is available, and how they may be distributed within the frequency ranges of the transmitting set.
5. Trace the mechanical circuit of the line-shaft mechanical elements.
6. Point out illustration II, and explain how the stopping drum and cam drum are driven.
7. Display Wall Chart No. 4.
8. Point out illustration V of Wall Chart No. 4, and describe the stop-ring and cam-drum assemblies.
9. Referring to illustration II of Wall Chart No. 3 and illustrations I and II of Wall Chart No. 4, describe the arrangement of the pawls and pawl springs.
10. Fully describe the actions which are shown in illustration I of Wall Chart No. 4, step by step.

11. Fully describe the actions which are shown in illustration II of Wall Chart No. 4, step by step.

12. Referring to illustrations III and V of Wall Chart No. 3, explain how the multiturn stop-ring, cam, and counter-cam drums are driven.

13. Referring to illustration III of Wall Chart No. 3, explain how the two limit switches are operated.

14. Referring to illustration VI of Wall Chart No. 4, describe the stop-ring, cam, and counter-cam assemblies.

15. Referring to illustration III of Wall Chart No. 3 and illustrations III and IV of Wall Chart No. 4, describe the arrangement of the multiturn pawls and pawl springs.

16. Fully describe the actions which are shown in illustration III of Wall Chart No. 4, step by step.

17. Fully describe the actions which are shown in illustration IV of Wall Chart No. 4, step by step.

18. Referring to illustration IV of Wall Chart No. 3, explain the electrical circuit of the Autotune system.

19. Display Wall Chart No. 1 and summarize the Autotune cycle, referring to the Autotune block diagram on this chart.

20. Display Wall Chart No. 2, and point out the various circuit elements which are contained in the Autotune system.

CONCLUSIONS

Proper operation of the Autotune system is determined by means of an operational check; that is, by operating the panel controls to their various positions, and noting the effect upon equipment performance.

ORAL QUIZ

1. To which Autotune unit is the circuit-seeking tap switch mechanically coupled?
2. Which tuned elements are positioned by the multiturn unit?
3. Can the Autotune system be adjusted so that a frequency of 400 kc. is tuned when the CHANNEL switch is operated to position 7?
4. Can the Autotune system be adjusted so that manual operation is selected when the CHANNEL switch is operated to position 3?
5. How many singleturn worms are there on the line shaft? How many multiturn worms?
6. What action prevents the single-tooth ratchet from driving the cam drum clockwise?
7. What mechanical elements permit adjustment of a stop ring without altering the angular position of either adjacent ring?
8. What is the contour of the manual stop ring?
9. In which direction are the Autotune dials rotating when the Autotune system is in forward movement?
10. Does the slip clutch drive the stop-ring drum clockwise, as well as counterclockwise?
11. What mechanical elements exercise basic control over the limits of extreme clockwise and counterclockwise rotation of the singleturn unit?
12. Which electrical component determines the exact moment at which the Autotune motor reverses?
13. What is the angular separation of adjacent slots on the cam drum?
14. What is the angular separation of adjacent contacts on the circuit-seeking tap switch?
15. How is each cam drum maintained in synchronism with every other cam drum?
16. How is the circuit-seeking tap switch maintained in synchronism with the cam drums?

17. Which electrical component determines the particular contact of the circuit-seeking tap switch that reverses the motor?
18. What series of mechanical components transfers power from multiturn worm I to the counter-drum shaft?
19. Which mechanical component of the multiturn unit actuates the limit switches?
20. By what means are the stop rings on either type of stop-ring drum locked in position?
21. Can the counter drum of the multiturn unit be locked?
22. What is the purpose of the anvil on the multiturn unit?
23. When the system is cycled to a numbered channel, the previous adjustment of what two mechanical elements determine the final position of the multiturn dial?
24. When the system is cycled to manual, how many revolutions does the multiturn dial make in the clockwise direction?
25. Why is the field winding of the Autotune motor energized when the system is at rest, as well as when it is cycling?
26. Which circuit element prevents the motor from reversing on the first counterclockwise sweep of the tap switch, S108, when the system begins its forward movement?
27. Which circuit element disables the dynamotor input and keying relays, when the system is cycling?

EXPERIMENT No. 16

TIME ALLOTTED: 4 HRS.

SUBJECT

The Autotune system.

OBJECTIVE

To become familiar with the operational check, adjustment, and preventive and corrective maintenance of the Autotune system.

EQUIPMENT REQUIRED

One or more AN/ART-13 type of transmitting sets with accessory components as listed in previous experiments.

For each transmitting set:

- One ohmmeter.
- One Autotune line-shaft crank.
- One 4-40 x 1/2" screw.
- One pencil.
- One camel's-hair brush.

A small container of each of the following lubricants:

- AN-O-6, Texaco Capella A, or equivalent oil.
- AN-G-3, Socony-Vacuum PD-535A, or equivalent grease.
- AN-G-10, Stano-Drip #39, or equivalent grease.
- Cities Service North Star 000, or equivalent oil.

INSTRUCTIONS

Intercable, connect, and plug in the units and accessory components as in previous experiments. Refer to the Trouble-Shooting Supplement for the placement of troubles in the equipment. Always approach dial settings in a clockwise direction.



PROCEDURE

1. Make certain that the LOCAL-REMOTE switch is at LOCAL, and the EMISSION switch is OFF. Set the transmitter on its rear surface, and remove the Autotune-cover plate and the transmitter bottom-cover plate. Make a general inspection of the five Autotune units, the motor-torque-retainer resistor, R115 (mounted adjacent to the left side of control E), the motor-reversing relay, K101 (mounted between controls D and E), the Autotune motor, B101 (mounted between controls D and A), the chain drive to the line shaft, the front and rear limit switches, S112 and S111 (mounted on the right side of the multiturn unit, control B), and the circuit-seeking tap switch, S109 (located behind the control A Autotune unit).
2. Make certain that the locking bar on each of the five Autotune dials is locked by holding the dial fixed with one hand, and turning the bar clockwise with the other. Set the power-level switch to CALIBRATE, and the EMISSION switch to VOICE. Operate the CHANNEL switch to MANUAL (if the CHANNEL switch was set to MANUAL before the EMISSION switch was operated to VOICE, operate the CHANNEL switch to L. FREQ. and immediately return it to MANUAL). Notice the characteristic whining sound of the Autotune motor. Notice that the dial of control B rotates much faster than the dials of the other four Autotune units. Notice that the Autotune dials are first driven counterclockwise to their extreme positions, and then clockwise to their opposite extreme positions. After the Autotune cycle is complete, inspect each Autotune unit, and notice that the toe of the first pawl (counting from front to rear) of each unit is resting against the front circular section of its respective stop-ring drum, indicating that the heel of the first pawl of each unit is resting in the slot of its respective cam. Notice that each Autotune is set at its extreme clockwise position, and that it moves freely all the way to its extreme counterclockwise position.
3. Locate the switch-operating arm and the front and rear limit switches on the right side of the multiturn unit. Cycle the system to MANUAL again. Notice the action of the switch-operating arm upon the front and rear limit switches.
4. Locate the circuit-seeking tap switch and cycle the system to MANUAL again. Notice the action of the tap-switch open-segment disc.

5. Cycle the system to channels 1, 2, 3, and 4, in turn. After the cycle is complete, for each channel, inspect the Autotune units and notice that the pawl selected, counting from front to rear, is the second for channel 1, the third for channel 2, the fourth for channel 3, and the fifth for channel 4.

6. Cycle the system to channel 5. After the cycle is complete, inspect the multiturn unit and notice that the pawl selected is the sixth, counting from front to rear. Inspect each singleturn unit, and notice that the seventh pawl is selected (the sixth is the home-stop pawl).

7. Cycle the system to channels 6, 7, 8, 9, and 10, in turn. Notice that the eighth, ninth, tenth, eleventh, and twelfth pawls are selected, in order, for each singleturn unit. Notice that the seventh, eighth, ninth, tenth, and eleventh pawls are selected, in order, for the multiturn unit.

8. Cycle the system to L. FREQ. Notice that the last (thirteenth) pawl is selected for each singleturn unit. Notice that the twelfth pawl is selected for the multiturn unit.

9. Cycle the system to MANUAL. Notice that the first pawl is selected for both the multiturn unit and each singleturn unit. Also, notice that the home-stop pawl of each unit is engaged; this pawl is the sixth pawl on the singleturn units, and the last (thirteenth) pawl on the multiturn unit.

10. Set the transmitter in its normal position. Cycle the system to channel 1. Loosen the locking bar on control B by turning the bar counterclockwise a quarter turn. Set the control dial to 90 (counter dial at any position). Grasp the dial knob with one hand, and the locking bar with the other. Slowly approach, *but do not pass*, the setting of zero, in a clockwise direction. When the setting of zero is reached, lock the dial by turning the bar clockwise with one hand while equalizing the force of the bar with the other hand, so that the dial does not move during the locking operation. Recycle the system to channel 1. Notice whether the control dial is repositioned exactly to zero. Practice this procedure a few times, so that skill is developed in accurately setting an Autotune dial.

11. Adjust the transmitter controls so that a frequency of 7.5 mc. is tuned on channel 1, 3.5 mc. is tuned on channel 5, and 500 kc. is tuned on the L. FREQ. channel. Check the system by cycling the system to each channel by means of the transmitter CHANNEL switch, and noticing whether the dials are repositioned to the proper settings. Operate the LOCAL-REMOTE switch to REMOTE. Operate the pilot's-control-box CHANNEL switch to positions 1, 5, and L. FREQ., in turn, and notice the effect upon the transmitter Autotune controls. Operate the LOCAL-REMOTE switch to LOCAL.

12. Adjust the transmitter controls so that a frequency of 500 kc. is tuned on channel 8, and 7.2 mc. is tuned on the L. FREQ. channel.

13. Operate the EMISSION switch to OFF. Set the transmitter on its rear surface. With the camel's-hair brush, apply a *small amount* of AN-O-6, Texaco Capella A, or equivalent oil to each of the following lubrication points:

a. All of the line-shaft bearings *except* the ball bearings at each end of the line shaft. *These bearings require no lubrication.*

b. The Autotune-motor bearings.

c. The front and rear cam-drum-shaft bearings on each Autotune unit.

d. The idler-gear bearings on each Autotune unit.

e. The front and rear counter-drum bearings on the multiturn unit.

f. The limit-switch drive-shaft bearings on the multiturn unit.

14. With the camel's-hair brush, apply a small amount of AN-G-3, Socony-Vacuum PD-535A, or equivalent grease to each of the following lubrication points:

a. The threads of all of the worms on the line shaft.

b. The teeth of the worm gears on all of the Autotune units.

c. The teeth of the spur and idler gears on all of the Autotune units.

d. The threads of the limit-switch drive shaft on the multiturn unit.

15. With the camel's-hair brush, apply a small amount of AN-G-10, Stano-Drip #39, or equivalent grease to the Autotune-motor sprocket and chain assembly.

16. With the camel's-hair brush, apply a small amount of Cities Service North Star 000, or equivalent oil to the pawl stacks of all of the Autotune units.

17. Set the transmitter on its rear surface. Place the hub of the Autotune line-shaft crank on the right end of the line shaft, turn the crank and push gently to the left until the crank hub slips into the line-shaft slot, and fasten the crank with the 4-40 x 1/2" screw. Turn the line shaft counterclockwise, with the crank, until all of the Autotune dials reach their extreme counterclockwise positions. Locate the fork (stop arm) of the anvil on the left side of the multiturn unit and pull it down, so that the pawl tails are free to engage the cams of the counter drum.

18. As the line shaft is rotated counterclockwise, notice that corresponding pawls (such as, all of the first pawls, or all of the second pawls) of the Autotune units do not drop into their respective cam slots at exactly the same instant. Continue to rotate the line shaft counterclockwise until only one of the fifth pawls (counting from the front) on the Autotune units drops into its cam slot. Note the position of the crank arm by marking a line on the casting with the pencil. Slowly continue to rotate the line shaft counterclockwise, and note the crank-arm positions at which the fifth pawl of each of the other units drops into its cam slot. Notice that all of the pawls drop into their respective cam slots within a quarter turn ahead or behind the crank-arm position at which the fifth pawl of the control A unit drops into its cam slot. Repeat this procedure for all of the remaining pawls.

19. When the Autotune system requires adjustment, turn the line shaft counterclockwise until the fifth pawl on the multiturn unit just drops into its cam slot, after performing the foregoing step. Loosen the two setscrews on the cam-drum spur-gear collar of the control A unit with a No. 6 Bristo wrench. Rotate the cam drum, manually, until the fifth pawl just drops into its cam slot. Insert a .005" leaf-type feeler gauge between the rear of the cam drum and the cam-drum spur gear. Push the cam-drum spur gear forward against the gauge and cam drum, rotate the gear clockwise to take up the angular play, and tighten the two setscrews. Check the synchronism by mechanically recycling the system. Readjust, if necessary. Adjust the remaining singleturn units, in the same manner, so that the fifth pawl on each unit drops into its cam slot within one-quarter turn of the crank-position at which the fifth pawl on the control A unit drops into its cam slot. Check the synchronism by mechanically recycling the system. Readjust, if necessary. Check the synchronism of the remaining pawls. Readjust, if necessary.

20. Turn the line shaft counterclockwise, with the crank, until all of the Autotune dials reach their extreme counterclockwise positions. Locate the circuit-seeking tap switch, S109. Continue to turn the line shaft counterclockwise. Notice that the pin of the switch driving arm completely engages the driven arm, but that the pin does not touch the frame of the switch at any point, as the driving arm is rotated through a complete revolution. Notice that there is approximately $\frac{5}{64}$ " ($\pm \frac{1}{64}$ ") of angular play between the pin and its place of contact on the driven arm. Remove plug U-8/U from jack J106 on the transmitter. Set the transmitter CHANNEL switch to position 1. Connect one lead of the ohmmeter (set to the low-resistance range) to ground, and the other lead to terminal 1 of jack J106. Notice that the ohmmeter reads zero resistance. Continue to rotate the line shaft counterclockwise until the last of the second pawls on the Autotune units drops into its cam slot. When this last one drops, note the position of the crank arm by marking a line on the casting with the pencil. Slowly continue to rotate the line shaft counterclockwise and notice that the ohmmeter reads infinite resistance at a crank-arm position within one-quarter to one full turn of the marked position. Repeat this procedure for each of the remaining channels, changing the connection of the ohmmeter to the corresponding terminal of jack J106, for each.

22. When the Autotune system requires adjustment, center the tap-switch exactly with the control A cam-drum shaft by loosening the mounting screws on the tap-switch, positioning the tap-switch shaft, and tightening the screws. Correct the synchronization by loosening the setscrews on the hub of the tap-switch driving arm with a No. 6 Bristo wrench, adjusting the position of the arm, as required, and tightening the setscrews; make certain that the pin completely engages the driven arm, but does not touch the tap-switch frame at any point as the driving arm is rotated through a complete revolution. Check the synchronization. Readjust, if necessary.

23. Turn the line shaft clockwise until all of the Autotune dials reach their final positions. Locate the switch operating arm on the multiturn unit. Continue to turn the line shaft clockwise until the rear limit switch snaps to its operated position. Continue to turn the line shaft clockwise until the snap pin of the hub of the operating arm engages the snap pin of the drive-shaft spur-gear collar, as indicated by the hub of the operating arm rotating with the drive shaft. Note the position of the Autotune crank by marking a line on the casting. Turn the line shaft counterclockwise until the rear limit switch snaps to its unoperated position. Notice that the switch snaps within $3\frac{1}{4}$ to $9\frac{1}{4}$ turns of the crank from the marked position. When the system requires adjustment, shims are added or removed from the rear end of the front-limit-switch insulator stack until the foregoing requirement is satisfied.

24. Connect the leads of the ohmmeter (set to the low-resistance range) to the two terminals of the front limit switch. Notice that the ohmmeter reads zero resistance. Turn the line shaft counterclockwise until all of the Autotune dials reach their extreme positions. Continue to turn the line shaft counterclockwise until the snap pin of the hub of the operating arm engages the snap pin of the front collar of the drive shaft, as indicated by the operating-arm hub rotating with the drive shaft. Notice that the ohmmeter now reads zero resistance. Note the position of the Autotune crank by marking a line on the casting. Turn the line shaft clockwise until the ohm-

meter first reads infinite resistance, and notice that the crank arm is within $3\frac{1}{4}$ to $9\frac{1}{4}$ turns of the marked position. Also notice that the long arm of the front limit switch follows the short arm for slightly less than $\frac{1}{32}$ " before contact is broken. When the Autotune system requires adjustment, a telephone-relay type of spring bender is used to adjust the top end of the long arm and the bottom end of the short arm, until the foregoing conditions are satisfied.

25. When the Autotune motor requires replacement, remove the four mounting screws, unsolder the four wires to the motor terminals, and remove the motor by pivoting it to clear the chain drive and lifting it out.

26. When the control A Autotune unit requires replacement, loosen the dial-locking bar and the two No. 10 Bristo setscrews on the dial knob. Remove the dial and locking bar by turning them counterclockwise together. Remove the dial back plate. Loosen the two long screws at the top of the unit, loosen the short screw at the bottom, and lift the unit out.

27. When the Autotune unit for control C, D, or E requires replacement, remove the four screws of the metal strip on which is mounted the KEY, SIDETONE 1 and 2, and MICROPHONE jacks, and pull the strip out as far as the connecting wires permit. Loosen the dial-locking bar and the two No. 10 Bristo setscrews on the dial knob. Remove the dial and locking bar by turning them counterclockwise together. Remove the dial back plate. Loosen the two long screws at the top of the unit, loosen the short screw at the bottom, and lift the unit out.

28. When the control B Autotune unit requires replacement, remove the right-end cover plate, dial, and back plate from the control A unit. Remove the No. 10 nut on the back end of the main-tuning-slug lead screw (attached to the multiplier-slug coupling yoke). Remove the two screws on the top edge of the multiturn-unit back plate, and the single screw on the bottom edge. Remove the two screws which hold the limit switch, and *carefully* pull the switch assembly away from the casting. *Note: Turning the main-tuning-slug lead screw during this operation requires that the high-frequency oscillator be recalibrated and realigned.*

29. When the Autotune line shaft or any of its worms requires replacement, remove all of the singleturn units. Back up the line shaft with a suitable anvil, and drive out all of the taper-groove pins (one in each worm and one in the sprocket). Remove the four screws from the thrust-bearing-retainer plate on the left end of the casting. Slowly work the shaft off the left end of the casting, removing each worm or the sprocket as it nears the end of the shaft. Install the new line shaft by reversing the foregoing operations. Use new taper-groove pins to secure the worms, sprocket, and thrust bearing to the replacement shaft ($\frac{1}{16}$ " x $\frac{3}{8}$ " pins for the worms and bearing, $\frac{5}{64}$ " x $\frac{1}{2}$ " pin for the sprocket).

30. When the chain drive requires replacement, it is necessary to remove the line shaft.

31. When any of the line-shaft bearings requires replacement, remove the line shaft, drive off the bearing with a mallet and blunt punch, and *gently* drive the new bearing into position.

32. When the line-shaft thrust bearing requires replacement, remove the four screws from the bearing-retainer plate on the left end of the casting. Remove the taper-groove pin from the line-shaft sprocket. Work the line-shaft end bearing out about an inch from the end of the casting. *Carefully* drive out the taper-groove pin from the inside bearing collar. Replace the inside collar

on the shaft, slide the new bearings on the shaft, and then slide the outside collar through the bearing into the inside collar. Install a new taper-groove pin. Slide the shaft back to its original position, replace the bearing plate, and install a new taper-groove pin in the sprocket.

33. When the multiturn-line-shaft assembly requires replacement, remove the control B unit. Remove the shaft in the same manner as the main line shaft. Use a $\frac{5}{64}$ " x $\frac{1}{2}$ " taper-groove pin on the large worm, and $\frac{1}{16}$ " x $\frac{3}{8}$ " taper-groove pins on the small worm and the thrust bearing.

34. Request the instructor to place a trouble in the equipment. By means of an operational check, visual inspection, and further voltage and resistance measurements, as required, isolate and locate the trouble, and correct it. Restore the transmitting set to its original condition.

CONCLUSIONS

1. How many turns counterclockwise must the locking bar be turned to unlock an Autotune dial?

2. The CHANNEL switch is operated to position 7. Which pawl is selected on each singleturn unit? Which pawl is selected on the multiturn unit?

3. Why is *no* lubrication of the ball bearings at each end of the line shaft required?

4. What type of lubricant is used on the Autotune-motor sprocket-and-chain assembly?

5. The line shaft is turned counterclockwise with the crank. In which direction are the Autotune dials rotated?

6. What is the allowable tolerance for the engagement of the pawl heels with their cam slots of the Autotune units with respect to that of the control A unit?

7. What is the allowable tolerance between the last occurrence of a pawl-heel engagement with its cam slot and the breaking of contact of the tap switch for the corresponding channel?

8. What is the allowable tolerance between the operation of either multiturn-unit limit switch and the engagement of the operating-arm snap pin with that of the collar at the end of the drive shaft?

9. What means is used to adjust the multiturn-unit rear limit switch?

10. What type of tool is used to adjust the front limit switch?

11. Must the line shaft be removed in order to replace the chain drive?

LECTURE 18

ALIGNMENT AND ADJUSTMENT

The correct alignment and adjustment procedures are given in detail in the earlier sections of this book, as follows:

Low-frequency oscillator—Experiment No. 3.

High-frequency oscillator—Experiment No. 4.

Multiplier unit—Experiment No. 5.

Transmitter vacuum contacts—Experiment No. 6.

MCW-CFI unit—Experiment No. 10.

Autotune system—Experiment No. 16.

LESSON PLAN No. 18

TIME ALLOTTED: 2 HRS.

SUBJECT

Alignment and adjustment.

OBJECTIVE

To review the alignment and adjustment procedures.

INTRODUCTION

The correct alignment and adjustment procedures have been covered in previous experiments.

SUBJECT MATERIAL

1. Refer to Experiment No. 3, and briefly review the alignment of the low-frequency oscillator.

2. Refer to Experiment No. 4, and briefly review the alignment of the high-frequency oscillator.

3. Refer to Experiment No. 5, and briefly review the alignment of the multiplier unit.

4. Refer to Experiment No. 6, and briefly review the adjustment of the transmitter vacuum contacts.

5. Refer to Experiment No. 10, and briefly review the alignment of the CFI unit, and the adjustment of the MCW oscillator.

6. Refer to Experiment No. 16, and briefly review the adjustment of the Autotune system.

CONCLUSIONS

Accurate alignment and adjustment is necessary in order to achieve proper equipment performance.

ORAL QUIZ

1. When aligning the low-frequency oscillator, why is it necessary to begin with the highest-frequency band and proceed toward the lowest-frequency band?

2. After the high-frequency oscillator has been aligned at 2.4 mc. and 3.0 mc., why is it necessary to check the calibration at 2.7 mc.?

3. Is it advisable to attempt the alignment of the multiplier unit without a wavemeter?

4. When aligning the multiplier unit, why is it necessary to remove the key-shortening plug before changing the position of control A?

5. What is the result of improperly adjusted transmitter vacuum contacts?

6. What is the result of adjusting the MCW control rheostat so that the plate meter reads well over 190 for MCW emission?

7. Why cannot a conventional d-c voltmeter be used for the alignment of the 8Q-2 calibration frequency indicator?

8. What is the cause of the rushing sound, heard in the headset, when the crystal oscillator in the MCW-CFI 8Q-1 unit is oscillating?

9. What is the allowable tolerance for the engagement of the pawl heels with their cam slots of the Autotune units with respect to that of the control A unit?

10. What is the allowable tolerance between the last occurrence of a pawl-heel engagement with its cam slot and the breaking of contact of the tap switch for the corresponding channel?

11. What is the allowable tolerance between the operation of either multiturn-unit limit switch and the engagement of the operating-arm snap pin with that of the collar at the end of the drive shaft?

12. What means is used to adjust the multiturn-unit rear limit switch?

13. What type of tool is used to adjust the front limit switch?

EXPERIMENT No. 17

The students will perform those alignment and adjustment procedures which the instructor, at his discretion, shall permit. The maximum time allotted is two hours.

LECTURE 19

TROUBLE SHOOTING

When a trouble is found to exist in the equipment, a careful visual inspection is made first. Such apparent trouble indications as loose or broken wires, cables, and terminals, or evidence of physical damage to components are noted and corrected.

Secondly, if the visual inspection does not reveal the cause of trouble, the operational check given in Chart 1 is made.

Finally, if performance of the operational check does not clear the trouble, the step-by-step trouble-shooting procedure in Chart 2 is used, while maintaining a constant vigil for visual indications of equipment malfunction.

THE PHILCO TROUBLE-SHOOTING PROCEDURE

The Philco trouble-shooting procedure is logical thorough, and easy to follow. It is based upon:

FIRST

LOCALIZATION OF THE TROUBLE to a functional section, or block of circuits.

SECOND

ISOLATION OF THE FAULTY CIRCUIT within that section.

THIRD

LOCATION OF THE DEFECTIVE PART within that circuit.

In the Philco procedure, localization of the trouble to a functional section is accomplished, if possible, by an operational check, which is in chart form for convenience. By means of this check, the serviceman often can localize the trouble to a block of circuits immediately, without needless testing.

If the trouble cannot be localized by the operational check, it should be localized by a step-by-step trouble-shooting procedure (test-point check), which is also in chart form. Each sectional chart refers to one or more major test points, ①, ②, etc.; a group of key test points, A, B, etc., and, if required, a group of secondary test points, A1, A2, etc.; all test points are indicated on the schematic diagram and photographs. Tests at the major test points throughout the equipment will definitely localize the trouble to a particular section, and eliminate other sections from suspicion.

After the trouble has been localized to a section, either by the operational check or by tests at major test points, additional tests at the key and secondary test points, specified in the chart, will isolate the faulty circuit. The defective part can then be located by testing tubes, by further voltage and resistance measurements, or by substitution of parts.

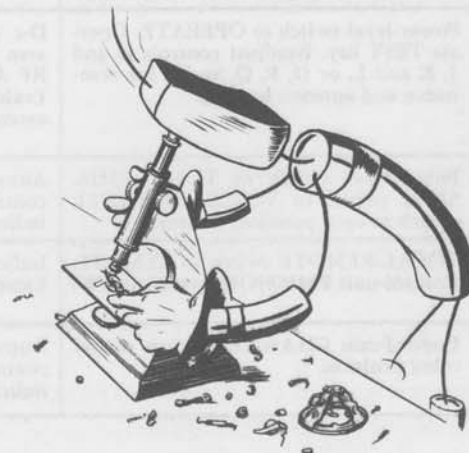

CHART 1
OPERATIONAL CHECK

STEP	EQUIPMENT CONTROLS	NORMAL INDICATION	POSSIBLE CAUSE OF ABNORMAL INDICATION
1	LOCAL-REMOTE switch to LOCAL. Power-level switch to TUNE. EMISSION switch to VOICE. Meter switch to BATTERY.	D-c meter needle within light-shaded area under BATTERY.	Transmitter overload relay open. Incorrect power-source voltage. Trouble in equipment; proceed to Chart 2.
2	CHANNEL switch to L. FREQ. for an instant, then to MANUAL.	Autotune system cycles, ending with controls A, B, C, D, and E in extreme clockwise positions. Indicator lamp on transmitter is out during cycle, but on after cycle is complete.	Trouble in equipment; proceed to Chart 2. Transmitter indicator lamp burned out. Trouble in equipment; proceed to Chart 2.
3	Power-level switch to CALIBRATE.	Characteristic whining sound of dynamotor running.	Dynamotor overload relay open. Trouble in equipment; proceed to Chart 2.
4	Controls A, B, and C to settings for crystal-check point in high-frequency range.	Audio beat note heard in headset.	Low setting of sidetone OUTPUT switch. Control A or C dial mark not in exact alignment with panel indicator mark. Trouble in equipment; proceed to Chart 2.
5	Power-level switch to TUNE. EMISSION switch to CW. Meter switch to P.A. GRID. Operate TEST key.	D-c meter needle within light-shaded area under P.A. GRID. Audio tone heard in headset.	Trouble in equipment; proceed to Chart 2.
6	Meter switch to P.A. PLATE. Operate TEST key. Adjust controls C, D, and E for resonance.	D-c meter indicates resonance dip.	Incorrect use of antenna shunt capacitor. Trouble in equipment; proceed to Chart 2.
7	Power-level switch to OPERATE. Operate TEST key. Readjust controls C, D, and E for resonance and antenna loading.	D-c meter needle within light-shaded area under CW. Needle deflection of ANTENNA CURRENT meter (value dependent upon frequency and antenna length).	Trouble in equipment; proceed to Chart 2.
8	EMISSION switch to VOICE. Speak into microphone with button depressed.	Speech is heard in headset. D-c meter needle fluctuates in red area.	Microphone-selector-switch position does not correspond with the type of microphone in use. Trouble in equipment; proceed to Chart 2.
9	EMISSION switch to MCW. Operate TEST key.	D-c meter within light-shaded area marked MCW. ANTENNA CURRENT meter indicates 40% greater value than in step 7.	Trouble in equipment; proceed to Chart 2.
10	Power-level switch to CALIBRATE. EMISSION switch to VOICE. Control C to 8. Control A to 13 (L.F.). Controls F and G to settings for crystal-check point in low-frequency range.	Audio beat note heard in headset.	Trouble in equipment; proceed to Chart 2.
11	Power-level switch to TUNE. EMISSION switch to CW. Meter switch to P.A. GRID. Operate TEST key.	D-c meter needle within light-shaded area under P.A. GRID.	Trouble in equipment; proceed to Chart 2.
12	Meter switch to P.A. PLATE. Operate TEST key. Adjust controls H and J, K and L, or O, P, Q, and R for resonance.	D-c meter needle indicates resonance dip.	Trouble in equipment; proceed to Chart 2.
13	Power-level switch to OPERATE. Operate TEST key. Readjust controls H and J, K and L, or O, P, Q, and R for resonance and antenna loading.	D-c meter needle within light-shaded area under CW. Needle deflection on RF AMPERES or AMPERES RF meter (value dependent upon frequency and antenna length).	Antenna is too short to realize full output power from transmitter. Operation of equipment at subnormal output on low transmission frequencies is a normal application. Trouble in equipment; proceed to Chart 2.
14	Power-level switch to TUNE. EMISSION switch to VOICE. CHANNEL switch to each position, in turn.	Autotune system cycles, ending with controls A, B, C, D, and E at settings indicated on tuning chart.	Trouble in equipment; proceed to Chart 2.
15	LOCAL-REMOTE switch to REMOTE. Control-unit EMISSION switch to CW.	Indicator lamp on transmitter is out. Lamp on pilot's control box is on.	Indicator lamp on pilot's control box burned out. Trouble in equipment; proceed to Chart 2.
16	Control-unit CHANNEL switch to any other position.	Autotune system cycles, ending with controls A, B, C, D, and E at settings indicated on tuning chart.	Trouble in equipment; proceed to Chart 2.

CHART 1 — Continued
OPERATIONAL CHECK

STEP	EQUIPMENT CONTROLS	NORMAL INDICATION	POSSIBLE CAUSE OF ABNORMAL INDICATION
17	Power-level switch to OPERATE. Depress key on pilot's control box.	D-c meter on transmitter indicates normally.	Trouble in equipment; proceed to Chart 2.
18	Control-unit EMISSION switch to MCW. Depress key.	D-c meter on transmitter indicates normally.	Trouble in equipment; proceed to Chart 2.
19	Control-unit EMISSION switch to VOICE. Speak into control-unit microphone with button depressed.	D-c meter on transmitter indicates normally.	Trouble in equipment; proceed to Chart 2.
20	Power-level switch to TUNE. Control-unit CHANNEL switch to each remaining position, in turn.	Autotune system cycles, ending with controls A, B, C, D, and E at settings indicated on tuning chart.	Trouble in equipment; proceed to Chart 2.

CHART 2
TROUBLE SHOOTING

All voltage and resistance measurements are made between the specified test points and ground. For those test points located at tube-socket contacts, remove the vacuum tube and make the measurement by inserting the meter lead into the appropriate socket hole from the top. The voltage values preceded by an asterisk (*) are valid only when a d-c voltmeter with a sensitivity of 1000 ohms per volt, set to the voltage range specified, is employed. Refer to figures 40 and 41 for physical locations of test points.

CAUTION: HIGH VOLTAGE IS PRESENT IN THE EQUIPMENT. USE CARE WHEN TROUBLE SHOOTING.

POWER-SUPPLY CIRCUITS						
Step	Test Point	Test Equipment	Transmitting-Set Controls	Normal Indication	If Indication Is Normal	If Indication Is Abnormal
1	①	1500-volt range of d-c voltmeter.	LOCAL-REMOTE switch to LOCAL. Power-level switch to CALIBRATE. EMISSION switch to VOICE.	1150 volts.	Proceed to step 3.	If Autotune system cycles continuously, proceed to step 98. Otherwise, proceed to step 2.
2	Ⓐ	None required.	Meter switch to BATTERY.	Needle within light-shaded area under BATTERY.	Proceed to step 3.	Open transmitter overload relay. Incorrect power-source voltage. Bad connection in power cable U-7/U-U-9/U. Bad contacts in EMISSION switch, LOCAL-REMOTE switch, meter switch, or primary power contactor. Open winding of primary power contactor. Defective d-c meter. Open multiplier resistor R128 or R132.
3	Ⓑ	750-volt range of d-c voltmeter.	No change.	410 volts.	If indication in step 1 was abnormal, proceed to step 7; if not, proceed to step 8.	If dynamotor overload relay is open, reset and proceed to step 7; if not, proceed to step 4.
4	Ⓑ+	750-volt range of d-c voltmeter.	No change.	440 volts.	Fuse is blown. Capacitor C126 shorted. Bad connection in U-7/U-U-9/U cable. Capacitor C121A, C2601/C401, or C107 shorted.	Proceed to step 5.

CHART 2 — Continued

TROUBLE SHOOTING

POWER-SUPPLY CIRCUITS—Continued						
Step	Test Point	Test Equipment	Transmitting-Set Controls	Normal Indication	If Indication Is Normal	If Indication Is Abnormal
5	Aural check.	None required.	No change.	Characteristic whining sound of dynamotor running.	Proceed to step 6.	Open top-cover interlock, if used. Bad brushes on motor of dynamotor. Bad connection in U-7/U—U-9/U cable. Rear limit switch on multiturn unit unoperated; if so, proceed to step 98. Bad contacts on dynamotor input or overload relay, or Autotune motor-reversing relay. Open contacts 1-3 of Autotune motor-reversing relay; if so, proceed to step 98. Bad contacts on voice relay, or EMISSION or LOCAL-REMOTE switch. Open winding of dynamotor-input or voice relay, dynamotor field, or choke L2701/L501.
6	B1	750-volt range of d-c voltmeter.	No change.	440 volts.	Proceed to step 7.	Shorted capacitor C2703/C504 or C2705. Bad brushes on 400-volt generator of dynamotor. Shorted capacitor C2716/C2707/C508, C2704B/C511, C2702/C512, C2704A or C2715/C2710/C509. Grounded cable U-7/U—U-9/U. Open choke L2702/L502. Open winding of 400-volt generator. Grounded meter switch.
7	C	1500-volt range of d-c voltmeter.	No change.	1150 volts.	Proceed to step 8.	Shorted capacitor C2706/C505, C128/C120A, C120B, C2714/C2708/C510, or C118. Bad brushes on 750-volt generator. Gassy JAN-811 modulator or JAN-813 power-amplifier tube. Bad connection or leakage to ground in U-7/U—U-9/U cable. Open choke L2704/L503. Open winding of 750-volt generator. Shorting, arcing, or leakage to ground in modulation-transformer winding, CW relay contacts, or output-circuit-selecting-relay contacts. Shorted barometric switch.
HIGH-FREQUENCY R-F CIRCUITS						
8	Visual and aural check.	None required.	CHANNEL switch to position corresponding to a frequency in the 6.0-mc. to 18.1-mc. range, for which the transmitter is tuned.	Autotune system cycles, ending with controls A, B, C, D, and E at settings indicated on tuning chart. Indicator lamp on transmitter is out during cycle, on after cycle is complete.	Proceed to step 9. Proceed to step 9.	If Autotune system cycles continuously, proceed to step 98. Otherwise, proceed to step 9. Burned out transmitter indicator lamp. Bad contacts on EMISSION switch S110 or LOCAL-REMOTE switch. Trouble in Autotune circuits; proceed to step 98.
9	2	None required.	EMISSION switch to CW. Power-level switch to OPERATE. Operate TEST key.	Indication of current flow (value dependent upon frequency and antenna length).	Proceed to step 39.	Proceed to step 10.
10	D	None required.	Meter switch to P.A. PLATE. Operate TEST key.	Needle within light-shaded area under CW.	Proceed to step 32.	Controls C, D, and E improperly set. If unable to obtain normal indication by retuning, proceed to step 11.
11	E	None required.	Meter switch to P.A. GRID. Operate TEST key.	Needle within light-shaded area marked P.A. GRID.	Proceed to step 31.	Proceed to step 12.

CHART 2 — Continued

TROUBLE SHOOTING

HIGH-FREQUENCY R-F CIRCUITS—Continued						
Step	Test Point	Test Equipment	Transmitting-Set Controls	Normal Indication	If Indication Is Normal	If Indication Is Abnormal
12	F	Neon lamp.	Operate TEST key.	Neon lamp glows.	Proceed to step 17.	Autotune control A or C dial mark not in exact alignment with panel indicator mark. Defective JAN-837 high-frequency-oscillator tube. Open filament in JAN-1625 low-frequency-oscillator tube or open resistor in blank panel. If these components are not defective, proceed to step 13.
13	F	750-volt range of d-c voltmeter.	Operate TEST key	410 volts.	Proceed to step 14.	Shorted or leaky capacitor C108. Open choke L104.
14	F1	250-volt range of d-c voltmeter.	Operate TEST key.	200 volts.	Proceed to step 15.	Shorted screen-by-pass capacitor C107, capacitor C126 or C2601/C401. Open screen choke L103, or resistor R117, R118, R119, or R120. Defective tube socket X101 or connector E128.
15	F2	Low-resistance range of ohmmeter.	EMISSION switch to OFF. Remove fuse. EMISSION switch to CW. Operate TEST key.	400 ohms.	Proceed to step 16.	Bad contacts on switch S114 or contacts E of keying relay. Bad contacts of control C interlock. Bad connection at J115—P101, J116—P102, or connector E128. Open cathode choke L102, or winding of keying relay. Defective tube socket X101 or TEST key contacts.
16	F3	Medium-resistance range of ohmmeter.	EMISSION switch to OFF. Replace fuse.	22,000 ohms.	Open grid-tank coil L101. Shorted plates on padding capacitor C134 or C135. Bad contacts on band switch S101. Autotune system maladjusted; proceed to Alignment and Adjustment.	Open grid-leak resistor R101. Defective tube socket X101.
17	G	Neon lamp.	EMISSION switch to CW. Operate TEST key.	Neon lamp glows.	Proceed to step 23.	Defective JAN-1625 first-frequency-multiplier tube. If this component is not defective, proceed to step 18.
18	G	750-volt range of d-c voltmeter.	Operate TEST key.	430 volts.	Proceed to step 19.	Shorted capacitor C131, C127, C136, or C138. Open plate-tank coil L105 or plate choke L115. Bad connection at J115—P101. Grounded band switch S102 or S103, or power-level switch.
19	G1	750-volt range of d-c voltmeter.	Operate TEST key.	410 volts.	Proceed to step 20.	Shorted screen-by-pass capacitor C110. Open screen resistor R104 or R105. Bad connection at J115—P101. Open screen choke L117, if used. Defective tube socket X102.
20	G2	Medium-resistance range of ohmmeter.	EMISSION switch to OFF.	22,000 ohms.	Proceed to step 21.	Open cathode resistor R130. Shorted cathode-by-pass capacitor C109. Bad contacts on switch S114. Defective socket X102. Autotune system maladjusted; proceed to Alignment and Adjustment.
21	G3	High-resistance range of ohmmeter.	No change.	100,000 ohms.	Proceed to step 22.	Leaky grid capacitor C108. Open or changed-value grid resistor R102 or R103. Defective socket X102.
22	G3	750-volt range of d-c voltmeter.	EMISSION switch to CW. Operate TEST switch.	Zero.	First-frequency-multiplier stage out of alignment with high-frequency-oscillator stage; proceed to Alignment and Adjustment.	Grid-blocking capacitor C108 defective.

CHART 2 — Continued

TROUBLE SHOOTING

HIGH-FREQUENCY R-F CIRCUITS—Continued						
Step	Test Point	Test Equipment	Transmitting-Set Controls	Normal Indication	If Indication Is Normal	If Indication Is Abnormal
23	H	Neon lamp.	Operate TEST switch.	Neon lamp glows.	Proceed to step 29.	Defective JAN-1625 second-frequency-multiplier tube. If this component is not defective, proceed to step 24.
24	H	750-volt range of d-c voltmeter.	Operate TEST switch.	420 volts.	Proceed to step 25.	Open plate-tank coil L106. Defective socket X103.
25	H1	750-volt range of d-c voltmeter.	Operate TEST switch.	400 volts.	Proceed to step 26.	Shorted screen-by-pass capacitor C114. Open screen resistor R108 or R109. Bad connection at J115—P101. Defective socket X103.
26	H2	Medium-resistance range of ohmmeter.	EMISSION switch to OFF.	1000 ohms.	Proceed to step 27.	Open cathode resistor R129. Shorted cathode-by-pass capacitor C113. Bad contacts on switch S115. Defective socket X103. Autotune system mal-adjusted; proceed to Alignment and Adjustment.
27	H3	High-resistance range of ohmmeter.	No change.	100,000 ohms.	Proceed to step 28.	Shorted or leaky grid-blocking capacitor C112. Open or changed-value grid resistor R106 or R107. Defective socket X103.
28	H3	750-volt range of d-c voltmeter.	EMISSION switch to CW. Operate TEST key.	Zero.	Second-frequency-multiplier stage out of alignment with first-frequency-multiplier stage; proceed to Alignment and Adjustment.	Defective grid-blocking capacitor C112.
29	E	None required.	Meter switch to P.A. GRID. Operate TEST key.	Needle within light-shaded area under P.A. GRID.	Proceed to step 31.	Defective JAN-813 power-amplifier tube. Open filament in either JAN-811 modulator tube. If these components are not defective, proceed to step 30.
30	F1	High-resistance range of ohmmeter.	EMISSION switch to OFF.	20,000 ohms.	Bad contacts on meter switch. Grounded contact on meter switch.	Open grid choke L107. Open or changed-value grid resistor R110 or R111.
31	D	None required.	EMISSION switch to CW. Meter switch to P.A. PLATE. Operate TEST key.	Needle within light-shaded area under CW.	Proceed to step 35.	Controls C, D, or E improperly adjusted. If unable to obtain normal indication by retuning, proceed to step 32.
32	D	None required.	If neither antenna loading nor switching unit is used, proceed to step 35. If either is used, set EMISSION switch to OFF, disconnect unit, and connect antenna directly to transmitter H.F. output terminal. EMISSION switch to CW. Operate TEST key.	Needle within light-shaded area under CW.	Trouble in antenna loading or switching unit. Proceed to step 37.	Proceed to step 33.
33	D	1500-volt range of d-c voltmeter.	No change.	1150 volts.	Proceed to step 34.	Open plate choke L108. Leaky or shorted plate-blocking capacitor C118. Shorted contacts on switch S114. Bad contacts on relay K105. Open plate choke L109. Bad contacts on CW relay, EMISSION switch, or LOCAL-REMOTE switch. Open winding of modulation transformer.

CHART 2 — Continued

TROUBLE SHOOTING

HIGH-FREQUENCY R-F CIRCUITS—Continued						
Step	Test Point	Test Equipment	Transmitting-Set Controls	Normal Indication	If Indication Is Normal	If Indication Is Abnormal
34	D ₂	750-volt range of d-c voltmeter.	Operate TEST key.	420 volts.	Proceed to step 35.	Open screen resistor R112. Bad contacts on keying relay. Open winding of modulation transformer. Defective socket X104.
35	J	None required.	Operate TEST key.	Indication of current flow.	Proceed to step 37.	Proceed to step 36.
36	J ₁	Neon lamp.	Operate TEST key.	Neon lamp glows.	Bad contacts on vacuum contacts S116. Bad connection to antenna. Defective antenna transformer T102 or ammeter M101. Grounded CONDENSER binding post J118.	Bad contacts on switch S113. Open tuning inductor L112, L113, or L114. Shorted tuning capacitor C122, C124, C125, C129, or C130.
37	K	Neon lamp.	Reconnect antenna loading or switching unit, if used, and operate TEST key. If not used, proceed to step 39.	Neon lamp glows.	Proceed to step 39.	Proceed to step 38.
38	K ₁	Neon lamp.	Operate TEST switch.	Neon lamp glows.	Bad contacts on vacuum contacts of break-in relay. Bad connection in U-11/U—U-12/U. Bad contacts on relay K105.	Grounded contacts on vacuum contacts of break-in relay. Grounded cable to H.F. INPUT terminal on antenna loading or switching unit. Grounded antenna terminal on loading or switching unit. Grounded antenna.
LOW-FREQUENCY R-F CIRCUITS						
39	Visual and aural check.	None required.	CHANNEL switch to L. FREQ.	Autotune system cycles, ending with control C at 8, and control A at 13 (L.F.).	Proceed to step 40.	If Autotune system cycles continuously, proceed to step 98. Otherwise, proceed to step 40.
40	3	None required, if CU-32/ART-13A or CU-25/ART-13 is used. Neon lamp, if CU-26/ART-13 is used.	EMISSION switch to CW. Power-level switch to OPERATE. Operate TEST key.	Indication of current flow (value dependent upon frequency and antenna length). Neon lamp glows.	Proceed to step 54.	Proceed to step 41.
41	D	None required.	Meter switch to P.A. PLATE. Operate TEST key.	Needle within light-shaded area under CW, but may be as low as 10 if antenna is short and frequency is low.	Proceed to step 52.	Control H or J, K or L, or O, P, Q, or R improperly set. If unable to obtain normal indication by retuning, proceed to step 42.
42	E	None required.	Meter switch to P.A. GRID. Operate TEST key.	Needle within light-shaded area marked P.A. GRID.	Proceed to step 50.	Proceed to step 43.
43	L	Neon lamp.	Operate TEST key.	Neon lamp glows.	Proceed to step 48.	Autotune control A or C dial mark not in exact alignment with panel indicator mark. Defective JAN-1625 low-frequency-oscillator tube. Open filament in JAN-837 high-frequency-oscillator tube. If these components are not defective, proceed to step 44.
44	L	750-volt range of d-c voltmeter.	Operate TEST key.	420 volts.	Proceed to step 45.	Open choke L2601/L402. Bad connection at J114—P2601/P401.

CHART 2 — Continued
TROUBLE SHOOTING

LOW-FREQUENCY R-F CIRCUITS—Continued						
Step	Test Point	Test Equipment	Transmitting-Set Controls	Normal Indication	If Indication Is Normal	If Indication Is Abnormal
45	L ₁	250-volt range of d-c voltmeter.	Operate TEST key.	210 volts.	Proceed to step 46.	Shorted screen-by-pass capacitor C2601/C401. Bad connection at J114—P2601/P401. Defective socket X2601/X401.
46	L ₂	Low-resistance range of ohmmeter.	EMISSION switch to OFF. Remove fuse. EMISSION switch to CW. Operate TEST key.	400 ohms.	Proceed to step 47.	Bad contacts on switch S114. Bad connection at J114—P2601/P401. Open cathode choke L2603/L403. Defective tube socket X2601/X401. Shorted capacitor C2605/C405. Shorted capacitor C2604/C404.
47	L ₃	Medium-resistance range of ohmmeter.	EMISSION switch to OFF. Replace fuse.	15,000 ohms.	Shorted plates on padding capacitor C2608A-B-C-D/C411A-B-C-D-E. Bad contacts on band switch S2601/S401. Autotune system maladjusted; proceed to Alignment and Adjustment.	Open grid-leak resistor R2601/R401. Shorted grid-leak capacitor C2603/C403. Defective tube socket X2601/X401. Open grid-tank coil L2602/L401.
48	E	None required.	Meter switch to P.A. GRID. Operate TEST key.	Needle within light-shaded area under P.A. GRID.	Proceed to step 49.	Bad contacts on switch S103. Shorted inductor L107.
49	D	None required.	EMISSION switch to CW. Meter switch to P.A. PLATE. Operate TEST key.	Needle within light-shaded area under CW.	Proceed to step 52.	Control H or J, K or L, or O, P, Q, or R improperly set. If unable to obtain normal indication by retuning, proceed to step 50.
50	D ₁	1500-volt range of d-c voltmeter.	No change.	1150 volts.	Proceed to step 51.	Open power - amplifier - plate choke L109. Bad contacts on relay K105.
51	3	None required, if CU-32/ART-13A or CU-25/ART-13 is used. Neon lamp, if CU-26/ART-13 is used.	Operate TEST key.	Indication of current flow. Neon lamp glows.	Proceed to step 54.	Proceed to step 52.
52	M ₁	Neon lamp.	Operate TEST key.	Neon lamp glows.	Proceed to step 53.	Defective capacitor C118. Grounded cable to L.F. INPUT or TRANSMITTER terminal on antenna loading unit or coil. Shorted loading-unit capacitor C2501 or C2502 (or corresponding loading-coil capacitor). Grounded series inductor or tuning switch in loading unit or loading coil. Grounded contacts of break-in relay or antenna switch in loading unit or switching unit. Grounded antenna.
53	M	Neon lamp.	Operate TEST key.	Neon lamp glows.	Proceed to step 54.	Bad contacts on break-in relay or antenna switch. Open series inductor in loading unit or loading coil. Bad contacts on tuning switch in loading unit or coil. Defective loading-unit meter M2501 (AMPERES RF meter on loading coil). Defective capacitor C2501 or C2502.

CHART 2 — Continued

TROUBLE SHOOTING

AUDIO-FREQUENCY CIRCUITS						
Step	Test Point	Test Equipment	Transmitting-Set Controls	Normal Indication	If Indication Is Normal	If Indication Is Abnormal
54	4	None required.	CHANNEL switch to position corresponding to a frequency in the 3.0-mc. to 18.1 mc. range, for which transmitter is tuned. EMISSION switch to VOICE. Power-level switch to OPERATE. Speak into microphone with button depressed.	Needle fluctuates in red area.	Proceed to step 74.	Proceed to step 55.
55	N	None required.	Speak into microphone with button depressed.	Speech is heard in headset.	Proceed to step 56.	Microphone-selector-switch position does not correspond to type of microphone in use. Defective JAN-12SJ7 first - audio - amplifier, JAN-6V6GT audio - driver, or sidetone - amplifier tube. If these components are not defective, proceed to step 56.
56	P	250-volt range of d-c voltmeter.	No change.	200 volts.	Proceed to step 57.	Bad connection at J112—P201. Defective socket X203. Grounded winding in transformer T202 or T203.
57	P1	250-volt range of d-c voltmeter.	No change.	200 volts.	Proceed to step 58.	Open winding in transformer T203. Defective socket X203.
58	P2	Low-resistance range of ohmmeter.	EMISSION switch to OFF.	250 ohms.	Proceed to step 59.	Defective resistor R215. Shorted capacitor C208. Defective socket X203.
59	P3	High-resistance range of ohmmeter.	No change.	100,000 ohms in AN/ART-13, ATC, or ATC-1. 470,000 ohms in AN/ART-13A.	Proceed to step 60.	Defective resistor R211. Shorted capacitor C206. Defective socket X203.
60	R	250-volt range of d-c voltmeter.	EMISSION switch to VOICE.	*110 volts in AN/ART-13, ATC, or ATC-1. *180 volts in AN/ART-13A.	Proceed to step 61.	Shorted or leaky capacitor C205. Defective resistor R209. Shorted capacitor C204. Defective socket X201.
61	R1	250-volt range of d-c voltmeter.	No change.	*40 volts.	Proceed to step 62.	Shorted or leaky capacitor C203. Defective resistor R208. Defective socket X201.
62	R2	Medium-resistance range of ohmmeter.	EMISSION switch to OFF.	2200 ohms.	Proceed to step 63.	Shorted capacitor C202. Defective resistor R207. Defective socket X201.
63	R3	Medium-resistance range of ohmmeter.	No change.	4000 ohms.	Proceed to step 64.	Shorted or grounded winding of transformer T201. Defective socket X201.
64	S	250-volt range of d-c voltmeter.	EMISSION switch to VOICE.	200 volts.	Proceed to step 65.	Open winding in transformer T202. Defective socket X202.
65	S1	Low-resistance range of ohmmeter.	EMISSION switch to OFF.	250 ohms.	Proceed to step 66.	Shorted capacitor C207. Defective resistor R214. Defective socket X202.
66	S2	High-resistance range of ohmmeter.	No change.	470,000 ohms.	Proceed to step 67.	Shorted or leaky capacitor C204. Defective resistor R210. Defective socket X202.

CHART 2 — Continued

TROUBLE SHOOTING

AUDIO-FREQUENCY CIRCUITS—Continued						
Step	Test Point	Test Equipment	Transmitting-Set Controls	Normal Indication	If Indication Is Normal	If Indication Is Abnormal
67	N	None required.	EMISSION switch to VOICE. Speak into microphone with button depressed.	Speech heard in headset.	Proceed to step 68.	Bad connection at J112—P201 or J116—P102. Bad contacts C on keying relay. Defective microphone, MICROPHONE jack, or microphone selector switch. Defective resistor R201, R202, R203, R204, R216, or R212. Defective capacitor C204 or C206. Defective transformer T201, T202, or T203. Defective sidetone output switch, SIDETONE 1 jack, or headset.
68	D	None required.	Speak into microphone with button depressed.	Needle fluctuates in red area.	Proceed to step 74.	Either JAN-811 modulator tube is defective. If these components are not defective, proceed to step 69.
69	T	1500-volt range of d-c voltmeter.	Operate TEST key.	1150 volts.	Proceed to step 72.	Proceed to step 70.
70	T1	1500-volt range of d-c voltmeter.	Operate TEST key.	1150 volts.	Proceed to step 71.	Bad contacts on CW relay. Grounded power-level or EMISSION switch.
71	T	1500-volt range of d-c voltmeter.	Operate TEST key.	1150 volts.	Proceed to step 72.	Open winding of modulation transformer.
72	T2	Low-resistance range of ohmmeter.	EMISSION switch to OFF.	100 ohms.	Proceed to step 73.	Measurement is being made at socket X106 with tube V105 removed. Bad connection at J112—P201. Open, shorted, or grounded winding of transformer T202. Shorted capacitor C209 or C210. Defective socket X105 or X106.
73	D	None required.	EMISSION switch to VOICE. Speak into microphone with button depressed.	Needle fluctuates in red area.	Proceed to step 74.	Defective transformer T101, power-level switch, contacts on CW relay, or contacts F of keying relay. Shorted capacitor C121A.
74	D	None required.	EMISSION switch to MCW. Operate TEST key.	Needle within light-shaded area marked MCW.	Proceed to step 81.	Maladjustment of MCW control rheostat. If normal indication cannot be obtained by readjustment, proceed to step 75.
75	N	None required.	Operate TEST key.	Audio tone heard in headset.	Proceed to step 76.	If MCW-CFI 8Q-2 unit is used, defective JAN-12SL7GT signal-detector/MCW oscillator tube or open filament in JAN-123L7GT crystal-oscillator/tripler tube. If these components are not defective, proceed to step 76. If MCW-CFI 8Q-1 unit is used, defective JAN-12SJ7 MCW oscillator tube or open filament in JAN-12SJ7 crystal-oscillator/mixer tube. If these components are not defective, proceed to step 79.
76	U	250-volt range of d-c voltmeter.	Operate TEST key.	*85 volts.	Proceed to step 77.	Shorted or leaky capacitor C2212A. Defective resistor R2211 or R2212. Bad connection at J111—P2201. Defective socket X2203.
77	U1	Low-resistance range of ohmmeter.	EMISSION switch to OFF.	220 ohms.	Proceed to step 78.	Defective resistor R2217. Defective socket X2203.
78	U2	High-resistance range of ohmmeter.	No change.	150,000 ohms.	Bad connection at J111—P2201 or J112—P201. Shorted, grounded, or bad contacts on power-level switch or voice relay. Defective MCW control rheostat R2201, resistor R2215, tank coil L2201, or capacitor C2212B.	Shorted or leaky capacitor C2214 or C2210. Defective resistor R2204. Defective socket X2203.

CHART 2 — Continued

TROUBLE SHOOTING

AUDIO-FREQUENCY CIRCUITS—Continued						
Step	Test Point	Test Equipment	Transmitting-Set Controls	Normal Indication	If Indication Is Normal	If Indication Is Abnormal
79	Z	750-volt range of d-c voltmeter.	EMISSION switch to MCW. Operate TEST key.	*330 volts.	Proceed to step 80.	Shorted or leaky capacitor C309A. Defective resistor R308. Bad connection at J111—P301. Defective socket X302.
80	Z1	Low-resistance range of ohmmeter.	EMISSION switch to OFF.	47 ohms.	Bad connection at J111—P301 or J112—P201. Shorted, grounded, or bad contacts on power-level switch or voice relay. Defective MCW control rheostat R310, resistor R309, or capacitor C309B or C309A.	Shorted capacitor C309B. Defective tank coil L302. Defective socket X302.
81	N	None required.	Power-level switch to CALIBRATE. EMISSION switch to VOICE. Control B to nearest crystal-check point.	Audio beat note heard in headset.	Proceed to step 98.	If MCW-CFI 8Q-2 unit is used, any one of the three tubes in unit is defective. If these components are not defective, proceed to step 82. If MCW-CFI 8Q-1 unit is used, either tube is defective. If these components are serviceable, proceed to step 94.
82	V	750-volt range of d-c voltmeter.	No change.	*370 volts.	Proceed to step 83.	Shorted capacitor C2213, C2203, C2211, or C2207. Defective resistor R2202 or R2210. Defective tank Z2201A. Bad connection at J111—P2201. Defective power-level switch or socket X2201.
83	V1	High-resistance range of ohmmeter.	EMISSION switch to OFF.	150,000 ohms.	Proceed to step 84.	Defective crystal Y2201, resistor R2216, capacitor C2213, or socket X2201.
84	W	750-volt range of d-c voltmeter.	EMISSION switch to VOICE.	400 volts.	Proceed to step 85.	Shorted or leaky capacitor C2202, C2207, C2211, or C2208. Defective resistor R2208, tank Z2202B, or socket X2202.
85	W1	750-volt range of d-c voltmeter.	No change.	410 volts.	Proceed to step 86.	Shorted capacitor C2208. Defective resistor R2209 or socket X2202.
86	W2	Low-resistance range of ohmmeter.	EMISSION switch to OFF.	220 ohms.	Proceed to step 87.	Defective resistor R2217 or socket X2202.
87	W3	High-resistance range of ohmmeter.	No change.	47,000 ohms.	Proceed to step 88.	Defective resistor R2205 or socket X2202.
88	W4	High-resistance range of ohmmeter.	No change.	47,000 ohms.	Proceed to step 89.	Defective resistor R2206 or socket X2202.
89	X	750-volt range of d-c voltmeter.	EMISSION switch to VOICE.	400 volts.	Proceed to step 90.	Shorted capacitor C2201 or C2207. Defective tank Z2202A or socket X2201.
90	X1	High-resistance range of ohmmeter.	EMISSION switch to OFF.	47,000 ohms.	Proceed to step 91.	Defective resistor R2203 or socket X2201.
91	Y	750-volt range of d-c voltmeter.	EMISSION switch to VOICE.	*200 volts.	Proceed to step 92.	Shorted capacitor C2209. Defective resistor R2214 or socket X2203.
92	Y1	Low-resistance range of ohmmeter.	EMISSION switch to OFF.	28 ohms.	Proceed to step 93.	Defective tank Z2201B or socket X2203.
93	Y2	High-resistance range of ohmmeter.	No change	470,000 ohms.	CFI unit requires alignment; proceed to Alignment and Adjustment.	Shorted or leaky capacitor C2205, C2206, or C2204. Defective resistor R2213 or socket X2203.

CHART 2 — Continued

TROUBLE SHOOTING

AUDIO-FREQUENCY CIRCUITS—Continued						
Step	Test Point	Test Equipment	Transmitting-Set Controls	Normal Indication	If Indication Is Normal	If Indication Is Abnormal
94	AA	750-volt range of d-c voltmeter.	EMISSION switch to VOICE.	*260 volts.	Proceed to step 95.	Shorted or leaky capacitor C309A. Bad connection at J111—P301. Defective resistor R308 or socket X302.
95	AA1	750-volt range of d-c voltmeter.	No change.	220 volts.	Proceed to step 96.	Shorted or leaky capacitor C303 or C304. Defective resistor R304, R305, or R311 or socket X301.
96	AA2	High-resistance range of ohmmeter.	EMISSION switch to OFF.	220,000 ohms.	Proceed to step 97.	Defective resistor R307 or socket X301.
97	AA3	High-resistance range of ohmmeter.	No change.	100,000 ohms.	Defective crystal Y301, capacitor C311 or C308, or tank Z301. CFI unit requires alignment; proceed to Alignment and Adjustment.	Defective resistor R301. Shorted or leaky capacitor C301 or C302. Defective socket X301.
AUTOTUNE CIRCUITS						
98	Aural and visual check.	None required.	EMISSION switch to VOICE. Power-level switch to TUNE. CHANNEL switch to each position, in turn.	Autotune system cycles, ending with controls A, B, C, D, and E at settings indicated on tuning chart.	Proceed to step 99.	If system cycles continuously—Defective rear limit switch S111. Bad contacts on motor-reversing relay K101 or front limit switch S112. Defective tap switch S109. Grounded LOCAL-REMOTE switch or CHANNEL switch S108. Maladjusted system; proceed to Alignment and Adjustment. If system fails to cycle—Keying line grounded. Control C dial mark not in exact alignment with panel indicator mark. Defective Autotune motor. Bad contacts on motor-reversing relay K101 or rear limit switch S111. Open winding of relay K101. Bad contacts G on keying relay. Defective LOCAL-REMOTE switch, tap switch S109, or CHANNEL switch S108. Maladjusted system; proceed to Alignment and Adjustment.
PILOT'S CONTROL BOX						
99	Visual check.	None required.	LOCAL-REMOTE switch to REMOTE. Control-unit CHANNEL switch to CW.	Indicator lamp on transmitter is out. Lamp on pilot's control box is on.	Proceed to step 100.	Burned out indicator lamp on pilot's control box. Bad connection in cable U-8/U—U-6/U. Bad contacts on LOCAL-REMOTE switch or EMISSION switch S602.
100	Aural and visual check.	None required.	Control-unit CHANNEL switch to any other position.	Autotune system cycles, ending with controls A, B, C, D, and E at settings indicated on tuning chart.	Proceed to step 101.	Bad connection in cable U-8/U—U-6/U. Defective CHANNEL switch S601.
101	D	None required.	Power-level switch to OPERATE. Depress key on pilot's control box.	Needle within light-shaded area under CW.	Proceed to step 102.	Bad connection in cable U-8/U—U-6/U. Defective telegraph key S603.
102	D	None required.	Control-unit EMISSION switch to MCW.	Needle within light-shaded area under MCW.	Proceed to step 103.	Bad connection in cable U-8/U—U-6/U. Defective LOCAL-REMOTE switch or EMISSION switch S602.
103	D	None required.	Control-unit EMISSION switch to VOICE. Speak into microphone with button depressed.	Needle fluctuates in red area.	Trouble-shooting procedure is complete.	Bad connection in cable U-8/U—U-6/U. Defective LOCAL-REMOTE switch, EMISSION switch S602, MIC. jack J602, or microphone.

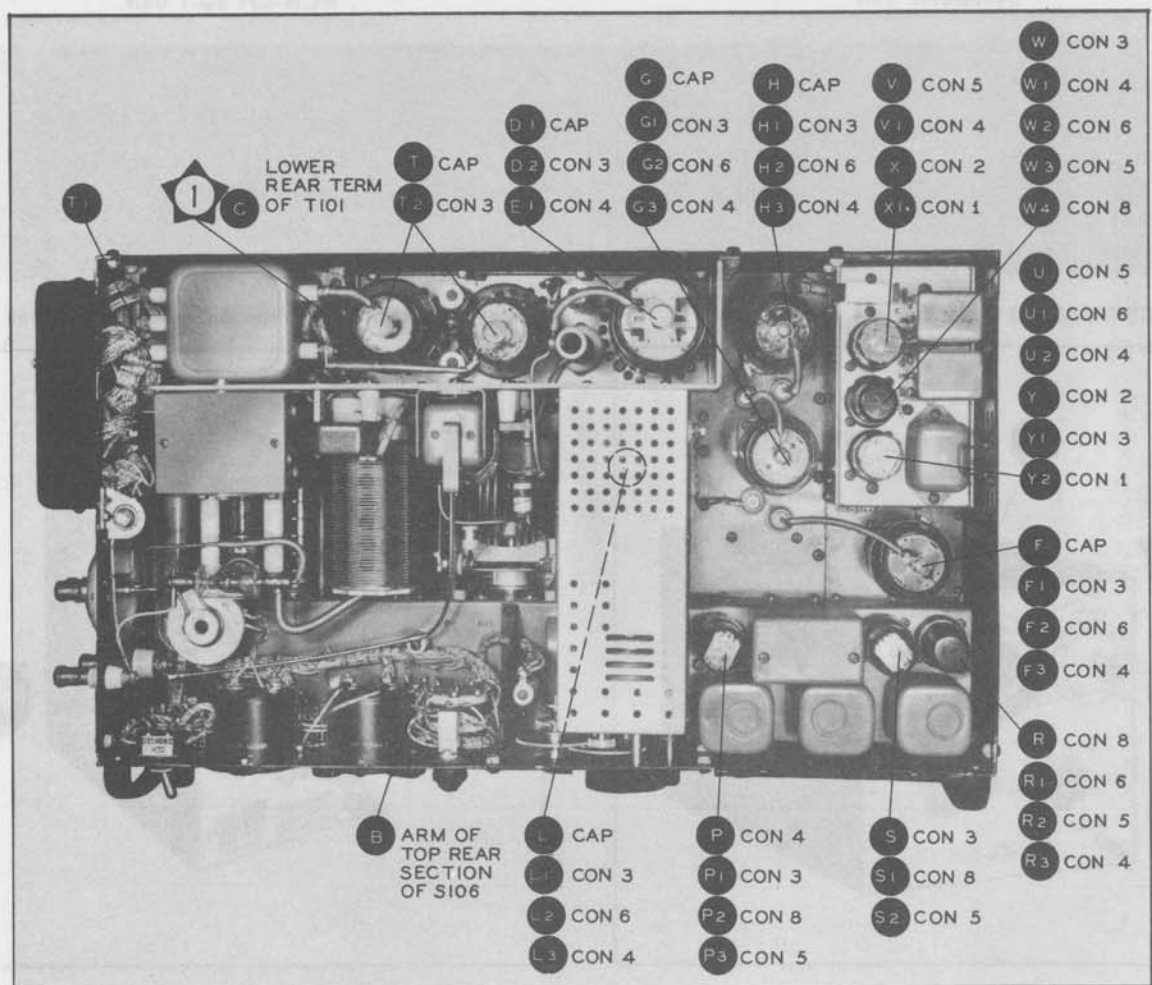
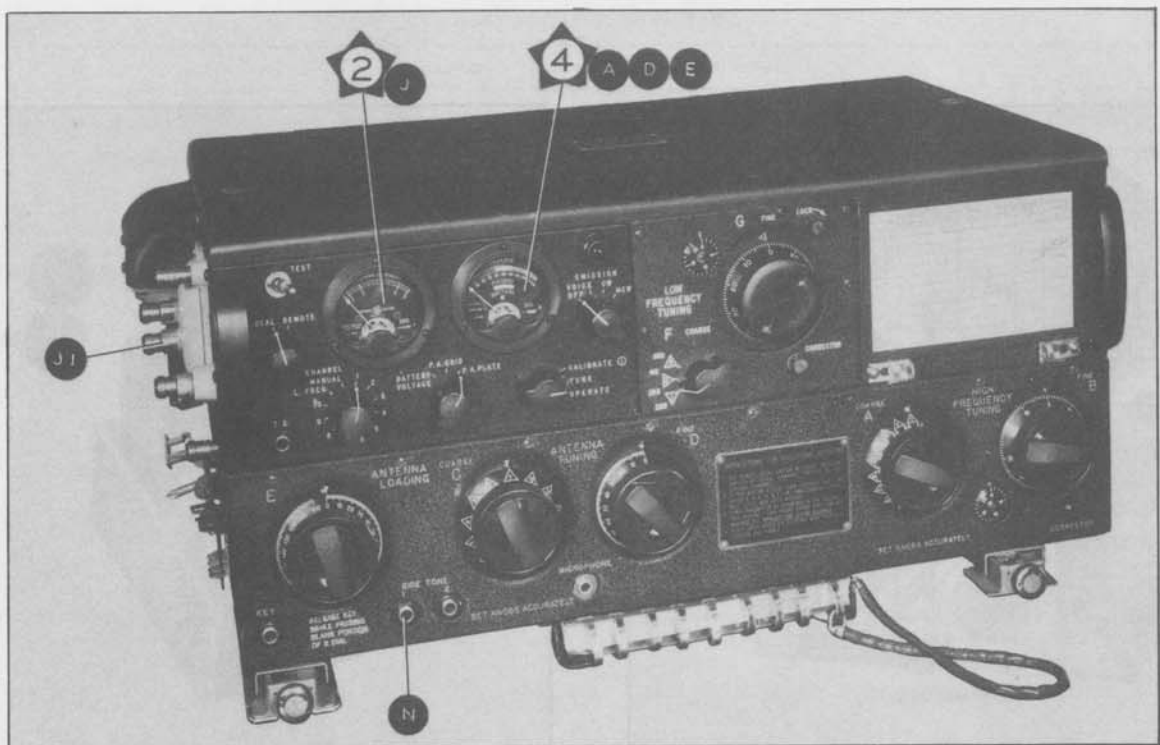
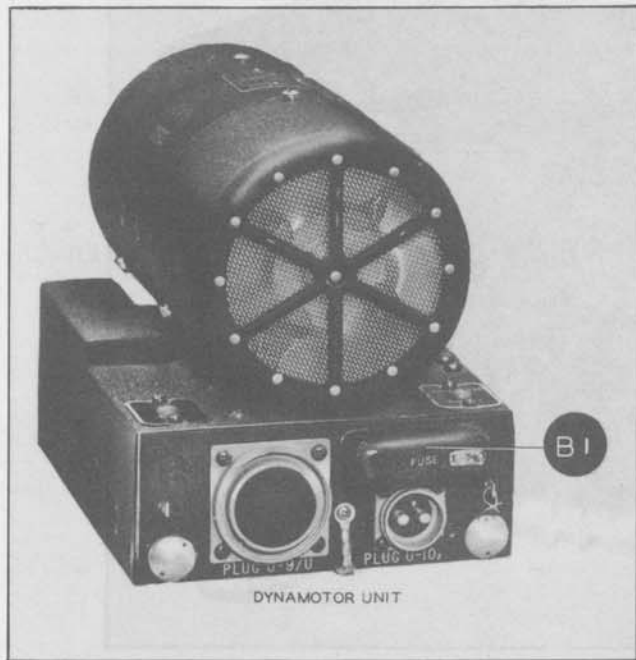
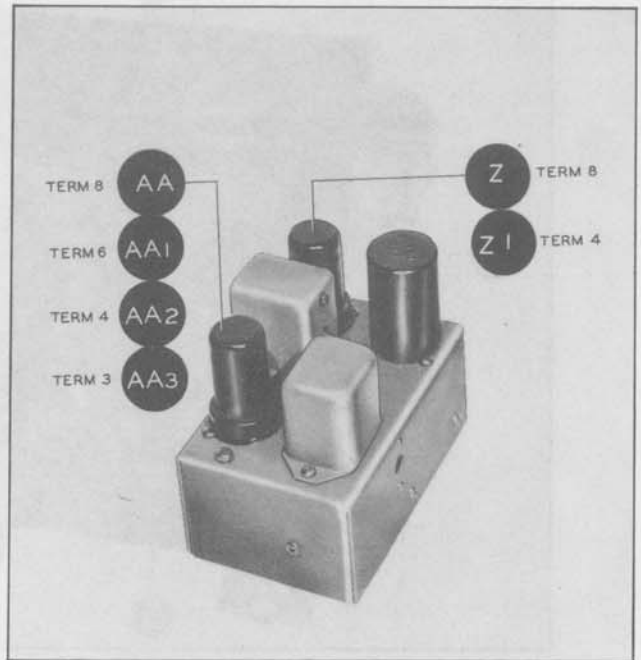

Figure 40. Physical Locations of Test Points



Dynamotor Unit



MCW-CFI 8Q-1 Unit



CU-25/ART-13 Type Antenna Loading Coil

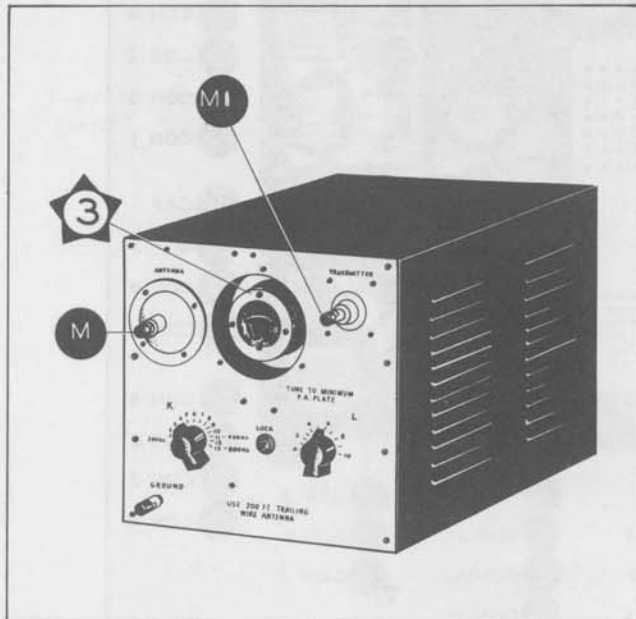

CU-26/ART-13 Type Antenna Loading Coil

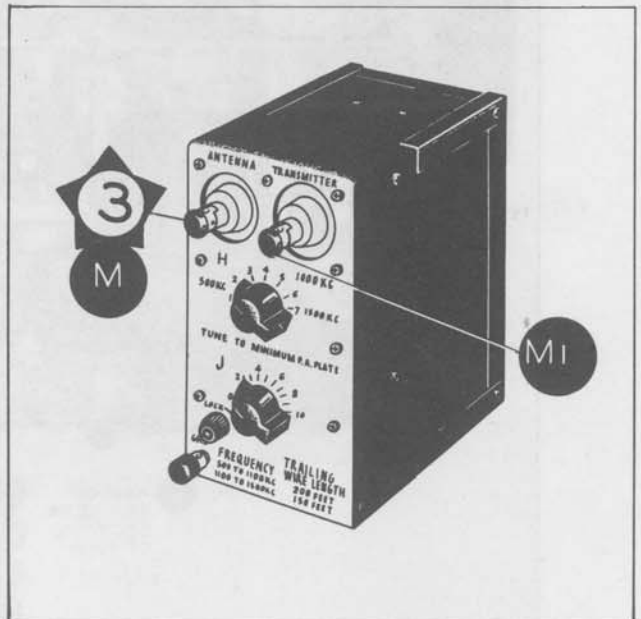

Figure 41. Physical Locations of Test Points

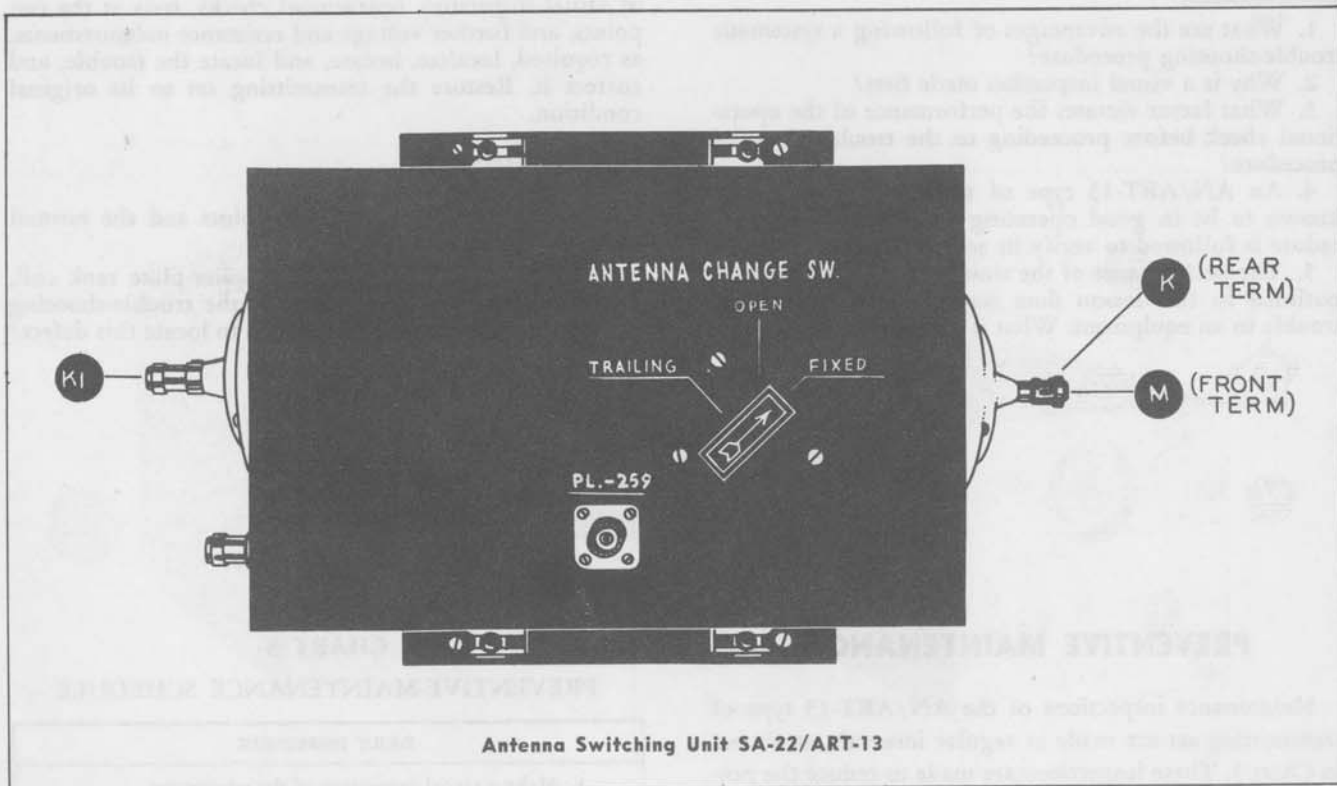
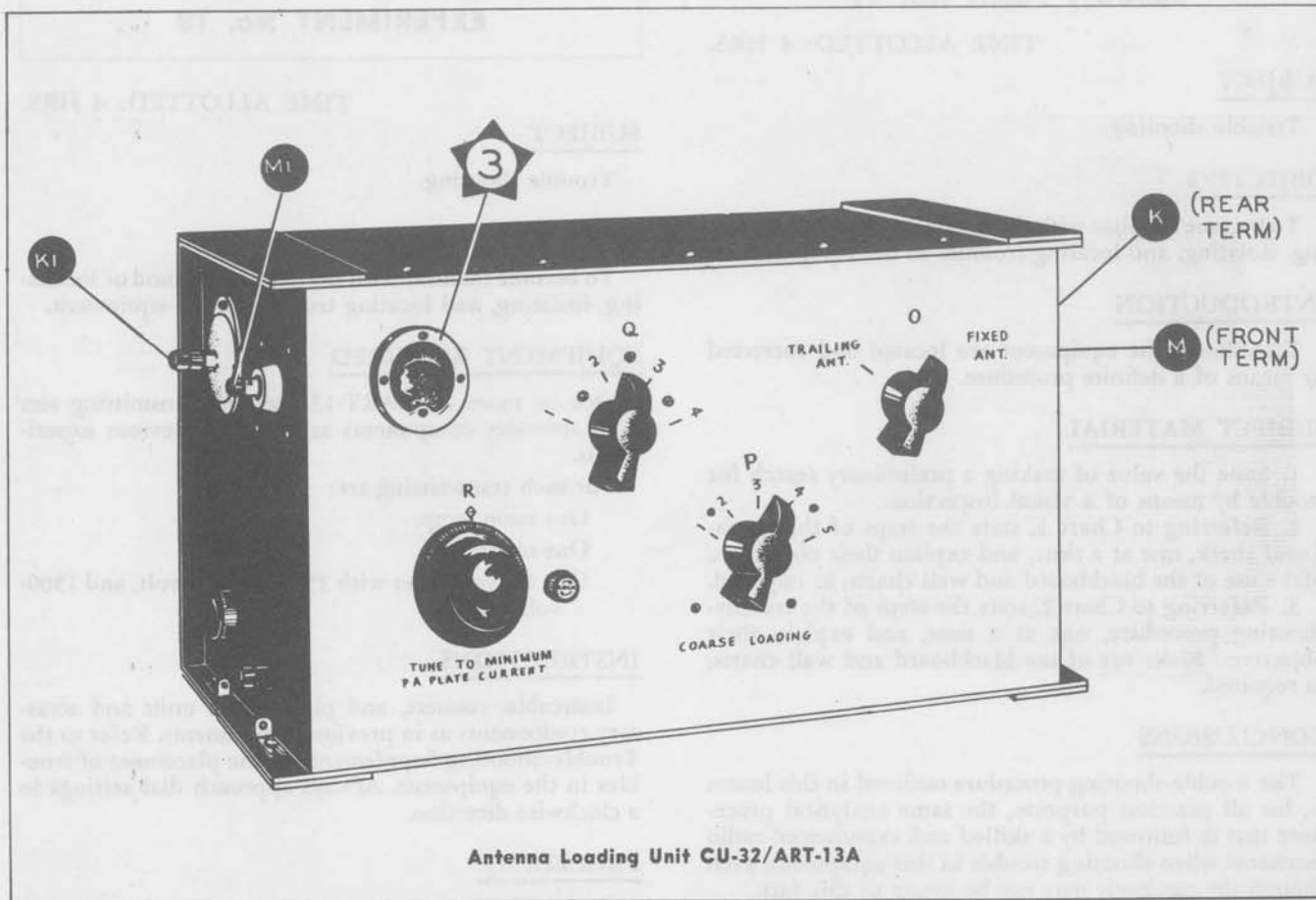

Figure 42. Physical Locations of Test Points

LESSON PLAN No. 19

TIME ALLOTTED: 4 HRS.

SUBJECT

Trouble shooting.

OBJECTIVE

To become familiar with the over-all method of localizing, isolating, and locating troubles in the equipment.

INTRODUCTION

Troubles in the equipment are located and corrected by means of a definite procedure.

SUBJECT MATERIAL

1. State the value of making a preliminary search for trouble by means of a visual inspection.
2. Referring to Chart 1, state the steps of the operational check, one at a time, and explain their objectives. Make use of the blackboard and wall charts, as required.
3. Referring to Chart 2, state the steps of the trouble-shooting procedure, one at a time, and explain their objectives. Make use of the blackboard and wall charts, as required.

CONCLUSIONS

The trouble-shooting procedure outlined in this lesson is, for all practical purposes, the same analytical procedure that is followed by a skilled and experienced radio mechanic when shooting trouble in this equipment, even though the mechanic may not be aware of this fact.

ORAL QUIZ

1. What are the advantages of following a systematic trouble-shooting procedure?
2. Why is a visual inspection made first?
3. What factor dictates the performance of the operational check before proceeding to the trouble-shooting procedure?
4. An AN/ART-13 type of transmitting set is not known to be in good operating condition. What procedure is followed to verify its serviceability?
5. The performance of the trouble-shooting procedure outlined in this lesson does not reveal the source of trouble in an equipment. What is the next step?

EXPERIMENT No. 18

TIME ALLOTTED: 4 HRS.

SUBJECT

Trouble shooting.

OBJECTIVE

To become familiar with the over-all method of localizing, isolating, and locating troubles in the equipment.

EQUIPMENT REQUIRED

One or more AN/ART-13 type of transmitting sets with accessory components as listed in previous experiments.

For each transmitting set:

- One neon lamp.
- One ohmmeter.
- One d-c voltmeter with 250-volt, 750-volt, and 1500-volt ranges.

INSTRUCTIONS

Intercable, connect, and plug in the units and accessory components as in previous experiments. Refer to the Trouble-Shooting Supplement for the placement of troubles in the equipment. Always approach dial settings in a clockwise direction.

PROCEDURE

1. Request the instructor to place as many troubles in the equipment as time permits, one at a time. By means of visual inspection, operational checks, tests at the test points, and further voltage and resistance measurements, as required, localize, isolate, and locate the trouble, and correct it. Restore the transmitting set to its original condition.

CONCLUSIONS

1. Name the four major test points and the normal indication at each.
2. If the second-frequency-multiplier-plate tank coil, L106, is open, how many steps in the trouble-shooting procedure is it necessary to perform to locate this defect?

LECTURE 20

PREVENTIVE MAINTENANCE

Maintenance inspections of the AN/ART-13 type of transmitting set are made at regular intervals, as shown in Chart 3. These inspections are made to reduce the possibility of trouble developing in the equipment during flight.

CHART 3

PREVENTIVE-MAINTENANCE SCHEDULE

DAILY INSPECTION

1. Make a visual inspection of the equipment.
2. Perform the steps in the operational check, as outlined in Chart 1.

CHART 3 — Continued

PREVENTIVE-MAINTENANCE SCHEDULE

100-HOUR INSPECTION
<ol style="list-style-type: none">1. Make a visual inspection of the equipment.2. Perform the steps in the operational check, as outlined in Chart 1.3. Lubricate the Autotune system, as outlined in Experiment No. 17.4. Remove and test all tubes. Replace those which are found to be defective.5. Repeat the operational check.
500-HOUR INSPECTION
<ol style="list-style-type: none">1. Make a visual inspection of the equipment.2. Perform the steps in the operational check, as outlined in Chart 1.3. Remove and test all tubes. Replace those which are found to be defective.4. Replace all seven oil wicks in the Autotune system (one in each line-shaft worm, and one in the Autotune motor).5. Lubricate the Autotune system, as outlined in Experiment No. 17.6. Repeat the operational check.

LESSON PLAN No. 20

TIME ALLOTTED: 1/4 HR.

SUBJECT

Preventive maintenance.

OBJECTIVE

To become familiar with the preventive-maintenance procedure.

INTRODUCTION

To reduce the possibility of equipment failure in flight, with subsequent loss of radio communication, maintenance inspections are performed at regular intervals.

SUBJECT MATERIAL

1. Stress the importance of unflinching performance of scheduled maintenance inspections.
2. Referring to Chart 3, state and explain the steps in each inspection.

CONCLUSIONS

The scheduled maintenance inspections can be performed quickly and easily, and may save a life, a cargo, or a plane.

ORAL QUIZ

1. Why is it necessary to test the tubes, even though the operational check indicates that the equipment is operating normally?
2. What may be the result if the Autotune system is not lubricated at the proper intervals?

EXPERIMENT No. 19

TIME ALLOTTED: 3/4 HR.

SUBJECT

Preventive maintenance.

OBJECTIVE

To become familiar with the steps in the maintenance-inspection schedule which have not already been performed.

EQUIPMENT REQUIRED

One or more AN/ART-13 type of transmitting sets with accessory components as listed in previous experiments. One tube checker for each transmitting set.

INSTRUCTIONS

Intercable, connect, and plug in the units and accessory components as in previous experiments. Always approach dial settings in a clockwise direction.

PROCEDURE

1. Perform an operational check of the equipment.
2. Remove all of the receiving-type tubes and test them. Check the transmitting-type tubes by substitution with new tubes, and compare equipment performance.
3. Locate all seven of the oil wicks.
4. Repeat the operational check.

CONCLUSIONS

1. What equipment trouble may develop due to excessive lubrication of the Autotune system?
2. Why is it necessary to lubricate the Autotune system after replacing the oil wicks?
3. Why is it necessary to perform an operational check after testing the tubes?

LECTURE 21

SPECIAL INFORMATION

Modification M1 of Radio Transmitter T-47/ART-13 entails the addition of the top-cover interlock switch. This interlock is incorporated as standard design in Radio

Transmitter T-47A/ART-13. The substitution of the MCW-CFI 8Q-2 unit for the MCW-CFI 8Q-1 unit in Radio Transmitter T-47/ART-13 is designated modification M2. Different calibration books accompany transmitters equipped with the 8Q-2 unit as compared with

those equipped with the 8Q-1 unit. A reliable check of the CFI-unit crystal-oscillator frequency may be made by comparison with the transmission frequency of radio station WWV, operated by the U. S. Bureau of Standards, if a suitable means of comparison is available.

Additional information concerning the AN/ART-13 type of transmitting set may be obtained by reference to Technical Orders AN 08-30ART-13-3 and AN 08-30-ART-13-4.

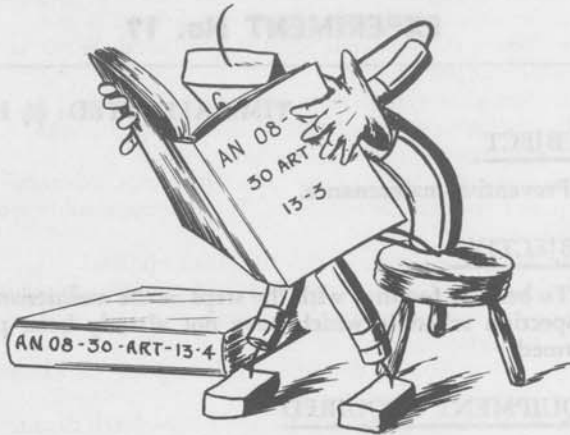

LESSON PLAN No. 21

TIME ALLOTTED: ¼ HR.

SUBJECT

Special information.

OBJECTIVE

To note several items of special information.

INTRODUCTION

There are certain facts regarding this equipment which must be presented to complete the course.

SUBJECT MATERIAL

1. State the two modifications which may be found in certain transmitters.
2. Explain how the crystal frequency of the CFI unit may be checked.
3. Display copies of Technical Orders AN 08-30ART-13-3 and AN 08-30ART-13-4, if they are available.

CONCLUSIONS

It is possible to check the CFI unit in the field by comparison with a reliable frequency standard.

ORAL QUIZ

1. Why is it necessary to use different calibration books for the MCW-CFI 8Q-1 and the MCW-CFI 8Q-2 units?

REVIEW No. 2

Review the salient points contained in Lectures 12 through 21 and Experiments 11 through 19 by interrogating the students, using each question contained in the Oral Quiz of each Lesson Plan and in the Conclusions of each Experiment, in turn. Fully explain the answers to those questions which cause the students difficulty. Permit

the students to ask questions of their own. Allow classroom discussion on questions within reasonable limits of time. The normal time allotment for this review is four hours. Make a written note of those questions which cause general difficulty.

FINAL REVIEW

Review those questions which have caused the students general difficulty by reference to the written notations made during previous reviews. Present each question before the class, and make a final attempt to erase all doubt from the students' minds. The normal time allotment for this review is three hours.

FINAL EXAMINATION

Do not permit the students to refer to any material while answering the questions in Part I of the examination. Display all four wall charts before presenting Part II. The normal time allotment for these two parts is two hours, total.

Part III of the examination is conducted in the laboratory. Provide each student with the necessary equipment. Refer to the Trouble-Shooting Supplement for the placement of troubles in the equipment. Do not place a rigid time limit on this part of the examination, but rate each student according to the time required to locate and correct each trouble. The normal time allotment for this part of the examination is three hours.

PART I

1. When aligning the low-frequency oscillator, why is it necessary to begin with the highest-frequency band and proceed toward the lowest-frequency band?
2. Is the high-frequency oscillator operative when the transmitter is in the unkeyed state?
3. Is the first frequency multiplier operative when the power-level switch is in the CALIBRATE position?
4. Is it necessary to utilize the antenna shunt capacitor when using a trailing-wire antenna?
5. When the low-frequency output circuits are considered with the antenna, what type of basic circuit do they resemble?
6. Is a sidetone signal heard in the headset when the audio-driver tube is too weak to drive the modulator?
7. What is the output frequency of the mixer in the MCW-CFI 8Q-2 unit?
8. Which two circuit components protect the dynamotor unit from damage?
9. To what length (minimum allowable) may the dynamotor brushes wear before replacement is necessary?
10. What causes the contacts of the barometric switch to close?
11. Is either indicator lamp lighted when the Autotune system is cycling?
12. Is the +1150/750 volt d-c potential applied to the modulator when CW emission is selected for the transmitter?
13. What two vacuum-tube stages are disabled when control A is in position 6 (4.8 mc. to 6.0 mc.)?
14. Can the Autotune system be set into operation when the control C interlock is open?
15. The power-level switch is at CALIBRATE. Is it necessary to close the TEST switch to key the equipment?

16. To which Autotune unit is the circuit-seeking tap switch mechanically coupled?

17. Can the Autotune system be adjusted so that a frequency of 400 kc. is tuned when the CHANNEL switch is operated to position 7?

18. Which electrical component determines the exact moment at which the Autotune motor reverses?

19. Which electrical component determines the particular contact of the circuit-seeking tap switch that has an effect upon the Autotune circuit?

20. Which mechanical component of the multiturn unit actuates the limit switches?

21. Which circuit element prevents the Autotune motor from reversing on the first counterclockwise sweep of the tap switch, when the system begins its forward movement?

22. Why is no lubrication of the ball bearings at each end of the line shaft required?

23. What is the allowable tolerance for the engagement of the pawl heels with the cam slot of the Autotune units with respect to that of the control A unit?

24. What is the allowable tolerance between the last occurrence of a pawl-heel engagement with its cam slot and the breaking of contact of the tap switch at the corresponding position?

25. What is the allowable tolerance between the operation of either multiturn-unit limit switch and the engagement of the operating-arm snap pin with that of the collar at each end of the drive shaft?

PART II

1. Which functional block is probably at fault if the indication obtained at major test point $\diamond 4$ is normal when operating on voice, but abnormal when operating on MCW?

- MCW oscillator.
- Crystal oscillator.
- Low-frequency oscillator.

2. What is the likely cause of a zero d-c voltage reading at test point $\bullet F$?

- Open resistor R102.
- Open inductor L104.
- Open capacitor C108.
- Shorted capacitor C107.

3. In which position is it logical to set control A when making a resistance measurement between test point $\bullet H2$ and ground?

- Position 13 (L.F.).
- Any position in the 2.0-mc. to 6.0-mc. range.
- Any position in the 6.0-mc. to 18.1-mc. range.
- In the MCW-CFI 8Q-2 unit, the indication noted

at test point $\bullet U2$ is 220 ohms. What is the probable cause of trouble?

- Open resistor R2204.
- Shorted capacitor C2210.
- Shorted capacitor C2214.
- Defective socket X2203.

5. If the indication obtained at test point $\diamond 1$ is zero, it is logical to make a test at which test point next?

- A .
- B .
- B1 .

6. Improper operation of the equipment is traced to an open dynamotor overload relay. The DYNA. RESET button is depressed, but it immediately snaps out when released. What is the next logical step to perform?

a. Shut down the equipment; determine and correct the cause of the overloaded dynamotor.

b. Operate the power-level switch to TUNE and depress the DYNA. RESET button again.

c. Repeatedly depress the DYNA. RESET button until it stays in.

7. The contacts of switch S115 do not make connection. What are the trouble symptoms?

- Complete equipment failure.
- No operation in the 6.0-mc. to 18.1-mc. range.
- No operation in the 2.0-mc. to 6.0-mc. range.

8. The arm of switch S108 is grounded. What is the trouble symptom?

- Autotune system does not cycle.
- Autotune system cycles to the wrong channel.
- Autotune system cycles continuously.

9. The switch-operating arm does not advance far enough to operate switch S112. What is the trouble symptom?

- Autotune system cycles to wrong channel.
- Autotune-system cycle ends with all units positioned to their extreme counterclockwise positions.
- Autotune system cycles continuously.

10. What is the probable consequence of excessive lubrication of an Autotune unit?

- Slip-clutch band fails to drive slip-clutch drum.
- Single-tooth ratchet fails to drive cam drum.

PART III

The instructor will place six separate troubles in the equipment, one at a time. By means of visual inspection, operational check, checks at test points, and further voltage and resistance measurements, as required, localize, isolate, and locate each trouble and correct it. Restore the transmitting set to its original condition.

FINAL-EXAMINATION REVIEW

State each question and trouble-shooting problem contained in the Final Examination. Fully explain the answers to those questions which cause general student difficulty. Permit the students to ask questions of their own. Allow classroom discussion on questions, within reasonable limits of time. The normal time allotment for this review is two hours.





