

TM 11-5820-549-12

DEPARTMENT OF THE ARMY TECHNICAL MANUAL

**OPERATOR AND ORGANIZATIONAL
MAINTENANCE MANUAL**

**RECEIVING SET, RADIO AN/PRR-9
TRANSMITTING SET, RADIO AN/PRT-4
AND AN/PRT-4A**

This copy is a reprint which includes current pages from Changes 1 through 8.

HEADQUARTERS, DEPARTMENT OF THE ARMY
OCTOBER 1966

CONDENSED OPERATING INSTRUCTIONS FOR RECEIVING SET, RADIO AN/PRR-9

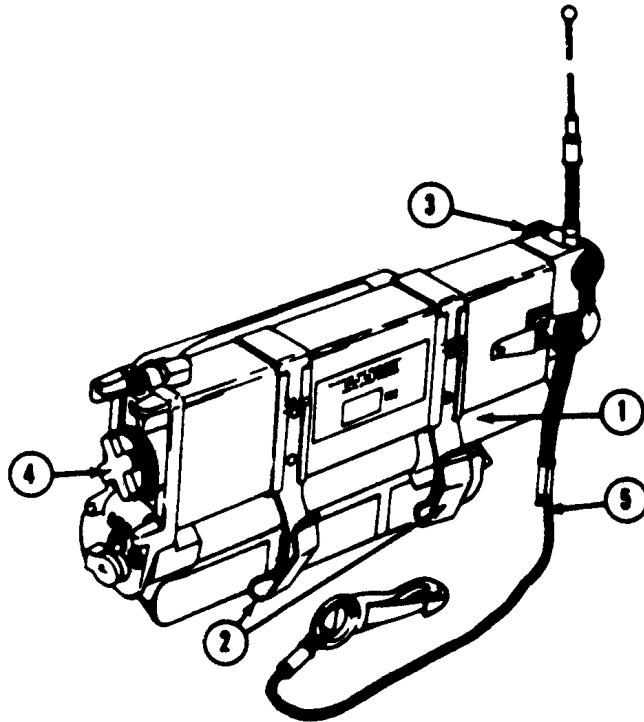

TO OPERATE SET

THE NUMBERS OF STEPS 1 THROUGH 5 ARE THE SAME AS THE NUMBERS ON THE ILLUSTRATION.

- (1) INSERT TUBULAR BATTERY, DRY BA 505, U THROUGH BATTERY CLIP AND INTO MATING CONNECTOR OF RECEIVER.
- (2) CLIP RECEIVER TO HELMET
- (3) LOOSEN ANTENNA RETAINING SCREW AND ROTATE ANTENNA UPRIGHT. TIGHTEN SCREW.
- (4) RECEIVER CONTROL

FOR RECEIVING WITH SQUELCH: ROTATE RECEIVER CONTROL CLOCKWISE FROM ITS OFF POSITION SET TO A COMFORTABLE LISTENING LEVEL WHEN VOICE OR TONE IS RECEIVED. IF CONTROL IS ROTATED TO ITS MAXIMUM CLOCKWISE POSITION, SQUELCH WILL BE TURNED OFF (BACKGROUND NOISE WILL BE HEARD). TO REACTIVATE SQUELCH, TURN CONTROL TO OFF THEN BACK ON.

FOR RECEIVING WITHOUT SQUELCH: ROTATE RECEIVER CONTROL FULLY CLOCKWISE FROM ITS OFF POSITION. ROTATE COUNTERCLOCKWISE FOR COMFORTABLE LISTENING LEVEL. USE RECEIVER WITHOUT SQUELCH WHEN RECEIVED SIGNALS ARE WEAK OR IN TERRAIN UNFAVORABLE FOR GOOD RECEPTION.

- (5) RECEIVER MAY BE WORN ON COMBAT SUSPENDERS, OR CLIPPED TO A POCKET OR BELT. IF MAXIMUM RANGE IS NOT REQUIRED IF RECEIVER IS WORN IN THIS MANNER LOOP CORD END OF LANYARD THROUGH EYELET. PULL HOOK END THROUGH THIS LOOP AND CLIP TO SLIDE ON SUSPENDERS.

TO TURN SET OFF

ROTATE RECEIVER CONTROL TO THE MAXIMUM COUNTERCLOCKWISE POSITION.

(INSTRUCTION FOR TRANSMITTING SET, RADIO AN/PRT-4 ARE LOCATED ON INSIDE BACK COVER)

Technical Manual }
 No 11-5820-549-12 }

HEADQUARTERS
 DEPARTMENT OF THE ARMY
 Washington, D C , 24 October 1966

**OPERATOR AND ORGANIZATIONAL MAINTENANCE MANUAL
 RECEIVING SET, RADIO AN/PRR-9 AND
 TRANSMITTING SETS, RADIO AN/PRT-4 AND AN/PRT-4A**

		Paragraph	Page
Chapter 1	INTRODUCTION		
Section I	General		
	Scope	1-1	1-1
	Indexes of publications	1-2	1-1
	Forms and records	1-3	1-1
	Reporting of errors	1-3 1	1-1
Section II	Description and Data		
	Purpose and use	1-4	1-1
	Technical characteristics	1-5	1-2
	Components	1-6	1-2
	Items comprising an operable equipment	1-6 1	1-3
	Common names	1-7	1-3
	Description of Receiving Set, Radio AN/PRR-9	1-8	1-3
	Minor components of Receiving Set, Radio AN/PRR-9	1-9	1-3
	Description of Transmitting Set, Radio AN/PRT-4	1-10	1-4
	Minor components of Transmitting Set, Radio AN/PRT-4	1-11	1-4
	Additional equipment required	1-12	1-4
Chapter 2	INSTALLATION		
	Unpacking Receiving Set, Radio AN/PRR-9	2-1	2-1
	Unpacking Transmitting Set, Radio AN/PRT-4	2-2	2-1
	Checking unpacked equipment	2-3	2-2
	Siting	2-4	2-3
	Installing Antenna AS-1998/PRR-9	2-5	2-3
	Installing Battery, Dry BA-505/U	2-6	2-4 1
	Installing Battery, Dry BA-399/U	2-7	2-4 2
	Installation of receiver lanyard	2-8	2-4 2
	Installation of transmitter lanyard	2-9	2-4 2
	Installing receiver on helmet	2-10	2-5
	Installing Headset, Electrical H-264/PRR-9	2-11	2-5
Chapter 3	OPERATING INSTRUCTIONS		
	Receiving Set, Radio AN/PRR-9 control and jack	3-1	3-1
	Transmitting Set, Radio AN/PRT-4 controls	3-2	3-1
	Receiver operating procedure	3-3	3-2
	Receiver stopping procedure	3-4	3-3
	Recognition and identification of jamming	3-5	3-3
	Antijamming	3-6	3-3
	Operating procedure under arctic conditions (batteries)	3-7	3-3
	Transmitter operating procedure	3-8	3-3
	Transmitter stopping procedure	3-9	3-4
	Operating procedure under arctic conditions (batteries)	3-10	3-4
Chapter 4	OPERATOR'S MAINTENANCE INSTRUCTIONS		
	Scope of operator's maintenance	4-1	4-1
	Operator's preventive maintenance	4-2	4-1
	Operator's preventive maintenance checks and services periods	4-3	4-1
	Operator's daily preventive maintenance checks and services chart	4-4	4-1

	Paragraph	Page
Cleaning	4-5	4-3
Operator's troubleshooting chart	4-6	4-4
Replacement of Battery, Dry BA-505/U	4-7	4-4
Replacement of Battery, Dry BA-399/U	4-8	4-4
5 ORGANIZATIONAL MAINTENANCE INSTRUCTIONS		
Scope of organizational maintenance	5-1	5-1
Materials, tools, and test equipment	5-2	5-1
Organizational preventive maintenance	5-3	5-1
Organizational monthly maintenance	5-4	5-1
Organizational monthly preventive maintenance checks and services chart	5-5	5-2
Touchup painting	5-6	5-2
Organizational troubleshooting	5-7	5-2
Repair	5-8	5-3
Replacement of Antenna AS-1998/PRR-9	5-11	5-3
Replacement of Antenna AS-1999/PRT-4	5-12	5-3
Replacement of receiver control knob	5-13	5-3
Replacement of Transmitter CH-1 - CH-2 switch knob	5-14	5-4
Replacement of transmitter TONE-VOICE switch knob	5-15	5-4
Battery testing	5-16	5-4
Changing channel frequencies	5-17	5-4
Alignment	5-18	5-9
Channel marking	5-19	5-9
Cleaning transmitter microphone	5-20	5-11
Replacement of AN/PRR-9 antenna housing assembly	5-21	5-11
Replacement of AN/PRT-4 antenna base assembly	5-22	5-11
Appendix A REFERENCES		A-1
B BASIC ISSUE ITEMS LIST		
Section I Introduction		B-1
II Basic issue items list		B-2
Appendix C MAINTENANCE ALLOCATION		
Section I Introduction		C-1
II Maintenance allocation chart (AN/PRT-4 & 4A)		C-2
III Tool and test equipment requirement (AN/PRR-9)		C-5
IV Maintenance allocation chart (AN/PRR-9)		C-6
V Tool and test equipment requirements (AN/PRR-9)		C-8

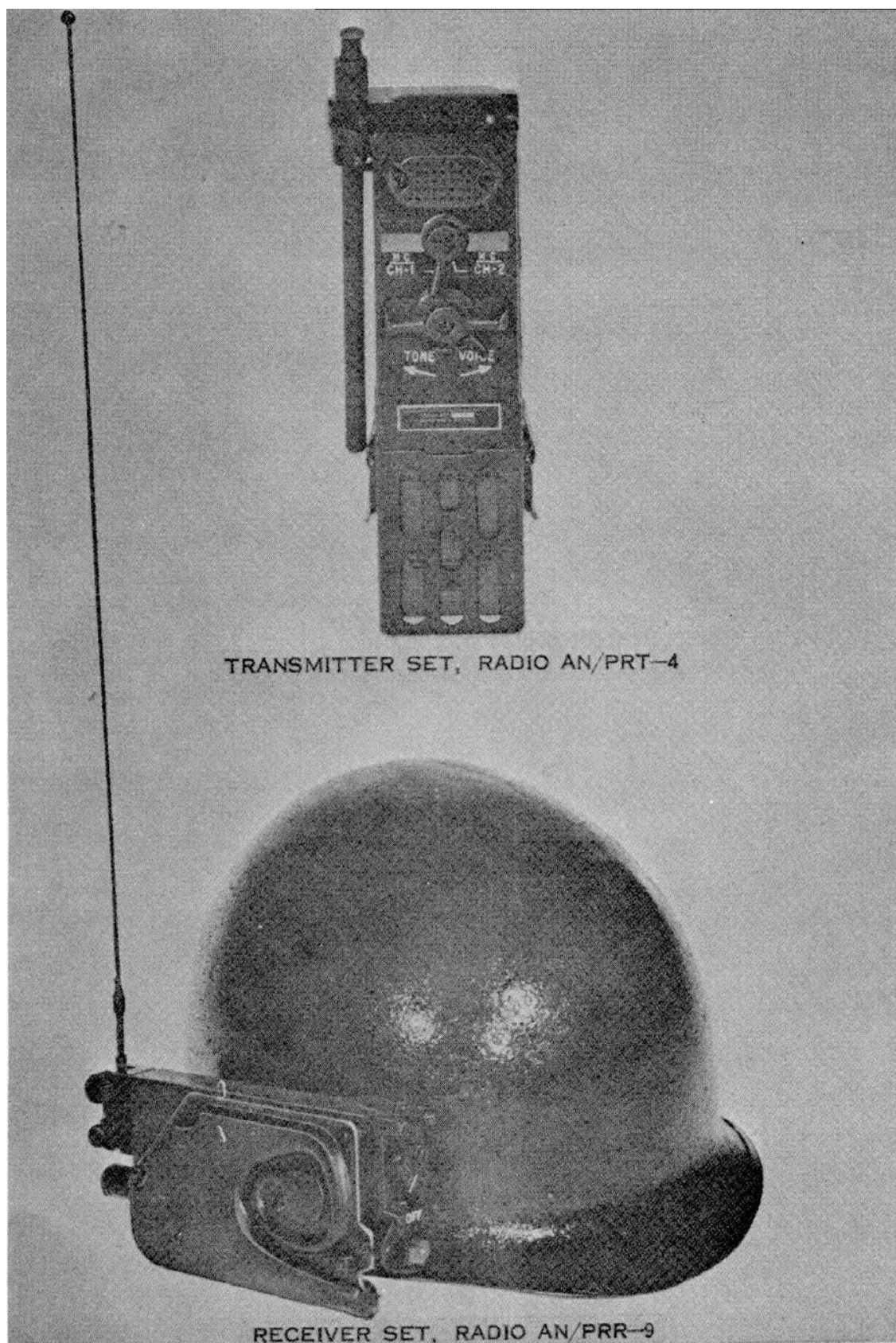

Figure 1-1. Receiving Set, Radio AN/PRR-9 and Transmitting Set, Radio AN/PRT-4.

CHAPTER 1 INTRODUCTION

Section I. GENERAL

1-1. Scope

This manual describes Receiving Set, Radio AN/PRR-9, Transmitting Set, Radio AN/PRT-4, and Transmitting Set, Radio AN/PRT-4A. The manual covers installation, operation, operator's maintenance, and organizational maintenance. It includes instructions for cleaning, checking, and inspecting the equipment and replacing batteries. The organizational maintenance chapter includes information on troubleshooting and repair procedures within the capabilities of the organization repairman. Alignment procedures are contained in TM 11-6625-937-12. Unless otherwise noted, all references to Transmitting Set, Radio AN/PRT-4 apply equally to Transmitting Set, Radio AN/PRT-4A.

1-2. Maintenance Forms and Records

Maintenance forms, records, and reports which are to be used by maintenance personnel at all maintenance levels are listed and prescribed by TM 38-750.

1-3. Reporting of Equipment Publication Improvements and Administrative Storage

a. Reporting of Equipment Publications Improvements. The reporting of errors, omissions, and recommendations for improving this publication by the individual user is encouraged. Reports should be submitted on DA Form 2028 (Recommended Changes to Publications and Blank Forms) and forwarded direct to Command, US Army Electronics Command, ATTN: AMSEL-MA-Q, Fort Monmouth, NJ 07703.

b. Administrative Storage. For procedures, forms, and records, and inspections required during administrative storage of this equipment refer to TM 740-90-1.

1-3.1. Destruction of Army Materiel to Prevent Enemy Use

Follow procedures for the destruction of Army materiel to prevent enemy use as contained in TM 750-244-2.

Section II. DESCRIPTION AND DATA

1-4. Purpose and Use (fig. 1-1)

a. Receiving Set, Radio AN/PRR-9, is a battery-operated, frequency-modulated (FM), crystal-controlled radio receiver which is designed for quick attachment and use on the standard helmet. It receives voice and tone-modulated signals on a preset frequency in the band of 47 to 57 megacycles (mc). The operating frequency is determined by the crystal installed in the receiver. An audio horn transducer is attached to the side of the

receiver and directs sound under the rim of the helmet toward the operator's ear. The receiver also may be used with reduced range when carried in a shirt pocket or clipped to a harness. A headset is also supplied.

b. Transmitting Set, Radio AN/PRT-4 is a handheld, battery-operated, dual-channel, crystal-controlled frequency-modulated transmitter designed for use in ~~the~~ 47- to 57-megacycle band. It transmits either audio tone or voice communication on either of two chan-

TM 11-5820-549-12

nels. The AN/PRT-4A RF signal, in addition, is modulated by a 150-cycle-per-second signal that is used to disable the squelch circuit of Radio Set AN/PRC-25 or Radio Set AN/PRC-77. The frequencies of operation are determined by the crystals installed in the transmitter.

c. When used together, Receiving Set, Radio AN/PRR-9 and Transmitting Set, Radio AN/PRT-4 provide one-way, short-range, portable, tactical communication.

1-5. Technical Characteristics

a. Receiving Set, Radio AN/PRR-9.

Frequency range	47 to 57 mc
Tuning	Single channel, crystal-controlled
Crystal type (pluck-out)	CR-81/U
Crystal marking (pluck-out)	In megacycles, 10 7 mc below channel frequency
Receiver type	Double-conversion superheterodyne
Number of transistors	14
Number of diodes	6
Number of soldered-in crystals	1
Number of pluck-out crystals	1
Number of printed circuit boards	2
Intermediate frequency, first conversion	10 7 mc
Intermediate frequency, second conversion	455 kc
Sensitivity at 5-milliwatt output with 5-volt battery source	0 5 v max
Image rejection	40 db
IF rejection	60 db
Frequency stability	0 01 %
Power output	5 mw nominal
Squelch release point for 10-db noise reduction	less than 0 5 μv

Frequency response (± 3 db)	300 to 2,500 cps
Battery type required	BA-505/U
Current drain 5 volts with squelch disabled	19 5 ma
Current drain 5 volts with squelch activated	12 5 ma

b. Transmitting Set, Radio AN/PRT-4.

Frequency range	47 to 57 mc
Type of modulation	Fm
Oscillator	Voltage-controlled, crystal-stabilized

Power output at 30% efficiency	
Channel 1	450 mw at 12 vdc
Channel 2	50 to 250 mw at 12 volts dc
Type of signal	Voice or internally generated tone
Number of transistors	
AN/PRT-4	13
AN/PRT-4A	11
Number of diodes	8
Number of soldered-in crystals	1
Number of pluck-out crystals	2
Crystal type (pluck-out)	CR-81/U
Crystal marking (pluck-out)	In megacycles, 10 7 mc below channel frequency
Printed circuit boards	3
Integrated circuits (AN/PRT-4A)	1
Battery type required	BA-399/U
Battery drain	
Channel 1	150 ma max at 12 volts dc
Channel 2	90 ma ± 5 max at 12 volts dc

1-6. Components

The components of Receiving Set, Radio AN/PRR-9 and Transmitting Set, Radio AN/PRT-4 are listed in the following chart:

Quantity	Item	Height (in)	Depth (in)	Width (in)	Unit Weight (oz)
1	Receiving Set, Radio AN/PRR-9, less antenna, lanyard, headset, harness slide, and battery	3 3/8 ^a	1 1/2	6 7/8	7 3
1	Antenna AS-1998/PRR-9	18 1/2			0 3
1	Headset, Electrical H-264/PRR-9				1 1
1	Lanyard assembly, receiving set	16			
1	Slide harness	1 1/8			0 75
1	Receiver Battery, Dry BA-505/U				1.1 b

Quantity	Item	Height (in)	Depth (in)	Width (in)	Unit Weight (oz)
1	Transmitting Set, Radio AN/PRR-9, less lanyard, slide harness and battery	9	2 1/4	3	15 6
1	Lanyard assembly, transmitting set	11			0 4
1	Slide harness	1 1/8			0 75
1	Transmitter Battery, Dry BA-399/U				i i ^b

^a Height, including antenna, is 21 1/2 in

^b Used with, but not supplied with, equipment

1-6.1. Items Comprising an Operable Equipment

<i>FSN</i>	<i>Qty</i>	<i>Nomenclature part No and mfr code</i>	<i>Fig No</i>
------------	------------	--	---------------

NOTE

The part number is followed by the applicable five digit Federal supply code for manufacturers or distributor or Government agency, etc , which is identified in SB 708-42

NOTE

Dry batteries shown are used with the equipment but are not considered part of the equipment They will not be preshipped automatically but are to be requisitioned in quantities necessary for the particular organization in accordance with SB 11-6

5820-069-8931		Receiving Set Radio AN/PRR-9, which includes	1-2
5985-933-2878	1	Antenna Assembly AS-1998/PRR-9, SM-C-523228, 80063	1-2
5965-926-2591	1	Headset Electrical H-264/PRR-9, SM-B-523427 80063	1-2
5820-868-8107		Transmitting Set Radio AN/PRT-4, which includes	1-3
5985-926-2589	1	Antenna Assembly AS-1999/PRT-4, AM-D-523372, 80063	1-3
5820-908-9189	1	Case Battery CY-6115/PRT-4, SM-C-523258, 80063	1-3
5820-133-8980		Transmitting Set Radio AN/PRT-4A, which includes	1-3
5985-926-2589	1	Antenna Assembly AS-1999/PRT-4A, AM-D-523372, 80063	1-3
5820-908-9189	1	Case Battery CY-6115/PRT-4A, SM-C-523258, 80063	1-3

1-7. Common Names

A list of the nomenclature assignments for the components of Receiving Set, Radio AN/PRR-9 and Transmitting Set, Radio AN/PRT-4 is given below. A common name is given after each item.

Nomenclature	Common name
Receiving Set, Radio AN/PRR-9	Receiver.
Transmitting Set, Radio AN/PRT-4	Transmitter.
Lanyard assembly, receiving set	Receiver lanyard.
Headset, Electrical H-264/PRR-9	Headset.
Cord Assembly, Electrical CX-1022/PRR-9 (p/o Headset, Electrical H-264/PRR-9)	Headset cord.
Slide, harness	Slide.
Lanyard assembly, transmitting set	Transmitter lanyard.
Antenna AS-1998/PRR-9	Receiver antenna.
Antenna AS-1999/PRT-4	Transmitter antenna.
Case, Battery CY-6115/PRT-4	Battery case.
Receiver on, OFF, volume, and squelch control.	Receiver control.
Indicator, Channel Alignment ID-1189/PR ^a .	Alignment indicator.

^a Not a part of Receiving Set, Radio AN/PRR-9 and Transmitting Set, Radio AN/PRT-4. Use for organizational maintenance.

1-8. Description of Receiving Set, Radio AN/PRR-9 (fig. 1-2)

a. General. The AN/PRR-9 is a self-contained, single-channel receiver designed to be used on a standard combat helmet, clipped to a harness, or placed in a shirt pocket. A lanyard is used as a retainer to prevent loss. Three clips are mounted on the receiver case, two of which are used to clip the receiver to the helmet, and the other can be used to clip the receiver to a harness.

b. Receiver Assembly. The electronic assembly is removed from the receiver by removing two screws (fig. 5-5) and pulling the assembly out of the case. Removal is required when changing the channel frequency or aligning the receiver.

c. Receiver Antenna. Two nomenclatures, AS-1998/PRR-9 and AS-1998A/PRR 9, indicating slight design differences, apply to the receiver antenna. The two models of the antenna are directly interchangeable. Both models of the receiver antenna are flexible stainless steel whips 18 inches long. The antenna is mounted to the antenna housing by the antenna retaining screw. The antenna housing is constructed to permit either two operating positions 90° apart, or in a later version, three operating positions 45° apart. When the receiver is clipped to the helmet (fig. 1-1), the antenna is positioned perpendicular to the length of the receiver. When the receiver is clipped to the harness, the antenna is positioned parallel to the length of the receiver.

d. Receiver Control. A single, multipurpose control (fig. 3-1) functions as an on-off switch, volume control, and squelch control.

e. Horn Transducer. A horn speaker directs the sound toward the operator's ear when the receiver is worn on the helmet. Holes in the horn direct the sound toward the operator's ear.

1-9. Minor Components of Receiving Set, Radio AN/PRR-9 (fig. 1-2)

a. Lanyard Assembly Receiving Set. The receiver lanyard is a 16-inch long cord with a loop at one end and a compression clasp at the other. The loop is fastened to the eyelet on the receiver, and the clasp attached to the slide on the field pack suspenders.

b. Headset, Electrical H-264/PRR-9. The headset can be worn in the ear to provide secure communication, or for better understanding in noisy areas. It is attached to the receiver with Cord Assembly, Electrical CX-1022/PRR-9 (p/o Headset, Electrical H-264/PRR-9). The plug on the cord fits into the connector receptacle in the receiver (fig. 3-1).

c. Slide, Harness. The slide is worn on Suspenders, Field Pack, Combat M-1956. The clasp on the receiver lanyard is secured to the slide.

**1-10. Description of Transmitting Set,
Radio AN/PRT-4
(fig. 1-3)**

a. *General.* The transmitter is a self-contained, dual-channel radio transmitter capable of transmitting voice or internally generated tone signals. It may be operated on either of two channels which may be separated up to 1 mc in frequency. The transmitter is handled during use. When not in use, it may be clipped to a pocket or belt. A lanyard may also be used to prevent loss.

b. *Access to Electronic Assembly.* Access to the electronic assembly (fig. 5-7) is gained by removing four screws and the rear cover. Access is required when changing one or both channel frequencies or aligning the transmitter.

c. *Transmitter Antenna.* The collapsible antenna is approximately 24 inches long when extended, and slides down along the side of the transmitter when collapsed.

d. *Transmitter Controls.* Two controls are required for operating the transmitter (fig. 3-2). The upper selector switch is used to determine the correct channel or frequency. The TONE-VOICE switch is used to select the type of transmission.

e. *Microphone.* The microphone above the upper selector switch (fig. 3-2) is used during voice transmission.

f. *Case, Battery CY-6115/PRT-4.* The battery case serves as a retainer for the transmitter battery. It is held to the transmitter by two clamps.

**1-11. Minor Components of Transmitting Set, Radio AN/PRT-4
(fig. 1-3)**

a. *Lanyard Assembly Transmitting Set.* The transmitter lanyard is an 11-inch long cord with a loop at one end and a clasp at the other. The loop is fastened to a bale on the bottom of the battery case, and the clasp is attached to the slide or field pack suspenders.

b. *Slide, Harness.* The slide is worn on suspenders, Field Pack Combat M-1956. The clasp on the transmitter lanyard is secured to the slide.

1-12. Additional Equipment Required

a. Battery, Dry BA-505/U (fig. 1-2) is not supplied as part of the receiver but is required for its use. A two-conductor male connector in the receiver mates with the connector in the battery. The BA-505/U provides a nominal 5 volts.

b. Battery, Dry BA-399/U (fig. 1-3) is not supplied as part of the transmitter but is required for its use. A four-conductor male connector in the bottom of the transmitter mates with a connector in the battery. The BA-399/U consists of two 7 1/2-volt sections.

c. Crystals, type CR-81/U, are supplied for the receiver and both channels of the transmitter for operation on 51 mc. The crystals are marked 40.3 mc, which is 10.7 mc below the operating frequency. Crystals for operation on other frequencies may be required by the using organization, but are not furnished as part of the radio sets. Possible operating frequencies of 47 mc (crystal marked 36.3 mc) to 57 mc (crystal marked 46.3) may be used in the receiver or transmitter (para 5-17c). A second operating frequency within 1 mc of the first may also be used in the transmitter.

d. Arctic accessories are required for operation of the receiver and transmitter under arctic conditions, but are not supplied as part of the transmitter or receiver. Use and application of the arctic accessories are covered in paragraphs 2-12 and 3-7. The arctic accessories (fig. 1-4) consist of the following:

(1) Cable Assembly, Special Purpose, Electrical CX-11990/PRR-9 (receiver battery extender cable) Federal Stock No. (FSN) 5995-179-8256.

(2) Cable Assembly, Special Purpose, Electrical CX-11991/PRT-4 (transmitter battery extender cable) FSN 5595-179-8257.

(3) Harness, Electrical Equipment ST-1 153/PRR-9 (receiver harness) FSN 5820-443-1050.

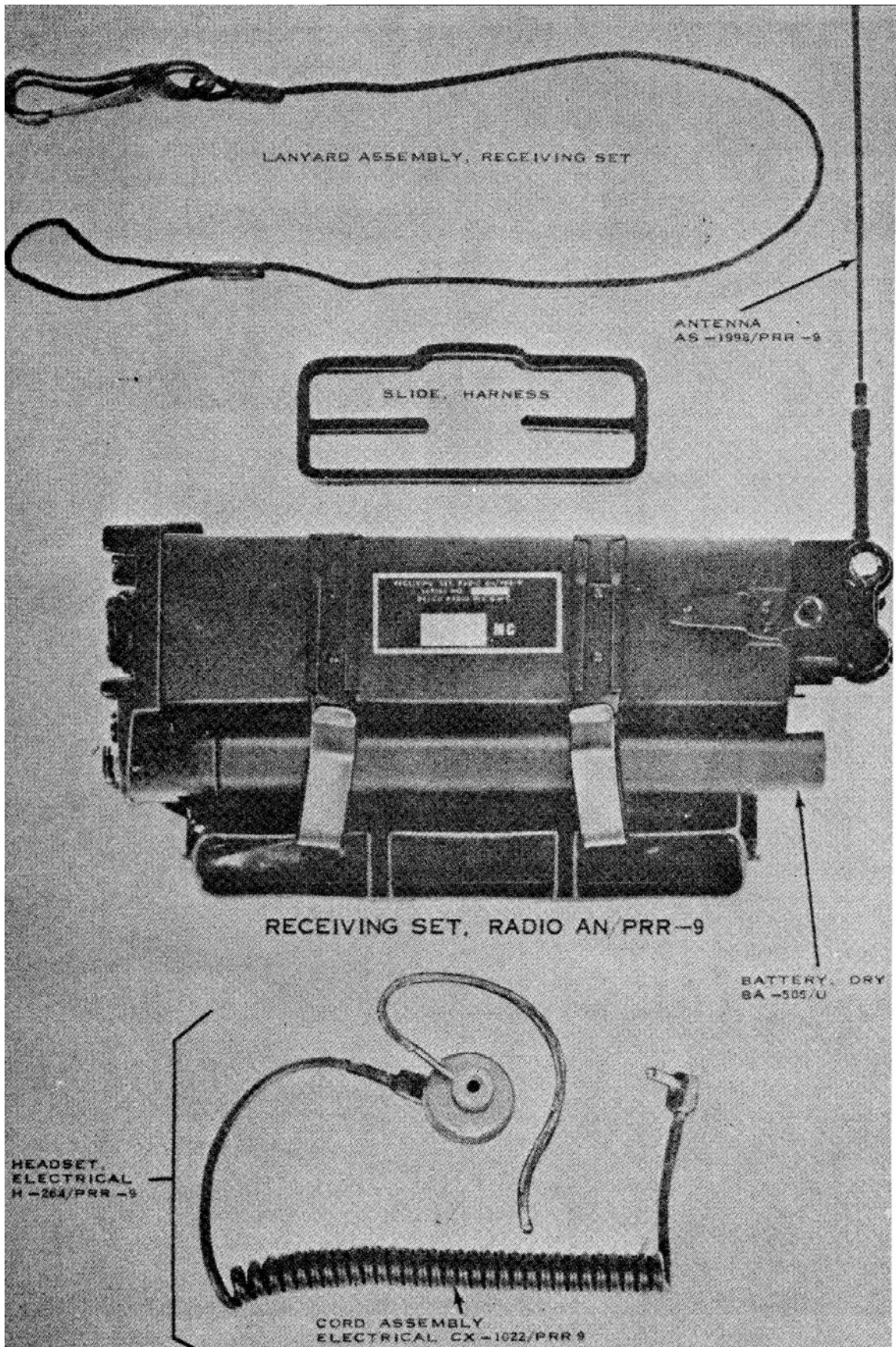

Figure 1-2. Receiving Set, Radio AN/PRR-9, components.

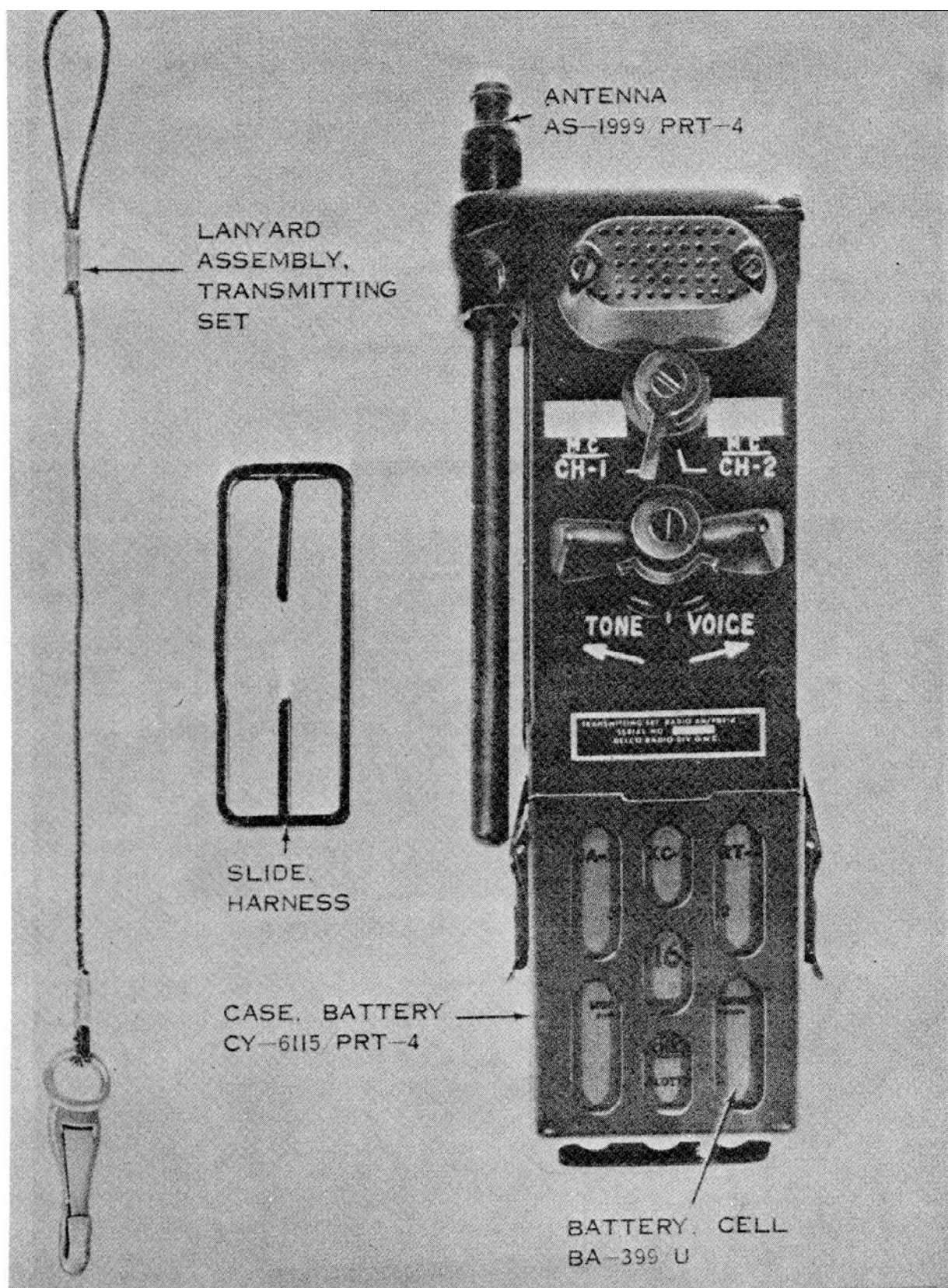

Figure 1-3. Transmitting Set, Radio AN, PRT-4, components.

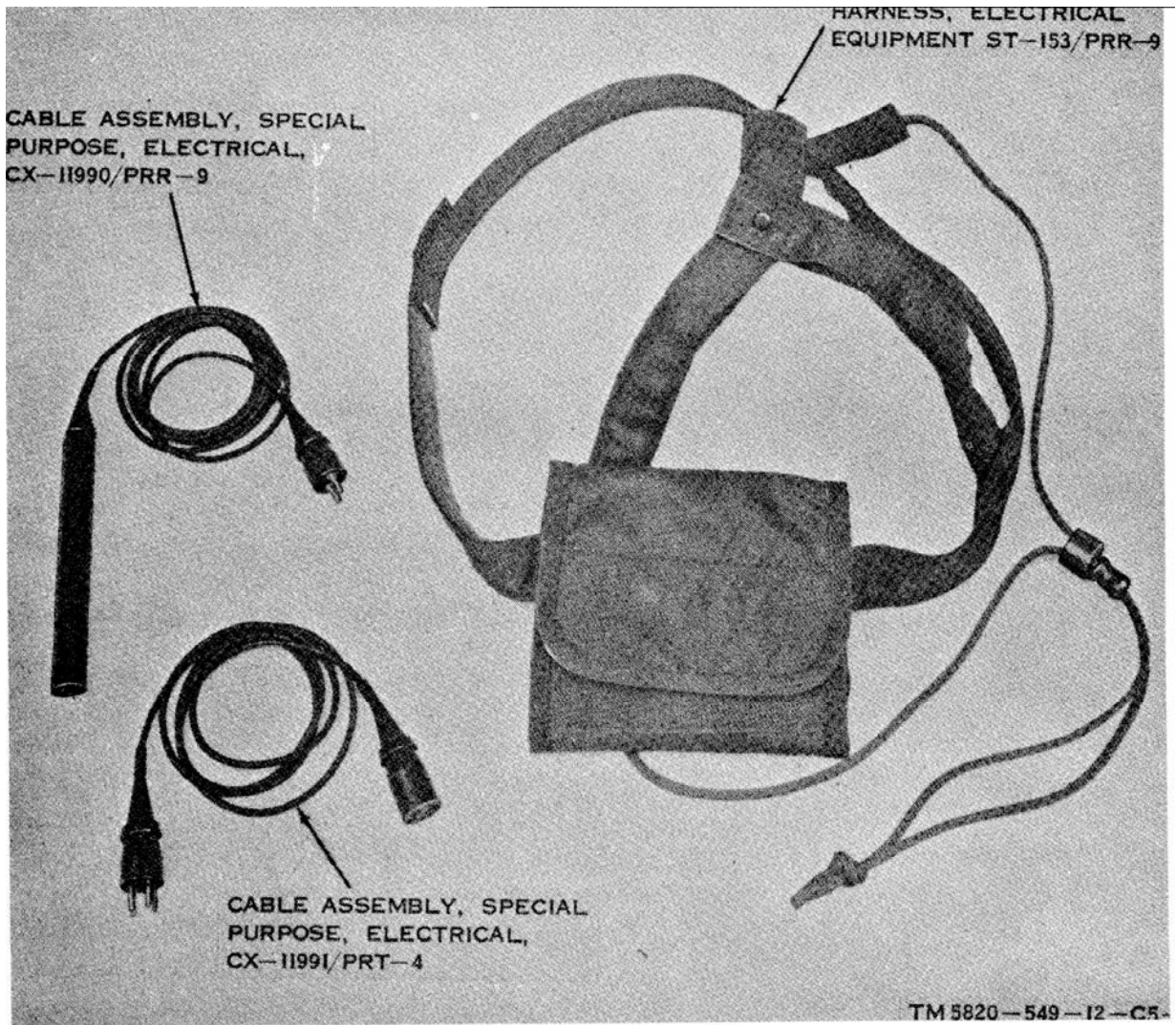

Figure 1-4. Arctic accessories.

CHAPTER 2 INSTALLATION

2-1. Unpacking Receiving Set, Radio AN/PRR-9 (fig. 2-1)

a. Packaging Data. When packed for shipment, the components of one receiver are placed

in an inner carton. A moisture-vaporproof barrier is placed around the inner carton. This package is placed in an outer unit carton. Twenty-five unit cartons are placed in a wooden packing box.

Package	Overall dimensions (in.)			Volume (cu ft)	Weight (lb)	Contents
	Height	Width	Depth			
Wooden crate -----	32	30-1/8	22-1/2	12.55	130	25 unit cartons. Receiver and antenna. Headset in envelope. Lanyard and slide in envelope. Technical manual in bag.
Unit carton -----	6	5-5/8	20-5/8	0.4	4-1/2	

c. Removing Contents.

Nota. When unpacking equipment that is packed only in cartons, omit the procedures given in (1), (2), and (8) below.

- (1) Cut and fold back the metal straps.
- (2) Remove the nails from the top and one side of the wooden packing box with a nailpuller. Do not pry off the boards. Prying may damage the equipment.
- (3) Open the moisture-vaporproof barrier that covers the unit cartons.
- (4) Remove the unit cartons and open those needed.
- (5) Remove any filler material and desiccant.

- (6) Remove and open the envelopes that contain the technical manual, headset lanyard, and slide.
- (7) Remove the receiver and receiver antenna.

2-2. Unpacking Transmitting Set, Radio AN/PRT-4 (fig. 2-1)

a. Packaging Data. When packed for shipment, the components of one transmitter are placed in an inner carton. A moisture-vaporproof barrier is placed around the inner carton. This package is placed in an outer unit carton. Twenty-five unit cartons are placed in a wooden packing box.

Package	Overall dimensions (in.)			Volume (cu ft)	Weight (lb)	Contents
	Height	Width	Depth			
Wooden crate -----	34-1/2	28-7/8	17	9.8	120	25 unit cartons. Transmitter. Lanyard and slide in envelope. Technical manual in bag.
Unit carton -----	6-1/2	5-3/8	15-1/8	0.8	4-1/2	

b. Removing Contents.

NOTE

When unpacking equipment that is packed only in cartons, omit the procedures given in (1), (2), and (3) below.

(1) Cut and fold back the metal straps.

(2) Remove the nails from the top and one side of the wooden packing box with a nailpuller. Do not pry off the boards. Prying may damage the equipment.

(3) Open the moisture-vaporproof barrier that covers the unit cartons.

(4) Remove the unit cartons and open those needed.

(5) Remove any filler material and desiccant.

(6) Remove and open the envelopes that contain the technical manual, lanyard, and slide.

(7) Remove the transmitter.

2-3. Checking Unpacked Equipment

a. Inspect the equipment for possible damage incurred during shipment. If the equipment has been damaged, report the damage on DD Form 6.

b. See that the equipment is complete as listed on the packing slip. If the packing slip is not available, check the equipment against the basic issue items list (app B) and paragraph 1-6.1. Report all discrepancies in accordance with AR 735-11-2.

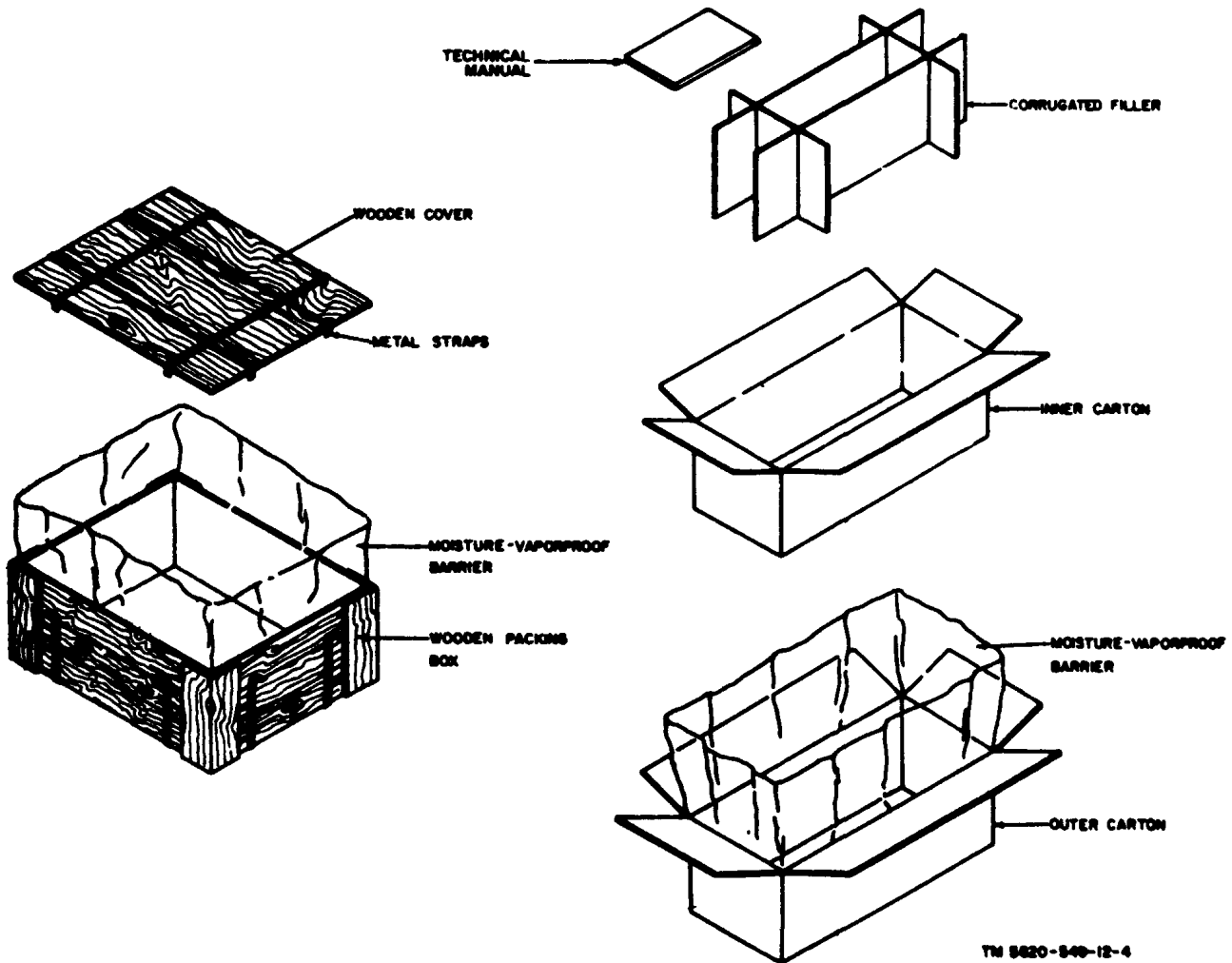

Figure 2-1. Typical packaging.

Shortage of a minor assembly or part that does not affect proper functioning of the equipment should not prevent use of the equipment.

c. If the equipment has been used or reconditioned, see whether it has been changed by a modification work order (MWO). If the equipment has been modified, the MWO number will appear on the front panel near the nomenclature plate. Check to see whether the MWO number (if any) and appropriate notations concerning the modification have been entered in the equipment manual.

Nota. Current MWO's applicable to the equipment are listed in DA Pam 310-4.

2-4. Siting

a. *General.* The AN/PRR-9 and AN/PRT-4 operate at low-power and on high frequencies; therefore, the location of the equipment greatly affects the operating range. Normally, a line-of-sight range can be expected; that is, if receiver can be seen from the transmitter location, satisfactory operation is probable. An intervening hill or a tall building may

hamper or prevent contact. Valleys, densely wooded areas, and low places may reduce the range of communications. Location on a hill-top or tower, especially if both transmitter and receiver are so located, will increase the operating distance. If possible, avoid locations near a source of electrical interference such as powerlines or telephone lines, radar sets, and field hospitals.

b. *Transmitting Antenna Angles.* The operating range of the equipment can be controlled to a certain extent by the angle of the transmitting antenna (fig. 2-2). When the transmitter is held so that the antenna is vertical, that is, perpendicular to the ground, equal range of transmission is obtained in all directions. When the transmitter is held so that the antenna is tipped forward, the minimum transmission is in front of the operator, and the maximum transmission distance is behind him.

2-5. Installing Antenna AS-1998/PRR-9

(fig. 2-3, 2-3.1, and 2-3.2)

a. Loosen the antenna retaining screw by turning it counterclockwise, and remove. Note

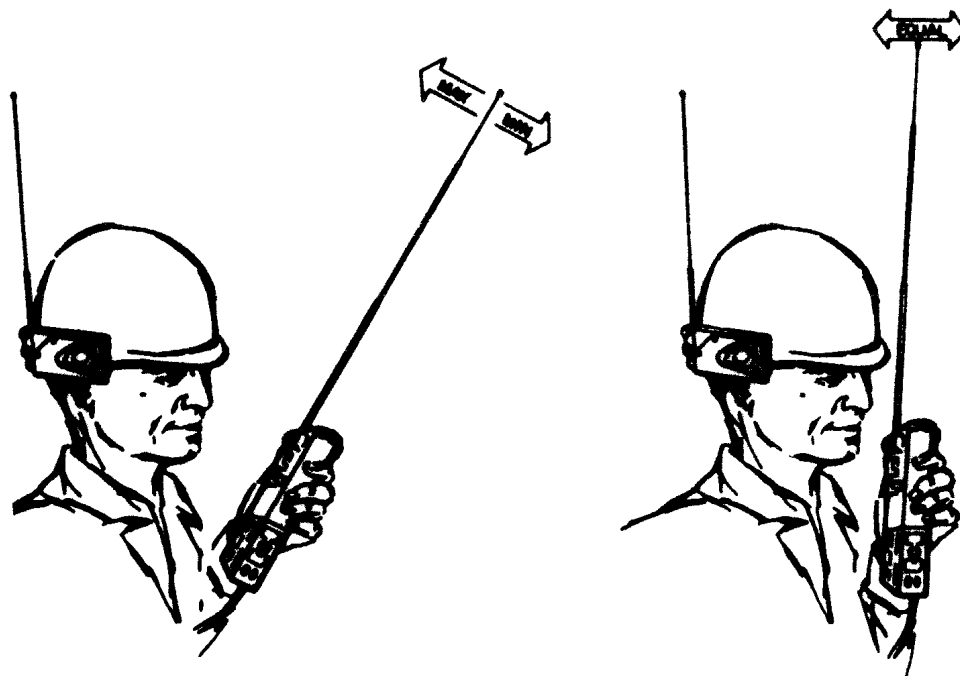

TM 5820-549-12-6

Figure 2-2. Effect of transmitter antenna angles.

Change 7 2-3

that this screw has two sets of threads. The smaller threads fit the brass insert in the antenna housing. The larger threads fit the hole on the opposite side of the antenna housing.

CAUTION

An antenna with two sets of blades (A, fig. 2-3.1) installed on the Receiving Set, Radio AN/PRR-9 or an antenna with a single set of blades, (B, fig. 2-3.1) improperly installed can possibly work loose from its locked-in position and could result in poor reception and could also result in loss of the antenna. Earlier models of Antenna AS-1998/PRR-9 that contain two sets of blades should be returned to organizational maintenance for removal of one set of blades (para 5-11).

b. Fit the lower end of the antenna (the end with the hole) between the two members of the antenna housing, making sure the set of blades faces the slotted brass insert (fig. 2-3.2).

NOTE

Later models of the receiver use a modified antenna retaining screw. This screw uses spring pressure to maintain the antenna position. This type of screw can be tightened at once (e below) as it permits changing the antenna position by exerting pressure against the spring.

c. Place the antenna retaining screw through the larger hole in the antenna housing, then through the antenna, and into the smaller hole in the antenna housing. Do not tighten.

d. Rotate the antenna until the blades in the lower end of the antenna fit into the desired grooves in the brass insert of the antenna housing. If the receiver is to be worn on the helmet, the antenna should be perpendicular (at a right angle) to the long dimension of the receiver. When the receiver is to be carried in a pocket, use the other set of grooves in the brass insert of the antenna housing. For best

reception, the antenna should be positioned vertically with respect to the ground.

e. Tighten the antenna retaining screw securely with finger pressure. Do not over-tighten.

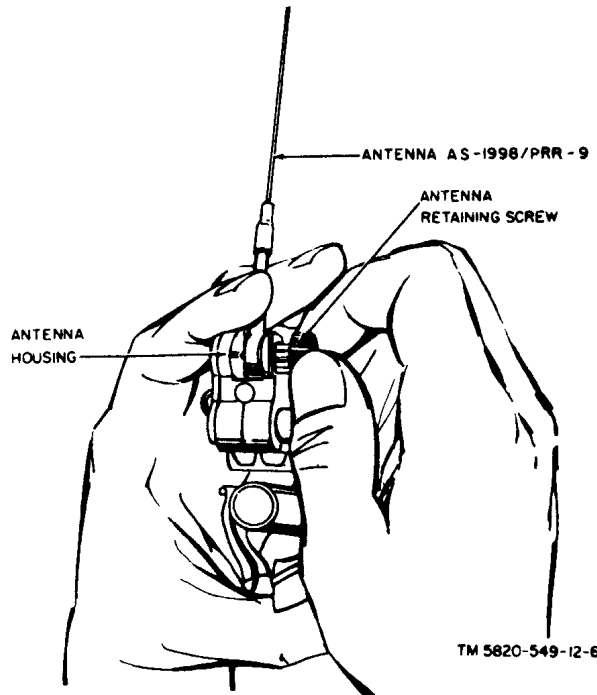

Figure 2-3. Antenna AS-1998/PRR-9, installation.

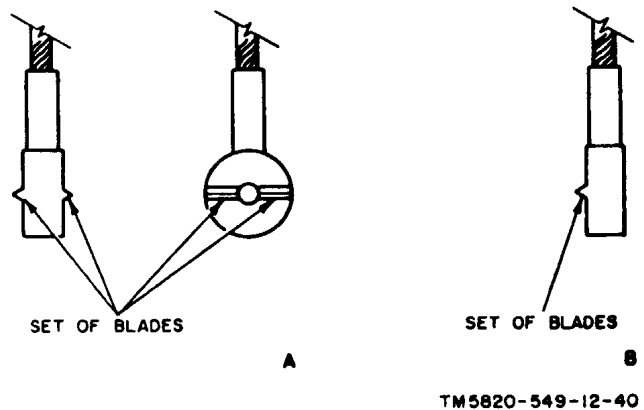
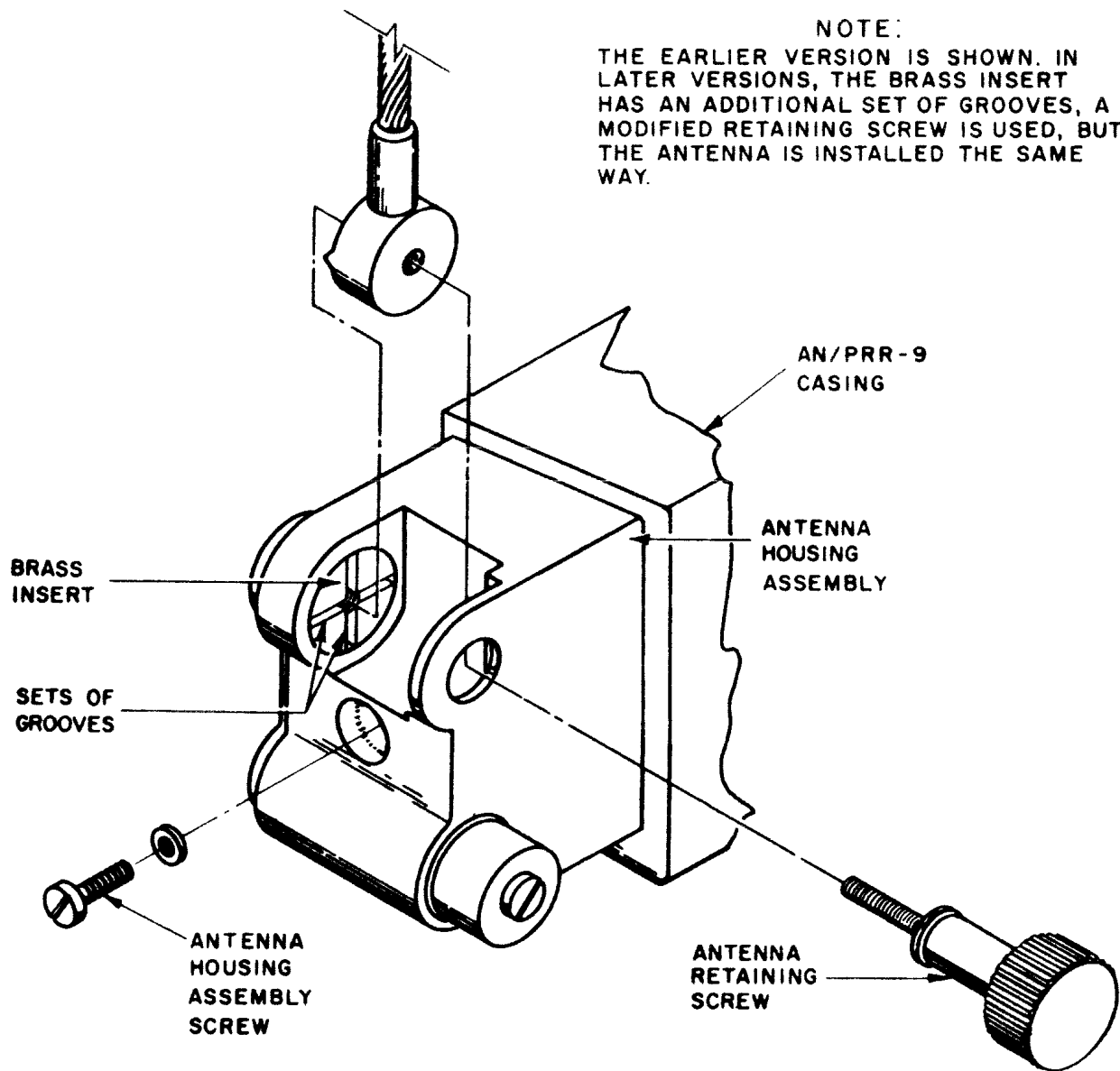

Figure 2-3.1 Edge views and face view, lower end of Antenna AS-1998/PRR-9.



TM 5820-549-12-C5-6

Figure 2-3.2 AN/PRR-9 antenna housing assembly and antenna installation detail.

2-6. Installing Battery, Dry BA-505/U (fig. 2-4)

CAUTION

If the receiver is not to be used immediately, be certain the receiver control is turned to the off position (completely counterclockwise). Remove the battery when the receiver is not to be used for a day or more.

a. With the receiver held in one hand, slide the new BA-505/U through the battery retaining clip.

b. Mate the battery connector with the battery contact pins on the receiver and push firmly into place. Note that the larger pin mates with the larger hole in the battery.

c. If the receiver is not to be used immediately, be sure the receiver control is in its maximum counterclockwise or off position.

2-7. Installing Battery, Dry BA-399/U
(fig. 2-5)

a. Release the clamps on the battery case, and remove the battery case. If the antenna is in the way, pull it up until it clears the battery case clamp. Put the battery case aside.

b. Insert the new BA-399/U so that its connector fits the mating pins in the transmitter housing. Push the battery firmly into place.

c. Replace the battery case and fasten the clamps.

CAUTION

Remove the BA-399/U when the equipment is not to be used for 1 day or more.

2-8. Installation of Receiver Lanyard
(fig. 3-1)

If the lanyard is to be used, put the loop end of the lanyard through the eyelet on the receiver. Pull the clasp end of the lanyard through this loop. Pull the loop tight. Attach the clasp end of the lanyard to the slide on the combat suspenders.

2-9. Installation of Transmitter Lanyard
(fig. 3-2)

If the lanyard is to be used, place the loop end of the lanyard around the bale in the bottom of the transmitter battery case. Pull the

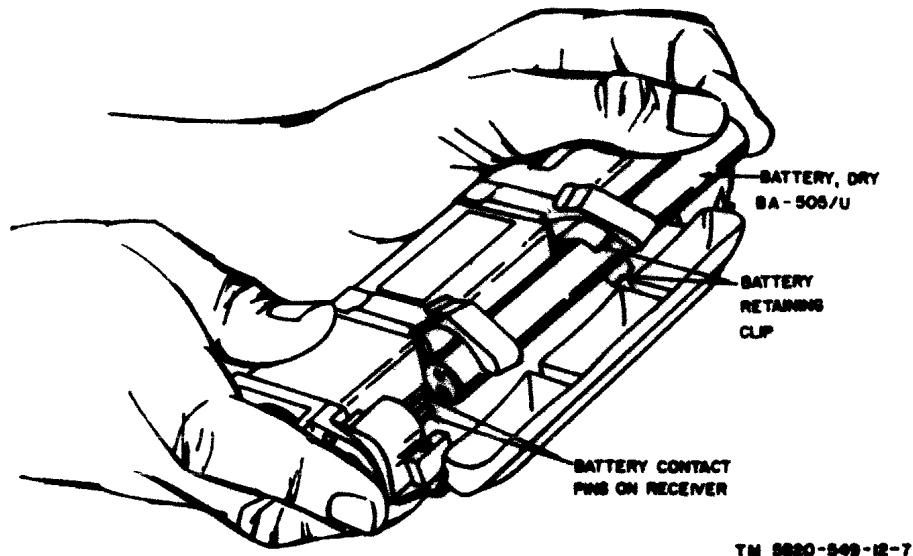

Figure 2-4. Battery, Dry BA-505/U, installation.

clasp end of the lanyard through this loop and tighten firmly against the bale. Attach the clasp to the slide on the combat suspenders.

2-10. Installing Receiver on Helmet
(fig. 2-6)

a. The receiver is normally worn on the helmet (not the helmet liner) opposite the operator's right ear, with the receiver control in the front and the antenna at the rear (fig. 1-1)

b. Place and push the receiver on the helmet so that the rim of the helmet fits all the way into the helmet clips on the receiver.

2-11. Installing Headset, Electrical H-264/PRR-9
(fig. 2-7)

a. Install Cord Assembly, Electrical CX-1022/PRR-9 by pushing the two-pin end into the receptacle on the headset.

b. Loop the end of the headset holder around the ear and place the earpiece of the headset into ear opening. If the headset is to be worn in the left ear, the headset can be reversed in its holder.

c. Plug the connector on the opposite end of the cord assembly into the receiver jack. Access to the receiver jack, which is located below the receiver control (fig. 3-1), is made by lifting the spring cover marked "P".

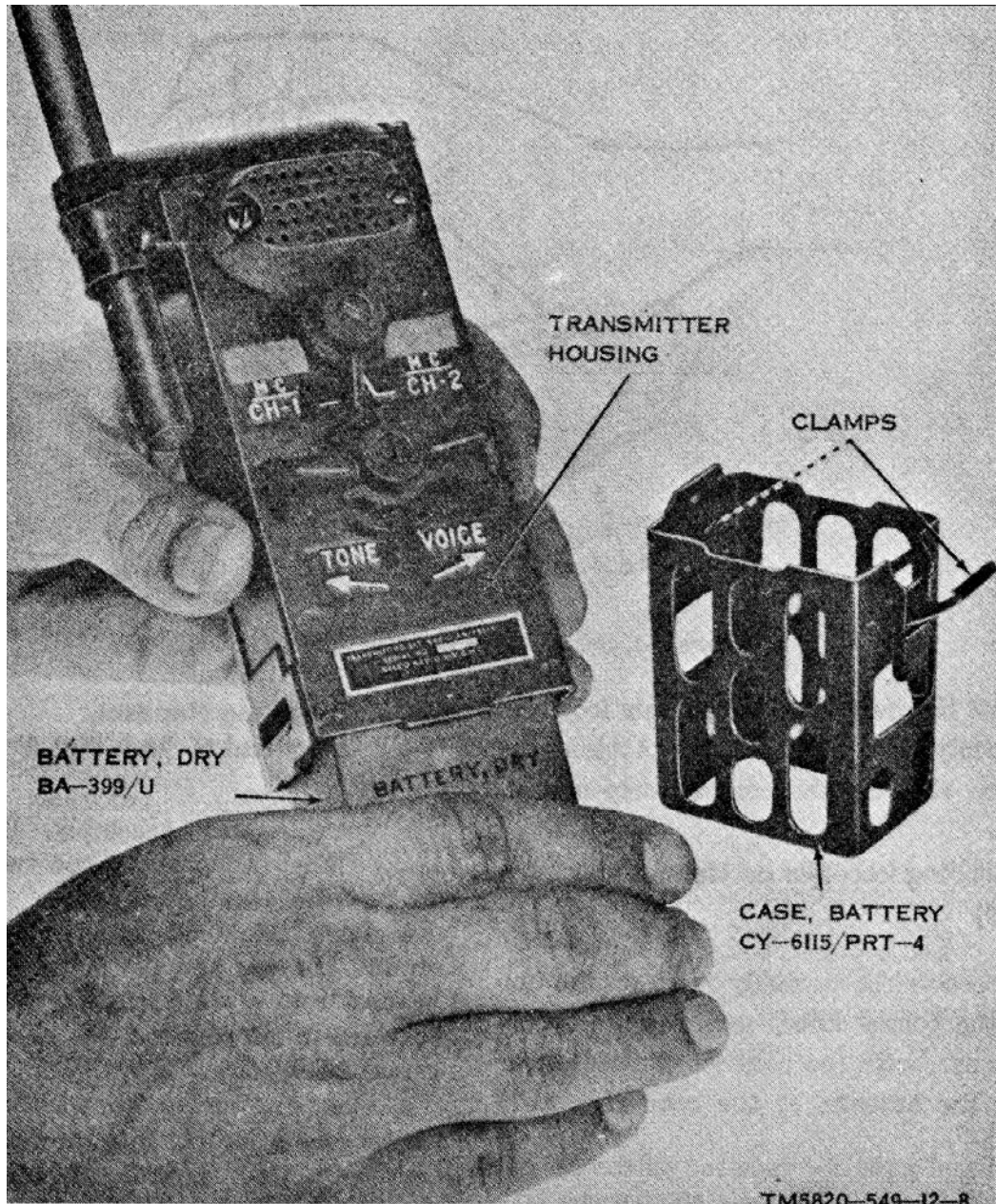
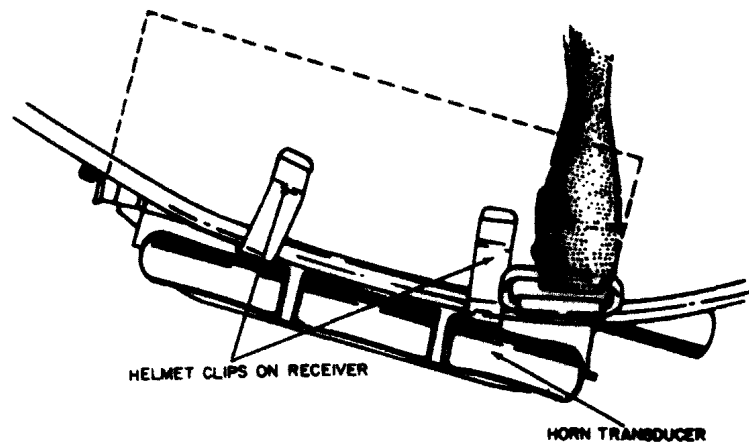
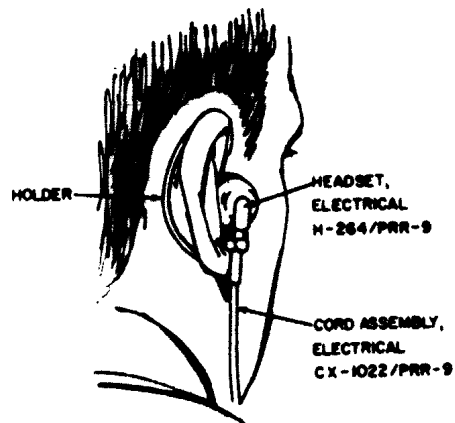

Figure 2-5. Battery, Dry BA-399/U, installation.



TM 5820-549-12-9

Figure 2-6. Receiving Set, Radio AN/PRR-9, installation on helmet.



TM 5820-549-12-10

Figure 2-7. Headset, Electrical H-264/PRR-9, installation.

2-12. Battery and Harness Installation, Arctic Conditions

a. Receiver Battery (A, fig. 2-8).

CAUTION

When connecting the CX-11990/PRR-9 receiver battery extender cable, make certain that the large pin of the plug connectors mates with the large hole of the socket connectors.

(1) Mate the receiver socket connector of the CX-11990/PRR-9 receiver battery extender cable with the battery contact pins and firmly push into place.

(2) Mate the battery plug connector with the battery socket and firmly push the two together.

b. Transmitter Battery (B, fig. 2-8).

CAUTION

When connecting the CX-11991/PRT-4 transmitter battery extender cable, make certain to match up the pins on the plug connector to the holes on the socket connector by observing the spacings between pins.

(1) With the CX-11991/PRT-4 transmitter battery extender cable, laced through the battery case in the correct direction, mate the transmitter socket connector with battery contact pins and firmly push in place.

(2) Mate the battery plug connector with the battery socket and firmly push the two together.

(3) Position the battery case for mounting to the transmitter case and secure in place with the clamps. The battery case becomes part of the transmitter antenna ground plane.

c. Receiver Head Harness (fig. 2-9).

NOTE

The use of the harness is not required when the helmet is worn without a covering.

(1) Connect the receiver, receiver battery extender cable, and battery (*a* above).

(2) Position the receiver, with the side that exposes the helmet clips, toward the open receiver pouch (A, fig. 2-9) and hook the receiver helmet clips through the openings under the helmet clips belt.

(3) Wrap the hook area of the receiver pouch around the receiver (B, fig. 2-9) and firmly hold in position until the pile area of the receiver pouch is brought down over the receiver and firmly pressed against the hook area. All areas of contact between the hook area and pile area should be firmly pressed together. The receiver is now securely fastened in the receiver pouch.

(4) Position the harness, with the receiver installed in the receiver pouch, over the helmet covering (C, fig. 2-9) or whatever external head covering is used, and secure the harness in place with the harness straps and the harness chin strap. The two harness straps are fastened by contacting the pile area of one strap against the hook area of the other and pressing the two firmly together. The chin strap is secured in place by holding the loose end of the chain strap in one hand and pushing the lock in the direction of the chin.

(5) Unfasten the pile and hook areas of contact by peeling back one area from the other, starting at an edge of the contact area.

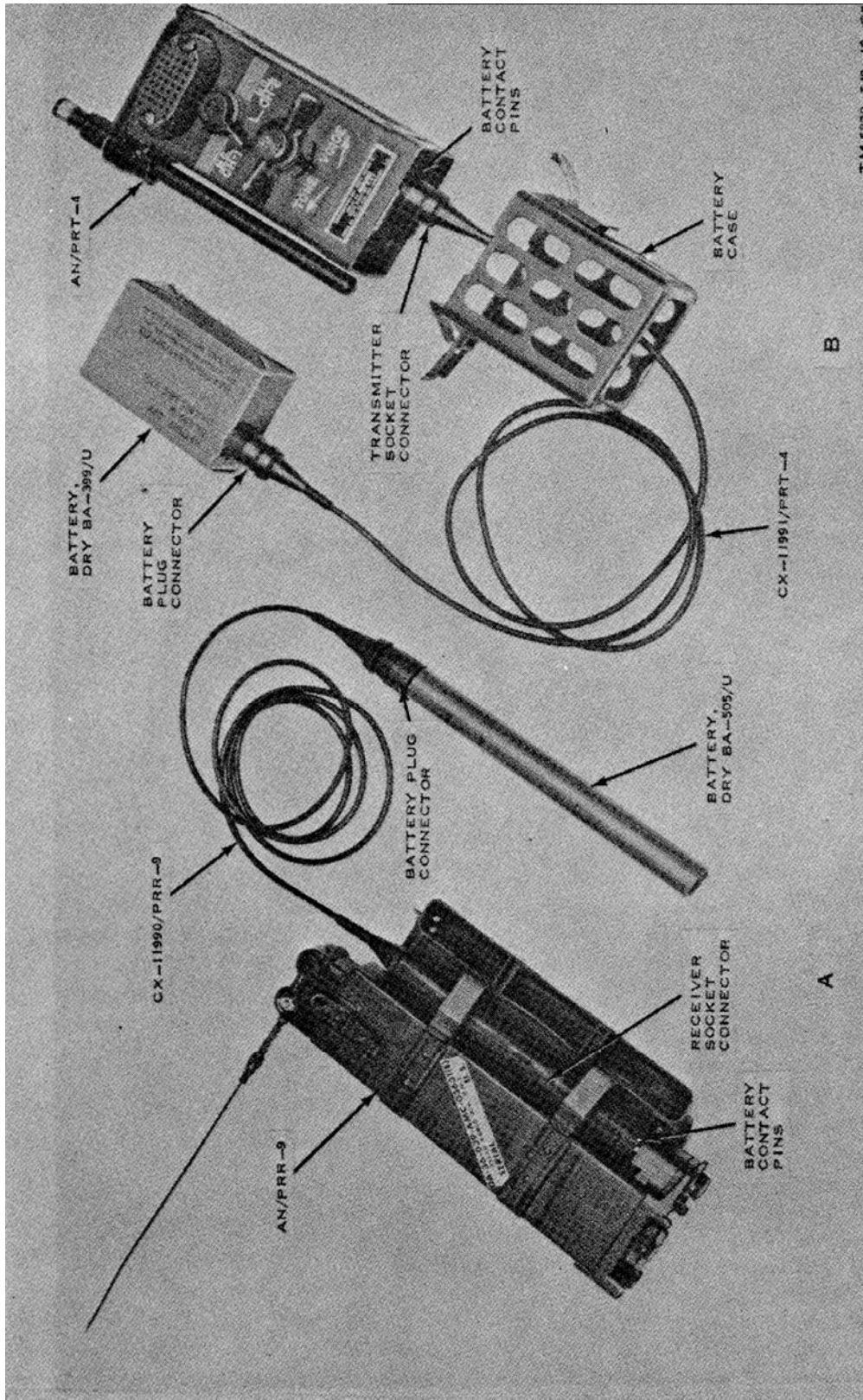

Figure 2-8. Battery extender cables installed.

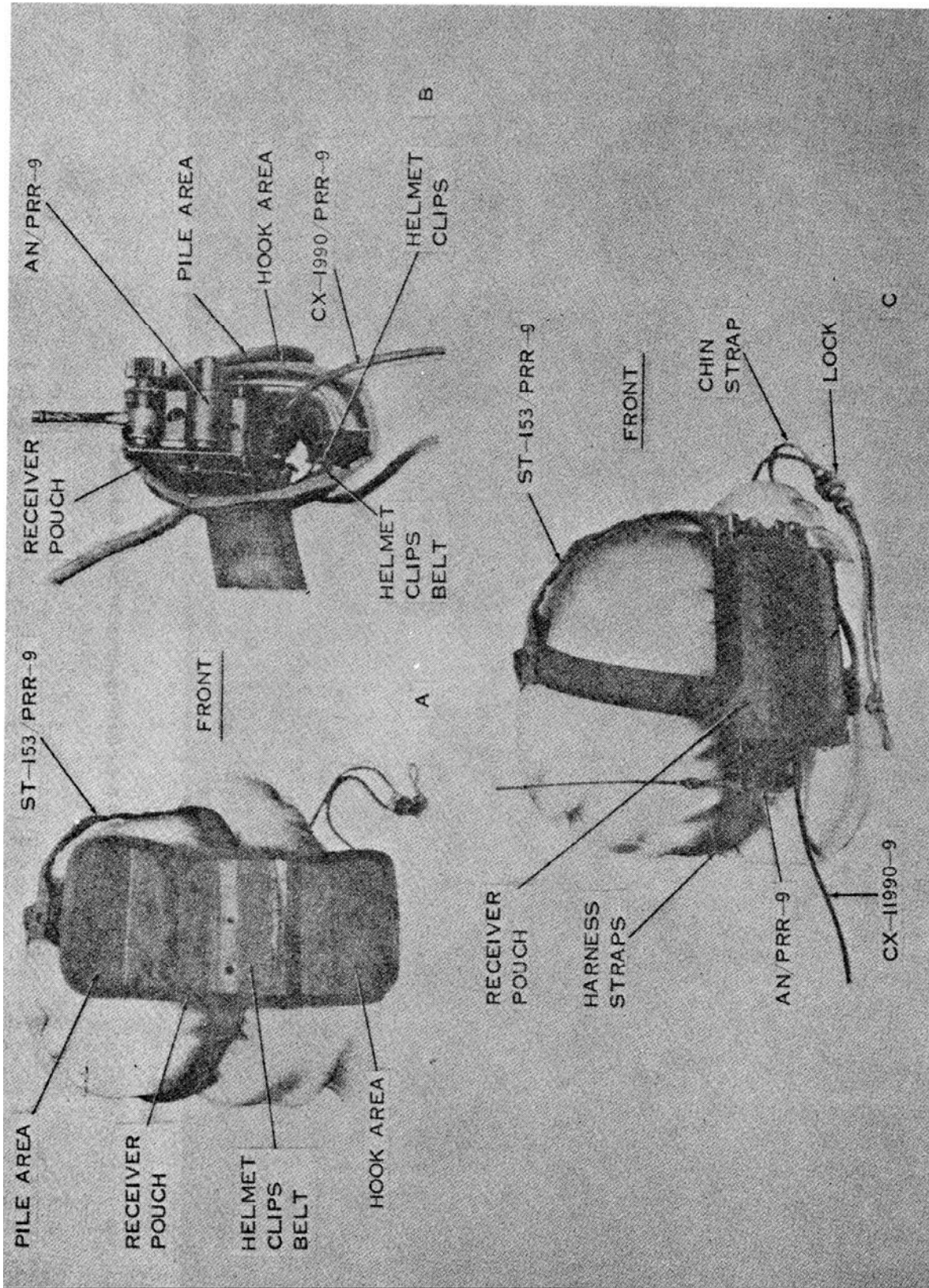

Figure 2-9. Receiver installation on ST-153/PRR-9 harness.

CHAPTER 3 OPERATING INSTRUCTIONS

3-1. Receiving Set, Radio AN/PRR-9 Control and Jack (fig. 3-1)

Control or jack	Function
Receiver control -----	Turns off power and resets squelch action when in the OFF position. When turned away from OFF position, turns on power, adjusts volume, and controls squelch operation.
Headset jack -----	Connection for headset plug. Spring-loaded cover market with a "P."

3-2. Transmitting Set, Radio AN/PRT-4 Controls (fig. 3-2)

Control	Function						
CH-1—CH-2 selector switch.	Selects channel.						
	<table style="width: 100%; border: none;"> <tr> <td style="text-align: center; width: 50%;">POS</td> <td style="text-align: center; width: 50%;">Function</td> </tr> </table>	POS	Function				
POS	Function						
TONE-VOICE switch (spring-loaded 3-position switch).	<table style="width: 100%; border: none;"> <tr> <td style="width: 50%;">TONE -----</td> <td>^aTurns on transmitter and transmits audio tone when switch is turned and held in direction of TONE arrow.</td> </tr> <tr> <td>VOICE -----</td> <td>^aTurns on transmitter and permits voice transmission when switch is turned and held in direction of VOICE arrow.</td> </tr> <tr> <td>Center off position.</td> <td>Turns transmitter off. Switch will return to this position if not held in TONE or VOICE position.</td> </tr> </table>	TONE -----	^a Turns on transmitter and transmits audio tone when switch is turned and held in direction of TONE arrow.	VOICE -----	^a Turns on transmitter and permits voice transmission when switch is turned and held in direction of VOICE arrow.	Center off position.	Turns transmitter off. Switch will return to this position if not held in TONE or VOICE position.
TONE -----	^a Turns on transmitter and transmits audio tone when switch is turned and held in direction of TONE arrow.						
VOICE -----	^a Turns on transmitter and permits voice transmission when switch is turned and held in direction of VOICE arrow.						
Center off position.	Turns transmitter off. Switch will return to this position if not held in TONE or VOICE position.						
Override spring -----	<table style="width: 100%; border: none;"> <tr> <td style="width: 50%;">TONE -----</td> <td>Permits TONE-VOICE switch to be pushed only in the TONE direction.</td> </tr> <tr> <td>Center (detent).</td> <td>Permits VOICE-TONE switch to be pushed in either direction.</td> </tr> <tr> <td>VOICE -----</td> <td>Permits the TONE-VOICE switch to be pushed only in the VOICE direction.</td> </tr> </table>	TONE -----	Permits TONE-VOICE switch to be pushed only in the TONE direction.	Center (detent).	Permits VOICE-TONE switch to be pushed in either direction.	VOICE -----	Permits the TONE-VOICE switch to be pushed only in the VOICE direction.
TONE -----	Permits TONE-VOICE switch to be pushed only in the TONE direction.						
Center (detent).	Permits VOICE-TONE switch to be pushed in either direction.						
VOICE -----	Permits the TONE-VOICE switch to be pushed only in the VOICE direction.						

^aIn addition, the AN/PRT-4A only, transmits a 150 cycle per second signal.

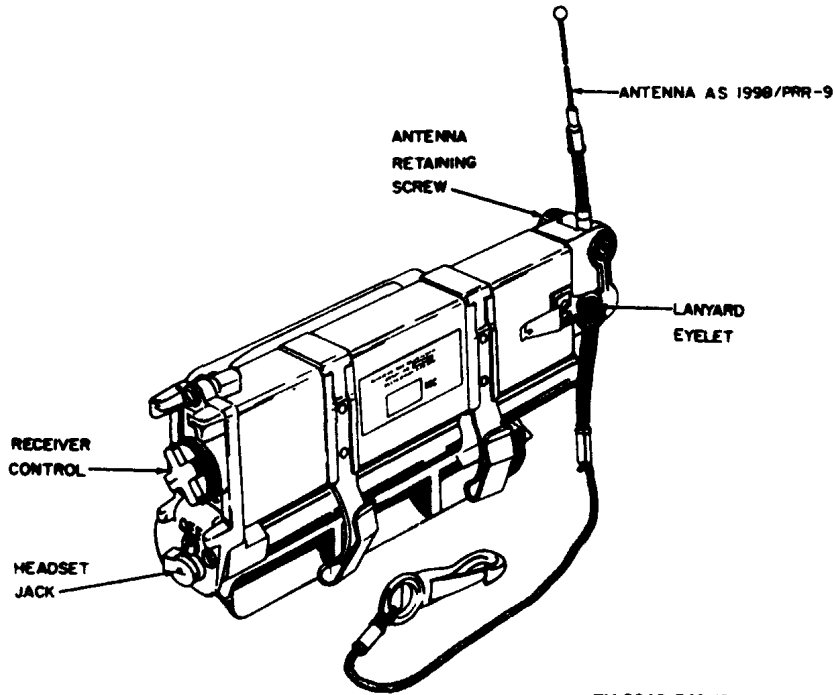

TM 5840-549-12-11

Figure 3-1. Receiving Set, Radio AN/PRR-9 control and jack.

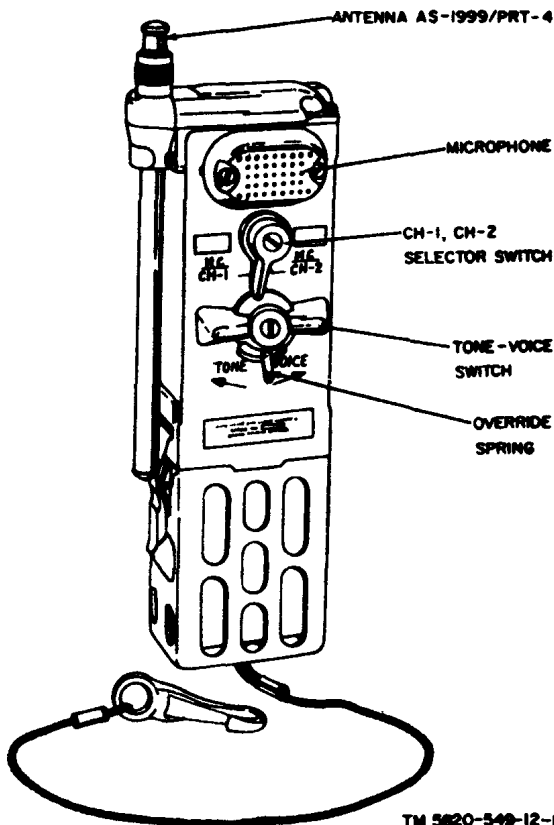

TM 5820-549-12-12

Figure 3-2. Transmitting Set, Radio AN/PRT-4 controls.

3-3. Receiver Operating Procedure (fig. 3-1)

a. *Modes of Operation.* The receiver may be operated with or without squelch. Squelched operation completely quiets the receiver so no noise is heard during the absence of a received signal. Unsquelched operation results in a hissing noise heard between transmissions. Unsquelched operation is used when receiver and transmitter are operating at maximum range or in unfavorable terrain (para 2-4).

b. *Squelched Operation.* Rotate the receiver control clockwise from its OFF position to a midposition. Upon receipt of a voice or tone transmission, adjust receiver control to a comfortable listening level. If receiver control is rotated fully clockwise, squelch action will be turned off and a loud hissing noise will be heard between transmissions. If received signals are intermittent, use unsequelched operation.

c. *Unsequelched Operation.* Rotate receive control completely clockwise from its OFF position. Rotate the receiver control counter-clockwise to a comfortable listening level. When a voice or tone signal is heard, readjust

the receiver control for best volume. To turn squelch on again, turn receiver off by rotating receiver control completely counterclockwise to the OFF position, then back on to desired position.

d. Antenna Position. To change the position of the receiver antenna, loosen the antenna retaining screw (fig. 2-3), adjust the antenna to the desired position, and tighten the antenna retaining screw. Do not allow the antenna to touch the helmet during operation.

e. Headset Operation. When the headset cord plug is connected to the headset jack, the horn speaker is cut off. This operation may be used in noisy locations or for secure operations. See paragraph 2-11 for installation of headset.

3-4. Receiver Stopping Procedure (fig. 3-1)

Turn the receiver control completely counterclockwise to the OFF position. This turns off power to the receiver.

3-5. Recognition and Identification of Jamming

Under real or simulated tactical conditions, it is possible for the receiver to be jammed by the enemy. Jamming is easily done by transmission of a strong signal on the frequency you are using, which makes it difficult or impossible to hear the desired signal. Unusual noises or strong interference heard on the receiver may be enemy jamming, signals from a friendly station, noise from a local source, or a defective receiver. To determine whether the interference is originating in the receiver, remove the antenna (para 2-5). If the interference continues, the receiver is defective.

3-6. Antijamming

When jamming of a channel is first noticed, notify the superior officer immediately and continue to operate the equipment. To provide maximum intelligibility of jammed signals, try the suggestions given in *a*, *b*, and *c* below.

a. Vary the receiver volume by rotating the receiver control. Try un-squelched operation

(para 3-3c). The level of the desired signal may be raised enough to be distinguished from the jamming signal.

b. Change the location so that nearby obstructions act as a screen in the direction of probable sites of enemy jamming transmitters. This screen action may also reduce the transmitted signal strength toward the enemy and thereby make it more difficult for him to intercept your signals. If possible, try several different locations within the designated area and stay at the one where jamming is minimum.

c. Use tone signals, if possible. These may come through the jamming enough to be understood.

3-7. Operating Receiver and Transmitter Under Arctic Conditions

a. Batteries. Dry batteries may fail or produce lower-than-normal voltages when exposed to below-freezing conditions. Preheat the battery by storage in a warm room or by holding it against the body. Batteries may be carried inside the operator's clothing and connected to the transmitter and receiver by use of the battery extender cables (para 2-12).

b. Transmitter. In extremely cold weather, coatings of frost may form on the microphone. This condition may affect the quality of communications, and in extreme conditions can permanently damage the microphone. To prevent such damage, do not shout directly into the microphone or hold the lips directly against the microphone.

c. Receiver. When arctic weather clothing requires a covering on the helmet, the operator can make use of the receiver head harness (para 2-12).

3-8. Transmitter Operating Procedure (fig. 3-2)

a. Modes of Operation. The transmitter provides either tone or voice signals on one or two channels. Channel 1 provides maximum power. Channel 2 provides from one-ninth to one-third the power output of channel 1. For proper operation, channel 2 must not be more than 1 mc above or 1 mc below the frequency

of channel 1. The distance between transmitter and receiver must be less for good channel 2 operation.

b. Channel Selection. Set the CH-1-CH-2 selector switch to the desired channel. Using a pencil, write the operating frequency in mc above the CH-1 position, and the corresponding operating frequency of the second channel above the CH-2 position.

c. Antenna.

(1) Raise the collapsible antenna to its full height.

CAUTION

Do not allow the antenna to touch the battery case clamp or the helmet during operation.

(2) To transmit a pattern of equal strength in all directions, keep the antenna vertical (fig. 2-2).

(3) To reduce strength in a given direction, hold transmitter so that the antenna is tilted at an approximate 45° angle toward the direction of transmission (fig. 2-2).

d. Override Spring. For normal operation

of either voice or tone transmissions, set the override spring to its center (detent) position. If tone transmissions only are to be used, set the override spring to the TONE position. This will prevent accidentally pushing the TONE-VOICE switch to the VOICE position. If only voice transmissions are to be used, set the override spring to the VOICE position. This will prevent accidental tone transmissions.

e. Voice Transmission. Press the TONE-VOICE switch in the direction of the VOICE arrow. Speak into the microphone in a normal tone of voice with lips about 1 inch from microphone.

f. Tone Transmissions. Press the TONE-VOICE switch in the direction of the TONE arrow, and hold it in that position for the desired length of tone.

3-9. Transmitter Stopping Procedure

a. Release the TONE-VOICE switch.

b. If the transmitter will not be used for some time, collapse the antenna by pushing it all the way down.

CHAPTER 4

OPERATOR'S MAINTENANCE INSTRUCTIONS

4-1. Scope of Operator's Maintenance

The maintenance duties assigned to the operator of the AN/PRR-9 and the AN/PRT-4 are listed below, together with a reference to the paragraphs covering specific maintenance functions. The duties assigned do not require tools or test equipment.

- a. Operator's daily preventive maintenance checks and services (para 4-4)
- b. Troubleshooting (para 4-6).
- c. Replacement of Battery, Dry BA-505/U (para 4-7).
- d. Replacement of Battery, Dry BA-399/U (para 4-8).

4-2. Operator's Preventive Maintenance

Operator's preventive maintenance is the systematic care, servicing, and inspection of equipment to prevent the occurrence of trouble, to reduce downtime, and to assure that the equipment is serviceable.

a. *Systematic Care.* The procedures given in paragraphs 4-3, 4-4, and 4-5 cover systematic care essential to proper upkeep and operation of the equipment.

b. *Maintenance and Service Inspection.* The preventive maintenance checks and services chart (para 4-4) outlines functions to be performed at specific intervals. These checks

and services are to maintain Army electronic equipment in combat-serviceable condition; that is, good general (physical) condition and in good operating condition. To assist operators in maintaining combat serviceability, the charts indicate what to check, how to check, and the normal conditions; the *References* column lists the illustration or paragraph that contains instructional information. If the defect cannot be remedied by the operator, higher category maintenance or repair is required. Records of these checks and services must be made in accordance with the requirements set forth in TM 38-750.

4-3. Operator's Preventive Maintenance Checks and Services Periods

Operator's preventive maintenance checks and services of the AN/PRR-9 and AN/PRT-4 is required on a daily basis. Paragraph 4-4 specifies the checks and services that must be accomplished daily and under the conditions listed below:

- a. Before the equipment is used when starting on a mission.
- b. When a mission is completed.
- c. At least once each week if the equipment is kept in a standby condition

4-4. Operator's Daily Preventive Maintenance Checks and Services Chart

a. Receiving Set, Radio AN/PRR-9.

Caution: Disconnect the battery and wipe the pins of the battery plug connector of the transmitter or receiver if the equipment is accidentally subjected to immersion in brackish (salt) water. The wiping should be done within an hour after reimmersion to halt the electrolytic corrosion of the pins and battery socket terminals.

Sequence No.	Item to be Inspected	Procedure	References
1	Receiver -----	Clean external surface of receiver -----	Para 4-5.
2	Antenna -----	Check to see that antenna is straight and unbroken or bent and that retaining screw is tight.	Fig. 2-3. ■
3	Horn transducer --	Check to see that horn transducer is free from dust and dirt.	Para 4-5.

Sequence No.	Item to be inspected	Procedure	References
4	Headset -----	Check earpiece and cord for cracks and breaks ----- Caution Disconnect the battery when it is known that the equipment will not be used for 1 day or more.	Fig 1-2.
5	Battery -----	Check for leakage, corrosion, or swelling. Replace if necessary.	Para 4-7.
6	Lanyard -----	Check lanyard for frayed or broken cord -----	Fig. 1-2.
7	Receiver control -----	While making operating check, (item 8), check control to make certain switch action is positive and control is smooth and free of external or internal binding.	Fig. 3-d.
8	Receiver control -----	OPERATION a. <i>Without a signal transmitted.</i> Turn receiver control completely clockwise. Rushing noise is heard in horn speaker. b. <i>Unsquelled Operation.</i> With a good transmitter operating in the near vicinity (approximately 100 feet away) at the same frequency as the receiver, turn receiver control until a comfortable listening level is heard. (1) Test transmission is heard loud and clear when transmission operator speaks in VOICE operation. (2) Rushing noise is heard in between transmissions. (3) A continuous tone is heard when transmission operator transmits tone signal. (4) Rushing noise is heard in between tone signal transmissions. c. <i>Squelched Operation.</i> Turn receiver control completely counterclockwise to OFF position, then turn receiver control to approximately one half of total range. When signal is heard, adjust the receiver control for a comfortable listening level. (1) Test transmission is heard loud and clear when transmission operator speaks on VOICE operation. No rushing noise is heard between transmissions. (2) A continuous tone is heard when transmitter operator transmits tone signals. No rushing noise is heard between transmissions. d. <i>Headset Use.</i> Repeat the procedure in c above with headset plugged into headset jack. Same results should be obtained.	Para 4-6.

b. *Transmitting Set, Radio AN/PRT-4.*

Sequence No.	Item to be inspected	Procedure	References
1	Transmitter -----	Clean external surface of transmitter -----	Para 4-5.
2	Antenna -----	Check to see that antenna raises and collapses smoothly.	Fig. 1-3.
3	Battery -----	Check for leakage, corrosion, or swelling. Replace if necessary.	Para 4-8.
4	CH-1—CH-2 selector switch.	Check switch action for smooth and positive action while making operating check (item 7).	Fig. 3-2.
5	TONE-VOICE switch	Check switch for positive spring-load action while making operating check (item 7).	Fig. 3-2.
6	Override spring -----	a. Check switch for smooth and positive action while making checks in b and c below.	Fig. 3-2.

Sequence	Item to be inspected	Procedure	References
		<ul style="list-style-type: none"> b Set override spring in TONE position. CH-1—CH-2 selector switch is limited to TONE position only when pressed. c Set override spring in VOICE position. CH-1—CH-2 selector switch is limited to VOICE position only when pressed. d Set override spring to center position. CH-1—CH-2 selector switch can be set to either TONE or VOICE position when pressed. 	

OPERATION

7	Preliminary -----	Position an operator with two known good receivers for various operations at a distance of approximately 100 feet. One receiver must be set for the same frequency as transmitter CH-1 channel and the other receiver set must be set for the same frequency as transmitter CH-2 channel. The operator of the receivers will control the receivers as necessary to check transmitter signals.	
8	TONE-VOICE switch	<p>Set CH-1—CH-2 selector switch in CH-1 position and set override spring in center position.</p> <ul style="list-style-type: none"> a Press TONE-VOICE switch into TONE position. A test tone, loud and clear, is heard in receiver. b Press TONE-VOICE switch into VOICE position and speak into microphone. A voice is heard loud and clear on receiver. c Repeat the instructions in a and b above with the CH-1—CH-2 selector switch in the CH-2 position. The second receiver should obtain the same results indicated in a and b above. 	Paragraph 4-6

4-5. Cleaning

Inspect the exterior surfaces of the transmitter and receiver. The exterior surfaces should be free of dust and dirt.

a. Remove dust and dirt with a clean, soft cloth.

b. Tap bottom of horn transducer of the receiver to loosen any dirt which may have become lodged in the horn transducer.

c. Tap the transmitter microphone gently against the hand to loosen any dirt which may have become lodged in the perforations in the microphone.

4-6. Operator's Troubleshooting Chart

a. Receiving Set, Radio AN/PRR-9.

<i>Item No.</i>	<i>Trouble symptom</i>	<i>Probable trouble</i>	<i>Checks and corrective measures</i>
1	No rushing noise is heard when receiver control is turned completely clockwise.	Defective battery -----	<ul style="list-style-type: none"> a. Replace battery (para 4-7). b. Check installation of antenna (para 3-3d). c. If trouble is not corrected, higher category of maintenance repair is required.
2	Signal is weak or is not heard when checked as in paragraph 4-4a, item 8b.	Defective battery -----	Repeat the instructions in a, b, and c above as required.

b. Transmitting Set, Radio AN/PRT-4.

<i>Item No.</i>	<i>Trouble symptom</i>	<i>Probable trouble</i>	<i>Checks and corrective measures</i>
1	Signal is weak or is not heard at all when the transmitter is tested under conditions of paragraph 4-4b, item 8.	<ul style="list-style-type: none"> a. Incorrect setting of controls. b. Antenna not extended. c. Defective battery ----- d. Other ----- 	<ul style="list-style-type: none"> a. Check setting of controls (para 3-8). b. Extend antenna (para 3-8c). c. Replace battery (para 4-8). d. If trouble is not corrected, higher category of maintenance repair is required.

4-7. Replacement of Battery, Dry BA-505/U (fig. 2-4)

- a. Hold the receiver in one hand and with the other hand, pull out the old BA-505/U.
- b. Slide the new BA-505/U through the battery retaining clip and mate the battery connector with the battery contact pins on the receiver. Note that the larger pin mates with the larger hole in the battery.

4-8. Replacement of Battery, Dry BA-399/U (fig. 2-5)

- a. Release the clamps on the battery case and remove the battery case. If the antenna is in the way, pull it up until it clears the battery case clamp. Put the battery case aside.
- b. Remove and discard the old BA-399/U.
- c. Insert the new BA-399/U so that its connector fits the mating pins in the transmitter housing. Push battery firmly into place.
- d. Replace battery case and fasten clamps.

CHAPTER 5

ORGANIZATIONAL MAINTENANCE INSTRUCTIONS

5-1. Scope of Organizational Maintenance

a. This chapter covers organizational maintenance, including the changing of channel frequencies of Receiving Set, Radio AN/PRR-9 and Transmitting Set, radio AN/PRT-4. Instructions for performing preventive maintenance, alignment required when changing channels, and repair which can be accomplished by the organizational repairman are also included. No lubrication is required at organizational maintenance.

b. Organizational maintenance includes the following.

- (1) Preventive maintenance (para 5-3, 5-4, and 5-5).
- (2) Battery testing (para 5-16).
- (3) Changing channel frequencies (para 5-17).
- (4) Alignment of transmitter and receiver (para 5-18).
- (5) Replacement of the following AN/PRR-9 parts.
 - (a) Antenna housing assembly (para 5-21).
 - (b) Antenna AS-1998/PRR-9 and retaining screw (para 5-11).
 - (c) Control knob (para 5-13).
 - (d) Lanyard and slide (para 2-8).
 - (e) Horn assembly (para 5-23).
 - (f) Headset, Electrical H-264/PRR-9 (para 2-11).
- (6) Replacement of the following AN/PRT-4 parts.
 - (a) Antenna base assembly (para 5-22).
 - (b) Antenna AS-1999/PRT-4 (para 5-12).
 - (c) CH-1—CH-2 selector switch knob (para 5-14).
 - (d) TONE-VOICE switch knob and compression and override springs (para 5-15).
 - (e) Microphone, fuzz buttons and housing transducer (para 5-20).
 - (f) Battery case (para 2-7).
 - (g) Lanyard and slide (para 2-9).

5-2. Materials, Tools, and Test Equipment Required

The materials, tools, and test equipment required for organizational maintenance are as follows:

- a.* Indicator, Channel Alignment ID-1189, PR (TM 11-6625-937-12).
- b.* Trichloroethane (NSN 6810-00-292-9625).
- c.* Toolkit, Electronic Equipment TK-101/G.

5-3. Organizational Preventive Maintenance

a. Preventive maintenance is the systematic care, inspection, and servicing of the equipment to maintain it in a serviceable condition, to prevent breakdowns, and to assure maximum operational capability. Preventive maintenance is the responsibility of all categories of maintenance concerned with the equipment, and includes the inspection, testing, and repair or replacement of parts, subassemblies, or units that inspection and test indicate would probably fail before the next scheduled periodic service. Preventive maintenance checks and services of the AN/PRT-4 and AN/PRR-9 at organizational maintenance are made at monthly intervals unless otherwise directed by the commanding officer.

b. Maintenance forms and records to be used and maintained on the equipment are specified in TM 38-750.

5-4. Organizational Monthly Maintenance

Perform the maintenance functions indicated on the monthly preventive maintenance checks and services chart (para 5-5) once each month. A month is defined as approximately 30 calendar days at 8-hour per day operation. If the equipment is operated 16 hours a day, the monthly preventive maintenance checks and services should be performed at 15-day

intervals; if 24 hours, at 10 day intervals. Adjust the maintenance interval to compensate for any unusual operating conditions. Equipment maintained in standby (ready for immediate operation) condition must have monthly preventive maintenance checks and services performed on it. Equipment in limited storage (requires service before operation) does not require monthly preventive maintenance.

5-5. Organizational Monthly Preventive Maintenance Checks and Services

To insure that the Receiving Set, Radio AN/PRR-9 and Transmitting Set Radio AN/PRT-4 are always ready for operation, they must be

inspected systematically so that defects may be discovered and corrected before they result in serious damage or failure. The necessary preventive maintenance checks and services to be performed are listed in the following chart. The item numbers indicate the sequence of minimum inspection requirements. Defects discovered during operation of the unit will be noted for future correction to be made as soon as operation has ceased. Stop operation immediately if a deficiency is noted which would damage the equipment during operation. Record all deficiencies together with the corrective action taken on DA Form 2407 (Maintenance Request).

Sequence No.	Item to be inspected	Procedure	References
1	Completeness -----	See that the equipment is complete -----	(App. B).
2	Preservation -----	Check all surfaces for evidence of fungus.	(Para 5-6).
3	Publications -----	See that all publications are complete, serviceable, and current.	(DA Pam 310-4, app. A).
4	Modifications -----	Check DA Pam 310-7 to determine if new applicable MWO's have been published. All MWO's must be applied.	TM 38-750 and DA Pam 310-7.
5	Batteries -----	Use the alignment indicator to check batteries.	(Para 5-16).
6	Transmitter and receiver --	Complete operational checks are covered in the operator's daily preventive maintenance checks and services chart.	(Para 4-4).

5-6. Organizational Cleaning

WARNING

The fumes of trichloroethane are toxic. Provide thorough ventilation whenever used. **DO NOT USE NEAR AN OPEN FLAME.** Trichloroethane is not flammable, but exposure of the fumes to an open flame or hot metal forms highly toxic phosgene gas.

The exterior surfaces of the transmitter and receiver should be free of grease and fungus.

a. Remove grease, fungus, and ground-in dirt from the receiver and transmitter; use a cloth dampened (not wet) with trichloroethane (NSN 6810-00-292-9625).

b. Remove dust and dirt from plugs and receptacles.

c. Clean the receiver control and transmitter controls with a soft cloth. If dirt is difficult

to remove, dampen (do not wet) the cloth with mild soap and water.

5-7. Organizational Troubleshooting

Troubleshooting of this equipment is based upon the operational checks in the operator's daily preventive maintenance checks and services chart (para 4-4). To troubleshoot the equipment, perform all procedures starting with item 7, paragraph 4-4a, for the receiver and item 7, paragraph 4-4b, for the transmitter. Follow the procedure until an abnormal condition or symptom is observed. Perform the checks and corrective measures indicated in the troubleshooting charts for the receiver and transmitter. If the corrective measures do not result in correction of the trouble, higher category of maintenance is required. The listed checks and corrective measures in the organizational troubleshooting chart supplement those that appear in the operator's troubleshooting chart (para 4-6).

<i>Item No</i>	<i>Trouble symptom</i>	<i>Probable trouble</i>	<i>Checks and corrective measures</i>
1	Signal is weak or not heard when checked as in item 8, paragraph 4-4a.	a. Defective antenna ----- b. Improperly aligned receiver ----- c. Cracked antenna housing assembly -----	a. Check antenna (item 2, para 4-4a) and replace defective antenna (para 5-11). b. Align receiver (para 5-18). c. Replace antenna housing assembly (para 5-21).
2	Adjustment of antenna loading coil during alignment procedures produces no results.	Defective antenna base assembly -----	Replace antenna housing assembly (para 5-21).
3	Signal is heard through headset and not horn assembly.	Faulty horn assembly -----	Replace horn assembly (para 5-23)
4	Signal is heard through horn assembly and not headset.	Faulty headset -----	Replace headset (para 2-11).

TRANSMITTER

5	Signal is weak or not heard when the transmitter is checked as in item 8, paragraph 4-4b.	a. Improperly aligned transmitter ----- b. Defective antenna ----- c. Cracked antenna base assembly ----- d. Defective microphone -----	a. Align transmitter (para 5-18). b. Check antenna (item 2, para 4-4a) and replace defective antenna (para 5-12). c. Replace antenna base assembly (para 5-22). d. Replace microphone element (para 5-20)
6	Adjustment of loading coil during alignment procedures produces no results.	Defective antenna base assembly -----	Replace antenna base assembly (para 5-22).
7	Transmitter transmits in TONE but not VOICE mode.	Faulty microphone -----	Replace microphone element (para 5-20)
8	TONE-VOICE switch sticks in one position.	Faulty override spring -----	Check position of knob, compression and override springs (para 5-15)

5-8. Repair

Organizational personnel may replace components of the AN/PRR-9 and AN/PRT-4 listed in TM 11-5820-549-20P Paragraphs containing parts replacement instructions are referenced in the listing in paragraph 5-1b.

5-9.

Deleted.

5-10.

Deleted.

**5-11. Replacement of Antenna
AS-1998/PRR-9
(fig. 2-3)**

a. Loosen antenna retaining screw, and remove screw from antenna housing.

b. Remove and discard the defective antenna. If the new antenna is an early model that contains two sets of blades (A, fig. 2-3.1), remove one set of blades by filing them off completely. Make certain that all filings are removed from the antenna before it is installed.

c. Fit the lower end of the antenna (the end with the hole) between the two members of the antenna housing. Make certain the blades on the antenna (B, fig. 2-3.1) face the grooves on the antenna brass insert (fig. 2-3.2).

d. Place the antenna retaining screw through the larger hole in the antenna housing, then through the antenna, and into the smaller hole in the antenna housing. Do not tighten.

e. Rotate the antenna until the blades on the lower end of the antenna fit into the desired grooves in the brass insert of the antenna housing.

f. Tighten the antenna retaining screw securely with finger pressure. Do not over-tighten.

**5-12. Replacement of Antenna
AS-1999/PRT-4
(fig. 5-3)**

a. Unscrew antenna retaining screw and pull out defective antenna through top of transmitter antenna housing.

b. Place new antenna down through hole in antenna housing from top.

c. Tighten antenna retaining screw of new antenna finger tight. Do not overtighten.

**5-13. Replacement of Receiver Control
Knob
(fig. 5-5)**

a. With hexagonal socket key (Allen wrench) for a No. 4 setscrew, loosen two setscrews in receiver control knob.

b. Remove old knob by pulling straight off.

c. With pliers, carefully turn shaft of receiver control maximum counterclockwise.

d. Loosen setscrews on new knob, so the knob will fit on receiver control shaft.

e. Place white pointer on new knob opposite the center of the word OFF on front of receiver. Tighten one setscrew.

f. Rotate receiver control to provide access to the second setscrew. Tighten setscrew.

g. Check rotation of the receiver control to be sure knob does not rub against receiver housing at any point. If knob rubs, loosen setscrews and raise knob slightly away from receiver housing. Tighten setscrews and re-check operation.

**5-14 Replacement of Transmitter
CH-1—CH-2 Selector Switch Knob
(fig. 5-2)**

a. Remove slotted screw in top of switch knob with a screwdriver.

b. Remove old knob and place new knob on switch shaft. Note that the shaft is flatted and knob can fit only one way.

c. Replace and tighten screw. Check switch operation.

**5-15. Replacement of Transmitter TONE-
VOICE Switch Knob and
Compression and Override Springs
(fig. 5-2)**

a. Remove slotted screw in top of switch knob with a screwdriver.

b. Carefully pry off knob and, if required,

remove compression spring and override spring.

c. To replace components, position the components on the switch shaft. Refer to figure 5-2 for correct placement of parts under knob and correct knob position.

d. Replace and tighten screw. Check operation of switch knob and override spring (sequence No. 6, para 4-4b).

5-16. Battery Testing

Battery, Dry BA-505/U and Battery, Dry BA-399/U may be tested in Indicator, Channel Alignment ID-1189/PR. For testing purposes the batteries are first removed from the equipment (para 4-7 and 4-8). Specific instructions for battery testing are covered in TM 11-6625-937-12.

5-17. Changing Channel Frequencies

a. *General.* The frequency of operation of both the AN/PRR-9 and AN/PRT-4 can be changed by replacing the pluck-out crystals with crystals for the new channels and realigning the equipment. The AN/PRR-9 has one pluck-out crystal to change. The AN/PRT-4 has one pluck-out crystal to change for each of its two channels. Instructions for changing crystals are given in *e* and *f* below. Instructions for alignment are given in paragraph 5-18.

b. *Determining Crystal Frequency.* Both the AN/PRR-9 and AN/PRT-4 use Crystal CR-81/PU. For both equipments, the crystal frequency, which is marked on the crystal, is 10.7 mc below the channel or operating frequency. To compute the crystal frequency, determine the desired channel frequency and subtract 10.7 mc.

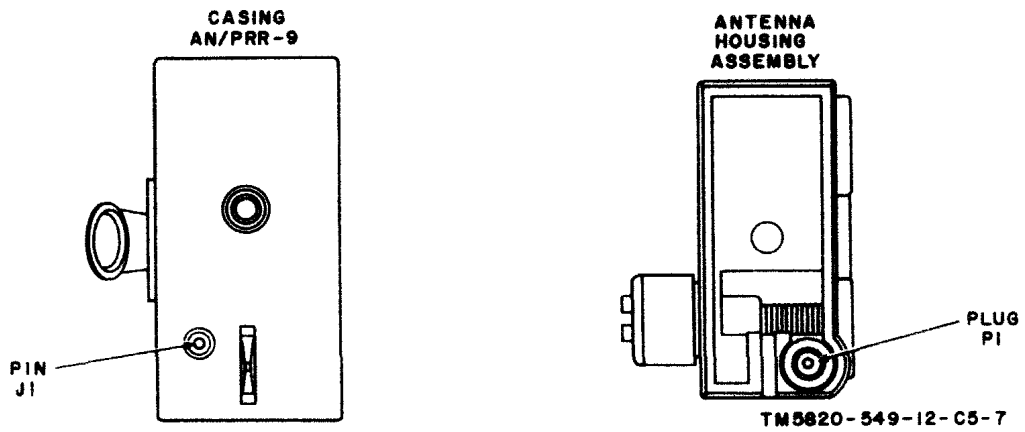

Figure 5-1. Mounting faces of AN/PRR-9 casing and antenna housing assembly.

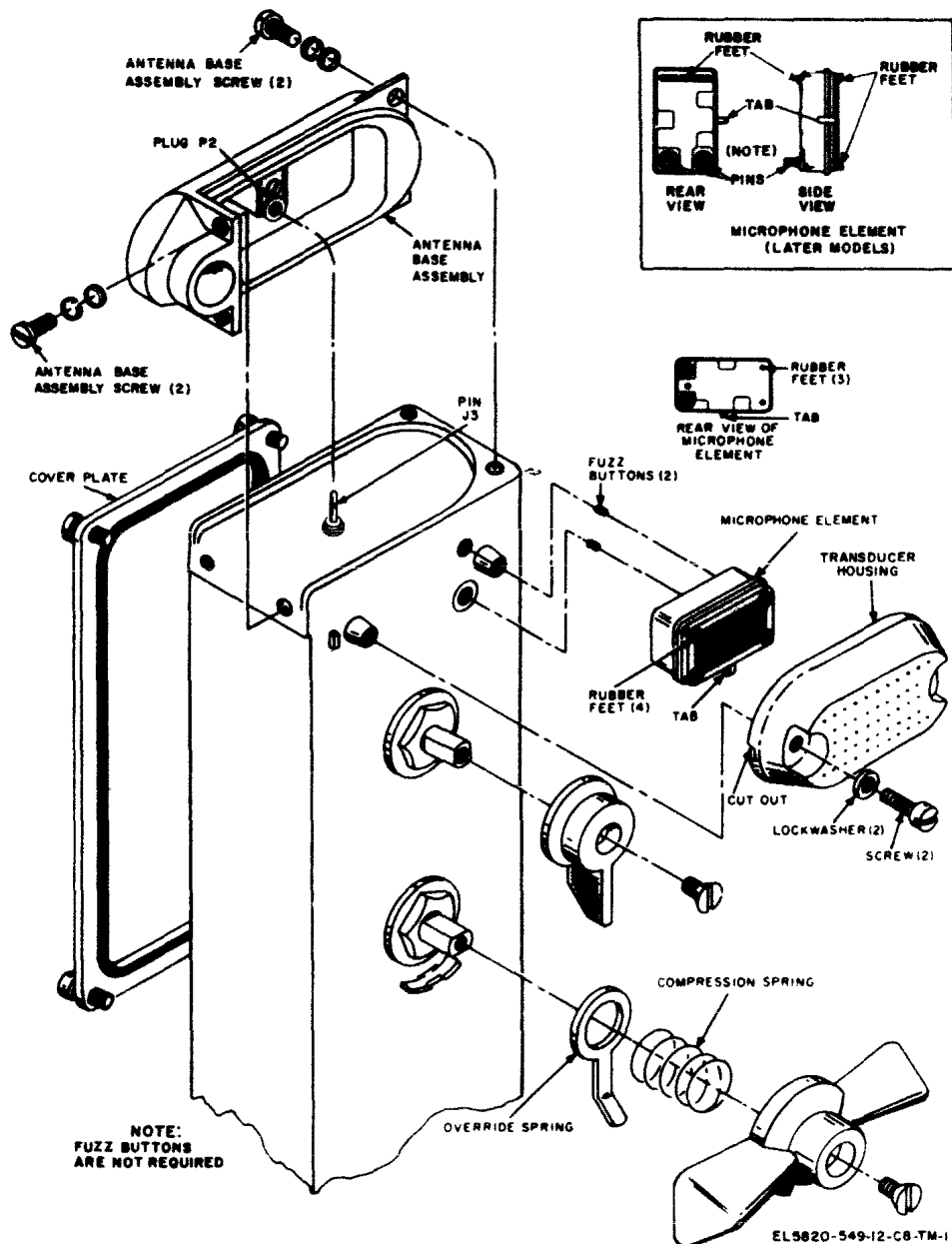

Figure 5-2. Transmitting Set, Radio AN/PRT-4, parts replacement.

Example:

Channel frequency desired ----- 53.9 mc
 Subtract 10.7 mc ----- -10.7 mc

Correct crystal frequency ----- 43.2 mc

Correct crystal frequencies may also be obtained by consulting the chart in c below.

c. Crystal Selection Chart for AN/PRR-9 and AN/PRT-4.

Crystal marking (mc) (osc freq)	Corresponding RF channel frequency (mc)
36.30	47.00
36.40	47.10
36.50	47.20
36.60	47.30
36.70	47.40
36.80	47.50
36.90	47.60
37.00	47.70

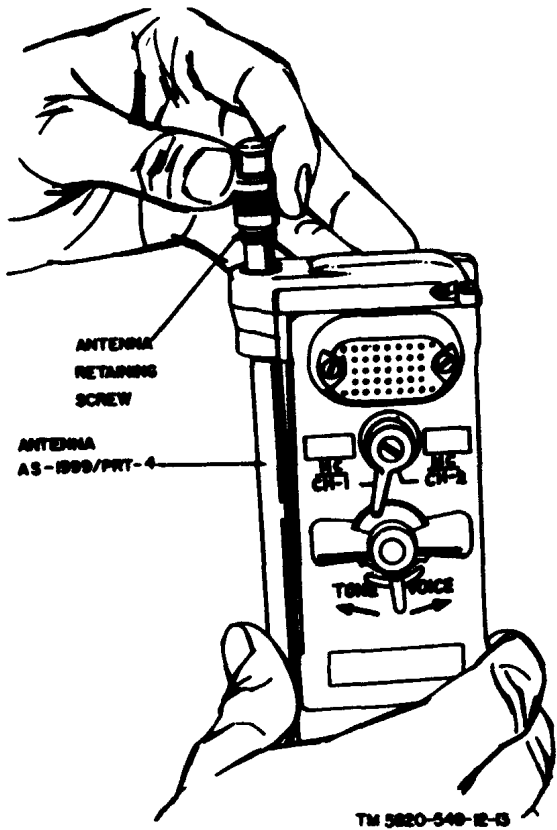

TM 5820-549-12-13

Figure 5-3. Antenna AS-1999/PRT-4, replacement.

Crystal marking (mc) (osc freq)	Corresponding RF channel frequency (mc)
39.40	50.10
39.50	50.20
39.60	50.30
39.70	50.40
39.80	50.50
39.90	50.60
40.00	50.70
40.10	50.80
40.20	50.90
40.30	51.00
40.35	51.05
40.40	51.10
40.45	51.15
40.50	51.20
40.55	51.25
40.60	51.30
40.65	51.35
40.70	51.40
40.75	51.45
40.80	51.50
40.85	51.55
40.90	51.60
40.95	51.65
41.00	51.70
41.05	51.75
41.10	51.80
41.15	51.85
41.20	51.90
41.30	52.00
41.40	52.10
41.50	52.20
41.60	52.30
41.70	52.40
41.80	52.50
41.90	52.60
42.00	52.70
42.10	52.80
42.20	52.90
42.30	53.00
42.40	53.10
42.50	53.20
42.60	53.30
42.70	53.40
42.80	53.50
42.90	53.60
43.00	53.70
43.10	53.80
43.20	53.90
43.30	54.00
43.40	54.10
43.50	54.20
43.60	54.30
43.70	54.40
43.80	54.50
43.90	54.60
44.00	54.70
44.10	54.80

Crystal marking (mc) (osc freq)	Corresponding RF channel frequency (mc)
37.10	47.80
37.20	47.90
37.30	48.00
37.40	48.10
37.50	48.20
37.60	48.30
37.70	48.40
37.80	48.50
37.90	48.60
38.00	48.70
38.10	48.80
38.20	48.90
38.30	49.00
38.40	49.10
38.50	49.20
38.60	49.30
38.70	49.40
38.80	49.50
38.90	49.60
39.00	49.70
39.10	49.80
39.20	49.90
39.30	50.00

Crystal marking (mc) (osc freq)	Corresponding RF channel frequency (mc)
44.20	54.90
44.30	55.00
44.40	55.10
44.50	55.20
44.60	55.30
44.70	55.40
44.80	55.50
44.90	55.60
45.00	55.70
45.10	55.80
45.20	55.90
45.30	56.00
45.40	56.10
45.50	56.20
45.60	56.30
45.70	56.40
45.80	56.50
45.90	56.60
46.00	56.70
46.10	56.80
46.20	56.90
46.30	57.00

d. Access to Crystals. In order to change crystals, it is necessary to partially disassemble the equipment. Use the screwdriver located in the ID-1189/PR cover.

Caution: Be extremely careful when changing crystals not to disturb any other parts on the printed circuit boards. Make certain receiver control panel gasket is in place before reassembly of electronic assembly and receiver case.

e. Changing Receiver Crystal (figs. 5-5 and 5-6).

- (1) Hold the receiver in one hand (fig. 2-4) and with the other hand remove the battery.
- (2) Loosen two electronic assembly retaining screws from front panel (fig. 5-5). These are captive screws and should not be completely removed. Remove one electronic assembly retaining screw that holds horn transducer to electronic assembly front plate.
- (3) Pull electronic assembly out of receiver case.
- (4) Pull cord up against bottom of crystal, and with cord, pull crystal up out of crystal socket as far as it will come. With thumbnail under top of crystal,

carefully push crystal completely out of crystal holder.

- (5) Place cord between the two contacts of crystal socket with free end of cord toward back of electronic assembly.
- (6) Start connector pins of new crystal into crystal socket. Be sure cord is between pins.
- (7) Push crystal into crystal holder, then straight down to seat pins in socket.
- (8) Align according to paragraph 5-18.

f. Changing Transmitter Crystals. Determine whether one or both transmitter crystals are to be changed. Perform the following steps in sequence:

- (1) Loosen 4 screws on transmitter cover plate (fig. 5-2) located on the back of the transmitter. The screws are captive and should not be removed from the cover.
- (2) Remove the cover. Note that the crystal for channel 1 is located toward the battery case (fig. 5-7), and the crystal for channel 2 is above the channel 1 crystal, toward the top of the transmitter.
- (3) Locate the desired crystal (fig. 5-7) and pull the cord straight up. This will partially remove the crystal from its socket.
- (4) Push the top of the crystal toward the center of the electronic assembly to release the crystal from the crystal holder, and remove the crystal.
- (5) Place the cord between the two contacts of the crystal socket, with free end of cord toward the center of the electronic assembly.
- (6) Start connector pins of new crystal into crystal socket, with the top of the crystal angled toward the center of the electronic assembly and away from the crystal holder. Be sure cord is between crystal pins.
- (7) Push crystal into crystal holder, then straight down to seat pins in socket.
- (8) Align transmitter according to paragraph 5-18.

TM 11-5820-549-12
C3

This page left blank intentionally.

5-8

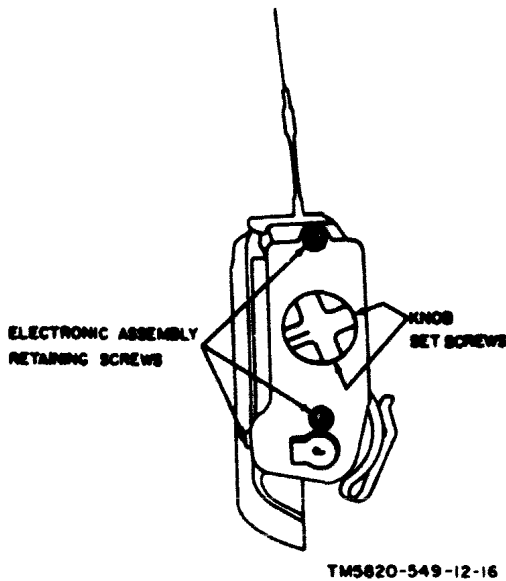

TM5820-549-12-16

Figure 5-5. Receiving Set, Radio AN/PRR-9, disassembly.

5-18. Alignment

Whenever operating frequencies of either the transmitter or receiver are changed, it is neces-

sary to realign the equipment for proper operation. Alignment is accomplished by the use of Indicator, Channel Alignment ID-1189/PR. Complete instructions for alignment are contained in TM 11-6625-937-12 as well as in instruction plates in the lid of the ID-1189/PR. Instructions include the replacement of parts which were removed to gain access to the crystals.

5-19. Channel Marking

The correct operating frequency of the receiver should be marked in pencil in the space provided on the receiver identification plate (fig. 1-2). The correct operating frequencies of the transmitter should be marked in the appropriate places above panel-marked positions of the CH-1—CH-2 channel selector switch. Double check to be sure you are writing the actual operating frequencies, not the crystal frequency (para 5-17c).

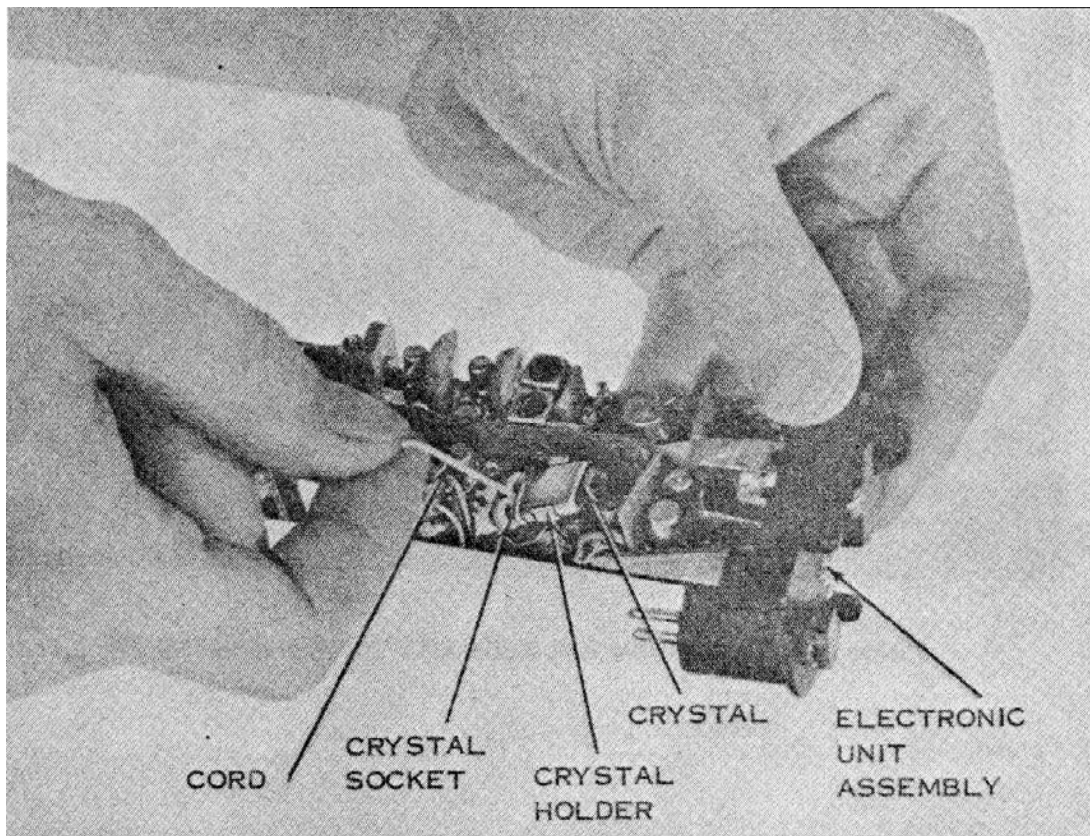

Figure 5-6. Receiving Set, Radio AN/PRR-9, crystal removal.

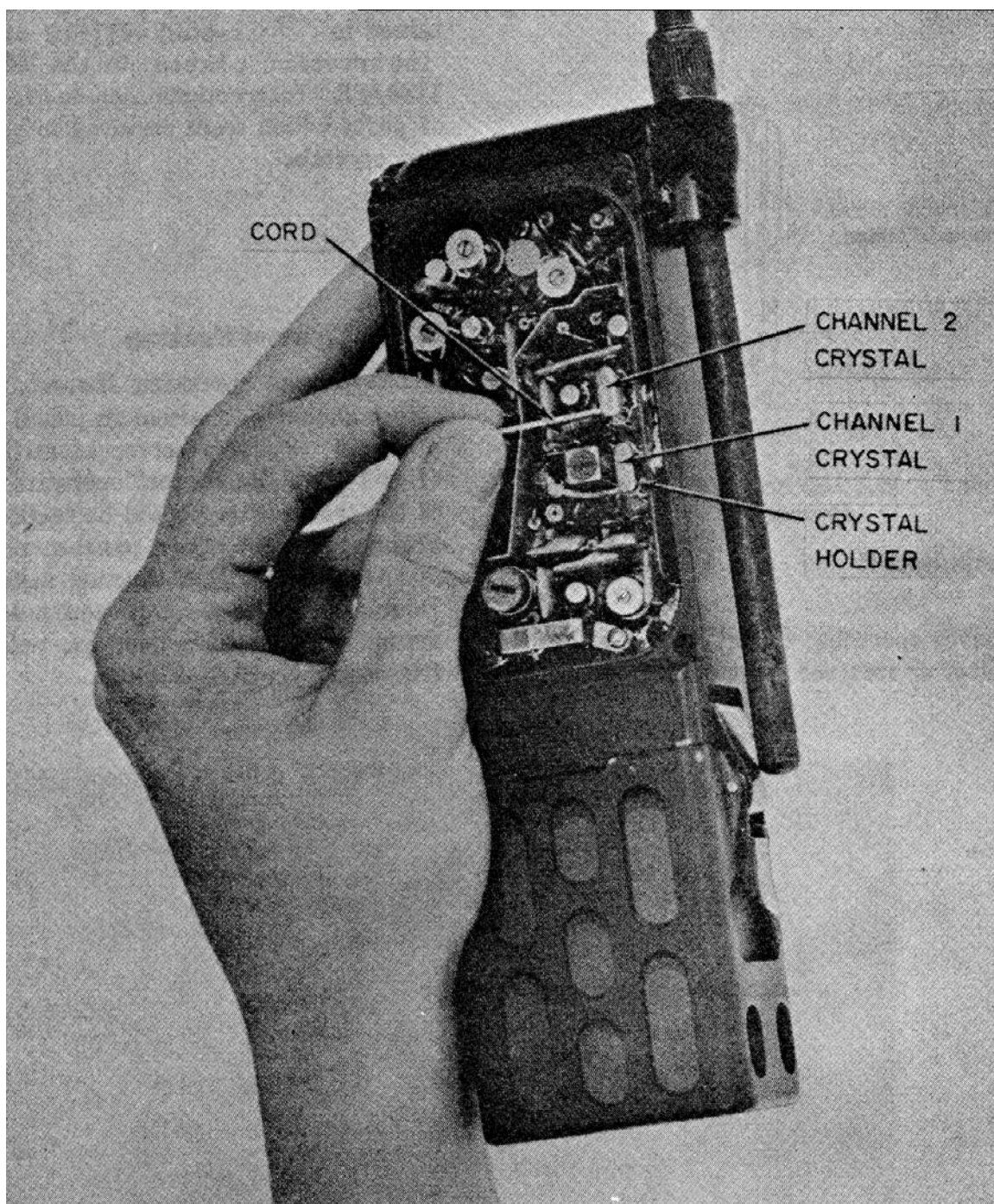

Figure 5-7. Transmitting Set, Radio AN/PRT-4, crystal removed.

**5-20. Replacement of Transmitter
Microphone, Fuzz Buttons, and
Transducer Housing**
(fig. 5-2)

CAUTION

Do not attempt to clean soft surface of microphone.

a. Remove the microphone element for replacement only when performance indicates that the trouble is an improperly working microphone (item No. 3 or 6, para 5-7).

b. The microphone assembly, consisting of transducer housing and microphone element, is held to the front of the AN/PRT-4 by two screws.

c. Remove the two screws and washers that hold the microphone assembly to the transmitter.

CAUTION

Do not lose fuzz buttons or rubber feet when removing microphone element and transducer housing. Early models of microphone element have smaller diameter pins and require the use of fuzz buttons to make electrical contact.

d. Lift the transducer housing straight away from the transmitter casing and remove the microphone element.

e. Remove any dust and dirt from the transducer housing and surface of the transmitter casing at the microphone location.

f. A visual inspection will indicate if fuzz buttons are required for the new microphone element pins. If required, place the fuzz buttons into the microphone pin jacks located on the transmitter casing.

CAUTION

Do not finger or exert pressure on the soft surface of the microphone element.

g. Position the microphone element so that the pins are inserted into the pin jacks on the casing. The microphone element that does not require the fuzz buttons will require firm pressure (note CAUTION above) for final seating.

h. Before replacing the transducer housing, note that the tab on the microphone element is designed to fit into the tab lock on the inside of the transducer housing. Also note that the cutout on the edge of one end of the transducer housing is designed to fit the cutout lock on the transmitter casing. Position the housing transducer in place and secure it with the screws and washers removed in *c* above.

i. With the transmitter battery in place, a quick operational check of the microphone can be made by turning the TONE-VOICE switch to TONE. A low-level audible output should be heard at the microphone.

**5-21. Replacement of AN/PRR-9 Antenna
Housing Assembly**

a. Remove Antenna AS-1998/PRR-9 (fig. 2-3) by turning antenna retaining screw counterclockwise until the screw and antenna are free.

b. Remove antenna housing assembly screw (fig. 2-3.2). Pull the antenna housing assembly in a direction away from the end of the AN/PRR-9 casing.

CAUTION

Care must be taken not to bend pin J1 (fig. 5-1) when positioning the new antenna housing assembly in place on the AN/PRR-9 casing.

c. Position the new antenna housing assembly on the AN/PRR-9 casing so that pin J1 mates with plug P1 and secure the assembly in place with the antenna housing assembly screw (fig. 2-3.2).

d. Replace Antenna AS-1998/PRR-9 (para 2-5).

**5-22. Replacement of AN/PRT-4 Antenna
Base Assembly**

a. Unscrew the antenna retaining screw (fig. 5-3) and pull Antenna AS-1999/PRT-4 out through the top of the antenna base assembly.

b. Remove the four antenna base assembly screws (fig. 5-2). Pull the antenna base assembly in a direction away from the end of the AN/PRT-4 casing.

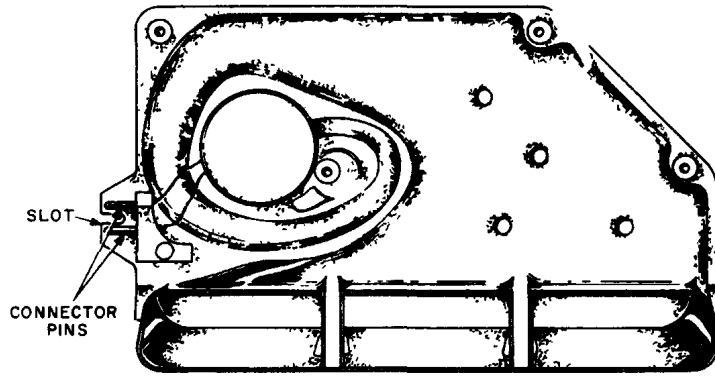

A CASE ASSEMBLY SIDE.

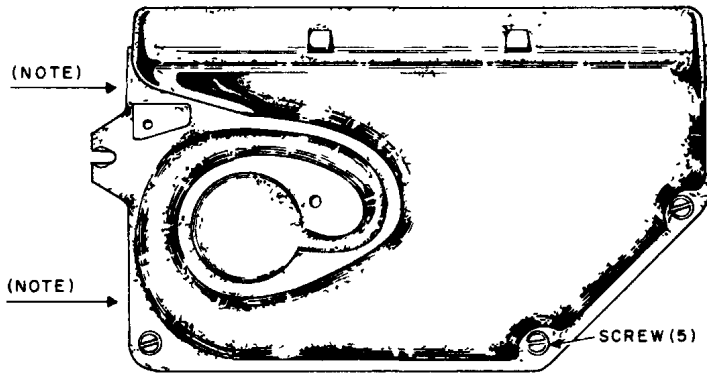

NOTE:
ARROWS INDICATE
DIRECTION FOR
APPLIED FORCE

B. EXTERNAL SIDE

EL5820-549-12-C8-TM-2

Figure 5-8. AN/PRR-9 horn assembly, replacement detail.

CAUTION

Care must be taken not to bend pin J3 (fig. 5-2) when positioning the new antenna base assembly in place.

c. Position the new antenna base assembly on the AN/PRT-4 casing so that pin J3 mates with plug P2. Secure the antenna base assembly in place with the four antenna base assembly screws.

d. Replace the antenna through the hole in the antenna base assembly and secure in place by tightening the antenna retaining screw finger tight. Do not overtighten.

5-23. Replacement of Horn Assembly
(fig. 5-8)

CAUTION

Unless the following procedures are used to remove and replace the horn assembly, the equipment or horn assembly can be damaged.

a. *Removal.*

(1) Five screws secure the horn assembly to the receiver case. Loosen the screw nearest the headphone jack approximately four full turns and then remove the other four screws and washers completely.

(2) To unplug the horn assembly, lift the end of the horn assembly that is nearest the antenna away from the receiver case approximately three quarters of an inch. While in that position, using fingers, exert force on the edge of the horn assembly in the direction shown by the arrows in B, figure 5-8, until the horn assembly is free of the receiver case.

b. Replacement.

(1) Position the slot of the horn assembly under the head of the loosened screw making

certain the washer and lock washer are between the screw head and the horn assembly slot. The connector pins should then be correctly aligned with the pin jacks on the case assembly. Firmly press the horn assembly into place until the screw holes on the horn assembly are aligned with the screw holes in the screw studs mounted on the case assembly.

(2) Replace and secure the four screws and washers removed in step a(1) above. Tighten the loosened screw.

APPENDIX A

REFERENCES

The following is a list of publications useful as references to operator and organizational maintenance personnel of Receiving Set, Radio AN/PRR-9 and Transmitting Set, Radio AN/PRT-4.

- | | |
|--------------------|--|
| DA Pam 310-4 | Index of Technical Manuals, Technical Bulletins, Supply Manuals (Types 7, 8, and 9), Supply Bulletins, and Lubrication Orders. |
| DA Pam 310-7 | U. S. Army Equipment Index of Modification Work Orders. |
| SB 38-100 | Preservation, Packaging, and Packing Materials, Supplies and Equipment Used by the Army. |
| TB 746-10 | Field Instructions for Painting and Preserving Electronics Command Equipment. |
| TM 11-5820-549-20P | Organizational Maintenance Repair Parts and Special Tools List: Transmitting Sets Radio AN/PRT-4 and AN/PRT-4A and Receiving Set Radio AN/PRR-9. |
| TM 11-6625-937-12 | Operator's and Organizational Maintenance Manual Including Repair Parts and Special Tool Lists: Indicator, Channel Alignment ID-1189/PR. |
| TM 38-750 | The Army Maintenance Management System (TAMMS). |
| TM 740-90-1 | Administrative Storage of Equipment. |
| TM 750-244-2 | Procedures for Destruction of Electronics Materiel to Prevent Enemy Use (Electronics Command). |

**APPENDIX B
BASIC ISSUE ITEMS LIST**

Section I. INTRODUCTION

B-1. Scope

This appendix lists only basic issue items required by the crew/operator for installation, operation, and maintenance of Receiving Set, Radio AN/PRR-9 and Transmitting Sets, Radio AN/PRT-4 and AN/PRT-4A.

B-2. General

The basic issue items list (Sec. II) is a list, in alphabetical sequence, of items which are furnished with, and which must be turned in with the end item.

B-3. Explanation of Columns

The following provides an explanation of columns found in the tabular listings:

a. Illustration. This column is divided as follows:

(1) *Figure Number.* Indicates the figure number of the illustration in which the item is shown.

(2) *Item Number.* Not applicable.

b. Federal Stock Number. Indicates the Federal stock number assigned to the item and will be used for requisitioning purposes.

c. Part Number. Indicates the primary number used by the manufacturer (individual, company, firm, corporation, or Government activity), which controls the design and characteristics of the item by means of its engineering drawings, specifications standards, and inspection requirements, to identify an

item or range of items.

d. Federal Supply Code for Manufacturer (FSCM). The FSCM is a 5 digit numeric code used to identify the manufacturer, distributor, or Government agency, etc., and is identified in SB 708-42.

e. Description. Indicates the Federal item name and a minimum description required to identify the item

f. Unit of Measure (U/M). Indicates the standard of basic quantity of the listed item as used in performing the actual maintenance function. This measure is expressed by a two-character alphabetical abbreviation, (e.g., ea, in., pr, etc.). When the unit of measure differs from the unit of issue, the lowest unit of issue that will satisfy the required units of measure will be requisitioned.

g. Quantity Furnished with Equipment (Basic Issue Items Only) Indicates the quantity of the basic issue item furnished with the equipment.

B-4. Special Information

Usable on codes are included in description Column. Uncoded items are applicable to all models. Identification of the usable on codes are as follows:

Code	Used on
1	AN/PRT-4
2	AN/PRT-4A
3	AN/PRR-9

SECTION II. BASIC ISSUE ITEMS LIST

(1) Illustration		(2) Federal Stock Number	(3) Part Number	(4) FSCM	(5) Description	(6) Unit of meas	(7) Qty furn with equip
(A) Fig No	(B) Item No				Usable on code		
1-2		5985-933-2879	SM-B-523304	80063	LANYARD ASSEMBLY	EA	1
1-2		5820-995-2261	AM-B-523391	80063	SLIDE	EA	1

APPENDIX C

MAINTENANCE ALLOCATION

Section I. INTRODUCTION

C-1. General

This appendix provides a summary of the maintenance operations for AN/PRR-9, AN/PRT-4 and AN/PRT-4A. It authorizes categories of maintenance for specific maintenance functions on repairable items and components and the tools and equipment required to perform each function. This appendix may be used as an aid in planning maintenance operations.

C-2. Maintenance Function

Maintenance functions will be limited to and defined as follows:

a. Inspect. To determine the serviceability of an item by comparing its physical, mechanical, and/or electrical characteristics with established standards through examination.

b. Test. To verify serviceability and to detect incipient failure by measuring the mechanical or electrical characteristics of an item and comparing those characteristics with prescribed standards.

c. Service. Operations required periodically to keep an item in proper operating condition, i.e., to clean, preserve, drain, paint, or to replenish fuel/lubricants/hydraulic fluids or compressed air supplies.

d. Adjust. Maintain within prescribed limits by bringing into proper or exact position, or by setting the operating characteristics to the specified parameters.

e. Align. To adjust specified variable elements of an item to about optimum or desired performance

f. Calibrate. To determine and cause corrections to be made or to be adjusted on instruments or test measuring and diagnostic equipment used in precision measurement. Consists of the comparison of two instruments, one of which is a certified standard of known accuracy, to detect and adjust any discrepancy in

the accuracy of the instrument being compared.

g. Install. The act of emplacing, seating, or fixing into position an item, part, module (component or assembly) in a manner to allow the proper functioning of the equipment system.

h. Replace. The act of substituting a serviceable like-type part, subassembly, model (component or assembly) for an unserviceable counterpart.

i. Repair. The application of maintenance services (inspect, test, service, adjust, align, calibrate, replace) or other maintenance actions (welding, grinding, riveting, straightening, facing, remachining, or resurfacing) to restore serviceability to an item by correcting specific damage, fault, malfunction, or failure in a part, subassembly, module component assembly, end item or system

j. Overhaul. That periodic maintenance effort (service/action) necessary to restore an item to a completely serviceable operational condition as prescribed by maintenance standards (e.g., DMWR) in appropriate technical publications. Overhaul is normally the highest degree of maintenance performed by the Army. Overhaul does not normally return an item to like-new condition

k. Rebuild. Consists of those services/actions necessary for the restoration of unserviceable equipment to a like-new condition in accordance with original manufacturing standards. Rebuild is the highest degree of materiel maintenance applied to Army equipment. The rebuild operation includes the act of returning to zero those age measurements (hours, miles, etc.) considered in classifying Army equipment/components.

C-3. Column Entries

a. Column 1—Group Number Column 1 lists

group numbers, the purpose of which is to identify components, assemblies, subassemblies and modules with the next higher assembly.

b. Column 2—Component/Assembly. Column 2 contains the noun names of components, assemblies, subassemblies, and modules for which maintenance is authorized.

c. Column 3—Maintenance Functions. Column 3 lists the functions to be performed on the item listed in column 2.

d. Column 4—Maintenance Category. Column 4 specifies, by the listing of a "worktime" figure in the appropriate subcolumn(s), the lowest level of maintenance authorized to perform the function listed in column 3. This figure represents the active time required to perform that maintenance function at the indicated category of maintenance. If the number or complexity of the tasks within the listed maintenance function vary at different maintenance categories, appropriate "worktime" figures will be shown for each category. The number of man-hours specified by the "worktime" figure represents the average time required to restore an item (assembly, subassembly, component, module, end item or system) to a serviceable condition under typical field operating conditions. This time includes preparation time, troubleshooting time and quality assurance/quality control time in addition to the time required to perform the specific tasks identified for the maintenance functions authorized in the maintenance allo-

cation chart. Subcolumns of column 4 are as follows:

- C ----Operator/crew
- O ----Organizational
- F ----Direct support
- H ----General support
- D ----Depot

e. Column 5, Tools and Equipment. Column 5 specifies by code, those common tool sets (not individual tools) and special tools, test, and support equipment required to perform the designated function.

C-4. Tool and Test Equipment Requirements (Table 1)

a. Tool or Test Equipment Reference Code. The numbers in this column coincide with the numbers used in the tools and equipment column of the MAC. The numbers indicate the applicable tool or test equipment for the maintenance functions.

b. Maintenance Category. The codes in this column indicate the maintenance category allocated the tool or test equipment.

c. Nomenclature. This column lists the noun name and nomenclature of the tools and test equipment required to perform the maintenance functions.

d. National/NATO Stock Number. This column lists the National/NATO stock number of the specific tool or test equipment.

e. Tool Number. This column lists the manufacturer's part number of the tool followed by the Federal supply code for manufacturers (5-digit) in parentheses.

SECTION II MAINTENANCE ALLOCATION CHART
FOR
RECEIVING SET, RADIO AM/PRR-9

(1) GROUP NUMBER	(2) COMPONENT/ASSEMBLY	(3) MAINTENANCE FUNCTION	(4) MAINTENANCE CATEGORY					(5) TOOLS AND EQUIPMENT
			C	O	F	H	D	
00	RECEIVING SET, RADIO AM/PRR-9	Inspect ¹	0.25					
		Test ²	0.06					
		Test ³		0.25				
		Test ⁴			0.50			1,2 2,3,4,10
		Test ⁵				1.00		2 thru 21
		Service ¹	0.08					
		Service ¹		0.08				1
		Align ⁶		0.25				1,2
		Align ⁷				1.25		2 thru 21
		Replace ⁸	0.08					
		Replace ⁹		0.17				1
		Replace ¹⁰			0.50			3,4
		Repair ¹¹				1.00		2 thru 21
		Repair					1.00	2 thru 22
Overhaul					2.00	2 thru 21		
Rebuild						2.50 2 thru 22		
01	ELECTRONIC UNIT ASSY. (A4) (PRINTED CIRCUIT BOARD)	Inspect				0.15		
		Test ¹¹				0.50		
		Align ⁷				1.25		
		Replace			0.50			
		Repair				1.00		
		Overhaul					1.50	

- (1) Exterior only
- (2) Operational only
- (3) Operational and crystal alignment tests, only
- (4) Operational and alignment test and testing before and after replacement of authorized parts
- (5) Diagnostic tests and post repair testing
- (6) Alignment only after crystal replacement
- (7) All alignments
- (8) Replacement of battery only
- (9) Replacement of knobs, antenna, slide, lanyard, headset, antenna housing assembly and horn assembly
- (10) Replacement of receiver control and jack housing assemblies
- (11) All repairs

TABLE I. TOOL AND TEST EQUIPMENT REQUIREMENTS
FOR
RECEIVING SET, RADIO AN/PRR-9

TOOL OR TEST EQUIPMENT REF CODE	MAINTENANCE CATEGORY	NOMENCLATURE	NATIONAL/NATO STOCK NUMBER	TOOL NUMBER
1	O	TOOL KIT, ELECTRONIC EQUIPMENT TK-101/G	5180-00-064-5178	
2	O,F,H,D	CHANNEL ALIGNMENT INDICATOR ID-1189/PR	6625-00-926-4357	
3	F,H,D	TOOL KIT, ELECTRONIC EQUIPMENT TK-100/G	5180-00-605-0079	
4	F,H,D	TOOL KIT, ELECTRONIC EQUIPMENT TK-105/G	5180-00-610-8177	
5	H,D	SIGNAL GENERATOR AN/URM-48	6625-00-553-1178	
6	H,D	POWER SUPPLY PP-3514/U	6130-00-445-6933	
7	H,D	OUTPUT METER TS-585B/U	6625-00-244-0501	
8	H,D	VOLTMETER ME-30B/U	6625-00-643-1670	
9	H,D	MULTIMETER ME-26B/U	6625-00-646-9409	
10	F,H,D	MULTIMETER TS-352B/U	6625-00-242-5023	
11	H,D	COUNTER AN/USM-207	6625-00-911-6368	
12	H,D	AUDIO OSCILLATOR TS-421A/U	6625-00-669-0228	
13	H,D	SIGNAL GENERATOR AN/GRM-50	6625-00-868-8353	
14	H,D	TEST CABLE NO. 1 ¹		
15	H,D	TEST CABLE NO. 2 ¹		
16	H,D	TEST CABLE NO. 3 ¹		
17	H,D	TEST CABLE NO. 4 ¹		
18	H,D	ANALYZER, DISTORTION TS-723B/U	6625-00-668-9418	
19	H,D	SIGNAL GENERATOR AN/URM-103	6625-00-868-8352	
20	H,D	CAPACITOR, DISC CERAMIC 2.2 pfd. ²		
21	H,D	CAPACITOR, DISC CERAMIC 4.7 pfd. ²		
22	D	DEPOT FACILITIES AND SUPPORT SHOPS		

(1) Fabricate per TM 11-5820-549-35
(2) See TM 11-5820-549-35

SECTION III MAINTENANCE ALLOCATION CHART
FOR

TRANSMITTING SETS, RADIO AN/PRT-4 AND AN/PRT-4A

(1) GROUP NUMBER	(2) COMPONENT/ASSEMBLY	(3) MAINTENANCE FUNCTION	(4) MAINTENANCE CATEGORY					(5) TOOLS AND EQUIPMENT
			C	O	F	H	D	
00	TRANSMITTING SET, RADIO AN/PRT-4 AND AN/PRT-4A	Inspect ¹	0.25					
		Test ²	0.08					
		Test ³			0.50			
		Test ⁴				0.75		2,3,4 3 thru 16
		Service ⁵	0.08					
		Align ⁶		0.25				1,2 2 thru 16
		Align ⁶				0.75		
		Replace ⁷	0.1					
		Replace ⁸		0.25				1 3,4 2 thru 17
		Replace ⁹			0.25			
Repair					1.00			
Repair						1.00		
Overhaul					2.00			
Rebuild						2.50		
01	ELECTRONIC UNIT ASSEMBLY (A7) (PRINTED CIRCUIT BOARD ASSY.)	Inspect				0.10		
		Test				0.75		2 thru 16
		Replace			0.50			2,3,4 2 thru 16
		Repair				0.75		2 thru 16
		Overhaul				1.50		2 thru 16

- (1) Exterior only
- (2) Operational test only
- (3) Operational and alignment tests and tests before and after replacement of authorized parts
- (4) Diagnostic tests and post repair testing
- (5) Alignment after crystal replacement
- (6) All alignments and adjustments
- (7) Replacement of battery only
- (8) Replacement of knobs, antenna, microphone element, microphone cover, battery case, slide, lanyard, fuz buttons, cover assembly, compression spring and override spring, antenna base assembly
- (9) Replace tone-voice switch, channel switch, connectors J1 and J2

TABLE I. TOOL AND TEST EQUIPMENT REQUIREMENTS FOR TRANSMITTING SETS, RADIO AN/PRT-4 AND AN/PRT-4A

TOOL OR TEST EQUIPMENT REF CODE	MAINTENANCE CATEGORY	NOMENCLATURE	NATIONAL/NATO STOCK NUMBER	TOOL NUMBER
1	O	TOOL KIT, ELECTRONIC EQUIPMENT TK-101/U	5180-00-064-5178	
2	O,F,H,D	CHANNEL ALIGNMENT INDICATOR ID-1189/FR	6625-00-926-4357	
3	F,H,D	TOOL KIT, ELECTRONIC EQUIPMENT TK-100/G	5180-00-605-0079	
4	F,H,D	TOOL KIT, ELECTRONIC EQUIPMENT TK-105/G	5180-00-610-8177	
5	H,D	POWER SUPPLY PF-3514/U	6625-00-445-6933	
6	H,D	MULTIMETER ME-26B/U	6625-00-646-9409	
7	H,D	MULTIMETER TS-352B/U	6625-00-242-5023	
8	H,D	AUDIO OSCILLATOR TS-421A/U	6625-00-669-0228	
9	H,D	VOLTMETER ME-30B/U	6625-00-643-1670	
10	H,D	MODULATION METER ME-57/U	6625-00-647-3737	
11	H,D	COUNTER, FREQUENCY AN/USM-207	6625-00-911-6368	
12	H,D	TEST CABLE NO.4 ¹		
13	H,D	TEST CABLE NO.5 ¹		
14	H,D	TEST CABLE NO.6 ¹		
15	H,D	CAPACITOR 3.3 pfd, DISC AND RESISTOR 1200 ohm ²		
16	H,D	SIGNAL GENERATOR AN/GRM-50	6625-00-868-8353	
17	H,D	SPECTRUM ANALYZER TS-723B/U	6625-00-668-9418	
18	D	DEPOT SUPPORT FACILITIES (SUPPORT SHOPS)		

(1) Fabricate per TM 11-5820-549-35
 (2) See TM 11-5820-549-35

By Order of the Secretary of the Army:

HAROLD K. JOHNSON,
General, United States Army,
Chief of Staff.

Official:

KENNETH G. WICKHAM,
Major General, United States Army,
The Adjutant General.

Distribution:

Active Army:

USASA (2)
CNGB (1)
CC-F (7)
Dir of Trans (1)
CofEngrs (1)
TSG (1)
CofSpts (1)
USACDCBRA (1)
USACDCCEA (1)
USACDCOA (1)
USACDCQMA (1)
USACDCTA (1)
USACDCADA (1)
USACDCARMA (1)
USACDCAVNA (1)
USACDCARTYA (1)
USACDCSWA (1)
USACDCCEA, Ft Huachuca (1)
USAAEHA (5)
USAARENBD (2)
USAAESWBD (5)
USAMC (5)
USCONARC (5)
ARADCOM (5)
ARADCOM Rgn (2)
OS Maj Comd (4)
LOGCOMD (2)
USAMICOM (4)
USASTRATCOM (4)
USAESC (85)
MDW (1)
Armies (2) except

Seventh (5)
EUSA (5)
Corps (2)
USAC (3)
Div (2)
1st GM bde (5)
13th Fld Sta (5)
USAG, Arlington Hall (5)
USMA (5)
Svc Colleges (2)
USASESCS (60)
USAADS (10)
USAAMS (30)
USAARMS (30)
USAIS (30)
USAES (10)
USAFS (5)
USAMPS (5)
MFSS (5)
USAOGMS (5)
USAQMS (5)
USAES (5)
USASA Tng Cen & Sch (5)
USATC (2) except
USAMEDTC (5)
USATC, FA (5)
WRAMC (1)
Army Pic Cen (2)
USACDCEC (10)
USAINTC (5)
USAJFKCENSPWAR (5)
USAOEC (5)

Instl (2) except
Ft Hancock (4)
Ft Gordon (10)
Ft Huachuca (10)
Ft Carson (25)
Ft Knox (12)
Ft Lee (5)
Gen Dep (2)
Sig Sec, Gen Dep (5)
Sig Dep (12)
Army Dep (2) except
LBAD (14)
TOAD (14)
SHAD (3)
SVAD (5)
ATAD (10)
SEAD (5)
SAAD (30)
LEAD (7)
NAAD (5)
CHAD (3)
BHAD (5)
WSMR (5)
Sig FLDMS (2)
AMS (1)
USACCREL (2)
USA Engr RD Lab (5)
USAERDAA (2)
USAERDAW (13)
KMAG (5)
USARMIS, (Costa Rica (5))
USARMIS, Guatemala (5)

USARMIS, Ecuador (5)	7-57
USARMIS, El Salvador (5)	7-100
USAEPG (5)	7-102
DPG (5)	7-168
USDB (5)	10-500 (JA-
Redstone Arsenal (10)	(JE)
Watertown Arsenal (10)	11-57
Units Org Under fol TOE (2 ea):	11-97
1-56	11-98
1-75	11-117
1-100	11-127
5-64	11-155
5-78	11-157
6-37	11-158
6-100	11-500(AA-
6-155	AC)
6-156	11-587
6-168	11-592
6-185	11-597
6-200	17-17
6-215	17-42
6-216	17-51
6-345	17-55
6-346	17-100
6-355	17-102
6-356	19-27
6-385	19-35
6-386	19-37
6-415	19-47
6-416	19-55
6-525	19-57
6-558	19-67
6-575	19-87
6-576	19-97
6-577	19-500(IC-
6-631	IE)
6-700	29-7
6-705	29-407
6-706	37-42
7-15	37-100
7-18	37-102
7-35	39-51
7-37	55-457
7-42	57-42
7-45	57-100
7-47	57-102
7-55	

NG:State AG (3).

USAR: None.

For explanation of abbreviations used, see AR 320-50.

CONDENSED OPERATING INSTRUCTIONS FOR TRANSMITTING SET, RADIO AN/PRT-4

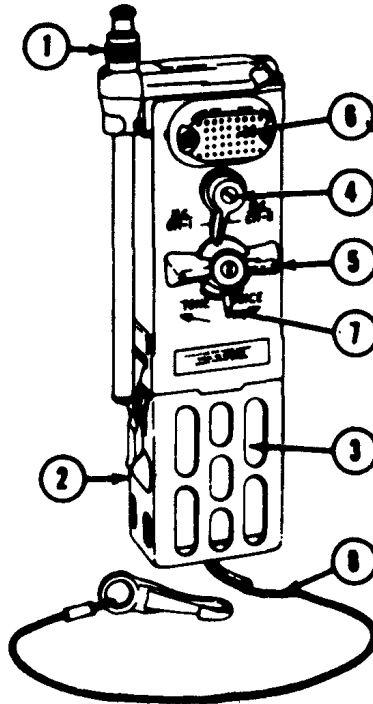

TO OPERATE SET

THE NUMBERS OF STEPS 1 THROUGH 7 ARE THE SAME AS THE NUMBERS ON THE ILLUSTRATION.

- (1) RAISE COLLAPSIBLE ANTENNA TO ITS FULL HEIGHT
- (2) RELEASE BOTH BATTERY CASE CLAMPS AND REMOVE BATTERY CASE.
- (3) INSERT BATTERY, DRY BA-300/U INTO MATING CONNECTOR AT BOTTOM OF TRANSMITTER. REPLACE BATTERY CASE AND SECURE CLAMPS.
- (4) SET UPPER SELECTOR SWITCH IN CH-1 POSITION FOR CHANNEL 1 OR CH-2 POSITION FOR CHANNEL 2. CHANNEL 2 OUTPUT POWER IS APPROXIMATELY ONE-THIRD OF CHANNEL 1.
- (5) TONE-VOICE SWITCH

FOR TONE SIGNAL: PRESS THE TONE-VOICE SWITCH IN THE DIRECTION OF TONE ARROW (CLOCKWISE ROTATION) AND HOLD IN THIS POSITION FOR AS LONG AS TONE SIGNAL IS DESIRED. RELEASE SWITCH AT END OF DESIRED TIME.

FOR VOICE COMMUNICATIONS: PRESS TONE-VOICE SWITCH IN THE DIRECTION OF VOICE ARROW (COUNTERCLOCKWISE ROTATION) AND HOLD IN THIS POSITION WHILE TRANSMITTING VOICE COMMUNICATIONS.
- (6) SPEAK IN MICROPHONE LOCATED ABOVE CHANNEL SELECTOR SWITCH, IN A NORMAL TONE OF VOICE WITH LIPS ABOUT 1" FROM MICROPHONE. RELEASE TONE-VOICE SWITCH AT END OF TRANSMISSION.
- (7) IF ONLY VOICE TRANSMISSION IS TO BE USED, POSITION THE OVERRIDE SPRING TO THE WORD VOICE. IN THIS POSITION THE TONE-VOICE SWITCH CAN BE PRESSED ONLY IN THE VOICE DIRECTION. FOR TONE ONLY USE, POSITION THE OVERRIDE SPRING TO THE WORD TONE. WHEN THE OVERRIDE SPRING IS IN ITS CENTER, DETENT POSITION, THE TONE-VOICE SWITCH CAN BE MOVED IN EITHER DIRECTION.
- (8) TRANSMITTER MAY BE CLIPPED TO POCKET, BELT OR COMBAT SUSPENDERS WHEN NOT IN USE, USING CLIP ON BACK OF TRANSMITTER TO PREVENT LOSS. PLACE LOOP END OF LANYARD THROUGH BALE ON BOTTOM OF BATTERY RETAINER. PULL CLASP END THROUGH THIS LOOP AND CLIP TO SLIDE ON SUSPENDERS.

DEPARTMENT OF THE ARMY
US ARMY AG PUBLICATIONS CENTER
1655 WOODSON ROAD
ST. LOUIS, MISSOURI 63114

OFFICIAL BUSINESS
PENALTY FOR PRIVATE USE, \$300

POSTAGE AND FEES PAID
DEPARTMENT OF THE ARMY
DOD 314

FOURTH CLASS

