

ARMY
NAVY
AIR FORCE
MARINE CORPS

TM 11-5895-1180-10
EE125-JC-OPI-010/PSC3
31R2-2PSC3-1
TM 5895-10/1

OPERATORS MANUAL



RADIO SET AN/PSC-3

(NSN 5820-01-145-4943)

DEPARTMENTS OF THE ARMY, THE NAVY, AND THE AIR FORCE
AND HEADQUARTERS, MARINE CORPS

This copy is a reprint which includes current
pages from Change 1.

EQUIPMENT
DESCRIPTION

OPERATOR
CONTROLS

PMCS

OPERATION

TROUBLE
SHOOTING

15 FEBRUARY 1988

Distribution authorized to the Department of Defense and DOD contractors only for official use or for administration or operational purposes. This determination was made on 27 October 1987. Other requests for this document will be referred to Commander, US Army Communications-Electronics Command and Fort Monmouth, ATTN: AMSEL-ME-P, Fort Monmouth, NJ 07703-5000.

DESTRUCTION NOTICE — Destroy by any method that will prevent disclosure of contents or reconstruction of the document.

Change

DEPARTMENTS OF THE ARMY,
THE NAVY, AND THE AIR FORCE
AND HEADQUARTERS, MARINE CORPS
Washington, DC, 15 January 1992

No. 1

Operator's Manual

**RADIO SET AN/PSC-3
(NSN 5820-01-1454943) (EIC: L2S)**

TM 11-5895-1180-10 / EE125-JC-OPI-010/PSC 3/ TO 31R2-2PSC3-1 / TM 5895-10/1, 15 February 1988, is changed as follows:

1. Pen and ink change. On front cover, following NSN, add: (EIC:L2S).
2. Remove old pages and insert new pages as indicated below. New or changed material is indicated by a vertical bar in the margin of the page.

Remove pages

i and ii
1-1 and 1-2
2-5 and 2-8
A-1 through A-4
B-1 through B-4
C-1 and C2

Insert pages

i and ii
1-1 and 1-2
2-5 and 2-6
A-1 through A-4
B-1 through B-4
C-1 and C-2

3. File this change sheet in front of the manual for reference purposes.

Distribution authorized to US Government agencies and their contractors for official use or for administrative or operational purposes only. This determination was made on 15 June 1991. Other requests for this document will be referred to Commander, US Army Communications-Electronics Command and Fort Monmouth, ATTN: AMSEL-LC-LM-LT, Fort Monmouth, New Jersey 07703-5007.

DESTRUCTION NOTICE - Destroy by any method that will prevent disclosure of contents or reconstruction of the document.

By Order of the Secretary of the Army:

GORDON R. SULLIVAN

Official:

Chief of Staff

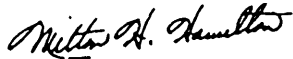

MILTON H. HAMILTON
Administrative Assistant to the
Secretary of the Army

00297

By Order of the Marine Corps:

H. E. REESE
Deputy for Support
Marine Corps Research
Development and Acquisition
Command

By Order of the Secretary of the Navy:

ROBERT AILES
Rear Admiral, United States Navy
Command, Space and Naval Warfare
Systems Command

By Order of the Secretary of the Air Force:

LARRY D. WELSH
General, United States Air Force
Chief of Staff

Official:

CHARLES D. McDONALD
General, United States Air Force
Commander, Air Force
Logistics Command

Distribution:

To be distributed in accordance with DA Form 12-51-E,
block 1587, Operator Maintenance requirements for
TM 11-5895-1180-10.

WARNING

ELECTROMAGNETIC RADIATION

Do NOT stand in direct path of the Medium Gain Antenna when power is on. Do NOT work on cables while power is on. Transmit antenna cables conduct radio frequency energy that can cause fatal internal burns and electrical shock. Ensure that power is off before working on antenna or connectors. If you feel a slight warming effect while near this equipment, MOVE AWAY QUICKLY!

CLEANING

Adequate ventilation should be provided while using TRICHLOROTRIFLUOROETHANE. Prolonged breathing of vapor should be avoided. The solvent should not be used near heat or open flame, the products of decomposition are toxic and irritating. Since TRICHLOROTRIFLUOROETHANE dissolves natural oils, prolonged contact with skin should be avoided. When necessary, use gloves which the solvent cannot penetrate. If the solvent is taken internally, consult a physician immediately.

Compressed air shall not be used for cleaning purposes except where reduced to less than 29 pounds per square inch (psi) and then only with effective chip guarding and personnel protective equipment. Do not use compressed air to dry parts when TRICHLOROTRIFLUOROETHANE has been used. Compressed air is dangerous and can cause serious bodily harm if protective means or methods are not observed to prevent chips or particles (of whatever size) from being blown into the eyes or unbroken skin of the operator or other personnel.

BLACKOUT

When operating Radio Set AN/PSC-3 in enemy territory, bright lights will make it easy for the enemy to detect your presence. Use blackout procedures to prevent detection by the enemy.



**SAFETY STEPS TO FOLLOW IF
SOMEONE IS THE VICTIM OF
ELECTRICAL SHOCK**

- 1** DO NOT TRY TO PULL OR GRAB THE INDIVIDUAL
- 2** IF POSSIBLE, TURN OFF THE ELECTRICAL POWER
- 3** IF YOU CANNOT TURN OFF THE ELECTRICAL POWER, PULL, PUSH, OR LIFT THE PERSON TO SAFETY USING A DRY WOODEN POLE OR A DRY ROPE OR SOME OTHER INSULATING MATERIAL
- 4** SEND FOR HELP AS SOON AS POSSIBLE
- 5** AFTER THE INJURED PERSON IS FREE OF CONTACT WITH THE SOURCE OF ELECTRICAL SHOCK, MOVE THE PERSON A SHORT DISTANCE AWAY AND IMMEDIATELY START ARTIFICIAL RESUSCITATION

WARNING

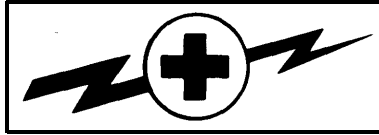

HIGH VOLTAGE

is used in the operation of this equipment

DEATH ON CONTACT

may result if personnel fail to observe safety precautions.

Never work on electronic equipment unless there is another person nearby who is familiar with the operation and hazards of the equipment and who is competent in administering first aid. When technicians are aided by operators, they must be warned about dangerous areas.

Whenever possible, the power supply to the equipment must be shut off before beginning work on the equipment. Take particular care to ground every capacitor likely to hold a dangerous potential. When working inside the equipment, after the power has been turned off, always ground every part before touching it.

Be careful not to contact high-voltage connections or 115 volt ac input connections when installing or operating this equipment.

Whenever the nature of the operation permits, keep one hand away from the equipment to reduce the hazard of current flowing through the body.

WARNING: DO NOT BE MISLED BY THE TERM "LOW VOLTAGE." POTENTIALS AS LOW AS 50 VOLTS MAY CAUSE DEATH UNDER ADVERSE CONDITIONS.

For Artificial Respiration, refer to FM 21-11.

WARNING

A lithium-sulfur dioxide (Li-SO₂) battery used with the RT-1402A/G contains pressurized sulfur dioxide (SO₂) gas. The gas is toxic, and the battery MUST NOT be abused in any way which may cause the battery to rupture.

Do not heat, short circuit, crush, puncture, mutilate, or disassemble batteries.

Do not use any battery which shows signs of damage, such as bulging, swelling, disfigurement, brown liquid in the plastic wrap, a swollen plastic wrap, etc.

Do not test Li-SO₂ batteries for capacity,

Do not recharge Li-SO₂ batteries.

Do not use water to extinguish Li-SO₂ battery fires if a shock hazard exists due to high voltage electrical equipment in the immediate vicinity (i.e., greater than 30 volts, alternating current (ac) or direct current (dc)).

If the battery compartment becomes hot to the touch, if you hear a hissing sound (i.e., battery venting), or smell irritating sulfur dioxide gas, IMMEDIATELY turn OFF the equipment. Remove the equipment to a well ventilated area or leave the area.

Do not use a Halon type fire extinguisher on a lithium battery fire.

In the event of a fire, near a lithium battery(ies), rapid cooling of the battery(ies) is important. Use a carbon dioxide (CO₂) extinguisher. Control of the equipment fire, and cooling, may prevent the battery from venting and potentially exposing lithium metal. In the event that lithium metal becomes involved in fire, the use of a graphite based Class D fire extinguisher is recommended, such as Lith-X or MET-L-X,

Do not store lithium batteries with other hazardous materials and keep them away from open flame or heat.

D

TM 11-5895-1180-10
EE125-JC-OPI-01A/PSC-3
31R2-2PSC3-1
TM 5895-10/1

Technical Manual
No. 11-5895-1180-10
Technical Manual
No. EE125-JC-OPI-01A/PSC3
Technical Order
No. 31R2-2PSC3-1
Technical Manual
No. 5895-10/1

DEPARTMENTS OF THE ARMY,
THE NAVY, THE AIR FORCE,
AND HEADQUARTERS,
MARINE CORPS

Washington, DC, 15 February 1988

**OPERATOR'S MANUAL
RADIO SET AN/PSC-3
(NSN 5820-01-145-4943) (EIC:L2S)**

**REPORTING ERRORS AND
RECOMMENDING IMPROVEMENTS**

You can help improve this manual. If you find any mistakes or if you know of a way to improve the procedures, please let us know. Mail our letter, DA Form 2028 (Recommended Changes to Publications and Blank Forms), or DA Form 2028-2, direct to: Commander, US Army Communications-Electronics Command and Fort Monmouth, ATTN: AMSEL-LC-LM-LT, Fort Monmouth, New Jersey 07703-5007.

For Air Force, submit AFTO Form 22 (Technical Order System Publication Improvement Report and Reply) in accordance with paragraph 6-5, Section VI, T.O. 00-5-1. Forward direct to prime ALC/MST.

For Navy, mail comments to the Commander, Space and Naval Warfare Systems Command, ATTN: SPAWAR 8122, Washington, DC, 20363-5100.

Marine Corps units, submit NAVMC 10772 (Recommended Changes to Technical Publications) to: Commanding General, Marine Corps Logistics Base (Code 850), Albany, Georgia 31704-5000.

In any case a reply will be furnished direct to you.

Change 1 i

	PAGE
HOW TO USE THIS MANUAL	ii
CHAPTER 1. INTRODUCTION	1-1
Section I. <u>General Information</u>	1-1
Section II. <u>Equipment Description and Data</u>	1-6
Section III. <u>Technical Principles of Operation</u>	1-17
CHAPTER 2. OPERATING INSTRUCTIONS	2-1
Section I. <u>Description and Use of Operator</u>	2-1
II. Preventive Maintenance Checks and	2-10
III. Operation Under Usual Conditions	2-16
IV. Operation Under Unusual Conditions	2-72
CHAPTER 3. MAINTENANCE INSTRUCTIONS	3-1
Section I. <u>Troubleshooting Procedures</u>	3-1
Section II. <u>Maintenance Procedures</u>	3-6
APPENDIX A. REFERENCES	A-1
B. COMPONENTS OF END ITEM	
AND BASIC ISSUE ITEMS LISTS	B-1
c. ADDITIONAL AUTHORIZATION	
LIST	C-1
D. EXPENDABLE SUPPLIES AND	
MATERIALS LIST	D-1

HOW TO USE THIS MANUAL

This manual is divided into three chapters.

- CHAPTER 1 contains an introduction to this manual with functional and physical description of Radio Set AN/PSC-3. Full view illustrations are provided to assist you in major component identification.

- CHAPTER 2 contains the description and use of operator controls with supporting illustrations, instructions for operation under usual and unusual conditions, and a table of preventive maintenance checks and services.
- CHAPTER 3 contains maintenance data. It provides operator troubleshooting procedures, maintenance procedures, and operator maintenance limitations for Radio Set AN/PSC-3.

Pages are numbered consecutively throughout the manual. Each chapter is divided into sections and sections into paragraphs. Certain section titles are boxed on the front cover. At the right edge of each box is a blackened area. This blackened area matches a black mark appearing on the first page of that section in the manual.

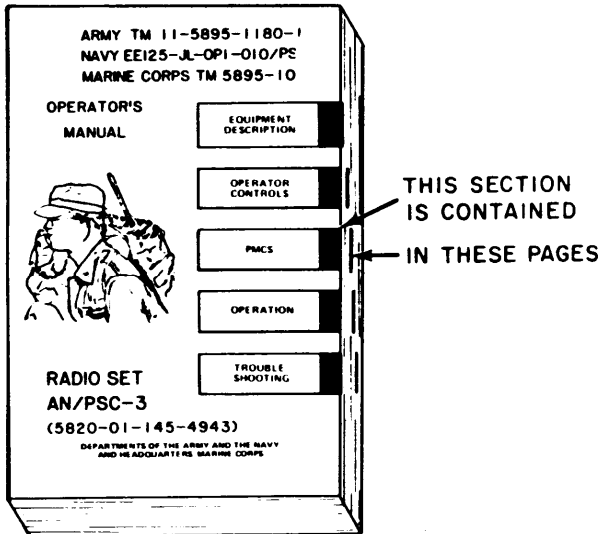

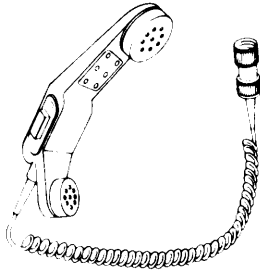

HANDSET

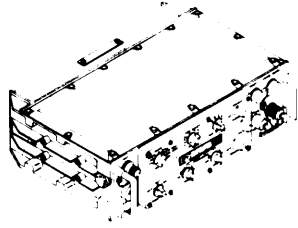

R/T
UNIT

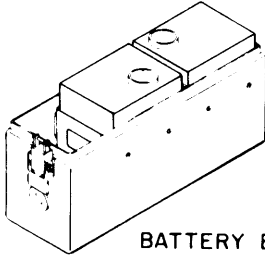

BATTERY BOX
WITH BATTERIES
INSTALLED

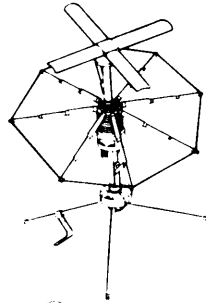

MEDIUM GAIN
ANTENNA AND
CARRYING CASE



WHIP
ANTENNA

RADIO SET AN/PSC-3 COMPONENTS

CHAPTER 1

INTRODUCTION

	PAGE
General Information	1-1
Equipment Description and Data.	1-6
Technical Principles of Operation.	1-17

Section I

GENERAL INFORMATION

1-1. SCOPE

This manual is for your use in operating Radio Set AN/PSC-3. In addition to detailed operating procedures, the manual will assist you in setting up for line-of-sight (LOS), satellite relay (SAT) and retransmit (XMT) operation. It will also provide you with operator maintenance.

1-2. MAINTENANCE FORMS, RECORDS, AND REPORTS

a. Reports of Maintenance and Unsatisfactory Equipment. Department of the Army forms and procedures used for equipment maintenance will be those prescribed by DA Pam 736-750, as contained in Maintenance Management Update. Air Force personnel will use AFR 66-1 for maintenance reporting and TO-00-35D54 for unsatisfactory equipment reporting. Navy personnel will report maintenance performed utilizing the Maintenance Data Collection Subsystem (MDCS) IAW OPNAVINST 4790.2, Vol 3 and unsatisfactory material/conditions (UR submissions) IAW OPNAVINST 4790.2, Vol 2, chapter 17. Marine Corps maintains forms and procedures as prescribed by TM 4700-15/1.

b. Report of Packaging and Handling Deficiencies. Fill out and forward SF 364 (Report of Discrepancy (ROD)) as prescribed in R 735-11-2/DLAR 4140.55/SECNAVINST 4355.18/AFR 400-54/MCO4430.3J.

c. Transportation Discrepancy Report (TDF) (SF 361). Fill out and forward Transportation Discrepancy Report (TDR) (SF 361) as prescribed in AR 55-38/NAVSUPINST 4610.33C/AFR 75-18/MCOP4610.19D/DLAR 4500.15.

1-3. HAND RECEIPT (-HR) MANUALS

This manual has a companion document with a TM number followed by "-HR" (which stands for Hand Receipt). The TM 11-5895-1180-1 0-HR consists of preprinted hand receipts (DA Form 2062) that list end item related equipment (i.e., COEI, BIL, and AAL) you must account for. As an aid to property accountability, additional -HR manuals may be requisitioned from the US Army Adjutant General Publications Center, Baltimore, MD, in accordance with the procedures in Chapter 3, AR 310-2, and DA Pam 310-10.

1-4. REPORTING EQUIPMENT IMPROVEMENT RECOMMENDATIONS (EIR)

a. Army. If your AN/PSC-3 needs improvement, let us know. Send us an EIR. You, the user, are the only one who can tell us what you don't like about your equipment. Let us know why you don't like the design or performance. Put it on an SF 368 (Product Quality Deficiency Report). Mail it to: Commander, US Army Communications-Electronics Command and Fort Monmouth, ATTN: AMSEL-ED-PH, Fort Monmouth, New Jersey 07703-5007. We'll send you a reply.

b. Air Force. Air Force Personnel are encouraged to submit EIR's in accordance with AFR 900-4.

c. Navy. Navy personnel are encouraged to submit EIR's through their local beneficial Suggestion Program.

d. Marine Corps Users. QDR shall be reported on SF 368 in accordance with MCO 1650.17, Quality Deficiency Report Manual. Submit to Commanding General, Marine Corps Logistics Base (Code 856), Albany, Georgia 31704-5000.

1-5. NOMENCLATURE CROSS-REFERENCE LIST

The following list should help you locate the official nomenclature of components of/or equipment used with Radio Set AN/PSC-3. Official nomenclature must be used when completing report forms or when looking up technical manuals.

COMMON NAME	OFFICIAL NOMENCLATURE
ALICE Pack	All-Purpose Lightweight Individual Carrying Equipment
Backpack Radio Set	Radio Set AN/PSC-3
Battery Box	Battery Box CY-8006/PSC-3
DMDG	Digital Message Device Group OA-8990/P
Handset	Handset H-250()/U
Medium Gain Antenna	Antenna AS-3567/G
Net Control Station or NCS	Radio Set AN/VSC-7
R/T Unit	Receiver/Transmitter RT-1402A/G
RXMT Cable	Retransmission Cable MK-456/GRC
Whip Antenna	Antenna AS-3566/G

1-6. LIST OF ABBREVIATIONS AND ACRONYMS

A complete list of all abbreviations and acronyms used in this manual are listed below.

ANT	Antenna
bps	bits per second
BPSK	Bi-Phase Shift Keying
CAL	Call
CON	Conference
cc w	counterclockwise
CT	Cipher Text
cw	clockwise
dB	Decibel
DBPSK	Differential Coding Bi-Phase Shift Keying

LIST OF ABBREVIATIONS AND ACRONYMS (cont)

dc	direct current
FM	Frequency Modulation
FM-FSK	Frequency Modulation - Frequency Shift Keying
Hz	Hertz
kbps	kilo bits per second
kHz	kilo Hertz
LOS	Line-of-Sight
MHz	Mega Hertz
Ni-Cad	Nickel-Cadmium Cell
PMCS	Preventive Maintenance Checks and Services
PSK	Phase Shift Keying
PTT	Push To Talk
RCV or REC	Receive
RF	Radio Frequency
RXMT	Retransmit
SAT	Satellite Relay
SEL	Selective
UHF	Ultra High Frequency
U/M	Unit of Measure
v	Volts
VSWR	Voltage Standing Wave Ratio
XMIT or XMT	Transmit
XMTR	Transmitter

1-7. GLOSSARY

ALPHANUMERIC - A set of characters containing both letters, numbers and other symbols.

AMP-HOUR - Ampere-hour is a current of one ampere flowing for one hour.

AUDIO - Frequencies that are heard.

BANDWIDTH - The difference in hertz between the highest and lowest frequency required for adequate signal transmission.

BURST MODE - Used in DATA mode. Transmitting or receiving data traffic at a high rate of speed in short bursts.

CHANNEL SPACING - The Frequency band in hertz between two channels.

DETUNE - To change the inductance and/or capacitance of a tuned circuit, causing it to be resonant at other than the desired frequency.

ENCRYPTION - To convert from ordinary language into cipher or code.

INTERFACE - Connecting and making two pieces of equipment compatible.

JAMMING Transmitted signals intended to interfere with the reception of signals from another station.

LINE-OF-SIGHT (LOS) - A straight line between communication networks.

OMNIDIRECTIONAL - All directional, not favoring any one direction.

RETRANSMIT (RXMT) - The transmission of information received from a previous transmission.

SAT OFFSET - The transmitter of a transceiver transmitting on one frequency while the receiver is receiving on a different preset offset frequency. The offset frequency is referenced to the transmit (dial) frequency of Radio Set AN/PSC-3.

EXAMPLE: Dial Frequency is 305.265 MHz, selected offset is 30.750 MHz, actual receive for the selected offset is $305.265 - 30.750 = 274.515$ MHz.

SATELLITE RELAY (SAT) - A signal transmitted to a satellite relay station at one frequency with the satellite relay station retransmitting the same data to distant stations. The satellite transmitted signal will be at a different frequency than the frequency received by the satellite.

Section II

EQUIPMENT DESCRIPTION AND DATA

1-8. PURPOSE

Radio Set AN/PSC-3 is a portable, battery operated, half duplex UHF transceiver. It provides two-way voice (secure and plain) and data communication via satellite relay (SAT) or line-of-sight (LOS) modes. It operates in the UHF frequency band of 225 MHz to 399.995 MHz range. Radio Set AN/PSC-3 is hereinafter referred to as the Backpack Radio Set. One operator is required to crew and operate it. For mobile operation it is harnessed to the back of the operator. For at halt operation, it is ground positioned by the operator.

Performance margins permit the use of an omnidirectional low-gain whip antenna for reception of selective and/or conference calls from a satellite relay station and for reception and transmission of LOS signals. A directional, medium gain, tripod mounted antenna is used for SAT operation.

Retransmit (RXMT) operation is possible using Radio Set AN/PRC-70, Radio Set AN/PRC-77 or Radio Set AN/V RC-12 series with Retransmission Cable MK-456/GRC. The equipment must be separated 25 to 100 feet to prevent interference.

1-9. CAPABILITIES AND FEATURES

- a. The receiver portion and transmitter portion of the R/T Unit each operate over the identical UHF frequency range of 225 to 399.995 MHz.
- b. Transmitter Output:
 - 27.8 Watts in SAT mode of operation with a medium gain antenna deployed.
 - 2 Watts in LOS mode of operation with the low-gain whip antenna deployed.

- c. Channel Spacing:
- 5 kHz increments for SAT mode of operation.
 - 25 kHz increments for LOS mode of operation.
- d. It is capable of receiving and transmitting in any one of the following modes in both SAT or LOS mode of operation.
- VOICE - Plain voice audio is standard analog FM using Handset H-250()/U. This mode will allow direct communication with other types of UHF radios particularly the AN/WSC-3(VI), PRT-25067, and AN/URC-101.
 - X modes - It will interface with either the TSEC/KY-57 or TSEC/KY-65 security devices:
 - X1 - TSEC/KY-65 for standard analog FM secure voice operation.
 - X2 - TSEC/KY-57 for 16 kbps (FM-FSK) wide-band digital secure voice or TSEC/KY-57 standard analog FM plain voice in PT or OFF positions of TSEC/KY-57.
 - RXMT - Retransmit mode is either plain voice or TSEC/KY-65 secure voice standard analog FM. Retransmit mode is compatible with Radio Sets AN/PRC-70, AN/PRC-77 and AN/VRC-12 series when using Retransmission Cable MK-456/GRC.

NOTE

CALL mode operation is a unique calling function. It allows the sending station to alert a distant unit with a visual white flag indication, and if desired, a five second audible alarm.

- CALL - It will receive conference calls and one of 15 individual selective calls or transmit conference calls. BPSK modulation is used in both transmit and receive modes.

- DATA - It will interface with Digital Message Device Group OA-8990/P at 300/1200 bps. The 2400 mode will interface with other MIL-STD-188C low level data devices at 2400 bps.

1-10. LOCATION AND DESCRIPTION OF MAJOR COMPONENTS

- The Backpack Radio Set can be configured for the SAT or LOS mode. The major components for SAT mode are Receiver/Transmitter RT-1402A/G, Battery Box CY-8006/PSC-3, and Antenna AS-3567/G. The primary components for operation are keyed in the following illustration.

SAT CONFIGURATION – MAJOR COMPONENTS

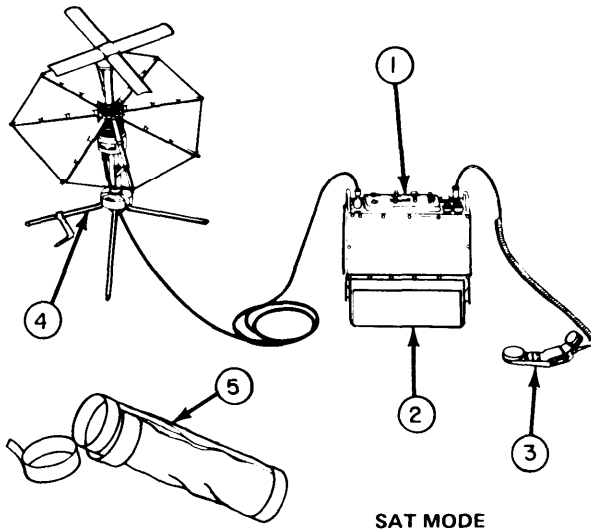

RECEIVER/TRANSMITTER RT-1402A/G ① . Referred to hereinafter as the R/T Unit, is the major unit of the Backpack Radio Set. Operator controls, indicators, meters, and 10 amp fuse are located on the front control panel. Battery meters and spare 10 amp fuse are located on rear of the case. Variable power control is mounted on the side of the R/T Unit and is used to adjust the output (XMT) power.

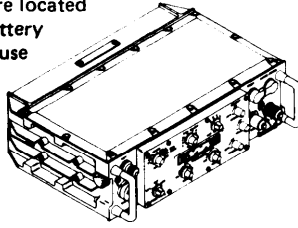

BATTERY BOX CY-8006/PSC-3 ② . Referred to hereinafter as the Battery Box, can house two BB-590/U, 24-volt, 1.8 amp-hour Ni-Cad rechargeable batteries or two BA-5590/U, 24-volt, 8 amp-hour non-rechargeable Lithium batteries. Provides a +24 V dc, 16 amp-hour, non-rechargeable source. Mounts to the R/T Unit front panel with a watertight panel and is attached by two spring-operated latches.

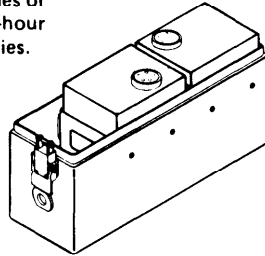

HANDSET H-250()/U ③ . Referred to hereinafter as the Handset, is used for voice communication.



ANTENNA AS-3567/G ④ . Referred to hereinafter as the Medium Gain Antenna, is directional and used for SAT communication. It includes a tripod for supporting the antenna, a mechanism for adjusting elevation, two 12.5 foot RF cables (RG-223/U), and a carrying case. It is collapsible for rapid deployment of less than two minutes from stored to deployed.

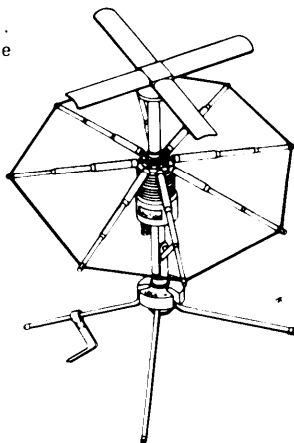

CARRYING CASE ⑤ . The canvas case is for transporting the Medium Gain Antenna. The case can be attached to the bottom of the ALICE Pack with two clips. A snap hook is provided for attaching the carrying case to your belt.

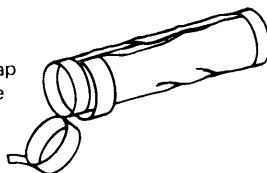

- b. The Backpack Radio Set can be configured for the LOS mode. The major components for LOS configuration are the R/T Unit, Battery Box, and Antenna AS-3566/G. The primary components necessary for operation are keyed in the following illustration.

- d. Tactical Speech Security Equipment TSEC/KY-65. An analog voice frequency system which provides half - duplex, tactical secure voice communications when used with compatible radio sets, integrated wire/multichannel radio systems or tactical/commercial wireline systems.
- e. Radio Set AN/PRC-77. A short-range, 920 channel, manpack, FM communication equipment, operating in the frequency range of 30 to 75.95 MHz inclusive in increments of 50 kHz.
- f. Radio Set AN/PRC-70. A manpack multimode (FM, CW, FSK, SSB, AM) communication equipment operating in the frequency range 2 to 75.9999 MHz.
- g. Radio Set AN/VRC-12 series. A vehicular, medium range, two-way radio-telephone communications set operating in the 30 to 75.95 MHz frequency range.
- h. Power Supply PP-6148/U. Used to charge Ni-Cad 24 volt batteries or to power the Backpack Radio Set. The power supply provides a nominal output voltage of either 14 V dc or 28 V dc, at currents up to 10 amperes, where available ac power is either 115 V or 230 V single phase 50, 60 or 400 Hz. The output voltage is continuously adjustable within a range of approximately 12 to 16 V dc or 24 to 32 V dc according to the nominal voltage selected. Output current limiting is selectable in five ranges from 0.5 to 10.0 amperes, and is adjustable within the four ranges from 0.5 to 8.0 amperes.
- i. Generator, Direct Current G-76/G. The dc generator is a portable hand-cranked electrical generator with accessories to provide power to military radios, coding equipment, rechargeable batteries, and other electronic equipment in the field.
- j. Digital Message Device Group OA-8990/P. Referred to hereinafter as the DMDG is a handheld, self-contained unit providing a means to enter and retrieve digital alphanumeric information in a free format style.

1-12. EQUIPMENT INTEROPERABLE WITH THE BACKPACK RADIO SET

- a. Satellite Communication Set AN/WSC-3(VI), commonly referred to as the Whiskey Three. The Whiskey Three is a highly flexible, new generation, ship/submarine UHF (225 to 399.995 MHz) SAT/LOS communications terminal which sends and receives AM/FM or data information. The Whiskey Three has a minimum of 100 watts output in FM or data modes. It features internal modulation and detection for 75 bps FSK or 75 bps to 9600 bps PSK. A 70 MHz interface capability is provided for expansion with a variety of external modems.
- b. Radio Set AN/VSC-7. Referred to hereinafter as the Net Control Station or NCS is described in paragraph 1-1 lb, page 1-12.
- c. Radio Set PRT-250B7. A portable satellite AM and FM communication system consisting of a transceiver, control unit, battery pack, VHF and UHF antenna, and a handset which provides the primary link between the operator and the radio set. The transceiver operates in the 116 to 150 MHz VHF band and 225 to 399.995 MHz UHF band, tunable in 25 kHz increments. The transmitter portion delivers 20 or 5 watts in the UHF band. The set is designed for manpack, vehicular and aircraft application, and has the TSEC/KY-65 and TSEC/KY-57 interface capability for secure operation. The PRT-250B7 is interoperable with the Backpack Radio Sat in VOICE, X MODE, and RXMT modes only.



LOS MODE

HANDSET ①. For detailed description of Handset, refer to page 1-9.

ANTENNA AS-3566/G ②. This is a low-gain antenna and will hereinafter be referred to as the Whip Antenna. It consists of a flexible radiating section and semi-rigid base station. It is omnidirectional and used for receiving selective and/or conference calls from a satellite relay station. Its main purpose is for reception and transmission of LOS signals. The Whip Antenna will be stored inside the ALICE Pack when operating in the SAT mode.



R/T UNIT ③. For detailed description of R/T Unit, refer to page 1-9.

ALL-PURPOSE LIGHTWEIGHT INDIVIDUAL CARRYING EQUIPMENT ④. Refer to page 1-12 for description.

1-11. EQUIPMENT USED IN CONJUNCTION WITH THE BACKPACK RADIO SET

- a. All-Purpose Lightweight Individual Carrying Equipment. This carrying equipment will hereinafter be referred to as the ALICE Pack. The Backpack Radio Set (R/T Unit with Battery Box attached) will be placed in the inside pocket of the large combat field pack. Detailed information for the ALICE Pack can be obtained from Field Manual FM 21-15. The ALICE Pack is an Additional Authorization List (AAL) item.
- b. Control-Converter C-11119A/VSC-7. Referred to hereinafter as NCS Applique, is a one-piece assembly that provides base station capabilities when interfaced with the Backpack Radio Set R/T Unit to configure Radio Set AN/VSC-7. In addition to providing the physical mount, the NCS Applique also provides:
 - Input power conditioning
 - 27.8 watt output
 - Automatic T/R changeover
 - Transmit and receive selective calling
 - EMI protection against other nearby transmitters
 - Continuous keydown operationThe NCS Applique permits the R/T Unit to be powered by the vehicular power system in use, i.e., +24 V in a vehicle or 110/220 V at 50/60 cycles in a communications shelter.
- c. Tactical Speech Security Equipment TSEC/KY-57. A small, lightweight, manpack, battery operated, wide-band secure voice digital communications equipment designed for use with FM and AM and VHF and UHF radio communications and wireline systems. It is a half-duplex, push-to-talk equipment operating at a 16,000 bits per second (bps) rate. The battery and battery case (Z-A1J) may be replaced by an HYP-57 Vehicular Power Supply and be operated in a vehicular configuration with appropriate installation kit.

1-13. EQUIPMENT DATA

WEIGHTS AND DIMENSIONS

R/T UNIT

Height 4 in. Length 9.63 in.
Width 13 in. Volume 400 cubic in.
Weight 15 lbs

Battery Box

Length 13 in. Height 4.63 in.
Width 4 in. Weight 2.25 lbs

Whip Antenna

Length 12 in. Weight 1.0 lb

Medium Gain Antenna

WEIGHT

VOLUME STORED

Antenna 2.3 lbs Diameter 5 in.
Tripod 1.0 lb Length 19 in.
Carrying Case 0.8 lb
RF Cables 0.8 lb

POWER REQUIREMENTS/SOURCE

Power Requirements +24 V dc nominal (+22 to 32 V dc)
Receive 400 ma FREQUENCY display light off
 600 ma FREQUENCY display light on
Transmit 2.5 ampere maximum in LOS mode
 6.0 ampere maximum in SAT mode
Source Battery Box with two BA-5590/U
 Lithium or two BB-590/U Ni-Cad
 Batteries
 Power Supply PP-6148/U
 Generator, Direct Current
 G-76/G
 Battery Storage BB-542/U

TECHNICAL DATA

R/T Unit

Frequency Range 225 MHz to 399.995 MHz
Power Output: SAT: Continuously variable from
less than 1 watt up to 27.8 watts
LOS: Continuously variable from
less than 1 watt up to 2 watts
Bandwidth 5 kHz (DATA) 25 kHz (VOICE)
Channel Spacing 5 kHz (SAT) 25 kHz (LOS)
Modulation Types FM, FM-FSK, BPSK, and DBPSK
Special Signaling Send and receive conference calls and
receive any one of 15 selective calls
Operating Conditions Temperature from -25°F to 125°F
Humidity from 5% to 100%
Altitude up to 10,000 feet
Duty Cycle 1 to 9 (XMT to REC) with 10 minute
continuous keying when using
rechargeable batteries. Three minute
continuous keying when using two
BA-5590/U Lithium batteries.

Medium Gain Antenna

Frequency Range 240 to 400 MHz
Beamwidth 85°
Orientation Directional Elevation (0 to 90°)
Input Impedance 50 ohms
VSWR 1.5:1
Gain 6 dB (240 to 318 MHz) . . . 5.5 dB (318 to 400 MHz)

Whip Antenna

Frequency Range 225 to 400 MHz
VSWR 1.5:1
Orientation Omnidirectional
Gain -2 dB (240 to 318 MHz)
-4 dB (225 to 240 MHz and 318 to
400 MHz)

Handset

Frequency Range 20 to 3500 Hz
Power Output -56 dBm minimum at 1 kHz and 150 ohms
Impedance 1000 ohms at 1 kHz

Section III

TECHNICAL PRINCIPLES OF OPERATION

1-14. GENERAL

The following paragraphs describe the basic principles of operation of the Backpack Radio Set. The LOS mode of operation is discussed first. SAT mode of operation and RX MT operation are illustrated and will be discussed separately.

1-15. LOS MODE OF OPERATION

LOS mode of operation allows the Backpack Radio Set to be transported by one person on foot or in a vehicle. With an assigned monitoring frequency (according to operation requirements) for LOS mode, you may continue in motion with the R/T Unit in a condition to receive a selective or conference calling signal. The reception of a selective calling signal will execute a SEL CAL white flag and a five second 1 kHz continuous audible alarm. Reception of a conference calling signal will execute a CON CAL white flag and a 1 kHz audible alarm switched on and off at a 1 Hz rate of five seconds. In LOS mode, the R/T Unit will transmit and receive on the frequency appearing in the FREQUENCY display. A basic LOS transmission scheme as illustrated consists of the following:

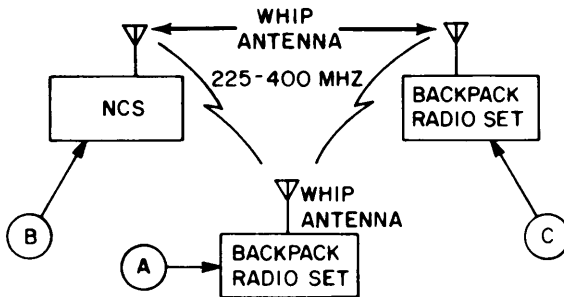

- The Backpack Radio Set at location (A) transmits the signal within the range of 225 to 399.995 MHz to the Backpack Radio Set at location (C) . .
- The signal may also be received by the NCS at location (B) .
- Any other Backpack Radio Set operating on the same frequency, within the line-of-sight and receiving distance of location (A) , will also receive the transmitted signal.
- The Backpack Radio Set at location (A) may receive a conference call transmitted from either location (B) or (C) .
- The Backpack Radio Set at location (A) or (C) will receive a selective call from the NCS at location B .

1-16. RXMT OPERATION

RXMT operation provides a satellite link for existing VHF tactical equipment. A basic, but comprehensive retransmission scheme as illustrated consists of the following:

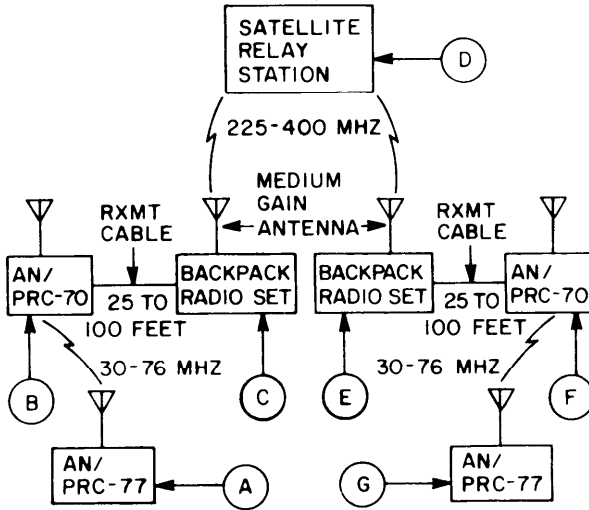

- Radio Set AN/PRC-77 at location (A) transmits within the range of 30 to 75.95 MHz to location (B).
- Radio Set AN/PRC-70 at location (B) receives the signal and sends this information via Retransmission Cable MK-456/GRC, hereinafter referred to as RXMT Cable, to the Backpack Radio Set located 25 to 100 feet away at location (C).
- At location (C), the Backpack Radio Set processes, modulates, and transmits the information within the range of 225 to 399.995 MHz to a satellite relay station (D). The transmitter at location (C) must transmit on the satellite receiver frequency.
- At location (D), the satellite will retransmit (relay) the received signal from location (C). The satellite transmits on the receive frequency plus or minus the OFFSET at location (E).
- At location (E), the Backpack Radio Set must be set to receive on the pre-determined OFFSET frequency. It will then receive the satellite transmission and output the signal via RXMT Cable to Radio Set AN/PRC-70 at location (F).
- At location (F), Radio Set AN/PRC-70 processes the signal from location (E) and transmits it within the frequency range 30 to 75.9999 MHz to location (G).
- At location (G), Radio Set AN/PRC-77 receives the signal completing the RXMT scheme.
- RXMT mode is always plain voice or TSEC/KY-65 secure voice standard narrowband FM.

1-17. SAT MODE OF OPERATION

SAT mode of operation provides a satellite link between Backpack Radio Sets and/or a Net Control Station. The Net Control Station may be installed in a communication shelter or vehicle. In SAT mode, the R/T Unit receive frequency will be OFFSET from the transmit frequency (appearing in FREQUENCY display) by the position of the SAT OFFSET control. Using the following illustration, a satellite relay scheme consists of the following:

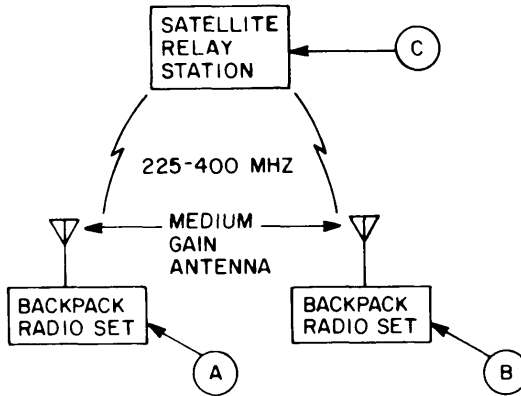

- The Backpack Radio Set at location (A) transmits the signal within the 225 to 399.995 MHz range to satellite relay station (C).
- The satellite relay station at location (C) will retransmit the signal received from (A) at the receive OFFSET frequency at location (B).
- At location (B), the Backpack Radio Set receives the relayed signal and outputs it to the Handset, Security, DMDG or other low level data device.
- Either location (A) or (B) may be a Net Control Station.

CHAPTER 2

OPERATING INSTRUCTIONS

	Page
Description and Use of Operator Controls and Indicators	2-1
Preventive Maintenance Checks and Services	2-10
Operation Under Usual Conditions	2-16
Operation Under Unusual Conditions	2-72

Section I

DESCRIPTION AND USE OF OPERATOR CONTROLS AND INDICATORS

2-1. GENERAL

This section Provides a general description of operator controls, indicators, and connectors. It will list their functions, operator actions, and provide illustrations to determine their locations. All operator controls and indicators are located on the R/T Unit front panel with the exception of the Variable Power control (XMT PWR), which is located on the side of the R/T Unit. Connectors are located on the front and rear panels of the R/T Unit. Section III and Section IV of this chapter present specific instructions for use during usual and unusual operating conditions:

2-2. R/T UNIT CONTROLS AND INDICATORS

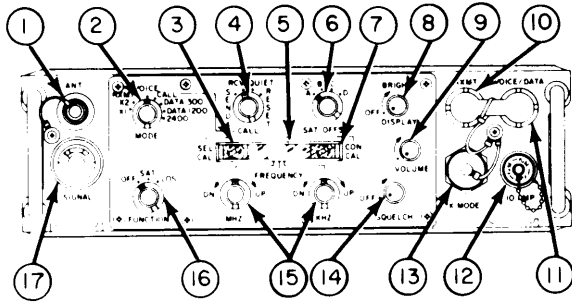

R/T UNIT, FRONT CONTROL PANEL

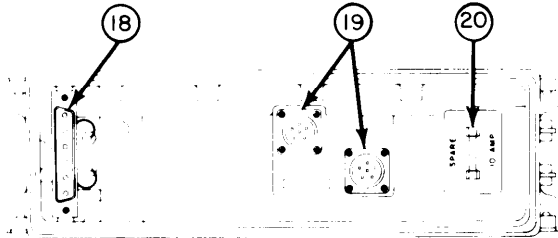

R/T UNIT, REAR PANEL

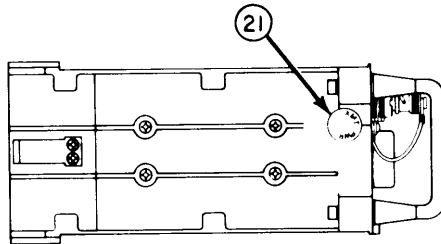

R/T UNIT, SIDE VIEW

ANT Connector ① Connector for the Whip Antenna in LOS mode and Medium Gain Antenna cable in SAT mode.

MODE Control ② . Selects one of eight communication modes.

- X1 - Selects interface operation with the TSEC/KY-65 encryption device for standard narrowband analog FM secure voice communication and is used in preset loading.
- X2 - Selects interface operation with the TSEC/KY-57 encryption device for wideband (16 kbps FM-FSK) secure voice digital communications or standard analog FM plain text communication and is used in preset loading.
- RX MT - Selects retransmit operation with Radio Set AN/PRC-70, AN/PRC-77 and AN/VRC-12 series.
- VOICE - Selects voice mode (plain voice) and used only with a Handset.
- CALL - Selects call mode of operation, used in conjunction with CALL control ④ .
- DATA 300- Selects operation for low level data equipment, continuous or burst (DMDG) at 300 bps.
- DATA 1200 - Selects interface operation for low level data equipment, continuous or burst (DMDG) at 1200 bps.
- 2400 - Selects interface operation with other MIL-STD-188C low level data equipment at 2400 bps.

SEL CAL Indicator ③ . Black and white ball, referred to hereinafter as a white flag, pivots to white upon receipt of a selective call signal.

CALL Control ④ . Selects any one of four functions. Used in conjunction with MODE control ② . Functions only when MODE control is set to the CALL position.

- SEND - This is a spring-loaded, momentary position. Initiates the transmission of the one minute conference call signal. This position is also used in preset loading.
- RCV - Provides for reception of a selective or conference call signal as follows:

Visual - The SEL CAL white flag will indicate the reception of a selective call, The CON CAL white flag will indicate the reception of a conference call.

Audible - The audible alarm concealed behind the front panel will sound continuously for five seconds for an incoming selective call and intermittently for an incoming conference call.

- QUIET The audible alarm will not sound upon reception of a call signal. The visual white flag indicators will operate normally.
- RESET - This is a spring-loaded momentary position. The RESET position will stop the one minute conference call transmission before allotted time of one minute and one minute time-out upon reception of a call. RESET will also reset SEL CAL and CON CAL visual indicator flags.

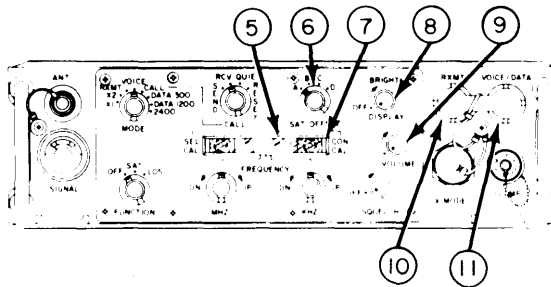

FREQUENCY Display Indicator ⑤ . This is a six digit electronic frequency readout and functions as follows:

- Displays transmitter and receiver frequency when operating in LOS mode.
- Displays only transmitter frequency when operating in SAT mode.
- Remains illuminated for four seconds after frequency selection. It may be re-illuminated for four seconds by the MHZ, KHZ, or DISPLAY controls.

NOTE

The FREQUENCY display can be illuminated for four seconds by the momentary rotation of either MHZ or KHZ control. This will also change the displayed frequency. Check for proper frequency after illuminating the FREQUENCY display with either control. A flashing indication is provided (SAT mode only) when selected transmitter frequency will offset the receive frequency beyond the range of the R/T Unit.

SAT OFFSET Control ⑥ . Selects any one of four preset/offset frequencies (see paragraph 2-11 SETTING PRESETS OR OFFSETS). The positions to be used will be determined by operation requirements.

CON CAL Indicator ⑦ . A white flag appears here upon receipt of a conference call signal.

DISPLAY Control ⑧ . Adjusts the intensity of the FREQUENCY display or extinguishes it for blackout operation. By rotating the DISPLAY control ccw to OFF and then cw, the FREQUENCY display will be re-illuminated for four seconds.

VOLUME Control ⑨ . Adjusts the audio output level of the Handset in VOICE mode, TSEC/KY-57 in X2 mode, and TSEC/KY-57 with its control set to OFF or PT.

RXMT Connector ⑩ . Interface connector for RXMT Cable when interfacing with Radio Set AN/PRC-70, Radio Set AN/PRC-77 or Radio Set AN/VRC-12 series.

VOICE/DATA Connector ⑪ . Interface connector for the Handset when operating in VOICE mode, CALL mode, and RXMT mode; DMDG interface cable connection in DATA 300/DATA 1200 modes or TSEC/KY-65 interface cable connection when operating in X1 mode.

10 AMP Fuse (12) . R/T Unit protection in case of excess current from power source or short in R/T Unit.

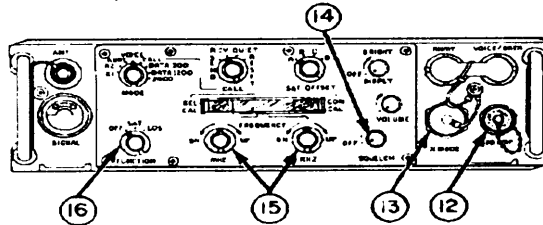

X MODE Connector (13) . Interface connector for the TSEC/KY-57.

SQUELCH Connector (14) . Adjusts the receiver gain to quiet the noise in VOICE, RXMT, X1 (TSEC/KY-65 secure voice), and X2 (TSEC/KY-57 plain voice) modes. SQUELCH control has no effect when operating in DATA or CALL modes. SQUELCH control must be disabled in X2 (secure voice) mode.

FREQUENCY Controls (15) . Provides selection of operating frequencies. Each spring-loaded control (MHZ and KHZ) is dual speed with the FREQUENCY display changing slowly at first and speeding up after three seconds.

- o MHZ Control – Controls the 1, 10, and 100 MHz digits for frequency selection.
 - DN – Decreases frequency
 - UP – Increases frequency
- o KHZ Control – Controls the 5, 10, and 100 kHz digits for frequency selection. Changes in 5 kHz increments for SAT mode and 25 kHz increments for LOS mode. When switching from SAT to LOS mode, rotating the KHZ control will change the frequency to the next 25 kHz increment. The FREQUENCY display will then move in 25 kHz increments.
 - DN – Decreases frequency
 - UP – Increases frequency

FUNCTION Control ⑩ . Turns input power on or off and selects either SAT or LOS mode of operation.

- OFF - Turns R/T Unit power off.
- SAT - Turns R/T Unit power on and selects 27.8 watts output power.
- LOS - Turns R/T Unit power on and selects 2 watts output power.

NOTE

The output (XMT) power of the R/T Unit is variable and controlled by the XMT PWR Control. The XMT PWR Control will always be at its full-up (extreme cw) position unless otherwise directed.

The R/T Unit contains an undervoltage shutoff to prevent discharging the battery(ies) below 17.5 to 19.5 volts. Resetting the unit is accomplished by placing the FUNCTION control to the OFF position momentarily and then back to the SAT or LOS position. If the R/T Unit continues to shutoff, it is likely that the battery(ies) in use need to be replaced.

SIGNAL Strength Meter ⑪ . Aids in directing the antenna for reception of optimum signal and indicates the relative transmitter power output for SAT and LOS modes.

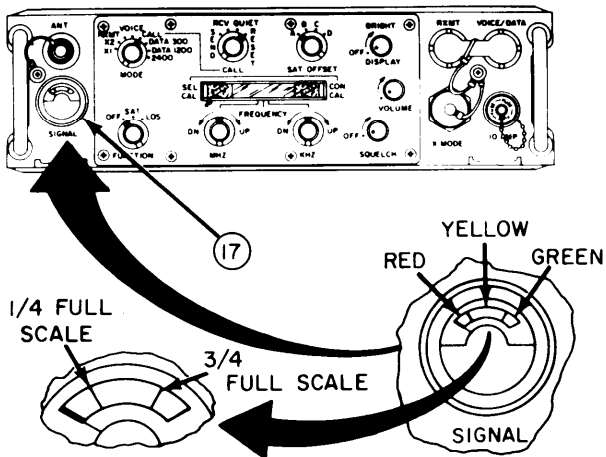

- Colors
 - Red - Weak signal
 - Yellow - Marginal signal
 - Green - Strong signal
- Receive Indication
 - In VOICE mode, interpretation of the three colors is as above.
 - In DATA modes, the red section is interpreted as marginal. The yellow and green sections remain as above.
- Transmit Indication
 - $\frac{1}{4}$ full scale (red) minimum output power.
 - Indication in yellow and green sections are most desirable.

NOTE

The above transmit indications are normal, but may vary according to operation requirements and position of XMT PWR control.

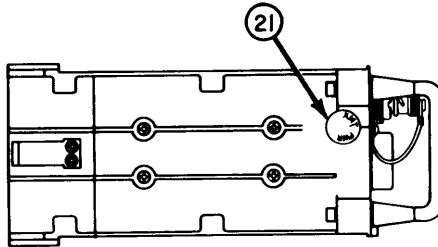
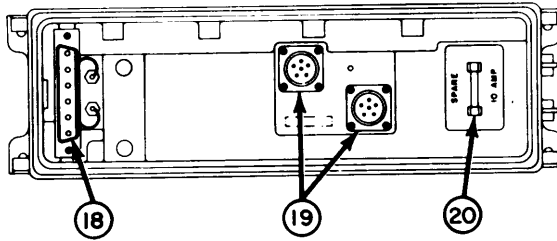

Battery Connector (18) . Interface connector for Battery Storage BB-542/U or Power Supply PP-6148/U.

Battery Connectors (19) . Interface connectors for batteries in the Battery Box.

SPARE 10 AMP Fuse (20) . Spare fuse for front panel.

XMT PWR Control (21) . Adjusts output (XMT) power. Leave in full-up (extreme cw) position unless otherwise directed.

Section II

PREVENTIVE MAINTENANCE CHECKS AND SERVICES

2-3. GENERAL

To ensure that the Backpack Radio Set is always ready for use you must do scheduled PREVENTIVE MAINTENANCE CHECKS AND SERVICES (PMCS).

2-4. PMCS TABLE

WHEN YOU ARE DOING ANY PMCS OR ROUTINE CHECKS, KEEP IN MIND THE WARNINGS AND CAUTIONS SHOWN IN THIS MANUAL.

A dot in one or more of the three INTERVAL columns indicates the check and/or service should be performed as follows:

- BEFORE OPERATION - Perform your **B** PMCS to make sure the Backpack Radio Set is ready for use.
- DURING OPERATION - Perform your **D** PMCS.
- AFTER OPERATION - Perform your **A** PMCS. This will help you keep the equipment in top condition.

The PROCEDURES column tells you how to perform the required checks and services. Carefully follow these instructions. If tools are needed or the chart tells you (EQUIPMENT IS NOT READY/AVAILABLE IF:), notify organizational maintenance.

If the Backpack Radio Set fails to operate, refer to Maintenance Instructions in chapter 3. Report any deficiencies using proper forms in accordance with DA Pam 738-750.

25. ROUTINE CHECKS

Routine checks (equipment inventory, cleaning, dusting, checking for frayed cables, storing items not in use, and checking loose nuts) are not listed as PMCS checks. They are things you should do anytime you see they must be done.

NOTE

Use the **ITEM NO.** column in your PMCS table to get the numbers for the **TM ITEM NO.** column on DA Form 2404 (Equipment Inspection and Maintenance Worksheet) when you fill out the form.



Table 2-1. OPERATOR PREVENTIVE MAINTENANCE CHECKS AND SERVICES

B – Before

D – During

A – After

ITEM NO.	INTERVAL			ITEM TO BE INSPECTED	PROCEDURES CHECK AND HAVE REPAIRED OR ADJUSTED AS NECESSARY	EQUIPMENT IS NOT READY/ AVAILABLE IF:
	B	D	A			
					NOTE	
				Backpack Radio Set	Set FUNCTION control to OFF position.	
1	•		•	Exterior Surface	Check that all equipment is clean, dry, and free of grease, dirt, and fungus. Refer to page 3-7 for cleaning instructions.	
2	•		•	Exterior Surface	Check that painted surfaces are free of bare spots. Notify organizational maintenance if service required.	

Table 2-1. OPERATOR PREVENTIVE MAINTENANCE CHECKS AND SERVICES (cont)

B – Before

D –During

A – After

ITEM NO.	INTERVAL			ITEM TO BE INSPECTED	PROCEDURES CHECK AND HAVE REPAIRED OR ADJUSTED AS NECESSARY	EQUIPMENT IS NOT READY/ AVAILABLE IF:
	B	D	A			
3	•		•	Connectors.	Check that all connectors are free of corrosion, foreign material or objects, or damaged.	Connectors have corrosion or damage.
4	•	•	•	Connectors not in use.	Check that all connectors are tight and covered and covers are securely in place.	If connectors are loose.
5	•	•	•	Connectors in use.	Check that all connectors are tight. Tighten all loose connectors.	

Table 2-1. OPERATOR PREVENTIVE MAINTENANCE CHECKS AND SERVICES (cont)

B – Before

D – During

A – After

ITEM NO.	INTERVAL			ITEM TO BE INSPECTED	PROCEDURES CHECK AND HAVE REPAIRED OR ADJUSTED AS NECESSARY	EQUIPMENT IS NOT READY/ AVAILABLE IF:
	B	D	A			
6	•		•	Controls and switches.	Check that all are free of corrosion, not loose, damaged, and operate smoothly.	The controls or switches are inoperable.
7	•			Whip Antenna.	Check that it is free of damage and can be properly installed.	
8	•			Medium Gain Antenna.	Check that it is free of damage and can be properly setup and connected to R/T Unit.	Damaged beyond repair.

Table 2-1. OPERATOR PREVENTIVE MAINTENANCE CHECKS AND SERVICES (cont)

B – Before

D – During

A – After

ITEM NO.	INTERVAL			ITEM TO BE INSPECTED	PROCEDURES CHECK AND HAVE REPAIRED OR ADJUSTED AS NECESSARY	EQUIPMENT IS NOT READY/ AVAILABLE IF:
	B	D	A			
9	•			Battery Box.	Check that latches are secured. Close latches if open.	Battery Box will not seat properly or latches will not close.
10	•		•	Backpack Radio Set.	Check complete system for proper operation. Refer to page 2-26 and perform operational test.	The Backpack Radio Set fails to function properly in any mode of operation.
11			•	R/T Unit.	Set FUNCTION control to OFF.	

2-15

Section III

OPERATION UNDER USUAL CONDITIONS

2-6. GENERAL

The Backpack Radio Set can be operated in the mobile (strapped to your back) configuration or in the at halt (stationary) configuration. Setup procedures are given in three parts - LOS operation, SAT operation, and RXMT operation. Operating procedures are provided for all modes in both transmit and receive. Complete shutdown procedures are also provided in this section. You must be aware of operation requirements prior to operating this equipment in the field.

2-7. LOS OPERATION SETUP

This setup allows the Backpack Radio Set to be transported by one person on foot or in a vehicle.

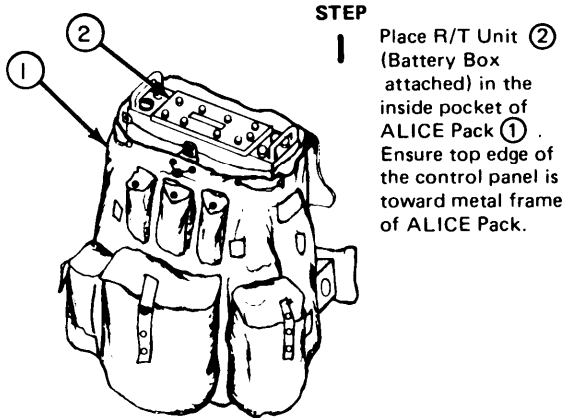

NOTE

Pack any available soft material around the R/T Unit. This will serve to insulate the R/T Unit from mechanical shock and cold weather.

ANT CONNECTOR

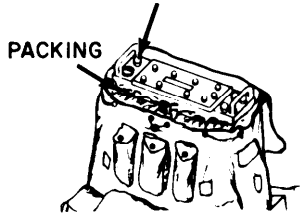

STEP

2 Remove dust cover from ANT connector and connect Whip Antenna. To connect Whip Antenna, hold the center (whip) of the antenna stationary with one hand while rotating the collar (base) of antenna with the other hand. Turn collar hand tight only. Do not use pliers or other tools to tighten.

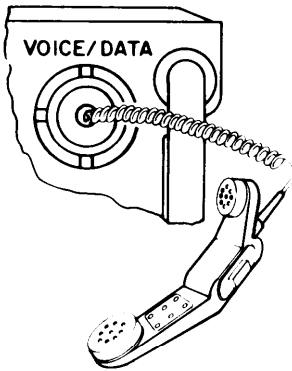
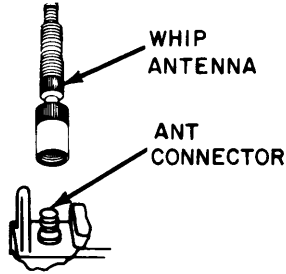

STEP

3 Remove dust cover from VOICE/DATA connector and connect Handset cable.



STEP

4

Set controls to operation requirements and as follows:

<u>CONTROL</u>	<u>SETTING</u>
FUNCTION	LOS
MODE	According to operation requirements.
MHZ/KHZ	According to operation requirements.
CALL.	According to operation requirements.
XMT PWR	Full-up (extreme cw) or according to operation requirements.



STEP

5

Secure strap across front panel of R/T Unit and mount assembled ALICE Pack on your shoulders. Adjust and secure all straps. For additional ALICE Pack Information, refer to field manual FM 21-15.

STEP

6

Store Medium Gain Antenna according to operation requirements.

STEP

7

Proceed to operating procedures (page 2-39) for desired operating mode according to operation requirements

2-8. SAT OPERATION SETUP

This configuration allows the Backpack Radio Set to be transported to a suitable location by one person or vehicle and set-up for operation. The Whip Antenna is removed and Medium Gain Antenna setup. Store your Whip Antenna in the ALICE Pack.

STEP

- 1** Open antenna carrying case cover by releasing velcro fastener. Remove antenna assembly from case.

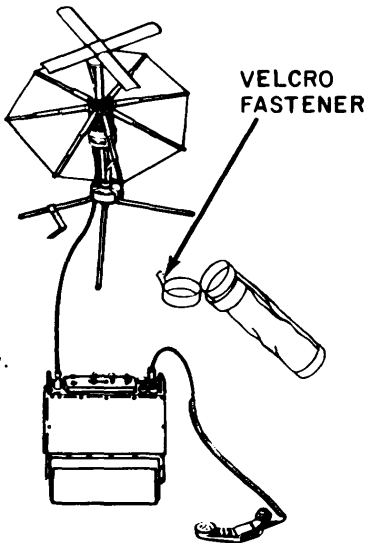

STEP

- 2** Release leg strap (12) holding tripod legs around antenna assembly.

STEP

- 3** Holding antenna upright, let tripod legs fall down into their spread out position. Ensure legs are completely down and rotate locking cap (2) ccw to LOCK position.

NOTE

Leg stop screw (10), located under tripod mounting shaft, is provided as an adjustment to compensate for manufacturing tolerances. If this screw is turned in too far, tripod legs cannot be locked. Adjust the screw to a snug -not tight- setting with tripod legs in down and locked position.

WARNING

Dipole elements are spring-loaded. Release elements away from immediate personnel.

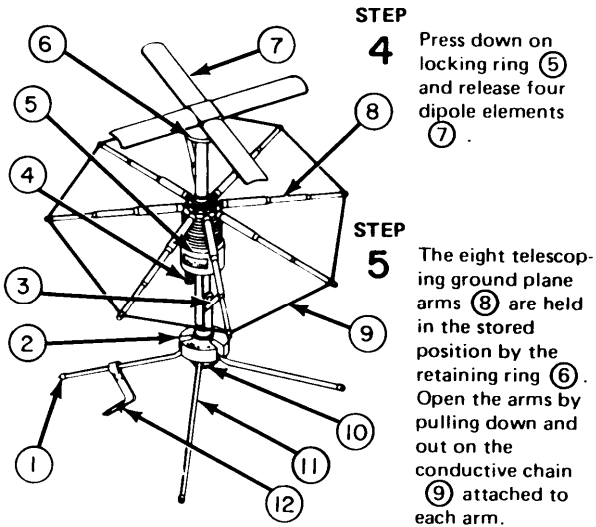

STEP

- 6** After all eight arms have been released from the retaining ring, press each arm down to locked position while feeling each arm latch in place.

STEP

- 7** While holding antenna assembly in vertical position, loosen (ccw) "T" screw ③, adjust antenna for desired elevation angle and hand tighten (cw) "T" screw.

STEP

- 8** Lift antenna assembly and using your compass, position dipole elements to desired azimuth according to operation requirements.

NOTE

In high wind conditions or for low level elevation angles, antenna assembly can be handheld by its shaft after removing the antenna from tripod assembly.

STEP

- 9** Additional ballast may be required when operating in high wind environments. The carrying case is designed to hold ballast (weights, rocks, etc.). Attach carrying case to tripod using either of the following methods:

- Remove rubber caps ① from two tripod legs and slide eyelet straps of carrying case onto legs. Replace rubber caps.
- Wrap CABLE compartment cover of carrying case around leg.
- Tripod leg strap may be wrapped around carrying case or other large object.

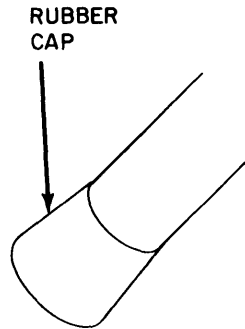

STEP

- 10** Remove antenna cables from CABLE compartments of carrying case and connect female end (hand tighten) to antenna connector ④. Connect male connector of antenna cable to ANT connector on R/T Unit front panel.

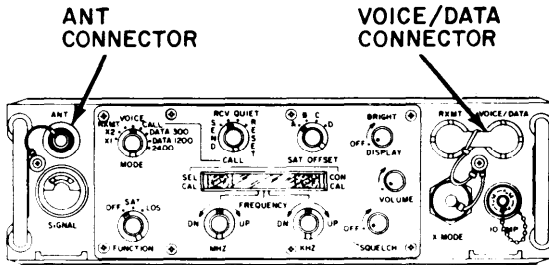

STEP

11

Remove dust cover from R/T Unit VOICE/DATA connector. Connect (hand tighten cw direction) Handset cable to VOICE/DATA connector when operating in VOICE, CALL and RXMT modes. Connect DMDG interface cable for DATA 300/DATA 1200 modes.

WARNING

ELECTROMAGNETIC RADIATION

Do not stand in the direct path of the Medium Gain Antenna when transmitting. Do not work on cables when power is on. Transmit antenna cables conduct radio frequency energy that can cause fatal internal burns and electrical shock. Ensure that power is off before working on antenna or connectors. If you feel the slightest warming effect while near this equipment, MOVE AWAY QUICKLY!

STEP

12

Proceed to operating procedures (page 2-39) for desired operating mode according to operation requirements.

2-9. RXMT OPERATION SETUP

The RXMT mode provides a satellite link for existing VHF tactical equipment such as Radio Set AN/PRC-70, Radio Set AN/PRC-77, and Radio Set AN/VRC-12 series. RXM operation may be performed in either SAT or LOS mode. On the SAT mode is illustrated in this manual. Step 1 thru Step 4 apply to both SAT and LOS operation.

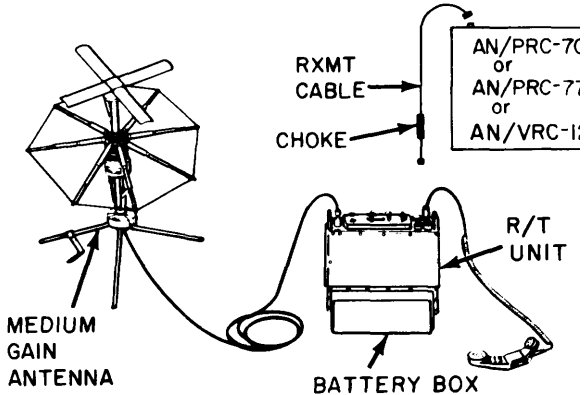

STEP

- 1 Setup for SAT operation (page 2-19, Step 1 thru Step 11) or LOS operation (page 2-16, Step 1 thru Step 3).

STEP

- 2 If permitted by operation requirements, establish SAT or LOS capability by performing the following operating procedures:
 - CALL mode - Transmit (page 2-40).
 - CALL mode - Receive (page 2-43).
 - VOICE mode - Transmit (page 2-58).
 - VOICE mode - Receive (page 2-61).

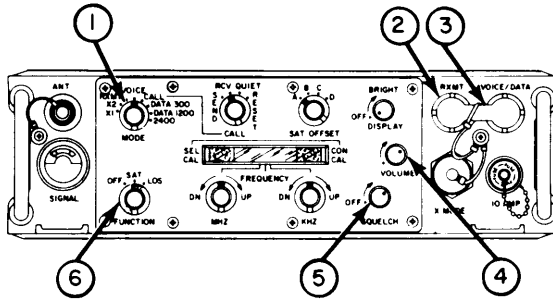

STEP

3 Set **FUNCTION** control **6** to **SAT** or **LOS**.

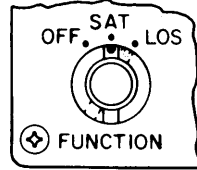

STEP

4 Set **MODE** control **1** to **VOICE**.

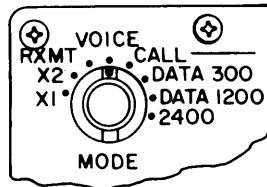

STEP

5 Adjust **SQUELCH** control **5** ccw to **OFF**.

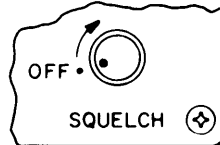

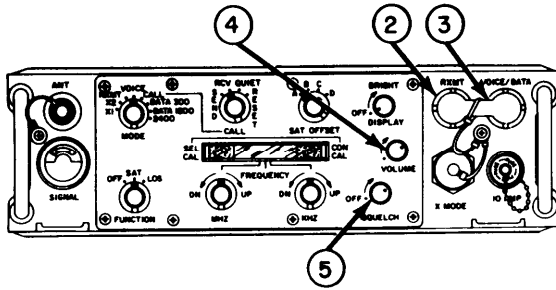

STEP

- 6** Adjust VOLUME control (4) to a desirable audio level in Handset.



STEP

- 7** Slowly adjust SQUELCH control (5) cw until audio mutes (receiver gets quiet).

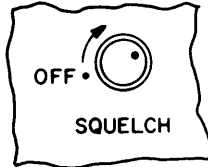

STEP

- 8** Disconnect (ccw) Handset cable from VOICE/DATA connector (3).

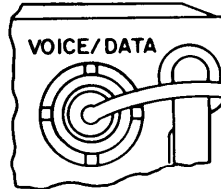

NOTE

When interfacing with TSEC/KY-57 or TSEC/KY-65, refer to page 2-68.

STEP

- 9** Remove dust cover from RXMT connector ② and connect (cw) the choke end of RXMT Cable.

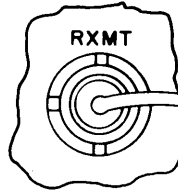

STEP

- 10** Connect other end of RXMT Cable to Radio Set AN/PRC-70, Radio Set AN/PRC-77 or Radio Set AN/VRC-12 series.

STEP

- 11** Position the Backpack Radio Set and Radio Set selected in STEP 10 as far away from each other as possible (minimum of 25 feet).

STEP

- 12** Proceed to RXMT operating procedures (page 2-56).

2-10. INITIAL ADJUSTMENTS, DAILY CHECKS AND OPERATIONAL TEST

The Backpack Radio Set requires no adjustments at the operator level. Your daily check will consist of PMCS Table 2-1 (page 2-12) and operational test of the complete unit. Take a known good Backpack Radio Set and the Backpack Radio Set you will be using, refer to page 2-16, and setup as illustrated on following page.

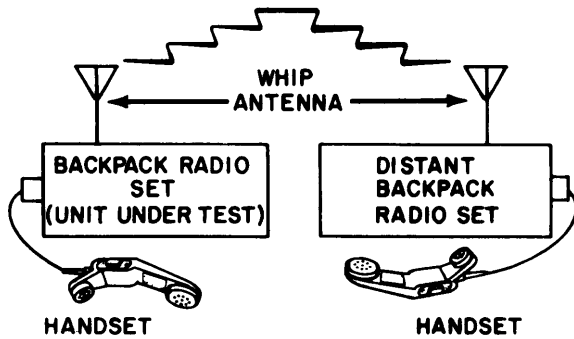

This setup will be used to check the operational performance of the Handset, Whip Antenna, Battery Box, and R/T Unit. The two Backpack Radio Sets must be separated by a minimum distance of five feet. If units should fail in any way, refer to page 3-1 for troubleshooting procedures. Observe all WARNINGS, CAUTIONS, and NOTES. Control settings for both units are as follows:

- MODE control - VOICE
- FUNCTION control - LOS
- MHZ/KHZ controls - as assigned by local frequency coordinator.

NOTE

Establish voice contact with distant Backpack Radio Set to ensure your Backpack Radio Set is performing properly.

For additional information for VOICE mode of operation, refer to page 2-58.

2-11. SETTING PRESETS OR OFFSETS

The AN/PSC-3 provides the operator with the capability of selecting up to 4 frequencies (LOS mode) or 4 frequency off sets (SAT mode) and presetting the manpack so that any of the preset frequencies or offsets may be immediately selected using the OFFSET control on the RT-1402A/G Front Panel.

In the SAT mode, an uplink (transmit) frequency and a downlink (receive) frequency are preset for each OFFSET position, thus establishing the transmit/receive offsets. The FREQUENCY DISPLAY will indicate only the transmit frequency during actual operation. In LOS operation where the same transmit and receive frequency is used, the same procedures used in SAT mode is followed except that identical transmit and receive frequencies are preset for a given OFFSET control position and the frequency offset is thus zero.

2-12. PRESET LOADING

STEP

Set RT-1402A/G controls as follows:

SQUELCH:.....OFF
VOLUME:.....OFF
DISPLAY:.....MID RANGE
SAT OFFSET:.... ANY POSITION
CALL:.....RCV
FUNCTION:..... OFF
MODE:..... ANY POSITION
POWER:..... ANY POSITION

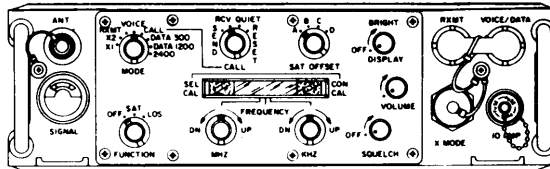

STEP

2 Set uplink (transmit) frequency as follows:

Set FUNCTION Switch to SAT.

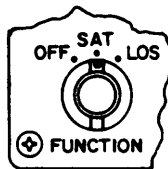

Set MODE Switch to X2.

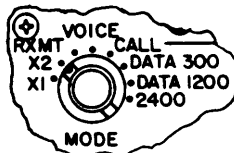

Set SAT OFFSET Switch to A, B, C or D depending upon offset or preset to be loaded.



Place CALL Switch in momentary SEND position and hold in this position.

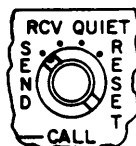

NOTE

The FREQUENCY Display will indicate either:

- a frequency between 225.000 MHz and 399.995 MHz (the last preset used), or
- 000.000 indicating that the current uplink preset is invalid.

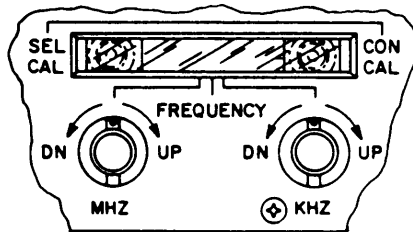

While holding the CALL Switch in SEND, use the MHZ and KHZ controls to adjust the frequency displayed to the desired uplink frequency.

Release the CALL Switch and allow it to return to RCV. The RT-1402A/G will return to normal operation.

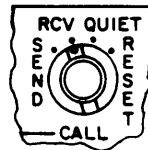

NOTE

At this point, the uplink frequency has been set. But, as a valid downlink frequency has not been set, the frequency offset has not been established.

STEP

3 Set downlink (receive) frequency as follows:

Set MODE Switch to X1.

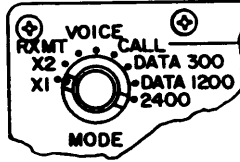

Set FUNCTION Switch to SAT.

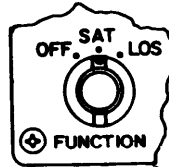

Place CALL Switch in momentary SEND position and hold in this position.



NOTE

The FREQUENCY Display will indicate either:

- a frequency between 225.000 MHz and 399.995 MHz (the last preset used), or
- 000.000 MHz indicating that the current downlink preset is invalid.

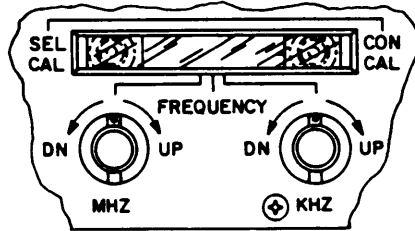

While holding the CALL Switch in SEND, use the MHZ and KHZ controls to adjust the frequency displayed to the desired downlink frequency.

Release the CALL Switch and allow it to return to RCV. The RT-1402A/G will return to normal operation.

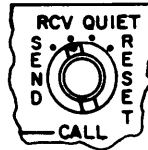

NOTE

At this point, the uplink and downlink frequencies have both been set and the offset associated with the SAT OFFSET Switch position has been established.

2-13. PRESET REVIEW

STEP

1

Set MODE Switch to X1.

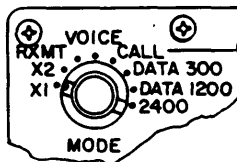

STEP

2

Set SAT OFFSET Switch to A, B, C or D.



NOTE

The FREQUENCY Display will indicate the uplink (transmit) frequency associated with the SAT OFFSET Switch position.

STEP

3

Place CALL Switch in the momentary RESET Position and hold in this position.

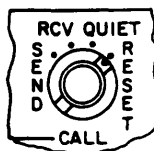

NOTE

The FREQUENCY Display will indicate the downlink (receive) frequency associated with the SAT OFFSET Switch position.

Presets for SAT OFFSET Positions A, B, C, and D are entered by following the procedure above with the SAT OFFSET Switch in the desired position (A, B, C, or D).

The X1 review discussed above will indicate the current downlink frequency. As:

Active downlink frequency =
active uplink frequency + SAT offset associated with SAT
OFFSET Position selected.

2-14. PRESET CLEARING

STEP

1

Set MODE Switch to X2.

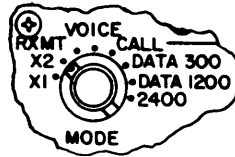

STEP

2

Set SAT OFFSET Switch to A, B, C, or D depending upon preset to be cleared.



STEP

3

Place CALL Switch in the momentary RESET position and hold in this position.

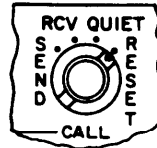

NOTE

The FREQUENCY Display will indicate the current uplink (transmit) frequency associated with the SAT OFFSET Switch position and then (within 2 to 4 seconds) will change to 000.000, and then to the current operating frequency. This indicates that the uplink (transmit) preset associated with the SAT OFFSET Switch position has been cleared.

- STEP**
4 Release the CALL Switch and turn it to RCV position.



- STEP**
5 Verify that the uplink (transmit) frequency has been cleared by placing the CALL Switch in SEND Position and hold momentarily in this position. The FREQUENCY Display will indicate 000.000.

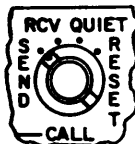

NOTE

When the CALL Switch is released (allowed to return to RCV), the FREQUENCY Display will be blank.

NOTE

At this point, the uplink (transmit) preset has been cleared but the current downlink (receive) frequency preset and the original frequency off sat have not been cleared. Should the operator enter a new uplink (transmit) frequency for the SAT OFFSET Switch position, the associated offset frequency would be automatically calculated using the existing downlink (receive) frequency.

2-15. EXAMPLE OF PRESET PROCEDURE

- 1) Set FUNCTION Switch to SAT.
- 2) Set MODE Switch to X2.
- 3) Set SAT OFFSET Switch to A, B, C, or D.
- 4) Place CALL Switch in momentary SEND Position and hold in this position.

NOTE

The FREQUENCY Display will indicate either:

- a frequency between 225.000 MHz and 398.995 MHz (the last preset used), or
 - 000.000 indicating that the current uplink (transmit) frequency is invalid.
- 5) While holding the CALL Switch in SEND Position, use the MHZ and KHZ controls to adjust the frequency displayed to 290.025 MHz. This will be the uplink (transmit) frequency.
 - 6) Release the CALL Switch and allow it to return to the RCV position. The RT-1402A/G will return to normal operation.
 - 7) Set MODE Switch to X1.
 - 8) Place CALL Switch in momentary SEND Position and hold in this position.
 - 9) While holding the CALL Switch in SEND, use the MHZ and KHZ controls to adjust the frequency displayed to 260.025 MHz. This will be the downlink (receive) frequency.

- 10) Release the CALL Switch and allow it to return to the RCV position. The RT-1402A/G will return to normal operation.

NOTE

At this point, the uplink and downlink frequencies have both been set and the offset associated with the SAT OFFSET Switch position has been established as -30.000 MHz.

- 11) Set FUNCTION Switch to OFF.
- 12) Set FUNCTION Switch to SAT.
- 13) Verify that SAT OFFSET Switch is in the same position as step 3.

NOTE

The frequency displayed will be 290.025 MHz (the uplink frequency stored for the SAT OFFSET Switch position).

- 14) Set MODE Switch to X1.
- 15) Place the CALL Switch in the momentary SEND Position and hold in this position.

NOTE

The frequency displayed will be 260.025 MHz (the downlink frequency stored for the SAT OFFSET Switch position).

NOTE

As the offset associated with the SAT OFFSET Switch position has been established as -30.000 MHz, changing the uplink (transmit) frequency associated with the SAT OFFSET Switch position will automatically change the downlink (receive) frequency associated with SAT OFFSET Switch position.

That is, were you to now set the uplink frequency for the SAT - OFFSET Switch position to 300.025 MHz, the associated downlink frequency would automatically be set to 270.025 MHz (in accordance with the established -30.000 MHz offset) provided you do not activate the CALL Switch.

If you wish to operate in a mode requiring the transmit and receive frequencies to be the same, the uplink and downlink frequencies associated with the SAT OFFSET Position used would have to be identical, thus establishing a 000.000 MHz offset.

2-16. OPERATING PROCEDURES

WARNING

When operating equipment in enemy territory, bright lights will make it easy for the enemy to detect your equipment. Use blackout procedures to prevent detection by the enemy.

You as the operator must be aware of operation requirements prior to referral to table 2-2. Selection of operation for desired mode will be facilitated by table 2-2. Operating procedures for all modes in both transmit or receive directly follow table 2-2.

NOTE

If your Backpack Radio Set should fail in any one of its operating modes, record the failure and notify organizational maintenance.

Due to limitations of the BA-5590/U Lithium Battery, continuous transmission must be limited to three minutes or less when operating with two BA-5590/U batteries in the Battery Box.

Table 2-2. OPERATING MODES MATRIX

<u>OPERATING MODE</u>	<u>TRANSMIT PAGE NO.</u>	<u>RECEIVE PAGE NO.</u>
CALL	2-40	2-43
DATA	2-45	2-48
X1	2-50	2-50
X2	2-53	2-53
RXMT	2-56	2-56
VOICE	2-58	2-61

CALL MODE - TRANSMIT

P

Ensure compliance with operation requirements. Adjust DISPLAY control ② cw to midrange.

WARNING

romagnetic radiation hazard exists within several feet of Medium Gain Antenna during transmit. Avoid prolonged exposure in front of the dipole elements during transmission.

NOTE

CALL PWR control (located on side of R/T Unit) should always be in the full-up (extreme cw) position unless otherwise directed.

Set up for SAT operation (page 2-19) or LOS operation (page 2-16).

Set CALL control ① to RCV.

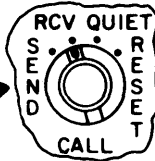

CALL MODE - TRANSMIT

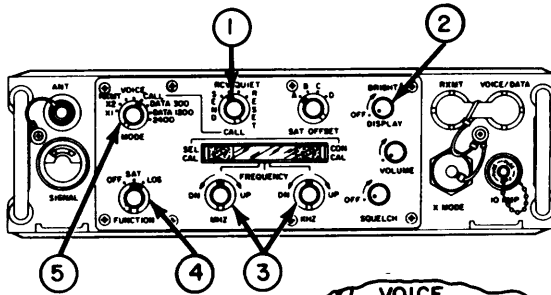

STEP

- 4** Set MODE control (2) to CALL.

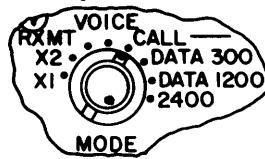

STEP

- 5** Set FUNCTION control (4) to either SAT or LOS.

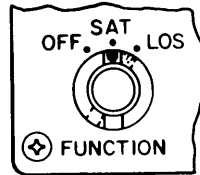

STEP

- 6** Adjust FREQUENCY MHZ/KHZ controls ③ according to operation requirements.

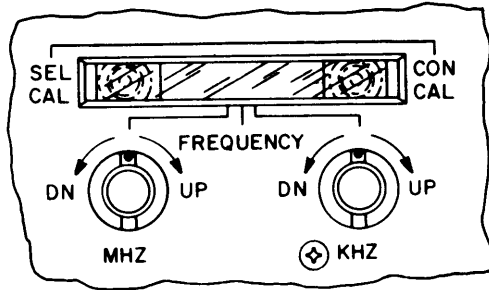

STEP

- 7** Set CALL control ① to SEND and release.

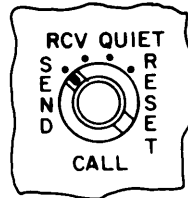

NOTE

All controls are locked out when the R/T Unit is transmitting, and have no effect until the one minute transmission is complete or is interrupted by moving the CALL control to the RESET position.

STEP

1 Ensure compliance with operation requirements. Adjust DISPLAY control (4) cw to midrange.

STEP

2 Set up for SAT operation (page 2-19) or LOS operation (page 2-16).

STEP

3 Set CALL control (2) to RCV (or QUIET according to tactical situation).

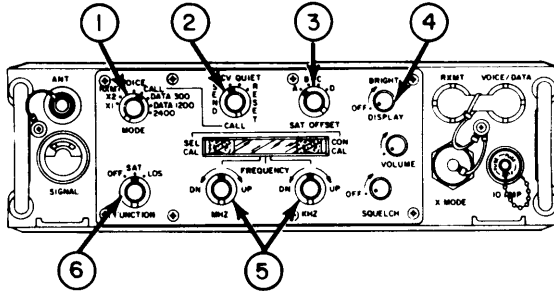
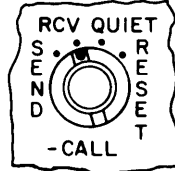

STEP

4 Set MODE control (1) to CALL.

STEP

5 Set SAT OFFSET control (3) according to operation requirements.

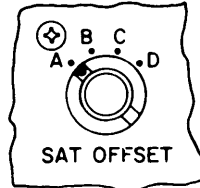
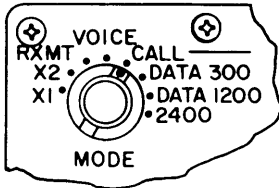

CALL MODE – RECEIVE

STEP

- 6** Set FUNCTION control ⑥ to SAT or LOS.

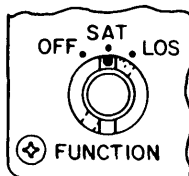

STEP

- 7** Adjust FREQUENCY MHZ/KHZ controls ⑤ according to operation requirements.

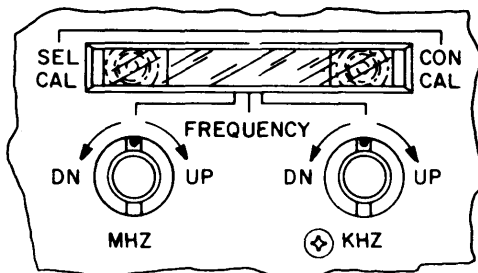

STEP

- 8** Upon reception of call signal:
- Selective call – SEL CAL white flag and continuous tone or white flag only (QUIET).
 - Conference call – CON CAL white flag and interrupted tone or white flag only (QUIET).

STEP

- 9** One minute after reception of call signal, set CALL control ② to RESET and release.

STEP

- 1 Ensure compliance with operation requirements. Adjust DISPLAY control ② cw to midrange.

WARNING

Electromagnetic radiation hazard exists within several feet of the Medium Gain Antenna during transmit. Avoid prolonged exposure in front of the dipole elements during transmit operation.

STEP

- 2 Set up for SAT operation (page 2-19) or LOS operation (page 2-16).

STEP

- 3 Remove dust cover from VOICE/DATA connector ③ and connect DMDG or other data device cable.

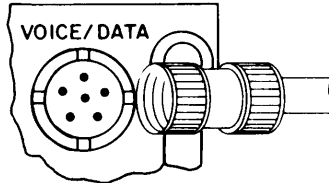

NOTE

DMDG Cable Assembly CX-13156/GR is stored in DMDG carrying case and connects to SAT connector on rear panel of DMDG.

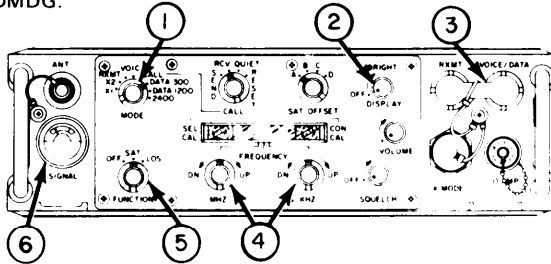

STEP

- 4** Set R/T Unit MODE control ① to DATA 300/DATA 1200 or 2400 according to operation requirements. Refer to applicable TM for data device control settings.

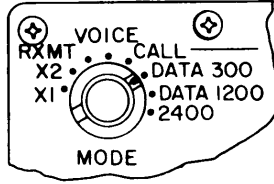

STEP

- 5** Set FUNCTION control ⑤ to SAT or LOS.

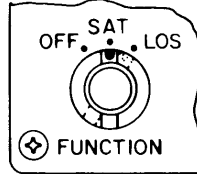

STEP

- 6** Adjust FREQUENCY MHZ/KHZ controls ④ according to operation requirements.

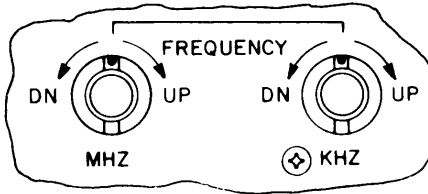

NOTE

The XMT PWR control (located on side of R/T Unit) should always be in the full-up (extreme cw) position unless otherwise directed.

STEP

7 Key DMDG or other data device.

STEP

8 Observe SIGNAL strength meter ⑥ for a minimum output of $\frac{1}{4}$ full scale when transmitting.

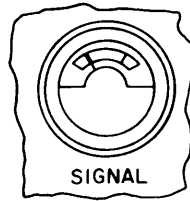

NOTE

SIGNAL strength meter may indicate less than $\frac{1}{4}$ full scale during transmit depending upon operation requirements and position of XMT PWR control.

STEP

- 1 Ensure compliance with operation requirements. Adjust **DISPLAY** control ③ cw to midrange.

STEP

- 2 Set UP for SAT operation (page 2-19) or LOS operation (page 2-16).

STEP

- 3 Remove dust cover from **VOICE/DATA** connector ④ and connect DMDG or other data device cable.

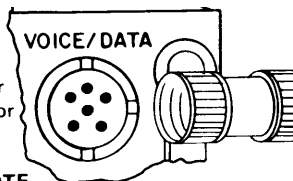

NOTE

DMDG Cable Assembly CX-13156/GR is stored in DMDG carrying case and connects to SAT connector on rear panel of DMDG.

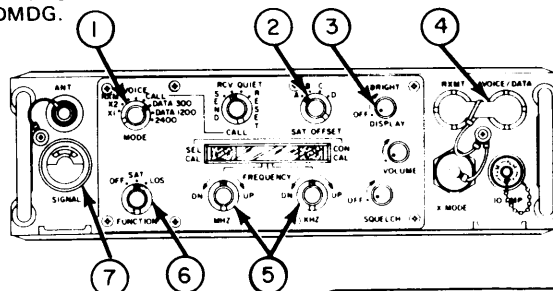

STEP

- 4 Set R/T Unit mode control ① to **DATA 300/ DATA 1200 or 2400** according to operation requirements. Refer to applicable TM for data device control settings.

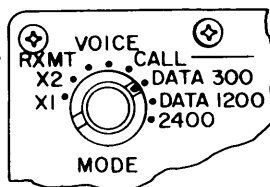

STEP

- 5** Set SAT OFFSET control ② according to operation requirements.

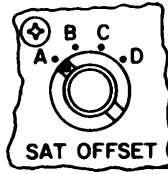

STEP

- 6** Set FUNCTION control ⑥ to SAT or LOS.

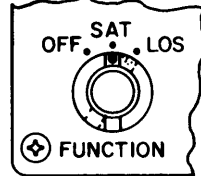

STEP

- 7** Adjust FREQUENCY MHZ/KHZ controls ⑤ according to operation requirements.

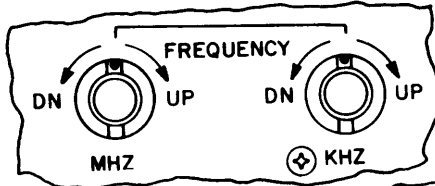

STEP

- 8** Observe SIGNAL meter ⑦ for greater than ¾ full scale for receive signal when receiving a good signal.

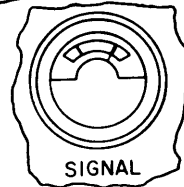

NOTE

If STEP 8 indication is less than ¾ full scale, reposition antenna for peak meter deflection.

STEP

- 9** Receive message on DMDG or other data device.

X1 MODE – TRANSMIT/RECEIVE

STEP

- 1 Ensure compliance with operation requirements. Adjust DISPLAY control ③ cw to midrange.

WARNING

Electromagnetic radiation hazard exists within several feet of the Medium Gain Antenna during transmit. Avoid prolonged exposure in front of the dipole elements during transmit operation.

STEP

- 2 Set up for SAT operation (page 2-19) or LOS operation (page 2-16).

STEP

- 3 Remove dust cover from VOICE/DATA connector Æ and connect Cable Assembly CX-13168/U. Connect other end of cable to RADIO connector on TSEC/KY-65.

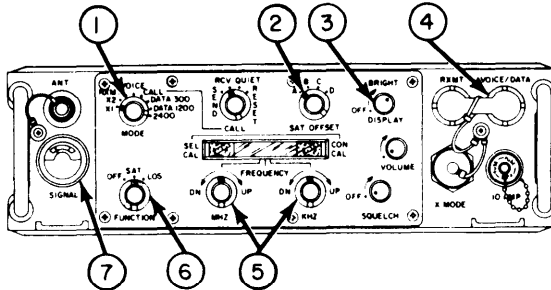
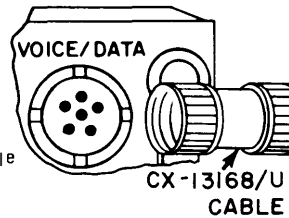

X1 MODE - TRANSMIT/RECEIVE

STEP

4

Connect Handset cable to TSEC/KY-65 HANDSET connector. Refer to TM 11-5810-280-12 for TSEC/KY-65 operating instructions.

STEP

5

Transmit- Ensure XMT PWR control (location on side of R/T Unit) is in the full-up (extreme cw) position unless otherwise directed.

Receive- Set SAT OFFSET control ② according to operation requirements.

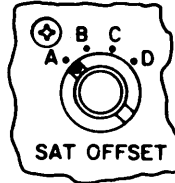

STEP

6

Set MODE control ① to X1.

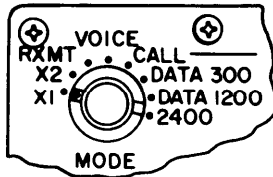

STEP

7

Set FUNCTION control ⑥ to SAT or LOS.

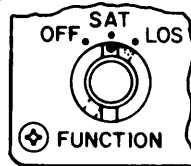

STEP

8

Adjust FREQUENCY MHZ/KHZ controls ⑤ according to operation requirements.

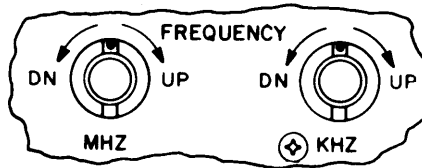

STEP

9

- Transmit - Key Handset and observe SIGNAL strength meter ⑦ for a minimum output of ¼ full scale.
- Receive - Observe SIGNAL strength meter ⑦ for greater than ¼ full scale. If indication is less than ¼ full scale, reposition antenna for peak meter deflection. Receive message via Handset.

NOTE

SIGNAL strength meter may indicate less than ¼ full scale during transmit depending upon operation requirements and position of XMT PWR control.

STEP

- 1 Ensure compliance with operation requirements. Adjust DISPLAY control ③ cw to midrange.

WARNING

Electromagnetic radiation hazard exists within several feet of the Medium Gain Antenna during transmit. Avoid prolonged exposure in front of the dipole elements during transmit operation.

STEP

- 2 Set up for SAT operation (page 2-19) or LOS operation (page 2-16).

STEP

- 3 Remove dust cover from X MODE connector and connect Cable Assembly CX-12991/U. Connect other end of cable to RAD connector on TSEC/KY-57.

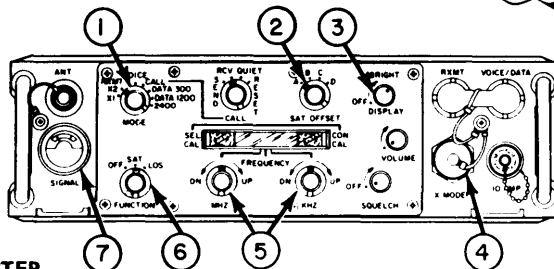
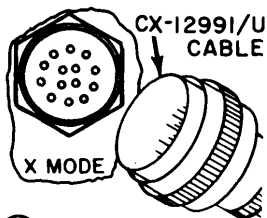

STEP

- 4 Connect Handset cable to TSEC/KY-57 AUDIO connector. Refer to TM 11-5810-256-12 for TSEC/KY-57 operating instructions.

STEP

5

Transmit- Ensure XMT PWR control (location on side of R/T Unit) is in the full-up (extreme cw) position unless otherwise directed.

Receive- Set SAT OFFSET control ② according to operation requirements.

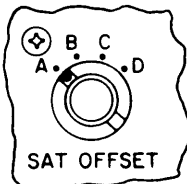

STEP

6

Set MODE control ① to X2.

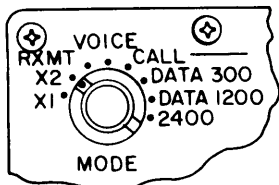

STEP

7

Set FUNCTION control ⑥ to SAT or LOS.

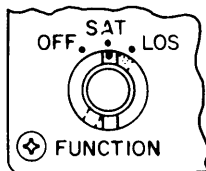

STEP

8

Adjust FREQUENCY MHZ/KHZ controls ⑤ according to operation requirements.

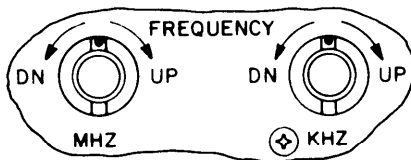

STEP

- 9** Transmit - Key Handset and observe SIGNAL strength meter ⑦ for a minimum output of ¼ full scale.
- Receive - Observe SIGNAL strength meter ⑦ for greater than ¼ full scale. If indication is less than ¼ full scale, reposition antenna for peak meter deflection. Receive message via Handset.

NOTE

SIGNAL strength meter may indicate less than ¼ full scale depending upon operation requirements and position of XMT PWR control.

STEP

- 1 Ensure compliance with operation requirements.

WARNING

Electromagnetic radiation hazard exists within several feet of the Medium Gain Antenna during transmit. Avoid prolonged exposure in front of the dipole elements during transmit operation.

STEP

- 2 Set up for SAT operation (page 2-19) or LOS operation (page 2-16).

STEP

- 3 Refer to RXMT setup (page 2-23) and perform STEP 2 thru 12.

STEP

- 4 Ensure FREQUENCY MHZ/KHZ controls (5), and SAT OFFSET control (2) are properly set according to operation requirements.

NOTE

The XMT PWR control (located on side of R/T Unit) should always be in the full-up (extreme cw) position unless otherwise directed.

STEP

- 5 With communication link established and equipment operating, set MODE control (1) to RXMT.

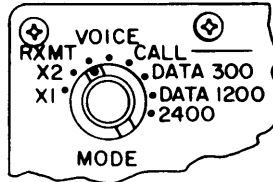

RXMT MODE – TRANSMIT/RECEIVE

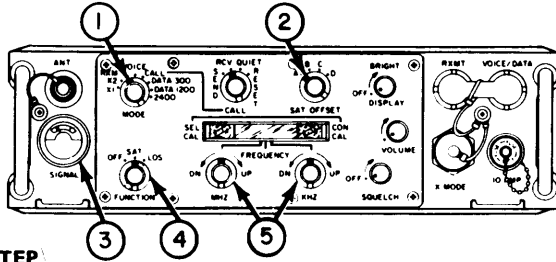

STEP

- 6** Adjust Radio Set AN/PRC-70, Radio Set AN/PRC-77 or Radio Set AN/VRC-12 series for retransmit operation according to procedures in applicable TM listed in Appendix A.

STEP

- 7** Observe SIGNAL strength meter ③ for acceptable indication during Transmit and Receive operation:

Transmit - ¼ full scale minimum when transmitting.

Receive - ¾ full scale minimum when receiving a good signal.

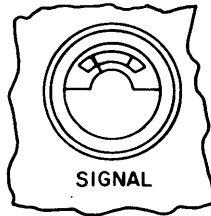

NOTE

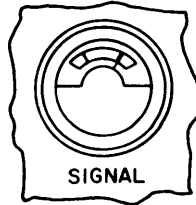

If ¾ full scale is not obtained for receive, reposition antenna for peak meter deflection.

SIGNAL strength meter may indicate less than ¼ full scale depending upon operation requirements and position of XMT PWR control.

STEP

- 1 Ensure compliance with operation requirements. Adjust DISPLAY control A cw to midrange.

WARNING

Electromagnetic radiation hazard exists within several feet of the Medium Gain Antenna during transmit. Avoid prolonged exposure in front of the dipole elements during transmit operation.

STEP

- 2 Set up for SAT operation (page 2-19) or LOS operation (page 2-16).

STEP

- 3 Remove dust cover from VOICE/DATA connector ③ and connect Handset cable.

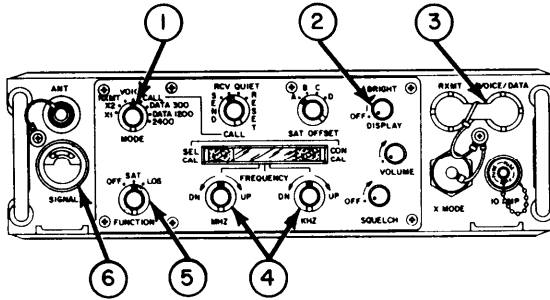
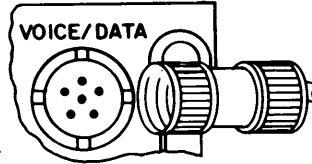

STEP

4 Set FUNCTION control ⑤ to SAT or LOS.

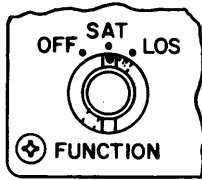

STEP

5 Set MODE control ① to VOICE.

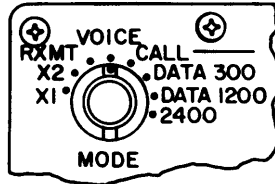

STEP

6 Adjust FREQUENCY MHZ/KHZ controls ④ according to operation requirements.

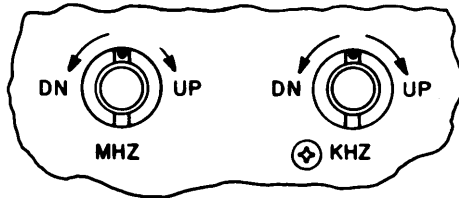

NOTE

The XMT PWR control (located on side of R/T Unit) should always be in the full-up (extreme cw) position unless otherwise directed.

STEP

7 Key Handset.

STEP

8 Observe SIGNAL strength meter **⑥** for a minimum output of $\frac{1}{4}$ full scale.

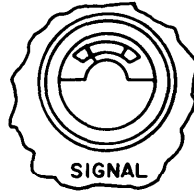

NOTE

SIGNAL Strength meter may indicate less than $\frac{1}{4}$ full scale in transmit depending upon operation requirements and position of XMT PWR Control.

STEP

1 Ensure compliance with operation requirements. Adjust DISPLAY control ③ cw to midrange.

STEP

2 Set up for SAT operation (page 2-19) or LOS operation (page 2-16).

STEP

3 Remove dust cover from VOICE/DATA connector ④ and connect Handset cable.

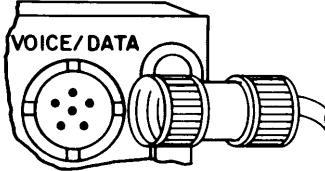

STEP

4 Set FUNCTION control ⑦ to SAT or LOS.

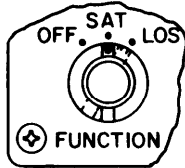

STEP

5 Set MODE control ① to VOICE.

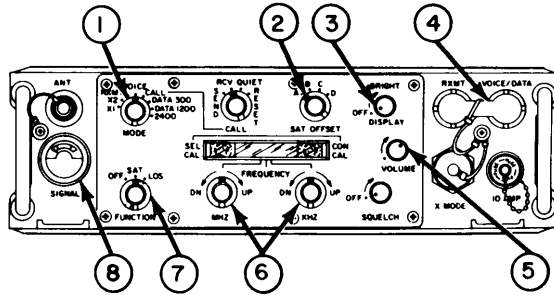
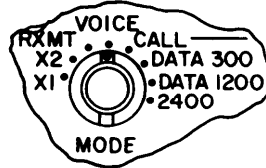

- STEP 6** Adjust FREQUENCY MHZ/KHZ controls (6) according to operation requirements.

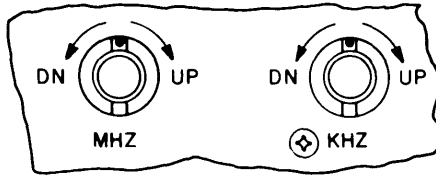

- STEP 7** Set SAT OFFSET control (2) according to operation requirements.

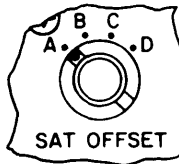

- STEP 8** Adjust VOLUME control (5) to midrange.

- STEP 9** Observe SIGNAL strength meter (8) for a deflection greater than $\frac{3}{4}$ full scale when receiving a good signal.

NOTE

If STEP 9 indication is less than $\frac{3}{4}$ full scale, reposition antenna for peak meter deflection.

- STEP 10** Adjust VOLUME control (5) for a comfortable level.

- STEP 11** Receive message via Handset.

2-17. SHUTDOWN PROCEDURES

Complete shutdown of the Backpack Radio Set is accomplished by setting the FUNCTION control to OFF.

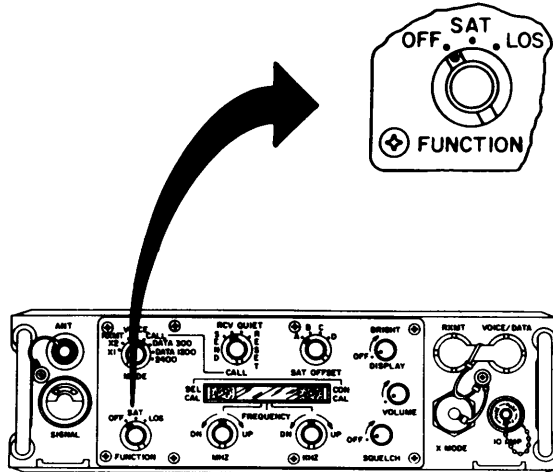

NOTE

For shutdown of auxiliary data and security devices, refer to applicable technical manuals in Appendix A.

2-63/(2-64 blank)

2-18. PREPARATION FOR MOVEMENT

Returning to mobile operation from at halt operation will take you less than two minutes. In mobile operation, selective or conference calls from a satellite relay station will be received. Refer to the following illustrations/procedures and proceed with STEP 1.

STEP

- 1 Shut down and disconnect any auxiliary or security devices. Leave Handset (2) connected to VOICE/DATA connector.

STEP

- 2 Set FUNCTION control to OFF.

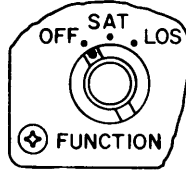

STEP

- 3 Disconnect antenna cable (4) from ANT connector (1).

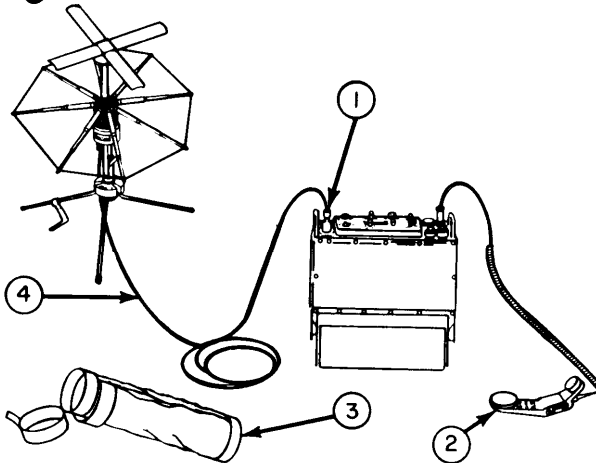

STEP

- 4** Disconnect antenna cable from antenna connector (7) and store cables inside pockets of carrying case (3).

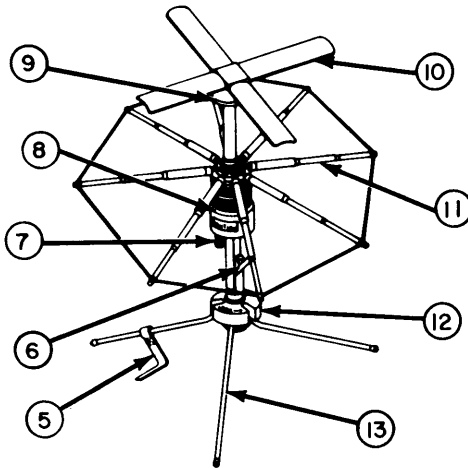

STEP

- 5** While holding antenna shaft, loosen "T" screw (6), reposition antenna shaft to vertical position and tighten (cw) "T" screw.

STEP

- 6** Lift up on each ground plane arm (11) to release from its latched position.

STEP

- 7** Press in and up on each ground plane arm (11) and latch it in retaining ring (9). Ensure all eight arms are properly secured in the retaining ring before proceeding to STEP 8.

WARNING

Dipole elements are spring-loaded. Use care when folding down elements.

STEP

8 Fold down the four dipole elements (10). While holding them down, press down on locking ring (8). Release locking ring to secure the dipole elements.

STEP

9 Rotate tripod locking cap (12) cw to unlock the tripod legs.

STEP

10 Fold each tripod leg (13) up around the antenna assembly. Secure legs using the velcro leg strap (5). Leg strap must wrap around all three legs.

STEP

11 Store antenna assembly (locking cap up) in antenna carrying case. Secure antenna carrying case cover and attach carrying case to your web belt, ALICE Pack, or place inside the ALICE Pack.

NOTE

In LOS operation, you can receive only selective/conference calls via satellite relay. You will have full LOS communication capabilities.

STEP

12 Refer to page 2-17 and perform STEP 2 thru STEP 7.

2-19. INTERFACE EQUIPMENT CONFIGURATION

a. The Backpack Radio Set interfaces or operates in conjunction with other equipment in both SAT or LOS modes of operation. The following illustrations will show you how to configure the auxiliary equipment for interface with it. For a basic description of this equipment, refer to page 1-14. For detailed information and operating instructions, refer to the appropriate technical manual listed in Appendix A.

b. The following modes of operation require interfacing with auxiliary equipment to complete the communications scheme.

- X1

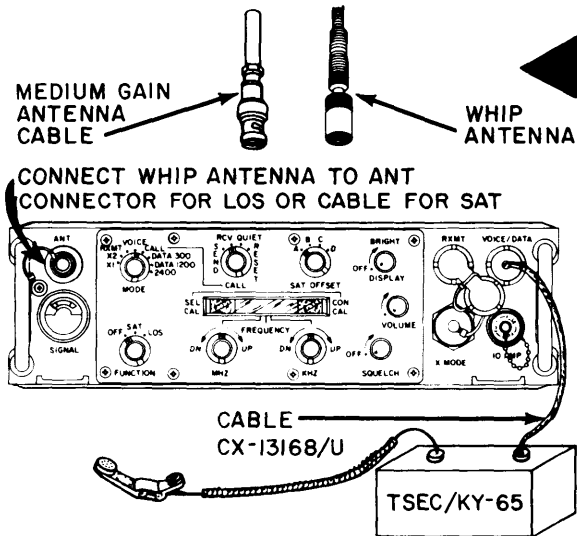

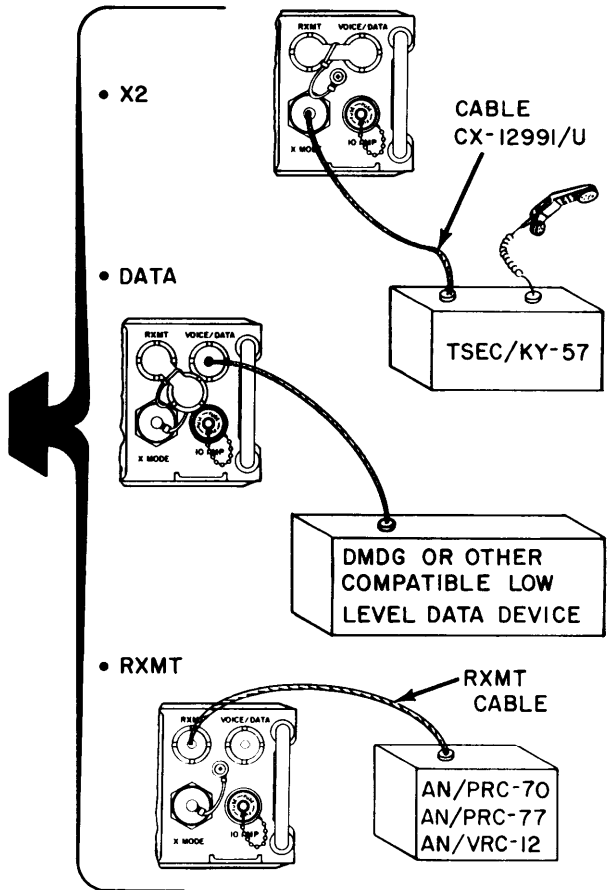

c. There are three auxiliary power sources that can be used in place of the Battery Box. These are Battery Storage BB-542/U, Power Supply PP-6148/U, and Generator, Direct Current G-76/G. The following illustrations and instructions will assist you in configuring each one when their use is required.

- Battery Storage BB-542/U. Hereinafter referred to as BB-542/U, will connect directly to the rear panel of the R/T Unit. It can be recharged using the Power Supply PP-6148/U or Generator, Direct Current G-76/G.

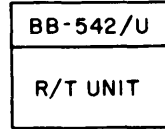

- I Generator, Direct Current G-76/G. Hereinafter referred to as G-76 Generator is handcranked and can also be used to recharge the BB-542/U. It is recommended that you power the R/T Unit through the BB-542/U using cable CX-13175/G. Only in an emergency will you connect the R/T Unit directly to the G-76 Generator using cables CX-13175/G and CX-13176/G (supplied with G-76 Generator). Both configurations are shown in the following illustrations.

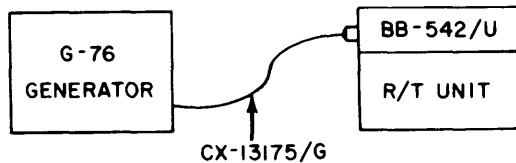

RECOMMENDED HOOK-UP USING G-76 GENERATOR

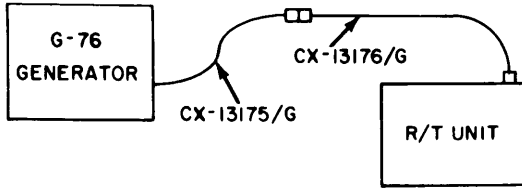

EMERGENCY HOOK-UP USING G-76 GENERATOR

- Power Supply PP-6148/U. Hereinafter referred to as PP-6148/U may be used to power the R/T Unit or recharge the BB-542/U. The PP-6148/U will connect directly to rear panel of the R/T Unit, External AC power (110/220 V ac) is required for this configuration. The PP-6148/U must be set for 24 to 30 V dc output at a current range of 10 amps and R/T Unit FUNCTION control set to OFF before mounting the R/T Unit on PP-6148/U. This configuration is shown in the following illustration.

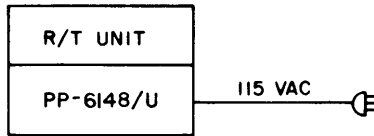

RECOMMENDED HOOK-UP USING PP-6148/U

Section IV

OPERATION UNDER UNUSUAL CONDITIONS

2-15. GENERAL

The Backpack Radio Set is fully capable of operation in hot, cold, or moderate climates. It will operate in blowing snow, rain, sand, and dust at temperatures from -25°F to +125°F and at altitudes to 10,000 feet above sea level. The R/T Unit with Battery Box and antenna attached will withstand being immersed in fresh water (up to three feet) for a period of up to two hours without water leakage. It has been designed so that you can operate it while wearing CBR protective clothing or cold weather clothing. The front panel DISPLAY control will either dim or eliminate the emission of light during blackout operation.

2-16. OPERATION IN UNUSUAL WEATHER

Under extreme conditions, the following precautions are necessary:

- a. Cold climates. Extreme cold causes field wires and cables to become hard, brittle, and difficult to handle.
 - Be careful when handling the cables and connecting them so that kinks and unnecessary loops will not result in permanent damage.
 - Make sure all connectors are free of frost, snow, and ice. Replace connector covers when they are not in use.
 - Never drag or place an open connector in the snow.
- b. Hot climates. In hot and dry climates connectors are subject to damage from dust and dirt.

2-72

- Replace the connector covers as soon as a cable is disconnected.
- Never place an open connector on the ground.

c. Warm and damp climates. In warm and damp climates the equipment is subject to accumulation of moisture and fungi. Wipe all moisture and fungi from equipment with a lint free cloth.

2-17. ANTI-JAMMING PROCEDURES

When it is determined that the incoming signal is being jammed, notify your immediate supervisor and continue to operate the equipment. To provide maximum intelligibility of jammed signals, follow one or more of the operational procedures given in the following steps. If these procedures do not provide sufficient signal separation for satisfactory operation, change to an alternate frequency.

Operate the Backpack Radio Set as outlined in operating procedures (page 2-39).

b. Vary VOLUME control. This may reduce jamming signal enough to permit a weak signal to be heard.

c. Detuning to either side of the jammed signal is only possible in X1, X2, RXMT or VOICE modes, and in 5 kHz increments. Tuning/detuning in 5 kHz increments is possible only in SAT mode. If the R/T Unit is to be used in LOS mode and detuning is to be attempted as an anti-jamming procedure, the following sequence must be used:

- Change FUNCTION control to SAT.
- Detune using the KHZ control.
- Change FUNCTION control back to LOS.
- Monitor channel to determine if this detuning increment provides satisfactory operation,
- Repeat procedure for different increments, on both sides of desired signal, if necessary.

If any of the OFFSETS are 000.000, the FUNCTION control may remain in SAT mode during the detuning procedure, provided the 000.000 OFFSET is selected by the SAT OFFSET control. If operating in SAT mode and detuning is attempted as an anti-jamming procedure, merely detune using the KHZ control.

WARNING

Before transmitting, return to assigned frequency. To prevent enemy detection, do not transmit on unauthorized frequencies.

2-18. EMERGENCY PROCEDURES

Any one of the following problems might occur creating a situation in which you must effect emergency repairs or procedures. Only the most likely are listed in the following subparagraphs.

a. Battery weakening. Should the tactical situation not permit replacing, battery duration may be extended by reducing transmission time or decreasing the number of transmissions.

b. Whip Antenna broken. As the Whip Antenna is not repairable, a substitute must be made. Number 16 wire, cut to the length shown in the following chart for a range of operating frequencies, should be inserted into the center conductor of the R/T Unit ANT connector.

<u>Operating Frequency</u>	<u>Wire Length</u>
225 to 260 MHz	12.5 in.
260 to 300 MHz	10.75 in.
300 to 346 MHz	9.5 in.
346 to 400 MHz	8.25 in.

Free space formula for determining exact antenna length for a specific frequency:

$$L \text{ (ft)} = \frac{246}{F \text{ (MHz)}}$$

c. Medium Gain Antenna.

WARNING

Electromagnetic radiation exists within several feet of the Medium Gain Antenna. Do not work on antenna with power on. Antenna cables conduct RF energy that can also cause fatal internal burns and electrical shock. Ensure that FUNCTION control is set to OFF before working on the antenna or cables.

- Conductive wire - Should the wire become separated draw the two ends together and braid.
- Antenna elements - Slight misalignment may be corrected by forcible repositioning. Gross misalignment should be corrected with considerable care to prevent breaking the elements away from the base.
- Tripod assembly - If tripod is unserviceable, the antenna must be supported using available materials.
- Elevation adjustment defective - Reduction in travel of elevation adjustment will necessitate approximations by you the operator. Once mechanically aligned, the antenna may be more finely positioned using the SIGNAL strength meter on the R/T Unit front panel.

2-75/(2-76 blank)

CHAPTER 3
MAINTENANCE INSTRUCTIONS

	Page
Troubleshooting Procedures	3-1
Maintenance Procedures	3-6

Section I

TROUBLESHOOTING PROCEDURES

3-1. GENERAL

The troubleshooting table provided in this section is for your use as the Backpack Radio Set operator. For the most part, you are not authorized to replace faulty components. The troubleshooting table will enable you to isolate the malfunction to the faulty area. If authorized, you will then replace the faulty component or notify organizational maintenance.

3-2. TROUBLESHOOTING PROCEDURES

Table 3-1 lists the common malfunctions which you may find during the operation or maintenance of the Backpack Radio Set or its components. You should perform the tests/inspections and corrective actions in the order listed.

This manual cannot list all malfunctions that may occur, nor all tests or inspections and corrective actions. If a malfunction is not listed or is not corrected by listed corrective actions, notify your supervisor.



Table 3-1. TROUBLESHOOTING PROCEDURES

MALFUNCTION	TEST OR INSPECTION	CORRECTIVE ACTION
--------------------	---------------------------	--------------------------

1. UNIT DOES NOT COME ON WHEN FUNCTION CONTROL SET TO SAT OR LOS POSITION.

Step 1. Check Battery Box.

If latches are loose, place in locked position.

If malfunction same, notify organizational maintenance.

2. UNIT SHUTS OFF DURING NORMAL OPERATION.

Step 1. Check batteries.

Set FUNCTION control to OFF and then to SAT or LOS.

If R/T Unit continues to shutoff, replace batteries in Battery Box. Set FUNCTION control to OFF and then to SAT or LOS.

If R/T Unit continues to shutoff, notify organizational maintenance.

Table 3-1. TROUBLESHOOTING PROCEDURES (cont)

MALFUNCTION	TEST OR INSPECTION	CORRECTIVE ACTION
--------------------	---------------------------	--------------------------

3. TRANSMIT, NO SIDETONE IN HANDSET, SIGNAL METER DEFLECTION GOOD.

Step 1. Check Handset to VOICE/DATA connection.

If connector loose, hand tighten.

If malfunction same or connector was tight, notify organizational maintenance.

4. TRANSMIT, NO SIDETONE IN HANDSET AND NO SIGNAL METER DEFLECTION.

Step 1. Check control settings.

If controls set wrong, reset.

Step 2. Check Handset to VOICE/DATA connection

If connector loose, hand tighten.

If malfunction same, notify organizational maintenance.

Table 3-1. TROUBLESHOOTING PROCEDURES (cont)

MALFUNCTION	TEST OR INSPECTION	CORRECTIVE ACTION
5. TRANSMIT, UNABLE TO CONTACT OTHER UNITS, SIGNAL METER DEFLECTION AND SIDETONE GOOD.	<p>Step 1. Refer to operating procedures for desired mode and check control settings.</p> <p>If controls are set wrong, set as directed by operating procedures.</p> <p>Step 2. Check antenna for loose connections, damage, or positioning.</p> <p>If connectors are loose, hand tighten.</p> <p>If in LOS mode and Whip Antenna damaged, notify organizational maintenance.</p> <p>If in SAT mode, reposition Medium Gain Antenna and if damaged, notify organizational maintenance.</p>	
6. RECEIVE, UNABLE TO RECEIVE CALLS OR MESSAGES FROM OTHER UNITS, NO SIGNAL METER DEFLECTION.	<p>Step 1. Refer to MALFUNCTION 5 and perform steps listed.</p>	

Table 3-1. TROUBLESHOOTING PROCEDURES (cont)

MALFUNCTION	TEST OR INSPECTION	CORRECTIVE ACTION
--------------------	---------------------------	--------------------------

7. RECEIVE, UNABLE TO RECEIVE CALLS OR MESSAGES FROM OTHER UNITS, SIGNAL METER DEFLECTION GOOD.

Step 1. Check R/T Unit/auxiliary equipment controls for proper setting.

 If controls set wrong, reset.

Step 2. Check interface cable connections.

 If connectors loose, hand tighten.

 If connected wrong, connect properly.

 If malfunction same, notify organizational maintenance.

Section II

MAINTENANCE PROCEDURES

3-3. GENERAL

Operator maintenance of the Backpack Radio Set is limited to the following:

- R/T Unit - Inspect and Test
- Whip Antenna - Inspect and Test
- Medium Gain Antenna - Inspect and Test
- Battery Box - Inspect and Replace Batteries

3-4. INSPECTION

To determine mechanical operability and serviceability of controls, indicators, and connectors, refer to Preventive Maintenance Checks and Services, page 2-10.

3-5. OPERATIONAL TEST

Refer to page 2-26 and perform operational test. Depending upon availability of auxiliary equipment (page 1-14), operate it in all possible modes of operation, page 2-39,

NOTE

If equipment does not operate correctly, notify organizational maintenance.

3-6. CLEANING

WARNING

Adequate ventilation should be provided while using TRICHLOROTRIFLUOROETHANE. Prolonged breathing of vapor should be avoided. The solvent should not be used near heat or open flame; the products of decomposition are toxic and irritating. Since TRICHLOROTRIFLUOROETHANE dissolves natural oils, prolonged contact with skin should be avoided. When necessary, use gloves which the solvent cannot penetrate. If the solvent is taken internally, consult a physician immediately.

Compressed air shall not be used for cleaning purposes except where reduced to less than 29 pounds per square inch (psi) and then only with effective chip guarding and personnel protective equipment. Do not use compressed air to dry parts when TRICHLOROTRIFLUOROETHANE has been used. Compressed air is dangerous and can cause serious bodily harm if protective means or methods are not observed to prevent chips or particles (of whatever size) from being blown into the eyes or unbroken skin of the operator or other personnel.

Inspect the exterior of the unit for dirt, moisture, grease and fungus. Correct discrepancies as follows:

- Remove dirt and moisture with dry, clean, lint-free soft cloth (Item 1, Appendix D).
- Remove grease, fungus and ground-in dirt with a clean soft cloth dampened (not wet) with trichlorotrifluoroethane (Item 2, Appendix D).
- Clean control knobs and switches with a clean soft cloth dampened with mild soap and water.
- Clean all connectors with a pencil eraser.

3-7. REMOVAL/INSTALLATION PROCEDURES

The following procedures cover removal/installation of items authorized at operator level. Defective items will be replaced with known good spares.

BATTERY - REMOVAL

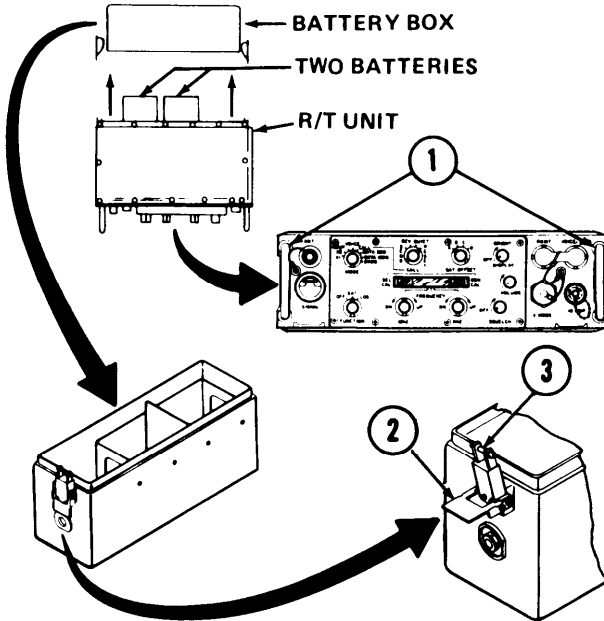

BATTERY – REMOVAL

STEP

1 Position R/T Unit on a solid flat surface with handles
① down.

STEP

2 Release finger-operated latches **②** (one on each end of Battery Box).

STEP

3 Check that latch bar **③** of each latch will clear ear on R/T Unit.

STEP

4 Carefully lift Battery Box from R/T Unit.

CAUTION

R/T Unit and battery connectors can be damaged if the batteries are not separated properly from the R/T Unit.

STEP

5 Grasp each battery and lift straight up.

STEP

6 Refer to BATTERY – INSTALLATION for replacing batteries and installing Battery Box.

BATTERY - INSTALLATION

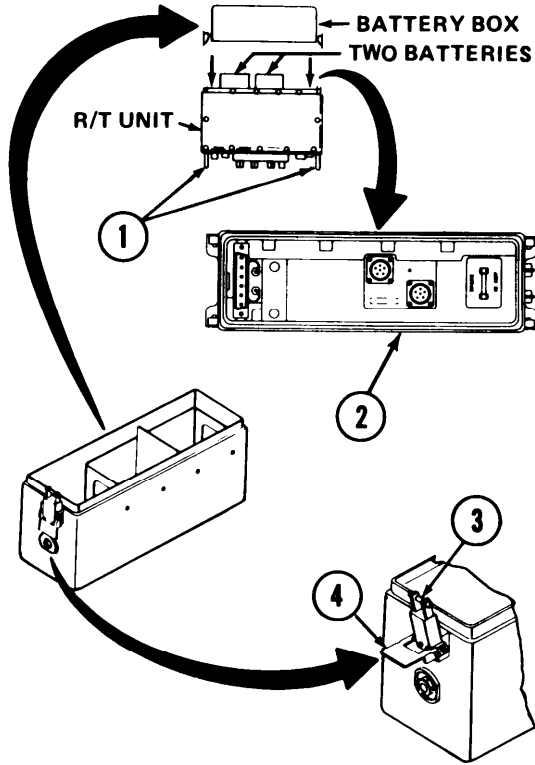

CAUTION

Check that R/T Unit FUNCTION control is set to OFF before installing batteries.

STEP

- 1** Position R/T Unit on a solid flat surface with handles
① down.

STEP

- 2** Check rear panel of R/T Unit to make sure gasket ②
is in place and in good condition.

CAUTION

R/T Unit and battery connectors can be damaged if the pins are not properly aligned before seating each battery.

STEP

- 3** Install two batteries of same type (BB-590/U Ni-Cad
or BA-5590/U Lithium), while carefully aligning
connectors and fully seating each battery.

STEP

- 4** With finger-operated latches ④ in open position, install
Battery Box over the batteries.

STEP

- 5** While pressing down on bottom of Battery Box, place
each latch bar ③ over R/T Unit ear and lock latches
(one on each end of Battery Box).

APPENDIX A

REFERENCES

A-1. PUBLICATIONS INDEXES

The following indexes should be consulted frequently for latest changes or revisions of references given in this appendix and for new publications relating to material covered in this manual.

Consolidated Index of Army Publications
and Blank Forms DA Pam 25-30 ■

A-2. FORMS

Equipment Inspection and Maintenance
Worksheet DA Form 2404
Product Quality Deficiency Report SF 368 ■
Recommended Changes to Equipment
Technical Manuals DA Form 2028-2

Recommended Changes to Publications
and Blank Forms DA Form 2028
Report of Discrepancy SF364

Transportation Discrepancy Report SF361 ■

A-3. TECHNICAL MANUALS

Painting Instructions for Field Use TM 9-213
Operator's and Organizational Maintenance
Manual for Tactical Speech Security
Equipment TSEC/K-57
(NSN 5810-00-434-3644) TM 11-5810-256-12
Operator's and Organizational Maintenance
Manual for Tactical Speech Security
Equipment TSEC/KY-65
(NSN 5810-01-050-2501) TM 11-5810-280-12

A-3. TECHNICAL MANUALS (cont)

- Operator's Manual for Radio Sets
 - AN/VRC-12 (NSN 5820-00-223-7412),
 - AN/VRC-43 (5820-00-223-7415),
 - AN/VRC-44 (5820-00-223-7417),
 - AN/VRC-45 (5820-00-223-7418),
 - AN/VRC-46 (5820-00-223-7433),
 - AN/VRC-47 (5820-00-223-7434),
 - AN/VRC-48 (5820-00-223-7435),
 - AN/VRC-49 (5820-00-223-7437)(Used Without An Intercom)
(Wheeled Vehicles) TM 11-5820 -401-10-1
- Operator's Manual for Radio Sets
 - AN/VRC-12 (NSN 5820-00-223-7412),
 - AN/VRC-43 (5820-00-223-7415),
 - AN/VRC-44 (5820-00-223-7417),
 - AN/VRC-45 (5820-00-223-7418),
 - AN/VRC-46 (5820-00-223-7433),
 - AN/VRC-47 (5820-00-223-7434),
 - AN/VRC-48 (5820-00-223-7435),
 - AN/VRC-49 (5820-00-223-7437)(Used With An Intercom System)
(Tracked Vehicles) TM 11-5820-401-10-2
- Operator's Manual for Radio Set
 - AN/PRC-70(NSN 5820-01-062-8246) , TM 11-5820-553-10
- Operator's and Organizational Maintenance Manual for Radio Set AN/PRC-77
 - (NSN 5820-00-930-3724) (Including Receiver-Transmitter, Radio RT-841/
 - PRC-77 (5820-00-930-3725) TM 11-5820-667-12
- Operator's Manual for Digital Message Device Group OA-8990/P
 - (NSN 5820-01-102-3921) TM 11-5820-887-10

A-3. TECHNICAL MANUALS (cont)

Operator's Manual for Generator, Direct
Current G-76(V)1/G (NSN 6115-01-
119-8170), G-76(V)2/G (NSN 6115-
01-124-0633), G-76/G (NSN 6115-01-
082-8107) TM 11-6115-470-10

Operator's and Organizational Maintenance
Manual for Power Supply PP-6148AJ
(NSN 6130-01-062-3618) TM 11-6130-356-12

Procedures for Destruction of Electronic
Materiel to Prevent Enemy Use
(Electronics Command) TM 750-244-2

A-4. MISCELLANEOUS PUBLICATIONS

Care and Use of Individual Clothing and
Equipment FM 21-15

The Maintenance Management Update. DA Pam 738-750 ■

Change 1 A-3/(A-4 blank)

APPENDIX B

COMPONENTS OF END ITEM AND BASIC ISSUE ITEMS LISTS

Section I. INTRODUCTION

B-1. SCOPE

This appendix lists components of end item and basic issue items for the AN/PSC-3 to help you inventory items required for safe and efficient operation.

B-2. GENERAL

The Components of End Item and Basic Issue Items Lists are divided into the following sections:

a. Section II. Components of End Item. This listing is for informational purposes only, and is not authority to requisition replacements. These items are part of the end item, but are removed and separately packaged for transportation or shipment. As part of the end item, these items must be within the end item whenever it is issued or transferred between property accounts. Illustrations are furnished to assist you in identifying the items.

b. Section III. Basic Issue items. These are the minimum essential items required to place the AN/PSC-3 in operation, to operate it, and to perform emergency repairs. Although shipped separately packaged, BII must be with the AN/PSC-3 during operation and whenever it is transferred between property accounts. The illustrations will assist you with hard-to-identify items. This manual is your authority to request/requisition replacement BII, based on TOE/MTOE authorization of end item.

B-3. EXPLANATION OF COLUMNS

The following is an explanation of the tabular listing columns:

a. Column (1) - Illustration Number (Illus Number). This column indicates the illustration number of item.

b. Column (2) - National Stock Number. Indicates the National Stock Number assigned to the item and will be used for requisitioning purposes.

B-3. EXPLANATION OF COLUMNS (cont);

- B-2**
- c. Column (3) - Description. Indicates the Federal item name. The last line for each item indicates the FSCM (in parentheses) followed by the part number.
- d. Column (4) - Unit of Measure (U/M). Indicates the measure used in performing the actual operational/maintenance function. This measure is expressed by a two-character alphabetical abbreviation (e.g., ea, in, pr).;
- e. Column (5) - Quantity required (Qty rqr). Indicates the quantity of the item authorized to be used with/on the equipment.
- Change 1**

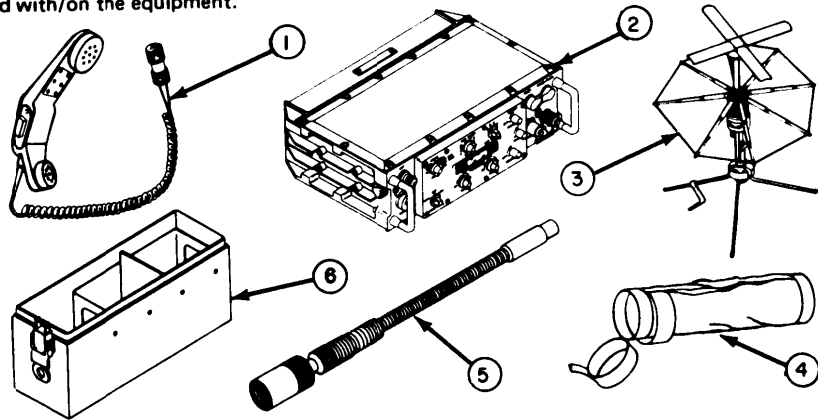

Section II. COMPONENTS OF END ITEM

(1) Illus Number	(2) National Stock Number	(3) Description FSCM and Part Number	Usable On Code	(4) U/M	(5) Qty rqr
1	5965-00-043-3463	HANDSET H-250()/U		EA	1
2	5820-01-238-0559	RECEIVER/TRANSMITTER RT-1402A/G (80045) B4028820		EA	1
3	5985-01-149-2576	ANTENNA AS-3567/G (85226) DM 1300021-003		EA	1
4	5820-01-128-6176	CARRYING CASE, AS-3567/G B4028430		EA	1

Change 1 B-3

Section III. BASIC ISSUE ITEMS

B-4
Change 1

(1) Illus Number	(2) National Stock Number	(3) Description FSCM and Part Number	Usable On Code	(4) U/M	(5) Qty rqr
5	5985-01-128-6417	ANTENNA AS-3566/G (56996) B4028550		EA	1
6	6160-01-128-6480	BATTERY BOX CY-8006/PSC-3 (80045) B4028410 Operator's Manual Radio Set AN/PSC-3, TM 11-5895-1180-10		EA EA	1 1

APPENDIX C

ADDITIONAL AUTHORIZATION LIST

Section 1. INTRODUCTION

C-1. SCOPE

This appendix lists additional items you are authorized for the support of the AN/PSC-3.

C-2. GENERAL

This list identifies items that do not have to accompany the AN/PSC-3 and that do not have to be turned in with it. These items are all authorized to you by CTA, MTOE, TDA, or JTA.

C-3. EXPLANATION OF LISTING

National stock numbers, descriptions, and quantities are provided to help you identify and request the additional items you require to support this equipment. The items are listed in alphabetical sequence by item name under the type document (i.e., CTA, MTOE, TDA, or JTA) which authorizes the item(s) to you.

C-2 Change 1

Section II. ADDITIONAL AUTHORIZATION LIST

(1) NATIONAL STOCK NUMBER	(2) DESCRIPTION FSCM & PART NUMBER	(3) USABLE ON CODE U/M	(4) QTY AUTH
8465-01-019-9103	ALICE Pack	EA	1
5820-01-102-3921	Digital Message Device Group OA-8990/U (23386)	EA	1
5995-00-973-1544	Retransmission Cable MK-456/GRC	EA	1
6140-01-089-7636	Battery Storage BB-542/U	EA	1
6115-01-082-8107	Generator, Direct Current G-76/G (83311)	EA	1
6115-01-192-2080	Generator, Direct Current G-76A/G	EA	1
6130-01-062-3618	Power Supply PP-6148/U	EA	1

APPENDIX D

EXPENDABLE SUPPLIES AND MATERIALS LIST

Section I. INTRODUCTION

D-1. SCOPE

This appendix lists expendable supplies and materials you will need to operate and maintain the AN/PSC-3. These items are authorized to you by CTA 50-970, Expendable Items (Except Medical Class V, Repair Parts, and Heraldic Items).

D-2. EXPLANATION OF COLUMNS

a. Column (1) – Item number. This number is assigned to the entry in the listing and is referenced to the narrative instructions to identify the material (e g., “Use cleaning compound, item 5, App. D”).

b. Column (2) – Level. This column identifies the lowest level of maintenance that requires the listed item.

C - Operator/Crew

O - Organizational Maintenance

F - Direct Support Maintenance

H - General Support Maintenance

c. Column (3) – National Stock Number. This is the National Stock Number assigned to the item; use it to request or requisition the item.

d. Column (4) – Description. Indicates the Federal Item Name and, if required, a description to identify the item. The last line for each item indicates the Federal Supply Code for Manufacturer (FSCM) in parentheses followed by the part number.

e. Column (5) – Unit of Measure (U/M). Indicates the measure used in performing the actual maintenance function, This measure is expressed by a two-character alphabetical abbreviation (e.g., ea, in, pr). If the unit of measure differs from the unit of issue, requisition the lowest unit of issue that will satisfy your requirements.

D-2

Section II. EXPENDABLE SUPPLIES AND MATERIALS LIST

(1) ITEM NO.	(2) LEVEL	(3) NATIONAL STOCK NUMBER	(4) DESCRIPTION	(5) U/M
1	C	8305-00- 267-3015	Cloth, Cotton Lintless (81348)	AR
2	C	6850-00- 105-3084	Trichlorotrifluoroethane (73925) Freon - TF	AR
3	C	6135-01- 036-3495	Battery, Lithium BA-5590/U	PR

INDEX

SUBJECT	PAGE
A	
Abbreviations	1-3
Additional Authorization List	C-1
ALICE Pack	1-12
Antenna, Whip	1-11
Antenna, Medium Gain	1-10
Anti-Jamming Procedures	2-73
Auxiliary Power Sources	2-70
B	
Battery Box	1-9
Battery installation	3-10
Battery Removal	3-8
Battery Storage BB-542/U	2-70
C	
Capabilities and Features	1-6
Cleaning	3-7
components of End Item and Basic Issue Item Lists	B-1
D	
Description and Use of Operator Controls and Indicators	2-1
E	
Emergency Procedures	2-74
Equipment Data	1-15
Equipment Description and Data	1-6

INDEX

SUBJECT	PAGE
E	
Equipment Interoperable with the Backpack Radio set	1-14
Equipment Used in Conjunction with the Backpack Radio Set	1-12
Expendable Supplies and Materials List	D-1
Example of Preset Procedure	2-36
G	
Generator, Direct Current G-76/G	2-70
Glossary	1-4
H	
Hand Receipt (-HR) Manuals	1-2
How to Use This Manual	ii
I	
Initial Adjustments, Daily Checks, and Operational Test	2-26
Inspection	3-6
Interface Equipment Configuration	2-68
Introduction	1-1
L	
Location and Description of Major Components	1-8
LOS Configuration - Major Components	1-11
LOS Operation Setup.....	2-16

INDEX

SUBJECT	PAGE
M	
Maintenance Forms, Records, and Reports	1-1
Maintenance Instructions	3-1
Maintenance Procedures	3-6
N	
Nomenclature Cross-Reference List.	1-3
O	
Offset Procedures	2-28
Operating Procedures	2-39
Operation in Unusual Weather	2-72
Operational Test	2-26
Operation Under Unusual Conditions.	2-72
Operation Under Usual Conditions.	2-16
P	
Power Requirements/Source	1-15
Power Supply PP-6148/U	2-71
Preparation For Movement	2-65
Preset Clearing	2-34
Preset Loading	2-28
Preset Review	2-33
Preventive Maintenance Checks and Services.	2-10
Purpose	1-6
R	
References	A-1
Removal/installation Procedures.	3-8

INDEX

SUBJECT	PAGE
R	
Reporting Equipment Improvement Recommendations (EIR's)	1-2
Reporting Errors and Recommending Improvements.	i
R/T Unit Controls and Indicators.	2-2
R/T Unit Description	1-9
RX MT Operation Setup	2-23
S	
SAT Configuration – Major Components.	1-8
SAT Operation Setup	2-19
Scope	1-1
Setting Presets or Offsets.	2-28
Shutdown Procedures	2-63
T	
Technical Data	1-16
Technical Principles of Operation	1-17
Troubleshooting Procedures3-1
W	
Weights and Dimensions	1-15

RECOMMENDED CHANGES TO EQUIPMENT TECHNICAL PUBLICATIONS



THEN JOT DOWN THE DOPE ABOUT IT ON THIS FORM. CAREFULLY TEAR IT OUT, FOLD IT AND DROP IT IN THE MAIL.

SOMETHING WRONG WITH THIS PUBLICATION?

FROM (PRINT YOUR UNIT'S COMPLETE ADDRESS):
 Commander
 Stateside Army Depot
 ATTN: AMSTA-US
 Stateside, N.J. 07703-5007

DATE SENT 10 July 1975

PUBLICATION NUMBER
 TM 11-5840-340-12

PUBLICATION DATE
 23 Jan 74

PUBLICATION TITLE
 Radar Set AN/PRC-76

BE EXACT PIN-POINT WHERE IT IS

PAGE NO	PARA. GRAPH	FIGURE NO	TABLE NO
2-25	2-28		
3-10	3-3		3-1
5-6	5-8		

IN THIS SPACE TELL WHAT IS WRONG AND WHAT SHOULD BE DONE ABOUT IT:

Recommend that the installation antenna alignment procedure be changed throughout to specify a 2° IFF antenna lag rather than 1°.

REASON: Experience has shown that with only a 1° lag, the antenna servo system is too sensitive to wind gusting in excess of 25 knots, and has a tendency to rapidly accelerate and decelerate as it hunts, causing strain to the drive train. Hunting is minimized by adjusting the lag to 2° without degradation of operation.

Item 5, Function column. Change "2 db" to "3db."

REASON: The adjustment procedure for the TRANS POWER FAULT indicator calls for a 3 db (500 watts) adjustment to light the TRANS POWER FAULT indicator.

Add new step f.1 to read, "Replace cover plate removed step e.1, above."

REASON: To replace the cover plate.

Zone C 3. On J1-2, change "+24 VDC to "+5 VDC."

REASON: This is the output line of the 5 VDC power supply. +24 VDC is the input voltage.

F03

PRINTED NAME GRADE OR TITLE AND TELEPHONE NUMBER
 SSG I. M. DeSpirito 999-1776

SIGN HERE

DA FORM 2028-2 1 JUL 79

PREVIOUS EDITIONS ARE OBSOLETE

P.S. IF YOUR OUTFIT WANTS TO KNOW ABOUT YOUR RECOMMENDATION MAKE A CARBON COPY OF THIS AND GIVE IT TO YOUR HEADQUARTERS

FILL IN YOUR
UNIT'S ADDRESS

FOLD BACK

DEPARTMENT OF THE ARMY

OFFICIAL BUSINESS

SAMPLE

Commander
US Army Communications-Electronics Command
and Fort Monmouth
ATTN: AMSEL-ME-MP
Fort Monmouth, New Jersey 07703-5000

MAIL ROOM REPRODUCTION UNIT

RECOMMENDED CHANGES TO EQUIPMENT TECHNICAL PUBLICATIONS



SOMETHING WRONG WITH THIS PUBLICATION?

THEN...JOT DOWN THE DOPE ABOUT IT ON THIS FORM. CAREFULLY TEAR IT OUT, FOLD IT AND DROP IT IN THE MAIL.

FROM: (PRINT YOUR UNIT'S COMPLETE ADDRESS)

DATE SENT

PUBLICATION NUMBER

TM 11-5895-1180-10

PUBLICATION DATE

15 Feb 1988

PUBLICATION TITLE

Radio Set AN/PSC-3

BE EXACT. PIN-POINT WHERE IT IS				IN THIS SPACE TELL WHAT IS WRONG AND WHAT SHOULD BE DONE ABOUT IT:
PAGE NO	PARA. GRAPH	FIGURE NO	TABLE NO	

PRINTED NAME GRADE OR TITLE AND TELEPHONE NUMBER

SIGN HERE

TEAR ALONG PERFORATED LINE

DA FORM 2028-2
1 JUL 79

PREVIOUS EDITIONS ARE OBSOLETE

P.S. - IF YOUR OUTFIT WANTS TO KNOW ABOUT YOUR RECOMMENDATION MAKE A CARBON COPIE OF THIS AND GIVE IT TO YOUR HEADQUARTERS.

FILL IN YOUR
UNIT'S ADDRESS

FOLD BACK

DEPARTMENT OF THE ARMY

OFFICIAL BUSINESS

Commander
US Army Communications-Electronics Command
and Fort Monmouth
ATTN: AMSEL-ME-MP
Fort Monmouth, New Jersey 07703-5000

THIS ADDRESS REPRESENTS UNIT

FILL IN YOUR
UNIT'S ADDRESS



FOLD BACK

DEPARTMENT OF THE ARMY

OFFICIAL BUSINESS

Commander
US Army Communications-Electronics Command
and Fort Monmouth
ATTN: AMSEL-ME-MP
Fort Monmouth, New Jersey 07703-5000

THIS ADDRESS IDENTIFIES THE UNIT

RECOMMEND CHANGES TO EQUIPMENT TECHNICAL PUBLICATIONS



SOMETHING WRONG WITH THIS PUBLICATION?

THEN...NOT DOWN THE DOME ABOUT IT ON THIS FORM. CAREFULLY TEAR IT OUT, FOLD IT AND DROP IT IN THE MAIL.

FROM: (PRINT YOUR UNIT'S COMPLETE ADDRESS)

DATE SENT

PUBLICATION NUMBER

TM 11-5895-1180-10

PUBLICATION DATE

15 Feb 1988

PUBLICATION TITLE

Radio Set AN/PSC-3

BE EXACT PIN-POINT WHERE IT IS

PAGE NO.	PAGE GROUP	FIGURE NO.	TABLE NO.

IN THIS SPACE TELL WHAT IS WRONG AND WHAT SHOULD BE DONE ABOUT IT:

PRINTED NAME GRADE OR TITLE AND TELEPHONE NUMBER

SIGN HERE

DA FORM 2028-2
1 JUL 79

PREVIOUS EDITIONS ARE OBSOLETE

P.S. - IF YOUR OUTFIT WANTS TO KNOW ABOUT YOUR RECOMMENDATION MAKE A CARBON COPE OF THIS AND GIVE IT TO YOUR HEADQUARTERS.

FILL IN YOUR
UNIT'S ADDRESS

FOLD BACK

DEPARTMENT OF THE ARMY

OFFICIAL BUSINESS

Commander
US Army Communications-Electronics Command
and Fort Monmouth
ATTN: AMSEL-ME-MP
Fort Monmouth, New Jersey 07703-5000

UNIT TELEPHONE NUMBER (DTL)

By Order of the Secretaries of the Army, the Navy and the Air Force

Official

CARL E. VUONO
*General, United States Army
Chief of Staff*

R. L. DILWORTH
*Brigadier General, United States Army
The Adjutant General*

H. A. HATCH
*Lieutenant General, USMC
Deputy Chief of Staff
for Installations and Logistics*

WILLIAM CHIAIESE
*Vice Admiral, United States Navy
Commander, Space and Naval Warfare
Systems Command*

Official

ALFRED G. HANSEN
*General, USAF, Commander, Air Force
Logistics Command*

LARRY D. WELSH
*General, USAF
Chief of Staff*

DISTRIBUTION:

To be distributed in accordance with DA Form 12-51 literature requirements for AN/PSC-3.

◆ U.S. GOVERNMENT PRINTING OFFICE: 1996-406-421/511

PIN: 063451-000