

# TM 11-4017

WAR DEPARTMENT TECHNICAL MANUAL

## RADIO TRANSMITTERS

BC-191-A, -B, -C, -E,

-F, AND -N

REPAIR INSTRUCTIONS

UNCLASSIFIED

*by WD Cir 231, 1941*  
**RESTRICTED. DISSEMINATION OF RESTRICTED MATTER.**  
No person is entitled solely by virtue of his grade or position  
to knowledge or possession of classified matter. Such matter  
is entrusted only to those individuals whose official duties  
require such knowledge or possession. (See also paragraph  
23b, AR 380-5, 15 March 1944.)

WAR DEPARTMENT

JUNE 1945

RADIO TRANSMITTERS  
BC-191-A,-B,-C,-E,-F, AND -N  
REPAIR INSTRUCTIONS



WAR DEPARTMENT

• JUNE 1945

---

RESTRICTED. *DISSEMINATION OF RESTRICTED MATTER.*

No person is entitled solely by virtue of his grade or position to knowledge or possession of classified matter. Such matter is entrusted only to those individuals whose official duties require such knowledge or possession.

(See also paragraph 23b, AR 380-5, 15 March 1944.)

---

WAR DEPARTMENT

Washington 25, D. C., 4 June 1945

TM 11-4017, Radio Transmitters BC-191-A, -B, -C, -D, -E, -F, and -N, Repair Instructions, is published for the information and guidance of all concerned.

[AG 300.7 (24 May 45)]

BY ORDER OF THE SECRETARY OF WAR:

OFFICIAL:

J. A. ULIO  
*Major General*  
*The Adjutant General*

G. C. MARSHALL  
*Chief of Staff*

DISTRIBUTION:

AAF (5); AGF (5); ASF (2); T of Opn (5); Dept (5); Base Comd (5); Island Comd (5); Def Comd (2); Arm & Sv Bd (1); S Div ASF (1); Tech Sv (2); PC&S (1); PE (2); Dep 11 (2); Gen Oversea SOS Dep (2); Pro Dist 11 (2); Gen & Sp Sv Sch (5); USMA (10); WDGS Lib (5); Lab 11 (2); Rep Shop 11 (2); A (5); CHQ (2); Three (3) copies to each of the following: T/O & E 11-7; 11-15; 11-47; 11-107; 11-127; 11-147S; 11-587; 11-592; 11-597.

Refer to FM 21-6 for explanation of distribution formula.

# CONTENTS

	<i>Paragraph</i>	<i>Page</i>
<b>SECTION I. DESCRIPTION OF RADIO TRANSMITTERS BC-191-A, -B, -C, -D, -E, -F, AND -N.</b>		
General .....	1	1
Frequency coverage .....	2	1
Types of transmission .....	3	1
Range .....	4	1
Power output .....	5	1
Power input .....	6	1
Over-all system function .....	7	2
<b>II. DIFFERENCES BETWEEN MODELS.</b>		
General .....	8	3
<b>III. INITIAL REPAIR PROCEDURES.</b>		
General .....	9	5
Removal of plug-in parts .....	10	5
Cleaning, inspection, and lubrication (other than plug-in parts) .....	11	6
Cleaning, inspection, and testing of plug-in parts .....	12	8
<b>IV. PRELIMINARY TROUBLE-SHOOTING PROCEDURES.</b>		
Input resistance test .....	13	9
Preparation of set for operation .....	14	9
Adjustments prior to operation .....	15	9
<b>V. ALIGNMENT PROCEDURE.</b>		
General .....	16	15
Frequency checks and adjustments .....	17	15
Neutralization .....	18	16
Antenna tuning circuit checks .....	19	17
Adjustments for C.W. operation .....	20	18
Adjustments for VOICE operation .....	21	18
Adjustments for TONE operation .....	22	19
<b>VI. DETAILED TROUBLE-SHOOTING PROCEDURES.</b>		
General checks for defective stages .....	23	21
Moistureproofing, fungiproofing, and refinishing .....	24	23
<b>VII. FINAL TESTING.</b>		
General .....	25	24
<b>VIII. INDIVIDUAL STAGE AND CIRCUIT REPAIR DATA.</b>		
Master oscillator .....	26	28
Power amplifier .....	27	30
Modulator .....	28	32
Speech amplifier .....	29	35
Filament and relay circuits .....	30	39
Switching relay 1165 .....	31	42
Checking TONE—C.W.-VOICE switch .....	32	52
Transmitter tuning units .....	33	54
Antenna Tuning Unit BC-306-(*) .....	34	62
<b>IX. SUPPLEMENTARY DATA.</b>		
Parts identification .....	35	64

**WARNING**

**HIGH VOLTAGE**

is used in the operation of this equipment

**DEATH ON CONTACT**

may result if safety precautions are not observed.



Figure 1. Radio Transmitter BC-191-(\*) full view, with Tuning Unit TU-6-A in place.



# RESTRICTED

## SECTION I

### DESCRIPTION OF RADIO TRANSMITTERS BC-191-A, -B, -C, -D, -E, -F, AND -N<sup>1</sup>

#### 1. General

*a.* SYMBOLS. Official nomenclature followed by (\*) is used to indicate all models of the item of equipment included in this Technical Manual. Thus Radio Transmitter BC-191-(\*) represents Radio Transmitters BC-191-A, -B, -C, -D, -E, -F, and -N; Transmitter Tuning Unit TU-3-(\*) represents Transmitter Tuning Units TU-3-A, TU-3-B, and TU-3-N. Antenna Tuning Unit BC-306-(\*) represents Antenna Tuning Units BC-306-A and -B. Official nomenclature followed by ( ) is used in making general reference to all models of equipment. Thus, Transmitter Tuning Unit TU-( )-A, or -B represents Transmitter Tuning Units TU-3-A or -B, TU-5-A or -B, TU-6-A or -B, TU-7-A or -B, TU-8-A or -B, TU-9-A or -B, TU-10-A or -B, TU-22-A or -B, and TU-26-A or -B.

*b.* CHARACTERISTICS. Radio Transmitters BC-191-(\*) (fig. 1), are five-tube, master-oscillator, power-amplifier radio transmitters. They have one stage of speech amplification, operating as a class A driver, to drive the grids of the push-pull class B modulators. On tone, the speech amplifier stage operates as an audio oscillator to supply tone modulation to the carrier.

*c.* PHYSICAL DESCRIPTION. The transmitter is housed in a shielded metal cabinet, made up of panels fastened with buttonhead screws to the tubular steel frame of the transmitter. The front cover of the tube compartment, located at the upper left front of the transmitter, is secured by snap-slide catches. Behind this panel are located the tubes; some of the controls, and the filament-resistor board. The antenna tuning controls occupy the right side of the transmitter front panel, and the transmitter tuning unit compartment is at the lower left. The transmitter-output terminals are located in the upper right corner of the transmitter, on both the top and the side. The power and control input sockets are on the left side and bottom of the transmitter.

<sup>1</sup> See TM11-800 for installation, operation, and other maintenance data on this equipment.

#### 2. Frequency Coverage

With the use of interchangeable transmitter tuning units, a frequency-range coverage from 200 to 800 kilocycles and from 1,500 to 12,500 kilocycles is possible with the nine tuning units. (See fig. 28.) In some cases, special transmitter tuning units are available to cover frequencies from 150 to 260 kilocycles, 260 to 400 kilocycles, and 800 to 1,500 kilocycles. These special units, however, are not standard equipment.

#### 3. Types of Transmission

*a.* C.W. C. W. refers to unmodulated continuous-wave telegraph signals.

*b.* TONE. Tone refers to tone-modulated, continuous-wave telegraph signals. These are amplitude-modulated signals.

*c.* VOICE. Voice refers to voice-modulated, continuous-wave telephone signals. These are amplitude-modulated signals.

#### 4. Range

The range of distances covered by the transmitters depends upon several variable factors, such as operating frequency, type of transmission, and type of antenna system, also whether the transmitter is located in an aircraft, at a fixed ground station, or in a vehicle.

#### 5. Power Output

Under average operating conditions, the normal power output on continuous-wave telegraph operation varies from 40 to 75 watts, depending upon the transmission frequency.

#### 6. Power Input

The following different types of power-supply equipment are used in these transmitters:

*a.* Some sets use a 12-volt storage battery floated across the charging generator of a motor vehicle. The battery, a component of the motor vehicle, supplies power directly to the vacuum-tube filaments and to the control circuits. A dynamotor operating from the same battery generates high voltage for the plate circuits of the transmitter.



b. A second type of power equipment is a gasoline engine-driven generator which generates both 12 volts and high voltage, and supplies all power required for transmitter operation.

c. A third type of authorized power-supply equipment is a rectifier type unit, operating from 110- or 220-volt alternating-current (a-c) power supplies. Separate rectifiers in the equipment furnish low and high direct-current (d-c) voltages for the transmitter's control and plate circuits respectively. The transmitter tube filaments are heated by low-voltage alternating current, supplied by a step-down transformer in the unit.

## 7. Over-all System Function

a. R-F SECTION. The simplified block diagram (fig. 2) shows the transmitter divided into separate blocks, each block representing an individual stage or, as with the tuning unit, a component of that stage. The frequency of transmission is determined by the master oscillator and the oscillation section of the transmitter tuning unit. Power generated by the oscillator is then coupled to the power amplifier. The power amplifier, shown by the power-amplifier block and the amplifier section of the

tuning unit, is then tuned to resonance with the master oscillator. The output of the power amplifier is coupled to the antenna tuning unit, which can be tuned and adjusted to load the different types of antennas to the proper operating frequency.

b. MODULATOR. In the audio section, voice frequencies are picked up by the microphone and coupled to the input of the speech-amplifier stage. The amplified signals from this stage are applied to the input of the class B push-pull modulator tubes. These greatly amplified signals from the output of the modulator stage are applied to the primary of the class B output transformer. Any variations of voltage or current in this primary winding will be present in the secondary winding. Because the plate current of the final power amplifier flows through this secondary, these variations, of the same frequency as those picked up by the microphone, are applied to the plate circuit of the power amplifier and modulate the radio-frequency (r-f) carrier.

c. POWER SUPPLIES. The block diagram (fig. 2) shows the three types of power supplies which may be used to furnish power necessary to operate the equipment. Any one of the three may be used; the type chosen depends upon where the equipment is installed.

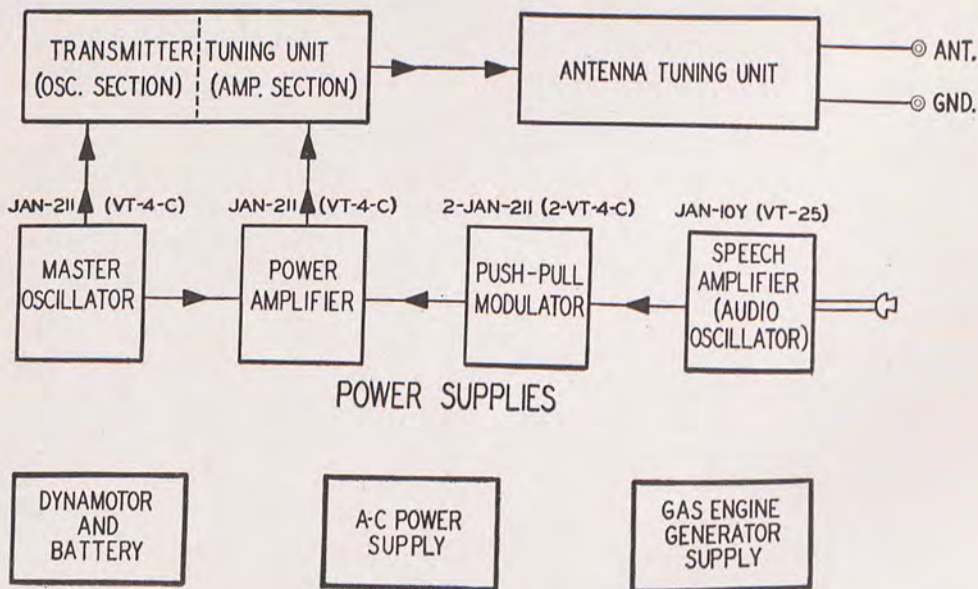

Figure 2. Radio Transmitter BC-191-(\*), simplified block diagram.

## SECTION II

### DIFFERENCES BETWEEN MODELS

---

#### 8. General

This text covers seven models of the equipment. Radio Transmitters BC-191-A to -F, inclusive and BC-191-N. All models are identical for all operating functions but vary slightly in small details, usually mechanical in nature. Table I lists the differences in these models. The first

column shows the parts affected, and the remaining columns, each headed by a model number, list the affected parts used in that particular model. In Radio Transmitters BC-191-A to BC-191-E, inclusive, the socket for Tube JAN-10Y (VT-25) is a regular plug-in wafer type, with no holding clamp for the tube.

TABLE I—Differences Between Models

Parts affected	BC-191-A	BC-191-B	BC-191-C	BC-191-D	BC-191-E	BC-191-F	BC-191-N
Antenna loading coil	1170.	Improved 1170.	Improved 1170.	Improved 1170.	Improved 1170.	Improved 1170.	Improved 1170.
Switching relay.	1165.	Improved relay 1165.	Improved relay 1165.	Improved relay 1165.	Improved relay 1165.	Improved relay 1165.	Improved relay 1165.
OFF-ON switch.	Rotary type 1132.	Rotary type 1132.	Toggle type 1194.	Toggle type 1194.	Toggle type 1194.	Toggle type 1194.	Toggle type 1194.
12V-14.2 V switch.	1139 and 1140.	1139 and 1140.	Replaced by 1190.	Replaced by 1190.	Replaced by 1190.	Replaced by 1190.	Replaced by 1190.
Panel meters.	White face, black letters.	White face, black letters.	Black face, white letters.	Black face, white letters.	Black face, white letters.	Black face, white letters.	Black face, white letters.
Filament resistor connection board.	A of fig. 7.	A of fig. 7.	A of fig. 7.	Redesigned as in B of fig. 7.	Redesigned as in B of fig. 7.	Redesigned as in B of fig. 7.	Redesigned as in B of fig. 7.
Antenna loading switch.	1171.	1171.	1171.	1198.	1198.	1198.	1198.
Capacitors.	1120, 1155, and 1163.	1120, 1155, and 1163.	1120, 1155, and 1163.	1120, 1155, and 1163.	Replaced by single unit, 1197a, b, c.	Replaced by single unit, 1197a, b, c.	Replaced by single unit, 1197a, b, c.
A-C D-C switch.	1136 and 1137.	1136 and 1137.	Replaced by 1195.	Replaced by 1195.	Replaced by 1195.	Replaced by 1195.	Replaced by 1195.
Interstage transformer.	1157.	1157.	1157.	1157.	1157.	1199.	1157.
Transmitter tuning units.	TU-( )-A.	TU-( )-A.	TU-( )-A. TU-( )-B.	TU-( )-B.	TU-( )-B.	TU-( )-B.	TU-( )-B.
Resistors 1152 and 1153.	Beneath speech-amplifier socket.	On resistor board	On resistor board.	On resistor board.	On resistor board.	On resistor board.	On resistor board.

Note. Transmitter Tuning Units TU-( )-A have two insulated binding posts in the upper right corner of the front panel. In Transmitter Tuning Units TU-( )-B these binding posts have been removed.

## SECTION III

### INITIAL REPAIR PROCEDURES

#### 9. General

*Note.* Before making any repairs or adjustments, all authorized modification work orders should be applied. See FM 21-6 for list of applicable MWO's.

*a.* **TOOLS.** Many repairs in the field are mechanical in nature. When a mechanical defect is encountered, be careful in removing the part

#### *b.* TOOLS REQUIRED.

Item	Description
Screw drivers and pliers .....	Assorted sizes (including off-set screwdrivers). Large and small. Assorted sizes.
Diagonal cutters ....	
Socket wrenches .....	
Soldering iron and solder .....	
Long-handle safety test probes .....	

#### *c.* TEST EQUIPMENT REQUIRED.

Item	Description
Frequency meter ....	Crystal or heterodyne type, calibrated for continuous coverage from 125 to 15,000 kc.
Voltmeter .....	Sensitivity of not less than 1,000-ohms per volt, preferably greater, measuring a-c or d-c voltages from 0 to 1,500 volts. (Select range to permit center-scale reading.)
Standard ohmmeter Standard oscilloscope R-f antenna meter...	0-5 amp range, thermo-couple type.
Capacitors (one each)	
Resistors (one each)	1,000-mmF; 5,000-vdew; mica. 600-mmF; 5,000-vdew; mica. 400-mmF; 5,000-vdew; mica. 300-mmF; 5,000-vdew; mica. 200-mmF; 5,000-vdew; mica. 100-mmF; 5,000-vdew; mica. 40-ohms; 75-watts; noninductive. 75-ohms; 75-watts; noninductive. 5-ohms; 75-watts; noninductive.

to be repaired. To avoid damaging the head of a nut or screw always use tools provided with the set or use wrenches and screw drivers of the correct size. Never use force to remove any part. A gentle, steady pressure should remove the part; if not, careful examination will locate the difficulty.

#### *d.* CLEANING AND INSPECTING EQUIPMENT.

Item	Description
Small flashlight or probing light	Tobacco pipe.
Clean, dry, compressed air or hand bellows	
Solvent, Dry-cleaning	
Pipe cleaners .....	
Dental mirror	
Paint brushes .....	½ inch to 3 inches, assorted.
Sandpaper .....	#0000.
Crocus cloth	Lint-free.
Clean cloths .....	

#### 10. Removal of Plug-in Parts

*a.* **TUBES.** Remove the tube-compartment cover by unlatching the two snap-slide catches at the bottom. Remove the four Tubes JAN-211 (VT-4C) by rotating them slightly counterclockwise to release them from the sockets.

*b.* **ANTENNA-OUTPUT TERMINAL BOARD.** Remove the terminal board by unscrewing the six retaining screws and pulling straight out. The antenna terminal board provides for various antenna and ground connections and consists of six terminals mounted on an insulating block. It may be mounted on either the top or the end of the transmitter case.

*c.* **TRANSMITTER TUNING UNITS.** Remove these units by unlatching the four snap-slide catches at each corner of the front panel. To remove, pull evenly, using both handles. (See fig. 3.) The plug-in tuning units used with Radio Transmitter BC-191-(\*) provide for a very wide frequency coverage. Each unit covers specified frequencies, as shown on the nameplate. These units contain a master-oscillator tuning control, a power-amplifier tuning con-

trol, an antenna-coupling switch; all models except Transmitter Tuning Units TU-7-(\*) to TU-10-(\*) inclusive, contain a band-change switch. All tuning units have a neutralizing adjustment behind the CALIBRATION CHART.

### 11. Cleaning, Inspection, and Lubrication (Other than Plug-in Parts)

a. CLEANING. (1) Remove cables.

(2) Remove side and top panels. (Tubes and tuning unit have already been removed.)

(3) Remove as much dust, dirt, and other foreign matter as possible from the entire unit by using dry compressed air. Hand bellows may be used if necessary.

(4) Use a small paint brush to remove any other accumulation of foreign material.

(5) Do not disturb the wiring when cleaning.

(6) Remove dust or corrosion. Use fine sandpaper if necessary.

(7) To clean, use dry-cleaning solvent (SD),

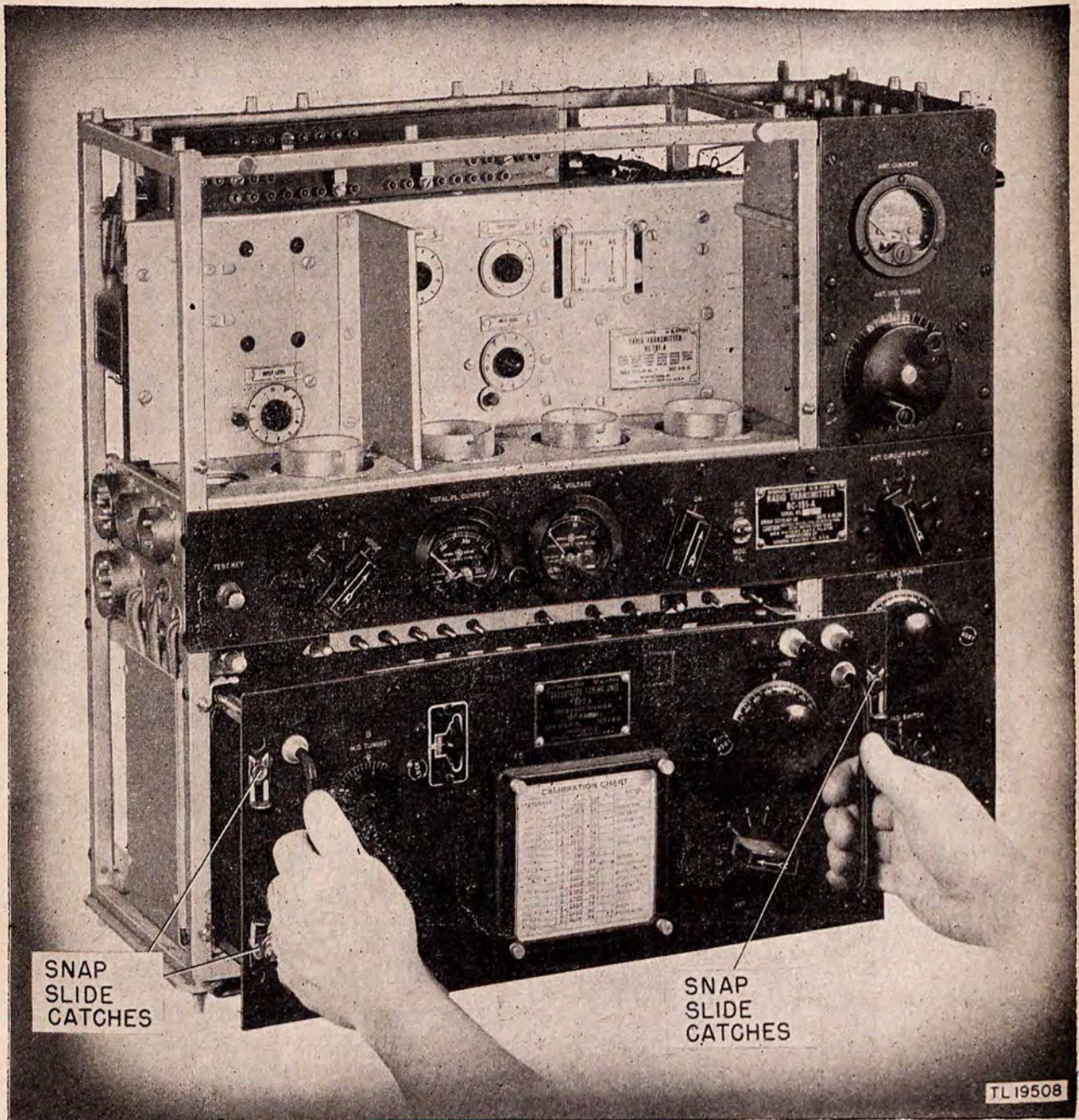
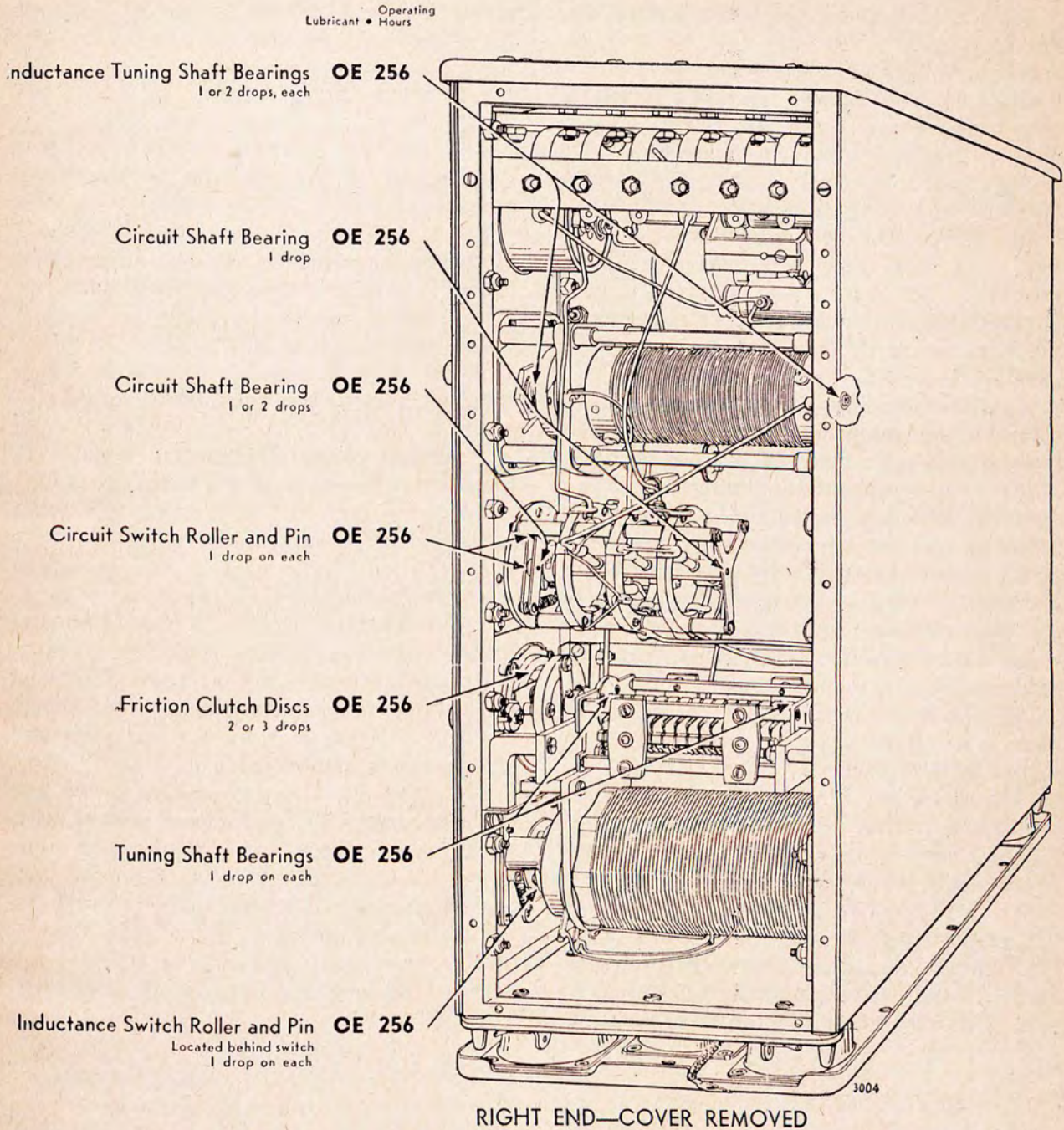

Figure 3. Radio Transmitter BC-191-(\*), removing tuning units.



— **KEY** —

LUBRICANTS	LOWEST EXPECTED AIR TEMPERATURE		
	above +32°F.	+32°F. to 0°F.	below 0°F.
<b>OE</b> —OIL, engine	<b>OE SAE 10</b>	<b>OE SAE 10</b>	<b>PS</b>
<b>PS</b> —OIL, lubricating, preservative, special.			

Figure 4. Transmitter lubrication data.

TL19509

and apply with a brush. Go over each part thoroughly.

(8) Clean all plug-in pins and sockets. Use fine sandpaper if necessary.

b. INSPECTION. (1) Disconnect all power to the transmitter. Remove top and rear panels, tube compartment cover and tubes. Make a note of defects, found during inspection.

(2) Check all panel controls for smooth operation and firmly secured dials.

(3) Inspect tubes and sockets for good contacts. See that there is no corrosion on the pins.

(4) Check all switches for good contacts and check insulators carefully. See that they do not have breaks or cracks.

(5) Check tuning capacitors for smooth operation and mechanical alignment. Be sure there is no foreign material between plates.

(6) Remove transmitter tuning unit. Check the terminal connectors to see that they are not corroded and that the contacts are good.

(7) Inspect antenna output terminal board. See that there is no broken insulation or corrosion on terminals.

(8) Check machine screws and rivets for tightness.

(9) Check the cord sockets to make sure there is no corrosion on the pins or on the inside of the receptacles.

(10) Check the circuit components of the transmitter tuning unit, as described above.

(11) Check wiring, coils, and resistors. There should be no signs of heating, defective soldering, or loose or broken parts.

c. LUBRICATION OF TRANSMITTER BC-191-(\*). Lubrication reduces friction between moving parts and protects against rust and corrosion. The lubrication chart (fig. 4) indicates

ten lubricating points and the type of oil to be used. Apply oil to these points after the transmitter has been moistureproofed and cleaned. Do not use more than indicated in the chart.

## 12. Cleaning, Inspection, and Testing of Plug-in Parts

a. TUBES. (1) Clean the tube base pins with a brush and use fine sandpaper to remove corrosion from pins.

(2) Test the four Tubes JAN-211 (VT-4C) by placing the tube to be tested in a transmitter known to be in good operating condition. Operate the test transmitter to check the tube.

(3) The speech-amplifier Tube JAN-10Y (VT-25) may be tested on a standard tube tester; however, the substitution method is better.

b. ANTENNA-OUTPUT TERMINAL BOARD. (1) Clean with cleaning fluid and a stiff brush. Remove corrosion from the terminal pins with fine sandpaper if necessary.

(2) Inspect for cracks in the insulating board or for loose connectors.

c. TRANSMITTER TUNING UNITS. (1) Remove the top and bottom panels. Blow dust from the wiring and coils with dry compressed air, and use a brush to loosen the dirt. Clean switch contacts with fine sandpaper, if necessary, and wash contacts with cleaning fluid.

(2) Check the antenna-coupling switch and the band-change switch for poor contact, dirt, or corrosion. Check soldered joints for signs of corrosion. Check contacts. See that they operate smoothly. Look for signs of overheating of coils and wiring.

(3) For repair information on checking the various transmitter tuning units, see paragraph 33.

## SECTION IV

### PRELIMINARY TROUBLE-SHOOTING PROCEDURES

#### 13. Input Resistance Test

*Note.* Be sure all cables are removed.

With an ohmmeter check from pin (61) of Plug PL-59 to pin (55) of Plug PL-61. The meter should read approximately 1.2 megohms.

*Note.* The four cord sockets mounted on the end and bottom of the transmitter case are labeled with the reference symbols for the *plugs* that fit into them, and not with the reference symbols for the *sockets* that are shown in the schematic diagram. In this text, the *plug* symbols shown on the transmitter case are used when referring to the transmitter cord *sockets*. (See fig. 5.)

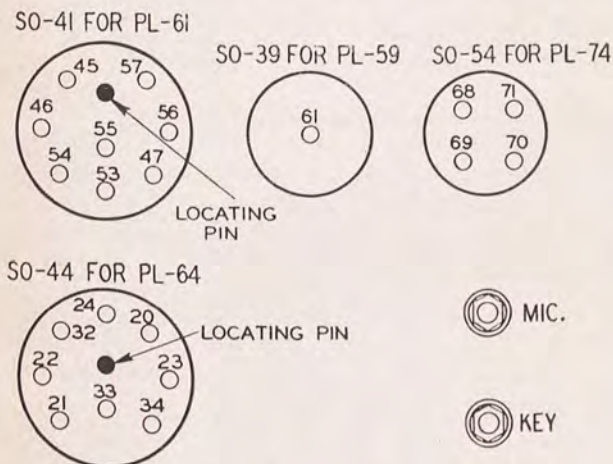

EXPLANATION OF PLUG MARKING  
EXAMPLE:— PL-61 ON TRANSMITTER PANEL IS THE SYMBOL FOR THE PLUG THAT SHOULD BE INSERTED IN S0-41.

TL19510

Figure 5. Cording socket pin nomenclature.

#### 14. Preparation of Set for Operation

*a.* REPLACEMENT OF PLUG-IN PARTS. (1) Replace the tubes by matching the numbers on the tubes with the number in front of each tube socket.

(2) Replace antenna terminal board and secure with six screws and retainers.

(3) Replace the transmitter tuning unit and secure with the four snap-slide fasteners.

**Warning:** Insertion of the tuning unit closes the interlock switch (1102), thus connecting high voltage to the transmitter when power is applied and switch 1132 is on.

*b.* CONNECTION OF POWER UNIT. (1) Connect cord from PL-59-TRANS. on the dynamotor to PL-59 on the transmitter.

(2) Connect cord from the 12-volt battery to the two wingnuts in the dynamotor terminal box.

*Note.* Because of the high current drain on the battery, it is necessary for the battery to be on charge at all times when the transmitter is used for any appreciable length of time.

(3) Do not connect the high-voltage cord from PL-61-TRANS. on the dynamotor to PL-61 on the transmitter until after the filament-resistor setting has been checked.

*c.* TURNING TRANSMITTER ON. Under the test procedure used, turning on full power in the transmitter is not accomplished at one time. In the filament-resistor adjustments following, voltage is applied to the filament circuit only. Later, under tuning procedure, plate voltage is turned on. This results in the application of full power to the transmitter.

#### 15. Adjustments Prior to Operation

*a.* FILAMENT-CIRCUIT SWITCHES, D-C OPERATION. On the panel behind the vacuum tubes in the tube compartment are several knobs and switches. (See fig. 6.) Between the fourth and fifth tubes, counting from Tube JAN-10Y (VT-25) at the left end, there are two switches, the 12V.-14.2V. switch and the A-C D-C switch. The proper operating position of these switches is determined by the power-supply equipment used. Place the A-C D-C switch in the D-C position when using a battery-driven dynamotor or an internal combustion engine-driven generator for power supply. Throw the 12V.-14.2V. switch to the 14.2V. position when the power supply is a battery-driven dynamotor in which the battery is on charge while the equipment is in operation. This condition exists in virtually all vehicle and aircraft installations. Move the switch to the 12V. position when using a battery-driven dynamotor supply in which the battery is not on charge. When the transmitter is used with the engine-driven generator power



supply, a fairly long connecting cord is used between the generator and the transmitter. The resistance of this cord and the resultant voltage drop are sufficiently high to require operation with the 12V.-14.2V. switch in the 12V. position, even though the generator output is 14.6 volts.

b. FILAMENT-CIRCUIT SWITCHES, A-C OPERATION. Set the A-C D-C switch in the A-C position and the 12V.-14.2V. switch in the 14.2V. position when the transmitter is operated with a rectifier type power supply from an a-c power source.

c. FILAMENT-VOLTAGE ADJUSTMENT, D-C OPERATION, STORAGE-BATTERY DYNAMOTOR SUPPLY. When operating the transmitter from a storage-battery dynamotor supply with the battery on charge, adopt the following procedure of filament-voltage adjustment:

(1) When the high-voltage cord to sockets

marked PL-59 is disconnected, place the transmitter OFF-ON switch at OFF.

(2) Remove the front cover from the tube compartment and place the A-C D-C switch in the D-C position. Also remove the 16 screws which fasten the transmitter top, and remove the top.

(3) The filament-resistor connection board is at the top left of the tube compartment. (See fig. 6.) On the left end of the board are the connector studs, labeled: COMP., C.W. FILAMENT, 14 VOLTS, and 12 VOLTS. (COMP. is abbreviation for compensator.) On the right are the connector studs MOD. FILAMENT, 14 VOLTS, and 12 VOLTS.

(4) Remove all links by unscrewing the holding screws; set the 14V.-14.2V. switch at the 14.2V. position set TONE-C.W.-VOICE switch in the C.W. position; set C.W. FIL.-MOD. FIL. switch in the C.W. FIL. position.

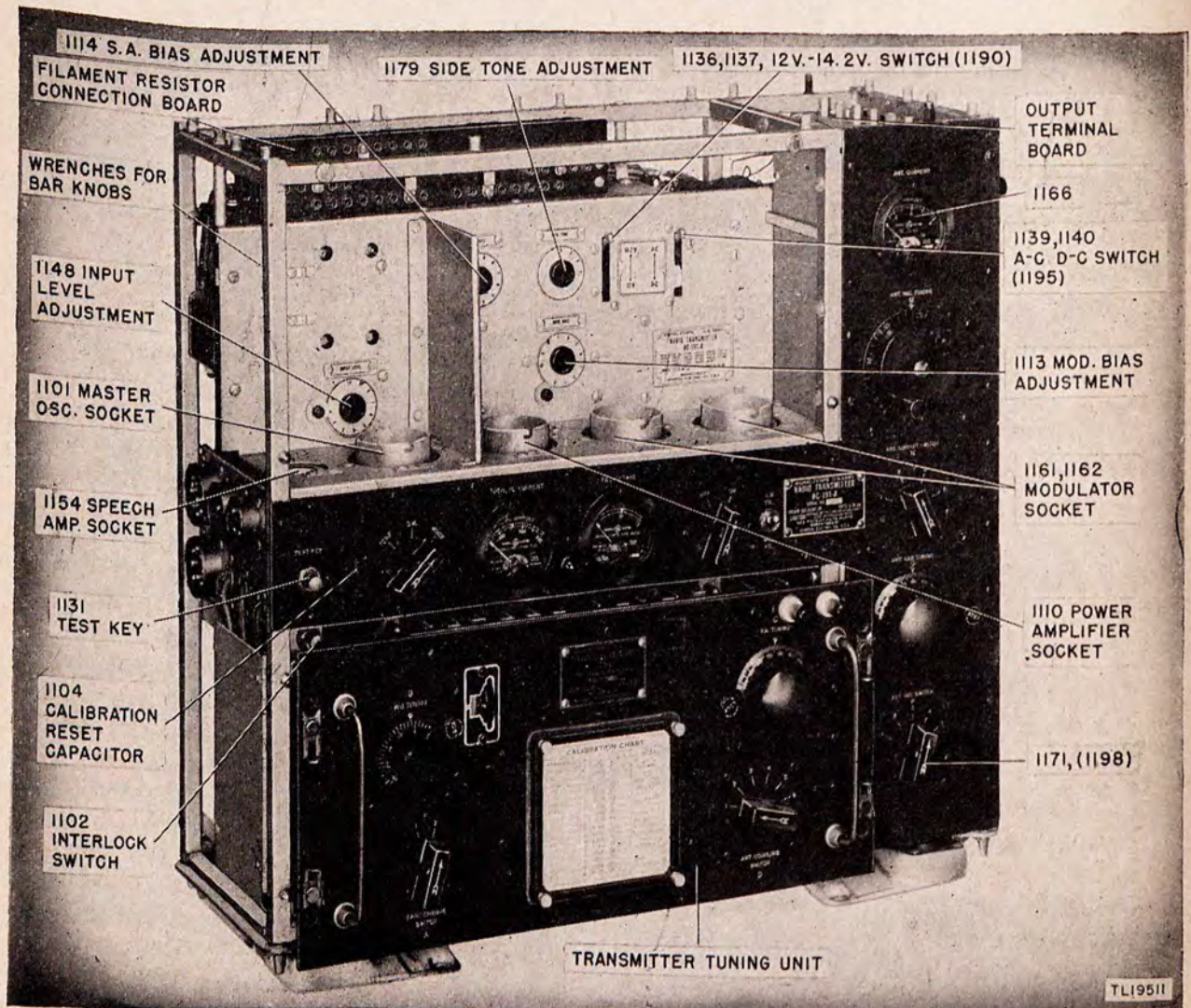

Figure 6. Controls in tube compartment.

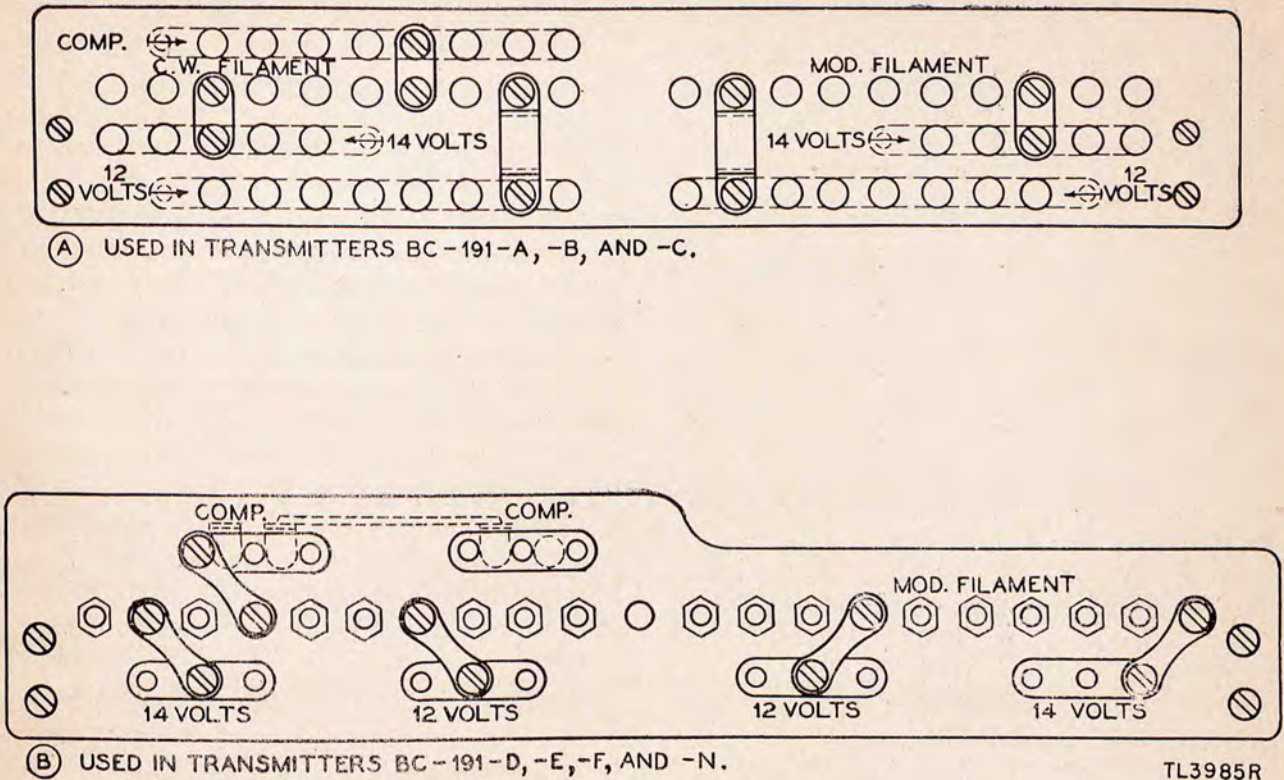

Figure 7. Filament-resistor connection boards.

(5) Set the transmitter OFF-ON switch at the ON position. This should start the dynamotor.

(6) With screw driver or short piece of Wire W-128 (or larger) used as a jumper, make a connection between the extreme left side of the C.W. FILAMENT row and the nearest stud on the 12 VOLTS row. The master-oscillator and power-amplifier tube filaments (two of the Tubes JAN-211) should light, and the FIL. VOLTAGE meter should give a reading. Progress to the right until a connection between rows of studs is found that causes FIL. VOLTAGE meter to read about 10.5 volts.

(7) Set transmitter OFF-ON switch at OFF position, and connect a link between the two studs just located. Screw it down securely.

(8) Set TONE-C.W.-VOICE switch at VOICE, C.W. FIL.-MOD. FIL. switch on MOD. FIL. and OFF-ON switch at ON.

(9) In a manner similar to that described in (6) above, begin at the extreme right end of the MOD. FILAMENT row and successively make connections to the nearest stud on the 14 VOLTS row, until a connection is found that will cause the FIL. VOLTAGE meter to read about 10.5 volts.

(10) Set the OFF-ON switch at the OFF

position and connect a link between the two studs.

(11) Set the C.W. FIL.-MOD. FIL. switch at C.W. FIL. and the OFF-ON switch at the ON position.

(12) The c-w filament voltage should now be less than 10 volts. Using the method described in (6) above starting with the first stud to the right of the connection made in (6), and moving to the right, locate a stud on the COMP. row and the one nearest it on the C.W. FILAMENT row which will cause the FIL. VOLTAGE meter to read about 10.5 volts.

(13) Set the OFF-ON switch at the OFF position and connect a link between the two studs. Screw it down securely.

(14) Turn the battery charger off, so that the battery is no longer on charge.

(15) Set the 12V.-14.2V. switch at the 12V. position, the TONE.-C.W.-VOICE switch at C.W., and the C.W. FIL.-MOD. FIL. switch at C.W. FIL.

(16) Place the OFF-ON switch at the ON position and allow the battery voltage to fall to a steady value on the FIL. VOLTAGE meter. It will be less than 10.5 volts. With the wire jumper, beginning at the right end of the C.W. FILAMENT row, successively connect between

studs on the C.W. FILAMENT row and the nearest stud on the 12 VOLTS row, working to the left, until a connection is found which gives a reading of about 10.5 volts on the FIL. VOLTAGE meter.

(17) Set the OFF-ON switch at OFF, and connect a link between the two studs. Secure it with the screws.

(18) Set the TONE-C.W.-VOICE switch at VOICE, and the C.W. FIL.-MOD. FIL. switch at MOD. FIL. Place OFF-ON switch at ON.

(19) Starting at the left end of the MOD. FILAMENT and 14 VOLTS row, and using the method described in (16) above, successively move to the right until a connection is found that will cause a reading of about 10.5 volts on the FIL. VOLTAGE meter.

(20) Turn OFF-ON switch to OFF, connect the link remaining between the studs just located, and place the 12V.-14.2V. switch at 14.2V. position.

(21) Replace transmitter top and front cover of tube compartment.

(22) The filament voltages are now adjusted so that they will not require readjustment if the transmitter mode of operation is changed through TONE, C.W., and VOICE in a given installation. If the charging generator, the storage battery, or the dynamotor is replaced, or if the length of the power cord is changed, repeat the adjustments (1) to (22) above.

*d.* FILAMENT - VOLTAGE ADJUSTMENT A - C OPERATION. When operating Radio Transmitter BC-191-(\*) from rectifier power supply equipment connected to an a-c power source, follow the procedure indicated in the following steps to adjust the filament voltages.

(1) Remove front cover from tube compartment on transmitter. Take out the 16 screws which hold the top plate. Remove the plate. Set the A-C D-C switch at A-C, the 12V.-14.2V. switch at 14.2V., and connect all power cords (except the high-voltage cords to sockets marked PL-49) between power-supply equipment and the transmitter.

(2) Turn transmitter OFF-ON switch to OFF.

(3) The filament-resistor connection board is at the top left of the tube compartment. On the left half of the board are the connector studs, marked: COMP., C.W. FILAMENT, 14 VOLTS and 12 VOLTS. Remove links connecting the studs by loosening the screws. Do not touch links and studs on the right half of the

board. (When the A-C D-C switch is set at A-C, the studs on the right half are cut out of the circuit, making adjustment unnecessary.)

(4) Place the TONE-C.W.-VOICE switch at C.W., and the C.W. FIL.-MOD. FIL. switch at the C.W. FIL. position.

(5) Set low-voltage OFF-ON power switch on the power-supply equipment at ON; set power-equipment high-voltage OFF-ON switch at OFF.

(6) Adjust filament-voltage control on power equipment so that the rectifier-filament-voltage meter reads 12 volts.

(7) Turn TONE-C.W.-VOICE switch to VOICE; leave C.W. FIL.-MOD. FIL. switch at C.W. FIL. The filaments of all tubes should be lit. (On a-c operation, the transmitter OFF-ON switch disconnects only the high-voltage plate supply; it does not disconnect the filament voltage.)

(8) Readjust the filament-voltage control on the rectifier until a reading of approximately 10.5 volts appears on the transmitter, FIL. VOLTAGE meter.

(9) Set TONE-C.W.-VOICE switch at C.W.; tube filaments should no longer be lit.

(10) Using a screw driver or a short piece of Wire W-128 as a jumper, make a connection between a stud at the left end of the C.W. FILAMENT row and the nearest stud on the 14 VOLTS row.

(11) Still maintaining this condition, take another short piece of wire and starting at the right end of the COMP. row, work to the left, successively connecting studs on the COMP. row to the nearest stud on the C.W. FILAMENT row, until a connection is found that gives a reading of about 10.5 volts on the transmitter FIL. VOLTAGE meter.

(12) If no connection gives this voltage reading, change the connection between the studs made in operation described in (10) above, moving the jumper to the right.

(13) Now repeat operation (11) above until the meter reads 10.5 volts. When this adjustment is properly made, movement of the TONE-C.W.-VOICE switch through its three positions should cause practically no change in the reading of the FIL. VOLTAGE meter.

(14) Turn rectifier power-supply equipment to OFF and replace the temporary wire jumper between studs with the links provided.

(15) Connect a link between the two studs

at the right ends of the C.W. FILAMENT and 12 VOLTS rows.

(16) If, in following the adjustment procedure just given, the specified voltages are not obtained, circuit trouble is indicated. See paragraph 30, for information on checking and locating trouble in the filament circuit.

(17) Replace top shield and tube-compartment cover. This completes the adjustment. Minor voltage variations can now be allowed for by use of the filament-voltage control on the power-supply equipment. If cording lengths are changed, or any major change is made in the installation, repeat operations (1) to (15) above, if necessary.

*Note.* Adjust the filament resistor so that the voltage does not change more than 0.5 volt when switching from C.W. to TONE or VOICE operation.

**Caution:** When the power-supply equipment is started or turned on, high voltage is present in the transmitter. BE CAREFUL.

e. PRELIMINARY CHECKS. (1) Make certain that all power-supply equipment is turned off. Set OFF-ON switch at OFF.

(2) Connect high-voltage cords into sockets marked PL-59 on the transmitter and power-supply equipment.

(3) Connect phantom antenna to output terminal strip. (See fig. 13). If tests are to be made at frequencies of 800 kilocycles or lower, connect Antenna Tuning Unit BC-306-A as shown in figure 8.

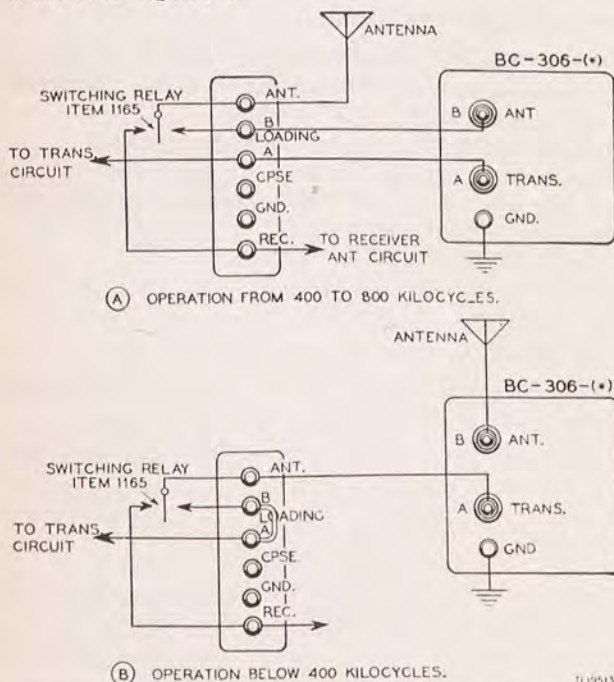

Figure 8. Methods of connecting Antenna Tuning Unit BC-306-(\*).

*Note.* The use of a particular transmitter tuning unit determines the type of phantom antenna that is to be used in testing instead of the regular antenna. The values of the resistors and capacitors in the phantom antenna should be the same as the values given in table II in the power-output test. (See par. 25c.)

(4) Adjustment of the controls in the tube compartment can be made safely with high voltages connected, since there are no exposed high-voltage elements if all tubes are inserted in their sockets. Removal of the transmitter tuning unit from the transmitter operates the safety interlock switch (1102) (fig. 6), which disconnects all voltages to the transmitter when the latter is operating from a d-c supply. Before power is turned on, preset the transmitter frequency approximately as described in (5) and (6) below.

(5) Insert transmitter tuning unit, covering the frequency range in which tests are to be made, and lock it in place with the snap-slide catches. The tuning units cover frequency ranges given in paragraph 33a.

*Note.* The serial numbers of transmitter tuning units must be identical with the serial number of the transmitter and the CALIBRATION CHART with which they are used. Do not interchange transmitter tuning units with those of another transmitter. The CALIBRATION CHART figures apply only when the transmitter tuning unit, CALIBRATION CHART, and transmitter have identical serial numbers.

(6) On the front panel of each tuning unit is a CALIBRATION CHART. Note that some of the lines of numbers are printed in red. These indicate frequencies reserved for special purposes. Do not transmit on them unless specifically authorized to do so by the local commander. There are four columns of figures on the chart, labeled from left to right, FREQUENCY, A, B, and C. If the frequency on which operation is planned is exactly one of those on the chart, the transmitter can be preset to a certain frequency as follows:

(a) In column marked A, there is a number opposite the frequency assignment. Set the BAND CHANGE SWITCH A to this number. (On Transmitter Tuning Units TU-7-A or -B to TU-10-A or -B, this control has been eliminated and column A is blank.)

(b) In column marked B, there is also a number opposite the frequency assignment. Set this number on the control marked M.O. TUNING B, as explained below.

(c) For example, to set the control for 2,000 kilocycles when using Transmitter Tuning

Unit TU-5-A or -B, look in column B on the CALIBRATION CHART for the number opposite 2,000 kilocycles. Assuming that the number is 1250, proceed as follows:

1. Release the LOCK control by turning it counterclockwise.
2. Rotate the knurled knob at the right of the LOCK control. This will cause the round, flat scale to revolve. Rotate until the graduations on the round flat scale for 12 (two graduations above 10), are directly under the marker.
3. Slowly rotate the knurled knob again, this time observing the numbers on its surface. Stop when 50 is reached.
4. Check round scale again. It should read midway between 12 and 13.
5. Lock control by turning LOCK knob clockwise. The control is now set at 1,250 kilocycles.

(d) In the column marked C is another number opposite the frequency assignment. This number is the reading on the control marked P.A. TUNING C. Set this control to the number just determined.

(e) Set switch marked ANT. COUPLING SWITCH D at position 1.

(f) If the exact frequency assignment is not listed on the CALIBRATION CHART, make an interpolation of dial readings at the two closest frequencies above and below the frequency to which the transmitter is to be tuned. When the transmitter is turned on, check this interpolation with a frequency meter.

(g) Never turn on transmitter without first making certain that the control marked P.A. TUNING C is approximately resonated with the master oscillator. Use the CALIBRA-

TION CHART figures to set this control to the same frequency as BAND CHANGE SWITCH A and M.O. TUNING B. If this precaution is not taken, excessive plate current may flow, causing damage to the equipment or burning out the fuses.

(h) Make all tuning adjustments with the transmitter operating in the C.W. position. Make certain that tube-compartment cover is in place and snap-slides are locked.

(i) Set transmitter OFF-ON switch at the ON position. Filaments should light, and the FIL. VOLTAGE meter should read approximately 10 volts, with the C.W. FIL-MOD. FIL switch in the C.W. FIL. position.

(j) Press TEST KEY.

(k) Tune power-amplifier circuit to resonance by varying the P.A. TUNING C control, until minimum total plate current is indicated on the TOTAL PL. CURRENT meter. When this circuit is properly tuned, the total plate current will be from 80 to 110 milliamperes.

*Note.* The tabular data in column C of the CALIBRATION CHART, relating to the setting of the control C, is given as a guide in pretuning. In any case, the final adjustment of the transmitter and the antenna tuning equipment may require a setting of control C which is slightly different from that indicated on the CALIBRATION CHART.

If a frequency meter is available, determine exact frequency setting for interpolated frequency and retune power amplifier to the new adjustment of the master-oscillator circuit, as described in (k) above.

*Note.* The calibration charts on the transmitter tuning units are reasonably accurate, and normally, the actual transmitted frequency will be within about 5 or 10 kilocycles of the figure given on the calibration charts. To tune more accurately, always check the operating frequency with a frequency meter, such as a crystal-frequency or heterodyne-frequency meter that is calibrated to cover the desired frequencies.

## SECTION V

### ALIGNMENT PROCEDURE

#### 16. General

Alignment of the transmitter is confined primarily to tuning and operational adjustments. To tune the transmitter properly, the following instructions must be thoroughly understood and carried out.

#### 17. Frequency Checks and Adjustments

*a. SETTING THE FREQUENCY.* Adjust the transmitter frequency by first selecting the proper transmitter tuning unit, plugging it into the transmitter, and setting the tuning controls to the proper positions. The settings for the tuning-unit controls are obtained from the calibration charts mounted on the front of each of the transmitter tuning units. Although these calibration charts are accurate to within five or ten kilocycles of the calibrated frequencies, the final adjustments should be made with a frequency meter. Also, if it is necessary to set up a frequency not covered on the calibration chart, an interpolation between two frequencies or near one frequency can be made for the preliminary adjustments, and the final settings can be made with the use of the frequency meter. After making the preliminary adjustments for the selected frequency, make the final adjustments as follows:

(1) Calibrate the frequency according to instructions furnished with the particular meter used.

(2) Turn the frequency-meter tuning control to the dial setting of the desired frequency, as given in the calibration book.

(3) With the frequency-meter antenna loosely coupled to the transmitter output, tune the transmitter to give an audible beat in the phones.

(4) Adjust the frequency meter to obtain a comfortable signal level in the headphones.

(5) Tune the transmitter control M.O. TUNING B to zero-beat with the frequency meter.

(6) Quickly tune the P.A. TUNING C control for minimum reading of the TOTAL PL. CURRENT meter on the front of the transmitter.

(7) For greatest accuracy, steps (2) to (6) above should be accomplished in the shortest possible interval after step (1) above; otherwise changes in voltages or temperature, or both, may cause the frequency meter to drift.

*b. MEASURING THE FREQUENCY.* To measure with accuracy the frequency of a transmitter set according to the calibration chart on the front panel of the transmitter tuning unit, first calibrate the frequency meter. Next loosely couple the frequency-meter antenna to the transmitter output and turn the frequency-meter tuning control to the zero-beat point nearest the setting given in the calibration book for the calibration chart frequency. Then determine the actual frequency of the transmitter by reading from the frequency column opposite the resultant frequency-meter dial setting the calibration book.

*c. CALIBRATION RESET.* Check the calibration of the transmitter periodically with a frequency meter. Each time the master-oscillator tube is changed it is most important to check the calibration. If the check indicates that the transmitter varies more than 2.5 kilocycles from the frequency indicated on the calibration chart, adjust the oscillator frequency as follows:

(1) Warm up the transmitter for at least 30 minutes, with the antenna tuned for rated output.

(2) Adjust the transmitter for C.W. operation. Tune to approximately the highest frequency which can be reached, using the transmitting tuning unit which tunes over the highest frequency range authorized for the radio set. Use data on calibration Chart and approach this setting from the lower dial readings.

(3) Tune frequency meter to the frequency corresponding to that at which the transmitter has been set.

(4) Open calibration-reset port, located to the right of TEST KEY (fig. 6) by turning it. With a screw driver slowly adjust calibration-reset capacitor (1104). Continue this adjustment until the signal from the transmitter zero-

beats with that of the frequency meter. Determine this by listening with headphones plugged into the frequency meter. Adjust for exact zero beat.

(5) Close calibration-reset port.

(6) The calibration is now correct for this particular transmitter tuning unit and will be fairly accurate when using the other tuning units supplied with the transmitter.

## 18. Neutralization

a. Radio Transmitter BC-191-(\*) is properly adjusted and neutralized by the manufacturer, and normally will not require adjustment before use. However, if this adjustment has been disturbed in any way, such as the neutralizing-capacitor locking screws coming loose or the neutralizing capacitor being replaced, it will be necessary to check the neutralization. To make this adjustment, proceed as follows:

(1) Make up a dummy load, as shown in table II or use Phantom Antenna A-58 and connect to transmitter. (See fig. 9). Connect a shorting wire across the two terminals of the 0-to 1-ampere, r-f meter.

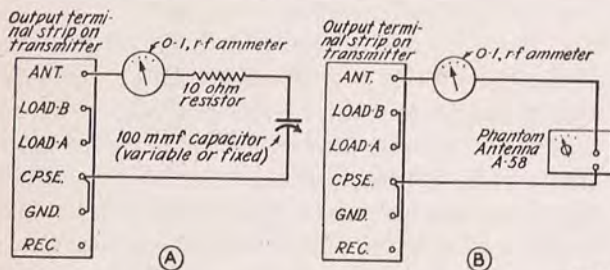

Figure 9. Phantom antennas for neutralizing.

(2) Tune the transmitter for C.W. operation. Tune to a frequency near the center of the frequency band covered by the transmitter tuning unit which is to be neutralized. Adjust ANT. COUPLING SWITCH D, so that the TOTAL PL. CURRENT meter reads about 200 milliamperes.

(3) Turn transmitter ON-OFF switch to the OFF position and disconnect the high-voltage cord leading from the transmitter to the power equipment.

(4) Remove tube-compartment shield.

(5) Remove power-amplifier tube from its socket (1110). Cover one filament pin with a piece of paper or tape and replace tube in socket. When transmitter is turned on, the filament of this tube should not light. Make

sure that only one filament pin of the power-amplifier tube is covered by the tape or paper.

(6) Place the TONE-C.W.-VOICE switch at C.W.

(7) Turn ON-OFF switch to ON.

(8) The FIL. VOLTAGE meter will now read more than 10 volts when the C.W. FIL-MOD. FIL. switch is set at C.W. FIL. Remove the C.W. FILAMENT link, the 12 VOLTS or 14 VOLTS link, depending on the power supply, and adjust until a reading of a little over 10 volts is obtained.

(9) Turn ON-OFF switch to OFF and reconnect the high-voltage cord. Remove the piece of wire shorting the two terminals of the 0-to 1-ampere, r-f meter.

(10) Turn ON-OFF switch to ON and press TEST KEY. If transmitter tuning unit is not neutralized properly, an appreciable deflection of the 0-to 1-ampere, r-f meter will occur.

(11) Release TEST KEY and remove the CALIBRATION CHART on the front of the tuning-unit panel by unscrewing the four knurled screws at the corners. This will provide access to the neutralizing adjustment.

(12) With a screw driver, unlock the neutralizing-capacitor lock by turning screw one-quarter turn counterclockwise.

(13) Press TEST KEY and rotate neutralizing-capacitor control until the current indicated on the 0-to 1-ampere, r-f meter is reduced to zero.

(14) Adjustment of this control reacts on the tuning of the power amplifier; therefore, slight readjustments must be made on the P.A. TUNING C and antenna controls. If the 0-to 1-ampere meter shows a current indication after this adjustment, repeat step (13) above if necessary. This completes the neutralization adjustment. Release TEST KEY and turn ON-OFF switch to OFF.

(15) Lock neutralizing-capacitor control in its final position by using the screw driver to turn screw lock one-quarter turn clockwise. Replace CALIBRATION CHART.

(16) Disconnect high-voltage cord again. Remove paper or tape covering the one filament pin of the power-amplifier tube.

(17) Turn ON-OFF switch to ON and replace the C.W. FILAMENT link of filament-resistor connection board in its original position. Filament voltage will again read a little over 10 volts.

(18) Turn ON-OFF switch to OFF and reconnect high-voltage cord. The set is now ready for normal operation. Note that when the neutralizing control is set properly, the capacitor plates are about half meshed.

b. An alternate method of checking neutralization is by use of a cathode-ray oscilloscope. The dummy or phantom antenna and the radio-frequency ammeter are not used. To use this method, proceed as follows:

(1) Disconnect the antenna from the transmitter and connect the vertical plates of the oscilloscope to the LOAD A and CPSE terminals of the transmitter-output terminal board.

(2) Perform operations in 18a (3) through (10).

(3) Place the ANT. IND. TUNING M control at zero, with ANT. CIRCUIT SWITCH N on position 3.

(4) Select a point on the M.O. dial near the 2,000 reading, if the tuning unit has no band switch, (and near the 500 reading on the highest band, if the unit has a band switch).

(5) Tune the power amplifier to resonance, as shown by the maximum amplitude of the radio-frequency carrier on the oscilloscope.

(6) Proceed by tuning the neutralizing control for minimum amplitude on the oscilloscope. At the same time, keep the power amplifier in tune. When the minimum is reached, with the power amplifier in tune, the tuning unit is neutralized. In the lower-frequency tuning units, the oscilloscope pick-up will be practically zero at neutralization, while on the higher-frequency units, considerable amplitude from stray ground currents will still be noticed.

(7) Now perform steps 18a (15) through (18).

## 19. Antenna Tuning Circuit Checks

The four tuning circuits, controlled by ANT. CIRCUIT SWITCH N, are checked as follows: (See figure 10 for the circuits at each position of the switch.)

**Caution:** Operate ANT. COUPLING SWITCH D, ANT. CIRCUIT SWITCH N, ANT. IND. SWITCH P on the transmitter, and ANT. VARIOMETER SWITCH E on Antenna Tuning Unit BC-306-(\*) only when the transmitter key is open.

a. ANT. CIRCUIT SWITCH N, POSITION 1. With the control marked ANT. CIRCUIT SWITCH N on position 1, the transmitter

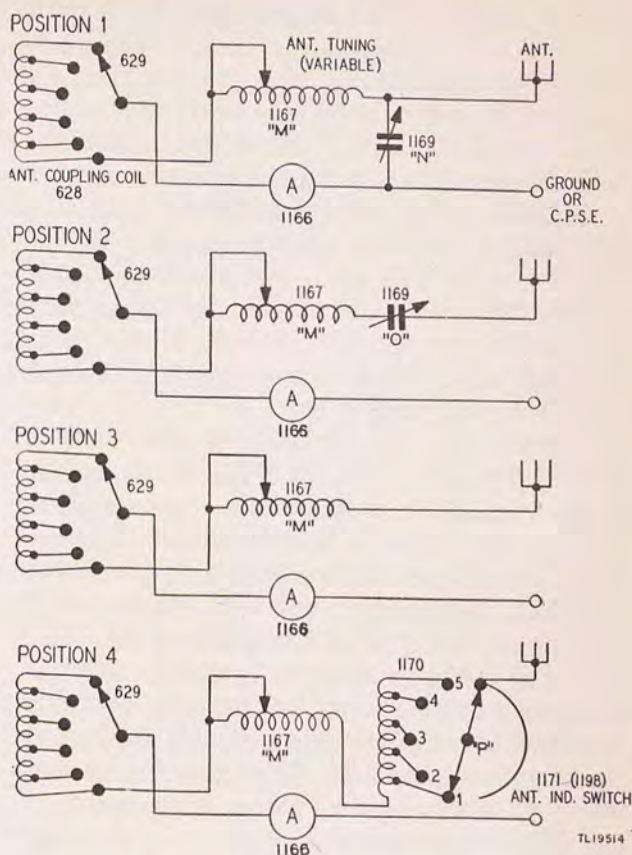

Figure 10. Antenna tuning circuits, functional diagrams.

works into a resonant circuit, in which the high voltage built up across the antenna tuning capacitor is used to voltage feed the antenna. This circuit is generally used for high frequencies and fairly long antennas; it is seldom used in tuning the standard antennas of most Army radio sets. The antenna feed circuit is maintained at resonance by the control marked ANT. IND. TUNING M; the voltage fed to the antenna is varied by the control marked ANT. CAP. TUNING O. Resonance is indicated by the ANT. CURRENT meter. The current in the feed circuit is adjusted by ANT. COUPLING SWITCH D and should not exceed six amperes. The step-by-step tuning procedure is as follows:

- (1) Set control 0 at any scale reading.
- (2) Resonate circuit by means of control M for a maximum reading on the ANT. CURRENT meter.
- (3) Adjust control D so that antenna reads slightly below six amperes.
- (4) Resonate the circuit again as in step (2) above.

(5) Repeat above procedure, shifting the setting of control 0 each time, until the proper power-amplifier loading is indicated on the TO-



TAL PL. CURRENT meter (180 to 220 milliamperes on c-w operation). Under some conditions of power-amplifier load, the lower the dial reading on control M and the lower the reading on the ANT. CURRENT meter, the more power will actually be delivered to the antenna.

**Caution:** When operating ANT. SWITCH N on position 1, always start with ANT. COUPLING SWITCH D on 1, and watch the ANT. CURRENT meter very closely. If the antenna is disconnected accidentally with control N on 1, a high value of r-f current may flow through the meter and burn it out.

b. ANT. CIRCUIT SWITCH N, POSITION 2. With ANT. CIRCUIT SWITCH N on position 2, the transmitter works into a series-resonant circuit. The antenna is current-fed. The antenna circuit is resonated by means of controls M and O. Resonance is indicated by a maximum reading on the ANT. CURRENT meter. This circuit is generally used for operation near the fundamental frequency of an antenna, and therefore is not particularly efficient for tuning the standard antennas. When this tuning network is selected, the value of capacitance should be the maximum (control O set at a high number) for which an inductance value can be found that will give resonance. This will be a minimum inductance value, with control M set at a low number.

c. ANT. CIRCUIT SWITCH N, POSITION 3. With control N on position 3, the transmitter works into a series-resonant circuit, providing current feed and inductive loading. This circuit is used for operation at frequencies lower than the fundamental frequency of the antenna. It is often used with aircraft trailing-wire antennas. The antenna circuit is resonated by means of the continuously variable inductor (1167), adjusted by control M.

d. ANT. CIRCUIT SWITCH N, POSITION 4. With control N on position 4, the antenna circuit is identical with the circuit of position 3, except that an additional inductor (1170), adjusted by control P, is connected in series with the variable inductor (1167). This circuit is used when the operating frequency is relatively far below the fundamental frequency of the antenna. The tuning procedure is as follows:

- (1) Set control D at 1.
- (2) Set control P at 1.
- (3) Rotate control M through its limits. Closely watch TOTAL PL. CURRENT meter for an indication of antenna-circuit resonance.

This is indicated by a sharp increase in the reading of the meter. If resonance is found, the transmitter is loaded to its proper value. If resonance is not found at this setting of control P, advance P, point by point, to higher settings and repeat the variation of control M for each position of control P until resonance is found.

(4) When the transmitter is operating at frequencies above 4,500 kilocycles, coil 1170 may resonate and cause absorption of useful r-f power from the transmitter by capacitive coupling, even when it is not connected in the circuit. To determine whether this is happening, shift ANT. IND. SWITCH P to several different settings. At the same time watch the ANT. CURRENT meter. Do not permit the control to remain at a setting which causes a decreased reading on the ANT. CURRENT meter. Usually no difficulty will occur if the following settings are used: When using Transmitter Tuning Unit TU-7-A or -B, place ANT. IND. SWITCH P at position 2; when using Transmitter Tuning Unit TU-8-A or -B, place ANT. IND. SWITCH P at position 5; when using Transmitter Tuning Unit TU-9-A or -B, place ANT. IND. SWITCH P at position 5; when using Transmitter Tuning Unit TU-10-A or -B, place ANT. IND. SWITCH P at position 5.

## 20. Adjustments for C.W. Operation

When the tuning operations have been completed, the transmitter is ready for c-w telegraph transmission and is put into operation as follows:

- a. Turn TONE-C.W.-VOICE switch to C.W.
- b. Connect the key by inserting its plug into either of the KEY jacks on the transmitter. (See figs. 5 and 32.) Turn the transmitter OFF-ON switch to ON and check all meters for normal readings when the key is closed. Closing the key starts the transmission.

**Caution:** A marked decrease in the life of the transmitter vacuum tubes results from applying over- or under-voltage to the filaments. Check filament voltage frequently and adjust if necessary.

## 21. Adjustments for Voice Operation

**Caution:** Operation on VOICE or TONE requires more current from the power-supply equipment than does C.W. operation. The following adjustment should be made only when

the power-supply equipment is in a stable condition.

*a.* MOD. BIAS ADJUSTMENT. Before attempting operation on VOICE or TONE adjust the modulator bias as follows:

(1) Note the reading of TOTAL PL. CURRENT meter when the transmitter is tuned for C.W. operation.

(2) Set OFF-ON switch at OFF.

(3) Place TONE-C.W.-VOICE switch at VOICE.

(4) Set OFF-ON switch at ON.

(5) Press TEST KEY and note the current indicated on the TOTAL PL. CURRENT meter. It should read a current 20 milliamperes higher than that noted in *a*(1) above, since the modulator tubes are now connected. (One small-scale division on the meter is equivalent to a 20-milliamperere current change.) If the current change is greater or less than 20 milliamperes, adjust the control marked MOD. BIAS, at the rear of the tube compartment (fig. 6) as follows:

(6) Release TEST KEY.

(7) Set OFF-ON switch at OFF.

(8) Remove tube-compartment cover.

(9) Insert a screw driver in dial-rotating device at the lower left on MOD. BIAS control. Rotate control to a higher setting to reduce the reading of TOTAL PL. CURRENT meter or to a lower setting to increase the reading. By successive small steps and by following the procedure given in *a*(1) to (7) above, rotate MOD. BIAS control in the direction which finally causes the TOTAL PL. CURRENT reading to be 20 milliamperes higher on VOICE than on C.W.

(10) Release TEST KEY, set OFF-ON switch at OFF, and release tube-compartment cover.

*Note.* When transmitter tuning units are changed to permit transmission on other frequency bands, recheck the modulator-bias adjustment, because total plate current on VOICE operation may be changed, making voice transmission unsatisfactory. If this is the case, readjust MOD. BIAS control. Follow the procedure outlined in *a*(1) to (10) above.

*b.* S.A. BIAS ADJUSTMENT. Above and to the left of the MOD. BIAS control is the S.A. BIAS control. (See fig. 6.) Normally this control is set properly during manufacture and needs no adjustment. Should the initial setting become displaced, remove the tube-compartment cover, and set the S.A. BIAS control between 6 and 7.5 by inserting a screw driver in

the dial-rotating device at the lower left of the S.A. BIAS control.

*c.* INPUT LEVEL ADJUSTMENT. This adjustment controls the voice level on VOICE operation. Proper adjustment is essential to prevent the transmission of broad signals which might cause interference with other stations operating on adjacent channels. If the level is set too high, overmodulation will result, and transmission on VOICE will be distorted and broad. Fuses in the transmitter may burn out. On the other hand, if the input level is set too low, the receiving station may be unable to hear the transmission through the usual amount of interference. Adhere to the following adjustment procedure:

(1) Insert microphone plug in one of the jacks marked MIC.

(2) Remove tube-compartment shield and insert a screw driver in the dial-rotating device located to the lower left of the INPUT LEVEL control at the back of the left-tube compartment. (See fig. 6.) Turn on transmitter and press button switch on microphone. With no speech being impressed on the microphone, the TOTAL PL. CURRENT meter reading should be 20 milliamperes higher than on C.W. operation.

(3) Hold microphone about two inches from the lips and speak in a normal conversational tone. The meter reading should fluctuate with the voice. Using the screw driver, rotate INPUT LEVEL control until TOTAL PL. CURRENT meter swings to a peak of 300 milliamperes. It should not stay at 300, but should fluctuate between lower readings and a maximum of 300.

(4) Release microphone-button switch.

(5) Turn transmitter OFF-ON switch to OFF and replace the tube-compartment cover.

*Note.* A microphone that has become packed (one in which the carbon granules have packed together) will sometimes cause voice transmission to sound weak and indistinct, even with the INPUT LEVEL control fully advanced. To clear this condition, tap the microphone lightly with a pencil or similar object, rotating the microphone at the same time. Do this with the transmitter in the OFF position. If this fails to clear the trouble, replace the microphone with a serviceable one.

## 22. Adjustments for Tone Operation

Having completed the procedure directed in paragraph 21*c*, continue as follows:

*a.* Insert key plug in one of the jacks marked KEY.

- b. Place TONE-C.W.-VOICE switch at TONE. using the microphone switch, the transmitting key, or the TEST KEY. The TOTAL PL. CURRENT meter reading should be between 300 and 350 milliamperes.
- c. Place transmitter OFF-ON switch at ON.
- d. Keying for tone modulation is effected by

## SECTION VI

### DETAILED TROUBLE-SHOOTING PROCEDURES

#### 23. General Checks for Defective Stages

When a transmitter is brought in without its accessories, use tubes, dynamotor, cording, key, and microphone that are known to be good. Existing trouble is then localized to the transmitter. Many times a transmitter will operate correctly on C.W. but not on VOICE. Always tune a transmitter for C.W. operation first. If it operates correctly with this type of transmission, check its operation with VOICE and TONE. If the transmitter operates on C.W. but not on VOICE, the trouble is isolated to the audio or modulation section. Make a thorough check of the switch which selects the type of operation. (See par. 32.) If it is evident that the switch is not at fault, make a complete check of the audio and modulator stages. Low-power audio stages, such as the speech-amplifier stage, can be checked with an output meter or a headset in series with a capacitor. If an output meter is used, speaking into the microphone will cause the reading to fluctuate. Sound should be heard if the headset is used. When using either the meter or the headset, work toward the microphone or input stage until a point is reached where the proper indication is observed. The defective stage will be the preceding stage which was tested. Do not use this method for testing high-power audio stages, such as the class B modulator in Transmitter BC-191-(\*). In most Signal Corps transmitters a meter is used to measure the plate current. Use the TOTAL PL. CURRENT meter on the panel of Transmitter BC-191-(\*). to help locate trouble by observing the various readings obtained while making the stage-by-stage adjustments of the transmitter. By making adjustments in the following order, the faulty stage can be located more readily.

a. R-F STAGES. With the TONE-C.W.-VOICE switch on C.W., M.O. TUNING control B and P.A. TUNING control C set according to the CALIBRATION CHART, press the TEST KEY, and, while watching the TOTAL PL. CURRENT meter, tune P.A. TUNING control C for a minimum reading, indicating resonance.

The total plate current should be from 80 to 110 milliamperes. If, after the TEST KEY has been pressed, the plate current is considerably lower than normal, it indicates trouble in the power amplifier. However, if pressing the TEST KEY results in an excessive plate-current reading, much higher than normal, the fault will probably be found in the master-oscillator circuit. If no trouble is encountered while making the master-oscillator and power-amplifier tuning adjustments, and the proper plate-current reading is obtained, it can be assumed that these two stages are operating properly. Before continuing with the checks, tune the antenna circuit to resonance. When the antenna circuit is resonated, the TOTAL PL. CURRENT meter should read from 180 to 220 milliamperes, no higher. If the antenna circuit cannot be tuned to resonance, as indicated if the TOTAL PL. CURRENT meter does not read the required 180 to 220 milliamperes, the trouble is probably in the antenna-tuning circuit or in the antenna or antenna load being used. Release TEST KEY.

*Note.* To prevent arcing or burning of the various contacts, always release TEST KEY and turn OFF-ON switch to OFF before changing switch positions.

b. MODULATOR STAGE. To continue the metering check, turn the TONE-C.W.-VOICE switch to VOICE, press TEST KEY, and note the plate-current reading. The reading should increase approximately 20 to 25 milliamperes. This additional current is the static (at rest) current of the class B modulators. An increase of considerably more than 25 milliamperes will indicate trouble in the modulator stage. Incorrect adjustment of the MOD. BIAS control will cause a more or less than normal increase in static current.

c. SPEECH AMPLIFIER, VOICE POSITION. If these tests are satisfactory, release TEST KEY and plug the microphone into jack marked MIC. Turn the OFF-ON switch to ON and press the microphone switch button. With no speech, the meter should still show the 20-to-25-milliamperes increase. Speaking into the mi-

crophone in a moderate tone should cause the plate-current meter to swing to approximately 300 milliamperes on voice peaks. Failure of the meter to approach this peak swing, or a meter reading considerably higher than this, indicates improper adjustment of the S.A BIAS control, the INPUT LEVEL control, or both. It also indicates plus other trouble in the speech-amplifier or microphone circuits.

d. SPEECH AMPLIFIER, TONE POSITION. If the above checks prove satisfactory, turn OFF-ON switch to OFF, set TONE-C.W.-VOICE switch to TONE, and plug a telegraph key in jack marked KEY. Turn the OFF-ON switch to ON and press the telegraph key. The TOTAL PL. CURRENT meter should now read from 300 to 350 milliamperes, indicating that the tone section of the transmitter is operating properly. If this increased reading is not obtained when the key is pressed, the trouble is in the tone circuit of the audio oscillator.

e. TYPICAL TROUBLES. The following trouble chart lists a number of typical troubles which may occur in this equipment. The test for each is given in its relative order of probability. Characteristic troubles for this equipment are given following this chart.

Indication	Test
No pronounced plate-current dip when control C is tuned. TOTAL PL. CURRENT meter reading is high. Tuning of control C shifts somewhat as antenna controls are tuned. ANT. CURRENT meter reading normal.	Check power amplifier tube. Check grid-bias voltage on this tube; if low or lacking, check resistance from pin G of power amplifier socket to frame; see resistance data (par. 28); check especially grid - biasing resistor 1115. Be sure the antenna-loading control D is not set too high.
Very high plate current on C. W. operation. No radio-frequency output on any position of control D. Control C will not resonate.	Master oscillator tube not functioning; replace if defective. Check high-voltage and filament circuits of master oscillator.
No plate current. Filament voltage normal.	Burned out high-voltage fuse in power supply or in the transmitter. Fuse failure caused by improper tuning procedure, or by defective high-voltage filter capacitors 1120, 1163, 1150. Check keying relay (1165); be sure the contacts are not
No filament voltage. Cording properly connected.	burned away. Check resistor 1115 for open. Check for defective plate-current meter. Open fuse or breaker in power supply. Short in power cord. Open power cord. TONE - C.W. - VOICE switch defective. Filament resistor 1138 defective.
Filament voltage normal on C.W., high on TONE and VOICE.	Modulator tubes burned out. Filament-resistor connection board improperly connected.
Total plate current 150 milliamperes on C.W. operation at resonance of control C. Control D set at 1. Antenna circuit detuned. TOTAL PL. CURRENT meter dips sharply at resonance of control C. Resonance setting of C is off CALIBRATION CHART figures. Filament voltage and other checks are normal.	Power amplifier probably requires neutralization. To check, replace transmitter tuning unit with one for another frequency band, and tune master oscillator and power amplifier controls at a point near the middle of the frequency band covered by the tuning unit. If operation is normal with the second tuning unit, replace the first unit and neutralize. See neutralizing procedure (par. 18a(1) through (18)).
Total plate current high on C.W. operation at all settings of control D. Low radio-frequency output on ANT. CURRENT meter. Plate-current dip at resonance of control C is very small. Power - amplifier tube checks normally. Condition exists with all transmitter tuning units supplied with set.	Master-oscillator tube is oscillating weakly, indicating worn-out tube or trouble in master-oscillator circuit. Check tube by replacement. If trouble continues, make resistance check of tube socket 1101 with power turned off.
Tuning of control C normal. No radio-frequency-current indication on ANT. CURRENT meter. Transmitter inoperative by report from another station. Antenna correctly installed. Antenna switch N at 1. Control D on any position. Operating frequency about 3,000 kilocycles. Plate current about 110 milliamperes.	Check for burned out ANT. CURRENT meter (1166) and disconnected antenna load. If the meter is operative, try working with control N on 2 or 3. With N on 1 at frequencies about 2,700 kilocycles, the ANT. CURRENT meter can be easily burned out by high-current surges, if the antenna or counterpoise is disconnected from the transmitter. Always be sure the anten-

Indication	Test	
Badly distorted signals on VOICE. Interference on adjacent channels reported when transmitting on TONE.	<p>na system is properly connected.</p> <p>Improper modulator or speech amplifier grid-bias adjustment, or defective modulator tubes. Bad power - amplifier tube will cause modulator and speech-amplifier bias to be of improper value. Check resistors 1112, 1113, and 1114.</p>	<p>Power amplifier will not load on C.W. operation (total plate current does not increase with tuning of antenna). Tuning of control C is normal.</p>
No modulation on VOICE. Modulation satisfactory on TONE. Plate current normal on TONE.	<p>Check INPUT LEVEL adjustment. If correct, check microphone cord and plug by replacement. Remove high voltage by disconnecting cord and Plug PL-59. Place high-resistance a-c voltmeter of test set across terminals 3 and 4 of transformer 1149 with the tube filaments on. Speak into microphone, with microphone push-button switch closed. On loud speech, a reading of 1 or 2 volts is normal. Check microphone d-c voltage with d-c voltmeter between terminal 2 of transformer 1149 and transmitter frame. A voltage of 4.5 to 5.3 volts, with microphone plugged in, is normal.</p>	<p>Check antenna for poor joints and leaky insulators. Check connections to output-terminal strip. Check pin jacks and plugs of terminal strip and set gap clearance at 0.171 inch. Check antenna-tuning circuits for broken insulation, dust, and dirt.</p>

*f.* POINT-TO-POINT TESTS. After the trouble has been isolated to one section or stage of the transmitter, make a complete check of all parts in the stage. First carefully inspect all parts for signs of failure such as loose or corroded connections, burned insulation, or broken parts. If this does not disclose the trouble, proceed with the voltage and resistance measurements for the defective stage as given in section VIII.

#### 24. Moistureproofing, Fungiproofing, and Refinishing

After the transmitter has been repaired and is functioning correctly, see TB SIG 13, TB 11-800-1, and TB 11-273-1. Moistureproof and fungiproof the equipment as instructed. If the transmitter panels have been scarred or chipped, remove any rough spots with No. 00 or No. 000 sandpaper and brush-paint. If the panels are sufficiently scarred and scratched enough to warrant complete refinishing, remove all panels and refinish them according to existing specifications.

## SECTION VII

### FINAL TESTING

#### 25. General

After the equipment has been moistureproofed and fungiproofed, it must be given a thorough tune-up adjustment, including a power-output and modulation check. Make a complete operational check of the equipment. Be sure that all parts function properly before turning it over to the operating personnel. For complete tune-up procedure, see sections IV, V and VI. After the tune-up adjustments have been made and the equipment is operating properly, make the modulation and power-output checks.

*a.* MODULATION CHECK WITH OSCILLOSCOPE. Checking the modulation of the transmitter with the oscilloscope is the preferred method, because the exact pattern of the modulation can be observed on the oscilloscope. If the scope screen is calibrated, the value of the modulated and unmodulated carrier can be read di-

rectly to check the percentage of modulation. Make this measurement as follows:

(1) Calibrate the oscilloscope to permit reading the carrier amplitude in volts, according to instructions furnished with oscilloscope.

(2) Remove top and rear panels from transmitter case.

(3) Locate ANT. INDUCTANCE coil M, in the upper part of the antenna tuning section. This is the coil with the roller contact.

(4) Make a pick-up coil, consisting of several turns of wire the approximate diameter of the antenna coil and terminating with a twisted pair of leads.

(5) Couple this pick-up coil to the rear of the antenna coil to furnish excitation to the vertical plates of the oscilloscope.

(6) Connect the twisted leads to the terminals of the oscilloscope.

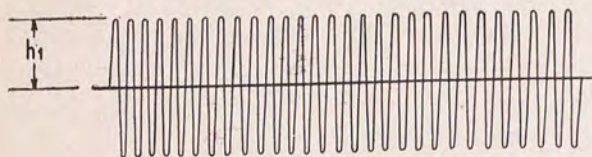

(A) R-F CARRIER, UNMODULATED

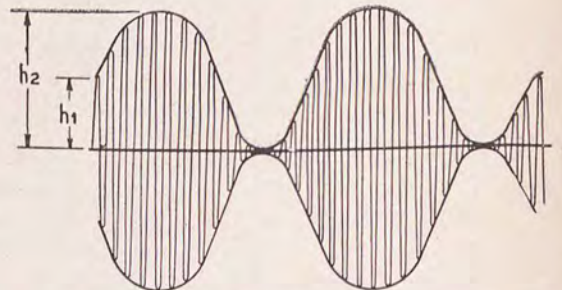

(C) R-F CARRIER, 100% MODULATED

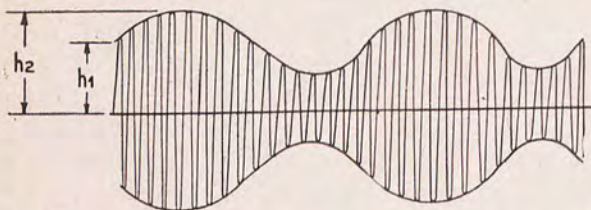

(B) R-F CARRIER, 50% MODULATED

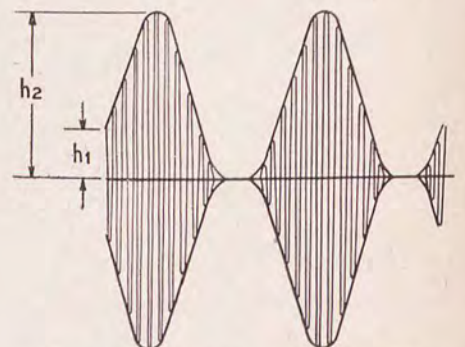

(D) R-F CARRIER, OVER-MODULATED

L19515

Figure 11. Oscilloscope modulation patterns.

(7) Turn TONE-C.W.-VOICE switch to TONE, the OFF-ON switch to ON, and press TEST KEY. With the transmitter delivering power to the antenna, synchronize the scope-sweep circuit so that not more than two stationary modulation envelopes appear on the screen.

**Caution:** With the top and rear panels removed and the transmitter operating, several points of high voltage dangerous to life are exposed. Operating personnel must observe the safety regulations at all times.

(8) Vary the position of the loop or the number of turns on the loop, if necessary, until a pattern of suitable amplitude appears on the screen.

(9) To observe the carrier pattern alone, set TONE-C.W. VOICE switch at C.W.; to see the effect of modulation, turn switch to TONE.

(10) When the height of the modulated pattern is just twice that of the unmodulated pattern, the carrier is considered to be 100 percent modulated. Any space between the two envelopes indicates overmodulation, and too little space between them indicates less than 100 percent modulation. See figure 11 (A), (B), (C), and (D) for a graphical representation of the different carrier waves mentioned above.

(11) Assuming that the modulation is symmetrical, determine the percentage of modulation from the pattern on the scope screen by measuring the maximum height of the pattern with and without modulation. The percentage of modulation is then

$$\% \text{ mod} = \frac{h_2 - h_1}{h_1} \times 100$$

Where  $h_1$  is height of unmodulated wave  
 $h_2$  is height of modulated wave.

**b. MODULATION CHECK WITH ANTENNA CURRENT METER.** An alternate method for checking the percentage of modulation, when an oscilloscope is not available, is by using the ANT. CURRENT meter readings as follows:

(1) With the transmitter operating and delivering power to the antenna, set the TONE-C.W.-VOICE switch at VOICE and observe the antenna current with no speech or modulation input. Let this current reading represent  $a_1$ .

(2) Set TONE-C.W.-VOICE switch at TONE and note the increased reading in antenna current. Let this second reading represent  $a_2$ .

(3) The percentage increase in reading is

$$\frac{a_2 - a_1}{a_1} \times 100$$

Suppose the  $a_1$  reading is 2.3 amperes and the  $a_2$  reading is 2.7 amperes. From that we get the percentage increase of

$$\frac{0.4}{2.3} \times 100 = 17.4\%$$

(4) Figure 12 shows a graph of the percentage of increase in antenna current plotted against the percentage of modulation. Referring to this graph, it can be seen that an increase in antenna current of 17.4 percent corresponds to approximately 86 percent modulation.

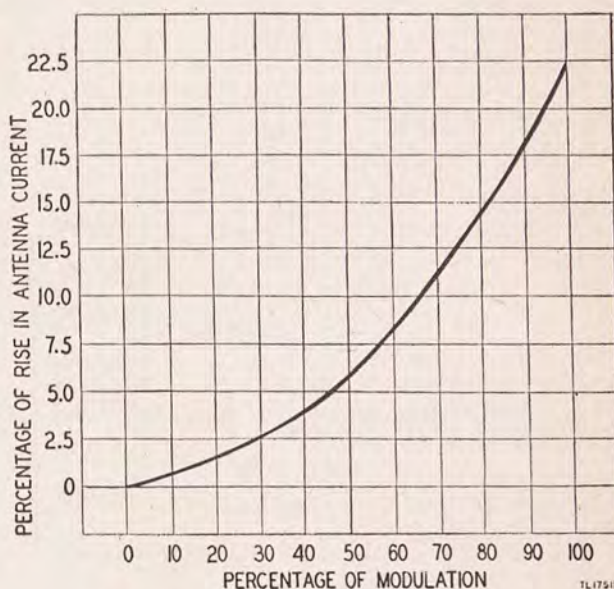

Figure 12. Modulation-percentage graph.

(5) For more general information on checking modulation, see TM-11-4000.

**c. POWER OUTPUT.** Measurement of power output may be made with the phantom antenna. See figure 13, and table II. When testing power output over a definite frequency range, 1,500 to 3,000 kilocycles for example, use a 200-mmf capacitor and a 5-ohm resistor. The procedure for all frequencies is to tune the phantom antenna to resonance. Under these conditions, the power factor of the circuit becomes unity, leaving the 5-ohm resistor as the total impedance into which the transmitter works. When resonance is established, the r-f ammeter readings will be proportional to the power output. Over the 1,500- to 3,000-kilocycle range, the ammeter reads approximately 2.82 amperes for 40 watts



output. Operate the transmitter with the TONE-C.W.-VOICE switch in the C.W. position while making these checks. During the test, maintain the input voltage to the dynamotor as near as possible to 14 volts. An external radio-frequency ammeter with a range of 0-5 amperes is used to read the current in the dummy load and is connected as shown in figure 13. The meter must always be connected in the ground side of the dummy load. Use the values for different frequencies as shown in table II. The transmit-

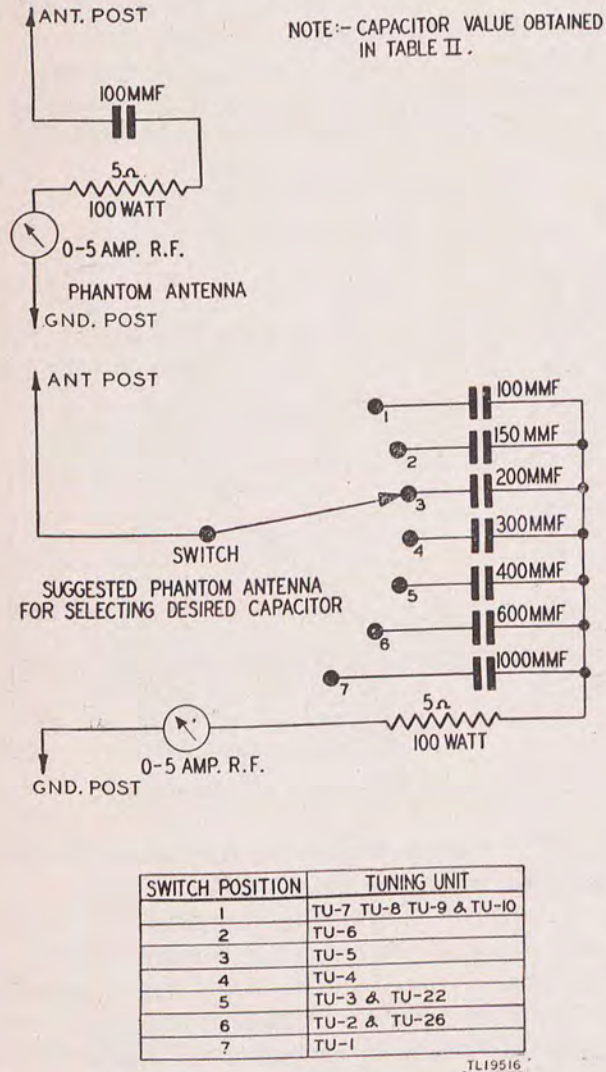

Figure 13. Phantom antenna for power output tests, schematic diagram.

ter must be adjusted so that the plate current does not exceed normal safe operating values. Table II gives the values of resistor and capacitor combinations to be used in the phantom antenna for checking a given frequency, the r-f ammeter reading, and the watts output for each condition. The readings of the ANT. CURRENT meter on the transmitter panel will usually be somewhat higher than those of the meter in the phantom-antenna circuit because of the inherent stray capacitance in the transmitter. When the checks are to be made on frequencies below 800 kilocycles for proper load conditions, use Antenna Tuning Unit BC-306-A with the phantom antenna. Parts A and B of figure 8 give the circuit connections for Antenna Tuning Unit BC-306-(\*), when operating below 800 kilocycles. With different test set-ups, the actual antenna-current readings may vary slightly from those shown in the chart, depending upon the frequency to which the tuning unit is set while making the check. Conditions for this test are as follows:

(1) All tuning must be done on C.W. position, and then switched to either TONE or VOICE.

(2) Correct operation must be obtained without retuning.

(3) The transmitter must be tuned for ultimate power output and must not exceed the total plate current values as follows:

(a) C.W. operation; 200 milliamperes maximum.

(b) PHONE operation; average values 300 milliamperes, peak value 325 milliamperes.

(c) TONE operation; 350 milliamperes maximum.

(4) The antenna loading circuits must be adjusted for proper rated plate current. This will be maximum plate current at resonance and also when the plate tank capacitor is tuned for minimum plate current.

(5) An increase in power or upward modulation must be obtained on phone when modulated. The transmitter must have been previously neutralized.

Table II.—Radio-frequency power output

Transmitter Tuning Unit	Frequency (kc)	Phantom antenna		R-f output (watts)			R-f amps (C.W.)
		Capacity (mmf)	Resistance (ohms)	C.W.	VOICE (unmod.)	TONE	
*TU-1	150-260	1,000	5	30	21	23	2.46
*TU-2	260-400	600	5	35	24.5	27	2.64
TU-3	400-800	400	5	38	27	29	2.76
TU-4	800-1,500	300	5	30	21	23	2.46
TU-5	1,500-3,000	200	5	40	28	31	2.83
TU-6	3,000-4,500	150	5	50	35	38.5	3.16
TU-7	4,500-6,200	100	5	50	35	38.5	3.16
TU-8	6,200-7,700	100	5	50	35	38.5	3.16
TU-9	7,700-10,000	100	5	50	35	38.5	3.16
TU-10	10,000-12,500	100	5	60	42	46	3.46
**TU-22	350-650	400	5	35	24.5	27	2.64
**TU-26	200-500	600	5	30	21	23	2.46

\* Antenna Tuning Unit BC-306-(\*), connected between the antenna binding post of the transmitter and the phantom antenna.

\*\* Antenna Tuning Unit BC-306-(\*), connected between the two loading binding posts of the transmitter.

## SECTION VIII

### INDIVIDUAL STAGE AND CIRCUIT REPAIR DATA

#### 26. Master Oscillator

*a. CIRCUIT REPAIR FEATURES.* The master-oscillator circuit, which controls the frequency of the transmitter, is made up of components contained in both the transmitter and the transmitter tuning unit being used. Resistor 1109 (three in series) functions as the master-oscillator grid leak which provides the tube with the required operating bias from the rectified grid current. Capacitor 1104 is the calibration reset capacitor by which the master-oscillator tuning circuit can be adjusted to correspond to calibration-chart settings when the circuit has been disturbed or the oscillator tube changed. Capacitor 1103, connected in parallel with capacitor 1104, is a sealed capacitor which provides the necessary thermal compensation for any frequency drift normally caused during warming-up or by any variation of the oscillator tube temperature.

*Note.* To complete the reference number of any part having a dash before the last two digits, substitute for the dash the nomenclature number of any of the transmitter tuning units. For example, part -09 would be 509 for Transmitter Tuning Unit TU-5-(\*) and 609 for Transmitter Tuning Unit TU-6-(\*). This same explanation applies to the transmitter tuning-unit schematics. (See fig. 28.)

*b. RESISTANCE AND VOLTAGE MEASUREMENTS.* Make the resistance measurements, shown in figure 14, from the tube-pin connections to ground and from the top of the socket with the tube removed. The plate voltage given at the tube-pin connection in figure 14 cannot be made at that point with the set in operation, because the socket pin is not accessible. Test under the following conditions:

(1) *Resistance measurements.* (a) Tubes and cords removed.

(b) TONE-C.W.-VOICE switch at VOICE.

(c) Transmitter Tuning Unit TU-5-(\*) or TU-6-(\*) inserted.

(d) OFF-ON switch at ON.

(e) Fuse FU-12-A in place.

(f) A-C D-C switch set at D-C.

(g) CW. FIL.-MOD. FIL. switch set at C.W. FIL.

(2) *Voltage measurements.* Because of the inaccessibility of the tube-socket pins while the set is in operation, the voltage measurements cannot be made at this point. However, it can be assumed that if the resistance measurements at the tube socket indicate no trouble, and a source of power is used that is known to be good, the plate voltage applied to the tube will be of the proper value. Make an over-all check on the plate voltage applied to the unit at the terminal of Socket SO-39. Uncover and use the duplicate Socket SO-39 not in use (see fig. 35). Conditions for this test are as follows:

(a) Use electronic or 20,000 ohm-per-volt voltmeter.

(b) Transmitter operating and delivering rated power to an antenna or a phantom load.

(c) TONE-C.W.-VOICE switch at TONE or VOICE.

(d) Measure voltage from center terminal of Socket SO-39 to ground. The voltage from this point should read approximately 800 to 900 volts with the transmitter delivering power to the antenna, and from 1,000 to 1,100 volts with the key open.

**Caution:** Making this high-voltage measurement will bring the operator in close contact with the high operating voltage of the equipment. Since this voltage is dangerous to life, safety regulations must be observed at all times. Make this check only when necessary and use well insulated test probes.

(e) With the rear panel removed and the transmitter operating, measure the master-oscillator grid-bias voltage from the resistor board. Make the measurement with the positive terminal of the voltmeter connected to ground and the negative terminal connected to the bottom end of the first of the three 1109 resistors, counting from the left end of the resistor board. The grid-bias voltage will be approximately 175 to 200 volts.

d. REPLACING MASTER - OSCILLATOR TUBE.  
When it is necessary to replace the master-oscillator tube, the oscillator circuit must be recalibrated so that the dial readings for a given fre-

quency will correspond to those on the calibration chart for that same frequency. To make this calibration, reset adjustment, following the instructions given in paragraph 17c.

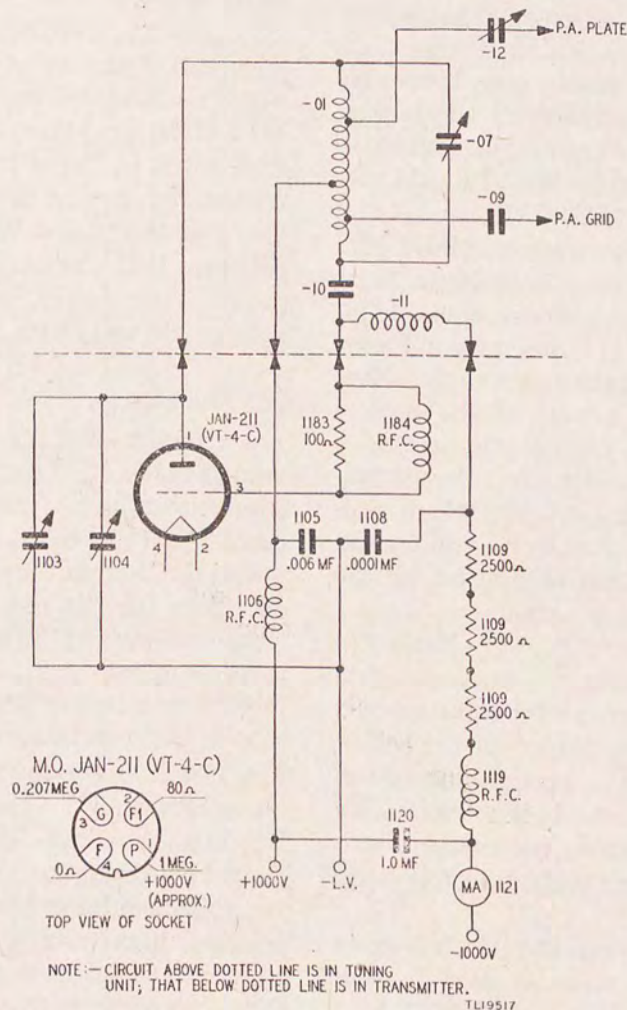

Figure 14. Master oscillator circuit diagram and voltage and resistance measurements.

### c. PARTS DATA (fig. 14).

Ref. symbol	Signal Corps Stock No.	Name of part and description	Function
1183, 1184	3Z6010-6	COIL: choke; r-f (m-o grid parasitic with four 100-ohm resistors in parallel).	M-o grid parasitic suppressor.
1103, 1104	3D8328	CAPACITOR ASSEMBLY: variable.	Tube thermal compensator and calibration reset.
1105	3DA6-4	CAPACITOR: mica; 0.006-mf, $\pm 5\%$ ; 2,500 vdew.	M-o plate bypass.
1108	3D9100-12	CAPACITOR: mica; 0.0001-mf, $\pm 10\%$ ; 600 vdew.	M-o grid r-f bypass.
1106	2C6191A/D1	COIL: r-f choke.	M-o plate filter.
1109	3Z6250	RESISTOR: wire; 2,500-ohm, $\pm 5\%$ ; 12-w.	M-o grid bias.
1119	2C6191A/D2	COIL: choke; 85 to 95 millihenries.	High-voltage supply, r-f filter.
*1120	2C6191A/C5	CAPACITOR: oil filled, 1-mf, $\pm 10\%$ ; 1,200 vdew.	High-voltage supply filter.
1121	3F222	AMMETER: 0 to 500 milliamperes dc; blocked in white from 210 to 220 milliamperes.	Total plate current indicator meter.

\* In Radio Transmitters BC-191-E and -F, capacitor 1120 is replaced with capacitor 1197C, one of three capacitors in a single container.

## 27. Power Amplifier

*a. CIRCUIT REPAIR FEATURES.* The power-amplifier plate-tank circuit, by means of which the plate-load impedance is adjusted, is contained in both the transmitter and the transmitter tuning unit being used. The power-amplifier grid receives excitation through capacitor -09 (fig. 28), which also keeps the master-oscillator d-c voltage from the power-amplifier grid. The power-amplifier negative grid bias is obtained from the rectified grid current through resistors 1112, 1113, and 1114, which form a part of the power-amplifier grid leak. Plate power for the power amplifier is coupled to the tuning unit through choke 1118, which, with capacitor 1117, prevents r-f current from flowing into the power supply. Neutralizing capacitor -12, a part of the power-amplifier circuit in the tuning unit, forms a part of a bridge circuit, including the power-amplifier grid-to-plate capacitance which prevents any reaction of the power amplifier on its grid-input circuit. Self-oscillation of the power amplifier is thus eliminated.

*b. RESISTANCE AND VOLTAGE MEASUREMENTS.* Make the resistance measurements shown in figure 15, from the tube-pin connections to ground and from the top of the socket with the tube removed. The plate voltage given in figure 15 cannot be made at that point with the set in operation, because the socket pin is not accessible. Make tests under the following conditions:

(1) *Resistance measurements.* Use the same test conditions for this stage as used for the master-oscillator stage. (See par. 26b(1).)

(2) *Voltage measurements.* (a) Voltage

*c. PARTS DATA (fig. 15).*

Ref. symbol	Signal Corps stock No.	Name of part and description	Function
1112	3Z6400-1	RESISTOR: wire; 4,000-ohm, $\pm 5\%$ ; 12-w.	P-a grid bias.
1113	2C6191A/R31	RESISTOR, variable: 3,000-ohm, $\pm 5\%$ , -0% no taper; wire-wound.	Modulator grid bias.
1114	2C6191A/R31	RESISTOR, variable; 3,000-ohm, $\pm 5\%$ , -0%; no taper; wire-wound.	S-a grid bias.
1115	3Z6120	RESISTOR: carbon; 200,000-ohm, $\pm 10\%$ ; 1-w.	Keying bias circuit.
1165	2C6191A/L1	RELAY: antenna-switching.	Antenna switching and transmitter keying
1116	3Z6725	RESISTOR: carbon; 250,000-ohm, $\pm 10\%$ ; 1-w.	High-voltage bleeder.
1117	3DA1-3	CAPACITOR: mica; 0.001-mf, $\pm 5\%$ ; 3,000-v peak.	P-a plate r-f bypass.
1118	2C6101A/D1	COIL: r-f choke.	P-a plate, r-f filter.
1107	3DA20-6	CAPACITOR: mica; 0.02-mf, $\pm 10\%$ ; 600 vdcw.	Filament r-f bypass.
1172	3Z1912A	FUSE, FU-12A: 0.5-amp; 1,000-v.	High-voltage supply.
1164	2C6191A/T1	TRANSFORMER: modulation.	Mod. plates to pa.
1163	2C6191A/C5	CAPACITOR: oil-filled; 1-mf, $\pm 10\%$ ; 1,200 vdcw.	Mod. plate bypass.
1111	3D9100-12	CAPACITOR: mica; 0.0001-mf, $\pm 10\%$ ; vdcw.	P-a grid r-f bypass.

measurements and test conditions for this stage are the same as for the master oscillator. (See par. 26b(2) (a) to (d).)

(b) Measure the power-amplifier grid-bias voltage from the resistor board with the rear panel removed and the transmitter operating. To make this measurement, place the positive terminal of the voltmeter at ground, and the negative terminal at the top end of resistor 1112. The grid-bias voltage will be approximately 100 to 150 volts. Keying voltage for the transmitter can be measured from the resistor board at this time. With the voltmeter across resistor 1115, and the positive terminal to ground, the meter should indicate approximately 200 volts with the key open.

## 28. Modulator

*a. CIRCUIT REPAIR FEATURES.* The modulator is made up of components contained in the transmitter unit. The modulators, two Tubes JAN-211 (VT-4-C), are operated in a push-pull class B circuit and are biased close to cut-off. Bias for the modulator tubes is obtained from resistor 1113, which is a part of the power-amplifier grid leak. The modulator tubes receive excitation from the speech-amplifier tube through an interstage transformer (1157). The two 1181 resistors across the secondary of transformer 1157 (1199 on Radio Transmitter BC-191-F) reduce the effective load variation caused by modulator grid current. Plate voltage for the modulator tubes is obtained from the positive high-voltage supply through transformer 1164; capacitor 1163 serves as a bypass for this power source. Switch 1179 on transformer 1157 selects the proper tap on this

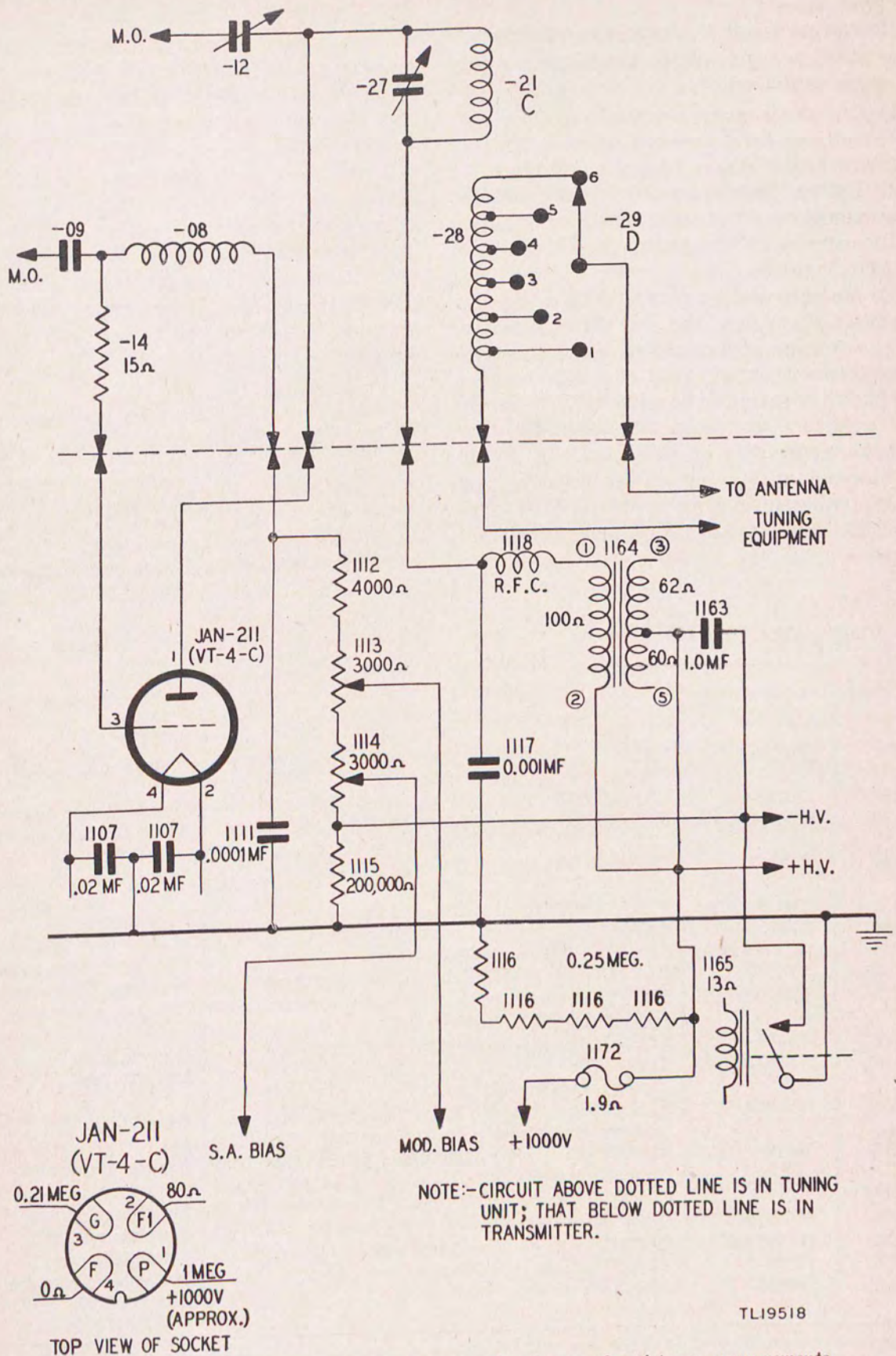

Figure 15. Power amplifier circuit diagram and voltage and resistance measurements.

transformer winding to give the desired side-tone level.

*b. RESISTANCE AND VOLTAGE MEASUREMENTS.* Make resistance and voltage measurements for this stage as follows:

(1) *Resistance measurements.* Use the same test conditions for this stage as used for the master-oscillator stage. (See par. 26*b*(1).)

(2) *Voltage measurements.* (a) Voltage measurements and test conditions for this stage are the same as for the master oscillator. (See par. 26*b*(2) (a) to (d).)

(b) Measure the grid bias voltage on the modulator stage with the rear panel removed and the transmitter operating. Place the voltmeter across capacitor 1160 (fig. 34), positive terminal to ground side of capacitor. The meter should indicate approximately 72 to 75 volts with the transmitter operating on VOICE. If the bias-voltage reading differs greatly from the approximate value given above. (See paragraph 21*a* for instructions on making this adjustment.

*c. SIDE-TONE VOLTAGE.* To measure the side-tone voltage, use an output meter such as the one that is part of Test Set I-56-(\*). Measure between pin 33 and ground of Socket SO-44 (Plug PL-64 on side of transmitter) across a load resistor. This measurement can also be made from the arm of switch 1179 to ground, with the back panel removed. The following table shows the side-tone tap, load resistor values and the voltage readings with the two types of transformer used. The numbers 434 and 445 in the voltage-reading columns indicate the two types of transformer; 434 has GE drawing No. P7761434G1 and 445 has GE drawing No. 7466445G1.

Side-tone dial (positions)	Load (ohms)	Voltage reading	
		434	445
1	150	2.4 to 4.5	1.75 to 3.25
2	150	4.0 to 7.5	4.5 to 7.5
3	2,000	9.6 to 18.0	7.5 to 12.5
4	2,000	16.0 to 30.0	17.5 to 30.0

*d. PARTS DATA (fig. 16).*

Ref. symbol	Sig. Corps stock No.	Name of part and description	Function
1181	3Z6630-4	RESISTOR: carbon; 30,000-ohm, $\pm 5\%$ ; 1-w; insulated.	Modulator, grid stabilizer.
1180	3DA10-13	CAPACITOR: mica; 0.01-mf, $\pm 5\%$ ; 1,200 vdcw.	Tone oscillator resonating.
1142	3DA1-10	CAPACITOR: mica; 0.001-mf, $\pm 10\%$ ; 1,200 vdcw.	Audio feedback on TONE or C.W.
1150	3DA1-7	CAPACITOR: mica; 0.001-mf, $\pm 5\%$ ; 2,500 vdcw.	Reasonating capacitor on transformer 1149.
1157	2C6191A/T2	TRANSFORMER: interstage audio.	S-a to mod grids.
1160	3DB1.1A	CAPACITOR: paper, 1-mf, $\pm 10\%$ ; 300 vdcw.	Modulator, grid bypass.
1164	2C6191A/T1	TRANSFORMER: audio frequency.	Modulator plates to pa.
*1163	2C6191A/C5	CAPACITOR: oil filled; 1-mf, $\pm 10\%$ ; 1,200 vdcw.	Modulator plate bypass.
1179	3Z9610A	SWITCH: single-section, 1-circuit; 4-point; non-shortening (SIDE TONE switch).	Side-tone adjustment.
1112	3Z6400-1	RESISTOR: wire, 4,000-ohm, $\pm 5\%$ ; 12-w.	P-a grid bias.
1113	2C6191A/R31	RESISTOR, variable; 3,000-ohm, $+5\%$ , $-0\%$ ; no taper; wire-wound.	Mod grid bias.
1114	2C6191A/R31	RESISTOR, variable; 3,000-ohm, $+5\%$ , $-0\%$ ; no taper; wire-wound.	S-a grid bias.
1115	3Z6720	RESISTOR: carbon, 200,000-ohm, $\pm 10\%$ ; 1-w; waxed; insulated.	Keying bias circuit.
1117	3DA1-3	CAPACITOR: mica; 0.001-mf, $\pm 5\%$ ; 3,000-v peak.	P-a plate r-f bypass.
1118	2C6191A/D1	COIL: plate choke.	P-a plate r-f filter.
**1155	2C6191A/C5	CAPACITOR: oil filled, 1-mf, $\pm 10\%$ ; 1,200 vdcw.	S-a plate bypass.
1156	3Z661-1	RESISTOR: wire, 11,000-ohm, $\pm 5\%$ ; 12-w.	S-a plate-voltage drop.
1141	3Z9625	SWITCH: rotary; 3-position.	Select TONE, C.W. or VOICE operation.

\* In Radio Transmitters BC-191-E, -F and -N, capacitor 1163 is replaced with 1197A, one of three capacitors in a single container.

\*\* In Radio Transmitters BC-191-E, -F and -N, capacitor 1155 is replaced with 1197B, one of three capacitors in a single container.

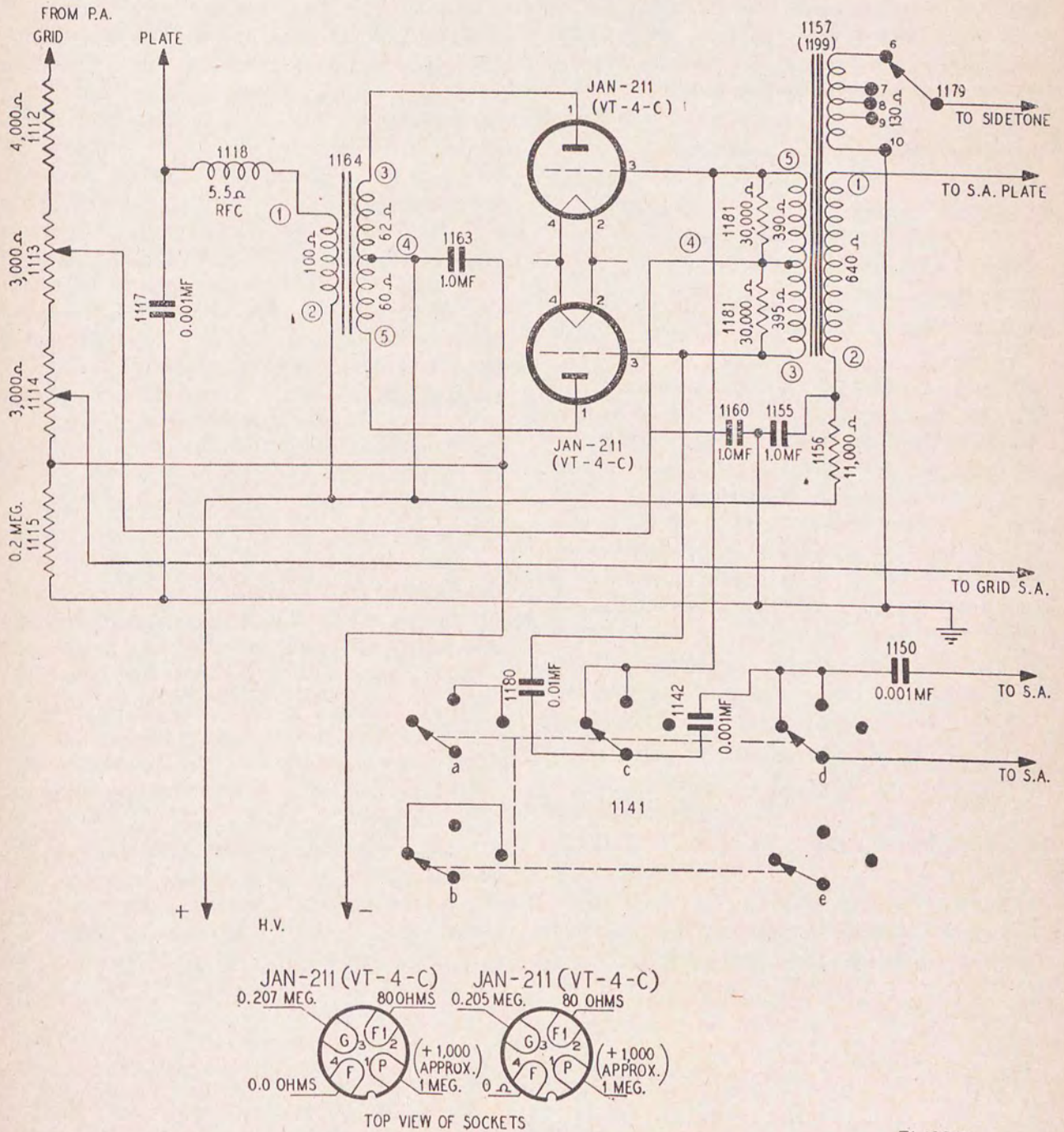

Figure 16. Modulator circuit diagram and voltage and resistance measurements.

TL19519





## 29. Speech Amplifier

*a. CIRCUIT REPAIR FEATURES.* The speech amplifier is made up of components contained in the transmitter unit. Grid bias is obtained by variable resistor 1114 which forms a part of the power-amplifier grid leak. Resistor 1114 and capacitor 1160 serve as a low impedance to ground for the speech-amplifier bias and modulator bias, respectively, at audio frequencies. Plate voltage for the speech amplifier is obtained from the positive high-voltage supply through resistor 1156, which limits it to the proper value; capacitor 1155 serves as an audio-frequency bypass for this power source. Switch 1141, in VOICE position (fig.17), disconnects tone capacitors 1142, 1150, and 1180, and connects the microphone circuit to the primary of input transformer 1149. The secondaries of input transformer 1149 and inter-stage transformer 1157 are resonated by capacitors 1150 and 1180, respectively, to provide the required tuned circuits in both grid and plate circuits of the audio oscillator. The tuning of these circuits establishes a frequency of oscillation of 500 to 1,000 cycles per second.

*b. RESISTANCE AND VOLTAGE MEASUREMENTS.* Make resistance measurements for the speech-amplifier stage (fig. 17) from the socket pins to ground and from the top of the socket with the tube removed. Test under the following conditions:

(1) *Resistance measurements.* Use the same test conditions for this stage as used for the master-oscillator stage. (See par. 26b(1).)

(2) *Voltage measurements.* With the transmitter operating, measure the plate voltage for this stage at the tube socket. Use a test set, such as Test Set I-56-(\*) along with a tube adapter. An alternate method is to use an adapter, with a piece of wire extending from

the plate pin, and any voltmeter with a range high enough to indicate the plate voltage. Do not use this method unless there is no other way of making the check. This same voltage check can be made from the back of the transmitter, with the rear panel removed, by measuring from terminal 1 of transformer 1157 to ground, with the negative terminal of the meter to ground. Conditions for this test are as follows:

(a) Use electronic or 20,000-ohm per volt voltmeter.

(b) Transmitter operating and delivering power to an antenna or phantom load.

(c) TONE-C.W.-VOICE switch at VOICE.

(d) The voltage read at the plate of the speech-amplifier tube should be approximately 425 volts.

*c. GRID-BIAS VOLTAGE.* Measure the grid-bias voltage on the speech-amplifier stage with the transmitter operating and the back panel removed. Place the voltmeter across capacitor 1144 (fig. 34), positive terminal to the ground side of the capacitor; the meter should indicate approximately 35 to 40 volts with the TONE-C.W.-VOICE switch at VOICE. If the bias voltage indicated is not the proper value, adjust it by the S.A. BIAS control. (See par. 21b.)

*d. MICROPHONE-SUPPLY VOLTAGE.* Check the microphone-supply voltage for this stage under the following conditions:

(1) Plug PL-59 disconnected.

(2) Microphone plugged in and button switch closed.

(3) OFF-ON switch at ON and tube filaments lit.

(4) With the voltmeter across resistor 1145 (fig. 34) and the negative terminal to ground, a reading of 4.5 to 5.3 volts should be indicated.

## e. PARTS DATA (fig. 17).

Ref. symbol	Sig. Corps stock No.	Name of part and description	Function
1149	**2Z9944	TRANSFORMER: microphone to grid.	Input to sa.
	2C6191A/T3		
1144	3DB1.1A	CAPACITOR: paper; 1-mf, $\pm 10\%$ ; 300 vdew.	S-a grid bypass.
*1155	2C6191A/C5	CAPACITOR: oil filled; 1-mf, $\pm 10\%$ ; 1,200 vdew.	S-a plate bypass.
1156	3Z6611-1	RESISTOR: wire; 11,000-ohm, $\pm 5\%$ ; 12 w.	S-a plate-voltage drop.
1151	3Z6020-4	RESISTOR: wire; 200-ohm, $\pm 5\%$ ; 2 w.	S-a input load.
1141	3Z9625	SWITCH; rotary; 3-position.	Select TONE, C.W., or VOICE operation.
1142	3DA1-10	CAPACITOR: mica; 0.001-mf, $\pm 10\%$ ; 1,200 vdew.	S-a input level control.
1150	3DA1-7	CAPACITOR: mica 0.001-mf, $\pm 5\%$ ; 2,500 vdew.	Resonating capacitor on transformer 1149.
1181	3Z6630-4	RESISTOR: carbon; 30,000-ohm, $\pm 5\%$ ; 1 w.	Modulator-grid stabilizer.
1179	3Z9610A	SWITCH: single-section 1-circuit; 4-point; nonshorting.	SIDE TONE adjustment.
1157	2C6191A/T2	TRANSFORMER: interstage audio.	S-a to modulator grids.
1152	3Z5991-2	RESISTOR: wire; 1-ohm, $\pm 5\%$ ; 4-w.	Current-limiting s-a filament.
1153	3Z5991-2	RESISTOR: wire; 1-ohm, $\pm 5\%$ ; 4-w.	Current-limiting s-a filament.
1112	3Z6400-1	RESISTOR: wire, 4,000-ohm, $\pm 5\%$ ; 12-w.	P-a grid bias.
1113	2C6191A/R31	RESISTOR: variable; 3,000-ohm, +5%, -0%; no taper; wire-wound.	Modulator-grid bias.
1114	2C6191A/R31	RESISTOR: variable; 3,000-ohm, +5%, -0%; no taper; wire-wound.	S-a grid bias.
1115	3Z6720	RESISTOR: carbon; 200,000-ohm, $\pm 10\%$ ; 1-w; waxed.	Keying bias circuit.
1180	3DA10-13	CAPACITOR: mica 0.01-mf, $\pm 5\%$ ; 1,200 vdew.	Tone-oscillator resonating.
1160	3DB1.1A	CAPACITOR: paper; 1-mf, $\pm 10\%$ ; 300 vdew.	Modulator-grid bypass.
1147	3DB25-4	CAPACITOR: electrolytic; 25-mf, +100%, -10%; 25 vdew.	Microphone filter.
1145	3Z6005-2	RESISTOR: wire; 50-ohm, $\pm 10\%$ ; 4-w.	Microphone voltage divider.
1182	3Z6005-2	RESISTOR: wire; 50-ohm, $\pm 10\%$ , 4-w.	Microphone voltage divider.
1146	***2C6191A/K1	COIL: a-f choke.	Microphone filter.
	3C324-4		
1148	2C6191A/R32	RESISTOR: variable; 200-ohm, $\pm 10\%$ ; no taper.	S-a input-level control.

\* In Radio Transmitters BC-191-E and -F, capacitor 1155 is replaced with 1197B, one of three capacitors in a single container.

\*\* Transformer, stock No. 2C6191A/T3 is used in Radio Transmitters BC-191-A and -B; 2Z9944 is used in Radio Transmitters BC-191-C, -D, -E, -F, and -N.

\*\*\* Coil, Stock No. 2C6191A/K1 is used in Radio Transmitters BC-191-A and -B; 3C324-4 is used in Radio Transmitters BC-191-C, -D, -E, -F, and -N.

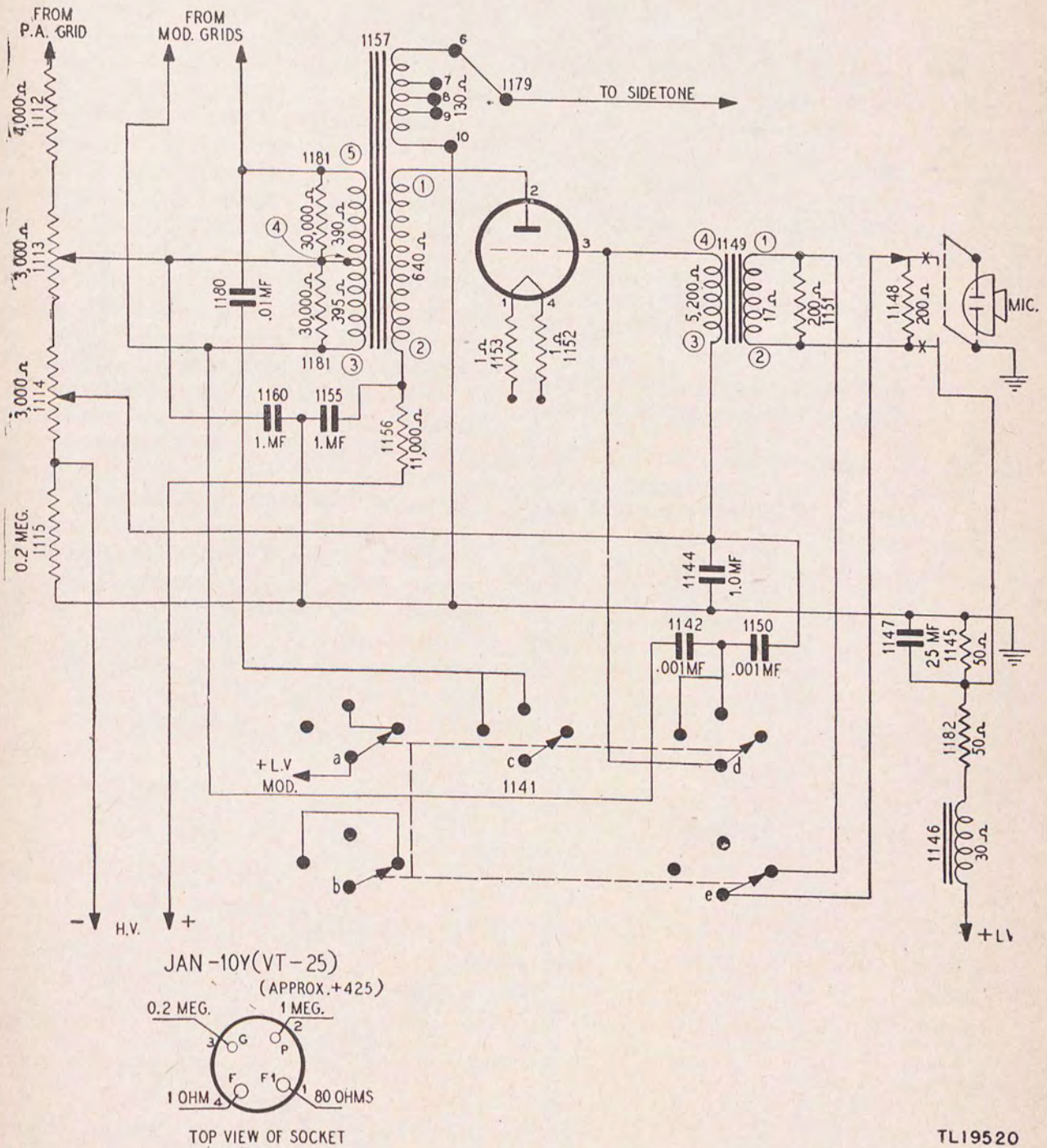
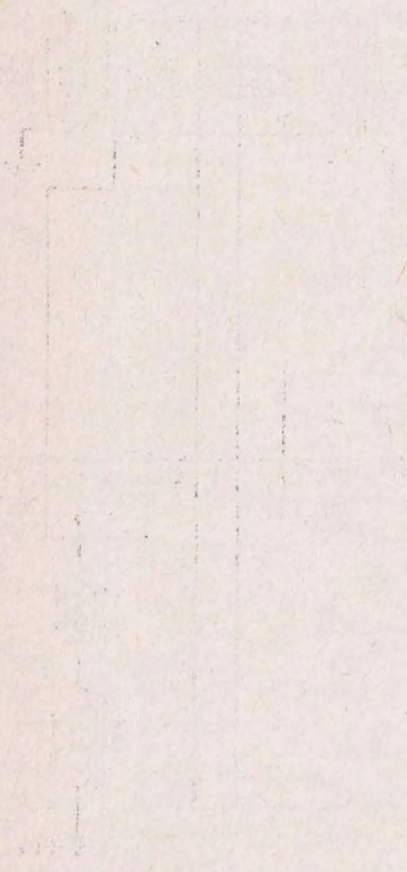

Figure 17. Speech amplifier circuit diagram and voltage and resistance measurements.



CS 3000

### 30. Filament and Relay Circuits

*a. CIRCUIT REPAIR FEATURES.* The filament circuit is such that the transmitter can be operated from either a d-c source or an a-c source, in connection with a power supply unit. This unit consists of a high-voltage rectifier for plate supply, a low-voltage rectifier for the control circuits, and a transformer to furnish a-c filament supply. Switch 1137 performs the circuit changes to allow the transmitter to be operated on a-c or d-c; switch 1141 selects the desired type of transmission, TONE, C.W., or VOICE. In the a-c position (fig. 18(B)) the filament circuit is separated from the control circuit, and the normally grounded side of the filament is disconnected from ground. Capacitor 1107 then serves to maintain the tube filaments at ground potential with respect to radio-frequency currents. Under the conditions of d-c filament supply (fig. 18(A)), resistor 1138 is used to adjust the filament voltage. The midtap of resistor 1138 is connected to the power source. One side of this resistor is used for the adjustment of the filaments of the tubes used for c-w operation; the other side is used for the modulator tubes. A portion of resistor 1138 may be shorted by switch 1190 (1139-1140), so that the correct filament voltage may be applied both when the power supply storage battery is being charged and when it is not being

charged. If the filaments are operated from an a-c source, resistor 1138 serves only as a compensating resistor it eliminates the need for readjusting the filament resistor when changing from C.W. to TONE or VOICE transmission. Operation of the keying contacts is accomplished by supplying power to the antenna-switching relay (1165). When the key, TEST KEY, or microphone button switch is operated, power is applied to relay 1165.

*b. RESISTANCE AND VOLTAGE MEASUREMENTS.* (1) *Voltage measurements.* Voltage measurements in the filament circuits (fig. 18) will necessarily be limited because of the few components involved. The operating filament voltages of the tubes can be read at all times on the FIL. VOLTAGE meter (1133). Measure the low-voltage input of 12 to 14.2 volts, depending on the power supply used, from terminal 45 of Socket SO-41 to ground.

(2) *Resistance measurements.* The few resistance measurements in this circuit will become apparent from the circuit diagram. (See fig. 18.) The S.A. FIL. dropping resistors (1152 and 1153) are mounted on the resistor board in all models except Radio Transmitter BC-191-A. In this model they are mounted under the chassis, directly below the speech-amplifier tube. (See fig. 37.)

## c. PARTS DATA (fig. 18).

Ref. symbol	Sig. Corps stock No.	Name of part and description	Function
1102	3Z9622-1	SWITCH: SPST: push-button type; momentary contact.	Interlock switch.
1107	3DA20-6	CAPACITOR: mica; 0.02-mf, $\pm 10\%$ ; 600 vdew.	Filament r-f bypass.
1122	2Z5927	LAMP, LM-27: 6.3-v; 250-ma; bayonet base Mazda No. 44.	Pilot lamp.
1123	3Z6003-3	RESISTOR: wire; 30-ohm, $\pm 10\%$ ; 4-w.	Limit pilot lamp current.
1131	3Z9622-1	SWITCH: SPST push-button type; momentary contact.	TEST KEY.
1133	3F7322	VOLTMETER IS-122: 0- to 15-v, a-c or d-c; white blocking on scale at 10 v.	Filament voltage indicator.
1134	3K5510321	CAPACITOR: mica; 0.01-mf, $\pm 10\%$ ; 1,000 vdew.	Filament voltmeter bypass.
1135	3Z9692-21189	SWITCH: toggle; SPDT; 1-amp at 250 v; 3 amp. at 125 v.	C.W. FIL.-MOD. FIL. switch.
1138	2C6191A/R5	RESISTOR ASSEMBLY: fixed; 1.2-ohm; wire-wound; mounted on terminal board.	Filament voltage adjustment.
1141	3Z9625	SWITCH: rotary; 3-position.	TONE-C.W.-VOICE selector.
1145	3Z6005-2	RESISTOR: fixed; 50-ohm, $\pm 10\%$ ; 4-w; wire-wound.	Microphone voltage divider.
1146	3C324-4	COIL: a-f choke; 5 henries; 1-amp.	Microphone filter.
1147	3DB25-4	CAPACITOR: electrolytic; 25-mf, $+100\%$ , $-10\%$ ; 25 vdew.	Microphone filter.
1148	2C6191A/R32	RESISTOR: variable; 200-ohm, $\pm 10\%$ ; wire-wound; no taper.	Input level control
1151	3Z6020-4	RESISTOR: fixed; 200-ohm, $\pm 5\%$ ; 2-w; wire-wound.	Input load.
1152	3Z5991-2	RESISTOR: fixed; 1-ohm, $\pm 5\%$ ; 4-w; wire-wound.	S-a filament dropping.
1153	3Z5991-2	RESISTOR: fixed; 1-ohm, $\pm 5\%$ ; 4-w; wire-wound.	S-a filament dropping.
1165	2C6191A/L1	RELAY.	Antenna switching and transmitter keying.
1182	3Z6005-2	RESISTOR: fixed; 50-ohm, $\pm 10\%$ ; 4-w; wire-wound.	Microphone voltage divider.
1190	3Z9508	SWITCH: DPST; 12-amp at 125 v; 6-amp at 250 v.	Adjust for 12- or 14-volt. filament supply.
1195	3Z9692-1	SWITCH: 4PST; 6-amp at 250 v; 12-amp at 125 v.	A-c d-c filament operation control.

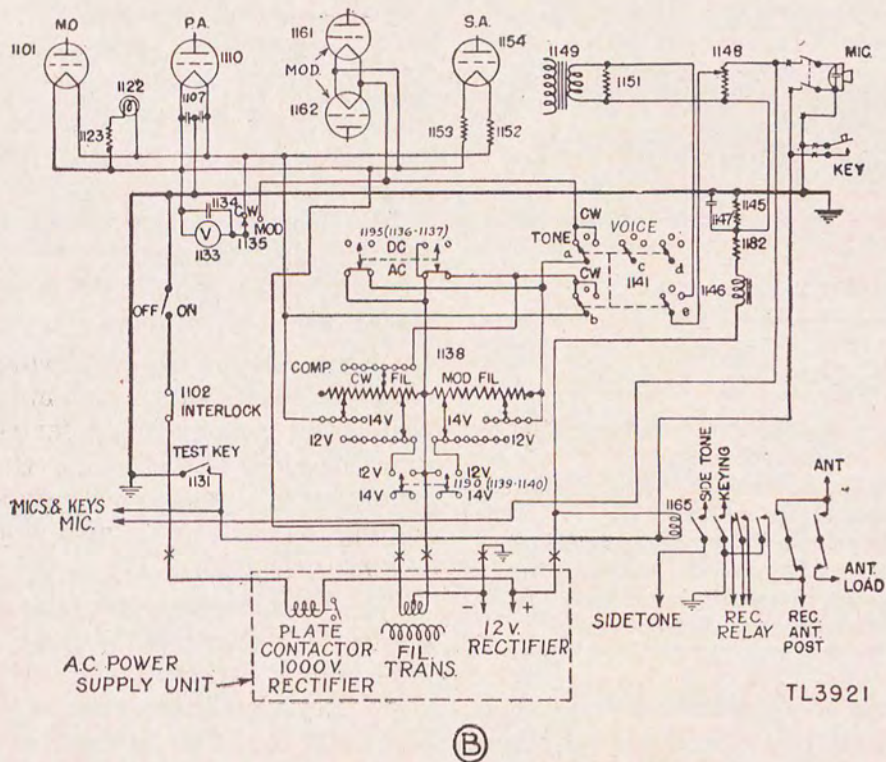
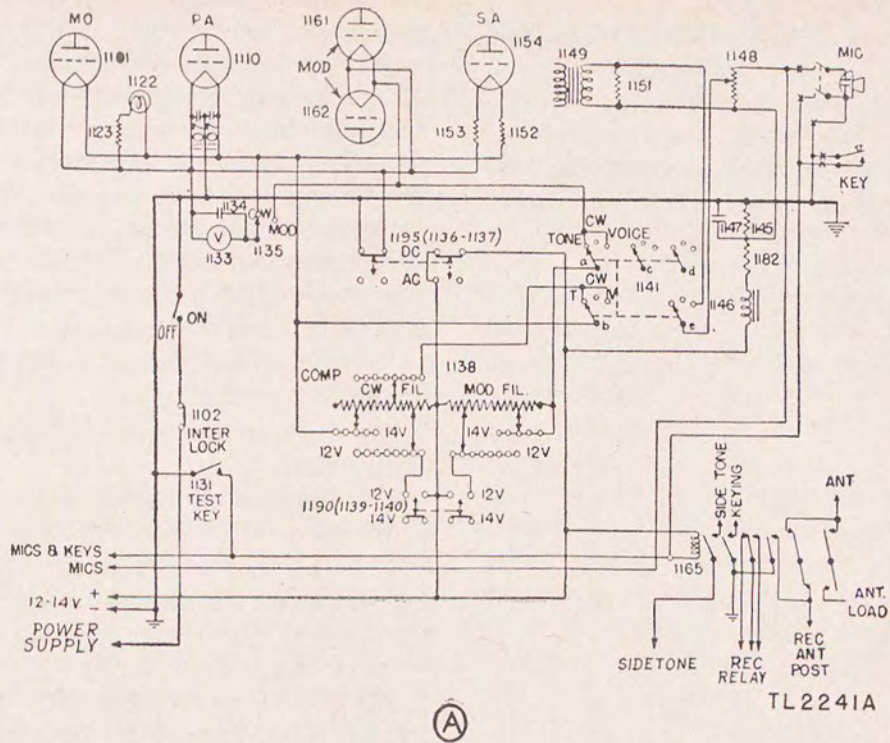
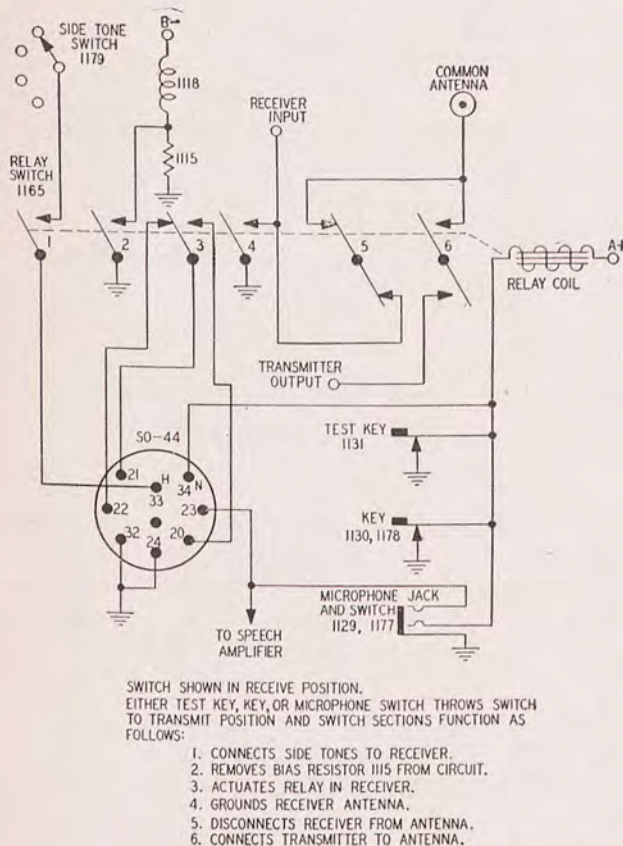

Figure 18. Filament and relay circuits for a-c and d-c operation, schematic diagrams.



### 31. Switching Relay 1165

a. **FUNCTION OF RELAY.** Relay 1165 is energized when either the TEST KEY, the telegraph key, or the push-to-talk button switch on the microphone is pressed. The functions performed by the six sets of contacts (fig. 19), when the relay is energized, are given below in table III.



TL19521

Figure 19. Switching relay, simplified diagram.

Table III. Relay functions.

Contact No.	Function
1	Connects side-tone line from transmitter to the receiver audio circuit.
2	Shunts out the stand-by biasing voltage developed across resistor 1115.
3	Operates stand-by relay in the receiver.
4	Grounds receiver antenna at transmitter.
5	Disconnects antenna from receiver.
6	Connects antenna to transmitter.

The proper sequence of operation is such that when the transmitter key is closed all other functions of the relay will be performed before the transmitter plate circuits are energized.

When the transmitter key is open, the transmitter plate circuits will be deenergized before any other function of the relay is performed. If making repairs other than necessary contact adjustments, and the relay is found to be defective, remove it and make the repairs. If the damage is such that repairs cannot be made, replace the damaged relay with a good one.

b. **REMOVING RELAY.** When removing any wires connected to the relay, tag all wire leads and mark them so that they can be connected to their original positions. Remove the relay in the following manner:

(1) Remove top and rear panels of transmitter case.

(2) Remove all circuit elements and wires connected to the relay.

(3) Take out the five screws holding the relay in place. These screws are reached from the back of the relay, and are best removed with an offset screw driver.

(4) With a swinging motion, pull the relay, left and first, through the opening between the top of the transmitter frame and the antenna inductor.

c. **CHECKING RELAY AND REPLACING DEFECTIVE PARTS.** (1) Take relay apart and examine it for defective parts such as bent armature, broken leads, cracked insulators, and bent, pitted, or worn contact points.

(2) Check the relay energizing coils for opens or shorts. Use the low-ohm scale of the ohmmeter for this check, since the approximate resistance of the relay coil is only 13 ohms.

(3) Replace any badly pitted or worn points or other defective parts.

(4) Clean all contact points with dry-cleaning solvent (SD) to remove any dirt or grease.

**Caution:** Do not use such materials as file or emery or crocus cloth for cleaning silver relay contacts as nonconducting materials may become imbedded in the points. On silver-plated contacts such abrasives will remove the plating, causing the contacts to burn or pit easily and to wear quickly.

(5) After cleaning and replacing all defective parts, reassemble the relay and mount it in place on the transmitter.

(6) Replace all wires and circuit elements; be careful that they are put in the positions marked on the tags.

d. **CHECKING RELAY-CONTACT SEQUENCE AND**

**TOTAL PL. CURRENT METER ACCURACY.** A simple type of tester that is very helpful in checking contact sequence of the relay and accuracy of the TOTAL PL. CURRENT meter on Radio Transmitter BC-191-(\*) is shown in figure 20. The pressure-arm attachment (fig. 20), when clamped to the relay (fig. 21), is used for operating the relay manually. By slowly pushing the pressure arm downward, the contacts of the relay can be closed one at a time. This slow action is necessary in order to check the closing of each individual contact by observing the test lights on the tester. The pressure-arm adjustment attachment (fig. 20) is mounted on the top panel of the transmitter and is used to operate the pressure arm so that a fixed pressure may be maintained, if necessary, when any adjustments have to be made on the relay contacts. The use of this attachment makes it possible to have both hands free for the adjustments. (See fig. 22.) If it is necessary to make adjustments on a number of relays, the pressure-arm adjustment attachment can be permanently mounted on a spare transmitter top panel. This can be used as a piece of the test equipment and will save considerable time in mounting and unmounting the adjustment plate. Along with this dummy top panel, a dummy antenna terminal board (fig. 20) can be made to use with the test equipment. Figure 25 gives the dimensions of the suggested pressure arm and pressure-arm adjustment attachments; the schematic diagram of the suggested sequence tester is shown in figure 26. The long-nose pliers (fig. 23) are made by drilling the tops and inserting small points to fit the holes in the relay-contact locknuts; the angle tool for making the contact adjustments is a piece of piano wire. Any arrangement that will satisfactorily do the work may be used for these adjustments. To connect and operate the tester, proceed as follows:

- (1) Remove all plugs and cables from transmitter.
- (2) Remove top and rear panels from transmitter.

(3) Connect Plugs PL-64 and PL-61 on tester to corresponding sockets on the transmitter. High voltage is not used with the tester.

(4) Connect a jumper between LOAD B and GND. terminals on transmitter-output terminal board.

(5) Connect a jumper between the common arm of SIDE TONE switch and chassis.

(6) Connect leads from ANT. and REC. terminals on transmitter-output terminal board to respective posts on tester.

(7) Clamp pressure-arm attachment on relay. (See fig. 21.)

(8) Connect sequence tester to 110-volt a-c. and turn the OFF-ON switch on the tester to ON; this should light the panel pilot lamp.

(9) Operate pressure-arm attachment slowly, and at the same time observe test lights 1 to 7, inclusive, for proper sequence operation. Use push button on tester to operate test light 7.

(10) If the test lights do not operate in order, if they flicker and are erratic, slowly screw down the pressure-arm adjustment attachment until the contacts causing the erratic operation are closed. (See fig. 24.) With the special long-nose pliers, or any substitute tool unlock the contact locknut and adjust the contact point until the light on the tester operates properly.

(11) When test light 6 is lit, both the TOTAL PL. CURRENT meter on the transmitter and the meter on the tester should indicate the same value of current,  $\pm 2$  percent. Test light 6 does not burn as brightly as the other lights because of the 10-ohm shunt resistor.

(12) After making the relay adjustments, remove the pressure arm and pressure-arm adjustment attachment and replace transmitter panels.

**Caution:** After completing the adjustments, do not forget to remove the jumper from the SIDE TONE switch to ground before replacing panels.

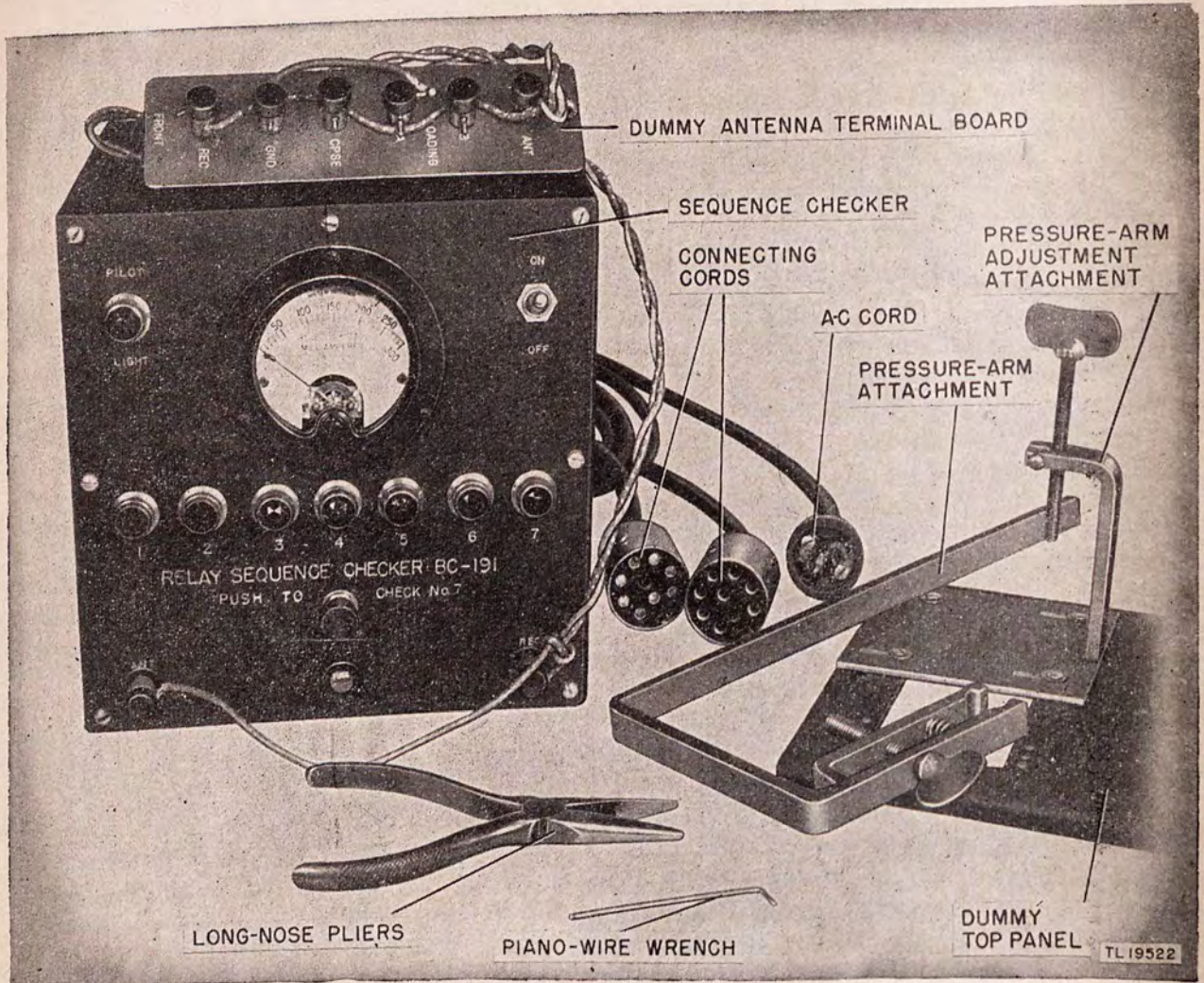
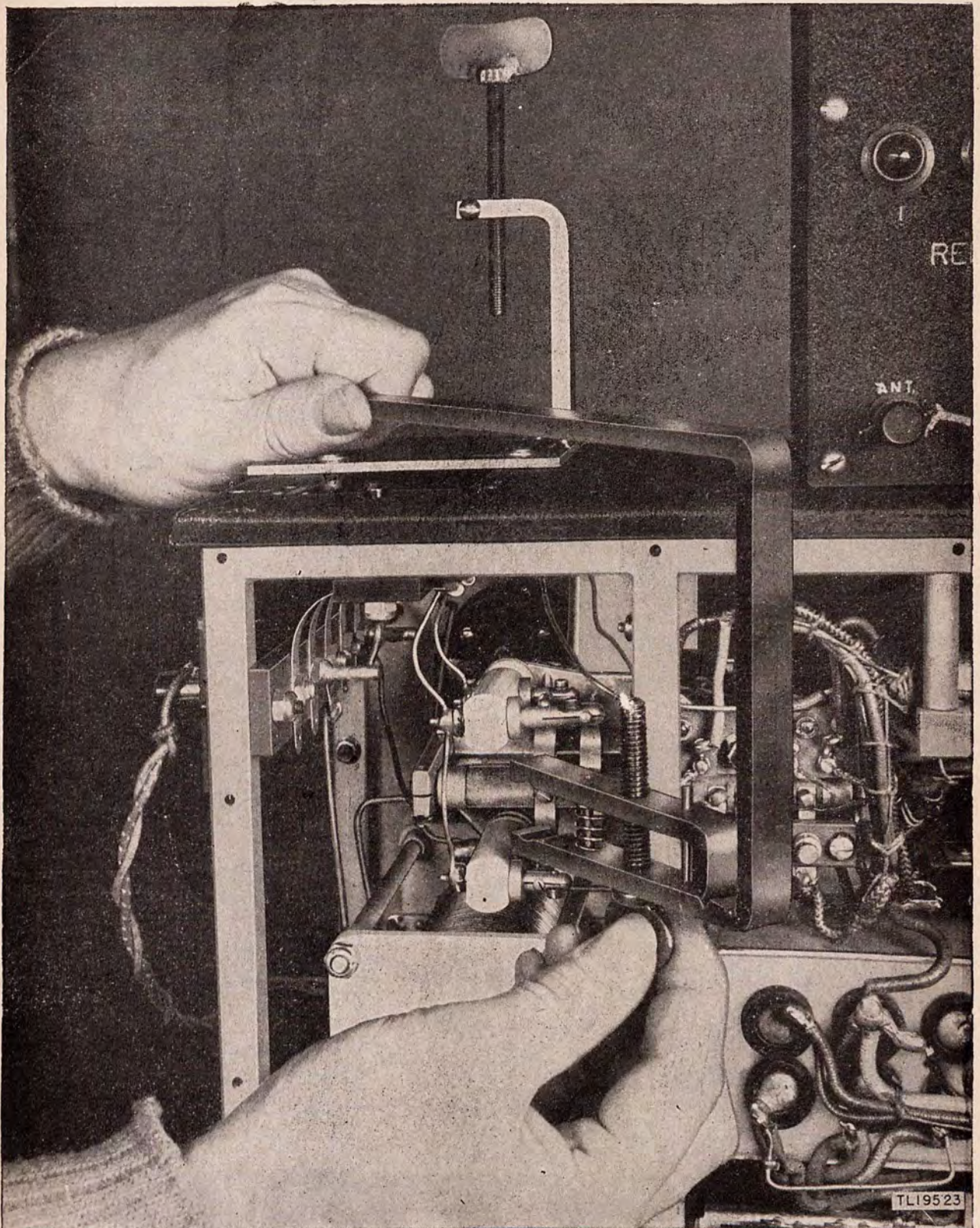

Figure 20. Relay-checking equipment.



*Figure 21. Clamping pressure-arm attachment to relay.*

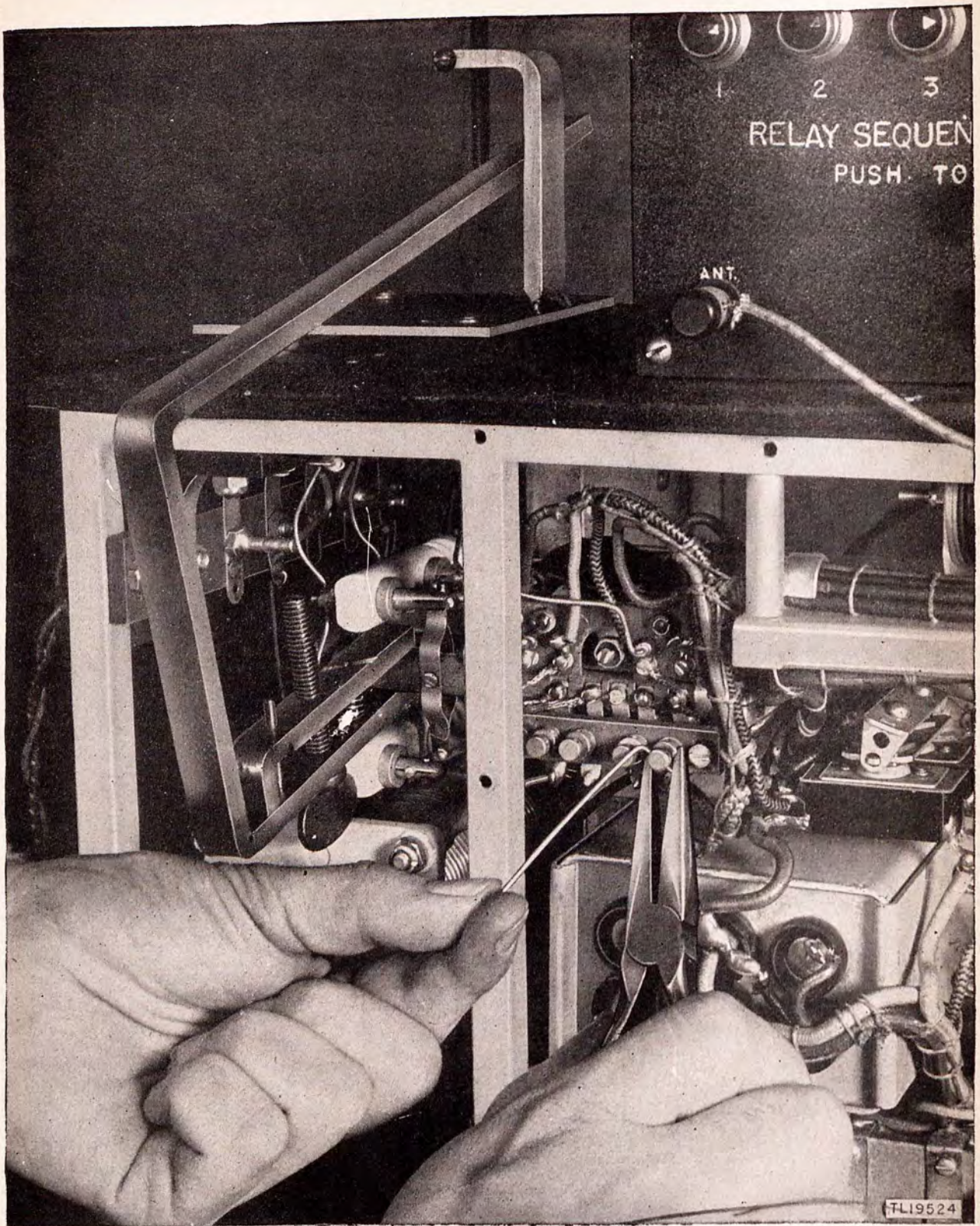

Figure 22. Pressure-arm adjustment attachment in use.

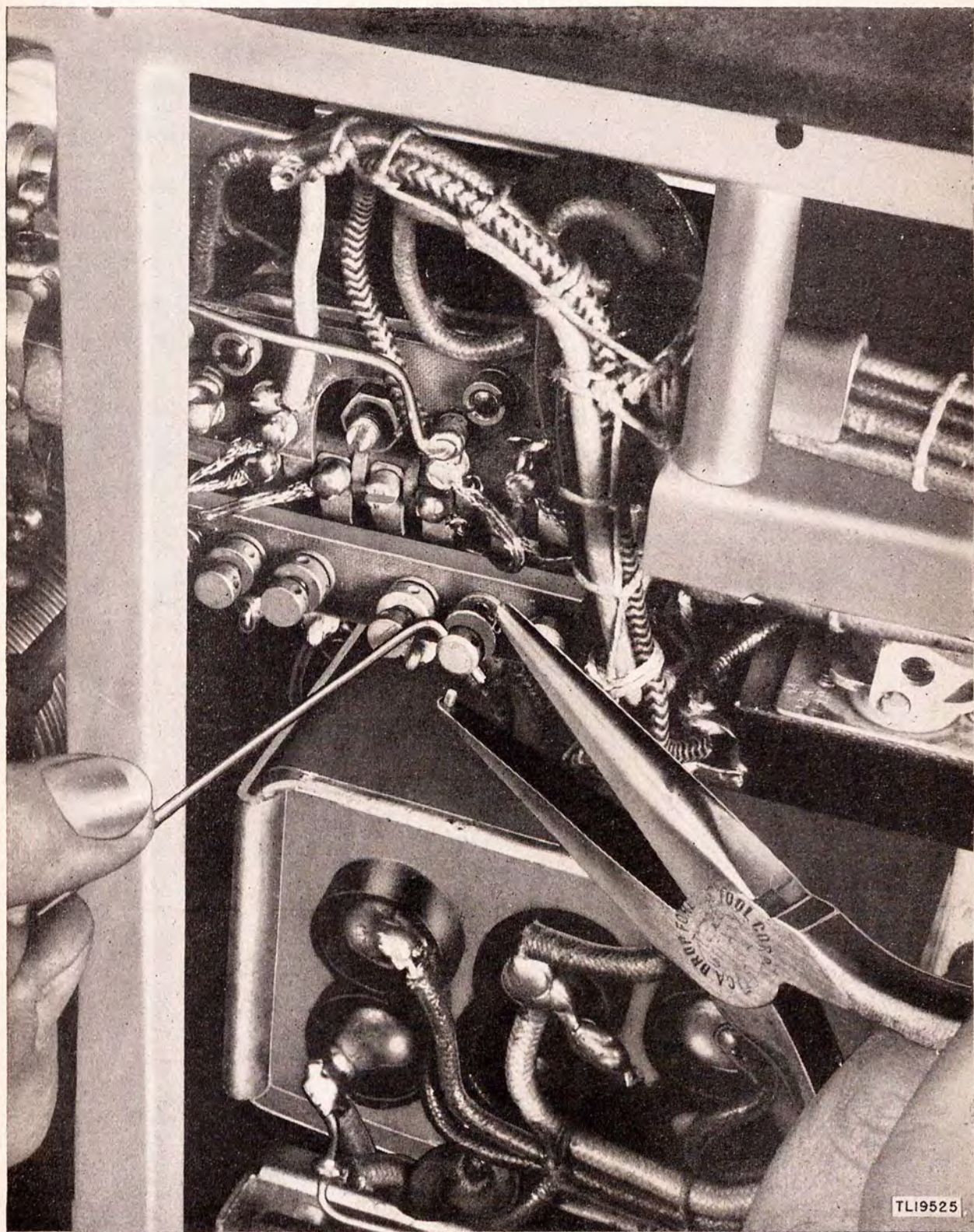

Figure 23. Close-up view of long-nose pliers.

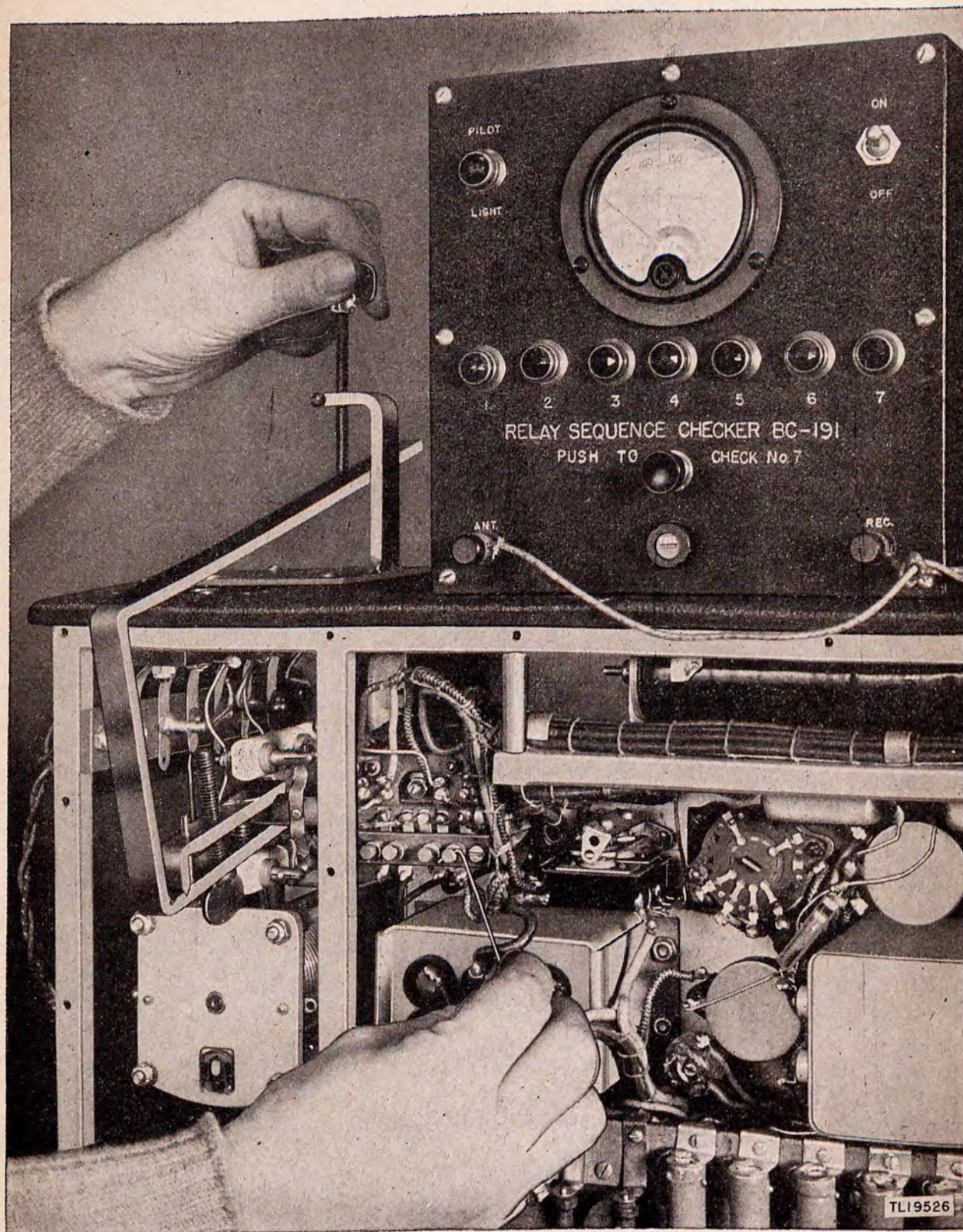

Figure 24. Operating pressure-arm adjustment attachment.

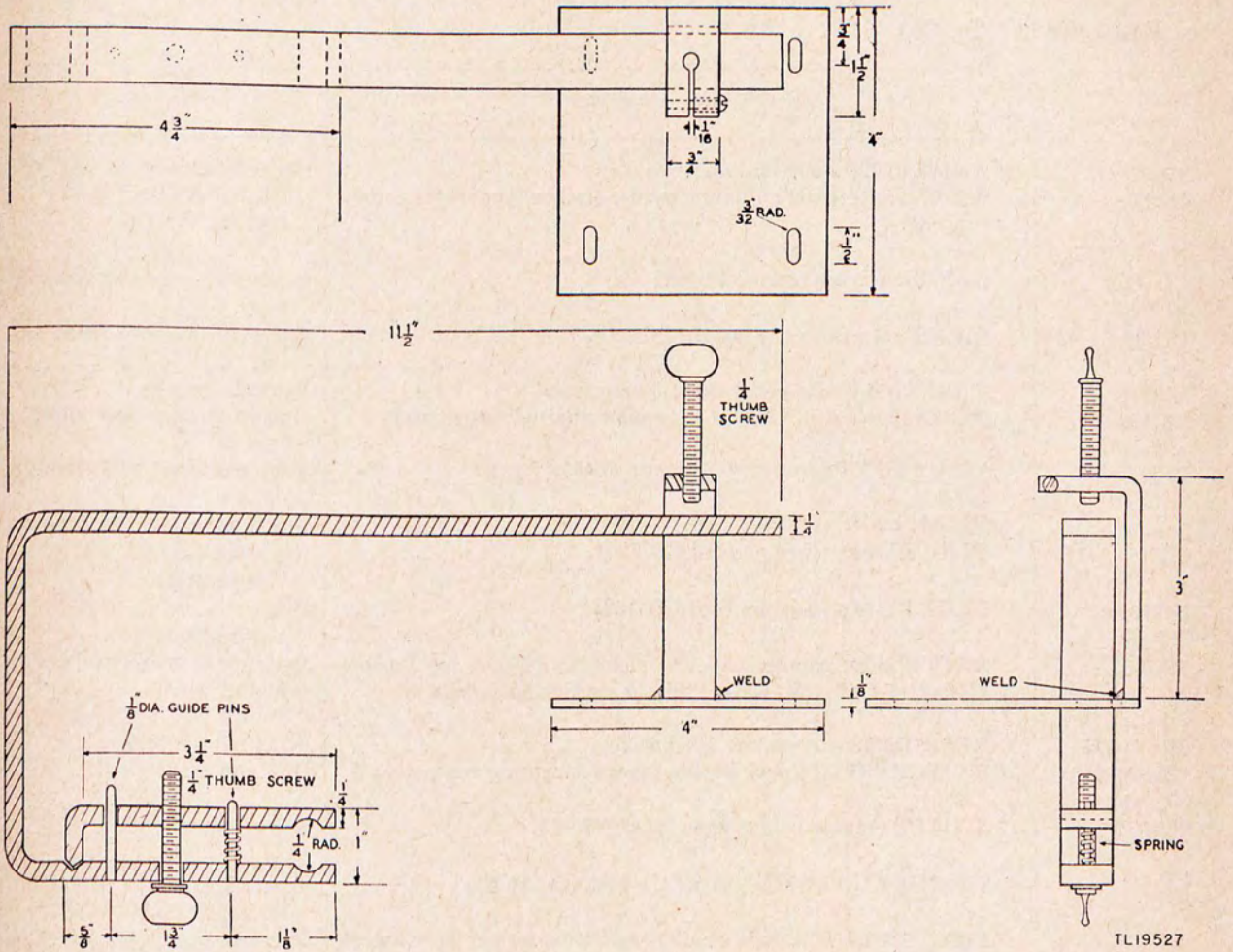
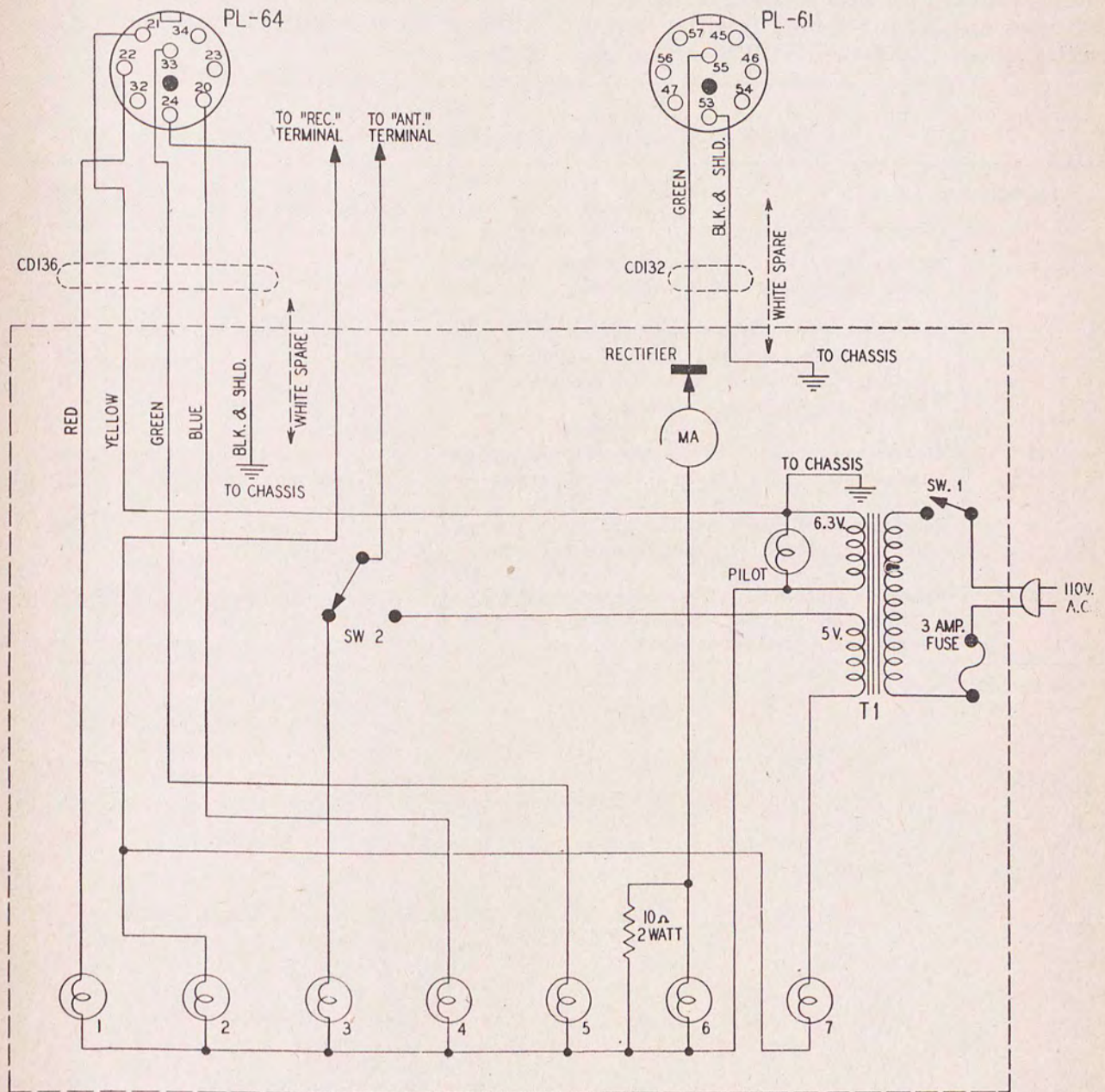

Figure 25. Constructional data for pressure arm and pressure-arm adjustment attachment.



## e. PARTS DATA (fig. 26).

Signal Corps stock No.	Name of part and description	Function
3F930 or 3F950	AMMETER: 0-500 milliamperes d-c. AMMETER: 0-300 milliamperes d-c (either type meter can be used).	Check accuracy of TOTAL PL. CURRENT meter on transmitter.
CD-136	CABLE: 6 wires; one not used.	Connects tester to transmitter.
CD-132	CABLE: 3 wires; one not used.	Connects tester to transmitter.
3Z3275 2Z5991-4	FUSE HOLDER: panel type; 3-amp fuse. MOUNTING ASSEMBLY: for pilot and indicator lights.	Protects tester. Holds indicator and pilot lights.
2Z5927	PILOT LAMPS: 6.3-v; 0.25-amp; (S44).	Pilot light and contact indicators.
2Z7164.3	PLUG: male; a-c type. PLUG PL-64: (used on cord CD-136).	Power cord plug for tester. Connects cord CD-136 to transmitter.
2Z7161.3	PLUG PL-61: (used on cord CD-132).	Connects cord CD-132 to transmitter.
3H4855	RECTIFIER: copper oxide or selenium; 2C679A for Remote Control Unit RM-13-A; 8 plates used in half-wave.	Rectifies ac to operate tester meter.
3RC41AE 3Z9824-259	RESISTOR: wire-wound 10-ohm 2-w. SWITCH: SPDT; push-button type; momentary contact (SW. 2).	Stabilizing resistor. Operates test light 7.
3Z8105	SWITCH: single-pole; toggle type (SW. 1).	OFF-ON switch.
	TERMINAL POSTS: (to REC) and (to ANT).	Connect tester to respective terminals on transmitter.
	TRANSFORMER: any small power transformer or filament transformer with 6.3-v and 5-v windings.	Supplies power for test lights and meter.



TL19528

Figure 26. Relay sequence tester, schematic diagram.

### 32. Checking Tone-C.W.-Voice Switch

Due to various functions of switch 1141, its failure to operate properly is usually due to worn or broken contacts or loose wires. With all tubes and cords removed from the transmitter, check TONE-C.W.-VOICE switch, ac-

ording to the procedure in table IV. With this procedure, a complete check of the switch can be made without removing it from the transmitter. The location of the test points and the wiring of the switch are shown in parts A and B figure 27.

TABLE IV. Resistance test of tone-C.W.-voice switch

Test No.	Test points *	Position of A-C D-C switch	TONE	C.W.	VOICE
1	Between 14-volt lug on resistor and filament of modulator tube. Checks section a of switch.	....	Zero	Open	Zero
2	Remove link from C.W. FILAMENT and COMP. row and check between COMP. terminal and filament of oscillator or power amplifier. Checks section b of switch. Replace link after test.	D-C	Zero	Open	Zero
3	Between top connection of capacitor 1142 and grid of the modulator tube. Checks section c of switch.	....	Zero	Zero	Open
4	Between grid of speech amplifier and bottom connection of capacitor 1142. Checks section d of switch.	....	Zero	Zero	Open
5	Between terminals 1 and 2 of microphone input transformer 1149 (fig. 34). Checks section e of switch. Input level control set at zero.	....	15 ohms	15 ohms	Zero

\* See figure 27

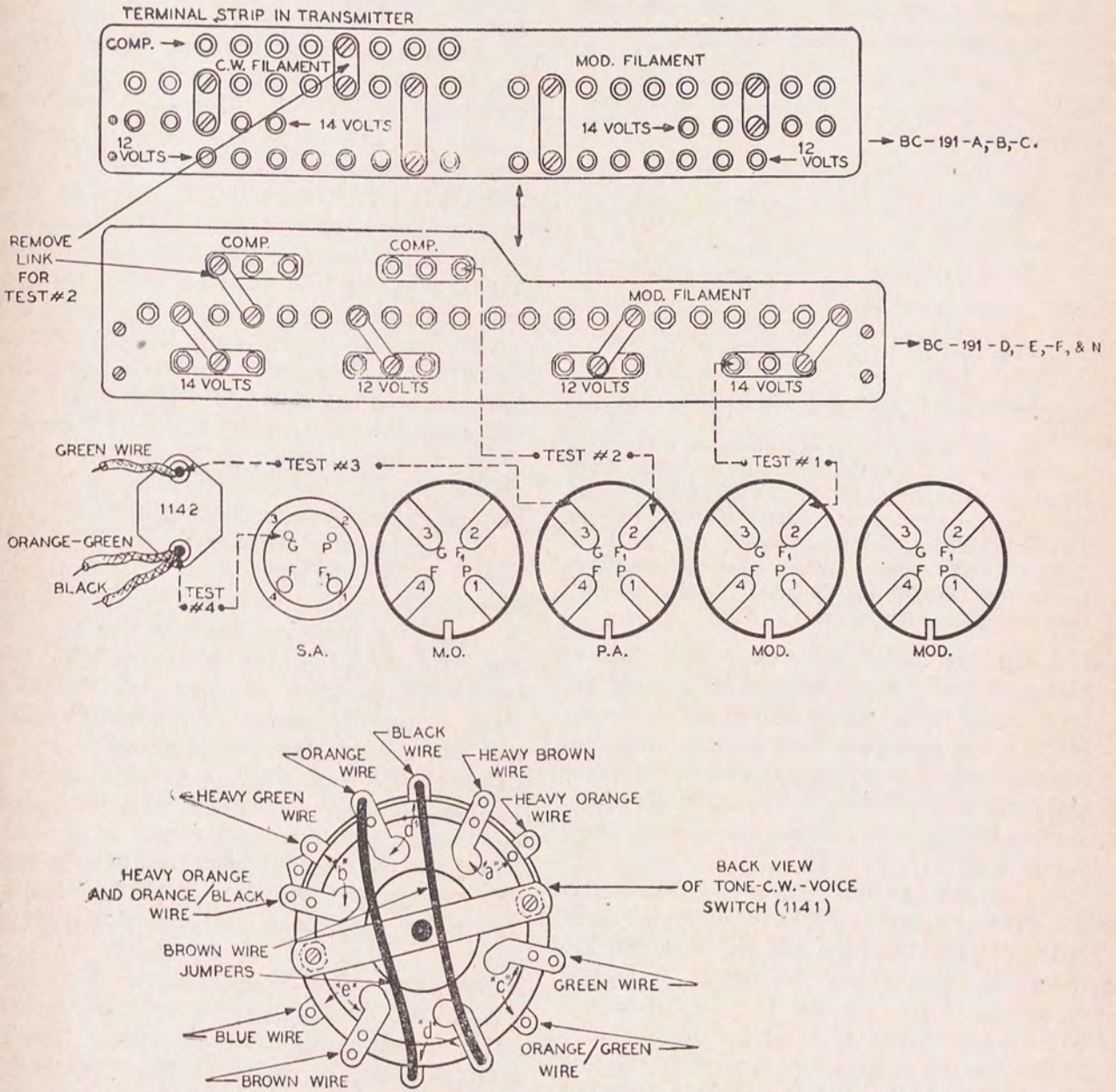

NOTE: SEE FIGURE 36 FOR LOCATION OF CAPACITOR 1142, AND FIGURE 34 FOR INPUT TRANSFORMER 1149.  
TL19529

Figure 27. Test points for checking TONE-C.W.-VOICE switch.

### 33. Transmitter Tuning Units

a. GENERAL. The frequency range covered by the transmitter tuning units in use is from 200 to 800 kilocycles and from 1,500 to 12,500 kilocycles. This frequency range is divided into nine bands, each covered by a plug-in transmitter tuning unit as indicated below.

Table V. Tuning unit frequency coverage

Transmitter Tuning Unit	Kilocycles
*TU-3-(* )	400 to 800
TU-5-(* )	1,500 to 3,000
TU-6-(* )	3,000 to 4,500
TU-7-(* )	4,500 to 6,200
TU-8-(* )	6,200 to 7,700
TU-9-(* )	7,700 to 10,000
TU-10-(* )	10,000 to 12,500
*TU-22-(* )	350 to 650
*TU-26-(* )	200 to 500

Note. The serial numbers of transmitter tuning units must be identical with the serial number of the transmitter and with the CALIBRATION CHART with which they are used. Do not interchange transmitter tuning units with those of other transmitters. The CALIBRATION CHART figures apply only when the transmitter tuning unit, CALIBRATION CHART, and transmitter have identical serial numbers.

b. CIRCUIT REPAIR FEATURES. The master-oscillator and power-amplifier r-f circuits are built into the transmitter tuning units. The removal of the top and bottom cover on each tuning unit will provide access to the inner parts and circuits. Following is brief analysis of the various tuning units grouped according to their similarities.

(1) In Transmitter Tuning Unit TU-8-(\*), coil 801 and capacitor 802 make up the r-f oscillating circuit. Both the coil and capacitor are thermally compensated to reduce frequency variations. Capacitor 802 is provided with a front panel control B to adjust the oscillator to the desired frequency. Capacitor 805 furnishes the power-amplifier grid excitation; the master-oscillator grid excitation is taken through capacitor 803 which also blocks the plate voltage from the grid circuit. The power-amplifier tank circuit is made up of coil 821 and capacitor 822. This capacitor has a panel control, labeled C, for tuning the circuit to resonance. Choke 806 provides a low-impedance path for d-c grid current and a high-impedance path at radio frequencies. Capacitor 807, the neu-

tralizing capacitor, forms part of a bridge circuit including the power-amplifier grid-to-plate capacitance. Balancing this circuit with capacitor 807 prevents reaction of the power amplifier on its grid-input circuit. Thus the possibility of self-oscillation of the amplifier is eliminated. The amplifier is inductively coupled to the antenna circuit by the tapped inductor 823, the taps being selected by panel switch 824, which is labeled ANT. COUPLING SWITCH D. The circuit description given above applies also to Transmitter Tuning Units TU-7-(\* ) and TU-9-(\* ). Transmitter Tuning Unit TU-10-(\* ) is practically the same as the above units except that the master-oscillator plate bypass capacitor 1009 and plate choke 1010 are added (fig. 28).

(2) The frequency range of Transmitter Tuning Unit TU-5-(\* ) is covered by four frequency bands controlled by switches 502 and 522, control A. The type of circuit and thermal frequency compensation is the same as in the units previously described. Resistor 517 is the power-amplifier grid parasitic resistor.

(3) Transmitter Tuning Units TU-6-(\* ) and TU-8-(\* ) are very similar. The same type of master-oscillator circuit is used in both units. However, the frequency range of Transmitter Tuning Unit TU-6-(\* ) is covered by two bands. Band-change switches 602 and 622, panel control A, connect fixed capacitors 603 and 623 in the master-oscillator circuit and power-amplifier circuit respectively, to cover the low-frequency end of the band. Capacitor 603 in the master-oscillator circuit is provided with a thermometal compensator (613) to provide the required frequency stability. Resistor 614 is the power-amplifier grid parasitic resistor.

(4) Transmitter Tuning Units TU-3-(\* ), TU-26-(\* ), and TU-22-(\* ) have the same circuits, as well as the same type of control and thermal frequency compensation. They differ only in frequency range and circuit parts. A description of Transmitter Tuning Unit TU-3-(\* ) will therefore be applicable to all three tuning units. The tapped variometer 301, with the voltage dividing network capacitors 310, 311, 312, 313, 314, and 315, comprises the basic master-oscillator tank. The band-change switch 307, control A, selects the proper taps on the variometer and connects the additional tank capacitors 308 and 309 into the circuit in order to cover the frequency range properly. The

\* Antenna Tuning Unit BC-306-(\* ) is to be used with these units.

thermal compensators 305, 319, and 320 consist of small capacitors with a special ceramic dielectric designed to provide the required thermal frequency stability. The master-oscillator plate and grid chokes are numbered 302 and 303 respectively; the master-oscillator grid blocking capacitor is numbered 304. Resistor 317 is located in the master-oscillator grid circuit to suppress parasitic oscillations. Excitation for the power amplifier is obtained across capacitor 314 through blocking capacitor 318. The power-amplifier grid choke is numbered 306. The tapped variometer 321 and fixed capacitors 323, 324, 325, and 326 tune the power-amplifier tank. Switch 322, ganged with Switch 307 to control A, selects the proper variometer tap and capacitor arrangement for the desired frequency. Voltage required to neutralize the power amplifier is obtained across capacitor 313 through neutralizing capacitor 316. Coil 327 and switch 328, control D, provide the necessary coupling to the antenna circuit.

Note. Model N tuning units are electrically and mechanically interchangeable with model B tuning units. Model A tuning units may be used in model N transmitters. Also, model N or B tuning units may be used in model A transmitters, if mycalex jack-board support is changed to part number K-7885093P1, a special part.

c. RESISTANCE AND VOLTAGE MEASUREMENTS. All circuits not broken by a capacitor are of low enough resistance to be checked with a continuity meter. The parasitic resistors are approximately 15 ohms, and the r-f chokes will have a resistance between 1 and 40 ohms, depending upon the tuning unit tested. No reference is made to voltage measurements in the tuning units because they must be removed from the transmitter rack before the top and bottom covers can be removed to provide access to the inner parts. Removing the units from the transmitter will open the interlock switch and remove the high voltage from the unit.

d. PARTS DATA FOR TRANSMITTER TUNING UNIT TU-3-(\*) (fig. 28).

Ref. symbol	Sig. Corps stock No.	Name of part and description	Function
301	2C8022A/36	COIL: variometer; bakelite form and rotor.	M-o tank inductor.
302	3C324-1	COIL: r-f choke.	M-o plate choke.
303	3C324-2	COIL: r-f choke.	M-o grid choke.
304	3DA2-62	CAPACITOR: mica; 0.002-mf, $\pm 10\%$ ; 5,000-v.	M-o grid blocking.
305	2C8003A/C1	CAPACITOR: thermal compensator; (ganged with 308).	M-o plate tank tuning.
306	3C324-3	COIL: r-f choke.	P-a grid choke.
307	3Z9615	SWITCH: rotary; 3-position; (ganged with 322).	M-o band change.
308	3D9100-11	CAPACITOR: 0.0001-mf, $\pm 2\%$ ; 3,000 vdew.	M-o tank tuning.
309	3D9200-1	CAPACITOR: 0.0002-mf, $\pm 5\%$ ; 3,000 vdew.	M-o tank tuning.
310	3DA3-10	CAPACITOR: mica; 0.003-mf, $\pm 5\%$ ; 5,000 vdew.	M-o to p-a coupling.
311	3DA3-10	CAPACITOR: mica; 0.003-mf, $\pm 5\%$ ; 5,000 vdew.	M-o to p-a coupling.
312	3DA5-29	CAPACITOR: 0.005-mf, $\pm 5\%$ ; 5,000 vdew.	M-o to p-a coupling.
313	3DA2-9	CAPACITOR: mica; 0.002-mf, $\pm 5\%$ ; 5,000-v.	M-o to p-a coupling.
314	3DA2-9	CAPACITOR: mica; 0.002-mf, $\pm 5\%$ ; 5,000-v.	M-o to p-a coupling.
315	3DA5-29	CAPACITOR: 0.005-mf, $\pm 5\%$ ; 5,000 vdet.	M-o to p-a coupling.
316	3DA9008V2	CAPACITOR: variable; max 26 mmf, $\pm 4\%$ ; min 8 mmf, $\pm 1.5$ mmf.	P-a neutralizing.
317	3Z6001E5	RESISTOR: 15-ohm, 4.5-w; (ganged with 303).	Parasitic suppressor.
318	3DA2-62	CAPACITOR: mica; 0.002-mf, $\pm 10\%$ ; 5,000-v.	P-a grid.
319	2C8003A/C2	CAPACITOR: thermal compensator; (ganged with 309).	M-o plate tank.
320	2C8003A/C3	CAPACITOR: thermal compensator; (ganged with 310 and 315).	M-o plate tank.
321	2C8022A/35	COIL: variometer; bakelite form and rotor.	P-a tank and antenna-coupling coil.
322	3Z9615	SWITCH: rotary; 3-position; (ganged with 307).	P-a band change.
323	3D9100-32	CAPACITOR: 0.0001-mf, $\pm 5\%$ ; 3,000-v.	P-a tank tuning.
324	3D9200-9	CAPACITOR: mica; 0.0002-mf, $\pm 5\%$ ; 3,000 vdet.	P-a tank tuning.
325	3DA1-3	CAPACITOR: mica; 0.001-mf, $\pm 5\%$ ; 3,000-v.	P-a tank tuning.
326	3DA1-3	CAPACITOR: mica; 0.001-mf, $\pm 5\%$ ; 3,000-v.	P-a tank tuning.
327	2C8022A/35	COIL: tapped inductance; (part of 321).	Antenna coupling.
328	3Z9604-2	SWITCH: rotary; 6-position.	Antenna coupling.
329	3DA2-38	CAPACITOR: 0.002-mf, $\pm 2\%$ ; 5,000-v.	Antenna coupling.

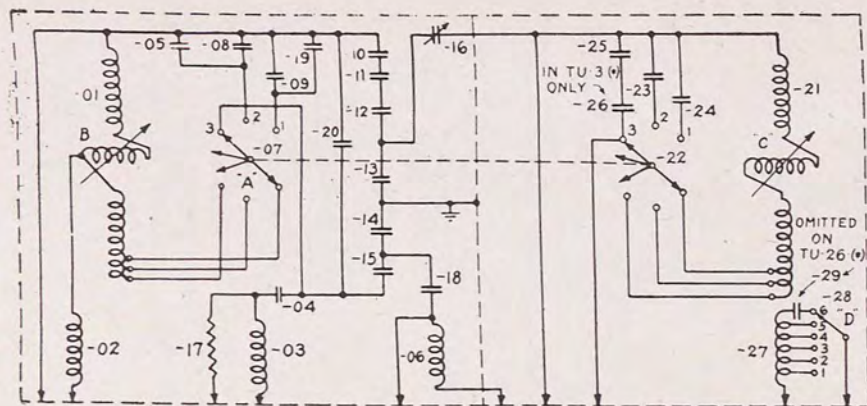

WIRING OF TU-3-(\*), TU-22-(\*), AND TU-26-(\*)

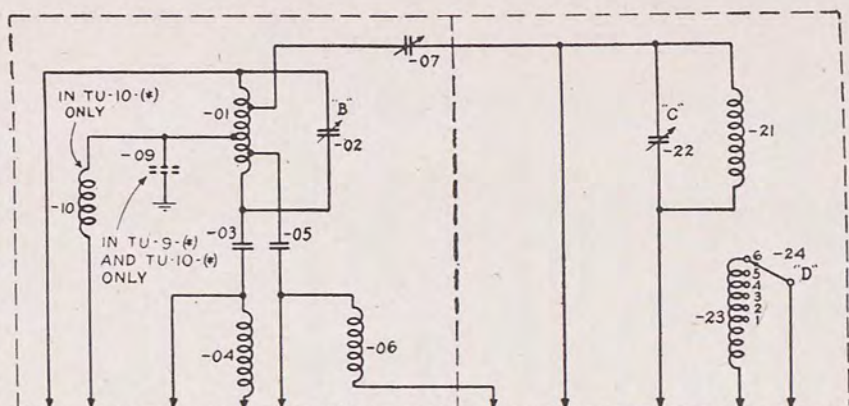

WIRING OF TU-7-(\*), TU-8-(\*), TU-9-(\*), AND TU-10-(\*)

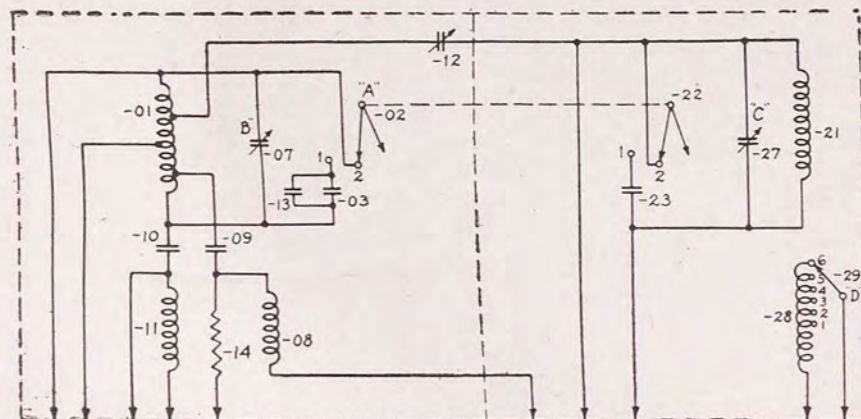

WIRING OF TU-6-(\*)

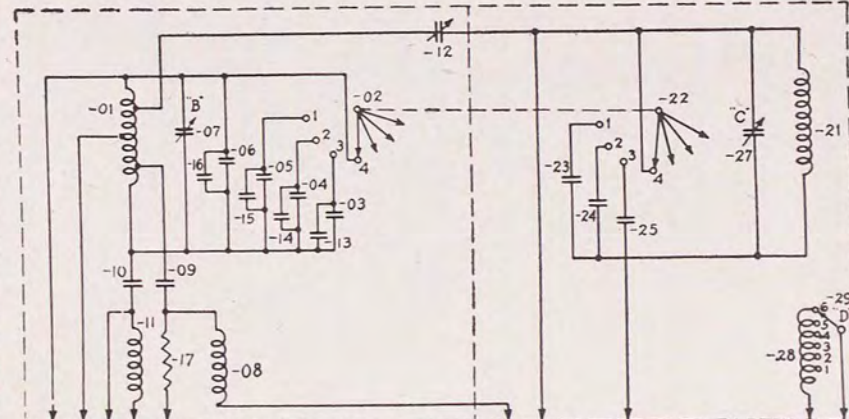

WIRING OF TU-5-(\*)

FOR COMPLETE REF. NUMBER IN ANY OF TUNING UNITS ABOVE, SUBSTITUTE NUMBER FOR DASH PRECEDING NUMBER INDICATED FOR A GIVEN PART. FOR EXAMPLE, PART-17" WOULD BE "317" FOR TU-3-(\*), AND "2217" FOR TU-22-(\*)

Figure 28. Transmitter tuning units, schematic diagrams.

## e. PARTS DATA FOR TRANSMITTER TUNING UNIT TU-5-(\*) (fig. 28).

Ref. symbol	Sig. Corps stock No.	Name of part and description	Function
501	2C8005A/D19	COIL ASSEMBLY: ceramic form; thermal compensator mounted inside coil.	M-o tank inductor.
502	3Z9614	SWITCH: rotary; 4-position; (ganged with 522).	M-o band change.
503	3D9100-11	CAPACITOR: 0.0001-mf, $\pm 2\%$ ; 3,000-v.	M-o tank tuning.
504	3D9100-11	CAPACITOR: 0.0001-mf, $\pm 2\%$ ; 3,000-v; (ganged with 514).	M-o tank tuning.
505	3D9100-11	CAPACITOR: 0.0001-mf, $\pm 2\%$ ; 3,000-v; (ganged with 515).	M-o tank tuning.
506	3D9030-1	CAPACITOR: 0.00003-mf, $\pm 5\%$ ; 2,000-v.	M-o tank tuning.
507	3D9020V-4	CAPACITOR: variable; max 135 mmf, $\pm 2\%$ ; min 20 mmf, $\pm 1$ mmf.	M-o tank tuning.
508	2C8005A/D10	COIL: r-f choke; with resistor 517.	P-a grid.
509	3D9400-6	CAPACITOR: 0.0004-mf, $\pm 10\%$ ; 2,500 vdcw.	P-a grid blocking.
510	3D9400-6	CAPACITOR: 0.0004-mf, $\pm 10\%$ ; 2,500 vdcw.	M-o grid blocking.
511	2C8005A/D11	COIL: r-f choke.	M-o grid choke.
512	3D9008V2	CAPACITOR: variable; max 26 mmf, $\pm 4\%$ ; min 8 mmf, $\pm 1.5$ mmf.	P-a neutralizing.
513		CAPACITOR: thermal compensator; (ganged with 503).	M-o tuning compensator.
514		CAPACITOR: thermal compensator; (ganged with 504).	M-o tuning compensator.
515		CAPACITOR: thermal compensator; (ganged with 505).	M-o tuning compensator.
516		CAPACITOR: thermal compensator; (ganged with 506).	M-o tuning compensator.
517	3Z6001E5	RESISTOR: 15-ohm; 4.5w; (ganged with 508).	P-a grid parasitic suppressor.
521	2C8005A/D17	COIL ASSEMBLY: contains coil 528.	P-a tank inductor.
522	3Z9614	SWITCH: rotary; 4-position; (ganged with 502).	P-a band change.
523	3D9090	CAPACITOR: mica; 0.00009mf, $\pm 5\%$ ; 3,000-v.	P-a tank tuning.
524	3D9090	CAPACITOR: mica; 0.00009mf, $\pm 5\%$ ; 3,000-v.	P-a tank tuning.
525	3D9090	CAPACITOR: mica; 0.0010-mf, $\pm 5\%$ ; 3,000-v.	P-a tank tuning.
527	3D9020V-5	CAPACITOR: variable; max 156 mmf, $\pm 3\%$ ; min 20 mmf, $\pm 1.5$ mmf.	P-a tank tuning.
528	2C8005A/D17	COIL: tapped inductance; mounted in 521.	Antenna coupling.
529	3Z9604-2	SWITCH: rotary; 6-position; (same as 328).	Antenna coupling.



## f. PARTS DATA FOR TRANSMITTER TUNING UNIT TU-6-(\*) (fig. 28).

Ref. symbol	Sig. Corps stock No.	Name of part and description	Function
601	2C8006A/D3	COIL ASSEMBLY: ceramaic form; includes temperature compensator.	M-o tank inductor.
602	3Z9612A	SWITCH: rotary; (ganged with 622).	M-o band change.
603	3D9050-3	CAPACITOR: mica; 0.00005-mf, $\pm 5\%$ ; 3,000-v.	M-o tank tuning.
607	3D9015V-9	CAPACITOR: variable; max 77 mmf, $\pm 2\%$ ; min 15 mmf, $\pm 1.5$ mmf.	M-o tank tuning.
608	2C8006A/D14	COIL: r-f choke; (ganged with 614).	P-a grid choke.
609	3D9400-6	CAPACITOR: mica; 0.0004-mf, $\pm 10\%$ ; 2,500 vdew.	P-a grid blocking.
610	3D9400-6	CAPACITOR: mica; 0.0004-mf, $\pm 10\%$ ; 2,500 vdew.	M-o grid blocking.
611	2C8006A/D15	COIL: r-f choke.	M-o grid choke.
612	3D9008V2	CAPACITOR: variable; max 26 mmf, $\pm 4\%$ ; min 8 mmf, $\pm 1.5$ mmf.	P-a neutralizing.
613	2C8006A/D30	CAPACITOR: thermal compensator; (ganged with 603).	M-o tank tuning.
614	3Z6001E5	RESISTOR: 15 ohm; 4.5-w; (ganged with 608).	P-a grid parasitic suppressor.
621	2C8006A/D4	COIL: inductance; contains 628.	P-a tank inductor.
622	3Z9612A	SWITCH: rotary; (ganged with 602).	P-a band change.
623	3D9050-1	CAPACITOR: mica; 0.00005-mf, $\pm 5\%$ ; 3,000-v.	P-a tank tuning.
627	3D9019V	CAPACITOR: variable; max 16mmf, $\pm 3\%$ ; min 19 mmf, $\pm 1.5$ mmf.	P-a tank tuning.
628	2C8006A/D23	COIL: tapped-inductance; mounted in 621.	Antenna coupling.
629	3Z9604-2	SWITCH: rotary; 6-position.	Antenna coupling.

## g. PARTS DATA FOR TRANSMITTER TUNING UNIT TU-7-(\*) (fig. 28).

Ref. symbol	Sig. Corps stock No.	Name of part and description	Function
701	2C8007B/D7	COIL: ceramic form; includes m-o temperature compensator.	M-o tank inductor.
702	3D9023V	CAPACITOR: variable; max 111-mmf, $\pm 2\%$ ; min 23-mmf, $\pm 1$ -mmf.	M-o tank tuning.
703	3D9400-6	CAPACITOR: 0.0004-mf, $\pm 10\%$ ; 2,500 vdew.	M-o grid blocking.
704	2C8006A/D15	COIL: r-f choke.	M-o grid choke.
705	3D9400-6	CAPACITOR: 0.0004-mf, $\pm 10\%$ ; 2,500 vdew.	P-a grid blocking.
706	2C8007A/D3	COIL: r-f choke.	P-a grid choke.
707	3D9008V2	CAPACITOR: variable; max 26-mmf, $\pm 4\%$ ; min 8mmf, $\pm 1.5$ -mmf.	P-a neutralizing.
721	2C8007/D10	COIL: contains antenna inductance 723.	P-a tank inductor.
722	3D9019V-1	CAPACITOR: variable; max 115-mmf, $\pm 2.5\%$ ; min 19-mmf, $\pm 1.5$ -mmf.	P-a tank tuning.
723	2C8007/D10	COIL: tapped-inductance; mounted in 721.	Antenna coupling.
724	3Z9604-2	SWITCH: rotary; 6-position.	Antenna coupling.

## h. PARTS DATA FOR TRANSMITTER TUNING UNIT TU-8-(\*) (fig. 28).

Ref. symbol	Sig. Corps stock No.	Name of part and description	Function
801	2C8008B/D8	COIL: r-f inductance; ceramic form; includes temperature compensator.	M-o tank inductor.
802	3D9014V-1	CAPACITOR: variable; max 66-mmF, $\pm 2\%$ ; min 14-mmF, $\pm 1$ mmF.	M-o tank tuning.
803	3D9400-6	CAPACITOR: 0.0004-mf, $\pm 10\%$ ; 2,500 vdcw.	M-o grid blocking.
804	2C8008A/D5	COIL: r-f choke.	M-o grid choke.
805	3D9400-6	CAPACITOR: 0.0004-mf, $\pm 10\%$ ; 2,500 vdcw.	P-a grid blocking.
806		COIL: r-f choke.	P-a grid choke.
807	3D9008V2	CAPACITOR: variable; max 26-mmF, $\pm 4\%$ ; min 8-mmF, $\pm 1.5$ mmF.	P-a neutralizing.
821	2C8008/D2	COIL: r-f inductance; contains 823.	P-a tank inductor.
822	3D9015V-10	CAPACITOR: variable; max 81-mmF, $\pm 3\%$ ; min 15 mmF, $\pm 1.5$ mmF.	P-a tank tuning.
823	2C8008/D2	COIL: tapped-inductance; mounted in 821.	Antenna coupling.
824	3Z9604-2	SWITCH: rotary; 6-position.	Antenna coupling.

## i. PARTS DATA FOR TRANSMITTER TUNING UNIT TU-9-(\*) (fig. 28).

Ref. symbol	Sig. Corps stock No.	Name of part and description	Function
901	2C8009A/D9	COIL: r-f inductance; ceramic form; includes temperature compensator.	M-o tank inductor.
902	3D9015V-9	CAPACITOR: variable; max 77-mmF, $\pm 2\%$ ; min 15-mmF, $\pm 1$ mmF.	M-o tank tuning.
903	3D9004-6	CAPACITOR: mica; 0.0004-mf, $\pm 10\%$ ; 2,500 vdcw.	M-o grid blocking.
904	2C8009A/D6	COIL: r-f choke.	M-o grid choke.
905	3D9004-6	CAPACITOR: mica; 0.0004-mf, $\pm 10\%$ ; 2,500 vdcw.	P-a grid blocking.
906	2C8009A/D7	COIL: r-f choke.	P-a grid choke.
907	3D9008V2	CAPACITOR: variable; max 26 mmF, $\pm 4\%$ ; min 8-mmF, $\pm 1.5$ mmF.	P-a neutralizing.
909	3D9400-3	CAPACITOR: 0.0004-mf, $\pm 5\%$ ; 5,000 vdcw.	M-o bypass.
921	2C8009A/D10	COIL: r-f inductance; contains 923.	P-a tank inductor.
922	3D9019V-1	CAPACITOR: variable; max 116 mmF, $\pm 2.5\%$ ; min 19-mmF, $\pm 1.5$ mmF.	P-a tank tuning.
923	2C8009A/D10	COIL: tapped-inductance; mounted in 921.	Antenna coupling.
924	3Z9604-2	SWITCH: rotary; 6-position.	Antenna coupling.

## j. PARTS DATA FOR TRANSMITTER TUNING UNIT TU-10-(\*) (fig. 28).

Ref. symbol	Sig. Corps stock No.	Name of part and description	Function
1001	2C8010A/D17	COIL: r-f inductance; ceramic form; includes temperature compensator.	M-o tank inductor.
1002	3D9014V-2	CAPACITOR: variable; max 62-mmF, $\pm 2\%$ ; min 14-mmF, $\pm 1$ mmF.	M-o tank tuning.
1003	3D9400-6	CAPACITOR: 0.0004-mf, $\pm 10\%$ ; 2,500 vdcw.	M-o grid blocking.
1004	2C8010A/D7	COIL: r-f choke.	M-o grid choke.
1005	3D9400-6	CAPACITOR: 0.0004-mf, $\pm 10\%$ ; 2,500 vdcw.	P-a grid blocking.
1006	2C8010A/D8	COIL: r-f choke.	P-a grid choke.
1007	3D9008V2	CAPACITOR: variable; max 26 mmF, $\pm 4\%$ ; min 8-mmF, $\pm 1.5$ mmF.	P-a neutralizing.
1009	3D9400-3	CAPACITOR: 0.0004-mf, $\pm 5\%$ ; 5,000 vdcw.	M-o bypass.
1010	2C8010A/D16	COIL: r-f choke.	M-o plate filter.
1021	2C8010A/D19	COIL: r-f inductance; contains 1023.	P-a tank inductor.
1022	3D9019V-1	CAPACITOR: variable; max 116 mmF, $\pm 2.5\%$ ; min 19-mmF, $\pm 1.5$ mmF.	P-a tank tuning.
1023	2C8010A/D19	COIL: tapped r-f inductance; mounted in 1021.	Antenna coupling.
1024	3Z9604-2	SWITCH: rotary; 6-position.	Antenna coupling.

## k. PARTS DATA FOR TRANSMITTER TUNING UNIT TU-22-(\*) (fig. 28).

Ref. symbol	Sig. Corps stock No.	Name of part and description	Function
2201	2C8022A/36	COIL: variometer; bakelite form and rotor.	M-o tank inductor.
2202	3C324-1	COIL: r-f choke.	M-o plate choke.
2203	3C324-2	COIL: r-f choke.	M-o grid choke.
2204	3DA2-62	CAPACITOR: mica; 0.002-mf, $\pm 10\%$ ; 5,000-v.	M-o grid.
2205		CAPACITOR: thermal compensator; (ganged with 2208).	M-o plate tank.
2206	3C324-3	COIL: r-f choke.	P-a grid choke.
2207	3Z9615	SWITCH: rotary; 3-position; (ganged with 2222).	M-o band change.
2208	3D9100-11	CAPACITOR: 0.0001-mf, $\pm 2\%$ ; 3,000 vdcw.	M-o tank tuning.
2209	3D9100-1	CAPACITOR: 0.0002-mf, $\pm 5\%$ ; 3,000 vdcw.	M-o tank tuning.
2210	3DA3-10	CAPACITOR: mica; 0.003-mf, $\pm 5\%$ ; 5,000 vdcw.	M-o to p-a coupling.
2211	3DA3-10	CAPACITOR: mica; 0.003-mf, $\pm 5\%$ ; 5,000 vdcw.	M-o to p-a coupling.
2212	3DA3.500	CAPACITOR: 0.0035-mf, $\pm 5\%$ ; 5,000-v.	M-o to p-a coupling.
2213	3DA2.40-1	CAPACITOR: 0.0024-mf, $\pm 5\%$ ; 5,000-v.	M-o to p-a coupling.
2214	3DA2.40-1	CAPACITOR: 0.0024-mf, $\pm 5\%$ ; 5,000-v.	M-o to p-a coupling.
2215	3DA3.500	CAPACITOR: 0.0035-mf, $\pm 5\%$ ; 5,000-v; (ganged with 2220).	M-o to p-a coupling.
2216	3D9008V2	CAPACITOR: variable; max 26-mmF, $\pm 4\%$ ; min 8-mmF, $\pm 1.5$ mmF.	P-a neutralizing.
2217	3Z6001E5	RESISTOR: 15-ohm; 4.5-w; (ganged with 2203).	M-o grid parasitic suppressor.
2218	3DA2-62	CAPACITOR: mica; 0.002-mf, $\pm 10\%$ ; 5,000-v.	P-a grid.
2219		CAPACITOR: thermal compensator; (ganged with 2209).	M-o tank.
2220		CAPACITOR: thermal compensator; (ganged with 2210 and 2215).	M-o tank.
2221	2C8022A/35	COIL: variometer; bakelite form and rotor.	P-a tank and antenna coupling coil.
2222	3Z9615	SWITCH: rotary; 3-position; (ganged with 2207).	P-a band change.
2223	3D9100-32	CAPACITOR: 0.0001-mf, $\pm 5\%$ ; 3,000-v.	P-a tank tuning.
2224	3D9200-9	CAPACITOR: mica; 0.0002-mf, $\pm 5\%$ ; 3,000-v.	P-a tank tuning.
2225	3D9800-2	CAPACITOR: 0.0008-mf, $\pm 5\%$ ; 3,000 vdcw.	P-a tank tuning.
2227	2C8022A/35	COIL: tapped inductance; (part of 2221).	Antenna coupling.
2228	3Z9604-2	SWITCH: rotary; 6-position.	Antenna coupling.
2229	3DA2-38	CAPACITOR: 0.002-mf, $\pm 2\%$ 5,000-v.	Antenna coupling.

l. PARTS DATA FOR TRANSMITTER TUNING UNIT TU-26-(\*) (fig. 28).

Ref. symbol	Sig. Corps stock No.	Name of part and description	Function
2601		COIL: variometer; bakelite form; molded rotor.	M-o tank inductor.
2602	3C324-1	COIL: r-f choke.	M-o plate choke.
2603	3C324-2	COIL: r-f choke.	M-o grid choke.
2604	3DA2-62	CAPACITOR: mica; 0.002-mf, $\pm 10\%$ ; 5,000-v.	M-o grid blocking.
2605	3D9017-3	CAPACITOR: thermal compensator; 17-mmf, $\pm 1$ -mmf.	M-o plate tank tuning.
2606	3C324-3	COIL: r-f choke.	P-a grid choke.
2607	3Z9615	SWITCH: rotary, 3-position; (ganged with 2622).	M-o band change.
2608	3D9400-11	CAPACITOR: 0.0004-mf, $\pm 5\%$ ; 3,000-v.	M-o tank tuning.
2609	3D9400-11	CAPACITOR: 0.0004-mf, $\pm 5\%$ ; 3,000-v; (ganged with 2619).	M-o tank tuning.
2610	3DA5-29	CAPACITOR: 0.005-mf, $\pm 5\%$ ; 5,000 vdct; (ganged with 2620).	M-o to p-a coupling.
2611	3DA4-16	CAPACITOR: 0.004-mf, $\pm 5\%$ ; 5,000-v.	M-o to p-a coupling.
2612	3DA4-16	CAPACITOR: 0.004-mf, $\pm 5\%$ ; 5,000-v.	M-o to p-a coupling.
2613	3DA3.500	CAPACITOR: 0.0035-mf, $\pm 5\%$ ; 5,000-v.	M-o to p-a coupling.
2614	3DA3.500	CAPACITOR: 0.0035-mf, $\pm 5\%$ ; 5,000-v.	M-o to p-a coupling.
2615	3DA5-29	CAPACITOR: 0.005-mf, $\pm 5\%$ ; 5,000 vdct.	M-o to p-a coupling.
2616	3D9008V2	CAPACITOR, variable: max 26-mmf, $\pm 4\%$ ; min 8-mmf, $\pm 1.5$ mmf.	P-a neutralizing.
2617	3Z6001E5	RESISTOR: 15-ohm, 4.5-w; (ganged with 2603).	M-o grid parasitic suppressor.
2618	3DA2-62	CAPACITOR: mica; 0.002-mf, $\pm 10\%$ ; 5,000-v.	P-a grid.
2619	3D9012-6	CAPACITOR: thermal compensator; 12-mmf, $\pm 1$ mmf; (ganged with 2609).	M-o plate tank.
2620	3D9035-7	CAPACITOR: thermal compensator; 35-mmf. $\pm 0$ mmf, $-2$ mmf; (ganged with 2610).	M-o plate tank.
2621		COIL: variometer; bakelite form; molded rotor.	P-a tank and antenna coupling coil.
2622	3Z9615	SWITCH: rotary; 3-position; (ganged with 2607).	P-a band change.
2623	3D9400-12	CAPACITOR: 0.004-mf, $\pm 5\%$ ; 3,000-v.	P-a tank tuning.
2624	3D9500-51	CAPACITOR: 0.005-mf, $\pm 5\%$ ; 3,000-v.	P-a tank tuning.
2625	3D9700-4	CAPACITOR: 0.0007-mf, $\pm 5\%$ ; 3,000-v.	P-a tank tuning.
2627		COIL: tapped inductance; (part of 2621).	Antenna coupling.
2628	3Z9604-2	SWITCH: rotary, 6 position.	Antenna coupling.

### 34. Antenna Tuning Unit BC-306-(\*)

a. GENERAL. Antenna Tuning Unit BC-306-(\* ) (figs. 29, 30, and 31) is an external tuning unit used for loading the antenna when Radio Transmitter BC-191-(\* ) is used with tuning units covering frequencies below 800 kilocycles. Coil 1502 is a tapped variometer used to furnish the additional series inductive reactance loading required to resonate the antenna on the

lower frequencies. The amount of required inductive reactance is selected and adjusted by the variable rotor labeled ANTENNA VARIOMETER F, and the three-gang tap switch 1501, labeled ANTENNA VARIOMETER SWITCH E. The three-gang type of switch construction allows arrangement of circuits so that the antenna tuning unit is cut out of the antenna circuit when control E is on tap 1.

#### b. PARTS DATA (fig. 31).

Ref. symbol	Sig. Corps stock No.	Name of part and description	Function
1501		SWITCH: rotary; 5-position; 3-section.	Antenna variometer adjustment.
1502		COIL: tapped variometer.	Antenna tuning.

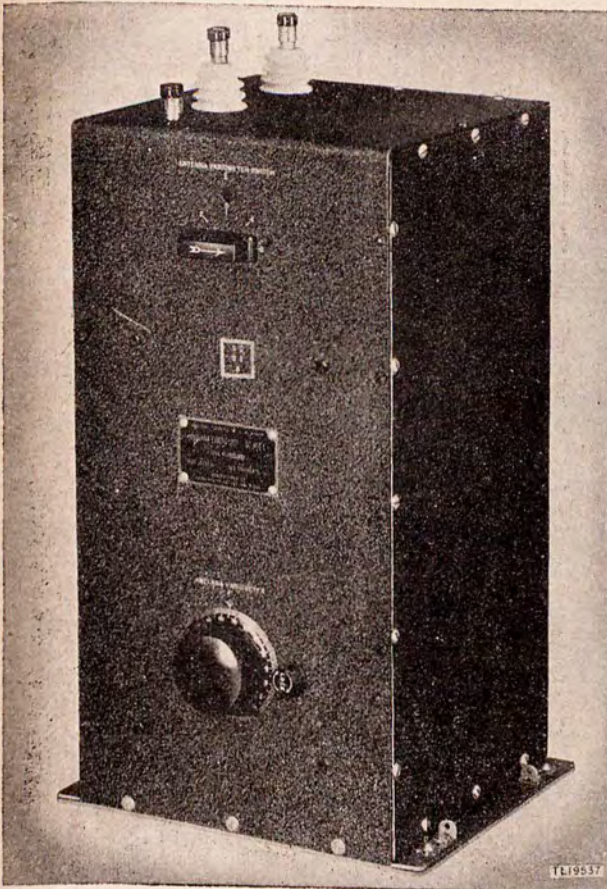

Figure 29. Antenna Tuning Unit BC-306-(\*).

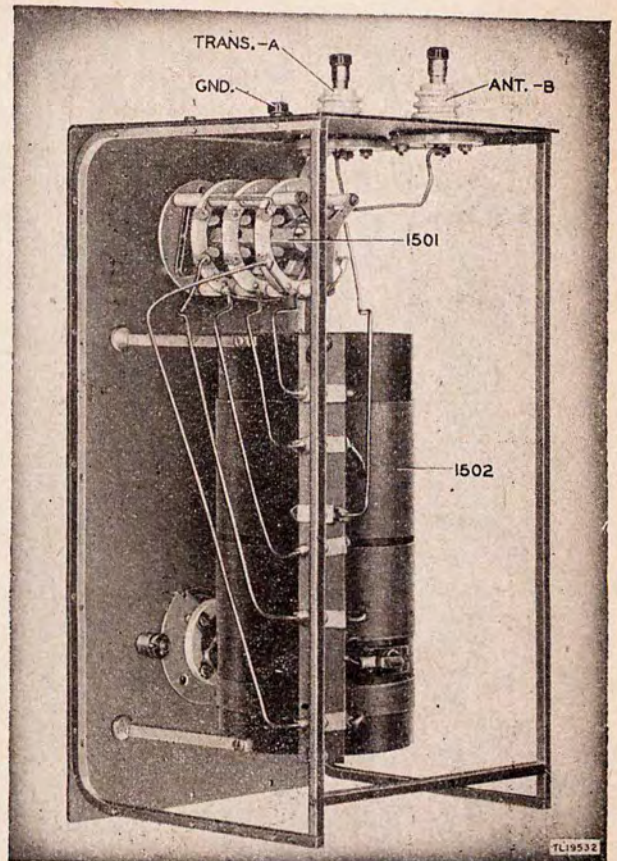

Figure 30. Antenna Tuning Unit BC-306-(\*), case removed.

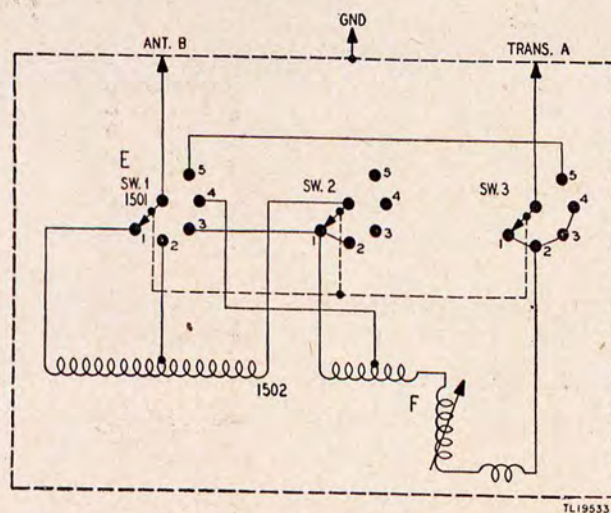

Figure 31. Antenna Tuning Unit BC-306-(\*), schematic diagram.

35. Parts Identification

The following illustrations are provided to aid

in identifying and servicing the various parts of Radio Transmitter BC-191-(\*).

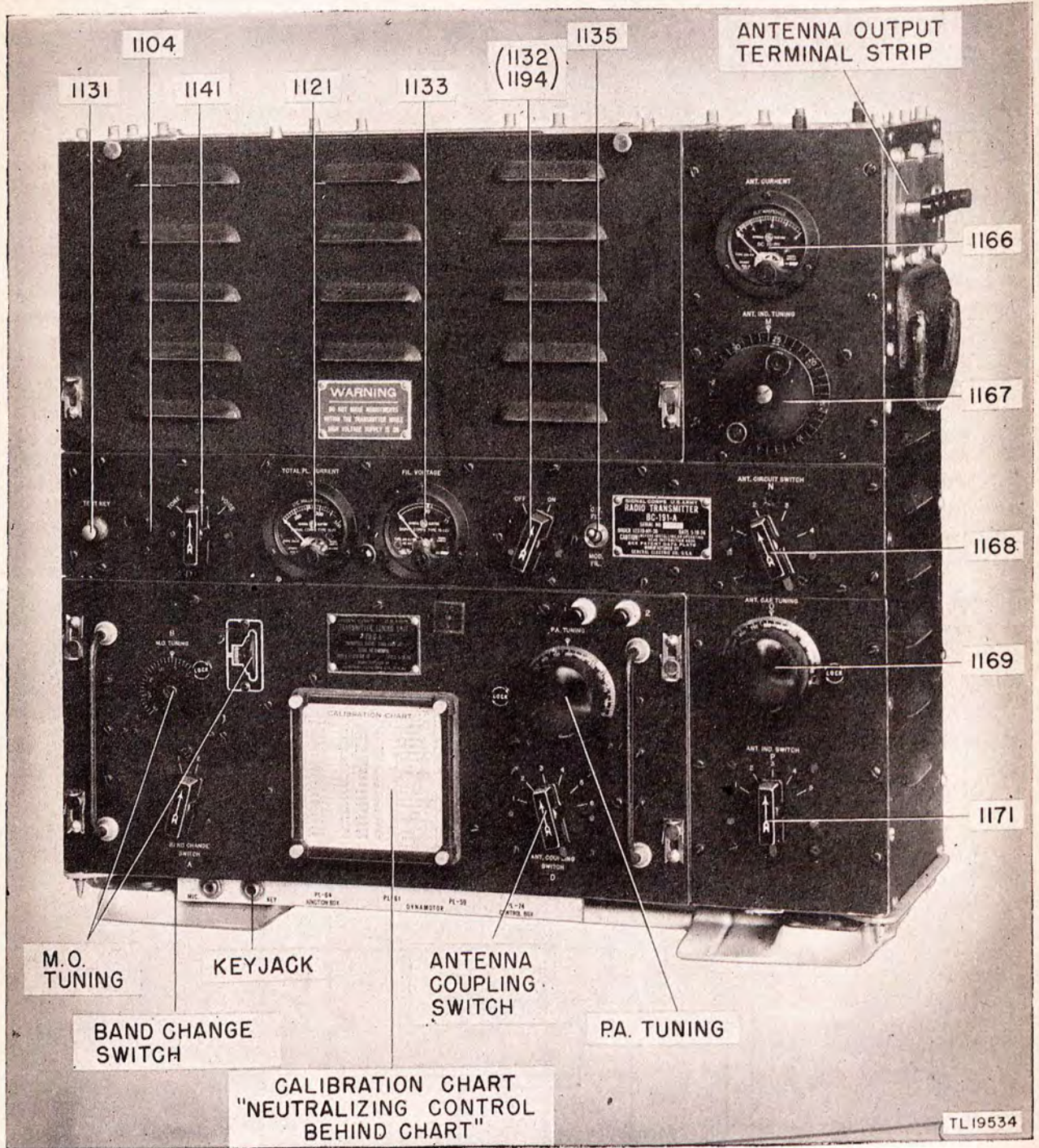

Figure 32. Radio Transmitter BC-191-(\*), front panel controls.

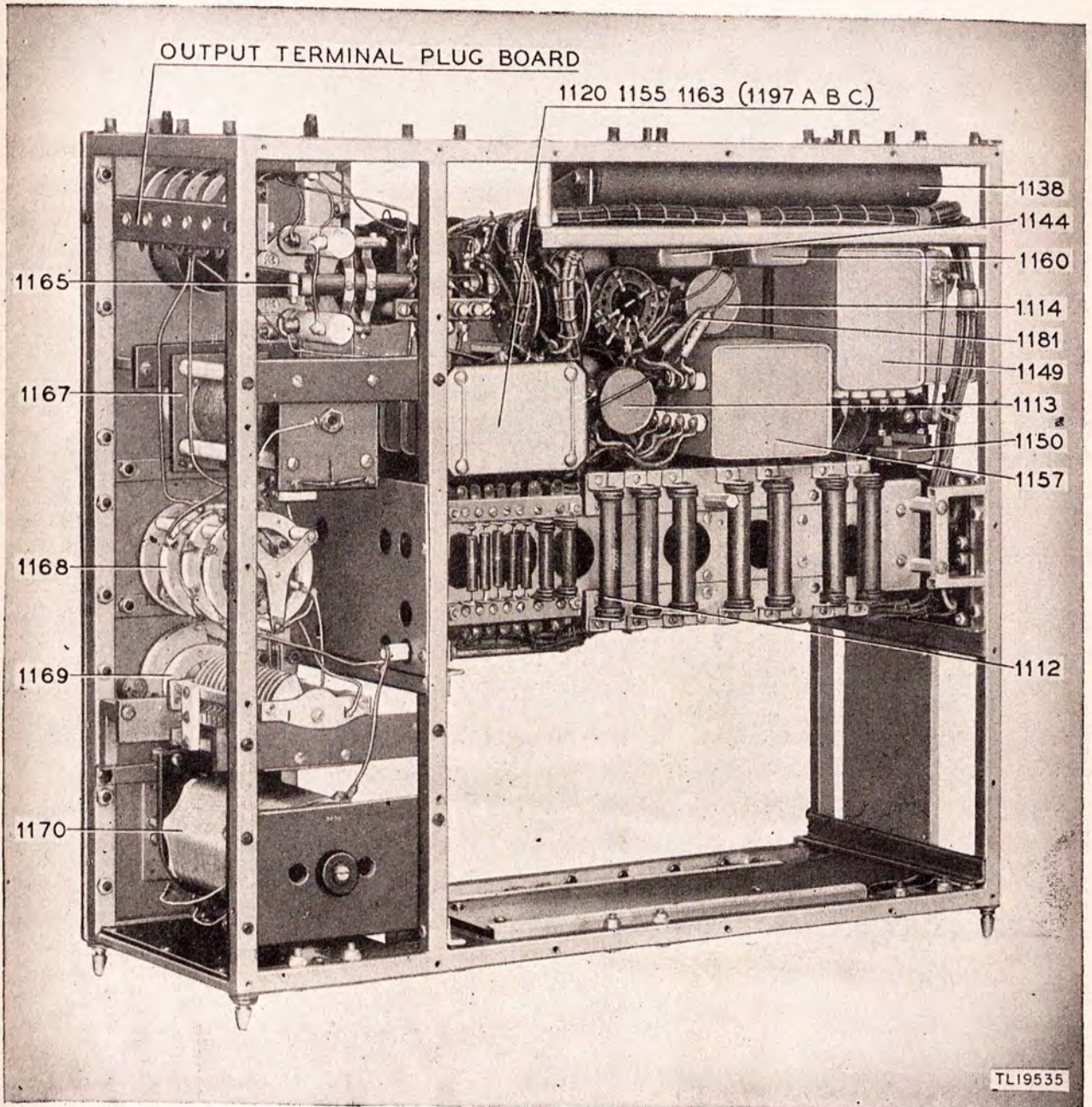

Figure 33. Radio Transmitters BC-191-(\*), left rear view, panels removed.



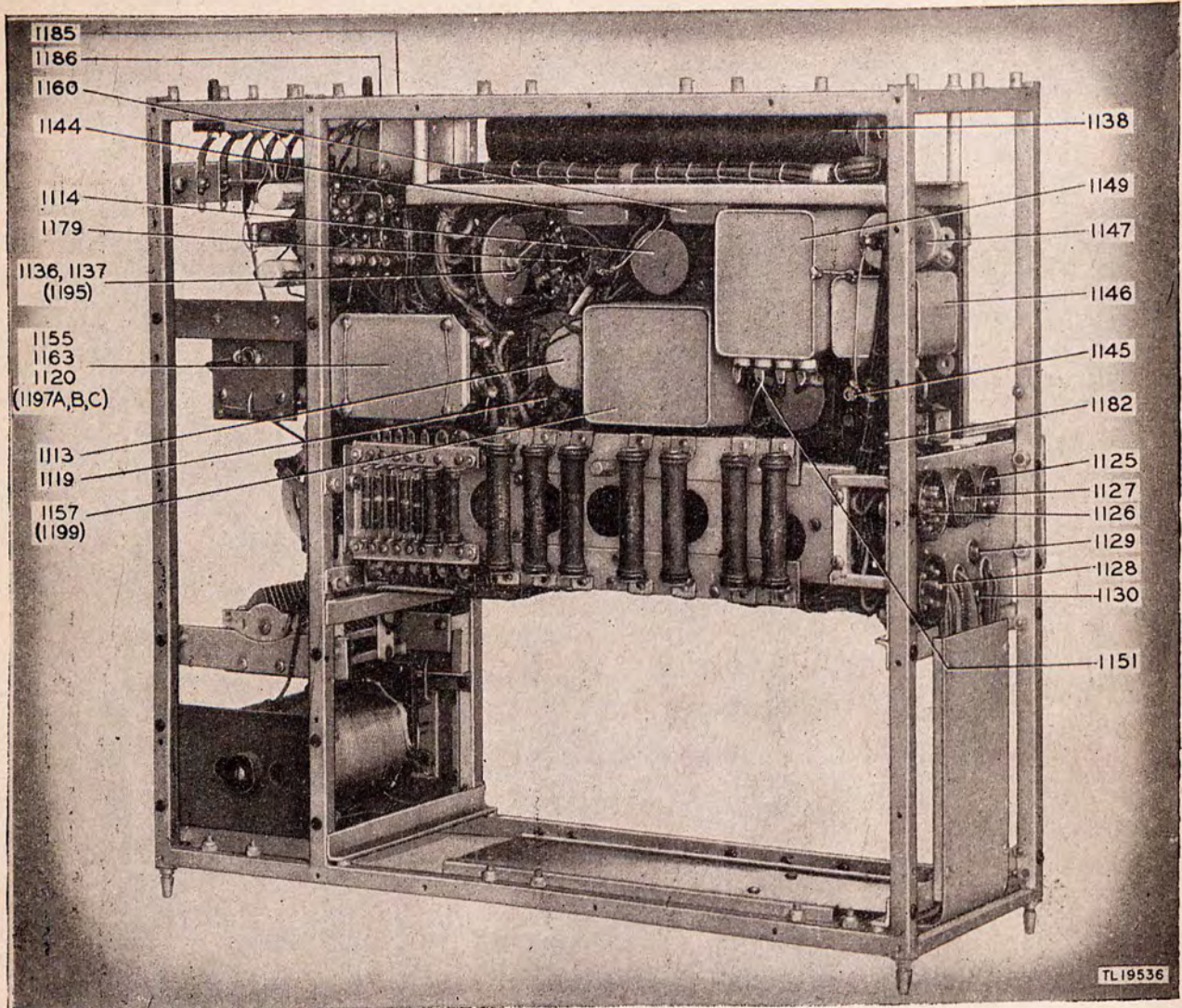

Figure 34. Radio Transmitter BC-191-(\*), right rear view, panels removed.

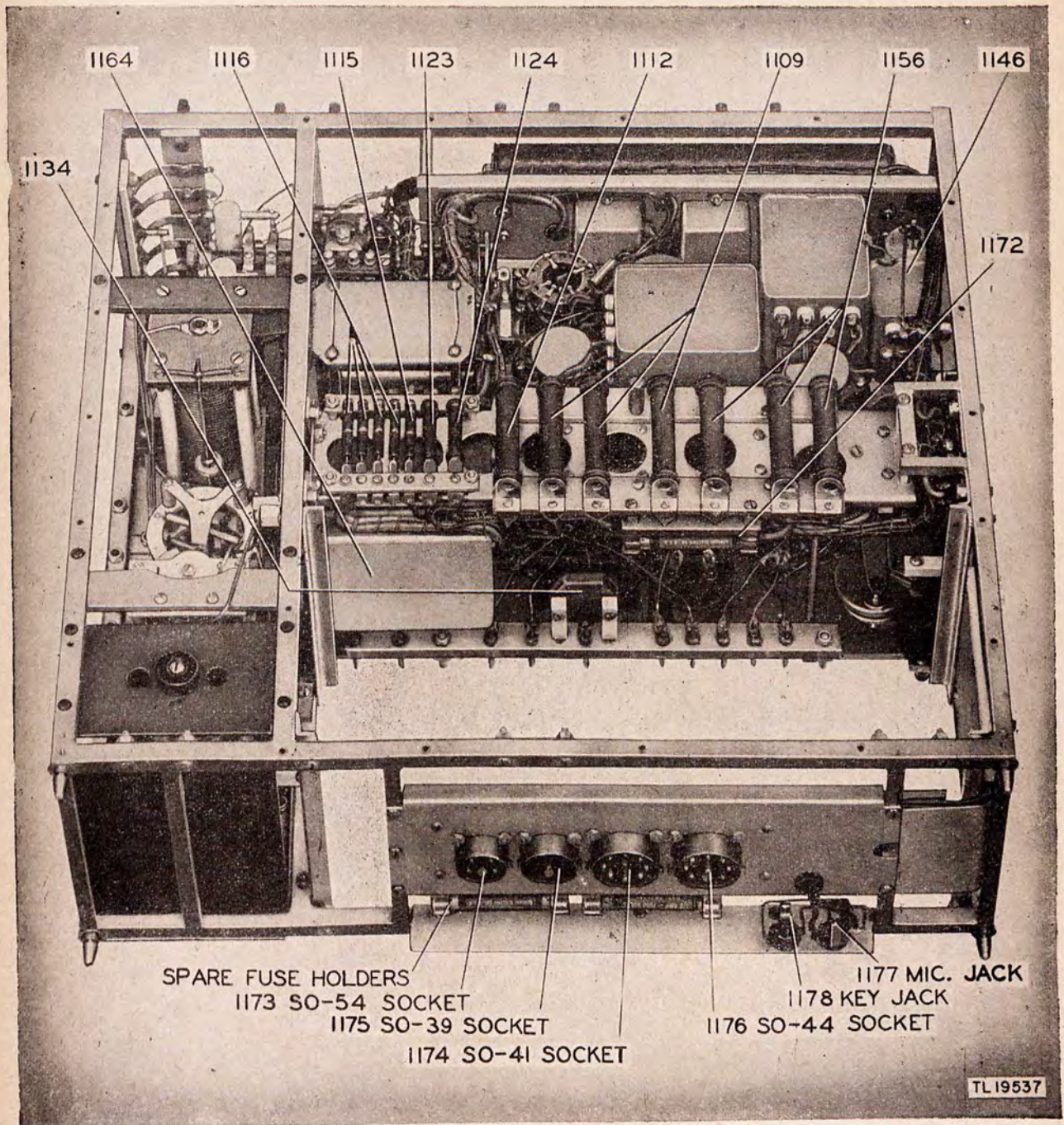

Figure 35. Radio Transmitter BC-191-(\*), bottom rear view, panels removed.

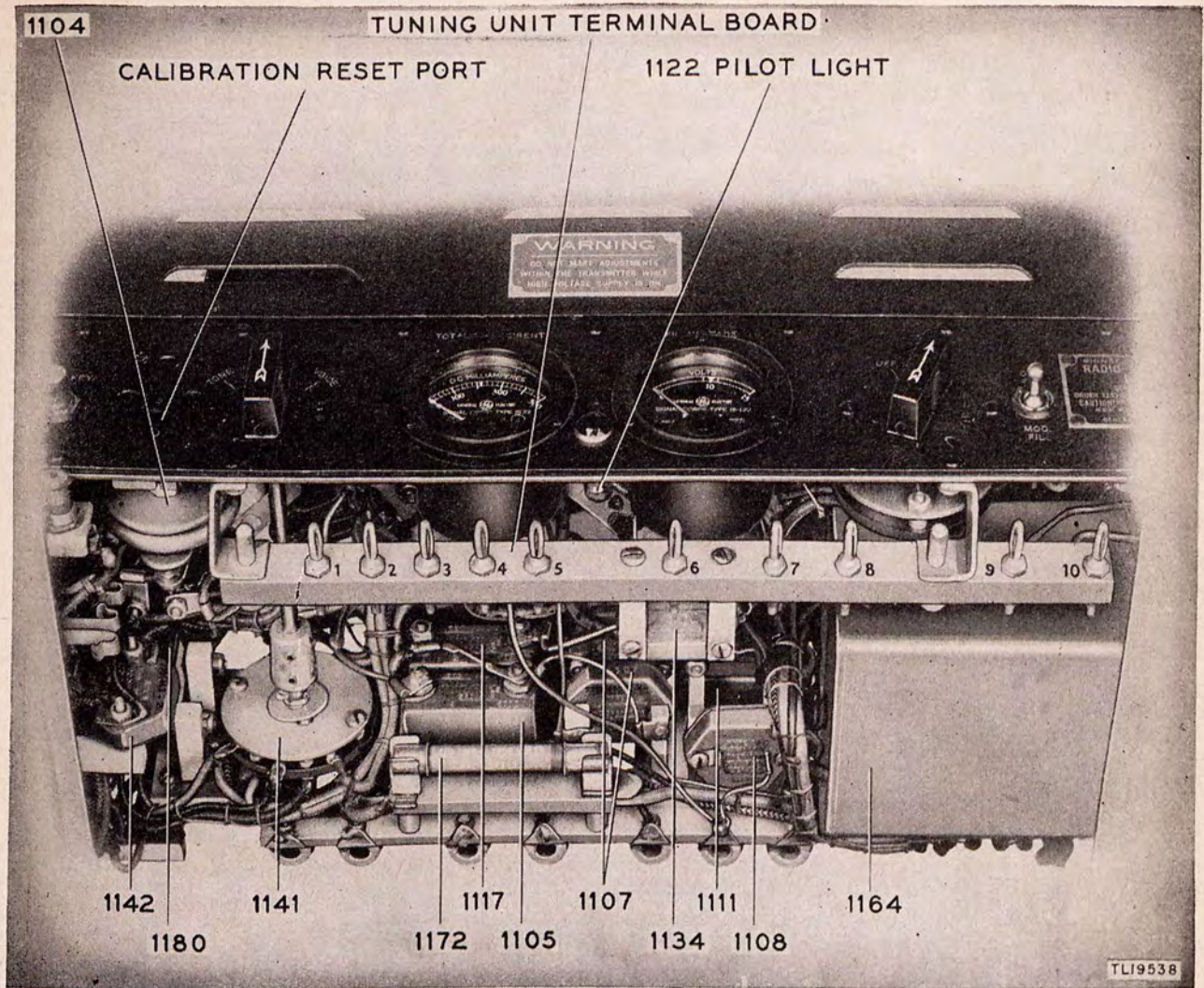
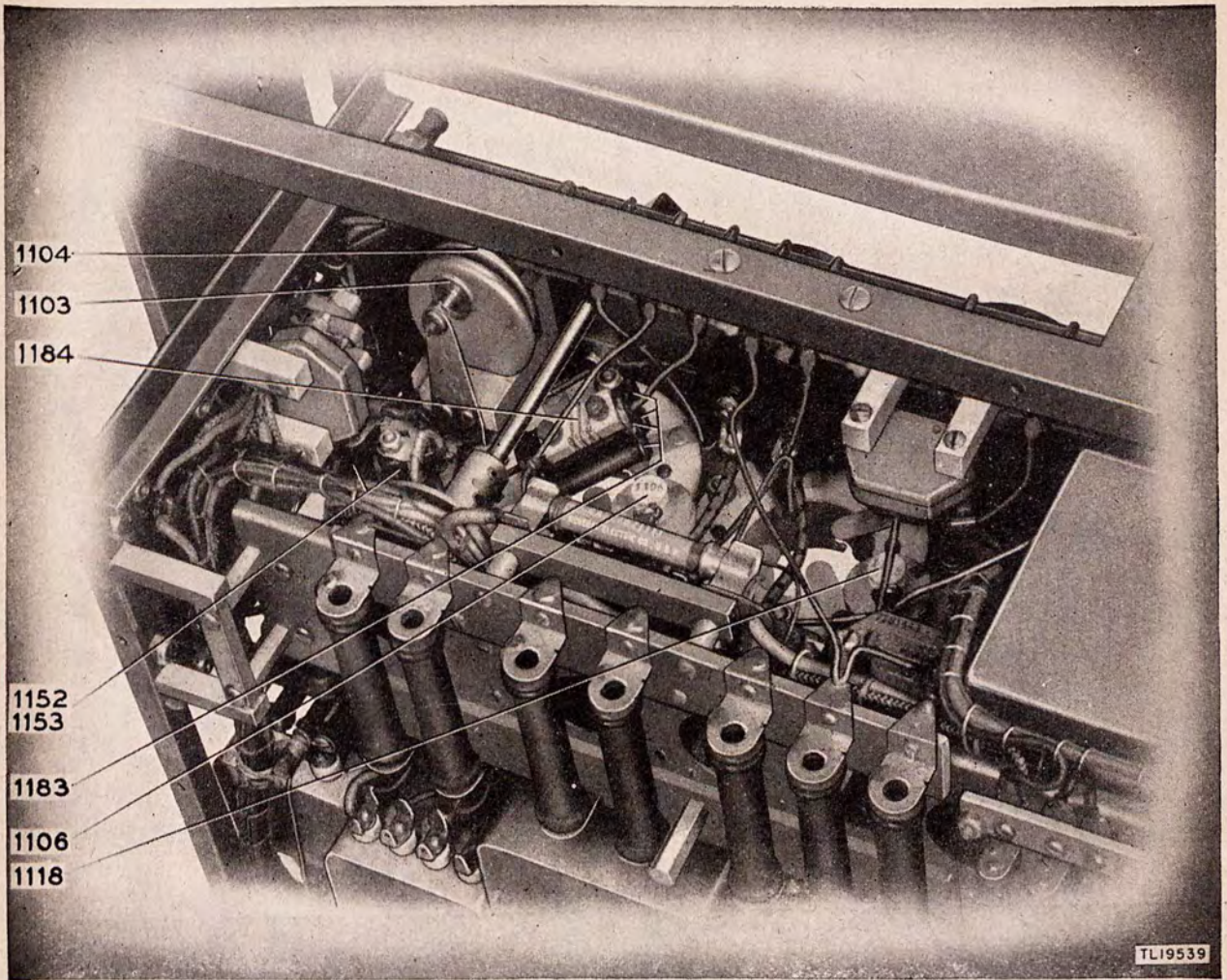

Figure 36. Radio Transmitter BC-191-(\*), detail view of back interior.



*Figure 37. Radio Transmitter BC-191-(\*), detail view of front interior.*

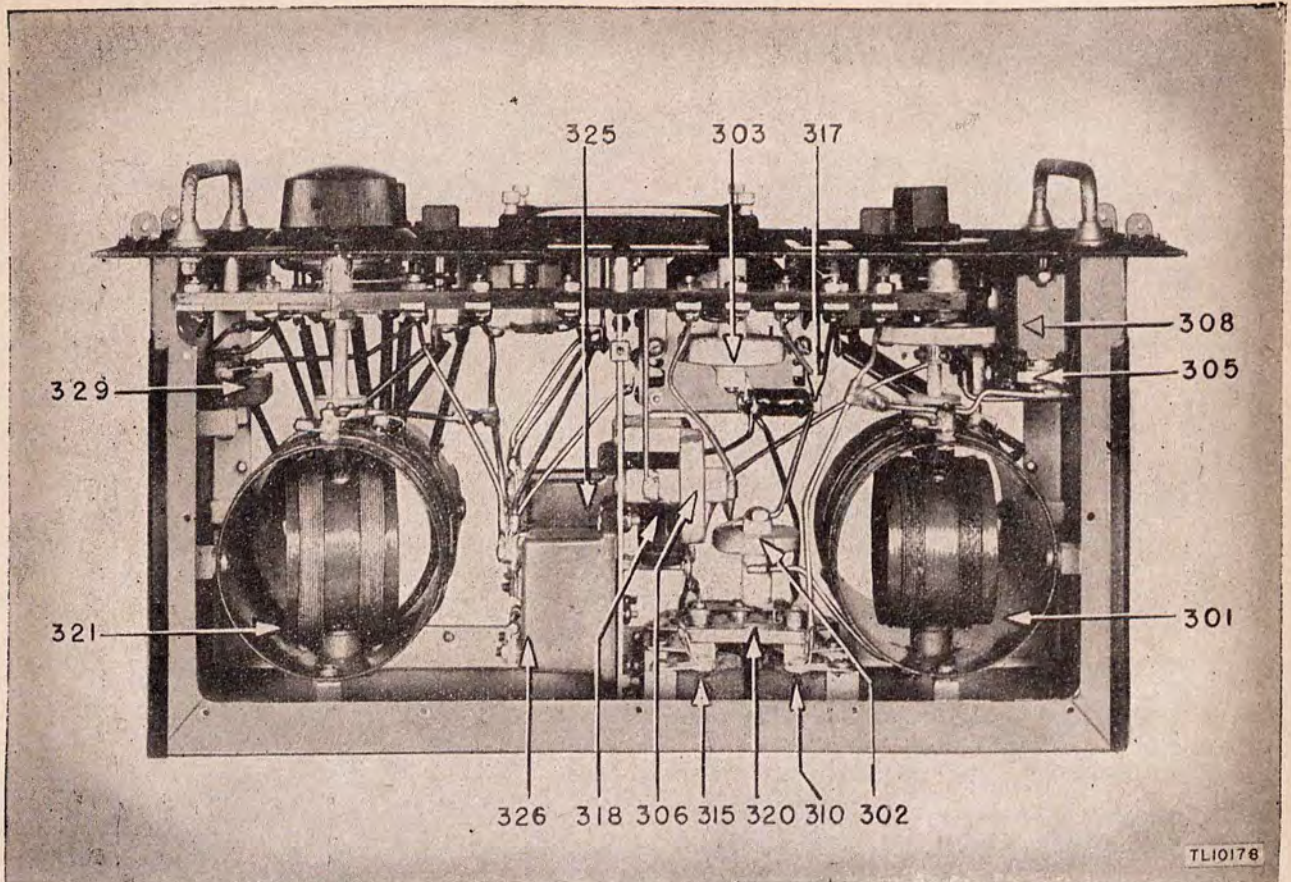

Figure 38. Transmitter Tuning Unit TU-3-(\*), top view, cover removed.

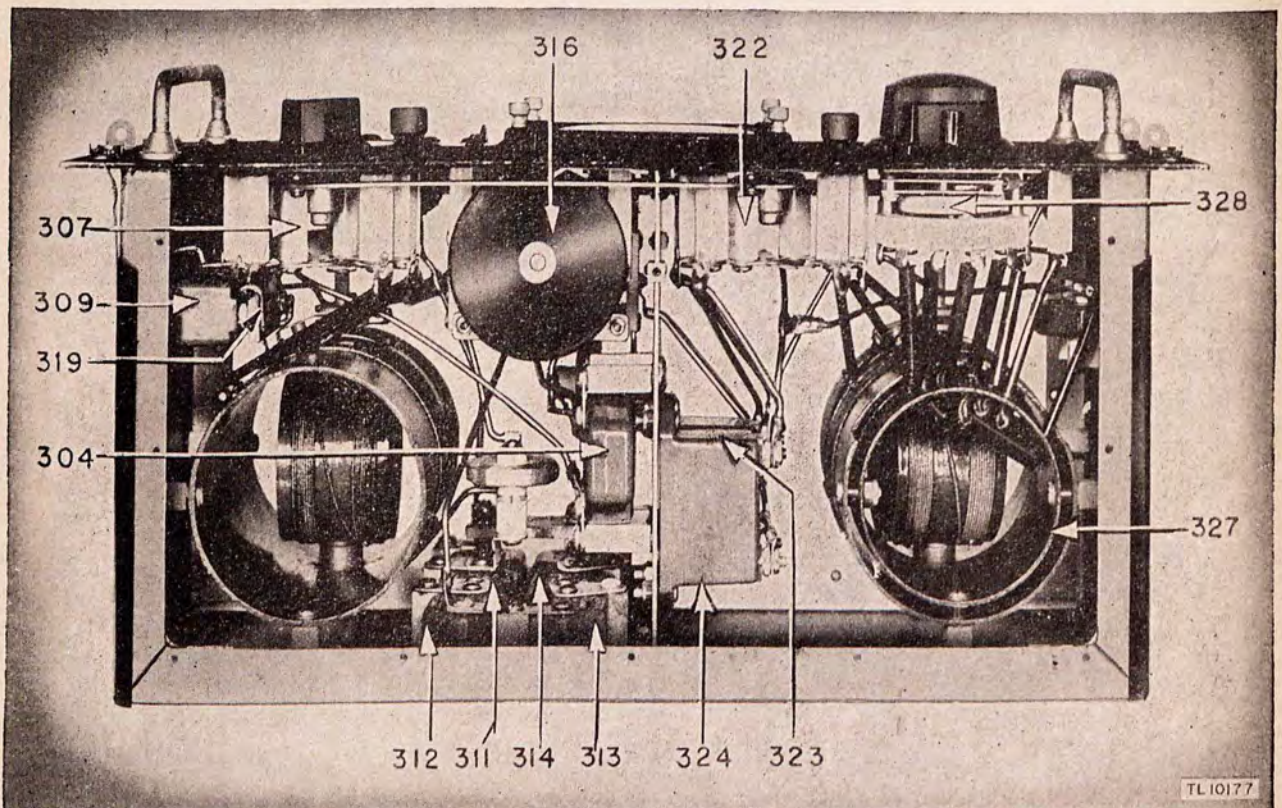

Figure 39. Transmitter Tuning Unit TU-3-(\*), bottom view, cover removed.

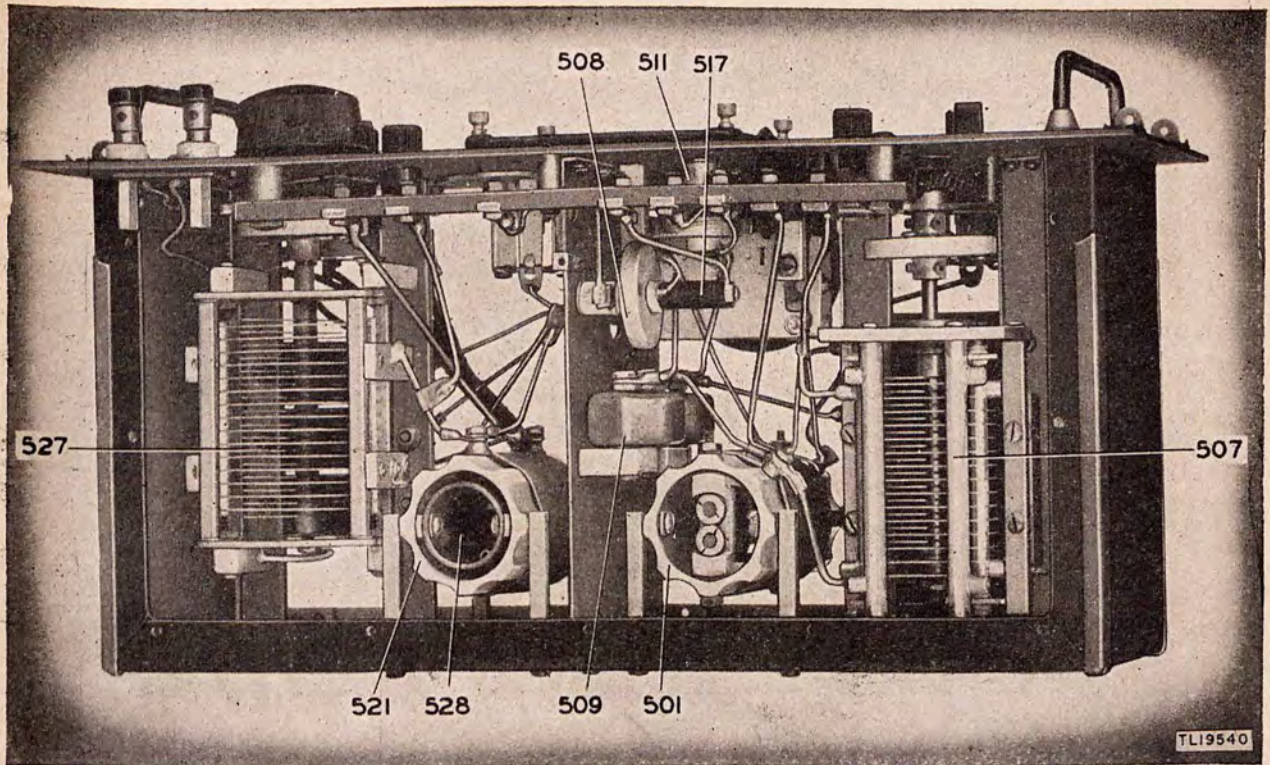

Figure 40. Transmitter Tuning Unit TU-5-(\*), top view, cover removed.

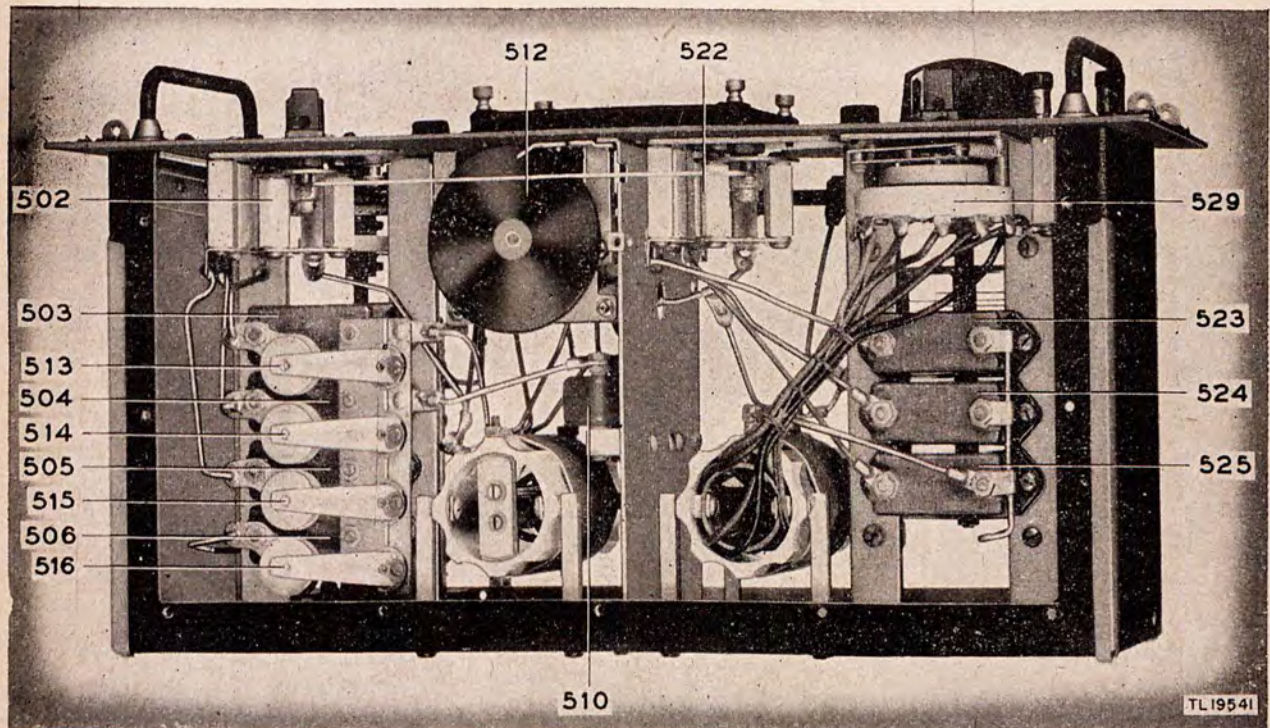

Figure 41. Transmitter Tuning Unit TU-5-(\*), bottom view, cover removed.

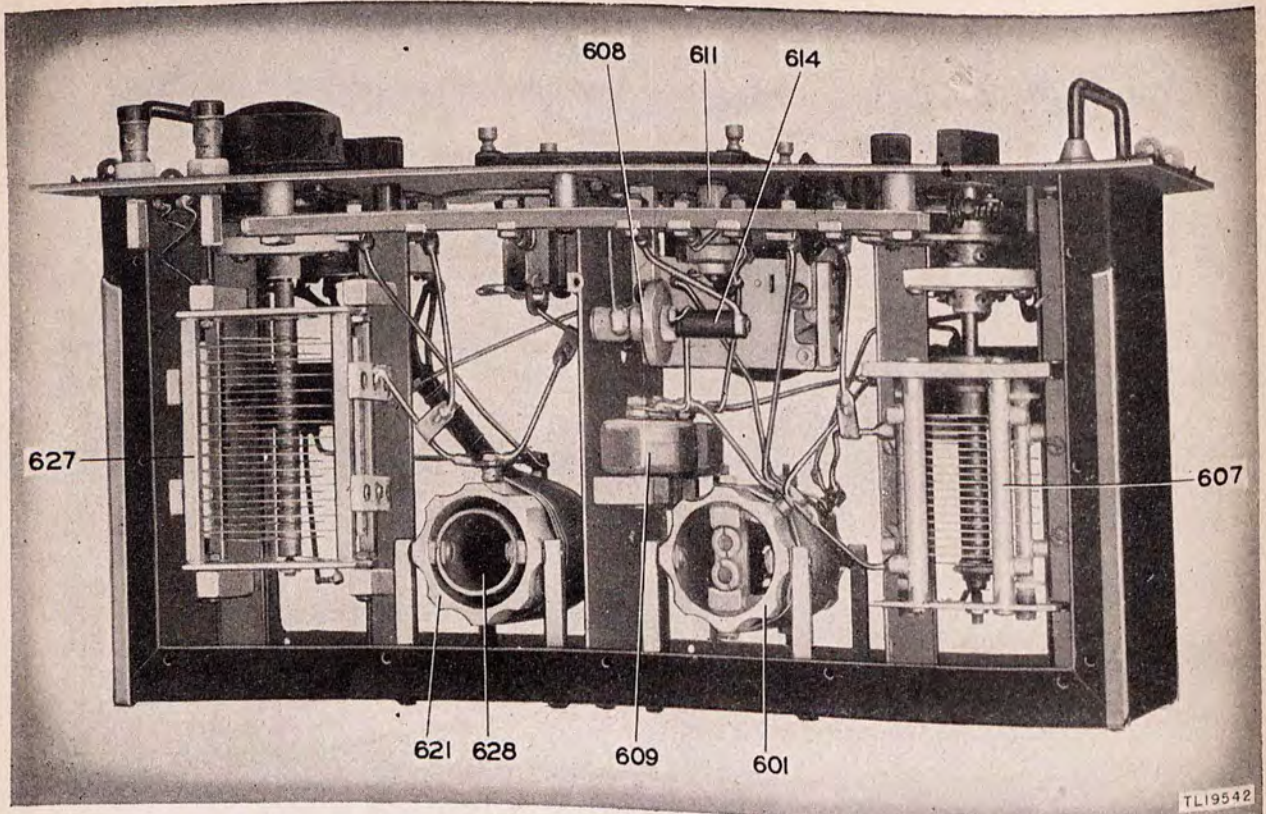

Figure 42. Transmitter Tuning Unit TU-6-(\*), top view, cover removed.

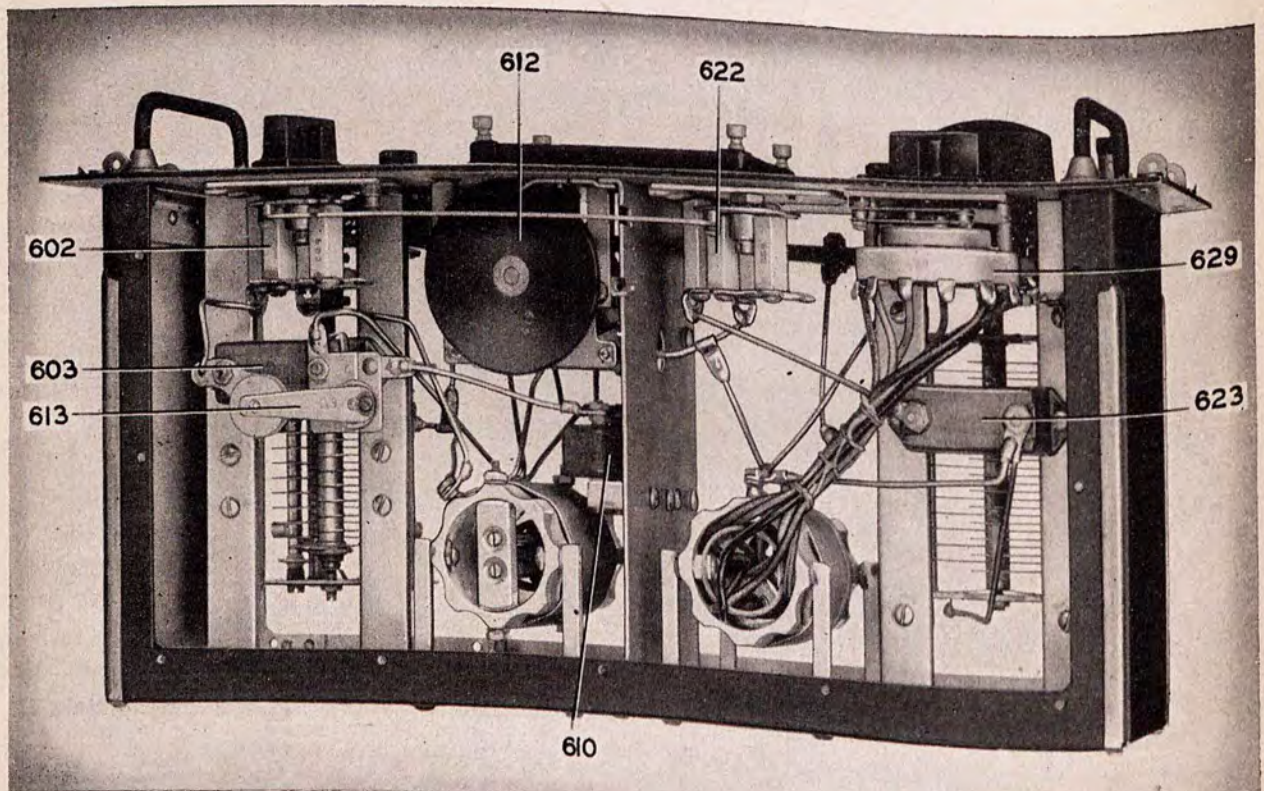

Figure 43. Transmitter Tuning Unit TU-6-(\*), bottom view, cover removed.

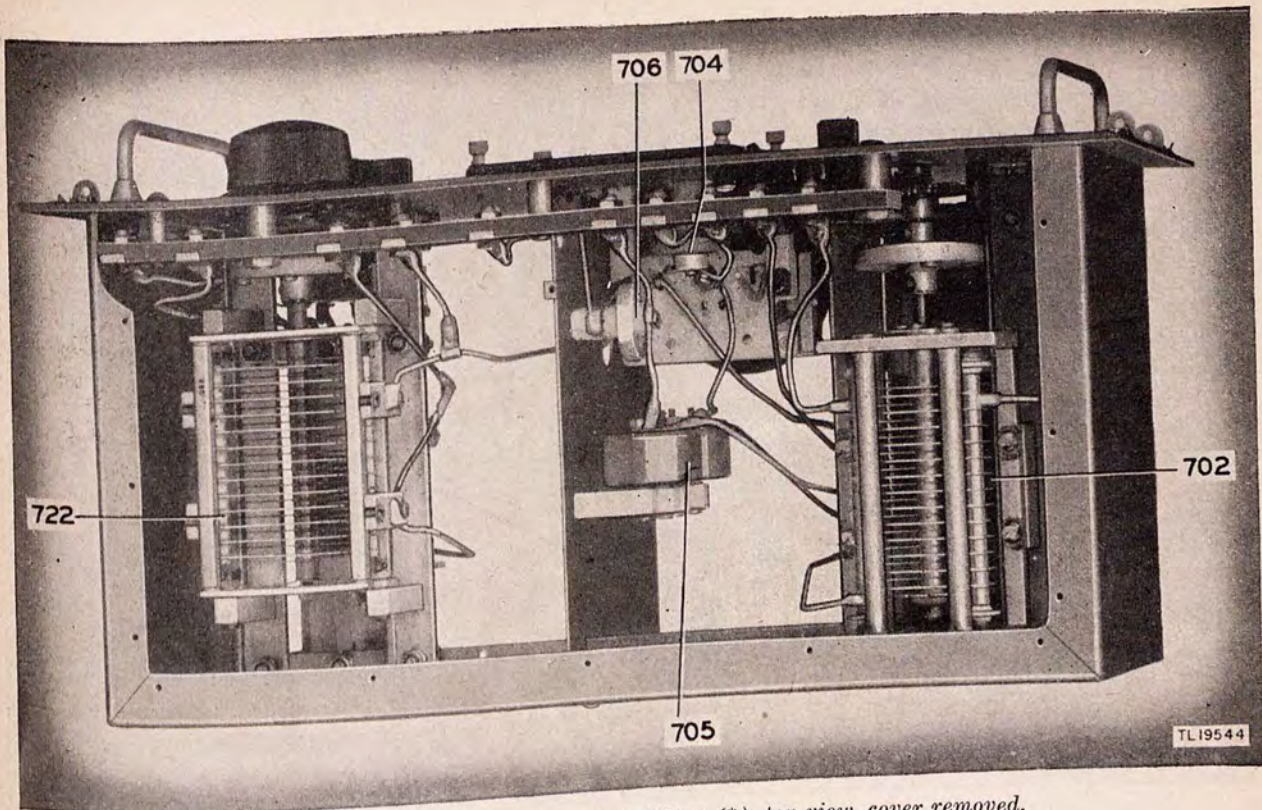

Figure 44. Transmitter Tuning Unit TU-7-(\*), top view, cover removed.

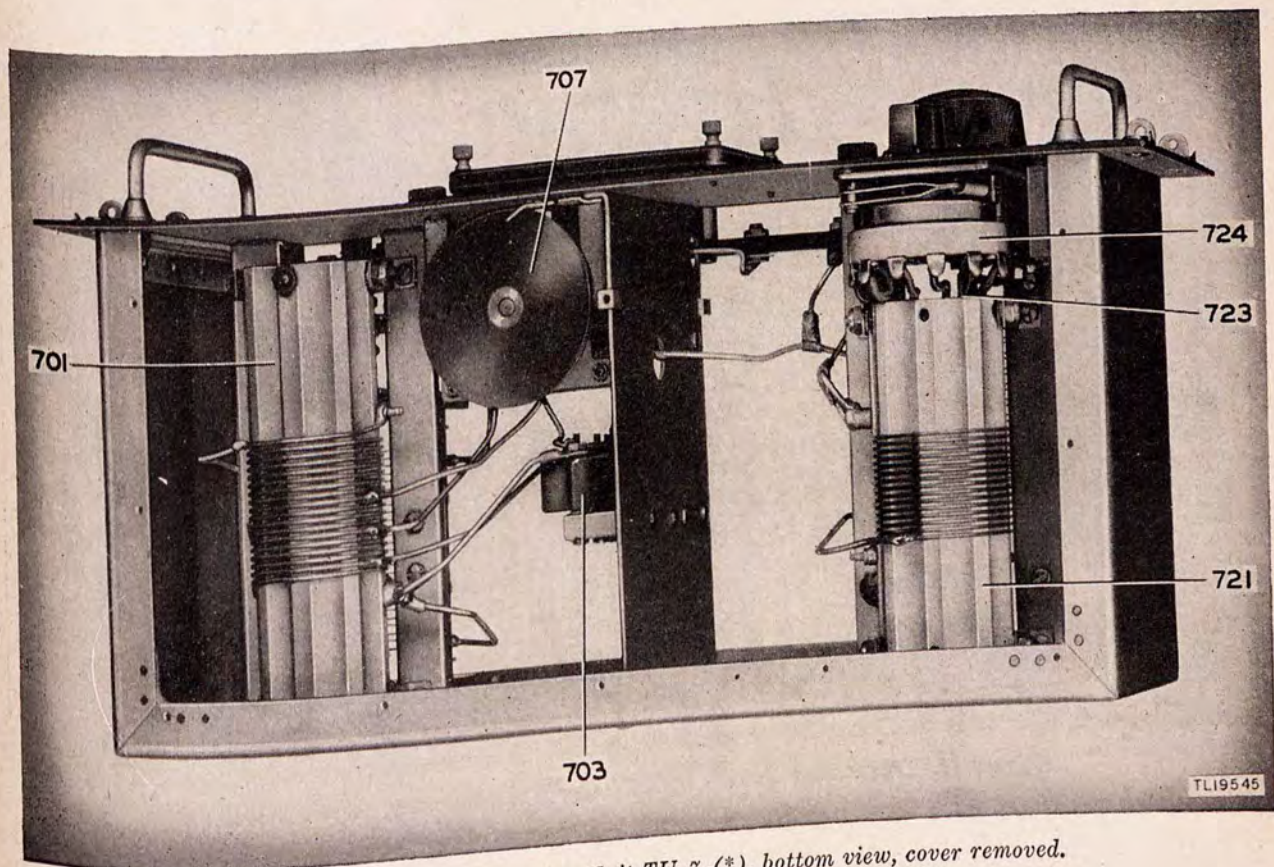

Figure 45. Transmitter Tuning Unit TU-7-(\*), bottom view, cover removed.



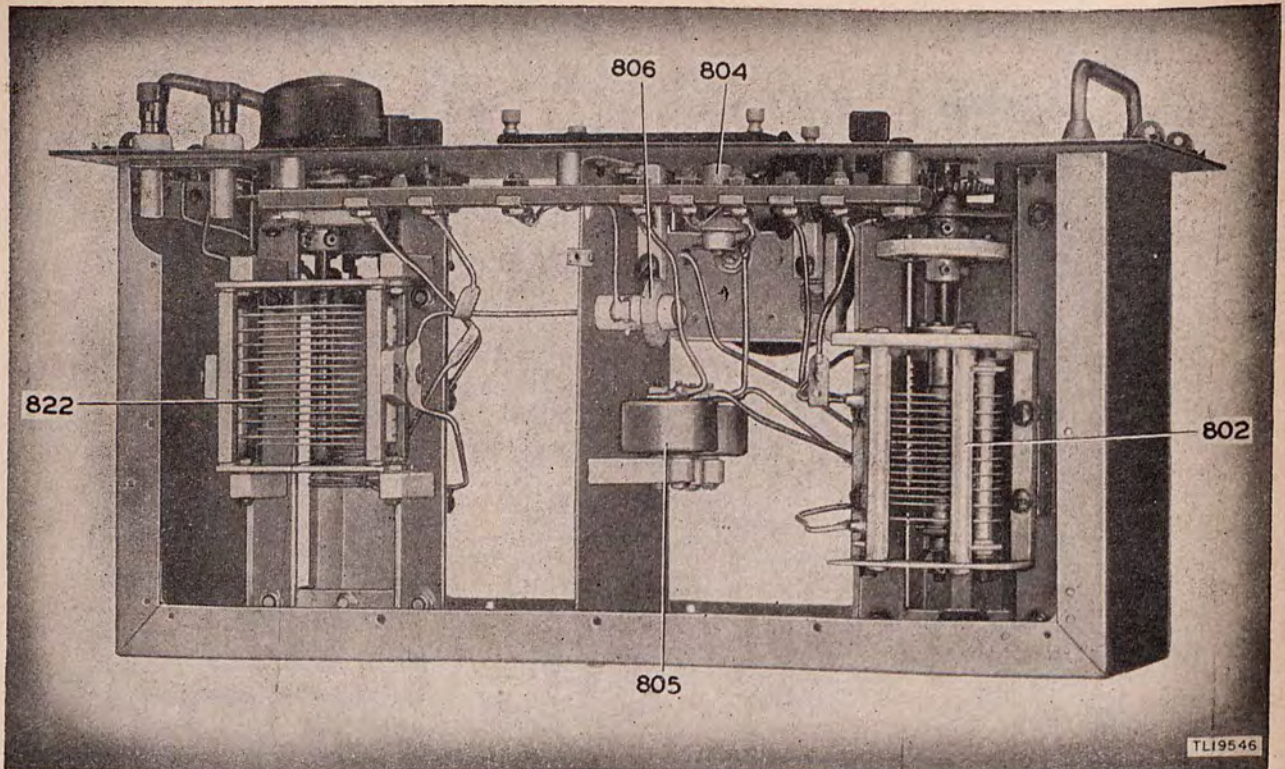

Figure 46. Transmitter Tuning Unit TU-8-(\*), top view, cover removed.

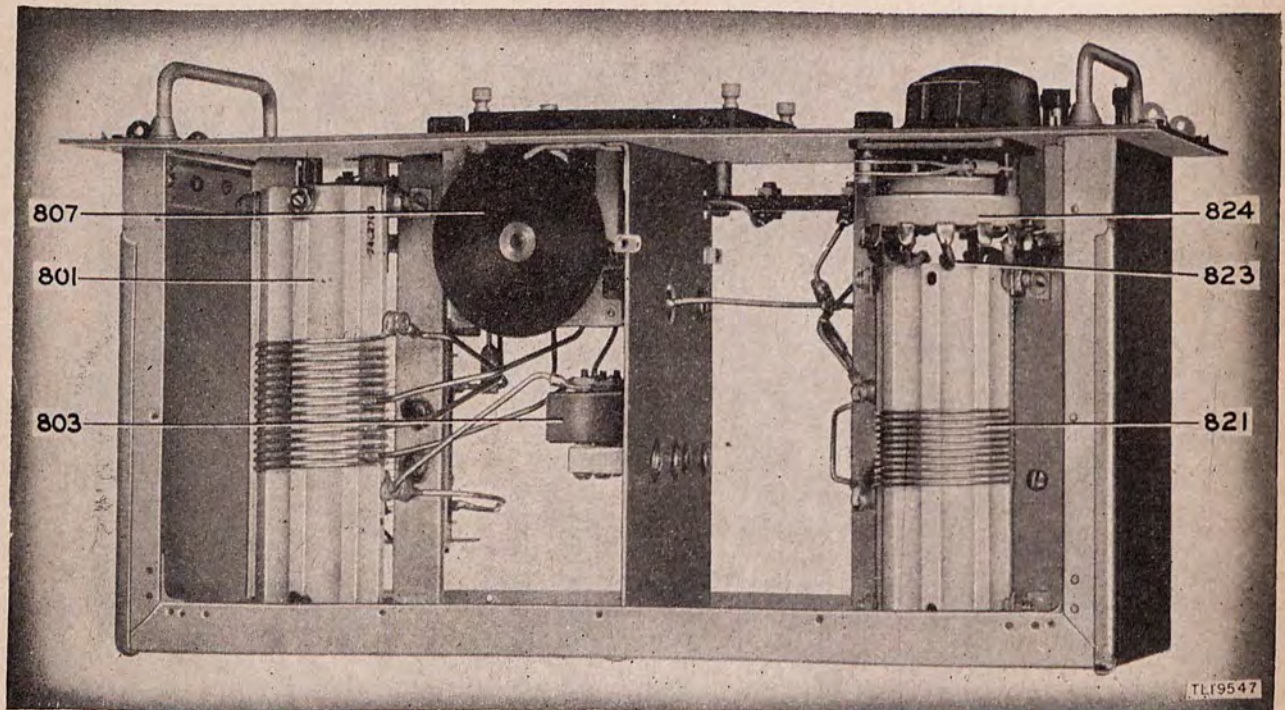

Figure 47. Transmitter Tuning Unit TU-8-(\*), bottom view, cover removed.

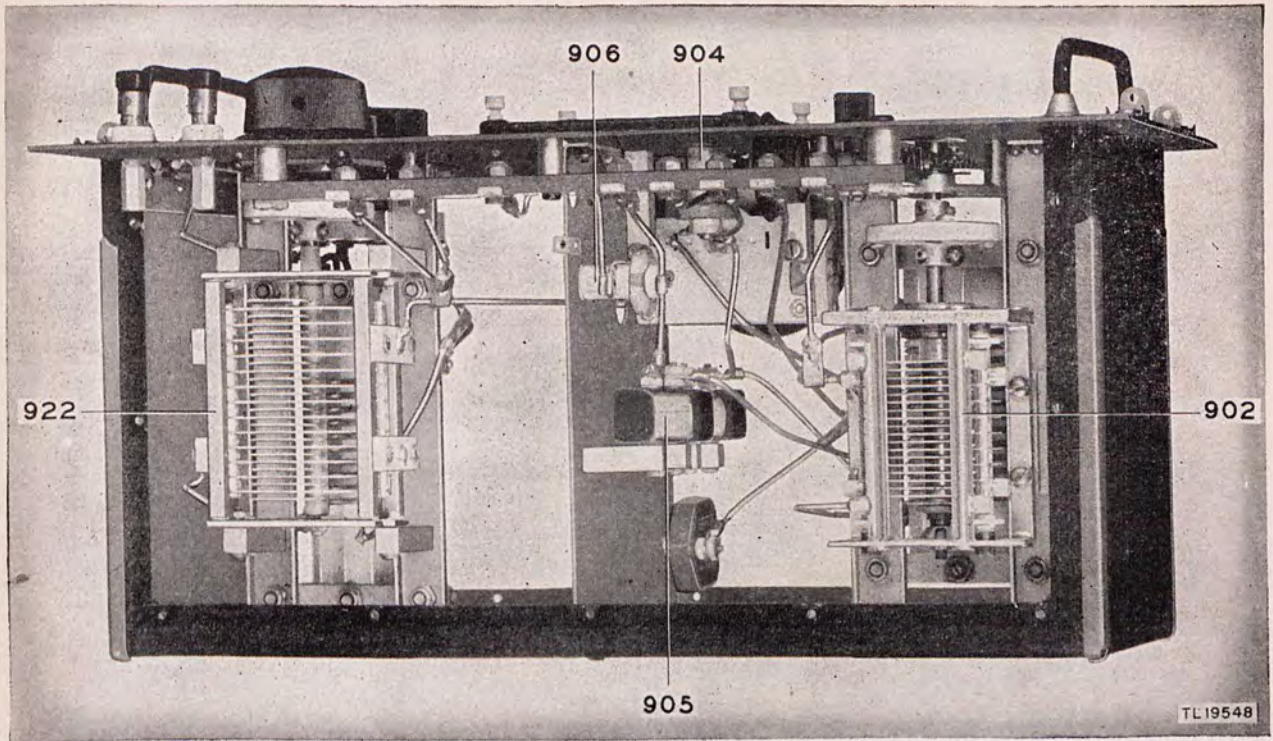

Figure 48. Transmitter Tuning Unit TU-9-(\*), top view, cover removed.

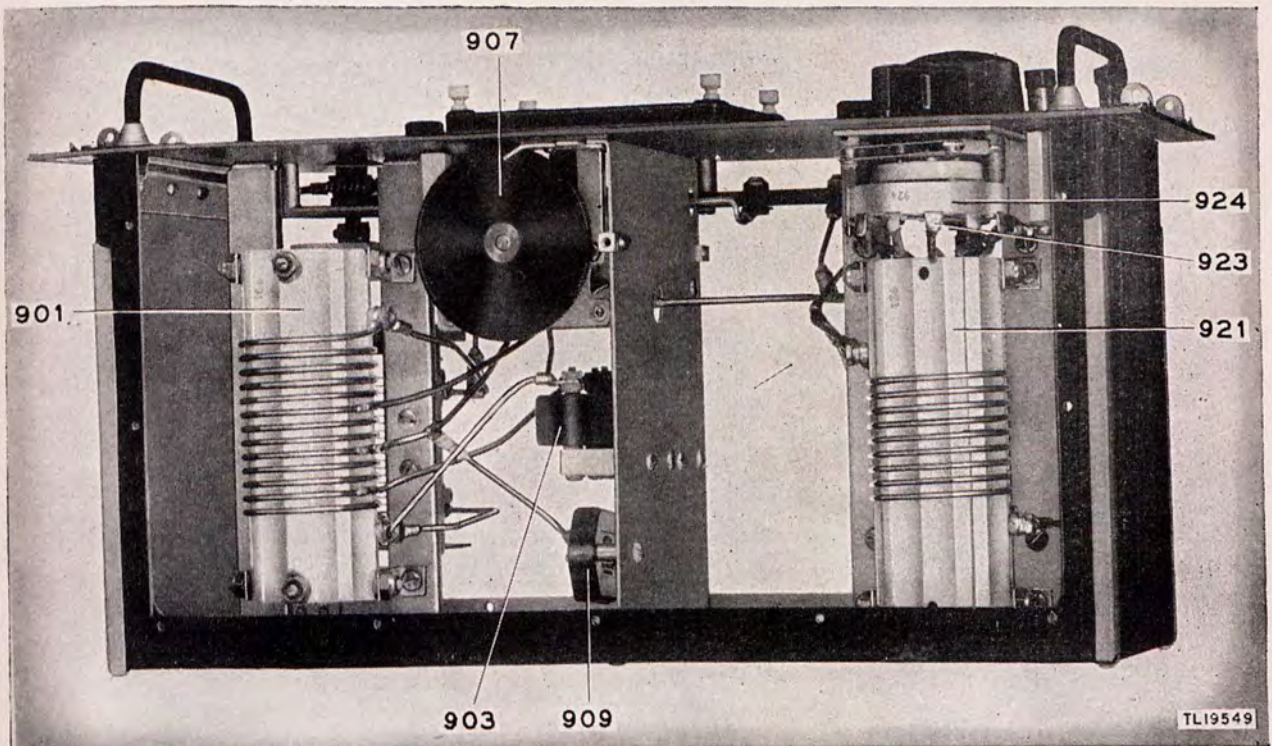

Figure 49. Transmitter Tuning Unit TU-9-(\*), bottom view, cover removed.

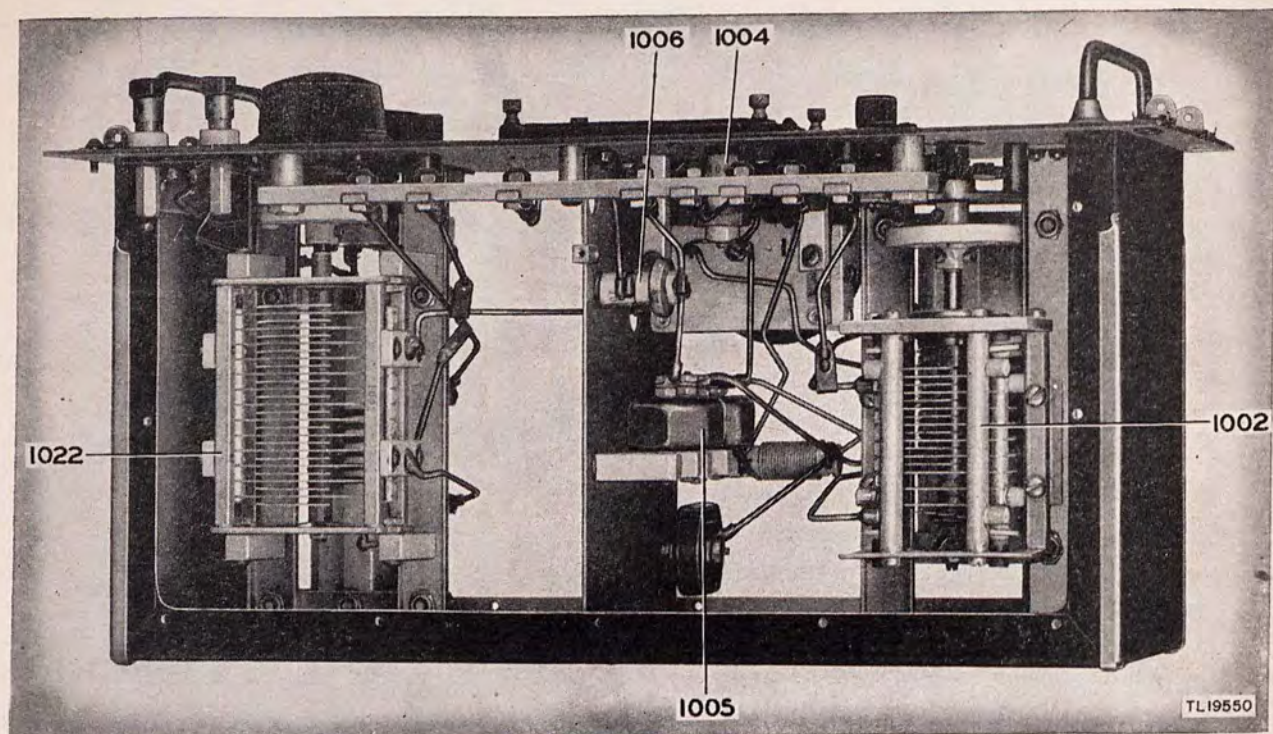

Figure 50. Transmitter Tuning Unit TU-10-(\*), top view, cover removed.

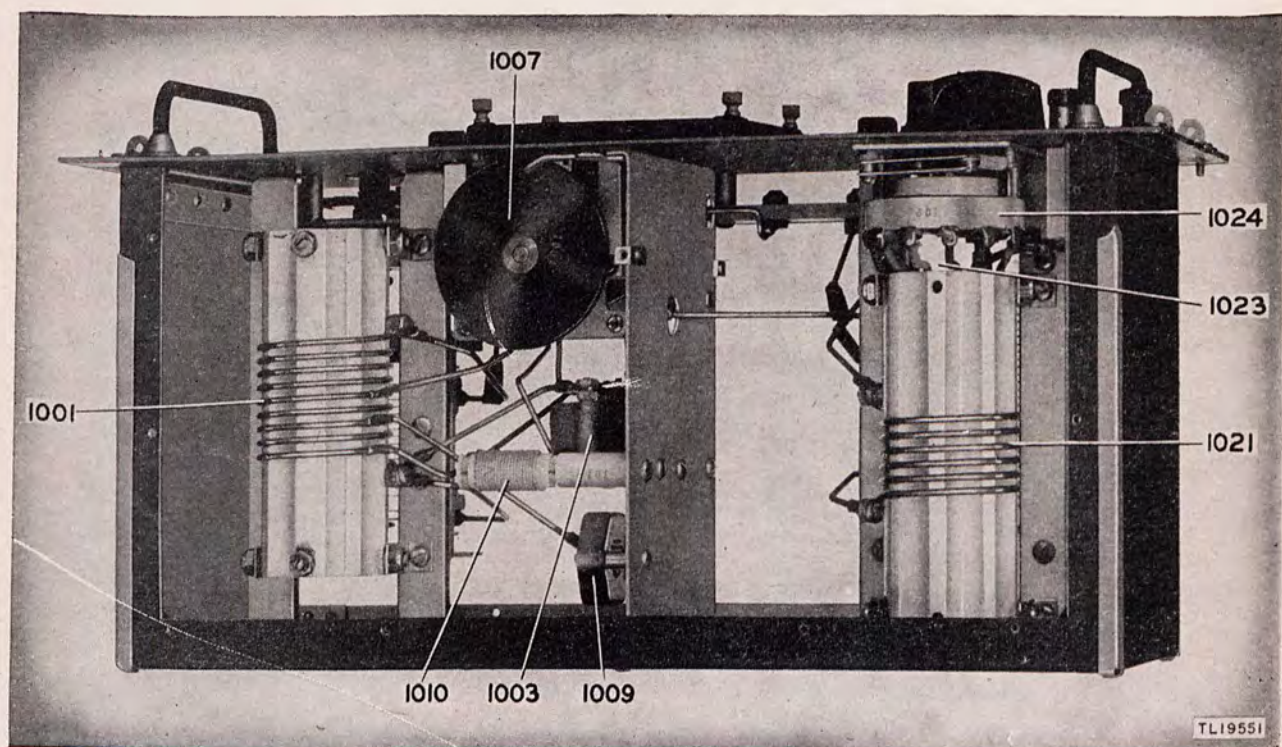

Figure 51. Transmitter Tuning Unit TU-10-(\*), bottom view, cover removed.

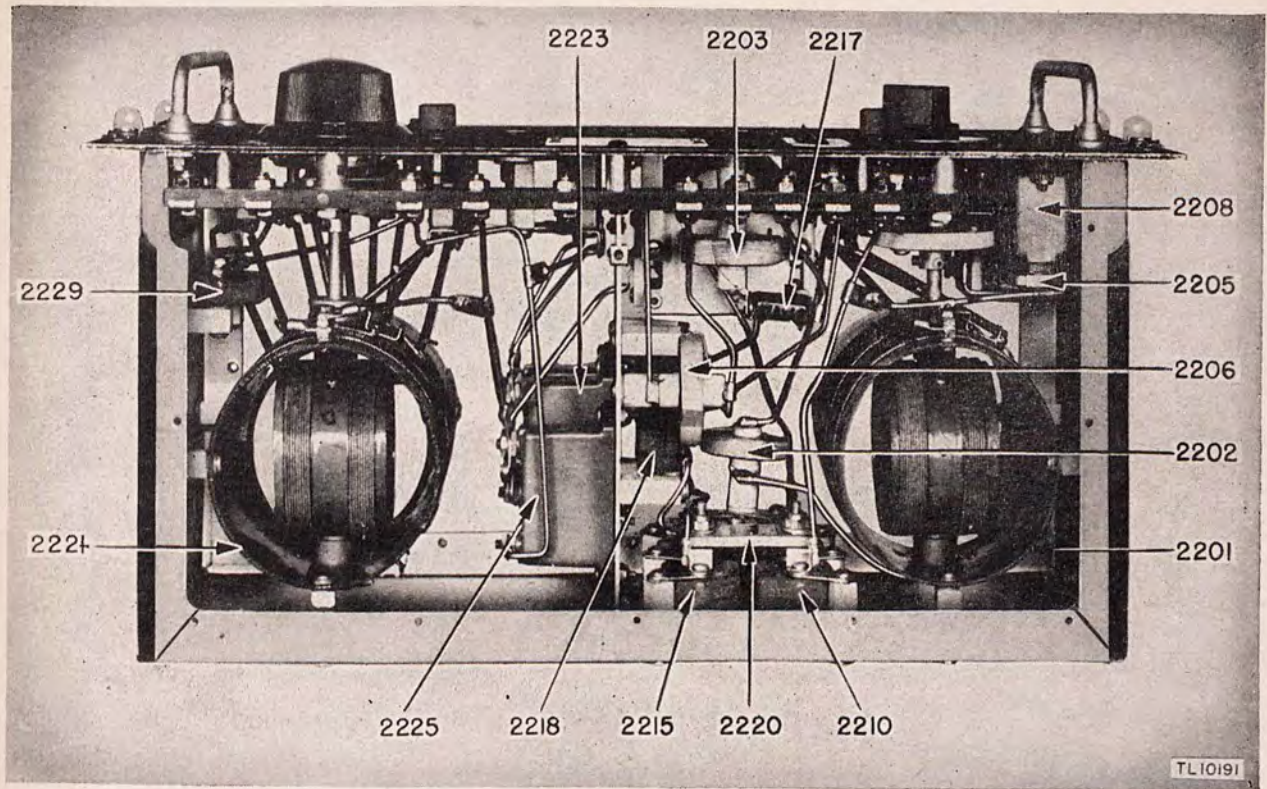

Figure 52. Transmitter Tuning Unit TU-22-(\*), top view, cover removed.

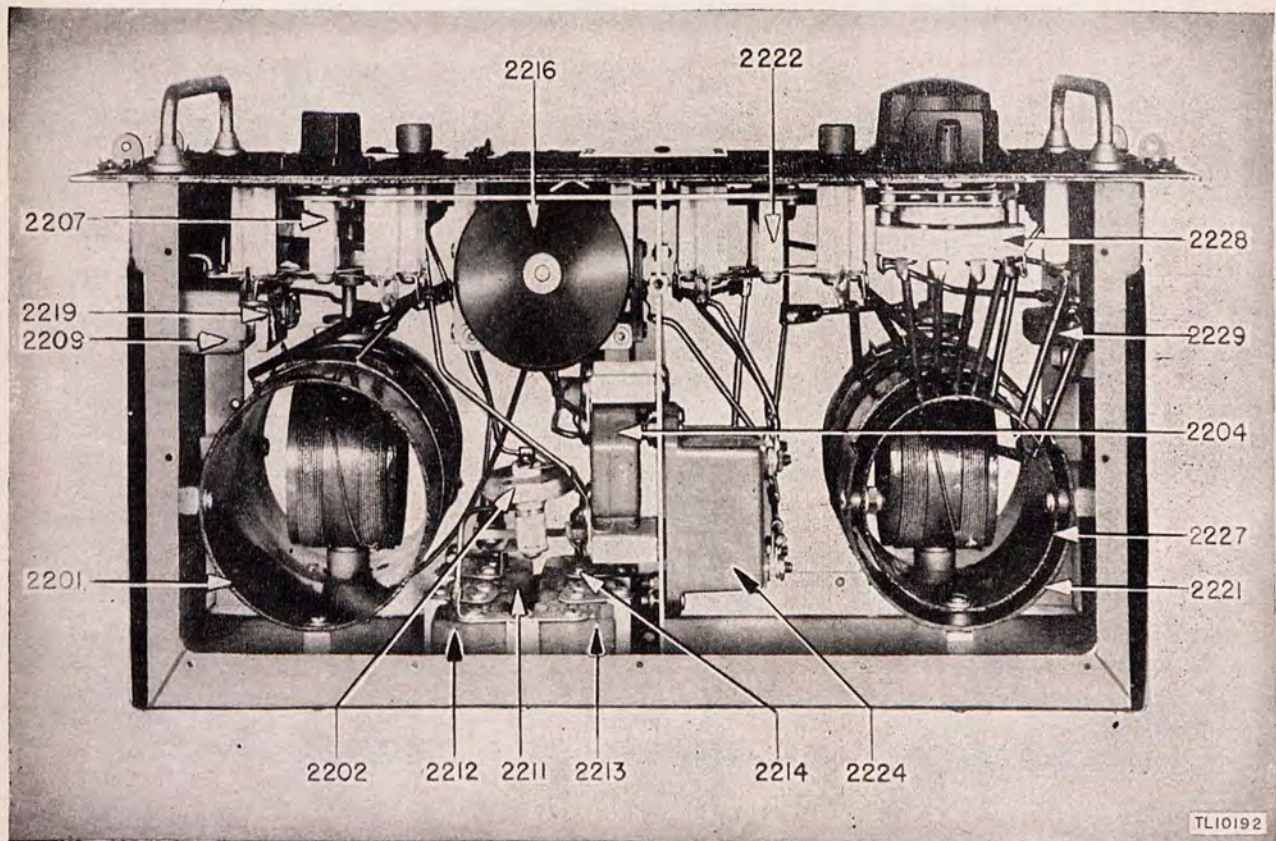

Figure 53. Transmitter Tuning Unit TU-22-(\*), bottom view, cover removed.

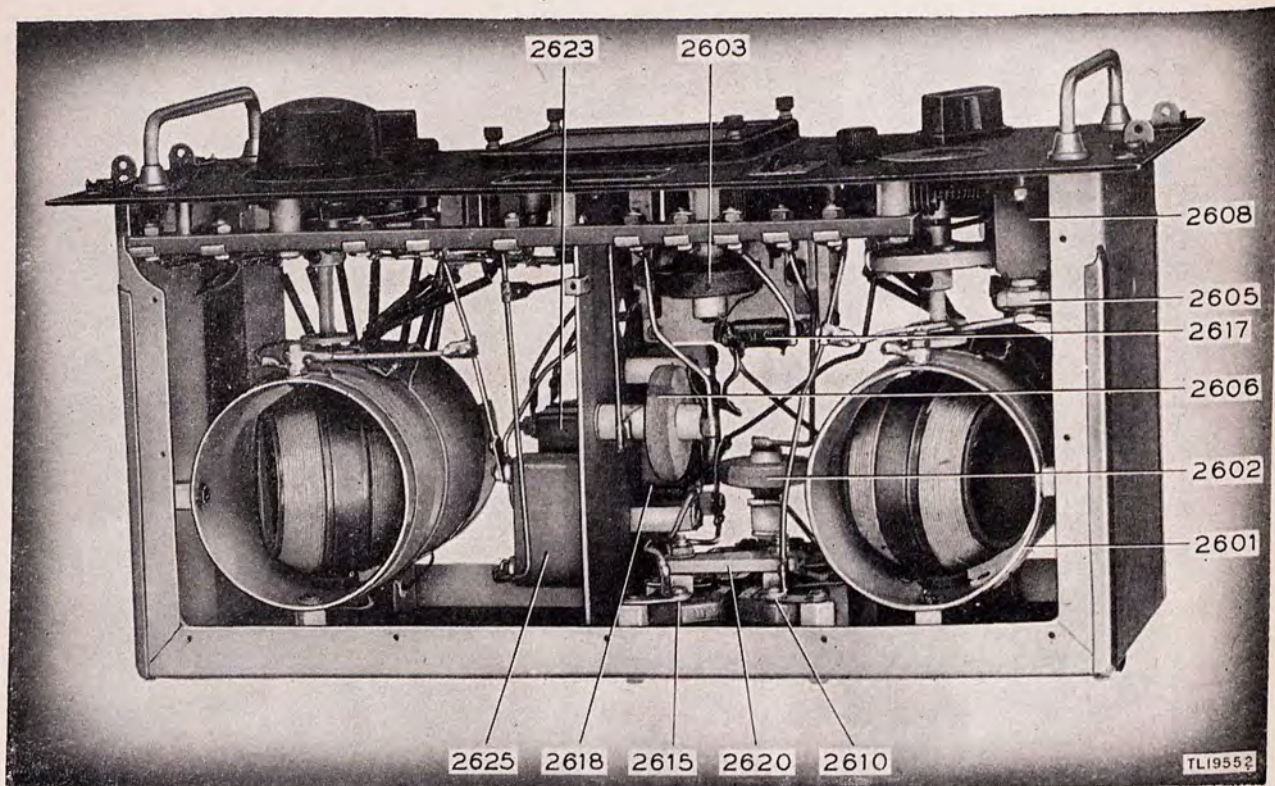

Figure 54. Transmitter Tuning Unit TU-26-(\*), top view, cover removed.

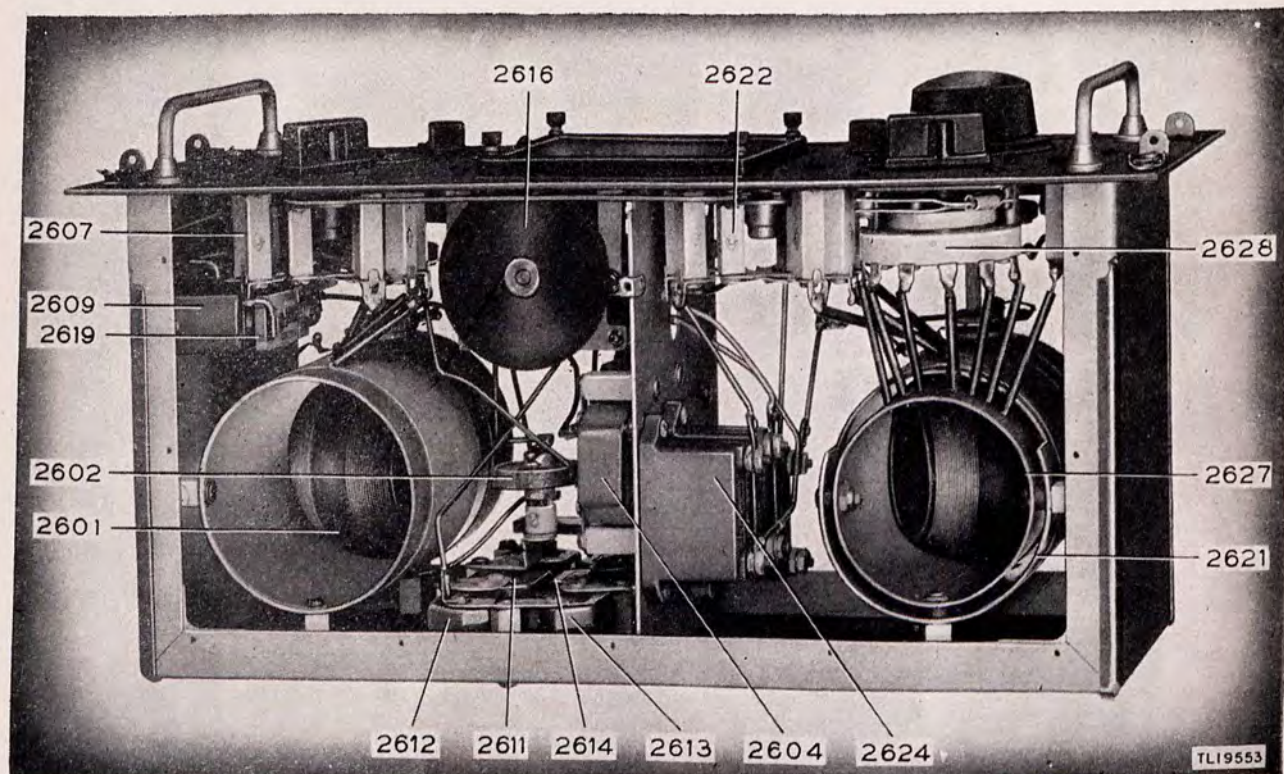
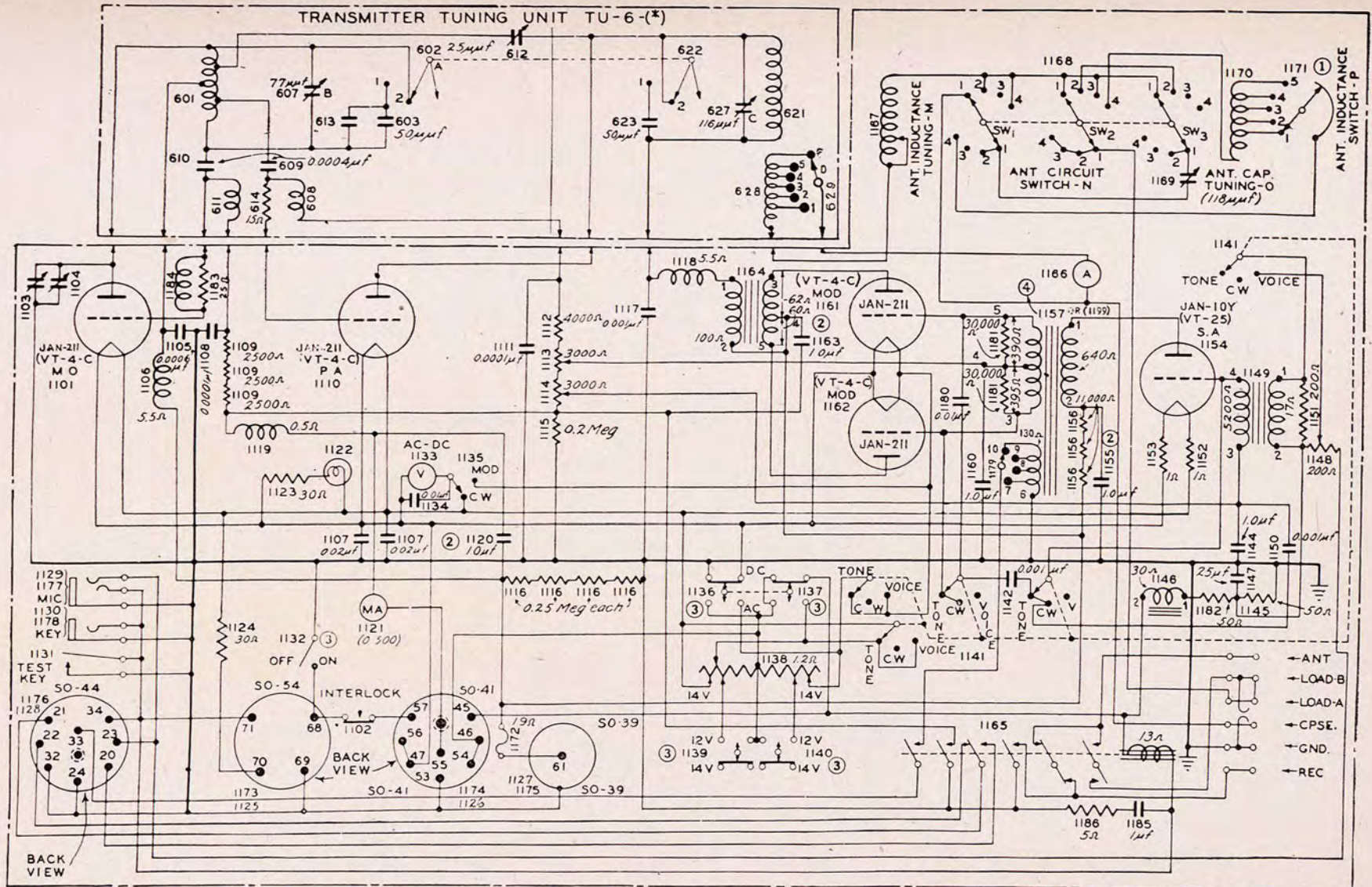

Figure 55. Transmitter Tuning Unit TU-26-(\*), bottom view, cover removed.



- ① On BC-191-D-E-F, & N. Switch 1171 is replaced by 1198.
- ② On BC-191-E-F, & N. Capacitors 1120, 1155 and 1163 are replaced by 3-Section Capacitor 1197a,b,c.
- ③ On BC-191-C-D-E-F, & N. Switch 1132 is replaced by 1194; 1136-1137 by 1195; 1139-1140 by 1190.
- ④ On BC-191-F, Transformer 1157 is replaced by 1199.

TL19554

Figure 56. Radio Transmitter BC-191-(\*), schematic diagram.

