

INSTRUCTION BOOK
FOR
OPERATION AND MAINTENANCE
OF
RADIO RECEIVER BC-348-S
AND
RADIO RECEIVER BC-224-L

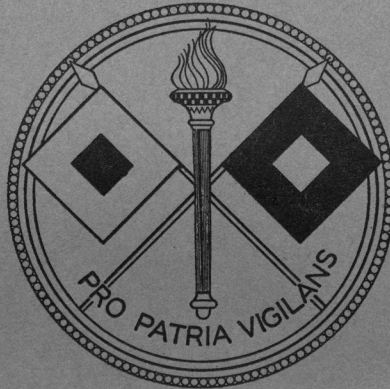

RESTRICTED

PUBLISHED BY AUTHORITY
OF
THE CHIEF SIGNAL OFFICER

FOR AIRPLANE TYPE B-24J
AAF Serial No. 42-73374

APRIL 21, 1943

INSTRUCTION BOOK
FOR
OPERATION AND MAINTENANCE
OF
RADIO RECEIVER BC-348-S
AND
RADIO RECEIVER BC-224-L

RESTRICTED

Notice:—This document contains information affecting the national defense of the United States within the meaning of the Espionage Act, 50 U. S. C., 31 and 32, as amended. Its transmission or the revelation of its contents in any manner to an unauthorized person is prohibited by law. (AR 380-5)

The information contained in restricted documents and the essential characteristics of restricted material will not be communicated to the public or to the press, but may be given to any person known to be in the service of the United States and to persons of undoubted loyalty and discretion who are cooperating in Government work.

PUBLISHED BY AUTHORITY
OF
THE CHIEF SIGNAL OFFICER

APRIL 21, 1943

Destruction of Abandoned Materiel in the Combat Zone

In case it should become necessary to prevent the capture of this
equipment and when ordered to do so,

**DESTROY IT SO THAT NO PART OF IT CAN BE SALVAGED, RECOGNIZED OR USED BY THE
ENEMY. BURN ALL PAPERS AND BOOKS.**

Means:-

1. Explosives, when provided.
2. Hammers, axes, sledges or whatever heavy object is readily available.
3. Burning by means of incendiaries such as gasoline, oil, paper or wood.
4. Grenades and shots from available arms.
5. Where possible, and when time permits, bury all debris or dispose of it in streams or other bodies of water.

Procedure:-

1. Obliterate all identifying marks. Destroy nameplates and circuit labels.
2. Demolish all panels, castings, switch- and instrument-boards.
3. Destroy all controls, switches, relays, connections and meters.
4. Rip out all wiring in electrical equipment. Smash gas, oil and water cooling systems in gas-engine generators, etc.
5. Smash every electrical or mechanical part whether rotating, moving or fixed.
6. Break up all operating instruments such as keys, phones, microphones, etc.
7. Destroy all classes of carrying cases, straps, containers, etc.

REPORT OF MAJOR FAILURE

In the event of major failure of any of the component units of this equipment, a report shall be submitted in the form indicated below. Copies of this report shall be forwarded to the Chief of Signal Section, Air Service Command, Patterson Field, Fairfield, Ohio, and to the Director, Signal Corps Aircraft Signal Service, Wright Field, Ohio.

- 1. Contract or order number.**
- 2. Organization and station.**
- 3. Nomenclature of equipment.**
- 4. Nomenclature of component unit.**
- 5. Date and nature of failure.**
- 6. Type of airplane in which installed.**
- 7. Recommendations.**

TABLE OF CONTENTS

PARAGRAPH

PAGE

SECTION I

DESCRIPTION AND INSTALLATION

1. GENERAL	1
2. INSTALLATION	1
<i>a.</i> Mounting	1
<i>b.</i> Power Connections	1
<i>c.</i> Radio Transmitter Connections	1
<i>d.</i> Output Connections	1
<i>e.</i> Bonding and Shielding.....	2
<i>f.</i> Mounting of Radio Receiver	2
<i>g.</i> Safety Wire	2
<i>h.</i> Ground	2
<i>i.</i> Antenna	2
<i>j.</i> Adjustment of Input Alignment Capacitor.....	2

SECTION II

PREPARATION FOR USE

3. PRELIMINARY CHECK	3
4. POWER CONNECTIONS	3
5. OPERATING TEST	3

SECTION III

OPERATION

6. OPERATING PROCEDURE	5
<i>a.</i> Controls	5

TABLE OF CONTENTS (Continued)

PARAGRAPH		PAGE
	SECTION III—OPERATION (Continued)	
6.	OPERATING PROCEDURE (CONTINUED)	5
	<i>b.</i> Modulated Signal Reception	5
	<i>c.</i> C-W Reception	5

SECTION IV

MAINTENANCE

7.	ALIGNMENT OF I-F AMPLIFIER	6
8.	TEST AND ADJUSTMENT OF CRYSTAL FILTER	6
9.	CHECK AND ALIGNMENT OF C-W OSCILLATOR	6
10.	ALIGNMENT OF R-F AMPLIFIER AND OSCILLATOR	7

SECTION V

SUPPLEMENTARY DATA

	TABLE OF REPLACEABLE PARTS FOR RADIO RECEIVERS BC-348-S AND BC-224-L	9
--	--	---

LIST OF ILLUSTRATIONS

FIGURE	PAGE
1. RADIO RECEIVER BC-348-S, FRONT VIEW.....	x
2. RADIO RECEIVER BC-348-S, CORDING DIAGRAM.....	2
3. RADIO RECEIVER BC-348-S, TOP VIEW OF CHASSIS.....	6
4. RADIO RECEIVER BC-348-S, REAR VIEW OF CHASSIS.....	7
5. RADIO RECEIVER BC-348-S, BOTTOM VIEW OF CHASSIS.....	8
6. RADIO RECEIVER BC-348-S, DRILLING PLAN.....	17
7. RADIO RECEIVER BC-348-S, OUTLINE DIMENSIONAL SKETCH.....	17
8. RADIO RECEIVER BC-348-S, SCHEMATIC DIAGRAM.....	19
9. RADIO RECEIVER BC-224-L, SCHEMATIC DIAGRAM.....	21

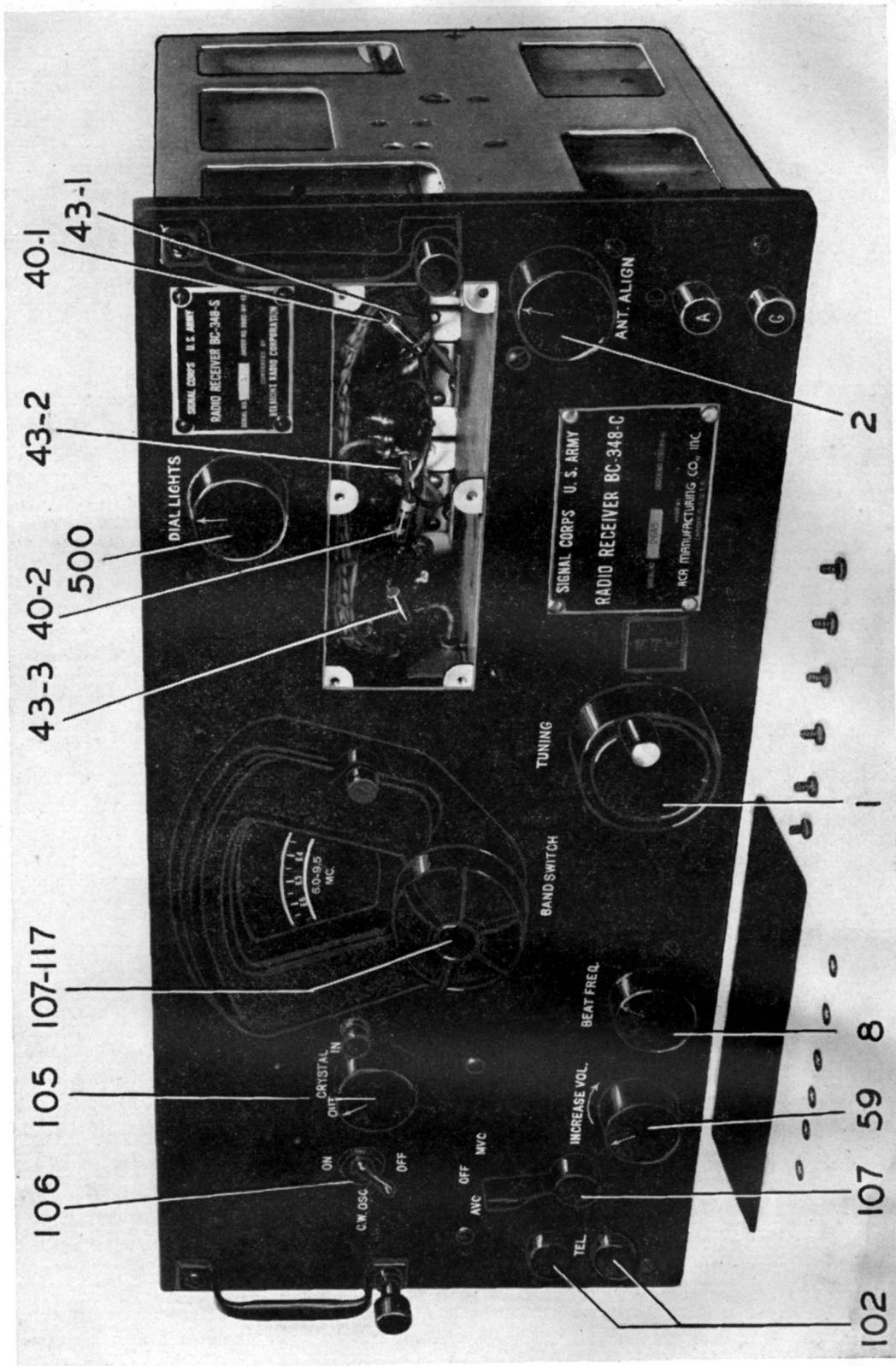

FIGURE 1—RADIO RECEIVER BC-348-S, FRONT VIEW*

* Illustrations throughout this book will be only of Radio Receiver BC-348-S, as the physical appearance of Radio Receivers BC-348-S and BC-224-L is identical. See schematic diagrams, pages 19 and 21, for electrical differences.

INSTRUCTION BOOK
For
OPERATION AND MAINTENANCE
of
RADIO RECEIVER BC-348-S
and
RADIO RECEIVER BC-224-L

SPECIAL NOTICE

Radio Receivers BC-348-S and BC-224-L have been converted from other production models (Radio Receivers BC-348-C and BC-224-C, respectively) by Belmont Radio Corporation, Chicago, Illinois. On equipments produced under this conversion, a name plate appears on the upper right of the panel of each of both types of receiver, identifying each equipment as Radio Receiver BC-348-S and Radio Receiver BC-224-L, respectively, in addition to the name plate for the original receivers—Radio Receivers BC-348-C and BC-224-C—which appears on the bottom right of the panel.

Although this instruction book covers both Radio Receivers BC-348-S and BC-224-L, only the former will be referred to throughout the book for convenience in reference, as the two equipments are essentially identical. See schematic diagrams, pages 19 and 21, for differences.

Restricted

SECTION I

DESCRIPTION AND INSTALLATION

1. GENERAL

Radio Receiver BC-348-S is a locally-controlled, 8-tube, 6-band superheterodyne receiver for use in U. S. Army aircraft and covers the frequency ranges of 200 kc to 500 kc and 1.5 to 18.0 megacycles. The receiver is not intended for remote control, and no features or units have been provided for remote operation. This radio receiver is capable of voice, tone and c-w reception with manual or automatic volume control. When equipped with tubes, dial lights and fuse, and with the antenna, ground and 28-volt* primary power source connections properly made, it becomes a complete and operative equipment by the addition of a headset, as all coils and the high-voltage power supply unit are built in. See Figure 2 for proper connection of terminals No. 2 and No. 6.

The most important considerations necessary for the successful installation and operation of this receiver are as follows:

2. INSTALLATION

a. Mounting

Mount the receiver on a plane surface, allowing sufficient clearance on all sides to permit free action of the shock absorber mounting. The mounting should be permanently attached to the rigid mem-

bers of the plane. The drilling plan of the mounting is shown in Figure 6.

b. Power Connections

Separate pairs of leads to the 28-volt primary power source may be used. See Figure 2.

c. Radio Transmitter Connections

Provisions have been made for the protection of this receiver when the associated radio transmitter is being used. Wire leads from plug terminals 2 and 6 to contacts on the transmitter relay. If the transmitter is removed from the installation, the wires from plug terminals 2 and 6 must be connected for the radio receiver to operate.

d. Output Connections

The output of this receiver has been brought to plug terminals 1 and 5. Leads from these terminals should be wired to the interphone system or as otherwise desired. If the output is desired only at the receiver, it should be taken directly from the phone jack and no connections made to plug terminals 1 and 5. Normal connection is to the 4000-ohm tap marked 4 on the output transformer case. Access to a 300-ohm tap is provided at the terminal marked 2.

*Radio Receiver BC-224-L requires a 14-volt primary power source.

Radio Receiver BC-348-S
Par. 2

e. Bonding and Shielding

At the time of installation of this equipment, make certain that the engine ignition system, generator and other possible causes of disturbance are properly shielded and that bonding of metal parts is carefully carried out.

f. Mounting of Radio Receiver

When proper wiring connections have been made, place the receiver on its mounting with the studs on the bottom of the cabinet entering the slots of the mounting. See that the cabinet is well down on the mounting and that all four studs are fully seated, then push the cabinet towards the rear and fasten by means of the snapslides on the lower front corners of the cabinet.

g. Safety Wire

Pass safety wire through the holes of the snapslide assemblies, being careful that the wires are not twisted too tightly.

h. Ground

Connect the ground-binding post G by a short, direct, low-resistance lead to some grounded metal portion of the plane and solder at that point, if practicable. The lead should have enough slack to prevent vibration being transmitted to the receiver.

i. Antenna

The antenna-circuit aligning capacitor is such that the antenna circuit can be properly aligned when using antennas that range in effective capacitance from 50 to 200 micromicro-farads. However, satisfactory performance will be obtained in practically any type of mast, fixed or trailing wire antenna, although in extreme cases, i.e., very short mast or very long trailing wire, optimum setting of the "antenna alignment" may not be obtained. In general, the most effective antenna is one whose length away from the grounded metal fuselage is the greatest. Place the receiver as near as possible to the lead-in insulator and connect it from the insulator to the antenna binding post A by a copper wire. The lead should have enough slack to prevent vibration being transmitted to the receiver.

j. Adjustment of Input Alignment Capacitor

With the receiver AVC—OFF—MVC switch in the MVC position, the band switch on Band 2, and using the tuning control, tune in a signal at approximately 3.5 mc to maximum signal strength. Reduce volume by means of the volume control knob until the signal is just audible. Adjust the ANTENNA ALIGNMENT control to give maximum volume.

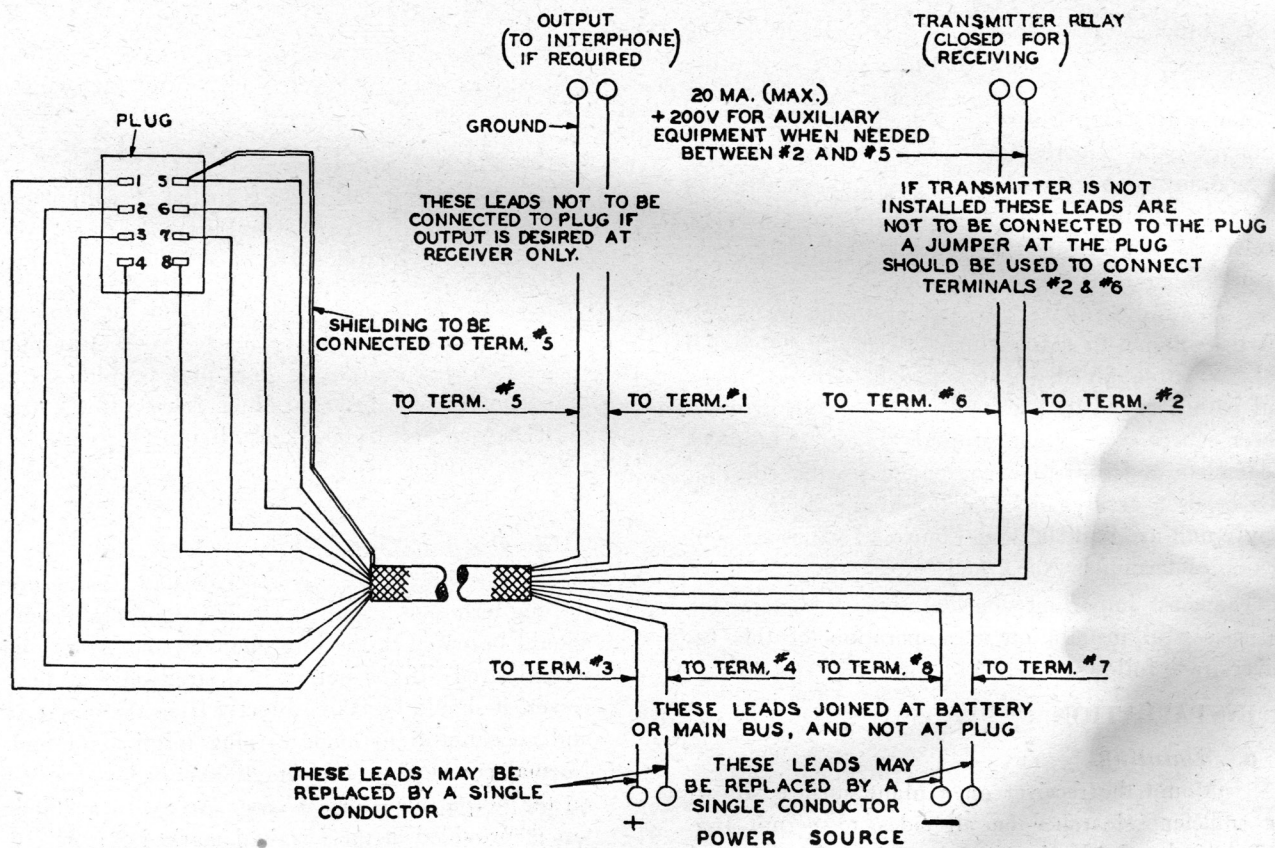

FIGURE 2—RADIO RECEIVER BC-348-S, CORDING DIAGRAM

SECTION II PREPARATION FOR USE

3. PRELIMINARY CHECK

Radio Receiver BC-348-S is a self-contained unit, having its high-voltage power supply and all coil sets built in.

a. Before installing the tubes, check them with the required tube checker.

b. Be sure that the proper tubes, well pushed down and firmly seated in their sockets, are installed, that the tube shield is properly seated and that grid caps fit tightly on the tubes.

c. Check dial lights and fuses and see that they are properly and securely placed.

d. Make sure that the leads to the dynamotor are properly connected at the dynamotor terminal strip and that the screws holding them in place are tight. No other precautions are necessary.

4. POWER CONNECTIONS

Power to the radio receiver is controlled by the receiver AVC—OFF—MVC switch. The table below shows the power connections in conjunction with this receiver switch.

The screen grid voltage supply leads are carried out of the receiver through the power plug to the keying relay of the associated radio transmitter where the circuit is opened when actually transmitting.

5. OPERATING TEST

When the receiver has been completely installed, an operating test should be made as follows:

a. Plug the headset into the TEL jack. Set the receiver switch to MVC. The dynamotor should start and after the tubes have warmed up (approximately 30 seconds), the volume control knob should be advanced until a slight background noise is heard. Set the BAND SWITCH to the frequency band in which test signals are available.

b. Using the TUNING knob and with reference to the calibrated scale on the dial, tune in the desired signal. NOTE: All tuning should be done on MVC with the volume control advanced only enough to give the desired signal strength. In the absence of a signal, the setting of the volume control can be judged by the loudness of the background noise. On MVC, with the volume control set at maximum, very strong carrier waves will block the receiver and intelligible signals cannot be received.

c. Set the receiver switch to AVC. The desired signal should still be heard.

POWER CONNECTIONS

<i>Receiver Switch Position</i>	<i>Dial Light Rheostat</i>	<i>Circuit Connection</i>
OFF	MIN	No power supplied to receiver
OFF	MAX	No power supplied to receiver
AVC	MIN	Filaments ON, dynamotor ON, dial lights OUT
AVC	MAX	Filaments ON, dynamotor ON, dial lights FULL ON
MVC	MIN	Filaments ON, dynamotor ON, dial lights OUT
MVC	MAX	Filaments ON, dynamotor ON, dial lights FULL ON

Radio Receiver BC-348-S

Par. 5

d. With the BEAT FREQ adjustment at zero beat position (arrow on knob pointing up), turn the c-w osc switch to the ON position. An audible beat note should be heard which should vary in pitch when the BEAT FREQ adjustment is changed.

e. With the FREQ c-w OSC still ON, throw the CRYSTAL filter switch to IN. Noise should be greatly reduced and the signal can be tuned out by a much smaller movement of the tuning control knob than when the CRYSTAL filter switch is in the OUT position.

f. Turn the DIAL LIGHT rheostat and observe if control of illumination is secured with both dial lights functioning.

g. Make a pre-flight check, with the airplane engine running. An increase of background noise when the engine starts indicates imperfect shielding or bonding, faulty generator regulator, faulty generator, open filter capacitors or a combination of these faults.

h. Always turn the receiver switch to the OFF position when the receiver is not to be used.

SECTION III OPERATION

6. OPERATING PROCEDURE

a. Controls

(i) *Antenna and Ground Binding Posts*

The antenna is connected to the binding post marked A, and the ground lead to the binding post marked G.

(ii) *ANT ALIGN Control*

This control is a variable capacitor for aligning the input circuit to a given antenna. This adjustment should be made with the receiver tuned to approximately 3.5 mc in Band 2.

(iii) *TUNING Control*

This control varies the setting of the 4-gang variable tuning capacitor.

(iv) *BAND SWITCH Control*

This control selects the desired frequency band as indicated on the dial mask.

(v) *DIAL LIGHTS Control*

This knob controls the intensity of dial illumination and is provided with an OFF position.

(vi) *c-w OSC Switch*

This toggle switch controls the operation of the c-w oscillator as well as the AVC time constant for c-w reception.

(vii) *CRYSTAL Switch*

This control permits the insertion of an i-f crystal filter when extreme selectivity is desired.

(viii) *BEAT FREQ Control*

This control permits vernier adjustment of the c-w oscillator frequency and, in tuning, it should be set near the zero beat position (arrow on knob pointing up).

(ix) *INCREASE VOL Control*

This control is for sensitivity adjustment on MVC operation and output level adjustment on AVC operation. When switching from MVC to AVC or vice versa, it will generally be necessary to readjust this control to maintain a given volume level, as only under certain conditions of signal strength will the volume level remain unchanged.

(x) *AVC—OFF—MVC Switch*

This three-position switch in the OFF position removes all power from the receiver. In the MVC position the receiver is operative with manual volume control, while in the AVC position the automatic volume control is functioning.

(xi) *TEL Jacks*

These are open circuit jacks providing connections to the headset.

b. Modulated Signal Reception

(i) Throw the AVC—OFF—MVC switch to MVC and set other switches and controls as follows:

C-W OSC—OFF

CRYSTAL Filter—OUT

ANT ALIGN set as in the initial installation adjustment.

(ii) Set the BAND SWITCH to the desired frequency band and adjust the TUNING control to the desired frequency with reference to the dial calibration. It is of greatest importance that this tuning be accomplished with the receiver switch in the MVC position.

(iii) Increase the VOL control until the desired signal is heard or the background noise attains a fair level.

(iv) Adjust the TUNING control until maximum output from the desired signal is obtained. This insures correct alignment or proper tuning of the receiver.

(v) If automatic volume control is desired, switch to the AVC position and readjust the VOL control for the desired output level.

(vi) NOTE: The AVC should not be employed while tuning in a signal. Tuning should always be done in the MVC position and with the volume control advanced only as far as required for a comfortable output level.

c. C-W Reception

(i) The procedure is the same as outlined above with the exception that the c-w OSC switch is ON and tuning accomplished with the BEAT FREQ control set near the zero beat position (arrow on knob pointing up).

(ii) After tuning in the desired signal, the BEAT FREQ control may be varied and the frequency of the beat note adjusted as desired.

(iii) Automatic volume control may be employed for c-w reception by switching to the AVC position and readjusting the volume control.

(iv) When extreme selectivity is desired to minimize interference, the CRYSTAL filter is switched IN. A slight readjustment of the tuning and beat frequency controls may be required to secure the desired beat note frequency.

(v) NOTE: The crystal band pass filter is intended primarily for use in c-w reception. However, the added selectivity may at times prove helpful in receiving modulated signals through heavy interference.

SECTION IV MAINTENANCE

7. ALIGNMENT OF I-F AMPLIFIER

The 4th i-f transformer (100) is slightly over-coupled with the resultant response peaks approximately 5 kc each side of 915 kc. Connect the modulated test oscillator to the grid of Tube VT-93. Adjust primary and secondary tuning cores of the 4th i-f transformer so that even peaks are obtained at approximately 920 kc and 910 kc with the slight dip between them at 915 kc. Visual adjustment may also be made with a cathode-ray oscilloscope. After ad-

8. TEST AND ADJUSTMENT OF CRYSTAL FILTER

Connect a microammeter with a range of approximately 200 microamperes in series with the cathode return of the AVC volume control (59-B orange lead). Throw the CRYSTAL switch (105) to the IN position and with an unmodulated 915 kc input from the test oscillator find the resonance peak of the crystal by slightly retuning the test oscillator until maximum deflection is indicated on the microammeter.

The band width with an input voltage ratio of 10 X

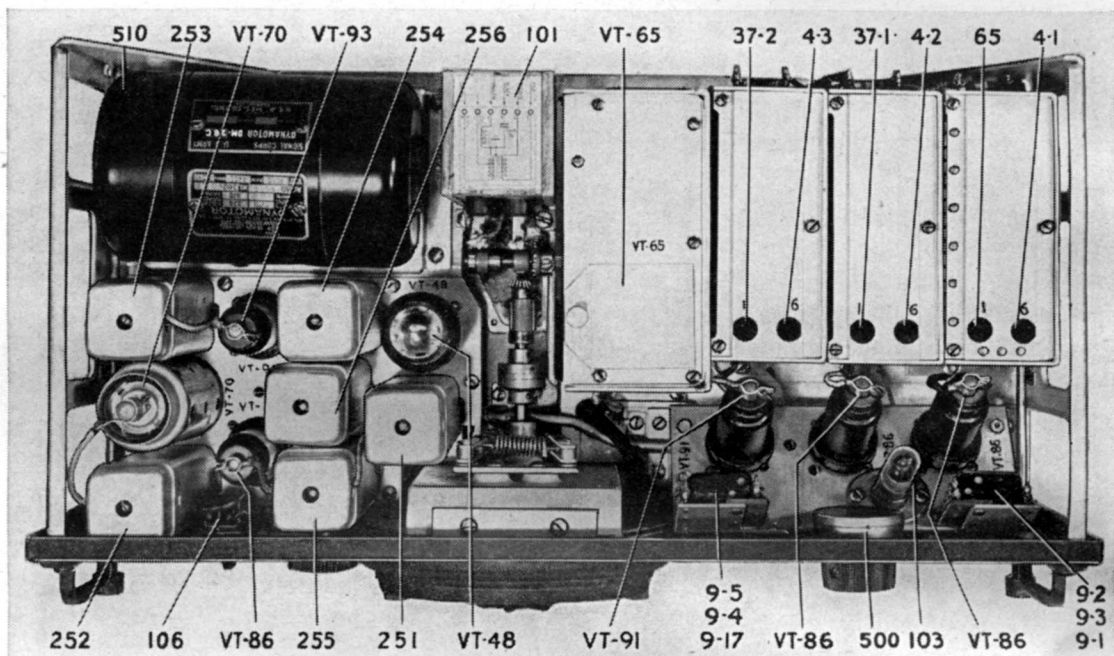

FIGURE 3—RADIO RECEIVER BC-348-S, TOP VIEW OF CHASSIS

justment of the 4th i-f transformer, couple the test oscillator to the grid of the converter Tube VT-91 and adjust primary and secondary cores of the 3rd i-f (99), 2nd i-f (97), crystal filter (96) and 1st i-f transformer (95) to resonance. A 4000-ohm output meter is plugged into the phone jack (102) for observing. Do not readjust the 4th i-f transformer.

is adjusted to approximately 2 kc by adjustment of the phasing trimmer (7).

9. CHECK AND ALIGNMENT OF C-W OSCILLATOR

The c-w oscillator (98) is checked and adjusted by coupling the 915 kc input (modulation off) to the grid of the converter Tube VT-91 and switching the c-w osc ON. With the beat frequency control set

at mid-position, the c-w oscillator inductor tuning core is adjusted for zero beat.

10. ALIGNMENT OF R-F AMPLIFIER AND OSCILLATOR

For a general alignment, start with Band No. 1 and proceed as in the table below. Use a 400-cycle

modulated test oscillator connected between antenna and ground through a 100-mmf dummy antenna. A 4000-ohm output meter is plugged into the phone jack (102) for observing. Adjust the oscillator frequency to the dial scale at the *Alignment Frequency* indicated in the table and then adjust 1st det., r-f and antenna trimmers as shown.

Band No.	Freq. Range	Alignment Frequency	Trimmers			
			Osc.	Det.	R-F	Ant.
1	500-200 kc	{ 500 kc 200 kc	6-1	37-2	37-1	65
			66			
2	3.5- 1.5 mc	3.5 mc	6-2	5-5	5-3	2 *
3	6.0- 3.5 mc	6.0 mc	6-3	3-4	3-2	3-1
4	9.5- 6.0 mc	9.5 mc	6-4	5-6	5-4	5-1
5	13.5- 9.5 mc	13.5 mc	6-5	3-5	3-3	3-8
6	18.0-13.5 mc	18.0 mc	3-6	4-3	4-2	4-1

*Antenna aligning capacity. Refer to the schematic diagrams, Figures 8 and 9, and marked photographs for location. The alignment controls for the various bands are numbered on the chassis adjacent to the control. Controls for band 1 are marked 1; those for 2 are marked 2, etc.

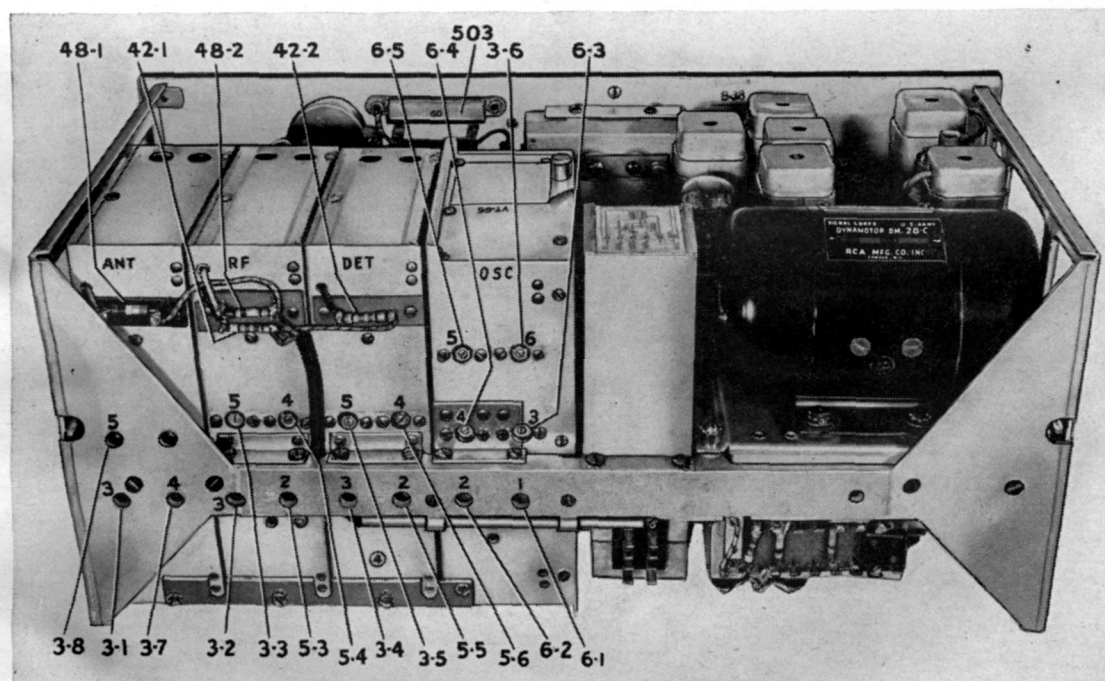

FIGURE 4—RADIO RECEIVER BC-348-S, REAR VIEW OF CHASSIS

Radio Receiver BC-348-S

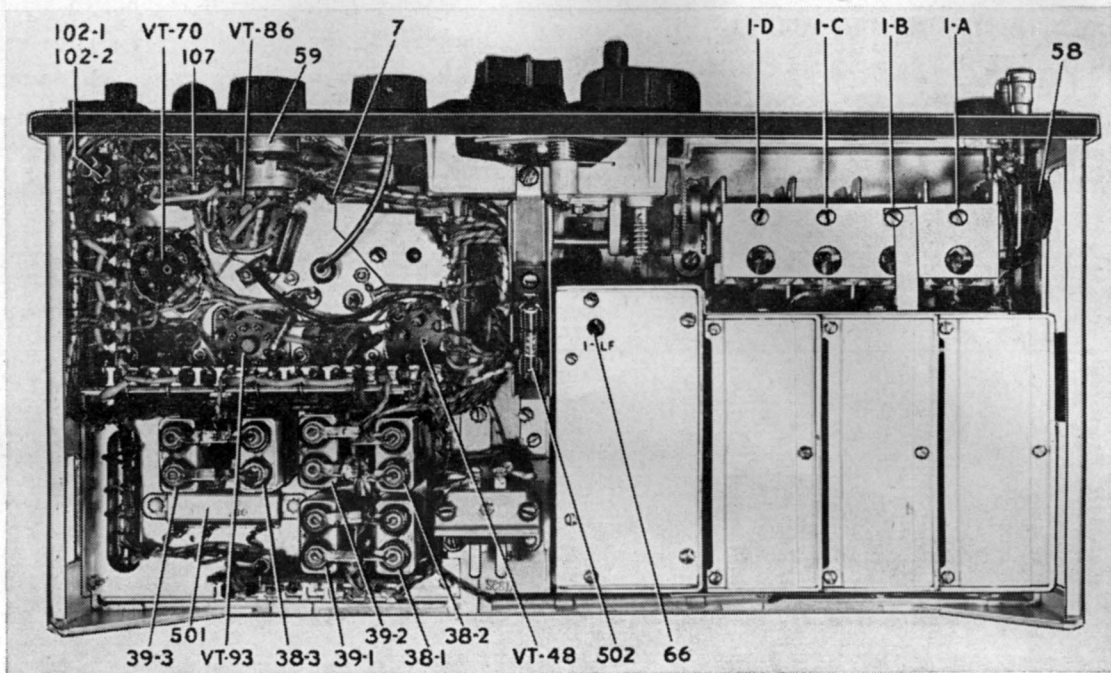

FIGURE 5—RADIO RECEIVER BC-348-S, BOTTOM VIEW OF CHASSIS

SECTION V
SUPPLEMENTARY DATA

**TABLE OF REPLACEABLE PARTS FOR
RADIO RECEIVERS BC-348-S AND BC-224-L**

<i>Reference Number</i>	<i>Name</i>	<i>Description</i>	<i>Function</i>
1-A } 1-B } 1-C } 1-D }	Capacitor	{ A. Section 13.5 to 331.6 mmf B. Section 13.5 to 331.6 mmf C. Section 13.5 to 331.6 mmf D. Section 13.5 to 331.6 mmf	Main tuning
2	Capacitor	Air trimmer 50 mmf max.	Ant. aligning
3-1	Capacitor	Air trimmer 50 mmf max.	Ant. trimmer
3-2	Capacitor	Air trimmer 50 mmf max.	R-F trimmer
3-3	Capacitor	Air trimmer 50 mmf max.	R-F trimmer
3-4	Capacitor	Air trimmer 50 mmf max.	Det. trimmer
3-5	Capacitor	Air trimmer 50 mmf max.	Det. trimmer
3-6	Capacitor	Air trimmer 50 mmf max.	Osc. trimmer
3-7	Capacitor	Air trimmer 50 mmf max.	Ant. trimmer
3-8	Capacitor	Air trimmer 50 mmf max.	Ant. trimmer
4-1	Capacitor	Air trimmer 50 mmf max.	Ant. trimmer
4-2	Capacitor	Air trimmer 50 mmf max.	R-F trimmer
4-3	Capacitor	Air trimmer 50 mmf max.	Det. trimmer
5-3	Capacitor	Air trimmer 25 mmf max.	R-F trimmer
5-4	Capacitor	Air trimmer 25 mmf max.	R-F trimmer
5-5	Capacitor	Air trimmer 25 mmf max.	Det. trimmer
5-6	Capacitor	Air trimmer 25 mmf max.	Det. trimmer
6-1	Capacitor	Air trimmer 25 mmf max.	Osc. trimmer
6-2	Capacitor	Air trimmer 25 mmf max.	Osc. trimmer
6-3	Capacitor	Air trimmer 25 mmf max.	Osc. trimmer
6-4	Capacitor	Air trimmer 25 mmf max.	Osc. trimmer
6-5	Capacitor	Air trimmer 25 mmf max.	Osc. trimmer
7	Capacitor	Air trimmer 10 mmf max.	Crystal filter adjustment
8	Capacitor	Air trimmer 10 mmf max.	C-W osc. adjustment
9-1	Capacitor	Mica 500 volts d-c .01 mf \pm 10% with leads	1st R-F cathode by-pass
9-2	Capacitor	Mica 500 volts d-c .01 mf \pm 10% with leads	1st R-F screen by-pass
9-3	Capacitor	Mica 500 volts d-c .01 mf \pm 10% with leads	2nd R-F cathode by-pass

**TABLE OF REPLACEABLE PARTS FOR
RADIO RECEIVERS BC-348-S AND BC-224-L (Continued)**

<i>Reference Number</i>	<i>Name</i>	<i>Description</i>	<i>Function</i>
9-4	Capacitor	Mica 500 volts d-c .01 mf \pm 10% with leads	2nd R-F screen by-pass
9-5	Capacitor	Mica 500 volts d-c .01 mf \pm 10% with leads	1st Det. screen by-pass
9-6	Capacitor	Mica 500 volts d-c .01 mf \pm 10% with leads	1st I-F transformer by-pass
9-7	Capacitor	Mica 500 volts d-c .01 mf \pm 10% with leads	Crystal transformer by-pass
9-9	Capacitor	Mica 500 volts d-c .01 mf \pm 10% with leads	1st I-F plate by-pass
9-10	Capacitor	Mica 500 volts d-c .01 mf \pm 10% with leads	2nd I-F transformer by-pass
9-12	Capacitor	Mica 500 volts d-c .01 mf \pm 10% with leads	C-W osc. plate by-pass
9-13	Capacitor	Mica 500 volts d-c .01 mf \pm 10% with leads	Plug terminal by-pass
9-14	Capacitor	Mica 500 volts d-c .01 mf \pm 10% with leads	A.V.C. by-pass
9-15	Capacitor	Mica 500 volts d-c .01 mf \pm 10% with leads	3rd I-F transformer by-pass
9-16	Capacitor	Mica 500 volts d-c .01 mf \pm 10% with leads	3rd I-F cathode by-pass
9-17	Capacitor	Mica 500 volts d-c .01 mf \pm 10% with leads	Heater by-pass
9-18	Capacitor	Mica 500 volts d-c .01 mf \pm 10% with leads	Battery by-pass
10-1	Capacitor	Mica 500 volts d-c .01 mf \pm 10% with lugs	Ant. coil by-pass
10-2	Capacitor	Mica 500 volts d-c .01 mf \pm 10% with lugs	1st R-F plate
10-3	Capacitor	Mica 500 volts d-c .01 mf \pm 10% with lugs	R-F coil by-pass
10-4	Capacitor	Mica 500 volts d-c .01 mf \pm 10% with lugs	2nd R-F plate
11-1	Capacitor	Mica 500 volts d-c .01 mf \pm 10% with lugs	Osc. plate
11-2	Capacitor	Mica 500 volts d-c .01 mf \pm 10% with lugs	1st Det. cathode by-pass
12-1	Capacitor	Mica 500 volts d-c .005 mf \pm 10% with leads	Audio transformer secondary by-pass
12-2	Capacitor	Mica 500 volts d-c .005 mf \pm 10% with leads	Antenna blocking
13	Capacitor	Mica 500 volts d-c 390 mf \pm 1.2% with leads	Osc. series
14	Capacitor	Mica 500 volts d-c 2240 mmf \pm 3% with leads	Osc. series
15-1	Capacitor	Mica 500 volts d-c 1500 mmf \pm 10% with leads	Audio coupling
15-2	Capacitor	Mica 500 volts d-c 1500 mmf \pm 10% with leads	Audio transformer primary shunt
16	Capacitor	Mica 500 volts d-c 670 mmf \pm 1.2% with leads	Osc. series
17	Capacitor	Mica 500 volts d-c 130 mmf \pm 5% with leads	Osc. series

**TABLE OF REPLACEABLE PARTS FOR
RADIO RECEIVERS BC-348-S AND BC-224-L (Continued)**

<i>Reference Number</i>	<i>Name</i>	<i>Description</i>	<i>Function</i>
18-1	Capacitor	Mica 500 volts d-c 500 mmf \pm 5% with leads	1st I-F secondary tuning
18-2	Capacitor	Mica 500 volts d-c 500 mmf \pm 5% with leads	1st I-F secondary tuning
19	Capacitor	Mica 500 volts d-c 285 mmf \pm 5% with leads	Crystal transformer tuning
20-1	Capacitor	Mica 500 volts d-c 260 mmf \pm 5% with leads	2nd I-F primary tuning
20-2	Capacitor	Mica 500 volts d-c 260 mmf \pm 5% with leads	2nd I-F secondary tuning
20-3	Capacitor	Mica 500 volts d-c 260 mmf \pm 5% with leads	3rd I-F secondary tuning
21-1	Capacitor	Mica 500 volts d-c 250 mmf \pm 5% with leads	1st I-F primary tuning
21-2	Capacitor	Mica 500 volts d-c 250 mmf \pm 5% with leads	3rd I-F primary tuning
22-1	Capacitor	Mica 500 volts d-c 240 mmf \pm 5% with leads	C-W osc. tuning
22-2	Capacitor	Mica 500 volts d-c 240 mmf \pm 5% with leads	2nd Det. by-pass
23	Capacitor	Mica 500 volts d-c 170 mmf \pm 1.2% with leads	Osc. series
24-1	Capacitor	Mica or Ceramic 500 volts d-c 155 mmf \pm 1.8% with leads	Ant. series
24-2	Capacitor	Mica or Ceramic 500 volts d-c 155 mmf \pm 1.8% with leads	R-F series
24-3	Capacitor	Mica or Ceramic 500 volts d-c 155 mmf \pm 1.8% with leads	Det. series
25	Capacitor	Mica or Ceramic 500 volts d-c 25 mmf \pm 10% with leads	Ant. shunt
26-1	Capacitor	Mica 500 volts d-c 150 mmf \pm 5% with leads	C-W osc. grid
26-2	Capacitor	Mica 500 volts d-c 150 mmf \pm 5% with leads	4th I-F secondary tuning
27	Capacitor	Mica 500 volts d-c 135 mmf \pm 1.2% with leads	Osc. series
28-1	Capacitor	Mica 500 volts d-c 135 mmf \pm 2% with leads	Ant. series
28-2	Capacitor	Mica 500 volts d-c 135 mmf \pm 2% with leads	R-F series
28-3	Capacitor	Mica 500 volts d-c 135 mmf \pm 2% with leads	Det. series
29-1	Capacitor	Mica 500 volts d-c 470 mmf \pm 2% with leads	Ant. series
29-2	Capacitor	Mica 500 volts d-c 470 mmf \pm 2% with leads	R-F series
29-3	Capacitor	Mica 500 volts d-c 470 mmf \pm 2% with leads	Det. series
30	Capacitor	Mica or Ceramic 500 volts d-c 100 mmf \pm 5% with leads	Osc. grid
31-1	Capacitor	Mica or Ceramic 500 volts d-c 75 mmf \pm 5% with leads	R-F shunt

TABLE OF REPLACEABLE PARTS FOR
RADIO RECEIVERS BC-348-S AND BC-224-L (Continued)

<i>Reference Number</i>	<i>Name</i>	<i>Description</i>	<i>Function</i>
31-2	Capacitor	Mica or Ceramic 500 volts d-c 75 mmf \pm 5% with leads	Det. shunt
31-4	Capacitor	Mica or Ceramic 500 volts d-c 75 mmf \pm 10% with leads	Diode coupling
32-1	Capacitor	Mica or Ceramic 500 volts d-c 47 mmf \pm 5% with leads	4th I-F primary tuning
32-2	Capacitor	Mica or Ceramic 500 volts d-c 47 mmf \pm 10% with leads	Det. shunt
33-1	Capacitor	Mica or Ceramic 500 volts d-c 50 mmf \pm 10% with leads	Ant. shunt
33-2	Capacitor	Mica or Ceramic 500 volts d-c 50 mmf \pm 10% with leads	R-F shunt
34	Capacitor	Ceramic 500 volts d-c 85 mmf \pm 2½% with leads	Osc. temp. compensating
35	Capacitor	Ceramic 500 volts d-c 47 mmf \pm 5% with leads	Osc. temp. compensating
36	Capacitor	Ceramic 500 volts d-c 30 mmf \pm 2½% with leads	Osc. temp. compensating
37-1	Capacitor	Air trimmer 25 mmf max.	R-F trimmer
37-2	Capacitor	Air trimmer 25 mmf max.	Det. trimmer
38-1A	Capacitor	Paper 250 volts d-c .5 mf \pm 15%	4th I-F filter
38-1B	Capacitor	Paper 250 volts d-c .5 mf \pm 15%	Volume control filter
38-2A	Capacitor	Paper 250 volts d-c .5 mf \pm 15%	Screen supply filter
38-2B	Capacitor	Paper 250 volts d-c .5 mf \pm 15%	Output plate filter
38-3A	Capacitor	Paper 250 volts d-c .5 mf \pm 15%	Noise compensator filter
38-3B	Capacitor	Paper 250 volts d-c .5 mf \pm 15%	1st I-F screen filter
39-1A	Capacitor	Paper 250 volts d-c .5 mf \pm 15%	4th I-F transformer filter
39-1B	Capacitor	Paper 250 volts d-c .5 mf \pm 15%	4th I-F transformer filter
39-2A	Capacitor	Paper 250 volts d-c .5 mf \pm 15%	Output grid filter
39-2B	Capacitor	Paper 250 volts d-c .5 mf \pm 15%	Screen supply filter
39-3A	Capacitor	Paper 250 volts d-c .5 mf \pm 15%	1st I-F screen filter
39-3B	Capacitor	Paper 250 volts d-c .5 mf \pm 15%	3rd I-F screen filter
40-1	Resistor	Insul. 470 ohms \pm 10% ½w	1st R-F cathode
40-2	Resistor	Insul. 470 ohms \pm 10% ½w	2nd R-F cathode
40-3	Resistor	Insul. 470 ohms \pm 10% ½w	1st I-F cathode
40-4	Resistor	Insul. 470 ohms \pm 10% ½w	2nd I-F cathode

**TABLE OF REPLACEABLE PARTS FOR
RADIO RECEIVERS BC-348-S AND BC-224-L (Continued)**

<i>Reference Number</i>	<i>Name</i>	<i>Description</i>	<i>Function</i>
41-1	Resistor	Insul. 1000 ohms \pm 10% 1/2w	Osc. plate
41-2	Resistor	Insul. 1000 ohms \pm 10% 1/2w	3rd I-F cathode
42-1	Resistor	Insul. 4700 ohms \pm 10% 1/2w	1st R-F plate
42-2	Resistor	Insul. 4700 ohms \pm 10% 1/2w	2nd R-F plate
42-3	Resistor	Insul. 4700 ohms \pm 10% 1/2w	1st Det. plate
42-4	Resistor	Insul. 4700 ohms \pm 10% 1/2w	1st R-F screen
42-5	Resistor	Insul. 4700 ohms \pm 10% 1/2w	1st I-F plate
42-6	Resistor	Insul. 4700 ohms \pm 10% 1/2w	Bleeder
42-7	Resistor	Insul. 4700 ohms \pm 10% 1/2w	3rd I-F cathode
43-1	Resistor	Insul. 10,000 ohms \pm 10% 1/2w	1st R-F screen
43-2	Resistor	Insul. 10,000 ohms \pm 10% 1/2w	2nd R-F screen
43-3	Resistor	Insul. 10,000 ohms \pm 10% 1/2w	1st Det. screen
43-4	Resistor	Insul. 10,000 ohms \pm 10% 1/2w	C-W osc. bleeder
44	Resistor	Insul. 12,000 ohms \pm 10% 1/2w	Voltage regulator series
45	Resistor	Insul. 15,000 ohms \pm 10% 1/2w	1st Det. cathode
46	Resistor	Insul. 56,000 ohms \pm 10% 1/2w	Output loading
47	Resistor	Insul. 68,000 ohms \pm 10% 1/2w	C-W osc. plate
48-1	Resistor	Insul. 100,000 ohms \pm 10% 1/2w	1st R-F grid
48-2	Resistor	Insul. 100,000 ohms \pm 10% 1/2w	2nd R-F grid
48-3	Resistor	Insul. 100,000 ohms \pm 10% 1/2w	Osc. grid
48-4	Resistor	Insul. 100,000 ohms \pm 10% 1/2w	Output grid filter
49	Resistor	Insul. 180,000 ohms \pm 10% 1/2w	3rd I-F screen
50-1	Resistor	Insul. 470,000 ohms \pm 10% 1/2w	Antenna protective
50-2	Resistor	Insul. 470,000 ohms \pm 10% 1/2w	1st I-F grid
50-3	Resistor	Insul. 470,000 ohms \pm 10% 1/2w	2nd I-F grid
50-4	Resistor	Insul. 470,000 ohms \pm 10% 1/2w	C-W osc. grid
50-5	Resistor	Insul. 470,000 ohms \pm 10% 1/2w	Det. coil shunt
51	Resistor	Insul. 560,000 ohms \pm 10% 1/2w	Output grid
52	Resistor	Insul. 1.5 meg. ohms \pm 10% 1/2w	A.V.C. diode
53	Resistor	Insul. 220,000 ohms \pm 10% 1/2w	A.V.C. filter
56	Resistor	Insul. 10,000 ohms \pm 10% 1w	Bleeder

**TABLE OF REPLACEABLE PARTS FOR
RADIO RECEIVERS BC-348-S AND BC-224-L (Continued)**

<i>Reference Number</i>	<i>Name</i>	<i>Description</i>	<i>Function</i>
57	Resistor	Insul. 27,000 ohms \pm 10% 1w	Voltage regulator
58	Resistor	Variable 3500 \pm 10% to 10 ohms .1 watt	Noise compensator
59-A	Resistor	Volume control front unit 20,000 ohms \pm 10% to 10 ohms 2 watt	M. V. C.
59-B	Resistor	Volume control back unit 350,000 ohms \pm 10% to 50 ohms .2 watt	A. V. C.
61	Resistor	Insul. 2400 ohms \pm 5% $\frac{1}{2}$ w	Output plate
62	Resistor	Insul. 47,000 ohms \pm 10% $\frac{1}{2}$ w	Bleeder
64	Capacitor	Ceramic 500 volts 35 mmf \pm 5% with leads	Osc. temp. compensating
65	Capacitor	Air trimmer 10 mmf max.	Ant. trimmer
66	Capacitor	Ceramic trimmer 25 mmf working	Osc. series padder
67	Capacitor	Mica 500 volts d-c 750 mmf \pm 5% with leads	R-F plate tuning
68	Capacitor	Molded paper .1 mfd. \pm 10% 400 volts	2nd I-F cathode by-pass
71	Inductance	Antenna band 1	1st R-F tuned circuit
72	Inductance	Antenna band 2	1st R-F tuned circuit
73	Inductance	Antenna band 3	1st R-F tuned circuit
74	Inductance	Antenna band 4	1st R-F tuned circuit
75	Inductance	Antenna band 5	1st R-F tuned circuit
76	Inductance	Antenna band 6	1st R-F tuned circuit
77	Inductance	R-F band 1	1st R-F to 2nd R-F coupling
78	Transformer	R-F band 2	1st R-F to 2nd R-F coupling
79	Transformer	R-F band 3	1st R-F to 2nd R-F coupling
80	Transformer	R-F band 4	1st R-F to 2nd R-F coupling
81	Transformer	R-F band 5	1st R-F to 2nd R-F coupling
82	Transformer	R-F band 6	1st R-F to 2nd R-F coupling
83	Transformer	1st det. band 1	2nd R-F to det. coupling
84	Transformer	1st det. band 2	2nd R-F to det. coupling
85	Transformer	1st det. band 3	2nd R-F to det. coupling
86	Transformer	1st det. band 4	2nd R-F to det. coupling
87	Transformer	1st det. band 5	2nd R-F to det. coupling
88	Transformer	1st det. band 6	2nd R-F to det. coupling

**TABLE OF REPLACEABLE PARTS FOR
RADIO RECEIVERS BC-348-S AND BC-224-L (Continued)**

<i>Reference Number</i>	<i>Name</i>	<i>Description</i>	<i>Function</i>
89	Transformer	Osc. band 1	Osc. to 1st det. coupling
90	Transformer	Osc. band 2	Osc. to 1st det. coupling
91	Transformer	Osc. band 3	Osc. to 1st det. coupling
92	Transformer	Osc. band 4	Osc. to 1st det. coupling
93	Transformer	Osc. band 5	Osc. to 1st det. coupling
94	Transformer	Osc. band 6	Osc. to 1st det. coupling
95	Transformer	1st I-F	1st Det. to crystal coupling
96	Transformer	Crystal filter	Crystal to 1st I-F coupling
97	Transformer	2nd I-F	1st I-F to 2nd I-F coupling
98	Transformer	C-W osc.	Grid & plate coupling
99	Transformer	3rd I-F	2nd I-F to 3rd I-F coupling
100	Transformer	4th I-F	3rd I-F to 2nd det. coupling
101-A	Transformer	Audio	Output
101-B	Choke	Audio frequency	Filter
101-C	Capacitor	Paper 400 volts d-c .05 mf \pm 10%	C-W osc. time constant
102-1	Jack	Single circuit	Headphone
102-2	Jack	Single circuit	Headphone
103	Regulator	Neon bulb type 991	Osc. plate voltage regulator
104	Lamp	6 to 8 volts type 44	Dial light
105	Switch	SPST type	Crystal filter (out-in)
106	Switch	DPST type	C-W osc. (on-off)
107	Switch	3 position, 2 wafer	A. V. C. Off M. V. C.
108	Switch	6 position, 1 wafer	Band switch, antenna unit
109	Switch	6 position, 1 wafer	Band switch, antenna unit
110	Switch	6 position, 1 wafer	Band switch, R-F unit
111	Switch	6 position, 1 wafer	Band switch, R-F unit
112	Switch	6 position, 1 wafer	Band switch, det. unit
113	Switch	6 position, 1 wafer	Band switch, det. unit
114	Switch	6 position, 1 wafer	Band switch, osc. unit
115	Switch	6 position, 1 wafer	Band switch, osc. unit

**TABLE OF REPLACEABLE PARTS FOR
RADIO RECEIVERS BC-348-S AND BC-224-L (Continued)**

<i>Reference Number</i>	<i>Name</i>	<i>Description</i>	<i>Function</i>
116	Switch	6 position, 1 wafer	Band switch, osc. unit
117	Switch	6 position, 1 wafer	Band switch, osc. unit
121	Crystal assembly	915 kc crystal mounted in case	I-F filter
251	1st I-F transformer assembly	Complete with shield can	1st det. to 1st I-F coupling
252	2nd I-F transformer assembly	Complete with shield can	1st I-F to 2nd I-F coupling
253	3rd I-F transformer assembly	Complete with shield can	2nd I-F to 3rd I-F coupling
254	4th I-F transformer assembly	Complete with shield can	3rd I-F to 2nd det. coupling
255	Crystal filter assembly	Complete with shield can	I-F selectivity
256	C-W osc. assembly	Complete with shield can	C-W reception
301	Choke	R-F	Dynamotor filter
302	Choke	R-F	Dynamotor filter
303-A	Capacitor	Paper 250 volts d-c .5 mf \pm 20%	Dynamotor filter
303-B	Capacitor	Paper 250 volts d-c .5 mf \pm 20%	Dynamotor filter
304-1	Capacitor	Mica 500 volts d-c .01 mf \pm 10%	Dynamotor filter
304-2	Capacitor	Mica 500 volts d-c .01 mf \pm 10%	Dynamotor filter
305	Capacitor	Paper 400 volts d-c 1.0 mf \pm 20%	Dynamotor filter
*500	Resistor	Variable 200 ohms \pm 10% 4 watts	Dial lamp control
*501-A	Resistor	Insulated 3 ohms + 10% - 50% 1.5 watts	Filament
*501-B	Resistor	Insulated 190 ohms + 10% - 15% 1.9 watts	Filament
*502	Fuse	5-Amp 25-volt Type	Primary protective
*503	Resistor	Insulated 60 ohms \pm 10% 3.7 watts	Dial lamps series
*510	Dynamotor	28 Volts 1.23 amp, 220 volts .070 amp, 4400 rpm.	Motor generator

PARTS USED ONLY IN BC-224-L

54	Resistor	Insul. 0.5 ohms \pm 10% 1 watt	Filament
55	Resistor	Insul. 68 ohms \pm 10% 1 watt	Filament balance
60	Resistor	Variable, 75 ohms \pm 10%	Dial lamp control
118	Fuse FU-23	10-Amp. 25-volt	Primary protective
300	Dynamotor	13.8 volts, 2.45 amp; 220 volt, .07 amp; 4400 r.p.m.	Motor generator

*Receiver BC-348-S only.

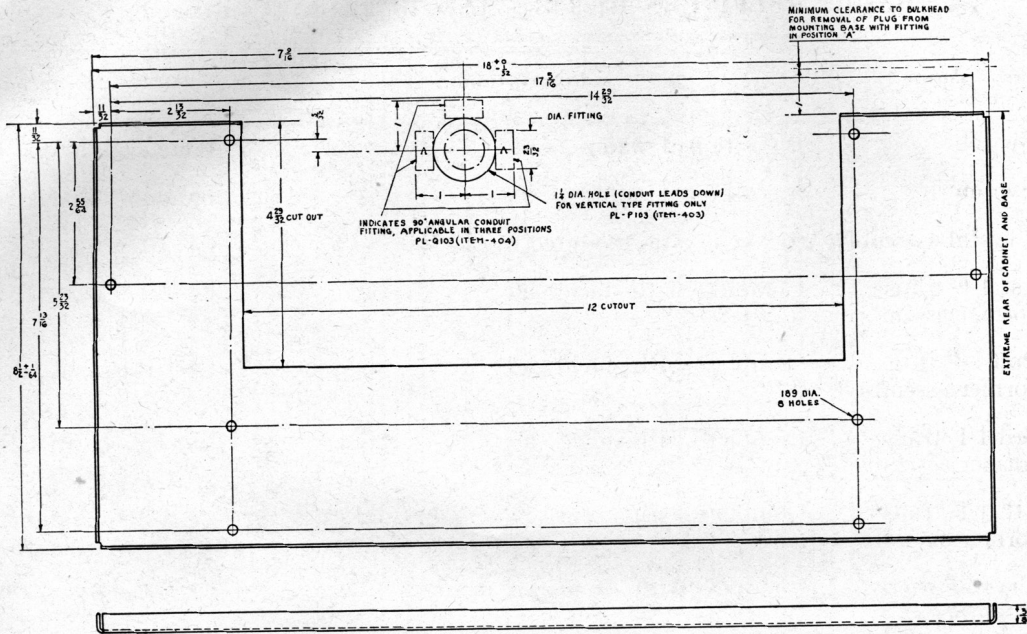

FIGURE 6—RADIO RECEIVER BC-348-S, DRILLING PLAN

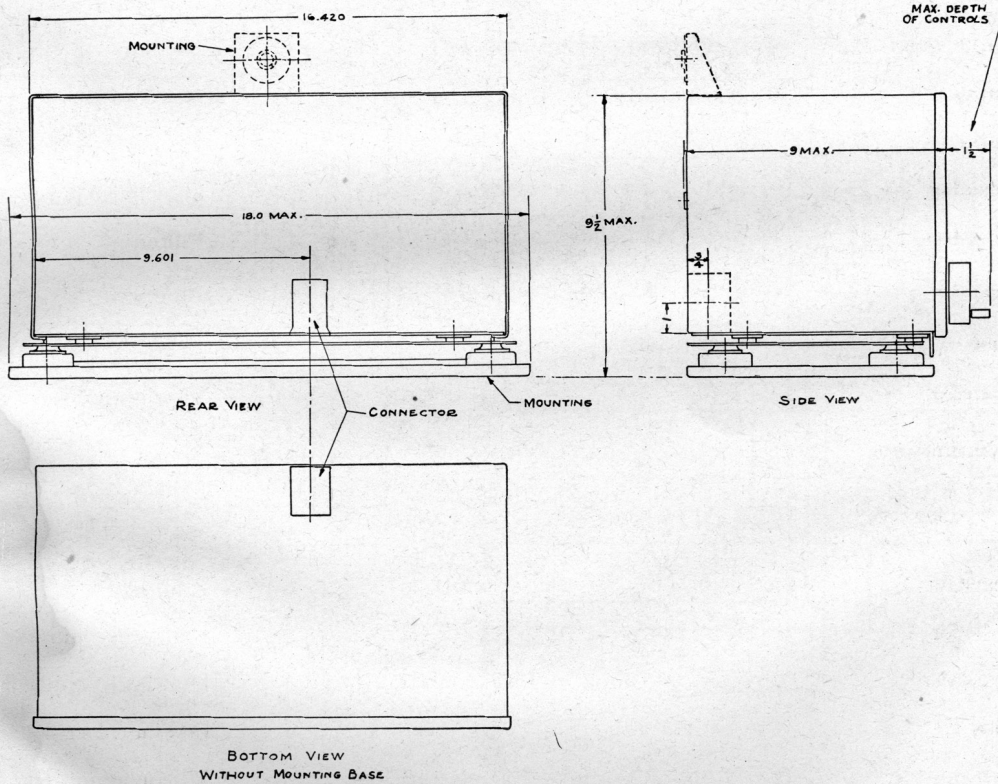

FIGURE 7—RADIO RECEIVER BC-348-S, OUTLINE DIMENSIONAL SKETCH

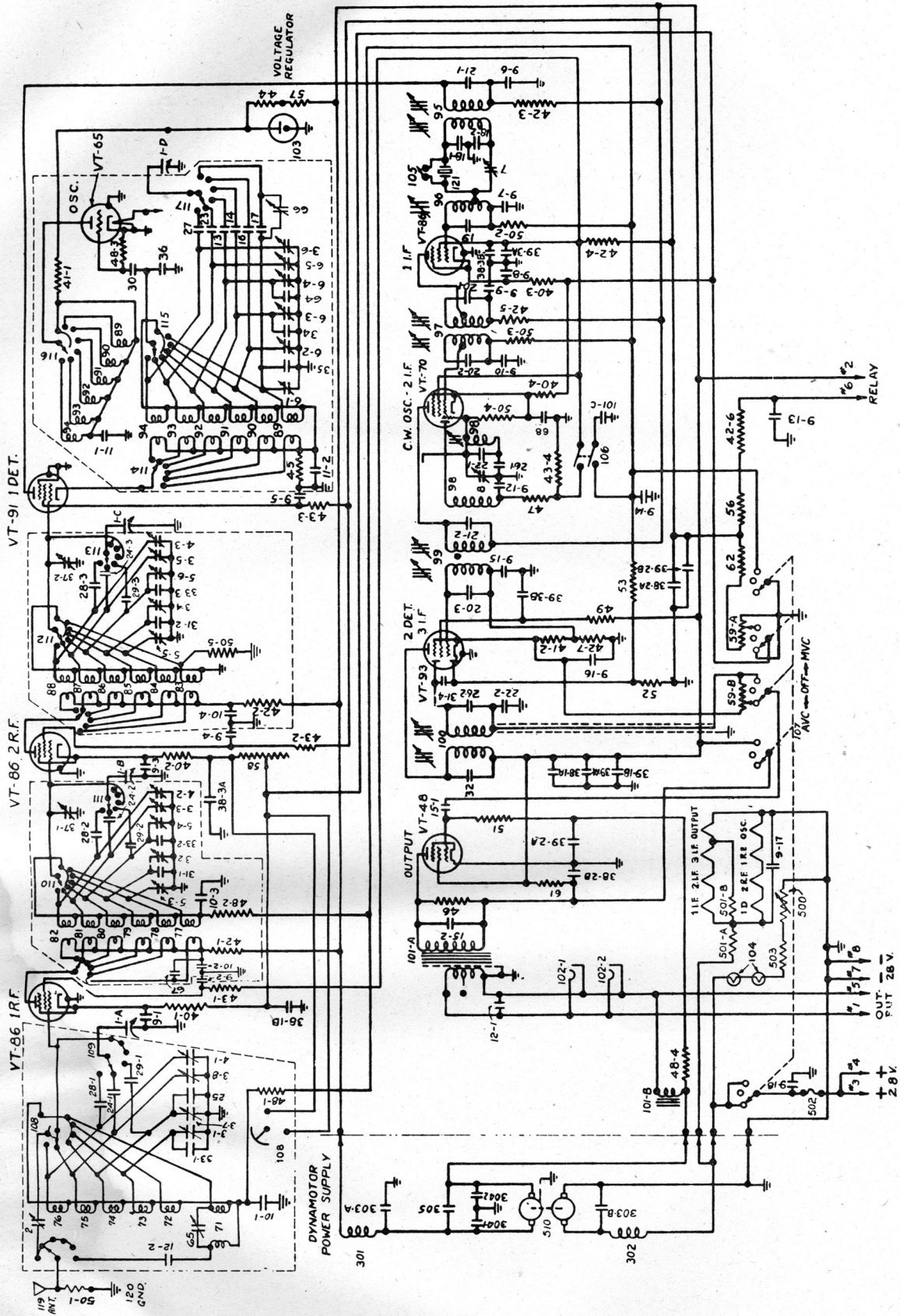

FIGURE 8—RADIO RECEIVER BC-348-S, SCHEMATIC DIAGRAM

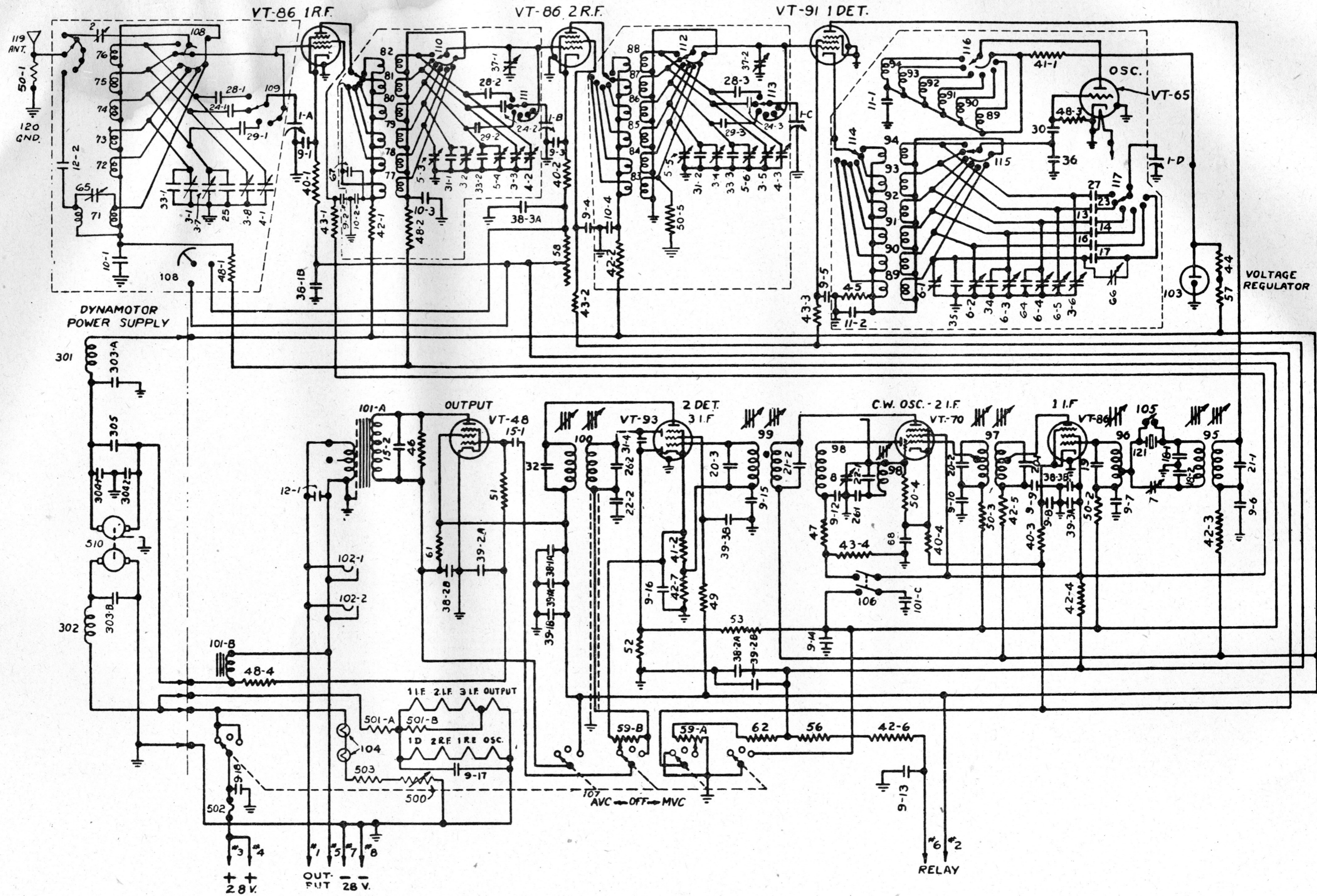

FIGURE 8—RADIO RECEIVER BC-348-S, SCHEMATIC DIAGRAM

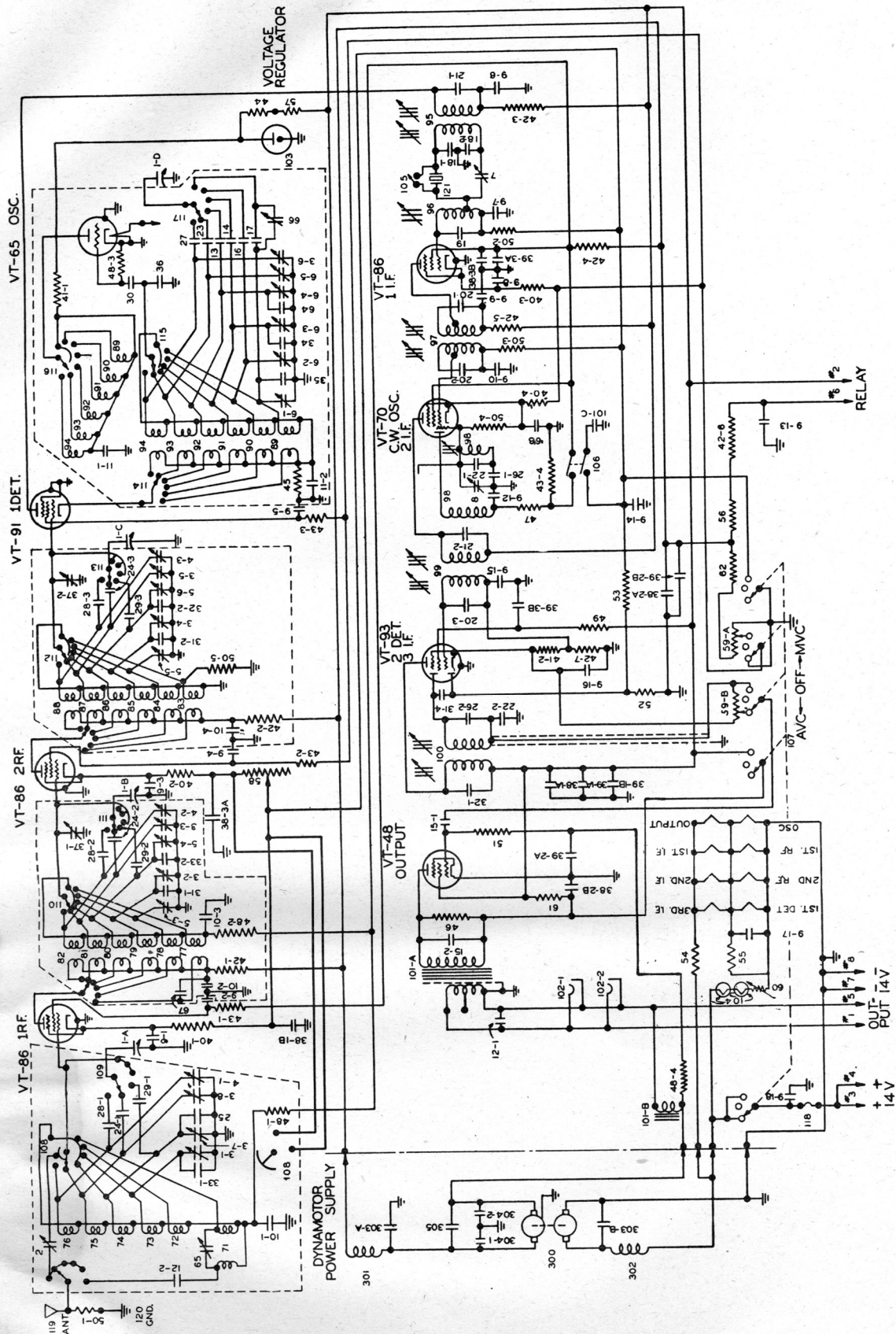

FIGURE 9—RADIO RECEIVER BC-224-L, SCHEMATIC DIAGRAM

FIGURE 9—RADIO RECEIVER BC-224-L, SCHEMATIC DIAGRAM

