

INSTRUCTION BOOK
•• FOR
OPERATION AND MAINTENANCE
OF
RADIO RECEIVER BC-348-S
AND
RADIO RECEIVER BC-224-L



RESTRICTED

PUBLISHED BY AUTHORITY
OF
THE CHIEF SIGNAL OFFICER

FOR AIRPLANE TYPE B-24J
AAF Serial No. 42-73374

APRIL 21, 1943

INSTRUCTION BOOK
FOR
OPERATION AND MAINTENANCE
OF
RADIO RECEIVER BC-348-S
AND
RADIO RECEIVER BC-224-L

RESTRICTED

Notice:—This document contains information affecting the national defense of the United States within the meaning of the Espionage Act, 50 U. S. C., 31 and 32, as amended. Its transmission or the revelation of its contents in any manner to an unauthorized person is prohibited by law. (AR 380-5)

The information contained in restricted documents and the essential characteristics of restricted material will not be communicated to the public or to the press, but may be given to any person known to be in the service of the United States and to persons of undoubted loyalty and discretion who are cooperating in Government work.

PUBLISHED BY AUTHORITY
OF
THE CHIEF SIGNAL OFFICER

APRIL 21, 1943

Destruction of Abandoned Materiel in the Combat Zone

In case it should become necessary to prevent the capture of this
equipment and when ordered to do so,

**DESTROY IT SO THAT NO PART OF IT CAN BE SALVAGED, RECOGNIZED OR USED BY THE
ENEMY. BURN ALL PAPERS AND BOOKS.**

Means:-

1. Explosives, when provided.
2. Hammers, axes, sledges or whatever heavy object is readily available.
3. Burning by means of incendiaries such as gasoline, oil, paper or wood.
4. Grenades and shots from available arms.
5. Where possible, and when time permits, bury all debris or dispose of it in streams or other bodies of water.

Procedure:-

1. Obliterate all identifying marks. Destroy nameplates and circuit labels.
2. Demolish all panels, castings, switch- and instrument-boards.
3. Destroy all controls, switches, relays, connections and meters.
4. Rip out all wiring in electrical equipment. Smash gas, oil and water cooling systems in gas-engine generators, etc.
5. Smash every electrical or mechanical part whether rotating, moving or fixed.
6. Break up all operating instruments such as keys, phones, microphones, etc.
7. Destroy all classes of carrying cases, straps, containers, etc.

REPORT OF MAJOR FAILURE

In the event of major failure of any of the component units of this equipment, a report shall be submitted in the form indicated below. Copies of this report shall be forwarded to the Chief of Signal Section, Air Service Command, Patterson Field, Fairfield, Ohio, and to the Director, Signal Corps Aircraft Signal Service, Wright Field, Ohio.

- 1. Contract or order number.**
- 2. Organization and station.**
- 3. Nomenclature of equipment.**
- 4. Nomenclature of component unit.**
- 5. Date and nature of failure.**
- 6. Type of airplane in which installed.**
- 7. Recommendations.**

TABLE OF CONTENTS

PARAGRAPH

PAGE

SECTION I

DESCRIPTION AND INSTALLATION

| | |
|---|---|
| 1. GENERAL | 1 |
| 2. INSTALLATION | 1 |
| <i>a.</i> Mounting | 1 |
| <i>b.</i> Power Connections | 1 |
| <i>c.</i> Radio Transmitter Connections | 1 |
| <i>d.</i> Output Connections | 1 |
| <i>e.</i> Bonding and Shielding | 2 |
| <i>f.</i> Mounting of Radio Receiver | 2 |
| <i>g.</i> Safety Wire | 2 |
| <i>h.</i> Ground | 2 |
| <i>i.</i> Antenna | 2 |
| <i>j.</i> Adjustment of Input Alignment Capacitor | 2 |

SECTION II

PREPARATION FOR USE

| | |
|----------------------------|---|
| 3. PRELIMINARY CHECK | 3 |
| 4. POWER CONNECTIONS | 3 |
| 5. OPERATING TEST | 3 |

SECTION III

OPERATION

| | |
|------------------------------|---|
| 6. OPERATING PROCEDURE | 5 |
| <i>a.</i> Controls | 5 |

TABLE OF CONTENTS (Continued)

| PARAGRAPH | | PAGE |
|-----------|--|------|
| | SECTION III—OPERATION (Continued) | |
| 6. | OPERATING PROCEDURE (CONTINUED) | 5 |
| | <i>b.</i> Modulated Signal Reception | 5 |
| | <i>c.</i> C-W Reception | 5 |

SECTION IV

MAINTENANCE

| | | |
|-----|---|---|
| 7. | ALIGNMENT OF I-F AMPLIFIER | 6 |
| 8. | TEST AND ADJUSTMENT OF CRYSTAL FILTER | 6 |
| 9. | CHECK AND ALIGNMENT OF C-W OSCILLATOR | 6 |
| 10. | ALIGNMENT OF R-F AMPLIFIER AND OSCILLATOR | 7 |

SECTION V

SUPPLEMENTARY DATA

| | | |
|--|--|---|
| | TABLE OF REPLACEABLE PARTS FOR RADIO RECEIVERS BC-348-S AND BC-224-L | 9 |
|--|--|---|

LIST OF ILLUSTRATIONS

| FIGURE | PAGE |
|---|------|
| 1. RADIO RECEIVER BC-348-S, FRONT VIEW..... | x |
| 2. RADIO RECEIVER BC-348-S, CORDING DIAGRAM..... | 2 |
| 3. RADIO RECEIVER BC-348-S, TOP VIEW OF CHASSIS..... | 6 |
| 4. RADIO RECEIVER BC-348-S, REAR VIEW OF CHASSIS..... | 7 |
| 5. RADIO RECEIVER BC-348-S, BOTTOM VIEW OF CHASSIS..... | 8 |
| 6. RADIO RECEIVER BC-348-S, DRILLING PLAN..... | 17 |
| 7. RADIO RECEIVER BC-348-S, OUTLINE DIMENSIONAL SKETCH..... | 17 |
| 8. RADIO RECEIVER BC-348-S, SCHEMATIC DIAGRAM..... | 19 |
| 9. RADIO RECEIVER BC-224-L, SCHEMATIC DIAGRAM..... | 21 |

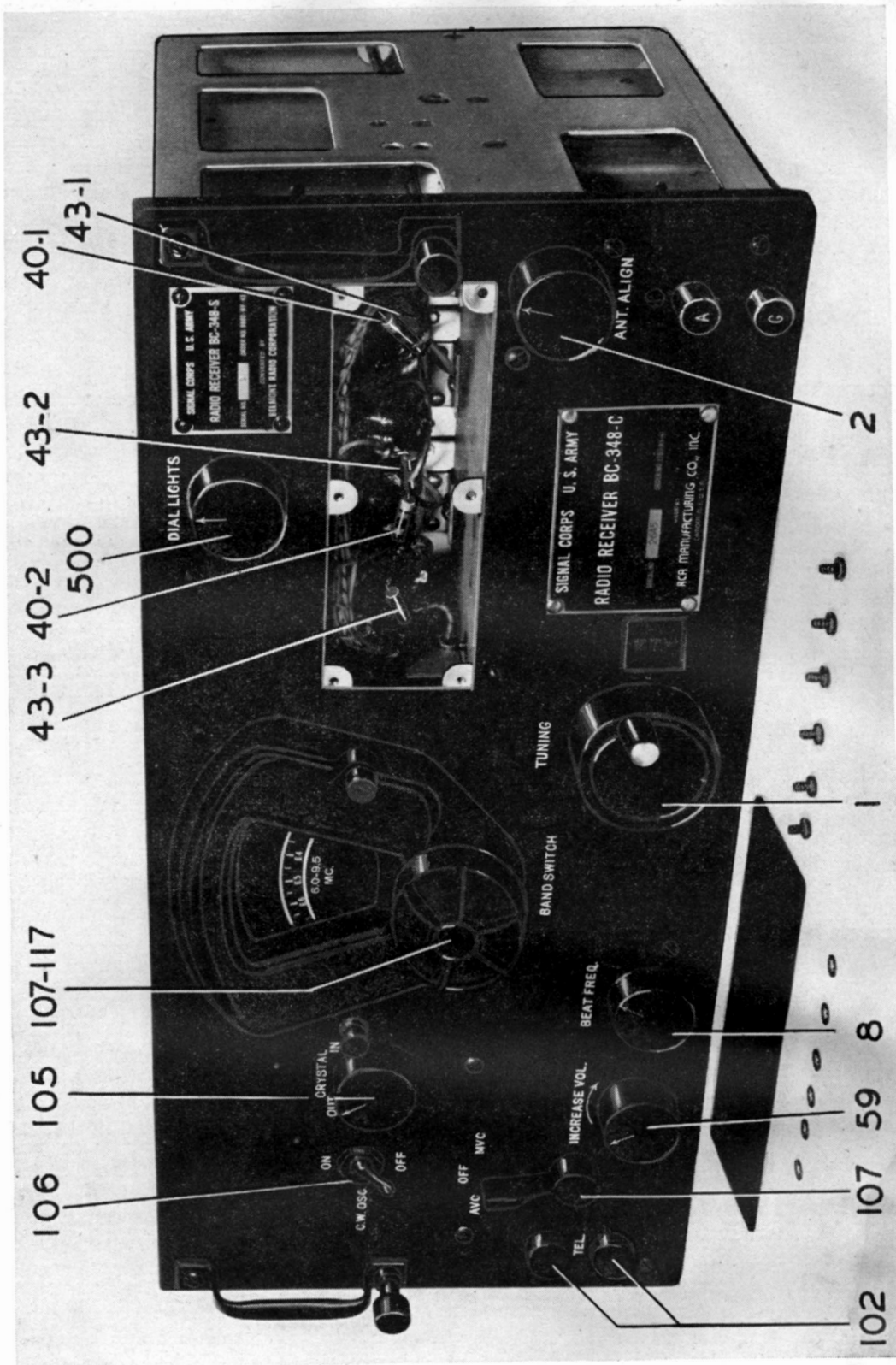

FIGURE 1—RADIO RECEIVER BC-348-S, FRONT VIEW*

* Illustrations throughout this book will be only of Radio Receiver BC-348-S, as the physical appearance of Radio Receivers BC-348-S and BC-224-L is identical. See schematic diagrams, pages 19 and 21, for electrical differences.

INSTRUCTION BOOK
For
OPERATION AND MAINTENANCE
of
RADIO RECEIVER BC-348-S
and
RADIO RECEIVER BC-224-L

SPECIAL NOTICE

Radio Receivers BC-348-S and BC-224-L have been converted from other production models (Radio Receivers BC-348-C and BC-224-C, respectively) by Belmont Radio Corporation, Chicago, Illinois. On equipments produced under this conversion, a name plate appears on the upper right of the panel of each of both types of receiver, identifying each equipment as Radio Receiver BC-348-S and Radio Receiver BC-224-L, respectively, in addition to the name plate for the original receivers—Radio Receivers BC-348-C and BC-224-C—which appears on the bottom right of the panel.

Although this instruction book covers both Radio Receivers BC-348-S and BC-224-L, only the former will be referred to throughout the book for convenience in reference, as the two equipments are essentially identical. See schematic diagrams, pages 19 and 21, for differences.

Restricted

SECTION I

DESCRIPTION AND INSTALLATION

1. GENERAL

Radio Receiver BC-348-S is a locally-controlled, 8-tube, 6-band superheterodyne receiver for use in U. S. Army aircraft and covers the frequency ranges of 200 kc to 500 kc and 1.5 to 18.0 megacycles. The receiver is not intended for remote control, and no features or units have been provided for remote operation. This radio receiver is capable of voice, tone and c-w reception with manual or automatic volume control. When equipped with tubes, dial lights and fuse, and with the antenna, ground and 28-volt* primary power source connections properly made, it becomes a complete and operative equipment by the addition of a headset, as all coils and the high-voltage power supply unit are built in. See Figure 2 for proper connection of terminals No. 2 and No. 6.

The most important considerations necessary for the successful installation and operation of this receiver are as follows:

2. INSTALLATION

a. Mounting

Mount the receiver on a plane surface, allowing sufficient clearance on all sides to permit free action of the shock absorber mounting. The mounting should be permanently attached to the rigid mem-

bers of the plane. The drilling plan of the mounting is shown in Figure 6.

b. Power Connections

Separate pairs of leads to the 28-volt primary power source may be used. See Figure 2.

c. Radio Transmitter Connections

Provisions have been made for the protection of this receiver when the associated radio transmitter is being used. Wire leads from plug terminals 2 and 6 to contacts on the transmitter relay. If the transmitter is removed from the installation, the wires from plug terminals 2 and 6 must be connected for the radio receiver to operate.

d. Output Connections

The output of this receiver has been brought to plug terminals 1 and 5. Leads from these terminals should be wired to the interphone system or as otherwise desired. If the output is desired only at the receiver, it should be taken directly from the phone jack and no connections made to plug terminals 1 and 5. Normal connection is to the 4000-ohm tap marked 4 on the output transformer case. Access to a 300-ohm tap is provided at the terminal marked 2.

*Radio Receiver BC-224-L requires a 14-volt primary power source.

Radio Receiver BC-348-S
Par. 2

e. Bonding and Shielding

At the time of installation of this equipment, make certain that the engine ignition system, generator and other possible causes of disturbance are properly shielded and that bonding of metal parts is carefully carried out.

f. Mounting of Radio Receiver

When proper wiring connections have been made, place the receiver on its mounting with the studs on the bottom of the cabinet entering the slots of the mounting. See that the cabinet is well down on the mounting and that all four studs are fully seated, then push the cabinet towards the rear and fasten by means of the snapslides on the lower front corners of the cabinet.

g. Safety Wire

Pass safety wire through the holes of the snapslide assemblies, being careful that the wires are not twisted too tightly.

h. Ground

Connect the ground-binding post G by a short, direct, low-resistance lead to some grounded metal portion of the plane and solder at that point, if practicable. The lead should have enough slack to prevent vibration being transmitted to the receiver.

i. Antenna

The antenna-circuit aligning capacitor is such that the antenna circuit can be properly aligned when using antennas that range in effective capacitance from 50 to 200 micromicro-farads. However, satisfactory performance will be obtained in practically any type of mast, fixed or trailing wire antenna, although in extreme cases, i.e., very short mast or very long trailing wire, optimum setting of the "antenna alignment" may not be obtained. In general, the most effective antenna is one whose length away from the grounded metal fuselage is the greatest. Place the receiver as near as possible to the lead-in insulator and connect it from the insulator to the antenna binding post A by a copper wire. The lead should have enough slack to prevent vibration being transmitted to the receiver.

j. Adjustment of Input Alignment Capacitor

With the receiver AVC—OFF—MVC switch in the MVC position, the band switch on Band 2, and using the tuning control, tune in a signal at approximately 3.5 mc to maximum signal strength. Reduce volume by means of the volume control knob until the signal is just audible. Adjust the ANTENNA ALIGNMENT control to give maximum volume.

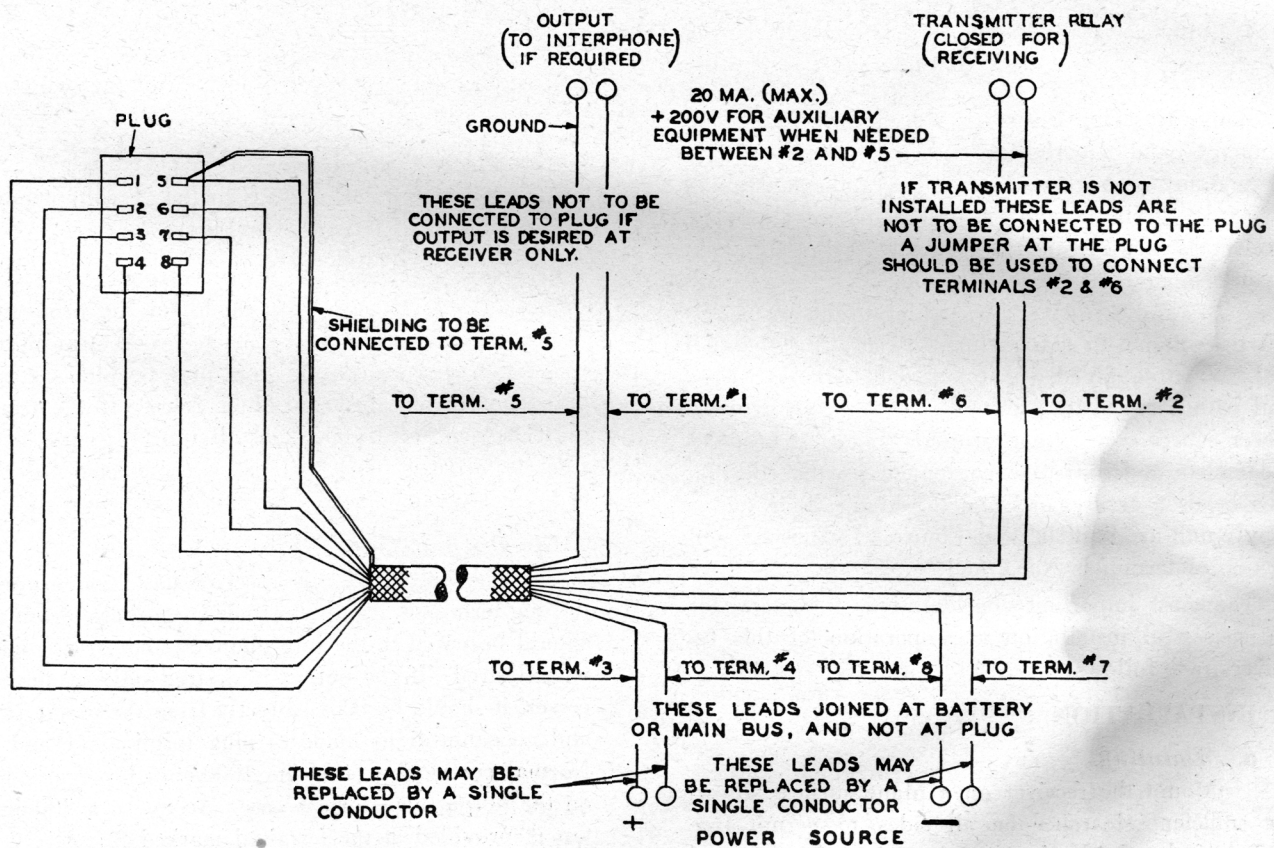

FIGURE 2—RADIO RECEIVER BC-348-S, CORDING DIAGRAM

SECTION II PREPARATION FOR USE

3. PRELIMINARY CHECK

Radio Receiver BC-348-S is a self-contained unit, having its high-voltage power supply and all coil sets built in.

a. Before installing the tubes, check them with the required tube checker.

b. Be sure that the proper tubes, well pushed down and firmly seated in their sockets, are installed, that the tube shield is properly seated and that grid caps fit tightly on the tubes.

c. Check dial lights and fuses and see that they are properly and securely placed.

d. Make sure that the leads to the dynamotor are properly connected at the dynamotor terminal strip and that the screws holding them in place are tight. No other precautions are necessary.

4. POWER CONNECTIONS

Power to the radio receiver is controlled by the receiver AVC—OFF—MVC switch. The table below shows the power connections in conjunction with this receiver switch.

The screen grid voltage supply leads are carried out of the receiver through the power plug to the keying relay of the associated radio transmitter where the circuit is opened when actually transmitting.

5. OPERATING TEST

When the receiver has been completely installed, an operating test should be made as follows:

a. Plug the headset into the TEL jack. Set the receiver switch to MVC. The dynamotor should start and after the tubes have warmed up (approximately 30 seconds), the volume control knob should be advanced until a slight background noise is heard. Set the BAND SWITCH to the frequency band in which test signals are available.

b. Using the TUNING knob and with reference to the calibrated scale on the dial, tune in the desired signal. NOTE: All tuning should be done on MVC with the volume control advanced only enough to give the desired signal strength. In the absence of a signal, the setting of the volume control can be judged by the loudness of the background noise. On MVC, with the volume control set at maximum, very strong carrier waves will block the receiver and intelligible signals cannot be received.

c. Set the receiver switch to AVC. The desired signal should still be heard.

POWER CONNECTIONS

| <i>Receiver Switch Position</i> | <i>Dial Light Rheostat</i> | <i>Circuit Connection</i> |
|-------------------------------------|--------------------------------|---|
| OFF | MIN | No power supplied to receiver |
| OFF | MAX | No power supplied to receiver |
| AVC | MIN | Filaments ON, dynamotor ON, dial lights OUT |
| AVC | MAX | Filaments ON, dynamotor ON, dial lights FULL ON |
| MVC | MIN | Filaments ON, dynamotor ON, dial lights OUT |
| MVC | MAX | Filaments ON, dynamotor ON, dial lights FULL ON |

Radio Receiver BC-348-S

Par. 5

d. With the BEAT FREQ adjustment at zero beat position (arrow on knob pointing up), turn the c-w osc switch to the ON position. An audible beat note should be heard which should vary in pitch when the BEAT FREQ adjustment is changed.

e. With the FREQ c-w OSC still ON, throw the CRYSTAL filter switch to IN. Noise should be greatly reduced and the signal can be tuned out by a much smaller movement of the tuning control knob than when the CRYSTAL filter switch is in the OUT position.

f. Turn the DIAL LIGHT rheostat and observe if control of illumination is secured with both dial lights functioning.

g. Make a pre-flight check, with the airplane engine running. An increase of background noise when the engine starts indicates imperfect shielding or bonding, faulty generator regulator, faulty generator, open filter capacitors or a combination of these faults.

h. Always turn the receiver switch to the OFF position when the receiver is not to be used.

SECTION III OPERATION

6. OPERATING PROCEDURE

a. Controls

(i) *Antenna and Ground Binding Posts*

The antenna is connected to the binding post marked A, and the ground lead to the binding post marked G.

(ii) *ANT ALIGN Control*

This control is a variable capacitor for aligning the input circuit to a given antenna. This adjustment should be made with the receiver tuned to approximately 3.5 mc in Band 2.

(iii) *TUNING Control*

This control varies the setting of the 4-gang variable tuning capacitor.

(iv) *BAND SWITCH Control*

This control selects the desired frequency band as indicated on the dial mask.

(v) *DIAL LIGHTS Control*

This knob controls the intensity of dial illumination and is provided with an OFF position.

(vi) *c-w OSC Switch*

This toggle switch controls the operation of the c-w oscillator as well as the AVC time constant for c-w reception.

(vii) *CRYSTAL Switch*

This control permits the insertion of an i-f crystal filter when extreme selectivity is desired.

(viii) *BEAT FREQ Control*

This control permits vernier adjustment of the c-w oscillator frequency and, in tuning, it should be set near the zero beat position (arrow on knob pointing up).

(ix) *INCREASE VOL Control*

This control is for sensitivity adjustment on MVC operation and output level adjustment on AVC operation. When switching from MVC to AVC or vice versa, it will generally be necessary to readjust this control to maintain a given volume level, as only under certain conditions of signal strength will the volume level remain unchanged.

(x) *AVC—OFF—MVC Switch*

This three-position switch in the OFF position removes all power from the receiver. In the MVC position the receiver is operative with manual volume control, while in the AVC position the automatic volume control is functioning.

(xi) *TEL Jacks*

These are open circuit jacks providing connections to the headset.

b. Modulated Signal Reception

(i) Throw the AVC—OFF—MVC switch to MVC and set other switches and controls as follows:

C-W OSC—OFF

CRYSTAL Filter—OUT

ANT ALIGN set as in the initial installation adjustment.

(ii) Set the BAND SWITCH to the desired frequency band and adjust the TUNING control to the desired frequency with reference to the dial calibration. It is of greatest importance that this tuning be accomplished with the receiver switch in the MVC position.

(iii) Increase the VOL control until the desired signal is heard or the background noise attains a fair level.

(iv) Adjust the TUNING control until maximum output from the desired signal is obtained. This insures correct alignment or proper tuning of the receiver.

(v) If automatic volume control is desired, switch to the AVC position and readjust the VOL control for the desired output level.

(vi) NOTE: The AVC should not be employed while tuning in a signal. Tuning should always be done in the MVC position and with the volume control advanced only as far as required for a comfortable output level.

c. C-W Reception

(i) The procedure is the same as outlined above with the exception that the c-w OSC switch is ON and tuning accomplished with the BEAT FREQ control set near the zero beat position (arrow on knob pointing up).

(ii) After tuning in the desired signal, the BEAT FREQ control may be varied and the frequency of the beat note adjusted as desired.

(iii) Automatic volume control may be employed for c-w reception by switching to the AVC position and readjusting the volume control.

(iv) When extreme selectivity is desired to minimize interference, the CRYSTAL filter is switched IN. A slight readjustment of the tuning and beat frequency controls may be required to secure the desired beat note frequency.

(v) NOTE: The crystal band pass filter is intended primarily for use in c-w reception. However, the added selectivity may at times prove helpful in receiving modulated signals through heavy interference.

SECTION IV MAINTENANCE

7. ALIGNMENT OF I-F AMPLIFIER

The 4th i-f transformer (100) is slightly over-coupled with the resultant response peaks approximately 5 kc each side of 915 kc. Connect the modulated test oscillator to the grid of Tube VT-93. Adjust primary and secondary tuning cores of the 4th i-f transformer so that even peaks are obtained at approximately 920 kc and 910 kc with the slight dip between them at 915 kc. Visual adjustment may also be made with a cathode-ray oscilloscope. After ad-

8. TEST AND ADJUSTMENT OF CRYSTAL FILTER

Connect a microammeter with a range of approximately 200 microamperes in series with the cathode return of the AVC volume control (59-B orange lead). Throw the CRYSTAL switch (105) to the IN position and with an unmodulated 915 kc input from the test oscillator find the resonance peak of the crystal by slightly retuning the test oscillator until maximum deflection is indicated on the microammeter.

The band width with an input voltage ratio of 10 X

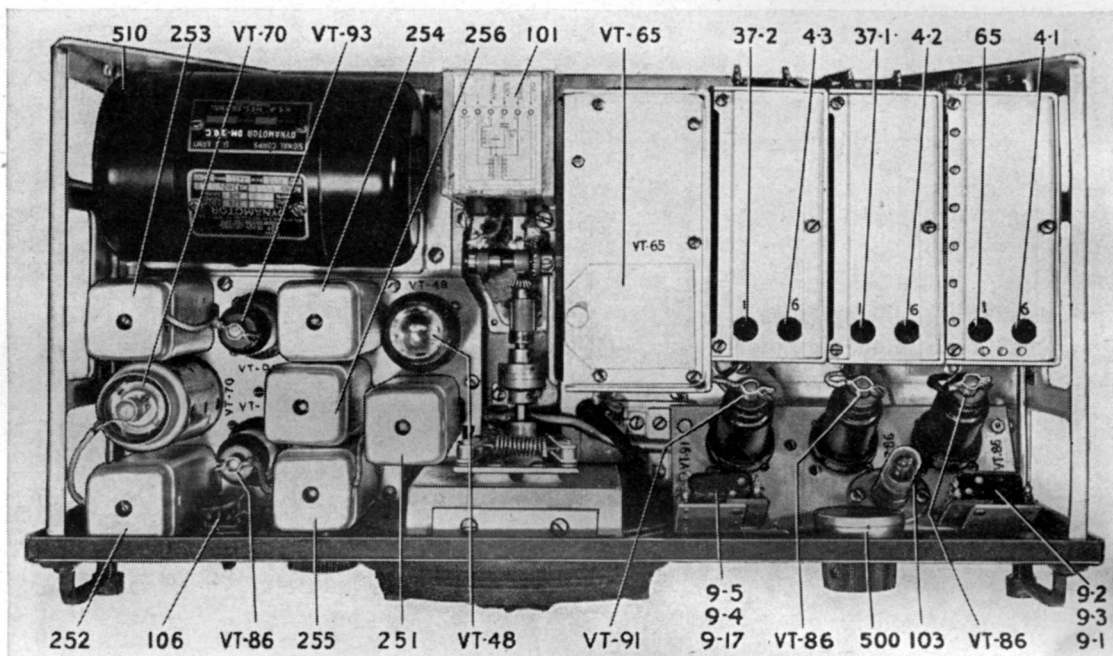

FIGURE 3—RADIO RECEIVER BC-348-S, TOP VIEW OF CHASSIS

justment of the 4th i-f transformer, couple the test oscillator to the grid of the converter Tube VT-91 and adjust primary and secondary cores of the 3rd i-f (99), 2nd i-f (97), crystal filter (96) and 1st i-f transformer (95) to resonance. A 4000-ohm output meter is plugged into the phone jack (102) for observing. Do not readjust the 4th i-f transformer.

is adjusted to approximately 2 kc by adjustment of the phasing trimmer (7).

9. CHECK AND ALIGNMENT OF C-W OSCILLATOR

The c-w oscillator (98) is checked and adjusted by coupling the 915 kc input (modulation off) to the grid of the converter Tube VT-91 and switching the c-w OSC ON. With the beat frequency control set

at mid-position, the c-w oscillator inductor tuning core is adjusted for zero beat.

10. ALIGNMENT OF R-F AMPLIFIER AND OSCILLATOR

For a general alignment, start with Band No. 1 and proceed as in the table below. Use a 400-cycle

modulated test oscillator connected between antenna and ground through a 100-mmf dummy antenna. A 4000-ohm output meter is plugged into the phone jack (102) for observing. Adjust the oscillator frequency to the dial scale at the *Alignment Frequency* indicated in the table and then adjust 1st det., r-f and antenna trimmers as shown.

| Band No. | Freq. Range | Alignment Frequency | Trimmers | | | |
|----------|--------------|----------------------|----------|------|------|------|
| | | | Osc. | Det. | R-F | Ant. |
| 1 | 500-200 kc | { 500 kc { 200 kc | 6-1 | 37-2 | 37-1 | 65 |
| | | | 66 | | | |
| 2 | 3.5- 1.5 mc. | 3.5 mc | 6-2 | 5-5 | 5-3 | 2 * |
| 3 | 6.0- 3.5 mc | 6.0 mc | 6-3 | 3-4 | 3-2 | 3-1 |
| 4 | 9.5- 6.0 mc | 9.5 mc | 6-4 | 5-6 | 5-4 | 5-1 |
| 5 | 13.5- 9.5 mc | 13.5 mc | 6-5 | 3-5 | 3-3 | 3-8 |
| 6 | 18.0-13.5 mc | 18.0 mc | 3-6 | 4-3 | 4-2 | 4-1 |

*Antenna aligning capacity. Refer to the schematic diagrams, Figures 8 and 9, and marked photographs for location. The alignment controls for the various bands are numbered on the chassis adjacent to the control. Controls for band 1 are marked 1; those for 2 are marked 2, etc.

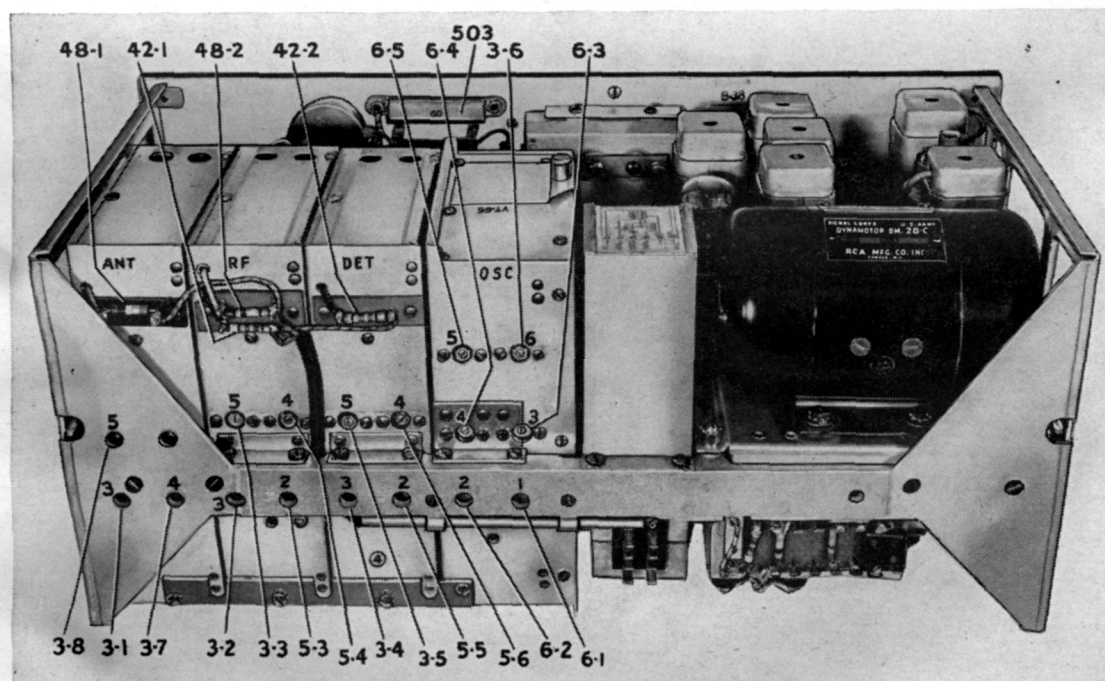

FIGURE 4—RADIO RECEIVER BC-348-S, REAR VIEW OF CHASSIS

Radio Receiver BC-348-S

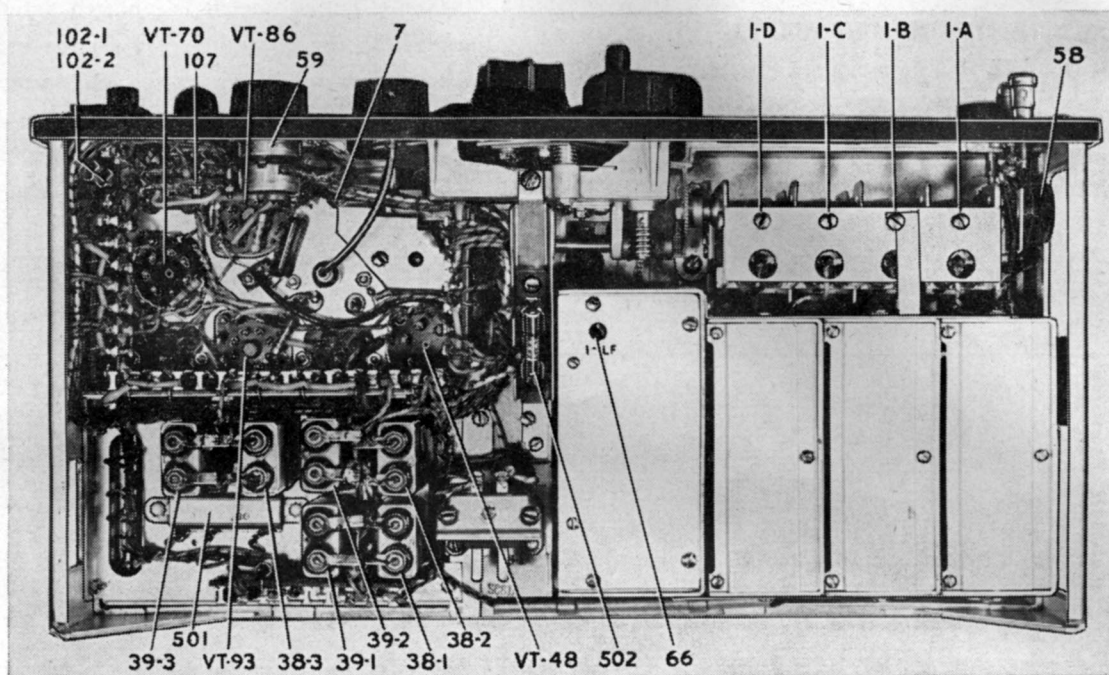

FIGURE 5—RADIO RECEIVER BC-348-S, BOTTOM VIEW OF CHASSIS

SECTION V
SUPPLEMENTARY DATA

**TABLE OF REPLACEABLE PARTS FOR
RADIO RECEIVERS BC-348-S AND BC-224-L**

| <i>Reference Number</i> | <i>Name</i> | <i>Description</i> | <i>Function</i> |
|----------------------------------|-------------|--|---------------------------|
| 1-A } 1-B } 1-C } 1-D } | Capacitor | { A. Section 13.5 to 331.6 mmf B. Section 13.5 to 331.6 mmf C. Section 13.5 to 331.6 mmf D. Section 13.5 to 331.6 mmf | Main tuning |
| 2 | Capacitor | Air trimmer 50 mmf max. | Ant. aligning |
| 3-1 | Capacitor | Air trimmer 50 mmf max. | Ant. trimmer |
| 3-2 | Capacitor | Air trimmer 50 mmf max. | R-F trimmer |
| 3-3 | Capacitor | Air trimmer 50 mmf max. | R-F trimmer |
| 3-4 | Capacitor | Air trimmer 50 mmf max. | Det. trimmer |
| 3-5 | Capacitor | Air trimmer 50 mmf max. | Det. trimmer |
| 3-6 | Capacitor | Air trimmer 50 mmf max. | Osc. trimmer |
| 3-7 | Capacitor | Air trimmer 50 mmf max. | Ant. trimmer |
| 3-8 | Capacitor | Air trimmer 50 mmf max. | Ant. trimmer |
| 4-1 | Capacitor | Air trimmer 50 mmf max. | Ant. trimmer |
| 4-2 | Capacitor | Air trimmer 50 mmf max. | R-F trimmer |
| 4-3 | Capacitor | Air trimmer 50 mmf max. | Det. trimmer |
| 5-3 | Capacitor | Air trimmer 25 mmf max. | R-F trimmer |
| 5-4 | Capacitor | Air trimmer 25 mmf max. | R-F trimmer |
| 5-5 | Capacitor | Air trimmer 25 mmf max. | Det. trimmer |
| 5-6 | Capacitor | Air trimmer 25 mmf max. | Det. trimmer |
| 6-1 | Capacitor | Air trimmer 25 mmf max. | Osc. trimmer |
| 6-2 | Capacitor | Air trimmer 25 mmf max. | Osc. trimmer |
| 6-3 | Capacitor | Air trimmer 25 mmf max. | Osc. trimmer |
| 6-4 | Capacitor | Air trimmer 25 mmf max. | Osc. trimmer |
| 6-5 | Capacitor | Air trimmer 25 mmf max. | Osc. trimmer |
| 7 | Capacitor | Air trimmer 10 mmf max. | Crystal filter adjustment |
| 8 | Capacitor | Air trimmer 10 mmf max. | C-W osc. adjustment |
| 9-1 | Capacitor | Mica 500 volts d-c .01 mf \pm 10% with leads | 1st R-F cathode by-pass |
| 9-2 | Capacitor | Mica 500 volts d-c .01 mf \pm 10% with leads | 1st R-F screen by-pass |
| 9-3 | Capacitor | Mica 500 volts d-c .01 mf \pm 10% with leads | 2nd R-F cathode by-pass |

**TABLE OF REPLACEABLE PARTS FOR
RADIO RECEIVERS BC-348-S AND BC-224-L (Continued)**

| <i>Reference Number</i> | <i>Name</i> | <i>Description</i> | <i>Function</i> |
|-------------------------|-------------|--|-------------------------------------|
| 9-4 | Capacitor | Mica 500 volts d-c .01 mf \pm 10% with leads | 2nd R-F screen by-pass |
| 9-5 | Capacitor | Mica 500 volts d-c .01 mf \pm 10% with leads | 1st Det. screen by-pass |
| 9-6 | Capacitor | Mica 500 volts d-c .01 mf \pm 10% with leads | 1st I-F transformer by-pass |
| 9-7 | Capacitor | Mica 500 volts d-c .01 mf \pm 10% with leads | Crystal transformer by-pass |
| 9-9 | Capacitor | Mica 500 volts d-c .01 mf \pm 10% with leads | 1st I-F plate by-pass |
| 9-10 | Capacitor | Mica 500 volts d-c .01 mf \pm 10% with leads | 2nd I-F transformer by-pass |
| 9-12 | Capacitor | Mica 500 volts d-c .01 mf \pm 10% with leads | C-W osc. plate by-pass |
| 9-13 | Capacitor | Mica 500 volts d-c .01 mf \pm 10% with leads | Plug terminal by-pass |
| 9-14 | Capacitor | Mica 500 volts d-c .01 mf \pm 10% with leads | A.V.C. by-pass |
| 9-15 | Capacitor | Mica 500 volts d-c .01 mf \pm 10% with leads | 3rd I-F transformer by-pass |
| 9-16 | Capacitor | Mica 500 volts d-c .01 mf \pm 10% with leads | 3rd I-F cathode by-pass |
| 9-17 | Capacitor | Mica 500 volts d-c .01 mf \pm 10% with leads | Heater by-pass |
| 9-18 | Capacitor | Mica 500 volts d-c .01 mf \pm 10% with leads | Battery by-pass |
| 10-1 | Capacitor | Mica 500 volts d-c .01 mf \pm 10% with lugs | Ant. coil by-pass |
| 10-2 | Capacitor | Mica 500 volts d-c .01 mf \pm 10% with lugs | 1st R-F plate |
| 10-3 | Capacitor | Mica 500 volts d-c .01 mf \pm 10% with lugs | R-F coil by-pass |
| 10-4 | Capacitor | Mica 500 volts d-c .01 mf \pm 10% with lugs | 2nd R-F plate |
| 11-1 | Capacitor | Mica 500 volts d-c .01 mf \pm 10% with lugs | Osc. plate |
| 11-2 | Capacitor | Mica 500 volts d-c .01 mf \pm 10% with lugs | 1st Det. cathode by-pass |
| 12-1 | Capacitor | Mica 500 volts d-c .005 mf \pm 10% with leads | Audio transformer secondary by-pass |
| 12-2 | Capacitor | Mica 500 volts d-c .005 mf \pm 10% with leads | Antenna blocking |
| 13 | Capacitor | Mica 500 volts d-c 390 mf \pm 1.2% with leads | Osc. series |
| 14 | Capacitor | Mica 500 volts d-c 2240 mmf \pm 3% with leads | Osc. series |
| 15-1 | Capacitor | Mica 500 volts d-c 1500 mmf \pm 10% with leads | Audio coupling |
| 15-2 | Capacitor | Mica 500 volts d-c 1500 mmf \pm 10% with leads | Audio transformer primary shunt |
| 16 | Capacitor | Mica 500 volts d-c 670 mmf \pm 1.2% with leads | Osc. series |
| 17 | Capacitor | Mica 500 volts d-c 130 mmf \pm 5% with leads | Osc. series |

**TABLE OF REPLACEABLE PARTS FOR
RADIO RECEIVERS BC-348-S AND BC-224-L (Continued)**

| <i>Reference Number</i> | <i>Name</i> | <i>Description</i> | <i>Function</i> |
|-------------------------|-------------|---|----------------------------|
| 18-1 | Capacitor | Mica 500 volts d-c 500 mmf \pm 5% with leads | 1st I-F secondary tuning |
| 18-2 | Capacitor | Mica 500 volts d-c 500 mmf \pm 5% with leads | 1st I-F secondary tuning |
| 19 | Capacitor | Mica 500 volts d-c 285 mmf \pm 5% with leads | Crystal transformer tuning |
| 20-1 | Capacitor | Mica 500 volts d-c 260 mmf \pm 5% with leads | 2nd I-F primary tuning |
| 20-2 | Capacitor | Mica 500 volts d-c 260 mmf \pm 5% with leads | 2nd I-F secondary tuning |
| 20-3 | Capacitor | Mica 500 volts d-c 260 mmf \pm 5% with leads | 3rd I-F secondary tuning |
| 21-1 | Capacitor | Mica 500 volts d-c 250 mmf \pm 5% with leads | 1st I-F primary tuning |
| 21-2 | Capacitor | Mica 500 volts d-c 250 mmf \pm 5% with leads | 3rd I-F primary tuning |
| 22-1 | Capacitor | Mica 500 volts d-c 240 mmf \pm 5% with leads | C-W osc. tuning |
| 22-2 | Capacitor | Mica 500 volts d-c 240 mmf \pm 5% with leads | 2nd Det. by-pass |
| 23 | Capacitor | Mica 500 volts d-c 170 mmf \pm 1.2% with leads | Osc. series |
| 24-1 | Capacitor | Mica or Ceramic 500 volts d-c 155 mmf \pm 1.8% with leads | Ant. series |
| 24-2 | Capacitor | Mica or Ceramic 500 volts d-c 155 mmf \pm 1.8% with leads | R-F series |
| 24-3 | Capacitor | Mica or Ceramic 500 volts d-c 155 mmf \pm 1.8% with leads | Det. series |
| 25 | Capacitor | Mica or Ceramic 500 volts d-c 25 mmf \pm 10% with leads | Ant. shunt |
| 26-1 | Capacitor | Mica 500 volts d-c 150 mmf \pm 5% with leads | C-W osc. grid |
| 26-2 | Capacitor | Mica 500 volts d-c 150 mmf \pm 5% with leads | 4th I-F secondary tuning |
| 27 | Capacitor | Mica 500 volts d-c 135 mmf \pm 1.2% with leads | Osc. series |
| 28-1 | Capacitor | Mica 500 volts d-c 135 mmf \pm 2% with leads | Ant. series |
| 28-2 | Capacitor | Mica 500 volts d-c 135 mmf \pm 2% with leads | R-F series |
| 28-3 | Capacitor | Mica 500 volts d-c 135 mmf \pm 2% with leads | Det. series |
| 29-1 | Capacitor | Mica 500 volts d-c 470 mmf \pm 2% with leads | Ant. series |
| 29-2 | Capacitor | Mica 500 volts d-c 470 mmf \pm 2% with leads | R-F series |
| 29-3 | Capacitor | Mica 500 volts d-c 470 mmf \pm 2% with leads | Det. series |
| 30 | Capacitor | Mica or Ceramic 500 volts d-c 100 mmf \pm 5% with leads | Osc. grid |
| 31-1 | Capacitor | Mica or Ceramic 500 volts d-c 75 mmf \pm 5% with leads | R-F shunt |

TABLE OF REPLACEABLE PARTS FOR
RADIO RECEIVERS BC-348-S AND BC-224-L (Continued)

| <i>Reference Number</i> | <i>Name</i> | <i>Description</i> | <i>Function</i> |
|-------------------------|-------------|---|----------------------------|
| 31-2 | Capacitor | Mica or Ceramic 500 volts d-c 75 mmf \pm 5% with leads | Det. shunt |
| 31-4 | Capacitor | Mica or Ceramic 500 volts d-c 75 mmf \pm 10% with leads | Diode coupling |
| 32-1 | Capacitor | Mica or Ceramic 500 volts d-c 47 mmf \pm 5% with leads | 4th I-F primary tuning |
| 32-2 | Capacitor | Mica or Ceramic 500 volts d-c 47 mmf \pm 10% with leads | Det. shunt |
| 33-1 | Capacitor | Mica or Ceramic 500 volts d-c 50 mmf \pm 10% with leads | Ant. shunt |
| 33-2 | Capacitor | Mica or Ceramic 500 volts d-c 50 mmf \pm 10% with leads | R-F shunt |
| 34 | Capacitor | Ceramic 500 volts d-c 85 mmf \pm 2½% with leads | Osc. temp. compensating |
| 35 | Capacitor | Ceramic 500 volts d-c 47 mmf \pm 5% with leads | Osc. temp. compensating |
| 36 | Capacitor | Ceramic 500 volts d-c 30 mmf \pm 2½% with leads | Osc. temp. compensating |
| 37-1 | Capacitor | Air trimmer 25 mmf max. | R-F trimmer |
| 37-2 | Capacitor | Air trimmer 25 mmf max. | Det. trimmer |
| 38-1A | Capacitor | Paper 250 volts d-c .5 mf \pm 15% | 4th I-F filter |
| 38-1B | Capacitor | Paper 250 volts d-c .5 mf \pm 15% | Volume control filter |
| 38-2A | Capacitor | Paper 250 volts d-c .5 mf \pm 15% | Screen supply filter |
| 38-2B | Capacitor | Paper 250 volts d-c .5 mf \pm 15% | Output plate filter |
| 38-3A | Capacitor | Paper 250 volts d-c .5 mf \pm 15% | Noise compensator filter |
| 38-3B | Capacitor | Paper 250 volts d-c .5 mf \pm 15% | 1st I-F screen filter |
| 39-1A | Capacitor | Paper 250 volts d-c .5 mf \pm 15% | 4th I-F transformer filter |
| 39-1B | Capacitor | Paper 250 volts d-c .5 mf \pm 15% | 4th I-F transformer filter |
| 39-2A | Capacitor | Paper 250 volts d-c .5 mf \pm 15% | Output grid filter |
| 39-2B | Capacitor | Paper 250 volts d-c .5 mf \pm 15% | Screen supply filter |
| 39-3A | Capacitor | Paper 250 volts d-c .5 mf \pm 15% | 1st I-F screen filter |
| 39-3B | Capacitor | Paper 250 volts d-c .5 mf \pm 15% | 3rd I-F screen filter |
| 40-1 | Resistor | Insul. 470 ohms \pm 10% ½w | 1st R-F cathode |
| 40-2 | Resistor | Insul. 470 ohms \pm 10% ½w | 2nd R-F cathode |
| 40-3 | Resistor | Insul. 470 ohms \pm 10% ½w | 1st I-F cathode |
| 40-4 | Resistor | Insul. 470 ohms \pm 10% ½w | 2nd I-F cathode |

**TABLE OF REPLACEABLE PARTS FOR
RADIO RECEIVERS BC-348-S AND BC-224-L (Continued)**

| <i>Reference Number</i> | <i>Name</i> | <i>Description</i> | <i>Function</i> |
|-------------------------|-------------|-------------------------------------|--------------------------|
| 41-1 | Resistor | Insul. 1000 ohms \pm 10% 1/2w | Osc. plate |
| 41-2 | Resistor | Insul. 1000 ohms \pm 10% 1/2w | 3rd I-F cathode |
| 42-1 | Resistor | Insul. 4700 ohms \pm 10% 1/2w | 1st R-F plate |
| 42-2 | Resistor | Insul. 4700 ohms \pm 10% 1/2w | 2nd R-F plate |
| 42-3 | Resistor | Insul. 4700 ohms \pm 10% 1/2w | 1st Det. plate |
| 42-4 | Resistor | Insul. 4700 ohms \pm 10% 1/2w | 1st R-F screen |
| 42-5 | Resistor | Insul. 4700 ohms \pm 10% 1/2w | 1st I-F plate |
| 42-6 | Resistor | Insul. 4700 ohms \pm 10% 1/2w | Bleeder |
| 42-7 | Resistor | Insul. 4700 ohms \pm 10% 1/2w | 3rd I-F cathode |
| 43-1 | Resistor | Insul. 10,000 ohms \pm 10% 1/2w | 1st R-F screen |
| 43-2 | Resistor | Insul. 10,000 ohms \pm 10% 1/2w | 2nd R-F screen |
| 43-3 | Resistor | Insul. 10,000 ohms \pm 10% 1/2w | 1st Det. screen |
| 43-4 | Resistor | Insul. 10,000 ohms \pm 10% 1/2w | C-W osc. bleeder |
| 44 | Resistor | Insul. 12,000 ohms \pm 10% 1/2w | Voltage regulator series |
| 45 | Resistor | Insul. 15,000 ohms \pm 10% 1/2w | 1st Det. cathode |
| 46 | Resistor | Insul. 56,000 ohms \pm 10% 1/2w | Output loading |
| 47 | Resistor | Insul. 68,000 ohms \pm 10% 1/2w | C-W osc. plate |
| 48-1 | Resistor | Insul. 100,000 ohms \pm 10% 1/2w | 1st R-F grid |
| 48-2 | Resistor | Insul. 100,000 ohms \pm 10% 1/2w | 2nd R-F grid |
| 48-3 | Resistor | Insul. 100,000 ohms \pm 10% 1/2w | Osc. grid |
| 48-4 | Resistor | Insul. 100,000 ohms \pm 10% 1/2w | Output grid filter |
| 49 | Resistor | Insul. 180,000 ohms \pm 10% 1/2w | 3rd I-F screen |
| 50-1 | Resistor | Insul. 470,000 ohms \pm 10% 1/2w | Antenna protective |
| 50-2 | Resistor | Insul. 470,000 ohms \pm 10% 1/2w | 1st I-F grid |
| 50-3 | Resistor | Insul. 470,000 ohms \pm 10% 1/2w | 2nd I-F grid |
| 50-4 | Resistor | Insul. 470,000 ohms \pm 10% 1/2w | C-W osc. grid |
| 50-5 | Resistor | Insul. 470,000 ohms \pm 10% 1/2w | Det. coil shunt |
| 51 | Resistor | Insul. 560,000 ohms \pm 10% 1/2w | Output grid |
| 52 | Resistor | Insul. 1.5 meg. ohms \pm 10% 1/2w | A.V.C. diode |
| 53 | Resistor | Insul. 220,000 ohms \pm 10% 1/2w | A.V.C. filter |
| 56 | Resistor | Insul. 10,000 ohms \pm 10% 1w | Bleeder |

**TABLE OF REPLACEABLE PARTS FOR
RADIO RECEIVERS BC-348-S AND BC-224-L (Continued)**

| <i>Reference Number</i> | <i>Name</i> | <i>Description</i> | <i>Function</i> |
|-------------------------|-------------|--|-----------------------------|
| 57 | Resistor | Insul. 27,000 ohms \pm 10% 1w | Voltage regulator |
| 58 | Resistor | Variable 3500 \pm 10% to 10 ohms .1 watt | Noise compensator |
| 59-A | Resistor | Volume control front unit 20,000 ohms \pm 10% to 10 ohms 2 watt | M. V. C. |
| 59-B | Resistor | Volume control back unit 350,000 ohms \pm 10% to 50 ohms .2 watt | A. V. C. |
| 61 | Resistor | Insul. 2400 ohms \pm 5% $\frac{1}{2}$ w | Output plate |
| 62 | Resistor | Insul. 47,000 ohms \pm 10% $\frac{1}{2}$ w | Bleeder |
| 64 | Capacitor | Ceramic 500 volts 35 mmf \pm 5% with leads | Osc. temp. compensating |
| 65 | Capacitor | Air trimmer 10 mmf max. | Ant. trimmer |
| 66 | Capacitor | Ceramic trimmer 25 mmf working | Osc. series padder |
| 67 | Capacitor | Mica 500 volts d-c 750 mmf \pm 5% with leads | R-F plate tuning |
| 68 | Capacitor | Molded paper .1 mfd. \pm 10% 400 volts | 2nd I-F cathode by-pass |
| 71 | Inductance | Antenna band 1 | 1st R-F tuned circuit |
| 72 | Inductance | Antenna band 2 | 1st R-F tuned circuit |
| 73 | Inductance | Antenna band 3 | 1st R-F tuned circuit |
| 74 | Inductance | Antenna band 4 | 1st R-F tuned circuit |
| 75 | Inductance | Antenna band 5 | 1st R-F tuned circuit |
| 76 | Inductance | Antenna band 6 | 1st R-F tuned circuit |
| 77 | Inductance | R-F band 1 | 1st R-F to 2nd R-F coupling |
| 78 | Transformer | R-F band 2 | 1st R-F to 2nd R-F coupling |
| 79 | Transformer | R-F band 3 | 1st R-F to 2nd R-F coupling |
| 80 | Transformer | R-F band 4 | 1st R-F to 2nd R-F coupling |
| 81 | Transformer | R-F band 5 | 1st R-F to 2nd R-F coupling |
| 82 | Transformer | R-F band 6 | 1st R-F to 2nd R-F coupling |
| 83 | Transformer | 1st det. band 1 | 2nd R-F to det. coupling |
| 84 | Transformer | 1st det. band 2 | 2nd R-F to det. coupling |
| 85 | Transformer | 1st det. band 3 | 2nd R-F to det. coupling |
| 86 | Transformer | 1st det. band 4 | 2nd R-F to det. coupling |
| 87 | Transformer | 1st det. band 5 | 2nd R-F to det. coupling |
| 88 | Transformer | 1st det. band 6 | 2nd R-F to det. coupling |

**TABLE OF REPLACEABLE PARTS FOR
RADIO RECEIVERS BC-348-S AND BC-224-L (Continued)**

| <i>Reference Number</i> | <i>Name</i> | <i>Description</i> | <i>Function</i> |
|-------------------------|-------------|--------------------------------------|------------------------------|
| 89 | Transformer | Osc. band 1 | Osc. to 1st det. coupling |
| 90 | Transformer | Osc. band 2 | Osc. to 1st det. coupling |
| 91 | Transformer | Osc. band 3 | Osc. to 1st det. coupling |
| 92 | Transformer | Osc. band 4 | Osc. to 1st det. coupling |
| 93 | Transformer | Osc. band 5 | Osc. to 1st det. coupling |
| 94 | Transformer | Osc. band 6 | Osc. to 1st det. coupling |
| 95 | Transformer | 1st I-F | 1st Det. to crystal coupling |
| 96 | Transformer | Crystal filter | Crystal to 1st I-F coupling |
| 97 | Transformer | 2nd I-F | 1st I-F to 2nd I-F coupling |
| 98 | Transformer | C-W osc. | Grid & plate coupling |
| 99 | Transformer | 3rd I-F | 2nd I-F to 3rd I-F coupling |
| 100 | Transformer | 4th I-F | 3rd I-F to 2nd det. coupling |
| 101-A | Transformer | Audio | Output |
| 101-B | Choke | Audio frequency | Filter |
| 101-C | Capacitor | Paper 400 volts d-c .05 mf \pm 10% | C-W osc. time constant |
| 102-1 | Jack | Single circuit | Headphone |
| 102-2 | Jack | Single circuit | Headphone |
| 103 | Regulator | Neon bulb type 991 | Osc. plate voltage regulator |
| 104 | Lamp | 6 to 8 volts type 44 | Dial light |
| 105 | Switch | SPST type | Crystal filter (out-in) |
| 106 | Switch | DPST type | C-W osc. (on-off) |
| 107 | Switch | 3 position, 2 wafer | A. V. C. Off M. V. C. |
| 108 | Switch | 6 position, 1 wafer | Band switch, antenna unit |
| 109 | Switch | 6 position, 1 wafer | Band switch, antenna unit |
| 110 | Switch | 6 position, 1 wafer | Band switch, R-F unit |
| 111 | Switch | 6 position, 1 wafer | Band switch, R-F unit |
| 112 | Switch | 6 position, 1 wafer | Band switch, det. unit |
| 113 | Switch | 6 position, 1 wafer | Band switch, det. unit |
| 114 | Switch | 6 position, 1 wafer | Band switch, osc. unit |
| 115 | Switch | 6 position, 1 wafer | Band switch, osc. unit |

**TABLE OF REPLACEABLE PARTS FOR
RADIO RECEIVERS BC-348-S AND BC-224-L (Continued)**

| <i>Reference Number</i> | <i>Name</i> | <i>Description</i> | <i>Function</i> |
|-------------------------|------------------------------|--|------------------------------|
| 116 | Switch | 6 position, 1 wafer | Band switch, osc. unit |
| 117 | Switch | 6 position, 1 wafer | Band switch, osc. unit |
| 121 | Crystal assembly | 915 kc crystal mounted in case | I-F filter |
| 251 | 1st I-F transformer assembly | Complete with shield can | 1st det. to 1st I-F coupling |
| 252 | 2nd I-F transformer assembly | Complete with shield can | 1st I-F to 2nd I-F coupling |
| 253 | 3rd I-F transformer assembly | Complete with shield can | 2nd I-F to 3rd I-F coupling |
| 254 | 4th I-F transformer assembly | Complete with shield can | 3rd I-F to 2nd det. coupling |
| 255 | Crystal filter assembly | Complete with shield can | I-F selectivity |
| 256 | C-W osc. assembly | Complete with shield can | C-W reception |
| 301 | Choke | R-F | Dynamotor filter |
| 302 | Choke | R-F | Dynamotor filter |
| 303-A | Capacitor | Paper 250 volts d-c .5 mf \pm 20% | Dynamotor filter |
| 303-B | Capacitor | Paper 250 volts d-c .5 mf \pm 20% | Dynamotor filter |
| 304-1 | Capacitor | Mica 500 volts d-c .01 mf \pm 10% | Dynamotor filter |
| 304-2 | Capacitor | Mica 500 volts d-c .01 mf \pm 10% | Dynamotor filter |
| 305 | Capacitor | Paper 400 volts d-c 1.0 mf \pm 20% | Dynamotor filter |
| *500 | Resistor | Variable 200 ohms \pm 10% 4 watts | Dial lamp control |
| *501-A | Resistor | Insulated 3 ohms + 10% - 50% 1.5 watts | Filament |
| *501-B | Resistor | Insulated 190 ohms + 10% - 15% 1.9 watts | Filament |
| *502 | Fuse | 5-Amp 25-volt Type | Primary protective |
| *503 | Resistor | Insulated 60 ohms \pm 10% 3.7 watts | Dial lamps series |
| *510 | Dynamotor | 28 Volts 1.23 amp, 220 volts .070 amp, 4400 rpm. | Motor generator |

PARTS USED ONLY IN BC-224-L

| | | | |
|-----|------------|--|--------------------|
| 54 | Resistor | Insul. 0.5 ohms \pm 10% 1 watt | Filament |
| 55 | Resistor | Insul. 68 ohms \pm 10% 1 watt | Filament balance |
| 60 | Resistor | Variable, 75 ohms \pm 10% | Dial lamp control |
| 118 | Fuse FU-23 | 10-Amp. 25-volt | Primary protective |
| 300 | Dynamotor | 13.8 volts, 2.45 amp; 220 volt, .07 amp; 4400 r.p.m. | Motor generator |

*Receiver BC-348-S only.

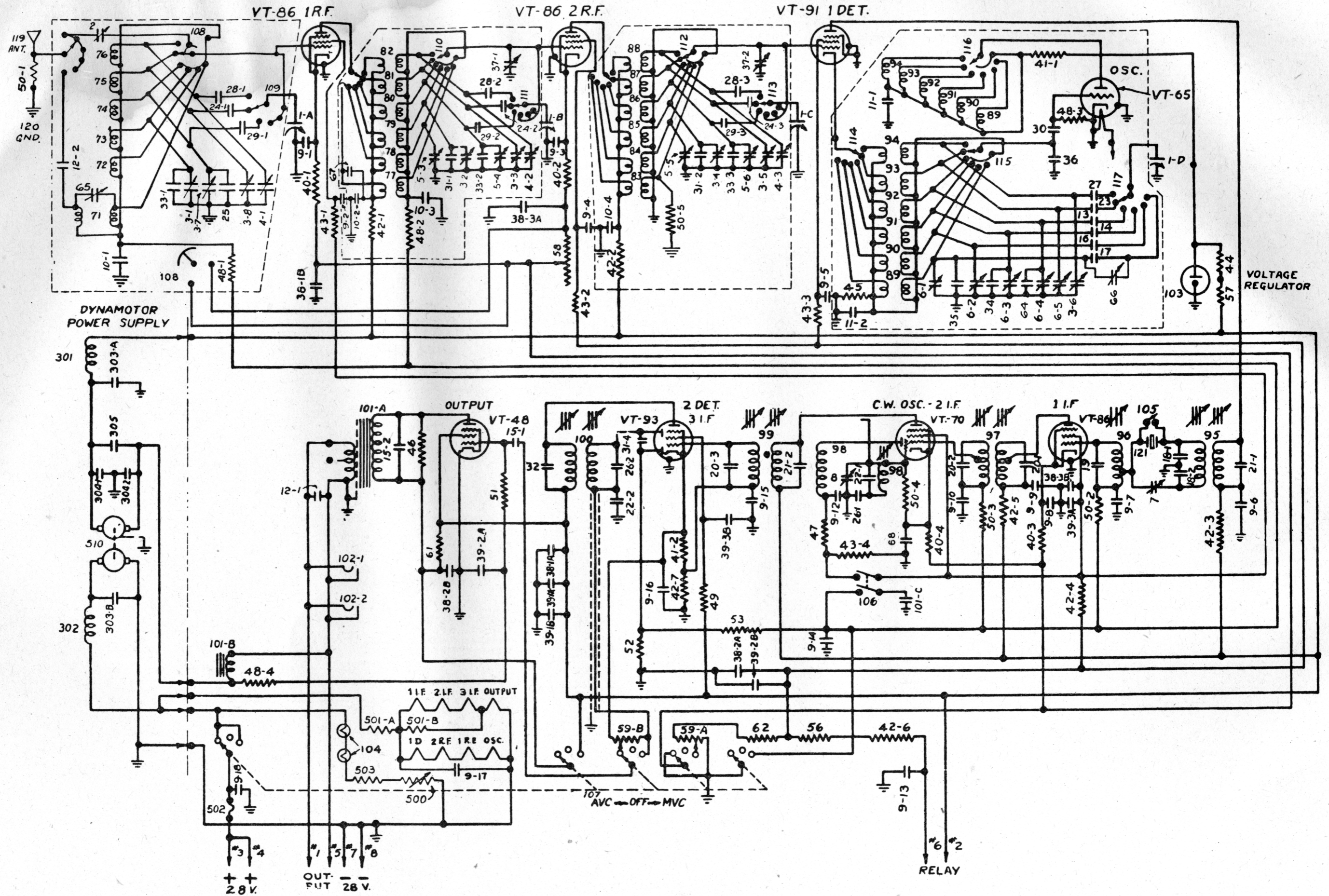

FIGURE 8—RADIO RECEIVER BC-348-S, SCHEMATIC DIAGRAM

FIGURE 9—RADIO RECEIVER BC-224-L, SCHEMATIC DIAGRAM

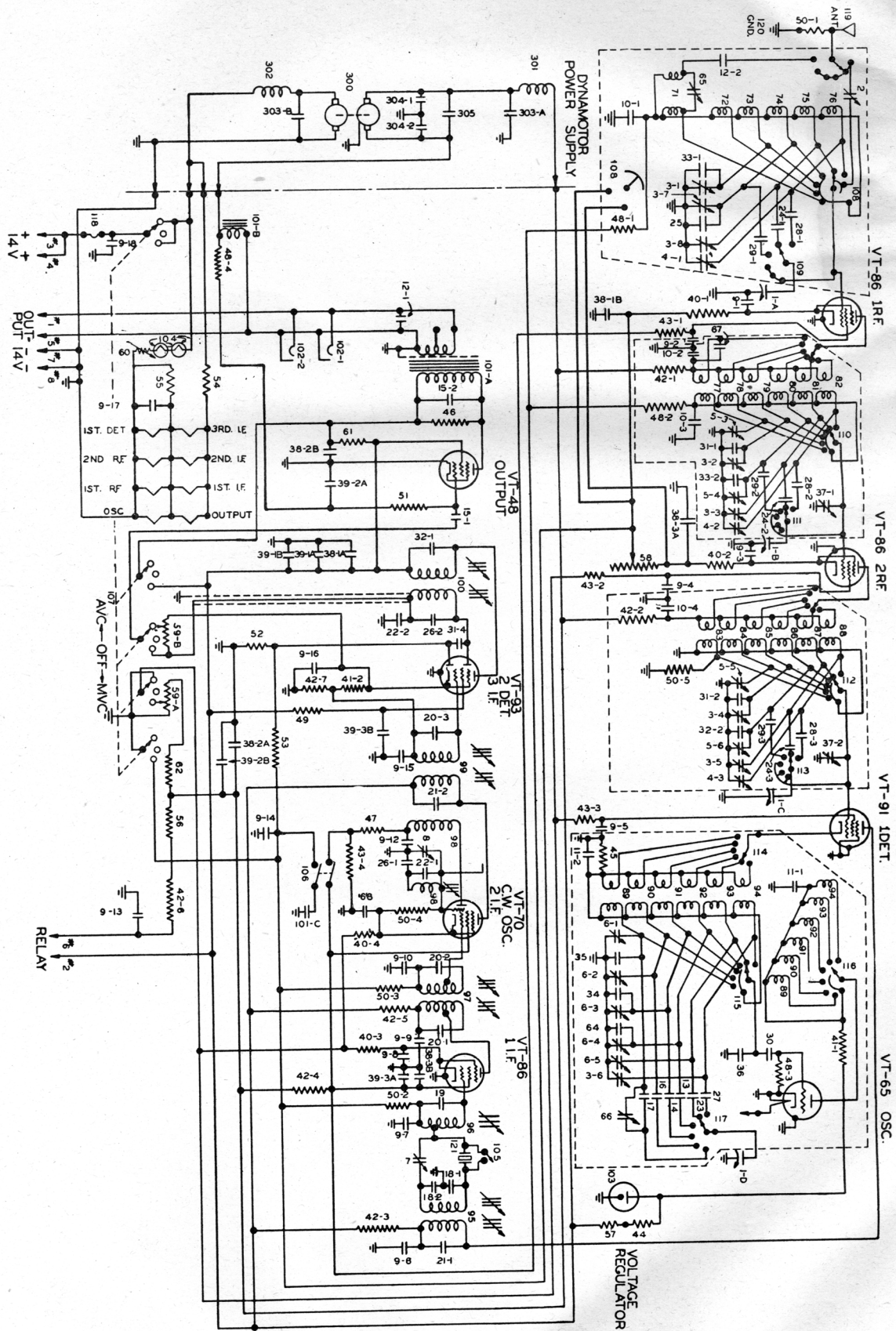

FIGURE 9—RADIO RECEIVER BC-224-L, SCHEMATIC DIAGRAM

