

23

# TM 11-4058

HISTORICAL

WAR DEPARTMENT TECHNICAL MANUAL

SECRET

## RADIO RECEIVER AND TRANSMITTERS BC-669-A,-B,-C,-D,-AM,-BM, and -CM REPAIR INSTRUCTIONS

SECRET

**WARNING:** THE MATERIAL FORMING THE SUBJECT matter of this manual is the property of the United States Government and it is printed and distributed solely for the use of the military, naval, and civilian personnel of the War and Navy Departments, and may not be published or reproduced in whole or in part in any manner or form (except by lawful copyright holders who may reproduce their copyrighted material in its original form) except upon specific approval by authorized military public relations agencies.

WAR DEPARTMENT • DECEMBER 1945

# CONTENTS

---

	<i>Paragraph</i>	<i>Page</i>
<b>SECTION I. DESCRIPTION OF RADIO RECEIVER AND TRANSMITTERS</b>		
<b>BC-669-(*)</b>		
General .....	1	1
Over-all system function .....	2	2
<b>II. DIFFERENCES BETWEEN MODELS.</b>		
Differences between models of Radio Receiver and Transmitter		
BC-669-(*) .....	3	5
Electrical and mechanical differences .....	4	5
<b>III. INITIAL REPAIR PROCEDURES.</b>		
General .....	5	9
Method of starting repairs .....	6	9
Tools, test and cleaning equipment .....	7	9
Removal of tubes and other plug-in parts .....	8	9
Chassis cleaning, inspecting, and lubricating .....	9	11
Cleaning operations .....	10	11
Inspection procedure .....	11	12
<b>IV. PRELIMINARY TROUBLE-SHOOTING PROCEDURES.</b>		
General .....	12	14
Resistance test of Power Supply Unit PE-110-(*) .....	13	14
Turning on Receiver and Transmitter BC-669-(*) .....	14	15
Voltage tests .....	15	17
Operating test .....	16	17
<b>V. ALIGNMENT PROCEDURE.</b>		
General .....	17	18
Alignment of receiver .....	18	18
I-f alignment .....	19	18
R-f alignment .....	20	18
B-f-o alignment .....	21	19
Transmitter presetting .....	22	19
Final adjustment .....	23	21
<b>VI. DETAILED TROUBLE-SHOOTING PROCEDURES.</b>		
Voltage and resistance measurements at tube sockets .....	24	23
Signal tracing .....	25	23
Signal substitution .....	26	32
Measuring individual stage gain .....	27	33
A-v-c check .....	28	34
Moistureproofing, fungiproofing, and refinishing .....	29	34
<b>VII. FINAL TESTING.</b>		
Alignment test .....	30	35
Signal-to-noise test .....	31	35
Sensitivity test .....	32	35
Selectivity test .....	33	36
Transmitter power output and modulation check .....	34	36
Operational test .....	35	37



	<i>Paragraph</i>	<i>Page</i>
<b>VIII. INDIVIDUAL STAGE AND CIRCUIT REPAIR DATA.</b>		
R-f amplifier stage .....	36	38
Mixer or converter stage .....	37	42
Heterodyne oscillator stage .....	38	43
I-f amplifier stage .....	39	46
Second detector, noise limiter, and a-v-c stage .....	40	49
Audio-voltage amplifier stage .....	41	51
A-f power-amplifier stage .....	42	54
Receiver b-f-o stage .....	43	56
Transmitter oscillator stage .....	44	59
R-f power-amplifier stage .....	45	62
Antenna coupling stage .....	46	66
Low-level microphone voltage amplifier stage .....	47	68
A-f power-amplifier stage of transmitter modulator .....	48	70
<b>IX. SUPPLEMENTARY DATA.</b>		
Initial repair procedure chart .....	49	75
Noisy receiver .....	50	75

## SAFETY NOTICE

---

This equipment uses *high voltages* which are *dangerous to life*. Electrical interlock switches are provided for your protection. They remove the high d-c voltage to the output circuits in the transmitter when the hinged doors of the cover are open or when either the cover or the back is removed. Always be sure that back, cover, and cover doors are closed *before applying plate power*.

When the transmitter is in operation *extremely high r-f voltages* are present in and around the antenna tuning unit, all its connecting leads, the antenna and the antenna insulator. You can get *dangerous burns* from arcs caused by touching the *antenna circuit*. *Be careful!* Do not attempt to make an adjustment unless you are thoroughly familiar with this equipment.

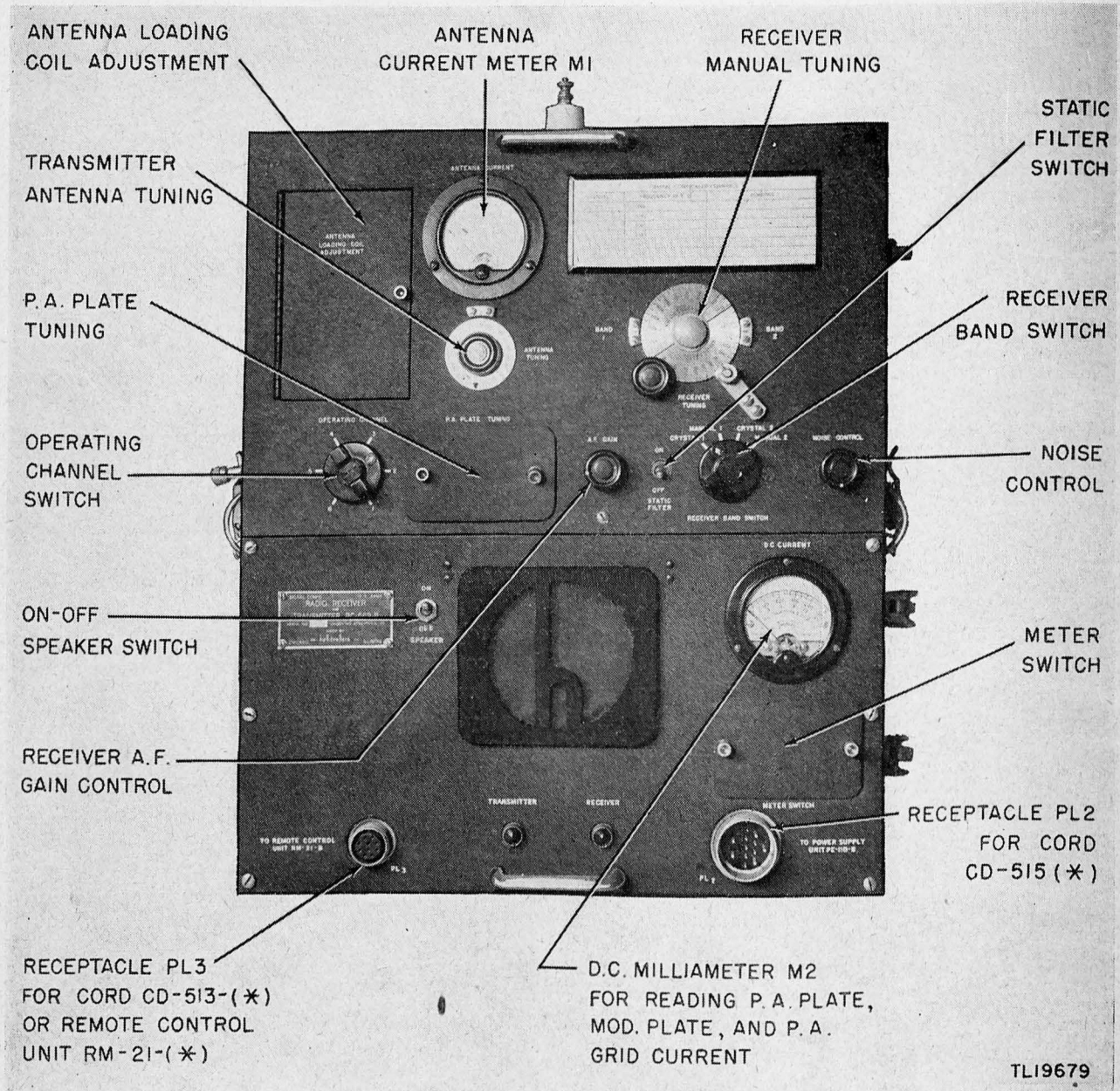

Figure 1. Radio Receiver and Transmitter BC-669-(\*), front panel view with explanatory data.



## SECTION I

### DESCRIPTION OF RADIO RECEIVER AND TRANSMITTERS BC-669-(\*)\*

#### 1. General

a. EXPLANATION OF SYMBOL. Official nomenclature followed by (\*) is used to indicate all models of the item of equipment included in this Technical Manual. Thus Radio Receiver and Transmitter BC-669-(\*) represents Radio Receiver and Transmitters BC-669-A, -B, -C, -D, -AM, -BM, and -CM, which are treated together in this manual.

b. PURPOSE. Radio Receiver and Transmitter BC-669-(\*) (fig. 1) is the radio component of Radio Set SCR-543-(\*). It provides instant change from reception to transmission and is suitable for operation by personnel of limited radio experience.

c. USE. The equipment is designed to operate either as a field station or a vehicular radio, providing radio-telephone and continuous-wave (c-w) communication to antiaircraft brigades and regiments.

d. TRANSMISSION AND RECEPTION. (1) The transmitter sends voice-modulated and continuous-wave symbols.

(2) The superheterodyne receiver detects both voice-modulated and tone-modulated c-w telegraph signals.

e. DISTANCE RANGE. Communications may be carried on over distances from 20 to 30 miles when the unit is operated as a field station. As a vehicular radio (vehicles in motion), the range is approximately 15 miles. Actual distances vary according to conditions of weather, height, location, or operating frequencies.

f. FREQUENCY COVERAGE. The frequency range is from 1,680 kilocycles (kc) to 4,450 kc.

g. CHANNELS. Six crystal-controlled frequencies within the operating range may be preset, and instantly selected for both reception and transmission. Manual control of the receiver is also provided.

(1) The frequencies supplied with the unit are as follows:

Channel	Transmitter crystal frequency	Receiver crystal frequency
1 .....	1,746 kc. ....	2,131 kc.
2 .....	2,082 kc. ....	2,467 kc.
3 .....	2,280 kc. ....	2,665 kc.
4 .....	2,340 kc. ....	2,725 kc.
5 .....	3,442.5 kc. ....	3,807.5 kc.
6 .....	4,255 kc. ....	3,870 kc.

(2) To permit instant change-over from transmitter crystal operation to receiver crystal operation, the receiver-oscillator crystal frequencies differ from the corresponding transmitter crystal frequencies by 385 kc, the receiver intermediate frequency (if). On channels 1, 2, 3, 4, and 5 the receiver-oscillator crystal frequencies are 385 kc higher than the transmitter frequencies in the same channels. On channel 6 the receiver-oscillator crystal frequency is 385 kc lower than the transmitter frequency.

h. POWER. (1) *Input.* The alternating-current (a-c) power drain is 220 watts while receiving and 550 watts while transmitting. Standby operation of the receiver is possible when Power Unit PE-108-(\*) is used with the receiver-transmitter. Receiver input power is obtained from a 12-volt storage battery in the power unit. Receiver filament voltage is obtained from the battery directly. Receiver plate voltage is obtained indirectly through the vibra-pack section of Power Supply Unit PE-110-(\*). Direct-current (d-c) power drain is 5.5 amperes.

(2) *Output.* The transmitter has a nominal output rating of 45 watts.

i. CONSTRUCTION. The receiver and transmitter are housed in a two-section steel cabinet (fig. 1), which in turn is shock-mounted in a wooden chest. The upper deck of the steel cabinet serves as a chassis for the radio-frequency (r-f) components of the receiver and transmitter. The lower deck serves as a chassis for the modulator of the transmitter and the audio output of the receiver. Upper and lower sections are fastened together by snap latches. They are held to the wooden chest by snap latches.

(1) *Receiver.* The receiver section of BC-669-(\*) (fig. 2) is a seven-tube, superheterodyne circuit operating in two frequency bands and six crystal-controlled channels. (See schematic diagrams, figs. 54 and 53.) Crystal or manual control is available in either band. Reception is either handset, headset, or loudspeaker. By using the static filter switch provided, 1,000-cycle code signals can be received. This switch when ON operates a peak limiter and 1,000-cycle tuned circuit. These effectively reduce static and electrical disturbances. Also a beat-frequency oscillator (bfo) is included for c-w telegraph reception. Operate CW-OSC SWITCH-

\* See TM 11-625 for installation, operation, and other maintenance data on this equipment.

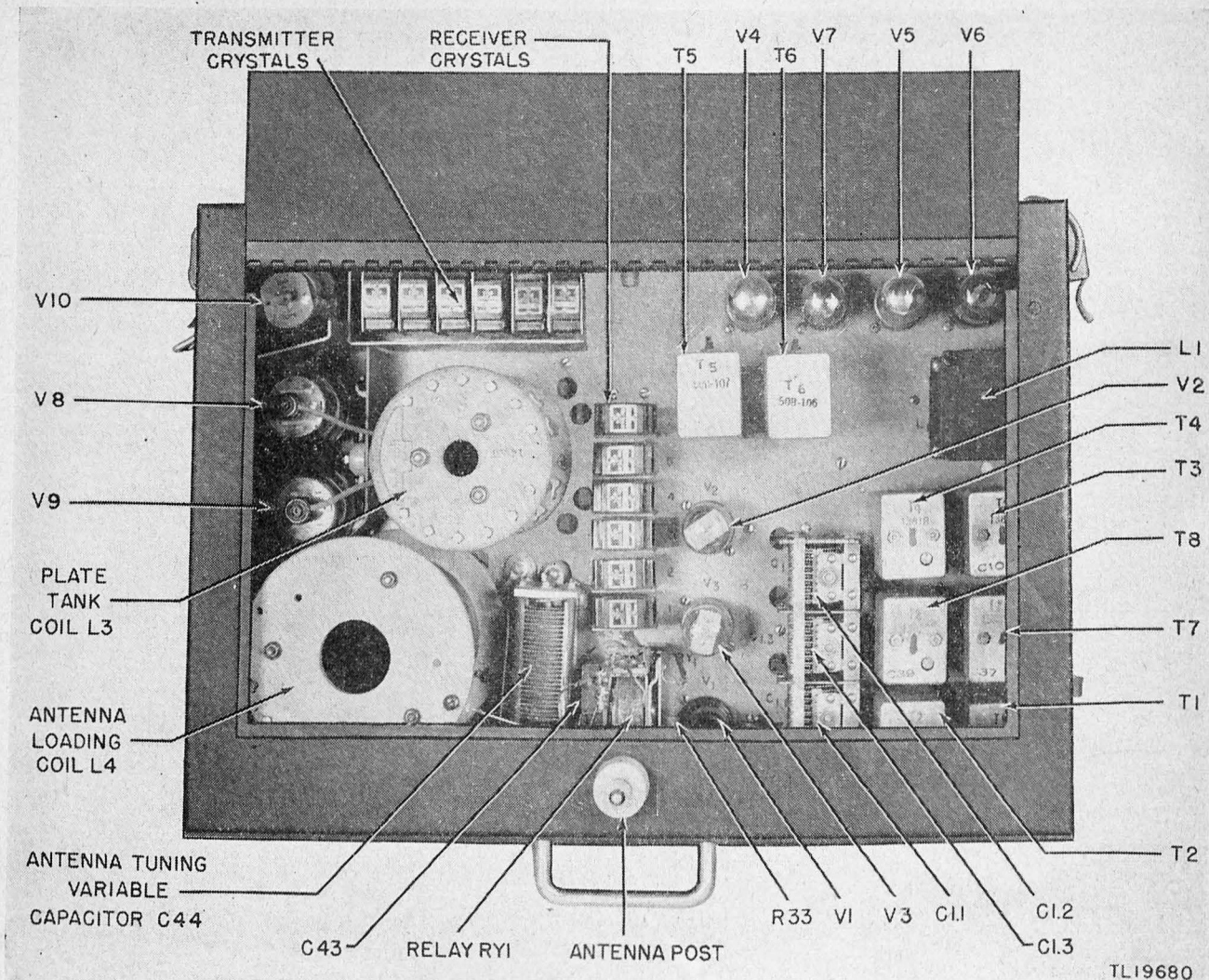

TL19680

Figure 2. Radio Receiver and Transmitter BC-669-(\*)—top view, r-f chassis.

S11 for CW reception. Antenna relay RY1 switches from reception to transmission.

(2) *Transmitter.* The transmitter section (fig. 2) is a crystal-controlled voice emission unit. It uses an oscillator tube JAN-6L6 and two r-f power-amplifier (p-a) tubes. The antenna coupling is controlled by frequency channel switches corresponding to selected frequencies. The antenna current is 1 to 1.5 amps. (See figs. 54 and 55.)

(3) *Modulator.* The modulator section consists of a driver Tube JAN-12J3GT (VT-115-A). These tubes operate in push-pull parallel as a class AB1, audio-frequency (a-f) power amplifier. (See figs. 3, 48, and 49.) The modulator section contains a switching arrangement for changing from modulation to telegraph transmission. Switching is effected through switch S14. Also jacks are provided for plugging in KEY, PHONES, MIC into jacks J1, J2, and J3 respectively.

(4) *Meters.* An antenna current meter and a

d-c millimeter for reading power-amplifier plate, modulator plate, and a p-a grid current are provided. (See fig. 1.)

## 2. Over-all System Function

*a. RECEIVER SECTION.* (1) *Radio-frequency amplification stage.* R-f amplifier Tube JAN-6SK7 (V1) amplifies signal voltages at radio frequencies, and, together with sharply tuned circuits of r-f transformers T1 or T2, greatly attenuates signals of undesired frequency. Signal voltages picked up by the antenna appear across the primary of the first r-f transformer. Through tuned parallel resonant circuit the signal voltage is fed to the control grid of the i-f tube. The r-f signal voltage gain is controlled by a variable resistor. Automatic volume control (avc) is applied to control grid of the r-f amplifier tube.

(2) *Mixer stage.* Grid No. 3 of the mixer Tube JAN-6SA7 (V2) receives an amplified signal



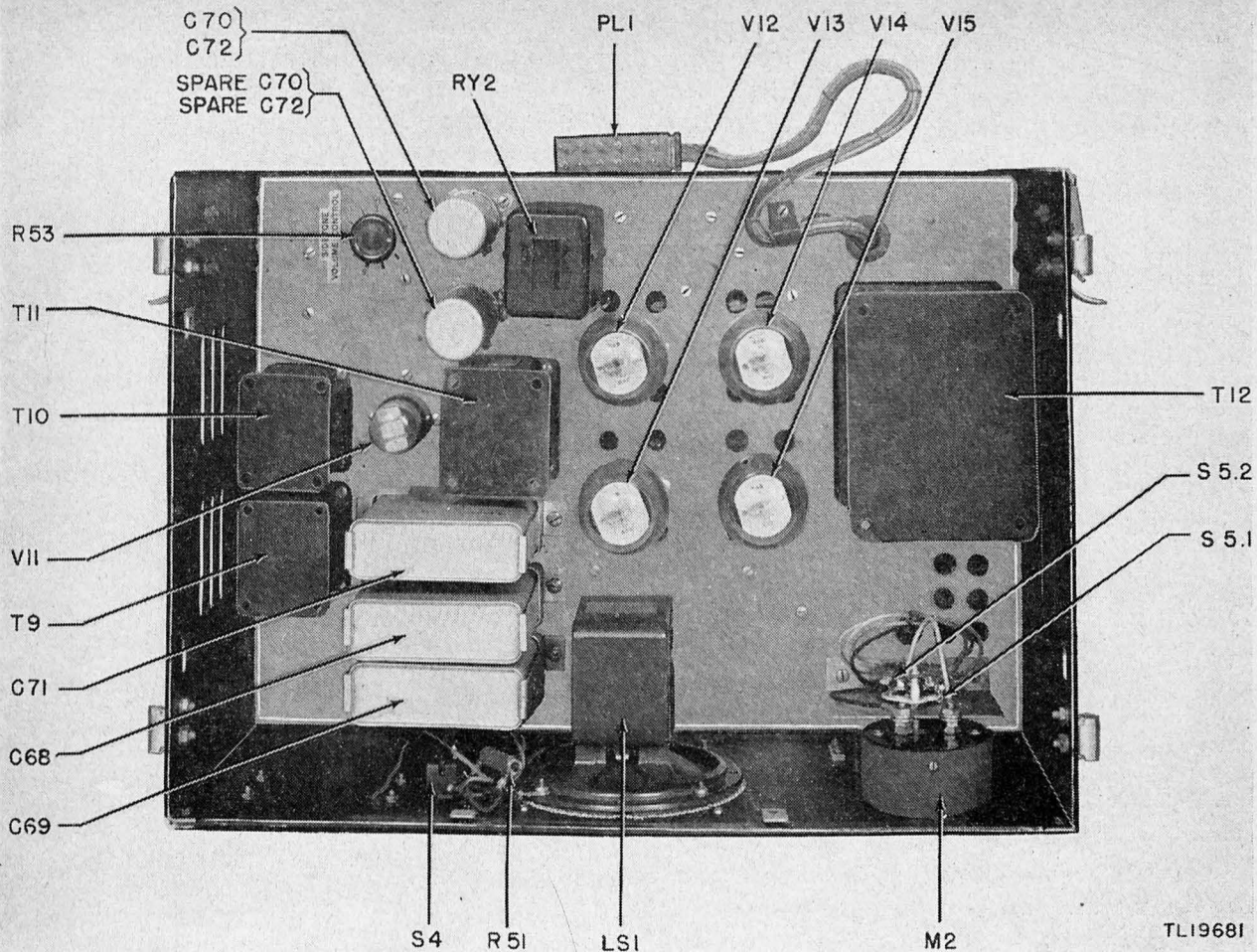

Figure 3. Radio Receiver and Transmitter BC-669-(\*), modulator chassis—top view.

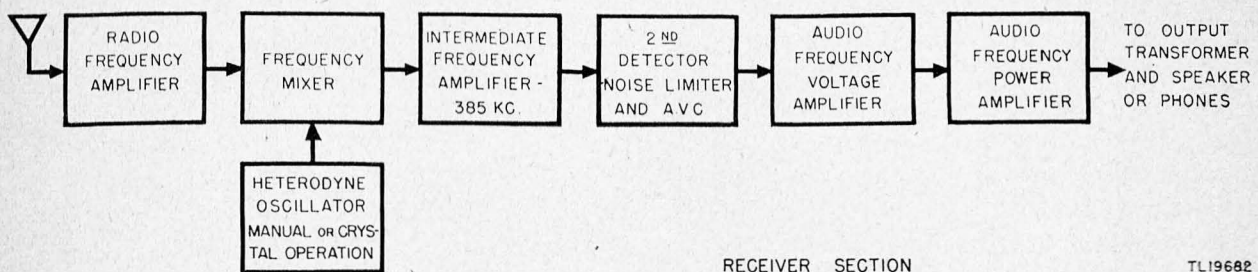

Figure 4. Radio Receiver and Transmitter BC-669-(\*), receiver section—block diagram.

through inductive and capacitive coupling. The function of this stage is to heterodyne the amplified r-f signal voltage supplied by tube V1 with high-frequency voltage from the heterodyne oscillator. A tuner circuit determines the frequency of the signal on grid No. 3. A-v-c voltage is applied to the control grid of tube V2.

(3) *Heterodyne oscillator stage.* Tube JAN-6J5 (V3) generates oscillations differing from the

signal frequency at receiver intermediate frequency.

(a) *Manual operation.* Oscillation frequency is determined by a tuned circuit of the Hartley type. Feedback is provided by grounding one end of the r-f coil and connecting a tap to the cathode of the tube.

(b) *Crystal operation.* Oscillation frequency is determined by the frequency of the crystal selected through the channel switch.

(4) *Intermediate-frequency amplifier stage.* Tube JAN-6SK7 (V4) amplifies intermediate frequency supplied by the mixer. The intermediate frequency of the receiver is 385 kc. The output of the mixer stage is inductively coupled to the control grid of the i-f tube. The frequency impressed on the grid is determined by primary and secondary parallel resonant circuits of the i-f transformer. Cathode bias controls the stage gain.

(5) *Second detector, noise limiter and a-v-c stage.* Tube JAN-6H6 (V7) functions both as detector, source of avc, and limiter of high noise-voltage peaks. A modulated 385 kc i-f signal is impressed across the primary of the diode i-f transformer. Through inductive coupling, the signal appears across the secondary and detector diode section of the tube. Only audio modulation appears across the i-f filter capacitor. D-c voltage supplied by the detector is fed through a filter resistor to supply a-v-c voltage to the control grids of the r-f and mixer, and the audio voltage amplifier stage. A toggle switch throws the peak limiter into operation.

(6) *Audio-frequency voltage amplifier stage.* Tube JAN-6SK7 (V5) amplifies audio voltage delivered by the detector and furnishes audio-output voltage sufficient to drive the second audio tube. Avc is applied to the control grid.

(7) *Audio-frequency power amplifier.* Tube JAN-6K6GT/G (V6) provides sufficient power to drive the loudspeaker. This stage amplifies the output of the first audio tube. Audio gain is controlled by variable resistor R21. Screen voltage comes direct from the plate supply. Plate voltage is supplied through the primary of audio-output transformer T9 (located on the modulator chassis). Audio output is delivered to the voice coil of the loudspeaker.

*b. TRANSMITTER SECTION.* (1) Oscillations generated by driver Tube JAN-6L6 (V10) at radio frequency, supply power for the final stage. The oscillator maintains these oscillations accurately at the desired frequency. Frequency is determined by crystals between the control grid and plate of the tube.

(2) R-f amplifier Tubes JAN-807 (V8 and V9) operate in parallel as a class C amplifier. Oscillations produced by tube V10 are capacitively coupled to the control grids of tubes V8 and V9. Plates of tubes V8 and V9 are powered through an r-f choke. Plate tank inductance is varied by sliding contactors which are selected on switch section S3.3.

(3) Antenna coupling is varied by a separate set of sliding contactors on the plate tank coil. These are selected on switch section S3.1. Loading inductance is varied by the sliding contactors on antenna-loading coil L4.

*c. MODULATOR SECTION.* (1) Driver Tube JAN-12J5GT (V11) amplifies low-level microphone voltage, and provides sufficient voltage swing to drive the modulator power stage.

(2) Modulator tubes JAN-6L6G (V12, V13, V14, and V15) operate in push-pull parallel as a class AB1, a-f power amplifier.

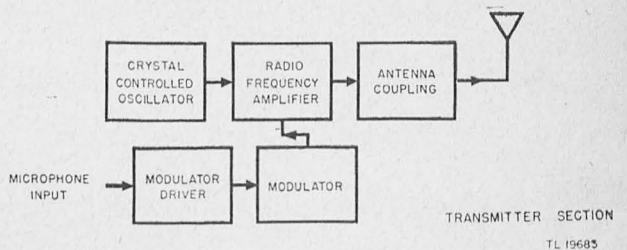

Figure 5. Radio Receiver and Transmitter BC-669-(\*), transmitter section and modulator, block diagram.



## SECTION II

### DIFFERENCES BETWEEN MODELS

#### 3. Differences Between Models of Radio Receiver and Transmitter BC-669-(\*)

The differences between the BC-669-A, -B, and -C consist of slight modifications in circuits; additions of small parts, changed values of some small parts and minor improvements in construction details of instrument housing. There are no operational differences and no design differences. The basic circuit is the same for all models. For changes in other components of Radio Sets SCR-543-A, -B, or -C, see TM 11-625.

#### 4. Electrical and Mechanical Differences

a. The changes made on Radio Receiver and Transmitter BC-669-B, on Signal Corps Order No. 4792-Phila-43, are as follows:

(1) Tubes V1, V2, V3, V4, V5, V7, and V10 are changed to glass.

(2) R-f choke L16 is added in the cathode circuit of V1 and V4.

(3) Capacitor C6 is reconnected to the arm of noise control R4.

(4) Two tie lugs are added to mount C6 and L16.

(5) Capacitor C88 is added to the cathode of tube V8.

(6) In tube V9, cathode resistor R40 is disconnected from R45 and is grounded directly.

(7) Transformer T9 has the following changes:

(a) The 6-ohm secondary is changed to an impedance of 100 ohms.

(b) Tap is connected to switch S4.

(8) Transmitter channel switches S3.1, S3.3, S3.4, S3.5, S3.6, and S3.7 have the following changes:

(a) Mounting dimensions are  $\frac{1}{16}$  inch longer (front to rear).

(b) Some metal spacers are replaced with ceramic spacers.

(c) Rotor contact blades are wider.

(9) In C45 to C50 inclusive, the locking ring is added to the lock shaft bushing to ceramic front plate.

(10) Trunk fasteners are replaced with improved type.

(11) Sliders on coils L5 and L4 are replaced with one-piece type.

(12) Ground binding post is replaced with captive type.

(13) Relay RY1 has the contact spacing increased; the contact diameter and thickness is decreased.

(14) R-f GAIN on panel is changed to NOISE CONTROL.

(15) Banana plug is replaced with heavier type.

(16) Crystal shield has additional section between tubes V8 and V10.

(17) Dial indicators are replaced with improved type.

(18) Antenna feed-through thumbnut is made captive.

(19) Slotted setscrews are replaced with Allen-head screws.

(20) Crystal holder nameplates are stamped TRAN. 1., REC. 1.

(21) I-f transformer T6 is moved closer to T5 so that the T6 aligning screw may be reached between tubes V4 and V7.

(22) Channel switch couplings are replaced with two-piece type, which are later replaced with a one-piece flexible type.

(23) Transmitter channel switch shield is revised to mount two types of capacitor C51.

(24) Insulator board is added to rear of resistor terminal board on channel switch shield.

(25) Side modulator cabinet clips are replaced with heavier type.

(26) Ground wire has been added from mounting screw on tank coil L3 to ground lug.

(27) The C44 mounting insulators have been changed to the type without brass inserts on the latter part of Order No. 4792-Phila-43.

(28) The following capacitors have been changed:

C2	C11	C31	C38	C59
C3	C12	C32	C39	C60
C5	C23	C34	C40	C61
C6	C26	C35	C51	C65
C9	C27	C36	C56	C66
C10	C29	C37	C58	

(29) R51 has been changed from 100 ohm  $\frac{1}{2}$  watt to 35 ohm 2 watt on some Radio Receivers and Transmitters BC-669-A on Signal Corps Order No. 1980-Cri-42, and then to 6 ohm 10 watt on Order No. 4792-Phila-43.

REF SYMBOL	VALUE	RATING
C64	0.5 MF	200 VDCW
C65	0.002 MF	500 VDCW
C66	0.002 MF	500 VDCW
C67	0.02 MF	600 VDCW
C68	8 MF	1,000 VDCW
C69	8 MF	1,000 VDCW
C70	40 MF	100 VDCW
C71	8 MF	1,000 VDCW
C72	40 MF	100 VDCW
C100	0.1 MF	400 VDCW
C101	500 MF	25 VDCW
C102	0.01 MF	400 VDCW

REF SYMBOL	VALUE	RATING
R48	40 OHMS	2 W
R49	40 OHMS	2 W
R51	BC-669-A, 100 OR 33 OHMS	1/2 W 2 W
R52	BC-669-B AND -C, 5 OHMS 100 OR 33 OHMS	2 W 1/2 W 2 W
R53	100,000 OHMS (POTENTIOMETER)	
R54	220,000 OHMS	1 W
R55	100,000 OHMS	1/2 W
R56	50,000 OHMS	1/2 W
R57	250,000 OHMS	1/2 W
R58	1,000 OHMS	1/2 W
R59	50 OHMS	1/2 W
R60	50 OHMS	1/2 W
R61	50 OHMS	1/2 W
R62	50 OHMS	1/2 W
R63	0.351 OHM	300 MA
R64	0.351 OHM	300 MA
R65	5,000 OHMS	20 W
R66	BC-669-A AND -B, 500 OHMS WITH 400- OHM TAP BC-669-C, 400 OHMS	50 W
R67	40,000 OHMS	20 W
R68	10,000 OHMS	10 W
R69	125 OHMS	10 W
R70	1,000 OHMS	2 W
R82	500 OHMS	50 W
R83	100,000 OHMS	1/2 W

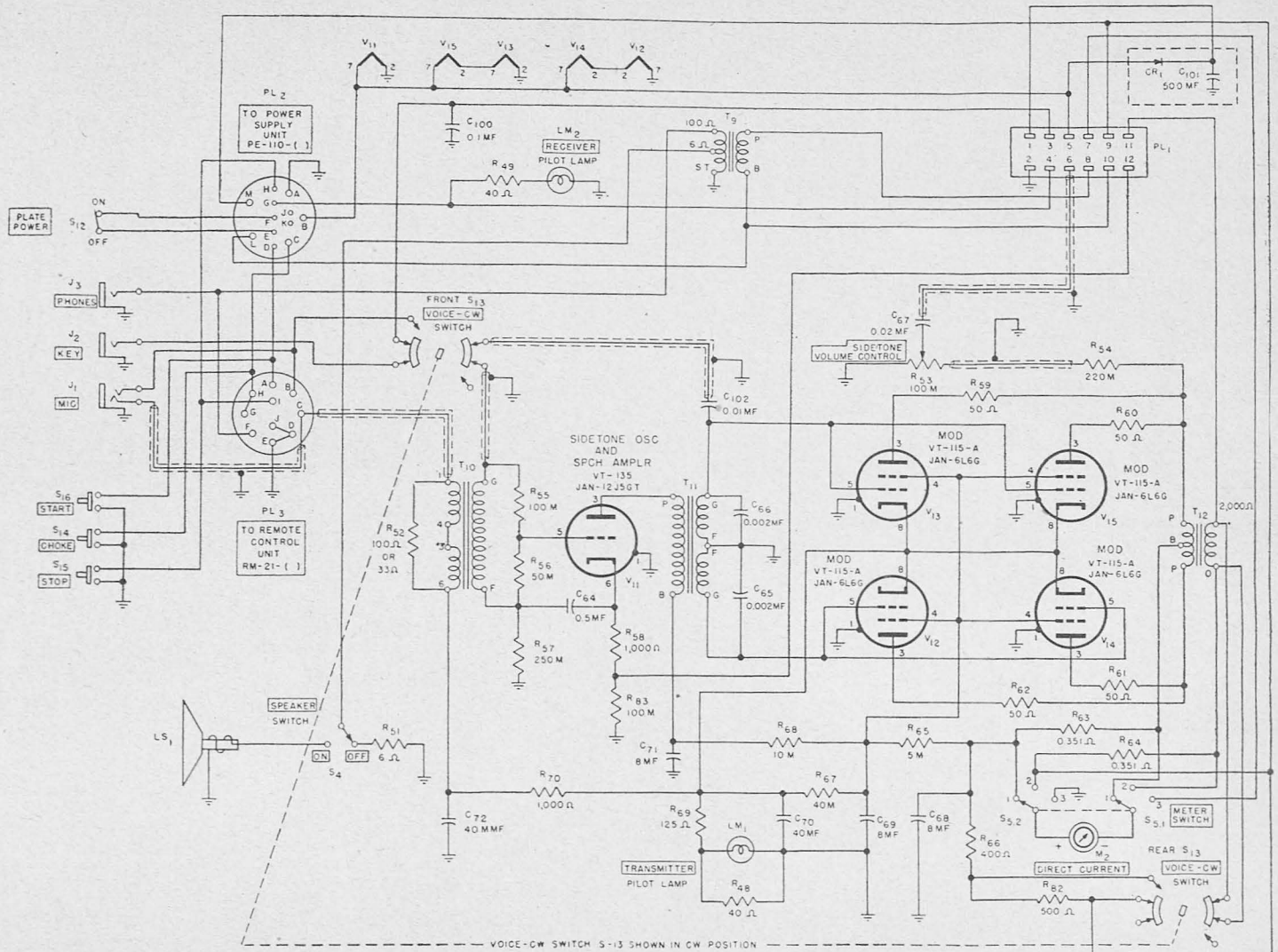

NOTE: R51 EQUALS 100Ω OR 33Ω IN BC-669-A  
 R66 EQUALS 400Ω IN BC-669-C  
 M=1,000 Ω  
 † IS SYMBOL FOR FIXED CAPACITOR

METER SWITCH  
 POSITION 1 - MOD. PLATE CURRENT  
 POSITION 2 - PA. PLATE CURRENT  
 POSITION 3 - PA. GRID CURRENT

FL12999-5

Figure 6. Radio Receiver and Transmitters BC-669-A, -B, and -C, modulator section, with modification for c-w operation.

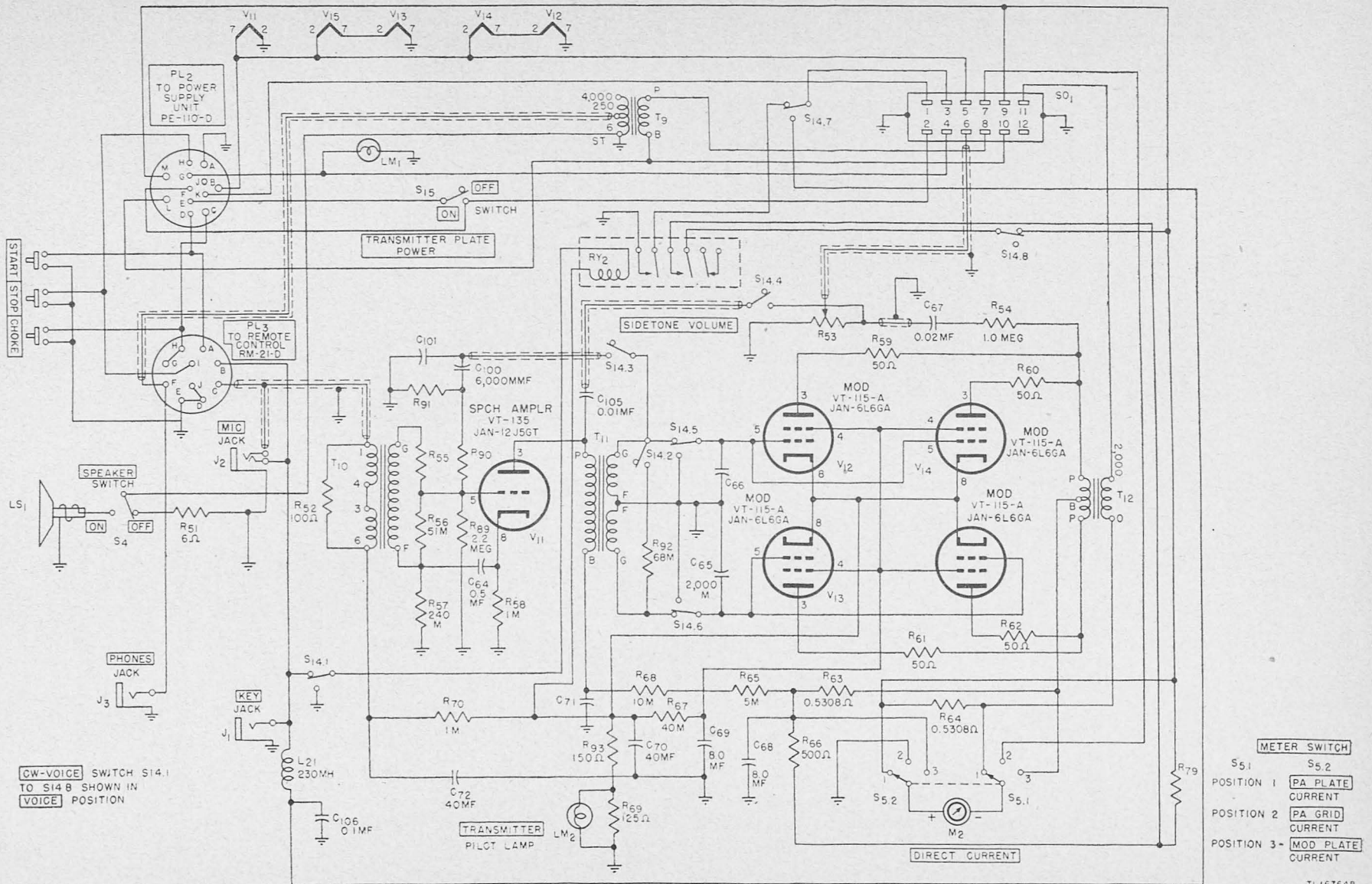

Figure 7. Radio Receiver and Transmitter BC-669-D, modulator section, schematic.



(30) The following miscellaneous parts have been changed:

RY1	T4	V2	V8
S3	T7	V3	V9
T1	T8	V4	V10
T2	T9	V5	
T3	V1	V7	

b. The changes made on Radio Receiver and Transmitter BC-669-B on some equipment produced on Signal Corps Order No. 15536-Phila-43 are as follows:

(1) Base clamps have been added to tubes V10, V12, V13, V14, V15.

(2) Tube-holder assembly has been added to tubes V8, and V9.

(3) Crystal clamps have been added.

(4) Steel strap has been added around capacitors C68, C69, and C71.

(5) Clamp has been added to hold cover of relay RY2 in place.

c. Differences between BC-669-B and BC-669-C include changes made on Radio Receiver and Transmitter BC-669-C on Signal Corps Orders Nos. 4791-Phila-43 and 15537-Phila-43 as follows:

(1) Capacitor C6 is connected between R3 and L18.

(2) Allenhead type setscrew not used.

(3) Fuse holders remain old type.

(4) Allen setscrew wrenches are not used.

(5) Knobs on the front panel differ in style.

d. The changes made on Radio Receiver and Transmitter BC-669-C on some sets produced on Signal Corps Orders Nos. 4791-Phila-43 and 15537-Phila-43 are as follows:

(1) Trunk fasteners mounting BC-669-C on the mounting pen have been changed to drawbolt clamps.

(2) The cover of relay RY1 is held in place by a setscrew.

(3) Straps holding down capacitors C68, C69, and C71 are constructed of heavier metal.

(4) Plates have been added below shock mounts to facilitate the removal of mounts.

(5) Channel switch coupling is a one-piece flexible type of different construction.

e. The radio sets on Orders Nos. 32780-Phila-43 and 32781-Phila-43 are identical in construction and are the same as some Radio Receivers and Transmitters BC-669-C produced on Signal Corps Orders Nos. 4791-Phila-43 and 15537-Phila-43, except that in Radio Receiver and Transmitter BC-669-B and BC-669-C.

(1) Resistor R50 has been changed from 25,000 ohms to 15,000 ohms.

(2) Resistor R76 has been added from coil of relay RY2 to ground. (See fig. 21.)

(3) Capacitor C74 and C75 changed to 8 mf, 475 volts direct current working.

(4) Capacitors C25, C31, C65, and C66 are of moulded paper type only.

(5) Knobs are slightly different in style.

(6) Nameplates are different.

(7) Nomenclature of respective parts is different.

f. MWO SIG 11-625-8 authorizes changes in the circuits of Radio Receiver and Transmitters BC-669, models A, B, and C. The modification provides c-w operation for all models by incorporating a bfo in the receiver section. In addition, a keying and break-in relay, a sidetone oscillator, and transmitter control arrangement are added in the modulator section of the transmitter. The control arrangement enables operation of Radio Receiver and Transmitters BC-669-A, -B, and -C, independent of Remote Control Unit RM-21-A, -B, and -C. The BC-669-D is now being manufactured with the above changes included. Radio Receiver and Transmitters BC-669-A, -B, and -C when modified are known as BC-669-AM, -BM, and CM.

## SECTION III

### INITIAL REPAIR PROCEDURES

*Note.* Before any repairs or adjustments are made all authorized modification work orders should be applied. See FM 21-6 for list of applicable MWO's.

#### 5. General

Maintenance personnel should follow the procedure outlined in this manual when repairing and overhauling Radio Receiver and Transmitter BC-669-(\*). The repair information in this and the following sections is presented in the order in which the repairman should actually perform the various operations on the equipment in the repair shop. This procedure permits repair of the equipment in the shortest time possible, resulting in sensitivity and selectivity comparable to that of new equipment.

#### 6. Method of Starting Repairs

*a. REMOVING EQUIPMENT FROM CABINET.* Observe the position of the latches mentioned in paragraph 1*h*. When the radio component has to be inspected or repaired, remove steel cabinet from wooden chest by laying *chest on its back*, unfastening the six rear snap latches and then *lifting receiver and transmitter out of chest by the two handles provided* on the top and bottom of the front panel.

*b. PREPARATION.* The object of all repairs on Radio Receiver and Transmitters BC-669-(\* ) is to return as many of these instruments as possible to a condition which will meet the minimum requirements of the Signal Corps. This requires careful attention to detail on the repairman's part. Speedy, accurate repairs can be made only when the construction of this unit is thoroughly known. Study carefully the over-all schematics as shown in figures 54 and 55. Study the stage schematics (figs. 28 to 41 incl.), the parts data, and the differences between the three models. Pay close attention to the practical wiring diagrams. (See figs. 50 to 53 incl.). In removing and reinstalling parts be very careful to remove them as shown in photographs in figures 42 to 46 inclusive. Resolder no connections unless they are thoroughly clean. Take nothing for granted. Make sure by checking all doubtful parts. Follow the established procedure of thoroughly cleaning before attempting visual inspection.

#### 7. Tools, Test and Cleaning Equipment

*a. OPERATING ACCESSORIES.* To make accurate

and effective repairs on Radio Receiver and Transmitters BC-669-(\*), it is necessary to have at hand and in good working condition the following accessory equipment:

(1) Remote Control Unit RM-21-(\* ) and Connector SO3 (fig. 9), including 1 Handset TS-11-(\*).

(2) Power Supply Unit PE-110-(\* ) (fig. 8), including 1 cord CD-515-(\* ) to Radio Receiver and Transmitter BC-669-(\* ) and 1 cord CD-511-(\* ) for connection to a-c power.

*b. TESTING INSTRUMENTS.* Testing instruments required are as follows:

Item	Description
Radio-frequency signal generator .....	Modulation 30%, 400 cycles, with amplitude modulation, and having metered output
Vacuum-tube voltmeter...	Voltomyst, or equivalent type of vacuum-tube voltmeter
Output meter .....	Weston No. 571
Phantom antenna .....	300 mmf, 30 ohms, non-inductive, series resistance
Radio-frequency output meter .....	30 ohms
Antenna, if conditions permit .....	Supplied with SCR-543-(* )

*c. CLEANING EQUIPMENT.* The use of drastic cleaning agents is not recommended for use on BC-669-(\*). The materials needed are:

- (1) Compressed air, or hand bellows.
- (2) Small fiber brushes.
- (3) Tobacco pipe cleaners.
- (4) Lint-free rags.
- (5) Solvent, Dry-cleaning.
- (6) Crocus cloth.
- (7) #0000 sandpaper.

#### 8. Removal of Tubes and Other Plug-in Parts

There are three classes of plug-in parts in Receiver and Transmitter BC-669-(\*). These classes are vacuum tubes, crystal holders, and electrolytic capacitors C70 and C72. (See fig. 10.)

*a.* Before pulling tubes, make sure where tube holders are used, that the tube-holder tightening screws are loosened. This also applies to electrolytic



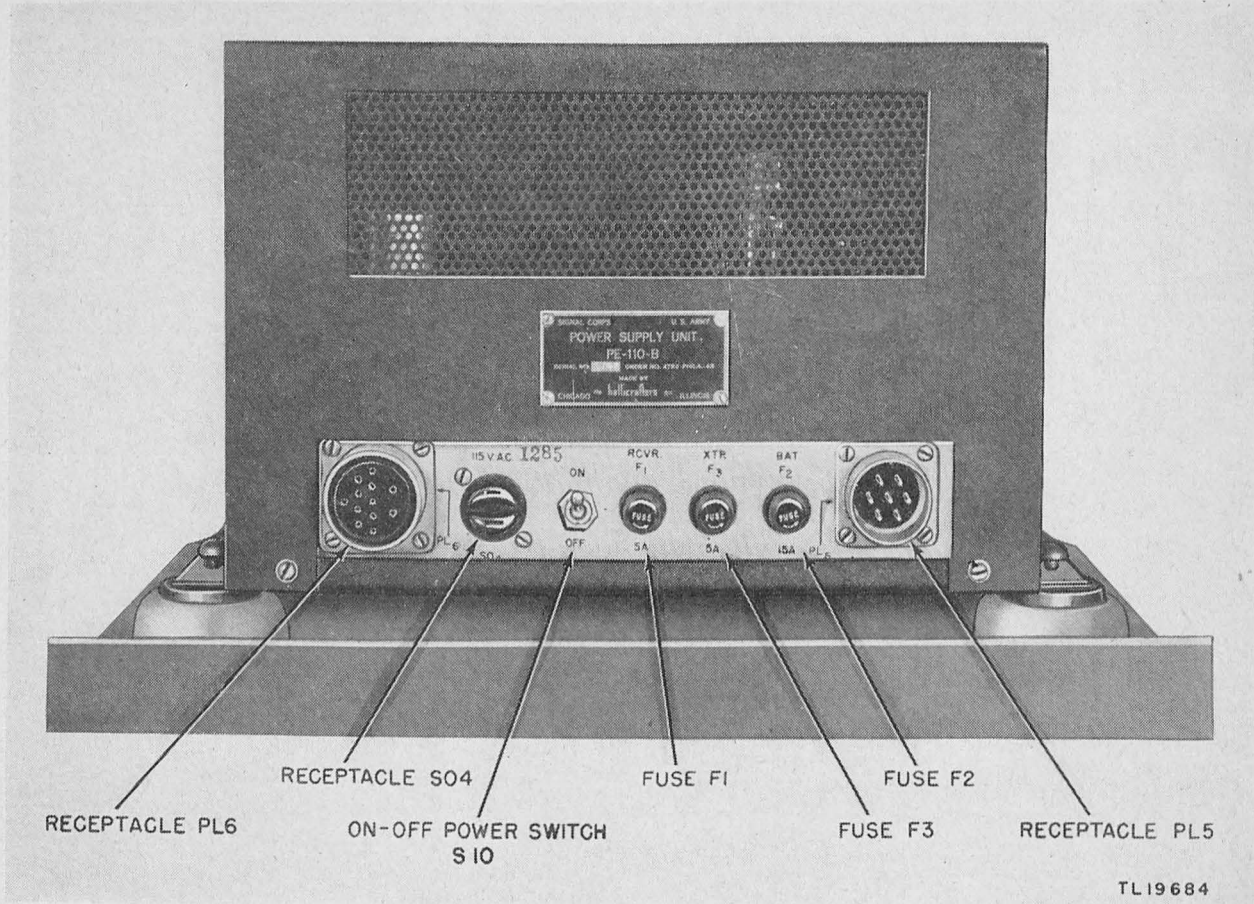

Figure 8. Power Supply Unit PE-110-(\*).

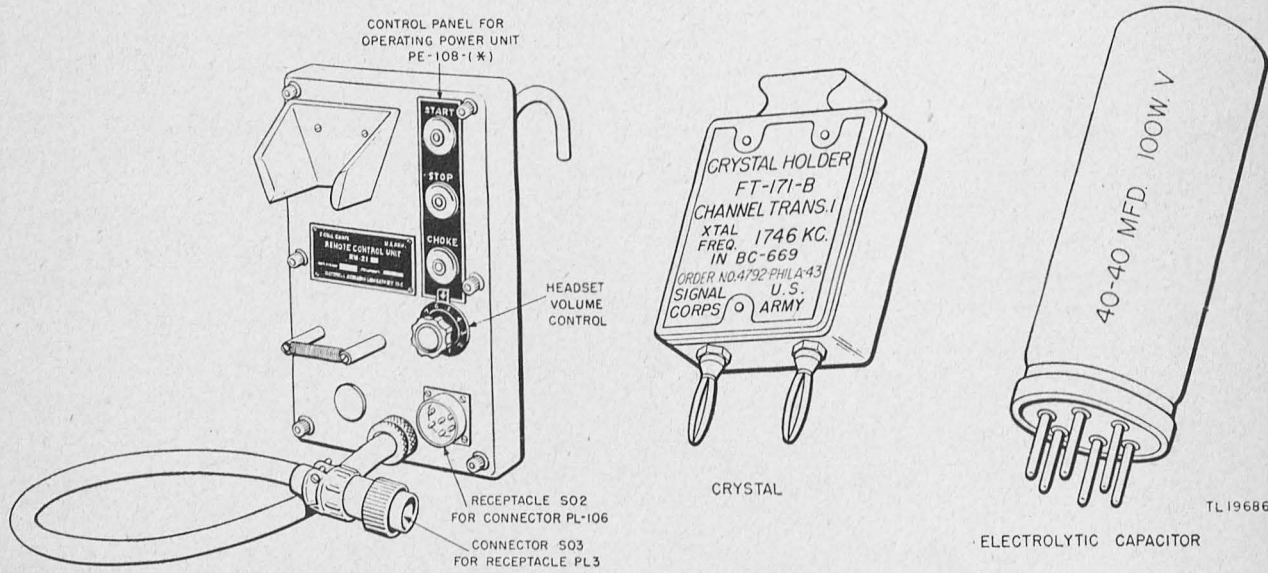

Figure 9. Remote Control Unit RM-21-(\*).

Figure 10. Radio Receiver and Transmitter BC-669-(\*), plug-in parts; a, crystals; b, electrolytic capacitors C70, C72 (housed in one can).

capacitors C70 and C72. To remove, gently pull the tubes straight up with the least wobble possible.

b. For use in the set, see that all crystal holders are solidly seated in their sockets. To remove crystals, first remove the lock bar, then pull the crystal holder straight up with as little wobble as possible.

c. Electrolytic capacitors C70 and C72 are cased in the same shield can. They are clamped in position by a holder similar to the tube holders. Loosen holder and pull out capacitors.

*Note.* Do not use screw driver in removing any plug-in part.

## 9. Chassis Cleaning, Inspecting, and Lubricating

a. Cleaning comprises removal of dust, grease, and traffic film. Loose surface dust should be blown out with an air-hose, where available, or hand bellows. Any remaining loose dust-film may be quickly wiped off with soft lint-free rags. Remove dirt or oil-film resulting from transportation or field operation with fiber brushes dipped in dry-cleaning solvent (SD). For delicate moving parts (capacitor blades and the like) use tobacco pipe cleaners dipped in dry-cleaning solvent (SD).

b. Preliminary cleaning on entrance to the repair shop must leave the instrument in a condition where visual inspection is quickly possible, and where visible defects can be noted accurately. Thoroughly clean *all* exposed surfaces inside and out with lint-free rags moistened in dry-cleaning solvent (SD), paying particular attention to corners and the areas around tube sockets. Chassis cleaning must leave all surfaces clean and free from streaks which can cause shorts. Chassis cleaning includes transformer covers, relay covers, and all metal shielding surfaces. Be careful to move dirt *away* from plug holes, tube sockets, or crystal pin sockets. These sockets should be cleaned out with tobacco pipe cleaners dipped in dry-cleaning solvent (SD). Use only enough pressure to remove dirt. Polish with dry pipe cleaners.

## 10. Cleaning Operations

a. TUBES. Clean the envelopes of glass tubes with a damp cloth and wipe thoroughly dry with a dry cloth. Carefully remove all accumulations of dust, grease, or traffic film from the tube bases and prongs. Wipe metal tubes clean with a dry cloth. Any oil deposit remaining on the metal envelope acts as a rust preventive. Clean prongs with dry-cleaning solvent (SD), and wipe off any residue with a clean dry cloth. Clean grid or plate caps, removing all tarnish or corrosion with crocus cloth. This should be done by exerting only a mild pressure. Any

excess solder that may have collected on prongs should be gently scraped off with a penknife.

### b. CAPACITORS.

**Caution:** Make sure that all high voltage capacitors are thoroughly cleaned to prevent arcing and losses. Discharge with shorting bar before cleaning, to prevent accident. Oil-filled, low-voltage capacitors require similar care.

All leads and terminals must be inspected for indications of looseness or corrosion, and porcelain insulators must be checked for cracks or breaks. Tubular capacitors should be checked for bulging, excessive swelling or wax leakage which indicates heating. The pigtail leads should be solid in contact. Do not use cloths to clean this type of capacitor as surrounding circuits may easily be damaged. Use a soft brush to clean the body of the capacitor and surrounding equipment. Inspect mica capacitors for cracked body conditions. Check leads (pigtail type) for tightness of connection. The high-voltage type requires the same care that other high-voltage capacitors receive. Trimmer capacitors require special attention. Trimmer capacitors attract and retain moisture under some operating conditions, therefore they should be dried out by a small portable heater. After shorting, (when the power is disconnected) feel the terminals of all high-voltage capacitors. They should be fairly cool. Excessive heat indicates possible loss because of dirty or corroded terminal connections. Feel the sides of oil-filled and electrolytic capacitors. They should be cool or only slightly warm. If very warm or hot, condition indicates excessive internal leakage. Remove and replace.

**Caution:** Do not use cleaning cloths on the padder capacitors, as very slight pressure will throw the plates out of alignment.

c. CLEANING RESISTORS. There are two main types of fixed resistors used in BC-669-(\*). The first group includes those with flat, broad soldering lugs. These resistors are used to handle heavy voltage loads, and are usually wire-wound. Resistors of the second type, whose terminals must also be soldered, are known as pigtail type resistors and are usually of the carbon type. Vitreous or ceramic type resistors connected across high voltage should be thoroughly cleaned by careful wiping to prevent flash-overs between terminals. Check pigtail type resistors for strength of soldered connections as well as resistance value and continuity. The standard method is to slide a small insulated stick lightly over the connections and inspect them visually for solidity. If the connection is weak or loose, resolder it immediately. The soldered connection is very important. If it is blistered, discolored or chipped, resolder it. Connections should be dusted with an air blower.



d. **CLEANING RELAYS.** Relays which are entirely inclosed in dustproof and moisture-proof cases will require less care than those having exposed moving or electrical parts. Therefore, if an inclosed relay is operative, assume that it requires only maintenance inspection. Any relay must be either replaced or repaired if it fails in any of the requirements mentioned below. (See fig. 47.) Make your inspection using a flashlight and mirror (dental type is best). Many relays can be inspected and cleaned without removing them from chassis or taking them apart. If it becomes necessary to take a relay apart tag all the leads as removed to make sure that reassembly will be rapid, easy, and correct. Clean the outside of the relay with a dry cloth. If it is very dirty, clean it with dry-cleaning solvent (SD) and a brush or cloth (except on exposed coils); then wipe it dry with a clean cloth taking special care to remove any white deposit left by the dry-cleaning solvent (SD). Inspect and tighten loose connections. Any relay is considered normal if—

(1) The relay assembly is free from dirt, dust, and other foreign matter.

(2) The contacts are not burned, pitted, or corroded.

(3) The contacts are properly lined up and correctly spaced.

(4) The contact springs are in good condition.

(5) Moving parts move freely and efficiently.

(6) Connections to the relay are tight.

(7) No insulation is frayed or torn.

(8) The relay is securely mounted.

(9) The coil indicates no overheating.

(10) Relay contacts are clean.

(a) *Corroded contacts.* First, dress contacts with either stick or strip of crocus material. When all corrosion is removed, wipe with clean cloth moistened with dry-cleaning solvent (SD). Then polish with clean dry cloth. Check to make sure that shape of contacts has not been altered.

(b) *Burned or pitted contacts.* First, resurface contacts, if needed, with #0000 sandpaper, keeping original shape and contour of contact. Smooth to high polish with crocus cloth. Wipe thoroughly to remove abrasive residue.

e. **CLEANING TRANSFORMERS AND CHOKE COILS.** The presence of dirt, dust, greasy traffic film, or moisture between terminals of high voltage transformers and chokes may cause flash-overs. Before repairs or circuit testing are attempted, all metal encased transformers must be wiped clean with a cloth moistened in dry-cleaning solvent (SD). Clean casing and surrounding area; also clean any connections that are dirty or corroded. Tighten the mountings carefully and make sure that all connections are solid.

f. **CLEANING VARIABLE RESISTORS.** Rheostats and potentiometers of the open type can be cleaned easily using a soft brush or cloth to remove dust, traffic film, or other accumulations and polishing with a soft clean cloth. If more cleaning is needed, add dry-cleaning solvent (SD) to previous operation and follow by polishing with a clean cloth. If contact arm is burned or pitted, place a piece of crocus cloth between contact arm and winding, and slide contact arm over crocus cloth until contact is clean. Remove crocus cloth and insert clean dry cloth. Rotate contact arm to remove abrasive residue.

g. **PLUGS AND RECEPTACLES.** To clean the cable use a cloth and dry-cleaning solvent (SD). To clean connectors and connections, use cloth and dry-cleaning solvent (SD). Use crocus cloth to remove corrosion. To clean plug bodies and shells, use cloth and dry-cleaning solvent (SD); use crocus cloth to remove corrosion. To clean receptacles, use cloth, and dry-cleaning solvent (SD) if necessary; use crocus cloth to remove corrosion.

h. **POINTS REQUIRING SPECIAL CARE IN CLEANING.** (1) *Relays.* Springs and contacts must be thoroughly cleaned and contact surfaces brightened. All signs of corrosion must be cleaned off.

(2) *Selector switches.* Remove dirt and corrosion gathered on contacts with a soft fiber brush dipped in dry-cleaning solvent (SD).

(3) *Variable capacitors.* Remove dust between blades with tobacco pipe cleaners dipped in cleaning fluid.

(4) *Sliding contactors.* Remove corrosion and traffic film on contactor clips and slide rods with tobacco pipe cleaners and a soft fiber brush, taking care not to touch the insulating lacquer on coils with dry-cleaning solvent (SD).

(5) *Binding posts and ground connections.* Remove corrosion and traffic film with a brush dipped in dry-cleaning solvent (SD). Where corrosion is stubborn, clear it with fine sandpaper or crocus cloth until a clean contact is established.

(6) *Interior.* Remove all dust, grease, and traffic film from interiors, so that the condition of paint, finish, and plating can be clearly seen.

## 11. Inspection Procedure

*Note.* See that all authorized modifications are made.

a. **PHYSICAL INSPECTION.** (1) Check for cleanliness inside and out.

(2) Observe conditions of finish and plating. Paint and plating should be free of corrosion, flaking, blisters, bare or worn spots, and scratches.

(3) Check meters. See that cases are sound, glass is whole (no cracks or breaks).



(4) Go over power cable. Note all breaks in insulation; if severed or taped see that these are not frayed but are sound and unbroken. Connectors should engage easily and make good contact.

(5) Look over chassis for dents. Look for evidence of dropping, bumping, or mishandling. This will make a difference in final repairs needed, as many broken connections and components can result from hard bumps.

(6) Determine condition of moistureproofing; examine touch-ups of breaks for resealing needed.

(7) Check dessicator bag. Blue color denotes dry

dessicator; pink shows excess moisture. Bag should be free of holes and tears.

*b. MECHANICAL INSPECTION.* (1) Rotate all controls. These should be smooth through their whole turning distance. There should be no backlash or slip.

(2) Try all switches. These should snap firmly and smoothly into contact.

(3) Go over all clamps and snaps. See that they are set solidly; there should be no play in any direction.

(4) Check all bolts, nuts, screws, and other hardware. These must be firmly in place.

**Caution:** Use no oil or other lubricants in servicing Radio Receiver and Transmitter BC-669-(\*).

## SECTION IV

### PRELIMINARY TROUBLE-SHOOTING PROCEDURES

#### 12. General

Assuming that inspection has been thorough and that repairs indicated have been made, the specific tests to locate faulty stages and defective parts must be made. To do this, see the list of testing instruments given in paragraph 7. The broad procedure to follow is to make sure that correct power is available at the power unit. Make both voltage and resistance checks, first at power terminals (figs. 8, 11, and 14 to 18 incl.), and afterwards throughout unit. Check against voltage and resistance charts to make sure that no damage will result to BC-669-(\*) on being connected to the power supply unit. Where voltages and resistances differ from chart values, circuit faults are indicated which must be corrected. Every resistance, in addition to visual inspection, must be tested with the ohmmeter. A faulty resistance can cause increasing misalignment, if not damage, to the whole unit. Therefore, make a real job of resistance and continuity checking. Replace all doubtful parts. There is no power supply unit integral with Radio Receiver and Transmitter BC-669-(\*), but it is supplied with the necessary voltage through Power Supply Unit PE-110-(\*). (See fig. 8.) Therefore, input resistance checks are made at SO4, PL2, the output of PE-110-(\*), the input to the modulator at PL2 and SO1 (fig. 3), and the input to the r-f section. Be sure when checking at SO4 that the power switch is in ON position (a-c power not connected).

**Caution:** When it becomes necessary during tests to separate the two sections of Radio Receiver and Transmitter BC-669-(\*), be sure, before releasing clasps holding upper and lower decks together, to pull PL1 away from SO1. (See fig. 3.)

For actual testing and checking with power on in both decks while separated, it will be necessary to substitute emergency connections because the cable on PL1 is not long enough to operate the two decks in a separated position. The r-f deck chassis cannot be tested with power on unless it is connected to the modulator deck.

#### 13. Resistance Test of Power Supply Unit PE-110-(\*)

**Caution:** Make resistance test with tubes OUT and power OFF. Make no resistance or voltage tests for this job at PL5. This is dangerous.

In order to be sure that it is safe to connect the receiver and transmitter to a source of a-c power it will be necessary to make the following tests at Power Supply Unit PE-110-(\*). When these resistances have been measured and found to correspond with the data given, the power supply unit can be considered serviceable.

a. A-C VOLTAGE LEADS FOR OPERATING PRIMARIES OF POWER TRANSFORMERS AND COILS OF RELAYS. Measure at pins *A* and *D* of PL5. Also measure from pin *A* of PL5 and *F* of PL6. There should be a small resistance reading, about 3 ohms. This is the resistance of the primary windings on transformers T13 and T14.

b. FILAMENT VOLTAGES FOR RECEIVER AND TRANSMITTER. To check the 12-volt a-c winding on transformer T13, which supplies the a-c filament voltage for both receiver and transmitter, connect the ohmmeter to contacts *A* and *B* of PL6. This should read 0 ohms. The receiver filament voltage circuit can be measured through pin *C* of PL5 and contact *G* of PL6.

c. B- OUTPUT TO RECEIVER. Disconnect capacitor C74 in PE-110-A, C75 in PE-110-C, and connect one test lead to contact 4 in the capacitor; connect the other lead to contact *L* in PL6. There should be a reading of approximately 650 ohms, d-c resistance. This tests Reactor L8.

d. B+ OUTPUT TO TRANSMITTER. Connect one lead of the ohmmeter to filament contact 4 of tube V19 and the other lead to contact *M* of PL6. There should be a reading of approximately 50 ohms, d-c resistance. This checks Reactor L9.

e. SECONDARIES OF TRANSFORMERS T13 AND T14. Connect the ohmmeter at the plate pins in the V16 socket; there should be a reading of approximately 140 ohms. From either plate pin to ground, there should be a reading of approximately 75 ohms. To check the secondary of T14, connect the test leads of the ohmmeter to a plate pin of each of tubes V19 and V20. The reading should be approximately 15 ohms.

f. RESISTANCE MEASUREMENTS IN CIRCUITS ON PLUGS PL6 AND PL2. Make the following measurements:

- (1) Pin *A* to ground.
- (2) Pin *B* to modulator and transmitter filaments (12 v).

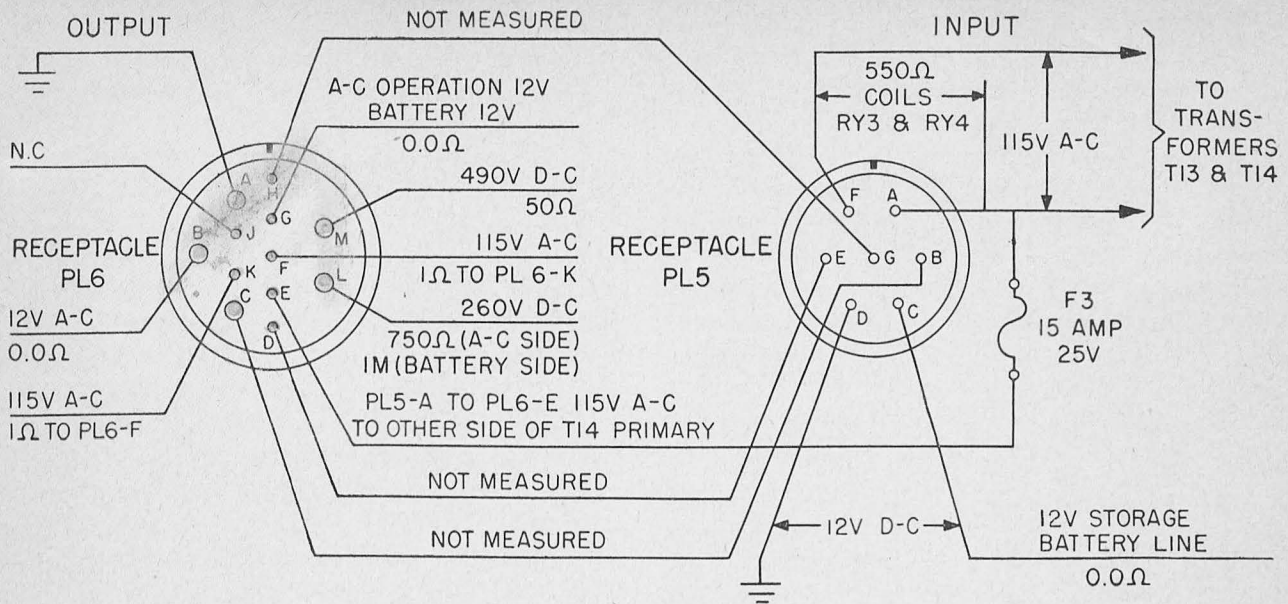

NOTE: ALL MEASUREMENTS MADE TO CHASSIS GROUND EXCEPT AS OTHERWISE INDICATED. CHECK TABLES I AND II FOR INFORMATION & DATA ON ALL MEASUREMENTS.

ALL MEASUREMENTS MADE WITH 1,000 OHM PER VOLT METER.

TL19687

Figure 11. Radio Receiver and Transmitter BC-669-(\*), Voltages and Resistances at Pins and Contacts of Plugs PL6 and PL5.

(3) Pin C to pin H on PL3 to Remote Control Unit RM-21-(\*).

(4) Pin D to pin A in PL3 to Remote Control Unit RM-21-(\*).

(5) Pin E to relay RY2.

(6) Pin F to relay RY2 to pin and contact No. 3 in PL1 and SO1.

(7) Pin G to pilot lamp LM2 pin and through contact No. 4 in PL1 and SO1 to receiver filaments.

(8) Pin H to pin and contact No. 1 in PL3.

(9) Pin J is open; there is no connection.

(10) Pin K to pin and contact No. 1 in PL1 and SO1, to relay RY1.

(11) Pin L to relay RY2 to pin and contact No. 10 in PL1 and SO1 to receiver B-.

(12) Pin M to No. 9 pin and contact in PL1 and SO1 to M2 to T10, T11, T12, and transmitter B+. Make all resistance and voltage tests with instruments specifically indicated in resistance and voltage charts wherever possible. If not available use equivalents.

g. DESCRIPTION OF TEST OF INPUT RESISTANCE AT POWER INPUT RESISTANCE AT POWER INPUT PLUG, PL2 OR CONNECTOR OF BC-669-(\*). (fig. 11). (1) Use an ohmmeter with several ranges, either a-c operated or battery type.

(2) Check directions for making tests on socket charts. (See figs. 11, 18, 19, and 20.)

(3) Make input resistance test on PL2 using the

same pin designations as on PL6 given in this paragraph.

(4) Make cable continuity test from pin contact list above using pins in PL2 and pins of PL1.

h. RESISTANCE TEST IN R-F SECTION. Separate the two decks of the receiver-transmitter, following the caution given at the beginning of this paragraph. Make the test from the contact of SO1 with all tubes removed. Check against the chart in figure 18 for correct values.

i. CONTINUITY CHECK. Check every socket in both decks against the values given in the charts showing socket resistances. Check all transformers for continuity.

j. TEST OF CABLE AND PLUG CONTINUITY. Bring the ends of Cord CD-515-(\*). up on the bench, taking similarly numbered or lettered pins or holes and contacting them with ohmmeter terminals.

#### 14. Turning on Receiver and Transmitter BC-669-(\*)

Having checked the resistances in accordance with the foregoing procedure and knowing from the tests that no harm can result from connecting the set to a source of 115-volt a-c power, the next step is to connect the set for the test and check-ups which will follow. The procedure given here is that of actually operating the set and should be referred to in making all subsequent tests.



a. PREPARATION OF SET FOR OPERATION. (1) *Putting back plug-in parts. (a) Tubes.* Loosen screw to release tension on tube clamps. Insert tube and tighten clamp. Lift bracket of tube hold-down clamp on tubes V8 and V9 high enough to clean tube caps and turn bracket 90°. Lift off caps and remove tube. Then insert tube, put grid caps in place and replace bracket.

(b) *Crystals.* Loosen knurled screws on crystal hold-down bracket. Slide bracket to side and remove crystals. Insert new crystals and replace hold-down bracket.

(2) *Connecting Remote Control Unit RM-21-(\*).* Insert plug-in cord of Remote Control Unit RM-21-(\*). (fig. 9) in receptacle PL3 on the front panel of the receiver-transmitter and screw the plug locking ring on by hand as far as it will turn.

(3) *Connecting Power Supply Unit PE-110-(\*).* Insert the right angle cord connector on the end of Cord CD-515-(\*). in receptacle PL2 on the front panel. Tighten the locking ring. Connect the other end with receptacle PL6 on Power Supply Unit PE-110-(\*). (See fig. 8.)

(4) *Operation from a-c source of power other than PE-108-(\*).* Because of the greater convenience for repair purposes of 110-120 volt a-c power outlets at the repair bench, this type of power rather than Power Unit PE-108-(\*). is to be used wherever possible.

**Caution:** Make no connection to PL5 on Power Supply Unit PE-110-(\*).

*This is dangerous.*

(a) Use Cord CD-511-(\*). to make the connection as follows:

1. Plug one end of Cord CD-511-(\*). in receptacle SO4 (marked 115 V A-C on PE-110-(\*)).

2. Plug the other end into a receptacle providing the a-c power.

(b) The receiver-transmitter may be fully operated from commercial or other 115-volt a-c power with the following exceptions:

1. No battery operation of receiver for standby monitoring is provided when operated from an a-c source other than PE-108-(\*).

2. Stopping and starting buttons on Remote Control Unit RM-21-(\*). (fig. 9) should not be used. They control only Power Unit PE-108-(\*). The ON-OFF switch on PE-110-(\*). (fig. 8) starts and stops operation for outside a-c power conditions.

b. TURNING ON SET. (MANUAL OPERATION) (fig. 1). Set the main power switch on the panel

of Power Supply Unit PE-110-(\*). to ON. The receiver pilot lamp on the panel of BC-669-(\*). will light. Allow about 60 seconds for filaments to heat, and the receiver will be ready for test.

(1) Turn NOISE CONTROL (RF GAIN on BC-669-A and-AM) to maximum at the extreme right.

(2) Release RECEIVER TUNING dial lock.

(3) If the signal to be tested is in the 1,680 kc to 2,750 kc frequency range:

(a) Set RECEIVER BAND SWITCH to MANUAL 1.

(b) Set RECEIVER TUNING dial to desired frequency reading at indicator marked BAND 1.

(4) If the signal to be tested is in the frequency range from 2,750 kc to 4,450 kc:

(a) Set RECEIVER BAND SWITCH to MANUAL 2.

(b) Set RECEIVER TUNING dial to desired frequency reading at indicator marked BAND 2.

(5) Set ON-OFF SPEAKER switch to ON.

(6) Advance AF GAIN control to right until signal is heard in loudspeaker. (If no signal is present, rush-noise or static will be heard indicating the receiver is in operation.)

(7) Extremely noisy conditions may be relieved by adjusting NOISE CONTROL (RF GAIN on BC-669-A and-AM) as follows: Set RECEIVER TUNING dial to a point at which no signal is heard in the loudspeaker. Turn the noise control to a point at which background noise is not too loud.

(8) Readjust RECEIVER TUNING dial until the signal is heard more clearly and with least background noise. This adjustment will be fairly sharp.

(9) Lock RECEIVER TUNING dial.

c. RECEIVER OPERATION WITH CRYSTAL CONTROL.

*Note.* The signal must be one for which a crystal of correct frequency has been selected and preset.

(1) Turn NOISE CONTROL to maximum (extreme right).

(2) Set operating channel switch to number corresponding to frequency selected.

(3) Release RECEIVER TUNING dial lock.

(4) If the signal is in the frequency range from 1,680 kc to 2,750 kc:

(a) Set RECEIVER BAND SWITCH to CRYSTAL 1.

(b) Set RECEIVER TUNING dial to desired frequency reading at indicator marked BAND 1.

(5) If the signal is in frequency range from 2,750 kc to 4,450 kc:

(a) Set RECEIVER BAND SWITCH to CRYSTAL 2.

(b) Set RECEIVER TUNING dial to desired frequency reading at indicator marked BAND 1.

## 15. Voltage Tests

Testing the a-c and d-c voltage components insures that the set is getting power adequate for satisfactory operation. Voltage tests on Radio Receiver and Transmitter BC-669-(\*) are taken with the power turned on. Unless otherwise indicated, tests are made to ground as the common measuring point. A 10,000-ohm-per-volt voltmeter should be used.

a. POWER SUPPLY UNIT PE-110-(\*) OUTPUT. Measure voltages at terminals of receptacle PL2. The voltages should be as indicated on figure 11 for the corresponding terminals on receptacle PL6.

b. MODULATOR VOLTAGES. These can be checked conveniently at PL1. It will also be necessary to check voltages at the sockets. Charts of socket voltages are shown in figure 17.

c. RECEIVER-TRANSMITTER VOLTAGES. These voltages can be checked at sockets in the upper deck chassis of BC-669-(\*). Check against charts in figures 14, 15, and 16.

## 16. Operating Test

*Note.* Make all authorized modifications before making any extensive preliminary tests.

a. Place the receiver on a rubber or felt pad or a padded bench. After turning on set as described in paragraph 14, watch the action of various components. Make sure that all tubes are heating. Observe the filaments in glass tubes. Feel the envelope of metal tubes. If they remain cold after the set has been turned on for about 30 seconds, they must be removed and tested further or replaced. Also check filament voltage and make sure that contact is made at filament pins. Look for gassy or burned out tubes. Look for broken connections. Look for swollen or blistered fixed capacitors. Watch out for broken or worn resistance elements in variable resistors, and scorched or blistered fixed resistors which indicates overheating (sometimes due to fungicide in moistureproofing and fungiproofing varnish). Make sure that rotor blades of tuning capacitors are not bent.

b. Units recently moistureproofed and fungiproofed are likely to smoke in operation. Smoke under those conditions may not be abnormal. The repairman must, however, be sure that smoke is not due to the

overheating of parts. Therefore, be sure of the origin of the smoke. Check the characteristic smell of smoke. Overheating of a component part, that boils where waxes or the ordinary lacquers are used, will provide a distinctive odor and show a color of smoke.

c. When reception of a transmitter signal is possible, the operation of the receiver should be observed for the presence of the following characteristics. This should be supplemented, if possible, by comparing its operation with that of a second Radio Receiver and Transmitter BC-669-(\*) known to be in satisfactory condition. While testing in the receive position, tap the chassis lightly with a padded mallet to simulate vibrations, which would normally be encountered in use.

(1) Reception of both voice and c-w signals should be clear and understandable and without distortion.

(2) Output should be steady, not subject to fading or gradual variations in volume.

(3) Operation of the volume control should produce a gradual and smooth increase or decrease in the output.

(4) Output should be constant. Intermittent reception may indicate loose connections, rosin joints, or like defects.

(5) Reception should be strong.

(6) Output should be free of noises obviously foreign to the transmitted signal, such as:

(a) Ringing noises or chirping sounds (as caused by microphonic tubes).

(b) Howls or whistling (as caused by loose or ungrounded shields).

(c) Clicking, knocking, or motor-boating (as caused by oscillation).

d. With the unit in transmit position, check the quality of its transmission on a receiver known to be in satisfactory condition. Tap the set under test with a padded mallet from time to time. Listen on all six channels for—

(1) Cutting off.

(2) Noisy transmission.

(3) Distortion of signal due to loose contacts.

(4) Microphonic conditions.

e. Make a recheck of operating voltages to be sure that they are correct and sufficient to operate the transmitter. (See par. 15.)



## SECTION V

### ALIGNMENT PROCEDURE

#### 17. General

Model BC-669-(\*) has variable inductance (iron core) transformers as well as trimmers and padding capacitors needing adjustment to set the tuned circuits to resonance at specified frequencies, therefore it is necessary to check circuit alignment to make sure of operation at desired frequency. Since vibration and weather conditions may change the frequency of the tuned circuits, careful alignment and alignment checks are necessary. The instruments needed for alignment and final alignment check are the r-f signal generator, a cathode-ray oscillograph and an output meter to make sure that the changes in volume which the ear cannot detect will be gauged accurately.

#### 18. Alignment of Receiver

*a.* **PRETUNING CHANNELS.** All pretuning adjustments for operation on frequencies outlined in paragraph 1*g* have been made at the manufacturer's plant before shipment.

*Note.* Check carefully the data and illustration of figure 12. No adjustments need be made on the receiver to pretune it other than to plug the desired crystals (in Crystal Holders FT-171-B) into the proper crystal sockets. The sockets are numbered to correspond to the position of the OPERATING CHANNEL switch. The receiver crystal frequency must differ from the desired receiving frequency by 385 kc. For example, if it is desired to receive on a frequency of 2,280 kc in Channel 3, a crystal having a frequency of 2,665 kc (or 1,895 kc) is plugged into receiver crystal socket No. 3.

*b.* **PRETUNING RECEIVER.** To pretune the receiver, plug a crystal of the proper frequency into the receiver crystal socket whose number corresponds with the number of the channel selected for operation.

*c.* **PREPARATIONS FOR RECEIVER ALIGNMENT** (fig. 12). (1) Check all signal generator frequencies with frequency meter.

(2) Modulate signal generator with 400 cycles at 30 percent.

(3) Turn A.F. GAIN control full ON.

(4) Turn SPEAKER switch to ON.

(5) Turn STATIC FILTER switch OFF.

(6) Turn NOISE CONTROL (R-F GAIN) full ON.

(7) Connect low side of signal generator to chassis.

(8) Connect one side of output meter through series capacitor 0.001 microfarad (mf) to plate of V6 (No. 3 pin); connect other side of meter to chassis.

#### 19. I-f Alignment

*a.* Set signal generator at 385 kc.

*b.* Connect high side of signal generator to grid of V2 (2). Use 0.001 mf capacitor in series.

*c.* Adjust secondary (3) and primary (4) of T6 (fig. 12) for maximum output.

*d.* Adjust secondary (5) and primary (6) of T5 for maximum output.

*e.* Repeat steps *c* and *d* above. Intermediate frequency is now aligned.

#### 20. R-f Alignment

*a.* 1,700 TO 2,700 KC BAND. (1) Set RECEIVER BAND SWITCH on MANUAL 1; set the RECEIVER TUNING dial to 2,700 kc.

(2) Set signal generator to 2,700 kc, and connect high side to antenna post with 150 mf capacitor in series.

(3) Adjust C37 in T7 (fig. 12(7)), C10 in T3 (fig. 12(8)), and C3 in T1 (fig. 10(9)), for maximum output.

(4) Set signal generator to 1,800 kc and RECEIVER TUNING dial to 1,800 kc.

(5) Check receiver calibration and sensitivity. If there is appreciable loss of sensitivity or miscalibration—

(*a*) Adjust slug T7 (fig. 12(10)) for maximum output.

(*b*) If necessary, repeat the operations indicated in (1) to (5) inclusive, above. The 1,700 to 2,700 kc band is now aligned.

*b.* 2,700 TO 4,400 KC BAND. (1) Set RECEIVER BAND SWITCH on MANUAL 2, the RECEIVER TUNING dial to 4,400 kc, and signal generator to 4,400 kc.

(2) Adjust C39 in T8 (fig. 13(11)), C11 in T4 (fig. 13(12)), and C5 in T2 (fig. 13(13)) for maximum output.

(3) Set RECEIVER TUNING dial to 2,900 kc, and the signal generator to 2,900 kc.

(4) Check receiver calibration and sensitivity. If there is appreciable loss of sensitivity or miscalibration:

(*a*) Adjust slug in T8 (fig. 13(14)) for maximum output.

(*b*) If necessary, repeat the operations indicated in (1) to (4) inclusive, above. The receiver is now aligned.

## 21. B-f-o Alignment

- Set signal generator at 385 kc. Do not use modulation.
- Connect high side of signal generator to grid of V2. Use 0.001-mf capacitor in series.
- Rotate CW OSC switch to ON position for beat-frequency oscillator.
- Adjust iron core in coil T17 to permit maximum audio output signal at about 1,000 cycles.

## 22. Transmitter Presetting

- PREPARATION. Figures 3 and 11 show the location of the transmitter crystal sockets and tuning components. Crystals (in Crystal Holders FT-171-B) having the same frequencies as the desired transmitter operating frequencies should be used. The crystal sockets are numbered to correspond to the positions of the OPERATING CHANNEL switch. Design of the equipment does not require that the crystals be arranged in any particular order, although they are usually arranged in order

of frequency for convenience in referring to the tuning chart on the front panel.

- PRETUNING TRANSMITTER. To pretune the transmitter, proceed as follows:

(1) With the set connected for operation and supplied with a-c power, turn the ON-OFF switch of Power Supply Unit PE-110-(\*) to ON.

**Warning:** This equipment uses *high voltages* which will give *severe shock* or *cause death* if touched. High r-f voltages can cause *painful burns*. Do not touch the antenna or antenna connections while operating. The r-f voltage at the antenna is the only exposed voltage. When the top cover of the transmitter is open, other r-f voltage points are exposed.

(2) On the transmitter, plug the crystal of desired frequency into the transmitter crystal socket whose number corresponds with the channel number selected for operation.

(3) Turn the OPERATING CHANNEL switch to the selected channel number.

### CONDITIONS FOR RECEIVER ALIGNMENT

- ALL FREQUENCIES SET ON SIGNAL GENERATOR ARE TO BE CHECKED WITH FREQUENCY METER.  
 SIGNAL GENERATOR IS MODULATED.  
 A.F. GAIN CONTROL FULL ON.  
 SPEAKER ON.  
 STATIC FILTER OFF.  
 R.F. GAIN OR NOISE CONTROL FULL ON.  
 CONNECT "LOW" SIDE SIGNAL GENERATOR TO CHASSIS.  
 CONNECT OUTPUT METER THROUGH SERIES CAPACITOR TO V6 PLATE (1) AND CHASSIS.

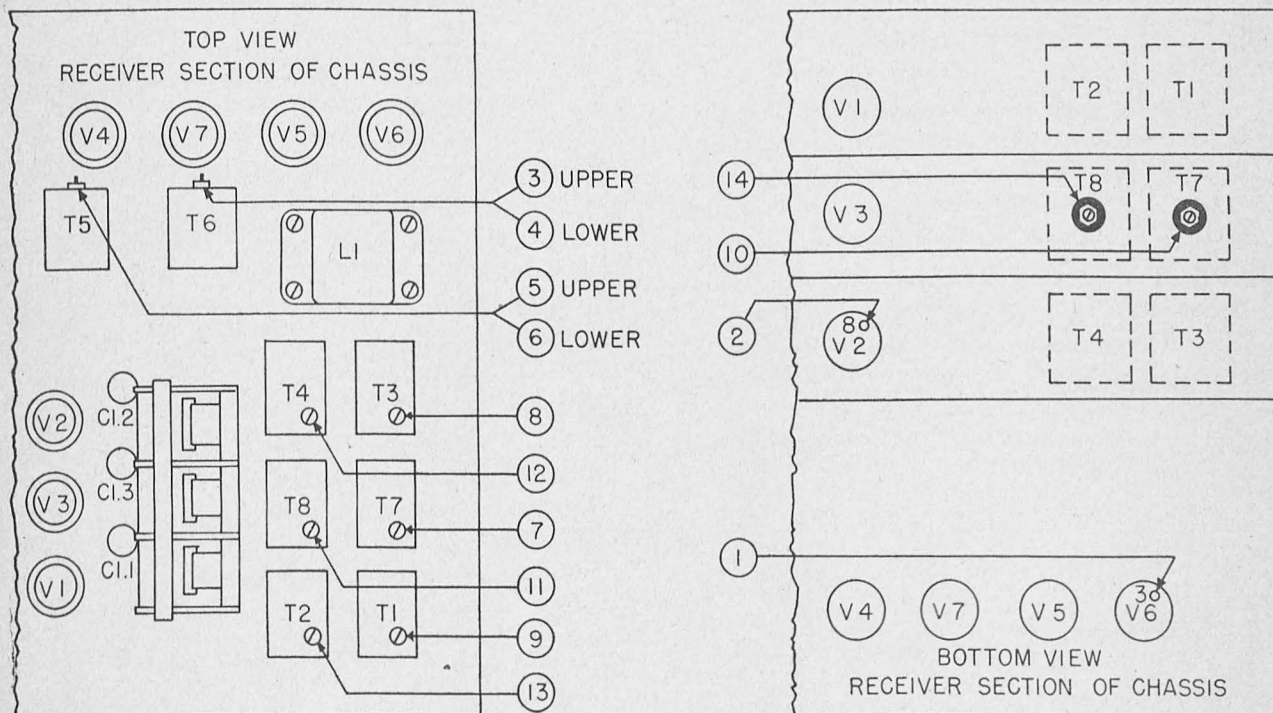

TL 19697

Figure 12. Radio Receiver and Transmitter BC-669-(\*), receiver alignment chart, diagram



## TRANSMITTER PRESETTING

- Remove plate under **P. A. PLATE TUNING**; leave antenna disconnected.
- Remove plate over **METER SWITCH** and set to **P. A. PLATE**.
- Open **ANTENNA LOADING COIL ADJUSTMENT** door.
- Set all **ANTENNA LOADING COIL** sliding contacts to mid-position.
- Set all **"A"** sliding contacts to bottom position.
- Set all **"P"** sliding contacts to mid-position.

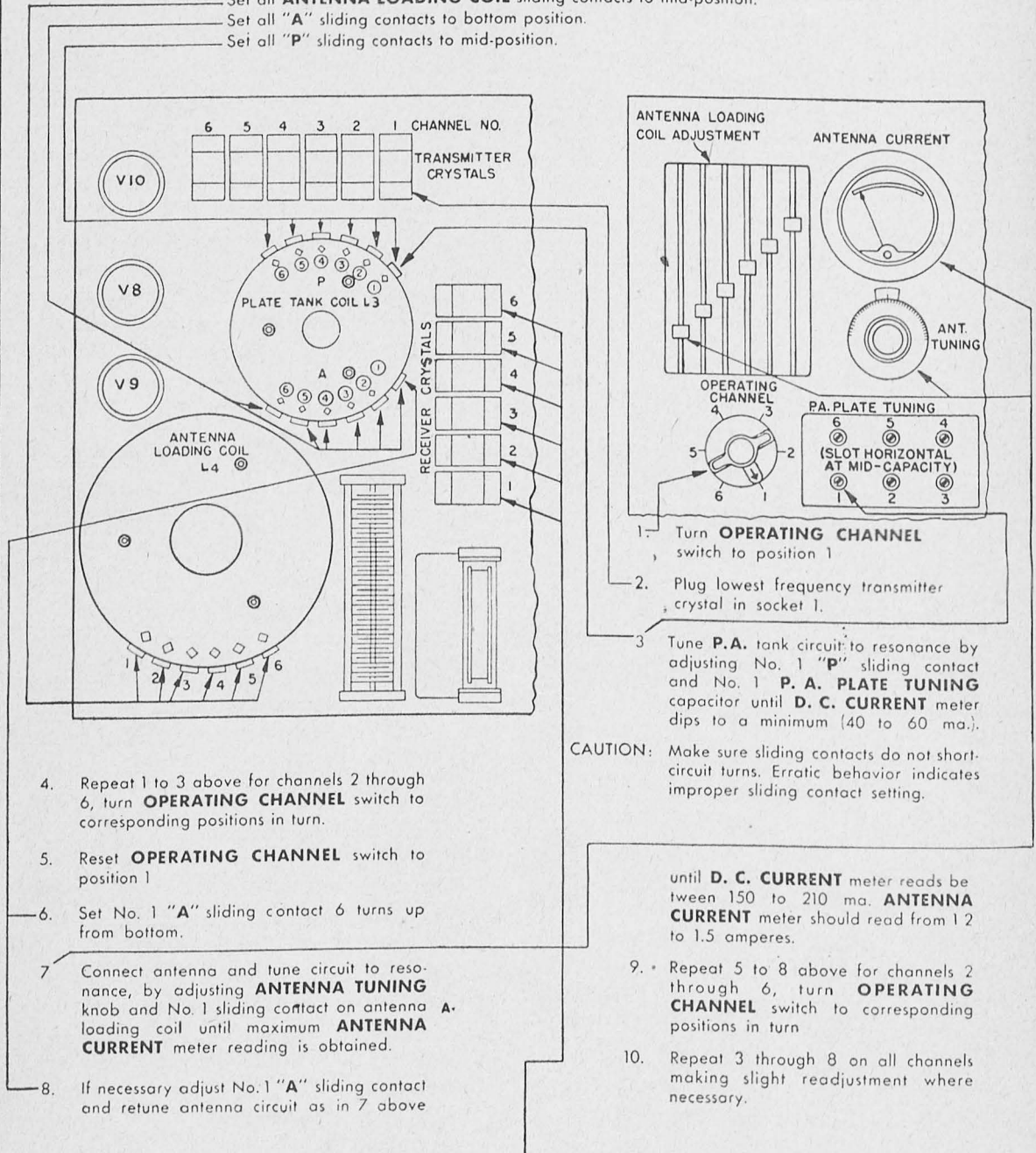

## RECEIVER PRESETTING

Plug receiving crystals into receiving crystal sockets. That is all that is required for operation on **CRYSTAL 1** or **CRYSTAL 2**.

Each receiving crystal is 385 KC higher than the corresponding transmitting crystal of the same channel number, except for channel 6 which is 385 KC lower

TL19698

Figure 13. Radio Receiver and Transmitter BC-669-(\*), transmitter presetting chart, diagram.

(4) Remove the cover plate under the inscription P.A. PLATE TUNING. This permits access to the plate tuning capacitor shafts.

(5) Move the sliding contactor (whose number corresponds to the channel number) on the *A* side of plate tank coil L3 down to the bottom of the coil.

(6) Move the sliding contactor on the *P* side under the numbered position corresponding to the channel number, to approximately the center of the coil.

(7) Remove the cover plate over the inscription METER SWITCH and set the switch to the position marked P.A. PLATE.

(8) Turn the transmitter on by pressing the press-to-talk switch on handset or microphone (DC CURRENT meter will now indicate some value).

(9) Use a 1/2-inch socket wrench to unlock the tuning shaft of the variable plate capacitors by loosening the locking nut. With a screw driver, turn the slotted shaft of the capacitor whose number corresponds to the channel number, until the plate current is at minimum.

*Note.* When the slot is horizontal the capacity is at mid-value. Do not turn it past the vertical position.

(10) Turn the transmitter off and move the same *P* sliding contactor on the plate tank coil L3 a few turns toward the top.

(11) Repeat steps (8), (9), and (10) above and continue these readjustments until the plate current dips to a minimum and rises again while the plate tuning capacitor is being turned in one direction. Do not turn through more than 180°, nor past vertical.

(12) Set the shaft to the position producing a minimum (40 to 60 milliamperes (ma)) plate current. If no current is obtained, repeat the above procedure, moving the sliding contactor downward instead of upward.

(13) Repeat the above procedure with any remaining channels whose frequency it is desired to change.

(14) Adjust the antenna circuit in the following manner:

(a) Set the OPERATING CHANNEL switch to the channel number selected for tuning.

(b) Move the corresponding numbered sliding contactor on the *A* side of plate tank coil L3 up approximately 5 turns.

(c) Open the door marked ANTENNA LOADING COIL ADJUSTMENT.

*Note.* The antenna must be connected to the antenna post of the transmitter from here on.

(d) Move the sliding contactor (whose number corresponds to the channel number) on antenna-loading coil L4 approximately half-way up the coil.

(e) Turn the transmitter on by pressing the press-to-talk switch of the handset or microphone.

(f) Rotate ANTENNA TUNING dial throughout the range from 0 to 100. During this operation, the antenna current should reach a maximum and then dip as the rotation is continued. Return the knob to the position at which the maximum ANTENNA CURRENT reading is secured, and release the press-to-talk switch.

**Caution:** Do not be misled by a false maximum caused by passing 0 or 100 on the ANTENNA TUNING dial.

(g) If the ANTENNA CURRENT meter does not show the above fluctuation in response to turning the ANTENNA TUNING knob, move the sliding contactor on antenna-loading coil L4 up or down. Repeat testing as in (e) and (f) above and adjusting the contactor on L4 until the desired action of the ANTENNA CURRENT meter is secured. If maximum ANTENNA CURRENT is reached as the ANTENNA TUNING dial is rotated past 0, move the contactor up one turn at a time. If the maximum is reached as the dial is rotated past 100, move the contactor down turn at a time. When proper antenna current variation is secured, return the ANTENNA TUNING knob to the position at which the maximum ANTENNA CURRENT reading is secured, and release the press-to-talk switch.

(h) Press the press-to-talk switch for 1 or 2 seconds and note the DC CURRENT meter reading. This reading should be between 150 and 210 ma for proper operation of the transmitter.

(i) If the DC CURRENT meter indication exceeds 210 ma, move the sliding contactor on the *A* side of plate tank coil L3 downward 1 turn at a time, repeating the antenna-loading coil L4 adjustment and ANTENNA TUNING knob adjustment as in (e), (f), and (g) above, until the DC CURRENT meter reads between 150 and 210 ma.

(j) If the DC CURRENT meter reads less than 150 ma repeat the procedure recommended in (i) above but move the sliding contactor on the *A* side of plate tank coil L3 upward instead of downward.

(k) When the correct adjustment is reached, the DC CURRENT meter will indicate 150 to 210 ma of plate current and ANTENNA CURRENT meter will indicate 1 to 1.5 amperes of antenna current.

(l) Repeat the above antenna tuning procedure for any remaining channels, using the sliding contactors pertinent to the corresponding operating channel numbers.

## 23. Final Adjustment

Check all tuning adjustments made in paragraph 21,



making readjustments where necessary to compensate for slight misalignment in tuning due to the effects of subsequent circuit adjustments.

**Caution:** Be careful not to locate any of the sliding contactors so that the contacting spring rests between turns, as this may shortcircuit these turns.

Erratic behavior of the transmitter during circuit adjustment indicates improper sliding contactor setting.

*a.* Using the  $\frac{1}{2}$ -inch socket wrench, lock the plate tuning capacitors by tightening the locking nut.

*b.* Recheck the tank tuning, making sure capacitors have not shifted while being locked.

## SECTION VI

### DETAILED TROUBLE-SHOOTING PROCEDURES

#### 24. Voltage and Resistance Measurements at Tube Sockets

*a. VOLTAGE MEASUREMENTS.* Connect Radio Receiver and Transmitter BC-669-(\*) to Power Supply Unit PE-110-(\*). Make sure all cording is properly connected. Turn speaker ON. Measure voltages at tube socket terminals using a 10,000-ohm-per-volt voltmeter, part of Test Set 1-56-(\*), or equivalent. Make measurements from tube socket terminals to chassis ground unless otherwise indicated on the diagrams. The values specified are average; actual readings will vary. All values indicated are positive volts.

(1) *Transmit position* (fig. 12). Connect Power Supply Unit PE-110-(\*) to 110-volt power source. Turn PE-110-(\*) power switch ON. If transmitter is operable, tune and load it. Set switches for voice transmission. Measure voltages. Push press-to-talk switch on Remote Control Unit RM-21-(\*) momentarily while taking readings. Values should be within 10 percent of those specified in figure 14. Values marked # on the diagram are average values for fully loaded antenna condition. Readings obtained may be less for unloaded antenna condition.

(2) *Receive position* (fig. 15). Connect Power Supply Unit PE-110-(\*) to 110-volt power source. Turn PE-110-(\*) power switch ON. Measure voltages. Values should be within 10 percent of the values specified in figure 15.

(3) *Vibrapack position* (fig. 16). Connect Power Supply Unit PE-110-(\*) to a 12-volt d-c source. Turn PE-110-(\*) power switch ON. Measure voltages. Values should be within 10 percent of those specified in figure 16.

(4) *Modulator section. (a) Transmit position.* Connect Power Supply Unit PE-110-(\*) to a 110-volt, 60 cycle power source. Turn PE-110-(\*) power switch ON. If transmitter is operable, tune and load it. Push press-to-talk switch momentarily while making readings. Measure voltages. Values obtained should be within 10 percent of the values specified in figure 17 for the transmit position.

*(b) Receive position.* Connect Power Supply Unit PE-110-(\*) to a 110-volt, 60-cycle power source. Turn PE-110-(\*) power switch ON. Measure voltages. Values should be within 10 percent of the values specified in figure 17 for the receive position.

*(c) Vibrapack position.* Connect Power Supply Unit PE-110-(\*) to a 12-volt d-c source. Turn PE-110-(\*) power switch ON. Measure voltages. Values obtained should be within 10 percent of the values specified in figure 17 for the vibrapack position.

*b. RESISTANCE MEASUREMENTS.* Disconnect all cording. Remove all tubes from their sockets. Disconnect PL1 and SO1. Measure resistance from tube socket terminals to chassis ground unless otherwise indicated. Resistance readings obtained should be within 10 percent of the values specified on the diagrams. The values given are average; actual values will vary.

(1) *R-f section.* Turn SIDETONE VOLUME CONTROL to maximum. Measure resistances at tube socket terminals in r-f section. Readings obtained should be within 10 percent of the values specified in figure 18.

(2) *Modulator section.* Turn A-F GAIN control to maximum. Turn R-F GAIN control or NOISE CONTROL to maximum. Set RECEIVER BAND SWITCH on MANUAL 1. Turn STATIC FILTER OFF. Measure resistances at tube socket terminals. Readings obtained should be within 10 percent of the values specified in figure 19.

(3) *Power Supply Unit PE-110-(\*).* Tube socket resistances for Power Supply Unit PE-110-(\*) are shown in figure 20. This diagram is included for reference in case the power supply unit is not operating satisfactorily.

#### 25. Signal Tracing

*a.* The interrelated circuits of the receiver section in BC-669-(\*) do not constitute a complicated problem in signal tracing. There is a real necessity, however, for thoroughly checking both receiver and transmitter oscillation in both frequency bands on both manual and crystal reception and on all six frequency channels for both receiver and transmitter. The tracing procedure must also indicate reasonable gain per stage, particularly between r-f, mixer, and i-f stages. The instruments needed for signal tracing in the receiver section of BC-669-(\*) are:

- (1) R-f, and a-f signal generator.
- (2) Cathode-ray oscilloscope.
- (3) Vacuum-tube voltmeter (VTVM).
- (4) R-f output meter, 1,208 or equivalent.





SOCKET VOLTAGES OF BC-669-(\*) R-F CHASSIS, RECEIVE POSITION  
FRONT EDGE OF CHASSIS

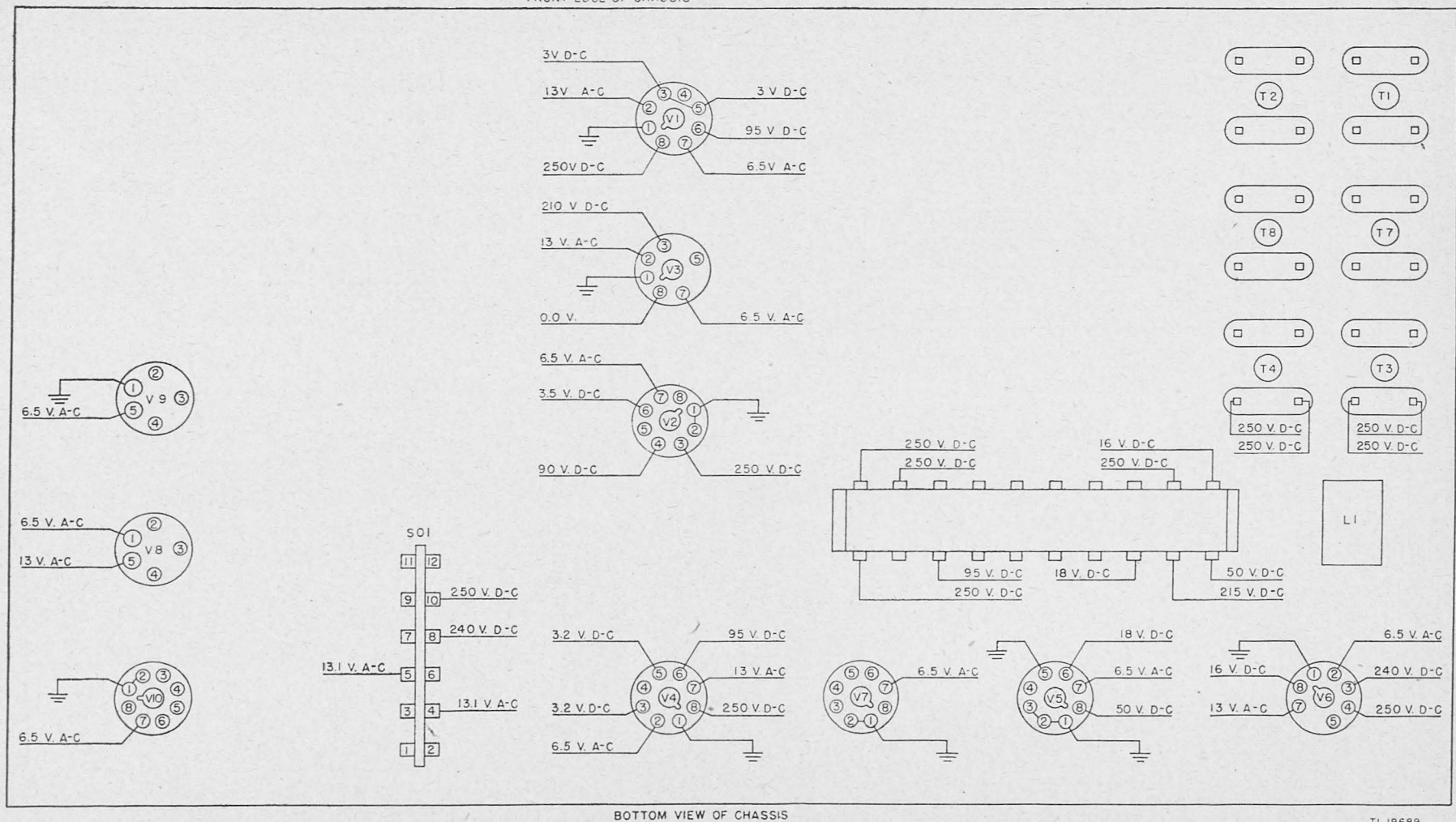

BOTTOM VIEW OF CHASSIS

TL 19689

Figure 15. Radio Receiver and Transmitter BC-669-(\*), receive position, socket voltage lay-out diagram.



SOCKET VOLTAGES OF BC-669-(\*) R-F CHASSIS, VIBRAPACK OPERATION OF RECEIVER  
FRONT EDGE OF CHASSIS

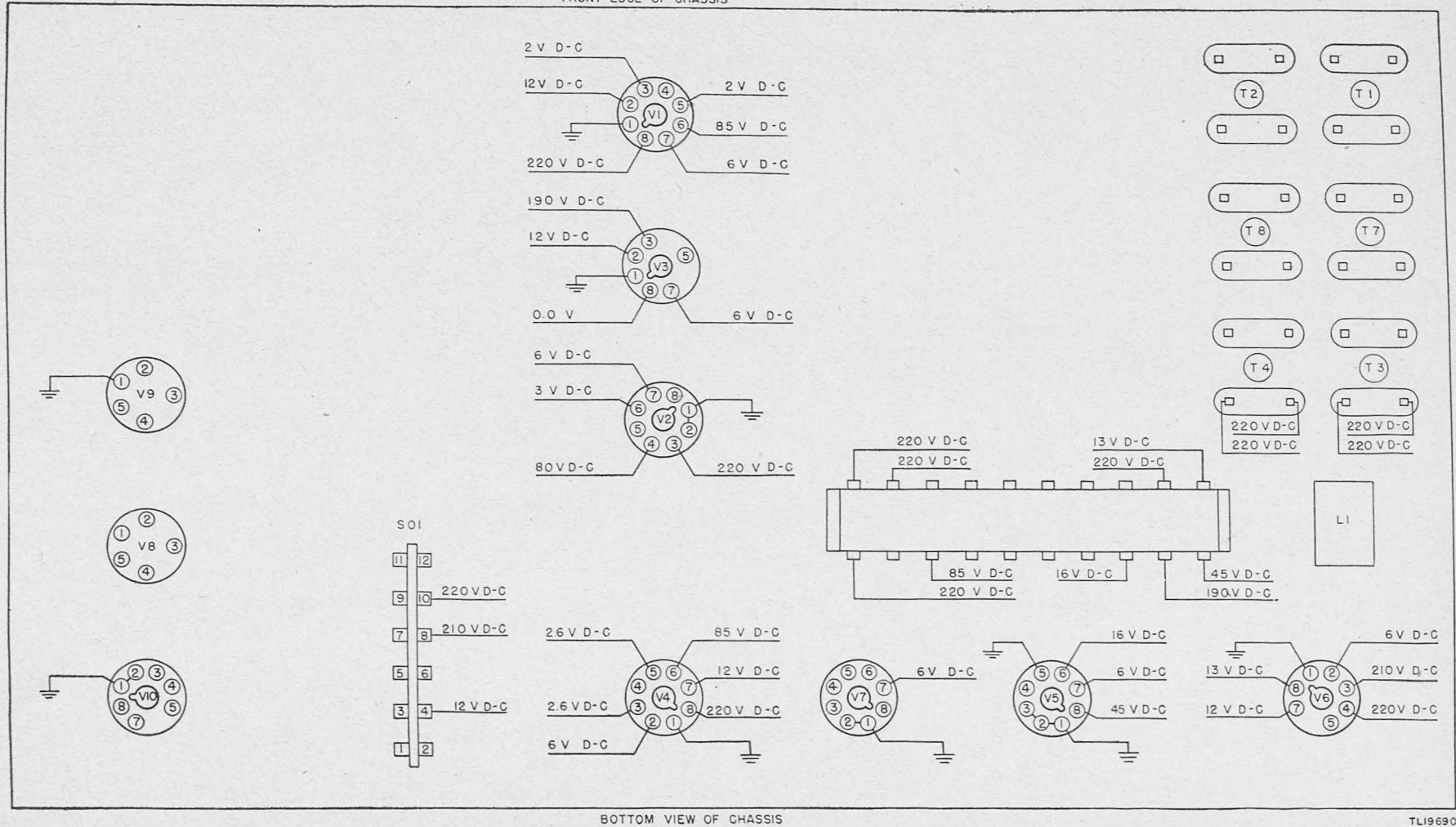

Figure 16. Radio Receiver and Transmitter BC-669-(\*), vibrapack position, socket voltage lay-out diagram.

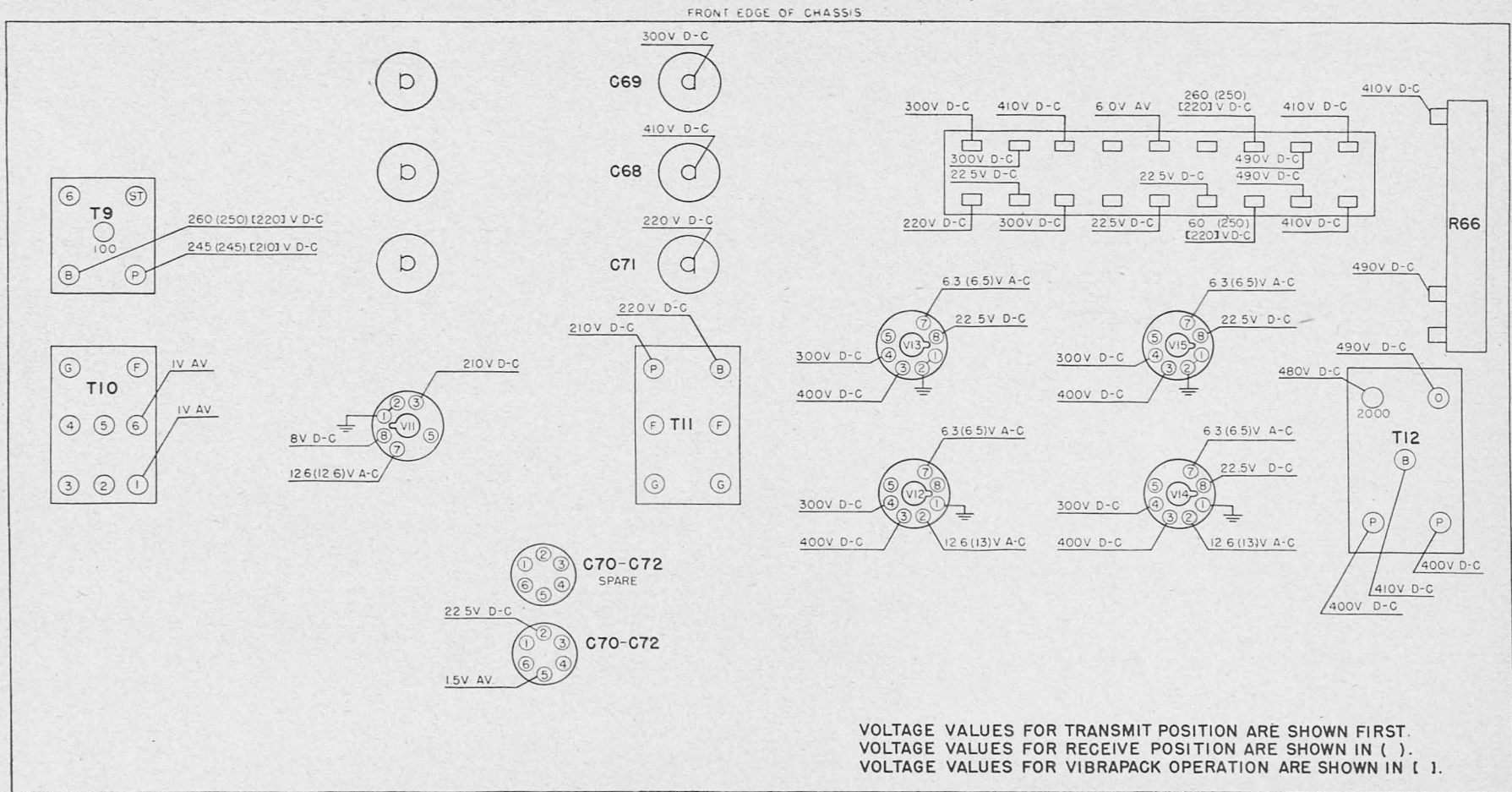

Figure 17. Radio Receiver and Transmitter BC-669-(\*), receiver, transmit, and vibrapack position, modulator socket voltage lay-out diagram.



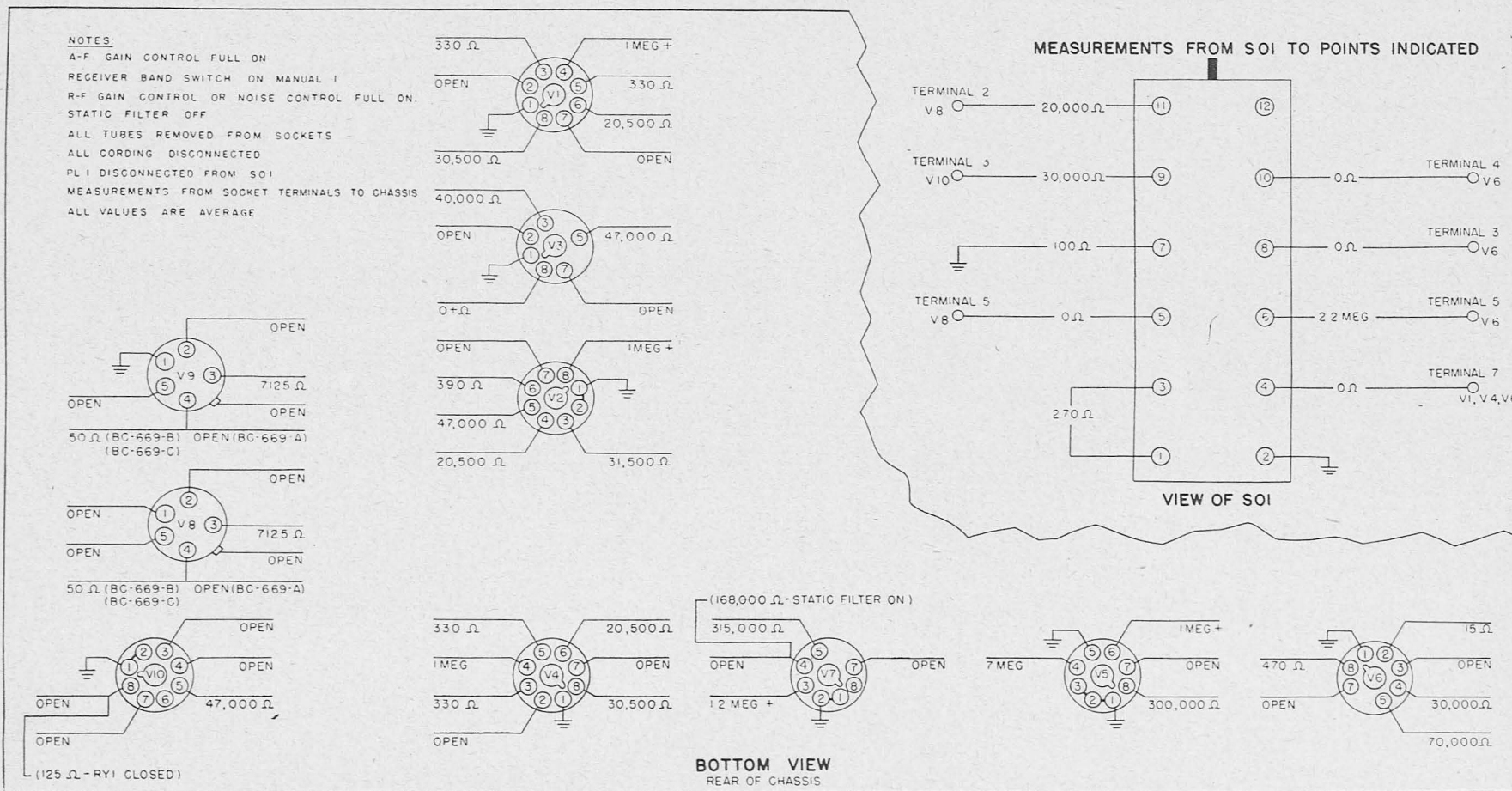
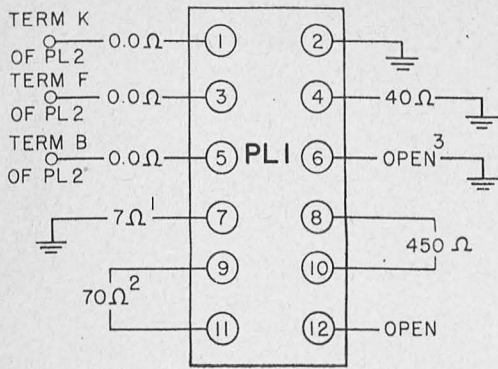

Figure 18. Radio Receiver and Transmitter BC-669-(\*), r-f section, diagram of resistances at sockets.

RESISTANCE MEASUREMENTS FROM PL1  
TO POINTS INDICATED



SIDETONE VOLUME CONTROL FULL ON.  
ALL TUBES REMOVED FROM SOCKETS.  
ALL CORDING DISCONNECTED.  
PL1 DISCONNECTED FROM SO1.  
MEASUREMENTS FROM TUBE SOCKETS TO CHASSIS.  
ALL VALUES ARE AVERAGE, ACTUAL READINGS MAY VARY.

1 - METER SWITCH AT PA GRID  
2 - METER SWITCH AT PA PLATE  
3 - RY 2 HELD CLOSED BY HAND

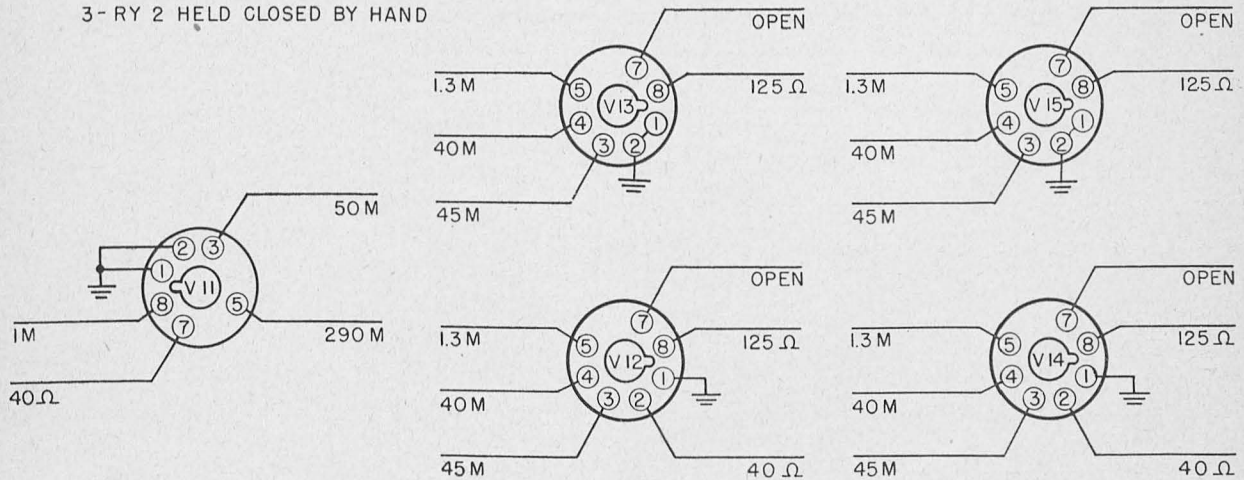

BOTTOM VIEW OF  
MODULATOR TUBE SOCKETS

TL19695

Figure 19. Radio Receiver and Transmitter BC-669-(\*), modulator section, diagram of resistances at sockets.

ALL TUBES REMOVED FROM SOCKETS.  
ALL CORDING DISCONNECTED.  
MEASUREMENTS FROM SOCKET TERMINALS TO CHASSIS.  
ALL VALUES ARE AVERAGE.

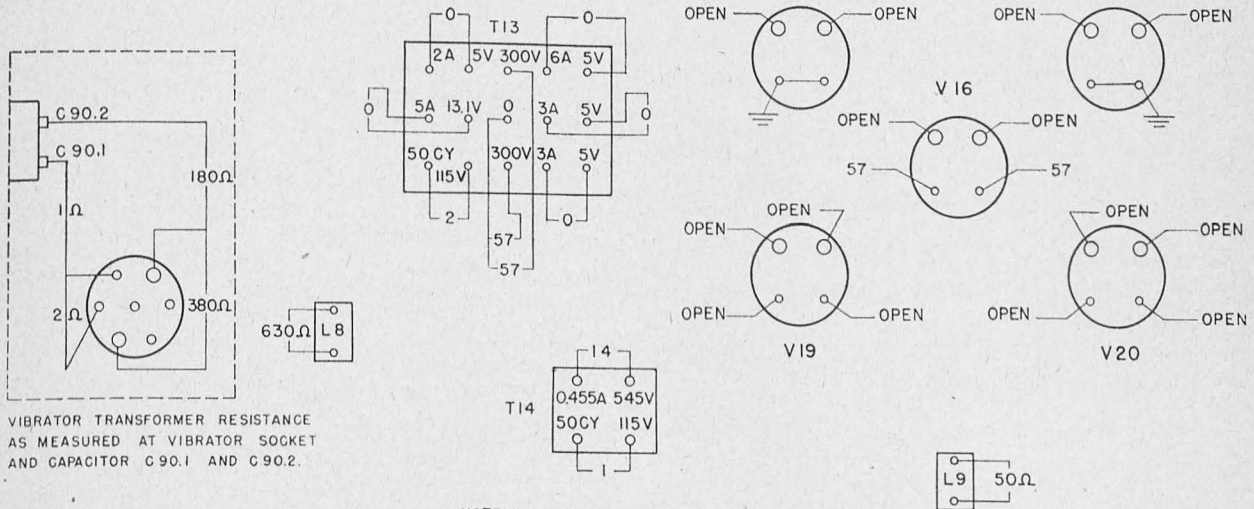

VIBRATOR TRANSFORMER RESISTANCE  
AS MEASURED AT VIBRATOR SOCKET  
AND CAPACITOR C90.1 AND C90.2.

NOTE: VALUES GIVEN IN OHMS ON THE  
OUTSIDE OF T13 AND T14.

BOTTOM VIEW - REAR OF CHASSIS

ALL VOLTAGES MEASURED WITH 10,000 OHM  
PER VOLT METER. ALL MEASUREMENTS MADE  
FROM PIN SOCKETS TO GROUND UNLESS  
OTHERWISE INDICATED.

TL19696

Figure 20. Power Supply Unit PE-110-(\*)-diagram of resistances at sockets.





NOTES.

1. CW SWITCH IN OFF POSITION
  2. RECEIVER BAND SWITCH ON MANUAL 1
  3. SQUELCH CONTROL FULLY OFF
  4. ALL TUBES REMOVED FROM SOCKETS
  5. ALL CORDING DISCONNECTED
  6. PL<sub>1</sub> DISCONNECTED FROM SO<sub>1</sub>
  7. MEASUREMENTS FROM SOCKET TERMINALS TO CHASSIS
  8. ALL VALUES ARE AVERAGE
  9. VOLUME CONTROL FULLY ON
- M=1,000Ω

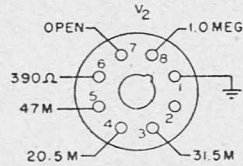
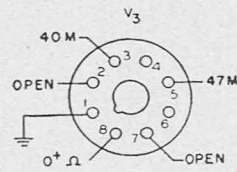
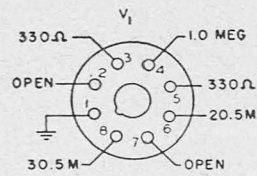

MEASUREMENTS FROM PL<sub>1</sub> TO POINTS INDICATED

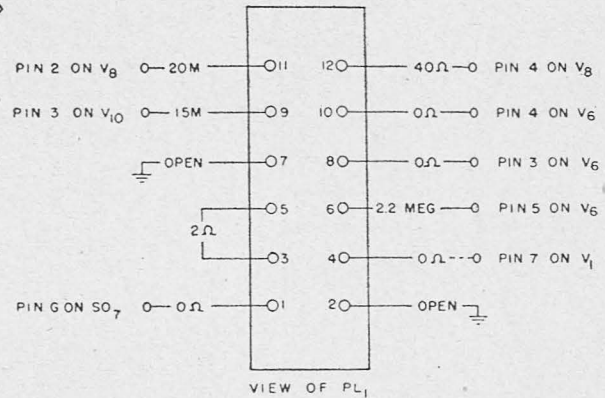

VIEW OF PL<sub>1</sub>

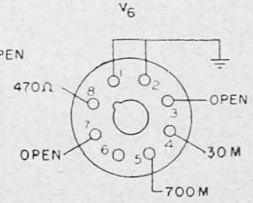
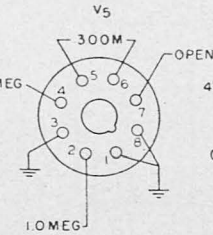
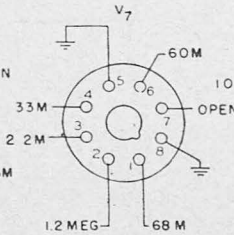
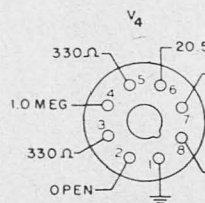
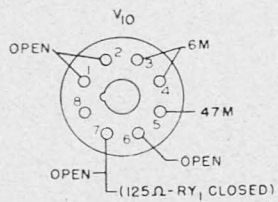
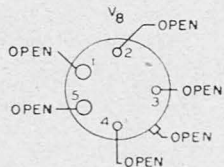
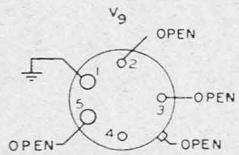

TL 12973-5

Figure 22. Radio Receiver and Transmitter BC-669-D, resistance measurements.

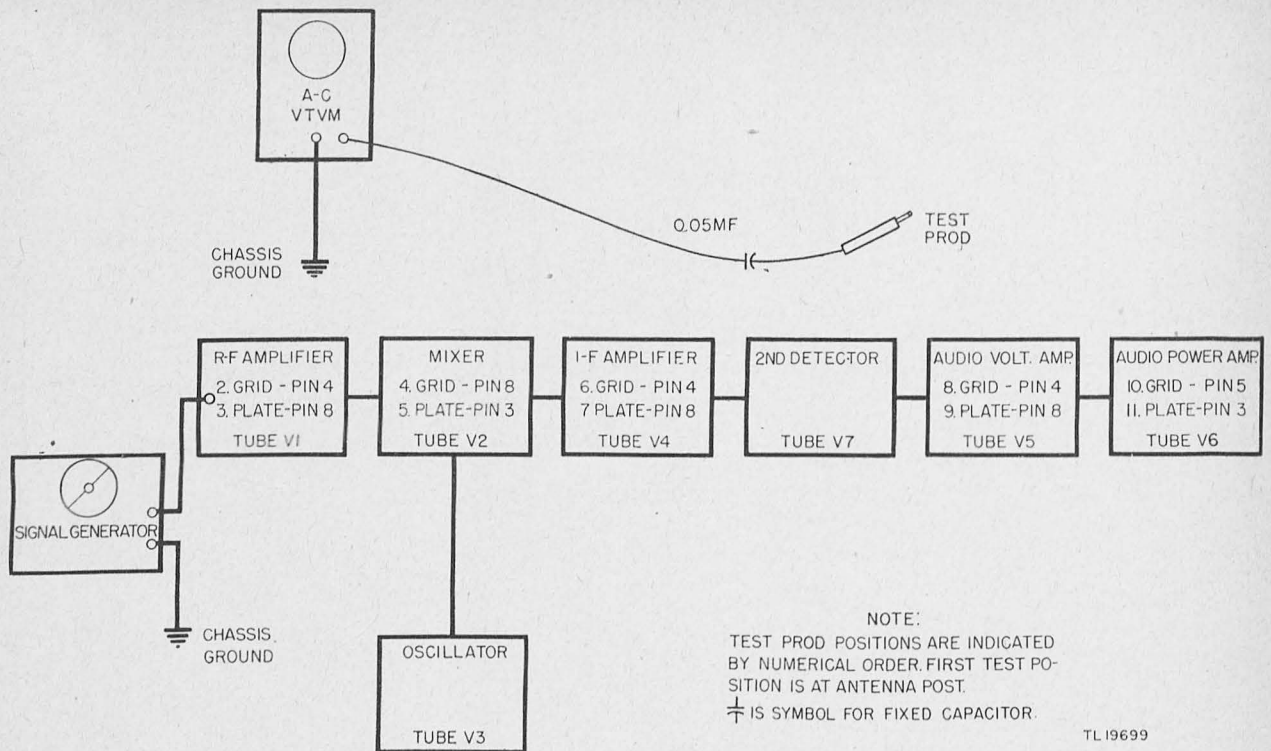

Figure 23. Radio Receiver and Transmitter BC-669-(\*), signal tracing block diagram.

b. Signal tracing on Receiver BC-669-(\*), constitutes feeding a signal to the antenna input and tracing its progress, beginning at the antenna input. (See fig. 23.)

(1) Connect high side of a signal generator to the antenna post.

(2) Connect ground lead of the signal generator to a chassis ground connection.

(3) Connect one lead of a VTVM to chassis.

(4) Short out a-v-c voltage by temporarily grounding common connection of R14 and R30 to chassis.

(5) Set the signal generator band switch at 2,280 kc.

(6) Set RECEIVER TUNING dial at 2,280 kc on BAND 1.

(7) Set OPERATING CHANNEL switch at channel 3.

(8) Set RECEIVER BAND SWITCH at CRYSTAL 1.

(9) Connect test prod of VTVM at contact No. 1 of transformer T1. This will check continuity of antenna coil of transformer T1.

(10) Connect test prod at VTVM at contact No. 3 of transformer T1. This will check continuity of secondary for transformer T1.

(11) Beginning at tube V1 as indicated in chart below, measure the voltage from grid to ground and from plate to ground for each of the tubes indicated. Keep signal generator volume low. Reduce gener-

ator's voltage at attenuator as needed between stages to keep reading at VTVM on scale. Keep a record of measurements obtained but do not write the results in this manual.

#### VOLTAGE TEST

Tube	Grid to ground		Plate to ground	
	Pin	Volts	Pin	Volts
V1 .....	4	.....	8	.....
V2 .....	8	.....	3	.....
V4 .....	4	.....	8	.....
V5 .....	4	.....	8	.....
V6 .....	5	.....	3	.....

(12) If no voltage or very weak voltage is obtained from grid of tube V4, check oscillator tube V3.

(13) If no voltage is obtained from grid of tube V5, check tube V7.

## 26. Signal Substitution

In this method of checking, the ground side of the signal generator is grounded to the receiver; the VTVM is likewise grounded and the test prod is connected to the output, that is, the plate of tube in the stage being tested. The appropriate signal of each stage is set up on the generator (r-f signal for r-f and mixer stages, i-f signal of 385 kc for i-f stage, and 400-cycle, a-f signal for a-f stages),

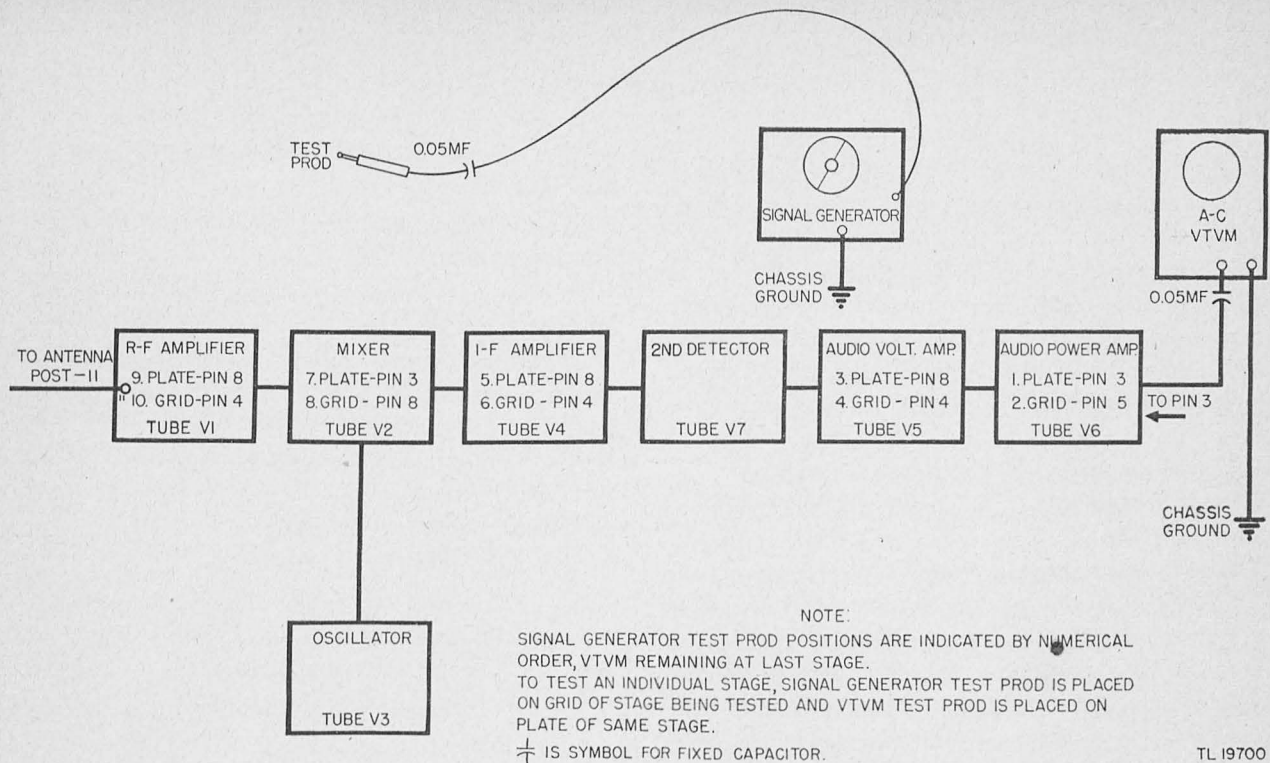

Figure 24. Radio Receiver and Transmitter BC-669-(\*), signal substitution, block diagram.

and the VTVM test prod is connected to output of the stage being tested. The test prod of the signal generator is connected to the input, or grid, of the tube in the stage under test. Instead of working forward from input to output as in signal tracing, signal substitution checks each separate stage working backwards from the a-f stage. (See fig. 24.) In repairing the separate stages, the substitution method is useful and is later referred to in section VIII.

## 27. Measuring Individual Stage Gain

To check the step-up of voltages in the stages of the receiver section of BC-669-(\*), it is necessary to follow a few simple rules. The gain in a stage of voltage amplification can be measured by reading the input and output voltages, and then figuring the ratio of the output to the input signal voltages. The ratio determined is the gain of the stage. The input voltage must remain constant while both readings are being taken.

*a. GAIN PER STAGE.* Gain per stage is determined as follows:

(1) Set up the signal generator for operation. Connect the ground lead of the signal generator to the chassis of the receiver.

(2) Turn the signal generator on.

(3) Set up the VTVM for alternating current. Use an isolating capacitor of 0.05 mf in one lead.

(4) Connect the test prod of the signal generator to the control grid of the tube in the stage being checked.

(5) Set the range switch of the VTVM so that 1 volt will measure near the upper end of the scale.

(6) Connect one prod of the VTVM to the chassis, the other to the control grid of the tube under test.

(7) Adjust the r-f or a-f output attenuator of the signal generator (a-f for a-f stages, r-f for r-f stages) so that a reading of 1 volt alternating current is obtained.

(8) Turn the receiver ON.

(9) Measure the signal voltage on the plate of the tube being tested, placing the VTVM test prod in contact with the plate pin.

*Note.* Be sure that the range switch is turned to a high-voltage scale for the first reading. Reduce to a lower range for close reading.

(10) Compute the voltage gain of the tube by using the formula

$$\text{Voltage gain equals } \frac{E \text{ output}}{E \text{ input}}$$

in which  $E$  is voltage.

*b. OSCILLATOR VOLTAGE TEST.* (1) Disconnect the signal generator, as it will not be needed for this test.

(2) Use the VTVM with an isolating resistor in the test prod.



(3) Connect the test prod of pin No. 5 (control grid) of V3, receiver-oscillator tube.

(4) Connect the ground side of the VTVM to the chassis of the receiver.

(5) Set the VTVM initially to the high-voltage range (50 volts). Reading obtained on this range will indicate proper range to be used for close reading.

(6) With RECEIVER BAND SWITCH set at MANUAL 1, rotate the tuning dial over the entire receiving range. The VTVM should indicate a voltage reading of at least several volts which should remain approximately constant throughout tuning range.

(7) Temporarily short the stator of oscillator tuning capacitor section C1.3. Voltage should drop to 0 on the VTVM.

(8) If on test no voltage is registered on the VTVM, or if the reading on the VTVM varies greatly over the tuning range, or if voltage does not drop to 0 when tuning capacitor section C1.3 is shorted, then the oscillator is not operating properly.

(9) Make a voltage, resistance, and continuity check of the entire stage. (*Make resistance and continuity check after voltage is off.*)

(10) This test should be repeated with RECEIVER BAND SWITCH at MANUAL 2, CRYSTAL 1 and CRYSTAL 2.

## 28. A-v-c Check

a. PURPOSE OF CHECK. Receiver BC-669-(\*) incorporates a simple a-v-c circuit. This circuit is included to make possible a steady volume at the loudspeaker and to reduce the possibility of fading during long-distance reception. The a-c-v circuit also maintains a steady volume under the constantly varying conditions of vehicular radio reception. The necessity in the field for dependable volume on all desired signals makes it necessary for the repairman to give the a-v-c circuit a very careful check and to bring it up to the requirements indicated in the a-v-c test.

b. MAKING THE A-v-c CHECK. Set up the receiver, signal generator and VTVM as outlined in

the signal-to-noise test. (See par. 30.) Make the test on BAND 1 as follows:

(1) Set R.F. GAIN (NOISE CONTROL) and A.F. GAIN at maximum (extreme right).

(2) Set speaker switch and static filter switch at OFF position.

(3) Set signal generator for low output at 30 per cent modulation and 400 cycles.

(4) Set receiver and signal generator at same frequency.

(5) Feed in 1 volt from the signal generator and adjust noise control (R.F. GAIN) to obtain a reading of 1.7 volts on the VTVM.

(6) Reduce signal generator output to get an 0.55-volt reading on the VTVM. The r-f signal generator should now indicate an r-f voltage output of 178 microvolts ( $\mu\text{v}$ ) or less.

(7) If 178  $\mu\text{v}$  or less is not obtained, it is an indication of defective a-v-c action. In this case check a-v-c tube V7 and the components of the a-v-c circuit before checking for other defects.

## 29. Moistureproofing, Fungiproofing, and Refinishing

a. Following the repairs made as indicated, the unit should be moistureproofed and fungiproofed. Complete instructions for this will be found in TB 11-625-2.

b. If preliminary cleaning and inspection reveals slight scars and scratches on case, remove rough spots with #000 sandpaper and apply paint to spots with a small brush. Make sure that paint surface next to spots is smoothed down so that touch-up will not be bumpy. Therefore, sand away paint within  $\frac{1}{2}$ -inch around scarred or chipped spots. If case is badly scarred or has large worn areas, remove both upper and lower chassis from case, scrub all dirt and rust away, using dry-cleaning solvent (SD) to insure a proper surface for painting. Be sure to remove with a clean dry cloth any superficial deposit left by the dry-cleaning solvent (SD). When case is clean, spray the entire case with paint authorized by existing regulations.

## SECTION VII

### FINAL TESTING

#### 30. Alignment Test

After all preliminary checks and repairs have been made and the unit has been refinished as needed, fungiproofed and moistureproofed, it will be necessary to check the alignment according to the procedure outlined in. (See fig. 12.) It may be necessary after moistureproofing and fungiproofing to realign the unit completely. This should be followed by additional tests indicated in the paragraphs which follow.

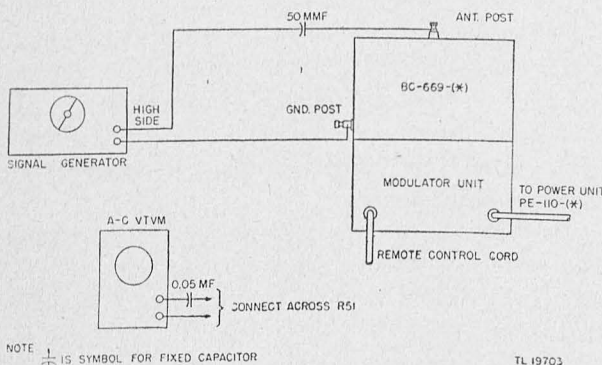

Figure 25. Radio Receiver and Transmitter BC-669-(\*) diagram of test circuit for sensitivity, selectivity, and a-c measurements in receiver section.

#### 31. Signal-to-noise Test

*a. PURPOSE.* This test is to make sure that the intensity of the receiver signal voltage is intelligible through and above the receiver's normal noise level voltage. Because BC-669-(\*) must operate under conditions where exterior noises, vehicular noise on roads, or even nearby artillery fire make reception difficult, it is important that the signal-to-noise ratio meet at least minimum Signal Corps requirements.

*b. PROCEDURE.* (1) Use an r-f signal generator and an a-c VTVM.

(2) Connect the high side of the signal generator to the antenna post of the receiver. (See fig. 25.)

(3) Connect the signal generator ground to the receiver chassis ground.

(4) Connect the a-c VTVM across resistor R51 with SPEAKER switch OFF. Insert an 0.05-mf capacitor in series with one of the leads.

(5) If resistor R51 is not a 6-ohm resistor, as may be the case in models BC-669-A, -B, -AM, or -BM, connect a 6-ohm resistor in parallel with resistor R51.

(6) Set RECEIVER BAND SWITCH at MANUAL 1.

(7) Set R.F. GAIN (NOISE CONTROL) at maximum (extreme right).

(8) Set A.F. GAIN at maximum (extreme right).

(9) Set SPEAKER switch at OFF.

(10) Set STATIC FILTER switch at OFF.

(11) Set the signal generator at a low output, at 30 percent modulation and 400 cycles.

(12) Turn both signal generator and receiver to the desired test frequency. Turn on all alternating current to receiver, signal generator, and VTVM.

(13) Increase the output of the signal generator until a value of 0.55 volts is obtained on the VTVM. This is the equivalent of an output of 50 milliwatts.

(14) Set the modulation switch on the signal generator to OFF.

(15) Rotate R.F. GAIN (NOISE CONTROL) to the left until the VTVM reads 0.27 volts.

(16) Set the signal generator modulation switch to ON position and readjust the signal generator output for an 0.55-volt reading on the VTVM.

(17) Turn the signal generator modulation switch OFF and readjust R.F. GAIN (NOISE CONTROL) until the VTVM indicates 0.27 volts.

*c. FINAL SETTINGS.* Final settings of the signal generator output and receiver R.F. GAIN (NOISE CONTROL) should be such that with signal generator modulation switch ON a reading of 0.55 volts is obtained on the VTVM, and with signal generator modulation switch OFF a reading of 0.27 volts is obtained on VTVM. This establishes a signal-to-noise ratio of 4 to 1. Failure to get a 4 to 1 ratio indicates faulty receiver operation. Locate the defective parts and correct the condition before proceeding to other tests.

*d. CORRECTIVE DATA.* For practical corrective data see paragraph 48. Make a very careful recheck of the r-f, i-f, and oscillator circuits.

#### 32. Sensivity Test

As in other superheterodyne circuits, lack of sensitivity in receiver BC-669-(\*) is indicated by weak signals and excessive tube noise.

*a. CAUSES OF POOR SENSITIVITY.* Poor sensitivity may be caused by oscillator tubes which have gone flat. This will be shown by their failure to operate at some frequencies despite their operation at others.



Other causes of poor sensitivity may be high-resistance joints in the primaries or secondaries of the tuned circuit. Such joints are due to poor soldering or corrosion. These joints may permit satisfactory voltage readings, but will present appreciable resistance to r-f signal voltage. Careful point-to-point resistance measurements must be made to locate such joints. Misalignment of BC-669-(\*) will also be found a common cause of lack of sensitivity.

b. PROCEDURE. Connect BC-669-(\*), r-f signal generator, VTVM, and a 50-mmF capacitor as outlined in the signal-to-noise test. (See par. 30b.) Check sensitivity of bands 1 and 2 using test frequencies shown in chart below. After adjusting receiver for a 4 to 1 signal-to-noise ratio at each frequency being checked, the r-f signal generator voltage required for a reading of 0.55 volts on the VTVM should be equal to, or lower than, the values shown in the chart.

SENSITIVITY TEST

Frequency (kc).. R-f signal generator voltage ( $\mu$ v)	Band 1		Band 2	
	1,800	2,700	2,900	4,400
	6	6	8	8

Similar sensitivity should be registered in operating in the crystal channels at the crystal frequencies. Failure to get the required values indicates defective receiver operation. When this is the case check the receiver alignment before making other tests and repairs. If the equipment being tested is new, the r-f signal generator voltages should be at least 2  $\mu$ v lower than values shown in the chart.

### 33. Selectivity Test

a. FUNCTION. The ability of a receiver such as the BC-669-(\*) to shut out interference of unwanted signals is of the greatest importance to a military organization using the receiver. Therefore it is necessary that the selectivity test be exacting and thorough. Mixer tube V2 and oscillator tube V3 should be thoroughly tested, both in the tube tester and in actual operation. Tracking should be carefully adjusted in the alignment of the receiver to insure that the basic requirements for good selectivity are present.

b. PROCEDURE. The receiver, signal generator, and VTVM are connected for this test as for the signal-to-noise test (par. 30b), with the following exceptions:

- (1) A 100-mmF capacitor is connected in series with the high side of the signal generator and grid pin No. 8 of mixer tube V2.
- (2) In this test it will be necessary to short out

the a-v-c action temporarily by grounding the common lead of resistors R14 and R30 to chassis.

Note. Remove this short after test has been completed.

(3) Set RECEIVER BAND SWITCH at MANUAL 1.

(4) Set both R.F. GAIN (NOISE CONTROL) and A.F. GAIN at maximum (extreme right).

(5) Set SPEAKER switch and STATIC FILTER at OFF.

(6) Adjust signal generator for low output at 385 kc using 30 percent modulation at 400 cycles.

(7) Adjust signal generator for 100  $\mu$ v output.

(8) If reading on VTVM exceeds 0.55 volts, decrease R.F. GAIN (NOISE CONTROL) until a 0.55-volt reading is obtained on VTVM.

(9) Increase signal generator to 1,000  $\mu$ v. Detune the signal generator to each side of resonance in order to obtain a reading of 0.55 volts on VTVM on each side of resonance.

(10) Subtract the below resonance frequency which resulted in the 0.55-volt VTVM reading from the above resonance frequency which resulted in the 0.55-volt VTVM reading. The difference in kilocycles should not be greater than shown under 10 times in chart below.

(11) Repeat the procedure in (9) and (10) above, increasing the signal generator to 100,000  $\mu$ v. If the bandwidths are greater than those given in the following chart under 1,000 times, the selectivity of the receiver is defective and the alignment of the i-f components should be rechecked before making any specific repairs.

SELECTIVITY TEST LIMITS

Increase in signal generator voltage	10 times	1,000 times
Band width .....	10 kc	45 kc

### 34. Transmitter Power Output and Modulation Check

A test of the power output and modulation capabilities of the transmitter section is made by connecting it as indicated in the test circuit (fig. 26), and then setting the transmitter up for operation. The dummy antenna consists of a 30-ohm (75-watt) noninductive resistor in series with a 500-mmF capacitor. The test ammeter is a 0- to 2.5-ampere, r-f ammeter inserted in series with the dummy antenna. The transmitter output is coupled to the vertical deflection plates of the oscilloscope by means of a 0- to 50-mmF variable capacitor. Unmesh the movable plates of this capacitor and adjust them to the position which results in an oscilloscope pattern of suitable height. Adjust the sweep voltage on the oscilloscope to make the width of the pattern slightly more than half the diameter of the screen. With



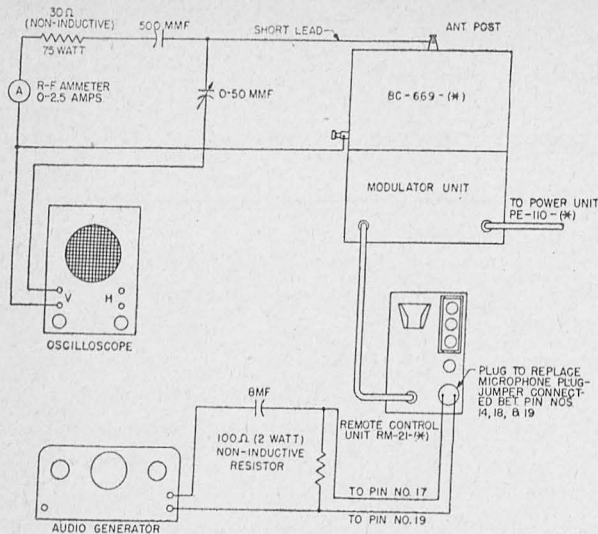

NOTE  $\times$  IS SYMBOL FOR FIXED CAPACITOR  
 $\diagdown$  IS SYMBOL FOR VARIABLE CAPACITOR

TL 19701

Figure 26. Radio Receiver and Transmitter, BC-669-(\*), showing test circuit for power output and measurements in transmitting section, block diagram.

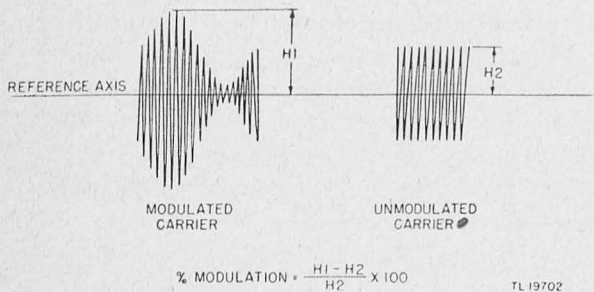

TL 19702

Figure 27. Radio Receiver and Transmitter, BC-669-(\*), oscilloscope pattern for modulation test.

the a-f generator turned off, the transmitter output is unmodulated and consists simply of the r-f carrier. Adjust the transmitter for maximum output at each one of the six operating channels, and read the maximum r-f current on the test ammeter. This should be a minimum of 1.08 amperes in each case, when no modulation is present, for a carrier output of 33 watts. The unmodulated r-f carrier will be seen on the oscilloscope and the height of the wave above the reference axis may be measured (H2). The a-f generator is connected to the transmitter

as shown in the test circuit, through an 8-mf capacitor and a 100-ohm (2-watt) noninductive resistor. If the a-f generator is set for 400 cycles and turned on, then the output of the transmitter will be modulated for 85 percent modulation; the r-f current in the test meter should increase approximately 16 percent, and should therefore be a minimum of 1.25 amperes. Increase the output of the a-f generator until this value is obtained. The output of the a-f generator should now be between 0.15 volt and 0.30 volt if the transmitter section is operating properly. Observe the modulated wave on the oscilloscope to make certain that the sine wave pattern obtained remains undistorted. The maximum height of the modulated wave (H1) as obtained on the oscilloscope should be 1.85 times as great as the height of the unmodulated wave (H2), indicating a modulation of 85 percent. If the microphone is substituted for the a-f generator, it should be possible also to obtain a modulated wave having a height 1.85 times as great as the height of the unmodulated wave when normal voice is used. When using the microphone, the r-f current should also increase from the minimum of 1.08 amperes to approximately 1.25 amperes. If the proper unmodulated power output cannot be obtained, check the r-f section of the transmitter for defects. If the proper modulation percentage cannot be obtained, check the modulator section of the transmitter for defects.

### 35. Operational Test

When all tests and all repairs indicated by tests have been made, the equipment must be inspected carefully to make sure that no detail has been overlooked. Workmanship must be neat and repairs made correctly. All components must be correctly reassembled. The unit must be clean. Then the test of the unit under actual operating conditions must be made. The receiver should operate accurately as to dial reading, with good volume and clarity. The transmitter should operate with no distortion at ordinary voice levels and on all the assigned frequencies. The test run should be long enough to insure that the unit will meet actual operating conditions.

## SECTION VIII

### INDIVIDUAL STAGE AND CIRCUIT REPAIR DATA

#### 36. R-f Amplifier Stage (fig. 28)

*a.* FUNCTION OF STAGE. R-f amplifier Tube JAN-6SK7 (V1) amplifies signal voltages at radio frequency, and, with sharply tuned circuits of transformers T1 or T2, attenuates undesired signal frequencies. Tube JAN-6SK7GT/G is used in BC-669-B, -C, -BM, and -CM.

(1) Antenna connection to r-f transformer T1 or T2 is through a set of closed relay contacts, normally closed for the receive position. The antenna is switched to either transformer on switch section S1.1.

(2) Signal voltages picked up on the antenna appear across the primary of T1 or T2, and are induced in the secondary. Secondary and variable capacitor section C1.1 forms a tuned parallel resonant circuit, and fixes the frequency of the signal impressed on the control grid of tube V1. Switch section S1.2 switches C1.1 and the control grid of tube V1 from T1 secondary to T2 secondary.

(3) The gain of tube V1 is controlled by varying the cathode bias by means of variable resistor R4, the movable tap of which is connected to the cathode through cathode bias resistor R3. One end of R4 is grounded in the receive position to a set of closed contacts in relay RY1. Capacitor C6 connects the movable tap of resistor R4 to ground, bypassing any noise of R4. The cathode is bypassed by capacitor C7. In BC-669-B, and -BM, r-f choke L16 is connected between the movable tap of resistor R4 and resistor R3. With capacitor C6, which is connected from the movable tap of R4 to ground, the arrangement provides for additional filtering of noise from R4. In BC-669-C and -CM (also BC-669-B and -BM on Order No. 32780-Phila-43), C6 is connected between r-f choke L16 and resistor R3 for the same purpose.

(4) A-v-c voltage is applied to the control grid of tube V1, through resistor R2 and r-f transformer secondaries. It is filtered by capacitor C4 to maintain constant level of signal voltage, and to prevent overloading of tube V1 by excessive signal voltages.

(5) Plate voltage in tube V1 is obtained through the primaries of r-f transformers T3 and T4 directly from the receiver plate voltage supply.

(6) The screen grid of tube V1 gets its voltage directly from the receiver screen voltage supply. The grid is bypassed by capacitor C8.

(7) Positive voltage is placed across the fixed element of variable resistor R4 through resistor R5 from the screen voltage supply. Part of this voltage, the amount of which depends on the setting of R4, appears on the cathode together with the positive voltage supplied by R3. A corresponding negative voltage appears on the control grid of V1. This permits greater attenuation of signal voltages at a given setting than would be obtained if only the voltage drop across R3 and R4 were used to bias the grid.

*b.* REPAIR DATA FOR R-F AMPLIFIER STAGE. (1) The following defects in a BC-669-(\*) receiver may be caused by difficulties in the r-f amplifier stage:

(a) Dead set may be due to an erratic r-f stage.

(b) Distortion may be due to an erratic r-f stage.

(c) Fading may be due to loose or dirty band-switch contacts. Loose windings may be found on r-f coils or chokes; improperly aligned paddler capacitors or defective dielectric in trimmers and paddlers may be present.

(d) Hum, because of shorts within r-f tubes or open capacitors, may occur.

(e) Intermittent reception may be caused by broken leads.

(f) Noise may be caused by a defective tube.

(g) Oscillation may originate in a defective tube, or may be caused by incorrect alignment, open capacitors, plate or screen voltages being too high, poorly soldered connections, open suppressor grid, coil shields not being properly grounded, or inductive or capacitive coupling between stages caused by improper lead dress.

(2) Replace r-f coils (fig. 44) as follows:

(a) Disconnect leads from coil lugs and remove the coil assembly from the chassis.

(b) Mount the new coil on the chassis, replace wires, and resolder.

*Note.* Be careful in the soldering of this unit. Solder is liable to drop from overheated lugs, and short the coil windings.

(c) Check the screen voltage (B+) at pin No. 6 of the socket. If voltage is absent, or fails to check with voltage charts, capacitor C8 may be defective. Also test resistors R25 and R26 or capacitor C30. Replace any defective components.

(d) Check a-v-c capacitor C4 to make sure that it is not open, thus preventing the antenna from tuning. Also check capacitor C7; a short here removes



the bias from the cathode and puts a load on the tuned circuit.

(e) Check switch sections S1.1, S1.2, and S1.3. See that the contacts are clean and snap into place as rotated. Remove any corrosion in accordance with cleaning instructions.

(f) Check the noise control (r-f gain control in BC-669-A). If it is inoperative, check choke L16 for continuity. Replace if it is shorted or open.

(g) Check the voltage at variable capacitor C1.1 from stator to chassis. Make sure that contacts in switch section S1.2 are operative to insure proper tuning at this point.

(h) After checking continuity of antenna transformers T1 and T2, make sure that they are properly aligned. Primaries of either transformer may be tested at pins No. 2 and 4; secondaries may be tested at pins No. 1 and 3.

(i) Make final adjustments after the oscillator stage has been tested and it is certain that tracking is correct. R-f operation must be tested in combination with the oscillator, i-f, and mixer stages.

(j) To replace receiver band switch (fig. 44):

1. Remove screws holding three shield partitions.
2. Unsolder all leads and disconnect all wires. Tag as unsoldered and disconnected to save confusion in replacing.
3. Remove the panel knob; remove the nut holding the rear bracket to the chassis; remove the nut holding the switch to the front panel and take out the switch.
4. Attach the new switch. Reconnect and resolder wires. Replace shield partitions.

*Note.* In making repairs on either chassis be sure to remove tubes.



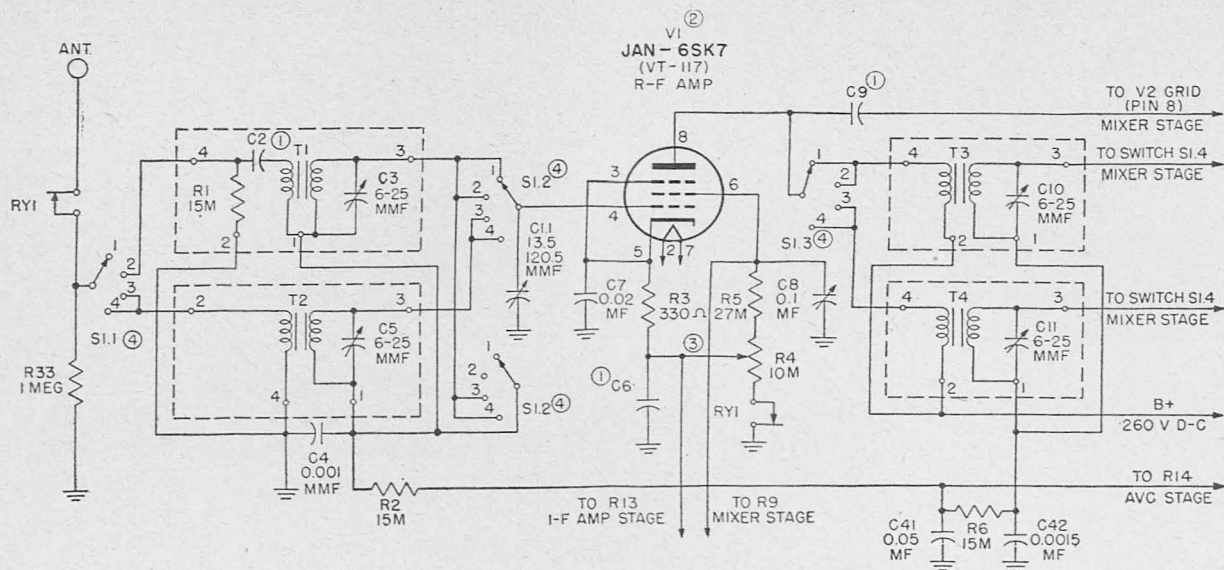

① VALUES OF THESE CIRCUIT ELEMENTS VARY IN DIFFERENT MODELS. VALUES ARE AS FOLLOWS:

MODEL	C2	C6	C9
BC-669-A	0.0045 MMF	1 MF	3 MMF
BC-669-B	0.006 MF	0.05 MF	2.5 MMF
BC-669-C	0.0045 MF	0.01 MF	3 MMF

② GLASS TUBE JAN-6SK7 GT/G (VT-117-A) USED IN BC-669-B AND BC-669-C.

③ CATHODE CIRCUIT VARIES BETWEEN MODELS. MAIN CIRCUIT DIAGRAM IS FOR BC-669-A. CATHODE CIRCUITS FOR BC-669-B AND BC-669-C ARE SHOWN IN SMALLER DIAGRAMS.

SI POSITION	OPERATION	BAND	FREQUENCY
1	CRYSTAL	1	1680-2750 KC
2	MANUAL	1	1680-2750 KC
3	CRYSTAL	2	2700-4450 KC
4	MANUAL	2	2700-4450 KC

⑤ BC-669-B ON ORDER NO. 32780-PHILA-43 IS THE SAME AS MODEL BC-669-C.

FOR TEST CONDITIONS SEE PARAGRAPH 23.

NOTE:

⊢ IS SYMBOL FOR FIXED CAPACITOR  
 ⊢ IS SYMBOL FOR VARIABLE CAPACITOR  
 M = 1,000 OHMS

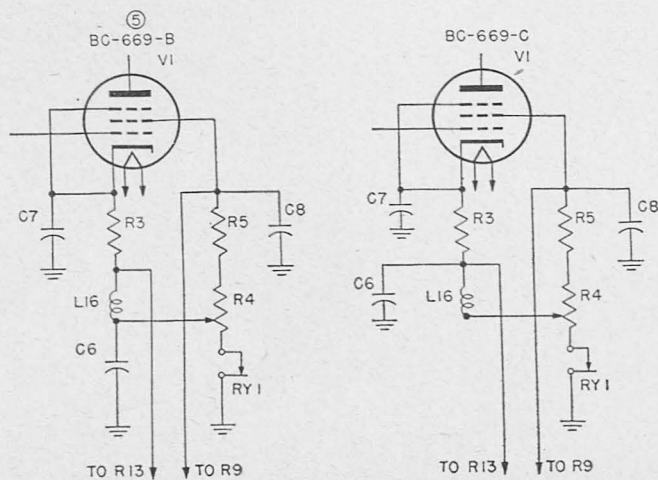
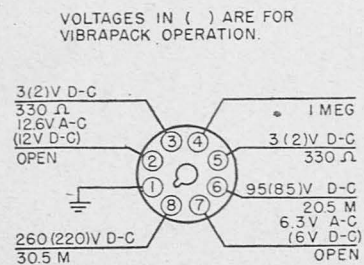

TL 19704

Figure 28. Radio Receiver and Transmitter BC-669-(\*), r-f amplifier stage, schematic diagram.

c. PARTS DATA.

Ref. symbol	Signal Corps stock No.	Name of part and description	Function
C1.1	3D9107VE6	CAPACITOR: single; 13.5 mmf to 120.5 mmf; section of 3-gang variable	Recvr ant. stage tuning.
C2 A <sup>1</sup>	3DA4.500-1	CAPACITOR: 0.0045 mf $\pm 20\%$ ; 300 vdcw; molded mica; postage stamp type	Recvr ant. coupling, band 1.
C2 B <sup>2</sup>	3DA4.500-1	CAPACITOR: 0.006 mf $-10\%$ $+20\%$ ; 300 vdcw; molded mica; postage stamp type	Recvr ant. coupling, band 1.
C2 C <sup>2</sup>	3DA4.500-1	CAPACITOR: 0.0045 mf $\pm 20\%$ ; 300 vdcw; molded mica; postage stamp type	Recvr ant. coupling, band 1.
C2 A, C <sup>1</sup>	3D9015V-41	CAPACITOR: 6-25 mmf; variable; air; 11-plate; ceramic base; with screw driver slot; special	T1 sec trimmer, band 1.
C3 B <sup>1</sup>	3D9015V-41	CAPACITOR: 6-25 mmf; variable; air; 8-plate; ceramic base special	T1 sec trimmer, band 1.
C4	3DA1-39	CAPACITOR: 0.001 mf $\pm 5\%$ ; 500 vdcw; molded, silver-mica; postage stamp type	Valve bypass.
C4 C <sup>1</sup>	3DA1-39	CAPACITOR: 0.001 mf $\pm 5\%$ ; 500 vdcw; tubular ceramic; postage stamp type	Valve bypass.
C5 A, C <sup>1</sup>	3D9015V-41	CAPACITOR: 6-25 mmf; variable; air; 11-plate; ceramic base special	T2 sec trimmer, band 2.
C5 B <sup>1</sup>	3D9015V-41	CAPACITOR: 6-25 mmf; variable; air; 8-plate; ceramic base special	T2 sec trimmer, band 2.
C6 A <sup>1</sup>	3D234	CAPACITOR, CA-234: 1 mf $+14\%$ $-6\%$ ; 200 vdcw; paper, oil-filled; bathtub type	R4 r-f filter.
C6 B <sup>1</sup>	3D234	CAPACITOR: 0.05 mf $-10\%$ $+20\%$ ; 400 vdcw; molded paper	R4 r-f filter.
C6 C <sup>1</sup>	3D234	CAPACITOR: 0.01 mf $\pm 20\%$ ; 400 vdcw; molded paper	R4 r-f filter.
C7 AB <sup>1</sup>	3DA20-45	CAPACITOR: 0.02 mf $-10\%$ $+20\%$ ; 400 vdcw; molded paper	V1 cathode bypass.
C7 C <sup>1</sup>	3DA20-45	CAPACITOR: 0.02 mf $\pm 20\%$ ; 400 vdcw; molded paper	V1 cathode bypass.
C8 A, B <sup>1</sup>	3DA20-45	CAPACITOR: 0.1 mf $-10\%$ $+20\%$ ; 400 vdcw; molded paper	V1 screen bypass.
C8 C <sup>1</sup>	3DA100-112	CAPACITOR: 0.1 mf $\pm 20\%$ ; 400 vdcw; molded paper	V1 screen bypass.
L16, B, C <sup>1</sup>	3C375	CHOKE r-f: 1 mh $\pm 3\%$ ; 24.8 ohms d-c resistance; 4 pi universal wound	R4 r-f filter.
R1	3Z6615-28	RESISTOR: 15,000 ohms $\pm 10\%$ ; $\frac{1}{3}$ watt; insulated carbon	Ant. static leak.
R1 B <sup>1</sup>	3Z6615-28	RESISTOR: 15,000 ohms $\pm 20\%$ ; $\frac{1}{2}$ watt; insulated carbon	Ant. static leak.
R2	3Z6615-40	RESISTOR: 15,000 ohms $\pm 20\%$ ; $\frac{1}{2}$ watt; insulated carbon	V1 filter.
R3	3Z6033-9	RESISTOR: 330 ohms $\pm 10\%$ ; $\frac{1}{2}$ watt; insulated carbon	V1 cathode bias.
R4	2Z7269-27	RESISTOR: 10,000 ohms; potentiometer, carbon; 3-terminal	Recvr noise control.
R5	3Z6627-3	RESISTOR: 27,000 ohms $\pm 10\%$ ; 1 watt; insulated carbon	V1 screen bleeder.
R33	3Z6801-41	RESISTOR: 1 megohm $\pm 20\%$ ; 2 watts; insulated carbon	Ant. static leak.
S1.1	3Z9825-62.9	SWITCH ASSEMBLY: 3-section ceramic wafer type; index plate 4-position through 90°	T1, T2 pri switching.
S1.2		(Part of S1.1)	T1, T2 sec switching.
T1 A, C <sup>1</sup>	2C5380-669C/C1	TRANSFORMER, antenna: 1,680 to 2,750 kc when tuned with C1.1; pri to match 500 mmf; 30-ohm antenna; contains trimmer capacitor C3A,C; special	Band 1 ant. coil.
T1 B <sup>1</sup>	2C5380-669C/C1	TRANSFORMER, antenna: 1,680 to 2,750 kc when tuned with C1.1; pri to match 60 mmf; 10-ohm antenna; contains trimmer capacitor C3B; special	Band 1 ant. coil.
T2 A, C <sup>1</sup>	2C5380-669C/C3	TRANSFORMER, antenna: 2,700 to 4,450 kc when tuned with C1.1; pri to match 500 mmf; 30-ohm antenna; contains trimmer capacitor C5A,C; special	Band 2 ant. coil.
T2 B <sup>1</sup>	2C5380-669C/C3	TRANSFORMER, antenna: 2,700 to 4,450 kc when tuned with C1.1; pri to match 60 mmf; 10-ohm antenna; contains trimmer capacitor C5B; special	Band 2 ant. coil.
V1 A <sup>1</sup>		Tube JAN-6SK7; VT-117	Recvr r-f amp.
V1 B, C <sup>1</sup>		Tube JAN-6SK7GT/G; VT-117-A	Recvr r-f amp.
V1 B, C <sup>2</sup>		Tube JAN-6SK7GT/G; VT-117-A	Recvr r-f amp.

<sup>1</sup> Applies only to models indicated.

<sup>2</sup> Applies only to models indicated on Order No. 32780-Phila-43.

### 37. Mixer or Converter Stage (fig. 29)

a. FUNCTION OF STAGE. (1) Grid No. 3 of Tube JAN-6SA7 (V2) receives signal voltage amplified by tube V1 through inductive coupling provided by r-f transformer T3 or T4. Primary switching for the two frequency bands is effected by switch section S1.3. Secondary switching in two frequency bands is provided by switch section S1.4. The tuned circuit formed by T3 secondary and capacitor section C1.2 determines the frequency of the signal received by grid No. 3.

(2) Tube V2 receives its plate voltage through resistor R11, the primary of i-f transformer T5, and resistor R10. The voltage is filtered of radio frequency by capacitor C14.

(3) The cathode of tube V2 is biased by the voltage drop across resistor R7, and is bypassed by capacitor C12.

(4) An a-v-c voltage is applied through resistor R6 and T3 secondary to grid No. 3 of tube V2, and is filtered by capacitor C41. Filtering assists in maintaining voltage level, and in preventing overloading of the tube by very strong signals.

b. REPAIR DATA ON MIXER OR CONVERTER STAGE. Defective action in a BC-669-(\*) receiver may be

caused by faults on the mixer stage. Among these are the following:

(1) *Dead set.* This may be due to a defective Tube JAN-6SA7, or to improper tube voltages. The oscillator may not be working, or it may be operating at a frequency which will not pass the i-f transformer. The i-f transformer may be defective. If no r-f signal is present, rub the metal part of the screw driver on the stator of the oscillator tuning capacitor. Little or no noise in the loudspeaker indicates a defective oscillator.

**Caution:** Keep fingers or body away from the metal part of the screw driver.

A negative voltage across oscillator grid leak R8 indicates an operative oscillator. No voltage, or positive voltage, indicates trouble. Infinity or high reading on an ohmmeter across oscillator coils T7, T8, or L2 indicates trouble.

(2) *Fading.* This may be caused by dirty or loose band-switch contacts. It may also be caused by loose windings on r-f coils, by open or shorted resistors, by poorly soldered contacts, or by defective dielectric in trimmers or padders.

(3) *Distortion.* This may be caused by a defective mixer tube, by open or shorted a-v-c capacitors,

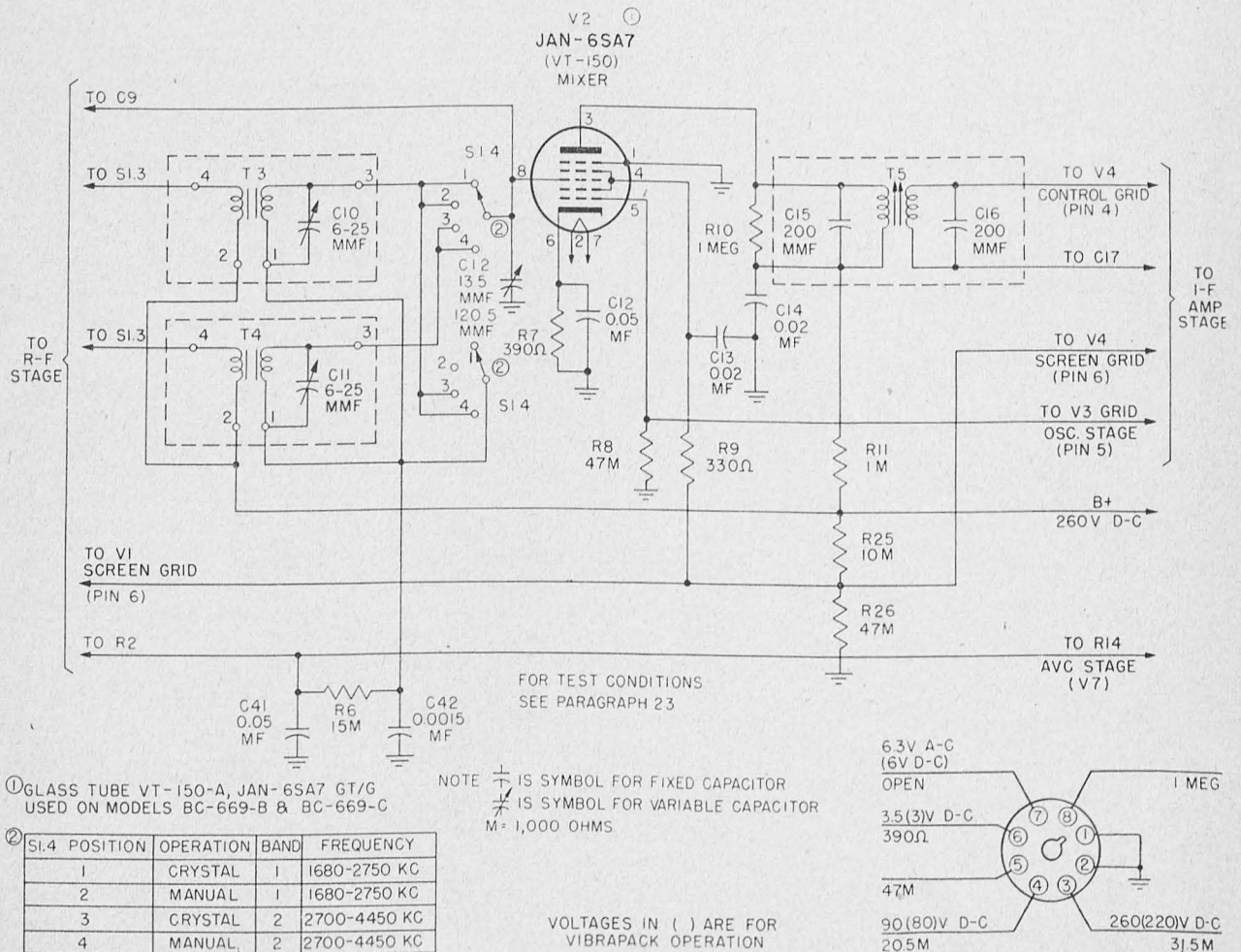

Figure 29. Radio Receiver and Transmitter BC-669-(\*), mixer stage, schematic diagram.



by defective resistors, or by an inoperative oscillator stage.

(4) *Hum.* This may be caused by an open filter capacitor C14, by shorts in the tube heater to the cathode, or by inductive coupling between the heater plate and grid leads owing to improper dress of the leads.

(5) *Oscillation.* Capacitor may be open. Plate or screen voltages may be too high.

c. REMOVAL OF R-F TRANSFORMERS. Procedure is identical with that of the antenna transformers in the r-f stage. (See fig. 44.)

### 38. Heterodyne Oscillator Stage (fig. 30)

a. FUNCTION OF STAGE. (1) In manual operation, the frequency of oscillation is determined by the tuned circuit formed by transformer T7 and capacitor section C1.3. The control grid of Tube JAN-6J5 (V3) is connected to one end of T7 through switch section S1.5 and padding capacitor C35, and to one end of T8 through padding capacitor C38. The other end of each coil connects to the cathode of tube V3 through switch section S1.7 to provide feedback. Grid leak resistor R8 provides a negative bias on grid of oscillator tube V3.

(2) In crystal operation, the oscillator frequency is determined by the frequency of the crystal selected by means of switch section S3.7. Capacitors C36 and C40 are connected in series across the selected crystal, and the cathode of tube V3 is connected between them through switch section S1.7, with coil L2 in parallel with capacitor C40 to provide sufficient feedback for the purpose of sustaining strong oscillations. Grid leak resistor R8 is connected to the control grid of tube V3 at all times. Capacitor C34 provides coupling between the control grid of tube V3, the oscillator transformer, and capacitor C1.3 when switch S1 is in either of the two manual positions.

(3) Switch section S1.6 grounds T7 when in either crystal position, and the crystals when in either manual position. A portion of switch section S1.7 grounds T8 cathode tap when in MANUAL 1 and CRYSTAL 2 position.

(4) The control grid of oscillator tube V3 is coupled directly to the injection grid, No. 1 of the mixer tube V2. Here the oscillator frequency is heterodyned with the incoming signal frequency to produce an intermediate frequency of 385 kc.

(5) The plate of tube V3 receives its voltage through resistor R32 and is bypassed by capacitor C33.

b. REPAIR DATA ON HETERODYNE OSCILLATOR STAGE. Oscillator coils are relatively simple devices, but it must be remembered that in Receiver BC-669-(\*) there are in effect two oscillators. One is a Hartley type oscillator for manual reception; the other is a crystal-controlled oscillator with a crystal in each of the six crystal frequency channels provided for crystal operation. As seen in paragraph 37a(3), T7 and T8 are shorted out for crystal operation. Therefore two sets of tests must be made of the oscillator stage. The common causes of receiver troubles which may originate in the oscillator stage and suggested remedies are as follows:

(1) *Dead unit.* Check tube V3. If defective replace it. Check the signal voltage at the plate, pin No. 3, of tube V3 against the chart of voltages at the socket. If the voltage is correct, check resistor R8. If open, shorted, or high, replace the resistor.

(2) *Wrong frequency.* Check the frequency against the signal generator. Frequency of the oscillator should be equal to the sum of the receiver intermediate frequency plus the frequency at which the signal generator is operating. If operating frequency is incorrect, check trimmer capacitors C37 and C39. If stage is inoperative check capacitor C33.

(3) *Motor-boating.* Check resistor R8. If open, replace it. Check both bands. Band 1: capacitor C35 may be open or shorted; transformer T7 may be open. Make a check and replace defective parts. Band 2: capacitor C38 may be open or shorted; transformer T8 may be open. Check, and make replacements needed. In crystal operation, capacitors C36 and C40 may be open or shorted. Cathode inductor, choke L2, may be open. Check and make replacements indicated as necessary.

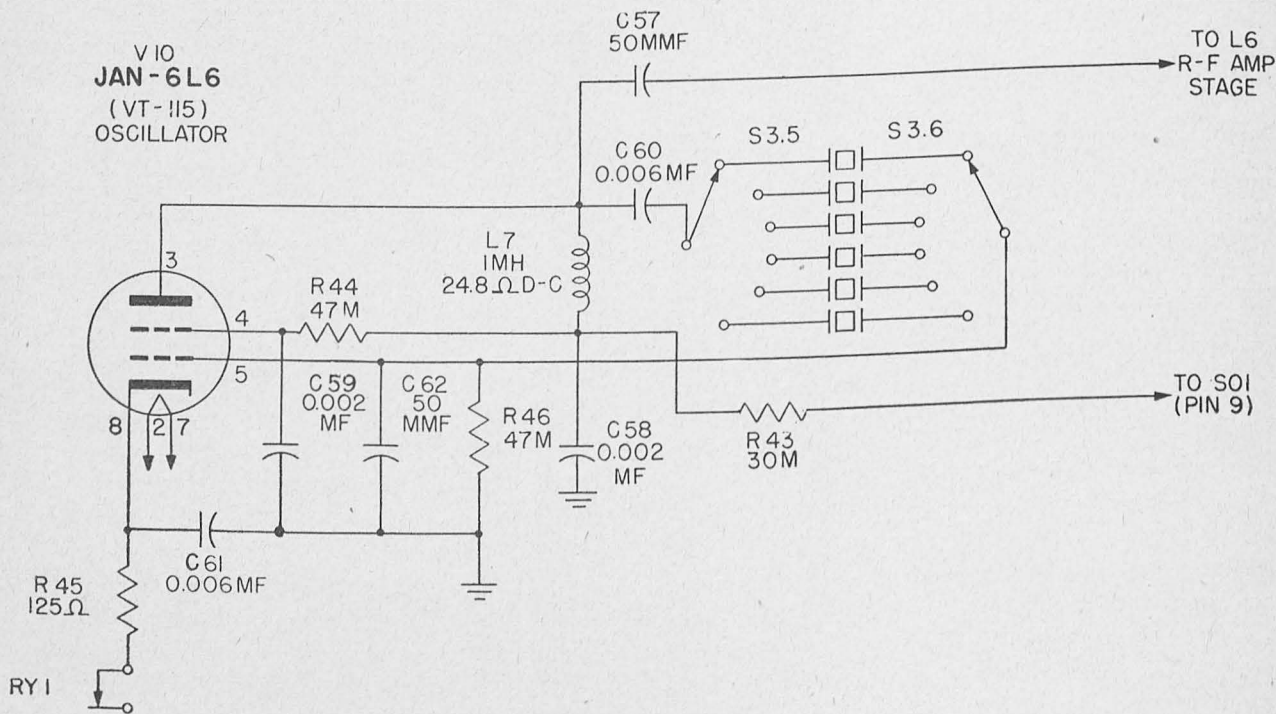

FOR TEST CONDITIONS  
SEE PARAGRAPH 23.

NOTE:  $\text{---} \perp \text{---}$  IS SYMBOL FOR FIXED CAPACITOR  
M = 1,000 OHMS.

VALUES IN [ ] APPLY TO TRANSMIT OPERATION.  
TUBES NOT EXCITED UNDER VIBRAPACK OPERATION.

TL 19706

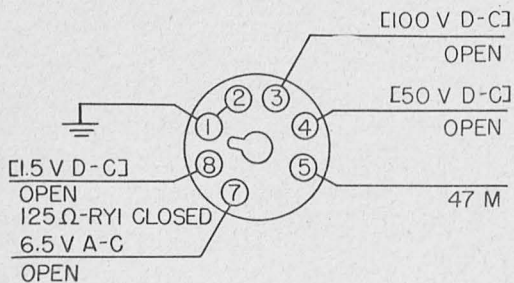

Figure 30. Radio Receiver and Transmitter BC-669-(\*), heterodyne oscillator stage, schematic diagram.

c. PARTS DATA.

Ref. symbol	Signal Corps stock No.	Name of part and description	Function
C1.3	3D9107VE6	CAPACITOR, single: 13.5 mmf to 120.5 mmf; section of 3-gang variable	Revr osc tuning.
C33 A, B <sup>1</sup>	3DA20-45	CAPACITOR: 0.02 mf -10% +20%; 600 vdcw; molded	V3 plate bypass.
C33 C <sup>1</sup>	3DA20-45	CAPACITOR: 0.02 mf ±20%; 600 vdcw; molded paper	V3 plate bypass.
C34 A <sup>1</sup>	3DA9025-16	CAPACITOR: 25mmf ±5%; 500 vdcw; molded mica; small postage stamp type	V3 grid coupling, manual position.
C34 B <sup>1</sup>	3DA9025-16	CAPACITOR: 25 mmf ±10%; 500 vdcw; molded silver mica; postage stamp type	V3 grid coupling, manual position.
C34 C <sup>1</sup>	3DA9025-16	CAPACITOR: 25 mmf ±5%; 500 vdcw; molded mica; small postage stamp type	V3 grid coupling, manual position.
C34 C <sup>1</sup>	3DA9025-16	CAPACITOR: 25 mmf ±5%; 500 vdcw; zero temp coef; tubular ceramic	V3 grid coupling, manual position.
C35 A <sup>1</sup>	3D9380	CAPACITOR: 380 mmf ±2%; 300 vdcw; molded silver-mica; postage stamp type	Osc pad, band 1.
C35 B, C <sup>1</sup>	3D9380	CAPACITOR: 380 mmf ±2%; 300 vdcw; molded silver-mica; small postage stamp type	Osc pad, band 1.
C35 C <sup>1</sup>	3D9380	CAPACITOR: 380 mmf ±2%; 300 vdcw; zero temp coef; tubular ceramic	Osc pad, band 1.
C36 A	3D9100-19A	CAPACITOR: 100mmf ±2%; 500 vdcw; molded mica; postage stamp type	V3 feedback for crystal operation.
C36 B, C <sup>1</sup>	3D9100-19A	CAPACITOR: 100 mmf ±5%; 500 vdcw; molded silver-mica; small postage stamp type	V3 feedback for crystal operation.
C36 C <sup>1</sup>	3D9110-19A	CAPACITOR: 100 mmf ±2%; 500 vdcw; molded silver-mica; small postage stamp type	V3 feedback for crystal operation.
C36 C <sup>1</sup>	3D9100-19A	CAPACITOR: 100 mmf ±2%; 500 vdcw; zero temp coef; tubular ceramic	V3 feedback for crystal operation.
C37 A, C <sup>1</sup>	3D9025V-41	CAPACITOR, variable: 6-25 mmf; air, 11-plate; ceramic base; with screw driver slot; special	T7 trimmer, band 1.
C37 B <sup>1</sup>	3D9025V-41	CAPACITOR, variable: 6-25 mmf; air, 8-plate; ceramic base; with screw driver slot; special	T7 trimmer, band 1.
C38 A <sup>1</sup>	3D9500-73	CAPACITOR: 500 mmf ±2%; 500 vdcw; molded silver-mica; postage stamp type	Osc pad, band 2.
C38 B, C <sup>1</sup>	3D9500-73	CAPACITOR: 500 mmf ±25%; 300 vdcw; molded silver-mica; small postage stamp type	Osc pad, band 2.
C38 C <sup>1</sup>	3D9500-73	CAPACITOR: 500 mmf ±2%; 300 vdcw; zero temp coef	Osc pad, band 2.
C39 A, C <sup>1</sup>	3D9025-41	CAPACITOR, variable: air, 11-plate; ceramic base; with screw driver slot; special	T8 trimmer, band 2.
C39 B <sup>1</sup>	3D9025-41	CAPACITOR, variable: 6-25 mmf; air, 8-plate; ceramic base; with screw driver slot; special	T8 trimmer, band 2.
C40 A <sup>1</sup>	3D9100-19A	CAPACITOR: 100 mmf ±2%; 500 vdcw; molded mica; postage stamp type	V3 feedback for crystal operation.
C40 B, C <sup>1</sup>	3D9100-19A	CAPACITOR: 100mmf ±5%; 500 vdcw; molded silver-mica; small postage stamp type	V3 feedback for crystal operation.
C40 C <sup>1</sup>	3D9100-19A	CAPACITOR: 100 mmf ±2%; 500 vdcw; molded silver-mica; small postage stamp type	V3 feedback for crystal operation.
L2	3D9100-19A	CHOKE, r-f: 1mh ±3%; 24.8 ohms d-c resistance; 4-pi universal wound	V3 cathode inductor crystal operation.
R32	3Z6610-32	RESISTOR: 10,000-ohm ±10%; 2 watts; insulated carbon	V3 plate dropping.
S1.5	3Z9825-29.2	Part of S1.2 (switch assembly, 3-position ceramic wafer type; index plate 4-position through 90°)	T7, T8 crystal switchings.
S1.6	3Z9825-29.2	Part of S1.2 (switch assembly, 3-section ceramic wafer type; index plate 4-position through 90°)	T7, T8 and crystal shorting.
S1.7	3Z9825-29.2	Part of S1.2 (switch assembly, 3-section ceramic wafer type; index plate 4-position through 90°)	V3 cathode switching.
S3.7 A <sup>1</sup>	3Z9825-62.9	Part of S3.1 (switch assembly, 5-section ceramic wafer type less index plate 6-position through 360°; shield disc between sections 4 and 5, special)	Revr osc crystal channel switching.

<sup>1</sup> Applies only to models indicated.



c. PARTS DATA—Continued.

Ref. symbol	Signal Corps stock No.	Name of part and description	Function
S3.7 B, C <sup>1</sup> . . . .	3Z9825-62.9 . . . .	Part of S3.1 (switch assembly, 5-section ceramic wafer type less index plate; 6-position through 360°; mtg bracket on front, shield disc between sections 4 and 5, special) . . . . .	Revr osc crystal switching.
T7, A, C <sup>1</sup> . . . .	2C5380-669C/C5	TRANSFORMER, osc: 2,065 to 3,135 kc when tuned with C1.3; permeability tuned; contains trimmer capacitor C37A,C; special . . . . .	Band 1 osc coil.
T7 B <sup>1</sup> . . . . .	2C5380-669C/C5	TRANSFORMER, osc: 2,065 to 3,135 kc when tuned with C1.3; permeability tuned; contains trimmer capacitor C37B; special . . . . .	Band 1 osc coil.
T8 A, C <sup>1</sup> . . . .	2C5380-669C/C4	TRANSFORMER, osc: 3,085 to 4,835 kc when tuned with C1.3; permeability tuned; contains trimmer capacitor C39A,C; special . . . . .	Band 2 osc coil.
T8 B <sup>1</sup> . . . . .	2C5380-669C/C4	TRANSFORMER, osc: 3,085 to 4,835 kc when tuned with C1.3; permeability tuned; contains trimmer capacitor C39B; special . . . . .	Band 2 osc coil.
V3 A <sup>1</sup> . . . . .	.....	TUBE JAN-6J5, VT-94 . . . . .	Revr osc.
V3 B, C <sup>1</sup> . . . .	.....	TUBE JAN-6J5GT/G, VT-94-D . . . . .	Revr osc.
V3 B, C <sup>2</sup> . . . .	.....	TUBE JAN-6J5GT/G, VT-94-D . . . . .	Revr osc.

<sup>1</sup> Applies only to models indicated.

<sup>2</sup> Applies only to models indicated on Order Nos. 32780-Phila-43 and 32871-Phila-43.

**39. I-f Amplifier Stage** (fig. 31)

a. FUNCTION OF STAGE. (1) The output of tube V2 (figs. 29, 54, and 55) is inductively coupled to the control grid of i-f Tube JAN-6SK7 (V4) through i-f transformer T5. The frequency which reaches the grid is determined by the primary and secondary parallel resonant circuits of transformer T5. The secondary is returned to the cathode through capacitor C17.

(2) The cathode of tube V4 is biased by resistor R13. This resistor is returned to the ground side of resistor R3, so that the gain of tube V4 may be controlled along with that of tube V1, using variable resistor R4. Capacitor C18 bypasses the cathode.

(3) Tube V4 obtains its screen-grid voltage directly from the receiver screen supply. The supply is bled by resistor R26 and dropped by resistor R25.

(4) The plate voltage of tube V4 is supplied directly through the primary of i-f transformer T6 from the receiver plate supply.

b. REPAIR DATA ON INTERMEDIATE-FREQUENCY STAGE. The intermediate frequency of BC-669-(\*) is 385 kc. All signal injection and signal substitution must be made at this frequency. While the frequency was established at the manufacturer's plant, it is always necessary to check this frequency and make sure that the r-f and oscillator stages track with it. Therefore, pay particular attention to the i-f stage, its transformers, and other components. I-f transformers are likely to have troubles similar to those of r-f transformer coils. Therefore the same tracing procedure to locate the spot where the signal voltage disappears, weakens, distorts, or becomes noisy must

be followed. A trouble which may appear on i-f transformers is electrolytic corrosion of primary windings. This is particularly true in units which have been operated in damp climates. Where noise is present in i-f stage, check for this type of corrosion in primary windings. Some of the types of trouble which may originate in the i-f stage, and remedies for them, are as follows:

(1) *Dead set.* Tube V4 may be defective. Transformers may be shorted or open in primary or secondary. Tube V2 may be defective. Replace defective tubes. Check transformers for continuity; if defective, replace coils. Capacitor C14 may be shorted. Check it and replace if defective. Resistor 13 may be open. Check and replace if necessary. There may be no B+ voltage reading at the screen-grid plate of V2 on voltmeter. This is probably caused by an open primary on the i-f transformer. Check and replace if necessary. Screen-grid bypass capacitor C13 may be open. Check and replace it if it is defective. If the stage is weak, carefully check its alignment. If slugs on transformers T5 and T6 do not peak the coils, padder capacitors C15, C16, C19, or C20 are either shorted or open and should be removed and replaced. Where i-f sensitivity is higher than normal, capacitors C12 or C18 may be shorted. Check and replace if defective. Where a sharp i-f picture appears when using the oscilloscope during visual alignment, resistor R10 is probably open. Disconnect one lead from transformer T5 and check continuity. Replace the resistor if it is defective. Open the control grid connection of Tube V4. Tap the lead against the contact pin. If a loud click is heard in the loudspeaker, the stage is operative.

(2) *Distorted output.* Check tube V4 for internal shorts. Check alignment of the stage.

(3) *Fading.* Check tubes. Check transformers for loose windings on coils, or loose or dirty connections. Check possible changing values of resistors due to heating after receiver is in operation. Check resistors R25, R26, R15, R13, and R12. Capacitors C17 or C18 may be intermittently open or leaky.

(4) *Hum.* Make sure that there is no inductive or capacitive coupling between filament, plate, and grid leads.

(5) *Intermittent reception.* When signal cuts off abruptly, stays off, is very weak for a period, and then becomes suddenly normal, make the visual inspection very carefully in the stage. Look particularly for poor connections, resin points, or loose pin contacts in tube sockets.

(6) *Noisy operation.* Be especially on the alert where audio output is low or strangled at the loudspeaker. Where this condition is found, the r-f and i-f components require very careful checking because any noise developed in these stages will be amplified by the stages that follow. Check the tubes. Check insulation.

(7) *Oscillation.* Check tube V4. Check the control grid of the tube by placing the fingers between control grid and ground. If oscillation disappears, it is present in the stage. Check the alignment. Check filter and bypass capacitors C22 and C18. Check plate and screen voltages. If they are too high, check resistors R12, R25, and R26. Replace defective capacitors and resistors. Make sure that all transformer shields are properly grounded.

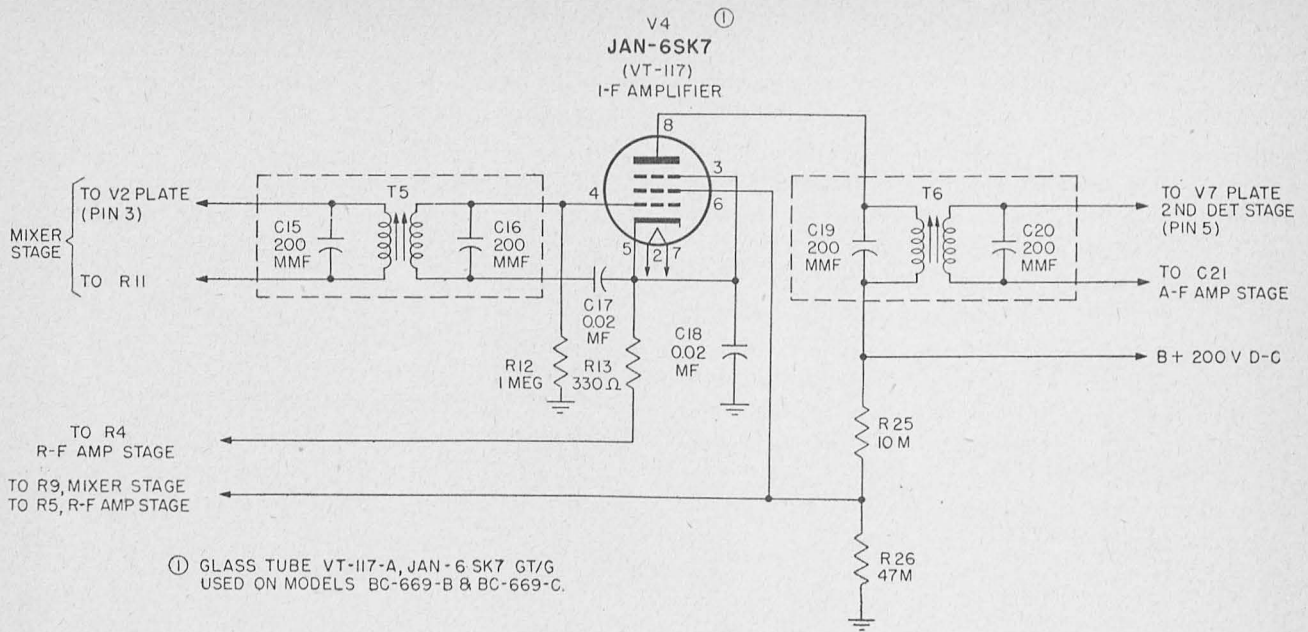

FOR TEST CONDITIONS  
SEE PARAGRAPH 23.

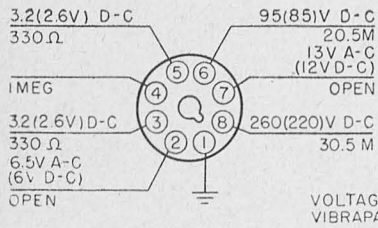

NOTE:  $\frac{1}{\text{---}}$  IS SYMBOL FOR FIXED CAPACITOR.  
M=1,000 OHMS.

TL 19707

VOLTAGES IN ( ) ARE FOR  
VIBRAPACK OPERATION.

Figure 31. Radio Receiver and Transmitter BC-669-(\*), i-f amplifier stage, schematic diagrams.

### c. PARTS DATA.

Ref. symbol	Signal Corps stock No.	Name of part and description	Function
C15	3D390	CAPACITOR: 200 mmf, $\pm 5\%$ ; 500 vdcw; molded silver-mica; small postage stamp type	T5 pri resonator.
C15 C <sup>1</sup>	3D390	CAPACITOR: 200 mmf, $\pm 5\%$ ; 500 vdcw; temp coef 0.0075; tubular, ceramic	T5 pri resonator.
C16	3D390	CAPACITOR: 200 mmf, $\pm 5\%$ ; 500 vdcw; molded silver-mica; small postage stamp type	T5 pri resonator.
C16 C <sup>1</sup>	3D390	CAPACITOR: 200 mmf, $\pm 5\%$ ; 500 vdcw; temp coef 0.00075; tubular, ceramic	T5 pri resonator.
C17 A, B <sup>1</sup>	3DA20-45	CAPACITOR: 0.02 mf, $-10\%$ $+20\%$ ; 400 vdcw; molded paper	T5 sec return.
C17 C <sup>1</sup>	3DA20-45	CAPACITOR: 0.02 mf, $\pm 20\%$ ; 400 vdcw; molded paper	T5 sec return.
C18 A, B <sup>1</sup>	3DA20-45	CAPACITOR: 0.02 mf, $-10\%$ $+20\%$ ; 400 vdcw; molded paper	V4 cathode bypass.
C18 C <sup>1</sup>	3DA20-45	CAPACITOR: 0.02 mf, $\pm 20\%$ ; 400 vdcw; molded paper	V4 cathode bypass.
R12	3Z6801-16	RESISTOR: 1-megohm $\pm 20\%$ $\frac{1}{2}$ watt; insulated carbon	V4 grid leak.
R13	3Z6033-9	RESISTOR: 330 ohms $\pm 10\%$ ; $\frac{1}{2}$ watt; insulated carbon	V4 cathode bias.
T5	2Z9641.11	TRANSFORMER, i-f: 385 kc; double permeability tuned; contains capacitors C14 and C16; special	1st i-f amp coil.
V4 A <sup>1</sup>		TUBE, JAN-6SK7, VT-117	Revr i-f amp.
V4 B, C <sup>1</sup>		TUBE, JAN-6SK7GT/G, VT-117-A	Revr i-f amp.
V4 B, C <sup>2</sup>		TUBE, JAN-6SK7GT/G, VT-117-A	Revr i-f amp.

<sup>1</sup> Applies only to models indicated.

<sup>2</sup> Applies only to models indicated on Orders Nos. 32780-Phila-43 and 32781-Phila-43.



#### 40. Second Detector, Noise Limiter, and A-V-C Stage (fig. 32)

a. FUNCTION OF STAGE. (1) The modulated 385-kc i-f signal amplified by tube V4 (figs. 54 and 55) appears across the primary of diode i-f transformer T6. Through the inductive coupling provided by transformer T6 the signal appears across the secondary of the detector diode section of Tube JAN-6H6 (V7). Only the audio modulation appears across i-f filter capacitor C21 as a result of the detector action; the audio modulation is filtered by resistor R15 and capacitor C22, audio-fed through a voltage dividing network, consisting of resistors R31, R28, and R29. It is then coupled by capacitor C31 to the control grid of tube V5.

(2) The d-c voltage supplied by the detector is fed through filter resistor R14 to supply an a-v-c voltage to the control grids of tubes V1 and V2, and through filter resistor R16 and grid leak resistor R17 as a-v-c voltage to the control grid of tube V5. Any portion of the audio component remaining is removed by capacitor C23.

(3) When switch S2.2 is closed, the peak limiter diode section of tube V7 is placed in operation. The cathode of this diode section is biased to a potential which is less negative than the plate resistor R30. When an audio peak having an amplitude not exceeding the absolute value of the difference between plate and cathode potentials appears across resistor R31, no plate current flows. But, when an audio peak which exceeds this value appears across resistor R31, the cathode becomes negative to the plate, causing a flow of plate current. The negative peaks of

the audio component are then bypassed to ground through capacitor C32, limiting the amplitude of the audio voltages reaching the control grid of tube V5 to a value controlled by the bias voltage on the diode plate.

b. REPAIR DATA FOR SECOND DETECTOR, NOISE LIMITER AND A-V-C STAGE. As indicated in *a* above, tube V7 and its circuits operate as a detector, noise limiter, and a-v-c stage. Tube JAN-6H6 (V7) is of the double diode type. The major troubles which show up in this stage are as follows:

(1) *Dead unit.* No B+ voltage reading is secured at output of i-f tube V4. Check the primary of i-f transformer T6. If the coil is defective, replace it. Also check i-f filter capacitor C22. The reading on the ohmmeter should be infinite with one lead disconnected. Replace the capacitor if it is defective.

(2) *Distortion.* Probably this is caused by a shorted a-v-c bypass capacitor C42, indicated by a low resistance reading from the a-v-c line to the chassis. Replace capacitor if it is defective.

(3) *Oscillation.* Oscillation stops when a good capacitor C42 is placed across a defective capacitor. Replace any defective part.

(4) *Dead noise limiter.* Check capacitors C27, C28, and choke L1. If open or shorted, replace. When the audio blocks on a strong signal, capacitors C24, C32, or resistor R30 may be shorted or open. Check and replace defective parts. If the signal output is higher with noise limiter switch ON, check capacitor C31. If defective, replace it. If noise limiter reaction to noise is poor, check capacitor C32. If open, replace it.

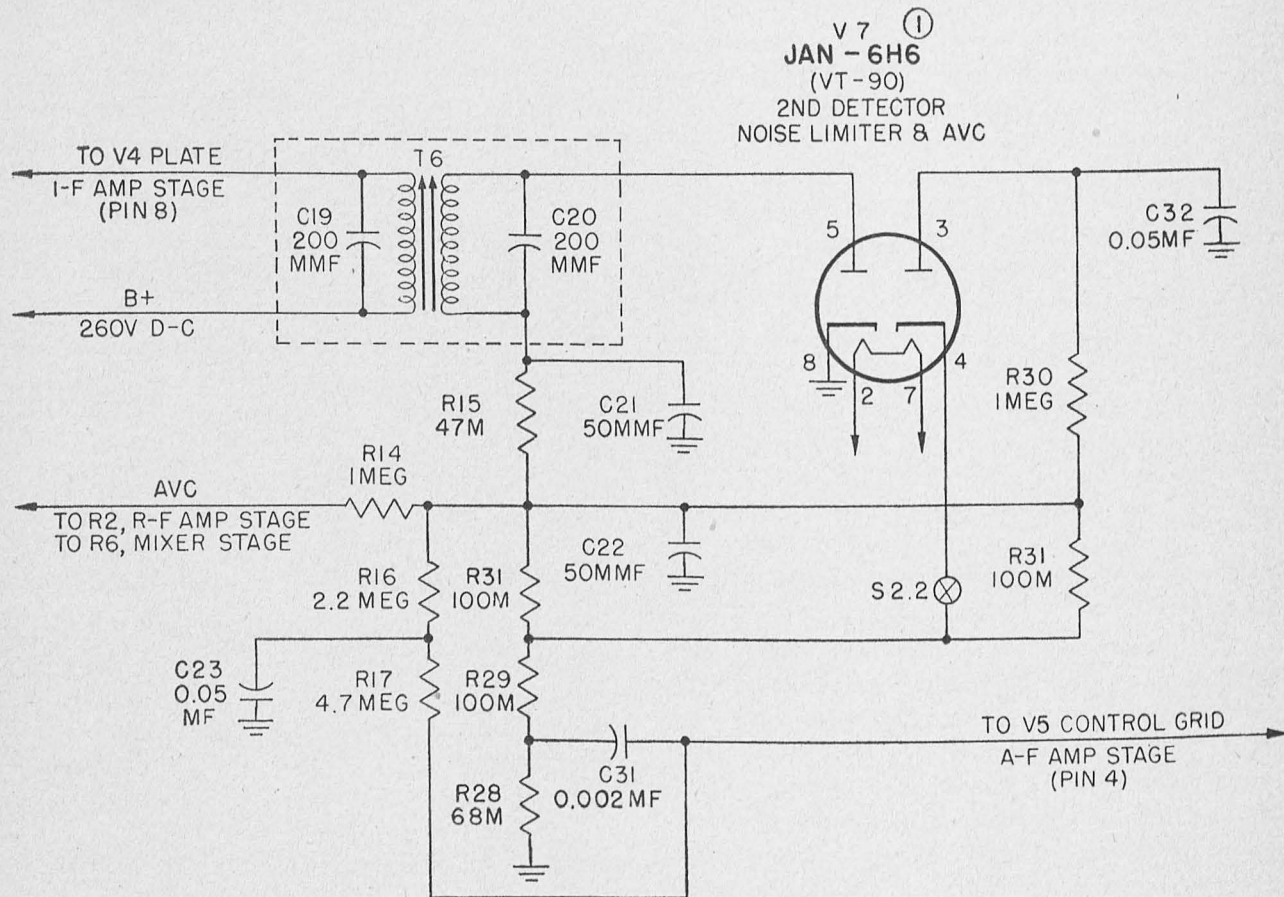

VALUES IN ( ) ARE FOR VIBRAPACK OPERATION

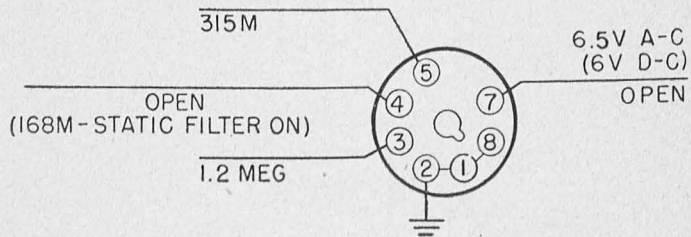

① V7 IS A JAN 6H6-GT/G GLASS TUBE FOR MODELS BC-669-B, AND BC-669-C

FOR TEST CONDITIONS SEE PARAGRAPH 23.

TL19708

NOTE:



-  IS SYMBOL FOR FIXED CAPACITOR
-  IS SYMBOL FOR VARIABLE CAPACITOR
- M = 1,000 OHMS

Figure 32. Radio Receiver and Transmitter BC-669-(\*) second detector, noise limiter, and a-v-c stage, schematic diagram.



c. PARTS DATA.

Ref. symbol	Signal Corps stock No.	Name of part and description	Function
C19	3D390	CAPACITOR: 200 mmf $\pm 5\%$ ; 500 vdcw; molded silver-mica; small postage stamp type	T6 pri resonator.
C19 C <sup>1</sup>	3D390	CAPACITOR: 200 mmf $\pm 5\%$ ; 500 vdcw; temp coef 0.00075; tubular, ceramic	T6 pri resonator.
C20	3D390	CAPACITOR: 200 mmf $\pm 5\%$ ; 500 vdcw; molded silver-mica; small postage stamp type	T6 sec resonator.
C20 C <sup>1</sup>	3D390	CAPACITOR: 200 mmf $\pm 5\%$ ; 500 vdcw; temp coef 0.00075; tubular, ceramic	T6 sec resonator.
C21	3D9050-10	CAPACITOR: 50 mmf $\pm 20\%$ ; 500 vdcw; molded mica; small postage stamp type; low-loss bakelite case	T6 sec return.
C21 C <sup>1</sup>	3D9050-10	CAPACITOR: 50 mmf $\pm 20\%$ ; 500 vdcw; temp coef 0.00075; tubular, ceramic	T6 sec return.
C22	3D9050-10	CAPACITOR: 50 mmf $\pm 20\%$ ; 500 vdcw; molded mica; small postage stamp type; low-loss bakelite case	I-f filter.
C22 C <sup>1</sup>	3D9050-10	CAPACITOR: 50 mmf $\pm 20\%$ ; 500 vdcw; temp coef 0.00075; tubular, ceramic	I-f filter.
C32 A <sup>1</sup>	3DA50-57	CAPACITOR: 0.05 mf $-10\%$ $+20\%$ ; 400 vdcw; molded paper	V7 a-n-1 diode bypass.
C32 B <sup>1</sup>	3DA50-57	CAPACITOR: 0.05 mf $-10\%$ $+20\%$ ; 400 vdcw; molded paper	V7 a-n-1 diode bypass.
C32 C <sup>1</sup>	3DA50-57	CAPACITOR: 0.05 mf $\pm 20\%$ ; 400 vdcw; molded paper	V7 a-n-1 diode bypass.
R14	3Z6801-16	RESISTOR: 1 megohm $\pm 20\%$ ; $\frac{1}{2}$ watt; insulated carbon	A-v-c filter.
R15	3Z6647-12	RESISTOR: 47,000 ohms $\pm 20\%$ ; $\frac{1}{2}$ watt; insulated carbon	Diode filter.
R28	3Z6668	RESISTOR: 68,000 ohms $\pm 10\%$ ; $\frac{1}{2}$ watt; insulated carbon	Audio voltage divider.
R29	3Z6700-72	RESISTOR: 100,000 ohms $\pm 20\%$ ; $\frac{1}{2}$ watt; insulated carbon	Audio voltage divider.
R30	3Z6801-16	RESISTOR: 1 megohm $\pm 20\%$ ; $\frac{1}{2}$ watt; insulated carbon	V7 a-n-1 diode bias.
R31	3Z6700-72	RESISTOR: 100,000 ohm $\pm 20\%$ ; $\frac{1}{2}$ watt; insulated carbon	A-n-1 peak limiting.
S2.2 A,B <sup>1</sup>	3Z9858-8.50	SWITCH: DPST toggle type; molded bakelite case	Static filter on-off; a-n-1 on-off.
S2.2 B,C <sup>1</sup>	3Z9858-8.50	SWITCH: DPST toggle type; molded bakelite case	Static filter on-off; a-n-1 on-off.
T6	2Z9641.13	TRANSFORMER: i-f 385 kc; double permeability tuned; contains capacitors C19 and C20; special	Diode i-f amp coil.
V7 A <sup>1</sup>		TUBE, JAN-6H6 (VT-90)	Rcvr second detector and a-n-1.
V7 B,C <sup>1</sup>		TUBE, JAN-6H6GT/G, (VT-90-A)	Rcvr second detector and a-n-1.
V7 B,C <sup>2</sup>		TUBE, JAN-6H6GT/G, (VT-90-A)	Rcvr second detector and a-n-1.

<sup>1</sup> Applies only to models indicated.

<sup>2</sup> Applies only to models indicated on Orders Nos. 32780-Phila-43 and 32781-Phila-43.

#### 41. Audio-voltage Amplifier Stage (fig. 33)

a. FUNCTION OF STAGE. (1) The cathode of Tube JAN-6SK7 (V5) is connected to ground, and the control grid receives its bias, filtered by resistor R16 and capacitor C23, from the a-v-c voltage supply through grid leak resistor R17.

(2) The screen grid of tube V5 receives its voltage filtered by resistor R18 and capacitor C25, through dropping resistor R19. The screen grid is bypassed by capacitor C24, and is returned to ground through a set of contacts in relay RY1. The relay is closed when in transmit position, cutting out the receiver.

(3) The plate receives its voltage, filtered by resistor R18 and capacitor C25, through load resistor R20.

b. REPAIR DATA ON AUDIO-VOLTAGE AMPLIFIER STAGE. As noted in the stage data in paragraph 41a(1) the two audio stages are capacitance-resistance coupled. Therefore, particular attention must be directed to the capacitor and resistance components of these stages. Excessive heat develops in the carbon resistors of this stage when shorts occur in its associated circuits. Capacitors, likewise, break down under excessive load conditions. Accordingly, the repairman must make sure that the audio component is in correct operating order. Listed below





c. PARTS DATA.

Ref. symbol	Signal Corps stock No.	Name of part and description	Function
C23 A <sup>1</sup> .....	3DA50-57 .....	CAPACITOR: 0.05 mf -10% +20%; 400 vdcw; molded paper .....	V5 a-v-c filter.
C23 B <sup>1</sup> .....	3DA50-57 .....	CAPACITOR: 0.05 mf -10% +20%; 400 vdcw; molded paper .....	V5 a-v-c filter.
C23 C <sup>1</sup> .....	3DA50-57 .....	CAPACITOR: 0.05 mf ±20%; 400 vdcw; molded paper .....	V5 a-v-c filter.
C24 A,B <sup>1</sup> .....	3DA100-112 .....	CAPACITOR: 0.1 mf -10% +20%; 400 vdcw; molded paper .....	V5 screen bypass.
C24 C <sup>1</sup> .....	3DA100-112 .....	CAPACITOR: 0.1 mf ±20%; 400 vdcw; molded paper .....	V5 screen bypass.
C25 A,B <sup>1</sup> .....	3DA50-57 .....	CAPACITOR: 0.05 mf -10% +20%; 600 vdcw; molded paper .....	V5 plate and screen filter.
C25 C <sup>1</sup> .....	3DA50-57 .....	CAPACITOR: 0.05 mf ±20%; 600 vdcw; molded paper .....	V5 plate and screen supply filter.
C26 A,C <sup>1</sup> .....	3DA50-57 .....	CAPACITOR: 0.005 mf ±20%; 300 vdcw; molded mica; postage stamp type .....	V6 audio coupling.
C26 B <sup>1</sup> .....	.....	CAPACITOR: 0.006 mf ±20%; 600 vdcw; molded paper .....	V6 audio coupling.
C26 C <sup>1</sup> .....	.....	CAPACITOR: 0.005 mf ±20%; 400 vdcw; molded paper .....	V6 audio coupling.
C27 A <sup>1</sup> .....	3DA7.500 .....	CAPACITOR: 0.0075 mf ±20%; 300 vdcw; molded mica; postage stamp type .....	Static filter resonator.
C27 B <sup>1</sup> .....	3DA7.500 .....	CAPACITOR: 0.007 mf ±20%; 400 vdcw; molded paper .....	Static filter resonator.
C27 C <sup>1</sup> .....	3DA7.500 .....	CAPACITOR: 0.0075 mf ±10%; 300 vdcw; molded mica; postage stamp type .....	Static filter resonator.
C28 A,B <sup>1</sup> .....	3DA1D0-112 .....	CAPACITOR: 0.1 mf -10% +20%; 400 vdcw; molded paper .....	V6 cathode filter.
C28 C <sup>1</sup> .....	3DA1D0-112 .....	CAPACITOR: 0.1 mf ±20%; 400 vdcw; molded paper .....	V6 cathode filter.
C31 A,C <sup>1</sup> .....	3DAZ-73 .....	CAPACITOR: 0.002 mf ±20%; 500 vdcw; molded mica; postage stamp type .....	V5 audio coupling.
C31 B <sup>1</sup> .....	3DAZ-73 .....	CAPACITOR: 0.002 mf ±20%; 600 vdcw; molded paper .....	V5 audio coupling.
C31 C <sup>1</sup> .....	3DAZ-73 .....	CAPACITOR: 0.002 mf ±20%; 400 vdcw; molded paper .....	V5 audio coupling.
L1 .....	3C371-3 .....	REACTOR: 3.3 henries ±10% at 1,000 cps; 185 ohms d-c resistance; metal case .....	1,000 cps static inductance.
R16 .....	3Z6802A2-9 .....	RESISTOR: 2.2 megohms ±20%; ½ watt; insulated carbon .....	Audio a-v-c filter.
R17 .....	3Z6804A7-3 .....	RESISTOR: 4.7 megohms ±20%; ½ watt; insulated carbon .....	V5 grid leak.
R18 .....	3Z6633-7 .....	RESISTOR: 33,000 ohms ±20%; ½ watt; insulated carbon .....	V5 plate and screen supply filter.
R19 .....	3Z6801-16 .....	RESISTOR: 1 megohm ±20%; ½ watt; insulated carbon .....	V5 screen dropping.
R20 .....	3Z6722-12 .....	RESISTOR: 220,000 ohms ±20%; ½ watt; insulated carbon .....	V5 plate load.
R21 .....	2Z7272-21 .....	RESISTOR: 500,000-ohm potentiometer; carbon; 3-terminal .....	Revr a-f gain.
R24 .....	3Z6747-14 .....	RESISTOR: 470,000 ohms ±20%; ½ watt; insulated carbon .....	V6 grid filter.
R25 .....	3Z6610-70 .....	RESISTOR: 10,000 ohms ±10%; 10 watts; vitreous enameled wire-wound .....	V1, V2, V4 screen dropping.
R26 .....	3Z6647-8 .....	RESISTOR: 47,000 ohms ±10%; 1 watt; insulated carbon .....	V1, V2, V4 screen bleeder.
S2.1 A,B .....	3Z9858-8.50 .....	SWITCH: DPST toggle type; molded bakelite case .....	Static filter on-off; a-n-1 on-off.
S2.1 B,C <sup>1</sup> .....	3Z9858-8.50 .....	SWITCH: DPST toggle type; molded bakelite case .....	Static filter on-off; a-n-1 on-off.
V5 A <sup>1</sup> .....	.....	TUBE: JAN-6SK7 (VT-117) .....	Revr 1st audio amp and avc.
V5 B,C <sup>1</sup> .....	.....	TUBE: JAN-6SK7GT/G (VT-117-A) .....	Revr 1st audio amp and avc.
V5 B,C <sup>2</sup> .....	.....	TUBE: JAN-6SK7GT/G (VT-117-A) .....	Revr 1st audio amp and avc.

<sup>1</sup> Applies only to models indicated.

<sup>2</sup> Applies only to models indicated on Orders Nos. 32780-Phila-43 and 32781-Phila-43.



## 42. A-f Power-amplifier Stage (fig. 34)

a. FUNCTION OF STAGE. Audio-frequency power-amplifier TUBE JAN-6K6-GT/G (V6) amplifies the output of tube V5, and provides sufficient power to drive speaker LS1.

(1) The output of tube V5 is capacity-coupled to the control grid of tube V6 by capacitor C26, by variable resistor R21, and by resistor R24. The audio gain is controlled by varying the input to the control grid with variable resistor R21.

(2) The cathode of tube V6 is biased by resistor R23. Capacitor C28 is connected from the grid return to the cathode to filter out variations in cathode voltage, and, together with resistor R24, to eliminate the need for a high-value cathode bypass capacitor across R23.

(3) Screen voltage for tube V6 is direct from receiver plate supply, bypassed by capacitor C30.

(4) Plate voltage is direct from output of output transformer T9 on the modulator chassis. Connection is made through contact No. 8 of socket SO1 and plug PL1. Plate is bypassed by capacitor C29.

(5) Audio-output power of tube V6 is transferred to the voice coil of speaker L1 by means of transformer T9. The secondary of T9 has an impedance of 6 ohms to match the voice coil impedance. The secondary is also connected to the headset through contact F on plug PL3 which connects to Remote Control Unit RM-21-(\*).

(6) BC-669-B and BC-669-C transformers T7 have 100-ohm secondaries which connect to Headset HS-30-(\*), through contact F on plug PL3 and through Remote Control Unit RM-21-(\*). Six-ohm taps are provided on T9 secondaries and connected to switch S4 (ON-OFF speaker switch).

(7) Audio choke L1 and capacitor C27 form a parallel-resonant circuit, resonant at 1,000 cycles. With switch S2.1 closed, the circuit connects across R21, offering low impedance between grid and ground to a-f currents outside of the 1,000-cycle frequency band.

(8) Switch S4 is provided for turning speaker LS1 on and off. At ON the voice coil connects to the secondary of transformer T9. At OFF, resistor R51 is connected in place of the speaker to maintain a proper load on transformer T9.

b. REPAIR DATA ON AUDIO-POWER AMPLIFIER STAGE. The audio-power amplifier stage should be carefully checked against an injected signal at its control grid, pin No. 5, only after all the preceding

stages have been carefully tested and the repairs indicated by the various tests have been made. Locating and eliminating defective circuit components leading up to the audio-power amplification stage makes it easier to determine and locate defects in this stage, and reduces the possibility of harm to the stage caused by operating the unit under generally defective conditions. The conditions met in this stage which cause receiver trouble are:

(1) *Dead stage.* To determine the cause, check tube V6 for internal shorts, breaks, or loose elements which cause the tube to go microphonic in this stage. If the tube is defective, replace it. Check B+ voltage at plate, pin No. 3, and at screen grid, pin No. 4. Check it also at pins No. 8 and 10 of Plug PL1. Check the voice coil in speaker LS1, with power off, for continuity. If the speaker rattles, take the speaker apart and see if the pole piece touches the voice coil. Replace an open or shorted voice coil. If the pole piece rubs, make needed adjustments or repairs. Check transformer T9 for continuity on both primary and secondary windings. If it is defective, replace it. Continuity of the secondary is checked between terminals 6 and S4 with the lead from T9 to ON-OFF switch disconnected. Primary reading is taken between terminals P and B. Check capacitors C28, C29, and C30. If defective, replace them. Check resistors R21, R23, and R24. Replace, if defective. Check particularly variable resistor R21. Make sure contact is positive and even over the entire range.

(2) *Distortion.* Make sure that the tube called for in the circuit diagram is in the socket of the stage. Check grid voltage. If it is too low or too high, check R24. Replace if defective. A leaky a-f coupling capacitor causes distortion. Check C26 and C31 and replace if defective. Check for open or short circuit in transformer T9; replace transformer if defective. For overloading of a-f amplifier due to excess signal voltage, reduce volume level. For loading of detector stage, reduce r-f volume. Check a-v-c line for leaky a-v-c capacitors, for bypass C4, and for a-v-c filter C23, C41, and C42. For improper filtering of the r-f component following demodulation, which allows radio frequency to enter audio circuits, check capacitor C22 in the i-f and r-f filters.

(3) *Hum.* This may be caused by an open potentiometer (volume control). Check, and replace it if defective. If grid circuit is open, check and repair it.



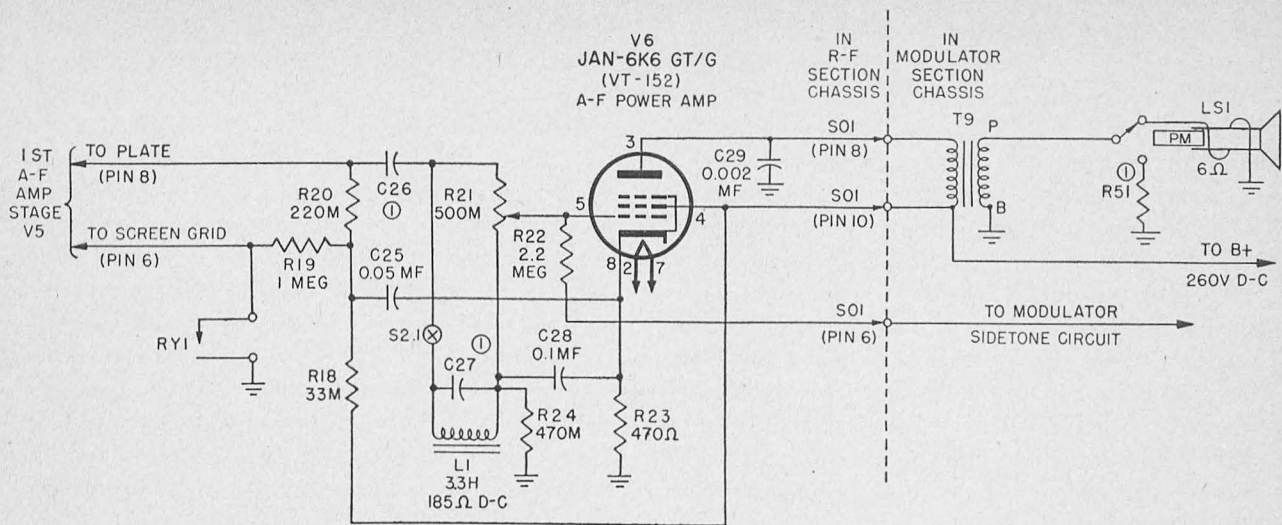

MODEL	C26	C27	R51
BC-669-A	0.005 MF	0.0075 MF	100Ω 33Ω
BC-669-B	0.006 MF	0.007 MF	6Ω
BC-669-C	0.005 MF	0.0075 MF	6Ω

VALUES IN ( ) ARE FOR VIBRAPACK OPERATION

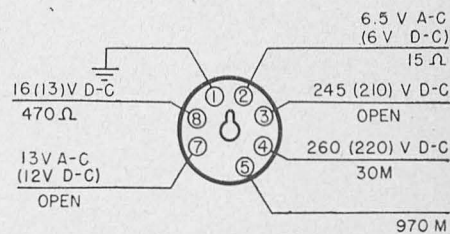

FOR TEST CONDITIONS SEE PARAGRAPH 23.

TL 19710

NOTE:

⊢ IS SYMBOL FOR FIXED CAPACITOR

⊢ IS SYMBOL FOR VARIABLE CAPACITOR

M=1,000 OHMS

Figure 34. Radio Receiver and Transmitter BC-669-(\*), audio-power amplifier stage, schematic diagram.

### c. PARTS DATA.

Ref. symbol	Signal Corps stock No.	Name of part and description	Function
C29 A*	3DA2-71	CAPACITOR: 0.002 mf $\pm 20\%$ ; 800 vdcw; molded mica; postage stamp type.....	V6 plate bypass.
C29 B,C*	3DA2-71	CAPACITOR: 0.002 mf $\pm 10\%$ ; 2,500 vdcw; molded mica .....	V6 plate bypass.
C30 A,B*	3DA50-57	CAPACITOR: 0.05 mf $-10\%$ $+20\%$ ; 600 vdcw; molded paper .....	V6 screen bypass.
C30 C	3DA50-57	CAPACITOR: 0.05 mf $\pm 20\%$ ; 600 vdcw; molded paper .....	V6 screen bypass.
R22	3Z6802A2-9	RESISTOR: 2.2 megohms $\pm 20\%$ ; $\frac{1}{2}$ watt; insulated carbon .....	Sidetone coupling.
R23	3Z6047-7	RESISTOR: 470 ohms $\pm 10\%$ ; 2 watts; insulated carbon .....	V6 cathode bias.
R47	3Z6001 E 5-2	RESISTOR: 15 ohms $\pm 10\%$ ; 10 watts.....	V6 fil dropping.
V6		TUBE, JAN-6K6GT/G, (VT-152) .....	Rev'r audio-power output.
V6 B,C*		TUBE, JAN-6K6GT/G, (VT-1252) .....	Rev'r audio-power output.

\* Applies only to indicated models.

### 43. Receiver B-f-o Stage (figs. 35 and 36)

*a. FUNCTION OF STAGE.* B-f-o Tube JAN-6J5 (V21) (for models AM, BM, and CM) or Tube JAN-12SN7GT (V7) (for model D) provides the oscillator frequency for beating against the 385-ke, i-f signal frequency. The frequency difference between the two signals can be varied by the CW OSC PITCH control to permit audible tone as desired.

*b. MODELS AM, BM, AND CM.* The oscillator gets its plate voltage through resistor R79 (bypassed by capacitor C94) from plate supply to i-f amplifier. The grid of the oscillator tube is coupled to coil T17 by a grid leak consisting of resistor R80 and capacitor C96. The cathode is connected to a tap on coil T17 near the ground end. Capacitors C97 and C99 are fixed across the coil. CW OSC PITCH control is a

variable capacitor C98. The coil is tuned to approximately 385 kc by an iron-core slug, which can be adjusted by a small control located near the bottom of transformer housing T17.

*c. MODEL D.* The plate voltage for this oscillator is obtained through resistor R80 (bypassed by capacitors C95 and C96) from the screen supply at the junction of resistors R25 and R26. The grid of the oscillator tube is coupled to coil T17 through capacitor C94 and the cathode is connected to a tap near the ground end of coil T17. Grid bias is built up by resistor R81. C93 is a fixed capacitor across the coil, and C92 is a variable capacitor used as the CW OSC PITCH control. The coil is tuned to approximately 385 kc by an iron-core slug as in models AM, BM, and CM.

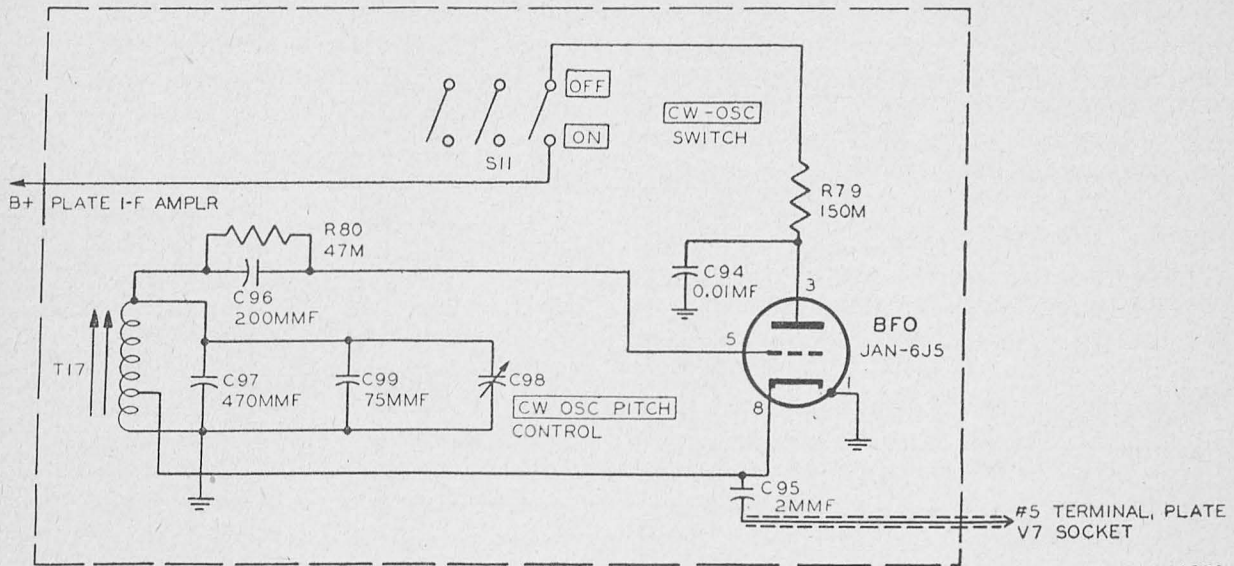

NOTE.  $\text{---} \text{||} \text{---}$  IS SYMBOL FOR FIXED CAPACITOR  
 $\text{---} \text{||} \text{---} / \text{---}$  IS SYMBOL FOR VARIABLE CAPACITOR.  
 M=1,000  $\Omega$

TL11952S

Figure 35. Radio Receiver and Transmitters BC-669-AM, -BM, and -CM, beat-frequency oscillator stage.

d. PARTS DATA (Receiver).

Ref. symbol	Signal Corps stock No.	Name of part and description	Function
C94	(*)		Plate bypass capacitor.
C95	3D9003-12	CAPACITOR: fixed; mica; 3 mf; $\pm 20\%$ ; 500 vdcw; Dubilier type 5WLS	Coupling capacitor.
C96		CAPACITOR: Same as C95	Grid coupling capacitor.
C97	3K2551143	CAPACITOR: fixed; silver mica; 500 mf; $\pm 2\%$ ; 300 vdcw; JAN type CM25D50011G	Padding capacitor.
C98		CAPACITOR: Same as C97	Pitch control capacitor.
C99	(*)		Padding capacitor.
R79	3RC21BE154M	RESISTOR: fixed; carbon; 150,000 ohms; $\pm 20\%$ ; $\frac{1}{2}$ watt	Plate voltage-dropping resistor.
R80	(*)		Grid bias resistor.
S1.1	3Z9825-80.2	SWITCH: rotary; selector; 7 pole; 4-position; 3-section; Erla No. 13848 (for model C only)	Circuit selector.
T17	2Z9641.182	COIL ASSEMBLY: radio; bfo; iron core; Erla No. 16117	B-f-o plate inductance.
VT-94	2J6J5	TUBE: JAN-6J5	Oscillator tube.

\* Indicates stock not available.



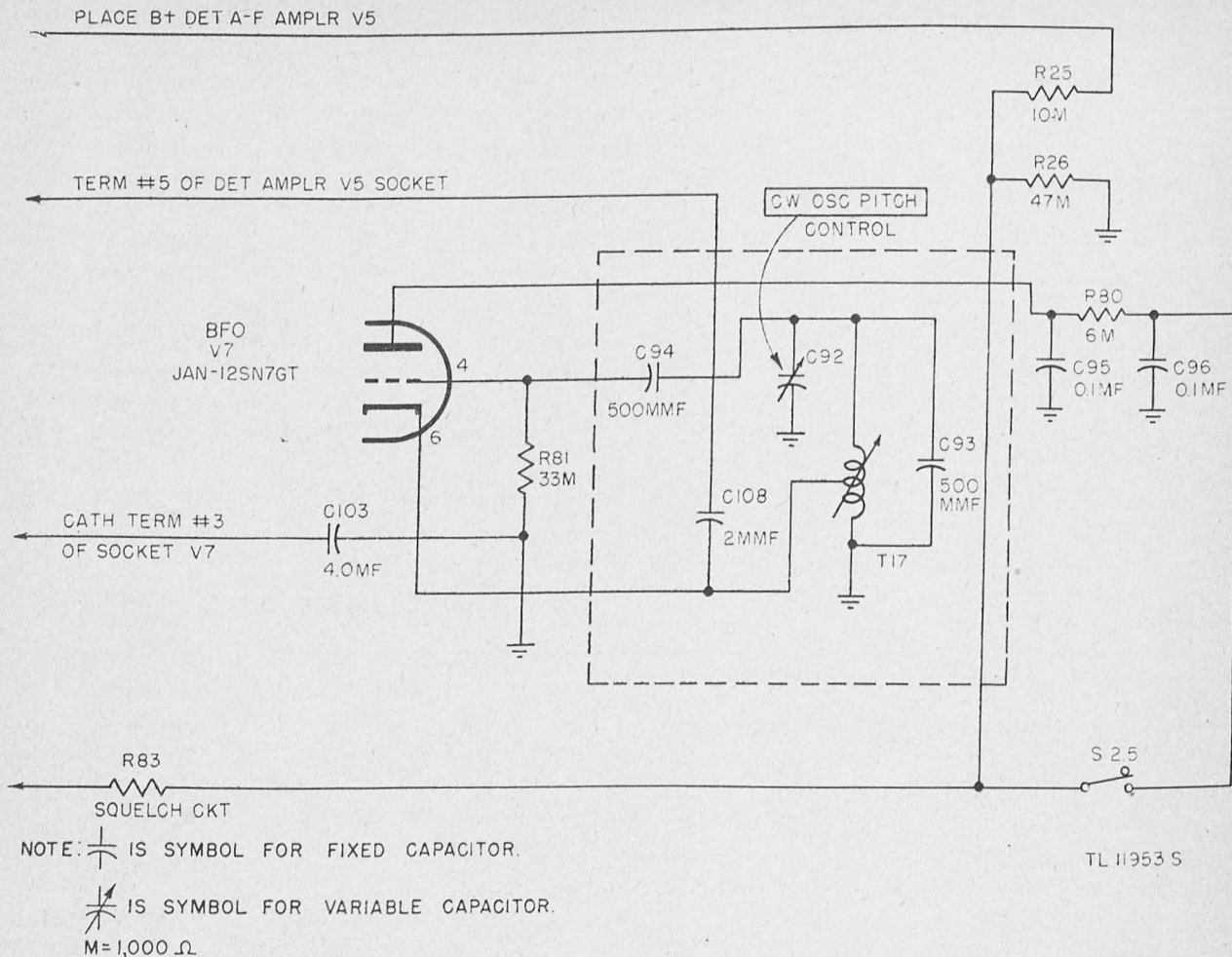

Figure 36. Radio Receiver and Transmitter BC-669-D, beat-frequency oscillator stage.

c. PARTS DATA (Model D) (Receiver.)

Ref. symbol	Signal Corps stock No.	Name of part and description	Function
C92	(*)		Pitch control capacitor.
C93	3K2551143	CAPACITOR: fixed; silver mica; 500 mmf; $\pm 2\%$ ; 300 vdcw; JAN type CM25D50011G	Padding capacitor.
C94		CAPACITOR: Same as C93	Grid coupling capacitor.
C95	3DA100-112.1	CAPACITOR: fixed; paper; 0.1 mf $\pm 20\%$ ; 100 vdcw molded mica; type 345-21	Filter capacitor.
C96		CAPACITOR: Same as C95	Filter capacitor.
C103	3DB4-165	CAPACITOR: fixed; paper; 4 mf $+14\%$ $-6\%$ ; 50 vdcw; Gudeman No. 7541	Cathode coupling capacitor.
R25	3Z6610-70	RESISTOR: fixed; wire-wound; 10,000 ohms $\pm 10\%$ ; 10 watt; Utah type VWQ	Plate voltage-dropping resistor.
R26	3RC21BE473K	RESISTOR: fixed; carbon; 47,000 ohms, $\pm 10\%$ ; 1 watt	Voltage regulating resistor.
R80	3RC21BE622	RESISTOR: fixed; carbon; 6,000 ohms, $\pm 10\%$ ; $\frac{1}{2}$ watt	Resistance filter.
R81	3RC21BE333M	RESISTOR: fixed; carbon; 33,000 ohms, $\pm 20\%$ ; $\frac{1}{2}$ watt	Grid leak resistor.
R83	3RC21BE224K	RESISTOR: fixed; carbon; 220,000 ohms, $\pm 10\%$ ; $\frac{1}{2}$ watt	Squelch cathode voltage dropping.
T17	2Z9641.182	COIL ASSEMBLY: radio; bfo; iron core; Erla No. 16117	B-f-o plate inductance.
S2.5	3Z9825-62.170	SWITCH: rotary; 2 position; 6 pole; Erla No. 16101	Circuit selector.
V7	2J12SN7GT	TUBE: JAN-12SN7GT	Oscillator tube.

\* Indicates stock not available.

#### 44. Transmitter Oscillator Stage (fig. 37)

*a. FUNCTION OF STAGE.* Oscillator Tube JAN-6L6 (V10) (VT-115) (fig. 37), generates oscillations at radio frequency to provide power to the final r-f amplifier stage, and maintains oscillations at selected frequency. (Models BC-669-B and BC-669-C use Tube JAN-6L6-G (VT-115A) for V10.)

(1) Oscillation frequency is determined by a selected crystal which is connected between the control grid and the plate of tube V10. Switch sections S3.5 and S3.6 control crystal selection switching. Capacitor C60 is connected in series with the crystals to keep the d-c voltage off the crystals. Capacitor C62 is connected across grid leak resistor R46 to provide excitation.

(2) Cathode bias is provided by a voltage drop across resistor R45. This resistor is grounded through a set of contacts in RY1, which is closed in the transmit position, but is open in the receive position to disconnect the transmitter oscillator. Cathode is bypassed by capacitor C61.

(3) The plate of tube V10 gets its voltage from the transmitter plate supply through contact No. 9 of socket SO1 and plug PL1, and through dropping resistor R43 and r-f choke L7. This choke prevents r-f voltages from entering the transmitter plate supply. Plate supply is bypassed by capacitor C58.

(4) Screen-grid voltage is supplied through resistor R44 and bypassed by capacitor C59.

*b. REPAIR DATA ON OSCILLATOR STAGE OF TRANSMITTER.* (1) *General.* Since the transmitter oscillator is tuned to a specific frequency only by the crystal selected, it is necessary to pay special attention to sections S3.5 and S3.6 of the channel switch to make certain that contacts shall be positive and clean. Good electrical contact must be established here to have the transmitter operating at full efficiency. In addition to dependable switching it is also necessary to be sure that the contacts in the crystal sockets are equally positive and clean. Con-

tacts at tube sockets, likewise, must be checked and adjusted to make sure that pins engage the contacts and that there are no open circuits between tube pins and contacts. Relay action must be carefully checked because the cathode of oscillator tube V10 is grounded by the relay action of RY1, when the transmitter is switched on through handset or headset operating through remote Control Unit RM-21-( ). Unless this contact is clear, the transmitter will not operate. For the purpose of checking and testing, a small piece of heavy cardboard or other nonconducting material can be inserted in relay RY1 to close the transmitter contacts and open the receiver contacts. Be sure to remove the cardboard on completion of the test.

(2) Specific points to be checked in the repair of the oscillator stage are as follows:

(a) Check the tube; replace if defective.

(b) Check voltages at sockets. Make sure that filament voltage (pins No. 2 and 7) is right. Check resistor R27. Replace it if it is shorted or open. Check grid voltages at pins No. 4 and 5. Check plate voltage at pin No. 3. Make certain that grid voltages are right.

(c) Carefully clean switch sections S3.5 and S3.6. Repair any looseness of contact if possible. If switch contacts are worn or otherwise defective, replace switch section.

(d) Check capacitors C57, C58, C59, C60, C61, and C62. Give capacitor C60 a very thorough check. As noted in the data on stage function, it keeps the direct current off the crystal.

(e) Check r-f choke L7. If open, there will be no plate current. Replace if defective.

(f) Check resistors R27, R43, R44, R45, and R46.

(g) Make point-to-point continuity check of components in this stage.

(h) Check relay contacts and action of RY1.

(i) Check crystals, both in actual operation and by means of frequency meter.

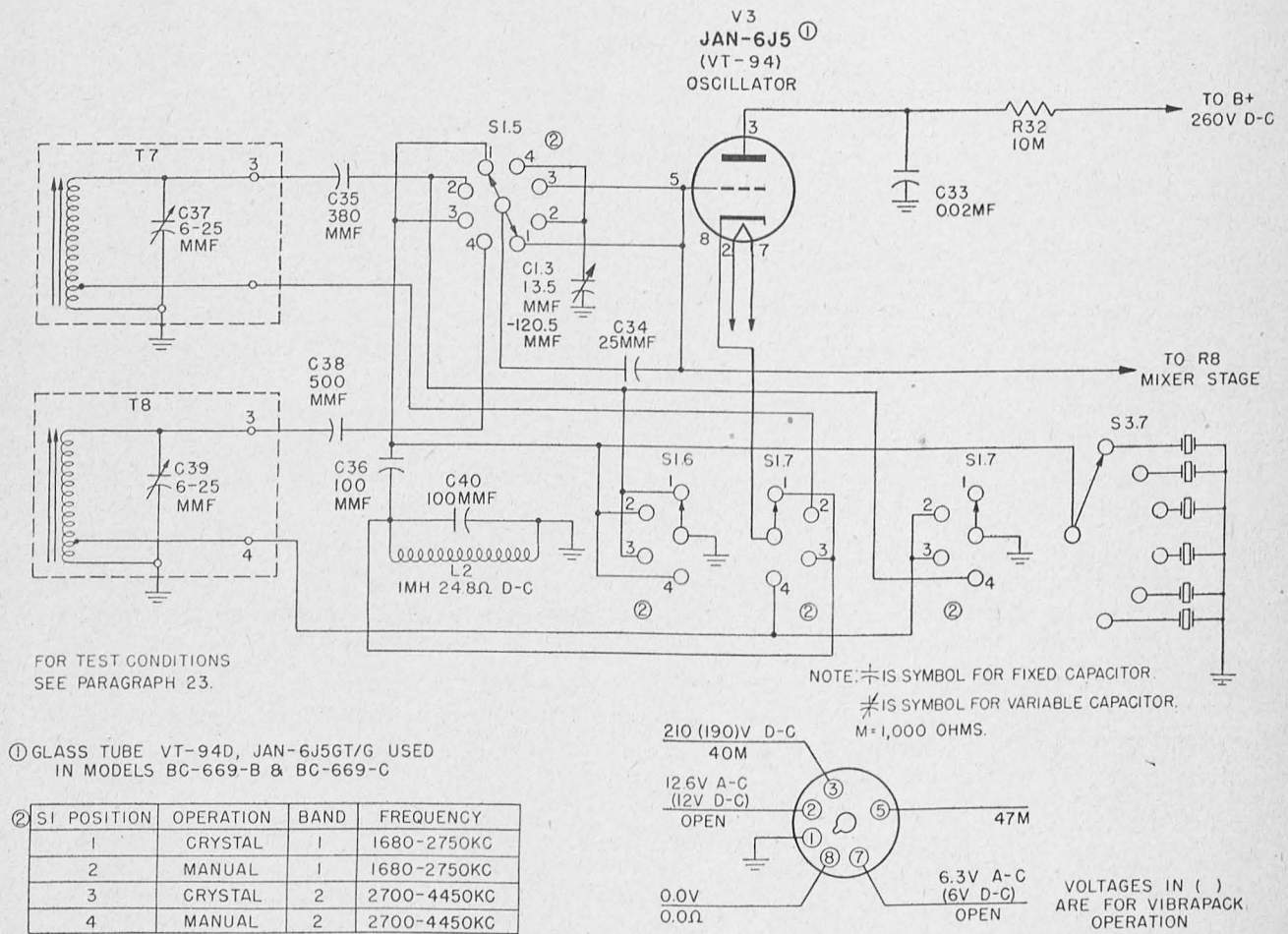

TL 19711

Figure 37. Radio Receiver and Transmitter BC-669-(\*), transmitter oscillator stage, schematic diagram



c. PARTS DATA.

Ref. symbol	Signal Corps stock No.	Name of part and description	Function
C57	3D9050-10	CAPACITOR: 50 mmf $\pm 5\%$ ; 500 vdcw; molded silver-mica; small postage stamp type	V9 grid d-c blocking.
C57 C <sup>1</sup>	3D9050-10	CAPACITOR: 50 mmf $\pm 50\%$ ; 500 vdcw; zero temp coef; tubular ceramic	V9 grid d-c blocking.
C58 A,C <sup>1</sup>	3DAZ-73	CAPACITOR: 0.002 mf $\pm 10\%$ ; 500 vdcw; molded mica; postage stamp type	V10 plate and screen supply bypass.
C58 B <sup>1</sup>	3DAZ-73	CAPACITOR: 0.002 mf $\pm 20\%$ ; 600 vdcw; molded paper	V10 plate and screen supply bypass.
C59 A,C <sup>1</sup>	3DAZ-73	CAPACITOR: 0.002 mf $\pm 10\%$ 500 vdcw; molded mica; postage stamp type	V10 screen bypass.
C59 B <sup>1</sup>	3DAZ-73	CAPACITOR: 0.002 mf $\pm 20\%$ ; 600 vdcw; molded paper	V10 screen bypass.
C60 A,C <sup>1</sup>	3DA6-45	CAPACITOR: 0.006 mf $\pm 10\%$ ; 300 vdcw; molded mica; postage stamp type	Trans crystal d-c blocking.
C60 B <sup>1</sup>	3DA6-45	CAPACITOR: 0.006 mf $\pm 20\%$ ; 600 vdcw; molded paper; postage stamp type	Trans crystal d-c blocking.
C61 A <sup>1</sup>	3DA6-45	CAPACITOR: 0.006 mf $\pm 10\%$ ; 300 vdcw; molded mica; postage stamp type	V10 cathode bypass.
C61 B <sup>1</sup>	3DA6-45	CAPACITOR: 0.006 mf $\pm 20\%$ ; 600 vdcw; molded paper	V10 cathode bypass.
C61 C <sup>1</sup>	3DA6-45	CAPACITOR: 0.006 mf $\pm 20\%$ ; 400 vdcw; molded paper	V10 cathode bypass.
C62 A,B <sup>1</sup>	3D9050-10	CAPACITOR: 50 mmf $+75 - \frac{1}{2}\%$ ; 500 vdcw; molded silver-mica; small postage stamp type	V10 grid excitation.
C62 C <sup>1</sup>	3D9050-10	CAPACITOR: 50 mmf $\pm 50\%$ ; 500 vdcw; zero temp coef; tubular ceramic	V10 grid excitation.
L7		COIL, r-f choke; 1 mh $\pm 3\%$ ; 24.8 ohms d-c resistance; 4-pi universal wound	V10 plate choke.
R27	3Z5997-7	RESISTOR: 7.5 ohms $\pm 10\%$ ; 10 watts; vitreous enameled; wire-wound	V10 fil dropping.
R43	3Z6630-20	RESISTOR: 30,000 ohms $\pm 10\%$ ; 10 watts; vitreous enameled; wire-wound	V10 plate and screen dropping.
R44	3Z6647-8	RESISTOR: 47,000 ohms $\pm 10\%$ ; 1 watt; insulated carbon	V10 screen dropping.
R45	3Z6012A5-3	RESISTOR: 125 ohms $\pm 10\%$ ; $\frac{1}{2}$ watt; insulated wire-wound	V10 cathode bias.
R46	3Z6647-8	RESISTOR: 47,000 ohms $\pm 10\%$ ; 1 watt; insulated carbon	V10 gridleak.
RY1 A,C <sup>1</sup>	2Z7638-3+1	RELAY: DPDT, plus one set of normally open contacts; coil 115 v 60 cps ac; special	Antenna change-over.
RY1 B <sup>1</sup>	2Z7638-3+1	RELAY: DPDT, plus one set of normally open contacts; coil 115 v 60 cps ac; special	Antenna change-over.
S3.5 A <sup>1</sup>	3Z9825-62.9	Part of S3.1 (switch assembly, 5-section ceramic wafer type less index plate; 6-position through 360°; shield disc between sections 4 and 5; special)	V10 plate circuit crystal channel switching.
S3.5 B,C <sup>1</sup>	3Z9825-62.9	Part of S3.1 (switch assembly, 5-section ceramic wafer type less index plate; 6-position through 360°; shield disc between sections 4 and 5; special)	V10 plate circuit crystal channel switching.
S3.6 A <sup>1</sup>	3Z9825-62.9	Part of S3.1 (switch assembly, 5-section ceramic wafer type less index plate; 6-position through 360°; shield disc between sections 4 and 5; special)	V10 grid circuit crystal channel switching.
S3.6 B,C <sup>1</sup>	3Z9825-62.9	Part of S3.1 (switch assembly, 5-section ceramic wafer type less index plate; 6-position through 360°; shield disc between sections 4 and 5; special)	V10 plate circuit crystal channel switching.
V10 A <sup>1</sup>		TUBE, JAN-6L6, (VT-115)	Transmitter oscillator.
V10 B,C <sup>1</sup>		TUBE, JAN-6L6G, (VT-115-A)	Transmitter oscillator.
V10 B,C <sup>2</sup>		TUBE, JAN-6L6GA	Transmitter oscillator.

<sup>1</sup> Applies only to models indicated.

<sup>2</sup> Applies only to models indicated on Orders Nos. 32780-Phila-43 and 32781-Phila-43.

## 45. R-f Power-amplifier Stage (fig. 38)

a. FUNCTION OF STAGE. R-f power-amplifier Tubes (V8 and V9) JAN-807 (VT-100), operate in parallel as a class C power amplifier.

(1) Oscillations produced by tube V10 are coupled to the control grids of tubes V8 and V9 through capacitor C57. This capacitor also prevents direct current from entering the amplifier grid circuit. Resistors R36 and R39 suppress parasitic oscillations in the grid circuit. Grids are grounded through r-f choke L6 and resistors R41 and R42.

(2) Cathodes of tubes V8 and V9 are connected and are biased by resistor R40. They are also connected to R45 and grounded with R40 through relay RY1. Cathodes are bypassed by capacitor C56.

(3) in BC-669-B, -C, -BM, and -CM, an additional capacitor C88 is connected between V8 cathode to ground as bypass. Cathode bias resistor R40 is disconnected from R45 and grounded directly.

(4) Plate voltage of tubes V8 and V9 is supplied through r-f choke L5, which prevents radio frequency from entering the transmitter plate supply. Capacitor C52 bypasses plate voltage supply. Resistors R34 and R37 are connected in series with tube plates to suppress parasitic oscillations.

(5) Screen voltages of V8 and V9 are obtained through resistors R35 and R38, and are bypassed by capacitors C54 and C55.

(6) The plate tank circuit comprises coil L3 in parallel with fixed capacitor C51 and variable capacitors C54, C46, C47, C48, C49, and C50. These are selectable on switch section S3.3. Capacitor C53 keeps direct current from tank coil L3.

(7) Meter M2 furnishes readings in this stage as follows:

(a) In position 2, meter connects to secondary of modulation transformer T12, in the high-voltage plate supply circuit of power-amplifier tubes V8 and V9, and indicates power-amplifier plate current. Resistor R64 acts as a shunt.

(b) In position 3, meter M2 connects to control grid circuit of tubes V8 and V9 through contact 7 of plug PL1 and socket SO1. In this position, the meter indicates power-amplifier grid current.

b. REPAIR DATA ON TRANSMITTER R-F AMPLIFIER STAGE. The components of this class C amplifier operating in parallel are matched in value to divide the voltage load and afford greater power output. The stage requires no neutralizing. For best results tubes V8 and V9 should be evenly matched. Handling the plate tank coil requires special care and the instructions given below must be closely followed. The air trimmers, capacitors C45, C46, C47, C48, C49, and C50, should be carefully cleaned and checked. This adjustment is covered in paragraph 22. Likewise

switch sections S3.1, S3.3, and S3.4 should be carefully examined to make sure that each channel is fully responsive. The repair procedure for this stage is as follows:

(1) Check tubes. Make sure that control grid leads and caps are clean and sound in contact. Replace if open or shorted.

(2) Check all voltages, including filament, grid, screen grid, plate, and cathode. Check power contacts, especially contacts *A*, *E*, *F*, and *M* of plug PL2.

(3) If there is no r-f current at meter M1, check r-f tank coil L3. If the coil is defective, replace it.

(4) If current is absent on only one frequency, the tank coil is shorted. Replace it.

(5) If no plate voltage appears on tubes V8 and V9, check other stages. Check resistors R34 and R37. If open, replace them. Check capacitor C53. If open or shorted, replace it.

(6) If no screen voltage appears on tubes V8 and V9, check other stages. Check capacitors C52, C54, and C55. If open or shorted, replace them. Also check resistors R35 and R38. If defective, replace them.

(7) If there is no p-a grid current check the connection between pin No. 7 of SO1 and PL1. Repair. Check choke L6. If open, replace it. Check resistors R36, R39, R41, and R42. If open, replace them.

(8) If there is no grid current, check the crystals. Replace dead crystals. Check tube V10. If defective, replace it. Check capacitor C60. If open, replace it. Check resistor R46. If open, replace it.

(9) Capacitors C45 to C50 are replaced as follows:

(a) Capacitors for channel 4, 5, or 6 are removed by first unscrewing the two nuts on capacitor 1, 2, or 3, according to the capacitor which is to be removed.

(b) Do not remove any wires from the capacitor on the top row; just lay the capacitor and its respective wires to the back of the chassis.

(c) Disconnect the leads from the defective capacitor by removing the nuts holding the rotor and stator leads down. Remove the wires and capacitor from its mounting.

(d) Insert new capacitor. Mount to chassis and bolt down leads.

(e) Replace top capacitor not disconnected, and redress all leads.

(10) Replace ceramic wafers on CHANNEL SWITCH. (See fig. 45.) It is easier to replace wafers than to remove the whole switch in doing this. Proceed as follows:

(a) Unsolder all leads from the defective wafer.

(b) Remove the four nuts located at the front end of the switch. Pull out the two rods at each side of the switch.



(c) Take off the inner C washer on the switch shaft, loosen the coupling and remove the shaft. Remove the defective wafer and replace new wafer exactly in the same position as the one taken out.

(d) Line up all switch centers. Gently ease the switch shaft through the switch centers.

**Caution:** Be careful when inserting switch centers, because they are easily damaged.

(e) Replace the C washer on the switch shaft. Insert the two rods and secure them in place with nuts.

(f) Align the CHANNEL SWITCH with the high-voltage switch and tighten the coupling set-screws.

(g) Connect and solder leads back on the wafer.

(h) Dress all leads to prevent shorts. Inspect wiring when finished.

(11) Replace tank coil L3 (fig. 42) as follows:

(a) Unsolder the 12 leads from the studs of tank coil L3.

(b) Loosen and remove the three nuts holding the coil to the chassis.

(c) Lift out coil and insert new coil.

(d) Remount new coil to chassis and resolder leads.

**Caution:** Because of the fragile nature of the ceramic coil heads, avoid bumping on reinstallation and turn nuts only tight enough to hold firmly. Excess crew pressure will result in breakage.



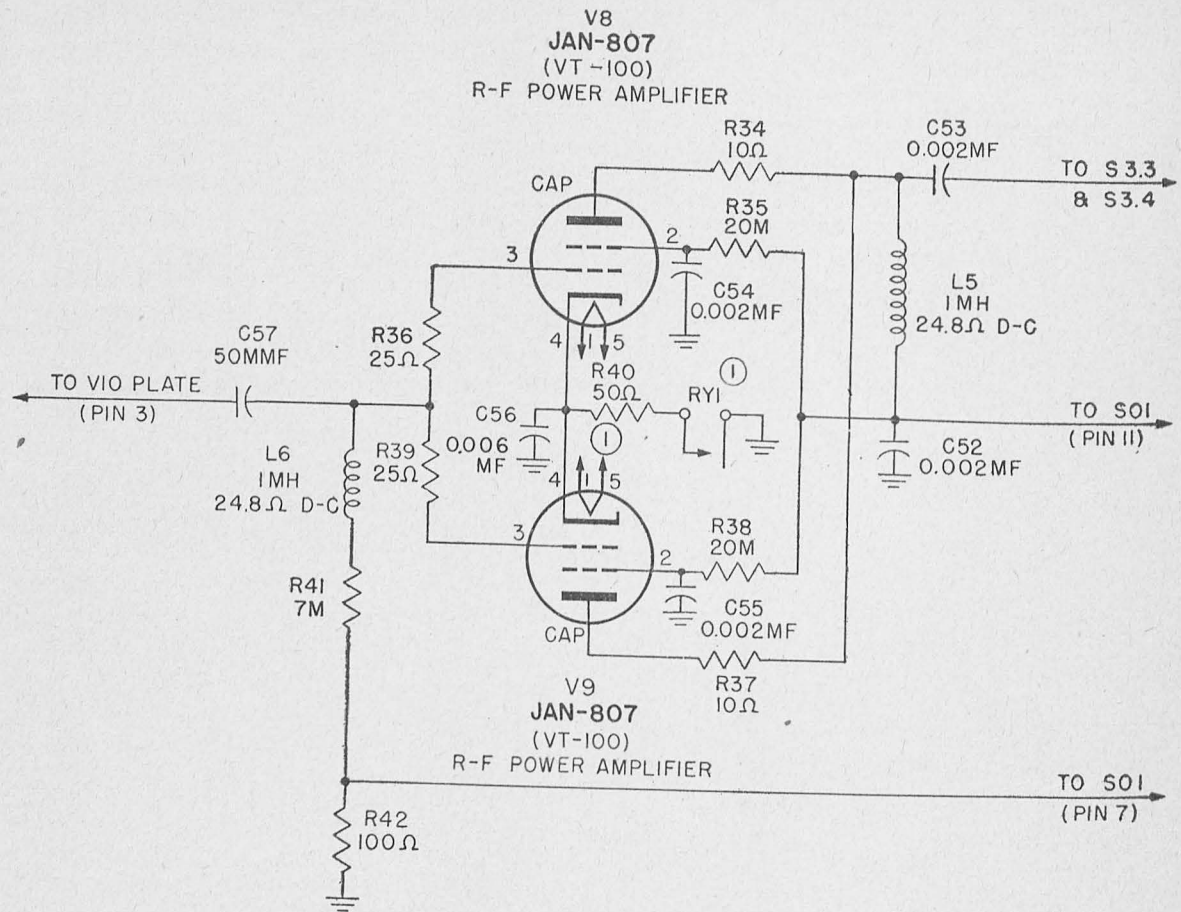

VALUES IN [ ] ARE FOR TRANSMIT OPERATION. TUBES NOT EXCITED UNDER VIBRA-PACK OPERATION.

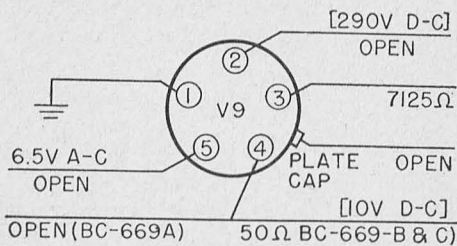
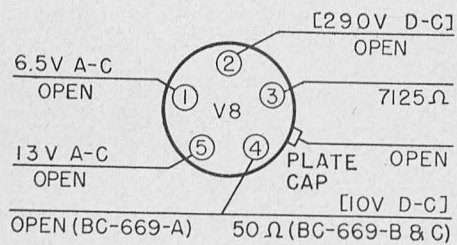

① FOR TEST CONDITIONS SEE PARAGRAPH 23.

② ON MODEL BC-669-B & C CATHODE CIRCUIT CHANGED AS SHOWN IN SMALL DIAGRAM.

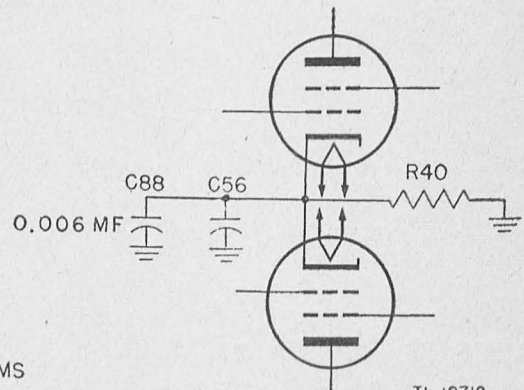

NOTE:

M = 1,000 OHMS

⊢ IS SYMBOL FOR FIXED CAPACITOR

⊢ IS SYMBOL FOR VARIABLE CAPACITOR

Figure 38. Radio Receiver and Transmitter BC-669-(\*), transmitter r-f amplifier stage, schematic diagram.

C. PARTS DATA.

Ref. symbol	Signal Corps stock No.	Name of part and description	Function
C45	3D9150V-5	CAPACITOR: 8 mmf to 150 mmf; variable, air	Trans r-f tank tuning, channel 1.
C46	3D9150V-5	CAPACITOR: 8 mmf to 150 mmf; variable, air	Trans r-f tank tuning, channel 2.
C47	3D9150V-5	CAPACITOR: 8 mmf to 150 mmf; variable, air	Trans r-f tank tuning, channel 3.
C48	3D9150V-5	CAPACITOR: 8 mmf to 150 mmf; variable, air	Trans r-f tank tuning, channel 4.
C49	3D9150V-5	CAPACITOR: 8 mmf to 150 mmf; variable, air	Trans r-f tank tuning, channel 5.
C50	3D9150V-5	CAPACITOR: 8 mmf to 150 mmf; variable, air	Trans r-f tank tuning, channel 6.
C51 A <sup>1</sup>	3D9070-7	CAPACITOR: 70 mmf $\pm 5\%$ ; 1,140 vacw; 1 amp r-f @ 2.5 mc; molded mica	Shunt capacitor for tank tuning capacitors.
C51 B <sup>1</sup>	3D9070-7	CAPACITOR: 70 mmf $\pm 5\%$ ; 1,140 vacw; 1 amp r-f @ 2.5 mc; molded mica	Shunt capacitor for tank tuning capacitors.
C51 C <sup>1</sup>	3D9070-7	CAPACITOR: 70 mmf $\pm 5\%$ ; 1,140 vacw; molded mica	Shunt capacitor for tank tuning.
C52	3DA2-71	CAPACITOR: 0.002 mf $\pm 10\%$ ; 2,500 vdcw; molded mica	V8, V9 plate and screen supply bypass.
C53	3DA2-71	CAPACITOR: 0.002 mf $\pm 10\%$ ; 2,500 vdcw; molded mica	L3 d-c blocking.
C54	3DA2-71	CAPACITOR: 0.002 mf $\pm 10\%$ ; 2,500 vdcw; molded mica	V8 screen bypass.
C55	3DA2-71	CAPACITOR: 0.002 mf $\pm 10\%$ ; 2,500 vdcw; molded mica	V9 screen bypass.
C56 A <sup>1</sup>	3DA6-45	CAPACITOR: 0.006 mf $\pm 10\%$ ; 300 vdcw; molded mica; postage stamp type	V9 cathode bypass.
C56 B <sup>1</sup>	3DA6-45	CAPACITOR: 0.006 mf $\pm 20\%$ ; 600 vdcw; molded paper	V9 cathode bypass.
C56 C <sup>1</sup>	3DA6-45	CAPACITOR: 0.006 mf $\pm 20\%$ ; 400 vdcw; molded paper	V9 cathode bypass.
L3	3C2510-7	COIL, r-f: 60 mf; special	R-f, p-a plate tank.
L5		COIL, r-f: choke; 1 mh $\pm 3\%$ ; 24.8 ohms d-c resistance; 4-pi universal wound	V8, V9 plate choke.
L6		COIL, r-f: choke. 1 mh $\pm 3\%$ ; 24.8 ohms d-c resistance; 4-pi universal wound	V8, V9 grid choke.
R34	3Z6001-10	RESISTOR: 10 ohms $\pm 10\%$ ; 2 watts; insulated wire-wound	V8 plate suppressor.
R35	3Z6620-54	RESISTOR: 20,000 ohms $\pm 10\%$ ; 10 watts; vitreous enameled wire-wound	V8 screen dropping.
R36	3Z6002E5-2	RESISTOR: 25 ohms $\pm 10\%$ ; $\frac{1}{2}$ watt; insulated wire-wound	V8 control grid suppressor.
R37	3Z6001-10	RESISTOR: 10 ohms $\pm 10\%$ ; 2 watts; insulated wire-wound	V9 plate suppressor.
R38		RESISTOR: 20,000 ohms $\pm 10\%$ ; 10 watts; vitreous enameled wire-wound	V9 screen dropping.
R39	3Z6002E5-2	RESISTOR: 25 ohms $\pm 10\%$ ; $\frac{1}{2}$ watt; insulated wire-wound	V9 control grid suppressor.
R40	3Z6005-36	RESISTOR: 50 ohms $\pm 10\%$ ; 10 watts; vitreous enameled wire-wound	V8, V9 cathode bias.
R41	3Z6570-8	RESISTOR: 7,000 ohms $\pm 10\%$ ; 2 watts; insulated carbon	V9 control grid load.
R42	3Z6010-18	RESISTOR: 100 ohms $\pm 10\%$ ; $\frac{1}{2}$ watt; insulated wire-wound	V8, V9 grid circuit return.
RY1 A,C <sup>1</sup>	2Z7638.3/1	RELAY: DPDT plus one set of normally open contacts; coil 115 v, 60 cps ac; special	Antenna change-over.
RY1 B <sup>1</sup>	2Z7638.3/1	RELAY: DPDT plus one set of normally open contacts; coil 115 v, 60 cps ac; special	Antenna change-over.
S3.1 A <sup>1</sup>	3Z9825-62.9	Switch Assembly: 5-section ceramic wafer type, less index plate; 6-position through 360°; shield disc between sections 4 and 5. Special	L3 ant. coupling switching.

<sup>1</sup> Applies only to models indicated.



c. PARTS DATA—Continued.

Ref. symbol	Signal Corps stock No.	Name of part and description	Function
S3.1 B,C <sup>1</sup> . . . .	3Z9825-62.9 . . . .	Switch Assembly: 5-section ceramic wafer type, less index plate; 6-position through 360°; shield disc between sections 4 and 5. Special . . . . .	
S3.3 A <sup>1</sup> . . . . .	3Z9825-62.9 . . . .	Part of S3.1 . . . . .	L3 ant. coupling switching.
S3.3 B,C <sup>1</sup> . . . .	3Z9825-62.9 . . . .	Part of S3.1 . . . . .	L3 plate switching.
S3.4 A <sup>1</sup> . . . . .	3Z9825-62.9 . . . .	Part of S3.1 . . . . .	L3 plate switching.
S3.4 B,C <sup>1</sup> . . . .	3Z9825-62.9 . . . .	Part of S3.1 . . . . .	C45, C46, C47, C48, C49, C50 selector.
V8 A <sup>1</sup> . . . . .		TUBE: JAN-807, VT-100 . . . . .	C45, C46, C47, C48, C49, C50 selector.
V8 B,C <sup>1</sup> . . . . .		TUBE: JAN-807, VT-100-A . . . . .	Transmitter final amplifier.
V8 B,C <sup>2</sup> . . . . .		TUBE: JAN-807, VT-100-A . . . . .	Transmitter final amplifier.
V9 A <sup>1</sup> . . . . .		TUBE: JAN-807, VT-100 . . . . .	Transmitter final amplifier.
V9 B,C <sup>1</sup> . . . . .		TUBE: JAN-807, VT-100-A . . . . .	Transmitter final amplifier.
V9 B,C <sup>2</sup> . . . . .		TUBE: JAN-807, VT-100-A . . . . .	Transmitter final amplifier.

<sup>1</sup> Applies only to models indicated.

<sup>2</sup> Applies only to models indicated on Orders Nos. 32780-Phila-43 and 32781-Phila-43.

### 46. Antenna Coupling Stage (fig. 39)

a. FUNCTION OF STAGE. Through a separate set of sliding contactors on plate tank coil L3, antenna coupling is varied to correspond with the operating frequency selected. The channel is selected on switch section S3.1. Plate tank coil L3 is connected to the antenna through antenna ammeter M1 and a series-resonant circuit comprising fixed capacitor C43, antenna-tuning capacitor C44, and antenna-loading coil L4. Loading inductance is varied by six sliding contactors on coil L4 selected on switch section S3.2. During reception, the transmitter contacts in relay RY1 are open.

b. METER FUNCTIONS. Antenna ammeter, meter M1, indicates when the antenna-loading circuit is tuned to resonance by proper setting of capacitor C44 and sliding contacts of loading coil L4. Resonance is indicated by a maximum r-f current reading of meter M1.

c. REPAIR DATA ON TRANSMITTER ANTENNA STAGE. The components of the antenna stage require careful checking to be certain that they will perform adequately. Because of the fact that the circuit is simple, it is necessary that continuity shall be complete and that parts function smoothly. In figure 13, transmitter presetting chart gives data on adjusting the antenna coil to proper operating frequencies. Repair procedure requires that the following points be carefully checked:

(1) Check switch section S3.1. See that contacts are clean and that they engage positively.

(2) Check meter M1 to make sure that it functions correctly. Check with exterior meter.

(3) Check antenna coil L4 for continuity in all the assigned frequencies.

(4) Check capacitors C43 and C44. Make sure that the dial readings on C44 correspond to the frequencies shown on the frequency meter and frequency indicated on crystal in the channel being tested.

(5) Make sure that antenna is not grounded.

(6) Check action and contacts of relay RY1.

(7) Check contacts between pins No. 7, No. 9, and No. 11 of plug PL1.

(8) If no current reading is obtained on antenna meter, make careful check of coil L4. If open or shorted replace.

d. REPLACEMENT OF ANTENNA-LOADING COIL L4 (fig. 43). (1) Unsolder the six leads to the coil studs and the two leads on the lugs mounted on the coil form.

(2) Loosen and remove the three screws holding the coil form to the chassis.

(3) Loosen tank coil L3 enough so that it can be shifted diagonally to the left. Do not remove nuts completely, but only sufficiently so that coil can be easily shifted.

(4) Holding tank coil L3 to one side, slip out antenna-loading coil L4. With coil L3 in the slanted position, slip new coil L4 into place and tighten down firmly, but do not crack ceramic base.



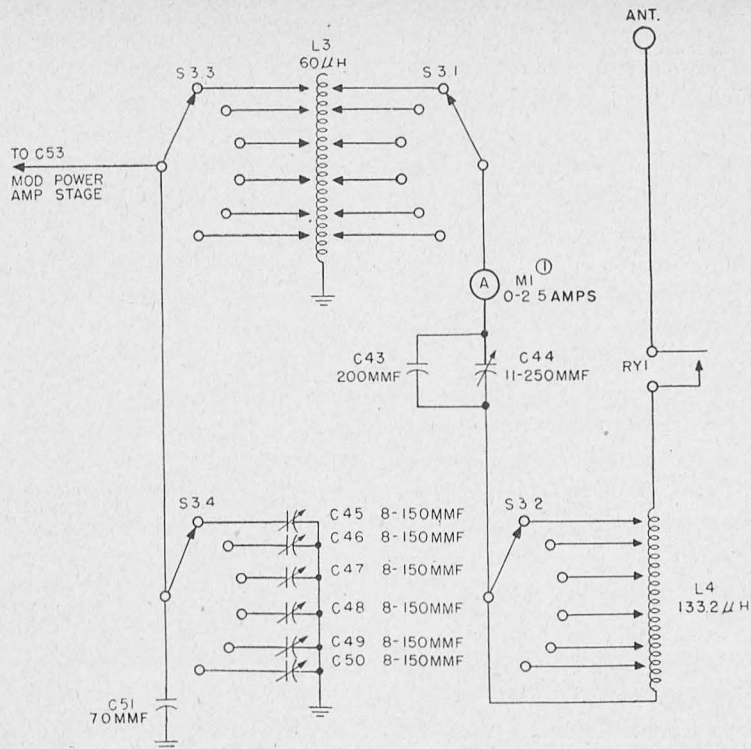

① ON BC-669-A, SOME UNITS HAVE METER MI CONNECTED ON THE ANTENNA SIDE OF COIL L4

NOTE:

⊢ IS SYMBOL FOR FIXED CAPACITOR

⊢ IS SYMBOL FOR VARIABLE CAPACITOR

TL 19713

Figure 39. Radio Receiver and Transmitter BC-669-(\*), transmitter antenna coupling stage, schematic diagram.

e. PARTS DATA.

Ref. symbol	Signal Corps stock No.	Name of part and description	Function
C43	3D9200-37	CAPACITOR: 200 mmf $\pm 5\%$ ; 1,430 vacw; 3.5 amps r-f @ 3,000 kc; molded mica	Shunt capacitor for C44.
C44	3D925CV-1	CAPACITOR: 11 mmf to 250 mmf; variable, air	Transmitter ant. tuning.
L4	3C4003-1	COIL ASSEMBLY, r-f: 133.2 mh; special	Transmitter ant. loading.
M1	3F511	AMMETER: 0 to 2.5 amps r-f; thermocouple type; accuracy $\pm 2\%$ full scale to 6 mc	Ant. current indicator.
RY1 A,C*	2Z7638.3/1	RELAY: DPDT plus one set of normally open contacts; coil 115 v, 60 cps ac; special	Antenna change-over.
RY1 B*	2Z7638.3/1	RELAY: DPDT plus one set of normally open contacts; coil 115 v, 60 cps ac; special	Antenna change-over.
S3.2	3Z9825-62.25	SWITCH ASSEMBLY: single-section ceramic; 6-position through 360°	L4 switching.

\* Applies only to models indicated.

## 47. Low-level Microphone Voltage Amplifier stage (fig. 40)

*a. FUNCTION OF STAGE.* This stage consists of a low-level microphone voltage amplifier. Driver Tube (JAN-12J5GT V11) (VT-135), amplifies low-level microphone voltage, providing a voltage swing sufficient to drive the modulator power stage. (See figs. 48 and 49.)

(1) Audio speech currents enter through contact C in plug PL3 and flow through primary of transformer T10. These currents are shunted by resistor R52.

(2) Induced audio voltage appearing across secondary of transformer T10 is divided by resistors R55 and R56. Part of the voltage is impressed on grid of tube V11.

(3) The voltage drop across resistor R58 biases the cathode of tube V11. Capacitor C64 together with resistor R57 make a bypass capacitor unnecessary across R58.

(4) Plate voltage comes through the primary of transformer T11 and resistor R68, and is filtered by capacitor C71.

*b. REPAIR DATA ON TRANSMITTER MODULATOR AND LOW-LEVEL MICROPHONE VOLTAGE AMPLIFIER STAGE.* The Remote Control Unit RM-21-(\*) and handset or headset used in checking must be in good working order. Repair here concerns only the driver stage of the transmitter modulator. Therefore, the only defects to be considered are within the stage itself. The conditions under which defective operation or nonoperation of the transmitter originate in the driver stage are as follows:

(1) If no plate voltage appears on plate of tube V11, check as follows:

(a) Check the primary of transformer T11. If open or shorted, replace the transformer.

(b) Check capacitors C68, C69, and C71. If shorted, replace them.

(c) Check resistor R65, R66, and R68. If open or shorted replace them.

(d) Check the tube. Replace it if defective.

(2) If there is failure of modulation at the handset or headset, check for the following possible causes of trouble:

(a) There may be no B+ on terminal B of transformer T9, or on contact 10 of plug PL1. Replace any defective parts.

(b) The coil of relay RY2 may be open. Replace if defective.

(c) Resistor R50 may be open. Replace if defective.

(d) Primaries or secondaries of transformers T10 or T11 may be open.

(e) Check capacitors C65, C66, C68, C69, C70, and C71. If defective, replace.

(f) Check resistors R55, R58, R59, R60, R61, R62, R63, R65, R66, R67, R68, and R69. If open, replace.

(g) Check continuity of circuits.

(3) If speaker operates on receiver but not on sidetone, check the following possible causes of trouble:

(a) Resistors R22, R53, or R54 may be open. Check and replace if defective.

(b) Check contacts of relay RY2. If open, replace.

(c) Check contact of pin No. 6 of SO1 and PL1. (Sidetone control R53 must be tuned to OFF position.)

(d) Check capacitor C67. If open, replace it.

*Note.* Make sure that shielded lead from contact C in PL3 to point No. 1 of transformer T10 is solidly grounded, otherwise microphone will pick up noise and hum.

V II  
**JAN-12J5GT**  
 (VT-135)  
 DRIVER

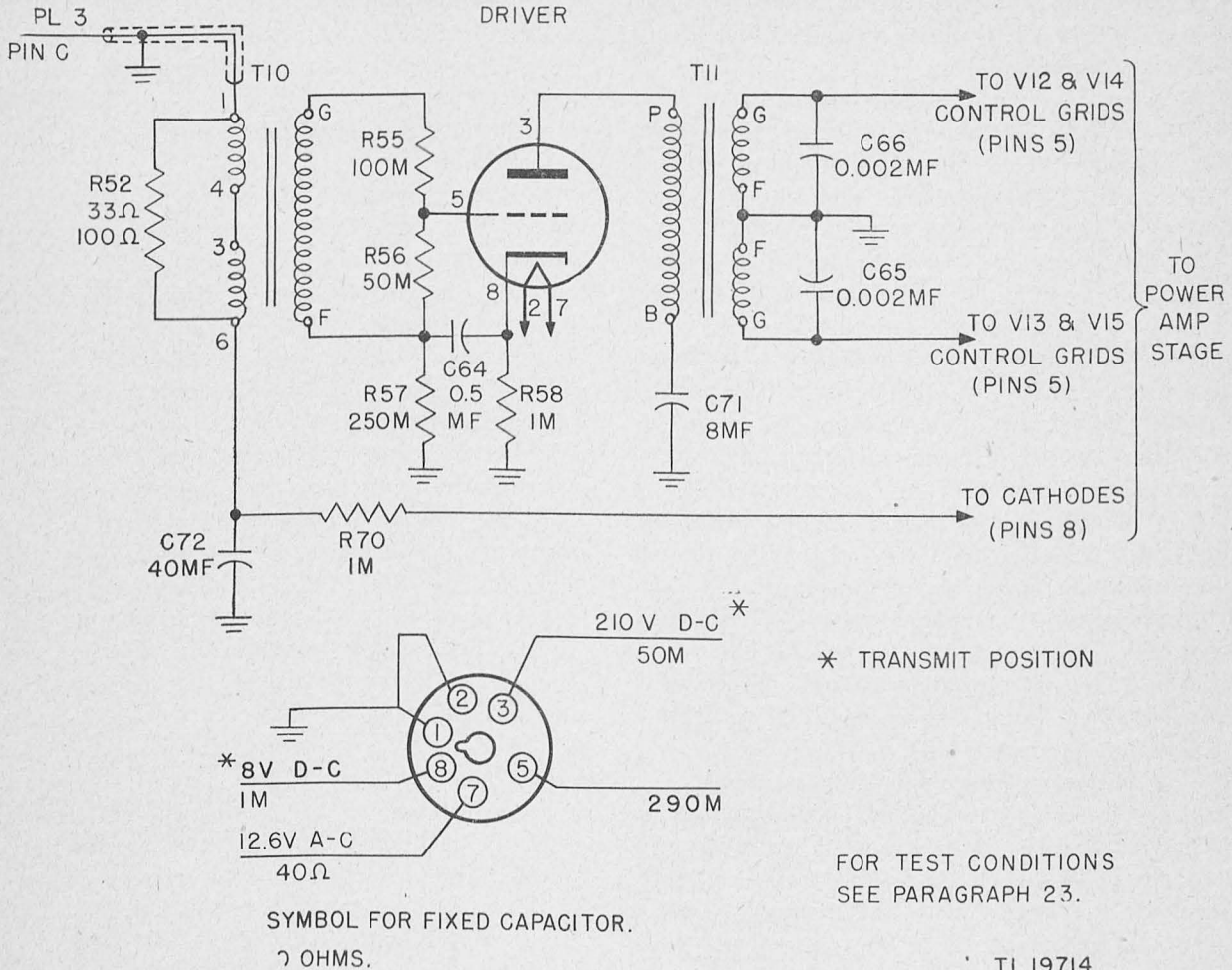

Figure 40. Radio Receiver and Transmitter BC-669-(\*), modulator low-level microphone voltage amplifier stage, schematic diagram.

c. PARTS DATA.

Ref. symbol	Signal Corps stock No.	Name of part and description	Function
C64	3DA500-73	CAPACITOR: 0.5 mf +14% -6%; 200 vdcw; paper, oil-filled; bathtub type	V11 cathode bypass.
C72	3DB40-17	CAPACITOR: dual; 40 mf, +65% -0; 100 vdcw; dry electrolytic tubular 5-pin plug-in	V12, V13, V14, V15, cathode bypass.
R52	3Z6010-18	RESISTOR: 100 ohms ±10%; ½ watt; insulated wire-wound	T10 pri load.
R52	3Z6010-18	RESISTOR: 35 ohms ±10%; 2 watts; insulated carbon	T10 pri load.
R55	3Z6010-18	RESISTOR: 100,000 ohms ±10%; ½ watt; insulated carbon	V11 input voltage divider.
R56	3Z6650-45	RESISTOR: 50,000 ohms ±10%; ½ watt; insulated carbon	V11 grid load.
R57	3Z6725-17	RESISTOR: 250,000 ohms ±10%; ½ watt; insulated carbon	V11 grid circuit filter.
R58	3Z4525	RESISTOR: 1,000 ohms ±10%; ½ watt; insulated carbon	V11 cathode bias.
R70	3Z6100-34	RESISTOR: 1,000 ohms ±10%; 2 watts; insulated wire-wound	Mic voltage filter and dropping.
T10	2Z9631.45	TRANSFORMER: microphone; pri to match 400-ohm carbon microphone; sec to match single class A grid; metal case	Microphone T-24( ) input to V11 grid.
V11		TUBE: JAN-12J5GT, VT-135	Modulator driver.
V11 B,C*		TUBE: JAN-12J5GT, VT-135	Modulator driver.

\* Applies only to models indicated.



#### 48. A-f Power-amplifier Stage of Transmitter Modulator (fig. 41)

a. FUNCTION OF STAGE. Tubes JAN-6L6G (V12, V13, V14, and V15) operate in push-pull as a class AB1 a-f power amplifier.

(1) Amplified audio voltage across the primary of transformer T11 transfers to the secondary which has a grounded center tap. Audio swings alternately to each half of the secondary. One side of the secondary connects to the control grids of tubes V12 and V14; the other side connects to the control grids of tubes V13 and V15. Grids are bypassed by capacitors C65 and C66.

(2) Bias voltage for the modulator tube cathode and microphone is provided by resistors R59 and R70 through the primary of transformer T10. Capacitor C70 bypasses the cathodes; capacitor C72 filters microphone voltage.

(3) Modulator plate voltage is supplied through resistors R66 and meter shunt resistor R63, through the center-tapped primary of transformer T12, and through parasitic suppressor resistors R69, R60, R61, and R62. Voltage is filtered by capacitor C68.

(4) Screen voltages are furnished through resistor R65, then filtered by capacitor C69 and bled to the cathode by resistor R67.

(5) The secondary of modulation transformer T12 connects in series with the high-voltage plate power supply of amplifier tubes V8 and V9, through contact No. 11 of plug PL1 and socket SO1. As a consequence, a-f fluctuations in the secondary result in proportional fluctuations in the plate voltage of the power-amplifier stage. These fluctuations cause the transmitter output power to vary correspondingly, developing a modulated radio-frequency carrier.

(6) A sidetone circuit is provided to monitor audio modulation. A portion of the modulator's output is drawn from the primary of transformer T12, fed through resistor R54, through sidetone volume control R53, through contact No. 6 of plug PL1 and socket SO1, and finally through resistor R22 to the grid of receiver audio power output tube V6. Audio

modulation can then be heard either in speaker LS1, if it is connected while the transmitter is modulated, or in headset or handset.

(7) Meter M2 (figs. 48 and 49), in position 1, is in series with the high-voltage plate supply circuit of modulator tubes V12, V13, V14, and V15, and indicates modulator plate current. In this case, R63 is a shunt resistor.

b. REPAIR DATA ON TRANSMITTER MODULATOR: AUDIO-FREQUENCY POWER AMPLIFIER STAGE. It is assumed that Remote Control Unit RM-21-(\*) and headset or handset are in good working order. The possible operating difficulties considered here are only those of the a-f amplifier stage with its four Tubes JAN-6L6G in push-pull parallel. Tubes must be matched for performance. Likewise, it is necessary that the other components in this stage, such as transformers, capacitors, and resistors, shall have balanced values. Voltage and resistance measurements must be checked carefully against the charts. (See figs. 19, 20, and 23.) Check the performance of the unit against a spare unit after repairs have been made. The troubles encountered in this stage, apart from the performance deficiency indicated on the test instruments, are as follows:

(1) Watch out for soft tubes, microphonics, and other substandard conditions.

(2) If no plate or screen voltage appears on tubes V12, V13, V14, and V15, check the following:

(a) Check the entire stage for continuity.

(b) Check transformers T11 and T12 for continuity. If defective, replace.

(c) Check capacitors C65, C66, C68, C69, C70, C71, and C72. If defective, replace.

(d) Check resistors R59, R60, R61, R62, R63, R64, R65, R66, R67, R68, R69, and R70 for opens or shorts. Replace defective parts.

(e) Check meter M2 in all three positions against external meter. Replace if defective.

(f) Make sure that both relays RY1 and RY2 operate.



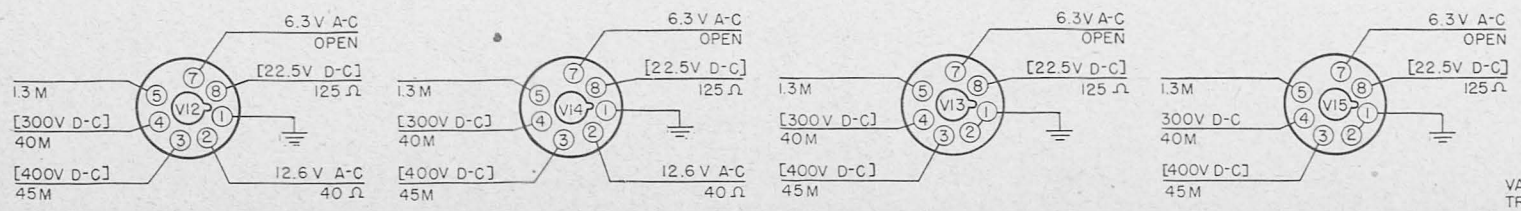
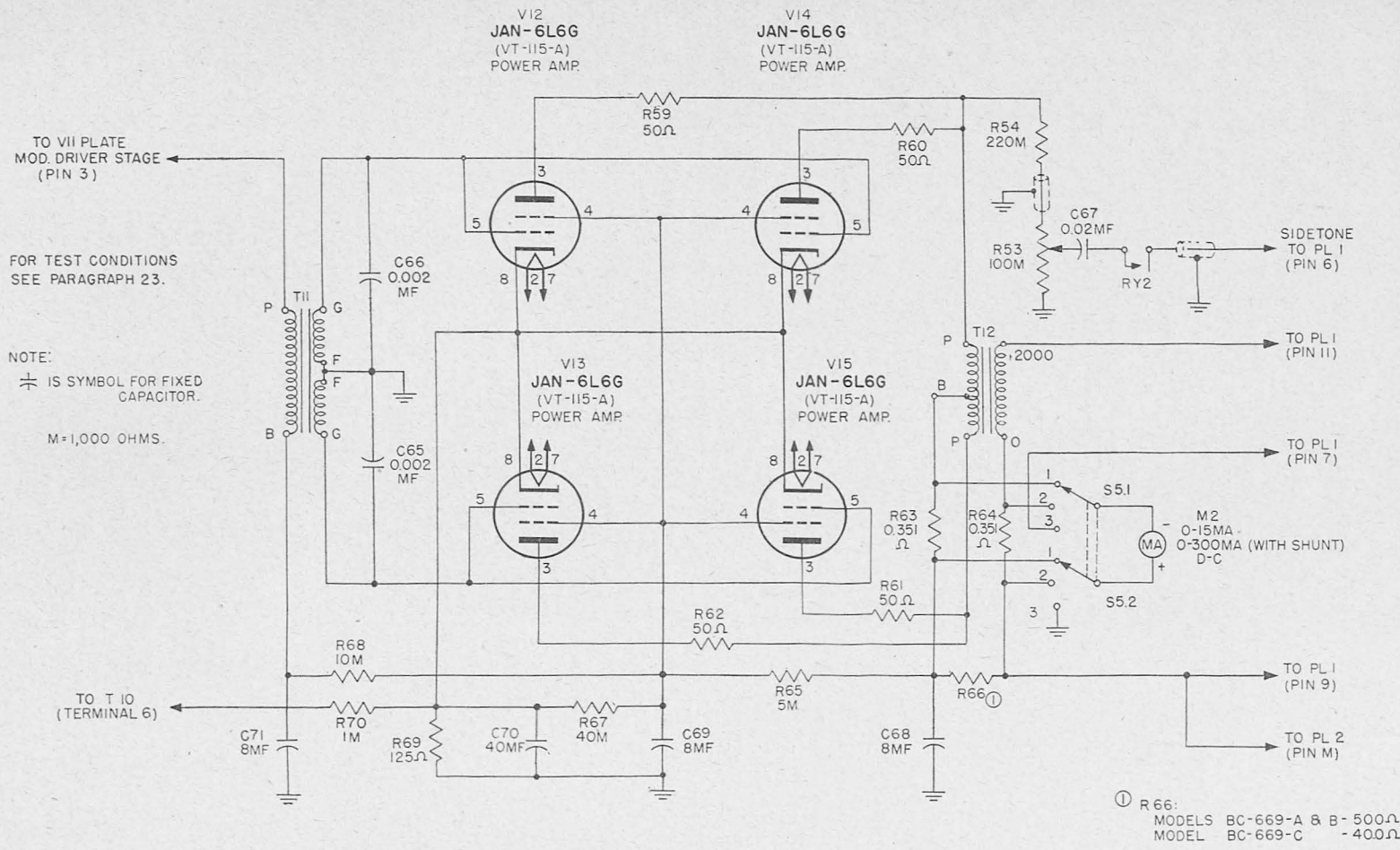

VALUES IN [ ] ARE FOR TRANSMIT OPERATION.  
 TL19715

Figure 41. Radio Receiver and Transmitter BC-669-(\*), modulator class AB1-af power-amplifier stage, schematic diagram



c. PARTS DATA.

Ref. symbol	Signal Corps stock No.	Name of part and description	Function
C65 A*	3DAZ-73	CAPACITOR: 0.002 mf $\pm 10\%$ ; 500 vdcw; molded mica; postage stamp type	V13, V15 control grid by-pass.
C65 B,C*	3DAZ-73	CAPACITOR: 0.002 mf $\pm 10\%$ ; 500 vdcw; molded mica; postage stamp type	V13, V15 control grid by-pass.
C65 C*	3DAZ-73	CAPACITOR: 0.002 mf $\pm 20\%$ ; 400 vdcw; molded paper	V13, V15 control grid by-pass.
C66 A*	3DAZ-73	CAPACITOR: 0.002 mf $\pm 10\%$ ; 500 vdcw; molded mica; postage stamp type	V12, V14 control grid by-pass.
C66 B,C*	3DAZ-73	CAPACITOR: 0.002 mf $\pm 10\%$ ; 500 vdcw; molded mica; postage stamp type	V12, V14 control grid by-pass.
C66 C*	3DAZ-73	CAPACITOR: 0.002 mf $\pm 20\%$ ; 400 vdcw; molded paper	V12, V14 control grid by-pass.
C67 A,B*	3DA20-45	CAPACITOR: 0.02 mf $+20\%$ $-10\%$ ; 600 vdcw; molded paper	V2 plate supply filter.
C67 C*	3DA20-45	CAPACITOR: 0.02 mf $\pm 20\%$ ; 600 vdcw; molded paper	V2 plate supply filter.
C68	3DB8-38	CAPACITOR: 8 mf $+14\%$ $-6\%$ ; 1,000 vdcw; oil-filled; metal case	Xmtr plate supply filter.
C69	3DB8-38	CAPACITOR: 8 mf $+14\%$ $-6\%$ ; 1,000 vdcw; oil-filled; metal case	Xmtr screen supply filter.
C70	3DB40-17	CAPACITOR, dual: 40 mf $+65\%$ $-0$ ; 100 vdcw; metal case	V12, V13, V14, V15 cathode bypass.
C71	3DB8-38	CAPACITOR: 8 mf $+14\%$ $-6\%$ ; 1,000 vdcw; oil-filled; metal case	V11 plate supply filter.
M2	3F901E5-4	MILLIAMETER: 0-15 ma d-c movement; 6.66 ohms internal resistance; 0-300 ma d-c with external shunt; accuracy $\pm 2\%$ full scale; special	V8, V9 plate and grid current.
R53	2Z7271-1	RESISTOR: 100,000-ohm potentiometer; carbon; 3-terminal; special	Sidetone volume.
R54	3Z6722-6	RESISTOR: 220,000 ohms $\pm 10\%$ ; 1 watt; insulated carbon	Sidetone coupling.
R59	3Z6005-34	RESISTOR: 50 ohms $\pm 10\%$ ; $\frac{1}{2}$ watt; insulated wire-wound	V12 plate suppressor.
R60	3Z6005-34	RESISTOR: 50 ohms $\pm 10\%$ ; $\frac{1}{2}$ watt; insulated wire-wound	V14 plate suppressor.
R61	3Z6005-34	RESISTOR: 50 ohms $\pm 10\%$ ; $\frac{1}{2}$ watt; insulated wire-wound	V15 plate suppressor.
R62	3Z6005-34	RESISTOR: 50 ohms $\pm 10\%$ ; $\frac{1}{2}$ watt; insulated wire-wound	V13 plate suppressor.
R63	3Z5983-5	RESISTOR: 0.351 ohm $\pm \frac{1}{2}\%$ ; meter shunt for 300 ma range; special	Mod plate current shunt for M2.
R64	3Z5983-5	RESISTOR: 0.351 ohm $\pm \frac{1}{2}\%$ ; meter shunt for 300 ma range; special	P-a plate current shunt for M2.
R65	3Z6500-74	RESISTOR: 5,000 ohms $+10\%$ ; 200 watts; vitreous enameled wire-wound	V12, V13, V14, V15 screen dropping.
R66 A,B*	3Z6050-64	RESISTOR: 500 ohms $+10\%$ ; 50 watts; with 400-ohm tap; vitreous enameled wire-wound; special	V12, V14 control grid by-pass.
R66 C*	3Z6050-64	RESISTOR: 400 ohms $\pm 10\%$ ; 50 watts; vitreous enameled	V12, V14 control grid by-pass.
R67	3Z6640-17	RESISTOR: 40,000 ohms $\pm 10\%$ ; 20 watts, vitreous enameled wire-wound	V12, V13, V14, V15 screen bleeder.
R68	3Z6610-70	RESISTOR: 10,000 ohms $\pm 10\%$ ; 10 watts; vitreous enameled wire-wound	V11 plate filter dropping.
R69	3Z6012A5-4	RESISTOR: 125 ohms $\pm 10\%$ ; 10 watts; vitreous enameled wire-wound	V12, V13, V14, V15 cathode bias.
S5.1	3Z9825-80.1	SWITCH: 2-pole bakelite rotary wafer type; index plate 3-position thru $120^\circ$ ; special	M2 circuit selector.
S5.2	3Z9825-80.1	SWITCH: 2-pole bakelite rotary wafer type; index plate 3-position thru $120^\circ$ ; special	M2 circuit selector.
T11	2Z9636.14	TRANSFORMER: interstage; pri to match single 10,000-ohm class A plate; sec to match P.P. class A grids; metal case	Interstage, V11 plate to V12, V13, V14, V15 grids.

<sup>1</sup> Applies only to models indicated.

c. PARTS DATA—Continued.

Ref. symbol	Signal Corps stock No.	Name of part and description	Function
T12 .....	2Z9634.14 .....	TRANSFORMER: pri to match P.P. 3500-ohm class AB plates; sec to match 2,000-ohm class final amp plate; metal case .....	Modulation, V12, V13, V14, V15, plates to V8, V9 plates.
V12, V13, V14, V15.	2J6L6G .....	TUBE: JAN-6L6G, VT-115-A; octal base .....	Modulator power output.
V12 B,C* V13 B,C* V14 B,C* V15 B,C*.	2J6L6GA .....	TUBE: JAN-6L6GA .....	Modulator power output.

\* Applies only to models indicated.

## SECTION IX

### SUPPLEMENTARY DATA

#### 49. Initial Repair Procedure Chart

*a.* RESUME OF GENERAL INSTRUCTIONS. (1) Visual inspection.

(2) Check power circuit. See that equipment can be connected without possibility of damage.

(3) Localize trouble. This is especially important when trouble is not simple.

(4) Locate defective part or parts.

(5) Replace defective part.

(6) Check over-all performance.

(7) Repeat all foregoing steps if over-all performance is unsatisfactory.

*b.* VISUAL INSPECTION. (1) Check for broken or burnt-out tubes, for any loose connections, broken wires, or other breaks. Make your own tube check-sheet and record results.

#### RECEIVER

V1	V2	V3	V4	V7	V5	V6
----	----	----	----	----	----	----

#### TRANSMITTER

V10	V8	V9
-----	----	----

#### MODULATOR

V11	V12	V13	V14	V15
-----	-----	-----	-----	-----

(2) See that everything is in its proper place.

(3) Inspect the following for dirt or moisture.

(*a.*) Entire unit.

(*b.*) Capacitors, especially those in i-f circuits across high-impedance circuits, or circuits having high a-c or d-c voltage in series within them.

(*c.*) Wire-wound resistors, especially those in voltage-divider networks. These are subject to breakage if excessive moisture is present.

(4) Check resistances.

(*a.*) Check power-input circuits to see that equipment can be connected without possibility of damage. Test at pins of PL2. Test at contacts of SO1. Use ground as point of common measurement.

(*b.*) Check for correct values with charts. (See figs. 15 to 23 incl.)

(5) Check operation.

(*a.*) With power turned on, check glass tubes to see that filaments light; feel metal tubes to make sure that they warm up. In case of transmitter, dummy antenna should be properly connected.

(*b.*) Operate equipment in normal manner to check which stages are defective.

#### 50. Noisy Receiver

*a.* If noise continues, disconnect antenna, and ground antenna post. If noise stops, trouble is external to receiver.

*b.* Make visual and mechanical inspections outlined in paragraph 47.

*c.* With receiver volume control at maximum,

ground control grids of first audio tube V5. If noise continues, ground control grids of individual stages working toward audio output. Use a 0.25-mf capacitor to shunt the grids, as grounding will alter bias.

*d.* Ground the control grid of mixer tube V2.

*e.* If noise continues, ground the control grid of each stage in turn, working toward the detector.

*f.* Ground the control grid at pin No. 4 of i-f amplifier tube VI.

*g.* If noise continues, ground the control grid of each amplifier stage in turn, and work toward the mixer.

*h.* Ground the control grid of the oscillator.

*i.* The stage immediately following the point where grounding does not eliminate noise is usually the seat of the trouble.



j. Proceed to locate defective parts by usual voltage and resistance continuity tests.

k. If noise is intermittent, repeat the previous procedure, tapping the parts of stage being checked. A very gentle tap is sufficient. The part requiring the lightest tap to produce noise is probably defective.

l. If noise is present only when injecting signal, apply unmodulated r-f signal to antenna, with receiver and signal generator tuned to low frequency, and of sufficient strength to make receiver microphonic. Ringing sounds in headphones or loud-speaker should be heard when receiver is tapped. Locate noisy parts by careful systematic tapping.

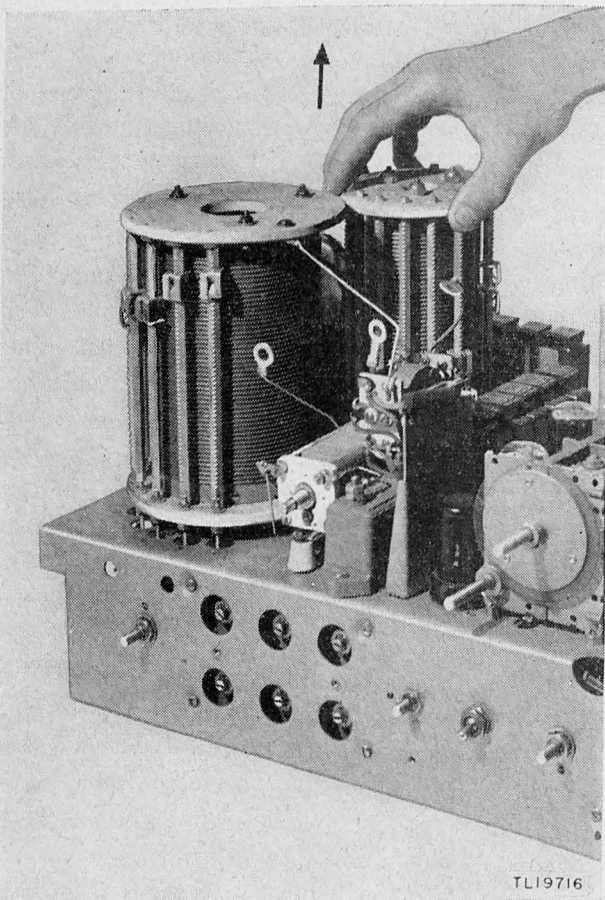

Figure 42. Radio Receiver and Transmitter BC-669-(\*), correct way of removing or replacing plate tank coil L3.

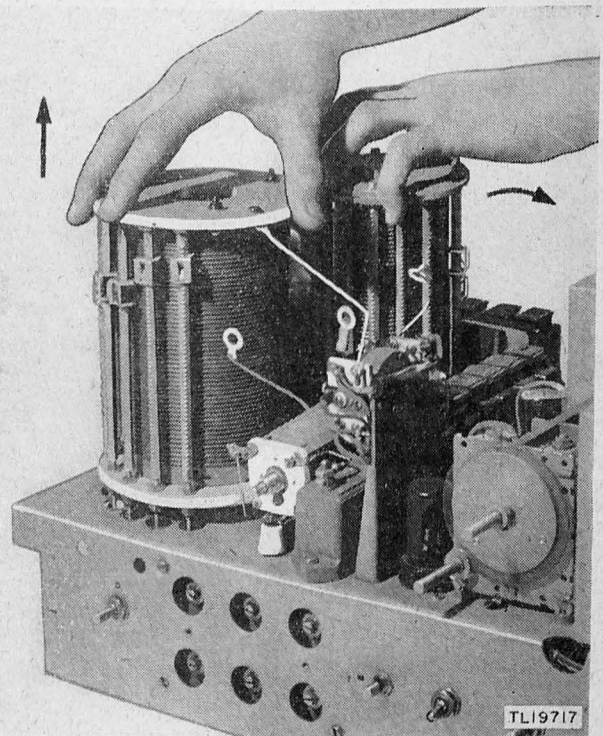
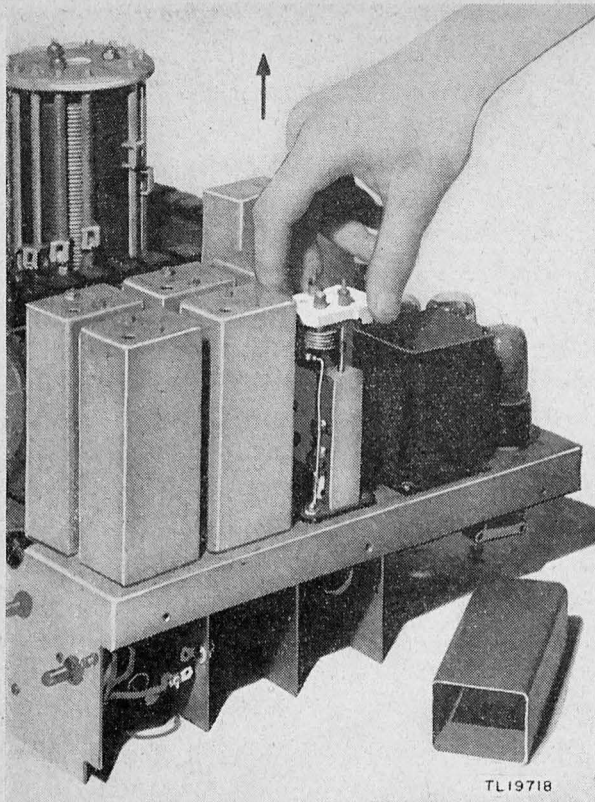
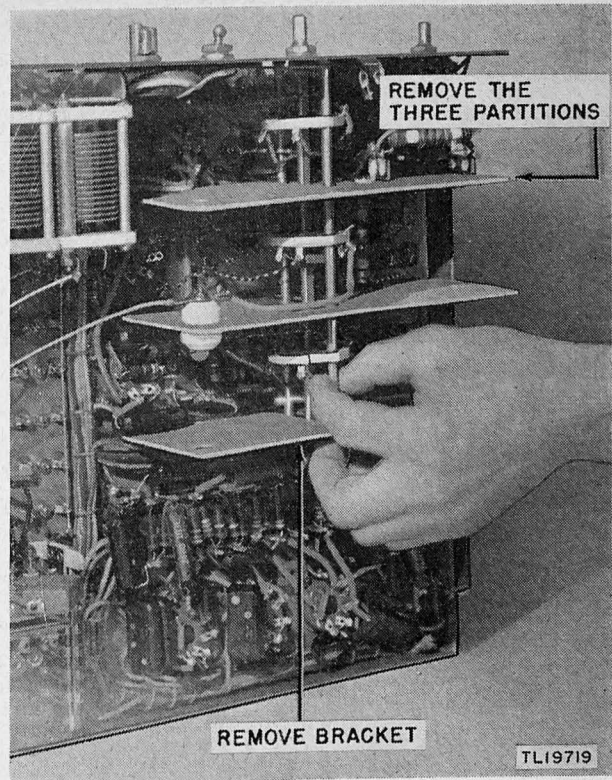

Figure 43. Radio Receiver and Transmitter BC-669-(\*), correct way of removing or replacing antenna loading coil L4.



TL19718

Figure 44. Radio Receiver and Transmitter BC-669-(\*), correct way of removing or replacing r-f or i-f transformers.



TL19719

Figure 45. Radio Receiver and Transmitter BC-669-(\*), correct way of removing or replacing receiver bandswitch.

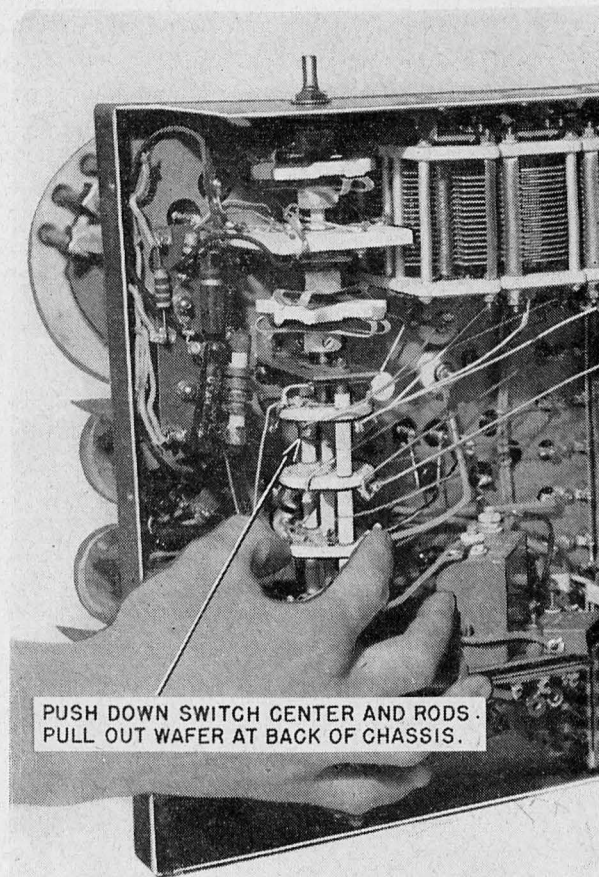

TL19720

Figure 46. Radio Receiver and Transmitter BC-669-(\*), correct way of removing or replacing ceramic wafers on channel switch.



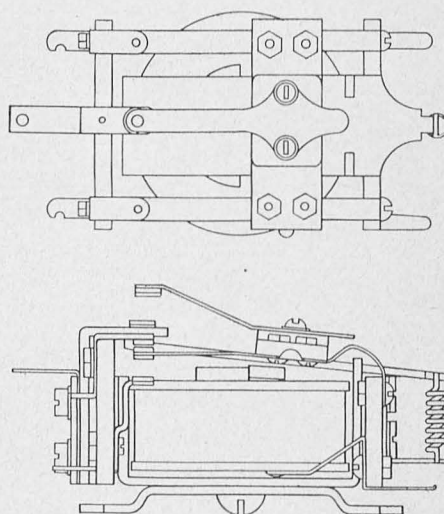
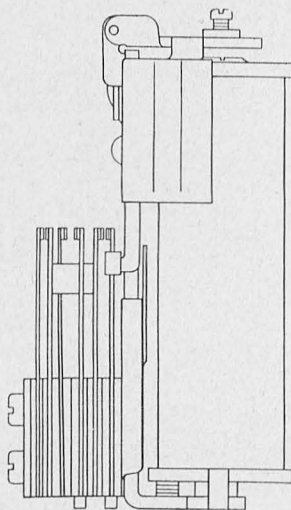
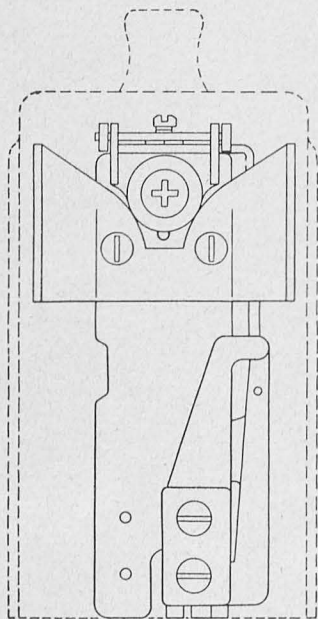

**MODULATOR RELAY**

SIDE-TONE CIRCUIT & TRANSMITTER HIGH-VOLTAGE  
 TRANSFORMER PRIMARY CIRCUIT BREAKER  
 PART NUMBER-RY2. S.C. STOCK NUMBER - 2Z7650.4

ELECTRICAL CHARACTERISTICS	C.P. CLARE & CO. MANUFACTURER'S STOCK NUMBERS	
	A 3733	C-12443
CONTACTS	1/8" DIA TUNGSTEN	18 GA. PALLADIUM
CONTACT SPACING	.010 INCH	.010 INCH
CONTACT PRESSURE	30 GRAMS ± 5 GRAMS	30 GRAMS ± 5 GRAMS
OPERATING CURRENT	.0035 ± .0005 AMP	.0035 ± .0005 AMP
RELEASE CURRENT	" "	" "
FOR USE IN MODELS	BC-669-A&B	BC-669-C

**ANTENNA CHANGEOVER RELAY**

PART NUMBER-RY1. S.C. STOCK NUMBER-2Z7638.3

ELECTRICAL CHARACTERISTICS	ADVANCE ELECTRIC & RELAY CO. MANUFACTURER'S STOCK NO'S	
	1000-1B	1004A-1B
CONTACTS	PURE SILVER	PURE SILVER
CONTACT SPACING	.030 INCH	.080 INCH
CONTACT PRESSURE	20 GRAMS	20 GRAMS
PULL-IN VOLTAGE-MINIMUM	90 A-C	90 A-C
HOLD-IN VOLTAGE-MINIMUM	75 A-C	75 A-C
FOR USE IN MODELS	BC-669-A,C	BC-669-B

Figure 47. Radio Receiver and Transmitter BC-669-(\*), relays RY1 and RY2.



TL19721

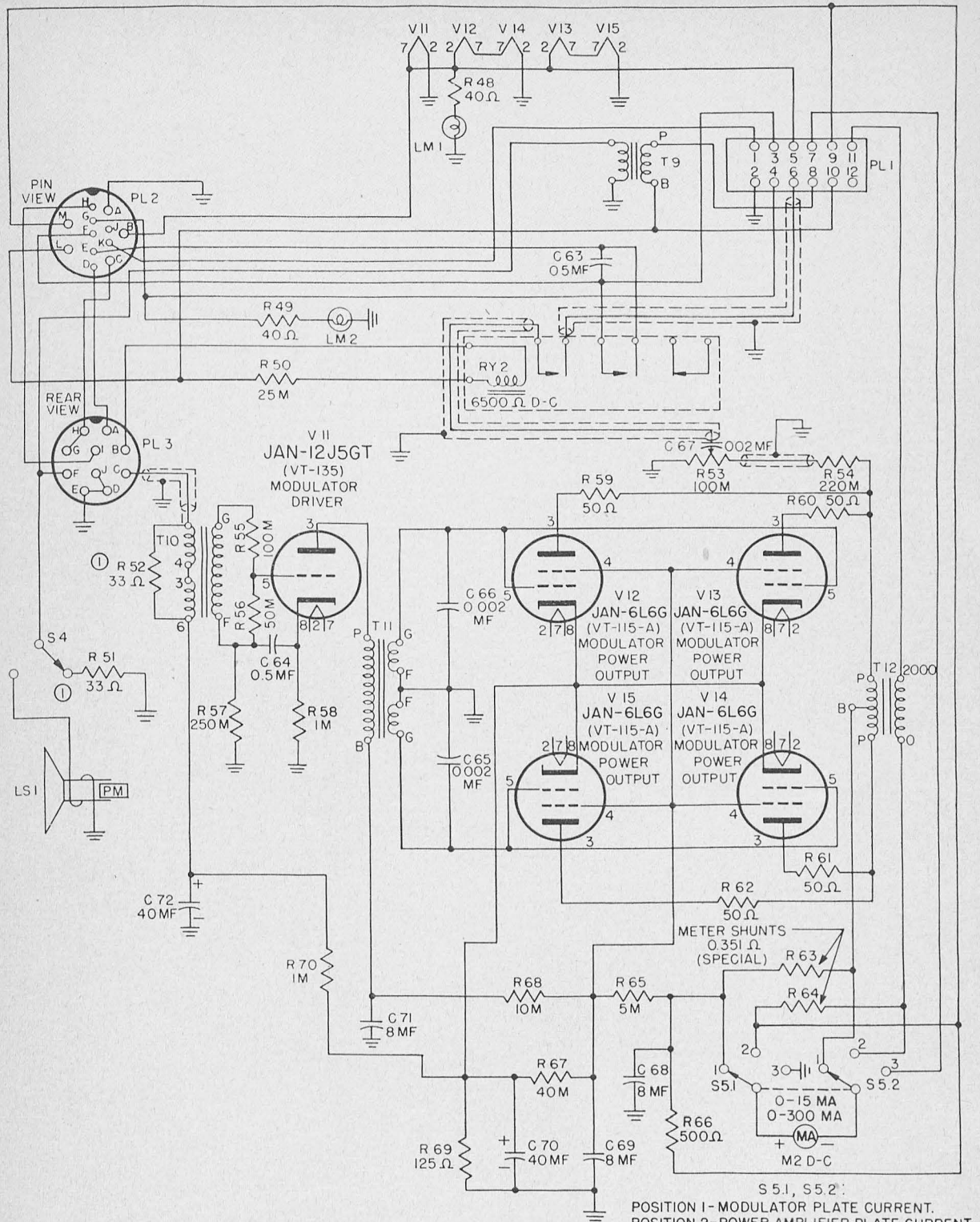



① 100.Ω WITH DIFFERENT ISSUES OF THE SAME MODEL.

NOTE:

-  IS SYMBOL FOR FIXED CAPACITOR
-  IS SYMBOL FOR VARIABLE CAPACITOR

M = 1,000 OHMS

S 5.1, S 5.2:  
 POSITION 1 - MODULATOR PLATE CURRENT.  
 POSITION 2 - POWER AMPLIFIER PLATE CURRENT.  
 POSITION 3 - POWER AMPLIFIER GRID CURRENT.

TL I9724

Figure 48. Radio Receiver and Transmitter BC-669-A, modulator section, schematic diagram.

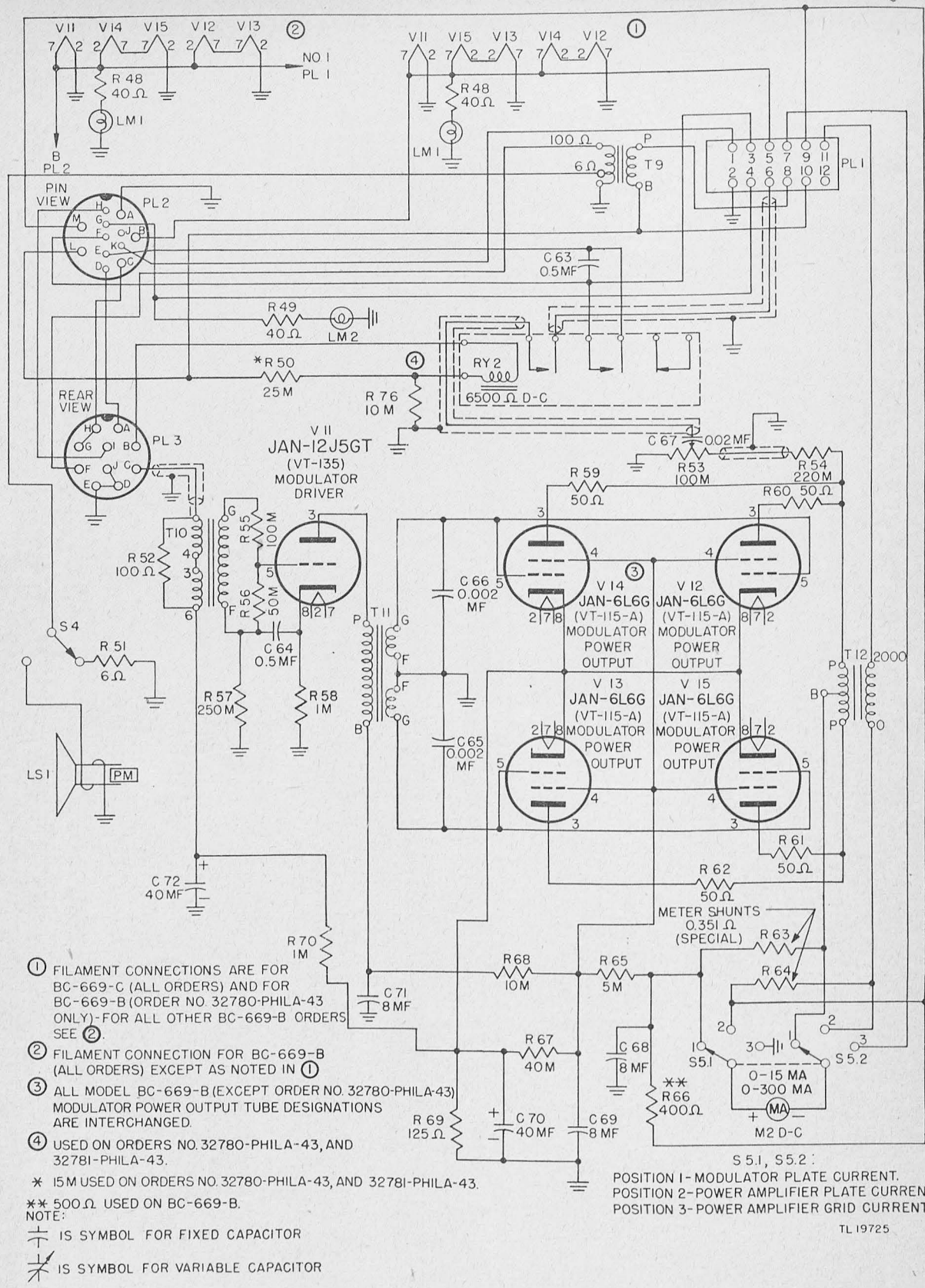

- ① FILAMENT CONNECTIONS ARE FOR BC-669-C (ALL ORDERS) AND FOR BC-669-B (ORDER NO 32780-PHILA-43 ONLY)-FOR ALL OTHER BC-669-B ORDERS SEE ②.
- ② FILAMENT CONNECTION FOR BC-669-B (ALL ORDERS) EXCEPT AS NOTED IN ①.
- ③ ALL MODEL BC-669-B (EXCEPT ORDER NO 32780-PHILA-43) MODULATOR POWER OUTPUT TUBE DESIGNATIONS ARE INTERCHANGED.
- ④ USED ON ORDERS NO 32780-PHILA-43, AND 32781-PHILA-43.

\* 15M USED ON ORDERS NO 32780-PHILA-43, AND 32781-PHILA-43.

\*\* 500.Ω USED ON BC-669-B.

NOTE:  
 ⊢ IS SYMBOL FOR FIXED CAPACITOR  
 ⊣ IS SYMBOL FOR VARIABLE CAPACITOR

M=1,000 OHMS

S 5.1, S 5.2:  
 POSITION 1-MODULATOR PLATE CURRENT.  
 POSITION 2-POWER AMPLIFIER PLATE CURRENT.  
 POSITION 3-POWER AMPLIFIER GRID CURRENT.

TL 19725

Figure 49. Radio Receiver and Transmitter BC-669-B and -C, modulator section, schematic diagram.



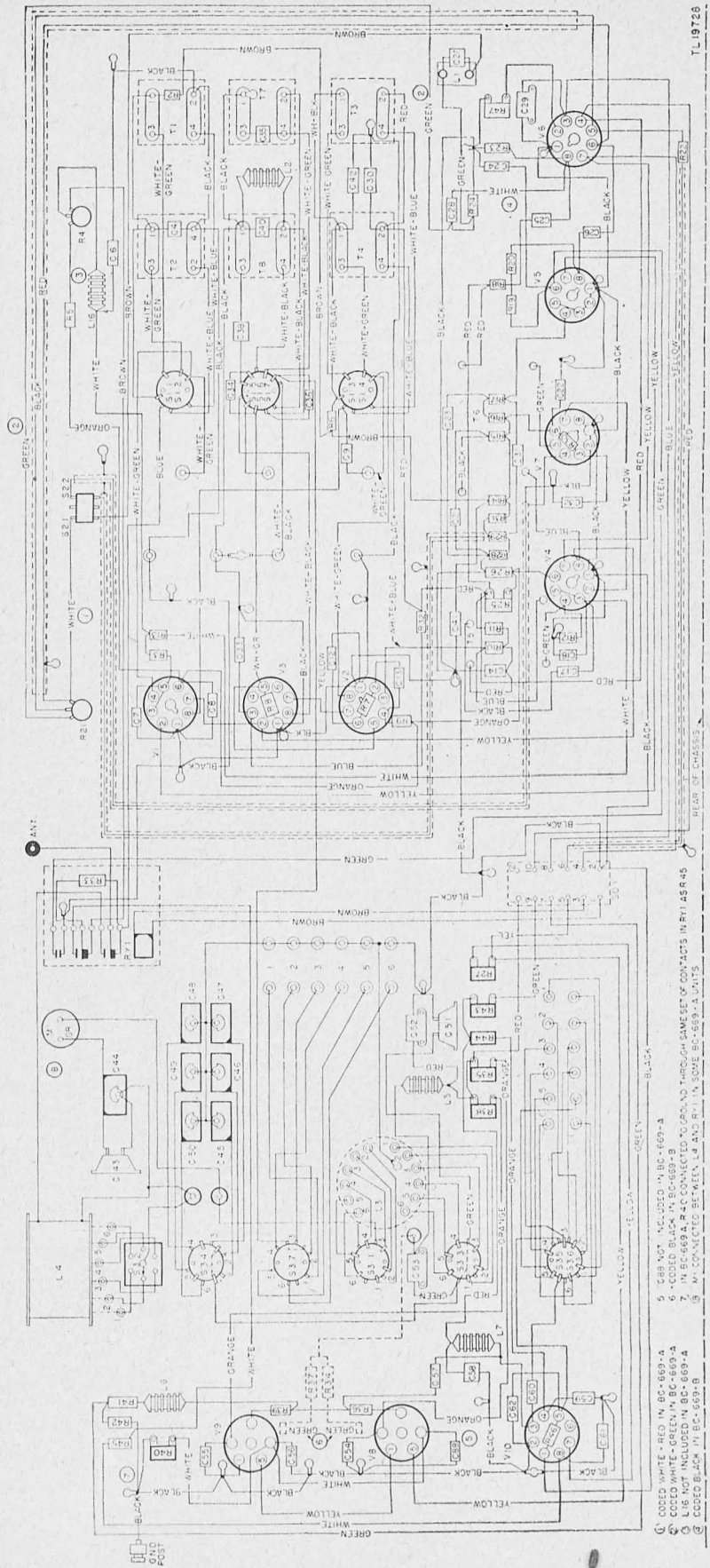

- ① CODED WHITE - RED IN BC-669-A
- ② CODED WHITE - GREEN IN BC-669-B
- ③ CODED BLACK IN BC-669-B
- ④ L-6 NOT INCLUDED IN BC-669-A
- ⑤ CODED BLACK IN BC-669-B
- ⑥ C-8 NOT INCLUDED IN BC-669-A
- ⑦ C-8 NOT INCLUDED IN BC-669-B
- ⑧ L-6 CONNECTED BETWEEN L-4 AND L-5 IN SETS BC-669-A AND -B
- ⑨ L-6 CONNECTED BETWEEN L-4 AND L-5 IN SETS BC-669-A AND -B
- ⑩ L-6 CONNECTED BETWEEN L-4 AND L-5 IN SETS BC-669-A AND -B

Figure 50. Radio Receiver and Transmitter BC-669-A, -B, and -C, receiver and transmitter, practical wiring diagram.

TL19726





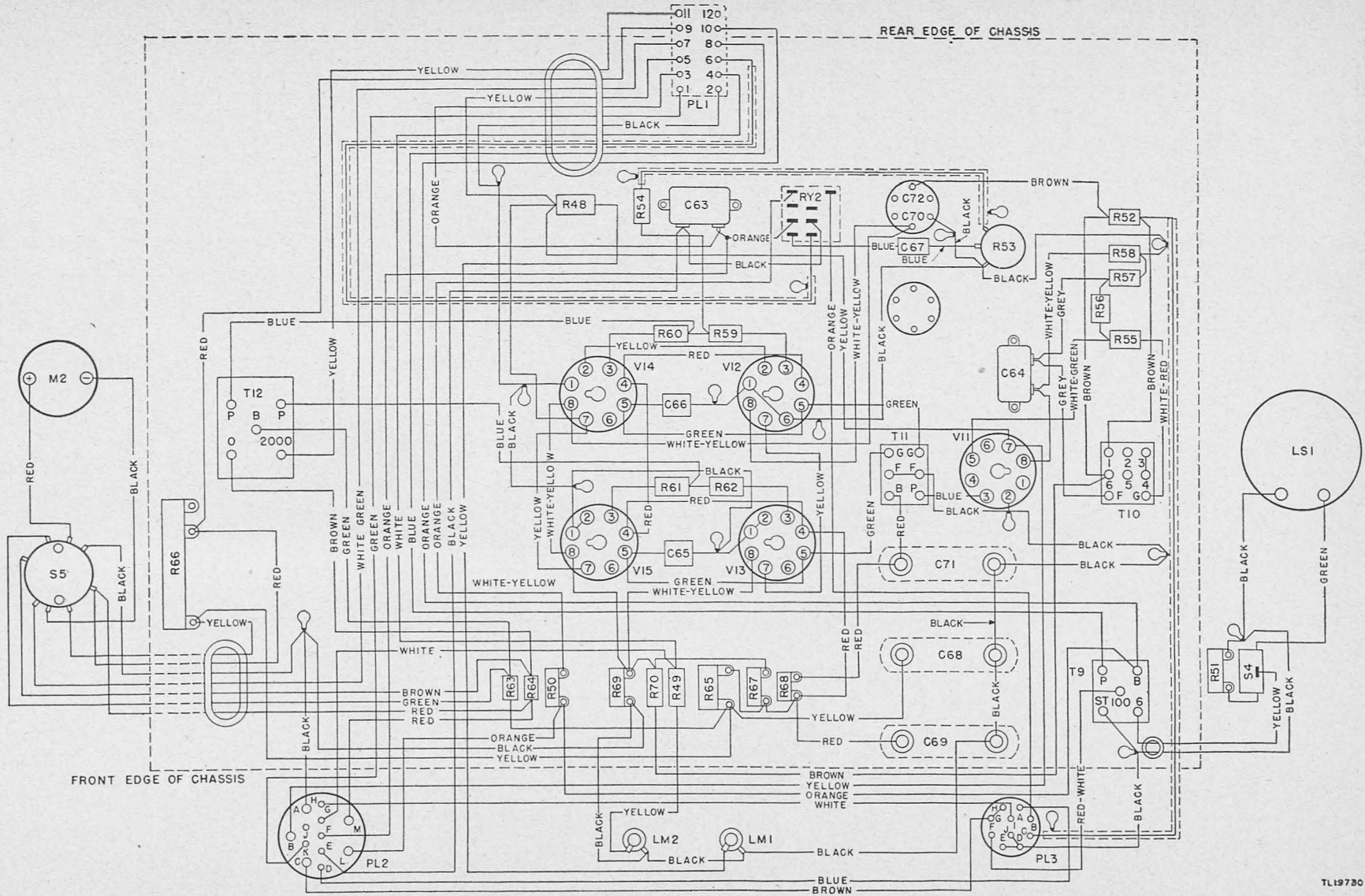

Figure 52. Radio Receiver and Transmitter BC-669-B, modulator section, practical wiring diagram.

TL19780

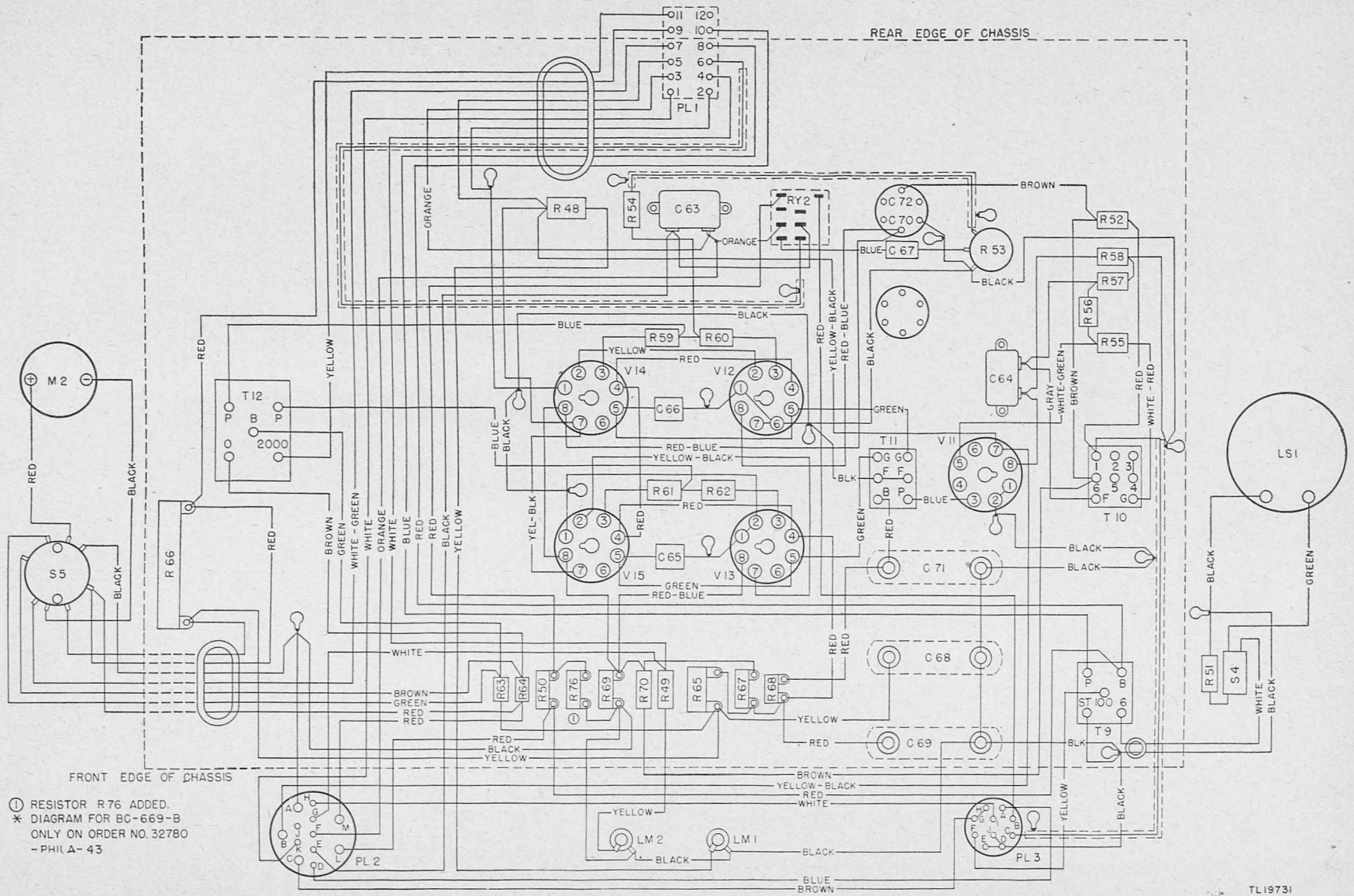
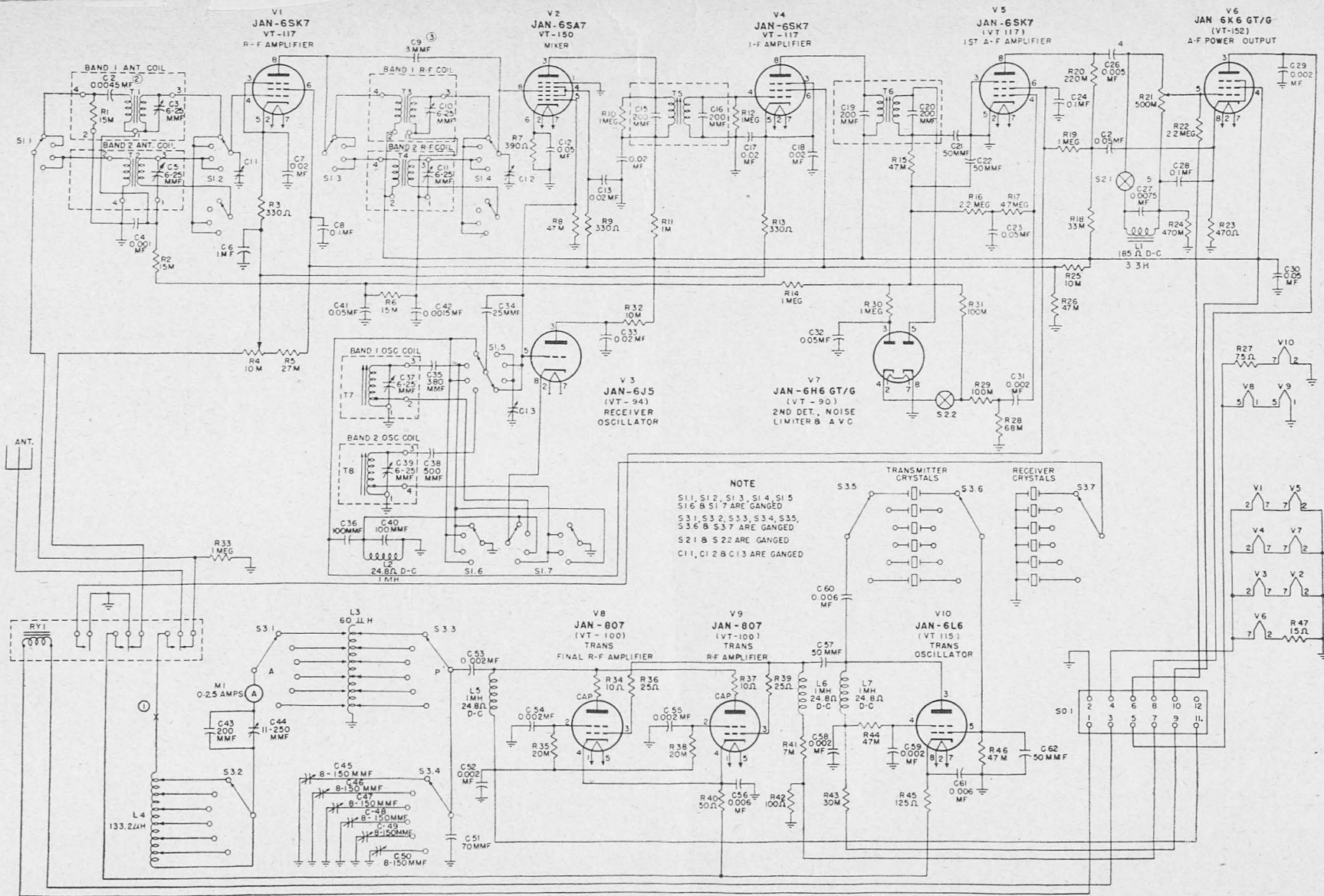
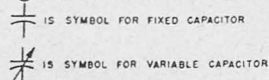

Figure 53. Radio Receiver and Transmitter BC-669-C, modulator section, practical wiring diagram.





NOTE: ○ SOME EARLY UNITS HAD M1 SERIES CONNECTED AT X



TL 19722

Figure 54. Radio Receiver and Transmitter BC-669-A, schematic diagram.

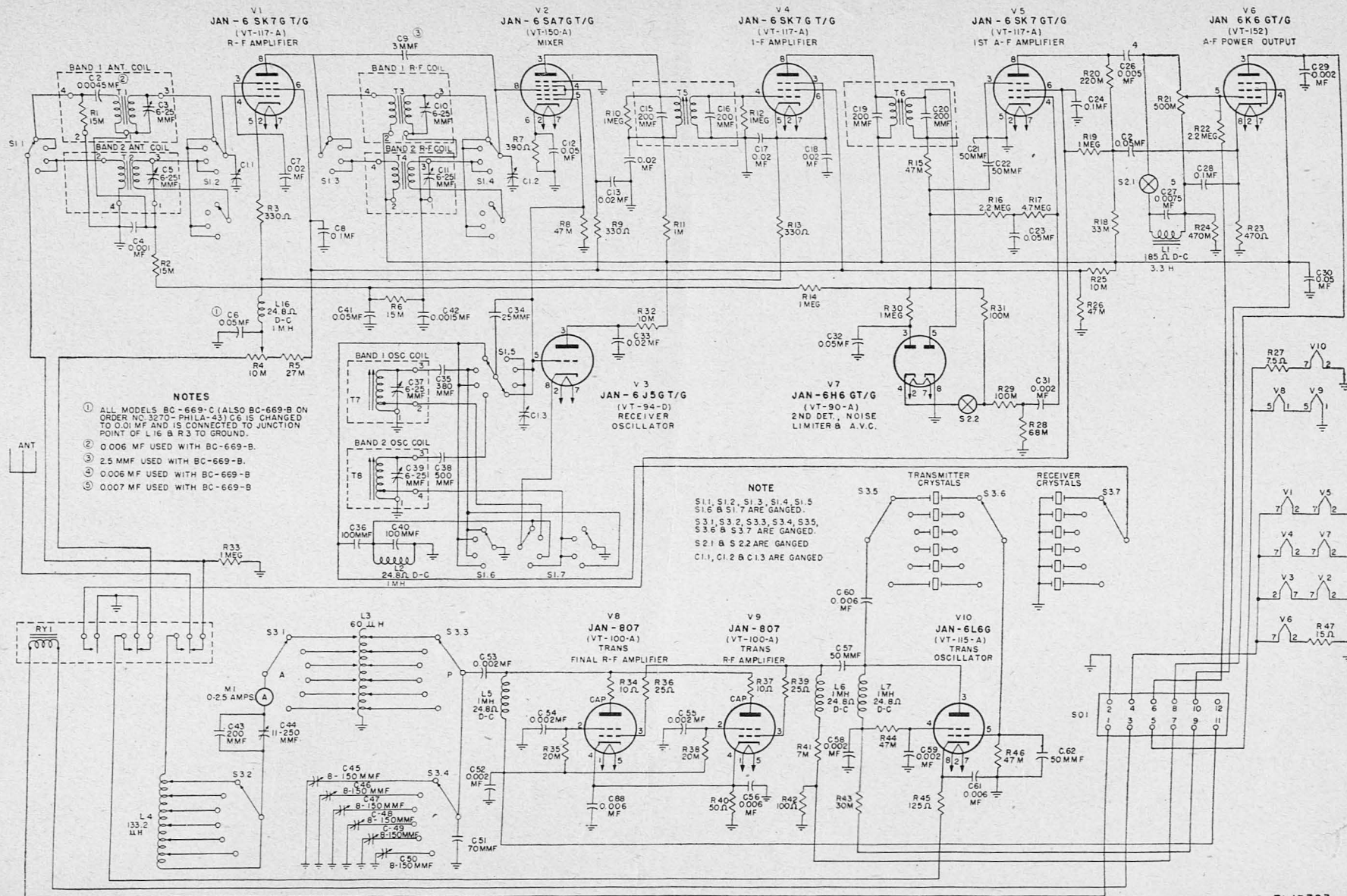

NOTE:  $\text{---}$  IS SYMBOL FOR FIXED CAPACITOR.  
 $\text{---}$  IS SYMBOL FOR VARIABLE CAPACITOR.

Figure 55. Radio Receiver and Transmitter BC-669-B and -C, schematic diagram.



REF SYMBOL	VALUE	RATING
C1.1	107.6 MMF	
C1.2	107.6 MMF	
C1.3	107.6 MMF	300 VDCW
C2	0.018 MF	
C3	6-25 MMF (VARIABLE)	500 VDCW
C4	1,000 MMF	
C5	6-25 MMF (VARIABLE)	200 VDCW
C6	BC-669-A, 1 MF	400 VDCW
	BC-669-B, 0.05 MF	400 VDCW
	BC-669-C, 0.01 MF	400 VDCW
C7	0.02 MF	400 VDCW
C8	0.1 MF	
C9	BC-669-A AND -C, 3 MMF	500 VDCW
	BC-669-B, 2.5 MMF	500 VDCW
C10	6-25 MMF (VARIABLE)	400 VDCW
C11	6-25 MMF (VARIABLE)	400 VDCW
C12	0.02 MF	600 VDCW
C13	0.02 MF	500 VDCW
C14	200 MMF	500 VDCW
C15	200 MMF	400 VDCW
C16	0.02 MF	500 VDCW
C17	0.02 MF	500 VDCW
C18	0.02 MF	500 VDCW
C19	200 MMF	500 VDCW
C20	50 MMF	500 VDCW
C21	50 MMF	400 VDCW
C22	53 MMF	400 VDCW
C23	0.05 MF	500 VDCW
C24	0.1 MF	500 VDCW
C25	0.05 MF	600 VDCW
C26	5,000 MMF	
C27	BC-669-A AND -C, 7,500 MMF	300 VDCW
	BC-669-B, 7,000 MMF	400 VDCW
	BC-669-C, 0.1 MF	2,500 VDCW
C29	2,000 MMF	500 VDCW
C30	0.05 MF	600 VDCW
C31	2,000 MMF	400 VDCW
C32	0.05 MF	600 VDCW
C33	0.02 MF	500 VDCW
C34	25 MMF	300 VDCW
C35	380 MMF	500 VDCW
C36	100 MMF	
C37	6-25 MMF (VARIABLE)	500 VDCW
C38	500 MMF	
C39	6-25 MMF (VARIABLE)	500 VDCW
C40	100 MMF	400 VDCW
C41	0.05 MF	500 VDCW
C42	1,500 MMF	1,430 VACW
C43	200 MMF	
C44	11-250 MMF (VARIABLE)	
C45	8-150 MMF (VARIABLE)	
C46	8-150 MMF (VARIABLE)	
C47	8-150 MMF (VARIABLE)	
C48	8-150 MMF (VARIABLE)	
C49	8-150 MMF (VARIABLE)	
C50	8-150 MMF (VARIABLE)	1,140 VACW
C51	70 MMF	2,500 VDCW
C52	2,000 MMF	

REF SYMBOL	VALUE	RATING
C53	2,000 MMF	2,500 VDCW
C54	2,000 MMF	2,500 VDCW
C55	2,000 MMF	2,500 VDCW
C56	6,000 MMF	400 VDCW
C57	50 MMF	500 VDCW
C58	2,000 MMF	600 VDCW
C59	6,000 MMF	600 VDCW
C60	6,000 MMF	600 VDCW
C61	6,000 MMF	600 VDCW
C62	50 MMF	500 VDCW
C63	6,000 MMF	600 VDCW

REF SYMBOL	VALUE	RATING
R1	15,000 OHMS	1/2 W
R2	15,000 OHMS	1/2 W
R3	330 OHMS	1/2 W
R4	10,000 OHMS (POTENTIOMETER)	
R5	27,000 OHMS	1 W
R6	15,000 OHMS	1/2 W
R7	390 OHMS -	1/2 W
R8	47,000 OHMS	1/2 W
R9	330 OHMS	1/2 W
R10	1 MEGOHM	1/2 W
R11	1 MEGOHM	1/2 W
R12	330 OHMS	1/2 W
R13	330 OHMS	1/2 W
R14	1 MEGOHM	1/2 W
R15	47,000 OHMS	1/2 W
R16	2.2 MEGOHMS	1/2 W
R17	4.7 MEGOHMS	1/2 W
R18	33,000 OHMS	1/2 W
R19	1 MEGOHM	1/2 W
R20	220,000 OHMS	400 VDCW
R21	500,000 OHMS (POTENTIOMETER)	
R22	2.2 MEGOHMS	1/2 W
R23	470 OHMS	2 W
R24	470,000 OHMS	1/2 W
R25	10,000 OHMS	10 W
R26	47,000 OHMS	1 W
R27	7.5 OHMS	10 W
R28	68,000 OHMS	1/2 W
R29	100,000 OHMS	1/2 W
R30	1 MEGOHM	1/2 W
R31	100,000 OHMS	1/2 W
R32	10,000 OHMS	2 W
R33	1 MEGOHM	2 W
R34	10 OHMS	2 W
R35	20,000 OHMS	10 W
R36	25 OHMS	1/2 W
R37	10 OHMS	2 W
R38	20,000 OHMS	10 W
R39	25 OHMS	1/2 W
R40	50 OHMS	10 W
R41	7,000 OHMS	2 W
R42	100 OHMS	1/2 W
R43	15,000 OHMS	10 W
R44	47,000 OHMS	1 W
R45	125 OHMS	1/2 W
R46	47,000 OHMS	1 W
R47	15 OHMS	10 W

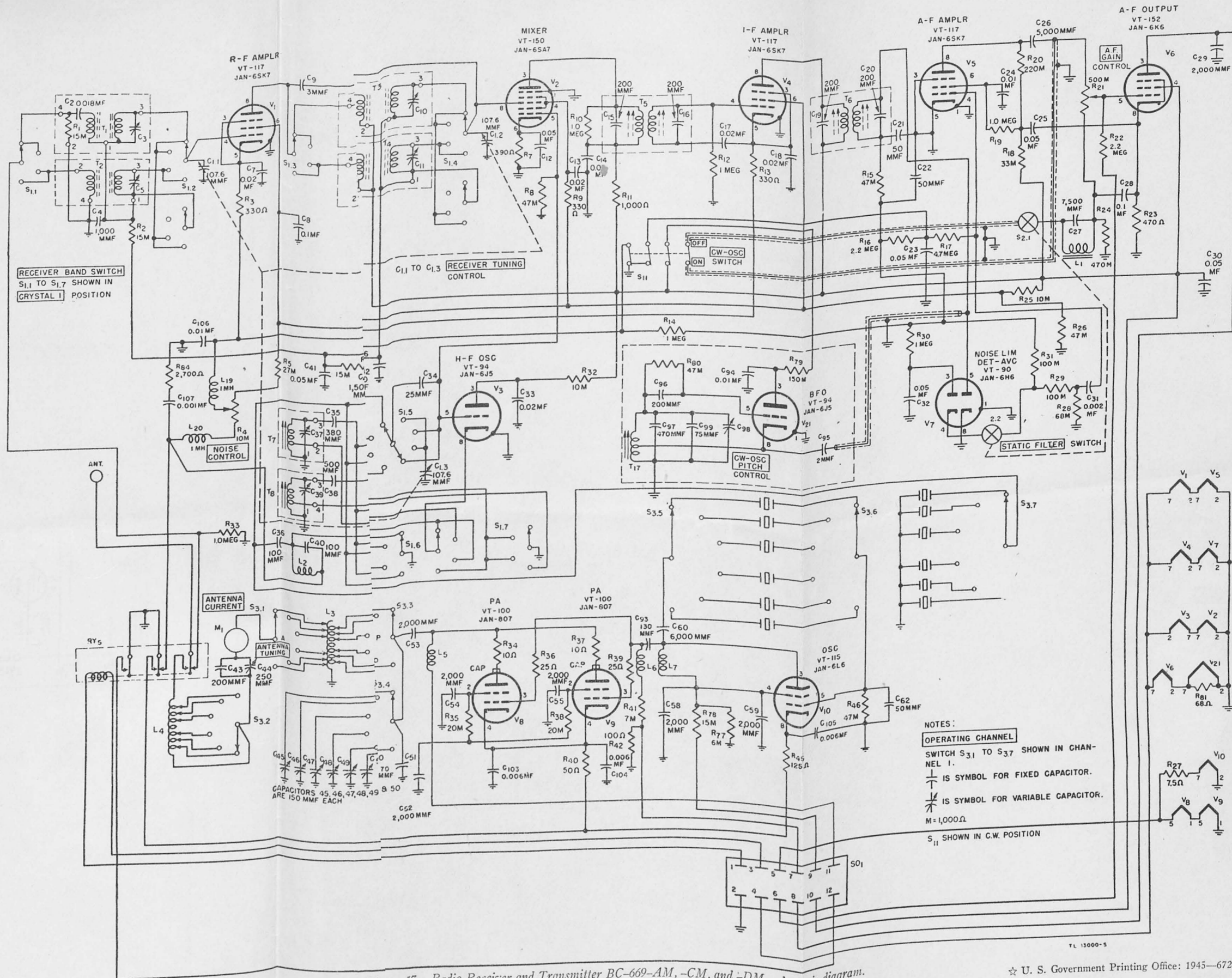

Figure 57. Radio Receiver and Transmitter BC-669-AM, -CM, and -DM, schematic diagram.