

UNCLASSIFIED

TECHNICAL MANUAL

*for*

**RHOMBIC ANTENNA COUPLER  
MODEL RAC**



THE TECHNICAL MATERIEL CORPORATION

MAMARONECK, N. Y.

OTTAWA, CANADA

★  
UNCLASSIFIED

TECHNICAL MANUAL  
*for*  
**RHOMBIC ANTENNA COUPLER**  
**MODEL RAC**



THE TECHNICAL MATERIEL CORPORATION  
MAMARONECK, N. Y.

OTTAWA, CANADA

COPYRIGHT 1964  
THE TECHNICAL MATERIEL CORPORATION

★  
1N-8006

Issu Dat ; Nov mb r 1, 1963

#### NOTICE

THE CONTENTS AND INFORMATION CONTAINED IN THIS INSTRUCTION MANUAL IS PROPRIETARY TO THE TECHNICAL MATERIEL CORPORATION TO BE USED AS A GUIDE TO THE OPERATION AND MAINTENANCE OF THE EQUIPMENT FOR WHICH THE MANUAL IS ISSUED AND MAY NOT BE DUPLICATED EITHER IN WHOLE OR IN PART BY ANY MEANS WHATSOEVER WITHOUT THE WRITTEN CONSENT OF THE TECHNICAL MATERIEL CORPORATION.



# THE TECHNICAL MATERIEL CORPORATION

C O M M U N I C A T I O N S   E N G I N E E R S

700 FENIMORE ROAD

MAMARONECK, N. Y.

## W a r r a n t y

The Technical Materiel Corporation, hereinafter referred to as TMC, warrants the equipment (except electron tubes,\* fuses, lamps, batteries and articles made of glass or other fragile or other expendable materials) purchased hereunder to be free from defect in materials and workmanship under normal use and service, when used for the purposes for which the same is designed, for a period of one year from the date of delivery F.O.B. factory. TMC further warrants that the equipment will perform in a manner equal to or better than published technical specifications as amended by any additions or corrections thereto accompanying the formal equipment offer.

TMC will replace or repair any such defective items, F.O.B. factory, which may fail within the stated warranty period, PROVIDED:

1. That any claim of defect under this warranty is made within sixty (60) days after discovery thereof and that inspection by TMC, if required, indicates the validity of such claim to TMC's satisfaction.
2. That the defect is not the result of damage incurred in shipment from or to the factory.
3. That the equipment has not been altered in any way either as to design or use whether by replacement parts not supplied or approved by TMC, or otherwise.
4. That any equipment or accessories furnished but not manufactured by TMC, or not of TMC design shall be subject only to such adjustments as TMC may obtain from the supplier thereof.

Electron tubes\* furnished by TMC, but manufactured by others, bear only the warranty given by such other manufacturers. Electron tube warranty claims should be made directly to the manufacturer of such tubes.

TMC's obligation under this warranty is limited to the repair or replacement of defective parts with the exceptions noted above.

At TMC's option any defective part or equipment which fails within the warranty period shall be returned to TMC's factory for inspection, properly packed with shipping charges prepaid. No parts or equipment shall be returned to TMC, unless a return authorization is issued by TMC.

No warranties, express or implied, other than those specifically set forth herein shall be applicable to any equipment manufactured or furnished by TMC and the foregoing warranty shall constitute the Buyers sole right and remedy. In no event does TMC assume any liability for consequential damages, or for loss, damage or expense directly or indirectly arising from the use of TMC Products, or any inability to use them either separately or in combination with other equipment or materials or from any other cause.

\*Electron tubes also include semi-conductor devices.

### *PROCEDURE FOR RETURN OF MATERIAL OR EQUIPMENT*

Should it be necessary to return equipment or material for repair or replacement, whether within warranty or otherwise, a return authorization must be obtained from TMC prior to shipment. The request for return authorization should include the following information:

1. Model Number of Equipment.
2. Serial Number of Equipment.
3. TMC Part Number.
4. Nature of defect or cause of failure.
5. The contract or purchase order under which equipment was delivered.

### *PROCEDURE FOR ORDERING REPLACEMENT PARTS*

When ordering replacement parts, the following information must be included in the order as applicable:

1. Quantity Required.
2. TMC Part Number.
3. Equipment in which used by TMC or Military Model Number.
4. Brief Description of the Item.
5. The *Crystal Frequency* if the order includes crystals.

### *PROCEDURE IN THE EVENT OF DAMAGE INCURRED IN SHIPMENT*

TMC's Warranty specifically excludes damage incurred in shipment to or from the factory. In the event equipment is received in damaged condition, the carrier should be notified immediately. Claims for such damage should be filed with the carrier involved and not with TMC.

All correspondence pertaining to Warranty Claims, return, repair, or replacement and all material or equipment returned for repair or replacement, within Warranty or otherwise, should be addressed as follows:

THE TECHNICAL MATERIEL CORPORATION  
Engineering Services Department  
700 Fenimore Road  
Mamaroneck, New York

CHANGE NO. 2



### INSTRUCTION BOOK CHANGE NOTICE

Date June 22, 1970

Manual affected: Rhombic Antenna Coupler Model RAC 8006  
IN

Page 1-4, Table 1-2, add the following information:

TMG Model No.	Military Nomenclature	Transformer Part No.	Frequency Range (MC/s)	Nominal Balanced Impedance (Ohms)	Unbalanced Impedance (Ohms)
RAC-48		TR-033	2 to 54	700/300	70

Page 5-2, Table 5-1, add the following information:

Transformer Part Number	Transformer Mounting Plate Assembly Number
TR-033	AX382-16

Page 5-3, Figure 5-1. Models RAC, Parts Callouts.

Add Model RAC-48 to "Models RAC-1 thru RAC-24"



TABLE OF CONTENTS

<u>Paragraph</u>		<u>Page</u>
	<u>SECTION 1 - GENERAL DESCRIPTION</u>	
1-1	Purpose - - - - -	1-1
1-2	Description - - - - -	1-1
1-3	Technical Specifications - - - - -	1-2
	<u>SECTION 2 - INSTALLATION</u>	
2-1	Unpacking - - - - -	-2-1
2-2	Installation - - - - -	2-1
	<u>SECTION 3 - THEORY OF OPERATION</u>	
3-1	General - - - - -	3-1
3-2	Operation - - - - -	3-1
3-3	Resistance Measurements - - - - -	3-1
	<u>SECTION 4 - MAINTENANCE</u>	
4-1	General - - - - -	4-1
4-2	Continuity Check - - - - -	4-1
	<u>SECTION 5 - PARTS LIST</u>	5-1



LIST OF ILLUSTRATIONS

<u>Figure</u>		<u>Page</u>
<u>SECTION 1 - GENERAL DESCRIPTION</u>		
1-1	Front View, Basic Rhombic Antenna Coupler - - - - -	iii
1-2	Inside View, RAC-7 fitted for RG-174B Cable - - - - -	iii
1-3	Typical Response Curve - - - - -	1-2
<u>SECTION 2 - INSTALLATION</u>		
2-1	Installation Mounting Dimensions, RAC - - - - -	2-1
<u>SECTION 3 - THEORY OF OPERATION</u>		
3-1	Schematic Diagram, TR-001 - - - - -	3-2
3-2	Simplified Schematic, Resistance Measurements - - - - -	3-2
<u>SECTION 5 - PARTS LIST</u>		
5-1	Models RAC, Parts Callouts - - - - -	5-3

LIST OF TABLES

<u>Table</u>		<u>Page</u>
<u>SECTION 1 - GENERAL DESCRIPTION</u>		
1-1	Technical Specifications, RAC - - - - -	1-3
1-2	Basic Rhombic Antenna Couplers - - - - -	1-4
1-3	Mounting Plate Connector Assemblies - -	1-4
<u>SECTION 5 - PARTS LIST</u>		
5-1	Transformer Mounting Plate Assemblies - - - - -	5-2

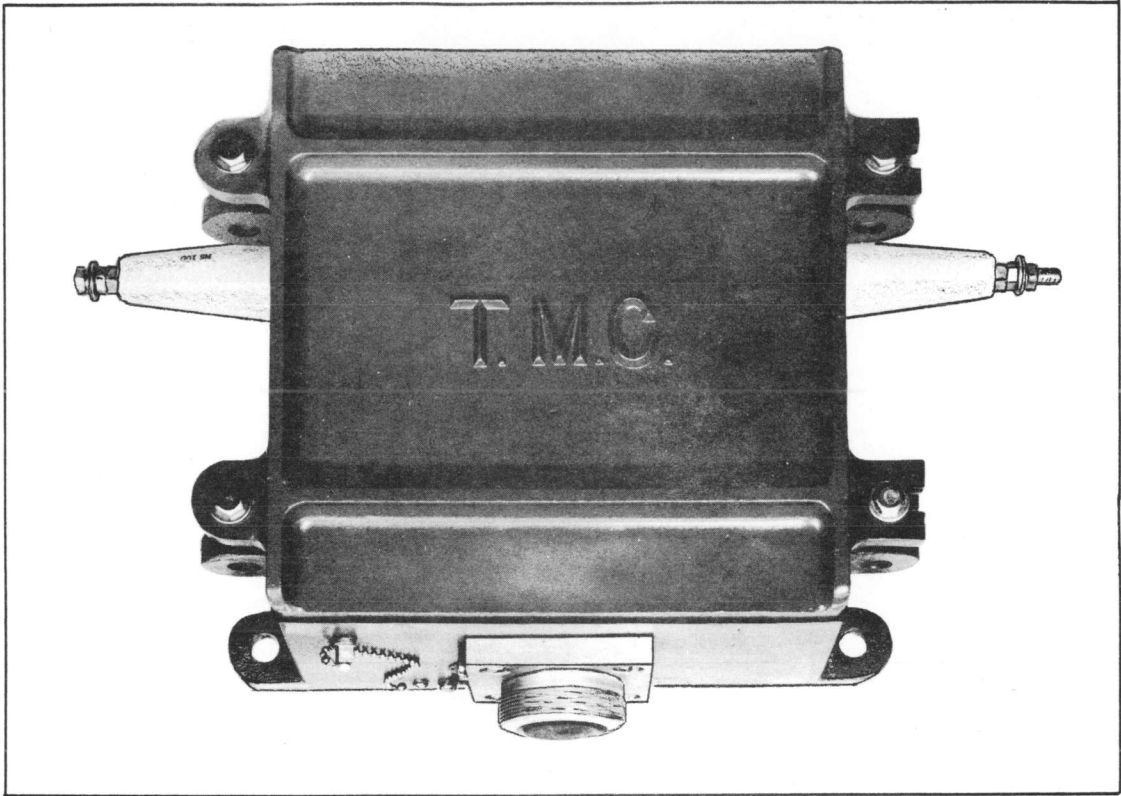

Figure 1-1. Front View, RAC Rhombic Antenna Coupler

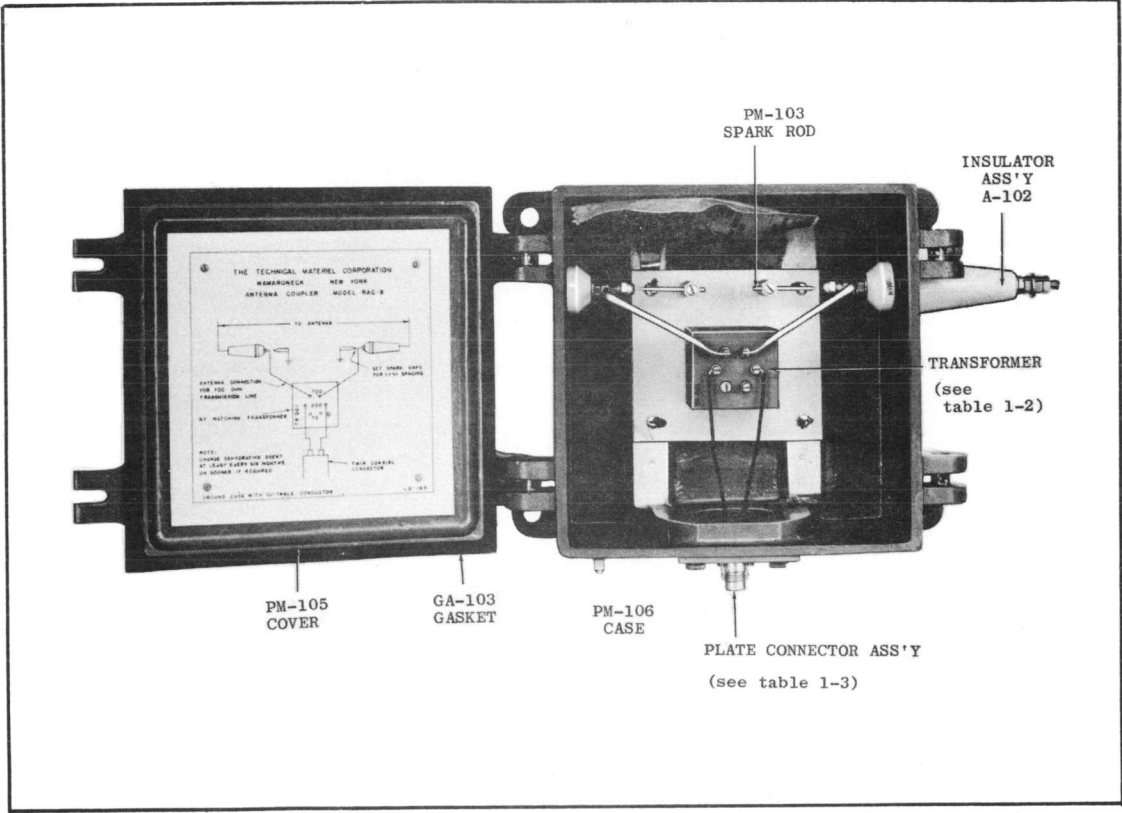

Figure 1-2. Inside View, RAC-7 Fitted for RG-17/U Cable

RAC circuitry is designed to permit DC checking of the continuity of the antenna and transmission line.

### 1-3 TECHNICAL SPECIFICATIONS

Table 1-1 lists specifications to which the RAC series are built. Table 1-2 lists the standard models and their corresponding characteristics. Figure 1-3 is a typical response curve for the TR-001 transformer. Table 1-3 lists the mounting plate connector assemblies available.

In addition to standard models listed, other varieties of the RAC are available on special order. Different combinations of impedance match and cable connectors are possible by varying transformers and plate/connector assemblies, respectively.

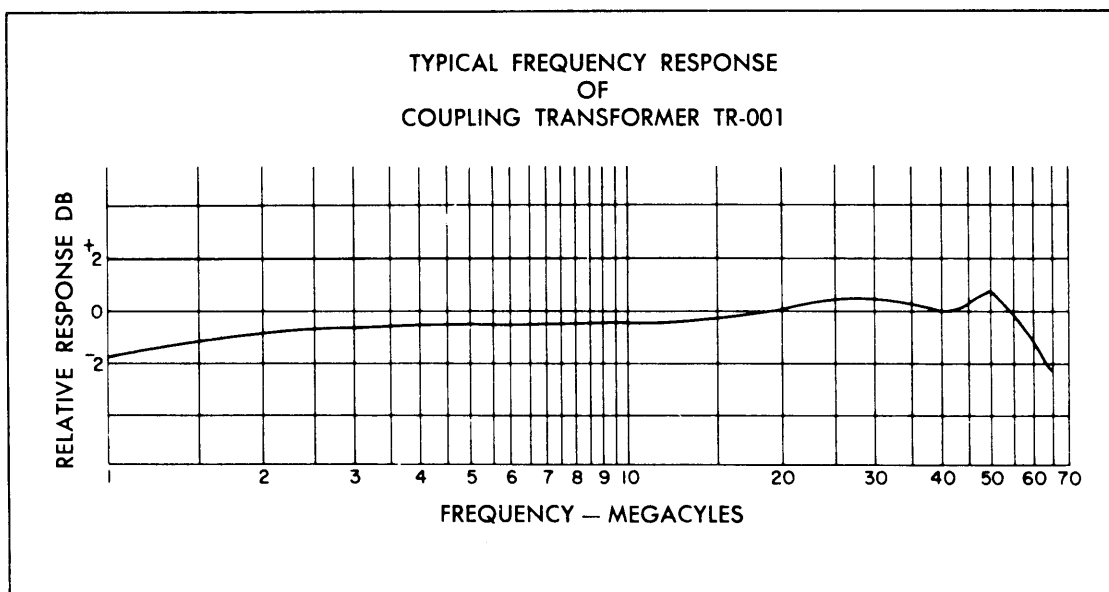

Figure 1-3. Typical Response Curve

TABLE 1-1. Technical Specifications, RAC

Item	Characteristic
INPUT IMPEDANCES:	See Table 1-2
OUTPUT IMPEDANCES:	See Table 1-2
FREQUENCY RANGE:	See Table 1-2
FREQUENCY RESPONSE:	Flat within 3 db over the frequency range
EQUIPMENT CASE:	Weather resistant, cast of aluminum alloy
INPUT TERMINALS:	Two ceramic insulators, properly spaced to accomodate the rhombic terminals
OUTPUT TERMINALS:	See Table 1-3
MOUNTING:	Pole mounting by means of four heavy cast mounting flanges. See Figure 2-1.
WEIGHT:	Net - 13 lbs. Gross - 16 lbs., packed for domestic shipment
COMPONENTS AND CONSTRUCTION:	Equipment is manufactured in accordance with JAN/MIL specifications wherever practicable

Tabl 1-2 BASIC RHOMBIC ANTENNA COUPLERS

TMC MODEL No.	MILITARY NOMENCLATURE	TRANSFORMER PART NO.	FREQUENCY RANGE (MC/s)	NOMINAL BALANCED IMPEDANCE (Ohms)	UNBALANCED IMPEDANCE (Ohms)
RAC-1		TR-001	2 to 60	700/200	70
RAC-3		TR-048	2 to 30	700/400	95
RAC-7		TR-090	2 to 32	600/200	50
RAC-7A		TR-069	2 to 32	600	70
RAC-9		TR-034	2 to 30	500	50
RAC-11		TR-012	2 to 30	300	50
RAC-12		TR-112	2 to 30	800	50
RAC-13		TR-168	2 to 30	500	70
RAC-20†		TR-054	2 to 32	600/200	70
RAC-24		TR-032	2 to 32	600	50
RAC-30		TR-130	2 to 32	700/200	70
RAC-30A		TR-132	2 to 32	600/200	70
RAC-32	CU-836/U	TR-132	2 to 32	600/200	70
RAC-34		TR-088	4 to 15	516	75

† Antenna continuity readings not possible with this unit.

Table 1-3 MOUNTING PLATE CONNECTOR ASSEMBLIES

MODEL NUMBER	DESCRIPTION
AX-256-1	Mounting Plate, Connector Assembly type UHF (L)
AX-259-1	Mounting Plate, Connector Assembly type N
AX-273-1	Mounting Plate, Connector Assembly QDL
AX-274-1	Mounting Flange for RG-85/U
AX-276-1	Adapter Assy, 3 1/8" — 50 ohm to LC female
AX-277-1	Adapter Assembly, 3 1/8" — 70 ohm to LC female
AX-281-1	Mounting Plate, Connector Assembly type UHF
AX-282-1	Mounting Plate Connector Assy., type UHF twin
AX-283-1	Mounting Plate, Connector Assembly type BN
AX-284-1	Mounting Plate, Connector Assembly type BNC
AX-285-1	Mounting Plate, Connector Assembly type HN
AX-286-1	Mounting Plate Connector Assembly, type C
AX-287-1	Mounting Plate, Connector Assy., type LC, 50 ohm
AX-287-5	Mounting Plate, Connector Assy., type LC, 70 ohm with mating plug
AX-289-1	Mounting Plate, Connector Assembly QDS
AX-310	Mounting Plate Assy., 1/2" Stuffing Tube
ES-ST7875	End Seal, Styroflex 7/8" 70 ohm
ES-ST5875	End Seal, Styroflex 7/8" 50 ohm

To provide flexibility for selection of a variety of RF fittings, table 1-2 is used in conjunction with table 1-3 as per the following sample:

RAC-1/AX-259-1

Basic RAC with TR 001 for 700/200 balanced to 70 ohm unbalanced.

Mounting Plate with Connector Assembly Type (N)

Indicates Mounting Plate & Connector (without mating cable connector) \*

SECTION 2  
INSTALLATION

2-1 UNPACKING

The RAC is shipped in one crate and is completely assembled at time of delivery. When the unit is uncrated it should be inspected for any damage incurred in transit. Inspect all packing material for parts which may have been shipped as loose items. With respect to damage to the equipment for which the carrier is liable, the Technical Materiel Corporation will assist in describing methods of repair and the furnishing of replacement parts.

2-2 INSTALLATION

Each unit has been factory tested and arrives ready for immediate installation and operation. No preliminary adjustments are necessary other than the connection of the two antenna leads to the RAC insulated terminal posts and the connection of the receiver lead-in cable to the RAC connector.

Figure 2-1 shows dimensions and information for a typical pole mounting. The case size and mounting holes are the same for all RAC units.

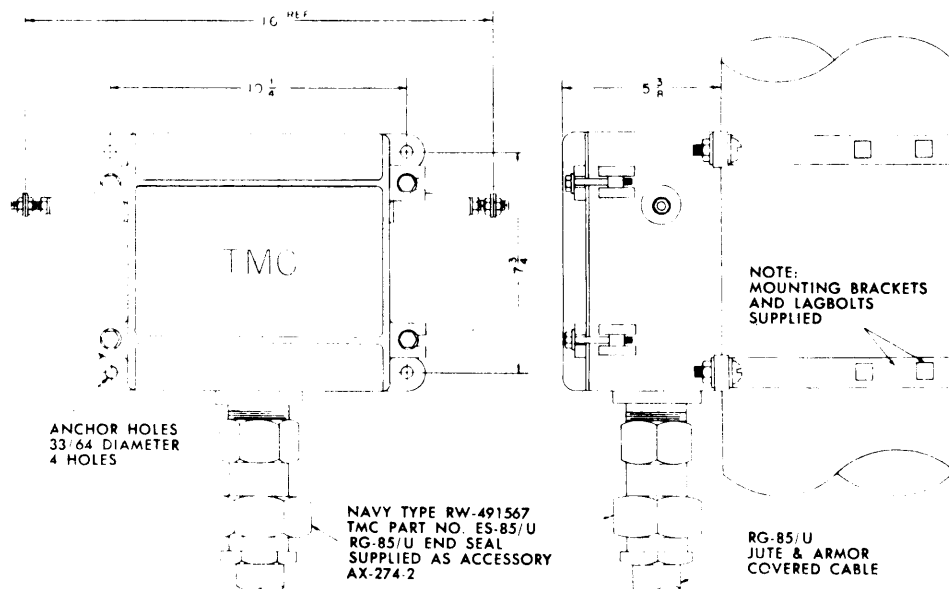

Figure 2-1. Installation Mounting Dimensions, RAC

SECTION 3  
THEORY OF OPERATION

3-1 GENERAL

The RAC consists essentially of a broadband auto-transformer. TR-001 is typical of this configuration and is shown in Figure 3-1.

3-2 OPERATION

Referring to Figure 3-1, the resistor R across the 70-ohm input has a value of 10,000-ohms and, since this is much greater than 70-ohms, the shunting effect on the 70-ohm winding is negligible. The purpose of this resistor is to allow a leakage path to ground for static charges which may accumulate on the antenna. The capacitor C connecting the halves of the transformer has a value of .05 mfd. Its reactance over the frequency range is also negligible, acting as a short circuit to radio frequencies. Its purpose is to isolate the windings for d-c current to permit resistance measurements of antenna termination as described in paragraph 3-3.

3-3 RESISTANCE MEASUREMENTS

A quick continuity check with an ohmmeter is outlined in paragraph 4-2. The analysis of circuit action is described here. Figure 3-2 is a simplified diagram to show capacitor function in d-c measurements. If a d-c ohmmeter is connected to the 70-ohm terminals, the current will be limited by RL, since R is greater than RL, therefore the ohmmeter will record essentially the termination resistance RL, (700-ohms or 200-ohms, as the case may be). Open circuit conditions in the input or output would give R reading on the ohmmeter.

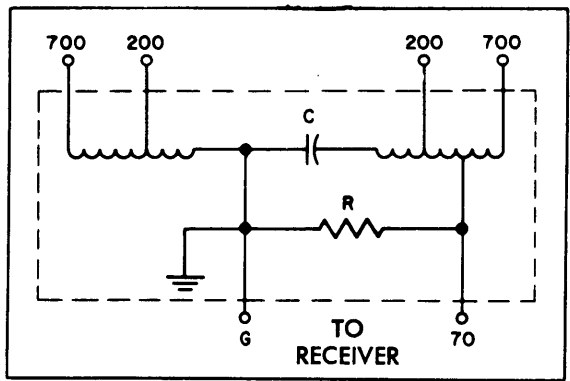

Figure 3-1 Schematic Diagram, TR-001

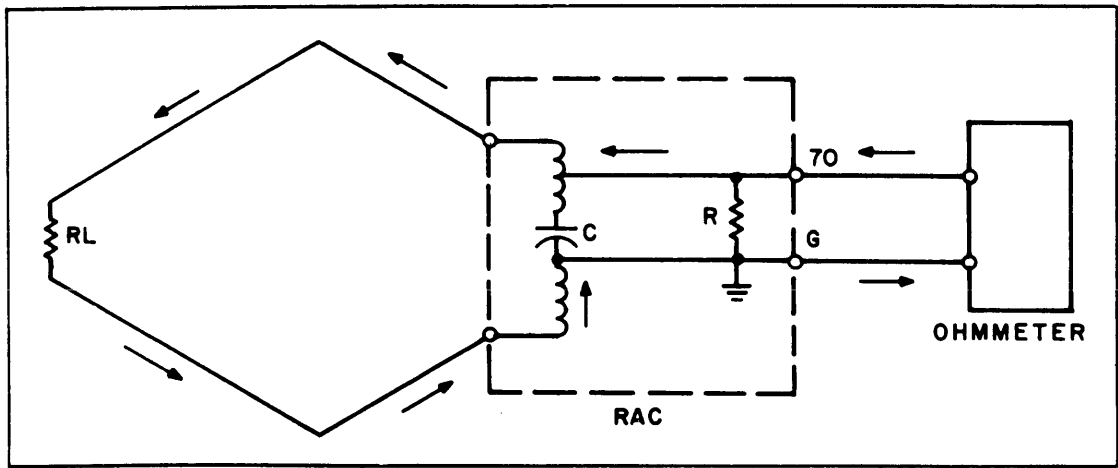

Figure 3-2 Simplified Schematic, Resistance Measurements



SECTION 4  
MAINTENANCE

4-1. GENERAL

Basically, the RAC is a passive impedance matching device and requires no power supply or tuning adjustment. However, when trouble occurs in a receiving system during operation, the RAC offers the facility of a check for continuity between antenna and transmission line.

Change the dehydrant every 6 months or sooner if required. Where a new supply of dehydrant is not available, the old may be reactivated by baking in an oven for 1 hour at 220 degrees F. Otherwise, the RAC normally requires no maintenance other than a periodic cleaning of electrical connections and a check that all external and internal connections are properly tightened.

4-2. CONTINUITY CHECK

To determine open-circuit or short circuit conditions in the RAC unit, a d-c ohmmeter is connected to the input or output terminals. With both input and output terminations open-circuited, the ohmmeter will read as listed below. This list contains measurements in reference to Figure 3-1. Similiar measurements for other units may be taken in reference to the applicable transformer schematic diagram shown on the inside cover of the RAC case.

Ohmmeter Connection (see figure 3-1)

<u>From</u>	<u>To</u>	<u>Reading (ohms)</u>
70 ohm output term.	G term.	10,000 $\pm$ 20%
700 ohm input term.	700 ohm input term.	10,000 $\pm$ 20%
200 ohm input term.	200 ohm input term.	10,000 $\pm$ 20%

With either input or output terminations short circuited, the ohmmeter will register a short.

**NOTE**

In some RAC models, the 10,000-ohm resistor between the 70-ohm terminal and ground has been omitted. The d-c continuity remains as stated above except that the ohmmeter reading will be the same as the termination used, very high if the termination is open, or zero if the termination is shorted.

If no short or open circuit conditions exist, the ohmmeter connected at either input or output will read the primary impedance (700, 200 - etc., as the case may be).

## SECTION - 5

PARTS LIST

## MODELS RAC

ITEM (See FIGURE 5-1)	DESCRIPTION	TMC PART NO.
1	Case	PM-106
	Case (Model RAC-7a)	PM-372
2	Dessicant	AD-101-1/6
3	Drain Plug	A-1291
4	Fuse, 4 Amp	FU-100-4
5	Fuse, Clip	FC-102-1-XX-N
6	Fuse, Clip	FH-102
7	Gasket	GA-104
8	Gasket, Cover	GA-103
9	Gasket, Inside	GA-101
10	Gasket, Outside	GA-100
11	Holder, Dessicant	MS-933
12	Insulator, Inside	NS-101
13	Insulator, Outside	NS-100
14	Lightning Arrestor	SW-176
15	Nut, Cap	NTC2520BNL
16	Nut, Hex	NTH2520SS14
17	Post	PM-102
18	Screw, Machine	SCBS0632BNG
19	Spark, Rod	PM-103
20	Stud, Sub Assy.	A-100
21	Tubing	FP-179
22	Washer, Flat	FN25MSS
23	Washer, Lock	LWE06MRN
24	Washer, Lock	FW25LBN

TABLE 5-1 Transformer Mounting Plate Assemblies

Transformer Part No.	Transformer Mounting Plate Assembly No.
TR-088	AX-381-1
TR-130	AX-381-3
TR-132	AX-381-4
TR-147	AX-381-7
TR-001	AX-382-1
TR-012	AX-382-3
TR-032	AX-382-4
TR-034	AX-382-5
TR-048	AX-382-7
TR-054	AX-382-8
TR-090	AX-382-9
TR-112	AX-382-10
TR-168	AX-382-12

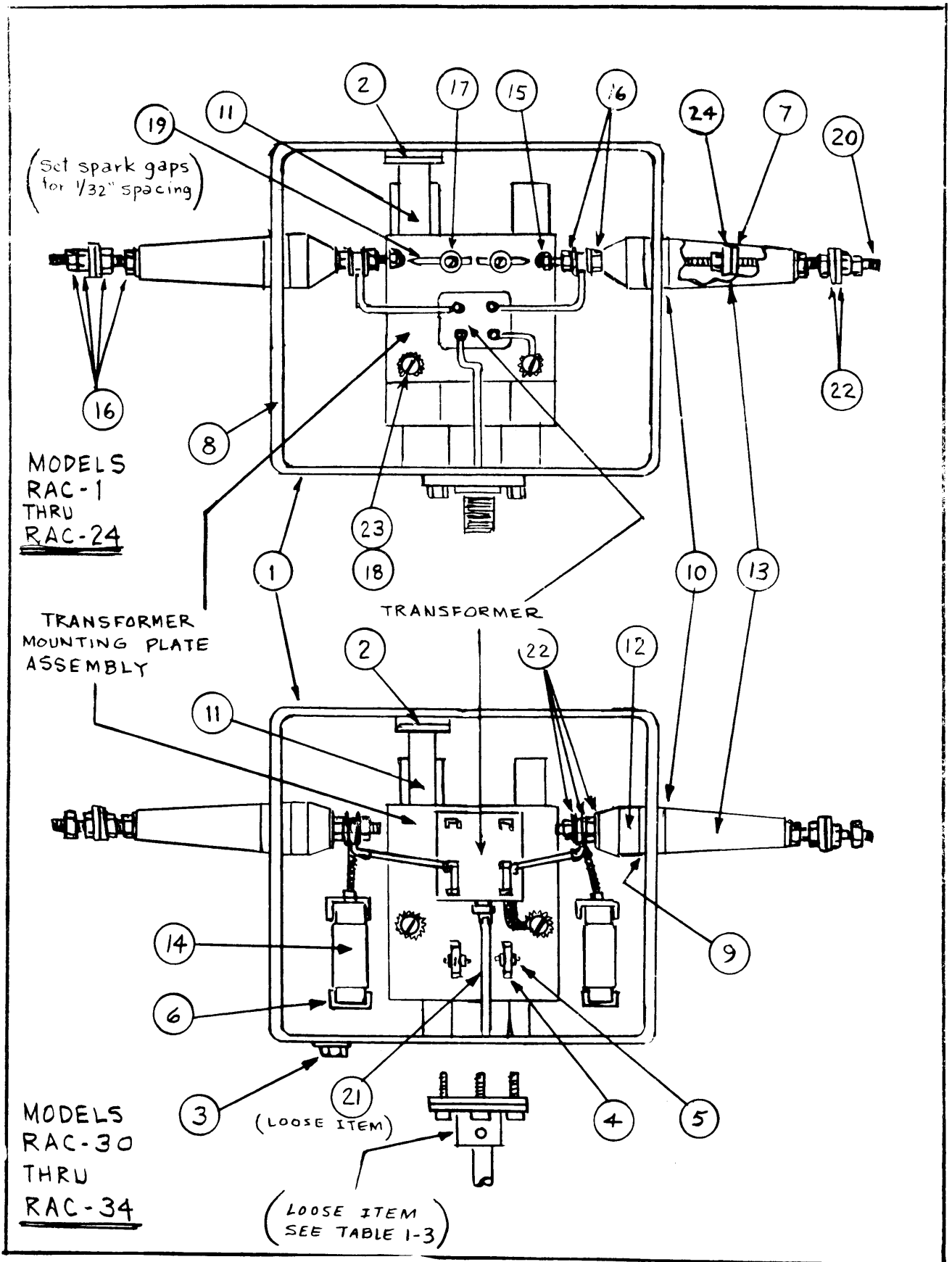

Figure 5-1. Models RAC, Parts Callouts.

TMC ASS'Y PART NO	ITEM PART NO'S				MATERIALS AND FINISHES		
	ITEM 1	ITEM 2	ITEM 3	ITEM 4	ITEM NO.	MATERIAL	FINISH
AX-281-1	PM-119	LWS25MSS	SCHH2520SSI2	LWS04MSS	1	ALUMINUM	IRIDITE
AX-281-2	PM-119	LWS25MSS	SCHH2520SSI2	LWS04MSS	2	STAINLESS STEEL	PASSIVATE
					3	STAINLESS STEEL	PASSIVATE
					4	STAINLESS STEEL	PASSIVATE
AX-281-1	SCBP044SS5	GA-149-4	JJ-214	NONE	5	STAINLESS STEEL	PASSIVATE
AX-281-2	SCBP044SS5	GA-149-4	JJ-214	NONE	6	NEOPRENE	NATURAL
					7	SEE CONNECTOR DWG.	
					8	SEE ADAPTER DWG.	
AX-281-1	NONE	GA-102	A-876		9	SEE CONNECTOR DWG.	
AX-281-2	PL-259A-TEF	GA-102	A-876		10	NEOPRENE	NATURAL
					11	COPPER	CAD PLATE

NOTE: ITEM 11 SUPPLIED AS LOOSE ITEM  
WITH RAC SERIES ONLY

