

INSTRUCTIONS

HIGH FREQUENCY

COMMUNICATIONS TRANSMITTER

AND

SPEECH AMPLIFIER

Manufactured by
RCA VICTOR DIVISION
of
RADIO CORPORATION OF AMERICA
Camden, New Jersey, U. S. A.

INSTRUCTIONS

HIGH FREQUENCY COMMUNICATIONS TRANSMITTER

MI-8167-H

MI-8167-J

a part of TYPE ET-4336-H H-F Transmitting Equipment

**Manufactured by
RCA VICTOR DIVISION
of
RADIO CORPORATION OF AMERICA
Camden, New Jersey, U. S. A.**

TABLE OF CONTENTS

| Title | Page |
|---|------|
| Technical Summary | |
| Electrical Characteristics | 7 |
| Tube Complement | 7 |
| Mechanical Specifications | 7 |
| Equipment | 8 |
| Description | |
| General | 8 |
| Construction | 8 |
| Circuits | 8 |
| (1) Oscillator | 8 |
| (2) Power Amplifier | 9 |
| (3) Keying | 9 |
| (4) Modulator | 9 |
| (5) Voltage Supply | 10 |
| Installation | |
| Location | 10 |
| (1) Illumination | 10 |
| (2) Power | 10 |
| (3) Clearance | 10 |
| Wiring | 10 |
| Typical Setup | 10 |
| Preliminary to Operation | 11 |
| Control Identification Chart | 11 |
| Panel Control Functions | 11 |
| Initial Switch Positions | 12 |
| Power Supply | 12 |
| Control Circuit Check | 12 |
| Tuning | 12 |
| (1) Oscillator Tuning | 13 |
| (2) Power Amplifier Tuning | 13 |
| (3) Antenna Loading | 13 |
| Modulator Adjustments | 14 |
| (1) Modulation and Keying Indicator | 14 |
| Typical Voltage and Current Values | 15 |
| Operation | |
| Telegraph | 15 |
| To Start Transmitter | 15 |
| To Stop Transmitter | 15 |

TABLE OF CONTENTS (Continued)

| | |
|-----------------------------|----|
| Telephone | 15 |
| To Start Transmitter..... | 15 |
| To Stop Transmitter..... | 15 |
| Maintenance | 16 |
| General | 16 |
| Fuse Replacement | 16 |
| Capacitor Replacement | 16 |
| Parts List..... | 17 |

LIST OF ILLUSTRATIONS

| Figure | Title | Page |
|--------|--|------|
| 1 | —Transmitter for Type ET-4336-H Equipment (Front View) | 6 |
| 2 | —Transmitter (Right Side View, Referred to Front) | 21 |
| 3 | —Transmitter (Left Side View, Referred to Front) | 22 |
| 4 | —Transmitter (Rear View) | 23 |
| 5 | —Antenna Tuning Chassis (Top Oblique View) | 24 |
| 6 | —Transmitter (Schematic P-621268) | 25 |
| 7 | —Transmitter (Interconnections P-727185 Sub 1) | 26 |
| 8 | —R-F Unit (Connections W-306491 Sub 1) | 27 |
| 9 | —Modulator Unit (Connections P-727182 Sub 3) | 28 |
| 10 | —Antenna Tuning Unit (Connections P-714951 Sub 1) | 29 |
| 11 | —Transmitter Assembly (Outline Drawing P-722258) | 30 |
| 12 | —Oscillator Tuning Curves (S-880320) | 31 |
| 13 | —Power Amplifier Tuning Curves (S-880321) | 32 |

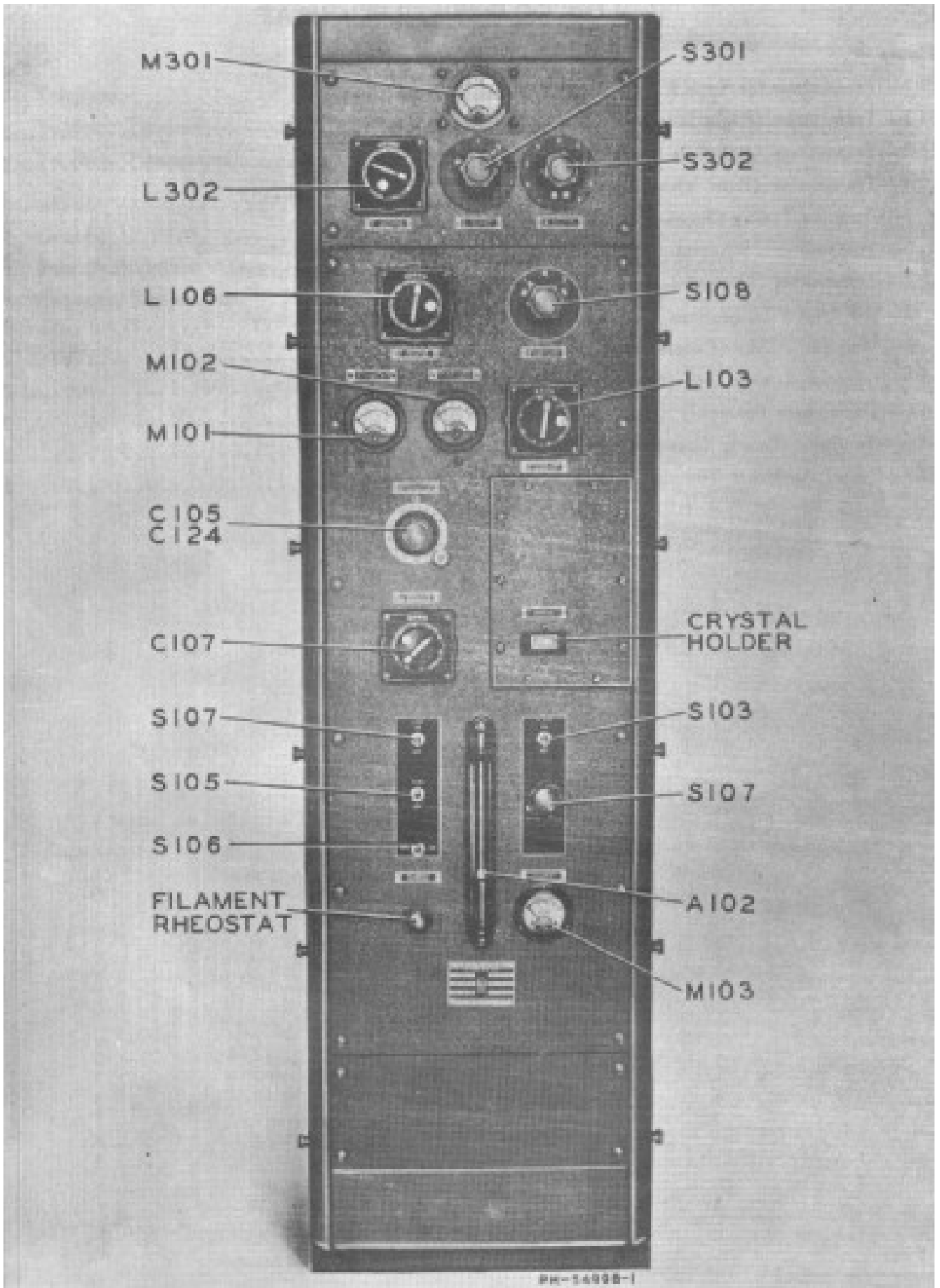

Figure 1—Transmitter for Type ET-4336-H Equipment (Front View)

TECHNICAL SUMMARY

ELECTRICAL CHARACTERISTICS—

| | |
|---|---|
| Frequency Range | 2000 to 20,000 kc |
| Power Output | |
| Telegraph | 350 watts |
| Telephone | 250 watts |
| Type of Modulation | Class B, high level |
| Audio-Input Impedance | 500 ohms |
| Audio-Input Level for 100 Per Cent Modulation | +39 vu |
| Power Supply Requirements | 190 to 250 volts, 1 phase, 50-60 cycles |
| Power Consumption | |
| Telegraph | 1.65 kw |
| Telephone, 100 Per Cent Modulation | 1.82 kw |

TUBE COMPLEMENT—

Transmitter

| | |
|-----------------------|-----------------|
| Oscillator | 1 RCA-807 |
| Power Amplifier | 2 RCA-813 |
| Modulator | 2 RCA-805 |
| Rectifier | 4 RCA-866-A/866 |

MECHANICAL SPECIFICATIONS—

Dimensions

| | |
|------------------------|--------------------------|
| Height (Cabinet) | *57 $\frac{5}{8}$ inches |
| (Overall) | *60 $\frac{1}{4}$ inches |
| Width | 17 $\frac{1}{4}$ inches |
| Depth | 24 $\frac{5}{8}$ inches |
| Weight (net) | 550 pounds |

*In the case of MI-8167-H add approximately 1 inch to height for channel mounting.

EQUIPMENT

The transmitter supplied as part of the Type ET-4336-H Transmitting Equipment for 190 to 250 volt operation is identified by the Stock Numbers MI-8167-H or MI-8167-J. This equipment is packed for shipment as noted below:

| Quantity | Item | Stock No. |
|----------|--------------------------------------|-----------|
| 1 | H-F Transmitting Unit | |
| 2 | Insulator, Bushing | |
| 2 | Side Shock Mounts (MI-8167-J only) | |
| 1 | Set of Resistors | |
| | (A) 3 Resistors (R102, R103, R117) | |
| | (B) 1 Resistor (R105) | |
| | (C) 2 Resistors (R115, R116) | |
| 1 | Bag or Envelope containing: | |
| | (A) 1 Wrench, No. 10 Allen Set Screw | |
| | (B) 1 Wrench, No. 8 Allen Set Screw | |
| | (C) 1 Wrench, No. 6 Allen Set Screw | |
| | (D) 2 Jacks | |

Associated equipment (not supplied), required if Master Oscillator conversion is desired:

| Quantity | Item | Stock No. |
|----------|-------------------|-----------|
| 1 | Master Oscillator | MI-19467 |
| 1 | Vacuum Tube | RCA-807 |

DESCRIPTION

GENERAL — The High-Frequency Communications Transmitters, MI-8167-H and MI-8167-J, are designed for either telephone or telegraph service within the range from 2000 to 20,000 kilocycles. Any desired operating frequency within this range may be selected and used by inserting a crystal unit ground to the wanted frequency. The transmitter is so designed that it may be converted, if desired, for operation with Master Oscillator MI-19467. Quick change from telephone to telegraph operation (or vice versa) is made possible by means of a switch mounted on the front panel. The tuning controls, operating switches, meters, as well as a modulation and keying indicator of the vapor-column type, are also mounted on this panel. The indicator is a glass tube, filled with a gas which ionizes when a voltage is applied. It is so designed that the height to which the gas ionizes is a function of the applied voltage. During telephone operation, the height of the ionized or illumined portion will vary with modulation and give an approximate indication of its percentage. During telegraph operation, the height of the illumined portion will be the same each time the key is closed.

A high-speed keying relay enables the transmitter to respond to keying at speeds as high as 100 words per minute.

The power output during telegraph operation is nominally 350 watts; for telephone operation the carrier power is 250 watts, nominal. The actual output will, of course, vary considerably with frequency and antenna constants.

CONSTRUCTION—The internal construction of the transmitter is shown in Figures 2, 3 and 4. All radio-frequency components except those of the antenna coupling network are on the large r-f chassis which is mounted vertically at the center of the cabinet. The antenna coupling components are installed on the small, horizontally-mounted chassis located above the r-f chassis.

The high-voltage power transformer and the modulator chassis are mounted at the bottom of the cabinet. The other power supply components are installed on the lower portion of the r-f chassis.

Each chassis is accessible upon removal of the perforated shields at the sides and rear of the cabinet. The shield perforations, as well as the perforations in the sides and top of the cabinet cover, provide for adequate ventilation of the equipment.

CIRCUITS—In the following descriptions of the transmitter circuits, identification of the component parts will be made by means of the symbol designations used on the schematic diagrams. These designations also appear on the associated connection diagrams and on the photographs. The transmitter is composed of two r-f circuits.

1. **Oscillator**—The first stage of the radio-frequency channel incorporates an RCA-807 tube (V102) operating as a crystal-controlled oscillator. The crystal determines the frequency of the grid circuit of this stage, while the combination of coil L107 and capacitors C105 and C124 tune

jacks should be used to replace those which are placed in the crystal socket at the factory.

Meter M101 indicates the plate current drawn by the oscillator tube.

Depending upon the connection of the RCA-807 screen lead at the terminal strip (TB2), the oscillator stage may, or may not, be keyed.

- 2. Power Amplifier**—The second r-f stage is the power amplifier, which stage utilizes two RCA-813 tubes (V103, V104) in parallel operation. Since these tubes are of the beam power type, no neutralization is necessary even at the highest operating frequency. The plate-tank circuit components (L103, C107, C114, C115, C116 and C117) are tuned to the desired output frequency by means of the variable inductor L103, the desired band being selected by switch S108. Cathode current for the power-amplifier tubes is indicated by meter M102.

The antenna matching network provided permits matching the output of the power amplifier to the antenna. This circuit (consisting of L106, L302, S301, S302, and C301 to C310) is designed primarily for use with an unbalanced antenna, and it will properly couple antennas, or single-wire feeders, of widely different impedances. The variable inductor L106 controls the coupling to the antenna. The connection of the antenna resonating components is controlled by the "ANTENNA SWITCH," control "G" (S301). The connection resulting from each of these positions is given below:

Position No. 1—The variable inductor L302 (panel control "F") is connected in series with the antenna.

Position No. 2—The variable inductor and any one of the combination of capacitors (selected by control "H," S302) are connected in series with the antenna and each other.

Position No. 3—The variable inductor L302 and L106 (control "E") and any capacitor combination selected by means of control "H" are connected to the antenna as a pi-network.

- 3. Keying**—Keying is accomplished by changing the potential applied to the screen of the power amplifier. When the keying relay is open, the negative voltage obtained from the voltage drop across the bias

*"Thyrite" unit R108 is applied to the grids of the power amplifier (PA) through resistor R104 and to the screens through resistor R110. Application of the voltage in this manner effectively blocks the tubes and prevents emission. When the keying relay is closed, +300 volts (the normal operating voltage) from a tap on the crystal oscillator plate and screen "Thyrite" regulator R107 is impressed on the screens of the power amplifier, permitting the tubes to function. This voltage also appears across the R104, R110 combination, which then form a potentiometer adjusted to deliver the correct value of negative control grid bias to the grids of the power amplifier through R-F choke L102. Values of R107, R108, R104 and R110 are so chosen that the bias applied to the grids of the power amplifier is essentially the same with the key open or closed.

When it is desired to key the oscillator in addition to the power amplifier, the link on TB No. 2 should be moved to connect terminals No. 2 and No. 3 rather than its normal connection of No. 1 and No. 3.

The keying relay K101 may be operated from either an external or the internal voltage source. To use the internal source, a link should be placed between terminal TB-1-12 and TB-1-13. To control the relay from an external source, the link should be removed and the ungrounded side of a 125 v. d.c. line be connected to TB-1-13, the other side of the line should be grounded. A 32 volt d. c. source may be utilized, in which case it will be necessary to remove resistor R112, located on TB-1, and replace it with a link between TB-1-10 and TB-1-7.

Remote control of the plate primary voltage is made possible by the use of a mercury relay K103. The contacts of this relay are in parallel with the plate switch S103, which is mounted on the front panel. Voltage to energize the relay coil is obtained from the low-voltage winding of the filament transformer. This relay may be closed or opened (which action controls application of plate voltage) when the leads from an external switch are connected between TB-1-14 and TB-1-15.

- 4. Modulator Circuit**—The modulator stage of the phone equipment uses two RCA-805 tubes (V201, V202) operated Class "B." The potentiometer R201 is employed as a

*"Thyrite" is a resistance material, the resistance of which decreases as the current flow through it increases. The voltage drop across any section of it remains practically constant. Assembled into sectional fin-cooled resistors, it may be used to maintain nearly constant potentials from otherwise unregulated power supply equipments.

hum balancing adjustor. Distortion is minimized by the use of individual bias controls (R202, R203) for each of the two tubes. Audio-frequency input from an external speech amplifier is coupled to the modulator through the driver transformer T202.

5. **Voltage Supply**—All plate and screen voltages are obtained from the output filter system of the mercury-vapor rectifier. The rectifier consists of four RCA-866-A/866 tubes connected in a full-wave parallel arrangement. Voltage is applied to the plate circuit of the power amplifier directly for telegraph operation, or through the secondary of the modulation transformer T203 for telephone operation. With the latter arrangement, the plates and screen grids of the power amplifier tubes are modulated simultaneously, modulated screen

voltage being fed to the screen grids of the power amplifier by means of resistor R105.

These changes are made by means of the "PHONE-C.W." switch located on the front panel.

The oscillator plate and screen voltages (as well as the power amplifier screen voltage for telegraph operation) together with the bias voltages are supplied from potentiometer circuits which include the "Thyrite" resistors R107 and R108. R107 controls the oscillator plate and screen grid voltages, while R108 supplies a regulated bias voltage of about 60 volts.

R107 is at the low potential end of the bleeder consisting of R117, R103, R102 and R107; from it, regulated voltages are available in steps of about 70 volts, up to 600 volts. R108 is connected in the rectifier negative lead.

INSTALLATION

LOCATION—The transmitter should be located in a room where there is a free circulation of clean air at moderate temperatures. At temperatures below 15° C. (59° F.), heaters (not supplied) should be installed in the equipment for the mercury vapor tubes. Under conditions of high humidity, heaters (such as electric light bulbs) should be installed and kept lighted, even when the equipment is not in use, to prevent condensation of moisture.

Selection of the best location within the room requires a consideration of several factors, the most important of which are listed below:

1. **Illumination** — Adequate lighting, either natural or artificial, is very important. The front panel controls should be clearly visible from the operator's position.
2. **Power**—The transmitter must be oriented so that space is available for the entrance of the power supply wiring conduit. It is also necessary that the antenna terminals be near the point of exit and that the ground connection be as short and direct as possible.
3. **Clearance**—Ample clearance should, if possible, be provided on all sides to permit access to the equipment for periodic inspection and servicing. An outline drawing of the transmitter is shown in Figure 11. Before selecting the final location, this drawing should be consulted.

NOTE: Figure 11 illustrates MI-8167-D as supplied; the shock mounts have been removed in the case of MI-8167-A. Channel mounts have been substituted, raising the overall height to approximately 61 $\frac{1}{8}$ inches or an increase of about $\frac{7}{8}$ inches in height.

WIRING—The points of connection to the external wiring are indicated in Figure 7, the interconnection diagram. Five lines are shown on this diagram, but satisfactory operation is possible when four are employed.

1. The leads from the A-C supply lines brought to terminals No. 1 and No. 2 on TB No. 1. These connections should be made with a heavy gauge copper wire with adequate insulation.
2. The line to the remote key may be made with No. 19 AWG twisted pair and run to terminals No. 7 and No. 8 of TB No. 1.
3. The leads from the 500 ohm output of the speech amplifier should be No. 19 AWG twisted and shielded pair, with a good ground to the shield. These leads go to terminals No. 5 and No. 6 of TB No. 3.
4. The auxiliary leads to terminals No. 13, No. 14 and No. 15 of TB No. 1 may be made with No. 19 AWG wire.

TYPICAL SETUP—A study of the leads available will suggest several possible setups for operation; one such setup will be described. Run all wires (except A-C supply) indicated in Figure 7 to the operating position. Run also a heavy gauge wire to serve as ground. The two leads of the shielded, twisted pair will go to the 500 ohm output of the speech amplifier. The pair from terminals No. 7 and No. 8 will go to the key, while an extension of No. 14 and No. 15 may be run to the push-to-talk switch on the microphone, if one is incorporated in its construction. Alternately the leads may be run to a switch if one is not provided on the microphone itself.

A line to terminals No. 14 and No. 15 will permit the operator to remove plate voltage during standby periods. The use of the lead for remote

keying source is given under r-f circuit description.

A good ground is a necessity; the equipment should be connected to it by means of a copper strap or tubing. A lightning switch or horn-type safety gap should be installed on each transmission line to protect the equipment during electrical storms.

When any one of the access shields is removed, an interlock switch will automatically cut off the

high voltage. These shields must therefore be in place whenever operation of the equipment is desired.

PRELIMINARY TO OPERATION — Several steps must be taken at the time of installation to place the equipment in an operating condition. For the purpose of explanation and familiarization, the subsequent paragraphs are devoted to the purpose and functions of the various panel controls.

CONTROL IDENTIFICATION CHART—

| Panel Designation | | Circuit Components | |
|-------------------|-----------------------------|--------------------|-----------|
| Letter | Name | Name | Symbol |
| ... | FILAMENT | Rheostat | R127 |
| ... | TUNE-OPERATE | Switch | S106 |
| ... | TEST-OFF | Switch (Key) | S105 |
| ... | LINE | Switch | S101 |
| ... | PHONE—C. W. | Switch | S107 |
| ... | PLATE | Switch | S103 |
| A | OSCILLATOR INDUCTOR | Coil | L107 |
| B | OSCILLATOR CAPACITOR | Capacitor | C105-C124 |
| C | POWER AMP. INDUCTOR | Coil | L103 |
| D | POWER AMPLIFIER BAND SWITCH | Switch | S108 |
| E | ANTENNA COUPLING | Coil | L106 |
| F | ANTENNA INDUCTOR | Coil | L302 |
| G | ANTENNA SWITCH | Switch | S301 |
| H | ANTENNA CAPACITOR | Switch | S302 |

PANEL CONTROL FUNCTIONS—

"FILAMENT"—This control is a rheostat R127 which is wired in series with the primary of the filament transformer. It is used as a fine control to adjust the filament potential to its correct value.

"TUNE-OPERATE"—This control is a S.P.S.T. switch S106; in its "TUNE" position the switch is open and the primary voltage for the plate transformer flows through a pair of resistors. The resultant voltage drop causes the plate voltage to be reduced for tuning purposes. Throwing the switch to "OPERATE" shorts the resistors and restores normal voltage.

"TEST-OFF"—This control is a S.P.S.T. switch S105; in the "TEST" position it takes the place of the remote key and permits application of plate voltage for test and adjustment. Placing switch in "OFF" position restores control to the key.

"LINE"—This control is a D.P.S.T. switch, S101; in its "ON" position line voltage is applied to the power and filament transformer primaries. Flipping switch in "OFF" position interrupts the line voltage.

"PHONE—C.W."—This switch is a five-section, two-position switch labeled S107. Its function is to transfer circuits when it is desired to change from telephone to telegraph operation, or vice versa.

"PLATE"—This control switch, S103, is a S.P.S.T. control used to make or break the circuit in the primary of the plate voltage transformer.

"A—OSCILLATOR INDUCTOR"—The setting of this control determines the amount of coil L107 in use at any time. Rotating the knob rotates a threaded coil, causing a runner to move along the coil. The number of turns used, together with some associated capacitors, determines the frequency of the oscillator plate circuit.

"B—OSCILLATOR CAPACITOR"—This control drives a split stator capacitor, C105, C124, which is across oscillator plate inductor L107.

"C—POWER AMP. INDUCTOR"—This control varies the inductance of the coil (L103) in the plate circuit of the r-f power amplifier. Its operation is similar to L107.

"D—POWER AMPLIFIER BAND SWITCH"—

This switch, S108, selects the amount of capacitance desired across L103.

"E—ANTENNA COUPLING" — This control varies the inductance of L106 and in turn the loading effect of the coil.

"F—ANTENNA INDUCTOR" — This control varies the inductance of coil L302, which coil is part of the antenna tuning circuit.

"G—ANTENNA SWITCH" — This control, switch S301, has three positions which may be selected at will. The switch is wired to give a position (No. 1) with no capacity, a position (No. 2) with series capacity in the antenna circuit and a position (No. 3) for parallel capacity setup.

"H—ANTENNA CAPACITOR"—This control, switch S302, is a nine-position switch which has selected values of capacity wired to its terminals. Rotation of this switch determines the amount of capacity available for selection by S301.

INITIAL SWITCH POSITIONS—The foregoing explanation should be helpful in understanding the reason for the procedure detailed in the subsequent paragraphs.

Set the "LINE" switch (S101) and the "PLATE" switch (S103) in their "OFF" positions. Place the "TUNE-OPERATE" switch (S106) in the "TUNE" position and flip the "TEST-OFF" toggle to its "TEST" position.

WARNING—OPERATION OF THIS EQUIPMENT INVOLVES THE USE OF HIGH VOLTAGE WHICH IS DANGEROUS TO HUMAN LIFE. THE OPERATING PERSONNEL MUST AT ALL TIMES OBSERVE ALL SAFETY REGULATIONS. DO NOT CHANGE TUBES OR MAKE ADJUSTMENTS INSIDE THE EQUIPMENT WITH PLATE VOLTAGE ON.

POWER SUPPLY—Taps are provided on the primary windings of the filament and plate transformers (T103, T104) to enable operation over a wide range of line voltage (190, 210, 230 and 250 volts). At the time of installation, measure the line voltage and select the tap which is nearest in rating to the voltage measured. The modulator filament transformer (T204) is similarly constructed and must likewise be adjusted for the specific line voltage.

The tubes may now be inserted in their respective sockets. The modulation and keying indicator may also be placed in position at this time. This tube should be inserted with the labelled (plate) end toward the bottom of the rack.

CONTROL CIRCUIT CHECK—The functioning of the various control circuits of the transmitter should now be checked. To make this check, proceed as follows:

1. Throw the "PHONE-C.W." switch (S107) to the desired position. Throw the "TUNE-OPERATE" switch (S106) to the "TUNE" position.
2. Throw the "LINE" switch (S101) to the "ON" position. The tube filaments should light.

WARNING — BEFORE APPLYING PLATE VOLTAGE, THE TUBES SHOULD BE ALLOWED A WARM-UP PERIOD. The tubes requiring the longest warm-up period are the four mercury-vapor rectifier tubes, type RCA-866-A/866. All mercury-vapor tubes, when first installed, require a "seasoning" period of at least 15 minutes with the filaments at operating temperature but with no plate voltage applied. The ordinary warm-up period required thereafter will be approximately one minute. At high ambient temperatures, this warm-up period may be reduced to as little as one-half minute, if the mercury-vapor rectifier tubes have been previously "seasoned." If metallic mercury is splashed onto the filaments at any time after this treatment, repeat treatment before placing the tubes in service.

3. After the necessary warm-up period has elapsed, place the "PLATE" switch (S103) in the "ON" position. This should apply reduced plate voltage to all tubes, since in the "TUNE" position, the "TUNE-OPERATE" switch permits the resistors R115 and R116 to be effective in the plate transformer primary circuit. (In the "OPERATE" position of this switch, these resistors are short-circuited, and the full line voltage is applied to the primary of the plate transformer.) Deflections on meters M101 and M102 will indicate that plate voltage is reaching the tubes.
4. Shut down the transmitter by operating the "PLATE" switch and then the "LINE" switch to their "OFF" positions.

TUNING—The transmitter is tuned entirely from the front panel. All tuning controls are designated by letters as well as functions on adjacent nameplates. The oscillator and power amplifier controls, "A" to "E" inclusive, are located together with the meters and the crystal in two vertical rows upon the main (central) panel.

When tuning adjustments are being made on a transmitter connected for telegraph operation, the "TEST-OFF" key must be set at the "TEST" position, in order to obtain normal operating potentials at the power-amplifier tubes. When the equipment is ready to be keyed, however, this key must be turned to "OFF".

When tuning adjustments are being made on a transmitter connected for telephone operation, no modulation should be applied.

1. Oscillator Tuning—With no plate voltage applied, insert a crystal unit ground for the desired output frequency through the front panel aperture marked "CRYSTAL." IF AN RCA CRYSTAL UNIT IS USED, IT SHOULD BE INSERTED WITH THE METAL NAMEPLATE AT THE TOP. With the "TUNE-OPERATE" switch adjusted to the "TUNE" position, apply plate voltage to the transmitter and set controls "A", "B", "C", "D", and "E" at approximately the positions indicated by Figures 12 and 13. Rotate control "A" in the direction which causes the scale numbers above to increase, until the "OSCILLATOR PLATE CURRENT" meter (M101) dips and then rises sharply. Then rotate control "A" slowly in the opposite direction until the point is again reached where the meter dips. Throw the plate switch to "OFF" and "ON" several times to ascertain whether the operation of the oscillator is stable, which condition will be indicated by the return of the meter pointer to the same low-scale position each time. If the oscillator is not stable, rotate the control "A" a fraction of a turn further in the direction it was last moved; check for stability, and repeat these operations until stability is indicated.

2. Power-Amplifier Tuning—After the oscillator has been tuned, and with reduced plate voltage still applied, the power amplifier stage should be tuned. The controls "C", "D" should be at the positions indicated for the desired frequency in Figure 13. Slowly readjust control "C" for minimum plate current as indicated by the "POWER AMP. PLATE CURRENT" meter (M102). This meter actually indicates the sum of the plate, screen and control grid currents but the largest component, by far, is the plate current.

3. Antenna Loading—The antenna loading equipment supplied will feed antennas ranging from several hundred ohms capacitive reactance to several hundred ohms inductive reactance, and having from less than ten to about one thousand ohms resistance. It is not possible to supply calibration curves for the antenna tuning controls, since relatively small differences in the construction and the location of the antenna may cause a considerable variation in its electrical constants. Therefore, the correct control settings for optimum coupling and for resonance must be found experimentally for each antenna at each operating frequency employed. These control settings should be recorded, in order to facilitate frequency shifting.

To properly adjust the output matching network proceed as follows:

- a. Adjust the "POWER AMP. INDUCTOR" control, "C" (L103) for the dip on the "POWER AMPLIFIER PLATE CURRENT" meter (M102), which indicates plate circuit resonance.
- b. Adjust the "ANTENNA COUPLING" control, "E" (L106) until the minimum

plate current indicated at the resonance dip is approximately 100 ma. (The inductances controlled by "C" and "E" are interreactive, and when one of these controls is adjusted, the setting of the other should be checked and the necessary readjustments made.)

The setting of control "E" (L106) will vary with frequency. At very high frequencies it may be necessary to short circuit the entire coil (L106) to unload the power amplifier; at lower frequencies, a considerable portion of L106 may remain in the circuit.

- c. Set the "ANTENNA SWITCH" control, "G" (S301) at position "1". Rotate the "ANTENNA INDUCTOR" control, "F" (L302) until meter M102 indicates a plate current peak. Then slowly readjust "F" until meter M301 indicates a maximum antenna current.
- d. Keeping the "ANTENNA INDUCTOR" control, "F", adjusted for a maximum antenna current indication, readjust the antenna coupling by adjusting the "ANTENNA COUPLING" control "E", at the same time maintain the PA tank circuit in resonance by means of control "C" until the indication on M102 at the resonance dip is approximately 150 ma. The "TUNE-OPERATE" switch should be retained in the "TUNE" position.
- e. Should an adjustment of control "F" (L302) produce no resonance indication with switch "G" at position "1", operate this switch to position "2". This connects one of several capacitor combinations (selectable by the "ANTENNA CAPACITOR" switch, "H", S302) in series with the antenna. The correct setting for switch "H" is that which inserts in series with the antenna, the greatest capacity that still allows the antenna to be resonated by the "ANTENNA INDUCTOR" control, "F". This setting must be found by trial. Set switch "H" at its lowest numbered setting and rotate control "F" over its range. If resonance is not indicated, move switch "G" to next position and "hunt" for resonance with control "E". Advance the position of switch "G" until resonance is obtained.
- f. Make final adjustments of controls "F", "E" and "C", so that the minimum PA plate current indicated on M102 at the resonance dip is approximately 150 ma.

Certain antennas have extremely high reactance or resistance, or both. This is true, for example, when a very short antenna is operated at a low frequency, or when a longer antenna is operated very near one of its natural harmonic frequencies.

These characteristics may be indicated by an inability to obtain normal antenna current, to resonate the antenna circuit, or to obtain sufficient coupling from the power amplifier for the rated plate-current drain. Such antennas cannot be fed efficiently through simple series inductance, or series capacitance, resonating circuits. They may be fed efficiently through a pi-network. At position "3" of switch "G" (S301) the output-matching components are connected in a pi-network. The capacitor selected by switch "H" (S302) then determines the output-matching impedance of the network (instead of the capacitance in series with the antenna).

For a preliminary adjustment, set switch "H" to a position at which the output-matching impedance of the network is estimated to match the antenna impedance, i. e., at a high setting (low capacity) when an electrically short, or an electrically very long antenna is to be fed; at a low setting when a moderately long (lower impedance) antenna is to be fed. Rotate control "F" (L302) over its range, noting carefully the plate current indication on meter M102 and the antenna current on meter M301. When a point of resonance is reached, adjust control "E" for the correct coupling indication (150 ma on M102 as stated in "d"). Recheck all the adjustments. Note or record the antenna current indicated on M301; advance control "H" one setting; re-resonate and recouple the system. If a lower antenna current occurs at resonance, reset control "H" to a new position in the opposite direction, and readjust the power amplifier and antenna circuits for maximum antenna current. This process should be continued until the optimum (highest maximum) antenna current for the particular antenna operating frequency is obtained.

NOTE—It is possible, with switch "G" at position "3" to have the antenna coupling network "load up" the power amplifier, but still not transfer power to the antenna. Therefore, an adjustment which causes an increase in the plate current only is incorrect; the correct adjustment must cause an antenna current maximum coincident with the plate-current increase.

g. With reduced plate voltage still applied to the transmitter ("TUNE-OPERATE" switch in the "TUNE" position), adjust controls "F", "G" and "H" until the maximum antenna current is obtained. Then throw the "TUNE-OPERATE" switch to the "OPERATE" position, causing application of the full plate voltage and a consequent increase in the antenna current. Readjust controls "F", "G" and "H" for maximum antenna current if necessary.

The current indicated by the power-amplifier milliammeter (M102) should not exceed the value stated (for the type of operation employed) in the tabulation, "TYPICAL OPERATING VOLTAGES AND CURRENTS." If a much lower indication is obtained, readjust coupling control "E" to give a greater deflection (readjusting the control "C" to resonate the power amplifier). Then readjust the antenna tuning control for maximum antenna current. If the power-amplifier plate current is excessive, adjust the coupling control "E" to produce a lower cur-

rent indication and make the other adjustments accordingly.

MODULATOR ADJUSTMENTS—Operate the "PHONE-C.W." switch (S107) to the "PHONE" position. Normal modulation should result when an a-f input of approximately 55 volts (in the 500 ohm line) is applied to the terminals No. 5 and No. 6 on TB No. 3. This input may be obtained from an external speech amplifier.

For proper operation of the modulator stage, first adjust the "no-signal" control-grid bias voltage of each tube to approximately 16 volts d. c. by means of the potentiometers R202 and R203. These potentiometers are located on the back edge of the modulator chassis, and are the lower left and right units as viewed from the rear (refer to Figure 4). The third potentiometer (R201) at the upper center is for hum adjustment.

1. Modulation and Keying Indicator—The indicator tube (A102) should be inserted with the labeled end (the connection to the plate electrode) at the bottom. It may be roughly calibrated by adjustment of the associated biasing potentiometer (R113) which is located on the lower right side of the vertical chassis (refer to Figure 3) and is accessible from the rear.

To adjust the indicator for telephone operation, the transmitter should be sine-wave modulated 100 per cent and the potentiometer (R113) adjusted so that the full height of the vapor-column is illuminated. Then with the modulation removed, but other conditions the same, adjust the top of the tubing on the lower part of the indicator so as to just reach the top of the residual glow. This position will vary slightly with the operating position of the transmitter.

The indicator should be adjusted for the principal telephone operating frequency. Minor variations in the height of the glow are not so serious as to require readjustment of R113, nor should R113 be readjusted for telegraph operation unless the transmitter is to be operated solely for telegraph emission.

The height of illuminated column, during telephone operation, affords an indication of the approximate percentage of modulation. It shows the relative instantaneous positive modulation voltage above the average value of the d-c voltage applied to the power amplifier screen-grids.

No attempt should be made to accurately calibrate the indicator. If a more accurate indication of modulation conditions is desired, an external cathode ray or rectifier type of modulation indicator (not supplied) should be employed.

If the transmitter is operated entirely on "CW Telegraph," it may be desirable to readjust the neon indicator. This adjustment may be made as follows:

With the "TEST-OFF" switch in the "TEST" position, adjust R113 until the neon column is at the desired height, and no residual glow is visible above the sleeve when the "TEST-OFF" switch is in the "OFF" position. It is necessary that the PA tuning circuit be at resonance when this adjustment is made.

TYPICAL VOLTAGE AND CURRENT VALUES—

| Stage | Measurement | Telegraph | | Telephone | |
|---------------------------------|-------------|-----------|---------|-----------|---------|
| | | Key Down | Key Up | 100% Mod. | No Mod. |
| Oscillator 1 RCA-807 | Ep | 450 | 600* | 510 | 510 |
| | Esg | 160 | -40** | 250 | 250 |
| | Ef | 6.3 | 6.3 | 6.3 | 6.3 |
| | Ip‡ | 35.0 | 0*** | 35 | 35 |
| Power Amplifier 2 RCA-813 | Ep | 2000 | 2200 | 1500 | 1500 |
| | Esg | 275 | -40 | 250 | 250 |
| | Eg | -100 | -40**** | -120 | -120 |
| | Ef‡ | 10 | 10 | 10 | 10 |
| | Ik | 465 | 20 | 355 | 355 |
| | Ip‡ | 380 | 0 | 300 | 300 |
| | lsg | 70 | 0 | 40 | 40 |
| lg | 15 | 0† | 15 | 15 | |
| Modulator 2 RCA-805 | Ep | 0 | 0 | 1500 | 1500 |
| | Eg | — | — | -20 | -16 |
| | Ef | 10 | 10 | 10 | 10 |
| | Ip | — | — | 400 | 60 |
| Modulator 4 RCA-866-A | Ef | 2.5 | 2.5 | 2.5 | 2.5 |

Plate and grid voltages measured to ground with 20,000 ohm/volt meter.

Keying circuit connected for Oscillator and PA keying.

*When oscillator is not keyed—plate voltage is 475.

**When oscillator is not keyed—screen voltage is 170.

***When oscillator is not keyed—plate current is 38.

****When oscillator is not keyed—grid volts are -80.

†When oscillator is not keyed—grid mils are 20.

‡Indicated by panel instruments.

Filaments to be values indicated within $\pm 5\%$ with filament rheostat set to give 10 volt filament volt-meter reading. Other values are shown as a guide to trouble shooting. Typical values are given, which vary with components and tube variations. Limiting values are those set by the tube manufacturers' guarantee, unless special exceptions are noted, as well as by the contractor's guarantee of transmitter performance.

OPERATION

It is assumed that all of the preliminary steps previously outlined have been taken, the a-c lines have been brought in and all necessary tuning adjustments have been made.

TELEGRAPH—Turn the "PHONE-CW" knob to its "CW" position with the "TEST-OFF" switch at "OFF" and the "TUNE-OPERATE" control at "OPERATE."

TO START TRANSMITTER—

1. Set the "LINE" switch in "ON" position.
2. Wait approximately one minute.
3. Snap "PLATE" toggle switch to "ON" position.
4. Transmitter should function when key or switch in keying relay circuit is closed.

TO STOP TRANSMITTER—

1. Place "PLATE" or remote switch in "OFF" position.

2. Return "LINE" switch to "OFF" position.

TELEPHONE—Twist "PHONE-CW" knob to its "PHONE" position with the "TEST-OFF" switch at "OFF" and the "TUNE-OPERATE" control at "OPERATE".

TO START TRANSMITTER—

1. Place the "LINE" switch in "ON" position.
2. Wait approximately one minute.
3. Flip "PLATE" or remote plate relay switch to "ON" position.
4. Speaking into the microphone should result in modulation. The modulation indicator should fluctuate while operator is talking.

TO STOP TRANSMITTER—

1. Flip "PLATE" or remote plate relay switch to "OFF" position.
2. Return "LINE" switch to "OFF" position.

MAINTENANCE

GENERAL—With ordinary care, little service will be required to keep the transmitter in operation. However, to avoid interruptions in communication due to failure of the equipment, a regular schedule of inspection should be established.

It is important that the transmitter be kept clean and free from dust, and that all connections be checked periodically and tightened when necessary. At such times, switch and relay contacts may be cleaned by applying carbon tetrachloride with a soft brush; and then burnished with a burnishing tool. All r-f ground connections should be kept tight.

A regular check should be made of all the tubes in the transmitter. Each tube should be inspected and tested upon receipt to make certain that no damage has occurred in shipment. So far as is possible, tube failures should be anticipated by keeping a log of tube life. All meter readings should be noted and checked against those readings previously taken. A ten per cent reduction in current usually denotes a decrease in filament emission. This may be checked by replacing the suspected tube with a new one and noting the new current indication.

Spare rectifier tubes should be aged by applying normal filament voltage with no plate voltage for a period of not less than 15 minutes. If this is done before the tubes are stocked as spares, they can be placed in service after a normal filament warm-up of 30 seconds, thus materially reducing the time of emergency shutdowns. Rectifier tubes must be handled and stocked in a vertical position after "seasoning." Any mercury splashed on the elements is visible and tubes

should be examined carefully before being placed in sockets.

EXTREME CARE SHOULD BE TAKEN NOT TO SPLASH MERCURY ON THE FILAMENTS OF THESE TUBES WHILE THEY ARE BEING HANDLED AFTER "SEASONING."

Should this occur, it will be necessary to "season," as previously described, before placing them in service.

Should the tubes reach a temperature lower than 10° C. (50° F.) the mercury may not ionize and insufficient mercury vapor will be present to support conduction. If the tubes fail to start when plate power is applied, it will be necessary to run them on filament along for a period of time to warm them. In extreme cases, it may be necessary to apply external heat.

FUSE REPLACEMENT — Fuses are accessible from the rear on the right side of the transmitter cabinet. They are on the left side of the r-f chassis (as viewed from the rear). When removing or replacing these fuses, place the "LINE" switch (S101) in the "OFF" position to avoid shock.

CAPACITOR REPLACEMENT — It should be noted that capacitor C124 is fully meshed when the dial setting is zero, and capacitor C105 is fully meshed when the dial setting is 10. If it becomes necessary to replace either of these capacitors, be certain that the replacement unit is adjusted to mesh fully at the correct dial setting. Care must be taken, in assembling the dial and knob to the shaft, to insure that one set-screw is tightened against the flat side of the shaft.

PARTS LIST

| <i>Symbol Desig.</i> | <i>Description</i> | <i>Drawing No.</i> | <i>Air Ministry Ref.</i> |
|----------------------------|---|--------------------|--------------------------|
| ANTENNA TUNING UNIT | | | |
| C301 | Capacitor, 15mmfd, UC-3311 | DL-501686-501 | 110C/562 |
| C302 | Capacitor, 31 mmfd, UC-3232 | DL-500597-501 | 110C/2656 |
| C303 | Capacitor, 0.0004 mfd, UC-3103 | DL-500497-501 | 110C/2657 |
| C304 | Capacitor, same as C303 | | |
| C305 | Capacitor, same as C303 | | |
| C306 | Capacitor, same as C303 | | |
| C307 | Capacitor, 0.0015 mfd, UC-3062-A | DL-500410-501 | 110C/773 |
| C308 | Capacitor, same as C307 | | |
| C309 | Capacitor, 50 mmfd, UC-3401 | DL-502372-501 | 110C/2658 |
| C310 | Capacitor, 0.006 mfd, case 351, UC-3021 | DL-500406-501 | 110C/501 |
| L302 | Coil | P-714847-507 | 110C/520 |
| M301 | Ammeter, 0-8 amps., R.F. | K-882189-1 | 110A/405 |
| R301 | Resistor, 2 megohms | K-845238-12 | 110C/2300 |
| S301 | Switch, 2 section, 9 position | M-429186-1 | 110F/450 |
| S302 | Switch, 1 section, 9 position | M-429105-2 | 110F/451 |
| R-F UNIT | | | |
| A102 | Lamp Modulation Indicator | K-862841-1 | 110E/61 |
| C101 | Capacitor | K-860935-501 | 110C/554 |
| C102 | Capacitor, 0.01 mfd, Model NF | K-36336-14 | 110C/691 |
| C103 | Capacitor, same as C102 | | |
| C104 | Capacitor, 0.01 mfd $\pm 20\%$, Model T | K-36091-23 | 110C/557 |
| C105 | Capacitor, 500 mmfd, E. F. Johnson Cat. No. 500E20 variable | M-429643-1 | 110C/558 |
| C106 | Capacitor, 0.0001 mfd, Model NF | K-36336-2 | 110C/848 |
| C107 | Capacitor, 0.0001 mfd, Case 351, UC-3127-A | DL-500123-501 | 110C/563 |
| C108 | Capacitor, same as C102 | | |
| C109 | Capacitor, same as C102 | | |
| C110 | Capacitor, same as C102 | | |
| C111 | Capacitor, same as C102 | | |
| C112 | Capacitor, 0.002 mfd, Model NF | K-36336-9 | 110C/1988 |
| C114 | Capacitor, 0.0006 mfd, Case 351, UC-3087 | DL-500412-501 | 110C/914 |
| C115 | Capacitor, same as C107 | | |
| C116 | Capacitor, same as C114 | | |
| C117 | Capacitor, same as C114 | | |
| C120 | Capacitor, 0.001 mfd, Case 351, UC-3071 | DL-500121-501 | 110C/774 |
| C121 | Capacitor, same as C104 | | |
| C122 | Capacitor, 10 mfd, 2000 v | M-418141-37 | 110C/567 |
| C123 | Capacitor, same as C122 | | |
| C124 | Capacitor, same as C105 | | |
| C126 | Capacitor, 0.01 mfd. | K-36187-553 | 110C/568 |
| C127 | Capacitor, 0.005 mfd, Model NF | K-36336-12 | 110C/1989 |
| C128 | Capacitor, same as C104 | | |
| C129 | Capacitor, same as C102 | | |

| <i>Symbol Desig.</i> | <i>Description</i> | <i>Drawing No.</i> | <i>Air Ministry Ref.</i> |
|----------------------|---|--------------------|--------------------------|
| C130 | Capacitor | K-860935-501 | 110C/554 |
| F105 | Fuse, 20 amperes, 250 v, renewable cartridge type | K-99108-5 | 110H/153 |
| F106 | Fuse, same as F105 | | |
| F107 | Fuse, same as F105 | | |
| F108 | Fuse, same as F105 | | |
| | Fuse link, 20 amps., 250 v | K-863940 | 110H/853 |
| J101 | Socket | K-838549-1 | |
| J102 | Plug | M-428086-7 | |
| K101 | Relay, keying | K-843567-1 | 110F/115 |
| K103 | Relay, plate-on | M-428350-1 | 110F/676 |
| L102 | Choke Coil, National Co. Type 100U | K-862943-1 | 110C/856 |
| L103 | Coil | P-713901-501 | 110C/525 |
| L104 | Choke Coil, National Co. Type R-154 | K-860483-2 | 110C/522 |
| L106 | Coil | P-714847-506 | 110C/2659 |
| L107 | Coil | P-714847-507 | 110C/520 |
| V105 | Socket | K-842821-1 | 110H/158 |
| V106 | Socket, same as V105 | | |
| V107 | Socket, same as V105 | | |
| V108 | Socket, same as V105 | | |
| V109 | Socket, Bryant Elec. Co., Cat. No. 1917 | K-881388-1 | 110H/159 |
| V110 | Socket, same as V109 | | |
| V111 | Socket, Bryant Elec. Co., Cat. No. 50715 | K-870684-1 | 110H/160 |
| V112 | Socket, same as V111 | | |
| X101 | Reactor, XT-2228B | K-900140-502 | 110C/2673 |
| X102 | Reactor, same as X101 | | |
| M101 | Milliammeter, 0-100 ma d.c. | K-882189-2 | 110A/63 |
| M102 | Milliammeter, 0-500 ma d.c. | K-882189-3 | 110A/64 |
| M103 | Voltmeter, 0-15 v a.c. | K-882189-4 | 110A/406 |
| R101 | Resistor, 56,000 ohms, 2 watts, carbon | K-78724-83 | 110C/573 |
| R102 | Resistor, 3150 ohms | K-99035-36 | 110C/533 |
| R103 | Resistor, same as R102 | | |
| R104 | Resistor, 3500 ohms, 5 watts | K-870646-4 | 110C/574 |
| R105 | Resistor, 31,500 ohms | K-99034-46 | 110C/575 |
| R106 | Resistor, 270 ohms, 1 watt | K-78728-55 | 110C/413 |
| R107 | Voltage Control | T-611564-503 | 110C/576 |
| R108 | Voltage Control, part of R107 | | |
| R109 | Resistor, 25 ohms, 10 watts | K-870631-3 | 110C/2660 |
| R110 | Resistor, 33,000 ohms | M-428781-3 | 110C/527 |
| R111 | Resistor, 4 ohms, 10 watts | K-870681-4 | 110C/578 |
| R112 | Resistor, 10,000 ohms, 2 watts | K-78724-74 | 110C/545 |
| R113 | Rheostat, 10,000 ohms | K-830871-6 | 110C/580 |
| R115 | Resistor, 110 volts, 660 watts, medium screw base | K-870683-1 | 110C/581 |
| R116 | Resistor, same as R115 | | |
| R117 | Resistor, same as R102 | | |
| R118 | Resistor, 100 ohms, 10 watts | K-870681-5 | 110C/582 |

| <i>Symbol Desig.</i> | <i>Description</i> | <i>Drawing No.</i> | <i>Air Ministry Ref.</i> |
|-----------------------|---|--------------------|--------------------------|
| R119 | Resistor, 22,000 ohms, 2 watts, carbon | K-78724-78 | 110C/583 |
| R120 | Resistor, same as R109 | | |
| R121 | Resistor, same as R112 | | |
| R127 | Rheostat, 25 ohms, 100 watts | K-849811-2 | 110C/3685 |
| R128 | Resistor, 2200 ohms, 3 watts | K-94309-66 | |
| R129 | Resistor, 1.6 ohms, 10 watts | K-870681-6 | |
| S101 | Switch | K-870682-1 | 110F/118 |
| S103 | Switch | K-870682-2 | 110F/125 |
| S105 | Switch, same as S103 | | |
| S106 | Switch, same as S103 | | |
| S107 | Switch, 5 section, 2 position | M-429128-1 | 110F/453 |
| S108 | Switch, 1 section, 3 position | M-429105-1 | 110C/454 |
| S109 | Switch, interlock | K-875643-1 | 110F/646 |
| S110 | Switch, same as S109 | | |
| S111 | Switch, same as S109 | | |
| T103 | Transformer, XT-3844 | K-901140-501 | 110K/643 |
| T104 | Transformer, XT-3845 (Located in bottom of cabinet) | K-901141-501 | 110K/644 |
| V101 | Socket, crystal holder | K-860643-501 | 110H/155 |
| V102 | Socket, medium 5 pin | K-843314-2 | 110H/156 |
| V103 | Socket, UT-104 | M-418317-1 | 110H/157 |
| V104 | Socket, same as V103 | | |
| V113 | Socket, crystal holder | K-860643-502 | 110H/1917 |
| MODULATOR UNIT | | | |
| C201 | Capacitor, 4 mfd, 500 v | P-72041-513 | 110C/585 |
| C202 | Capacitor, part of C201 | P-72041-513 | 110C/585 |
| C203 | Capacitor, 0.01 mfd, 1200 v | K-36331-14 | 110C/2751 |
| C204 | Capacitor, same as C203 | | |
| R201 | Potentiometer, 25 ohms, 25 watts | K-867295-1 | 110C/586 |
| R202 | Potentiometer, 250 ohms, 25 watts | K-867295-2 | 110C/2653 |
| R203 | Potentiometer, 250 ohms, 25 watts | K-867295-2 | 110C/2653 |
| R204 | Resistor, 10,000 ohms, 1 watt | K-78728-74 | 110C/2297 |
| R205 | Resistor, same as R204 | | |
| R206 | Resistor, 150 ohms | K-863916-19 | 110C/2654 |
| R207 | Resistor, 50 ohms | K-863916-21 | 110C/2655 |
| T202 | Transformer, XT-3202 | K-900679-501 | 110K/117 |
| T203 | Transformer, XT-3302, located in bottom of cabinet | K-900763-501 | 110K/118 |
| T204 | Transformer, XT-3846 | K-901142-501 | 110K/916 |
| V201 | Socket | K-842105-1 | 110H/150 |
| V202 | Socket, same as V201 | | |

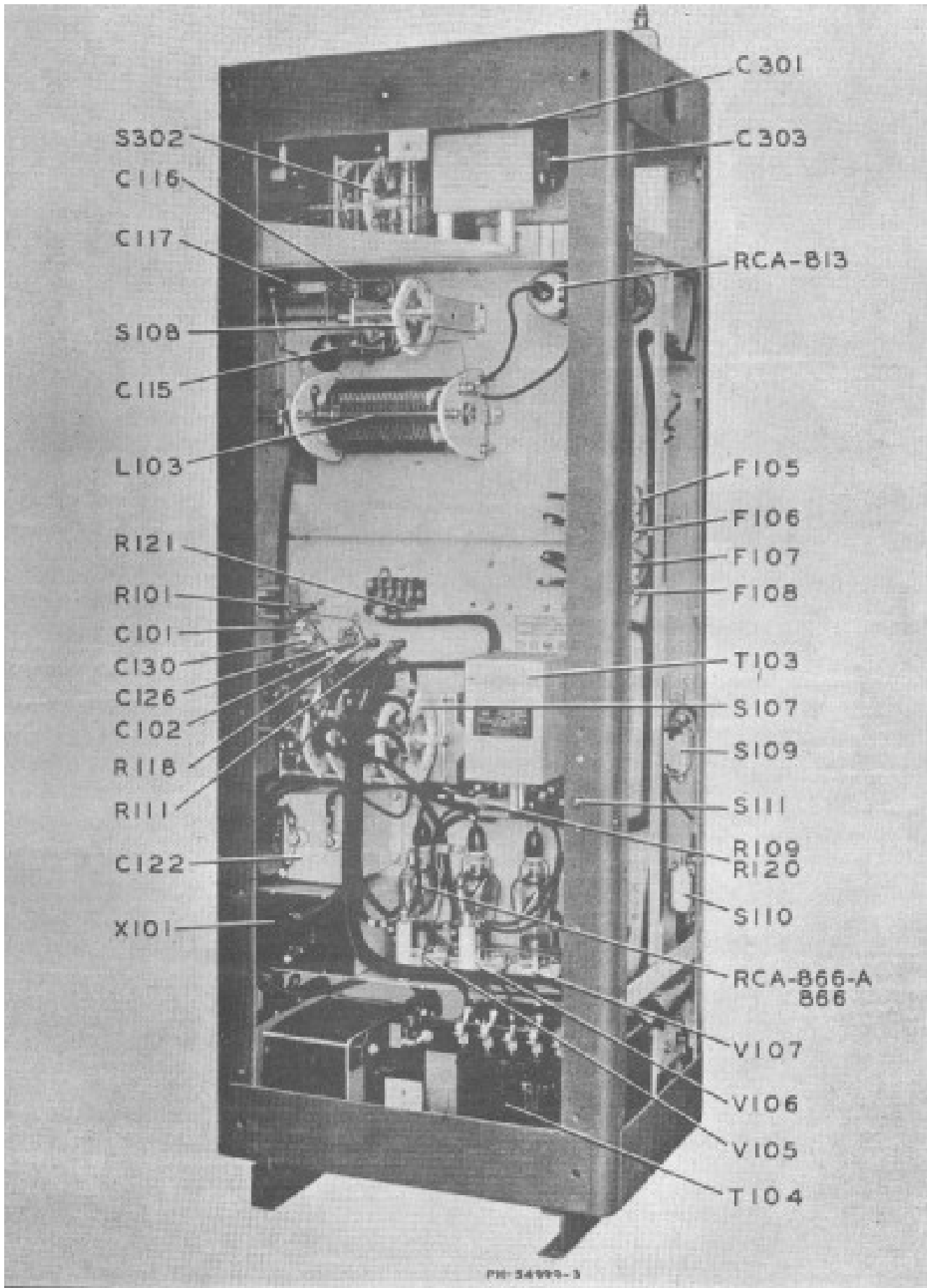

Figure 2—Transmitter (Right Side View, Referred to Front)

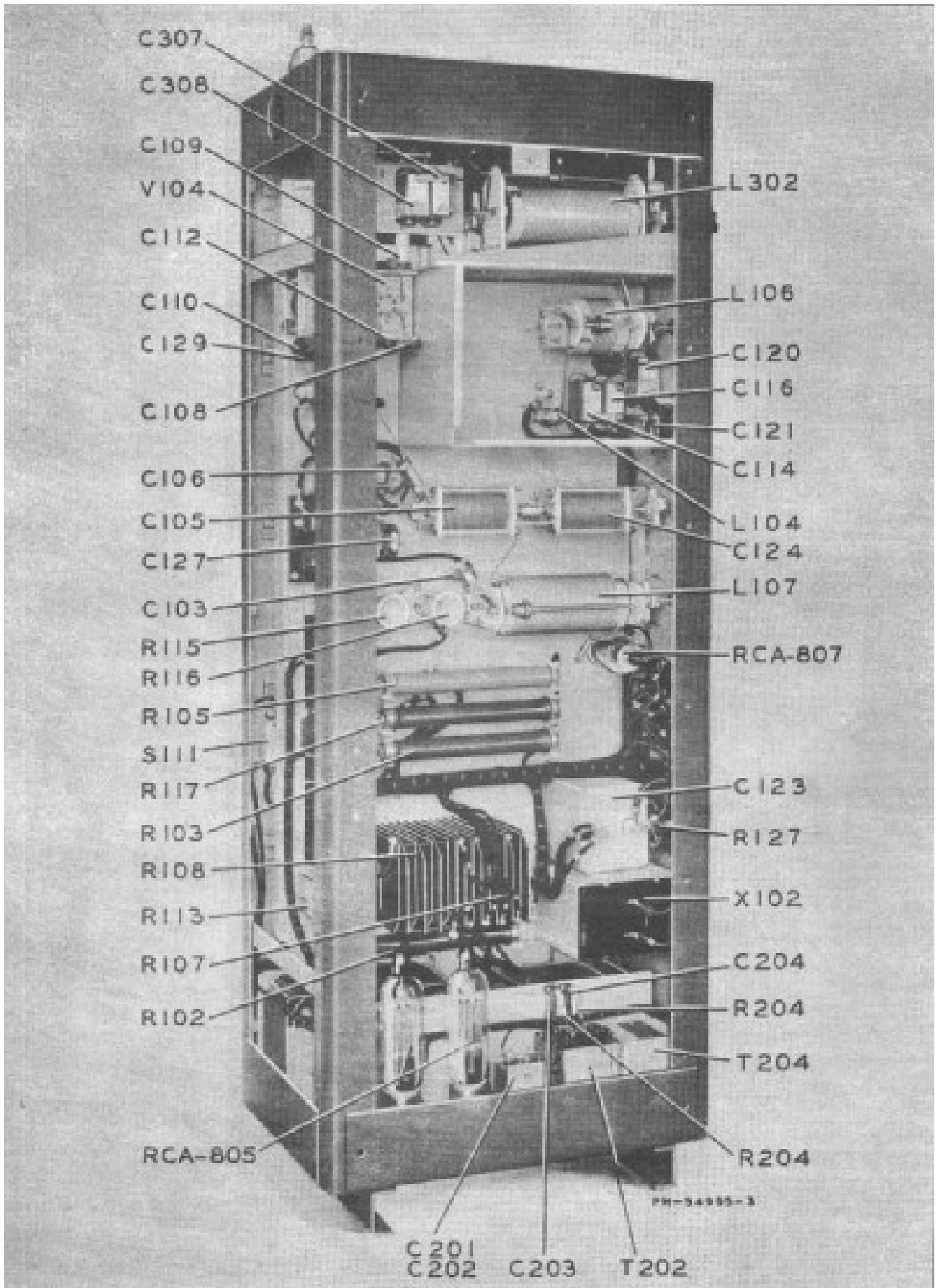

Figure 3—Transmitter (Left Side View, Referred to Front)

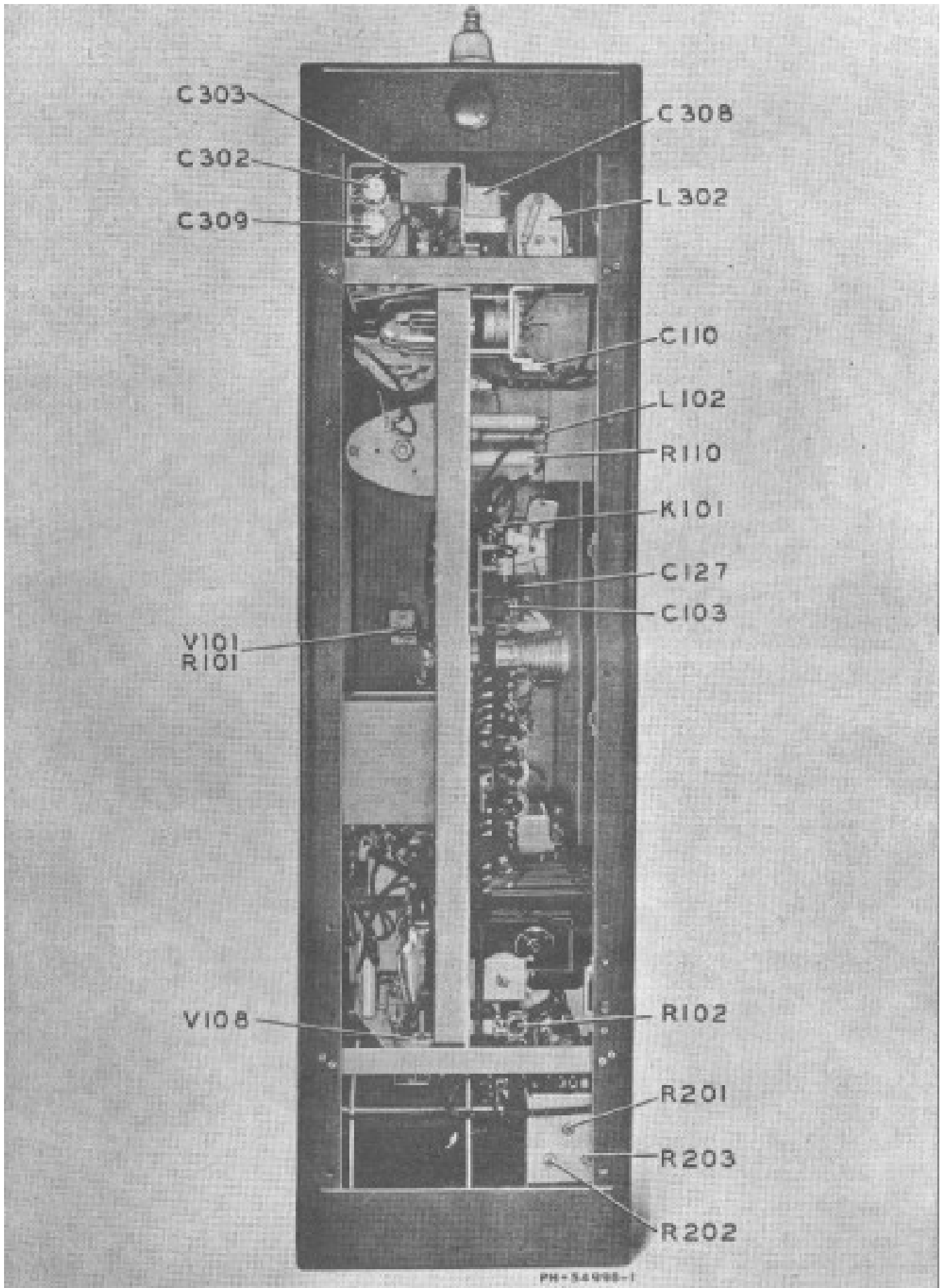

Figure 4—Transmitter (Rear View)

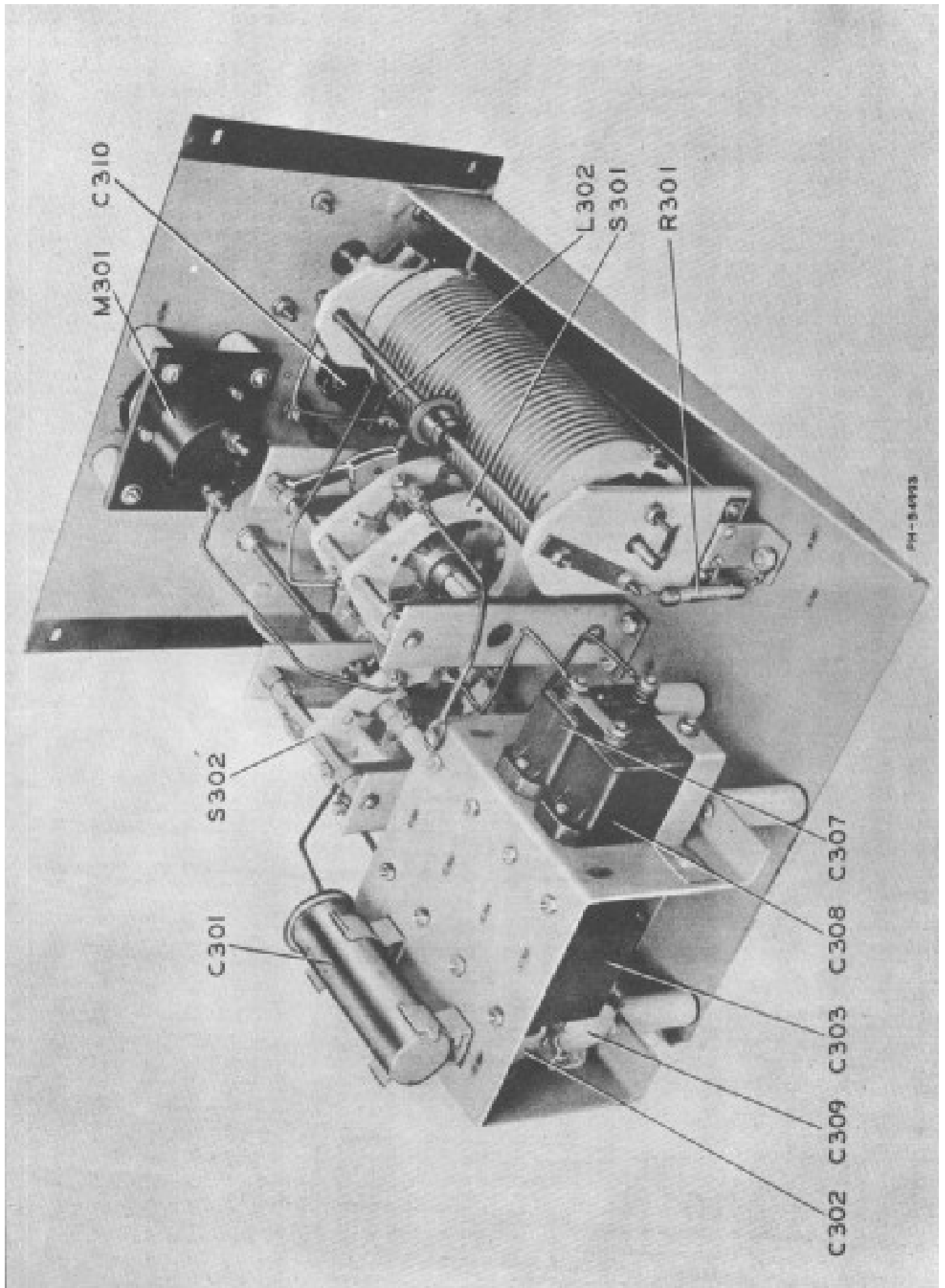

Figure 5—Antenna Tuning Chassis (Top Oblique View)

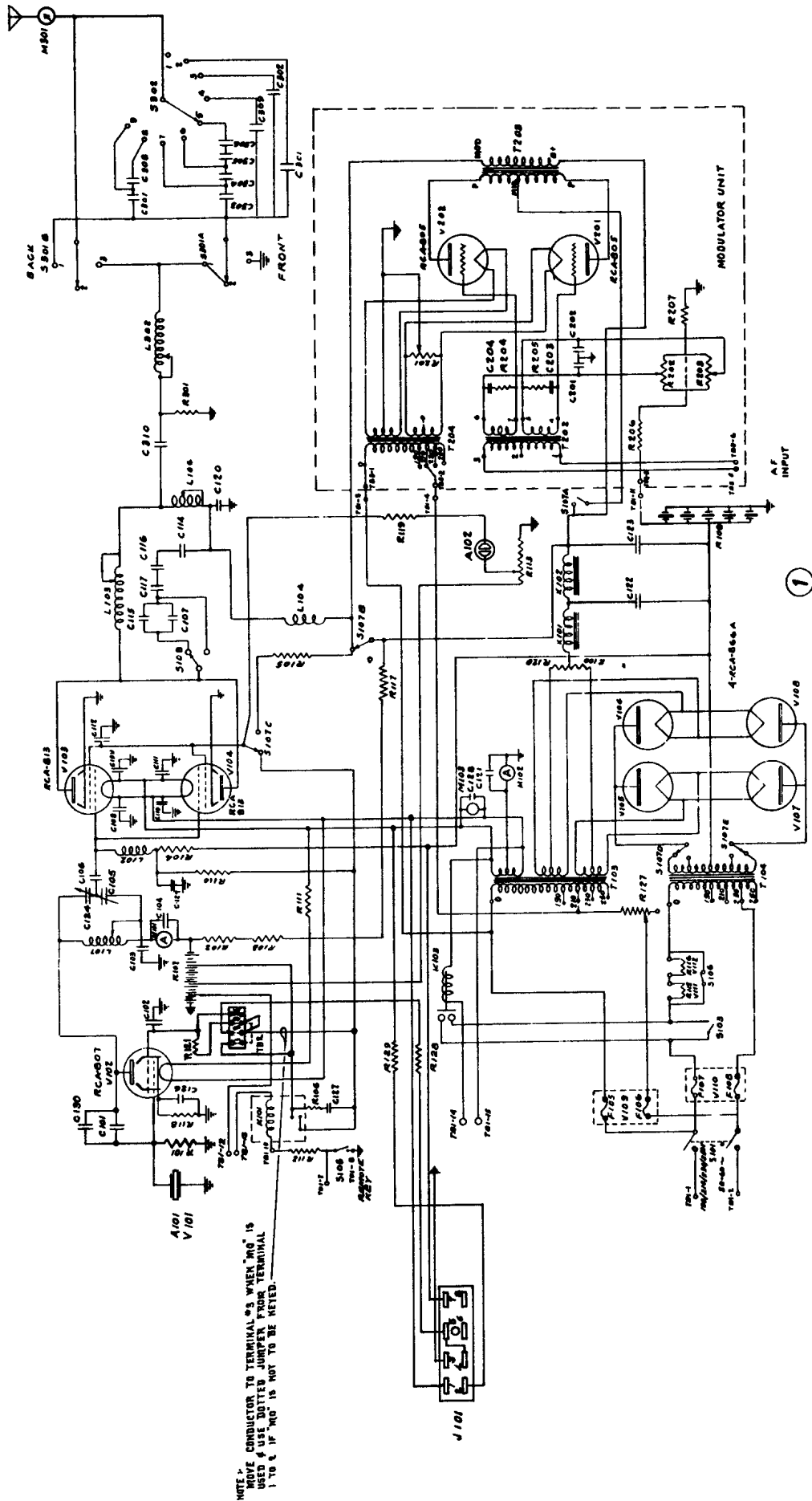
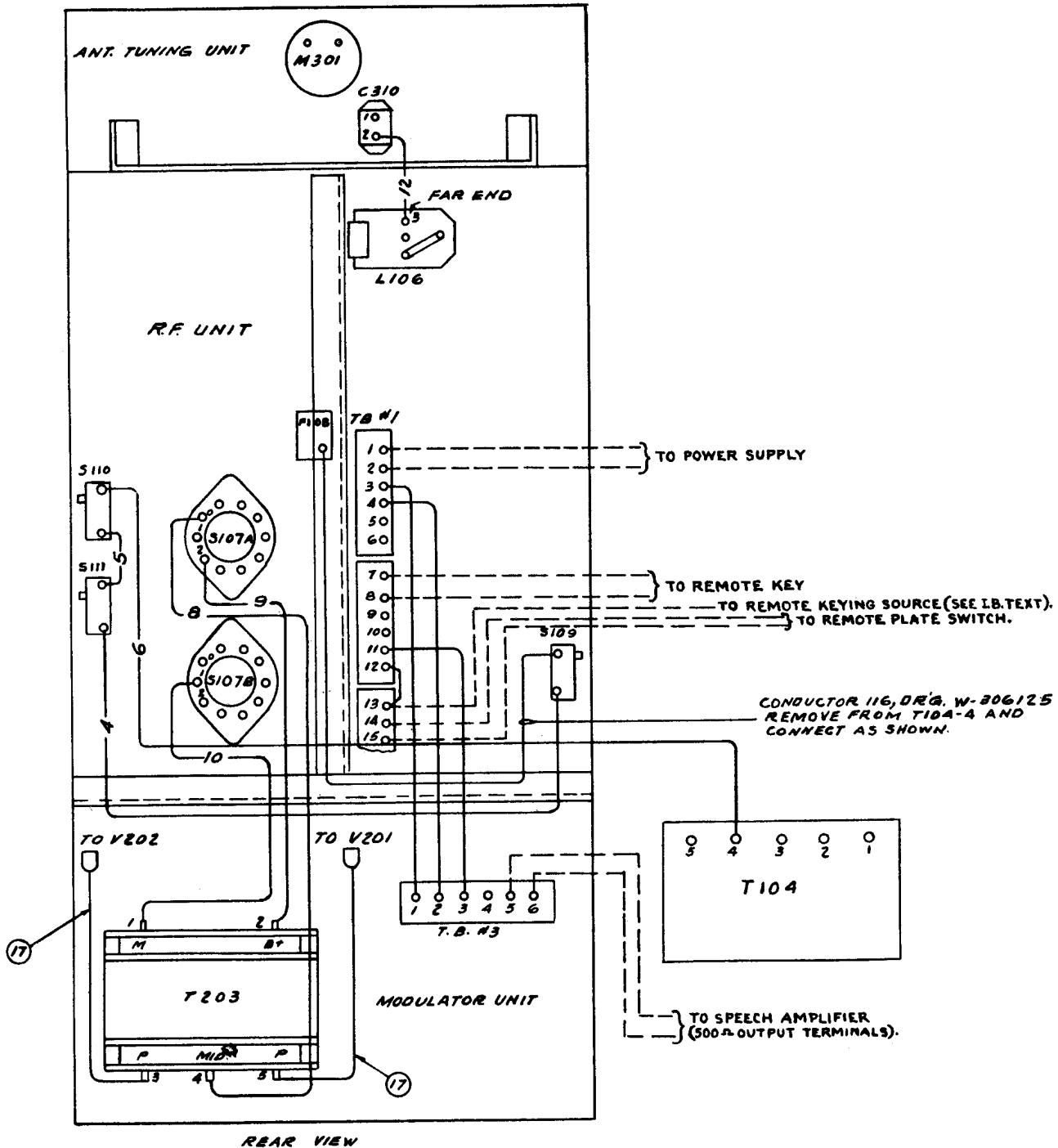

Figure 6—Transmitter (Schematic P-621268)



P-727185

Figure 7—Transmitter (Interconnections P-727185 Sub 1)

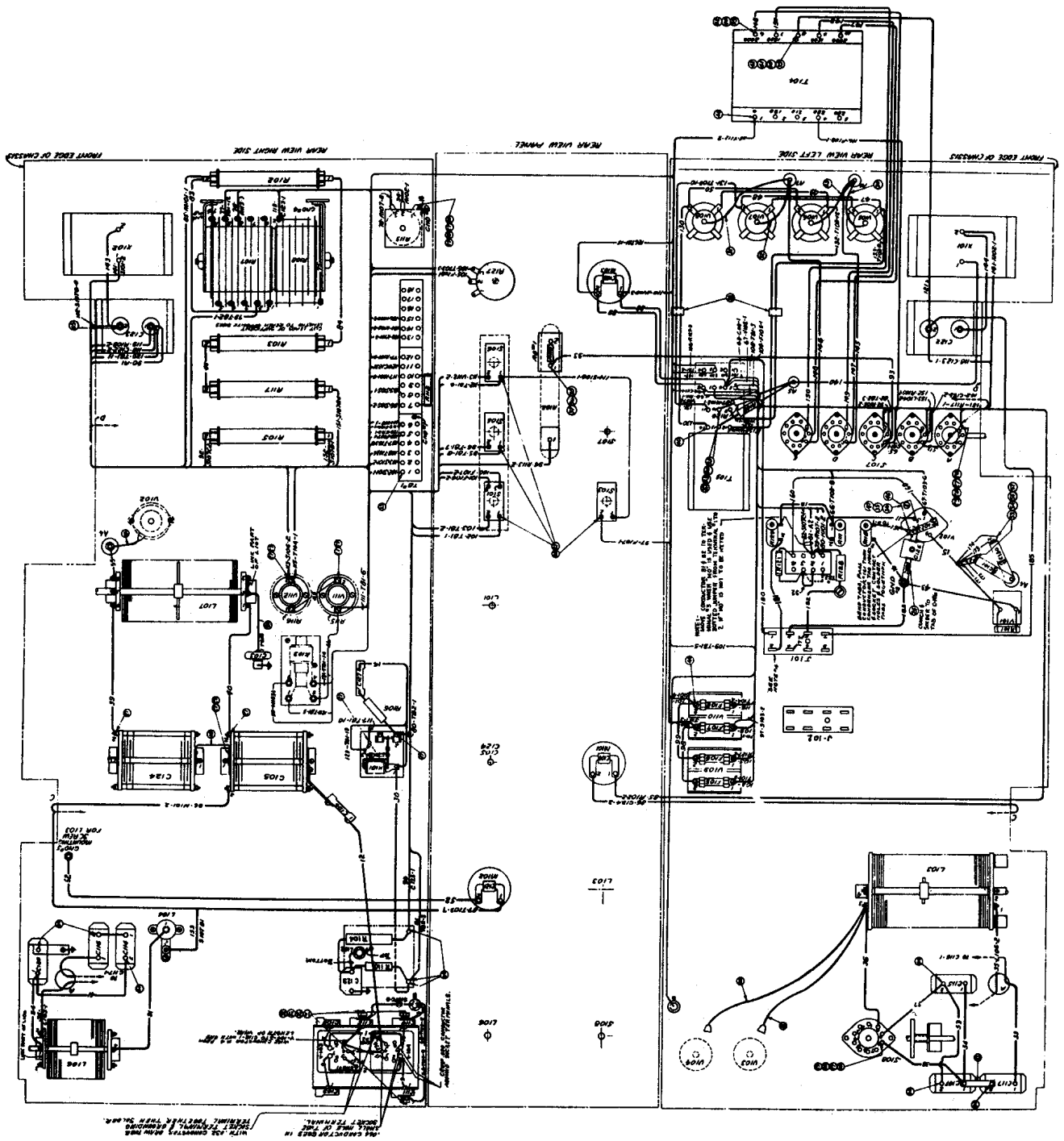
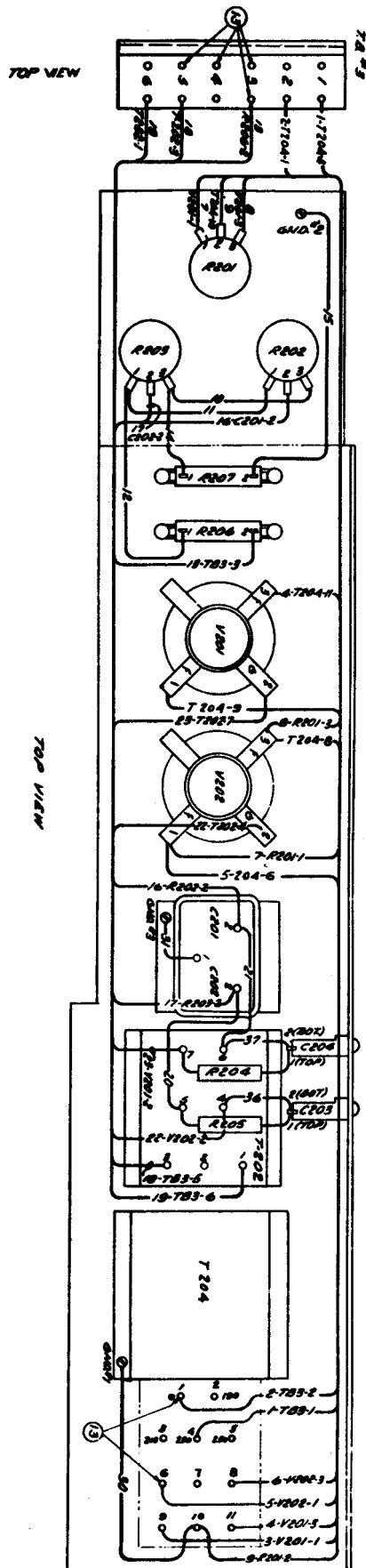

Figure 8—R-F Unit (Connections W-306491 Sub 1)



NOTE¹: CODING AT ENDS OF WIRES INDICATE WIRE NUMBER & DESTINATION OF WIRES RESPECTIVELY, THUS 1-723-1 INDICATES WIRE NO. 1 TERMINATES AT 723-1. A LETTER FOLLOWED BY A NUMBER INDICATES AN ELECTRICAL ITEM, THUS T 204.

Figure 9—Modulator Unit (Connections P-727182 Sub 3)

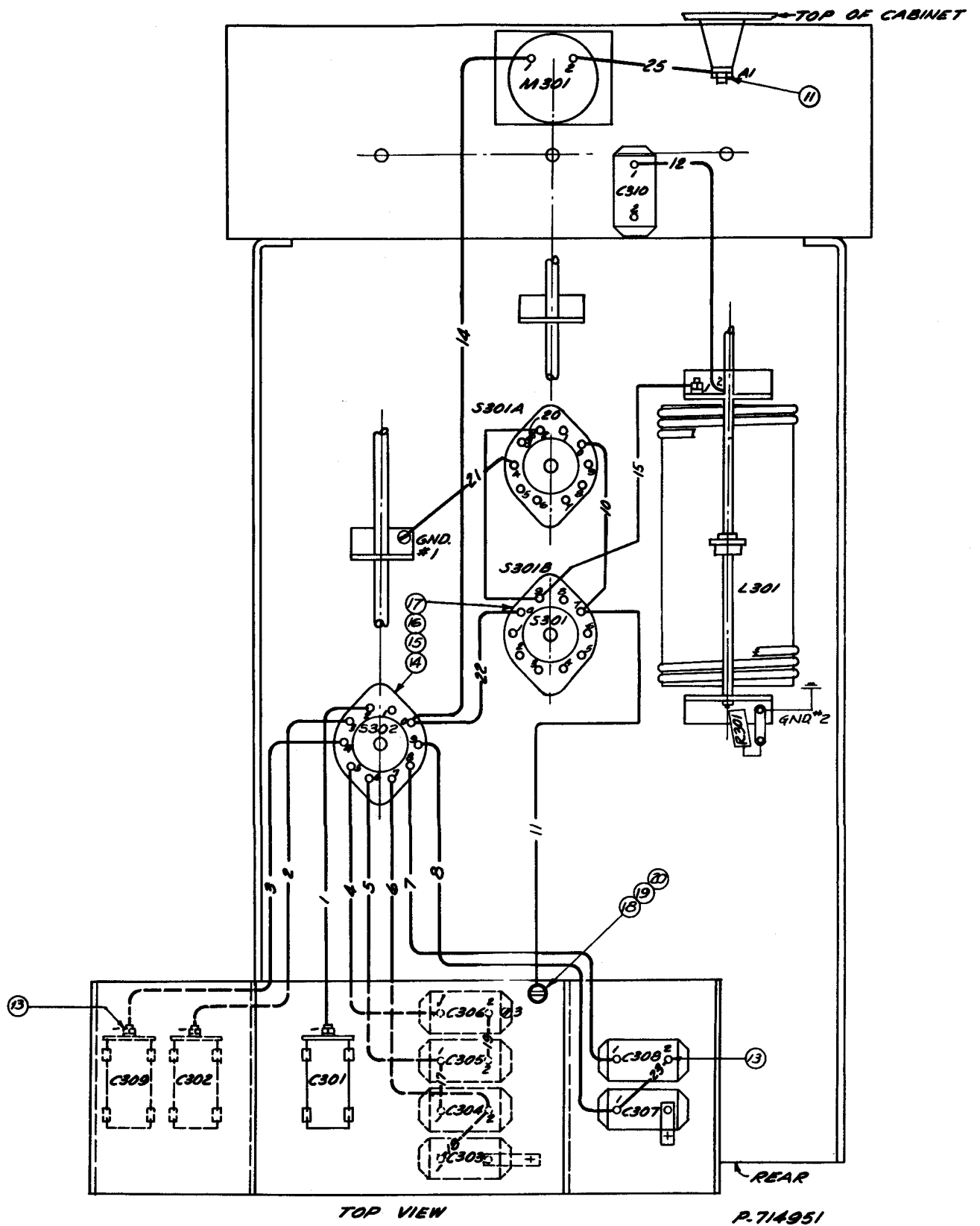

Figure 10—Antenna Tuning Unit (Connections P-714951 Sub 1)

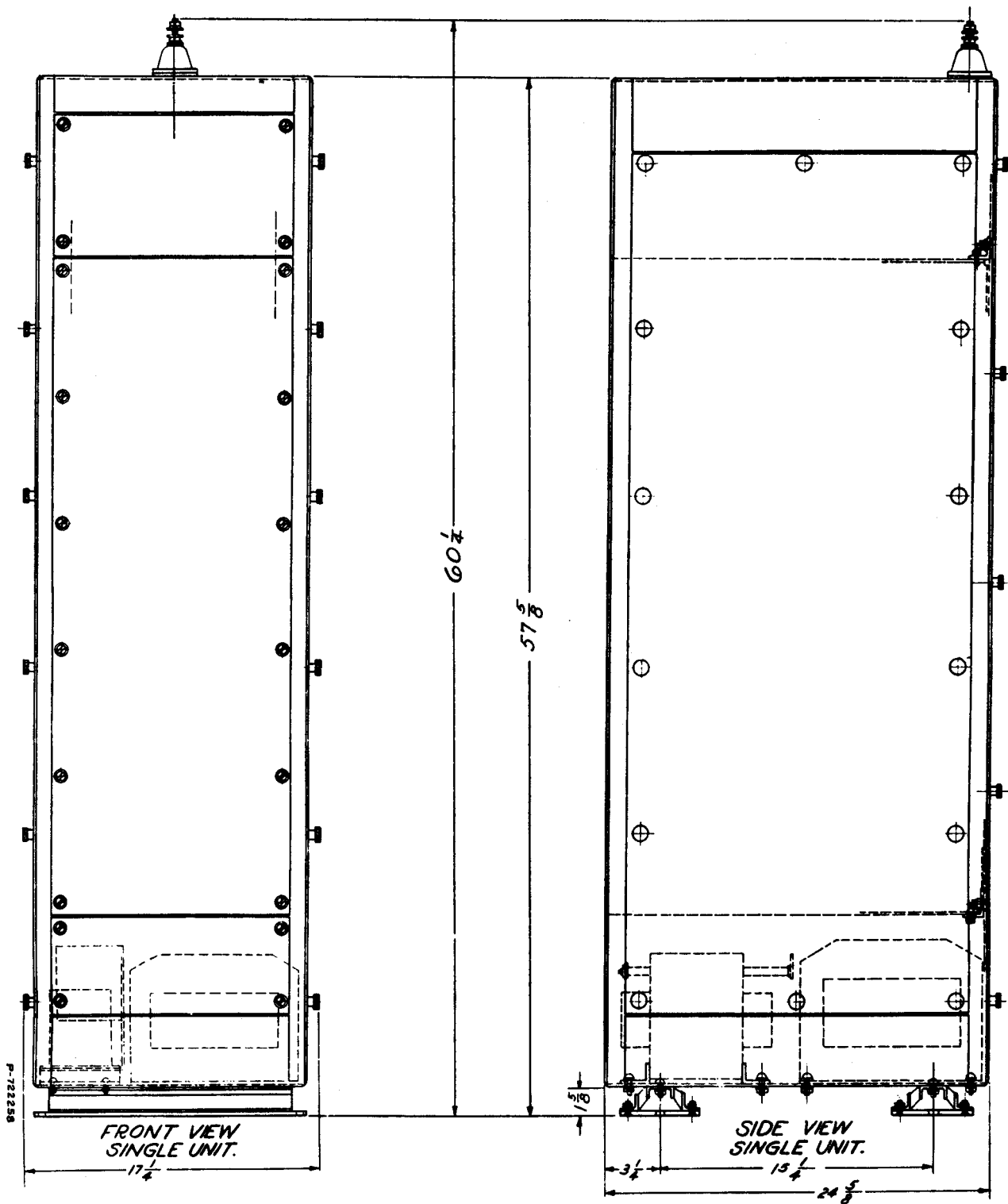

Figure 11—Transmitter Assembly (Outline Drawing P-722258)

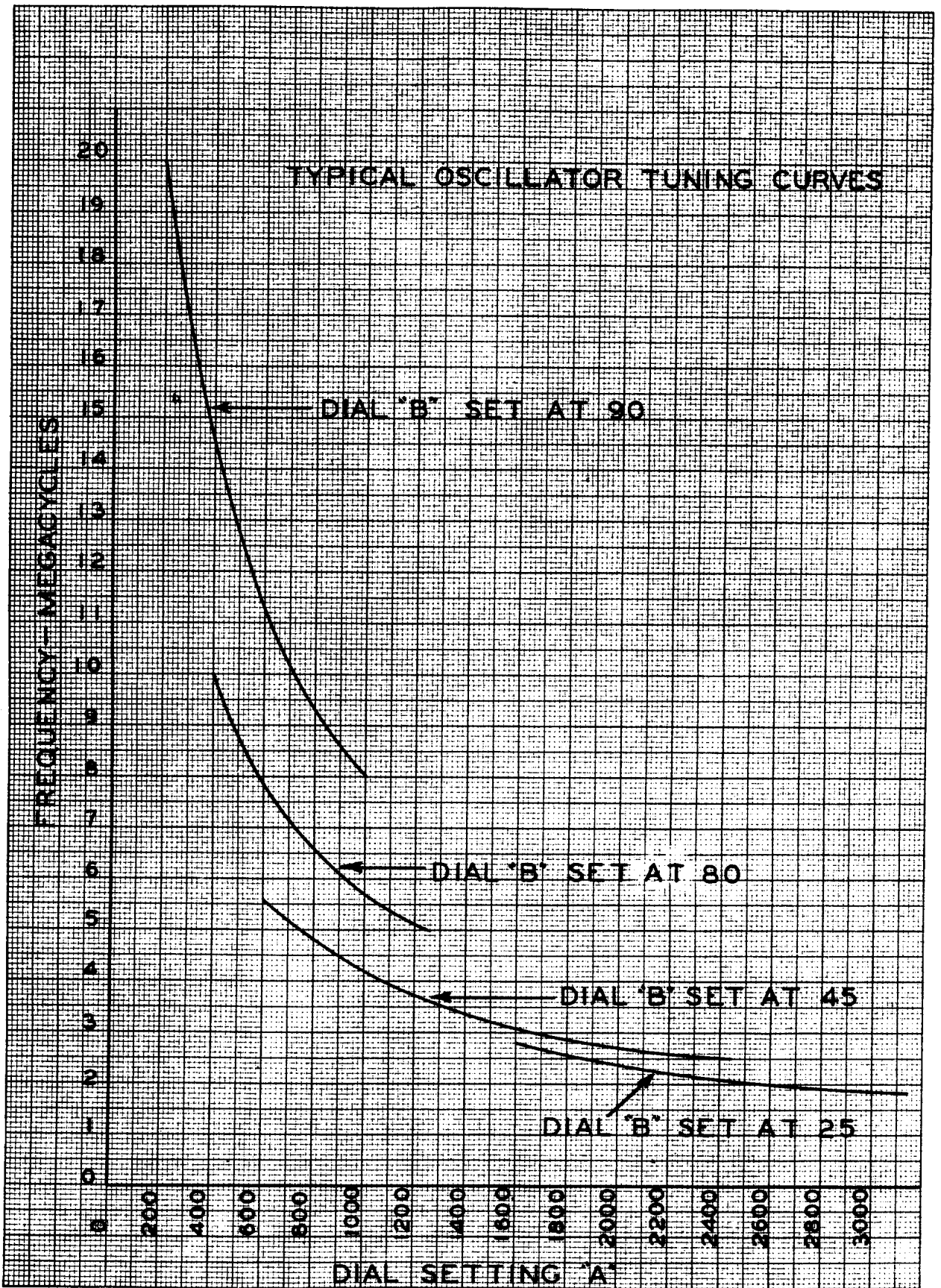

Figure 12—Oscillator Tuning Curves (S-880320)

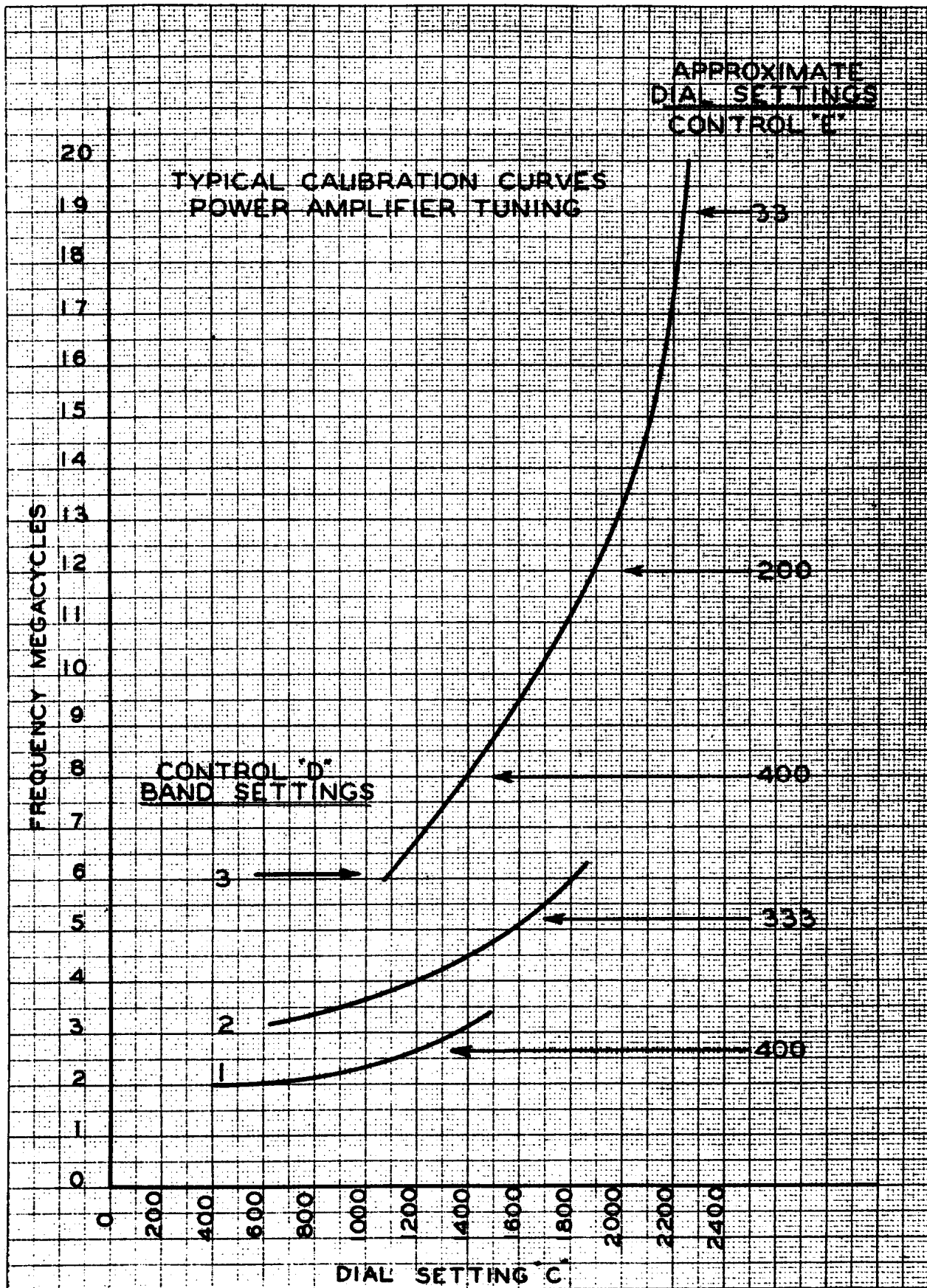

Figure 13—Power Amplifier Tuning Curves (S-880321)

INSTRUCTIONS

SPEECH AMPLIFIER

MI-11220

MI-11220-B

MI-11220-A

MI-11220-C

**Manufactured by
RCA VICTOR DIVISION
of
RADIO CORPORATION OF AMERICA
Camden, New Jersey, U. S. A.**

TABLE OF CONTENTS

| Title | Page |
|----------------------------------|------|
| Technical Summary | |
| Electrical Characteristics | 5 |
| Tube Complement | 5 |
| Mechanical Specifications | 5 |
| Description | |
| General | 6 |
| MI-11220 | 6 |
| MI-11220-A | 6 |
| MI-11220-B | 6 |
| MI-11220-C | 6 |
| Circuits | 6 |
| Installation | |
| Preliminary | 6 |
| Wiring | 6 |
| Operation | |
| To Turn On | 7 |
| Output Level Control | 7 |
| To Turn Off | 7 |
| Maintenance | |
| General | 7 |
| Fuse Replacement | 7 |
| Parts List | 8 |

LIST OF ILLUSTRATIONS

| Title | Page |
|---|------|
| Figure 1—MI-11220 Speech Amplifier..... | 4 |
| Figure 2—Amplifier Chassis (Top View) | 10 |
| Figure 3—Amplifier Chassis (Bottom View) | 10 |
| Figure 4—Amplifier (Schematic, P-171537-Sub 2)..... | 11 |
| Figure 5—Amplifier (Wiring TT-161357-Sub 2) | 12 |
| Figure 6—Socket Voltage Diagram (P-171611-Sub 1)..... | 13 |
| Figure 7—Terminal Board Layout (M-142081-Sub 0)..... | 14 |

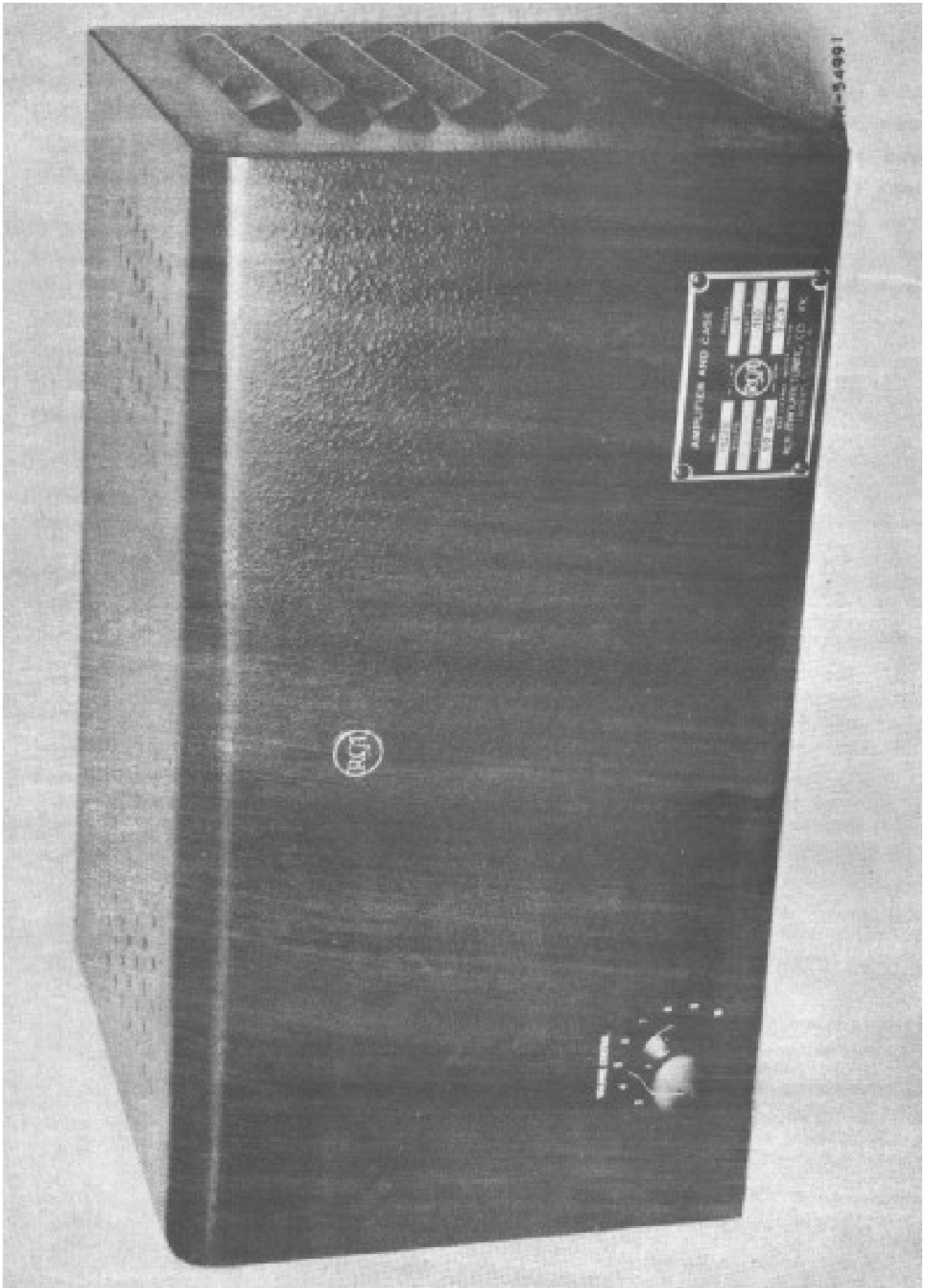

Figure 1—MI-11220 Speech Amplifier

TECHNICAL SUMMARY

ELECTRICAL CHARACTERISTICS—

| | | |
|-------------------------------------|---|--|
| Input Impedances | | 250 or 30 ohms |
| Output Impedances | | 500-600/15/7.5/5 ohms |
| Input Level { | Normal | -60 db (.001 W. ref.) |
| | Maximum | -25 db (.001 W. ref.) |
| Power Output | | 12 watts (+40.8 db, .001 W. ref.) |
| Harmonic Distortion in Output | | Less than 3% (operated into resistive load) |
| Frequency Range | | Voice Frequency |
| Noise Level in Output { | Volume Control Max. | -20 db (.001 W. ref.) |
| | Volume Control Min. | -42 db (.001 W. ref.) |
| Gain | | 101 db @ 1000 cps |
| Gain Control | Internal; potentiometer in grid circuit of 2nd stage. Log Taper | |
| Power Consumption | | 112 watts |
| Power Supply { | MI-11220 } | 190-250 v, 50-60 cycles, 1ph. |
| | MI-11220-A } | |
| | MI-11220-B } | 105-125 v, 50-60 cycles, 1ph. |
| | MI-11220-C } | |

TUBE COMPLEMENT—

- 1—RCA-6J7 (or RCA-1620) Pentode operated
- 3—RCA-6J7 (or RCA-1620) Triode operated
- 2—RCA-6L6 (or RCA-1622) Beam Power Output
- 1—RCA-5U4-G Rectifier

MECHANICAL SPECIFICATIONS—

| | | |
|--------------------|--|-------------------------|
| Weight (net) | | 38 lbs. |
| Height | | 9 inches |
| Width | | 17 $\frac{1}{8}$ inches |
| Depth | | 11 $\frac{1}{2}$ inches |

NOTE: On MI-11220 and MI-11220-B add 5/16 inch to height for felt feet, on MI-11220-A and MI-11220-C add 1 $\frac{1}{8}$ inches to height for shock mounts.

Finish

RCA No. 674 Deep Umber Gray Lacquer

DESCRIPTION

GENERAL—The MI-11220 series of speech amplifiers are designed, for use with communications transmitters, as audio driver units. They are contained in attractive metal cabinets which are designed for separate mounting on the desk of the operator or at any other convenient location (see Figure 1). Cases are supplied equipped with either four rubber shock mounts or four felt mounting feet as the requirement may be. All cases are also provided with holes for mounting. These holes may be used for fastening the cabinet rigidly to a surface, with mounting bolts.

The amplifiers are designed to operate either as speech amplifiers for 250 ohm, low-level microphones, or as line amplifiers for signals received from a 500 ohm line. In the latter case, a suitable bridging pad must be inserted ahead of the amplifier. Maximum gain of the amplifiers is approximately 101 db. The gain is adjustable by means of a control knob on the front panel.

The leads from the 500 ohm winding of the output transformer are connected to the terminal board in each case, the low impedance leads are not connected.

For 500 ohm line applications, it may be desired to operate an amplifier at a lower gain. The gain can be reduced by omitting the second tube of the amplifier. To accomplish this, the following steps should be taken:

1. Remove the grid leak from the grid cap of V-2 (second stage RCA-6J7 or RCA-1620).
2. Remove V-2 from its socket.
3. Remove the grid lead from the grid cap of V-3 (the first RCA-6J7 or RCA-1620 in the third stage).
4. Connect the grid lead which was removed from the cap of V-2 to the grid cap of V-3.

After these changes have been made, the amplifier will have become a three-stage amplifier having the same characteristics, except for the tube complement, gain and noise level, as specified for the normal MI-11220 series amplifier. Overall gain will now be approximately 70 db.

In order to secure rated power output, the inter-stage volume control should be operated near its maximum position.

This series of speech amplifiers contains its own

power supply, their operation is completely independent of associated equipment.

The four amplifiers of this series with their chief differences are listed below:

MI-11220 SPEECH AMPLIFIER—A case containing the MI-11209-G Amplifier. It is designed to operate on a nominal line voltage of 230 volts a-c. The case is provided with felt feet for mounting.

MI-11220-A SPEECH AMPLIFIER—Identical with MI-11220 above except rubber shock-mounts are provided instead of felt feet for mounting.

MI-11220-B SPEECH AMPLIFIER—Identical with MI-11220 above except that it contains the MI-11209-I amplifier which is designed to operate on a nominal line voltage of 115 volts a-c.

MI-11220-C SPEECH AMPLIFIER—Identical with MI-11220-A above except that it contains the MI-11209-H amplifier which is designed to operate on a nominal line voltage of 115 volts a-c.

CIRCUITS—The symbol designations referred to in the following circuit description appear upon the schematic diagram, Figure 4.

The amplifier consists of three resistance-coupled amplifying stages, the last of which includes phase inversion, and a push-pull output stage. The plate circuit of this output stage is transformer coupled to match a 500 ohm line. Four RCA-6J7 (or RCA-1620) tubes are used for the voltage amplifiers and phase-inverter. Two RCA-1622 (or 6L6) beam power tubes are used in the output stage. Inverse feed-back is applied from a secondary winding on the output transformer (T2), through resistor R24, to the cathode of the third amplifier tube (V3).

The overall gain is controlled by the volume control (R3) in the grid circuit of the second amplifier tube (V2).

All operating voltages are obtained from the output of a voltage divider network in the filter circuit following the RCA-5U4-G rectifier tube.

A 1000 ohm resistor (R43) is mounted internally across the output terminals. Consequently, when the amplifier is loaded with a 600 ohm load, 8.1 watts rather than the rated 12 watts are available to the external load.

INSTALLATION

PRELIMINARY—Open the door in the cabinet and place the tubes in their sockets according to the designations marked on the chassis. Either RCA-1620 or RCA-6J7 tubes may be installed in the sockets marked "6J7."

WIRING—All connections at the amplifier are made to the terminal board located at the rear

of the chassis. Connect the microphone line, or bridging pad, to the terminals marked "IN." A 500 or 600 ohm line may be fed from the terminals marked "OUTPUT." The audio input and output leads need not be larger than No. 19 AWG, but should be shielded, twisted pairs insulated for at least 200 volts. To avoid undesirable hum pickup, the leads should not run ad-

adjacent to, nor be interlaced with, the power supply wiring. The a-c power supply should be connected to the "AC" input terminals. A D.P.S.T. switch (not supplied) should be inserted in the line at the desired control position. The "ON-OFF" switch on the amplifier chassis may then be left in the "ON" position. The a-c power leads should be No. 14 AWG rubber-covered twisted-pair, insulated for 600 volts. For proper

operation, it is essential that the transformer (T3) be connected correctly for the existing power supply. When the amplifier is shipped, the transformer is connected for operation as indicated by the asterisk (*) in table A below. If the line voltage is noticeably higher or lower than this value, the voltage tap should be changed. The identification of the power transformer primary leads is given in Table A.

TABLE A
TRANSFORMER PRIMARY COLOR CODE

| For MI-11220 or MI-11220-A | | For MI-11220-B or MI-11220-C | |
|----------------------------|--------------------|------------------------------|--------------------|
| <i>Color Code</i> | <i>Voltage Tap</i> | <i>Color Code</i> | <i>Voltage Tap</i> |
| Black | 0 Volt (start) | Red | 0 Volt (start) |
| Black & Green | 190 Volt | Black | 105 Volt |
| Blue | 210 Volt | *Black & Red | 115 Volt |
| *Black & Yellow | 230 Volt | Black & Red | 125 Volt |
| Black & Red | 250 Volt | Tracer | |

OPERATION

TO TURN ON—Assuming the chassis "ON-OFF" switch to be in the "ON" position, it is only necessary to flip the switch (supplied by the customer) in the a-c line to the "ON" position to place amplifier in operation.

should be manipulated for proper output level. To increase output; turn clockwise. To decrease; turn counterclockwise.

OUTPUT LEVEL CONTROL—With amplifier in operation, the knob on the volume control

TO TURN OFF—It is only necessary to throw the switch in the a-c line to its "OFF" position to discontinue amplifier operation.

MAINTENANCE

GENERAL—With reasonable care, this unit will provide reliable, trouble-free operation over long periods of time. Dust should be removed before the accumulation becomes too great. For the purpose of dust removal, a small blower is advantageous.

is maintained of these monthly readings, tube failures may be anticipated and replacement made before an actual failure occurs.

All tubes should be checked at intervals of not more than once a month. The tubes may be checked in any standard tube checker. If a record

FUSE REPLACEMENT—To remove the power line fuse, unscrew the cap of the fuse container, which cap is located at the front center of the amplifier chassis. The fuse is then readily accessible.

PARTS LIST

| Item | Description | Drawing Number |
|-----------|---|----------------|
| C1 | Capacitor, 40 mfd, 200 v | M-86011-2 |
| C2 | Capacitor, 560 mmfd, 400 v | M-95099-521 |
| C3 | Same as C1 | |
| C4 | Capacitor, 0.1 mfd, 500 v | P-72043-510 |
| C5 | Not used | |
| C6 | Same as C1 | |
| C7 | Same as C4 | |
| C8 | Not used | |
| C9 | Same as C4 | |
| C10 | Same as C1 | |
| C11 | Capacitor, 0.0025 mfd, 1000 v | P-72043-524 |
| C12 | Same as C11 | |
| C13 | Capacitor, 30 mfd, 450 v | M-86038-8 |
| C14 | Same as C13 | |
| C15 | Capacitor, 20 mfd, 450 v | M-86027-7 |
| C16 | Capacitor, 10 mfd, 450 v | M-86028-3 |
| C17 | Same as C16 | |
| C18 | Capacitor, 1 mfd, 450 v | P-72043-533 |
| C19 | Same as C4 | |
| C20 | Not used | |
| C21 | Same as C2 | |
| F1 | Fuse, 3 amps., 200 v | K-55544-4 |
| R1 | Resistor, 1500 ohms, 1/2 watt | K-78727-64 |
| R2 | Resistor, 100,000 ohms, 1 watt | K-78728-86 |
| R3 | Potentiometer, 250,000 ohms | K-182233-7 |
| R4 | Resistor, 1000 ohms, 1/2 watt | K-78727-62 |
| R5 | Resistor, 47,000 ohms, 1 watt | K-78728-199 |
| R6 | Resistor, 470,000 ohms, 1/2 watt | K-78727-94 |
| R7 | Not used | |
| R8 | Resistor, 2700 ohms, 1/2 watt | K-78727-169 |
| R9 | Same as R8 | |
| R10 | Resistor, 82,000 ohms, 1 watt | K-78728-85 |
| R11 | Same as R10 | |
| R12 | Resistor, 150,000 ohms, 1/2 watt | K-78727-211 |
| R13 | Resistor, 12,000 ohms, 1/2 watt | K-78727-185 |
| R14 | Same as R12 | |
| R15 | Resistor, 180 ohms, 10 watts | M-140294-32 |
| R16 | Resistor, 470 ohms, 2 watts | K-78724-58 |
| R17 | Same as R16 | |
| R18,19,20 | Resistor, voltage divider (170 ohms, 3000 ohm and 18,000 ohm section) | K-181961-1 |
| R21 | Resistor, 10,000 ohms, 1 watt | K-78728-74 |
| R22 | Same as R21 | |
| R23 | Same as R21 | |
| R24 | Resistor, 24,000 ohms, 1 watt | K-78728-192 |
| R25 | Not used | |
| R26 | Same as R2 | |
| R27 | Same as R10 | |
| R43 | Resistor, 1000 ohms, 2 watts | K-78724-62 |

| Item | Description | Drawing Number |
|----------------------------|--|----------------|
| S1 | Switch, S.P.S.T. toggle | K-181196-2 |
| T1 | Transformer, input | K-900849-501 |
| T2 | Transformer, output | K-901041-501 |
| T3 | Transformer, power, (MI-11220,-11220A) 230 v | K-901139-501 |
| T3 | Transformer, power, (MI-11220-B,-11220C) 115 v | K-900491-502 |
| MISCELLANEOUS PARTS | | |
| | Cushions, floating socket mounting, (including screws and nuts) | K-184892-501 |
| | Holder, fuse | K-844027-1 |
| | Plate, bakelite mounting, for capacitor (with two mounting lugs) | K-85558-1 |
| | Plate, bakelite mounting, for capacitor (with three mounting lugs) | K-85558-2 |
| | Socket, 8 contact ceramic type | K-844041-503 |
| | Socket, 8 contact, phenolic, for chassis mounting | K-87156-1 |
| | Socket, 8 contact wafer type | K-82747-16 |
| | Knob, control | M-414778-505 |

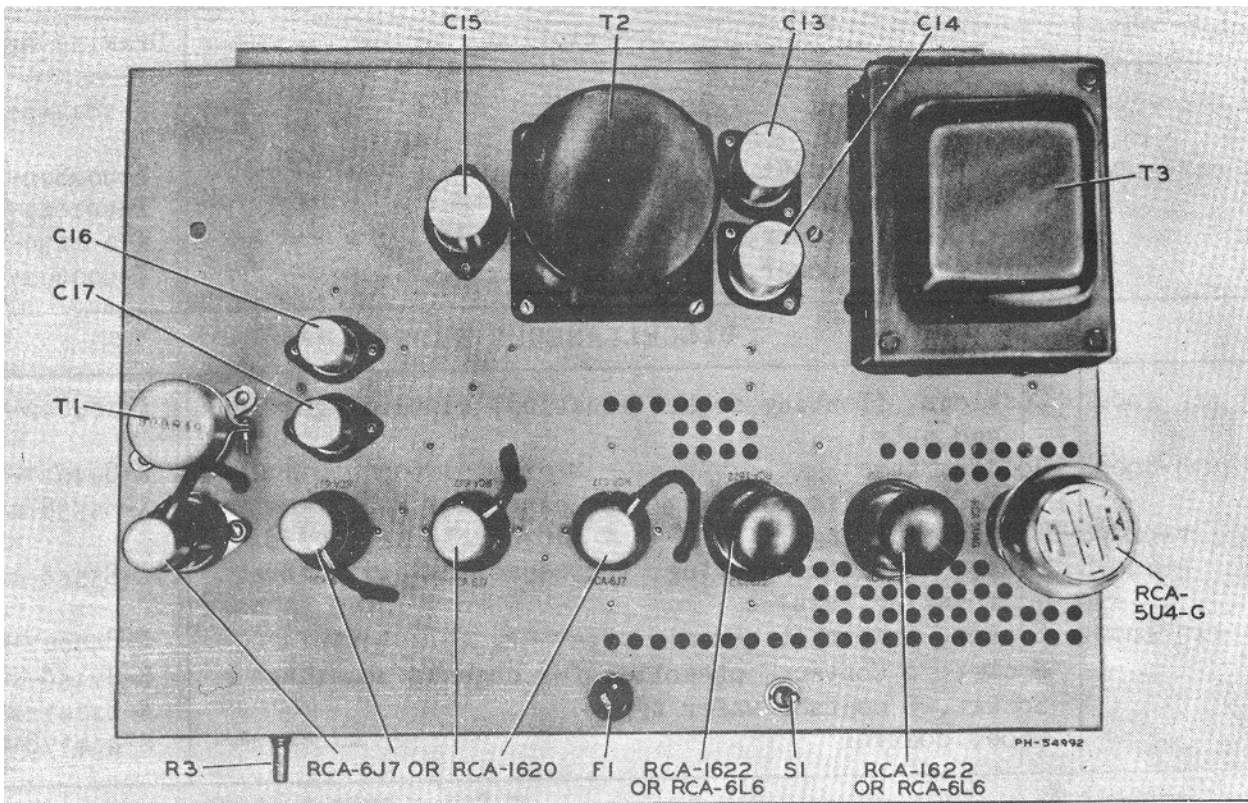

Figure 2—Amplifier Chassis (Top View)

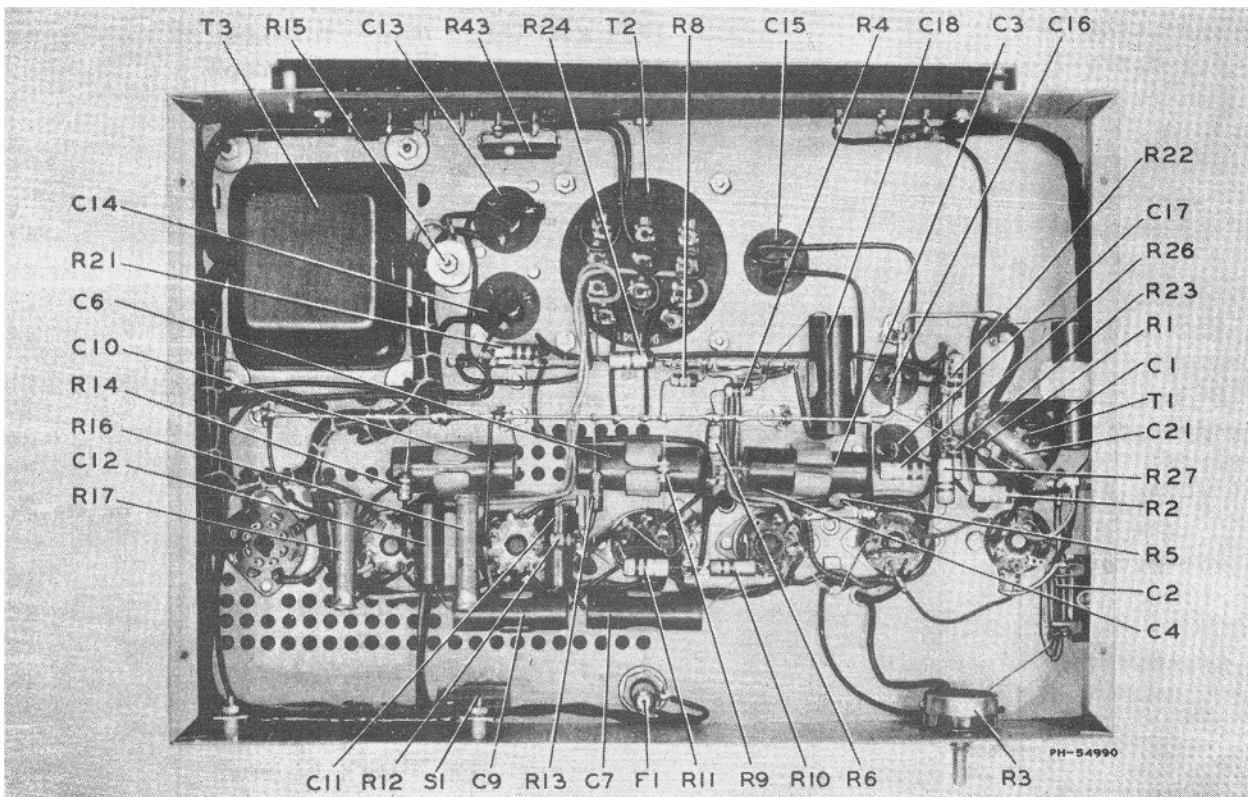

Figure 3—Amplifier Chassis (Bottom View)

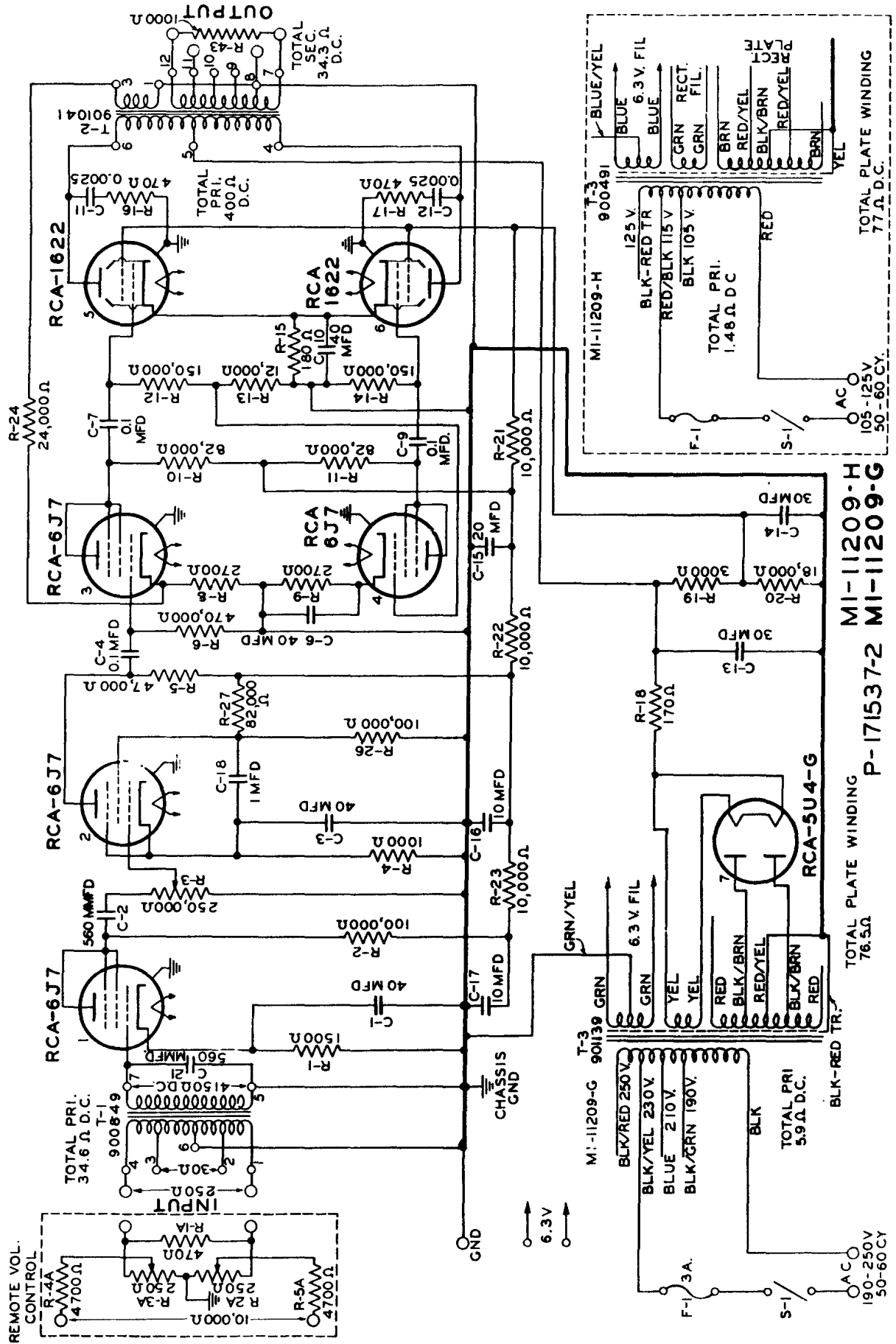
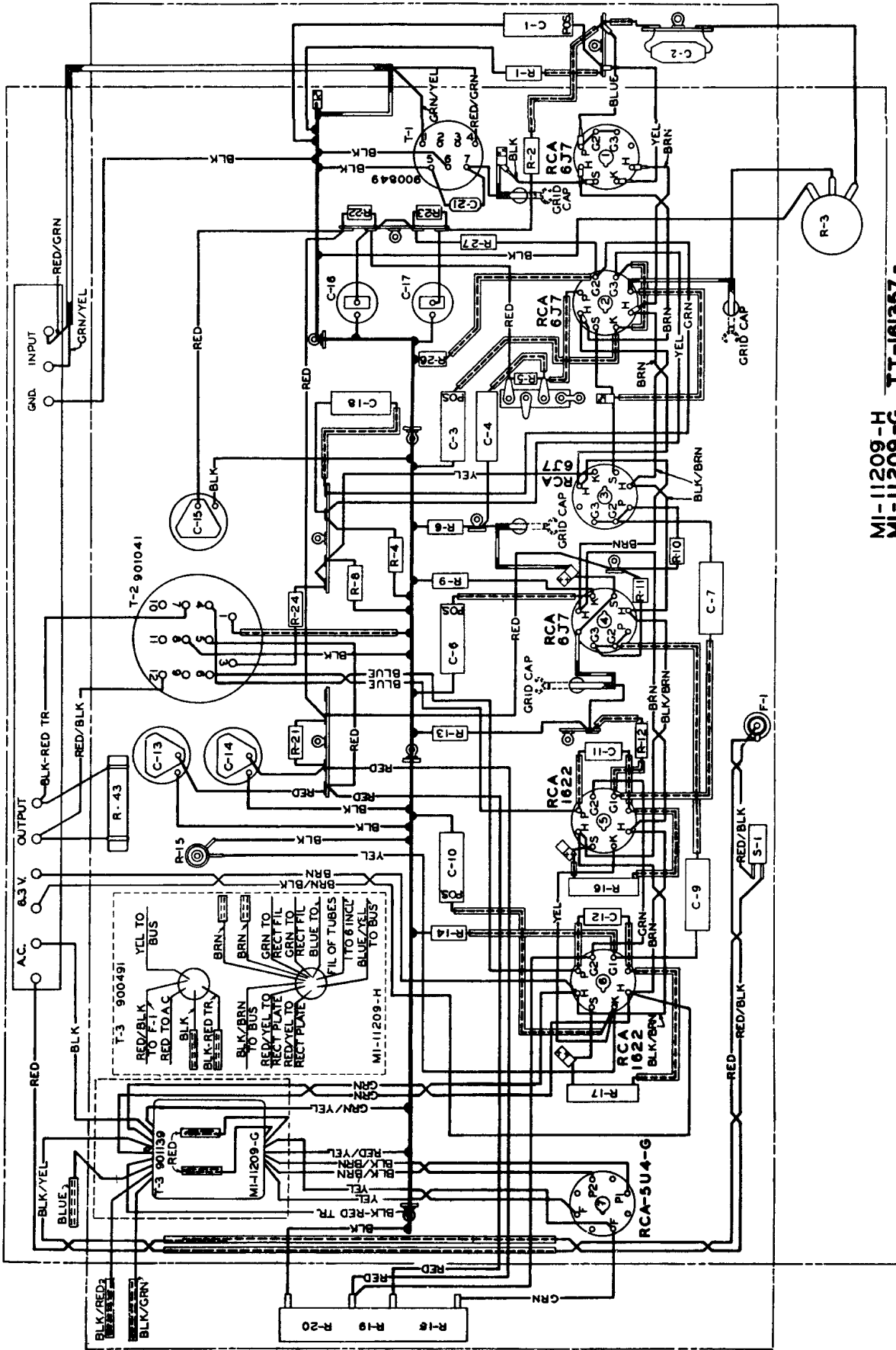

Figure 4—Amplifier (Schematic, P-171537-Sub 2)



MI-11209-H
MI-11209-G TT-161357-

Figure 5—Amplifier (Wiring TT-161357-Sub 2)

BACK

"ALL VOLTAGES DC. UNLESS OTHERWISE NOTED."
DC. VOLTAGES MEASURED WITH 20,000 OHM PER VOLT VOLTMETER

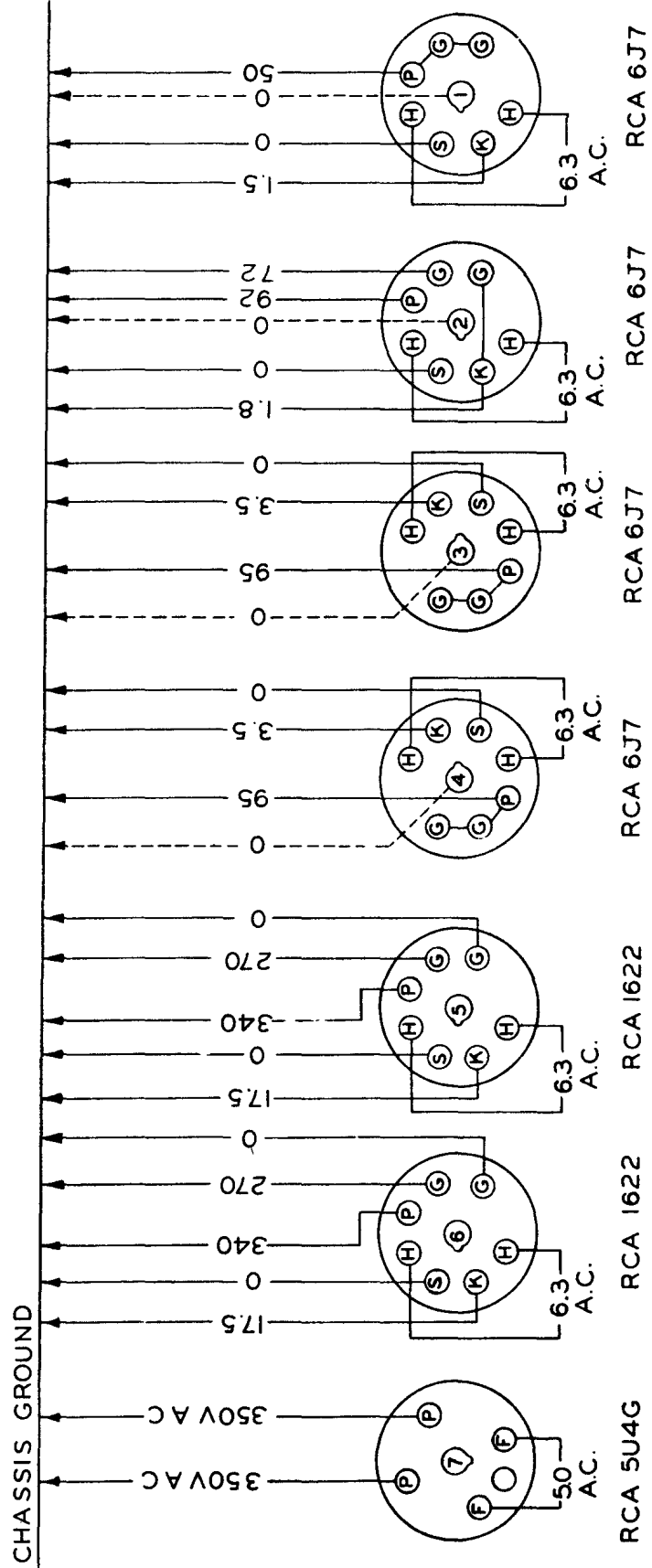

BOTTOM VIEW OF CHASSIS

FRONT

Figure 6—Socket Voltage Diagram (P-171611-Sub 1)

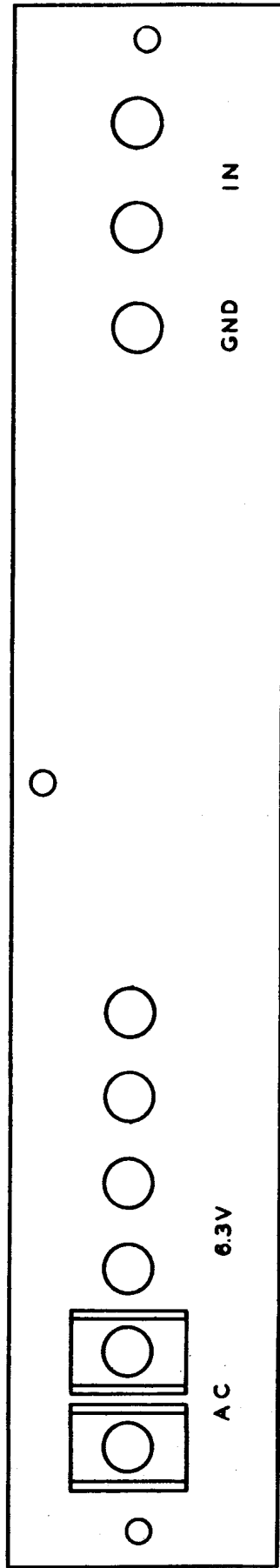

MI - 11209 - E, G & H

M - 142081 - 1

Figure 7—Terminal Board Layout (M-142081-Sub 0)