TECHNICAL MANUAL

**OPERATION, MAINTENANCE, INSTALLATION INSTRUCTIONS
AND ILLUSTRATED PARTS BREAKDOWN**

HF DSP RECEIVER MODEL RX-340

**TEN-TEC, INC.
1185 DOLLY PARTON PARKWAY
SEVIERVILLE, TN 37862**

THIS MANUAL WAS PREPARED IN ACCORDANCE WITH MIL-HDBK-1221

PART No. 74262
1ST PRINTING - 1/01
PRINTED IN U.S.A.

RECORD OF CHANGES

CHANGE NO.	DATE	TITLE OR BRIEF DESCRIPTION	ENTERED BY
		Replaced Three FIRMWARE clips with LATEST VERSION. VI.10A	

WARNING

HIGH VOLTAGE

is used in the operation of this equipment.

DEATH ON CONTACT

may result if personnel fail to observe safety precautions.

Learn the areas containing high voltage within the equipment.
Be careful not to contact high voltage connections when installing,
operating or maintaining this equipment.

Before working inside the equipment, turn power
and ground points of high potential OFF before touching them.

TABLE OF CONTENTS

*Summary - Hoel
in Setty, Tern
Scan Letter.*

PARAGRAPH	PAGE
LIST OF ILLUSTRATIONS	v
LIST OF TABLES	vii
INTRODUCTION	viii
1. GENERAL INFORMATION	
1-1 PURPOSE AND FUNCTION	1-1
1-2 SPECIFICATIONS	1-4
1-3 ENVIRONMENTAL CONDITIONS	1-6
1-4 MECHANICAL	1-7
1-5 EQUIPMENT/PARTS SUPPLIED	1-7
2. PREPARATION FOR USE AND INSTALLATION	
2-1 UNPACKING AND INSPECTION	2-1
2-2 MOUNTING	2-1
2-3 POWER	2-1
2-4 ANTENNA	2-1
2-5 IF OUT	2-1
2-6 SIG MON	2-1
2-7 1ST MIXER OUT	2-1
2-8 2ND MIXER OUT	2-1
2-9 EXT REFERENCE	2-1
2-10 RS232	2-1
2-11 LINE A	2-1
2-12 LINE B	2-1
2-13 AUDIO	2-1
2-14 DC DOUPLED AUDIO	2-1
2-15 AUX OUTPUT	2-1
2-16 MONO HEADPHONE	2-1
2-17 ISB HEADPHONE	2-1
2-18 CHASSIS GROUND	2-1
3. GENERAL THEORY OF OPERATION	
3-1 INTRODUCTION	3-1
3-2 PRESELECTOR (81878)	3-1
3-3 PREAMP/ATTN	3-1
3-4 FIRST MIXER (81823)	3-1
3-5 SECOND MIXER/THIRD LOCAL OSCILLATOR (81817)	3-6
3-6 CONVERTER-I/O BOARD (81790)	3-6
3-7 FIRST LO SYNTHESIZER (81772)	3-7
3-8 SECOND LOCAL OSCILLATOR (81772)	3-7

TABLE OF CONTENTS continued

PARAGRAPH	PAGE
3. GENERAL THEORY OF OPERATION continued	
3-9 10 MHz REFERENCE OSCILLATOR (81772).....	3-8
3-10 DSP/CPU (81807).....	3-8
3-11 FRONT PANEL CPU (81819).....	3-8
3-12 KEYPAD BOARD (81820).....	3-9
3-13 LOGIC BOARD <-> CPU INTERCONNECTIONS	3-9
 4. LOCAL OPERATION	
4-1 INTRODUCTION	4-1
4-2 FRONT PANEL OVERVIEW	4-1
4-3 MAIN TUNING KNOB	4-1
4-4 LOCK BUTTON	4-2
4-5 STEP← → BUTTONS	4-2
4-6 MODE ← → BUTTONS	4-2
4-7 BITE BUTTONS	4-2
4-8 ↑/+ AND ↓/- BUTTONS	4-3
4-9 ATTN/PREAMP BUTTON	4-3
4-10 MANUAL GAIN KNOB	4-3
4-11 REMOTE BUTTON	4-3
4-12 ISB SPEAKER SOURCE BUTOTN	4-3
4-13 SPEAKER KNOB	4-4
4-14 PHONES KNOB	4-4
4-15 AUXILIARY PARAMETER OVERVIEW	4-4
4-16 BANDWIDTH (BW) BUTTON	4-4
4-17 BEAT FREQUENCY OSCILLATOR (BFO) BUTTON	4-5
4-18 PASSBAND (PBT) BUTTON	4-6
4-19 DUMP BUTTON	4-6
4-20 AUTOMATIC GAIN CONTROL (AGC) BUTTON	4-6
4-21 NOTCH BUTTON	4-7
4-22 SQUELCH (SQL) BUTTON	4-8
4-23 NOISE BLANKER (NB) BUTTON	4-8
4-24 OPT-1 BUTTON	4-9
4-25 OPT-2 BUTTON	4-9
4-26 MEMORY/SCAN OVERVIEW	4-9
4-27 STORE THE CURRENT OPERATING FREQUENCY IN A SPECIFIED CHANNEL (0-100)	4-10
4-28 STORE THE CURRENT OPERATING FREQUENCY IN THE LOWEST EMPTY CHANNEL NUMBER	4-10
4-29 STORE THE CURRENT OPERATING FREQUENCY IN THE SCRATCHPAD MEMORY	4-11
4-30 TO RECALL A SPECIFIC CHANNEL FROM MEMORY	4-11

TABLE OF CONTENTS cont.

PARAGRAPH	PAGE
4. LOCAL OPERATION continued.	
4-31 USING THE SCROLL FUNCTION TO PREVIEW THE CHANNEL MENU	4-11
4-32 USING THE TUNE FUNCTION TO ACCESS FREQUENCIES FROM THE CHANNEL MENU	4-12
4-33 CLEARING OCCUPIED CHANNELS TO CREATE EMPTY CHANNELS	4-12
4-34 SCAN MODE PRIMER	4-13
4-35 TO SETUP A PSCAN (PROGRAMMED $F_1 \rightarrow F_2$) FREQUENCY SWEEP	4-14
4-36 INITIATING SCAN	4-16
4-37 FREQUENCY LOCKOUTS	4-16
4-38 TO SET UP A MEMORY/SCAN FREQUENCY SWEEP	4-18
4-39 INITIATING MSCAN	4-19
4-40 LOCKING OUT MSCAN CHANNELS	4-20
4-41 PAUSING AND RESTARTING SCANS	4-20
5. DETAILED OPERATING INSTRUCTIONS	
5-1 MULTI-DROP NETWORK	5-1
5-2 RECEIVER CONTROL	5-2
5-3 RECEIVER RESPONSE COMMANDS	5-2
5-4 RECEIVER CONTROL COMMANDS	5-3
5-5 RX-340 RECEIVER MEMORY COMMAND SET	5-7
5-6 RX-340 RECEIVER QUERY COMMAND SET	5-8
5-7 RX-340 RECEIVER BITE	5-9
5-8 DSP DATA OUTPUT	5-10
5-9 SCAN OPERATION	5-10
5-10 SECURITY FUNCTIONS	5-12
6. MAINTENANCE INSTRUCTIONS	
6-1 INTRODUCTION	6-1
6-2 CLEANING AND LUBRICATION	6-1
6-3 TROUBLESHOOTING	6-1
6-4 INSPECTION	6-1
6-5 PERFORMANCE VERIFICATION TEST FOR MODEL RX-340	6-1
6-5.1 TEST EQUIPMENT REQUIRED FOR MODEL RX-340	6-1
6-5.2 FUNCTIONAL TESTS FOR MODEL RX-340	6-2
7. PREPARATION FOR SHIPMENT OR STORAGE	
7-1 PREPARATION FOR RESHIPMENT	7-1
7-2 PREPARATION FOR STORAGE	7-1
8. SINGLE SOURCE PARTS LIST	
8-1 INTRODUCTION	8-1

TABLE OF CONTENTS continued

PARAGRAPH

PAGE

9. FINAL ASSEMBLY MODEL RX-340

9-1 INTRODUCTION 9-1

10. ILLUSTRATIONS AND PARTS LIST

10-1 INTRODUCTION 10-1

LIST OF ILLUSTRATIONS

FIGURE		PAGE
1-1	RX-340 FRONT VIEW	1-2
1-2	RX-340 REAR VIEW	1-3
3-1	RX-340 TOP VIEW	3-2
3-2	RX-340 FRONT PANEL REAR VIEW	3-3
3-3	RX-340 BOTTOM VIEW	3-4
3-4	RX-340 INTERCONNECT DIAGRAM	3-5
5-1	CONNECTION DIAGRAM	5-1
5-2	CONFIGURATION DIAGRAM	5-13
5-3	SERIAL/PARALLEL INTERFACE	5-14
5-4	DB25 PIN ASSIGNMENTS	5-15
10-1	MODEL RX-340 BLOCK DIAGRAM	10-2
10-2	LOGIC BOARD BLOCK DIAGRAM	10-3
10-3	SYNTHESIZER BLOCK DIAGRAM	10-4
10-4	81878 CIRCUIT TRACE TOP	10-5
10-5	81878 CIRCUIT TRACE BOTTOM	10-6
10-6	81878 RX PRESELECTOR TOP COMPONENT LAYOUT	10-7
10-7	81878 RX PRESELECTOR BOTTOM COMPONENT LAYOUT	10-8
10-8	81878 RX PRESELECTOR SCHEMATIC	10-9
10-9	81823.SMD 1ST MIXER TOP CIRCUIT TRACE	10-13
10-10	81823.SMD 1ST MIXER BOTTOM CIRCUIT TRACE	10-14
10-11	81823.SMD 1ST MIXER TOP COMPONENT LAYOUT.....	10-15
10-12	81823.SMD 1ST MIXER BOTTOM COMPONENT LAYOUT.....	10-16
10-13	81823.SMD 1ST MIXER SCHEMATIC.....	10-17
10-14	81817.SMD 2ND MIXER/IF TOP CIRCUIT TRACE.....	10-21
10-15	81817.SMD 2ND MIXER/IF BOTTOM CIRCUIT TRACE.....	10-22
10-16	81817.SMD 2ND MIXER/IF TOP COMPONENT LAYOUT.....	10-23
10-17	81817.SMD 2ND MIXER/IF BOTTOM COMPONENT LAYOUT.....	10-24
10-18	81817.SMD 2ND MIXER/IF SCHEMATIC.....	10-25
10-19	81790.SMD CONVERTER/IO TOP CIRCUIT TRACE.....	10-29
10-20	81790.SMD CONVERTER/IO BOTTOM CIRCUIT TRACE.....	10-30
10-21	81790.SMD CONVERTER/IO BOARD TOP COMPONENT LAYOUT.....	10-31
10-22	81790.SMD CONVERTER/IO BOARD BOTTOM COMPONENT LAYOUT.....	10-32
10-23	81790.SMD CONVERTER/IO BOARD SCHEMATIC.....	10-33
10-24	81772.TCXO TOP CIRCUIT TRACE - SYNTHESIZER.....	10-37
10-25	81772.TCXO INNER CIRCUIT TRACE-SYNTHESIZER	10-38
10-26	81772.TCXO BOTTOM CIRCUIT TRACE - SYNTHESIZER.....	10-39
10-27	81772.TCXO TOP COMPONENT LAYOUT - SYNTHESIZER.....	10-40
10-28	81772.TCXO BOTTOM COMPONENT LAYOUT-SYNTHESIZER	10-41
10-29	81772.TCXO SYNTHESIZER SCHEMATIC.....	10-43
10-30	81824 POWER SUPPLY FILTER TOP CIRCUIT TRACE.....	10-48
10-31	81824 POWER SUPPLY FILTER BOTTOM CIRCUIT TRACE.....	10-49
10-32	81824 POWER SUPPLY FILTER COMPONENT LAYOUT.....	10-50

LIST OF ILLUSTRATIONS continued

FIGURE

PAGE

10-33	81824 POWER SUPPLY FILTER SCHEMATIC.....	10-51
10-34	81807 DSP/CPU TOP CIRCUIT TRACE.....	10-53
10-35	818 07 DSP/CPU BOTTOM CIRCUIT TRACE.....	10-54
10-36	81807 DSP/CPU COMPONENT LAYOUT.....	10-55
10-37	81807 DSP/CPU SCHEMATIC (page 1 of 2).....	10-57
10-38	81807 DSP/CPU SCHEMATIC (page 2 of 2).....	10-59
10-39	81819 FRONT PANEL CPU TOP CIRCUIT	10-62
10-40	81819 FRONT PANEL CPU BOTTOM CIRCUIT	10-63
10-41	81819 FRONT PANEL CPU TOP COMPONENTS	10-64
10-42	81819 FRONT PANEL CPU BOTTOM COMPONENTS	10-65
10-43	81819 FRONT PANEL CPU SCHEMATIC	10-66
10-44	81820 KEYPAD BOARD TOP CIRCUIT	10-69
10-45	81820 KEYPAD BOARD BOTTOM CIRCUIT	10-70
10-46	81820 KEYPAD BOARD TOP COMPONENTS	10-71
10-47	81820 KEYPAD BOARD BOTTOM COMPONENTS	10-72
10-48	81820 KEYPAD BOARD SCHEMATIC	10-73

LIST OF TABLES

TABLE		PAGE
8-1	MODEL RX-340 SINGLE SOURCE PARTS LIST	8-1
8-2	PART MANUFACTURER'S INFORMATION	8-5
9-1	RX-340 MODULES	9-1
9-2	FINAL ASSEMBLY REPLACEABLE PARTS	9-2
10-1	81878 RX PRESELECTOR PARTS LIST	10-11
10-2	81823 1ST MIXER PARTS LIST.....	10-19
10-3	81817 2ND MIXER/IF PARTS LIST.....	10-27
10-4	81790 CONVERTER/IO BOARD PARTS LIST.....	10-35
10-5	81772 SYNTHESIZER PARTS LIST.....	10-45
10-6	81824 POWER SUPPLY FILTER PARTS LIST.....	10-52
10-7	81807 DSP/CPU BOARD PARTS LIST.....	10-61
10-8	81819 FRONT PANEL CPU BOARD PARTS LIST	10-68
10-9	81820 KEYPAD BOARD PARTS LIST	10-75
10-10	RECORD OF CHANGES	10-76

INTRODUCTION

This technical manual provides operation and maintenance instructions for the RX-340 HF DSP Receiver. The manual was prepared in accordance with MIL-HDBK-1221, "Department of Defense Handbook for Evaluation of Commercial Off-The-Shelf (COTS) Manuals." It is organized into ten chapters along with a Table of Contents, List of Illustrations, and List of Tables.

Chapter 1 presents general information about the Receiver, which includes functional capabilities, performance specifications, and physical dimensions. Chapter 2 provides information concerning the unpacking and initial installation of the receiver. A general theory of operation is provided in Chapter 3 which describes the functioning of the Receiver's individual circuit boards. Chapter 4 provides detailed descriptions of all front-panel operating controls, plus complete instructions for local operation. Chapter 5 contains information on operation of the multi-drop RS-232 Interface and the Parallel Data Output. Chapter 6 provides information on maintenance and troubleshooting measures to be employed at the user's level. Instructions pertaining to the reshipment or long term storage are provided in Chapter 7. A detailed list of unique single-source parts is provided in Chapter 8. In addition, Chapter 8 contains a list of manufacturers for these parts and their addresses. Chapter 9 provides a listing of replaceable modules and parts. Chapter 10 contains detailed parts lists for each of the replaceable modules. Chapter 10 also contains schematic diagrams for the electronic circuits.

CHAPTER 1

GENERAL INFORMATION

1-1 PURPOSE AND FUNCTION: The TENTECH RX-340 is an all-mode, general-coverage receiver that delivers military-grade performance at off-the-shelf commercial pricing. Powerful digital signal processing (DSP) and over 60,000 lines of intensive code provide a level of performance and flexibility unattainable with conventional analog circuitry.

The RX-340 may be controlled locally from the front panel, or operated remotely through a RS-232 interface. Knobs, switches, and displays are arranged ergonomically into four intuitive control groups. Frequency, Mode, and Tuning Rate are presented in 12.5mm blue-green fluorescent characters on the receiver's main alphanumeric display. Operating frequency is controlled by direct keypad entry or by a weighted main tuning knob, with continuous coverage from below 50 kHz to 30 MHz. Ten step-tuning rates are provided (from 1 Hz to 1 MHz) to accommodate a wide range of tuning requirements. Display resolution is 1 Hz, and frequency stability is ± 1 ppm over an operating range of 0-50 degrees C.

In addition to manual tuning, 100 channel memories are provided to retain and recall operating frequency, mode, and other basic operating parameters. Sophisticated programmable *Memory-Scan* (MScan) and F1-F2 frequency-scan (Pscan) modes are also provided, along with up to 100 frequency-lockouts and a rapid-access scratchpad memory. A two-line alphanumeric display provides continuous presentation of the receiver's *Memory/Scan* status, and a dedicated *Memory/Scan* knob facilitates menu management and scan programming.

Signal amplification, filtering, and processing are divided between analog and digital circuitry. Analog features include 1/2-octave front-end filters, ruggedized balanced mixers, and triple-conversion design to ensure wide dynamic range and superior rejection of unwanted signals. A sophisticated multistage *Automatic Gain Control* (AGC) system provides

80dB of control range ahead of the A-to-D converters plus an additional 40 dB in DSP. A switchable attenuator and preamp expand signal-handling range to over 140 dB.

Digitally-controlled operating parameters include an adjustable, offset beat-frequency oscillator (BFO), variable passband tuning (PBT), tunable notch filter (Notch), wide-range squelch (SQL), and a variable noise blanker (NB). An extensive bandwidth (BW) menu provides 57 standard-shape DSP filters ranging from 100 Hz to 16 kHz, plus an added selection of fast filters for enhanced reception of delay-critical digital modes such as SITOR. Three preset AGC rates (Fast, Medium, and Slow) are provided, along with a unique Program Mode that supports fully-adjustable Attack, Hang, and Decay settings. A momentary AGC-cancel switch (Dump) instantly restores full receiver sensitivity on demand. A dedicated two-line alphanumeric display continuously presents operating-parameter status, and a companion *Aux Parameters* knob adjusts selected operating characteristics.

Detection modes include USB, LSB, ISB, CW, CW1, NBFM, AM, and Synchronous AM, with selectable sidebands. SAM significantly reduces fading and adjacent-channel interference on AM signals. Separate headphone and speaker gain controls adjust listening level (speaker-level audio is routed to a built-in 4-inch speaker and a switchable external-speaker jack). An AF-channel selector routes upper, lower, or both sideband channels to the speaker line in ISB and SAM modes. In addition, balanced and unbalanced line-level outputs are available on the rear panel for remote monitoring.

Signal strength is displayed in either S-units or dBm on a large-scale, 2-1/2-inch analog meter. Meter sensitivity is automatically compensated when the preamp or attenuator are activated or manual gain is adjusted.

RX-340 FRONT VIEW

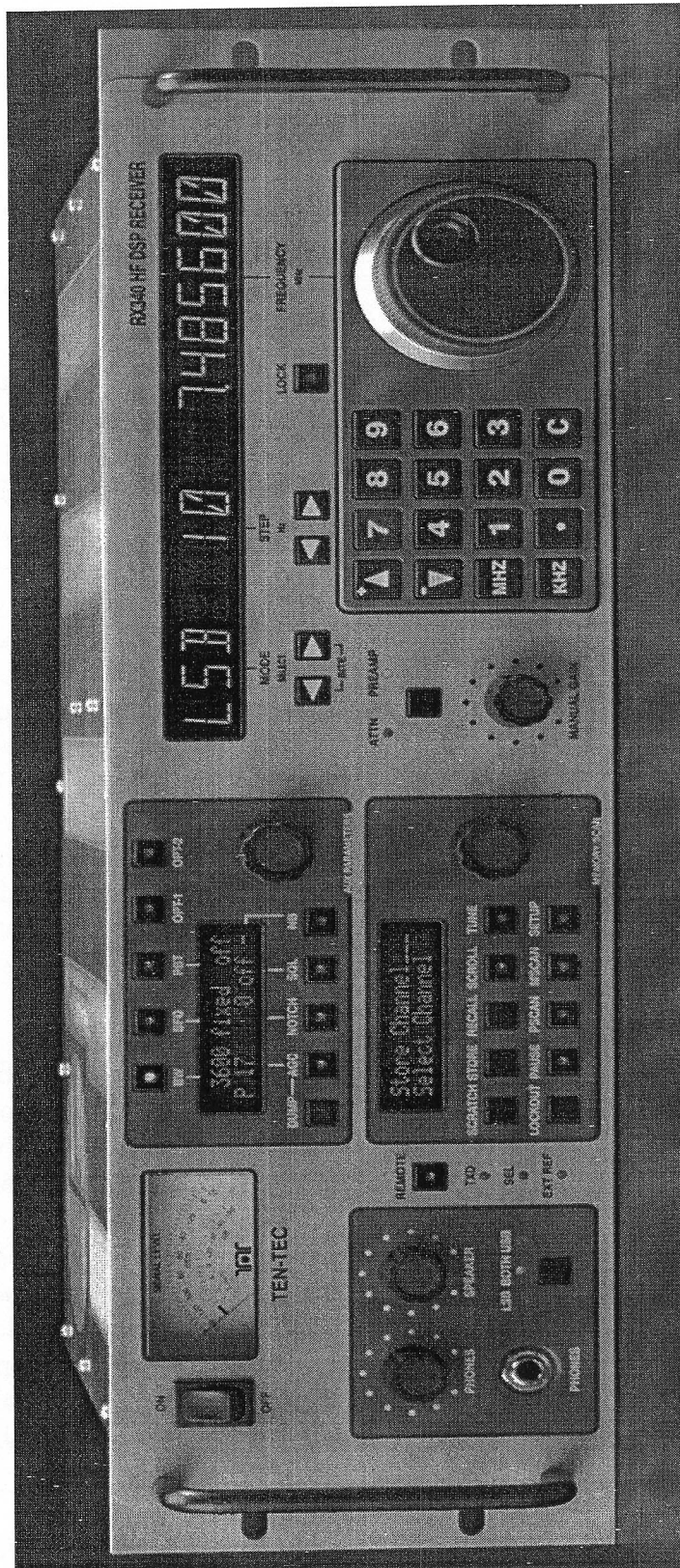

FIGURE 1-1

RX-340 REAR VIEW

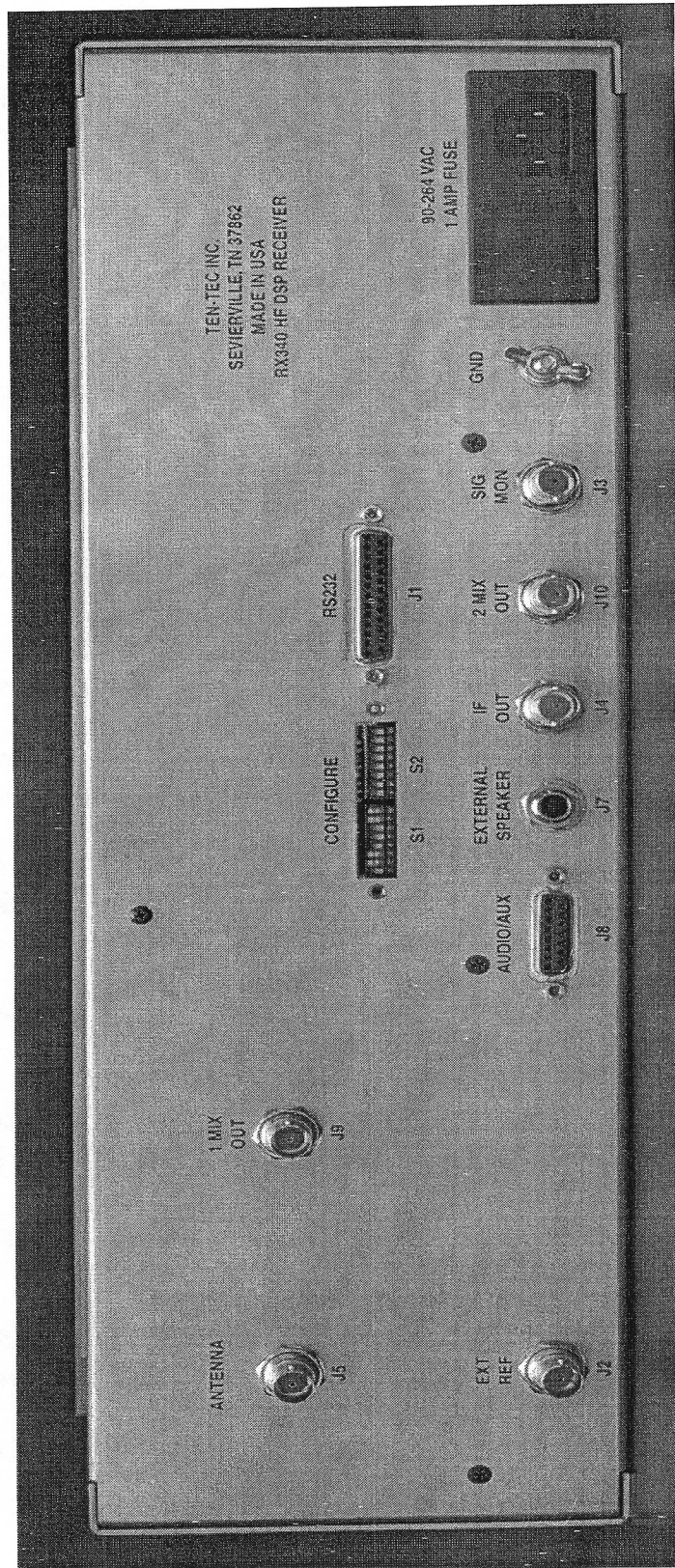

FIGURE 1-2

Rear-panel BNC jacks provide inputs for the antenna and external reference oscillator, plus access to mixer and I.F. monitoring points. A standard DB-25 jack accepts a Multi-drop RS-232 line for remote receiver operation. The RX-340's built-in power supply is designed for international use, accepting a wide range of voltages and line frequencies. Conservative engineering, all-SMD circuitry, and rugged mechanical construction ensure reliable long-term performance.

1-2 SPECIFICATIONS:

Applicable from 50 kHz to 30 MHz, unless otherwise stated.

Power Supply: Internal, accepts 48-440 Hz line power, 90-264 VAC. 30 watts nominal.

Frequency Tuning System:

Tuning Range: 50 kHz to 30 MHz at typical sensitivity. Tunable to 0 MHz with degraded performance.

Tuning Increment: 1 Hz minimum.

Synthesizer lock time: 10 mS nominal.

BFO: Tunable in CW mode only, ± 8 kHz, 10 Hz steps. Fixed frequency in SSB and ISB modes, disabled in AM and FM modes.

Accuracy: All internal oscillators may be locked to either internal or external frequency standards.

The internal reference is adjustable by a continuously variable trimmer, allowing calibration to any desired accuracy.

Stability (internal standard): ± 1 ppm within the 0-50 degrees C operating range.

External Frequency Standard: 1, 2, 5, or 10 MHz ± 1 ppm, 500 mV-2V p-p, high impedance load. The receiver automatically detects and uses the external standard upon application, at power-up, or after serial link activity. If the external standard slews far outside the ± 1 ppm specified, internal circuitry will lose lock until the input returns to within specification, or will re-lock at the next power-up or serial activity provided the input is within spec. at a valid reference frequency (1, 2, 5, or 10 MHz). A frequency-out-of-lock condition is always reported over the serial link. Removal of the external

frequency standard input immediately returns the receiver to the internal standard.

Tuning Method: Local tuning via direct keypad entry, step-arrow keys, or main tuning knob.

Remote tuning via multi-drop RS232.

Frequency Indication: Local indication via main alphanumeric display, 1-Hz resolution.

Remote frequency status reported via the RS-232 serial link.

Interface Connections:

RF Input:

Impedance: 50 ohms nominal

VSWR: 2.5:1 maximum in preselector passband.

Connector: Rear-panel BNC

Protection: Internal Surge Protector

Balanced Line-level Audio Output:

Two 600-ohm Lines

Level: 0 dBm nominal, center-tapped, ungrounded.

Connector: DA-15, 3 pins.

Function: Upper and Lower sideband audio on separate lines in ISB mode. Same signal on both lines in other modes.

Single-ended Line-level Audio Outputs:

Level: 10 mW into 600 ohms, one AC-coupled and one DC coupled.

Connector: DA-15, two pins each line.

Function: Upper, lower, or both sidebands in ISB mode, software configured.

Mono/Stereo Headphones:

Level: 10 mW into 600 ohms per channel, front-panel volume control.

Connector: Front-panel 1/4" stereo phone jack.

Function: Monaural except in ISB, where USB and LSB are split in stereo phones.

Monaural Speaker-Level Output:

Level: 1.5 W into 4 ohms at 10% THD, 4" internal or external speaker.

Front-panel volume control.

Connector: External, 1/4" rear-panel mono jack.

Function: Monaural monitoring, all modes.

Signal Monitor Delayed AGC:

Frequency: 455 kHz center (inverted, 1 kHz tuning step)

Bandwidth: 16 kHz (-6 dB).

Level: -10 dBm nominal (+/- 3 dBm).

AGC delayed 40 dB.

Impedance: 50 ohms nominal.

Connector: Rear panel BNC.

IF Output, Post DSP:

Frequency: 455 kHz center (inverted).

Bandwidth: Determined by IF filter selection.

Level: -10 dBm nominal (AGC leveled).

Impedance: 50 ohms nominal.

Connector: Rear panel BNC.

1st Mixer Out, Wideband:

Frequency: 45.455 MHz Center frequency
(inverted, 1 kHz tuning step, no AGC).

Bandwidth: Determined by preselector filter.

Level: -16 dB relative to RX input
(Preamp and Attenuator OFF).

Impedance: 50 ohms nominal.

Connector: Rear panel BNC.

2nd Mixer Out, no AGC:

Frequency: 455 kHz center frequency (inverted,
1kHz tuning steps).

Bandwidth: 16 kHz (-6 dB).

Level: 0 dB rel to RX input (PRESEL/
ATTN OFF).

Impedance: 50 ohms nominal.

Connector: Rear panel BNC.

Receiver Sensitivity:

Dynamic Range:

Mode	Noise Figure (dB)		3rd Order Intercept (dBm)	
	Typ	Max	Typ	Min
10 dB PREAMP ON	10	14	20	15
PREAMP OFF	17	19	30	25
15 dB ATTN	32	34	45	40

VLF Sens., Typ, .3 kHz bandwidth preamp OFF.

16 dB SINAD

>500 kHz	-116 dBm (.35uV)
100 kHz	-115 dBm (.4uV)
50 kHz	-114 dBm (.45uV)
20 kHz	-107 dBm (1 uV)
15 kHz	-104 dBm (1.4uV)
10 kHz	-94 dBm (4.5 uV)
5 kHz	-82 dBm (18uV)

Spurious Responses: All spurious less than
-119 dBm equivalent input- preamp ON.

Control Interface:

Standard: Multi-drop RS-232.

Config: Dipswitch programmable, 300 to
19200 baud, 7 or 8 data bits, even,
odd, or no parity.

Connector: DB-25 female.

Sensitivity By Mode

Mode	BW	SINAD	Preamp OFF		Preamp ON	
			Typical	Max	Typical	Max
AM: (50% Mod @ 400 Hz)	6 kHz	10 dB	-103 dBm/ 1.6 uV	-101 dBm/ 2.0 uV	-112dBm/ 0.56 uV	-108dBm/ 0.9 uV
FM: (6 kHz dev @ 1 kHz)	16 kHz	16 dB	-102 dBm/ 1.8 uV	-100 dBm/ 2.2 uV	-108dBm/ 0.9 uV	-104dBm/ 1.4 uV
USB/LSB/ISB:	3.2 kHz	10 dB	-112 dBm/ 0.6 uV	-110 dBm/ 0.7 uV	-119dBm/ 0.25 uV	-115dBm/ 0.4 uV
CW:	300 Hz	16 dB	-116 dBm/ 0.35 uV	-114 dBm/ 0.45 uV	-124dBm/ 0.14 uV	-120dBm/ 0.22 uV

Gain Characteristics:

Gain control:

Receiver operates with automatic (AGC) or manual gain control. Manual gain control reduces receiver gain and increases AGC threshold by up to 120 dB.

AGC:

Range: 90 dB minimum
Threshold: 3 uV typical
Attack Time: 15 mS typical, to within ± 3 dB of 20 dB step.

Release Time:

MODE	ATTACK (dB/ms)	HANG (sec)	DECAY (dB/sec.)
FAST	0.8	0	1200
MEDIUM	0.8	0	100
SLOW	0.8	0	25
PROGRAMMABLE	0.01-1.0	0.01-99.9	0.01-99.9

Manual AGC:

Range: 120 dB. Controlled through the Front Panel or RS-232 interface.
Attack/Release Times: Limited only by RS-232 serial transfer rate.

Programmable AGC:

Setting Ranges:

Attack: 0.01-1.0 dB/ms
Hang: 0.01-99.9 seconds
Decay: 0.01-99.9 dB/s

Signal Handling Characteristics (Preamp Off):

Image Rejection: 90 dB typical, 80 dB minimum (all mixers).

IF Rejection: 90 dB typical, 80 dB minimum (all IFs).

Third order intercept point: 30 dBm typical, 25 dBm minimum (See chart P1-5).

Second order intercept point: +75 dBm, typ, 60 dBm minimum.

Selectivity: 57 bandwidths selectable from 0.1 to 16 kHz. Shape factor better than 1.5:1 (6 to 60 dB).

Bandwidth Selection via Menu:

100 Hz, 120 Hz, 150 Hz, 170 Hz, 200 Hz, 220 Hz, 250 Hz, 300 Hz, 350 Hz, 400 Hz, 450 Hz, 500 Hz, 600 Hz, 700 Hz, 800 Hz, 900 Hz, 1 kHz, 1.1 kHz, 1.2 kHz, 1.3 kHz, 1.4 kHz, 1.5 kHz, 1.6 kHz, 1.7 kHz, 1.8 kHz,

1.9 kHz, 2.0 kHz, 2.2 kHz, 2.4 kHz, 2.6 kHz, 2.8 kHz, 3.0 kHz, 3.2 kHz, 3.4 kHz, 3.6 kHz, 3.8 kHz, 4.0 kHz, 4.4 kHz, 4.8 kHz, 5.2 kHz, 5.6 kHz, 6.0 kHz, 6.4 kHz, 6.8 kHz, 7.2 kHz, 7.6 kHz, 8.0 kHz, 8.8 kHz, 9.6 kHz, 10.4 kHz, 11.2 kHz, 12.0 kHz, 12.8 kHz, 13.6 kHz, 14.4 kHz, 15.2 kHz, 16.0 kHz.

Bandwidth Selection via Keypad Entry:

Upon entry, receiver automatically selects the closest filter in the menu of equal or greater bandwidth.

Fast-Filters:

Fast Filters offer reduced signal latency and degraded shape factors to facilitate reception of delay-critical digital modes.

Fast-Filter Selection:

All standard menu bandwidths up to 4 kHz are available as Fast Filters.

Fixed Bandwidths:

Bandwidth is fixed at 3.2 kHz in ISB mode. Minimum available bandwidth is 600 Hz in FM mode, and 4 kHz in SAM mode.

Blocking on tune: <5% THD: -6 dBm input 30% AM 1 kHz.

Blocking off tune: 200 kHz offset. 15 dBm typ. 10 dBm min for 3 dB desense.

Ultimate Rejection: Greater than 70 dB regardless of filter selected.

Group Delay: No more than .1 ms variation overpassband of 300 Hz to 3050 Hz (Notch OFF).

Lo Phase noise: -120 dBc/Hz @ 20 kHz offset typical, -110 dBc/Hz max.

1-3 ENVIRONMENTAL CONDITIONS

Normal Operating:

Temperature: 0 to 50 degree C (32-122F)

Humidity: Up to 95% Rel, non-cond.

Altitude: Up to 10,000 feet MSL

Shock: Not applicable

Vibration: Not applicable

Storage/Transport:

Temperature: -46 to 71 degree C (-50-160F)

Humidity: Up to 95% Rel, non-cond.

Altitude: Up to 15,000 feet MSL

Shock: 10 G, 11 mS duration

Vibration: 1-1/2 G, 5 to 200 Hz

1-4 MECHANICAL

Size: 5.25" H x 19.0" W x 12.5" D or
133.35mm H x 482.6mm W x 17.5mm D

Weight: 12.5 lbs. or (5.67 kg.)

Cooling: Air convection cooled within fan ventilated rack cabinet. Units are directly stackable with no fillers required between chassis.

Mounting: Model RX-340 conforms to EIA standard 19" rack mount panel space and is 3U high. Slide mechanism attachment points (10-32 thread) are compatible with Jonathan slide type 375 QD.

Cable connectors Rear panel:

Receiver Antenna input: BNC female
IF output 455 kHz: BNC female
1st Mixer Out: BNC female
2nd Mixer Out: BNC female
Signal Monitor: BNC female
External Reference: BNC female

Cable Connectors, Rear Panel:

Receiver Antenna input: BNC female
IF output 455 kHz: BNC female
1st Mixer Out: BNC female
2nd Mixer Out: BNC female
Signal Monitor: BNC female
External Reference: BNC female
Remote Control: (RS-232) DB25, female
Main Power: Detachable 3 conductor AC cord
Audio/Aux: 15 pin D connector, female
External Speaker: 1/4" monaural phone jack
Ground: 10-24 stud

Front Panel:

Stereo headphone: 1/4" stereo jack

1-5 EQUIPMENT/PARTS SUPPLIED

Qty	Item	Ten-Tech part #
1	HF DSP RECEIVER MODEL RX-340	27071
1	AC POWER CORD	46138
1	TECHNICAL MANUAL	74262
1	.050 ALLEN WRENCH	38040
1	.062 ALLEN WRENCH	38088
1	WARRANTY CARD	74020
4	RUBBER FEET	42020
4	LOCK WASHERS	51001
4	6x32 SCREWS	60010
1	FUSE, 1A, GDC-1A	27071

5x20 mm. (spare fuse in power entry module at rear of RX-340).

Specifications subject to change without notice.

CHAPTER 2

PREPARATION FOR USE AND INSTALLATION

2-1 UNPACKING AND INSPECTION: Examine the shipping carton for damage before unpacking. If the carton is damaged, attempt to open it in the presence of an agent of the shipping carrier. If undamaged, retain the carton and packing material for further inspection in case damage to the unit is discovered later.

Remove the bubble packing from the top of the unit, then lift the radio free from its carton (there are no additional packing materials inside the radio's cabinet). Replace the bubble packing material in the carton and save for possible reshipment at a future time.

Inspect the unit for external damage. Pay particular attention to dents or bent sheet metal. If external damage is evident, remove the top and bottom covers and inspect for internal damage such as cracked circuit boards or broken components. Do not attempt to operate the unit if internal damage is noted.

2-2 MOUNTING: RX-340 is designed for EIA standard 19" panel space rack. Slide-mechanism attachment points (10-32 thread) are compatible with Jonathan slide type 375QD.

2-3 POWER: A fused power receptacle accepts a standard 3-wire instrumentation-type AC power cord. Receiver operates from 90-264 VAC (48-440 Hz) without setting switches or jumpers.

2-4 ANTENNA: A standard 50 Ω antenna input connection is provided at BNC jack J5.

2-5 IF OUT: A DSP-processed 455-kHz output with 120-dB AGC range and adjustable bandwidth is available at J4 (inverted, 1-Hz tuning step).

2-6 SIG MON: A 455-kHz inverted signal with 16-kHz bandwidth and 80-dB AGC range is available at J3 (1-kHz tuning step).

2-7 1ST MIXER OUT: An inverted 45.455-

MHz signal with no AGC and bandwidth determined by preselector is available at J9 (1-kHz tuning step).

2-8 2ND MIXER OUT: A 455-kHz inverted signal with fixed 16-kHz bandwidth and no AGC is available at J10 (1-kHz tuning step).

2-9 EXT REF: A 1-MHz, 2-MHz, 5-MHz or 10-MHz @ 200 mV rms (minimum) signal may be applied to J2 to automatically override the internal 10-MHz reference.

2-10 RS-232: A RS-232 input jack at J1 accepts a standard DB-25 connector for remote operation.

2-11 LINE A: A independent 600 Ω balanced line-level output is available at DB-15 jack J8.

2-12 LINE B: A second independent-channel 600 Ω balanced line-level output is provided at J8.

2-13 AUDIO: A combined-channel 600 Ω unbalanced AC-coupled output is provided at J8.

2-14 DC-COUPLED AUDIO: A combined-channel 600 Ω DC-coupled output is provided at J8.

2-15 AUX OUTPUT: Four digital-level user outputs, controllable by RS-232 command, are available at J8.

2-16 EXTERNAL SPEAKER: A monaural unbalanced 4 Ω @ 2.5-W speaker output is available at 1/4" monaural phone-jack J7. Inserting external speaker plug disables internal speaker.

2-17 HEADPHONE: A front-panel mounted 1/4" stereo phone jack provides two discrete audio channels (split for ISB, monaural all other modes). Level is controlled by front-panel *Phones* control.

2-18 CHASSIS GROUND: A 10-24 chassis-ground stud with a wingnut accepts a #10 ground-strap lug.

CHAPTER 3

GENERAL THEORY OF OPERATION

3-1 INTRODUCTION: The TEN-TEC Model RX-340 receiver combines a high, dynamic range front end with a versatile DSP back end to provide extraordinary performance and flexibility. Refer to the overall block diagram Figure (10-1) and interconnect diagram Figure (3-4).

RF signals applied to the receiver's *Antenna Input* (J5) are preselected by a switchable 1/2-octave bandpass filter network. Balanced amplifiers and a high-level 1st-mixer preserve 2nd and 3rd-order intercept points during conversion to the 1st-IF frequency of 45.455 MHz. A pair of 2-pole crystal filters provide a 1st-IF selectivity of 16 kHz to reject 1st-mixer spurious products and the 2nd-mixer image at 910 kHz offset. Both mixer outputs are available at rear panel connectors J9 and J10.

After conversion to the 2nd-IF frequency (455 kHz), signals are filtered for a 16-kHz bandwidth and applied to the AGC-controlled 2nd-IF amplifier, which provides up to 80 dB gain. Amplified signals are filtered again for 16-kHz bandwidth and split off to the 3rd-mixer stage and *Signal Monitor* output (J3).

The 3rd mixer converts signals to a center frequency of 16-2/3 kHz where they pass through a low-pass filter and are applied to an analog-to-digital converter. The A/D converter produces a serial data stream at a 66-2/3 kHz sample rate for input to the Digital Signal Processor.

Serial data from the DSP (at a 133-1/3 kHz sample rate) is applied to a digital-to-analog converter. The D/A output samples are de-multiplexed into two or three output channels depending upon mode selection. Half of the D/A output time is devoted to the DSP's IF output, which is first converted back to 455 kHz by mixing with the third LO, then filtered for a 16-kHz bandwidth and finally made available at the *IF Output* connector (J4).

The other half of the D/A bandwidth is separated into USB and LSB audio channels in ISB mode, or into a single audio channel in all other modes.

3-2 PRESELECTOR (81878): Refer to Figure (10- 8). Eight 1/2-octave bandpass filters spanning 500 kHz to 30 MHz are selected by diode switching (D1-D16). Switches are biased into conduction by control voltages supplied by the DSP/CPU board (81807). A high-level, push-pull parallel FET amplifier (Q7-Q12) compensates for filter and switching losses prior to the first mixer.

3-3 PREAMP/ATTN: For normal reception, switching diodes D19-D20 provide a straight-through signal path to the FET pre-mixer amplifier. For weak signal reception, D21-D22 route signals through preamplifier Q13 for 10 dB added pre-mix gain. For very strong signal reception, D17-D18 route signals through a 15-dB attenuator prior to the pre-mixer amplifier.

3-4 FIRST MIXER (81823): Refer to figure (10-13). Signals from the preselector board are routed through a 30-MHz low-pass filter (L7-L10) and sent to the RF-input port of high-level balanced mixer D1-D4 (T3). The 1st-LO signal is amplified by Q1 and routed through a low-bandpass filter (L5,L6) for application to the mixer's LO port (T2). The resultant mixer products appear at output port T4. Here, signals are divided, with one branch routed via balun T5 to the rear-panel *1st-Mixer Output* (J9). The other branch is applied to a high-level push-pull parallel FET amplifier stage Q2-Q7. This stage boosts signals prior to filtering by FL1- FL2. FL1-FL2 are 45.455-MHz crystal roofing filters cascaded to provide a 4-pole response for rejecting the unwanted mixer image plus other spurious products. Post-filter amplifier Q8 boosts the level of the selected 45.455-MHz IF product prior to application to the 2nd mixer.

RX-340 TOP VIEW

PRESELECTOR
81878

1ST MIXER
81823.SMD

DSP/CPU
81807

POWER SUPPLY
FILTER
81824

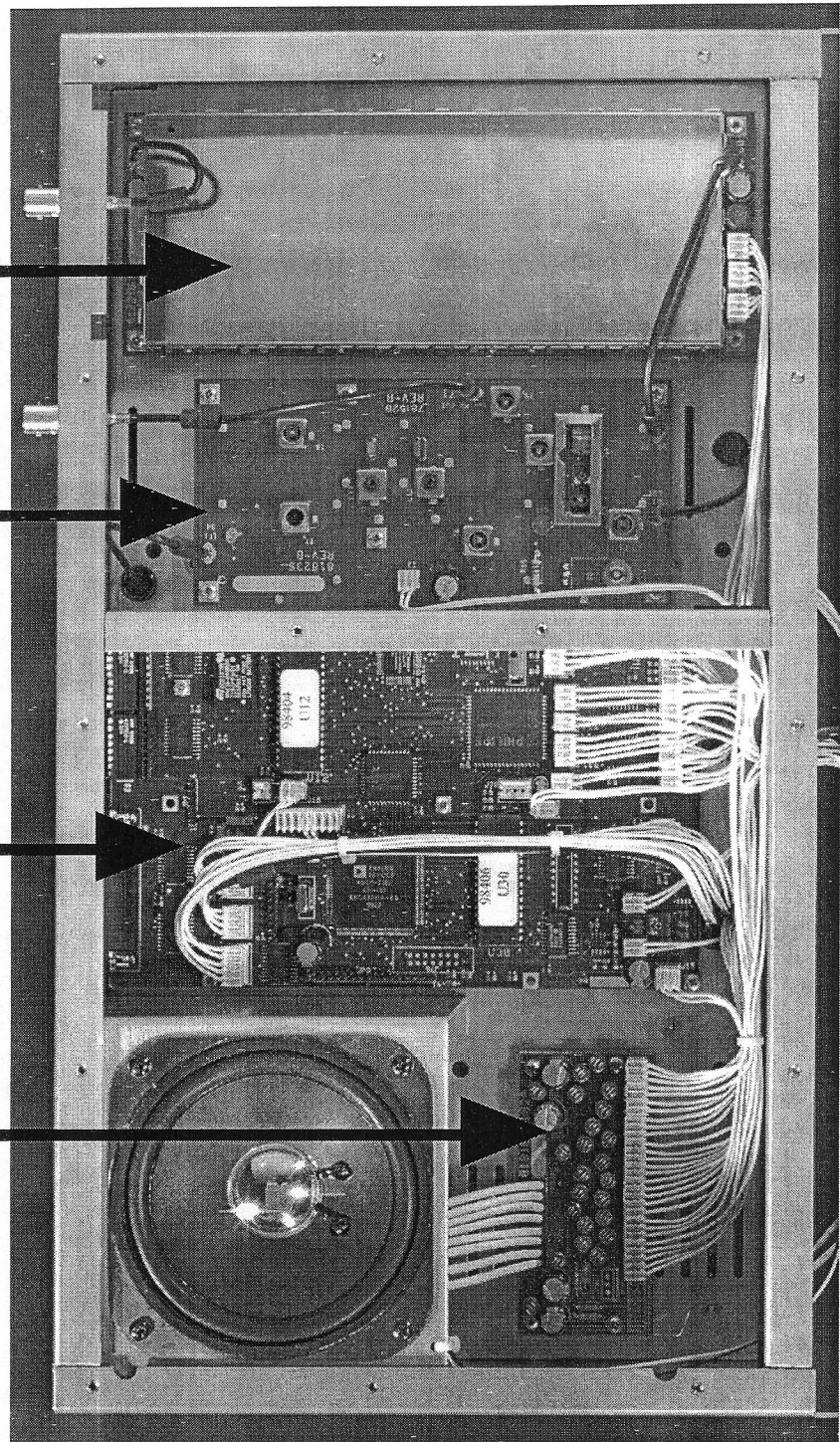

FIGURE 3-1

RX-340 FRONT PANEL REAR VIEW

**FRONT PANEL CPU
81819** →

**KEYPAD
81819
(UNDER FRONT PANEL CPU)** →

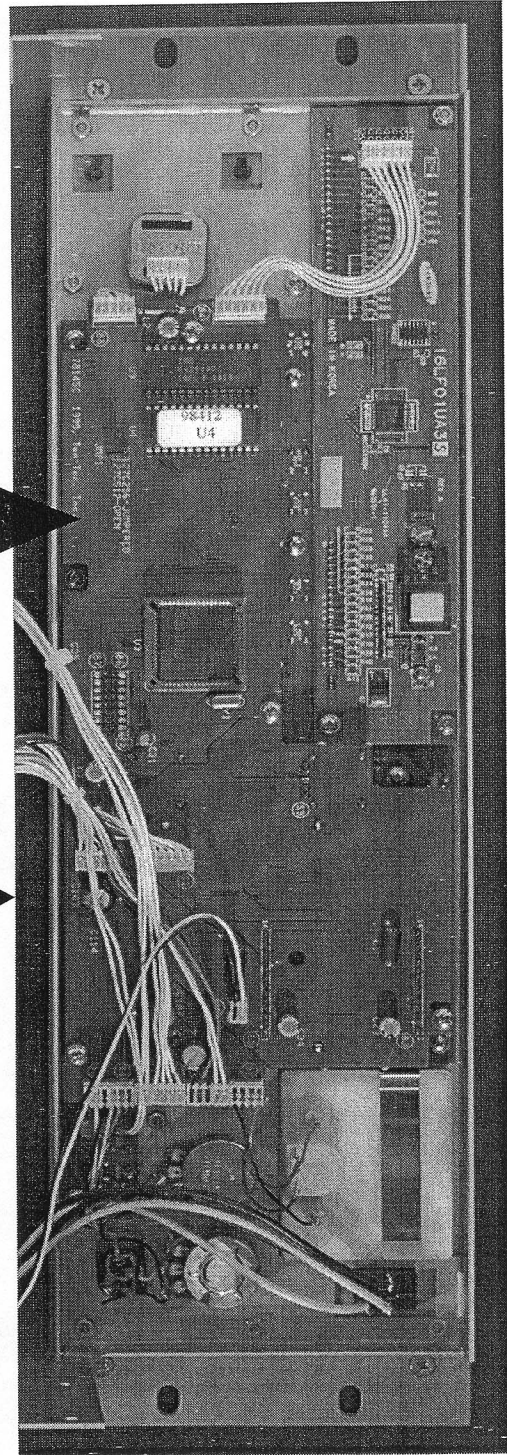

FIGURE 3-2

RX-340 BOTTOM VIEW

POWER SUPPLY
21200

2ND MIXER
8187.SMD

I/O CONVERTER
81790.JMD

SYNTHESIZER
81772.TXCXO

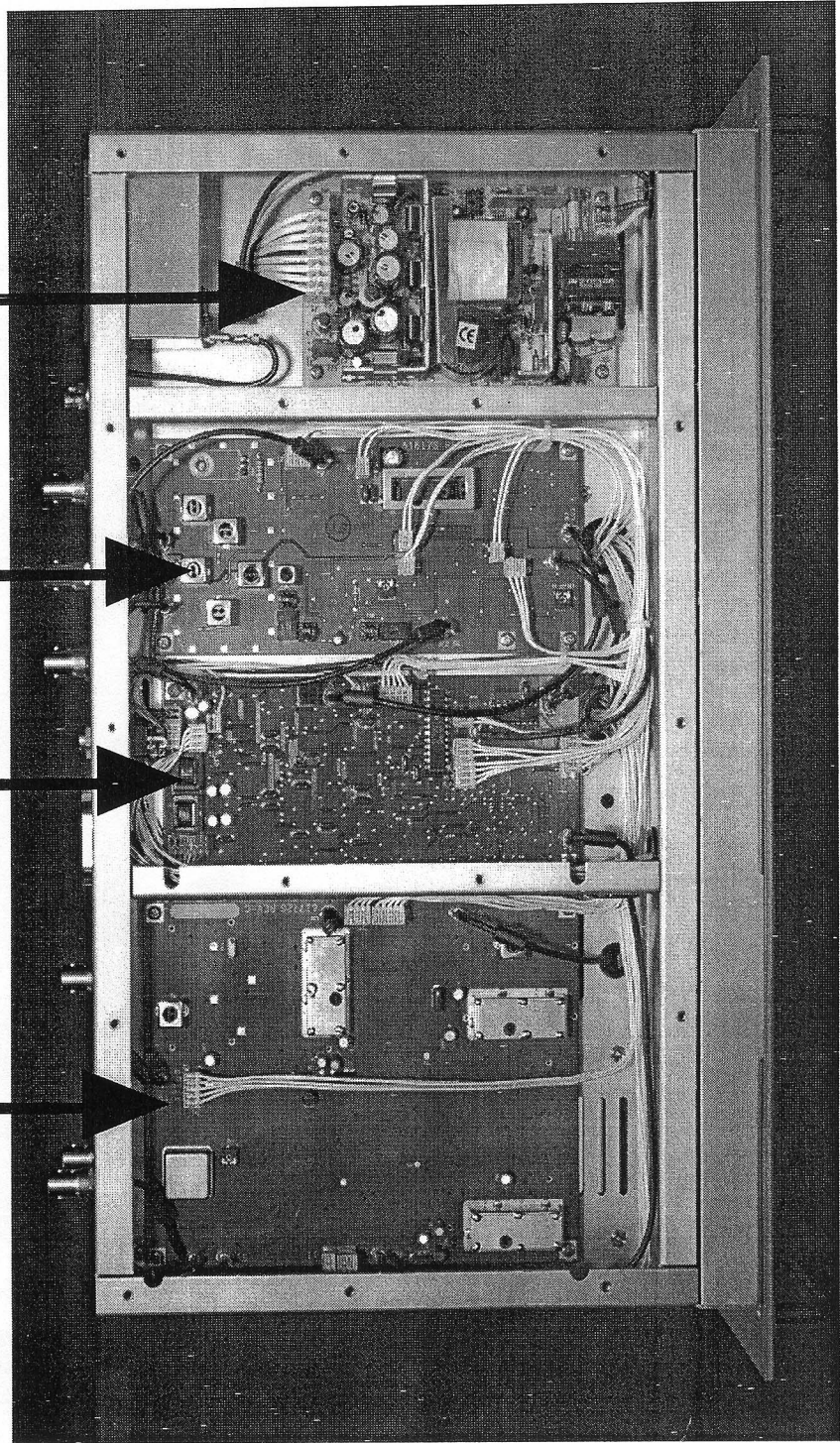

FIGURE 3-3

INTERCONNECT DIAGRAM

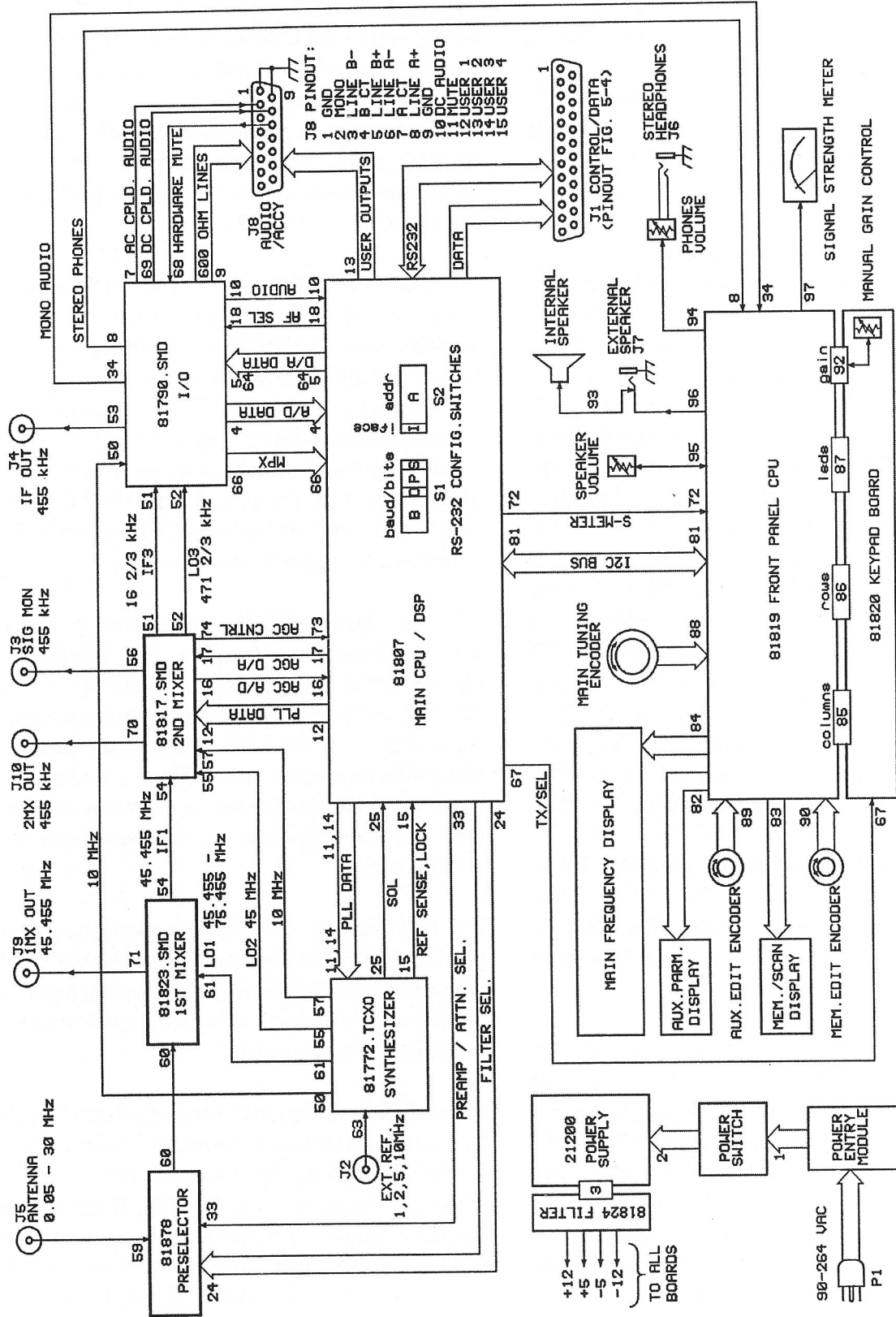

FIGURE 3-4

3-5 SECOND MIXER / 3RD LO (81817): The 2nd mixer / 3rdLO board down-converts the 45.455-MHz 1st IF to the 455 kHz 2nd IF, and 16-2/3 kHz 3rd IF, respectively. It also provides outputs to the following connector locations: *2nd Mixer* output (J10), *Signal Monitor* output (J3), A/D converter (51), AGC DET (16), AGC control (7A) and LO3 (52). Inputs are: 1st IF (5A), LO2 (55), 10-MHz reference (57), PLL data (12), AGC DAC (17), power $\pm 5V$ (20) and $+12V$ (21).

Refer to schematic Figure (10-18). The 1st-IF signal (45.455 MHz) is applied to high-level diode-ring mixer D3-D6 at input-port T4. The 2nd-LO is amplified by Q7, filtered at L3-L5, and applied to the mixer's LO port T5. The resulting products are buffered by a parallel FET common-gate array Q10-Q13. A smaller sample of the mixer's output is buffered by Q8-Q9 and routed to *2nd mixer out*, connector J-10. The desired 455-kHz 2nd-IF product is selected by ceramic bandpass filter FL1 and fed to controlled-gain IF-amplifier U6. The output of U6 is post-filtered by FL2 and split three ways. One leg is applied to AGC detector Q14-Q15, which pulls the voltage on AGC integrating capacitors C71-C73 low at a rate of 31.25 mV per dB when the output signal exceeds a threshold set by AGC-ADJ pot R97. A second leg is applied to op-amp U7a, which buffers the 455-kHz IF output and applies it to the *Signal Monitor* jack (J3). The remaining leg is applied to 3rd-mixer U4, a Gilbert-Cell DBM. A 471-2/3 kHz 3rd-LO signal is also applied to mixer U4 to yield a 3rd-IF output of 16-2/3 kHz. This product passes through anti-aliasing, lowpass filter U5 to the 3rd-IF output connector 59. R81 nulls DC-offset from the 3rd-IF output line.

AGC-detector voltage is buffered by op-amp U7b and routed to AGC-DET connector 16. Op-amp U8b provides a means for setting the IF gain externally via AGC-DAC connector 17. The D/A converter connected to AGC-DAC pulls the AGC detector voltage low, overriding AGC detector output and reducing IF gain at the rate of 32 dB/Volt. A high-level output from Q16 to AGC control connector 74 (pin-D) indicates when the DAC is overriding the AGC detector. A high-level output from

U8a to 74 (pin-A) indicates the AGC detector is overriding the DAC. The combination of U8a and Q16 can be thought of as a 2-bit ADC with 1-dB hysteresis. PLL U3, charge pump Q1-Q4, VCO Q5, and dividers U1-U2 develop the third Local Oscillator frequency of 471-2/3 kHz. This signal is applied to both 3rd-Mixer U4 and the 3rd-LO output connector 52. For receive frequencies above 20 kHz, the PLL is fixed-programmed by the CPU for a reference frequency of 66-2/3 kHz and a VCO frequency of 37-1 1/15 MHz.

3-6 CONVERTER-I/O BOARD (81790): The main A/D and D/A converters on this board provide interface to (1.) the Digital Signal Processor, (2.) the timing and multiplexing circuits for separating D/A data into various audio and IF channels, and (3.) the analog reconstruction filters and audio drivers that form the final audio outputs of the receiver. This board also contains the mixer and filter used to convert baseband IF signals back to 455 kHz for the DSP-processed IF-output to rear panel J4.

Refer to Figure (10-23). Connectors 4, 5 and 64 carry serial data to and from the DSP. Word framing signals for the A/D and D/A converters (CVST and LDAC), and timing signals for the analog switch demultiplexers (AF, IF, USB, and LSB) are formed by the dividers and combinational logic circuits U1-U5. Refer to the timing diagram on the schematic for the timing relationships between the converters and demultiplexers.

The 16-2/3 kHz 3rd-IF signal at connector 51 is applied to the sampling input of A/D-converter U7. On command of CVST from U4a, the analog input voltage is converted to a serial bit stream and transferred to the DSP via connector 4.

Serial data from the DSP is transferred to D/A converter U8 via connectors 5 and 64. Under control of LDAC (U4d), the output samples are presented as discrete voltages at V-out (pin 20). Each sample is steered to the proper audio or IF channel by analog switch de-multiplexers U9 and U10, timed by AF/IF and USB/LSB signals from U4b,c and U5a,c.

Reconstruction filters U11-U14 attenuate the sample-clock frequencies (66-2/3 or 33-1/3 kHz) and present a smoothed analog voltage to mode switches U9z and U10z.

For the IF channel, smoothed signals are sent to switching mixer U14b-U15x. The 471-2/3 kHz 3rd-LO signal (from 52) is subtractively mixed with the 16-2/3 kHz baseband IF signal in U15x and filtered by 16-kHz bandpass filter FL1 to yield a 455-kHz component. This signal is then buffered by op-amp U18b and routed to the DSP-processed *IF Output* (J4).

Based on the mode selected by the CPU/DSP via connector 5, U9z and U10z connect the appropriate reconstruction filter outputs to audio and line drivers U16 and U17. Connector 8 carries both audio channels to the front panel ISB level control and to the front-panel stereo phone jack. Connector 9 supplies transformer-coupled audio to the 600-ohm line connections on rear-chassis J8. All audio outputs and IF outputs can be muted by a connection to ground at connector 68, which is available at rear panel DB-15 connector J8 on pin-11. A parallel mute line is tied to the 2nd-LO's shutdown pin via connector 75.

Controlled by SB select lines from connector 18, U15y and U15z connect either one or both audio channels to the monaural audio driver U18a and to audio connectors 7, 10 and 34, rear panel J8, CPU/DSP board and front panel mono level control and front-panel *phones* jack J6.

3-7 FIRST LO SYNTHESIZER (81772): Refer to Figures (10-3) and (10-29). The 1st-LO synthesizer has three-loop architecture. For the fine loop (PLL3), U12 and charge pump Q43-46, Q52 steer VCO Q47-D26-d27 over a range of 80 to 99.6 MHz in 400-kHz steps. This VCO output is buffered by common-base amplifiers Q48 and Q49, then divided by 400 in the N-divider of Mixing Loop U11. This configuration yields a fine-tuning loop output of 200 to 249 kHz in 1-kHz steps.

For the coarse loop (PLL1), U10 and charge pump Q-28, Q10-Q13 steer VCO Q14-D-22-D23 over

a range of 45.7 to 75.7 MHz in 50-kHz steps. This VCO output is buffered by common-base amplifiers Q15-Q16 and routed to phase-shift networks L13-L14-C58 and L17-C69-C70 to form quadrature inputs for loop mixers U6 and U7 respectively.

For the mixing loop (PLL2), U11 and charge pump Q42, Q31-Q33 steer VCO Q35-D24-D25 over the 1st-LO frequency range of 45.455 to 75.455 MHz in 1-kHz steps. This loop is programmed with a fixed N-divider of 400 and a fixed R-divider of 1 so its VCO runs at the VCO frequency of the coarse loop (PLL1), offset by the divided-down VCO frequency of the fine loop (PLL3). VCO output is split and buffered by common base amplifiers Q36-Q37, amplified by Q38, Q39, bandpass filtered at L26-L28, and routed to connector 61. The output of Q36 is used to drive the signal- input port of mixers U6-U7 for translation to quadrature intermediate frequencies of 200 to 249 kHz.

Mixing-loop acquisition is aided by phase detector U8, comparator U9b, and charge-sink circuit Q26-Q27. During certain transient conditions—such as power-up or for large negative frequency steps when the mixing-loop VCO frequency is temporarily above the coarse-loop VCO frequency—the output of U8 drops below the comparator threshold and the charge-sink ramps the mixing-loop control voltage lower to steer the mixing-loop VCO toward the correct offset.

A pre-steer circuit (U9a, Q18-Q19) forces the mixing loop control voltage to within ± 1 V of the coarse-loop control voltage. This ensures the maximum mixing-loop offset is always less than 5 MHz, and the U6-U7 mixer outputs remain below the cutoff frequency of lowpass filters L15-16 and at L18-19.

3-8 SECOND LOCAL OSCILLATOR (81772): The 45-MHz injection frequency required by the 2nd Mixer is developed by first dividing the 10-MHz reference by 2 in U4 to produce a 5-MHz square wave, then selecting the 9th harmonic with 45-MHz monolithic filter FL1. The resulting 45 MHz sine wave is amplified by Q8-Q9, bandpass filtered at L2-L4, and applied to connector 55.

3-9 10 MHz REFERENCE OSCILLATOR

(81772): The main frequency standard for the RX340 is a 10-MHz, high-stability TCVCXO that can be locked to an external reference of 1, 2, 5, or 10 MHz. Differential amplifier Q1,Q2 presents a high impedance to board connector 63 and *External Reference* jack J2. A sample of Q2's output is rectified by level-detector D1 and compared to a threshold voltage by U3a. When the external reference amplitude exceeds the threshold set by U3a, transistors Q3-Q5 turn OFF, allowing the gate of switch Q6 to pull high and switch the FET ON. This connects the filtered output of PLL U1 to the TCVCXO tuning pin (pin-1) and completes the loop to lock the TCVCXO to 10 MHz. When no external reference is applied, transistors Q3-Q5 conduct, holding Q6's gate low. In this condition, the TCVCXO range is set by trimpot R32, and the open-loop TCVCXO becomes the frequency standard for the receiver.

3-10 DSP/CPU (81807):

Refer to Figure (10-2). The DSP/CPU board contains two separate processor systems; the MAIN CPU (U1) which controls the RX-340 interface, and the DSP CPU (U15) which performs signal-processing functions. The two systems' busses integrate through an I/O expansion IC (U11). Communication between the MAIN CPU and the DSP CPU is handled by a combination of hardware and software, providing bi-directional data capability.

The main CPU system consists of CPU (U1), CPLD (U4), ROM (U12) and battery backed RAM (U3)(See Figures 10-37,38). Latches U5 and U6 buffer rear panel switch settings, while a portion of CPLD U4 is used for address control. Serial/parallel converter U28 adds additional output capability to the system. RS-232 interface controller chip (U2) handles buffering and level translation for the Multi-drop network. This is a special RS-232 IC that allows its output to be completely turned OFF when not active. It is this feature of U2 that permits multiple connects to a common RS-232 bus. Audio outputs are monitored by U1 via an internal A/D converter.

U17, U23 and U24 process the DSP digital output.

A programmable-logic device, U17, converts the DSP serial output data to a dual-byte, parallel output and creates the HIBYTE/LOWBYTE, STROBE, IF/AF and USB/LSB control signals. Latches U23 and U24 provide output buffering for the data and control signals. In addition, U23 and U24 add tri-state capability to the interface which can be selected via software command.

The DSP system core consists of the DSP Processor (U15), ROM (U30), and AGC DAC (U18). The DSP system is connected to the I/O converter board via connectors 4, 5, 18 and 64. Serial data travels from the converter board to the DSP CPU at a 66-2/3 kHz sample rate. After signal processing, serial data travels to the converter board at twice the input rate, or 133-1/3 kHz. The DSP output data is multiplexed to provide audio and IF data to the converter board which de-multiplexes the data and directs it to the proper output.

The RX-340 provides *programmable* AGC which is implemented as a combination of hardware and DSP software. The DSP system provides an analog AGC control voltage output on connector J17 which is delivered to the second mixer board. Circuitry on the second mixer board compares the control voltage to the received signal level and provides feedback to the DSP via connector J73. The two signals on J73 tell the DSP if the applied AGC voltage is greater than or less than an AGC voltage derived from the received signal. The DSP then uses this information to control shaping of the analog AGC response. Four user-programmable control outputs are provided on the rear panel J8 and are programmed by commands sent from a controller or PC. These logic level outputs are capable of providing approximately 10 mA of current. External circuitry should be added if more power is required. They may be connected to external devices to provide additional control capability to the system.

3-11 FRONT PANEL CPU (81819): Refer to Figure (10-43). This PC board subassembly contains the CPU complex, support logic and an audio-amplifier section. The microprocessor (U3) is a Philips 80C552 with an oscillator frequency of 22.11 MHz.

There is 8k of RAM (U9, HY6264A) and jumper-selectable 32k to 128k of ROM (U4, 27C256 to 27C010) on this board. An analog-to-digital converter in the 80C552 reads the position of the manual gain control mounted on the keypad board.

The three rotary encoders on the front panel are of the two-phase type. The main encoder is connected to the CPU board on cable 88, while the two auxiliary encoders are mounted directly on the board. XOR circuitry U2 and U6 on the CPU board generates an interrupt when any of the three encoders is moved. Latch U5 is then addressed by U10 logic and read by the CPU to determine which encoder changed, and by storing the last-known latch value, the direction. Some portions of logic gates U2 and U10 are unused.

The main display is a 16-character-by-1-line alphanumeric display with serial data transfer over SCLK and D0 on cable 84. The auxiliary displays are 16-character-by-2-line ASCII-type displays; data is transferred in parallel mode on four data lines D0-D3. These displays are mounted directly on the CPU board. The signals to both auxiliary displays and the keypad board are buffered by U7 and U8. The 80C552 also includes pulse-width modulation generators, which are used to drive a Darlington-pair dimming circuit Q200 and Q201 for the meter (connector J97) and a dimming signal to the keypad board (385) for dimming of the LED's via the BLANK pin of U2, U3 and U4. Dimming of the displays is performed by command instead of hardware. The dimming function is accessed by holding in the *Setup* button and turning the *Memory/Scan* knob.

The audio section of the CPU board is unrelated to CPU operation and includes the power amplifier U11, a TDA1013B, for speaker audio. The speaker and headphones volume controls and the headphones jack are mounted on the front panel and connected to the audio section of the CPU board. Headphones audio arrives from the I/O converter board on cable 8 as a stereo signal. Main monophonic speaker audio arrives on cable 34. After amplification, audio returns to the rear panel switching-type speaker jack on cable 96. There is no amplification of the head-

phones audio before traveling to the headphones volume control and jack. The meter is driven by the logic board via cable 72.

3-12 KEYPAD BOARD (81820): Refer to Figure (10-48). The keypad board contains the LEDs, led drivers and the keypad matrix circuitry. U2, U3 and U4 are serially-loaded UCN6810 LED driver IC's. LED data is transferred from the CPU by synchronous serial transfer over clock, data, and enable lines KCLK, D0 and OENA on connector 85. Two LEDs are driven directly by the Logic board: TXD and SEL via cable 67.

The keypad matrix is comprised of the 74HC154 column decoder, U1 and 43 keys on a 3-row-by-15-column matrix. The column decoder uses the four encoded scan lines KS0-KS3 and generates a 16-line output to drive the columns of the switch matrix. A pressed key is read by the CPU on the row input lines, KR0-KR2. The keypad matrix is only scanned when a key is pressed.

The manual gain port is mounted on the keypad board and the wiper connection returns to the CPU board on connector 85.

3-13 LOGIC BOARD <-> CPU INTERCONNECTIONS: The RX-340 main logic board is connected to the front panel CPU board by a synchronous Inter-Integrated Circuit (I²C) bus (cable #81) which transfers commands and data bidirectionally at a rate of approximately 80,000 bits per second. The bus signals are CLK, DAT and ALERT. When the front panel is in local mode, the front panel controls the receiver over this bus. During Remote mode, however, operation is limited to RS-232 control only. Likewise, during Local mode (Remote OFF) the RS-232 is limited in control and the front panel takes priority. Since the logic board and the CPU board are very interdependent, they must be connected by the I²C bus to function properly. The partition of tasks falls with the front panel performing all user interface functions, encoder polling, and display formatting, and the logic board controls the receiver functions and communications over the RS-232 port.

CHAPTER 4

DETAILED OPERATING INSTRUCTIONS

4-1 INTRODUCTION:

This portion of the manual describes how to operate the RX-340 using front-panel controls and displays. It begins with an overview of panel layout, followed by in-depth instructions for using each function and control feature. Detailed front and rear panel illustrations are provided in Figures 1-1 and 1-2. Please refer to these figures, as needed, to supplement written instructions.

4-2 FRONT PANEL OVERVIEW:

The RX-340 panel is ergonomically arranged for convenient operation, with most controls positioned within the four shaded control groups highlighted below:

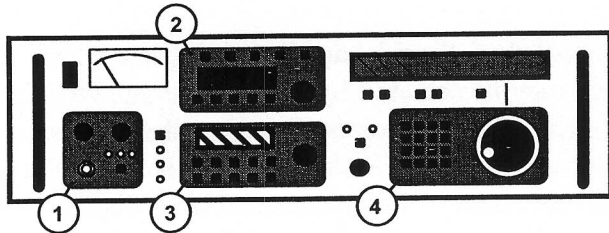

1. Audio Group: The panel's *Audio* group (1) provides separate headphone and speaker volume controls, plus a channel selector which is used when using selectable sideband sync AM or monitoring ISB signals. A standard 1/4" stereo front-panel headphone jack is mounted directly below the headphone volume control.

2. Auxiliary Parameters Group: The controls in the *Auxiliary Parameters* group (2) are used to program receiver operating characteristics such as bandwidth, AGC response, BFO offset, etc. The status of each operating parameter appears in a two-line alphanumeric display window positioned in the center of the block. Push-button switches select individual function for programming.

Programming is accomplished using the group's dedicated edit-control knob and main keypad (4).

3. Memory/Scan Group: The controls in the *Memory/Scan* group (3) are used to store or recall memory channels and to set up specific scan operations. Push-button switches select individual functions, and a dedicated edit-control knob plus the main keypad (4) are used to perform data-entry and menu-search functions. Status information appears in the group's two-line alphanumeric display window.

4. Tuning/Keypad Group: The controls in the *Tuning/keypad* block (4) are used to set receiver operating frequency. In addition, the keypad is used to enter numeric data for some auxiliary parameters and scan setups. The receiver's main alphanumeric display, located directly above the tuning-control block, provides a continuous presentation of operating mode, tuning step, and operating frequency. It also displays selected keypad entries and status messages.

Other prominent front-panel features include a manual IF-gain control and Pre-amp/Attenuator switch located to the left of the main keypad (4). The receiver's signal-strength meter and main power switch are located above the volume controls at the front panel's top-left corner. To adjust the intensity of the front panel illumination, push and hold the *Setup* button in the *Memory/Scan* group and turn the *Memory/Scan* knob.

4-3 MAIN TUNING knob:

The *Main Tuning* knob is used to select operating frequency over the receiver's 30-MHz range. This control operates in step-tune mode, with ten preset tuning rates available from 1 Hz to 1 MHz per step (see 4-5). Selected step size is displayed continuously on the main alphanumeric display directly above the *Step* selector buttons.

Rotating the *Main Tuning* knob changes operating frequency by the chosen step size, with clockwise rotation increasing frequency and counterclockwise rotation decreasing it. The *Main Tuning* knob is automatically disabled whenever the dial-lock function is engaged (See 4-4).

4-4 LOCK button:

The *Lock* button is used to prevent accidental frequency changes. When pressed on, the *Lock* LED illuminates and both the *Main Tuning* knob and *-/+ Step Tuning* keypad functions are disabled. When toggled off, the LED goes out and normal tuning is restored. The dial-lock feature doesn't affect the keypad's sign (\pm) functions, which are used for programming *BFO*, *PBT*, and *Notch* parameters. Only the *Main Tuning* function is disabled.

4-5 STEP $\leftarrow \rightarrow$ buttons:

These switches are used to select step-tuning rate. A total of ten tuning increments are available: 1 Hz, 10 Hz, 50 Hz, 100 Hz, 1 kHz, 5 kHz, 9 kHz, 10 kHz, 0.1 MHz, and 1 MHz. Pressing [\leftarrow] decreases rate, and pressing [\rightarrow] increases it. Larger tuning increments (0.1 MHz and 1 MHz) provide rapid frequency excursions to other portions of the HF spectrum, while smaller increments complement the operating mode in use (AM, FM, SSB, etc).

Step rate is presented continuously on the main alphanumeric display directly above the *Step* selector buttons.

Important Note: Newly entered step-rate increments do not take effect *until the tuning dial (or keypad) is activated*. If you are tuned to 3.900020 MHz and increase the tuning step from 10 Hz to 100 Hz, nothing will happen until you begin to tune the radio. At this point, the new tuning increments will become 3.900100, 3.900200, 3.900300, etc.

4-6 MODE $\leftarrow \rightarrow$ buttons:

The *Mode* $\leftarrow \rightarrow$ switches are used to step through

the receiver's detection modes. The *Mode* menu is circular, and may be stepped through from either direction. A total of eight detection modes are available on the RX-340:

- AM:** Amplitude Modulation
- SAM:** Synchrous AM, selectable sideband
- USB:** Upper Sideband
- LSD:** Lower Sideband
- ISB:** Independent Sideband, selectable sideband
- CW:** Continuous Wave, variable BFO
- CW1:** Continuous Wave, 0-Hz Offset
- FM:** Frequency Modulation

Detection-mode is displayed in the main display window directly above the *Mode* $\leftarrow \rightarrow$ switches. Audio from upper, lower, or both sidebands may be selected in ISB and SAM modes (See 4-12). The SAM detector *must be locked onto the carrier of an incoming AM signal* in order to provide Synchronous AM reception. Lockup is indicated when periods punctuate the mode-display:

S.A.M. (locked) vs. S A M (unlocked)

When locked, the sideband containing less interference may be selected by the AF channel switch. Normal AM reception occurs when the detector is unlocked. Minimum SAM bandwidth is 4 kHz. Note that the *Mode* $\leftarrow \rightarrow$ buttons restore *Mode* display for inspection or editing whenever the main display is overwritten by *Mute* (after a software *Mute* command). Only inspection is possible in Remote mode. Return to Local mode to edit the mode setting (and reset the *Mute* condition).

4-7 BITE buttons:

The RX-340 features a Built-In Test Equipment (*BITE*) mode which is used to conduct various internal self-diagnostic procedures. To place the receiver in BITE mode, press both *Mode* $\leftarrow \rightarrow$ switches simultaneously. The main alphanumeric display will then present the message 'ENTER BITE LEVEL'. Pressing a designated keypad digit (1, 2, 3, etc.) initiates the specific test-level sequence you wish to conduct. See Section 5-7 for a full description of RX-340 self-diagnostic capabilities and procedures.

4-8 ↑/+ and ↓/- buttons:

The ↑/+ and ↓/- buttons are located in the upper left-hand quadrant of the receiver's keypad:

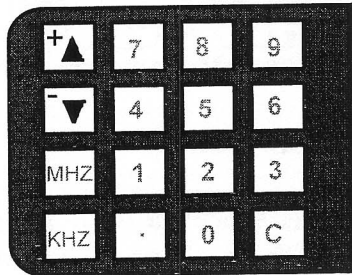

A. Tuning Function: In addition to the main tuning knob, the ↑/+ and ↓/- keys may be used to step-tune the receiver. Pressing ↑ once increases frequency by one step, and pressing ↓ once decreases it. Holding either button down provides continuous tuning. Keypad tuning is disabled by the dial lock.

B. Sign Function: The tuning keys also double as sign function keys (+ and -) when entering *Auxiliary Parameter* settings via the keypad. When used for parameter entry, the sign key *must be pressed after the numeric entry*. If the sign is entered first, the receiver will interpret it as a tuning command and change operating frequency. Note that the dial lock does not affect the sign function. Also note that the *Aux* function button has to be pressed after + or - is entered.

4-9 ATTN/PREAMP button:

This switch is used to step through a circular menu providing three selections: *Attenuator On*, *Normal*, and *Preamp On*:

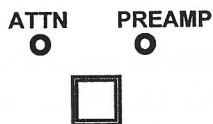

When *Attn* is selected, approximately 15 dB of RF attenuation is inserted into the signal path. When *Preamp* is selected, approximately 10 dB of supplemental RF gain is added to the signal path. When no LEDs are illuminated, the receiver is operating in its *Normal* (or straight-through) configuration. Note that the receiver's S-meter is automatically compensated to remain calibrated for all three settings.

4-10 MANUAL GAIN knob:

The *Manual Gain* control is used to adjust the receiver's IF-amplification level over a 120-dB range. As the control is adjusted, a corresponding IF-gain level appears in the AGC area of the *Auxiliary Parameter* display window:

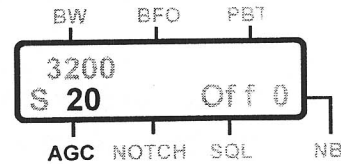

Note that this number represents *gain reduction* in dB *below maximum*. (Example: 20 = 20 dB reduction). This reading may also be interpreted as a 20-dB *increase* in the receiver's AGC threshold.

4-11 REMOTE button:

The *Remote* switch is used to activate the RS-232 control mode. When activated, the LED will illuminate and a 'Remote Mode' message will appear in the *Memory/Scan* display window:

REMOTE MODE

In *Local* mode, all front-panel knobs and switches are active. In *Remote* mode, most panel controls are locked out and operation is conducted via the remote RS-232 bus (only the Phones and Speaker level controls plus the main power ON/OFF switch remain active). Local operation may be restored by disengaging the *Remote* switch—unless the *Remote With Local Lockout* function has been activated over the RS-232 interface. When this security feature is turned on, the *Remote* switch or power cycling cannot be used to restore local operation. Only a radio reset will exit this mode.

4-12 ISB SPEAKER SOURCE button:

The ISB speaker-source button functions in ISB and SAM modes, and is used to step through a circular menu containing three audio-source selections: *LSB*, *BOTH*, and *USB*. Three LED indicators display

the selected choice (see below):

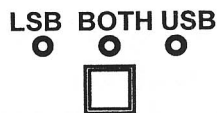

In ISB or SAM mode, either sideband—or BOTH—may be selected. In all other modes, the *BOTH* LED remains illuminated to indicate normal operation.

Exceptions: When the *Mute* function is activated over the *Remote* RS-232 bus, all three LEDs extinguish and the status message 'MUTE' appears in the *Mode* area of the main display. Also, sideband selection doesn't occur when the synchronous detector is in an unlocked condition in SAM mode.

4-13 SPEAKER knob:

The *Speaker* potentiometer is used to adjust volume level for the internal or external speaker. An external speaker may be plugged into J7 on the rear panel, disabling the internal speaker.

4-14 PHONES knob:

The *Phones* potentiometer adjusts volume level to the *front-panel* *Phones* jack. This jack accepts a standard 1/4" stereo or monaural phone plug.

4-15 AUXILIARY PARAMETER Overview:

Controls in the *Auxiliary Parameter* group are used for setting up and controlling various receiver operating characteristics. These include:

- A. Receiver IF bandwidth
- B. BFO-Offset Frequency
- C. Passband Tuning
- D. AGC Parameters
- E. Notch-filter Frequency
- F. Squelch Sensitivity
- G. Noise Blanker Pulse Width
- H. Optional Features

A dedicated two-line alphanumeric display shows the operating status of each auxiliary function, and the group's *Edit Knob* controls various menu selections and control setting.

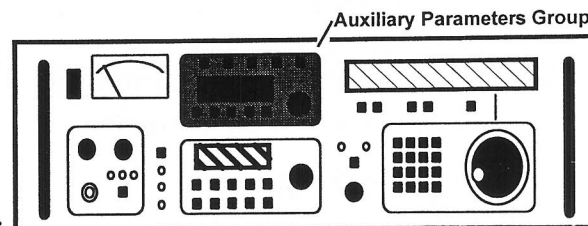

4-16 BW (Bandwidth) button:

The *BW* button is used to activate the *IF Bandwidth* edit mode. Bandwidth is continuously displayed in either Hz or kHz in the *BW* area of the display window. The bandwidth menu contains a selection of 57 pre-programmed bandwidth settings, ranging from 100 Hz to 16.0 kHz. Additional *Fast Filters* are also provided at 0.2 to 4 kHz and below for enhanced digital-mode reception.

To change bandwidth, press the *BW* button. It will illuminate and assign the *Edit Knob* to the bandwidth menu:

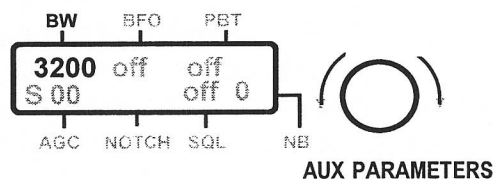

A. Set Bandwidth via the Edit Knob: Rotate the *Edit Knob* to scroll through the bandwidth selections. When scrolling, the receiver's bandwidth will actively change with each new menu selection. Pressing a different *Auxiliary Parameters* switch will disengage the *Edit Knob* from the bandwidth menu and exit the bandwidth edit mode. The displayed bandwidth will remain selected until a new choice is made.

B. Set Bandwidth Via Keypad: Enter the desired bandwidth (in Hz) via the keypad. The receiver's main frequency display will blank and the keypad entry will appear. Next, press the *BW* button to complete the edit operation. Your selection (or the nearest standard bandwidth above it) will transfer to the *Auxiliary Parameters* display window. Also, the filter will become activated and the main display will restore to the receiver's operating frequency.

C. Set Fast Filters: An alternate set of *Fast Filters* may be selected for bandwidths of 0.2- 4 kHz. *Fast Filters* offer reduced signal latency and degraded shape factors to facilitate reception of delay-critical HF-digital modes such as SITOR and QPSK. To activate the *Fast Filter* Menu, first activate the *BW* function and enter a bandwidth of 0.2-4 kHz. Then, press *BW* a second time. The letter 'F' will appear in the *BW* window in front of the bandwidth to indicate that the fast filter is in place:

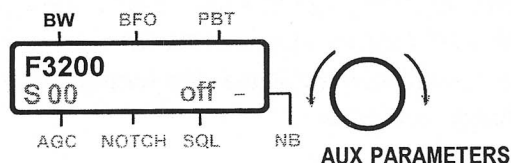

You may toggle between the Fast Filter mode and normal mode by continuing to press the *BW* button.

D. Exceptions: The receiver's *Notch* function is not available in the Fast Filter mode and is automatically deactivated. Also, in ISB mode, IF bandwidth is fixed at 3.2 kHz. Minimum bandwidth for FM mode is 600 Hz, and 4 kHz for SAM mode. Notch only works for CW, CW1, LSB, and USB.

4-17 BFO (Beat Frequency Oscillator) button:

In the CW detection mode, the receiver's BFO (Beat Frequency Oscillator) may be adjusted to select sideband (CWU or CWL) and offset frequency. To enter the *BFO Edit* function, place the receiver in CW mode and press the *BFO* button. The button will illuminate and the *Edit Knob* will be assigned to function as the BFO frequency offset control. Offset frequency is displayed continuously in Hz in the BFO area of the display window:

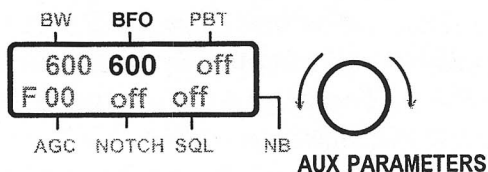

A. Set BFO Offset via the Edit Knob: Rotate the *Edit Knob* to select both the desired *Sideband* and *Offset* frequency. *Offset* may be adjusted con-

tinuously from -8 kHz to +8 kHz, a frequency span which takes in both upper and lower sidebands:

1. To select LSB-CW: A positive *Offset* number (+) places the receiver in CW-LSB mode.

2. To select USB-CW: A negative *Offset* number (-) places the receiver in CW-USB mode.

For CW reception, the offset frequency is normally adjusted to correspond with the operator's preferred CW listening pitch (400 Hz for example). For digital signal reception, offset is normally set to the median frequency between the highest and lowest AF tones required by the modem. When the *PBT* function is disengaged, BFO offset frequency relates to the center of the receiver's selected bandpass filter (*BW*).

Activating another edit parameter switch will disengage the *Edit Knob* from the offset function and exit the BFO Edit mode. The displayed offset remains selected until a new choice is made.

B. Set BFO Offset via the Keypad: Enter the desired *Offset* frequency (in Hz) via the keypad followed by the desired sign (+ or -). Your keypad entry will appear in the main display window. Next, *press* the *BFO* button to complete the edit operation. Your selection will then transfer to the *Auxiliary Parameter* display, become activated, and the main display will automatically restore to the receiver's operating frequency.

Important Note: You must *enter* a sign (+ or -) after entering the numbers and before pressing the *BFO* button. If you enter the sign before, the receiver will interpret it as a step-tuning command and change frequency.

C. Exceptions: *BFO Offset* is fix-tuned to 0 Hz in CW1 and fix-tuned to ± 1800 Hz in ISB. In USB and LSB, offset is pre-programmed to track the selected bandwidth for best AF response characteristics. Note that the *BFO Offset* function works only in CW mode, and the *BFO display* remains blanked in other modes. To temporarily view a fixed offset frequency in other modes, *press* and *hold* the *BFO*

button. The fixed *Offset* will appear in the display window until the button is released. For example, in ISB, the display will read 'BFO Freq: ± 1800 Hz', and in AM where no BFO is required, it will read 'No BFO in FM/AM'. The LED on the BFO switch normally remains unlit in all modes except CW.

4-18 PBT (Passband Tuning) button:

The *PBT* button is used in the CW, USB and LSB modes to shift the receiver's passband center without altering operating frequency. The *PBT* feature is especially useful for rejecting interference caused by encroaching signals, and for altering the receiver's audio characteristics during SSB or data reception.

To activate the *PBT* edit feature, *press* the *PBT* button. The switch will illuminate, the *Edit Knob* will be assigned to the *PBT* shift function, the previous *PBT* setting will be activated, and its frequency will be displayed in the *PBT* portion of the display:

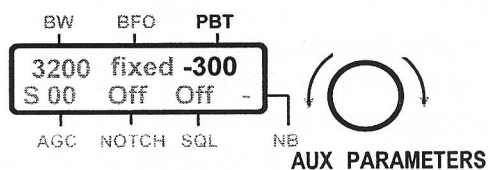

A. To set Passband Tuning via the Edit Knob:

Rotate the *Edit Knob* for a setting that reduces unwanted interference or produces a desired change in audio characteristics. Shift is adjustable over a 4000-Hz range (-2000 to +2000 Hz). The shift frequency is shown in Hz in the *PBT* area of the display window. In USB mode, a plus (+) shift moves the passband toward higher-frequency audio response, and a minus (-) shift moves it toward lower-frequency response. In LSB, this effect is reversed. In CW, the *PBT* and *BFO Offset* functions interact and should be set for preference.

Once the desired shift is selected, it may be toggled in or out with the *PBT* button. The current shift will be retained until a new value is entered. Activating another edit parameter button will disengage the *Edit Knob* from the *PBT* function and exit the *PBT* edit mode.

B. Set Passband Tuning via the Key Pad: Enter the desired *PBT* shift (in Hz) via the keypad *followed* by the desired + or - sign to indicate direction of shift (numerical values from 0 to 2000 are valid). When entering this number, the receiver's main frequency display will blank and your entry will appear. When the entry is completed, press the *PBT* button. Your selection will transfer to the *Auxiliary Parameter* display, become activated, and the main display will automatically restore to the receiver's operating frequency. Note that you must *enter the sign (+ or -) after entering the numbers and before pressing the PBT button*. If you enter the sign first, the receiver will interpret it as a step-tuning command and change frequency.

4-19 DUMP button:

The *Dump* button is used to cancel normal AGC recovery time to restore full receiver sensitivity. This feature is especially useful when attempting to copy a weak signal in the wake of an extremely strong one, especially with slower AGC settings in place. *Dump* may also be applied in special applications when the receiver is operating under external control. When the *Dump* button is depressed, a status message appears in the *AGC* area of the display:

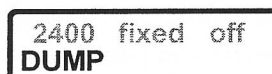

When the *Dump* button is released, the current AGC settings will be restored.

4-20 AGC button:

The *AGC* button is used to select AGC rate. Three pre-programmed settings (*Slow*, *Medium*, and *Fast*) are available, plus a fourth fully programmable setting (*Prog*). To change AGC rate, press the *AGC* button. It will illuminate and the *Edit Knob* will be assigned to *AGC* menu. To step through the menu options, rotate the *Edit Knob*. Each selection will spell out in the *AGC* area for two seconds, then become activated:

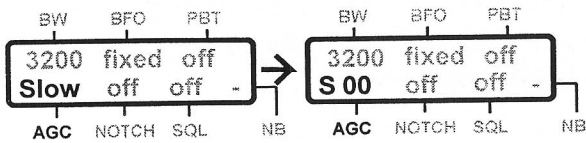

Upon activation, the display will revert to a single-letter (*S, M, F, P*) preceding the Manual Gain control setting (see 4-10).

To Set Up Programmable AGC: This mode provides three adjustable parameters: *Attack* in dB/mS, *Hang* in seconds, and *Decay* in dB/Sec. To alter existing settings, first press *AGC* to enter the AGC edit mode, Next, select 'Prog' with the *Edit Knob*. To begin programming, press the *AGC* button a second time. The display will change, as shown below:

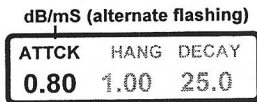

1. Set Attack Time: The first displayed parameter, *AGC Attack Time*, will flash alternately between *ATTCK* and *dB/mS* at 1 second intervals. To alter *ATTCK*, rotate the *Edit Knob* through the range of available settings and choose the desired value. *Attack Time* is continuously adjustable from 0.01 mS/dB to 1.00 mS/dB.

2. Set Hang Time: To advance the edit menu to *Hang Time*, press the *AGC* button again. The second parameter, *HANG*, should now flash alternately with *Sec*. To alter hang time, rotate the *Edit Knob* to select the desired value. Hang time is adjustable from 0.00 to 99.9 seconds.

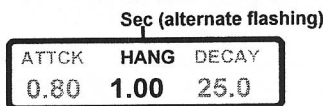

3. Set Decay Time: To advance to *Decay Time*, press the *AGC* button again. The third parameter, *DECAY*, should flash alternately with *dB/S*. Rotate the *Edit Knob* and select the desired value. Decay is adjustable from 0.01 dB/Sec to 99.9 dB/Sec.

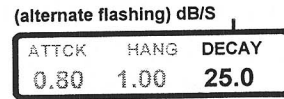

Press the *AGC* button one more time to disengage the edit function and restore the normal *AGC* display.

Activating any other edit parameter button will disengage the *AGC* edit function and the current settings will be retained until a new selection is made. Note that the *AGC* is always operational, even when the edit function is turned OFF and the *AGC* light is off.

4-21 NOTCH button:

The *Notch* button is used to activate a narrow-band reject filter to eliminate unwanted single-frequency heterodynes. The Notch works in CW, CW1, LSB, and USB modes only, and tunes manually over a 4000-Hz range (± 2000 Hz). Note that the Notch disengages automatically when bandwidth settings exceed 4 kHz or when *Fast Filters* are selected.

To enable the filter, press the *Notch* button. It's LED will illuminate and the *Edit Knob* will be assigned to the filter's control function. Once enabled, the previously-entered filter frequency (in Hz) will appear in the display:

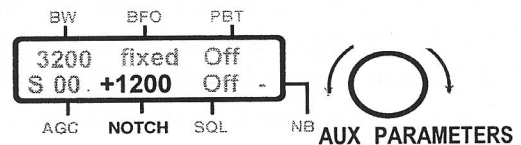

A. Adjust Notch via the Edit Knob: Rotate the *Edit Knob* to eliminate the undesired signal or heterodyne. The filter's new center frequency will appear in the display. Note that a + notch frequency cancels heterodynes in the USB passband, and a - frequency cancels them in the LSB passband. Pressing another function button deactivates the *Edit Knob*. To fully deactivate the *Notch* filter, press the *Notch* button for *OFF*, as indicated in the *Aux Parameter* window.

B. Set Notch Filter Frequency via the Keypad: Enter the desired filter frequency (between 0 and

2000 Hz) via the keypad, followed by the sign: '+' for USB, and '-' for LSB. The main frequency display will show your entry. Press the *Notch* button to activate the entry and transfer the notch frequency to the *Auxiliary Parameters* display window. Upon activation, the main display will restore to the receiver's operating frequency. Note that you must *enter* the sign (+ or -) after entering the numbers and before *pressing* the *Notch* button. If you enter the sign first, the receiver will interpret your entry as a step-tuning command and change frequency.

C. Exceptions: The notch function is not available with Fast Filters or wide BW settings, and its LED will not illuminate in unavailable modes.

4-22 SQL (Squelch) button:

The *Squelch* function is used to eliminate unwanted background noise when no incoming signal is present. This feature operates in all detection modes, and mutes receiver audio when in the "closed" state. Squelch threshold (the strength a signal must have to open the squelch) is tied to the receiver's AGC system and is continuously adjustable from -140 dBm to +10 dBm.

To enable the Squelch, press the *SQL* button. It will illuminate and the *Edit Knob* will be assigned to the squelch control function. Also, the squelch circuit will activate and the previous threshold setting (in dBm) will appear in the *SQL* display area of the display. If the squelch is closed, the setting is bracketed by arrows (example: >-90<). If it is open, the arrows are not displayed:

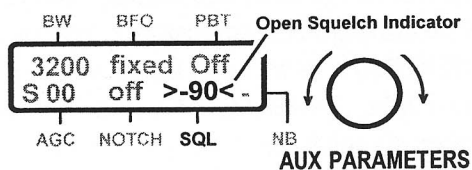

A. Set Squelch Threshold via the Edit Knob:

Rotate the *Edit Knob* for a setting where undesired background noise is cut off (the arrows will appear). Once set, the squelch may be toggled on and off manually with the *SQL* button—the current threshold setting will be retained until a new value is entered. Activating another edit parameter button disengages

the *Edit Knob*. To fully deactivate the squelch function, press the *SQL* button for *OFF*, as indicated in the *Aux Parameter* window.

B. Set Squelch Threshold via the Keypad: Enter the desired threshold setting numerically (between -140 and +10 dBm) via the keypad. The entry will appear in the main frequency display. To activate your entry, press the *SQL* button. It will illuminate and the new threshold will transfer to the *Aux Parameters* display. The main display will automatically restore to the receiver's operating frequency. Note that you must *enter the sign (+ or -) after entering the numbers and before pressing the SQL button*. If you enter the sign first, the receiver will interpret your entry as a step-tuning command and change frequency.

C. Exceptions: In ISB and locked-up SAM modes, the squelch is controlled only by the signal present in the channel (or channels) selected by the channel selector switch (LSB, BOTH, or USB). Signals in a deselected channel will not open the squelch. *Squelch* threshold can still be adjusted.

4-23 NB (Noise Blanker) button:

The noise blanker reduces interference from unwanted pulse noise. This feature operates in all detection modes, providing a total of ten blanker settings.

To enable the blanker, press the *NB* button. It will illuminate and the *Edit Knob* will be assigned to the blanker's edit function. Also, the blanker will become activated and the previous setting (0-9) will appear in the *NB* display area of the display:

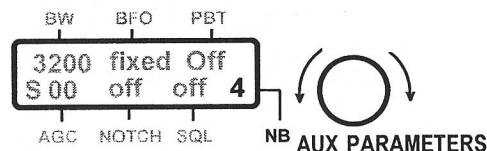

1. Set Noise Blanker via the Edit Knob: Rotate the *Edit Knob* for the lowest setting where significant reduction of the unwanted noise occurs. The new setting will appear in the *NB* area of the display. The blanker may be toggled in or out with the *NB* button, and the current setting will be retained until a

new value is entered. Activating another edit parameter button disengages the *Edit Knob*. To fully deactivate the blanker, *press* the *NB* button for a ' - ' indication in the *Aux Parameter* window.

B. Set Noise Blanker via the Keypad: Enter the desired blanker setting (between 0 and 9) via the keypad. The receiver's main frequency display will blank and show your entry. To activate your entry, press the *NB* button. The blanker level will transfer to the *Auxiliary Parameter* display, become activated, and the main display will automatically restore to the receiver's operating frequency.

4-24 OPT-1 (Option 1) Button: Reserved for future applications.

4-25 OPT-2 (Option-2) Button: Reserved for future applications.

4-26 MEMORY/SCAN Overview: Controls in the *Memory/Scan* group may be used to store and recall frequently-used channels, and also to search selected channels or frequency spans for activity.

1. Storing Frequencies: The receiver's *Channel Memory* stores up to 100 numbered channels, retaining frequency, mode, and basic operating parameters for each. In addition, a un-numbered *Scratch-Pad* memory is available for rapid storage and retrieval of an alternate operating frequency. Frequencies may be entered into memory as follows:

A. *Store* current operating frequency in a channel selected by keypad entry (1-100).

B. *Store* current operating frequency in the lowest-numbered empty channel (1-100).

C. *Store* current operating frequency in *Scratchpad* memory for rapid recall.

2. Recalling Frequencies: Several options are available to retrieve and activate pre-programmed frequencies from the memory channels:

A. *Keypad-Enter* a channel number, then press *Recall* to activate it.

B. *Scroll* through the channel menu with the *Edit Knob*, then press *Recall* to activate it.

C. *Tune* through the channel menu with the *Edit Knob* for instant activation.

D. *MScan* the channel menu using *Mscan* set-up options to conduct an automated search.

E. Press *Recall, Scratch* to quickly activate frequency stored in the scratchpad memory.

A number of set-up options are available to customize the *Mscan* feature, including variable channel range, dwell time, dead time, and gaze time—plus several pause or stop options. Also, up to 100 lock-outs are available to exclude selected memory channels from *Mscan* searches.

3. Clearing Memories: Frequency entries stored in the channel memory may be replaced or deleted in the following ways:

A. *Overwrite* an existing entry, replacing it with a new entry.

B. *Clear* an existing entry to create an empty channel for future use.

4. Frequency Search: In addition to *Mscan* monitoring, the RX-340 also provides a sophisticated *Pscan* (Programmable Scan) mode which may be used to search out activity over specified frequency spans. A number of special *Pscan* features are available to meet the unique requirements of multi-mode F1-F2 scanning.

5. Security functions: Special security functions are available to lock out unauthorized tampering with front-panel controls. Alphanumeric screens may also be blanked during Remote operation.

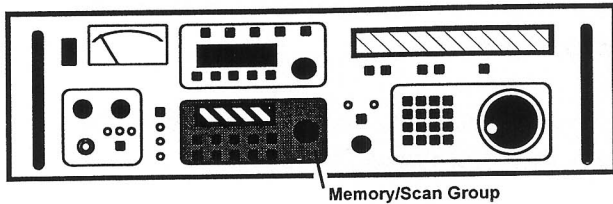

4-27 STORE THE CURRENT OPERATING FREQUENCY IN A SPECIFIED CHANNEL (1-100):

This function is used to *Store* the current operating frequency under a memory-channel number of your choice. To enter the *Store* mode:

1. Press the *Store* button. '*Store Channel ---*' will appear in the top line of the *Memory/Scan* display and '*Select Channel*' will appear below:

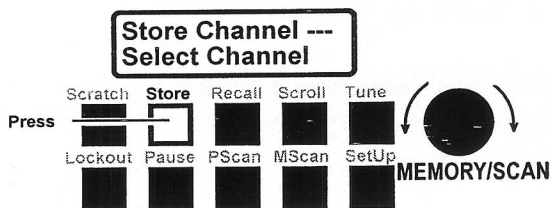

2. Compose any channel number between 1 and 100 (your choice), and enter it on the receiver's *Main Keypad* (example: enter 25). This number will appear on the *Memory/Scan* display, as shown below:



Important Note: When using keypad entry, if the channel number chosen is already occupied, a *new* entry will overwrite the existing one without notification. If you are concerned about overwriting an occupied channel by mistake, check the channel menu using the receiver's scroll mode to ensure the slot chosen is empty (See 4-31).

3. To complete the entry, *press* the *Store* button a second time. This enters the receiver's current frequency, mode, and basic *Aux/Parameter* settings

into channel number selected. Upon entry, the *Memory/Scan* display will change to show the channel, operating frequency, mode, and bandwidth in normal channel-menu format:

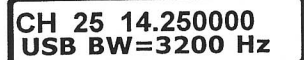

Important Note: You may exit the '*Store Channel ---*' function at any time and resume normal receiver operation *without* completing an entry-in-progress. To escape, *press* 'C' (Clear) on the main keypad. Pressing the 'C' key will terminate most other *Memory-Scan* programming functions, as well:

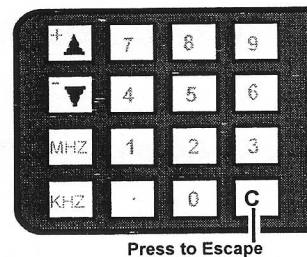

4-28 STORE THE CURRENT OPERATING FREQUENCY IN THE LOWEST EMPTY CHANNEL NUMBER:

This function is used to fill gaps in the channel menu by assigning the current operating frequency to the *lowest empty channel number* available (1-100). To use this feature, simply *press* the *Store* button *twice*, in succession, when making your entry:

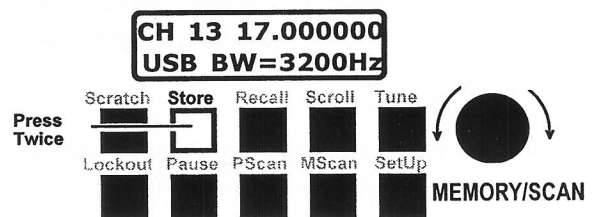

On the first press, the display will read '*Store Channel ---*'. On the second press, the lowest, empty channel number and the current operating frequency will appear in channel-menu format.

If no empty channels are available, '*Memory Full*' will appear for three seconds, then restore to '*Select Channel*.' In the event of a full memory, you may *Overwrite* an occupied channel (See 4-31, 4-32),

or *Clear* an occupied channel to create an *Empty Channel* (See Section 4-33).

4-29 Store the Current Operating Frequency in the *Scratchpad Memory*:

The *Scratchpad Memory* has no assigned channel number and is accessible without entering into the channel menu. To store the current operating frequency in the *Scratchpad*, press the *Store* button, then the *Scratch* button:

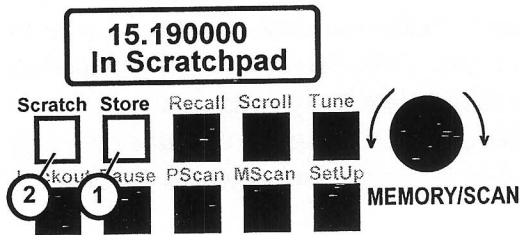

When the *Store* button is pressed, '*Store Channel ---*' appears in the display. When *Scratch* is pressed, the display momentarily shows the current frequency plus the notation '*In Scratchpad*'. When the *Scratch* button is released, the display reverts to the channel-menu display—showing frequency plus mode and bandwidth.

4-30 TO RECALL A SPECIFIC CHANNEL FROM MEMORY:

This function is used to recall a specific channel number from the menu, and to make it the receiver's current operating frequency. To enter the *Recall* mode:

1. Press the *Recall* button. '*Recall Chan ---*' and '*Select Channel*' will appear in the *Memory/Scan* display:

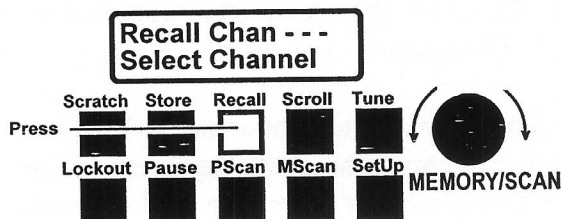

2. Enter the number of the channel you wish to recall on the *Main Keypad*. The number you enter will

appear in the top line of the *Memory/Scan* display (example, enter 25):



3. Press the *Recall* button again. The *Memory/Scan* display will show '*Channel 25 Recalled*' for approximately two seconds, and then present the channel number and operating frequency in menu format. Simultaneously, the receiver's other displays will shift to the recalled channel settings and the receiver will operate on the recalled channel:

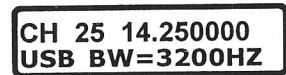

Important Note: Once a channel has been recalled, you may tune the receiver and adjust its operating parameters normally. However, these amended settings *will not* be retained in memory unless you activate the *Store* function and overwrite the old ones.

4-31 USING THE *SCROLL* FUNCTION TO PREVIEW THE CHANNEL MENU:

The *Scroll* function is used to preview the listing of occupied channels stored in the receiver's channel menu.

To scroll through the channel menu, press the *Scroll* button. The *Scroll* button will illuminate and the *Memory/Scan Edit Knob* will be assigned to the scroll function. Rotate the *Edit Knob* to preview menu contents, as shown:

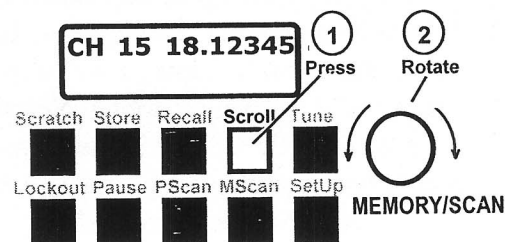

1. To Recall a channel while scrolling: To recall a displayed channel, simply *press* the *Recall* button. The selected channel will load into the receiver and become active. Pressing *Recall* cancels the *Scroll* function, so you must *press* the *Scroll* button again if you elect to resume scrolling. Push and hold *tune* to monitor *Tune* to write text.

2. To Store a channel while scrolling: To overwrite a menu entry with the frequency in current use, press the *Store* button. The display will present a request for confirmation (this is done to prevent accidental overwrites):

Store Data Over
CH 25 14.250000

If you wish to complete the overwrite, press *Store* one more time. The old information will be overwritten and the current operating frequency will replace it. Also, the display will revert to channel-menu format:

CH 25 3.850000
LSB BW=3200Hz

If you *do not* wish to complete the overwrite when the confirmation message appears, *press 'C'* twice on the main keypad to escape and restore the channel-menu.

4-32 Using the *Tune* Function to Access Frequencies from the Channel Menu:

Like the *Scroll* function, the *Tune* function may be used to view the listing of occupied channels stored in the receiver's channel menu. However, as each entry appears in the menu window, it will also be temporarily activated to permit monitoring. Note that *Tune* selections are not fully recalled in that *the main displays do not change and receiver settings may not be altered by the front panel controls.*

To tune through the channel menu, *press* the *Tune* button. It will illuminate and the *Memory/Scan Edit Knob* will be assigned to the tune function. Rotate

the *Edit Knob* to simultaneously preview menu contents and monitor channel activity, as shown below:

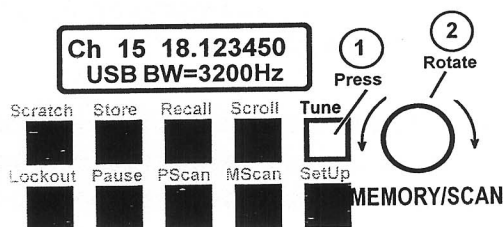

1. To Recall a channel in *Tune* mode: To fully activate a channel while in *Tune* mode, press the *Recall* button. The selected channel will load and become fully activated. Pressing *Recall* cancels the tune function, so you must *press* the *Tune* button again if you elect to resume tuning via the *Edit Knob*.

2. To Store a channel while in *Tune* mode: To overwrite a stored channel with the frequency in current use, *press* the *Store* button. The display will present a confirmation request:

Store Data Over
CH 25 14.250000

If you wish to complete the overwrite, press *Store* one more time. The old information will be overwritten and the current operating frequency will replace it. Also, the display will revert to channel-menu format:

CH 25 3.850000
LSB BW=3200 Hz

If you *do not* wish to complete the overwrite when the confirmation message appears, *press 'C'* on the main keypad to escape.

4-33 Clearing Occupied Channels to Create Empty Channels:

This function is used to clear un-needed frequencies from the program menu, emptying slots for future use. Channel clearing is done via the *Tune* mode.

Begin by pressing the *Tune* button. It will illuminate and the *Edit Knob* will be assigned to the tune

function. Rotate the *Edit Knob* to the channel you wish to clear, as shown below:

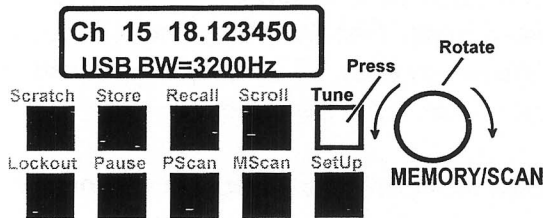

1. Clear a Single Channel: When the desired channel-menu entry appears in the *Memory/Scan* display, *press 'C' (Clear)* on the main keypad. A confirmation request will appear in the *Memory/Scan* window:

Push C again to
Clear this chan

The confirmation message remains on-screen for approximately two seconds. During that interval *press 'C' again* to clear the channel. The display will change to:

Channel
cleared

This message will remain on screen for about two seconds. At the end of that interval, the menu will advance to the next-higher menu entry.

Important Note: If you elect *not* to clear the slot after the confirmation request appears, *do not* press 'C' a second time. In a couple of seconds, the display will revert back to the current menu setting and the operation will be halted.

2. Clearing Sequential Channels: To clear sequentially- numbered slots in rapid succession, select the lowest-numbered channel in the group with the *Edit Knob* and *press 'C' twice*, in rapid succession. When the next-higher channel entry appears in the *Memory/Scan* window, *press 'C' twice*, again. Continue this procedure until all channels in the sequence are empty. All channels are cleared when the receiver is reset See Ssection 4-37).

4-34 SCAN MODE Primer:

The following terms and concepts are used when setting up *PScan* and *MScan* parameters. Programming will be easier if you understand each:

1. Finite Dwell: *Finite Dwell* is the time interval (in seconds) the receiver will remain on frequency after locking onto a signal. The *Finite Dwell* feature is especially useful when scanning a band containing many continuous-carrier AM signals. In this mode, the scanner locks onto the incoming carrier for a *specified period of time*, then quits the channel and resumes searching for another signal. Dwell is adjustable from 0.1 to 29 seconds.

2. Infinite Dwell: *Infinite Dwell* means the receiver will remain on the frequency for as long as the squelch is held opened by a signal. *Infinite Dwell* is especially useful when scanning two-way intermittent push-to-talk communication. When set for *Infinite Dwell*, the scanner locks onto the signal for as long as its there.

3. Dead Time: *Dead Time* is the time interval (in seconds) the receiver will remain on a frequency *after* the incoming signal either goes off-air or falls below the *Squelch* threshold. This function is especially useful when anticipating a two-way reply, or when it may be necessary to bridge signal fading and pauses in SSB speech. *Dead Time* is programmable from 0.1 to 29 seconds.

4. Gaze Time: *Gaze Time* is the interval the receiver will wait for activity to appear on a dead frequency before moving on to the next. Lengthening this parameter is useful when CW, SSB, or pulse-type data signals cause short activity gaps. *Gaze Time* is programmable from 0.01 to 29.9 seconds.

The relationship between *Dwell*, *Dead*, and *Gaze Time* is shown here:

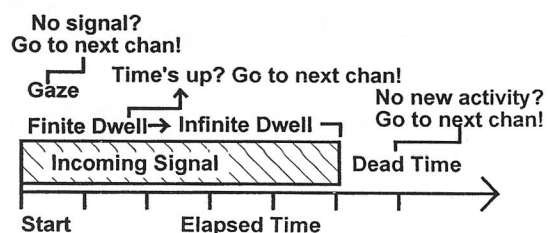

5. Channel Lockouts: *Channel Lockouts* are used to instruct the scanner to skip over specified menu channels during searches for activity in the MScan mode.

6. Frequency Lockouts: *Frequency Lockouts* are used to eliminate scan interruptions caused by unwanted signals. The *Frequency Lockout* has two components: 1.) a Lockout Center, and 2.) the Bandwidth Attribute. The Lockout Center is determined by the receiver's operating frequency at the time of the lockout entry. The Bandwidth Attribute is determined by receiver's selected bandwidth (BW). Together, these parameters establish the *Frequency Interval* that will be skipped on subsequent scans. To calculate the boundaries of the *Frequency Interval*, use the formula:

$$Interval = (Center) \pm 1/2(Attribute)$$

To illustrate how frequency lockouts work, suppose WWV at 10 MHz disrupts a scan searching for intermittent push-to-talk signals. Now, suppose the receiver's bandwidth is set at 10 kHz:

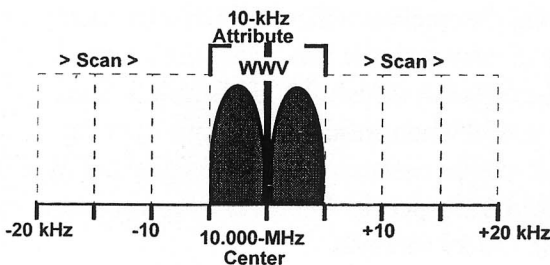

Entering the *Lockout* command while the receiver is paused on the unwanted station will automatically program a 10.000-MHz Lockout Center and a 10-kHz Bandwidth Attribute into the *PScan* memory. As a result of this entry, when scanning resumes, the *Frequency Interval* between 9.995 MHz and 10.005 MHz will be excluded on future passes—eliminating the interference problem.

Important Note: When initiating a new *PScan* setup, it's usually advisable to clear all previous lockouts from memory and start with a clean "slate". All lockouts and channels are cleared when the receiver is reset (See section 4-37).

4-35 TO SETUP A PSCAN (PROGRAMMED F₁ → F₂) FREQUENCY SWEEP:

The PScan mode is used to search all frequencies between a specified *Start* frequency (F₁) and an *End* frequency (F₂). F₁ is the lower frequency in the search, and F₂ is the higher.

To enter the Scan Setup mode, clear any other scan functions and press the *Setup* button. It will light and the 'Select Scan Type' message will appear:

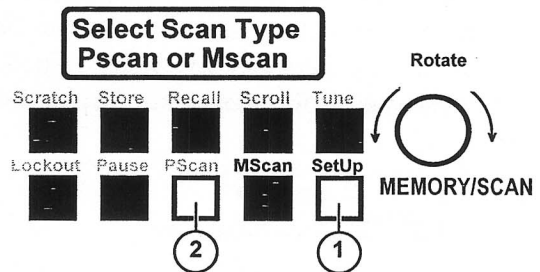

Now, press the *PScan* button. It will illuminate, and the *Edit Knob* will be assigned to the *PScan* menu. The display will present the 'Start Frequency' menu prompt, along with the last-entered value for F₁:

Start Frequency
F1 = 1.000000

1. F₁ Start Frequency: Use the main keypad to enter the desired start frequency, followed by the *MHz* or *kHz* key (as appropriate). Your entry will appear in the *Memory/Scan* display window, and will overwrite the old entry when you *press* the *MHz* or *kHz* key (example, enter 4.5, then *MHz*):

Start Frequency
F1 = 4.5



Start Frequency
F1 = 4.500000

Important Note: If you make a mistake while entering a frequency, *press* 'C' to clear the screen. To change F₁ after an entry is complete, simply start over again.

2. F₂ Stop Frequency: Rotate the *Edit Knob* clockwise to the next menu prompt, 'Stop Frequency' which will display the last-entered F₂:

Stop Frequency
F2 = 30.000000

To enter a new *F2*, use the keypad as in step-1 (example, 5.5 MHz):

Stop Frequency
F2 = 5.5



Stop Frequency
F2 = 5.500000

3. Step Size: Step size defines the frequency shift for each “hop” the scanner will make as it moves from *F1* toward *F2*. Step size is most easily programmed in kHz, and is adjustable from 1 Hz (.001 kHz) upward.

To enter Step Size, rotate the *Edit Knob* clockwise to the next menu prompt, 'Step Size' plus the last-entered value. Use the main keypad to enter the desired numbers followed by the kHz key (example, 10 kHz):

Step Size
10



Step Size
10.000 kHz

4. Dwell Time: *Dwell* is the time in seconds the receiver remains on one frequency *after* it locks onto a signal. Two Dwell-time options are available: *Finite Dwell* and *Infinite Dwell*. If your objective is to stop on each station briefly, before moving on to the next, set a *Finite Dwell* for any desired period between 0.1 and 29 seconds. If your objective is to continue monitoring for as long as the signal is present (as when monitoring intermittent push-to-talk traffic), then enter any time of *30 seconds or greater* to initiate the *Infinite Dwell* default.

To enter a new Dwell time, advance the *Edit Knob* clockwise to the *Dwell* menu prompt:

A. Finite Dwell Time: Use the main keypad to keystroke in a *two-number* entry between 0.1 and 29 seconds (0.1, 1.2, 5.0, 10, etc.). The entry will self-complete automatically when the second number is keyed in:

Dwell 20
(Setup to Exit)



Dwell 20.0 Sec
(Setup to Exit)

B. Infinite Dwell Time: Use the main keypad to keystroke in a *two-number* entry of 30 seconds or greater. The program will automatically default to *Infinite Dwell Time*, and the following message will appear in the *Memory/Scan* display:

Dwell Infinite
(Setup to Exit)

At this point, you may exit *PScan Setup* to begin scanning, or you may edit the *Dead Time* and *Gaze Time* settings. If you know the existing *Dead* and *Gaze* parameters are acceptable for your task, exit at this time. If you do not know what they are or need to amend them, continue with the setup procedure.

C. To Exit: If you elect to exit Setup at this point, press the *Setup* button. The switch will toggle off, the *Setup* and *PScan* LEDs will go out, and the *Memory/Scan* display will go dark until you initiate a new *Memory/Scan* function.

5. Dead Time: *Dead Time* is the interval the receiver will remain on frequency after a signal drops out and the squelch closes. This function holds the receiver on frequency (or channel) between push-to-talk exchanges and during pauses in SSB speech.

To enter a new dead time, advance the *Edit Knob* clockwise to the *Dead Time* prompt. *Dead Time* is adjustable from 0.1 second to 29 seconds (same as dwell time). Use the main keypad to keystroke in a *two-number* entry (0.1, 1.2, 5.0, 10, etc.). The entry will self-complete automatically when the second number is keystroked in:

Dead 5.0
(Setup to Exit)



Dead 5.0 Sec
(Setup to Exit)

At this point, you may either *Exit* the *PScan* setup or continue on and enter a *Gaze* time. To *Exit*, press the *Setup* button.

6. Gaze Time: *Gaze* represents the interval—in seconds—the receiver will wait for a signal to appear on a quiet frequency before moving to the next. Longer *Gaze* times are useful when searching for CW, SSB, and some digital-mode signals where short pauses or gaps may be present. Short *Gaze* times are preferred for carrier-based signals such as AM and FM.

To enter a new *Gaze* Time, advance the *Edit Knob* clockwise to the *Gaze* prompt. The *Gaze* interval is continuously adjustable from 0.01 -29.9 seconds. Use the main keypad to keystroke in a *three number* entry (0.01, 1.20, 5.00, 10.0, etc.). The entry will self-complete automatically when the third number is keystroked in:



At this point, *PScan* setup is complete. Rotate the *Edit Knob* in either direction to review entries, or exit *PScan Setup*. To exit, press the *Setup* button. The *Setup* and *PScan* LEDs will go out, and the *Memory/Scan* display will go dark until a new *Memory/Scan* function is initiated.

4-36 INITIATING PSCAN:

Once scanning parameters are set up, ensure the *Setup* button is off before attempting to begin the scan run. Also, to reduce background noise or to eliminate undesirably weak stations, set the receiver's *Squelch* control to a desirable threshold level (much as you would to quiet a FM scanner receiver). Setting the *Squelch* control above the background noise is especially important when using *Infinite Dwell*, since background noise alone could permanently halt the scan from progressing.

To initiate a *PScan*, press the *PScan* button *once*. The LED will illuminate and the *Memory/Scan* display will show the *PScan* function, F1 frequency, and *Dwell Time* (see below):

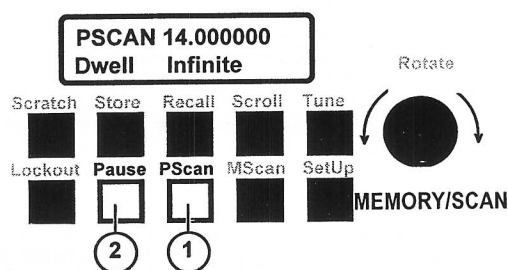

With each advancing step in the scan sequence, the *Aux Parameter* display and main frequency display will update to show operating parameters and operating frequency. To may halt the scan temporarily at any point, *press* the *Pause* button *twice*. Pressing it a second time will resume scanning.

If *Infinite Dwell* has been selected, reception of any continuously transmitting signal sufficiently strong to open the *Squelch* will halt the scan. To resume scanning, press *Pause* twice. To insert a *Frequency Lockout* to eliminate the signal on future passes, refer to section 4-37 (Frequency Lockouts) below.

Important Note: To alter the *Squelch* threshold (or any other *Aux Parameter* settings) during a scan, you must first disengage the *PScan* function. *Press* the *PScan* button *once* to disengage.

4-37 FREQUENCY LOCKOUTS:

Frequency Lockouts are used to eliminate unwanted interference that would otherwise disrupt a continuous F1-to-F2 *PScan* search. Unlike a channel lockout, the *Frequency Lockout* has a Central Frequency plus a Bandwidth Attribute. The Bandwidth Attribute allows the scan to circumvent the signal's modulation and heterodyne products, ensuring a consistent lockout when those products span more than one scanning step. When initiating a new *PScan* set-up, it's usually advisable to clear all previous lockouts from memory (See Section 4-34).

1. Clearing Frequency Lockouts: To clear existing lockouts, press *Setup*, *PScan*, and *Lockout* in sequence. The *Setup* and *PScan* buttons will illuminate, and the *Edit Knob* will be assigned to the lockout menu. Additionally, the first entry in the lockout menu will appear in the *Memory/Scan* display,

showing both the Bandwidth Attribute and the Lockout Center (example, *2800 Hz Attribute at 12.6 MHz Center*):

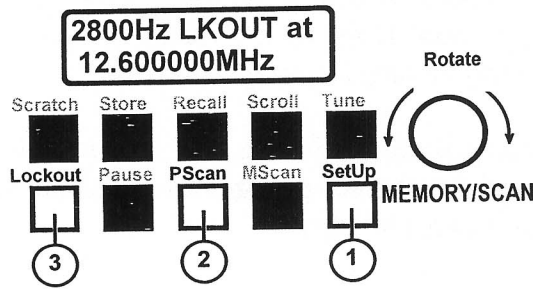

To delete the displayed lockout, press *Lockout* a second time. The message 'Lockout Deleted' will appear while the button is depressed, and the next lockout menu entry will be appear when the button is released:

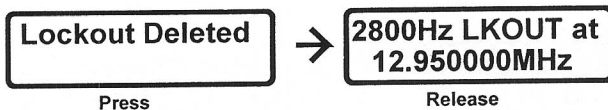

To delete the next entry, press *Lockout* once again. You may continue this procedure until all existing lockouts have been canceled. Alternatively, you may delete selected lockouts by scrolling through the lockout menu with the *Edit Knob* and pressing *Lockout* on only those entries you wish to delete. At the end of the menu, the display will flash 'End of List', then revert back to the last entry:



When all entries have been removed from the menu, pressing *Lockout* will cause the display to flash 'No Lockouts to delete'. The display will then revert to the *PScan* set-up menu:

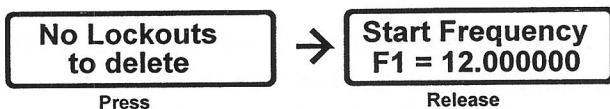

2. Adding Frequency Lockouts: *Frequency Lockouts* are normally added when the *PScan* is in

progress becomes halted by an unwanted station. To add a lockout, first press *Pause* to suspend the scan, then press *Lockout*. The *Pause* button will illuminate and a prompt will appear in the display to confirm the frequency (example, *12.1-MHz center with 5-kHz BW*):

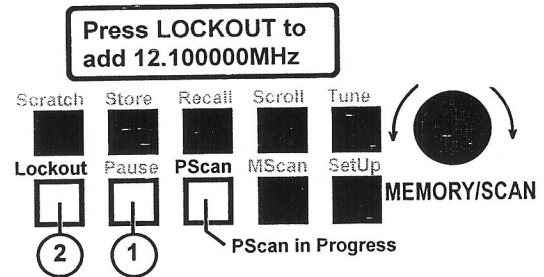

To add the indicated lockout, press *Lockout* a second time. The display will change to show the entry has been recorded:



After your entry is complete, press *Pause* off to resume scanning. The LED will go out and the display will revert to the normal *PSCAN* running message:

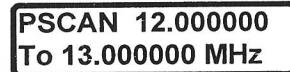

If you decide to *not* enter a lockout after setting it up, first press 'C' (clear) on the main keyboard, then press *Pause* to escape. Note that *Pause* will not disengage unless the *Lockout* command is either completed (with a second press) or canceled via the keypad, by pressing 'C'.

3. Channel Lockouts from Main Tuning:

Finally, it is possible to toggle frequency Lockouts in or out of the channel list while remaining in receive mode. Simply press the *Lockout* button while the desired frequency is displayed during normal receiver operation, and a confirmation message will appear in the *Memory/Scan* window. By pressing the *Lockout* button a second time, the *Memory/Scan* window will confirm Lockout deletion.

Important Note: You must press *Pause* to suspend the PScan before attempting to enter the *Lockout* command. If you press *Lockout* without first pausing the *scan*, the display will prompt you to use the *Pause* button:

Must be in
PAUSE mode

4-38 TO SET UP A MEMORY /SCAN FREQUENCY SWEEP:

The *MScan* mode is used to search frequencies stored in the receiver's channel memory for activity. To enter the scan setup mode, press the *Setup* button. It will illuminate and a 'Select Scan Type' message will appear in the display:

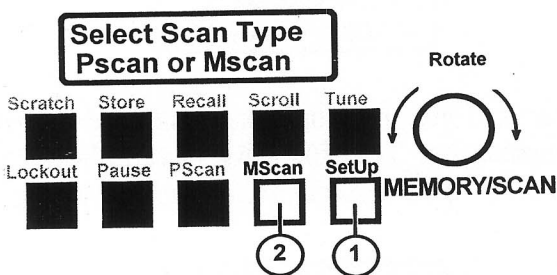

Now, press the *MScan* button. It will illuminate, the *Edit Knob* will be assigned to the *MScan* menu, and the display will present the 'Start Channel' menu prompt which includes the previous start point:

Start Channel
Ch 01 1.000000

OR

Start Channel
Ch 01 Empty

1. Start Channel: To enter a new Start Channel, use the main keypad to keystroke in the desired channel as a *three-digit number* (001, 050, 100, etc). Your entry will appear in the *Memory/Scan* display window, and will overwrite into memory automatically *when the third digit is entered:* (example, enter 050 for channel 50):

Important Note: For this and other scan parameters, terminate entries with *MScan* button or turn on the *Memory/Scan* edit knob.

Start Channel
Ch 050



Start Channel
Ch 50 4.500000

If you make a mistake while entering, *press 'C'* to clear the entry. If you wish to change the start point after entry is complete, simply start over.

2. Stop Channel: Rotate the *Edit Knob* clockwise to the next menu prompt; 'Stop Channel' with the last-entered selection:

Stop Channel
Ch 75 22.100000

To enter a new Stop Channel, use the main keypad (as in step-1) to keystroke in the desired three-digit channel number (example, 080 for channel 80):

Stop Channel
Ch 080



Stop Channel
Ch 80 25.160000

If you make a mistake while entering the channel, *press 'C'* to clear the entry. If you wish to change the start point after entry is complete, simply start over.

3. Dwell Time: *Dwell* is the time in seconds the receiver remains on one frequency after it locks onto a signal. Two Dwell-Time options are available: *Finite Dwell* and *Infinite Dwell*. If your objective is to stop on each occupied channel briefly, then move on to the next, set a *Finite Dwell* for any desired period between 0.1 and 29 seconds. If your objective is to continue monitoring an occupied channel for as long as activity is present (as when monitoring two-way traffic), then enter any time of 30 seconds or greater to initiate the *Infinite Dwell* default.

To enter a new Dwell Time, advance the *Edit Knob* clockwise to the *Dwell* menu prompt:

A. Finite Dwell Time: Use the main keypad to keystroke in a two-number entry between 0.1 and 29 seconds (0.1, 1.2, 5.0, 10, etc.). The entry will self-complete automatically *when the second number is entered:*



B. Infinite Dwell Time: Use the main keypad to keystroke in a two-number entry of 30 seconds or greater. The program will automatically default to *Infinite Dwell Time*, and the following message will appear in the *Memory/Scan* display:



At this point, you may exit *MScan* Setup to begin scanning, or you may edit the *Dead Time* and *Gaze Time* settings. If you know the existing *Dead* and *Gaze* parameters are acceptable for your task, exit now. If you do not know what they are or need to amend them, continue with the setup procedure.

C. To Exit: If you elect to exit Setup at this point, press the *Setup* button. The switch will toggle off, the Setup and *MScan* LEDs will go out, and the *Memory/Scan* display will go dark until you initiate a new *Memory/Scan* function.

4. Dead Time: *Dead Time* is the interval the receiver will remain on frequency after a signal drops out and the *Squelch* closes. This function holds the receiver on frequency (or channel) between push-to-talk exchanges and during pauses in SSB speech or data.

To enter a new *Dead Time*, advance the *Edit Knob* clockwise to the *Dead Time* prompt. *Dead Time* is adjustable from 0.1 second to 29 seconds (same as dwell time). Use the main keypad to keystroke in a two-number entry (0.1, 1.2, 5.0, 10, etc.). The entry will self-complete automatically *when the second number is entered*.

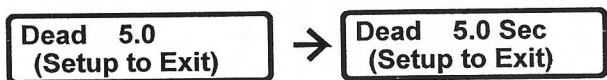

At this point, you may either Exit the *PScan* setup or continue on and enter a *Gaze Time*. To Exit, press the *Setup* button.

5. Gaze Time: *Gaze* represents the interval—in seconds—the receiver will wait for a signal to appear on a quiet channel before moving on to the next. Longer *Gaze Times* are useful when searching for CW, SSB, and some digital-mode signals where short pauses or gaps may be present. Short *Gaze Times* are preferred for carrier-based signals like FM and AM.

To enter a new *Gaze Time*, advance the *Edit Knob* clockwise to the *Gaze* prompt. The *Gaze* interval is continuously adjustable from 0.01 -29.9 seconds. Use the main keypad to keystroke in a three number entry (0.01, 1.20, 5.00, 10.0, etc.). The entry will self-complete automatically *when the third number is entered*:



At this point, the *MScan* Setup is complete. You may rotate the *Edit Knob* in either direction to review your entries, or exit *MScan* Setup. To exit, press the *Setup* button. The *Setup* and *PScan* LEDs will go out, and the *Memory/Scan* display will go dark until you initiate a new *Memory/Scan* function.

Important Note: *Gaze*, *Dwell*, and *Dead Times* are shared by both *PScan* and *MScan* functions. When changing from one mode to the next, remember to check and—if need be—reset these parameters.

4-39 INITIATING MSCAN:

To initiate an *MScan*, first make sure the *Setup* function is turned off and the *Squelch* threshold is set to eliminate background noise and undesirably weak signals (as with any scanner). Setting the *Squelch* is especially important when using *Infinite Dwell*, since the scan function will not advance to the next channel while the *Squelch* is open. To initiate the scan, press *MScan*, *once*:

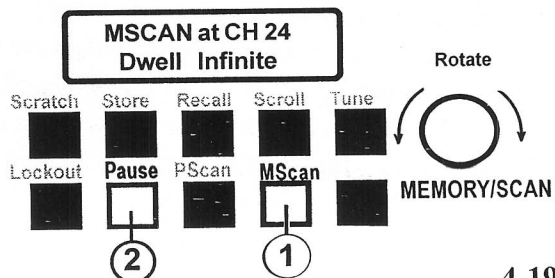

The LED will illuminate and the *Memory Scan* display will show the *PScan* function, current channel number, and *Dwell Time*. With each captured channel, the *Aux Parameters* display shows the receiver parameters for that channel. You may halt the scan sequence temporarily at any point by pressing the *Pause* button *twice*. Pressing it a second time will resume scanning.

If *Infinite Dwell* has been selected, reception of any sufficiently strong, continuously-transmitting signal to open the *Squelch* will halt the scan. To override and resume scanning, press *Pause*, *twice*. To insert *MScan Frequency Lockouts* to eliminate unwanted channels on future passes (See Section 4-40).

Important Note: To alter the *Squelch* threshold or to alter any other *Aux Parameter* settings during *MScan*, press the *Pause* button *once* to disengage. Press it again to resume scan operation.

4-40 LOCKING OUT MSCAN CHANNELS:

1. Clearing or Adding Lockouts Via the Menu: *MScan Lockouts* are used to eliminate unwanted channels that would normally "hang up" and disrupt a useful channel search. In some cases, you may wish to clear some (or all) existing lockouts before beginning your *MScan*. This is done in the receiver's *Channel Scroll* mode:

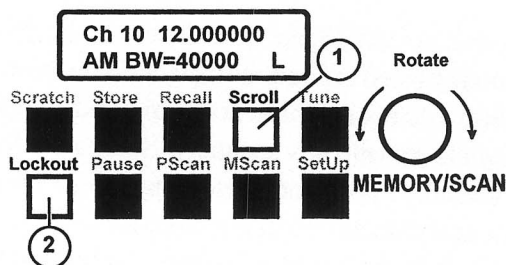

To scroll the channel menu, press the *Scroll* button *once*, and use the *Edit Knob* to select channels. Note that any channel previously locked out will display the letter 'L' in the lower right side of the display. To eliminate the lockout, press the *Lockout* button *twice*. The 'L' will disappear and the channel will be restored to the scan list.

The *Lockout* button is a toggle control, so pressing it again will reinstate any lockout. By the same token, you may select *any* channel in the *Scroll* menu and either lock or unlock it by toggling the *Lockout* button. Note that the *MScan Lockout* function works in the *Scroll* mode only and will not work in *Tune* mode.

2. Adding Lockouts While Scanning: Channels may also be added (but not removed) from the lockout list while an *MScan* is in progress. To lockout an unwanted channel, simply press *Pause* while the scanner is held up on the station *once*, then press the *Lockout* button *twice*. A brief *Channel Locked* message will appear while the button is being depressed, indicating the entry has been made.

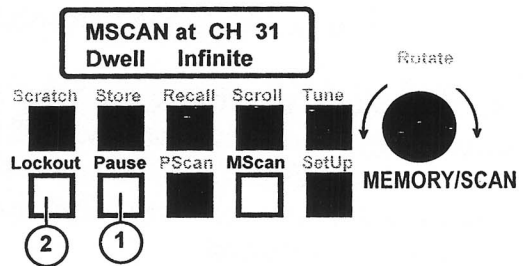

4-41 PAUSING AND RESTARTING SCANS:

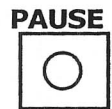

In *Programmed* or *Memory/Scan* mode, push the unlit *Pause* button to enter *Pause* mode, temporarily stopping the scanning at the current frequency or channel. The *Pause* LED lights, and the *Memory/Scan* display reads:

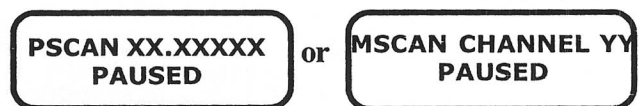

where *XX....* or *YY* is the current frequency or channel in the scan sequence.

When a scan is *Paused*, the displays reflect the presently active *Receive Frequency* and *Auxiliary Parameters*. The scan can be restarted at the next Channel or Frequency in the scan sequence by pushing the *Pause* button again, extinguishing the *Pause* LED. The next Channel or Frequency is held for a minimum of one second to allow double pushes of the *Pause* button to single step through the scan sequence.

Pause mode may also be exited by pushing the lit *PScan* or *MScan* button. This will exit *both* Pause and Scan modes, extinguishing the *Pause* and *MScan* or *PScan* LEDs. This will not return the *Memory/Scan*, *Auxiliary Parameter*, *Main Display* and *Receive Frequency* to the settings that existed before the scan was started.

In Pause mode, the receiver can be tuned and *Auxiliary Parameters* can be changed to look more closely at the received signal. In Paused *PScan* mode, the *XX...frequency* displayed in the *Memory/Scan* Display remains fixed regardless of any receiver tuning adjustments. Any changes to the *Auxiliary Parameters* are ignored when the scan is restarted.

Scan Setup Parameters can be changed while a scan is paused. The *Scan Setup* procedures are the same as before except the *Select Scan Type* prompt never appears, and the *Pause* LED is lit. When *Pause* and *Scan Setup* modes are enabled concurrently, pushing the lit *Pause* button will exit both modes and restart the scan.

In *PScan Pause* mode, frequency lockouts may be added to the lockout list. Push the *Lockout* button to store the current receiver tuned frequency and IF Bandwidth in one of the *Lockout* memory locations. The *Memory/Scan* Display reads:

In *PScan*
**PRESS "LOCK-
 OUT" TO ADD
 XX.XXXXXX MHZ**

In *MScan*
CHANNEL LOCKED

for three seconds, and then returns to its previous display. The new Lockout Frequency will be skipped

in subsequent scan passes. If there are no empty Lockout locations available, the display reads:

MEMORY FULL

for three seconds, and then returns to its previous display. A new *Lockout* with a Center Frequency identical to an existing Lockout overwrites the existing Lockout and does not require an additional memory location. Scan Setup mode may be entered to delete an existing *Lockout* and make room for the new one, if desired.

Similarly, to quickly change a channel from *include* to *skip* status, push the *Lockout* button during a *Paused MScan*. Channel may be toggled while in scroll mode by pressing the *Lockout* button. 'L' appears in the display to indicate a locked-out channel. The *Memory/Scan* display reads:

CHANNEL LOCKED

for three seconds, where *XX* and *YY...* relate to the paused channel. The channel will be skipped in subsequent scan passes. Editing is restricted to the Paused Channel.

If the *Lockout* button is pushed during an actively scanning (or dwelling) scan, the *Memory/Scan* display reads:

**MUST BE IN
 PAUSE MODE**

for three seconds, and then returns to its previous display. In this case, the scan is suspended at the present frequency for three additional seconds to allow the operator time to *Pause* the scan, if desired.

CHAPTER 5

DETAILED REMOTE RS-232 OPERATING INSTRUCTIONS

5-1 MULTI-DROP NETWORK:

In addition to front-panel control, the RX-340 may be controlled remotely via its MULTI-DROP RS-232 interface using a PC (Personal Computer). The RX-340 must be in *Local* mode for front-panel operation and *Remote* mode for RS-232 control. See section (5-10) for details of the *Remote* button and the RS-232 security commands. Control software is necessary for remote operation. The RX-340 interface is based on plain text (ASCII) codes and strings which reduces the software design burden. An ASCII based interface allows the operator to exercise the RX-340 using a dedicated terminal or through a PC running terminal-emulation software. In this way, software designers can quickly become familiar with commands and responses of the RX-340.

The RX-340 operates as a DCE device for serial interface applications, and a 3-wire interface is required for connection to a suitable controller (TXDATA, RXDATA and GND). When connecting multiple RX-340s to a single controller, all units are wired parallel to the control bus. In this way, all receivers share a single TXDATA line, RXDATA line and GND line (See figure 5-1). After the receivers have been wired, they must be configured. Dipswitches S1 and S2 located on the rear panel allow users to set serial interface parameters and receiver addresses. Dip switch S1 is used to select serial interface parameters (See figure 5-2). Dip switch S2 is used to set the receivers address

(range 0 to 127). Switch S2-1 is not used for address selection and should be left in the down position for normal operation. (This switch is used to activate Non-Multidrop RS-232 default).

The RX-340 is interfaced to a PC or other suitable controller via a Multidrop serial network. Signal levels for the network are RS-232 compatible. However, unlike conventional RS-232 systems which allow only a single connection, the RX-340 has been designed to allow multiple connections. While any number of receivers may be interconnected at one time, the number of simultaneous connections is limited by line capacitance. Total capacitance should not exceed 2500 pF. However, the Baud rate and RS-232 drive delay may be adjusted to allow operation with a less than perfect installation (See Section 5-4, Hnnn command).

The multi-drop feature may be disabled by sending the 'U5' command. After this command is received, the interface becomes standard RS-232C (single receiver system). The 'U4' command restores the multi-drop feature. Set dip switch S2-1 to configure the power-up default of the Multidrop feature (See Figure 5-2).

Important Note: A standard serial cable *will not work*. An interface cable for the RX-340 must use pins 2, 3 and 7 only. Other pins on the DB-25 connector carry DSP data.

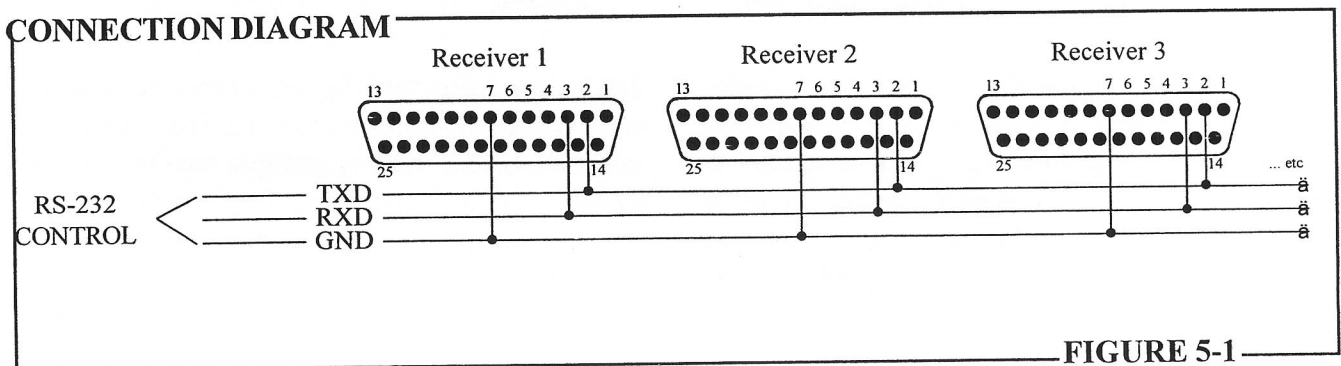

5-2 RECEIVER CONTROL:

Control of the RX- 340 is achieved through plain text (ASCII) command codes sent from a remote PC or other control unit. Command codes provide control of frequency, mode, and other operating parameters--plus control of BITE self-diagnostics and *Scan/Memory* functions. All command codes consist of a single ASCII letter. The comma ', ' and dollar sign '\$' are also used in addressing operations. In addition to a command code letter, additional information may be required immediately following the letter (See specific codes). All command strings must be terminated by a carriage return ASCII 13 (hex 0D). Only capital letters are allowed in command strings.

The desired receiver (or group of receivers) must be selected or addressed before commands can be issued. The *Select* light on the front panel will illuminate when radio has been addressed. Dipswitch S2 (on the rear panel of each receiver) allows a receiver's address to be set from 0 to 127 (See Figure 5-2). To select a receiver, send '\$' followed by the assigned address number. For example, to address receiver 15, send '\$15'. To address more than one receiver, list each one separating each address by a comma. For example, to address receivers 9, 15, and 22, send '\$9,15,22'. Receivers remain addressed until another addressing command is issued.

Once a receiver (or group) is addressed, additional receiver commands may be sent to control frequency, mode, operating parameters, etc. Some receiver commands are single characters--such as 'X'--which tells a receiver to report the current incoming signal level. Other commands require added information to complete the command, such as 'F10.12345' to set frequency or 'D3' to set the detection mode to CW.

It is important to follow proper syntax when issuing commands. Receivers not included in the command address ignore commands intended for designated receivers. In addition, if a selected receiver detects an error in the incoming command string, it will ignore the command *and* de-select itself as a safeguard against data errors.

Multiple addresses and multiple operating commands may be placed in the same command-string as long as the total command string length does not exceed 256 characters, including the terminating carriage return. For example, '\$0,2F10.1D1M4A100' <CR> would command receivers 0 and 2 to tune 10.1 MHz, AM detection mode, programmable AGC, with attenuation set for 100 dB.

5-3 RECEIVER RESPONSE COMMANDS:

Some commands interrogate the receiver, requiring it to return data to the controller. These responses are generally similar to the command format. For example, if a receiver is asked to report its current operating frequency (TF), the response might be: 'F10.12345'. In addition, whenever a receiver *sends* information, a status code is appended to the end of each response. The status code is the letter S followed by a number such as, 'S1' which indicates that the receiver is operating in remote mode. The status number is encoded as follows:

- 1 Receiver is in remote control mode.
- 2 Synthesizer is out of lock.
- 4 Not used.
- 8 Last string had character transmission error.
- 16 Last string had data error.
- 32 Last string had lost data.
- 64 External reference applied.
- 128 Receiver in mute (activated by command).

If the receiver and interface are operating properly, the receiver would report a status code of 'S1' (or 'S64' if using an external reference). Each receiver response is terminated with a carriage return ASCII 13 (hex 0D).

Important Note: Interrogation commands may be directed to *only one receiver* at a time. Response commands addressed to multiple receivers are ignored.

5-4 RECEIVER CONTROL COMANDS:

Control commands affect receiver operating status (setting of frequency, mode, bandwidth, etc.). All commands in this group require additional data following the command code. If a command code is sent to a receiver without properly-formatted supplemental data, the receiver will ignore the command code and deselect itself. It will then ignore any incoming characters until it receives a

carriage return (ASCII 13).

The section below describes individual commands plus the type and range of data that should follow to properly complete the command. For example, 'Fnn.nnnnnn' represents the *Set Frequency* command 'F', which should be followed by up to two digits, a decimal point, and then six digits. In most commands a decimal point will be required (any exceptions will be noted below).

<u>COMMAND</u>	<u>DESCRIPTION</u>	<u>VALIDRANGE</u>
Ammn	MANUAL AGC ATTENUATION Selects the amount of <i>AGC Attenuation</i> to use (same as <i>Manual Gain</i> setting on front panel). Adjusts over 120-dB range, may be set in any mode. Receiver gain is reduced and AGC threshold is increased by the number of dB indicated. Example: 'A30' (Set Attenuation to 30 dB)	0 - 120 dB
B+n.nnn (B-n.nnn)	BFO FREQUENCY +/- 8000 Hz Sets <i>BFO-Offset</i> frequency when receiver is in CW mode. BFO is fixed in sideband and CW1 modes, and not operational in others. In CW mode, BFO Offset is relative to the receiver's tuned frequency (which is also the passband center when passband tuning is turned OFF). Example: 'B-0.2' (Set BFO to 200 Hz) 'B-2.0' (Set BFO to -2000 Hz)	+/- 8000 Hz
Dn	DETECTION MODE This command allows setting the receiver detection mode. Detection mode designators are: <ol style="list-style-type: none">1 AM2 FM3 CW (with variable-offset BFO)4 CW1 (BFO fixed at 0 Hz)5 ISB (both sidebands, 3.2 kHz fixed BW)6 LSB7 USB8 SAM (Synchronous AM)	1 - 8

Example: 'D3' (Set receiver to CW mode)
'D1' (Set receiver to AM mode)

E[U,L,B,M]

AUDIO / IF SELECT

Allows *Audio/IF* selection and receiver muting. Affects the IF output and audio outputs. Either Upper, Lower, or both ISB audio channels may be selected for output. Either Upper or Lower IF may be selected for output. If *Both* is selected, IF selection remains at last setting. Also, receiver may be muted by using the 'M' selection. A receiver which is muted will set the mute flag in the status byte and display 'Mute' in the *Mode* area of the main display. The *Mode* display may be restored momentarily by pushing either *Mode* button (in *Remote Mode*). return to local mode to clear the mute condition and edit the *Mode* setting.

E, U or B

Example: 'EU' (Select Upper IF and Upper Audio)
'ELEB' (Select Lower IF and Both Audio)

Fnn.nnnnnn

FREQUENCY

Allows setting operating *Frequency* with a resolution of 1 Hz from 0-30 MHz. Least significant digits may be dropped (assumed 0). A decimal point is required except when frequency is 0 Hz (it is not necessary to have any frequency data in the command string for 0 Hz). Display frequency is the suppressed-carrier frequency in sideband modes and pass-band center in all other modes.

0 - 30 MHz

Example: 'F14.123456' (set frequency to 14.123456 MHz)
'F14.1' (set frequency to 14.100000 MHz)
'F'<CR> (set frequency to 0 Hz)

Hnnn

SET RS-232 DELAY

Controls the time between tx-output enable and the occurrence of the first transmitted bit on the RS-232 transmit line. This command may be used to overcome an RS-232 controller with a slow response. Units are in milliseconds.

0 - 255 ms

Example: 'H40' (Set delay to 40 milliseconds)

Inn.nn

IF FILTER

This command selects the IF-filter *Bandwidth*. Bandwidth range is 100 Hz to 16 kHz in all detection modes except ISB (600 Hz is FM, SAM, ISB narrow filter limit. 4 kHz is SAM narrow filter limit). BW is fixed at 3.2 kHz in ISB mode. If operator requests an unavailable filter, the receiver will select the closest wider filter to the request. Units are in kHz. Appending a 'C' to

.1 - 16 kHz
(FM .6 - 16 kHz)

the 'I' command will access a *Fast Filter* for bandwidths below 4 kHz. An 'F' is displayed in front of the filter selected on the front panel when *Fast Filters* are used. Fast Filters exhibit reduced delay times with degraded shape factors. Fast Filters should only be used in systems sensitive to filter delay.

Example: 'I3.2' (Set IF Bandwidth to 3.2 kHz)
'I0.5' (Set IF Bandwidth to 500 Hz)

Kn **PRE-AMP/ATTENUATOR** 1 - 3
Allows control of *Pre-amp* and *Attenuator*
'K1' Normal - Preamp OFF, attenuator OFF
'K2' Preamp on, attenuator OFF
'K3' Attenuator on, preamp OFF

Mn **AGC OPERATING MODE** 1-4
Selects the AGC operating mode. 'F', 'M', 'S', and 'P' are displayed in front of AGC seting on front panel. Where 'n' is one of the following:

'M1' Fast AGC
'M2' Medium AGC
'M3' Slow AGC
'M4' Programmable AGC

Note: The receiver will accept and execute a manual gain 'A' command in any of the AGC modes.

PROGRAMMABLE AGC MODE SETTINGS

Note: Receiver accepts new parameters for Programmable AGC at any time, but uses them only in *Programmable* mode (M4).

MA	Set <i>Attack Rate</i> in dB/mS. Example: 'MA0.40' Program for 0.4 dB/mS	Range: 00.01 to 01.00
MD	Program <i>Decay Rate</i> in dB/sec.	Range: 00.01 to 99.99
MH	Program <i>Hang Time</i> in seconds.	Range: 00.01 to 99.99
#	<i>Dump</i> AGC state and restart AGC process.	
TM	Query the <i>Programmed AGC</i> settings. The receiver will respond with a string similiar to:	

'M1MA00.90MD75.00MH02.00S1'

| | | | |
 | | | | | Hang Time (sec)
 | | | | | Decay Rate (dB/sec)
 | | | | | Attack Rate (dB/msec)
 | | | | | AGC Mode (1,2,3 or 4)

Pre-programmed AGC modes are set up as follows:

<u>AGC Mode</u>	<u>Attack</u>	<u>Decay</u>	<u>Hang</u>
<i>Fast</i> (M1)	0.8 dB/msec	1200 dB/sec	0
<i>Med</i> (M2)	0.8 dB/msec	100 dB/sec	0
<i>Slow</i> (M3)	0.8 dB/msec	25 dB/sec	0

Nnn.nnn

NOTCH FREQUENCY

Allows tuning the receiver's *Notch Filter*. The notch filter functions in CW, CW1, LSB and USB modes for bandwidth settings of 4 kHz or less, and may be tuned +/- 2 kHz either side of the passband center. A notch frequency of 0 Hz effectively turns the filter OFF. The notch frequency indicates the audio (in Hz) to be removed. Notch frequencies are relative to BFO offset.

**=/- 2000 Hz
(around pass-band center)**

Example: 'N.500' (Notch 500 Hz Audio Tone).
 'N4.000' (Notch 4000 Hz Audio Tone).

Onn

NOISE BLANKER SETTINGS

Allows setting the *Noise Blanker* setting threshold. Range is from 0(off) to 9.

0 - 9

Example: 'O5' (Set Blanker width to 5).
 'O0' (Set Blanker to OFF).

Pnn.nnn

PASS BAND TUNING

Allows setting *Passband Tuning*. Feature is available in CW, AM, or SSB modes and shifts the filter's center frequency without affecting receiver's operating frequency or BFO.

+/- 2000 Hz

Example: P1.8' (Shift passband 1.8 kHz).
 P-1.0' (Shift passband -1 kHz).

Qnnn

SQUELCH

Allows setting *Squelch* control. Entry of 0 represents minimum threshold (open squelch) and 150 represents maximum threshold (closed squelch).

**0-150
(-140 - +10dBm)**

Example: 'Q50' (Set Squelch threshold to -90 dBm).

Un

DIGITAL DSP INTERFACE CONTROL

1-5

Allows setting operational status of DSP digital output.

- 1 Interface OFF.
- 2 Interface ON - no control flags in serial data.
- 3 Interface ON - control bits included in serial data.
- 4 Enable Multidrop interface (default when S2-1 is down).
- 5 Disable Multidrop interface (single receiver system default when S2-1 is up).

Z

MASTER RESET

This command forces all receiver parameters back to factory default conditions and also takes it out of *Remote* mode. All memories are cleared. About three seconds are required to complete the process.

!n[+/-]

USER OUTPUT CONTROL

Sets the state of each *User Output* provided on the rear panel of the RX-340. Outputs are programmed individually by setting 'n' to 1,2,3 or 4. Outputs are programmed to be *On* '+5v' by appending a '+' sign to the command. Appending a '-' sign will program the output to the *Off* state (0v). All *User Outputs* are programmed to the *Off* state at *Power-On* and after a *Reset*.

Example: '!1+' Turns on user output 1.
 !'3-' Turns off user output 3.

5-5 RX-340 RECEIVER MEMORY COMMAND SET:

The command set provides two commands for accessing the receiver's 100 memories. Memories are stored in a battery-backed RAM and will remain stored during power down and storage. A master reset will clear all stored memories.

1-100

Wnnn

WRITE MEMORY

Write current *Operating Parameters* to memory number 'nnn' (1-100) available. The memory holds all basic receiver operating parameters such as frequency, mode, filter selection, etc.

Example: 'W20' (Write parameters to memory 20).

Rnnn

RECALL MEMORY

Recall memory 'nnn' to main operating Parameters. Memory channels 1-100 available.

Example: 'R20' (recall memory 20).

1-100

5-6 RX-340 RECEIVER QUERY COMMAND SET: Some commands request the receiver to send information back to the controller. These responses generally follow the same format as an issued command. For example, a typical response to a *Current Operating-Frequency* query might be: 'F10.12345' (or 10.123.450 MHz). In addition, whenever the receiver sends information, a status code is appended to the end of each response. The status code is the letter 'S', followed by a number. For example, 'S1' indicates the receiver is operating in remote mode. The status number codes are as follows:

- 1 Receiver is in remote control mode.
- 2 Synthesizer is out of lock.
- 4 Not used.
- 8 Last string had character transmission error.
- 16 Last string had data error.
- 32 Last string had lost data.
- 64 External reference applied.

A properly operating receiver and interface typically returns an 'S1' status code terminated with a carriage return ASCII 13 (hex 0D).

G

REPORT STATUS

Receiver responds with all operating parameters relevant to the current operating mode. Parameters that are OFF, or are not relevant to the current mode, will not be included in the response. See, also, command 'J'.

Command: 'G'
Response 'F15.010000D2B-1800'...etc...<CR>

Tx (xxx)

REPORT SPECIFIC STATUS

The receiver responds with the operating data, as specified, prefaced by the command.

Example 1: (single request)

Command: 'TF' - Request receiver operating frequency.
Response: 'F15.0100000' <CR>
For: frequency=15.01 MHz

Example 2: (multiple requests)

Command: 'TFBNX'- Request operating frequency, BFO offset, notch-filter setting, and current S-meter level.
Response: 'F15.0100000B-00N0.00X020'<CR>
For: frequency=15.01 MHz
BFO= -1800 Hz
Notch=0.00 Hz (OFF Position)
S-meter=20db Signal

X

REPORT SIGNAL LEVEL

This command requests signal level (or S-meter reading). Range is 0-150 covering the 150-dB dynamic range of the receiver (-140 to +10 dBm).

Example:

Command: 'X'-Request S-meter reading.
Response: 'X015'
For: S-meter= -125dBm signal level.

V

REPORT FIRMWARE REVISION NUMBER

The receiver will respond with a number indicating the revision level of the firmware.

Example:

Command: 'V' -Request firmware revision number.
Response: 'V1.90'
For: Firmware revision number of 1.90

J

REPORT ALL OPERATING PARAMETERS

The receiver responds with all operating parameters regardless of their current use or relation to the current operating modes. See command 'G' for additional information.

5-7 RX-340 RECEIVER BITE (Built-In Test Equipment):

The RX-340 contains BITE firmware routines to assist in field level trouble-shooting and repair. Three levels of testing are provided. Although each level executes the identical test routines, the data are interpreted and processed differently. Accordingly, each BITE level has its own particular response set. BITE Level-1 provides a simple pass/fail response. BITE Level-2 provides a board-level diagnosis and responds with one or more RX-340 sub-assembly numbers representing likely failures. BITE Level-3 provides a Pass/Fail result on individual internal tests.

Control codes to initiate the different levels of BITE are:

- S3** Initiate Level-1 BITE
Responses: *Pass* or *Fail*
- S4** Initiate Level-2 BITE
Responses: *Pass* or *Fail* followed by one or more sub-assembly numbers.
- S5** Initiate Level-3 BITE
Responses: *Pass* or *Fail* followed by a pair of decimal numbers separated by a colon (Example: 127:64). Numbers represent individual test results encoded into two bytes. The eight bits of each byte represent different BITE tests. If the bit is

set at '1', its corresponding BITE test failed. If clear '0', it passed. The two bytes are encoded as follows:

First byte:

- 'd0' Generate Audio Tone and Measure with CPU A/D
- 'd1' Check LO1 Lock Status
- 'd2' Check LO2 Lock Status
- 'd3' Check LO3 Lock Status
- 'd4' Check REF Lock Status
- 'd5' Check LO1 Loop Lock Time
- 'd6' Check LO2 Loop Lock Time

Second byte:

- 'd0' Check CPU/DSP Interface
- 'd1' Check IF for high noise level
- 'd2' Check IF for normal signal levels
- 'd3' Check S-Meter Level
- 'd4' Apply Manual AGC and Measure
- 'd5' Remove Manual AGC and Measure
- 'd6' DSP RESET FAILURE FLAG
- 'd7' not assigned

5-8 DSP DATA OUTPUT:

The RX-340 receiver contains a digital output interface providing post-DSP IF and AF data from the Digital Signal Processor. This output may be interfaced with user-supplied equipment for additional signal processing. Signal quality between the RX-340 and external devices is maintained since D/A and A/D stages are eliminated. In addition, the data streams may be turned ON or OFF as needed by remote command. Because the RX-340 provides both audio and IF outputs, the data streams to have control signals associated with them. Also, because the serial and parallel interfaces are implemented differently, the control signals associated with each are different.

The *Serial Interface* provides Serial Clock, Serial Data and Frame Start signals. The Serial Data output provides a 14-bit signed sample. Additional control signals are provided to indicate the origin of the sample. The IF/AF line indicates if a sample is *IF Data* or *AF Data*. The 'U/L' line indicates if the AF sample is from the *Upper* or *Lower Sideband*. In all receiver modes, except ISB, the Upper and Lower samples are the same. When in ISB mode, the Upper and Lower samples are selected by remote commands.

The *Parallel Data* stream consists of a 14-bit signed sample embedded in a 16-bit word, with the Upper two bits providing additional information about the sample. These two bits are encoded to indicate the origin of the sample. Bit 15 indicates if the sample is an IF or AF sample. If bit 15 indicates an AF sample, bit 14 will indicate either a Upper or Lower sample. In all modes except ISB, the Upper and Lower samples are the same. When in ISB mode, Upper and Lower samples may be controlled by remote commands. Also the control bits (bit 14 and bit 15) can be turned OFF (or forced to logic 0) by remote command.

5-19 SCAN OPERATION:

The RX-340 provides two scanning modes (Refer to Chapter 4 for a complete explanation of all scan functions). Briefly, channel scanning, called *M-Scan*, allows the radio to search for activity on pre-programmed

memory channels. F1-F2 scanning, called *P-Scan* allows the radio to search for activity in a given frequency range. Commands are provided for setting the various parameters for each of the scanning modes. Time controls are common to both scanning modes. Frequency data is entered in MHz and must fall within the radio's 0-30 MHz range. The allowable range for time data is 0 to 99.99 seconds. Allowable channel numbers and lockout numbers are 1-100. 100 Lockouts and 100 Memory channels are provided.

A. To Configure Program-Scan; f1 to f2 with lockouts.

*C0ff.ffff	<i>PScan</i> entry of Starting Frequency in MHz (*C012.250000 for 12.250 MHz).
*C1ff.ffff	<i>PScan</i> entry of Ending Frequency in MHz (*C113.250000 for 13.250 MHz).
*C2ff.ffff	<i>PScan</i> entry of Step Size in MHz (example (*C200.010000 for 10 kHz).
*CAff.ffff	Add <i>Lockout</i> at specified frequency in MHz. (*CA12.000000 for 12 MHz).
*CDff.ffff	Delete <i>Lockout</i> at specified frequency in MHz (*CD12.000000 for 12 MHz).
*CBff.ffff-ff.ffff	Add <i>Lockout Range</i> of F1-F2 (*CB12.000000-12500000 for 12-12.5 MHz).
*CNnmn	Delete <i>Lockout</i> by Number. Use *TA to get lockout list. (*CN021 for #21)

B. Configure Memory-Scan; Channel to Channel with Lockouts.

*C4ccc	Start Channel for <i>MScan</i> : Range 0-100 (example: *C4020 for channel 20).
*C5ccc	Stop Channel for <i>MScan</i> : Range 0-100 (example: *C5040 for channel 40).
*CSccc	Skip Channel in <i>MScan</i> : (example: *CS030 for channel 30).
*CUccc	Include Channel in <i>MScan</i> : (example: *CU060 for channel 60).
*CEccc	Delete Memory by number. Use *TM to get list of memories. (*CE050)

C. Common Scanning Time Control Functions

*C3dd.dd	Set <i>Dwell Time</i> in seconds (example: *C301.00 or 1 second).
*C6	Reserved for future use.
*C7dd.dd	Set <i>Dead Time</i> in seconds--Default to 8 seconds.
*C8dd.dd	Set <i>Gaze Time</i> in seconds (example *C800.50 for 0.5 second)

D. Scanning Control Functions

*CP	Pause if scan running. Ignore if scan not active.
*CG	Continue if dwelling or paused.
*CF	Start <i>PScan</i> . Ignore if already scanning or if F1 is greater than F2.
*CM	Start <i>MScan</i> . Ignore if already scanning or if C start is greater than C stop.
*CX	Stop scanning and return to manual mode. Ignore if not scanning.

E. Scanning Query Functions

*TS	Request scan status. Returns single *TSbXsss
-----	---

'b' is a single decimal number containing bit-encoded status information:

- Bit 0 Set if *Scan* is in *Dwell-Time* cycle.
- Bit 1 Set if *Dwell* is set to infinite (Dwell time set to zero)
- Bit 2 Set if *Squelch* is open (channel is active).
- Bit 3 Set if running *MScan*. Cleared if running *PScan*.
- Bit 4 Set if *Scan* (*MScan* or *PScan*) is active. Cleared otherwise.
- Bit 5 Set if *Scan* is in *Dead-Time* cycle.
- Bit 6 Set if *Scan* is in *Gaze-Time* cycle.
- Bit 7 Set if *Scan* is in *Pause* state.

- *TA Report all *PScan* Lockouts. No response if lockout list is empty.
- *TM Report all active memory channels. 'S' appended if channel is skipped. No response if empty.
- *TD Report lockout by number. Use *TA to get complete lockout list. No response if lockout empty.
- *TR Report memory by number. Use *TM to get complete memory list. No response if empty.
- *TC Report all *Scan* settings except *Lockouts* and contents of memory channels.
- *TL Tell last lockout number.
- *TF Tell number of free *Lockouts*.
- *CK Kill all *Lockouts*.
- *Tiff.fffff Tell if specified frequency is in a *Lockout*.

5-11 RX-340 SECURITY FUNCTIONS:

The RX-340 operates in one of three control modes: *Local*, *Remote*, or *Local Lockout* mode. The RX-340 may be switched between *Local* and *Remote* mode by pressing the *Remote* button or sending the appropriate *R or *L RS-232 interface command. In *Remote* mode, the RS-232 interface has control and front panel operation is not allowed. The user may return the RX-340 to *Local* mode by pressing the lit *Remote* button. In *Local Lockout* mode, the lit *Remote* button will not return control to the front panel.

The RX-340 includes additional commands for interface control and secure operation. The new commands are part of the extended command set which is a superset of the Ten-Tec RX-331 command interface.

The following commands control *Remote* operation of the RX-340 through its RS-232 interface:

- *R1 Remote Control ON.
- *R0 Remote Control OFF.

Similar to remote mode, but operator cannot override remote operation:

- *L1 Remote Control with Local Lockout ON.
- *L0 Remote Control with Local Lockout OFF.

Important Note: When in *L1 mode, the only ways to exit are: 1.) Entering *L0, *R0, or *R1 and 2.) Radio reset.

Screen blanking for secure operation. Radio will function normally. All numeric indicators are blanked:

- *S1 Remote Screen Blanking-Blank Screen.
- *S0 Remote Screen Blanking-Normal Screen.

CONFIGURATION DIAGRAM

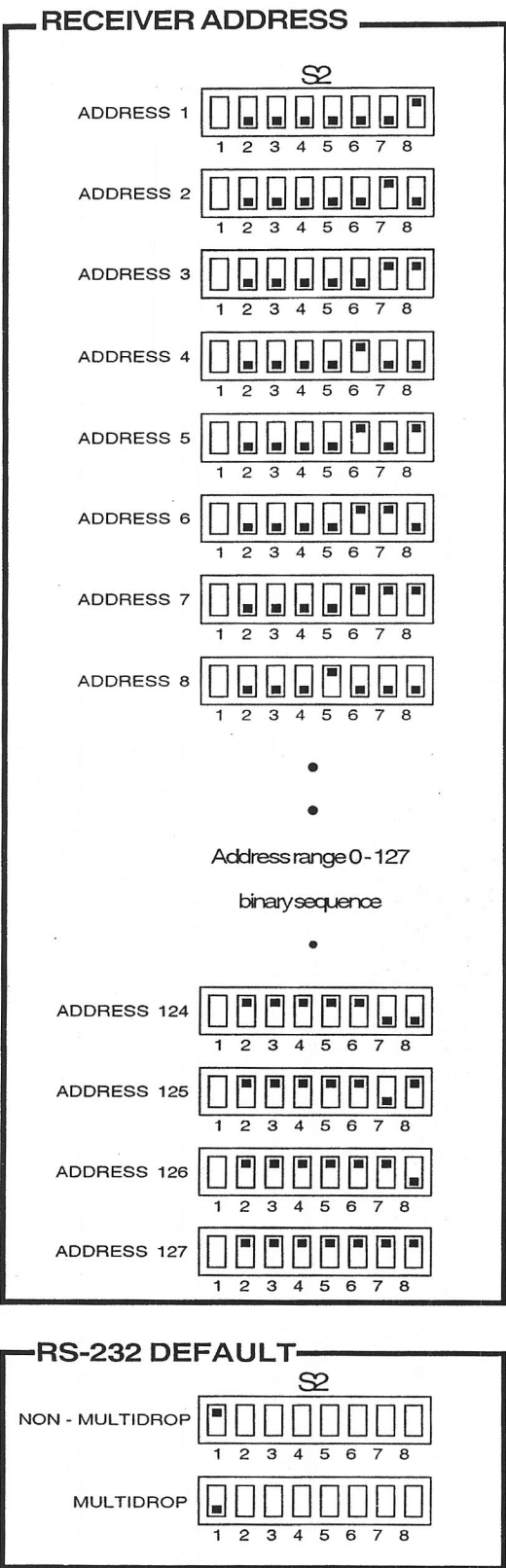
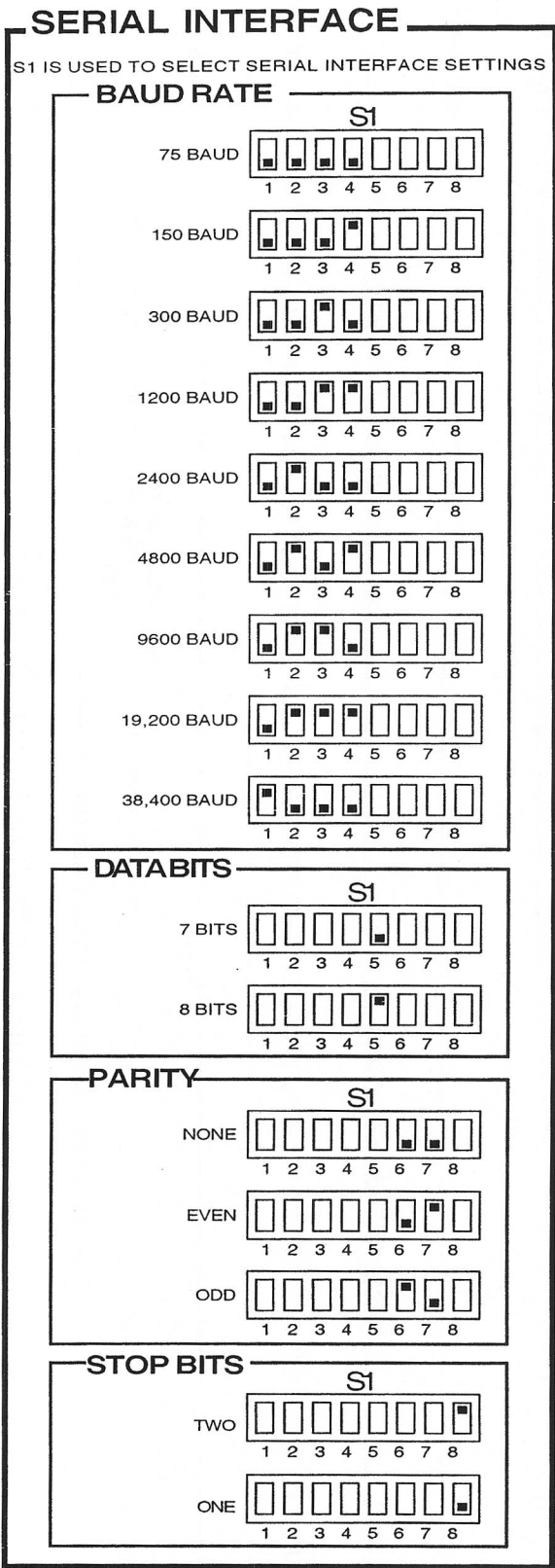

FIGURE 5-2

RX-340 SERIAL/PARALLEL INTERFACE

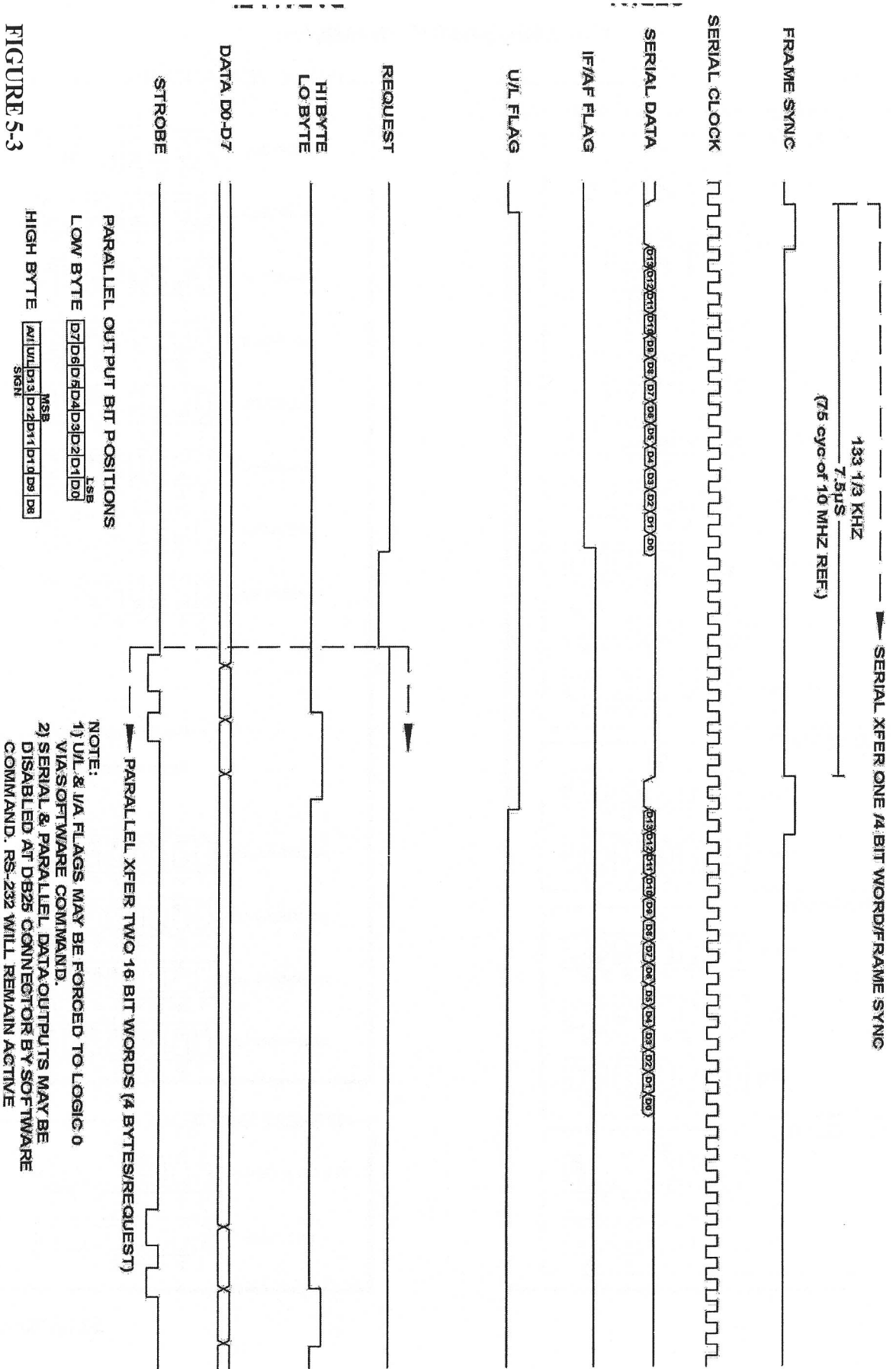
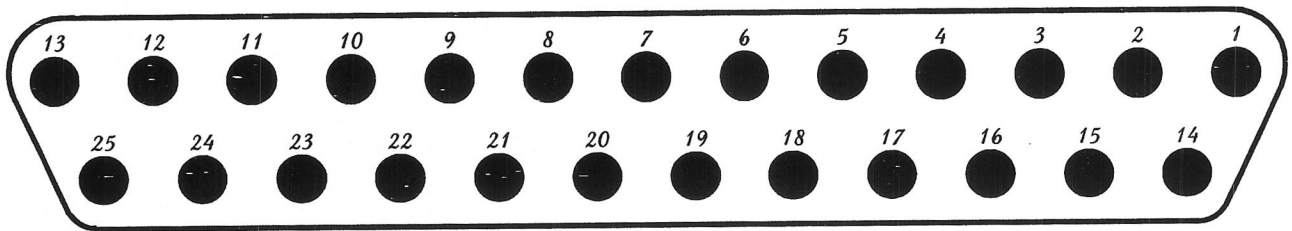

FIGURE 5-3

RX-340 DB25 PIN ASSIGNMENTS



1	GND	14	DSP SERIAL	FRAME SYNC
2	RS232 TXO	15	DSP SERIAL	SERIAL DATA
3	RS232 RXO	16	DSP SERIAL	SERIAL CLOCK
4	DSP PARALLEL HI/LO BYTE INDICATOR	17	DSP PARALLEL	DATAD1
5	DSP PARALLEL DATAD0	18	DSP PARALLEL	DATAD3
6	DSP PARALLEL DATAD2	19	DSP PARALLEL	DATAD4
7	GND	20	DSP PARALLEL	DATAD6
8	DSP PARALLEL DATAD5	21	GND	
9	DSP PARALLEL DATAD7	22	+5V	
10	DSP PARALLEL REQUEST	23	DSP PARALLEL	DATA STROBE
11	GND	24	GND	
12	DSP PARALLEL IF/AF INDICATOR	25	DSP PARALLEL	U/L INDICATOR
13	GND			

FIGURE 5-4

6-5.2 FUNCTIONAL TESTS FOR MODEL RX-340:

SPECIFICATION	TEST SETUP	TYP.	MIN/MAX
Sensitivity Preamp OFF Attenuator OFF	Connect a signal generator to the receiver RF input. Connect an audio analyzer with SINAD measurement capability to the mono audio output. Set receiver-tuned frequency to 15.01 MHz, preamp OFF.		
(Noise Fig. 18 dB typ. 20 dB max.)	USB MODE: IF BW 3.2 kHz MAGC = 0. Apply -109 dBm, 15.011 MHz. Adjust level for 10 dB SINAD.	-112 dBm	-110 dBm MAX
	CW MODE: IF BW 300 Hz. BFO -1000. Apply -113 dBm, 15.01 MHz. Adjust level for 16 dB SINAD.	-116 dBm	-114 dBm MAX
	AM MODE: IF BW 6 kHz Apply -100 dBm, 15.01 MHz, 50% modulation @ 400 Hz. Adjust level for 10 dB SINAD.	-103 dBm	-101 dBm MAX
	FM MODE: IF BW 16 kHz Apply -99 dBm, 15.01 MHz, 6 kHz Peak Deviation @ 1 kHz Adjust level for 16 dB SINAD.	-102 dBm	-100 dBm MAX
Preamp on (Noise Fig. 10 dB typ. 14dB max.)	USB MODE: Preamp ON IF BW 3.2 kHz MAGC = 0 Apply -119 dBm, 15.011 MHz Adjust level for 10 dB SINAD.	-119 dBm (.25 uV)	-115 dBm MAX
IMAGE REJ. (90 dB typ. 80 dB min.)	FIRST MIXER: Receive frequency 15.01 MHz., preamp OFF USB Mode IF BW 3.2 kHz BFO -1800 Hz		

SPECIFICATION	TEST SETUP	TYP.	MIN/MAX
	MAGC = 0 Apply 105.924 MHz, -50 dBm Increase level for 10 dB SINAD.	>10 dBm	-32 dBm MIN
	SECOND MIXER: Receive frequency 15.01 MHz. USB Mode IF BW 3.2 kHz BFO -1800 Hz MAGC = 0 Apply 15.923 MHz, -50 dBm Increase level for 10 dB SINAD.	-25 dBm	-32 dBm MIN
IF REJECTION (90 dB typ. 80 dB min.)	FIRST IF: Receive frequency 29.995 MHz, preamp OFF USB Mode IF BW 3.2 kHz BFO -1800 Hz MAGC = 0 Apply 45.456 MHz, -50 dBm Increase level for 10 dB SINAD.	>10 dBm	-32 dBm MIN
	SECOND IF: Receive frequency 0.500 MHz. Apply 456 kHz -50 dBm Increase level for 10 dB SINAD.	>10 dBm	-32 dBm MIN
3RD ORDER INTERCEPT POINT (+ 30 dBm typ. +25 dBm min.)	Configure the Two-Tone test set to produce a lowpass-filtered 16.208 MHz / 16.308 MHz two-tone output with each tone at 0 dBm (6 dBm PEP). Third order products and harmonics at the combiner output must be less than -80 dBm. Connect the two-tone output through a 1 dB step attenuator to the receiver RF input. Receive frequency 16.1072 MHz, preamp OFF Set MAGC to 65 dB Note audio output level in dBv. Reduce the two-tone level by 3 dB and observe a 9 dB drop in audio output. Remove the two-tone generator and step attenuator. Connect a 16.1082-MHz generator to RF input. Adjust generator level for the same audio level noted above. Generator level should be:	-60 dBm	-50 dBm MAX

SPECIFICATION	TEST SETUP	TYP.	MIN/MAX
Second Order Intercept Point (+75 dBm typ. +60 dBm min.)	Receive frequency 26.005 MHz, preamp OFF. MAGC = 0. Set generator to 22.728 MHz. Connect sufficient lowpass filtering to generator output to reduce 2nd harmonic to -100 dBc at -30 dBm output. Connect filtered generator to RF input. Adjust generator level for 10 dB SINAD. Generator level should be:	-17 dBm	-26dBm MIN
Inband IMD (-55 dB typ. -50 dB max.)	Configure the two-tone test set to produce a lowpass filtered 16.208/16.2085 MHz two-tone with each tone at -16 dBm (-10 dBm PEP). Third order products and harmonics must be less than -80 dBm. Connect the two-tone to the receiver RF input. Receive frequency 16.207 MHz, USB, AGC=SLOW, preamp OFF. Send a status request command to the receiver and note the received signal level. Add 10 to the signal level, and set the Manual Gain (Attenuation) to this number. Connect the audio spectrum analyzer to the MONO AUDIO output. Analyzer settings: 1250 Hz CF 30 Hz RBW 10 Hz VBW 200 Hz/div 0 dBm Input Level 20 dBm Log Reference 1 sec/div Scan Time Adjust Display Reference to place each main tone at -6 dB. Third order products should be: Turn attenuator ON Each main tone should drop to:	-55 dB -20 dB	-50 dB MAX +/- 3 dB
Lo Phase Noise @ 20 kHz offset	Connect a 16.208 MHz / 15 dBm crystal oscillator thru 10 dB and 1 dB step attenuators to RF in. Connect audio analyzer to MONO AUDIO output. Receive frequency 16.227 MHz, USB, preamp OFF. Set attenuator to 80 dB		

SPECIFICATION	TEST SETUP	TYP.	MIN/MAX
(120 dB/Hz typ. -110 dB/Hz max.)	MAGC = 20. Note audio noise level in dBm. Decrease attenuator setting for a 10 dB rise in noise level. Attenuator setting should be:	42 dB	52 dB MAX

Important Note: 10-dB rise above typical receiver noise floor of -122 dBm/3.2 kHz is -147 dBm/Hz. Subtract RF input level from this to obtain dBc/Hz phase noise. Phase noise of the *xtal oscillator* or *signal generator* used must be at least 20 dB better than the expected measurement.

Blocking ON Tune (<5% THD: 0 dBm input 30% AM 1 kHz)	AM Mode, 6 kHz BW. Receive frequency 15.01 MHz, preamp OFF. Connect signal generator to RF input. Set signal generator to 15.01 MHz, 30% AM/ 1 kHz, -6 dBm MAGC = 0. AGC Mode = Slow. Set audio analyzer to read % distortion. Distortion should be less than:	2.5%	5% MAX
--	--	------	--------

Blocking OFF Tune (200 kHz offset 15 dBm typ. 10 dBm min.)	Receive frequency 16.408 MHz, preamp OFF. Connect a +15 dBm, 16.208-MHz crystal oscillator through a step attenuator to a directional coupler input. Connect the direct output of the directional coupler to the receiver RF input. Terminate the forward port of the coupler. Connect a -40 dBm, 16.408 MHz, 30% AM/ 1 kHz, signal generator to the reverse port of the directional coupler. Set step attenuator to 50 dB Set audio analyzer to read AC Level in dBm. Increase MAGC setting until the AC Level reading drops by 10 dBm Reduce attenuator setting until blocking begins (3 dB drop in AC Level). RF input level should be:	> 15 dBm	10 dBm MIN
--	--	----------	------------

CHAPTER 7

PREPARATION FOR SHIPMENT OR STORAGE

7-1 PREPARATION FOR RESHIPMENT: If the Model RX-340 ever needs to be packaged for reshipment, it is recommended that the following steps be taken:

1. Remove all cords or cables attached to the unit.
2. Ensure that there is sufficient bubble packing material in the shipping carton to protect the unit from any hard impact that may occur during shipment.
3. Place the unit in the center of the shipping carton.
4. Cover the unit with bubble packing material.
5. If using a cardboard packing carton, securely tape the seams of the carton's top cover, bottom cover, and side flaps with reinforced tape.
6. Fasten labels or stamps.
7. With indelible ink, write the word FRAGILE on the top, bottom, and all sides of the carton.

7-2 PREPARATION FOR STORAGE: If the Model RX-340 is not going to be used for a long period of time, it should be stored in its shipping case or some other suitable carton. The unit is rated for storage at temperatures from -50° F to 160° F. To prepare the unit for storage perform the following steps:

1. Remove all cords or cables attached to the unit.
2. Ensure that there is sufficient bubble packing material in the container.
3. Place the unit in the center of the packing container.
4. Cover the unit with bubble packing material.
5. If using a cardboard packing carton, securely tape the container with reinforced packing tape.
6. Fasten labels or stamps.
7. With indelible ink, write the word FRAGILE on the top, bottom, and all sides of the container. Also, write the Model No. and quantities in large characters on top of the carton.

CHAPTER 8

SINGLE SOURCE PARTS LIST

8-1 INTRODUCTION: Table 8-1 is a listing of all the parts available from only one unique manufacturer or source. The table lists the Sub-Assembly Number, Manufacturer Part Number, Manufacturer Code, Part Description, and the Ten-Tec Part Number.

TABLE 8-1 MODEL RX-340 SINGLE SOURCE PARTS LIST

S/A NO.	MFR. PART No.	MFR. CODE	DESCRIPTION	TEN-TEC PART No.
81772.TCXO	BLBC-2TX3-4P	CTC	TRANSFORMER-TRIFILAR BALUN	211531
81772.TCXO	E528 SN-100067	TOKO	COIL-ADJ 6.5T .214uH	21253
81772.TCXO	E540SN-15001	TOKO	COIL-ADJ 15.5T	21254
81772.TCXO	MC145170D1	MOT	IC-PLL	25405
81772.TCXO	2N7002LT1	MOT	FET	25412
81772.TCXO	MC145157DW2	MOT	IC	25440
81772.TCXO	BB132	SPS	DIODE-VARACTOR	28131
81772.TCXO	TMP-J01X-U6	TKD	JACK-MINICOAX TMP VERT.	35225
81772.TCXO	KC155 (10MM)	CTC	SHIELD CAN-10MM	38226
81772.TCXO	HC-45UPAD	FM	INSULATOR PAD HC-45U	38262
81772.TCXO	38F401	VE	TERMINAL PIN .041 DIA	41009
81772.TCXO	3132B	PTI	MONOLYTHIC FILTER 45MHZ	48202
81772.TCXO	VTX014010G	SCT	VCTCXO 10 MHZ	48256
81772.TCXO	DFA20-HAV10MHZ A1	FRDL	VCTCXO 10 MHZ	48255
81772.TCXO	85419-4	TT	COIL 8T #24	85419-4
81772.TCXO	85419-5	TT	COIL 4T #22	85419-5
81772.TCXO	85419-9	TT	COIL 9T #24	85419-9
81772.TCXO	91744	TT	ENCLOSURE VCO	91744
81772.TCXO	91745	TT	COVER VCO	91745
81772.TCXO	93171	TT	SHIELD 2ND MIXER	93171
81772.TCXO	93459	TT	SHIELD .750X1.750	93459
81772.TCXO	93467	TT	INSULATOR FOR 49255	93467

TABLE 8-1 MODEL RX-340 SINGLE SOURCE PARTS LIST (cont.)

S/A NO.	MFGR. PART NO.	MFGR. CODE	DESCRIPTION	TEN-TEC PART NO.
81790.SMD	42XLO16	MEI	TRANSFORMER 600Ω CT.	21185
81790.SMD	AD7872JN	AD	IC - ANALOG TO DIGITAL CONVERTER	25348
81790.SMD	AD7840JN	AD	IC - DIGITAL TO ANALOG CONVERTER	25349
81790.SMD	TMP-J01X-U6	TKD	JACK-MINICOAX TMP VERT.	35225
81790.SMD	CFU455D2	MERA	455 KHz FILTER	48198
81807	27C010-150	TT	EPROM, PROGRAMMED	98404
81807	27C010-150	TT	EPROM, PROGRAMMED	98406
81807	80C552-5	SPS	IC - CPU-U1	25331
81807	ADSP2181KS-133	AD	IC -DSP CPU	25362
81807	M48Z58Y-70	SGS	IC-SRAM	25401
81807	MAX 242CWN	MAX	IC - CONVERTER	25415
81807	9536-15VQ44C	XIL	IC- GATE ARRAY	25416
81807	CS82C55A-5	HC	IC- PLCC	25417
81807	DAC0800LCM	NS	IC -DIGITAL TO ANALOG CONVERTER	25418
81807	AD7945BR	AD	IC-ANALOG TO DIGITAL CONVERTER	25424
81807	TMP-J01X-U6	TKD	JACK-MINICOAX TMP VERT.	35225
81817.SMD	BLBC-2TX2-4P	CTC	TRANSFORMER - BIFILAR BALUN	21152
81817.SMD	BLBC-2TX3-4P	CTC	TRANSFORMER - TRIFILAR BALUN	21153
81817.SMD	TBC-#30TRIFX8T-FT23	3LG	TRANSFORMER-TRIFILAR	21255
81817.SMD	TBC-#30 BIFX12T-FT23	3LG	TRANSFORMER-BIFILAR	21256
81817.SMD	2SC1971	MEAI	VHF-TRANSISTOR	25337
81817.SMD	MC145170D1	MOT	IC - PLL	25405
81817.SMD	MCI2019D	MOT	IC ÷20/21 PRESCALER	25427
81817.SMD	AD600JR	AD	IC - DUAL AMPLIFIER	25432
81817.SMD	SVC321SPA	AII	DIODE-VARACTOR	28099
81817.SMD	MMBD352WT1	MOT	DIODE DUAL SCHOTTKY	28132

TABLE 8-1 MODEL RX-340 SINGLE SOURCE PARTS LIST (cont.)

S/A NO.	MFR. PART NO.	MFR. CODE	DESCRIPTION	TEN-TEC PART NO.
81817.SMD	7MM	AMC	SHIELD CAN-COIL, 7MMNI PLATED	38131
81817.SMD	TMP-J01X-U6	TKD	JACK-MINICOAX TMP VERT.	35225
81817.SMD	KC155 (10MM)	CTC	SHIELD CAN-10MM	38226
81817.SMD	CFW455D	MERA	455KH FILTER	48203
81817.SMD	91744	TT	ENCLOSURE-VCO	91744
81819	80C552-5	SPS	CPU	25331
81819	TDA1013BU	SPS	AUDIO AMP	25356
81819	HPRG-17R	HP	ENCODER 120CPR	32114
81819	CLH-109-F-D-PE	STI	SOCKET PASS THROUGH 18 PIN	35301
81819	HC-45UPAD	FM	INSULATOR PAD HC-45U	38262
81819	AT27C25620	TT	IC, PROGRAMMED	98412
81820	A6810SLW	AGO	IC-LEDDRIVER	25407
81820	TL1240N/1JBLK	ESW	SWITCH-TACTILE	32125
81820	TL2406/2JBLK	ESW	SWITCH-TACTILE	32126
81820	TSW-109-1	STI	TERMINAL STRIP 18 PIN	35302
81820	98408	TT	SWITCH SCREENED LARGE	98408
81820	98409	TT	SWITCH SCREENED SMALL	98409
81823.SMD	BLBC-2TX2-4P	CTC	TRANSFORMER - BIFILAR BALUN	21152
81823.SMD	BLBC-2TX3-4P	CTC	TRANSFORMER - TRIFILAR BALUN	21153
81823.SMD	456PS-1011	TOKO	TRANSFORMER, DIRECTIONAL COUPLER	21191
81823.SMD	K1SO-1.1uH	3LG	COIL-ADJ 1uH W/CT	21194
81823.SMD	K1SO-3T:3T-HD9	3LG	COIL-ADJ .68uH W/CT	21251
81823.SMD	2SC1971	MEAI	VHF-TRANSISTOR	25337
81823.SMD	MMBD352WT1	MOT	DIODE DUAL SCHOTTKY	28132
81823.SMD	TMP-J01X-U6	TKD	JACK-MINICOAX TMP VERT.	35225
81823.SMD	KC155(10MM)	TKD	SHIELD CAN 10MM	38226

TABLE 8-1 MODEL RX-340 SINGLE SOURCE PARTS LIST (cont.)

S/A NO.	MFR. PART NO.	MFR. CODE	DESCRIPTION	TEN-TEC PART NO.
81823.SMD	HC-45UPAD	FM	INSULATOR PAD HC-45U	38262
81823.SMD	8390B	PTI	MONOLITHIC FILTER PAIR 45,455MHZ	48226
81823.SMD	85414-11	TT	TRANSFORMER, TRIFILAR	85414-11
81823.SMD	91744	TT	ENCLOSURE-VCO	91744
81823.SMD	93172	TT	SHIELD 1ST MIXER	93172
81823.SMD	93368	TT	VCO BOTTOM SHIELD	93368
81824				
81878	A6810SLW	AGO	IC-LEDDRIVER	25407
81878	2027-23-B	JLY	ANTENNA SURGE PROTECTOR	27040
81878	MA4P7001F-1072T	MCOM	DIODE PIN	28144
81878	TMP-J01X-U6	TKD	JACK-MINICOAX TMP VERT.	35225
81878	CBS-TYPE51	LDR	FENCE	38272
81878	85414-10	TT	COIL	85414-10
81878	85414-11	TT	COIL	85414-11
81878	93175	TT	SHIELD	93175
81878	93351	TT	COVER FOR PERSELECTOR	93351
FINAL	16LF01UA3	SMG	DISPLAY, VFD 1 X 16	28137
FINAL	90Q125-02-00245	OAK	ENCODER-ROTARY, 128 PULSE	32089
FINAL	PSA-4541	PHO	SWITCHING POWER SUPPLY	21200
FINAL	SGSM4Z28	SGS	BATTERY	37008
FINAL	34055	TT	METER SCREENED FOR RX 340	98457
FINAL	CU16025ECPB-U1J	NCI	DISPLAY VFD 2 X 16	28138
FINAL	78181	HTI	OVERLAY	72181

TABLE 8-2 PART MANUFACTURER'S INFORMATION

MFGR'S CODE	MANUFACTURER NAME AND ADDRESS
3LG	3L GLOBAL 2915 ANVIL STREET N, ST.PETERSBURG, FL 33710
AD	ANALOG DEVICES INC., ONE TECHNOLOGY WAY, PO BOX 9106, NORWOOD, MA 02060-9106
AGO	ALLEGRO MICROSYSTEMS INC., 115 NORTHEAST CUTOFF BOX 15036, WORCESTER, MA 01615
AII	ALPHA INDUSTRIES, INC. 20 SYLVAN ROAD WWOBURN, MA 01801
AMC	AURA MRG. COMPANY, 50 MC DERMATT RD., NORTH HAVEN, CT 06473
CTC	CTC COILS LTD FLAT L-M, 141 F HARIBEST IND'L BLDG., 45-47 AU PUI, WAM STREET FO-TAN, SHATIN, NT HONG KONG
ESW	E-SWITCH 7153 NORTHLAND DR., BROOKLYN PARK, MN 55428
FM	FREQUENCY MANAGEMENT, 15302 BOLSA CHICA ST., HUNTINGTON BEACH, CA 92649
FOX	FOX ELECTRONICS, 5570 ENTERPRISE PKY., FT. MYERS, FL 33905
FRDL	FORDAHL USA 8875 KNOLL DRIVE (EXT) GAINSVILLE, GA 30506
HC	HARRIS CORP, SEMICONDUCTOR PRODUCTS DIV., PO BOX 883, MELBOURNE, FL 32902
HP	HEWLETT PACKARD CO., PO BOX 10301, PALO ALTO, CA 94303-0890
HTI	HALLMARK TECHNOLOGIES INC. 1717 EAST LINCOLN AVENUE MT. DORA, FL 32757
JLY	JOSLYN ELECTRONICS SYSTEMS 6868 CORTONA DR. GOLETA, CA 93116
LDR	LEADER TECH, 14100 MC CORMICK DRIVE, TAMPA, FL 33626
MAX	MAXIM INTEGRATED PRODUCTS INC., 120 SAN GABRIEL DR., SUNNYVALE, CA 94086
MCOM	M/ACOM 1011 PAWTUCKET BOULEVARD, LOWELL, MA 01853
MEAI	MITSUBISHI ELECTRONICS AMERICA, INC. 1050 EAST ARQUES AVENUE, SUNNYVALE, CA 94086
MEI	MOUSER ELECTRONICS INC., 1175 N.E. 24 STREET, PO BOX 5727 FORT LAUDERDALE, FL 33310

TABLE 8-2 PART MANUFACTURER'S INFORMATION (cont.)

MFR'S CODE	MANUFACTURER NAME AND ADDRESS
MERA	MURATA ERIE NORTH AMERICA INC., 1148 FRANKLIN RD S.E., MARIETTA, GA 30067
MOT	MOTOROLA SEMICONDUCTOR PRODUCTS INC., 3501 ED BLUESTEIN BLVD., AUSTIN, TX 78721
NCI	NORTAKE COMPONENTS INC. 3091 HOLCOMB BRIDGE RD. SWEET E1 NORCROSS, GA 30071
NS	NATIONAL SEMICONDUCTOR 2900 SEMICONDUCTOR DRIVE, P.O.BOX 58090, SANTA CLARA, CALIFORINA 95052-8090
OAK	OAKGRIGSBY 84 NORTH DUGAN ROAD P.O.BOX 890, SUGAR GRAVE, IL 50554-0590
PHO	PHIHONG USA, 374 S. MILPITAS BLVD. MILPITAS, CA 95035
PTI	PIEZO TECHNOLOGY INC., 2525 SHADER RD., PO BOX 547859, ORLANDO, FL 32854-7859
SCT	SIWARD CRYSTAL TECHNOLOGY CO., LTD 15.LANE 81,TAN-FU,SEC.2 TA FUNG TSUN,TANTZU HSING, TAI-CHUNG, TAIWAN, R.O.C.
SGS	SGS-THOMSON, 55 OLD BEDFORD ROAD, LINCOLN, MA 01773
SMG	SAMSUNG IN CARE OF ESI 303 WILLIAM AVE. SWEET 422 HUNTSVILLE, AL 35801
SPS	SIGNETICS/PHILLIPS SEMICONDUCTORS, 811 EAST ARQUES AVE, SUNNYVALE, CA 94088-3409
STI	SAMTEC ,INC. P.O.BOX 1147 NEW ALBANY, IN 47151-1147
TKD	TAIKO DENKI 3-7-3, YAGUCHI,OTA-KU, TOKYO 146
TOKO	TOKO AMERICA, 1250 PEEHANVILLE DRIVE, MOUNT PROSPECT, IL MOUNT PROSPECT, IL 60056
TT	TEN-TEC, INC., 1185 DOLLY PARTON PARKWAY, SEVIERVILLE, TN 37862
VE	VECTOR ELECTRONICS 11115 VANOWEN ST., NORTH HOLLYWOOD, CA 91605-6371
XIL	XILINX, 2100 LOGIC DRIVE, SAN JOSE, CA 95124-3400

CHAPTER 9

FINAL ASSEMBLY

9-1 INTRODUCTION: Table 9-1 is a listing of all the modules in the RX-340 that can be replaced in corrective maintenance procedures. Figure 3-1 illustrates where the modules are located in the chassis. Table 9-2 is a listing of additional small parts which may need to be replaced if the receiver has been damaged.

TABLE 9-1 RX-340 MODULES

DESCRIPTION	TT PART NO.
81772.TCXO	SYNTHESIZER
81790.SMD	CONVERTER(I/O)
81807	CPU/DSP
81817.SMD	2ND MIXER 3RD/LO
81819	FRONT PANEL CPU
81820	KEYPAD
81823.SMD	1ST MIXER
81824	P.S. FILTER
81878	RXPRESELECTOR

TABLE 9-2 FINAL ASSEMBLY REPLACEABLE PARTS

DESCRIPTION	TT PART NO.
SWITCHING POWER SUPPLY	21200
FUSE 1A TIME/DELAY 5X20MM	27071
RES-VAR 1K LIN	30087
RES VAR DUAL 1K GANGED	30621
SWITCH DPDT CURVETTE	32131
JACK-PHONE 1CKCT	35008
JACK-PHONE .25 DIA	35144
D-CONNECTOR 15 PIN	35287
BNC SHIELDED CONNECTOR	35286
POWER ENTRY MODULE	35299
BATTERY	37008
BUMPER RUBBER 3/4 DIA	42020
AC CORD DETACHABLE	46138
SPEAKER 4-IN. SQ.	47017
DISPLAY VFD 1 X 16	28137
ENCODER ROTARY 128 PULSE	32089
RACK HANDLE 4 IN.	38222
MAIN TUNING KNOB	81569
DISPLAY VFD 2 X 16	28138
MEDIUM KNOB	90880
SMALL KNOB ID.250	90930
SMALL KNOB ID .236	90930-A
POINTER FOR SMALL KNOB	90931
KNOB DRAG BACK-UP	92856
ADDRESS COVER	93170
BEZEL PIN	93246
TOP	93371
BOTTOM	93372
LEFT SIDE-RIGHT SIDE	93373
CHASSIS RX 340	93375
REAR PANEL	93376-1A
SUB PANEL	93377
FRONT SUB-PANEL	93378
FRONT PANEL	93379-FE
SHIELD -1	93380-01
SHIELD -2	93380-02
SHIELD -3	93380-03
METER BRACKET	93412
SPEAKER PLATE	93424
BEZEL	93496
METER SCREENED RX340	98457

CHAPTER 10

ILLUSTRATIONS

10-1 INTRODUCTION: This chapter contains the detailed illustrations for the manual. This includes the block and schematic diagrams, parts lists, component location illustrations, and circuit board trace views.

MODEL RX-340 BLOCK DIAGRAM

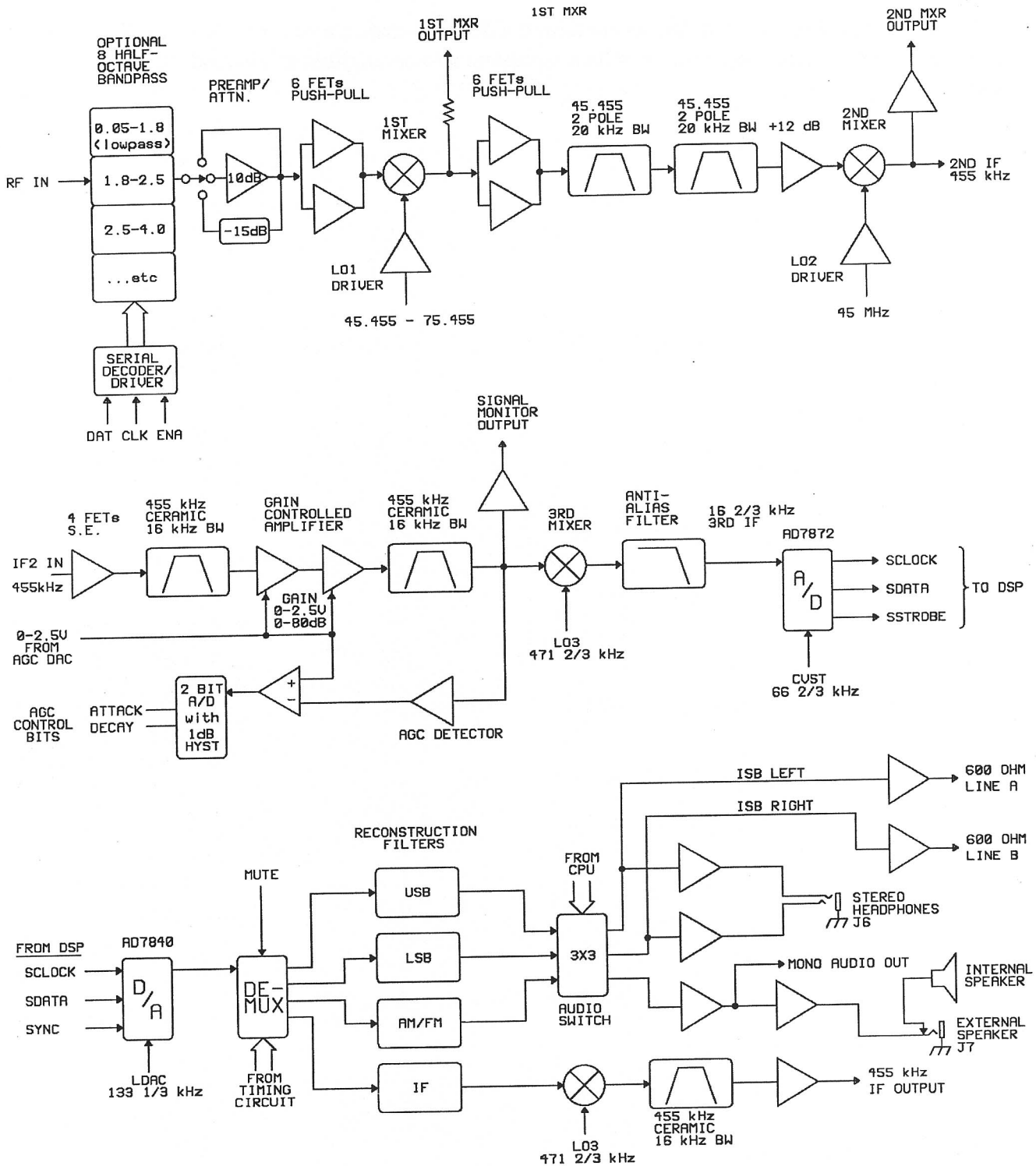

FIGURE 10-1

LOGIC BOARD BLOCK DIAGRAM

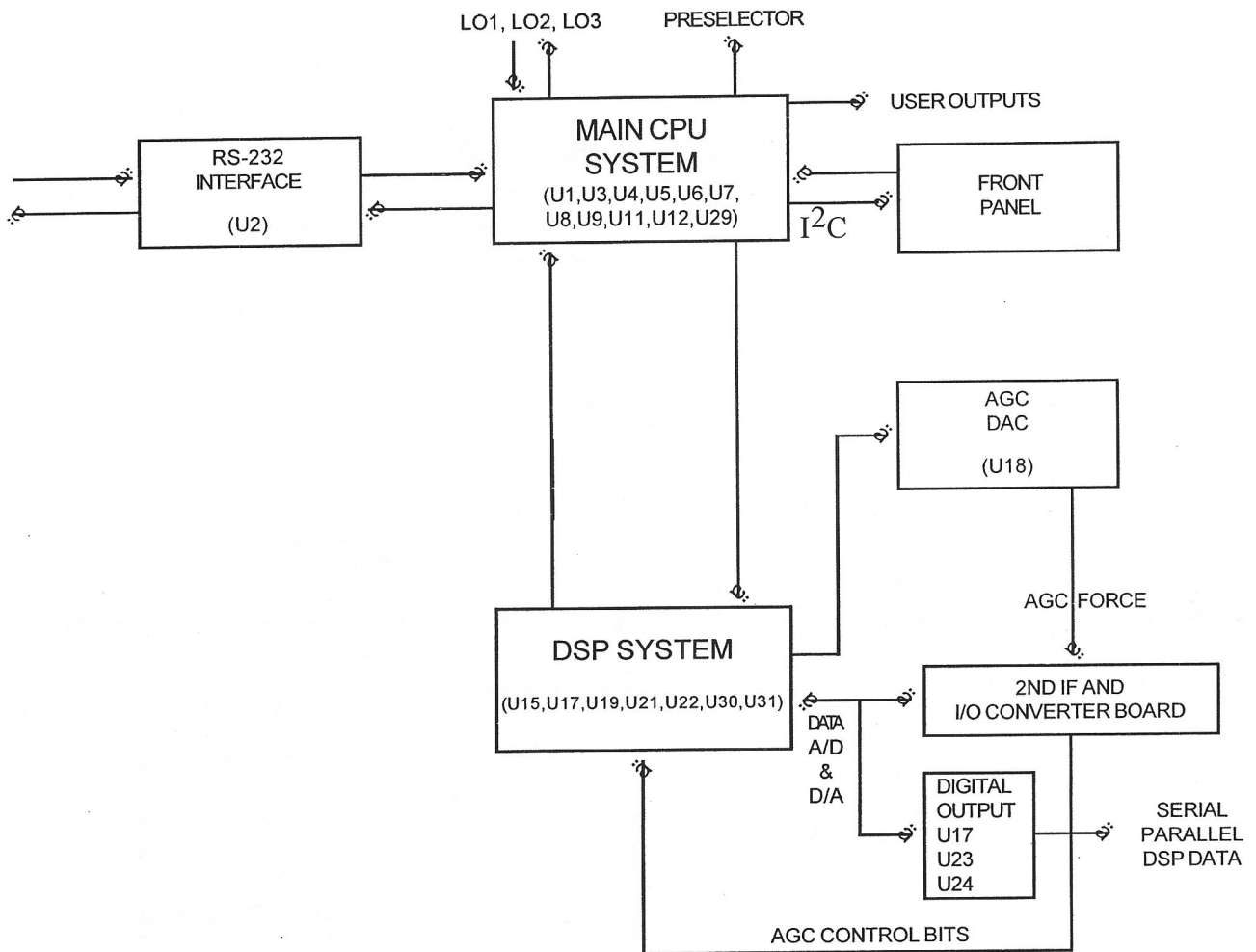

FIGURE 10-2

SYNTHESIZER BLOCK DIAGRAM

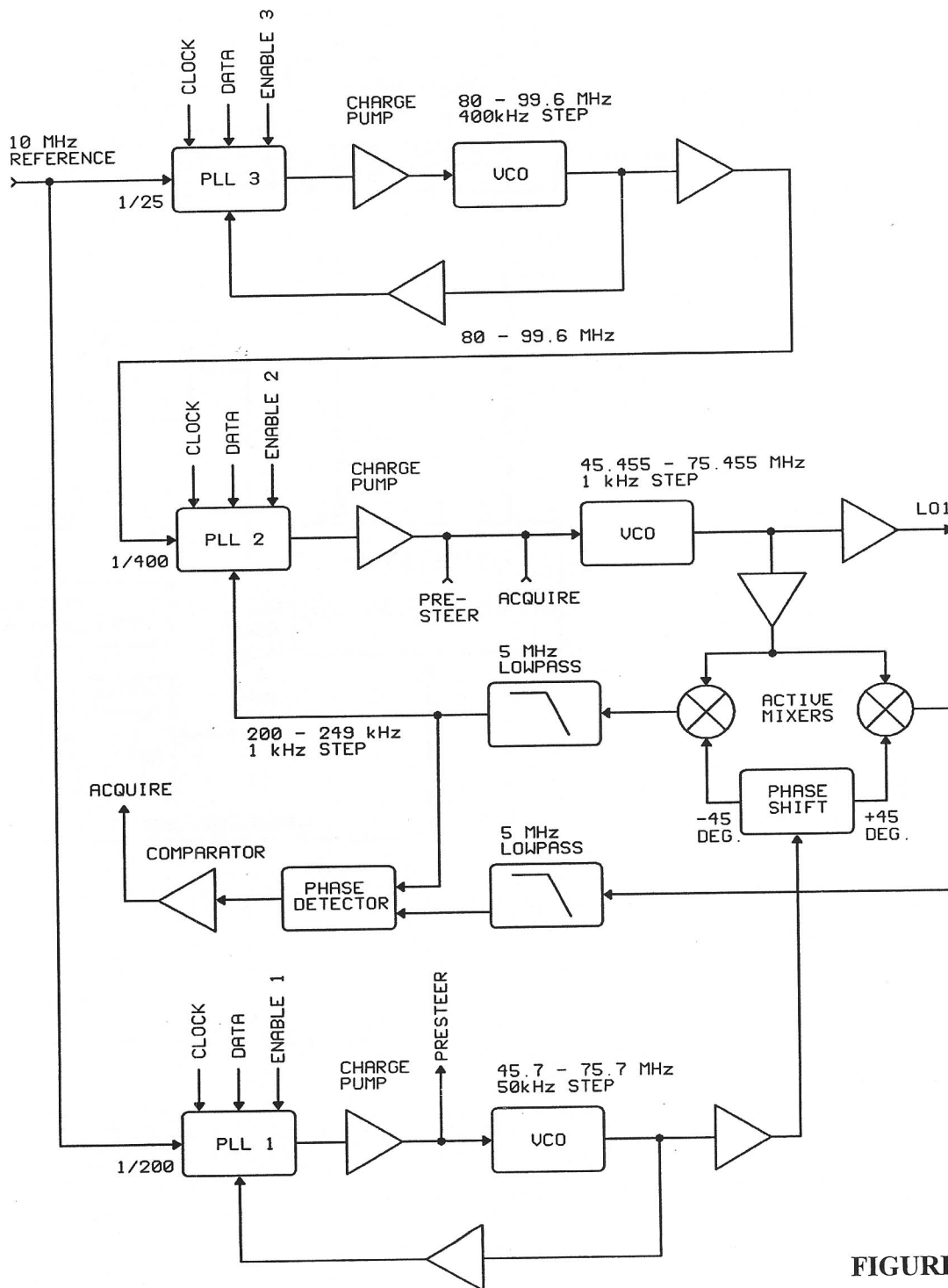
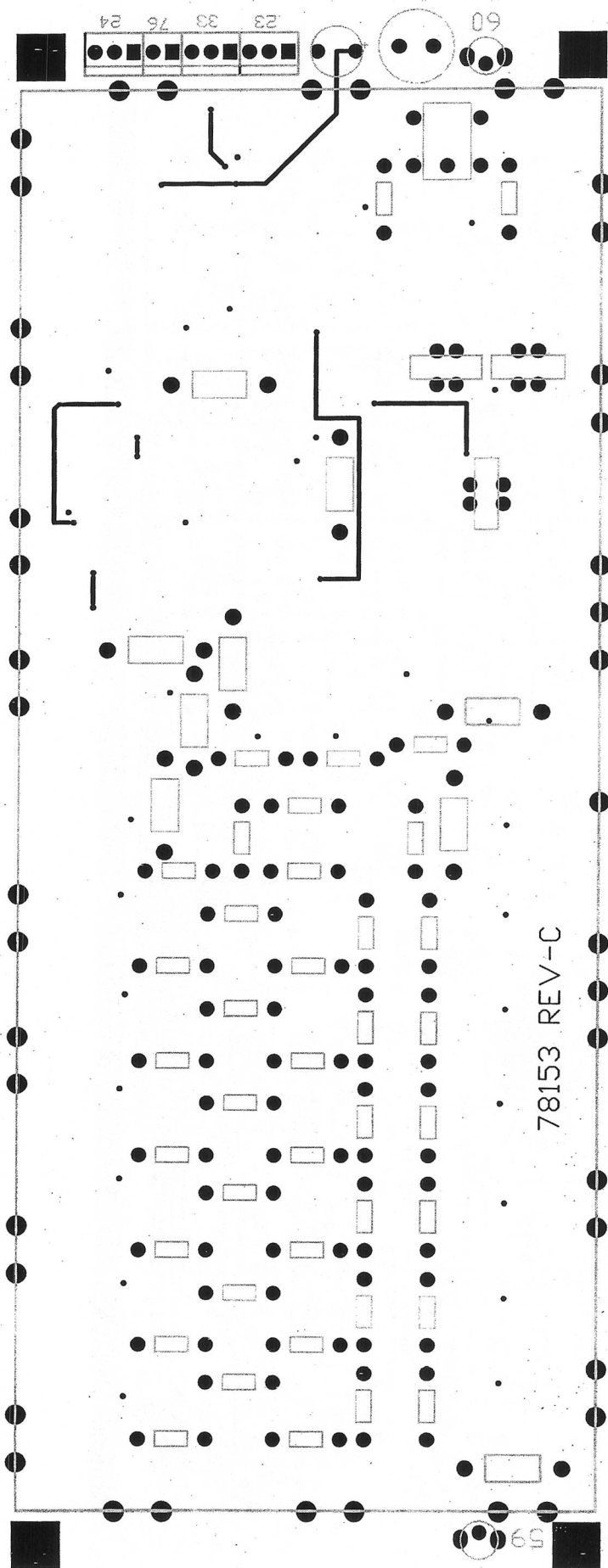

FIGURE 10-3

81878 PRESELECTOR TOP COPPER



78153 REV-C

FIGURE 10-4

81878 PRESELECTOR BOTTOM COPPER

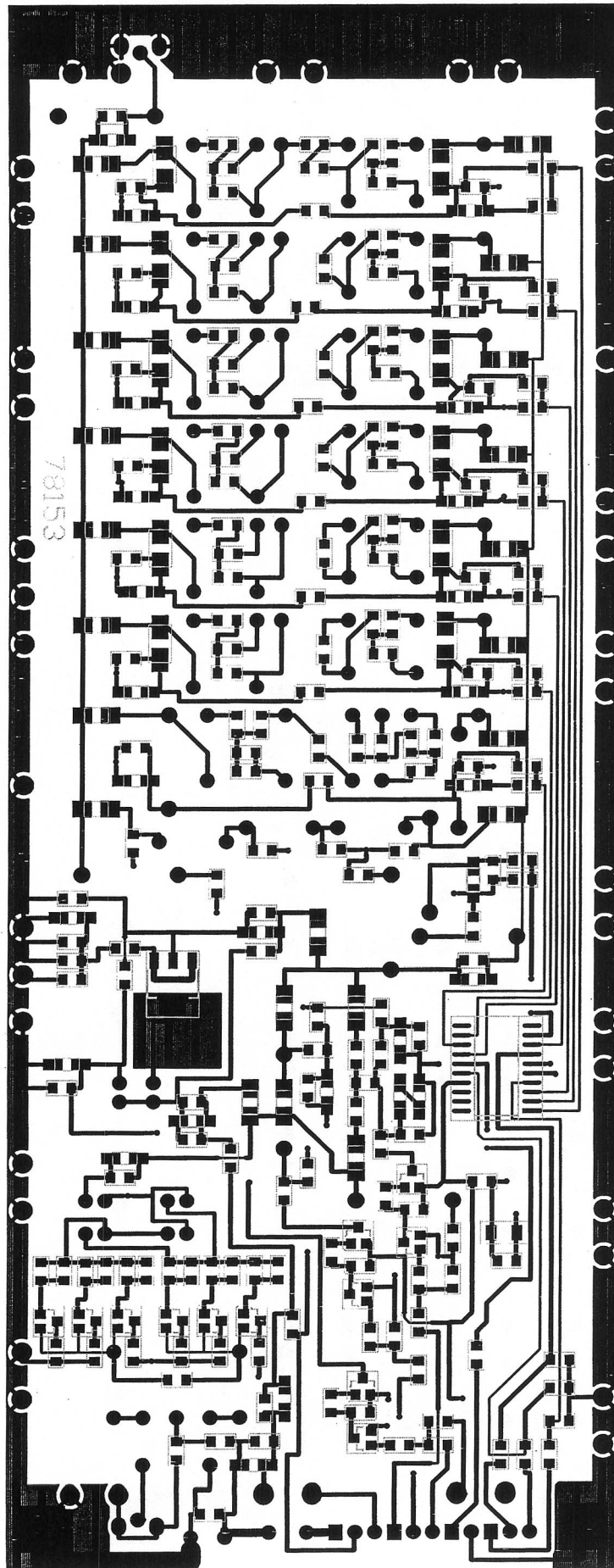

FIGURE 10-5

81878 PRESELECTOR TOP COMPONENT LAYOUT

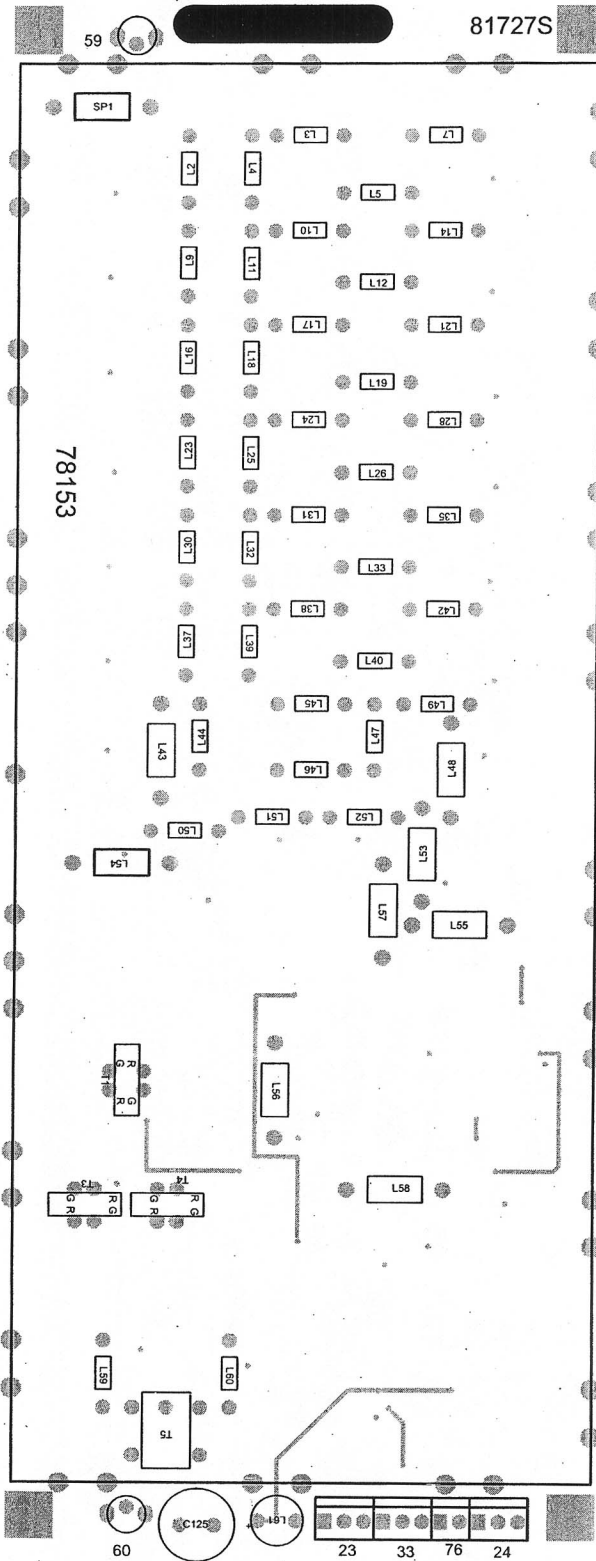

FIGURE 10-6

81878 PRESELECTOR BOTTOM COMPONENT LAYOUT

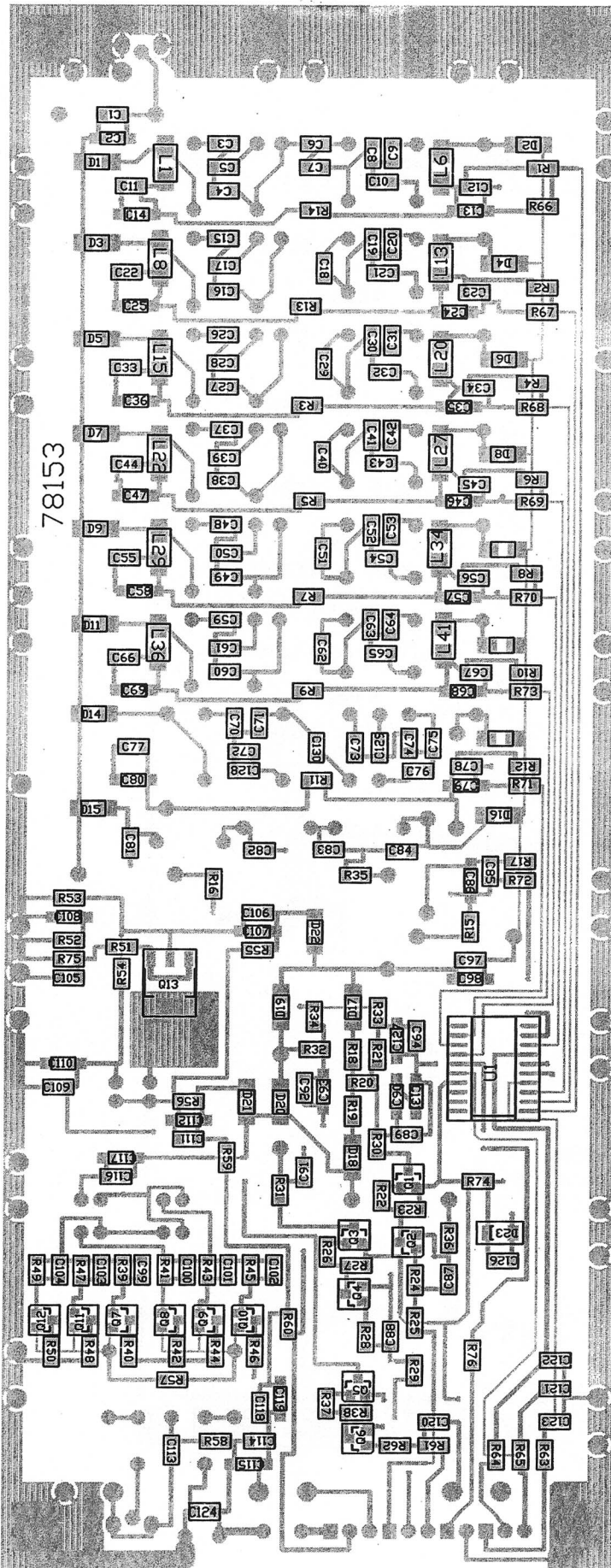
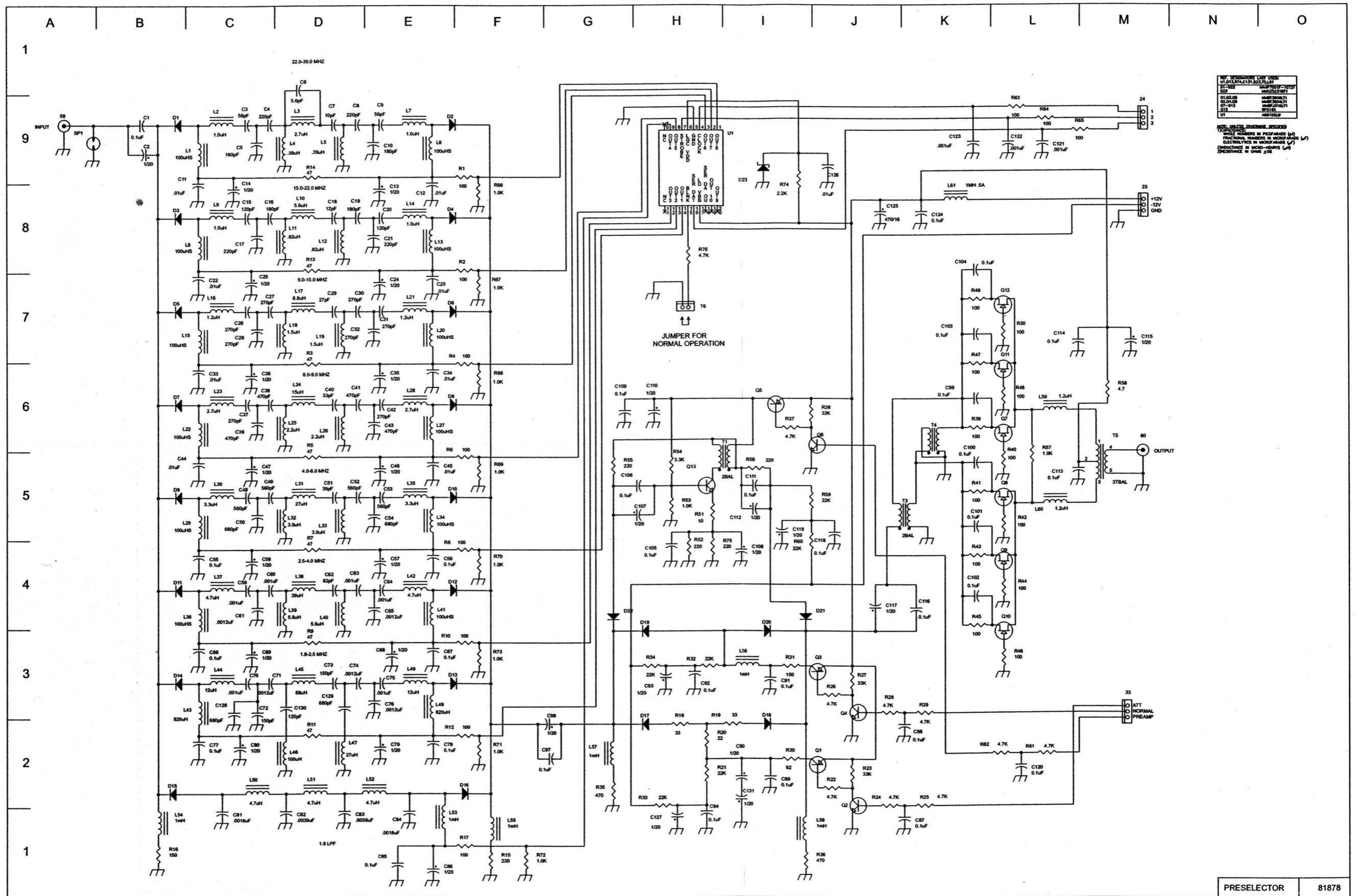

FIGURE 10-7



REF. DESIGNATION LAST USED
 U1 01A307A C131 023 PLSU1
 U2 01A307A C131 023 PLSU1
 U3 01A307A C131 023 PLSU1
 U4 01A307A C131 023 PLSU1
 U5 01A307A C131 023 PLSU1
 U6 01A307A C131 023 PLSU1
 U7 01A307A C131 023 PLSU1
 U8 01A307A C131 023 PLSU1
 U9 01A307A C131 023 PLSU1
 U10 01A307A C131 023 PLSU1
 U11 01A307A C131 023 PLSU1
 U12 01A307A C131 023 PLSU1
 U13 01A307A C131 023 PLSU1
 U14 01A307A C131 023 PLSU1
 U15 01A307A C131 023 PLSU1
 U16 01A307A C131 023 PLSU1
 U17 01A307A C131 023 PLSU1
 U18 01A307A C131 023 PLSU1
 U19 01A307A C131 023 PLSU1
 U20 01A307A C131 023 PLSU1
 U21 01A307A C131 023 PLSU1
 U22 01A307A C131 023 PLSU1
 U23 01A307A C131 023 PLSU1
 U24 01A307A C131 023 PLSU1
 U25 01A307A C131 023 PLSU1
 U26 01A307A C131 023 PLSU1
 U27 01A307A C131 023 PLSU1
 U28 01A307A C131 023 PLSU1
 U29 01A307A C131 023 PLSU1
 U30 01A307A C131 023 PLSU1
 U31 01A307A C131 023 PLSU1
 U32 01A307A C131 023 PLSU1
 U33 01A307A C131 023 PLSU1
 U34 01A307A C131 023 PLSU1
 U35 01A307A C131 023 PLSU1
 U36 01A307A C131 023 PLSU1
 U37 01A307A C131 023 PLSU1
 U38 01A307A C131 023 PLSU1
 U39 01A307A C131 023 PLSU1
 U40 01A307A C131 023 PLSU1
 U41 01A307A C131 023 PLSU1
 U42 01A307A C131 023 PLSU1
 U43 01A307A C131 023 PLSU1
 U44 01A307A C131 023 PLSU1
 U45 01A307A C131 023 PLSU1
 U46 01A307A C131 023 PLSU1
 U47 01A307A C131 023 PLSU1
 U48 01A307A C131 023 PLSU1
 U49 01A307A C131 023 PLSU1
 U50 01A307A C131 023 PLSU1
 U51 01A307A C131 023 PLSU1
 U52 01A307A C131 023 PLSU1
 U53 01A307A C131 023 PLSU1
 U54 01A307A C131 023 PLSU1
 U55 01A307A C131 023 PLSU1
 U56 01A307A C131 023 PLSU1
 U57 01A307A C131 023 PLSU1
 U58 01A307A C131 023 PLSU1
 U59 01A307A C131 023 PLSU1
 U60 01A307A C131 023 PLSU1
 U61 01A307A C131 023 PLSU1
 U62 01A307A C131 023 PLSU1
 U63 01A307A C131 023 PLSU1
 U64 01A307A C131 023 PLSU1
 U65 01A307A C131 023 PLSU1
 U66 01A307A C131 023 PLSU1
 U67 01A307A C131 023 PLSU1
 U68 01A307A C131 023 PLSU1
 U69 01A307A C131 023 PLSU1
 U70 01A307A C131 023 PLSU1
 U71 01A307A C131 023 PLSU1
 U72 01A307A C131 023 PLSU1
 U73 01A307A C131 023 PLSU1
 U74 01A307A C131 023 PLSU1
 U75 01A307A C131 023 PLSU1
 U76 01A307A C131 023 PLSU1
 U77 01A307A C131 023 PLSU1
 U78 01A307A C131 023 PLSU1
 U79 01A307A C131 023 PLSU1
 U80 01A307A C131 023 PLSU1
 U81 01A307A C131 023 PLSU1
 U82 01A307A C131 023 PLSU1
 U83 01A307A C131 023 PLSU1
 U84 01A307A C131 023 PLSU1
 U85 01A307A C131 023 PLSU1
 U86 01A307A C131 023 PLSU1
 U87 01A307A C131 023 PLSU1
 U88 01A307A C131 023 PLSU1
 U89 01A307A C131 023 PLSU1
 U90 01A307A C131 023 PLSU1
 U91 01A307A C131 023 PLSU1
 U92 01A307A C131 023 PLSU1
 U93 01A307A C131 023 PLSU1
 U94 01A307A C131 023 PLSU1
 U95 01A307A C131 023 PLSU1
 U96 01A307A C131 023 PLSU1
 U97 01A307A C131 023 PLSU1
 U98 01A307A C131 023 PLSU1
 U99 01A307A C131 023 PLSU1
 U100 01A307A C131 023 PLSU1

FIGURE 10-8 81878 PRESELECTOR SCHEMATIC

PART NO. 81878
 1st Printing 2/01
 Printed in U.S.A.

TABLE 10-1 81878 RX PRESELECTOR PARTS LIST

I.D.	Description	Part No.
C6	5.6pF	23459
C7	10pF	23462
C18	12pF	23463
C29	27pF	23467
C40	33pF	23468
C51	39pF	23469
C3,C9	56pF	23471
C62	82pF	23473
C15,C20,C130	120pF	23475
C72,C73	150pF	23476
C5,C10,C16,C19	180pF	23477
C4,C8,C17,C21	220pF	23478
C26,C27,C28,C30,C31,C32,C37, C42	270pF	23479
C38,C39,C41,C43	470pF	23482
C48,C49,C52,C53	560pF	23483
C50,C54,C128,C129	680pF	23484
C59,C60,C63,C64,C70,C75,C121,C122,C123	.001uF	23486
C61,C65,C71,C74,C76	.0012uF	23521
C81,C84	.0018uF	23522
C83,C82	.0039uF	23501
C11,C12,C22,C23,C33,C34,C44,C45,C126	.01uF	23487
C1,C55,C56,C66,C67,C77,C78,C85,C87,C88,C89,C91,C92, C94,C97,C99,C100,C101,C102,C103,C104,C105,C106,C109, C111,C113,C114,C116,C118,C120,C124.	0.1uF	23488
C2,C13,C14,C24,C25,C35,C36,C46,C47,C57,C58,C68,C69, C79,C80,C86,C90,C93,C98,C107,C108,C110,C112,C115, C117,C119,C127,C131.	-----	-----
C125	470/16	23501
D1,D2,D3,D4,D5,D6,D7,D8,D9,D10,D11,D12,D13,D14,D15, D16,D17,D18,D19,D20, D21,D22.	-----	-----
D23	MA4P7001F	28144
L4,L5	-----	-----
L12,L11	MMSZ5231BT1	28127
L2,L7,L9,L14	.39uH	21107
L16,L21,L59,L60	.82uH	21111
L18,L19	1.0uH	21112
L25,L26	1.2uH	21113
L3,L23,L28	1.5uH	21114
L30,L35	2.2uH	21116
L32,L33	2.7uH	21117
L37,L42,L50,L51,L52	3.3uH	21118
L10,L39,L40	3.9uH	21119
L17	4.7uH	21120
	5.6uH	21121
	6.8uH	21122

TABLE 10-1 81878 RX PRESELECTOR PARTS LIST (continued)

I.D.	Description	Part No.
L44,L49	12uH	21125
L24	15uH	21126
L31,L47	27uH	21129
L38	39uH	21159
L45	68uH	21162
L46	100uH	21164
L1,L6,L8,L13,L15,L20,L22,L27,L29,L34,L36,L41	100uHS	21192
L43,L48	820uH	21095
L53,L54,L55,L56,L57,L58	1mH	21261
L61	1mH .5A	21262
Q7,Q8,Q9,Q10,Q11,Q12	MMBFJ310LT1	25377
Q2,Q4,Q6	MMBT3904LT1	25375
Q1,Q3,Q5	MMBT3906LT1	25376
Q13	BFG16A	25431
R58	4.7	30634
R51	10	30638
R20	22	30642
R19,R18	33	30644
R3,R5,R7,R9,R11,R13,R14	47	30646
R30	82	30649
R1,R2,R4,R6,R8,R10,R12,R17,R39,R40,R41,R42,R43,R44, R45,R46,R47,R48,R49,R50,R63,R64,R65.	100	30650
R31,R16	150	30652
R15,R52,R55,R56,R75	220	30654
R35,R36	470	30658
R53,R57,R66,R67,R68,R69,R70,R71,R72,R73	1.0K	30662
R74	2.2K	30666
R54	3.3K	30668
R22,R24,R25,R26,R28,R29,R37,R61,R62,R76	4.7K	30670
R21,R32,R33,R34,R59,R60	22K	30678
R23,R27,R38	33K	30680
SP1	2027-23-B	27040
T1,T3,T4	TOROID	85414-10
T5	TOROID	85414-11
U1	A6810SLW	25407

81823.SMD 1ST MIXER TOP COPPER

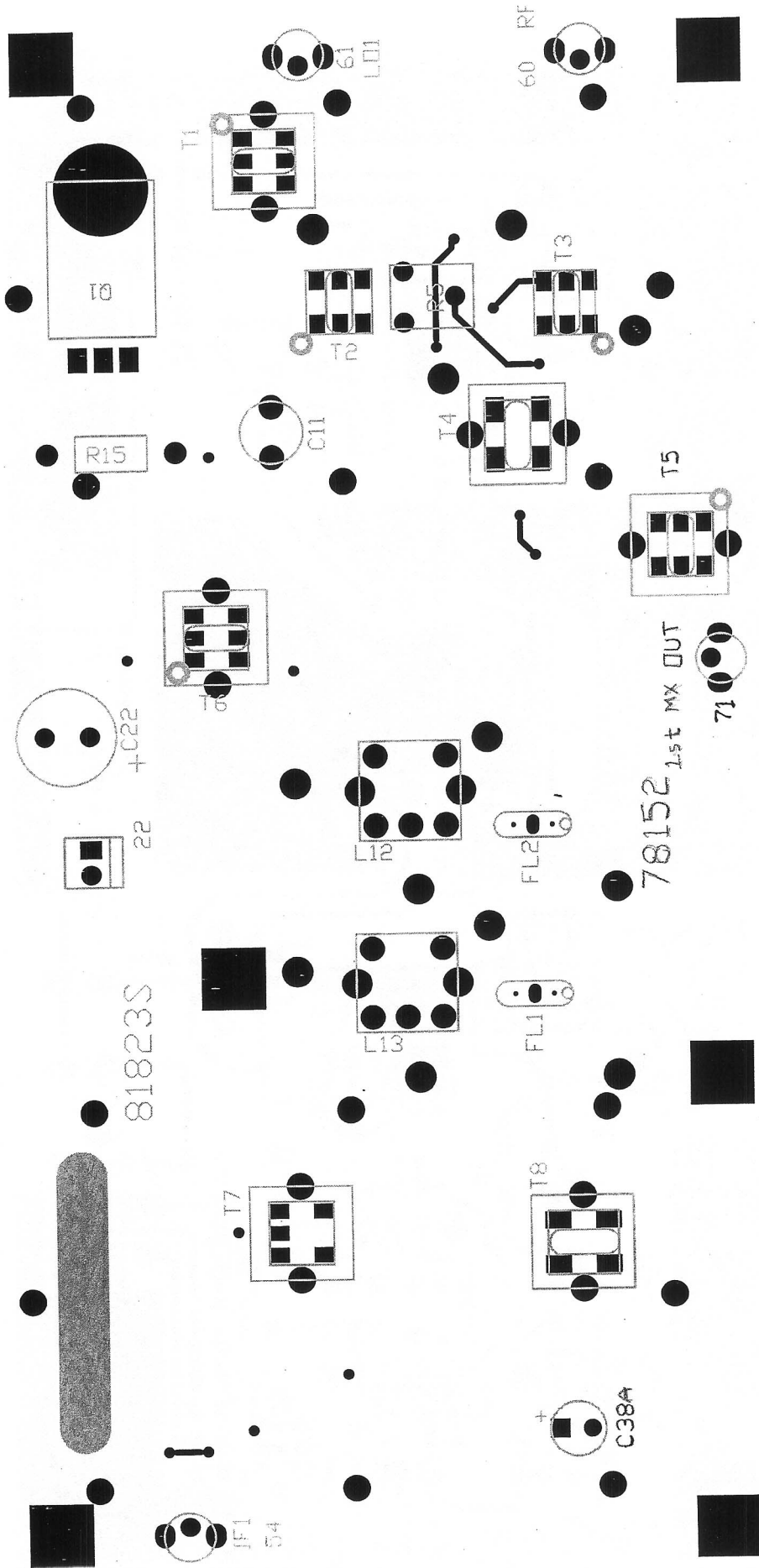

FIGURE 10-9

81823.SMD 1ST MIXER BOTTOM COPPER

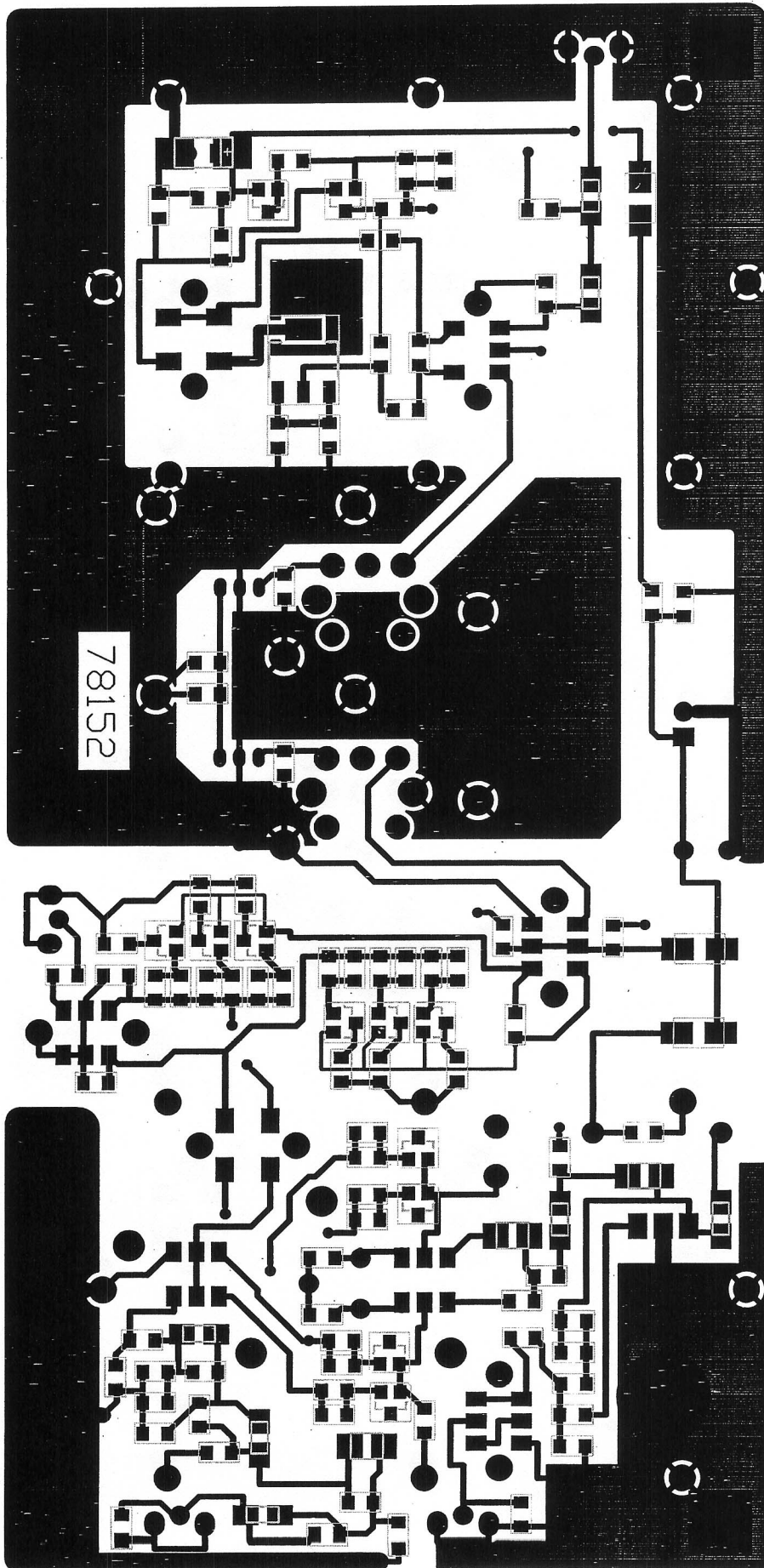

FIGURE 10-10

81823.SMD 1ST MIXER TOP COMPONENT LAYOUT

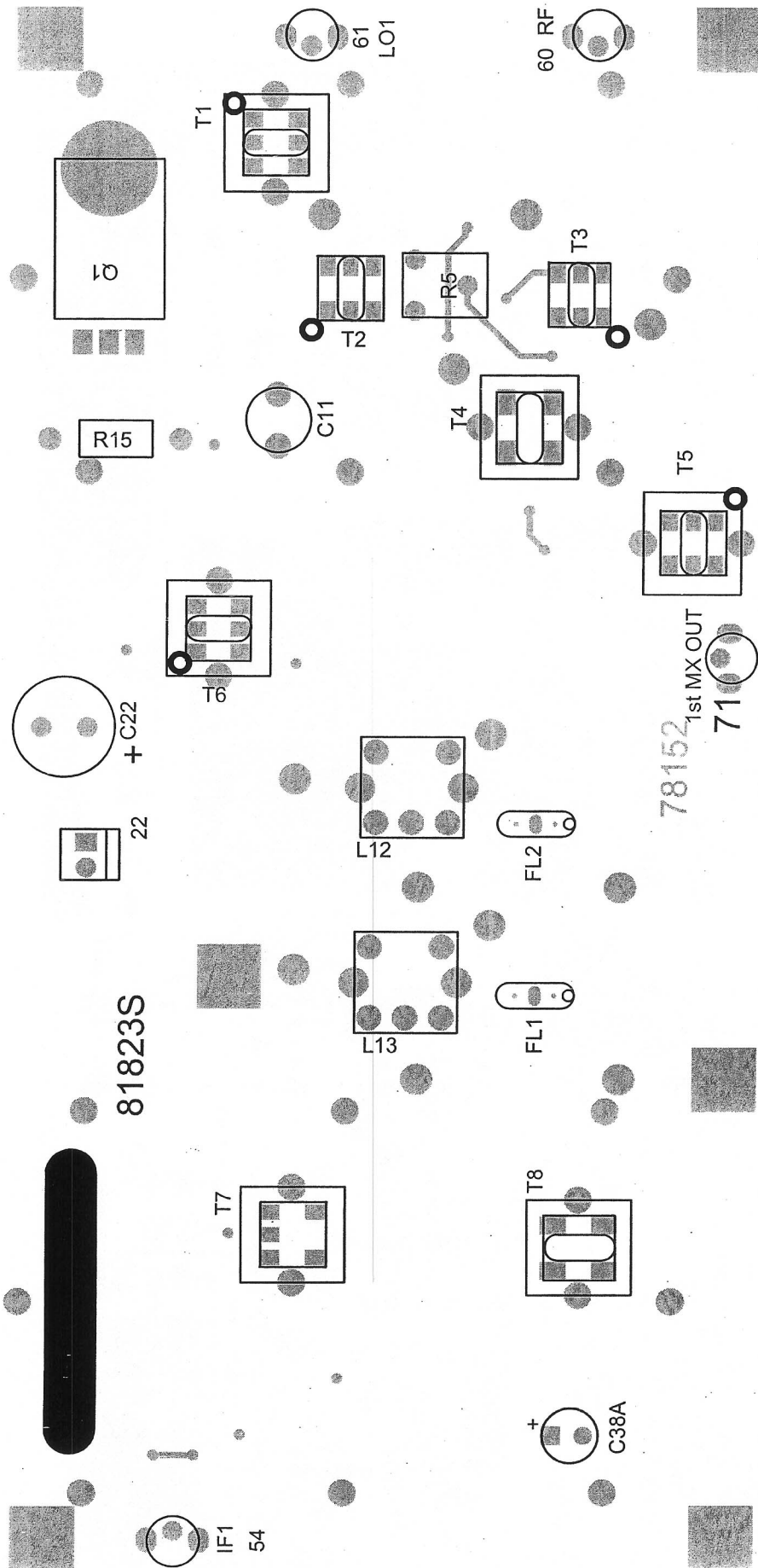

FIGURE 10-11

81823.SMD 1ST MIXER BOTTOM COMPONENT LAYOUT

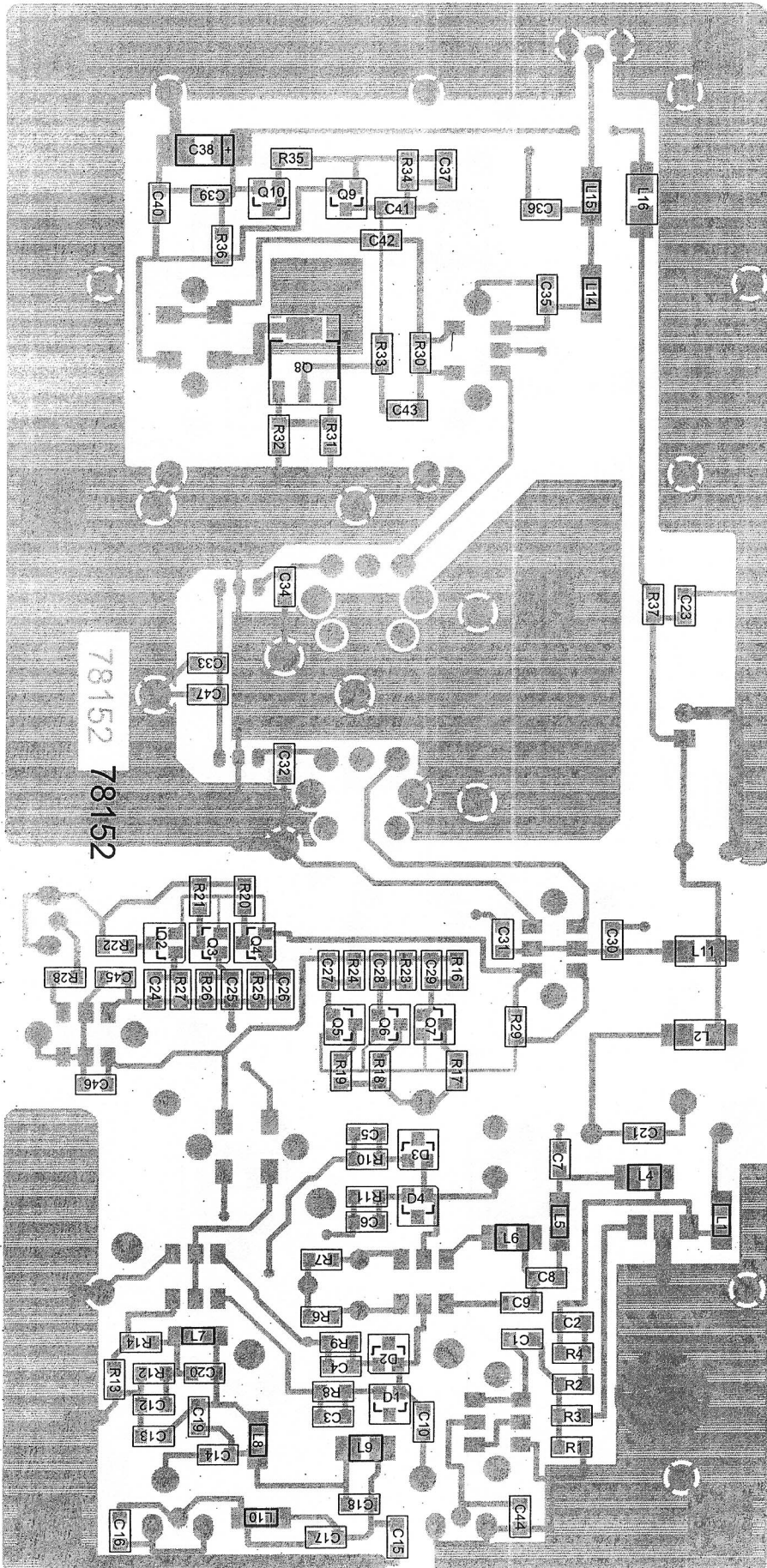

FIGURE 10-12

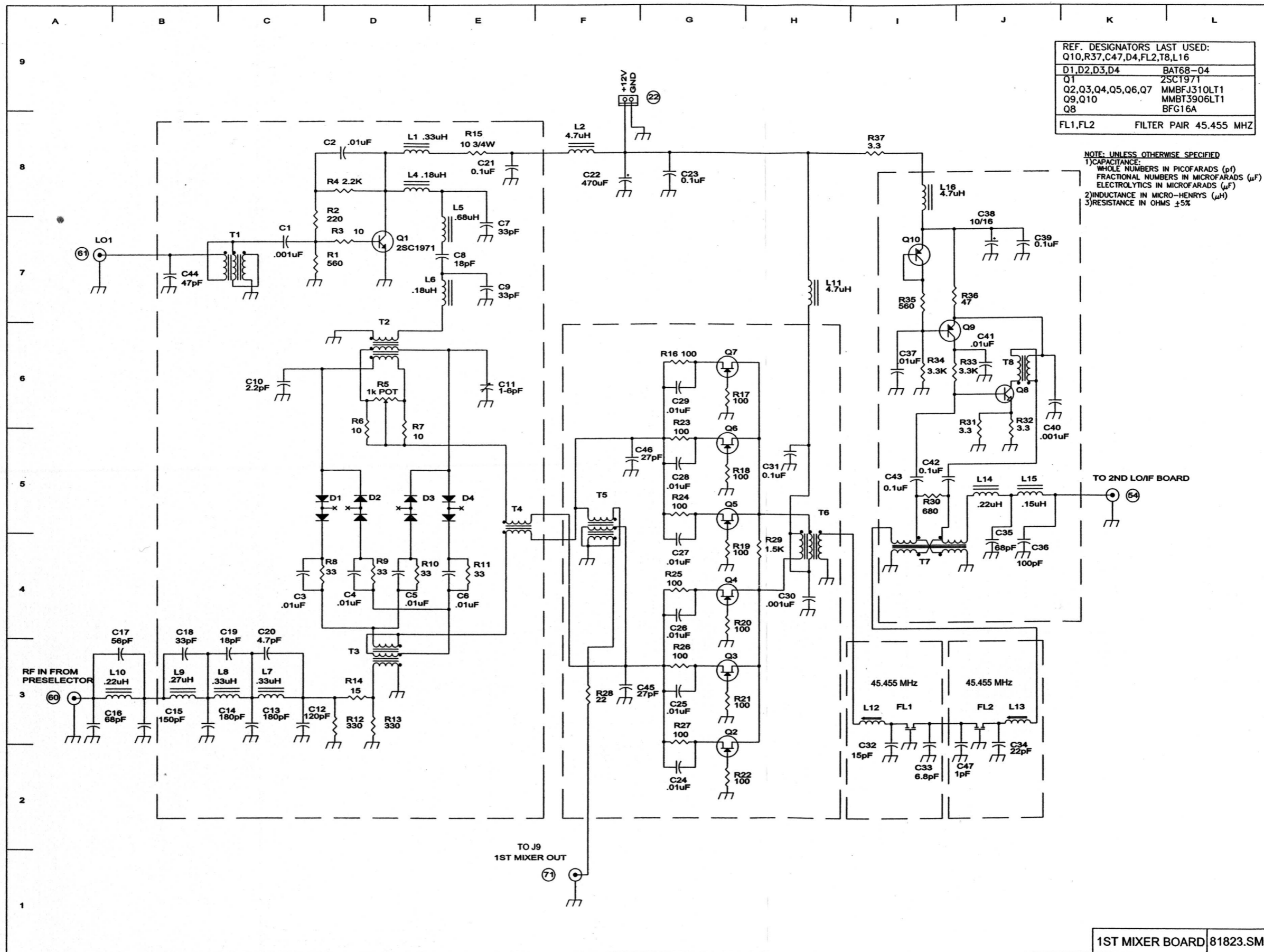

FIGURE 10-13 81823.SMD 1ST MIXER SCHEMATIC

TABLE 10-2 81823.SMD 1ST MIXER PARTS LIST

I.D.	Description	Part No
C47	NOT USED	
C11	1-6pF	23244
C10	2.2pF	23454
C20	4.7pF	23458
C33	6.8pF	23460
C32	15pF	23464
C8,C19	18pF	23465
C34	22pF	23466
C45,C46	27pF	23467
C7,C9,C18	33pF	23468
C44	47pF	23470
C17	56pF	23471
C35,C16	68pF	23472
C36	100pF	23474
C12	120pF	23475
C15	150pF	23476
C13,C14	180pF	23477
C2,C3,C4,C5,C6,C24,C25,C26,C27,C28,C29,C37,C41	.01uF	23487
C1,C30,C40	.001uF	23486
C21,C23,C31,C39,C42,C43	0.1uF	23488
C38	10/16	23525
C38A (REPLACES C38)	10/25	23266
C22	470uF	23228
D1,D2,D3,D4	BAT68_04	28132
FL1,FL2	45MONO	48226
L15	.15uH	21212
L4,L6	.18uH	21213
L10,L14	.22uH	21214
L9	.27uH	21215
L1,L7,L8	.33uH	21216
L5	.68uH	21220
L2,L11,L16	4.7uH	21197
L12	VAR 1uH	21194
L13	VAR .68uH	21251
Q1	2SC1971	25337
Q2,Q3,Q4,Q5,Q6,Q7	MMBFJ310LT1	25377
Q10,Q9	MMBT3906LT1	25376
Q8	BFG16A	25431
R31,R32,R37	3.3	30633
R3,R6,R7	10	30638
R14	15	30640
R28	22	30642
R8,R9,R10,R11	33	30644
R36	47	30646

TABLE 10-2 81823.SMD 1ST MIXER PARTS LIST (continued)

I.D.	Description	Part No
R16,R17,R18,R19,R20,R21,R22,R23,R24,R25,R26,R27	100	30650
R5	1K POT	30618
R2	220	30654
R13,R12	330	30656
R1,R35	560	30659
R30	680	30660
R29	1.5K	30664
R4	2.2K	30666
R34,R33	3.3K	30668
R15	10 3/4W	30022
T4,T8	2BAL	21152
T1,T2,T3,T5,T6	3BAL	21153
T7	DIR COUPLER	21191

81817.SMD 2ND MIXER TOP COPPER

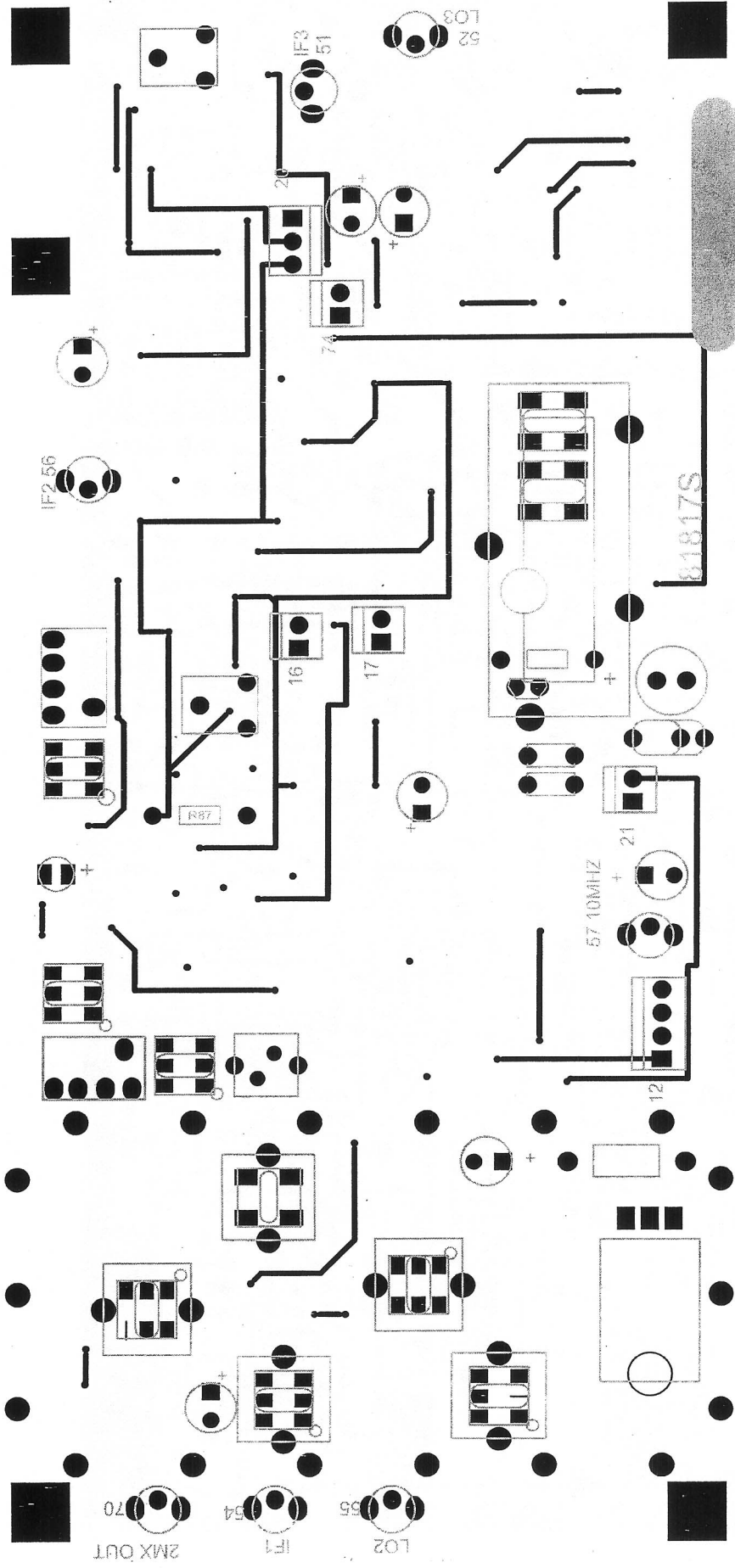

FIGURE 10-14

81817.SMD 2ND MIXER BOTTOM COPPER

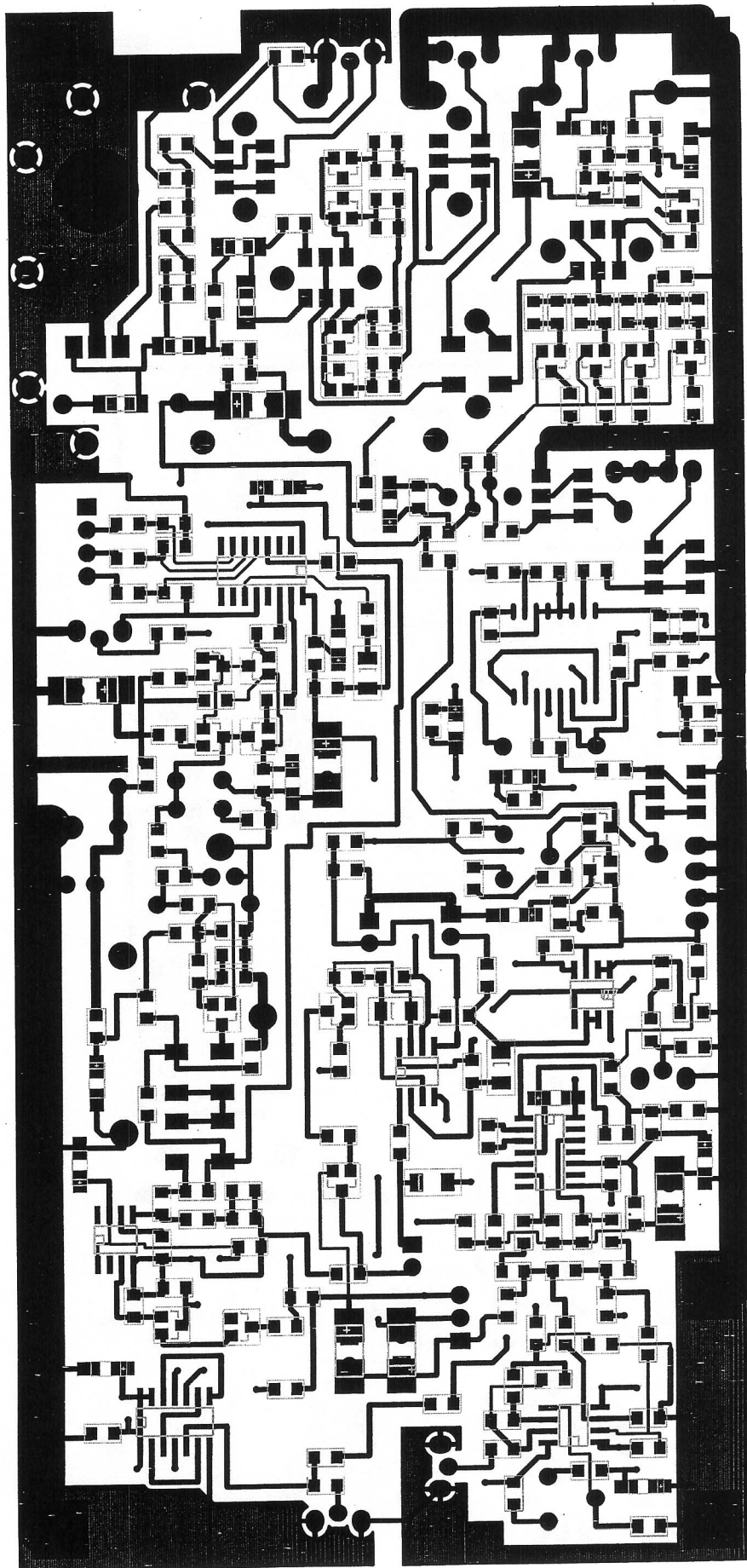

FIGURE 10-15

81817.SMD 2ND MIXER TOP COMPONENT LAYOUT

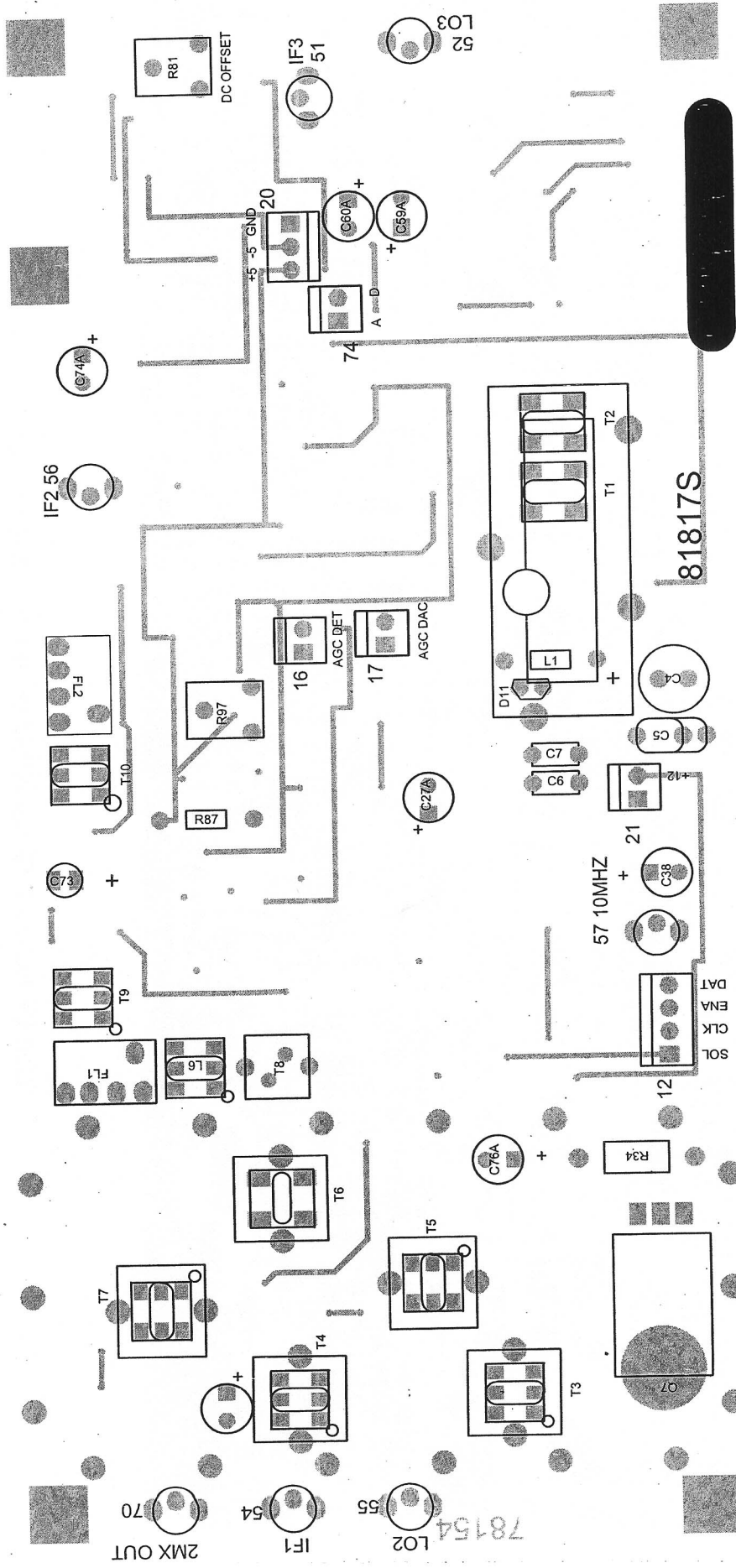

FIGURE 10-16

81817.SMD 2ND MIXER BOTTOM COMPONENT LAYOUT

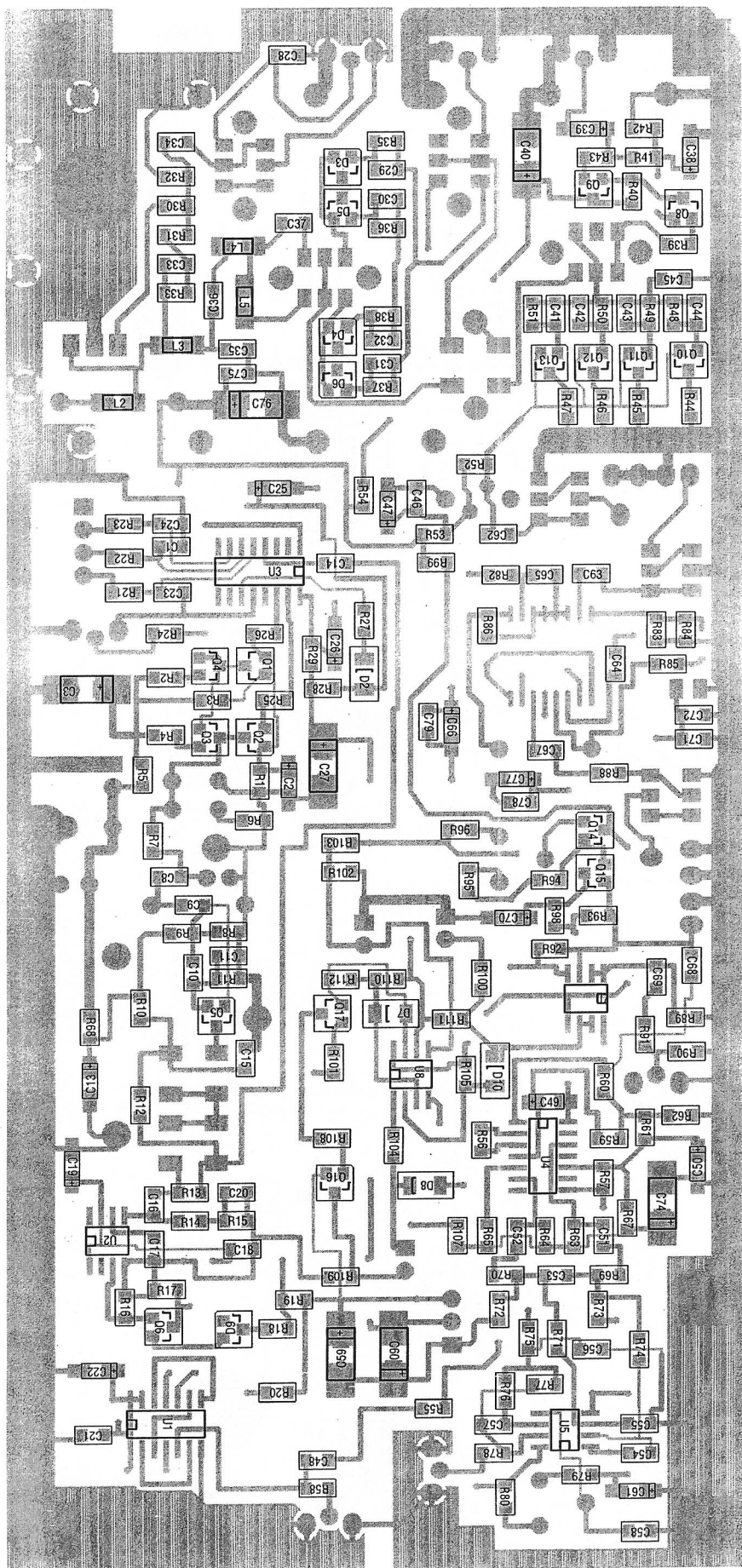

FIGURE 10-17

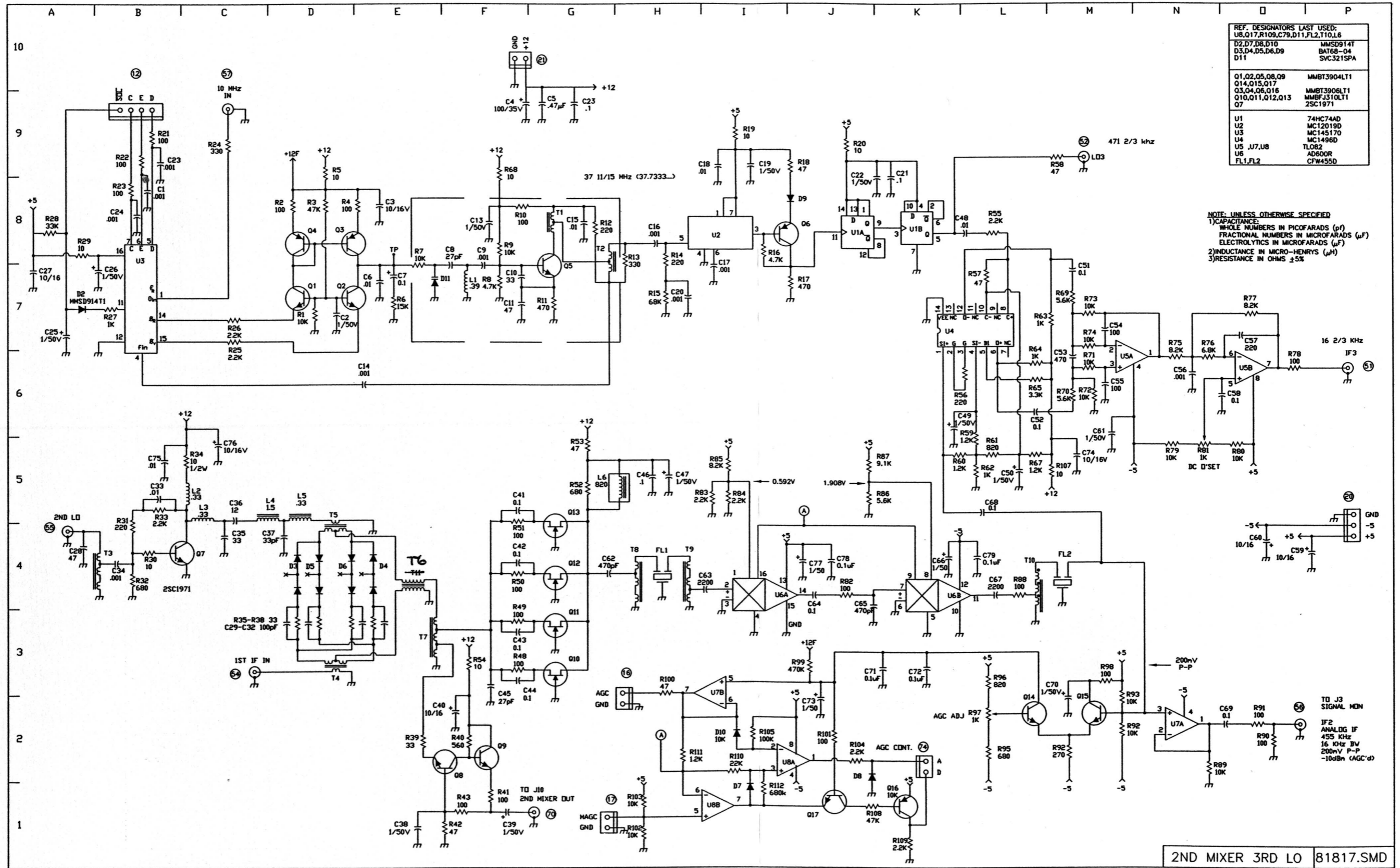

FIGURE 10-18 81817.SMD 2nd MIXER/IF SCHEMATIC

TABLE 10-3 81817.SMD 2ND MIXER PARTS LIST

I.D.	Description	Part No
C36	12pF	23463
C45,C8	27pF	23467
C10,C35,C37	33pF	23468
C11,C28	47pF	23470
C29,C30,C31,C32,C54,C55, C65	100pF	23474
C57	220pF	23478
C53,C62	470pF	23482
C7,C63	2200pF	23498
C15,C18,C33,C48,C75	.01uF	23487
C6	.01uF	23340
C1,C9,C14,C16,C17,C20,C23,C24,C34,C56	.001uF	23486
C21,C41,C42,C43,C44,C46,C51,C52,C58,C64,C68,C69,C71, C72,C78,C79.	0.1uF	23488
	----	-----
C7	.1uF	23328
C5	.47uF	23330
C73	1/20	23264
C2,C13,C19,C22,C25,C26,C38,C39,C47,C49,C50,C61,C66, C70,C77.	1/16	23524
	----	-----
C3,C27,C40,C59,C60,C74, C76	10/16	23525
C3A,C27A,C40A,C59A,C60A,C74A,C76A	10/25	23266
(REPLACES C3,C27,C40,C59,C60,C74,C76)	-----	-----
C4	100/35	23189
D2,D7,D8,D10	MMSD914T1	28124
D3,D4,D5,D6,D9	BAT68_04	28132
D11	SVC321SPA	28099
FL1,FL2	455FILT	48203
L2,L3,L5	.33uH	21216
L1	.39uH	21107
L4	1.5uH	21224
L6	820uH	21095
Q1,Q2,Q5,Q8,Q9,Q14,Q15,Q17	MMBT3904LT1	25375
Q3,Q4,Q6,Q16	MMBT3906LT1	25376
Q7	2SC1971	25337
Q10,Q11,Q12,Q13	MMBFJ310LT1	25377
R34	10 3/4W	30022
R5,R19,R20,R29,R30,R54,R68, R107	10	30638
R35,R36,R37,R38,R39	33	30644
R18,R42,R53,R57,R58,R100	47	30646

TABLE 10-3 81817.SMD 2ND MIXER PARTS LIST (continued)

I.D.	Description	Part No
R2,R4,R10,R21,R22,R23,R41,R43,R44,R45,R46,R47	100	30650
R48,R49,R50,R51,R78,R82,R88,R90,R91,R98,R101.	----	-----
R12,R14,R31,R56	220	30654
R94	270	30655
R24,R13	330	30656
R11,R17	470	30658
R40	560	30659
R32,R52,R95	680	30660
R61,R96	820	30661
R27,R62,R63,R64	1.0K	30662
R97,R81	1.0K POT	30618
R59,R60,R67,R111	1.2K	30663
R25,R26,R33,R55,R83,R84,R104, R109	2.2K	30666
R8,R16,R65	4.7K	30670
R69,R70,R86	5.6K	30671
R76	6.8K	30672
R75,R77,R85	8.2K	30673
R87	9.1K	30622
R1,R7,R9,R71,R72,R73,R74,R79,R80,R89,R92,R93,R102,R103	10K	30674
R6	15K	30676
R110	22K	30678
R28	33K	30680
R3,R108	47K	30682
R15	68K	30684
R105	100K	30686
R99	470K	30694
T1,T2	2BAL	21152
T3,T4,T5,T7	3BAL	21153
T8,T9,T10	TORROID-TRI	21255
T6	TORROID-BIF	21256
U1	74HC74AD	25430
U2	MC12019D	25427
U3	MC145170D	25405
U4	MC1496D	25435
U5, U7, U8	TL082	25406
U6	AD600R	25434

81790.SMD CONVERTER/IO TOP COPPER

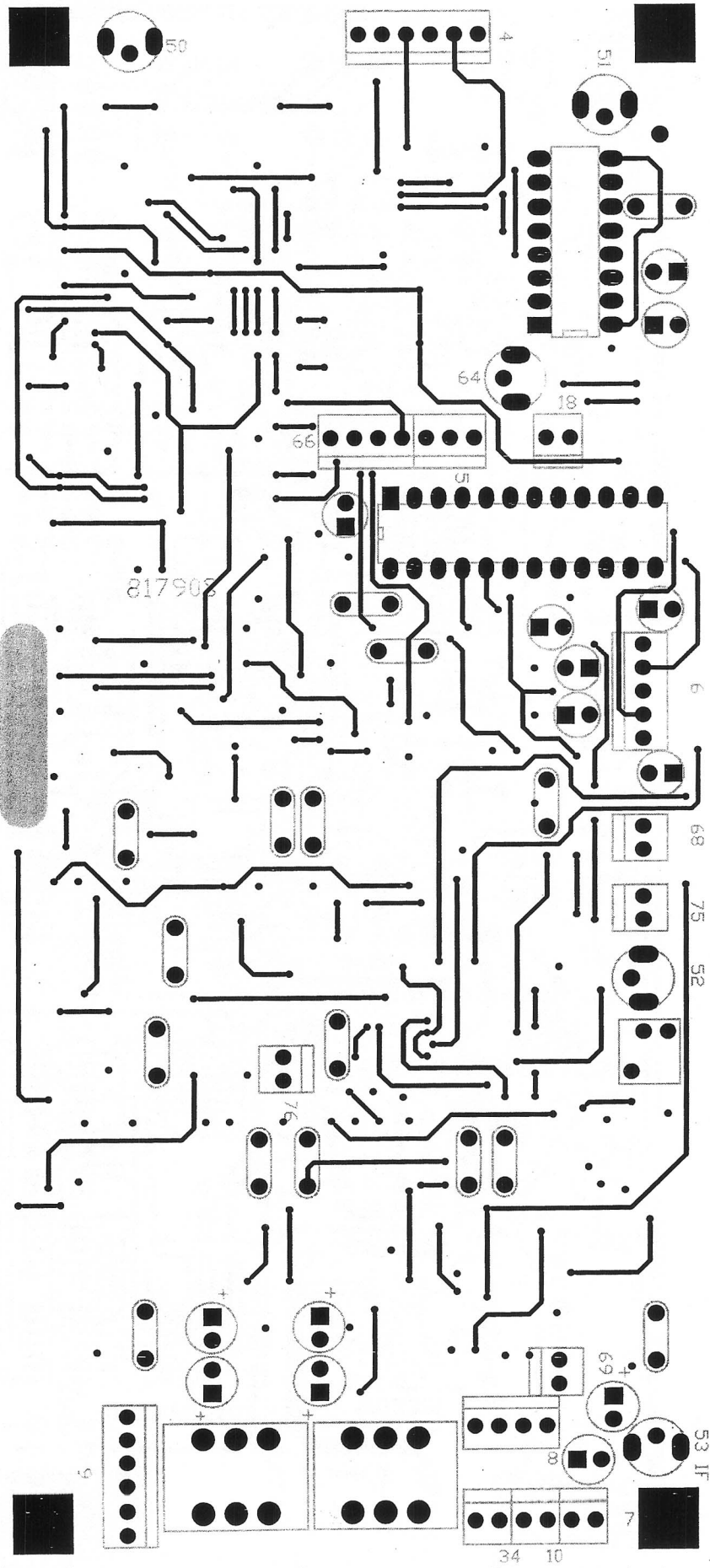

FIGURE 10-19

81790.SMD CONVERTER/IO BOTTOM COPPER

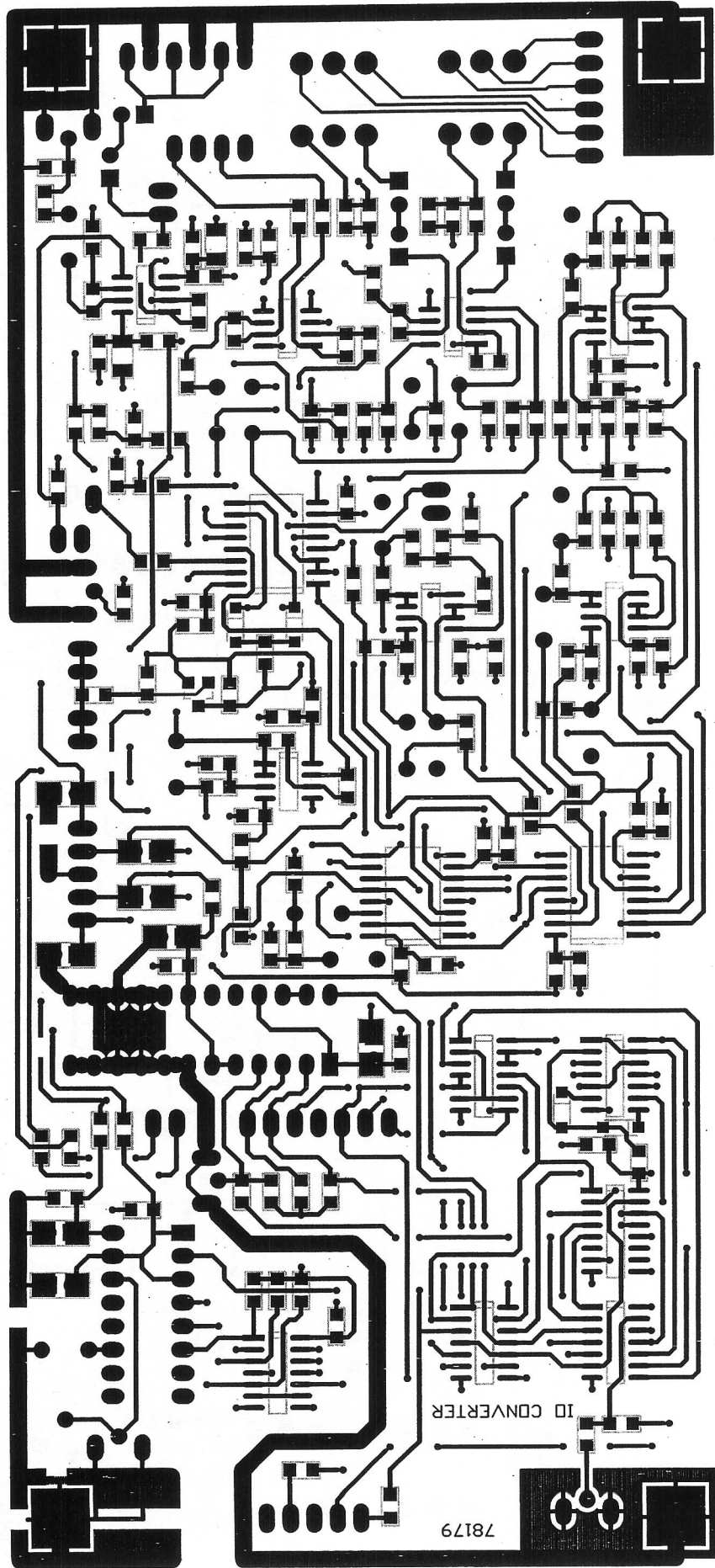

FIGURE 10-20

81790.SMD CONVERTER/IO TOP COMPONENT LAYOUT

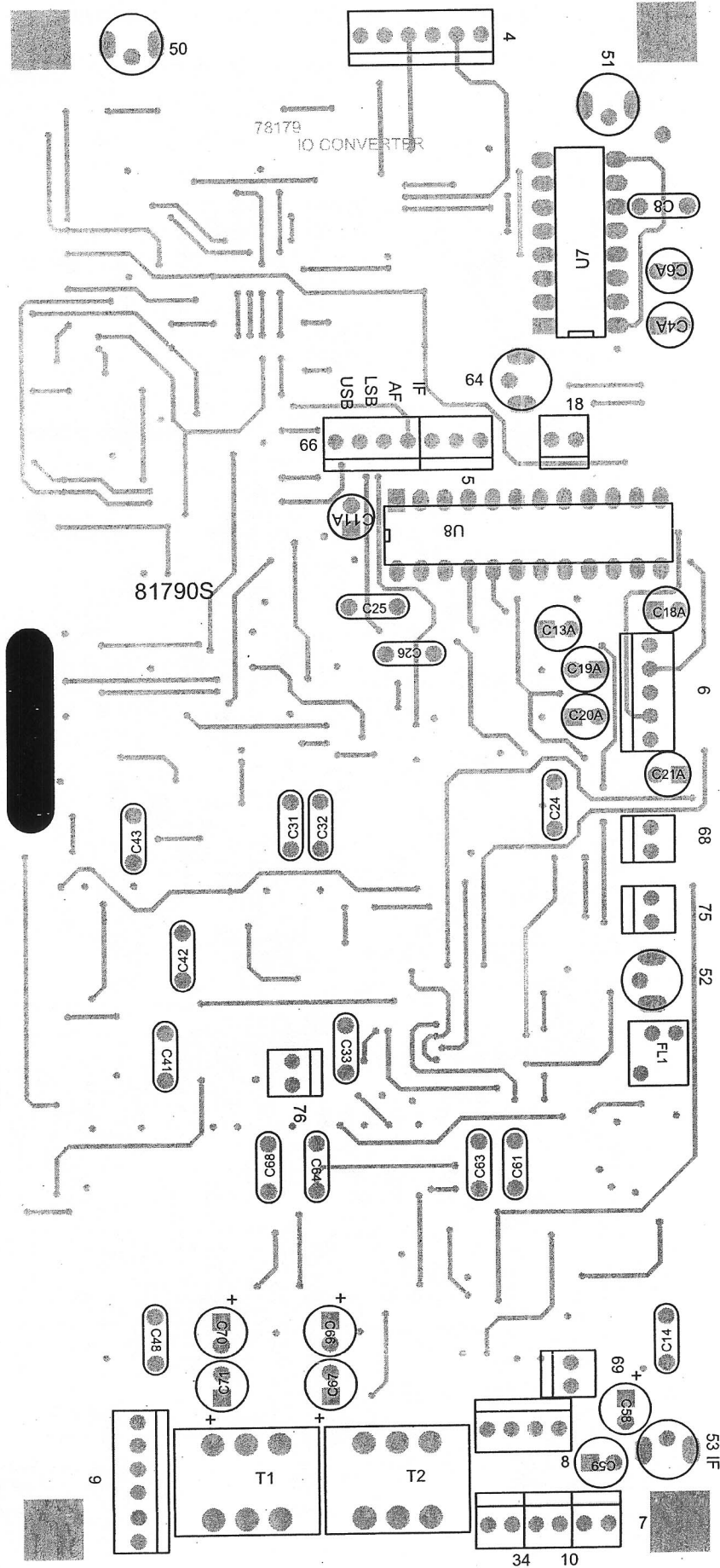

FIGURE 10-21

81790.SMD CONVERTER/IO BOTTOM COMPONENT LAYOUT

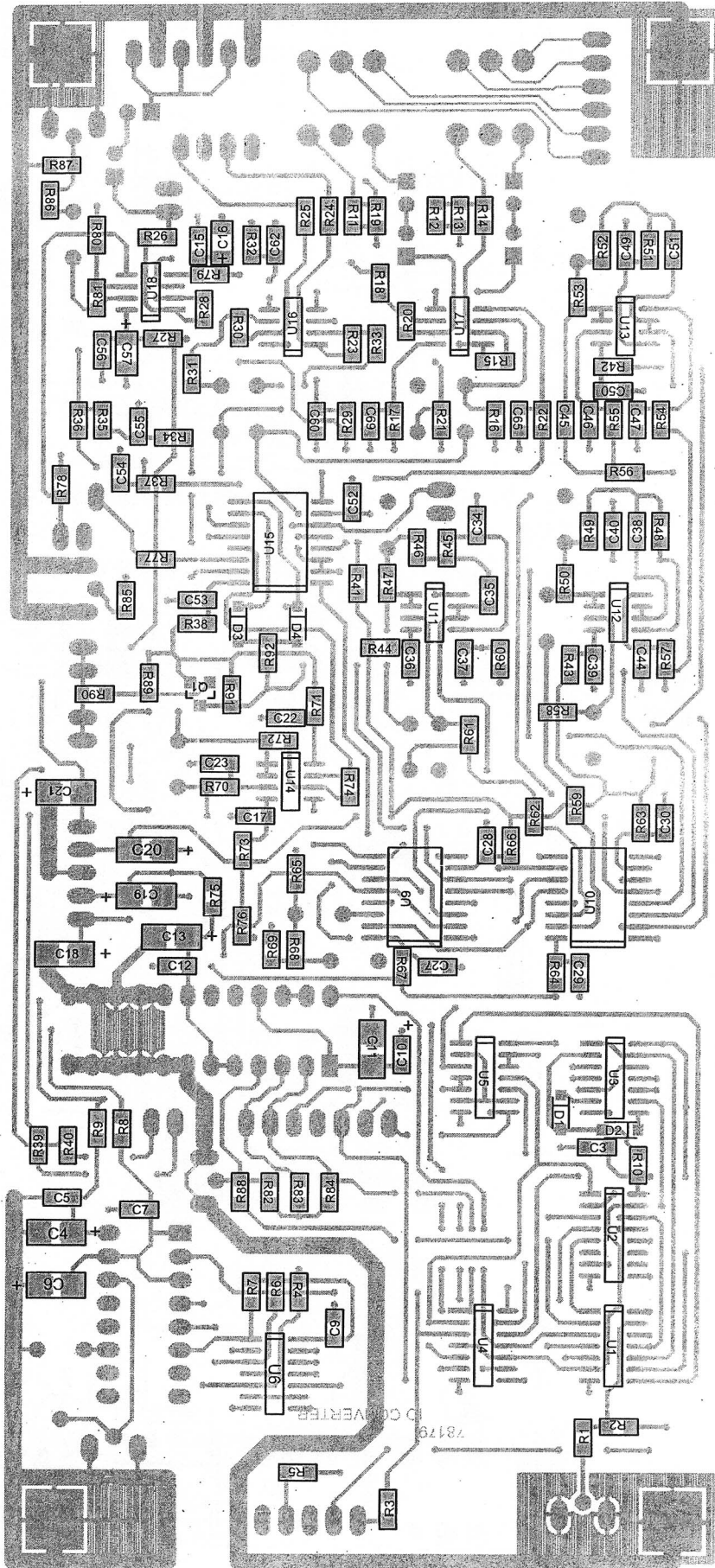

FIGURE 10-22

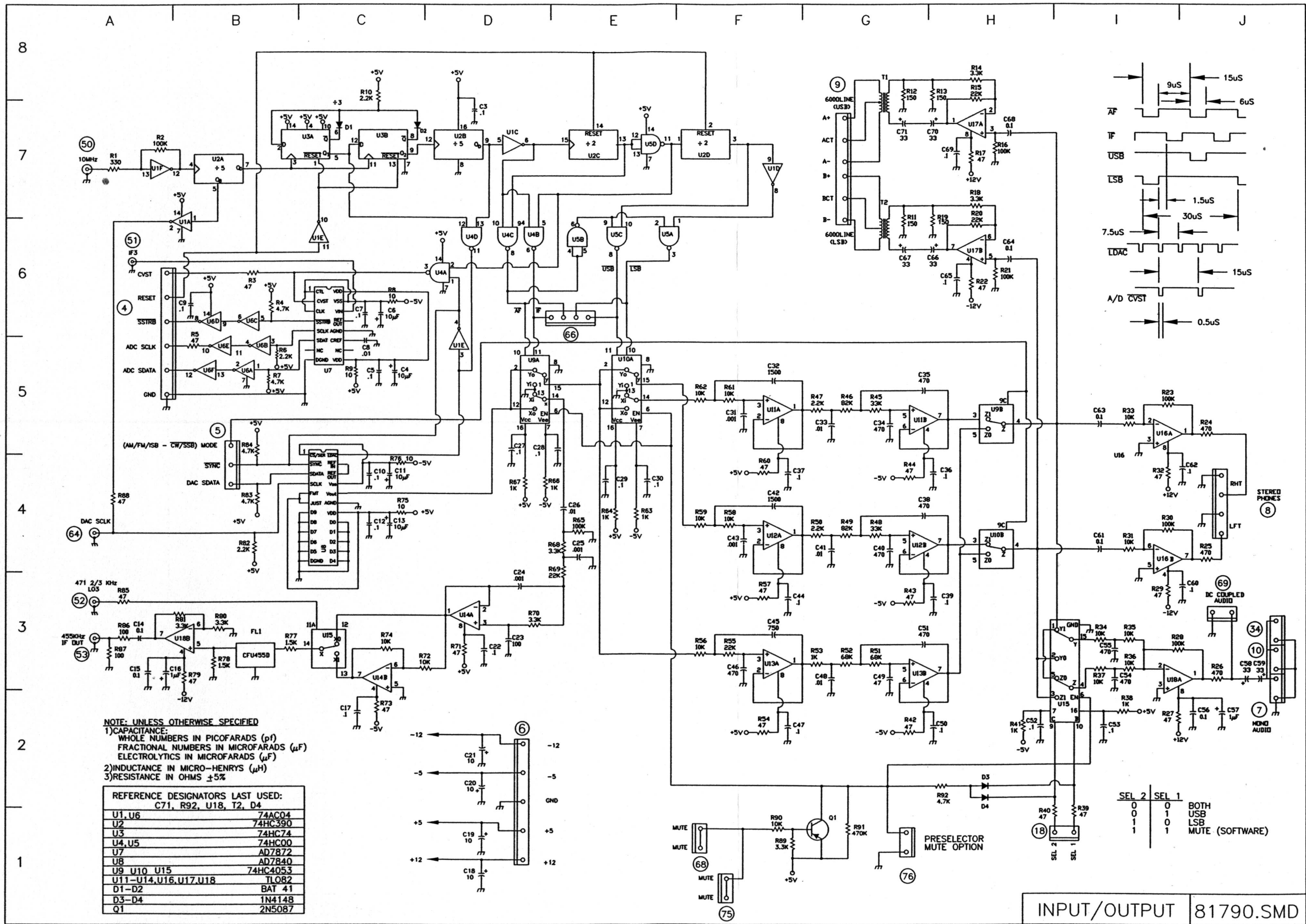

FIGURE 10-23 81790.SMD I/O CONVERTER SCHEMATIC

TABLE 10-4 81790.SMD CONVERTER-I/O BOARD PARTS LIST

I.D.	Description	Part No
C49	47pF	23470
C23	100pF	23474
C34,C35,C38,C40,C46,C51,C54,C55.	470pF	23482
C45	820pF	23485
C3,C5,C7,C9,C10,C12,C15,C17,C22,C27,C28,C29,C30,C36, C37,C39,C44,C47,C50,C52,C53,C56,C60,C62,C65,C69.	.1uF	23488
C24,C25,C31,C43	.001uF FILM	23282
C32,C42	.0015uF FILM	23284
C8,C26,C33,C41,C48	.01uF FILM	23340
C14,C61,C63,C64,C68	.1uF FILM	23328
C58,C59,C66,C67,C70,C71	33uF	23308
C16,C57	1/16	23524
C4,C6,C11,C13,C18,C19,C20,C21	10/16	23525
C4A,C6A,C11A,C13A,C18A,C19A,C20A,C21A (REPLACES C4,C6,C11,C13,C18,C19,C20,C21)	10/25	23266
D1,D2,D3,D4	MMSD914	28124
FL1	LTU455D	48198
Q1	MMBT3906LT1	25376
R8,R9,R75,R76	10	30638
R3,R5,R17,R22,R27,R29, R32,R39,R40,R42,R43,R44,R54, R57, R60,R71,R73,R79,R85,R88.	47	30646
R87,R86	-----	-----
R11,R12,R13,R19	100	30650
R1	150	30652
R24,R25,R26	330	30656
R38,R41,R53,R63,R64,R66,R67.	470	30658
R78,R77	1K	30662
R6,R10,R47,R50,R82	1.5K	30664
R14,R18,R68,R70,R80,R81,R89.	2.2K	30666
R4,R7,R83,R84,R92	3.3K	30668
R31,R33,R34,R35,R36,R37,R56	4.7K	30670
R58,R59,R61,R62,R72,R74,R90	10K	30674
R15,R20,R55,R69		
R45,R48	22K	30678
R52,R51	33K	30680
R46,R49	68K	30684
R2,R16,R21,R23,R28,R30,R65	82K	30685
R91	100K	30686
	470K	30694
T1,T2	600CT-600CT	21185

TABLE 10-4 81790.SMD CONVERTER-I/O BOARD PARTS LIST (continued)

I.D.	Description	Part No
U4,U5	74HC00 AD	25426
U1,U6	74HC04 AD	25428
U2	74HC390 D	25429
U3	74HC74 AD	25430
U7	AD7872JN	25348
U8	AD7840JN	25349
U9,U10,U15	74HC4053 DW	25420
U11,U12,U13,U14,U16,U17,U18	TL082 CD	25406

81772.TCXO SYNTHESIZER TOP COPPER

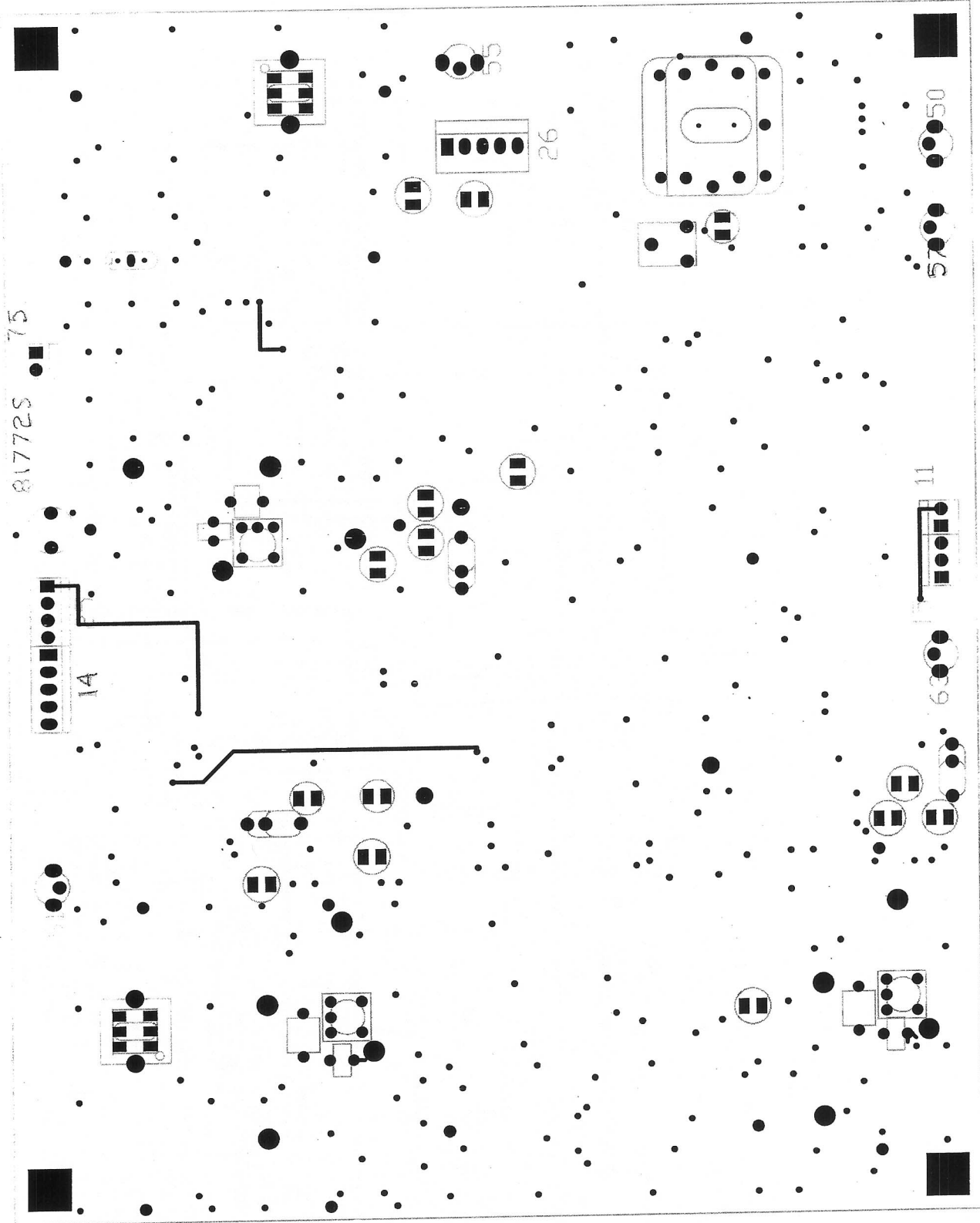

FIGURE 10-24

81772.TCXO SYNTHESIZER INNER CIRCUIT

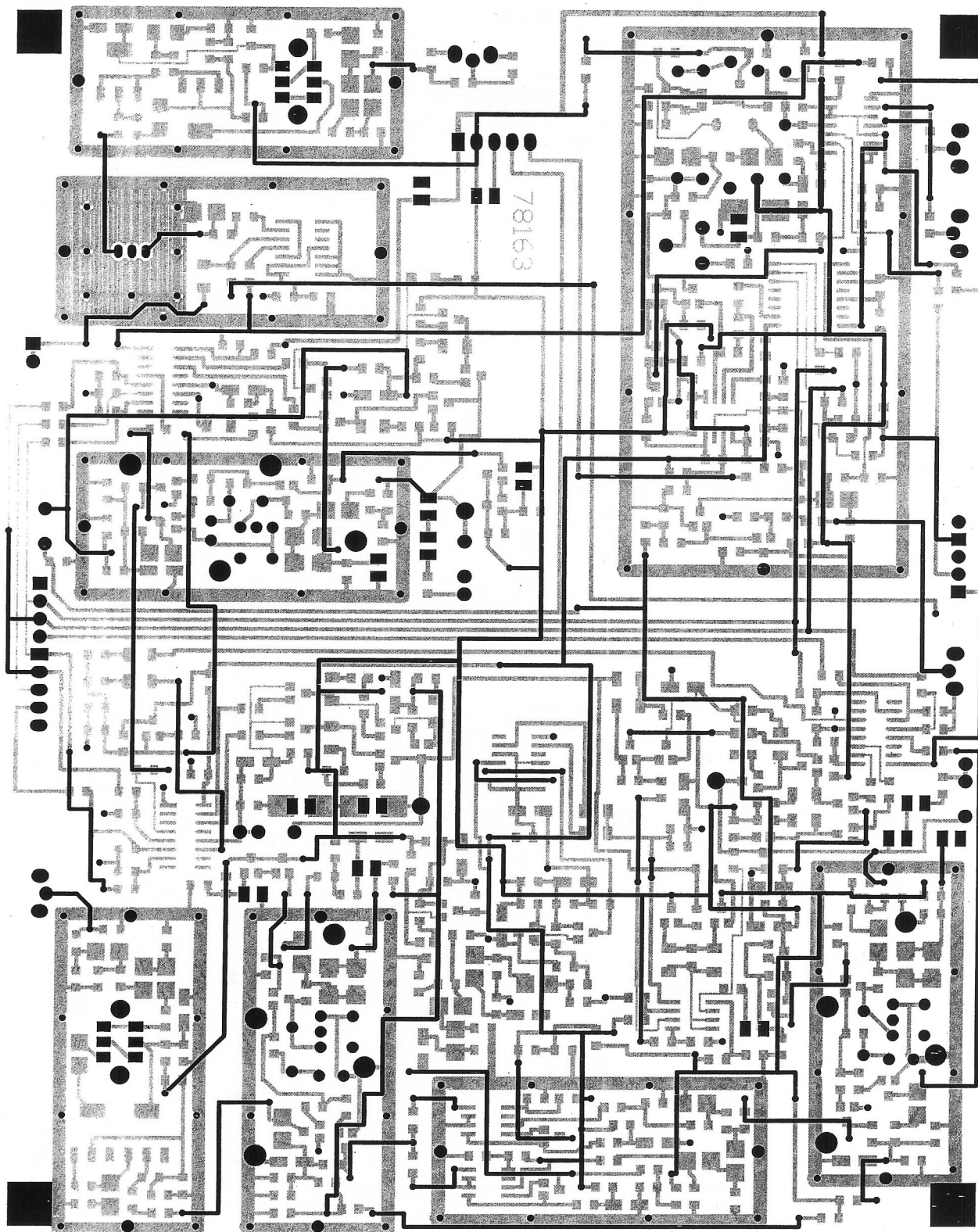

FIGURE 10-25

81772.TCXO SYNTHESIZER BOTTOM COPPER

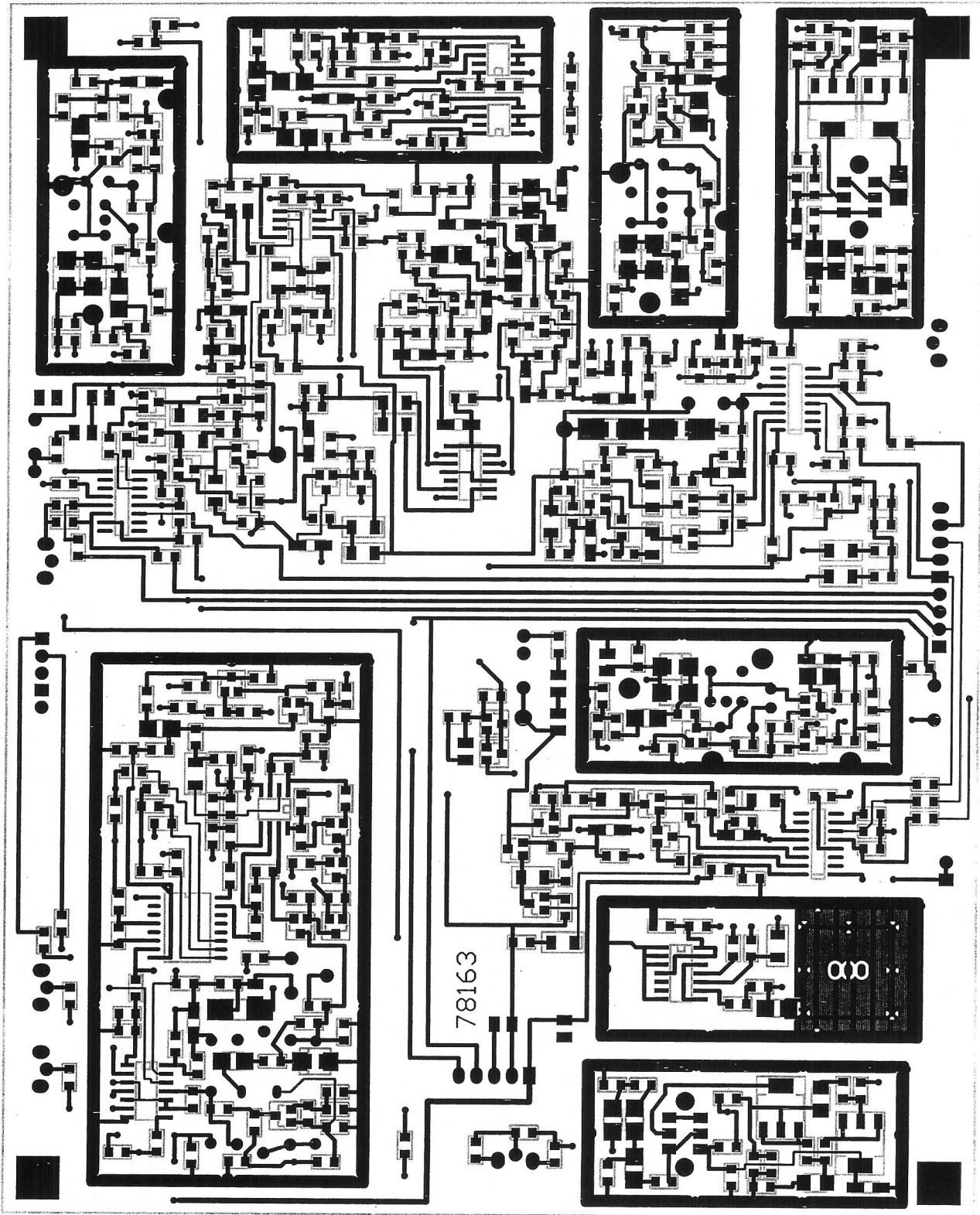

FIGURE 10-26

81772.ECXO SYNTHESIZER TOP COMPONENT LAYOUT

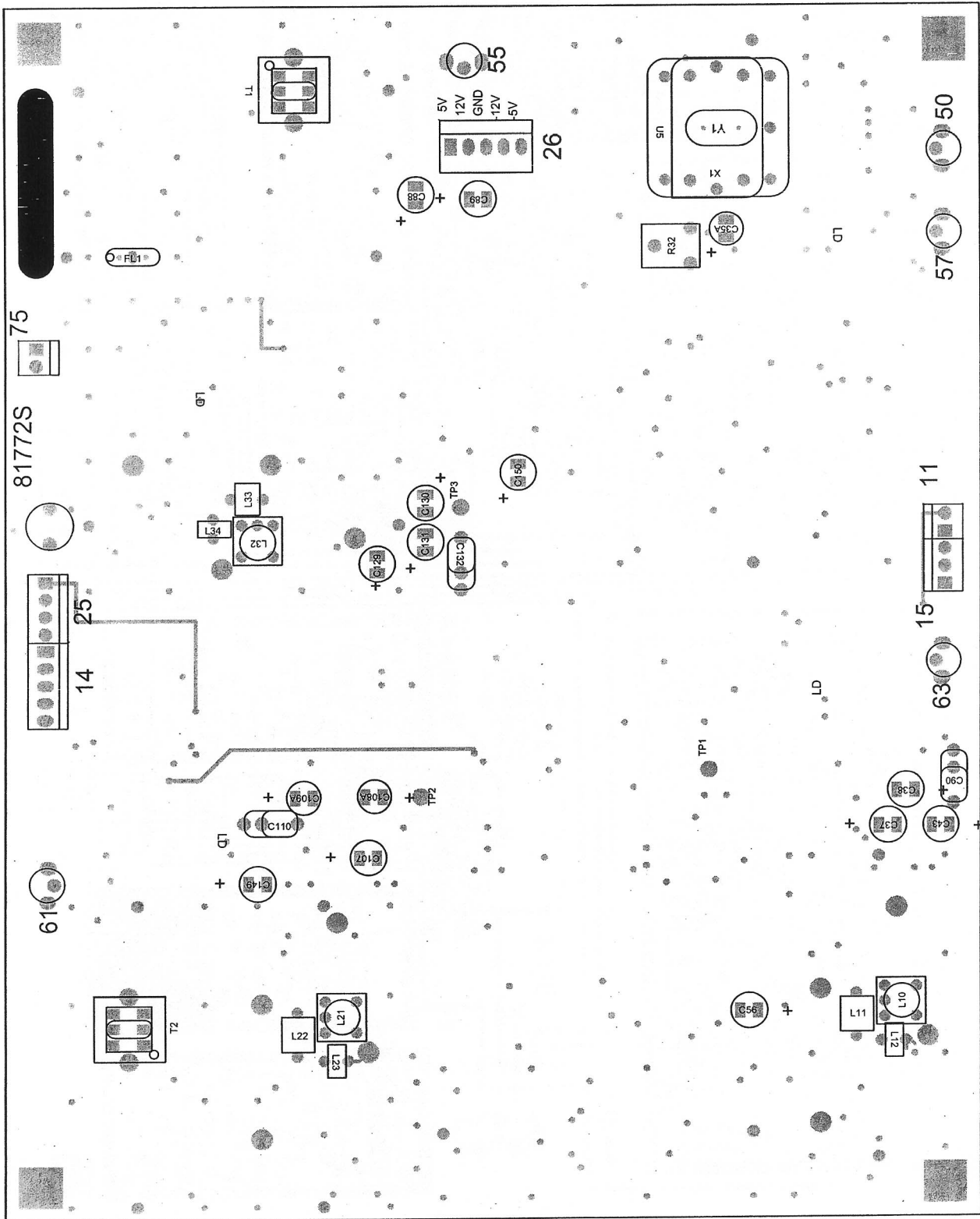

FIGURE 10-27

81772.TCXO SYNTHESIZER BOTTOM COMPONENT LAYOUT

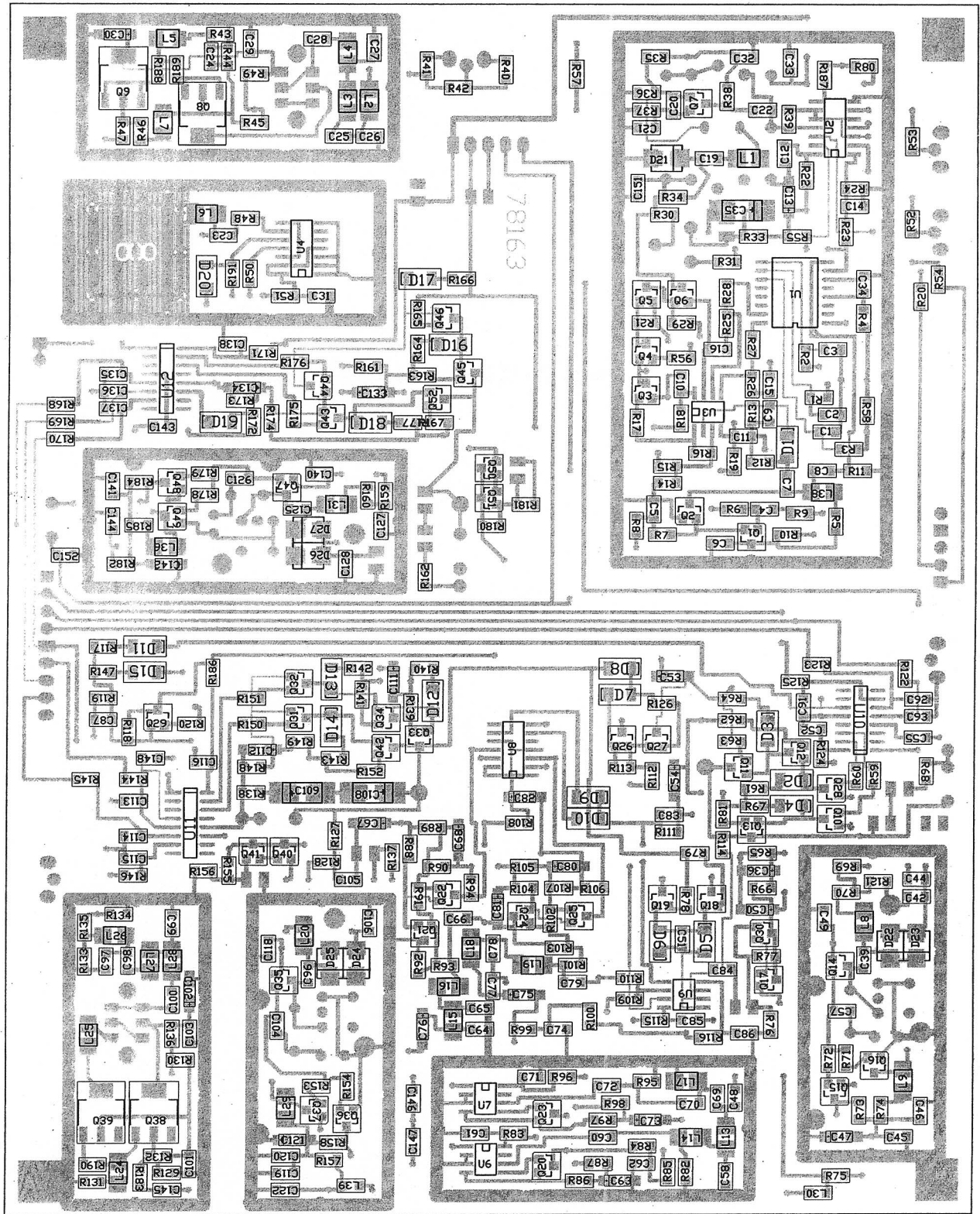
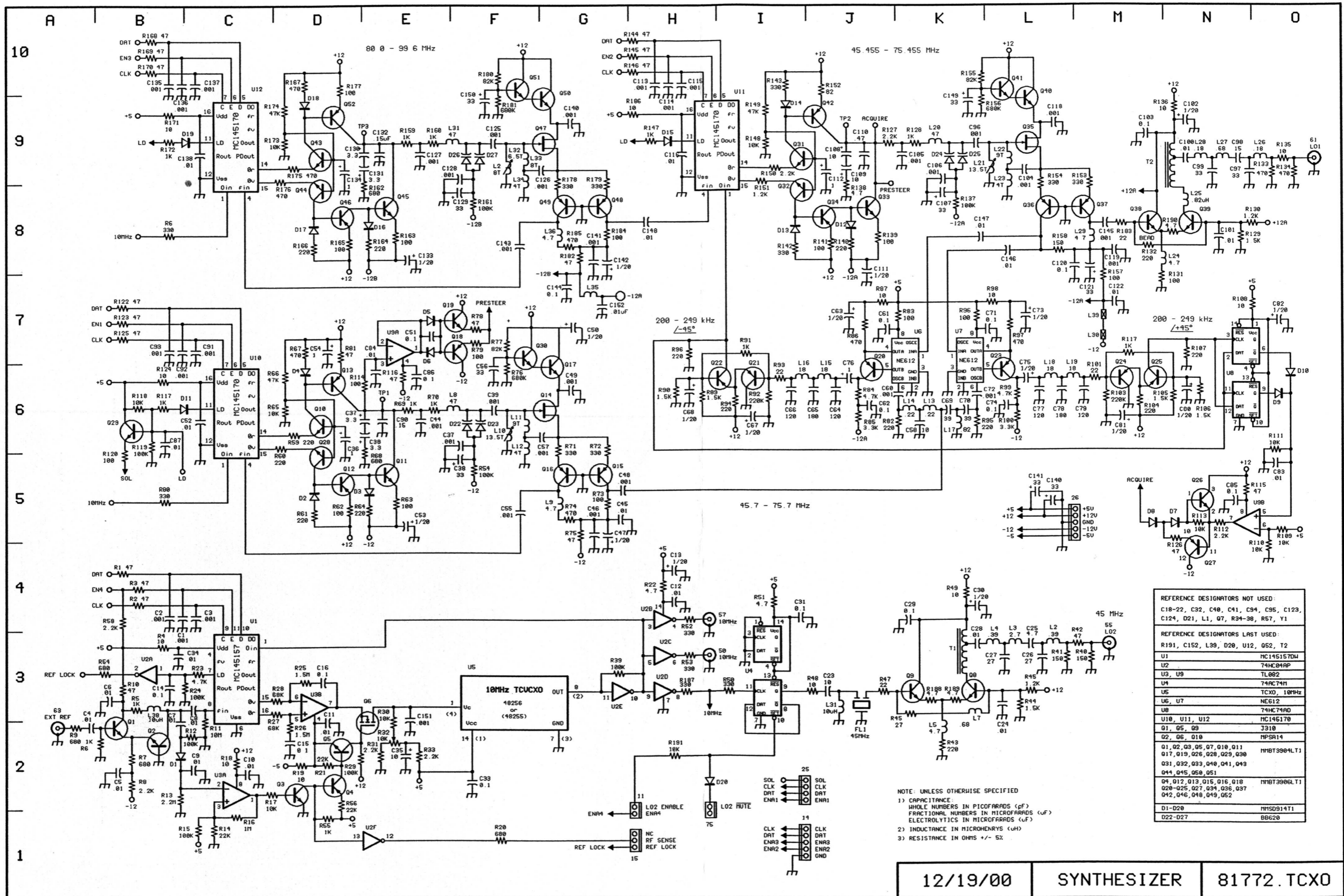

FIGURE 10-28

(page 10-42 intentionally left blank)



REFERENCE DESIGNATORS NOT USED:
 C18-22, C32, C40, C41, C94, C95, C123, C124, D21, L1, Q7, R34-38, R57, Y1

REFERENCE DESIGNATORS LAST USED:

U1	NC145157DW
U2	74HC04AP
U3, U9	TL062
U4	74ACT41H
U5	TCXO, 10MHz
U6, U7	NE612
U8	74HC74AD
U10, U11, U12	NC145170
Q1, Q5, Q9	J310
Q2, Q6, Q10	MPSA14
Q1, Q2, Q3, Q5, Q7, Q10, Q11	MMBT3904LT1
Q17, Q19, Q26, Q28, Q29, Q30	MMBT3906LT1
Q31, Q32, Q33, Q48, Q41, Q43	MMBT3906LT1
Q44, Q45, Q50, Q51	
Q4, Q12, Q13, Q15, Q16, Q18	MMBT3906LT1
Q20-Q25, Q27, Q34, Q36, Q37	
Q42, Q46, Q48, Q49, Q52	
D1-D20	MM5D914T1
D22-D27	BB620

NOTE: UNLESS OTHERWISE SPECIFIED
 1) CAPACITANCE:
 WHOLE NUMBERS IN PICOFARADS (pF)
 FRACTIONAL NUMBERS IN MICROFARADS (uF)
 ELECTROLYTICS IN MICROFARADS (uF)
 2) INDUCTANCE IN MICROHENRYS (uH)
 3) RESISTANCE IN OHMS +/- 5%

FIGURE 10-29 81772.TCXO SYNTHESIZER SCHEMATIC

TABLE 10-5 81772.TCXO SYNTHESIZER PARTS LIST

I.D.	Description	Part No
C25	4.7pF	23458
C58,C23	10pF	23462
C98	15pF	23464
C27,C26	27pF	23467
C99,C97	33pF	23468
C69,C70	39pF	23469
C64,C66,C77,C79	120pF	23475
C65,C78	180pF	23477
C37,C38,C130,C131	3.3/50	23265
C132,C90	.15uF	23343
C110	.47uF	23330
C4,C5,C6,C7,C8,C9,C10,C11,C12,C24,C28,C34,C42	.01uF	23487
C45,C52,C83,C84,C87,C100,C101,C106,C122,C128,C146,C147	-----	-----
C148,C152.	-----	-----
C1,C2,C3,C39,C44,C46,C48, C49,C55,C57,C60,C72,C91,C92,	.001uF	23486
C93,C96,C104,C105,C113,C114,C115,C118,C119,C125,C126,	-----	-----
C127,C135,C136,C137,C140,C141,C143,C145,C151.	-----	-----
C35,C108,C109	10/16	23525
C35A,C108A,C109A (REPLACES C35,C108,C109)	10/25	23266
C14,C15,C16,C29,C31,C33,C51,C61,C62,C71,C74,C85	0.1uF	23488
C86,C103,C116,C120,C138,C144	-----	-----
C43,C56,C88,C89,C107,C129,C149,C150.	33/16	23308
C13,C30,C36,C47,C50,C53,C54,C63,C67,C68,C73,C75,C76,	1/16	23524
C80,C81,C82,C102,C111,C112,C121,C133,C134,C142.	-----	-----
D1,D2,D3,D4,D5,D6,D7,D8,D9,D10,D11,D12,D13,D14,D15,	MMSD914T1	28124
D16,D17,D18,D19,D20	-----	-----
D22,D23,D24,D25,D26,D27	BB132	28131
FL1	45MONO	48202
L28,L26	.18uH	21213
L13,L14	.22uH	21214
L4,L2	.39uH	21217
L27,L7	.68uH	21220
L25,L17	.82uH	21221
L6	1.0uH	21222
L3	2.2uH	21226
L5,L9,L24,L29,L36	4.7uH	21197
L38	10uH	21234
L15,L16,L18,L19	18uH	21237
L8,L20,L31	47uH	21242
L21,L10	13.5T	21254

TABLE 10-5 81772.TCXO SYTHESIZER PARTS LIST (continued)

I.D.	Description	Part No
L22,L11	9T #24	85419-9
L35	LI	21179
L32	6.5T	21253
L33	8T #24	85419-4
L12,L23,L34	4T #22	85419-5
L30,L39	FB	21205
Q1,Q2,Q3,Q5,Q10,Q11,Q17,Q19,Q26,Q28,Q29,Q30,Q31, Q32,Q33,Q40,Q41,Q43,Q44,Q45,Q50,Q51.	MMBT3904LT1	25375
Q4,Q12,Q13,Q15,Q16,Q18,Q20,Q21,Q22,Q23,Q24,Q25,Q27, Q34,Q36,Q37,Q42,Q46,Q48,Q49,Q52.	-----	-----
Q8,Q9,Q38,Q39	MMBT3906LT1	25376
Q6	-----	-----
Q14,Q35,Q47	BFG16A	25431
	2N7002LT1	25412
	MMBFJ310LT1	25377
R22,R51,R138,R188,R189,R190	4.7	30634
R4,R18,R19,R48,R49,R87,R98,R108,R124,R135,R136, R171,R186.	10	30638
R47,R93,R101,R183	-----	-----
R46	22	30642
R1,R2,R3,R10,R42,R75,R78,R115,R116,R122,R123,R125,R126, R144,R145,R146,R168,R169,R170,R182.	27	30643
R152	47	30646
R43,R62,R63,R73,R79,R81,R83,R96,R114,R120,R131,R139, R141,R157,R158,R163,R165,R177,R184.	-----	-----
R41,R40	82	30649
R61,R64,R82,R88,R94,R95,R104,R107,R132,R140,R164R166.	100	30650
R50,R52,R53,R71,R72,R80,R142,R143,R153,R154,R178 R179,R187.	-----	-----
R59,R60,R67,R74,R86,R97,R133,R134,R167,R175,R176, R185.	150	30652
R7,R9,R20,R54,R68,R162	220	30654
R5,R6,R55,R69,R70,R91,R102,R117,R128,R147,R159,R160, R172.	330	30656
R45,R130,R151	-----	-----
R44,R89,R90,R105,R106,R129.	470	30658
R8,R31,R33,R58,R112,R127,R150.	-----	-----
R85,R100	680	30660
R23,R84,R99	1.0K	30662
R17,R30,R35,R65,R109,R110,R111,R113,R118,R148,R173	-----	-----
R14,R21,R56	1.2K	30663
R66,R149,R174	1.5K	30664
R27,R28	2.2K	30666
R77,R155,R180	3.3K	30668
	4.7K	30670
	10K	30674
	22K	30678
	47K	30682
	68K	30684
	82K	30685

TABLE 10-5 81772.SMD SYNTHESIZERPARTS LIST (continued)

I.D.	Description	Part No
R12,R15,R24,R29,R39,R119,R121,R137,R161	100K	30686
R92,R103	220K	30690
R76,R156,R181	680K	30696
R16	1M	30698
R25,R26	1.5M	30699
R13	2.2M	30700
R11	10M	30704
R32	10K VAR	30619
T1,T2	3BAL	21153
U10,U11,U12	MC145170D1	25405
U9,U3	TLO82 CD	25406
U1	MC145157DW	25440
U8	74HC74AD	25430
U4	74AC74M	25446
U6,U7	NE612AD	25441
U2	74HC04AD	25428
U5	TCVCXO 10MHz	48256
Note: U5 replaces C19-22, C32, R34-38, R57, D21, L1, Q7, Y1		(OR 48255)

81824 POWER SUPPLY FILTER TOP COPPER

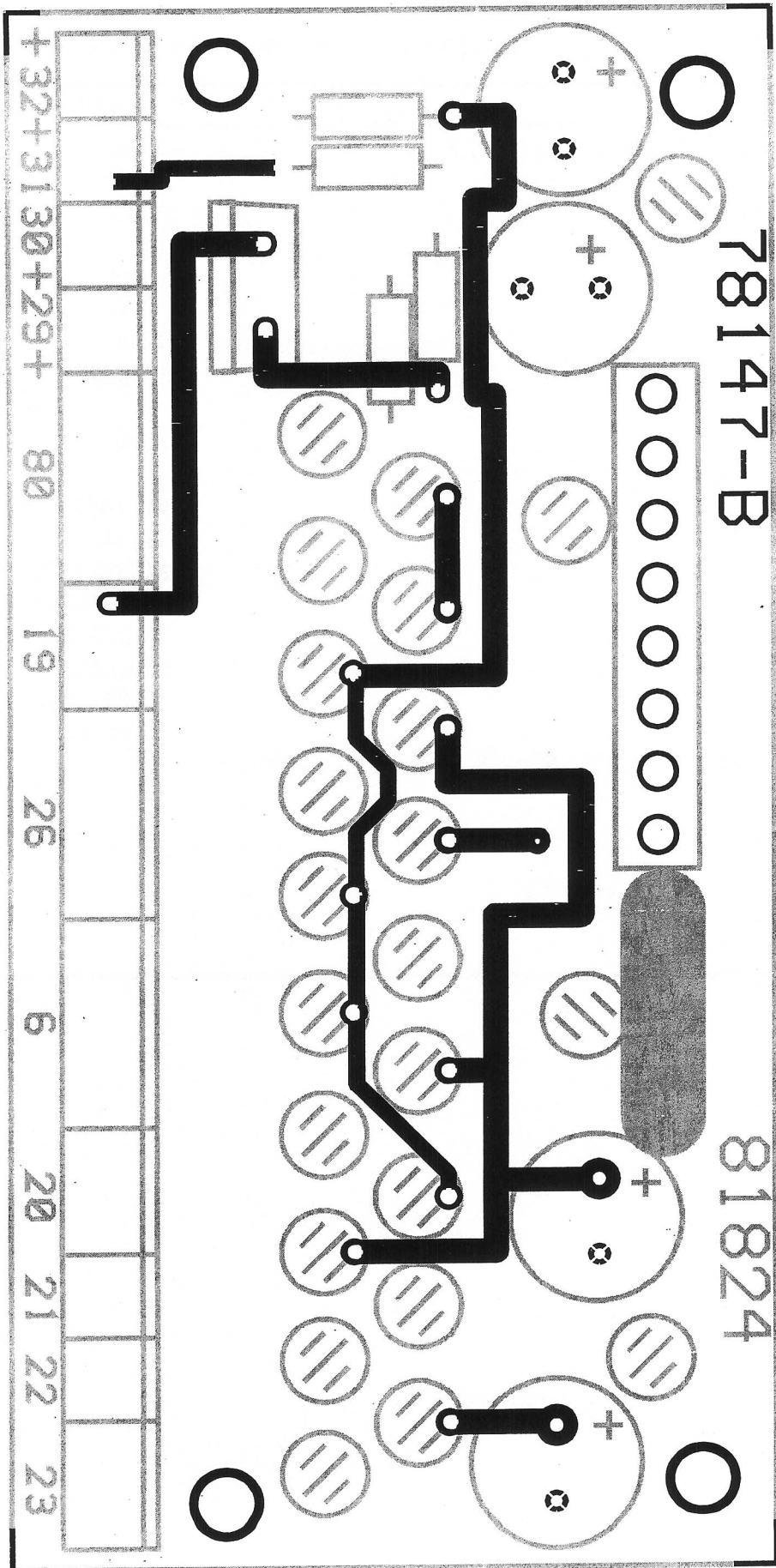

FIGURE 10-30

81824 POWER SUPPLY FILTER BOTTOM COPPER

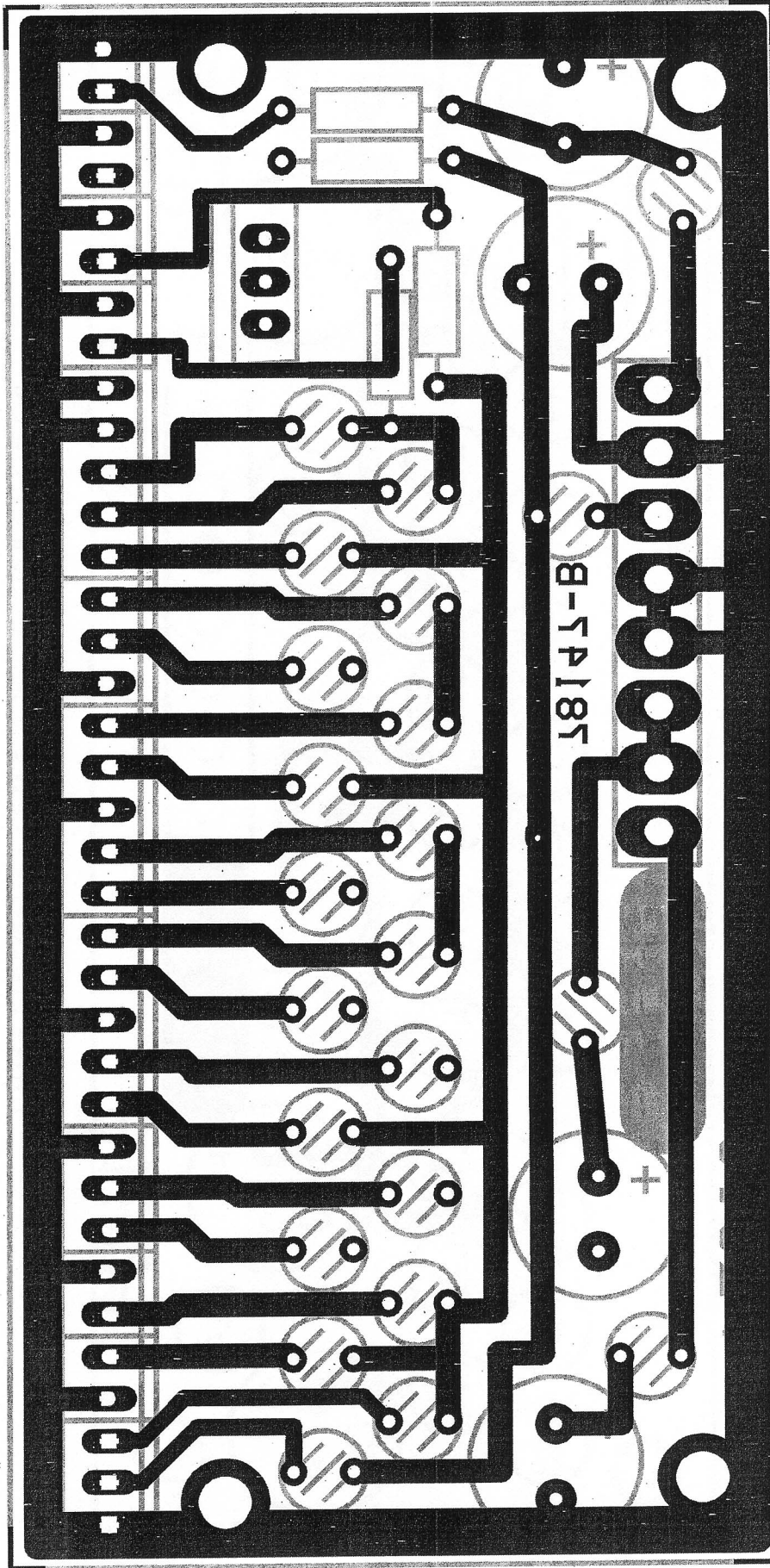

FIGURE 10-31

81824 POWER SUPPLY FILTER TOP COMPONENT LAYOUT

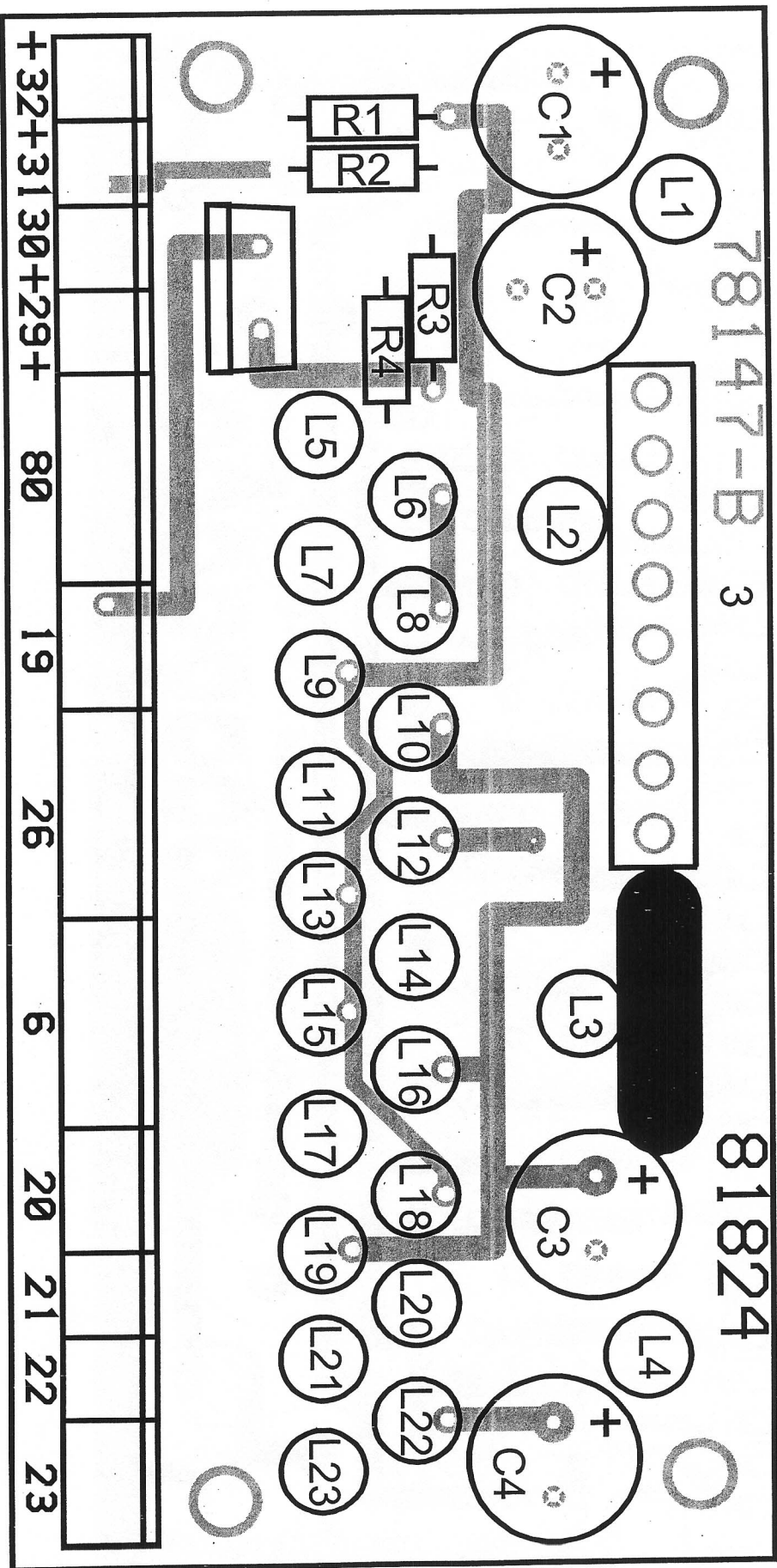

FIGURE 10-32

81824 POWER SUPPLY FILTER SCHEMATIC

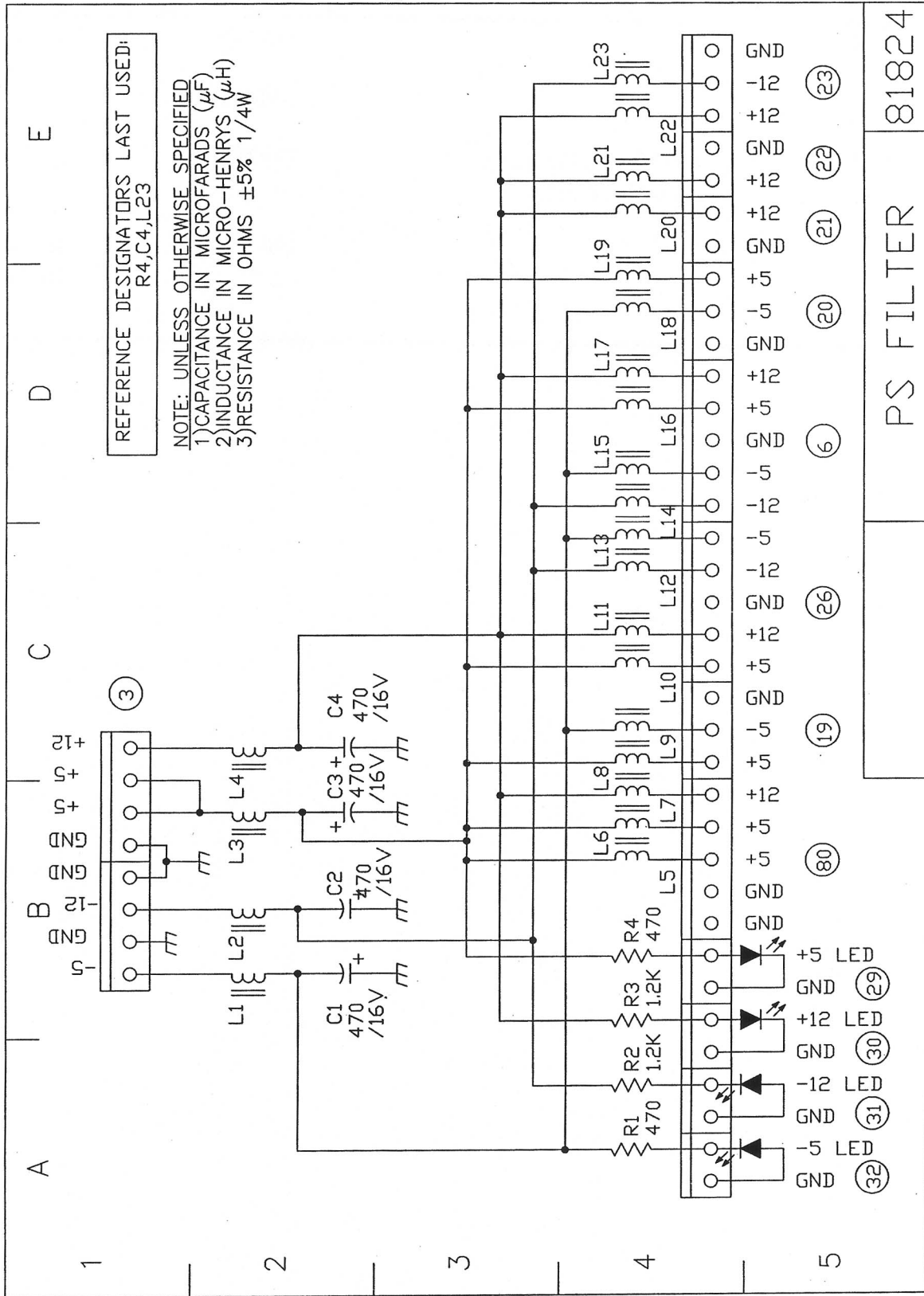

FIGURE 10-33

TABLE 10-6 81824 POWER SUPPLY FILTER PARTS LIST

I.D.	Description	Part No
C1,C2,C3,C4	470/16V	23228
D1,D2,D3,D4	HMLP1700	28066
L1,L2,L3,L4,L5,L6,L7,L8,L9,L10,L11,L12,L13 L14,L15,L16,L17,L18,L19,L20,L21,L22,L23.	CHOKE -----	21179 -----
R1,R4	470	30134
R2,R3	1.2K	30139

81807 DSP/CPU TOP COPPER

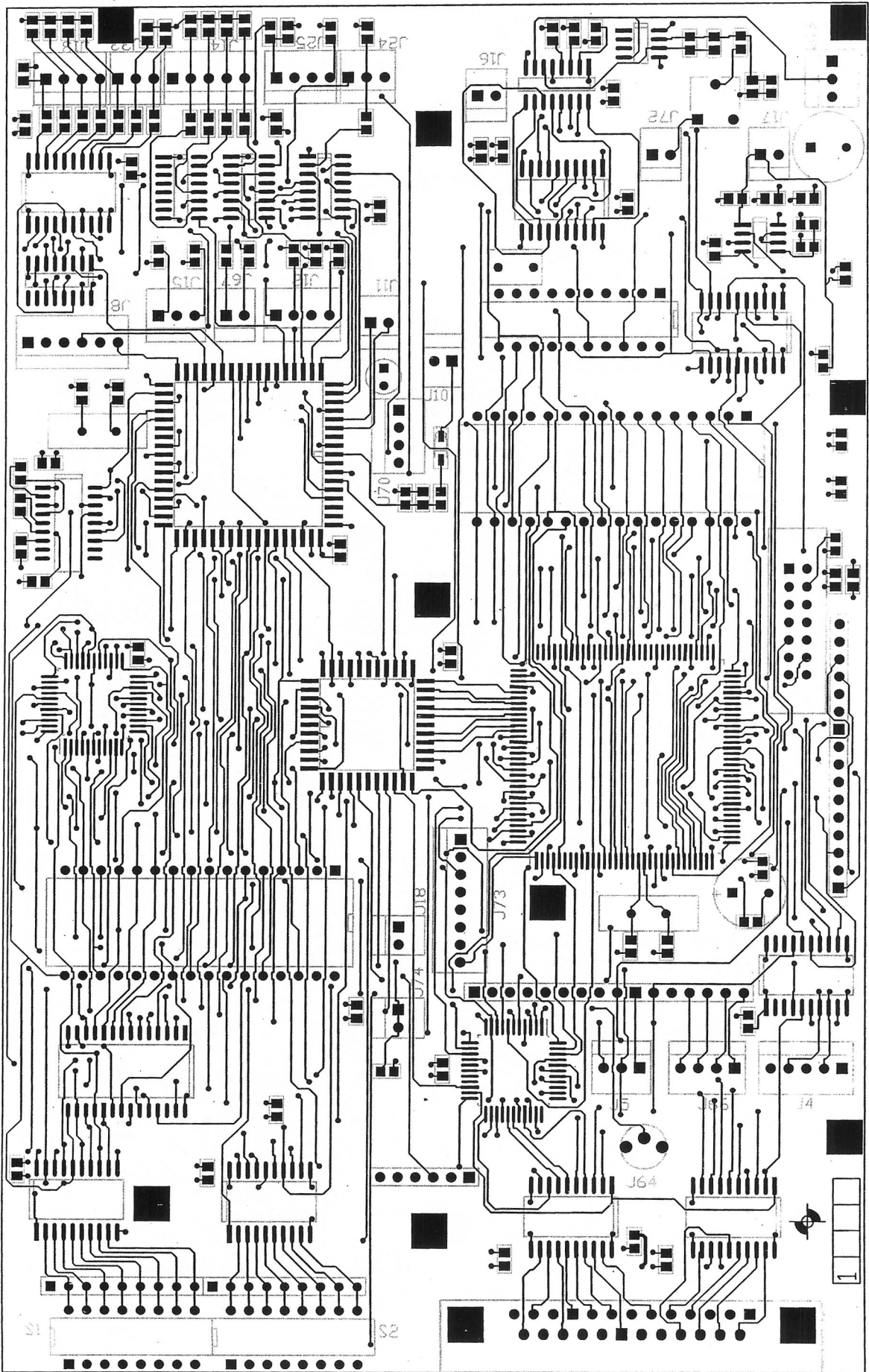

FIGURE 10-34

81807 DSP/CPU BOTTOM COPPER

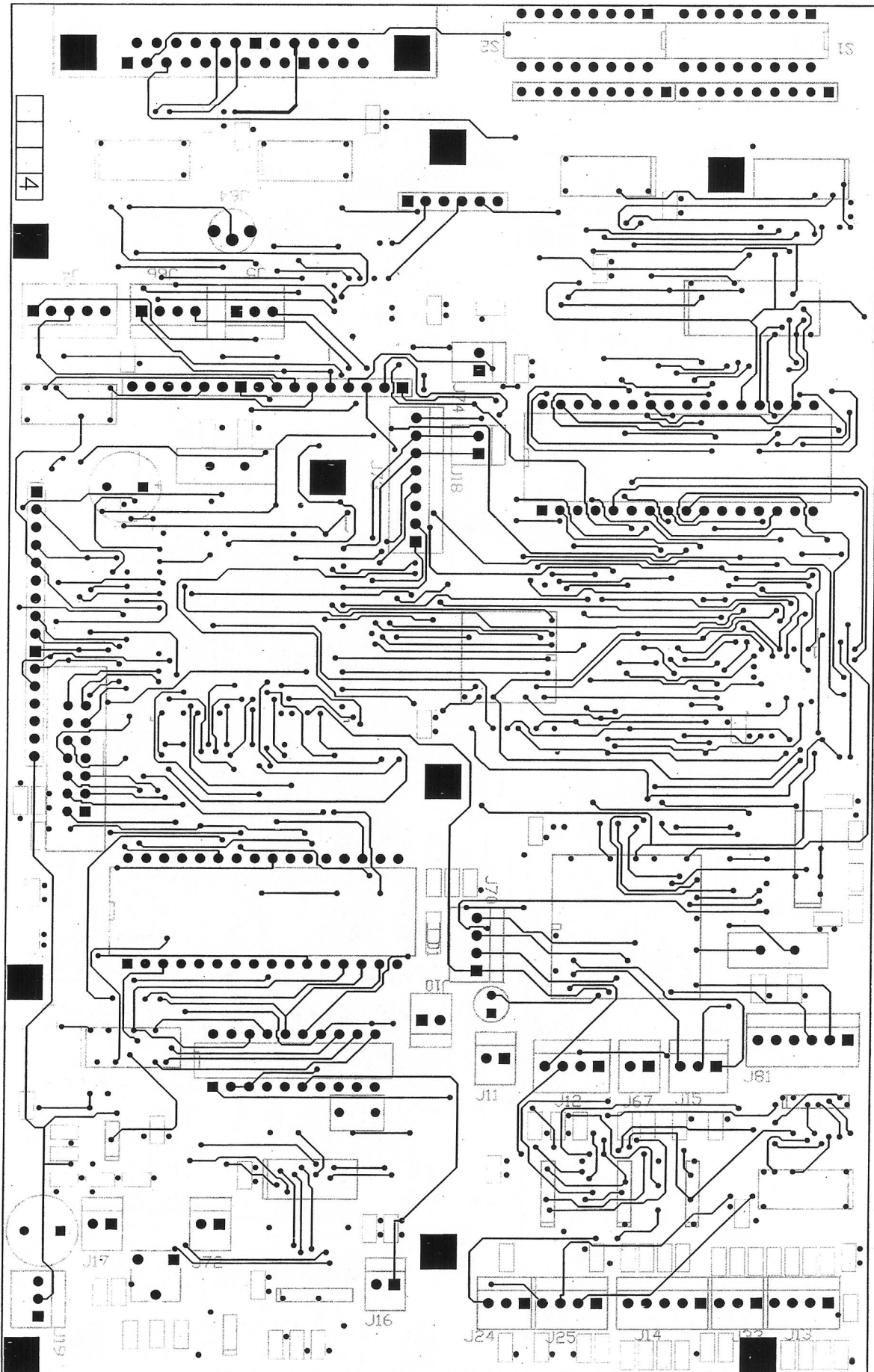

FIGURE 10-35

81807 DSP/CPU TOP COMPONENT LAYOUT

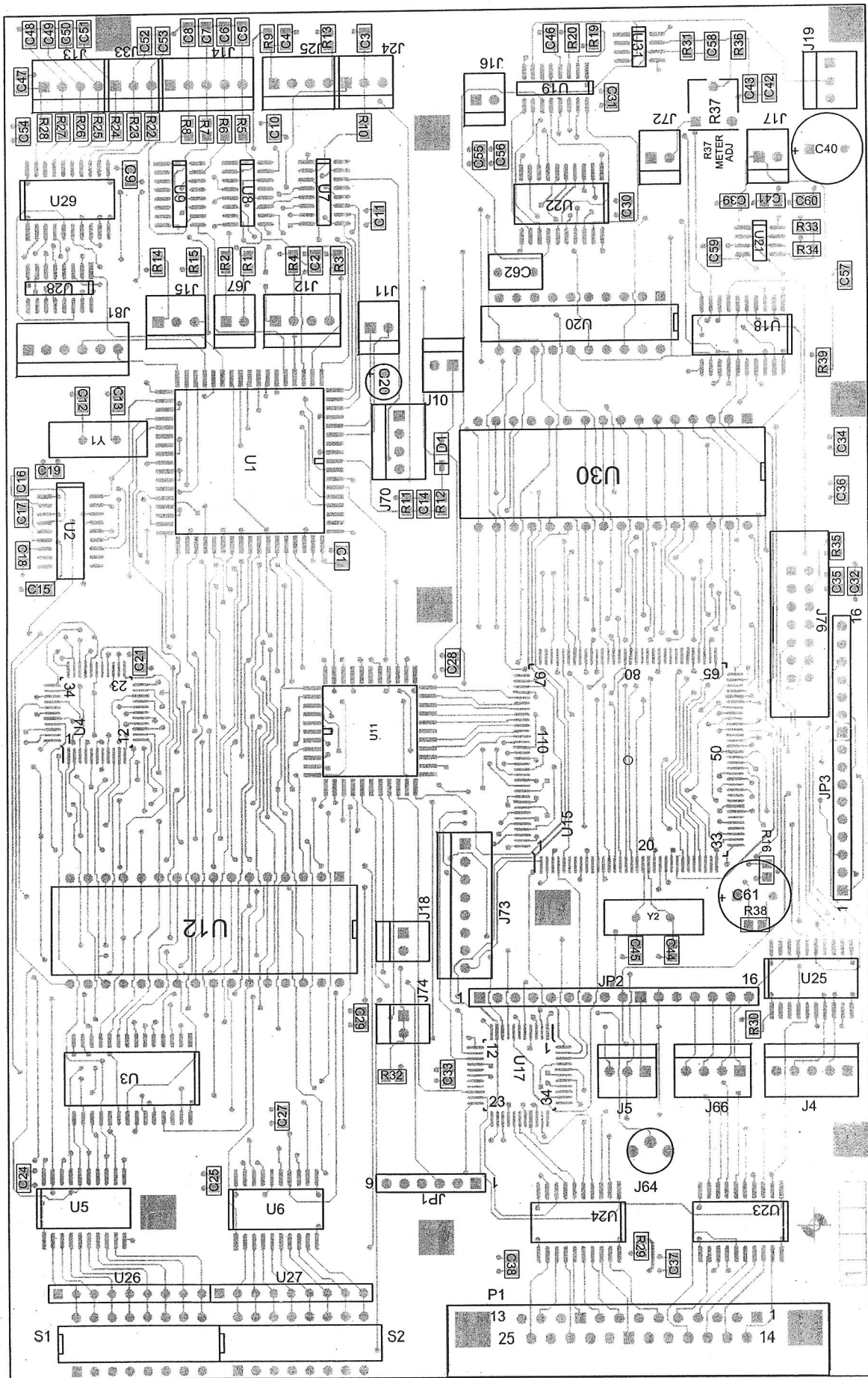

FIGURE 10-36

(page 10-56 intentionally left blank)

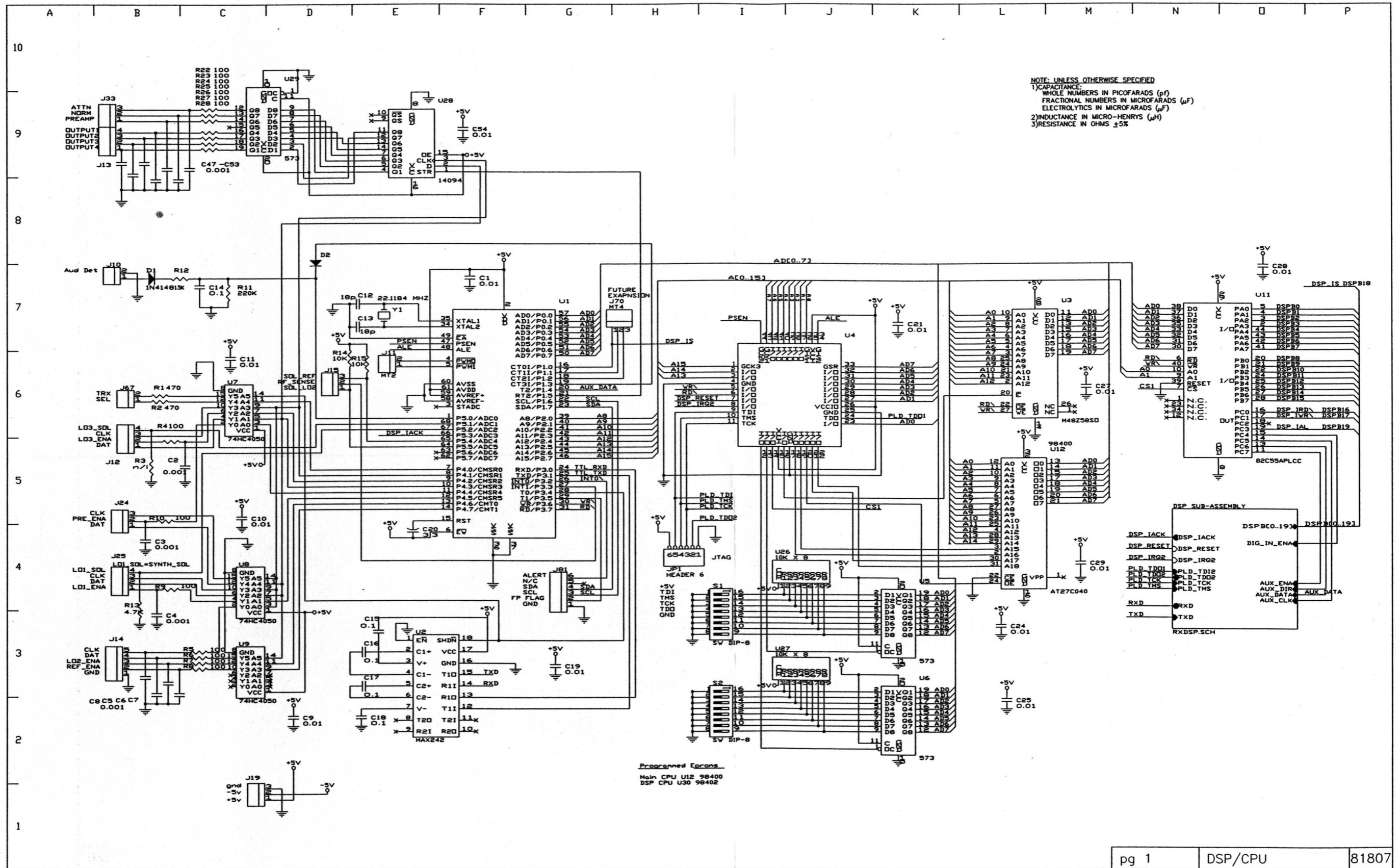

FIGURE 10-37 81807 CPU-DSP SCHEMATIC

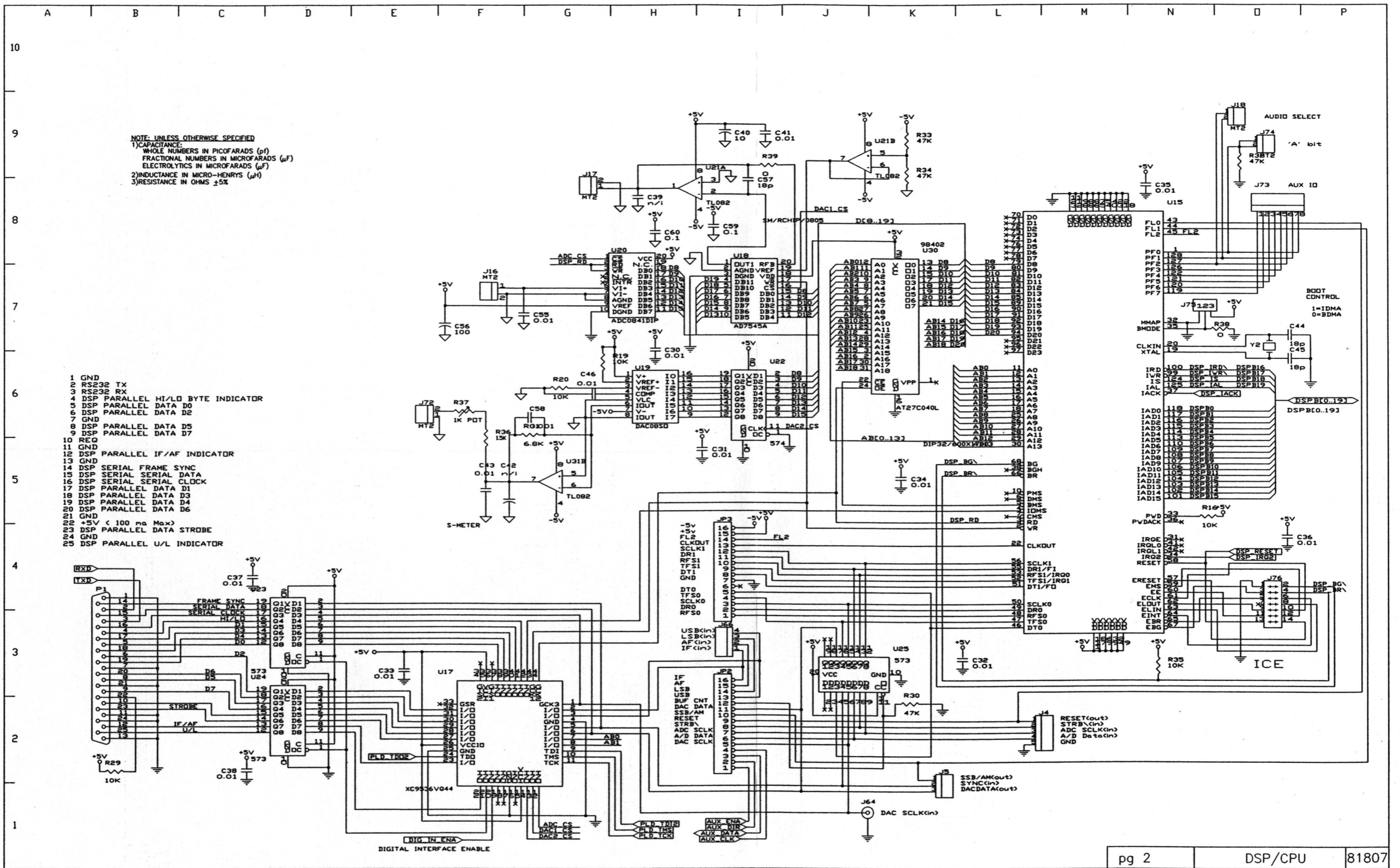

FIGURE 10-38 81807 CPU-DSP SCHEMATIC

TABLE 10-7 81807 DSP/CPU BOARD PARTS LIST

I.D.	Description	Part No
C12,C13,C44,C45,C57	20pF	23465
C42,C56	100 (ohm)	N/I
C2,C3,C4,C5,C6,C7,C8,C47,C48,C49,C50,C51,C52,C53,C58.	.001uF	23486
C1,C9,C10,C11,C19,C21,C24, C25,C27,C28,C29,C30,C31,	.01uF	23487
C32,C33,C34,C35,C36,C37,C38,C41,C43,C46,C54,C55.	-----	-----
C14,C15,C16,C17,C18,C39N/I,C59,C60	.1uF	23488
C20	3.3uF	23265
C40,C61	10uF	23266
D1	1N4148	28001
D2	MMSD914T1	28124
P1	D-SUB 25 PIN	35251
R38, R39	0	30629
R4,R5,R6,R7,R8,R9,R10,R22,R23,R24,R25,R26,R27.R28.	100	30650
R1, R2	470	30658
R12,R36	1.5K	30664
R13	4.7K	30670
R31	6.8K	30672
R14,R15,R16,R19,R20.R29,R35	10K	30674
R3N/I,R30,R32,R33N/I,R34	47K	30682
R11	220K	30690
R37	10K Pot	30618
R40	47K	30300
U1	80C552	25331
U2	MAX242	25415
U3	M48Z58SO	25401
U4,U17	XC9536VQ44	25416
U5, U6,U23,U24,U25,U29	573	25413
U7,U8,U9	74HC4050	25414
U11	82C55APLCC	25417
U12,U30	27C010-150	25432
U15	ADSP2181KS	25362
U18	AD7545A	25424
U19	DAC8SO	25418
U21,U31	TL082	25406
U22	574	25404
U26,U27	10K X 8	30404
U28	14094	25422
Y1	22.1184 MHz	48201
Y2	16.667 MHz	48209

81819 FRONT PANEL CPU TOP COPPER

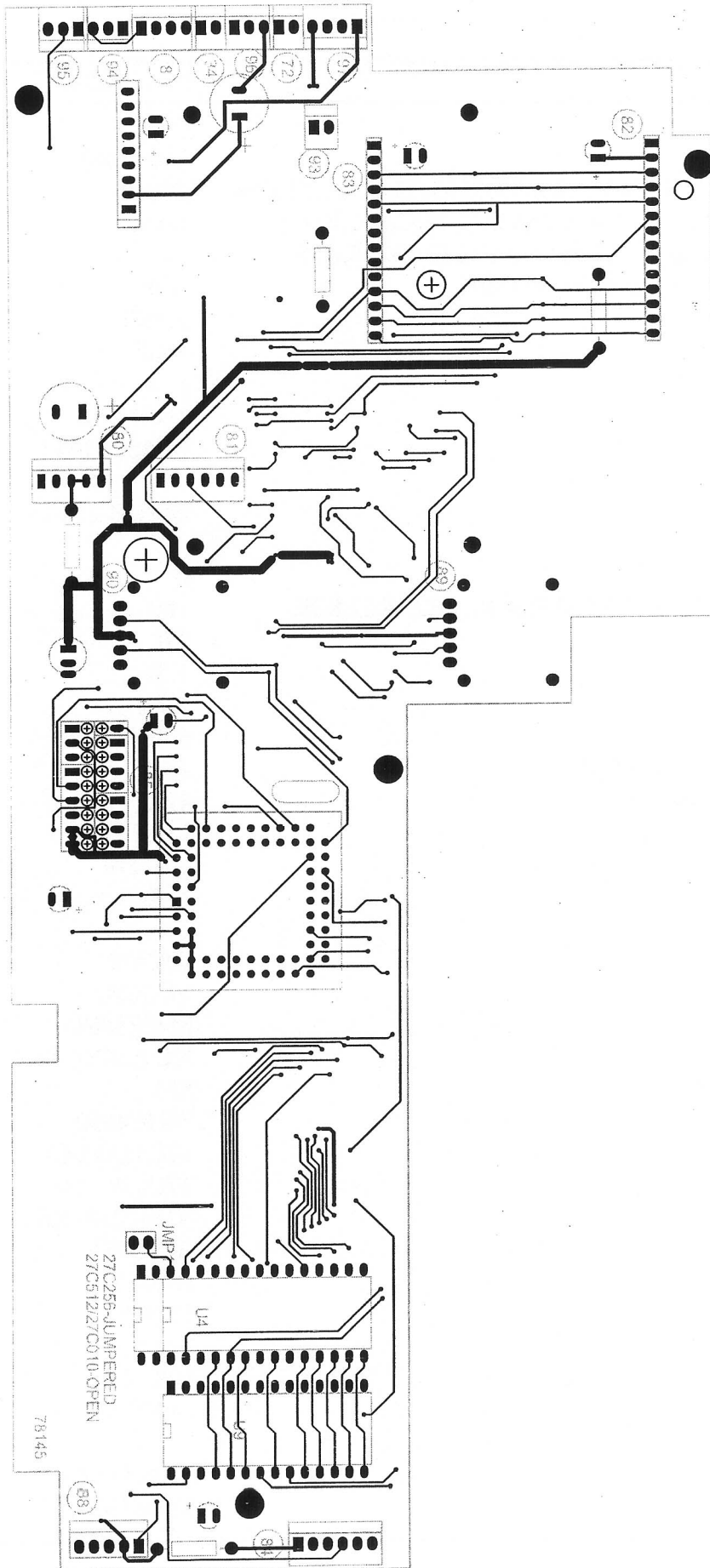
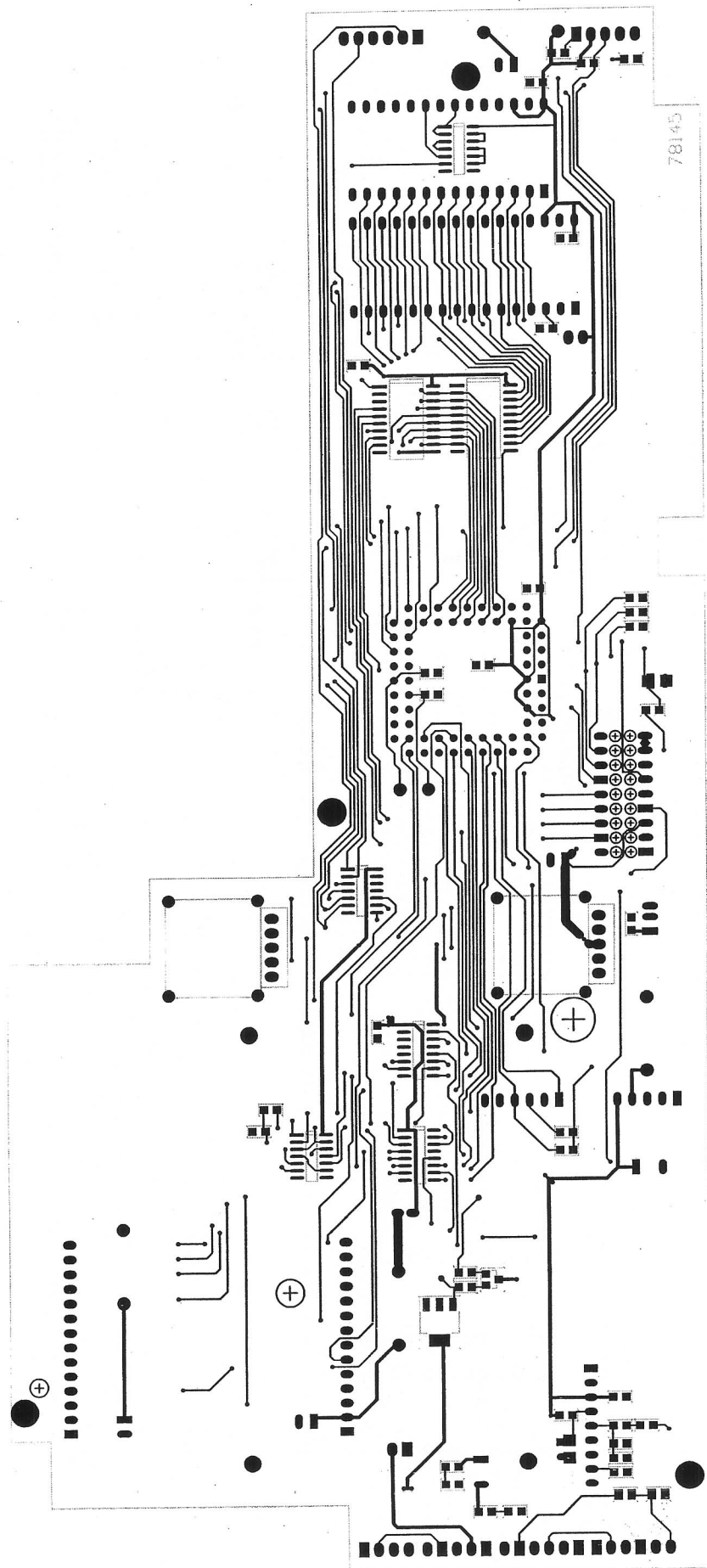

FIGURE 10-39

81819 FRONT PANEL CPU BOTTOM COPPER



78145

FIGURE 10-40

81819 FRONT PANEL CPU TOP COMPONENT LAYOUT

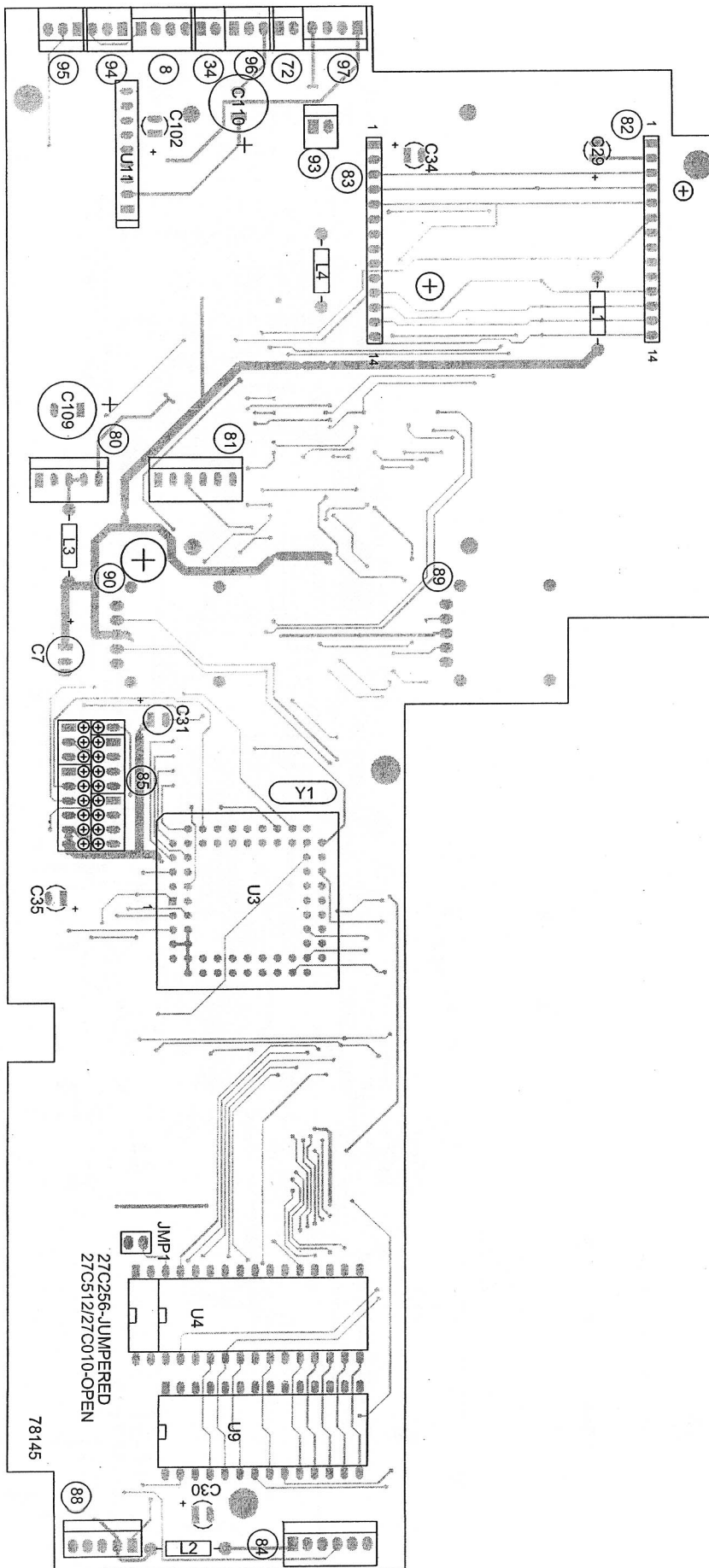

FIGURE 10-41

81819 FRONT PANEL CPU BOTTOM COMPONENT LAYOUT

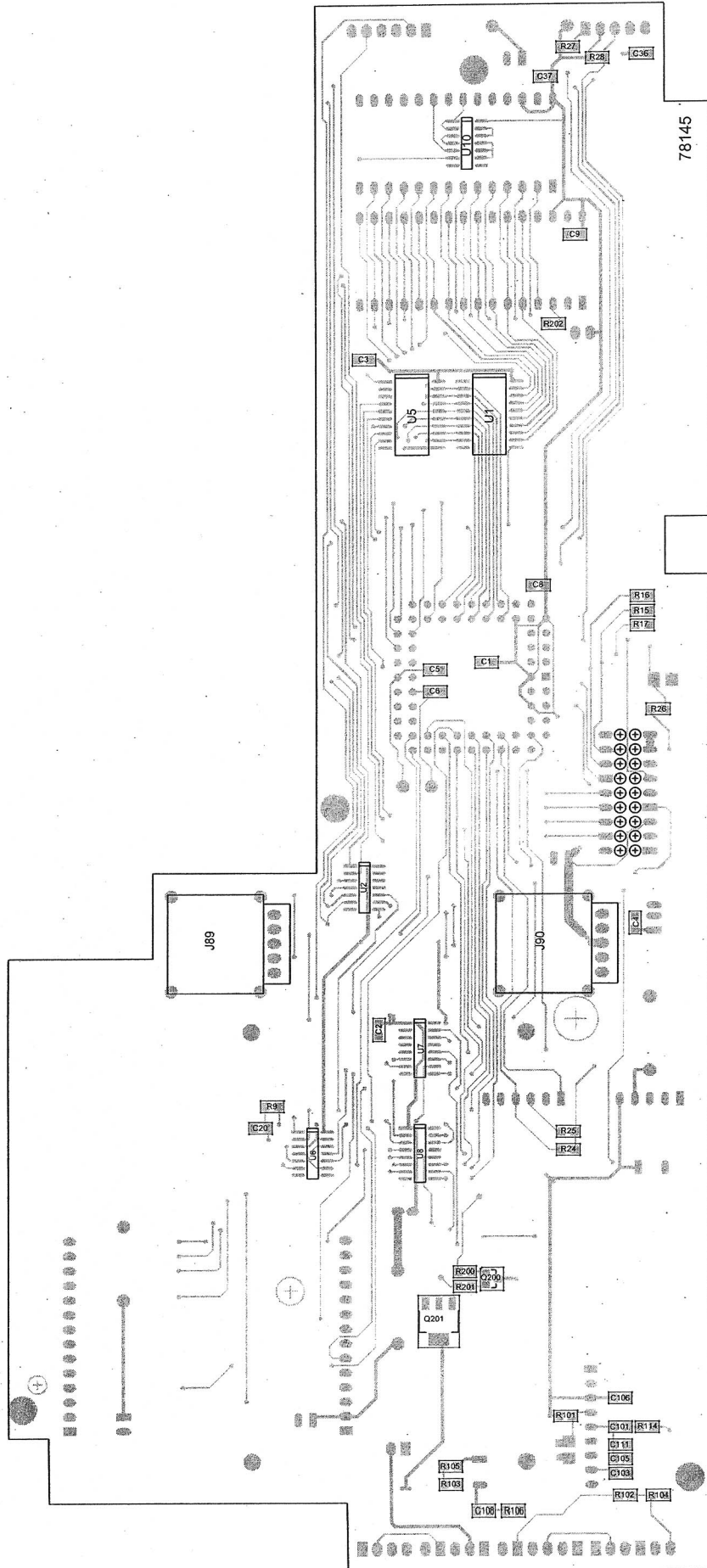

FIGURE 10-42

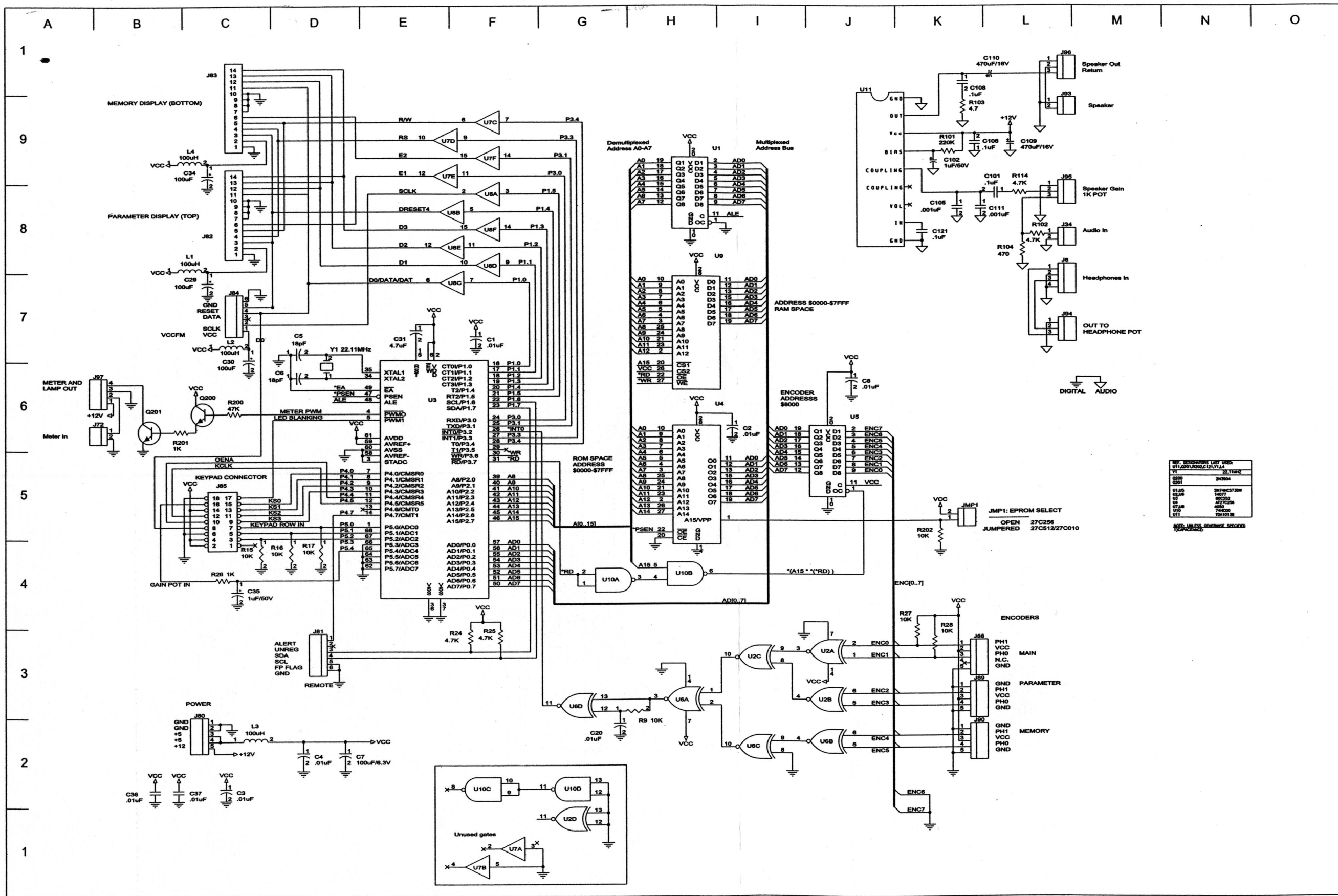

FIGURE 10-43 81819 FRONT PANEL CPU SCHEMATIC

TABLE 10-8 81819 FRONT PANEL CPU BOARD PARTS LIST

I.D.	Description	Part No
C6,C5	18pF	23465
C111,C105	.001uF	23486
C1,C2,C3,C4,C8,C20,C36,C37	.01uF	23487
C9,C101,C103,C106,C108	.1uF	23488
C35,C102	1uF/16	23524
C35A,C102A (REPLACES C35,C102)	1/20	23264
C31	4.7uF	23310
C7,C29,C30,C34	100uF/6.3V	23267
C109,C110	470uF/16V	23228
E1,E2	ENC_1	32114
L1,L2,L3,L4	100uH	21179
Q200	2N3904	25375
Q201	PZT2222	25378
R103	3.3	30633
R104	470	30658
R26,R201	1K	30662
R24,R25,R102,R114	4.7K	30670
R9,R15,R16,R17,R27,R28,R202	10K	30674
R200	47K	30682
R101	220K	30690
U4	AT27C25620	25251
U9	U6264AD	25301
U3	80C552-5	25331
U11	TDA1013B	25365
U1,U5	SN74HC573DW	25413
U7,U8	74HC4050D	25414
U6,U2	MC14077BD	25419
U10	74HC00AD	25426
Y1	22.1184MHz	48201

81820 KEYPAD TOP COPPER

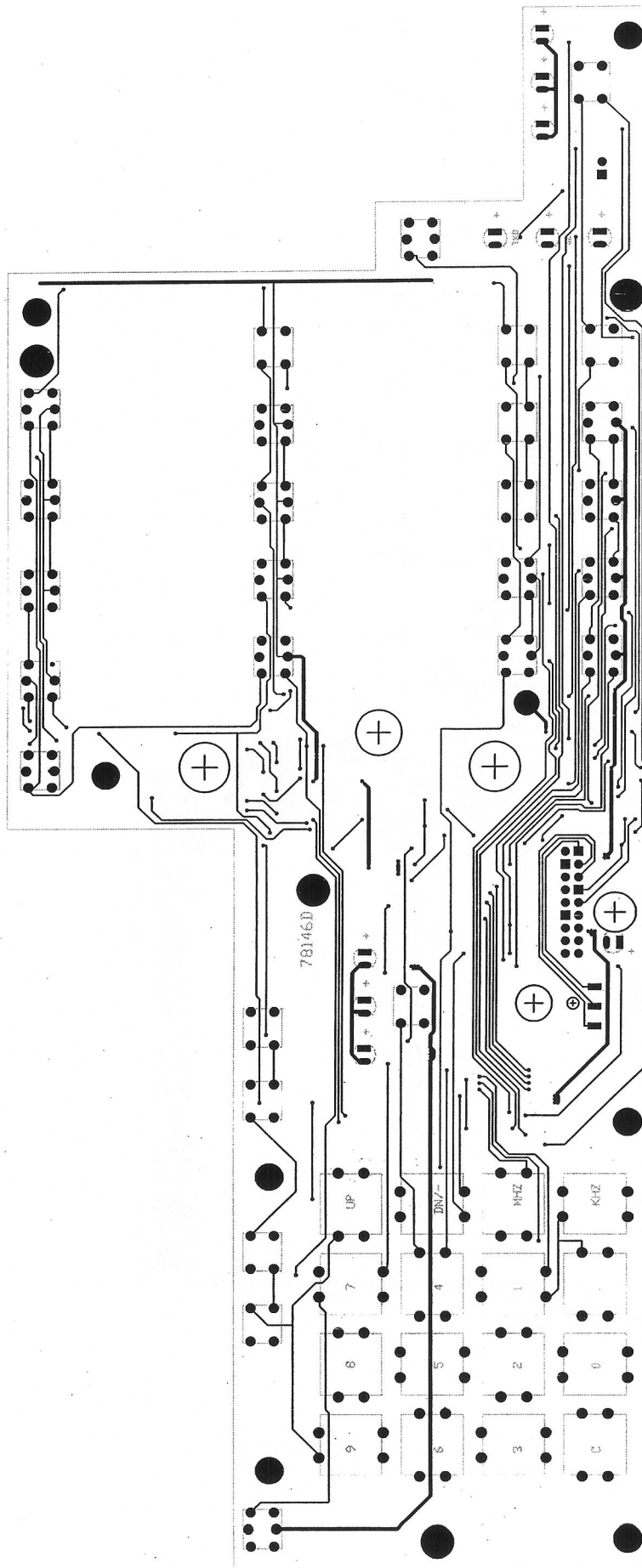

FIGURE 10-44

81820 KEYPAD BOTTOM COPPER

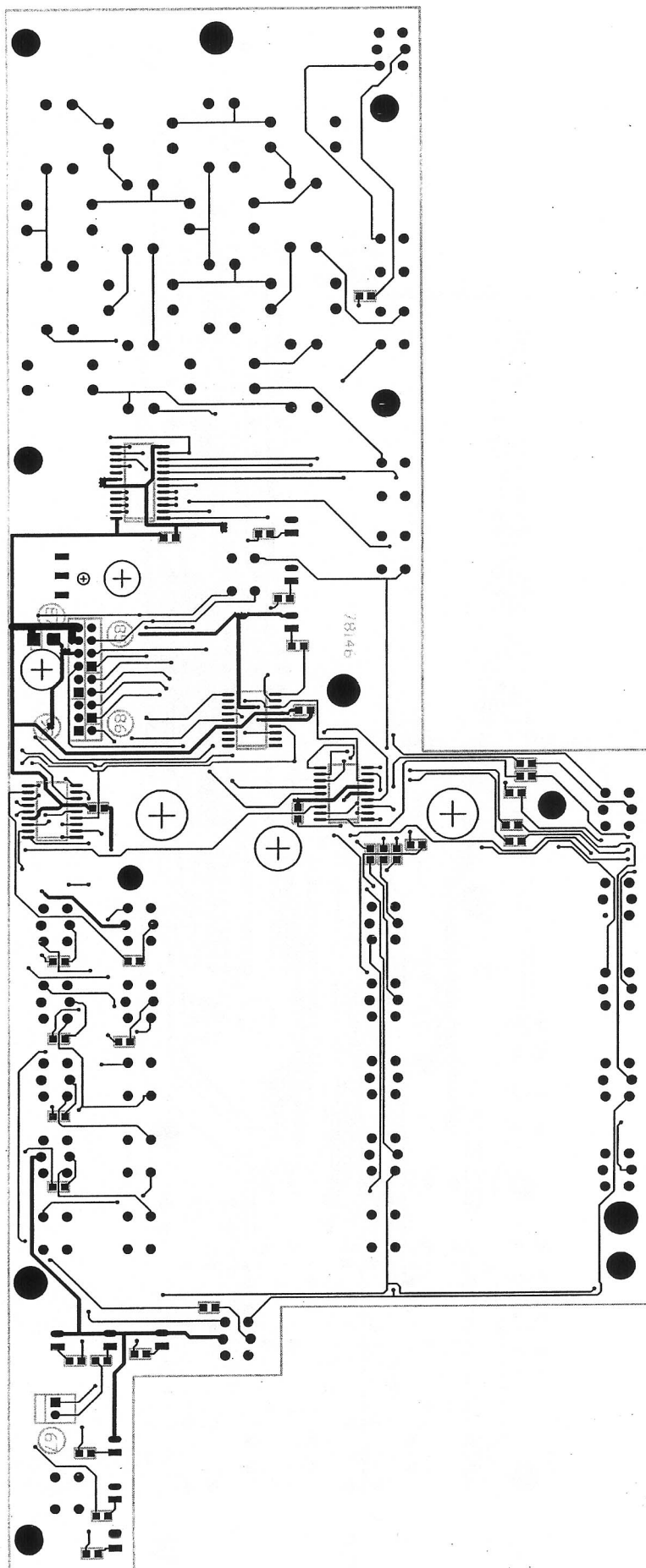

FIGURE 10-45

81820 KEYPAD TOP COMPONENT LAYOUT

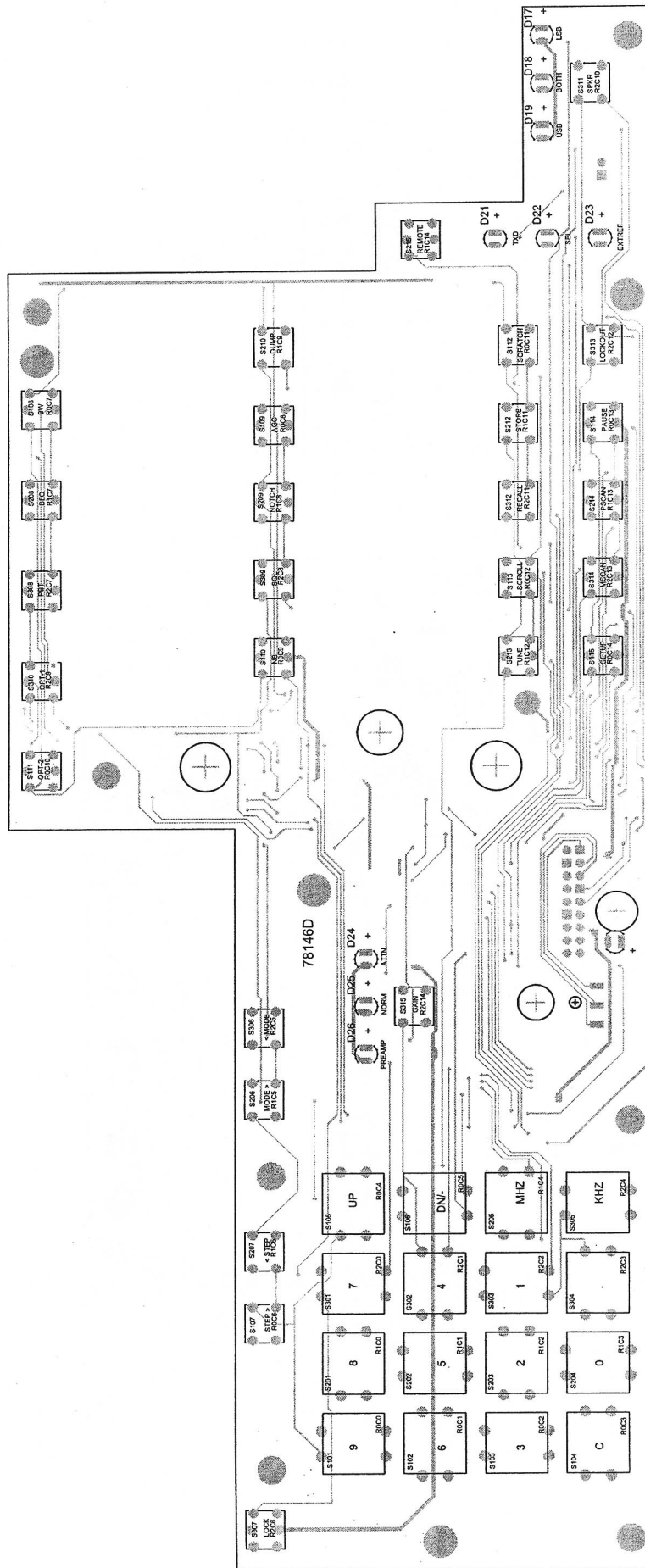

FIGURE 10-46

81820 KEYPAD BOTTOM COMPONENT LAYOUT

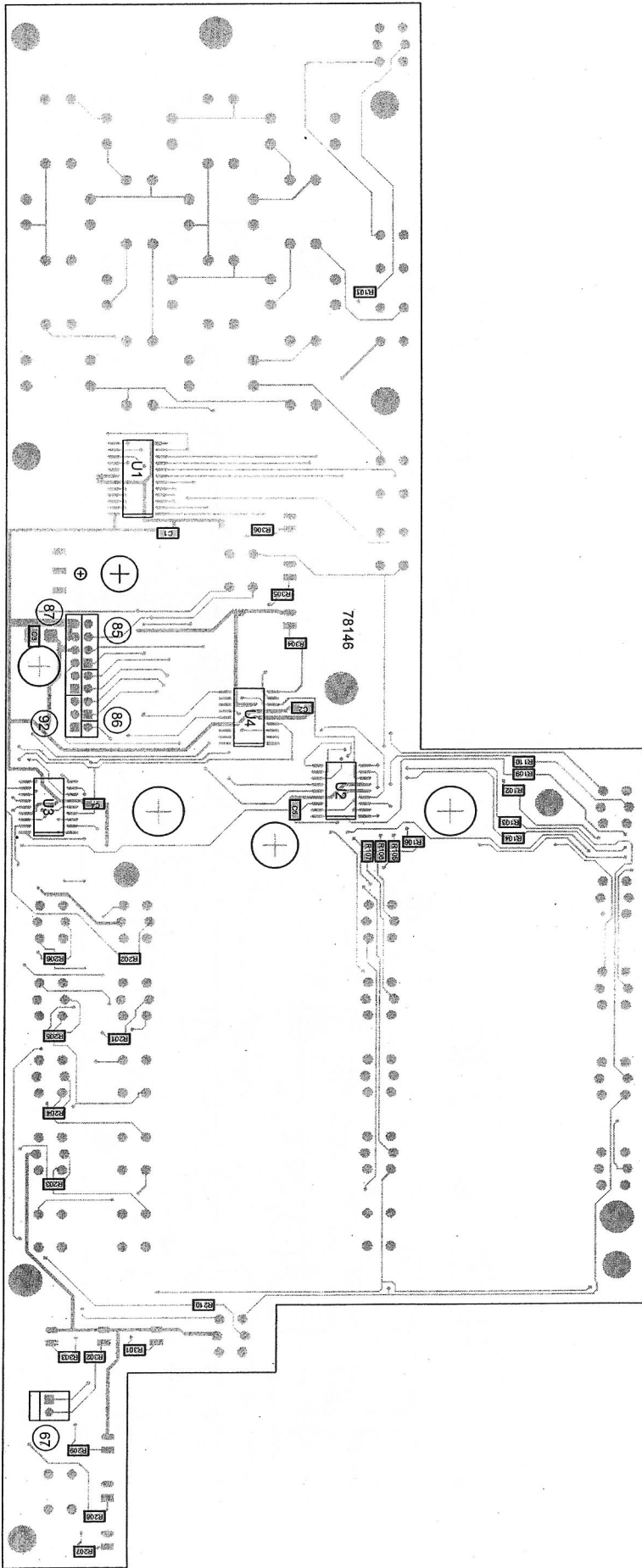

FIGURE 10-47

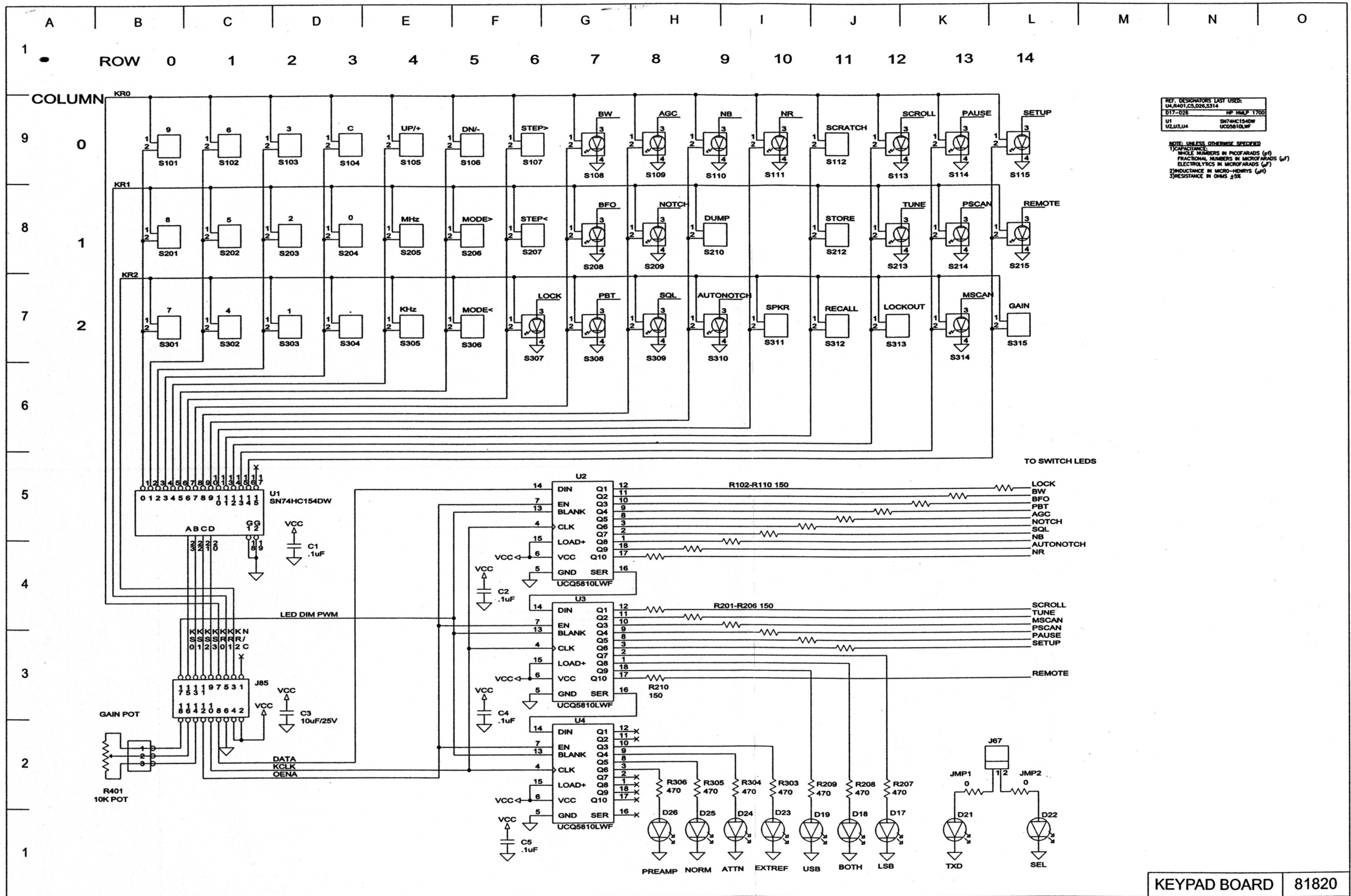

FIGURE 10-48 81820 KEYPAD SCHEMATIC

TABLE 10-9 81820 KEYPAD BOARD PARTS LIST

I.D.	Description	Part No
C1,C2,C4,C5	.1uF	23488
C3	10/25	23266
C3A (REPLACES C3)	10/16	23525
D17,D18,D19,D23,D24,D25,D26	LED 1/8 YELLOW	28025
D21,D22	LED 1/8 RED	28024
D25		N/I
R401	10K POT	30267
R101,R102,R103,R104,R105,R106,R107,R108,R109,R110,R201, R202,R203,R204,R205,R206,R210.	150	30652
R207,R208,R209,R303,R304,R305,R306	470	30658
S101,S102,S103,S104,S105,S106,S201,S202,S203,S204,S205, S301,S302,S303,S304,S305.	Large Switch	32124
S107,S112,S206,S207,S210,S212,S306,S311,S312,S313,S315	Small Switch	32125
S108,S109,S110,S111,S113,S114,S115,S208,S209,S213,S214, S215,S307,S308,S309,S310,S314.	Illum. Switch	32126
U2,U3,U4	A6810SLW	25407
U1	SN74HC154DW	25421

TABLE 10-10
RECORD OF CHANGES

CHANGE NO.	DATE	TITLE OR BRIEF DESCRIPTION	ENTERED BY

WARNING

HIGH VOLTAGE

is used in the operation of this equipment.

DEATH ON CONTACT

may result if personnel fail to observe safety precautions.
Learn the areas containing high voltage within the equipment.
Be careful not to contact high voltage connections when installing,
operating or maintaining this equipment.
Before touching or working inside the equipment, turn power
and ground points of high potential OFF.