

Product Manual

Full Line Product Information

Antenna Trimming Chart - 60
Ground Loop Solution - 13
Installing Line Isolators - 16
Installing Antennas in Trees - 20
Power & Control Line Isolators - 18
RF Ground Systems - 7
Second Floor Grounding - 15
Tower Installation - 32
Ultimate Sealing Technique - 4
Weatherproofing - 3

Installation Checkoff Lists - 26

Inverted-V
Before installing your antenna as
an inverted-V, read page 61.

IMPORTANT - Read pages 2 - 4
and all related instructions before
beginning any installation!

Copyright © 1997, 1999, 2002, 2003, 2006 All rights reserved

The RADIO WORKS

Where Ham Radio Is a Contact Sport™!

Box 6159, Portsmouth, VA 23703 U.S.A.
757-484-0140
FAX 757-483-1873
WEB Site <http://www.radioworks.com>

CAUTION

Read This Text

This page is included to help you make your antenna installation safe. The following cautions are general, and they apply to all antenna and balun installations; they are not specific to any RADIO WORKS antenna, balun, or accessory.

HAZARDS

This antenna or antenna component is **USER INSTALLED**. The RADIO WORKS has no control over its installation. Before you begin, you must be qualified and must be fully aware of the **CONSEQUENCES** and **DANGERS** involved in antenna, balun and transmission line installations.

If you are not totally familiar with **SAFE** antenna and balun installation practices, **GET COMPETENT HELP** and **ADVICE** before installing this antenna, antenna part or accessory.

POWER LINES

DO NOT build, erect or install any antenna or tower (or part of an antenna, such as a balun or transmission line) near **POWER LINES, POWER POLES, OR ANYTHING ASSOCIATED WITH THEM. THIS INCLUDES THE POWER LINES THAT RUN FROM A POWER POLE TO A BUILDING.** Mount your antenna so that it **CANNOT** fall (or be blown by high winds) into power lines.

LIGHTNING

LIGHTNING is providential, and provisions must be made for it. Use appropriate **LIGHTNING** protection, and install it following the instructions supplied with the device. Also, disconnect all your antennas from your equipment and disconnect your equipment from the power lines during weather that is likely to produce lightning.

SHOCK

HIGH VOLTAGE may exist on certain parts of antennas, baluns, and transmission lines. This represents a possible **SHOCK** or **FIRE HAZARD!** It is not a fault of the design or the designer. It is a consequence of the physical laws involved. Most antennas will develop **HIGH VOLTAGE** at some point on their physical structure. **HIGH VOLTAGE** can occur in some antenna types even when applying low RF power. Be certain that your antenna installation provides for this **POTENTIAL HAZARD**. Locate all parts of the antenna well out of the reach of people. It is also desirable and proper installation practice to keep all antenna components away from any object not made of insulating material.

WARNING!

PROTECT YOUR WARRANTY!

THE ENCLOSED CoaxSeal® MUST BE USED AND APPLIED CORRECTLY.

Most weatherproofing techniques used by Hams are not reliable. Occasionally, a customer returns an antenna or balun that no longer works properly. In nearly every case, the product had not failed. Connectors or coaxial cable had failed as the result of improperly applied weatherproofing. Often, no weatherproofing was used! Nearly all failures have been traced to corroded connectors and moisture contaminated coax.

As a service to our customers, we are including CoaxSeal® with each product.

Applying CoaxSeal®

**** If any other weather sealer or weatherproofing technique is used with any RADIO WORKS product or if the CoaxSeal® is not installed according to directions, the warranty is void.***

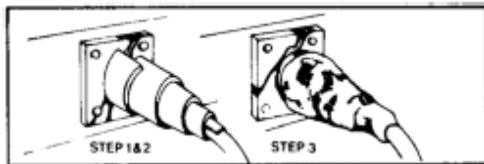

1. Make sure the coaxial connector and the coaxial cable are clean and dry.
2. Peel approximately five (5) inches of CoaxSeal® from its paper backing. Start winding from the coax jacket towards the connector. Allow one-half overlap with each winding, making sure all joints are well covered. This is shown in the illustration, "STEP 1 & 2."
3. After the entire connector and coaxial cable are covered with 3/16" layers, mold and form the CoaxSeal® with your fingers to make a smooth surface and to force out any air. CoaxSeal® must stick to the connector and coax's jacket. See illustration "STEP 3."
4. If more CoaxSeal® is necessary to complete the seal, simply cut the needed amount from the roll and add it to the existing CoaxSeal®. Mold and press into the other material. CoaxSeal® sticks to itself with slight pressure.
5. Carefully inspect the seal to make certain that all openings are covered and sealed.

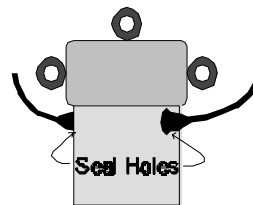

It is not necessary to seal the eyebolts. Seal only the wires exiting the case and the coaxial connector.

Baluns, Line Isolators, and Matching Transformers are filled with a sealing compound. However, to prevent any moisture from entering the case, apply CoaxSeal® to fill the holes where wires exit the balun's or matching transformer's case.

Pull **lightly** on each of the two wires to be sure they are fully extended out of the case. Peel a small piece of CoaxSeal® from its paper backing. Ball up this CoaxSeal® and press around one of the wires where it exits the case. Press and mold the CoaxSeal® so that it sticks to the case and to the wire's jacket.

Repeat for the second wire on the opposite side of the case.

Inspect for complete sealing.

Again, pull **LIGHTLY** on each wire to be sure that the seal is secure.

Ultimate Sealing Technique

All sealing products are available at the **RADIO WORKS.**



You need Coax Seal, STUF, Cold-shrink and electrical tape



Apply STUF to the connector as shown.



When connector is tightened, "STUF" is compressed and forced to fill any voids in the connectors. Moisture and excess STUF is forced out.



Compression causes STUF to fill all cavities and voids inside the connectors. Since all voids are filled with STUF, a Teflon dielectric material, any path for moisture reentry is eliminated.

Important
Clean off excess STUF

A layer of quality electrical tape is carefully applied in overlapping layers. The PL-259 connector is completely covered from the balun case (or other surface) to at least 1" on the coaxial cable.



Overlap a layer of electrical tape from body of the device and continue well on the cable.



Apply one overlapping layer of Coax Seal. Press so that it sticks to the device and covers at least 1" of cable. The seal must be solid from device to cable.



IMPORTANT - Make sure the Coax Seal is well whetted (stuck) to the device as well as to the cable.



Optional, but recommended, apply a layer of Cold-shrink tape completely over the Coax Seal.

Cover the Cold Shrink with a layer of electrical tape



You should enjoy years of trouble-free service from this sealing technique.

STUF seals from the inside

Electrical Tape makes removal of the Coax Seal easier and forms the next layer of protection.

Coax Seal provides a totally waterproof seal

Cold-Shrink Tape is a tough, solid outer layer which puts a squeezing force on the Coax Seal to improve the seal. It provides an extra layer of protection.

Important - Power Ratings

Check the Specs Most products are rated at 1500 watts peak output on CW and SSB under normal amateur radio duty-cycles. Antennas, baluns, and Line Isolators are not rated for AM, FM, RTTY, or other high duty-cycle modes unless specifically rated for those modes in the specifications.

Baluns and Line Isolators

All RADIO WORKS' products' power ratings are for standard Amateur Radio SSB and CW duty-cycles. Normally, that is 25%, which equates to 25% transmitting time followed by 75% listening time. Often these numbers are even more conservative in actual amateur service. We do not rate any of our products for high duty-cycle modes. This includes AM, FM, RTTY and high duty-cycle digital modes. Essentially, these modes require devices designed for commercial service. I have checked on prices for a commercial 2 kW balun and the price was nearly \$1500. This is certainly beyond the range of most of our budgets. I know that there are balun manufacturers that claim very high power ratings. However, they say nothing about duty-cycle nor do they mention the load conditions under which they will survive their rated power. I am being up-front with our ratings.

It has been only during that past five years that the interest in very high power operation has been more than a very isolated case. We have been building baluns and Line Isolators for nearly two decades, and our power ratings were more than adequate. Most operators were using SSB and CW. Most still operate those modes. Then came the resurgence of AM operation and the apparent disregard of power limits. For example, an AM transmitter generating 1500 watts of carrier produces 6 dB higher output when fully modulated. In other words, the 1500 watt transmitter delivers 6000 watts of modulated RF to the antenna components. That's for a fully plate modulated carrier. The legal limit is 375 watts of carrier, by the way. That results in 1500 watts of modulated output.

The operating style of AM, FM and most RTTY operators, especially when contesting or when just being long-winded, is to run key-down for long periods of time. The same goes for the new digital modes. There is no cool-down time for antenna components. Another problem with older transmitters which run "class-C" output stages is the very high harmonic and spurious signal components in the output signal. Some antenna components, among them, high quality current baluns and Line Isolators, absorb much of the harmonic and spurious energy. This can result in core saturation and excessive heating. You may say that this doesn't happen in other types of devices. The reason is that these devices just pass the harmonics and spurious signals along to the antenna. This isn't to say that current baluns and Line Isolators can be used as "low pass filters." Special devices are needed for that purpose. Each has its own function and they should be used together.

PSK-31 operation is OK, and our baluns and Line Isolators will not contribute to distortion products or increasing your IMD. Just keep the power in the 100 watt range.

I have to mention the PSK-31 operators. While PSK-31 is a high duty-cycle mode, nearly every operator I've heard on the bands runs low power and gets through just fine. One reason for this is that PSK-31 operators are very conscientious about keeping their IMD products low. They reduce power until their rigs produce a clean signal. I wish this concern for clean signals would spread throughout operators of other modes. Perhaps if our receivers had an IMD or "distortion" meter, things would change.

Antennas

The matching transformers and Line Isolators used in our antenna systems are based on the same designs and parts used in our baluns and undedicated Line Isolators. Therefore, all of the above information on power limits applies to our antenna systems, too.

IMPORTANT

Do Not Ignore the Installation Checkoff Lists

CAUTION

KEEP ANTENNAS AWAY FROM ELECTRIC UTILITIES

An RF ground is very important. See the grounding information in this product manual starting on page 7.

DO NOT use your house ground system as your radio ground system. This is sure to cause RFI and even more serious problems. Do not use water pipes for grounds.

If your radio room is not on the ground floor where very short ground runs are possible, you will probably have RFI and RF feedback problems with any antenna system. The solution is to install ground mounted and in-station Line Isolators. Use a “single-point” ground system and run multiple ground runs. See page 15.

The checkoff lists start on page 26, following the complete general installation instructions on page 20. These lists are step-by-step installation guides. **Use them.** They are specific and detailed. Also, pay attention to the “Do’s and Don’ts” list on page 25.

For maximum life and performance from your antenna, do not assume that the “Installation Checkoff Lists” are not important.

If your antenna is not installed properly, it will not perform properly!

If you call with questions about your antenna installation, we use the lists to help identify any problems with your antenna system. In 99% of the calls, the problems could have been avoided if these instructions had been followed.

RF GROUND SYSTEMS

The UN-GROUND

Ground systems that aren't

From the telephone calls we receive, many of you are having problems with RF ground systems. RF ground? Yes, most of us have ground systems that provide adequate DC grounding. Unfortunately, a good DC ground system may not be a good RF ground system. In fact, you may have an 'UN-GROUND.'

UN-GROUND? Absolutely. There are situations where your ground system may actually un-ground your station. The reason lies in the fundamental difference between DC and RF circuits.

Definition

IMPEDANCE

The total opposition (resistance and reactance) a circuit offers to the flow of alternating current. Impedance is measured in ohms. The common symbol is Z.

Definition

REACTANCE

Symbolized by X, it is the opposition to the flow of alternating current. Capacitive reactance (X_C) is the opposition offered by capacitors and inductive reactance (X_L) is the opposition offered by a coil or other inductance. Both are measured in ohms.

Any wire will have inductance and therefore, inductive reactance. The longer the wire, the higher the inductive reactance and the higher the opposition to the flow of RF current. The fatter or larger the wire, the lower the opposition to the flow of RF current. The effect is similar to the DC resistance of a wire. The longer the wire, the higher the DC resistance will be.

The fatter the wire the lower the DC resistance for the same length wire. There is an important 'however,' that we must consider. When the X_L (inductive reactance) is measured along the length of a wire, the magnitude of X_L (the opposition to RF current flow) varies from very low to very high values. It continues to alternate between low and high values in cycles that have a direct relationship between the length of wire and the frequency of the applied RF energy. DC resistance, on the other hand, has no cycle. It simply increases linearly with the length of the wire.

When measuring X_L , its value is very high when the length of the wire is around one-quarter wavelength long. Increasing the length wire to one-half wavelength, returns X_L to a low value.

The length of the wire does not have to be very long for this effect to be observed. For example, at 28 MHz an **8' ground wire** (or any wire for that matter) is approximately one-quarter wavelength long. If this 8 foot long ground wire connects your 10 meter rig to may actually prevent RF from traveling to ground. This is an **UN-GROUND!**

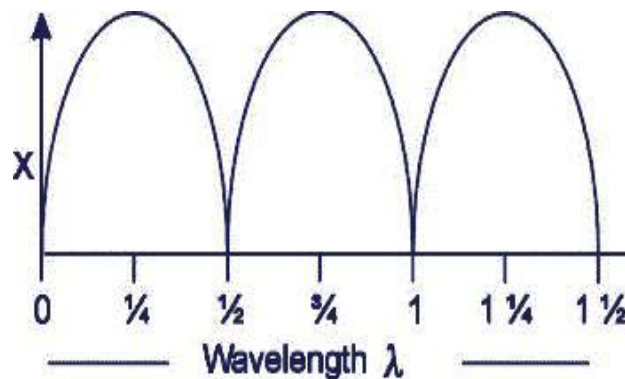

Figure 1
Reactance vs Wavelength

Why? As illustrated above, the inductive reactance of wire that is one-quarter wavelength long is very high and impedes RF current flow (thus the term - impedance).

On other bands, where the length of the wire is not an odd multiple of a quarter wavelength long, the inductive reactance (X_L) is at some intermediate or low value.

High RF Voltage

Figure 2 shows a grounding diagram of a typical ham station.

There is a heavy ground strap running along the back of the equipment. The ground strap eventually reaches the earth ground system, a ground rod, through a heavy gauge copper wire 11 feet in length. The ground connection for each piece of equipment goes directly to the heavy ground strap that runs behind the station equipment. **The antenna is a ladder-line fed, 80 meter dipole** used on all bands. The ladder line is brought directly into the operating position where it connects to the balanced output of the tuner (transmatch). The ladder line is about 60 feet long and goes directly to the antenna, but passes very close to a metal rain gutter. Such a station should be effective and trouble free. Unfortunately, this station is experiencing problems on several bands. There is RF feedback distorting the transmitted signal, and there are some TVI and RFI problems. What could be wrong?

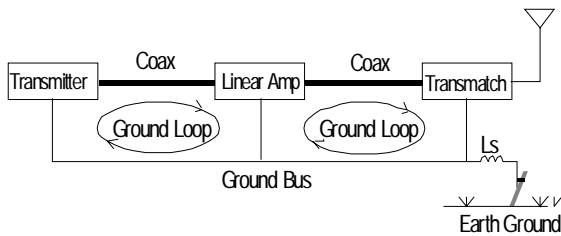

If we tune up on 20 meters, the 80 meter dipole becomes a center-fed, two wavelength antenna. The feedpoint impedance is around 4500 ohms. The length of the ladder line feeding the antenna is about one wavelength long. It is a characteristic of transmission line that it will duplicate its load impedance every half-wave along its length. So, the very high antenna feedpoint impedance appears right at the tuner's (transmatch) output terminals. However, before reaching the tuner (transmatch), the ladder line runs very close to a metal rain gutter. Feedline balance is upset, and it begins to radiate at that point.

The tuner (transmatch) uses a voltage-type balun to create a balanced output. Baluns do not work well in high impedance circuits, and **voltage-type baluns are especially bad in this application.** With a high impedance load, the voltage balun's core will saturate even at moderate power levels. Output balance is poor.* This contributes to additional radiation from the balanced line.

In this illustration, we have several problems, each compounding the other. First, all of the ground system and ground loop problems still exist, but we now have a **tuner (transmatch) balun that is saturating and generating high level harmonics.** Signal distortion may be noticeable because the balun is no longer operating in its linear region. The ladder-line is not balanced so it radiates, and the equipment at the operating position becomes part of the antenna system. **Here is a real shocker!** There is RF all over the equipment. The Microphone is biting your lips. Your computer crashed. The packet TNC will not talk to you anymore, but none of this matters because the station power supply shut itself down and you are off the air. Sound impossible? Unfortunately, it's not. This is a true story and this isn't the end.

* Voltage-type baluns provide their best balance when feeding matched loads. Current baluns provide better balance under most conditions.

HIGH ABOVE THE GROUND

The ground wire is about 11 feet long. On 15 meters, this length is almost exactly 1/4 wavelength

A length of wire or coax that is 1/4 wavelength long is an impedance inverter. One end is at low impedance, so the other end presents a high impedance to the circuit connected to it. In other words, the ground wire is near zero impedance at the ground end, but due to the impedance inverting characteristic, the station equipment 'sees' a very high impedance at the equipment end of the ground wire. In effect, the equipment is **UNGROUND**ED at high RF frequencies.

On 20 meters, the 11 foot ground wire is .15 wavelengths long. Referring to figure 1 and interpolating between zero and 1/4 wavelength, the inductive reactance of the ground wire is still quite high. To our station equipment, the ground wire simulates an inductive reactance in series with the resistance of the ground wire. This is illustrated by the coil L_s in figure 2. We'll disregard the DC resistance of the ground wire.

Without getting into great detail, let's just agree that it would be better if the station had a direct, low impedance path to ground. In this illustration, this is not the case. The path to ground is a high impedance on the higher frequency bands. In fact, there are alternate grounds available to the station equipment. Other, undesirable, ground paths may present a lower impedance path to earth or may act as a counterpoise. Unfortunately, one of those ground systems is the electrical power lines at the operating position. RF from the transmitter, seeking a ground path, may have to pass by or through several electronic appliances (TVs, VCRs, etc.) that would work better if they were isolated from your transmitting equipment.

Due to the inductive reactance of the ground system, none of the equipment in this station is effectively grounded on the higher HF bands. If an RF potential exists on the station ground system, the entire station may 'float' up to that RF potential. Thus, the earth ground reference is actually several volts above ground. All sorts of RFI problems can be the result, including RF feedback into station microphones, computers, monitors, TNCs, power supplies, etc.

Solid state equipment is especially sensitive to ground problems.

Solid state equipment is especially sensitive to ground problems. Each piece of equipment in figure 2 is interconnected by two ground paths, a ground strap and the coaxial cable that interconnects the equipment. The two paths form a ground loop. Since there is high system gain involved from the millivolts of the transceiver's input circuits to the kilovolts of the linear's output circuit, ground loops can be a serious problem. It's even worse if the ground system is ineffective and the entire station is 'floating' above ground. Breaking the ground loops can lead to the solution to long unsolved RFI problems.

The RADIO WORKS' Line Isolatorssm are very effective at solving ground loop problems.

The Shocking Truth

Have you ever calculated what the voltage across a 4500 ohm reactive load is at 1.5 KW? It is more than a few volts. Actually, it's a few thousand volts. It's unbalanced, and it's looking for somewhere to go. As we predicted in previous paragraphs, the antenna feedpoint impedance and corresponding high RF voltage is transferred directly across the output terminals of the tuner (transmatch). **Several thousand volts of RF** is only a few feet away and at RF, the station is poorly grounded.

I'm not going to bore you with a lot of math, but let's simplify this situation to a simple series circuit. In figure 3, the antenna, tuner (transmatch), and ground system are represented by a simple voltage divider. This simple circuit will allow me to illustrate what is happening to the ground bus in the ham shack.

First, let's assume the voltage at point 'A' on the tuner (transmatch) is 500 volts. It is really much higher. The impedance at the output terminals of the tuner (transmatch) is 4500 ohms, and the reactance of the ground system is 500 ohms. I did not calculate the value for the ground system, the 500 ohm value is for illustration.

Reducing the problem to its simplest terms, we have a 4500 ohm resistor in series with a 500 ohm resistor. The ground system is the tap between the two. In this example, if there are 500 volts at the tuner (transmatch), the station ground system will 'float' above earth ground. The potential is about 50 volts. Your ground system and all your equipment, in effect, has 50 volts of RF applied to the equipment grounds. **This is just like having a 50 volt input signal** if the input circuits were at ground potential.

Another way to look at this problem is to visualize the antenna and ground system as a big coil that represent the inductive reactance of the ground system and tuner (transmatch). The antenna is at one end of the coil, and the ground is at the other. We are tapped several turns up the coil. The higher the impedance of the ground system, the higher up the coil the 'tap' is located. The only way to keep RF off the station equipment and station ground is to move the point where the rig is tapped into the coil closer to ground.

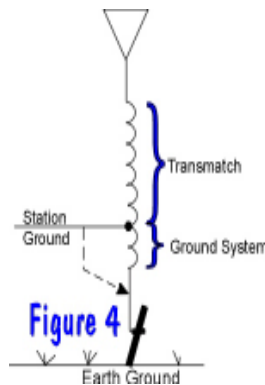
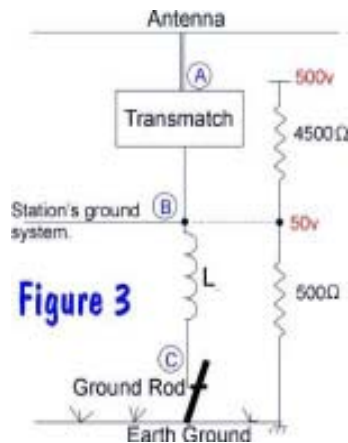

Of course, it's never this simple. My numbers are only representative, but they do serve as an illustration. **The RF voltage on the station ground system does reach very high levels** under some circumstances. I have had hams tell me of severe RF burns and visible 'arcing' from microphones, equipment chassis, ground busses. Obviously, at these levels of RF voltage, there will be terrible problems. But, what happens when the RF voltage on the ground system is only a few volts? You may not know that RF energy is there, causing RFI or other problems.

Symptoms

There are some symptoms that may suggest the existence of station grounding problems. A list must include such obvious things as 'mic bite,' a tingly feeling when touching metal while transmitting. A less obvious symptom is transmitted signal distortion due to RF feedback. RFI and TVI problems can often be traced to grounding problems. Here are a few other observations that were the result of an UN-GROUND.

- (1) Two SWR meters, one in your transceiver and the second in the tuner (transmatch) that are in wide disagreement. This assumes that both meters are accurate, your SWR is low and the interconnecting coaxial cable is short.
- (2) A change in indicated SWR when the station ground system is temporarily disconnected from all equipment.
- (3) A change in indicated SWR reading after adding a 1/4 wavelength counterpoise in parallel with the station ground system. Information on making a counterpoise is covered later in this chapter.
- (4) Adding a Line Isolator™ at the output of your transceiver changes the drive to your linear, alters meter readings, requires changes in tuner (transmatch) settings or results in a different SWR reading on either the transceiver's or linear's watt-meter.

If any of these observations suggest that there is a ground or ground loop problem, there are several things you can do. Eliminating a ground system problem may clear up both existing and potential RFI problems.

Fortunately, under most circumstances we do not have severe problems with our ground systems; still there may be symptoms that go unnoticed.

The Cure

Tracking down grounding problems is most often a tedious process. Adopting a step-by-step approach will produce the best results.

Here is one procedure you may want to try if you suspect you are a victim of an UN-GROUND.

Procedure

Using this procedure for hunting an UN-GROUND or solving an RF feedback problem requires several (four to eight) 1/4" or 1/2" snap-together RFI cores or MFJ-701 'break-apart' toroids. I suggest using our "snap-together" RFI cores first in each step. If you notice an improvement, try one or more MFJ-701 toroids so see if there is further improvement.

After completing each step, reconnect power to the rig, go on the air and see if the symptoms persist. Unless the symptom is eliminated, continue with each succeeding step.

- [] Temporarily disconnect the ground wires from all equipment. Make sure that a shock hazard does not exist when doing this.
- [] Disconnect all leads to ancillary equipment.
- [] Ground only the antenna tuner (tuner).
- [] Snap on two or more RFI cores or wrap the coax that connects the transceiver's output to the linear amplifier or tuner around one or more MFJ-701 cores following the instructions supplied.
- [] Install RFI cores (it may require several) or wrap the power cords to all equipment around MFJ-701 cores.

Determine the effect of the following. Remember to evaluate any improvement in the RFI problem after each step.

- [] Reconnect all ancillary equipment
- [] Reconnect the microphone
- [] Reconnect all control cables.

If the problem worsens when any cable is reconnected, first try the "snap-together" RFI cores and if any improvement is noted, install an MFJ-701 core or more "snap-together" ferrite cores, to see if further improvement is achieved.

- [] Reconnect the ground system, grounding each piece of equipment independently to a single, central ground point. This will be your tuner, if one is used. If not, ground central is the last piece of equipment in line. It's the one that connects to the antenna.

Having completed these steps, there should be a noticeable improvement in the symptoms previously observed. If not, the problem is so severe that you will need to follow the suggestions in one of the RFI handbooks.

- [] Remove the "snap-together RFI cores and the MFJ-701 toroids, one-by-one, making sure the problem does not return. This procedure will confirm the specific source of the problem.

If a change in symptoms is observed when connecting or disconnecting the ground system, follow the suggestions for installing an effective RF ground system that follows.

If placing RFI cores or MFJ toroids on one or more of the coaxial cables that interconnect the transceiver, linear, and tuner (transmatch) is effective, install Line Isolators™ in place of the cores. The RADIO WORKS' Line Isolators™ are much more effective than any practical number of RFI cores or toroids.

If placing MFJ cores on one or more control interconnect cables or power cables proves to be effective, permanently install the RFI cores or MFJ-701 toroids on those cables.

In most installations, it is a good idea to install the line Isolators even if grounding problems are not evident. The T-4 series of Line Isolators™ are very effective in RFI prevention.

The station ground must provide both effective DC and RF grounding. Creating a good DC ground is not a problem, but an effective RF ground must be carefully planned.

The ground system should generally follow these suggestions:

- (1) The ground wire should be as short as possible, preferably much shorter than a quarter-wavelength long on the highest frequency band operated.
- (2) The ground wire should be very large. I sometimes use the braid removed from a piece of RG-213. Better yet, use one or more lengths of 1/2" or 1" tinned braided strap. If you can manage it, use 2" or 3" solid copper strap.
- (3) Clamp this short, heavy ground wire to your ground rod(s) or radial system.
- (4) Use several different lengths of ground wires in parallel, each connected to a separate ground rod. This provides multiple, parallel ground paths.

GROUND SYSTEMS

SIMPLE - a single ground rod driven into the earth just outside the ham shack.

INTERMEDIATE - Several ground rods, connected in parallel with very heavy wire or braided strap.

The RADIO WORKS
Box 6159 Portsmouth, VA 23703

ELABORATE, and very effective - 25 short (6-12") ground rods spaced approximately 4' apart and interconnected in series by a 100' length of heavy braided or solid ground strap. This system is very efficient. The original design used stainless-steel pegs for ground rods and stainless steel wire to prevent efficiency reducing corrosion. Copper will lose its effectiveness over time, but it's still worth the trouble. Regular ground system maintenance is necessary. I have installed one of these systems at my station and plan to install two more. I can say that this ground system, combined with grounded Line Isolators at ground level and standard Line Isolators in the shack produces exceptional results with significant improvements in RF grounding, reduction of RF ground loops and feedback. Plus, I noticed a major reduction in receiver noise. I'll have more information on this system on page 18 and page 19.

SOLUTION - RF Grounds

What can we do? A lot, but all the explanations and details deserve an entire chapter or a good lecture at your ham club. Here are a few quick suggestions:

- (1) **Lower the ground system impedance.**
 - a. Use multiple ground paths - two or more ground runs from station ground central to earth ground via large gauge copper wire or straps. Each run is a slightly different length. Each run terminates into one or more ground rod or other ground system.
 - b. Install a radial system
 - c. Use heavier ground cable, braid, or strap.
 - d. Shorten the ground wire
 - e. Install a counterpoise system
 - f. Be sure that the ground system is not
 - g. Use an MFJ-931 artificial ground.
 - h. Eliminate ground loops with Line Isolators™
- (2) **Lower the level of RF voltage on the ground system:**
 - a. If you are using balanced line, improve the installation of the balanced line to keep it balanced.
 - b. Change the length of the feedline by 1/4 wavelength or odd multiple (i.e. 1/4, 3/4, etc.)
- (3) **Change antenna systems**
 - a. Closed loops - their impedance values stay much lower than open antennas and loops operated on multiple bands.
 - b. Use trap antennas for multiband use.
 - c. The CAROLINA WINDOM™, CAROLINA BEAM™ or CAROLINA Short™, and the SuperLoop™ are high performance, multiband antennas that keep the impedance excursions under control and the feedline SWR low.

Continuing with our original story - Of course this isn't the end of the problem. The antenna was changed to a CAROLINA WINDOM, the ground system improved and 99% for the problems were gone. However, a few potential problems remain. You may not know you have any RFI problems until you install accessories, like a computer and use its sound card for signal processing.

IMPOSSIBLE SITUATIONS

There are circumstances where an effective RF ground is simply impossible using conventional techniques. Driving a ground rod into the ground and running a 25 or 30 foot hunk of ground wire, no matter how heavy gauge the wire. It is just not going to work. The length of wire is much too long. There are alternatives.

If you cannot get close enough to earth to run a very short ground wire and install a good, quality ground system, try a counterpoise. An easy example of a counterpoise is the ground plane used with vertical antennas when they are mounted high in the air.

In its simplest form, a counterpoise can be a single wire, one-quarter wavelength long or just slightly longer. For best results, a separate wire is required for each band. If you really want to get elaborate, use two or more wires routed in different directions to make up your counterpoise. The wires for different bands may be close together, insulated and routed in a convenient way around a room. This technique is recommended only in extremem cases and only when running low power.

Counterpoise Length

160 meters	123 - 136 feet
80 meters	65 - 70 feet
40 meters	34.5 feet
30 meters	24.3 feet
20 meters	17.3 feet
17 meters	13.5 feet
15 meters	11.6 feet
12 meters	9.8 feet
10 meters	8.6 feet

As you can see from this table, the length of a counterpoise can be quite long on the lower bands. Where do you put 66 feet of wire? Before I answer that, let's look first at a suggestion for making the counterpoise for multiple bands.

A multiband counterpoise consists of several separate wires, each cut to the proper length for a single band. You can probably eliminate counterpoise wires for bands that are harmonically related in odd multiples. 15 and 40 meters or 80 and 30 meters are examples.

Do not run the counterpoise wire(s) near your equipment or other electronic gear. The counterpoise is part of the antenna and will radiate.

So now that you have the counterpoise made, what do you do with it?

If you are installing your counterpoise, you may want to hide or camouflage it. It can be routed under carpets, along baseboards, out a window and down the side of the building. I have heard of some industrious types who removed the floor molding, laid the flat cable along the floor and then reinstalled the molding. Before permanent installation, we have to make sure the counterpoise is working or even needed.

Testing the Counterpoise

Tune up your rig, but leave the counterpoise disconnected. You should experience the problem that brought you to the point of building a counterpoise in the first place. What ever the problem, RF in shack, 'mic bite,' flashing panel lights on the equipment, whatever, you will still have the problem. Note the severity of the problem in some quantitative way so you can tell if the counterpoise makes a difference. Note the SWR readings, tube plate current or output transistor collector current on the rigs meters. Note the ALC reading.

Connect the counterpoise and look for changes. If luck is with you, there will be an improvement. Note that the counterpoise was cut slightly long. If there is an improvement, try shortening the wire cut for the band you are using by rolling it up for a short distance. If there was further improvement in the problem, continue lengthening and shortening until the ideal length is found. Repeat for other bands.

When tuning the counterpoise, it is very important that the counterpoise is very close to its final, installed location. If you are going to run it along a baseboard, that is where it should be located during the test. If it will be installed under a carpet, do the testing with the counterpoise on top of the carpet. Not only will the location of the counterpoise affect its tuning, you will have the opportunity to see if a particular location makes the problem worse. In that case, you will want to run the counterpoise in another direction.

The counterpoise radiates. That must be considered in its installation.

There are other ways to tune a counterpoise. If you are putting in the counterpoise system as a preventive measure, cutting the wires to 1/4 wavelength is a good place to start.

The best way to set up the counterpoise is with an MFJ-931. Buy one or borrow one if you can. The MFJ-931 is a series tuned circuit that resonates nearly any length of counterpoise or ground wire. This makes the ground appear to be a very low impedance at the rig though the length is not ideal. With the '931 you can probably get by with just one or two lengths of wire for your counterpoise. This saves much work and makes the counterpoise easier to hide.

Counterpoise as a Preventive Measure

Most cliff dwellers (people who live in tall building with dense populations) want to avoid even a hint of any TVI or RFI problems. Some of them will install the counterpoise system, use good low pass filters, Line Isolators, and every other RFI reduction trick they can think of. I guess, it's like the old saying, "an ounce of prevention . . ."

This article was first printed in the RADIO WORKS' Reference Catalog, page 85, Copyright 1992.

The Ground Loop Solution

Multiple ground loops around various pieces of equipment can cause all sorts of problems. Even if you are not having RFI problems right now, let's just try to avoid problems before they start. Solving the ground loop problem may be as simple as adding 'Line Isolators' in series with the coaxial cables interconnecting station equipment.

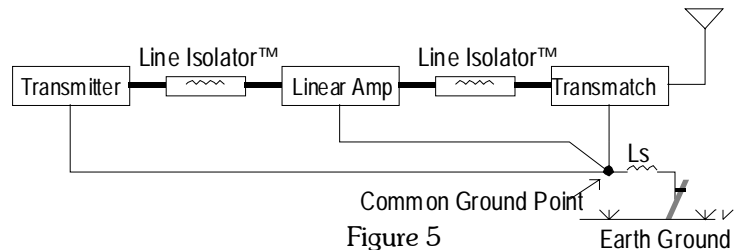

Figure 5
Line Isolators & Ground Loops

First, eliminate the heavy copper strap running along the back of the station equipment. Use your tuner (transmatch) as a common ground point, 'Ground Central.' The heavy gauge wire from your outdoor ground system will connect directly to the 'common ground point' on the back of the tuner (transmatch). Each piece of equipment will then be connected directly to the 'common ground point'. Actually, each piece of equipment is already connected, in a round about way, to the tuner (transmatch) through the various pieces of coax that interconnect station equipment. Of course, it is this "round about way" that causes the ground loops. We can't eliminate the ground braid on the coax, but we can break up the ground loops with Line Isolators™.

Line Isolators™

The Line Isolator™ setup in figure 5 works well in most stations. Customers report that Line Isolators™ inserted in series with the cables interconnecting the transceiver, linear and tuner (transmatch) have eliminated stubborn RFI problems that resisted being solved by other means.

HOW IT WORKS

Placing a Line Isolator™ at the output of the transceiver or linear amplifier, prevents RF from traveling along the outer surface of the coax's shield. Any RF current flowing on the coax braid that can be radiated or coupled to other equipment is forced to ground by the very high impedance of the Line Isolator.™ RF current takes the path of least resistance. Of course, the Line Isolator™ does not affect the signal traveling inside the coaxial cable.

The Line Isolator™ installed in series with the transceiver and linear amplifier helps the transceiver's output filters work effectively by breaking a secondary (leakage) path. As in the example above, the ground loop path to the linear is eliminated.

It's an idea worth a try.

A Line Isolator™ is not a substitute for good Low-pass filters. Both lowpass filters and Line Isolators™ should be used together for maximum effectiveness.

This article was first printed in the RADIO WORKS' Reference Catalog, Copyright 1992, page 87

The RADIO WORKS Box 6159 Portsmouth, VA 23703

Installing Line Isolators

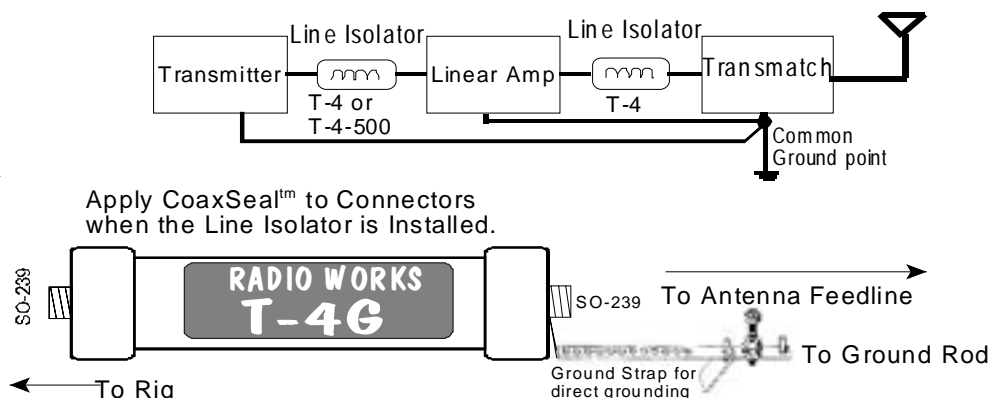

<i>Grounded Line Isolators</i>	<i>Jumpers</i>
<p>Several Line Isolator models feature ground straps. The ground strap provides a direct path to earth for any undesired, stray RF traveling along the outside of your coax's shield. It's a direct path to ground so any stray RF heading for your shack sees only the very high impedance of the Line Isolator and taking the least path of resistance, heads straight to ground. The grounded Line Isolator should be installed directly at a properly installed ground rod or other station ground system.</p>	<p>All Line Isolators are made with an SO-239 connector at each end. This permits you to use jumpers with PL-259s on each end.</p> <p>We have a selection of factory made jumpers for this purpose. You will need at least one jumper per Line Isolator.</p>

Which end goes to the antenna?

The end of the Line Isolator with the ground strap goes to the antenna. The opposite end goes to the transmitter. Ungrounded Line Isolator models are bidirectional.

Where do I put the Line Isolator?

1. The ground strap on grounded Line Isolators is connected directly to a ground rod placed as close to the operating position as practical. Apply Coax Seal as shown on page 4. The Line Isolator can lay on the ground.
2. The only Line Isolator that can be used at the output side of a tuner is the T-4G, and then only when it is grounded properly and the SWR on the feedline is relatively low.
3. Inside the shack, the first place to install a Line Isolator is between your linear amplifier and tuner (transmatch). If a tuner is not used, then it is installed at the output of your linear. If a linear amplifier is not used, the Line Isolator is installed at the output of your transmitter.
4. In really stubborn RFI and RF feedback cases, try an additional Line Isolator between the transmitter and linear amplifier. This insures that all the critical ground loops have been broken up.
5. In addition to Line Isolators, it may be necessary to install ferrite cores on the control and signal cables connected to your equipment. Our PCLI-2 is made to isolate the power supply leads.
6. If you are using a vertical antenna, a Line Isolator should be installed right at the antenna's feedpoint. If you have a ground mounted vertical, use a T-4G and ground the Line Isolator separately from the vertical antenna's ground system.

Second Floor Grounding Solution

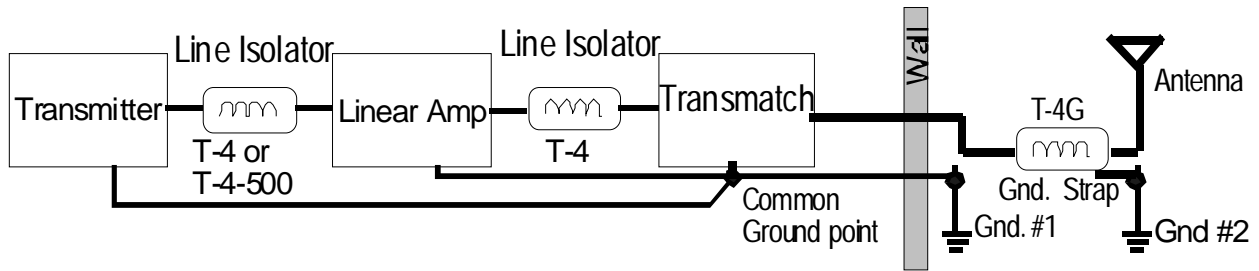

Apply CoaxSeal™ to Connectors when the Line Isolator is Installed.

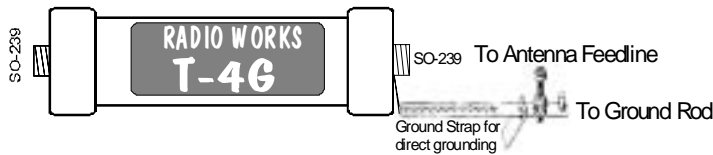

Use a T-4G following a tuner only with low SWR antenna systems such as dipoles, verticals, and most RADIO WORKS antenna systems.

Ground systems

It is nearly impossible to establish an effective ground system for a station located above the ground floor of a building. When I moved my shack to new locations on the second floor of my home, for the first time I experienced severe RFI and RF feedback problems. My new transceiver was rendered essentially useless. An RF probe revealed that there was a tremendous level of RF current traveling on my ground system and on the coaxial cables entering the shack from the antennas. The solution to the problem eluded me until I developed the "grounded Line Isolator." Installing a properly grounded T-4G on the coax coming from my antenna solved most of my problems. Installing Line Isolators between my linear amplifier and tuner and a second Line Isolator between my transceiver and linear amplifier broke up the ground loops. The final step was to use 'single point grounding.' Ground leads from each piece of equipment were connected to a single grounding point on the back of the transmatch. One-inch braided ground straps were connected to the same terminal on the transmatch.

This was an elaborate solution, but it worked. An even more elaborate system was installed later. See page 18.

Follow the procedures suggested at the front of this manual for establishing a good RF ground. Remember that your ground system will be compromised due to your second or third floor location. In the schematic above, 'Gnd #1' is the station's main ground system. 'Gnd #2' may be the station's main ground system, or it may be a separate ground rod. The important matter in this case is that the T-4G must be grounded using its own ground strap. Each coaxial cable entering the shack should have its own T-4G, but several T-4G's may be grounded by the same ground rod or ground system.

There may be less elaborate solutions, and you may want to take a step-by-step approach, installing each Line Isolator as needed. Also, this solution may not work at every QTH. There are simply too many variables. For example, this system does nothing to prevent RF from exiting or entering the shack via the power lines or telephone lines. Those are separate problems with different solutions. This system has proven itself effective for keeping solid state gear happy in the shack, and I recommend it. You may have to employ other techniques to solve RFI problems with telephones, VCR's and other entertainment equipment. Still, the use of Line Isolators has solved RFI problems which eluded a solution for years.

Line Isolator Installation

"The RFI Quick Fix™"

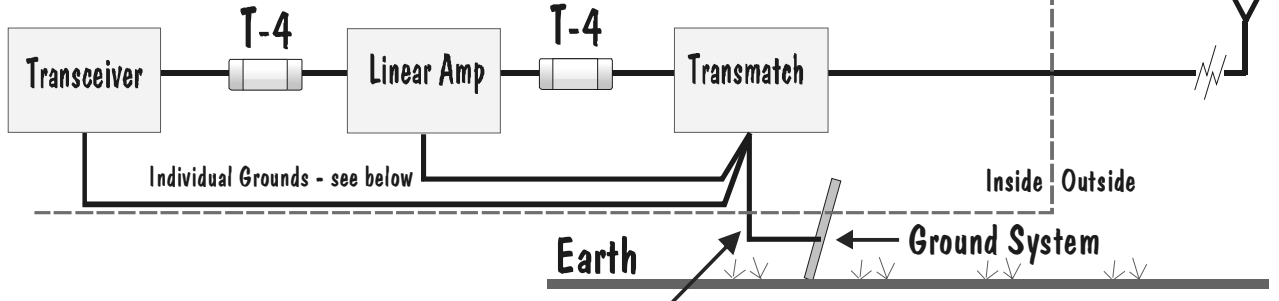

Ground Run- As short as possible. Very Large Gauge Copper. 1"-2" Copper Strap. 2 or 3 ground runs of slightly different lengths is more effective.

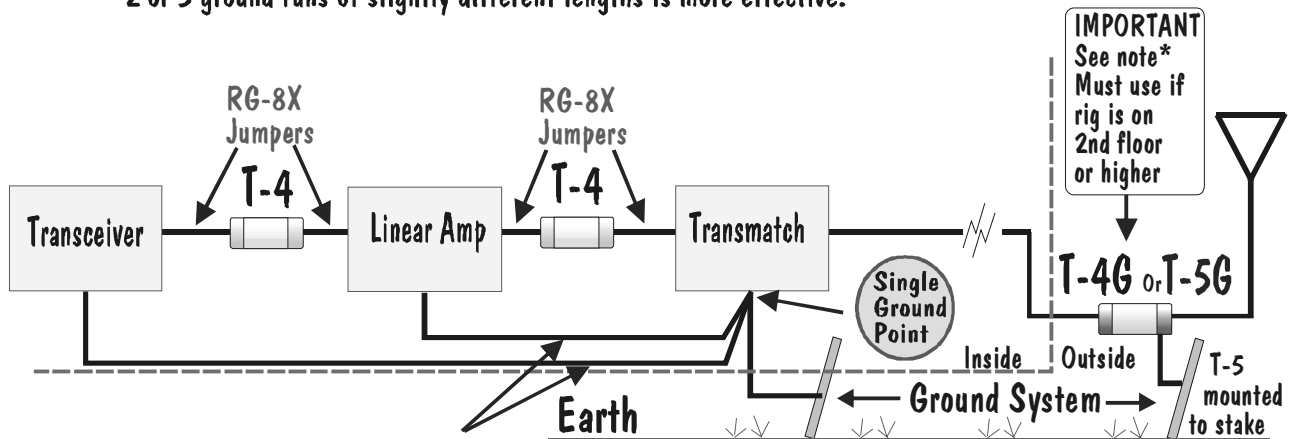

1/2" - 1" Braid or Strap from each piece of equipment to a single point at the highest potential point in the station.

Ground system - 1 or more (more is preferred) copper ground stakes, interconnected with 2" copper strap or individually brought back to radio equipment with separate, short ground runs.

* Important Note - Line Isolators have power limits and must be derated when the SWR on the feedline is high. This is often the case when using a tuner. Obviously, I recommend using only RADIO WORKS' antenna systems. With our antennas, the SWR is well controlled and there should be no problems operating up to the full power ratings our antennas. Installing Line Isolators after a tuner is its most hostile environment. If you are using antennas of other designs, the SWR must be low (<3:1) for full power operation. Read the power rating information on page 5. Always monitor your reflected power. Any change in reflected power when transmitting can mean that the Line Isolators are heating up. Steps must be taken to prevent this.

Don't be fooled by domestic imitations, either.



Beware of Imitations

"Check the Specs" before you buy.

Yea, right! "A New Concept in Filters" reads the headlines in QST. Imagine a *marvelous NEW* device from Japan bragging about 50-60 dB common-mode attenuation with a choking impedance of 1.1 - 5.7 K. Our Line Isolators produce a choking impedance in the 75 K range! Even more amazing is the price tag of only \$99 for a 250 watt model and \$129 for a 5 KW model. You'll

Don't be fooled by those big ads from Japan. These are copies of our Line Isolators that we have been marking for nearly 15 years. And... we have far better specs. along with our much

The RADIO WORKS Box 6159 Portsmouth, VA 23703

RFI Quick Fix™ General Instructions For Remote Tuners

First intended for marine and RV installations, but applicable to most stations.

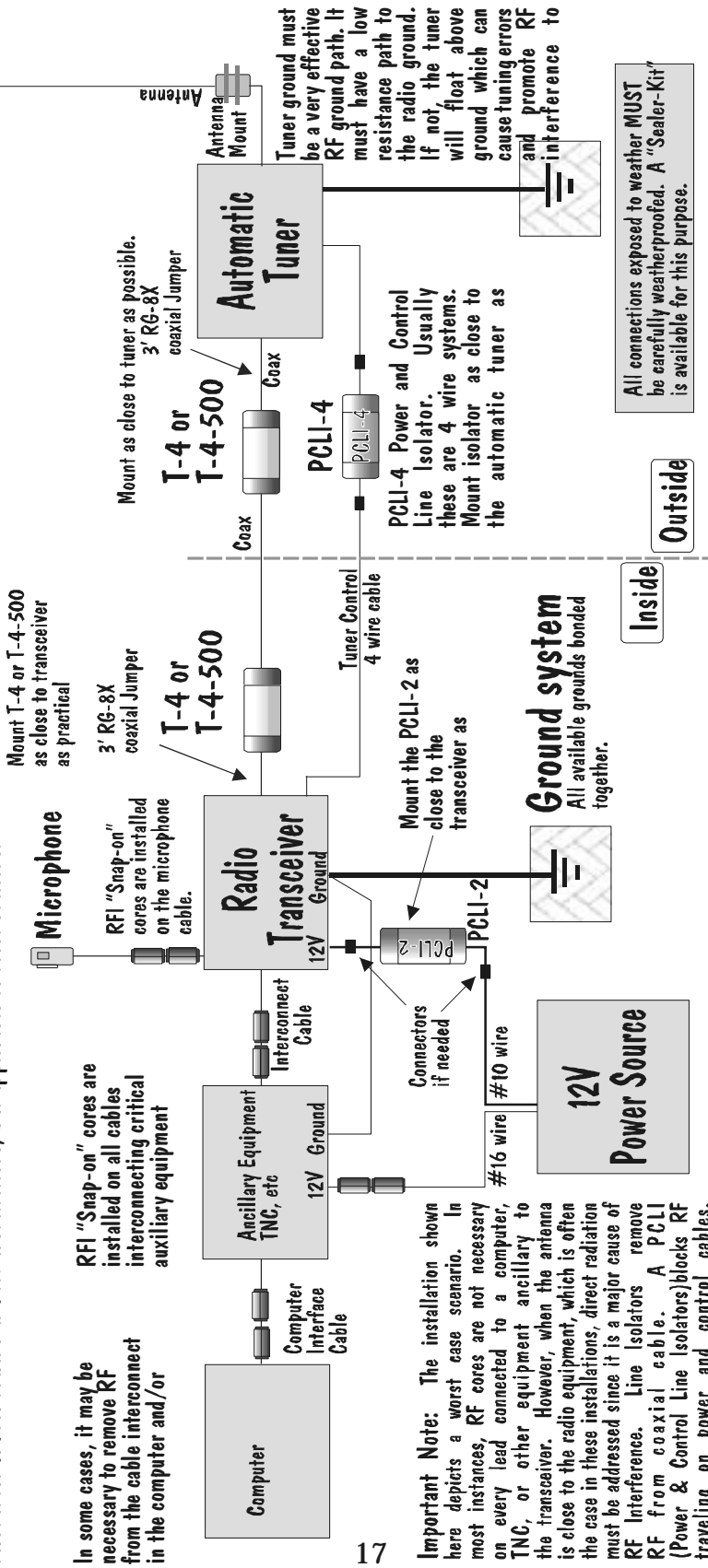

17

Important Note: The installation shown here depicts a worst case scenario. In most instances, RF cores are not necessary on every lead connected to a computer, TNC, or other equipment ancillary to the transceiver. However, when the antenna is close to the radio equipment, which is often the case in these installations, direct radiation must be addressed since it is a major cause of RF interference. Line isolators remove RF from coaxial cable. A PCLLI (Power & Control Line Isolators) blocks RF traveling on power and control cables.

There are instances where all of these measures will have to be utilized. Fortunately, the installation of "Snap-on" RF cores and Line Isolators are simple. Installation of a PCLLI requires installing mating connectors.

The importance of an effective RF Ground system cannot be over emphasized in marine, RV, and mobile installations. The efficiency of the HF antenna system and thus radio communication is dependant on the effectiveness of the RF ground. Just as important, proper RF ground systems reduce problems with RF interference and ground-loops.

A secondary problem is "direct radiation," the result of HF antennas and equipment being physically close to one another. These problems are generally solved with shielded cables and RFI "snap-on" cores.

Ground systems are different with each in stallation. Boat installations require special considerations. Use accepted marine RF grounding techniques. RV installations require keeping the antenna as far away from the equipment as possible. Use the RV chassis as a ground system. Use large ground straps, 1/2" to 3" is appropriate. Bond the ground strap so that the connection has the minimum possible resistance.

Single-point grounding technique is recommended. Ground all ancillary equipment directly to radio transceiver ground lug using 1/2" to 1" strap or tinned braid. A short, heavy ground strap (1/2" - 2" wide) or larger is connected from the radio to the RF ground system. All connections must have very low resistance.

Installation Instructions: October 15, 2001

Station Grounding

The ground system currently used at W4THU is a version of the so-called "Army Ground." This system is reported to be far more efficient than a standard 6' or 8' ground rod, or even several of them. This is a very elaborate system and it consists of 100' of heavy copper strap. In this case it is 1/2" tinned-plated copper. I have used this same material in saltwater and it has lasted well. You will probably want to use standard 1/2" to 2" copper strap or even 1/2" or 3/4" copper pipe. If I ever put in another ground system like this, I will probably use copper pipe and the appropriate pipe fittings to interconnect the 25 ground rods used in the "Army Ground". In my system, each ground rod is 1 foot long, so you get 10 rods out of a 10' length of 1/2" ground rod. I'll comment on further details in the illustrations. This is only a small part of the overall grounding system used at W4THU. The entire ground system consists of three of these 100' systems, plus the use of ferrite cores and several Line Isolators at ground level and in the radio room itself. Also, very careful attention is paid to single point grounding within the shack. I'll have full details on the complete system in future publications and on the web.



Twenty-five ground rods are used. I used copper pipe, though other more desirable materials are available. This is the inexpensive way to go.

For maximum mechanical strength and conductivity, I used the following system. Each ground rod has a cut in the end of the pipe that is a bit over 1" long. The cut is the same width as the copper strap and was made using a Motor Tool and a cutting wheel. The copper strap is pushed down into the ground rod as shown and a copper pipe end-cap is fitted. At this point the strap is soldered to the pipe and the end cap is soldered into place. This produces a very low resistance connection that is mechanically strong. This is repeated for each of the 25 ground rods which are placed every 4 feet along the 100' length of ground strap.

In this photograph, two separate ground straps are connected together. This was necessary since my ground strap material was only 25' long. To connect the pieces together, two screws are used to mechanically hold the two pieces of copper strap together. Following that, the two straps are soldered together over a two or three inch length.



This is the first of three "Army Ground" installations. On the right side of the photograph is a set of ground rods with their interconnecting ground strap. Also shown, but hard to see are several ground rods poking out of the trench ready to be hammered in. The trench is only about 8" deep because the ground doesn't freeze very deeply in this part of the country. Once the ground rods are hammered to the bottom of the trench, 5 cables will be added. There are three Super 400 low loss coaxial cables, one BR-240, a special high power, low loss RG-8X cable and one rotator cable. This installation took place during Christmas vacation. By spring, I couldn't see any evidence of the trench. Two other ground systems will be installed later. Since coax will not be buried, in the additional

This is where all the cable comes up out of the ground. There is a pair of 5' ground rods with copper pipe cross members which permit installing T-4G Line Isolators. The feedlines from all antennas will be routed to this location. If more than four antennas are used, a coax switch will be installed to accommodate the added cable. This location is beside a wooden shed about midway down the back yard. A box, similar to the one you will see on the next page will be used to terminate the cables and house the coax switch.

only a small slit in the dirt will be used to bury the additional grounds.

Getting the Ground Strap and Coaxial Cables Into the Radio Room

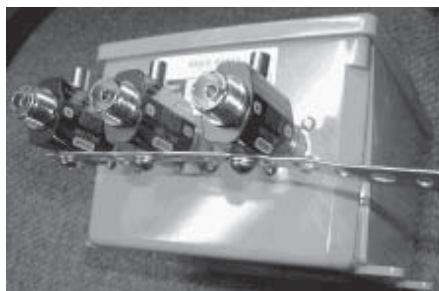

Before the cables are routed inside the house, the three Super 400 cables go through a lightning surge suppressor as shown in the photo on the left. A ground strap connects the surge suppressors directly to earth ground. This is easily seen the picture on the right. Inside the box are three *enhanced* T-4G Line Isolators. The cables leaving the top of the box (all BR-240 coax) are then routed together with the RG-8X in the ground and a BR-240 cable run to a

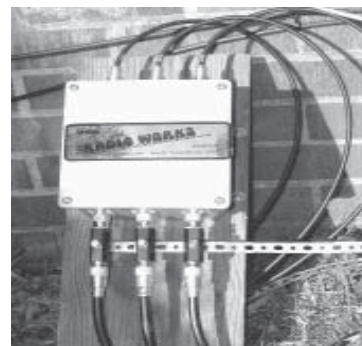

“InTreeVert,” our 1/2 wave 2 meter vertical that’s supported by a rope at the 70’ level in a nearby tree. All cables entering the radio room are BR-240, low loss, higher power, RG-8X-type cable. BR-240 is used because it is much easier to run than larger types while providing ample power rating and very high shielding. Also, in the cable loom running to the shack are three separate ground straps, each of a different length before being attached to their Army Ground installations. The last cable in the loom is the rotator cable.



The assemblage of cables and ground straps are tied together with cable-ties and are routed directly into the radio room as shown in the photo at left. From there, all cables and ground straps are routed directly to a single-point ground system which will be described further in other publications. The three ground straps are spaced evenly around the other cables to offer some shielding. Each ground run is a different length by a couple of feet to provide at least several non-resonant ground runs on each band. Not shown in these photos are two additional ground straps running down the right side of the large window under the siding. In all, there are five ground runs. Combined with further techniques used inside the ham shack, this has proved to be a very efficient ground system. All traces of RF problems have vanished. Once all of the equipment is installed in the shack, and all interconnecting wiring is in place, RF current measurements will be made



on each cable in the shack. Tests will be made with the ground system connected and with parts of it disconnected so the differences in stray RF can be measured and quantified.

The extra ground strap material in the photo on the right are awaiting the installation of the additional ground systems. The two coaxial cables running horizontally are from a satellite dish and are not part of the ham station. It’s unfortunate that the cable loom runs in front of the large porch window, but to route the cables in a way that would not be visible would add an extra 12 feet to the ground run. This would have defeated much of the effectiveness of this project. If I had planned far enough ahead, I would have installed all of the coax, control and rotator cables, plus all five ground straps when I enclosed the upper and lower porches, installed the hamshack on the upper level porch and then installed siding. But then, there was a ten year period between projects!

The purpose of these two pages is to illustrate an effective, though elaborate, ground system. It does not stand alone, but is combined with other techniques employed within the radio room to further enhance grounding effectiveness and to avoid problems with stray RF. I will put more information, along with color photographs on the RADIO WORKS’ website. I’m not suggesting that you have to install such an elaborate ground system, but you can certainly take advantage of part of it. This system, while elaborate, does illustrate how an effective ground system can be installed that will complement a second floor ham shack location.

The RADIO WORKS Box 6159 Portsmouth, VA 23703

Installing Wire Antennas in Trees

SUPPORTS

Before selecting an antenna system, you must first find a place to put it.

Visually survey your property and find out exactly where your right to put up antennas and your neighbor's right to tear them down ends. This sets your limits. If there is an XYL involved, the available space may be artificially restricted even further. If you are fortunate, you may have a neighbor who will permit you to use one of his trees to support an end of your antenna.

NATURAL HIGH

Nature, in its wisdom has favored ham radio with a vast supply of tall, non-conductive, self-maintaining antenna supports - trees. Unfortunately, most neighborhoods seem to want an unobstructed view of utility poles, power lines and other people's houses, so they cut down most of the trees.

Trees are frustrating.

Using trees for antenna supports is a double-edged sword. At their very best, trees are frustrating. On a calm day, with your antenna strung from the very top limbs of a couple of well placed tall trees are wonderful. However, when our kindly old tree and wind and storms get together to do a little mischief, the combination is a real beast. Treetops whip around and two trees never move in the same direction. When the trees move in opposite directions, the only thing trying to hold them together is your antenna... the antenna doesn't have a chance. Maybe it's nature's way of seeing just how far your support ropes will stretch before they break. Maybe it's just nature's way for trees to get rid of all that junk we hang from them.

Whatever the reason, tree hung antennas require special treatment and installation procedures. Once trees are conquered though, they are worth all the effort and trouble.

Now wait a minute, I'm getting ahead of myself. An antenna can't fall down until after you get it up. Let's look at some ways to get your antenna support rope in the top of a tree.

Methods for getting the support rope up a tree

1. Tie a light string around a rock and toss it over a convenient tree limb.
2. If you are a good fly fisherman, you can lob a line over any limb of choice.
3. A powerful slingshot will put a lightweight fishing sinker and light weight monofilament fishing line about 70 feet up a tree. See our EZ Hang on page 22.
4. The real pros are the archers. Forget picking a particular limb, select a tiny branch all the way up in the top of the tree and an archer will lay a line right over the spot and do it the first time. That's how I put support lines into trees.

One hint for Archers

If you add extra weight on the front of the arrow, it will drag the monofilament or 'Game Tracker' line out of the tree and down to the ground where you can reach it.

ALTERNATIVES

Getting practical, anything that will propel a projectile over the selected limb is what is needed. It can be a sling shot, bow and arrow, baseball, it doesn't matter. So whatever installation method you select, the following suggestions will apply.

First, be absolutely sure that safety is the major priority.

The small line goes up first

Use light weight monofilament fishing line or something similar as the first line up the tree. A light weight line produces minimal drag on whatever projectile you're hurling over the tree. Ignoring mathematics, this simply means that you can get higher in the tree for the same effort. I use 10 pound test fishing line.

Paying out the monofilament line can be done in two relatively efficient ways. The first involves unwinding enough line off the spool to make the trip up the tree and back down. The line is carefully routed around your meticulously groomed lawn where it can be pulled aloft by the projectile while avoiding a snag that will completely stop the progress of this project. You will not fully appreciate how much junk is on your lawn until you try this method.

... a snag will completely stop the progress of this project.

Having had poor results with the lawn technique, I discovered casting or spinning fishing reels. A rod isn't necessary. Select a reel that will hold at least enough line to make it up and down the tallest trees you ever plan to conquer. The line must come off the reel without any drag at all.

The technique here is simple. One person holds the reel (which is attached to something he can hold on to) and you shoot, throw, or whatever, the line over the selected limb.

A Better Technique

In my opinion, the best way to get a line into a tree's top branches, well above the climbing level, is to use a bow and arrow and a device called a 'Game Tracker.' With a compound bow and the 'Game Tracker,' you can probably get a line 125 to 150-feet into the air if you have trees that tall.

Often a compound bow is overkill and a 'long bow' or 'recurve' bow with a 40 or 50 pound pull will do the job. **A WORD OF CAUTION: *You cannot be too careful when using a bow. It is a lethal weapon. Should an arrow get loose from its trailing line, it can travel a great distance. Always have a lookout to make sure the path is clear for several hundred feet in the direction of the arrow's travel. Use a high trajectory so the arrow will come down in your yard.***

I learned this lesson the hard way when I found that my compound, which will launch a target arrow 80 yards with only a few inches of drop, could hurl an arrow over a tree and continue traveling for a city block before touching down. Behind my house is a school yard that was unoccupied at the time. I was using a lookout, and nothing was harmed.

The Game Tracker

A 'Game Tracker' is a hunting accessory that attaches to a bow. It is a small canister of very light weight, but strong, nylon line. It has practically zero drag on the arrow. You tie the tracker line to your arrow. Though designed to leave a string trail behind recently shot game, this device is perfect for shooting arrows over tree limbs. The only draw back (no pun intended) is the relative high price of the tracking string. It is not reusable. You will aim more carefully once you realize that each shot is costing you a buck. (There I go again with my puns).

A 'Game Tracker' may be substituted for the monofilament line used with other techniques. Its convenience is unequalled. You can find a 'Game Tracker' at most archery or hunting stores and on the Web.

NEXT UP, A MIDDLE WEIGHT LINE

Once you have your monofilament line or 'tracker' line in the tree where you want it, you will have to pull up heavier lines to hold the antenna. I usually use three steps. The medium-weight line follows the monofilament or 'tracker' line and should be strong enough to pull up the final antenna support line. It cannot be so heavy that it breaks the monofilament line. For my second line, I use lightweight nylon twine or cord. It is strong enough that I can't break it by pulling on it as hard as I can, but it's still very light in weight.

Tie the monofilament or 'tracker' line and the medium-weight, second line together, using knots that will not snag as you pull the lines through the tree limbs. Pull up the medium-weight line.

THE FINAL SUPPORT LINE

The medium-weight line is then used to pull up the final line that will directly support the antenna or pulley system.

There will, of course, be abrasion of the support line's fabric as the tree sways in the wind.

Once you have your final support line over your favorite limb, the task is nearly done. If everything works out OK you'll have one end of your support rope on the side of the tree in the direction of the antenna. The other end of the rope will be somewhere on the other side of the tree near where you started. You simply repeat the procedure in a second tree.

If you have chosen the proper support lines, you will enjoy long and useful service from this installation. There will, of course, be abrasion of the support line's fabric as the tree sways in the wind. There is also the normal weathering and deterioration caused by the sun. Both effects limit the life of the support rope. To reduce this, read the "pulley" information on page 23.

THE INSPECTION

It is a good idea to inspect your antenna support system every few months or as a minimum, once a year. One way to accomplish this is to re-use the medium weight rope you used when installing your wire antenna support system. Tie one end to the antenna support rope. Secure the free end of the 'medium' line. Pull down 'antenna support' rope from the antenna end. Usually, just untying the support ropes will drop the antenna. Once the entire

length of the antenna support rope is on the ground, check it out for deterioration. Pay close attention to the points where the rope crosses any tree limbs. If the rope is frayed, replace it. If all is well, pull the support rope and the antenna back up and inspect the line in the second tree. The entire procedure takes only a short time, much less than the time required to replace a broken support line.



EZ Hang

EZ-Hang is a specially selected spinning reel combined with a hunting slingshot and the proper weights and line to make your next antenna installation a snap.

The slingshot has a tempered steel yoke, welded construction with easy release button and fixed arm support. It uses the highest quality tubular thrust bands and has a padded wrist support for extra comfort. The extra bright yellow weights make it easy to see in the trees.

The "Intermediate Line Dispenser" features 500-feet of #18 Nylon line with 155-pound break strength. The line color is an easy to see orange color.

If you've read my suggestions for installing wire antennas, you've seen my three-line method. The EZ-Hang supports my recommended system. The first line is the light fishing line off the spinning reel. The "Intermediate Line Dispenser" is the second line and is pulled into the tree with the lightweight line from the slingshot. The final line is our Mil Spec line or our Double Dacron™ antenna rope as the final support rope pulled up by the second line. This is the easy way to get your antenna into the air.

It's the easy way to get lines into your trees. See our General Catalog for current EZ Hang prices.

The RADIO WORKS Box 6159 Portsmouth, VA 23703

KNOTS

The knot of choice for nearly every antenna chore is the BOWLINE. This knot is easy to tie and it will not slip under any condition. With this knot, the more load you put on it, the tighter it gets.

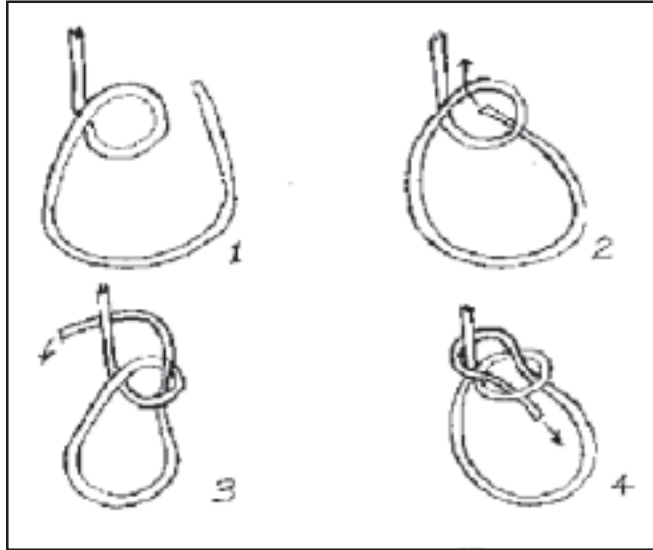

The Bowline Knot

Use the Bowline to tie the support rope to each pulley, insulator, center-insulator, balun, etc. You can even tie two ropes together using the bowline.

Here is an easy way to remember how to tie the Bowline: It's the way we teach it to new Boy Scouts.

With the end of the rope in your right hand, make an overhand loop. Hold the loop in your left hand. *Using the Boy Scout verbiage, "the rabbit (the end of the rope) comes out of his hole (the loop), goes around the tree (the long end of the rope) and then the rabbit goes back in his hole."*

If this sounds too complicated, just follow the diagram above.

PULLEYS

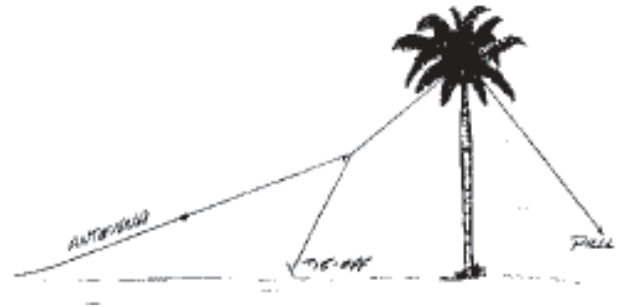

Adding pulleys to your wire antenna support system will greatly increase its reliability. As an additional benefit, changing or repairing your antenna will be much easier.

There are several methods for installing pulleys in trees. Of course, you can climb the tree and install the pulley directly in the tree. The method I suggest, which can be accomplished from the ground, is shown above. A heavy, 'pulley line' is supported by the tree. A pulley, attached to the heavy support rope, is pre-strung with the antenna support line. The pulley is hoisted high into the tree, as near to the top as practical. The loose, opposite end of the heavy rope is then conveniently tied off to the tree near the ground. The antenna is pulled into the air with the antenna support rope. The free end of that rope is tied off near the ground.

Usually, the 'antenna support rope' is smaller than the pulley support rope (the one in the tree). Done this way, as the antenna moves in the wind, the 'antenna support rope' moves through the pulley. The 'pulley support rope' is stationary in the tree, so abrasion is practically eliminated. As a secondary benefit, it is now easy to change antennas, and the chance of a support line getting tangled in the tree is reduced.

To further protect against the wind breaking the lines, some installations use counter weights or springs at the ground end of the 'antenna support rope.' I recommend against this. It can be dangerous if the weights fall. It also puts too much stress on the antenna. I use long lengths of support rope and leave a little slack in the antenna. This method has survived two hurricanes.

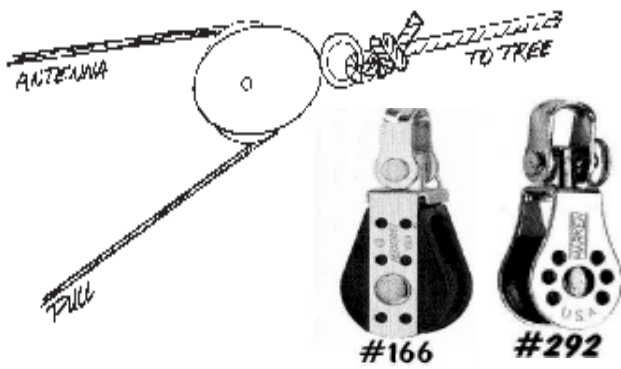

CHOOSING A PULLEY

The best pulleys for antenna installations are found at sailboat outfitters and at the RADIO WORKS. The junk you'll find in most hardware stores is just that, junk. Marine pulleys are carefully designed and manufactured for a specific application.

Purchase pulleys designed for the size line you plan to use. I also suggest choosing pulleys with swivels as shown above. If your rope twists, the force does not transfer to your antenna.

High Quality, stainless-steel marine-grade pulleys are available from the RADIO WORKS' General Catalog.

A HINT

Tie a bunch of knots in each end of the antenna support ropes about 10 feet from each end. Tie the knots to form a large 'clump.' The idea is this: If one end of the rope accidentally gets loose, it will jam when the knot reaches the pulley. You can release the 'pulley support rope' and pull the pulley to the ground where you can recover both ends of the antenna support line.

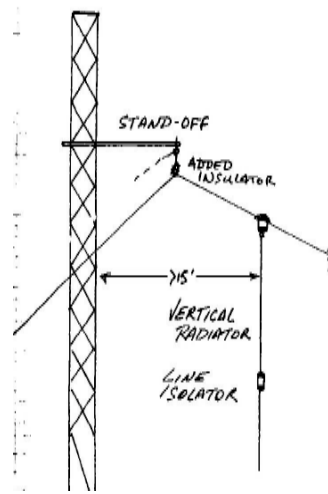

Up to this point, I have only been talking about trees as antenna supports. You may have other options.

A building can be an antenna support, although this is not ideal. Keep your antennas as far away from buildings as possible. Use the building to support only one end of the antenna.

Metal or wooden masts can be fabricated into excellent antenna supports. Wooden masts up to about 40' can be made with little difficulty.

USE WHAT YOU HAVE

If you plan to put up a tower that has to be guyed, why not use the guy wires as low-band antennas. If you don't want to use guy wires, add an outrigger arm to the tower to accommodate wire antennas. The outrigger is often a 10-foot pipe, metal or plastic, that is securely attached near the top of the tower. At the end of the outrigger, away from the tower, mount a pulley.

CAROLINA WINDOM

See page 32 for specific tower mounting instructions.

Do's and Don'ts of Antenna Installation

Follow the check lists. Failure to do so will result in your antenna not achieving maximum performance.

Do's

Inspect coaxial cable for flaws in its jacket. Don't be concerned about minor jacket irregularities.

Pay particular attention to station grounding. ***This cannot be over emphasized.***

In most cases, it is OK to bury standard coax. You can add some protection by running it inside standard garden hose. Bury coax below the frost line.

Carefully seal any coaxial connector exposed to weather. Follow the procedure outlined in this publication.

Check available space before purchasing an antenna. Make sure the antenna will fit. Reasonable bending of wire antenna elements will not hurt. Elements must never be bent back on themselves. If space is limited, consider alternative antennas.

To avoid kinks in antenna wire, roll it out hand-over-hand.

Antennas will work in trees. In most cases, it doesn't hurt if the wire touches leaves, though you might set a leaf or two on fire. If you want, consider using insulated wire.

Definitely use Dacron™ antenna support line. Nylon, Polypropylene, Hemp, Cotton, or other rope types are not suitable in this application. Use Kevlar™ only if you don't want any stretch in support lines, however, some stretch is desirable.

Install your antenna as far away as possible from your or your neighbor's house. Antennas close to houses can cause RFI and TVI problems.

Don'ts

Do not change the length of manufactured antennas. Antenna lengths are critical.

Do not roll up the ladder line in G5RVs or SuperLoops.

Do not bury Ladder Line or let it get close to the ground or anything metal. Do not run it near other cables. It must be in the clear.

Do not rely too much on inexpensive antenna analyzers. You can't be sure what parameter you're actually measuring.

Do not support a CAROLINA WINDOM so that its Vertical Radiator is closer than 15' from a tower or other metal object. If less than 15', direct it away from the metal pole or tower at an angle.

Do not tie down the Vertical Radiator of a CAROLINA WINDOM. It must move with the antenna, or the connectors will pull apart. However, don't let the Vertical Radiator swing around enough to hit something. The weight of the coax and Line Isolator is usually enough to keep the Vertical Radiator in place.

Don't lay the CAROLINA WINDOM's Vertical Radiator on your roof .

Don't use heavy weights in combination with pulleys to hold an antenna taut. Free falling weights accelerate the antenna like a bow string. The wire fails. Don't pull the antenna up too tight. Leave some slack.

Type CAROLINA WINDOM™ Installation Checkoff List

Caution

KEEP ANTENNAS AWAY FROM ELECTRIC UTILITIES.

Read and apply all applicable information which precedes this page.

1. Install antenna support ropes. If practical, use the pulley system described on page 23.
2. The antenna should be in the clear and far away from anything metal.
3. If a metal center support is to be used (i.e., a tower or mast), see pages 24, 32 and 33 for details.
4. The antenna should be as straight as possible. It is acceptable to bend the antenna at its feed point with angles greater than 120-degrees between legs. An example would be an Inverted-V.
5. Ends of the antenna may be bent as much as 90-degrees, but the bent portion of the antenna should be less than 10% of the leg length. Antennas with built-in bends should not be modified.
6. Once the support ropes are installed and secured, unwind the antenna on the ground. Use a hand-over-hand motion to avoid kinks and tangles.
7. Carefully tie the antenna support rope to the antenna end insulators.
8. Pull the antenna into the air so that you can easily reach the matching transformer.
9. Apply coax Seal to the WHITE WIRES as directed on page 3 of this manual.
10. "Knead" the Coax Seal again to assure a perfect seal. Make sure it "whets" to the case and to the wire.
11. You received a length of coaxial cable with two PL-259 connectors installed. This is the "Vertical Radiator." Screw one of the Vertical Radiator's PL-259s on the Matching Transformer's mating connector. Tighten with hard finger-thumb pressure. **Apply Coax Seal.** Make sure it "whets" to both the coax and the Matching Unit's case. **Do not cover the hole in the bottom of some matching units.**
12. Optionally, cover the Coax Seal with electrical tape to keep it clean.
13. Pull the antenna further into the air so that the end of the Vertical Radiator is easily reached.
14. Screw the remaining PL-259 on the lower end of the Vertical Radiator coaxial cable into one of the SO-239 connectors on the Line Isolator.
15. Attach your coaxial cable to the Line Isolator. Apply Coax Seal to each of the two coaxial connectors on the Line Isolator. RG-8X coax is recommended. It places less physical stress on the antenna.
16. Pull the antenna into the air. **Don't** pull the antenna up tight. It performs best when the ends are slightly higher than the feedpoint.
17. Let the Vertical Radiator swing in the "breeze." **DO NOT TIE or RESTRAIN IT SO IT CAN'T MOVE.** Doing so will cause antenna or connector failure during moderate and high winds.
18. Before applying power, measure across the PL-259 at the radio end of your coax. You should have a reading of about one-ohm. This is normal. If you use an antenna analyzer, you will find a resonance inside the lowest band covered. On the higher frequency bands, resonance will occur just above the band limits.
19. Hook up the coax to your tuner and enjoy your new, high performance antenna.

The RADIO WORKS Box 6159 Portsmouth, VA 23703

SuperLooptm Installation Checkoff List

Caution

KEEP ANTENNAS AWAY FROM ELECTRIC UTILITIES.

Read and apply all applicable information which precedes this page.

1. Install antenna support ropes. Use the pulley installation described on page 23.
2. The antenna should be in the clear and as far away from anything metal as possible. **KEEP IT AWAY FROM ELECTRIC UTILITIES.** It should be above minimum recommended height.
3. If a metal center support is to be used (i.e., a tower or mast), see page 24, 32 and 33 for details.
4. The antenna should be as straight as possible, but not too tight. Leave some slack in the wire.
5. The SuperLoop may be reshaped from a triangle to a rectangle by adding extra insulators.
6. Once the support ropes are installed and secured, unwind the antenna on the ground. Lay it out to roughly resemble the triangular shape of the antenna. Use a hand-over-hand motion to avoid kinks and tangles.
7. Carefully tie the antenna support ropes to the antenna end insulators.
8. Pull the antenna into the air so that the two loose ends of the wire can easily reach the matching unit.
9. Unwind the ladder line. On the end of the ladder line is a heavy-duty cable tie. There is a matching cable-tie on the matching transformer's top eye-bolt. Push two or three inches of the matching unit's cable tie through the "eye" on the end of the cable time on the end of the ladder line. This is a mechanical connection only and it keeps the ladder line from rolling up.
10. Wind each of the two loose antenna wires around one of the eye-bolts on the matching unit. After passing through the eye-bolt, wrap the wire around itself for at least seven tight turns. See figure above.
11. Strip the insulation off each to the two white wires exiting the matching transformer's case. Wrap a couple of turns of each white wire around the nearest antenna wire. These turns should be immediately adjacent to the previous seven turn winding as shown above.
12. Solder the two white wires to the antenna wire. Use as little heat as possible to make a good solder joint. Don't use a torch. Too much heat weakens the wire.
13. Apply Coax Seal to the WHITE WIRES where they exit the matching transformer as directed on page 3 of this manual.
14. "Knead" the Coax Seal to assure a perfect seal. Make sure it "whets" to the case and to the wire.
15. Attach your coaxial cable to the matching unit and tighten the PL-259 with your fingers. Carefully seal the coaxial connector with Coax Seal, or follow the instruction for the Ultimate weatherproofing on page 4. **DO NOT COVER** the drain hole in the bottom of the matching unit. RG-8X coax is recommended. It places less physical stress on the antenna.
16. Following the instructions beginning on page 23, pull the antenna into the air. Don't pull the antenna up tight. It performs best when the ends are slightly higher than the middle of the antenna. The SuperLoop is not a perfect triangle. The diagonal sides are supposed to "bloom" slightly.
17. Before applying power, measure across the PL-259 at the radio end of your coax. You should have a reading of about one-ohm. This is normal. If you use an antenna analyzer, you will find a resonance inside the lowest band covered.
18. Hook up the coax to your tuner and enjoy your new, high performance antenna.

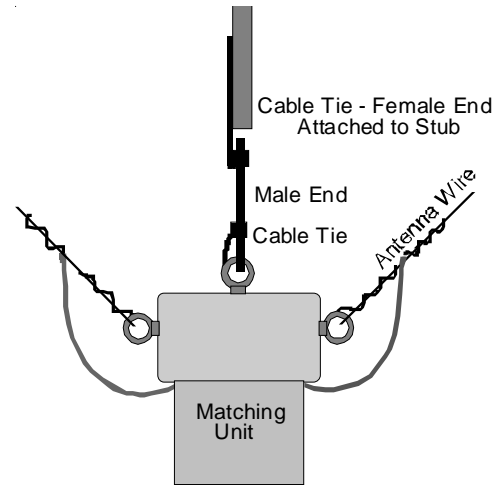

General Antenna Installation Checkoff List

Caution

KEEP ANTENNAS AWAY FROM ELECTRIC UTILITIES.

Read and apply all applicable information which precedes this page.

1. Install antenna support ropes. Use the pulley procedure described on page 23.
2. The antenna should be in the clear and far away from anything metal.
3. If a metal center support is to be used (i.e., a tower or mast), see page 24 and 32 for details.
4. The antenna should be as straight as possible. It is acceptable to bend the antenna as its feed point with angles greater than 120-degrees between legs. An example would be an Inverted-V.
5. Ends of the antenna may be bent as much as 90-degrees, but the bent portion of the antenna should be less than 10% of the leg length.
6. Once the support ropes are installed and secured, unwind the antenna on the ground. Use a hand-over-hand motion to avoid kinks and tangles.
7. Carefully tie the antenna support rope to the antenna end insulators.
8. Pull the antenna into the air so that you can easily reach the balun or matching transformer.
9. Apply coax Seal to the WHITE WIRES where they exit the balun's case as directed on page 4 of this manual.
10. "Knead" the Coax Seal to assure a perfect seal. Make sure it "whets" to the case and to the wire.
11. Attach your coax cable to the balun and apply Coax Seal to the coaxial connector. RG-8X coax is recommended. It places less physical stress on the antenna.
12. Following the instructions on page 23, pull the antenna into the air. Don't pull the antenna up tight. Some sag is desirable and will increase the life of the antenna.
13. Hook up the coax to your tuner, if you are using one, and enjoy your new, high performance antenna.

What Makes The CAROLINA WINDOM Work So Well?

At hamfests, I spend a lot of time talking about antennas. The number one topic is "What makes the CAROLINA WINDOM WORK?" Here is the story in a nutshell.

The magic of the CAROLINA WINDOM is its 'Vertical Radiator.' When the vertical radiator is removed, the antenna still operates, but, not surprisingly, the radiation patterns are just about the same as they are for any multiband antenna of the same length.

Presented at right are two radiation patterns. Each is a CAROLINA WINDOM 80 operating on 20 meters. In *Figure 1*, the vertical radiator has been removed. In *Figure 2*, the vertical radiator is operating. What an amazing difference the Vertical Radiator makes. As you can see in *Figure 1*, when the vertical radiator is absent, radiation at low takeoff angles diminishes as the radiation pattern approaches the horizon. On the other hand, in the pattern where the Vertical Radiator is operating, radiation from the antenna continuously increases up to a point less than 5 degrees above the horizon. This is where "ground-effects" prevent a zero-degree takeoff angle. This is a significant radiation pattern improvement at the important very low takeoff angles.

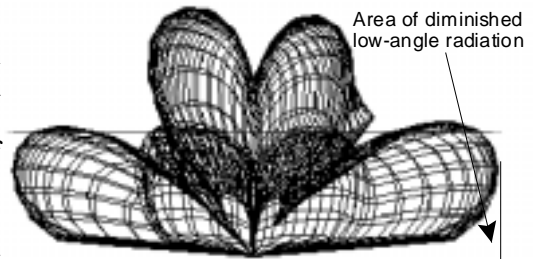

Figure 1
CAROLINA WINDOM 80
Operating on 20 meters with its Vertical Radiator removed.

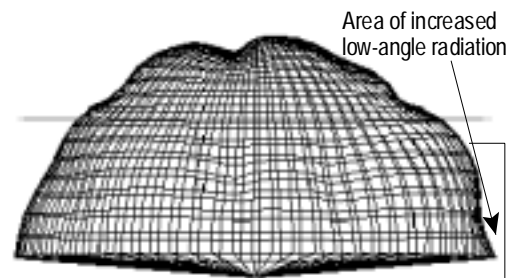

Figure 2
CAROLINA WINDOM 80
Operating on 20 meters with the Vertical Radiator operating.

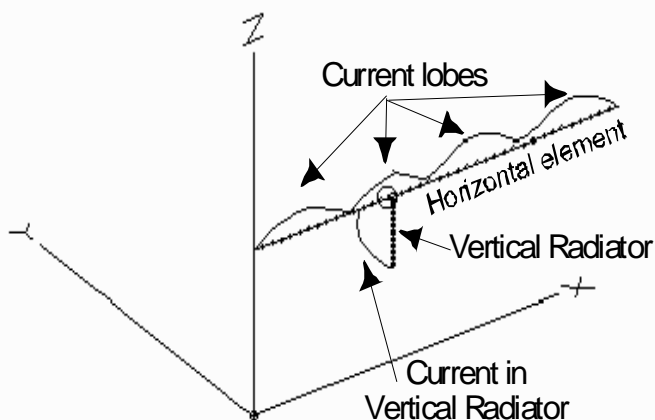

Figure 3

Current distribution of the antenna is shown in Figure 3. It is the high current in the Vertical Radiator which causes the radiation pattern to change as it does from Figure 1 to Figure 2.

Location is IMPORTANT

Pick a location for your CAROLINA WINDOM™ that is as far from buildings, towers and other antennas as possible.

The Vertical Radiator is an inverted vertical antenna. Its counterpoise is the flattop portion of the antenna. Both the horizontal and vertical elements of the CAROLINA WINDOM combine to form an antenna system which produces an exceptional radiation pattern. Radiated energy is concentrated at low to moderate takeoff angles. Such a pattern is not possible with conventional horizontal wire antennas.

The RADIO WORKS Box 6159 Portsmouth, VA 23703

CAROLINA WINDOMS

Location is IMPORTANT

Pick a location for your CAROLINA WINDOM™ that is as far from buildings, towers and other antennas as possible.

Running your antenna over the top of your house can increase chances of RFI inside your house. This is true for all antennas.

Flat-top and Inverted-V

There are many ways to install your CAROLINA WINDOM. If two supports for the ends are available, suspend the antenna as a "Flat Top." If only a single, non-metallic support is available, use it to support the antenna by the eye-bolt on the matching transformer. The ends of the antenna slope downward toward the ground. Keep the angle between the two halves of the antenna at least 120-degrees. This configuration is known as an "Inverted-V" because the shape of the antenna resembles an upside down letter "V." The low ends of the antenna and Vertical Radiator must be at least 8 feet off the ground, well out of the reach of man or beast.

Sloper

The "Sloper" is a second, single support alternative. Here, a single high support holds one end of the antenna. The entire antenna slopes toward the ground. As with the Inverted-V antenna, keep the lower end of the antenna at least 10 feet off the ground, again for safety reasons. A slope angle of 45 - 60 degrees is popular and appears to work well. You will need a tree or other support about 56' tall for the standard CAROLINA WINDOM. Double that height for the CAROLINA 160. Keep the feed line as vertical as practical.

Bending the ends of the antenna

If you do not have quite enough horizontal room to support your antenna, it may be shortened by bending the ends of the antenna as much as 90 degrees horizontally or vertically, up or down. 10 - 15 % off each end is the maximum I would recommend. Add extra insulators as shown on page 33.

Minimum Height

Antenna height is important. Within reason, the higher the antenna the better. Fortunately, the CAROLINA WINDOM will work satisfactorily at low heights above ground. If you have any choice, support the matching transformer and Vertical Radiator as high as possible. Most of the antenna's radiation comes from that part of the antenna. The ends of the antenna radiate less and can be closer to the ground.

As a rule, the minimum height for a CAROLINA WINDOM equals the length of the Vertical Radiator plus eight feet.

How Close?

Try to keep your antenna at least 15 feet from anything conductive. The greater the distance, the better. If you must be closer than 15 feet, there will be some detuning of the antenna and a reduction in antenna performance. Again, you have to mount the antenna in the space you have available. Just be aware of the compromises you are accepting.

Coax Length? Use whatever coax length is practical

Certain lengths of feedline will produce a lower SWR reading at your tuner. If you find that it is difficult to tune your antenna with your automatic tuner, try adding 1/4 wavelength of coax calculated for the frequency hardest to tune. Take into account the velocity factor of the coax. This trick will not always work, but it is often useful. If you use a manual tuner or one of the wide range automatic tuners like the LDG tuner, use whatever length of coax is practical.

SAFETY FIRST - Read the Caution Page in this manual before proceeding with installation.

The RADIO WORKS Box 6159 Portsmouth, VA 23703

CAROLINA WINDOM 80 Support Configurations

GENERAL MOUNTING REQUIREMENTS

- *Mounting height of vertical section: >30'
- *Minimum angle between legs = 126 degrees
- *Minimum height at ends = 8'

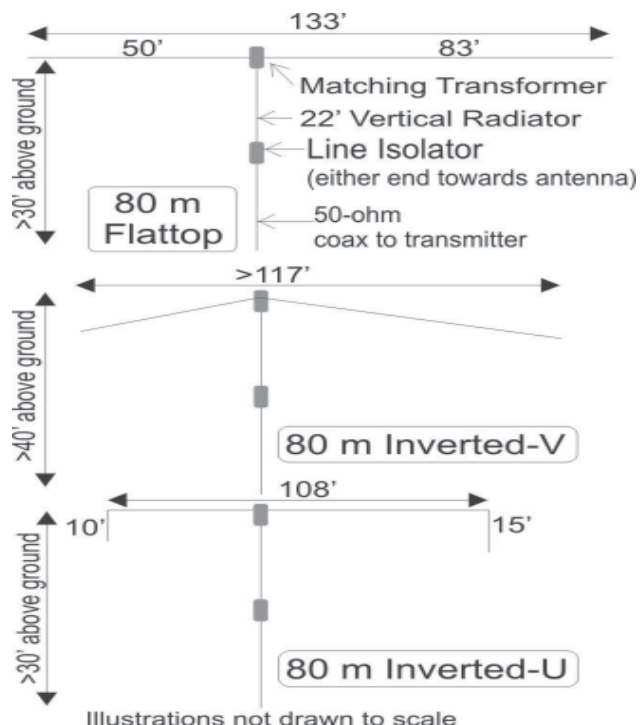

GROUND SPACE REQUIRED

Configuration vs. Length needed

- Flat top: 133'
- Inverted-V @ 40' height: $77' + 40' = 117'$
- Inverted-V @ 60' height: $73' + 34' = 107'$
- Inverted-U @ >30' height: Length = 114'
- Inverted-U Bend: 10' short leg; 15' long leg
- Sloper @ 40': 128' (not recommended)
- Sloper @ 60': 121'

It's OK to bend the outermost 10 - 15% of each leg of a CAROLINA WINDOM™. Bends must be <90°.

Recommended mounting configuration

Flat-top, suspended between two tall trees located >140' apart.

The support configuration of a CAROLINA WINDOM is not critical. The ends may be bent downward, upward, or sideways. One end can go up and the other end down. If pattern distortion is to be avoided, these bends should not use more than 15% of the wire in the element being bent. Ideally, the CAROLINA WINDOM is installed as a flattop. It does not hurt the performance of the antenna at all if the antenna droops in the middle. In fact, a 10' droop is completely acceptable and center droops between zero and 6 feet may actually add to the overall performance of the antenna. In the Inverted-V configuration, any angle less than 120° is not recommended due to adverse pattern changes on the higher bands. (See page 62)

Keep the Vertical Radiator and Line Isolator as far away as possible from any conductors. A recommended minimum is 15 feet. See page 32 for tower mounting information.

The CAROLINA WINDOM will perform well at moderate heights, but as is the case with all antennas, heights up to about 1 wavelength will produce more desirable radiation patterns. Since this is an antenna which covers 80 through 10 meters, one wavelength on 10 meters is only 32 feet. Obviously, to insure optimum performance on the lower bands, it is necessary to sacrifice performance on the higher bands. Therefore, support heights between 60 - 100 feet are perfectly acceptable, but high angle lobes will be developed on 10 and 15 meters. If this compromise is not acceptable, I recommend installing two CAROLINA WINDOMS - a **CW 80** to cover 80 and 40 meters and a **CW 40** to cover 10 and 15 meters. Either antenna will perform very well on 40 and 20 meters. Having two antennas in the air permits switching between them and selecting the antenna producing the loudest signal under prevailing band conditions.

Watch your wattmeter closely. If any of the antenna's components are being over stressed, you will see a drift in reflected power. Reduce transmitter power until there is no drift in meter readings.

The RADIO WORKS Box 6159 Portsmouth, VA 23703

CAROLINA WINDOM™

LINE ISOLATOR

The Line Isolator™ is a refinement introduced in the original RADIO WORKS' CAROLINA WINDOM™ systems. The Line Isolator™ performs two major functions. First, it provides a method of determining precisely the portion of the feed line that acts as a vertical radiator. Second, the Line Isolator™ prevents RF from traveling along the braided shield of the coaxial cable beyond the point the Line Isolator™ is inserted into the cable. This prevents RF feedback problems.

Over the years, the Line Isolator has been refined to produce optimum performance from each different antenna system. Consequently, Line Isolators and Matching Transformers are not interchangeable. Off-the-shelf Line Isolators (i.e., T-4) perform the same function as the Line Isolators used in the CAROLINA WINDOM. However, the Vertical Radiator and Line Isolator work together in the CAROLINA WINDOM to provide maximum feedline isolation, maximum low angle performance and proper antenna matching. Non-optimized parts are not effective in this role.

HOW IT WORKS

The CAROLINA WINDOM is fed off-center. Current in each of the two horizontal radiator sections of the antenna is severely out of balance. Coaxial cable (which is not a balanced line) will radiate when the voltage and phase relationships are not proper. Thus, part of the coaxial feedline is forced to radiate.

The RF transformer used to match the transmission line (coaxial feedline) to the antenna is a special design that enhances transmission line radiation. The coaxial cable serves not only as the antenna's transmission line (feedline) but also as a very effective vertical radiator. The horizontal half-wave wire portion of the antenna is the counterpoise for the vertical section. The result is an inverted-vertical antenna located high in the air and free of ground losses. It is a very efficient vertical antenna.

Radiation from the horizontal radiator is conventional. As frequency is increased, multiple horizontally polarized lobes are developed. This combination of vertical and horizontal radiation patterns produce an exceptional signal on each band. This is the secret of the CAROLINA WINDOM's outstanding performance.

Tower Mounting Technique

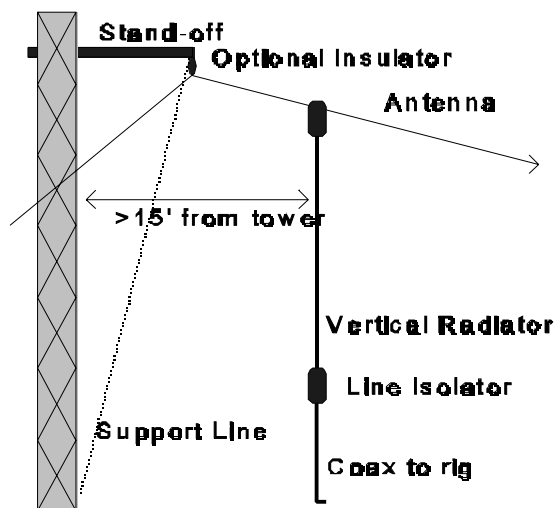

IMPORTANT

All antennas, especially those with 'Vertical Radiators' must be kept well away from metallic objects such as towers, masts, gutters, metal roofing, etc.

Use a tower stand-off (4' or more). A 10' length of 2" PVC pipe may be used to hold the antenna away from the tower.

Antennas that use Vertical Radiators should be mounted so the Vertical Radiator is > 15 feet from the tower. To simplify tower mounting, the CAROLINA WINDOM™ has an extra insulator in the package that you can install on the long leg of the antenna. You will have to add your own insulator to other antennas. Use this insulator to support the antenna as illustrated above. Installation instructions are on the next page. The Vertical Radiator and LINE ISOLATOR™ should be held at least 15 feet away from the tower.

Use the same procedure for other antennas, such as the CAROLINA BEAM™ series, The CAROLINA WINDOM Special™ series, and the VRD™.

Installing the Optional Strain Insulators

Some antennas are supplied with one or more extra insulators for use in reconfiguring antennas. For example, an extra insulator is included with CAROLINA WINDOMS of all types to aid in tower or mast mounting. The BigSig Loop and Super Loop have two extra insulators for reconfiguring loops from triangular configurations to rectangular configurations. However, in the case of loop antennas, it is recommended that you install them as delta-loops, if possible.

The extra insulators must be installed by the user, but they are made to be slipped over the wire and twisted into place. You do not have to thread the antenna wire through an "eye" on a standard insulator, so these insulators are simple to install.



Step 1

At the proper point along the antenna wire, press the antenna wire through the clips on the side of the insulator. Bend the wire around the insulator and press the wire through the clip on the opposite side of the insulator.



Step 2

Tightly twist the wire together for several turns. Soldering is not necessary. The wire will not untwist if the twists are tight.



Step 3

Thread several inches of support rope through the insulator as shown above.



Step 4

Tie the support rope with a reliable knot. A Bowline is shown in the installation section of this manual. Shown above are two half-hitches.

CAROLINA WINDOM 40, 40 Performance Plus, CAROLINA WINDOM 20 & 620

Follow the installation procedures outlined starting on page 20.

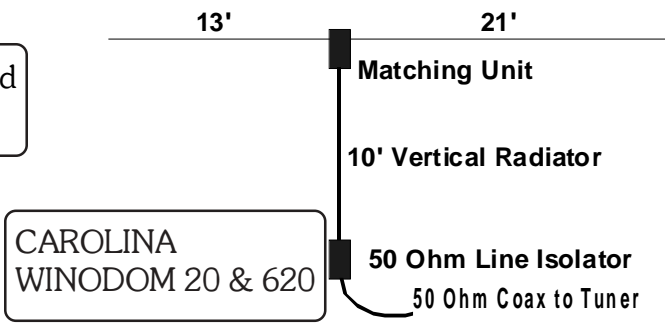
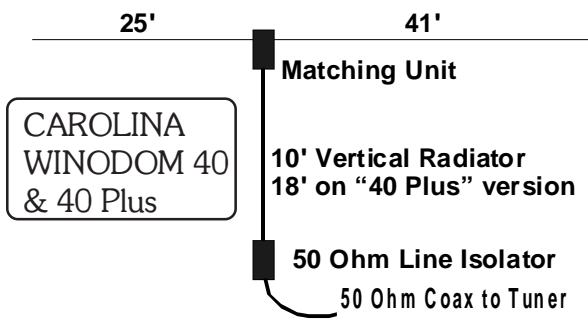

GENERAL MOUNTING REQUIREMENTS

- *Mounting height of vertical section: >25'
- *"40 Plus" version requires > 33'
- *Minimum recommended angle between legs = 126° .
- *Minimum angle between legs = 90°
- *Minimum height at ends = 8'

Configuration vs. Length needed

- Flat top: 70'
- Inverted-V @ 40' height: 100' minimum
- Inverted-V @ 60' height: 120' minimum
- Inverted-U @ >30' height: length = 41'
- Inverted-U Bend = 5' short leg; 10' long leg
- Sloper @ 40' = 58'
- Sloper @ 60' = 40'
- It's OK to bend the ends of the antenna.

Recommended mounting configuration:

Flat-top, suspended between two tall trees located >70' apart.

IMPORTANT

The vertical section **MUST** be kept well away from metallic objects, such as towers, masts, gutters, metal roofing, etc.

See Tower mounting technique - page 32.

SAFETY FIRST - Read the Caution Page in this manual before proceeding with installation.

The RADIO WORKS Box 6159 Portsmouth, VA 23703

GENERAL MOUNTING REQUIREMENTS

- *Mounting height of vertical section: >25'
- *Minimum recommended angle between legs = 126°
- *Minimum height at ends = 8'

GROUND SPACE REQUIRED

This antenna is only 34 feet long. You can support your CAROLINA WINDOM 20 or 620 as a flattop, sloper, or inverted-V.

Recommended configuration:

Flattop, suspended between two tall trees or similar supports located >40' apart.

Special considerations for 6 meter operation.

You will want the best performance possible from your CAROLINA WINDOM 620 when you are operating on 6 meters. Two issues must be considered.

1. Antenna location and configuration
2. Feed line

For maximum 6 meter performance, supporting this antenna as a flattop is best. Bending the antenna into an inverted-V will reduce 6 meter performance. With the short length of this antenna, this should not be a problem.

Feed lines - Since 6 meters is in the VHF spectrum, more care must be taken when choosing coaxial cable for the antenna's feed line. Unless the length of feed line is short, less than 75 feet, you should use RG-213 or better coax. For shorter lengths than 75 feet, quality RG-8X will be fine.

You will be using a tuner with this antenna on 6 meters, so you want feed line with the minimum loss possible. However, unless you need to run a very long coax run, there is no real need to use expensive, low-loss coax types.

CAROLINA WINDOM 160™

Follow the installation procedures outlined starting on page 20.

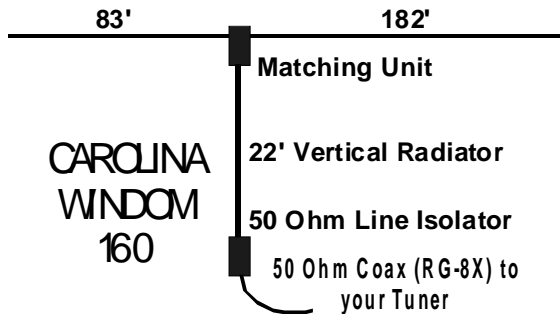

SPECIFICATIONS

Freq. coverage: 160 - 10 meters
 Gain: As much as 10 dBd* reported
 Radiator length: Horizontal 265' Vertical 22'
 Polarization: Both vertical and horizontal
 Matching method: Tuner
 Tuner needed: Yes
 Power Rating: 1500 Watts CW/SSB See page 5.
 Recommended Hgt.: >40'- Usable at 35'
 Radials? Not required
 * Based on user reports, field evaluations, and product reviews.

IMPORTANT

Vertical section **MUST** be kept well away from metallic objects, such as towers, masts, gutters, metal roofing, etc.

See *Tower mounting technique* detailed earlier in this manual.

Watch your wattmeter closely. If any of the antenna's components are being over stressed, you will see an upward drift in reflected power. Reduce transmitter power until there is no drift in meter readings.

Read the information on the CAROLINA WINDOM 80.

Support Configurations

GENERAL MOUNTING REQUIREMENTS

- *Mounting height of vertical section: >40'
- *Minimum angle between legs = 126 degrees
- *Minimum height at ends = 8'

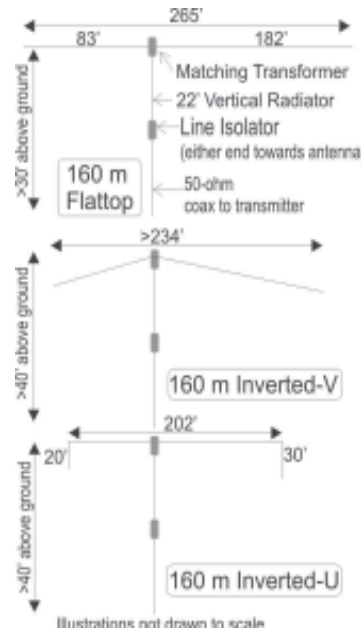

GROUND SPACE NEEDED

Mount your 160 meter CAROLINA WINDOM™ using good HF antenna installation technique. Due to the very large size of this antenna, you may want to bend the ends of the antenna vertically or horizontally if the full 270' of mounting space is not available. This will not usually reduce the performance of the CAROLINA WINDOM™ on the lower bands. There may be some effect on the radiation pattern on the higher bands.

Of course, it is best, if you have the room, to put the antenna in the air as a flat top or inverted-V. SWR is only one indicator of an antenna's performance. Reactance, band to band, is well controlled and the SWR, though not below 2:1, is low enough to avoid high losses in the coaxial feed line. Your tuner easily matches the antenna feed system to your rig.

You have all the convenience of an open-wire fed antenna, with the convenience of coaxial cable.

As the CAROLINA WINDOM 160™ comes to you, it is adjusted for maximum radiation performance on all bands.

Operating on other frequencies

Operating a CAROLINA WINDOM™ outside the amateur radio bands is possible. **Transmitter power will usually have to be reduced to a few hundred watts. Do not use your linear.** You will need a wide range, manual tuner.

SAFETY FIRST - Read the Caution Page in this manual before proceeding with installation.

The RADIO WORKS Box 6159 Portsmouth, VA 23703

IMPORTANT

Follow the installation procedures outlined starting on page 20.

CAROLINA WINDOM Low Profile "LP" Versions

CAROLINA WINDOM 80 LP

CAROLINA WINDOM 40 LP

CAROLINA WINDOM 40 Performance PLUS LP

CAROLINA WINDOM Short 80 LP

CAROLINA WINDOM Short 80 LP

CAROLINA WINDOM 20LP

CAROLINA WINDOM 620 LP

Installation

Follow all of the installation instructions for the standard CAROLINA WINDOM versions.

The "LP" versions of the CAROLINA WINDOM antennas are identical to the standard size versions with the exception of the matching transformer, Line Isolator, and power limits. The "LP" is a full performance CAROLINA WINDOM.

Antenna Support Height

Since these are easier to hide, stealthy antennas, they have been optimized for lower support heights. Standard CAROLINA WINDOMS are optimized for a support height of 50 feet, whereas the LP versions are optimized for a height between 30 and 40 feet.

Though optimized for a height of between 30 and 40 feet, performance will be improved if the antenna is supported higher off the ground. There is nothing wrong with supporting a CAROLINA WINDOM LP at 60, 80 or even 100 feet off the ground. Only the SWR at the transmitter end of your feedline will increase while the radiation pattern and thus antenna performance will be improved. Never substitute height for a lower SWR.

Power Limits

The power limit for all "LP" versions of the CAROLINA WINDOM is 600 watts CW/SSB output under normal duty-cycles. That duty-cycle is 25%. In other words, no more than 25% transmitting time followed by 75% listening time. Maximum key down time is 30 seconds.

Watch your reflected power meter when using the antenna. If the reflected power drifts upward or downward, as you transmit, the components inside the matching transformer or Line Isolator are overheating. There are many things which can cause this. Most often it is excessive power, spurious output or parasitic oscillation from your linear amplifier, or a combination of all three. Sometimes, the reflected power will change as an antenna "swings" in the breeze. This is normal.

The 600 watt power rating of the "LP" series of CAROLINA WINDOMS means that it should be able to handle the output power of many solid state linears and 811-class amplifiers like the Ameritron AL-811 or Collins 30L-1. The Ameritron AL-811H and some single tube 3-500 amps may be used with the "LP" series of antennas but you will have to keep the power down and don't overdo your speech processing. If you need to run more power, you need that standard version of the CAROLINA WINDOM.

Operating Modes

CW and SSB are the design modes. PSK-31 should be OK if you run your rig at 100 watts or less. AM, FM, RTTY and other high duty-cycle modes are not recommended, and will probably result in antenna component failure.

CAROLINA WINDOM Short 80™

GENERAL MOUNTING REQUIREMENTS

- *Mounting height of vertical section: >35'
(30' if two 16' verticals are used)
- *Recommended configuration: Flat-top
- *Inverted-V configuration is usable if the angle is large.
- Note: Inverted-V configuration upsets element spacing and alters the pattern.
- *Minimum height at vertical ends: >8'

Recommended mounting configuration

Flat-top, suspended between two tall trees located >100' apart.

LINE ISOLATOR

The 'Line Isolator' is a refinement introduced in the original RADIO WORKS CAROLINA WINDOM systems. The line isolator performs two major functions. First, it determines precisely the portion of the feed line that acts as a vertical radiator. Secondly, the Line Isolator prevents RF from traveling along the outside of the braided coax's shield beyond the point where the Line Isolator is inserted. This is important in preventing RF feedback problems.

Can I Turn My CAROLINA WINDOM into a CAROLINA Short?

Each DMU (Dedicated Matching Unit) in the CAROLINA WINDOM and CAROLINA Short is optimized for a specific antenna system. A DMU must provide the correct current imbalance and output impedance to produce maximum efficiency from a particular antenna.

Similarly, the new CAROLINA Short's 'DEDICATED MATCHING UNIT' provides the load reactance and proper phase response necessary for proper operation of the CAROLINA Short's 'Vertical Radiator Element.'

Unfortunately, the DMUs cannot be interchanged. Just bending up a CAROLINA WINDOM means you would **give up much of the performance capability of the CAROLINA Short.**

The CAROLINA WINDOM Short 80™ was previously know as the CAROLINA BEAM 80™. Likewise the CAROLINA WINDOM Short 40™ was previously know as the CAROLINA BEAM 40™.

HOW IT WORKS

The CAROLINA WINDOM Short 80™ or CAROLINA WINDOM Short 40™ antenna system combines the best characteristics of the CAROLINA WINDOM and the 'Bobtail Curtain.' The main reason for the CAROLINA WINDOM's exceptional performance is its 'Vertical Radiator Section.' The **CAROLINA WINDOM Short** is similar to the CAROLINA WINDOM in that it is fed off-center. This forces the current in each half of the horizontal radiator sections of the antenna to be severely out of balance. Coaxial cable (which is not a balanced line) will radiate when the voltage and phase relationships are not properly balanced.

The RF transformer used to match the transmission line (coaxial feedline) to the antenna is a special design that enhances transmission line radiation. Thus, the coaxial cable serves not only as the antenna's transmission line (feedline) but it functions, simultaneously, as an effective vertical radiator. The horizontal wire portion of the antenna interconnects the three vertical sections. The result is a multi-element inverted-vertical antenna high in the air and free of major ground losses. Radiation from the horizontal section of the antenna is conventional.

SAFETY FIRST - Read the Caution Page in this manual before proceeding with installation.

The RADIO WORKS Box 6159 Portsmouth, VA 23703

CAROLINA WINDOM Short 40™ and Short 80™

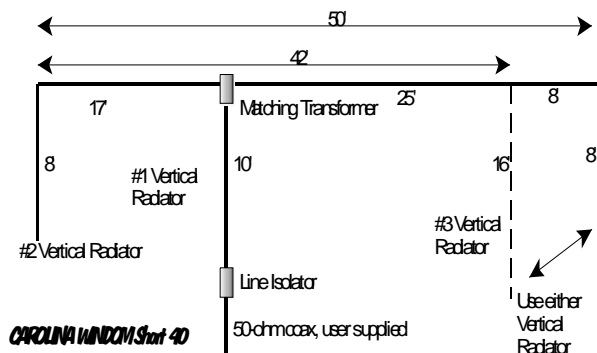

Freq. coverage: 40 - 10 meters
 Radiator length: Horizontal 42' or 50'
 Verticals 8', 10', 8' or 8', 10', 16'
 Polarization: Vertical and horizontal
 Feed line: 50 ohm Coaxial cable
 Matching method: Tuner
 Tuner needed: Yes, on all bands.
 Power Rating: 1500 Watts CW/SSB See page 5
 Recommended Hgt. >35'- Usable at 30'

All **CAROLINA WINDOM Short 40™** elements are interactive and must be in alignment for proper operation of the antenna. SWR is only one factor that affects an antenna's performance. Reactance, band to band, is well controlled and the SWR, though not below 2:1, is low enough to avoid high losses in the coaxial feed line. Your manual tuner easily matches the antenna feed system to your rig. This gives you all the convenience of an open-wire fed antenna, with the convenience of coaxial cable.

As the **CAROLINA WINDOM Short 40™** comes to you, it is adjusted for maximum radiation performance on all bands, 40 through 10 meters.

Follow the installation procedures outlined starting on page 20.

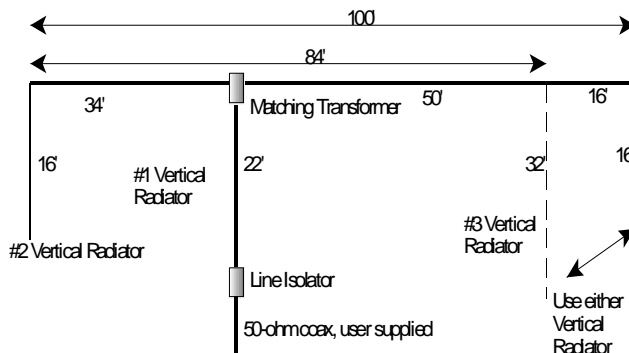

Freq. coverage: 80 - 10 meters
 Radiator length: Horizontal 84' or 100'
 Verticals 16'/22'/32' or 16'/22'/16'
 Polarization: Vertical and horizontal
 Feed line: 50 ohm Coaxial cable
 Matching method: Tuner
 Tuner needed: Yes, on all bands.
 Power Rating: 1500 Watts CW/SSB See page 5
 Recommended Hgt. >35'- Usable at 30'

The **CAROLINA WINDOM Short 80™** is a unique combination of the **CAROLINA WINDOM™** and the very high performance wire beam, the 'Bobtail Curtain.'

The **CAROLINA WINDOM Short 80™**'s radiation pattern is different from simple dipoles and similar antennas. The **CAROLINA WINDOM Short 80™** combines three vertical elements with a single horizontal radiator. It is this unique combination of horizontal and vertical radiating elements that account for the outstanding performance of this antenna system. An added benefit of this system is the short length of the **CAROLINA WINDOM Short 80™**. At only 84' or 100' in length, it is much smaller than an 80 meter dipole.

As the **CAROLINA WINDOM Short 80™** comes to you, it is adjusted for maximum radiation performance on 80 - 10 meters.

All **CAROLINA WINDOM Short 80™** elements are interactive. Reactance, band to band, is well controlled and the SWR, though not below 2:1, is low enough to avoid high losses in the coaxial feed line. Your manual tuner easily matches the antenna feed system to your rig. This gives you all the convenience of an open-wire fed antenna, with the convenience of coaxial cable.

SAFETY FIRST - Read the Caution Page in this manual before proceeding with installation.

The RADIO WORKS Box 6159 Portsmouth, VA 23703

Field Reconfigurable

The pattern of the CAROLINA Short™ is adjustable. The insulators are installed at the proper points to allow any of three configurations. Typically, the pattern of a CAROLINA Short™ has multiple, large major lobes, with deep nulls between. The angle of radiation is very low and favors long-haul DX. You may want to experiment with the three different CAROLINA Short™ configurations and the resulting pattern changes. It is easy to change configurations - simply insert your support rope into the appropriate insulator, and the job is done.

Standard Configuration

This configuration will give the best overall patterns on the higher bands. The shorter Vertical radiators are optimized for the two highest frequency bands. The spacing between the elements will produce a multi-lobe pattern on all but the lowest band. There will be significant radiation off the ends of the antenna.

Use insulators #2 and #4 to support the antenna. You may want to hang weights or use light weight support lines at insulators #1 and #5 to keep the Vertical Radiators in place.

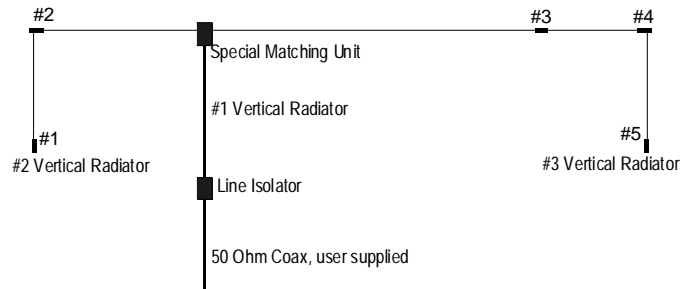

CAROLINA Short

Alternate Configurations

Short Flat-Top

The #3 Vertical Radiator is doubled in length. This generally improves the radiation pattern on the next to the lowest frequency band. The antenna is now shorter which can be an added benefit to some users. The radiation pattern of this configuration will have multiple lobes and very deep nulls. The takeoff angle is very low and favors long-haul DX.

To set up your CAROLINA Short in this configuration, simply use insulators #2 and #3 to support the antenna. Again, you may want to hang weights or use light weight support lines at insulators #1 and #5 to keep the Vertical Radiators in place.

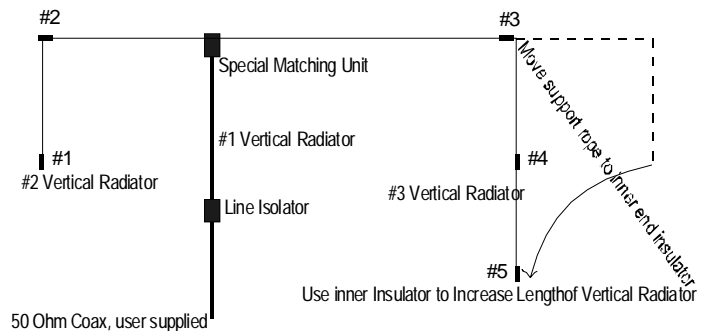

Short Flat-top Configuration

CAROLINA WINDOM

You have the option to turn your CAROLINA Short™ into an antenna similar to a CAROLINA WINDOM. This would be the choice if you find the pattern of the CAROLINA Short™ to be too aggressive for your needs. You may want to use one configuration for contests and another for everyday use. Try the various configurations and see which work best for you.

The pattern will contain multiple lobes on the higher bands, but the nulls between lobes will not be as severe. Radiation off the ends of the antenna will be low-angle and vertically polarized. To put the CAROLINA Short™ into the CAROLINA WINDOM mode, use insulators #1 and #5 to support the antenna.

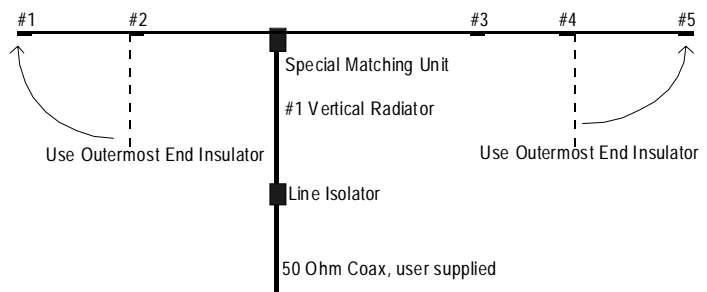

CAROLINA WINDOM Configuration

The RADIO WORKS Box 6159 Portsmouth, VA 23703

CAROLINA WINDOM Special Versions

CAROLINA WINDOM 160 Special™
CAROLINA WINDOM 80 Special™

CAROLINA Short 160 Special™
CAROLINA Short 80 Special™

It is possible to make a CAROLINA WINDOM work on 160 meters. The feed point impedance is very low, so the Matching Transformer and Line Isolator are very heavily stressed. Special Matching Transformers and Line Isolators are required to handle the high RF current applied when operating the half-frequency band. The SWR will be high, but fortunately, on 160 and 80 meters, quality coaxial cable has practically no loss, so an elevated SWR does not produce excessive loss in the feed line.

There are unavoidable losses

There are unavoidable losses in the Line Isolator™ and Matching Unit due to the very high RF Current being fed to the antenna. We could optimize the Matching Unit and Line Isolator for the low feed point impedance, but if we did, we introduce unacceptably high losses on all the higher frequency bands. Consequently, the compromises are made on 160 meters (or 80 meters in the case of the CW 80 Special and CW Beam 80 Special).

You Must Reduce Power on the Lowest Frequency Band.

Special heavy-duty matching transformers and Line Isolators are used in all the “Special”

Transmitter power must be limited to 500 watts or less on SSB and CW with normal duty-cycles.

antennas, but it is not practical to build these parts to handle full legal power. They would be too large and too heavy.

Therefore, transmitter power must be limited to 500 watts or less on SSB and CW with normal duty-cycles. When using higher duty-cycle modes, power must be reduced further.

installation where further reduction in power may be required. Remember, adding the extra band at the low frequency end of the antenna’s normal operating range is done only to permit casual operation on that band while retaining full performance on all the higher bands.

Where does the signal go?

Component losses, combined with the very short radiator length on 160 meters results in a loss of overall system efficiency on that band. Compared with full-sized 160 meter antennas, you can expect your signal

Operation on 160 meters results in a loss in overall system efficiency, but not on the higher bands.

to be down between one and two S-units. However, in situations where a 160 meter antenna is not practical, you will be able to operate with a capable signal. It’s an excellent

compromise and permits experiencing one of the lower frequency bands when space doesn’t permit larger antennas.

Because there is a significant amount of power dissipated in the matching transformer and Line Isolator, you must lower power to a maximum of 500 watts on the lowest frequency band. Failing to do so will cause overheating of the matching transformer and Line Isolator and their ultimate failure.

On the higher bands, 80 - 10 meters, where the antenna is now operating in its normal design mode, losses are minimal and the antenna takes on its usual exceptional characteristics. Performance is not compromised on these bands, and full power may be used.

The RADIO WORKS Box 6159 Portsmouth, VA 23703

CAROLINA WINDOM 80 & 160 SPECIAL™

Follow the installation procedures outlined starting on page 20.

CAROLINA WINDOM 160 Special

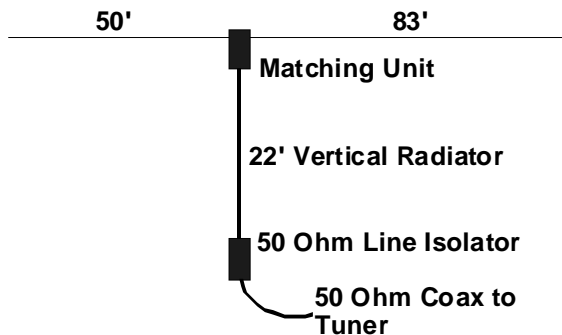

Most automatic tuners do not have tuning range to match this antenna on 160. In that case, a wide range manual tuner is required. Unsatisfactory tuning with manual tuners can usually be traced to improper station grounding or ground loops.

Specifications

Freq. coverage: 160 - 10 meters
 Feed line: 50 ohm coaxial cable
 Tuner needed: Yes, all bands
 Power Rating: 1500 Watts (40 - 10 m)*
500 w MAX (160 m)*
 Recommended Hgt.: >35'- Usable at 30'

*CW/SSB duty-cycles only.

Watch your wattmeter closely. If any of the antenna's components are being over stressed, you will see an upward drift in reflected power. Reduce transmitter power until there is no drift in meter readings.

CAROLINA WINDOM 80 Special

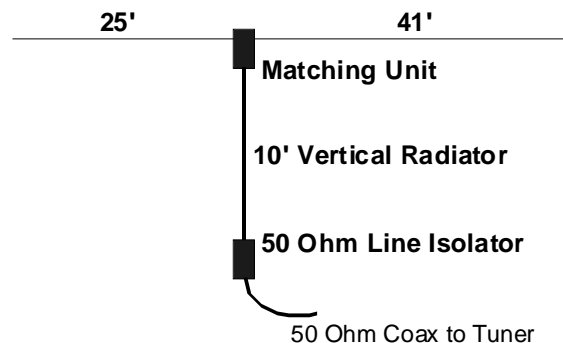

Specifications

Freq. coverage: 80 - 10 meters
 Feed line: 50 ohm coaxial cable
 Tuner needed: Yes, all bands
 Power Rating: 1500 Watts (40 - 10 m)*
500 w MAX (80 m)*
 Recommended Hgt.: >30'- Usable at 25'

*CW/SSB duty-cycles only.

In both antennas, all elements are interactive and must be in alignment for proper operation of the CAROLINA WINDOM Special. Reactance, band to band, is well controlled and the SWR, though not below 2:1, is low enough to avoid high losses in the coaxial feed line. Your wide range manual tuner easily matches the antenna feed system to your rig.

If you use an automatic antenna tuner on 40 - 10 meters, and the CAROLINA WINDOM's SWR is beyond the tuning range of your automatic tuner, trimming the length of coax feedline will usually produce acceptable results.

Try adding a short jumper in series with the feed line at the transmitter. 6' to 12' is a good starting length. Since all installations are different, you may want to experiment to achieve the best results. You have all the utility of an open-wire fed antenna, with the convenience coaxial cable. Automatic tuners generally do not have sufficient tuning range for the lowest frequency band covered.

SAFETY FIRST - Read the Caution Page in this manual before proceeding with installation.

The RADIO WORKS Box 6159 Portsmouth, VA 23703

CAROLINA WINDOM Short 160 Special & Short 80 Special

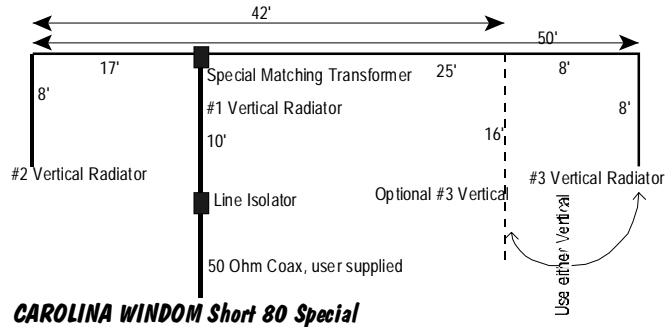
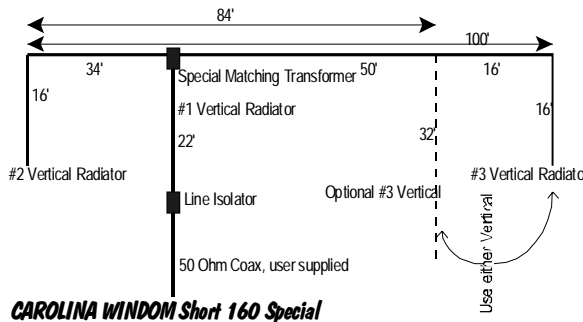

Follow the installation procedures outlined starting on page 20.

All CAROLINA WINDOM Short Special™ antenna elements are interactive and must be in alignment for proper operation of the antenna. Reactance, band to band, is well controlled and the SWR, though not below 2:1, is low enough to avoid high losses in the coaxial feed line. Your tuner easily matches the antenna feed system to your rig. This gives you all the convenience of an open-wire fed antenna with the convenience coaxial cable.

Can I Turn My CAROLINA WINDOM into a CAROLINA WINDOM Short?

Each DMU (Dedicated Matching Unit) in the CAROLINA WINDOM and CAROLINA Short is optimized for a specific antenna system. A DMU must provide the correct current balance and output impedance to produce maximum efficiency from a particular antenna.

Similarly, the new CAROLINA Short's 'DEDICATED MATCHING UNIT' provides the load reactance and proper phase response necessary for proper operation of the CAROLINA BEAM's 'Vertical Radiator Element.'

Unfortunately, the DMUs cannot be interchanged. Just bending up a CAROLINA WINDOM means you would **give up much of the performance capability of the CAROLINA Short.**

The CAROLINA WINDOM Short

The 'CAROLINA WINDOM Short 160 SPECIAL™' and the 'CAROLINA WINDOM Short 80 SPECIAL™' are a unique combination of the CAROLINA WINDOM™ and the very high performance wire beam, the 'Bobtail Curtain.'

The CAROLINA WINDOM Short SPECIAL's™ radiation pattern is different from simple dipoles and similar antennas. The CAROLINA Short SPECIAL™ combines three vertical elements with a single horizontal radiator. It is this unique combination of horizontal and vertical radiating elements that account for the outstanding performance of this antenna system.

An added benefit of this system is the reduced length of the CAROLINA WINDOM Short SPECIAL.™

CAROLINA WINDOM Short 160 Special

When operating the CAROLINA WINDOM Short version on its lowest design frequency, the feedpoint impedance is very low. This results in a high SWR. Feed line losses are low on 80 and 160 m, so loss due to the SWR are low. However, very high RF current passes through the DMU and the Line Isolator. The high current requires that you keep the transmitter output below 500 watts (CW and SSB duty cycles).

SAFETY FIRST - Read the Caution Page in this manual before proceeding with installation.

The RADIO WORKS Box 6159 Portsmouth, VA 23703

CAROLINA WINDOM Shortwave

Follow the installation procedures outlined starting on page 20.

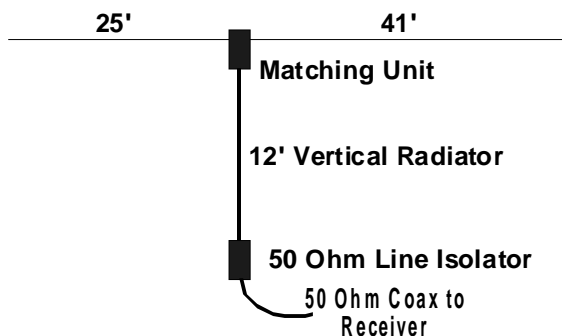

SPECIFICATIONS

Freq. coverage:	HF Spectrum
Radiator length:	Horizontal 66' Vertical 12'
Polarization:	Both vertical and horizontal components
Feed line:	50 ohm coaxial cable, RG-8X recommended.
Matching method:	Dedicated Matching Unit
Recommended Height:	>30'- Usable at 20'
Radials?	Not required

* Based on user reports, field evaluations, and product reviews.

General Mounting Requirements

- *Mounting height of the antenna: >20'
- *Minimum recommended angle between legs = 126° .
- *Minimum angle between legs = 90 degrees
- *Minimum height at ends = 8'

Recommended mounting configurations:

Flattop, suspended between two tall trees located >70' apart.

This antenna is very forgiving and can be bent to fit the available space. Bends in the wire should not be less than 90-degrees (the angle between legs). Larger angles are recommended. As with all antennas, the higher the antenna is in the air, the better the performance.

IMPORTANT

Vertical section MUST be kept well away from metallic objects, such as towers, masts, gutters, metal roofing, etc.

See Tower mounting technique - See page 32.

The *CAROLINA WINDOM Shortwave* is a new application of the *CAROLINA WINDOM*. Our new "Low Profile" matching transformer and Line Isolator are featured. The antenna is designed to cover the HF spectrum, but it is usable in the BC band and up to 50 MHz. It is optimized for frequencies between 5 and 30 MHz.

A manual antenna tuner can improve performance in critical applications, but is generally not necessary and does not produce a worthwhile improvement in reception. The reception pattern is essentially omnidirectional which is ideal for shortwave listening. This antenna is intended for quality receivers as the excellent signal capture effect of this antenna may overload some receivers. This is the simple consequence of an efficient antenna that produces gain at most medium and higher shortwave frequencies. You may find it useful to use your receiver's attenuator under some circumstances.

The *CAROLINA WINDOM Shortwave* provides increasing performance when signals are arriving at very low angles. This effect can enhance distant stations significantly.

SAFETY FIRST - Read the Caution Page in this manual before proceeding with installation.

The RADIO WORKS Box 6159 Portsmouth, VA 23703

Troubleshooting Antennas

The **CAROLINA WINDOMS**

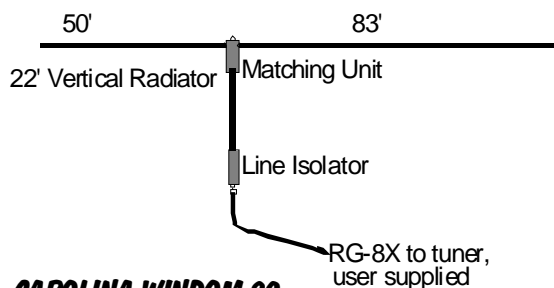

CAROLINA WINDOM 80

CHECK THE SWR

Use low power and measure the SWR at several different frequencies between 3.5 MHz and 3.8 MHz. A normal CAROLINA WINDOM 80 will have an SWR minimum of about 1.5:1 at 3.65 MHz. This frequency may vary 100 KHz up or down depending on the antenna's environment. Also, the SWR may be higher or lower. On the CAROLINA WINDOM 40, the lowest SWR will be in the middle of the 40 meter band. Similarly, other models will exhibit the lowest SWR on the band covered. The exceptions are the "Special" versions where the lowest SWR will be on the band next to the lowest band covered.

If you do not measure this drop in SWR somewhere in the lower part of the lowest band covered, either the antenna is severely detuned by its environment or there is a problem with the system. Vertical Radiator must be at least 15-feet from any metal object.

It is normal for the SWR to run between 2:1 and 4:1 when your tuner is out of the circuit.

In the CAROLINA WINDOM's history, there have been very few failures. First, check for open or shorted connectors and damaged coaxial cable. The 'Dedicated Matching Unit' and the 'Line Isolators' are generally bulletproof.

Checking out the CAROLINA WINDOM Antenna with an Ohm Meter

1. Measure across the coaxial connector at the transmitter end of the coaxial cable, the ohmmeter should indicate a very low resistance (approximately 1 ohm).

Occasionally, you will put up an antenna, and it will not work as anticipated. Most often the fault is improperly installed connectors, bad coax, an installation error or something else easily remedied. If your antenna does not seem to be performing properly, below are a few simple tests to help locate the problem.

2. Disconnect the 'Line Isolator' from the 'Dedicated Matching Unit' and repeat the measurement. This time the measurement should indicate an open circuit at the transmitter end of the cable. If not, check for a shorted connector or bad coax.

The only DC short in the system is in the 'Dedicated Matching Unit' or 'DMU.' All inputs and outputs of the 'DMU' should be a very low resistance from any terminal to another. If there is an open circuit, the 'DMU' is bad.

The Coax and Line Isolator should present an open circuit when measuring across a connector. You will measure a low resistance when measuring from the input center-pin of the Line Isolator to the center-pin of the connector at the end of the vertical radiator. Measure from center pin to center pin and from nut to nut. (The nut is the part of the coaxial connector that is free to spin.) A short circuit can usually be traced to a bad connector.

Intermittents: If there is an intermittent problem with your antenna, it can usually be traced to the feedline and its connectors. Check each connector in the system. Repeat the procedure in the paragraph above, and gently pull or twist each connector. Any change in a meter reading indicates a bad connector. Also, make sure there are no signs of moisture entering the connector or coax.

SuperLoop 80™ & SuperLoop 40™

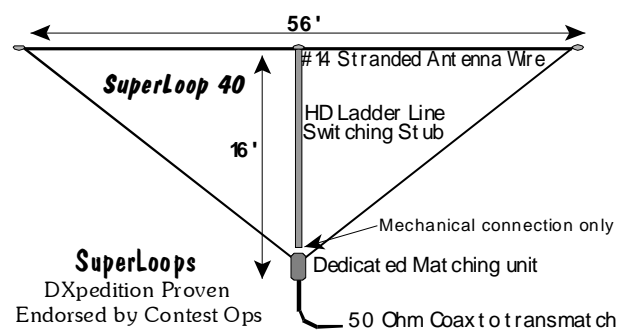
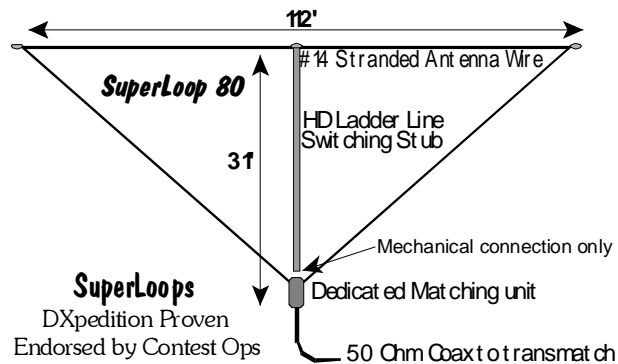

See page 27 for installation instructions.

Installation of the 80 or 40 meter SuperLoops are identical.

The SuperLoop 80™ is a remarkable antenna. It is an automatic bandswitching 80 through 10 meter loop antenna. The SuperLoop 80 reconfigures itself from a full-size, full-wave loop on 80 meters into a multi-wavelength “Bi-square” on higher frequency bands. The SuperLoop’s™ impedances and reactances are so well managed that the SuperLoop 80 may be fed on all bands with coaxial cable. You will have to use your tuner (transmatch).

The Dedicated Matching Unit, along with all the other components in the antenna, works together to provide a relatively low SWR on all bands. The SWR is not below 2:1. However, it is low enough to allow the use of coaxial cable. Losses are low.

One further purpose of the dedicated tuning unit is to provide the interface between the unbalanced coaxial cable and balanced loop antenna. In other words, the dedicated tuning unit functions as both a multiband antenna matching device and a high performance balun.

INSTALLATION

Your SuperLoop 80 or 40 comes to you assembled except two connections which must be soldered. It is complete with a custom designed “Dedicated Matching Unit.” You provide a couple of convenient trees or other suitable structures that are at least 120' apart and a minimum of 35 feet high.

Erect your SuperLoop as a ‘Delta loop’ with the apex down. If this is not possible, you may add insulators to the loop and form it into a rectangle or square. See page 33 for insulator installation instructions. As a last choice, you may turn the antenna upside down and feed it from the top with the apex up. The SuperLoop is designed to be supported apex down.

HOW IT WORKS

On 80 meters your RADIO WORKS' SuperLoop™ is a high performance, full size, full wave loop antenna. On 40 meters the SuperLoop™ is a 2-wavelength antenna that is similar to a Bi-square. On this band its gain approaches 4 dB. Gain will be higher due to the low take-off angle of the radiation pattern. A Bi-square loop is not a closed loop. It is open-circuited exactly one wavelength around the loop. This is one purpose of the stub at the center of the top section of the loop. It creates open circuit at the center of the antenna when operating on even harmonically related bands starting with 40 meters.

Opening the SuperLoop into a rectangle or square may slightly improve gain and bandwidth on 80 and 75 meters, but could shift resonance with 40 meter band.

SuperLoop™ Height

If the supports available are shorter than the minimum required height, you may tilt or slope a SuperLoop antenna. Just pull the bottom of the antenna to one side, so that it does not hang vertically. Like all sloping antennas, the SuperLoop will tend to favor stations in the direction of the downward slope. You may use this effect to some advantage in DX operations.

The SuperLoop is an excellent antenna for shortwave listening.

SAFETY FIRST - Read the Caution Page in this manual before proceeding with installation.

The RADIO WORKS
Box 6159, Portsmouth, VA 23703

ULTIMA DIPOLE™

Heavy Duty, Single Band Dipoles

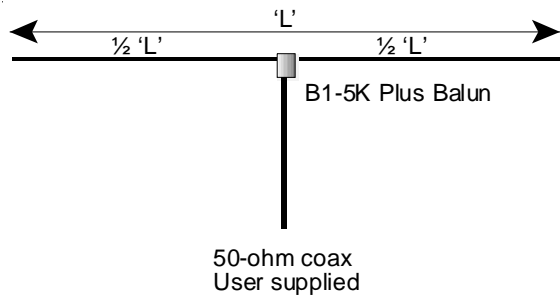

Follow the installation procedures outlined starting on page 20.

User Supplied Parts

- RG-8X, RG-8, RG-213 or similar coaxial cable
- 2 each PL-259 connectors for your coax
- Support rope

Installing your Ultima Dipole

You have made an excellent antenna choice. Now it's time to put your Ultima Dipole into the air. Any of the configurations outlined earlier are appropriate.

Antennas for the higher bands may be supported vertically from one end. Supported vertically, the antenna will radiate in all directions with a low radiation angle. Always direct the transmission line away from the antenna at a right angle for as long a distance as possible (>1/4 wavelength is desirable) to reduce interaction between the coax and the antenna.

Tuning your Ultima Dipole

Your antenna comes to you cut for the CW end of the band. On 160, 80, or 40 meters, you may want to trim the antenna for your favorite part of the band. Sometimes, the antenna may need trimming due to interaction with other antennas or particular conditions at your antenna site.

If the lowest SWR occurs at a frequency lower than needed, shorten the antenna a few inches. Similarly, if the SWR is lowest at a higher frequency, lengthen the antenna. Refer to the "Tuning Chart" on page 60. This chart will give you a general idea of the length of wire involved in moving the resonant frequency of the antenna a given number of KHz.

Lengthening or shortening the antenna is done at the end insulators. To shorten the antenna, unwind the wire as it wraps around itself at the end insulator. Move the insulator the required length toward the center of the antenna. Re-wrap the antenna wire to secure the end insulator.

The antenna comes to you tuned to the CW portion of the band. It is unusual to have to lengthen the antenna.

Using a tuner

You may use a tuner (transmatch) with your ULTIMA DIPOLE. This is most often done on 160 or 80 meters to allow full band operation. Typically a dipole covers only about 200 KHz (or less) of the band between 2:1 SWR points on 80 meters. In some parts of the band, the SWR will rise to a fairly high figure (>4:1). A transmatch will provide a good match to the transmitter.

Do not use a dipole at twice its design frequency, even with a transmatch. (i.e. an 80 meter antenna will not work well on 40 M when fed with coax) You may use an antenna at three times its design frequency. For example, a 7 MHz antenna can be used on 21 MHz. You will probably need to use your transmatch to get an acceptable SWR.

ANTENNA LENGTH					
L(in feet) = 468/MHz					
Frequency	Length "L"	Frequency	Length "L"	Frequency	Length "L"
3.5 MHz	134'	7.2 MHz	65'	21.2 MHz	22'
3.6	130'	10.12	46.2'	24.93	18.75'
3.7	126.5'	14.0	33.5'	28.0	16.7'
3.8	123'	14.2	33'	28.5'	16.4'
3.9	120'	18.12	25.8'	29.0	16.1'
7.0	66.5'	21.0	22.3'	29.5	15.9'

SAFETY FIRST - Read the Caution Page in this manual before proceeding with installation.

The RADIO WORKS Box 6159 Portsmouth, VA 23703

BigSig Loop™

SPECIFICATIONS

Freq. coverage:	Available for all bands
Radiator length:	3/2 wave
Feed Impedance:	50 ohms
Matching method:	Balanced Matching Unit
Feed line:	50 ohm coaxial cable (RG-8X)
SWR:	Low: Full coverage on bands except 75/80 M.
Power Rating:	1500 watts HF CW/SSB 300 watts on 6 meters. see pg. 5
Radials:	No

The *BigSig Loop™* is an unusual 3/2 wavelength loop that delivers outstanding performance.

The advantage of the *BigSig Loop™* is its large capture area, its low radiation angle and ease of installation. The enhanced, low angle, radiation pattern of the *BigSig Loop™* antenna gives you the competitive edge over other stations using dipoles, inverted-V's, or trap antennas, operating under similar conditions.

A balanced dedicated matching unit was custom designed to match the BigSig loop antenna's high impedance to your 50 ohm coaxial cable. BigSig Loops are easy to get up and get going.

The Larger the Internal Area of a Loop, the Better the Performance.

After deciding the shape of the loop based on the space and supports you have available, you will need to choose the feed point location. I generally feed all my loops at the bottom. I find this convenient. For enhanced DX performance, it may be desirable to have the feed point at one corner of the loop. (Corner feeding a rectangular loop yields a vertically polarized pattern and a lower radiation angle). A DELTA configuration results in a combination of vertical and horizontal polarization.

If possible, mount your *BigSig Loop™* as a square or apex down Delta. This puts most of the antenna as high in the air as possible. Turning the apex of a delta upward will work, but a large portion of the antenna wire will be parallel to the earth. This reduces the effective average height of the antenna.

Sloping Loops

You may tilt a loop antenna. This can be helpful if you do not have enough support height. Just pull the bottom away so that the antenna is no longer vertical. Like all sloper antennas, the loop will tend to favor stations in the direction of the downward slope. You may use this effect to some advantage in DX operations. You can easily reverse the direction from the ground.

Assembly

Assembly of the BigSig Loop™ is similar to the SuperLoop™. Refer to the SuperLoop's assembly instructions.

INSTALLATION

You may build your *BigSig Loop™* as a square, triangle, rectangle, or other geometric figure. Some shapes are marginally better than the others. The best is a circle, followed closely by a square, a rectangle, and a triangle. The larger the internal area of the loop, the higher the theoretical performance in terms of gain and bandwidth. The difference in actual performance is probably not worth the debate. Your antenna site will usually dictate the loop's final shape. Use the instructions for the SuperLoop on page 27 omitting the installation of the ladder line stub.

SAFETY FIRST - Read the Caution Page in this manual before proceeding with installation.

The RADIO WORKS Box 6159 Portsmouth, VA 23703

BigSig Configurations and Dimensions

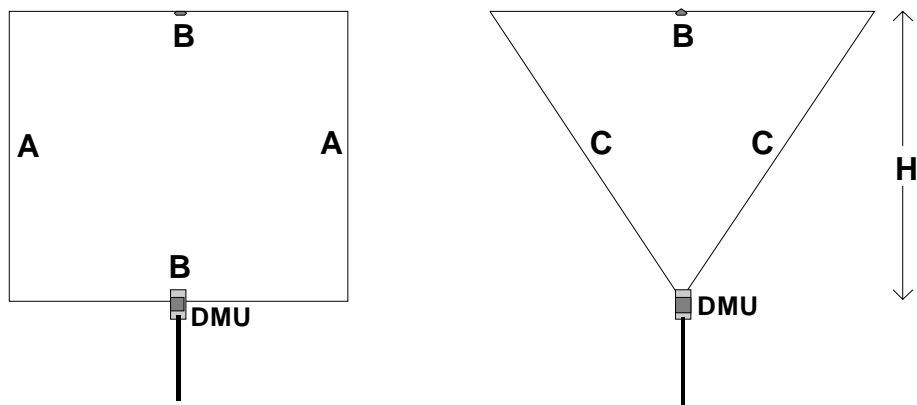

Band	Rectangular Loop			Apex Down Loop		
	Radiator Length	Height = A	Side B	Height = H	Side B Top Length	Side C
80	420'	50'	160'	65'	190'	115'
40	210'	40'	65'	40'	90'	60'
30	150'	37.5'	37.5'	38.7'	55'	47.5'
20	105'	26'	27'	30'	35'	35'
17	84'	21'	21'	24.25'	28'	28'
15	72'	18'	18'	20.75'	24'	24'
12	60'	15'	15'	17.3'	20'	20'
10	54'	13.5'	13.5'	15.6'	18'	18'

Antennas are precut to the appropriate dimensions for the band of operation.

6 meters

Due to small size on 6 meters its installation is flexible. It is only 13' 6" across the top as it comes from the factory. It may be reconfigured as a rectangle or square. For best performance keep the area inside the loop as large as possible.

- TUNING -

You may need to lengthen or shorten the wire elements depending on your antenna's location and its interaction with other antennas. Changing the shape of the antenna may also require slight trimming. Do not cut the wire when trimming the antenna, simply use more or less wire at the insulators. This way, you can always change your mind if you find you have made the antenna too short when it really should have been lengthened.

The RADIO WORKS Box 6159 Portsmouth, VA 23703

G5RV PLUS™

only by The RADIO WORKS

Specifications

Frequency Coverage: 80 - 10 m
Radiator Length: 102'
Matching Method: Stub
Line Isolator: Y1-5K Balun
Transmatch: Required
Power Rating: > 1500 watts, see page 5
Radials: No
Recommended height: > 40'

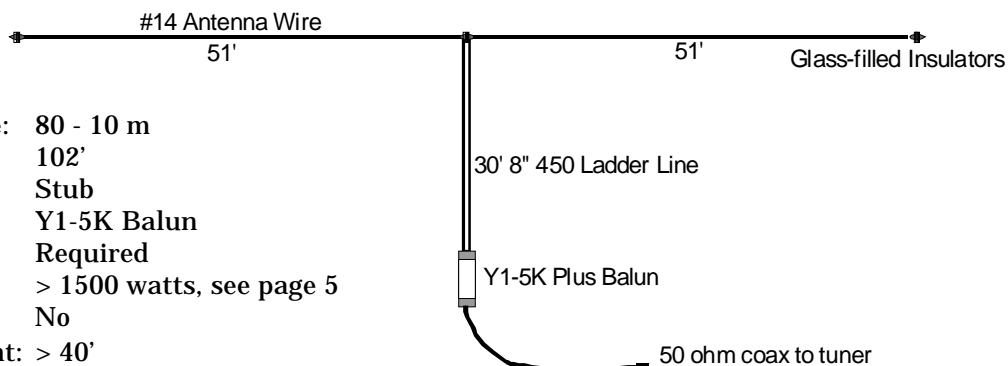

System SWR

The SWR of the G5RV is lowest in the middle of the 20 meter band. Here the SWR is typically 1.8:1. On other bands, the SWR can be considerably higher. An SWR of 4:1 is not unusual. This is normal and is due to the reactive nature of the feed system. Transmission line losses are low, so system efficiency is high.

Effects of Nearby Objects

As with all antennas, mount your G5RV PLUS as high and in the clear as possible. The ladder line stub is critical to the proper operation of the antenna. The ladder line stub **MUST** be kept away from anything that could affect its characteristics. This includes any non-insulating material and the ground. The stub should be routed perpendicularly away from the radiator. The coaxial cable may be handled in any convenient manner.

Automatic Tuners

Manual or external automatic tuners are best, but the G5RV PLUS is compatible with many built-in "automatic" tuners. Tuning range may be limited on part of 80/75 meters.

CAVEAT

One short caveat. On some frequencies, the G5RV PLUS may be too reactive for the limited tuning range of automatic tuners built into some rigs. An external automatic tuner or a manual tuner can match a variety of loads and are perfectly suitable for use with the G5RV PLUS.

System Ground

It is necessary to provide a good ground system for your station's equipment. This is done for a variety of reasons. As a minimum, ground your equipment by driving a long "ground rod" into earth. See the section on grounding. Connect the ground rod to your rig with a short, heavy gauge copper wire, braid, or strap.

Installing Your New G5RV PLUS

There are many ways to install your G5RV PLUS antenna. Read information beginning on page 20 for installation tips. It is important to **keep the ladder line matching section of the G5RV away from anything metal. It must not come in contact with the ground.** The ladder line stub may be directed away from the antenna at an angle if support height is less than 32 feet.

The G5RV PLUS was designed to be supported in the flattop configuration. Bending or sloping the antenna will affect the G5RV's matching system. This doesn't mean that your G5RV PLUS won't work. It will just tune up differently.

To hang the G5RV PLUS from its center, simply wrap your support line between a pair of the ribs in the center insulator.

The RADIO WORKS Box 6159 Portsmouth, VA 23703

The RADIO WORKS Is BALUNS

Check the Specs™

The RADIO WORKS introduced a full line of precision, Current-type™ baluns in 1986. We were actually producing Current-type™ baluns in 1984, but it was not until 1986 that they became generally available to the public. They were instantly popular because Current-type™ baluns avoid the problems conventional 'Voltage-type' baluns exhibit.

Since low impedance antennas are current-fed, a balun that produces equal and opposite current at its output over a wide range of load impedances is desirable. 'Voltage-type' baluns produce equal and opposite voltages at the balun's balanced port. There is little to be gained by forcing the voltages of the two antenna halves, whether the antenna is balanced or not, to be equal and opposite in phase. The antenna field is proportional to the currents in the elements, not the voltages at the feed point.

Current-type™ baluns are not a new idea. They have been used in TV receivers for many, many years. TV tuners require a very wide bandwidth balun that will work with a severely mismatched antenna, like a TV's so-called 'rabbit ears' antenna. The Current-type™ balun was the best choice for that application.

Unfortunately, when baluns were first popularized for use with antennas, a voltage-type design was chosen. Other balun makers just followed along. It was years before the first true, Current-type baluns appeared on the market.

Of course, times change and today you can find entire books devoted to Current-type™ baluns. The Radio Works was the first to offer you a full line of Current-type baluns for every application.

(This text was taken from the RADIO WORKS' Reference Catalog, copyright 1992, page 11.)

Misconceptions

1. Baluns will not improve SWR (the exception is where a balun is used as part of a matching network, i.e., 4:1 baluns used in loops)
2. They are not lightning arresters. The winding inductance in most baluns is far too low.
3. Built-in spark-gaps do not work. The radio equipment is destroyed long before the 'spark gap' arcs over.
4. Baluns do not allow multiband operation of single band, coax fed, antennas. They do not make antennas more broadbanded.

These are all generalizations and, of course, there may be specific exceptions to any of them.

A balun really has only two jobs

1. Isolate transmission line from the antenna.
2. Provide balanced output, either voltage or current.

Proper Balun Design

A properly engineered balun will include these design points:

1. High winding inductance (high reactance)
2. Low stray capacitance
3. Very short internal transmission lines - $\ll 1/4$ wave, the shorter the better
4. High power components - High voltage wire insulation to withstand high power or a mismatch.
5. Large gauge wire to reduce I^2R losses.
6. Large cores - prevents saturation and provides the necessary high inductive reactance values on the low bands.
7. Mechanical considerations: Weather-proofing, rustproof hardware and a strong case to withstand high mechanical loads.

The RADIO WORKS' Baluns

Balun cases are high quality PVC. Eye-bolts, if they are used, are made of stainless-steel. Wires from the internal windings are brought directly outside the case for connection to the antenna. This eliminates any chance of an unreliable connection.

In most models, the all-important wire used to make the internal transmission line(s) is insulated with Teflon® or similar materials. Top of the line models use silver-plated wire and Teflon® insulation for maximum power handling and minimum power loss.

All 1:1 and some 4:1 models are Current-type™ designs. Current-type™ baluns are extraordinarily saturation resistant and provide superior reactance characteristics. Signal distortion and RFI due to core overload are practically eliminated. Current-type™ baluns are very forgiving when feeding antennas that do not provide an ideal load.

Retrofit models

Installing a properly designed current balun or Line Isolator can substantially improve antenna performance by giving the antenna balanced current at the feed point plus excellent feed line isolation. Beyond improving an antenna's radiation pattern, the retrofitting of a current balun or Line Isolator will significantly reduce feedline radiation and dramatically decrease

RFI, TVI and RF feedback problems. Beam antennas benefit from improved balanced drive and superior feedline isolation which results in improved front-to-back and front-to-side ratios. Further, receiver noise may be reduced by eliminating signal pickup by the feedline. The Y1-5K 'YagiBalun' plus the T-4 and T-4G are considered retrofit devices.

Remote Balun

You can have the convenience of coaxial cable combined with the flexibility of open wire.

The *RemoteBalun™* is a special, saturation resistant, Current-Type® balun capable of handling the legal power limit with loads of *moderately* high impedance. Power must be reduced with high impedance loads.

Unlike other baluns, the *RemoteBaluns™* are designed specifically for antennas fed with open-wire, ladder line or twin-lead. The balun is located outside. A short length of very low loss coaxial cable connects your transmatch to the *RemoteBalun™*. This eliminates the complication of routing balanced feeders into the radio room.

RFI Applications

Current-type baluns and Line Isolators are especially effective in reducing RF current on the outer surface of a coaxial cable's shield. This type balun has several exceptional features not present in other balun designs.

For example, in RFI reduction, the most important factor is very high load isolation over a wide bandwidth.

FEEDLINE ISOLATION

In this discussion we will look at the RF energy distribution on a coaxial cable feeding an antenna. There are three different RF currents flowing on or within a coaxial cable. There is an I_1 current flowing on the center conductor of the cable. Due to the skin-effect, there are two currents flowing on the cable's shield. On the inner surface of the shield, there is the I_2 current. At the antenna end of the coax, I_2 divides into I_3 and I_4 . Without a device to isolate the antenna from its feed line, the outer surface of the coax's shield is part of the antenna, thus the division of current. I_3 is radiated by the antenna and I_4 flows along the coax. On its way back down the coax, some I_4 current is radiated and some is conducted back to the transmitter and onto the station's ground system, etc.

A balun or Line Isolator substantially reduces I_4 .

A balun has little or no effect on I_1 and I_2 currents. With I_4 reduced near to zero, $I_2 \approx I_3$. This means that nearly all of the I_2 current is radiated by the antenna and none by the feed line. The antenna pattern improves, and most of the RF current flowing down the outer surface of the coax's shield is eliminated.

The problem is isolating the antenna from its transmission line. A current balun is the perfect device for the task, since we are working with RF currents at the feed point. Any of the RADIO WORKS' current-type baluns are well suited to this application. Current-type baluns all have excellent output balance and unmatched isolation factors.

Although a well-designed current balun will eliminate I_4 current, there will be an induced current, call it I_{4i} (subscript "i" for "induced") flowing along the outer surface of the coax's shield. This current is the result of

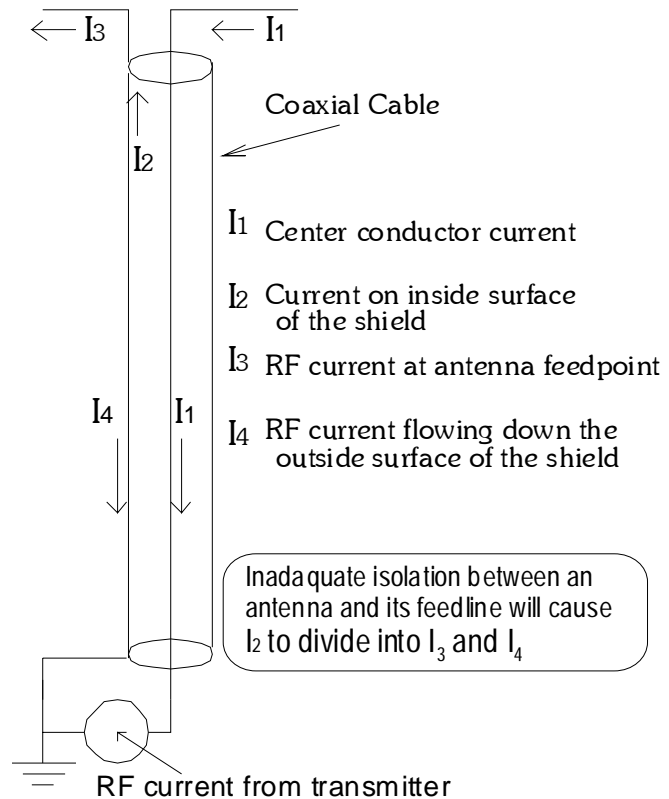

the coax being within the radiation field of the antenna. Since the coax conducts the RF energy to the antenna, it is not possible to physically isolate the coax from the effects of the antenna's radiation field. **Consequently, it is advisable to install a Line Isolator[™] at the transmitter end of the coax. This eliminates the ground path for I_4 and I_{4i} .**

The length of the coaxial feedline will have some influence on the RF induced onto the coax. Lines close to multiples of $\frac{1}{2}$ wavelength are more susceptible to I_{4i} current.

You may notice that when you add a RADIO WORKS Current-type™ balun to an existing antenna system, a dipole for example, the resonant frequency will move upwards a bit. When this happens, you know that the coax was acting as part of the antenna making it appear longer. The current balun isolated the coax from the antenna, and the antenna is now operating closer to its formula frequency.

Experiencing this effect leaves little doubt that the balun was needed and is useful even with dipoles and similar, simple antennas.

Current or Voltage Baluns?

Most commercial baluns are voltage-types. As such, their performance is poor unless operating conditions are nearly ideal. Even under the best of conditions, a perfect match, low power, etc., insufficient winding inductance and poorly designed transmission lines sacrifice efficiency and reduce bandwidth.

The B4-2KX balun is an excellent example of a current-balun which overcomes problems typical of voltage-type baluns. It is a high quality, high power, twin transformer 4:1 balun. Two special ferrite toroids help manage reactance and provide the inductance values necessary in a 4:1 balun. The output impedance of the B4-2KX balun is 200 ohms. The inductive reactance of the internal windings should be at least five times the load impedance to effectively isolate your antenna from its transmission line. 1000 ohms is the required value for a 4:1 balun. I have measured some popular commercial baluns where this value is only 240 ohms. This is a uselessly low value. The winding's inductive reactance of the B4-2KX is over 1000 ohms. Here is another example: The transmission lines in many 1:1 and 4:1 baluns are made with #14 enamel-covered wire. The impedance of such a transmission line (two wires in parallel) is generally between 20 and 25 ohms. This value is totally inappropriate. It should be 50 ohms if the balun is to be used with 50 ohm coax. Otherwise, bandwidth will suffer and unwanted reactance can be introduced into your antenna system.

We design our transmission lines very carefully. The spacing between the wires in a transmission line determines the line's impedance. In every RADIO WORKS balun, every aspect of construction is carefully engineered to provide maximum bandwidth and power handling, with a minimum effect on antenna tuning. Look at the diagram above. Here, our B4-2KX is compared with a famous 4:1 balun. Notice the competitor's balun. Its SWR is low over a very narrow band of frequencies. Compare it with the nearly perfect curve of the B4-2KX.

A Flat SWR Curve

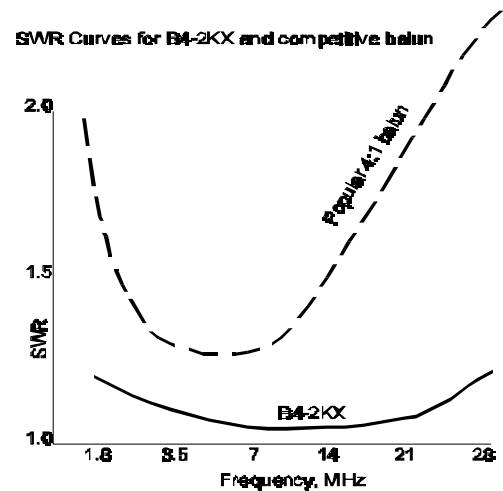

Achieving this kind of result is difficult. It is hard to produce the necessary inductance reactance on the low bands without introducing unacceptable capacitive reactance and leakage on the upper bands. Broadband performance is possible only through the correct application of selected ferrites, properly designed transmission lines and occasionally, **L/C compensation networks**. The mechanical construction of the balun also influences the final characteristics of any balun.

Wire Lead Length and Detuning Effects

The length of a balun's output lead can have a significant effect on the tuning of your antenna. **Output leads are part of the antenna** and depending on the application the effect is to lengthen the antenna or to add an inductive reactance between the balun and the antenna's feedpoint. The effect is greatest on 10 meters where the length of the balun output leads are the longest in terms of antenna length. On 80 meters there should be no noticeable effect.

The Yagi Baluns have precisely measured leads. Occasionally, you may have to take lead length into account. However, most of the time, an inch or two, will make little difference if Gamma, Beta, and similar matching schemes are used.

Effect of Balun Lead Length on Balun Measurements

Because the balun's leads are an inductive reactance in series with the balun's windings, you cannot measure the SWR by placing a non-inductive resistor at the end of the balun's output leads. If this is done, serious errors will occur on the higher frequencies. Ideally, the load should be placed directly at the output of the balun (i.e. at the core). This is not practical without taking the balun apart, so the best compromise is to place the load across the output leads of the balun as close to the balun's case as possible. You can use needles to poke through the wire's insulation and attach the non-inductive resistor to the needles. When dealing with any RF device, the length and impedance of input and output leads must be considered.

POWER RATING

All products made by the RADIO WORKS will handle the legal power limit, unless otherwise specified. Some models are designed for low power or receiving applications. Since The RADIO WORKS advocates adherence to the legal power limit, we do not endorse transmitter power above the legal limit. However, since 2:1 and 3:1 safety factors are often desirable, the RADIO WORKS does build heavy duty components.

Rated power assumes an SWR of less than 2:1 unless otherwise noted. The rated frequency is 3.5 MHz. Duty-cycle is CW or SSB with normal processing. High duty cycle modes, like RTTY, AM, FM, Slow Scan, etc. may over stress a balun and require lowering the maximum power rating. See page 5.

SATURATION

When a ferrite core balun saturates, there will be a noticeable upward drift in SWR long before the balun fails. Core saturation can be caused by too great a mismatch at the load (antenna) or by running too much power or a combination of both. If you see an upward movement in SWR, determine the problem immediately. If you must stay on the air, lower power until SWR drift ceases.

In new installations, tune the antenna system for minimum SWR. Apply a few hundred watts of power on each band the system covers. Monitor the SWR with power applied. Increase power gradually until maximum power output is achieved. Watch the SWR or reflected power meter closely. If the SWR drifts, determine the problem before continuing operation.

RemoteBalun™

RemoteBaluns™ are a special case. They operate under the most difficult conditions. The check out procedure for the RemoteBaluns™ is the same as in the previous paragraph. If you notice the SWR drift on one or two bands, this usually means that the load impedance is too high or too low for efficient balun operation. Changing the length of the balanced feeders (ladder line) by a few feet, or ideally, 1/4 wavelength will often remedy the situation and permit full power operation.

INSTALLATION

While there are no special mounting requirements, I do suggest strain relief for long unsupported transmission lines.

BEAM ANTENNAS

Use standoffs for your coaxial cable. This can improve the front-to-back and front-to-side ratios of your beam antenna. It doesn't make sense to put up a good beam and then let the feed line radiate (because of a poor balun). It also doesn't do your antenna system any good to couple your coaxial cable to a large vertical antenna (like your tower). Taping your coaxial cable to a tower leg creates a large capacitor which effectively couples your beam to the tower. The tower acts as a large vertical antenna. Use stand-offs to hold the coaxial cable away from the tower leg. This procedure in combination with a RADIO WORKS balun can dramatically improve the front-to-side ratio of some beams.

A balun may be supported by its eye-bolt. Baluns and Line Isolators™ may be strapped to the antenna's boom, secured with waterproof tape or quality hose-clamps.

LIGHTNING PROTECTION

Some balun manufacturers will tell you that their baluns have built in lightning protection. Those that do use spark gaps that are absolutely useless. The high winding inductance of our baluns offers some protection, but for proper protection use devices intended specifically for lightning "surge" protection.

Balun Cases

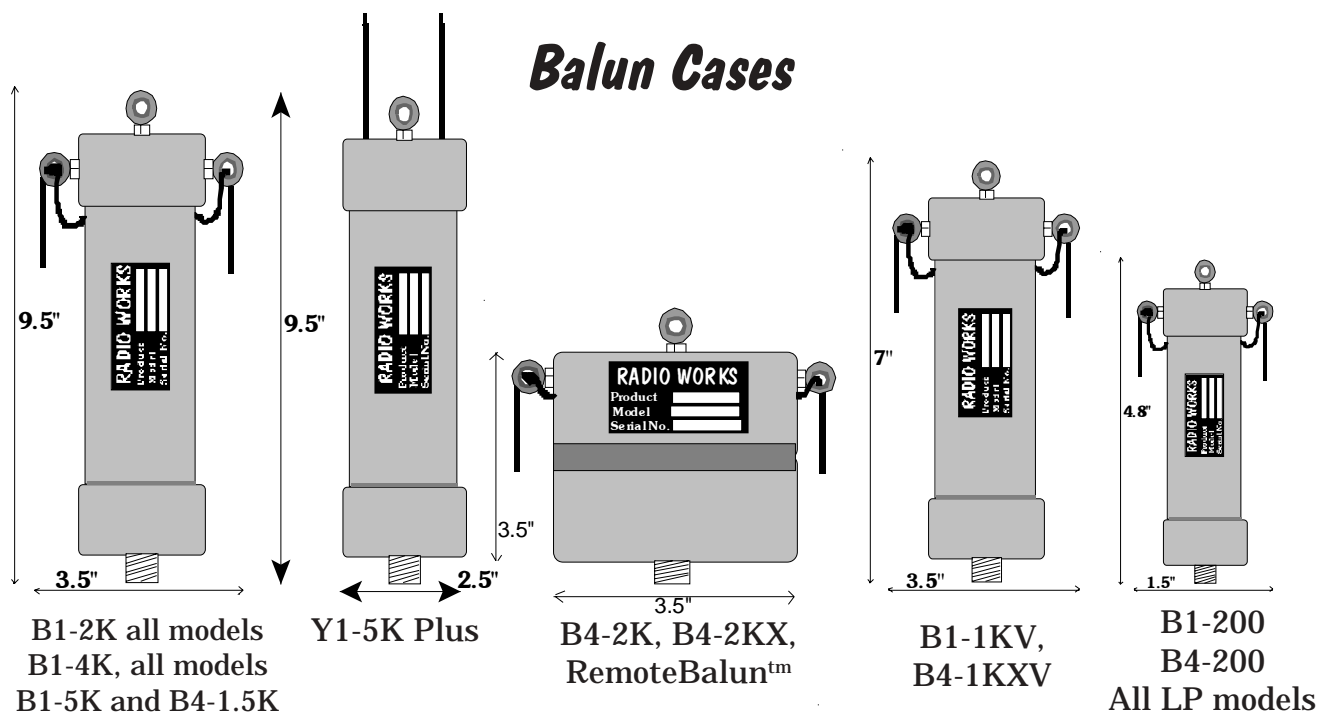

Important

In all RADIO WORKS' baluns the output wires are brought directly from the windings through holes in the balun's case. This eliminates any possibility of poor connections. This is just one more way we give you the utmost in high performance. However, since there are holes in the balun's case, water can enter the balun through these holes. Coax Seal™ is supplied with each balun to seal these holes and for weatherproofing the coaxial connector on your coax. We could apply the Coax Seal™ when we make the balun, but during storage and shipping the tenacious wetting properties of Coax Seal™ can be a bit messy. It will stick to anything, including the package, literature, etc. It is best applied when the balun is put into use. So, we have left the application of the Coax Seal™ to you. Just follow the instructions on page 3 of this manual. Even though each balun is filled with a waterproof foam plastic, it is very important to apply the Coax Seal™.

Do not skip this step.

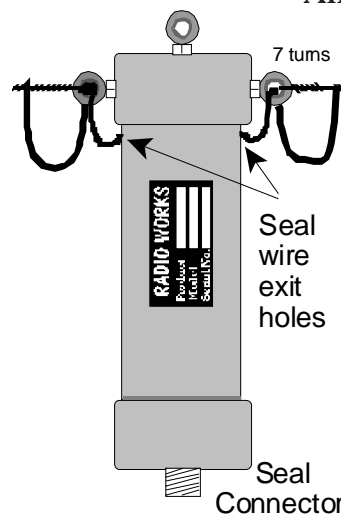

Installation

Use the eye-bolts for antenna wire strain-relief. Bring antenna wire through eye-bolt and wind the wire back on itself for at least 7 tight turns. Solder the balun output wires directly to the antenna wire.

Connect the PL-259 on your feedline to the SO-239 connector on the bottom of the baluns. **Seal with Coax following the instructions on page 3.** Don't cover the drain hole on the bottom of the balun.

RemoteBalun™

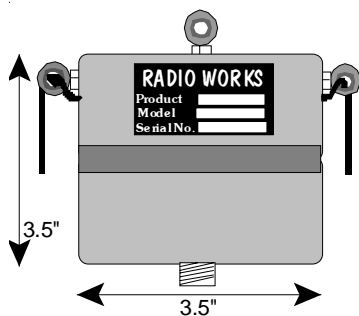

A different kind of balun - RemoteBalun™

Most modern tuner circuits are T-networks or similar circuits which do not accommodate balanced transmission lines (feed lines). To provide a balanced output, a tuner of this type will have a built-in balun. Unfortunately, a voltage balun is almost always used. Voltage baluns are inappropriate in this application, because they do not work well when their loads are mismatched. This is almost always the case in this application. Even worse is excessive power, especially in combination with reactive loads can cause most voltage baluns to saturate, and this can lead to TVI and other RF interference.

To further enhance output balance, a special circuit, we call it the 'X' configuration, uses a twin core, balanced design that produces a balanced output under a wide range of conditions.

Power Rating

The RemoteBalun's power rating is 1500 watts under normal SSB and CW duty-cycles. It is not possible to put a specific value on this specification because the power rating depends on so many factors. The load impedance and reactance presented to the RemoteBalun, combined with the operating frequency and duty cycle are interrelated factors which must be taken into account. The 1500 watt power rating assumes normal duty cycle modes (CW and SSB) with the balun operating into a *moderate* electrical environment. The same thing holds true for very high or very low impedances. Under any of these adverse conditions, you should derate the maximum power delivered to your tuner (transmatch).

Applications

The RemoteBalun™ is an interface between balanced feeders and coaxial cable. The RemoteBalun™ is located outside the house or building where the balanced feed line is available without obstruction. A short length of very low loss coaxial cable connects your tuner at the operating position to the RemoteBalun.™ The inconvenience of routing balanced feeders into the radio room is eliminated.

These are Current-type™ baluns. Unlike voltage baluns, Current-type™ baluns maintain output balance over a wide range of loads. This makes them ideal for use at the transition between balanced feeders and unbalanced coax.

Maximum Power As with all electrical components, there are limits. The maximum power which may be applied to the RemoteBalun™ depends on the magnitude of mismatch.

Checking the power limit

It is a good practice to insure that your operating conditions are not causing overheating of the RemoteBalun. Check the balun's operating temperature on each of the bands you operate. The procedure is simple. Monitor your SWR or reflected power after you have properly adjusted your tuner. A drift in SWR indicates heating of the RemoteBalun's core.

If overheating occurs, there are two solutions. One is to reduce the level of mismatch, and the second is to reduce power. Another often effective, simple solution is to change the length of the balanced transmission line. A small change in the length of the balanced transmission line can have a dramatic effect on the load impedance presented to the RemoteBalun. In difficult cases, the addition or deletion of 1/4 wavelength of transmission (on the band causing the greatest overheating) will usually do the job.

As a last resort it may be necessary to reduce power, but in most cases, adjusting the length of the balanced feeders will eliminate the problem.

Installation

The RemoteBalun™ is located outside. A short length of low loss coaxial cable connects the RemoteBalun to your transmatch.

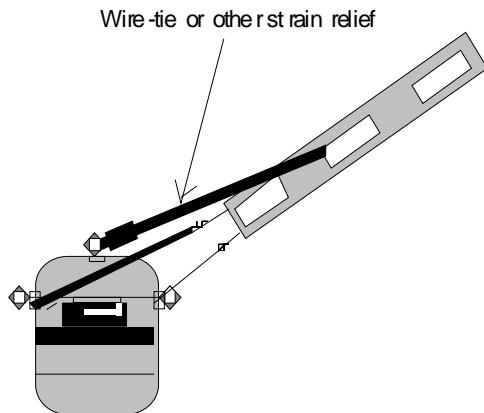
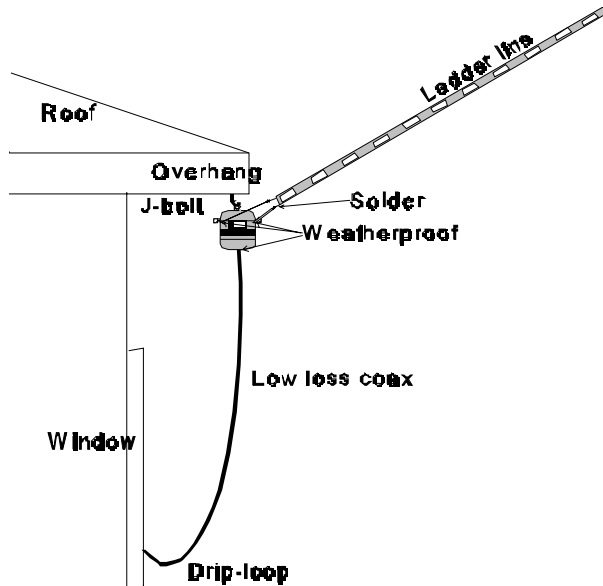

1. With as much slack in the ladder line as possible, solder each of the wires from your balanced feedline (ladder-line, twin-lead, open-wire) to one of the balun's output wires. Leave as much extra ladder line as possible. You may want to shorten the ladder line after initial tune up.
2. Add strain-relief by attaching the balanced line to the balun with a large wire tie, rope, etc. This takes the strain off the soldered connections.
3. Mount the RemoteBalun™ using a J-bolt, hook, or whatever method you prefer.
4. Prepare the low loss coaxial cable, or order one premade from The RADIO WORKS. Use quality connectors. Screw one end of the coax to SO-239 connector on the RemoteBalun™.
5. Apply CoaxSeal® to the connector, following the instructions on the package and on pages 3 and 4 in this manual. Also, apply CoaxSeal® where the wires come out of the balun's case. Make sure the CoaxSeal® sticks to the case and to the wires.
6. Bring the free end of the coax into the building. Leave a little slack to form a 'drip loop.'
7. Connect the coax to your tuner.
8. Tune tuner for lowest SWR. Test for over heating by following the procedures outlined previously.

TUNING YOUR ANTENNA

CAROLINA WINDOM

Since the CAROLINA WINDOM and all of its derivatives are off-center fed, changing the length of the antenna is done in a 1:2 proportion. If you want to shorten the antenna one foot, take 4 inches off the short leg and 8 inches off the long leg. However, it is best to use the factory antenna lengths. They have proved to be the best compromise for all band operation.

I suggest using the antenna just as it comes out of the package and use a transmatch on all bands.

Using a tuner (transmatch)

Most of our antennas are designed to be used with a wide-range, manual transmatch (tuner). Some modern transceivers have built-in tuners which will satisfactorily tune our antennas on most bands. This is not the case with older transceivers. Further, your particular installation may result in conditions out of the range of your transceiver's built-in tuner. It is best not to rely on an automatic antenna tuner but to plan to use a good, manual transmatch at your station. There is an exception: External automatic tuners, especially those made by LDG and SGC, have enough tuning range to tune any of our antennas.

Dipoles and Tuners

You may use a tuner with the Ultima Dipole. This is most often done on 160 or 80 meters to permit full band operation. Typically, a dipole covers only about 200 KHz (or less) of the band between 2:1 SWR points on 80 meters. In some parts of the band, the SWR will rise to a fairly high figure (>4:1). Under conditions where the SWR is elevated, a transmatch will provide a low SWR interface between your transmitter and feedline.

Do not use a dipole on even harmonics, even with a transmatch. (i.e. an 80 meter antenna will not work well on 40 M when fed with coax) You may use an antenna at three times its design frequency. For example, a 7 MHz antenna can be used on 21 MHz but you will probably need to use your transmatch to get an acceptable SWR.

Trimming a SuperLoop™ or BigSig Loop™

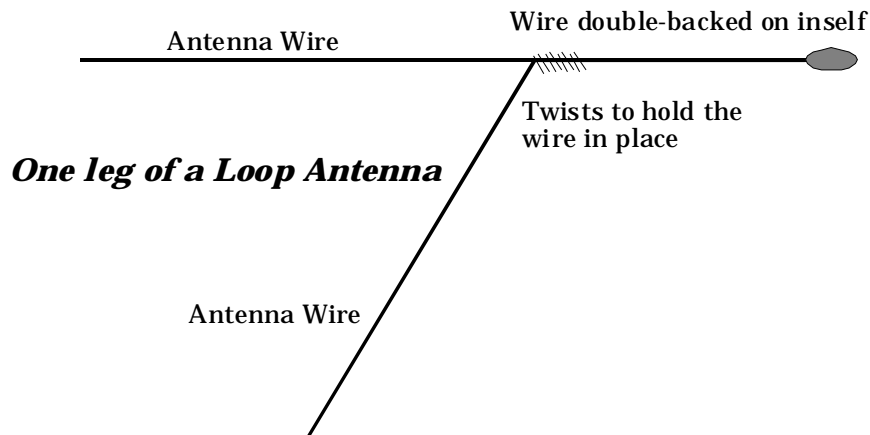

Procedure

1. Do not cut any wire from the antenna.
2. To raise the resonant frequency, shorten the loop using the technique shown in the illustration.
3. Hold the antenna wires together at each insulator and wrap with a few turns of wire (any copper wire will do) or twist the antenna wires together. Twist or wrap with enough turns to insure that the adjustment does not pull loose.
4. Do not try to move the loop too far off its design frequency. Loop size and multiband operation are interactive. With multiband loops, changing the resonant point on one band will alter the SWR curves on all other bands.
5. You may restore the antenna to its original dimensions by removing the wrapped wire or twists installed in step 3.

SuperLoop

You can move the 80 meter resonance higher in frequency. Do this by making the loop smaller. You do not change the actual overall length of the wire. Instead, simply twist the loop's wire together at the insulators. You will need to twist the wire for a foot at both insulators to notice a significant effect. Don't overdo it, or you will affect things on 40 meters.

We suggest this method of tuning the SuperLoop because it does not change the shape of the loop, and the antenna may easily returned to its original dimensions.

Antenna Trimming Chart

Use this chart as an aid in trimming the length of your antenna. It gives you an idea of the change in wire length needed to move antenna resonance a specific number of KHz.

- * Dimensions are for **each leg** of a half-wave dipole
- * For quarter-wave antennas (i.e. verticals) use the dimensions directly from this chart
- * Full-wavelength antennas (loops) - multiply the chart dimensions by four (4) and change the overall length of the antenna by that amount.

Lengths are estimates. Many factors will affect their exact value.

+ value = add to length of antenna - value = shorten antenna

To Move	80/75 m	40 m	20 m	15 m	10 m
-400 KHz	+6' 8"	1' 9"	+6 1/2"	+2 1/2"	+1 1/4"
-300 KHz	+5'	+1' 4"	+5"	+1 3/4"	+1"
-200 KHz	+3' 4"	+10"	+3 1/4"	+ 1 1/4"	+5/8"
-100 KHz	+1' 7"	+5"	+ 1 1/2"	+1/2"	+3/8"
00 KHz	0	0	0	0	0
+100 KHz	-1' 7"	-5"	-1 1/2"	-1/2"	-3/8"
+200 KHz	-3' 4"	-10"	-3 1/4"	-1 1/4"	-5/8"
+300 KHz	-5'	-1' 4"	-5"	1 3/4"	-1"
+400 KHz	-6' 8"	-1' 9"	-6 1/2"	-2 1/2"	-1 1/4"
+500 KHz	-8' 4"	-2'	-8"	-3"	-1.5"

Example

You have measured the SWR of your 40 meter dipole at various frequencies across the band. You have determined that the SWR is lowest at 7.00 MHz. You actually want the lowest SWR to occur up in the sideband portion of the band, so you need to move resonance up in frequency about 200 KHz.

According to the chart, to move +200 KHz on 40 meters, you will have to shorten **each leg** of the dipole 10-inches. The overall length of the antenna is shortened a total of 20 inches.

Lengthening or shortening the antenna is done at the end insulators. To shorten the antenna, unwind the antenna wire as it wraps around itself at the end insulator. Move the insulator the suggested distance toward the center of the antenna. Re-wrap the antenna wire to secure the end insulator. Do not cut the wire. Wrap it back around the antenna wire. You may need to lengthen the antenna later.

Installing ground straps

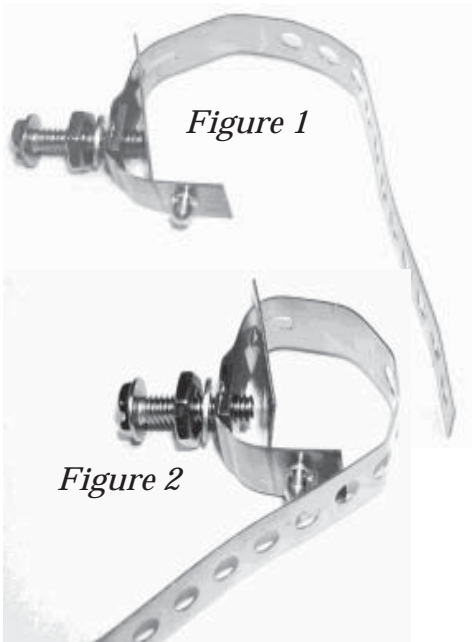

This the procedure for wrapping the Line Isolator ground straps around a ground rod. It is not shown in these illustrations, but the end of the ground strap is screwed to the Line Isolator. Don't loosen the screw on the Line Isolator.

Figure 1 - Begin by starting to form the strap into a circle as shown in **Figures 1 and 2**. Unscrew the adjustment screw so that only a few threads are showing.

Figure 3 - Shows how the clamp is locked into place. Simply push the retaining pin through the appropriate hole needed to permit placing the strap around your ground rod or pipe. The groove in the retaining pin will hold the ground strap in the selected hole once the adjustment screw is tightened.

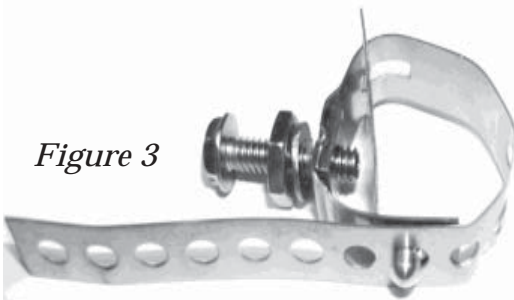

Figure 4 - This is really part of figure 3. The ground strap has been placed around a socket wrench to show how the strap wraps around a rod or pipe. Make sure the copper plate is under the end of the screw.

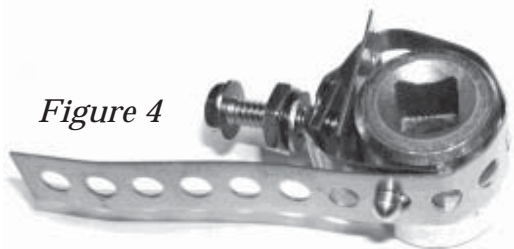

Figure 5 - Simply tighten up the adjustment screw until taut. The copper plate between the end of the screw and the surface of the simulated ground rod are easily seen in this illustration. This copper plate improves contact with the ground rod and doesn't remove copper from a copper-plated ground rod when the adjustment screw is tightened. There is a copper-to-copper connection. This little copper plate also protects copper pipe when it is used for a ground rod. The copper plate permits significant tightening without smashing the hollow copper pipe.



Note: I am not suggesting using copper water pipe in your house as a ground. This is for those, like me, who use copper pipe as ground rods driven into the earth.

As a last step, screw the "jam-nut" until it is tight against the ground strap.

Figure 5

Index

Caution - Read This!	2	Antennas	
		BigSig Loop	47
Weatherproofing	3	CAROLINA Short 40	37
Coax Seal	3	CAROLINA Short 80	37
Ultimate Sealing Technique	4	CAROLINA Short 80 Special	40
		CAROLINA Short 160 Special	40
Grounding		CAROLINA WINDOM Shortwave	43
Ground System, 2 nd floor	15	CAROLINA WINDOM in general	29
Ground Systems	7-19	CAROLINA WINDOM 80	31
Power Rating	5	CAROLINA WINDOM 160	35
Line Isolators	14-17, 32	CAROLINA WINDOM 20 & 620	34
		CAROLINA WINDOM 40 & 40 Plus	34
		CAROLINA WINDOM 80 & 160 Special	40-42
Baluns	50-57	CAROLINA WINDOM "LP" series	36
		G5RV Plus	49
		SuperLoop 40	45
		SuperLoop 80	45
		ULTIMA DIPOLE	46
		Antenna Installation	
		Do's and Don't of antenna installation	25
		Antenna Installation lists	26
		Installing Wire Antennas	20-28
		Antenna Trimming Chart	60
		Pulleys	23
		Tower Mounting	32, 33
		Tree Installation of antennas	20-24
		Tuning your antenna	58, 59

Antennas not specifically listed in this index should follow the general installations instructions beginning on page 20.

RADIO WORKS

Where Ham Radio Is a Contact Sport™!

*The following exceptional products are brought
to you exclusively by The RADIO WORKS!*

CAROLINA WINDOM™

SuperLoop™ BigSig Loop™

Vertically Radiating Dipoles™

InTreeVert™

High Power Current Baluns

Line Isolators™

All proudly made in the U.S.A.