

DYC-817



External dynamic compressor for the FT-817

Thank you for choosing to buy a kit from the FUNKAMATEUR Readers' Service. A lot of care was invested in the development of this equipment and it should give you no problems from the moment you switch it on, providing you follow the instructions below carefully. We would be grateful for any comments and suggestions for improvements.

The DYC-817 audio compressor is designed to be inserted into the microphone lead of the original Yaesu microphone. It receives its operating voltage from the +5 V pin of the microphone plug; the current drawn is not quite 10 mA. The compressor is not suitable for the optional DTMF-microphone.

The reduction in the dynamics of the modulated audio creates an increase in the average transmitted power. Especially in the case of weak-signal SSB reception this characteristic has a positive effect on the speech intelligibility. Receiving stations will register an increase of around 6 dB on their S-Meter, although the subjective effect on the signal heard can even be more than that.

The circuit diagram of the compressor can be found in FUNKAMATEUR 4/2002. The compressor can be inserted into the microphone cable without having to change the microphone amplification default values in the FT-817.

To provide you with the opportunity of varying the compression ratio to suit your own wishes, the resistance of Pin 6 of the IC1 against mass can be varied between 47 kohm and 147 kohm. The resulting compression ratio covers the range from 4:1 to 9:1, which should be adequate for all practical purposes. The sliding switch S1 is used for turning the compressor on and off. IC1 provides 18 dB of amplification and is eliminated at the output by the voltage divider.

The compressor also comprises a basic signal-generator. Using this, it is possible to generate a stable signal for matching antennas etc. The signal provided by the CMOS generator will fully drive the FT-817 with the default setting of 50 for "MIC-SSB" (menu 46).

To activate the signal-generator, press the DOWN-button while the PTT is already pressed, which can be done with one hand. The functions of the buttons on the microphone are not affected by this. Pressing in the other order starts the scan function.

Packing list: The kit contains everything you need for the dynamic compressor. In addition, a short length of 8-core cable has been included so you can practise removing the insulation and soldering. We also provide some solder for the SMD-ICs, although some circuit boards have already been fitted with the SMD-ICs.

Construction: Please use a suitable soldering iron with a sharp point, and begin with the SMD-ICs. To make sure you solder them in the right way round, you have to orientate yourself by using the label of the SSM2165 and the indentation on the 4093. Check the figures on the other page. Please make sure you do use a small soldering iron tip and start by soldering only one of the legs first. This will allow you to correct the positioning of the IC if necessary, and also that of the connections on the soldering pads. Next, you should solder the resistors and capacitors. 100 nF are marked with »104«, 10 nF with »103«, and 1 nF with »102«. Position the capacitors as close to the board as possible.

Solder C5 in front of the choke L1. Make sure you have the polarity of the capacitors right! Minus is marked. A little bit of pressure is needed to press the regulators into the pre-drilled holes. Pay attention to the cathode ring on the diodes. One side of the transistor casing has been smoothed off to make it clear which way round it should be mounted. The RJ45-socket also needs a bit of pressure to mount it properly.

The trickiest bit is soldering the RJ45 cable to the transceiver, as the wires have a fairly stiff insulating cover and are not too easy to work with. First, remove 10 mm of the black outside cover. Then insulate the individual wires with the different lengths as shown on the sketch. Orientate yourself by the outside wires which have black and white insulation. After that you can make grooves in the thermal plastic insulation with a hot soldering iron, then drill and solder the thinner wires.

Before the cable can be soldered it has to be threaded through the shallow slit from the outside to the inside. While doing this you can orientate yourself on the outer black and white wires. The component side of the board should be on top, with the black wire in the direction of the sliding switch. Now you should stick the shorter wires into the soldering holes and solder them into position. Lay the cable flat, stick the remaining four wires through the pre-drilled holes and solder them into position. Now fix the cable in place with the cable binder. It is important to tighten the cable binder properly, otherwise it will not take the strain properly.

Calibration: Before connecting the compressor to the FT-817 for the first time, test the current consumption at 5 V. At an operating voltage of +5 V, the current should be roughly 10 mA, 12 mA at the most. If the current is more than this, you have made a mistake somewhere. Current consumption significantly higher than this can damage the 5 V output at the microphone socket.

After making sure the current consumption is within the limits and that you have made no mistakes during the construction, the circuit should work as designed.

Using the compressor for the first time: The two regulators are factory set in a middle position which should be sufficient to provide noticeable improvement.

When using maximum audio amplification or the maximum amount of compression, it is essential to check your signal on the air or have a QSO partner give you a critical report of your signal quality. High audio amplification can cause the background noise to swamp the noise gate of the compressor IC and, together with a high amount of compression, adversely affect the on-air signal. It is recommended to use the compressor for SSB only.

Opportunity is available to exchange views on the compressor at www.funkamateur.de/Foren/FT-817-Kompressor. Please confine remarks to the equipment in question.

Have fun, and gd DX!

Other kits from our range:

AAS-817: Automatic antenna switch for the FT-817. Useful when operating from a fixed QTH, as there is no need to plug antennas in and out. Suitable from 160 m to 70 cm. \$ 54.00

EE-817: Empty case made of brushed powder sheet steel the same size as the FT-817. Ideal for home construction of accessories such as power supplies, antenna tuners, linear amplifiers etc. \$ 17.00

Kits being planned:

IMC-817: Alternative circuit board for the Yaesu microphone with audio compressor and tone generator.

PS-817: Conventional power supply.

MAT-817: Manual antenna tuner.

Addresses for orders:

FUNKAMATEUR-Leserservice, Box 73, 10122 Berlin

Fax: ++49 30 44559469

www.funkamateur.de > Online-Shop > FT-817-Zubehör

www.box73.com (starting on 5/18/2002)

Price \$ 22.00 S&H (air mail) \$ 7.00 = **\$ 29.00 total**

We accept credit cards (visa master amex).

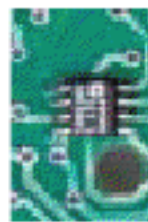
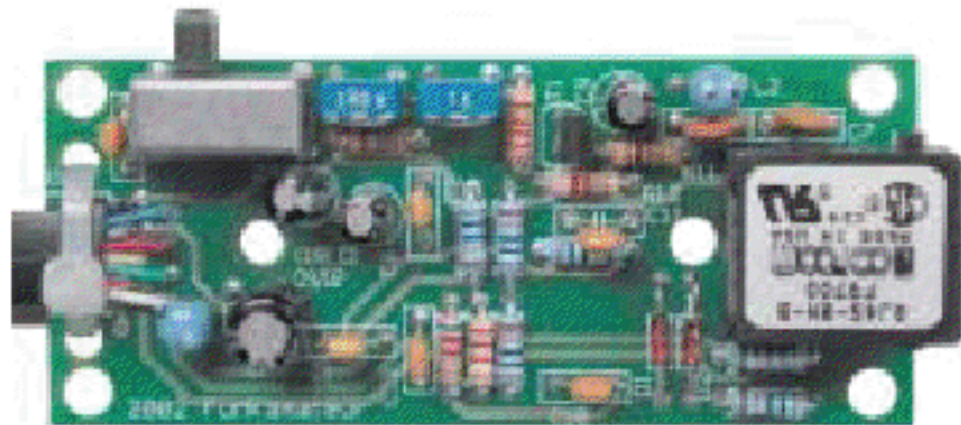
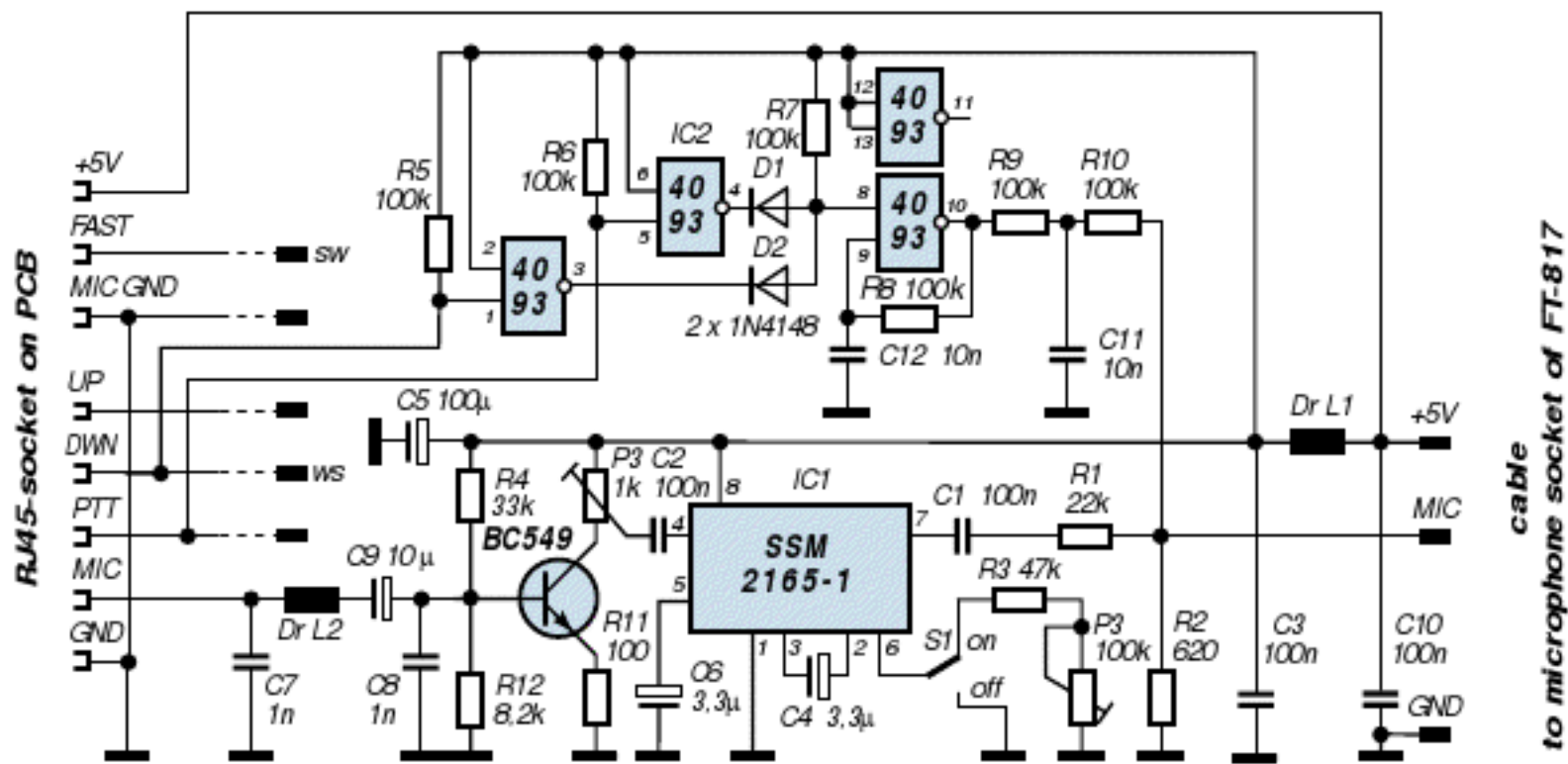

SSM2165 on PCB

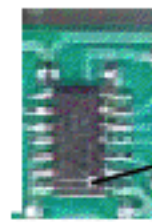

4093 on PCB

point

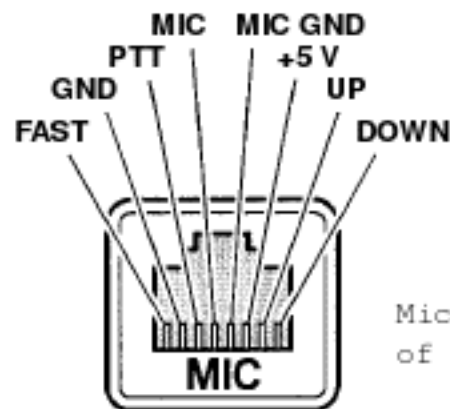
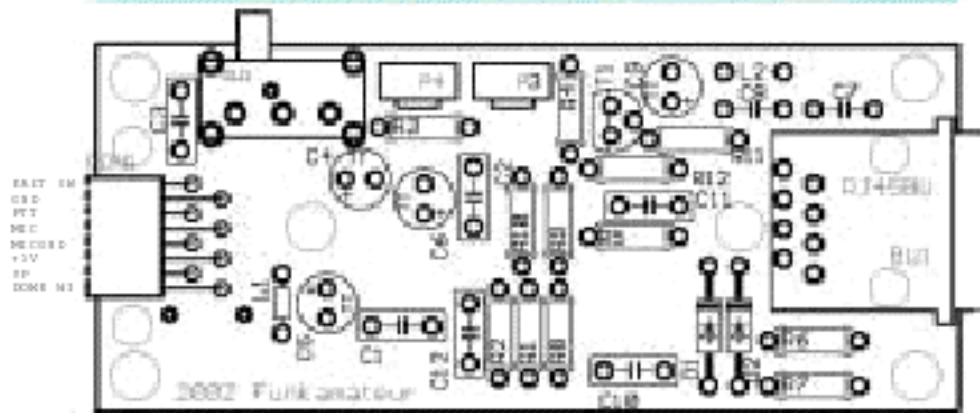

Microphone socket of the FT-817

mic gain compression
P3 1kΩ P4 100kΩ

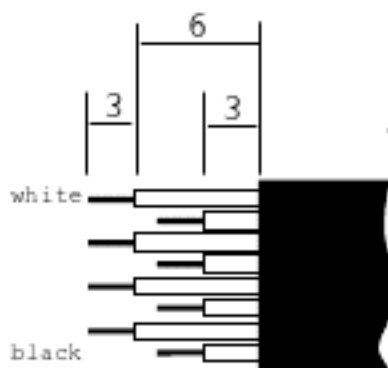
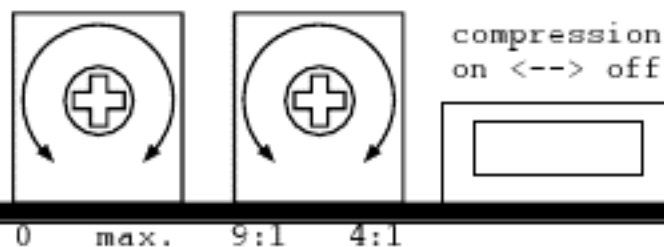

cabel

preparation of the end of the cable before soldering

Part list

IC1	SSM2165-1	SMC-IC, 8polig
IC2	4093SMD	SMD-IC, 14polig
T1	BC549C	transistor, npn, TO-92
D1, D2	1N4148	rectifier
R1	22 kohm	red-red-orange
R2	620 ohm	blue-red-braun
R3	47 kohm	gelb-violett-orange
R4	33 kohm	orange-orange-orange
R5	100 kohm	brown-black-yellow
R6	100 kohm	brown-black-yellow
R7	100 kohm	brown-black-yellow
R8	100 kohm	brown-black-yellow
R9	100 kohm	brown-black-yellow
R10	100 kohm	brown-black-yellow
R11	100 ohm	brown-black-brown
R12	8,2 kohm	gray-red-red
C1	100 nF	»104«
C2	100 nF	»104«
C3	100 nF	»104«
C4	3,3 µF	3,3
C5	100 µF	100
C6	3,3 µF	3,3
C7	1 nF	»102«
C8	1 nF	»102«
C9	10 µF	10/25 V
C10	100 nF	»104«
C11	10 nF	»103«
C12	10 nF	»103«
P3	1 kohm	1 k
P4	100 kohm	100 k
L1, L2	RF-chocke	
S1	switch	
Bu1	RJ45-socket, flat	
PCB	14/02	
cable	with RJ45-jack	
cable	10 cm for training	
enclosure	ready for assembly with all holes	
plastic binder	for fixing the cable	

Components



L1/L2 100µ 10µ 3,3µ 100n 10n 1n